

# IDEAcomm Mac<sup>®</sup>

---

Macintosh SE to IBM Midrange Communications

IDEA

The intelligence to do things better.

# **IDEAcomm Mac®**

IBM Midrange Communications for  
the Macintosh SE

---

**User's Guide**

**IDEA®**

# Warning

The IDEAComm Mac card generates and uses radio frequency energy and if not installed and used properly, that is, in strict accordance with the manufacturer's instructions, may cause interference to radio and television reception. It has been type tested and found to comply with the limits for a Class A computing device in accordance with the specifications in Subpart J of Part 15 of FCC Rules, which are designed to provide reasonable protection against such interference in a commercial environment. Operation of this equipment in a residential area is likely to cause interference, in which case the user at his own expense will be required to take whatever measures may be required to correct the interference.

## Note

External cables not supplied by the manufacturer of this equipment must be shielded to maintain compliance with the FCC rules.

---

Le présent appareil numérique n'émet pas de bruits radioélectriques dépassant les limites applicables aux appareils numériques de classe A prescrites dans le règlement sur le brouillage radioélectrique édicté par le Ministère des Communications du Canada.

---

# **IDEA, Inc.**

## **Limited Warranty**

IDEA, Inc. guarantees this IDEA Product to be in good working order for a period of 1 year from the date of purchase from IDEA or an authorized IDEA dealer. If this Product fails to be in good working order at any time during this one year warranty period, IDEA will, at its option, repair or replace this product at no additional charge except as set forth below. Repair parts and replacement products will be furnished on an exchange basis and will be either reconditioned or new. All replaced parts and products become the property of IDEA. This limited warranty does not include service to repair damages to the product resulting from accident, disaster, misuse, abuse, or non-IDEA modification of the product.

Limited Warranty service can be obtained by delivering the product during the one year warranty period to an authorized IDEA dealer or by sending the product to IDEA. IDEA will not accept products without a Materials Return Authorization (MRA) number issued by its Customer Support Department, with a proof of purchase date. If this product is delivered to IDEA by mail, you agree to insure the product or assume risk of loss or damage in transit, to prepay shipping charges to the warranty service location and to use the original shipping container or equivalent.

**ALL EXPRESS AND IMPLIED WARRANTIES FOR THIS PRODUCT INCLUDING THE WARRANTIES OF MERCHANTABILITY AND FITNESS FOR A PARTICULAR PURPOSE, ARE LIMITED IN DURATION TO A PERIOD OF 1 YEAR FROM THE DATE OF PURCHASE, AND NO WARRANTIES, WHETHER EXPRESS OR IMPLIED, WILL APPLY AFTER THIS PERIOD. SOME STATES DO NOT ALLOW LIMITATIONS ON HOW LONG AN IMPLIED WARRANTY LASTS, SO THE ABOVE LIMITATIONS MAY NOT APPLY TO YOU.**

**IF THIS PRODUCT IS NOT IN GOOD WORKING ORDER AS WARRANTED ABOVE, YOUR SOLE REMEDY SHALL**

(Continued)

BE REPAIR OR REPLACEMENT AS PROVIDED ABOVE. IN NO EVENT WILL IDEA BE LIABLE TO YOU FOR ANY DAMAGES, INCLUDING ANY LOST PROFITS, LOST SAVINGS OR OTHER INCIDENTAL OR CONSEQUENTIAL DAMAGES ARISING OUT OF THE USE OF OR INABILITY TO USE SUCH PRODUCT, EVEN IF IDEA OR AN AUTHORIZED IDEA PERSONAL COMPUTER DEALER HAS BEEN ADVISED OF THE POSSIBILITY OF SUCH DAMAGES, OR FOR ANY CLAIM BY ANY OTHER PARTY.

SOME STATES DO NOT ALLOW THE EXCLUSION OR LIMITATION OF INCIDENTAL OR CONSEQUENTIAL DAMAGES FOR CONSUMER PRODUCTS, SO THE ABOVE LIMITATIONS OR EXCLUSIONS MAY NOT APPLY TO YOU.

THIS WARRANTY GIVES YOU SPECIFIC LEGAL RIGHTS, AND YOU MAY ALSO HAVE OTHER RIGHTS WHICH MAY VARY FROM STATE TO STATE.

To obtain Limited Warranty coverage, you must complete and return the enclosed Warranty Card.

Information on warranty service is in the appendix on Customer Support at the end of this manual.

# Table of Contents

---

Warning .....	ii
IDEA, Inc. Limited Warranty .....	iii
Customer Survey Form .....	ix
Notice .....	xi
Copyright .....	xi
Trademarks .....	xi
Service .....	xi
<b>Section I: Introduction .....</b>	<b>1</b>
Overview of IDEAcomm Mac .....	1
Features and Benefits .....	1
Software Requirements .....	2
Components .....	2
About This Manual .....	3
Related Publications .....	4
Notation Conventions .....	5
<b>Section II: Getting Started .....</b>	<b>7</b>
Checking your Inventory .....	7
Serial Number and Version Number .....	8
What You Need to Supply .....	8
Installation of the Card .....	9
How to Terminate the Card .....	9
Connecting the TWINAX Cable .....	10
Installing the IDEAcomm Software .....	11
<b>Section III: Basic Setup .....</b>	<b>15</b>
<b>Section IV: Using Emulation .....</b>	<b>23</b>
Overview: Activating Emulation Software .....	23
Loading the IDEAcomm Mac Software .....	23
Primary and Secondary Station Addresses .....	23
Using the Emulated Keyboard .....	26
Using IDEAcomm Mac with MultiFinder .....	27
Operating in Emulation Using LUs .....	28
The Sign-on Screen and Status Line .....	28
Status Line Indicators .....	29
Windows: Viewing More than One Session at Once .....	30
Freeing and Reserving Sessions .....	30
Ending Emulation .....	31

<b>Section V: Displays and Windows</b> .....	33
Overview .....	33
General Information .....	33
Tips on Using Windows .....	35
The 3180 Display: Viewing 132 Columns .....	36
Viewing 3180 Emulation .....	36
<b>Section VI: Printing</b> .....	37
Before Installing Printer Software .....	37
Installation of Printer Software .....	38
The Printer Control Panel .....	40
Optional Available on the Printer Control Panel .....	42
Indicators on the Printer Control Panel ...	46
Status Line Information .....	47
Printer Error Messages .....	48
<b>Section VII: File Transfer</b> .....	51
Using IDEAlink .....	52
Copying IDEAlink to Hard Disk .....	52
Running IDEAlink .....	54
Performing a File Transfer .....	59
Creating File Transfer Buttons .....	65
<b>Appendix A: Troubleshooting, Error Messages, and Charts</b> .....	67
Overview .....	67
Troubleshooting Tips .....	67
Display .....	67
Printer .....	69
Printer Output from Host .....	70
Diagnostic Program .....	71
IDEAcomm Mac Error Messages .....	73
IDEAcomm Mac Warning Messages .....	75
Numbered Error Messages from IDEAlink ....	76
Attaching the IDEAcomm TWINAX Line to IBM Remote Controllers .....	81
Adding IDEAcomm Mac to a 5294/5394 or 5251 Model 12 Remote Controller ..	81
Adding the IDEAcomm Mac Card to an Existing TWINAX Run .....	82
Creating a New Run .....	82
<b>Appendix B: Keyboard and Terminal Defaults</b> .....	83
Overview .....	83
Keyboard Maps .....	83
Emulated Keys on the Macintosh .....	86
Attribute Appearance for 5250 Display Station and the Macintosh SE .....	91

<b>Appendix C: Hardware Installation for the Authorized Apple Reseller</b>	<b>95</b>
Handling the IDEA Card	95
Inventory Checklist	96
What the User Must Supply	96
Opening the Macintosh SE	97
Installation Steps	101
Reassembling the Macintosh	110
<b>Appendix D: The IBM Applications Program Interface</b>	<b>111</b>
Macintosh Calling Sequences	111
Format of Calling Sequences	111
<b>Appendix E: IDEAcmm Utilities Package</b>	<b>115</b>
Overview	115
Configuring Display Options with the IDEAcmm Utilities Package	115
<b>Appendix F: IDEA Glossary</b>	<b>121</b>
<b>Appendix G: IDEA Products</b>	<b>125</b>
<b>Appendix H: Customer Support Information</b>	<b>129</b>
Telephone Support	129
Repair Policy	130
Warranty Card	130
Limited Warranty	130
<b>Index</b>	<b>131</b>





# Customer Survey Form

---

Product: IDEAcomm Mac  
Rev. 0

1. Were there any errors in the manual? If yes, list page numbers and kind of error:
2. Was information:  
easy to understand \_\_\_\_\_  
difficult \_\_\_\_\_  
List information that was hard to find:
3. Was information:  
complete \_\_\_\_\_  
incomplete \_\_\_\_\_
4. What features of the product did you particularly like?
5. What features would you like to see added to the product in future revisions?



NO POSTAGE  
NECESSARY IF  
MAILED IN  
THE UNITED  
STATES

**BUSINESS REPLY MAIL**  
FIRST CLASS      PERMIT NO. 50      BILLERICA, MA

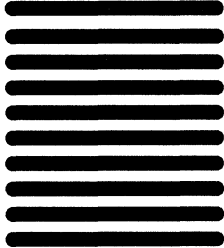

Postage will be paid by addressee

**IDEA, Inc.**  
29 Dunham Road  
Billerica, MA 01821-9947

Attn: Documentation Dept.

-----  
Fold back here and tape — do NOT use staples

- 6. Compared to similar manuals, how would you rate the documentation?  
 Better than most \_\_\_\_\_  
 Average \_\_\_\_\_  
 Worse than most \_\_\_\_\_
- 7. Please rate your knowledge of personal computers:  
 Experienced \_\_\_\_\_  
 Some previous use \_\_\_\_\_  
 First-time user \_\_\_\_\_
- 8. Please use the rest of this page for additional comments.
- 9. Name and Address (optional) \_\_\_\_\_

\_\_\_\_\_  
\_\_\_\_\_

# Notice

---

## Copyright

Copyright ©1989 by IDEA, Inc. All rights reserved.

## Trademarks

Apple and the Apple logo are registered trademarks of Apple Computer, Inc.

AS/400 is a trademark of International Business Machines.

Excel is a trademark of Microsoft Corp.

Finder is a trademark of Apple Computer, Inc.

HyperCard is a trademark of Apple Computer, Inc.

IBM, PC Support /36, and PC Support/38 are registered trademarks of International Business Machines.

IDEAcomm is a registered trademark of IDEA, Inc. in the United States of America.

Macintosh is a registered trademark of Apple Computer Inc.

MultiFinder is a trademark of Apple Computer, Inc.



# Section I:

## Introduction

---

### Overview of IDEAcomm Mac®

This manual teaches you about IDEAcomm Mac. IDEAcomm Mac lets you use your Macintosh SE as a multi-purpose workstation.

You'll be able to use the Macintosh SE as both a microcomputer and as a device emulator for an IBM midrange computer (System/36, System/38, or AS/400). Using HyperCard and IDEALink you'll be able to transfer data to or from the midrange computer, to manipulate and reformat data and to customize reports.

### Features and Benefits

The IDEA communications system provides the following features:

- The ability to configure 4 Logical Units (LUs) or host sessions with IDEAcomm Mac
- Emulation of the following terminal types:
  - IBM 3180 display station
  - IBM 3196 display station
- Support of 1 printer LU from the following emulated printer types:
  - IBM 5224/25 printer, model 1
  - IBM 5256 printer
- The ability to view multiple sessions
- Control of individual host sessions: ability to free and reserve sessions without logging off the host
- Low level program interface (API) documentation that allows you to create custom applications using HyperCard
- One year limited warranty

# Software Requirements

Macintosh system software must be of at least version level 4.2. Versions prior to 4.2 are not supported. For an updated version of your system software see your Apple dealer.

## Components

### Hardware:

- Emulation card with items listed in Appendix C
- Twinaxial cable and T-connector

### Software:

Version 1.0 of IDEAcomm Mac should include the following files:

IDEAcomm Mac®	Emulation and configuration program
IDEAlink folder	Contains the IDEAlink stack file
IDEAcomm® MI.4	Emulation microcode
IDEAcomm® Printer INIT and DA	Files for printer emulation
IDEAcomm® Utilities	For non-U.S.A. setup
IDEAcomm® Prefs	Configuration data file, copied to or created in the System Folder. All configuration information is saved in this file.
IDEAcomm® Diag	Diagnostic file
International Tables folder	Contains internationalization tables for printing, emulation, and file transfer

### For the IBM Host:

- IDEAlink file transfer software

# About This Manual

Here's what you'll find in this manual:

- Section 1, "Introduction," summarizes the features and benefits of this product and lists software requirements for using IDEAcomm Mac.
- Section 2, "Getting Started," describes connecting your Macintosh SE to the Twinax cable run and setting up your IDEAcomm Mac software.
- Section 3, "Basic Setup," tells you how to set up the IDEAcomm Mac program.
- Section 4, "Using Emulation," describes the Sign-On Screen and Status Line. It also explains how to use Multifinder to shift between emulation and other Macintosh applications.
- Section 5, "Displays and Windows," tells you how to move between windows in order to access a host session. Viewing 132 columns with 3180 emulation is described.
- Section 6, "Printing," tells you how to install and set up the printer software to emulate a system printer.
- Section 7, "File Transfer," explains how to use IDEALink, the HyperCard stack, which lets you transfer files between the host system and your Macintosh.
- Appendix A, "Troubleshooting, Error Messages, and Charts," includes diagnostic programs, a list of Error Messages, and display and printer tables.
- Appendix B, "Keyboard and Terminals Defaults," describes keyboard functions and display attributes of the emulated terminal.
- Appendix C, "Hardware Installation for the Authorized Apple Reseller," is for the authorized Apple dealer. It describes the installation of the IDEAcomm Mac Card.
- Appendix D, "The IDEA Applications Program Interface," for advanced users. Describes available Macintosh calling sequences so that the advanced user can write specialized software to customize the system.
- Appendix E, "IDEAcomm Utilities," describes configuration options if you are using your IDEAcomm



Mac outside the United States or require a special configuration.

- Appendix F, “Glossary,” defines terms used with 5251 emulation.
- Appendix G, “IDEA Products,” summarizes currently available IDEA products.
- Appendix H, “Customer Support Information,” describes what to do if you have any problems using IDEAcmm Mac.

## Related Publications

Several documents are available to provide reference for the various pieces of this product. They include the following:

### **System/36**

*IBM System/36 Changing Your System Configuration*  
(SC21-9052)

*IBM System/36 Systems Reference Manual* (SC21-9020)

*5250 Information Display System to System/38 System Unit Product Attachment Information*

### **System/38**

*IBM System/38 Guide to Program Product Installation and Device Configuration* (GC21-7775)

*5250 Information Display System to System/38 System Unit Product Attachment Information*

### **AS/400**

*AS/400 Device Configuration Guide* (SC21-8106-0)

*AS/400 Programming Command Reference Summary*  
(SC21-8076-1)

*AS/400 System Operations Operator's Guide* (SC-8082-0)

## **Macintosh**

*HyperCard® User's Guide* (030-3081-C)

*Inside Macintosh (Volume III)* (030-1280-B)

*Macintosh® SE Owner's Guide* (030-3296-A)

*Macintosh® System Software User's Guide* (030-3281-A)

Shafer, Dan. *HyperTalk™ Programming*. Hayden Books, Indianapolis, Indiana 1988

## **Notation Conventions**

IDEAcomm      The name of the IDEAcomm emulation  
Mac              program

Host             The IBM System/36, System/38, or AS/400



# Section II: Getting Started

---

This section will help you get started with IDEComm Mac. You'll find instructions on:

- checking your inventory
- entering important information about your IDEComm Mac in this manual
- what you'll need to supply
- having your authorized Macintosh dealer install the IDEComm Mac Card
- connecting your Macintosh SE to the Twinax run
- installing IDEComm software

## Checking Your Inventory

The first thing to do is to make sure that you have everything you're supposed to. Take all the materials from the packing box and see if you have received everything listed below:

- IDEComm Mac card installed (or see Appendix C)
- Short twinaxial cable with T-connector
- Software diskette, 3.5 inches
- *IDEComm Mac User's Guide* (this book)
- *IDEALink Host Operations*
- IDEComm Mac keyboard templates
- Host file transfer software
- Warranty card

If you haven't received everything, contact the dealer where you purchased IDEComm Mac.

# Serial Number and Version Number

After you've made certain that you have a complete package, enter the serial number of the emulation card from your Warranty Card below.

Serial Number

---

Date of Purchase

---

Software Version Number

---

The Warranty Card should be filled out by your authorized Apple dealer who installs the IDEAcomm Card. The serial number also appears on the outside of the IDEAcomm Mac box.

Be sure to have the IDEAcomm Mac warranty card filled out and mailed in. Also, you should save the packing materials to protect your card from damage.

## What You Need to Supply

To attach your Macintosh SE to the TWINAX line, you'll need the following:

1. Small flat blade screwdriver for attaching the TWINAX cable connector
2. Twinaxial or twisted pair cable

# Installation of the Card

The IDEComm Mac Card should be installed by an authorized Apple dealer. You should not open the case of the Macintosh SE because this will void your warranty as does installation by other than authorized Macintosh service personnel. Appendix C of this Manual describes the installation steps.

## How to Terminate the Card

After the IDEComm Mac Card has been installed by your authorized Apple dealer, you need to connect your Macintosh to the controller (connected to the host computer) by using a TWINAX cable.

To connect your Macintosh to the TWINAX cable locate the termination switch on the T-connector (Figure 2-1). Notice that the words TERM and THRU appear on the T-connector. If your Macintosh is the last device on the TWINAX run, be sure to flip the Termination switch to TERM. You need to set these switches correctly or the equipment will not work properly.

# Connecting the TWINAX Cable

To connect your Macintosh SE to the Twinax cable run:

1. Locate the 15-pin male connector on the IDEAComm Mac card. This connector protrudes from the rear panel of the Macintosh SE (Figure 2-1). Attach this connector to the 15-pin female TWINAX cable connector provided by IDEA. Tighten the two mounting screws using a flat blade screwdriver to turn the screws clockwise.
2. Attach the TWINAX cable run (the cable that connects to the controller) to the T-connector. (Push the T-connector into the cable connector so that the button on the cable connector fits into the slot on the T-connector. Then twist the collar of the Twinax cable until it fits tightly onto the T-connector.)

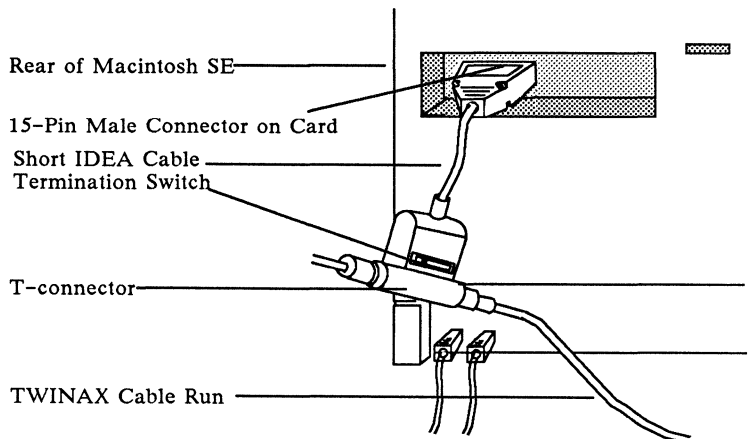

Figure 2-1: Connecting the Twinaxial Cable

# Installing IDEAcomm Software

Now that your authorized Apple dealer has installed the IDEAcomm card in the Macintosh SE and you have connected the Macintosh SE to the TWINAX run, you're ready to install your IDEAcomm software. To install the software:

1. Make backup copies of your diskettes and store your original software in a safe place. Then you can install using your backup software.
2. Insert your backup of the IDEAcomm Mac diskette. If you are using a hard disk, copy the IDEA software to your hard disk. Although it is possible to use IDEAcomm on diskette drive(s) only, we strongly recommend that you use a hard disk.

You can copy the following files to any location on your hard disk:

IDEAcomm Mac  
IDEALink folder  
IDEAcomm Utilities  
International Tables folder

However, the following files must be copied to your System Folder:

IDEAcomm Prefs (if not copied to System Folder  
will be created the first time you run the  
application)  
IDEAcomm MI.4  
IDEAcomm Diag  
IDEAcomm Printer INIT

Microcode for emulation and for diagnostics must be copied into the System Folder. We have included a sample configuration file (IDEAcomm prefs). If you copy this file to your System folder, you will configure your Macintosh SE as a 3196 display in Session I. If you do not copy it into the System Folder, you will be prompted to set up your own configuration (see #6 which follows).



3. Use the Font/DA Mover (see Macintosh SE Owner's Guide) to copy the IDEAcomm Printer DA file if you are configuring one of the LUs (Logical Units) as a system printer. (Disregard if you are not using printer emulation.)
4. Double-click your IDEAcomm Mac folder to open it, then double-click on the IDEAcomm Mac application to run it.
5. This will display the following screen (if you are using the default IDEAcomm Prefs file):

IDEAcomm® Mac Host Sessions Available				
Session #	Device Type	Primary Address	Alt	Station Status
Session #1	3196	1		ADDRESS TEST...
Session #2	None			
Session #3	None			
Session #4	None			

Figure 2-2

6. If there is no IDEAcomm Prefs file in the System Folder you'll see the following screen:

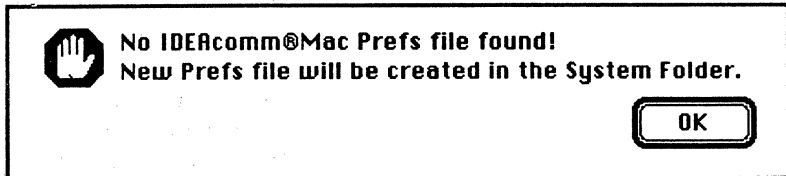

Figure 2-3

Click the OK button. This will create an IDEComm Prefs file in your System Folder and a screen similar to Figure 2-2 will appear. In this case there will be no device types configured.

At this point you have installed the IDEComm software. See Section 3 for step-by-step instructions on how to configure your system.



# Section III: Basic Setup

---

This section tells you how to configure your software so that you can communicate with the IBM midrange host.

When you run the IDEAComm Mac program you will be able to configure the displays you want to emulate. If you have already completed configuration, go to Section IV.

## Note

For printer emulation see Section VI.

In order to use the IDEAComm Mac program, you'll need information about your host configuration. Before you begin, make certain that you know the following for each host session you want to install:

- **Session Name.** Any name you want to assign to this session. (Installing a Session Name is optional.)
- **Device Type:** IDEAComm Mac offers the following display options:
  - 3180
  - 3196
- **Primary Station address (0 to 6).** Note that, if the IDEAComm Mac card is connected to the host, IDEAComm Mac checks the station addresses currently in use and will not use those. Your Host system administrator or someone who has access to system configuration should tell you what model number and station address you can access.
- **Alternate Station address (0 to 6, excluding the primary address).** The alternate address is used in the event that the primary address is in use.

After you've determined how you're going to set up your system, you're then actually ready to do the setup. To set up your system after you've installed the software (see Section II), select Setup from the Utilities menu.

You'll see a screen which looks like the following:

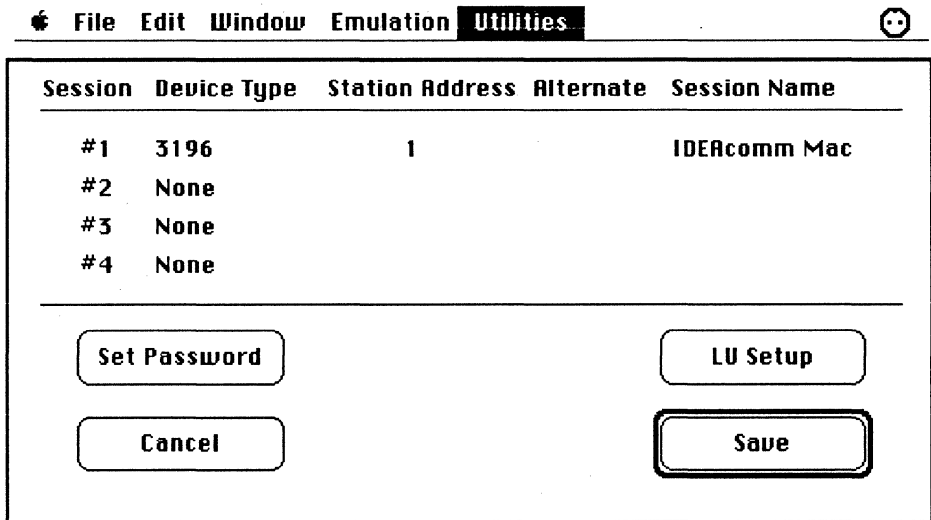

Figure 3-1

#### Note

If you have any Sessions Active, you will have to free them before you can change the configuration.

Here's how to enter or choose each item in this dialog box:

You may decide, for security reasons, to limit access to IDEAcomm Mac. You can limit access by using the Set Password feature. This will require that users enter the correct password before they can access emulation. Using this password limits access to IDEAcomm Mac. Note that this is not the same password as the logon password on the host signon screen.

**Set Password** is a button which lets you select or change a password. If a password is set, you cannot access LU Setup without entering the correct password. When you click the Set Password button you'll see the following screen:

The image shows a rectangular dialog box with a black border. At the top, it says "To change your IDEComm® Mac password...". Below this are three lines of text, each followed by a rectangular input field: "Enter your existing password:", "Enter your new password:", and "Re-enter your new password:". At the bottom of the dialog box are two buttons: "Cancel" on the left and "Accept" on the right.

Figure 3-2

To enter your IDEComm Mac password for the first time:

1. Enter your new password (up to 10 characters including spaces) in the box on the right of **Enter your existing password:**. Then press the Enter key.

**Note**

If you mistype at any time just select the Cancel button and start again.

2. Re-enter your new password in the box on the right of this instruction. Do not press your Enter key.
3. Click the Accept button. Be sure to keep track of your new password.

You'll see the following:



Figure 3-3

Click the OK button. This will install your new password.

To change your IDEComm Mac password:

1. Using the mouse, move your cursor into the box to the right of **Enter your existing password:** and carefully enter the existing password. Then press the Enter key.
2. Using the mouse, move your cursor into the box to the right of **Enter your new password:** and carefully enter the new password. Then press the Enter key.

#### Note

If you mistype at any time just select the Cancel button and start again.

3. Using the mouse, move your cursor into the box to the right of **Re-enter your new password:** and carefully re-enter the new password in this field. Do not press your Enter key.
4. Click the Accept button. Be sure to keep track of your new password.
5. You'll see a dialog box similar to the one in Figure 3-3. Click the OK button. This will install your new password.

#### Note

If you determine that you no longer want a password, just leave the **Enter your new password:** and **Re-enter your new password:** fields blank and click on the Accept button.

You'll automatically return to the initial screen. Select the LU Setup button and you'll see the following screen.

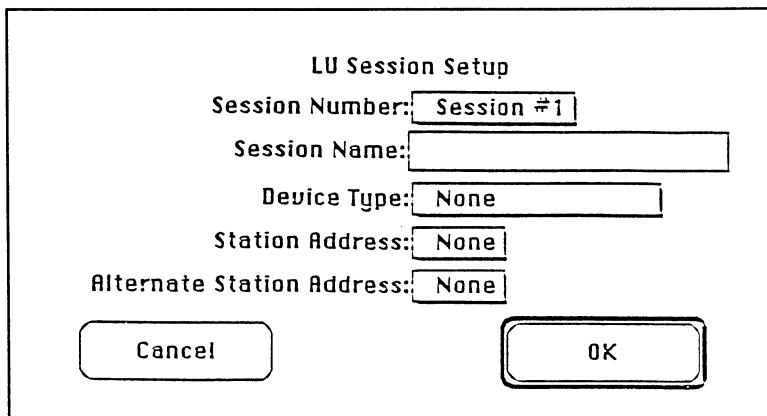

The image shows a dialog box titled "LU Session Setup". It contains several input fields: "Session Number" with a dropdown menu showing "Session #1", "Session Name" with an empty text box, "Device Type" with a dropdown menu showing "None", "Station Address" with a dropdown menu showing "None", and "Alternate Station Address" with a dropdown menu showing "None". At the bottom, there are two buttons: "Cancel" on the left and "OK" on the right.

Figure 3-4

Here's how to enter or choose each item in this dialog box:

**Session Number** is a popup menu which lets you use your mouse to Select from among four sessions (see below). To select an item from this or any other popup menu hold down the mouse button, point to the desired selection until it becomes highlighted, and then release.

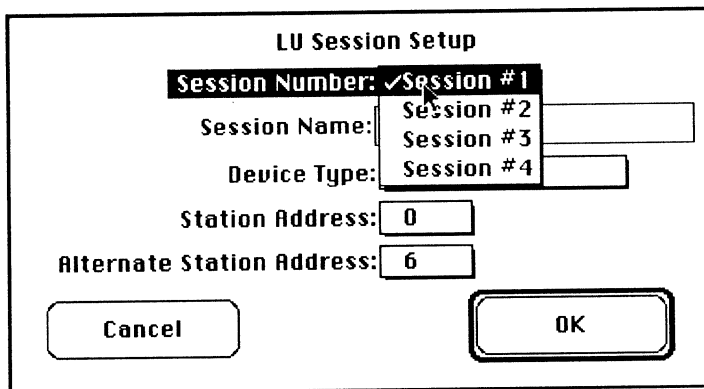

The image shows the same "LU Session Setup" dialog box, but with a popup menu open over the "Session Number" field. The popup menu lists four options: "Session #1" (which is highlighted with a checkmark), "Session #2", "Session #3", and "Session #4". The "Session Name" field now contains "Session #2", "Device Type" contains "Session #4", "Station Address" contains "0", and "Alternate Station Address" contains "6". The "Cancel" and "OK" buttons remain at the bottom.

Figure 3-5

These session numbers (Session #1, Session #2 etc.) are the default names which will appear in the title bar of each emulation screen if you do not select a Session Name (see next item).



The next section is the **Session Name**. Here you can enter any identifying name you choose (or even leave this blank). Do not press the return key after you have entered a name or you'll have to select Setup IDEComm again. After you have entered a Session Name, that name (and not the session number) will appear in the title bar of subsequent emulation screens.

By selecting **Device Type** you'll get a pop-up menu which has the possible device types highlighted. A sample device type menu appears below. Printer device types are for informational purposes only. You must configure a printer session using the IDEA Printer DA.

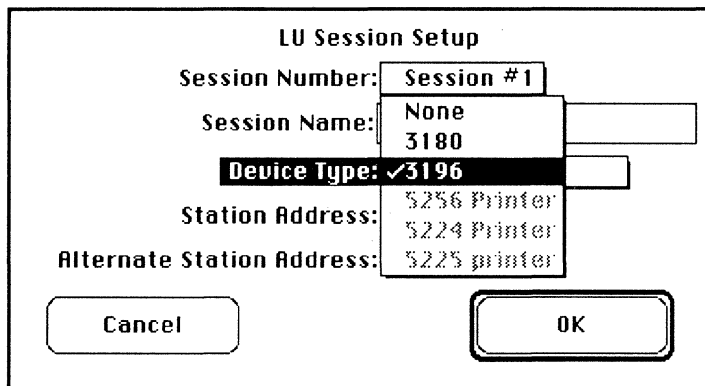

Figure 3-6

The final two pop-up menus are the **Station Address** and **Alternate Station Address**. You'll need a station address for every device you plan to emulate. Your host system supervisor or someone who has access to system configuration should tell you what station address you can access (and its corresponding device type).

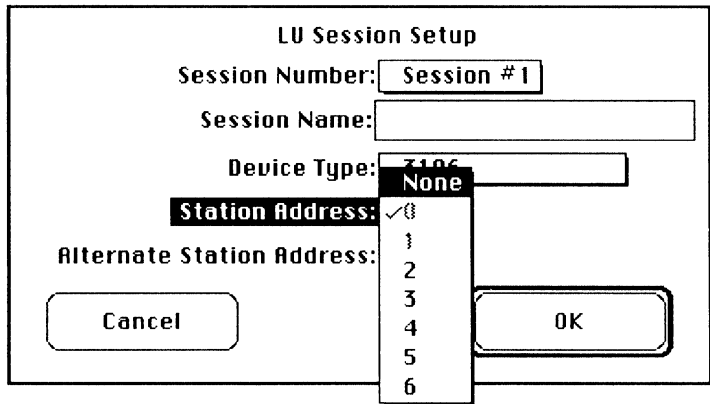

Figure 3-7

IDEA highly recommends that you also select an Alternate station address. The Station Address is used unless that address is currently in use. If that address is in use, the alternate station address is used.

It is most practical to use Alternate Station Addresses when:

- your system has many users and
- the users do not necessarily need to access the system at the same time

In this situation, by having an alternate station address, you (and other users) will have two possible stations which could be accessed.

Locate your choice for alternate station address and select the corresponding number (0-6) at the cursor. Again, you will not be able to enter an alternate station address that has already been chosen as it will be dimmed.

**LU Session Setup**

Session Number:

Session Name:

Device Type:

Station Address:

Alternate Station Address:

2  
3  
4  
5  
6

Figure 3-8

When you select an alternate station address, be sure that it is for a compatible device type. If, for example, the addresses are for incompatible displays or if the station address is for a display and the alternate is for a printer, then the emulation software will not operate correctly.

Click the OK button when you have finished setting up.

# Section IV: Using Display Emulation

---

## Overview: Activating Emulation Software

This section covers display emulation. It describes emulation, from the time you load the software until you end your emulation session. The topics covered include:

- primary and secondary station addresses
- using the emulation keyboard
- using MultiFinder (if available)
- a description of the status line symbols

### Note

Printer emulation is activated from the **IDEAcomm Printer Emulation DA** of the Apple Menu (see Section VI).

## Loading the IDEAcomm Mac Software

To load the emulation software, double-click the IDEAcomm Mac folder and then double-click the IDEAcomm Mac file.

## Primary and Secondary Station Addresses

When you run the IDEAcomm Mac application, the software performs a station identification check to verify that the configured station address is not already in use.

After this check is completed, the listing in the dialog box changes and displays the granted station addresses. If the configured primary address is not being used, the address is granted. The software automatically switches to the alternate session if the primary session is in use. This is the reason it is practical to configure an alternate address when you do an LU setup. If both the primary and alternate addresses are already

in use, the host session becomes inactive and the Address column shows "ACCESS DENIED."

If either your Primary or Alternate address is available, screens similar to the following will appear:

The Station Status will change from ADDRESS TEST... to ACCESS PENDING,

IDEAcomm® Mac System 3x LUs Available				
Session #	Device Type	Primary Address	Alt	Station Status
Session #1	3196	0	1	ACCESS PENDING
Session #2	3196	1	0	ADDRESS TEST...
Session #3	3196	3	2	ADDRESS TEST...
Session #4	None			

Figure 4-1

followed by ACCESS GRANTED.

IDEAcomm® Mac System 3x LUs				
Session #	Device Type	Primary Address	Alt	Station Status
Session #1	3196	0	2	ACCESS GRANTED
Session #2	3196	1	3	ACCESS GRANTED
Session #3	3196	2	3	ACCESS GRANTED
Session #4	None			

Figure 4-2

**Note**

If system is temporarily unavailable, you may see the following dialog box:

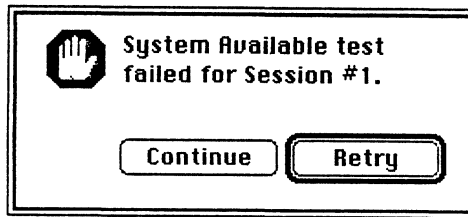

Figure 4-3

If you click on the Retry button, IDEAcmm Mac will again attempt to access the host through the same session. If you click on the Continue button, IDEAcmm Mac will attempt to access the following session on the host.

Note that your primary address will appear under the Alt column if it is already in use by someone else. In this case, the alternate and primary addresses are switched on the screen for the duration of this session.

If you subsequently release, then reserve this session, you will be using the Primary Address (if it is available).

The next screen to appear should be the host sign-on screen. When you see a screen similar to the one which follows (for an IBM System/36), you are connected to the host.

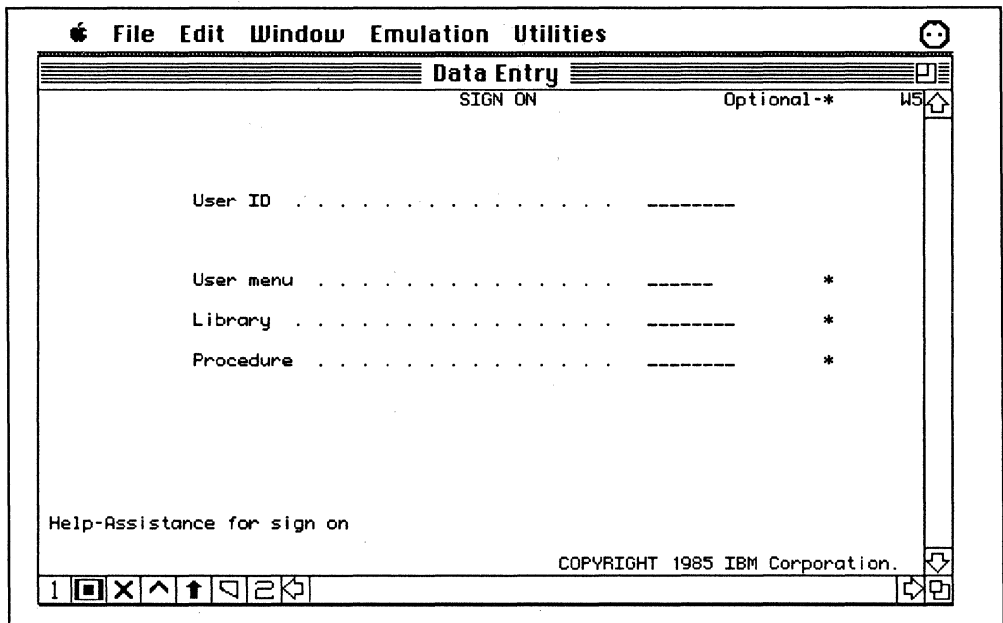

Figure 4-4: Sign-on Screen for a System/36

## Using the Emulated Keyboard

When you are connected to the host, it will be necessary to use one of the keyboard templates (either standard or extended) which are included with your IDEAComm product. For example, the Enter key in emulation is NOT the Return Key on the Macintosh keyboard. Select either the standard or the extended keyboard template, depending on the type of keyboard you are using.

The Macintosh SE Standard and Extended keyboards do not have all the keys on an IBM Minicomputer keyboard. For example, there is no Reset key. Therefore, IDEA has provided keystroke combinations to emulate the IBM Minicomputer keys. Use the template that accompanies this manual, or the charts in Appendix B, to find the keystroke combinations for emulated keys.

# Using IDEAcmm Mac with MultiFinder

In order to use MultiFinder with emulation, you will need 2.5MB of memory installed in your Macintosh SE.

The advantage of using MultiFinder with IDEAcmm Mac is that you can switch back and forth between IDEAcmm Mac emulation and other Macintosh applications. By switching out of IDEAcmm Mac using MultiFinder, you can run IDEAcmm Mac and then start another application from the Apple menu or by clicking the MultiFinder Icon (on the upper right of your screen). MultiFinder suspends the IDEAcmm application yet emulation is still running in the background.

For example, while you are running IDEAcmm Mac and are connected to the host, you may need to run file transfer, edit a file with a word processor, or use another Macintosh application.

You can leave IDEAcmm Mac at any time, whether the system is idle or whether any program or command is executing. You return to whatever Macintosh application was executing when you switched out of IDEAcmm Mac, and continue from where that command or program left off.

When you return to emulation, you see the same host session displayed as when you left IDEAcmm Mac. If a program was running when you left emulation, the program continued to run even though the host session may not have been displayed. Therefore, the host session screen display may be different than the one displayed when you used the MultiFinder to access another application.



# Operating in Emulation

## Using LUs

The IDEAComm Mac software supports emulation of four system devices (one device may be a printer). Thus several tasks, such as order entry, file transfer, and printing, can be done at one time. Each emulated display or printer is called a **Host Session** or **Logical Unit (LU)**. For example, a few possible configurations are:

- 4 IBM displays
- 3 IBM displays and 1 printer. Printer LUs are configured and accessed through the Apple menu (see Section VI).
- 2 IBM 3180 displays  
Note: A 3180 LU display requires 2 LUs.

## The Sign-on Screen and Status Line

Once IDEAComm Mac has checked (and granted) access, you will see the window for the first display LU available. For a display LU, you will see the host sign-on screen, which varies with your host and your application.

### Note

For a Printer, use the IDEAComm Mac Printer DA, not display emulation.

A sample sign-on screen appears in Figure 4-4. The bottom line of the screen is the IDEA status line:

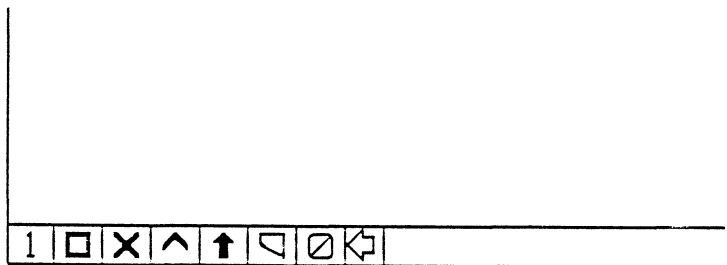

Figure 4-5: Status Line

## Status Line Indicators

An IBM Midrange display station has status indicators along the bottom left edge of the screen.

IDEAcomm Mac displays the session number to the left of the status indicators, and the Host station address between the status indicators and the scroll bar.

Each of the indicators (see below) can be either active or inactive, and all indicators are displayed constantly. The status line items are either highlighted (to indicate that they are active) or unhighlighted (to indicate that they are inactive). Table 4-1 below shows the indicators in an inactive status.

Indicator	Icon	Explanation of the Status
Session #	2	The n indicates the Host Session number that is currently displayed.
System Available	☐	The 5250 controller and the IDEAcomm Mac program are operating and ready.
Input Inhibited	✕	Your keyboard is locked because your terminal is waiting for the controller to respond, the system is processing the previous function key, or there is some error condition.
Insert Mode	^	Your keyboard is in Insert mode.
Keyboard Shift	↑	Your keyboard is in Shifted mode.
Message Waiting	▽	Your terminal has messages to be displayed.
Station Address #	⊘	The n indicates the Station Address number that is currently displayed.

## Windows: Viewing More than One Session at Once

Each session has its own window that can be sized, moved or scrolled in the standard Macintosh way. Therefore, by moving windows around and sizing them appropriately, you can view multiple sessions simultaneously. For example, you can monitor printer status in one session while typing data in another and, at the same time, checking when compilation finishes in a third session.

The window with the active window's title bar will be the currently active process.

Section V discusses how to view more than one LU at once. To create windows refer to Section V of this manual.

### Freeing and Reserving Sessions

To exit from a particular session, log off your application and then choose **Free** from the Emulation Menu and the name of that session. To reactivate that session subsequently, choose **Reserve** from the Emulation Menu. If the desired session is not in use by another machine, you can reserve it. Later, if another user has finished with that session address, you will then be able to start a session with that same address.

# Ending Emulation

To exit emulation select **Quit** from the File menu (or **⌘ - Q**).

A dialog box like the one shown below will appear.

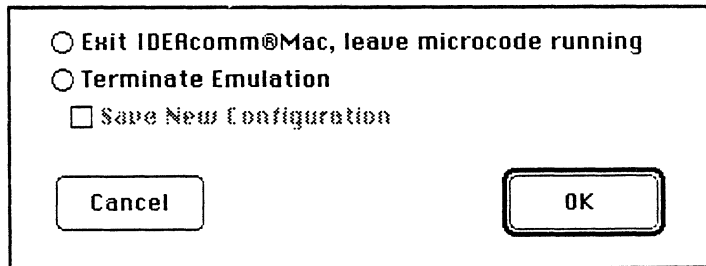

Figure 4-6

To terminate emulation click the **Terminate Emulation** button (followed by the **OK** button). By terminating emulation, you free any sessions you had reserved, possibly enabling another user to access those sessions.

To quit and leave the microcode running click the **Exit IDEAcmm Mac, leave microcode running** button (followed by the **OK** button). This option causes emulation to terminate but does not unload the microcode. The advantage is that any processes already started on the host can continue (as the host acts as if you are still connected).

If you were running a program or command before you use the **Exit IDEAcmm Mac, leave Microcode Running** button, that program or command will continue to run and the screen may be different when you return to that session.

The advantage of exiting IDEAcmm Mac and leaving the microcode running is that you can return to emulation at the exact menu location on the host as when you quit emulation. You do not risk losing your session and can continue a process that you previously started.

If you had changed the freed and reserved status of addresses and alternate addresses, by clicking the **Save Configuration** box, you can save the new configuration of station addresses. For example, you might want to switch a primary and an alternate station address.

#### Notes

If you make a mistake or wish to change your selection (before clicking the OK button) just click the **Cancel** button.

On the System/36 you must return to the Sign On screen before you terminate emulation. If you don't return to the Sign On screen first, you'll generate an error message on the host which will have to be cleared on the host.

# Section V: Displays and Windows

---

## Overview

By reading this section you'll be able to:

- View 4 windows at one time.
- Activate any available window
- Free and reserve windows
- Resize, reshape, and relocate windows
- Use (132 column) 3180 emulation

## General Information

You can view from 1 to 4 session windows on the Macintosh SE at one time. Each window represents a host display session. By clicking your mouse on visible windows you can move between windows in order to access a host session. All windows are concurrently updated by the host regardless of the host session with which you are working.

There are three ways you can move between windows in order to access a host session. These are:

1. Click in a window.
2. In the Window menu, choose the name of the session/window that you want.
3. Press the Apple key (sometimes called the CMD key) and then the number of the session you want brought to the front and activated. (For example, CMD-4 activates session #4). The number can be selected either from the keypad or the number keys.

In the following example, if CMD-1 is pressed (see Figure 5-1 which follows) the Accounting window, which is session 1, is brought to the front and activated.

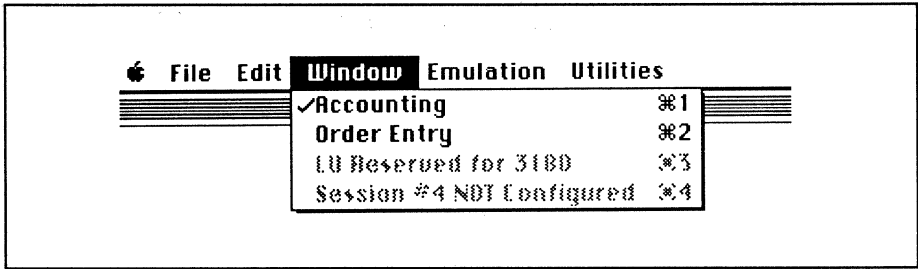

Figure 5-1

Notes:

If any session is configured as a 3180 display, an additional, dimmed menu item **LU area Reserved for 3180** will appear. If a second session is configured as a 3180 display another additional, dimmed menu item will appear in the menu. Thus, a maximum of two sessions can be configured as 3180 displays.

If a Session Name (Order Entry, for example) was specified in Setup then the session window will have that name (in the Title Bar) and will first appear as follows:

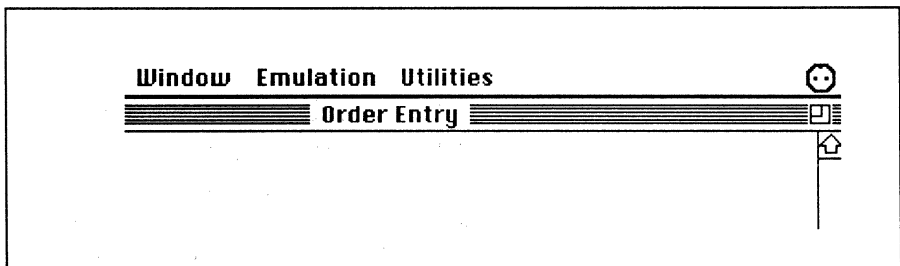

Figure 5-2

Otherwise, you'll see the default names:  
Session 1,  
Session 2 etc.

When each window is selected during emulation it will appear as an active window (as it comes to the front). By resizing and moving each window you will be able to have as many as 4 LUs visible at one time.

## Tips on Using Windows

For each host session configured as a display, the status line is displayed along the bottom of the session to the left of the horizontal scroll bar. (Refer to Status Line Indicators in Section IV.)

The sizes, shapes and locations of the host sessions can be changed by clicking in the size box and dragging it until the desired shape and size is obtained. The window can be moved by dragging it by its title bar to its desired location.

The next time you open this window it will have the same size, shape, and location as when it was last closed.



# The 3180 Display: Viewing 132 Columns

IDEAcomm provides 132 column, 3180 emulation by scrolling your window.

This option is available only if you have configured a host session as a 3180 display.

## Viewing 3180 Emulation

To view all the columns and lines, use the scroll bars (both vertical and horizontal) to move to different portions of the display into your Macintosh SE window.

To scroll from line to line, click the up or down arrows at the top and bottom of the vertical scroll bar. To scroll left or right, click the left or right arrows on the horizontal scroll bar. To click to the next (or previous) full window, click the gray area in the scroll bar either above or below the scroll box.

# Section VI: Printing

---

By reading this section you'll be able to set up your Macintosh SE and ImageWriter for system printer emulation. In this section you'll also learn about the printer control options and potential printer error messages.

## Note

The term **Apple printer** refers to the local printer for the Macintosh SE microcomputer. In release 1.0 of IDEAcmm Mac, the ImageWriter (I, II, and LQ Models) printers are supported.

## Before Installing Printer Software

Before you use IDEAcmm Mac Printer Emulation, make sure, using the Chooser desk accessory, that the Apple printer (ImageWriter) is selected and ready to print. If the host sends data while the Apple printer is off, an error condition can occur.

If possible, have the New York 10 point font installed on your Macintosh SE. If this font is not available, the Geneva font (permanently installed on all systems) will be used.

# Installation of Printer Software

To install printer software:

1. The IDEAcmm Mac Printer DA must be installed in the System file using the Font/DA Mover. See your Macintosh SE manual for information on using the Font/DA Mover.
2. In addition, you must copy the IDEAcmm Printer INIT file to your System Folder.
3. Be sure that the IDEAcmm microcode has been installed in your system folder (see Section II).
4. International (non-U.S.A.) users should run the IDEAcmm Utilities program to localize their printer emulation.

## Note

When you boot your system after installing the Printer INIT file, you will see a lightbulb icon, similar to the following, on the lower left hand side of your screen:

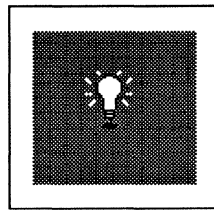

Figure 6-1

This indicates that your Printer INIT is working properly.

If you see a dimmed lightbulb icon similar to the following, this indicates a problem.

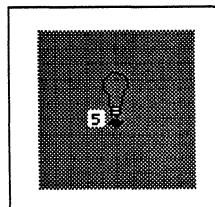

Figure 6-2

The dimmed bulb will be preceded by a number which has the following meaning:

Table 6-1: Printer Init Error Messages

ICON #	
1.	Wrong machine. Requires Macintosh SE.
2.	No board installed. Have your Apple dealer make sure that the IDEAcmm Mac board is installed properly.
3.	Wrong system version (4.2 or higher required). Check the version number of your system software and install an updated version, if necessary.
4.	Too many INITs. Go into the system folder and rename the IDEAcmm Printer INIT file by putting an ! before it. The file would then be named  !IDEAcmm® Printer INIT.
5.	Unable to install print driver. (Recopy the file from your IDEAcmm Mac diskette.)
6.	Out of Memory. Go into the system folder and rename the IDEAcmm Printer INIT file by putting an ! before it. The file would then be named  !IDEAcmm® Printer INIT.
7.	Unable to read Language Customization table from the IDEAcmm Prefs file. Run the IDEAcmm utilities program (see Appendix E).

# The Printer Control Panel

To view printer sessions use the **Printer Control Panel**, not the Windows option.

This IDEAcmm Printer Control Panel appears when you select the **IDEAcmm Printer Emulation DA** from the Apple menu. You'll see:

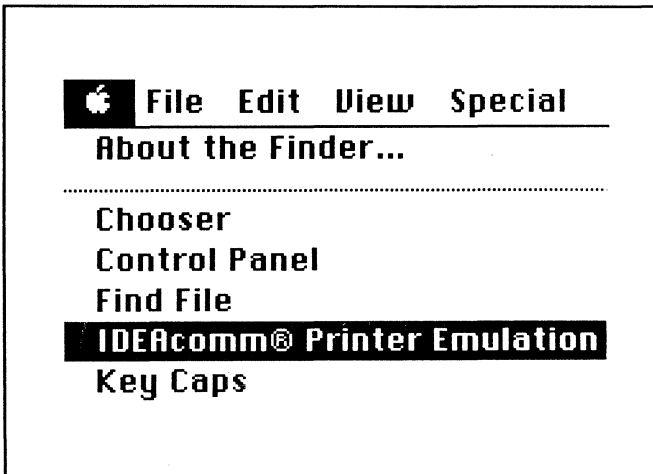

Figure 6-3: Selecting Printer Emulation

Select the **IDEAcomm Printer Emulation DA** and you'll see a window similar to the following (if a printer has already been configured):

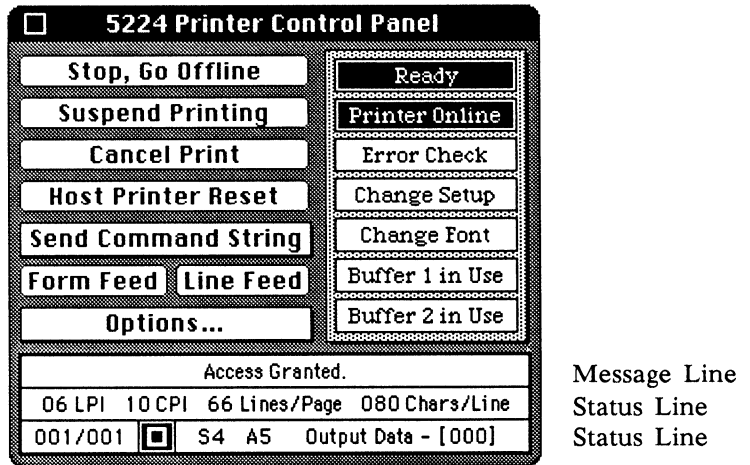

Figure 6-4: Printer Control Panel

By selecting **IDEAcomm® Printer Emulation** followed by **Start, Go Online**, you'll actually be starting an emulated printer session.

By using the Printer Control Panel, you can change the status of the printer and monitor parameter settings and printer activity.

#### Notes

In Figure 6-4 above, the Message Line and both status lines will be blank unless a printer has already been configured.

You must configure the printer with Options before printing.

If your message line shows an error (or any other message), you can clear the message line by clicking anywhere in the message box other than on a button. Messages are explained at the end of this Section.

## Options Available on the Printer Control Panel

To activate any of the options on the panel just click on the button for that option. Each of the options is explained below:

**Start, Go Online** — Click this item from the Printer Control Panel to start the emulated printer. Once you click “Go Online” the button becomes **Stop, Go Offline**, and the Printer Online indicator is highlighted. You may not print from other applications while the Printer Online indicator is highlighted.

### Notes

When you click Go Online, the Print Emulation DA determines which printer and port to use by using the latest Chooser settings. If you change printers, the change will not take effect until you **Go Offline** and then **Go Online** again.

Also, to correct certain error conditions, it may be preferable to Go Offline and then Online, rather than doing a Host Printer Reset (which completely aborts the printout).

**Suspend Printing** — Click the Suspend Printing field to suspend printing temporarily. For example, you would suspend printing to change a ribbon, or to add or adjust paper. After this option is selected, the suspend printing message is replaced by **Resume Printing**.

**Cancel Print** — Select this item to terminate the printout.

**Host Printer Reset** — This sends a reset command to the host that aborts the printout, and may put the printer offline for the host. In order to clear the Error condition check indicator you must go back online.

**Send Command String** — By selecting this item you’ll get a pop-up menu which permits you to select from four command strings (if strings have already been created). For example, you could send a command string to use ultracondensed printing (132 column) or to cancel ultracondensed printing. Drag the mouse to the string that corresponds to the desired Printer Command String.

By editing command strings you will be able to have the printer print in bold, condensed (132 column), italic etc. Refer to your printer manual to find relevant command strings.

The next time you select Send Command String, the last string which was selected will automatically be highlighted.

**Form Feed** — Select this item to issue a form feed to the printer and send the paper to the top of the next page.

**Line Feed** — Select this item to issue a line feed to the printer that causes the paper to move down one line.

By clicking Options you'll see the following pop-up menu:



Figure 6-5

## About

Select About for a display of the name and version of the IDEA Printer Emulation.

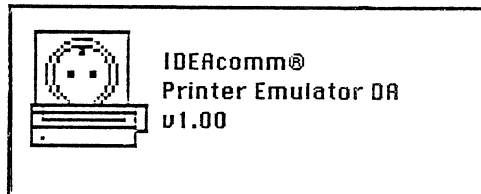

Figure 6-6

## Edit Command Strings

You can edit command strings and their names. You will see the following dialog box:



Edit Printer Command Strings	
String Name	String Data
First Command String	^M
Second Command String	^M
Third Command String	^M
Fourth Command String	^M

Figure 6-7

When sending command strings to the printer you can send in Hexadecimal and control format. Hex characters begin with \$ and control characters begin with ^.

For example, in making text ultracondensed (17 characters per inch) so that you can print 132 columns on a standard-width 80 column printer, you would send any of the following command strings:

\$1B\$51	- Hex format only
^[Q	- Control format

In addition, you can mix the two formats as in the following:

^[ \$51	- Control and Hex formats mixed
---------	---------------------------------

Any of these strings would generate ultracondensed printing. In addition, control strings are not case sensitive.

#### Notes

If you make an entry which cannot be processed, you will hear a beep and see an alert box which indicates

the bad string name and suggests the correct format for an entry.

To generate ^ enter ^^.

To generate \$ enter \$\$.

## Printer Configuration

By releasing at **Printer Configuration...** you'll see a dialog box similar to the following:

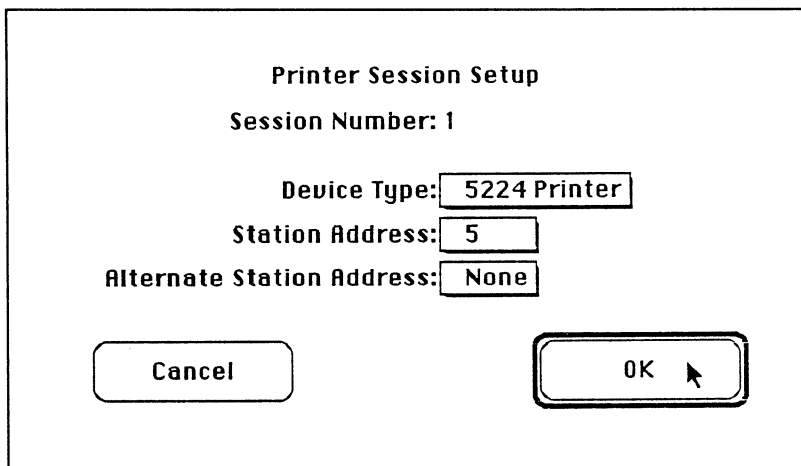

The image shows a dialog box titled "Printer Session Setup". It contains the following fields and controls:

- Session Number:** 1
- Device Type:** 5224 Printer
- Station Address:** 5
- Alternate Station Address:** None
- Buttons:** Cancel and OK (with a mouse cursor pointing to the OK button).

Figure 6-8

Use this box to select the system printer you wish to emulate, the address assigned by the host, and the alternate address if desired. Note that, if an address is already assigned, you should first free it with the option discussed below.

## Free Printer Sessions

This option from the Printer Control Panel releases the printer's station address so that you can edit printer configuration.

## Indicators on the Printer Control Panel

**Ready** — When the printer is online to the host and ready for communication from the host, this box will be highlighted.

**Printer Online** — When the Apple printer is online, this box will be highlighted. Do not attempt to print from another Macintosh program while this indicator is on.

**Error Check** — If error check is active, this box becomes highlighted, and the printer goes offline.

To clear the error condition select the Host Printer Reset option, then select the Offline/Online option to put the printer back online.

**Change Setup** (for 5219 Printer only) This indicates a printer setup change, e.g., a report of a different width than previous report. The printer goes offline to the host and the field in the Message Area displays one of the following messages:

001 = manual feed  
002 = tractor feed  
003 = automatic cut sheet feed

You must change the feed type (if manual feed, insert the sheet) and put the printer back Online from the Printer Control Panel.

**Change Font** (for 5219 Printer only) The Output Data field displays the decimal number of the font you must insert in the printer. After the font is changed, you must select the **Start, Go Online** option to put the printer back online.

**Buffer 1 in Use** or **Buffer 2 in Use** If either of these boxes is highlighted, that indicates that the buffer is presently active.

If either buffer is highlighted but the information sent to the printer is not printing, the printer may be faulty or printing may be suspended. You may need to take corrective action.

## Status Line Information

The following information will appear on the status lines of the Printer Control Panel. The bottom two lines on the printer Control Panel are the status lines.

**LPI (Lines per Inch)** — The numbers in front of this item indicate the current lines per inch setting of the print job.

**CPI (Characters per Inch)** — The numbers in front of this item indicate the current characters per inch setting of the print job.

**Lines/Page (Lines per Page)**— The numbers in front of this item indicate the current lines per page setting of the print job.

**Chars/Line (Characters per Line)** — The numbers in front of this item indicate the current characters per line setting of the print job.

The exact location currently being printed will be indicated on the lower status line according to **row/column**. For example, 001/002 would indicate that the first row, second column is printing.

The **Station Available** icon  will be highlighted if it is active.

**Sn** indicates the **Host Session** number that is currently displayed.

**An** indicates the **TWINAX Station** address of the displayed Host Session.

**Output Data [nnn]**. If there is no error condition the Output Data will read 000. If there is an error condition you will see an error message on the Message Line and the decimal value of the error character or command will appear in the Output Data field on the Status Line.

# Printer Error Messages

The following tables provide information on the meaning of error check messages which appear on the Message Line on the Printer Control Panel.

Table 6-2: Printer Error Classes	
Error Class	Error Message
0	Invalid Printer Command
1	Invalid Parameters Command
2	Invalid number of Parameters
3	Graphics Check*

\* Graphic Check — unprintable character received.

Error classes 0 to 2 will be accompanied by the printer command number in the Output Data field (see Table 6-2).

If your printer configuration is correct, and you are still receiving an error message, contact your system administrator. If the system administrator cannot resolve the problem, call IDEA Technical Support for assistance and give them the number(s) or the error code(s) displayed.

Table 6-3: Printer Command Numbers for Error Class 0 to 2

Printer Command Numbers		
Number	Command	
01	NL	New Line
02	CR	Carriage Return
03	LF	Line Feed
04	FF	Form Feed
05	PP	Print Position, Absolute Horizontal
06	PP	Print Position, Absolute Vertical
07	PP	Print Position, Relative Horizontal
08	PP	Print Position, Relative Vertical
09	TRN	Transparent
10	SCD	Set Character Distance
11	SLD	Set Line Density
12	SVF	Set Vertical Format
13	STAB	Set Horizontal Tab Stops
14	HT	Horizontal Tab
15	BUS	Begin Underscore
16	EUS	End Underscore
17	SPS	Superscript
18	SBS	Subscript
19	BOS	Begin Overstrike
20	EOS	End Overstrike
21	BS	Backspace
22	SHM	Set Horizontal Margins
23	JTF	Justify Text Field
24	SJM	Set Justify Mode
25	SSLD	Set Single Line Distance
26	[SHMI]	Set Horizontal Motion Index
27	[SVMI]	Set Vertical Motion Index
28	[STM]	Set Top Margin Error
29	[JT]	Justify Text
30	SIC	Set Initial Conditions
31	SFG	Set FID through GFID
32	SIL	Set Indent Level
33	RLM	Release Left Margin
34	SLS	Set Line Spacing
35	SPPS	Set Presentation Page Size
36	SVM	Set Vertical Margins
37	SPSU	Set Print Setup
38	RNL	Required New Line
39	SEA	Set Exception Action
40	SPACE	Space Command
41	PPM	Page Presentation Media (multibin printing)
42	STO	Set Text Orientation (portrait/landscape printing)



# Section VII: File Transfer

---

This section provides a step-by-step overview of how to transfer files. Host specific information will need to be provided by your System Administrator.

IDEALink is a HyperCard stack used for transferring files between Host systems and your Macintosh. Using IDEALink file transfer enables you to access the power, speed and high storage capacity of your host system and then to transfer the raw data. You can format or manipulate this data for use in Excel or other Macintosh applications. In this way you can create presentation quality spreadsheet information.

**To use IDEALink will require that the proper files be installed on the host side. Use the *IDEALink Host Operations Manual* to install the files on your host.**



# Using IDEALink

IDEALink is a HyperCard stack. To use IDEALink you need to have HyperCard (Version 1.2 or higher) installed. It is strongly recommended that you install IDEALink on a hard disk.

You will also need 2.5MB of memory installed if you have HyperCard, Multifinder, and emulation.

## Copying IDEALink to Hard Disk

There are three ways to start IDEALink using a hard disk:

1. Copy the IDEALink stack to a folder on your hard disk. To use IDEALink you just double-click the file.
2. Copy the IDEALink stack to a folder on your hard disk. Double-click the HyperCard file from the Finder to open it. Select Open Stack from the File menu to locate and open the IDEALink stack.
3. Use either of the above methods and then copy the IDEALink button to the HyperCard home card.

You can do this by opening the IDEALink stack. You'll see a card similar to the following:

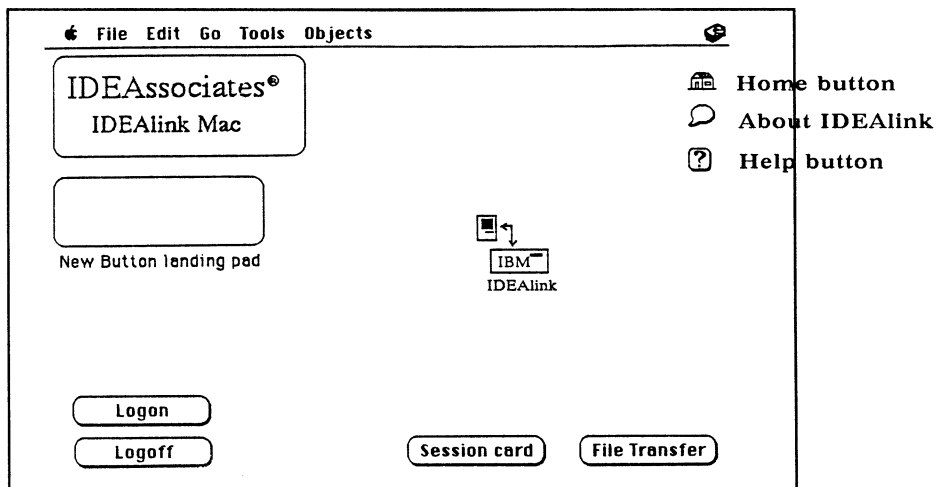
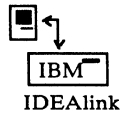

Figure 7-1: IDEALink Card

From this card use the button tool to select the IDEALink button.



Then use the **Cut Button** and the **Paste button** (from the edit menu) to place the IDEALink button onto the HyperCard home Card. To run IDEALink, click on the IDEALink button from the HyperCard Home Card.

See your *HyperCard User's Guide* for information on copying, cutting, and pasting buttons.

#### Notes

To paste the button onto the home card, your user level must be 4 ("Authoring") or higher. The user level is set on the User Preferences card of the home stack (see HyperCard user's guide). While using the IDEALink stack, the user level is set automatically, but when you leave the IDEALink stack to go to the home card, it is reset to what it was when the IDEALink stack was opened.

If you are not using a hard disk you will be using two 800 KB diskettes (the HyperCard program diskette and another diskette with a copy of IDEALink).

## Running IDEALink

On the IDEALink Card click the Session Card Button to configure for a file transfer session. You'll see a Session Card similar to the one below.

The screenshot shows a software window titled "IDEALink Mac" with a menu bar containing "File", "Edit", "Go", "Tools", and "Objects". The window is divided into several sections:

- System:** Three radio button options:  S/36,  S/38, and  AS/400.
- Host Session:** Four radio button options:  LU1,  LU2,  LU3, and  LU4.
- Fields:** A vertical list of text input fields: "User ID" (containing "ID"), "Password", "User Menu", "Library", "Procedure", "IDEALink ID" (containing "IDEA"), and "IDEALink Password" (containing "IDEA").
- Checkboxes:** Two checkboxes:  AutoLogon and  AutoLogoff.
- Buttons:** A "Save" button and two arrow buttons (left and right).

Figure 7-2: Session Card

For the IBM System 38 the screen will be slightly different as follows:

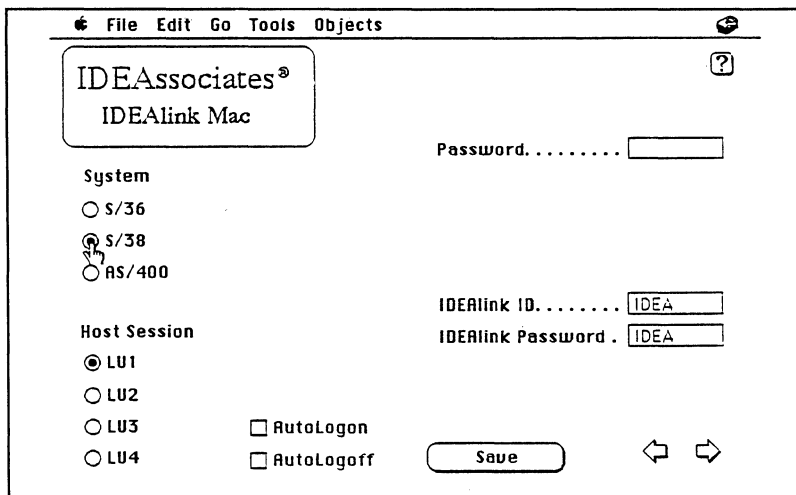

Figure 7-3: Session Card (System 38)

Fill in the Session Card the first time you use IDEALink. This card contains information on the system used, and on logon information for the host and for IDEALink.

The items on these cards are explained on the following pages.

You'll see the following buttons on the Session Card:

- **SAVE** saves the current settings as defaults to be used at startup time (each time the IDEALink stack is opened).

If **AutoLogon** is checked, IDEALink uses this information on this card to log you onto the host when you run a file transfer transaction. If you are already logged on in emulation, leave this unchecked.

- **AutoLogoff** specifies that IDEA will log you off as soon as a file transfer operation is completed. If you want to stay logged on after a transfer, leave this unchecked.

### Notes

If you wish to perform more than one file transfer **both** **AutoLogon** and **AutoLogoff** should either be checked or unchecked. (If unchecked, you should already be logged on the host.) This way the host will not be left in a state in which it cannot perform another file transfer with the same session parameters. For example, if **AutoLogon** is checked, but not **AutoLogoff**, the next transaction will fail when IDEALink attempts to logon to the host session again (when the session was not logged off).

**AutoLogon** only works if the host screen immediately following the signon screen is a command screen. If this is not the case in your particular host configuration, you will not be able to use the **AutoLogon** feature and will need to logon and get to a command screen in emulation.

- Left arrow takes you to the first IDEA card; right arrow takes you to File Transfer card.

From the Session Card you'll need to enter the following information:

- the Host System (S/36, S/38, or AS/400).
- the host session LU # which you'll be using for this file transfer session. You can get this information from your

System Administrator. This LU must be configured as a display.

- the host system User ID (User ID field), if used
- the host system password (Password field). You can get this information from your System Administrator. Leave it blank if a password is not used on your system.
- User Menu field, if used
- Library field, if used
- Procedure field, if used
- the IDEALink ID and IDEALink password (IDEALink ID and IDEALink Password fields). You can get this information from your System Administrator.

#### Note

User Menu, Library, and Procedure may be used on some systems. If they are not used on a particular system, they should be left blank.

Once you've completed setting up for a file transfer session you can save this setup. If you select **Save** (from the Session Card), you will then be prompted to save current settings as defaults. See dialog box below:

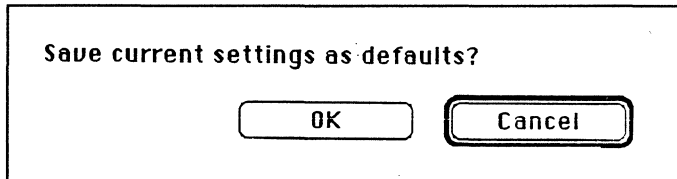

Figure 7-4

By clicking OK you'll save these settings as defaults.

Once you fill in this card, you can perform a file transfer by clicking on the right arrow and going to the File Transfer Card.

You see the following card:

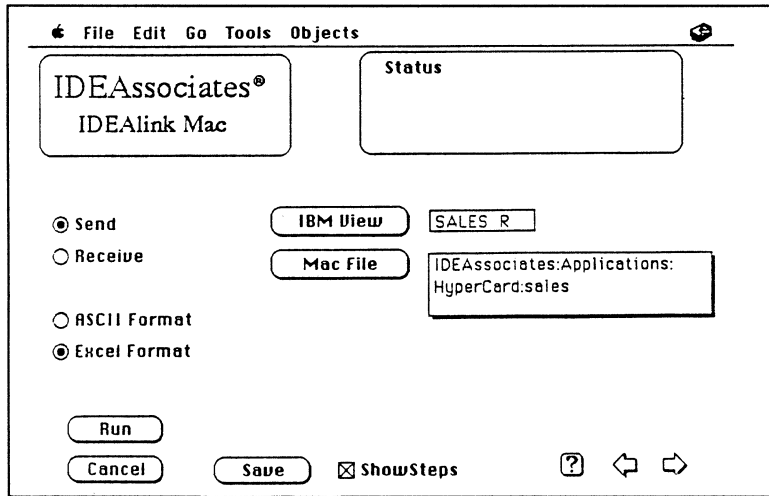

Figure 7-5: File Transfer Card (Send)

The settings on this card, together with those of the Session card, define a particular file transfer.

## Performing a File Transfer

To perform a file transfer go to the File Transfer Card. There are five parameters you need to get before you can do the transfer.

1. The direction of the transfer. Click the Send button if the file is being sent from the Macintosh SE to the host. Click the Receive button if the file is being sent from the host to the Macintosh SE.
2. The file format. Here you select either ASCII format or Excel format. Excel format designates a text file that has tab delimited fields, return delimited records, which can be opened by most Macintosh spreadsheets and databases.

### Notes

This format can be read and written by Excel and many other spreadsheets and data bases.

Files downloaded from the host in this format can be opened directly by Excel and other programs. If you are using Excel to create files to be uploaded to the host, you will need to save them as text (one of the options for file format when you choose **Save As** from Excel's File Menu).

ASCII format has undelimited fields and return delimited records. If ASCII format is selected, only character data can be downloaded from the host. For numeric fields on the host, use EXCEL format.

3. The IBM View. The View has to be set up by the system administrator. You will be able to get information on the IBM view from your system administrator.

When you click the IBM view button, you get a dialog box with a list of views on the IBM host. You must be logged on the host (or have AutoLogon/Logoff option checked) to get this list. These views are created by the host System Administrator.

If necessary, use the scroll bar to see more names.



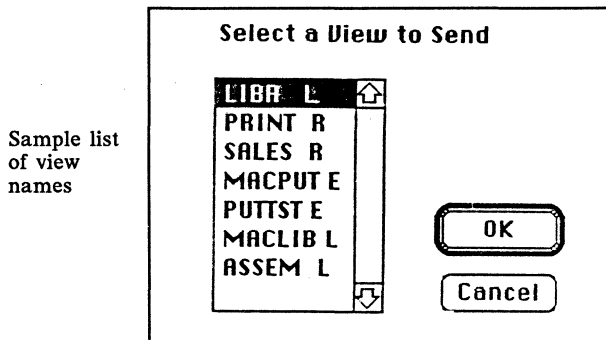

Figure 7-6

Following the view name is a letter describing the view type – ‘E’ for enter, ‘R’ for read, ‘L’ for library.

**E (enter views)** – data views that can be accessed as Entry (Write) only (data sent from the Macintosh SE to the host).

**R (read views)** – data views that can be accessed as Read only (data sent from the host to the Macintosh SE).

**L (library)** – library reference view that can be accessed as Read/Write (can be both uploaded to and downloaded from the Macintosh SE).

Select a view or type it in. If you type it in, the text you type is truncated or padded to six characters and converted to upper case. If you don’t indicate the view type (by typing a space and ‘R’, ‘E’, or ‘L’ after the six character view name, you’ll be asked to designate the view type as soon as you click or tab out of the view field.

You’ll be queried about the type of view.

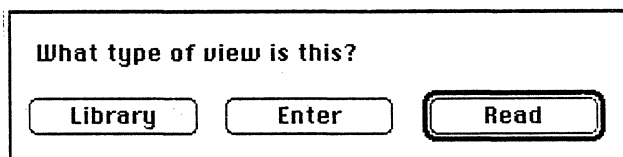
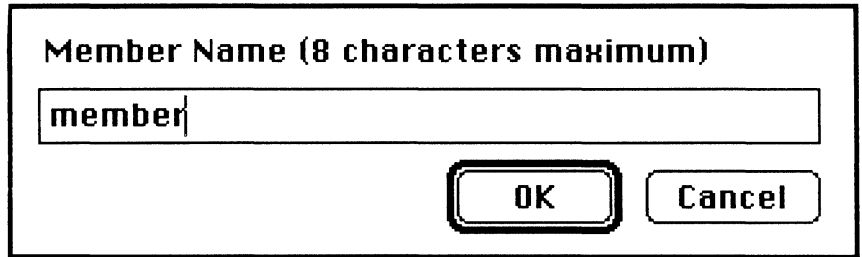

Figure 7-7

When the current view is a library view, you may option-click the IBM view button to set the library member information only (bypassing the dialog box and the scrolling list of views).

If you select Library (L), you'll be prompted to enter a Member Name:



A dialog box with a title bar that reads "Member Name (8 characters maximum)". Below the title bar is a text input field containing the word "member" with a vertical cursor at the end. To the right of the input field are two buttons: "OK" and "Cancel".

Figure 7-8

followed by the Member Type. The Member type is either Source or Procedure (for the System/36) or Program or System (for the System/38 or AS/400). The following dialog box appears on the System 36:

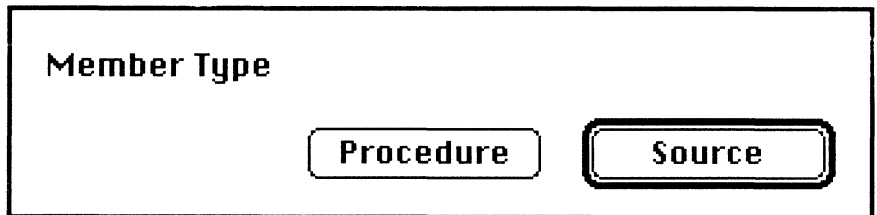

A dialog box with a title bar that reads "Member Type". Below the title bar are two buttons: "Procedure" and "Source". The "Source" button is highlighted with a thick border, indicating it is the selected option.

Figure 7-9

If you are sending a file you will be prompted to indicate the record length. The default figure, for example, 96 on the System/36, will always appear:

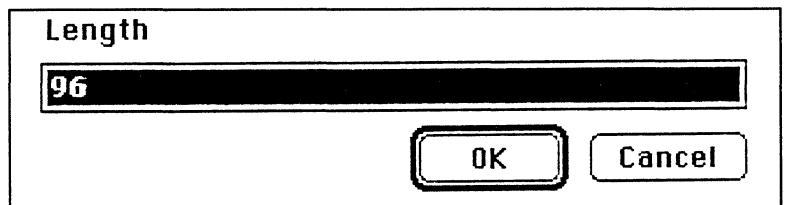

A dialog box with a title bar that reads "Length". Below the title bar is a text input field containing the number "96". To the right of the input field are two buttons: "OK" and "Cancel".

Figure 7-10

If you are sending a file you will then be prompted as to whether you want to Replace the file:

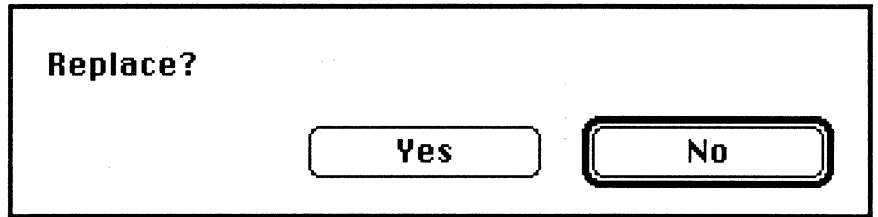

Figure 7-11

**Careful:** Because library members are not “replaced” for safety reasons click **Yes** only if the file exists and you want to append this transfer to an existing file. Click **No** if it is a new member with nothing in it yet.

4. The Mac File. Here you will enter the pathname to the file that you are sending or receiving. If you click the Mac file button, you get a standard file selection dialog box. This allows you to locate files in any folder or disk for a Send or Append, or to create files anywhere for a Receive operation. Alternatively, you may type the name directly into the field. If you do this, however, you must include the full pathname separated by colons. The first approach is easier.

5. For a Receive operation, choose whether to append or overwrite previous data (Replace). You'll see the following card:

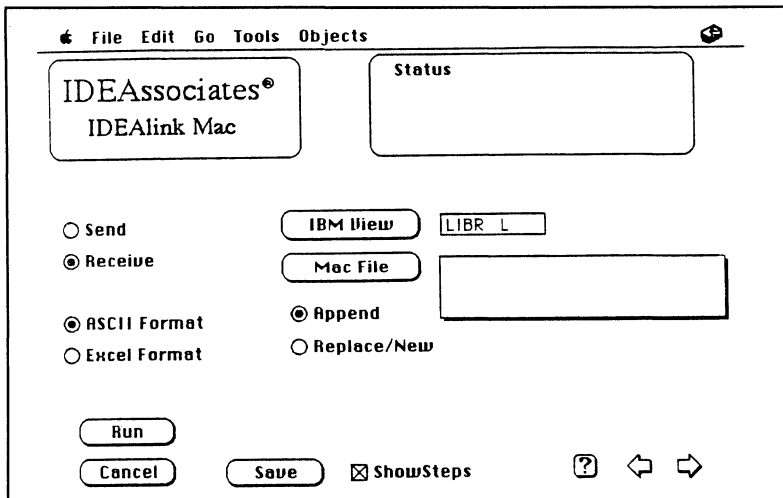

Figure 7-12: File Transfer Card (Receive)

6. If you will be repeating the same file transfer process, you should save the parameters of the transfer by clicking the Save button. By creating file transfer buttons you'll be able to automate the file transfer processes.

By clicking Save you will be saving the parameters of this file transfer and creating a button which can subsequently be used to execute a file transfer with these parameters. When you want to repeat a file transfer it will only be necessary to click that file transfer button. The entire file transfer, which you've previously defined, will occur.

You will be prompted to name this transfer process and a button will be created with the name you choose. When you subsequently run IDEalink, you'll be able to execute that file transfer by simply clicking the button with the name you saved. All configuration information will have been saved for this transfer so you will only have to click that button (without entering any additional information).

7. If **Show Steps** is checked, then you will see the steps of the button creation process.
  
8. **Run** executes the file transfer that is defined in the current settings. If **AutoLogon** is checked you will automatically be logged on. If **AutoLogon** was not previously selected, you are expected to be logged onto the host. The file will then be sent or received in the format chosen using the **IBM** view and **Macintosh** file chosen. If the **Macintosh** file exists, the file will either be replaced or appended to as specified.

If **AutoLogoff** is checked along with **Save**, after this file transfer is completed, you will automatically be logged off.

At the completion of a transaction, you should see the message in the status box:     **File Transfer Successful**

If the transfer is not successful, you'll see an alert box showing one of the messages listed in the **Appendix A** of this manual.

## Creating File Transfer Buttons

By creating file transfer buttons you'll be able to automate particular file transfer processes. When you want to repeat a file transfer it will only be necessary to click that file transfer button. The entire file transfer, which you've previously defined, will occur.

File transfer buttons are created from the settings of the Session and File Transfer cards.

Clicking **Save** displays a dialog box to name the new button, such as **Marketing Report**. If **Show Steps** is checked, you will see, briefly, the first card, with the new button name moving to the New Button landing pad:

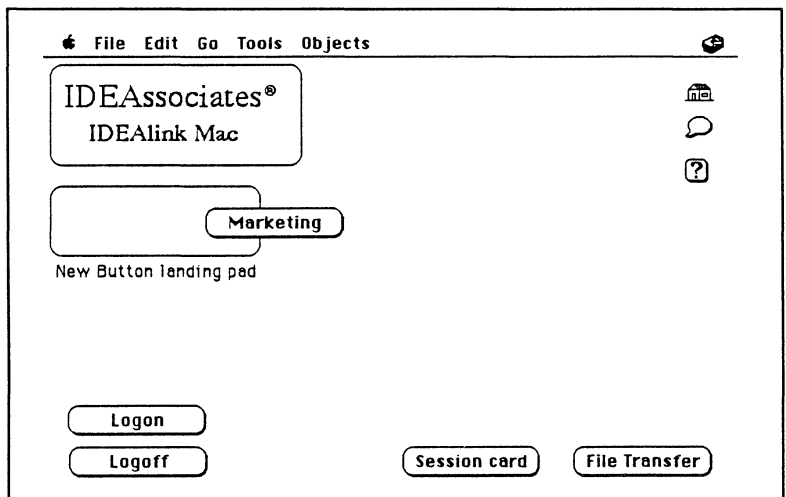

Figure 7-13

You should then “drag” the new button to any convenient location on the card using the button tool. If you drag it to another place on this IDEAlink card, the card may eventually look like the following:

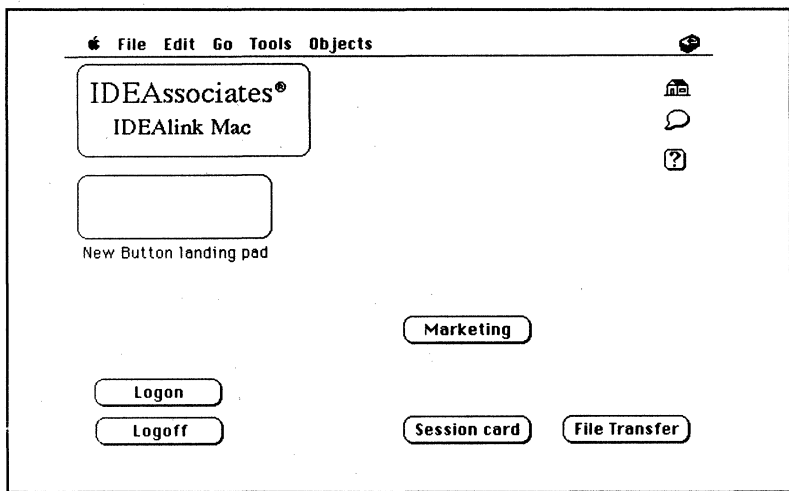

Figure 7-14: IDEALink Card

When you subsequently run IDEALink, you can simply click this button, which you've just created, and run the file transfer just defined.

If you have many transactions that are repeated regularly, you may want to create another card to hold some of the buttons. The mechanism for creating cards, as well as that for copying, cutting, and pasting buttons, is described in the HyperCard User's Guide.

You can create additional cards and arrange the buttons in any manner.

When you create a transfer button, the current settings of the Session and File transfer cards are saved in the IDEALink stack as resource of type 'XFER'. When you click a transfer button, the settings are loaded from this resource.

#### Notes

You can load the settings for a transfer without running it by Option-clicking a transfer button.

Also, when you cut or clear a button that has an associated 'XFER' resource, you are asked if you want to delete the resource. Choose yes if you are getting rid of the button. Choose no if you are cutting it to paste it somewhere else in the IDEALink stack.

# Appendix A: Troubleshooting, Error Messages, and Charts

---

## Overview

This section includes:

- A list of symptoms and corrective action for trouble-shooting IDEAcomm Mac
- Diagnostics programs
- Error messages
- IDEAlink Error messages
- Installation and cabling of remote controllers

## System Memory Requirements

In order to use MultiFinder, HyperCard, and emulation you will need 2.5MB of memory installed in your Macintosh SE.

## Troubleshooting Tips

If you are having difficulty using the emulated printer, display, or file transfer, it may be due to the configuration of the IDEAcomm Mac hardware or software. The following text provides a description of symptoms and corrective action.

### Display

1. Your emulated display is normal but one or several workstations down line from the microcomputer are offline.
  - Check the termination switch on the IDEAcomm Mac T-connector as well as any external terminators on the TWINAX cable run. The cable run should be terminated only at the end of the run.



- Verify the station address that each device is using. Each station address must be unique.
2. The cursor remains in the top left corner of the display.

The System Available icon  is highlighted in the bottom left corner of the screen.

    - Verify that the station address for this device is a valid station address.
    - From the system console check to be sure you are varied on.
  3. The cursor remains in the top right corner of the screen. The Station Available icon is flashing or not highlighted.
    - Verify that the IDEAcmm Mac card is terminated correctly.
    - Verify that the IDEAcmm Mac TWINAX cable locking mechanism is correctly connected to the TWINAX run. Also check the other end of the connection. The mounting screws of the 15-pin connector should be tightened with a screwdriver.
    - Swap the IDEAcmm Mac twinaxial cable and connector with a known good cable and connector.
    - Verify that this junction of the TWINAX allows another device to come up successfully.
    - Verify the station address.
  4. When you send printed output to the display, such as CATALOG or LISTLIBER, there is a display station error.
    - The host may have this session configured as a 3180 (wide screen), while your Macintosh may have it configured as another display type.

# Printer

1. The emulated printer does not print.
  - Verify that there is a printer configured in the Printer Control Panel DA (Desk Accessory), and that the station address is valid with the host.
  - Print Emulation sends print requests to the printer port indicated by the Chooser. If your printer is not set up to use that port, you must make the necessary changes.
  - Verify that the printer prints locally (when you are not in emulation). You can do this by running another application and then printing as usual.
  - Go to the Printer Control Panel. Look at the status. Both READY and PRINTER ONLINE should be highlighted.
  - Verify that the Apple printer is online by checking the “SELECT” status light on the front of the printer.
  - Run the host Test Request diagnostic program.
2. The emulated printer does not print correctly.
  - If you are not using the ImageWriter (ImageWriter II, ImageWriter LQ), printing may be unpredictable.
  - Verify that the printer configured with the Chooser matches the printer physically attached to the Macintosh.

## Printer Output from Host

If there is no printer output from the host, you can run the host Test Request and use the results to troubleshoot the problem. To run this test, do the following:

1. From the Logon screen, press the IBM CMD key and the IBM BACKSPACE key together. The host Option Menu is displayed.
2. From the Option Menu, choose the Workstation Printer Verification option. The Workstation Printer Verification Menu is displayed.
3. On the Workstation Printer Verification Menu, enter the appropriate printer identification that corresponds to your printer address. If an error message is displayed it may mean one of the following conditions:
  - printer is offline.
  - the configured printer is not attached.
  - an incorrect station address was chosen.
4. If no error occurred in step 3, a menu is displayed with several test choices you can select. Select the Print Test 1 Time option. When the test has finished, the PC printer should print the host diagnostic code.
5. To back out of the menus, press the C key until you reach the original screen displayed when you began the test.

# Diagnostic Program

In order to run the IDEAcmm Diagnostic Program, disconnect the TWINAX cable from the IDEAcmm card. Run the IDEAcmm Mac program.

From the Utilities menu select IDEAcmm Diagnostics.  
(Note that the following file is required: IDEAcmm Diag which should be in the System Folder.)

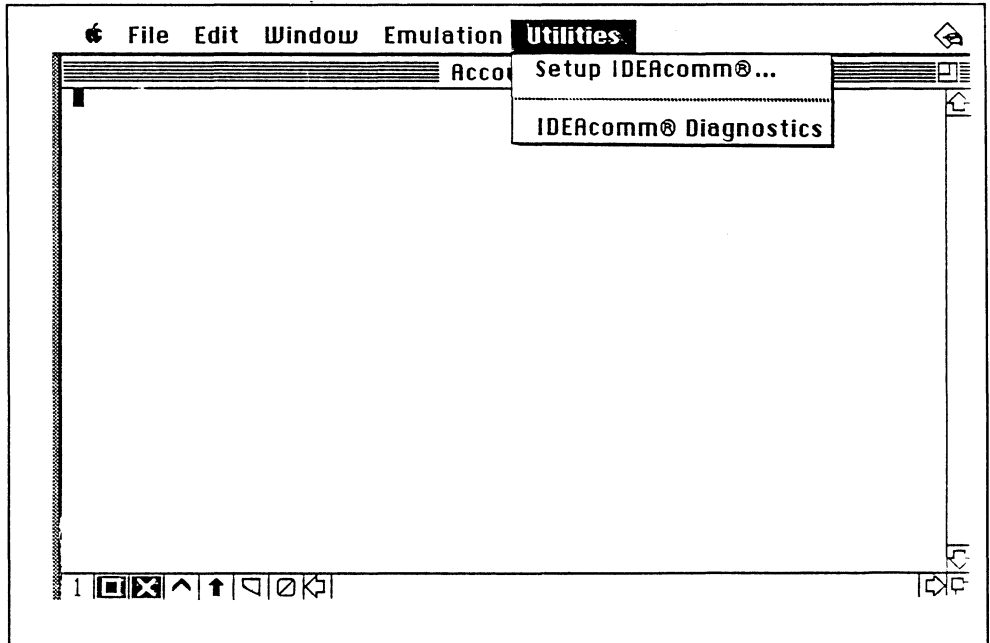

Figure A-1: Selecting IDEAcmm Diagnostics

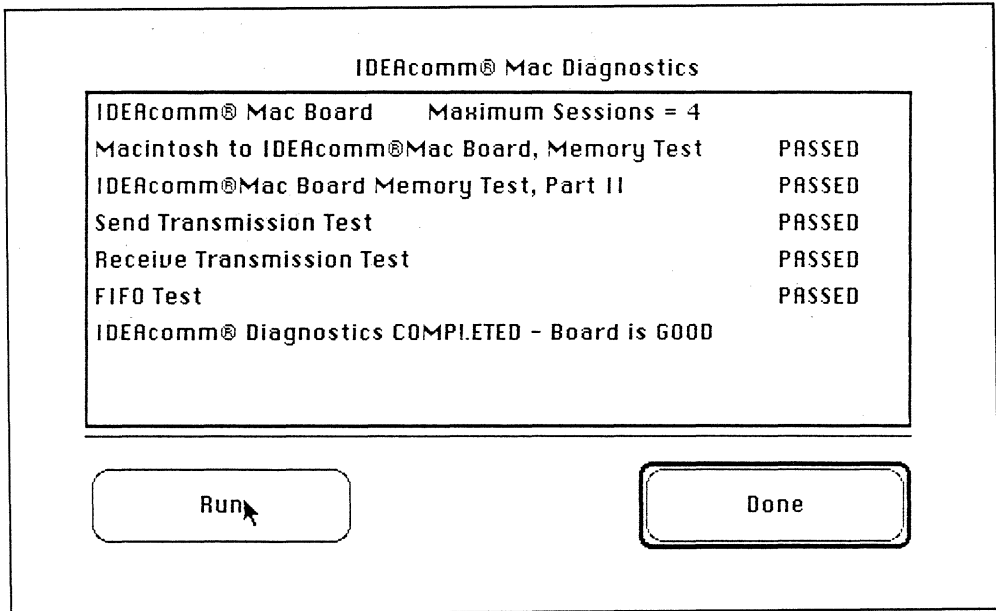

Figure A-2: Example of Screen from IDEComm Diagnostics  
(If card is good)

# IDEAcomm Mac Error Messages

These messages may appear during emulation:

**001**

**IDEAcomm Mac ERROR – Unknown MEMORY Configuration**

Run IDEAcomm Diagnostics.

**002**

**IDEAcomm Mac ERROR – No Board Installed.**

Emulation can not be run. Check that the IDEAcomm Card is firmly and correctly installed.

**003**

**IDEAcomm Mac ERROR – Configuration Information is wrong**

Run IDEAcomm Setup.

**004**

**IDEAcomm Mac ERROR – Unable to Load Microcode**  
Copy IDEAcomm Microcode (IDEAcomm.4mi) into  
IDEAcomm folder.

**005**

**IDEAcomm Mac ERROR – Machine Type**

IDEAcomm Mac presently works on Macintosh SE only.

**006**

**IDEAcomm Mac ERROR – WRITING**

Unable to configure IDEAcomm board.

Run IDEAcomm Diagnostics.

**007**

**IDEAcomm Mac ERROR – WRITING**

Twinax Control not responding.

Run IDEAcomm Diagnostics.

**008**

**IDEAcomm Mac ERROR – WRITING**

Unable to WRITE to Data Buffer.

Run IDEAcomm Diagnostics.

**009**

**IDEAcomm Mac ERROR – WRITING**

Unable to WRITE to Status Buffer.

Run IDEAcomm Diagnostics.

**010**

**IDEAcomm Mac ERROR – WRITING**

Unable to WRITE to IDEAcomm Mac memory location.

**011**

**IDEAcomm Mac ERROR – READING**

Unable to READ from IDEAcomm Mac memory location.

Run IDEAcomm Diagnostics.

**012**

**IDEAcomm Mac ERROR – MEMORY**

BAD IDEAcomm Mac memory at Location \_\_\_\_.

Run IDEAcomm Diagnostics.

**013**

**IDEAcomm Mac ERROR – MICROCODE**

Error loading microcode.

Microcode Volume Information NOT FOUND.

Copy microcode (IDEAcomm.4mi) from latest diskette into  
IDEAcomm Mac folder.

**014**

**IDEAcomm Mac ERROR – MICROCODE**

Unable to OPEN Microcode.

Place microcode (IDEAcomm.4mi) into IDEAcomm Mac  
folder.

**015**

**IDEAcomm Mac ERROR – MICROCODE**

Error with Microcode EOF.

Reload microcode into IDEAcomm Mac folder.

**016**

**IDEAcomm Mac ERROR – MICROCODE**

Unable to load Microcode.

Insufficient Macintosh memory.

**017**

**IDEAcomm Mac ERROR – MICROCODE**

Unable to READ Microcode

Place microcode in same folder as IDEAcomm Mac.

**018**

**IDEAcomm Mac ERROR – MICROCODE**

Microcode size is wrong

Reload microcode into folder.

**020****IDEAcomm Mac ERROR – IPCA**

Error Initializing IPCA for Session# \_\_\_\_ .

Run IDEAcomm Diagnostics.

**021 IDEAcomm Mac ERROR – System Incorrect**

System Version MUST be at LEAST V4.2

Upgrade Macintosh System to at least V4.2.

**022 IDEAcomm Mac ERROR – NOT AN OPTION**

OPTION NOT OPERATIONAL.

Please make another selection.

**023 IDEAcomm Mac ERROR – CONFIGURATION**

Unable to save configuration to System Folder.

Unlock System Folder, then run IDEAcomm Setup.

## IDEAcomm Mac Warning Messages

**001**

**IDEAcomm Mac WARNING – Board Installed.**

The board is installed but the microcode may not be running properly. If emulation does not work, run IDEAcomm diagnostics.

**002**

**IDEAcomm Mac WARNING – No Systems Available.**

Launch IDEAcomm Mac. Restart emulation. If you still get this message, check that the controller and the host are operating.

**003**

**IDEAcomm Mac WARNING – Irregular SignOn Detected!**

Examine System Console. Check the host console for sign on messages (such as improper access rights).



# Numbered Error Messages from IDEALink

Listed below are the possible error messages displayed by IDEALink. All such error messages are preceded by a two digit error number for ease of reference.

## **00 EMULATOR NOT RUNNING**

The emulation program has not been or is not now active.

## **01 LU NOT CONFIGURED OR INVALID**

The emulation program is active but the Session to be used did not exist or is currently in use and not available for file transfer, or is a printer session.

## **02 IDEALink UNEXPECTEDLY QUIT OR NOT STARTED**

Communications with IDEALink on the host was lost. Check the host screen to determine the problem.

If your host expects number input on menus (as does the System/38), you must choose a menu option that returns you to a command line and your cursor must be positioned on the command line.

On the System/38 and AS/400, be sure that your workstation is not in BREAK mode and that no user issued the SNDBRKMSG command for your workstation.

## **03 TIMED OUT**

Host has not acknowledged transaction in allotted time.

## **04 UNABLE TO LOGOFF HOST SESSION**

IDEALink is unable to log off the host session. Check the session to determine why the Signoff was not accepted.

## **05 FUNCTION NOT SUPPORTED**

The function selected is not supported in this activation of IDEALink, or files may not have been initialized on the host before you tried to upload data. You may be trying to create a file that already exists, or replace a file that does not exist.

## **10 INVALID USER [ID or PASSWORD]**

An invalid (undefined) user ID or Password was entered. Enter correct data.

**11 NAME NOT FOUND**

The view named is not defined; no such name was found in the host directory.

**12 ACCESS NOT ALLOWED**

The user's security level does not permit access to the view named, or the service requested.

**13 [READ or ENTRY] ONLY**

The view named allows only the operation specified: READ or ENTRY.

**14 SYS UNAVAIL OR INPUT INHIBITED**

Unable to reserve session for file transfer because the system is unavailable or input is inhibited. Check host session.

**15 INPUT INHIBITED AND SAFETY ON**

An attempt was made to send a Scan Code to the host while input was inhibited with the safety option.

**16 MISSING PARAMETERS**

A call was made to the XFCN, with parameter(s) missing.

**17 EMPTY BUFFER PASSED**

An attempt was made to perform a PutScreen with an empty buffer.

**18 ENTRY FILE NOT SEQUENTIAL**

The file specified by an ENTRY only data view must be sequential and is either Direct or Indexed. Edit the view definition on the host.

**19 INVALID COMMAND**

An invalid command was received by the host data Base Program.

**20 ASCII TO EBCDIC CONVERSION FAILED****21 EBCDIC TO ASCII CONVERSION FAILED****23 ALPHA FIELDS ONLY IN ASCII FORMAT**

A field other than Alpha is defined in the view. Only Alpha fields may be defined for an ASCII format file. For numeric fields, use Excel format.

**24 BAD RECORD FORMAT**

The data record sent to or received from the host is not compatible with that used by the named view. Check view format versus data format.

### **28 READ ERROR**

A host disk error occurred in attempting to read the View Directory – contact host Operations.

### **29 DISK I/O ERROR**

A host disk error occurred in reading/writing data. Contact host Operations.

### **30 HOST FILE(S) NOT FOUND**

A file was not available for use by the named view. The file must already exist. For a library member, the library member set may be full. In this case, not even Replace will work. Contact host operations.

Invalid Printer ID (File) if Print Operation.

On the System/38, you may have no access rights to this file, or you may have specified as Direct or Indexed a data view that must be sequential. Edit the view definition on the host.

### **31 LIBRARY ERROR**

The error made a library operation invalid:

- 1: No space in library for member (PUT).
- 2: No space in library directory (PUT).
- 3: Library is in use by System Edit Utility (PUT).
- 4: Member was not found (GET or PUT).
- 5: Member by same name already exists (PUT).

### **32 FILE EMPTY**

No data exists in the host file (GET operation).

### **33 FILE FULL**

If the operation was a PUT to a data file, the capacity of the file to store data was exceeded. No data is appended to that host file and the PUT operation is aborted. Contact host operations and discuss the file capacities needed to support your work.

### **34 NOT ON PROPER SCREEN FOR SIGNON**

An attempt was made to logon from a screen other than the signon screen. Check the host session.

### **35 NO USERID FIELD ON SIGNON SCREEN**

A User ID was entered in the session parameters card and no User ID field can be found on the signon screen.

**36 NO PASSWORD FIELD ON SIGNON SCREEN**

A password was entered in the session parameters card and no password field can be found on the signon screen.

**37 NO MENU FIELD ON SIGNON SCREEN**

A menu was entered in the session parameters card and no menu field can be found on the signon screen.

**38 NO LIBRARY FIELD ON SIGNON SCREEN**

A library was entered in the session parameters card and no library field can be found on the signon screen.

**39 NO PROCEDURE FIELD ON SIGNON SCREEN**

A procedure was entered in the session parameters card and no procedure field can be found on the signon screen.

**40 STILL ON THE LOGON SCREEN**

The host is still on the logon screen after an attempt to logon was made. Check the host session.

**41 RELEASE FAILED**

A session that was reserved for file transfer could not be released, probably because communications were lost.

**42 SEND FAILED**

An error occurred while attempting to send a scan code to the host.

**43 TRANSACTION FAILED**

An AID key was not acknowledged by the host.

**44 GETSCREEN FAILED**

An attempt to read a block of data to the screen buffer of the IDEAcmm board failed.

**45 PUTSCREEN FAILED**

An attempt to write a block of data to the screen buffer of the IDEAcmm board failed.

**46 MEMORY ALLOCATION FAILED**

Sufficient memory could not be allocated to complete an operation. If you are using MultiFinder, try increasing the amount of memory allotted to HyperCard.

**47 READ TWINAX FAILED**

An attempt to read a byte of data from the IDEAcmm board failed.

**48 WRITE TWINAX FAILED**

An attempt to write a byte of data to the IDEAcmm board failed.

**49 RESOURCE ERROR**

A resource error occurred while creating or accessing an XFER resource. Try the operation again.

**50 CONVERSION TABLES NOT FOUND**

Tables for converting ASCII to EBCDIC, EBCDIC to ASCII, and ASCII to Scan Codes could not be found.

# Attaching the IDEAcomm TWINAX Line to IBM Remote Controllers

The IDEAcomm Mac card can be attached to the IBM 5251 Model 12, IBM 5294 or IBM 5394 remote controller for the IBM Midrange System. Since an IBM controller is limited in the number of devices it can support, check your controller to determine the maximum number of devices you can attach. The following text describes how to reconfigure your 5294/5394 or 5251 Model 12 when you add the IDEAcomm card.

## Adding IDEAcomm Mac to a 5294/5394 or 5251 Model 12 Remote Controller

1. Verify that all workstations (terminals and printers) are powered ON. (Note that the 5294/5394 or 5251 Model 12 do not recognize any device that is powered off.)
2. Check the TWINAX cables on all display devices and printers to be sure they are firmly attached.
3. At the Macintosh SE with the IDEAcomm Mac card, start emulation by double-clicking on IDEAcomm Mac. The cursor will be at the upper right corner of the screen.
4. At the 5294/5394 or 5251 Model 12 controller, set the TEST/NORMAL switch to TEST, then set the POWER switch to ON.
5. From any display station (3180, 3196) or from a microcomputer with IDEAcomm Mac emulation loaded, press the **CMD** key, then the **BACKSPACE** key. This allows the 5294/5394 or 5251 Model 12 to recognize the devices attached to its ports. A setup screen displays the attached devices. Verify that the station addresses correspond to the work stations and printers you attached. If this screen does not accurately reflect the attached devices, refer to the *IBM Setup Procedure for the 5294 (5394 or 5251 Model 12)* for instructions. Press the Enter key twice to save the configuration.
6. Turn POWER switch to OFF. Set TEST/NORMAL switch to NORMAL then turn the POWER switch to ON.

The system operator at your host site must now configure a new device at the host if he or she has not already done this.

If you are adding IDEAcmm Mac to a 5251 Model 12 Remote Controller, the switch settings on the Port Selector Switch Bank (located on the back of the 5251 Model 12) determine which ports are active. Refer to Table A-1 for appropriate switch settings. The 5251 Model 12 periodically polls ports that are active to determine which devices are currently on line.

## Attaching the IDEAcmm Mac Card to an Existing TWINAX Run

If a TWINAX run is already attached to an active port, you do not need to change the Port Selector Switch Bank settings when adding IDEAcmm.

## Creating a New Run

If you have the first device on a Model 12 port, you must set the Port Selector Switch Bank switches to activate the port. (Refer to Table A-1 for appropriate switch settings.)

At the host, if a new device is varied on and the Port Switch Setting switches are incorrect, a DEVICE MISMATCH ERROR occurs when the controller is connected to the host System/3X.

Switch Settings				
Active Ports	1	2	3	4
1	OFF	OFF		
1, 2	OFF	ON		
1, 2, 3	ON	OFF		
1, 2, 3, 4	ON	ON		
5			OFF	OFF
5, 6			OFF	ON
5, 6, 7			ON	OFF
5, 6, 7, 8			ON	ON

# Appendix B: Keyboard and Terminal Defaults

---

## Overview

This appendix provides keyboard functions and display attributes of the emulated terminal.

## Keyboard Maps

Refer to the keyboard maps which follow for emulation on both the Standard and Extended Apple keyboards.



# IDEAcomm® Mac Template for the Apple Standard Keyboard

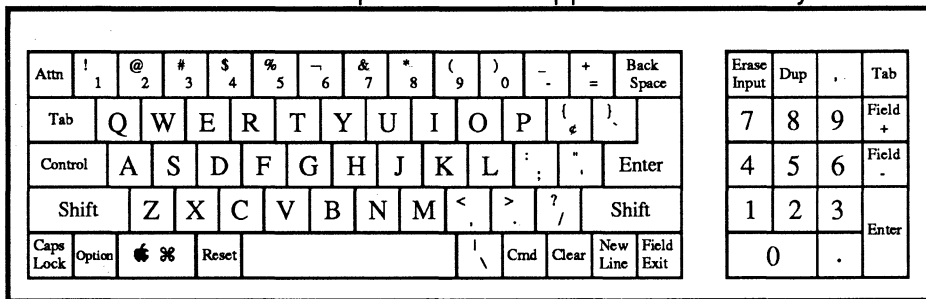

Copyright© IDEA, Inc. 1989 PN 403-13695

- Insert \_\_\_\_\_ Control + I
- Help \_\_\_\_\_ Control + H
- Print \_\_\_\_\_ Control + P
- Roll Up \_\_\_\_\_ Control + Shift + 8 (on keypad)
- Roll Down \_\_\_\_\_ Control + Shift + 2 (on keypad)
- Cursor Left \_\_\_\_\_ Control + 4 (on keypad)
- Cursor Right \_\_\_\_\_ Control + 6 (on keypad)
- Cursor Down \_\_\_\_\_ Control + 2 (on keypad)
- Cursor Up \_\_\_\_\_ Control + 8 (on keypad)
- Delete \_\_\_\_\_ Control + Backspace
- Home \_\_\_\_\_ Control + Attn
- Sys Request \_\_\_\_\_ Shift + Attn
- Hex \_\_\_\_\_ Control + 6
- Backtab \_\_\_\_\_ Control + Tab
- Tilde \_\_\_\_\_ Control + 1
- Split Vert Rule \_\_\_\_\_ Control + 2
- Test Request \_\_\_\_\_ Control + T

## IDEAcomm® Mac Template for the Apple Extended Keyboard

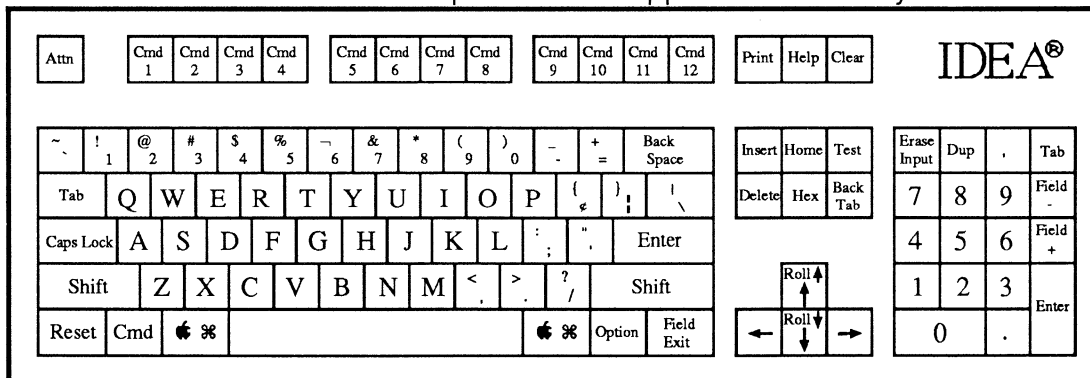

Cmd13 - Cmd 24 ——— Shift of F1 - F12  
 New Line ——— Option + Enter  
 Sys Request ——— Shift + Attn

# Emulated Keys on the Macintosh

IDEAcomm Mac includes emulation of the IBM host keyboard on two different keyboards: the Apple Standard keyboard and the Apple Extended keyboard. You can select the keyboard type you want to use from the Setup utility.

**Shift Keys:** When the Shift key is pressed:

- The special characters on the key tops of the numeric and symbol keys are entered.
- The alphabetic characters are entered as uppercase letters.

**Shift Lock Key:** When the Caps Lock is pressed:

- The special characters on the key tops of the numeric and symbol keys are entered.
- The alphabetic characters are entered as uppercase letters.
- The function control keys perform the function shown on the bottom half of the emulated keys.
- The keyboard locks in shifted mode until the Shift key is pressed and released.

The following tables describe the function of the keys on the Macintosh keyboard when you are in emulation.

Table B-1: Emulated Keys on the Microcomputer		
IBM 3X Key	US Standard Keyboard	US Extended Keyboard
Attn	ESC	ESC
Change Host Session	⌘ + Session #	⌘ + Session #
Cmd	←	Left Option
Cursor Left	CTRL + 4 (on keypad)	←
Cursor Right	CTRL + 6 (on keypad)	→
Cursor Up	CTRL + 8 (on keypad)	↑
Cursor Down	CTRL + 2 (on keypad)	↓
Back Tab	CTRL + Tab	Page Down
Roll up	CTRL + Shift + 8	Shift + ↑
Roll down	CTRL + Shift + 2	Shift + ↓
Del	CTRL + Backspace	Del
Dup	= (on keypad)	= (on Keypad)
Enter/Rec Adv	Return or Enter	Return or Enter
Erase Input	Clear (on keypad)	Clear (on keypad)
Reset	-	Left CTRL
Field +	+ (on keypad)	+ (on keypad)
Field -	- (on keypad)	- (on keypad)
Field Exit	↑	Right CTRL
Help	CTRL + H	F14
Home	CTRL + ESC	Home
Ins	CTRL + I	HELP
New Line	↓	Option + Return
Print	CTRL + P	F13
Sys Req	Shift + ESC	Shift + ESC
Test Req	CTRL + T	Page Up
~	Shift + 6	Shift + 6
Cent sign	[	[
< or >	Shift , or .	Shift , or .
- (Tilde)	CTRL + 1	-
' (Accent)	]	'
! (Split Vertical rule)	CTRL + 2	]
CMD1/CMD13	CMD+1/Shift+CMD+1	F1/F1 Shifted
CMD2/CMD14	CMD+2/Shift+CMD+2	F2/F2 Shifted
CMD3/CMD15	CMD+3/Shift+CMD+3	F3/F3 Shifted
CMD4/CMD16	CMD+4/Shift+CMD+4	F4/F4 Shifted
CMD5/CMD17	CMD+5/Shift+CMD+5	F5/F5 Shifted
CMD6/CMD18	CMD+6/Shift+CMD+6	F6/F6 Shifted
CMD7/CMD19	CMD+7/Shift+CMD+7	F7/F7 Shifted
CMD8/CMD20	CMD+8/Shift+CMD+8	F8/F8 Shifted
CMD9/CMD21	CMD+9/Shift+CMD+9	F9/F9 Shifted
CMD10/CMD22	CMD+10/Shift+CMD+10	F10/F10 Shifted
CMD11/CMD23	CMD+11/Shift+CMD+11	F11/F11 Shifted
CMD12/CMD24	CMD+12/Shift+CMD+12	F12/F12 Shifted

Table B-2: Emulated Key Functions

IBM 5250 Key	Function
Attn	Notifies host of sign-on change.
Cmd	Command key is system dependent. With most systems, pressing this key directs the system to disregard the normal function shown on the top row key and to perform the function assigned to the key in the system program.
Cursor Control	<p>Horizontal Movement keys cause the cursor to move in the direction indicated by the arrow on the key top.</p> <p>Vertical Movement keys cause the cursor to move up or down one line depending on the direction of the arrow on the key top.</p> <p>New Line Key moves the cursor forward (right) to the first character position of the field following the field it is in.</p> <p>Field Backspace key moves the cursor back (left) to the first character position of the field it is in. If the cursor is in the first position of a field, it moves back to the first position of the preceding input field.</p> <p>Field Tab key moves the cursor forward (right) to the first character position of the field following the field it is in.</p>
Del	Delete, deletes the characters where the cursor is located.

Table B-2: Emulated Key Functions (Continued)

IBM 5250	Function
Dup	Duplicate requests that the system program duplicate the information from the same field in the previous record.
Enter/Rec Adv	Enter/Record Advance indicates that the entered data is ready to be sent to the host system.
Erase Input	Erase Input when pressed with a Shift key erases data entered in all input fields. The cursor moves to the home position on the screen. In free key mode, this key erases everything on the screen and moves the cursor to the first input position on line 1.
Reset	Reset unlocks the keyboard when it is locked because of an error condition. It can also be used to reset the help, insert, system request, and command modes.
Field +	Field + operates as a field exit key in all fields.
Field -	Field - is system dependent. With most systems it operates the same as Field and Field Exit except that it is allowed in signed numeric and numeric fields only.
Field Exit	Field Exit is used to exit input fields that are specified by a program as right adjusted or field exit required fields.
Help	Help displays a description of the current error condition. Press the Error Reset key to reset the help message and the error condition, restore the display screen, and unlock the keyboard.
Home	Home moves the cursor to the system designated home position when the display screen is under system program control.

Table B-2: Emulated Key Functions (Continued)

IBM 5250	Function
Home (cont'd)	<p>In Free Key mode, Home returns the cursor to the first input position on line 1.</p> <p>When supported by the host system program, this key is pressed to display a previous record if the cursor is in the home position.</p> <p>NOTE: In some screens, if this key is pressed twice you will lose data.</p>
Ins	<p>Insert sets the keyboard to insert mode so that data will be entered at the cursor position and all data to the right of the cursor will move right. To exit insert mode, press the Reset key combination.</p>
New Line	<p>Moves the cursor to the first input position of the first field of a new line.</p>
Print	<p>Print sends a print request to the host system.</p>
Roll keys	<p>Roll keys when pressed move information up or down. The system program controls the use of these keys for each job.</p>
Sys Req	<p>System Request key is system dependent. With most systems, it can be used to initiate sign-on, select an alternate job, temporarily stop the present display activity and allow selection of a new activity.</p>
Test Req	<p>Test Request is system dependent.</p>

# Attribute Appearance for 5250 Display Station and the Macintosh SE

The following pages list how the Macintosh SE displays IBM attributes.

In the following chart:

- Normal means a dark character on a light background.
- Bold means a darker character on a light background.
- Null refers to any keystroke or non-keystroke that displays as a blank or space.



**Table B-3: Attributes**

<b>5250 Attribute Code (HEX)</b>	<b>IBM Attribute</b>	<b>Macintosh Display Result</b>
20	NORMAL	Black characters on white background
21	REVERSE	Black characters on white background
22	HIGH INTENSITY, NORMAL	Bold black characters on white background
23	REVERSE HIGH INTENSITY	Bold black characters on white background
24	UNDERScore NORMAL	Black characters on white background with black underscore
25	UNDERScore REVERSE	Black characters on white background with black underscore
26	UNDERScore HIGH INTENSITY, NORMAL	Bold black characters on white background with black underscore
27	NO DISPLAY	No display
28	BLINK, NORMAL	Black characters on white background
29	BLINK, REVERSE	Black characters on white background
2A	BLINK, HIGH INTENSITY, NORMAL	Bold black characters on white background
2B	BLINK, HIGH INTENSITY, REVERSE	Bold black characters on white background
2C	BLINK, UNDERScore NORMAL	Black characters on white background with black underscore
2D	BLINK, UNDERScore REVERSE	Black characters on white background with black underscore

**Table B-3: Attributes**

<b>5250 Attribute Code (HEX)</b>	<b>IBM Attribute</b>	<b>Macintosh Display Result</b>
2E	BLINK, UNDERSCORE, HIGH INTENSITY, NORMAL	Bold black characters on white background with black underscores
2F	NO DISPLAY	No display
30	COLUMN SEPARATORS, NORMAL	Black characters on white background with black underscores in null positions
31	COLUMN SEPARATORS, REVERSE	Black characters on white background with black underscores in null positions
32	COLUMN SEPARATORS, HIGH INTENSITY NORMAL	Bold black characters on white background with black underscores in null positions
33	COLUMN SEPARATOR HIGH INTENSITY, REVERSE	Bold black characters on white background with black underscores in null positions
34	COLUMN SEPARATOR, UNDERSCORE, NORMAL	Black characters on white background with black underscores in null positions
35	COLUMN SEPARATORS, UNDERSCORE REVERSE	Black characters on white background with black underscores in null positions
36	COLUMN SEPARATOR UNDERSCORE HIGH INTENSITY NORMAL	Bold black characters on white background with black underscores in null positions
37	COLUMN SEPARATORS	No display

**Table B-3: Attributes**

<b>5250 Attribute Code (HEX)</b>	<b>IBM Attribute</b>	<b>Macintosh Display Result</b>
38	COLUMN SEPARATORS, BLINK, NORMAL	Black characters on white background with black underscores in null positions
39	COLUMN SEPARATORS, BLINK, REVERSE	Black characters on white background with black underscores in null positions
3A	COLUMN SEPARATORS, BLINK, HIGH INTENSITY NORMAL	Bold black characters on white background with black underscores in null positions.
3B	COLUMN SEPARATORS, BLINK, HIGH INTENSITY, REVERSE	Bold black characters on white background with black underscores in null positions
3C	COLUMN SEPARATORS, BLINK, UNDERSCORE, NORMAL	Black characters on white background with black underscores in null positions
3D	COLUMN SEPARATORS, BLINK, UNDERSCORE, REVERSE	Black characters on white background with black underscores in null positions
3E	COLUMN SEPARATORS, BLINK, UNDERSCORE, HIGH INTENSITY NORMAL	Bold black characters on white background with black underscores in null positions
3F	COLUMN SEPARATORS	No display

# Appendix C: Hardware Installation for the Authorized Apple Reseller

---

This section describes installing your IDEComm Mac card. **Installation should be done only by an authorized Apple dealer or representative.**

## Handling the IDEA Card

During unpacking and installation, please be careful with the IDEComm Mac card. Keep all food and beverages away from the card. Do not bend or drop the card.

# Inventory Checklist

The following is a list of the components you should have received:

- IDEAcomm Mac card
- Ribbon cable with 15 pin serial connector
- Twinax plate and Phillips head screws
- 2 plastic standoff posts
- Short twinaxial cable with T-connector
- Software diskettes
- *IDEAcomm Mac User's Guide* (this book)
- IDEAcomm Mac template
- Warranty card

## What the User Must Supply

1. Size T15 Torx tool to open the cover of the Macintosh (See Figure C-1)
2. A device to be used to separate the cover of the Macintosh from its chassis (See Figure C-2)
3. Small flat blade screwdriver for attaching the TWINAX cable connector
4. Twinaxial cable with connectors (installation is described in Section II)

# Opening the Macintosh SE

To prepare for installing the IDEComm Mac, carefully follow these instructions.

## WARNING

The IDEComm Mac card must be installed by an authorized Apple dealer. Opening the case of the Macintosh SE voids your warranty. Installation, by other than authorized Macintosh service personnel, will void the Macintosh SE warranty.

Because the video monitor is built-in, there are dangerous voltages inside the case of the Macintosh SE. In particular, the video tube and video circuitry may hold dangerous charges long after the computer's power is turned off. Only qualified service personnel should install this card.

Let the computer sit, unplugged, for at least 20 minutes to reduce the possibility of severe shock when handling.

## Preliminary Steps

- Turn off the Macintosh SE power switch.
- Turn off power to any peripheral devices (printer, etc.).
- Unplug the computer and all peripherals from the wall outlet.
- Disconnect the keyboard.
- Carefully note where each cable is attached so that you can reattach them later. Disconnect all cables from the back of the SE.
- **AVOID RISKING DAMAGE DUE TO STATIC ELECTRICITY.** Before handling the IDEComm Mac Card which is a static-sensitive device, be sure to ground yourself so that you do not damage the card with static electricity. Also, to reduce the likelihood of damage from static electricity, handle the card on its edges and avoid touching the components or connectors on the card.

- If a programmer's switch is installed, remove it from the SE.
- Use the Torx tool to loosen the four cover screws from the rear of the SE.

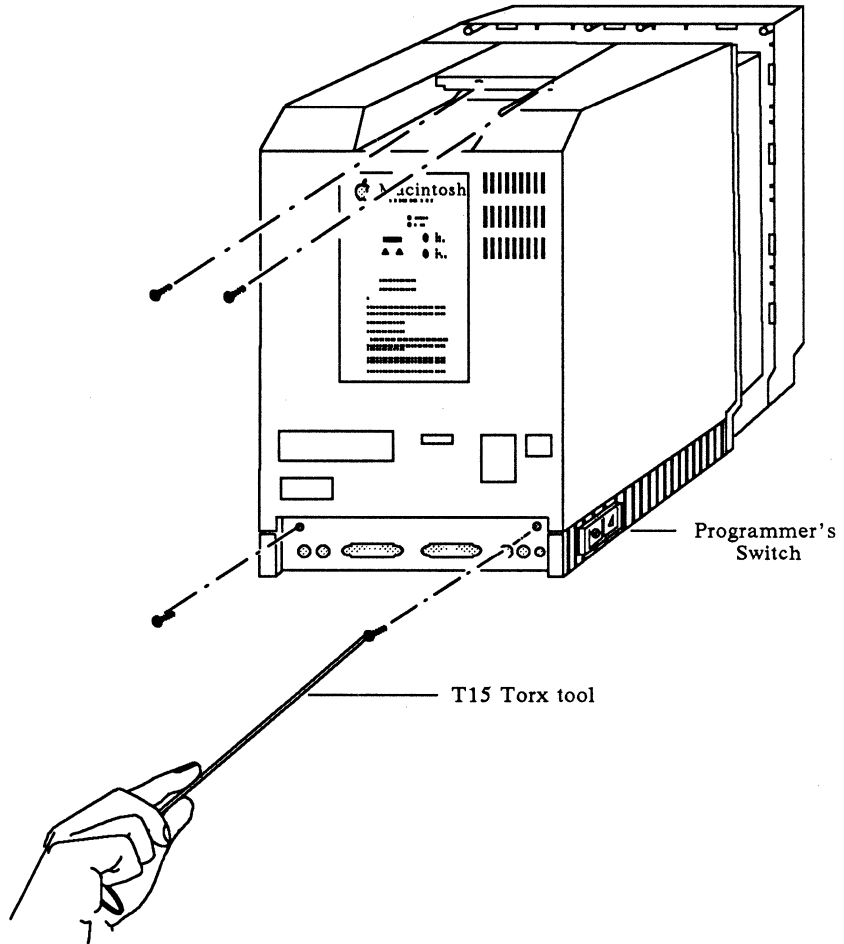

Figure C-1: Loosening Screws

- Pry the cover from the SE chassis, using any tool which can fit between these two sections without damaging them.

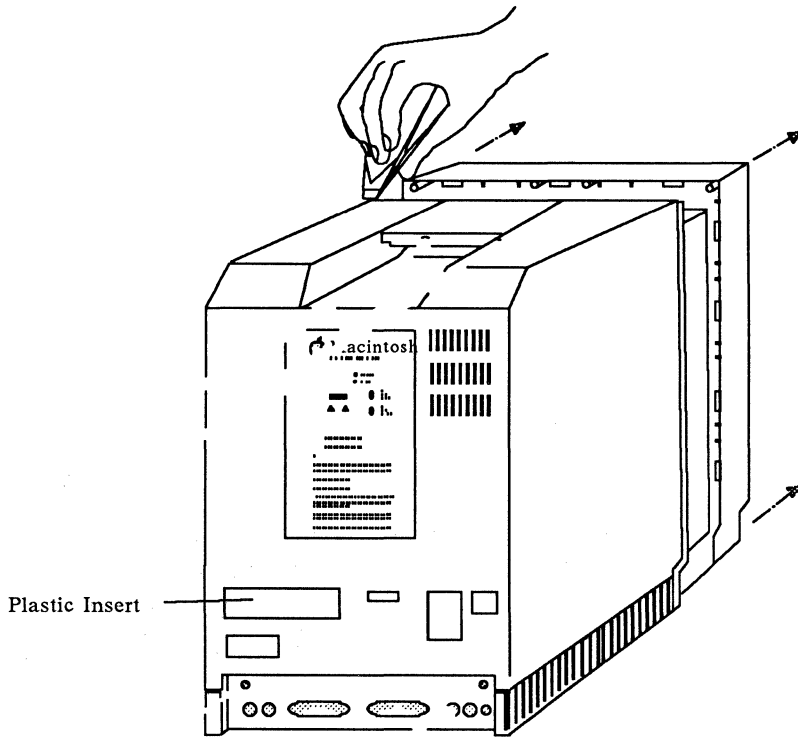

Figure C-2: Prying Cover from Chassis



- Carefully slide the cover away from the unit and slide the emissions cover off.

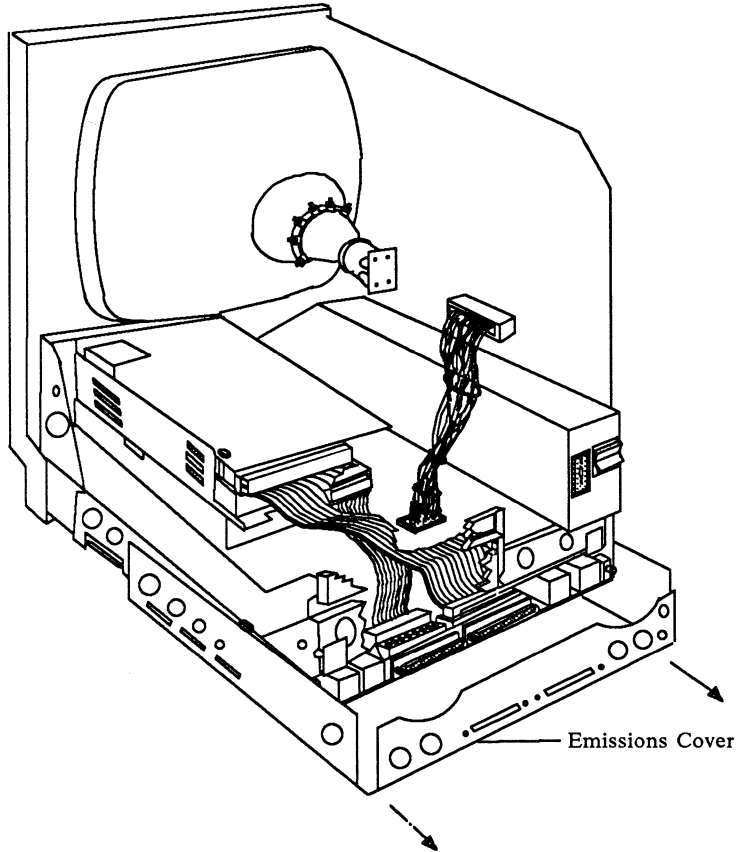

Figure C-3: Sliding Emissions Cover from Chassis

## Installation Steps

- Before removing any cables carefully note where each cable is attached so that you can reattach them later.
- Identify the power cable harness which connects to the motherboard.

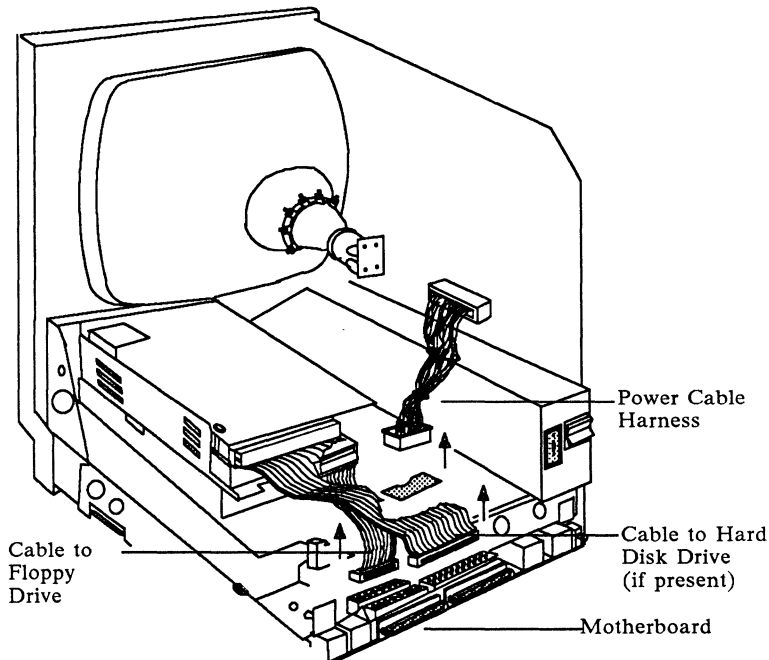

Figure C-4: Cables

- Unplug and remove the power cable harness from the motherboard end only. Figure C-4 shows the cable being lifted from the motherboard. Do not disconnect the other end.

- Identify the two cables connecting both the floppy and hard disk drives (Figure C-4). This assumes that your system includes both a floppy and a hard drive.
- Unplug and remove the narrower cable (which connects to the floppy drive) from the motherboard.
- If your system has a hard disk installed, unplug and remove the wider cable (which connects to the hard disk drive) from the motherboard.
- Lay the chassis on its front, with the CRT facing down. Be sure to pad the front of the chassis to prevent scratches.

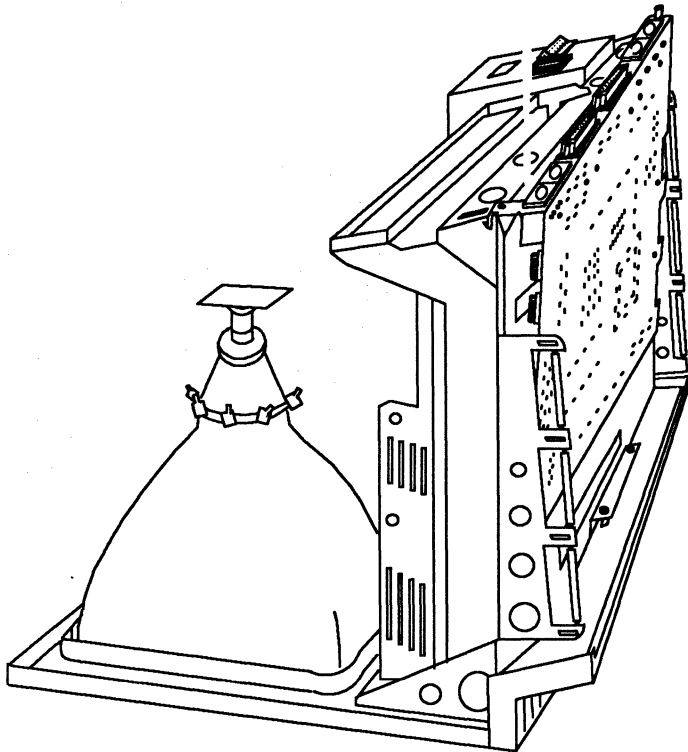

Figure C-5: Chassis Lying on Front

- Pull the two connecting tabs on the top of the motherboard (Figure C-6) from their slots (on the Macintosh Chassis). These tabs are keyed and must be pulled up and out.

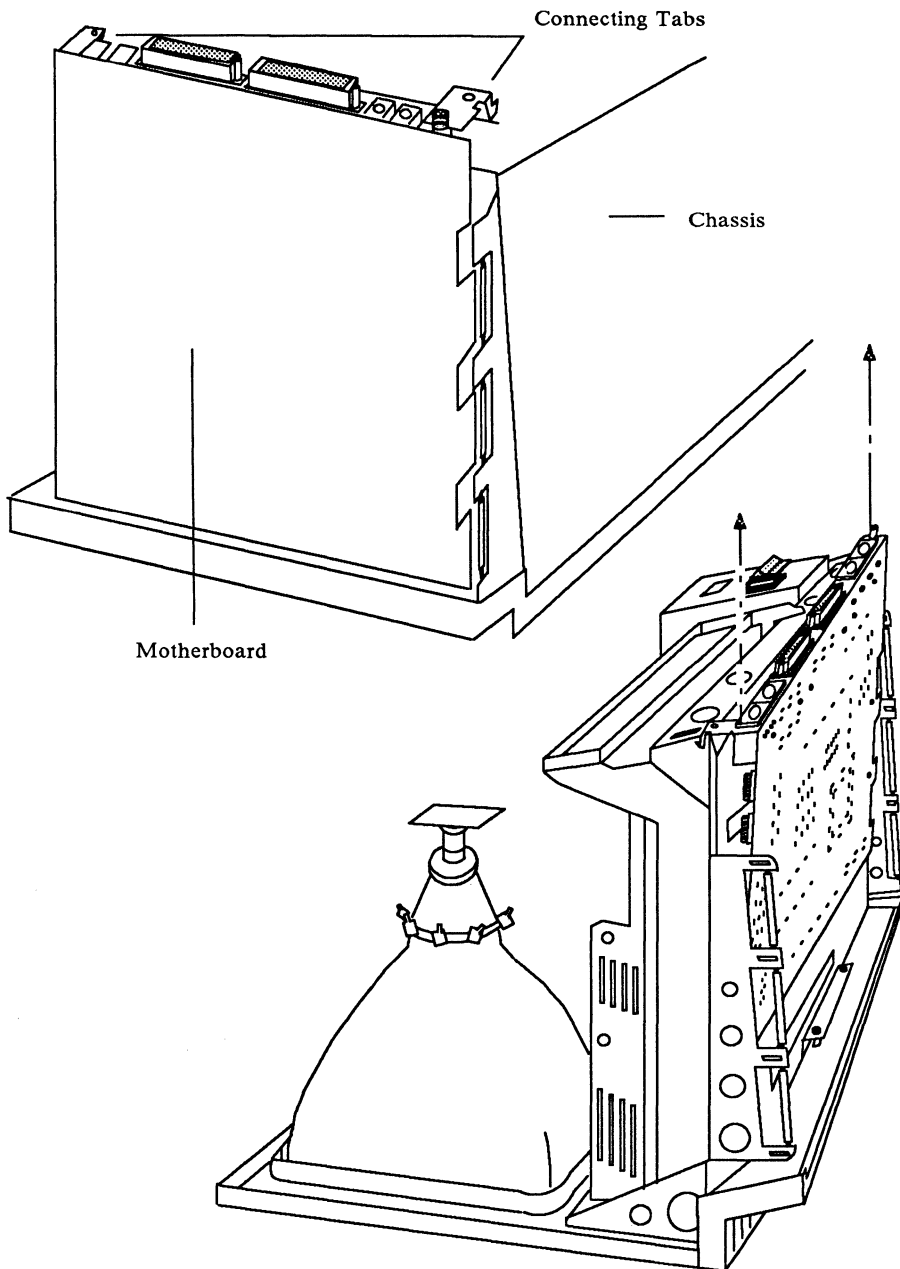

Figure C-6: Connecting Tabs Viewed from Bottom and Side

- Lift up the motherboard until the slots (on the motherboard) are adjacent to the openings on the side (right rear) of the chassis.

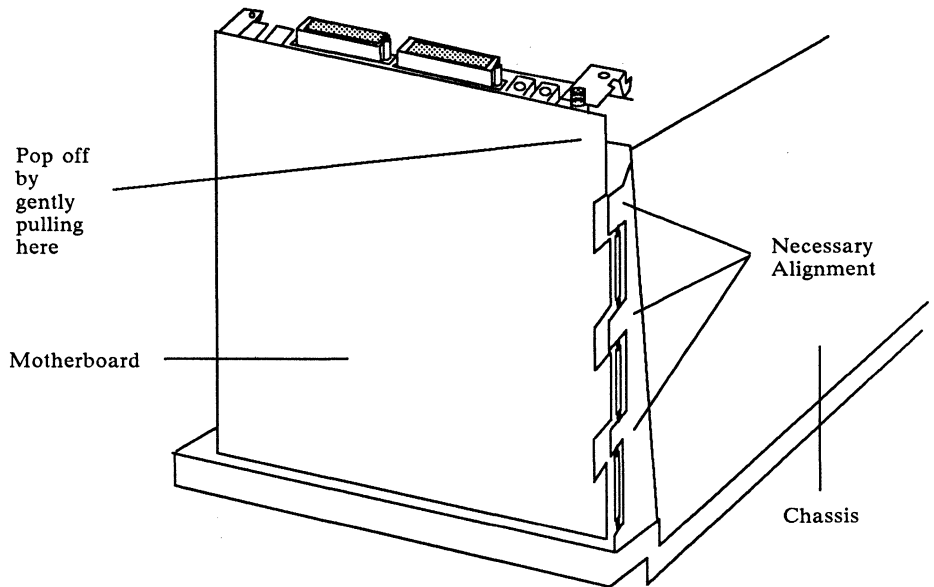

Figure C-7: Connecting Tabs Properly Aligned

- To remove, assuming that you're directly facing the bottom of the motherboard, gently pull the board from the right side of the motherboard toward you until it pops out. After the motherboard pops out, remove it by pulling it toward your right and then off. Carefully move it several inches toward your right so that it disengages from the chassis. Only partially pull it out (to avoid damaging the cable connections). Note that the speaker cable is still connected to the motherboard.

- Disconnect the black speaker cable (Figure C-8) from the motherboard by gently pulling the plastic connector. DO NOT PULL THE WIRES.

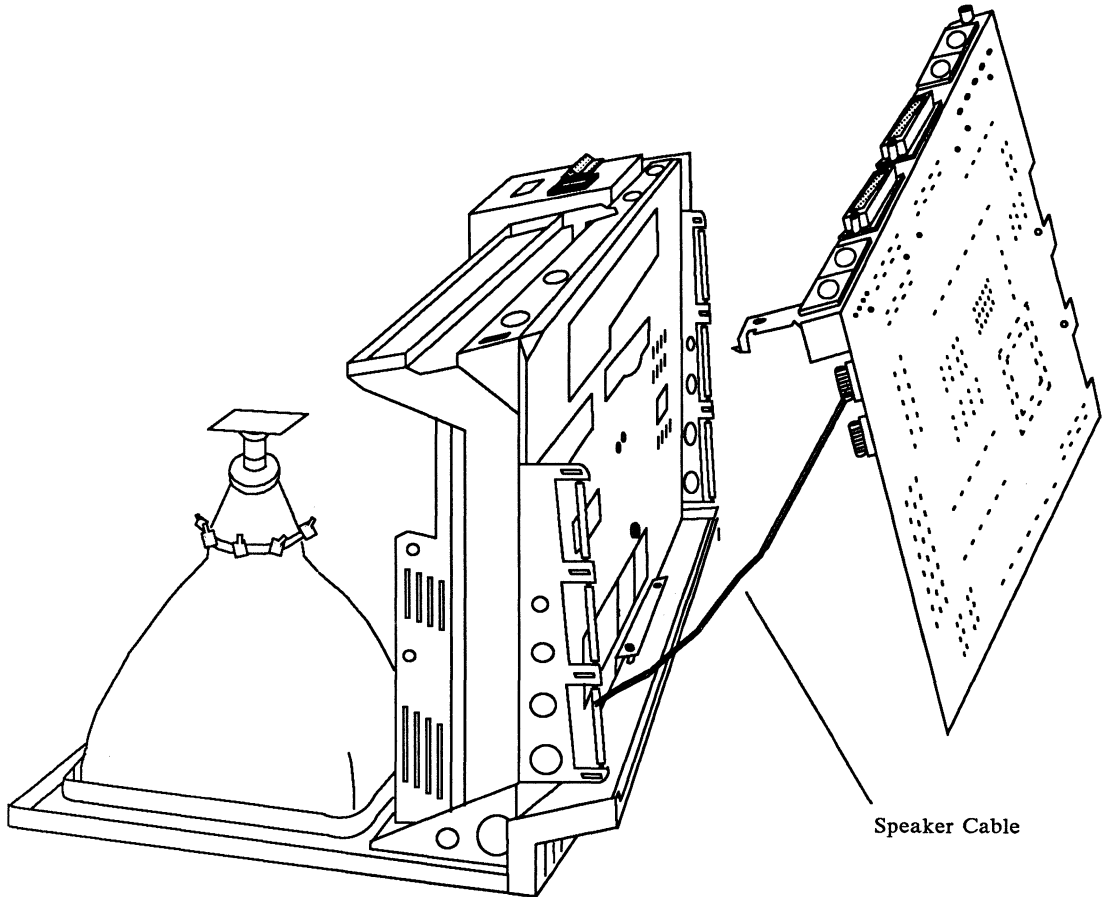

Figure C-8: View of Speaker Cable

- Place the motherboard on a clean, flat work surface so that the components are facing up.

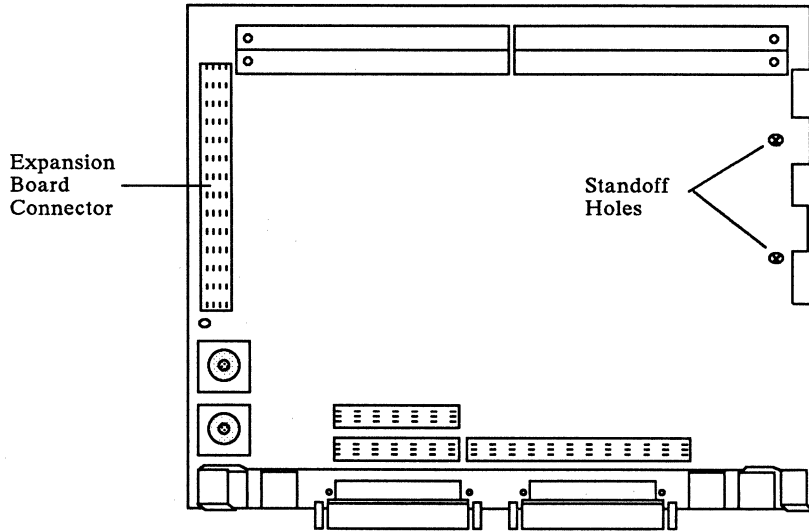

Figure C-9: Motherboard

Identify the 2 plastic standoffs supplied with the IDEComm card.

Press the plastic standoffs into the IDEComm card.

Insert the IDEComm card so that the male pins are inserted into the female openings of the expansion board connector on the motherboard.

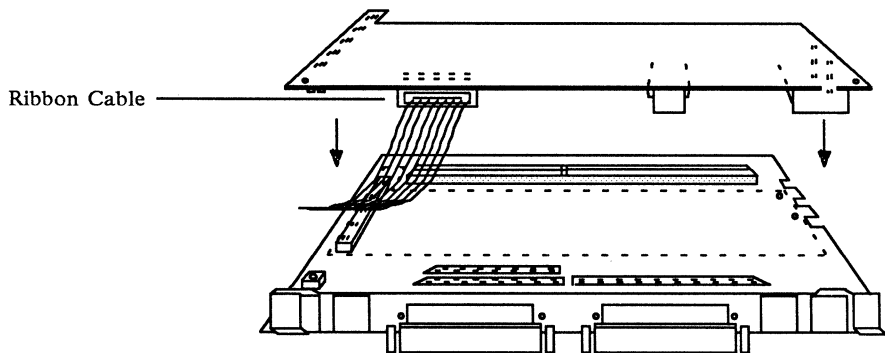

Figure C-10: IDEComm Card and Motherboard

- Connect the ribbon cable to the male connections on the base of the IDEComm card. Be sure that the red stripe on the ribbon cable is connected to pins 1 and 2 on the IDEComm card (see Figure C-12).
- Press the other ends of the plastic standoffs now on the IDEComm card into the motherboard, until you hear them click into place. The IDEComm card, represented by the dotted line (Figure C-11) will now be connected to the motherboard.

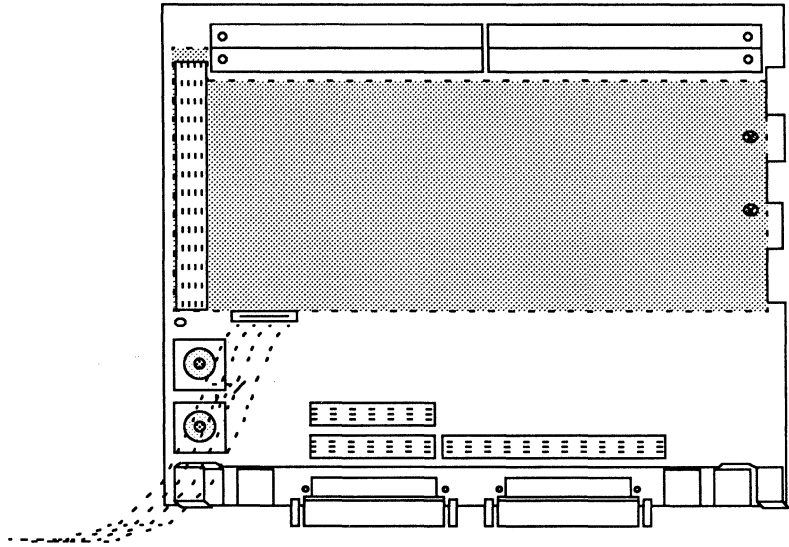

Figure C-11: Motherboard with IDEComm Card (Shaded) and Cable (Transparent) Superimposed



- Remove the plastic insert (see Figure C-2) from the back panel of the cover of the SE as this provides an opening for the Twinax cable.
- Pull the ribbon cable with the Twinax plate attached through the opening in the chassis which looks like the following:

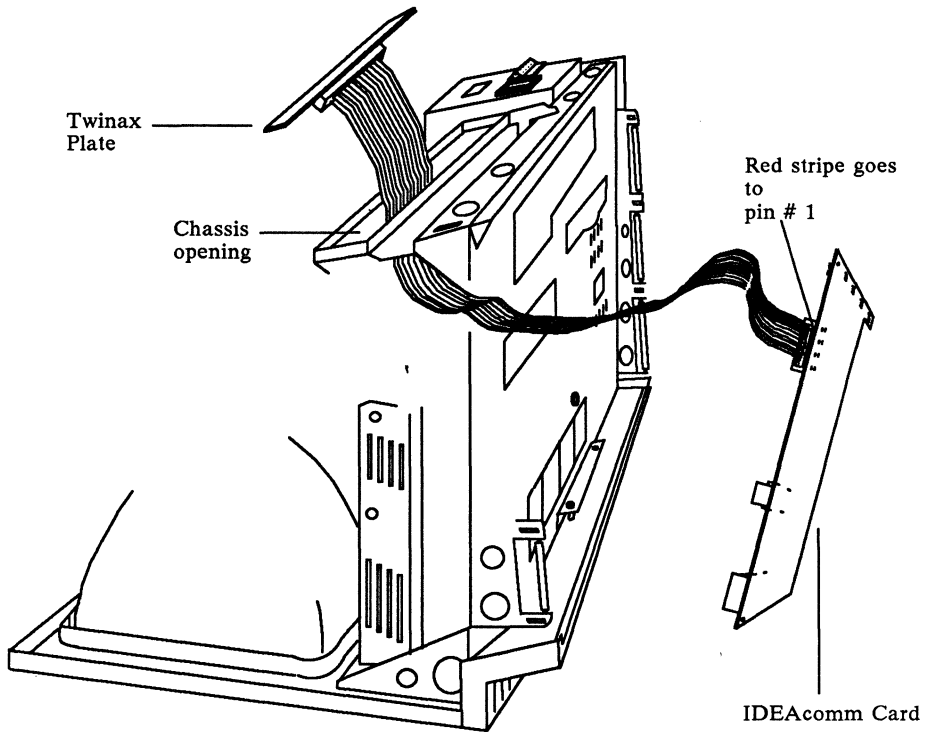

Figure C-12 Twinax Plate Installation

- Inset the plate into the SE. Be sure that it is oriented as shown below (Figure C-14). Secure the plate using the Phillips head screws which are supplied with the IDEAcComm Card.

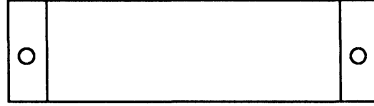

Figure C-13: Opening for Twinax Plate

- Be sure that the plate is oriented so that you see the following when the Macintosh is “right side up”:

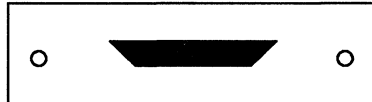

Figure C-14: Twinax Plate Installation

**WARNING**

The IDEAcComm Mac card must be installed by an authorized Apple dealer. Any other installation will void the Macintosh SE warranty.

See safety warning on page 97 of this manual.

## Reassembling the Macintosh

To reassemble the Macintosh with the IDEComm Card installed simply reverse the previous steps.

- Reconnect the hard disk ribbon cable (if present) to the motherboard. Note that this cable can only be connected one way.
- Reconnect the floppy disk ribbon cable to the motherboard into the connector, on the motherboard, labeled Lower Drive. Note that this cable can only be connected one way.
- Reinsert the power cable (cables can only fit correctly one way – do not force)
- Reinsert and secure the SE cover on the chassis.
- Use the Torx tool to tighten screws.
- Reconnect all peripheral cables and power cables.

# Appendix D: The IDEA Applications Program Interface

---

This appendix is designed for advanced users. It provides the advanced user with enough information about IDEA's interface area to write specialized software (in the form of HyperCard stacks) for the Macintosh SE. This specialized software bypasses the IDEAcomm Mac emulation package and drives the emulation hardware and microcode directly.

The following documentation of the API assumes that you are familiar with HyperCard, stack-building, and writing scripts in HyperTalk.

## Macintosh Calling Sequences

The API has calling sequences in HyperTalk.

### Format of Calling Sequences

There is one XFCN named Twinax for exchanging data between the Macintosh SE and the host. There is another XFCN named IDEAcomm for loading and unloading the microcode and other initialization functions.

For each of these XFCNs, the first parameter is the name of the command to be invoked. This name must be in quotes. Unknown commands return an error message. The second parameter for the Twinax XFCN is always the current LU number. The LU parameter must be the number of a session that is configured as a display. Parameters must be enclosed in parentheses and separated by commas.

## Commands Supported

The following low-level commands are available from HyperTalk scripts in any HyperCard stack that contains the Twinax and IDEAcomm XFCNs. These are already contained in the IDEALink stack. To use these commands in other stacks, you will need to copy these two XFCN resources from the IDEALink stack to other stacks using ResEdit, the ResCopy, XCMD by Steve Maller of Apple computer or any of several other public domain resource copying tools.

The IDEAcomm XFCN takes care of starting and shutting down the IDEAcomm communications interface and loading and unloading ASCII to EBCDIC, EBCDIC to ASCII, and ASCII to Scan code translation tables.

### **IDEAcomm("Open")**

Performs initialization. This includes starting up the IDEAcomm board if necessary and loading ASCII to EBCDIC, EBCDIC to ASCII, and ASCII to Scan code translation tables. The return value is either empty or contains an error message. If you are using this API in a stack other than the IDEALink stack, you should call this at the beginning (on openStack).

### **IDEAcomm("Close", Soft/Shut)**

Cleans things up when you are through using your stack. It disposes of the translation tables and can either terminate communications or leave sessions running depending on its second argument. Soft close (1) leaves microcode running. Shut (2) unloads microcode. The return value is either empty or contains an error message. If you are using this API in a stack other than the IDEALink stack, you should call this at the end (on closeStack).

### **Twinax("Reserve", CurrentLU)**

Reserves a display LU for File Transfer. Checks for microcode. Return value is either empty or contains an error message.

Here Current LU equals the LU session number.

Example:

```
put Twinax("Reserve",CurrentLU) into Error
if Error is not empty then
    put Error
end if
```

**Twinax(“Release”, CurrentLU)**

Releases LU reserved for File Transfer. Return value is empty or contains an error message.

**Twinax(“SendScanCode”, CurrentLU, ScanCode, Safety/Force)**

Sends the scan code argument to the key buffer. Safety (1) will not send if Input Inhibit is high. Force (2) sends Scan Code even if Input Inhibit is high. Clears Input Inhibit History. Return Value is empty or contains an error message. Here Scan Code is the decimal Scan Code value.

**Twinax(“WaitTransaction”, CurrentLU, Timeout)**

Waits for a host transaction to occur. Checks to see if Input Inhibit History is high. If so, it continuously checks for System Available to be high and Input Inhibit to be low. If this does not occur within “Timeout” ticks, returns an error message. Otherwise, returns empty. Only used for AID keys such as Enter.

**Twinax(“PutScreen”, CurrentLU, offset, length, buffer)**

Puts “length” bytes of EBCDIC from “buffer” to screen buffer of CurrentLU at “offset.” Clears Input Inhibit History. Buffer is a handle to a zero-terminated string of bytes. Return Value is empty or contains an error message.

Example:

```
put Twinax(“PutScreen”, 2, 0, 11, buffer) into-
Error
if Error is not empty then
    put Error
end if
```

This command writes an 11 byte buffer to offset 0 of the LU2 display buffer (screen). “Buffer” must be a handle to a zero-terminated string of bytes of EBCDIC. (See conversion routines below.)

**Twinax(“GetScreen”, CurrentLU, offset, length)**

Gets “length” bytes of EBCDIC from screen buffer of CurrentLU at “offset.” Allocates handle to contain data. Returns a handle to a zero-terminated string of bytes. An Empty return value indicates an error.

Example:

```
put Twinax("GetScreen", CurrentLU, offset, length) into-  
Variable  
if Variable is empty then  
    put "Error getting data"  
end if
```

**Twinax("SendScanString", CurrentLU, Timeout)**

Sends the ScanCodes for an ASCII zero terminated string to the key buffer. If Input Inhibit is high, the string will not be sent. Return Value is empty or contains an error message.

**Twinax("AsciiToEbcDic", buffer, length)**

The ASCII data in buffer is converted in place to EBCDIC for "length." Buffer is a handle to a string of bytes. Length is the number of bytes to be converted. If length is 0, the string is assumed to be zero terminated and the entire string is converted. Return Value is empty or contains an error message.

**Twinax("EbcDicToAscii", buffer, length)**

The EBCDIC data in buffer is converted in place to ASCII for "length." Buffer is a handle to a string of bytes. Length is the number of bytes to be converted. If length is 0, the string is assumed to be zero terminated and the entire string is converted. Return Value is empty or contains an error message.

# Appendix E: IDEAcomm Utilities Package

---

## Overview

The IDEAcomm Utilities Package is an application that moves tables (stored as Macintosh resources) from their individual files into the IDEAcomm Prefs file located in the System Folder.

This package allows you to customize Terminal Emulation, Printer Emulation, and File Transfer so that they conform to local languages.

The appropriate table for the local language is installed using the IDEAcomm Utilities Package. You should not change tables unless your system administrator notifies you that the host is configured for a non U.S. language.

## Configuring Display Options with the IDEAcomm Utilities Package

Before you run the IDEAcomm Utilities Package, you should make a copy of the **IDEAcomm Mac** diskette.

Run your backup copy of the **IDEAcomm Utilities Package** first so that the right language tables will be used.

### Note

It is best not to run the IDEAcomm Utilities Package while you are running emulation. By making changes before you run emulation, you will be sure that all changes will have taken effect when you do enter emulation.



To install a table:

Double-click the IDEComm Utilities Package and you will see the following introductory window:

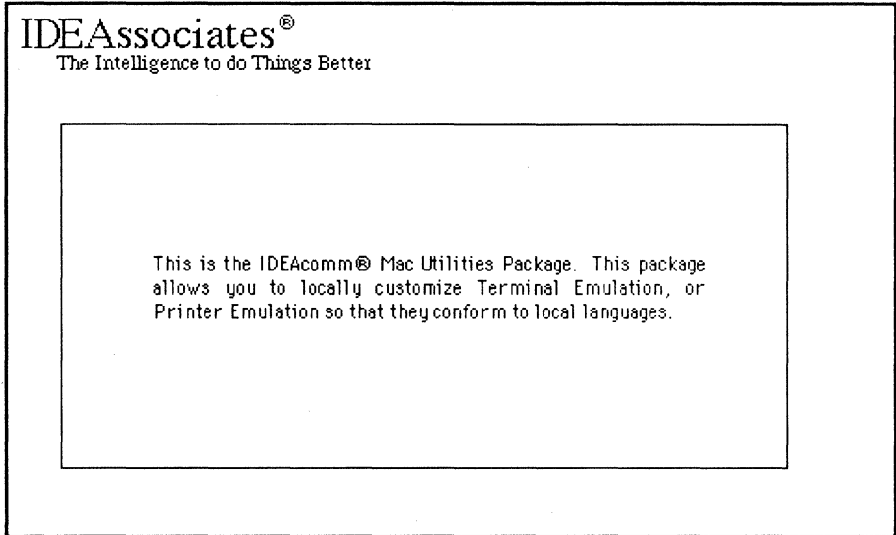

Figure E-1

This introductory window will disappear when you click on it.

When you choose the Install Tables menu from the IDEAComm Utilities Package, you see the following items.

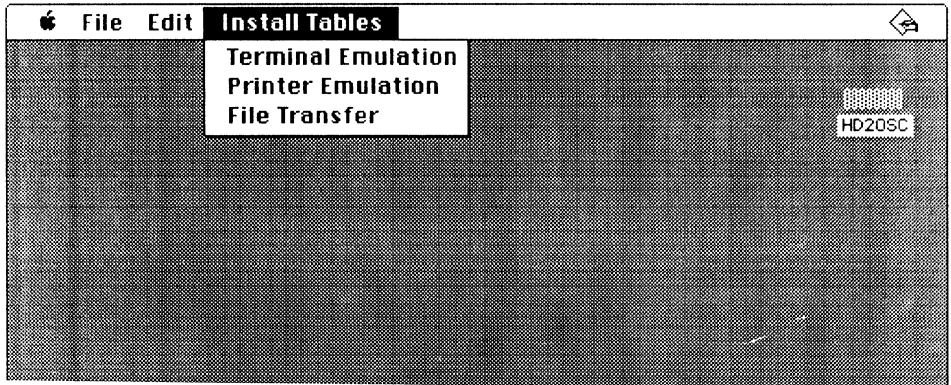

Figure E-2

IDEAComm Mac uses several translation tables including the following:

- Terminal Emulation
  - Display Fonts
  - Standard Keyboard Table
  - Extended Keyboard table
- Printer Emulation
  - Printer Emulation Table
- File Transfer
  - ASCII to EBCDIC Translation Table
  - EBCDIC to ASCII Translation Table
  - ASCII to Scan Code Translation Table
  - System Logon Search String

#### Note

Since all tables are stored in the IDEAComm Prefs file, it is best to make a copy of it before installing new tables. Then, if the wrong table is installed, the old IDEAComm Prefs file can be restored.

To install a new translation table:

1. Select the item you wish to change (Printer Emulation, Terminal Emulation, or File Transfer).
2. For example, by selecting Terminal Emulation, you'll see a dialog box similar to the following:

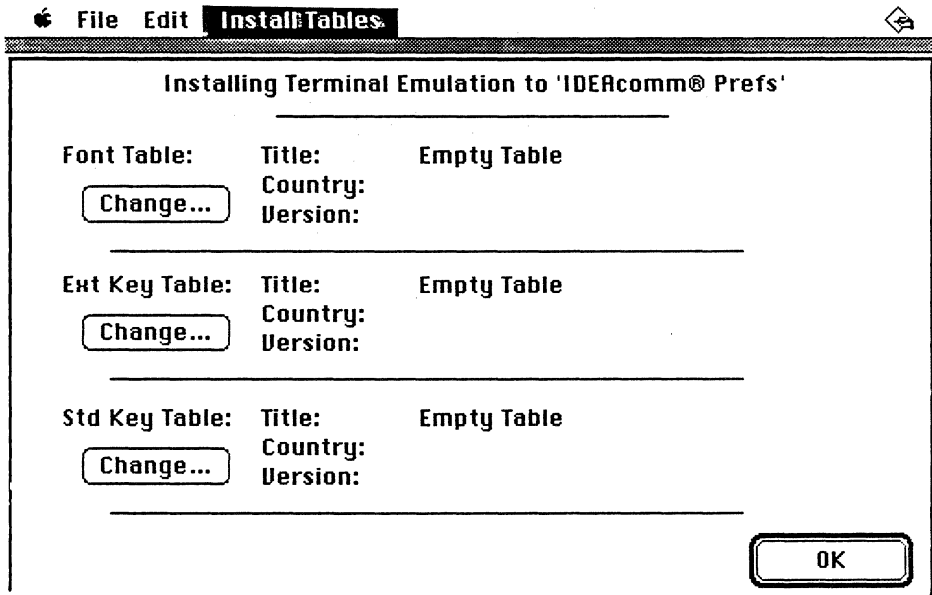

Figure E-3

**Note**

The phrase "Empty Table" appears when the IDEAcomm Utilities Package finds no table in the IDEAcomm Prefs file.

3. Click the Change button for any of the tables you want to change.
4. After clicking Change, a dialog box appears with a directory of folders and files.

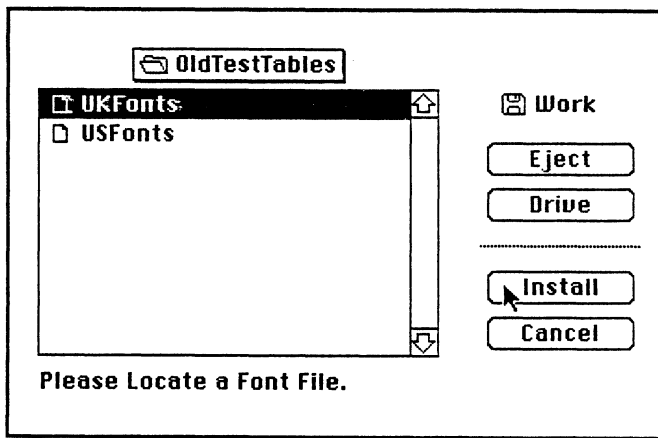

Figure E-4

5. For example, if you want to change the Font Table to a British Font Set, locate and select the UK Fonts file and click the Install button (or double click on the name of the file).

You'll then see a dialog box similar to the following:

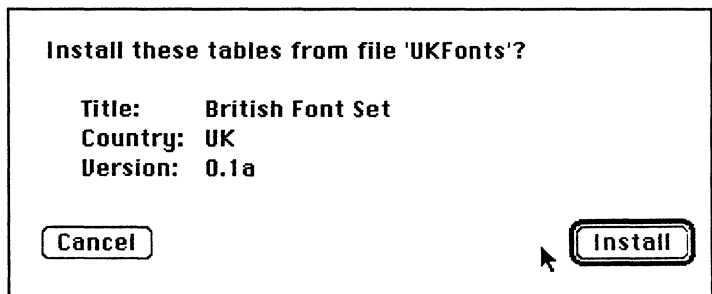

Figure E-5

6. To confirm that this is the table to be installed, click the Install button (or press return). If you change your mind after seeing the table title information, click the Cancel button and no changes will be made.
7. Click OK or press Return or Enter when you've completed your changes.

You'll then see an updated version of the window in Figure E-3, which will reflect the change you just made.

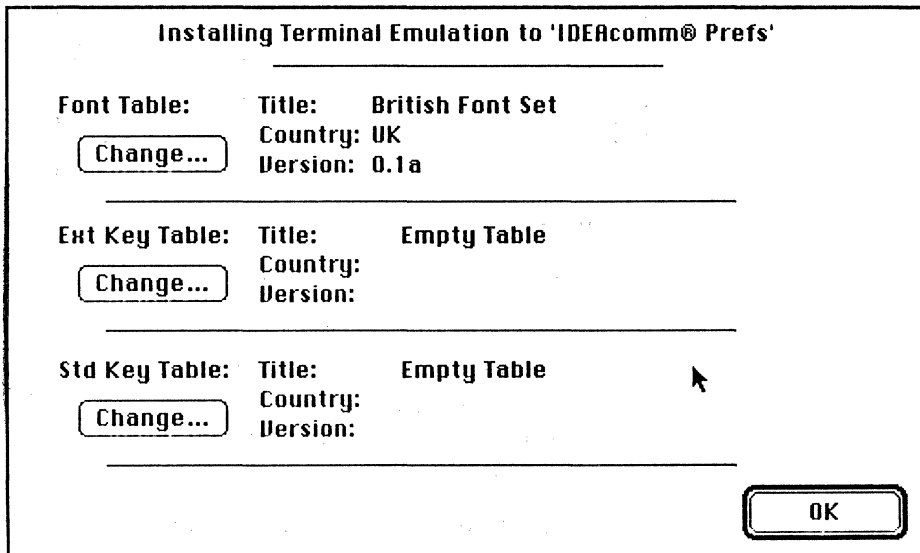

Figure E-6

In the event of an error in the installation of new tables, you'll see a dialog box similar to the following:

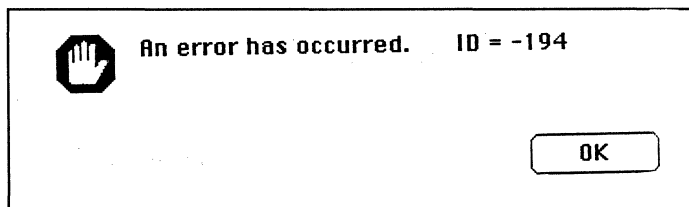

Figure E-7

For the error explanation, refer to *Inside Macintosh* (Volume III).

Installation of Printer Emulation or File Transfer tables is similar to that outlined above.

# Appendix F:

## Glossary

---

### **Alert Box**

A box that appears on the screen which gives you a warning or an error message. You'll also hear an alert sound when this box appears.

### **Apple Menu**

The menu on the left side of the menu bar. Its symbol is an apple. You can use desk accessories by selecting this menu.

### **ASCII**

American Standard Code for Information Interchange, a coding scheme wherein letters, numbers, and special symbols are represented as unique seven-bit values, allowing for standardization between data communications devices. The Macintosh uses ASCII.

### **Bit**

Abbreviation for **binary digit**. A bit is the smallest unit of information recognized by a computer, expressed as the digits 1 or 0.

### **Board**

In this manual, **board** and **card** are used interchangeably for the small printed circuit boards that can be added to the Macintosh SE.



### **Buffer**

Temporary storage for characters that need to be collected prior to processing.

### **Card**

In this manual, **card** and **board** are used interchangeably for the small printed circuit boards that plug into the Macintosh SE.

### **Command Key**

By pressing this key with another key, you cause a command to take effect. This key is marked on some keyboards with a  and on other keyboards with .

### **Desk Accessories**

Mini-application which can run at any time from the Apple menu. These mini-applications can be used regardless of

which application you're using. Examples include the Calculator, Scrapbook, and the Alarm Clock.

**Dialog Box**

A box which requests some information. It may also give a warning (accompanied by a beep) about something that the computer cannot do.

**EBCDIC**

Extended Binary Coded Decimal Information Code, a coding scheme wherein letters, numbers and special symbols are represented as unique six-bit values, allowing for standardization between data communications devices; used by the System 3X and AS/400.

**Emulation**

The ability to make a host computer (such as the System 3X) recognize a microcomputer as one of its own terminals, printers, or other devices.

**Finder**

The application that lets you manage documents and other applications and to transfer information from disk to disk.

**Free key mode**

State of a terminal or printer not varied on by the host.

**Host computer**

Primary or controlling computer in a multiple computer system upon which the smaller computers depend to allocate the resources of the system. For IDEAcmm Mac, the host is a System/36, System/38, or AS/400.

**Host Session**

Logical Unit, an emulated display or printer. Also called a LU (Logical Unit).

**LU**

Logical Unit, an emulated display or printer. Also called a Host Session.

**MultiFinder**

Permits multitasking on the Macintosh SE so that you can have more than one application open at the same time.

**Offline**

Communications devices which are not using a communications medium.

**Online**

Communications devices which are physically connected to and using a communications medium.

**Peripheral**

A noncomputing input or output device, such as a printer or hard disk drive.

**Port**

A connection that allows communications between the Macintosh and devices.

**Printer control panel**

A desk accessory that you use to set and change preferences when you are using an emulated system printer.

**Protocol**

Rules by which to exchange information, including the organization of units of data to be transferred.

**Resident**

Used to describe a program that is in live memory.

**Station address**

A unique address in the range of 0–6. It identifies a System terminal or printer on the TWINAX cable run to the host.

**System 3X**

The IBM System/34, /36, or /38.

**TWINAX**

Twinaxial cable is a type of cable used in System 3X installations.

**TWINAX run**

A series of one or more devices all on the same twinaxial cable that connects to the controller.

**Varied on**

Recognized as ON or set ON by the host. The Macintosh as an emulated terminal must be varied on by the host before the host will accept data from it.





# Appendix G: IDEA Products

---

For information or to order these products, call IDEA at (800) 257-5027. In Massachusetts call (508) 663-6878.

**Communications Products -- Micro to System 3X**  
IDEAcomm 5251/Plus provides local access for PCs or PS/2s to IBM 34/36/38 and AS/400 systems via a twinaxial cable, by emulating 5251 series terminals and printers with 7 logical units available.

IDEAcomm 5251/Gateway Plus is a gateway product that links PCs or PS/2s attached to an IBM NetBIOS™ compatible local area network with an IBM mid-range using just one IDEAcomm 5251 emulation board. It also allows PCs not on a network to access the IBM Midrange via RS-232 connections.

IDEAcomm 5250/Remote provides remote access for PCs or PS2s to an IBM mid-range system via an external synchronous modem by emulating 5251 series terminals, printers, and cluster controllers.

IDEAcomm 5250/Remote Share is a resource sharing product designed for the IDEAcomm 5250/Remote card that allows four remote PCs or PS/2s to communicate with a System 3X.

IDEAcomm 5250/Remote Gateway links remote PCs or PS/2s attached to an IBM NetBIOS compatible LAN to an IBM mid-range system with only one IDEAcomm 5250/Remote card.

**Communications Products -- Micro to Mainframe**  
IDEAcomm 3278 links PC products to a 3270 mainframe by emulating a 3278/79 display terminal through coaxial attachment to a 3X7X controller. IDEAcomm 3278 supports APL, IBM, and IRMA keyboard layouts.

IDEAcomm 3278/DFT offers coaxial connection to an IBM 3X7X controller attached to a mainframe. Five concurrent host sessions provide support for 3278/79 terminal and 3287 printer emulations.

IDEAcomm 3278/DFT-GW provides NetBIOS compatible Local Area Networks with connections to the IBM SNA/SDLC Mainframe environment over coaxial cable. Each Gateway with a coax board supports up to five host sessions which can be shared by the user nodes. Four Gateways per LAN support 20 users.

IDEAcomm 3270/SNA supports remote communications with an IBM mainframe via a synchronous modem utilizing the SNA/SDLC protocol. Eight concurrent host sessions provide support for 3278/79 terminal, 3287 printer and 3X7X controller emulations.

IDEAcomm 3270/SNA-GW provides a remote Gateway for NetBIOS compatible Local Area Networks to link to an IBM SNA/SDLC mainframe environment via a synchronous modem. Four Gateways give 32 usernodes access to the mainframe. Each Gateway with a Supercomm board supports eight concurrent host sessions.

IDEAcomm 3770/SNA and IDEAcomm 3780/BSC allow the PC to duplicate the functions of remote job entry terminals through a synchronous modem. Ideal for applications requiring bath transfers of data between the PC and 3270 mainframe.

IDEA Minicomm is a half sized remote communications adapter. An RS-232 interface allows for remote PC to mainframe connection via a synchronous modem.

IDEA Supercomm is an adapter board with 80188 processor and 512KB on board memory to offload processing from the PC. The intelligence offers flexibility to be used with custom written software. An RS-232 interface allows for remote PC to mainframe connection via a synchronous modem.

### **Terminals**

IDEA Model 197-1 features 3197/3180 emulation with green or amber display, alternate station addressing, 80 or 132 column display, record/playback, type-ahead keyboard buffering, and a programmable software lock. The 122 key keyboard supports 16 languages.

IDEA Model 197-2 offers all the features of 197-1 plus split screen (dual session) capability for viewing two concurrent host display sessions.

IDEA Model 197-PT includes all of the above, plus system printer emulation, dual session that includes 2 display sessions or 1 printer and 1 display session,, with full graphics support in 5224/5225 emulation and support of the most popular serial and parallel PC printers.

### **Multifunction Cards**

IDEAmax 30 provides as much as 8 MB of expanded memory for the PC/XT and PS/2 model 30, compatible with the Lotus/Intel/Microsoft expanded memory specification.

IDEAmax/MC provides as much as 12 MB of extended memory for the IBM PS/2. As much as 8MB can be configured to provide expanded memory. It is fully compatible with IBM micro channel architecture.

IDEAmax AT is the only multifunction board for the IBM AT that gives you 16MB of memory (conventional, extended, or expanded), plus two serial ports and a parallel port.

IDEAmax Plus 30 provides as much as 8 MB of expanded memory with 2 serial and 1 parallel port. Fully compatible with Lotus/Intel/Microsoft expanded memory specifications.

IDEAmax Plus MC provides as much as 8 MB of extended memory for the IBM PS/2, with 2 serial ports. Fully compatible with Lotus/Intel/Microsoft expanded memory specifications and IBM micro channel architecture.

IDEAmini is an I/O short card with one or two serial ports, printer interface, optional clock, and game port.

IDEA Minimax, designed for the short slot in the IBM Portable, XT, or AT, lets you add up to 512K on a single card.

# Appendix H: Customer Support Information

---

## Telephone Support

If you have any problems using our product, please follow these steps before contacting our technical support staff.

1. Make sure your computer system meets all the hardware requirements listed in the manual.
2. Referring to your manual, carefully check all the cables to make sure they are connected correctly.
3. Complete the following checklist:
  - Software name \_\_\_\_\_  
Serial number \_\_\_\_\_  
Version number \_\_\_\_\_
  - Computer brand name \_\_\_\_\_  
Model number \_\_\_\_\_  
RAM (memory) \_\_\_\_\_ bytes  
System Version \_\_\_\_\_  
Finder Version \_\_\_\_\_  
Multifinder Version \_\_\_\_\_
  - Disk Configuration  
Size: \_\_\_\_\_  
Hard Disk: \_\_\_\_\_ Floppy: \_\_\_\_\_  
Brand Name: \_\_\_\_\_  
Model Number: \_\_\_\_\_
4. Be sure you can answer the following questions:
  - Did the program ever work properly? If so, have you changed anything in your operating environment?
  - Did any error messages appear? If so, what were they?
  - What is the exact sequence of steps required to produce the problem?
5. With your computer on and the software loaded, call IDEA Technical Support at the number which follows.

# Repair Policy

If your product is still under the original one year limited warranty, IDEA will repair or replace it at no charge. If the product is out of the warranty period, IDEA will repair it and charge you on a time and materials basis.

If you are having problems with your IDEA product, take the following steps:

1. Go through the checklist above.
2. Call the IDEA Technical Support Department at (800) 343-0056. In Massachusetts, call (508)-663-6878. (Be sure that you have the version and serial numbers from your software diskettes and from your IDEA hardware.) If the Technical Support representative determines that your product requires factory service, you will be issued a Materials Return Authorization (MRA) number. IDEA will not accept returned products without an MRA number.
3. Box the product in the original shipping container or other secure package. Write your MRA number clearly on the outside of the box. For all warranty repairs, enclose a copy of the original purchase receipt as proof of date of purchase.
4. Ship by the most economical means to:

IDEA, Inc.  
MRA # \_\_\_\_\_  
29 Dunham Road  
Billerica, MA 01821

Once your product has been repaired, IDEA will return it to you by UPS or the most economical carrier at IDEA's expense.

## Warranty Card

Please complete and promptly return the enclosed warranty card. The warranty card should be filed by the party who installs the IDEA product.

## Limited Warranty

For IDEA's Limited Warranty, see page iii of this manual.

# Index:

---

## Numbers

3180 (wide screen) display, 36

## A

Alert Box defined, 121

Apple Menu defined, 121

ASCII defined, 121

Attribute appearance, 91

## B

Bit defined, 121

Board defined, 121

Buffer defined, 121

## C

Cable, connecting, 10

Calling Sequences, 111

Card defined, 121

Checking your inventory, 7

Command Key defined, 121

Configuring IDEAcmm Mac, 15ff

Customer support information, I29ff

## D

Desk Accessories defined, 121

Devices, configuring, 20

Diagnostic Program, 71ff

Dialog Box defined, 122

Display attributes, 91

## E

EBCDIC defined, 122

Emulation activating, 23

Emulation defined, 122

Emulation, ending, 36

Emulation, using, 23 ff

Error messages

    IDEAcmm Mac, 73

    IDEAcmm Mac warnings, 75

    Numbered from IDEAlink, 76

    Printer, 7-6



## **F**

FCC certification, ii  
Field attributes, displaying, 91ff  
Finder defined, 122  
File transfer, 51 ff  
File transfer, performing, 59  
File transfer, creating Buttons, 65  
Freeing sessions, 30

## **G**

Glossary, 121

## **H**

Hardware, installation, 95 ff  
Host computer defined, 122  
Host Session defined, 122

## **I**

IBM remote controller, attaching, 81  
IDEAcomm Mac card, installing, 95ff  
IDEAcomm Mac features, 1  
Installation hardware, 91 ff  
Installation software, 11  
Inventory checklist, 96

## **K**

Keyboard layouts, 86

## **L**

Limited warranty, iii  
Logical Units, moving between, 33  
LU defined, 122

## **M**

Messages

    IDEAcomm Mac Error, 73  
    IDEAcomm Mac Warning, 75  
    IDEALink Error, 76  
    Printer Error, 48  
MultiFinder defined, 122  
MultiFinder, using, 27

## **O**

Offline defined, 122  
Online defined, 122  
Opening the Macintosh, 91

## **P**

Port defined, 123  
Printer, installing software, 38  
Printer, Status Line Information, 47  
Printer Control Panel, 40

Printer Control Panel defined, 123

Protocol defined, 123

## **R**

Reassembling the Macintosh, 110

Resident defined, 123

Remote IBM controller, attaching, 81

Repair policy, 130

Reserving sessions, 30

## **S**

Setup, 15ff

Sign-on screen, 28

Station address, 20

Station address defined, 123

Status line indicators, 29

System/3X defined, 123

## **T**

Telephone support, 129

Termination of the card, 9

TWINAX run defined, 123

Twinaxial cable, connecting, 10

## **U**

Utilities program, 115 ff

Utilities program configuring display options, 115

## **V**

Varied on defined, 123

## **W**

Warranty, iii

Windows, 30

Windows, 33ff

Windows, Viewing 132 Columns, 36

Windows, Viewing 3180 Emulation, 36



