

Domestic Manufacturing Representatives

MALLORY

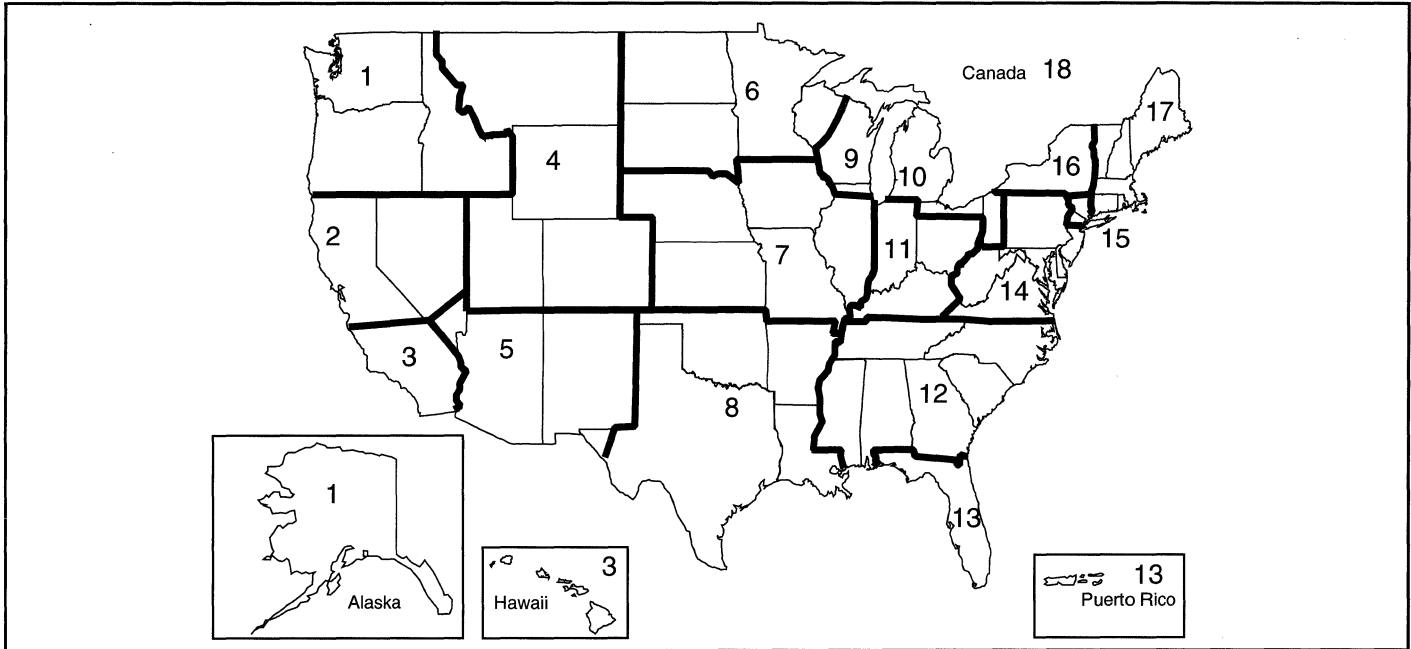

- | | | | | | | | | |
|---|---|---|---|---|---|---|---|---|
| <p>1. Jas. J. Backer
221 West Galer Street
P.O. Box 9327
Seattle, WA 98109
Phone: (206) 285-1300
FAX: (206) 282-2967</p> <p>10550 S. W. Allen Blvd.
Suite 225
Beaverton, OR 97005
Phone: (503) 627-0168
FAX: (503) 627-0927</p> | <p>2. Ross Marketing & Assoc.
3350 Scott Blvd. Bldg. 51
Santa Clara, CA 95054
Phone: (408) 988-8111
Fax: (408) 492-0197</p> | <p>3. West Electronic Sales Co.
16581 Burke Lane
Huntington Beach, CA 92647
Phone: (714) 375-6500
(310) 493-5569
FAX: (714) 375-6507</p> <p>9524 Kearny Villa Rd.
Suite 105-C
San Diego, CA 92126
Phone: (619) 566-8430
FAX: (619) 566-8854</p> | <p>4. Delltron Company
6424 S. Quebec
Englewood, CO 80111
Phone: (303) 741-2122
FAX: (303) 741-1936</p> | <p>5. C.T. Carlberg & Assoc., Inc.
2102 E. Osborn
Phoenix, AZ 85016
Phone: (602) 468-0750
FAX: (602) 468-0782</p> <p>4701 Montano Blvd. N. W.
Suite 105
Albuquerque, NM 87120
Phone: (505) 899-2155
FAX: (505) 899-2160</p> | <p>6. North American Capacitor Co
7545 Rockville Rd.
Indianapolis, IN 46214
Phone: (317)273-0090
Fax: (317)273-2400</p> <p>7. KKB & Company
1610 S. Big Bend Blvd.
St. Louis, MO 63117
Phone: (314) 647-2400
FAX: (314) 647-3773</p> <p>104 North 12th
Blue Springs, MO 64015
Phone: (816) 229-0001
FAX: (816) 228-1466</p> <p>465 Northland Ave. N. E.
Suite 202
Cedar Rapids, IA 52402
Phone: (319) 373-1730
FAX: (319) 373-2019</p> <p>8. Pro-Comp Sales Company
231 Loop 820 N. E., Suite 124
Hurst, TX 76053
Phone: (817) 589-0336
FAX: (817) 595-1369</p> <p>20815 Durand Oak Ct.
Cypress, TX 77429
Phone: (713) 373-0238
FAX: (713) 373-0310</p> <p>1701 N. Greenville Ave.
Suite 824
Richardson, TX 75081
Phone: (214) 669-1500
FAX: (214) 669-1293</p> <p>12703A Research Blvd.
Suite 239
Austin, TX 78759
Phone: (512) 331-0800
FAX: (512) 331-0090</p> | <p>9. The Dombrow Company
2401 W. Hassell Road
Suite 1565
Hoffman Estates, IL 60195
Phone: IL: (708) 885-9922
WI: (414) 263-4116
FAX: (708) 885-9475</p> <p>10. Electronic Salesmasters, Inc.
24100 Chagrin Blvd.
Beachwood, OH 44122
Phone: (216) 831-9555
FAX: (216) 831-8647</p> <p>11. D-M Associates
4351 E. 82nd Street, Suite D
Indianapolis, IN 46250
Phone: (317) 842-4424
FAX: (317) 842-4449</p> <p>12. Mountain Electro Marketing
6025-H Atlantic Blvd.
Norcross, GA 30071
Phone: (404) 448-5594
FAX: (404) 448-8230</p> <p>Aspen Building
3125 Poplarwood Court
Suite 101
Raleigh, NC 27625
Phone: (919) 876-0704
FAX: (919) 876-0804</p> <p>190 Lime Quarry Road
Suite 106
Madison, AL 35758
Phone: (205) 772-9038
FAX: (205) 772-9597</p> <p>13. Component Design Marketing
7616 Southland Blvd.
Suite 103
Orlando, FL 32809
Phone: (407) 240-3903
FAX: (407) 240-4305</p> | <p>800 Corporate Drive
Suite 230
Ft. Lauderdale, FL 33354
Phone: (305)492-1160
Fax: (305)492-1167</p> <p>14. DVS Company
9 Princess Road
Lawrenceville, NJ 08648
Phone: (609) 896-1112
FAX: (609) 896-8117</p> <p>15. Aurora-Schmitt
738 Smithtown Bypass
Smithtown, NY 11787
Phone: (516) 979-1313
FAX: (516) 979-1384</p> <p>16. Micro-Tech Marketing, Inc.
1548 Buffalo Rd.
Rochester, NY 14624
Phone: (716) 426-0806
Fax: (716) 426-5535</p> <p>9 Valhank Drive
Ulster Park, NY 12487
Phone: (914) 339-0817
Fax: (914) 339-0817</p> <p>3100 E. Brutus St. Rd.
Weedsport, NY 13166
Phone: (315) 834-6167</p> | <p>17. Logan Sales
192 Worcester Street
Wellesley, MA 02181
Phone: (617) 235-6868
FAX: (617) 235-5010</p> <p>18. A.C. Simmonds & Sons
975 Dillingham Road
Pickering, Ontario, Canada
L1W3B2
Phone: (905) 839-8041
FAX: (905) 839-2667</p> |
|---|---|---|---|---|---|---|---|---|

INTRODUCTION

This General Catalog presents the vast array of capacitors, piezoceramic audible signal devices and other electronic components that are manufactured and distributed by North American Capacitor Company. In addition to the General Catalog, NACC has detailed technical bulletins available for some of the products. Over the life of this catalog, NACC cannot guarantee availability of individual parts, and in limited cases, line item minimums may be required.

For pricing, please request resale pricing from any of our Authorized Sales Representatives or Distributors.

Table of Contents

Product	Page	Product	Page
WET TANTALUM ELECTROLYTIC CAPACITORS	1	DISC CERAMIC CAPACITORS	113
INDUSTRIAL (NON-MILITARY) TYPES		General Purpose, 50 to 1000 WVDC	115
MTP — Silver Case, Subminiature	3	Temperature Compensating, EIA Class I	118
MTPH — Silver Case, Subminiature, High Reliability	4	Temperature/Frequency Stable, EIA Class II	121
TBS — (Formerly W13) All Tantalum, High Temperature Button	20	High Voltage, EIA Class II	121
THT — Tantalum Case, High Temperature, Hermetic Seal	16	High Capacitance, EIA Class III	122
THX — Tantalum Case, High Temperature, Extended Range, Hermetic Seal	18	Spark Arrestors	122
TLH — Silver Case, Elastomer Seal, Extended Range	7	Across-the-Line, X Type Filter	123
TLS — Silver Case, Elastomer Seal	5	MULTILAYER CERAMIC CAPACITORS	124
TLW — Silver Case, High Temperature, Hermetic Seal	9	INDUSTRIAL TYPES	
XT — Silver Case, High Temperature, Hermetic Seal	11	M — Resin Dipped, NPO, X7R, and Z5U, Radial Leaded	127
XT Configurations	14	P — Resin Dipped, NPO, X7R, and Z5U, Axial Leaded	132
MODULES		SURFACE MOUNT	
TMX — All Tantalum, CLR81 Capacitor Module	22	Chip Capacitors	134
W14 — All Tantalum, W13 Button Capacitor Module	21	MILITARY (NON ESTABLISHED RELIABILITY) MIL-C-11015	
MILITARY (NON-ESTABLISHED RELIABILITY)		CK — Resin Molded Case, X7R, Radial and Axial	138
CL64/65 — Mil-C-3965/4 Silver Case, Elastomer Seal (TLS)	25	MILITARY (ESTABLISHED RELIABILITY) MIL-C-39014	
CRL01/02/03 — Mil-C-83500/01 All Tantalum Button Capacitor (TBS)	20	CKR — Resin Molded Case, X7R, Radial and Axial	138
MILITARY (ESTABLISHED RELIABILITY)		DC FILM CAPACITORS	141
CLR10 — MIL-C-39006/18 Silver Case High Temp (XT)	27	GENERAL PURPOSE	
CLR14 — MIL-C-39006/19 Silver Case High Temp (XT)	28	150 — Metallized Polyester, Axial Leads	143
CLR17 — MIL-C-39006/20 Silver Case High Temp (XT)	29	160 — Metallized Polyester, Radial Leads	146
CLR65 — MIL-C-39006/09 Silver Case (TLX)	31	167/184 — Metallized Polyester, Radial Leads 7.5mm LS	150
CLR69 — MIL-C-39006/21 Silver Case Extended Range (TXX)	34	168/185 — Metallized Polyester, Radial Leads 5mm LS	153
CLR79 — MIL-C-39006/22 Tantalum Case (TLT)	36	170 — Metallized Polypropylene, Axial Leads	156
CLR81 — MIL-C-39006/25 Tantalum Case Extended Range (TXT)	39	171 — Metallized Polypropylene, Radial Leads	159
CLR90 — MIL-C-39006/30 Tantalum Case - Higher Ripple - Lower ESR, Superior to CLR79	41	PVC — Film/Foil, Radial Leads	161
CLR91 — MIL-C-39006/31 Tantalum Case - Higher Ripple - Lower ESR, Superior to CLR81	44	PRECISION FILM	
SOLID TANTALUM ELECTROLYTIC CAPACITORS	46	SX — Polystyrene Foil, Axial Leads	165
INDUSTRIAL (NON-MILITARY) TYPES		INTERFERENCE SUPPRESSORS	
HERMETICALLY SEALED — AXIAL LEADS		158X — Metallized Polyester, Radial Leads - X2 Suppressor	168
TAS — Metal Case	48	Q/QRL (Quencharc®) — RC Snubber Network	169
THF — Metal Case, High Frequency	51	MICROWAVE CAPACITORS — Porcelain, Ceramic, Trimmer	170
TXA — Metal Case, Extended Range	50	AC PRODUCTS	
MOLDED CASE		MPF — AC Motor Run Capacitors - Metallized Polypropylene	172
TAC — Molded Case, Axial Leads	61	MSF — 660 VAC Rated Capacitors for Power Supplies	173
TIM — Molded Case, Radial Leads	63	PSU — AC Motor Start Capacitors	171
DIPPED		SOUND DEVICES	174
TDC — Resin Dipped, Radial Leads - .125/.250 Lead Spacing	65	SONALERT® — Commercial and Industrial	176
TDL — Resin Dipped, Radial Leads - .100/.200 Lead Spacing	67	SONALERT® — Multi-Tone	181
SURFACE MOUNT		SONALERT® — Military	184
T491 — Tantalum Chip Capacitor	69	SONALERT II™ — Subminiature Audible Signal Device	185
T495 — Tantalum Chip Capacitor (Very low ESR, high ripple capability)	71	TRANSDUCER — Piezoelectric	187
MILITARY — ESTABLISHED RELIABILITY TYPE		ACCESSORIES —	183
CSR13 — MIL-C-39003/01 Metal Case (TAS)	52	DC VOLTAGE ROTARY FANS	189
CSR23 — MIL-C-39003/03 Metal Case Extended Range (TXA)	57	CONTROL PRODUCTS	192
CSR21 — MIL-C-39003/09 Metal Case High Frequency (THF)	59	MR — 3 Watt, Multiple Mounting Wirewound Controls	193
ALUMINUM ELECTROLYTIC CAPACITORS	72	R, M, VW, VWS, LW, MG — 3 to 12.5 Watt, Bushing Mount Wirewound Controls	194
LARGE CAN TYPES		L, MGL, LL, MGLL, T, R, RR — Wirewound Audio Attenuators	196
CG — Computer Grade, Long Life, High Reliability	79	3000 Series — General Purpose Rotary Switches	198
CGH — Computer Grade, High Capacitance, High Voltage	81	HARDWARE	
CGO — Computer Grade, SMPS Output Filter	82	Capacitor Hardware	200
CGR — Computer Grade, High Ripple Current	83	Control Hardware	199
CGS — Computer Grade, General Purpose	75	MALLOBINS — Merchandisers	202
HES — High Energy Storage (Charge-Discharge Applications)	85	Competitive Cross-Reference	203
SNAP MOUNT		Capacitors	203
LP — 105°C Operation, Long Life	86	Fans	205
LPW — 85°C Operation, Low Voltage, General Purpose	88	Capacitance & Dimension Conversion Charts	208
LPX — 85°C Operation, High Voltage, General Purpose	90	Domestic Representatives	Inside Back Cover
AXIAL LEADED		International Manufacturing Representatives	206
SKA — General Purpose 85°C, Decade Ratings	111		
TC — General Purpose 85°C	106		
TCG — General Purpose 85°C	108		
TCX — Long Life 105°C, High Ripple Current	110		
TT — See SKA	110		
RADIAL LEADED			
NKR — General Purpose, Non-Polar	100		
SKR — General Purpose - 85°C	93		
SSR — Sub Miniature - 85°C, 7mm Case Height	99		
TKR — Long Life - 105°C	95		
TMR — Very Long Life - 105°C	97		
VPR — Low Impedance, Molded Top	104		
WGR — Low Impedance 105°C	102		
TAPE AND PACKAGING SPECIFICATIONS - Radial and Axial	92		

A1126	Hardware	199	M60	Multilayer Ceramic Capacitor	131	SXK/SXL	DC Film Capacitor	166
ACR15KT	AC Motor Start Resistor	171	M39003/01	Solid Tantalum Capacitor	52	SXM/SX	DC Film Capacitor	167
ASR	Disc Ceramic Capacitor	122	M39003/03	Solid Tantalum Capacitor	57	T	Wirewound Audio Attenuator .	197
AT	Disc Ceramic Capacitor	122	M39003/09	Solid Tantalum Capacitor	59	T491	Tantalum Chip Capacitor	69
ATR	Disc Ceramic Capacitor	122	M39006/09	Wet Tantalum Capacitor	31	T491KIT	Mallobin	202
BNR1	Sound Device Mounting Nut ..	183	M39006/18	Wet Tantalum Capacitor	27	T495	Tantalum Chip Capacitor	71
BP6	Mounting Wafer	179	M39006/19	Wet Tantalum Capacitor	28	TA	See SKA	
C0805	Ceramic Chip Capacitor	135	M39006/20	Wet Tantalum Capacitor	29	TAC	Solid Tantalum Capacitor	61
C1206	Ceramic Chip Capacitor	135	M39006/21	Wet Tantalum Capacitor	34	TAC151	Mallobin	202
C1210	Ceramic Chip Capacitor	135	M39006/22	Wet Tantalum Capacitor	36	TAS	Solid Tantalum Capacitor	48
CEC	Disc Ceramic Capacitor	118	M39006/25	Wet Tantalum Capacitor	39	TBS	Wet Tantalum Capacitor	20
CES	Disc Ceramic Capacitor	118	M39006/30	Wet Tantalum Capacitor	41	TC	Aluminum Capacitor	106
CEU	Disc Ceramic Capacitor	118	M39006/31	Wet Tantalum Capacitor	44	TC151	Mallobin	202
CG	Aluminum Capacitor	79	M39014/01	Multilayer Ceramic Capacitor	138	TC151A	Mallobin	202
CGH	Aluminum Capacitor	81	M39014/02	Multilayer Ceramic Capacitor	139	TCG	Aluminum Capacitor	108
CGO	Aluminum Capacitor	82	M39014/05	Multilayer Ceramic Capacitor	139	TCG151	Mallobin	202
CGR	Aluminum Capacitor	83	M83500/01	Wet Tantalum Capacitor	20	TCX	Aluminum Capacitor	110
CGS	Aluminum Capacitor	75	MAV	Microwave Capacitor	170	TDC	Solid Tantalum Capacitor	65
CK05	Multilayer Ceramic Capacitor	138	MG	Wirewound Control	195	TDC151A	Mallobin	202
CK06	Multilayer Ceramic Capacitor	139	MGL	Wirewound Audio Attenuator .	196	TDL	Solid Tantalum Capacitor	67
CK12	Multilayer Ceramic Capacitor	139	MGLL	Wirewound Audio Attenuator .	196	TH	Hardware	200
CK13	Multilayer Ceramic Capacitor	140	MHK	Microwave Capacitor	170	THF	Solid Tantalum Capacitor	51
CK14	Multilayer Ceramic Capacitor	140	MHP	Microwave Capacitor	170	THT	Wet Tantalum Capacitor	16
CK15	Multilayer Ceramic Capacitor	140	MHQ	Microwave Capacitor	170	THX	Wet Tantalum Capacitor	18
CK16	Multilayer Ceramic Capacitor	140	MIL-C-11015/18	Multilayer Ceramic Capacitor	138	TIM	Solid Tantalum Capacitor	63
CKR05	Multilayer Ceramic Capacitor	138	MIL-C-11015/19	Multilayer Ceramic Capacitor	139	TKR	Aluminum Capacitor	95
CKR06	Multilayer Ceramic Capacitor	139	MIL-C-11015/20	Multilayer Ceramic Capacitor	139	TMR	Aluminum Capacitor	97
CKR11	Multilayer Ceramic Capacitor	139	MIL-C-3965/4	Wet Tantalum Capacitor	25	TLH	Wet Tantalum Capacitor	7
CKR12	Multilayer Ceramic Capacitor	140	MONO151A	Mallobin	202	TLS	Wet Tantalum Capacitor	5
CKR14	Multilayer Ceramic Capacitor	140	MPF	AC Motor Run Capacitor	172	TLW	Wet Tantalum Capacitor	9
CKR15	Multilayer Ceramic Capacitor	140	MPR	Microwave Capacitor	170	TMX	Wet Tantalum Capacitor	22
CKR16	Multilayer Ceramic Capacitor	140	MPT	Microwave Capacitor	170	TSC	See T491	
CL10 to CL18	Contact NACC for info.		MPV	Microwave Capacitor	170	TSC151	See T491KIT	
CL55	Contact NACC for info.		MP6	Mounting Wafer	179	TT	See SKA	
CL65	Wet Tantalum Capacitor	25	MR	Wirewound Control	193	TXA	Solid Tantalum Capacitor	50
CL66/CL67	Contact NACC for info.		MRS	Hardware	199	UN	Disc Ceramic Capacitor	123
CLR10	Wet Tantalum Capacitor	27	MSF	AC Power Supply Capacitor ..	173	VPR	Aluminum Capacitor	104
CLR14	Wet Tantalum Capacitor	28	MSO	Sound Device	185	VPR151	Mallobin	202
CLR17	Wet Tantalum Capacitor	29	MSR	Sound Device	185	VR	Hardware	200
CLR65	Wet Tantalum Capacitor	31	MTC	Contact NACC for info.		VTH	See TKR	
CLR69	Wet Tantalum Capacitor	34	MTD	Microwave Capacitor	170	VTL	See SKR	
CLR79	Wet Tantalum Capacitor	36	MTP	Wet Tantalum Capacitor	3	VTL151	See SKR151	
CLR81	Wet Tantalum Capacitor	39	MTPH	Wet Tantalum Capacitor	4	VTM	See SSR	
CLR90	Wet Tantalum Capacitor	41	MTR	Microwave Capacitor	170	VTN	See NKR	
CLR91	Wet Tantalum Capacitor	44	MVC	Microwave Capacitor	170	VTZ	See WGR	
CMC	Disc Ceramic Capacitor	119	NKR	Aluminum Capacitor	100	VW	Wirewound Control	194
CMU	Disc Ceramic Capacitor	119	OB	Hardware	201	VWS	Wirewound Control	195
CMW	Disc Ceramic Capacitor	119	OC	Hardware	201	W13	See TBS	
CNR1	Sound Device Mounting Nut ..	183	P10 to P40	Multilayer Ceramic Capacitor	132	W14	Wet Tantalum Capacitor	21
CPC	Disc Ceramic Capacitor	119	PL, PLA	Hardware	200	WGR	Aluminum Capacitor	102
CRC	Disc Ceramic Capacitor	120	PNR1	Sound Device Mounting Nut ..	183	XTH/K/L/M/V	Wet Tantalum Capacitor	11
CRL01/02/03	Wet Tantalum Capacitor	20	PSU	AC Motor Start Capacitor	171	104M	RC Snubber Network	169
CSR13	Solid Tantalum Capacitor	52	PT	Sound Device	187	105M	RC Snubber Network	169
CSR21	Solid Tantalum Capacitor	59	PVC	DC Film Capacitor	161	148	Contact NACC for info.	
CSR23	Solid Tantalum Capacitor	57	PW	Compression Washer	179	150	DC Film Capacitor	143
CTZ	Disc Ceramic Capacitor	120	Q/QRL	RC Snubber Network	169	158X	DC Film Capacitor	168
DISC151M	Mallobin	202	R	Wirewound Control	194	160	DC Film Capacitor	146
GE	Disc Ceramic Capacitor	115	RB	Hardware	199,201	167	DC Film Capacitor	150
GH	Disc Ceramic Capacitor	115	RPE60	Mallobin	202	168	DC Film Capacitor	153
GM	Disc Ceramic Capacitor	116	RPE6768	Mallobin	202	170	DC Film Capacitor	156
GP	Disc Ceramic Capacitor	116	RR	Wirewound Audio Attenuator .	197	171	DC Film Capacitor	159
GR	Disc Ceramic Capacitor	117	RT	Wirewound Audio Attenuator .	197	184	DC Film Capacitor	150
GS	Disc Ceramic Capacitor	117	SBM	Sound Device	176	185	DC Film Capacitor	153
GS5149A	Hardware	199	SC	Sound Device	176	1910K	Hardware	199
GT	Disc Ceramic Capacitor	117	SCMB	Sound Device Mounting Box ..	183	21FB to 24FB	AC Motor Run Capacitor	173
HB	Hardware	200	SCVC	Sound Device Volume Control	183	21FD to 24FD	AC Motor Run Capacitor	173
HES	Aluminum Capacitor	85	SKA	Aluminum Capacitor	111	225	Hardware	199
HS	Disc Ceramic Capacitor	121	SKR	Aluminum Capacitor	93	232	Hardware	199
HT	Disc Ceramic Capacitor	121	SKR151	Mallobin	202	255	Hardware	199
JF	DC Voltage Rotary Fan	189	SM	Disc Ceramic Capacitor	121	31112J to 3243J	Hardware	198
L	Wirewound Audio Attenuator .	196	SMTCEP	Mallobin	202	32FB to 38FB	AC Motor Run Capacitor	172
LC	Disc Ceramic Capacitor	122	SMTKIT	Mallobin	202	32FD to 38FD	AC Motor Run Capacitor	172
LE	Disc Ceramic Capacitor	122	SNP	Sound Device	176	32KB	AC Power Supply Capacitor ..	173
LL	Wirewound Audio Attenuator .	196	SONAK	Mallobin	202	32KC to 38KC	AC Power Supply Capacitor ..	173
LP	Aluminum Capacitor	86	SP	Disc Ceramic Capacitor	121	32KD to 38KD	AC Power Supply Capacitor ..	173
LPW	Aluminum Capacitor	88	SSR	Aluminum Capacitor	99	32KE and 37KE	AC Power Supply Capacitor ..	173
LPX	Aluminum Capacitor	90	ST	Sound Device	176	364 to 368	Hardware	199
LW	Wirewound Control	195	STX	DC Film Capacitor	167	372 to 495	Hardware	199
M	Wirewound Control	194	SX301	Mallobin	202	504M	RC Snubber Network	169
M15 to M50	Multilayer Ceramic Capacitor	127						

Commercial Types

Type	Features	Capacitance Range	Voltage Range	Temperature Range	Tolerances (%)	Case Dimensions (Inches)	Page Number
Elastomer Seal							
MTP	Max CV per Unit Volume Low DCL Low DF Silver Case	3.3 μ F to 470 μ F	6 to 60	-55°C +85°C	\pm 10 \pm 20	(D x L) .115 x .300 to .225 x .778	3
MTPH	Max CV per Unit Volume Low DCL Low DF Silver Case 100% Burn-In	4.7 μ F to 470 μ F	6 to 60	-55°C +85°C	\pm 10 \pm 20	(D x L) .115 x .403 to .225 x .778	4
TLS	Standard Range Silver Case Low DCL Low ESR	1.7 μ F to 1200 μ F	6 to 125	-55°C +125°C	\pm 10 \pm 20 \pm 5 (Special Order)	(D x L) .188 x .453 to .375 x 1.062	5
TLH	Extended Range Silver Case Low DCL Low ESR	22 μ F to 2200 μ F	6 to 75	-55°C +125°C	\pm 10 \pm 20 \pm 5 (Special Order)	(D x L) .188 x .453 to .375 x 1.062	7

Glass to Metal Seal							
TLW	Silver Case Low DCL Low ESR Commercial CLR65	2.5 μ F to 1200 μ F	6 to 125	-55°C +175°C (With proper derating)	\pm 10 \pm 20 \pm 5 (Special Order)	(D x L) .188 x .453 to .375 x 1.062	9
XTH XTK XTL XTM XTV	High Capacitance High Voltage High Reliability	2 μ F to 2200 μ F	8 to 900	-55°C +175°C (With proper derating)	-15 +50% (Others Available)	(D x L) .656 x .438 to 1.125 x 2.810	11

All Tantalum - Glass to Metal Seal							
THT	Reverse Voltage 200°C Operation High Ripple Capability Low DCL Low ESR	1.7 μ F to 1200 μ F	6 to 125	-55°C +200°C (With proper derating)	\pm 5 \pm 10 \pm 20	(D x H) .188 x .453 to .375 x 1.062	16
THX	Extended Range 175°C Operation High Ripple Capability Low DCL Low ESR	6.8 μ F to 2200 μ F	6 to 125	-55°C +175°C (With proper derating)	\pm 10 \pm 20	(D x H) .188 x .453 to .375 x 1.062	18
TBS	Stud or Pin Mounting 200°C Operation 100% Burn-In Commercial MIL-C-83500 Custom Designs Available	47 μ F to 1500 μ F	6 to 125	-55°C +150°C	\pm 10 \pm 20	(D x H) .853 x .320	20

Modules							
W14	High Capacitance Reverse Voltage Constituent Units of W13 Design Long Life	94 μ F to 7500 μ F	6 to 125	-55°C +125°C (With proper derating)	\pm 10 \pm 20	2.000 x 2.000 .460 Thick Molded Package	21
TMX	High Capacitance Reverse Voltage Constituent Units of CLR81 Design Low DCL	25 μ F to 39,600 μ F	6 to 200	-55°C +125°C (With proper derating)	\pm 10 \pm 20	12 Package Sizes	22

Military - Established Reliability

MIL Specification	MIL QPL Approvals Failure Rate Levels	Features	Capacitance Range	Voltage Range	Temperature Range	Tolerances (%)	Case Dimensions (Inches)	Page Number
M3965/4 CL65	Not Applicable	Elastomer Seal Silver Case Rugged Construction Low DCL Low ESR	1.7 μ F to 560 μ F	6 to 125	-55°C +125°C (With proper derating)	\pm 10 \pm 20 \pm 5 (special)	(D x L) .219 x .608 to .406 x .921	25
M83500/01 CRL01 CRL02 CRL03	Not Applicable	All Tant Construction 3 Volts Reverse 200°C Operation 100% Burn-In Stud or Pin Mounting	47 μ F to 1200 μ F	6 to 125	-55°C +125°C (With proper derating)	\pm 10 \pm 20	(D x L) .853 x .320	20
M39006/18 CLR10	L, M, P	High Temperature High Voltage Hermetically Sealed Rugged Construction Long Shelf Life	2 μ F to 140 μ F	8 to 360	-55°C +125°C (With proper derating)	-15% +50%	(D x L) .656 x .438 to 1.781	27
M39006/19 CLR14	L, M, P	High Temperature High Voltage Hermetically Sealed Rugged Construction Long Shelf Life	3.5 μ F to 200 μ F	20 to 630	-55°C +125°C (With proper derating)	-15% +75%	(D x L) .875 x .540 to 4.062	28
M39006/20 CLR17	L, M, P	High Temperature High Voltage Hermetically Sealed Rugged Construction Long Shelf Life	12 μ F to 1300 μ F	30 to 630	-55°C +125°C (With proper derating)	\pm 20% -15% +50%	(D x L) 1.125 x .600 to 2.810	29
M39006/09 CLR65	M, P, R	Silver Case Hermetic Seal Low DCL Low DF Long Life	1.7 μ F to 1200 μ F	6 to 125	-55°C +125°C (With proper derating)	\pm 10 \pm 20 \pm 5 (special)	(D x L) .219 x .608 to .406 x 1.217	31
M39006/21 CLR69	M, P, R	Silver Case Hermetic Seal Low DCL Low DF Long Life	6.8 μ F to 2200 μ F	6 to 126	-55°C +125°C (With proper derating)	\pm 10 \pm 20	(D x L) .219 x .608 to .406 x 1.217	34
M39006/22 CLR79	M, P, R	Tantalum Case 3 Volts Reverse Low DCL Low DF High Ripple Capability	1.7 μ F to 1200 μ F	6 to 125	-55°C +125°C (With proper derating)	\pm 10 \pm 20 \pm 5 (special)	(D x L) .219 x .608 to .406 x 1.217	36
M39006/25 CLR81	M, P, R	Tantalum Case 3 Volts Reverse Extended Range Low DCL Low DF	6.8 μ F to 2200 μ F	6 to 125	-55°C +125°C (With proper derating)	\pm 10 \pm 20	(D x L) .219 x .608 to .406 x 1.217	39
M39006/30 CLR90	M, P, R	Tantalum Case 3 Volts Reverse Extended Range Low DCL Low DF Lower ESR than CLR79	1.7 μ F to 1200 μ F	6 to 125	-55°C +125°C (With proper derating)	\pm 10 \pm 20 \pm 5 (special)	(D x L) .219 x .608 to .406 x 1.217	41
M39006/31 CLR91	M, P, R	Tantalum Case 3 Volts Reverse Extended Range Low DCL Low DF Lower ESR than CLR81	6.8 μ F to 2200 μ F	6 to 125	-55°C +125°C (With proper derating)	\pm 10 \pm 20	(D x L) .219 x .608 to .406 x 1.217	44

Type MTP Wet Tantalum Capacitors

MALLORY

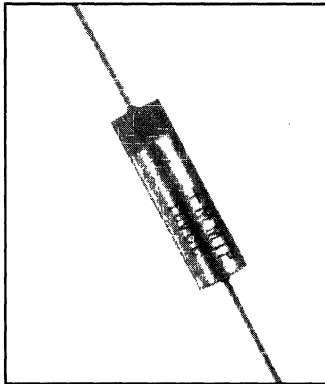

- Maximum CV / Unit Volume
- Ruggedized Construction
- Low Dissipation Factor
- Low DC Leakage
- 100% 25°C DCL Screening
- 100% Voltage Age @ 85°C - 8 Hours
- 100 % Cap & DF Screening
- Monthly Lot Conformance
- Reliability: 2.0%/1000 Hrs.

GENERAL SPECIFICATIONS

Operating Temperature:
-55°C to +85°C

Voltage Range:
6 to 60 VDC

Reverse Voltage:
None

Capacitance Range:
3.3 μ F to 470 μ F

Tolerance Range:
 $\pm 10\%$, $\pm 20\%$

DC Leakage:
At +25°C - 2.0 μ A max
At +85°C - 6.0 to 10.0 μ A max

Max RMS Ripple Current @ 85°C:
Case Code: D A B C
Milliamps: 7.5 12.5 50 140

Case Sizes: (Four)
.115 x .300 to .225 x .778

Some Typical Applications

Timing Circuits
Filter Coupling
Energy Storage
By-Pass Circuits

Wet Tantalum Capacitors

Physical Specifications

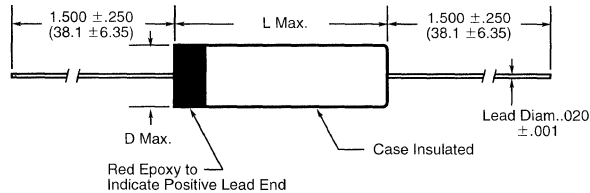

CASE	D INCHES(mm)	L INCHES(mm)	APPROX WT GRAMS
D	.115 (2.92)	.300 (7.62)	0.40
A	.115 (2.92)	.403 (10.23)	0.50
B	.145 (3.68)	.600 (15.24)	1.00
C	.225 (5.72)	.778 (19.76)	2.60

(1 Gram = .035 oz.)

Part Number Nomenclature

- | MTP | 156 | K | 006 | P | 1 | D |
|-----|-----|-----|-----|-----|-----|-----|
| (1) | (2) | (3) | (4) | (5) | (6) | (7) |
- MTP Series - Sub-miniature
 - Capacitance Code (Expressed in Picofarads)
First 2 digits: Significant Figures
Third digit: Number of zeros (Example: 156 = 15 μ F)
 - Capacitance Tolerance:
M = $\pm 20\%$, K = $\pm 10\%$
 - DC Voltage Rating:
Zeros are used to precede the voltage rating where necessary to complete the three digit block
 - P = Polar
 - 1 = Mylar Sleeve
 - Case Size Code

Cap (μ F)	Volts DC	Case Size	Catalog Number	Max DCL μ A		Max ESR Ω +25°C	Max Z Ω -55°C	Max Δ C from +25°C	
				+25°C	+85°C			-55°C	+85°C
15	6	D	MTP156*006P1D	2.0	6.0	17.6	300	-40	+15
47	6	A	MTP476*006P1A	2.0	6.0	6.8	85	-60	+15
150	6	B	MTP157*006P1B	2.0	8.0	2.2	35	-50	+15
180	6	B	MTP187*006P1B	2.0	8.0	1.9	32	-50	+15
450	6	C	MTP457*006P1C	2.0	10.0	1.0	25	-60	+15
470	6	C	MTP477*006P1C	2.0	10.0	1.0	23	-60	+15
10	10	D	MTP106*010P1D	2.0	6.0	21.2	380	-40	+15
33	10	A	MTP336*010P1A	2.0	6.0	8.4	100	-40	+15
100	10	B	MTP107*010P1B	2.0	8.0	2.7	46	-45	+15
120	10	B	MTP127*010P1B	2.0	8.0	2.3	42	-50	+15
300	10	C	MTP307*010P1C	2.0	10.0	1.1	31	-60	+15
330	10	C	MTP337*010P1C	2.0	10.0	1.0	31	-60	+15
22	15	A	MTP226*015P1A	2.0	6	10.8	120	-40	+12
68	15	B	MTP686*015P1B	2.0	8.0	3.7	58	-45	+12
80	15	B	MTP806*015P1B	2.0	8.0	3.4	50	-45	+12
200	15	C	MTP207*015P1C	2.0	10.0	1.4	37	-50	+12
220	15	C	MTP227*015P1C	2.0	10.0	1.4	36	-50	+12
6.8	20	D	MTP685*020P1D	2.0	6.0	27.3	445	-35	+11
15	20	A	MTP156*020P1A	2.0	6.0	14.0	150	-40	+11
47	20	B	MTP476*020P1B	2.0	8.0	5.0	73	-40	+11
60	20	B	MTP606*020P1B	2.0	8.0	4.0	60	-45	+11
150	20	C	MTP157*020P1C	2.0	10.0	1.8	38	-50	+11

Cap (μ F)	Volts DC	Case Size	Catalog Number	Max DCL μ A		Max ESR Ω +25°C	Max Z Ω -55°C	Max Δ C from +25°C	
				+25°C	+85°C			-55°C	+85°C
6	30	D	MTP605*030P1D	2.0	6.0	26.5	459	-40	+10
10	30	A	MTP106*030P1A	2.0	6.0	18.5	200	-35	+10
45	30	B	MTP456*030P1B	2.0	8.0	5.3	80	-35	+10
120	30	C	MTP127*030P1C	2.0	10.0	2.2	42	-45	+10
4.7	35	D	MTP475*035P1D	2.0	6.0	33.8	570	-30	+10
10	35	A	MTP106*035P1A	2.0	6.0	18.5	240	-35	+10
100	35	C	MTP107*035P1C	2.0	10.0	2.2	48	-45	+10
4	50	D	MTP405*050P1D	2.0	6.0	33.1	600	-30	+10
6.8	50	A	MTP685*050P1A	2.0	6.0	27.0	310	-30	+10
30	50	B	MTP306*050P1B	2.0	8.0	6.2	120	-30	+10
33	50	B	MTP336*050P1B	2.0	8.0	3.2	120	-30	+10
68	50	C	MTP686*050P1C	2.0	10.0	2.9	54	-40	+10
78	50	C	MTP786*050P1C	2.0	10.0	2.4	52	-40	+10
3.3	60	D	MTP335*060P1D	2.0	6.0	40.2	680	-25	+9
4.7	60	A	MTP475*060P1A	2.0	6.0	39.5	400	-30	+9
6.8	60	A	MTP685*060P1A	2.0	6.0	27.3	367	-30	+9
10	60	B	MTP106*060P1B	2.0	8.0	22.5	217	-35	+9
15	60	B	MTP156*060P1B	2.0	8.0	15.9	174	-35	+9
22	60	B	MTP226*060P1B	2.0	8.0	10.8	140	-30	+9
33	60	C	MTP336*060P1C	2.0	10.0	5.0	75	-35	+9
47	60	C	MTP476*060P1C	2.0	10.0	4.0	62	-40	+9
68	60	C	MTP686*060P1C	2.0	10.0	2.7	51	-40	+9

* Insert Proper Letter Code For Tolerance: M = $\pm 20\%$, K = $\pm 10\%$

Type MTPH Wet Tantalum Capacitors



Wet Tantalum Capacitors

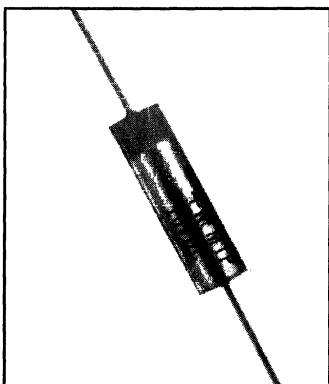

- Maximum CV / Unit Volume
- Ruggedized Construction
- Very Low Dissipation Factor
- Very Low DC Leakage
- 100% "Hot" 85°C DCL Screening
- 100% Voltage Age @ 85°C - 48 Hours
- Quality Assurance Testing on Each Production Lot to MIL-STD-202
- Accelerated Life: .65%/AQL
- Recorded Available Test Data
- Reliability: 0.1%/1000 Hrs.

GENERAL SPECIFICATIONS

Operating Temperature:
-55°C to +85°C

Voltage Range:
6 to 60VDC

Reverse Voltage:
None

Capacitance Range:
4.7 μ F to 470 μ F

Tolerance Range:
 \pm 10%, \pm 20%

DC Leakage:
At +25°C - 2.0 μ A max
At +85°C - 6.0 to 10.0 μ A max

Max RMS Ripple Current @ 85°C:
Case Code: A B C
Milliamps: 12.5 50 140

Case Sizes: (Three)
.115 x .403 to .225 x .778

Some Typical Applications

Timing Circuits
Filter Coupling
Energy Storage
By-Pass Circuits

Physical Specifications

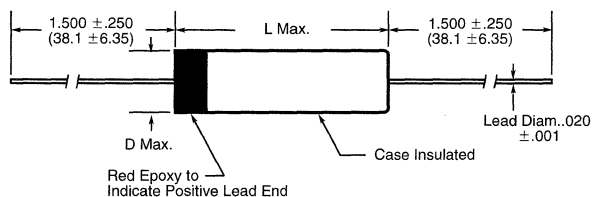

CASE	D INCHES(mm)	L INCHES(mm)	APPROX WT GRAMS
A	.115 (2.92)	.403 (10.23)	0.50
B	.145 (3.68)	.600 (15.24)	1.00
C	.225 (5.72)	.778 (19.76)	2.60

(1 Gram = .035 oz.)

Part Number Nomenclature

- | MTPH | 156 | K | 006 | P | 1 | D |
|------|-----|-----|-----|-----|-----|-----|
| (1) | (2) | (3) | (4) | (5) | (6) | (7) |
- MTPH Series - Sub-miniature/High Reliability
 - Capacitance Code (Expressed in Picofarads)
First 2 digits: Significant Figures
Third digit: Number of zeros (Example: 156 = 15 μ F)
 - Capacitance Tolerance:
M = \pm 20%, K = \pm 10%
 - DC Voltage Rating:
Zeros are used to precede the voltage rating where necessary to complete the three digit block
 - P = Polar
 - 1 = Mylar Sleeve
 - Case Size Code

Cap (μ F)	Volts DC	Case Size	Catalog Number	Max DCL μ A		Max ESR Ω +25°C	Max Z Ω -55°C	Max % Δ C from +25°C	
				+25°C	+85°C			-55°C	+85°C
47	6	A	MTPH476*006P1A	2.0	6.0	6.8	85	-60	+15
150	6	B	MTPH157*006P1B	2.0	8.0	2.2	35	-50	+15
180	6	B	MTPH187*006P1B	2.0	8.0	1.9	32	-50	+15
450	6	C	MTPH457*006P1C	2.0	10.0	1.0	25	-60	+15
470	6	C	MTPH477*006P1C	2.0	10.0	1.0	23	-60	+15
33	10	A	MTPH336*010P1A	2.0	6.0	8.4	100	-40	+15
100	10	B	MTPH107*010P1B	2.0	8.0	2.7	46	-45	+15
120	10	B	MTPH127*010P1B	2.0	8.0	2.3	42	-50	+15
300	10	C	MTPH307*010P1C	2.0	10.0	1.1	31	-60	+15
330	10	C	MTPH337*010P1C	2.0	10.0	1.0	31	-60	+15
22	15	A	MTPH226*015P1A	2.0	6	10.8	120	-40	+12
68	15	B	MTPH686*015P1B	2.0	8.0	3.7	58	-45	+12
80	15	B	MTPH806*015P1B	2.0	8.0	3.4	50	-45	+12
200	15	C	MTPH207*015P1C	2.0	10.0	1.4	37	-50	+12
220	15	C	MTPH227*015P1C	2.0	10.0	1.4	36	-50	+12
15	20	A	MTPH156*020P1A	2.0	6.0	14.0	150	-40	+11
47	20	B	MTPH476*020P1B	2.0	8.0	5.0	73	-40	+11
60	20	B	MTPH606*020P1B	2.0	8.0	4.0	60	-45	+11
150	20	C	MTPH157*020P1C	2.0	10.0	1.8	38	-50	+11

Cap (μ F)	Volts DC	Case Size	Catalog Number	Max DCL μ A		Max ESR Ω +25°C	Max Z Ω -55°C	Max % Δ C from +25°C	
				+25°C	+85°C			-55°C	+85°C
10	30	A	MTPH106*030P1A	2.0	6.0	18.5	200	-35	+10
45	30	B	MTPH456*030P1B	2.0	8.0	5.3	80	-35	+10
120	30	C	MTPH127*030P1C	2.0	10.0	2.2	42	-45	+10
10	35	A	MTPH106*035P1A	2.0	6.0	18.5	240	-35	+10
100	35	C	MTPH107*035P1C	2.0	10.0	2.2	48	-45	+10
6.8	50	A	MTPH685*050P1A	2.0	6.0	27.0	310	-30	+10
30	50	B	MTPH306*050P1B	2.0	8.0	6.2	120	-30	+10
33	50	B	MTPH336*050P1B	2.0	8.0	3.2	120	-30	+10
68	50	C	MTPH686*050P1C	2.0	10.0	2.9	54	-40	+10
78	50	C	MTPH786*050P1C	2.0	10.0	2.4	52	-40	+10
4.7	60	A	MTPH475*060P1A	2.0	6.0	39.5	400	-30	+9
6.8	60	A	MTPH685*060P1A	2.0	6.0	27.3	367	-30	+9
10	60	B	MTPH106*060P1B	2.0	8.0	22.5	217	-35	+9
15	60	B	MTPH156*060P1B	2.0	8.0	15.9	174	-35	+9
22	60	B	MTPH226*060P1B	2.0	8.0	10.8	140	-30	+9
33	60	C	MTPH336*060P1C	2.0	10.0	5.0	75	-35	+9
47	60	C	MTPH476*060P1C	2.0	10.0	4.0	62	-40	+9
68	60	C	MTPH686*060P1C	2.0	10.0	2.7	51	-40	+9

* Insert Proper Letter Code For Tolerance: M = \pm 20%, K = \pm 10%

Type TLS Wet Tantalum Capacitors

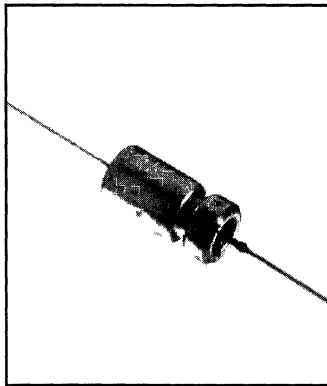

- Silver Case Technology
- High Capacitance per Case Size
- Extremely Low DCL
- Long Operating Life
- Rugged Mechanical Construction
- Wide Operating Temperature Range

GENERAL SPECIFICATIONS

Operating Temperature:
-55°C to +125°C

Voltage Range:
6 to 125 VDC @ 85°C
4 to 85 VDC @ 125°C

Capacitance:
1.7 to 1200 μ F

Tolerance Range:
 \pm 20%, \pm 10%
(\pm 5% on special order)

TYPICAL APPLICATIONS

Filtering, coupling, bypass circuits
Critical timing circuits
Low source impedance circuits
High charging current circuits

Wet Tantalum Capacitors

Physical Specifications

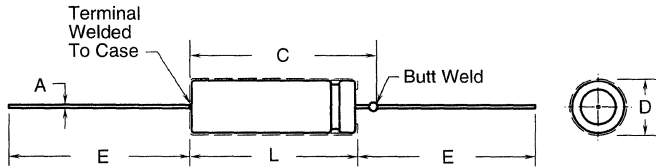

Part Number Nomenclature

TLS 405 K 060 C 1 A
(1) (2) (3) (4) (5) (6) (7)

1. TLS Series - Silver Case/Standard Capacitance Ratings
2. Capacitance Code (Expressed in Picofarads)
First 2 digits: Significant Figures
Third digit: Number of zeros (Example: 405 = 4 μ F)
3. Capacitance Tolerance:
M = \pm 20%, K = \pm 10%, J = \pm 5%
4. DC Voltage Rating:
Zeros are used to precede the voltage rating where necessary to complete the three digit block
5. C = Temp Range
6. 1 = Mylar Sleeve
7. Case Size Code

INCHES

(DIMENSIONS)

MILLIMETERS

Case #	MIL	Uninsulated		Insulated		C	A		E	Approximate Weight (Grams) (1 gram = .035 Oz.)	Case #	MIL	Uninsulated		Insulated		C	A		E
		D	L	D	L		Lead Dia	Lead Lgth					D	L	Lead Dia	Lead Lgth				
A	T1	.188	.453	.219	.608	.734	.025	#22	1.500	1.4	A	T1	4.78	11.51	5.56	15.45	18.64	.64	#22	38.10
B	T2	.281	.641	.312	.796	.922	.025	#22	2.250	3.0	B	T2	7.14	16.28	7.92	20.22	23.41	.64	#22	57.15
C	T3	.375	.766	.406	.921	1.047	.025	#22	2.250	5.6	C	T3	9.53	19.46	10.31	23.40	26.59	.64	#22	57.15
F	T4	.375	1.062	.406	1.217	1.343	.025	#22	2.250	9.2	F	T4	9.53	26.97	10.31	30.91	34.11	.64	#22	57.15

Cap μ F	Case Code	Catalog Number	Max DCL μ A		Max ESR Ω	Max Z Ω	Max % Cap Change From 25°C		
			25°C	85°C/125°C			-55°C	-55°C	+85°C

6 WVDC; 7 VDC Surge @ 85°C
4 WVDC; 4.7 VDC Surge @ 125°C

30	A	TLS306*006C1A	1	2	4.0	100	-40	+10.5	+12
68	A	TLS686*006C1A	1	2	4.3	60	-40	+14	+16
140	B	TLS147*006C1B	1	3	2.0	40	-40	+14	+16
270	B	TLS277*006C1B	1	6.5	4.0	25	-44	+17.5	+20
330	C	TLS337*006C1C	2	7.9	2.0	20	-44	+14	+16
560	C	TLS567*006C1C	2	13	3.0	25	-64	+17.5	+20
1200	F	TLS128*006C1F	3	14	1.5	20	-80	+25	+25

8 WVDC; 9.2 VDC Surge @ 85°C
5 WVDC; 5.7 VDC Surge @ 125°C

25	A	TLS256*008C1A	1	2	4.0	100	40	+10.5	+12
56	A	TLS566*008C1A	1	2	4.0	59	-40	+14	+16
220	B	TLS227*008C1B	1	7	4.0	30	-44	+17.5	+20
430	C	TLS437*008C1C	2	14	2.8	25	-64	+17.5	+20
850	F	TLS857*008C1F	4	16	1.0	22	-80	+25	+25

* Insert Proper Letter Code For Tolerance: M = \pm 20%, K = \pm 10%, J = \pm 5%

Cap μ F	Case Code	Catalog Number	Max DCL μ A		Max ESR Ω	Max Z Ω	Max % Cap Change From 25°C		
			25°C	85°C/125°C			-55°C	-55°C	+85°C

10 WVDC; 11.5 VDC Surge @ 85°C
7 WVDC; 8 VDC Surge @ 125°C

20	A	TLS206*010C1A	1	2	4.0	175	-32	+10.5	+12
47	A	TLS476*010C1A	1	2	5.0	100	-36	+14	+16
100	B	TLS107*010C1B	1	4	2.0	60	-36	+14	+16
180	B	TLS187*010C1B	1	7	3.8	40	-36	+14	+16
250	C	TLS257*010C1C	2	10	2.0	30	-40	+14	+16
390	C	TLS397*010C1C	2	16	2.9	25	-64	+17.5	+20
750	F	TLS757*010C1F	4	16	1.0	23	-80	+25	+25

15 WVDC; 17.2 VDC Surge @ 85°C
10 WVDC; 11.5 VDC Surge @ 125°C

15	A	TLS156*015C1A	1	2	5.0	155	-24	+10.5	+12
33	A	TLS336*015C1A	1	2	5.0	90	-28	+14	+16
70	B	TLS706*015C1B	1	4	2.5	75	-28	+14	+16
120	B	TLS127*015C1B	1	7	4.0	50	-28	+17.5	+20
170	C	TLS177*015C1C	2	10	2.0	35	-32	+14	+16
270	C	TLS277*015C1C	2	16	3.0	30	-56	+17.5	+20
540	F	TLS547*015C1F	6	24	1.2	23	-80	+25	+25

Type TLS Wet Tantalum Capacitors



Wet Tantalum Capacitors

Cap μ F	Case Code	Catalog Number	Max DCL μ A		Max ESR Ω + 25°C	Max Z Ω -55°C	Max % Cap Change From 25°C		
			25°C	85°C			-55°C	+85°C	+125°C
25 WVDC; 28.8 VDC Surge @ 85°C 15 WVDC; 17.2 VDC Surge @ 125°C									
10	A	TLS106*025C1A	1	2	6.0	220	-16	+8	+9
22	A	TLS226*025C1A	1	2	4.8	140	-20	+10.5	+12
100	B	TLS107*025C1B	1	10	4.0	50	-28	+13	+15
180	C	TLS187*025C1C	2	18	3.8	32	-48	+13	+15
350	F	TLS357*025C1F	7	28	1.3	24	-70	+25	+25

Cap μ F	Case Code	Catalog Number	Max DCL μ A		Max ESR Ω + 25°C	Max Z Ω -55°C	Max % Cap Change From 25°C		
			25°C	85°C			-55°C	+85°C	+125°C
30 WVDC; 34.5 VDC Surge @ 85°C 20 WVDC; 23 VDC Surge @ 125°C									
8	A	TLS805*030C1A	1	2	7.5	275	-16	+8	+12
15	A	TLS156*030C1A	1	2	8.0	175	-20	+10.5	+12
40	B	TLS406*030C1B	1	5	4.0	65	-24	+10.5	+12
68	B	TLS686*030C1B	1	8	2.4	60	-24	+13	+15
100	C	TLS107*030C1C	2	12	2.5	40	-28	+10.5	+12
150	C	TLS157*030C1C	2	18	4.0	35	-48	+13	+15
300	F	TLS307*030C1F	8	32	1.5	25	-60	+25	+25

Cap μ F	Case Code	Catalog Number	Max DCL μ A		Max ESR Ω + 25°C	Max Z Ω -55°C	Max % Cap Change From 25°C		
			25°C	85°C			-55°C	+85°C	+125°C
50 WVDC; 57.5 VDC Surge @ 85°C 30 WVDC; 34.5 VDC Surge @ 125°C									
5	A	TLS505*050C1A	1	2	6.0	400	-16	+5	+6
10	A	TLS106*050C1A	1	2	4.0	250	-24	+8	+9
25	B	TLS256*050C1B	1	5	3.0	95	-20	+10.5	+12
47	B	TLS476*050C1B	1	9	3.0	70	-28	+13	+15
60	C	TLS606*050C1C	2	12	2.0	45	-16	+10.5	+12
82	C	TLS826*050C1C	2	16	3.0	45	-32	+13	+15
160	F	TLS167*050C1F	8	32	2.0	27	-50	+25	+25

Cap μ F	Case Code	Catalog Number	Max DCL μ A		Max ESR Ω + 25°C	Max Z Ω -55°C	Max % Cap Change From 25°C		
			25°C	85°C			-55°C	+85°C	+125°C
60 WVDC; 69 VDC Surge @ 85°C 40 WVDC; 46 VDC Surge @ 125°C									
4	A	TLS405*060C1A	1	2	8.0	550	-16	+5	+6
8.2	A	TLS825*060C1A	1	2	5.0	275	-24	+8	+9
20	B	TLS206*060C1B	1	5	3.0	105	-16	+10.5	+12
39	B	TLS396*060C1B	1	9	4.0	90	-28	+10.5	+12
50	C	TLS506*060C1C	2	12	2.0	50	-16	+10.5	+12
68	C	TLS686*060C1C	2	16	3.0	50	-32	+10.5	+12
140	F	TLS147*060C1F	8	32	2.4	28	-40	+20	+20

Cap μ F	Case Code	Catalog Number	Max DCL μ A		Max ESR Ω + 25°C	Max Z Ω -55°C	Max % Cap Change From 25°C		
			25°C	85°C			-55°C	+85°C	+125°C
75 WVDC; 86.2VDC Surge @ 85°C 50 WVDC; 57.5 VDC Surge @ 125°C									
3.5	A	TLS355*075C1A	1	2	8.0	650	-16	+5	+6
6.8	A	TLS685*075C1A	1	2	5.0	300	-20	+8	+9
15	B	TLS156*075C1B	1	5	3.0	150	-16	+8	+9
33	B	TLS336*075C1B	1	10	4.0	90	-24	+10.5	+15
40	C	TLS406*075C1C	2	12	2.0	60	-16	+10.5	+12
56	C	TLS566*075C1C	2	17	4.0	60	-28	+10.5	+15
110	F	TLS117*075C1F	9	36	2.6	29	-35	+20	+20

Cap μ F	Case Code	Catalog Number	Max DCL μ A		Max ESR Ω + 25°C	Max Z Ω -55°C	Max % Cap Change From 25°C		
			25°C	85°C			-55°C	+85°C	+125°C
100 WVDC; 115 VDC Surge @ 85°C 65 WVDC; 74.8 VDC Surge @ 125°C									
2.5	A	TLS255*100C1A	1	2	12.0	950	-16	+7	+8
4.7	A	TLS475*100C1A	1	2	6.0	500	-16	+7	+8
11	B	TLS116*100C1B	1	4	4.0	200	-16	+7	+8
22	B	TLS226*100C1B	1	9	4.0	100	-16	+7	+8
30	C	TLS306*100C1C	2	12	3.0	80	-16	+7	+8
43	C	TLS436*100C1C	2	17	4.0	70	-20	+7	+8
86	F	TLS866*100C1F	9	36	3.0	30	-25	+15	+15

Cap μ F	Case Code	Catalog Number	Max DCL μ A		Max ESR Ω + 25°C	Max Z Ω -55°C	Max % Cap Change From 25°C		
			25°C	85°C			-55°C	+85°C	+125°C
125 WVDC; 144 VDC Surge @ 85°C 85 WVDC; 97.8 VDC Surge @ 125°C									
1.7	A	TLS175*125C1A	1	2	14.0	1250	-16	+7	+8
3.6	A	TLS365*125C1A	1	2	8.0	600	-16	+7	+8
9	B	TLS905*125C1B	1	5	5.0	240	-16	+7	+8
14	B	TLS146*125C1B	1	7	6.0	167	-16	+7	+8
18	C	TLS186*125C1C	2	9	3.0	129	-16	+7	+8
25	C	TLS256*125C1C	2	13	5.0	93	-16	+7	+8
56	F	TLS566*125C1F	10	40	4.0	32	-25	+15	+15

* Insert Proper Letter Code For Tolerance: M = \pm 20%, K = \pm 10%, J = \pm 5%

Type TLH Wet Tantalum Capacitors

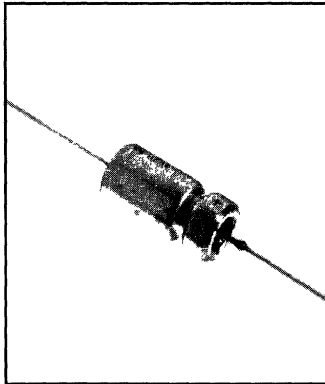

- Silver Case Technology
- Extended Capacitance Range
- Extremely Low DCL
- Long Operating Life
- Rugged Mechanical Construction
- Wide Operating Temperature Range

GENERAL SPECIFICATIONS

Operating Temperature:
-55°C to +125°C

Voltage Range:
6 to 75 VDC @ 85°C
4 to 50 VDC @ 125°C

Capacitance:
22 to 2200 μ F

Tolerance Range:
 \pm 20%, \pm 10%
(\pm 5% on special order)

TYPICAL APPLICATIONS

Filtering, coupling, bypass circuits
Critical timing circuits
Low source impedance circuits
High charging current circuits

Wet Tantalum Capacitors

Physical Specifications

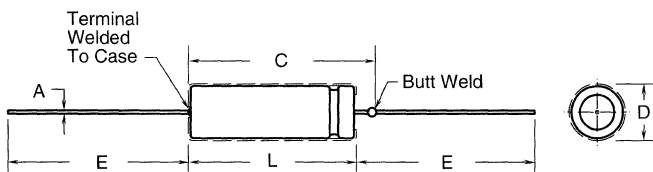

Part Number Nomenclature

TLH **276** **K** **060** **C** **1** **A**
(1) (2) (3) (4) (5) (6) (7)

1. TLH Series - Silver Case/Extended Capacitance Ratings
2. Capacitance Code (Expressed in Picofarads)
First 2 digits: Significant Figures
Third digit: Number of zeros (Example: 276 = 27 μ F)
3. Capacitance Tolerance:
M = \pm 20%, K = \pm 10%, J = \pm 5%
4. DC Voltage Rating:
Zeros are used to precede the voltage rating where necessary to complete the three digit block
5. C = Temp Range
6. 1 = Mylar Sleeve
7. Case Size Code

INCHES

(DIMENSIONS)

MILLIMETERS

Case #	MIL	Uninsulated		Insulated		C	A Lead Dia Nom	E Lead Lgth \pm .250	Approximate Weight (Grams) (1 gram = .035 Oz.)	Case #	MIL	Uninsulated		Insulated		C	A Lead Dia Nom	E Lead Lgth \pm 6.35
		D	L	D	L							D	L	D	L			
A	T1	.188	.453	.219	.608	.734	.025 #22	1.500	1.4	A	T1	4.78	11.51	5.56	15.45	18.64	.64 #22	38.10
B	T2	.281	.641	.312	.796	.922	.025 #22	2.250	4.2	B	T2	7.14	16.28	7.92	20.22	23.41	.64 #22	57.15
C	T3	.375	.766	.406	.921	1.047	.025 #22	2.250	7.4	C	T3	9.53	19.46	10.31	23.40	26.59	.64 #22	57.15
F	T4	.375	1.062	.406	1.217	1.343	.025 #22	2.250	7.8	F	T4	9.53	26.97	10.31	30.91	34.11	.64 #22	57.15

Cap μ F	Case Code	Catalog Number	Max DCL μ A		Max ESR Ω +25°C	Max Z Ω -55°C	Max % Cap Change From 25°C		
			25°C	85°C/125°C			-55°C	-55°C	+85°C
6 WVDC; 7 VDC Surge @ 85°C 4 WVDC; 4.7 VDC Surge @ 125°C									
220	A	TLH227*006C1A	3	9	3.2	36	-64	+18	+21
820	B	TLH827*006C1B	5	14	2.5	18	-88	+18	+21
1500	C	TLH158*006C1C	6	20	1.5	18	-90	+20	+25
2200	F	TLH228*006C1F	8	24	1.1	13	-90	+25	+30

Cap μ F	Case Code	Catalog Number	Max DCL μ A		Max ESR Ω +25°C	Max Z Ω -55°C	Max % Cap Change From 25°C		
			25°C	85°C/125°C			-55°C	-55°C	+85°C
8 WVDC; 9.2 VDC Surge @ 85°C 5 WVDC; 5.7 VDC Surge @ 125°C									
180	A	TLH187*008C1A	3	9	3.3	45	-60	+16	+20
680	B	TLH687*008C1B	5	14	2.2	22	-83	+18	+21
1500	C	TLH158*008C1C	6	20	1.5	18	-90	+20	+25
1800	F	TLH188*008C1F	8	25	1.0	14	-90	+25	+30

Cap μ F	Case Code	Catalog Number	Max DCL μ A		Max ESR Ω +25°C	Max Z Ω -55°C	Max % Cap Change From 25°C		
			25°C	85°C/125°C			-55°C	-55°C	+85°C
10 WVDC; 11.5 VDC Surge @ 85°C 7 WVDC; 8 VDC Surge @ 125°C									
150	A	TLH157*010C1A	3	9	3.1	54	-55	+16	+20
560	B	TLH567*010C1B	5	16	2.4	27	-77	+18	+21
1200	C	TLH128*010C1C	6	20	1.5	18	-88	+20	+25
1500	F	TLH158*010C1F	8	25	1.0	15	-88	+25	+30

Cap μ F	Case Code	Catalog Number	Max DCL μ A		Max ESR Ω +25°C	Max Z Ω -55°C	Max % Cap Change From 25°C		
			25°C	85°C/125°C			-55°C	-55°C	+85°C
15 WVDC; 17.2 VDC Surge @ 85°C 10 WVDC; 11.5 VDC Surge @ 125°C									
100	A	TLH107*015C1A	3	9	4.0	72	-44	+13	+16
390	B	TLH397*015C1B	5	16	2.4	31	-66	+16	+20
820	C	TLH827*015C1C	6	24	1.7	22	-77	+20	+25
1000	F	TLH108*015C1F	8	32	1.2	17	-77	+25	+30

* Insert Proper Letter Code For Tolerance: M = \pm 20%, K = \pm 10%, J = \pm 5%

Type TLH Wet Tantalum Capacitors



Wet Tantalum Capacitors

Cap μ F	Case Code	Catalog Number	Max DCL μ A		Max ESR Ω	Max Z Ω	Max % Cap. Change From 25°C		
			25°C	85°C/ 125°C			+25°C	-55°C	+85°C
25 WVDC; 28.8 VDC Surge @ 85°C 15 WVDC; 17.2 VDC Surge @ 125°C									
68	A	TLH686*025C1A	3	9	4.1	90	-40	+13	+16
270	B	TLH277*025C1B	5	16	2.6	33	-62	+13	+16
560	C	TLH567*025C1C	7	28	1.8	24	-72	+20	+25
680	F	TLH687*025C1F	8	32	1.2	19	-72	+25	+30

Cap μ F	Case Code	Catalog Number	Max DCL μ A		Max ESR Ω	Max Z Ω	Max % Cap. Change From 25°C		
			25°C	85°C/ 125°C			+25°C	-55°C	+85°C
30 WVDC; 34.5 VDC Surge @ 85°C 20 WVDC; 23 VDC Surge @ 125°C									
56	A	TLH566*030C1A	3	9	5.0	100	-38	+12	+15
220	B	TLH227*030C1B	5	16	2.5	36	-60	+13	+16
470	C	TLH477*030C1C	8	32	1.9	25	-65	+20	+25
560	F	TLH567*030C1F	9	36	1.3	20	-65	+25	+30

Cap μ F	Case Code	Catalog Number	Max DCL μ A		Max ESR Ω	Max Z Ω	Max % Cap. Change From 25°C		
			25°C	85°C/ 125°C			+25°C	-55°C	+85°C
50 WVDC; 57.5 VDC Surge @ 85°C 30 WVDC; 34.5 VDC Surge @ 125°C									
33	A	TLH336*050C1A	3	9	5.0	135	-29	+10	+12
120	B	TLH127*050C1B	5	24	2.5	49	-42	+12	+15
270	C	TLH277*050C1C	8	32	1.8	29	-46	+20	+25
330	F	TLH337*050C1F	9	36	1.2	22	-46	+25	+30

* Insert Proper Letter Code For Tolerance: M = \pm 20%, K = \pm 10%, J = \pm 5%

Cap μ F	Case Code	Catalog Number	Max DCL μ A		Max ESR Ω	Max Z Ω	Max % Cap. Change From 25°C		
			25°C	85°C/ 125°C			+25°C	-55°C	+85°C
60 WVDC; 69 VDC Surge @ 85°C 40 WVDC; 46 VDC Surge @ 125°C									
27	A	TLH276*060C1A	3	12	5.0	144	-24	+10	+12
100	B	TLH107*060C1B	5	20	2.5	54	-36	+12	+15
220	C	TLH227*060C1C	8	32	1.8	29	-40	+16	+20
270	F	TLH277*060C1F	9	36	1.2	23	-45	+20	+25

Cap μ F	Case Code	Catalog Number	Max DCL μ A		Max ESR Ω	Max Z Ω	Max % Cap. Change From 25°C		
			25°C	85°C/ 125°C			+25°C	-55°C	+85°C
75 WVDC; 86.2 VDC Surge @ 85°C 50 WVDC; 57.5 VDC Surge @ 125°C									
22	A	TLH226*075C1A	3	12	5.0	157	-19	+10	+12
82	B	TLH826*075C1B	5	24	2.3	63	-30	+12	+15
180	C	TLH187*075C1C	9	36	1.8	30	-35	+16	+20
220	F	TLH227*075C1F	10	40	2.2	24	-40	+20	+25

Type TLW Wet Tantalum Capacitors

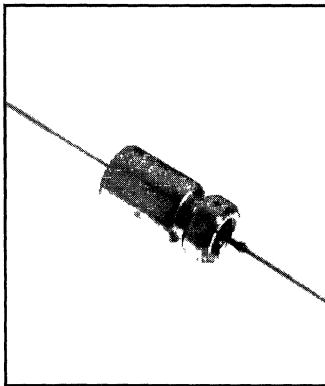

- 175°C Operation
- Silver Case Technology
- MIL-C-39006/09 Designs
- Hermetically Sealed
- Rugged Construction
- High Shock and Vibration Capability
- High Capacitance per Case Size
- Low DCL and ESR
- Long Shelf Life

GENERAL SPECIFICATIONS

Operating Temperature:
-55°C to +175°C
with proper derating

Voltage Range:
6 to 125 VDC @ 85°C

Capacitance Range:
1.7 μ F to 1200 μ F

Tolerance Range:
 \pm 10%, \pm 20%
(\pm 5% by special order)

Case Sizes: (Four)
188 x .453 to .375 x 1.062

TYPICAL APPLICATIONS

Filtering, bypass circuits
Coupling and timing circuits
Low source impedance circuits
High charging current circuits

Maximum rms Ripple Current @ 85°C

Case Code	mA
A	50
B	250
C	500
F	750

Physical Specifications

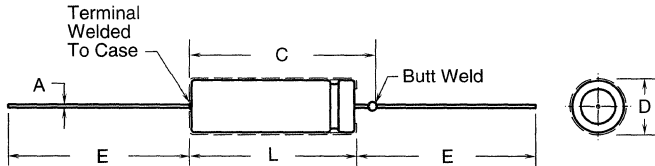

Part Number Nomenclature

TLW 107 K 010 P 6 A
(1) (2) (3) (4) (5) (6) (7)

- TLW Series - Silver Case/High Temperature Capability
- Capacitance Code (Expressed in Picofarads)
First 2 digits: Significant Figures
Third digit: Number of zeros (Example: 107 = 100 μ F)
- Capacitance Tolerance:
M = \pm 20%, K = \pm 10%, J = \pm 5%
- DC Voltage Rating:
Zeros are used to precede the voltage rating where necessary to complete the three digit block
- P = Polar
- 6 = Kapton Sleeve
- Case Size Code

INCHES (DIMENSIONS) MILLIMETERS

Case #	MIL	Uninsulated		Insulated		C	A		E	Approximate Weight (Grams) (1 gram = .035 Oz.)	Case #	MIL	Uninsulated		Insulated		C	A		E
		D	L	D	L		Lead Dia	Lead Lgth					D	L	Lead Dia	Lead Lgth				
A	T1	.188	.453	.219	.608	.734	.025	#22	1.500	2.7	A	T1	4.78	11.51	5.56	15.45	18.64	.64	#22	38.10
B	T2	.281	.641	.312	.796	.922	.025	#22	2.250	6.5	B	T2	7.14	16.28	7.92	20.22	23.41	.64	#22	57.15
C	T3	.375	.766	.406	.921	1.047	.025	#22	2.250	12.0	C	T3	9.53	19.46	10.31	23.40	26.59	.64	#22	57.15
F	T4	.375	1.062	.406	1.217	1.343	.025	#22	2.250	18.0	F	T4	9.53	26.97	10.31	30.91	34.11	.64	#22	57.15

Cap μ F	Case Code	Catalog Number	Max DCL μ A			Max Z Ω	Max % Cap Change from 25°C	
			25°C	125°C	175°C		-55°C	85°C
6 WVDC @ 85°C 4 WVDC @ 125°C; 3 WVDC @ 175°C								
30	A	TLW306*006P6A	1.0	2.0	5.8	100	+10.5	+12
68	A	TLW686*006P6A	1.0	2.0	13.0	60	+14	+16
140	A	TLW147*006P6A	1.0	3.0	27.0	40	+14	+16
270	B	TLW277*006P6B	1.0	6.5	52.0	25	+17.5	+20
330	C	TLW337*006P6C	2.0	7.9	70.0	20	+14	+16
560	C	TLW567*006P6C	2.0	13.0	110.0	25	+17.5	+20
1000	C	TLW108*006P6C	3.0	14.0	200.0	20	+20	+20
1200	F	TLW128*006P6F	3.0	14.0	230.0	20	+25	+25

Cap μ F	Case Code	Catalog Number	Max DCL μ A			Max Z Ω	Max % Cap Change from 25°C	
			25°C	125°C	175°C		-55°C	85°C
8 WVDC @ 85°C 5 WVDC @ 125°C; 4 WVDC @ 175°C								
25	A	TLW256*008P6A	1.0	2.0	6.4	100	+10.5	+12
56	A	TLW566*008P6A	1.0	2.0	14.0	59	+14	+16
120	A	TLW127*008P6A	1.0	4.0	30.0	50	+14	+16
220	B	TLW227*008P6B	1.0	7.0	56.0	30	+17.5	+20
430	B	TLW437*008P6B	2.0	14.0	110.0	25	+17.5	+20
850	C	TLW857*008P6C	4.0	16.0	218.0	22	+25	+25
1000	F	TLW108*008P6F	4.0	16.0	250.0	16	+25	+25

Cap μ F	Case Code	Catalog Number	Max DCL μ A			Max Z Ω	Max % Cap Change from 25°C	
			25°C	125°C	175°C		-55°C	85°C
10 WVDC @ 85°C 7 WVDC @ 125°C; 5 WVDC @ 175°C								
20	A	TLW206*010P6A	1.0	2.0	6.4	175	+10.5	+12
39	A	TLW396*010P6A	1.0	2.0	12.0	80	+12	+15
47	A	TLW476*010P6A	1.0	2.0	15.0	100	+14	+16
82	A	TLW826*010P6A	1.0	2.0	26.0	70	+14	+16
100	A	TLW107*010P6A	1.0	4.0	32.0	60	+14	+16
180	B	TLW187*010P6B	1.0	7.0	58.0	40	+14	+16
250	B	TLW257*010P6B	2.0	10.0	80.0	30	+14	+16
390	B	TLW397*010P6B	2.0	16.0	120.0	25	+17.5	+20
600	C	TLW607*010P6C	5.0	16.0	150.0	20	+20	+25
680	F	TLW687*010P6F	4.0	16.0	175.0	18	+20	+25
750	C	TLW757*010P6C	4.0	16.0	210.0	23	+20	+25
820	F	TLW827*010P6F	4.0	16.0	240.0	17	+20	+25

* Insert Proper Letter Code For Tolerance: M = \pm 20%, K = \pm 10%, J = \pm 5%

Type TLW Wet Tantalum Capacitors



Wet Tantalum Capacitors

Cap μF	Case Code	Catalog Number	Max DCL μA			Max Z Ω	Max % Cap Change from 25°C	
			25°C	125°C	175°C		-55°C	85°C
15 WVDC @ 85°C 10 WVDC @ 125°C; 8 WVDC @ 175°C								
15	A	TLW156*015P6A	1.0	2.0	7.2	155	+10.5	+12
33	A	TLW336*015P6A	1.0	2.0	16.0	90	+14	+16
55	B	TLW556*015P6B	1.0	4.0	17.0	90	+14	+16
68	A	TLW686*015P6A	1.0	4.0	34.0	80	+14	+16
70	B	TLW706*015P6B	1.0	4.0	34.0	75	+14	+16
120	B	TLW127*015P6B	2.0	7.0	58.0	50	+17.5	+20
170	C	TLW177*015P6C	2.0	10.0	82.0	35	+14	+16
270	C	TLW277*015P6C	2.0	16.0	130.0	30	+17.5	+20
540	C	TLW547*015P6C	6.0	24.0	260.0	23	+20	+25
560	F	TLW567*015P6F	6.0	24.0	270.0	19	+20	+25

Cap μF	Case Code	Catalog Number	Max DCL μA			Max Z Ω	Max % Cap Change from 25°C	
			25°C	125°C	175°C		-55°C	85°C
20 WVDC @ 85°C 13 WVDC @ 125°C; 10 WVDC @ 175°C								
27	A	TLW276*020P6A	1.0	2.0	25.0	100	+11	+14
56	A	TLW566*020P6A	2.0	9.0	55.0	90	+13	+16
100	B	TLW107*020P6B	1.0	7.0	96.0	50	+12	+15
170	B	TLW177*020P6B	2.0	16.0	150.0	35	+17.5	+20
220	B	TLW227*020P6B	3.0	16.0	220.0	35	+16	+20
390	C	TLW397*020P6C	6.0	24.0	350.0	25	+20	+25
470	F	TLW477*020P6F	6.0	24.0	450.0	20	+20	+25

Cap μF	Case Code	Catalog Number	Max DCL μA			Max Z Ω	Max % Cap Change from 25°C	
			25°C	125°C	175°C		-55°C	85°C
25 WVDC @ 85°C 15 WVDC @ 125°C; 13 WVDC @ 175°C								
10	A	TLW106*025P6A	1.0	2.0	8.0	220	+8	+9
22	A	TLW226*025P6A	1.0	2.0	18.0	140	+10.5	+12
47	A	TLW476*025P6A	1.0	4.0	38.0	100	+14	+16
50	B	TLW506*025P6B	1.0	4.0	38.0	100	+14	+16
100	B	TLW107*025P6B	1.0	10.0	80.0	50	+13	+15
180	B	TLW187*025P6B	2.0	18.0	140.0	32	+13	+15
350	C	TLW357*025P6C	7.0	28.0	280.0	24	+25	+25
390	F	TLW397*025P6F	7.0	28.0	312.0	21	+25	+25

Cap μF	Case Code	Catalog Number	Max DCL μA			Max Z Ω	Max % Cap Change from 25°C	
			25°C	125°C	175°C		-55°C	85°C
30 WVDC @ 85°C 20 WVDC @ 125°C; 15 WVDC @ 175°C								
18	A	TLW186*030P6A	1.0	2.0	8.0	130	+10.5	+20
39	A	TLW396*030P6A	1.0	5.0	37.0	110	+16	+20
40	B	TLW406*030P6B	1.0	5.0	38.0	65	+16	+20
68	B	TLW686*030P6B	1.0	8.0	65.0	60	+13	+20
100	C	TLW107*030P6C	2.0	12.0	96.0	40	+10.5	+20
150	C	TLW157*030P6C	2.0	18.0	140.0	35	+13	+20
300	C	TLW307*030P6C	8.0	32.0	290.0	25	+20	+20
330	F	TLW337*030P6F	8.0	32.0	320.0	40	+20	+20

Cap μF	Case Code	Catalog Number	Max DCL μA			Max Z Ω	Max % Cap Change from 25°C	
			25°C	125°C	175°C		-55°C	85°C
35 WVDC @ 85°C 23 WVDC @ 125°C; 18 WVDC @ 175°C								
12	A	TLW126*035P6A	1.0	2.0	13.0	175	+10.5	+20
15	A	TLW156*035P6A	1.0	7.0	17.0	170	+10.5	+20
27	A	TLW276*035P6A	2.0	9.0	30.0	150	+10.5	+20
33	A	TLW336*035P6A	2.0	9.0	37.0	130	+12	+20
56	B	TLW566*035P6B	1.0	7.0	63.0	60	+12	+20
68	B	TLW686*035P6B	1.0	7.0	76.0	60	+13	+20
100	C	TLW107*035P6C	3.0	16.0	110.0	50	+10.5	+20
120	B	TLW127*035P6B	3.0	16.0	135.0	45	+11	+20
180	C	TLW187*035P6C	8.0	32.0	200.0	30	+20	+20
220	F	TLW227*035P6F	8.0	32.0	250.0	25	+20	+20
270	F	TLW277*035P6F	8.0	32.0	300.0	23	+20	+20

* Insert Proper Letter Code For Tolerance: M = ±20%, K = ±10%, J = ±5%

Cap μF	Case Code	Catalog Number	Max DCL μA			Max Z Ω	Max % Cap Change from 25°C	
			25°C	125°C	175°C		-55°C	85°C
50 WVDC @ 85°C 30 WVDC @ 125°C; 25 WVDC @ 175°C								
10	A	TLW106*050P6A	1.0	2.0	16.0	250	+8	+20
22	A	TLW226*050P6A	1.0	5.0	35.0	200	+14	+20
25	B	TLW256*050P6B	1.0	5.0	40.0	95	+10.5	+20
47	B	TLW476*050P6B	1.0	9.0	75.0	70	+13	+20
82	C	TLW826*050P6C	2.0	16.0	130.0	45	+13	+20
160	C	TLW167*050P6C	8.0	32.0	260.0	27	+20	+20
180	F	TLW186*050P6F	8.0	32.0	260.0	25	+20	+20

Cap μF	Case Code	Catalog Number	Max DCL μA			Max Z Ω	Max % Cap Change from 25°C	
			25°C	125°C	175°C		-55°C	85°C
60 WVDC @ 85°C 40 WVDC @ 125°C; 30 WVDC @ 175°C								
8.2	A	TLW825*060P6A	1.0	2.0	16.0	275	+8	+20
18	A	TLW186*060P6A	1.0	6.0	35.0	245	+12	+20
39	B	TLW396*060P6B	1.0	9.0	75.0	90	+10.5	+20
68	C	TLW686*060P6C	2.0	16.0	130.0	50	+10.5	+20
140	C	TLW147*060P6C	3.0	25.0	270.0	55	+16	+20
150	F	TLW157*060P6F	8.0	32.0	290.0	45	+16	+20

Cap μF	Case Code	Catalog Number	Max DCL μA			Max Z Ω	Max % Cap Change from 25°C	
			25°C	125°C	175°C		-55°C	85°C
75 WVDC @ 85°C 50 WVDC @ 125°C; 38 WVDC @ 175°C								
5.6	A	TLW565*075P6A	1.0	2.0	14.0	320	+8	+20
6.8	A	TLW685*075P6A	1.0	2.0	16.0	300	+8	+20
12	A	TLW126*075P6A	1.0	5.0	28.0	200	+8	+20
15	B	TLW156*075P6B	1.0	5.0	36.0	175	+8	+20
27	B	TLW276*075P6B	1.0	10.0	52.0	95	+8	+20
33	B	TLW336*075P6B	1.0	10.0	79.0	75	+10.5	+20
47	B	TLW476*075P6B	2.0	16.0	115.0	60	+10.5	+20
56	B	TLW566*075P6B	2.0	17.0	130.0	55	+10.5	+20
82	C	TLW826*075P6C	9.0	36.0	200.0	50	+12	+20
100	F	TLW107*075P6F	9.0	36.0	240.0	35	+12	+20
110	C	TLW117*075P6C	9.0	36.0	260.0	33	+20	+20
120	F	TLW127*075P6F	3.0	25.0	290.0	27	+16	+20

Cap μF	Case Code	Catalog Number	Max DCL μA			Max Z Ω	Max % Cap Change from 25°C	
			25°C	125°C	175°C		-55°C	85°C
100 WVDC @ 85°C 65 WVDC @ 125°C; 50 WVDC @ 175°C								
2.5	A	TLW255*100P6A	1.0	2.0	8.0	950	+7	+20
3.9	A	TLW395*100P6A	1.0	2.0	12.0	600	+7	+20
4.7	A	TLW475*100P6A	1.0	2.0	15.0	500	+7	+20
10	B	TLW106*100P6B	1.0	4.0	32.0	200	+7	+20
11	B	TLW116*100P6B	1.0	4.0	35.0	200	+7	+20
15	B	TLW156*100P6B	1.0	7.0	48.0	135	+7	+20
18	B	TLW186*100P6B	1.0	5.0	57.0	110	+7	+20
22	B	TLW226*100P6B	1.0	5.0	70.0	100	+7	+20
25	B	TLW256*100P6B	2.0	13.0	80.0	150	+8	+20
33	C	TLW336*100P6C	2.0	16.0	106.0	80	+7	+20
43	C	TLW436*100P6C	2.0	16.0	140.0	70	+7	+20
68	F	TLW686*100P6F	9.0	36.0	215.0	30	+15	+20
86	F	TLW866*100P6F	9.0	36.0	280.0	30	+15	+20

Cap μF	Case Code	Catalog Number	Max DCL μA			Max Z Ω	Max % Cap Change from 25°C	
			25°C	125°C	175°C		-55°C	85°C
125 WVDC @ 85°C 85 WVDC @ 125°C; 62 WVDC @ 175°C								
1.7	A	TLW175*125P6A	1.0	2.0	7.0	1240	+7	+20
3.6	A	TLW365*125P6A	1.0	2.0	14.0	600	+7	+20
9.0	B	TLW905*125P6B	1.0	5.0	36.0	240	+7	+20
14	B	TLW146*125P6B	1.0	7.0	56.0	167	+7	+20
18	C	TLW186*125P6C	2.0	9.0	72.0	129	+7	+20
25	C	TLW256*125P6C	2.0	13.0	100.0	93	+7	+20
56	F	TLW566*125P6F	10.0	40.0	220.0	32	+15	+20

Types XTH - K - L - M - V Wet Tantalum Capacitors

MALLORY

Wet Tantalum Capacitors

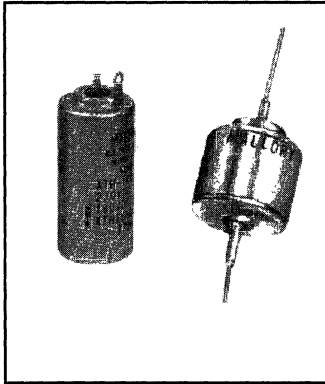

- High Temperature
- High Voltage
- High Capacitance
- Withstands High Frequency Vibration to 2000 Hz
- Hermetically Sealed
- Long Shelf Life

GENERAL SPECIFICATIONS

Operating Temperature:
-55°C to +175°C
with proper derating

Voltage Range:
8 to 900 VDC @ 85°C

Reverse Voltage:
None

Capacitance Range:
2 μF to 2200 μF

Tolerance Range:
-15 +50% (Standard for XTK, M, V)
-15 +75% (Standard for XTH, L)
±20% (Special order)

Case Sizes:

Type	D	H
XTK - XTM	.656	.438 to 1.781
XTL - XTH	.875	.540 to 4.062
XTV	1.125	.600 to 2.810

Note: Photo of XTH-L-V shown with optional solder lug (Configuration C) available as special order. Other configurations also available. See pages 14-15.

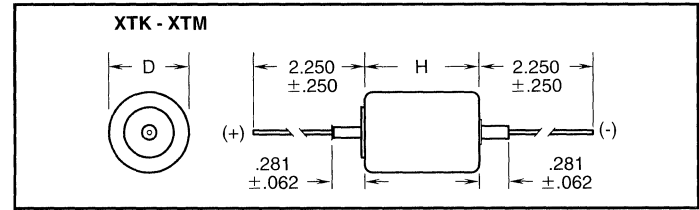
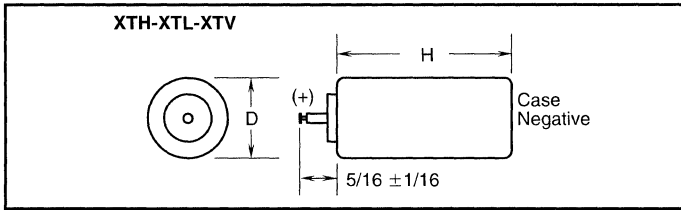

Capacitance (μF)	Maximum Working Voltage		Typical ESR (Ohms)	Maximum DCL @ Maximum WVDC in μA			Max Z 85°C (Ohms)	Maximum % Capacitance Change from Room Temperature			Approx Weight (Grams)	Max Ripple 120 Hz RMS -55°C to +175°C (mA)	Size		Catalog Number
	+125°C	+175°C		+85°C	+125°C	+175°C		-55°C	+85°C	+175°C			D	H	
8 WVDC @ 85°C															
70	7	5	10.0	30	45	60	60	-60	+30	+30	14	137	.656	.438	XTK706*008P0A
140	7	5	5.0	50	75	100	30	-60	+30	+30	15	213	.656	.562	XTM147*008P0A
10 WVDC @ 85°C															
50	8.5	7	10.0	25	37	50	75	-60	+30	+30	14	137	.656	.438	XTK506*010P0A
100	8.5	7	5.0	45	67	90	40	-60	+30	+30	15	213	.656	.562	XTM107*010P0A
12 WVDC @ 85°C															
580	10	8	1.5	135	197	270	20	-90	+20	+35	48	550	1.125	.600	XTV587*012P0A
850	10	8	1.5	135	197	270	20	-90	+20	+35	50	550	1.125	.600	XTV857*012P0A
1100	10	8	1.5	135	197	270	20	-90	+20	+35	60	694	1.125	1.100	XTV118*012P0A
2200	10	8	1.5	135	197	270	20	-90	+20	+35	82	694	1.125	1.100	XTV228*012P0A
18 WVDC @ 85°C															
35	15	12	10.0	30	45	60	85	-60	+30	+30	14	137	.656	.438	XTK356*018P0A
70	15	12	5.0	50	75	100	45	-60	+30	+30	15	213	.656	.562	XTM706*018P0A
120	15	12	2.8	50	75	100	30	-60	+15	+40	26	328	.875	.540	XTL127*018P0A
240	15	12	2.5	80	120	160	20	-60	+15	+40	32	390	.875	.732	XTH247*018P0A
390	15	12	1.5	165	227	330	20	-85	+20	+35	48	550	1.125	.600	XTV397*018P0A
560	15	12	1.5	165	227	330	20	-85	+20	+35	50	550	1.125	.600	XTV567*018P0A
900	15	12	1.5	165	227	330	20	-85	+20	+35	68	694	1.125	1.100	XTV907*018P0A
1800	15	12	1.5	165	227	330	20	-85	+20	+35	82	694	1.125	1.100	XTV188*018P0A
20 WVDC @ 85°C															
28	17.5	13	10.0	30	45	60	85	-60	+30	+30	14	137	.656	.438	XTK286*020P0A
56	17.5	13	5.0	50	75	100	45	-60	+30	+30	15	213	.656	.562	XTM566*020P0A
100	17.5	13	2.8	50	75	100	30	-60	+15	+40	26	328	.875	.540	XTL107*020P0A
200	17.5	13	2.5	80	120	160	20	-60	+15	+40	32	390	.875	.732	XTH207*020P0A
30 WVDC @ 85°C															
20	25	20	10.0	35	52	70	125	-40	+20	+20	14	137	.656	.438	XTK206*030P0A
40	25	20	5.0	60	90	120	75	-40	+20	+20	15	213	.656	.562	XTM406*030P0A
75	25	20	2.7	55	82	110	45	-45	+15	+30	26	333	.875	.540	XTL756*030P0A
150	25	20	2.7	90	135	180	30	-45	+15	+30	32	375	.875	.732	XTH157*030P0A
250	25	20	2.5	195	287	390	20	-65	+20	+35	48	427	1.125	.600	XTV257*030P0A
370	25	20	1.5	125	170	215	15	-65	+20	+35	50	550	1.125	.600	XTV377*030P0A
650	25	20	1.5	145	202	250	15	-85	+20	+35	68	694	1.125	1.100	XTV657*030P0A
1300	25	20	1.5	190	282	375	10	-85	+20	+35	82	694	1.125	1.100	XTV138*030P0A

*Insert Tolerance Code: T = -15+50% (Standard for XTK, XTM, XTV)
 U = -15+75% (Standard for XTH, XTL)
 M = ±20% (Available by Special Order)

Types XTH - K - L - M - V Wet Tantalum Capacitors



Wet Tantalum Capacitors

Capacitance (μ F)	Maximum Working Voltage		Typical ESR (Ohms)	Maximum DCL @ Maximum WVDC in μ A			Max Z 85°C (Ohms)	Maximum % Capacitance Change from Room Temperature			Approx Weight (Grams)	Max Ripple 120 Hz RMS -55°C to +175°C (mA)	Size		Catalog Number
	+125°C	+175°C		+85°C	+125°C	+175°C		-55°C	+85°C	+175°C			D + .031 - .015	H + .062 - .062	
35 WVDC @ 85°C															
20	30	23	10.0	35	52	72	125	-40	+20	+20	14	137	.656	.438	XTK206*035P0A
40	30	23	5.0	60	90	120	75	-40	+20	+20	15	213	.656	.562	XTM406*035P0A
60	30	23	2.7	55	82	110	45	-45	+10	+30	26	333	.875	.540	XTL606*035P0A
40 WVDC @ 85°C															
190	34	27	2.5	195	297	400	20	-55	+20	+35	48	427	1.125	.600	XTV197*040P0A
290	34	27	2.5	200	300	400	20	-55	+20	+35	50	427	1.125	.600	XTV297*040P0A
500	34	27	1.5	200	300	400	20	-75	+20	+35	68	694	1.125	1.100	XTV507*040P0A
1000	34	27	1.5	195	297	400	20	-75	+20	+35	82	694	1.125	1.100	XTV108*040P0A
50 WVDC @ 85°C															
900	44	32	1.5	195	297	400	25	-85	+20	+35	82	694	1.125	1.100	XTV907*050P0A
60 WVDC @ 85°C															
12	50	40	10.0	35	52	70	180	-30	+20	+20	14	137	.656	.438	XTK126*060P0A
25	50	40	5.0	60	90	120	90	-30	+20	+20	15	213	.656	.562	XTM256*060P0A
40	50	40	2.7	60	90	120	65	-35	+10	+20	26	333	.875	.540	XTL406*060P0A
70	50	40	2.7	90	135	180	40	-35	+10	+20	32	375	.875	.732	XTH706*060P0A
80	50	40	2.7	95	142	190	35	-35	+10	+20	32	375	.875	.732	XTH806*060P0A
130	50	40	2.5	210	315	420	30	-50	+20	+35	48	427	1.125	.600	XTV137*060P0A
200	50	40	1.5	135	182	230	30	-50	+20	+35	50	550	1.125	.600	XTV207*060P0A
350	50	40	1.5	155	210	265	25	-70	+20	+35	68	694	1.125	1.100	XTV357*060P0A
700	50	40	1.5	200	275	350	15	-70	+20	+35	82	694	1.125	1.100	XTV707*060P0A
750	50	40	1.5	200	275	350	29	-70	+20	+35	82	694	1.125	1.100	XTV757*060P0A
90 WVDC @ 85°C															
8	80	60	10.0	35	52	70	250	-30	+20	+20	14	137	.656	.438	XTK805*090P0A
16	80	60	5.0	60	90	120	125	-30	+20	+20	15	213	.656	.562	XTM166*090P0A
25	80	60	2.7	55	82	110	90	-35	+10	+20	26	333	.875	.540	XTL256*090P0A
50	80	60	2.7	90	135	180	45	-35	+10	+20	32	375	.875	.732	XTH506*090P0A
84	80	60	2.5	195	287	390	40	-40	+20	+35	48	427	1.125	.600	XTV846*090P0A
120	80	60	1.5	135	182	230	40	-40	+20	+35	50	550	1.125	.600	XTV127*090P0A
220	80	60	1.5	145	202	250	30	-60	+20	+35	68	694	1.125	1.100	XTV227*090P0A
450	80	60	1.5	195	215	235	25	-60	+20	+35	82	694	1.125	1.100	XTV457*090P0A
180 WVDC @ 85°C															
2	160	120	20.0	75	112	150	850	-30	+20	+20	21	108	.656	.719	XTK205*180P0A
4	160	120	20.0	35	52	70	500	-30	+20	+20	21	117	.656	.719	XTK405*180P0A
8	160	120	10.0	60	90	120	250	-30	+20	+20	23	186	.656	.938	XTM805*180P0A
12	160	120	5.6	55	82	110	180	-35	+10	+20	44	282	.875	.920	XTL126*180P0A
25	160	120	5.3	90	135	180	90	-35	+10	+20	56	341	.875	1.300	XTH256*180P0A
42	160	120	5.0	120	162	205	75	-40	+20	+35	74	363	1.125	.976	XTV426*180P0A
60	160	120	3.0	135	182	230	60	-40	+20	+35	78	363	1.125	.976	XTV606*180P0A
110	160	120	3.0	145	202	250	60	-60	+20	+35	114	631	1.125	1.938	XTV117*180P0A
230	160	120	3.0	200	275	350	50	-60	+20	+35	142	631	1.125	1.938	XTV237*180P0A
270 WVDC @ 85°C															
2.5	240	180	30.0	35	52	70	750	-30	+20	+20	28	112	.656	1.031	XTK255*270P0A
5	240	180	15.0	55	82	110	375	-30	+20	+20	31	179	.656	1.375	XTM505*270P0A
8	240	180	8.3	55	82	110	270	-35	+10	+20	62	266	.875	1.270	XTL805*270P0A
16	240	180	8.3	90	135	180	135	-35	+10	+20	81	320	.875	1.865	XTH166*270P0A
28	240	180	7.5	120	162	205	80	-40	+20	+35	100	339	1.125	1.350	XTV286*270P0A
40	240	180	7.5	135	182	230	100	-40	+20	+35	104	339	1.125	1.350	XTV406*270P0A
75	240	180	4.5	145	202	250	90	-60	+20	+35	160	608	1.125	2.812	XTV756*270P0A
150	240	180	4.5	195	215	235	75	-60	+20	+35	202	608	1.125	2.812	XTV157*270P0A
360 WVDC @ 85°C															
2	320	240	40.0	35	52	70	1000	-30	+20	+20	37	108	.656	1.312	XTK205*360P0A
4	320	240	20.0	60	90	120	500	-30	+20	+20	41	175	.656	1.781	XTM405*360P0A
6	320	240	11.0	55	82	110	360	-35	+10	+20	80	258	.875	1.635	XTL605*360P0A
12	320	240	11.0	90	135	180	180	-35	+10	+20	105	314	.875	2.420	XTH126*360P0A
22	320	240	10.0	125	170	215	100	-40	+20	+35	126	323	1.125	1.705	XTV226*360P0A
30	320	240	10.0	135	182	230	120	-40	+20	+35	133	323	1.125	1.705	XTV306*360P0A

*Insert Tolerance Code: T = -15+50% (Standard for XTK, XTM, XTV)
 U = -15+75% (Standard for XTH, XTL)
 M = \pm 20% (Available by Special Order)

Types XTH - K - L - M - V Wet Tantalum Capacitors



Capacitance (μ F)	Maximum Working Voltage		Typical ESR (Ohms)	Maximum DCL @ Maximum WVDC in μ A			Max Z 85°C (Ohms)	Maximum % Capacitance Change from Room Temperature			Approx Weight (Grams)	Max Ripple 120 Hz RMS -55°C to +175°C (mA)	Size		Catalog Number
	+125°C	+175°C		+85°C	+125°C	+175°C		-55°C	+85°C	+175°C			D +0.031 -0.015	H +0.062 -0.062	
450 WVDC @ 85°C															
5	400	300	13.0	55	82	110	450	-35	+10	+20	98	262	.875	2.000	XTL505*450P0A
10	400	300	13.0	90	135	180	225	-35	+10	+20	130	318	.875	2.980	XTH106*450P0A
17	400	300	12.5	125	170	215	130	-40	+20	+35	152	315	1.125	2.080	XTV176*450P0A
25	400	300	12.5	135	182	230	150	-40	+20	+35	164	315	1.125	2.080	XTV256*450P0A
540 WVDC @ 85°C															
4	480	360	16.6	55	82	110	540	-35	+10	+20	114	250	.875	2.365	XTL405*540P0A
8	480	360	16.6	90	135	180	270	-35	+10	+20	154	306	.875	3.532	XTH805*540P0A
14	480	300	15.0	120	162	205	160	-40	+20	+35	178	309	1.125	2.435	XTV146*540P0A
20	480	300	15.0	135	182	230	170	-40	+20	+35	196	309	1.125	2.435	XTV206*540P0A
630 WVDC @ 85°C															
3.5	560	420	18.9	55	82	110	630	-35	+10	+20	133	249	.875	2.720	XTL355*630P0A
7	560	420	18.9	90	135	180	315	-35	+10	+20	179	308	.875	4.062	XTH705*630P0A
12	560	420	17.5	120	162	205	180	-40	+20	+35	204	306	1.125	2.810	XTV126T630P0A
18	560	420	17.5	135	182	230	200	-40	+20	+35	225	306	1.125	2.810	XTV186*630P0A
720 WVDC @ 85°C															
3.5	640	480	21.6	55	82	110	800	-20	+10	+20	153	246	.875	3.062	XTL355*720P0A
810 WVDC @ 85°C															
2.8	720	540	24.3	55	82	110	900	-20	+10	+20	170	245	.875	3.440	XTL285*810P0A
900 WVDC @ 85°C															
2.5	800	600	27.0	55	82	110	1000	-20	+10	+20	190	244	.875	3.795	XTL255*900P0A

*Insert Tolerance Code: T = -15+50% (Standard for XTK, XTM, XTV)
 U = -15+75% (Standard for XTH, XTL)
 M = \pm 20% (Available by Special Order)

Part Number Nomenclature						
XTV	126	T	630	P	0	A
(1)	(2)	(3)	(4)	(5)	(6)	(7)
1.	Series - (XTH, XTK, XTL, XTM, XTV)					
2.	Capacitance Code (Expressed in Picofarads)					
	First 2 digits: Significant Figures		Third digit: Number of zeros (Example: 126 = 12 μ F)			
3.	Capacitance Tolerance:					
	T = -15+50% (Standard for XTK, XTM, XTV)					
	U = -15+75% (Standard for XTH, XTL)					
	M = \pm 20% (Available by Special Order)					
4.	DC Voltage Rating:					
	Zeros are used to precede the voltage rating where necessary to complete the three digit block					
5.	P = Polar					
6.	Insulation:					
	0 = Uninsulated (Standard)					
	1 = Mylar (+125°C limit)					
	4 = Teflon (+200°C limit)					
7.	Terminal Configuration:					
	See next page (A is standard)					

Types XTH - L - V Configurations Wet Tantalum Capacitors



Wet Tantalum Capacitors

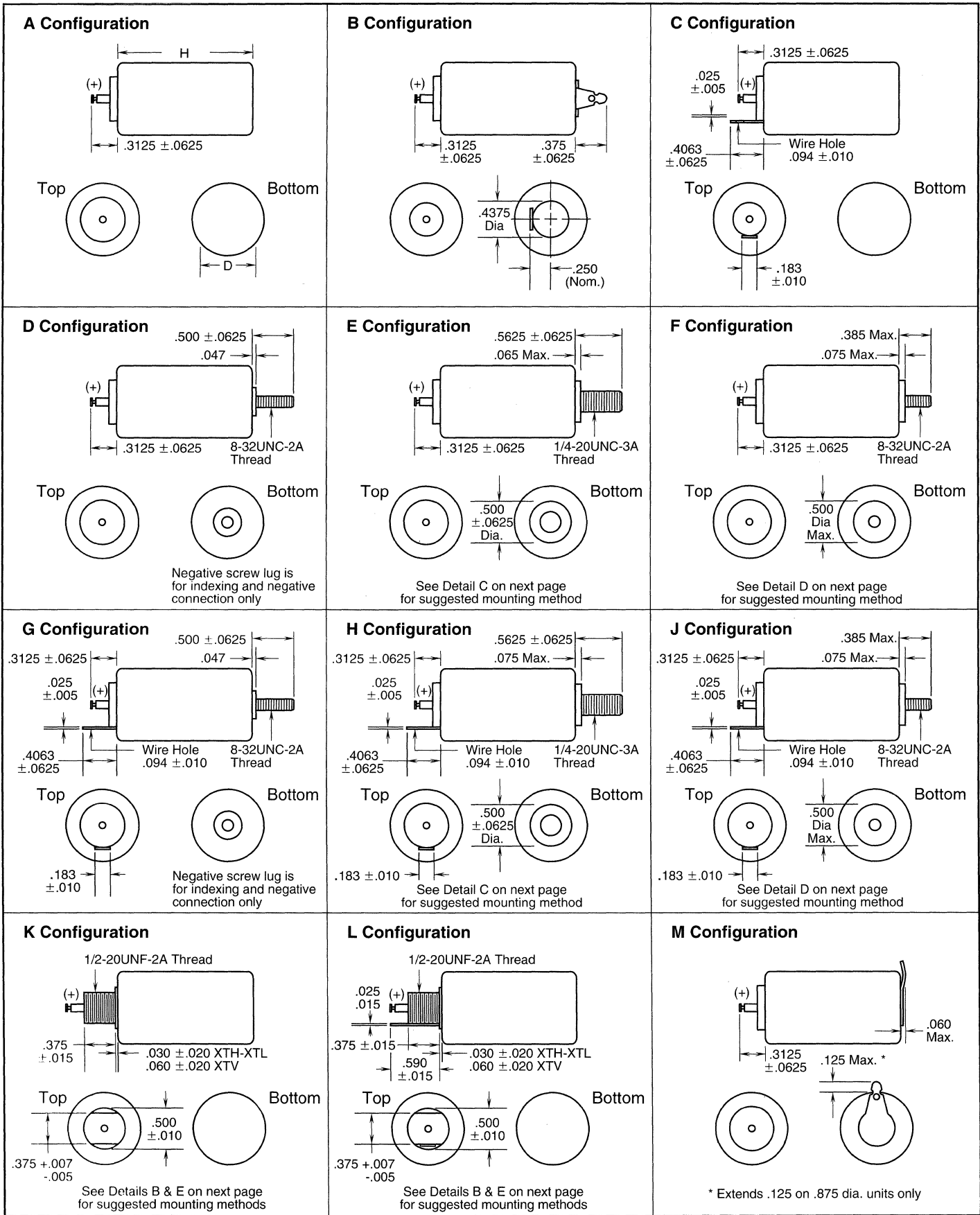

Types XTK - M Configurations Wet Tantalum Capacitors

MALLORY

Wet Tantalum Capacitors

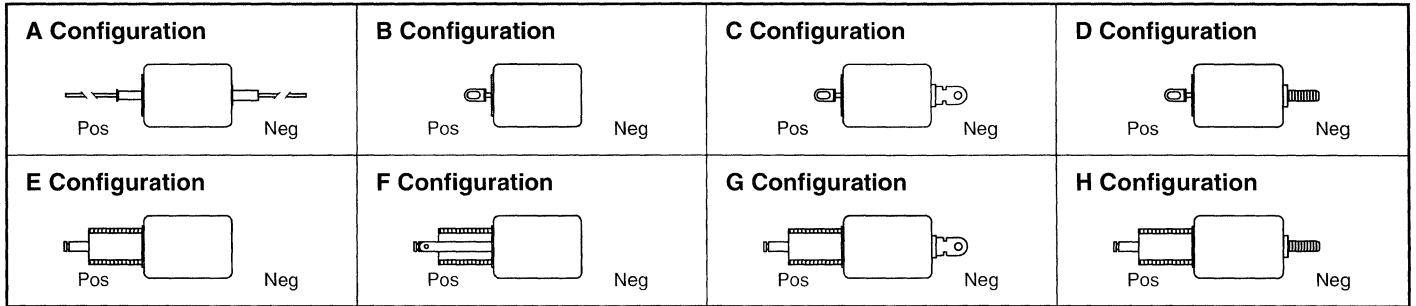

Positive Terminals for XTK and XTM

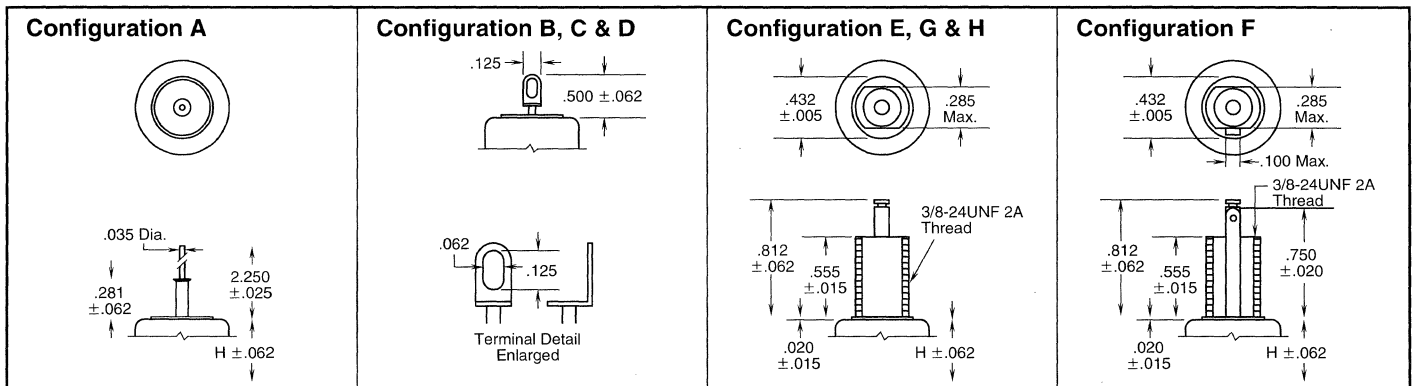

Negative Terminals for XTK and XTM

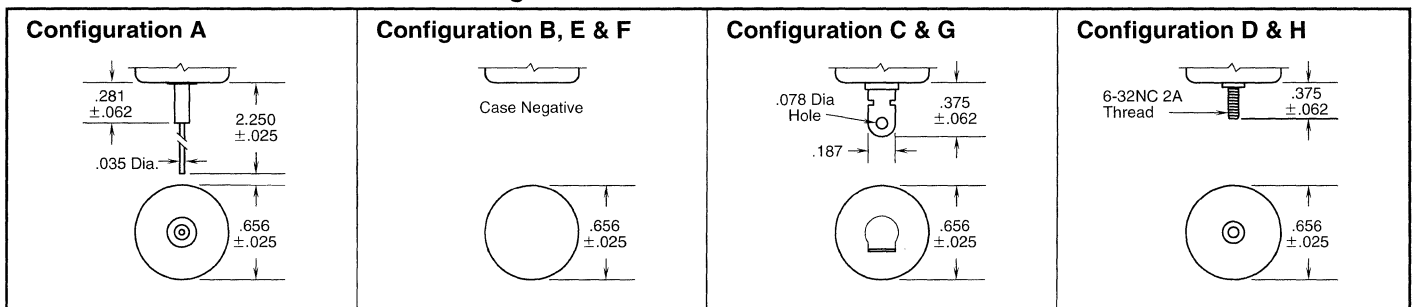

XTH, XTL and XTV Mounting Methods

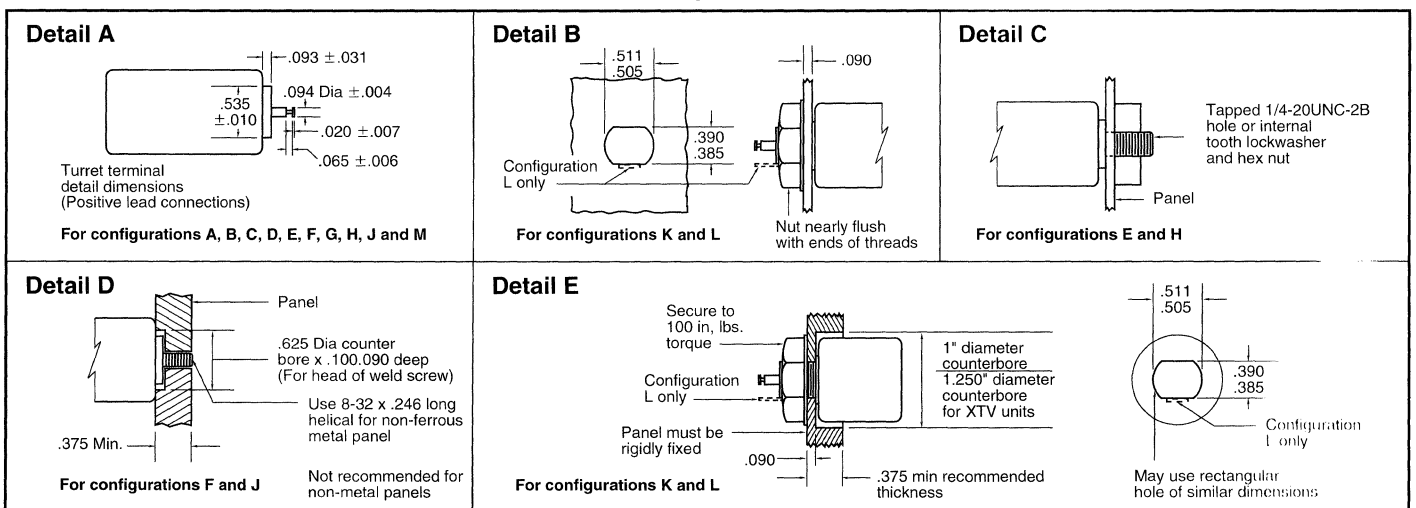

Type THT Wet Tantalum Capacitors



Wet Tantalum Capacitors

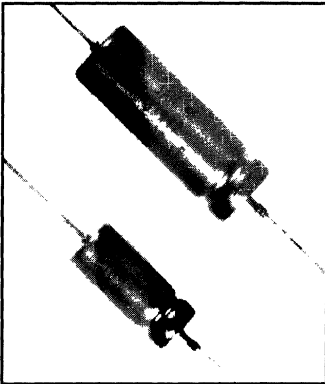

- Tantalum Case Technology
- Hermetically Sealed
- Rugged Construction
- Stable in Hostile Environments
- 200°C Operating Temperature
- Up to 3 Volts Reverse Capability @ 85°C
- High Ripple Current Rating
- Low DCL
- Low ESR
- Long Active Life
- Long Shelf Life

GENERAL SPECIFICATIONS

Operating Temperature:
-55°C to +200°C
with proper derating

Voltage Range:
6 to 125 VDC @ 85°C
3.6 to 75 VDC @ 200°C

Capacitance Range:
1.7 μF to 1200 μF

Tolerance Range:
±20%, ±10%, ±5%

Case Sizes: (Four)
.188 x .453 to .375 x 1.062

The maximum ripple current carrying capability at 40 kHz and 85°C is shown in the Standard Rating Table. Maximum ripple capability at other frequencies and temperatures can be determined using the following table based on 60% of the rated voltage.

Freq.	Ripple Multipliers at:				
	≤55°C	85°C	125°C	175°C	200°C
120 Hz	.60	.60	.27	.19	.13
1 kHz	.72	.72	.32	.23	.16
10 kHz	.88	.88	.40	.28	.19
40 kHz	1.0	1.0	.45	.32	.22
100 kHz	1.1	1.1	.50	.35	.24

Physical Specifications

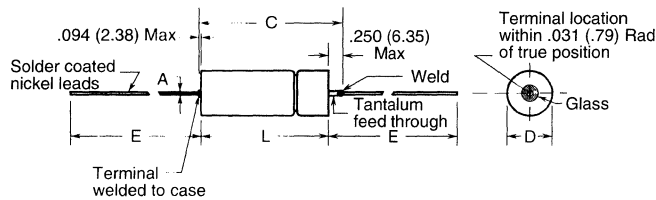

Part Number Nomenclature

THT 505 K 050 P 6 A
(1) (2) (3) (4) (5) (6) (7)

- THT Series - Tantalum Case/High Temperature
- Capacitance Code (Expressed in Picofarads)
First 2 digits: Significant Figures
Third digit: Number of zeros (Example: 505 = 5 μF)
- Capacitance Tolerance:
M = ±20%, K = ±10%, J = ±5%
- DC Voltage Rating:
Zeros are used to precede the voltage rating where necessary to complete the three digit block
- P = Polar
- 6 = Kapton Sleeve
- Case Size Code

INCHES (DIMENSIONS) MILLIMETERS

Case #	MIL	Uninsulated		Insulated		C	A Lead Dia Nom	E Lead Lgth ±.250	Approximate Weight (Grams) (1 gram = .035 Oz.)	Case #	MIL	Uninsulated		Insulated		C	A Lead Dia Nom	E Lead Lgth ±6.35
		D	L	D	L							D	L	D	L			
A	T1	.188	.453	.219	.608	.734	.025 #22	1.500	2.7	A	T1	4.78	11.51	5.56	15.45	18.64	.64 #22	38.10
B	T2	.281	.641	.312	.796	.922	.025 #22	2.250	6.5	B	T2	7.14	16.28	7.92	20.22	23.41	.64 #22	57.15
C	T3	.375	.766	.406	.921	1.047	.025 #22	2.250	12.0	C	T3	9.53	19.46	10.31	23.40	26.59	.64 #22	57.15
F	T4	.375	1.062	.406	1.217	1.343	.025 #22	2.250	18.0	F	T4	9.53	26.97	10.31	30.91	34.11	.64 #22	57.15

Cap μF	Case Code	Catalog Number	Max DCL μA				Max ESR Ω 120 Hz + 25°C	Max Ripple mA rms 40 kHz 85°C
			25°C	125°C	175°C	200°C		
6 WVDC @ 85°C 3.6 WVDC @ 200°C								
30	A	THT306*006P6A	1	2	4	6	4.0	820
68	A	THT686*006P6A	1	2	4	6	2.9	960
140	B	THT147*006P6B	1	3	6	9	2.2	1200
270	B	THT277*006P6B	1	7	14	21	2.0	1375
330	C	THT337*006P6C	2	8	16	24	1.4	1800
560	C	THT567*006P6C	2	13	26	39	1.3	1900
1200	F	THT128*006P6F	3	14	28	42	1.0	2265

Cap μF	Case Code	Catalog Number	Max DCL μA				Max ESR Ω 120 Hz + 25°C	Max Ripple mA rms 40 kHz 85°C
			25°C	125°C	175°C	200°C		
10 WVDC @ 85°C 6 WVDC @ 200°C								
20	A	THT206*010P6A	1	2	4	6	4.0	820
47	A	THT476*010P6A	1	2	4	6	3.7	855
100	B	THT107*010P6B	1	4	8	12	2.4	1200
180	B	THT187*010P6B	1	7	14	21	2.2	1365
250	C	THT257*010P6C	2	10	20	30	1.8	1720
390	B	THT397*010P6B	2	16	32	48	1.5	1800
750	F	THT757*010P6F	4	16	32	48	1.0	2360

Cap μF	Case Code	Catalog Number	Max DCL μA				Max ESR Ω 120 Hz + 25°C	Max Ripple mA rms 40 kHz 85°C
			25°C	125°C	175°C	200°C		
8 WVDC @ 85°C 4.8 WVDC @ 200°C								
25	A	THT256*008P6A	1	2	4	6	4.0	820
56	A	THT566*008P6A	1	2	4	6	3.3	900
120	B	THT127*008P6B	1	2	4	6	2.6	1220
220	B	THT227*008P6B	1	7	14	21	2.4	1370
290	C	THT297*008P6C	2	6	12	18	1.8	1770
430	C	THT437*008P6C	2	14	28	42	1.4	1825
850	F	THT857*008P6F	4	16	32	48	1.0	2330

Cap μF	Case Code	Catalog Number	Max DCL μA				Max ESR Ω 120 Hz + 25°C	Max Ripple mA rms 40 kHz 85°C
			25°C	125°C	175°C	200°C		
15 WVDC @ 85°C 9 WVDC @ 200°C								
15	A	THT156*015P6A	1	2	3	4	4.4	780
33	A	THT336*015P6A	1	2	3	4	4.0	820
70	B	THT706*015P6B	1	4	6	8	2.8	1150
120	B	THT127*015P6B	1	7	11	14	2.6	1450
170	C	THT177*015P6C	2	10	15	20	2.4	1480
270	C	THT277*015P6C	2	16	24	32	2.2	1740
540	F	THT547*015P6F	6	24	36	48	1.0	2300

* Insert Proper Letter Code For Tolerance: M = ±20%, K = ±10%, J = ±5%

Type THT Wet Tantalum Capacitors

MALLORY

Wet Tantalum Capacitors

Cap μF	Case Code	Catalog Number	Max DCL μA				Max ESR Ω 120 Hz + 25°C	Max Ripple mA rms 40 kHz 85°C
			25°C	125°C	175°C	200°C		

25 WVDC @ 85°C 12 WVDC @ 200°C								
10	A	THT106*025P6A	1	2	3	4	5.3	715
22	A	THT226*025P6A	1	2	3	4	4.2	825
50	B	THT506*025P6B	1	2	3	4	3.0	1130
100	B	THT107*025P6B	1	10	15	20	2.8	1435
120	C	THT127*025P6C	2	6	9	12	2.6	1450
180	C	THT187*025P6C	2	18	27	36	2.2	1525
350	F	THT357*025P6F	7	28	42	56	1.3	1970

30 WVDC @ 85°C 18 WVDC @ 200°C								
8	A	THT805*030P6A	1	2	3	4	6.6	640
15	A	THT156*030P6A	1	2	3	4	6.2	780
40	B	THT406*030P6B	1	5	8	10	4.0	1120
68	B	THT686*030P6B	1	8	12	16	2.9	1285
100	C	THT107*030P6C	2	12	18	24	2.7	1450
150	C	THT157*030P6C	2	18	27	36	2.3	1525
300	F	THT307*030P6F	8	32	48	64	1.4	1950

35 WVDC @ 85°C 21 WVDC @ 200°C								
7	A	THT705*035P6A	1	2	3	4	7.0	620
15	A	THT156*035P6A	1	2	3	4	6.2	660
35	B	THT356*035P6B	1	5	8	10	4.2	1000
68	B	THT686*035P6B	1	8	12	16	2.9	1195
82	C	THT826*035P6C	2	12	18	24	2.5	1400
120	C	THT127*035P6C	2	18	27	36	2.4	1490
270	F	THT277*035P6F	8	32	48	64	1.4	1950

50 WVDC @ 85°C 30 WVDC @ 200°C								
5	A	THT505*050P6A	1	2	3	4	8.0	580
10	A	THT106*050P6A	1	2	3	4	6.4	715
25	B	THT256*050P6B	1	5	8	10	4.6	1005
47	B	THT476*050P6B	1	9	14	18	3.7	1155
60	C	THT606*050P6C	2	12	18	24	2.9	1335
82	C	THT826*050P6C	2	16	24	32	2.5	1400
160	F	THT167*050P6F	8	32	48	64	1.5	1900

Cap μF	Case Code	Catalog Number	Max DCL μA				Max ESR Ω 120 Hz + 25°C	Max Ripple mA rms 40 kHz 85°C
			25°C	125°C	175°C	200°C		

60 WVDC @ 85°C 36 WVDC @ 200°C								
4	A	THT405*060P6A	1	2	3	4	9.3	525
8.2	A	THT825*060P6A	1	2	3	4	6.6	625
20	B	THT206*060P6B	1	5	8	10	4.7	930
39	B	THT396*060P6B	1	9	14	18	4.1	1110
50	C	THT506*060P6C	2	12	18	24	2.9	1330
68	C	THT686*060P6C	2	16	24	32	2.5	1365
140	F	THT147*060P6F	8	32	48	64	1.5	1850

75 WVDC @ 85°C 45 WVDC @ 200°C								
3.5	A	THT355*075P6A	1	2	3	4	9.5	525
6.8	A	THT685*075P6A	1	2	3	4	6.8	610
15	B	THT156*075P6B	1	5	8	10	5.3	890
33	B	THT336*075P6B	1	10	15	20	4.2	1000
40	C	THT406*075P6C	2	12	18	24	3.0	1250
56	C	THT566*075P6C	2	17	26	34	2.6	1335
110	F	THT117*075P6F	9	36	54	72	1.5	1850

100 WVDC @ 85°C 60 WVDC @ 200°C								
2.5	A	THT255*100P6A	1	2	3	4	10.6	505
4.7	A	THT475*100P6A	1	2	3	4	8.5	565
11	B	THT116*100P6B	1	4	6	8	6.0	835
22	B	THT226*100P6B	1	9	14	18	4.8	965
30	C	THT306*100P6C	2	12	18	24	3.3	1240
43	C	THT436*100P6C	2	17	26	34	2.6	1335
86	F	THT866*100P6F	9	36	54	72	1.6	1800

125 WVDC @ 85°C 75 WVDC @ 200°C								
1.7	A	THT175*125P6A	1	2	3	4	16.0	415
3.6	A	THT365*125P6A	1	2	3	4	10.1	520
9.0	B	THT905*125P6B	1	5	8	10	7.6	755
14	B	THT146*125P6B	1	7	11	14	5.8	860
18	C	THT186*125P6C	2	9	14	18	3.8	1130
25	C	THT256*125P6C	2	13	20	26	3.2	1200
56	F	THT566*125P6F	10	40	60	80	1.6	1800

* Insert Proper Letter Code For Tolerance: M = ±20%, K = ±10%, J = ±5%

Type THX Wet Tantalum Capacitors



Wet Tantalum Capacitors

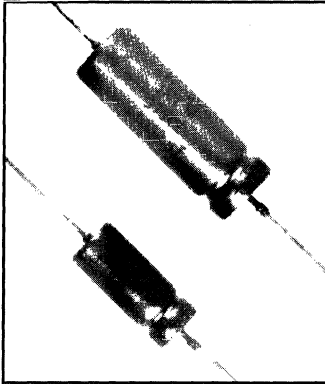

- Extended Range
- Tantalum Case Technology
- Hermetically Sealed
- Rugged Construction
- Stable in Hostile Environments
- Up to 3 Volts Reverse Capability
- High Ripple Current Rating
- Low DCL and ESR
- Long Active Life
- Long Shelf Life

GENERAL SPECIFICATIONS

Operating Temperature:
-55°C to +175°C
with proper derating

Voltage Range:
6 to 125 VDC @ 85°C
4 to 85 VDC @ 175°C

Capacitance Range:
6.8 μF to 2200 μF

Tolerance Range:
±20%, ±10%

Case Sizes: (Four)
.188 x .453 to .375 x 1.062

The maximum ripple current carrying capability at 40 kHz and 85°C is shown in the Standard Rating Table. Maximum ripple capability at other frequencies and temperatures can be determined using the following table based on 60% of the rated voltage.

Freq.	Ripple Multipliers at:			
	≤55°C	85°C	125°C	175°C
120 Hz	.60	.60	.27	.19
1 kHz	.72	.72	.32	.23
10 kHz	.88	.88	.40	.28
40 kHz	1.0	1.0	.45	.32
100 kHz	1.1	1.1	.50	.35

Physical Specifications

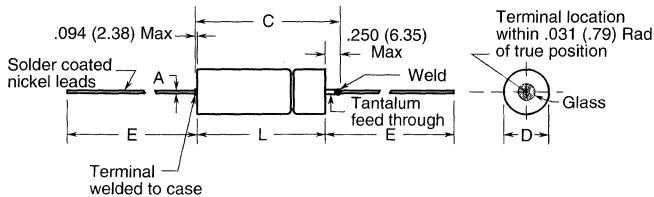

Part Number Nomenclature

THX 228 K 006 P 6 F
(1) (2) (3) (4) (5) (6) (7)

- THX Series - High Capacity Tantalum Case/Hi Temperature
- Capacitance Code (Expressed in Picofarads)
First 2 digits: Significant Figures
Third digit: Number of zeros (Example: 228 = 2200 μF)
- Capacitance Tolerance:
M = ±20%, K = ±10%
- DC Voltage Rating:
Zeros are used to precede the voltage rating where necessary to complete the three digit block
- P = Polar
- 6 = Kapton Sleeve
- Case Size Code

INCHES

(DIMENSIONS)

MILLIMETERS

Case #	MIL	Uninsulated		Insulated		C	A	E	Approximate Weight (Grams) (1 gram = .035 Oz.)	Case #	MIL	Uninsulated		Insulated		C	A	E
		D	L	D	L							D	L	D	L			
A	T1	.188	.453	.219	.608	.734	.025 #22	1.500	2.7	A	T1	4.78	11.51	5.56	15.45	18.64	.64 #22	38.10
B	T2	.281	.641	.312	.796	.922	.025 #22	2.250	6.5	B	T2	7.14	16.28	7.92	20.22	23.41	.64 #22	57.15
C	T3	.375	.766	.406	.921	1.047	.025 #22	2.250	12.0	C	T3	9.53	19.46	10.31	23.40	26.59	.64 #22	57.15
F	T4	.375	1.062	.406	1.217	1.343	.025 #22	2.250	18.0	F	T4	9.53	26.97	10.31	30.91	34.11	.64 #22	57.15

Cap μF	Case Code	Catalog Number	Max DCL μA			Max ESR Ω	Max DF %	Max Ripple mA rms
			25°C	125°C	175°C			
6 WVDC @ 85°C 4 WVDC @ 175°C								
220	A	THX227*006P6A	2	9	18	2.7	50	1010
820	B	THX827*006P6B	3	14	28	2.2	155	1550
1500	C	THX158*006P6C	5	20	40	1.3	172	1930
2200	F	THX228*006P6F	6	24	48	.9	170	2330

Cap μF	Case Code	Catalog Number	Max DCL μA			Max ESR Ω	Max DF %	Max Ripple mA rms
			25°C	125°C	175°C			
8 WVDC @ 85°C 5 WVDC @ 175°C								
180	A	THX187*008P6A	2	9	18	2.4	36	1010
680	B	THX687*008P6B	3	14	28	2.3	130	1550
1500	A	THX158*008P6A	5	20	40	1.3	170	1930
1800	F	THX188*008P6F	7	25	50	.9	195	2330

* Insert Proper Letter Code For Tolerance: M = ±20%, K = ±10%

Cap μF	Case Code	Catalog Number	Max DCL μA			Max ESR Ω	Max DF %	Max Ripple mA rms
			25°C	125°C	175°C			
10 WVDC @ 85°C 7 WVDC @ 175°C								
120	A	THX127*010P6A	2	6	12	2.8	28	930
150	A	THX157*010P6A	2	9	18	2.7	34	960
470	B	THX477*010P6B	3	9	18	1.7	67	1500
560	B	THX567*010P6B	3	16	32	1.6	76	1550
1000	C	THX108*010P6C	6	18	36	1.2	98	1930
1200	C	THX128*010P6C	5	20	40	1.1	117	1930
1200	F	THX128*010P6F	7	25	50	.9	90	2330
1500	F	THX158*010P6F	7	25	50	.9	114	2330

Cap μF	Case Code	Catalog Number	Max DCL μA			Max ESR Ω	Max DF %	Max Ripple mA rms
			25°C	125°C	175°C			
15 WVDC @ 85°C 10 WVDC @ 175°C								
82	A	THX826*015P6A	2	6	12	2.9	20	915
100	A	THX107*015P6A	2	9	18	3.6	30	930
390	B	THX397*015P6B	3	16	32	1.8	59	1470
680	C	THX687*015P6C	6	18	36	1.2	71	1860
827	C	THX827*015P6C	6	24	48	1.1	80	1930
1000	F	THX108*015P6F	8	32	64	.9	75	2330

Type THX Wet Tantalum Capacitors



Wet Tantalum Capacitors

Cap μ F	Case Code	Catalog Number	Max DCL μ A			Max ESR Ω 120 Hz + 25°C	Max DF % 120 Hz +25°C	Max Ripple mA rms 40kHz 85°C
			25°C	125°C	175°C			
25 WVDC @ 85°C 15 WVDC @ 175°C								
68	A	THX686*025P6A	2	9	18	3.9	22	850
270	B	THX277*025P6B	3	16	32	1.8	42	1430
560	C	THX567*025P6C	7	28	56	1.6	76	1750
680	F	THX687*025P6F	8	32	64	1.1	61	2120

Cap μ F	Case Code	Catalog Number	Max DCL μ A			Max ESR Ω 120 Hz + 25°C	Max DF % 120 Hz +25°C	Max Ripple mA rms 40kHz 85°C
			25°C	125°C	175°C			
30 WVDC @ 85°C 20 WVDC @ 175°C								
47	A	THX476*030P6A	2	6	12	3.6	14	830
56	A	THX566*030P6A	2	9	18	3.2	15	890
150	B	THX157*030P6B	3	9	18	2.2	28	1340
180	B	THX187*030P6B	3	9	18	2.0	30	1400
220	B	THX227*030P6B	3	16	32	2.3	42	1400
390	C	THX397*030P6C	6	18	36	1.4	47	1740
470	C	THX477*030P6C	8	32	64	1.3	53	1800
560	F	THX567*030P6F	9	36	72	1.1	54	2040

Cap μ F	Case Code	Catalog Number	Max DCL μ A			Max ESR Ω 120 Hz + 25°C	Max DF % 120 Hz +25°C	Max Ripple mA rms 40kHz 85°C
			25°C	125°C	175°C			
35 WVDC @ 85°C 23 WVDC @ 175°C								
39	A	THX396*035P6A	2	6	12	3.7	12	820
330	C	THX337*035P6C	6	18	36	1.6	44	1640
470	F	THX477*030P6F	9	36	72	1.1	46	2040

Cap μ F	Case Code	Catalog Number	Max DCL μ A			Max ESR Ω 120 Hz + 25°C	Max DF % 120 Hz +25°C	Max Ripple mA rms 40kHz 85°C
			25°C	125°C	175°C			
50 WVDC @ 85°C 30 WVDC @ 175°C								
33	A	THX336*050P6A	2	9	18	4.0	11	795
120	B	THX127*050P6B	4	24	48	2.2	22	1315
270	C	THX277*050P6C	8	32	64	1.6	37	1560
330	F	THX337*050P6F	9	36	72	1.3	32	2040

* Insert Proper Letter Code For Tolerance: M = $\pm 20\%$, K = $\pm 10\%$

Cap μ F	Case Code	Catalog Number	Max DCL μ A			Max ESR Ω 120 Hz + 25°C	Max DF % 120 Hz +25°C	Max Ripple mA rms 40kHz 85°C
			25°C	125°C	175°C			
60 WVDC @ 85°C 40 WVDC @ 175°C								
27	A	THX276*060P6A	3	12	24	4.0	9	785
100	B	THX107*060P6B	4	20	40	2.3	20	1240
220	C	THX227*060P6C	8	32	64	1.6	30	1520
270	F	THX277*060P6F	9	36	72	1.2	27	1970

Cap μ F	Case Code	Catalog Number	Max DCL μ A			Max ESR Ω 120 Hz + 25°C	Max DF % 120 Hz +25°C	Max Ripple mA rms 40kHz 85°C
			25°C	125°C	175°C			
75 WVDC @ 85°C 50 WVDC @ 175°C								
22	A	THX226*075P6A	3	12	24	4.0	8	745
68	B	THX686*075P6B	4	16	32	2.6	15	1200
82	B	THX826*075P6B	4	24	48	2.2	15	1200
180	C	THX187*075P6C	8	36	72	1.6	24	1490
220	F	THX227*075P6F	10	40	80	2.0	24	1900

Cap μ F	Case Code	Catalog Number	Max DCL μ A			Max ESR Ω 120 Hz + 25°C	Max DF % 120 Hz +25°C	Max Ripple mA rms 40kHz 85°C
			25°C	125°C	175°C			
100 WVDC @ 85°C 65 WVDC @ 175°C								
10	A	THX106*100P6A	3	12	36	5.9	4	800
39	B	THX396*100P6B	5	24	48	3.2	10.4	1300
68	C	THX686*100P6C	10	40	80	2.0	11.3	1600
120	F	THX127*100P6F	12	48	96	2.5	25	2000

Cap μ F	Case Code	Catalog Number	Max DCL μ A			Max ESR Ω 120 Hz + 25°C	Max DF % 120 Hz +25°C	Max Ripple mA rms 40kHz 85°C
			25°C	125°C	175°C			
125 WVDC @ 85°C 85 WVDC @ 175°C								
6.8	A	THX685*125P6A	3	12	24	10.6	6	700
27	B	THX276*125P6B	5	24	48	3.2	7.2	1200
47	C	THX476*125P6C	10	40	80	2.0	7.9	1500
82	F	THX826*125P6F	12	48	96	2.5	17.4	1900

Type TBS All-Tantalum Button (Formerly W13) Wet Tantalum Capacitors



Wet Tantalum Capacitors

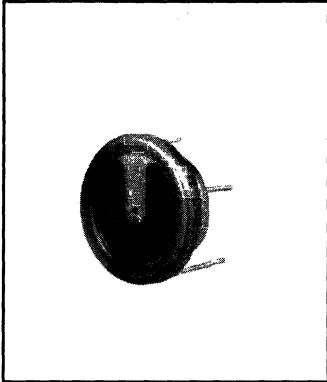

- High AC and Surge Currents
- All Tantalum Construction
- Qualified to MIL-C- 83500
- 3 Volt Reverse Voltage To 125°C
- 100% Burn In
- Custom Designs Available

GENERAL SPECIFICATIONS

Operating Temperature:
-55°C to +150°C
with voltage derating

Voltage Range:
6 to 125 VDC

Capacitance Range:
47µF to 1500µF

Ripple Current:
Max at 85°C: 40kHz up to 2.9A
rms, dependent on C/V rating

Leakage Current:
At 25°C: 2 µA to 8 µA
depending on voltage rating

Approximate Weight:
Pin Mount: 17.3 grams
Stud mount: 18.1 grams

The TBS design was the first unit of All-Tantalum construction. It was developed to provide a wet-slug unit with no metal migration, or reverse voltage and shelf life degradation. Since the 1960's millions of units in critical applications have demonstrated unsurpassed reliability and performance. The TBS series is qualified to MIL-C-83500 and meets the equivalent requirements of MIL-C-39006. The capacitors are also approved to NATO and European standards.

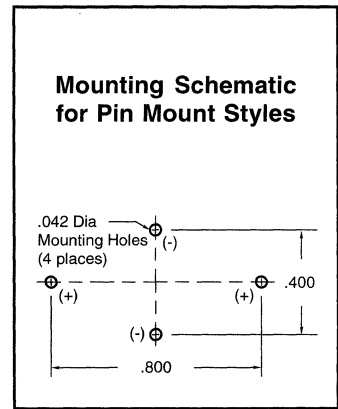
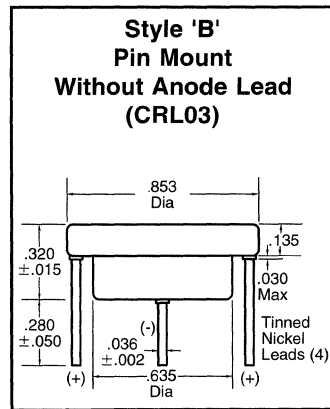
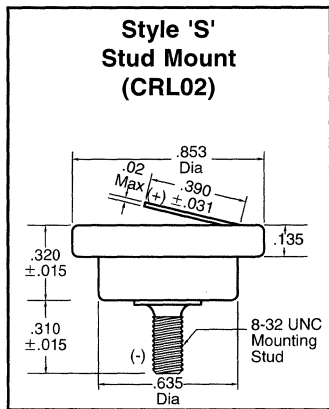
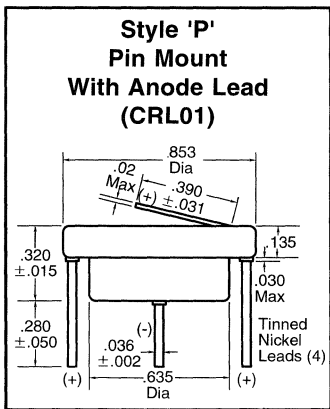

MIL Qualified Ratings

VDC @ 85°C	Cap µF	Cap Tol %	Catalog Number	Equivalent MIL Part No M83500/01----		
				PC Style CRL 01	STUD Style CRL 02	PC (Bare) Style CRL 03
6	1200	20	TBS1200M0006*	0001	1001	2001
8	1000	20	TBS1000M0008*	0002	1002	2002
10	820	20	TBS0820M0010*	0003	1003	2003
15	680	10	TBS0680K0015*	0004	1004	2004
15	680	20	TBS0680M0015*	0005	1005	2005
20	560	10	TBS0560K0020*	0006	1006	2006
20	560	20	TBS0560M0020*	0007	1007	2007
20	470	10	TBS0470K0020*	0008	1008	2008
20	470	20	TBS0470M0020*	0009	1009	2009
20	390	10	TBS0390K0020*	0010	1010	2010
20	390	20	TBS0390M0020*	0011	1011	2011
30	330	10	TBS0330K0030*	0012	1012	2012
30	330	20	TBS0330M0030*	0013	1013	2013
30	270	10	TBS0270K0030*	0014	1014	2014
30	270	20	TBS0270M0030*	0015	1015	2015
50	220	10	TBS0220K0050*	0016	1016	2016
50	220	20	TBS0220M0050*	0017	1017	2017
50	180	10	TBS0180K0050*	0018	1018	2018
50	180	20	TBS0180M0050*	0019	1019	2019
50	150	10	TBS0150K0050*	0020	1020	2020
50	150	20	TBS0150M0050*	0021	1021	2021
75	120	10	TBS0120K0075*	0022	1022	2022
75	120	20	TBS0120M0075*	0023	1023	2023
75	100	10	TBS0100K0075*	0024	1024	2024
75	100	20	TBS0100M0075*	0025	1025	2025
75	82	10	TBS0082K0075*	0026	1026	2026
75	82	20	TBS0082M0075*	0027	1027	2027
75	68	10	TBS0068K0075*	0028	1028	2028
75	68	20	TBS0068M0075*	0029	1029	2029
100	56	10	TBS0056K0100*	0030	1030	2030
100	56	20	TBS0056M0100*	0031	1031	2031
125	47	10	TBS0047K0125*	0032	1032	2032
125	47	20	TBS0047M0125*	0033	1033	2033

TO ORDER BY MIL NUMBER:

Indicate the prefix M83500/01 followed by the applicable MIL dash number.
Example: For M83500/01-1001; order M83500/011001

The Commercial 150°C Ratings listed below are designed to give high stability up to 200°C. Every unit is burned in for 16 hours at 200°C prior to final test. In addition to standard military applications, this device is aimed at down the hole drilling activities, high temperature engine control and other high stress environments.

The Commercial Extended Range Ratings are an extension of the MIL ratings, utilizing select materials to result in a capacitor with higher CV product while retaining all the essential features of the MIL range.

Commercial 150°C Ratings

VDC @ 150°C	Cap µF	Cap Tol %	Catalog Number
6	330	20	TBS0330M0006*
10	270	20	TBS0270M0010*
15	220	20	TBS0220M0015*
25	150	20	TBS0150M0025*
35	100	20	TBS0100M0035*
50	68	20	TBS0068M0050*
75	47	20	TBS0047M0075*

Commercial Extended Range Ratings

VDC @ 85°C	Cap µF	Cap Tol %	Catalog Number
6	1500	20	TBS1500M0006*
10	1000	20	TBS1000M0010*
10	1200	20	TBS1200M0010*
15	680	20	TBS0680M0015*
15	820	20	TBS0820M0015*
25	470	20	TBS0470M0025*
25	560	20	TBS0560M0025*
40	270	20	TBS0270M0040*
40	330	20	TBS0330M0040*
40	390	20	TBS0390M0040*
60	220	20	TBS0220M0060*
75	150	20	TBS0150M0075*
75	180	20	TBS0180M0075*
100	100	20	TBS0100M0100*
100	120	20	TBS0120M0100*
125	82	20	TBS0082M0125*

* Insert Style letter:

- P = Pin Mount with Anode Lead (CRL01)
- S = Screw Mount (CRL02)
- B = Pin Mount without Anode Lead (CRL03)

Type W14 All-Tantalum Module Wet Tantalum Capacitors

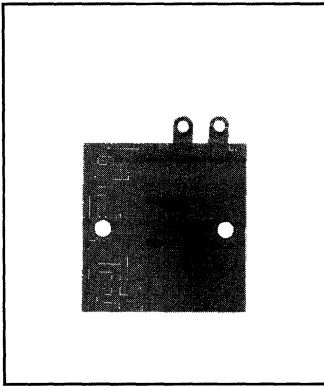

- High AC and Surge Currents
- All Tantalum Construction Of Constituent Units
- Long Operating & Shelf Life
- 3 Volt Reverse Voltage to 125°C
- High Efficiency Package
- Custom Designs Available

GENERAL SPECIFICATIONS

Operating Temperature:
-55°C to +125°C
with voltage derating

Voltage Range:
6 to 125 VDC

Capacitance Range:
94 μ F to 7500 μ F

Ripple Current:
Max at 85°C, 40kHz up to 11.7A rms, dependent on C/V rating

Leakage Current:
At 25°C: 15 μ A to 75 μ A depending on voltage rating

Module Weight:
130 Grams Approximate

The W14 series capacitor module has been designed to meet the requirements for a very high CV device, in excess of what is available in an individual capacitor. The standard arrangement of five type TBS units connected in parallel achieves excellent volumetric efficiency.

An experienced application engineering department is available to assist in the design of special packages to meet specific customer needs for both prototype and production quantities.

Dimensions: (Inches) (Unless specified, tolerances \pm .010)	A max 2.080	B max .460	C ctrs .750	D ctrs 1.500	E dia .190	F dim .260	G min .170	H dim 1.000
---	-------------------	------------------	-------------------	--------------------	------------------	------------------	------------------	-------------------

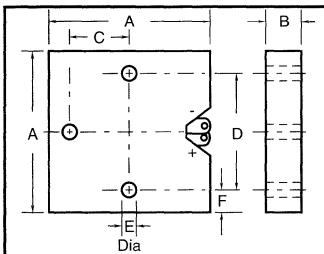

Type MA - Standard 2-Terminal
A package of five TBS type units connected in parallel.

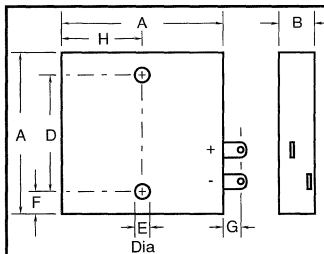

Type MB - Off-Set Terminal
Identical to the type MA, but with protruding terminals.

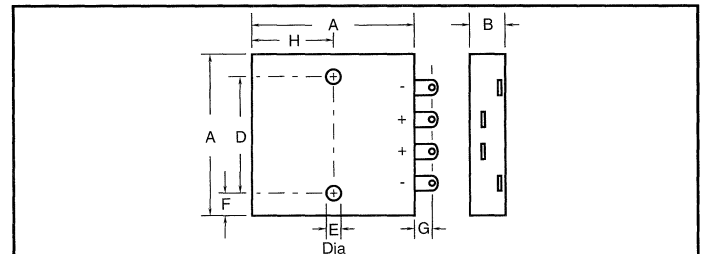

Type MC - Four Terminal
This arrangement has a bank of two parallel connected TBS units and a bank of three parallel connected TBS units. Each bank has a terminal pair.

VDC @ 85°C	Cap μ F	Cap Tol %	Catalog Number
------------	-------------	-----------	----------------

Standard Range			
6	6000	20	W146000M0006MA
8	5000	20	W145000M0008MA
10	4100	20	W144100M0010MA
15	3400	20	W143400M0015MA
20	2800	20	W142800M0020MA
20	2350	20	W142350M0020MA
20	1950	20	W141950M0020MA
30	1650	20	W141650M0030MA
30	1350	20	W141350M0030MA
50	1100	20	W141100M0050MA
50	900	20	W14900M0050MA
50	750	20	W14750M0050MA
75	600	20	W14600M0075MA
75	500	20	W14500M0075MA
75	410	20	W14410M0075MA
75	340	20	W14340M0075MA
100	280	20	W14280M0100MA
125	235	20	W14235M0125MA

High Cap Range			
6	7500	20	W147500M0006MA
10	6000	20	W146000M0010MA
10	5000	20	W145000M0010MA
15	3400	20	W143400M0015MA
15	4100	20	W144100M0015MA
25	2800	20	W142800M0025MA
25	2350	20	W142350M0025MA
40	1950	20	W141950M0040MA
40	1650	20	W141650M0040MA
40	1350	20	W141350M0040MA
60	1100	20	W141100M0060MA
75	900	20	W14900M0075MA
75	750	20	W14750M0075MA
100	600	20	W14600M0100MA
100	500	20	W14500M0100MA
125	410	20	W14410M0125MA

VDC @ 85°C	Cap μ F	Cap Tol %	Catalog Number
------------	-------------	-----------	----------------

Standard Range			
6	6000	20	W146000M0006MB
8	5000	20	W145000M0008MB
10	4100	20	W144100M0010MB
15	3400	20	W143400M0015MB
20	2800	20	W142800M0020MB
20	2350	20	W142350M0020MB
20	1950	20	W141950M0020MB
30	1650	20	W141650M0030MB
30	1350	20	W141350M0030MB
50	1100	20	W141100M0050MB
50	900	20	W14900M0050MB
50	750	20	W14750M0050MB
75	600	20	W14600M0075MB
75	500	20	W14500M0075MB
75	410	20	W14410M0075MB
75	340	20	W14340M0075MB
100	280	20	W14280M0100MB
125	235	20	W14235M0125MB

High Cap Range			
6	7500	20	W147500M0006MB
10	6000	20	W146000M0010MB
10	5000	20	W145000M0010MB
15	3400	20	W143400M0015MB
15	4100	20	W144100M0015MB
25	2800	20	W142800M0025MB
25	2350	20	W142350M0025MB
40	1950	20	W141950M0040MB
40	1650	20	W141650M0040MB
40	1350	20	W141350M0040MB
60	1100	20	W141100M0060MB
75	900	20	W14900M0075MB
75	750	20	W14750M0075MB
100	600	20	W14600M0100MB
100	500	20	W14500M0100MB
125	410	20	W14410M0125MB

VDC @ 85°C	Cap μ F	Cap Tol %	Catalog Number
------------	-------------	-----------	----------------

(Right Hand) Terminal Pair 1			
6	2400	20	W1424—M06—MC
8	2000	20	W1420—M08—MC
10	1640	20	W1416—M10—MC
15	1360	20	W1413—M15—MC
20	1120	20	W1411—M20—MC
20	940	20	W1494—M20—MC
20	780	20	W1478—M20—MC
30	660	20	W1466—M30—MC
30	540	20	W1454—M30—MC
50	440	20	W1444—M50—MC
50	360	20	W1436—M50—MC
50	300	20	W1430—M50—MC
75	240	20	W1424—M75—MC
75	200	20	W1420—M75—MC
75	164	20	W1416—M75—MC
75	136	20	W1413—M75—MC
100	112	20	W1411—M10—MC
125	94	20	W1494—M12—MC

VDC @ 85°C	Cap μ F	Cap Tol %	Catalog Number
------------	-------------	-----------	----------------

(Left Hand) Terminal Pair 2			
6	3600	20	W14—36M—06MC
8	3000	20	W14—30M—08MC
10	2460	20	W14—24M—10MC
15	2040	20	W14—20M—15MC
20	1680	20	W14—16M—20MC
20	1410	20	W14—14M—20MC
20	1170	20	W14—11M—20MC
30	990	20	W14—99M—30MC
30	810	20	W14—81M—30MC
50	660	20	W14—66M—50MC
50	540	20	W14—54M—50MC
50	450	20	W14—45M—50MC
75	360	20	W14—36M—75MC
75	300	20	W14—30M—75MC
75	246	20	W14—24M—75MC
75	204	20	W14—20M—75MC
100	168	20	W14—16M—10MC
125	141	20	W14—14M—12MC

Assume the Right Hand Terminals are to be 1640 μ F/10 Volts and the Left Hand Terminals are to be 3600 μ F/6 Volts
The Part Number would be W141636M1006MC

Type TMX - All-Tantalum Module Wet Tantalum Capacitors



Wet Tantalum Capacitors

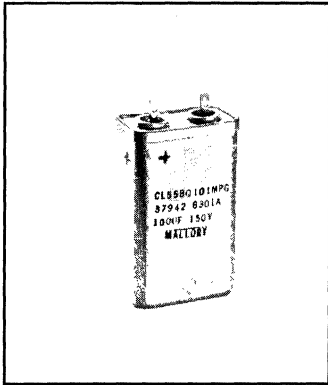

- High Capacitance per Case Size
- Hermetic Seal
- All Tantalum Construction Of Constituent Units
- Wide Operating Temp Range
- Temperature & Life Stability
- Low DCL
- Long Shelf Life
- Very High Ripple Current Capability
- Reverse Voltage Capability
- High Freq Vibration - 80g's
- Random Vibration - 50g's

GENERAL SPECIFICATIONS

Operating Temperature:
-55°C to +125°C
with voltage derating

Voltage Range:
6 to 250 VDC @ 85°C
4 to 165 VDC @ 125°C

Capacitance:
to 39,600 µF

Tolerance:
±10%, ±20%

Ripple Current Capability:
to 41.4 Amps @ 40 kHz

The TMX capacitor is a module consisting of several TXT (M39006/25) wet slug, all-tantalum units wired in parallel, insulated and mounted in a rectangular metal case. The case is potted with a compound that provides excellent thermal conductivity, high heat performance, increased shock resistance and improved coefficient of thermal expansion. The assembly leads are brought out through glass-to-metal hermetic seals on the cover and the cover is soldered to the container.

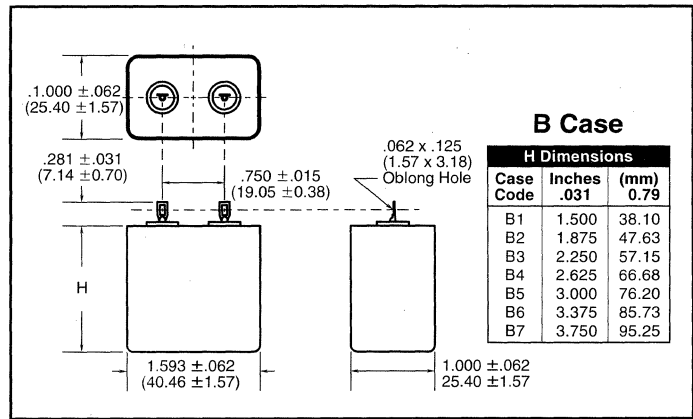
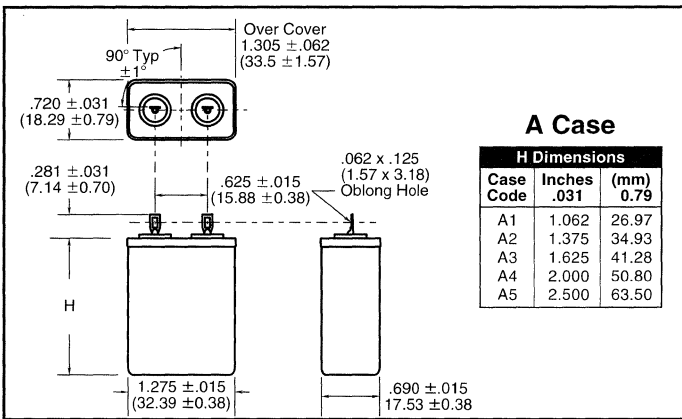

RIPPLE CURRENT MULTIPLIERS FOR FREQUENCY, TEMPERATURE, AND APPLIED PEAK VOLTAGE

Applied Voltage in Percent of Rated WVDC	Ripple Current Frequency																			
	120 Hz				1 kHz				10 kHz				40 kHz				100 kHz			
	Operating Temperature °C																			
	≤55°	85°	105°	125°	≤55°	85°	105°	125°	≤55°	85°	105°	125°	≤55°	85°	105°	125°	≤55°	85°	105°	125°
100%	.60	.39	—	—	.72	.45	—	—	.88	.55	—	—	1.0	.63	—	—	1.1	.69	—	—
90%	.60	.46	—	—	.72	.55	—	—	.88	.67	—	—	1.0	.77	—	—	1.1	.85	—	—
80%	.60	.52	.35	—	.72	.62	.42	—	.88	.76	.52	—	1.0	.87	.59	—	1.1	.96	.65	—
70%	.60	.58	.44	—	.72	.70	.52	—	.88	.85	.64	—	1.0	.97	.73	—	1.1	1.07	.80	—
66-2/3% and below	.60	.60	.46	.27	.72	.72	.55	.32	.88	.88	.68	.40	1.0	1.0	.77	.45	1.1	1.1	.85	.50

Part Number Nomenclature

TMX 458 K 006 P 0 A1
(1) (2) (3) (4) (5) (6) (7)

1. TMX Series - CLR81 All-Tantalum Module
2. Capacitance Code (Expressed in Picofarads)
First 2 digits: Significant Figures
Third digit: Number of zeros (Example: 458 = 4500 µF)
3. Capacitance Tolerance:
M = ±20%, K = ±10%
4. DC Voltage Rating:
Zeros are used to precede the voltage rating where necessary to complete the three digit block
5. P = Polar
6. 0 = Indicates terminals insulated from bare metal case
7. Case Size Code

Type TMX - All-Tantalum Module Wet Tantalum Capacitors



Wet Tantalum Capacitors

Cap μF	Case Code	Catalog Number	Max 85°C 40 kHz Ripple (Amps rms)	DC Leakage μA (max)		Max ESR Ω +25°C	Max Imp Ω
				+25°C	+85°C & +125°C		
6 WVDC; 7 VDC Surge @ 85°C 4 WVDC; 4.7 VDC Surge @ 125°C							
4,500	A1	TMX458*006P0A1	5.7	15	60	.13	6.0
6,000	A2	TMX608*006P0A2	7.6	20	80	.10	5.0
7,500	A3	TMX758*006P0A3	9.5	25	100	.08	4.0
9,000	A4	TMX908*006P0A4	11.4	30	120	.067	3.0
12,000	A5	TMX129*006P0A5	15.2	40	160	.05	2.5
13,200	B1	TMX1328*006P0B1	13.8	36	144	.075	1.0
17,600	B2	TMX1768*006P0B2	18.4	48	192	.056	.80
22,000	B3	TMX229*006P0B3	23.0	60	240	.045	.65
26,400	B4	TMX2648*006P0B4	27.6	72	288	.037	.54
30,800	B5	TMX3088*006P0B5	32.2	84	336	.032	.46
35,200	B6	TMX3528*006P0B6	36.8	96	384	.028	.40
39,600	B7	TMX3968*006P0B7	41.2	100	432	.025	.36

Cap μF	Case Code	Catalog Number	Max 85°C 40 kHz Ripple (Amps rms)	DC Leakage μA (max)		Max ESR Ω +25°C	Max Imp Ω
				+25°C	+85°C & +125°C		
25 WVDC; 28.8 VDC Surge @ 85°C 15 WVDC; 17.2 VDC Surge @ 125°C							
1,700	A1	TMX178*025P0A1	5.25	21	84	.17	8.0
2,200	A2	TMX228*025P0A2	7.0	28	112	.13	6.0
2,800	A3	TMX288*025P0A3	8.75	35	140	.10	5.0
3,400	A4	TMX348*025P0A4	10.5	42	168	.085	4.0
4,000	B1	TMX408*025P0B1	12.6	48	192	.092	1.58
4,500	A5	TMX458*025P0A5	14.0	56	224	.064	3.0
5,400	B2	TMX548*025P0B2	16.8	64	256	.069	1.19
6,800	B3	TMX688*025P0B3	21.0	80	320	.055	.95
8,100	B4	TMX818*025P0B4	25.2	96	384	.046	.79
9,500	B5	TMX958*025P0B5	29.4	112	448	.039	.68
10,900	B6	TMX1098*025P0B6	33.6	128	512	.034	.59
12,200	B7	TMX1228*025P0B7	37.8	144	576	.03	.53

Cap μF	Case Code	Catalog Number	Max 85°C 40 kHz Ripple (Amps rms)	DC Leakage μA (max)		Max ESR Ω +25°C	Max Imp Ω
				+25°C	+85°C & +125°C		
8 WVDC; 9.2 VDC Surge @ 85°C 5 WVDC; 5.7 VDC Surge @ 125°C							
4,500	A1	TMX458*008P0A1	5.7	15	60	.13	6.0
6,000	A2	TMX608*008P0A2	7.6	20	80	.10	5.0
7,500	A3	TMX758*008P0A3	9.5	25	100	.08	4.0
9,000	A4	TMX908*008P0A4	11.4	30	120	.067	3.0
10,800	B1	TMX1088*008P0B1	13.8	42	150	.075	1.15
12,000	A5	TMX129*008P0A5	15.2	40	160	.05	2.5
14,400	B2	TMX1448*008P0B2	18.4	56	200	.056	.87
18,000	B3	TMX189*008P0B3	23.0	70	250	.045	.70
21,600	B4	TMX2168*008P0B4	27.6	84	300	.037	.58
25,200	B5	TMX2528*008P0B5	32.2	98	350	.032	.50
28,800	B6	TMX2888*008P0B6	36.8	112	400	.028	.43
32,400	B7	TMX3248*008P0B7	41.2	126	450	.025	.39

Cap μF	Case Code	Catalog Number	Max 85°C 40 kHz Ripple (Amps rms)	DC Leakage μA (max)		Max ESR Ω +25°C	Max Imp Ω
				+25°C	+85°C & +125°C		
30 WVDC; 34.5 VDC Surge @ 85°C 20 WVDC; 23 VDC Surge @ 125°C							
1,400	A1	TMX148*030P0A1	4.5	24	96	.15	9.0
1,900	A2	TMX198*030P0A2	6.0	32	128	.11	7.0
2,300	A3	TMX238*030P0A3	7.5	40	160	.094	6.0
2,800	A4	TMX288*030P0A4	9.0	48	192	.077	5.0
3,300	B1	TMX338*030P0B1	12.0	54	216	.092	1.67
3,800	A5	TMX388*030P0A5	12.0	64	256	.057	3.5
4,500	B2	TMX458*030P0B2	16.0	72	288	.069	1.25
5,600	B3	TMX568*030P0B3	20.0	90	360	.055	1.0
6,700	B4	TMX678*030P0B4	24.0	108	432	.046	.83
7,800	B5	TMX788*030P0B5	28.0	126	504	.039	.71
8,900	B6	TMX898*030P0B6	32.0	144	576	.034	.62
10,000	B7	TMX109*030P0B7	36.0	162	648	.03	.55

Cap μF	Case Code	Catalog Number	Max 85°C 40 kHz Ripple (Amps rms)	DC Leakage μA (max)		Max ESR Ω +25°C	Max Imp Ω
				+25°C	+85°C & +125°C		
10 WVDC; 11.5 VDC Surge @ 85°C 7 WVDC; 8 VDC Surge @ 125°C							
3,600	A1	TMX368*010P0A1	5.5	15	60	.13	6.0
4,800	A2	TMX488*010P0A2	7.4	20	80	.10	5.0
6,000	A3	TMX608*010P0A3	9.25	25	100	.08	4.0
7,200	A4	TMX728*010P0A4	11.1	30	120	.067	3.0
9,000	B1	TMX908*010P0B1	13.8	42	150	.075	1.25
9,600	A5	TMX968*010P0A5	14.8	40	160	.05	2.5
12,000	B2	TMX129*010P0B2	18.4	56	200	.056	.93
15,000	B3	TMX159*010P0B3	23.0	70	250	.045	.75
18,000	B4	TMX189*010P0B4	27.6	84	300	.037	.62
21,000	B5	TMX219*010P0B5	32.2	98	350	.032	.53
24,000	B6	TMX249*010P0B6	36.8	112	400	.028	.47
27,000	B7	TMX279*010P0B7	41.4	126	450	.025	.42

Cap μF	Case Code	Catalog Number	Max 85°C 40 kHz Ripple (Amps rms)	DC Leakage μA (max)		Max ESR Ω +25°C	Max Imp Ω
				+25°C	+85°C & +125°C		
50 WVDC; 57.5 VDC Surge @ 85°C 30 WVDC; 34.5 VDC Surge @ 125°C							
800	A1	TMX807*050P0A1	4.35	24	96	.22	10.0
1,100	A2	TMX118*050P0A2	5.8	32	128	.16	8.0
1,300	A3	TMX138*050P0A3	7.25	40	160	.14	7.0
1,600	A4	TMX168*050P0A4	8.7	48	192	.11	5.0
2,000	B1	TMX208*050P0B1	11.4	54	216	.11	1.83
2,200	A5	TMX228*050P0A5	11.6	64	256	.082	4.0
2,600	B2	TMX268*050P0B2	15.2	72	288	.081	1.37
3,300	B3	TMX338*050P0B3	19.0	90	360	.065	1.10
4,000	B4	TMX408*050P0B4	22.8	108	432	.054	.92
4,600	B5	TMX468*050P0B5	26.6	126	504	.046	.78
5,300	B6	TMX538*050P0B6	30.4	144	576	.041	.69
5,900	B7	TMX598*050P0B7	34.2	162	648	.036	.61

Cap μF	Case Code	Catalog Number	Max 85°C 40 kHz Ripple (Amps rms)	DC Leakage μA (max)		Max ESR Ω +25°C	Max Imp Ω
				+25°C	+85°C & +125°C		
15 WVDC; 17.2 VDC Surge @ 85°C 10 WVDC; 11.5 VDC Surge @ 125°C							
2,500	A1	TMX258*015P0A1	5.4	18	72	.13	8.0
3,300	A2	TMX338*015P0A2	7.2	24	96	.10	6.0
4,100	A3	TMX418*015P0A3	9.0	30	120	.08	5.0
4,900	A4	TMX498*015P0A4	10.8	36	144	.069	4.0
6,000	B1	TMX608*015P0B1	13.8	48	192	.092	1.42
6,600	A5	TMX668*015P0A5	14.4	48	192	.051	3.0
8,000	B2	TMX808*015P0B2	18.4	64	256	.069	1.06
10,000	B3	TMX109*015P0B3	23.0	80	320	.055	.85
12,000	B4	TMX129*015P0B4	27.6	96	384	.046	.71
14,000	B5	TMX149*015P0B5	32.2	112	448	.039	.61
16,000	B6	TMX169*015P0B6	36.8	128	512	.034	.53
18,000	B7	TMX189*015P0B7	41.4	144	576	.03	.47

Cap μF	Case Code	Catalog Number	Max 85°C 40 kHz Ripple (Amps rms)	DC Leakage μA (max)		Max ESR Ω +25°C	Max Imp Ω
				+25°C	+85°C & +125°C		
60 WVDC; 69 VDC Surge @ 85°C 40 WVDC; 46 VDC Surge @ 125°C							
660	A1	TMX667*060P0A1	4.2	24	96	.22	10.0
880	A2	TMX887*060P0A2	5.6	32	128	.16	8.0
1,100	A3	TMX118*060P0A3	7.0	40	160	.13	6.0
1,300	A4	TMX138*060P0A4	8.4	48	192	.11	5.0
1,600	B1	TMX168*060P0B1	11.1	54	216	.10	1.92
1,800	A5	TMX188*060P0A5	11.2	64	256	.08	4.0
2,200	B2	TMX228*060P0B2	14.8	72	288	.075	1.44
2,700	B3	TMX278*060P0B3	18.5	90	360	.06	1.15
3,200	B4	TMX328*060P0B4	22.2	108	432	.05	.96
3,800	B5	TMX388*060P0B5	25.9	126	504	.043	.82
4,300	B6	TMX438*060P0B6	29.6	144	576	.038	.72
4,900	B7	TMX498*060P0B7	33.3	162	648	.033	.64

* Insert Proper Letter Code For Tolerance: M = ±20%, K = ±10%

Type TMX - All-Tantalum Module Wet Tantalum Capacitors



Wet Tantalum Capacitors

Cap μF	Case Code	Catalog Number	Max 85°C 40 kHz Ripple (Amps rms)	DC Leakage μA (max)		Max ESR Ω +25°C	Max Imp Ω
				+25°C	+85°C & +125°C		
75 WVDC; 86.2 VDC Surge @ 85°C 50 WVDC; 57.5 VDC Surge @ 125°C							
540	A1	TMX547*075P0A1	3.9	27	108	.26	10.0
720	A2	TMX727*075P0A2	5.2	36	144	.20	8.0
900	A3	TMX907*075P0A3	6.5	45	180	.16	7.0
1,100	A4	TMX118*075P0A4	7.8	54	216	.13	5.0
1,300	B1	TMX138*075P0B1	10.8	60	240	.13	2.0
1,400	A5	TMX148*075P0A5	10.4	72	288	.10	4.0
1,800	B2	TMX188*075P0B2	14.4	80	320	.10	1.5
2,200	B3	TMX228*075P0B3	18.0	100	400	.08	1.2
2,600	B4	TMX268*075P0B4	21.6	120	480	.067	1.0
3,100	B5	TMX318*075P0B5	25.2	140	560	.057	.86
3,500	B6	TMX358*075P0B6	28.8	160	640	.05	.75
4,000	B7	TMX408*075P0B7	32.4	180	720	.044	.67

Cap μF	Case Code	Catalog Number	Max 85°C 40 kHz Ripple (Amps rms)	DC Leakage μA (max)		Max ESR Ω +25°C	Max Imp Ω
				+25°C	+85°C & +125°C		
150 WVDC; 172 VDC Surge @ 85°C 100 WVDC; 115 VDC Surge @ 125°C							
90	A1	TMX906*150P0A1	1.3	10	40	1.60	60.0
180	A2	TMX187*150P0A2	2.6	18	72	.80	30.0
220	A3	TMX227*150P0A3	3.6	20	80	.65	24.0
270	A4	TMX277*150P0A4	3.9	27	108	.53	20.0
330	B1	TMX337*150P0B1	5.4	30	120	.53	8.0
360	A5	TMX367*150P0A5	5.2	36	144	.40	15.0
440	B2	TMX447*150P0B2	7.2	40	160	.40	6.0
550	B3	TMX557*150P0B3	9.0	50	200	.32	4.8
660	B4	TMX667*150P0B4	10.8	60	240	.27	4.0
770	B5	TMX777*150P0B5	12.6	70	280	.23	3.4
880	B6	TMX887*150P0B6	14.4	80	320	.20	3.0
990	B7	TMX997*150P0B7	16.2	90	360	.18	2.7

Cap μF	Case Code	Catalog Number	Max 85°C 40 kHz Ripple (Amps rms)	DC Leakage μA (max)		Max ESR Ω +25°C	Max Imp Ω
				+25°C	+85°C & +125°C		
100 WVDC; 115 VDC Surge @ 85°C 65 WVDC; 74.8 VDC Surge @ 125°C							
200	A1	TMX207*100P0A1	4.8	30	120	.48	14.0
270	A2	TMX277*100P0A2	6.4	40	160	.35	10.0
340	A3	TMX347*100P0A3	8.0	50	200	.28	8.0
400	A4	TMX407*100P0A4	9.6	60	240	.24	7.0
540	A5	TMX547*100P0A5	12.8	80	320	.18	5.0
720	B1	TMX727*100P0B1	12.0	72	288	.15	2.5
960	B2	TMX967*100P0B2	16.0	96	384	.11	1.88
1,200	B3	TMX128*100P0B3	20.0	120	480	.09	1.5
1,400	B4	TMX148*100P0B4	24.0	144	576	.075	1.25
1,700	B5	TMX178*100P0B5	28.0	168	672	.064	1.07
1,900	B6	TMX198*100P0B6	32.0	192	768	.056	.94
2,200	B7	TMX228*100P0B7	36.0	216	864	.05	.83

Cap μF	Case Code	Catalog Number	Max 85°C 40 kHz Ripple (Amps rms)	DC Leakage μA (max)		Max ESR Ω +25°C	Max Imp Ω
				+25°C	+85°C & +125°C		
200 WVDC; 230 VDC Surge @ 85°C 130 WVDC; 149 VDC Surge @ 125°C							
35	A1	TMX356*200P0A1	1.6	10	40	2.50	40.0
70	A2	TMX706*200P0A2	3.2	20	80	1.25	20.0
100	A3	TMX107*200P0A3	4.8	30	120	.85	15.0
120	A4	TMX127*200P0A4	4.0	24	96	.90	15.0
140	A5	TMX147*200P0A5	6.4	40	160	.65	10.0
180	B1	TMX187*200P0B1	6.0	36	144	.60	10.0
240	B2	TMX247*200P0B2	8.0	48	192	.45	7.5
300	B3	TMX307*200P0B3	10.0	60	240	.36	6.0
360	B4	TMX367*200P0B4	12.0	72	288	.30	5.0
420	B5	TMX427*200P0B5	14.0	84	336	.25	4.3
480	B6	TMX487*200P0B6	16.0	96	384	.23	3.75
540	B7	TMX547*200P0B7	18.0	108	432	.20	3.3

Cap μF	Case Code	Catalog Number	Max 85°C 40 kHz Ripple (Amps rms)	DC Leakage μA (max)		Max ESR Ω +25°C	Max Imp Ω
				+25°C	+85°C & +125°C		
125 WVDC; 144 VDC Surge @ 85°C 100 WVDC; 115 VDC Surge @ 125°C							
140	A1	TMX147*125P0A1	4.5	30	120	.51	17.0
190	A2	TMX197*125P0A2	6.0	40	160	.38	13.0
240	A3	TMX247*125P0A3	7.5	50	200	.30	10.0
280	A4	TMX287*125P0A4	9.0	60	240	.26	8.0
380	A5	TMX387*125P0A5	12.0	80	320	.19	6.0
500	B1	TMX507*125P0B1	11.4	72	288	.16	5.3
660	B2	TMX667*125P0B2	15.2	96	384	.13	4.0
820	B3	TMX827*125P0B3	19.0	120	480	.10	3.2
980	B4	TMX987*125P0B4	22.8	144	576	.084	2.6
1,150	B5	TMX1157*125P0B5	26.6	168	672	.072	2.3
1,310	B6	TMX1317*125P0B6	30.4	192	768	.063	2.0
1,480	B7	TMX1487*125P0B7	34.2	216	864	.056	1.8

Cap μF	Case Code	Catalog Number	Max 85°C 40 kHz Ripple (Amps rms)	DC Leakage μA (max)		Max ESR Ω +25°C	Max Imp Ω
				+25°C	+85°C & +125°C		
250 WVDC; 288 VDC Surge @ 85°C 165 WVDC; 190 VDC Surge @ 125°C							
25	A1	TMX256*250P0A1	1.5	10	40	2.50	100.0
47	A2	TMX476*250P0A2	3.0	20	80	1.25	50.0
70	A3	TMX706*250P0A3	4.5	30	120	.85	32.0
80	A4	TMX806*250P0A4	3.8	24	96	1.00	32.0
90	A5	TMX906*250P0A5	6.0	40	160	.65	25.0
120	B1	TMX127*250P0B1	5.7	36	144	.67	21.0
160	B2	TMX167*250P0B2	7.6	48	192	.50	16.0
200	B3	TMX207*250P0B3	9.5	60	240	.40	12.8
240	B4	TMX247*250P0B4	11.4	72	288	.33	10.7
280	B5	TMX287*250P0B5	13.3	84	336	.29	9.1
320	B6	TMX327*250P0B6	15.2	96	384	.25	8.0
360	B7	TMX367*250P0B7	17.1	108	432	.22	7.1

* Insert Proper Letter Code For Tolerance: M = ±20%, K = ±10%

CL65 (MIL-C-3965/4) Wet Tantalum Capacitors

MALLORY

Wet Tantalum Capacitors

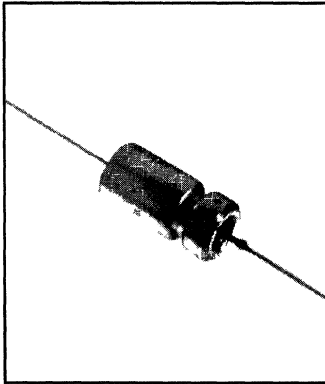

- High Capacitance Per Case Size
- Extremely Low DCL
- Long Operating Life
- Rugged Mechanical Construction
- Wide Operating Temperature Range

GENERAL SPECIFICATIONS

Operating Temperature:
-55°C to +125°C
with voltage derating

Voltage Range:
6 to 125 VDC @ 85°C
4 to 85 VDC @ 125°C

Capacitance:
1.7 μ F to 560 μ F

Tolerance Range:
 $\pm 10\%$, $\pm 20\%$
($\pm 5\%$ on special order)

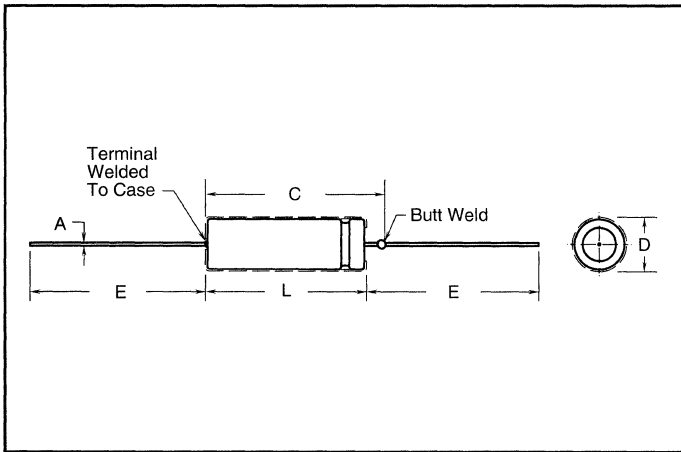

Part Number Nomenclature

- | CL65 | B | E | 271 | M | P | E |
|------|---|-----|-----|-----|-----|-----|
| (1) | (2) | (3) | (4) | (5) | (6) | (7) |
| 1. | CL65 Series - Silver Case/Mylar Sleeve
CL64 Series - Silver Case/Uninsulated | | | | | |
| 2. | Operating Temperature Code:
B = -55°C to +85°C | | | | | |
| 3. | Voltage Code @ 85°C: B = 6 C = 8 D = 10 E = 15
G = 25 H = 30 J = 50 K = 60
L = 75 N = 100 P = 125 | | | | | |
| 4. | Capacitance Code (Expressed in Microfarads)
First 2 digits: Significant Figures
Third digit: Number of zeros (Example: 271 = 270 μ F) | | | | | |
| 5. | Capacitance Tolerance:
J, , M = $\pm 20\%$, K = $\pm 10\%$, J = $\pm 5\%$ | | | | | |
| 6. | P = Polarized | | | | | |
| 7. | Seal & Vibration Code: E = 10 to 2000 cps | | | | | |

INCHES

(DIMENSIONS)

MILLIMETERS

Case Code	D		C	A		E	Approximate Weight (Grams) (1 gram = .035 Oz.)	Case Code	D		C	A		E
	Max	L		Max	Lead Dia Nom				Lead Lgth $\pm .250$	Max		L	Max	
T1	.219	.608	.734	.025	#22	1.500	1.4	T1	5.56	15.45	18.64	.64	#22	38.10
T2	.312	.796	.922	.025	#22	2.250	3.0	T2	7.92	20.22	23.41	.64	#22	57.15
T3	.4062	.921	1.047	.025	#22	2.250	5.6	T3	10.31	23.40	26.59	.64	#22	57.15

Cap μ F	Case Code	Catalog Number	Max DCL μ A		Max DF	Max Z Ω	Max % Cap Change From 25°C		
			25°C	85°C/125°C			+25°C	-55°C	-55°C
6 WVDC; 6.9 VDC Surge @ 85°C 4 WVDC; 4.7 VDC Surge @ 125°C									
30	T1	CL65BB300*PE	1	2	9.1	100	-40	+10.5	+12
68	T1	CL65BB680*PE	1	2	20.4	60	-40	+14	+16
140	T2	CL65BB141*PE	1	3	21.3	40	-40	+14	+16
270	T2	CL65BB271*PE	1	6.5	81.8	25	-44	+17.5	+20
330	T3	CL65BB331*PE	2	7.9	49.6	20	-44	+14	+16
560	T3	CL65BB561*PE	2	13	128	25	-64	+17.5	+20

Cap μ F	Case Code	Catalog Number	Max DCL μ A		Max DF	Max Z Ω	Max % Cap Change From 25°C		
			25°C	85°C/125°C			+25°C	-55°C	-55°C
15 WVDC; 17.2 VDC Surge @ 85°C 10 WVDC; 11.5 VDC Surge @ 125°C									
15	T1	CL65BE150*PE	1	2	5.7	155	-24	+10.5	+12
33	T1	CL65BE330*PE	1	2	12.5	90	-28	+14	+16
70	T2	CL65BE700*PE	1	4	13.1	75	-28	+14	+16
120	T2	CL65BE121*PE	1	7	36.8	50	-28	+17.5	+20
170	T3	CL65BE171*PE	2	10	25.4	35	-32	+14	+16
270	T3	CL65BE271*PE	2	16	60.9	30	-56	+17.5	+20

Cap μ F	Case Code	Catalog Number	Max DCL μ A		Max DF	Max Z Ω	Max % Cap Change From 25°C		
			25°C	85°C/125°C			+25°C	-55°C	-55°C
8 WVDC; 9.2 VDC Surge @ 85°C 5 WVDC; 5.7 VDC Surge @ 125°C									
25	T1	CL65BC250*PE	1	2	7.6	100	-40	+10.5	+12
56	T1	CL65BC560*PE	1	2	17	59	-40	+14	+16
220	T2	CL65BC221*PE	1	7	66.4	30	-44	+17.5	+20
430	T3	CL65BC431*PE	2	14	91.5	25	-64	+17.5	+20

Cap μ F	Case Code	Catalog Number	Max DCL μ A		Max DF	Max Z Ω	Max % Cap Change From 25°C		
			25°C	85°C/125°C			+25°C	-55°C	-55°C
25 WVDC; 28.8 VDC Surge @ 85°C 15 WVDC; 17.2 VDC Surge @ 125°C									
10	T1	CL65BG100*PE	1	2	4.6	220	-16	+8	+9
22	T1	CL65BG220*PE	1	2	8.3	140	-20	+10.5	+12
100	T2	CL65BG101*PE	1	10	31.5	50	-28	+13	+15
180	T3	CL65BG181*PE	2	18	54.3	32	-48	+13	+15

Cap μ F	Case Code	Catalog Number	Max DCL μ A		Max DF	Max Z Ω	Max % Cap Change From 25°C		
			25°C	85°C/125°C			+25°C	-55°C	-55°C
10 WVDC; 11.5 VDC Surge @ 85°C 7 WVDC; 8 VDC Surge @ 125°C									
20	T1	CL65BD200*PE	1	2	6.1	175	-32	+10.5	+12
47	T1	CL65BD470*PE	1	2	18.1	100	-36	+14	+16
100	T2	CL65BD101*PE	1	4	15.2	60	-36	+14	+16
180	T2	CL65BD181*PE	1	7	54.4	40	-36	+14	+16
250	T3	CL65BD251*PE	2	10	37.8	30	-40	+14	+16
390	T3	CL65BD391*PE	2	16	87.6	25	-64	+17.5	+20

Cap μ F	Case Code	Catalog Number	Max DCL μ A		Max DF	Max Z Ω	Max % Cap Change From 25°C		
			25°C	85°C/125°C			+25°C	-55°C	-55°C
30 WVDC; 34.5 VDC Surge @ 85°C 20 WVDC; 23 VDC Surge @ 125°C									
8	T1	CL65BH080*PE	1	2	4.5	275	-16	+8	+12
15	T1	CL65BH150*PE	1	2	9.1	175	-20	+10.5	+12
40	T2	CL65BH400*PE	1	5	12.2	65	-24	+10.5	+12
68	T2	CL65BH680*PE	1	8	31	60	-24	+13	+15
100	T3	CL65BH101*PE	2	12	19	40	-28	+10.5	+12
150	T3	CL65BH151*PE	2	18	46	35	-48	+13	+15

* Insert Proper Letter Code For Tolerance: M = $\pm 20\%$, K = $\pm 10\%$, J = $\pm 5\%$

CL65 (MIL-C-3965/4) Wet Tantalum Capacitors



Wet Tantalum Capacitors

Cap μ F	Case Code	Catalog Number	Max DCL μ A		Max DF + 25°C	Max Z Ω -55°C	Max % Cap Change From 25°C		
			25°C	85°C/ 125°C			-55°C	+85°C	+125°C
50 WVDC; 57.5 VDC Surge @ 85°C 30 WVDC; 34.5 VDC Surge @ 125°C									
5	T1	CL65BJ050*PE	1	2	3.4	400	-16	+5	+6
10	T1	CL65BJ100*PE	1	2	6	250	-24	+8	+9
25	T2	CL65BJ250*PE	1	5	11.2	95	-20	+10.5	+12
47	T2	CL65BJ470*PE	1	9	21.4	70	-28	+13	+15
60	T3	CL65BJ600*PE	2	12	13.6	45	-16	+10.5	+12
82	T3	CL65BJ820*PE	2	16	24.9	45	-32	+13	+15

Cap μ F	Case Code	Catalog Number	Max DCL μ A		Max DF + 25°C	Max Z Ω -55°C	Max % Cap Change From 25°C		
			25°C	85°C/ 125°C			-55°C	+85°C	+125°C
60 WVDC; 69 VDC Surge @ 85°C 40 WVDC; 46 VDC Surge @ 125°C									
4	T1	CL65BK040*PE	1	2	3	550	-16	+5	+6
8.2	T1	CL65BK8R2*PE	1	2	5	275	-24	+8	+9
20	T2	CL65BK200*PE	1	5	7.6	105	-16	+10.5	+12
39	T2	CL65BK390*PE	1	9	20.7	90	-24	+10.5	+12
50	T3	CL65BK500*PE	2	12	15.3	50	-16	+10.5	+12
68	T3	CL65BK680*PE	2	16	30.7	50	-32	+10.5	+12

Cap μ F	Case Code	Catalog Number	Max DCL μ A		Max DF + 25°C	Max Z Ω -55°C	Max % Cap Change From 25°C		
			25°C	85°C/ 125°C			-55°C	+85°C	+125°C
75 WVDC; 86.2 VDC Surge @ 85°C 50 WVDC; 57.5 VDC Surge @ 125°C									
3.5	T1	CL65BL3R5*PE	1	2	2.5	650	-16	+5	+6
6.8	T1	CL65BL6R8*PE	1	2	4.1	300	-20	+8	+9
15	T2	CL65BL150*PE	1	5	7.5	150	-16	+8	+9
33	T2	CL65BL330*PE	1	10	17.5	90	-24	+10.5	+15
40	T3	CL65BL400*PE	2	12	15.2	60	-16	+10.5	+12
56	T3	CL65BL560*PE	2	17	26	60	-28	+10.5	+15

Cap μ F	Case Code	Catalog Number	Max DCL μ A		Max DF + 25°C	Max Z Ω -55°C	Max % Cap Change From 25°C		
			25°C	85°C/ 125°C			-55°C	+85°C	+125°C
100 WVDC; 115 VDC Surge @ 85°C 65 WVDC; 74.8 VDC Surge @ 125°C									
2.5	T1	CL65BN2R5*PE	1	2	5	950	-16	+7	+8
4.7	T1	CL65BN4R7*PE	1	2	3.6	500	-16	+7	+8
11	T2	CL65BN110*PE	1	4	5	200	-16	+7	+8
22	T2	CL65BN220*PE	1	9	11.8	100	-16	+7	+8
30	T3	CL65BN300*PE	2	12	9.1	80	-16	+7	+8
43	T3	CL65BN430*PE	2	17	10.7	70	-20	+7	+8

Cap μ F	Case Code	Catalog Number	Max DCL μ A		Max DF + 25°C	Max Z Ω -55°C	Max % Cap Change From 25°C		
			25°C	85°C/ 125°C			-55°C	+85°C	+125°C
125 WVDC; 144 VDC Surge @ 85°C 85 WVDC; 97.8 VDC Surge @ 125°C									
1.7	T1	CL65BP1R7*PE	1	2	7	1250	-16	+7	+8
3.6	T1	CL65BP3R6*PE	1	2	4.1	600	-16	+7	+8
9	T2	CL65BP090*PE	1	5	10.2	240	-16	+7	+8
14	T2	CL65BP140*PE	1	7	12.7	167	-16	+7	+8
25	T3	CL65BP250*PE	2	13	19	93	-16	+7	+8

* Insert Proper Letter Code For Tolerance: M = \pm 20%, K = \pm 10%, J = \pm 5%

CLR10 (MIL-C-39006/18) Wet Tantalum Capacitors

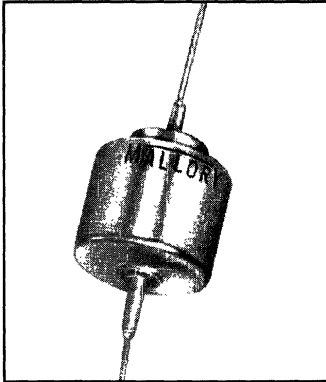

- High Temperature
- High Voltage
- High Capacitance
- Withstands High Frequency Vibration to 2000 Hz
- Hermetically Sealed
- Long Shelf Life
- Failure Rate Levels L, M and P

GENERAL SPECIFICATIONS

Operating Temperature:
-55°C to +125°C
with voltage derating

Voltage Range:
8 to 360 VDC @ 85°C

Reverse Voltage:
None

Capacitance Range:
2 μ F to 140 μ F

Tolerance Range:
-15+50%

$$ESR = \frac{10,000 \times DF}{6.28 \times f \times \mu F}$$

DF = Dissipation Factor %
f = Frequency in Hz

Case Sizes:
Diam Lgth
.656 .438 to 1.781

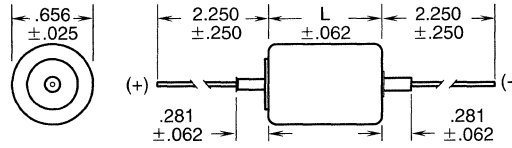

Capacitance (μ F)	Maximum Working Voltage		Surge Voltage @ +85°C	Part Number MIL-C-39006/18 Failure Rate Level (% / 1000 Hrs)			Max DF (%)	Max Z -55°C (Ohms)	Maximum DC Leakage (μ A)			Maximum % Capacitance Change from Room Temperature -55°C	Dimension L \pm .062
	+85°C	+125°C		L (2.0)	M (1.0)	P (0.1)			+25°C	+85°C	+125°C		
70	8	7	9.2	1000	1018	1036	47	60	6	30	48	-60	.438
140	8	7	9.2	1001	1019	1037	47	30	10	50	80	-60	.562
50	10	9	11.5	1002	1020	1038	35	75	5	25	40	-60	.438
100	10	9	11.5	1003	1021	1039	35	40	9	45	72	-60	.562
28	20	18	23	1004	1022	1040	21	85	6	30	48	-60	.438
56	20	18	23	1005	1023	1041	21	45	10	50	80	-60	.562
20	30	26	34.5	1006	1024	1042	15	125	7	35	56	-40	.438
40	30	26	34.5	1007	1025	1043	15	75	12	60	96	-40	.562
12	60	52	69	1008	1026	1044	9.1	180	7	35	56	-30	.438
25	60	52	69	1009	1027	1045	9.6	90	12	60	96	-30	.562
8	90	78	103	1010	1028	1046	6.1	250	7	35	56	-30	.438
16	90	78	103	1011	1029	1047	6.1	125	12	60	96	-30	.562
4	180	155	207	1012	1030	1048	6.1	500	7	35	56	-30	.719
8	180	155	207	1013	1031	1049	6.1	250	12	60	96	-30	.938
2.5	270	235	310	1014	1032	1050	5.7	750	7	35	56	-30	1.031
5	270	235	310	1015	1033	1051	5.7	375	11	55	88	-30	1.375
2	360	310	414	1016	1034	1052	6.1	1000	7	35	56	-30	1.312
4	360	310	414	1017	1035	1053	6.1	500	12	60	96	-30	1.781

TO ORDER: Indicate the prefix M39006/18 followed by the applicable MIL dash number
Example: For M39006/18-1036 order M39006/181036

CLR14 (MIL-C-39006/19) Wet Tantalum Capacitors



Wet Tantalum Capacitors

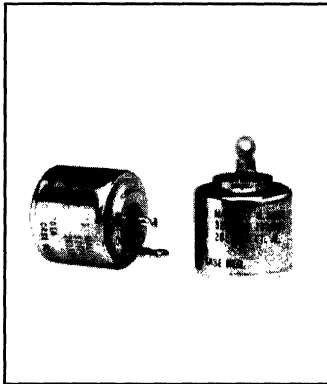

- High Temperature
- High Voltage
- High Capacitance
- Withstands High Frequency Vibration to 2000 Hz
- Hermetically Sealed
- Long Shelf Life
- Failure Rate Levels L, M and P

GENERAL SPECIFICATIONS

Operating Temperature:
-55°C to +125°C
with voltage derating

Voltage Range:
20 to 630 VDC @ 85°C

Reverse Voltage:
None

Capacitance Range:
5 μ F to 200 μ F

Tolerance Range:
-15 +75%

$$ESR = \frac{10,000 \times DF}{6.28 \times f \times \mu F}$$

DF = Dissipation Factor %
f = Frequency in Hz

Case Sizes:
Diam Lgth
.875 .540 to 4.062

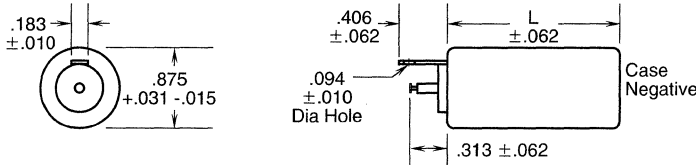

Capacitance (μ F)	Maximum Working Voltage		Surge Voltage @ +85°C	Part Number MIL-C-39006/18 Failure Rate Level (% / 1000 Hrs)			Max DF (%)	Max Z -55°C (Ohms)	Maximum DC Leakage (μ A)			Maximum % Capacitance Change from Room Temperature -55°C	Dimension L \pm .062
	+85°C	+125°C		L (2.0)	M (1.0)	P (0.1)			+25°C	+85°C	+125°C		
100	20	18	23	1000	1020	1040	21	30	10	50	80	-60	.540
200	20	18	23	1001	1021	1041	36	20	16	80	128	-60	.732
75	30	26	34.5	1002	1022	1042	15	45	11	55	88	-45	.540
150	30	26	34.5	1003	1023	1043	29	30	13	90	104	-45	.732
40	60	52	69	1004	1024	1044	8.2	65	12	60	96	-35	.540
80	60	52	69	1005	1025	1045	16	35	19	95	152	-35	.732
25	90	78	103	1006	1026	1046	5.1	90	11	55	88	-35	.540
50	90	78	103	1007	1027	1047	10	45	18	90	144	-35	.732
12	180	155	207	1008	1028	1048	5.1	180	11	55	88	-35	.920
25	180	155	207	1009	1029	1049	10	90	18	90	144	-35	1.300
8	270	235	310	1010	1030	1050	5.1	270	11	55	88	-35	1.270
16	270	235	310	1011	1031	1051	10	135	18	90	144	-35	1.865
6	360	310	414	1012	1032	1052	5	360	11	55	88	-35	1.635
12	360	310	414	1013	1033	1053	10	180	18	90	144	-35	2.420
5.0	450	390	518	1014	1034	1054	4.9	450	11	55	88	-35	2.000
10	450	390	518	1015	1035	1055	9.8	225	18	90	144	-35	2.980
4.0	540	470	621	1016	1036	1056	5.1	540	11	55	88	-35	2.365
8.0	540	470	621	1017	1037	1057	10	270	18	90	144	-35	3.532
3.5	630	545	724	1018	1038	1058	5	630	11	55	88	-35	2.720
7.0	630	545	724	1019	1039	1059	10	315	18	90	144	-35	4.062

TO ORDER: Indicate the prefix M39006/19 followed by the applicable MIL dash number
Example: For M39006/19-1030 order M39006/191030

CLR17 (MIL-C-39006/20) Wet Tantalum Capacitors



Wet Tantalum Capacitors

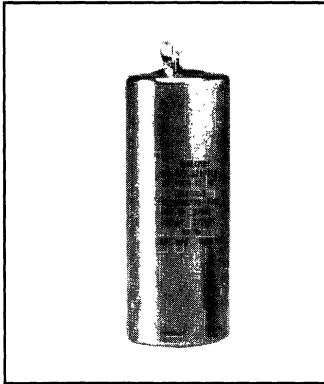

- High Temperature
- High Voltage
- High Capacitance
- Withstands High Frequency Vibration to 2000 Hz
- Hermetically Sealed
- Long Shelf Life
- Failure Rate Levels L, M and P

GENERAL SPECIFICATIONS

Operating Temperature:
-55°C to +125°C
with voltage derating

Voltage Range:
30 to 630 VDC @ 85°C

Reverse Voltage:
None

Capacitance Range:
12 μ F to 1300 μ F

Tolerance Ranges:
 \pm 20%
-15 +50%

$$ESR = \frac{10,000 \times DF}{6.28 \times f \times \mu F}$$

DF = Dissipation Factor %
f = Frequency in Hz

Case Sizes:
Diam Lgth
1.125 .600 to 2.812

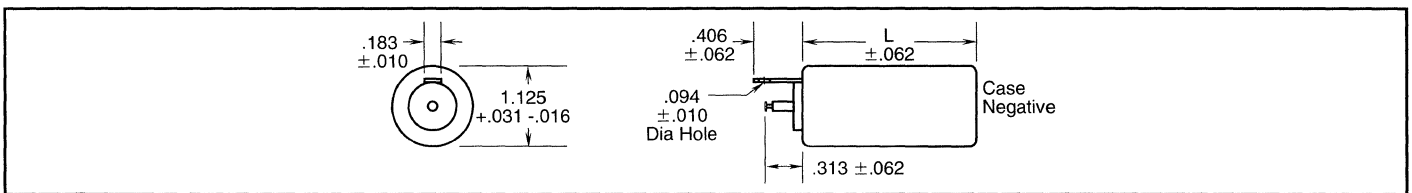

Cap (μ F)	Cap Tol	Maximum Working Voltage		Surge Voltage @ +85°C	Part Number MIL-C-39006/20 Failure Rate Level (% / 1000 Hrs)			Max DF (%)	Max Z -55°C (Ohms)	Maximum DC Leakage (μ A)			Maximum % Capacitance Change from Room Temperature -55°C	Dimension L \pm .062
		+85°C	+125°C		L (2.0)	M (1.0)	P (0.1)			+25°C	+85°C	+125°C		
370	\pm 20	30	26	34.5	1000	1050	1100	39	15	18	125	180	-65	.600
370	-15+50	30	26	34.5	1001	1051	1101	39	15	18	125	180	-65	.600
650	\pm 20	30	26	34.5	1002	1052	1102	60	15	21	145	210	-85	1.100
650	-15+50	30	26	34.5	1003	1053	1103	60	15	21	145	210	-85	1.100
1300	\pm 20	30	26	34.5	1004	1054	1104	83	10	27	190	270	-85	1.100
1300	-15+50	30	26	34.5	1005	1055	1105	83	10	27	190	270	-85	1.100
200	\pm 20	60	52	69	1006	1056	1106	22	30	19	135	190	-50	.600
200	-15+50	60	52	69	1007	1057	1107	22	30	19	135	190	-50	.600
350	\pm 20	60	52	69	1008	1058	1108	37	25	22	155	220	-70	1.100
350	-15+50	60	52	69	1009	1059	1109	37	25	22	155	220	-70	1.100
700	\pm 20	60	52	69	1010	1060	1110	62	15	29	200	290	-70	1.100
700	-15+50	60	52	69	1011	1061	1111	62	15	29	200	290	-70	1.100
120	\pm 20	90	78	103	1012	1062	1112	13	40	19	135	190	-40	.600
120	-15+50	90	78	103	1013	1063	1113	13	40	19	135	190	-40	.600
220	\pm 20	90	78	103	1014	1064	1114	24	30	21	145	210	-60	1.100
220	-15+50	90	78	103	1015	1065	1115	24	30	21	145	210	-60	1.100
450	\pm 20	90	78	103	1016	1066	1116	45	25	29	195	290	-60	1.100
450	-15+50	90	78	103	1017	1067	1117	45	25	29	195	290	-60	1.100
42	\pm 20	180	155	207	1018	1068	1118	16	75	17	120	170	-40	.976
42	-15+50	180	155	207	1019	1069	1119	16	75	17	120	170	-40	.976
60	\pm 20	180	155	207	1020	1070	1120	13	60	19	135	190	-40	.976
60	-15+50	180	155	207	1021	1071	1121	13	60	19	135	190	-40	.976
110	\pm 20	180	155	207	1022	1072	1122	24	60	21	145	210	-60	1.938
110	-15+50	180	155	207	1023	1073	1123	24	60	21	145	210	-60	1.938
230	\pm 20	180	155	207	1024	1074	1124	46	50	29	200	290	-60	1.938
230	-15+50	180	155	207	1025	1075	1125	46	50	29	200	290	-60	1.938
28	\pm 20	270	235	310	1026	1076	1126	16	80	19	120	190	-40	1.350
28	-15+50	270	235	310	1027	1077	1127	16	80	19	120	190	-40	1.350
40	\pm 20	270	235	310	1028	1078	1128	22	100	19	135	190	-40	1.350
40	-15+50	270	235	310	1029	1079	1129	22	100	19	135	190	-40	1.350
75	\pm 20	270	235	310	1030	1080	1130	24	90	21	145	210	-60	2.812
75	-15+50	270	235	310	1031	1081	1131	24	90	21	145	210	-60	2.812
150	\pm 20	270	235	310	1032	1082	1132	45	75	28	195	280	-60	2.812
150	-15+50	270	235	310	1033	1083	1133	45	75	28	195	280	-60	2.812
22	\pm 20	360	310	414	1034	1084	1134	16	100	18	125	180	-40	1.705
22	-15+50	360	310	414	1035	1085	1135	16	100	18	125	180	-40	1.705

TO ORDER: Indicate the prefix M39006/20 followed by the applicable MIL dash number
Example: For M39006/20-1076 order M39006/201076

CLR17 (MIL-C-39006/20) Wet Tantalum Capacitors



Wet Tantalum Capacitors

Cap (μ F)	Cap Tol	Maximum Working Voltage		Surge Voltage @ +85°C	Part Number MIL-C-39006/20 Failure Rate Level (% / 1000 Hrs)			Max DF (%)	Max Z -55°C (Ohms)	Maximum DC Leakage (μ A)			Maximum % Capacitance Change from Room Temperature	Dimension L \pm .062
		+85°C	+125°C		L (2.0)	M (1.0)	P (0.1)			+25°C	+85°C	+125°C		
		-55°C												
30	\pm 20	360	310	414	1036	1086	1136	22	120	19	135	190	-40	1.705
30	-15+50	360	310	414	1037	1087	1137	22	120	19	135	190	-40	1.705
17	\pm 20	450	390	518	1038	1088	1138	16	130	18	125	180	-40	2.080
17	-15+50	450	390	518	1039	1089	1139	16	130	18	125	180	-40	2.080
25	\pm 20	450	390	518	1040	1090	1140	23	150	19	135	190	-40	2.080
25	-15+50	450	390	518	1041	1091	1141	23	150	19	135	190	-40	2.080
14	\pm 20	540	470	621	1042	1092	1142	16	160	17	120	170	-40	2.435
14	-15+50	540	470	621	1043	1093	1143	16	160	17	120	170	-40	2.435
20	\pm 20	540	470	621	1044	1094	1144	22	170	19	135	190	-40	2.435
20	-15+50	540	470	621	1045	1095	1145	22	170	19	135	190	-40	2.435
12	\pm 20	630	545	724	1046	1096	1146	16	180	17	120	170	-40	2.810
12	-15+50	630	545	724	1047	1097	1147	16	180	17	120	170	-40	2.810
18	\pm 20	630	545	724	1048	1098	1148	23	200	19	135	190	-40	2.810
18	-15+50	630	545	724	1049	1099	1149	23	200	19	135	190	-40	2.810

TO ORDER: Indicate the prefix M39006/20 followed by the applicable MIL dash number
Example: For M39006/20-1076 order M39006/201076

CLR65 (MIL-C-39006/09) Wet Tantalum Capacitors

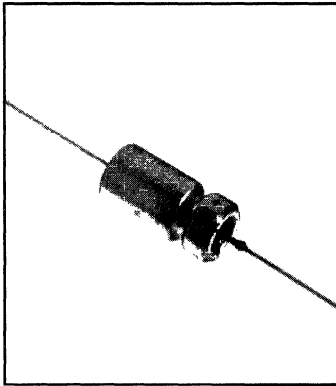

- Silver Case Technology
- Hermetically Sealed
- Rugged Construction
- High Shock and Vibration Capability
- High Capacitance per Case Size
- Low DCL and ESR
- Long Shelf Life
- Failure Rate Levels M, P and R

GENERAL SPECIFICATIONS

Operating Temperature:
-55°C to +125°C
with voltage derating

Voltage Range:
6 to 125 VDC

Capacitance Range:
1.7 μ F to 1200 μ F

Tolerance Range:
 $\pm 10\%$, $\pm 20\%$
($\pm 5\%$ by special order)

Case Sizes: (Four)
.188 x .453 to .375 x 1.062

Maximum rms Ripple Current @ 85°C	
Case Code	mA
A	50
B	250
C	500
F	750

Wet Tantalum Capacitors

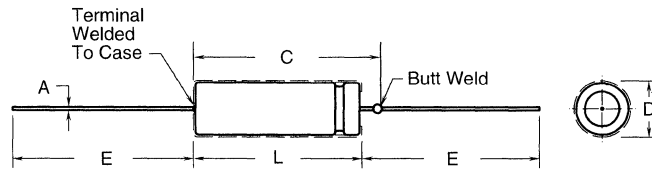

INCHES

(DIMENSIONS)

MILLIMETERS

Case Code	Uninsulated		Insulated		C	A Lead Dia Nom AWG	E Lead Lgth $\pm .250$	Approximate Weight (Grams) (1 gram = .035 Oz.)	Case Code	Uninsulated		Insulated		C	A Lead Dia Nom AWG	E Lead Lgth ± 6.35
	D $\pm .016$	L +.031, -.016	D Max	L Max						D $\pm .41$	L +.79, -.41	D Max	L Max			
T1	.188	.453	.219	.608	.734	.025 #22	1.500	1.2	T1	4.78	11.51	5.56	15.45	18.64	.64 #22	38.10
T2	.281	.641	.312	.796	.922	.025 #22	2.250	3.1	T2	7.14	16.28	7.92	20.22	23.41	.64 #22	57.15
T3	.375	.766	.406	.921	1.047	.025 #22	2.250	5.8	T3	9.53	19.46	10.31	23.40	26.59	.64 #22	57.15
T4	.375	1.062	.406	1.217	1.343	.025 #22	2.250	9.0	T4	9.53	26.97	10.31	30.91	34.11	.64 #22	57.15

Cap (μ F)	Cap Tol (\pm)	Maximum Working Voltage		Surge Voltage @ +85°C	Part Number MIL-C-39006/09 Failure Rate Level (% / 1000 Hrs.)			Max DF (%)	Max Z -55°C (Ohms)	Maximum DC Leakage (μ A)		Maximum % Capacitance Change from Room Temperature			Case Code
		+85°C	+125°C		M (1.0)	P (0.1)	R (0.01)			+25°C	+85°C & +125°C	-55°C	+85°C	+125°C	
30	20	6	4	6.9	8206	8411	8616	9.1	100	1	2	-40	+10.5	+12	T1
30	10	6	4	6.9	8207	8412	8617	9.1	100	1	2	-40	+10.5	+12	T1
68	20	6	4	6.9	8209	8414	8619	20.4	60	1	2	-40	+14	+16	T1
68	10	6	4	6.9	8210	8415	8620	20.4	60	1	2	-40	+14	+16	T1
140	20	6	4	6.9	8212	8417	8622	21.3	40	1	3	-40	+14	+16	T2
140	10	6	4	6.9	8213	8418	8623	21.3	40	1	3	-40	+14	+16	T2
270	20	6	4	6.9	8215	8420	8625	81.8	25	1	6.5	-40	+17.5	+20	T2
270	10	6	4	6.9	8216	8421	8626	81.8	25	1	6.5	-44	+17.5	+20	T2
330	20	6	4	6.9	8218	8423	8628	49.6	20	2	7.9	-44	+14	+16	T3
330	10	6	4	6.9	8219	8424	8629	49.6	20	2	7.9	-44	+14	+16	T3
560	20	6	4	6.9	8221	8426	8631	128	25	2	13	-64	+17.5	+20	T3
560	10	6	4	6.9	8222	8427	8632	128	25	2	13	-64	+17.5	+20	T3
1200	20	6	4	6.9	8224	8429	8634	144.4	20	3	14	-80	+25	+25	T4
1200	10	6	4	6.9	8225	8430	8635	144.4	20	3	14	-80	+25	+25	T4
25	20	8	5	9.2	8226	8431	8636	7.6	100	1	2	-40	+10.5	+12	T1
25	10	8	5	9.2	8227	8432	8637	7.6	100	1	2	-40	+10.5	+12	T1
56	20	8	5	9.2	8229	8434	8639	17	59	1	2	-40	+14	+16	T1
56	10	8	5	9.2	8230	8435	8640	17	59	1	2	-40	+14	+16	T1
220	20	8	5	9.2	8232	8437	8642	66.4	30	1	7	-44	+17.5	+20	T2
220	10	8	5	9.2	8233	8438	8643	66.4	30	1	7	-44	+17.5	+20	T2
430	20	8	5	9.2	8235	8440	8645	91.5	25	2	14	-64	+17.5	+20	T3
430	10	8	5	9.2	8236	8441	8646	91.5	25	2	14	-64	+17.5	+20	T3
850	20	8	5	9.2	8238	8443	8648	65.8	22	4	16	-80	+25	+25	T4
850	10	8	5	9.2	8239	8444	8649	65.8	22	4	16	-80	+25	+25	T4

TO ORDER: Indicate the prefix M39006/09 followed by the applicable MIL dash number
Example: For M39006/09-8210 order M39006/098210

CLR65 (MIL-C-39006/09) Wet Tantalum Capacitors



Wet Tantalum Capacitors

Cap (μ F)	Cap Tol (\pm)	Maximum Working Voltage		Surge Voltage @ +85°C	Part Number MIL-C-39006/09 Failure Rate Level (% / 1000 Hrs.)			Max DF (%)	Max Z -55°C (Ohms)	Maximum DC Leakage (μ A)		Maximum % Capacitance Change from Room Temperature			Case Code
		+85°C	+125°C		M (1.0)	P (0.1)	R (0.01)			+25°C	+85°C & +125°C	-55°C	+85°C	+125°C	
		20	20		10	7	11.5			8240	8445	8650	6.1	175	
20	10	10	7	11.5	8241	8446	8651	6.1	175	1	2	-32	+10.5	+12	T1
47	20	10	7	11.5	8243	8448	8653	18.1	100	1	2	-36	+14	+16	T1
47	10	10	7	11.5	8244	8449	8654	18.1	100	1	2	-36	+14	+16	T1
100	20	10	7	11.5	8246	8451	8656	15.2	60	1	4	-36	+14	+16	T2
100	10	10	7	11.5	8247	8452	8657	15.2	60	1	4	-36	+14	+16	T2
180	20	10	7	11.5	8249	8454	8659	54.4	40	1	7	-36	+14	+16	T2
180	10	10	7	11.5	8250	8455	8660	54.4	40	1	7	-36	+14	+16	T2
250	20	10	7	11.5	8252	8457	8662	37.8	30	2	10	-40	+14	+16	T3
250	10	10	7	11.5	8253	8458	8663	37.8	30	2	10	-40	+14	+16	T3
390	20	10	7	11.5	8255	8460	8665	87.6	25	2	16	-64	+20	+20	T3
390	10	10	7	11.5	8256	8461	8666	87.6	25	2	16	-64	+20	+20	T3
750	20	10	7	11.5	8258	8463	8668	56.5	23	4	16	-80	+25	+25	T4
750	10	10	7	11.5	8259	8464	8669	56.5	23	4	16	-80	+25	+25	T4
15	20	15	10	17.2	8260	8465	8670	5.7	155	1	2	-24	+10.5	+12	T1
15	10	15	10	17.2	8261	8566	8671	5.7	155	1	2	-24	+10.5	+12	T1
33	20	15	10	17.2	8263	8468	8673	12.5	90	1	2	-28	+14	+16	T1
33	10	15	10	17.2	8264	8569	8674	12.5	90	1	2	-28	+14	+16	T1
70	20	15	10	17.2	8266	8471	8676	13.1	75	1	4	-28	+14	+16	T2
70	10	15	10	17.2	8267	8472	8677	13.1	75	1	4	-28	+14	+16	T2
120	20	15	10	17.2	8269	8474	8679	36.8	50	1	7	-28	+17.5	+20	T2
120	10	15	10	17.2	8270	8475	8680	36.8	50	1	7	-28	+17.5	+20	T2
170	20	15	10	17.2	8272	8477	8682	25.4	35	2	10	-32	+14	+16	T3
170	10	15	10	17.2	8273	8478	8683	25.4	35	2	10	-32	+14	+16	T3
270	20	15	10	17.2	8275	8480	8685	60.9	30	2	16	-56	+17.5	+20	T3
270	10	15	10	17.2	8276	8481	8686	60.9	30	2	16	-56	+17.5	+20	T3
540	20	15	10	17.2	8278	8483	8688	49	23	6	24	-80	+25	+25	T4
540	10	15	10	17.2	8279	8484	8689	49	23	6	24	-80	+25	+25	T4
10	20	25	15	28.8	8280	8485	8690	4.6	220	1	2	-16	+8	+9	T1
10	10	25	15	28.8	8281	8486	8691	4.6	220	1	2	-16	+8	+9	T1
22	20	25	15	28.8	8283	8488	8693	8.3	140	1	2	-20	+10.5	+15	T1
22	10	25	15	28.8	8284	8489	8694	8.3	140	1	2	-20	+10.5	+15	T1
100	20	25	15	28.8	8286	8491	8696	31.4	50	1	10	-28	+13	+15	T2
100	10	25	15	28.8	8287	8492	8697	31.4	50	1	10	-28	+13	+15	T2
180	20	25	15	28.8	8289	8494	8699	54.3	32	2	18	-48	+13	+15	T3
180	10	25	15	28.8	8290	8495	8700	54.3	32	2	18	-48	+13	+15	T3
350	20	25	15	28.8	8292	8497	8702	35	24	7	28	-70	+25	+25	T4
350	10	25	15	28.8	8293	8498	8703	35	24	7	28	-70	+25	+25	T4
8	20	30	20	34.5	8294	8499	8704	4.5	275	1	2	-16	+8	+12	T1
8	10	30	20	34.5	8295	8500	8705	4.5	275	1	2	-16	+8	+12	T1
15	20	30	20	34.5	8297	8502	8707	9.1	175	1	2	-20	+10.5	+12	T1
15	10	30	20	34.5	8298	8503	8708	9.1	175	1	2	-20	+10.5	+12	T1
40	20	30	20	34.5	8300	8505	8710	12.2	65	1	5	-24	+10.5	+12	T2
40	10	30	20	34.5	8301	8506	8711	12.2	65	1	5	-24	+10.5	+12	T2
68	20	30	20	34.5	8303	8508	8713	31	60	1	8	-24	+13	+15	T2
68	10	30	20	34.5	8304	8509	8714	31	60	1	8	-24	+13	+15	T2
100	20	30	20	34.5	8306	8511	8716	19	40	2	12	-28	+10.5	+12	T3
100	10	30	20	34.5	8307	8512	8717	19	40	2	12	-28	+10.5	+12	T3
150	20	30	20	34.5	8309	8514	8719	46	35	2	18	-48	+13	+15	T3
150	10	30	20	34.5	8310	8515	8720	46	35	2	18	-48	+13	+15	T3
300	20	30	20	34.5	8312	8517	8722	35	25	8	32	-60	+25	+25	T4
300	10	30	20	34.5	8313	8518	8723	35	25	8	32	-60	+25	+25	T4
5	20	50	30	57.5	8314	8519	8724	3.4	400	1	2	-16	+5	+6	T1
5	10	50	30	57.5	8315	8520	8725	3.4	400	1	2	-16	+5	+6	T1
10	20	50	30	57.5	8317	8522	8727	6	250	1	2	-24	+8	+9	T1
10	10	50	30	57.5	8318	8523	8728	6	250	1	2	-24	+8	+9	T1
25	20	50	30	57.5	8320	8525	8730	11.2	95	1	5	-20	+10.5	+12	T2
25	10	50	30	57.5	8321	8526	8731	11.2	95	1	5	-20	+10.5	+12	T2
47	20	50	30	57.5	8323	8528	8733	21.4	70	1	9	-28	+13	+15	T2
47	10	50	30	57.5	8324	8529	8734	21.4	70	1	9	-28	+13	+15	T2
60	20	50	30	57.5	8326	8531	8736	13.6	45	2	12	-16	+10.5	+12	T3
60	10	50	30	57.5	8327	8532	8737	13.6	45	2	12	-16	+10.5	+12	T3
82	20	50	30	57.5	8329	8534	8739	24.9	45	2	16	-32	+13	+15	T3
82	10	50	30	57.5	8330	8535	8740	24.9	45	2	16	-32	+13	+15	T3
160	20	50	30	57.5	8332	8537	8742	25.7	27	8	32	-50	+25	+25	T4
160	10	50	30	57.5	8333	8538	8743	25.7	27	8	32	-50	+25	+25	T4

TO ORDER: Indicate the prefix M39006/09 followed by the applicable MIL dash number
Example: For M39006/09-8210 order M39006/098210

CLR65 (MIL-C-39006/09) Wet Tantalum Capacitors



Wet Tantalum Capacitors

Cap (μ F)	Cap Tol (\pm)	Maximum Working Voltage		Surge Voltage @ +85°C	Part Number MIL-C-39006/09 Failure Rate Level (% / 1000 Hrs.)			Max DF (%)	Max Z -55°C (Ohms)	Maximum DC Leakage (μ A)		Maximum % Capacitance Change from Room Temperature			Case Code
		+85°C	+125°C		M (1.0)	P (0.1)	R (0.01)			+25°C	+85°C & +125°C	-55°C	+85°C	+125°C	
		4	20		60	40	69			8334	8539	8744	3	550	
4	10	60	40	69	8335	8540	8745	3	550	1	2	-16	+5	+6	T1
8.2	20	60	40	69	8337	8542	8747	5	275	1	2	-24	+8	+9	T1
8.2	10	60	40	69	8338	8543	8748	5	275	1	2	-24	+8	+9	T1
20	20	60	40	69	8340	8544	8750	7.6	105	1	5	-16	+10.5	+12	T2
20	10	60	40	69	8341	8546	8751	7.6	105	1	5	-16	+10.5	+12	T2
39	20	60	40	69	8343	8548	8753	20.7	90	1	9	-28	+10.5	+12	T2
39	10	60	40	69	8344	8549	8754	20.7	90	1	9	-28	+10.5	+12	T2
50	20	60	40	69	8346	8551	8756	15.3	50	2	12	-16	+10.5	+12	T3
50	10	60	40	69	8347	8552	8757	15.3	50	2	12	-16	+10.5	+12	T3
68	20	60	40	69	8349	8554	8759	30.7	50	2	16	-32	+10.5	+12	T3
68	10	60	40	69	8350	8555	8760	30.7	50	2	16	-32	+10.5	+12	T3
140	20	60	40	69	8352	8557	8762	25.7	28	8	32	-40	+20	+20	T4
140	10	60	40	69	8353	8558	8763	25.7	28	8	32	-40	+20	+20	T4
3.5	20	75	50	86.2	8354	8559	8764	2.5	650	1	2	-16	+5	+6	T1
3.5	10	75	50	86.2	8355	8560	8765	2.5	650	1	2	-16	+5	+6	T1
6.8	20	75	50	86.2	8357	8562	8767	4.1	300	1	2	-20	+8	+9	T1
6.8	10	75	50	86.2	8358	8563	8768	4.1	300	1	2	-20	+8	+9	T1
15	20	75	50	86.2	8360	8565	8770	7.5	150	1	5	-16	+8	+9	T2
15	10	75	50	86.2	8361	8566	8771	7.5	150	1	5	-16	+8	+9	T2
33	20	75	50	86.2	8363	8568	8773	17.5	90	1	10	-24	+10.5	+15	T2
33	10	75	50	86.2	8364	8569	8774	17.5	90	1	10	-24	+10.5	+15	T2
40	20	75	50	86.2	8366	8571	8776	15.2	60	2	12	-16	+10.5	+12	T3
40	10	75	50	86.2	8367	8572	8777	15.2	60	2	12	-16	+10.5	+12	T3
56	20	75	50	86.2	8369	8574	8779	26	60	2	17	-28	+10.5	+15	T3
56	10	75	50	86.2	8370	8575	8780	26	60	2	17	-28	+10.5	+15	T3
110	20	75	50	86.2	8372	8577	8782	25.7	29	9	36	-35	+20	+20	T4
110	10	75	50	86.2	8373	8578	8783	25.7	29	9	36	-35	+20	+20	T4
2.5	20	100	65	115	8374	8579	8784	5	950	1	2	-16	+7	+8	T1
2.5	10	100	65	115	8375	8580	8785	5	950	1	2	-16	+7	+8	T1
4.7	20	100	65	115	8377	8582	8787	3.6	500	1	2	-16	+7	+8	T1
4.7	10	100	65	115	8378	8583	8788	3.6	500	1	2	-16	+7	+8	T1
11	20	100	65	115	8380	8585	8790	5	200	1	4	-16	+7	+8	T2
11	10	100	65	115	8381	8586	8791	5	200	1	4	-16	+7	+8	T2
22	20	100	65	115	8383	8588	8793	11.8	100	1	9	-16	+7	+8	T2
22	10	100	65	115	8384	8589	8794	11.8	100	1	9	-16	+7	+8	T2
30	20	100	65	115	8386	8591	8796	9.1	80	2	12	-16	+7	+8	T3
30	10	100	65	115	8387	8592	8797	9.1	80	2	12	-16	+7	+8	T3
43	20	100	65	115	8389	8594	8799	19.7	70	2	17	-20	+7	+8	T3
43	10	100	65	115	8390	8595	8800	19.7	70	2	17	-20	+7	+8	T3
86	20	100	65	115	8392	8597	8802	20.7	30	9	36	-25	+15	+15	T4
86	10	100	65	115	8393	8598	8803	20.7	30	9	36	-25	+15	+15	T4
1.7	20	125	85	144	8394	8599	8804	7	1250	1	2	-16	+7	+8	T1
1.7	10	125	85	144	8395	8600	8805	7	1250	1	2	-16	+7	+8	T1
3.6	20	125	85	144	8397	8602	8807	4.1	600	1	2	-16	+7	+8	T1
3.6	10	125	85	144	8398	8603	8808	4.1	600	1	2	-16	+7	+8	T1
9	20	125	85	144	8400	8605	8810	10.2	240	1	5	-16	+7	+8	T2
9	10	125	85	144	8401	8606	8811	10.2	240	1	5	-16	+7	+8	T2
14	20	125	85	144	8403	8608	8813	12.7	167	1	7	-16	+7	+8	T2
14	10	125	85	144	8404	8609	8814	12.7	167	1	7	-16	+7	+8	T2
18	20	125	85	144	8406	8611	8816	15	129	2	9	-16	+7	+8	T3
18	10	125	85	144	8407	8612	8817	15	129	2	9	-16	+7	+8	T3
25	20	125	85	144	8409	8614	8819	19	93	2	13	-16	+7	+8	T3
25	10	125	85	144	8410	8615	8820	19	93	2	13	-16	+7	+8	T3
56	20	125	85	144	9030	9033	9036	17.5	32	10	40	-25	+15	+15	T4
56	10	125	85	144	9031	9034	9037	17.5	32	10	40	-25	+15	+15	T4

TO ORDER: Indicate the prefix M39006/09 followed by the applicable MIL dash number
Example: For M39006/09-8210 order M39006/098210

CLR69 (MIL-C-39006/21) Wet Tantalum Capacitors



Wet Tantalum Capacitors

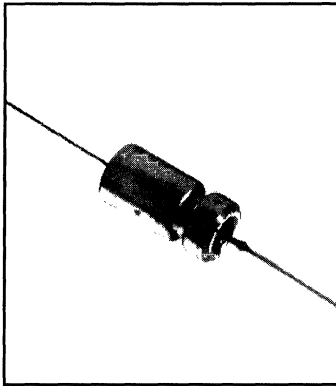

- Silver Case Technology
- Hermetically Sealed
- Rugged Construction
- High Shock and Vibration Capability
- High Capacitance per Case Size
- Low DCL and ESR
- Long Shelf Life
- Failure Rate Levels M, P and R

GENERAL SPECIFICATIONS

Operating Temperature:
-55°C to +125°C
with voltage derating

Voltage Range:
6 to 125 VDC

Capacitance Range:
6.8 μ F to 2200 μ F

Tolerance Range:
 $\pm 10\%$, $\pm 20\%$

Case Sizes: (Four)
.188 x .453 to .375 x 1.062

Maximum rms Ripple Current @ 85°C	
Case Code	mA
A	50
B	250
C	500
F	750

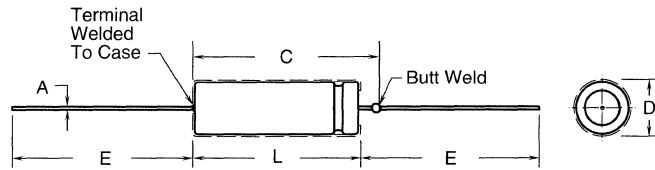

INCHES

(DIMENSIONS)

MILLIMETERS

Case Code	Uninsulated		Insulated		C	A		E	Approximate Weight (Grams) (1 gram = .035 Oz.)	Case Code	Uninsulated		Insulated		C	A		E
	D	L	D	L		Lead Dia	Lead Lgth				D	L	Lead Dia	Lead Lgth				
T1	.188	.453	.219	.608	.734	.025	#22	1.500	1.2	T1	4.78	11.51	5.56	15.45	18.64	.64	#22	38.10
T2	.281	.641	.312	.796	.922	.025	#22	2.250	3.1	T2	7.14	16.28	7.92	20.22	23.41	.64	#22	57.15
T3	.375	.766	.406	.921	1.047	.025	#22	2.250	5.8	T3	9.53	19.46	10.31	23.40	26.59	.64	#22	57.15
T4	.375	1.062	.406	1.217	1.343	.025	#22	2.250	9.0	T4	9.53	26.97	10.31	30.91	34.11	.64	#22	57.15

Cap (μ F)	Cap Tol (\pm)	Maximum Working Voltage		Surge Voltage @ +85°C	Part Number MIL-C-39006/21 Failure Rate Level (% / 1000 Hrs.)			Max DF (%)	Max Z -55°C (Ohms)	Maximum DC Leakage (μ A)		Maximum % Capacitance Change from Room Temperature			Case Code
		+85°C	+125°C		M (1.0)	P (0.1)	R (0.01)			+25°C	+85°C & +125°C	-55°C	+85°C	+125°C	
		220	20		6	4	6.9			0089	0177	0265	50	36	
220	10	6	4	6.9	0090	0178	0266	50	36	2	9	-64	+13	+16	T1
820	20	6	4	6.9	0091	0179	0267	155	18	3	14	-88	+16	+20	T2
820	10	6	4	6.9	0092	0180	0268	155	18	3	14	-88	+16	+20	T2
1500	20	6	4	6.9	0093	0181	0269	172	18	5	20	-90	+20	+25	T3
1500	10	6	4	6.9	0094	0182	0270	172	18	5	20	-90	+20	+25	T3
2200	20	6	4	6.9	0095	0183	0271	170	13	6	24	-90	+25	+30	T4
2200	10	6	4	6.9	0096	0184	0272	170	13	6	24	-90	+25	+30	T4
180	20	8	5	9.2	0097	0185	0273	41	45	2	9	-60	+13	+16	T1
180	10	8	5	9.2	0098	0186	0274	41	45	2	9	-60	+13	+16	T1
680	20	8	5	9.2	0099	0187	0275	130	22	3	14	-83	+16	+20	T2
680	10	8	5	9.2	0100	0188	0276	130	22	3	14	-83	+16	+20	T2
1500	20	8	5	9.2	0101	0189	0277	170	18	5	20	-90	+20	+25	T3
1500	10	8	5	9.2	0102	0190	0278	170	18	5	20	-90	+20	+25	T3
1800	20	8	5	9.2	0103	0191	0279	138	14	7	25	-90	+25	+30	T4
1800	10	8	5	9.2	0104	0192	0280	138	14	7	25	-90	+25	+30	T4
150	20	10	7	11.5	0105	0193	0281	34	54	2	9	-55	+13	+16	T1
150	10	10	7	11.5	0106	0194	0282	34	54	2	9	-55	+13	+16	T1
560	20	10	7	11.5	0107	0195	0283	106	27	3	16	-77	+16	+20	T2
560	10	10	7	11.5	0108	0196	0284	106	27	3	16	-77	+16	+20	T2
1200	20	10	7	11.5	0109	0197	0285	137	18	5	20	-77	+20	+25	T3
1200	10	10	7	11.5	0110	0198	0286	137	18	5	20	-77	+20	+25	T3
1500	20	10	7	11.5	0111	0199	0287	114	15	7	25	-88	+25	+30	T4
1500	10	10	7	11.5	0112	0200	0288	114	15	7	25	-88	+25	+30	T4

TO ORDER: Indicate the prefix M39006/21 followed by the applicable MIL dash number
Example: For M39006/21-0197 order M39006/210197

CLR69 (MIL-C-39006/21) Wet Tantalum Capacitors



Cap (μ F)	Cap Tol (\pm)	Maximum Working Voltage		Surge Voltage @ +85°C	Part Number MIL-C-39006/21 Failure Rate Level (% / 1000 Hrs.)			Max DF (%)	Max Z -55°C (Ohms)	Maximum DC Leakage (μ A)		Maximum % Capacitance Change from Room Temperature			Case Code
		+85°C	+125°C		M (1.0)	P (0.1)	R (0.01)			+25°C	+85°C & +125°C	-55°C	+85°C	+125°C	
		100	20		15	10	17.2			0113	0201	0289	30	72	
100	10	15	10	17.2	0114	0202	0290	30	72	2	9	-44	+13	+16	T1
390	20	15	10	17.2	0115	0203	0291	74	31	3	16	-66	+16	+20	T2
390	10	15	10	17.2	0116	0204	0292	74	31	3	16	-66	+16	+20	T2
820	20	15	10	17.2	0117	0205	0293	111	22	6	28	-77	+20	+25	T3
820	10	15	10	17.2	0118	0206	0294	111	22	6	28	-77	+20	+25	T3
1000	20	15	10	17.2	0119	0207	0295	92	17	8	32	-77	+25	+30	T4
1000	10	15	10	17.2	0120	0208	0296	92	17	8	32	-77	+25	+30	T4
68	20	25	15	28.8	0121	0209	0297	22	90	2	9	-40	+12	+15	T1
68	10	25	15	28.8	0122	0210	0298	22	90	2	9	-40	+12	+15	T1
270	20	25	15	28.8	0123	0211	0299	55	33	3	16	-62	+13	+16	T2
270	10	25	15	28.8	0124	0212	0300	55	33	3	16	-62	+13	+16	T2
560	20	25	15	28.8	0125	0213	0301	76	24	7	28	-72	+20	+25	T3
560	10	25	15	28.8	0126	0214	0302	76	24	7	28	-72	+20	+25	T3
680	20	25	15	28.8	0127	0215	0303	63	19	8	32	-72	+25	+30	T4
680	10	25	15	28.8	0128	0216	0304	63	19	8	32	-72	+25	+30	T4
56	20	30	20	34.5	0129	0217	0305	22	100	2	9	-38	+12	+15	T1
56	10	30	20	34.5	0130	0218	0306	22	100	2	9	-38	+12	+15	T1
220	20	30	20	34.5	0131	0219	0307	42	36	3	16	-60	+13	+16	T2
220	10	30	20	34.5	0132	0220	0308	42	36	3	16	-60	+13	+16	T2
470	20	30	20	34.5	0133	0221	0309	64	25	8	32	-65	+20	+25	T3
470	10	30	20	34.5	0134	0222	0310	64	25	8	32	-65	+20	+25	T3
560	20	30	20	34.5	0135	0223	0311	55	20	9	36	-65	+25	+30	T4
560	10	30	20	34.5	0136	0224	0312	55	20	9	36	-65	+25	+30	T4
33	20	50	30	57.5	0137	0225	0313	12.3	135	2	9	-29	+10	+12	T1
33	10	50	30	57.5	0138	0226	0314	12.3	135	2	9	-29	+10	+12	T1
120	20	50	30	57.5	0139	0227	0315	22.5	49	4	24	-42	+12	+15	T2
120	10	50	30	57.5	0140	0228	0316	22.5	49	4	24	-42	+12	+15	T2
270	20	50	30	57.5	0141	0229	0317	37	29	8	32	-46	+20	+25	T3
270	10	50	30	57.5	0142	0230	0318	37	29	8	32	-46	+20	+25	T3
330	20	50	30	57.5	0143	0231	0319	38	22	9	36	-46	+25	+30	T4
330	10	50	30	57.5	0144	0232	0320	38	22	9	36	-46	+25	+30	T4
27	20	60	40	69	0145	0233	0321	10.2	144	3	12	-24	+10	+12	T1
27	10	60	40	69	0146	0234	0322	10.2	144	3	12	-24	+10	+12	T1
100	20	60	40	69	0147	0235	0323	19	54	4	20	-36	+12	+15	T2
100	10	60	40	69	0148	0236	0324	19	54	4	20	-36	+12	+15	T2
220	20	60	40	69	0149	0237	0325	30	29	8	32	-40	+16	+20	T3
220	10	60	40	69	0150	0238	0326	30	29	8	32	-40	+16	+20	T3
270	20	60	40	69	0151	0239	0327	27	23	9	36	-45	+20	+25	T4
270	10	60	40	69	0152	0240	0328	27	23	9	36	-45	+20	+25	T4
22	20	75	50	86.2	0153	0241	0329	8.5	157	3	12	-19	+10	+12	T1
22	10	75	50	86.2	0154	0242	0330	8.5	157	3	12	-19	+10	+12	T1
82	20	75	50	86.2	0155	0243	0331	15.2	63	4	24	-30	+12	+15	T2
82	10	75	50	86.2	0156	0244	0332	15.2	63	4	24	-30	+12	+15	T2
180	20	75	50	86.2	0157	0245	0333	24.4	30	9	36	-35	+16	+20	T3
180	10	75	50	86.2	0158	0246	0334	24.4	30	9	36	-35	+16	+20	T3
220	20	75	50	86.2	0159	0247	0335	37	24	10	40	-40	+20	+25	T4
220	10	75	50	86.2	0160	0248	0336	37	24	10	40	-40	+20	+25	T4
10	20	100	65	115	0161	0249	0337	4.5	200	3	12	-17	+10	+12	T1
10	10	100	65	115	0162	0250	0338	4.5	200	3	12	-17	+10	+12	T1
39	20	100	65	115	0163	0251	0339	10.5	80	5	24	-20	+12	+15	T2
39	10	100	65	115	0164	0252	0340	10.5	80	5	24	-20	+12	+15	T2
68	20	100	65	115	0165	0253	0341	11.3	40	10	40	-30	+14	+16	T3
68	10	100	65	115	0166	0254	0342	11.3	40	10	40	-30	+14	+16	T3
120	20	100	65	115	0167	0255	0343	25	30	12	48	-35	+15	+17	T4
120	10	100	65	115	0168	0256	0344	25	30	12	48	-35	+15	+17	T4
6.8	20	125	85	144	0169	0257	0345	6	300	3	12	-14	+10	+12	T1
6.8	10	125	85	144	0170	0258	0346	6	300	3	12	-14	+10	+12	T1
27	20	125	85	144	0171	0259	0347	7.2	90	5	24	-18	+12	+15	T2
27	10	125	85	144	0172	0260	0348	7.2	90	5	24	-18	+12	+15	T2
47	20	125	85	144	0173	0261	0349	7.9	50	10	40	-26	+14	+16	T3
47	10	125	85	144	0174	0262	0350	7.9	50	10	40	-26	+14	+16	T3
82	20	125	85	144	0175	0263	0351	17.4	32	12	48	-30	+15	+17	T4
82	10	125	85	144	0176	0264	0352	17.4	32	12	48	-30	+15	+17	T4

Wet Tantalum Capacitors

TO ORDER: Indicate the prefix M39006/21 followed by the applicable MIL dash number
 Example: For M39006/21-0197 order M39006/210197

CLR79 (MIL-C-39006/22) Wet Tantalum Capacitors

MALLORY

Wet Tantalum Capacitors

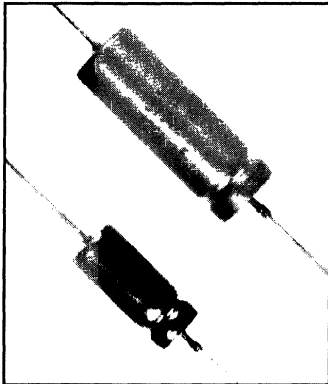

- All Tantalum Case
- Hermetically Sealed
- Up to 3 Volts Reverse Capability
- Higher Ripple Current Capability
- Low DCL and ESR
- Rugged Construction
- Failure Rate Levels M, P and R

GENERAL SPECIFICATIONS

Operating Temperature:
-55°C to +125°C
with voltage derated

Voltage Range:
6 to 125 VDC

Capacitance Range:
1.7 μ F to 1200 μ F

Tolerance Range:
 \pm 10%, \pm 20%
(\pm 5% by special order)

Case Sizes: (Four)
.188 x .453 to .375 x 1.062

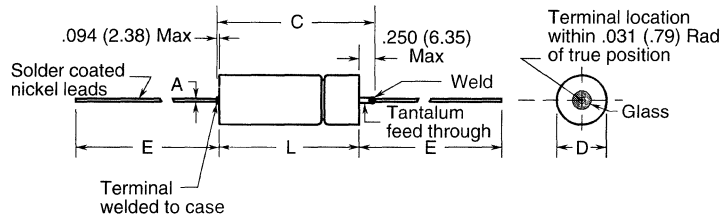

INCHES (DIMENSIONS) MILLIMETERS

Case Code	Uninsulated		Insulated		C	A Lead Dia Nom AWG	E Lead Lgth \pm .250	Approximate Weight (Grams) (1 gram = .035 Oz.)	Case Code	Uninsulated		Insulated		C	A Lead Dia Nom AWG	E Lead Lgth \pm 6.35
	D \pm .016	L +.031 -.016	D Max	L Max						D Max	L Max	D \pm .41	L +.79 -.41			
T1	.188	.453	.219	.608	.734	.025 #22	1.500	2.0	T1	4.78	11.51	5.56	15.45	18.64	.64 #22	38.10
T2	.281	.641	.312	.796	.922	.025 #22	2.250	4.5	T2	7.14	16.28	7.92	20.22	23.41	.64 #22	57.15
T3	.375	.766	.406	.921	1.047	.025 #22	2.250	8.0	T3	9.53	19.46	10.31	23.40	26.59	.64 #22	57.15
T4	.375	1.062	.406	1.217	1.343	.025 #22	2.250	12.0	T4	9.53	26.97	10.31	30.91	34.11	.64 #22	57.15

Cap (μ F)	Cap Tol (\pm)	Maximum Working Voltage		Surge Voltage @ +85°C	Part Number MIL-C-39006/22 Failure Rate Level % / 1,000 Hrs			Max DF (%)	Max ESR Ω @ +25°C	Maximum DC Leakage (μ A)		Max Ripple @ 85°C 40kHz (mA)	Maximum % Capacitance Change from Room Temperature			Case Code
		+85°C	+125°C		M (1.0)	P (0.1)	R (0.01)			+25°C	+85°C & +125°C		-55°C	+85°C	+125°C	
30	20	6	4	6.92	0001	0221	0441	9	3.98	1	2	820	-40	+10.5	+12	T1
30	10	6	4	6.9	0002	0222	0442	9	3.98	1	2	820	-40	+10.5	+12	T1
68	20	6	4	6.9	0004	0224	0444	15	3.16	1	2	960	-40	+14	+16	T1
68	10	6	4	6.9	0005	0225	0445	15	3.16	1	2	960	-40	+14	+16	T1
140	20	6	4	6.9	0007	0227	0447	21	1.99	1	3	1200	-40	+14	+16	T2
140	10	6	4	6.9	0008	0228	0448	21	1.99	1	3	1200	-40	+14	+16	T2
270	20	6	4	6.9	0010	0230	0450	45	2.21	1	6.5	1375	-44	+20	+17.5	T2
270	10	6	4	6.9	0011	0231	0451	45	2.21	1	6.5	1375	-44	+20	+17.5	T2
330	20	6	4	6.9	0013	0233	0453	36	1.45	2	7.9	1800	-44	+16	+14	T3
330	10	6	4	6.9	0014	0234	0454	36	1.45	2	7.9	1800	-44	+16	+14	T3
560	20	6	4	6.9	0016	0236	0456	55	1.30	2	13	1900	-64	+20	+17.5	T3
560	10	6	4	6.9	0017	0237	0457	55	1.30	2	13	1900	-64	+20	+17.5	T3
1200	20	6	4	6.9	0019	0239	0459	90	1.00	3	14	2265	-80	+25	+25	T4
1200	10	6	4	6.9	0020	0240	0460	90	1.00	3	14	2265	-80	+25	+25	T4
25	20	8	5	9.2	0021	0241	0461	7.5	3.98	1	2	820	-40	+10.5	+12	T1
25	10	8	5	9.2	0022	0242	0462	7.5	3.98	1	2	820	-40	+10.5	+12	T1
56	20	8	5	9.2	0024	0244	0464	14	3.32	1	2	900	-40	+14	+16	T1
56	10	8	5	9.2	0025	0245	0465	14	3.32	1	2	900	-40	+14	+16	T1
120	20	8	5	9.2	0027	0247	0467	20	2.21	1	2	1220	-44	+17.5	+20	T2
120	10	8	5	9.2	0028	0248	0468	20	2.21	1	2	1220	-44	+17.5	+20	T2
220	20	8	5	9.2	0030	0250	0470	37	2.23	1	7	1370	-44	+17.5	+20	T2
220	10	8	5	9.2	0031	0251	0471	37	2.23	1	7	1370	-44	+17.5	+20	T2
290	20	8	5	9.2	0033	0253	0473	34	1.56	2	6	1770	-64	+17.5	+20	T3
290	10	8	5	9.2	0034	0254	0474	34	1.56	2	6	1770	-64	+17.5	+20	T3
430	20	8	5	9.2	0036	0256	0476	46	1.42	2	14	1825	-64	+17.5	+20	T3
430	10	8	5	9.2	0037	0257	0477	46	1.42	2	14	1825	-64	+17.5	+20	T3
850	20	8	5	9.2	0039	0259	0479	60	0.94	4	16	2330	-80	+25	+25	T4
850	10	8	5	9.2	0040	0260	0480	60	0.94	4	16	2330	-80	+25	+25	T4

TO ORDER: Indicate the prefix M39006/22 followed by the applicable MIL dash number
Example: For M39006/22-0251 order M39006/220251. To obtain the optional
vibration and shock requirements, add 'H' (M39006/220251H)

CLR79 (MIL-C-39006/22) Wet Tantalum Capacitors



Wet Tantalum Capacitors

Cap (μ F)	Cap Tol (\pm)	Maximum Working Voltage		Surge Voltage @ +85°C	Part Number MIL-C-39006/22 Failure Rate Level % / 1,000 Hrs			Max DF (%)	Max ESR Ω @ +25°C	Maximum DC Leakage (μ A)		Max Ripple @ 85°C 40kHz (mA)	Maximum % Capacitance Change from Room Temperature			Case Code
		+85°C	+125°C		M (1.0)	P (0.1)	R (0.01)			+25°C	+85°C & +125°C		-55°C	+85°C	+125°C	
		20	20		10	7	11.5			0041	0261		0481	6	3.98	
20	10	10	7	11.5	0042	0262	0482	6	3.98	1	2	820	-32	+10.5	+12	T1
47	20	10	7	11.5	0044	0264	0484	13	3.67	1	2	855	-36	+14	+16	T1
47	10	10	7	11.5	0045	0265	0485	13	3.67	1	2	855	-36	+14	+16	T1
100	20	10	7	11.5	0047	0267	0487	15	1.99	1	4	1200	-36	+14	+16	T2
100	10	10	7	11.5	0048	0268	0488	15	1.99	1	4	1200	-36	+14	+16	T2
180	20	10	7	11.5	0050	0270	0490	30	2.21	1	7	1365	-36	+14	+16	T2
180	10	10	7	11.5	0051	0271	0491	30	2.21	1	7	1365	-36	+14	+16	T2
250	20	10	7	11.5	0053	0273	0493	30	1.59	2	10	1720	-40	+14	+16	T3
250	10	10	7	11.5	0054	0274	0494	30	1.59	2	10	1720	-40	+14	+16	T3
390	20	10	7	11.5	0056	0276	0496	44	1.50	2	16	1800	-64	+17.5	+20	T3
390	10	10	7	11.5	0057	0277	0497	44	1.50	2	16	1800	-64	+17.5	+20	T3
750	20	10	7	11.5	0059	0279	0499	50	0.88	4	16	2360	-80	+25	+25	T4
750	10	10	7	11.5	0060	0280	0500	50	0.88	4	16	2360	-80	+25	+25	T4
15	20	15	10	17.2	0061	0281	0501	5	4.42	1	2	780	-24	+10.5	+12	T1
15	10	15	10	17.2	0062	0282	0502	5	4.42	1	2	780	-24	+10.5	+12	T1
33	20	15	10	17.2	0064	0284	0504	10	4.02	1	2	820	-28	+14	+16	T1
33	10	15	10	17.2	0065	0285	0505	10	4.02	1	2	820	-28	+14	+16	T1
70	20	15	10	17.2	0067	0287	0507	13	2.46	1	4	1150	-28	+14	+16	T2
70	10	15	10	17.2	0068	0288	0508	13	2.46	1	4	1150	-28	+14	+16	T2
120	20	15	10	17.2	0070	0290	0510	18	1.99	1	7	1450	-28	+17.5	+20	T2
120	10	15	10	17.2	0071	0291	0511	18	1.99	1	7	1450	-28	+17.5	+20	T2
170	20	15	10	17.2	0073	0293	0513	25	1.95	2	10	1480	-32	+14	+16	T3
170	10	15	10	17.2	0074	0294	0514	25	1.95	2	10	1480	-32	+14	+16	T3
270	20	15	10	17.2	0076	0296	0516	32	1.57	2	16	1740	-56	+17.5	+20	T3
270	10	15	10	17.2	0077	0297	0517	32	1.57	2	16	1740	-56	+17.5	+20	T3
540	20	15	10	17.2	0079	0299	0519	40	0.98	4	24	2300	-80	+25	+25	T4
540	10	15	10	17.2	0080	0300	0520	40	0.98	4	24	2300	-80	+25	+25	T4
10	20	25	15	28.8	0081	0301	0521	4	5.31	1	2	715	-16	+8	+9	T1
10	10	25	15	28.8	0082	0302	0522	4	5.31	1	2	715	-16	+8	+9	T1
22	20	25	15	28.8	0084	0304	0524	6.6	3.98	1	2	825	-20	+10.5	+12	T1
22	10	25	15	28.8	0085	0305	0525	6.6	3.98	1	2	825	-20	+10.5	+12	T1
50	20	25	15	28.8	0087	0307	0527	11	2.92	1	2	1130	-28	+13	+15	T2
50	10	25	15	28.8	0088	0308	0528	11	2.92	1	2	1130	-28	+13	+15	T2
100	20	25	15	28.8	0090	0310	0530	15	1.99	1	10	1435	-28	+13	+15	T2
100	10	25	15	28.8	0091	0311	0531	15	1.99	1	10	1435	-28	+13	+15	T2
120	20	25	15	28.8	0093	0313	0533	21	2.32	2	6	1450	-32	+13	+15	T3
120	10	25	15	28.8	0094	0314	0534	21	2.32	2	6	1450	-32	+13	+15	T3
180	20	25	15	28.8	0096	0316	0536	26	1.92	2	18	1525	-48	+13	+15	T3
180	10	25	15	28.8	0097	0317	0537	26	1.92	2	18	1525	-48	+13	+15	T3
350	20	25	15	28.8	0099	0319	0539	35	1.33	7	28	1970	-70	+25	+25	T4
350	10	25	15	28.8	0100	0320	0540	35	1.33	7	28	1970	-70	+25	+25	T4
8	20	30	20	34.5	0101	0321	0541	4	6.64	1	2	640	-16	+8	+12	T1
8	10	30	20	34.5	0102	0322	0542	4	6.64	1	2	640	-16	+8	+12	T1
15	20	30	20	34.5	0104	0324	0544	5	4.42	1	2	780	-20	+10.5	+12	T1
15	10	30	20	34.5	0105	0325	0545	5	4.42	1	2	780	-20	+10.5	+12	T1
40	20	30	20	34.5	0107	0327	0547	10	3.32	1	5	1120	-24	+10.5	+12	T2
40	10	30	20	34.5	0108	0328	0548	10	3.32	1	5	1120	-24	+10.5	+12	T2
68	20	30	20	34.5	0110	0330	0550	13	2.54	1	8	1285	-24	+13	+15	T2
68	10	30	20	34.5	0111	0331	0551	13	2.54	1	8	1285	-24	+13	+15	T2
100	20	30	20	34.5	0113	0333	0553	17	2.26	2	12	1450	-28	+10.5	+12	T3
100	10	30	20	34.5	0114	0334	0554	17	2.26	2	12	1450	-28	+10.5	+12	T3
150	20	30	20	34.5	0116	0336	0556	23	2.03	2	18	1525	-48	+13	+15	T3
150	10	30	20	34.5	0117	0337	0557	23	2.03	2	18	1525	-48	+13	+15	T3
300	20	30	20	34.5	0119	0339	0559	31	1.37	8	32	1950	-60	+25	+25	T4
300	10	30	20	34.5	0120	0340	0560	31	1.37	8	32	1950	-60	+25	+25	T4
5	20	50	30	57.5	0121	0341	0561	3	7.96	1	2	580	-16	+5	+6	T1
5	10	50	30	57.5	0122	0342	0562	3	7.96	1	2	580	-16	+5	+6	T1
10	20	50	30	57.5	0124	0344	0564	4	5.31	1	2	715	-24	+8	+9	T1
10	10	50	30	57.5	0125	0345	0565	4	5.31	1	2	715	-24	+8	+9	T1
25	20	50	30	57.5	0127	0347	0567	8	4.25	1	5	1005	-20	+10.5	+12	T2
25	10	50	30	57.5	0128	0348	0568	8	4.25	1	5	1005	-20	+10.5	+12	T2
47	20	50	30	57.5	0130	0350	0570	11	3.11	1	9	1155	-28	+13	+15	T2
47	10	50	30	57.5	0131	0351	0571	11	3.11	1	9	1155	-28	+13	+15	T2

TO ORDER: Indicate the prefix M39006/22 followed by the applicable MIL dash number
 Example: For M39006/22-0251 order M39006/220251. To obtain the optional
 vibration and shock requirements, add 'H' (M39006/220251H)

CLR79 (MIL-C-39006/22) Wet Tantalum Capacitors



Wet Tantalum Capacitors

Cap (μ F)	Cap Tol (\pm)	Maximum Working Voltage		Surge Voltage @ +85°C	Part Number MIL-C-39006/22 Failure Rate Level % / 1,000 Hrs			Max DF (%)	Max ESR Ω @ +25°C	Maximum DC Leakage (μ A)		Max Ripple @ 85°C 40kHz (mA)	Maximum % Capacitance Change from Room Temperature			Case Code
		+85°C	+125°C		M (1.0)	P (0.1)	R (0.01)			+25°C	+85°C & +125°C		-55°C	+85°C	+125°C	
		60	20		50	30	57.5			0133	0353		0573	12	2.65	
60	10	50	30	57.5	0134	0354	0574	12	2.65	2	12	1335	-16	+10.5	+12	T3
82	20	50	30	57.5	0136	0356	0576	15	2.43	2	16	1400	-32	+13	+15	T3
82	10	50	30	57.5	0137	0357	0577	15	2.43	2	16	1400	-32	+13	+15	T3
160	20	50	30	57.5	0139	0359	0579	17	1.41	8	32	1900	-50	+25	+25	T4
160	10	50	30	57.5	0140	0360	0580	17	1.41	8	32	1900	-50	+25	+25	T4
4	20	60	40	69	0141	0361	0581	2.8	9.29	1	2	525	-16	+5	+6	T1
4	10	60	40	69	0142	0362	0582	2.8	9.29	1	2	525	-16	+5	+6	T1
8.2	20	60	40	69	0144	0364	0584	4	6.47	1	2	625	-24	+8	+9	T1
8.2	10	60	40	69	0145	0365	0585	4	6.47	1	2	625	-24	+8	+9	T1
20	20	60	40	69	0147	0367	0587	7	4.64	1	5	930	-16	+10.5	+12	T2
20	10	60	40	69	0148	0368	0588	7	4.64	1	5	930	-16	+10.5	+12	T2
39	20	60	40	69	0150	0370	0590	10	3.40	1	9	1110	-28	+10.5	+12	T2
39	10	60	40	69	0151	0371	0591	10	3.40	1	9	1110	-28	+10.5	+12	T2
50	20	60	40	69	0153	0373	0593	10	2.65	2	12	1330	-16	+10.5	+12	T3
50	10	60	40	69	0154	0374	0594	10	2.65	2	12	1330	-16	+10.5	+12	T3
68	20	60	40	69	0156	0376	0596	13	2.54	2	16	1365	-32	+10.5	+12	T3
68	10	60	40	69	0157	0377	0597	13	2.54	2	16	1365	-32	+10.5	+12	T3
140	20	60	40	69	0159	0379	0599	16	1.52	8	32	1850	-40	+20	+20	T4
140	10	60	40	69	0160	0380	0600	16	1.52	8	32	1850	-40	+20	+20	T4
3.5	20	75	50	86.2	0161	0381	0601	2.5	9.48	1	2	525	-16	+5	+6	T1
3.5	10	75	50	86.2	0162	0382	0602	2.5	9.48	1	2	525	-16	+5	+6	T1
6.8	20	75	50	86.2	0164	0384	0604	3.5	6.83	1	2	610	-20	+8	+9	T1
6.8	10	75	50	86.2	0165	0385	0605	3.5	6.83	1	2	610	-20	+8	+9	T1
15	20	75	50	86.2	0167	0387	0607	6	5.31	1	5	890	-16	+8	+9	T2
15	10	75	50	86.2	0168	0388	0608	6	5.31	1	5	890	-16	+8	+9	T2
33	20	75	50	86.2	0170	0390	0610	10	4.02	1	10	1000	-24	+10.5	+15	T2
33	10	75	50	86.2	0171	0391	0611	10	4.02	1	10	1000	-24	+10.5	+15	T2
40	20	75	50	86.2	0173	0393	0613	9	2.99	2	12	1250	-16	+10.5	+12	T3
40	10	75	50	86.2	0174	0394	0614	9	2.99	2	12	1250	-16	+10.5	+12	T3
56	20	75	50	86.2	0176	0396	0616	11	2.61	2	17	1335	-28	+10.5	+15	T3
56	10	75	50	86.2	0177	0397	0617	11	2.61	2	17	1335	-28	+10.5	+15	T3
110	20	75	50	86.2	0179	0399	0619	12	1.45	9	36	1850	-35	+20	+20	T4
110	10	75	50	86.2	0180	0400	0620	12	1.45	9	36	1850	-35	+20	+20	T4
2.5	20	100	65	115	0181	0401	0621	2	10.62	1	2	505	-16	+7	+8	T1
2.5	10	100	65	115	0182	0402	0622	2	10.62	1	2	505	-16	+7	+8	T1
4.7	20	100	65	115	0184	0404	0624	3	8.47	1	2	565	-16	+7	+8	T1
4.7	10	100	65	115	0185	0405	0625	3	8.47	1	2	565	-16	+7	+8	T1
11	20	100	65	115	0187	0407	0627	5	6.03	1	4	835	-16	+8	+8	T2
11	10	100	65	115	0188	0408	0628	5	6.03	1	4	835	-16	+8	+8	T2
22	20	100	65	115	0190	0410	0630	7.5	4.52	1	9	965	-16	+8	+8	T2
22	10	100	65	115	0191	0411	0631	7.5	4.52	1	9	965	-16	+8	+8	T2
30	20	100	65	115	0193	0413	0633	7	3.10	2	12	1240	-16	+8	+8	T3
30	10	100	65	115	0194	0414	0634	7	3.10	2	12	1240	-16	+8	+8	T3
43	20	100	65	115	0196	0416	0636	8.5	2.62	2	17	1335	-20	+8	+8	T3
43	10	100	65	115	0197	0417	0637	8.5	2.62	2	17	1335	-20	+8	+8	T3
86	20	100	65	115	0199	0419	0639	10	1.54	9	36	1800	-25	+15	+15	T4
86	10	100	65	115	0200	0420	0640	10	1.54	9	36	1800	-25	+15	+15	T4
1.7	20	125	85	144	0201	0421	0641	2	15.61	1	2	415	-16	+7	+8	T1
1.7	10	125	85	144	0202	0422	0642	2	15.61	1	2	415	-16	+7	+8	T1
3.6	20	125	85	144	0204	0424	0644	2.7	9.95	1	2	520	-16	+7	+8	T1
3.6	10	125	85	144	0205	0425	0645	2.7	9.95	1	2	520	-16	+7	+8	T1
9	20	125	85	144	0207	0427	0647	5	7.37	1	5	755	-16	+7	+8	T2
9	10	125	85	144	0208	0428	0648	5	7.37	1	5	755	-16	+7	+8	T2
14	20	125	85	144	0210	0430	0650	6	5.69	1	7	860	-16	+7	+8	T2
14	10	125	85	144	0211	0431	0651	6	5.69	1	7	860	-16	+7	+8	T2
18	20	125	85	144	0213	0433	0653	5	3.69	2	9	1130	-16	+7	+8	T3
18	10	125	85	144	0214	0434	0654	5	3.69	2	9	1130	-16	+7	+8	T3
25	20	125	85	144	0216	0436	0656	6	3.18	2	13	1200	-16	+7	+8	T3
25	10	125	85	144	0217	0437	0657	6	3.18	2	13	1200	-16	+7	+8	T3
56	20	125	85	144	0219	0439	0659	6.5	1.54	10	40	1800	-25	+15	+15	T4
56	10	125	85	144	0220	0440	0660	6.5	1.54	10	40	1800	-25	+15	+15	T4

TO ORDER: Indicate the prefix M39006/22 followed by the applicable MIL dash number
 Example: For M39006/22-0251 order M39006/220251. To obtain the optional
 vibration and shock requirements, add 'H' (M39006/220251H)

CLR81 (MIL-C-39006/25) Wet Tantalum Capacitors



Wet Tantalum Capacitors

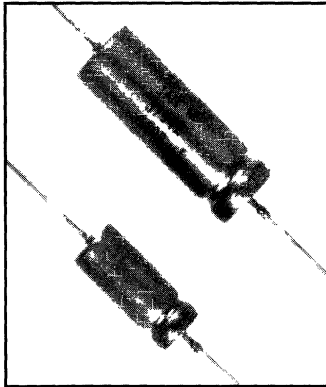

- Extended Range
- All Tantalum Case
- Hermetically Sealed
- Up to 3 Volts Reverse Capability
- Highest CV per Case Size
- Low DCL and ESR
- Rugged Construction
- Failure Rate Levels M, P and R

GENERAL SPECIFICATIONS

Operating Temperature:
-55°C to +125°C
with voltage derated

Voltage Range:
6 to 125 VDC

Capacitance Range:
6.8 μF to 2200 μF

Tolerance Range:
±10%, ±20%

Case Sizes: (Four)
.188 x .453 to .375 x 1.062

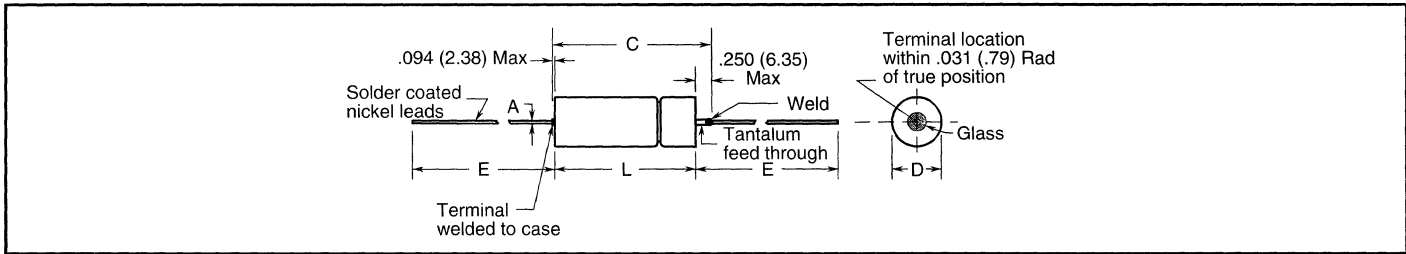

		INCHES							(DIMENSIONS)		MILLIMETERS							
Case Code	Uninsulated L		Insulated L		C	A		E	Approximate Weight (Grams) (1 gram = .035 Oz.)	Case Code	Uninsulated L		Insulated L		C	A		E
	D	+.031, -.016	D	L		Lead Dia Nom	Lead Dia AWG				Lead Dia Nom	Lead Dia AWG	D	+.79, -.41		D	L	
T1	.188	.453	.219	.608	.734	.025	#22	1.500	2.0	T1	4.78	11.51	5.56	15.45	18.64	.64	#22	38.10
T2	.281	.641	.312	.796	.922	.025	#22	2.250	5.5	T2	7.14	16.28	7.92	20.22	23.41	.64	#22	57.15
T3	.375	.766	.406	.921	1.047	.025	#22	2.250	10.0	T3	9.53	19.46	10.31	23.40	26.59	.64	#22	57.15
T4	.375	1.062	.406	1.217	1.343	.025	#22	2.250	16.0	T4	9.53	26.97	10.31	30.91	34.11	.64	#22	57.15

Cap (μF)	Cap Tol (±)	Maximum Working Voltage		Surge Voltage @ +85°C	Part Number MIL-C-39006/25 Failure Rate Level % / 1,000 Hrs			Max DF (%)	Max ESR Ω @ +25°C	Maximum DC Leakage (μA)		Max Ripple @ 85°C 40kHz (mA)	Maximum % Capacitance Change from Room Temperature			Case Code
		+85°C	+125°C		M (1.0)	P (0.1)	R (0.01)			+25°C	+85°C & +125°C		-55°C	+85°C	+125°C	
		220	20		6	4	6.9			0001	0089		0177	50	3.02	
220	10	6	4	6.9	0002	0090	0178	50	3.02	2	9	1000	-64	+13	+16	T1
820	20	6	4	6.9	0003	0091	0179	155	2.51	3	14	1500	-88	+16	+20	T2
820	10	6	4	6.9	0004	0092	0180	155	2.51	3	14	1500	-88	+16	+20	T2
1500	20	6	4	6.9	0005	0093	0181	172	1.52	5	20	1900	-90	+20	+25	T3
1500	10	6	4	6.9	0006	0094	0182	172	1.52	5	20	1900	-90	+20	+25	T3
2200	20	6	4	6.9	0007	0095	0183	170	1.03	6	24	2300	-90	+25	+30	T4
2200	10	6	4	6.9	0008	0096	0184	170	1.03	6	24	2300	-90	+25	+30	T4
180	20	8	5	9.2	0009	0097	0185	41	3.02	2	9	1000	-60	+13	+16	T1
180	10	8	5	9.2	0010	0098	0186	41	3.02	2	9	1000	-60	+13	+16	T1
680	20	8	5	9.2	0011	0099	0187	130	2.54	3	14	1500	-83	+16	+20	T2
680	10	8	5	9.2	0012	0100	0188	130	2.54	3	14	1500	-83	+16	+20	T2
1500	20	8	5	9.2	0013	0101	0189	170	1.50	5	20	1900	-90	+20	+25	T3
1500	10	8	5	9.2	0014	0102	0190	170	1.50	5	20	1900	-90	+20	+25	T3
1800	20	8	5	9.2	0015	0103	0191	138	1.02	7	25	2300	-90	+25	+30	T4
1800	10	8	5	9.2	0016	0104	0192	138	1.02	7	25	2300	-90	+25	+30	T4
150	20	10	7	11.5	0017	0105	0193	34	3.01	2	9	900	-55	+13	+16	T1
150	10	10	7	11.5	0018	0106	0194	34	3.01	2	9	900	-55	+13	+16	T1
560	20	10	7	11.5	0019	0107	0195	106	2.51	3	16	1450	-77	+16	+20	T2
560	10	10	7	11.5	0020	0108	0196	106	2.51	3	16	1450	-77	+16	+20	T2
1200	20	10	7	11.5	0021	0109	0197	137	1.51	5	20	1850	-88	+20	+25	T3
1200	10	10	7	11.5	0022	0110	0198	137	1.51	5	20	1850	-88	+20	+25	T3
1500	20	10	7	11.5	0023	0111	0199	114	1.01	7	25	2300	-88	+25	+30	T4
1500	10	10	7	11.5	0024	0112	0200	114	1.01	7	25	2300	-88	+25	+30	T4
100	20	15	10	17.2	0025	0113	0201	30	3.98	2	9	900	-44	+13	+16	T1
100	10	15	10	17.2	0026	0114	0202	30	3.98	2	9	900	-44	+13	+16	T1
390	20	15	10	17.2	0027	0115	0203	74	2.52	3	16	1450	-66	+16	+20	T2
390	10	15	10	17.2	0028	0116	0204	74	2.52	3	16	1450	-66	+16	+20	T2

TO ORDER: Indicate the prefix M39006/25 followed by the applicable MIL dash number
Example: For M39006/25-0193 order M39006/250193. To obtain the optional vibration and shock requirements, add 'H' (M39006/250193H)

CLR81 (MIL-C-39006/25) Wet Tantalum Capacitors



Wet Tantalum Capacitors

Cap (μ F)	Cap Tol (\pm)	Maximum Working Voltage		Surge Voltage @ +85°C	Part Number MIL-C-39006/25 Failure Rate Level % / 1,000 Hrs			Max DF (%)	Max ESR Ω @ +25°C	Maximum DC Leakage (μ A)		Max Ripple @ 85°C 40kHz (mA)	Maximum % Capacitance Change from Room Temperature			Case Code
		+85°C	+125°C		M (1.0)	P (0.1)	R (0.01)			+25°C	+85°C & +125°C		-55°C	+85°C	+125°C	
		820	20		15	10	17.2			0029	0117		0205	111	1.80	
820	10	15	10	17.2	0030	0118	0206	111	1.80	6	20	1800	-77	+20	+25	T3
1000	20	15	10	17.2	0031	0119	0207	92	1.22	8	25	2300	-77	+25	+30	T4
1000	10	15	10	17.2	0032	0120	0208	92	1.22	8	25	2300	-77	+25	+30	T4
68	20	25	15	28.8	0033	0121	0209	22	4.29	2	9	850	-40	+12	+15	T1
68	10	25	15	28.8	0034	0122	0210	22	4.29	2	9	850	-40	+12	+15	T1
270	20	25	15	28.8	0035	0123	0211	55	2.70	3	16	1400	-62	+13	+16	T2
270	10	25	15	28.8	0036	0124	0212	55	2.70	3	16	1400	-62	+13	+16	T2
560	20	25	15	28.8	0037	0125	0213	76	1.80	7	28	1750	-72	+20	+25	T3
560	10	25	15	28.8	0038	0126	0214	76	1.80	7	28	1750	-72	+20	+25	T3
680	20	25	15	28.8	0039	0127	0215	63	1.23	8	32	2100	-72	+25	+30	T4
680	10	25	15	28.8	0040	0128	0216	63	1.23	8	32	2100	-72	+25	+30	T4
56	20	30	20	34.5	0041	0129	0217	22	5.21	2	9	800	-38	+12	+15	T1
56	10	30	20	34.5	0042	0130	0218	22	5.21	2	9	800	-38	+12	+15	T1
220	20	30	20	34.5	0043	0131	0219	42	2.53	3	16	1200	-60	+13	+16	T2
220	10	30	20	34.5	0044	0132	0220	42	2.53	3	16	1200	-60	+13	+16	T2
470	20	30	20	34.5	0045	0133	0221	64	1.81	8	32	1500	-65	+20	+25	T3
470	10	30	20	34.5	0046	0134	0222	64	1.81	8	32	1500	-65	+20	+25	T3
560	20	30	20	34.5	0047	0135	0223	55	1.30	9	36	2000	-65	+25	+30	T4
560	10	30	20	34.5	0048	0136	0224	55	1.30	9	36	2000	-65	+25	+30	T4
33	20	50	30	57.5	0049	0137	0225	12.3	4.95	2	9	700	-29	+10	+12	T1
33	10	50	30	57.5	0050	0138	0226	12.3	4.95	2	9	700	-29	+10	+12	T1
120	20	50	30	57.5	0051	0139	0227	22.5	2.49	4	24	1200	-42	+12	+15	T2
120	10	50	30	57.5	0052	0140	0228	22.5	2.49	4	24	1200	-42	+12	+15	T2
270	20	50	30	57.5	0053	0141	0229	37	1.82	8	32	1450	-46	+20	+25	T3
270	10	50	30	57.5	0054	0142	0230	37	1.82	8	32	1450	-46	+20	+25	T3
330	20	50	30	57.5	0055	0143	0231	38	1.53	9	36	1900	-46	+25	+30	T4
330	10	50	30	57.5	0056	0144	0232	38	1.53	9	36	1900	-46	+25	+30	T4
27	20	60	40	69	0057	0145	0233	10.2	5.01	3	12	700	-24	+10	+12	T1
27	10	60	40	69	0058	0146	0234	10.2	5.01	3	12	700	-24	+10	+12	T1
100	20	60	40	69	0059	0147	0235	19	2.52	4	20	1100	-36	+12	+15	T2
100	10	60	40	69	0060	0148	0236	19	2.52	4	20	1100	-36	+12	+15	T2
220	20	60	40	69	0061	0149	0237	30	1.81	8	32	1400	-40	+16	+20	T3
220	10	60	40	69	0062	0150	0238	30	1.81	8	32	1400	-40	+16	+20	T3
270	20	60	40	69	0063	0151	0239	27	1.33	9	36	1850	-45	+20	+25	T4
270	10	60	40	69	0064	0152	0240	27	1.33	9	36	1850	-45	+20	+25	T4
22	20	75	50	86.2	0065	0153	0241	8.5	5.13	3	12	600	-19	+10	+12	T1
22	10	75	50	86.2	0066	0154	0242	8.5	5.13	3	12	600	-19	+10	+12	T1
82	20	75	50	86.2	0067	0155	0243	15.2	2.46	4	24	1000	-30	+12	+15	T2
82	10	75	50	86.2	0068	0156	0244	15.2	2.46	4	24	1000	-30	+12	+15	T2
180	20	75	50	86.2	0069	0157	0245	24.4	1.80	9	36	1300	-35	+16	+20	T3
180	10	75	50	86.2	0070	0158	0246	24.4	1.80	9	36	1300	-35	+16	+20	T3
220	20	75	50	86.2	0071	0159	0247	37	2.23	10	40	1800	-40	+20	+25	T4
220	10	75	50	86.2	0072	0160	0248	37	2.23	10	40	1800	-40	+20	+25	T4
10	20	100	65	115	0073	0161	0249	4.5	5.97	3	12	800	-17	+10	+12	T1
10	10	100	65	115	0074	0162	0250	4.5	5.97	3	12	800	-17	+10	+12	T1
39	20	100	65	115	0075	0163	0251	10.4	3.54	5	24	1300	-20	+12	+15	T2
39	10	100	65	115	0076	0164	0252	10.4	3.54	5	24	1300	-20	+12	+15	T2
68	20	100	65	115	0077	0165	0253	11.3	2.21	10	40	1600	-30	+14	+16	T3
68	10	100	65	115	0078	0166	0254	11.3	2.21	10	40	1600	-30	+14	+16	T3
120	20	100	65	115	0079	0167	0255	25	2.76	12	48	2000	-35	+15	+17	T4
120	10	100	65	115	0080	0168	0256	25	2.76	12	48	2000	-35	+15	+17	T4
6.8	20	125	85	144	0081	0169	0257	6	11.71	3	12	700	-14	+10	+12	T1
6.8	10	125	85	144	0082	0170	0258	6	11.71	3	12	700	-14	+10	+12	T1
27	20	125	85	144	0083	0171	0259	7.2	3.54	5	24	1200	-18	+12	+15	T2
27	10	125	85	144	0084	0172	0260	7.2	3.54	5	24	1200	-18	+12	+15	T2
47	20	125	85	144	0085	0173	0261	7.9	2.23	10	40	1500	-26	+14	+16	T3
47	10	125	85	144	0086	0174	0262	7.9	2.23	10	40	1500	-26	+14	+16	T3
82	20	125	85	144	0087	0175	0263	17.4	2.82	12	48	1900	-30	+15	+17	T4
82	10	125	85	144	0088	0176	0264	17.4	2.82	12	48	1900	-30	+15	+17	T4

TO ORDER: Indicate the prefix M39006/25 followed by the applicable MIL dash number
 Example: For M39006/25-0193 order M39006/250193. To obtain the optional
 vibration and shock requirements, add 'H' (M39006/250193H)

CLR90 (MIL-C-39006/30) Wet Tantalum Capacitors

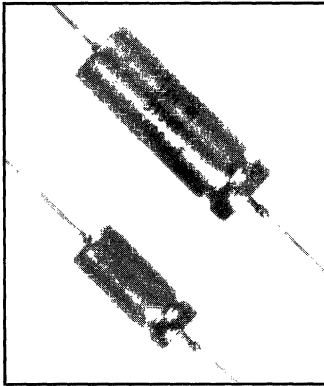

- All Tantalum Case
- Hermetically Sealed
- Up to 3 Volts Reverse Capability
- Higher Ripple Current Superior to CLR79
- Lower ESR Than CLR79
- Rugged Construction
- Failure Rate Levels M, P and R

GENERAL SPECIFICATIONS

Operating Temperature:
55°C to +125°C
with voltage derated

Voltage Range:
6 to 125 VDC

Capacitance Range:
1.7 μ F to 1200 μ F

Tolerance Range:
 \pm 10%, \pm 20%
(\pm 5% by special order)

Case Sizes: (Four)
.188 x .453 to .375 x 1.062

Wet Tantalum Capacitors

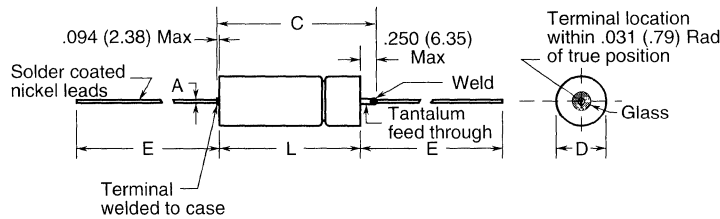

INCHES (DIMENSIONS) MILLIMETERS

Case Code	Uninsulated		Insulated		C	A Lead Dia Nom AWG	E Lead Lgth \pm .250	Approximate Weight (Grams) (1 gram = .035 Oz.)	Case Code	Uninsulated		Insulated		C	A Lead Dia Nom AWG	E Lead Lgth \pm 6.35
	D	L	D	L						D	L	D	L			
T1	.188	.453	.219	.608	.734	.025 #22	1.500	2.0	T1	4.78	11.51	5.56	15.45	18.64	.64 #22	38.10
T2	.281	.641	.312	.796	.922	.025 #22	2.250	4.5	T2	7.14	16.28	7.92	20.22	23.41	.64 #22	57.15
T3	.375	.766	.406	.921	1.047	.025 #22	2.250	8.0	T3	9.53	19.46	10.31	23.40	26.59	.64 #22	57.15
T4	.375	1.062	.406	1.217	1.343	.025 #22	2.250	12.0	T4	9.53	26.97	10.31	30.91	34.11	.64 #22	57.15

Cap (μ F)	Cap Tol (\pm)	Maximum Working Voltage		Surge Voltage @ +85°C	Part Number MIL-C-39006/30 Failure Rate Level % / 1,000 Hrs			Max DF (%)	Max ESR Ω @ +25°C	Maximum DC Leakage (μ A)		Max Ripple @ 85°C 40kHz (mA)	Maximum % Capacitance Change from Room Temperature			Case Code
		+85°C	+125°C		M (1.0)	P (0.1)	R (0.01)			+25°C	+85°C & +125°C		-55°C	+85°C	+125°C	
		30	20		6	4	6.9			0001	0221		0441	4.5	1.99	
30	10	6	4	6.9	0002	0222	0442	4.5	1.99	1	2	1180	-40	+10.5	+12	T1
68	20	6	4	6.9	0004	0224	0444	7.5	1.58	1	2	1320	-40	+14	+16	T1
68	10	6	4	6.9	0005	0225	0445	7.5	1.58	1	2	1320	-40	+14	+16	T1
140	20	6	4	6.9	0007	0227	0447	10.5	.99	1	3	2080	-40	+14	+16	T2
140	10	6	4	6.9	0008	0228	0448	10.5	.99	1	3	2080	-40	+14	+16	T2
270	20	6	4	6.9	0010	0230	0450	22.5	1.11	1	6.5	1970	-44	+17.5	+20	T2
270	10	6	4	6.9	0011	0231	0451	22.5	1.11	1	6.5	1970	-44	+17.5	+20	T2
330	20	6	4	6.9	0013	0233	0453	18	.73	2	7.9	2580	-44	+14	+16	T3
330	10	6	4	6.9	0014	0234	0454	18	.73	2	7.9	2580	-44	+14	+16	T3
560	20	6	4	6.9	0016	0236	0456	27.5	.65	2	13	2730	-64	+17.5	+20	T3
560	10	6	4	6.9	0017	0237	0457	27.5	.65	2	13	2730	-64	+17.5	+20	T3
1200	20	6	4	6.9	0019	0239	0459	45	.50	3	14	3290	-80	+25	+25	T4
1200	10	6	4	6.9	0020	0240	0460	45	.50	3	14	3290	-80	+25	+25	T4
25	20	8	5	9.2	0021	0241	0461	3.75	1.99	1	2	1180	-40	+10.5	+12	T1
25	10	8	5	9.2	0022	0242	0462	3.75	1.99	1	2	1180	-40	+10.5	+12	T1
56	20	8	5	9.2	0024	0244	0464	7	1.66	1	2	1290	-40	+14	+16	T1
56	10	8	5	9.2	0025	0245	0465	7	1.66	1	2	1290	-40	+14	+16	T1
120	20	8	5	9.2	0027	0247	0467	10	1.11	1	2	1970	-44	+17.5	+20	T2
120	10	8	5	9.2	0028	0248	0468	10	1.11	1	2	1970	-44	+17.5	+20	T2
220	20	8	5	9.2	0030	0250	0470	18.5	1.12	1	7	1960	-44	+17.5	+20	T2
220	10	8	5	9.2	0031	0251	0471	18.5	1.12	1	7	1960	-44	+17.5	+20	T2
290	20	8	5	9.2	0033	0253	0473	17	.78	2	6	2490	-64	+17.5	+20	T3
290	10	8	5	9.2	0034	0254	0474	17	.78	2	6	2490	-64	+17.5	+20	T3
430	20	8	5	9.2	0036	0256	0476	23	.71	2	14	2610	-64	+17.5	+20	T3
430	10	8	5	9.2	0037	0257	0477	23	.71	2	14	2610	-64	+17.5	+20	T3
850	20	8	5	9.2	0039	0259	0479	30	.47	4	16	3390	-80	+25	+25	T4
850	10	8	5	9.2	0040	0260	0480	30	.47	4	16	3390	-80	+25	+25	T4

TO ORDER: Indicate the prefix M39006/30 followed by the applicable MIL dash number
 Example: For M39006/30-0251 order M39006/300251. To obtain the optional
 vibration and shock requirements, add 'H' (M39006/300251H)

CLR90 (MIL-C-39006/30) Wet Tantalum Capacitors



Wet Tantalum Capacitors

Cap (μ F)	Cap Tol (\pm)	Maximum Working Voltage		Surge Voltage @ +85°C	Part Number MIL-C-39006/30 Failure Rate Level % / 1,000 Hrs			Max DF (%)	Max ESR Ω @ +25°C	Maximum DC Leakage (μ A)		Max Ripple @ 85°C (mA)	Maximum % Capacitance Change from Room Temperature			Case Code
		+85°C	+125°C		M (1.0)	P (0.1)	R (0.01)			+25°C	+85°C & +125°C		-55°C	+85°C	+125°C	
		20	20		10	7	11.5			0041	0261		0481	3	1.99	
20	10	10	7	11.5	0042	0262	0482	3	1.99	1	2	1180	-32	+10.5	+12	T1
47	20	10	7	11.5	0044	0264	0484	6.5	1.84	1	2	1220	-36	+14	+16	T1
47	10	10	7	11.5	0045	0265	0485	6.5	1.84	1	2	1220	-36	+14	+16	T1
100	20	10	7	11.5	0047	0267	0487	7.5	.99	1	4	2080	-36	+14	+16	T2
100	10	10	7	11.5	0048	0268	0488	7.5	.99	1	4	2080	-36	+14	+16	T2
180	20	10	7	11.5	0050	0270	0490	15	1.11	1	7	1970	-36	+14	+16	T2
180	10	10	7	11.5	0051	0271	0491	15	1.11	1	7	1970	-36	+14	+16	T2
250	20	10	7	11.5	0053	0273	0493	15	.80	2	10	2480	-40	+14	+16	T3
250	10	10	7	11.5	0054	0274	0494	15	.80	2	10	2480	-40	+14	+16	T3
390	20	10	7	11.5	0056	0276	0496	22	.75	2	16	2540	-64	+17.5	+20	T3
390	10	10	7	11.5	0057	0277	0497	22	.75	2	16	2540	-64	+17.5	+20	T3
750	20	10	7	11.5	0059	0279	0499	25	.44	4	16	3500	-80	+25	+25	T4
750	10	10	7	11.5	0060	0280	0500	25	.44	4	16	3500	-80	+25	+25	T4
15	20	15	10	17.2	0061	0281	0501	2.5	2.21	1	2	1120	-24	+10.5	+12	T1
15	10	15	10	17.2	0062	0282	0502	2.5	2.21	1	2	1120	-24	+10.5	+12	T1
33	20	15	10	17.2	0064	0284	0504	5	2.01	1	2	1170	-28	+14	+16	T1
33	10	15	10	17.2	0065	0285	0505	5	2.01	1	2	1170	-28	+14	+16	T1
70	20	15	10	17.2	0067	0287	0507	6.5	1.23	1	4	1870	-28	+14	+16	T2
70	10	15	10	17.2	0068	0288	0508	6.5	1.23	1	4	1870	-28	+14	+16	T2
120	20	15	10	17.2	0070	0290	0510	9	.99	1	7	2080	-28	+17.5	+20	T2
120	10	15	10	17.2	0071	0291	0511	9	.99	1	7	2080	-28	+17.5	+20	T2
170	20	15	10	17.2	0073	0293	0513	12.5	.98	2	10	2220	-32	+14	+16	T3
170	10	15	10	17.2	0074	0294	0514	12.5	.98	2	10	2220	-32	+14	+16	T3
270	20	15	10	17.2	0076	0296	0516	16	.79	2	16	2480	-56	+17.5	+20	T3
270	10	15	10	17.2	0077	0297	0517	16	.79	2	16	2480	-56	+17.5	+20	T3
540	20	15	10	17.2	0079	0299	0519	20	.49	6	24	3320	-80	+25	+25	T4
540	10	15	10	17.2	0080	0300	0520	20	.49	6	24	3320	-80	+25	+25	T4
10	20	25	15	28.8	0081	0301	0521	2	2.66	1	2	1020	-16	+8	+9	T1
10	10	25	15	28.8	0082	0302	0522	2	2.66	1	2	1020	-16	+8	+9	T1
22	20	25	15	28.8	0084	0304	0524	3.3	1.99	1	2	1180	-20	+10.5	+12	T1
22	10	25	15	28.8	0085	0305	0525	3.3	1.99	1	2	1180	-20	+10.5	+12	T1
50	20	25	15	28.8	0087	0307	0527	5.5	1.46	1	2	1710	-28	+13	+15	T2
50	10	25	15	28.8	0088	0308	0528	5.5	1.46	1	2	1710	-28	+13	+15	T2
100	20	25	15	28.8	0090	0310	0530	7.5	.99	1	10	2080	-28	+13	+15	T2
100	10	25	15	28.8	0091	0311	0531	7.5	.99	1	10	2080	-28	+13	+15	T2
120	20	25	15	28.8	0093	0313	0533	10.5	1.16	2	6	2040	-32	+13	+15	T3
120	10	25	15	28.8	0094	0314	0534	10.5	1.16	2	6	2040	-32	+13	+15	T3
180	20	25	15	28.8	0096	0316	0536	13	.96	2	18	2250	-48	+13	+15	T3
180	10	25	15	28.8	0097	0317	0537	13	.96	2	18	2250	-48	+13	+15	T3
350	20	25	15	28.8	0099	0319	0539	17.5	.67	7	28	2840	-70	+25	+25	T4
350	10	25	15	28.8	0100	0320	0540	17.5	.67	7	28	2840	-70	+25	+25	T4
8	20	30	20	34.5	0101	0321	0541	2	3.32	1	2	910	-16	+8	+12	T1
8	10	30	20	34.5	0102	0322	0542	2	3.32	1	2	910	-16	+8	+12	T1
15	20	30	20	34.5	0104	0324	0544	2.5	2.21	1	2	1120	-20	+10.5	+12	T1
15	10	30	20	34.5	0105	0325	0545	2.5	2.21	1	2	1120	-20	+10.5	+12	T1
40	20	30	20	34.5	0107	0327	0547	5	1.66	1	5	1610	-24	+10.5	+12	T2
40	10	30	20	34.5	0108	0328	0548	5	1.66	1	5	1610	-24	+10.5	+12	T2
68	20	30	20	34.5	0110	0330	0550	6.5	1.27	1	8	1840	-24	+13	+15	T2
68	10	30	20	34.5	0111	0331	0551	6.5	1.27	1	8	1840	-24	+13	+15	T2
100	20	30	20	34.5	0113	0333	0553	8.5	1.13	2	12	2070	-28	+10.5	+12	T3
100	10	30	20	34.5	0114	0334	0554	8.5	1.13	2	12	2070	-28	+10.5	+12	T3
150	20	30	20	34.5	0116	0336	0556	11.5	1.02	2	18	2190	-48	+13	+15	T3
150	10	30	20	34.5	0117	0337	0557	11.5	1.02	2	18	2190	-48	+13	+15	T3
300	20	30	20	34.5	0119	0339	0559	15.5	.69	8	32	2800	-60	+25	+25	T4
300	10	30	20	34.5	0120	0340	0560	15.5	.69	8	32	2800	-60	+25	+25	T4
5	20	50	30	57.5	0121	0341	0561	1.5	3.98	1	2	835	-16	+5	+6	T1
5	10	50	30	57.5	0122	0342	0562	1.5	3.98	1	2	835	-16	+5	+6	T1
10	20	50	30	57.5	0124	0344	0564	2	2.66	1	2	1020	-24	+8	+9	T1
10	10	50	30	57.5	0125	0345	0565	2	2.66	1	2	1020	-24	+8	+9	T1
25	20	50	30	57.5	0127	0347	0567	4	2.13	1	5	1420	-20	+10.5	+12	T2
25	10	50	30	57.5	0128	0348	0568	4	2.13	1	5	1420	-20	+10.5	+12	T2
47	20	50	30	57.5	0130	0350	0570	5.5	1.56	1	9	1660	-28	+13	+15	T2
47	10	50	30	57.5	0131	0351	0571	5.5	1.56	1	9	1660	-28	+13	+15	T2

Indicate the prefix M39006/30 followed by the applicable MIL dash number
TO ORDER: Example: For M39006/30-0251 order M39006/300251. To obtain the optional
vibration and shock requirements, add 'H' (M39006/300251H)

CLR90 (MIL-C-39006/30) Wet Tantalum Capacitors



Cap (μ F)	Cap Tol (\pm)	Maximum Working Voltage		Surge Voltage @ +85°C	Part Number MIL-C-39006/30 Failure Rate Level % / 1,000 Hrs			Max DF (%)	Max ESR Ω @ +25°C	Maximum DC Leakage (μ A)		Max Ripple @ 85°C 40kHz (mA)	Maximum % Capacitance Change from Room Temperature			Case Code
		+85°C	+125°C		M (1.0)	P (0.1)	R (0.01)			+25°C	+85°C & +125°C		-55°C	+85°C	+125°C	
		60	20		50	30	57.5			0133	0353		0573	6	1.33	
60	10	50	30	57.5	0134	0354	0574	6	1.33	2	12	1910	-16	+10.5	+12	T3
82	20	50	30	57.5	0136	0356	0576	7.5	1.22	2	16	2000	-32	+13	+15	T3
82	10	50	30	57.5	0137	0357	0577	7.5	1.22	2	16	2000	-32	+13	+15	T3
160	20	50	30	57.5	0139	0359	0579	8.5	.71	8	32	2760	-50	+25	+25	T4
160	10	50	30	57.5	0140	0360	0580	8.5	.71	8	32	2760	-50	+25	+25	T4
4	20	60	40	69	0141	0361	0581	1.4	4.65	1	2	770	-16	+5	+6	T1
4	10	60	40	69	0142	0362	0582	1.4	4.65	1	2	770	-16	+5	+6	T1
8.2	20	60	40	69	0144	0364	0584	2	3.24	1	2	925	-24	+8	+9	T1
8.2	10	60	40	69	0145	0365	0585	2	3.24	1	2	925	-24	+8	+9	T1
20	20	60	40	69	0147	0367	0587	3.5	2.32	1	5	1360	-16	+10.5	+12	T2
20	10	60	40	69	0148	0368	0588	3.5	2.32	1	5	1360	-16	+10.5	+12	T2
39	20	60	40	69	0150	0370	0590	5	1.70	1	9	1590	-28	+10.5	+12	T2
39	10	60	40	69	0151	0371	0591	5	1.70	1	9	1590	-28	+10.5	+12	T2
50	20	60	40	69	0153	0373	0593	5	1.33	2	12	1910	-16	+10.5	+12	T3
50	10	60	40	69	0154	0374	0594	5	1.33	2	12	1910	-16	+10.5	+12	T3
68	20	60	40	69	0156	0376	0596	6.5	1.27	2	16	1950	-32	+10.5	+12	T3
68	10	60	40	69	0157	0377	0597	6.5	1.27	2	16	1950	-32	+10.5	+12	T3
140	20	60	40	69	0159	0379	0599	8	.76	8	32	2660	-40	+20	+20	T4
140	10	60	40	69	0160	0380	0600	8	.76	8	32	2660	-40	+20	+20	T4
3.5	20	75	50	86.2	0161	0381	0601	1.25	4.74	1	2	765	-16	+5	+6	T1
3.5	10	75	50	86.2	0162	0382	0602	1.25	4.74	1	2	765	-16	+5	+6	T1
6.8	20	75	50	86.2	0164	0384	0604	1.75	3.42	1	2	900	-20	+8	+9	T1
6.8	10	75	50	86.2	0165	0385	0605	1.75	3.42	1	2	900	-20	+8	+9	T1
15	20	75	50	86.2	0167	0387	0607	3	2.66	1	5	1270	-16	+8	+9	T2
15	10	75	50	86.2	0168	0388	0608	3	2.66	1	5	1270	-16	+8	+9	T2
33	20	75	50	86.2	0170	0390	0610	5	2.01	1	10	1460	-24	+10.5	+15	T2
33	10	75	50	86.2	0171	0391	0611	5	2.01	1	10	1460	-24	+10.5	+15	T2
40	20	75	50	86.2	0173	0393	0613	4.5	1.50	2	12	1800	-16	+10.5	+12	T3
40	10	75	50	86.2	0174	0394	0614	4.5	1.50	2	12	1800	-16	+10.5	+12	T3
56	20	75	50	86.2	0176	0396	0616	5.5	1.31	2	17	1920	-28	+10.5	+15	T3
56	10	75	50	86.2	0177	0397	0617	5.5	1.31	2	17	1920	-28	+10.5	+15	T3
110	20	75	50	86.2	0179	0399	0619	6	.73	9	36	2720	-35	+20	+20	T4
110	10	75	50	86.2	0180	0400	0620	6	.73	9	36	2720	-35	+20	+20	T4
2.5	20	100	65	115	0181	0401	0621	1	5.31	1	2	720	-16	+7	+8	T1
2.5	10	100	65	115	0182	0402	0622	1	5.31	1	2	720	-16	+7	+8	T1
4.7	20	100	65	115	0184	0404	0624	1.5	4.24	1	2	810	-16	+7	+8	T1
4.7	10	100	65	115	0185	0405	0625	1.5	4.24	1	2	810	-16	+7	+8	T1
11	20	100	65	115	0187	0407	0627	2.5	3.02	1	4	1190	-16	+8	+8	T2
11	10	100	65	115	0188	0408	0628	2.5	3.02	1	4	1190	-16	+8	+8	T2
22	20	100	65	115	0190	0410	0630	3.75	2.26	1	9	1380	-16	+8	+8	T2
22	10	100	65	115	0191	0411	0631	3.75	2.26	1	9	1380	-16	+8	+8	T2
30	20	100	65	115	0193	0413	0633	3.5	1.55	2	12	1770	-16	+8	+8	T3
30	10	100	65	115	0194	0414	0634	3.5	1.55	2	12	1770	-16	+8	+8	T3
43	20	100	65	115	0196	0416	0636	4.25	1.31	2	17	1920	-20	+8	+8	T3
43	10	100	65	115	0197	0417	0637	4.25	1.31	2	17	1920	-20	+8	+8	T3
86	20	100	65	115	0199	0419	0639	5	.77	9	36	2650	-25	+15	+15	T4
86	10	100	65	115	0200	0420	0640	5	.77	9	36	2650	-25	+15	+15	T4
1.7	20	125	85	144	0201	0421	0641	1	7.81	1	2	595	-16	+7	+8	T1
1.7	10	125	85	144	0202	0422	0642	1	7.81	1	2	595	-16	+7	+8	T1
3.6	20	125	85	144	0204	0424	0644	1.35	4.98	1	2	745	-16	+7	+8	T1
3.6	10	125	85	144	0205	0425	0645	1.35	4.98	1	2	745	-16	+7	+8	T1
9	20	125	85	144	0207	0427	0647	2.5	3.69	1	5	1080	-16	+7	+8	T2
9	10	125	85	144	0208	0428	0648	2.5	3.69	1	5	1080	-16	+7	+8	T2
14	20	125	85	144	0210	0430	0650	3	2.85	1	7	1230	-16	+7	+8	T2
14	10	125	85	144	0211	0431	0651	3	2.85	1	7	1230	-16	+7	+8	T2
18	20	125	85	144	0213	0433	0653	2.5	1.85	2	9	1620	-16	+7	+8	T3
18	10	125	85	144	0214	0434	0654	2.5	1.85	2	9	1620	-16	+7	+8	T3
25	20	125	85	144	0216	0436	0656	3	1.59	2	13	1740	-16	+7	+8	T3
25	10	125	85	144	0217	0437	0657	3	1.59	2	13	1740	-16	+7	+8	T3
56	20	125	85	144	0219	0439	0659	3.25	.77	10	40	2650	-25	+15	+15	T4
56	10	125	85	144	0220	0440	0660	3.25	.77	10	40	2650	-25	+15	+15	T4

Wet Tantalum Capacitors

TO ORDER: Indicate the prefix M39006/30 followed by the applicable MIL dash number
Example: For M39006/30-0251 order M39006/300251. To obtain the optional
 vibration and shock requirements, add 'H' (M39006/300251H)

CLR91 (MIL-C-39006/31) Wet Tantalum Capacitors



Wet Tantalum Capacitors

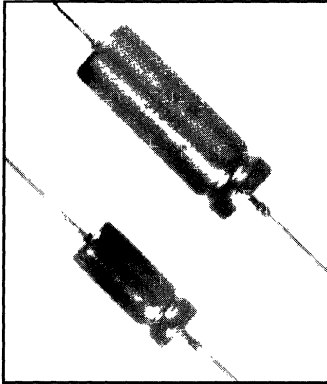

- Extended Range
- All Tantalum Case
- Hermetically Sealed
- Up to 3 Volts Reverse Capability
- Highest CV per Case Size
- **Lower ESR Than CLR81**
- Rugged Construction
- Failure Rate Levels M, P and R
- **Higher Ripple Current Superior to CLR81**

GENERAL SPECIFICATIONS

Operating Temperature:
-55°C to +125°C
with voltage derated

Voltage Range:
6 to 125 VDC

Capacitance Range:
6.8 μF to 2200 μF

Tolerance Range:
±10%, ±20%

Case Sizes: (Four)
.188 x .453 to .375 x 1.062

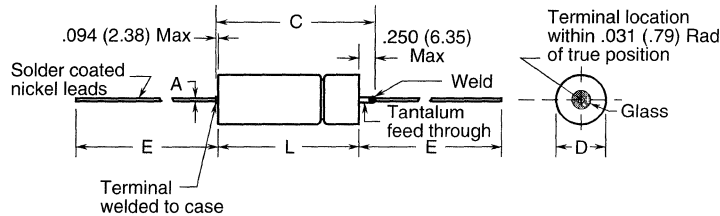

INCHES

(DIMENSIONS)

MILLIMETERS

Case Code	Uninsulated		Insulated		C	A		E	Approximate Weight (Grams) (1 gram = .035 Oz.)	Case Code	Uninsulated		Insulated		C	A		E
	D	L	D	L		Lead Dia Nom	Lead Lgth ±.250				D	L	D	L		Lead Dia Nom	Lead Lgth ±.635	
T1	.188	.453	.219	.608	.734	.025	#22	1.500	2.0	T1	4.78	11.51	5.56	15.45	18.64	.64	#22	38.10
T2	.281	.641	.312	.796	.922	.025	#22	2.250	5.5	T2	7.14	16.28	7.92	20.22	23.41	.64	#22	57.15
T3	.375	.766	.406	.921	1.047	.025	#22	2.250	10.0	T3	9.53	19.46	10.31	23.40	26.59	.64	#22	57.15
T4	.375	1.062	.406	1.217	1.343	.025	#22	2.250	16.0	T4	9.53	26.97	10.31	30.91	34.11	.64	#22	57.15

Cap (μF)	Cap Tol (±)	Maximum Working Voltage		Surge Voltage @ +85°C	Part Number MIL-C-39006/31 Failure Rate Level % / 1,000 Hrs			Max DF (%)	Max ESR Ω @ +25°C	Maximum DC Leakage (μA)		Max Ripple @ 85°C 40kHz (mA)	Maximum % Capacitance Change from Room Temperature			Case Code
		+85°C	+125°C		M (1.0)	P (0.1)	R (0.01)			+25°C	+85°C & +125°C		-55°C	+85°C	+125°C	
		220	20		6	4	6.9			0001	0089		0177	25	1.51	
220	10	6	4	6.9	0002	0090	0178	25	1.51	2	9	1350	-64	+13	+16	T1
820	20	6	4	6.9	0003	0091	0179	77.5	1.26	3	14	1840	-88	+16	+20	T2
820	10	6	4	6.9	0004	0092	0180	77.5	1.26	3	14	1840	-88	+16	+20	T2
1500	20	6	4	6.9	0005	0093	0181	86	.76	5	20	2520	-90	+20	+25	T3
1500	10	6	4	6.9	0006	0094	0182	86	.76	5	20	2520	-90	+20	+25	T3
2200	20	6	4	6.9	0007	0095	0183	85	.52	6	24	3220	-90	+25	+30	T4
2200	10	6	4	6.9	0008	0096	0184	85	.52	6	24	3220	-90	+25	+30	T4
180	20	8	5	9.2	0009	0097	0185	20.5	1.51	2	9	1350	-60	+13	+16	T1
180	10	8	5	9.2	0010	0098	0186	20.5	1.51	2	9	1350	-60	+13	+16	T1
680	20	8	5	9.2	0011	0099	0187	65	1.27	3	14	1840	-83	+16	+20	T2
680	10	8	5	9.2	0012	0100	0188	65	1.27	3	14	1840	-83	+16	+20	T2
1500	20	8	5	9.2	0013	0101	0189	85	.75	5	20	2540	-90	+20	+25	T3
1500	10	8	5	9.2	0014	0102	0190	85	.75	5	20	2540	-90	+20	+25	T3
1800	20	8	5	9.2	0015	0103	0191	69	.51	7	25	3250	-90	+25	+30	T4
1800	10	8	5	9.2	0016	0104	0192	69	.51	7	25	3250	-90	+25	+30	T4
150	20	10	7	11.5	0017	0105	0193	17	1.51	2	9	1350	-55	+13	+16	T1
150	10	10	7	11.5	0018	0106	0194	17	1.51	2	9	1350	-55	+13	+16	T1
560	20	10	7	11.5	0019	0107	0195	53	1.26	3	16	1840	-77	+16	+20	T2
560	10	10	7	11.5	0020	0108	0196	53	1.26	3	16	1840	-77	+16	+20	T2
1200	20	10	7	11.5	0021	0109	0197	68.5	.76	5	20	2520	-88	+20	+25	T3
1200	10	10	7	11.5	0022	0110	0198	68.5	.76	5	20	2520	-88	+20	+25	T3
1500	20	10	7	11.5	0023	0111	0199	57	.51	7	25	3250	-88	+25	+30	T4
1500	10	10	7	11.5	0024	0112	0200	57	.51	7	25	3250	-88	+25	+30	T4
100	20	15	10	17.2	0025	0113	0201	15	1.99	2	9	1180	-44	+13	+16	T1
100	10	15	10	17.2	0026	0114	0202	15	1.99	2	9	1180	-44	+13	+16	T1

TO ORDER: Indicate the prefix M39006/31 followed by the applicable MIL dash number
Example: For M39006/31-0193 order M39006/310193. To obtain the optional
vibration and shock requirements, add 'H' (M39006/310193H)

CLR91 (MIL-C-39006/31) Wet Tantalum Capacitors

MALLORY

Cap (μ F)	Cap Tol (\pm)	Maximum Working Voltage		Surge Voltage @ +85°C	Part Number MIL-C-39006/31 Failure Rate Level % / 1,000 Hrs			Max DF (%)	Max ESR Ω @ +25°C	Maximum DC Leakage (μ A)		Max Ripple @ 85°C 40kHz (mA)	Maximum % Capacitance Change from Room Temperature			Case Code
		+85°C	+125°C		M (1.0)	P (0.1)	R (0.01)			+25°C	+85°C & +125°C		-55°C	+85°C	+125°C	
		390	20		15	10	17.2			0027	0115		0203	37	1.26	
390	10	15	10	17.2	0028	0116	0204	37	1.26	3	16	1840	-66	+16	+20	T2
820	20	15	10	17.2	0029	0117	0205	55.5	.90	6	20	2320	-77	+20	+25	T3
820	10	15	10	17.2	0030	0118	0206	55.5	.90	6	20	2320	-77	+20	+25	T3
1000	20	15	10	17.2	0031	0119	0207	46	.61	8	25	2970	-77	+25	+30	T4
1000	10	15	10	17.2	0032	0120	0208	46	.61	8	25	2970	-77	+25	+30	T4
68	20	25	15	28.8	0033	0121	0209	11	2.15	2	9	1130	-40	+12	+15	T1
68	10	25	15	28.8	0034	0122	0210	11	2.15	2	9	1130	-40	+12	+15	T1
270	20	25	15	28.8	0035	0123	0211	27.5	1.35	3	16	1780	-62	+13	+16	T2
270	10	25	15	28.8	0036	0124	0212	27.5	1.35	3	16	1780	-62	+13	+16	T2
560	20	25	15	28.8	0037	0125	0213	38	.90	7	28	2320	-72	+20	+25	T3
560	10	25	15	28.8	0038	0126	0214	38	.90	7	28	2320	-72	+20	+25	T3
680	20	25	15	28.8	0039	0127	0215	31.5	.62	8	32	2950	-72	+25	+30	T4
680	10	25	15	28.8	0040	0128	0216	31.5	.62	8	32	2950	-72	+25	+30	T4
56	20	30	20	34.5	0041	0129	0217	11	2.61	2	9	1030	-38	+12	+15	T1
56	10	30	20	34.5	0042	0130	0218	11	2.61	2	9	1030	-38	+12	+15	T1
220	20	30	20	34.5	0043	0131	0219	21	1.27	3	16	1840	-60	+13	+16	T2
220	10	30	20	34.5	0044	0132	0220	21	1.27	3	16	1840	-60	+13	+16	T2
470	20	30	20	34.5	0045	0133	0221	32	.91	8	32	2310	-65	+20	+25	T3
470	10	30	20	34.5	0046	0134	0222	32	.91	8	32	2310	-65	+20	+25	T3
560	20	30	20	34.5	0047	0135	0223	27.5	.65	9	36	2880	-65	+25	+30	T4
560	10	30	20	34.5	0048	0136	0224	27.5	.65	9	36	2880	-65	+25	+30	T4
33	20	50	30	57.5	0049	0137	0225	6.15	2.48	2	9	1050	-29	+10	+12	T1
33	10	50	30	57.5	0050	0138	0226	6.15	2.48	2	9	1050	-29	+10	+12	T1
120	20	50	30	57.5	0051	0139	0227	11.25	1.25	4	24	1850	-42	+12	+15	T2
120	10	50	30	57.5	0052	0140	0228	11.25	1.25	4	24	1850	-42	+12	+15	T2
270	20	50	30	57.5	0053	0141	0229	18.5	.91	8	32	2310	-46	+20	+25	T3
270	10	50	30	57.5	0054	0142	0230	18.5	.91	8	32	2310	-46	+20	+25	T3
330	20	50	30	57.5	0055	0143	0231	19	.77	9	36	2650	-46	+25	+30	T4
330	10	50	30	57.5	0056	0144	0232	19	.77	9	36	2650	-46	+25	+30	T4
27	20	60	40	69	0057	0145	0233	5.1	2.51	3	12	1050	-24	+10	+12	T1
27	10	60	40	69	0058	0146	0234	5.1	2.51	3	12	1050	-24	+10	+12	T1
100	20	60	40	69	0059	0147	0235	9.5	1.26	4	20	1840	-36	+12	+15	T2
100	10	60	40	69	0060	0148	0236	9.5	1.26	4	20	1840	-36	+12	+15	T2
220	20	60	40	69	0061	0149	0237	15	.91	8	32	2310	-40	+16	+20	T3
220	10	60	40	69	0062	0150	0238	15	.91	8	32	2310	-40	+16	+20	T3
270	20	60	40	69	0063	0151	0239	13.5	.67	9	36	2840	-45	+20	+25	T4
270	10	60	40	69	0064	0152	0240	13.5	.67	9	36	2840	-45	+20	+25	T4
22	20	75	50	86.2	0065	0153	0241	4.25	2.57	3	12	1030	-19	+10	+12	T1
22	10	75	50	86.2	0066	0154	0242	4.25	2.57	3	12	1030	-19	+10	+12	T1
82	20	75	50	86.2	0067	0155	0243	7.6	1.23	4	24	1870	-30	+12	+15	T2
82	10	75	50	86.2	0068	0156	0244	7.6	1.23	4	24	1870	-30	+12	+15	T2
180	20	75	50	86.2	0069	0157	0245	12.2	.90	9	36	2320	-35	+16	+20	T3
180	10	75	50	86.2	0070	0158	0246	12.2	.90	9	36	2320	-35	+16	+20	T3
220	20	75	50	86.2	0071	0159	0247	18.5	1.12	10	40	2190	-40	+20	+25	T4
220	10	75	50	86.2	0072	0160	0248	18.5	1.12	10	40	2190	-40	+20	+25	T4
10	20	100	65	115	0073	0161	0249	2.25	2.99	3	12	960	-17	+10	+12	T1
10	10	100	65	115	0074	0162	0250	2.25	2.99	3	12	960	-17	+10	+12	T1
39	20	100	65	115	0075	0163	0251	5.2	1.77	5	24	1550	-20	+12	+15	T2
39	10	100	65	115	0076	0164	0252	5.2	1.77	5	24	1550	-20	+12	+15	T2
68	20	100	65	115	0077	0165	0253	5.65	1.11	10	40	2080	-30	+14	+16	T3
68	10	100	65	115	0078	0166	0254	5.65	1.11	10	40	2080	-30	+14	+16	T3
120	20	100	65	115	0079	0167	0255	12.5	1.38	12	48	2000	-35	+15	+17	T4
120	10	100	65	115	0080	0168	0256	12.5	1.38	12	48	2000	-35	+15	+17	T4
6.8	20	125	85	144	0081	0169	0257	3	5.86	3	12	700	-14	+10	+12	T1
6.8	10	125	85	144	0082	0170	0258	3	5.86	3	12	700	-14	+10	+12	T1
27	20	125	85	144	0083	0171	0259	3.6	1.77	5	24	1550	-18	+12	+15	T2
27	10	125	85	144	0084	0172	0260	3.6	1.77	5	24	1550	-18	+12	+15	T2
47	20	125	85	144	0085	0173	0261	3.95	1.12	10	40	2080	-26	+14	+16	T3
47	10	125	85	144	0086	0174	0262	3.95	1.12	10	40	2080	-26	+14	+16	T3
82	20	125	85	144	0087	0175	0263	8.7	1.41	12	48	1960	-30	+15	+17	T4
82	10	125	85	144	0088	0176	0264	8.7	1.41	12	48	1960	-30	+15	+17	T4

Wet Tantalum Capacitors

TO ORDER: Indicate the prefix M39006/31 followed by the applicable MIL dash number
 Example: For M39006/31-0193 order M39006/310193. To obtain the optional
 vibration and shock requirements, add 'H' (M39006/310193H)

Index Solid Tantalum Capacitors

MALLORY

Solid Tantalum Capacitors

Type	Features	Capacitance Range	Voltage Range	Temperature Range	Tolerances (%)	Case Dimensions (Inches)	Page Number
Hermetically Sealed /Axial							
TAS	Low DC Leakage Temperature Stable Frequency Stable Commercial CSR13	.0047 μ F to 330 μ F	6 VDC to 100 VDC	-55°C +125°C (With proper derating)	$\pm 5^*$ ± 10 ± 20	(D x L) .135 x .286 to .351 x .786	48
TXA	Extended Capacitance Low DC Leakage Temperature Stable Frequency Stable Commercial CSR23	1.2 μ F to 1,000 μ F	6 VDC to 50 VDC	-55°C +125°C (With proper derating)	$\pm 5^*$ ± 10 ± 20	(D x L) .135 x .286 to .351 x .786	50
THF	High Ripple Current Low Impedance Low ESR Temperature Stable Commercial CSR21	5.6 μ F to 330 μ F	6 VDC to 50 VDC	-55°C +125°C (With proper derating)	$\pm 5^*$ ± 10 ± 20	(D x L) .289 x .686 to .3511 x .786	51

Molded Case							
TAC	Axial Leads Taped and Reeled Highest CV per Case Automatic Insertion	0.1 μ F to 330 μ F	6 VDC to 50 VDC	-55°C +125°C (With proper derating)	$\pm 5^*$ ± 10	(D x L) .095 x .260 to .300 x .710	61
TIM	Radial Leads Precision Molded Low DC Leakage Low ESR	0.1 μ F to 220 μ F	6 VDC to 50 VDC	-55°C +125°C (With proper derating)	± 10 ± 20	(H x W x T) .345 x .230 x .105 to .375 x .600 x .195	63
T491	Surface Mount Precision Molded Taped and Reeled EIA and IECQ Standards	0.1 μ F to 220 μ F	4 VDC to 50 VDC	-55°C +125°C (With proper derating)	± 10 (± 20 by special order only)	(L x W x H) .126 x .063 x .063 to .287 x .169 x .157	69
T495	Surface Mount Very Low ESR Precision Molded Taped and Reeled EIA and IECQ Standards	4.7 μ F to 150 μ F	6 VDC to 50 VDC	-55°C +125°C (With proper derating)	± 10 (± 20 by special order only)	(L x W x H) .287 x .169 x .110 and .287 x .169 x .157	71

Dipped							
TDC	Radial Leads Low Cost Conformally Coated Low DCL & ESR Resistant to Shock and Vibration	0.1 μ F to 330 μ F	6 VDC to 50 VDC	-55°C +125°C (With proper derating)	$\pm 5^*$ ± 10 ± 20	(D x H) .175 x .350 to .350 x .650 Lead Spacing: .125 and .250	65
TDL	Radial Leads Low Profile Conformally Coated Low DCL & ESR Resistant to Shock and Vibration	0.1 μ F to 330 μ F	6 VDC to 50 VDC	-55°C +125°C (With proper derating)	$\pm 5^*$ ± 10 ± 20	(D x H) .180 x .280 to .440 x .680 Lead Spacing: .100 and .200	68

Military - Established Reliability Type

MIL Specification	MIL QPL Approvals Failure Rate Levels	Features	Capacitance Range	Voltage Range	Temperature Range	Tolerances (%)	Case Dimensions (Inches)	Page Number
M39003/01 CSR13	Exponential: M, P, R, S Weibull: B, C, D	Graded Reliability Low DC Leakage Temperature Stable Long Shelf Life	.0047 μ F to 330 μ F	6 VDC to 100 VDC	-55°C +125°C (With proper derating)	$\pm 5^*$ ± 10 ± 20	(D x L) .135 x .286 to .351 x .786	52
M39003/09 CSR21	Exponential: M, P, R, S Weibull: B, C, D	High Ripple Current Low Impedance Low ESR Graded Reliability Low DC Leakage Long Shelf Life	5.6 μ F to 330 μ F	6 VDC to 50 VDC	-55°C +125°C (With proper derating)	$\pm 5^*$ ± 10 ± 20	(D x L) .289 x .686 to .351 x .786	59
M39003/03 CSR23	Exponential: M, P, R, S Weibull: B, C, D	Extended Capacitance Graded Reliability Low DC Leakage Long Shelf Life	1.2 μ F to 1,000 μ F	6 VDC to 50 VDC	-55°C +125°C (With proper derating)	$\pm 5^*$ ± 10 ± 20	(D x L) .135 x .286 to .351 x .786	57

* ± 5 Tolerances by special order only.

Part Number Nomenclature Solid Tantalum Capacitors

MALLORY

Solid Tantalum Capacitors

Metal Case

TAS	474	M	035	P	1	A
THF	157	K	006	P	1	F
TXA	186	M	020	P	1	C
(1)	(2)	(3)	(4)	(5)	(6)	(7)

- TAS, THF, TXA Series - Metal Case Solid Tantalum
- Capacitance Code (Expressed in Picofarads)
First 2 digits: Significant Figures
Third digit: Number of zeros (Example: 474 = 0.47 μ F)
(Example: 157 = 150 μ F)
(Example: 186 = 18 μ F)
- Capacitance Tolerance:
K = $\pm 10\%$, M = $\pm 20\%$, (J = $\pm 5\%$, special order only)
- DC Voltage Rating:
Zeros are used to precede the voltage rating where necessary to complete the three digit block
- P = Polar
- 1 = Mylar Sleeve
- Case Size Code

Molded Case

TAC	107	K	006	P	0	7
TIM	335	M	025	P	0	W
(1)	(2)	(3)	(4)	(5)	(6)	(7)

- TAC, TIM Series - Molded Case Solid Tantalum
- Capacitance Code (Expressed in Picofarads)
First 2 digits: Significant Figures
Third digit: Number of zeros (Example: 107 = 100 μ F)
(Example: 335 = 3.3 μ F)
- Capacitance Tolerance:
K = $\pm 10\%$, M = $\pm 20\%$, (J = $\pm 5\%$, special order only)
- DC Voltage Rating:
Zeros are used to precede the voltage rating where necessary to complete the three digit block
- P = Polar
- 0 = Molded Epoxy Case
- Case Size Code

Dipped - .125 & .250 Lead Spacing

TDC	395	K	015	N	S	E
(1)	(2)	(3)	(4)	(5)	(6)	(7)

- TDC Series - Dipped Solid Tantalum
- Capacitance Code (Expressed in Picofarads)
First 2 digits: Significant Figures
Third digit: Number of zeros (Example: 395 = 3.9 μ F)
- Capacitance Tolerance:
K = $\pm 10\%$, M = $\pm 20\%$, (J = $\pm 5\%$, special order only)
- DC Voltage Rating:
Zeros are used to precede the voltage rating where necessary to complete the three digit block
- Lead Spacing
N = .125
W = .250
- Leads
S = .187 Length
- Case Size Code

Dipped - .100 & .200 Lead Spacing

TDL	104	M	050	S	1	A
(1)	(2)	(3)	(4)	(5)	(6)	(7)

- TDL Series - Dipped Solid Tantalum
- Capacitance Code (Expressed in Picofarads)
First 2 digits: Significant Figures
Third digit: Number of zeros (Example: 104 = 0.10 μ F)
- Capacitance Tolerance:
K = $\pm 10\%$, M = $\pm 20\%$, (J = $\pm 5\%$, special order only)
- DC Voltage Rating:
Zeros are used to precede the voltage rating where necessary to complete the three digit block
- Lead Spacing
S = .100
M = .200
- Leads
1 = Straight .390 Long
2 = Standoff .187 Long
- Case Size Code

Precision Molded - Surface Mount

T491	B	105	K	035	A	S
(1)	(2)	(3)	(4)	(5)	(6)	(7)

- T491 Series - Surface Mount
T495 Series - Surface Mount - Very Low ESR
- Case Size Code:
A, B, C, D, X, S, T
- Capacitance Code (Expressed in Picofarads)
First 2 digits: Significant Figures
Third digit: Number of zeros (Example: 395 = 3.9 μ F)
- Capacitance Tolerance:
K = $\pm 10\%$, (M = $\pm 20\%$, special order only)
- DC Voltage Rating:
Zeros are used to precede the voltage rating where necessary to complete the three digit block
- Failure Rate: A = Not applicable
- Lead Material
S = Standard Solder Coated
G = Gold Plated

Type TAS Solid Tantalum Capacitors

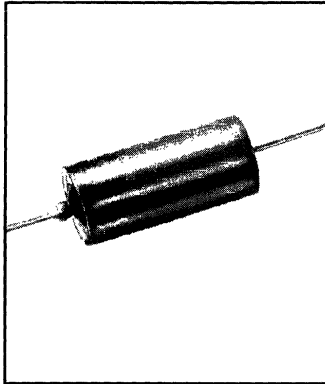

- Hermetically Sealed
- High Capacitance
- Low DC Leakage
- Low Dissipation Factor
- Temperature Stable
- Frequency Stable
- Moisture/Solvent Resistant
- Miniature Size
- Long Shelf Life

GENERAL SPECIFICATIONS

Operating Temperature:
-55°C to +125°C
(With proper derating)
Voltage Range:
6 to 100 WVDC @ 85°C
Reverse Voltage (Non-continuous):
15% of rated voltage @ 25°C
5% of rated voltage @ 85°C
1% of rated voltage @ 125°C
Capacitance Range:
.0047 μF to 330 μF
Capacitance Tolerance:
±10%, ±20%
(±5% by special order)

DC Leakage:
At +25°C - See Table Limit
At +85°C - 10 x Table Limit
At +125°C - 12.5 x Table Limit
Capacitance Change Maximum:
-10% @ -55°C
+8% @ +85°C
+12% @ +125°C

Maximum Power Dissipation @ 25°C:

Case Code	Watts
A	.09
C	.100
F	.125
G	.180

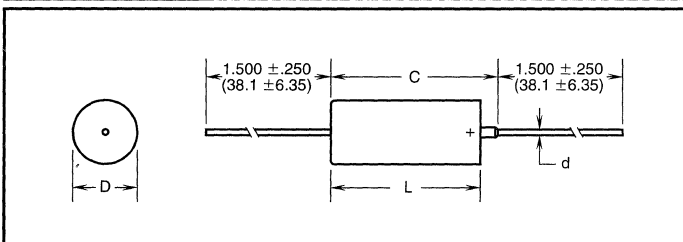

Case Code	Uninsulated		Insulated		C Maximum	d ±.001 (±.03)
	D ±.005 (±.13)	L ±.031 (±.79)	D ±.010 (±.25)	L ±.031 (±.79)		
A	.125(3.18)	.250(6.35)	.135(3.43)	.286(7.26)	.422(10.72)	.020(.51)
C	.175(4.45)	.438(11.13)	.185(4.70)	.474(12.04)	.610(15.49)	.020(.51)
F	.279(7.09)	.650(16.51)	.289(7.34)	.686(17.42)	.822(20.88)	.025(.64)
G	.341(8.66)	.750(19.05)	.351(8.92)	.786(19.96)	.922(23.42)	.025(.64)

Cap (μF)	Case Code	Max DCL @ +25°C (μA)	Max D.F. % @ +25°C 120 Hz	Catalog Number
6 WVDC @ 85°C 4 WVDC @ 125°C				
2.2	A	0.3	4	TAS225*006P1A
2.7	A	0.3	4	TAS275*006P1A
3.3	A	0.3	4	TAS335*006P1A
3.9	A	0.3	4	TAS395*006P1A
4.7	A	0.3	4	TAS475*006P1A
5.6	A	0.3	4	TAS565*006P1A
6.8	A	0.3	6	TAS685*006P1A
8.2	C	0.3	6	TAS825*006P1C
10	C	0.3	6	TAS106*006P1C
12	C	0.5	6	TAS126*006P1C
15	C	0.9	6	TAS156*006P1C
18	C	0.9	6	TAS186*006P1C
22	C	0.9	6	TAS226*006P1C
27	C	0.9	6	TAS276*006P1C
33	C	0.9	6	TAS336*006P1C
39	C	0.9	6	TAS396*006P1C
47	C	1.5	6	TAS476*006P1C
56	C	1.5	6	TAS566*006P1C
68	F	3.0	6	TAS686*006P1F
82	F	3.0	6	TAS826*006P1F
100	F	3.0	6	TAS107*006P1F
120	F	3.0	6	TAS127*006P1F
150	F	4.5	6	TAS157*006P1F
180	F	5.5	6	TAS187*006P1F
220	G	6.0	8	TAS227*006P1G
270	G	6.0	8	TAS277*006P1G
330	G	7.5	8	TAS337*006P1G

Cap (μF)	Case Code	Max DCL @ +25°C (μA)	Max D.F. % @ +25°C 120 Hz	Catalog Number
10 WVDC @ 85°C 7 WVDC @ 125°C				
6.8	C	1.0	6	TAS685*010P1C
8.2	C	1.0	6	TAS825*010P1C
10	C	1.0	6	TAS106*010P1C
12	C	1.0	6	TAS126*010P1C
15	C	1.0	6	TAS156*010P1C
18	C	1.0	6	TAS186*010P1C
22	C	2.0	6	TAS226*010P1C
27	C	2.0	6	TAS276*010P1C
33	C	2.0	6	TAS336*010P1C
39	C	2.0	6	TAS396*010P1C
47	F	3.0	6	TAS476*010P1F
56	F	3.0	6	TAS566*010P1F
68	F	3.0	6	TAS686*010P1F
82	F	3.0	6	TAS826*010P1F
100	F	5.0	6	TAS107*010P1F
120	F	5.0	6	TAS127*010P1F
150	G	9.0	6	TAS157*010P1G
180	G	9.0	6	TAS187*010P1G
220	G	10.0	8	TAS227*010P1G

Cap (μF)	Case Code	Max DCL @ +25°C (μA)	Max D.F. % @ +25°C 120 Hz	Catalog Number
15 WVDC @ 85°C 10 WVDC @ 125°C				
10	C	1.0	6	TAS106*015P1C
12	C	1.0	6	TAS126*015P1C
15	C	2.0	6	TAS156*015P1C
18	C	2.0	6	TAS186*015P1C
22	C	2.0	6	TAS226*015P1C
27	F	3.0	6	TAS276*015P1F
33	F	3.0	6	TAS336*015P1F
39	F	3.0	6	TAS396*015P1F
47	F	4.0	6	TAS476*015P1F
56	F	4.0	6	TAS566*015P1F
68	F	5.0	6	TAS686*015P1F
82	G	6.0	6	TAS826*015P1G
100	G	6.0	6	TAS107*015P1G
120	G	6.0	6	TAS127*015P1G
150	G	8.0	6	TAS157*015P1G

Cap (μF)	Case Code	Max DCL @ +25°C (μA)	Max D.F. % @ +25°C 120 Hz	Catalog Number
10 WVDC @ 85°C 7 WVDC @ 125°C				
1.0	A	0.3	3	TAS105*010P1A
1.2	A	0.3	4	TAS125*010P1A
1.5	A	0.3	4	TAS155*010P1A
1.8	A	0.3	4	TAS185*010P1A
2.2	A	0.3	4	TAS225*010P1A
2.7	A	0.3	4	TAS275*010P1A
3.3	A	0.3	4	TAS335*010P1A
3.9	A	0.3	4	TAS395*010P1A
4.7	A	0.4	4	TAS475*010P1A
5.6	C	0.4	4	TAS565*010P1C

Cap (μF)	Case Code	Max DCL @ +25°C (μA)	Max D.F. % @ +25°C 120 Hz	Catalog Number
15 WVDC @ 85°C 10 WVDC @ 125°C				
0.33	A	0.3	3	TAS334*015P1A
0.39	A	0.3	3	TAS394*015P1A
0.47	A	0.3	3	TAS474*015P1A
0.56	A	0.3	3	TAS564*015P1A
0.68	A	0.3	3	TAS684*015P1A
0.82	A	0.3	3	TAS824*015P1A
1.0	A	0.3	3	TAS105*015P1A
1.2	A	0.3	4	TAS125*015P1A
1.5	A	0.3	4	TAS155*015P1A
1.8	A	0.3	4	TAS185*015P1A
2.2	A	0.3	4	TAS225*015P1A
2.7	A	0.3	4	TAS275*015P1A
3.3	A	0.4	4	TAS335*015P1A
3.9	C	0.4	4	TAS395*015P1C
4.7	C	0.7	4	TAS475*015P1C
5.6	C	0.7	4	TAS565*015P1C
6.8	C	0.7	6	TAS685*015P1C
8.2	C	0.7	6	TAS825*015P1C

Cap (μF)	Case Code	Max DCL @ +25°C (μA)	Max D.F. % @ +25°C 120 Hz	Catalog Number
20 WVDC @ 85°C 13 WVDC @ 125°C				
0.047	A	0.1	3	TAS473*020P1A
0.056	A	0.1	3	TAS563*020P1A
0.068	A	0.1	3	TAS683*020P1A
0.082	A	0.1	3	TAS823*020P1A
0.10	A	0.3	3	TAS104*020P1A
0.12	A	0.3	3	TAS124*020P1A
0.15	A	0.3	3	TAS154*020P1A
0.18	A	0.3	3	TAS184*020P1A
0.22	A	0.3	3	TAS224*020P1A
0.27	A	0.3	3	TAS274*020P1A
0.33	A	0.3	3	TAS334*020P1A
0.39	A	0.3	3	TAS394*020P1A
0.47	A	0.3	3	TAS474*020P1A
0.56	A	0.3	3	TAS564*020P1A
0.68	A	0.3	3	TAS684*020P1A
0.82	A	0.3	3	TAS824*020P1A
1.0	A	0.3	3	TAS105*020P1A
1.2	A	0.3	4	TAS125*020P1A
1.5	A	0.3	4	TAS155*020P1A
1.8	A	0.3	4	TAS185*020P1A
2.2	A	0.4	4	TAS225*020P1A
2.7	C	0.5	4	TAS275*020P1C

* Indicate capacitance tolerance: J = 5±%, K = ±10%, M = ±20%

Type TAS Solid Tantalum Capacitors



Cap (μ F)	Case Code	Max DCL @ +25°C (μ A)	Max D.F. % @+25°C 120 Hz	Catalog Number
20 WVDC @ 85°C 13 WVDC @ 125°C				
3.3	C	1.0	4	TAS335*020P1C
3.9	C	1.0	4	TAS395*020P1C
4.7	C	1.0	4	TAS475*020P1C
5.6	C	1.0	4	TAS565*020P1C
6.8	C	1.0	6	TAS685*020P1C
8.2	C	1.0	6	TAS825*020P1C
10	C	1.0	6	TAS106*020P1C
12	C	1.0	6	TAS126*020P1C
15	C	2.0	6	TAS156*020P1C
18	F	2.0	6	TAS186*020P1F
22	F	2.5	6	TAS226*020P1F
27	F	2.5	6	TAS276*020P1F
33	F	3.0	6	TAS336*020P1F
39	F	3.0	6	TAS396*020P1F
47	F	4.5	6	TAS476*020P1F
56	G	5.5	6	TAS566*020P1G
68	G	6.0	6	TAS686*020P1G
82	G	6.0	6	TAS826*020P1G
100	G	10.0	6	TAS107*020P1G

Cap (μ F)	Case Code	Max DCL @ +25°C (μ A)	Max D.F. % @+25°C 120 Hz	Catalog Number
35 WVDC @ 85°C 23 WVDC @ 125°C				
0.0047	A	0.1	3	TAS472*035P1A
0.0056	A	0.1	3	TAS562*035P1A
0.0068	A	0.1	3	TAS682*035P1A
0.0082	A	0.1	3	TAS822*035P1A
0.01	A	0.1	3	TAS103*035P1A
0.012	A	0.1	3	TAS123*035P1A
0.015	A	0.1	3	TAS153*035P1A
0.018	A	0.1	3	TAS183*035P1A
0.022	A	0.1	3	TAS223*035P1A
0.027	A	0.1	3	TAS273*035P1A
0.033	A	0.1	3	TAS333*035P1A
0.039	A	0.1	3	TAS393*035P1A
0.047	A	0.1	3	TAS473*035P1A
0.056	A	0.1	3	TAS563*035P1A
0.068	A	0.1	3	TAS683*035P1A
0.082	A	0.1	3	TAS823*035P1A
0.10	A	0.5	3	TAS104*035P1A
0.12	A	0.5	3	TAS124*035P1A
0.15	A	0.5	3	TAS154*035P1A
0.18	A	0.5	3	TAS184*035P1A
0.22	A	0.5	3	TAS224*035P1A
0.27	A	0.5	3	TAS274*035P1A
0.33	A	0.5	3	TAS334*035P1A
0.39	A	0.5	3	TAS394*035P1A
0.47	A	0.5	3	TAS474*035P1A
0.56	A	0.5	3	TAS564*035P1A
0.68	A	0.5	3	TAS684*035P1A
0.82	A	0.5	3	TAS824*035P1A
1.0	A	0.5	3	TAS105*035P1A
1.2	C	0.5	4	TAS125*035P1C
1.5	C	0.5	4	TAS155*035P1C
1.8	C	0.5	4	TAS185*035P1C
2.2	C	1.0	4	TAS225*035P1C
2.7	C	1.0	4	TAS275*035P1C
3.3	C	1.0	4	TAS335*035P1C
3.9	C	1.0	4	TAS395*035P1C
4.7	C	1.0	4	TAS475*035P1C
5.6	C	1.0	4	TAS565*035P1C
6.8	C	1.5	4	TAS685*035P1C
8.2	F	3.0	4	TAS825*035P1F
10	F	3.0	4	TAS106*035P1F
12	F	3.0	4	TAS126*035P1F
15	F	3.0	4	TAS156*035P1F
18	F	3.0	4	TAS186*035P1F
22	F	4.0	4	TAS226*035P1F
27	G	4.5	4	TAS276*035P1G
33	G	5.5	4	TAS336*035P1G
39	G	6.0	4	TAS396*035P1G
47	G	8.0	4	TAS476*035P1G

Cap (μ F)	Case Code	Max DCL @ +25°C (μ A)	Max D.F. % @+25°C 120 Hz	Catalog Number
50 WVDC @ 85°C 33 WVDC @ 125°C				
0.0047	A	0.1	2	TAS472*050P1A
0.0056	A	0.1	2	TAS562*050P1A
0.0068	A	0.1	2	TAS682*050P1A
0.0082	A	0.1	2	TAS822*050P1A
0.01	A	0.1	2	TAS103*050P1A
0.012	A	0.1	2	TAS123*050P1A
0.015	A	0.1	2	TAS153*050P1A
0.018	A	0.1	2	TAS183*050P1A
0.022	A	0.1	2	TAS223*050P1A
0.027	A	0.1	2	TAS273*050P1A
0.033	A	0.1	2	TAS333*050P1A
0.039	A	0.1	2	TAS393*050P1A
0.047	A	0.1	2	TAS473*050P1A
0.056	A	0.1	2	TAS563*050P1A
0.068	A	0.1	2	TAS683*050P1A
0.082	A	0.1	2	TAS823*050P1A
0.10	A	0.3	2	TAS104*050P1A
0.12	A	0.3	2	TAS124*050P1A
0.15	A	0.3	2	TAS154*050P1A
0.18	A	0.3	2	TAS184*050P1A
0.22	A	0.3	2	TAS224*050P1A
0.27	A	0.3	2	TAS274*050P1A
0.33	A	0.3	2	TAS334*050P1A
0.39	A	0.3	2	TAS394*050P1A
0.47	A	0.3	2	TAS474*050P1A
0.56	A	0.3	2	TAS564*050P1A
0.68	A	0.3	2	TAS684*050P1A
0.82	A	0.3	2	TAS824*050P1A
1.0	A	0.4	2	TAS105*050P1A
1.2	C	0.4	4	TAS125*050P1C
1.5	C	0.5	4	TAS155*050P1C
1.8	C	0.5	4	TAS185*050P1C
2.2	C	0.8	4	TAS225*050P1C
2.7	C	0.8	4	TAS275*050P1C
3.3	C	1.2	4	TAS335*050P1C
3.9	C	1.5	4	TAS395*050P1C
4.7	C	1.7	4	TAS475*050P1C
5.6	F	2.2	4	TAS565*050P1F
6.8	F	2.2	4	TAS685*050P1F
8.2	F	2.5	4	TAS825*050P1F
10	F	2.5	4	TAS106*050P1F
12	F	3.0	4	TAS126*050P1F
15	F	4.0	4	TAS156*050P1F
18	F	4.5	4	TAS186*050P1F
22	G	5.5	4	TAS226*050P1G

Cap (μ F)	Case Code	Max DCL @ +25°C (μ A)	Max D.F. % @+25°C 120 Hz	Catalog Number
75 WVDC @ 85°C 50 WVDC @ 125°C				
0.0047	A	0.3	2	TAS472*075P1A
0.0056	A	0.3	2	TAS562*075P1A
0.0068	A	0.3	2	TAS682*075P1A
0.0082	A	0.3	2	TAS822*075P1A
0.01	A	0.3	2	TAS103*075P1A
0.012	A	0.3	2	TAS123*075P1A
0.015	A	0.3	2	TAS153*075P1A
0.018	A	0.3	2	TAS183*075P1A
0.022	A	0.3	2	TAS223*075P1A
0.027	A	0.3	2	TAS273*075P1A
0.033	A	0.3	2	TAS333*075P1A
0.039	A	0.3	2	TAS393*075P1A
0.047	A	0.3	2	TAS473*075P1A
0.056	A	0.3	2	TAS563*075P1A
0.068	A	0.3	2	TAS683*075P1A
0.082	A	0.3	2	TAS823*075P1A
0.10	A	0.3	2	TAS104*075P1A
0.12	A	0.3	2	TAS124*075P1A
0.15	A	0.3	2	TAS154*075P1A
0.18	A	0.3	2	TAS184*075P1A
0.22	A	0.3	2	TAS224*075P1A
0.27	A	0.3	2	TAS274*075P1A
0.33	A	0.3	2	TAS334*075P1A

Cap (μ F)	Case Code	Max DCL @ +25°C (μ A)	Max D.F. % @+25°C 120 Hz	Catalog Number
75 WVDC @ 85°C 50 WVDC @ 125°C				
0.39	A	0.3	2	TAS394*075P1A
0.47	A	0.3	2	TAS474*075P1A
0.56	A	0.3	2	TAS564*075P1A
0.68	A	0.3	2	TAS684*075P1A
0.82	C	0.3	2	TAS824*075P1C
1.0	C	0.3	2	TAS105*075P1C
1.2	C	0.3	4	TAS125*075P1C
1.5	C	0.6	4	TAS155*075P1C
1.8	C	0.7	4	TAS185*075P1C
2.2	C	0.8	4	TAS225*075P1C
2.7	C	1.0	4	TAS275*075P1C
3.3	C	1.2	4	TAS335*075P1C
3.9	C	1.5	4	TAS395*075P1C
4.7	F	3.0	4	TAS475*075P1F
5.6	F	3.0	4	TAS565*075P1F
6.8	F	5.0	4	TAS685*075P1F
8.2	F	5.0	4	TAS825*075P1F
10	F	5.0	4	TAS106*075P1F
12	G	5.0	4	TAS126*075P1G
15	G	7.0	4	TAS156*075P1G

Cap (μ F)	Case Code	Max DCL @ +25°C (μ A)	Max D.F. % @+25°C 120 Hz	Catalog Number
100 WVDC @ 85°C 67 WVDC @ 125°C				
0.0047	A	0.3	2	TAS472*100P1A
0.0056	A	0.3	2	TAS562*100P1A
0.0068	A	0.3	2	TAS682*100P1A
0.0082	A	0.3	2	TAS822*100P1A
0.01	A	0.3	2	TAS103*100P1A
0.012	A	0.3	2	TAS123*100P1A
0.015	A	0.3	2	TAS153*100P1A
0.018	A	0.3	2	TAS183*100P1A
0.022	A	0.3	2	TAS223*100P1A
0.027	A	0.3	2	TAS273*100P1A
0.033	A	0.3	2	TAS333*100P1A
0.039	A	0.3	2	TAS393*100P1A
0.047	A	0.3	2	TAS473*100P1A
0.056	A	0.3	2	TAS563*100P1A
0.068	A	0.3	2	TAS683*100P1A
0.082	A	0.3	2	TAS823*100P1A
0.10	A	0.3	2	TAS104*100P1A
0.12	A	0.3	2	TAS124*100P1A
0.15	A	0.3	2	TAS154*100P1A
0.18	A	0.3	2	TAS184*100P1A
0.22	A	0.3	2	TAS224*100P1A
0.27	A	0.3	2	TAS274*100P1A
0.33	A	0.3	2	TAS334*100P1A
0.39	A	0.3	2	TAS394*100P1A
0.47	A	0.3	2	TAS474*100P1A
0.56	A	0.3	2	TAS564*100P1A
0.68	C	0.3	2	TAS684*100P1C
0.82	C	0.4	2	TAS824*100P1C
1.0	C	0.5	2	TAS105*100P1C
1.2	C	0.5	3	TAS125*100P1C
1.5	C	0.7	3	TAS155*100P1C
1.8	C	0.7	3	TAS185*100P1C
2.2	C	0.9	3	TAS225*100P1C
2.7	C	1.1	3	TAS275*100P1C
3.3	F	1.5	3	TAS335*100P1F
3.9	F	1.5	3	TAS395*100P1F
4.7	F	2.5	3	TAS475*100P1F
5.6	F	2.5	3	TAS565*100P1F
6.8	F	2.5	3	TAS685*100P1F
8.2	G	5.0	3	TAS825*100P1G
10	G	5.0	3	TAS106*100P1G

* Indicate capacitance tolerance:
J = $\pm 5\%$
K = $\pm 10\%$
M = $\pm 20\%$

Type TXA Solid Tantalum Capacitors

MALLORY

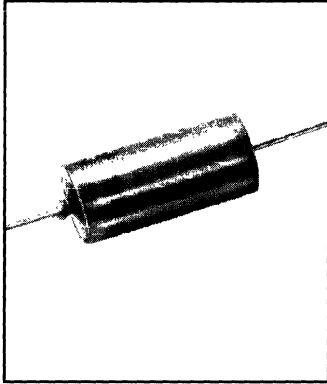

- Extended Range
- Hermetically Sealed
- Low DC Leakage
- Low Dissipation Factor
- Temperature Stable
- Frequency Stable
- Moisture/Solvent Resistant
- Miniature Size
- Long Shelf Life

GENERAL SPECIFICATIONS

Operating Temperature:
-55°C to +125°C
(With proper derating)
Voltage Range:
6 to 50 WVDC @ 85°C
Reverse Voltage (Non-continuous):
15% of rated voltage @ 25°C
5% of rated voltage @ 85°C
1% of rated voltage @ 125°C
Capacitance Range:
1.2 μF to 1000 μF
Capacitance Tolerance:
±10%, ±20%
(±5% by special order)

DC Leakage:
At +25°C - See Table Limit
At +85°C - 10 x Table Limit
At +125°C - 12.5 x Table Limit
Maximum Capacitance Change:
-10% @ -55°C
+8% @ +85°C
+12% @ +125°C

Maximum Power Dissipation @ 25°C:

Case Code	Watts
A	.09
C	.100
F	.125
G	.180

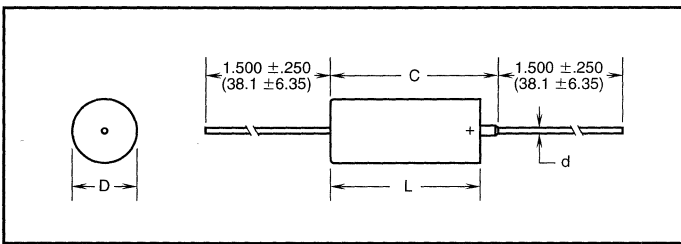

Case Code	Uninsulated		Insulated		C Maximum	d ±.001 (±.03)
	D ±.005 (±.13)	L ±.031 (±.79)	D ±.010 (±.25)	L ±.031 (±.79)		
A	.125(3.18)	.250(6.35)	.135(3.43)	.286(7.26)	.422(10.72)	.020(.51)
C	.175(4.45)	.438(11.13)	.185(4.70)	.474(12.04)	.610(15.49)	.020(.51)
F	.279(7.09)	.650(16.51)	.289(7.34)	.686(17.42)	.822(20.88)	.025(.64)
G	.341(8.66)	.750(19.05)	.351(8.92)	.786(19.96)	.922(23.42)	.025(.64)

Cap (μF)	Case Code	Max DCL @ +25°C (μA)	Max D.F. % @ +25°C 120 Hz	Catalog Number
6 WVDC @ 85°C 4 WVDC @ 125°C				
8.2	A	0.9	6	TXA825*006P1A
10	A	0.9	6	TXA106*006P1A
12	A	1.0	6	TXA126*006P1A
82	C	3.0	6	TXA826*006P1C
100	C	6.0	6	TXA107*006P1C
220	F	10.0	8	TXA227*006P1F
270	F	10.0	8	TXA277*006P1F
330	F	10.0	8	TXA337*006P1F
390	F	10.0	10	TXA397*006P1F
470	F	10.0	10	TXA477*006P1F
560	G	20.0	10	TXA567*006P1G
680	G	20.0	10	TXA687*006P1G
820	G	20.0	10	TXA827*006P1G
1000	G	20.0	10	TXA108*006P1G

Cap (μF)	Case Code	Max DCL @ +25°C (μA)	Max D.F. % @ +25°C 120 Hz	Catalog Number
15 WVDC @ 85°C 10 WVDC @ 125°C				
27	C	3.0	6	TXA276*015P1C
33	C	5.0	6	TXA336*015P1C
39	C	5.0	6	TXA396*015P1C
82	F	8.0	6	TXA826*015P1F
100	F	10.0	6	TXA107*015P1F
120	F	10.0	6	TXA127*015P1F
150	F	15.0	8	TXA157*015P1F
180	F	15.0	8	TXA187*015P1F
220	G	20.0	8	TXA227*015P1G
270	G	20.0	8	TXA277*015P1G
330	G	20.0	8	TXA337*015P1G

Cap (μF)	Case Code	Max DCL @ +25°C (μA)	Max D.F. % @ +25°C 120 Hz	Catalog Number
30 WVDC @ 85°C 20 WVDC @ 125°C				
39	F	6.0	6	TXA396*030P1F
47	F	7.0	6	TXA476*030P1F
56	F	7.0	6	TXA566*030P1F
68	F	7.0	6	TXA686*030P1F
100	G	10.0	8	TXA107*030P1G

Cap (μF)	Case Code	Max DCL @ +25°C (μA)	Max D.F. % @ +25°C 120 Hz	Catalog Number
10 WVDC @ 85°C 7 WVDC @ 125°C				
5.6	A	1.0	4	TXA565*010P1A
6.8	A	1.0	6	TXA685*010P1A
8.2	A	1.2	6	TXA825*010P1A
47	C	4.0	6	TXA476*010P1C
56	C	5.0	6	TXA566*010P1C
68	C	6.0	6	TXA686*010P1C
82	C	7.0	6	TXA826*010P1C
150	F	8.0	8	TXA157*010P1F
180	F	8.0	8	TXA187*010P1F
220	F	13.0	8	TXA227*010P1F
270	F	13.0	8	TXA277*010P1F
330	G	16.0	8	TXA337*010P1G
390	G	16.0	10	TXA397*010P1G
470	G	16.0	10	TXA477*010P1G
560	G	20.0	10	TXA567*010P1G

Cap (μF)	Case Code	Max DCL @ +25°C (μA)	Max D.F. % @ +25°C 120 Hz	Catalog Number
20 WVDC @ 85°C 13 WVDC @ 125°C				
2.7	A	0.8	4	TXA275*020P1A
3.3	A	1.0	4	TXA335*020P1A
3.9	A	1.2	4	TXA395*020P1A
4.7	A	1.2	4	TXA475*020P1A
18	C	3.0	6	TXA186*020P1C
22	C	3.0	6	TXA226*020P1C
27	C	4.0	6	TXA276*020P1C
56	F	7.0	6	TXA566*020P1F
68	F	8.0	6	TXA686*020P1F
82	F	10.0	6	TXA826*020P1F
100	F	12.0	6	TXA107*020P1F
120	F	12.0	6	TXA127*020P1F
150	G	15.0	8	TXA157*020P1G
180	G	15.0	8	TXA187*020P1G

Cap (μF)	Case Code	Max DCL @ +25°C (μA)	Max D.F. % @ +25°C 120 Hz	Catalog Number
35 WVDC @ 85°C 23 WVDC @ 125°C				
1.5	A	0.8	4	TXA155*035P1A
1.8	A	1.0	4	TXA185*035P1A
8.2	C	3.0	4	TXA825*035P1C
10	C	3.0	4	TXA106*035P1C
27	F	7.0	6	TXA276*035P1F
33	F	8.0	6	TXA336*035P1F
39	F	10.0	6	TXA396*035P1F
47	F	10.0	6	TXA476*035P1F
56	G	12.0	6	TXA566*035P1G
68	G	12.0	6	TXA686*035P1G

Cap (μF)	Case Code	Max DCL @ +25°C (μA)	Max D.F. % @ +25°C 120 Hz	Catalog Number
15 WVDC @ 85°C 10 WVDC @ 125°C				
3.9	A	1.0	4	TXA395*015P1A
4.7	A	1.0	4	TXA475*015P1A
5.6	A	1.3	4	TXA565*015P1A

Cap (μF)	Case Code	Max DCL @ +25°C (μA)	Max D.F. % @ +25°C 120 Hz	Catalog Number
30 WVDC @ 85°C 20 WVDC @ 125°C				
1.8	A	1.0	4	TXA185*030P1A
2.2	A	1.0	4	TXA225*030P1A
2.7	A	1.0	4	TXA275*030P1A
12	C	3.0	4	TXA126*030P1C
15	C	3.0	4	TXA156*030P1C
18	C	3.0	4	TXA186*030P1C
33	F	6.0	6	TXA336*030P1F

Cap (μF)	Case Code	Max DCL @ +25°C (μA)	Max D.F. % @ +25°C 120 Hz	Catalog Number
50 WVDC @ 85°C 33 WVDC @ 125°C				
1.2	A	0.6	4	TXA125*050P1A
1.5	A	0.8	4	TXA155*050P1A
5.6	C	2.5	4	TXA565*050P1C
6.8	C	2.5	4	TXA685*050P1C
22	F	7.0	6	TXA226*050P1F
27	F	8.0	6	TXA276*050P1F
33	G	10.0	6	TXA336*050P1G
39	G	10.0	6	TXA396*050P1G

* Indicate capacitance tolerance:
J = ±5%
K = ±10%
M = ±20%

Solid Tantalum Capacitors

Type THF Solid Tantalum Capacitors

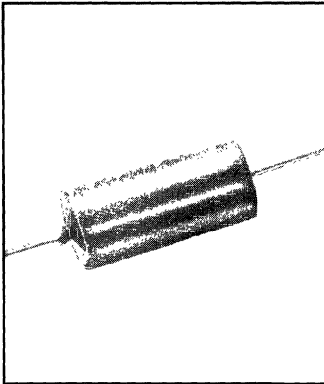

- High Ripple Current
- Low ESR
- Lower Impedance at High Frequencies
- Small Size
- Extremely Stable Capacitance
- Hermetic Seal
- Long Life
- Switching Regulators
- High Frequency Power Supplies
- By-pass Filtering

GENERAL SPECIFICATIONS

Operating Temperature:
-55°C to +125°C
(With proper derating)

Voltage Range:
6 to 50 WVDC @ 85°C

Capacitance Range:
5.6 μF to 330 μF

Capacitance Tolerance:
Standard ±20%
(±10% by special order)

DC Leakage:
At +25°C - See Table Limit
At +85°C - 10 x Table Limit
At +125°C - 12.5 x Table Limit

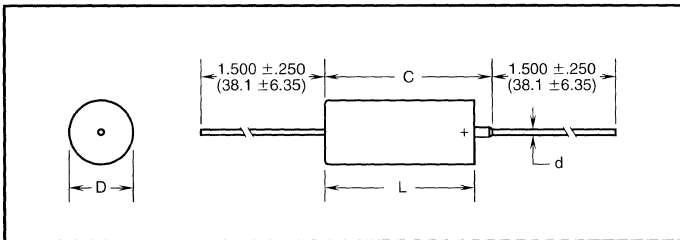

Case Code	Uninsulated		Insulated		C Maximum	d ±.001 (±.03)
	D ±.005 (±.13)	L ±.031 (±.79)	D ±.010 (±.25)	L ±.031 (±.79)		
F	.279(7.09)	.650(16.51)	.289(7.34)	.686(17.42)	.822(20.88)	.025(.64)
G	.341(8.66)	.750(19.05)	.351(8.92)	.786(19.96)	.922(23.42)	.025(.64)

Cap (μF)	Case Code	Max DCL @ +25°C (μA)	Max D.F. % @ +25°C 1 kHz	Max ESR (ohms) @ 100kHz +25°C	Max Ripple RMS Amps @ 40kHz +25°C	Catalog Number
6 WVDC @ 85°C 4 WVDC @ 125°C						
150	F	4.5	10	.065	3.3	THF157*006P1F
180	F	5.5	10	.060	3.4	THF187*006P1F
270	G	6.5	10	.050	4.1	THF277*006P1G
330	G	7.5	12	.045	4.3	THF337*006P1G

Cap (μF)	Case Code	Max DCL @ +25°C (μA)	Max D.F. % @ +25°C 1 kHz	Max ESR (ohms) @ 100kHz +25°C	Max Ripple RMS Amps @ 40kHz +25°C	Catalog Number
35 WVDC @ 85°C 23 WVDC @ 125°C						
10	F	4.0	4	.161	1.5	THF106*035P1F
22	F	4.0	4	.160	2.1	THF226*035P1F
27	G	4.5	4	.145	2.4	THF276*035P1G
33	G	5.5	5	.130	2.5	THF336*035P1G
39	G	7.0	5	.120	2.6	THF396*035P1G
47	G	8.0	5	.110	2.7	THF476*035P1G

Cap (μF)	Case Code	Max DCL @ +25°C (μA)	Max D.F. % @ +25°C 1 kHz	Max ESR (ohms) @ 100kHz +25°C	Max Ripple RMS Amps @ 40kHz +25°C	Catalog Number
10 WVDC @ 85°C 7 WVDC @ 125°C						
82	F	4.0	8	.085	2.9	THF826*010P1F
100	F	5.0	8	.075	3.0	THF107*010P1F
120	F	6.0	8	.070	3.2	THF127*010P1F
180	G	9.0	8	.060	3.7	THF187*010P1G
220	G	10	10	.055	3.9	THF227*010P1G

Cap (μF)	Case Code	Max DCL @ +25°C (μA)	Max D.F. % @ +25°C 1 kHz	Max ESR (ohms) @ 100kHz +25°C	Max Ripple RMS Amps @ 40kHz +25°C	Catalog Number
50 WVDC @ 85°C 33 WVDC @ 125°C						
5.6	F	2.2	3	.300	1.5	THF565*050P1F
6.8	F	2.2	3	.275	1.6	THF685*050P1F
8.2	F	2.5	3	.250	1.6	THF825*050P1F
10	F	2.5	3	.230	1.7	THF106*050P1F
12	F	3.0	3	.210	1.8	THF126*050P1F
15	F	4.0	3	.190	1.9	THF156*050P1F
18	F	4.5	4	.175	2.0	THF186*050P1F
22	G	5.5	4	.160	2.3	THF226*050P1G

Cap (μF)	Case Code	Max DCL @ +25°C (μA)	Max D.F. % @ +25°C 1 kHz	Max ESR (ohms) @ 100kHz +25°C	Max Ripple RMS Amps @ 40kHz +25°C	Catalog Number
15 WVDC @ 85°C 10 WVDC @ 125°C						
56	F	4.0	6	.100	2.6	THF566*015P1F
68	F	5.0	6	.095	2.7	THF686*015P1F
120	G	9.0	8	.070	3.5	THF127*015P1G
150	G	10	8	.065	3.6	THF157*015P1G

* Indicate capacitance tolerance:
K = 10%
M = 20%

Cap (μF)	Case Code	Max DCL @ +25°C (μA)	Max D.F. % @ +25°C 1 kHz	Max ESR (ohms) @ 100kHz +25°C	Max Ripple RMS Amps @ 40kHz +25°C	Catalog Number
20 WVDC @ 85°C 13 WVDC @ 125°C						
27	F	2.5	5	.145	2.2	THF276*020P1F
33	F	3.5	5	.130	2.3	THF336*020P1F
39	F	4.0	5	.120	2.4	THF396*020P1F
47	F	4.5	6	.110	2.5	THF476*020P1F
56	G	5.5	6	.100	2.9	THF566*020P1G
68	G	7.0	6	.095	3.0	THF686*020P1G
82	G	8.0	6	.085	3.1	THF826*020P1G
100	G	10	8	.075	3.3	THF107*020P1G

CSR13 (MIL-C-39003/01) Solid Tantalum Capacitors

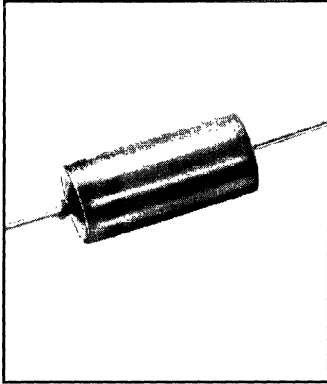

- Hermetically Sealed
- Graded Failure Rates
- Low DC Leakage
- Low Dissipation Factor
- Temperature Stable
- Frequency Stable
- Moisture/Solvent Resistant
- Miniature Size
- Long Shelf Life

GENERAL SPECIFICATIONS

Operating Temperature:
-55°C to +125°C
(With proper derating)
Voltage Range:
6 to 100 WVDC @ 85°C
Reverse Voltage (non-continuous):
15% of rated voltage @ 25°C
5% of rated voltage @ 85°C
1% of rated voltage @ 125°C
Capacitance Range:
.0047 μF to 330 μF
Capacitance Tolerance:
±10%, ±20%
(±5% by special order)

DC Leakage:
At +25°C - See Table Limit
At +85°C - 10 x Table Limit
At +125°C - 12.5 x Table Limit
Capacitance Change Maximum:
-10% @ -55°C
+8% @ +85°C
+12% @ +125°C

Maximum Power Dissipation @ 25°C:

Case Code	Watts
A	.09
B	.100
C	.125
D	.180

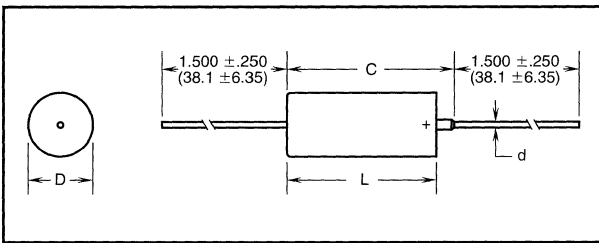

Case Code	Uninsulated		Insulated		C Maximum	d ±.001 (±.03)
	D ±.005 (±.13)	L ±.031 (±.79)	D ±.010 (±.25)	L ±.031 (±.79)		
A	.125(3.18)	.250(6.35)	.135(3.43)	.286(7.26)	.422(10.72)	.020(.51)
B	.175(4.45)	.438(11.13)	.185(4.70)	.474(12.04)	.610(15.49)	.020(.51)
C	.279(7.09)	.650(16.51)	.289(7.34)	.686(17.42)	.822(20.88)	.025(.64)
D	.341(8.66)	.750(19.05)	.351(8.92)	.786(19.96)	.922(23.42)	.025(.64)

Cap (μF)	Cap Tolerance (±)	Case Code	Max. DCL @ +25°C (μA)	Max D.F. % @ +25°C 120 Hz	MIL-C-39003/1(CSR 13) Dash Numbers							MIL Reference Number (Do not order by this number.) See below
					Exponential Failure Rate (% per 1000 hours)				Weibull Failure Rate (% per 1000 hours)			
					'M' Level (1.0)	'P' Level (.10)	'R' Level (.01)	'S' Level (.001)	'B' Level (.10)	'C' Level (.01)	'D' Level (.001)	

6 WVDC @ 85°C — 4 WVDC @ 125°C

5.6	10	A	0.3	4	2241	2481	2721	2961	6002	7002	8002	CSR13B565K*
6.8	10	A	0.3	6	2242	2482	2722	2962	6004	7004	8004	CSR13B685K*
6.8	20	A	0.3	6	2243	2483	2723	2963	6005	7005	8005	CSR13B685M*
47	10	B	1.5	6	2244	2484	2724	2964	6007	7007	8007	CSR13B476K*
47	20	B	1.5	6	2245	2485	2725	2965	6008	7008	8008	CSR13B476M*
56	10	B	1.5	6	2246	2486	2726	2966	6010	7010	8010	CSR13B566K*
150	10	C	4.5	6	2247	2487	2727	2967	6012	7012	8012	CSR13B157K*
150	20	C	4.5	6	2248	2488	2728	2968	6013	7013	8013	CSR13B157M*
180	10	C	5.5	6	2249	2489	2729	2969	6015	7015	8015	CSR13B187K*
270	10	D	6.0	8	2250	2490	2730	2970	6017	7017	8017	CSR13B277K*
330	10	D	7.5	8	2251	2491	2731	2971	6019	7019	8019	CSR13B337K*
330	20	D	7.5	8	2252	2492	2732	2972	6020	7020	8020	CSR13B337M*

10 WVDC @ 85°C — 7 WVDC @ 125°C

3.9	10	A	0.3	4	2253	2493	2733	2973	6022	7022	8022	CSR13C395K*
4.7	10	A	0.4	4	2254	2494	2734	2974	6024	7024	8024	CSR13C475K*
4.7	20	A	0.4	4	2255	2495	2735	2975	6025	7025	8025	CSR13C475M*
27	10	B	2.0	6	2256	2496	2736	2976	6027	7027	8027	CSR13C276K*
33	10	B	2.0	6	2257	2497	2737	2977	6029	7029	8029	CSR13C336K*
33	20	B	2.0	6	2258	2498	2738	2978	6030	7030	8030	CSR13C336M*
39	10	B	2.0	6	2259	2499	2739	2979	6032	7032	8032	CSR13C396K*
82	10	C	3.0	6	2260	2500	2740	2980	6034	7034	8034	CSR13C826K*
100	10	C	5.0	6	2261	2501	2741	2981	6036	7036	8036	CSR13C107K*
100	20	C	5.0	6	2262	2502	2742	2982	6037	7037	8037	CSR13C107M*
120	10	C	6.0	6	2263	2503	2743	2983	6039	7039	8039	CSR13C127K*
180	10	D	9.0	6	2264	2504	2744	2984	6041	7041	8041	CSR13C187K*
220	10	D	10.0	8	2265	2505	2745	2985	6043	7043	8043	CSR13C227K*
220	20	D	10.0	8	2266	2506	2746	2986	6044	7044	8044	CSR13C227M*

15 WVDC @ 85°C — 10 WVDC @ 125°C

2.7	10	A	0.3	4	2267	2507	2747	2987	6046	7046	8046	CSR13D275K*
3.3	10	A	0.4	4	2268	2508	2748	2988	6048	7048	8048	CSR13D335K*
3.3	20	A	0.4	4	2269	2509	2749	2989	6049	7049	8049	CSR13D335M*
18	10	B	2.0	6	2270	2510	2750	2990	6051	7051	8051	CSR13D186K*
22	10	B	2.0	6	2271	2511	2751	2991	6053	7053	8053	CSR13D226K*
22	20	B	2.0	6	2272	2512	2752	2992	6054	7054	8054	CSR13D226M*

TO ORDER: Indicate the prefix M39003/01 followed by the applicable MIL dash number.
Example: For M39003/01-2241 or CSR13B565KM; order M39003/012241

* Failure rate level indicator (M, P, R, S)

CSR13 (MIL-C-39003/01) Solid Tantalum Capacitors



Cap (μ F)	Cap Tolerance (\pm)	Case Code	Max. DCL @ +25°C (μ A)	Max D.F. % @ +25°C 120 Hz	MIL-C-39003/1 (CSR 13) Dash Numbers							MIL Reference Number (Do not order by this number.) See below
					Exponential Failure Rate (% per 1000 hours)				Weibull Failure Rate (% per 1000 hours)			
					'M' Level (1.0)	'P' Level (.10)	'R' Level (.01)	'S' Level (.001)	'B' Level (.10)	'C' Level (.01)	'D' Level (.001)	
15 WVDC @ 85°C — 10 WVDC @ 125°C												
56	10	C	4.0	6	2273	2513	2753	2993	6056	7056	8056	CSR13D566K*
68	10	C	5.0	6	2274	2514	2754	2994	6058	7058	8058	CSR13D686K*
68	20	C	5.0	6	2275	2515	2755	2995	6059	7059	8059	CSR13D686M*
120	10	D	6.0	6	2276	2516	2756	2996	6061	7061	8061	CSR13D127K*
150	10	D	8.0	6	2277	2517	2757	2997	6063	7063	8063	CSR13D157K*
150	20	D	8.0	6	2278	2518	2758	2998	6064	7064	8064	CSR13D157M*
20 WVDC @ 85°C — 13 WVDC @ 125°C												
1.2	10	A	0.3	6	2279	2519	2759	2999	6066	7066	8066	CSR13E125K*
1.5	10	A	0.3	6	2280	2520	2760	3000	6068	7068	8068	CSR13E155K*
1.5	20	A	0.3	6	2281	2521	2761	3001	6069	7069	8069	CSR13E155M*
1.8	10	A	0.3	6	2282	2522	2762	3002	6071	7071	8071	CSR13E185K*
2.2	10	A	0.4	6	2283	2523	2763	3003	6073	7073	8073	CSR13E225K*
2.2	20	A	0.4	6	2284	2524	2764	3004	6074	7074	8074	CSR13E225M*
8.2	10	B	1.0	6	2285	2525	2765	3005	6076	7076	8076	CSR13E825K*
10	10	B	1.0	6	2286	2526	2766	3006	6078	7078	8078	CSR13E106K*
10	20	B	1.0	6	2287	2527	2767	3007	6079	7079	8079	CSR13E106M*
12	10	B	1.0	6	2288	2528	2768	3008	6081	7081	8081	CSR13E126K*
15	10	B	2.0	6	2289	2529	2769	3009	6083	7083	8083	CSR13E156K*
15	20	B	2.0	6	2290	2530	2770	3010	6084	7084	8084	CSR13E156M*
27	10	C	2.5	6	2291	2531	2771	3011	6086	7086	8086	CSR13E276K*
33	10	C	3.0	6	2292	2532	2772	3012	6088	7088	8088	CSR13E336K*
33	20	C	3.0	6	2293	2533	2773	3013	6089	7089	8089	CSR13E336M*
39	10	C	3.0	6	2294	2534	2774	3014	6091	7091	8091	CSR13E396K*
47	10	C	4.5	6	2295	2535	2775	3015	6093	7093	8093	CSR13E476K*
47	20	C	4.5	6	2296	2536	2776	3016	6094	7094	8094	CSR13E476M*
56	10	D	5.5	6	2297	2537	2777	3017	6096	7096	8096	CSR13E566K*
68	10	D	6.0	6	2298	2538	2778	3018	6098	7098	8098	CSR13E686K*
68	20	D	6.0	6	2299	2539	2779	3019	6099	7099	8099	CSR13E686M*
82	10	D	6.0	6	2300	2540	2780	3020	6101	7101	8101	CSR13E826K*
100	10	D	10.0	6	2301	2541	2781	3021	6103	7103	8103	CSR13E107K*
100	20	D	10.0	6	2302	2542	2782	3022	6104	7104	8104	CSR13E107M*
35 WVDC @ 85°C — 23 WVDC @ 125°C												
5.6	10	B	1.0	4	2303	2543	2783	3023	6106	7106	8106	CSR13F565K*
6.8	10	B	1.5	4	2304	2544	2784	3024	6108	7108	8108	CSR13F685K*
6.8	20	B	1.5	4	2305	2545	2785	3025	6109	7109	8109	CSR13F685M*
22	10	C	4.0	4	2306	2546	2786	3026	6111	7111	8111	CSR13F226K*
22	20	C	4.0	4	2307	2547	2787	3027	6112	7112	8112	CSR13F226M*
27	10	D	4.5	4	2308	2548	2788	3028	6114	7114	8114	CSR13F276K*
33	10	D	5.5	4	2309	2549	2789	3029	6116	7116	8116	CSR13F336K*
33	20	D	5.5	4	2310	2550	2790	3030	6117	7117	8117	CSR13F336M*
39	10	D	6.0	4	2311	2551	2791	3031	6119	7119	8119	CSR13F396K*
47	10	D	6.0	4	2312	2552	2792	3032	6121	7121	8121	CSR13F476K*
47	20	D	8.0	4	2313	2553	2793	3033	6122	7122	8122	CSR13F476M*
50 WVDC @ 85°C — 33 WVDC @ 125°C												
0.0047	10	A	0.1	2	2314	2554	2794	3034	6124	7124	8124	CSR13G472K*
0.0047	20	A	0.1	2	2315	2555	2795	3035	6125	7125	8125	CSR13G472M*
0.0056	10	A	0.1	2	2316	2556	2796	3036	6127	7127	8127	CSR13G562K*
0.0068	10	A	0.1	2	2317	2557	2797	3037	6129	7129	8129	CSR13G682K*
0.0068	20	A	0.1	2	2318	2558	2798	3038	6130	7130	8130	CSR13G682M*
0.0082	10	A	0.1	2	2319	2559	2799	3039	6132	7132	8132	CSR13G822K*
0.01	10	A	0.1	2	2320	2560	2800	3040	6134	7134	8134	CSR13G103K*
0.01	20	A	0.1	2	2321	2561	2801	3041	6135	7135	8135	CSR13G103M*
0.012	10	A	0.1	2	2322	2562	2802	3042	6137	7137	8137	CSR13G123K*
0.015	10	A	0.1	2	2323	2563	2803	3043	6139	7139	8139	CSR13G153K*
0.015	20	A	0.1	2	2324	2564	2804	3044	6140	7140	8140	CSR13G153M*
0.018	10	A	0.1	2	2325	2565	2805	3045	6142	7142	8142	CSR13G183K*
0.022	10	A	0.1	2	2326	2566	2806	3046	6144	7144	8144	CSR13G223K*
0.022	20	A	0.1	2	2327	2567	2807	3047	6145	7145	8145	CSR13G223M*
0.027	10	A	0.1	2	2328	2568	2808	3048	6147	7147	8147	CSR13G273K*
0.033	10	A	0.1	2	2329	2569	2809	3049	6149	7149	8149	CSR13G333K*
0.033	20	A	0.1	2	2330	2570	2810	3050	6150	7150	8150	CSR13G333M*
0.039	10	A	0.1	2	2331	2571	2811	3051	6152	7152	8152	CSR13G393K*

TO ORDER: Indicate the prefix M39003/01 followed by the applicable MIL dash number.
Example: For M39003/01-2241 or CSR13B565KM; order M39003/012241

* Failure rate level indicator (M, P, R, S)

CSR13 (MIL-C-39003/01) Solid Tantalum Capacitors



Solid Tantalum Capacitors

Cap (μ F)	Cap Tolerance (\pm)	Case Code	Max DCL @ +25°C (μ A)	Max D.F. % @ +25°C 120 Hz	MIL-C-39003/1(CSR 13) Dash Numbers							MIL Reference Number (Do not order by this number.) See below
					Exponential Failure Rate (% per 1000 hours)				Weibull Failure Rate (% per 1000 hours)			
					'M' Level (1.0)	'P' Level (.10)	'R' Level (.01)	'S' Level (.001)	'B' Level (.10)	'C' Level (.01)	'D' Level (.001)	
50 WVDC @ 85°C — 33 WVDC @ 125°C												
0.047	10	A	0.1	2	2332	2572	2812	3052	6154	7154	8154	CSR13G473K*
0.047	20	A	0.1	2	2333	2573	2813	3053	6155	7155	8155	CSR13G473M*
0.056	10	A	0.1	2	2334	2574	2814	3054	6157	7157	8157	CSR13G563K*
0.068	10	A	0.1	2	2335	2575	2815	3055	6159	7159	8159	CSR13G683K*
0.068	20	A	0.1	2	2336	2576	2816	3056	6160	7160	8160	CSR13G683M*
0.082	10	A	0.1	2	2337	2577	2817	3057	6162	7162	8162	CSR13G823K*
0.1	10	A	0.3	2	2338	2578	2818	3058	6164	7164	8164	CSR13G104K*
0.1	20	A	0.3	2	2339	2579	2819	3059	6165	7165	8165	CSR13G104M*
0.12	10	A	0.3	2	2340	2580	2820	3060	6167	7167	8167	CSR13G124K*
0.15	10	A	0.3	2	2341	2581	2821	3061	6169	7169	8169	CSR13G154K*
0.15	20	A	0.3	2	2342	2582	2822	3062	6170	7170	8170	CSR13G154M*
0.18	10	A	0.3	2	2343	2583	2823	3063	6172	7172	8172	CSR13G184K*
0.22	10	A	0.3	2	2344	2584	2824	3064	6174	7174	8174	CSR13G224K*
0.22	20	A	0.3	2	2345	2585	2825	3065	6175	7175	8175	CSR13G224M*
0.27	10	A	0.3	2	2346	2586	2826	3066	6177	7177	8177	CSR13G274K*
0.33	10	A	0.3	2	2347	2587	2827	3067	6179	7179	8179	CSR13G334K*
0.33	20	A	0.3	2	2348	2588	2828	3068	6180	7180	8180	CSR13G334M*
0.39	10	A	0.3	2	2349	2589	2829	3069	6182	7182	8182	CSR13G394K*
0.47	10	A	0.3	2	2350	2590	2830	3070	6184	7184	8184	CSR13G474K*
0.47	20	A	0.3	2	2351	2591	2831	3071	6185	7185	8185	CSR13G474M*
0.56	10	A	0.3	2	2352	2592	2832	3072	6187	7187	8187	CSR13G564K*
0.68	10	A	0.3	2	2353	2593	2833	3073	6189	7189	8189	CSR13G684K*
0.68	20	A	0.3	2	2354	2594	2834	3074	6190	7190	8190	CSR13G684M*
0.82	10	A	0.3	2	2355	2595	2835	3075	6192	7192	8192	CSR13G824K*
1.0	10	A	0.4	2	2356	2596	2836	3076	6194	7194	8194	CSR13G105K*
1.0	20	A	0.4	2	2357	2597	2837	3077	6195	7195	8195	CSR13G105M*
1.2	10	B	0.4	4	2358	2598	2838	3078	6197	7197	8197	CSR13G125K*
1.5	10	B	0.5	4	2359	2599	2839	3079	6199	7199	8199	CSR13G155K*
1.5	20	B	0.5	4	2360	2600	2840	3080	6200	7200	8200	CSR13G155M*
1.8	10	B	0.5	4	2361	2601	2841	3081	6202	7202	8202	CSR13G185K*
2.2	10	B	0.8	4	2362	2602	2842	3082	6204	7204	8204	CSR13G225K*
2.2	20	B	0.8	4	2363	2603	2843	3083	6205	7205	8205	CSR13G225M*
2.7	10	B	0.8	4	2364	2604	2844	3084	6207	7207	8207	CSR13G275K*
3.3	10	B	1.2	4	2365	2605	2845	3085	6209	7209	8209	CSR13G335K*
3.3	20	B	1.2	4	2366	2606	2846	3086	6210	7210	8210	CSR13G335M*
3.9	10	B	1.5	4	2367	2607	2847	3087	6212	7212	8212	CSR13G395K*
4.7	10	B	1.7	4	2368	2608	2848	3088	6214	7214	8214	CSR13G475K*
4.7	20	B	1.7	4	2369	2609	2849	3089	6215	7215	8215	CSR13G475M*
5.6	10	C	2.2	4	2370	2610	2850	3090	6217	7217	8217	CSR13G565K*
6.8	10	C	2.2	4	2371	2611	2851	3091	6219	7219	8219	CSR13G685K*
6.8	20	C	2.2	4	2372	2612	2852	3092	6220	7220	8220	CSR13G685M*
8.2	10	C	2.5	4	2373	2613	2853	3093	6222	7222	8222	CSR13G825K*
10	10	C	2.5	4	2374	2614	2854	3094	6224	7224	8224	CSR13G106K*
10	20	C	2.5	4	2375	2615	2855	3095	6225	7225	8225	CSR13G106M*
12	10	C	0.3	4	2376	2616	2856	3096	6227	7227	8227	CSR13G126K*
15	10	C	4.0	4	2377	2617	2857	3097	6229	7229	8229	CSR13G156K*
15	20	C	4.0	4	2378	2618	2858	3098	6230	7230	8230	CSR13G156M*
18	10	C	4.5	4	2379	2619	2859	3099	6232	7232	8232	CSR13G186K*
22	10	D	5.5	4	2380	2620	2860	3100	6234	7234	8234	CSR13G226K*
22	20	D	5.5	4	2381	2621	2861	3101	6235	7235	8235	CSR13G226M*
75 WVDC @ 85°C — 50 WVDC @ 125°C												
0.1	10	A	0.3	2	2382	2622	2862	3102	6237	7237	8237	CSR13H104K*
0.1	20	A	0.3	2	2383	2623	2863	3103	6238	7238	8238	CSR13H104M*
0.12	10	A	0.3	2	2384	2624	2864	3104	6240	7240	8240	CSR13H124K*
0.15	10	A	0.3	2	2385	2625	2865	3105	6242	7242	8242	CSR13H154K*
0.15	20	A	0.3	2	2386	2626	2866	3106	6243	7243	8243	CSR13H154M*
0.18	10	A	0.3	2	2387	2627	2867	3107	6245	7245	8245	CSR13H184K*
0.22	10	A	0.3	2	2388	2628	2868	3108	6247	7247	8247	CSR13H224K*
0.22	20	A	0.3	2	2389	2629	2869	3109	6248	7248	8248	CSR13H224M*
0.27	10	A	0.3	2	2390	2630	2870	3110	6250	7250	8250	CSR13H274K*
0.33	10	A	0.3	2	2391	2631	2871	3111	6252	7252	8252	CSR13H334K*
0.33	20	A	0.3	2	2392	2632	2872	3112	6253	7253	8253	CSR13H334M*
0.39	10	A	0.3	2	2393	2633	2873	3113	6255	7255	8255	CSR13H394K*
0.47	10	A	0.3	2	2394	2634	2874	3114	6257	7257	8257	CSR13H474K*
0.47	20	A	0.3	2	2395	2635	2875	3115	6258	7258	8258	CSR13H474M*
0.68	20	A	0.3	2	2398	2638	2878	3118	6263	7263	8263	CSR13H684M*

TO ORDER: Indicate the prefix M39003/01 followed by the applicable MIL dash number.
Example: For M39003/01-2241 or CSR13B565KM; order M39003/012241

* Failure rate level indicator
(M, P, R, S)

CSR13 (MIL-C-39003/01) Solid Tantalum Capacitors



Cap (μ F)	Cap Tolerance (\pm)	Case Code	Max DCL @ +25°C (μ A)	Max D.F. % @ +25°C 120 Hz	MIL-C-39003/1 (CSR 13) Dash Numbers							MIL Reference Number (Do not order by this number.) See below
					Exponential Failure Rate (% per 1000 hours)				Weibull Failure Rate (% per 1000 hours)			
					'M' Level (.10)	'P' Level (.10)	'R' Level (.01)	'S' Level (.001)	'B' Level (.10)	'C' Level (.01)	'D' Level (.001)	
75 WVDC @ 85°C — 50 WVDC @ 125°C												
0.56	10	A	0.3	2	2396	2636	2876	3116	6260	7260	8260	CSR13H564K*
0.68	10	A	0.3	2	2397	2637	2877	3117	6262	7262	8262	CSR13H684K*
0.82	10	B	0.3	2	2399	2639	2879	3119	6265	7265	8265	CSR13H824K*
1.0	10	B	0.3	2	2400	2640	2880	3120	6267	7267	8267	CSR13H105K*
1.0	20	B	0.3	2	2401	2641	2881	3121	6268	7268	8268	CSR13H105M*
1.2	10	B	0.3	4	2402	2642	2882	3122	6270	7270	8270	CSR13H125K*
1.5	10	B	0.6	4	2403	2643	2883	3123	6272	7272	8272	CSR13H155K*
1.5	20	B	0.6	4	2404	2644	2884	3124	6273	7273	8273	CSR13H155M*
1.8	10	B	0.7	4	2405	2645	2885	3125	6275	7275	8275	CSR13H185K*
2.2	10	B	0.8	4	2406	2646	2886	3126	6277	7277	8277	CSR13H225K*
2.2	20	B	0.8	4	2407	2647	2887	3127	6278	7278	8278	CSR13H225M*
2.7	10	B	1.0	4	2408	2648	2888	3128	6280	7280	8280	CSR13H275K*
3.3	10	B	1.2	4	2409	2649	2889	3129	6282	7282	8282	CSR13H335K*
3.3	20	B	1.2	4	2410	2650	2890	3130	6283	7283	8283	CSR13H335M*
3.9	10	B	1.5	4	2411	2651	2891	3131	6285	7285	8285	CSR13H395K*
4.7	10	C	3.0	4	2412	2652	2892	3132	6287	7287	8287	CSR13H475K*
4.7	20	C	3.0	4	2413	2653	2893	3133	6288	7288	8288	CSR13H475M*
5.6	10	C	3.0	4	2414	2654	2894	3134	6290	7290	8290	CSR13H565K*
6.8	10	C	5.0	4	2415	2655	2895	3135	6292	7292	8292	CSR13H685K*
6.8	20	C	5.0	4	2416	2656	2896	3136	6293	7293	8293	CSR13H685M*
8.2	10	C	5.0	4	2417	2657	2897	3137	6295	7295	8295	CSR13H825K*
10	10	C	5.0	4	2418	2658	2898	3138	6297	7297	8297	CSR13H106K*
10	20	C	5.0	4	2419	2659	2899	3139	6298	7298	8298	CSR13H106M*
12	10	D	7.0	4	2420	2660	2900	3140	6300	7300	8300	CSR13H126K*
15	10	D	7.0	4	2421	2661	2901	3141	6302	7302	8302	CSR13H156K*
15	20	D	7.0	4	2422	2662	2902	3142	6303	7303	8303	CSR13H156M*

100 WVDC @ 85°C — 67 WVDC @ 125°C												
0.0047	10	A	0.3	2	2423	2663	2903	3143	6305	7305	+8305	CSR13J472K*
0.0047	20	A	0.3	2	2424	2664	2904	3144	6306	7306	+8306	CSR13J472M*
0.0056	10	A	0.3	2	2425	2665	2905	3145	6308	7308	+8308	CSR13J562K*
0.0068	10	A	0.3	2	2426	2666	2906	3146	6310	7310	+8310	CSR13J682K*
0.0068	20	A	0.3	2	2427	2667	2907	3147	6311	7311	+8311	CSR13J682M*
0.0082	10	A	0.3	2	2428	2668	2908	3148	6313	7313	+8313	CSR13J822K*
0.01	10	A	0.3	2	2429	2669	2909	3149	6315	7315	+8315	CSR13J103K*
0.01	20	A	0.3	2	2430	2670	2910	3150	6316	7316	+8316	CSR13J103M*
0.012	10	A	0.3	2	2431	2671	2911	3151	6318	7318	+8318	CSR13J123K*
0.015	10	A	0.3	2	2432	2672	2912	3152	6320	7320	+8320	CSR13J153K*
0.015	20	A	0.3	2	2433	2673	2913	3153	6321	7321	+8321	CSR13J153M*
0.018	10	A	0.3	2	2434	2674	2914	3154	6323	7323	+8323	CSR13J183K*
0.022	10	A	0.3	2	2435	2675	2915	3155	6325	7325	+8325	CSR13J223K*
0.022	20	A	0.3	2	2436	2676	2916	3156	6326	7326	+8326	CSR13J223M*
0.027	10	A	0.3	2	2437	2677	2917	3157	6328	7328	+8328	CSR13J273K*
0.033	10	A	0.3	2	2438	2678	2918	3158	6330	7330	+8330	CSR13J333K*
0.033	20	A	0.3	2	2439	2679	2919	3159	6331	7331	+8331	CSR13J333M*
0.039	10	A	0.3	2	2440	2680	2920	3160	6333	7333	+8333	CSR13J393K*
0.047	10	A	0.3	2	2441	2681	2921	3161	6335	7335	+8335	CSR13J473K*
0.047	20	A	0.3	2	2442	2682	2922	3162	6336	7336	+8336	CSR13J473M*
0.056	10	A	0.3	2	2443	2683	2923	3163	6338	7338	+8338	CSR13J563K*
0.068	10	A	0.3	2	2444	2684	2924	3164	6340	7340	+8340	CSR13J683K*
0.068	20	A	0.3	2	2445	2685	2925	3165	6341	7341	+8341	CSR13J683M*
0.082	10	A	0.3	2	2446	2686	2926	3166	6343	7343	+8343	CSR13J823K*
0.1	10	A	0.3	2	2447	2687	2927	3167	6345	7345	+8345	CSR13J104K*
0.1	20	A	0.3	2	2448	2688	2928	3168	6346	7346	+8346	CSR13J104M*
0.12	10	A	0.3	2	2449	2689	2929	3169	6348	7348	+8348	CSR13J124K*
0.15	10	A	0.3	2	2450	2690	2930	3170	6350	7350	+8350	CSR13J154K*
0.15	20	A	0.3	2	2451	2691	2931	3171	6351	7351	+8351	CSR13J154M*
0.18	10	A	0.3	2	2452	2692	2932	3172	6353	7353	+8353	CSR13J184K*
0.22	10	A	0.3	2	2453	2693	2933	3173	6355	7355	+8355	CSR13J224K*
0.22	20	A	0.3	2	2454	2694	2934	3174	6356	7356	+8356	CSR13J224M*
0.27	10	A	0.3	2	2455	2695	2935	3175	6358	7358	+8358	CSR13J274K*
0.33	10	A	0.3	2	2456	2696	2936	3176	6360	7360	+8360	CSR13J334K*
0.33	20	A	0.3	2	2457	2697	2937	3177	6361	7361	+8361	CSR13J334M*

TO ORDER: Indicate the prefix M39003/01 followed by the applicable MIL dash number.
Example: For M39003/01-2241 or CSR13B565KM; order M39003/012241

+ C failure rate: Not QPL for -7390 thru -7401
+ D failure rate: Not QPL for -8305 thru -8401

* Failure rate level indicator
(M, P, R, S)

CSR13 (MIL-C-39003/01) Solid Tantalum Capacitors



Cap (μ F)	Cap Tolerance (\pm)	Case Code	Max DCL @ +25°C (μ A)	Max D.F. % @ +25°C 120 Hz	MIL-C-39003/1 (CSR 13) Dash Numbers							MIL Reference Number (Do not order by this number.) See below
					Exponential Failure Rate (% per 1000 hours)				Weibull Failure Rate (% per 1000 hours)			
					'M' Level (1.0)	'P' Level (.10)	'R' Level (.01)	'S' Level (.001)	'B' Level (.10)	'C' Level (.01)	'D' Level (.001)	
100 WVDC @ 85°C — 67 WVDC @ 125°C												
0.39	10	A	0.3	2	2458	2698	2938	3178	6363	7363	+8363	CSR13J394K*
0.47	10	A	0.3	2	2459	2699	2939	3179	6365	7365	+8365	CSR13J474K*
0.47	20	A	0.3	2	2460	2700	2940	3180	6366	7366	+8366	CSR13J474M*
0.56	10	A	0.3	2	2461	2701	2941	3181	6368	7368	+8368	CSR13J564K*
0.68	10	B	0.3	2	2462	2702	2942	3182	6370	7370	+8370	CSR13J684K*
0.68	20	B	0.3	2	2463	2703	2943	3183	6371	7371	+8371	CSR13J684M*
0.82	10	B	0.4	2	2464	2704	2944	3184	6373	7373	+8373	CSR13J824K*
1.0	10	B	0.5	2	2465	2705	2945	3185	6375	7375	+8375	CSR13J105K*
1.0	20	B	0.5	2	2466	2706	2946	3186	6376	7376	+8376	CSR13J105M*
1.2	10	B	0.5	3	2467	2707	2947	3187	6378	7378	+8378	CSR13J125K*
1.5	10	B	0.7	3	2468	2708	2948	3188	6380	7380	+8380	CSR13J155K*
1.5	20	B	0.7	3	2469	2709	2949	3189	6381	7381	+8381	CSR13J155M*
1.8	10	B	0.7	3	2470	2710	2950	3190	6383	7383	+8383	CSR13J185K*
2.2	10	B	0.9	3	2471	2711	2951	3191	6385	7385	+8385	CSR13J225K*
2.2	20	B	0.9	3	2472	2712	2952	3192	6386	7386	+8386	CSR13J225M*
2.7	10	B	1.1	3	2473	2713	2953	3193	6388	7388	+8388	CSR13J275K*
3.3	10	C	1.5	3	5157	5357	5557	5757	6390	+7390	+8390	CSR13J335K*
3.3	20	C	1.5	3	5158	5358	5558	5758	6391	+7391	+8391	CSR13J335M*
3.9	10	C	1.5	3	5160	5360	5560	5760	6393	+7393	+8393	CSR13J395K*
4.7	10	C	2.5	3	5162	5362	5562	5762	6395	+7395	+8395	CSR13J475K*
4.7	20	C	2.5	3	5163	5363	5563	5763	6396	+7396	+8396	CSR13J475M*
5.6	10	C	2.5	3	5165	5365	5565	5765	6398	+7398	+8398	CSR13J565K*
6.8	10	C	2.5	3	5167	5367	5567	5767	6400	+7400	+8400	CSR13J685K*
6.8	20	C	2.5	3	5168	5368	5568	5768	6401	+7401	+8401	CSR13J685M*

Solid Tantalum Capacitors

TO ORDER: Indicate the prefix M39003/01 followed by the applicable MIL dash number.
Example: For M39003/01-2241 or CSR13B565KM; order M39003/012241

+ C failure rate: Not QPL for -7390 thru -7401
+ D failure rate: Not QPL for -8305 thru -8401

* Failure rate level indicator
(M, P, R, S)

CSR23 (MIL-C-39003/03) Solid Tantalum Capacitors

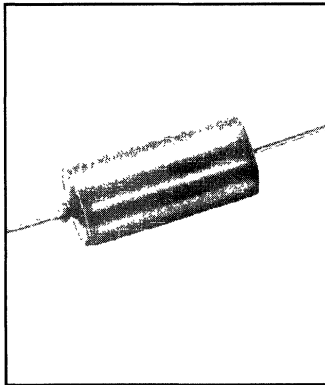

- Extended Capacitance
- Graded Failure Rates
- Hermetically Sealed
- Low DC Leakage
- Low Dissipation Factor
- Temperature Stable
- Frequency Stable
- Moisture/Solvent Resistant
- Miniature Size
- Long Shelf Life

GENERAL SPECIFICATIONS

Operating Temperature:
-55°C to +125°C
(With proper derating)
Voltage Range:
6 to 50 WVDC @ 85°C
Reverse Voltage (Non-continuous):
15% of rated voltage @ 25°C
5% of rated voltage @ 85°C
1% of rated voltage @ 125°C
Capacitance Range:
1.2 μF to 1000 μF
Capacitance Tolerance:
±10%, ±20%
(±5% by special order)

DC Leakage:
At +25°C - See Table Limit
At +85°C - 10 x Table Limit
At +125°C - 12.5 x Table Limit
Capacitance Change Maximum:
-10% @ -55°C
+8% @ +85°C
+12% @ +125°C

Maximum Power Dissipation @ 25°C:

Case Code	Watts
A	.09
B	.100
C	.125
D	.180

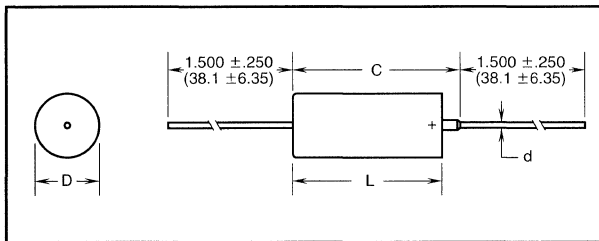

Case Code	Uninsulated		Insulated		C Maximum	d ±.001 (±.03)
	D ±.005 (±.13)	L ±.031 (±.79)	D ±.010 (±.25)	L ±.031 (±.79)		
A	.125(3.18)	.250(6.35)	.135(3.43)	.286(7.26)	.422(10.72)	.020(.51)
B	.175(4.45)	.438(11.13)	.185(4.70)	.474(12.04)	.610(15.49)	.020(.51)
C	.279(7.09)	.650(16.51)	.289(7.34)	.686(17.42)	.822(20.88)	.025(.64)
D	.341(8.66)	.750(19.05)	.351(8.92)	.786(19.96)	.922(23.42)	.025(.64)

Cap (μF)	Cap Tolerance (±)	Case Code	Max DCL @ +25°C (μA)	Max D.F. % @ +25°C 120 Hz	MIL-C-39003/3(CSR 23) Dash Numbers						
					Exponential Failure Rate (% per 1000 hours)				Weibull Failure Rate (% per 1000 hours)		
					'M' Level (1.0)	'P' Level (.10)	'R' Level (.01)	'S' Level (.001)	'B' Level (-10)	'C' Level (.01)	'D' Level (.001)

6 WVDC @ 85°C — 4 WVDC @ 125°C

10	10	A	0.9	6	0101	0201	0301	0401	2001	3001	4001
10	20	A	0.9	6	0102	0202	0302	0402	2002	3002	4002
12	10	A	1.0	6	0103	0203	0303	0403	2003	3003	4003
100	10	B	6.0	8	0104	0204	0304	0404	2004	3004	4004
100	20	B	6.0	8	0105	0205	0305	0405	2005	3005	4005
330	10	C	15.0	8	0106	0206	0306	0406	2006	3006	4006
330	20	C	15.0	8	0107	0207	0307	0407	2007	3007	4007
390	10	C	15.0	10	0108	0208	0308	0408	2008	3008	4008
470	10	C	15.0	10	0109	0209	0309	0409	2009	3009	4009
470	20	C	15.0	10	0110	0210	0310	0410	2010	3010	4010
680	10	D	20.0	10	0111	0211	0311	0411	2011	3011	4011
680	20	D	20.0	10	0112	0212	0312	0412	2012	3012	4012
820	10	D	20.0	10	0113	0213	0313	0413	2013	3013	4013
1000	10	D	30.0	10	0114	0214	0314	0414	2014	3014	4014
1000	20	D	30.0	10	0115	0215	0315	0415	2015	3015	4015

10 WVDC @ 85°C — 7 WVDC @ 125°C

6.8	10	A	1.0	6	0116	0216	0316	0416	2016	3016	4016
6.8	20	A	1.0	6	0117	0217	0317	0417	2017	3017	4017
8.2	10	A	1.2	6	0118	0218	0318	0418	2018	3018	4018
47	10	B	5.0	6	0119	0219	0319	0419	2019	3019	4019
47	20	B	5.0	6	0120	0220	0320	0420	2020	3020	4020
56	10	B	6.0	6	0121	0221	0321	0421	2021	3021	4021
68	10	B	7.0	6	0122	0222	0322	0422	2022	3022	4022
68	20	B	7.0	6	0123	0223	0323	0423	2023	3023	4023
82	10	B	8.0	6	0124	0224	0324	0424	2024	3024	4024
220	10	C	15.0	6	0125	0225	0325	0425	2025	3025	4025
220	20	C	15.0	6	0126	0226	0326	0426	2026	3026	4026
270	10	C	15.0	8	0127	0227	0327	0427	2027	3027	4027
390	10	D	20.0	10	0128	0228	0328	0428	2028	3028	4028
470	10	D	20.0	10	0129	0229	0329	0429	2029	3029	4029
470	20	D	20.0	10	0130	0230	0330	0430	2030	3030	4030
560	10	D	30.0	10	0131	0231	0331	0431	2031	3031	4031

TO ORDER: Indicate the prefix M39003/03 followed by the applicable MIL dash number.
Example: For M39003/03-0182; order M39003/030182

CSR23 (MIL-C-39003/03) Solid Tantalum Capacitors



Solid Tantalum Capacitors

Cap (μ F)	Cap Tolerance (\pm)	Case Code	Max DCL @ +25°C (μ A)	Max D.F. % @ +25°C 120 Hz	MIL-C-39003/3 (CSR 23) Dash Numbers							
					Exponential Failure Rate (% per 1000 hours)				Weibull Failure Rate (% per 1000 hours)			
					'M' Level (1.0)	'P' Level (.10)	'R' Level (.01)	'S' Level (.001)	'B' Level (.10)	'C' Level (.01)	'D' Level (.001)	
15 WVDC @ 85°C — 10 WVDC @ 125°C												
4.7	10	A	1.0	4	0132	0232	0332	0432	2032	3032	4032	
4.7	20	A	1.0	4	0133	0233	0333	0433	2033	3033	4033	
5.6	10	A	1.3	4	0134	0234	0334	0434	2034	3034	4034	
33	10	B	6.0	6	0135	0235	0335	0435	2035	3035	4035	
33	20	B	6.0	6	0136	0236	0336	0436	2036	3036	4036	
39	10	B	15.0	6	0137	0237	0337	0437	2037	3037	4037	
150	10	C	15.0	8	0138	0238	0338	0438	2038	3038	4038	
150	20	C	15.0	8	0139	0239	0339	0439	2039	3039	4039	
180	10	C	20.0	8	0140	0240	0340	0440	2040	3040	4040	
220	10	D	20.0	8	0141	0241	0341	0441	2041	3041	4041	
220	20	D	20.0	8	0142	0242	0342	0442	2042	3042	4042	
270	10	D	20.0	8	0143	0243	0343	0443	2043	3043	4043	
330	10	D	20.0	8	0144	0244	0344	0444	2044	3044	4044	
330	20	D	20.0	8	0145	0245	0345	0445	2045	3045	4045	
20 WVDC @ 85°C — 13 WVDC @ 125°C												
2.7	10	A	0.8	4	0146	0246	0346	0446	2046	3046	4046	
3.3	10	A	1.0	4	0147	0247	0347	0447	2047	3047	4047	
3.3	20	A	1.0	4	0148	0248	0348	0448	2048	3048	4048	
3.9	10	A	1.2	4	0149	0249	0349	0449	2049	3049	4049	
18	10	B	4.0	6	0150	0250	0350	0450	2050	3050	4050	
22	10	B	4.0	6	0151	0251	0351	0451	2051	3051	4051	
22	20	B	4.0	6	0152	0252	0352	0452	2052	3052	4052	
27	10	B	5.0	6	0153	0253	0353	0453	2053	3053	4053	
56	10	C	9.0	6	0154	0254	0354	0454	2054	3054	4054	
68	10	C	10.0	6	0155	0255	0355	0455	2055	3055	4055	
68	20	C	10.0	6	0156	0256	0356	0456	2056	3056	4056	
82	10	C	10.0	6	0157	0257	0357	0457	2057	3057	4057	
100	10	C	15.0	6	0158	0258	0358	0458	2058	3058	4058	
100	20	C	15.0	6	0159	0259	0359	0459	2059	3059	4059	
120	10	C	15.0	6	0160	0260	0360	0460	2060	3060	4060	
150	10	D	20.0	8	0161	0261	0361	0461	2061	3061	4061	
150	20	D	20.0	8	0162	0262	0362	0462	2062	3062	4062	
180	10	D	20.0	8	0163	0263	0363	0463	2063	3063	4063	
35 WVDC @ 85°C — 23 WVDC @ 125°C												
1.8	10	A	1.0	4	0164	0264	0364	0464	2064	3064	4064	
8.2	10	B	3.5	6	0165	0265	0365	0465	2065	3065	4065	
10	10	B	4.0	6	0166	0266	0366	0466	2066	3066	4066	
10	20	B	4.0	6	0167	0267	0367	0467	2067	3067	4067	
33	10	C	10.0	6	0168	0268	0368	0468	2068	3068	4068	
33	20	C	10.0	6	0169	0269	0369	0469	2069	3069	4069	
39	10	C	10.0	6	0170	0270	0370	0470	2070	3070	4070	
47	10	C	10.0	6	0171	0271	0371	0471	2071	3071	4071	
47	20	C	10.0	6	0172	0272	0372	0472	2072	3072	4072	
56	10	D	15.0	6	0173	0273	0373	0473	2073	3073	4073	
68	10	D	15.0	6	0174	0274	0374	0474	2074	3074	4074	
68	20	D	15.0	6	0175	0275	0375	0475	2075	3075	4075	
50 WVDC @ 85°C — 33 WVDC @ 125°C												
1.2	10	A	0.9	4	0176	0276	0376	0476	2076	3076	4076	
1.5	10	A	1.2	4	0177	0277	0377	0477	2077	3077	4077	
1.5	20	A	1.2	4	0178	0278	0378	0478	2078	3078	4078	
5.6	10	B	4.5	4	0179	0279	0379	0479	2079	3079	4079	
6.8	10	B	4.5	6	0180	0280	0380	0480	2080	3080	4080	
6.8	20	B	4.5	6	0181	0281	0381	0481	2081	3081	4081	
22	10	C	10.0	6	0182	0282	0382	0482	2082	3082	4082	
22	20	C	10.0	6	0183	0283	0383	0483	2083	3083	4083	
27	10	C	10.0	6	0184	0284	0384	0484	2084	3084	4084	
33	10	D	10.0	6	0185	0285	0385	0485	2085	+ 3085	+ 4085	
33	20	D	10.0	6	0186	0286	0386	0486	2086	+ 3086	+ 4086	
39	10	D	10.0	6	0187	0287	0387	0487	2087	+ 3087	+ 4087	

TO ORDER: Indicate the prefix M39003/03 followed by the applicable MIL dash number.
Example: For M39003/03-0182; order M39003/030182

+ C failure rate: Not QPL for -3085 thru -3087
+ D failure rate: Not QPL for -4085 thru -4087

CSR21 (MIL-C-39003/09) Solid Tantalum Capacitors

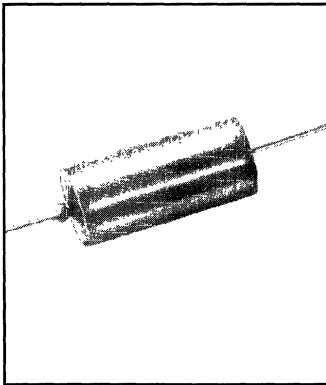

- High Frequency Operation
- High Ripple Capability
- Very Low ESR/Impedance
- Hermetically Sealed
- Graded Failure Rates
- Low DC Leakage
- Temperature Stable
- Frequency Stable
- Moisture/Solvent Resistant
- Miniature Size
- Long Shelf Life

GENERAL SPECIFICATIONS

Operating Temperature:
-55°C to +125°C
(With proper derating)

Voltage Range:
6 to 50 WVDC @ 85°C

Reverse Voltage (Non-continuous):
15% of rated voltage @ 25°C
5% of rated voltage @ 85°C
1% of rated voltage @ 125°C

Capacitance Range:
5.6 μF to 330 μF

Capacitance Tolerance:
±10%, ±20%

Capacitance Change Maximum:
-10% @ -55°C
+8% @ +85°C
+12% @ +125°C

DC Leakage:
At +25°C - See Table Limit
At +85°C - 10 x Table Limit
At +125°C - 12.5 x Table Limit

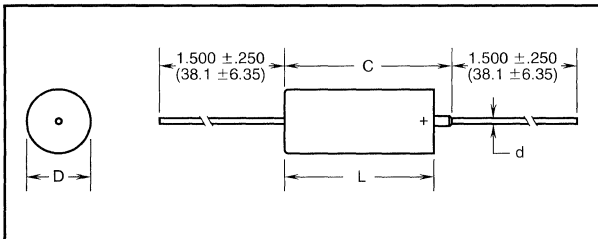

Case Code	Uninsulated		Insulated		C Maximum	d ±.001 (±.03)
	D ±.005 (±.13)	L ±.031 (±.79)	D ±.010 (±.25)	L ±.031 (±.79)		
C	.279(7.09)	.650(16.51)	.289(7.34)	.686(17.42)	.822(20.88)	.025(.64)
D	.341(8.66)	.750(19.05)	.351(8.92)	.786(19.96)	.922(23.42)	.025(.64)

Cap (μF)	Cap Tolerance (±)	Case Code	Max DCL @ +25°C (μA)	Max D.F. % @ +25°C 1kHz	Max ESR (ohms) @ 100kHz +25°C	Max Ripple RMS Amps @ 40kHz +25°C	MIL-C-39003/9(CSR 21) Dash Numbers						
							Exponential Failure Rate (% per 1000 hours)				Weibull Failure Rate (% per 1000 hours)		
							'M' Level (1.0)	'P' Level (.10)	'R' Level (.01)	'S' Level (.001)	'B' Level (.10)	'C' Level (.01)	'D' Level (.001)

6 WVDC @ 85°C — 4 WVDC @ 125°C

150	10	C	4.5	10	.065	3.3	0002	0102	0202	0302	2002	3002	4002
150	20	C	4.5	10	.065	3.3	0003	0103	0203	0303	2003	3003	4003
180	10	C	5.5	10	.060	3.4	0005	0105	0205	0305	2005	3005	4005
270	10	D	6.5	10	.050	4.1	0007	0107	0207	0307	2007	3007	4007
330	10	D	7.5	12	.045	4.3	0009	0109	0209	0309	2009	3009	4009
330	20	D	7.5	12	.045	4.3	0010	0110	0210	0310	2010	3010	4010

10 WVDC @ 85°C — 7 WVDC @ 125°C

82	10	C	4.0	8	.085	2.9	0012	0112	0212	0312	2012	3012	4012
100	10	C	5.0	8	.075	3.0	0014	0114	0214	0314	2014	3014	4014
100	20	C	5.0	8	.075	3.0	0015	0115	0215	0315	2015	3015	4015
120	10	C	6.0	8	.070	3.2	0017	0117	0217	0317	2017	3017	4017
180	10	D	9.0	8	.060	3.7	0019	0119	0219	0319	2019	3019	4019
220	10	D	10.0	10	.055	3.9	0021	0121	0221	0321	2021	3021	4021
220	20	D	10.0	10	.055	3.9	0022	0122	0222	0322	2022	3022	4022

15 WVDC @ 85°C — 13 WVDC @ 125°C

56	10	C	4.0	6	.100	2.6	0024	0124	0224	0324	2024	3024	4024
68	10	C	5.0	6	.095	2.7	0026	0126	0226	0326	2026	3026	4026
68	20	C	5.0	6	.095	2.7	0027	0127	0227	0327	2027	3027	4027
120	10	D	9.0	8	.070	3.5	0029	0129	0229	0329	2029	3029	4029
150	10	D	10.0	8	.065	3.6	0031	0131	0231	0331	2031	3031	4031
150	20	D	10.0	8	.065	3.6	0032	0132	0232	0332	2032	3032	4032

20 WVDC @ 85°C — 13 WVDC @ 125°C

27	10	C	2.5	5	.145	2.2	0034	0134	0234	0334	2034	3034	4034
33	10	C	3.5	5	.130	2.3	0036	0136	0236	0336	2036	3036	4036
33	20	C	3.5	5	.130	2.3	0037	0137	0237	0337	2037	3037	4037
39	10	C	4.0	5	.120	2.4	0039	0139	0239	0339	2039	3039	4039
47	10	C	4.5	6	.110	2.5	0041	0141	0241	0341	2041	3041	4041
47	20	C	4.5	6	.110	2.5	0042	0142	0242	0342	2042	3042	4042
56	10	D	5.5	6	.100	2.9	0044	0144	0244	0344	2044	3044	4044
68	10	D	7.0	6	.095	3.0	0046	0146	0246	0346	2046	3046	4046
68	20	D	7.0	6	.095	3.0	0047	0147	0247	0347	2047	3047	4047

TO ORDER: Indicate the prefix M39003/09 followed by the applicable MIL dash number.
Example: For M39003/09-0002; order M39003/090002

CSR21 (MIL-C-39003/09) Solid Tantalum Capacitors



Cap (μ F)	Cap Tolerance (\pm)	Case Code	Max DCL @ +25°C (μ A)	Max D.F. % @ +25°C 1kHz	Max ESR (ohms) @100kHz +25°C	Max Ripple RMS Amps @ 40kHz +25°C	MIL-C-39003/9(CSR 21) Dash Numbers						
							Exponential Failure Rate (% per 1000 hours)				Weibull Failure Rate (% per 1000 hours)		
							'M' Level (1.0)	'P' Level (.10)	'R' Level (.01)	'S' Level (.001)	'B' Level (.10)	'C' Level (.01)	'D' Level (.001)
20 WVDC @ 85°C — 13 WVDC @ 125°C													
82	10	D	8.0	6	.085	3.1	0049	0149	0249	0349	2049	3049	4049
100	10	D	10.0	8	.075	3.3	0051	0151	0251	0351	2051	3051	4051
100	20	D	10.0	8	.075	3.3	0052	0152	0252	0352	2052	3052	4052
35 WVDC @ 85°C — 23 WVDC @ 125°C													
22	10	C	4.0	4	.160	2.1	0054	0154	0254	0354	2054	3054	4054
22	20	C	4.0	4	.160	2.1	0055	0155	0255	0355	2055	3055	4055
27	10	D	4.5	4	.145	2.4	0057	0157	0257	0357	2057	3057	4057
33	10	D	5.5	5	.130	2.5	0059	0159	0259	0359	2059	3059	4059
33	20	D	5.5	5	.130	2.5	0060	0160	0260	0360	2060	3060	4060
39	10	D	7.0	5	.120	2.6	0062	0162	0262	0362	2062	3062	4062
47	10	D	8.0	5	.110	2.7	0064	0164	0264	0364	2064	3064	4064
47	20	D	8.0	5	.110	2.7	0065	0165	0265	0365	2065	3065	4065
50 WVDC @ 85°C — 33 WVDC @ 125°C													
5.6	10	C	2.2	3	.300	1.5	0067	0167	0267	0367	2067	3067	4067
6.8	10	C	2.2	3	.275	1.6	0069	0169	0269	0369	2069	3069	4069
6.8	20	C	2.2	3	.250	1.6	0070	0170	0270	0370	2070	3070	4070
8.2	10	C	2.5	3	.250	1.6	0072	0172	0272	0372	2072	3072	4072
10	10	C	2.5	3	.230	1.7	0074	0174	0274	0374	2074	3074	4074
10	20	C	2.5	3	.230	1.7	0075	0175	0275	0375	2075	3075	4075
12	10	C	3.0	3	.210	1.8	0077	0177	0277	0377	2077	3077	4077
15	10	C	4.0	3	.190	1.9	0079	0179	0279	0379	2079	3079	4079
15	20	C	4.0	3	.190	1.9	0080	0180	0280	0380	2080	3080	4080
18	10	C	4.5	4	.175	2.0	0082	0182	0282	0382	2082	3082	4082
22	10	D	5.5	4	.160	2.3	0084	0184	0284	0384	2084	3084	4084
22	20	D	5.5	4	.160	2.3	0085	0185	0285	0385	2085	3085	4085

TO ORDER: Indicate the prefix M39003/09 followed by the applicable MIL dash number.
Example: For M39003/09-0002; order M39003/090002

Solid Tantalum Capacitors

Type TAC Solid Tantalum Capacitors

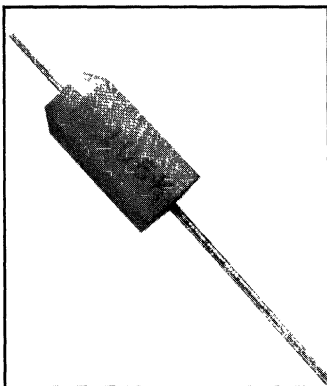

- Precision Molded
- Flame Retardent
- Resistant to Shock & Vibration
- Tapered for Polarity Identification
- Taped and Reeled
- Highest CV per Case Size
- Long Shelf Life
- Miniature Sizes

GENERAL SPECIFICATIONS

Operating Temperature:
-55°C to +125°C
(With proper derating)

Voltage Range:
6 to 50 WVDC @ 85°C

Reverse Voltage (Non-continuous):
15% of rated voltage @ 25°C
5% of rated voltage @ 85°C
1% of rated voltage @ 125°C

Capacitance Range:
.10 μF to 330 μF

Capacitance Tolerance:
±10% (±5% by special order)

Capacitance Change Maximum:
-10% @ -55°C
+10% @ +85°C
+12% @ +125°C

Reel Packaged per EIA-RS 296

Case Code	Quantity
1	4500 per 12" Reel
2	4000 per 12" Reel
5 & 6	2500 per 12" Reel
7 & 8	500 per 12" Reel

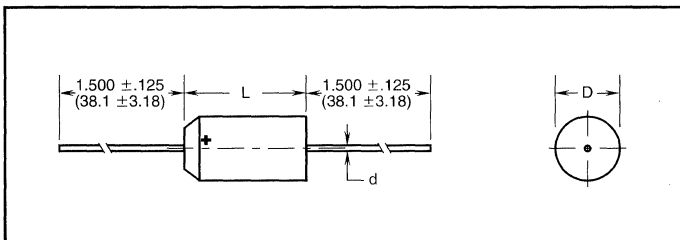

Dimensions - Inches (Millimeters)

Case Code	D (Max)	L (Max)	d
1	.095 (2.41)	.260 (6.6)	.020 (.51)
2	.110 (2.79)	.290 (7.37)	.020 (.51)
5	.180 (4.57)	.345 (8.76)	.020 (.51)
6	.180 (4.57)	.420 (10.67)	.020 (.51)
7	.280 (7.11)	.530 (13.46)	.025 (.64)
8	.300 (7.62)	.710 (18.03)	.025 (.64)

Cap (μF)	Case Code	Max DCL @ +25°C (μA)	Max D.F. % @ +25°C 120 Hz	Catalog Number
----------	-----------	----------------------	---------------------------	----------------

6 WVDC @ 85°C 4 WVDC @ 125°C

3.3	1	0.5	4	TAC335K006P01
3.9	1	0.5	4	TAC395K006P01
4.7	1	0.5	4	TAC475K006P01
5.6	2	0.5	4	TAC565K006P02
6.8	2	0.5	6	TAC685K006P02
8.2	2	0.5	6	TAC825K006P02
10	2	0.5	6	TAC106K006P02
12	2	0.6	6	TAC126K006P02
15	2	0.7	6	TAC156K006P02
18	5	0.9	6	TAC186K006P05
22	5	1.1	6	TAC226K006P05
27	5	1.3	6	TAC276K006P05
33	5	1.5	6	TAC336K006P05
39	6	1.9	6	TAC396K006P06
47	6	2.3	6	TAC476K006P06
56	6	2.7	6	TAC566K006P06
68	6	3.3	6	TAC686K006P06
82	7	3.9	8	TAC826K006P07
100	7	4.8	8	TAC107K006P07
120	7	5.0	8	TAC127K006P07
150	7	5.0	8	TAC157K006P07
180	7	8.6	8	TAC187K006P07
220	7	10	8	TAC227K006P07
270	8	10	8	TAC277K006P08
330	8	10	8	TAC337K006P08

10 WVDC @ 85°C 7 WVDC @ 125°C

2.2	1	0.5	4	TAC225K010P01
2.7	1	0.5	4	TAC275K010P01
3.3	1	0.5	4	TAC335K010P01
3.9	2	0.5	4	TAC395K010P02
4.7	2	0.5	4	TAC475K010P02
5.6	2	0.5	4	TAC565K010P02
6.8	2	0.5	6	TAC685K010P02
8.2	2	0.7	6	TAC825K010P02
10	2	0.8	6	TAC106K010P02
12	5	1.0	6	TAC126K010P05
15	5	1.2	6	TAC156K010P05
18	5	1.4	6	TAC186K010P05
22	5	1.5	6	TAC226K010P05

Cap (μF)	Case Code	Max DCL @ +25°C (μA)	Max D.F. % @ +25°C 120 Hz	Catalog Number
----------	-----------	----------------------	---------------------------	----------------

10 WVDC @ 85°C 7 WVDC @ 125°C

27	6	2.2	6	TAC276K010P06
33	6	2.6	6	TAC336K010P06
39	6	3.1	6	TAC396K010P06
47	6	3.8	6	TAC476K010P06
56	7	4.4	6	TAC566K010P07
68	7	5.0	6	TAC686K010P07
82	7	5.0	8	TAC826K010P07
100	7	8.0	8	TAC107K010P07
120	7	9.6	8	TAC127K010P07
150	7	10.0	8	TAC157K010P07
180	8	10.0	8	TAC187K010P08
220	8	10.0	8	TAC227K010P08

15 WVDC @ 85°C 10 WVDC @ 125°C

1.5	1	0.5	4	TAC155K015P01
1.8	1	0.5	4	TAC185K015P01
2.2	1	0.5	4	TAC225K015P01
2.7	2	0.5	4	TAC275K015P02
3.3	2	0.5	4	TAC335K015P02
3.9	2	0.5	4	TAC395K015P02
4.7	2	0.6	4	TAC475K015P02
5.6	2	0.7	4	TAC565K015P02
6.8	2	0.8	6	TAC685K015P02
8.2	5	1.0	6	TAC825K015P05
10	5	1.2	6	TAC106K015P05
12	5	1.4	6	TAC126K015P05
15	5	1.5	6	TAC156K015P05
18	6	2.2	6	TAC186K015P06
22	6	2.6	6	TAC226K015P06
27	6	3.2	6	TAC276K015P06
33	6	4.0	6	TAC336K015P06
39	7	4.7	6	TAC396K015P07
47	7	5.0	6	TAC476K015P07
56	7	6.7	6	TAC566K015P07
68	7	8.2	6	TAC686K015P07
82	7	9.8	8	TAC826K015P07
100	7	10.0	8	TAC107K015P07
120	8	10.0	8	TAC127K015P08
150	8	10.0	8	TAC157K015P08

Cap (μF)	Case Code	Max DCL @ +25°C (μA)	Max D.F. % @ +25°C 120 Hz	Catalog Number
----------	-----------	----------------------	---------------------------	----------------

20 WVDC @ 85°C 13 WVDC @ 125°C

1.0	1	0.5	4	TAC105K020P01
1.2	1	0.5	4	TAC125K020P01
1.5	1	0.5	4	TAC155K020P01
1.8	2	0.5	4	TAC185K020P02
2.2	2	0.5	4	TAC225K020P02
2.7	2	0.5	4	TAC275K020P02
3.3	2	0.5	4	TAC335K020P02
3.9	2	0.6	4	TAC395K020P02
4.7	2	0.8	4	TAC475K020P02
5.6	5	0.9	4	TAC565K020P05
6.8	5	1.1	6	TAC685K020P05
8.2	5	1.3	6	TAC825K020P05
10	5	1.6	6	TAC106K020P05
12	6	1.9	6	TAC126K020P06
15	6	2.4	6	TAC156K020P06
18	6	2.9	6	TAC186K020P06
22	6	3.5	6	TAC226K020P06
27	7	4.3	6	TAC276K020P07
33	7	5.0	6	TAC336K020P07
39	7	6.2	6	TAC396K020P07
47	7	7.5	6	TAC476K020P07
56	7	8.9	6	TAC566K020P07
68	7	10.0	6	TAC686K020P07
82	8	10.0	8	TAC826K020P08
100	8	10.0	8	TAC107K020P08

25 WVDC @ 85°C 17 WVDC @ 125°C

0.47	1	0.5	3	TAC474K025P01
0.56	1	0.5	3	TAC564K025P01
0.68	1	0.5	3	TAC684K025P01
0.82	1	0.5	3	TAC824K025P01
1.0	1	0.5	3	TAC105K025P01
1.2	2	0.5	3	TAC125K025P02
1.5	2	0.5	3	TAC155K025P02
1.8	2	0.5	3	TAC185K025P02
2.2	2	0.5	3	TAC225K025P02
2.7	2	0.5	3	TAC275K025P02
3.3	2	0.7	3	TAC335K025P02
3.9	5	0.8	3	TAC395K025P05

NACC reserves the right to substitute a tighter tolerance, higher voltage capacitor within the same case size.

Type TAC Solid Tantalum Capacitors



Solid Tantalum Capacitors

Cap (μF)	Case Code	Max DCL @ +25°C (μA)	Max D.F. % @ +25°C 120 Hz	Catalog Number
25 WVDC @ 85°C 17 WVDC @ 125°C				
4.7	5	0.9	4	TAC475K025P05
5.6	5	1.1	4	TAC565K025P05
6.8	5	1.4	4	TAC685K025P05
8.2	5	1.5	4	TAC825K025P05
10	5	1.5	4	TAC106K025P05
12	6	2.4	4	TAC126K025P06
15	6	3.0	4	TAC156K025P06
18	7	3.6	6	TAC186K025P07
22	7	4.4	6	TAC226K025P07
27	7	5.4	6	TAC276K025P07
33	7	6.6	6	TAC336K025P07
39	7	7.8	6	TAC396K025P07
47	7	9.4	6	TAC476K025P07
56	8	10.0	6	TAC566K025P08
68	8	10.0	6	TAC686K025P08

Cap (μF)	Case Code	Max DCL @ +25°C (μA)	Max D.F. % @ +25°C 120 Hz	Catalog Number
35 WVDC @ 85°C 23 WVDC @ 125°C				
0.10	1	0.5	3	TAC104K035P01
0.12	1	0.5	3	TAC124K035P01
0.15	1	0.5	3	TAC154K035P01
0.18	1	0.5	3	TAC184K035P01
0.22	1	0.5	3	TAC224K035P01
0.27	1	0.5	3	TAC274K035P01
0.33	1	0.5	3	TAC334K035P01

Cap (μF)	Case Code	Max DCL @ +25°C (μA)	Max D.F. % @ +25°C 120 Hz	Catalog Number
35 WVDC @ 85°C 23 WVDC @ 125°C				
0.39	1	0.5	3	TAC394K035P01
0.47	1	0.5	3	TAC474K035P01
0.56	2	0.5	3	TAC564K035P02
0.68	2	0.5	3	TAC684K035P02
0.82	2	0.5	3	TAC824K035P02
1.0	2	0.5	3	TAC105K035P02
1.2	2	0.5	3	TAC125K035P02
1.5	2	0.5	3	TAC155K035P02
1.8	5	0.5	3	TAC185K035P05
2.2	5	0.6	3	TAC225K035P05
2.7	5	0.8	3	TAC275K035P05
3.3	5	0.9	4	TAC335K035P05
3.9	5	1.1	4	TAC395K035P05
4.7	5	1.3	4	TAC475K035P05
5.6	6	1.6	4	TAC565K035P06
6.8	6	1.9	4	TAC685K035P06
8.2	6	2.3	4	TAC825K035P06
10	6	2.8	4	TAC106K035P06
12	7	3.3	4	TAC126K035P07
15	7	4.2	6	TAC156K035P07
18	7	5.0	6	TAC186K035P07
22	7	6.2	6	TAC226K035P07
27	7	7.5	6	TAC276K035P07
33	7	9.2	6	TAC336K035P07
39	8	10.0	6	TAC396K035P08
47	8	10.0	6	TAC476K035P08

Cap (μF)	Case Code	Max DCL @ +25°C (μA)	Max D.F. % @ +25°C 120 Hz	Catalog Number
50 WVDC @ 85°C 33 WVDC @ 125°C				
0.10	1	0.5	3	TAC104K050P01
0.12	1	0.5	3	TAC124K050P01
0.15	1	0.5	3	TAC154K050P01
0.18	1	0.5	3	TAC184K050P01
0.22	1	0.5	3	TAC224K050P01
0.27	1	0.5	3	TAC274K050P01
0.33	2	0.5	3	TAC334K050P02
0.39	2	0.5	3	TAC394K050P02
0.47	2	0.5	3	TAC474K050P02
0.56	2	0.5	3	TAC564K050P02
0.68	2	0.5	3	TAC684K050P02
0.82	2	0.5	3	TAC824K050P02
1.0	2	0.5	3	TAC105K050P02
1.2	5	0.5	3	TAC125K050P05
1.5	5	0.6	4	TAC155K050P05
1.8	5	0.7	4	TAC185K050P05
2.2	5	0.9	4	TAC225K050P05
2.7	6	1.1	4	TAC275K050P06
3.3	6	1.3	4	TAC335K050P06
3.9	6	1.6	4	TAC395K050P06
4.7	6	1.9	4	TAC475K050P06
5.6	7	2.2	4	TAC565K050P07
6.8	7	2.7	4	TAC685K050P07
8.2	7	3.2	4	TAC825K050P07
10	7	4.0	6	TAC106K050P07
12	8	4.8	6	TAC126K050P08
15	8	6.0	6	TAC156K050P08
18	8	7.2	6	TAC186K050P08
22	8	8.8	6	TAC226K050P08

NACC reserves the right to substitute a tighter tolerance, higher voltage capacitor within the same case size.

Type TIM Solid Tantalum Capacitors

MALLORY

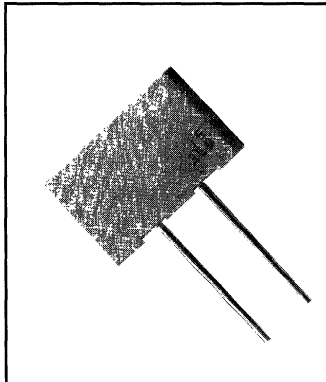

- Precision Molded
- Radial Leads
- Low DCL
- Low ESR
- Excellent Temperature Stability
- Resistant to Shock & Vibration
- Standoffs for Easier Flux Removal
- Radius on Vertical Edge Allows for Polarization During Automatic Insertion
- Tape & Reel Optional

GENERAL SPECIFICATIONS

Operating Temperature: -55°C to +125°C
(With proper derating)
Voltage Range: 6 to 50 WVDC @ 85°C
Capacitance Range: .10 μ F to 220 μ F
Capacitance Tolerance: $\pm 10\%$, $\pm 20\%$
Capacitance Change Maximum:
-10% @ -55°C
+10% @ +85°C
+15% @ +125°C

DC Leakage:
25°C - See Table Limit
85°C - 10 x 25°C Limit
125°C - 12.5 x 25°C Limit
Maximum Power Dissipation:
Case W & X .090 Watts
Case Y .100 Watts
Case Z .125 Watts

Reel Packaging per EIA-RS 468

Case Code	Quantity
W	1,500 per 14" Reel
X	1,500 per 14" Reel
Y	1,500 per 14" Reel
Z	N/A

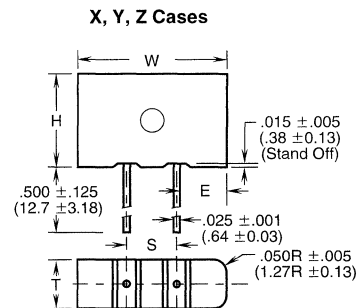
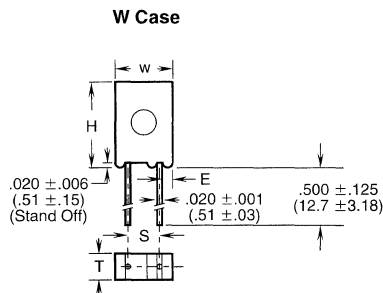

Note:
On the 'X' case size, the standoff appears only between the two leads

Dimensions - Inches (Millimeters)

Case Code	H Case Height	W Case Width	T Case Thickness	E Case to Wire	S Lead Spacing
W	.345 \pm .008 (8.76 \pm .203)	.230 \pm .005 (5.84 \pm .127)	.105 \pm .005 (2.67 \pm .127)	.050 \pm .010 (1.27 \pm .25)	.125 \pm .005 (3.18 \pm .127)
X	.225 \pm .015 (5.71 \pm .38)	.285 \pm .015 (7.24 \pm .38)	.170 \pm .015 (4.32 \pm .38)	.042 \pm .010 (1.07 \pm .25)	.200 \pm .005 (5.08 \pm .127)
Y	.325 \pm .015 (8.26 \pm .38)	.325 \pm .015 (8.26 \pm .38)	.170 \pm .015 (4.32 \pm .38)	.062 \pm .010 (1.57 \pm .25)	.200 \pm .005 (5.08 \pm .127)
Z	.375 \pm .015 (9.53 \pm .38)	.600 \pm .015 (15.24 \pm .38)	.195 \pm .015 (4.95 \pm .38)	.200 \pm .010 (5.08 \pm .25)	.200 \pm .005 (5.08 \pm .127)

Cap (μ F)	Case Code	Max DCL @ +25°C (μ A)	Max D.F. % @ +25°C 120 Hz	Max Ripple mA rms		Catalog Number
				@ 120Hz +25°C	@ 1kHz +25°C	

6 WVDC @ 85°C 4 WVDC @ 125°C

22	X	1	6	35	290	TIM226*006P0X
56	Y	5	6	89	570	TIM566*006P0Y
68	Y	5	6	100	630	TIM686*006P0Y
220	Z	10	6	350	1000	TIM227*006P0Z

10 WVDC @ 85°C 7 WVDC @ 125°C

10	W	1	6	26	220	TIM106*010P0W
15	W	1	6	39	270	TIM156*010P0W
6.8	X	1	6	18	150	TIM685*010P0X
10	X	1	6	26	220	TIM106*010P0X
15	X	1	6	39	270	TIM156*010P0X
22	Y	2	6	58	360	TIM226*010P0Y
33	Y	2	6	87	440	TIM336*010P0Y
39	Y	5	6	100	480	TIM396*010P0Y
47	Y	5	6	120	590	TIM476*010P0Y
56	Y	5	6	140	650	TIM566*010P0Y
150	Z	10	6	390	920	TIM157*010P0Z

* Indicate capacitance tolerance: K = $\pm 10\%$, M = $\pm 20\%$

Cap (μ F)	Case Code	Max DCL @ +25°C (μ A)	Max D.F. % @ +25°C 120 Hz	Max Ripple mA rms		Catalog Number
				@ 120Hz +25°C	@ 1kHz +25°C	

15 WVDC @ 85°C 10 WVDC @ 125°C

5.6	X	1	6	22	180	TIM565*015P0X
6.8	X	1	6	27	180	TIM685*015P0X
8.2	X	1	6	32	200	TIM825*015P0X
10	Y	1	6	35	270	TIM106*015P0Y
15	Y	2	6	59	290	TIM156*015P0Y
22	Y	5	6	87	360	TIM226*015P0Y
27	Y	5	6	100	390	TIM276*015P0Y
33	Y	5	6	130	440	TIM336*015P0Y

20 WVDC @ 85°C 13 WVDC @ 125°C

5.6	W	1	6	29	180	TIM565*020P0W
6.8	W	1	6	36	200	TIM685*020P0W

25 WVDC @ 85°C 17 WVDC @ 125°C

1.0	X	1	6	9.3	77	TIM105*025P0X
3.3	W	1	4	21	150	TIM335*025P0W
3.3	X	1	6	21	150	TIM335*025P0X
4.7	X	1	6	31	180	TIM475*025P0X
6.8	Y	1	6	45	200	TIM685*025P0Y

NACC reserves the right to substitute a tighter tolerance, higher voltage capacitor within the same case size.

Type TIM Solid Tantalum Capacitors



Cap (μ F)	Case Code	Max DCL @ +25°C (μ A)	Max D.F. % @ +25°C 120 Hz	Max Ripple mA rms		Catalog Number
				@ 120Hz +25°C	@ 1kHz +25°C	

25 WVDC @ 85°C 17 WVDC @ 125°C						
10	X	1	6	40	190	TIM106*025P0X
10	Y	1	6	66	240	TIM106*025P0Y
12	Y	1	6	79	260	TIM126*025P0Y
15	Y	2	6	99	290	TIM156*025P0Y

35 WVDC @ 85°C 23 WVDC @ 125°C						
-----------------------------------	--	--	--	--	--	--

2.2	W	1	4	20	120	TIM225*035P0W
2.7	W	1	4	25	140	TIM275*035P0W
0.10	X	1	6	1.0	9.0	TIM104*035P0X
0.22	X	1	6	2.0	17	TIM224*035P0X
0.47	X	1	6	4.3	36	TIM474*035P0X
1.0	X	1	6	9.3	77	TIM105*035P0X
2.2	X	1	6	20	120	TIM225*035P0X
3.3	X	1	6	30	150	TIM335*035P0X
3.9	Y	1	6	35	180	TIM395*035P0Y
4.7	X	1	6	32	155	TIM475*035P0X
4.7	Y	1	6	43	200	TIM475*035P0Y
6.8	Y	2	6	63	210	TIM685*035P0Y
8.2	Y	5	6	76	220	TIM825*035P0Y
10	Y	5	6	93	240	TIM106*035P0Y
22	Z	10	6	200	400	TIM226*035P0Z
27	Z	10	6	250	450	TIM276*035P0Z
33	Z	10	6	300	490	TIM336*035P0Z

Cap (μ F)	Case Code	Max DCL @ +25°C (μ A)	Max D.F. % @ +25°C 120 Hz	Max Ripple mA rms		Catalog Number
				@ 120Hz +25°C	@ 1kHz +25°C	

50 WVDC @ 85°C 33 WVDC @ 125°C						
0.10	X	1	6	1.3	11	TIM104*050P0X
0.22	X	1	6	2.9	24	TIM224*050P0X
0.33	X	1	6	4.4	36	TIM334*050P0X
1.0	W	1	4	13	86	TIM105*050P0W
1.0	X	1	6	13	87	TIM105*050P0X
1.5	W	1	4	19	100	TIM155*050P0W
1.5	X	1	6	19	100	TIM155*050P0X
2.2	X	1	6	29	120	TIM225*050P0X
4.7	Y	5	6	62	200	TIM475*050P0Y
5.6	Y	5	6	74	220	TIM565*050P0Y
6.8	Z	5	6	90	220	TIM685*050P0Z
10	Z	5	6	130	270	TIM106*050P0Z
15	Z	10	6	190	330	TIM156*050P0Z

NACC reserves the right to substitute a tighter tolerance, higher voltage capacitor within the same case size.

* Indicate capacitance tolerance: K = $\pm 10\%$, M = $\pm 20\%$

Solid Tantalum Capacitors

Type TDC Solid Tantalum Capacitors

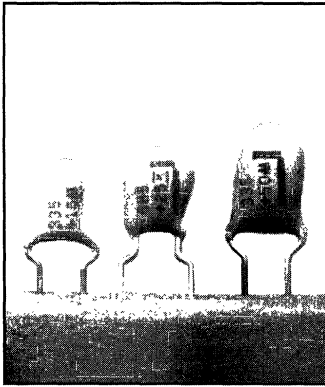

- Tough Plastic Case
- UL94V0 Flammability Rating
- Laser Marking Clarity and Permanence
- Low Cost
- Low DCL
- Low ESR & Impedance
- Temperature Stable
- Long Shelf Life
- High Shock & Vibration
- Optional Reel Packaging Available

GENERAL SPECIFICATIONS

Operating Temperature:
-55°C to +125°C
(With proper derating)

Voltage Range:
6 to 50 WVDC @ 85°C

Reverse Voltage (Non-continuous):
15% of rated voltage @ 25°C
5% of rated voltage @ 85°C
1% of rated voltage @ 125°C

Capacitance Range:
.10 μ F to 330 μ F

Capacitance Tolerance:
 $\pm 10\%$, $\pm 20\%$
($\pm 5\%$ by special order)

Capacitance Change From Initial +25°C Value:
-10% @ -55°C
+10% @ +85°C
+12% @ +125°C

DC Leakage:
At +25°C - See Table Limit
At +85°C - 10 x Table Limit
At +125°C - 12.5 x Table Limit

Dimensions - Inches (Millimeters)

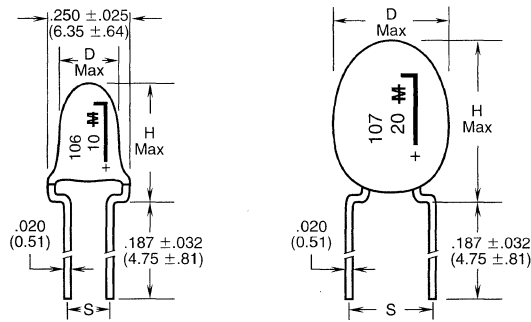

E and F Case Codes:
Lead Spacing = .125 \pm .025
(3.17 \pm .64)

G Case Code:
Lead Spacing = .125 \pm .025
(3.17 \pm .64)

Case Code	D (Max.)	H (Max.)	Leads	
			S	Code
E	.175 (4.45)	.350 (8.89)	.125 (3.17) (Standard)	N
			.250 (6.35) (Special)	W
F	.250 (6.35)	.500 (12.7)	.125 (3.17) (Standard)	N
			.250 (6.35) (Special)	W
G	.350 (8.89)	.650 (16.51)	.250 (6.35) (Standard)	W

Catalog Numbers listed below reflect dimensions and lead forms as shown in the outline drawing. Other lead spacing and lead lengths of .500 (12.7) minimum are available by special order.

Cap (μ F)	Case Code	Lead Spacing S	Max DCL @ +25°C (μ A)	Max D.F. % @ +25°C 120 Hz	Catalog Number
6 WVDC; 8 VDC Surge @ 85°C 4 WVDC; 5 VDC Surge @ 125°C					
3.3	E	.125	0.5	5	TDC335*006NSE
3.9	E	.125	0.5	5	TDC395*006NSE
4.7	E	.125	0.5	5	TDC475*006NSE
5.6	E	.125	0.5	5	TDC565*006NSE
6.8	E	.125	0.5	5	TDC685*006NSE
8.2	E	.125	0.5	6	TDC825*006NSE
10	E	.125	0.5	6	TDC106*006NSE
12	E	.125	0.6	6	TDC126*006NSE
15	F	.125	0.7	6	TDC156*006NSF
18	F	.125	0.9	6	TDC186*006NSF
22	F	.125	1.1	6	TDC226*006NSF
27	F	.125	1.3	6	TDC276*006NSF
33	F	.125	1.6	6	TDC336*006NSF
39	F	.125	1.9	6	TDC396*006NSF
47	F	.125	2.3	6	TDC476*006NSF
56	F	.125	2.7	6	TDC566*006NSF
68	F	.125	3.3	6	TDC686*006NSF
82	F	.125	3.9	8	TDC826*006NSF
100	F	.125	4.8	8	TDC107*006NSF
120	G	.250	5.8	8	TDC127*006WSG
150	G	.250	7.2	8	TDC157*006WSG
180	G	.250	8.6	8	TDC187*006WSG
220	G	.250	10.0	8	TDC227*006WSG
270	G	.250	10.0	8	TDC277*006WSG
330	G	.250	10.0	8	TDC337*006WSG

Cap (μ F)	Case Code	Lead Spacing S	Max DCL @ +25°C (μ A)	Max D.F. % @ +25°C 120 Hz	Catalog Number
10 WVDC; 13 VDC Surge @ 85°C 7 WVDC; 9 VDC Surge @ 125°C					
3.9	E	.125	0.5	5	TDC395*010NSE
4.7	E	.125	0.5	5	TDC475*010NSE
5.6	E	.125	0.5	5	TDC565*010NSE
6.8	E	.125	0.5	5	TDC685*010NSE
8.2	E	.125	0.7	6	TDC825*010NSE
10	F	.125	0.8	6	TDC106*010NSF
12	F	.125	1.0	6	TDC126*010NSF
15	F	.125	1.2	6	TDC156*010NSF
18	F	.125	1.4	6	TDC186*010NSF
22	F	.125	1.8	6	TDC226*010NSF
27	F	.125	2.2	6	TDC276*010NSF
33	F	.125	2.6	6	TDC336*010NSF
39	F	.125	3.1	6	TDC396*010NSF
47	F	.125	3.8	6	TDC476*010NSF
56	F	.125	4.5	6	TDC566*010NSF
68	F	.125	5.4	6	TDC686*010NSF
82	G	.250	6.6	8	TDC826*010WSG
100	G	.250	8.0	8	TDC107*010WSG
120	G	.250	9.6	8	TDC127*010WSG
150	G	.250	10.0	8	TDC157*010WSG
180	G	.250	10.0	8	TDC187*010WSG
220	G	.250	10.0	8	TDC227*010WSG

Cap (μ F)	Case Code	Lead Spacing S	Max DCL @ +25°C (μ A)	Max D.F. % @ +25°C 120 Hz	Catalog Number
10 WVDC; 13 VDC Surge @ 85°C 7 WVDC; 9 VDC Surge @ 125°C					
2.2	E	.125	0.5	5	TDC225*010NSE
2.7	E	.125	0.5	5	TDC275*010NSE
3.3	E	.125	0.5	5	TDC335*010NSE

Cap (μ F)	Case Code	Lead Spacing S	Max DCL @ +25°C (μ A)	Max D.F. % @ +25°C 120 Hz	Catalog Number
15 WVDC; 20 VDC Surge @ 85°C 10 WVDC; 12 VDC Surge @ 125°C					
1.5	E	.125	0.5	5	TDC155*015NSE
1.8	E	.125	0.5	5	TDC185*015NSE
2.2	E	.125	0.5	5	TDC225*015NSE
2.7	E	.125	0.5	5	TDC275*015NSE
3.3	E	.125	0.5	5	TDC335*015NSE
3.9	E	.125	0.5	5	TDC395*015NSE

* Indicate capacitance tolerance: K = $\pm 10\%$, M = $\pm 20\%$, (J = $\pm 5\%$, Special Order)

NACC reserves the right to substitute a tighter tolerance, higher voltage capacitor within the same case size.

Type TDC Solid Tantalum Capacitors

MALLORY

Solid Tantalum Capacitors

Cap (μ F)	Case Code	Lead Spacing S	Max DCL @ +25°C (μ A)	Max D.F. % @ +25°C 120 Hz	Catalog Number
15 WVDC; 20 VDC Surge @ 85°C 10 WVDC; 12 VDC Surge @ 125°C					
4.7	E	.125	0.6	5	TDC475*015NSE
5.6	E	.125	0.7	5	TDC565*015NSE
6.8	E	.125	0.9	5	TDC685*015NSE
8.2	E	.125	1.0	6	TDC825*015NSE
10	F	.125	1.3	6	TDC106*015NSF
12	F	.125	1.5	6	TDC126*015NSF
15	F	.125	1.8	6	TDC156*015NSF
18	F	.125	2.2	6	TDC186*015NSF
22	F	.125	2.6	6	TDC226*015NSF
27	F	.125	3.2	6	TDC276*015NSF
33	F	.125	4.0	6	TDC336*015NSF
39	G	.250	4.7	6	TDC396*015WSG
47	G	.250	5.6	6	TDC476*015WSG
56	G	.250	6.8	6	TDC566*015WSG
68	G	.250	8.2	6	TDC686*015WSG
82	G	.250	9.8	8	TDC826*015WSG
100	G	.250	10.0	8	TDC107*015WSG
120	G	.250	10.0	8	TDC127*015WSG
150	G	.250	10.0	8	TDC157*015WSG

Cap (μ F)	Case Code	Lead Spacing S	Max DCL @ +25°C (μ A)	Max D.F. % @ +25°C 120 Hz	Catalog Number
20 WVDC; 26 VDC Surge @ 85°C 13 WVDC; 16 VDC Surge @ 125°C					
1.0	E	.125	0.5	3	TDC105*020NSE
1.2	E	.125	0.5	5	TDC125*020NSE
1.5	E	.125	0.5	5	TDC155*020NSE
1.8	E	.125	0.5	5	TDC185*020NSE
2.2	E	.125	0.5	5	TDC225*020NSE
2.7	E	.125	0.5	5	TDC275*020NSE
3.3	E	.125	0.5	5	TDC335*020NSE
3.9	E	.125	0.6	5	TDC395*020NSE
4.7	E	.125	0.8	5	TDC475*020NSE
5.6	F	.125	0.9	5	TDC565*020NSF
6.8	F	.125	1.1	5	TDC685*020NSF
8.2	F	.125	1.3	6	TDC825*020NSF
10	F	.125	1.6	6	TDC106*020NSF
12	F	.125	1.9	6	TDC126*020NSF
15	F	.125	2.4	6	TDC156*020NSF
18	F	.125	2.9	6	TDC186*020NSF
22	F	.125	3.5	6	TDC226*020NSF
33	G	.250	5.3	6	TDC336*020WSG
39	G	.250	6.2	6	TDC396*020WSG
47	G	.250	7.5	6	TDC476*020WSG
56	G	.250	9.0	6	TDC566*020WSG
68	G	.250	10.0	6	TDC686*020WSG
82	G	.250	10.0	8	TDC826*020WSG
100	G	.250	10.0	8	TDC107*020WSG

Cap (μ F)	Case Code	Lead Spacing S	Max DCL @ +25°C (μ A)	Max D.F. % @ +25°C 120 Hz	Catalog Number
25 WVDC; 32 VDC Surge @ 85°C 17 WVDC; 22 VDC Surge @ 125°C					
1.0	E	.125	0.5	3	TDC105*025NSE
1.2	E	.125	0.5	5	TDC125*025NSE
1.5	E	.125	0.5	5	TDC155*025NSE
1.8	E	.125	0.5	5	TDC185*025NSE
2.2	E	.125	0.5	5	TDC225*025NSE
2.7	E	.125	0.5	5	TDC275*025NSE
3.3	E	.125	0.7	5	TDC335*025NSE
3.9	E	.125	0.8	5	TDC395*025NSE
4.7	F	.125	0.9	5	TDC475*025NSF
5.6	F	.125	1.1	5	TDC565*025NSF
6.8	F	.125	1.4	5	TDC685*025NSF
8.2	F	.125	1.6	6	TDC825*025NSF
10	F	.125	2.0	6	TDC106*025NSF
12	F	.125	2.4	6	TDC126*025NSF
15	F	.125	3.0	6	TDC156*025NSF
18	F	.125	3.6	6	TDC186*025NSF
22	F	.125	4.4	6	TDC226*025NSF
27	G	.250	5.4	6	TDC276*025WSG
33	G	.250	6.6	6	TDC336*025WSG
39	G	.250	7.8	6	TDC396*025WSG
47	G	.250	9.4	6	TDC476*025WSG

Cap (μ F)	Case Code	Lead Spacing S	Max DCL @ +25°C (μ A)	Max D.F. % @ +25°C 120 Hz	Catalog Number
25 WVDC; 32 VDC Surge @ 85°C 17 WVDC; 22 VDC Surge @ 125°C					
56	G	.250	10.0	6	TDC566*025WSG
68	G	.250	10.0	6	TDC686*025WSG

Cap (μ F)	Case Code	Lead Spacing S	Max DCL @ +25°C (μ A)	Max D.F. % @ +25°C 120 Hz	Catalog Number
35 WVDC; 46 VDC Surge @ 85°C 23 WVDC; 28 VDC Surge @ 125°C					
0.10	E	.125	0.5	3	TDC104*035NSE
0.12	E	.125	0.5	3	TDC124*035NSE
0.15	E	.125	0.5	3	TDC154*035NSE
0.18	E	.125	0.5	3	TDC184*035NSE
0.22	E	.125	0.5	3	TDC224*035NSE
0.27	E	.125	0.5	3	TDC274*035NSE
0.33	E	.125	0.5	3	TDC334*035NSE
0.39	E	.125	0.5	3	TDC394*035NSE
0.47	E	.125	0.5	3	TDC474*035NSE
0.56	E	.125	0.5	3	TDC564*035NSE
0.68	E	.125	0.5	3	TDC684*035NSE
0.82	E	.125	0.5	3	TDC824*035NSE
1.0	E	.125	0.5	3	TDC105*035NSE
1.2	E	.125	0.5	5	TDC125*035NSE
1.5	E	.125	0.5	5	TDC155*035NSE
1.8	E	.125	0.5	5	TDC185*035NSE
2.2	E	.125	0.6	5	TDC225*035NSE
2.7	F	.125	0.7	5	TDC275*035NSF
3.3	F	.125	0.9	5	TDC335*035NSF
3.9	F	.125	1.0	5	TDC395*035NSF
4.7	F	.125	1.3	5	TDC475*035NSF
5.6	F	.125	1.6	5	TDC565*035NSF
6.8	F	.125	1.9	5	TDC685*035NSF
8.2	F	.125	2.3	6	TDC825*035NSF
10	F	.125	2.8	6	TDC106*035NSF
12	G	.250	3.4	6	TDC126*035WSG
15	G	.250	4.2	6	TDC156*035WSG
18	G	.250	5.0	6	TDC186*035WSG
22	G	.250	6.2	6	TDC226*035WSG
27	G	.250	7.6	6	TDC276*035WSG
33	G	.250	9.2	6	TDC336*035WSG
39	G	.250	10.0	6	TDC396*035WSG
47	G	.250	10.0	6	TDC476*035WSG

Cap (μ F)	Case Code	Lead Spacing S	Max DCL @ +25°C (μ A)	Max D.F. % @ +25°C 120 Hz	Catalog Number
50 WVDC; 65 VDC Surge @ 85°C 33 WVDC; 40 VDC Surge @ 125°C					
0.10	E	.125	0.5	3	TDC104*050NSE
0.12	E	.125	0.5	3	TDC124*050NSE
0.15	E	.125	0.5	3	TDC154*050NSE
0.18	E	.125	0.5	3	TDC184*050NSE
0.22	E	.125	0.5	3	TDC224*050NSE
0.27	E	.125	0.5	3	TDC274*050NSE
0.33	E	.125	0.5	3	TDC334*050NSE
0.39	E	.125	0.5	3	TDC394*050NSE
0.47	E	.125	0.5	3	TDC474*050NSE
0.56	E	.125	0.5	3	TDC564*050NSE
0.68	E	.125	0.5	3	TDC684*050NSE
0.82	E	.125	0.5	3	TDC824*050NSE
1.0	E	.125	0.5	3	TDC105*050NSE
1.2	E	.125	0.5	5	TDC125*050NSE
1.5	E	.125	0.6	5	TDC155*050NSE
1.8	F	.125	0.7	5	TDC185*050NSF
2.2	F	.125	0.9	5	TDC225*050NSF
2.7	F	.125	1.1	5	TDC275*050NSF
3.3	F	.125	1.3	5	TDC335*050NSF
3.9	F	.125	1.6	5	TDC395*050NSF
4.7	F	.125	1.9	5	TDC475*050NSF
5.6	F	.125	2.2	5	TDC565*050NSF
6.8	G	.250	2.7	5	TDC685*050WSG
8.2	G	.250	3.3	6	TDC825*050WSG
10	G	.250	4.0	6	TDC106*050WSG
12	G	.250	4.8	6	TDC126*050WSG
15	G	.250	6.0	6	TDC156*050WSG
18	G	.250	7.2	6	TDC186*050WSG
22	G	.250	8.8	6	TDC226*050WSG

* Indicate capacitance tolerance: K = $\pm 10\%$, M = $\pm 20\%$, (J = $\pm 5\%$, Special Order)

NACC reserves the right to substitute a tighter tolerance, higher voltage capacitor within the same case size.

Type TDL Solid Tantalum Capacitors

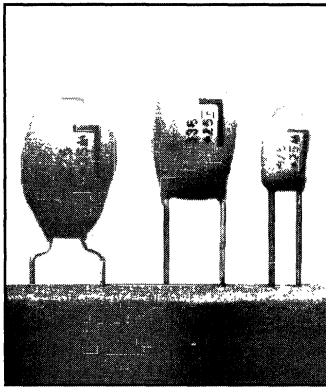

- Tough Plastic Case
- UL94V0 Flammability Rating
- Laser Marking Clarity and Permanence
- Low Cost
- Low DCL
- Low ESR & Impedance
- Temperature Stable
- Long Shelf Life
- High Shock & Vibration
- Optional Reel Packaging Available

GENERAL SPECIFICATIONS

Operating Temperature:
-55°C to +125°C
(With proper derating)

Voltage Range:
6 to 50 WVDC @ 85°C

Reverse Voltage (Non-continuous):
15% of rated voltage @ 25°C
5% of rated voltage @ 85°C
1% of rated voltage @ 125°C

Capacitance Range:
.10 μF to 330 μF

Capacitance Tolerance:
±10%, ±20%
(±5% by special order)

Capacitance Change From Initial +25°C Value:
-10% @ -55°C
+10% @ +85°C
+12% @ +125°C

DC Leakage:
At +25°C - See Table Limit
At +85°C - 10 x Table Limit
At +125°C - 12.5 x Table Limit

Dimensions - Inches (Millimeters)

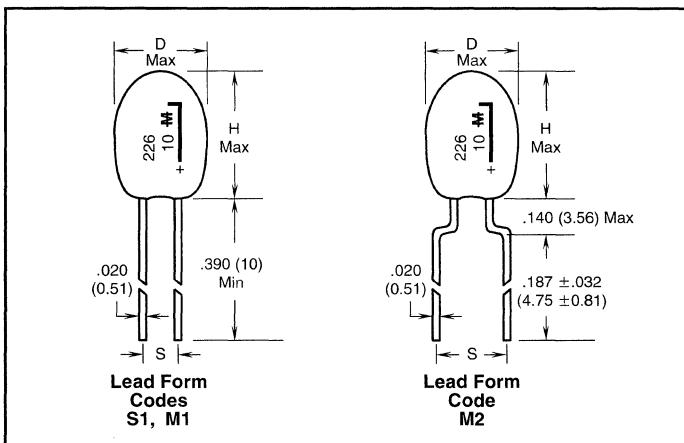

Case Code	D (Max.)	H (Max.)	Leads	
			S	Code
A	.180 (4.57)	.280 (7.11)	.100 (2.54) (Standard)	S1 M2
			.200 (5.08) (Special)	
B	.200 (5.08)	.300 (7.62)	.100 (2.54) (Standard)	S1 M2
			.200 (5.08) (Special)	
C	.260 (6.60)	.360 (9.14)	.100 (2.54) (Standard)	S1 M2
			.200 (5.08) (Special)	
D	.340 (8.64)	.400 (10.16)	.100 (2.54) (Standard)	S1 M2
			.200 (5.08) (Special)	
E	.400 (10.16)	.560 (14.22)	.200 (5.08) (Standard)	M1
F	.440 (11.18)	.680 (17.27)	.200 (5.08) (Standard)	M1

Listed Catalog Numbers reflect standard lead forms as indicated below. M2 lead form and lead lengths of .500 (12.7) minimum are available by special order.

Cap (μF)	Case Code	Lead Spacing S	Max DCL @ +25°C (μA)	Max D.F. % @ +25°C 120 Hz	Catalog Number
6.3 WVDC; 8 VDC Surge @ 85°C 4 WVDC; 5 VDC Surge @ 125°C					
3.3	A	.100	0.5	5	TDL335*006S1A
3.9	A	.100	0.5	5	TDL395*006S1A
4.7	A	.100	0.5	5	TDL475*006S1A
5.6	A	.100	0.5	5	TDL565*006S1A
6.8	A	.100	0.5	5	TDL685*006S1A
8.2	B	.100	0.5	6	TDL825*006S1B
10	B	.100	0.5	6	TDL106*006S1B
12	B	.100	0.6	6	TDL126*006S1B
15	B	.100	0.7	6	TDL156*006S1B
18	B	.100	0.9	6	TDL186*006S1B
22	C	.100	1.1	6	TDL226*006S1C
27	C	.100	1.3	6	TDL276*006S1C
33	C	.100	1.6	6	TDL336*006S1C
39	C	.100	1.9	6	TDL396*006S1C
47	D	.100	2.3	6	TDL476*006S1D
56	D	.100	2.7	6	TDL566*006S1D
68	D	.100	3.3	6	TDL686*006S1D
82	D	.100	3.9	8	TDL826*006S1D
100	D	.100	4.8	8	TDL107*006S1D
120	D	.200	5.8	8	TDL127*006M1D
150	E	.200	7.2	8	TDL157*006M1E
180	E	.200	8.6	8	TDL187*006M1E
220	E	.200	10.0	8	TDL227*006M1E
270	E	.200	10.0	8	TDL277*006M1E
330	F	.200	10.0	8	TDL337*006M1F

Cap (μF)	Case Code	Lead Spacing S	Max DCL @ +25°C (μA)	Max D.F. % @ +25°C 120 Hz	Catalog Number
10 WVDC; 13 VDC Surge @ 85°C 7 WVDC; 9 VDC Surge @ 125°C					
4.7	A	.100	0.5	5	TDL475*010S1A
5.6	A	.100	0.5	5	TDL565*010S1A
6.8	B	.100	0.5	5	TDL685*010S1B
8.2	B	.100	0.7	6	TDL825*010S1B
10	B	.100	0.8	6	TDL106*010S1B
12	C	.100	1.0	6	TDL126*010S1C
15	C	.100	1.2	6	TDL156*010S1C
18	C	.100	1.4	6	TDL186*010S1C
22	C	.100	1.8	6	TDL226*010S1C
27	C	.100	2.2	6	TDL276*010S1C
33	D	.100	2.6	6	TDL336*010S1D
39	D	.100	3.1	6	TDL396*010S1D
47	D	.100	3.8	6	TDL476*010S1D
56	D	.100	4.5	6	TDL566*010S1D
68	D	.100	5.4	6	TDL686*010S1D
82	E	.200	6.6	8	TDL826*010M1E
100	E	.200	8.0	8	TDL107*010M1E
120	E	.200	9.6	8	TDL127*010M1E
150	E	.200	10.0	8	TDL157*010M1E
180	E	.200	10.0	8	TDL187*010M1E
220	F	.200	10.0	8	TDL227*010M1F

Cap (μF)	Case Code	Lead Spacing S	Max DCL @ +25°C (μA)	Max D.F. % @ +25°C 120 Hz	Catalog Number
10 WVDC; 13 VDC Surge @ 85°C 7 WVDC; 9 VDC Surge @ 125°C					
2.2	A	.100	0.5	5	TDL225*010S1A
2.7	A	.100	0.5	5	TDL275*010S1A
3.3	A	.100	0.5	5	TDL335*010S1A
3.9	A	.100	0.5	5	TDL395*010S1A

Cap (μF)	Case Code	Lead Spacing S	Max DCL @ +25°C (μA)	Max D.F. % @ +25°C 120 Hz	Catalog Number
16 WVDC; 20 VDC Surge @ 85°C 10 WVDC; 12 VDC Surge @ 125°C					
1.5	A	.100	0.5	5	TDL155*016S1A
1.8	A	.100	0.5	5	TDL185*016S1A
2.2	A	.100	0.5	5	TDL225*016S1A
2.7	A	.100	0.5	5	TDL275*016S1A
3.3	A	.100	0.5	5	TDL335*016S1A
3.9	B	.100	0.5	5	TDL395*016S1B
4.7	B	.100	0.6	5	TDL475*016S1B
5.6	B	.100	0.7	5	TDL565*016S1B

* Indicate capacitance tolerance: K = ±10%, M = ±20%, (J = ±5%, Special Order)

NACC reserves the right to substitute a tighter tolerance, higher voltage capacitor within the same case size.

Type TDL Solid Tantalum Capacitors



Solid Tantalum Capacitors

Cap (μ F)	Case Code	Lead Spacing S	Max DCL @ +25°C (μ A)	Max D.F. % @ +25°C 120 Hz	Catalog Number
16 WVDC; 20 VDC Surge @ 85°C 10 WVDC; 12 VDC Surge @ 125°C					
6.8	B	.100	0.9	5	TDL685*016S1B
8.2	C	.100	1.0	6	TDL825*016S1C
10	C	.100	1.3	6	TDL106*016S1C
12	C	.100	1.5	6	TDL126*016S1C
15	C	.100	1.8	6	TDL156*016S1C
18	C	.100	2.2	6	TDL186*016S1C
22	D	.100	2.6	6	TDL226*016S1D
27	D	.100	3.2	6	TDL276*016S1D
33	D	.100	4.0	6	TDL336*016S1D
39	E	.200	4.7	6	TDL396*016M1E
47	E	.200	5.6	6	TDL476*016M1E
56	E	.200	6.8	6	TDL566*016M1E
68	E	.200	8.2	6	TDL686*016M1E
82	E	.200	9.8	8	TDL826*016M1E
100	F	.200	10.0	8	TDL107*016M1F
120	F	.200	10.0	8	TDL127*016M1F
150	F	.200	10.0	8	TDL157*016M1F

Cap (μ F)	Case Code	Lead Spacing S	Max DCL @ +25°C (μ A)	Max D.F. % @ +25°C 120 Hz	Catalog Number
20 WVDC; 26 VDC Surge @ 85°C 13 WVDC; 16 VDC Surge @ 125°C					
1.0	A	.100	0.5	3	TDL105*020S1A
1.2	A	.100	0.5	5	TDL125*020S1A
1.5	A	.100	0.5	5	TDL155*020S1A
1.8	A	.100	0.5	5	TDL185*020S1A
2.2	A	.100	0.5	5	TDL225*020S1A
2.7	A	.100	0.5	5	TDL275*020S1A
3.3	A	.100	0.5	5	TDL335*020S1A
3.9	B	.100	0.6	5	TDL395*020S1B
4.7	B	.100	0.8	5	TDL475*020S1B
5.6	B	.100	0.9	5	TDL565*020S1B
6.8	B	.100	1.1	5	TDL685*020S1B
8.2	B	.100	1.3	6	TDL825*020S1B
10	C	.100	1.6	6	TDL106*020S1C
12	C	.100	1.9	6	TDL126*020S1C
15	C	.100	2.4	6	TDL156*020S1C
18	C	.100	2.9	6	TDL186*020S1C
22	C	.100	3.5	6	TDL226*020S1C
27	E	.200	4.3	6	TDL276*020M1E
33	E	.200	5.3	6	TDL336*020M1E
39	E	.200	6.2	6	TDL396*020M1E
47	E	.200	7.5	6	TDL476*020M1E
56	E	.200	9.0	6	TDL566*020M1E
68	E	.200	10.0	6	TDL686*020M1E
82	F	.200	10.0	8	TDL826*020M1F
100	F	.200	10.0	8	TDL107*020M1F

Cap (μ F)	Case Code	Lead Spacing S	Max DCL @ +25°C (μ A)	Max D.F. % @ +25°C 120 Hz	Catalog Number
25 WVDC; 32 VDC Surge @ 85°C 16.5 WVDC; 21.5 VDC Surge @ 125°C					
1.0	A	.100	0.5	3	TDL105*025S1A
1.2	A	.100	0.5	5	TDL125*025S1A
1.5	A	.100	0.5	5	TDL155*025S1A
1.8	A	.100	0.5	5	TDL185*025S1A
2.2	B	.100	0.5	5	TDL225*025S1B
2.7	B	.100	0.5	5	TDL275*025S1B
3.3	B	.100	0.7	5	TDL335*025S1B
3.9	B	.100	0.8	5	TDL395*025S1B
4.7	C	.100	0.9	5	TDL475*025S1C
5.6	C	.100	1.1	5	TDL565*025S1C
6.8	C	.100	1.4	5	TDL685*025S1C
8.2	C	.100	1.6	6	TDL825*025S1C
10	C	.100	2.0	6	TDL106*025S1C
12	C	.100	2.4	6	TDL126*025S1C
15	D	.100	3.0	6	TDL156*025S1D
18	D	.100	3.6	6	TDL186*025S1D
22	D	.100	4.4	6	TDL226*025S1D
27	E	.100	5.4	6	TDL276*025M1E
33	E	.100	6.6	6	TDL336*025M1E
39	E	.100	7.8	6	TDL396*025M1E
47	E	.100	9.4	6	TDL476*025M1E

Cap (μ F)	Case Code	Lead Spacing S	Max DCL @ +25°C (μ A)	Max D.F. % @ +25°C 120 Hz	Catalog Number
25 WVDC; 32 VDC Surge @ 85°C 16.5 WVDC; 21.5 VDC Surge @ 125°C					
56	E	.100	10.0	6	TDL566*025M1E
68	F	.100	10.0	6	TDL686*025M1F

Cap (μ F)	Case Code	Lead Spacing S	Max DCL @ +25°C (μ A)	Max D.F. % @ +25°C 120 Hz	Catalog Number
35 WVDC; 46 VDC Surge @ 85°C 23 WVDC; 28 VDC Surge @ 125°C					
0.10	A	.100	0.5	3	TDL104*035S1A
0.12	A	.100	0.5	3	TDL124*035S1A
0.15	A	.100	0.5	3	TDL154*035S1A
0.18	A	.100	0.5	3	TDL184*035S1A
0.22	A	.100	0.5	3	TDL224*035S1A
0.27	A	.100	0.5	3	TDL274*035S1A
0.33	A	.100	0.5	3	TDL334*035S1A
0.39	A	.100	0.5	3	TDL394*035S1A
0.47	A	.100	0.5	3	TDL474*035S1A
0.56	A	.100	0.5	3	TDL564*035S1A
0.68	A	.100	0.5	3	TDL684*035S1A
0.82	A	.100	0.5	3	TDL824*035S1A
1.0	B	.100	0.5	3	TDL105*035S1B
1.2	B	.100	0.5	5	TDL125*035S1B
1.5	B	.100	0.5	5	TDL155*035S1B
1.8	B	.100	0.5	5	TDL185*035S1B
2.2	C	.100	0.6	5	TDL225*035S1C
2.7	C	.100	0.7	5	TDL275*035S1C
3.3	C	.100	0.9	5	TDL335*035S1C
3.9	C	.100	1.0	5	TDL395*035S1C
4.7	D	.100	1.3	5	TDL475*035S1D
5.6	D	.100	1.6	5	TDL565*035S1D
6.8	D	.100	1.9	5	TDL685*035S1D
8.2	D	.100	2.3	6	TDL825*035S1D
10	D	.100	2.8	6	TDL106*035S1D
12	E	.200	3.4	6	TDL126*035M1E
15	E	.200	4.2	6	TDL156*035M1E
18	E	.200	5.0	6	TDL186*035M1E
22	E	.200	6.2	6	TDL226*035M1E
27	E	.200	7.6	6	TDL276*035M1E
33	F	.200	9.2	6	TDL336*035M1F
39	F	.200	10.0	6	TDL396*035M1F
47	F	.200	10.0	6	TDL476*035M1F

Cap (μ F)	Case Code	Lead Spacing S	Max DCL @ +25°C (μ A)	Max D.F. % @ +25°C 120 Hz	Catalog Number
50 WVDC; 65 VDC Surge @ 85°C 33 WVDC; 40 VDC Surge @ 125°C					
0.10	A	.100	0.5	3	TDL104*050S1A
0.12	A	.100	0.5	3	TDL124*050S1A
0.15	A	.100	0.5	3	TDL154*050S1A
0.18	A	.100	0.5	3	TDL184*050S1A
0.22	A	.100	0.5	3	TDL224*050S1A
0.27	A	.100	0.5	3	TDL274*050S1A
0.33	A	.100	0.5	3	TDL334*050S1A
0.39	A	.100	0.5	3	TDL394*050S1A
0.47	B	.100	0.5	3	TDL474*050S1B
0.56	B	.100	0.5	3	TDL564*050S1B
0.68	B	.100	0.5	3	TDL684*050S1B
0.82	B	.100	0.5	3	TDL824*050S1B
1.0	C	.100	0.5	3	TDL105*050S1C
1.2	C	.100	0.5	5	TDL125*050S1C
1.5	C	.100	0.6	5	TDL155*050S1C
1.8	C	.100	0.7	5	TDL185*050S1C
2.2	D	.100	0.9	5	TDL225*050S1D
2.7	D	.100	1.1	5	TDL275*050S1D
3.3	D	.100	1.3	5	TDL335*050S1D
3.9	D	.100	1.6	5	TDL395*050S1D
4.7	D	.100	1.9	5	TDL475*050S1D
5.6	D	.100	2.2	5	TDL565*050S1D
6.8	F	.200	2.7	5	TDL685*050M1F
8.2	F	.200	3.3	6	TDL825*050M1F
10	F	.200	4.0	6	TDL106*050M1F
12	F	.200	4.8	6	TDL126*050M1F
15	F	.200	6.0	6	TDL156*050M1F
18	F	.200	7.2	6	TDL186*050M1F
22	F	.200	8.8	6	TDL226*050M1F

NACC reserves the right to substitute a tighter tolerance, higher voltage capacitor within the same case size.

* Indicate capacitance tolerance: K = $\pm 10\%$, M = $\pm 20\%$, (J = $\pm 5\%$, Special Order)

Type T491 - Chips Solid Tantalum Capacitors

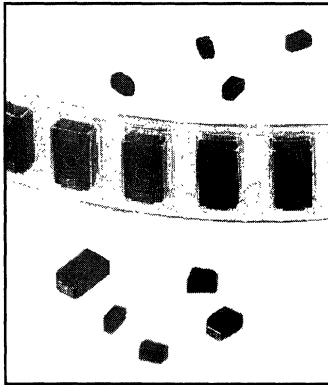

- Highest Capacitance per Case
- Low DF and DC Leakage
- Temperature Stable
- Compatible with all Soldering Techniques
- Soldering Temperature up to 260°C for 10 Seconds
- Meets IECQ Standard QC300801/US0001 and EIA Standard 535BAAC
- Compatible with all Tape-Fed Automatic Pick and Place Systems

GENERAL SPECIFICATIONS

Operating Temperature:
-55°C to +125°C
(with proper derating)

Voltage Range:
4 to 50 VDC

Capacitance Range:
0.10 µF to 220 µF

Cap Change From Initial Limit
-10% @ -55°C; +10% @ +85°C
+12% @ +125°C

DC Leakage:
At 25°C - See P/N List
At 85°C - 10 x 25°C Limit
At 125°C - 12 x 25°C Limit

Dissipation Factor:
.1 µF to 1.0 µF — 4%
1.5 µF to 68 µF — 6%
100 µF to 220 µF — 8%

Standard Packaging
Tape & Reel per EIA RS-481-1

Case Code	EIA/IECQ	Qty per 7" Reel	Tape	
			Width	Pitch
S	3216L	2,500	8mm	4mm
T	3528L	2,500	8mm	4mm
A	3216	2,000	8mm	4mm
B	3528	2,000	8mm	4mm
C	6032	500	12mm	8mm
D	7343	500	12mm	8mm
X	7343H	500	12mm	8mm

13" Reels Available on Special Order

Capacitor Outline Drawing

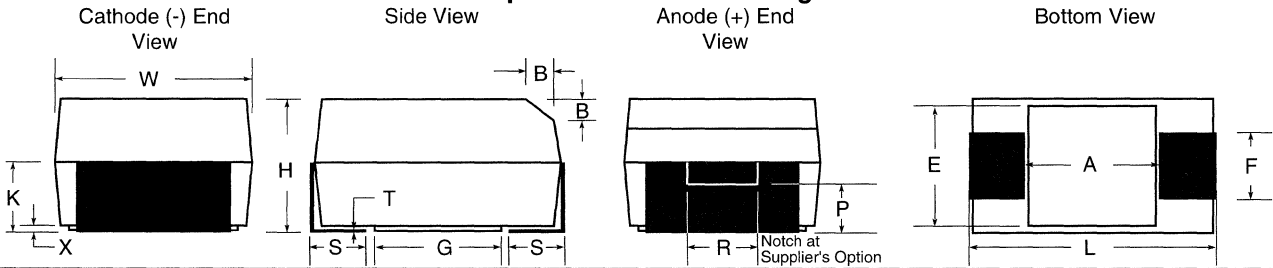

Case Code		Dimensions - Millimeters (Inches)													
NACC	EIA/IECQ	L	W	H	K	F	S	B (Ref)	X (Ref)	P (Ref)	R (Ref)	T (Ref)	A (Min)	G (Ref)	E (Ref)
A	3216	3.2 ± 0.2 (.126 ± .008)	1.6 ± 0.2 (.063 ± .008)	1.6 ± 0.2 (.063 ± .008)	0.9 ± 0.2 (.035 ± .008)	1.2 ± 0.1 (.047 ± .004)	0.8 ± 0.3 (.031 ± .012)	0.4 ± 0.15 (.016 ± .006)	0.10 ± 0.10 (.004 ± .004)	0.4 (.016)	0.4 (.016)	0.13 (.005)	0.8 (.031)	1.1 (.043)	1.3 (.051)
B	3528	3.5 ± 0.2 (.138 ± .008)	2.8 ± 0.2 (.110 ± .008)	1.9 ± 0.2 (.075 ± .008)	1.1 ± 0.2 (.043 ± .008)	2.2 ± 0.1 (.087 ± .004)	0.8 ± 0.3 (.031 ± .012)	0.4 ± 0.15 (.016 ± .006)	0.10 ± 0.10 (.004 ± .004)	0.5 (.020)	1.0 (.039)	0.13 (.005)	1.1 (.043)	1.8 (.071)	2.2 (.087)
C	6032	6.0 ± 0.3 (.236 ± .012)	3.2 ± 0.3 (.126 ± .012)	2.5 ± 0.3 (.098 ± .012)	1.4 ± 0.2 (.055 ± .008)	2.2 ± 0.1 (.087 ± .004)	1.3 ± 0.3 (.051 ± .012)	0.5 ± 0.15 (.020 ± .006)	0.10 ± 0.10 (.004 ± .004)	0.9 (.035)	1.0 (.039)	0.13 (.005)	2.5 (.098)	2.8 (.110)	2.9 (.114)
D	7343	7.3 ± 0.3 (.287 ± .012)	4.3 ± 0.3 (.169 ± .012)	2.8 ± 0.3 (.110 ± .012)	1.5 ± 0.2 (.059 ± .008)	2.4 ± 0.1 (.094 ± .004)	1.3 ± 0.3 (.051 ± .012)	0.5 ± 0.15 (.020 ± .006)	0.10 ± 0.10 (.004 ± .004)	0.9 (.035)	1.0 (.039)	0.13 (.005)	3.8 (.150)	3.5 (.138)	3.5 (.138)
X	7343H	7.3 ± 0.3 (.287 ± .012)	4.3 ± 0.3 (.169 ± .012)	4.0 ± 0.3 (.157 ± .012)	2.3 ± 0.2 (.091 ± .008)	2.4 ± 0.1 (.094 ± .004)	1.3 ± 0.3 (.051 ± .012)	0.5 ± 0.15 (.020 ± .006)	0.10 ± 0.10 (.004 ± .004)	1.7 (.067)	1.0 (.039)	0.13 (.005)	3.8 (.150)	3.5** (.138)	3.5** (.138)

- Notes: 1 Metric dimensions govern
2 (Ref) - Dimensions provided for reference only
** Round Glue Pad 2.9 ± 0.1mm (.114 ± .004) in diameter at Supplier's option

Low Profile Capacitors

Case Code		Dimensions - Millimeters (Inches)													
NACC	EIA/IECQ	L	W	H Max.	K Min.	F	S	B (Ref)	X (Ref)	P (Ref)	R (Ref)	T (Ref)	A (Min)	G (Ref)	E (Ref)
S	3216L	3.2 ± 0.2 (.126 ± .008)	1.6 ± 0.2 (.063 ± .008)	1.2 (.047)	0.3 (.012)	1.2 ± 0.1 (.047 ± .004)	0.8 ± 0.3 (.031 ± .012)	Note 3	0.05 (.002)	Note 3	Note 3	0.13 (.005)	0.8 (.031)	1.1 (.043)	1.3 (.051)
T	3528L	3.5 ± 0.2 (.138 ± .008)	2.8 ± 0.2 (.110 ± .008)	1.2 (.047)	0.3 (.012)	2.2 ± 0.1 (.087 ± .004)	0.8 ± 0.3 (.031 ± .012)	Note 3	0.05 (.002)	Note 3	Note 3	0.13 (.005)	1.1 (.043)	1.8 (.071)	2.2 (.087)

- Notes: 1 Metric dimensions govern
2 (Ref) - Dimensions provided for reference only
3 No dimensions provided for B, P or R because low profile cases do not have a bevel or notch

Part Number Nomenclature

T491 **B** **105** **K** **035** **A** **S**
(1) (2) (3) (4) (5) (6) (7)

1. T491 Series - Precision Molded Case
T495 Series - Precision Molded Case - Low ESR
2. Case Size Code:
S, T, A, B, C, D, X
3. Capacitance Code (Expressed in Picofarads)
First 2 digits: Significant Figures
Third digit: Number of zeros (Example: 395 = 3.9 µF)
4. Capacitance Tolerance:
K = ±10%, (M = ±20%, special order only)
5. DC Voltage Rating:
Zeros are used to precede the voltage rating where necessary to complete the three digit block
6. Failure Rate: A = Not applicable
7. Lead Material
S = Standard Solder Coated
G = Gold Plated

Type T491 - Chips Solid Tantalum Capacitors

MALLORY

Cap μF	* Cap Tol	Case Code		Catalog Number	DC Leakage μA @+25°C Max	DF % @ +25°C 120 Hz Max
		⊕	EIA/ IECQ			

**4 WVDC @ +85°C
(2.7 WVDC @ +125°C)**

3.3	10%	A	3216	T491A335K004AS	0.5	6.0
4.7	10%	A	3216	T491A475K004AS	0.5	6.0
+ 6.8	10%	A	3216	T491A685K004AS	0.5	6.0
+ 6.8	10%	S	3216L	T491S685K004AS	0.5	6.0
+ 10	10%	A	3216	T491A106K004AS	0.5	6.0
10	10%	B	3528	T491B106K004AS	0.5	6.0
+ 15	10%	A	3216	T491A156K004AS	0.6	6.0
15	10%	B	3528	T491B156K004AS	0.6	6.0
+ 15	10%	T	3528L	T491T156K004AS	0.6	6.0
+ 22	10%	B	3528	T491B226K004AS	0.9	6.0
22	10%	C	6032	T491C226K004AS	0.9	6.0
+ 33	10%	B	3528	T491B336K004AS	1.3	6.0
33	10%	C	6032	T491C336K004AS	1.3	6.0
+ 47	10%	C	6032	T491C476K004AS	1.9	6.0
+ 68	10%	C	6032	T491C686K004AS	2.7	6.0
68	10%	D	7343	T491D686K004AS	2.7	6.0
+ 100	10%	C	6032	T491C107K004AS	4.0	8.0
100	10%	D	7343	T491D107K004AS	4.0	8.0
+ 150	10%	D	7343	T491D157K004AS	6.0	8.0

*** 6 WVDC @ +85°C
(4 WVDC @ +125°C)**

2.2	10%	A	3216	T491A225K006AS	0.5	6.0
3.3	10%	A	3216	T491A335K006AS	0.5	6.0
+ 4.7	10%	A	3216	T491A475K006AS	0.5	6.0
+ 4.7	10%	S	3216L	T491S475K006AS	0.5	6.0
+ 6.8	10%	A	3216	T491A685K006AS	0.5	6.0
6.8	10%	B	3528	T491B685K006AS	0.5	6.0
+ 10	10%	A	3216	T491A106K006AS	0.6	6.0
10	10%	B	3528	T491B106K006AS	0.6	6.0
+ 10	10%	T	3528L	T491T106K006AS	0.6	6.0
+ 15	10%	B	3528	T491B156K006AS	0.9	6.0
15	10%	C	6032	T491C156K006AS	0.9	6.0
+ 22	10%	B	3528	T491B226K006AS	1.4	6.0
22	10%	C	6032	T491C226K006AS	1.4	6.0
+ 33	10%	C	6032	T491C336K006AS	2.0	6.0
+ 47	10%	C	6032	T491C476K006AS	2.9	6.0
47	10%	D	7343	T491D476K006AS	2.9	6.0
+ 68	10%	C	6032	T491C686K006AS	4.1	6.0
68	10%	D	7343	T491D686K006AS	4.1	6.0
+ 100	10%	D	7343	T491D107K006AS	6.0	8.0
+ 150	10%	D	7343	T491D157K006AS	9.0	8.0
+ 220	10%	X	7343H	T491X227K006AS	13.2	8.0

**10 WVDC @ +85°C
(7 WVDC @ +125°C)**

1.5	10%	A	3216	T491A155K010AS	0.5	6.0
2.2	10%	A	3216	T491A225K010AS	0.5	6.0
+ 3.3	10%	A	3216	T491A335K010AS	0.5	6.0
+ 3.3	10%	S	3216L	T491S335K010AS	0.5	6.0
+ 4.7	10%	A	3216	T491A475K010AS	0.5	6.0
4.7	10%	B	3528	T491B475K010AS	0.5	6.0
+ 6.8	10%	A	3216	T491A685K010AS	0.7	6.0
6.8	10%	B	3528	T491B685K010AS	0.7	6.0
+ 6.8	10%	T	3528L	T491T685K010AS	0.7	6.0
+ 10	10%	B	3528	T491B106K010AS	1.0	6.0
10	10%	C	6032	T491C106K010AS	1.0	6.0
+ 15	10%	B	3528	T491B156K010AS	1.5	6.0
15	10%	C	6032	T491C156K010AS	1.5	6.0
+ 22	10%	C	6032	T491C226K010AS	2.2	6.0
+ 33	10%	C	6032	T491C336K010AS	3.3	6.0
33	10%	D	7343	T491D336K010AS	3.3	6.0
+ 47	10%	C	6032	T491C476K010AS	4.7	6.0
47	10%	D	7343	T491D476K010AS	4.7	6.0
+ 68	10%	D	7343	T491D686K010AS	6.8	6.0
+ 100	10%	D	7343	T491D107K010AS	10.0	8.0
+ 150	10%	X	7343H	T491X157K010AS	15.0	8.0

Cap μF	* Cap Tol	Case Code		Catalog Number	DC Leakage μA @+25°C Max	DF % @ +25°C 120 Hz Max
		⊕	EIA/ IECQ			

**16 WVDC @ +85°C
(10 WVDC @ +125°C)**

1	10%	A	3216	T491A105K016AS	0.5	4.0
1.5	10%	A	3216	T491A155K016AS	0.5	6.0
+ 2.2	10%	A	3216	T491A225K016AS	0.5	6.0
+ 2.2	10%	S	3216L	T491S225K016AS	0.5	6.0
+ 3.3	10%	A	3216	T491A335K016AS	0.5	6.0
3.3	10%	B	3528	T491B335K016AS	0.5	6.0
+ 4.7	10%	A	3216	T491A475K016AS	0.8	6.0
4.7	10%	B	3528	T491B475K016AS	0.8	6.0
+ 4.7	10%	T	3528L	T491T475K016AS	0.8	6.0
+ 6.8	10%	B	3528	T491B685K016AS	1.1	6.0
6.8	10%	C	6032	T491C685K016AS	1.1	6.0
+ 10	10%	B	3528	T491B106K016AS	1.6	6.0
10	10%	C	6032	T491C106K016AS	1.6	6.0
+ 15	10%	C	6032	T491C156K016AS	2.4	6.0
+ 22	10%	C	6032	T491C226K016AS	3.6	6.0
22	10%	D	7343	T491D226K016AS	3.6	6.0
+ 33	10%	C	6032	T491C336K016AS	5.3	6.0
33	10%	D	7343	T491D336K016AS	5.3	6.0
+ 47	10%	D	7343	T491D476K016AS	7.5	6.0
+ 68	10%	D	7343	T491D686K016AS	10.9	6.0
+ 100	10%	X	7343H	T491X107K016AS	16.0	8.0

**20 WVDC @ +85°C
(13 WVDC @ +125°C)**

0.68	10%	A	3216	T491A684K020AS	0.5	4.0
1	10%	A	3216	T491A105K020AS	0.5	4.0
+ 1.5	10%	A	3216	T491A155K020AS	0.5	6.0
+ 1.5	10%	S	3216L	T491S155K020AS	0.5	6.0
+ 2.2	10%	A	3216	T491A225K020AS	0.5	6.0
2.2	10%	B	3528	T491B225K020AS	0.5	6.0
+ 3.3	10%	A	3216	T491A335K020AS	0.7	6.0
3.3	10%	B	3528	T491B335K020AS	0.7	6.0
+ 3.3	10%	T	3528L	T491T335K020AS	0.7	6.0
+ 4.7	10%	B	3528	T491B475K020AS	1.0	6.0
4.7	10%	C	6032	T491C475K020AS	1.0	6.0
+ 6.8	10%	B	3528	T491B685K020AS	1.4	6.0
6.8	10%	C	6032	T491C685K020AS	1.4	6.0
+ 10	10%	C	6032	T491C106K020AS	2.0	6.0
+ 15	10%	C	6032	T491C156K020AS	3.0	6.0
+ 15	10%	D	7343	T491D156K020AS	3.0	6.0
+ 22	10%	C	6032	T491C226K020AS	4.4	6.0
22	10%	D	7343	T491D226K020AS	4.4	6.0
+ 33	10%	D	7343	T491D336K020AS	6.6	6.0
+ 47	10%	D	7343	T491D476K020AS	9.4	6.0
+ 68	10%	X	7343H	T491X686K020AS	13.6	6.0

**25 WVDC @ +85°C
(17 WVDC @ +125°C)**

0.33	10%	A	3216	T491A334K025AS	0.5	4.0
0.47	10%	A	3216	T491A474K025AS	0.5	4.0
+ 0.68	10%	A	3216	T491A684K025AS	0.5	4.0
+ 1	10%	A	3216	T491A105K025AS	0.5	4.0
1	10%	B	3528	T491B105K025AS	0.5	4.0
+ 1.5	10%	B	3528	T491B155K025AS	0.5	6.0
+ 2.2	10%	B	3528	T491B225K025AS	0.6	6.0
2.2	10%	C	6032	T491C225K025AS	0.6	6.0
+ 3.3	10%	C	6032	T491C335K025AS	0.9	6.0
4.7	10%	C	6032	T491C475K025AS	1.2	6.0
+ 6.8	10%	C	6032	T491C685K025AS	1.7	6.0
+ 10	10%	C	6032	T491C106K025AS	2.5	6.0
10	10%	D	7343	T491D106K025AS	2.5	6.0
+ 15	10%	D	7343	T491D156K025AS	3.8	6.0
+ 22	10%	D	7343	T491D226K025AS	5.5	6.0
+ 33	10%	X	7343H	T491X336K025AS	8.3	6.0

- * - ± 20% Tolerance Available by Special Order
- + - Extended Values
- # - Max Capacitance Change @ 125°C = +15% (All others are +12%)
- * - 6 volt product is equivalent to 6.3 volt product

Note: NACC reserves the right to offer higher rated voltage substitutes within the same case size. The marking will indicate the higher voltage.

Type T491 - Chips Solid Tantalum Capacitors



Cap μF	* Cap Tol	Case Code		Catalog Number	DC Leakage μA @+25°C Max	DF % @ +25°C 120 Hz Max
		⊕	EIA/ IECQ			
35 WVDC @ +85°C (23 WVDC @ +125°C)						
0.1	10%	A	3216	T491A104K035AS	0.5	4.0
+ 0.15	10%	A	3216	T491A154K035AS	0.5	4.0
0.22	10%	A	3216	T491A224K035AS	0.5	4.0
0.33	10%	A	3216	T491A334K035AS	0.5	4.0
+ 0.47	10%	A	3216	T491A474K035AS	0.5	4.0
0.47	10%	B	3528	T491B474K035AS	0.5	4.0
0.68	10%	B	3528	T491B684K035AS	0.5	4.0
1.0	10%	B	3528	T491B105K035AS	0.5	4.0
1.5	10%	C	6032	T491C155K035AS	0.5	6.0
2.2	10%	C	6032	T491C225K035AS	0.8	6.0
3.3	10%	C	6032	T491C335K035AS	1.2	6.0
+ 4.7	10%	C	6032	T491C475K035AS	1.7	6.0
4.7	10%	D	7343	T491D475K035AS	1.7	6.0
6.8	10%	D	7343	T491D685K035AS	2.4	6.0
+ 10	10%	D	7343	T491D106K035AS	3.5	6.0
+ 15	10%	X	7343H	T491X156K035AS	5.3	6.0
+ 22	10%	X	7343H	T491X226K035AS	7.7	6.0

Cap μF	* Cap Tol	Case Code		Catalog Number	DC Leakage μA @+25°C Max	DF % @ +25°C 120 Hz Max
		⊕	EIA/ IECQ			
50 WVDC @ +85°C (33 WVDC @ +125°C)						
0.10	10%	A	3216	T491A104K050AS	0.5	4.0
+ 0.15	10%	A	3216	T491A154K050AS	0.5	4.0
0.15	10%	B	3528	T491B154K050AS	0.5	4.0
0.22	10%	B	3528	T491B224K050AS	0.5	4.0
0.33	10%	B	3528	T491B334K050AS	0.5	4.0
+ 0.47	10%	B	3528	T491B474K050AS	0.5	4.0
0.47	10%	C	6032	T491C474K050AS	0.5	4.0
0.68	10%	C	6032	T491C684K050AS	0.5	4.0
1.0	10%	C	6032	T491C105K050AS	0.5	4.0
+ 1.5	10%	C	6032	T491C155K050AS	0.5	6.0
1.5	10%	D	7343	T491D155K050AS	0.8	6.0
2.2	10%	D	7343	T491D225K050AS	1.1	6.0
3.3	10%	D	7343	T491D335K050AS	1.7	6.0
+ 4.7	10%	D	7343	T491D475K050AS	2.4	6.0
+ 6.8	10%	X	7343H	T491X685K050AS	3.5	6.0

Note: NACC reserves the right to offer higher rated voltage substitutes within the same case size. The marking will indicate the higher voltage.

- * - ± 20% Tolerance Available by Special Order
- + - Extended Values
- # - Max Capacitance Change @ 125°C = +15% (All others are +12%)

Type T495 - Chips Solid Tantalum Capacitors



- Designed for Very Low ESR
- High Ripple Current Capability
- High Surge Current Capability
- 100% Accelerated Steady-Rate Aging
- 100% In-Line Multi-Cycle Surge Current Conditioning

- Low Equivalent Series Inductance (<2nH ESL)
- New Extended Values Available
- Precision-Molded, Laser-Marked Case
- Symmetrical, Compliant Terminations
- Taped and Reeled per EIA 481-1

Cap μF	* Cap Tol	Case Code		Catalog Number	Max DC Leakage μA @+25°C	Max DF % @+25°C 120 Hz	Max ESR Ω @+25°C 100 kHz	Max Ripple Current Ams @+25°C 100 kHz
		⊕	EIA/ IECQ					
6 WVDC @ +85°C (4 WVDC @ +125°C)								
+ 68	10%	D	7343	T495D686K006AS	3.3	4.0	0.175	0.9
+ 150	10%	X	7343H	T495X150K006AS	7.2	6.0	0.125	1.1
10 WVDC @ +85°C (7 WVDC @ +125°C)								
47	10%	D	7343	T495D476K010AS	3.8	4.0	0.200	0.9
68	10%	X	7343H	T495X686K010AS	5.4	4.0	0.150	1.0
+ 100	10%	D	7343	T495D107K010AS	10.0	8.0	0.100	1.2
100	10%	X	7343H	T495X107K010AS	8.0	6.0	0.100	1.3
16 WVDC @ +85°C (10 WVDC @ +125°C)								
33	10%	D	7343	T495D336K016AS	4.2	4.0	0.250	0.8
+ 47	10%	D	7343	T95D476K016AS	7.5	6.0	0.200	0.9
20 WVDC @ +85°C (13 WVDC @ +125°C)								
15	10%	D	7343	T495D156K020AS	2.4	4.0	0.275	0.7
22	10%	D	7343	T495D226K020AS	3.5	4.0	0.275	0.7
47	10%	X	7343H	T495X476K020AS	7.5	4.0	0.150	1.0

Cap μF	* Cap Tol	Case Code		Catalog Number	Max DC Leakage μA @+25°C	Max DF % @+25°C 120 Hz	Max ESR Ω @+25°C 100 kHz	Max Ripple Current Ams @+25°C 100 kHz
		⊕	EIA/ IECQ					
25 WVDC @ +85°C (17 WVDC @ +125°C)								
+ 15	10%	D	7343	T495D156K025AS	3.8	6.0	0.275	0.7
15	10%	X	7343H	T495X156K025AS	3.0	4.0	0.200	0.9
22	10%	X	7343H	T495D226K025AS	4.4	4.0	0.225	0.9
33	10%	X	7343H	T495X336K025AS	6.6	4.0	0.175	1.0
35 WVDC @ +85°C (23 WVDC @ +125°C)								
6.8	10%	X	7343H	T495X685K035AS	1.9	4.0	0.300	0.7
10	10%	X	7343	T495X106K035AS	2.8	4.0	0.200	0.9
+ 22	10%	X	7343H	T495X226K035AS	7.7	6.0	0.300	0.7
50 WVDC @ +85°C (33 WVDC @ +125°C)								
4.7	10%	X	7343H	T495X475K050AS	1.9	4.0	0.300	0.7

- * - ± 20% Tolerance Available by Special Order
- + - Extended Values

Note: NACC reserves the right to offer higher rated voltage substitutes within the same case size. The marking will indicate the higher voltage.

Index Aluminum Electrolytic Capacitors

MALLORY

Type	Features	Capacitance Range	Voltage Range	Temperature Range	Termination	Nominal Case Size	Page Number
Large Can							
CGS	Standard High CV Computer Grade	75 μ F to 1,000,000 μ F	10 to 450	-40°C +85°C	Screw Terminals or PC Mount	1.375 x 2.125 3.000 x 8.625	75
CG	High Reliability Long Life	40 μ F to 160,000 μ F	10 to 450	-40° +105°C	Screw Terminals or PC Mount	1.375 x 2.125 3.000 x 8.625	79
CGH	Very High Capacitance High Ripple Current	350 μ F to 22,000 μ F	250 to 500	-40°C +85°C	Screw Terminals	2.000 x 2.125 3.000 x 8.625	81
CGO	SMPS Output Filter Very Low ESR	2,800 μ F to 45,000 μ F	5 to 55	-40°C +85°C	Low Post Screw Terminals	1.375 x 2.125 1.375 x 5.625	82
CGR	High Ripple Current Long Life	330 μ F to 100,000 μ F	7.5 to 200	-40°C +105°C	Screw Terminals	1.375 x 3.625 3.000 x 5.625	83
HES	High Energy Discharge Capability	300 μ F to 5,600 μ F	350 to 450	-40°C +105°C	Screw Terminals	1.750 x 3.125 3.000 x 5.625	85

See pages 73 and 74 for part number formatting and outline dimensions.

Snap Mount							
LPW	High Capacitance Low Voltage	820 μ F to 22,000 μ F	10 to 100	-40°C +85°C	2 Pin Terminals 10mm Lead Spacing	22mm x 25mm 35mm x 50mm	88
LPX	High Capacitance High Voltage	56 μ F to 2,700 μ F	160 to 450	-40°C +85°C	2 Pin Terminals 10mm Lead Spacing	22mm x 25mm 35mm x 50mm	90
LP	High Temperature Long Life	100 μ F to 47,000 μ F	6.3 to 250	-40°C +105°C	2 Pin Terminals 10mm Lead Spacing	22mm x 25mm 35mm x 50mm	86

Radial Leaded							
SKR	General Purpose	0.47 μ F to 15,000 μ F	6.3 to 450	-40°C +85°C	Radial Leads	5mm x 11mm 18mm x 42mm	93
TKR	Long Life High Reliability	0.47 μ F to 15,000 μ F	6.3 to 400	-40°C +105°C	Radial Leads	5mm x 11mm 18mm x 42mm	95
TMR	Extra Long Life Very High Reliability	0.47 μ F to 4,700 μ F	6.3 to 250	-40°C +105°C	Radial Leads	5mm x 11mm 18mm x 42mm	97
SSR	Sub-Miniature General Purpose	0.10 μ F to 100 μ F	10 to 63	-40°C +85°C	Radial Leads	4mm x 7mm 6.3mm x 7mm	99
NKR	Non-Polar General Purpose	0.47 μ F to 2,200 μ F	6.3 to 100	-40°C +85°C	Radial Leads	5mm x 11mm 16mm x 32mm	100
WGR	Very Low Impedance +105°C Long Life	47 μ F to 4,700 μ F	10 to 100	-55°C +105°C	Radial Leads	8mm x 16mm 18mm x 42mm	102
VPR	Low Impedance Wide Temperature Range	34 μ F to 12,000 μ F	6.3 to 100	-55°C +105°C	Radial Leads	.512 x 1.024 1.000 x 3.625	104

Axial Leaded							
TC	General Purpose	1.0 μ F to 5,000 μ F	16 to 450	-40°C +85°C	Axial Leads	.197 x .472 1.000 x 3.625	106
TCG	General Purpose	10 μ F to 10,000 μ F	10 to 450	-40°C +85°C	Axial Leads	.315 x .787 1.000 x 3.125	108
TCX	Wide Temperature Range Long Life	27 μ F to 12,000 μ F	10 to 150	-55°C +105°C	Axial Leads	.625 x 1.125 1.000 x 3.625	110
TT	See SKA						
SKA	Miniature-Decade Ratings General Purpose	0.47 μ F to 15,000 μ F	6.3 to 450	-40°C +85°C	Axial Leads	6.3mm x 13mm 18mm x 43mm	111

See page 200 for Capacitor Hardware.

Types CGS, CG, CGR, CGO, CGH, HES

Part Number Information

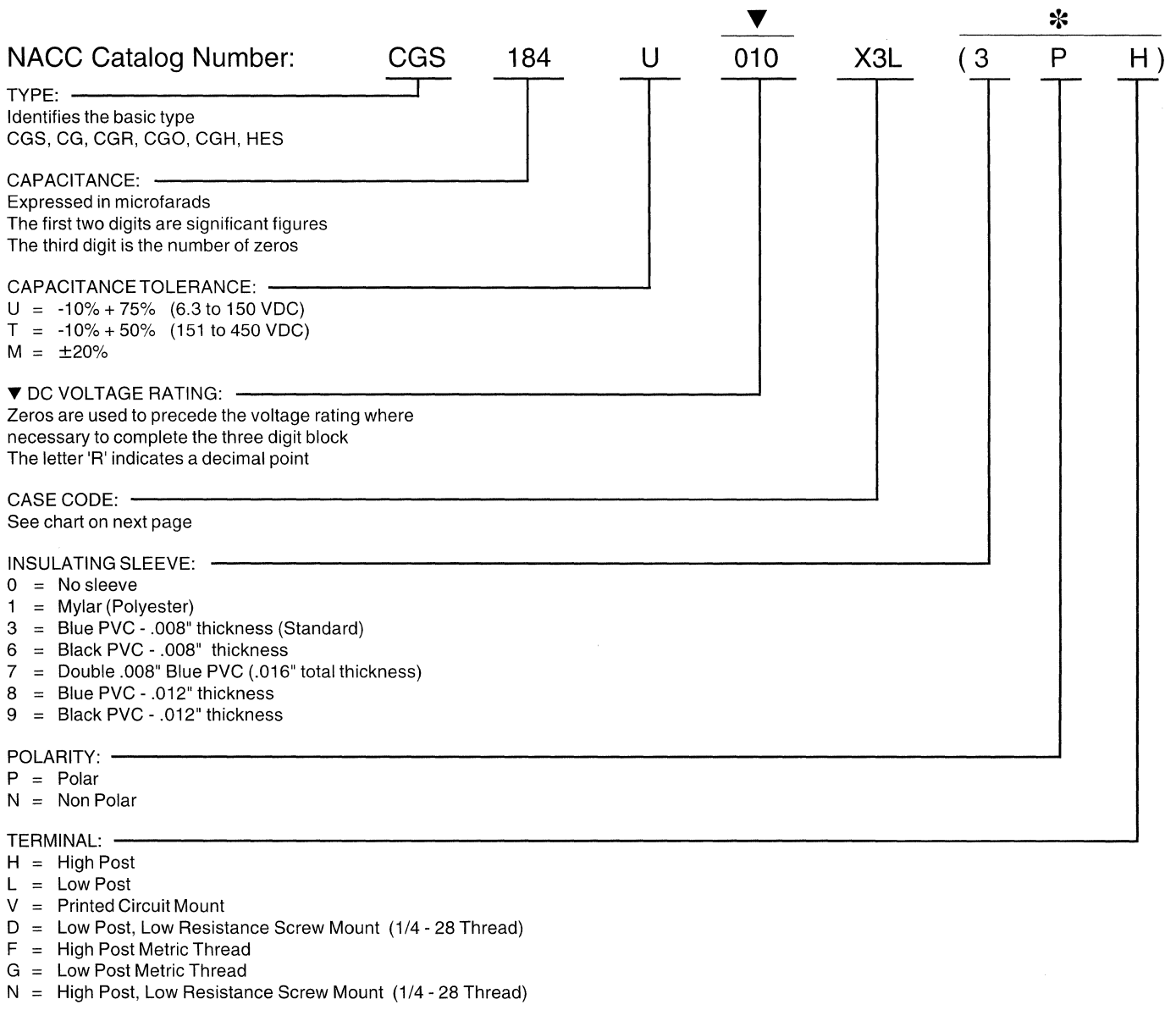

NOTE: * NACC maintains a 15 digit maximum for its part numbering system.
Most parts shown in the General Catalog have PVC sleeving and are polar, with high post terminals.
The 3PH is left off the part number, but is assumed.
Type CGO has a 'L' at the end of the part number which stands for 'low post', while the case code has been omitted.
Check Standard Parts List for case size.

▼ Non-standard part numbers may require coding of the voltage to properly describe the part within the 15 digit limit.
Voltage codes are shown below.

Contact the Product Specialist at NACC if help is needed to properly set up a non-standard part number.

Voltage	Code	Voltage	Code	Voltage	Code	Voltage	Code	Voltage	Code	Voltage	Code
5	A	15-16	F	35	K	60-63	P	200	U	450	Z
6.3	B	20	G	40	L	75	Q	250	V	500	ZZ
7.5	C	25	H	45	M	80	R	300	W		
10	D	28	I	50	N	100	S	350	X		
12	E	30	J	55	O	150	T	400	Y		

Aluminum Capacitors

Types CGS, CG, CGR, CGO, CGH Dimensions and Size Charts



Case Code Chart

Case Code	Inches		mm		Inches	mm	Mounting Bracket
	D	L	D	L			
R2C	1.375	2.125	35	54	.500	12.7	VR3
R2L	1.375	2.625	35	67	.500	12.7	VR3
R3C	1.375	3.125	35	79.4	.500	12.7	VR3
R3L	1.375	3.625	35	92	.500	12.7	VR3
R4C	1.375	4.125	35	105	.500	12.7	VR3
R4L	1.375	4.625	35	117.5	.500	12.7	VR3
R5C	1.375	5.125	35	130	.500	12.7	VR3
R5L	1.375	5.625	35	143	.500	12.7	VR3
U2C	1.750	2.125	44.5	54	.750	19	VR6
U2L	1.750	2.625	44.5	67	.750	19	VR6
U3C	1.750	3.125	44.5	79.4	.750	19	VR6
U3L	1.750	3.625	44.5	92	.750	19	VR6
U4C	1.750	4.125	44.5	105	.750	19	VR6
U4L	1.750	4.625	44.5	117.5	.750	19	VR6
U5C	1.750	5.125	44.5	130	.750	19	VR6
U5L	1.750	5.625	44.5	143	.750	19	VR6
V2C	2.000	2.125	50.8	54	.875	22.2	VR8
V2L	2.000	2.625	50.8	67	.875	22.2	VR8
V3C	2.000	3.125	50.8	79.4	.875	22.2	VR8
V3L	2.000	3.625	50.8	92	.875	22.2	VR8
V4C	2.000	4.125	50.8	105	.875	22.2	VR8
V4L	2.000	4.625	50.8	117.5	.875	22.2	VR8
V5C	2.000	5.125	50.8	130	.875	22.2	VR8
V5L	2.000	5.625	50.8	143	.875	22.2	VR8
W3C	2.500	3.125	63.5	79.4	1.125	28.6	VR10
W3L	2.500	3.625	63.5	92	1.125	28.6	VR10
W4C	2.500	4.125	63.5	105	1.125	28.6	VR10
W4L	2.500	4.625	63.5	117.5	1.125	28.6	VR10
W5C	2.500	5.125	63.5	130	1.125	28.6	VR10
W5L	2.500	5.625	63.5	143	1.125	28.6	VR10
X3L	3.000	3.625	76.2	92	1.250	31.7	VR12
X4C	3.000	4.125	76.2	105	1.250	31.7	VR12
X4L	3.000	4.625	76.2	117.5	1.250	31.7	VR12
X5C	3.000	5.125	76.2	130	1.250	31.7	VR12
X5L	3.000	5.625	76.2	143	1.250	31.7	VR12
X5R	3.000	5.875	76.2	149	1.250	31.7	VR12
X6L	3.000	6.625	76.2	168	1.250	31.7	VR12
X7L	3.000	7.625	76.2	194	1.250	31.7	VR12
X8L	3.000	8.625	76.2	219	1.250	31.7	VR12

Add .015 inches to diameter and .045 inches to length for PVC insulating sleeve.

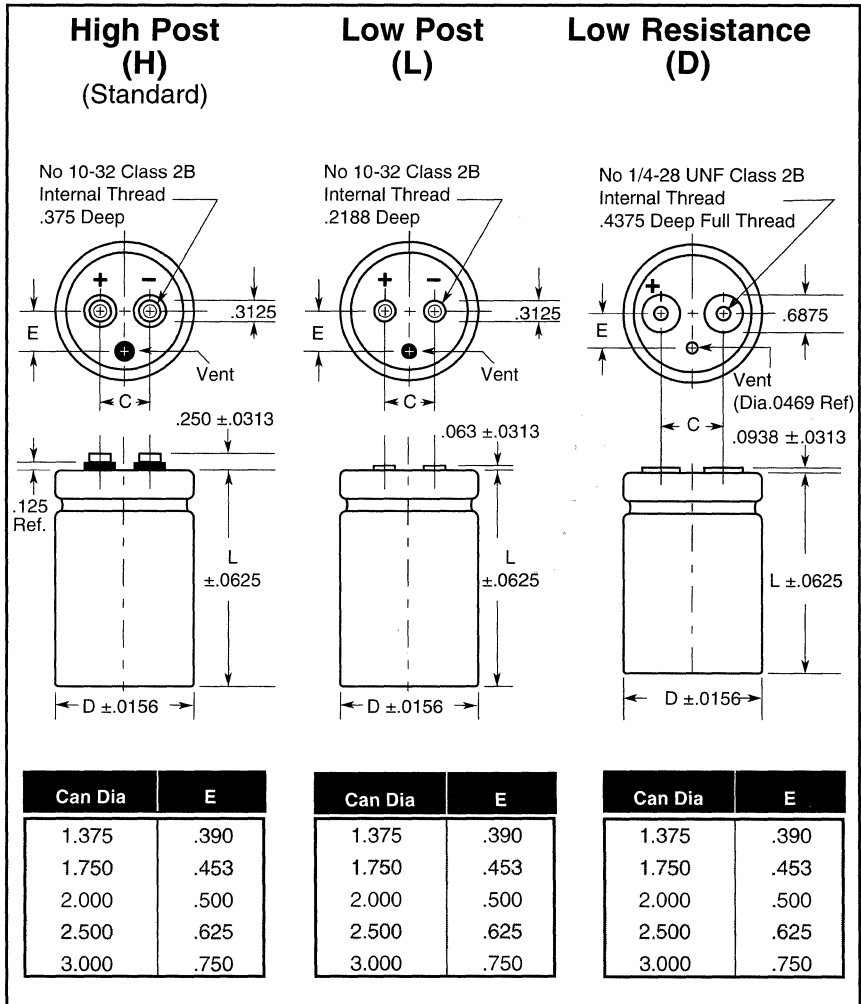

Aluminum Capacitors

PC Mounting Board Dimensions

Case Code	Inches						
	D	L	H	A	B	C	E
R1N	1.375	1.750	1.937	.550	.375	.500	.250
R2C	1.375	2.125	2.312	.550	.375	.500	.250
R2L	1.375	2.625	2.812	.550	.375	.500	.250
R3C	1.375	3.125	3.312	.550	.375	.500	.250
R3L	1.375	3.625	3.812	.550	.375	.500	.250
R4C	1.375	4.125	4.312	.550	.375	.500	.250
R4L	1.375	4.625	4.812	.550	.375	.500	.250
R5C	1.375	5.125	5.312	.550	.375	.500	.250
R5L	1.375	5.625	5.812	.550	.375	.500	.250
V2C	2.000	2.125	2.312	1.000	.575	.800	.400
V2L	2.000	2.625	2.812	1.000	.575	.800	.400
V3C	2.000	3.125	3.312	1.000	.575	.800	.400
V3L	2.000	3.625	3.812	1.000	.575	.800	.400
V4C	2.000	4.125	4.312	1.000	.575	.800	.400
V4L	2.000	4.625	4.812	1.000	.575	.800	.400
V5C	2.000	5.125	5.312	1.000	.575	.800	.400
V5L	2.000	5.625	5.812	1.000	.575	.800	.400

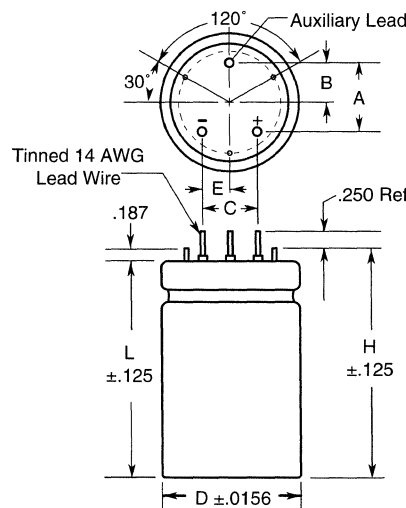

Printed Circuit Board (V)

Type CGS Computer Grade Capacitors

MALLORY

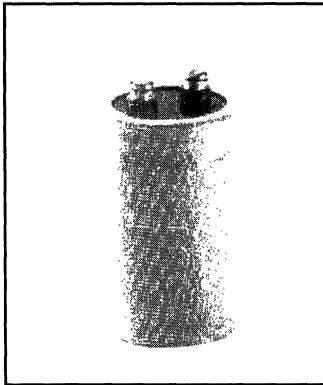

- High CV Product
- Screw Terminals
- Suitable for use in most demanding applications requiring high current filtering or energy storage
- Custom Designs Available Upon Request

GENERAL SPECIFICATIONS

Operating Temperature:
-40°C to +85°C

Voltage Range:
6.3 WVDC to 450 WVDC

Capacitance Range:
75µF to 1,000,000µF

Capacitance Tolerance:
-10% +75% (6.3-150 WVDC)
-10% +50% (200-450 WVDC)

DC Leakage Current:
I = .006 √CV after 30 minutes
Not to exceed 6mA
C = Capacitance in µF
V = Rated Voltage
I = Leakage Current in mA

QA Stability Test:
Apply WVDC for 1,000 hrs at 85°C

- Capacitance change ≤10% from initial limits
- DC leakage current meets initial limits
- ESR ≤ 175% of initial measured value

The maximum ripple current at 85°C and 120 Hz for CGS capacitors is shown in the Standard Rating Table. Maximum ripple current may be adjusted by the multipliers in the following tables:

Rated WVDC	Ripple Multipliers				
	60 Hz	120 Hz	400 Hz	1000Hz	2500KHz
3 to 50	0.8	1.0	1.05	1.10	1.14
51 to 150	0.8	1.0	1.08	1.13	1.16
151 & Up	0.8	1.0	1.15	1.21	1.25

Ambient Temperature	Ripple Multiplier
+85°C	1.00
+75°C	1.4
+65°C	1.7
+55°C	2.0
+45°C	2.2

Cap µF	Max ESR (ohms) @ 120Hz	Max Ripple RMS Amps @ 120Hz +85°C	Dia	Length	Catalog Number
10 WVDC; 12 VDC Surge					
7,200	.035	4.5	1.375	2.125	CGS722U010R2C
12,000	.034	4.6	1.375	2.125	CGS123U010R2C
14,000	.030	4.9	1.375	2.125	CGS143U010R2C
18,000	.078	3.1	1.375	2.125	CGS183U010R2C
20,000	.025	5.9	1.375	2.625	CGS203U010R2L
26,000	.020	7.0	1.375	3.125	CGS263U010R3C
33,000	.018	7.4	1.375	3.125	CGS333U010R3C
44,000	.013	9.4	2.000	2.125	CGS443U010V2C
94,000	.007	16.3	2.000	4.125	CGS943U010V4C
110,000	.008	16.7	2.500	3.625	CGS114U010W3L

Cap µF	Max ESR (ohms) @ 120Hz	Max Ripple RMS Amps @ 120Hz +85°C	Dia	Length	Catalog Number
16 WVDC; 20 VDC Surge					
68,000	.017	9.5	2.000	3.125	CGS683U016V3C
70,000	.008	15.2	2.000	4.125	CGS703U016V4C
77,000	.015	11.8	2.000	4.625	CGS773U016V4L
80,000	.009	18.9	3.000	4.125	CGS803U016X4C
83,000	.015	12.9	2.000	5.625	CGS833U016V5L
91,000	.009	14.7	2.000	4.125	CGS913U016V4C
100,000	.007	22.5	3.000	5.125	CGS104U016X5C
110,000	.010	16.0	2.500	4.125	CGS114U016W4C
120,000	.007	20.1	3.000	3.625	CGS124U016X3L
130,000	.009	17.6	2.500	4.625	CGS134U016W4L
150,000	.007	19.3	3.000	4.125	CGS154U016X4C
170,000	.004	23.5	2.000	4.125	CGS174U016V4C
180,000	.006	24.3	3.000	4.625	CGS184U016X4L
210,000	.005	29.2	3.000	5.875	CGS214U016X5R
220,000	.005	25.2	3.000	4.125	CGS224U016X4C
260,000	.003	29.8	2.000	5.625	CGS264U016V5L
640,000	.002	30.0	3.000	5.625	CGS644U016X5L
640,000	.002	44.9	3.000	5.625	CGS644UFX5L3PD

Cap µF	Max ESR (ohms) @ 120Hz	Max Ripple RMS Amps @ 120Hz +85°C	Dia	Length	Catalog Number
16 WVDC; 20 VDC Surge					
5,500	.037	4.4	1.375	2.125	CGS552U016R2C
8,900	.034	4.6	1.375	2.125	CGS892U016R2C
10,000	.033	4.7	1.375	2.125	CGS103U016R2C
10,000	.024	6.4	1.375	3.125	CGS103U016R3C
12,000	.031	4.8	1.375	2.125	CGS123U016R2C
15,000	.026	5.6	1.375	2.625	CGS153U016R2L
15,000	.061	4.5	1.375	4.125	CGS153U016R4C
17,000	.022	6.7	1.375	3.125	CGS173U016R3C
19,000	.021	6.8	1.375	3.125	CGS193U016R3C
21,000	.037	5.5	1.375	3.625	CGS213U016R3L
23,000	.027	7.6	2.000	3.125	CGS233U016V3C
24,000	.032	5.6	1.375	3.125	CGS243U016R3C
25,000	.016	8.8	1.375	4.125	CGS253U016R4C
25,000	.031	6.1	2.000	2.125	CGS253U016V2C
33,000	.020	7.9	1.375	4.125	CGS333U016R4C
33,000	.028	6.5	2.000	2.125	CGS333U016V2C
34,000	.020	9.8	1.375	4.125	CGS343U016R4C
34,000	.016	8.8	2.000	4.125	CGS343U016V4C
38,000	.019	9.4	1.375	3.125	CGS383U016R3C
38,000	.021	8.6	2.000	3.125	CGS383U016V3C
50,000	.011	11.7	2.000	3.125	CGS503U016V3C
55,000	.015	10.2	1.375	3.625	CGS553U016R3L
55,000	.018	9.6	2.000	3.625	CGS553U016V3L
66,000	.012	11.6	1.375	4.125	CGS663U016R4C
66,000	.017	10.8	2.000	4.125	CGS663U016V4C

Cap µF	Max ESR (ohms) @ 120Hz	Max Ripple RMS Amps @ 120Hz +85°C	Dia	Length	Catalog Number
20 WVDC; 22 VDC Surge					
1,000,000	.002	30.0	3.000	8.625	CGS105UGX8L6PH
1,000,000	.002	50.0	3.000	8.625	CGS105UGX8L6PD

Cap µF	Max ESR (ohms) @ 120Hz	Max Ripple RMS Amps @ 120Hz +85°C	Dia	Length	Catalog Number
25 WVDC; 30 VDC Surge					
3,000	.235	1.8	1.375	2.125	CGS302U025R2C
5,600	.026	6.1	1.375	3.125	CGS562U025R3C
6,000	.035	4.5	1.375	2.125	CGS602U025R2C
6,800	.096	2.8	1.375	2.125	CGS682U025R2C
8,200	.019	8.1	1.375	4.125	CGS822U025R4C
8,900	.024	6.4	1.375	3.125	CGS892U025R3C
10,000	.024	6.4	1.375	3.125	CGS103U025R3C
12,000	.023	6.6	1.375	3.125	CGS123U025R3C
12,000	.024	8.1	2.000	3.125	CGS123U025V3C
13,000	.082	3.9	1.375	4.125	CGS133U025R4C
14,000	.037	5.6	2.000	2.125	CGS143U025V2C
16,000	.017	8.5	1.375	4.125	CGS163U025R4C

Aluminum Capacitors

Type CGS Computer Grade Capacitors



Aluminum Capacitors

Cap μF	Max ESR (ohms) @ 120Hz	Max Ripple RMS Amps @ 120Hz +85°C	Dia	Length	Catalog Number
-----------	---------------------------------	---	-----	--------	-------------------

25 WVDC; 30 VDC Surge

18,000	.017	8.6	1.375	4.125	CGS183U025R4C
18,000	.052	6.1	2.000	4.125	CGS183U025V4C
20,000	.023	6.5	1.375	3.125	CGS203U025R3C
20,000	.014	10.3	1.375	5.125	CGS203U025R5C
20,000	.024	8.0	2.000	3.125	CGS203U025V3C
22,000	.043	5.2	2.000	2.125	CGS223U025V2C
28,000	.028	7.5	2.000	3.125	CGS283U025V3C
29,000	.018	10.5	2.000	4.125	CGS293U025V4C
30,000	.029	8.4	2.500	3.125	CGS303U025W3C
32,000	.018	10.3	2.000	4.125	CGS323U025V4C
33,000	.018	9.3	2.000	3.125	CGS333U025V3C
41,000	.020	9.8	2.000	4.125	CGS413U025V4C
43,000	.022	8.5	1.375	4.125	CGS433U025R4C
43,000	.021	12.2	3.000	4.125	CGS433U025X4C
47,000	.022	9.5	2.000	4.125	CGS473U025V4C
50,000	.018	11.7	2.000	5.625	CGS503U025V5L
50,000	.010	14.9	2.500	3.625	CGS503U025W3L
57,000	.017	14.6	3.000	5.125	CGS573U025X5C
65,000	.009	16.5	2.500	4.125	CGS653U025W4C
68,000	.006	17.9	2.000	4.125	CGS683U025V4C
70,000	.010	18.1	3.000	4.125	CGS703U025X4C
90,000	.007	21.4	2.500	5.625	CGS903U025W5L
92,000	.008	21.6	3.000	5.125	CGS923U025X5C
95,000	.011	16.9	3.000	4.125	CGS953U025X4C
100,000	.005	22.8	2.000	5.625	CGS104U025V5L
100,000	.011	16.0	3.000	3.625	CGS104U025X3L
110,000	.008	20.7	3.000	5.125	CGS114U025X5C
110,000	.009	20.9	3.000	5.625	CGS114U025X5L
120,000	.007	21.6	3.000	4.125	CGS124U025X4C
180,000	.004	30.3	3.000	4.125	CGS184U025X4C
204,000	.006	29.9	3.000	8.625	CGS2043U25X8L
270,000	.003	30.0	3.000	5.625	CGS274U025X5L
270,000	.003	36.6	3.000	5.625	CGS274UHX5L3PD

30 WVDC; 40 VDC Surge

4,500	.037	4.4	1.375	2.125	CGS452U030R2C
5,000	.037	4.5	1.375	2.125	CGS502U030R2C
8,000	.024	6.4	1.375	3.125	CGS802U030R3C
9,200	.024	6.4	1.375	3.125	CGS922U030R3C
12,000	.018	8.4	1.375	4.125	CGS123U030R4C
13,000	.018	8.4	1.375	4.125	CGS133U030R4C
15,000	.016	9.3	1.375	4.625	CGS153U030R4L
20,000	.013	11.0	1.375	5.625	CGS203U030R5L
30,000	.019	10.0	2.000	4.125	CGS303U030V4C
33,000	.020	9.8	2.000	4.125	CGS333U030V4C
44,000	.015	11.7	2.500	3.125	CGS443U030W3C
50,000	.016	12.7	2.000	5.625	CGS503U030V5L
55,000	.009	16.3	2.500	4.125	CGS553U030W4C
78,000	.011	16.8	3.000	4.125	CGS783U030X4C
100,000	.008	22.4	3.000	5.625	CGS104U030X5L

35 WVDC; 45 VDC Surge

4,400	.145	2.2	1.375	2.125	CGS442U035R2C
8,200	.024	6.4	1.375	3.125	CGS822U035R3C
10,000	.038	5.5	2.000	2.125	CGS103U035V2C
12,000	.018	8.4	1.375	4.125	CGS123U035R4C
21,000	.023	6.4	1.375	3.125	CGS213U035R3C
21,000	.029	7.3	2.000	3.125	CGS213U035V3C
30,000	.028	8.6	2.500	3.125	CGS303U035W3C
31,000	.021	9.6	2.000	4.125	CGS313U035V4C
70,000	.012	16.6	3.000	4.125	CGS703U035X4C

Cap μF	Max ESR (ohms) @ 120Hz	Max Ripple RMS Amps @ 120Hz +85°C	Dia	Length	Catalog Number
-----------	---------------------------------	---	-----	--------	-------------------

40 WVDC; 50 VDC Surge

2,200	.044	4.1	1.375	2.125	CGS222U040R2C
2,700	.042	4.2	1.375	2.125	CGS272U040R2C
3,500	.038	4.4	1.375	2.125	CGS352U040R2C
4,200	.028	6.0	1.375	3.125	CGS422U040R3C
4,700	.036	4.5	1.375	2.125	CGS472U040R2C
5,100	.026	6.1	1.375	3.125	CGS512U040R3C
6,000	.025	6.2	1.375	3.125	CGS602U040R3C
6,200	.020	7.9	1.375	4.125	CGS622U040R4C
7,500	.019	8.1	1.375	4.125	CGS752U040R4C
9,000	.019	8.2	1.375	4.125	CGS902U040R4C
9,300	.024	8.1	2.000	3.125	CGS932U040V3C
11,000	.024	8.0	2.000	3.125	CGS113U040V3C
12,000	.049	5.0	1.375	4.125	CGS123U040R4C
12,000	.067	4.2	2.000	2.125	CGS123U040V2C
13,000	.017	10.5	2.000	4.125	CGS133U040V4C
17,000	.025	6.1	1.375	3.125	CGS173U040R3C
17,000	.029	7.4	2.000	3.125	CGS173U040V3C
17,000	.018	10.4	2.000	4.125	CGS173U040V4C
20,000	.014	13.6	2.000	5.625	CGS203U040V5L
22,000	.031	7.1	2.000	3.125	CGS223U040V3C
23,000	.020	9.9	2.000	4.125	CGS233U040V4C
32,000	.021	9.5	2.000	4.125	CGS323U040V4C
33,000	.021	9.7	2.000	4.125	CGS333U040V4C
35,000	.015	12.8	2.000	5.625	CGS353U040V5L
40,000	.014	9.9	2.000	3.125	CGS403U040V3C
40,000	.010	16.3	2.500	4.125	CGS403U040W4C
40,000	.010	18.1	3.000	4.125	CGS403U040X4C
43,000	.020	13.8	3.000	5.125	CGS433U040X5C
47,000	.010	15.8	2.500	4.125	CGS473U040W4C
53,000	.008	21.5	3.000	5.125	CGS533U040X5C
55,000	.011	16.9	2.500	5.625	CGS553U040W5L
68,000	.012	16.0	3.000	4.125	CGS683U040X4C
78,000	.009	22.7	3.000	6.625	CGS783U040X6L
150,000	.003	30.0	3.000	5.625	CGS154U040X5L
150,000	.003	36.6	3.000	5.625	CGS154ULX5L3PD

50 WVDC; 65 VDC Surge

1,600	.048	3.9	1.375	2.125	CGS162U050R2C
2,200	.044	4.1	1.375	2.125	CGS222U050R2C
2,900	.030	5.7	1.375	3.125	CGS292U050R3C
3,000	.040	4.3	1.375	2.125	CGS302U050R2C
3,300	.182	2.0	1.375	2.125	CGS332U050R2C
4,100	.022	7.6	1.375	3.125	CGS412U050R3C
4,300	.022	7.6	1.375	4.125	CGS432U050R4C
4,900	.023	7.0	1.375	3.625	CGS492U050R3L
5,000	.026	6.1	1.375	3.125	CGS502U050R3C
5,700	.096	3.2	1.375	3.125	CGS572U050R3C
6,100	.020	7.9	1.375	4.125	CGS612U050R4C
6,500	.025	7.9	2.000	3.125	CGS652U050V3C
6,700	.022	7.2	1.375	3.625	CGS672U050R3L
6,800	.024	6.4	1.375	3.125	CGS682U050R3C
7,500	.019	8.1	1.375	4.125	CGS752U050R4C
8,000	.043	5.2	2.000	2.125	CGS802U050V2C
9,600	.018	10.3	2.000	4.125	CGS962U050V4C
10,000	.017	8.5	1.375	4.125	CGS103U050R4C
10,000	.049	4.9	2.000	2.125	CGS103U050V2C
12,000	.014	10.7	1.375	5.625	CGS123U050R5L
13,000	.031	6.2	1.375	3.125	CGS133U050R3C
13,000	.029	7.3	2.000	3.125	CGS133U050V3C
14,000	.031	7.1	2.000	5.625	CGS143U050V5L
14,500	.022	7.3	2.000	3.125	CGS1452U050V3C
15,000	.019	10.0	2.000	4.125	CGS153U050V4C
18,000	.034	6.8	2.000	3.125	CGS183U050V3C
20,000	.019	8.2	1.375	4.125	CGS203U050R4C
20,000	.021	9.5	2.000	4.125	CGS203U050V4C

Type CGS Computer Grade Capacitors

MALLORY

Cap μF	Max ESR (ohms) @ 120Hz	Max Ripple RMS Amps @ 120Hz +85°C	Dia	Length	Catalog Number
50 WVDC; 65 VDC Surge					
20,000	.014	13.2	2.000	5.625	CGS203U050V5L
24,000	.014	12.1	2.500	3.125	CGS243U050W3C
25,000	.021	9.8	1.750	4.125	CGS253U050U4C
25,000	.024	10.2	2.500	4.125	CGS253U050W4C
27,000	.022	9.3	2.000	4.125	CGS273U050V4C
28,000	.018	11.4	2.000	5.125	CGS283U050V5C
30,000	.016	12.4	2.000	5.625	CGS303U050V5L
31,000	.028	9.6	2.500	4.125	CGS313U050W4C
33,000	.025	10.0	2.500	4.125	CGS333U050W4C
41,000	.009	19.2	3.000	4.625	CGS413U050X4L
43,000	.023	12.7	3.000	5.125	CGS433U050X5C
48,000	.012	16.2	3.000	4.125	CGS483U050X4C
50,000	.008	20.4	2.500	5.625	CGS503U050W5L
56,000	.005	23.1	3.000	3.625	CGS563U050X3L
60,000	.010	19.8	3.000	5.125	CGS603U050X5C
63,000	.017	16.1	3.000	6.625	CGS633U050X6L
70,000	.016	15.7	3.000	5.625	CGS703U050X5L
82,000	.004	29.2	3.000	4.125	CGS823U050X4C
100,000	.007	29.3	3.000	8.625	CGS104U050X8L
120,000	.003	30.0	3.000	5.625	CGS124U050X5L
120,000	.003	36.6	3.000	5.625	CGS124UNX5L3PD

Cap μF	Max ESR (ohms) @ 120Hz	Max Ripple RMS Amps @ 120Hz +85°C	Dia	Length	Catalog Number
75 WVDC; 95 VDC Surge					
820	.591	1.1	1.375	2.125	CGS821U075R2C
1,500	.041	4.9	1.375	3.125	CGS152U075R3C
2,100	.036	5.3	1.375	3.125	CGS212U075R3C
2,200	.041	4.2	1.375	2.125	CGS222U075R2C
2,300	.028	6.6	1.375	4.125	CGS232U075R4C
2,900	.032	5.6	1.375	3.125	CGS292U075R3C
3,300	.120	2.9	1.375	3.125	CGS332U075R3C
4,200	.023	7.4	1.375	4.125	CGS422U075R4C
4,800	.031	6.7	1.375	3.125	CGS482U075R3C
4,800	.030	7.2	2.000	3.125	CGS482U075V3C
5,600	.021	7.8	1.375	4.125	CGS562U075R4C
6,300	.017	9.8	1.375	5.625	CGS632U075R5L
7,100	.022	9.5	2.000	4.125	CGS712U075V4C
7,300	.078	4.5	2.000	3.125	CGS732U075V3C
7,500	.017	12.3	2.000	5.625	CGS752U075V5L
10,000	.029	5.8	1.375	3.125	CGS103U075R3C
10,000	.041	6.2	2.000	3.125	CGS103U075V3C
10,000	.024	9.0	2.000	4.125	CGS103U075V4C
12,000	.021	7.6	1.375	4.125	CGS123U075R4C
12,000	.026	8.7	2.000	4.125	CGS123U075V4C
15,000	.018	11.9	2.000	5.625	CGS153U075V5L
17,000	.033	8.8	2.500	4.125	CGS173U075W4C
17,000	.033	9.8	3.000	4.125	CGS173U075X4C
18,000	.009	14.5	2.000	4.125	CGS183U075V4C
25,000	.024	11.7	2.500	5.625	CGS253U075W5L
25,000	.039	9.0	3.000	4.125	CGS253U075LA
25,000	.014	15.0	3.000	4.125	CGS253U075X4C
26,000	.028	10.3	2.000	4.125	CGS263U075V4C
26,000	.037	10.6	3.000	5.875	CGS263U075X5R
27,000	.019	12.5	3.000	3.625	CGS273U075X3L
33,000	.019	12.7	3.000	4.125	CGS333U075X4C
37,000	.011	16.4	2.000	5.625	CGS373U075V5L
37,000	.010	19.7	3.000	5.625	CGS373U075X5L
55,000	.008	27.4	3.000	8.625	CGS553U075X8L
68,000	.005	30.0	3.000	5.625	CGS683U075X5L

Cap μF	Max ESR (ohms) @ 120Hz	Max Ripple RMS Amps @ 120Hz +85°C	Dia	Length	Catalog Number
100 WVDC; 125 VDC Surge					
850	.120	2.5	1.375	2.125	CGS851U100R2C
1,200	.062	3.5	1.375	3.125	CGS122U100R3C
1,700	.069	3.8	1.375	3.125	CGS172U100R3C
2,400	.050	5.0	1.375	4.125	CGS242U100R4C
3,100	.036	6.4	1.375	5.125	CGS312U100R5C
4,000	.031	6.2	1.375	4.125	CGS402U100R4C
4,000	.036	7.3	2.000	4.125	CGS402U100V4C
6,000	.033	7.6	2.000	4.125	CGS602U100V4C
9,000	.024	10.2	2.000	5.625	CGS902U100V5L
10,000	.040	8.0	2.500	4.125	CGS103U100W4C
15,000	.036	7.3	2.000	4.125	CGS153U100V4C
15,000	.043	8.6	2.500	5.625	CGS153U100V5L
15,000	.051	7.9	3.000	4.125	CGS153U100X4C
33,000	.009	25.0	3.000	8.625	CGS333U100X8L

Cap μF	Max ESR (ohms) @ 120Hz	Max Ripple RMS Amps @ 120Hz +85°C	Dia	Length	Catalog Number
150 WVDC; 175 VDC Surge					
400	.137	2.3	1.375	2.125	CGS401U150R2C
720	.063	3.5	1.375	3.125	CGS721U150R3C
950	.087	3.4	1.375	3.125	CGS951U150R3C
1,100	.064	4.4	1.375	4.125	CGS112U150R4C
2,400	.117	3.7	2.000	3.125	CGS242U150V3C
3,300	.032	8.4	2.000	5.125	CGS332U150V5C
3,500	.031	11.4	2.000	5.625	CGS352U150V5L
4,800	.030	9.5	2.500	4.625	CGS482U150W4L
5,700	.037	9.3	3.000	4.125	CGS572U150X4C
6,200	.025	11.4	2.500	5.625	CGS622U150W5L
7,700	.029	11.3	3.000	5.125	CGS772U150X5C
8,700	.027	12.5	3.000	5.875	CGS872U150X5R
10,000	.034	10.4	3.000	5.125	CGS103U150X5C
12,000	.014	16.5	2.000	5.625	CGS123U150V5L
12,000	.013	17.8	3.000	5.625	CGS123U150X5L

Cap μF	Max ESR (ohms) @ 120Hz	Max Ripple RMS Amps @ 120Hz +85°C	Dia	Length	Catalog Number
200 WVDC; 250 VDC Surge					
590	.151	2.6	1.375	3.125	CGS591T200R3C
1,000	.097	3.6	1.375	4.125	CGS102T200R4C
1,000	.113	3.2	2.000	2.125	CGS102T200V2C
1,400	.081	4.4	2.000	3.125	CGS142T200V3C
1,600	.074	4.6	2.000	3.125	CGS162T200V3C
2,000	.057	5.8	2.000	4.125	CGS202T200V4C
2,200	.054	6.0	2.000	4.125	CGS222T200V4C
2,700	.048	6.4	2.000	4.125	CGS272T200V4C
3,300	.060	6.5	2.500	4.125	CGS332T200W4C
3,400	.076	5.8	2.500	4.125	CGS342T200W4C
3,600	.042	6.7	2.000	4.125	CGS362T200V4C
4,000	.062	5.0	2.000	3.125	CGS402T200V3C
4,000	.055	6.8	2.500	4.125	CGS402T200W4C
4,600	.047	8.2	3.000	4.125	CGS462T200X4C
4,800	.042	6.8	2.000	4.125	CGS482T200V4C
5,000	.036	9.2	2.500	5.125	CGS502T200W5C
5,200	.021	11.0	2.000	5.625	CGS522T200V5L
5,400	.021	12.6	3.000	4.625	CGS542T200X4L
6,200	.039	9.0	3.000	4.125	CGS622T200X4C
7,200	.019	11.5	2.000	5.625	CGS722T200V5L
7,400	.018	15.0	3.000	5.625	CGS742T200X5L
7,700	.018	15.0	3.000	5.625	CGS772T200X5L
9,400	.021	12.1	3.000	4.125	CGS942T200X4C
14,000	.015	16.1	3.000	5.625	CGS143T200X5L
18,000	.016	15.9	3.000	5.625	CGS183T200X5L
30,000	.011	22.7	3.000	8.625	CGS303T200X8L

Aluminum Capacitors

Type CGS Computer Grade Capacitors



Cap μF	Max ESR (ohms) @ 120Hz	Max Ripple RMS Amps @ 120Hz +85°C	Dia	Length	Catalog Number
-----------	---------------------------------	---	-----	--------	-------------------

250 WVDC; 300 VDC Surge

200	.241	1.7	1.375	2.125	CGS201T250R2C
250	.278	1.6	1.375	2.125	CGS251T250R2C
470	.438	1.5	1.375	3.125	CGS471T250R3C
550	.098	3.6	1.375	4.125	CGS551T250R4C
720	.110	3.4	1.375	4.125	CGS721T250R4C
1,000	.078	4.6	1.375	5.625	CGS102T250R5L
1,200	.080	4.4	2.000	3.125	CGS122T250V3C
1,700	.057	5.8	2.000	4.125	CGS172T250V4C
1,900	.105	4.9	2.000	5.625	CGS192T250V5L
2,500	.041	7.8	2.000	5.625	CGS252T250V5L
2,800	.046	6.5	2.000	4.125	CGS282T250V4C
2,900	.043	8.0	2.500	4.625	CGS292T250W4L
2,900	.050	8.0	3.000	4.125	CGS292T250X4C
4,100	.021	10.7	2.000	5.625	CGS412T250V5L
4,200	.023	11.9	2.500	5.625	CGS422T250W5L
6,000	.022	10.1	2.000	5.625	CGS602T250V5L
6,000	.047	9.2	3.000	5.625	CGS602T250X5L
7,200	.023	11.7	3.000	4.125	CGS722T250X4C
10,000	.016	15.6	3.000	5.625	CGS103T250X5L

300 WVDC; 350 VDC Surge

1,500	.107	4.9	2.500	4.125	CGS152T300W4C
3,500	.066	7.8	3.000	5.625	CGS352T300X5L
4,000	.058	8.3	3.000	5.625	CGS402T300X5L
6,000	.022	15.9	3.000	8.625	CGS602T300X8L

350 WVDC; 400 VDC Surge

130	.683	1.0	1.375	2.125	CGS131T350R2C
250	.478	1.4	1.375	3.125	CGS251T350R3C
380	.318	2.0	1.375	4.125	CGS381T350R4C
650	.212	2.7	2.000	3.125	CGS651T350V3C
800	.170	3.4	2.000	4.125	CGS801T350V4C
1,000	.111	3.3	1.375	4.125	CGS102T350R4C
1,000	.140	3.7	2.000	4.125	CGS102T350V4C
1,300	.108	4.8	2.000	5.625	CGS132T350V5L
1,500	.123	4.5	2.500	4.125	CGS152T350W4C
1,600	.072	5.2	2.000	4.125	CGS162T350V4C
2,100	.067	5.4	3.000	4.125	CGS212T350X4C
2,200	.063	7.2	2.500	5.625	CGS222T350W5L
2,400	.040	7.9	2.000	5.625	CGS242T350V5L
3,000	.048	9.3	3.000	5.875	CGS302T350X5R
3,300	.038	8.1	2.000	5.625	CGS332T350V5L
3,300	.044	9.5	3.000	5.625	CGS332T350X5L
3,400	.043	9.6	3.000	5.625	CGS342T350X5L
4,200	.035	9.4	3.000	4.125	CGS422T350X4C
6,300	.025	12.7	3.000	5.625	CGS632T350X5L

Cap μF	Max ESR (ohms) @ 120Hz	Max Ripple RMS Amps @ 120Hz +85°C	Dia	Length	Catalog Number
-----------	---------------------------------	---	-----	--------	-------------------

450 WVDC; 525 VDC Surge

75	.835	.9	1.375	2.125	CGS750T450R2C
100	.737	1.0	1.375	2.125	CGS101T450R2C
140	.496	1.4	1.375	3.125	CGS141T450R3C
170	.456	1.5	1.375	3.125	CGS171T450R3C
210	.332	1.9	1.375	4.125	CGS211T450R4C
250	.308	2.0	1.375	4.125	CGS251T450R4C
320	.253	2.5	2.000	3.125	CGS321T450V3C
350	.226	3.2	1.375	5.125	CGS351T450R5C
400	.198	2.9	1.375	5.625	CGS401T450R5L
450	.188	2.9	2.000	3.125	CGS451T450V3C
480	.171	3.4	2.000	4.125	CGS481T450V4C
650	.154	3.7	2.000	4.125	CGS651T450V4C
800	.108	4.4	2.000	4.625	CGS801T450V4L
970	.096	4.5	2.000	4.125	CGS971T450V4C
1,000	.082	5.5	2.500	4.125	CGS102T450W4C
1,100	.076	6.5	3.000	4.125	CGS112T450X4C
1,400	.059	6.5	2.000	5.625	CGS142T450V5L
1,400	.060	7.1	2.500	5.125	CGS142T450W5C
1,500	.059	7.4	3.000	4.125	CGS152T450X4C
1,500	.057	8.1	3.000	5.125	CGS152T450X5C
1,800	.048	9.3	3.000	5.875	CGS182T450X5R
2,000	.045	9.1	3.000	5.125	CGS202T450X5C
2,200	.045	8.4	3.000	4.125	CGS222T450X4C
2,400	.048	7.2	2.500	4.125	CGS242T450W4C
2,400	.038	10.3	3.000	5.625	CGS242T450X5L
3,300	.031	11.4	3.000	5.625	CGS332T450X5L

Type CG Computer Grade Capacitors

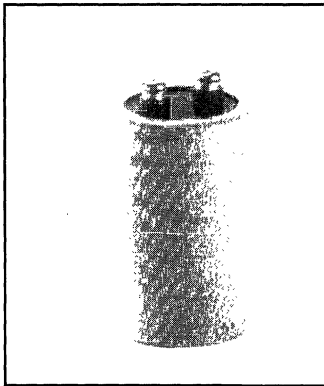

- High Reliability 105°C
- Screw Terminals
- Long Life
- Custom Designs Available Upon Request

GENERAL SPECIFICATIONS

Operating Temperature:
-40°C to +105°C

Voltage Range:
10 WVDC to 450 WVDC

Capacitance Range:
40 μ F to 160,000 μ F

Capacitance Tolerance:
-10% +75% (10 - 150 WVDC)
-10% +50% (151 - 450 WVDC)

DC Leakage Current:
I = 6×10^{-6} CV after 30 minutes
Not to exceed 4.0mA
C = Capacitance in μ F
V = Rated Voltage
I = Leakage Current in mA

QA Stability Test:
Apply WVDC for 2,000 hrs at 85°C

- Capacitance change \leq 15% from initial limits
- DC leakage current meets initial limits
- ESR \leq 175% of initial measured value

The maximum ripple current at 85°C and 120 Hz for CG capacitors is shown in the Standard Rating Table. Maximum ripple current may be adjusted by the multipliers in the following tables:

Rated WVDC	Ripple Multipliers				
	120 Hz	400 Hz	1000 Hz	2500Hz	10KHz
10 to 75	1.0	1.050	1.085	1.135	1.150
76 to 250	1.0	1.075	1.125	1.155	1.210
251 to 450	1.0	1.080	1.130	1.175	1.230

Ambient Temperature	Ripple Multiplier
+85°C	1.00
+65°C	1.42
+55°C	1.58
+45°C	1.72
+35°C	1.88
+25°C	2.00

Cap μ F	Max ESR (ohms) @ 120Hz	Max Ripple RMS Amps @ 120Hz +85°C	Dia	Length	Catalog Number
-------------	------------------------	-----------------------------------	-----	--------	----------------

10 WVDC; 15 VDC Surge

160,000	.006	27.10	3.000	5.625	CG164U010X5L
---------	------	-------	-------	-------	--------------

16 WVDC; 20 VDC Surge

2,500	.047	3.90	1.375	2.125	CG252U016R2C
6,500	.039	4.30	1.375	2.125	CG652U016R2C
10,500	.027	7.60	2.000	3.125	CG1052U016V3C
12,000	.024	6.40	1.375	3.125	CG123U016R3C
18,000	.018	8.30	1.375	4.125	CG183U016R4C
21,000	.012	10.50	1.750	3.125	CG213U016U3C
27,000	.012	11.40	2.000	3.125	CG273U016V3C
40,000	.009	14.70	2.000	4.125	CG403U016V4C

25 WVDC; 40 VDC Surge

1,500	.058	3.50	1.375	2.125	CG152U025R2C
2,800	.036	5.20	1.375	3.125	CG282U025R3C
3,300	.043	4.10	1.375	2.125	CG332U025R2C
4,500	.006	14.80	1.750	3.125	CG452U025U3C
6,000	.029	7.30	2.000	3.125	CG602U025V3C
6,300	.028	5.90	1.375	3.125	CG632U025R3C
8,500	.022	9.40	2.000	4.125	CG852U025V4C
9,200	.022	7.50	1.375	4.125	CG922U025R4C
10,000	.026	7.10	1.750	3.125	CG103U025U3C
13,000	.024	8.00	2.000	3.125	CG133U025V3C
20,000	.019	10.10	2.000	4.125	CG203U025V4C
20,000	.019	12.90	3.000	4.125	CG203U025X4C
32,000	.010	15.90	2.500	4.125	CG323U025W4C
48,000	.005	25.20	3.000	4.125	CG483U025X4C

35 WVDC; 50 VDC Surge

1,100	0.063	3.40	1.375	2.125	CG112U035R2C
2,100	0.039	5.00	1.375	3.125	CG212U035R3C
2,300	0.051	3.80	1.375	2.125	CG232U035R2C
4,300	0.030	5.70	1.375	3.125	CG432U035R3C
9,500	0.025	7.90	2.000	3.125	CG952U035V3C

Cap μ F	Max ESR (ohms) @ 120Hz	Max Ripple RMS Amps @ 120Hz +85°C	Dia	Length	Catalog Number
-------------	------------------------	-----------------------------------	-----	--------	----------------

35 WVDC; 50 VDC Surge

11,000	0.021	11.00	2.500	4.125	CG113U035W4C
11,000	0.020	9.10	1.750	4.125	CG113U035U4C
14,000	0.018	10.40	2.000	4.125	CG143U035V4C
22,000	0.011	15.20	2.500	4.125	CG223U035W4C
33,000	0.006	23.00	3.000	4.125	CG333U035X4C

50 WVDC; 75 VDC Surge

800	0.072	3.20	1.375	2.125	CG801U050R2C
1,500	0.058	3.50	1.375	2.125	CG152U050R2C
1,500	0.044	4.70	1.375	3.125	CG152U050R3C
2,000	0.033	6.10	1.375	4.125	CG202U050R4C
2,500	0.037	6.00	1.750	3.125	CG252U050U3C
2,900	0.036	5.20	1.375	3.125	CG292U050R3C
3,300	0.035	6.70	2.000	3.125	CG332U050V3C
4,300	0.026	6.90	1.375	4.125	CG432U050R4C
4,500	0.026	8.60	2.000	4.125	CG452U050V4C
5,000	0.029	6.70	1.750	3.125	CG502U050U3C
6,500	0.017	9.60	2.000	3.125	CG652U050V3C
7,300	0.023	10.50	2.500	4.125	CG732U050W4C
7,400	0.022	8.70	1.750	4.125	CG742U050U4C
9,500	0.013	12.20	2.000	4.125	CG952U050V4C
10,000	0.013	15.60	3.000	4.125	CG103U050X4C
15,000	0.009	16.80	2.500	4.125	CG153U050W4C
16,500	0.010	20.50	3.000	5.625	CG1652U050X5L
22,000	0.006	22.50	3.000	4.125	CG223U050X4C
33,000	0.005	29.00	3.000	5.625	CG333U050X5L

75 WVDC; 100 VDC Surge

600	0.085	2.90	1.375	2.125	CG601U075R2C
800	0.072	3.20	1.375	2.125	CG801U075R2C
1,000	0.053	4.30	1.375	3.125	CG102U075R3C
1,500	0.037	5.80	1.375	4.125	CG152U075R4C
1,500	0.045	4.70	1.375	3.125	CG152U075R3C
2,000	0.039	5.80	1.750	3.125	CG202U075U3C
2,500	0.036	6.60	2.000	3.125	CG252U075V3C

Aluminum Capacitors

Type CG Computer Grade Capacitors



Cap μF	Max ESR (ohms) @ 120Hz	Max Ripple RMS Amps @ 120Hz +85°C	Dia	Length	Catalog Number
75 WVDC; 100 VDC Surge					
2,600	0.035	6.10	1.750	3.125	CG262U075U3C
3,300	0.022	8.40	2.000	3.125	CG332U075V3C
3,450	0.027	8.50	2.000	4.125	CG3451U075V4C
4,900	0.015	11.30	2.000	4.125	CG492U075V4C
7,900	0.012	14.50	2.500	4.125	CG792U075W4C
8,200	0.012	16.30	3.000	4.125	CG822U075X4C
11,000	0.009	18.80	3.000	4.125	CG113U075X4C
12,500	0.009	21.80	3.000	5.625	CG1252U075X5L
100 WVDC; 135 VDC Surge					
400	0.180	2.00	1.375	2.125	CG401U100R2C
1,000	0.068	4.30	1.375	4.125	CG102U100R4C
1,300	0.066	4.50	1.750	3.125	CG132U100U3C
1,700	0.050	5.70	1.750	4.125	CG172U100W4C
2,250	0.036	7.30	2.000	4.125	CG2251U100V4C
2,500	0.030	8.00	2.000	4.125	CG252U100V4C
3,600	0.020	11.30	2.500	4.125	CG362U100W4C
4,000	0.019	11.50	2.500	4.125	CG402U100W4C
150 WVDC; 185 VDC Surge					
275	0.170	2.10	1.375	2.125	CG2750U150R2C
500	0.103	3.10	1.375	3.125	CG501U150R3C
1,550	0.052	6.10	2.000	4.125	CG1551U150V4C
2,500	0.030	9.20	2.500	4.125	CG252U150W4C
3,600	0.022	9.40	3.000	4.125	CG362U150X4C
5,600	0.014	17.00	3.000	3.625	CG562U150X3L
200 WVDC; 250 VDC Surge					
180	0.280	1.60	1.375	2.125	CG181T200R2C
450	0.120	3.20	1.375	4.125	CG451T200R4C
550	0.150	3.00	1.750	3.125	CG551T200U3C
750	0.085	4.80	2.000	3.125	CG751T200V3C
1,000	0.050	7.10	2.000	4.125	CG102T200V4C
1,650	0.102	3.90	2.500	4.125	CG1651T200W4C
2,450	0.034	9.70	3.000	4.125	CG2451T200X4C
3,800	0.023	13.20	3.000	5.625	CG382T200X5L

Cap μF	Max ESR (ohms) @ 120Hz	Max Ripple RMS Amps @ 120Hz +85°C	Dia	Length	Catalog Number
250 WVDC; 300 VDC Surge					
140	0.310	1.50	1.375	2.125	CG141T250R2C
375	0.130	3.10	1.375	4.125	CG3750T250R4C
600	0.091	4.10	2.000	3.125	CG601T250V3C
800	0.072	4.60	2.000	4.125	CG801T250V4C
3,000	0.020	14.20	3.000	5.625	CG302T250X5L
300 WVDC; 350 VDC Surge					
525	0.095	4.00	2.000	3.125	CG5250T300V3C
350 WVDC; 400 VDC Surge					
100	0.720	1.00	1.375	2.125	CG101T350R2C
180	0.500	1.40	1.375	3.125	CG181T350R3C
250	0.290	2.10	1.375	4.125	CG251T350R4C
400	0.260	2.40	2.000	3.125	CG401T350V3C
550	0.180	3.30	2.000	4.125	CG551T350V4C
2,000	0.061	8.10	3.000	5.625	CG202T350X5L
400 WVDC; 475 VDC Surge					
325	0.220	3.00	2.000	4.125	CG3250T400V4C
450 WVDC; 525 VDC Surge					
40	3.240	0.50	1.375	2.125	CG400T450R2C
110	1.220	1.00	1.375	4.125	CG111T450R4C
240	0.330	2.40	2.000	4.125	CG241T450V4C

Aluminum Capacitors

Type CGH Computer Grade Capacitors

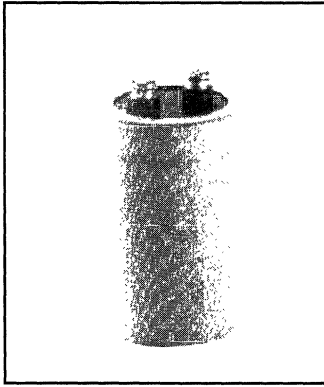

- High Ripple Current
- Very High Capacitance
- High Reliability
- Suitable for Use in Most AC Drive and UPS Applications

GENERAL SPECIFICATIONS

Operating Temperature:
-40°C to +85°C

Voltage Range:
250 WVDC to 500 WVDC

Capacitance Range:
350 μ F to 22,000 μ F

Capacitance Tolerance:
-10% +50%

DC Leakage Current:
I = .006 \sqrt{CV} after 5 minutes
Not to exceed 6mA
C = Capacitance in μ F
V = Rated Voltage
I = Leakage Current in mA

- QA Stability Test:
Apply WVDC for 2,000 hrs at 85°C
- Capacitance change \leq 10% from initial limits
 - DC leakage current meets initial limits
 - ESR \leq 175% of initial measured value

The maximum ripple current at 85°C and 120 Hz for CGH capacitors is shown in the Standard Rating Table. Maximum ripple current may be adjusted by the multipliers in the following tables.

Rated WVDC	Ripple Multipliers				
	120Hz	400Hz	1000Hz	2500Hz	10kHz
250 to 500	1.00	1.08	1.113	1.175	1.23

Ambient Temperature	Ripple Multiplier
+85°C	1.0
+75°C	1.4
+65°C	1.7
+55°C	2.0
+45°C	2.25
+35°C	2.45

Cap μ F	Max ESR (mOHMS)		Max Ripple RMS Amps		Dia	Length	Catalog Number High Post
	120 Hz	20 kHz	120 Hz	20 kHz			

Cap μ F	Max ESR (mOHMS)		Max Ripple RMS Amps		Dia	Length	Catalog Number High Post
	120 Hz	20 kHz	120 Hz	20 kHz			

250 WVDC; 300 VDC Surge

1,700	65.8	42.1	4.0	5.0	2.000	2.625	CGH172T250V2L
2,900	53.1	34.0	5.7	7.1	2.000	3.625	CGH292T250V3L
4,100	25.7	16.4	9.1	11.4	2.000	4.625	CGH412T250V4L
5,000	26.9	17.2	9.2	11.5	2.500	3.625	CGH502T250W3L
5,300	20.6	13.2	11.0	13.8	2.000	5.625	CGH532T250V5L
7,000	20.1	12.9	11.7	14.6	2.500	4.625	CGH702T250W4L
7,400	27.1	17.3	10.3	12.9	3.000	3.625	CGH742T250X3L
9,000	16.3	10.4	14.1	17.6	2.500	5.625	CGH902T250W5L
10,000	20.4	13.1	13.0	16.3	3.000	4.625	CGH103T250X4L
13,000	16.8	10.8	15.6	19.5	3.000	5.625	CGH133T250X5L
22,000	11.5	7.4	22.3	27.9	3.000	8.625	CGH223T250X8L

450 WVDC; 525 VDC Surge

620	159.6	102.1	2.9	3.6	2.000	2.625	CGH621T450V2L
1,000	83.4	53.4	4.8	6.0	2.000	3.625	CGH102T450V3L
1,400	60.3	38.6	5.9	7.4	2.000	4.625	CGH142T450V4L
1,700	55.3	35.4	6.4	8.0	2.500	3.625	CGH172T450W3L
1,800	47.6	30.5	7.2	9.0	2.000	5.625	CGH182T450V5L
2,400	40.1	25.7	8.3	10.4	2.500	4.625	CGH242T450W4L
2,500	44.9	28.7	8.0	10.0	3.000	3.625	CGH252T450X3L
3,100	31.7	20.3	10.1	12.6	2.500	5.625	CGH312T450W5L
3,600	32.6	20.9	10.3	12.9	3.000	4.625	CGH362T450X4L
4,600	26.2	16.8	12.4	15.5	3.000	5.625	CGH462T450X5L
7,700	17.3	11.1	18.2	22.8	3.000	8.625	CGH772T450X8L

350 WVDC; 400 VDC Surge

1,000	162.6	104.1	2.9	3.6	2.000	2.625	CGH102T350V2L
1,700	81.9	52.4	4.6	5.8	2.000	3.625	CGH172T350V3L
2,400	58.8	37.6	6.0	7.5	2.000	4.625	CGH242T350V4L
2,700	54.3	34.8	6.5	8.1	2.500	3.625	CGH272T350W3L
2,900	53.1	34.0	6.8	8.5	2.500	3.625	CGH292T350W3L
3,100	46.2	29.6	7.4	9.3	2.000	5.625	CGH312T350V5L
3,800	39.3	25.2	8.4	10.5	2.500	4.625	CGH382T350W4L
4,000	44.3	28.4	8.1	10.1	3.000	3.625	CGH402T350X3L
4,100	38.6	24.7	8.6	10.8	2.500	4.625	CGH412T350W4L
4,300	43.5	27.8	8.4	10.5	3.000	3.625	CGH432T350X3L
4,900	31.5	20.2	10.1	12.6	2.500	5.625	CGH492T350W5L
5,200	31.1	19.9	10.3	12.9	2.500	5.625	CGH522T350W5L
5,700	32.5	20.8	10.3	12.9	3.000	4.625	CGH572T350X4L
6,000	32.3	20.7	10.6	13.3	3.000	4.625	CGH602T350X4L
7,300	25.9	16.6	12.5	15.6	3.000	5.625	CGH732T350X5L
7,800	25.6	16.4	12.8	16.0	3.000	5.625	CGH782T350X5L
10,000	20.7	13.2	16.6	20.8	3.000	8.625	CGH103T350X8L

500 WVDC; 550 VDC Surge

350	692.0	612.0	1.3	1.5	2.000	2.125	CGH351T500V2C
520	470.0	416.0	1.7	1.9	2.000	2.625	CGH521T500V2L
710	345.0	305.0	2.1	2.4	2.000	3.125	CGH711T500V3C
900	272.0	241.0	2.5	2.8	2.000	3.625	CGH901T500V3L
1100	225.0	199.0	3.1	3.3	2.000	4.125	CGH112T500V4C
1200	218.0	196.0	3.1	3.4	2.500	3.125	CGH122T500W3C
1300	192.0	170.0	3.3	3.7	2.000	4.625	CGH132T500V4L
1500	168.0	148.0	3.7	4.1	2.000	5.125	CGH152T500V5C
1500	172.0	153.0	3.6	4.1	2.500	3.625	CGH152T500W3L
1700	149.0	132.0	4.0	4.5	2.000	5.625	CGH172T500V5L
1800	142.0	126.0	4.2	4.7	2.500	4.125	CGH182T500W4C
2100	121.0	108.0	4.8	5.3	2.500	4.625	CGH212T500W4L
2200	124.0	111.0	4.8	5.4	3.000	3.625	CGH222T500X3L
2400	106.0	94.1	5.3	6.0	2.500	5.125	CGH242T500W5C
2700	93.9	83.5	5.9	6.6	2.500	5.625	CGH272T500W5L
2700	103.0	91.8	5.6	6.3	3.000	4.125	CGH272T500X4C
3100	87.4	78.4	6.3	7.0	3.000	4.625	CGH312T500X4L
3600	76.3	68.4	7.0	7.8	3.000	5.125	CGH362T500X5C
4100	67.8	60.8	7.7	8.6	3.000	5.625	CGH412T500X5L
6900	41.0	36.9	11.9	13.2	3.000	8.625	CGH692T500X8L

Aluminum Capacitors

Type CGO Computer Grade Capacitors

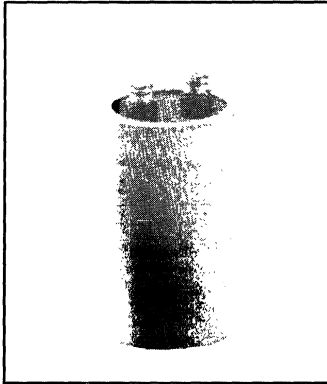

- Output Filter for SMPS Applications
- Extremely Low Symmetrically Controlled ESR
- 35 mm Diameter

GENERAL SPECIFICATIONS

Operating Temperature:
-40°C to +85°C

Voltage Range:
5 WVDC to 55 WVDC

Capacitance Range:
2,800 μ F to 45,000 μ F

Capacitance Tolerance:
 \pm 20%

DC Leakage Current:
 $I = .0015 \sqrt{CV}$ after 5 minutes
 C = Capacitance in μ F
 V = Rated Voltage
 I = Leakage Current in mA

QA Stability Test:
Apply WVDC for 3,000 hrs at 85°C

- Capacitance change \leq 15% from initial limits
- DC leakage current meets initial limits
- ESR \leq 175% of initial measured value

The maximum ripple current at 85°C and 20 kHz for CGO capacitors is shown in the Standard Rating Table. Maximum ripple current may be adjusted by the multipliers in the following tables:

Rated WVDC	Ripple Multipliers				
	120 Hz	400 Hz	1000Hz	2500 kHz	10 kHz
5 to 55	.84	.85	.86	.87	.95

Cap μ F	Max ESR (ohms)		Max Ripple RMS Amps @ 20 kHz +85°C	Dia	Length	Catalog Number
	@ 120Hz 25°C	@ 20kHz 25°C				

5 WVDC; 6 VDC Surge

18000	.0166	.0099	9.8	1.375	2.125	CGO183M005L
-------	-------	-------	-----	-------	-------	-------------

7.5 WVDC; 9 VDC Surge

15000	.0158	.0096	9.4	1.375	2.125	CGO153M7R5L
21000	.0131	.0083	10.9	1.375	2.625	CGO213M7R5L
27000	.0108	.0071	12.7	1.375	3.125	CGO273M7R5L
33000	.0094	.0064	14.2	1.375	3.625	CGO333M7R5L
39000	.0086	.0060	15.5	1.375	4.125	CGO393M7R5L
45000	.0076	.0052	17.5	1.375	4.625	CGO453M7R5L

10 WVDC; 12 VDC Surge

14000	.0180	.0103	9.3	1.375	2.125	CGO143M010L
19000	.0133	.0083	10.9	1.375	2.625	CGO193M010L

16 WVDC; 18 VDC Surge

10000	.0167	.0096	9.3	1.375	2.125	CGO103M016L
18000	.0113	.0071	12.6	1.375	3.125	CGO183M016L
22000	.0098	.0064	14.2	1.375	3.625	CGO223M016L

20 WVDC; 22 VDC Surge

12000	.0142	.0085	10.8	1.375	2.625	CGO123M020L
16000	.0115	.0072	12.6	1.375	3.125	CGO163M020L
20000	.0100	.0065	14.1	1.375	3.625	CGO203M020L
22000	.0093	.0061	15.4	1.375	4.125	CGO223M020L
27000	.0080	.0053	17.4	1.375	4.625	CGO273M020L
34000	.0071	.0049	19.6	1.375	5.625	CGO343M020L

Ambient Temperature	Ripple Multiplier
+85°C	1.00
+75°C	1.30
+65°C	1.50
+55°C	1.72
+45°C	1.93
+35°C	2.15

Cap μ F	Max ESR (ohms)		Max Ripple RMS Amps @ 20 kHz +85°C	Dia	Length	Catalog Number
	@ 120Hz 25°C	@ 20kHz 25°C				

28 WVDC; 32 VDC Surge

6300	.0213	.0121	8.3	1.375	2.125	CGO632M028L
8800	.0170	.0101	9.9	1.375	2.625	CGO882M028L
8900	.0165	.0100	10.1	1.375	2.625	CGO892M028L
14000	.0119	.0075	13.1	1.375	3.625	CGO143M028L

35 WVDC; 40 VDC Surge

4500	.0235	.0124	8.2	1.375	2.125	CGO452M035L
6300	.0185	.0104	9.8	1.375	2.625	CGO632M035L
8100	.0150	.0087	11.5	1.375	3.125	CGO812M035L
10000	.0129	.0077	13.0	1.375	3.625	CGO103M035L
14000	.0100	.0061	16.1	1.375	4.625	CGO143M035L

45 WVDC; 50 VDC Surge

3800	.0320	.0177	8.1	1.375	2.125	CGO382M045L
4600	.0242	.0134	9.7	1.375	2.625	CGO462M045L
10000	.0219	.0128	15.6	1.375	4.625	CGO103M045L

55 WVDC; 64 VDC Surge

2800	.0302	.0150	7.5	1.375	2.125	CGO282M055L
3900	.0233	.0123	9.0	1.375	2.625	CGO392M055L
5000	.0188	.0102	10.6	1.375	3.125	CGO502M055L
10000	.0109	.0064	17.2	1.375	5.625	CGO103M055L

Aluminum Capacitors

Type CGR Computer Grade Capacitors

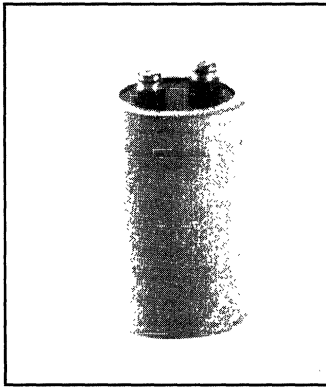

- High Ripple Current
- Very Low ESR
- 105°C Operation
- Custom Designs Available Upon Request

GENERAL SPECIFICATIONS

Operating Temperature:
-40°C to +105°C

Voltage Range:
7.5 WVDC to 200 WVDC

Capacitance Range:
330 μ F to 100,000 μ F

Capacitance Tolerance:
-10% +75% (7.5 - 50 WVDC)
-10% +50% (51 - 100 WVDC)

DC Leakage Current:
 $I = 6 \times 10^{-6} CV$ after 5 minutes
Not to exceed 4 mA
C = Capacitance in μ F
V = Rated Voltage
I = Leakage Current in mA

QA Stability Test:
Apply WVDC for 2,000 hrs at 85°C

- Capacitance change $\leq 15\%$ from initial limits
- DC leakage current meets initial limits
- ESR $\leq 175\%$ of initial measured value

The maximum ripple current at 85°C and 120 Hz for CGR capacitors is shown in the Standard Rating Table. Maximum ripple current may be adjusted by the multipliers in the following tables:

Rated WVDC	Ripple Multipliers				
	120 Hz	400 Hz	1000 Hz	2500Hz	10KHz
10 to 75	1.0	1.050	1.085	1.135	1.150
76 to 250	1.0	1.075	1.125	1.155	1.210

Ambient Temperature	Ripple Multiplier
+85°C	1.00
+65°C	1.42
+55°C	1.58
+45°C	1.72
+35°C	1.88
+25°C	2.00

Cap μ F	Max ESR (ohms) @ 120 Hz	Max Ripple RMS Amps @ 120 Hz +85°C	Dia	Length	Catalog Number
-------------	-------------------------	------------------------------------	-----	--------	----------------

7.5 WVDC; 12 VDC Surge

34,000	.0128	14.4	1.750	3.125	CGR343U7R5U3C
47,000	.0098	17.8	2.000	3.125	CGR473U7R5V3C
66,000	.0068	23.8	2.000	4.125	CGR663U7R5V4C

10 WVDC; 12 VDC Surge

24,000	.0110	9.5	1.375	3.125	CGR243U010R3C
--------	-------	-----	-------	-------	---------------

12 WVDC; 15 VDC Surge

12,000	.0154	10.6	1.375	2.625	CGR123U012R2L
100,000	.0043	30.0	2.500	5.125	CGR104U012W5C

16 WVDC; 20 VDC Surge

7,700	.0231	7.9	1.375	2.125	CGR772U016R2C
11,000	.0161	10.3	1.375	2.625	CGR113U016R2L
14,000	.0119	12.9	1.375	3.125	CGR143U016R3C
16,000	.0173	11.6	1.750	2.625	CGR163U016U2L
20,000	.0084	17.2	1.375	4.125	CGR203U016R4C
30,000	.0098	17.8	2.000	3.125	CGR303U016V3C
42,000	.0075	22.7	2.000	4.125	CGR423U016V4C
51,000	.0085	22.0	2.500	3.125	CGR513U016W3C

20 WVDC; 30 VDC Surge

4,600	.0224	8.1	1.375	2.125	CGR462U020R2C
10,000	.0105	14.6	1.375	3.625	CGR103U020R3L
21,000	.0090	19.7	2.000	3.625	CGR213U020V3L

Cap μ F	Max ESR (ohms) @ 120 Hz	Max Ripple RMS Amps @ 120 Hz +85°C	Dia	Length	Catalog Number
-------------	-------------------------	------------------------------------	-----	--------	----------------

30 WVDC; 45 VDC Surge

2,200	.0350	5.9	1.375	1.875	CGR222U030R1N
4,900	.0248	10.3	1.750	2.125	CGR492U030U2C
7,400	.0105	14.6	1.375	3.625	CGR742U030R3L
10,000	.0077	18.9	1.375	4.625	CGR103U030R4L
12,000	.0098	17.8	2.000	3.125	CGR123U030V3C
15,000	.0090	19.7	2.000	3.625	CGR153U030V3L
27,000	.0053	30.0	2.000	5.625	CGR273U030V5L
30,000	.0060	29.1	2.500	4.125	CGR303U030W4C

40 WVDC; 60 VDC Surge

2,100	.0245	7.7	1.375	2.125	CGR212U040R2C
3,900	.0133	12.2	1.375	3.125	CGR392U040R3C
5,600	.0091	16.6	1.375	4.125	CGR562U040R4C
7,400	.0100	12.3	1.375	5.125	CGR742U040R5C
9,600	.0090	19.7	2.000	3.625	CGR962U040V3L
13,000	.0068	25.0	2.000	4.625	CGR133U040V4L
22,000	.0060	30.0	2.500	4.625	CGR223U040W4L
31,000	.0051	30.0	3.000	4.625	CGR313U040X4L

50 WVDC; 75 VDC Surge

1,000	.1001	3.5	1.375	1.875	CGR102U050R1N
1,500	.0672	4.7	1.375	2.125	CGR152U050R2C
2,900	.0357	7.4	1.375	3.125	CGR292U050R3C
4,100	.0180	8.3	1.375	4.125	CGR412U050R4C
6,200	.0168	14.0	1.375	5.625	CGR622U050R5L
7,600	.0165	13.7	2.000	3.125	CGR762U050V3C
10,000	.0113	18.5	2.000	4.125	CGR103U050V4C
16,000	.0085	24.2	2.000	5.625	CGR163U050V5L
21,000	.0077	26.8	2.500	4.625	CGR213U050W4L
27,000	.0060	30.0	2.500	5.625	CGR273U050W5L
37,000	.0051	30.0	3.000	5.625	CGR373U050X5L

Type CGR Computer Grade Capacitors

MALLOY

Cap μ F	Max ESR (ohms) @ 120 Hz	Max Ripple RMS Amps @ 120 Hz +85°C	Dia	Length	Catalog Number
75 WVDC; 100 VDC Surge					
1,200	.0497	5.9	1.375	2.625	CGR122T075R2L
1,800	.0329	8.2	1.375	3.625	CGR182T075R3L
2,000	.0220	6.7	1.375	3.125	CGR202U075R3C
2,200	.0200	7.9	1.375	4.125	CGR222T075R4C
3,100	.0350	11.0	2.000	2.625	CGR312T075V2L
4,100	.0140	10.9	1.750	4.125	CGR412T075U4C
4,700	.0150	15.2	2.000	3.625	CGR472T075V3L
7,500	.0095	16.2	2.000	5.625	CGR752U075V5L
8,000	.0085	16.4	2.500	3.625	CGR802T075W3L
9,600	.0094	23.2	2.500	4.125	CGR962T075W4C
11,000	.0102	23.8	3.000	3.625	CGR113T075X3L
19,000	.0056	30.0	3.000	5.625	CGR193T075X5L

Cap μ F	Max ESR (ohms) @ 120 Hz	Max Ripple RMS Amps @ 120 Hz +85°C	Dia	Length	Catalog Number
100 WVDC; 135 VDC Surge					
330	.0940	2.8	1.375	2.125	CGR331T100R2C
2,700	.0120	18.8	2.000	4.625	CGR272T100V4L
4,500	.0094	24.3	2.500	4.625	CGR452T100W4L
8,000	.0085	21.8	3.000	5.625	CGR802T100X5L
200 WVDC; 250 VDC Surge					
3,500	.0240	11.5	3.000	4.125	CGR352T200X4C
5,200	.0170	15.4	3.000	5.625	CGR522T200X5L

Aluminum Capacitors

Type HES Computer Grade Capacitors

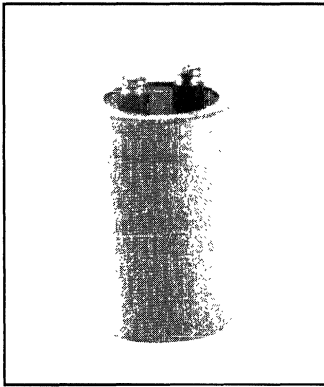

- High Reliability
- 105°C Operation
- Custom Designs Available Upon Request
- Charge-Discharge Applications
 - Welders
 - Photoflash
 - Strobe Lights
 - Magnetizers
 - Demagnetizers
 - Laser Activation

GENERAL SPECIFICATIONS

Operating Temperature:
-40°C to +105°C

Voltage Range:
350 WVDC to 450 WVDC

Capacitance Range:
300 μ F to 5,600 μ F

Capacitance Tolerance:
-0 +50%

DC Leakage Current:
 $I = 6 \times 10^{-6} CV$ after 30 minutes,
 Not to exceed 4.0 mA
 C = Capacitance in μ F
 V = Rated Voltage
 I = Leakage Current in mA

- QA Stability Test:
Apply WVDC for 2,000 hrs at 85°C
- Capacitance change \leq 15% from initial limits
 - DC leakage current meets initial limits
 - ESR \leq 175% of initial measured value

The maximum ripple current at 85°C and 120 Hz for HES capacitors is shown in the Standard Rating Table. Maximum ripple current may be adjusted by the multipliers in the following tables:

Rated WVDC	Ripple Multipliers				
	120Hz	400Hz	1000Hz	2500Hz	10kHz
350 to 450	1.00	1.08	1.113	1.175	1.23

Ambient Temperature	Ripple Multiplier
+85°C	1.00
+65°C	1.42
+55°C	1.58
+45°C	1.72
+35°C	1.88
+25°C	2.00

Cap μ F	Max ESR (ohms) @ 120 Hz	Max Ripple RMS Amps @ 120 Hz +85°C	Dia	Length	Catalog Number
350 WVDC; 400 VDC Surge					
600	0.173	2.60	2.000	2.125	HES601G350V2C
900	0.110	4.60	2.000	5.125	HES901G350V5C
1,100	0.099	4.00	2.000	3.125	HES112G350V3C
1,400	0.080	6.20	2.500	5.125	HES142G350W5C
1,600	0.062	5.60	2.000	4.125	HES162G350V4C
1,900	0.053	6.40	2.000	4.625	HES192G350V4L
2,500	0.045	7.40	2.500	4.125	HES252G350W4C
3,100	0.040	8.60	3.000	3.625	HES312G350X3L
3,400	0.034	9.40	2.500	5.125	HES342G350W5C
3,700	0.034	9.80	3.000	4.125	HES372G350X4C
4,400	0.029	11.00	3.000	4.625	HES442G350X4L
5,000	0.026	12.10	3.000	5.125	HES502G350X5C
5,600	0.024	13.20	3.000	5.625	HES562G350X5L

Cap μ F	Max ESR (ohms) @ 120 Hz	Max Ripple RMS Amps @ 120 Hz +85°C	Dia	Length	Catalog Number
400 WVDC; 450 VDC Surge					
300	0.275	2.20	1.750	3.125	HES301G400U3C
500	0.180	2.60	2.000	2.125	HES501G400V2C
1,300	0.066	5.40	2.000	4.125	HES132G400V4C
2,000	0.044	14.30	2.000	5.625	HES202G400V5L
2,000	0.048	7.30	2.500	4.125	HES202G400W4C
2,100	0.045	9.50	3.000	5.625	HES212G400X5L
3,000	0.033	9.90	2.500	5.625	HES302G400W5L
3,500	0.031	10.70	3.000	4.625	HES352G400X4L
4,100	0.027	11.90	3.000	5.125	HES412G400X5C
4,600	0.025	13.00	3.000	5.625	HES462G400X5L

Cap μ F	Max ESR (ohms) @ 120 Hz	Max Ripple RMS Amps @ 120 Hz +85°C	Dia	Length	Catalog Number
450 WVDC; 525 VDC Surge					
300	0.268	2.40	2.000	3.125	HES301G450V3C
400	0.203	2.90	2.000	3.625	HES401G450V3L
550	0.150	3.60	2.000	4.125	HES551G450V4C
700	0.125	3.50	2.000	3.125	HES701G450V3C
1,200	0.069	7.10	3.000	4.625	HES122G450X4L
1,500	0.056	8.50	3.000	5.625	HES152G450X5L
1,600	0.053	6.90	2.000	5.625	HES162G450V5L
1,700	0.051	7.10	2.500	4.125	HES172G450W4C
2,000	0.041	9.70	3.000	5.625	HES202G450X5L
2,200	0.040	10.10	3.000	5.625	HES222G450X5L
2,400	0.038	9.00	2.500	5.125	HES242G450W5C
2,700	0.034	9.90	2.500	5.625	HES272G450W5L
3,600	0.028	11.70	3.000	5.125	HES362G450X5C
4,000	0.025	12.70	3.000	5.625	HES402G450X5L

Aluminum Capacitors

Type LP Radial Snap-In Capacitors

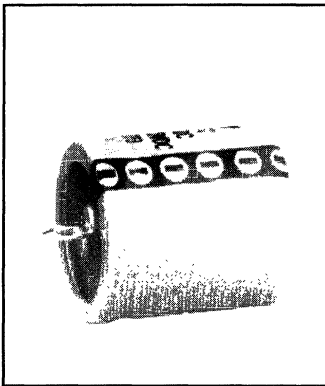

- 105°C - Long Life
- 22 to 35 mm Diameters
10 mm Lead Spacing
- High Reliability
- Stable ESR

GENERAL SPECIFICATIONS

Operating Temperature:
-40°C to +105°C

Voltage Range:
16 WVDC to 250 WVDC

Capacitance Range:
100 μ F to 47,000 μ F

Capacitance Tolerance:
 \pm 20% (Standard)

DC Leakage Current:
I = .02 CV
C = Capacitance in μ F
V = Rated Voltage
I = Leakage Current in μ A

QA Stability Test:
Apply WVDC for 1,000 hrs at 105°C

- Capacitance change \leq 20% from initial limits
- DC leakage current meets initial limits
- ESR \leq 200% of initial measured value

The maximum ripple current at 105°C and 120 Hz for LP capacitors is shown in the Standard Rating Table. Maximum ripple current may be adjusted by the multipliers in the following tables.

Rated WVDC	Ripple Multipliers					
	50 Hz	1000Hz	300Hz	1000Hz	10kHz	100kHz
10 to 50	.90	1.0	1.03	1.05	1.10	1.10
63 to 100	.85	1.0	1.07	1.13	1.19	1.20
160 to 250	.80	1.0	1.15	1.25	1.35	1.40

Ambient Temperature	Ripple Multiplier
+85°C	1.65
+65°C	2.25
+45°C	2.55

Cap μ F	Max ESR Ohms @ 120Hz 25°C	Max Ripple Amps @ 120Hz 105°C	Size (inches)		Size (millimeters)		Catalog Number
			D	L	D	L	

Cap μ F	Max ESR Ohms @ 120Hz 25°C	Max Ripple Amps @ 120Hz 105°C	Size (inches)		Size (millimeters)		Catalog Number
			D	L	D	L	

16 WVDC; 25 VDC Surge

4,700	.141	1.200	.866	.984	22	25	LP472M016A1P3
5,600	.120	1.429	.984	.984	25	25	LP562M016C1P3
8,200	.081	1.820	.866	1.378	22	35	LP822M016A5P3
8,200	.080	1.771	1.181	.984	30	25	LP822M016E1P3
12,000	.055	2.380	1.181	1.181	30	30	LP123M016E3P3
15,000	.046	3.000	1.378	1.181	35	30	LP153M016H3P3
22,000	.030	3.530	1.181	1.575	30	40	LP223M016E7P3
27,000	.025	4.270	1.378	1.575	35	40	LP273M016H7P3
33,000	.020	5.000	1.378	1.969	35	50	LP333M016H9P3

50 WVDC; 63 VDC Surge

1,200	.280	.860	.866	.984	22	25	LP122M050A1P3
1,500	.225	.983	.866	.984	22	25	LP152M050A1P3
2,200	.151	1.330	.866	1.378	22	35	LP222M050A5P3
2,200	.150	1.429	1.181	.984	30	25	LP222M050E1P3
3,300	.101	1.176	1.181	1.181	30	30	LP332M050E3P3
3,300	.101	1.710	.984	1.378	25	35	LP332M050C5P3
3,300	.101	1.710	.984	1.181	25	30	LP332M050C3P3
3,900	.085	1.970	.984	1.575	25	40	LP392M050C7P3
4,700	.071	2.270	1.378	1.181	35	30	LP472M050H3P3
5,600	.059	2.600	1.378	1.378	35	35	LP562M050H5P3
6,800	.049	3.160	1.181	1.575	30	40	LP682M050E7P3
6,800	.049	3.160	1.181	1.969	30	50	LP682M050E9P3
8,200	.040	3.429	1.378	1.969	35	50	LP822M050H9P3

25 WVDC; 32 VDC Surge

2,700	.180	1.000	.984	.984	25	25	LP272M025C1P3
3,300	.151	1.160	.866	.984	22	25	LP332M025A1P3
3,300	.150	1.143	.984	.984	25	25	LP332M025C1P3
4,700	.106	1.480	.984	.984	25	25	LP472M025C1P3
5,600	.090	1.857	1.181	.984	30	25	LP562M025E1P3
5,600	.089	1.730	.984	1.181	25	30	LP562M025C3P3
6,800	.073	1.940	.984	1.378	25	35	LP682M025C5P3
10,000	.050	3.333	1.378	1.181	35	30	LP103M025H3P3
12,000	.041	2.970	1.378	1.181	35	30	LP123M025H3P3
15,000	.033	3.360	1.181	1.575	30	40	LP153M025E7P3
22,000	.023	4.857	1.378	1.969	35	50	LP223M025H9P3

63 WVDC; 75 VDC Surge

820	.300	.770	.866	.984	22	25	LP821M063A1P3
1,200	.210	.990	.984	.984	25	25	LP122M063C1P3
1,800	.138	1.340	.866	1.575	22	40	LP182M063A7P3
1,800	.140	1.371	1.181	.984	30	25	LP182M063E1P3
2,200	.113	1.550	1.181	1.181	30	30	LP222M063E3P3
3,300	.076	1.200	1.378	1.181	35	30	LP332M063H3P3
4,700	.053	2.840	1.181	1.969	30	50	LP472M063E9P3
6,800	.037	3.360	1.378	1.969	35	50	LP682M063H9P3

35 WVDC; 44 VDC Surge

1,800	.188	1.040	.866	.984	22	25	LP182M035A1P3
2,700	.155	1.257	.984	.984	25	25	LP272M035C1P3
3,900	.108	1.571	1.181	.984	30	25	LP392M035E1P3
5,600	.074	2.050	1.181	1.181	30	30	LP562M035E3P3
6,800	.060	2.286	1.181	1.378	30	35	LP682M035E5P3
6,800	.061	2.320	.984	1.575	25	40	LP682M035C7P3
8,200	.051	2.690	1.378	1.181	35	30	LP822M035H3P3
10,000	.041	3.000	1.181	1.575	30	40	LP103M035E7P3
12,000	.035	3.590	1.378	1.575	35	40	LP123M035H7P3
15,000	.028	4.000	1.378	1.969	35	50	LP153M035H9P3

100 WVDC; 125 VDC Surge

820	.300	.980	1.181	.984	30	25	LP821M100E1P3
2,200	.113	2.030	1.378	1.575	35	40	LP222M100H7P3
2,700	.092	2.320	1.378	1.969	35	50	LP272M100H9P3
2,700	.092	2.320	1.378	1.575	35	40	LP272M100H7P3

Aluminum Capacitors

Type LP Radial Snap-In Capacitors



Cap μ F	Max ESR Ohms @ 120Hz 25°C	Max Ripple Amps @ 120Hz 105°C	Size (inches)		Size (millimeters)		Catalog Number
			D	L	D	L	
200 WVDC; 250 VDC Surge							
150	1.650	.509	.984	.984	25	25	LP151M200C1P3
150	1.650	.509	.866	.984	22	25	LP151M200A1P3
180	1.400	.571	.984	.984	25	25	LP181M200C1P3
220	1.100	.646	.984	.984	25	25	LP221M200C1P3
220	1.100	.646	1.181	.984	30	25	LP221M200E1P3
220	1.130	.660	.866	1.181	22	30	LP221M200A3P3
270	.920	.790	1.181	.984	30	25	LP271M200E1P3
270	.920	.790	.984	1.181	25	30	LP271M200C3P3
330	.750	.886	1.181	1.181	30	30	LP331M200E3P3
390	.640	.980	.984	1.378	25	35	LP391M200C5P3
470	.540	1.143	1.181	1.378	30	35	LP471M200E5P3
470	.540	1.140	1.181	.984	30	25	LP471M200E1P3
470	.540	1.143	1.378	1.181	35	30	LP471M200H3P3
560	.440	1.310	1.378	1.181	35	30	LP561M200H3P3
680	.370	1.520	1.181	1.181	30	30	LP681M200E3P3
680	.370	1.510	1.181	1.378	30	35	LP681M200E5P3
680	.370	1.510	1.378	.984	35	25	LP681M200H1P3
820	.300	1.750	1.378	1.575	35	40	LP821M200H7P3
820	.300	1.750	1.378	1.181	35	30	LP821M200H3P3
1,000	.250	2.114	1.378	1.969	35	50	LP102M200H9P3
1,000	.250	2.114	1.378	1.378	35	35	LP102M200H5P3
1,200	.165	2.810	1.181	1.969	30	50	LP122M200E9P3
1,200	.165	2.740	1.378	1.378	35	35	LP122M200H5P3
1,500	.134	3.330	1.378	1.772	35	45	LP152M200H4P3
1,800	.112	3.800	1.378	1.969	35	50	LP182M200H9P3

Cap μ F	Max ESR Ohms @ 120Hz 25°C	Max Ripple Amps @ 120Hz 105°C	Size (inches)		Size (millimeters)		Catalog Number
			D	L	D	L	
250 WVDC; 300 VDC Surge							
100	2.500	.410	.866	.984	22	25	LP101M250A1P3
150	1.660	.540	.984	.984	25	25	LP151M250C1P3
180	1.400	.686	.984	1.181	25	30	LP181M250C3P3
220	1.130	.710	1.181	.984	30	25	LP221M250E1P3
270	.922	.840	.984	1.181	25	30	LP271M250C3P3
330	.750	.914	1.181	1.181	30	30	LP331M250E3P3
390	.640	1.090	1.378	1.181	35	30	LP391M250H3P3
470	.530	1.260	1.181	1.575	30	40	LP471M250E7P3
470	.530	1.260	1.378	.984	35	25	LP471M250H1P3
560	.347	1.800	1.378	1.181	35	30	LP561M250H3P3
680	.370	1.920	1.181	1.969	30	50	LP681M250E9P3
680	.370	2.070	1.378	1.378	35	35	LP681M250H5P3
820	.243	2.400	1.378	1.575	35	40	LP821M250H7P3
1,000	.200	2.720	1.378	1.772	35	45	LP102M250H4P3
1,200	.165	3.100	1.378	1.969	35	50	LP122M250H9P3

Outline Dimensions

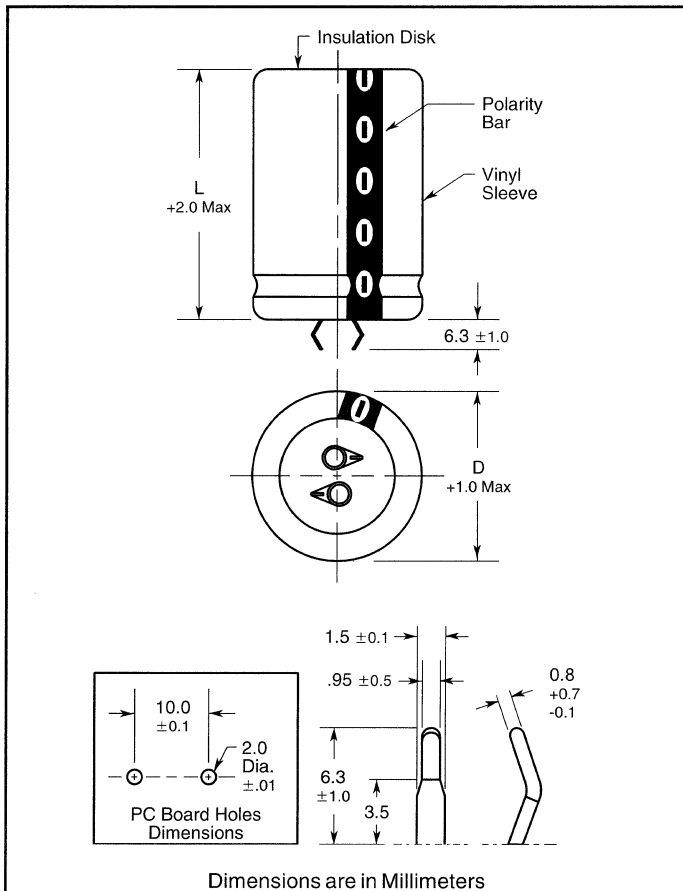

Part Number Nomenclature

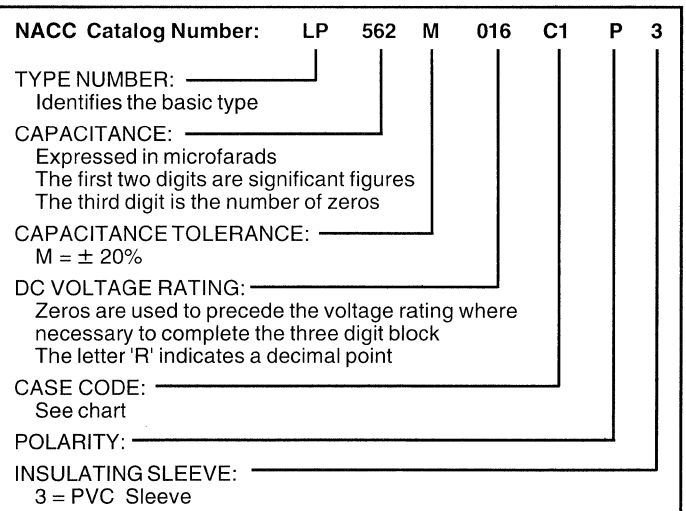

Case Code Chart

Diameter	Length					
	25	30	35	40	45	50
mm	(1.00)	(1.18)	(1.38)	(1.57)	(1.77)	(2.00)
(Inches)	(1.00)	(1.18)	(1.38)	(1.57)	(1.77)	(2.00)
22	A1	A3	A5	A7	A4	A9
25	C1	C3	C5	C7	C4	C9
30	E1	E3	E5	E7	E4	E9
35	H1	H3	H5	H7	H4	H9

Aluminum Capacitors

Type LPW Radial Snap-In Capacitors

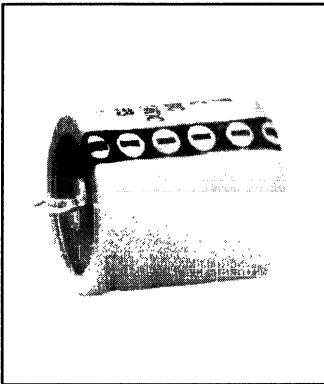

- 85°C - Low Voltage General Purpose
- 22 to 35 mm Diameters
10 mm Lead Spacing
- Ideal For Input Filter in Consumer Electronic Equipment

GENERAL SPECIFICATIONS

Operating Temperature:
-40°C to +85°C
Voltage Range:
10 WVDC to 100 WVDC
Capacitance Range:
820 μ F to 22,000 μ F
Capacitance Tolerance:
 \pm 20% at +20°C 120Hz

DC Leakage Current:
 $I \leq .03CV$ or 3mA
C = Capacitance in μ F
V = Rated Voltage
I = Leakage Current in μ A
QA Stability Test:
Apply WVDC for 1,000 hrs at 85°C

- Capacitance change \leq 20% from initial limits
- DC leakage current meets initial limits
- ESR \leq 150% of initial measured value

See Type LPX for 85°C - High Voltage (160 to 450 WVDC)
General Purpose Snap Mount Capacitors

The maximum ripple current at 85°C and 120 Hz for LPW capacitors is shown in the Standard Rating Table. Maximum ripple current may be adjusted by the multipliers in the following tables.

Rated WVDC	Ripple Multipliers				
	60 Hz	120 Hz	1kHz	10kHz	100kHz
10 to 35	.90	1.0	1.05	1.10	1.10
50 to 100	.90	1.0	1.15	1.20	1.20

Ambient Temperature	Ripple Multiplier
+70°C	1.20
+60°C	1.30
+45°C	1.55

Cap μ F	Max ESR Ohms @120Hz 25°C	Max Ripple Amps @120Hz 85°C	Size (inches)		Size (millimeters)		Catalog Number
			D	L	D	L	
10 WVDC; 13 VDC Surge							
8,200	.101	2.39	.866	.984	22	25	LPW822M1AN25V-W
8,200	.101	2.46	.984	.984	25	25	LPW822M1AO25V-W
10,000	.083	2.69	.866	1.181	22	30	LPW103M1AN30V-W
10,000	.083	2.57	.984	.984	25	25	LPW103M1AO25V-W
12,000	.083	2.81	.866	1.181	22	30	LPW123M1AN30V-W
12,000	.083	2.84	1.181	.984	30	25	LPW123M1AP25V-W
15,000	.066	3.14	.866	1.378	22	35	LPW153M1AN35V-W
15,000	.066	2.97	1.181	.984	30	25	LPW153M1AP25V-W
22,000	.045	3.79	.866	1.772	22	45	LPW223M1AN45V-W
22,000	.045	3.45	1.181	1.181	30	30	LPW223M1AP30V-W

Cap μ F	Max ESR Ohms @120Hz 25°C	Max Ripple Amps @120Hz 85°C	Size (inches)		Size (millimeters)		Catalog Number
			D	L	D	L	
25 WVDC; 32 VDC Surge							
12,000	.062	3.74	.866	1.969	22	50	LPW123M1EN50V-W
12,000	.062	3.75	1.378	1.181	35	30	LPW123M1EQ30V-W
15,000	.050	3.78	.984	1.772	25	45	LPW153M1EO45V-W
15,000	.050	3.89	1.378	1.181	35	30	LPW153M1EQ30V-W
22,000	.034	4.94	1.181	1.969	30	50	LPW223M1EP50V-W

Cap μ F	Max ESR Ohms @120Hz 25°C	Max Ripple Amps @120Hz 85°C	Size (inches)		Size (millimeters)		Catalog Number
			D	L	D	L	
16 WVDC; 20 VDC Surge							
4,700	.141	1.81	.866	.984	22	25	LPW472M1CN25V-W
4,700	.141	2.21	.984	.984	25	25	LPW472M1CO25V-W
6,800	.122	2.40	.866	.984	22	25	LPW682M1CN25V-W
6,800	.122	2.47	.984	.984	25	25	LPW682M1CO25V-W
8,200	.101	2.70	.866	1.181	22	30	LPW822M1CN30V-W
8,200	.101	2.73	1.181	.984	30	25	LPW822M1CP25V-W
10,000	.083	3.00	.866	1.378	22	35	LPW103M1CN35V-W
10,000	.083	2.84	1.181	.984	30	25	LPW103M1CP25V-W
12,000	.069	3.30	.866	1.575	22	40	LPW123M1CN40V-W
12,000	.069	3.16	1.181	1.181	30	30	LPW123M1CP30V-W
15,000	.055	3.62	.866	1.772	22	45	LPW153M1CN45V-W
15,000	.055	3.55	1.378	.984	35	25	LPW153M1CQ25V-W
22,000	.038	4.25	.984	1.772	25	45	LPW223M1CO45V-W
22,000	.038	4.37	1.378	1.181	35	30	LPW223M1CQ30V-W

Cap μ F	Max ESR Ohms @120Hz 25°C	Max Ripple Amps @120Hz 85°C	Size (inches)		Size (millimeters)		Catalog Number
			D	L	D	L	
35 WVDC; 44 VDC Surge							
3,300	.176	2.04	.866	.984	22	25	LPW332M1VN25V-W
3,300	.176	2.10	.984	.984	25	25	LPW332M1VO25V-W
4,700	.123	2.41	.866	1.181	22	30	LPW472M1VN30V-W
4,700	.123	2.44	1.181	.984	30	25	LPW472M1VP25V-W
6,800	.085	2.98	.866	1.575	22	40	LPW682M1VN40V-W
6,800	.085	2.86	1.181	1.181	30	30	LPW682M1VP30V-W
8,200	.071	3.25	.866	1.772	22	45	LPW822M1VN45V-W
8,200	.071	3.42	1.378	1.181	35	30	LPW822M1VQ30V-W
10,000	.058	3.41	.984	1.772	25	45	LPW103M1VO45V-W
10,000	.058	3.51	1.378	1.181	35	30	LPW103M1VQ30V-W
12,000	.048	3.68	.984	1.969	25	50	LPW123M1VO50V-W
12,000	.048	3.84	1.378	1.378	35	35	LPW123M1VQ35V-W
15,000	.039	4.08	1.181	1.772	30	45	LPW153M1VP45V-W

Cap μ F	Max ESR Ohms @120Hz 25°C	Max Ripple Amps @120Hz 85°C	Size (inches)		Size (millimeters)		Catalog Number
			D	L	D	L	
25 WVDC; 32 VDC Surge							
3,300	.176	2.03	.866	.984	22	25	LPW332M1EN25V-W
3,300	.176	2.09	.984	.984	25	25	LPW332M1EO25V-W
4,700	.159	2.49	.866	1.181	22	30	LPW472M1EN30V-W
4,700	.159	2.31	.984	.984	25	25	LPW472M1EO25V-W
6,800	.110	2.87	.866	1.378	22	35	LPW682M1EN35V-W
6,800	.110	2.72	1.181	.984	30	25	LPW682M1EP25V-W
8,200	.091	3.16	.866	1.575	22	40	LPW822M1EN40V-W
8,200	.091	3.03	1.181	1.181	30	30	LPW822M1EP30V-W
10,000	.075	3.45	.866	1.772	22	45	LPW103M1EN45V-W
10,000	.075	3.14	1.181	1.181	30	30	LPW103M1EP30V-W

Cap μ F	Max ESR Ohms @120Hz 25°C	Max Ripple Amps @120Hz 85°C	Size (inches)		Size (millimeters)		Catalog Number
			D	L	D	L	
50 WVDC; 63 VDC Surge							
2,200	.226	1.92	.866	.984	22	25	LPW222M1HN25V-W
2,200	.226	1.98	.984	.984	25	25	LPW222M1HO25V-W
3,300	.151	2.51	.866	1.378	22	35	LPW332M1HN35V-W
3,300	.151	2.38	1.181	.984	30	25	LPW332M1HP25V-W
4,700	.106	2.89	.866	1.575	22	40	LPW472M1HN40V-W
4,700	.106	2.99	1.378	.984	35	25	LPW472M1HQ25V-W
6,800	.073	3.37	.984	1.772	25	45	LPW682M1HO45V-W
6,800	.073	3.46	1.378	1.181	35	30	LPW682M1HQ30V-W
8,200	.061	3.62	.984	1.969	25	50	LPW822M1HO50V-W
8,200	.061	3.79	1.378	1.378	35	35	LPW822M1HQ35V-W
10,000	.050	3.72	1.181	1.772	30	45	LPW103M1HP45V-W

Aluminum Capacitors

Type LPW Radial Snap-In Capacitors



Cap μ F	Max ESR Ohms @ 120Hz 25°C	Max Ripple Amps @ 120Hz 85°C	Size (inches)		Size (millimeters)		Catalog Number
			D	L	D	L	
63 WVDC; 79 VDC Surge							
1,000	.414	1.42	.866	.984	22	25	LPW102M1JN25V-W
1,000	.414	1.46	.984	.984	25	25	LPW102M1JO25V-W
1,500	.276	1.74	.866	.984	22	25	LPW152M1JN25V-W
1,500	.276	1.81	1.181	.984	30	25	LPW152M1JP25V-W
2,200	.226	2.08	.866	1.181	22	30	LPW222M1JN30V-W
2,200	.226	2.10	1.181	.984	30	25	LPW222M1JP25V-W
3,300	.151	2.81	.866	1.772	22	45	LPW332M1JN45V-W
3,300	.151	2.76	1.378	.984	35	25	LPW332M1JQ25V-W
4,700	.106	3.11	.984	1.772	25	45	LPW472M1JO45V-W
4,700	.106	3.20	1.378	1.181	35	30	LPW472M1JQ30V-W
6,800	.073	3.54	1.181	1.772	30	45	LPW682M1JP45V-W

Cap μ F	Max ESR Ohms @ 120Hz 25°C	Max Ripple Amps @ 120Hz 85°C	Size (inches)		Size (millimeters)		Catalog Number
			D	L	D	L	
100 WVDC; 125 VDC Surge							
820	.404	1.55	.866	1.181	22	30	LPW821M2AN30V-W
820	.404	1.54	.984	.984	25	25	LPW821M2AO25V-W
1,000	.332	1.71	.866	1.181	22	30	LPW102M2AN30V-W
1,000	.332	2.20	1.181	.984	30	25	LPW102M2AP25V-W
1,500	.276	2.38	.866	1.575	22	40	LPW152M2AN40V-W
1,500	.276	2.54	1.378	1.181	35	30	LPW152M2AQ30V-W
2,200	.188	2.77	.984	1.772	25	45	LPW222M2AO45V-W
2,200	.188	3.07	1.378	1.181	35	30	LPW222M2AQ30V-W
3,300	.126	3.27	1.181	1.772	30	45	LPW332M2AP45V-W

Outline Dimensions

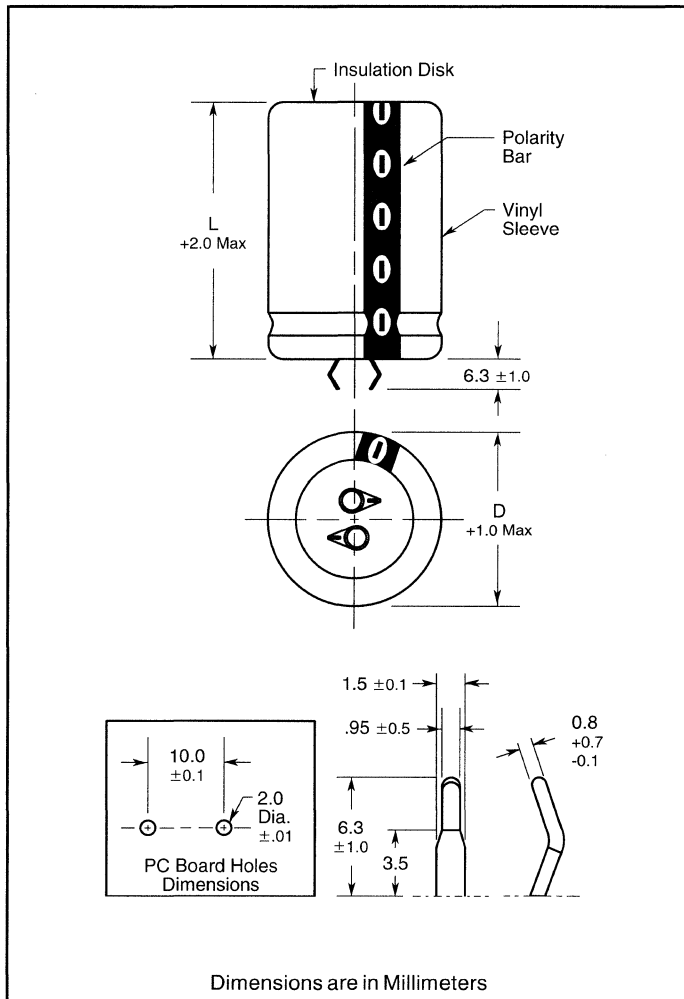

Part Number Nomenclature

NACC Catalog Number: LPW 332 M 1J Q 25 V-W

TYPE NUMBER: _____
Identifies the basic type

CAPACITANCE: _____
Expressed in microfarads
The first two digits are significant figures
The third digit is the number of zeros

CAPACITANCE TOLERANCE: _____
M = $\pm 20\%$

DC VOLTAGE RATING CODE: _____
1A = 10 WVDC 1H = 50 WVDC
1C = 16 WVDC 1J = 63 WVDC
1E = 25 WVDC 2A = 100 WVDC
1V = 35 WVDC

CASE DIAMETER CODE: _____
N = 22 Millimeters
O = 25 Millimeters
P = 30 Millimeters
Q = 35 Millimeters

CASE LENGTH: _____
Millimeters

CASE TYPE and TERMINATION: _____
V = Vented Case
- = (Dash must be included)
W = Snap-In Terminals

Aluminum Capacitors

Type LPX Radial Snap-In Capacitors

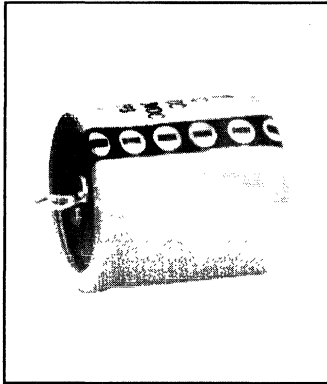

- 85°C - High Voltage General Purpose
- High Capacitance
- 22 to 35 mm Diameters
10 mm Lead Spacing
- Ideal For Input Filter in SMPS

GENERAL SPECIFICATIONS

Operating Temperature:
-40°C to +85°C

Voltage Range:
160 WVDC to 450 WVDC

Capacitance Range:
56 μ F to 2,700 μ F

Capacitance Tolerance:
 \pm 20% at +20°C 120Hz

DC Leakage Current:

$$I = 3\sqrt{CV}$$

C = Capacitance in μ F

V = Rated Voltage

I = Leakage Current in μ A

QA Stability Test:

Apply WVDC for 2,000 hrs at 85°C

- Capacitance change < 20% from initial limits
- DC leakage current meets initial limits
- ESR < 200% of initial measured value

See Type LPW for 85°C - Low Voltage (10 to 100WVDC)
General Purpose Snap Mount Capacitors

The maximum ripple current at 85°C and 120 Hz for LPX capacitors is shown in the Standard Rating Table. Maximum ripple current may be adjusted by the multipliers in the following tables.

Rated WVDC	Ripple Multipliers		
	120 Hz	1000 Hz	10 to 50 KHz
160 to 250	1.0	1.15	1.20
315 to 450	1.0	1.10	1.15

Ambient Temperature	Ripple Multiplier
+75°C	1.6
+65°C	2.2
+55°C	2.6
+45°C	3.0

Cap μ F	Max ESR Ohms @ 120Hz 25°C	Max Ripple Amps @ 120Hz 85°C	Size (inches)		Size (millimeters)		Catalog Number
			D	L	D	L	

Cap μ F	Max ESR Ohms @ 120Hz 25°C	Max Ripple Amps @ 120Hz 85°C	Size (inches)		Size (millimeters)		Catalog Number
			D	L	D	L	

160 WVDC; 200 VDC Surge

390	.510	1.3	.866	.984	22	25	LPX391M160A1P3
470	.423	1.6	.984	.984	25	25	LPX471M160C1P3
470	.423	1.6	.866	1.181	22	30	LPX471M160A3P3
560	.355	1.8	.984	1.181	25	30	LPX561M160C3P3
560	.355	1.8	.866	1.378	22	35	LPX561M160A5P3
680	.293	2.0	1.181	.984	30	25	LPX681M160E1P3
680	.293	2.1	.866	1.575	22	40	LPX681M160A7P3
680	.293	2.0	.984	1.181	25	30	LPX681M160C3P3
820	.243	2.0	.984	1.378	25	35	LPX821M160C5P3
820	.243	2.3	1.181	1.181	30	30	LPX821M160E3P3
820	.243	2.4	.866	1.772	22	45	LPX821M160A4P3
1,000	.199	2.6	.984	1.575	25	40	LPX102M160C7P3
1,000	.199	2.3	1.378	.984	35	25	LPX102M160H1P3
1,000	.199	2.5	1.181	1.181	30	30	LPX102M160E3P3
1,200	.166	3.0	.984	1.772	25	45	LPX122M160C4P3
1,200	.166	2.6	1.378	1.181	35	30	LPX122M160H3P3
1,200	.166	2.9	1.181	1.378	30	35	LPX122M160E5P3
1,500	.133	3.3	1.378	1.378	35	35	LPX152M160H5P3
1,500	.133	3.3	1.181	1.575	30	40	LPX152M160E7P3
1,800	.111	4.0	1.181	1.969	30	50	LPX182M160E9P3
1,800	.111	3.7	1.378	1.575	35	40	LPX182M160H7P3
2,200	.090	4.2	1.378	1.772	35	45	LPX222M160H4P3
2,700	.074	4.6	1.378	1.969	35	50	LPX272M160H9P3

200 WVDC; 250 VDC Surge

1,200	.166	3.1	1.378	1.378	35	35	LPX122M200H5P3
1,200	.166	3.5	1.181	1.772	30	45	LPX122M200E4P3
1,500	.133	4.0	1.181	1.969	30	50	LPX152M200E9P3
1,500	.133	3.6	1.378	1.575	35	40	LPX152M200H7P3
1,800	.111	4.0	1.378	1.772	35	45	LPX182M200H4P3
2,200	.090	4.5	1.378	1.969	35	50	LPX222M200H9P3

250 WVDC; 300 VDC Surge

270	.737	1.4	.866	1.181	22	30	LPX271M250A3P3
270	.737	1.4	.984	.984	25	25	LPX271M250C1P3
330	.603	1.7	.984	1.181	25	30	LPX331M250C3P3
330	.603	1.7	.866	1.378	22	35	LPX331M250A5P3
390	.510	1.8	1.181	.984	30	25	LPX391M250E1P3
390	.510	1.9	.866	1.575	22	40	LPX391M250A7P3
390	.510	1.8	.984	1.181	25	30	LPX391M250C3P3
470	.423	2.2	.866	1.772	22	45	LPX471M250A4P3
470	.423	2.1	.984	1.378	25	35	LPX471M250C5P3
470	.423	2.1	1.181	1.181	30	30	LPX471M250E3P3
560	.355	2.5	.866	1.969	22	50	LPX561M250A9P3
560	.355	2.1	1.378	.984	35	25	LPX561M250H1P3
560	.355	2.2	1.181	1.181	30	30	LPX561M250E3P3
560	.355	2.4	.984	1.575	25	40	LPX561M250C7P3
680	.293	2.5	1.378	1.181	35	30	LPX681M250H3P3
680	.293	2.7	.984	1.772	25	45	LPX681M250C4P3
680	.293	2.6	1.181	1.378	30	35	LPX681M250E5P3
820	.243	3.0	1.378	1.378	35	35	LPX821M250H5P3
820	.243	3.0	1.181	1.575	30	40	LPX821M250E7P3
1,000	.199	3.4	1.378	1.575	35	40	LPX102M250H7P3
1,000	.199	3.4	1.181	1.772	30	45	LPX102M250E4P3
1,200	.166	3.8	1.378	1.772	35	45	LPX122M250H4P3
1,500	.133	4.2	1.378	1.969	35	50	LPX152M250H9P3

350 WVDC; 400 VDC Surge

100	1.989	.6	.866	.984	22	25	LPX101M350A1P3
120	1.658	.7	.984	.984	25	25	LPX121M350C1P3
120	1.658	.7	.866	1.181	22	30	LPX121M350A3P3
150	1.326	.8	.984	1.181	25	30	LPX151M350C3P3
150	1.326	.8	.866	1.378	22	35	LPX151M350A5P3
180	1.105	.9	.866	1.575	22	40	LPX181M350A7P3
180	1.105	.9	.984	1.181	25	30	LPX181M350C3P3

Aluminum Capacitors

Type LPX Radial Snap-In Capacitors



Cap μF	Max ESR Ohms @ 120Hz 25°C	Max Ripple Amps @ 120Hz 85°C	Size (inches)		Size (millimeters)		Catalog Number
			D	L	D	L	

350 WVDC; 400 VDC Surge							
180	1.105	1.0	1.181	.984	30	25	LPX181M350E1P3
220	.904	1.1	.866	1.772	22	45	LPX221M350A4P3
220	.904	1.1	1.181	1.181	30	30	LPX221M350E3P3
220	.904	1.1	.984	1.378	25	35	LPX221M350C5P3
270	.737	1.2	1.181	1.181	30	30	LPX271M350E3P3
270	.737	1.2	.984	1.575	25	40	LPX271M350C7P3
270	.737	1.3	.866	1.969	22	50	LPX271M350A9P3
270	.737	1.3	1.378	.984	35	25	LPX271M350H1P3
330	.603	1.4	.984	1.772	25	45	LPX331M350C4P3
330	.603	1.4	1.378	1.181	35	30	LPX331M350H3P3
330	.603	1.4	1.181	1.378	30	35	LPX331M350E5P3
390	.510	1.6	1.378	1.181	35	30	LPX391M350H3P3
390	.510	1.8	1.181	1.575	30	40	LPX391M350E7P3
470	.423	1.8	1.378	1.378	35	35	LPX471M350H5P3
470	.423	1.9	1.181	1.772	30	45	LPX471M350E4P3
560	.355	2.1	1.378	1.575	35	40	LPX561M350H7P3
680	.293	2.4	1.378	1.772	35	45	LPX681M350H4P3

400 WVDC; 450 VDC Surge							
82	2.426	.6	.866	.984	22	25	LPX820M400A1P3
100	1.989	.7	.866	1.181	22	30	LPX101M400A3P3
120	1.658	.7	.866	1.181	22	30	LPX121M400A3P3
120	1.658	.7	.984	.984	25	25	LPX121M400C1P3
150	1.326	.9	.984	1.181	25	30	LPX151M400C3P3
180	1.105	1.0	.866	1.575	22	40	LPX181M400A7P3
180	1.105	1.0	.984	1.378	25	35	LPX181M400C5P3
220	.904	1.2	1.181	1.181	30	30	LPX221M400E3P3
220	.904	1.2	1.378	.984	35	25	LPX221M400H1P3
220	.904	1.2	.984	1.575	25	40	LPX221M400C7P3
270	.737	1.4	.984	1.772	25	45	LPX271M400C4P3
270	.737	1.4	1.181	1.378	30	35	LPX271M400E5P3
270	.737	1.4	1.378	1.181	35	30	LPX271M400H3P3
330	.603	1.6	1.181	1.575	30	40	LPX331M400E7P3
330	.603	1.5	1.378	1.181	35	30	LPX331M400H3P3

Cap μF	Max ESR Ohms @ 120Hz 25°C	Max Ripple Amps @ 120Hz 85°C	Size (inches)		Size (millimeters)		Catalog Number
			D	L	D	L	

400 WVDC; 450 VDC Surge							
390	.510	1.8	1.378	1.378	35	35	LPX391M400H5P3
390	.510	1.8	1.181	1.772	30	45	LPX391M400E4P3
470	.423	2.0	1.378	1.575	35	40	LPX471M400H7P3
470	.423	2.0	1.181	1.969	30	50	LPX471M400E9P3
560	.355	2.3	1.378	1.772	35	45	LPX561M400H4P3
680	.293	2.6	1.378	1.969	35	50	LPX681M400H9P3

450 WVDC; 500 VDC Surge							
56	3.553	.5	.866	.984	22	25	LPX560M450A1P3
68	2.926	.6	.866	1.181	22	30	LPX680M450A3P3
82	2.426	.7	.984	.984	25	25	LPX820M450C1P3
82	2.426	.7	.866	1.181	22	30	LPX820M450A3P3
100	1.989	.8	.984	1.181	25	30	LPX101M450C3P3
100	1.989	.8	.866	1.378	22	35	LPX101M450A5P3
120	1.658	.9	1.181	.984	30	25	LPX121M450E1P3
120	1.658	1.0	.984	1.378	25	35	LPX121M450C5P3
120	1.658	.9	.866	1.575	22	40	LPX121M450A7P3
150	1.326	1.1	.866	1.969	22	50	LPX151M450A9P3
150	1.326	1.1	1.181	1.181	30	30	LPX151M450E3P3
150	1.326	1.1	.984	1.575	25	40	LPX151M450C7P3
180	1.105	1.3	.984	1.772	25	45	LPX181M450C4P3
180	1.105	1.2	1.378	.984	35	25	LPX181M450H1P3
180	1.105	1.4	1.181	1.575	30	40	LPX181M450E7P3
220	.904	1.5	1.378	1.181	35	30	LPX221M450H3P3
220	.904	1.5	.984	1.969	25	50	LPX221M450C9P3
220	.904	1.6	1.181	1.575	30	40	LPX221M450E7P3
270	.737	1.7	1.181	1.772	30	45	LPX271M450E4P3
270	.737	1.7	1.378	1.378	35	35	LPX271M450H5P3
330	.603	2.0	1.378	1.575	35	40	LPX331M450H7P3
330	.603	2.0	1.181	1.969	30	50	LPX331M450E9P3
390	.510	2.2	1.378	1.772	35	45	LPX391M450H4P3
470	.423	2.5	1.378	1.969	35	50	LPX471M450H9P3

Outline Dimensions

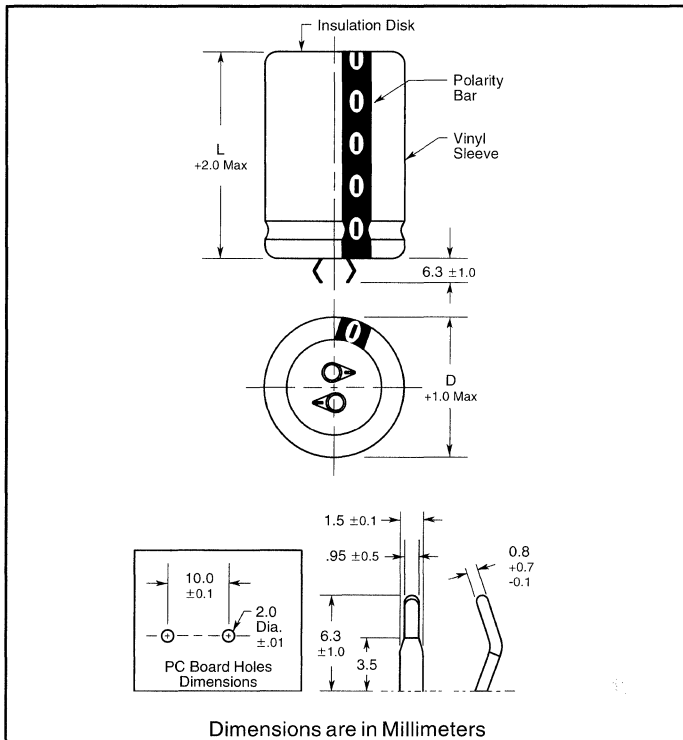

Part Number Format

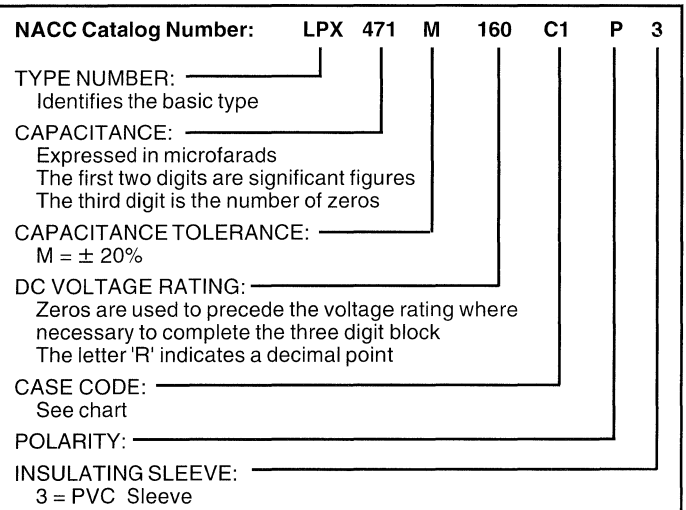

Case Code Chart

Diameter mm (Inches)	Length mm (Inches)					
	25 (1.00)	30 (1.18)	35 (1.38)	40 (1.57)	45 (1.77)	50 (2.00)
22 (.87)	A1	A3	A5	A7	A4	A9
25 (1.00)	C1	C3	C5	C7	C4	C9
30 (1.18)	E1	E3	E5	E7	E4	E9
35 (1.38)	H1	H3	H5	H7	H4	H9

Aluminum Capacitors

Radial Leaded Capacitors

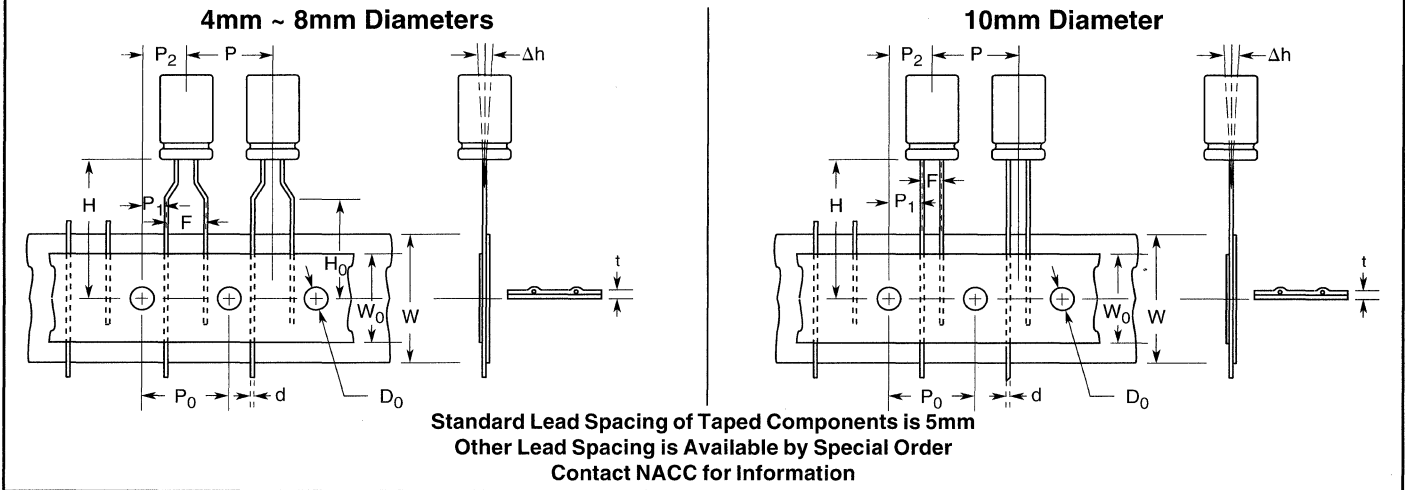

Radial leaded aluminum capacitors 10mm x 21mm or smaller are available taped, in Ammo Pack, for automatic insertion equipment. To order, change the third character of the catalog number to the code letter 'P'. For example: SKR100M1ED11 would be changed to SKP100M1ED11.

Radial Lead Taping Dimensions (mm)

Item	Symbol	Case Size						Tol				
		4x7	5x7	6.3x7	5x11	6.3x11	8x11		10x13	10x16	10x18	10x21
Lead wire diameter	d	0.45	0.5	0.6								±0.05
Pitch of components	P				12.7							±1.0
Feed hole pitch	P ₀				12.7							±0.2
Hole center to lead	P ₁				3.85							±0.7
Feed hole center to component center	P ₂				6.35							±1.0
Lead-to-lead distance	F				5.0							+0.8 -0.2
Height of component from tape center	H	17.5	18.5	20		18.5						±0.75
Lead wire clinch height	H ₀		16.0			N/A						±0.5
Tape width	W				18.0							±0.5
Adhesive tape width	W ₀				12.5							min
Feed hole diameter	D ₀				4.0							±0.3
Total tape thickness	t				0.7							±0.3
Alignment deviation	Δh				0							±1.0

Ammo Pack

Capacitor Diameter D (mm)	Ammo Pack Box Dimensions (mm)			Quantity per Ammo Pack Box
	A±5	B±5	C±3	
4	175	335	45	2,000
5	235	335	50	2,000
6.3	280	335	50	2,000
8	235	335	50	1,000
10≤(L16)	295	335	50	800
10≤(L21)	295	335	55	800

Ammo Pack boxes are shipped 5 to the outer packing carton

Axial Leaded Capacitors

Axial leaded aluminum capacitors 10mm x 27mm or smaller are available taped, in Ammo Pack, for automatic insertion equipment. To order, change the third character of the catalog number to the code letter reflecting the desired inside tape spacing dimension (W). (See codes in chart below). For example: SKA100M1HE13V would be changed to SKJ100M1HE13V to order taped, with 63mm inside tape spacing, in Ammo Pack.

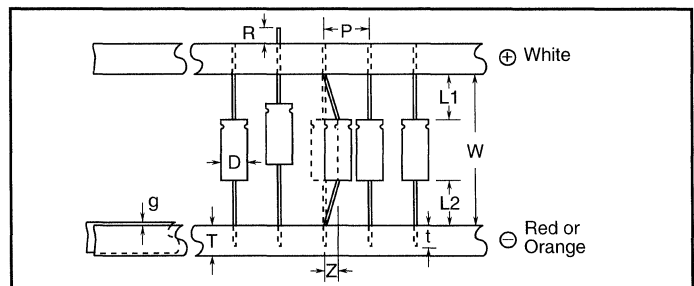

Axial Lead Taping Dimensions (mm)

Item	Symbol	Dimensions		Tolerance
		Ø5 - Ø10		
Inside Tape Spacing	W	52, 63, 73		±2.0
Lead Wire Protrusion	R	0.5		max.
Pitch of Components	P	Ø5-8 Ø10	10 15	±0.5
Lead Flexing	Z	1.2		max.
Body Deviation	L1-L2	1.5		max.
Adhesive length for Lead Wire	t	3.2		min.
Adhesive Tape Width	T	6		±1.0
Adhesive Tape Border	g	0.8		max.

Ammo Pack

Code	Inside Tape Spacing W		
	H	J	T
H	52mm		
J	63mm		
T	73mm		

Code	Capacitor Diameter D (mm)			Quantity per Inner Box
	A±2 (mm)	B±2 (mm)	C±2 (mm)	
H	294	294	82	5
J	294	294	94	6.3
T	294	294	104	8
				10

Ammo Pack boxes are shipped 10 to the outer packing carton

Type SKR Radial Leaded Capacitors



- 85°C General Purpose
- Radial Leads
Miniature Size
- High CV per Case Size
- 2000 Hour Load Life
Data for Longer Life
- Suitable for Consumer
Electronic Products,
Such as Stereo Radio, TV, etc.

**SKR parts are available taped in Ammo pack.
See page 92 for details.**

GENERAL SPECIFICATIONS

Operating Temperature:
-40°C to +85°C

Voltage Range:
6.3 WVDC to 450 WVDC

Capacitance Range:
0.47 μ F to 15,000 μ F

Capacitance Tolerance:
 \pm 20%

DC Leakage Current:
6.3 - 100VDC
 $I \leq .03CV$ or $4\mu A$
whichever is greater
after 3 minutes

Over 100VDC
 $I \leq .03CV + 40\mu A$ Max
C = Capacitance in μF
V = Rated Voltage
I = Leakage Current in μA

QA Stability Test:
Apply WVDC for 2,000 hrs at 85°C

- Capacitance change \leq 20% from initial limits
- DC leakage current meets initial limits
- ESR \leq 150% of initial measured value

The maximum ripple current at 85°C and 120 Hz for SKR capacitors is shown in the Standard Rating Table. Maximum ripple current may be adjusted by the multipliers in the following tables.

Rated WVDC	Ripple Multipliers			Ambient Temperature	Ripple Multiplier
	60Hz	120Hz	1kHz		
6 to 25	.85	1.0	1.10	+85°C	1.00
35 to 100	.80	1.0	1.15	+75°C	1.14
160 to 250	.75	1.0	1.25	+65°C	1.25
350 to 450	.70	1.0	1.30		

Cap μF	Max ESR Ohms 120Hz 25°C	Max Ripple mA 120Hz 85°C	Size (Millimeters)				Catalog Number
			D Diameter	L Length	S Lead Space	d	
6.3 WVDC; 8 VDC Surge							
100	3.98	130	5	11	2.0	.5	SKR101M0JD11
220	1.81	210	6.3	11	2.5	.5	SKR221M0JE11V
330	1.21	260	6.3	11	2.5	.5	SKR331M0JE11V
1,000	.40	560	10	13	5.0	.6	SKR102M0JG13V
2,200	.20	980	10	21	5.0	.6	SKR222M0JG21V
3,300	.14	1180	13	21	5.0	.6	SKR332M0JJ21V
4,700	.11	1460	13	26	5.0	.6	SKR472M0JJ26V
6,800	.09	1700	16	25	7.5	.8	SKR682M0JK25V
10,000	.07	2100	16	32	7.5	.8	SKR103M0JK32V
15,000	.06	2370	18	35	7.5	.8	SKR153M0JL35V

Cap μF	Max ESR Ohms 120Hz 25°C	Max Ripple mA 120Hz 85°C	Size (Millimeters)				Catalog Number
			D Diameter	L Length	S Lead Space	d	
10 WVDC; 13 VDC Surge							
33	7.54	90	5	11	2.0	.5	SKR330M1AD11
47	6.00	100	5	11	2.0	.5	SKR470M1AD11
100	3.32	140	5	11	2.0	.5	SKR101M1AD11
220	1.51	230	6.3	11	2.5	.5	SKR221M1AE11V
330	1.01	330	8	11	3.5	.6	SKR331M1AF11V
470	.71	390	8	11	3.5	.6	SKR471M1AF11V
1,000	.33	670	10	16	5.0	.6	SKR102M1AG16V
2,200	.17	1080	13	21	5.0	.6	SKR222M1AJ21V
3,300	.12	1270	13	21	5.0	.6	SKR332M1AJ21V
4,700	.10	1610	16	25	7.5	.8	SKR472M1AK25V
6,800	.08	2010	16	32	7.5	.8	SKR682M1AK32V
10,000	.06	2260	18	35	7.5	.8	SKR103M1AL35V
15,000	.05	2670	18	42	7.5	.8	SKR153M1AL42V

Cap μF	Max ESR Ohms 120Hz 25°C	Max Ripple mA 120Hz 85°C	Size (Millimeters)				Catalog Number
			D Diameter	L Length	S Lead Space	d	
16 WVDC; 20 VDC Surge							
22	11.30	75	5	11	2.0	.5	SKR220M1CD11
33	7.54	90	5	11	2.0	.5	SKR330M1CD11
47	6.00	100	5	11	2.0	.5	SKR470M1CD11
100	2.82	170	6.3	11	2.5	.5	SKR101M1CE11V
220	1.28	290	8	11	3.5	.6	SKR221M1CF11V
330	.85	350	8	11	3.5	.6	SKR331M1CF11V
470	.60	460	10	13	5.0	.6	SKR471M1CG13V
1,000	.28	820	10	21	5.0	.6	SKR102M1CG21V

Outline Dimensions (Millimeters)

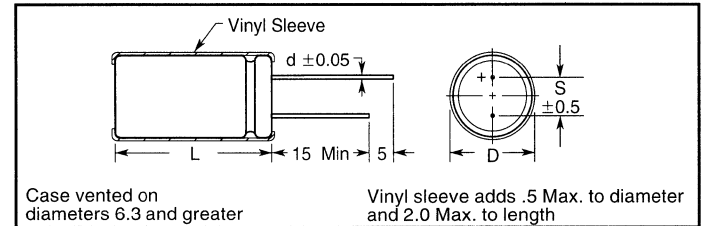

Case vented on diameters 6.3 and greater

Vinyl sleeve adds .5 Max. to diameter and 2.0 Max. to length

Cap μF	Max ESR Ohms 120Hz 25°C	Max Ripple mA 120Hz 85°C	Size (Millimeters)				Catalog Number
			D Diameter	L Length	S Lead Space	d	
16 WVDC; 20 VDC Surge							
2,200	.14	1160	13	21	5.0	.6	SKR222M1CJ21V
3,300	.11	1490	13	26	5.0	.6	SKR332M1CJ26V
4,700	.09	1900	16	32	7.5	.8	SKR472M1CK32V
6,800	.07	2170	18	35	7.5	.8	SKR682M1CL35V
10,000	.06	2560	18	42	7.5	.8	SKR103M1CL42V

Cap μF	Max ESR Ohms 120Hz 25°C	Max Ripple mA 120Hz 85°C	Size (Millimeters)				Catalog Number
			D Diameter	L Length	S Lead Space	d	
25 WVDC; 32 VDC Surge							
10	24.87	50	5	11	2.0	.5	SKR100M1ED11
22	11.30	75	5	11	2.0	.5	SKR220M1ED11
33	7.54	90	5	11	2.0	.5	SKR330M1ED11
47	5.29	110	5	11	2.0	.5	SKR470M1ED11
100	2.49	180	6.3	11	2.5	.5	SKR101M1EE11V
220	1.13	310	8	11	3.5	.6	SKR221M1EF11V
330	.75	410	10	13	5.0	.6	SKR331M1EG13V
470	.53	530	10	16	5.0	.6	SKR471M1EG16V
1,000	.25	880	13	21	5.0	.6	SKR102M1EJ21V
2,200	.13	1350	13	26	5.0	.6	SKR222M1EJ26V
3,300	.10	1790	16	32	7.5	.8	SKR332M1EK32V
4,700	.08	2040	18	35	7.5	.8	SKR472M1EL35V
6,800	.06	2440	18	42	7.5	.8	SKR682M1EL42V

Cap μF	Max ESR Ohms 120Hz 25°C	Max Ripple mA 120Hz 85°C	Size (Millimeters)				Catalog Number
			D Diameter	L Length	S Lead Space	d	
35 WVDC; 44 VDC Surge							
10	16.58	60	5	11	2.0	.5	SKR100M1VD11
22	7.54	90	5	11	2.0	.5	SKR220M1VD11
33	6.03	100	5	11	2.0	.5	SKR330M1VD11
47	4.23	140	6.3	11	2.5	.5	SKR470M1VE11V
100	1.99	230	8	11	3.5	.6	SKR101M1VF11V
220	.90	370	10	13	5.0	.6	SKR221M1VG13V
330	.60	500	10	16	5.0	.6	SKR331M1VG16V
470	.42	670	10	21	5.0	.6	SKR471M1VG21V
1,000	.20	990	13	21	5.0	.6	SKR102M1VJ21V
2,200	.11	700	16	32	7.5	.8	SKR222M1VK32V
3,300	.08	2000	18	35	7.5	.8	SKR332M1VL35V
4,700	.07	2380	18	42	7.5	.8	SKR472M1VL42V

Aluminum Capacitors

Type SKR Radial Leaded Capacitors



Aluminum Capacitors

Cap μF	Max ESR Ohms 120Hz 25°C	Max Ripple mA 120Hz 85°C	Size (Millimeters)				Catalog Number
			D Diameter	L Length	S Lead Space	d	

50 WVDC; 63 VDC Surge							
0.47	352.74	13	5	11	2.0	.5	SKRR47M1HD11
1.0	165.79	19	5	11	2.0	.5	SKR010M1HD11
2.2	75.36	29	5	11	2.0	.5	SKR2R2M1HD11
3.3	50.24	35	5	11	2.0	.5	SKR3R3M1HD11
4.7	35.27	42	5	11	2.0	.5	SKR4R7M1HD11
10	16.58	60	5	11	2.0	.5	SKR100M1HD11
22	7.54	90	5	11	2.0	.5	SKR220M1HD11
33	5.02	130	6.3	11	2.5	.5	SKR330M1HE11V
47	3.53	150	6.3	11	2.5	.5	SKR470M1HE11V
100	1.66	250	8	11	3.5	.6	SKR101M1HF11V
220	.75	440	10	16	5.0	.6	SKR221M1HG16V
330	.50	610	10	21	5.0	.6	SKR331M1HG21V
470	.35	740	13	21	5.0	.6	SKR471M1HJ21V
1,000	.19	1220	16	25	7.5	.8	SKR102M1HK25V
2,200	.07	1890	18	35	7.5	.8	SKR222M1HL35V
3,300	.07	2320	18	42	7.5	.8	SKR332M1HL42V

63 WVDC; 79 VDC Surge							
0.47	282.19	15	5	11	2.0	.5	SKRR47M1JD11
1.0	132.63	22	5	11	2.0	.5	SKR010M1JD11
2.2	60.29	32	5	11	2.0	.5	SKR2R2M1JD11
3.3	40.19	39	5	11	2.0	.5	SKR3R3M1JD11
4.7	28.22	47	5	11	2.0	.5	SKR4R7M1JD11
10	16.58	60	5	11	2.0	.5	SKR100M1JD11
22	7.54	100	6.3	11	2.5	.5	SKR220M1JE11V
33	5.02	130	6.3	11	2.5	.5	SKR330M1JE11V
47	3.53	170	8	11	3.5	.6	SKR470M1JF11V
100	1.66	270	10	13	5.0	.6	SKR101M1JG13V
220	.75	500	10	21	5.0	.6	SKR221M1JG21V
330	.50	620	13	21	5.0	.6	SKR331M1JJ21V
470	.35	820	13	26	5.0	.6	SKR471M1JJ26V
1,000	.17	1360	16	32	7.5	.8	SKR102M1JK32V

100 WVDC; 125 VDC Surge							
0.47	282.19	15	5	11	2.0	.5	SKRR47M2AD11
1.0	132.63	22	5	11	2.0	.5	SKR010M2AD11
2.2	60.29	32	5	11	2.0	.5	SKR2R2M2AD11
3.3	40.19	39	5	11	2.0	.5	SKR3R3M2AD11
4.7	28.22	47	5	11	2.0	.5	SKR4R7M2AD11
10	13.26	80	6.3	11	2.5	.5	SKR100M2AE11V
22	6.03	130	8	11	3.5	.6	SKR220M2AF11V
33	4.02	180	10	13	5.0	.6	SKR330M2AG13V
47	2.82	230	10	16	5.0	.6	SKR470M2AG16V
100	1.33	380	13	21	5.0	.6	SKR101M2AJ21V
220	.60	640	16	25	7.5	.8	SKR221M2AK25V
330	.40	780	16	25	7.5	.8	SKR331M2AK25V
470	.28	1040	16	32	7.5	.8	SKR471M2AK32V

160 WVDC; 200 VDC Surge							
0.47	705.47	12	6.3	11	2.5	.5	SKRR47M2CE11V
1.0	331.57	18	6.3	11	2.5	.5	SKR010M2CE11V
2.2	150.72	27	6.3	11	2.5	.5	SKR2R2M2CE11V
3.3	100.48	33	6.3	11	2.5	.5	SKR3R3M2CE11V
4.7	70.55	39	6.3	11	2.5	.5	SKR4R7M2CE11V
10	33.16	65	8	11	3.5	.5	SKR100M2CF11V
22	15.07	120	10	16	5.0	.6	SKR220M2CG16V
33	10.05	160	10	21	5.0	.6	SKR330M2CG21V
47	7.06	190	13	21	5.0	.6	SKR470M2CJ21V
100	3.32	310	13	26	5.0	.6	SKR101M2CJ26V
220	1.51	540	16	35	7.5	.8	SKR221M2CK35V
330	1.01	710	18	42	7.5	.8	SKR331M2CL42V

Cap μF	Max ESR Ohms 120Hz 25°C	Max Ripple mA 120Hz 85°C	Size (Millimeters)				Catalog Number
			D Diameter	L Length	S Lead Space	d	

200 WVDC; 250 VDC Surge							
0.47	705.47	13	6.3	11	2.5	.5	SKRR47M2DE11V
1.0	331.57	19	6.3	11	2.5	.5	SKR010M2DE11V
2.2	150.72	29	6.3	11	2.5	.5	SKR2R2M2DE11V
3.3	100.48	35	6.3	11	2.5	.5	SKR3R3M2DE11V
4.7	70.55	48	8	11	3.5	.6	SKR4R7M2DF11V
10	33.16	75	10	13	5.0	.6	SKR100M2DG13V
22	15.07	140	10	21	5.0	.6	SKR220M2DG21V
33	10.05	170	13	21	5.0	.6	SKR330M2DJ21V
47	7.06	210	13	21	5.0	.6	SKR470M2DJ21V
100	3.32	340	16	25	7.5	.8	SKR101M2DK25V
220	1.51	620	18	42	7.5	.8	SKR221M2DL42V

250 WVDC; 300 VDC Surge							
0.47	705.47	14	6.3	11	2.5	.5	SKRR47M2EE11V
1.0	331.57	21	6.3	11	2.5	.5	SKR010M2EE11V
2.2	150.72	31	6.3	11	2.5	.5	SKR2R2M2EE11V
3.3	100.48	44	8	11	3.5	.6	SKR3R3M2EF11V
4.7	70.55	50	8	11	3.5	.6	SKR4R7M2EF11V
10	33.16	90	10	16	5.0	.6	SKR100M2EG16V
22	15.07	150	13	21	5.0	.6	SKR220M2EJ21V
33	10.05	190	13	21	5.0	.6	SKR330M2EJ21V
47	7.06	250	13	26	5.0	.6	SKR470M2EJ26V
100	3.32	410	16	32	7.5	.8	SKR101M2EK32V

350 WVDC; 400 VDC Surge							
0.47	881.84	14	8	11	3.5	.6	SKRR47M2VF11V
1.0	414.47	21	8	11	3.5	.6	SKR010M2VF11V
2.2	188.39	31	8	11	3.5	.6	SKR2R2M2VF11V
3.3	125.60	41	10	13	5.0	.6	SKR3R3M2VG13V
4.7	88.18	49	10	13	5.0	.6	SKR4R7M2VG13V
10	41.45	85	10	21	5.0	.6	SKR100M2VG21V
22	18.84	130	13	21	5.0	.6	SKR220M2VJ21V
33	12.56	180	13	26	5.0	.6	SKR330M2VJ26V
47	8.82	220	16	25	7.5	.8	SKR470M2VK25V
100	4.15	360	18	35	7.5	.8	SKR101M2VL35V

400 WVDC; 450 VDC Surge							
0.47	881.84	15	8	11	3.5	.6	SKRR47M2GF11V
1.0	414.47	21	8	11	3.5	.6	SKR010M2GF11V
2.2	188.39	32	8	11	3.5	.6	SKR2R2M2GF11V
3.3	125.60	42	10	13	5.0	.6	SKR3R3M2GG13V
4.7	88.18	55	10	16	5.0	.6	SKR4R7M2GG16V
10	41.45	90	13	21	5.0	.6	SKR100M2GJ21V
22	18.84	150	13	26	5.0	.6	SKR220M2GJ26V
33	12.56	190	16	25	7.5	.8	SKR330M2GK25V
47	8.82	250	16	32	7.5	.8	SKR470M2GK32V

450 WVDC; 500 VDC Surge							
0.47	881.84	12	8	11	3.5	.6	SKRR47M2WF11V
1.0	414.47	18	8	11	3.5	.6	SKR010M2WF11V
2.2	188.39	29	10	13	5.0	.6	SKR2R2M2WG13V
3.3	125.60	38	10	16	5.0	.6	SKR3R3M2WG16V
4.7	88.18	48	10	18	5.0	.6	SKR4R7M2WG18V
10	41.45	75	13	21	5.0	.6	SKR100M2WJ21V
22	18.84	130	16	25	7.5	.8	SKR220M2WK25V
33	12.56	170	16	32	7.5	.8	SKR330M2WK32V
47	8.82	210	18	35	7.5	.8	SKR470M2WL35V

Type TKR Radial Leaded Capacitors

JAMICON MALLORY

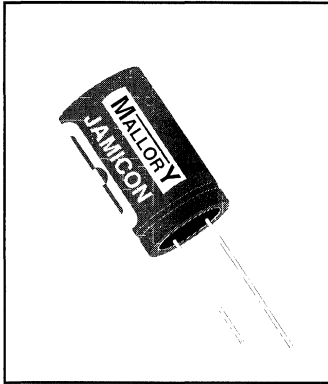

- 105°C - Long Life
- High Reliability

GENERAL SPECIFICATIONS

Operating Temperature:
-40°C to +105°C

Voltage Range:
6.3 WVDC to 400 WVDC

Capacitance Range:
0.47 μ F to 15,000 μ F

Capacitance Tolerance:
 \pm 20%

DC Leakage Current:
6.3 - 100VDC
 $I \leq .03CV$ or $4\mu A$
whichever is greater
after 3 minutes

Over 100VDC
 $I \leq .03CV + 40\mu A$ Max
C = Capacitance in μF
V = Rated Voltage
I = Leakage Current in μA

- QA Stability Test:
Apply WVDC for 1,000 hrs at 105°C
- Capacitance change
6.3 - 16VDC \leq 25% of initial limits
25 - 400VDC \leq 20% of initial limits
 - DC leakage current meets initial limits
 - ESR \leq 200% of initial measured value

TKR parts are available taped in Ammo pack.
See page 92 for details.

Outline Dimensions (Millimeters)

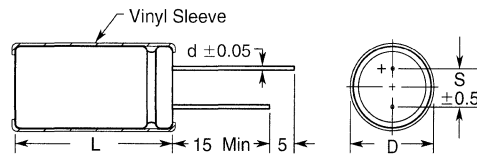

Case vented on diameters 6.3 and greater

Vinyl sleeve adds .5 Max. to diameter and 2.0 Max. to length

Cap μF	Max ESR Ohms 120Hz 25°C	Max Ripple mA 120Hz 105°C	Size (Millimeters)				Catalog Number
			D Diameter	L Length	S Lead Space	d	
6.3 WVDC; 8 VDC Surge							
100	3.98	75	5	11	2.0	.5	TKR101M0JD11
220	1.81	130	6.3	11	2.5	.5	TKR221M0JE11V
330	1.21	160	6.3	11	2.5	.5	TKR331M0JE11V
470	.85	210	8	11	3.5	.6	TKR471M0JF11V
1,000	.40	340	10	13	5.0	.6	TKR102M0JG13V
2,200	.20	590	10	21	5.0	.6	TKR222M0JG21V
3,300	.14	700	13	21	5.0	.6	TKR332M0JJ21V
4,700	.11	880	13	26	5.0	.6	TKR472M0JJ26V
6,800	.09	1020	16	25	7.5	.8	TKR682M0JK25V
10,000	.07	1260	16	32	7.5	.8	TKR103M0JK32V
15,000	.06	1420	18	35	7.5	.8	TKR153M0JL35V

Cap μF	Max ESR Ohms 120Hz 25°C	Max Ripple mA 120Hz 105°C	Size (Millimeters)				Catalog Number
			D Diameter	L Length	S Lead Space	d	
10 WVDC; 13 VDC Surge							
47	6.00	60	5	11	2.0	.5	TKR470M1AD11
100	3.32	80	5	11	2.0	.5	TKR101M1AD11
220	1.51	140	6.3	11	2.5	.5	TKR221M1AE11V
330	1.01	190	8	11	3.5	.6	TKR331M1AF11V
470	.71	230	8	11	3.5	.6	TKR471M1AF11V
1,000	.33	400	10	16	5.0	.6	TKR102M1AG16V
2,200	.17	650	13	21	5.0	.6	TKR222M1AJ21V
3,300	.12	760	13	21	5.0	.6	TKR332M1AJ21V
4,700	.10	960	16	25	7.5	.8	TKR472M1AK25V
6,800	.08	1210	16	32	7.5	.8	TKR682M1AK32V
10,000	.06	1350	18	35	7.5	.8	TKR103M1AL35V
15,000	.05	1600	18	42	7.5	.8	TKR153M1AL42V

Cap μF	Max ESR Ohms 120Hz 25°C	Max Ripple mA 120Hz 105°C	Size (Millimeters)				Catalog Number
			D Diameter	L Length	S Lead Space	d	
16 WVDC; 20 VDC Surge							
33	7.54	55	5	11	2.0	.5	TKR330M1CD11
47	6.00	60	5	11	2.0	.5	TKR470M1CD11
100	2.82	100	6.3	11	2.5	.5	TKR101M1CE11V
220	1.28	170	8	11	3.5	.6	TKR221M1CF11V
330	.85	210	8	11	3.5	.6	TKR331M1CF11V
470	.60	270	10	13	5.0	.6	TKR471M1CG13V
1,000	.28	490	10	21	5.0	.6	TKR102M1CG21V
2,200	.14	700	13	21	5.0	.6	TKR222M1CJ21V
3,300	.11	890	13	26	5.0	.6	TKR332M1CJ26V
4,700	.09	1140	16	32	7.5	.8	TKR472M1CK32V
6,800	.07	1300	18	35	7.5	.8	TKR682M1CL35V
10,000	.06	1530	18	42	7.5	.8	TKR103M1CL42V

Cap μF	Max ESR Ohms 120Hz 25°C	Max Ripple mA 120Hz 105°C	Size (Millimeters)				Catalog Number
			D Diameter	L Length	S Lead Space	d	
25 WVDC; 32 VDC Surge							
10	24.87	30	5	11	2	.5	TKR100M1ED11
22	11.30	44	5	11	2.0	.5	TKR220M1ED11
33	7.54	55	5	11	2.0	.5	TKR330M1ED11
47	5.29	65	5	11	2.0	.5	TKR470M1ED11
100	2.49	110	6.3	11	2.5	.5	TKR101M1EE11V
220	1.13	180	8	11	3.5	.6	TKR221M1EF11V
330	.75	240	10	13	5.0	.6	TKR331M1EG13V
470	.53	320	10	16	5.0	.6	TKR471M1EG16V
1,000	.25	530	13	21	5.0	.6	TKR102M1EJ21V
2,200	.13	810	13	26	5.0	.6	TKR222M1EJ26V
3,300	.10	1070	16	32	7.5	.8	TKR332M1EK32V
4,700	.08	1220	18	35	7.5	.8	TKR472M1EL35V
6,800	.06	1460	18	42	7.5	.8	TKR682M1EL42V

Cap μF	Max ESR Ohms 120Hz 25°C	Max Ripple mA 120Hz 105°C	Size (Millimeters)				Catalog Number
			D Diameter	L Length	S Lead Space	d	
35 WVDC; 44 VDC Surge							
22	7.54	55	5	11	2.0	.5	TKR220M1VD11
33	6.03	60	5	11	2.0	.5	TKR330M1VD11
47	4.23	80	6.3	11	2.5	.5	TKR470M1VE11V
100	1.99	140	8	11	3.5	.6	TKR101M1VF11V
220	.90	220	10	13	5.0	.6	TKR221M1VG13V
330	.60	300	10	16	5.0	.6	TKR331M1VG16V
470	.42	400	10	21	5.0	.6	TKR471M1VG21V
1,000	.20	590	13	21	5.0	.6	TKR102M1VJ21V
2,200	.11	1020	16	32	7.5	.8	TKR222M1VK32V
3,300	.08	1200	18	35	7.5	.8	TKR332M1VL35V
4,700	.07	1420	18	42	7.5	.8	TKR472M1VL42V

Cap μF	Max ESR Ohms 120Hz 25°C	Max Ripple mA 120Hz 105°C	Size (Millimeters)				Catalog Number
			D Diameter	L Length	S Lead Space	d	
50 WVDC; 63 VDC Surge							
0.47	352.74	8	5	11	2.0	.5	TKR47M1HD11
1.0	165.79	12	5	11	2.0	.5	TKR010M1HD11
2.2	75.36	17	5	11	2.0	.5	TKR2R2M1HD11
3.3	50.24	21	5	11	2.0	.5	TKR3R3M1HD11
4.7	35.27	25	5	11	2.0	.5	TKR4R7M1HD11
10	16.58	37	5	11	2.0	.5	TKR100M1HD11
22	7.54	55	5	11	2.0	.5	TKR220M1HD11
33	5.02	75	6.3	11	2.5	.5	TKR330M1HE11V
47	3.53	90	6.3	11	2.5	.5	TKR470M1HE11V
100	1.66	150	8	11	3.5	.6	TKR101M1HF11V
220	.75	270	10	16	5.0	.6	TKR221M1HG16V

Aluminum Capacitors

Type TKR Radial Leaded Capacitors



Aluminum Capacitors

Cap μF	Max ESR Ohms 120Hz 25°C	Max Ripple mA 120Hz 105°C	Size (Millimeters)				Catalog Number
			D Diameter	L Length	S Lead Space	d	
50 WVDC; 63 VDC Surge							
330	.50	370	10	21	5.0	.6	TKR331M1HG21V
470	.35	440	13	21	5.0	.6	TKR471M1HJ21V
1,000	.17	730	16	25	7.5	.8	TKR102M1HK25V
2,200	.09	1130	18	35	7.5	.8	TKR222M1HL35V
3,300	.07	1390	18	42	7.5	.8	TKR332M1HL42V

Cap μF	Max ESR Ohms 120Hz 25°C	Max Ripple mA 120Hz 105°C	Size (Millimeters)				Catalog Number
			D Diameter	L Length	S Lead Space	d	
63 WVDC; 79 VDC Surge							
4.7	28.22	28	5	11	2.0	.5	TKR47M1JD11
10	16.58	37	5	11	2.0	.5	TKR100M1JD11
22	7.54	60	6.3	11	2.5	.5	TKR220M1JE11V
33	5.02	75	6.3	11	2.5	.5	TKR330M1JE11V
47	3.53	100	8	11	3.5	.6	TKR470M1JF11V
100	1.66	160	10	13	5.0	.6	TKR101M1JG13V
220	.75	300	10	21	5.0	.6	TKR221M1JG21V
330	.50	370	13	21	5.0	.6	TKR331M1JJ21V
470	.35	490	13	26	5.0	.6	TKR471M1JJ26V
1,000	.17	810	16	32	7.5	.8	TKR102M1JK32V

Cap μF	Max ESR Ohms 120Hz 25°C	Max Ripple mA 120Hz 105°C	Size (Millimeters)				Catalog Number
			D Diameter	L Length	S Lead Space	d	
100 WVDC; 125 VDC Surge							
0.47	282.19	9	5	11	2.0	.5	TKRR47M2AD11
1.0	132.63	13	5	11	2.0	.5	TKR010M2AD11
2.2	60.29	19	5	11	2.0	.5	TKR2R2M2AD11
3.3	40.19	24	5	11	2.0	.5	TKR3R3M2AD11
4.7	28.22	28	5	11	2.0	.5	TKR47M2AD11
10	13.26	47	6.3	11	2.5	.5	TKR100M2AE11V
22	6.03	80	8	11	3.5	.6	TKR220M2AF11V
33	4.02	110	10	13	5.0	.6	TKR330M2AG13V
47	2.82	140	10	16	5.0	.6	TKR470M2AG16V
100	1.33	230	13	21	5.0	.6	TKR101M2AJ21V
220	.60	380	16	25	7.5	.8	TKR221M2AK25V
330	.40	470	16	25	7.5	.8	TKR331M2AK25V
470	.28	620	16	32	7.5	.8	TKR471M2AK32V

Cap μF	Max ESR Ohms 120Hz 25°C	Max Ripple mA 120Hz 105°C	Size (Millimeters)				Catalog Number
			D Diameter	L Length	S Lead Space	d	
160 WVDC; 200 VDC Surge							
0.47	705.47	7	6.3	11	2.5	.5	TKRR47M2CE11V
1.0	331.57	11	6.3	11	2.5	.5	TKR010M2CE11V
2.2	150.72	16	6.3	11	2.5	.5	TKR2R2M2CE11V
3.3	100.48	20	6.3	11	2.5	.5	TKR3R3M2CE11V
4.7	70.55	23	6.3	11	2.5	.5	TKR47M2CE11V
10	33.16	39	8	11	3.5	.6	TKR100M2CF11V
22	15.07	70	10	16	5.0	.6	TKR220M2CG16V
33	10.05	95	10	21	5.0	.6	TKR330M2CG21V
47	7.06	120	13	21	5.0	.6	TKR470M2CJ21V
100	3.32	180	13	26	5.0	.6	TKR101M2CJ26V
220	1.51	320	16	35	7.5	.8	TKR221M2CK35V
330	1.01	420	18	42	7.5	.8	TKR331M2CL42V

Cap μF	Max ESR Ohms 120Hz 25°C	Max Ripple mA 120Hz 105°C	Size (Millimeters)				Catalog Number
			D Diameter	L Length	S Lead Space	d	
200 WVDC; 250 VDC Surge							
0.47	705.47	8	6.3	11	2.5	.5	TKRR47M2DE11V
1.0	331.57	12	6.3	11	2.5	.5	TKR010M2DE11V
2.2	150.72	17	6.3	11	2.5	.5	TKR2R2M2DE11V
3.3	100.48	21	6.3	11	2.5	.5	TKR3R3M2DE11V
4.7	70.55	29	8	11	3.5	.6	TKR47M2DF11V
10	33.16	46	10	13	5.0	.6	TKR100M2DG13V
22	15.07	85	10	21	5.0	.6	TKR220M2DG21V
33	10.05	110	13	21	5.0	.6	TKR330M2DJ21V
47	7.06	120	13	21	5.0	.6	TKR470M2DJ21V
100	3.32	200	16	25	7.5	.8	TKR101M2DK25V
220	1.51	370	18	42	7.5	.8	TKR221M2DL42V

Cap μF	Max ESR Ohms 120Hz 25°C	Max Ripple mA 120Hz 105°C	Size (Millimeters)				Catalog Number
			D Diameter	L Length	S Lead Space	d	
250 WVDC; 300 VDC Surge							
0.47	705.47	9	6.3	11	2.5	.5	TKRR47M2EE11V
1.0	331.57	13	6.3	11	2.5	.5	TKR010M2EE11V
2.2	150.72	19	6.3	11	2.5	.5	TKR2R2M2EE11V
3.3	100.48	26	8	11	3.5	.6	TKR3R3M2EF11V
4.7	70.55	31	8	11	3.5	.6	TKR47M2EF11V
10	33.16	55	10	16	5.0	.6	TKR100M2EG16V
22	15.07	90	13	21	5.0	.6	TKR220M2EJ21V
33	10.05	110	13	21	5.0	.6	TKR330M2EJ21V
47	7.06	150	13	26	5.0	.6	TKR470M2EJ26V
100	3.32	250	16	32	7.5	.8	TKR101M2EK32V

Cap μF	Max ESR Ohms 120Hz 25°C	Max Ripple mA 120Hz 105°C	Size (Millimeters)				Catalog Number
			D Diameter	L Length	S Lead Space	d	
350 WVDC; 400 VDC Surge							
0.47	881.84	8	8	11	3.5	.6	TKRR47M2VF11V
1.0	414.47	12	8	11	3.5	.6	TKR010M2VF11V
2.2	188.39	18	8	11	3.5	.6	TKR2R2M2VF11V
3.3	125.60	24	10	13	5.0	.6	TKR3R3M2VG13V
4.7	88.18	29	10	13	5.0	.6	TKR47M2VG13V
10	41.45	50	10	21	5.0	.6	TKR100M2VG21V
22	18.84	85	13	26	5.0	.6	TKR220M2VJ26V
33	12.56	110	16	25	7.5	.8	TKR330M2VK25V
47	8.82	150	16	35	7.5	.8	TKR470M2VK35V
100	4.15	230	18	42	7.5	.8	TKR101M2VL42V

Cap μF	Max ESR Ohms 120Hz 25°C	Max Ripple mA 120Hz 105°C	Size (Millimeters)				Catalog Number
			D Diameter	L Length	S Lead Space	d	
400 WVDC; 450 VDC Surge							
0.47	881.84	9	8	11	3.5	.6	TKRR47M2GF11V
1.0	414.47	13	8	11	3.5	.6	TKR010M2GF11V
2.2	188.39	20	10	13	5.0	.6	TKR2R2M2GG13V
3.3	125.60	25	10	13	5.0	.6	TKR3R3M2GG13V
4.7	88.18	33	10	16	5.0	.6	TKR47M2GG16V
10	41.45	55	13	21	5.0	.6	TKR100M2GJ21V
22	18.84	90	13	26	5.0	.6	TKR220M2GJ26V
33	12.56	130	16	32	7.5	.8	TKR330M2GK32V
47	8.82	150	18	35	7.5	.8	TKR470M2GL35V

Type TMR Radial Leaded Capacitors

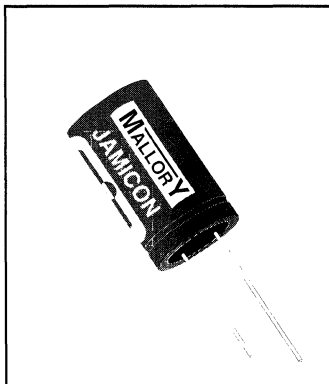

- 105°C Extra Long Life
- Very High Reliability

GENERAL SPECIFICATIONS

Operating Temperature: -40°C to +105°C
 Voltage Range: 6.3 WVDC to 250 WVDC
 Capacitance Range: 0.47 μ F to 4,700 μ F
 Capacitance Tolerance: \pm 20%

DC Leakage Current: 6.3 - 100VDC
 $I \leq .03CV$ or $4\mu A$ whichever is greater after 3 minutes
 Over 100VDC
 $I \leq .03CV + 40\mu A$ Max
 C = Capacitance in μ F
 V = Rated Voltage
 I = Leakage Current in μA
 QA Stability Test:
 Apply WVDC for 2,000 hrs at 105°C

- Values 6.3 to 16VDC: \leq 25% from initial limits
- Values 25 to 250VDC: \leq 20% from initial limits
- DC leakage current meets initial limits
- ESR \leq 200% of initial value

TMR parts are available taped in Ammo pack.
 See page 92 for details.

Outline Dimensions (Millimeters)

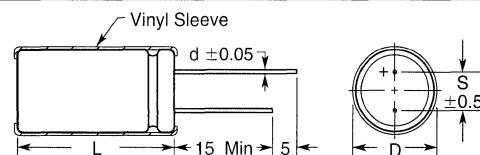

Case vented on diameters 6.3 and greater

Vinyl sleeve adds .5 Max. to diameter and 2.0 Max. to length

The maximum ripple current at 105°C and 120 Hz for TMR capacitors is shown in the Standard Rating Table. Maximum ripple current may be adjusted by the multipliers in the following tables.

Rated WVDC	Ripple Multipliers				Ambient Temperature	Ripple Multiplier
	60Hz	120Hz	1kHz	10kHz		
6 to 25	.80	1.0	1.10	1.20	+105°C	1.00
35 to 100	.75	1.0	1.30	1.40	+85°C	1.50
160 to 250	.70	1.0	1.40	1.60	+70°C	1.80

Cap μ F	Max ESR Ohms 120Hz 25°C	Max Ripple mA 120Hz 105°C	Size (Millimeters)				Catalog Number
			D Diameter	L Length	S Lead Space	d	

6.3 WVDC; 8 VDC Surge

47	7.06	65	5	11	2.0	.5	TMR470M0JD11
100	3.32	100	6.3	11	2.5	.5	TMR101M0JE11V
220	1.51	180	8	11	3.5	.6	TMR221M0JF11V
330	1.01	240	10	13	5.0	.6	TMR331M0JG13V
470	.71	280	10	13	5.0	.6	TMR471M0JG13V
1000	.33	500	10	21	5.0	.6	TMR102M0JG21V
2200	.17	790	13	26	5.0	.6	TMR222M0JJ26V
3300	.12	950	16	25	7.5	.8	TMR332M0JK25V
4700	.10	1200	16	32	7.5	.8	TMR472M0JK32V

10 WVDC; 13 VDC Surge

47	6.00	70	5	11	2.0	.5	TMR470M1AD11
100	2.82	110	6.3	11	2.5	.5	TMR101M1AE11V
220	1.28	190	8	11	3.5	.6	TMR221M1AF11V
330	.85	260	10	13	5.0	.6	TMR331M1AG13V
470	.60	330	10	16	5.0	.6	TMR471M1AG16V
1000	.28	550	10	21	5.0	.6	TMR102M1AG21V
2200	.14	850	13	26	5.0	.6	TMR222M1AJ26V
3300	.11	1020	16	25	7.5	.8	TMR332M1AK25V
4700	.09	1270	16	32	7.5	.8	TMR472M1AK32V

16 WVDC; 20 VDC Surge

33	7.54	60	5	11	2.0	.5	TMR330M1CD11
47	5.29	80	6.3	11	2.5	.5	TMR470M1CE11V
100	2.49	120	6.3	11	2.5	.5	TMR101M1CE11V
220	1.13	220	10	13	5.0	.6	TMR221M1CG13V
330	.75	300	10	16	5.0	.6	TMR331M1CG16V
470	.53	370	10	18	5.0	.6	TMR471M1CG18V
1000	.25	590	13	21	5.0	.6	TMR102M1CJ21V
2200	.13	920	16	25	7.5	.8	TMR222M1CK25V
3300	.10	1190	16	32	7.5	.8	TMR332M1CK32V
4700	.08	1360	18	35	7.5	.8	TMR472M1CL35V

25 WVDC; 32 VDC Surge

10	19.89	37	5	11	2.0	.5	TMR100M1ED11
22	9.04	55	5	11	2.0	.5	TMR220M1ED11
33	6.03	75	6.3	11	2.5	.5	TMR330M1EE11V
47	4.23	90	6.3	11	2.5	.5	TMR470M1EE11V
100	1.99	150	8	11	3.5	.6	TMR101M1EF11V
220	.90	270	10	16	5.0	.6	TMR221M1EG16V
330	.60	350	10	18	5.0	.6	TMR331M1EG18V
470	.42	450	10	21	5.0	.6	TMR471M1EG21V
1000	.20	720	13	26	5.0	.6	TMR102M1EJ26V
2200	.11	1140	16	32	7.5	.8	TMR222M1EK32V
3300	.08	1330	18	35	7.5	.8	TMR332M1EL35V
4700	.07	1590	18	42	7.5	.8	TMR472M1EL42V

35 WVDC; 44 VDC Surge

10	16.58	41	5	11	2.0	.5	TMR100M1VD11
22	7.54	70	6.3	11	2.5	.5	TMR220M1VE11V
33	5.02	85	6.3	11	2.5	.5	TMR330M1VE11V
47	3.53	120	8	11	3.5	.6	TMR470M1VF11V
100	1.66	180	10	13	5.0	.6	TMR101M1VG13V
220	.75	310	10	18	5.0	.6	TMR221M1VG18V
330	.50	410	10	21	5.0	.6	TMR331M1VG21V
470	.35	500	13	21	5.0	.6	TMR471M1VJ21V
1000	.17	810	16	25	7.5	.8	TMR102M1VK25V
2200	.09	1260	18	35	7.5	.8	TMR222M1VL35V
3300	.07	1550	18	42	7.5	.8	TMR332M1VL42V

50 WVDC; 63 VDC Surge

.47	317.46	9	5	11	2.0	.5	TMR47M1HD11
1	149.21	14	5	11	2.0	.5	TMR10M1HD11
2.2	67.82	20	5	11	2.0	.5	TMR22M1HD11
3.3	45.21	25	5	11	2.0	.5	TMR33M1HD11
4.7	31.75	30	5	11	2.0	.5	TMR47M1HD11
10	14.92	43	5	11	2.0	.5	TMR100M1HD11
22	6.78	75	6.3	11	2.5	.5	TMR220M1HE11V
33	4.52	100	8	11	3.5	.6	TMR330M1HF11V
47	3.18	120	8	11	3.5	.6	TMR470M1HF11V
100	1.49	210	10	16	5.0	.6	TMR101M1HG16V
220	.68	350	10	21	5.0	.6	TMR221M1HG21V

Aluminum Capacitors

Type TMR Radial Leaded Capacitors



Cap μF	Max ESR Ohms 120Hz 25°C	Max Ripple mA 120Hz 105°C	Size (Millimeters)				Catalog Number
			D Diameter	L Length	S Lead Space	d	
50 WVDC; 63 VDC Surge							
330	.45	440	13	21	5.0	.6	TMR331M1HJ21V
470	.32	570	13	26	5.0	.6	TMR471M1HJ26V
1000	.15	950	16	32	7.5	.8	TMR102M1HK32V
2200	.08	1430	18	42	7.5	.8	TMR222M1HL42V
63 WVDC; 79 VDC Surge							
4.7	31.75	30	5	11	2.0	.5	TMR4R7M1JD11
10	14.92	49	6.3	11	2.5	.5	TMR100M1JE11V
22	6.78	85	8	11	3.5	.6	TMR220M1JF11V
33	4.52	100	8	11	3.5	.6	TMR330M1JF11V
47	3.18	130	10	13	5.0	.6	TMR470M1JG13V
100	1.49	220	10	18	5.0	.6	TMR101M1JG18V
220	.68	300	13	21	5.0	.6	TMR221M1JJ21V
330	.45	480	13	26	5.0	.6	TMR331M1JJ26V
470	.32	590	16	25	7.5	.8	TMR471M1JK25V
1000	.15	980	18	35	7.5	.8	TMR102M1JL35V
100 WVDC; 125 VDC Surge							
.47	246.92	11	5	11	2.0	.5	TMR4R7M2AD11
1	116.05	15	5	11	2.0	.5	TMR010M2AD11
2.2	52.75	23	5	11	2.0	.5	TMR2R2M2AD11
3.3	35.17	32	6.3	11	2.5	.5	TMR3R3M2AE11V
4.7	24.69	38	6.3	11	2.5	.5	TMR4R7M2AE11V
10	11.61	65	8	11	3.5	.6	TMR100M2AF11V
22	5.28	100	10	13	5.0	.6	TMR220M2AG13V
33	3.52	140	10	16	5.0	.6	TMR330M2AG16V
47	2.47	170	10	18	5.0	.6	TMR470M2AG18V
100	1.16	270	13	21	5.0	.6	TMR101M2AJ21V
220	.53	460	16	25	7.5	.8	TMR221M2AK25V
330	.35	620	16	32	7.5	.8	TMR331M2AK32V
470	.25	760	18	35	7.5	.8	TMR471M2AL35V

Cap μF	Max ESR Ohms 120Hz 25°C	Max Ripple mA 120Hz 105°C	Size (Millimeters)				Catalog Number
			D Diameter	L Length	S Lead Space	d	
160 WVDC; 200 VDC Surge							
1	248.68	16	6.3	11	2.5	.5	TMR010M2CE11V
2.2	113.04	28	8	11	3.5	.6	TMR2R2M2CF11V
3.3	75.36	37	10	13	5.0	.6	TMR3R3M2CG13V
4.7	52.91	44	10	13	5.0	.6	TMR4R7M2CG13V
10	24.87	70	10	16	5.0	.6	TMR100M2CG16V
22	11.30	120	13	21	5.0	.6	TMR220M2CJ21V
33	7.54	160	13	26	5.0	.6	TMR330M2CJ26V
47	5.29	200	16	25	7.5	.8	TMR470M2CK25V
100	2.49	320	16	32	7.5	.8	TMR101M2CK32V
200 WVDC; 250 VDC Surge							
1	198.94	18	6.3	11	2.5	.5	TMR010M2DE11V
2.2	90.43	30	8	11	3.5	.6	TMR2R2M2DF11V
3.3	60.29	40	10	13	5.0	.6	TMR3R3M2DG13V
4.7	42.33	47	10	13	5.0	.6	TMR4R7M2DG13V
10	19.89	80	10	18	5.0	.6	TMR100M2DG18V
22	9.04	130	13	21	5.0	.6	TMR220M2DJ21V
33	6.03	170	13	26	5.0	.6	TMR330M2DJ26V
47	4.23	210	16	25	7.5	.8	TMR470M2DK25V
100	1.99	350	18	35	7.5	.8	TMR101M2DL35V
250 WVDC; 300 VDC Surge							
1	165.79	22	8	11	3.5	.6	TMR010M2EF11V
2.2	75.36	35	10	13	5.0	.6	TMR2R2M2EG13V
3.3	50.24	43	10	13	5.0	.6	TMR3R3M2EG13V
4.7	35.27	55	10	16	5.0	.6	TMR4R7M2EG16V
10	16.58	90	10	21	5.0	.6	TMR100M2EG21V
22	7.54	150	13	26	5.0	.6	TMR220M2EJ26V
33	5.02	190	16	25	7.5	.8	TMR330M2EK25V
47	3.53	250	16	32	7.5	.8	TMR470M2EK32V
100	1.66	380	18	35	7.5	.8	TMR101M2EL35V

Type SSR Radial Leaded Capacitors

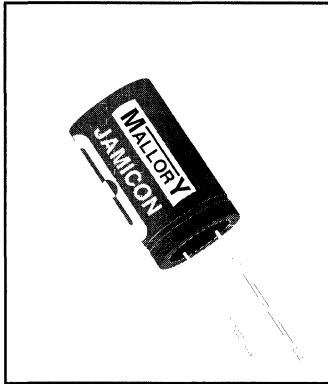

- 85°C - Sub-Miniature
- Radial Leads
- 4, 5 and 6.3mm Diameters
7mm Height
- Ideal For High Density Electronic Equipment, Such as Pocket Calculators, Lap-Top Computers, Car Stereo, Mini Tape Recorders and Where Space is Limited.

SSR parts are available taped in Ammo pack.
See page 92 for details.

GENERAL SPECIFICATIONS

Operating Temperature:
-40°C to +85°C

Voltage Range:
10 WVDC to 63 WVDC

Capacitance Range:
0.1 μ F to 100 μ F

Capacitance Tolerance:
 \pm 20%

DC Leakage Current:
 $I = .01CV$ or $3\mu A$
whichever is greater after 2 minutes

C = Capacitance in μ F
 V = Rated Voltage
 I = Leakage Current in μA

QA Stability Test:
Apply WVDC for 1,000 hrs at 85°C

- Capacitance change \leq 20% of initial limits
- DC leakage current meets initial limits
- ESR \leq 200% of initial measured value

Outline Dimensions (Millimeters)

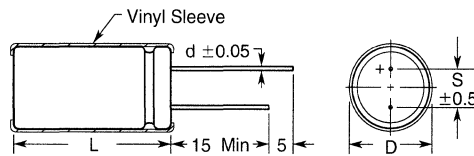

Case vented on diameters 6.3 and greater.

Vinyl sleeve adds .5 Max. to diameter and 2.0 Max. to length.

Cap μ F	Max ESR Ohms 120Hz 25°C	Max Ripple mA 120Hz 85°C	Size (Millimeters)				Catalog Number
			D Diameter	L Length	S Lead Space	d	
10 WVDC; 13 VDC Surge							
22	12.06	36	4	7	1.5	.45	SSR220M1AC07
33	8.04	44	4	7	1.5	.45	SSR330M1AC07
47	5.64	60	5	7	2.0	.45	SSR470M1AD07
100	2.65	100	6.3	7	2.5	.45	SSR101M1AE07V
16 WVDC; 20 VDC Surge							
10	22.54	26	4	7	1.5	.45	SSR100M1CC07
22	10.25	39	4	7	1.5	.45	SSR220M1CC07
33	6.83	55	5	7	2.0	.45	SSR330M1CD07
47	4.80	75	6.3	7	2.5	.45	SSR470M1CE07V
100	2.25	110	6.3	7	2.5	.45	SSR101M1CE07V
25 WVDC; 32 VDC Surge							
10	19.89	28	4	7	1.5	.45	SSR100M1EC07
22	9.04	47	5	7	2.0	.45	SSR220M1ED07
33	6.03	65	6.3	7	2.5	.45	SSR330M1EE07V
35 WVDC; 44 VDC Surge							
10	15.91	36	5	7	2.0	.45	SSR100M1VD07
22	7.23	60	6.3	7	2.5	.45	SSR220M1VE07V

Cap μ F	Max ESR Ohms 120Hz 25°C	Max Ripple mA 120Hz 85°C	Size (Millimeters)				Catalog Number
			D Diameter	L Length	S Lead Space	d	
50 WVDC; 63 VDC Surge							
0.1	1326.12	3	4	7	1.5	.45	SSR0R1M1HC07
0.22	602.78	5	4	7	1.5	.45	SSRR22M1HC07
0.33	401.85	6	4	7	1.5	.45	SSRR33M1HC07
0.47	282.15	7	4	7	1.5	.45	SSRR47M1HC07
1.0	132.61	11	4	7	1.5	.45	SSR010M1HC07
2.2	60.28	16	4	7	1.5	.45	SSR2R2M1HC07
3.3	40.19	20	4	7	1.5	.45	SSR3R3M1HC07
4.7	28.22	27	4	7	1.5	.45	SSR4R7M1HC07
10	13.26	45	6.3	7	2.5	.45	SSR100M1HE07V
63 WVDC; 79 VDC Surge							
0.1	1326.12	3	4	7	1.5	.45	SSR0R1M1JC07
0.22	602.78	5	4	7	1.5	.45	SSRR22M1JC07
0.33	401.85	6	4	7	1.5	.45	SSRR33M1JC07
0.47	282.15	7	4	7	1.5	.45	SSRR47M1JC07
1.0	132.61	11	4	7	1.5	.45	SSR010M1JC07
2.2	60.28	16	4	7	1.5	.45	SSR2R2M1JC07
3.3	40.19	22	5	7	2.0	.45	SSR3R3M1JD07
4.7	28.22	31	6.3	7	2.5	.45	SSR4R7M1JE07V

Aluminum Capacitors

Type NKR Radial Leaded Capacitors

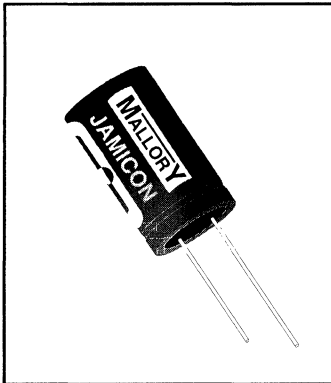

- 85°C Non-Polar
- Radial Leads
- Small Size
- Suitable For Use in Circuits Where Polarity is Unknown or Reversed Such as Signal Coupling Circuits & Speakers

GENERAL SPECIFICATIONS

Operating Temperature:
-40°C to +85°C

Voltage Range:
6.3 WVNP to 100 WVNP

Capacitance Range:
0.47 μ F to 2200 μ F

Capacitance Tolerance:
 \pm 20%

DC Leakage Current:
 $I \leq .04CV + 4\mu A$ after 5 minutes
C = Capacitance in μ F
V = Rated Voltage
I = Leakage Current in μA

QA Stability Test:
Apply WV for 1,000 hrs at 85°C

- Capacitance change \leq 20% of initial limits
- DC leakage current meets initial limits
- ESR \leq 150% of initial measured value

NKR parts are available taped in Ammo pack.
See page 92 for details.

Outline Dimensions (Millimeters)

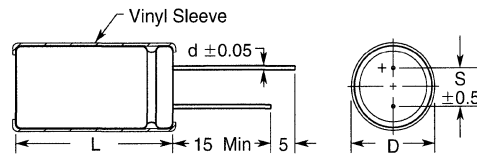

Case vented on diameters 6.3 and greater.

Vinyl sleeve adds .5 Max. to diameter and 2.0 Max. to length.

Cap μ F	Max ESR Ohms 120Hz 25°C	Max Ripple mA 120Hz 85°C	Size (Millimeters)				Catalog Number
			D Diameter	L Length	S Lead Space	d	
6.3 WVNP; 8 VNP Surge							
33	12.06	70	5	11	2.0	.5	NKR330M0JD11
47	8.47	100	6.3	11	2.5	.5	NKR470M0JE11V
100	3.98	160	8	11	3.5	.6	NKR101M0JF11V
220	1.81	260	10	13	5.0	.6	NKR221M0JG13V
330	1.21	350	10	16	5.0	.6	NKR331M0JG16V
470	.85	470	10	21	5.0	.6	NKR471M0JG21V
1,000	.40	770	13	26	5.0	.6	NKR102M0JJ26V
2,200	.20	1250	16	32	7.5	.8	NKR222M0JK32V
10 WVNP; 13 VNP Surge							
22	15.07	65	5	11	2.0	.5	NKR220M1AD11
33	10.05	90	6.3	11	2.5	.5	NKR330M1AE11V
47	7.06	110	6.3	11	2.5	.5	NKR470M1AE11V
100	3.32	180	8	11	3.5	.6	NKR101M1AF11V
220	1.51	310	10	16	5.0	.6	NKR221M1AG16V
330	1.01	430	10	21	5.0	.6	NKR331M1AG21V
470	.71	530	13	21	5.0	.6	NKR471M1AJ21V
1,000	.33	960	16	32	7.5	.8	NKR102M1AK32V
2,200	.17	1410	16	35	7.5	.8	NKR222M1AK35V
16 WVNP; 20 VNP Surge							
10	28.18	47	5	11	2.0	.5	NKR100M1CD11
22	12.81	80	6.3	11	2.5	.5	NKR220M1CE11V
33	8.54	110	8	11	3.5	.6	NKR330M1CF11V
47	6.00	130	8	11	3.5	.6	NKR470M1CF11V
100	2.82	230	10	16	5.0	.6	NKR101M1CG16V
220	1.28	380	10	21	5.0	.6	NKR221M1CG21V
330	.85	480	13	21	5.0	.6	NKR331M1CJ21V
470	.60	630	13	26	5.0	.6	NKR471M1CJ26V
1,000	.28	1040	16	32	7.5	.8	NKR102M1CK32V
25 WVNP; 32 VNP Surge							
5	59.97	32	5	11	2.0	.5	NKR47M1ED11
10	28.18	55	6.3	11	2.5	.5	NKR100M1EE11V
22	12.81	90	8	11	3.5	.6	NKR220M1EF11V
33	8.54	110	8	11	3.5	.6	NKR330M1EF11V
47	6.00	140	10	13	5.0	.6	NKR470M1EG13V
100	2.82	260	10	21	5.0	.6	NKR101M1EG21V

Cap μ F	Max ESR Ohms 120Hz 25°C	Max Ripple mA 120Hz 85°C	Size (Millimeters)				Catalog Number
			D Diameter	L Length	S Lead Space	d	
25 WVNP; 32 VNP Surge							
220	1.28	390	13	21	5.0	.6	NKR221M1EJ21V
330	.85	540	16	25	7.5	.8	NKR331M1EK25V
470	.60	710	16	32	7.5	.8	NKR471M1EK32V
35 WVNP; 44 VNP Surge							
5	52.91	34	5	11	2.0	.5	NKR47M1VD11
10	24.87	55	6.3	11	2.5	.5	NKR100M1VE11V
22	11.30	95	8	11	3.5	.6	NKR220M1VF11V
33	7.54	130	10	13	5.0	.6	NKR330M1VG13V
47	5.29	170	10	16	5.0	.6	NKR470M1VG16V
100	2.49	280	13	21	5.0	.6	NKR101M1VJ21V
220	1.13	460	13	26	5.0	.6	NKR221M1VJ26V
330	.75	570	16	25	7.5	.8	NKR331M1VK25V
470	.53	760	16	32	7.5	.8	NKR471M1VK32V
50 WVNP; 63 VNP Surge							
0.47	423.28	12	5	11	2.0	.5	NKRR47M1HD11
1.0	198.90	18	5	11	2.0	.5	NKR010M1HD11
2.2	90.43	26	5	11	2.0	.5	NKR2R2M1HD11
3.3	60.29	37	6.3	11	2.5	.5	NKR3R3M1HE11V
4.7	42.33	44	6.3	11	2.5	.5	NKR4R7M1HE11V
10	19.89	75	8	11	3.5	.6	NKR100M1HF11V
22	9.04	120	10	13	5.0	.6	NKR220M1HG13V
33	6.03	160	10	16	5.0	.6	NKR330M1HG16V
47	4.23	210	10	21	5.0	.6	NKR470M1HG21V
100	1.99	340	13	26	5.0	.6	NKR101M1HJ26V
220	.90	580	16	32	7.5	.8	NKR221M1HK32V
330	.60	740	16	35	7.5	.8	NKR331M1HK35V

More NKR parts on next page

Type NKR Radial Leaded Capacitors

JAMICON MALLORY

Cap μ F	Max ESR Ohms 120Hz 25°C	Max Ripple mA 120Hz 85°C	Size (Millimeters)				Catalog Number
			D Diameter	L Length	S Lead Space	d	
63 WVNP; 79 VNP Surge							
2.2	82.89	27	5	11	2.0	.5	NKR2R2M1JD11
3.3	55.26	38	6.3	11	2.5	.5	NKR3R3M1JE11V
4.7	38.80	46	6.3	11	2.5	.5	NKR4R7M1JE11V
10	18.24	75	8	11	3.5	.6	NKR100M1JF11V
22	8.29	130	10	16	5.0	.6	NKR220M1JG16V
33	5.53	190	10	21	5.0	.6	NKR330M1JG21V
47	3.88	220	13	21	5.0	.6	NKR470M1JJ21V
100	1.82	370	16	25	7.5	.8	NKR101M1JK25V
220	.83	610	16	32	7.5	.8	NKR221M1JK32V

Cap μ F	Max ESR Ohms 120Hz 25°C	Max Ripple mA 120Hz 85°C	Size (Millimeters)				Catalog Number
			D Diameter	L Length	S Lead Space	d	
100 WVNP; 125 VNP Surge							
.47	352.74	13	5	11	2.0	.5	NKRR47M2AD11
1.0	165.79	19	5	11	2.0	.5	NKR010M2AD11
2.2	75.36	33	6.3	11	2.5	.5	NKR2R2M2AE11V
3.3	50.24	46	8	11	3.5	.6	NKR3R3M2AF11V
4.7	35.27	55	8	11	3.5	.6	NKR4R7M2AF11V
10	16.58	95	10	16	5.0	.6	NKR100M2AG16V
22	7.54	160	13	21	5.0	.6	NKR220M2AJ21V
33	5.02	220	13	26	5.0	.6	NKR330M2AJ26V
47	3.53	260	16	25	7.5	.8	NKR470M2AK25V
100	1.66	430	16	32	7.5	.8	NKR101M2AK32V

Type WGR Radial Leaded Capacitors

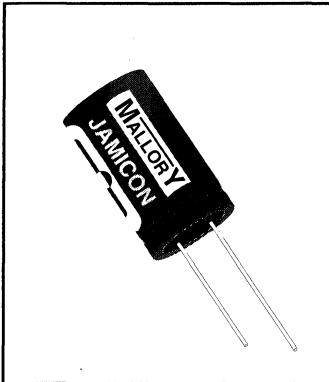

- Low Impedance
- High Ripple
- Long Life
- 2000 Hour Load Life
- Ideal in Applications for Output Switching Power Supplies

GENERAL SPECIFICATIONS

Operating Temperature:
-55°C to +105°C

Voltage Range:
10 WVDC to 100 WVDC

Capacitance Range:
47 μ F to 4700 μ F

Capacitance Tolerance:
 \pm 20%

DC Leakage Current:
I = \leq .01CV after 3 minutes
C = Capacitance in μ F
V = Rated Voltage
I = Leakage Current in μ A

QA Stability Test:
Apply WVDC for 2,000 hrs at 105°C

- Capacitance change \leq 15% from initial limits
- DC leakage current meets initial limits
- ESR \leq 150% of initial measured value

**WGR parts are available taped in Ammo pack.
See page 92 for details.**

The maximum ripple current at 105°C and 100 kHz for WGR capacitors is shown in the Standard Rating Table. Maximum ripple current may be adjusted by the multipliers in the following tables.

Temperature (C)	65	75	85	95	105
Multiplier	2.12	1.92	1.69	1.50	1.00

Rated WVDC	Ripple Multipliers					
	60Hz	120Hz	400Hz	1kHz	10kHz	100kHz
10 - 16	.45	.60	.83	.94	.98	1.00
25 - 35	.38	.50	.75	.90	.97	1.00
50 - 100	.36	.46	.70	.88	.94	1.00

Cap μ F	Max ESR Ohms 100kHz 25°C	Max Ripple Amps 100kHz 105°C	Size (Millimeters)				Catalog Number
			D Diameter	L Length	S Lead Space	d	

10 WVDC; 13 VDC Surge							
220	.180	.43	8	16	3.5	.6	WGR221M1AF16V
330	.152	.49	8	16	3.5	.6	WGR331M1AF16V
330	.144	.56	10	18	5.0	.6	WGR331M1AG18V
470	.124	.61	10	18	5.0	.6	WGR471M1AG18V
470	.118	.72	10	21	5.0	.6	WGR471M1AG21V
680	.098	.79	10	21	5.0	.6	WGR681M1AG21V
680	.093	.95	10	26	5.0	.6	WGR681M1AG26V
1,000	.080	.96	10	21	5.0	.6	WGR102M1AG21V
1,000	.076	1.17	13	26	5.0	.6	WGR102M1AJ26V
2,200	.046	1.47	13	26	5.0	.6	WGR222M1AJ26V
2,200	.043	1.95	13	41	5.0	.6	WGR222M1AJ41V
3,300	.038	1.82	13	31	5.0	.6	WGR332M1AJ31V
3,300	.036	2.13	16	35	7.5	.8	WGR332M1AK35V
4,700	.032	2.26	13	41	5.0	.6	WGR472M1AJ41V
4,700	.031	2.51	16	42	7.5	.8	WGR472M1AK42V

16 WVDC; 20 VDC Surge							
100	.330	.31	8	16	3.5	.6	WGR101M1CF16V
220	.180	.43	8	16	3.5	.6	WGR221M1CF16V
220	.171	.49	10	18	5.0	.6	WGR221M1CG18V
330	.144	.56	10	18	5.0	.6	WGR331M1CG18V
330	.137	.64	10	21	5.0	.6	WGR331M1CG21V
470	.118	.72	10	21	5.0	.6	WGR471M1CG21V
470	.112	.84	10	26	5.0	.6	WGR471M1CG26V
680	.093	.95	10	26	5.0	.6	WGR681M1CG26V
680	.088	1.02	13	26	5.0	.6	WGR681M1CJ26V
1,000	.076	1.17	13	26	5.0	.6	WGR102M1CJ26V
1,000	.072	1.33	13	31	5.0	.6	WGR102M1CJ31V
2,200	.043	1.71	13	31	5.0	.6	WGR222M1CJ31V
2,200	.041	1.97	16	35	7.5	.8	WGR222M1CK35V
3,300	.036	2.21	13	41	5.0	.6	WGR332M1CJ41V
3,300	.034	2.41	16	42	7.5	.8	WGR332M1CK42V
4,700	.031	2.51	16	42	7.5	.8	WGR472M1CK42V

25 WVDC; 32 VDC Surge							
100	.330	.37	8	16	3.5	.6	WGR101M1EF16V
100	.313	.42	10	18	5.0	.6	WGR101M1EG18V
220	.170	.58	10	18	5.0	.6	WGR221M1EG18V
220	.160	.66	10	21	5.0	.6	WGR221M1EG21V

Outline Dimensions (Millimeters)

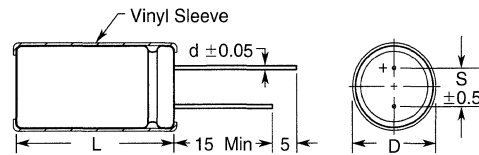

Case vented on diameters 6.3 and greater

Vinyl sleeve adds .5 Max. to diameter and 2.0 Max. to length

Cap μ F	Max ESR Ohms 100kHz 25°C	Max Ripple Amps 100kHz 105°C	Size (Millimeters)				Catalog Number
			D Diameter	L Length	S Lead Space	d	

25 WVDC; 32 VDC Surge							
330	.136	.76	10	21	5.0	.6	WGR331M1EG21V
330	.129	.89	10	26	5.0	.6	WGR331M1EG26V
470	.112	1.00	10	26	5.0	.6	WGR471M1EG26V
470	.106	1.08	13	26	5.0	.6	WGR471M1EJ26V
680	.088	1.22	13	26	5.0	.6	WGR681M1EJ26V
680	.084	1.40	13	31	5.0	.6	WGR681M1EJ31V
1,000	.072	1.60	13	31	5.0	.6	WGR102M1EJ31V
1,000	.068	1.93	13	41	5.0	.6	WGR102M1EJ41V
2,200	.041	2.44	13	41	5.0	.6	WGR222M1EJ41V
2,200	.039	2.69	16	42	7.5	.8	WGR222M1EK42V
3,300	.034	2.89	16	42	7.5	.8	WGR332M1EK42V

35 WVDC; 44 VDC Surge							
68	.355	.35	8	16	3.5	.6	WGR680M1VF16V
100	.311	.39	8	16	3.5	.6	WGR101M1VF16V
100	.295	.45	10	18	5.0	.6	WGR101M1VG18V
220	.161	.66	10	21	5.0	.6	WGR221M1VG21V
220	.152	.78	10	26	5.0	.6	WGR221M1VG26V
330	.129	.89	10	26	5.0	.6	WGR331M1VG26V
330	.122	.96	13	26	5.0	.6	WGR331M1VJ26V
470	.105	1.08	13	26	5.0	.6	WGR471M1VJ26V
470	.100	1.24	13	31	5.0	.6	WGR471M1VJ31V
680	.083	1.40	13	31	5.0	.6	WGR681M1VJ31V
680	.079	1.70	13	41	5.0	.6	WGR681M1VJ41V
1,000	.068	1.93	13	41	5.0	.6	WGR102M1VJ41V
1,000	.064	2.17	16	35	7.5	.8	WGR102M1VK35V
2,200	.039	2.69	16	42	7.5	.8	WGR222M1VK42V

50 WVDC; 63 VDC Surge							
47	.430	.34	8	16	3.5	.6	WGR470M1HF16V
68	.352	.38	8	16	3.5	.6	WGR680M1HF16V
68	.334	.43	10	18	5.0	.6	WGR680M1HG18V
100	.292	.49	10	18	5.0	.6	WGR101M1HG18V
100	.278	.56	10	21	5.0	.6	WGR101M1HG21V
220	.151	.85	10	26	5.0	.6	WGR221M1HG26V
220	.143	.92	13	26	5.0	.6	WGR221M1HJ26V
330	.121	1.05	13	26	5.0	.6	WGR331M1HJ26V
330	.115	1.22	13	31	5.0	.6	WGR331M1HJ31V

Aluminum Capacitors

Type WGR Radial Leaded Capacitors



Cap μ F	Max ESR Ohms 100kHz 25°C	Max Ripple Amps 100kHz 105°C	Size (Millimeters)				Catalog Number
			D Diameter	L Length	S Lead Space	d	
50 WVDC; 63 VDC Surge							
470	.099	1.35	13	31	5.0	.6	WGR471M1HJ31V
470	.094	1.65	13	41	5.0	.6	WGR471M1HJ41V
680	.078	1.85	13	41	5.0	.6	WGR681M1HJ41V
680	.074	2.10	16	35	7.5	.8	WGR681M1HK35V
1,000	.064	2.35	16	42	7.5	.8	WGR102M1HK42V
63 WVDC; 79 VDC Surge							
47	.424	.26	8	16	3.5	.6	WGR470M1JF16V
47	.403	.39	10	18	5.0	.6	WGR470M1JG18V
68	.330	.43	10	18	5.0	.6	WGR680M1JG18V
68	.313	.51	10	21	5.0	.6	WGR680M1JG21V
100	.274	.56	10	21	5.0	.6	WGR101M1JG21V
100	.260	.67	10	26	5.0	.6	WGR101M1JG26V
220	.142	.92	13	26	5.0	.6	WGR221M1JJ26V
220	.134	1.09	13	31	5.0	.6	WGR221M1JJ31V
330	.113	1.22	13	31	5.0	.6	WGR331M1JJ31V
330	.108	1.52	13	41	5.0	.6	WGR331M1JJ41V
470	.093	1.66	13	41	5.0	.6	WGR471M1JJ41V
470	.088	1.91	16	35	7.5	.8	WGR471M1JK35V
680	.073	2.10	16	42	7.5	.8	WGR681M1JK42V

Cap μ F	Max ESR Ohms 100kHz 25°C	Max Ripple Amps 100kHz 105°C	Size (Millimeters)				Catalog Number
			D Diameter	L Length	S Lead Space	d	
100 WVDC; 125 VDC Surge							
47	.368	.42	10	26	5.0	.6	WGR470M2AG26V
47	.349	.51	13	31	5.0	.6	WGR470M2AJ31V
68	.286	.59	13	26	5.0	.6	WGR680M2AJ26V
68	.271	.69	13	41	5.0	.6	WGR680M2AJ41V
100	.238	.67	13	31	5.0	.6	WGR101M2AJ31V
100	.226	.81	16	35	7.5	.8	WGR101M2AK35V
220	.135	1.05	16	35	7.5	.8	WGR221M2AK35V
220	.116	1.31	16	42	7.5	.8	WGR221M2AK42V
330	.098	1.44	18	42	7.5	.8	WGR331M2AL42V

Part Number Nomenclature

SK R 101 M 1C E 11 V
(1) (2) (3) (4) (5) (6) (7) (8)

- Capacitor Series
Radial Leaded: **NK, SK, SS, TK, WG**
Axial Leaded: **SK**
- Type & Forming
Radial Leaded:
R = Bulk Pack
P = Taped Leads In Ammo Pack
C = Lead Cut
F = Lead Cut and Form
B = Lead Form Only
Axial Leaded:
A = Bulk Pack
H = Taped Leads (Tape Spacing = 52mm)
J = Taped Leads (Tape Spacing = 63mm)
T = Taped Leads (Tape Spacing = 73mm)
M = Lead Cut and Form
- Capacitance Code (Expressed in Microfarads)
First 2 digits: Significant Figures
Third digit: Number of zeros (Example: 101 = 10 μ F)
- Capacitance Tolerance
M = $\pm 20\%$
- DC Voltage Rating
0J = 6.3 VDC | 1H = 50 VDC | 2E = 250 VDC
1A = 10 VDC | 1J = 63 VDC | 2V = 350 VDC
1C = 16 VDC | 2A = 100 VDC | 2G = 400 VDC
1E = 25 VDC | 2C = 160 VDC | 2W = 450 VDC
1V = 35 VDC | 2D = 200 VDC
- Diameter Code - mm (Inches)
C = 4 (.157) | F = 8 (.315) | J = 13 (.512)
D = 5 (.197) | G = 10 (.394) | K = 16 (.630)
E = 6.3 (.248) | I = 12.5 (.492) | L = 18 (.709)
- Length in mm (Example: 11 = 11mm)
- V = Vented Case (Diameter 6.3 or larger)

Type VPR Radial Leaded Capacitors

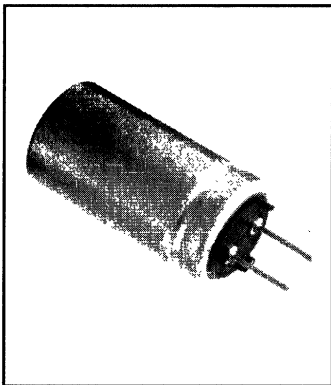

- 105°C - Long Life
- Low ESR
- High Reliability
- Ideal For Use as an Output Filter for SMPS

GENERAL SPECIFICATIONS

Operating Temperature:
-55°C to +105°C

Voltage Range:
6.3 WVDC to 100 WVDC
Up to 250 WVDC available

Capacitance Range:
34 μF to 12,000 μF

Capacitance Tolerance:
-10%+75%
Other tolerances available

DC Leakage Current:
 $I = .002CV$
C = Capacitance in μF
V = Rated Voltage
I = Leakage Current in μA

QA Stability Test:
Apply WVDC for 2,000 hrs at 105°C

- Capacitance change within 15% of initial limits
- DC leakage current meets initial limits
- ESR \leq 150% of initial measured value

The maximum ripple current at 85°C and 10 kHz for VPR capacitors is shown in the Standard Rating Table. Maximum ripple current may be adjusted by the multipliers in the following tables.

Ambient Temperature	Ripple Multipliers
95°C	.75
85°C	1.0
75°C	1.2
65°C	1.37
55°C	1.52
45°C	1.66

Part Number Nomenclature

NACC Catalog Number: **VPR 372 U 016 L2C**

TYPE NUMBER: _____
Identifies the basic type

CAPACITANCE: _____
Expressed in microfarads
The first two digits are significant figures
The third digit is the number of zeros

CAPACITANCE TOLERANCE: _____
U = -10%+75%, T = -10%+50%
Other tolerances are available on special request

DC VOLTAGE RATING: _____
Zeros are used to precede the voltage rating where necessary to complete the three digit block
The letter 'R' indicates a decimal point

CASE CODE: _____
Denotes uninsulated diameter and length

Case Code Chart Uninsulated Case Size

Case Code	Inches			Millimeters			Lead Wire Size	
	D	L	S	D	L	S	Inches	AWG
E1A	.512	1.024	.200	13	26	5.08	.023	#20
E1E	.512	1.300	.200	13	33	5.08	.023	#20
E1L	.512	1.654	.200	13	42	5.08	.023	#20
J1C	.750	1.125	.250	19.1	28.6	6.35	.040	#18
J1L	.750	1.625	.250	19.1	41.3	6.35	.040	#18
J2C	.750	2.125	.250	19.1	53.9	6.35	.040	#18
J2L	.750	2.625	.250	19.1	66.7	6.35	.040	#18
J3C	.750	3.125	.250	19.1	79.4	6.35	.040	#18
J3L	.750	3.625	.250	19.1	92.1	6.35	.040	#18
L1C	.875	1.125	.300	22.2	28.6	7.62	.040	#18
L1L	.875	1.625	.300	22.2	41.3	7.62	.040	#18
L2C	.875	2.125	.300	22.2	53.9	7.62	.040	#18
L2L	.875	2.625	.300	22.2	66.7	7.62	.040	#18
L3C	.875	3.125	.300	22.2	79.4	7.62	.040	#18
L3L	.875	3.625	.300	22.2	92.1	7.62	.040	#18
N1C	1.000	1.125	.400	25.4	28.6	10.16	.040	#18
N1L	1.000	1.625	.400	25.4	41.3	10.16	.040	#18
N2C	1.000	2.125	.400	25.4	53.9	10.16	.040	#18
N2L	1.000	2.625	.400	25.4	66.7	10.16	.040	#18
N3C	1.000	3.125	.400	25.4	79.4	10.16	.040	#18
N3L	1.000	3.625	.400	25.4	92.1	10.16	.040	#18

Outline Dimensions (Inches)

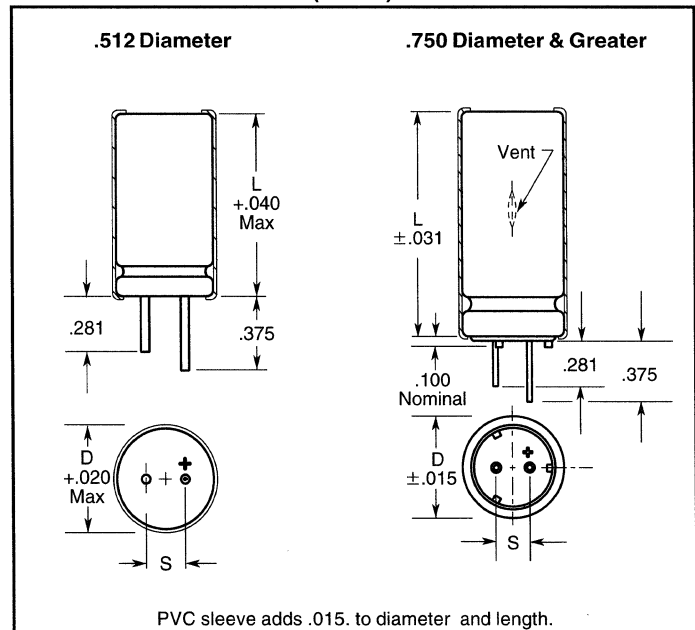

Aluminum Capacitors

Type VPR Radial Leaded Capacitors

MALLORY

Cap μF	Max ESR Ohms 10kHz 25°C	Max Ripple Amps 10kHz 85°C	Size (Inches)				Catalog Number
			D Diameter	L Length	S Lead Space	d	
6.3 WVDC; 8 VDC Surge							
880	.121	1.430	.512	1.024	.200	.023	VPR881U6R3E1A
5,600	.034	3.767	1.000	1.625	.400	.040	VPR562U6R3N1L
8,800	.023	5.131	1.000	2.125	.400	.040	VPR882U6R3N2C
12,000	.018	6.364	1.000	2.625	.400	.040	VPR123U6R3N2L
7.5 WVDC; 10 VDC Surge							
780	.117	1.450	.512	1.024	.200	.023	VPR781U7R5E1A
1,700	.057	2.590	.512	1.024	.200	.023	VPR172U7R5E1A
2,600	.037	2.862	.750	1.625	.250	.040	VPR262U7R5J1L
4,900	.031	3.820	1.000	1.625	.400	.040	VPR492U7R5N1L
10 WVDC; 13 VDC Surge							
660	.115	1.470	.512	1.024	.200	.023	VPR661U010E1A
990	.076	1.970	.512	1.300	.200	.023	VPR991U010E1E
4,200	.032	3.702	1.000	1.625	.400	.040	VPR422U010N1L
12 WVDC; 18 VDC Surge							
1,200	.055	2.640	.512	1.654	.200	.023	VPR122U012E1L
1,800	.044	2.519	.750	1.625	.250	.040	VPR182U012J1L
5,600	.021	4.932	1.000	2.125	.400	.040	VPR562U012N2C
16 WVDC; 20 VDC Surge							
500	.110	1.500	.512	1.024	.200	.023	VPR501U016E1A
1,600	.044	2.465	.750	1.625	.250	.040	VPR162U016J1L
2,300	.040	2.863	.875	1.625	.300	.040	VPR232U016L1L
3,200	.029	3.637	1.000	1.625	.400	.040	VPR322U016N1L
3,700	.026	3.981	.875	2.125	.300	.040	VPR372U016L2C
5,000	.020	4.887	1.000	2.125	.400	.040	VPR502U016N2C
6,900	.017	6.105	1.000	2.625	.400	.040	VPR692U016N2L
10,000	.012	8.033	1.000	3.625	.400	.040	VPR103U016N3L
25 WVDC; 30 VDC Surge							
640	.067	2.390	.512	1.654	.200	.023	VPR641U025E1L
940	.037	2.404	.750	1.625	.250	.040	VPR941U025J1L
1,300	.035	2.729	.875	1.625	.300	.040	VPR132U025L1L
1,400	.026	3.230	.750	2.125	.250	.040	VPR142U025J2C
1,800	.035	3.006	1.000	1.625	.400	.040	VPR182U025N1L
2,800	.018	4.732	.875	2.625	.300	.040	VPR282U025L2L
2,800	.023	4.107	1.000	2.125	.400	.040	VPR282U025N2C
3,900	.018	5.191	1.000	2.625	.400	.040	VPR392U025N2L
5,900	.014	6.616	1.000	3.625	.400	.040	VPR592U025N3L

Cap μF	Max ESR Ohms 10kHz 25°C	Max Ripple Amps 10kHz 85°C	Size (Inches)				Catalog Number
			D Diameter	L Length	S Lead Space	d	
40 WVDC; 50 VDC Surge							
160	.171	1.200	.512	1.024	.200	.023	VPR161U040E1A
240	.114	1.610	.512	1.300	.200	.023	VPR241U040E1E
360	.091	2.050	.512	1.654	.200	.023	VPR361U040E1L
540	.044	1.925	.750	1.625	.250	.040	VPR541U040J1L
760	.040	2.194	.875	1.625	.300	.040	VPR761U040L1L
850	.029	2.683	.750	2.125	.250	.040	VPR851U040J2C
1,100	.018	3.695	.750	2.625	.250	.040	VPR112U040J2L
1,600	.021	3.755	1.000	2.125	.400	.040	VPR162U040N2C
2,200	.017	4.732	1.000	2.625	.400	.040	VPR222U040N2L
2,800	.014	5.651	1.000	3.125	.400	.040	VPR282U040N3C
3,300	.014	6.437	1.000	3.625	.400	.040	VPR332U040N3L
50 WVDC; 65 VDC Surge							
110	.317	.880	.512	1.024	.200	.023	VPR111U050E1A
160	.218	1.160	.512	1.300	.200	.023	VPR161U050E1E
250	.139	1.660	.512	1.654	.200	.023	VPR251U050E1L
600	.049	1.964	.875	1.625	.300	.040	VPR601U050L1L
1,200	.028	3.297	1.000	2.125	.400	.040	VPR122U050N2C
2,400	.015	5.639	1.000	3.625	.400	.040	VPR242U050N3L
75 WVDC; 95 VDC Surge							
62	.489	.710	.512	1.024	.200	.023	VPR620U075E1A
140	.216	1.330	.512	1.654	.200	.023	VPR141U075E1L
350	.063	2.047	.750	2.125	.250	.040	VPR351U075J2C
450	.102	1.779	1.000	1.625	.400	.040	VPR451U075N1L
680	.069	2.420	1.000	2.125	.400	.040	VPR681U075N2C
1,100	.044	3.577	1.000	3.125	.400	.040	VPR112U075N3C
100 WVDC; 125 VDC Surge							
34	.691	.530	.512	1.024	.200	.023	VPR340U100E1A
78	.301	1.010	.512	1.654	.200	.023	VPR780U100E1L
130	.164	1.124	.750	1.625	.250	.040	VPR131U100J1L
190	.143	1.441	.750	2.125	.250	.040	VPR191U100J2C
250	.111	1.818	1.000	1.625	.400	.040	VPR251U100N1L

Aluminum Capacitors

Type TC Axial Leaded Capacitors

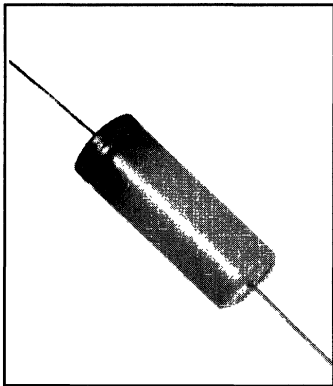

- 85°C General Purpose
- Axial Leads for Low Profile Mounting
- Long Life
- High Reliability with High Ripple, Suitable for Consumer Electronic Equipment

GENERAL SPECIFICATIONS

Operating Temperature:
-40°C to +85°C

Voltage Range:
16 WVDC to 450 WVDC

Capacitance Range:
1 μ F to 5,000 μ F

Capacitance Tolerance:
.625 diameter & larger:
6 to 150 WVDC -10% +75%
Over 150 WVDC -10% +50%
Under .625 Dia. \pm 20%

DC Leakage Current:
 $I = 6 \sqrt{CV}$ after 5 minutes
Not to exceed 3 mA @ 25°C
C = Capacitance in μ F
V = Rated Voltage
I = Leakage Current in μ A

QA Stability Test:
Apply WVDC for 1,000 hrs at 85°C

- Capacitance change \pm 15% from initial limits
- DC leakage current meets initial limits
- ESR \leq 150% of initial measured value

The maximum ripple current at 85°C and 120 Hz for TC capacitors is shown in the Standard Rating Table. Maximum ripple current may be adjusted by the multipliers in the following tables:

Rated WVDC	Ripple Multipliers			
	60 Hz	400 Hz	1000 Hz	2400 Hz
0 to 50	0.8	1.05	1.10	1.14
51 to 150	0.8	1.08	1.13	1.16
151 & up	0.8	1.15	1.21	1.25

Ambient Temperature	Ripple Multiplier
+85°C	1.0
+75°C	1.4
+65°C	1.7
+55°C	2.0
+45°C	2.2

Outline Dimensions

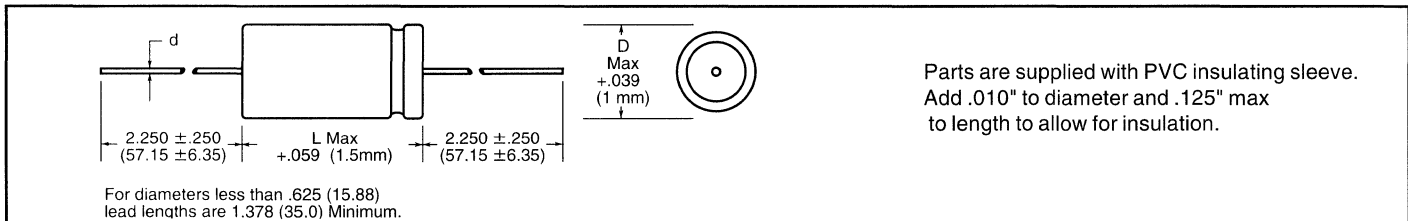

Aluminum Capacitors

Cap μ F	Max ESR Ohms 120Hz 25°C	Max Ripple Amps 120Hz 85°C	Size (Inches)			Catalog Number
			D Diameter	L Length	d	
16 WVDC; 20 VDC Surge						
3,000	.11	2.066	.875	1.625	.040	TC1530
4,000	.08	2.518	.875	1.875	.040	TC1540
5,000	.07	3.217	.875	2.625	.040	TC1550
25 WVDC; 30 VDC Surge						
1,500	.14	1.881	.750	2.125	.040	TC2515
2,000	.11	2.204	.875	1.875	.040	TC2520
3,000	.07	3.108	.875	2.625	.040	TC2530
4,000	.06	3.779	1.000	2.625	.040	TC2540
5,000	.05	4.136	1.000	2.625	.040	TC2550
50 WVDC; 65 VDC Surge						
1,000	.08	2.949	.875	2.625	.040	TC50100
1,500	.07	3.423	1.000	2.625	.040	TC50150
2,000	.07	3.448	1.000	2.625	.040	TC50200
3,000	.05	4.766	1.000	3.625	.040	TC50300
5,000	.03	5.820	1.000	3.625	.040	TC50500
75 WVDC; 95 VDC Surge						
100	.77	.597	.625	1.375	.032	TC75101
250	.37	1.024	.750	1.625	.040	TC75251
500	.19	1.765	.875	2.125	.040	TC75501
1,000	.10	2.344	1.000	1.625	.040	TC75102
2,000	.05	3.991	1.000	2.625	.040	TC75202

Cap μ F	Max ESR Ohms 120Hz 25°C	Max Ripple Amps 120Hz 85°C	Size (Inches)			Catalog Number
			D Diameter	L Length	d	
100 WVDC; 125 VDC Surge						
100	.36	.974	.750	1.375	.040	TC10101
150	.24	1.276	.750	1.625	.040	TC10151
250	.15	1.885	.875	1.875	.040	TC10251
500	.08	3.251	1.000	2.625	.040	TC10501
1,000	.08	3.918	1.000	3.875	.040	TC10102
1,500	.06	4.495	1.000	3.625	.040	TC10152
150 WVDC; 175 VDC Surge						
80	1.96	.670	.750	1.625	.040	TC492
100	.70	.748	.750	1.625	.040	TC493
150	.47	.993	.875	1.625	.040	TC495
200	.35	1.293	.875	2.125	.040	TC496
300	.24	1.687	1.000	2.125	.040	TC499
500	.15	2.362	1.000	2.625	.040	TC4990
250 WVDC; 300 VDC Surge						
8	15.27	.197	.625	1.125	.032	TC51
10	12.22	.220	.625	1.125	.032	TC52
12	8.65	.262	.625	1.125	.032	TC53
16	7.64	.304	.625	1.375	.032	TC54
20	6.13	.345	.750	1.125	.040	TC55
30	4.09	.461	.750	1.375	.040	TC57
40	2.69	.573	.750	1.625	.040	TC58
50	2.15	.640	.750	1.625	.040	TC59
100	1.08	1.220	.875	2.625	.040	TC1265
160	.30	1.649	1.000	2.625	.040	TC1266
225	.22	2.105	1.000	3.125	.040	TC1267

Type TC Axial Leaded Capacitors



Cap μF	Max ESR Ohms 120Hz 25°C	Max Ripple Amps 120Hz 85°C	Size (Inches)			Catalog Number
			D Diameter	L Length	d	
300 WVDC; 350 VDC Surge						
150	.36	1.624	1.000	3.125	.040	TC593
200	.28	1.865	1.000	3.125	.040	TC594
350 WVDC; 400 VDC Surge						
5	30.48	.139	.625	1.125	.032	TC60
8	19.05	.193	.625	1.375	.032	TC61
10	15.25	.215	.625	1.375	.032	TC62
12	12.71	.239	.750	1.125	.040	TC63
16	9.54	.302	.750	1.375	.040	TC64
20	7.63	.337	.750	1.375	.040	TC65
40	3.96	.514	.875	1.625	.040	TC67
60	2.78	.691	.875	2.125	.040	TC68
100	1.35	1.093	.875	2.625	.040	TC69
150	.96	1.495	1.000	3.625	.040	TC692

Cap μF	Max ESR Ohms 120Hz 25°C	Max Ripple Amps 120Hz 85°C	Size (Inches)			Catalog Number
			D Diameter	L Length	d	
450 WVDC; 525 VDC Surge						
2	86.91	.082	.625	1.125	.032	TC695
4	43.47	.116	.625	1.125	.032	TC697
5	35.86	.144	.750	1.125	.040	TC70
8	21.74	.183	.750	1.125	.040	TC71
10	17.39	.243	.875	1.375	.040	TC72
12	14.50	.267	.875	1.375	.040	TC73
16	10.88	.304	.750	1.625	.040	TC74
20	8.71	.371	.875	1.625	.040	TC75
30	5.82	.488	1.000	1.625	.040	TC77
40	4.36	.653	1.000	2.125	.040	TC78
50	3.06	.709	1.000	2.125	.040	TC79
60	2.55	.855	1.000	2.625	.040	TC795
80	2.19	1.068	1.000	3.125	.040	TC80
100	1.97	1.178	1.000	3.125	.040	TC807

Type TCG Axial Leaded Capacitors

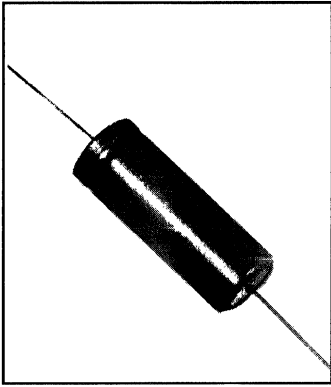

- 85°C Industrial Grade
- Computer Grade Quality
- 1000 Hours Load Life at Rated Temperature
- Axial Leads for Low Profile Mounting
- Ideal for Computers, Communication Equipment, and Power Supplies

GENERAL SPECIFICATIONS

Operating Temperature:
-40°C to +85°C

Voltage Range:
10 WVDC to 450 WVDC

Capacitance Range:
10 μ F to 10,000 μ F

Capacitance Tolerance:
6 to 150 WVDC - 10%+75%
Over 150 WVDC - 10%+50%

DC Leakage Current:
 $I = 6 \sqrt{CV}$ after 5 minutes
Not to exceed 3 mA @ 25°C
C = Capacitance in μ F
V = Rated Voltage
I = Leakage Current in μ A

QA Stability Test:
Apply WVDC for 1,000 hrs at 85°C

- Capacitance change \pm 15% from initial limits
- DC leakage current meets initial limits
- ESR \leq 150% of initial measured value

The maximum ripple current at 85°C and 120 Hz for TCG capacitors is shown in the Standard Rating Table. Maximum ripple current may be adjusted by the multipliers in the following tables:

Rated WVDC	Ripple Multipliers			
	60 Hz	400 Hz	1000 Hz	2400 Hz
0 to 50	0.8	1.05	1.10	1.14
51 to 150	0.8	1.08	1.13	1.16
151 & up	0.8	1.15	1.21	1.25

Ambient Temperature	Ripple Multiplier
+85°C	1.0
+75°C	1.4
+65°C	1.7
+55°C	2.0
+45°C	2.2

Outline Dimensions

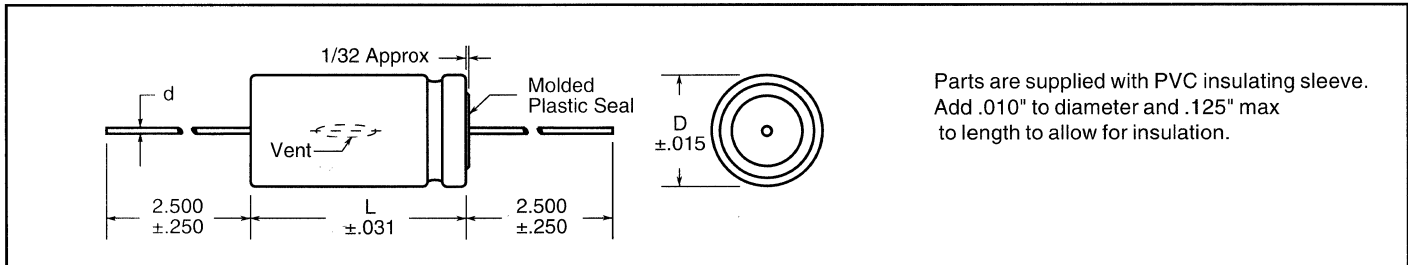

Aluminum Capacitors

Cap μ F	Max ESR Ohms 120Hz 25°C	Max Ripple Amps 120Hz 85°C	Size (Inches)			Catalog Number
			D Diameter	L Length	d	
10 WVDC; 12 VDC Surge						
2,500	.170	1.407	.875	1.125	.040	TCG252U010L1C
2,500	.171	1.521	1.000	1.125	.040	TCG252U010N1C
3,500	.092	2.424	1.000	1.625	.040	TCG352U010N1L
5,000	.082	2.488	1.000	1.375	.040	TCG502U010N1G
5,500	.081	2.584	1.000	1.625	.040	TCG552U010N1L
10,000	.048	3.772	1.000	2.125	.040	TCG103U010N2C
10,000	.046	4.274	.875	3.125	.040	TCG103U010L3C
15 WVDC; 20 VDC Surge						
2,500	.126	1.989	.625	2.625	.032	TCG252U015G2L
2,900	.110	2.134	.625	2.625	.032	TCG292U015G2L
4,000	.085	2.518	1.000	1.625	.040	TCG402U015N1L
4,100	.083	2.544	1.000	1.625	.040	TCG412U015N1L
5,000	.067	3.015	.750	2.625	.040	TCG502U015J2L
6,300	.055	3.612	.875	2.625	.040	TCG632U015L2L
8,000	.045	4.269	1.000	2.625	.040	TCG802U015N2L
8,200	.044	4.310	1.000	2.625	.040	TCG822U015N2L
10,000	.038	4.634	1.000	2.625	.040	TCG103U015N2L
25 WVDC; 30 VDC Surge						
1,000	.216	1.352	1.000	1.125	.040	TCG102U025N1C
1,100	.190	1.431	.750	1.625	.040	TCG112U025J1L
2,000	.154	2.137	1.000	1.625	.040	TCG202U025N1L
2,200	.098	2.487	.750	2.625	.040	TCG222U025J2L
4,000	.057	3.827	.875	3.125	.040	TCG402U025L3C

Cap μ F	Max ESR Ohms 120Hz 25°C	Max Ripple Amps 120Hz 85°C	Size (Inches)			Catalog Number
			D Diameter	L Length	d	
30 WVDC; 40 VDC Surge						
500	.369	.874	.750	1.125	.040	TCG501U030J1C
1,100	.169	1.721	.625	2.625	.032	TCG112U030G2L
2,100	.072	3.159	.875	2.625	.040	TCG212U030L2L
2,400	.082	2.961	.875	2.625	.040	TCG242U030L2L
2,500	.078	3.005	1.000	2.625	.040	TCG252U030N2L
3,000	.065	3.004	.875	2.125	.040	TCG302U030L2C
50 WVDC; 65 VDC Surge						
250	.499	.742	.625	1.375	.032	TCG251U050G1G
500	.156	1.788	.625	2.625	.032	TCG501U050G2L
500	.262	1.227	1.000	1.125	.040	TCG501U050N1C
600	.215	1.363	.875	1.375	.040	TCG601U050L1G
600	.211	1.539	.625	2.625	.032	TCG601U050G2L
1,100	.105	2.480	1.000	1.375	.040	TCG112U050N1G
1,100	.094	2.698	1.000	2.125	.040	TCG112U050N2C
1,200	.110	2.313	.875	2.125	.040	TCG122U050L2C
2,300	.062	3.653	1.000	2.625	.040	TCG232U050N2L
2,500	.058	3.777	1.000	2.625	.040	TCG252U050N2L
150 WVDC; 175 VDC Surge						
100	.696	.748	.750	1.625	.040	TCG101T150J1L
110	.634	.784	.750	1.625	.040	TCG111T150J1L
250	.284	1.439	.875	2.125	.040	TCG251T150L2C
530	.139	2.639	1.000	3.125	.040	TCG531T150N3C
560	.133	2.705	1.000	3.125	.040	TCG561T150N3C

Type TCG Axial Leaded Capacitors



Cap μF	Max ESR Ohms 120Hz 25°C	Max Ripple Amps 120Hz 85°C	Size (Inches)			Catalog Number
			D Diameter	L Length	d	
200 WVDC; 250 VDC Surge						
210	.646	1.780	1.000	2.125	.040	TCG211T200N2C
300	.517	1.977	1.000	2.125	.040	TCG301T200N2C
430	.411	2.116	1.000	3.625	.040	TCG431U200N3L
250 WVDC; 300 VDC Surge						
50	2.450	.607	.875	1.375	.040	TCG500T250L1G
100	1.230	1.039	.875	2.125	.040	TCG101T250L2C
200	.277	1.726	1.000	2.625	.040	TCG201T250N2L
350 WVDC; 400 VDC Surge						
20	9.520	.276	.750	1.125	.040	TCG200T350J1C
20	9.500	.294	.625	1.625	.032	TCG200T350G1L
30	6.368	.369	.875	1.125	.040	TCG300T350L1C
30	6.336	.408	.625	2.125	.032	TCG300T350G2C
40	4.200	.460	1.000	1.125	.040	TCG400T350N1C
50	3.353	.560	1.000	1.375	.040	TCG500T350N1G
100	1.680	.957	1.000	2.125	.040	TCG101T350N2C
160	.469	1.327	1.000	2.625	.040	TCG161T350N2L
180	.417	1.524	1.000	3.125	.040	TCG181T350N3C

Cap μF	Max ESR Ohms 120Hz 25°C	Max Ripple Amps 120Hz 85°C	Size (Inches)			Catalog Number
			D Diameter	L Length	d	
450 WVDC; 525 VDC Surge						
10	17.404	.204	.750	1.125	.040	TCG100T450J1C
10	17.392	.217	.625	1.625	.032	TCG100T450G1L
12	14.500	.244	.750	1.375	.040	TCG120T450J1G
20	8.704	.384	.625	2.625	.032	TCG200T450G2L
20	8.732	.341	1.000	1.125	.040	TCG200T450N1C
50	4.742	.709	1.000	1.625	.040	TCG500T450N1L
50	4.049	.548	1.000	2.125	.040	TCG500T450N2C
60	3.950	.890	1.000	2.625	.040	TCG600T450N2L
75	1.980	.944	1.000	2.125	.040	TCG750T450N2C
85	1.869	.998	1.000	2.625	.040	TCG850T450N2L

Case Codes and Part Number Format Types TCG and TCX

Case Code Chart

Case Code	Inches		Millimeters		d	
	D	L	D	L	Inches	AWG
E1G	.500	1.375	12.7	34.9	.032	#20
E2C	.500	2.125	12.7	53.9	.032	#20
G1C	.625	1.125	15.9	28.6	.032	#20
G1G	.625	1.375	15.9	34.9	.032	#20
G1L	.625	1.625	15.9	41.3	.032	#20
G2C	.625	2.125	15.9	53.9	.032	#20
G2L	.625	2.625	15.9	66.7	.032	#20
G3C	.625	3.125	15.9	79.4	.032	#20
G3L	.625	3.625	15.9	92.1	.032	#20
J1C	.750	1.125	19.1	28.6	.040	#18
J1G	.750	1.375	19.1	34.9	.040	#18
J1L	.750	1.625	19.1	41.3	.040	#18
J2C	.750	2.125	19.1	53.9	.040	#18
J2L	.750	2.625	19.1	66.7	.040	#18
J3C	.750	3.125	19.1	79.4	.040	#18
J3L	.750	3.625	19.1	92.1	.040	#18
L1C	.875	1.125	22.2	28.6	.040	#18
L1G	.875	1.375	22.2	34.9	.040	#18
L1L	.875	1.625	22.2	41.3	.040	#18
L2C	.875	2.125	22.2	53.9	.040	#18
L2L	.875	2.625	22.2	66.7	.040	#18
L3C	.875	3.125	22.2	79.4	.040	#18
L3L	.875	3.625	22.2	92.1	.040	#18
N1C	1.000	1.125	25.4	28.6	.040	#18
N1G	1.000	1.375	25.4	34.9	.040	#18
N1L	1.000	1.625	25.4	41.3	.040	#18
N2C	1.000	2.125	25.4	53.9	.040	#18
N2L	1.000	2.625	25.4	66.7	.040	#18
N3C	1.000	3.125	25.4	79.4	.040	#18
N3L	1.000	3.625	25.4	92.1	.040	#18

Part Number Nomenclature

NACC Catalog Number: TCG 252 U 016 G2L
TCX 282 U 050 N3L

TYPE NUMBER: _____
Identifies the basic type

CAPACITANCE: _____
Expressed in microfarads
The first two digits are significant figures
The third digit is the number of zeros

CAPACITANCE TOLERANCE: _____
U = -10%+75%, T = -10%+50%
Other tolerances are available on special request

DC VOLTAGE RATING: _____
Zeros are used to precede the voltage rating where
necessary to complete the three digit block.
The letter 'R' indicates a decimal point

CASE CODE: _____
Denotes uninsulated diameter and length

Aluminum Capacitors

Type TCX Axial Leaded Capacitors

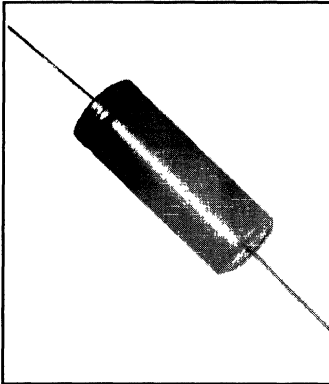

- 105°C High Performance
- Computer Grade Quality
- 2000 Hours Load Life at Rated Temperature
- Low DCL, Low ESR
- Axial Leads

GENERAL SPECIFICATIONS

Operating Temperature:
-55°C to +105°C

Voltage Range:
10 WVDC to 150 WVDC

Capacitance Range:
27 μF to 12,000 μF

Capacitance Tolerance:
10 to 75 WVDC - 10% +75%
Over 75 WVDC - 10% +50%

DC Leakage Current:
 $I = 2 \sqrt{CV}$ after 5 minutes
Not to exceed 2mA @ 25°C
C = Capacitance in μF
V = Rated Voltage
I = Leakage Current in μA

QA Stability Test:
Apply WVDC for 2,000 hrs at 105°C

- Capacitance change $\pm 15\%$ from initial limits
- DC leakage current meets initial limits
- ESR $\leq 150\%$ of initial measured value

The maximum ripple current at 85°C and 120 Hz for TCX capacitors is shown in the Standard Rating Table. Maximum ripple current may be adjusted by the multipliers in the following tables:

Rated WVDC	Ripple Multipliers			
	60 Hz	400 Hz	1000 Hz	2400 Hz
0 to 150	0.8	1.05	1.10	1.14

Ambient Temperature	Ripple Multiplier
+95°C	0.7
+85°C	1.0
+75°C	1.2
+65°C	1.4
+55°C	1.58
+45°C	1.7

Outline Dimensions

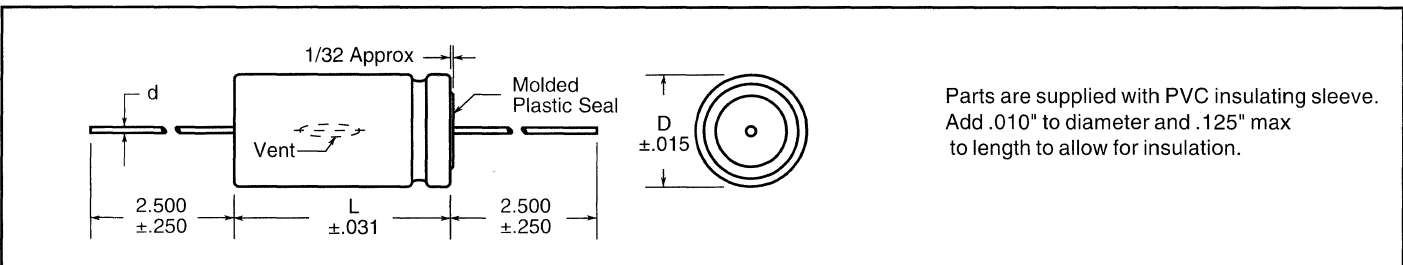

Parts are supplied with PVC insulating sleeve. Add .010" to diameter and .125" max to length to allow for insulation.

Aluminum Capacitors

Cap μF	Max ESR Ohms 120Hz 25°C	Max Ripple Amps 120Hz 85°C	Size (Inches)			Catalog Number
			D Diameter	L Length	d	
10 WVDC; 12 VDC Surge						
10,000	.024	5.952	.875	3.125	.040	TCX103U010L3C
15 WVDC; 20 VDC Surge						
1,000	.145	1.394	.750	1.125	.040	TCX102U015J1C
2,100	.071	2.337	.750	1.625	.040	TCX212U015J1L
8,200	.025	5.796	1.000	2.625	.040	TCX822U015N2L
12,000	.019	7.589	1.000	3.625	.040	TCX123U015N3L
25 WVDC; 30 VDC Surge						
560	.207	1.249	.500	2.125	.032	TCX561U025E2C
1,200	.109	1.899	1.000	1.125	.040	TCX122U025N1C
1,800	.071	2.557	.875	1.625	.040	TCX182U025L1L
2,400	.057	3.081	1.000	1.625	.040	TCX242U025N1L
3,700	.037	4.370	.875	2.625	.040	TCX372U025L2L
7,200	.023	6.882	1.000	3.625	.040	TCX722U025N3L
30 WVDC; 40 VDC Surge						
310	.316	.852	.625	1.125	.032	TCX311U030G1C
470	.214	1.149	.750	1.125	.040	TCX471U030J1C
1,400	.075	2.583	.750	2.125	.040	TCX142U030J2C
2,700	.043	4.091	.875	2.625	.040	TCX272U030L2L
3,000	.039	4.643	.875	3.125	.040	TCX302U030L3C
40 WVDC; 50 VDC Surge						
360	.230	1.107	.750	1.125	.040	TCX361U040J1C
1,000	.088	2.290	.875	1.625	.040	TCX102U040L1L
1,400	.063	3.107	.750	2.625	.040	TCX142U040J2L

Cap μF	Max ESR Ohms 120Hz 25°C	Max Ripple Amps 120Hz 85°C	Size (Inches)			Catalog Number
			D Diameter	L Length	d	
40 WVDC; 50 VDC Surge						
2,100	.045	3.975	.875	2.625	.040	TCX212U040L2L
4,200	.028	6.361	1.000	3.625	.040	TCX422U040N3L
50 WVDC; 65 VDC Surge						
110	.686	.560	.500	1.375	.032	TCX111U050E1G
250	.306	.947	.625	1.375	.032	TCX251U050G1G
370	.216	1.250	.875	1.125	.040	TCX371U050L1C
500	.155	1.624	.625	2.125	.032	TCX501U050G2C
710	.118	1.989	1.000	1.375	.040	TCX711U050N1G
950	.089	2.456	1.000	1.625	.040	TCX951U050N1L
1,400	.061	3.436	.875	2.625	.040	TCX142U050L2L
1,900	.047	4.170	1.000	2.625	.040	TCX192U050N2L
2,800	.035	5.655	1.000	3.625	.040	TCX282U050N3L
75 WVDC; 95 VDC Surge						
65	2.961	.419	.625	1.125	.032	TCX650U075G1C
100	1.932	.574	.750	1.125	.040	TCX101U075J1C
560	.115	2.491	.875	2.625	.040	TCX561U075L2L
740	.090	3.033	1.000	2.625	.040	TCX741U075N2L
1,100	.084	3.633	1.000	3.625	.040	TCX112U075N3L
100 WVDC; 125 VDC Surge						
110	.404	.996	.875	1.375	.040	TCX111T100L1G
150	.297	1.248	.875	1.625	.040	TCX151T100L1L
150 WVDC; 175 VDC Surge						
27	5.720	.322	.625	1.125	.032	TCX270T150G1C
150	.404	1.224	.750	2.625	.040	TCX151T150J2L

Type SKA Axial Leaded Capacitors

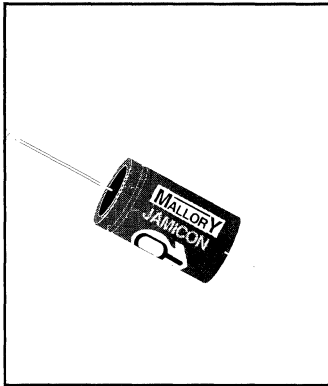

- 85°C General Purpose
- Axial Leads
Miniature Size
- High CV per Case Size
- 2000 Hour Load Life
Data for Longer Life
- Suitable for Consumer
Electronic Products,
Such as Stereo Radio, TV, etc.

**SKA parts are available taped, in Ammo Pack.
See page 92 for details.**

GENERAL SPECIFICATIONS

Operating Temperature:
-40°C to +85°C
(For 105°C device, contact NACC)

Voltage Range:
6.3 WVDC to 450 WVDC

Capacitance Range:
0.47 μ F to 15,000 μ F

Capacitance Tolerance:
 \pm 20%

DC Leakage Current:
6.3 - 100VDC
 $I \leq .03CV$ or $4\mu A$
whichever is greater
after 3 minutes.

Over 100VDC
 $I \leq .03CV + 40\mu A$ Max
C = Capacitance in μ F
V = Rated Voltage
I = Leakage Current in μ A

QA Stability Test:
Apply WVDC for 2,000 hrs at 85°C

- Capacitance change \leq 20% from initial limits
- DC leakage current meets initial limits
- ESR \leq 150% of initial measured value

The maximum ripple current at 85°C and 120 Hz for SKA capacitors is shown in the Standard Rating Table. Maximum ripple current may be adjusted by the multipliers in the following tables.

Rated WVDC	Ripple Multipliers			Ambient Temperature	Ripple Multiplier
	60Hz	120Hz	1kHz		
6 to 25	.85	1.0	1.10	+85°C	1.00
35 to 100	.80	1.0	1.15	+75°C	1.14
160 to 250	.75	1.0	1.25	+65°C	1.25
350 to 450	.70	1.0	1.30		

Outline Dimensions (Millimeters)

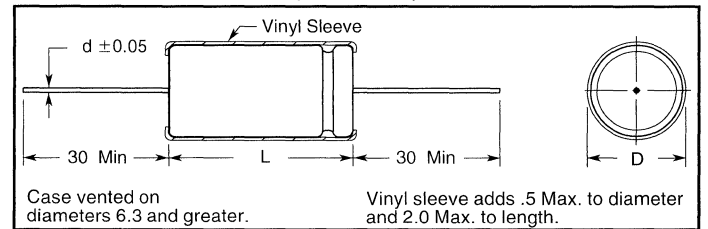

Cap μ F	Max ESR Ohms 120Hz 25°C	Max Ripple mA 120Hz 85°C	Size (Millimeters)			Catalog Number
			D Diameter	L Length	d	
6.3 WVDC; 8 VDC Surge						
100	3.98	130	6.3	13	.6	SKA101M0JE13V
220	1.81	210	6.3	16	.6	SKA221M0JE16V
330	1.21	260	8	16	.6	SKA331M0JF16V
470	.85	350	8	16	.6	SKA471M0JF16V
1,000	.40	560	10	22	.6	SKA102M0JG22V
2,200	.20	980	13	27	.6	SKA222M0JJ27V
3,300	.14	1180	13	27	.6	SKA332M0JJ27V
4,700	.11	1460	13	32	.6	SKA472M0JJ32V
6,800	.09	1700	16	33	.8	SKA682M0JK33V
10,000	.07	2100	16	43	.8	SKA103M0JK43V
15,000	.06	2370	18	43	.8	SKA153M0JL43V

Cap μ F	Max ESR Ohms 120Hz 25°C	Max Ripple mA 120Hz 85°C	Size (Millimeters)			Catalog Number
			D Diameter	L Length	d	
25 WVDC; 32 VDC Surge						
33	7.54	90	6.3	13	.6	SKA330M1EE13V
47	5.29	110	6.3	16	.6	SKA470M1EE16V
100	2.49	180	6.3	16	.6	SKA101M1EE16V
220	1.13	310	8	16	.6	SKA221M1EF16V
330	.75	410	8	21	.6	SKA331M1EF21V
470	.53	530	10	22	.6	SKA471M1EG22V
1,000	.25	880	13	27	.6	SKA102M1EJ27V
2,200	.13	1350	13	35	.6	SKA222M1EJ35V
3,300	.10	1790	16	33	.8	SKA332M1EK33V
4,700	.08	2040	18	43	.8	SKA472M1EL43V

Cap μ F	Max ESR Ohms 120Hz 25°C	Max Ripple mA 120Hz 85°C	Size (Millimeters)			Catalog Number
			D Diameter	L Length	d	
10 WVDC; 13 VDC Surge						
47	6.00	100	6.3	13	.6	SKA470M1AE13V
100	3.32	140	6.3	16	.6	SKA101M1AE16V
220	1.51	230	6.3	16	.6	SKA221M1AE16V
330	1.01	330	8	16	.6	SKA331M1AF16V
470	.71	390	8	16	.6	SKA471M1AF16V
1,000	.33	670	10	22	.6	SKA102M1AG22V
2,200	.17	1080	13	27	.6	SKA222M1AJ27V
3,300	.12	1270	13	32	.6	SKA332M1AJ32V
4,700	.10	1610	13	35	.6	SKA472M1AJ35V
6,800	.08	2010	16	33	.8	SKA682M1AK33V

Cap μ F	Max ESR Ohms 120Hz 25°C	Max Ripple mA 120Hz 85°C	Size (Millimeters)			Catalog Number
			D Diameter	L Length	d	
35 WVDC; 44 VDC Surge						
22	7.54	90	6.3	13	.6	SKA220M1VE13V
33	6.03	100	6.3	16	.6	SKA330M1VE16V
47	4.23	140	6.3	16	.6	SKA470M1VE16V
100	1.99	230	8	16	.6	SKA101M1VF16V
220	.90	370	8	21	.6	SKA221M1VF21V
330	.60	500	10	22	.6	SKA331M1VG22V
470	.42	670	10	27	.6	SKA471M1VG27V
1,000	.20	990	13	32	.6	SKA102M1VJ32V
2,200	.11	700	16	33	.8	SKA222M1VK33V
3,300	.08	2000	16	43	.8	SKA332M1VK43V

Cap μ F	Max ESR Ohms 120Hz 25°C	Max Ripple mA 120Hz 85°C	Size (Millimeters)			Catalog Number
			D Diameter	L Length	d	
16 WVDC; 20 VDC Surge						
47	6.00	100	6.3	13	.6	SKA470M1CE13V
100	2.82	170	6.3	16	.6	SKA101M1CE16V
220	1.28	290	8	16	.6	SKA221M1CF16V
330	.85	350	8	16	.6	SKA331M1CF16V
470	.60	460	8	21	.6	SKA471M1CF21V
1,000	.28	820	10	27	.6	SKA102M1CG27V
2,200	.14	1160	13	32	.6	SKA222M1CJ32V
3,300	.11	1490	13	35	.6	SKA332M1CJ35V
4,700	.09	1900	16	33	.8	SKA472M1CK33V
6,800	.07	2170	16	43	.8	SKA682M1CK43V

Cap μ F	Max ESR Ohms 120Hz 25°C	Max Ripple mA 120Hz 85°C	Size (Millimeters)			Catalog Number
			D Diameter	L Length	d	
50 WVDC; 63 VDC Surge						
0.47	352.74	13	6.3	13	.6	SKAR47M1HE13V
1.0	165.79	19	6.3	13	.6	SKA010M1HE13V
2.2	75.36	29	6.3	13	.6	SKA2R2M1HE13V
3.3	50.24	35	6.3	13	.6	SKA3R3M1HE13V
4.7	35.27	42	6.3	13	.6	SKA4R7M1HE13V
10	16.58	60	6.3	13	.6	SKA100M1HE13V
22	7.54	90	6.3	16	.6	SKA220M1HE16V
33	5.02	130	6.3	16	.6	SKA330M1HE16V
47	3.53	150	6.3	16	.6	SKA470M1HE16V
100	1.66	250	8	16	.6	SKA101M1HF16V
220	.75	440	10	22	.6	SKA221M1HG22V
330	.50	610	10	27	.6	SKA331M1HG27V
470	.35	740	13	27	.6	SKA471M1HJ27V
1,000	.17	1220	13	35	.6	SKA102M1HJ35V
2,200	.09	1890	18	43	.8	SKA222M1HL43V

Aluminum Capacitors

Type SKA Axial Leaded Capacitors



Aluminum Capacitors

Cap μF	Max ESR Ohms 120Hz 25°C	Max Ripple mA 120Hz 85°C	Size (Millimeters)			Catalog Number
			D Diameter	L Length	d	
63 WVDC; 79 VDC Surge						
10	16.58	60	6.3	13	.6	SKA100M1JE13V
22	7.54	100	6.3	16	.6	SKA220M1JE16V
33	5.02	130	6.3	16	.6	SKA330M1JE16V
47	3.53	170	8	16	.6	SKA470M1JF16V
100	1.66	270	8	21	.6	SKA101M1JF21V
220	.75	500	10	27	.6	SKA221M1JG27V
330	.50	620	13	27	.6	SKA331M1JJ27V
470	.35	820	13	32	.6	SKA471M1JJ32V
1,000	.17	1360	16	33	.8	SKA102M1JK33V
100 WVDC; 125 VDC Surge						
0.47	282.19	15	6.3	13	.6	SKAR47M2AE13V
1.0	132.63	22	6.3	13	.6	SKA010M2AE13V
2.2	60.29	32	6.3	13	.6	SKA2R2M2AE13V
3.3	40.19	39	6.3	13	.6	SKA3R3M2AE13V
4.7	28.22	47	6.3	13	.6	SKA4R7M2AE13V
10	13.26	80	6.3	16	.6	SKA100M2AE16V
22	6.03	130	8	16	.6	SKA220M2AF16V
33	4.02	180	8	21	.6	SKA330M2AF21V
47	2.82	230	8	21	.6	SKA470M2AF21V
100	1.06	380	10	27	.6	SKA101M2AG27V
220	.60	640	13	32	.6	SKA221M2AJ32V
330	.40	780	13	35	.6	SKA331M2AJ35V
470	.28	1040	16	43	.8	SKA471M2AK43V
160 WVDC; 200 VDC Surge						
0.47	705.47	12	6.3	13	.6	SKAR47M2CE13V
1.0	331.57	18	6.3	13	.6	SKA010M2CE13V
2.2	150.72	27	6.3	16	.6	SKA2R2M2CE16V
3.3	100.48	33	8	16	.6	SKA3R3M2CF16V
4.7	70.55	39	8	16	.6	SKA4R7M2CF16V
10	33.16	65	10	22	.6	SKA100M2CG22V
22	15.07	120	10	27	.6	SKA220M2CG27V
33	10.05	160	13	27	.6	SKA330M2CJ27V
47	7.06	190	13	32	.6	SKA470M2CJ32V
100	3.32	310	16	33	.8	SKA101M2CK33V
220	1.51	540	18	43	.8	SKA221M2CL43V
200 WVDC; 250 VDC Surge						
0.47	705.47	13	6.3	13	.6	SKAR47M2DE13V
1.0	331.57	19	6.3	13	.6	SKA010M2DE13V
2.2	150.72	29	6.3	16	.6	SKA2R2M2DE16V
3.3	100.48	35	8	16	.6	SKA3R3M2DF16V
4.7	70.55	48	8	16	.6	SKA4R7M2DF16V
10	33.16	75	10	22	.6	SKA100M2DG22V
22	15.07	140	13	27	.6	SKA220M2DJ27V
33	10.05	170	13	32	.6	SKA330M2DJ32V
47	7.06	210	13	32	.6	SKA470M2DJ32V
100	3.32	340	16	43	.8	SKA101M2DK43V

Cap μF	Max ESR Ohms 120Hz 25°C	Max Ripple mA 120Hz 85°C	Size (Millimeters)			Catalog Number
			D Diameter	L Length	d	
250 WVDC; 300 VDC Surge						
0.47	705.47	14	6.3	13	.6	SKAR47M2EE13V
1.0	331.57	21	6.3	16	.6	SKA010M2EE16V
2.2	150.72	31	8	16	.6	SKA2R2M2EF16V
3.3	100.48	44	8	16	.6	SKA3R3M2EF16V
4.7	70.55	50	10	22	.6	SKA4R7M2EG22V
10	33.16	90	10	27	.6	SKA100M2EG27V
22	15.07	150	13	27	.6	SKA220M2EJ27V
33	10.05	190	13	32	.6	SKA330M2EJ32V
47	7.06	250	13	35	.6	SKA470M2EJ35V
100	3.32	410	16	43	.6	SKA101M2EK43V
350 WVDC; 400 VDC Surge						
0.47	881.84	14	6.3	16	.6	SKAR47M2VE16V
1.0	414.47	21	8	16	.6	SKA010M2VF16V
2.2	188.39	31	8	21	.6	SKA2R2M2VF21V
3.3	125.60	41	10	22	.6	SKA3R3M2VG22V
4.7	88.18	49	10	27	.6	SKA4R7M2VG27V
10	41.45	85	13	27	.6	SKA100M2VJ27V
22	18.84	130	13	32	.6	SKA220M2VJ32V
33	12.56	180	16	33	.8	SKA330M2VK33V
47	8.82	220	18	43	.8	SKA470M2VL43V
400 WVDC; 450 VDC Surge						
0.47	881.84	15	6.3	16	.6	SKAR47M2GE16V
1.0	414.47	21	8	16	.6	SKA010M2GF16V
2.2	188.39	32	8	21	.6	SKA2R2M2GF21V
3.3	125.60	42	10	22	.6	SKA3R3M2GG22V
4.7	88.18	55	10	27	.6	SKA4R7M2GG27V
10	41.45	90	13	27	.6	SKA100M2GJ27V
22	18.84	150	16	33	.8	SKA220M2GK33V
33	12.56	190	16	43	.8	SKA330M2GK43V
450 WVDC; 500 VDC Surge						
1.0	414.47	18	8	16	.6	SKA010M2WF16V
2.2	188.39	29	8	21	.6	SKA2R2M2WF21V
3.3	125.60	38	10	22	.6	SKA3R3M2WG22V
4.7	88.18	48	10	27	.6	SKA4R7M2WG27V
10	41.45	75	13	27	.6	SKA100M2WJ27V
22	18.84	130	16	43	.8	SKA220M2WK43V
33	12.56	170	18	43	.8	SKA330M2WL43V

Index and General Specifications Disc Ceramic Capacitors

Class	Capacitance Range	Voltage Range	Insulation Resistance	Dissipation Factor (Max)	Test Frequency	Breakdown Voltage	Page Number
General Purpose	1 to 100,000 pF	50, 100, 500, 1,000 VDC	10,000 megohms (min)	Z5U: 4.0% Y5U: 4.0% Y5V: 5.0% All others: 2.5%	1,000 Hz	2.5 x rated (5 seconds max)	115
EIA class 1 Temp Compensating	1 to 910 pF	50, 500, 1,000 3,000 VDC	10,000 megohms (min)	5.0%	1 MHz	3 x rated (5 seconds max)	118
EIA Class 2 Temp/Freq Stable	100 to 10,000 pF	500 and 1,000 VDC	10,000 megohms (min)	1.5%	1,000 Hz	2.5 x rated (5 seconds max)	121
EIA Class 2 High Voltage	100 to 10,000 pF	2,000 and 3,000 VDC	10,000 megohms (min)	2.5%	1,000 Hz	2.5 x rated (5 seconds max)	121
EIA Class 3 Reduced Titanite High Capacitance	.01 to .22 μ F	12, 25, 50 VDC	1 megohm (min)	Y5R: 1.5% Y5U: 7.0% Y5V: 5.0%	1,000 Hz (operating)	2.5 x rated (5 seconds max)	122
Spark-Arrestor	.75 pF max (gap only) to .01 μ F	1 - 3 KVDC	n/a	n/a	n/a	n/a	122
U.L., CSA & VDE Recognized Across-The-Line	.001 to .01 μ F	125 vrms 60 Hz	>10K megohms @ 25°C, 500 VDC	2.5%	1,000 Hz	3250 min vrms, 60 Hz (1 minute max)	123

CLASS 2 & 3 EIA TEMPERATURE COEFFICIENT CODES

A combination of characters designating capacitance drift over a temperature range.
Example: Y5E could change $\pm 4.7\%$ over a temperature range of -30°C to $+85^\circ\text{C}$.

Letter Symbol	Low Temp Requirement	Number Symbol	High Temp Requirement	Letter Symbol	Maximum Capacitance Change Over Temp Rating
X	-55°C	2	+45°C	A	$\pm 1.0\%$
		4	+65°C	B	$\pm 1.5\%$
Y	-30°C	5	+85°C	C	$\pm 2.2\%$
		6	+105°C	D	$\pm 3.3\%$
Z	+10°C	7	+125°C	E	$\pm 4.7\%$
				F	$\pm 7.5\%$
				P	$\pm 10.0\%$
				R	$\pm 15.0\%$
				S	$\pm 22.0\%$
				T	+22%, -33%
				U	+22%, -56%
				V	+22%, -82%

CLASS 1 TEMPERATURE COEFFICIENT CODES

Temperature Range	% Change Per 1°C
-55°C +125°C	
NPO-(COG)	$\pm 30\text{ppm}$
N330	-330ppm
N470	-470ppm
N750	-750ppm
N1000	-1000ppm
N1500	-1500ppm
N2200	-2200ppm
N3300	-3300ppm
N4700	-4700ppm
N5600	-5600ppm
SL	-750, +100ppm
	$\pm .075\%$ Max

Physical Specifications

Case: Conformal Coating

Lead material: Tinned copper wire. (Minimum lead content: 5%)

Note: Part numbers with 'X' suffix are multilayer construction rather than disc, and are rectangular in shape.
The diameter dimension is the largest dimension of the footprint.

Tape and Reel Available upon Request

Leads are formed to .200 (5.0mm) lead spacing

For D less than .315 (8.0mm) - Quantity/Reel = 2500 pcs
For D .315 (8.0mm) to .472 (12.0mm) - Quantity/Reel = 2000 pcs

Tape and Reel not available for D greater than .472 (12mm)

Tape and Reel not available for 2000 & 3000 volt parts

Note: Part numbers with 'X' suffix are all available in tape and reel: 2000 pcs per reel

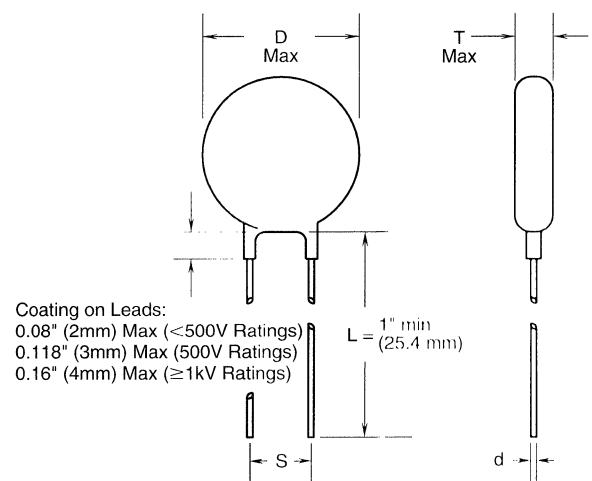

CLASS 1

Capacitance vs. Temperature

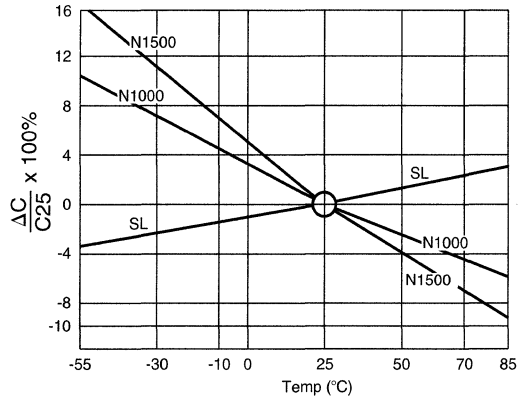
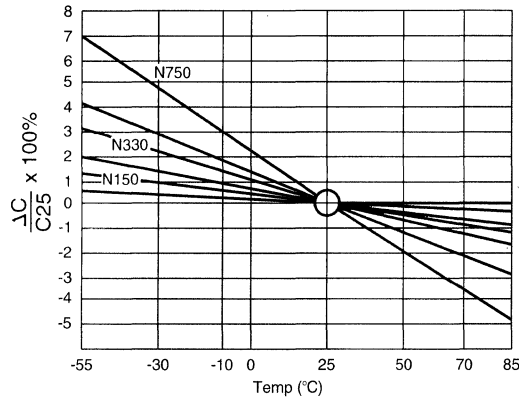

Capacitance vs. Frequency

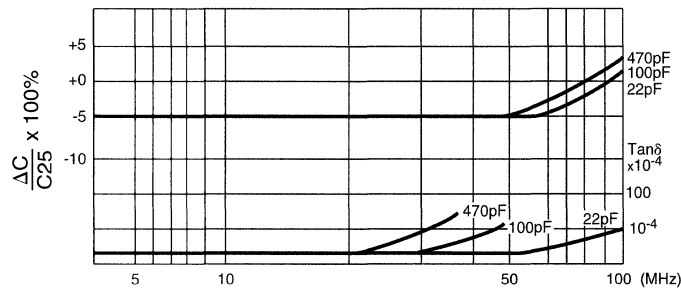

CLASS 2 AND 3

JIS Standard		EIA Standard			
Temp Range -25°C +85°C	Cap Change (%)	Temp Range -25°C +85°C	Cap Change (%)	Temp Range -25°C +85°C	Cap Change (%)
YA	±4.7	Y5D (Special)	±3.3 (50V only)		
		Y5E	±4.7	X5F	±7.5
		Y5F	±7.5		
YB	±8	Y5P	±10	X5R	±15
		Y5R	±15		
		Y5S	±22		
YD	+5 -30	Y5T	+22 -33	X5T	+22 -33
YE	+5 -30	Y5U	+22 -56		
YF	+10 -80	Y5V	+22 -82		
ZF	+10 -80	Z5V	+22 -82		

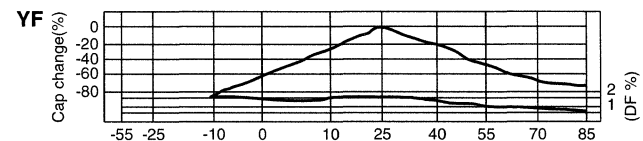
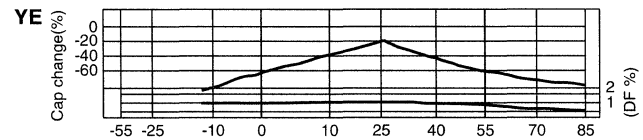
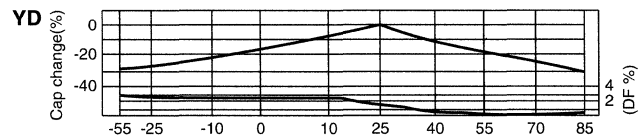
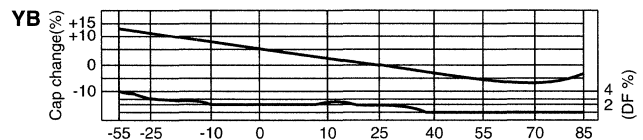
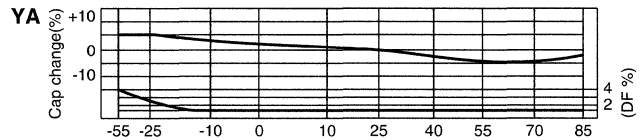

General Purpose Disc Ceramic Capacitors

MALLORY

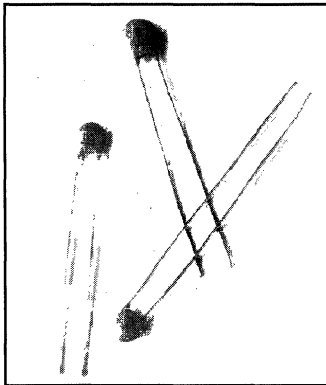

- General Purpose
- Ideal For Use in Non-critical Coupling, Bypass and Filter Applications
- Conformally Coated
- Radial Leads

GENERAL SPECIFICATIONS

Temperature Range: -30°C to +85°C
 Voltage Range: 50, 100, 500, 1,000, 2,000, 3,000 WVDC
 Capacitance Range: 1 pF to 100,000 pF
 Lead Length: 1 inch minimum

Insulation Resistance: 10,000 megohms (min)
 Power Factor @ 1kHz: 2.5% Max (Y5V: 5%)
 Breakdown Voltage: 2.5 x rated (5 seconds Max)

Capacity pF	Tol	Temp Coef	Size (Inches)				Size (Millimeters)				Catalog Number
			D	T	S	d	D	T	S	d	
50 WVDC											
1	.25pF	SL	.157	.118	.098	.016	4.0	3.0	2.5	.4	GE010C
3	.25pF	SL	.157	.118	.098	.016	4.0	3.0	2.5	.4	GE030C
5	.25pF	SL	.157	.118	.098	.016	4.0	3.0	2.5	.4	GE050C
6	.5pF	SL	.157	.118	.098	.016	4.0	3.0	2.5	.4	GE060D
7	.5pF	SL	.157	.118	.098	.016	4.0	3.0	2.5	.4	GE070D
8	.5pF	SL	.157	.118	.098	.016	4.0	3.0	2.5	.4	GE080D
10	.5pF	SL	.157	.118	.098	.016	4.0	3.0	2.5	.4	GE100D
12	10%	SL	.157	.118	.098	.016	4.0	3.0	2.5	.4	GE120K
15	10%	SL	.157	.118	.098	.016	4.0	3.0	2.5	.4	GE150K
18	10%	SL	.157	.118	.098	.016	4.0	3.0	2.5	.4	GE180K
20	10%	SL	.157	.118	.098	.016	4.0	3.0	2.5	.4	GE200K
22	10%	SL	.157	.118	.098	.016	4.0	3.0	2.5	.4	GE220K
24	10%	SL	.157	.118	.098	.016	4.0	3.0	2.5	.4	GE240K
27	10%	SL	.157	.118	.098	.016	4.0	3.0	2.5	.4	GE270K
33	10%	SL	.157	.118	.098	.016	4.0	3.0	2.5	.4	GE330K
39	10%	SL	.157	.118	.098	.016	4.0	3.0	2.5	.4	GE390K
47	10%	SL	.157	.118	.098	.016	4.0	3.0	2.5	.4	GE470K
51	10%	SL	.157	.118	.098	.016	4.0	3.0	2.5	.4	GE510K
56	10%	SL	.157	.118	.098	.016	4.0	3.0	2.5	.4	GE560K
68	10%	SL	.157	.118	.098	.016	4.0	3.0	2.5	.4	GE680K
75	10%	SL	.157	.118	.098	.016	4.0	3.0	2.5	.4	GE750K
82	10%	SL	.197	.118	.098	.016	5.0	3.0	2.5	.4	GE820K
91	10%	SL	.197	.118	.098	.016	5.0	3.0	2.5	.4	GE910K
100	10%	Y5P	.157	.118	.098	.016	4.0	3.0	2.5	.4	GE101K
120	10%	Y5P	.157	.118	.098	.016	4.0	3.0	2.5	.4	GE121K
150	10%	Y5P	.157	.118	.098	.016	4.0	3.0	2.5	.4	GE151K
180	10%	Y5P	.157	.118	.098	.016	4.0	3.0	2.5	.4	GE181K
220	10%	Y5P	.157	.118	.098	.016	4.0	3.0	2.5	.4	GE221K
270	10%	Y5P	.157	.118	.098	.016	4.0	3.0	2.5	.4	GE271K
330	10%	Y5P	.157	.118	.098	.016	4.0	3.0	2.5	.4	GE331K
390	10%	Y5P	.157	.118	.098	.016	4.0	3.0	2.5	.4	GE391K
470	10%	Y5P	.157	.118	.098	.016	4.0	3.0	2.5	.4	GE471K
560	10%	Y5P	.157	.118	.098	.016	4.0	3.0	2.5	.4	GE561K
680	10%	Y5P	.157	.118	.098	.016	4.0	3.0	2.5	.4	GE681K
820	10%	Y5P	.157	.118	.098	.016	4.0	3.0	2.5	.4	GE821K
1,000	10%	Y5P	.197	.118	.098	.016	5.0	3.0	2.5	.4	GE102K
1,000	20%	Y5T	.157	.118	.098	.016	4.0	3.0	2.5	.4	GE102M
1,000	-20+80	Y5V	.157	.118	.098	.016	4.0	3.0	2.5	.4	GE102Z
1,500	10%	Y5P	.197	.118	.098	.016	5.0	3.0	2.5	.4	GE152K
1,500	20%	Y5T	.197	.118	.098	.016	5.0	3.0	2.5	.4	GE152M
1,800	10%	Y5P	.236	.118	.197	.020	6.0	3.0	5.0	.5	GE182K
2,200	10%	Y5P	.236	.118	.197	.020	6.0	3.0	5.0	.5	GE222K
2,200	20%	Y5U	.197	.118	.098	.016	5.0	3.0	2.5	.4	GE222M
2,700	10%	Y5P	.276	.118	.197	.020	7.0	3.0	5.0	.5	GE272K
3,300	10%	Y5P	.276	.118	.197	.020	7.0	3.0	5.0	.5	GE332K
3,300	20%	Y5U	.236	.118	.197	.020	6.0	3.0	5.0	.5	GE332M
3,900	10%	Y5P	.315	.118	.197	.020	8.0	3.0	5.0	.5	GE392K
4,700	10%	Y5P	.315	.118	.197	.020	8.0	3.0	5.0	.5	GE472K
4,700	20%	Y5U	.236	.118	.197	.020	6.0	3.0	5.0	.5	GE472M
4,700	-20+80	Y5U	.236	.118	.197	.020	6.0	3.0	5.0	.5	GE472Z
5,600	10%	Y5P	.354	.118	.197	.020	9.0	3.0	5.0	.5	GE562K
6,800	10%	Y5P	.374	.118	.197	.020	9.5	3.0	5.0	.5	GE682K
6,800	20%	Y5U	.276	.118	.197	.020	7.0	3.0	5.0	.5	GE682M
8,200	10%	Y5P	.394	.118	.197	.020	10.0	3.0	5.0	.5	GE822K

Capacity pF	Tol	Temp Coef	Size (Inches)				Size (Millimeters)				Catalog Number
			D	T	S	d	D	T	S	d	
50 WVDC											
10,000	10%	Y5P	.472	.118	.197	.020	12.0	3.0	5.0	.5	GE103K
10,000	20%	Y5U	.315	.118	.197	.020	8.0	3.0	5.0	.5	GE103M
10,000	-20+80	Y5V	.236	.118	.197	.020	6.0	3.0	5.0	.5	GE103Z
22,000	20%	Y5U	.472	.118	.197	.020	12.0	3.0	5.0	.5	GE223M

Capacity pF	Tol	Temp Coef	Size (Inches)				Size (Millimeters)				Catalog Number
			D	T	S	d	D	T	S	d	
100 WVDC											
100	10%	Y5P	.236	.118	.252	.025	6.0	3.0	6.4	.6	GH101K
120	10%	Y5P	.236	.118	.252	.025	6.0	3.0	6.4	.6	GH121K
150	10%	Y5P	.236	.118	.252	.025	6.0	3.0	6.4	.6	GH151K
180	10%	Y5P	.236	.118	.252	.025	6.0	3.0	6.4	.6	GH181K
220	10%	Y5P	.236	.118	.252	.025	6.0	3.0	6.4	.6	GH221K
270	10%	Y5P	.236	.118	.252	.025	6.0	3.0	6.4	.6	GH271K
330	10%	Y5P	.236	.118	.252	.025	6.0	3.0	6.4	.6	GH331K
390	10%	Y5P	.236	.118	.252	.025	6.0	3.0	6.4	.6	GH391K
470	10%	Y5P	.236	.118	.252	.025	6.0	3.0	6.4	.6	GH471K
560	10%	Y5P	.236	.118	.252	.025	6.0	3.0	6.4	.6	GH561K
680	10%	Y5P	.236	.118	.252	.025	6.0	3.0	6.4	.6	GH681K
820	10%	Y5P	.236	.118	.252	.025	6.0	3.0	6.4	.6	GH821K
1,000	10%	Y5P	.236	.118	.252	.025	6.0	3.0	6.4	.6	GH102K
1,200	10%	Y5P	.236	.118	.252	.025	6.0	3.0	6.4	.6	GH122K
1,500	10%	Y5P	.236	.118	.252	.025	6.0	3.0	6.4	.6	GH152K
1,500	20%	Y5U	.236	.118	.252	.025	6.0	3.0	6.4	.6	GH152M
1,500	-20+80	Y5U	.236	.118	.252	.025	6.0	3.0	6.4	.6	GH152Z
1,800	10%	Y5P	.236	.118	.252	.025	6.0	3.0	6.4	.6	GH182K
2,200	10%	Y5P	.315	.118	.252	.025	8.0	3.0	6.4	.6	GH222K
2,200	20%	Y5U	.236	.118	.252	.025	6.0	3.0	6.4	.6	GH222M
2,200	-20+80	Y5U	.236	.118	.252	.025	6.0	3.0	6.4	.6	GH222Z
2,700	10%	Y5P	.315	.118	.252	.025	8.0	3.0	6.4	.6	GH272K
3,300	10%	Y5P	.315	.118	.252	.025	8.0	3.0	6.4	.6	GH332K
3,300	20%	Y5U	.236	.118	.252	.025	6.0	3.0	6.4	.6	GH332M
3,300	-20+80	Y5U	.236	.118	.252	.025	6.0	3.0	6.4	.6	GH332Z
3,900	10%	Y5P	.315	.118	.252	.025	8.0	3.0	6.4	.6	GH392K
4,700	10%	Y5P	.374	.118	.252	.025	9.5	3.0	6.4	.6	GH472K
4,700	20%	Y5U	.315	.118	.252	.025	8.0	3.0	6.4	.6	GH472M
4,700	-20+80	Y5U	.315	.118	.252	.025	8.0	3.0	6.4	.6	GH472Z
5,600	10%	Y5P	.374	.118	.252	.025	9.5	3.0	6.4	.6	GH562K
6,800	10%	Y5P	.472	.118	.252	.025	12.0	3.0	6.4	.6	GH682K
6,800	20%	Y5U	.315	.118	.252	.025	8.0	3.0	6.4	.6	GH682M
6,800	-20+80	Y5U	.315	.118	.252	.025	8.0	3.0	6.4	.6	GH682Z
10,000	10%	Y5P	.472	.118	.252	.025	12.0	3.0	6.4	.6	GH103K
10,000	20%	Y5U	.374	.118	.252	.025	9.5	3.0	6.4	.6	GH103M
10,000	-20+80	Y5U	.374	.118	.252	.025	9.5	3.0	6.4	.6	GH103Z
22,000	-20+80	Y5V	.472	.118	.252	.025	12.0	3.0	6.4	.6	GH223Z
100,000	-20+80	Z5U	.413	.150	.374	.025	10.5	3.8	9.5	.6	GH104ZX*
100,000	-20+80	Z5U	.311	.157	.374	.025	7.9	4.0	9.5	.6	GH104ZX3*

* Multilayer construction and rectangular in shape. The diameter dimension is the largest dimension of the footprint.

Disc Ceramic Capacitors

General Purpose Disc Ceramic Capacitors



Capacity pF	Tol	Temp Coef	Size (Inches)			Size (Millimeters)			Catalog Number
			D	T	S	d	D	T	

500 WVDC

1	.25pF	SL	.236	.157	.252	.025	6.0	4.0	6.4	.6	GM010C
3	.25pF	SL	.236	.157	.252	.025	6.0	4.0	6.4	.6	GM030C
3.3	.25pF	SL	.236	.157	.252	.025	6.0	4.0	6.4	.6	GM3R3C
5	.25pF	SL	.236	.157	.252	.025	6.0	4.0	6.4	.6	GM050C
6	.5pF	SL	.236	.157	.252	.025	6.0	4.0	6.4	.6	GM060D
6.8	.5pF	SL	.236	.157	.252	.025	6.0	4.0	6.4	.6	GM6R8D
7	.5pF	SL	.236	.157	.252	.025	6.0	4.0	6.4	.6	GM070D
7.5	.5pF	SL	.236	.157	.252	.025	6.0	4.0	6.4	.6	GM7R5D
8	.5pF	SL	.236	.157	.252	.025	6.0	4.0	6.4	.6	GM080D
10	.5pF	SL	.236	.157	.252	.025	6.0	4.0	6.4	.6	GM100D
12	10%	SL	.236	.157	.252	.025	6.0	4.0	6.4	.6	GM120K
15	10%	SL	.236	.157	.252	.025	6.0	4.0	6.4	.6	GM150K
18	10%	SL	.236	.157	.252	.025	6.0	4.0	6.4	.6	GM180K
20	10%	SL	.236	.157	.252	.025	6.0	4.0	6.4	.6	GM200K
22	10%	SL	.236	.157	.252	.025	6.0	4.0	6.4	.6	GM220K
24	10%	SL	.236	.157	.252	.025	6.0	4.0	6.4	.6	GM240K
27	10%	SL	.236	.157	.252	.025	6.0	4.0	6.4	.6	GM270K
33	10%	SL	.236	.157	.252	.025	6.0	4.0	6.4	.6	GM330K
39	10%	SL	.236	.157	.252	.025	6.0	4.0	6.4	.6	GM390K
47	10%	SL	.236	.157	.252	.025	6.0	4.0	6.4	.6	GM470K
51	10%	SL	.236	.157	.252	.025	6.0	4.0	6.4	.6	GM510K
56	10%	SL	.236	.157	.252	.025	6.0	4.0	6.4	.6	GM560K
68	10%	SL	.236	.157	.252	.025	6.0	4.0	6.4	.6	GM680K
75	10%	SL	.236	.157	.252	.025	6.0	4.0	6.4	.6	GM750K
82	10%	SL	.236	.157	.252	.025	6.0	4.0	6.4	.6	GM820K
91	10%	SL	.236	.157	.252	.025	6.0	4.0	6.4	.6	GM910K
100	10%	Y5P	.236	.157	.252	.025	6.0	4.0	6.4	.6	GM101K
120	10%	Y5P	.236	.157	.252	.025	6.0	4.0	6.4	.6	GM121K
150	10%	Y5P	.236	.157	.252	.025	6.0	4.0	6.4	.6	GM151K
180	10%	Y5P	.236	.157	.252	.025	6.0	4.0	6.4	.6	GM181K
220	10%	Y5P	.236	.157	.252	.025	6.0	4.0	6.4	.6	GM221K
270	10%	Y5P	.236	.157	.252	.025	6.0	4.0	6.4	.6	GM271K
330	10%	Y5P	.236	.157	.252	.025	6.0	4.0	6.4	.6	GM331K
390	10%	Y5P	.236	.157	.252	.025	6.0	4.0	6.4	.6	GM391K
470	10%	Y5P	.236	.157	.252	.025	6.0	4.0	6.4	.6	GM471K
560	10%	Y5P	.236	.157	.252	.025	6.0	4.0	6.4	.6	GM561K
680	10%	Y5P	.236	.157	.252	.025	6.0	4.0	6.4	.6	GM681K
820	10%	Y5P	.236	.157	.252	.025	6.0	4.0	6.4	.6	GM821K
1,000	10%	Y5P	.236	.157	.252	.025	6.0	4.0	6.4	.6	GM102K
1,000	20%	Y5U	.236	.157	.252	.025	6.0	4.0	6.4	.6	GM102M
1,000	-20+80	Y5U	.236	.157	.252	.025	6.0	4.0	6.4	.6	GM102Z
1,500	10%	Y5P	.291	.157	.252	.025	7.4	4.0	6.4	.6	GM152K
1,500	20%	Y5U	.236	.157	.252	.025	6.0	4.0	6.4	.6	GM152M
1,500	-20+80	Y5U	.236	.157	.252	.025	6.0	4.0	6.4	.6	GM152Z
1,800	10%	Y5P	.339	.157	.252	.025	8.6	4.0	6.4	.6	GM182K
2,200	10%	Y5P	.339	.157	.250	.025	8.6	4.0	6.4	.6	GM222K
2,200	20%	Y5U	.236	.157	.252	.025	6.0	4.0	6.4	.6	GM222M
2,200	-20+80	Y5U	.236	.157	.252	.025	6.0	4.0	6.4	.6	GM222Z
2,700	10%	Y5P	.374	.157	.252	.025	9.5	4.0	6.4	.6	GM272K
3,300	10%	Y5P	.433	.157	.252	.025	11.0	4.0	6.4	.6	GM332K
3,300	20%	Y5U	.291	.157	.252	.025	7.4	4.0	6.4	.6	GM332M
3,300	-20+80	Y5U	.291	.157	.252	.025	7.4	4.0	6.4	.6	GM332Z
3,900	10%	Y5P	.433	.157	.252	.025	11.0	4.0	6.4	.6	GM392K
4,700	10%	Y5P	.492	.157	.252	.025	12.5	4.0	6.4	.6	GM472K
4,700	20%	Y5U	.339	.157	.252	.025	8.6	4.0	6.4	.6	GM472M
4,700	-20+80	Y5U	.339	.157	.252	.025	8.6	4.0	6.4	.6	GM472Z
5,600	10%	Y5P	.492	.157	.252	.025	12.5	4.0	6.4	.6	GM562K
6,800	10%	Y5P	.571	.157	.374	.025	14.5	4.0	9.5	.6	GM682K
6,800	20%	Y5U	.433	.157	.252	.025	11.0	4.0	6.4	.6	GM682M
6,800	-20+80	Y5U	.433	.157	.252	.025	11.0	4.0	6.4	.6	GM682Z
8,200	10%	Y5P	.571	.157	.374	.025	14.5	4.0	9.5	.6	GM822K
10,000	10%	Y5P	.642	.157	.374	.025	16.3	4.0	9.5	.6	GM103K
10,000	20%	Y5U	.492	.157	.252	.025	12.5	4.0	6.4	.6	GM103M
10,000	-20+80	Y5U	.492	.157	.252	.025	12.5	4.0	6.4	.6	GM103Z
22,000	20%	Y5U	.642	.157	.374	.025	16.3	4.0	9.5	.6	GM223M
22,000	-20+80	Y5U	.642	.157	.374	.025	16.3	4.0	9.5	.6	GM223Z
30,000	20%	Z5U	.413	.150	.374	.025	10.5	3.8	9.5	.6	GM303MX*
30,000	20%	Z5U	.311	.157	.374	.025	7.9	4.0	9.5	.6	GM303MX3*
50,000	20%	Z5U	.413	.150	.374	.025	10.5	3.8	9.5	.6	GM503MX*
50,000	20%	Z5U	.311	.157	.374	.025	7.9	4.0	9.5	.6	GM503MX3*
100,000	20%	Z5U	.413	.150	.374	.025	10.5	3.8	9.5	.6	GM104MX*
100,000	20%	Z5U	.311	.157	.201	.025	7.9	4.0	5.1	.6	GM104MX2*

Capacity pF	Tol	Temp Coef	Size (Inches)			Size (Millimeters)			Catalog Number
			D	T	S	d	D	T	

1000 WVDC

3.3	.25PF	SL	.236	.177	.252	.025	6.0	4.5	6.4	.6	GP533
5	.25PF	SL	.236	.177	.252	.025	6.0	4.5	6.4	.6	GP550
6.8	.5PF	SL	.236	.177	.252	.025	6.0	4.5	6.4	.6	GP568
8	.5PF	SL	.236	.177	.252	.025	6.0	4.5	6.4	.6	GP580
10	.5PF	SL	.236	.177	.252	.025	6.0	4.5	6.4	.6	GP410
12	10%	SL	.236	.177	.252	.025	6.0	4.5	6.4	.6	GP412
15	10%	SL	.236	.177	.252	.025	6.0	4.5	6.4	.6	GP415
18	10%	SL	.236	.177	.252	.025	6.0	4.5	6.4	.6	GP418
20	10%	SL	.236	.177	.252	.025	6.0	4.5	6.4	.6	GP420
22	10%	SL	.236	.177	.252	.025	6.0	4.5	6.4	.6	GP422
27	10%	SL	.236	.177	.252	.025	6.0	4.5	6.4	.6	GP427
30	10%	SL	.236	.177	.252	.025	6.0	4.5	6.4	.6	GP430
33	10%	SL	.236	.177	.252	.025	6.0	4.5	6.4	.6	GP433
39	10%	SL	.236	.177	.252	.025	6.0	4.5	6.4	.6	GP439
47	10%	SL	.236	.177	.252	.025	6.0	4.5	6.4	.6	GP447
56	10%	SL	.236	.177	.252	.025	6.0	4.5	6.4	.6	GP456
68	10%	SL	.236	.177	.252	.025	6.0	4.5	6.4	.6	GP468
91	10%	Y5P	.236	.177	.252	.025	6.0	4.5	6.4	.6	GP491
100	10%	Y5P	.236	.177	.252	.025	6.0	4.5	6.4	.6	GP310
120	10%	Y5P	.236	.177	.252	.025	6.0	4.5	6.4	.6	GP312
150	10%	Y5P	.236	.177	.252	.025	6.0	4.5	6.4	.6	GP315
180	10%	Y5P	.236	.177	.252	.025	6.0	4.5	6.4	.6	GP318
220	10%	Y5P	.236	.177	.252	.025	6.0	4.5	6.4	.6	GP322
270	10%	Y5P	.236	.177	.252	.025	6.0	4.5	6.4	.6	GP327
330	10%	Y5P	.236	.177	.252	.025	6.0	4.5	6.4	.6	GP333
390	10%	Y5P	.236	.177	.252	.025	6.0	4.5	6.4	.6	GP339
470	10%	Y5P	.236	.177	.252	.025	6.0	4.5	6.4	.6	GP347
560	10%	Y5P	.236	.177	.252	.025	6.0	4.5	6.4	.6	GP356
680	10%	Y5P	.236	.177	.252	.025	6.0	4.5	6.4	.6	GP368
750	10%	Y5P	.236	.177	.252	.025	6.0	4.5	6.4	.6	GP375
820	10%	Y5P	.236	.177	.252	.025	6.0	4.5	6.4	.6	GP382
1,000	10%	Y5P	.291	.177	.252	.025	7.4	4.5	6.4	.6	GP210
1,500	10%	Y5P	.339	.177	.252	.025	8.6	4.5	6.4	.6	GP215
1,800	10%	Y5P	.374	.177	.252	.025	9.5	4.5	6.4	.6	GP218
2,200	10%	Y5P	.374	.177	.252	.025	9.5	4.5	6.4	.6	GP222
2,700	10%	Y5P	.433	.177	.252	.025	11.0	4.5	6.4	.6	GP227
3,300	10%	Y5P	.433	.177	.252	.025	11.0	4.5	6.4	.6	GP233P
3,900	10%	Y5P	.492	.177	.252	.025	12.5	4.5	6.4	.6	GP239
4,700	20%	Y5U	.433	.177	.252	.025	11.0	4.5	6.4	.6	GP247
5,600	10%	Y5P	.591	.177	.374	.025	15.0	4.5	9.5	.6	GP256
6,800	10%	Y5P	.669	.177	.374	.025	17.0	4.5	9.5	.6	GP268P
10,000	20%	Y5U	.591	.177	.374	.025	15.0	4.5	9.5	.6	GP110
22,000	20%	Y5U	.748	.177	.374	.025	19.0	4.5	9.5	.6	GP122

Disc Ceramic Capacitors

Multilayer construction and rectangular in shape.
The diameter dimension is the largest dimension of the footprint.

General Purpose Disc Ceramic Capacitors

MALLORY

Capacity pF	Tol	Temp Coef	Size (Inches)				Size (Millimeters)				Catalog Number
			D	T	S	d	D	T	S	d	
2000 WVDC											
1	.25pf	SL	.315	.197	.252	.032	8.0	5.0	6.4	.8	GR510
1.5	.25pf	SL	.315	.197	.252	.032	8.0	5.0	6.4	.8	GR515
2	.25pf	SL	.315	.197	.252	.032	8.0	5.0	6.4	.8	GR520
3	.25pf	SL	.315	.197	.252	.032	8.0	5.0	6.4	.8	GR530
4	.25pf	SL	.315	.197	.252	.032	8.0	5.0	6.4	.8	GR540
5	.25pf	SL	.315	.197	.252	.032	8.0	5.0	6.4	.8	GR550
6	.5pf	SL	.315	.197	.252	.032	8.0	5.0	6.4	.8	GR560
7	.5pf	SL	.315	.197	.252	.032	8.0	5.0	6.4	.8	GR570
8	.5pf	SL	.315	.197	.252	.032	8.0	5.0	6.4	.8	GR580
9	.5pf	SL	.315	.197	.252	.032	8.0	5.0	6.4	.8	GR590
10	.5pf	SL	.315	.197	.252	.032	8.0	5.0	6.4	.8	GR410
11	5%	SL	.315	.197	.252	.032	8.0	5.0	6.4	.8	GR411
12	5%	SL	.315	.197	.252	.032	8.0	5.0	6.4	.8	GR412
13	5%	SL	.315	.197	.252	.032	8.0	5.0	6.4	.8	GR413
15	5%	SL	.315	.197	.252	.032	8.0	5.0	6.4	.8	GR415
16	5%	SL	.315	.197	.252	.032	8.0	5.0	6.4	.8	GR416
18	5%	SL	.315	.197	.252	.032	8.0	5.0	6.4	.8	GR418
20	5%	SL	.315	.197	.252	.032	8.0	5.0	6.4	.8	GR420
22	5%	SL	.315	.197	.252	.032	8.0	5.0	6.4	.8	GR422
24	5%	SL	.315	.197	.252	.032	8.0	5.0	6.4	.8	GR424
27	5%	SL	.315	.197	.252	.032	8.0	5.0	6.4	.8	GR427
30	5%	SL	.315	.197	.252	.032	8.0	5.0	6.4	.8	GR430
33	5%	SL	.315	.197	.252	.032	8.0	5.0	6.4	.8	GR433
36	5%	SL	.315	.197	.252	.032	8.0	5.0	6.4	.8	GR436
39	5%	SL	.394	.197	.252	.032	10.0	5.0	6.4	.8	GR439
43	5%	SL	.394	.197	.252	.032	10.0	5.0	6.4	.8	GR443
47	5%	SL	.394	.197	.252	.032	10.0	5.0	6.4	.8	GR470
51	5%	SL	.394	.197	.252	.032	10.0	5.0	6.4	.8	GR451
56	5%	SL	.394	.197	.252	.032	10.0	5.0	6.4	.8	GR456
62	5%	SL	.394	.197	.252	.032	10.0	5.0	6.4	.8	GR462
68	5%	SL	.394	.197	.252	.032	10.0	5.0	6.4	.8	GR468
75	5%	SL	.394	.197	.252	.032	10.0	5.0	6.4	.8	GR475
82	5%	SL	.472	.197	.252	.032	12.0	5.0	6.4	.8	GR482
91	5%	SL	.472	.197	.252	.032	12.0	5.0	6.4	.8	GR491
100	5%	SL	.472	.197	.252	.032	12.0	5.0	6.4	.8	GR310
100	10%	Y5P	.315	.197	.252	.032	8.0	5.0	6.4	.8	GS310
110	5%	SL	.472	.197	.252	.032	12.0	5.0	6.4	.8	GR311
120	5%	SL	.591	.197	.374	.032	15.0	5.0	9.5	.8	GR312
120	10%	Y5P	.315	.197	.252	.032	8.0	5.0	6.4	.8	GS312
130	5%	SL	.591	.197	.374	.032	15.0	5.0	9.5	.8	GR313
150	5%	SL	.591	.197	.374	.032	15.0	5.0	9.5	.8	GR315
150	10%	Y5P	.315	.197	.252	.032	8.0	5.0	6.4	.8	GS315
160	5%	SL	.591	.197	.374	.032	15.0	5.0	9.5	.8	GR316
180	5%	SL	.591	.197	.374	.032	15.0	5.0	9.5	.8	GR318
180	10%	Y5P	.315	.197	.252	.032	8.0	5.0	6.4	.8	GS318
200	5%	SL	.591	.197	.374	.032	15.0	5.0	9.5	.8	GR320
220	5%	SL	.591	.197	.374	.032	15.0	5.0	9.5	.8	GR322
220	10%	Y5P	.315	.197	.252	.032	8.0	5.0	6.4	.8	GS322
240	5%	SL	.787	.197	.374	.032	20.0	5.0	9.5	.8	GR324
270	5%	SL	.787	.197	.374	.032	20.0	5.0	9.5	.8	GR327
270	10%	Y5P	.315	.197	.252	.032	8.0	5.0	6.4	.8	GS327
300	5%	SL	.787	.197	.374	.032	20.0	5.0	9.5	.8	GR330
330	5%	SL	.787	.197	.374	.032	20.0	5.0	9.5	.8	GR333
330	10%	Y5P	.315	.197	.252	.032	8.0	5.0	6.4	.8	GS333
360	5%	SL	.787	.197	.374	.032	20.0	5.0	9.5	.8	GR336
390	5%	SL	.787	.197	.374	.032	20.0	5.0	9.5	.8	GR339
390	10%	Y5P	.315	.197	.252	.032	8.0	5.0	6.4	.8	GS339
430	5%	SL	.787	.197	.374	.032	20.0	5.0	9.5	.8	GR343
470	10%	Y5P	.394	.197	.252	.032	10.0	5.0	6.4	.8	GS347
560	10%	Y5P	.394	.197	.252	.032	10.0	5.0	6.4	.8	GS356
680	10%	Y5P	.394	.197	.252	.032	10.0	5.0	6.4	.8	GS368
820	10%	Y5P	.394	.197	.252	.032	10.0	5.0	6.4	.8	GS382
1,000	10%	Y5P	.472	.197	.252	.032	12.0	5.0	6.4	.8	GS210
1,200	10%	Y5P	.472	.197	.252	.032	12.0	5.0	6.4	.8	GS212
1,500	10%	Y5P	.591	.197	.374	.032	15.0	5.0	9.5	.8	GS215
1,800	10%	Y5P	.591	.197	.374	.032	15.0	5.0	9.5	.8	GS218
2,200	10%	Y5P	.591	.197	.374	.032	15.0	5.0	9.5	.8	GS222
2,700	10%	Y5P	.591	.197	.374	.032	15.0	5.0	9.5	.8	GS272
3,300	10%	Y5P	.787	.197	.374	.032	20.0	5.0	9.5	.8	GS233
3,900	10%	Y5P	.787	.197	.374	.032	20.0	5.0	9.5	.8	GS239
4,700	10%	Y5P	.787	.197	.374	.032	20.0	5.0	9.5	.8	GS247

Capacity pF	Tol	Temp Coef	Size (Inches)				Size (Millimeters)				Catalog Number
			D	T	S	d	D	T	S	d	
3000 WVDC											
1	.25pF	SL	.394	.236	.374	.032	10.0	6.0	9.5	.8	GT510
1.5	.25pF	SL	.394	.236	.374	.032	10.0	6.0	9.5	.8	GT515
2	.25pF	SL	.394	.236	.374	.032	10.0	6.0	9.5	.8	GT520
3	.25pF	SL	.394	.236	.374	.032	10.0	6.0	9.5	.8	GT530
4	.25pF	SL	.394	.236	.374	.032	10.0	6.0	9.5	.8	GT540
5	.25pF	SL	.394	.236	.374	.032	10.0	6.0	9.5	.8	GT550
6	.5pF	SL	.394	.236	.374	.032	10.0	6.0	9.5	.8	GT560
7	.5pF	SL	.394	.236	.374	.032	10.0	6.0	9.5	.8	GT570
8	.5pF	SL	.394	.236	.374	.032	10.0	6.0	9.5	.8	GT580
9	.5pF	SL	.394	.236	.374	.032	10.0	6.0	9.5	.8	GT590
10	.5pF	SL	.394	.236	.374	.032	10.0	6.0	9.5	.8	GT410
11	5%	SL	.394	.236	.374	.032	10.0	6.0	9.5	.8	GT411
12	5%	SL	.394	.236	.374	.032	10.0	6.0	9.5	.8	GT412
13	5%	SL	.394	.236	.374	.032	10.0	6.0	9.5	.8	GT413
14	5%	SL	.394	.236	.374	.032	10.0	6.0	9.5	.8	GT415
16	5%	SL	.394	.236	.374	.032	10.0	6.0	9.5	.8	GT416
18	5%	SL	.394	.236	.374	.032	10.0	6.0	9.5	.8	GT418
20	5%	SL	.394	.236	.374	.032	10.0	6.0	9.5	.8	GT420
22	5%	SL	.394	.236	.374	.032	10.0	6.0	9.5	.8	GT422
24	5%	SL	.394	.236	.374	.032	10.0	6.0	9.5	.8	GT424
27	5%	SL	.394	.236	.374	.032	10.0	6.0	9.5	.8	GT427
30	5%	SL	.394	.236	.374	.032	10.0	6.0	9.5	.8	GT430
36	5%	SL	.394	.236	.374	.032	10.0	6.0	9.5	.8	GT436
39	5%	SL	.394	.236	.374	.032	10.0	6.0	9.5	.8	GT439
44	5%	SL	.394	.236	.374	.032	10.0	6.0	9.5	.8	GT443
47	5%	SL	.394	.236	.374	.032	10.0	6.0	9.5	.8	GT447
51	5%	SL	.394	.236	.374	.032	10.0	6.0	9.5	.8	GT451
56	5%	SL	.394	.236	.374	.032	10.0	6.0	9.5	.8	GT456
62	5%	SL	.472	.236	.374	.032	12.0	6.0	9.5	.8	GT462
68	5%	SL	.472	.236	.374	.032	12.0	6.0	9.5	.8	GT468
75	5%	SL	.472	.236	.374	.032	12.0	6.0	9.5	.8	GT475
82	5%	SL	.472	.236	.374	.032	12.0	6.0	9.5	.8	GT482
91	5%	SL	.591	.236	.374	.032	15.0	6.0	9.5	.8	GT491
100	5%	SL	.591	.236	.374	.032	15.0	6.0	9.5	.8	GT310
110	5%	SL	.591	.236	.374	.032	15.0	6.0	9.5	.8	GT311
160	5%	SL	.591	.236	.374	.032					

EIA Class 1 Temperature Compensating Disc Ceramic Capacitors

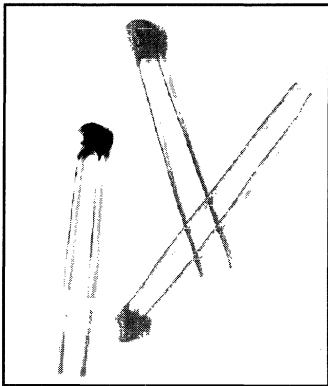

- Temperature Compensating
- Ideal For Use in Timing and Oscillating Circuits
- Conformally Coated
- Radial Leads

GENERAL SPECIFICATIONS

Temperature Range:
-55°C to +125°C

Voltage Range:
50, 500,
1,000, 2,000, 3,000 WVDC

Capacitance Range:
1 pF to 470 pF

Lead Length: 1 inch minimum

Insulation Resistance:
10,000 megohms (min.)

Power Factor @ 1 MHz:
5% Max

Breakdown Voltage:
3 x rated
(5 seconds Max)

Capacity pF	Tol	Temp Coef	Size (Inches)				Size (Millimeters)				Catalog Number
			D	T	S	d	D	T	S	d	
50 WVDC											
1	.25PF	NPO	.157	.118	.098	.015	4.0	3.0	2.5	.4	CEC10C
1.5	.25PF	NPO	.157	.118	.098	.015	4.0	3.0	2.5	.4	CEC1R5C
2	.25PF	NPO	.157	.118	.098	.015	4.0	3.0	2.5	.4	CEC020C
2	.25PF	N330	.157	.118	.098	.015	4.0	3.0	2.5	.4	CES020C
3	.25PF	NPO	.157	.118	.098	.015	4.0	3.0	2.5	.4	CEC030C
3	.25PF	N330	.157	.118	.098	.015	4.0	3.0	2.5	.4	CES030C
4	.25PF	NPO	.157	.118	.098	.015	4.0	3.0	2.5	.4	CEC040C
4	.25PF	N330	.157	.118	.098	.015	4.0	3.0	2.5	.4	CES040C
5	.25PF	NPO	.157	.118	.098	.015	4.0	3.0	2.5	.4	CEC050C
5	.25PF	N330	.157	.118	.098	.015	4.0	3.0	2.5	.4	CES050C
6	.5PF	NPO	.157	.118	.098	.015	4.0	3.0	2.5	.4	CEC060D
6	.5PF	N330	.157	.118	.098	.015	4.0	3.0	2.5	.4	CES060D
7	.5PF	NPO	.157	.118	.098	.015	4.0	3.0	2.5	.4	CEC070D
7	.5PF	N330	.157	.118	.098	.015	4.0	3.0	2.5	.4	CES070D
8	.5PF	NPO	.157	.118	.098	.015	4.0	3.0	2.5	.4	CEC080D
8	.5PF	N330	.157	.118	.098	.015	4.0	3.0	2.5	.4	CES080D
9	.5PF	NPO	.157	.118	.098	.015	4.0	3.0	2.5	.4	CEC090D
9	.5PF	N330	.157	.118	.098	.015	4.0	3.0	2.5	.4	CES090D
10	.5PF	NPO	.157	.118	.098	.015	4.0	3.0	2.5	.4	CEC100J
10	.5PF	N330	.157	.118	.098	.015	4.0	3.0	2.5	.4	CES100D
10	.5PF	N750	.157	.118	.098	.015	4.0	3.0	2.5	.4	CEU100D
11	.5PF	NPO	.157	.118	.098	.015	4.0	3.0	2.5	.4	CEC110J
11	.5PF	N330	.157	.118	.098	.015	4.0	3.0	2.5	.4	CES110J
12	.5PF	NPO	.157	.118	.098	.015	4.0	3.0	2.5	.4	CEC120J
12	.5PF	N330	.157	.118	.098	.015	4.0	3.0	2.5	.4	CES120J
13	.5PF	NPO	.157	.118	.098	.015	4.0	3.0	2.5	.4	CEC130J
13	.5PF	N330	.157	.118	.098	.015	4.0	3.0	2.5	.4	CES130J
15	.5PF	NPO	.157	.118	.098	.015	4.0	3.0	2.5	.4	CEC150J
15	.5PF	N330	.157	.118	.098	.015	4.0	3.0	2.5	.4	CES150J
16	.5PF	NPO	.157	.118	.098	.015	4.0	3.0	2.5	.4	CEC160J
16	.5PF	N330	.157	.118	.098	.015	4.0	3.0	2.5	.4	CES160J
18	.5PF	NPO	.157	.118	.098	.015	4.0	3.0	2.5	.4	CEC180J
18	.5PF	N330	.157	.118	.098	.015	4.0	3.0	2.5	.4	CES180J
20	.5PF	NPO	.157	.118	.098	.015	4.0	3.0	2.5	.4	CEC200J
20	.5PF	N330	.157	.118	.098	.015	4.0	3.0	2.5	.4	CES200J
22	.5PF	NPO	.157	.118	.098	.015	4.0	3.0	2.5	.4	CEC220J
22	.5PF	N330	.157	.118	.098	.015	4.0	3.0	2.5	.4	CES220J
22	.5PF	N750	.157	.118	.098	.015	4.0	3.0	2.5	.4	CEU220J
24	.5PF	NPO	.157	.118	.098	.015	4.0	3.0	2.5	.4	CEC240J
24	.5PF	N330	.157	.118	.098	.015	4.0	3.0	2.5	.4	CES240J
27	.5PF	NPO	.197	.118	.098	.015	5.0	3.0	2.5	.4	CEC270J
27	.5PF	N330	.197	.118	.098	.015	5.0	3.0	2.5	.4	CES270J
30	.5PF	NPO	.197	.118	.098	.015	5.0	3.0	2.5	.4	CEC300J
30	.5PF	N330	.197	.118	.098	.015	5.0	3.0	2.5	.4	CES300J
33	.5PF	NPO	.197	.118	.098	.015	5.0	3.0	2.5	.4	CEC330J
33	.5PF	N330	.197	.118	.098	.015	5.0	3.0	2.5	.4	CES330J
36	.5PF	NPO	.197	.118	.197	.020	5.0	3.0	5.0	.5	CEC360J
36	.5PF	N330	.197	.118	.098	.015	5.0	3.0	2.5	.4	CES360J
39	.5PF	NPO	.197	.118	.197	.020	5.0	3.0	5.0	.5	CEC390J
39	.5PF	N330	.197	.118	.098	.015	5.0	3.0	2.5	.4	CES390J
43	.5PF	NPO	.236	.118	.197	.020	6.0	3.0	5.0	.5	CEC430J
43	.5PF	N330	.197	.118	.197	.020	5.0	3.0	5.0	.5	CES430J
47	.5PF	NPO	.236	.118	.197	.020	6.0	3.0	5.0	.5	CEC470J
47	.5PF	N330	.197	.118	.197	.020	5.0	3.0	5.0	.5	CES470J

Capacity pF	Tol	Temp Coef	Size (Inches)				Size (Millimeters)				Catalog Number
			D	T	S	d	D	T	S	d	
50 WVDC											
51	5%	NPO	.236	.118	.197	.020	6.0	3.0	5.0	.5	CEC510J
51	5%	N330	.236	.118	.197	.020	6.0	3.0	5.0	.5	CES510J
51	5%	N750	.197	.118	.098	.015	5.0	3.0	2.5	.4	CEU510J
56	5%	NPO	.236	.118	.197	.020	6.0	3.0	5.0	.5	CEC560J
56	5%	N330	.236	.118	.197	.020	6.0	3.0	5.0	.5	CES560J
62	5%	NPO	.276	.118	.197	.020	7.0	3.0	5.0	.5	CEC620J
62	5%	N330	.236	.118	.197	.020	6.0	3.0	5.0	.5	CES620J
68	5%	NPO	.276	.118	.197	.020	7.0	3.0	5.0	.5	CEC680J
68	5%	N330	.236	.118	.197	.020	6.0	3.0	5.0	.5	CES680J
68	5%	N750	.197	.118	.197	.020	5.0	3.0	5.0	.5	CEU680J
75	5%	NPO	.276	.118	.197	.020	7.0	3.0	5.0	.5	CEC750J
75	5%	N330	.276	.118	.197	.020	7.0	3.0	5.0	.5	CES750J
82	5%	NPO	.276	.118	.197	.020	7.0	3.0	5.0	.5	CEC820J
82	5%	N330	.276	.118	.197	.020	7.0	3.0	5.0	.5	CES820J
91	5%	NPO	.315	.118	.197	.020	8.0	3.0	5.0	.5	CEC910J
91	5%	N330	.276	.118	.197	.020	7.0	3.0	5.0	.5	CES910J
100	5%	NPO	.315	.118	.197	.020	8.0	3.0	5.0	.5	CEC101J
100	5%	N330	.276	.118	.197	.020	7.0	3.0	5.0	.5	CES101J
100	5%	N750	.236	.118	.197	.020	6.0	3.0	5.0	.5	CEU101J
110	5%	NPO	.315	.118	.197	.020	8.0	3.0	5.0	.5	CEC111J
110	5%	N330	.315	.118	.197	.020	8.0	3.0	5.0	.5	CES111J
120	5%	NPO	.315	.118	.197	.020	8.0	3.0	5.0	.5	CEC121J
120	5%	N330	.315	.118	.197	.020	8.0	3.0	5.0	.5	CES121J
120	5%	N750	.236	.118	.197	.020	6.0	3.0	5.0	.5	CEU121J
130	5%	NPO	.354	.118	.197	.020	9.0	3.0	5.0	.5	CEC131J
130	5%	N330	.315	.118	.197	.020	8.0	3.0	5.0	.5	CES131J
150	5%	NPO	.354	.118	.197	.020	9.0	3.0	5.0	.5	CEC151J
150	5%	N330	.315	.118	.197	.020	8.0	3.0	5.0	.5	CES151J
160	5%	NPO	.354	.118	.197	.020	9.0	3.0	5.0	.5	CEC161J
160	5%	N330	.354	.118	.197	.020	9.0	3.0	5.0	.5	CES161J
180	5%	NPO	.374	.118	.197	.020	9.5	3.0	5.0	.5	CEC181J
180	5%	N330	.354	.118	.197	.020	9.0	3.0	5.0	.5	CES181J
200	5%	NPO	.414	.118	.197	.020	10.5	3.0	5.0	.5	CEC201J
200	5%	N330	.374	.118	.197	.020	9.5	3.0	5.0	.5	CES201J
220	5%	NPO	.413	.118	.197	.020	10.5	3.0	5.0	.5	CEC221J
220	5%	N330	.374	.118	.197	.020	9.5	3.0	5.0	.5	CES221J
220	5%	N750	.315	.118	.197	.020	8.0	3.0	5.0	.5	CEU221J
240	5%	NPO	.472	.118	.197	.020	12.0	3.0	5.0	.5	CEC241J
240	5%	N330	.413	.118	.197	.020	10.5	3.0	5.0	.5	CES241J
270	5%	NPO	.472	.118	.197	.020	12.0	3.0	5.0	.5	CEC271J
270	5%	N330	.413	.118	.197	.020	10.5	3.0	5.0	.5	CES271J
270	5%	N750	.374	.118	.197	.020	9.5	3.0	5.0	.5	CEU271J
300	5%	NPO	.472	.118	.197	.020	12.0	3.0	5.0	.5	CEC301J
300	5%	N330	.472	.118	.197	.020	12.0	3.0	5.0	.5	CES301J
300	5%	N750	.354	.118	.197	.020	9.0	3.0	5.0	.5	CEU301J
330	5%	N330	.472	.118	.197	.020	12.0	3.0	5.0	.5	CES331J
330	5%	N750	.354	.118	.197	.020	9.0	3.0	5.0	.5	CEU331J
360	5%	N330	.472	.118	.197	.020	12.0	3.0	5.0	.5	CES361J
390	5%	N330	.472	.118	.197	.020	12.0	3.0	5.0	.5	CES391J
390	5%	N750	.413	.118	.197	.020	10.5	3.0	5.0	.5	CEU391J
470	5%	N750	.413	.118	.197	.020	10.5	3.0	5.0	.5	CEU471J

Disc Ceramic Capacitors

EIA Class 1 Temperature Compensating Disc Ceramic Capacitors



Capacity pF	Tol	Temp Coef	Size (Inches)			Size (Millimeters)			Catalog Number
			D	T	S d	D	T	S d	
500 WVDC									
1	.25pF	NPO	.236	.157	.252 .025	6.0	4.0	6.4 .6	CMC010C
1.5	.25pF	NPO	.236	.157	.252 .025	6.0	4.0	6.4 .6	CMC1R5C
1.5	.25pF	N750	.236	.157	.252 .025	6.0	4.0	6.4 .6	CMU1R5C
2	.25pF	NPO	.236	.157	.252 .025	6.0	4.0	6.4 .6	CMC020C
3	.25pF	NPO	.236	.157	.252 .025	6.0	4.0	6.4 .6	CMC030C
3.3	.25pF	N750	.236	.157	.252 .025	6.0	4.0	6.4 .6	CMU3R3C
4	.25pF	NPO	.236	.157	.252 .025	6.0	4.0	6.4 .6	CMC040C
4.7	.25pF	N750	.236	.157	.252 .025	6.0	4.0	6.4 .6	CMU4R7C
5	.25pF	NPO	.236	.157	.252 .025	6.0	4.0	6.4 .6	CMC050C
5	.25pF	N750	.236	.157	.252 .025	6.0	4.0	6.4 .6	CMU050C
6	.5pF	NPO	.236	.157	.252 .025	6.0	4.0	6.4 .6	CMC060D
6.8	.5pF	N750	.236	.157	.252 .025	6.0	4.0	6.4 .6	CMU6R8D
7	.5pF	NPO	.236	.157	.252 .025	6.0	4.0	6.4 .6	CMC070D
8	.5pF	NPO	.236	.157	.252 .025	6.0	4.0	6.4 .6	CMC080D
8.2	.5pF	N750	.236	.157	.252 .025	6.0	4.0	6.4 .6	CMU8R2D
9	.5pF	NPO	.236	.157	.252 .025	6.0	4.0	6.4 .6	CMC090D
10	5%	NPO	.236	.157	.252 .025	6.0	4.0	6.4 .6	CMC100J
10	.5pF	N750	.236	.157	.252 .025	6.0	4.0	6.4 .6	CMU100D
10	.5pF	N1500	.236	.157	.252 .025	6.0	4.0	6.4 .6	CMW100D
11	5%	NPO	.236	.157	.252 .025	6.0	4.0	6.4 .6	CMC110J
12	5%	NPO	.236	.157	.252 .025	6.0	4.0	6.4 .6	CMC120J
12	5%	N750	.236	.157	.252 .025	6.0	4.0	6.4 .6	CMU120J
13	5%	NPO	.236	.157	.252 .025	6.0	4.0	6.4 .6	CMC130J
15	5%	NPO	.236	.157	.252 .025	6.0	4.0	6.4 .6	CMC150J
15	5%	N750	.236	.157	.252 .025	6.0	4.0	6.4 .6	CMU150J
16	5%	NPO	.236	.157	.252 .025	6.0	4.0	6.4 .6	CMC160J
18	5%	NPO	.236	.157	.252 .025	6.0	4.0	6.4 .6	CMC180J
18	5%	N750	.236	.157	.252 .025	6.0	4.0	6.4 .6	CMU180J
20	5%	NPO	.236	.157	.252 .025	6.0	4.0	6.4 .6	CMC200J
20	5%	N750	.236	.157	.252 .025	6.0	4.0	6.4 .6	CMU200J
22	5%	NPO	.236	.157	.252 .025	6.0	4.0	6.4 .6	CMC220J
22	5%	N750	.236	.157	.252 .025	6.0	4.0	6.4 .6	CMU220J
22	5%	N1500	.236	.157	.252 .025	6.0	4.0	6.4 .6	CMW220J
24	5%	NPO	.236	.157	.252 .025	6.0	4.0	6.4 .6	CMC240J
27	5%	NPO	.236	.157	.252 .025	6.0	4.0	6.4 .6	CMC270J
30	5%	NPO	.236	.157	.252 .025	6.0	4.0	6.4 .6	CMC300J
33	5%	NPO	.291	.157	.252 .025	7.4	4.0	6.4 .6	CMC330J
33	5%	N750	.236	.157	.252 .025	6.0	4.0	6.4 .6	CMU330J
36	5%	NPO	.291	.157	.252 .025	7.4	4.0	6.4 .6	CMC360J
39	5%	NPO	.291	.157	.252 .025	7.4	4.0	6.4 .6	CMC390J
39	5%	N750	.236	.157	.252 .025	6.0	4.0	6.4 .6	CMU390J
43	5%	NPO	.291	.157	.252 .025	7.4	4.0	6.4 .6	CMC430J
47	5%	NPO	.291	.157	.252 .025	7.4	4.0	6.4 .6	CMC470J
47	5%	N750	.236	.157	.252 .025	6.0	4.0	6.4 .6	CMU470J
51	5%	NPO	.374	.157	.252 .025	9.5	4.0	6.4 .6	CMC510J
51	5%	N750	.236	.157	.252 .025	6.0	4.0	6.4 .6	CMU510J
51	5%	N1500	.236	.157	.252 .025	6.0	4.0	6.4 .6	CMW510J
56	5%	NPO	.374	.157	.252 .025	9.5	4.0	6.4 .6	CMC560J
56	5%	N750	.236	.157	.252 .025	6.0	4.0	6.4 .6	CMU560J
56	5%	N1500	.236	.157	.252 .025	6.0	4.0	6.4 .6	CMW560J
62	5%	NPO	.374	.157	.252 .025	9.5	4.0	6.4 .6	CMC620J
68	5%	NPO	.374	.157	.252 .025	9.5	4.0	6.4 .6	CMC680J
68	5%	N750	.291	.157	.252 .025	7.4	4.0	6.4 .6	CMU680J
75	5%	NPO	.374	.157	.252 .025	9.5	4.0	6.4 .6	CMC750J
82	5%	NPO	.374	.157	.252 .025	9.5	4.0	6.4 .6	CMC820J
91	5%	NPO	.433	.157	.252 .025	11.0	4.0	6.4 .6	CMC910J
100	5%	NPO	.433	.157	.252 .025	11.0	4.0	6.4 .6	CMC101J
100	5%	N750	.291	.157	.252 .025	7.4	4.0	6.4 .6	CMU101J
100	5%	N1500	.291	.157	.252 .025	7.4	4.0	6.4 .6	CMW101J
110	5%	NPO	.433	.157	.252 .025	11.0	4.0	6.4 .6	CMC111J
120	5%	NPO	.433	.157	.252 .025	11.0	4.0	6.4 .6	CMC121J
130	5%	NPO	.492	.157	.252 .025	12.5	4.0	6.4 .6	CMC131J
150	5%	NPO	.492	.157	.252 .025	12.5	4.0	6.4 .6	CMC151J
160	5%	NPO	.492	.157	.252 .025	12.5	4.0	6.4 .6	CMC161J
180	5%	NPO	.571	.157	.374 .025	14.5	4.0	9.5 .6	CMC181J
200	5%	NPO	.571	.157	.374 .025	14.5	4.0	9.5 .6	CMC201J
220	5%	NPO	.571	.157	.374 .025	14.5	4.0	9.5 .6	CMC221J
240	5%	NPO	.571	.157	.374 .025	14.5	4.0	9.5 .6	CMC241J
270	5%	NPO	.642	.157	.374 .025	16.3	4.0	9.5 .6	CMC271J
300	5%	NPO	.642	.157	.374 .025	16.3	4.0	9.5 .6	CMC301J
330	5%	NPO	.642	.157	.374 .025	16.3	4.0	9.5 .6	CMC331J
360	5%	NPO	.748	.157	.374 .025	19.0	4.0	9.5 .6	CMC361J

Capacity pF	Tol	Temp Coef	Size (Inches)			Size (Millimeters)			Catalog Number
			D	T	S d	D	T	S d	
500 WVDC									
390	5%	NPO	.748	.157	.374 .025	19.0	4.0	9.5 .6	CMC391J
390	5%	N1500	.492	.157	.252 .025	12.5	4.0	6.4 .6	CMW391J
430	5%	NPO	.748	.157	.374 .025	19.0	4.0	9.5 .6	CMC431J
1000 WVDC									
1	.25pF	NPO	.236	.177	.252 .025	6.0	4.5	6.4 .6	CPC010C
1.5	.25pF	NPO	.236	.177	.252 .025	6.0	4.5	6.4 .6	CPC1R5C
2.2	.25pF	NPO	.236	.177	.252 .025	6.0	4.5	6.4 .6	CPC2R2C
3.3	.25pF	NPO	.236	.177	.252 .025	6.0	4.5	6.4 .6	CPC3R3C
4.7	.25pF	NPO	.236	.177	.252 .025	6.0	4.5	6.4 .6	CPC4R7C
6.8	.5pF	NPO	.236	.177	.252 .025	6.0	4.5	6.4 .6	CPC6R8D
8.2	.5pF	NPO	.236	.177	.252 .025	6.0	4.5	6.4 .6	CPC8R2D
9.6	.5pF	NPO	.236	.177	.252 .025	6.0	4.5	6.4 .6	CPC9R6D
10	.5pF	NPO	.236	.177	.252 .025	6.0	4.5	6.4 .6	CPC100D
11	5%	NPO	.236	.177	.252 .025	6.0	4.5	6.4 .6	CPC110J
12	5%	NPO	.236	.177	.252 .025	6.0	4.5	6.4 .6	CPC120J
13	5%	NPO	.236	.177	.252 .025	6.0	4.5	6.4 .6	CPC130J
15	5%	NPO	.236	.177	.252 .025	6.0	4.5	6.4 .6	CPC150J
16	5%	NPO	.236	.177	.252 .025	6.0	4.5	6.4 .6	CPC160J
18	5%	NPO	.236	.177	.252 .025	6.0	4.5	6.4 .6	CPC180J
20	5%	NPO	.236	.177	.252 .025	6.0	4.5	6.4 .6	CPC200J
22	5%	NPO	.236	.177	.252 .025	6.0	4.5	6.4 .6	CPC220J
24	5%	NPO	.291	.177	.252 .025	7.4	4.5	6.4 .6	CPC240J
27	5%	NPO	.291	.177	.252 .025	7.4	4.5	6.4 .6	CPC270J
30	5%	NPO	.291	.177	.252 .025	7.4	4.5	6.4 .6	CPC300J
33	5%	NPO	.291	.177	.252 .025	7.4	4.5	6.4 .6	CPC330J
36	5%	NPO	.374	.177	.252 .025	9.5	4.5	6.4 .6	CPC360J
39	5%	NPO	.374	.177	.252 .025	9.5	4.5	6.4 .6	CPC390J
43	5%	NPO	.374	.177	.252 .025	9.5	4.5	6.4 .6	CPC430J
47	5%	NPO	.374	.177	.252 .025	9.5	4.5	6.4 .6	CPC470J
51	5%	NPO	.374	.177	.252 .025	9.5	4.5	6.4 .6	CPC510J
56	5%	NPO	.374	.177	.252 .025	9.5	4.5	6.4 .6	CPC560J
62	5%	NPO	.374	.177	.252 .025	9.5	4.5	6.4 .6	CPC620J
68	5%	NPO	.433	.177	.252 .025	11.0	4.5	6.4 .6	CPC680J
75	5%	NPO	.433	.177	.252 .025	11.0	4.5	6.4 .6	CPC750J
82	5%	NPO	.433	.177	.252 .025	11.0	4.5	6.4 .6	CPC820J
91	5%	NPO	.433	.177	.252 .025	11.0	4.5	6.4 .6	CPC910J
100	5%	NPO	.512	.177	.252 .025	13.0	4.5	6.4 .6	CPC101J
110	5%	NPO	.512	.177	.252 .025	13.0	4.5	6.4 .6	CPC111J
120	5%	NPO	.512	.177	.252 .025	13.0	4.5	6.4 .6	CPC121J
130	5%	NPO	.512	.177	.252 .025	13.0	4.5	6.4 .6	CPC131J
150	5%	NPO	.591	.177	.374 .025	15.0	4.5	9.5 .6	CPC151J
160	5%	NPO	.591	.177	.374 .025	15.0	4.5	9.5 .6	CPC161J
180	5%	NPO	.591	.177	.374 .025	15.0	4.5	9.5 .6	CPC181J
200	5%	NPO	.669	.177	.374 .025	17.0	4.5	9.5 .6	CPC201J
220	5%	NPO	.669	.177	.374 .025	17.0	4.5	9.5 .6	CPC221J
270	5%	NPO	.748	.177	.374 .025	19.0	4.5	9.5 .6	CPC271J
300	5%	NPO	.748	.177	.374 .025	19.0	4.5	9.5 .6	CPC301J
330	5%	NPO	.748	.177	.374 .025	19.0	4.5	9.5 .6	CPC331J

Disc Ceramic Capacitors

EIA Class 1 Temperature Compensating Disc Ceramic Capacitors



Capacity pF	Tol	Temp Coef	Size (Inches)				Size (Millimeters)				Catalog Number
			D	T	S	d	D	T	S	d	
2000 WVDC											
1	.25pF	NPO	.315	.197	.252	.032	8.0	5.0	6.4	.8	CRC010C
1.5	.25pF	NPO	.315	.197	.252	.032	8.0	5.0	6.4	.8	CRC1R5C
2	.25pF	NPO	.315	.197	.252	.032	8.0	5.0	6.4	.8	CRC020C
3	.25pF	NPO	.315	.197	.252	.032	8.0	5.0	6.4	.8	CRC030C
4	.25pF	NPO	.315	.197	.252	.032	8.0	5.0	6.4	.8	CRC040C
5	.25pF	NPO	.315	.197	.252	.032	8.0	5.0	6.4	.8	CRC050C
6	.5pF	NPO	.315	.197	.252	.032	8.0	5.0	6.4	.8	CRC060D
7	.5pF	NPO	.315	.197	.252	.032	8.0	5.0	6.4	.8	CRC070D
9	.5pF	NPO	.315	.197	.252	.032	8.0	5.0	6.4	.8	CRC090D
10	.5pF	NPO	.315	.197	.252	.032	8.0	5.0	6.4	.8	CRC100D
11	5%	NPO	.315	.197	.252	.032	8.0	5.0	6.4	.8	CRC110J
12	5%	NPO	.315	.197	.252	.032	8.0	5.0	6.4	.8	CRC120J
13	5%	NPO	.394	.197	.252	.032	10.0	5.0	6.4	.8	CRC130J
15	5%	NPO	.394	.197	.252	.032	10.0	5.0	6.4	.8	CRC150J
16	5%	NPO	.394	.197	.252	.032	10.0	5.0	6.4	.8	CRC160J
20	5%	NPO	.394	.197	.252	.032	10.0	5.0	6.4	.8	CRC200J
22	5%	NPO	.394	.197	.252	.032	10.0	5.0	6.4	.8	CRC220J
24	5%	NPO	.394	.197	.252	.032	10.0	5.0	6.4	.8	CRC240J
27	5%	NPO	.472	.197	.252	.032	12.0	5.0	6.4	.8	CRC270J
30	5%	NPO	.472	.197	.252	.032	12.0	5.0	6.4	.8	CRC300J
33	5%	NPO	.472	.197	.252	.032	12.0	5.0	6.4	.8	CRC330J
36	5%	NPO	.472	.197	.252	.032	12.0	5.0	6.4	.8	CRC360J
39	5%	NPO	.591	.197	.374	.032	15.0	5.0	9.5	.8	CRC390J
43	5%	NPO	.591	.197	.374	.032	15.0	5.0	9.5	.8	CRC430J
47	5%	NPO	.591	.197	.374	.032	15.0	5.0	9.5	.8	CRC470J
51	5%	NPO	.591	.197	.374	.032	15.0	5.0	9.5	.8	CRC510J
56	5%	NPO	.591	.197	.374	.032	15.0	5.0	9.5	.8	CRC560J
62	5%	NPO	.591	.197	.374	.032	15.0	5.0	9.5	.8	CRC620J
68	5%	NPO	.591	.197	.374	.032	15.0	5.0	9.5	.8	CRC680J
75	5%	NPO	.787	.197	.374	.032	20.0	5.0	9.5	.8	CRC750J
82	5%	NPO	.787	.197	.374	.032	20.0	5.0	9.5	.8	CRC820J
91	5%	NPO	.787	.197	.374	.032	20.0	5.0	9.5	.8	CRC910J
100	5%	NPO	.787	.197	.374	.032	20.0	5.0	9.5	.8	CRC101J
110	5%	NPO	.787	.197	.374	.032	20.0	5.0	9.5	.8	CRC111J
120	5%	NPO	.787	.197	.374	.032	20.0	5.0	9.5	.8	CRC121J
130	5%	NPO	.787	.197	.374	.032	20.0	5.0	9.5	.8	CRC131J

Capacity pF	Tol	Temp Coef	Size (Inches)				Size (Millimeters)				Catalog Number
			D	T	S	d	D	T	S	d	
3000 WVDC											
1	.25pF	NPO	.394	.236	.374	.032	10.0	6.0	9.5	.8	CTZ010C
1.5	.25pF	NPO	.394	.236	.374	.032	10.0	6.0	9.5	.8	CTZ1R5C
2	.25pF	NPO	.394	.236	.374	.032	10.0	6.0	9.5	.8	CTZ020C
3	.25pF	NPO	.394	.236	.374	.032	10.0	6.0	9.5	.8	CTZ030C
4	.25pF	NPO	.394	.236	.374	.032	10.0	6.0	9.5	.8	CTZ040C
5	.25pF	NPO	.394	.236	.374	.032	10.0	6.0	9.5	.8	CTZ050C
6	.5pF	NPO	.394	.236	.374	.032	10.0	6.0	9.5	.8	CTZ060D
7	.5pF	NPO	.394	.236	.374	.032	10.0	6.0	9.5	.8	CTZ070D
9	.5pF	NPO	.394	.236	.374	.032	10.0	6.0	9.5	.8	CTZ090D
10	.5pF	NPO	.394	.236	.374	.032	10.0	6.0	9.5	.8	CTZ100D
11	5%	NPO	.394	.236	.374	.032	10.0	6.0	9.5	.8	CTZ110J
12	5%	NPO	.394	.236	.374	.032	10.0	6.0	9.5	.8	CTZ120J
13	5%	NPO	.394	.236	.374	.032	10.0	6.0	9.5	.8	CTZ130J
15	5%	NPO	.394	.236	.374	.032	10.0	6.0	9.5	.8	CTZ150J
16	5%	NPO	.394	.236	.374	.032	10.0	6.0	9.5	.8	CTZ160J
18	5%	NPO	.472	.236	.374	.032	12.0	6.0	9.5	.8	CTZ180J
20	5%	NPO	.472	.236	.374	.032	12.0	6.0	9.5	.8	CTZ200J
22	5%	NPO	.472	.236	.374	.032	12.0	6.0	9.5	.8	CTZ220J
22	10%	SL	.394	.236	.374	.032	10.0	6.0	9.5	.8	CTZ220K
24	5%	NPO	.472	.236	.374	.032	12.0	6.0	9.5	.8	CTZ240J
27	5%	NPO	.591	.236	.374	.032	15.0	6.0	9.5	.8	CTZ270J
30	5%	NPO	.591	.236	.374	.032	15.0	6.0	9.5	.8	CTZ300J
33	5%	NPO	.591	.236	.374	.032	15.0	6.0	9.5	.8	CTZ330J
36	5%	NPO	.591	.236	.374	.032	15.0	6.0	9.5	.8	CTZ360J
39	5%	NPO	.591	.236	.374	.032	15.0	6.0	9.5	.8	CTZ390J
43	5%	NPO	.591	.236	.374	.032	15.0	6.0	9.5	.8	CTZ430J
47	5%	NPO	.591	.236	.374	.032	15.0	6.0	9.5	.8	CTZ470J
51	5%	NPO	.591	.236	.374	.032	15.0	6.0	9.5	.8	CTZ510J
56	5%	NPO	.787	.236	.374	.032	20.0	6.0	9.5	.8	CTZ560J
62	5%	NPO	.787	.236	.374	.032	20.0	6.0	9.5	.8	CTZ620J
68	5%	NPO	.787	.236	.374	.032	20.0	6.0	9.5	.8	CTZ680J
75	5%	NPO	.787	.236	.374	.032	20.0	6.0	9.5	.8	CTZ750J
82	5%	NPO	.787	.236	.374	.032	20.0	6.0	9.5	.8	CTZ820J
91	5%	NPO	.787	.236	.374	.032	20.0	6.0	9.5	.8	CTZ910J
100	10%	SL	.591	.236	.374	.032	15.0	6.0	9.5	.8	CTZ101K

EIA Class 2 Temperature/ Frequency Stable Disc Ceramic Capacitors

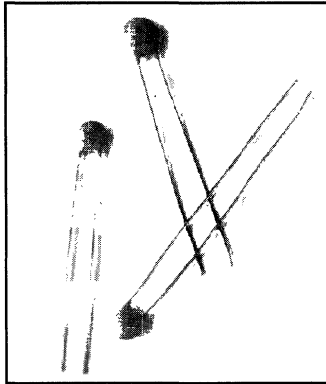

- Provides Exceptional Stability Where Minimum Variation in Capacitance is Required
- Conformally Coated
- Radial Leads

GENERAL SPECIFICATIONS

Temperature Range: -30°C to +85°C
 Voltage Range: 500 and 1,000 VDC
 Capacitance Range: 100 pF to 10,000 pF
 Lead Length: 1 inch minimum

Insulation Resistance: 10,000 megohms (min)
 Power Factor @ 1000 Hz: 1.5% Max
 Breakdown Voltage: 2.5 x rated (5 seconds Max)

Capacity pF	Tol	Temp Coef	Size (Inches)				Size (Millimeters)				Catalog Number
			D	T	S	d	D	T	S	d	
500 WVDC											
150	10%	Y5E	.236	.157	.252	.025	6.0	4.0	6.4	.6	SM151K
220	10%	Y5E	.236	.157	.252	.025	6.0	4.0	6.4	.6	SM221K
390	10%	Y5E	.236	.157	.252	.025	6.0	4.0	6.4	.6	SM391K
470	10%	Y5E	.236	.157	.252	.025	6.0	4.0	6.4	.6	SM471K
560	10%	Y5E	.236	.157	.252	.025	6.0	4.0	6.4	.6	SM561K
680	10%	Y5E	.236	.157	.252	.025	6.0	4.0	6.4	.6	SM681K
1,000	10%	Y5E	.339	.157	.252	.025	8.6	4.0	6.4	.6	SM102K
2,200	10%	Y5E	.433	.157	.252	.025	11.0	4.0	6.4	.6	SM222K
4,700	10%	Y5E	.571	.157	.374	.025	14.5	4.0	9.5	.6	SM472K
6,800	10%	Y5E	.748	.157	.374	.025	19.0	4.0	9.5	.6	SM682K
10,000	10%	Y5E	.748	.157	.374	.025	19.0	4.0	9.5	.6	SM103K

Capacity pF	Tol	Temp Coef	Size (Inches)				Size (Millimeters)				Catalog Number
			D	T	S	d	D	T	S	d	
1000 WVDC											
100	10%	Y5P	.236	.177	.252	.025	6.0	4.5	6.4	.6	SP101K
150	10%	Y5P	.236	.177	.252	.025	6.0	4.5	6.4	.6	SP151K
180	10%	Y5P	.236	.177	.252	.025	6.0	4.5	6.4	.6	SP181K
220	10%	Y5P	.236	.177	.252	.025	6.0	4.5	6.4	.6	SP221K
270	10%	Y5P	.236	.177	.252	.025	6.0	4.5	6.4	.6	SP271K
330	10%	Y5P	.236	.177	.252	.025	6.0	4.5	6.4	.6	SP331K
390	10%	Y5P	.236	.177	.252	.025	6.0	4.5	6.4	.6	SP391K
470	10%	Y5P	.236	.177	.252	.025	6.0	4.5	6.4	.6	SP471K
560	10%	Y5P	.236	.177	.252	.025	6.0	4.5	6.4	.6	SP561K
680	10%	Y5P	.236	.177	.252	.025	6.0	4.5	6.4	.6	SP681K
1,000	10%	Y5P	.291	.177	.252	.025	7.4	4.5	6.4	.6	SP102K
1,500	10%	Y5P	.339	.177	.252	.025	8.6	4.5	6.4	.6	SP152K
1,800	10%	Y5P	.374	.177	.252	.025	9.5	4.5	6.4	.6	SP182K
2,200	10%	Y5P	.374	.177	.252	.025	9.5	4.5	6.4	.6	SP222K
2,700	10%	Y5P	.433	.177	.252	.025	11.0	4.5	6.4	.6	SP272K
3,900	10%	Y5P	.492	.177	.252	.025	12.5	4.5	6.4	.6	SP392K
4,700	10%	Y5P	.591	.177	.374	.025	15.0	4.5	9.5	.6	SP472K

HIGH VOLTAGE

- Highly Efficient for Bypass and Coupling Applications
- Designed Around EIA Test Spec. RS-165A
- Radial Leads

GENERAL SPECIFICATIONS

Temperature Range: -30°C to +85°C
 Voltage Range: 2,000 and 3,000 WVDC
 Capacitance Range: 100pF to 10,000 pF

Insulation Resistance: 10,000 megohms (min)
 Power Factor @ 1000 Hz: 2.5% Max
 Breakdown Voltage: 2.5 x rated (5 seconds Max)
 Lead Length: 1 inch minimum

Capacity pF	Tol	Temp Coef	Size (Inches)				Size (Millimeters)				Catalog Number
			D	T	S	d	D	T	S	d	
2000 WVDC											
1,000	20%	Y5U	.394	.197	.252	.032	10.0	5.0	6.4	.8	HS102M
1,500	20%	Y5U	.394	.197	.252	.032	10.0	5.0	6.4	.8	HS152M
2,200	20%	Y5U	.472	.197	.252	.032	12.0	5.0	6.4	.8	HS222M
3,300	20%	Y5U	.591	.197	.374	.032	15.0	5.0	9.5	.8	HS332M
4,700	20%	Y5U	.591	.197	.374	.032	15.0	5.0	9.5	.8	HS472M
6,800	20%	Y5U	.787	.197	.374	.032	20.0	5.0	9.5	.8	HS682M
10,000	20%	Y5U	.787	.197	.374	.032	20.0	5.0	9.5	.8	HS103M
3000 WVDC											
100	10%	Y5P	.394	.236	.374	.032	10.0	6.0	9.5	.8	HT101K
120	10%	Y5P	.394	.236	.374	.032	10.0	6.0	9.5	.8	HT121K
150	10%	Y5P	.394	.236	.374	.032	10.0	6.0	9.5	.8	HT151K
180	10%	Y5P	.394	.236	.374	.032	10.0	6.0	9.5	.8	HT181K
220	10%	Y5P	.394	.236	.374	.032	10.0	6.0	9.5	.8	HT221K
270	10%	Y5P	.394	.236	.374	.032	10.0	6.0	9.5	.8	HT271K
330	10%	Y5P	.394	.236	.374	.032	10.0	6.0	9.5	.8	HT331K

Capacity pF	Tol	Temp Coef	Size (Inches)				Size (Millimeters)				Catalog Number
			D	T	S	d	D	T	S	d	
3000 WVDC											
390	10%	Y5P	.394	.236	.374	.032	10.0	6.0	9.5	.8	HT391K
470	10%	Y5P	.394	.236	.374	.032	10.0	6.0	9.5	.8	HT471K
560	10%	Y5P	.394	.236	.374	.032	10.0	6.0	9.5	.8	HT561K
680	10%	Y5P	.472	.236	.374	.032	12.0	6.0	9.5	.8	HT681K
820	10%	Y5P	.472	.236	.374	.032	12.0	6.0	9.5	.8	HT821K
1,000	10%	Y5P	.591	.236	.374	.032	15.0	6.0	9.5	.8	HT102K
1,000	20%	Y5U	.394	.236	.374	.032	10.0	6.0	9.5	.8	HT102M
1,200	10%	Y5P	.591	.236	.374	.032	15.0	6.0	9.5	.8	HT122K
1,500	10%	Y5P	.591	.236	.374	.032	15.0	6.0	9.5	.8	HT152K
1,500	20%	Y5U	.472	.236	.374	.032	12.0	6.0	9.5	.8	HT152M
1,800	10%	Y5P	.591	.236	.374	.032	15.0	6.0	9.5	.8	HT182K
1,800	20%	Y5U	.591	.236	.374	.032	15.0	6.0	9.5	.8	HT182M
2,200	10%	Y5P	.787	.236	.374	.032	20.0	6.0	9.5	.8	HT222K
2,200	20%	Y5U	.591	.236	.374	.032	15.0	6.0	9.5	.8	HT222M
2,700	10%	Y5P	.787	.236	.374	.032	20.0	6.0	9.5	.8	HT272K
3,300	10%	Y5P	.787	.236	.374	.032	20.0	6.0	9.5	.8	HT332K
4,700	20%	Y5U	.787	.236	.374	.032	20.0	6.0	9.5	.8	HT472M
6,800	20%	Y5U	.787	.236	.374	.032	20.0	6.0	9.5	.8	HT682M

Disc Ceramic Capacitors

EIA Class 3, Semiconductor Type Disc Ceramic Capacitors

MALLORY

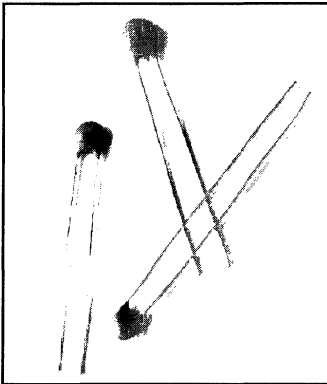

Reduced Titanite

- Ideal in Transistorized Circuitry for Bypass and Coupling Applications
- Low Power Factor & Superior Radio Frequency Impedance Characteristics
- Meets RS-198C for Class 3 Ceramic Capacitors
- Radial Leads

GENERAL SPECIFICATIONS

Temperature Range: -30°C to +85°C
 Voltage Range: 25 & 50 VDC
 Capacitance Range: .01 μ F to .22 μ F
 Lead Length: 1 inch minimum

Insulation Resistance: 1 megohm (min)
 Power Factor @ 1000 Hz: 7.0% Max
 Breakdown Voltage: 2.5 x rated (5 seconds Max)

Capacity μ F	Tol	Temp Coef	Size (Inches)				Size (Millimeters)				Catalog Number
			D	T	S	d	D	T	S	d	
25 WVDC											
.010	20%	Y5R	.235	.138	.250	.025	6.0	3.5	6.4	.6	LC103M
.022	20%	Y5R	.315	.138	.250	.025	8.0	3.5	6.4	.6	LC223M
.033	20%	Y5R	.350	.138	.250	.025	8.9	3.5	6.4	.6	LC333M
.100	20%	Y5R	.495	.138	.250	.025	12.6	3.5	6.4	.6	LC104M
.220	20%	Y5U	.495	.138	.250	.025	12.6	3.5	6.4	.6	LC224M

Capacity μ F	Tol	Temp Coef	Size (Inches)				Size (Millimeters)				Catalog Number
			D	T	S	d	D	T	S	d	
50 WVDC											
.010	20%	Y5U	.230	.138	.250	.025	5.8	3.5	6.4	.6	LE103M
.022	20%	Y5U	.290	.138	.250	.025	7.4	3.5	6.4	.6	LE223M
.047	20%	Y5U	.359	.138	.250	.025	9.1	3.5	6.4	.6	LE473M
.100	20%	Y5U	.484	.138	.250	.025	12.3	3.5	6.4	.6	LE104M

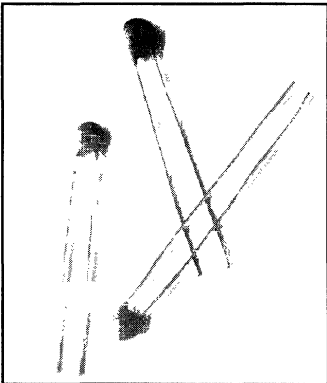

Spark-Arrestor

- Radial Leads
- 1 Inch Leads (minimum)
- Lead Material Tinned Copper Wire

GENERAL SPECIFICATIONS

Type 1 Spark-Arrestor

Consists of a wire loop encased in phenolic resin. After the loop has been encased, a precise slot is cut through the wire loop and its protective case to form a gap. Type 1 does not include a parallel disc ceramic.

Type 2 Spark-Arrestor

A combination of a ceramic disc in parallel with the gap. Useful in either industrial or commercial applications which require bypassing of transient over voltages. The precise gap allows the stray transients to be harmlessly bypassed.

Temperature Characteristic = Z5U



Type 1

Type 2

Capacity	Voltage	Type	Size (Inches)				Size (Millimeters)				Catalog Number
			D	H	S	d	D	H	S	d	
1 - 3 KVDC											
* .75pF max	1-2 KVDC	1	.350	.500	.250	.032	8.9	12.7	6.4	.8	ASR75A
* .75pF max	2-3 KVDC	1	.350	.500	.250	.032	8.9	12.7	6.4	.8	ATR75A
# .01 μ F	2-3 KVDC	2	.770	1.000	.375	.032	19.6	25.4	9.5	.8	AT103A

* Inherent capacity of gap only. No parallel disc ceramic.

Includes parallel disc ceramic. Tol. +80,-20%

Disc Ceramic Capacitors

X Type Across-The-Line Filter Disc Ceramic Capacitors

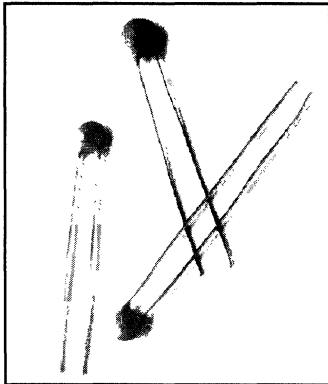

- UL Recognized
UL 1414, File E38785
- CSA Certified
CSA 22.2#1, File LR33468
- VDE Recognized
Specification 57-565-1
Files: 13751-4670-1002/A1B
13971-4670-1001/A2E

* For other X Type capacitors,
see our 158X Film Capacitors
on page 168

GENERAL SPECIFICATIONS

Temperature Coefficient:
Z5U
Voltage Range:
125 VAC or 2000 VDC
Capacitance Range:
.001 μ F to .01 μ F
Capacity Tolerance:
 \pm 20%
Dielectric Strength:
3250 vrms minimum
for 2 minutes
Lead Material:
Tin Plated Copper

Dissipation Factor:
2.5% Max at 25°C
Operating Temperature:
+10°C to +85°C
Case Breakdown:
> 1000 VAC (RMS)
at 60Hz for 1 minute
Insulation Resistance:
10K megohms @ 25°C
Discharge Tests:
220 VAC @ 85°C for 42 days,
then cycle at 1/10 sec/hr. for
42 days at 440 VAC
50% humidity

Capacity μ F	Tol	Size (Inches)				Size (Millimeters)				Catalog Number
		D	T	S	d	D	T	S	d	
125 VAC (rms) / 2000 VDC										
.001	20%	.472	.315	.375	.032	12.0	8.0	9.5	.8	UN102M
.0015	20%	.472	.315	.375	.032	12.0	8.0	9.5	.8	UN152M
.002	20%	.472	.315	.375	.032	12.0	8.0	9.5	.8	UN202M
.003	20%	.590	.315	.375	.032	15.0	8.0	9.5	.8	UN302M
.0047	20%	.748	.315	.375	.032	19.0	8.0	9.5	.8	UN472M

Capacity μ F	Tol	Size (Inches)				Size (Millimeters)				Catalog Number
		D	T	S	d	D	T	S	d	
125 VAC (rms) / 2000 VDC										
.005	20%	.748	.315	.375	.032	19.0	8.0	9.5	.8	UN502M
.0068	20%	.787	.315	.375	.032	20.0	8.0	9.5	.8	UN682M
.01	20%	.905	.315	.500	.032	23.0	8.0	12.7	.8	UN103M
.01	20%	.905	.315	.375	.032	23.0	8.0	9.5	.8	UN103MS

Index and Dimensions Multilayer Ceramic Capacitors

MALLOY

Multilayer Ceramic Capacitors

Type	Style	Capacitance Range	Voltages	Dimensions (Inches)					Dimensions (Millimeters)					Page Number
				L	H	T	S	d	L	H	T	S	d	
Radial Leaded														
M15	Standard - Conformally Coated	1.0pF to .1 μ F	50, 100, 200	.150	.210	.100	.100	.020	3.8	5.3	2.5	2.5	.51	127
M20	Standard - Conformally Coated	1.0pF to .56 μ F	50, 100, 200	.200	.260	.125	.100	.020	5.1	6.6	3.2	2.5	.51	
M22	Standard - Conformally Coated	1.0pF to .56 μ F	50, 100, 200	.200	.260	.125	.200	.020	5.1	6.6	3.2	5.1	.51	
M30	Standard - Conformally Coated	2700pF to 1.8 μ F	50, 100, 200	.300	.360	.150	.200	.020	7.6	9.1	3.8	5.1	.51	
M40	Standard - Conformally Coated	.012 μ F to 4.7 μ F	50, 100, 200	.400	.460	.150	.200	.020	10.2	11.7	3.8	5.1	.51	
M50	Standard - Conformally Coated	.039 μ F to 6.8 μ F	50, 100, 200	.500	.560	.200	.400	.025	12.7	14.2	5.1	10.2	.64	
M60	Standard - Conformally Coated	.1 μ F to 100 μ F	25, 50, 100, 250	See Standard Parts List									131	
CK05 CKR05	MIL-C-11015/18 - Molded MIL-C-39014/01 - Molded	10pF to .1 μ F 10pF to .1 μ F	50, 100, 200 50, 100, 200	.190	.190	.090	.200	.025	4.8	4.8	2.3	5.1	.64	138
				.190	.190	.090	.200	.025	4.8	4.8	2.3	5.1	.64	
CK06 CKR06	MIL-C-11015/19 - Molded MIL-C-39014/02 - Molded	1200pF to 1.0 μ F 1200pF to 1.0 μ F	50, 100, 200 50, 100, 200	.290	.290	.090	.200	.025	7.4	7.4	2.3	5.1	.64	139
				.290	.290	.090	.200	.025	7.4	7.4	2.3	5.1	.64	

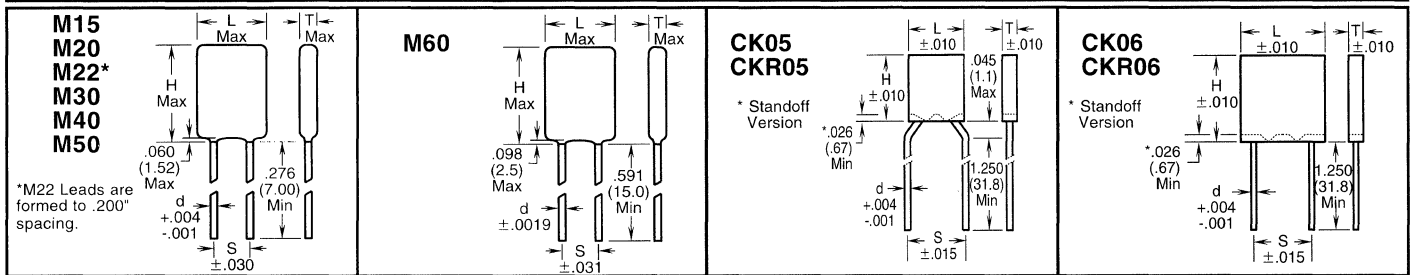

Type	Style	Capacitance Range	Voltages	Dimensions (Inches)			Dimensions (Millimeters)			Page Number
				D	L	d	D	L	d	
Axial Leaded										
P10	Standard - Conformally Coated	10pF to .22 μ F	50, 100	.100	.170	.020	2.5	4.3	.51	132
P12	Standard - Conformally Coated	1200pF to .33 μ F	50, 100	.120	.170	.020	3.1	4.3	.51	
P20	Standard - Conformally Coated	560pF to .33 μ F	50, 100	.100	.260	.020	2.5	6.6	.51	
P30	Standard - Conformally Coated	1800pF to .47 μ F	50, 100	.150	.290	.020	3.8	7.4	.51	
P40	Standard - Conformally Coated	5600pF to 1.0 μ F	50, 100	.150	.400	.020	3.8	10.2	.51	
CK12 CKR11	MIL-C-11015/20 - Molded MIL-C-39014/05 - Molded	10pF to .01 μ F 10pF to .01 μ F	50, 100 50, 100	.090	.160	.020	2.3	4.0	.51	139
				.090	.160	.020	2.3	4.0	.51	
CK13 CKR12	MIL-C-11015/20 - Molded MIL-C-39014/05 - Molded	5600pF to .047 μ F 5600pF to .047 μ F	50, 100 50, 100	.090	.250	.020	2.3	6.4	.51	140
				.090	.250	.020	2.3	6.4	.51	
CK14 CKR14	MIL-C-11015/20 - Molded MIL-C-39014/05 - Molded	.012 μ F to .27 μ F .012 μ F to .27 μ F	50, 100 50, 100	.140	.390	.025	3.6	9.9	.64	140
				.140	.390	.025	3.6	9.9	.64	
CK15 CKR15	MIL-C-11015/20 - Molded MIL-C-39014/05 - Molded	.056 μ F to 1.0 μ F .056 μ F to 1.0 μ F	50, 100 50, 100	.250	.500	.025	6.4	12.7	.64	140
				.250	.500	.025	6.4	12.7	.64	
CK16 CKR16	MIL-C-11015/20 - Molded MIL-C-39014/05 - Molded	.47 μ F to 3.3 μ F .47 μ F to 3.3 μ F	50, 100 50, 100	.350	.690	.025	8.9	17.5	.64	140
				.350	.690	.025	8.9	17.5	.64	

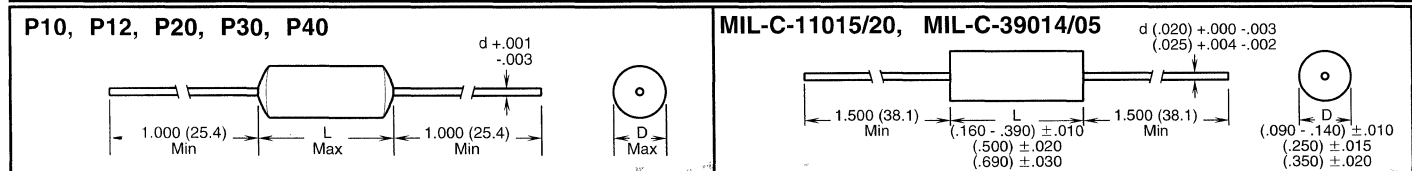

Type	Size Codes	Capacitance Range	Voltages	Dimensions	Page
CHIPS	0805, 1206, 1210	1 pF to .47 μ F	50, 100, 200	See Standard Parts List	134

Performance Characteristics Multilayer Ceramic Capacitors

MALLORY

Multilayer Ceramic Capacitors

The EIA Standard for ceramic dielectric capacitors (RS-198C) divides into three classes. NACC multilayer ceramic capacitors are available in the three most popular temperature characteristics:

COG: Class I (Also known as 'NPO')
Temperature Compensating capacitors, suitable for resonant circuits where stable capacitance and high Q are necessary. They are made of non ferro-electric materials yielding superior stability and low volumetric efficiency.

X7R: Class II
Stable capacitors, made of ferro electric materials, yielding higher volumetric efficiency but less stability. These capacitors are suitable for by-pass or coupling applications where stability and Q are not a major factor.

Z5U: Class III
General Purpose capacitors, suitable for bypass coupling where dielectric losses, high insulation resistance and stability are not required. Made of ferro-electric materials, Class III capacitors have the lowest stability, but the highest volumetric efficiency.

Parameter	COG (NPO)	X7R	Z5U
Temperature Characteristics:			
Range, °C:	-55°C to +125°C	-55°C to +125°C	+10°C to +85°C
Capacitance change without DC voltage:	0 ±30 PPM/°C *	±15 %	+22 %, -56 %
Aging Rate: % ΔC / Decade Hour, Maximum:			
	0 %	2.5 %	5.0 %
Dissipation Factor:			
Test Conditions @ 25°C:	> 1000 pF w/1.0 vrms @ 1 KHz.	w/ 1.0 vrms @ 1 KHz.	w/ 0.5 vrms @ 1 KHz.
	≤ 1000 pF w/1.0 vrms @ 1 MHz.		
Limits:	0.15 % Max.	2.5 % Max.	3.0 % Max.
Insulation Resistance (IR):			
At rated voltage, whichever is smaller:	1000 megohms x μF	1000 megohms x μF	1000 megohms x μF
	or 100 gigaohms	or 100 gigaohms	or 10 gigaohms
Moisture Resistance: EIA RS-198C, Method B2, Condition A (10 cycles without applied voltage)			
Post test limits @ 25°C, whichever is smaller:	100 megohms x μF	100 megohms x μF	100 megohms x μF
	or 10 gigaohms	or 10 gigaohms	or 1 gigaohm
Immersion Cycling: EIA RS-198C Method D2, Condition A (2 cycles @ 15 minutes each. Each cycle consists of immersion in hot bath @ 65°C followed by immersion in cold tap water.)			
Post test limits @ 25°C:			
Insulation Resistance, whichever is smaller:	100 megohms x μF	100 megohms x μF	100 megohms x μF
	or 10 gigaohms	or 10 gigaohms	or 1 gigaohm
Life Test: - 1000 Hrs.			
Test Potential and Temperature:	200 % V @ 125°C	200 % V @ 125°C	150 % V @ 85°C
Post test limits @ 25°C:			
Capacitance Change, whichever is greater:	±2% or 0.5pF	±20% of initial value**	±30 % of initial value**
Dissipation Factor:	0.25 % Max.	3.0 % Max.	4.0 % Max.
Insulation Resistance, whichever is smaller:	100 megohms x μF	100 megohms x μF	100 megohms x μF
	or 10 gigaohms	or 10 gigaohms	or 1 gigaohm
Dielectric Strength 2.5 times rated voltage with current limited to 50 mA.			

* 60 PPM/°C below 10pF nominal.
+53 PPM -30 PPM/°C from +25°C to -55°C comparable to MIL-C-20

** X7R and Z5U dielectrics exhibit aging characteristics; therefore, it is highly recommended that capacitors be de-aged for 2 hours @ 150°C and stabilized at room temperature for 48 hours before capacitor measurements are made.

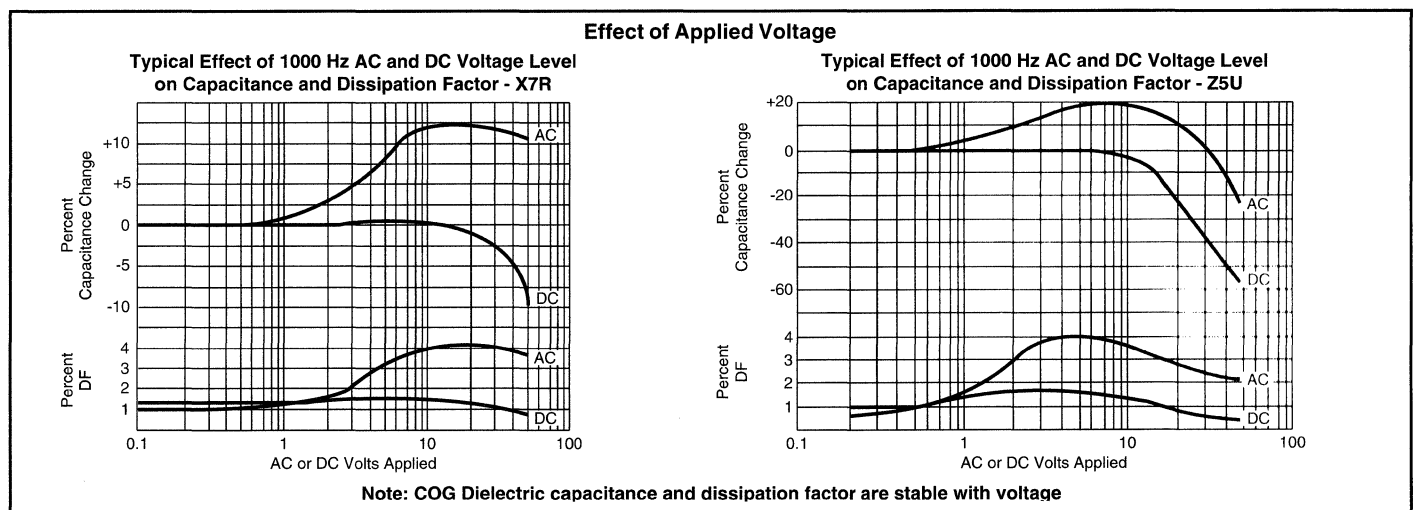

Performance Characteristics Multilayer Ceramic Capacitors



Multilayer Ceramic Capacitors

Effect of Temperature

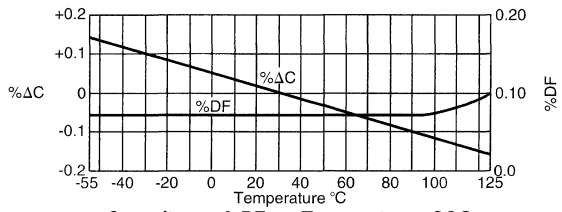

Capacitance & DF vs. Temperature - COG

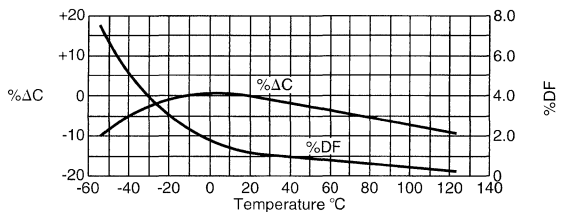

Capacitance & DF vs. Temperature - X7R

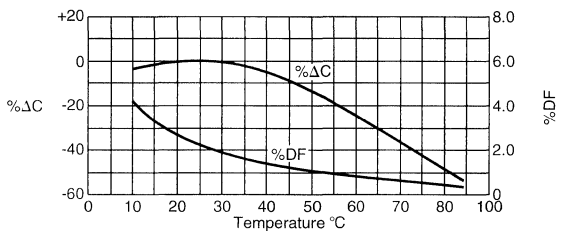

Capacitance & DF vs. Temperature - Z5U

Effect of Time

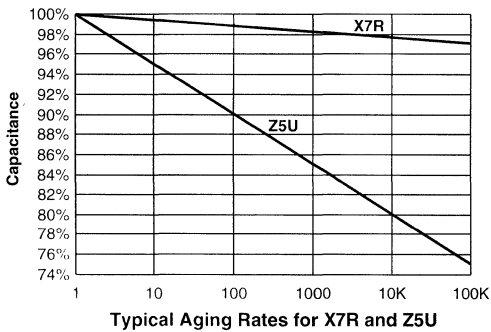

Typical Aging Rates for X7R and Z5U

Effect of Frequency

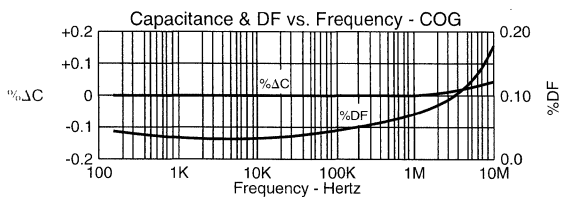

Capacitance & DF vs. Frequency - X7R & Z5U

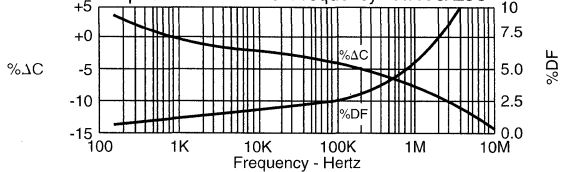

Impedance Vs. Frequency

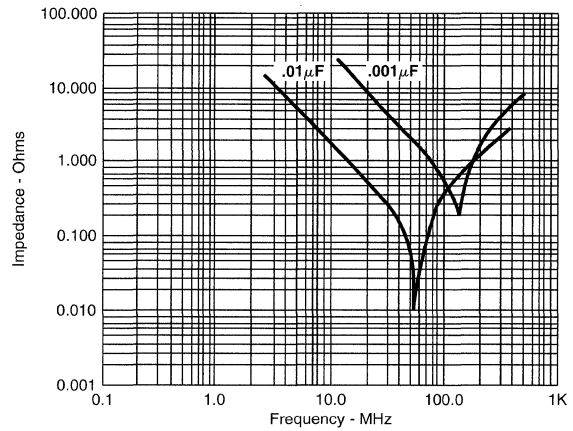

Impedance vs. Frequency for COG Dielectric

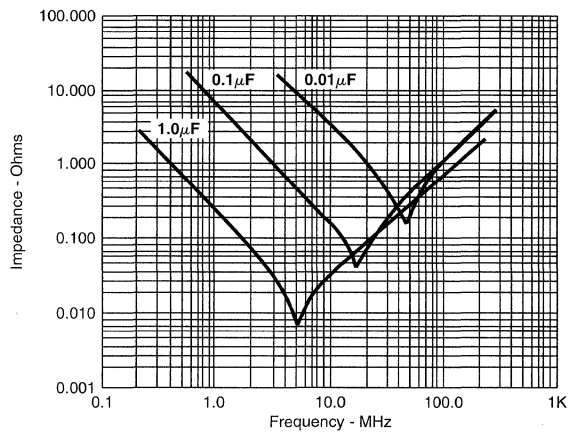

Impedance vs. Frequency for X7R Dielectric

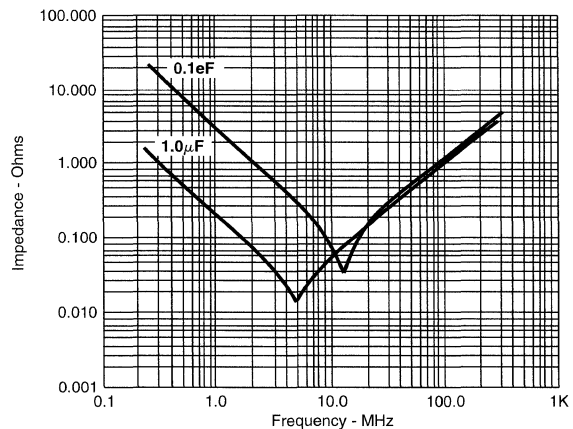

Impedance vs. Frequency for Z5U Dielectric

M15 to M50 Series Multilayer Ceramic Capacitors



Multilayer Ceramic Capacitors

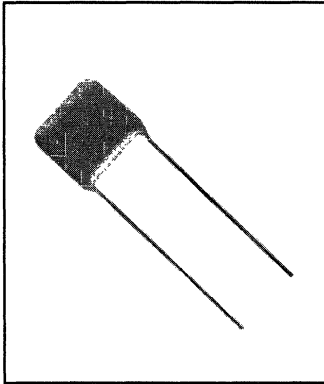

- Radial Leaded
Conformally Coated
 - Encapsulation consists of a moisture and shock resistant coating that meets UL94V-0
 - Over 300 CV values available
 - Applications:
Filtering, Bypass, Coupling
 - IECQ Approved to:
QC300601/US0002 - NPO
QC300701/US0002 - X7R
QC300701/US0004 - Z5U
- GENERAL SPECIFICATIONS**
- Voltage Range:
50, 100, 200 VDC
- Capacitance Range:
1 pF to 6.8 μ F
- Temperature Coefficients:
COG(NPO), X7R, Z5U

Available in Tape and Reel configuration:
Add 'TR' to end of catalog number.

COG (NPO) Temperature Coefficient 200 VOLTS

Capacity	Size (Inches)				Catalog Number	Capacity	Size (Inches)				Catalog Number	Capacity	Size (Inches)				Catalog Number
	L	H	T	S			L	H	T	S			L	H	T	S	
1.0 pF	.150	.210	.100	.100	M15G109D2	27 pF	.150	.210	.100	.100	M15G270*2	470 pF	.150	.210	.100	.100	M15G471*2
1.0 pF	.200	.260	.125	.100	M20G109D2	27 pF	.200	.260	.125	.100	M20G270*2	470 pF	.200	.260	.125	.100	M20G471*2
1.0 pF	.200	.260	.125	.200	M22G109D2	27 pF	.200	.260	.125	.200	M22G270*2	470 pF	.200	.260	.125	.200	M22G471*2
1.5 pF	.150	.210	.100	.100	M15G159D2	33 pF	.150	.210	.100	.100	M15G330*2	560 pF	.200	.260	.125	.100	M20G561*2
1.5 pF	.200	.260	.125	.100	M20G159D2	33 pF	.200	.260	.125	.100	M20G330*2	560 pF	.200	.260	.125	.200	M22G561*2
1.5 pF	.200	.260	.125	.200	M22G159D2	33 pF	.200	.260	.125	.200	M22G330*2	680 pF	.200	.260	.125	.100	M20G681*2
2.2 pF	.150	.210	.100	.100	M15G229D2	39 pF	.150	.210	.100	.100	M15G390*2	680 pF	.200	.260	.125	.200	M22G681*2
2.2 pF	.200	.260	.125	.100	M20G229D2	39 pF	.200	.260	.125	.100	M20G390*2	820 pF	.200	.260	.125	.100	M20G821*2
2.2 pF	.200	.260	.125	.200	M22G229D2	39 pF	.200	.260	.125	.200	M22G390*2	820 pF	.200	.260	.125	.200	M22G821*2
2.7 pF	.150	.210	.100	.100	M15G279D2	47 pF	.150	.210	.100	.100	M15G470*2	1000 pF	.200	.260	.125	.100	M20G102*2
2.7 pF	.200	.260	.125	.100	M20G279D2	47 pF	.200	.260	.125	.100	M20G470*2	1000 pF	.200	.260	.125	.200	M22G102*2
2.7 pF	.200	.260	.125	.200	M22G279D2	47 pF	.200	.260	.125	.200	M22G470*2	1200 pF	.200	.260	.125	.100	M20G122*2
3.3 pF	.150	.210	.100	.100	M15G339D2	56 pF	.150	.210	.100	.100	M15G560*2	1200 pF	.200	.260	.125	.200	M22G122*2
3.3 pF	.200	.260	.125	.100	M20G339D2	56 pF	.200	.260	.125	.100	M20G560*2	1500 pF	.200	.260	.125	.100	M20G152*2
3.3 pF	.200	.260	.125	.200	M22G339D2	56 pF	.200	.260	.125	.200	M22G560*2	1500 pF	.200	.260	.125	.200	M22G152*2
3.9 pF	.150	.210	.100	.100	M15G399D2	68 pF	.150	.210	.100	.100	M15G680*2	1800 pF	.200	.260	.125	.100	M20G182*2
3.9 pF	.200	.260	.125	.100	M20G399D2	68 pF	.200	.260	.125	.100	M20G680*2	1800 pF	.200	.260	.125	.200	M22G182*2
3.9 pF	.200	.260	.125	.200	M22G399D2	68 pF	.200	.260	.125	.200	M22G680*2	2200 pF	.200	.260	.125	.100	M20G222*2
4.7 pF	.150	.210	.100	.100	M15G479D2	82 pF	.150	.210	.100	.100	M15G820*2	2200 pF	.200	.260	.125	.200	M22G222*2
4.7 pF	.200	.260	.125	.100	M20G479D2	82 pF	.200	.260	.125	.100	M20G820*2	2700 pF	.200	.260	.125	.100	M20G272*2
4.7 pF	.200	.260	.125	.200	M22G479D2	82 pF	.200	.260	.125	.200	M22G820*2	2700 pF	.200	.260	.125	.200	M22G272*2
5.6 pF	.150	.210	.100	.100	M15G569D2	100 pF	.150	.210	.100	.100	M15G101*2	2700 pF	.300	.360	.150	.200	M30G272*2
5.6 pF	.200	.260	.125	.100	M20G569D2	100 pF	.200	.260	.125	.100	M20G101*2	3300 pF	.200	.260	.125	.100	M20G332*2
5.6 pF	.200	.260	.125	.200	M22G569D2	100 pF	.200	.260	.125	.200	M22G101*2	3300 pF	.200	.260	.125	.200	M22G332*2
6.8 pF	.150	.210	.100	.100	M15G689D2	120 pF	.150	.210	.100	.100	M15G121*2	3300 pF	.300	.360	.150	.200	M30G332*2
6.8 pF	.200	.260	.125	.100	M20G689D2	120 pF	.200	.260	.125	.100	M20G121*2	3900 pF	.300	.360	.150	.200	M30G392*2
6.8 pF	.200	.260	.125	.200	M22G689D2	120 pF	.200	.260	.125	.200	M22G121*2	4700 pF	.300	.360	.150	.200	M30G472*2
8.2 pF	.150	.210	.100	.100	M15G829D2	150 pF	.150	.210	.100	.100	M15G151*2	5600 pF	.300	.360	.150	.200	M30G562*2
8.2 pF	.200	.260	.125	.100	M20G829D2	150 pF	.200	.260	.125	.100	M20G151*2	6800 pF	.300	.360	.150	.200	M30G682*2
8.2 pF	.200	.260	.125	.200	M22G829D2	150 pF	.200	.260	.125	.200	M22G151*2	8200 pF	.300	.360	.150	.200	M30G822*2
10 pF	.150	.210	.100	.100	M15G100*2	180 pF	.150	.210	.100	.100	M15G181*2	.01 μ F	.300	.360	.150	.200	M30G103*2
10 pF	.200	.260	.125	.100	M20G100*2	180 pF	.200	.260	.125	.100	M20G181*2	.012 μ F	.300	.360	.150	.200	M30G123*2
10 pF	.200	.260	.125	.200	M22G100*2	180 pF	.200	.260	.125	.200	M22G181*2	.012 μ F	.400	.460	.150	.200	M40G123*2
12 pF	.150	.210	.100	.100	M15G120*2	220 pF	.150	.210	.100	.100	M15G221*2	.015 μ F	.300	.360	.150	.200	M30G153*2
12 pF	.200	.260	.125	.100	M20G120*2	220 pF	.200	.260	.125	.100	M20G221*2	.015 μ F	.400	.460	.150	.200	M40G153*2
12 pF	.200	.260	.125	.200	M22G120*2	220 pF	.200	.260	.125	.200	M22G221*2	.018 μ F	.300	.360	.150	.200	M30G183*2
15 pF	.150	.210	.100	.100	M15G150*2	270 pF	.150	.210	.100	.100	M15G271*2	.018 μ F	.400	.460	.150	.200	M40G183*2
15 pF	.200	.260	.125	.100	M20G150*2	270 pF	.200	.260	.125	.100	M20G271*2	.022 μ F	.400	.460	.150	.200	M40G223*2
15 pF	.200	.260	.125	.200	M22G150*2	270 pF	.200	.260	.125	.200	M22G271*2	.027 μ F	.400	.460	.150	.200	M40G273*2
18 pF	.150	.210	.100	.100	M15G180*2	330 pF	.150	.210	.100	.100	M15G331*2	.033 μ F	.400	.460	.150	.200	M40G333*2
18 pF	.200	.260	.125	.100	M20G180*2	330 pF	.200	.260	.125	.100	M20G331*2	.039 μ F	.400	.460	.150	.200	M40G393*2
18 pF	.200	.260	.125	.200	M22G180*2	330 pF	.200	.260	.125	.200	M22G331*2	.039 μ F	.500	.560	.200	.400	M50G393*2
22 pF	.150	.210	.100	.100	M15G220*2	390 pF	.150	.210	.100	.100	M15G391*2	.047 μ F	.400	.460	.150	.200	M40G473*2
22 pF	.200	.260	.125	.100	M20G220*2	390 pF	.200	.260	.125	.100	M20G391*2	.047 μ F	.500	.560	.200	.400	M50G473*2
22 pF	.200	.260	.125	.200	M22G220*2	390 pF	.200	.260	.125	.200	M22G391*2	.056 μ F	.500	.560	.200	.400	M50G563*2
												.068 μ F	.500	.560	.200	.400	M50G683*2

Add 'TR' to end of part number for Tape & Reel
M15, M20, M22 - 2,500 per reel
M30 - 1,500 per reel
M40 - 1,000 per reel
M50 - N/A
(Available in full reels only)

* Insert proper letter symbol for tolerance:
(1 pF to 8.2 pF available in D = $\pm 5\%$ pF only)
10 pF to 22 pF: J = $\pm 5\%$, K = $\pm 10\%$
27 pF to 47 pF: G = $\pm 2\%$, J = $\pm 5\%$, K = $\pm 10\%$
56 pF & Up: F = $\pm 1\%$, G = $\pm 2\%$, J = $\pm 5\%$, K = $\pm 10\%$

M15 to M50 Series Multilayer Ceramic Capacitors

MALLORY

Multilayer Ceramic Capacitors

COG (NPO) Temperature Coefficient 100 VDC

Capacity	Size (Inches)				Catalog Number
	L	H	T	S	
120 pF	.150	.210	.100	.100	M15G121*1
150 pF	.150	.210	.100	.100	M15G151*1
180 pF	.150	.210	.100	.100	M15G181*1
220 pF	.150	.210	.100	.100	M15G221*1
270 pF	.150	.210	.100	.100	M15G271*1
330 pF	.150	.210	.100	.100	M15G331*1
390 pF	.150	.210	.100	.100	M15G391*1
470 pF	.150	.210	.100	.100	M15G471*1
560 pF	.150	.210	.100	.100	M15G561*1
680 pF	.150	.210	.100	.100	M15G681*1
680 pF	.200	.260	.125	.100	M20G681*1
680 pF	.200	.260	.125	.200	M22G681*1
820 pF	.150	.210	.100	.100	M15G821*1
820 pF	.200	.260	.125	.100	M20G821*1
820 pF	.200	.260	.125	.200	M22G821*1
1000 pF	.150	.210	.100	.100	M15G102*1
1000 pF	.200	.260	.125	.100	M20G102*1
1000 pF	.200	.260	.125	.200	M22G102*1
1200 pF	.200	.260	.125	.100	M20G122*1
1200 pF	.200	.260	.125	.200	M22G122*1

Capacity	Size (Inches)				Catalog Number
	L	H	T	S	
1500 pF	.200	.260	.125	.100	M20G152*1
1500 pF	.200	.260	.125	.200	M22G152*1
1800 pF	.200	.260	.125	.100	M20G182*1
1800 pF	.200	.260	.125	.200	M22G182*1
2200 pF	.200	.260	.125	.100	M20G222*1
2200 pF	.200	.260	.125	.200	M22G222*1
2700 pF	.200	.260	.125	.100	M20G272*1
2700 pF	.200	.260	.125	.200	M22G272*1
3300 pF	.200	.260	.125	.100	M20G332*1
3300 pF	.200	.260	.125	.200	M22G332*1
3300 pF	.300	.360	.150	.200	M30G332*1
3900 pF	.200	.260	.125	.100	M20G392*1
3900 pF	.200	.260	.125	.200	M22G392*1
3900 pF	.300	.360	.150	.200	M30G392*1
4700 pF	.200	.260	.125	.100	M20G472*1
4700 pF	.200	.260	.125	.200	M22G472*1
4700 pF	.300	.360	.150	.200	M30G472*1
5600 pF	.200	.260	.125	.100	M20G562*1
5600 pF	.200	.260	.125	.200	M22G562*1
5600 pF	.300	.360	.150	.200	M30G562*1

Capacity	Size (Inches)				Catalog Number
	L	H	T	S	
6800 pF	.300	.360	.150	.200	M30G682*1
8200 pF	.300	.360	.150	.200	M30G822*1
.01 uF	.300	.360	.150	.200	M30G103*1
.012 uF	.300	.360	.150	.200	M30G123*1
.015 uF	.300	.360	.150	.200	M30G153*1
.018 uF	.300	.360	.150	.200	M30G183*1
.022 uF	.300	.360	.150	.200	M30G223*1
.027 uF	.300	.360	.150	.200	M30G273*1
.027 uF	.400	.460	.150	.200	M40G273*1
.033 uF	.400	.460	.150	.200	M40G333*1
.039 uF	.400	.460	.150	.200	M40G393*1
.039 uF	.500	.560	.200	.400	M50G393*1
.047 uF	.400	.460	.150	.200	M40G473*1
.047 uF	.500	.560	.200	.400	M50G473*1
.056 uF	.400	.460	.150	.200	M40G563*1
.056 uF	.500	.560	.200	.400	M50G563*1
.068 uF	.400	.460	.150	.200	M40G683*1
.068 uF	.500	.560	.200	.400	M50G683*1
.082 uF	.500	.560	.200	.400	M50G823*1
.1 uF	.500	.560	.200	.400	M50G104*1
.12 uF	.500	.560	.200	.400	M50G124*1

* Insert proper letter symbol for tolerance:
F = ±1%, G = ±2%, J = ±5%, K = ±10%

X7R Temperature Coefficient 200 VDC

Capacity	Size (Inches)				Catalog Number
	L	H	T	S	
100 pF	.150	.210	.100	.100	M15R101*2
120 pF	.150	.210	.100	.100	M15R121*2
150 pF	.150	.210	.100	.100	M15R151*2
180 pF	.150	.210	.100	.100	M15R181*2
220 pF	.150	.210	.100	.100	M15R221*2
270 pF	.150	.210	.100	.100	M15R271*2
330 pF	.150	.210	.100	.100	M15R331*2
390 pF	.150	.210	.100	.100	M15R391*2
470 pF	.150	.210	.100	.100	M15R471*2
560 pF	.150	.210	.100	.100	M15R561*2
680 pF	.150	.210	.100	.100	M15R681*2
820 pF	.150	.210	.100	.100	M15R821*2
1000 pF	.150	.210	.100	.100	M15R102*2
1000 pF	.200	.260	.125	.100	M20R102*2
1000 pF	.200	.260	.125	.200	M22R102*2
1200 pF	.150	.210	.100	.100	M15R122*2
1200 pF	.200	.260	.125	.100	M20R122*2
1200 pF	.200	.260	.125	.200	M22R122*2
1500 pF	.150	.210	.100	.100	M15R152*2
1500 pF	.200	.260	.125	.100	M20R152*2
1500 pF	.200	.260	.125	.200	M22R152*2
1800 pF	.150	.210	.100	.100	M15R182*2
1800 pF	.200	.260	.125	.100	M20R182*2
1800 pF	.200	.260	.125	.200	M22R182*2

Capacity	Size (Inches)				Catalog Number
	L	H	T	S	
2200 pF	.150	.210	.100	.100	M15R222*2
2200 pF	.200	.260	.125	.100	M20R222*2
2200 pF	.200	.260	.125	.200	M22R222*2
2700 pF	.200	.260	.125	.100	M20R272*2
2700 pF	.200	.260	.125	.200	M22R272*2
3300 pF	.200	.260	.125	.100	M20R332*2
3300 pF	.200	.260	.125	.200	M22R332*2
3900 pF	.200	.260	.125	.100	M20R392*2
3900 pF	.200	.260	.125	.200	M22R392*2
4700 pF	.200	.260	.125	.100	M20R472*2
4700 pF	.200	.260	.125	.200	M22R472*2
5600 pF	.200	.260	.125	.100	M20R562*2
5600 pF	.200	.260	.125	.200	M22R562*2
6800 pF	.200	.260	.125	.100	M20R682*2
6800 pF	.200	.260	.125	.200	M22R682*2
8200 pF	.200	.260	.125	.100	M20R822*2
8200 pF	.200	.260	.125	.200	M22R822*2
.01 uF	.200	.260	.125	.100	M20R103*2
.01 uF	.200	.260	.125	.200	M22R103*2
.012 uF	.200	.260	.125	.100	M20R123*2
.012 uF	.200	.260	.125	.200	M22R123*2
.015 uF	.200	.260	.125	.100	M20R153*2
.015 uF	.200	.260	.125	.200	M22R153*2
.015 uF	.300	.360	.150	.200	M30R153*2

Capacity	Size (Inches)				Catalog Number
	L	H	T	S	
.018 uF	.200	.260	.125	.100	M20R183*2
.018 uF	.200	.260	.125	.200	M22R183*2
.018 uF	.300	.360	.150	.200	M30R183*2
.022 uF	.200	.260	.125	.100	M20R223*2
.022 uF	.200	.260	.125	.200	M22R223*2
.022 uF	.300	.360	.150	.200	M30R223*2
.027 uF	.300	.360	.150	.200	M30R273*2
.033 uF	.300	.360	.150	.200	M30R333*2
.039 uF	.300	.360	.150	.200	M30R393*2
.047 uF	.300	.360	.150	.200	M30R473*2
.056 uF	.300	.360	.150	.200	M30R563*2
.068 uF	.300	.360	.150	.200	M30R683*2
.082 uF	.300	.360	.150	.200	M30R823*2
.082 uF	.400	.460	.150	.200	M40R823*2
.1 uF	.300	.360	.150	.200	M30R104*2
.1 uF	.400	.460	.150	.200	M40R104*2
.12 uF	.400	.460	.150	.200	M40R124*2
.15 uF	.400	.460	.150	.200	M40R154*2
.18 uF	.400	.460	.150	.200	M40R184*2
.22 uF	.400	.460	.150	.200	M40R224*2
.22 uF	.500	.560	.200	.400	M50R224*2
.27 uF	.400	.460	.150	.200	M40R274*2
.27 uF	.500	.560	.200	.400	M50R274*2
.33 uF	.500	.560	.200	.400	M50R334*2
.39 uF	.500	.560	.200	.400	M50R394*2
.47 uF	.500	.560	.200	.400	M50R474*2

* Insert proper letter symbol for tolerance:
K = ±10%, M = ±20%

Add 'TR' to end of part number for Tape & Reel
M15, M20, M22 - 2,500 per reel
M30 - 1,500 per reel
M40 - 1,000 per reel
M50 - N/A
(Available in full reels only)

M15 to M50 Series Multilayer Ceramic Capacitors



Multilayer Ceramic Capacitors

X7R Temperature Coefficient 100 VDC

Capacity	Size (Inches)				Catalog Number
	L	H	T	S	
820 pF	.150	.210	.100	.100	M15R821*1
1000 pF	.150	.210	.100	.100	M15R102*1
1200 pF	.150	.210	.100	.100	M15R122*1
1500 pF	.150	.210	.100	.100	M15R152*1
1800 pF	.150	.210	.100	.100	M15R182*1
2200 pF	.150	.210	.100	.100	M15R222*1
2700 pF	.150	.210	.100	.100	M15R272*1
3300 pF	.150	.210	.100	.100	M15R332*1
3900 pF	.150	.210	.100	.100	M15R392*1
4700 pF	.150	.210	.100	.100	M15R472*1
4700 pF	.200	.260	.125	.200	M20R472*1
4700 pF	.200	.260	.125	.200	M22R472*1
5600 pF	.150	.210	.100	.100	M15R562*1
5600 pF	.200	.260	.125	.100	M20R562*1
5600 pF	.200	.260	.125	.200	M22R562*1
6800 pF	.150	.210	.100	.100	M15R682*1
6800 pF	.200	.260	.125	.100	M20R682*1
6800 pF	.200	.260	.125	.200	M22R682*1
8200 pF	.150	.210	.100	.100	M15R822*1
8200 pF	.200	.260	.125	.100	M20R822*1
8200 pF	.200	.260	.125	.200	M22R822*1
.01 uF	.150	.210	.100	.100	M15R103*1
.01 uF	.200	.260	.125	.100	M20R103*1
.01 uF	.200	.260	.125	.200	M22R103*1

Capacity	Size (Inches)				Catalog Number
	L	H	T	S	
.012 uF	.200	.260	.125	.100	M20R123*1
.012 uF	.200	.260	.125	.200	M22R123*1
.015 uF	.200	.260	.125	.100	M20R153*1
.015 uF	.200	.260	.125	.200	M22R153*1
.018 uF	.200	.260	.125	.100	M20R183*1
.018 uF	.200	.260	.125	.200	M22R183*1
.022 uF	.200	.260	.125	.100	M20R223*1
.022 uF	.200	.260	.125	.200	M22R223*1
.027 uF	.200	.260	.125	.100	M20R273*1
.027 uF	.200	.260	.125	.200	M22R273*1
.033 uF	.200	.260	.125	.100	M20R333*1
.033 uF	.200	.260	.125	.200	M22R333*1
.039 uF	.200	.260	.125	.100	M20R393*1
.039 uF	.200	.260	.125	.200	M22R393*1
.047 uF	.200	.260	.125	.100	M20R473*1
.047 uF	.200	.260	.125	.200	M22R473*1
.056 uF	.200	.260	.125	.100	M20R563*1
.056 uF	.200	.260	.125	.200	M22R563*1
.068 uF	.200	.260	.125	.100	M20R683*1
.068 uF	.200	.260	.125	.200	M22R683*1
.068 uF	.300	.360	.150	.200	M30R683*1
.082 uF	.200	.260	.125	.100	M20R823*1
.082 uF	.200	.260	.125	.200	M22R823*1
.082 uF	.300	.360	.150	.200	M30R823*1

Capacity	Size (Inches)				Catalog Number
	L	H	T	S	
.1 uF	.200	.260	.125	.100	M20R104*1
.1 uF	.200	.260	.125	.200	M22R104*1
.1 uF	.300	.360	.150	.200	M30R104*1
.12 uF	.300	.360	.150	.200	M30R124*1
.15 uF	.300	.360	.150	.200	M30R154*1
.18 uF	.300	.360	.150	.200	M30R184*1
.22 uF	.300	.360	.150	.200	M30R224*1
.27 uF	.300	.360	.150	.200	M30R274*1
.33 uF	.300	.360	.150	.200	M30R334*1
.33 uF	.400	.460	.150	.200	M40R334*1
.39 uF	.300	.360	.150	.200	M30R394*1
.39 uF	.400	.460	.150	.200	M40R394*1
.47 uF	.300	.360	.150	.200	M30R474*1
.47 uF	.400	.460	.150	.200	M40R474*1
.56 uF	.400	.460	.150	.200	M40R564*1
.68 uF	.400	.460	.150	.200	M40R684*1
.68 uF	.500	.560	.200	.400	M50R684*1
.82 uF	.400	.460	.150	.200	M40R824*1
.82 uF	.500	.560	.200	.400	M50R824*1
1.0 uF	.400	.460	.150	.200	M40R105*1
1.0 uF	.500	.560	.200	.400	M50R105*1
1.2 uF	.500	.560	.200	.400	M50R125*1

* Insert proper letter symbol for tolerance:
K = ±10%, M = ±20%

X7R Temperature Coefficient 50 VDC

Capacity	Size (Inches)				Catalog Number
	L	H	T	S	
3300 pF	.150	.210	.100	.100	M15R332*5
3900 pF	.150	.210	.100	.100	M15R392*5
4700 pF	.150	.210	.100	.100	M15R472*5
5600 pF	.150	.210	.100	.100	M15R562*5
6800 pF	.150	.210	.100	.100	M15R682*5
8200 pF	.150	.210	.100	.100	M15R822*5
.01 uF	.150	.210	.100	.100	M15R103*5
.012 uF	.200	.260	.125	.100	M20R123*5
.012 uF	.200	.260	.125	.200	M22R123*5
.015 uF	.200	.260	.125	.100	M20R153*5
.015 uF	.200	.260	.125	.200	M22R153*5
.018 uF	.200	.260	.125	.100	M20R183*5
.018 uF	.200	.260	.125	.200	M22R183*5
.022 uF	.200	.260	.125	.100	M20R223*5
.022 uF	.200	.260	.125	.200	M22R223*5
.027 uF	.200	.260	.125	.100	M20R273*5
.027 uF	.200	.260	.125	.200	M22R273*5

Capacity	Size (Inches)				Catalog Number
	L	H	T	S	
.033 uF	.150	.210	.100	.100	M15R333*5
.033 uF	.200	.260	.125	.100	M20R333*5
.033 uF	.200	.260	.125	.200	M22R333*5
.039 uF	.200	.260	.125	.100	M20R393*5
.039 uF	.200	.260	.125	.200	M22R393*5
.047 uF	.200	.260	.125	.100	M20R473*5
.047 uF	.200	.260	.125	.200	M22R473*5
.056 uF	.200	.260	.125	.100	M20R563*5
.056 uF	.200	.260	.125	.200	M22R563*5
.068 uF	.200	.260	.125	.100	M20R683*5
.068 uF	.200	.260	.125	.200	M22R683*5
.082 uF	.200	.260	.125	.100	M20R823*5
.082 uF	.200	.260	.125	.200	M22R823*5
.1 uF	.200	.260	.125	.100	M20R104*5
.1 uF	.200	.260	.125	.200	M22R104*5
.12 uF	.200	.260	.125	.100	M20R124*5
.12 uF	.200	.260	.125	.200	M22R124*5
.15 uF	.200	.260	.125	.100	M20R154*5
.15 uF	.200	.260	.125	.200	M22R154*5
.15 uF	.300	.360	.150	.200	M30R154*5
.18 uF	.200	.260	.125	.100	M20R184*5
.18 uF	.200	.260	.125	.200	M22R184*5
.18 uF	.300	.360	.150	.200	M30R184*5

Capacity	Size (Inches)				Catalog Number
	L	H	T	S	
.22 uF	.200	.260	.125	.100	M20R224*5
.22 uF	.200	.260	.125	.200	M22R224*5
.22 uF	.300	.360	.150	.200	M30R224*5
.27 uF	.200	.260	.125	.100	M20R274*5
.27 uF	.200	.260	.125	.200	M22R274*5
.27 uF	.300	.360	.150	.200	M30R274*5
.33 uF	.300	.360	.150	.200	M30R334*5
.39 uF	.300	.360	.150	.200	M30R394*5
.47 uF	.300	.360	.150	.200	M30R474*5
.56 uF	.300	.360	.150	.200	M30R564*5
.68 uF	.300	.360	.150	.200	M30R684*5
.82 uF	.300	.360	.150	.200	M30R824*5
1.0 uF	.300	.360	.150	.200	M30R105*5
1.0 uF	.400	.460	.150	.200	M40R105*5
1.2 uF	.400	.460	.150	.200	M40R125*5
1.5 uF	.400	.460	.150	.200	M40R155*5
1.8 uF	.400	.460	.150	.200	M40R185*5
2.2 uF	.400	.460	.150	.200	M40R225*5
2.2 uF	.500	.560	.200	.400	M50R225*5
2.7 uF	.500	.560	.200	.400	M50R275*5
3.3 uF	.500	.560	.200	.400	M50R335*5
3.9 uF	.500	.560	.200	.400	M50R395*5

* Insert proper letter symbol for tolerance:
K = ±10%, M = ±20%

Add 'TR' to end of part number for Tape & Reel
M15, M20, M22 - 2,500 per reel
M30 - 1,500 per reel
M40 - 1,000 per reel
M50 - N/A
(Available in full reels only)

M15 to M50 Series Multilayer Ceramic Capacitors

MALLOY

Multilayer Ceramic Capacitors

Z5U Temperature Coefficient 100 VDC

Capacity	Size (Inches)				Catalog Number
	L	H	T	S	
1000 pF	.150	.210	.100	.100	M15U102*1
1200 pF	.150	.210	.100	.100	M15U122*1
1500 pF	.150	.210	.100	.100	M15U152*1
1800 pF	.150	.210	.100	.100	M15U182*1
2200 pF	.150	.210	.100	.100	M15U222*1
2700 pF	.150	.210	.100	.100	M15U272*1
3300 pF	.150	.210	.100	.100	M15U332*1
3900 pF	.150	.210	.100	.100	M15U392*1
4700 pF	.150	.210	.100	.100	M15U472*1
5600 pF	.150	.210	.100	.100	M15U562*1
6800 pF	.150	.210	.100	.100	M15U682*1
8200 pF	.150	.210	.100	.100	M15U822*1
.01 uF	.150	.210	.100	.100	M15U103*1
.01 uF	.200	.260	.125	.100	M20U103*1
.01 uF	.200	.260	.125	.200	M22U103*1
.012 uF	.150	.210	.100	.100	M15U123*1
.012 uF	.200	.260	.125	.100	M20U123*1
.012 uF	.200	.260	.125	.200	M22U123*1
.015 uF	.150	.210	.100	.100	M15U153*1
.015 uF	.200	.260	.125	.100	M20U153*1
.015 uF	.200	.260	.125	.200	M22U153*1
.018 uF	.150	.210	.100	.100	M15U183*1
.018 uF	.200	.260	.125	.100	M20U183*1
.018 uF	.200	.260	.125	.200	M22U183*1

Capacity	Size (Inches)				Catalog Number
	L	H	T	S	
.022 uF	.200	.260	.125	.100	M20U223*1
.022 uF	.200	.260	.125	.200	M22U223*1
.027 uF	.200	.260	.125	.100	M20U273*1
.027 uF	.200	.260	.125	.200	M22U273*1
.033 uF	.200	.260	.125	.100	M20U333*1
.033 uF	.200	.260	.125	.200	M22U333*1
.039 uF	.200	.260	.125	.100	M20U393*1
.039 uF	.200	.260	.125	.200	M22U393*1
.047 uF	.200	.260	.125	.100	M20U473*1
.047 uF	.200	.260	.125	.200	M22U473*1
.056 uF	.200	.260	.125	.100	M20U563*1
.056 uF	.200	.260	.125	.200	M22U563*1
.068 uF	.200	.260	.125	.100	M20U683*1
.068 uF	.200	.260	.125	.200	M22U683*1
.082 uF	.200	.260	.125	.100	M20U823*1
.082 uF	.200	.260	.125	.200	M22U823*1
.1 uF	.200	.260	.125	.100	M20U104*1
.1 uF	.200	.260	.125	.200	M22U104*1
.1 uF	.300	.360	.150	.200	M30U104*1
.12 uF	.200	.260	.125	.100	M20U124*1
.12 uF	.200	.260	.125	.200	M22U124*1
.12 uF	.300	.360	.150	.200	M30U124*1
.15 uF	.200	.260	.125	.100	M20U154*1

Capacity	Size (Inches)				Catalog Number
	L	H	T	S	
.15 uF	.200	.260	.125	.200	M22U154*1
.15 uF	.300	.360	.150	.200	M30U154*1
.18 uF	.300	.360	.150	.200	M30U184*1
.22 uF	.300	.360	.150	.200	M30U224*1
.27 uF	.300	.360	.150	.200	M30U274*1
.33 uF	.300	.360	.150	.200	M30U334*1
.33 uF	.400	.460	.150	.200	M40U334*1
.39 uF	.300	.360	.150	.200	M30U394*1
.39 uF	.400	.460	.150	.200	M40U394*1
.47 uF	.300	.360	.150	.200	M30U474*1
.47 uF	.400	.460	.150	.200	M40U474*1
.56 uF	.400	.460	.150	.200	M40U564*1
.68 uF	.400	.460	.150	.200	M40U684*1
.82 uF	.400	.460	.150	.200	M40U824*1
1.0 uF	.400	.460	.150	.200	M40U105*1
1.0 uF	.500	.560	.200	.400	M50U105*1
1.2 uF	.400	.460	.150	.200	M40U125*1
1.2 uF	.500	.560	.200	.400	M50U125*1
1.5 uF	.400	.460	.150	.200	M40U155*1
1.5 uF	.500	.560	.200	.400	M50U155*1
1.8 uF	.500	.560	.200	.400	M50U185*1
2.2 uF	.500	.560	.200	.400	M50U225*1

* Insert proper letter symbol for tolerance:
M = ±20%, Z = + 80% - 20%, P = + 100% - 0%

Z5U Temperature Coefficient 50 VDC

Capacity	Size (Inches)				Catalog Number
	L	H	T	S	
4700 pF	.150	.210	.100	.100	M15U472*5
5600 pF	.150	.210	.100	.100	M15U562*5
6800 pF	.150	.210	.100	.100	M15U682*5
8200 pF	.150	.210	.100	.100	M15U822*5
.01 uF	.150	.210	.100	.100	M15U103*5
.012 uF	.150	.210	.100	.100	M15U123*5
.015 uF	.150	.210	.100	.100	M15U153*5
.018 uF	.150	.210	.100	.100	M15U183*5
.022 uF	.150	.210	.100	.100	M15U223*5
.027 uF	.150	.210	.100	.100	M15U273*5
.027 uF	.200	.260	.125	.100	M20U273*5
.027 uF	.200	.260	.125	.200	M22U273*5
.033 uF	.150	.210	.100	.100	M15U333*5
.033 uF	.200	.260	.125	.100	M20U333*5
.033 uF	.200	.260	.125	.200	M22U333*5
.039 uF	.150	.210	.100	.100	M15U393*5
.039 uF	.200	.260	.125	.100	M20U393*5
.039 uF	.200	.260	.125	.200	M22U393*5
.047 uF	.150	.210	.100	.100	M15U473*5
.047 uF	.200	.260	.125	.100	M20U473*5
.047 uF	.200	.260	.125	.200	M22U473*5
.056 uF	.150	.210	.100	.100	M15U563*5
.056 uF	.200	.260	.125	.100	M20U563*5
.056 uF	.200	.260	.125	.200	M22U563*5

Capacity	Size (Inches)				Catalog Number
	L	H	T	S	
.068 uF	.150	.210	.100	.100	M15U683*5
.068 uF	.200	.260	.125	.100	M20U683*5
.068 uF	.200	.260	.125	.200	M22U683*5
.082 uF	.200	.260	.125	.100	M20U823*5
.082 uF	.200	.260	.125	.200	M22U823*5
.1 uF	.150	.210	.100	.100	M15U104*5
.1 uF	.200	.260	.125	.100	M20U104*5
.1 uF	.200	.260	.125	.200	M22U104*5
.12 uF	.200	.260	.125	.100	M20U124*5
.12 uF	.200	.260	.125	.200	M22U124*5
.15 uF	.200	.260	.125	.100	M20U154*5
.15 uF	.200	.260	.125	.200	M22U154*5
.18 uF	.200	.260	.125	.100	M20U184*5
.18 uF	.200	.260	.125	.200	M22U184*5
.22 uF	.200	.260	.125	.100	M20U224*5
.22 uF	.200	.260	.125	.200	M22U224*5
.27 uF	.200	.260	.125	.100	M20U274*5
.27 uF	.200	.260	.125	.200	M22U274*5
.27 uF	.300	.360	.150	.200	M30U274*5
.33 uF	.200	.260	.125	.100	M20U334*5
.33 uF	.200	.260	.125	.200	M22U334*5
.33 uF	.300	.360	.150	.200	M30U334*5
.39 uF	.200	.260	.125	.100	M20U394*5
.39 uF	.200	.260	.125	.200	M22U394*5
.39 uF	.300	.360	.150	.200	M30U394*5

Capacity	Size (Inches)				Catalog Number
	L	H	T	S	
.47 uF	.200	.260	.125	.100	M20U474*5
.47 uF	.200	.260	.125	.200	M22U474*5
.47 uF	.300	.360	.150	.200	M30U474*5
.56 uF	.200	.260	.125	.100	M20U564*5
.56 uF	.200	.260	.125	.200	M22U564*5
.56 uF	.300	.360	.150	.200	M30U564*5
.68 uF	.300	.360	.150	.200	M30U684*5
.82 uF	.300	.360	.150	.200	M30U824*5
1.0 uF	.300	.360	.150	.200	M30U105*5
1.2 uF	.300	.360	.150	.200	M30U125*5
1.2 uF	.400	.460	.150	.200	M40U125*5
1.5 uF	.300	.360	.150	.200	M30U155*5
1.5 uF	.400	.460	.150	.200	M40U155*5
1.8 uF	.300	.360	.150	.200	M30U185*5
1.8 uF	.400	.460	.150	.200	M40U185*5
2.2 uF	.400	.460	.150	.200	M40U225*5
2.7 uF	.400	.460	.150	.200	M40U275*5
3.3 uF	.400	.460	.150	.200	M40U335*5
3.9 uF	.400	.460	.150	.200	M40U395*5
3.9 uF	.500	.560	.200	.400	M50U395*5
4.7 uF	.400	.460	.150	.200	M40U475*5
4.7 uF	.500	.560	.200	.400	M50U475*5
5.6 uF	.500	.560	.200	.400	M50U565*5
6.8 uF	.500	.560	.200	.400	M50U685*5

* Insert proper letter symbol for tolerance:
M = ±20%, Z = + 80% - 20%, P = + 100% - 0%

Add 'TR' to end of part number for Tape & Reel
M15, M20, M22 - 2,500 per reel
M30 - 1,500 per reel
M40 - 1,000 per reel
M50 - N/A
(Available in full reels only)

M60 Series Multilayer Ceramic Capacitors

MALORY

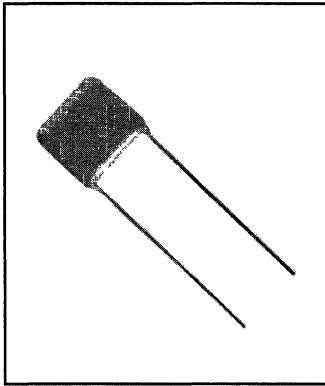

- Radial Leaded
Conformally Coated
- Ultra High Insulation
Resistance and Withstand
Voltage
- Excellent Noise Suppression
- Applications :
Ignition Noise Suppression
for Automotive Application

GENERAL SPECIFICATIONS

Voltage Range:
25, 50, 100, 250 WVDC

Capacitance Range:
.1 μ F to 100 μ F

Capacitance Tolerance:
 \pm 20%

Temperature Coefficient:
Y5U

Operating Temperature:
-55°C to +125°C

Dissipation Factor:
2.5% Maximum

Insulation Resistance:
 \geq 1000 Ω x μ F or 10,000 M Ω .
whichever is less

Withstand Voltage:
250% of rated voltage is
applied for 1 to 5 seconds

Available in Tape and Ammo pack
configuration: Add 'TA' to end of
catalog number

Multilayer Ceramic Capacitors

Capacity μ F	Volts	Temp Coeff	Size (Inches)					Catalog Number
			L	H	T	S	d	
1	25	Y5U	.197	.177	.138	.197	.020	M60U1M25
1.5	25	Y5U	.248	.197	.157	.197	.020	M60U1R5M25
2.2	25	Y5U	.248	.197	.157	.197	.020	M60U2R2M25
3.3	25	Y5U	.295	.295	.157	.197	.020	M60U3R3M25
4.7	25	Y5U	.295	.285	.157	.197	.020	M60U4R7M25
6.8	25	Y5U	.394	.394	.197	.197	.020	M60U6R8M25
10	25	Y5U	.394	.394	.197	.197	.020	M60U10M25
15	25	Y5U	.500	.472	.197	.394	.024	M60U15M25
22	25	Y5U	.500	.472	.197	.394	.024	M60U22M25
33	25	Y5U	.866	.591	.295	.787	.031	M60U33M25
47	25	Y5U	.866	.591	.295	.787	.031	M60U47M25
68	25	Y5U	1.102	.591	.295	.984	.031	M60U68M25
100	25	Y5U	1.102	.591	.295	.984	.031	M60U100M25
4.7	50	Y5U	.394	.394	.197	.197	.020	M60U4R7M50
6.8	50	Y5U	.394	.394	.197	.197	.020	M60U6R8M50
10	50	Y5U	.500	.472	.197	.394	.024	M60U10M50
15	50	Y5U	.500	.472	.197	.394	.024	M60U15M50
22	50	Y5U	.866	.591	.295	.787	.031	M60U22M50
33	50	Y5U	.866	.591	.295	.787	.031	M60U33M50
47	50	Y5U	1.102	.591	.295	.984	.031	M60U47M50
68	50	Y5U	1.102	.591	.295	.984	.031	M60U68M50

Capacity μ F	Volts	Temp Coeff	Size (Inches)					Catalog Number
			L	H	T	S	d	
2.2	100	Y5U	.394	.394	.197	.197	.020	M60U2R2M100
3.3	100	Y5U	.394	.394	.197	.197	.020	M60U3R3M100
4.7	100	Y5U	.500	.472	.197	.394	.024	M60U4R7M100
6.8	100	Y5U	.500	.472	.197	.394	.024	M60U6R8M100
10	100	Y5U	.866	.591	.295	.787	.031	M60U10M100
15	100	Y5U	.866	.591	.295	.787	.031	M60U15M100
22	100	Y5U	1.102	.591	.295	.984	.031	M60U22M100
33	100	Y5U	1.102	.591	.295	.984	.031	M60U33M100
.1	250	Y5U	.197	.177	.138	.197	.020	M60UR10M250
.15	250	Y5U	.248	.197	.157	.197	.020	M60UR15M250
.22	250	Y5U	.295	.295	.157	.197	.020	M60UR22M250
.33	250	Y5U	.295	.295	.157	.197	.020	M60UR33M250
.47	250	Y5U	.394	.394	.197	.197	.020	M60UR47M250
.68	250	Y5U	.394	.394	.197	.197	.020	M60UR68M250
1	250	Y5U	.500	.472	.197	.394	.024	M60U1M250
1.5	250	Y5U	.500	.472	.197	.394	.024	M60U1R5M250
2.2	250	Y5U	.866	.591	.295	.787	.031	M60U2R2M250
3.3	250	Y5U	.866	.591	.295	.787	.031	M60U3R3M250
4.7	250	Y5U	1.102	.591	.295	.984	.031	M60U4R7M250
6.8	250	Y5U	1.102	.591	.295	.984	.031	M60U6R8M250

Add 'TA' to end of part number for lead taping.
Available in Ammo Pack only. (Full boxes only)

LENGTH	QUANTITY PER BOX
.197	2,000 pcs
.248	2,000 pcs
.394	1,500 pcs
Not available in larger sizes	

P10 to P40 Series Multilayer Ceramic Capacitors



Multilayer Ceramic Capacitors

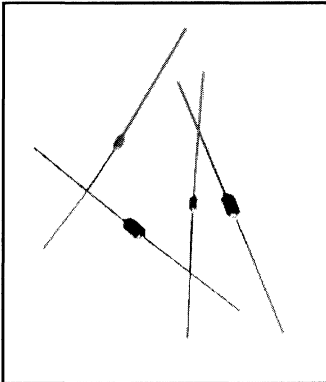

- Axial Leaded
Conformally Coated
- Encapsulation consists of a moisture and shock resistant coating that meets UL94V-0
- Over 138 CV values available
- Applications:
Filtering, Bypass, Coupling
- IECQ Approved to:
QC300601/US0001 - NPO
QC300701/US0003 - X7R
QC300701/US0001 - Z5U

GENERAL SPECIFICATIONS

Voltage Range:
50, 100 VDC

Capacitance Range:
10 pF to 1.0 μ F

Temperature Coefficients:
COG(NPO), X7R, Z5U

Available in Tape and Reel configuration:
Add 'TR' to end of catalog number

COG (NPO) Temperature Coefficient 100 VDC

Capacity	Size (Inches)		Catalog Number	Capacity	Size (Inches)		Catalog Number	Capacity	Size (Inches)		Catalog Number
	D	L			D	L			D	L	
10 pF	.100	.170	P10G100*1	220 pF	.100	.170	P10G221*1	1800 pF	.150	.290	P30G182*1
12 pF	.100	.170	P10G120*1	270 pF	.100	.170	P10G271*1	2200 pF	.100	.260	P20G222*1
15 pF	.100	.170	P10G150*1	330 pF	.100	.170	P10G331*1	2200 pF	.150	.290	P30G222*1
18 pF	.100	.170	P10G180*1	390 pF	.100	.170	P10G391*1	2700 pF	.150	.290	P30G272*1
22 pF	.100	.170	P10G220*1	470 pF	.100	.170	P10G471*1	3300 pF	.150	.290	P30G332*1
27 pF	.100	.170	P10G270*1	560 pF	.100	.170	P10G561*1	3900 pF	.150	.290	P30G392*1
33 pF	.100	.170	P10G330*1	560 pF	.100	.260	P20G561*1	4700 pF	.150	.290	P30G472*1
39 pF	.100	.170	P10G390*1	680 pF	.100	.170	P10G681*1	5600 pF	.150	.290	P30G562*1
47 pF	.100	.170	P10G470*1	680 pF	.100	.260	P20G681*1	5600 pF	.150	.400	P40G562*1
56 pF	.100	.170	P10G560*1	820 pF	.100	.170	P10G821*1	6800 pF	.150	.290	P30G682*1
68 pF	.100	.170	P10G680*1	820 pF	.100	.260	P20G821*1	6800 pF	.150	.400	P40G682*1
82 pF	.100	.170	P10G820*1	1000 pF	.100	.170	P10G102*1	8200 pF	.150	.290	P30G822*1
100 pF	.100	.170	P10G101*1	1000 pF	.100	.260	P20G102*1	8200 pF	.150	.400	P40G822*1
120 pF	.100	.170	P10G121*1	1200 pF	.100	.260	P20G122*1	.01 μ F	.150	.400	P40G103*1
150 pF	.100	.170	P10G151*1	1500 pF	.100	.260	P20G152*1	.012 μ F	.150	.400	P40G123*1
180 pF	.100	.170	P10G181*1	1800 pF	.100	.260	P20G182*1	.015 μ F	.150	.400	P40G153*1

* Insert proper letter symbol for tolerance: J = \pm 5%, K = \pm 10%

COG (NPO) Temperature Coefficient 50 VDC

Capacity	Size (Inches)		Catalog Number	Capacity	Size (Inches)		Catalog Number	Capacity	Size (Inches)		Catalog Number
	D	L			D	L			D	L	
560 pF	.100	.170	P10G561*5	1800 pF	.120	.170	P12G182*5	5600 pF	.150	.290	P30G562*5
680 pF	.100	.170	P10G681*5	1800 pF	.100	.260	P20G182*5	6800 pF	.150	.290	P30G682*5
820 pF	.100	.170	P10G821*5	2200 pF	.120	.170	P12G222*5	6800 pF	.150	.400	P40G682*5
1000 pF	.100	.170	P10G102*5	2200 pF	.100	.260	P20G222*5	8200 pF	.150	.290	P30G822*5
1000 pF	.100	.260	P20G102*5	2700 pF	.120	.170	P12G272*5	8200 pF	.150	.400	P40G822*5
1200 pF	.120	.170	P12G122*5	2700 pF	.150	.290	P30G272*5	.01 μ F	.150	.400	P40G103*5
1200 pF	.100	.260	P20G122*5	3300 pF	.150	.290	P30G332*5	.012 μ F	.150	.400	P40G123*5
1500 pF	.120	.170	P12G152*5	3900 pF	.150	.290	P30G392*5	.015 μ F	.150	.400	P40G153*5
1500 pF	.100	.260	P20G152*5	4700 pF	.150	.290	P30G472*5				

* Insert proper letter symbol for tolerance:
J = \pm 5%, K = \pm 10%

Add 'TR' to end of part number for Tape & Reel
P10, P12, P20 - 5,000 per reel
P30, P40 - 2,500 per reel
(Available in full reels only)

P10 to P40 Series Multilayer Ceramic Capacitors

MALLORY

Multilayer Ceramic Capacitors

X7R Temperature Coefficient 100 VDC

Capacity	Size (Inches)		Catalog Number	Capacity	Size (Inches)		Catalog Number	Capacity	Size (Inches)		Catalog Number
	D	L			D	L			D	L	
470 pF	.100	.170	P10R471*1	5600 pF	.100	.170	P10R562*1	.027 uF	.100	.260	P20R273*1
560 pF	.100	.170	P10R561*1	6800 pF	.100	.170	P10R682*1	.033 uF	.100	.260	P20R333*1
680 pF	.100	.170	P10R681*1	8200 pF	.100	.170	P10R822*1	.033 uF	.150	.290	P30R333*1
820 pF	.100	.170	P10R821*1	.01 uF	.100	.170	P10R103*1	.039 uF	.150	.290	P30R393*1
1000 pF	.100	.170	P10R102*1	.012 uF	.100	.170	P10R123*1	.047 uF	.150	.290	P30R473*1
1200 pF	.100	.170	P10R122*1	.012 uF	.100	.260	P20R123*1	.056 uF	.150	.290	P30R563*1
1500 pF	.100	.170	P10R152*1	.015 uF	.120	.170	P12R153*1	.068 uF	.150	.290	P30R683*1
1800 pF	.100	.170	P10R182*1	.015 uF	.100	.260	P20R153*1	.082 uF	.150	.290	P30R823*1
2200 pF	.100	.170	P10R222*1	.018 uF	.120	.170	P12R183*1	.082 uF	.150	.400	P40R823*1
2700 pF	.100	.170	P10R272*1	.018 uF	.100	.260	P20R183*1	.1 uF	.150	.290	P30R104*1
3300 pF	.100	.170	P10R332*1	.022 uF	.120	.170	P12R223*1	.1 uF	.150	.400	P40R104*1
3900 pF	.100	.170	P10R392*1	.022 uF	.100	.260	P20R223*1	.12 uF	.150	.290	P40R124*1
4700 pF	.100	.170	P10R472*1	.027 uF	.120	.170	P12R273*1	.15 uF	.150	.400	P40R154*1

* Insert proper letter symbol for tolerance: K = ±10%, M = ±20%

X7R Temperature Coefficient 50 VDC

Capacity	Size (Inches)		Catalog Number	Capacity	Size (Inches)		Catalog Number	Capacity	Size (Inches)		Catalog Number
	D	L			D	L			D	L	
8200 pF	.100	.170	P10R822*5	.047 uF	.100	.170	P10R473*5	.12 uF	.150	.290	P30R124*5
.01 uF	.100	.170	P10R103*5	.056 uF	.120	.170	P12R563*5	.15 uF	.150	.290	P30R154*5
.012 uF	.100	.170	P10R123*5	.056 uF	.100	.260	P20R563*5	.18 uF	.150	.290	P30R184*5
.015 uF	.100	.170	P10R153*5	.068 uF	.120	.170	P12R683*5	.22 uF	.150	.290	P30R224*5
.018 uF	.100	.170	P10R183*5	.068 uF	.100	.260	P20R683*5	.27 uF	.150	.290	P30R274*5
.022 uF	.100	.170	P10R223*5	.082 uF	.120	.170	P12R823*5	.27 uF	.150	.400	P40R274*5
.027 uF	.100	.170	P10R273*5	.082 uF	.100	.260	P20R823*5	.33 uF	.150	.400	P40R334*5
.033 uF	.100	.170	P10R333*5	.1 uF	.120	.170	P12R104*5				
.039 uF	.100	.170	P10R393*5	.1 uF	.100	.260	P20R104*5				

* Insert proper letter symbol for tolerance: K = ±10%, M = ±20%

Z5U Temperature Coefficient 100 VDC

Capacity	Size (Inches)		Catalog Number	Capacity	Size (Inches)		Catalog Number	Capacity	Size (Inches)		Catalog Number
	D	L			D	L			D	L	
.01 uF	.100	.170	P10U103*1	.033 uF	.100	.260	P20U333*1	.1 uF	.150	.290	P30U104*1
.012 uF	.100	.170	P10U123*1	.039 uF	.100	.260	P20U393*1	.12 uF	.150	.290	P30U124*1
.015 uF	.100	.170	P10U153*1	.047 uF	.100	.260	P20U473*1	.15 uF	.150	.290	P30U154*1
.018 uF	.100	.170	P10U183*1	.056 uF	.150	.290	P30U563*1	.18 uF	.150	.400	P40U184*1
.022 uF	.100	.170	P10U223*1	.068 uF	.150	.290	P30U683*1	.22 uF	.150	.400	P40U224*1
.027 uF	.100	.260	P20U273*1	.082 uF	.150	.290	P30U823*1				

* Insert proper letter symbol for tolerance: M = ±20%, Z = +80 - 20%, P = +100 - 0%

Z5U Temperature Coefficient 50 VDC

Capacity	Size (Inches)		Catalog Number	Capacity	Size (Inches)		Catalog Number	Capacity	Size (Inches)		Catalog Number
	D	L			D	L			D	L	
.027 uF	0.100	0.170	P10U273*5	.15 uF	0.100	0.170	P10U154*5	.33 uF	0.120	0.170	P12U334*5
.033 uF	0.100	0.170	P10U333*5	.15 uF	0.100	0.260	P20U154*5	.33 uF	0.100	0.260	P20U334*5
.039 uF	0.100	0.170	P10U393*5	.18 uF	0.100	0.170	P10U184*5	.33 uF	0.150	0.290	P30U334*5
.047 uF	0.100	0.170	P10U473*5	.18 uF	0.100	0.260	P20U184*5	.39 uF	0.150	0.290	P30U394*5
.056 uF	0.100	0.170	P10U563*5	.22 uF	0.100	0.170	P10U224*5	.47 uF	0.150	0.290	P30U474*5
.068 uF	0.100	0.170	P10U683*5	.22 uF	0.100	0.260	P20U224*5	.56 uF	0.150	0.400	P40U564*5
.082 uF	0.100	0.170	P10U823*5	.22 uF	0.150	0.290	P30U224*5	.68 uF	0.150	0.400	P40U684*5
.1 uF	0.100	0.170	P10U104*5	.27 uF	0.120	0.170	P12U274*5	.82 uF	0.150	0.400	P40U824*5
.12 uF	0.100	0.170	P10U124*5	.27 uF	0.100	0.260	P20U274*5	.1 uF	0.150	0.400	P40U105*5
.12 uF	0.100	0.260	P20U124*5	.27 uF	0.150	0.290	P30U274*5				

* Insert proper letter symbol for tolerance:
M = ±20%, Z = +80 - 20%, P = +100 - 0%

Add 'TR' to end of part number for Tape & Reel
P10, P12, P20 - 5,000 per reel
P30, P40 - 2,500 per reel
(Available in full reels only)

Chips Multilayer Ceramic Capacitors



Multilayer Ceramic Capacitors

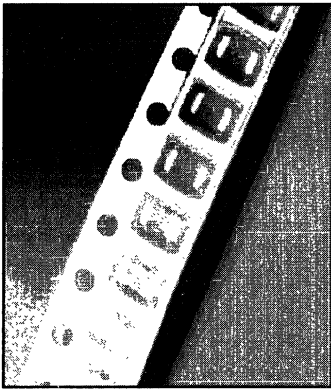

- Surface Mount
- COG, X7R, Z5U Temperature Coefficients
- Nickel Barrier/Solder Terminations
- Tape and Reel — Standard
- Z5U meets Y5V Characteristics
- 50 Volt Units Can Be Used For 63 Volt Applications

GENERAL SPECIFICATIONS

Voltage Range:
 COG: 50, 100 and 200 VDC
 X7R: 50, 100 and 200 VDC
 Z5U: 50 and 100 VDC

Capacitance Range:
 COG: 1 pF to .012 μ F
 X7R: 220 pF to .33 μ F
 Z5U: 6800 pF to .47 μ F

Standard Sizes: (Three)
 0805, 1206, 1210

Tape and Reel:

7" reel per EIA RS 481-1
 Parts with ^ (caret) following part number are 2,500 pcs. per reel.
 All others are 4,000 pcs per reel.
 13" reels are available by special request.

Note: Other chip sizes are available upon special request. Contact NACC for availability and prices.

Performance Characteristics

Parameter	COG (NPO)	X7R	Z5U
Temperature Characteristics:			
Range, °C:	-55°C to +125°C	-55°C to +125°C	+10°C to +85°C
Capacitance change without DC voltage:	0 \pm 30 PPM/°C*	\pm 15%	+22%, -56%
Aging Rate: % Δ C / Decade Hour, Maximum:			
	0%	2.5%	5.0%
Dissipation Factor:			
Test Conditions @ 25°C:	> 100 pF w/1.0 vrms @ 1 KHz	w/ 1.0 vrms @ 1 KHz	w/ 0.5 vrms @ 1 KHz
	\leq 100 pF w/1.0 vrms @ 1 MHz		
Limits:	0.10 % Max	2.5 % Max	4.0 % Max
Insulation Resistance (IR):			
After 2 min. electrification @ 25°C with rated voltage applied:	1000 megohms x μ F	1000 megohms x μ F	1000 megohms x μ F
	or 100 gigaohms	or 100 gigaohms	or 10 gigaohms
Moisture Resistance: MIL-STD-202, Method 106 (20 cycles with 50 Volts applied)			
Post test limits @ 25°C, whichever is smaller:	100 megohms x μ F	100 megohms x μ F	100 megohms x μ F
	or 10 gigaohms	or 10 gigaohms	or 1 gigaohm
Immersion Cycling: MIL-STD-202, Method 104, Condition B (2 cycles @ 15 minutes each. Each cycle consists of immersion in hot bath @ 65°C followed by immersion in cold salt water bath.)			
Post test limits @ 25°C:			
Insulation Resistance, whichever is smaller:	100 megohms x μ F	100 megohms x μ F	100 megohms x μ F
	or 10 gigaohms	or 10 gigaohms	or 1 gigaohm
Life Test: - 1000 Hrs.			
Test Potential and Temperature:	200% V @ 125°C	200% V @ 125°C	150% V @ 85°C
Post test limits @ 25°C:			
Capacitance Change, whichever is greater:	< 2% or 0.5pF	\pm 15% of initial value**	\pm 30% of initial value**
Dissipation Factor:	0.25% Max	2.5% Max	5.0% Max
Insulation Resistance, whichever is smaller:	100 megohms x μ F	100 megohms x μ F	100 megohms x μ F
	or 10 gigaohms	or 10 gigaohms	or 1 gigaohm
Dielectric Strength 2.5 times rated voltage for 5 seconds with current limited to 50 mA			

* 60 PPM/°C below 10pF nominal
 +53 PPM -30 PPM/°C from +25°C to -55°C comparable to MIL-C-20

** X7R and Z5U dielectrics exhibit aging characteristics; therefore, it is highly recommended that capacitors be de-aged for 2 hours @ 150°C and stabilized at room temperature for 48 hours before capacitor measurements are made.

Z5U meets all Y5V requirements and can be used in its place

Y5V - Δ C \leq +22/-82% over -30°C to +85°C
 Z5U - Δ C \leq +22/-56% over +10°C to +85°C

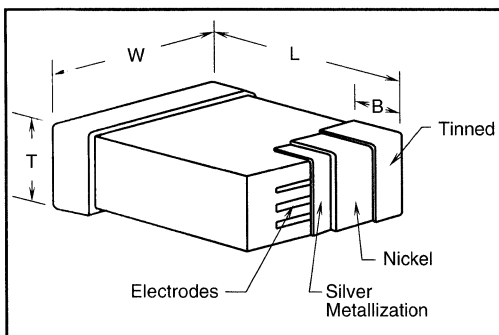

Dimensions - Millimeters (Inches)				
Size Code	L Length	W Width	T Thickness Maximum	B Bandwidth
0805	2.0(.079) \pm 0.2(.008)	1.25(.049) \pm 0.2(.008)	1.3(.051)	0.5(.020) \pm 0.25(.010)
1206	3.2(.126) \pm 0.2(.008)	1.6(.063) \pm 0.2(.008)	1.5(.059)	0.5(.020) \pm 0.25(.010)
1210	3.2(.126) \pm 0.2(.008)	2.5(.098) \pm 0.2(.008)	1.7(.067)	0.5(.020) \pm 0.25(.010)

Chips Multilayer Ceramic Capacitors

MALORY

Multilayer Ceramic Capacitors

COG (NPO) Temperature Coefficient

0805 Size Code			
Capacitance	Catalog Number		
	50 VDC	100 VDC	200 VDC
1.0pF	C0805C109*5GAC	C0805C109*1GAC	C0805C109*2GAC^
1.2pF	C0805C129*5GAC	C0805C129*1GAC	C0805C129*2GAC^
1.5pF	C0805C159*5GAC	C0805C159*1GAC	C0805C159*2GAC^
1.8pF	C0805C189*5GAC	C0805C189*1GAC	C0805C189*2GAC^
2.2pF	C0805C229*5GAC	C0805C229*1GAC	C0805C229*2GAC^
2.7pF	C0805C279*5GAC	C0805C279*1GAC	C0805C279*2GAC^
3.3pF	C0805C339*5GAC	C0805C339*1GAC	C0805C339*2GAC^
3.9pF	C0805C399*5GAC	C0805C399*1GAC	C0805C399*2GAC^
4.7pF	C0805C479*5GAC	C0805C479*1GAC	C0805C479*2GAC^
5.6pF	C0805C569*5GAC	C0805C569*1GAC	C0805C569*2GAC^
6.8pF	C0805C689*5GAC	C0805C689*1GAC	C0805C689*2GAC^
8.2pF	C0805C829*5GAC	C0805C829*1GAC	C0805C829*2GAC^
10pF	C0805C100*5GAC	C0805C100*1GAC	C0805C100*2GAC^
12pF	C0805C120*5GAC	C0805C120*1GAC	C0805C120*2GAC^
15pF	C0805C150*5GAC	C0805C150*1GAC	C0805C150*2GAC^
18pF	C0805C180*5GAC	C0805C180*1GAC	C0805C180*2GAC^
22pF	C0805C220*5GAC	C0805C220*1GAC	C0805C220*2GAC^
27pF	C0805C270*5GAC	C0805C270*1GAC	C0805C270*2GAC^
33pF	C0805C330*5GAC	C0805C330*1GAC	C0805C330*2GAC^
39pF	C0805C390*5GAC	C0805C390*1GAC	C0805C390*2GAC^
47pF	C0805C470*5GAC	C0805C470*1GAC	C0805C470*2GAC^
56pF	C0805C560*5GAC	C0805C560*1GAC	C0805C560*2GAC^
68pF	C0805C680*5GAC	C0805C680*1GAC	C0805C680*2GAC^
82pF	C0805C820*5GAC	C0805C820*1GAC	C0805C820*2GAC^
100pF	C0805C101*5GAC	C0805C101*1GAC	C0805C101*2GAC^
120pF	C0805C121*5GAC	C0805C121*1GAC	C0805C121*2GAC^
150pF	C0805C151*5GAC	C0805C151*1GAC	C0805C151*2GAC^
180pF	C0805C181*5GAC	C0805C181*1GAC	C0805C181*2GAC^
220pF	C0805C221*5GAC	C0805C221*1GAC	C0805C221*2GAC^
270pF	C0805C271*5GAC	C0805C271*1GAC	C0805C271*2GAC^
330pF	C0805C331*5GAC	C0805C331*1GAC	C0805C331*2GAC^
390pF	C0805C391*5GAC	C0805C391*1GAC	C0805C391*2GAC^
470pF	C0805C471*5GAC	C0805C471*1GAC	C0805C471*2GAC^
560pF	C0805C561*5GAC	C0805C561*1GAC	C0805C561*2GAC^
680pF	C0805C681*5GAC	C0805C681*1GAC	C0805C681*2GAC^
820pF	C0805C821*5GAC	C0805C821*1GAC	C0805C821*2GAC^
1000pF	C0805C102*5GAC	C0805C102*1GAC	C0805C102*2GAC^
1200pF	C0805C122*5GAC	C0805C122*1GAC	C0805C122*2GAC^
1500pF	C0805C152*5GAC	C0805C152*1GAC	C0805C152*2GAC^
1800pF	C0805C182*5GAC	C0805C182*1GAC	C0805C182*2GAC^

1206 Size Code			
Capacitance	Catalog Number		
	50 VDC	100 VDC	200 VDC
180pF	C1206C181*5GAC	C1206C181*1GAC	C1206C181*2GAC^
220pF	C1206C221*5GAC	C1206C221*1GAC	C1206C221*2GAC^
270pF	C1206C271*5GAC	C1206C271*1GAC	C1206C271*2GAC^
330pF	C1206C331*5GAC	C1206C331*1GAC	C1206C331*2GAC^
390pF	C1206C391*5GAC	C1206C391*1GAC	C1206C391*2GAC^
470pF	C1206C471*5GAC	C1206C471*1GAC	C1206C471*2GAC^
560pF	C1206C561*5GAC	C1206C561*1GAC	C1206C561*2GAC^
680pF	C1206C681*5GAC	C1206C681*1GAC	C1206C681*2GAC^
820pF	C1206C821*5GAC	C1206C821*1GAC	C1206C821*2GAC^
1000pF	C1206C102*5GAC	C1206C102*1GAC	C1206C102*2GAC^
1200pF	C1206C122*5GAC	C1206C122*1GAC	C1206C122*2GAC^
1500pF	C1206C152*5GAC	C1206C152*1GAC	C1206C152*2GAC^
1800pF	C1206C182*5GAC	C1206C182*1GAC	C1206C182*2GAC^
2200pF	C1206C222*5GAC	C1206C222*1GAC	C1206C222*2GAC^
2700pF	C1206C272*5GAC	C1206C272*1GAC	C1206C272*2GAC^
3300pF	C1206C332*5GAC	C1206C332*1GAC	C1206C332*2GAC^
3900pF	C1206C392*5GAC	C1206C392*1GAC	C1206C392*2GAC^
4700pF	C1206C472*5GAC	C1206C472*1GAC	C1206C472*2GAC^
5600pF	C1206C562*5GAC	C1206C562*1GAC	C1206C562*2GAC^

1210 Size Code			
Capacitance	Catalog Number		
	50 VDC	100 VDC	200 VDC
10pF	C1210C100*5GAC	C1210C100*1GAC	C1210C100*2GAC^
12pF	C1210C120*5GAC	C1210C120*1GAC	C1210C120*2GAC^
15pF	C1210C150*5GAC	C1210C150*1GAC	C1210C150*2GAC^
18pF	C1210C180*5GAC	C1210C180*1GAC	C1210C180*2GAC^
22pF	C1210C220*5GAC	C1210C220*1GAC	C1210C220*2GAC^
27pF	C1210C270*5GAC	C1210C270*1GAC	C1210C270*2GAC^
33pF	C1210C330*5GAC	C1210C330*1GAC	C1210C330*2GAC^
39pF	C1210C390*5GAC	C1210C390*1GAC	C1210C390*2GAC^
47pF	C1210C470*5GAC	C1210C470*1GAC	C1210C470*2GAC^
56pF	C1210C560*5GAC	C1210C560*1GAC	C1210C560*2GAC^
68pF	C1210C680*5GAC	C1210C680*1GAC	C1210C680*2GAC^
82pF	C1210C820*5GAC	C1210C820*1GAC	C1210C820*2GAC^
100pF	C1210C101*5GAC	C1210C101*1GAC	C1210C101*2GAC^
120pF	C1210C121*5GAC	C1210C121*1GAC	C1210C121*2GAC^
150pF	C1210C151*5GAC	C1210C151*1GAC	C1210C151*2GAC^
180pF	C1210C181*5GAC	C1210C181*1GAC	C1210C181*2GAC^
220pF	C1210C221*5GAC	C1210C221*1GAC	C1210C221*2GAC^
270pF	C1210C271*5GAC	C1210C271*1GAC	C1210C271*2GAC^
330pF	C1210C331*5GAC	C1210C331*1GAC	C1210C331*2GAC^
390pF	C1210C391*5GAC	C1210C391*1GAC	C1210C391*2GAC^
470pF	C1210C471*5GAC	C1210C471*1GAC	C1210C471*2GAC^
560pF	C1210C561*5GAC	C1210C561*1GAC	C1210C561*2GAC^
680pF	C1210C681*5GAC	C1210C681*1GAC	C1210C681*2GAC^
820pF	C1210C821*5GAC	C1210C821*1GAC	C1210C821*2GAC^
1000pF	C1210C102*5GAC	C1210C102*1GAC	C1210C102*2GAC^
1200pF	C1210C122*5GAC	C1210C122*1GAC	C1210C122*2GAC^
1500pF	C1210C152*5GAC	C1210C152*1GAC	C1210C152*2GAC^
1800pF	C1210C182*5GAC	C1210C182*1GAC	C1210C182*2GAC^
2200pF	C1210C222*5GAC	C1210C222*1GAC	C1210C222*2GAC^
2700pF	C1210C272*5GAC	C1210C272*1GAC	C1210C272*2GAC^
3300pF	C1210C332*5GAC	C1210C332*1GAC	C1210C332*2GAC^
3900pF	C1210C392*5GAC	C1210C392*1GAC	C1210C392*2GAC^
4700pF	C1210C472*5GAC	C1210C472*1GAC	C1210C472*2GAC^
5600pF	C1210C562*5GAC	C1210C562*1GAC	C1210C562*2GAC^
6800pF	C1210C682*5GAC	C1210C682*1GAC	C1210C682*2GAC^
8200pF	C1210C822*5GAC	C1210C822*1GAC	C1210C822*2GAC^
10000pF	C1210C103*5GAC	C1210C103*1GAC	C1210C103*2GAC^
12000pF	C1210C123*5GAC	C1210C123*1GAC	C1210C123*2GAC^

1206 Size Code			
Capacitance	Catalog Number		
	50 VDC	100 VDC	200 VDC
1.0pF	C1206C109*5GAC	C1206C109*1GAC	C1206C109*2GAC^
1.2pF	C1206C129*5GAC	C1206C129*1GAC	C1206C129*2GAC^
1.5pF	C1206C159*5GAC	C1206C159*1GAC	C1206C159*2GAC^
1.8pF	C1206C189*5GAC	C1206C189*1GAC	C1206C189*2GAC^
2.2pF	C1206C229*5GAC	C1206C229*1GAC	C1206C229*2GAC^
2.7pF	C1206C279*5GAC	C1206C279*1GAC	C1206C279*2GAC^
3.3pF	C1206C339*5GAC	C1206C339*1GAC	C1206C339*2GAC^
3.9pF	C1206C399*5GAC	C1206C399*1GAC	C1206C399*2GAC^
4.7pF	C1206C479*5GAC	C1206C479*1GAC	C1206C479*2GAC^
5.6pF	C1206C569*5GAC	C1206C569*1GAC	C1206C569*2GAC^
6.8pF	C1206C689*5GAC	C1206C689*1GAC	C1206C689*2GAC^
8.2pF	C1206C829*5GAC	C1206C829*1GAC	C1206C829*2GAC^
10pF	C1206C100*5GAC	C1206C100*1GAC	C1206C100*2GAC^
12pF	C1206C120*5GAC	C1206C120*1GAC	C1206C120*2GAC^
15pF	C1206C150*5GAC	C1206C150*1GAC	C1206C150*2GAC^
18pF	C1206C180*5GAC	C1206C180*1GAC	C1206C180*2GAC^
22pF	C1206C220*5GAC	C1206C220*1GAC	C1206C220*2GAC^
27pF	C1206C270*5GAC	C1206C270*1GAC	C1206C270*2GAC^
33pF	C1206C330*5GAC	C1206C330*1GAC	C1206C330*2GAC^
39pF	C1206C390*5GAC	C1206C390*1GAC	C1206C390*2GAC^
47pF	C1206C470*5GAC	C1206C470*1GAC	C1206C470*2GAC^
56pF	C1206C560*5GAC	C1206C560*1GAC	C1206C560*2GAC^
68pF	C1206C680*5GAC	C1206C680*1GAC	C1206C680*2GAC^
82pF	C1206C820*5GAC	C1206C820*1GAC	C1206C820*2GAC^
100pF	C1206C101*5GAC	C1206C101*1GAC	C1206C101*2GAC^
120pF	C1206C121*5GAC	C1206C121*1GAC	C1206C121*2GAC^
150pF	C1206C151*5GAC	C1206C151*1GAC	C1206C151*2GAC^

* Insert proper letter code for desired tolerance:
 ±0.25pF (C) is standard on values less than 10 pF
 ±5% (J) is standard on values ≥ 10 pF

Other Available Tolerances:
 Values less than 27pF:
 C = ±0.25pF, D = ±0.5pF
 Values greater than 10 pF:
 F = ±1%; G = ±2%; H = ±2.5%;
 J = ±5%; K = ±10%; M = ±20%

^ Parts with caret (^) following catalog number are 2,500 pcs per reel
 All others are 4,000 pcs per reel

50 volt units can be used for 63 volt applications

Chips Multilayer Ceramic Capacitors



Multilayer Ceramic Capacitors

X7R Temperature Coefficient

0805 Size Code			
Capacitance	Catalog Number		
	50 VDC	100 VDC	200 VDC
220pF	C0805C221*5RAC	C0805C221*1RAC	C0805C221*2RAC ^
270pF	C0805C271*5RAC	C0805C271*1RAC	C0805C271*2RAC ^
330pF	C0805C331*5RAC	C0805C331*1RAC	C0805C331*2RAC ^
390pF	C0805C391*5RAC	C0805C391*1RAC	C0805C391*2RAC ^
470pF	C0805C471*5RAC	C0805C471*1RAC	C0805C471*2RAC ^
560pF	C0805C561*5RAC	C0805C561*1RAC	C0805C561*2RAC ^
680pF	C0805C681*5RAC	C0805C681*1RAC	C0805C681*2RAC ^
820pF	C0805C821*5RAC	C0805C821*1RAC	C0805C821*2RAC ^
1000pF	C0805C102*5RAC	C0805C102*1RAC	C0805C102*2RAC ^
1200pF	C0805C122*5RAC	C0805C122*1RAC	C0805C122*2RAC ^
1500pF	C0805C152*5RAC	C0805C152*1RAC	C0805C152*2RAC ^
1800pF	C0805C182*5RAC	C0805C182*1RAC	C0805C182*2RAC ^
2200pF	C0805C222*5RAC	C0805C222*1RAC	C0805C222*2RAC ^
2700pF	C0805C272*5RAC	C0805C272*1RAC	C0805C272*2RAC ^
3300pF	C0805C332*5RAC	C0805C332*1RAC	C0805C332*2RAC ^
3900pF	C0805C392*5RAC	C0805C392*1RAC	C0805C392*2RAC ^
4700pF	C0805C472*5RAC	C0805C472*1RAC	C0805C472*2RAC ^
5600pF	C0805C562*5RAC	C0805C562*1RAC	C0805C562*2RAC ^
6800pF	C0805C682*5RAC	C0805C682*1RAC	C0805C682*2RAC ^
8200pF	C0805C822*5RAC	C0805C822*1RAC	C0805C822*2RAC ^
10000pF	C0805C103*5RAC	C0805C103*1RAC	
12000pF	C0805C123*5RAC		
15000pF	C0805C153*5RAC		
18000pF	C0805C183*5RAC		
22000pF	C0805C223*5RAC		
27000pF	C0805C273*5RAC		
33000pF	C0805C333*5RAC		
39000pF	C0805C393*5RAC		
47000pF	C0805C473*5RAC		
56000pF	C0805C563*5RAC ^		
68000pF	C0805C683*5RAC ^		
82000pF	C0805C823*5RAC ^		
.1uF	C0805C104*5RAC ^		

1210 Size Code			
Capacitance	Catalog Number		
	50 VDC	100 VDC	200 VDC
2200pF	C1210C222*5RAC	C1210C222*1RAC	C1210C222*2RAC ^
2700pF	C1210C272*5RAC	C1210C272*1RAC	C1210C272*2RAC ^
3300pF	C1210C332*5RAC	C1210C332*1RAC	C1210C332*2RAC ^
3900pF	C1210C392*5RAC	C1210C392*1RAC	C1210C392*2RAC ^
4700pF	C1210C472*5RAC	C1210C472*1RAC	C1210C472*2RAC ^
5600pF	C1210C562*5RAC	C1210C562*1RAC	C1210C562*2RAC ^
6800pF	C1210C682*5RAC	C1210C682*1RAC	C1210C682*2RAC ^
8200pF	C1210C822*5RAC	C1210C822*1RAC	C1210C822*2RAC ^
10000pF	C1210C103*5RAC	C1210C103*1RAC	C1210C103*2RAC ^
12000pF	C1210C123*5RAC	C1210C123*1RAC	C1210C123*2RAC ^
15000pF	C1210C153*5RAC	C1210C153*1RAC	C1210C153*2RAC ^
18000pF	C1210C183*5RAC	C1210C183*1RAC	C1210C183*2RAC ^
22000pF	C1210C223*5RAC	C1210C223*1RAC	C1210C223*2RAC ^
27000pF	C1210C273*5RAC	C1210C273*1RAC	C1210C273*2RAC ^
33000pF	C1210C333*5RAC	C1210C333*1RAC	C1210C333*2RAC ^
39000pF	C1210C393*5RAC	C1210C393*1RAC	C1210C393*2RAC ^
47000pF	C1210C473*5RAC	C1210C473*1RAC	C1210C473*2RAC ^
56000pF	C1210C563*5RAC	C1210C563*1RAC ^	
68000pF	C1210C683*5RAC	C1210C683*1RAC ^	
82000pF	C1210C823*5RAC	C1210C823*1RAC ^	
.1uF	C1210C104*5RAC	C1210C104*1RAC ^	
.12uF	C1210C124*5RAC		
.15uF	C1210C154*5RAC		
.18uF	C1210C184*5RAC		
.22uF	C1210C224*5RAC		
.27uF	C1210C274*5RAC		
.33uF	C1210C334*5RAC		

* Insert proper letter code for desired tolerance:

±10 (K) Tolerance is standard
J = ±5%, K = ±10%, M = ±20%

^ Parts with caret (^) following catalog number are 2,500 pcs per reel.
All others are 4,000pcs per reel

1206 Size Code			
Capacitance	Catalog Number		
	50 VDC	100 VDC	200 VDC
1000pF	C1206C102*5RAC	C1206C102*1RAC	C1206C102*2RAC ^
1200pF	C1206C122*5RAC	C1206C122*1RAC	C1206C122*2RAC ^
1500pF	C1206C152*5RAC	C1206C152*1RAC	C1206C152*2RAC ^
1800pF	C1206C182*5RAC	C1206C182*1RAC	C1206C182*2RAC ^
2200pF	C1206C222*5RAC	C1206C222*1RAC	C1206C222*2RAC ^
2700pF	C1206C272*5RAC	C1206C272*1RAC	C1206C272*2RAC ^
3300pF	C1206C332*5RAC	C1206C332*1RAC	C1206C332*2RAC ^
3900pF	C1206C392*5RAC	C1206C392*1RAC	C1206C392*2RAC ^
4700pF	C1206C472*5RAC	C1206C472*1RAC	C1206C472*2RAC ^
5600pF	C1206C562*5RAC	C1206C562*1RAC	C1206C562*2RAC ^
6800pF	C1206C682*5RAC	C1206C682*1RAC	C1206C682*2RAC ^
8200pF	C1206C822*5RAC	C1206C822*1RAC	C1206C822*2RAC ^
10000pF	C1206C103*5RAC	C1206C103*1RAC	C1206C103*2RAC ^
12000pF	C1206C123*5RAC	C1206C123*1RAC	C1206C123*2RAC ^
15000pF	C1206C153*5RAC	C1206C153*1RAC	C1206C153*2RAC ^
18000pF	C1206C183*5RAC	C1206C183*1RAC	C1206C183*2RAC ^
22000pF	C1206C223*5RAC	C1206C223*1RAC ^	C1206C223*2RAC ^
27000pF	C1206C273*5RAC	C1206C273*1RAC ^	
33000pF	C1206C333*5RAC	C1206C333*1RAC ^	
39000pF	C1206C393*5RAC	C1206C393*1RAC ^	
47000pF	C1206C473*5RAC	C1206C473*1RAC ^	
56000pF	C1206C563*5RAC		
68000pF	C1206C683*5RAC		
82000pF	C1206C823*5RAC		
.1uF	C1206C104*5RAC		
.12uF	C1206C124*5RAC		
.15uF	C1206C154*5RAC		
.18 uF	C1206C184*5RAC		
.22 uF	C1206C224*5RAC		

50 volt units can be used for 63 volt applications

Z5U Temperature Coefficient

0805 Size Code			
Capacitance	Catalog Number		
	50 VDC	100 VDC	200 VDC
6800pF	C0805C682*5UAC	C0805C682*1UAC	
8200pF	C0805C822*5UAC	C0805C822*1UAC	
10000pF	C0805C103*5UAC	C0805C103*1UAC	
12000pF	C0805C123*5UAC		
15000pF	C0805C153*5UAC		
18000pF	C0805C183*5UAC		
22000pF	C0805C223*5UAC		
27000pF	C0805C273*5UAC		
33000pF	C0805C333*5UAC ^		
39000pF	C0805C393*5UAC ^		
47000pF	C0805C473*5UAC ^		
56000pF	C0805C563*5UAC ^		
68000pF	C0805C683*5UAC ^		
82000pF	C0805C823*5UAC ^		
.1uF	C0805C104*5UAC ^		

1210 Size Code			
Capacitance	Catalog Number		
	50 VDC	100 VDC	200 VDC
47000pF	C1210C473*5UAC	C1210C473*1UAC	
56000pF	C1210C563*5UAC	C1210C563*1UAC	
68000pF	C1210C683*5UAC	C1210C683*1UAC	
82000pF	C1210C823*5UAC	C1210C823*1UAC	
.1uF	C1210C104*5UAC		
.15uF	C1210C154*5UAC		
.18uF	C1210C184*5UAC		
.22uF	C1210C224*5UAC ^		
.27uF	C1210C274*5UAC ^		
.33uF	C1210C334*5UAC ^		
.39uF	C1210C394*5UAC ^		
.47uF	C1210C474*5UAC ^		

* Insert proper letter code for desired tolerance:
 ±20 (M) Tolerance is standard
 M = ±20%; Z = +80%-0%

^ Parts with caret (^) following catalog number are 2,500 pcs per reel
 All others are 4,000 pcs per reel

1206 Size Code			
Capacitance	Catalog Number		
	50 VDC	100 VDC	200 VDC
10000pF	C1206C103*5UAC	C1206C103*1UAC	
12000pF	C1206C123*5UAC	C1206C123*1UAC	
15000pF	C1206C153*5UAC	C1206C153*1UAC	
18000pF	C1206C183*5UAC	C1206C183*1UAC	
22000pF	C1206C223*5UAC	C1206C223*1UAC	
27000pF	C1206C273*5UAC	C1206C273*1UAC	
33000pF	C1206C333*5UAC	C1206C333*1UAC	
39000pF	C1206C393*5UAC	C1206C393*1UAC	
47000pF	C1206C473*5UAC		
56000pF	C1206C563*5UAC		
68000pF	C1206C683*5UAC		
82000pF	C1206C823*5UAC		
.1uF	C1206C104*5UAC		
.12uF	C1206C124*5UAC ^		
.15uF	C1206C154*5UAC ^		
.18uF	C1206C184*5UAC ^		
.22uF	C1206C224*5UAC ^		

50 volt units can be used for 63 volt applications

Z5U meets all Y5V requirements and can be used in its place

Y5V - $\Delta C \leq +22/-82\%$ over -30°C to $+85^{\circ}\text{C}$

Z5U - $\Delta C \leq +22/-56\%$ over $+10^{\circ}\text{C}$ to $+85^{\circ}\text{C}$

MIL-C-11015 & 39014 Multilayer Ceramic Capacitors



Multilayer Ceramic Capacitors

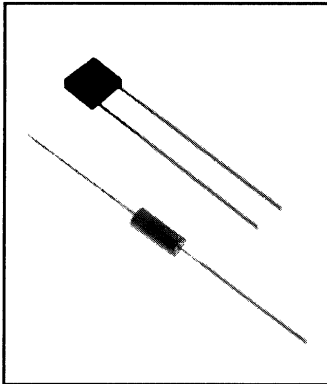

- Radial and Axial Leaded
- Molded Case Construction
- Stand-off Version Available in Radial Leaded CKR Type
- Hot Solder Dipped Leads in CKR Type

GENERAL SPECIFICATIONS

Voltage Range:
50, 100, 200 VDC

Capacitance Range:
10 pF to 3.3 μ F

Temperature Coefficient:
X7R (Mil BX or BR)

Available in Tape and Reel configuration:
Add 'TR' to end of catalog number

Cap	Tol %	MIL-C-11015/18	MIL-C-39014/01 Reference	39014/01 Failure Rate Levels			
				M	P	R	S
200 WVDC - Radial Leaded - CK05/M39014/01							
10 pF	10	CK05BX100K	CKR05BX100K*	1201	1241	1281	1321
10 pF	20	CK05BX100M	CKR05BX100M*	1202	1242	1282	1322
12 pF	10	CK05BX120K	CKR05BX120K*	1203	1243	1283	1323
15 pF	10	CK05BX150K	CKR05BX150K*	1204	1244	1284	1324
15 pF	20	CK05BX150M	CKR05BX150M*	1205	1245	1285	1325
18 pF	10	CK05BX180K	CKR05BX180K*	1206	1246	1286	1326
22 pF	10	CK05BX220K	CKR05BX220K*	1207	1247	1287	1327
22 pF	20	CK05BX220M	CKR05BX220M*	1208	1248	1288	1328
27 pF	10	CK05BX270K	CKR05BX270K*	1209	1249	1289	1329
33 pF	10	CK05BX330K	CKR05BX330K*	1210	1250	1290	1330
33 pF	20	CK05BX330M	CKR05BX330M*	1211	1251	1291	1331
39 pF	10	CK05BX390K	CKR05BX390K*	1212	1252	1292	1332
47 pF	10	CK05BX470K	CKR05BX470K*	1213	1253	1293	1333
47 pF	20	CK05BX470M	CKR05BX470M*	1214	1254	1294	1334
56 pF	10	CK05BX560K	CKR05BX560K*	1215	1255	1295	1335
68 pF	10	CK05BX680K	CKR05BX680K*	1216	1256	1296	1336
68 pF	20	CK05BX680M	CKR05BX680M*	1217	1257	1297	1337
82 pF	10	CK05BX820K	CKR05BX820K*	1218	1258	1298	1338
100 pF	10	CK05BX101K	CKR05BX101K*	1219	1259	1299	1339
100 pF	20	CK05BX101M	CKR05BX101M*	1220	1260	1300	1340
120 pF	10	CK05BX121K	CKR05BX121K*	1221	1261	1301	1341
150 pF	10	CK05BX151K	CKR05BX151K*	1222	1262	1302	1342
150 pF	20	CK05BX151M	CKR05BX151M*	1223	1263	1303	1343
180 pF	10	CK05BX181K	CKR05BX181K*	1224	1264	1304	1344
220 pF	10	CK05BX221K	CKR05BX221K*	1225	1265	1305	1345
220 pF	20	CK05BX221M	CKR05BX221M*	1226	1266	1306	1346
270 pF	10	CK05BX271K	CKR05BX271K*	1227	1267	1307	1347
330 pF	10	CK05BX331K	CKR05BX331K*	1228	1268	1308	1348
330 pF	20	CK05BX331M	CKR05BX331M*	1229	1269	1309	1349
390 pF	10	CK05BX391K	CKR05BX391K*	1230	1270	1310	1350
470 pF	10	CK05BX471K	CKR05BX471K*	1231	1271	1311	1351
470 pF	20	CK05BX471M	CKR05BX471M*	1232	1272	1312	1352
560 pF	10	CK05BX561K	CKR05BX561K*	1233	1273	1313	1353
680 pF	10	CK05BX681K	CKR05BX681K*	1234	1274	1314	1354
680 pF	20	CK05BX681M	CKR05BX681M*	1235	1275	1315	1355
820 pF	10	CK05BX821K	CKR05BX821K*	1236	1276	1316	1356
1000 pF	10	CK05BX102K	CKR05BX102K*	1237	1277	1317	1357
1000 pF	20	CK05BX102M	CKR05BX102M*	1238	1278	1318	1358

Cap	Tol %	MIL-C-11015/18	MIL-C-39014/01 Reference	39014 /01 Failure Rate Levels			
				M	P	R	S
100 WVDC - Radial Leaded - CK05/M39014/01							
1200 pF	10	CK05BX122K	CKR05BX122K*	1239	1279	1319	1359
1500 pF	10	CK05BX152K	CKR05BX152K*	1240	1280	1320	1360
1500 pF	20	CK05BX152M	CKR05BX152M*	1441	1481	1521	1561
1800 pF	10	CK05BX182K	CKR05BX182K*	1442	1482	1522	1562
2200 pF	10	CK05BX222K	CKR05BX222K*	1443	1483	1523	1563
2200 pF	20	CK05BX222M	CKR05BX222M*	1444	1484	1524	1564
2700 pF	10	CK05BX272K	CKR05BX272K*	1445	1485	1525	1565
3300 pF	10	CK05BX332K	CKR05BX332K*	1446	1486	1526	1566
3300 pF	20	CK05BX332M	CKR05BX332M*	1447	1487	1527	1567
3900 pF	10	CK05BX392K	CKR05BX392K*	1448	1488	1528	1568
4700 pF	10	CK05BX472K	CKR05BX472K*	1449	1489	1529	1569
4700 pF	20	CK05BX472M	CKR05BX472M*	1450	1490	1530	1570
5600 pF	10	CK05BX562K	CKR05BX562K*	1451	1491	1531	1571
6800 pF	10	CK05BX682K	CKR05BX682K*	1452	1492	1532	1572
6800 pF	20	CK05BX682M	CKR05BX682M*	1453	1493	1533	1573
8200 pF	10	CK05BX822K	CKR05BX822K*	1454	1494	1534	1574
.01 μ F	10	CK05BX103K	CKR05BX103K*	1455	1495	1535	1575
.01 μ F	20	CK05BX103M	CKR05BX103M*	1456	1496	1536	1576

Cap	Tol %	MIL-C-11015/18	MIL-C-39014/01 Reference	39014 /01 Failure Rate Levels			
				M	P	R	S
50 WVDC - Radial Leaded - CK05/M39014/01							
.012 μ F	10	CK05BX123K	CKR05BX123K*	1457	1497	1537	1577
.015 μ F	10	CK05BX153K	CKR05BX153K*	1458	1498	1538	1578
.015 μ F	20	CK05BX153M	CKR05BX153M*	1459	1499	1539	1579
.018 μ F	10	CK05BX183K	CKR05BX183K*	1460	1500	1540	1580
.022 μ F	10	CK05BX223K	CKR05BX223K*	1461	1501	1541	1581
.022 μ F	20	CK05BX223M	CKR05BX223M*	1462	1502	1542	1582
.027 μ F	10	CK05BX273K	CKR05BX273K*	1463	1503	1543	1583
.033 μ F	10	CK05BX333K	CKR05BX333K*	1464	1504	1544	1584
.033 μ F	20	CK05BX333M	CKR05BX333M*	1465	1505	1545	1585
.039 μ F	10	CK05BX393K	CKR05BX393K*	1466	1506	1546	1586
.047 μ F	10	CK05BX473K	CKR05BX473K*	1467	1507	1547	1587
.047 μ F	20	CK05BX473M	CKR05BX473M*	1468	1508	1548	1588
.056 μ F	10	CK05BX563K	CKR05BX563K*	1469	1509	1549	1589
.068 μ F	10	CK05BX683K	CKR05BX683K*	1470	1510	1550	1590
.068 μ F	20	CK05BX683M	CKR05BX683M*	1471	1511	1551	1591
.082 μ F	10	CK05BX823K	CKR05BX823K*	1472	1512	1552	1592
.1 μ F	10	CK05BX104K	CKR05BX104K*	1473	1513	1553	1593
.1 μ F	20	CK05BX104M	CKR05BX104M*	1474	1514	1554	1594

Add 'TR' to end of part number for Tape & Reel
Leads will be trimmed to .625" length
CK05 - 2,000 per reel
CKR05 - 1,700 per reel
(Available in full reels only)

* Insert proper letter symbol for Failure Rate Designator:
M = 1% / 1000 Hours, P = 0.1% / 1000 Hours
R = 0.01% / 1000 Hours, S = 0.001% / 1000 Hours

Add 'V' at end of failure rate designator if stand-off design is required. (CKR only)

TO ORDER MIL-C-11015 PARTS: Order by CK part number shown above.
Example: CK05BX104M

TO ORDER MIL-C-39014 PARTS: Indicate the prefix M39014/-- followed by the applicable MIL dash number.
Example: For M39014/01-1594 (CKR05BX104MS); order M39014/01 1594

MIL-C-11015 & 39014 Multilayer Ceramic Capacitors



Multilayer Ceramic Capacitors

Cap	Tol %	MIL-C-11015/19	MIL-C-39014/02 Reference	39014/02 Failure Rate Levels			
				M	P	R	S
200 WVDC - Radial Leaded - CK06/M39014/02							
1200 pF	10	CK06BX122K	CKR06BX122K*	1201	1241	1281	1321
1500 pF	10	CK06BX152K	CKR06BX152K*	1202	1242	1282	1322
1500 pF	20	CK06BX152M	CKR06BX152M*	1203	1243	1283	1323
1800 pF	10	CK06BX182K	CKR06BX182K*	1204	1244	1284	1324
2200 pF	10	CK06BX222K	CKR06BX222K*	1206	1246	1286	1326
2200 pF	20	CK06BX222M	CKR06BX222M*	1207	1247	1287	1327
2700 pF	10	CK06BX272K	CKR06BX272K*	1208	1248	1288	1328
3300 pF	10	CK06BX332K	CKR06BX332K*	1209	1249	1289	1329
3300 pF	20	CK06BX332M	CKR06BX332M*	1210	1250	1290	1330
3900 pF	10	CK06BX392K	CKR06BX392K*	1211	1251	1291	1331
4700 pF	10	CK06BX472K	CKR06BX472K*	1212	1252	1292	1332
4700 pF	20	CK06BX472M	CKR06BX472M*	1213	1253	1293	1333
5600 pF	10	CK06BX562K	CKR06BX562K*	1214	1254	1294	1334
6800 pF	10	CK06BX682K	CKR06BX682K*	1215	1255	1295	1335
6800 pF	20	CK06BX682M	CKR06BX682M*	1216	1256	1296	1336
8200 pF	10	CK06BX822K	CKR06BX822K*	1217	1257	1297	1337
.01 uF	10	CK06BX103K	CKR06BX103K*	1218	1258	1298	1338
.01 uF	20	CK06BX103M	CKR06BX103M*	1219	1259	1299	1339

Cap	Tol %	MIL-C-11015/19	MIL-C-39014/02 Reference	39014/02 Failure Rate Levels			
				M	P	R	S
100 WVDC - Radial Leaded - CK06/M39014/02							
.047 uF	10	CK06BX473K	CKR06BX473K*	1225	1265	1305	1345
.047 uF	20	CK06BX473M					
.056 uF	10	CK06BX563K	CKR06BX563K*	1226	1266	1306	1346
.068 uF	10	CK06BX683K	CKR06BX683K*	1227	1267	1307	1347
.068 uF	20	CK06BX683M					
.082 uF	10	CK06BX823K	CKR06BX823K*	1229	1269	1309	1349
.1 uF	10	CK06BX104K	CKR06BX104K*	1230	1270	1310	1350
.1 uF	20	CK06BX104M					

Cap	Tol %	MIL-C-11015/19	MIL-C-39014/02 Reference	39014/02 Failure Rate Levels			
				M	P	R	S
100 WVDC - Radial Leaded - CK06/M39014/02							
.012 uF	10	CK06BX123K	CKR06BX123K*	1231	1271	1311	1351
.015 uF	10	CK06BX153K	CKR06BX153K*	1220	1260	1300	1340
.015 uF	20	CK06BX153M					
.018 uF	10	CK06BX183K	CKR06BX183K*	1221	1261	1301	1341
.022 uF	10	CK06BX223K	CKR06BX223K*	1222	1262	1302	1342
.022 uF	20	CK06BX223M					
.027 uF	10	CK06BX273K	CKR06BX273K*	1232	1272	1312	1352
.033 uF	10	CK06BX333K	CKR06BX333K*	1223	1263	1303	1343
.033 uF	20	CK06BX333M					
.039 uF	10	CK06BX393K	CKR06BX393K*	1224	1264	1304	1344

Cap	Tol %	MIL-C-11015/19	MIL-C-39014/02 Reference	39014/02 Failure Rate Levels			
				M	P	R	S
50 WVDC - Radial Leaded - CK06/M39014/02							
.12 uF	10	CK06BX124K	CKR06BX124K*	1233	1273	1313	1353
.15 uF	10	CK06BX154K	CKR06BX154K*	1234	1274	1314	1354
.15 uF	20	CK06BX154M					
.18 uF	10	CK06BX184K	CKR06BX184K*	1235	1275	1315	1355
.22 uF	10	CK06BX224K	CKR06BX224K*	1236	1276	1316	1356
.22 uF	20	CK06BX224M					
.27 uF	10	CK06BX274K	CKR06BX274K*	1237	1277	1317	1357
.33 uF	10	CK06BX334K	CKR06BX334K*	1238	1278	1318	1358
.33 uF	20	CK06BX334M					
.39 uF	10	CK06BX394K	CKR06BX394K*	1239	1279	1319	1359
.47 uF	10	CK06BX474K	CKR06BX474K*	1240	1280	1320	1360
.47 uF	20	CK06BX474M					
.56 uF	10	CK06BX564K	CKR06BX564K*	1404	1408	1412	1416
.68 uF	10	CK06BX684K	CKR06BX684K*	1405	1409	1413	1417
.68 uF	20	CK06BX684M					
.82 uF	10	CK06BX824K	CKR06BX824K*	1406	1410	1414	1418
1.0 uF	10	CK06BX105K	CKR06BX105K*	1407	1411	1415	1419
1.0 uF	20	CK06BX105M					

Add 'TR' to end of part number for Tape & Reel
Leads will be trimmed to .625" length
CK06 - 1,500 per reel
CKR06 - 1,500 per reel
(Available in full reels only)

* Insert proper letter symbol for Failure Rate Designator:
M = 1% / 1000 Hours, P = 0.1% / 1000 Hours,
R = 0.01% / 1000 Hours, S = 0.001% / 1000 Hours
Add 'V' at end of failure rate designator if stand-off design is required. (CKR only)

Cap	Tol %	MIL-C-11015/20	MIL-C-39014/05 Reference	39014/05 Failure Rate Levels			
				M	P	R	S
100 WVDC - Axial Leaded - CK12/M39014/05							
10 pF	10	CK12BX100K	CKR11BX100K*	2601	2801	2001	2201
10 pF	20	CK12BX100M	CKR11BX100M*	2602	2802	2002	2202
12 pF	10	CK12BX120K	CKR11BX120K*	2603	2803	2003	2203
15 pF	10	CK12BX150K	CKR11BX150K*	2604	2804	2004	2204
15 pF	20	CK12BX150M	CKR11BX150M*	2605	2805	2005	2205
18 pF	10	CK12BX180K	CKR11BX180K*	2606	2806	2006	2206
22 pF	10	CK12BX220K	CKR11BX220K*	2607	2807	2007	2207
22 pF	20	CK12BX220M	CKR11BX220M*	2608	2808	2008	2208
27 pF	10	CK12BX270K	CKR11BX270K*	2609	2809	2009	2209
33 pF	10	CK12BX330K	CKR11BX330K*	2610	2810	2010	2210
33 pF	20	CK12BX330M	CKR11BX330M*	2611	2811	2011	2211
39 pF	10	CK12BX390K	CKR11BX390K*	2612	2812	2012	2212
47 pF	10	CK12BX470K	CKR11BX470K*	2613	2813	2013	2213
47 pF	20	CK12BX470M	CKR11BX470M*	2614	2814	2014	2214
56 pF	10	CK12BX560K	CKR11BX560K*	2615	2815	2015	2215
68 pF	10	CK12BX680K	CKR11BX680K*	2616	2816	2016	2216
68 pF	20	CK12BX680M	CKR11BX680M*	2617	2817	2017	2217
82 pF	10	CK12BX820K	CKR11BX820K*	2618	2818	2018	2218
100 pF	10	CK12BX101K	CKR11BX101K*	2619	2819	2019	2219
100 pF	20	CK12BX101M	CKR11BX101M*	2620	2820	2020	2220
120 pF	10	CK12BX121K	CKR11BX121K*	2621	2821	2021	2221
150 pF	10	CK12BX151K	CKR11BX151K*	2622	2822	2022	2222
150 pF	20	CK12BX151M	CKR11BX151M*	2623	2823	2023	2223
180 pF	10	CK12BX181K	CKR11BX181K*	2624	2824	2024	2224
220 pF	10	CK12BX221K	CKR11BX221K*	2625	2825	2025	2225
220 pF	20	CK12BX221M	CKR11BX221M*	2626	2826	2026	2226
270 pF	10	CK12BX271K	CKR11BX271K*	2627	2827	2027	2227
330 pF	10	CK12BX331K	CKR11BX331K*	2628	2828	2028	2228
330 pF	20	CK12BX331M	CKR11BX331M*	2629	2829	2029	2229
390 pF	10	CK12BX391K	CKR11BX391K*	2630	2830	2030	2230

Add 'TR' to end of part number for Tape & Reel
CK12 - 5,000 per reel
CKR11 - 5,000 per reel
(Available in full reels only)

Cap	Tol %	MIL-C-11015/20	MIL-C-39014/05 Reference	39014/05 Failure Rate Levels			
				M	P	R	S
100 WVDC - Axial Leaded - CK12/M39014/05							
470 pF	10	CK12BX471K	CKR11BX471K*	2631	2831	2031	2231
470 pF	20	CK12BX471M	CKR11BX471M*	2632	2832	2032	2232
560 pF	10	CK12BX561K	CKR11BX561K*	2633	2833	2033	2233
680 pF	10	CK12BX681K	CKR11BX681K*	2634	2834	2034	2234
680 pF	20	CK12BX681M	CKR11BX681M*	2635	2835	2035	2235
820 pF	10	CK12BX821K	CKR11BX821K*	2636	2836	2036	2236
1000 pF	10	CK12BX102K	CKR11BX102K*	2637	2837	2037	2237
1000 pF	20	CK12BX102M	CKR11BX102M*	2638	2838	2038	2238
1200 pF	10	CK12BX122K	CKR11BX122K*	2639	2839	2039	2239
1500 pF	10	CK12BX152K	CKR11BX152K*	2640	2840	2040	2240
1500 pF	20	CK12BX152M	CKR11BX152M*	2641	2841	2041	2241
1800 pF	10	CK12BX182K	CKR11BX182K*	2642	2842	2042	2242
2200 pF	10	CK12BX222K	CKR11BX222K*	2643	2843	2043	2243
2200 pF	20	CK12BX222M	CKR11BX222M*	2644	2844	2044	2244
2700 pF	10	CK12BX272K	CKR11BX272K*	2645	2845	2045	2245
3300 pF	10	CK12BX332K	CKR11BX332K*	2646	2846	2046	2246
3300 pF	20	CK12BX332M	CKR11BX332M*	2647	2847	2047	2247
3900 pF	10	CK12BX392K	CKR11BX392K*	2648	2848	2048	2248
4700 pF	10	CK12BX472K	CKR11BX472K*	2649	2849	2049	2249
4700 pF	20	CK12BX472M	CKR11BX472M*	2650	1850	2050	2250

Cap	Tol %	MIL-C-11015/20	MIL-C-39014/05 Reference	39014/05 Failure Rate Levels			
				M	P	R	S
50 WVDC - Axial Leaded - CK12/M39014/05							
5600 pF	10	CK12BX562K	CKR11BX562K*	2651	2851	2051	2251
6800 pF	10	CK12BX682K	CKR11BX682K*	2652	2852	2052	2252
6800 pF	20	CK12BX682M	CKR11BX682M*	2653	2853	2053	2253
8200 pF	10	CK12BX822K	CKR11BX822K*	2654	2854	2054	2254
0.01 uF	10	CK12BX103K	CKR11BX103K*	2655	2855	2055	2255
0.01 uF	20	CK12BX103M	CKR11BX103M*	2656	2856	2056	2256

* Insert proper letter symbol for Failure Rate Designator:
M = 1% / 1000 Hours, P = 0.1% / 1000 Hours,
R = 0.01% / 1000 Hours, S = 0.001% / 1000 Hours

MIL-C-11015 & 39014 Multilayer Ceramic Capacitors

MALLORY

Multilayer Ceramic Capacitors

Cap	Tol %	MIL-C-11015/19	MIL-C-39014/05 Reference	39014/05 Failure Rate Levels			
				M	P	R	S
100 WVDC - Axial Leaded - CK13/M39014/05							
5600 pF	10	CK13BX562K	CKR12BX562K*	2657	2857	2057	2257
6800 pF	10	CK13BX682K	CKR12BX682K*	2658	2858	2058	2258
6800 pF	20	CK13BX682M	CKR12BX682M*	2659	2859	2059	2259
8200 pF	10	CK13BX822K	CKR12BX822K*	2660	2860	2060	2260
.01 uF	10	CK13BX103K	CKR12BX103K*	2661	2861	2061	2261
.01 uF	20	CK13BX103M	CKR12BX103M*	2662	2862	2062	2262

50 WVDC - Axial Leaded - CK13/M39014/05							
.012 uF	10	CK13BX123K	CKR12BX123K*	2663	2863	2063	2263
.015 uF	10	CK13BX153K	CKR12BX153K*	2664	2864	2064	2264
.015 uF	20	CK13BX153M	CKR12BX153M*	2665	2865	2065	2265
.018 uF	10	CK13BX183K	CKR12BX183K*	2666	2866	2066	2266
.022 uF	10	CK13BX223K	CKR12BX223K*	2667	2867	2067	2267
.022 uF	20	CK13BX223M	CKR12BX223M*	2668	2868	2068	2268
.027 uF	10	CK13BR273K	CKR12BX273K*	2669	2869	2069	2269
.033 uF	10	CK13BR333K	CKR12BX333K*	2670	2870	2070	2270
.033 uF	20	CK13BR333M	CKR12BX333M*	2671	2871	2071	2271
.039 uF	10	CK13BR393K	CKR12BX393K*	2672	2872	2072	2272
.047 uF	10	CK13BR473K	CKR12BX473K*	2673	2873	2073	2273
.047 uF	20	CK13BR473M	CKR12BX473M*	2674	2874	2074	2274

Cap	Tol %	MIL-C-11015/19	MIL-C-39014/05 Reference	39014/05 Failure Rate Levels			
				M	P	R	S
100 WVDC - Axial Leaded - CK15/M39014/05							
.056 uF	10		CKR15BX563K*	2706	2906	2106	2306
.068 uF	10		CKR15BX683K*	2707	2907	2107	2307
.068 uF	20		CKR15BX683M*	2708	2908	2108	2308
.082 uF	10		CKR15BX823K*	2709	2909	2109	2309
.1 uF	10	CK15BX104K	CKR15BX104K*	2710	2910	2110	2310
.1 uF	20	CK15BX104M	CKR15BX104M*	2711	2911	2111	2311
.12 uF	10	CK15BR124K	CKR15BR124K*	2712	2912	2112	2312
.15 uF	10	CK15BR154K	CKR15BR154K*	2713	2913	2113	2313
.15 uF	20	CK15BR154M	CKR15BR154M*	2714	2914	2114	2314
.18 uF	10	CK15BR184K	CKR15BR184K*	2715	2915	2115	2315
.22 uF	10	CK15BR224K	CKR15BR224K*	2716	2916	2116	2316
.22 uF	20	CK15BR224M	CKR15BR224M*	2717	2917	2117	2317
.27 uF	10	CK15BR274K	CKR15BR274K*	2718	2918	2118	2318

50 WVDC - Axial Leaded - CK15/M39014/05							
.33 uF	10	CK15BR334K	CKR15BR334K*	2719	2919	2119	2319
.33 uF	20	CK15BR334M	CKR15BR334M*	2720	2920	2120	2320
.47 uF	10	CK15BR474K	CKR15BR474K*	2721	2921	2121	2321
.47 uF	20	CK15BR474M	CKR15BR474M*	2722	2922	2122	2322
.68 uF	10		CKR15BR684K*	2723	2923	2123	2323
.68 uF	20		CKR15BR684M*	2724	2924	2124	2324
1.0 uF	10	CK15BR105K	CKR15BR105K*	2725	2925	2125	2325
1.0 uF	20	CK15BR105M	CKR15BR105M*	2726	2926	2126	2326

Cap	Tol %	MIL-C-11015/19	MIL-C-39014/05 Reference	39014/05 Failure Rate Levels			
				M	P	R	S
100 WVDC - Axial Leaded - CK14/M39014/05							
.012 uF	10	CK14BX123K	CKR14BX123K*	2675	2875	2075	2275
.015 uF	10	CK14BX153K	CKR14BX153K*	2676	2876	2076	2276
.015 uF	20	CK14BX153M	CKR14BX153M*	2677	2877	2077	2277
.018 uF	10	CK14BX183K	CKR14BX183K*	2678	2878	2078	2278
.022 uF	10	CK14BX223K	CKR14BX223K*	2679	2879	2079	2279
.022 uF	20	CK14BX223M	CKR14BX223M*	2680	2880	2080	2280
.027 uF	10	CK14BX273K	CKR14BX273K*	2681	2881	2081	2281
.033 uF	10	CK14BX333K	CKR14BX333K*	2682	2882	2082	2282
.033 uF	20	CK14BX333M	CKR14BX333M*	2683	2883	2083	2283
.039 uF	10	CK14BX393K	CKR14BX393K*	2684	2884	2084	2284
.047 uF	10	CK14BX473K	CKR14BX473K*	2685	2885	2085	2285
.047 uF	20	CK14BX473M	CKR14BX473M*	2686	2886	2086	2286
.056 uF	10	CK14BR563K	CKR14BR563K*	2693	2893	2093	2293
.068 uF	10	CK14BR683K	CKR14BR683K*	2694	2894	2094	2294
.068 uF	20	CK14BR683M	CKR14BR683M*	2695	2895	2095	2295
.082 uF	10	CK14BR823K	CKR14BR823K*	2696	2896	2096	2296
.1 uF	10	CK14BR104K	CKR14BR104K*	2697	2897	2097	2297
.1 uF	20	CK14BR104M	CKR14BR104M*	2698	2898	2098	2298

50 WVDC - Axial Leaded - CK14/M39014/05							
.056 uF	10		CKR14BX563K*	2687	2887	2087	2287
.068 uF	10		CKR14BX683K*	2688	2888	2088	2288
.068 uF	20		CKR14BX683M*	2689	2889	2089	2289
.082 uF	10		CKR14BX823K*	2690	2890	2090	2290
.1 uF	10		CKR14BX104K*	2691	2891	2091	2291
.1 uF	20		CKR14BX104M*	2692	2892	2092	2292
.12 uF	10	CK14BR124K	CKR14BR124K*	2699	2899	2099	2299
.15 uF	10	CK14BR154K	CKR14BR154K*	2700	2900	2100	2300
.15 uF	20	CK14BR154M	CKR14BR154M*	2701	2901	2101	2301
.18 uF	10	CK14BR184K	CKR14BR184K*	2702	2902	2102	2302
.22 uF	10	CK14BR224K	CKR14BR224K*	2703	2903	2103	2303
.22 uF	20	CK14BR224M	CKR14BR224M*	2704	2904	2104	2304
.27 uF	10	CK14BR274K	CKR14BR274K*	2705	2905	2105	2305

Cap	Tol %	MIL-C-11015/19	MIL-C-39014/05 Reference	39014/05 Failure Rate Levels			
				M	P	R	S
100 WVDC - Axial Leaded - CK16/M39014/05							
.47 uF	10	CK16BR474K	CKR16BR474K*	2727	2927	2127	2327
.47 uF	20	CK16BR474M	CKR16BR474M*	2728	2928	2128	2328
.68 uF	10		CKR16BR684K*	2729	2929	2129	2329
.68 uF	20		CKR16BR684M*	2730	2930	2130	2330

50 WVDC - Axial Leaded - CK16/M39014/05							
1 uF	10	CK16BR105K	CKR16BR105K*	2731	2931	2131	2331
1 uF	20	CK16BR105M	CKR16BR105M*	2732	2932	2132	2332
2.2 uF	10	CK16BR225K	CKR16BR225K*	2733	2933	2133	2333
2.2 uF	20	CK16BR225M	CKR16BR225M*	2734	2934	2134	2334
3.3 uF	10	CK16BR335K	CKR16BR335K*	2735	2935	2135	2335
3.3 uF	20	CK16BR335M	CKR16BR335M*	2736	2936	2136	2336

Add 'TR' to end of part number for Tape & Reel
 CK13 - 5,000 per reel, CKR12 - 5,000 per reel
 CK14 - 3,000 per reel, CKR14 - 3,000 per reel
 CK15 - 500 per reel, CKR15 - 500 per reel
 CK16 - 300 per reel, CKR16 - 300 per reel
 (Available in full reels only)

* Insert proper letter symbol for Failure Rate Designator:
 M = 1% / 1000 Hours, P = 0.1% / 1000 Hours,
 R = 0.01% / 1000 Hours, S = 0.001% / 1000 Hours

TO ORDER MIL-C-11015 PARTS:

Order by CK part number shown above.
 Example: CK05BX104M

TO ORDER MIL-C-39014 PARTS:

Indicate the prefix M39014/-- followed by the applicable MIL dash number.
 Example: For M39014/01-1594 (CKR05BX104MS); order M39014/011594

Series	Description	Lead Spacing	Capacitance Range	Voltage Range	Temperature Range (°C)	Standard Cap Tolerance % (±)	Page
--------	-------------	--------------	-------------------	---------------	------------------------	------------------------------	------

General Purpose

150	Metallized Polyester Axial Leads	N/A	0.001 to 10 μ F	63 to 1000 VDC 40 to 250 VAC	-55 to +125	5, 10, 20	143
160	Metallized Polyester Radial Leads	.394" to 1.083" 10mm to 27.5mm	0.0022 to 10 μ F	63 to 1000 VDC 40 to 250 VAC	-55 to +125	5, 10, 20	146
167/ 184	Metallized Polyester Radial Leads	.295" 7.5mm	0.001 to 1.0 μ F	63 to 630 VDC 40 to 220 VAC	-55 to +125	5, 10, 20	150
168/ 185	Metallized Polyester Radial Leads	.200" 5.0mm	0.001 to 1.0 μ F	50 to 400 VDC 30 to 200 VAC	-55 to +125	5, 10, 20	153
170	Metallized Polypropylene Axial Leads	N/A	0.001 to 4.7 μ F	160 to 630 VDC 90 to 250 VAC	-55 to +105	5, 10, 20	156
171	Metallized Polypropylene Radial Leads	.295" to 1.083" 7.5mm to 27.5mm	0.0022 to 3.3 μ F	160 to 630 VDC 90 to 250 VAC	-55 to +105	5, 10, 20	159
PVC	Polyester - Foil (to 600V) Polypropylene Foil (1000-2000V) Radial Leads	.500" to 1.344" 12.7mm to 34.1mm	0.001 to .68 μ F	100 to 2000 VDC 70 to 500 VAC	-55 to +105 (1600 - 2000 VDC) -55 to +125 (100 - 1000 VDC)	10	161

Precision Film Capacitors

SX	Polystyrene Foil Axial Leads	N/A	20 pF to 0.1 μ F	33 to 630 VDC	-40 to +70	5% SX 2.5% SXK to SXM	165
-----------	------------------------------	-----	----------------------	---------------	------------	--------------------------	-----

Interference Suppressor

158X	Metallized Polyester Radial Across-the-Line (X2) Type Suppressor Capacitor	.591" to 1.48" 15mm to 37.5mm	.01 to 2.2 μ F	250 VAC	-40 to +100	10, 20	168
-------------	--	----------------------------------	--------------------	---------	-------------	--------	-----

QUENCHARC® Noise and Arc Suppressor/RC Snubber Network

Q/QRL	Metallized Polyester Capacitors in series with a Carbon Composition Resistor	.82" to 1.20" 20.8mm to 30.5mm	.10, .50 and 1.0 μ F	200VDC(125VAC) 600VDC(250VAC)	-55 to +85	Capacitor - 20 Resistor - 10	169
--------------	--	-----------------------------------	--------------------------	----------------------------------	------------	---------------------------------	-----

Note: Other QUENCHARC® ratings available by special request

Typical Curves Polyester and Polypropylene Film Capacitors



DC Film Curves

Capacitance Change as a function of Frequency (Room Temperature)

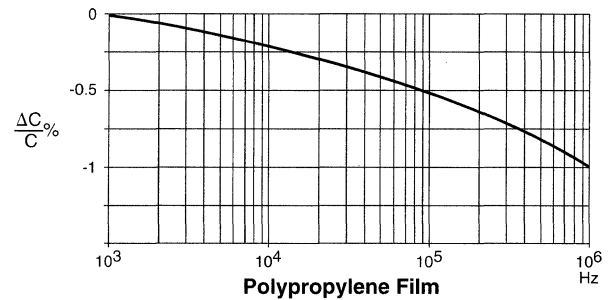
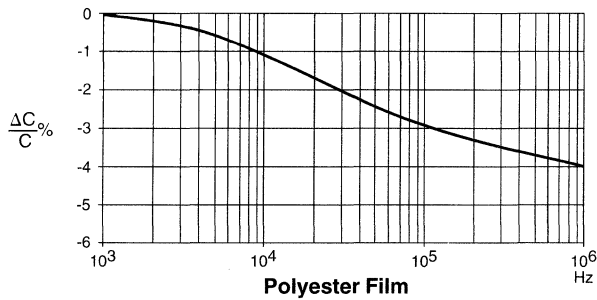

Capacitance Variation as a function of Temperature @ 1KHz

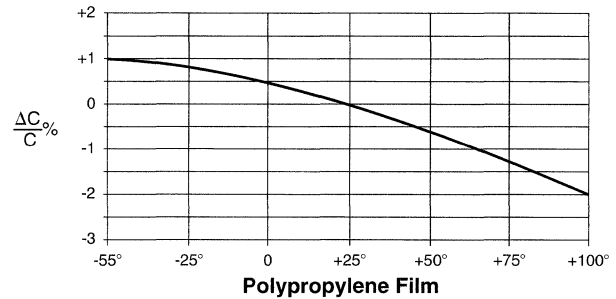
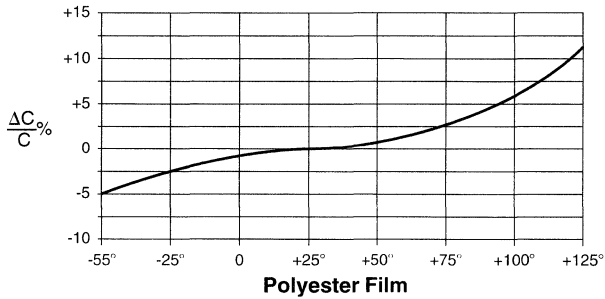

Dissipation Factor Variation as a function of Temperature at 1KHz

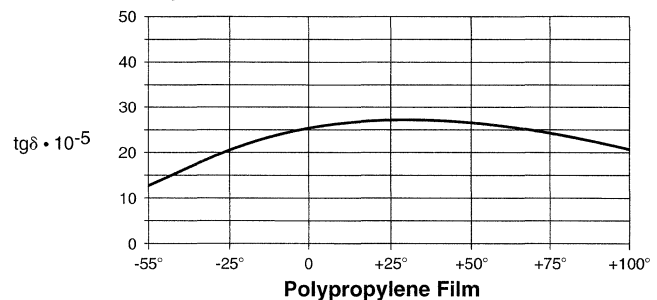
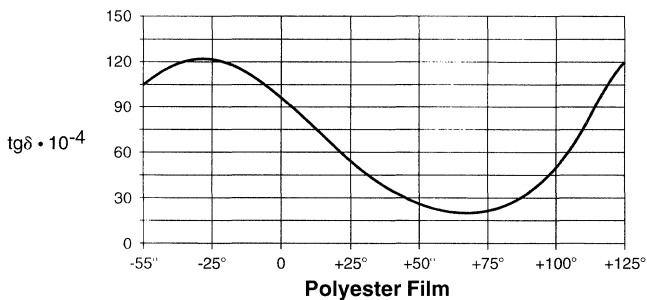

Dissipation Factor Change as a function of Frequency (Room Temperature)

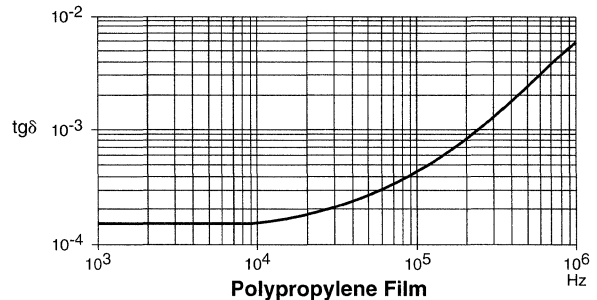
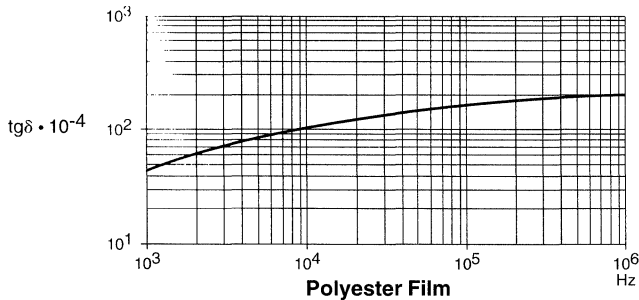

Insulation Resistance as a function of Temperature

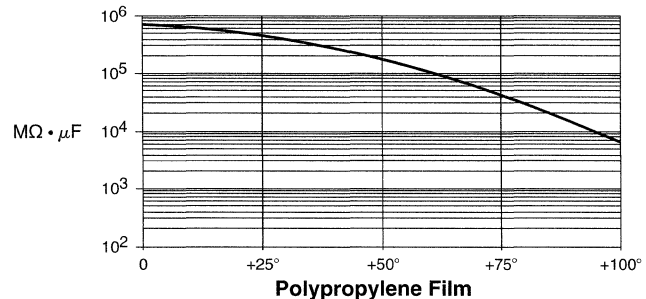
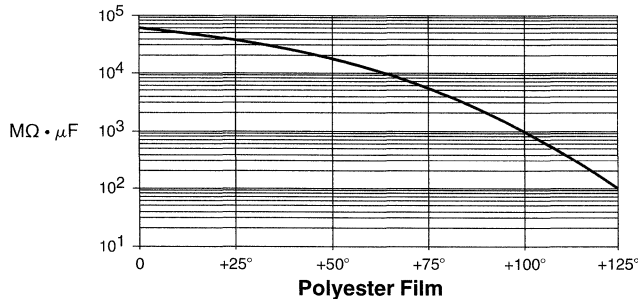

150 Series Metallized Polyester / Axial Leads

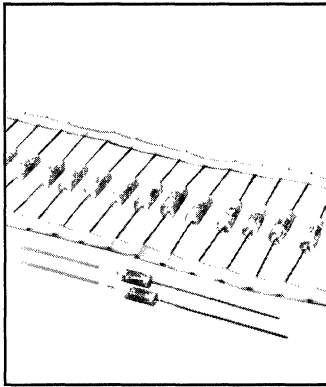

- Low Leakage
- Non-Polar
- Axial Leads
Lead Material - Tinned Copper Wire (Min. Lead content 5%)
- Available Tape and Reel
- Tape Wrapped with Epoxy End Fill
- Non Inductively Wound
- Flame Retardant Polyester Wrap Meets UL510
- Epoxy End Fill Meets UL94V0

GENERAL SPECIFICATIONS

Operating Temperature: -55°C to +125°C with voltage derating above 85°C

Voltage Range: 63 VDC to 1000 VDC

Capacitance Range: 0.001 μ F to 10 μ F

Capacitance Tolerance: \pm 5%, \pm 10%, \pm 20%

Total Self Inductance (L): 1nH maximum per 1mm lead and capacitor length

Dielectric Withstand: 1.6 x Vn applied for 2 sec at +25°C \pm 5°C

CECC Approval: Detail Specification 30401-021

Excellent choice for general purpose applications such as blocking, bypass, decoupling, smoothing and some timing, energy storage/discharge and arc suppression.

Dissipation Factor (DF) $tg\delta \times 10^{-4}$ at +25°C \pm 5°C

	KHz	C \leq 0.1 μ F	0.1 μ F<C \leq 1 μ F	C>1 μ F
Max Value	1	80	80	100
Typical Value	10	150	150	—
Value	100	250	—	—

Maximum Pulse Rise Time dv/dt and Pulse Characteristic (Wo)

Vn	L max				
	\leq 16.5	19-20.5	26.5-28	31.5-33	
50-63	4	2	1.5	1	dv/dt (V/ μ sec)
	504	252	189	126	Wo (V ² / μ sec)
100	5	3	2	1	dv/dt (V/ μ sec)
	1,000	600	400	300	Wo (V ² / μ sec)
250	10	7	4	2.5	dv/dt (V/ μ sec)
	5,000	3,500	2,000	1,250	Wo (V ² / μ sec)
400	13.5	10	6.5	4	dv/dt (V/ μ sec)
	10,800	8,000	5,200	3,200	Wo (V ² / μ sec)
630	20	15	10	6	dv/dt (V/ μ sec)
	25,200	18,900	12,600	7,560	Wo (V ² / μ sec)

If the working voltage (V) is less than the nominal voltage (Vn), the capacitor can work at higher dv/dt. In this case, the maximum value allowed is obtained by multiplying the above value (See table dv/dt) with the ratio Vn/V. The pulse characteristic (Wo) is a function of the peak-to-peak voltage and may not exceed the value given in the above table.

Tape and Reel Specifications[^]

L Max (Body Length)		Lead Spacing		Distance Between Reel Flanges		Class
Inches	mm	Inches	mm	Inches	mm	
\leq .433	\leq 11	2.06	52.4	3.0	75	1
.551 - .808	14 - 20.5	2.5	63.6	3.4	86	2
\geq 1.03	\geq 26	2.87	73	3.7	95	3

[^] Add class number (1, 2, or 3) to Catalog Number to indicate tape and reel

Diameter		Quantity per Reel
Inches	mm	
.197	5	3,000
.236 thru .256	6.0 thru 6.5	1,200
.276	7	1,100
.315 thru .346	8 thru 8.5	800
.354 thru .413	9 thru 10.5	500
.433 thru .512	11 thru 13	300
.551 thru .571	14 thru 14.5	200
>.571	>14.5	Not available

Test Method and Performance

Insulation Resistance

Test Conditions

Temperature: 25°C \pm 5°C
Voltage Charge Time: 1 minute
Voltage Charge: 50 VDC for Vn < 100 VDC
100 VDC for Vn \geq 100 VDC

Performance

For Vn > 100 VDC: \geq 30,000 M Ω for C \leq 0.33 μ F
 \geq 10,000 M Ω x μ F for C > 0.33 μ F

For Vn \leq 100 VDC: \geq 10,000 M Ω for C \leq 0.1 μ F
 \geq 1,000 M Ω x μ F for C > 0.1 μ F

Damp Heat Test

Test Conditions

Temperature: +40°C
Relative Humidity: 95%
Test Duration: 21 days

Performance

Capacitance Change Δ C/C: \pm 5%
DF Change Δ tg δ : \leq 50 x 10⁻⁴ at 1KHz
Insulation Resistance: \geq 50% of limit value

Life Test

Test Conditions

Temperature: +85°C
Test Duration: 1000 h
Voltage Applied: 1.25 x Vn

Performance

Capacitance Change Δ C/C: \leq \pm 5%
DF Change Δ tg δ : \leq 30 x 10⁻⁴ at 10KHz for C \leq 1 μ F
 \leq 20 x 10⁻⁴ at 1KHz for C > 1 μ F
Insulation Resistance: \geq 50% of limit value

Soldering

Test Conditions

Soldering Temperature: 260°C \pm 5°C
Soldering Duration: 10 sec \pm 1 sec

Performance

Capacitance Change Δ C/C: \leq \pm 2%
DF Change Δ tg δ : \leq 30 x 10⁻⁴ at 10 KHz for C \leq 1 μ F
 \leq 20 x 10⁻⁴ at 1 KHz for C > 1 μ F
Insulation Resistance: \geq 50% of limit value

Long Term Stability (after two years)

Storage Performance

Standard Environmental Conditions
Capacitance Change Δ C/C: \leq \pm 3% for C \leq 0.1 μ F
 \leq \pm 2% for C > 0.1 μ F

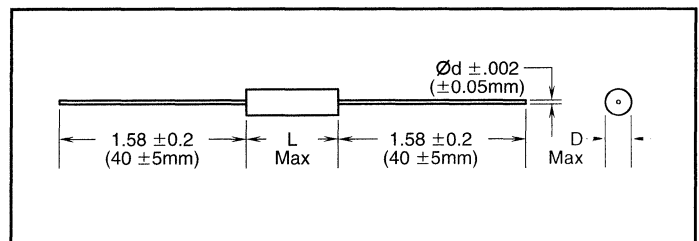

150 Series Metallized Polyester / Axial Leads

MALLORY

General Purpose Film

Catalog Number	Cap μ F	Inches			Millimeters		
		D Max	L Max	ϕ d	D Max	L Max	ϕ d
63 VDC/40 VAC							
150154*63AA^	.15	.197	.433	.024	5	11	.6
150184*63AA^	.18	.197	.433	.024	5	11	.6
150224*63BB^	.22	.236	.650	.024	6	16.5	.6
150274*63BB^	.27	.236	.650	.024	6	16.5	.6
150334*63BB^	.33	.236	.650	.024	6	16.5	.6
150394*63CB^	.39	.256	.650	.024	6.5	16.5	.6
150474*63DB^	.47	.276	.650	.024	7	16.5	.6
150564*63DB^	.56	.276	.650	.024	7	16.5	.6
150684*63DC^	.68	.276	.807	.024	7	20.5	.6
150824*63EC^	.82	.315	.807	.031	8	20.5	.8
150105*63EC^	1.0	.315	.807	.031	8	20.5	.8
150155*63HC^	1.5	.374	.807	.031	9.5	20.5	.8
150225*63HE^	2.2	.374	1.102	.031	9.5	28	.8
150335*63KE^	3.3	.433	1.102	.031	11	28	.8
150475*63ME^	4.7	.492	1.299	.031	12.5	33	.8
150685*63QF^	6.8	.571	1.299	.031	14.5	33	.8
150106*63TF^	10	.610	1.299	.031	15.5	33	.8

100 VDC/63 VAC							
150683*100AA^	.068	.197	.433	.024	5	11	.6
150823*100AA^	.082	.197	.433	.024	5	11	.6
150104*100AA^	.1	.197	.433	.024	5	11	.6
150124*100BB^	.12	.236	.650	.024	6	16.5	.6
150154*100BB^	.15	.236	.650	.024	6	16.5	.6
150184*100CB^	.18	.256	.650	.024	6.5	16.5	.6
150224*100CB^	.22	.256	.650	.024	6.5	16.5	.6
150274*100CB^	.27	.256	.650	.024	6.5	16.5	.6
150334*100EB^	.33	.315	.650	.031	8	16.5	.8
150394*100EB^	.39	.315	.650	.031	8	16.5	.8
150474*100DC^	.47	.276	.807	.031	7	20.5	.8
150564*100EC^	.56	.315	.807	.031	8	20.5	.8
150684*100FC^	.68	.335	.807	.031	8.5	20.5	.8
150824*100HC^	.82	.374	.807	.031	9.5	20.5	.8
150105*100IC^	1.0	.394	.807	.031	10	20.5	.8
150155*100IE^	1.5	.394	1.102	.031	10	28	.8
150225*100LE^	2.2	.453	1.102	.031	11.5	28	.8
150335*100PE^	3.3	.531	1.102	.031	13.5	28	.8
150475*100RF^	4.7	.591	1.299	.031	15	33	.8
150685*100WF^	6.8	.689	1.299	.031	17.5	33	.8
150106*100YF^	10	.807	1.299	.031	20.5	33	.8

250 VDC/160 VAC							
150123*250AA^	.012	.197	.433	.024	5	11	.6
150153*250AA^	.015	.197	.433	.024	5	11	.6
150183*250AA^	.015	.197	.433	.024	5	11	.6
150183*250AA^	.018	.197	.433	.024	5	11	.6
150223*250AA^	.022	.197	.433	.024	5	11	.6
150273*250AA^	.027	.197	.433	.024	5	11	.6
150333*250AA^	.033	.197	.433	.024	5	11	.6
150393*250AA^	.039	.197	.433	.024	5	11	.6
150473*250AA^	.047	.197	.433	.024	5	11	.6
150563*250AA^	.056	.197	.433	.024	5	11	.6
150683*250BB^	.068	.236	.650	.024	6	16.5	.6
150823*250BB^	.082	.236	.650	.024	6	16.5	.6
150104*250CB^	.10	.256	.650	.024	6.5	16.5	.6
150124*250DB^	.12	.276	.650	.024	7	16.5	.6
150154*250EB^	.15	.315	.650	.031	8	16.5	.8
150184*250EB^	.18	.315	.650	.031	8	16.5	.8
150224*250FB^	.22	.335	.650	.031	8.5	16.5	.8
150274*250EC^	.27	.315	.807	.031	8	20.5	.8
150334*250FC^	.33	.335	.807	.031	8.5	20.5	.8
150394*250GC^	.39	.354	.807	.031	9	20.5	.8
150474*250HC^	.47	.374	.807	.031	9.5	20.5	.8
150564*250IC^	.56	.394	.807	.031	10	20.5	.8
150684*250GE^	.68	.354	1.102	.031	9	28	.8
150824*250HE^	.82	.374	1.102	.031	9.5	28	.8
150105*250JE^	1.0	.413	1.102	.031	10.5	28	.8
150155*250ME^	1.5	.492	1.102	.031	12.5	28	.8
150225*250PF^	2.2	.531	1.299	.031	13.5	33	.8
150335*250TF^	3.3	.610	1.299	.031	15.5	33	.8
150475*250XF^	4.7	.728	1.299	.031	18.5	33	.8
150685*250ZF^	6.8	.845	1.299	.031	21.5	33	.8

Catalog Number	Cap μ F	Inches			Millimeters		
		D Max	L Max	ϕ d	D Max	L Max	ϕ d
400 VDC/200 VAC							
150822*400AA^	.0082	.197	.433	.024	5	11	.6
150103*400AA^	.01	.197	.433	.024	5	11	.6
150123*400AA^	.012	.197	.433	.024	5	11	.6
150153*400BB^	.015	.236	.650	.024	6	16.5	.6
150183*400BB^	.018	.236	.650	.024	6	16.5	.6
150223*400BB^	.022	.236	.650	.024	6	16.5	.6
150273*400BB^	.027	.236	.650	.024	6	16.5	.6
150333*400BB^	.033	.236	.650	.024	6	16.5	.6
150393*400CB^	.039	.256	.650	.024	6.5	16.5	.6
150473*400DB^	.047	.276	.650	.024	7	16.5	.6
150563*400EB^	.056	.315	.650	.024	8	16.5	.6
150683*400DC^	.068	.276	.807	.024	7	20.5	.6
150823*400EC^	.082	.315	.807	.031	8	20.5	.8
150104*400EC^	.10	.315	.807	.031	8	20.5	.8
150154*400GC^	.15	.354	.807	.031	9	20.5	.8
150184*400EE^	.18	.315	1.102	.031	8	28	.8
150224*400FE^	.22	.335	1.102	.031	8.5	28	.8
150274*400GE^	.27	.354	1.102	.031	9	28	.8
150334*400IE^	.33	.394	1.102	.031	10	28	.8
150394*400JE^	.39	.413	1.102	.031	10.5	28	.8
150474*400LF^	.47	.453	1.299	.031	11.5	33	.8
150564*400LF^	.56	.453	1.299	.031	11.5	33	.8
150684*400MF^	.68	.492	1.299	.031	12.5	33	.8
150824*400PF^	.82	.531	1.299	.031	13.5	33	.8
150105*400QF^	1.0	.571	1.299	.031	14.5	33	.8
150155*400WF^	1.5	.689	1.299	.031	17.5	33	.8
150225*400YF^	2.2	.807	1.299	.031	20.5	33	.8

630 VDC/220 VAC							
150102*630AA^	.001	.197	.433	.024	5	11	.6
150122*630AA^	.0012	.197	.433	.024	5	11	.6
150152*630AA^	.0015	.197	.433	.024	5	11	.6
150182*630AA^	.0018	.197	.433	.024	5	11	.6
150222*630AA^	.0022	.197	.433	.024	5	11	.6
150272*630AA^	.0027	.197	.433	.024	5	11	.6
150332*630AA^	.0033	.197	.433	.024	5	11	.6
150392*630AA^	.0039	.197	.433	.024	5	11	.6
150472*630AA^	.0047	.197	.433	.024	5	11	.6
150562*630AA^	.0056	.197	.433	.024	5	11	.6
150682*630AA^	.0068	.197	.433	.024	5	11	.6
150822*630BB^	.0082	.236	.650	.024	6	16.5	.6
150103*630BB^	.01	.236	.650	.024	6	16.5	.6
150123*630BB^	.012	.236	.650	.024	6	16.5	.6
150153*630BB^	.015	.236	.650	.024	6	16.5	.6
150183*630CB^	.018	.256	.650	.024	6.5	16.5	.6
150223*630DB^	.022	.276	.650	.024	7	16.5	.6
150273*630CC^	.027	.256	.807	.024	6.5	20.5	.6
150333*630EC^	.033	.315	.807	.031	8	20.5	.8
150393*630EC^	.039	.315	.807	.031	8	20.5	.8
150473*630EC^	.047	.315	.807	.031	8	20.5	.8
150563*630FC^	.056	.335	.807	.031	8.5	20.5	.8
150683*630GC^	.068	.354	.807	.031	9	20.5	.8
150823*630HC^	.082	.374	.807	.031	9.5	20.5	.8
150104*630FE^	.10	.335	1.102	.031	8.5	28	.8
150124*630GE^	.12	.354	1.102	.031	9	28	.8
150154*630IE^	.15	.394	1.102	.031	10	28	.8
150184*630JE^	.18	.413	1.102	.031	10.5	28	.8
150224*630LE^	.22	.453	1.102	.031	11.5	28	.8
150274*630ME^	.27	.492	1.102	.031	12.5	28	.8
150334*630NF^	.33	.512	1.299	.031	13	33	.8
150394*630QF^	.39	.571	1.299	.031	14.5	33	.8
150474*630RF^	.47	.591	1.299	.031	15	33	.8
150564*630TF^	.56	.630	1.299	.031	16	33	.8
150684*630WF^	.68	.689	1.299	.031	17.5	33	.8
150824*630XF^	.82	.728	1.299	.031	18.5	33	.8
150105*630YF^	1.0	.807	1.299	.031	20.5	33	.8

* Indicate capacitance tolerance

J = $\pm 5\%$

K = $\pm 10\%$

M = $\pm 20\%$

^ If ordering Tape & Reel, insert 1, 2, or 3

(See page 143 to determine which class applies)

150 Series Metallized Polyester / Axial Leads



Catalog Number	Cap μ F	Inches			Millimeters		
		D Max	L Max	\varnothing d	D Max	L Max	\varnothing d
1000 VDC/250 VAC							
150102*1000CB^	.001	.256	.650	.031	6.5	16.5	.8
150152*1000CB^	.0015	.256	.650	.031	6.5	16.5	.8
150222*1000CB^	.0022	.256	.650	.031	6.5	16.5	.8
150332*1000CB^	.0033	.256	.650	.031	6.5	16.5	.8
150472*1000DB^	.0047	.276	.650	.031	7.0	16.5	.8
150682*1000EB^	.0068	.315	.650	.031	8.0	16.5	.8
150103*1000DC^	.01	.276	.807	.031	7.0	20.5	.8
150153*1000FC^	.015	.335	.807	.031	8.5	20.5	.8
150223*1000HC^	.022	.374	.807	.031	9.5	20.5	.8

Catalog Number	Cap μ F	Inches			Millimeters		
		D Max	L Max	\varnothing d	D Max	L Max	\varnothing d
1000 VDC/250 VAC							
150333*1000FE^	.033	.335	1.102	.031	8.5	28.0	.8
150473*1000HE^	.047	.374	1.102	.031	9.5	28.0	.8
150683*1000KE^	.068	.433	1.102	.031	11.0	28.0	.8
150104*1000NE^	.1	.512	1.102	.031	13.0	28.0	.8
150154*1000OF^	.15	.551	1.299	.031	14.0	33.0	.8
150224*1000WF^	.22	.650	1.299	.031	16.5	33.0	.8
150334*1000YF^	.33	.787	1.299	.031	20.0	33.0	.8
150474*1000Z1F^	.47	.945	1.299	.031	24.0	33.0	.8

* Indicate capacitance tolerance

J = \pm 5%

K = \pm 10%

M = \pm 20%

^ If ordering Tape & Reel, insert 1, 2, or 3

(See page 143 to determine which class applies)

160 Series Metallized Polyester / Radial Leads

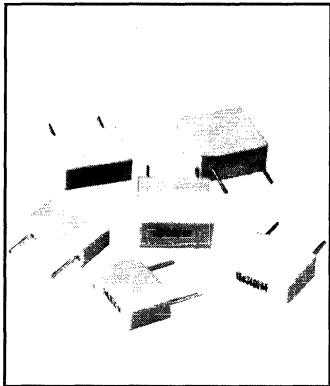

- Radial Leaded (10 mm to 27.5 mm)
- Non Inductively Wound
- Non-Polar
- Flame Retardant Case Meets UL94V0
- Epoxy Encapsulant Meets UL94V0
- Lead Material
Tinned Copper Clad Steel

Excellent choice for general purpose applications such as bypass, decoupling, smoothing and some timing, energy storage/discharge and arc suppression.

GENERAL SPECIFICATIONS

Operating Temperature:
-55°C to +125°C with voltage derating above 85°C

Voltage Range:
63 VDC to 1000 VDC

Capacitance Range:
0.0022 μ F to 10 μ F

Capacitance Tolerance:
 $\pm 5\%$, $\pm 10\%$, $\pm 20\%$

CECC Approval:
Detail Specification 30401-009

Total Self Inductance (L):

Pitch (mm)	10	15	22.5	27.5
L (nH) \approx	9	10	18	18

Dielectric Withstand:

1.6 x Vn applied for 2 sec at +25°C $\pm 5^\circ$ C

Dissipation Factor (DF):

$\text{tg}\delta \times 10^{-4}$ at +25°C $\pm 5^\circ$ C

KHz	C $\leq 1\mu$ F	C $> 1\mu$ F
1	≤ 100	≤ 100
10	≤ 150	

Maximum Pulse Rise Time (dv/dt)

Vn	(Pitch mm)			
	10	15	22.5	27.5
63	3	1.5	1	1
100/160	6/8	3	2	1
250	11	7	4	3
400	20	10	5.5	5
630	30	15	8	7
1000	60	25	15	10

If the working voltage (V) is less than the nominal voltage (Vn), the capacitor can work at higher dv/dt. In this case, the maximum value allowed is obtained by multiplying the above value (See table dv/dt) with the ratio Vn/V.

Test Method and Performance

Insulation Resistance	
Test Conditions	
Temperature	25°C $\pm 5^\circ$ C
Voltage Charge Time	1 minute
Voltage Charge	50 VDC for Vn < 100 VDC 100 VDC for Vn \geq 100 VDC
Performance	
For Vn > 100 VDC	$\geq 30,000 \text{ M}\Omega$ for C $\leq 0.33\mu$ F $\geq 10,000 \text{ M}\Omega \times \mu$ F for C > 0.33 μ F
For Vn \leq 100 VDC	$\geq 10,000 \text{ M}\Omega$ for C $\leq 0.1\mu$ F $\geq 1,000 \text{ M}\Omega \times \mu$ F for C > 0.1 μ F
Damp Heat Test	
Test Conditions	
Temperature	+40°C
Relative Humidity	95%
Test Duration	21 days
Performance	
Capacitance Change Δ C/C	$\leq \pm 5\%$
DF Change Δ tg δ	$\leq 50 \times 10^{-4}$ at 1KHz
Insulation Resistance	$\geq 50\%$ of limit value
Life Test	
Test Conditions	
Temperature	+85°C
Test Duration	1000 h
Voltage Applied	1.25 x Vn
Performance	
Capacitance Change Δ C/C	$\leq \pm 5\%$
DF Change Δ tg δ	$\leq 30 \times 10^{-4}$ at 10KHz for C $\leq 1\mu$ F $\leq 20 \times 10^{-4}$ at 1KHz for C > 1 μ F
Insulation Resistance	$\geq 50\%$ of limit value
Soldering	
Test Conditions	
Soldering Temperature	260°C $\pm 5^\circ$ C
Soldering Duration	10 sec ± 1 sec
Performance	
Capacitance Change Δ C/C	$\leq \pm 2\%$
DF Change Δ tg δ	$\leq 30 \times 10^{-4}$ at 10KHz for C $\leq 1\mu$ F $\leq 20 \times 10^{-4}$ at 1KHz for C > 1 μ F
Long Term Stability (after two years)	
Storage Performance	Standard Environmental Conditions
Capacitance Change Δ C/C	$\leq \pm 3\%$ for C $\leq 0.1\mu$ F $\leq \pm 2\%$ for C > 0.1 μ F
Corona (Partial Discharge Inception Voltage)	200 VAC for 100 VDC, 200 VDC 250 VAC for 400 VDC, 630 VDC, 1000 VDC

Outline Dimensions

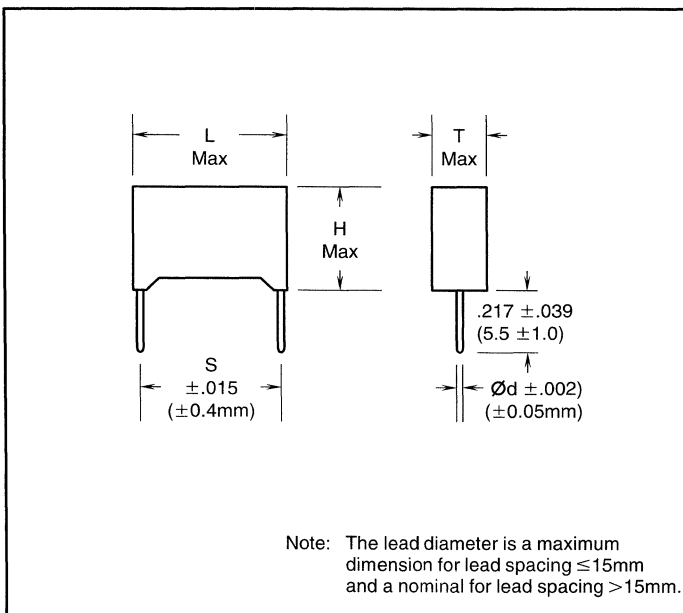

160 Series Metallized Polyester / Radial Leads

MALLORY

Catalog Number	Cap μ F	Inches					Millimeters				
		L	T	H	S	\varnothing d	L	T	H	S	\varnothing d
63 VDC/40 VAC											
160224*63C	.22	.512	.157	.374	.394	.031	13	4	9.5	10	.8
160274*63C	.27	.512	.157	.374	.394	.031	13	4	9.5	10	.8
160334*63C	.33	.512	.157	.374	.394	.031	13	4	9.5	10	.8
160394*63C	.39	.512	.157	.374	.394	.031	13	4	9.5	10	.8
160474*63D	.47	.512	.197	.433	.394	.031	13	5	11	10	.8
160564*63D	.56	.512	.197	.433	.394	.031	13	5	11	10	.8
160684*63D	.68	.512	.197	.433	.394	.031	13	5	11	10	.8
160684*63F	.68	.709	.197	.433	.591	.031	18	5	11	15	.8
160824*63E	.82	.512	.236	.472	.394	.031	13	6	12	10	.8
160824*63F	.82	.709	.197	.433	.591	.031	18	5	11	15	.8
160105*63E	1.0	.512	.236	.472	.394	.031	13	6	12	10	.8
160105*63F	1.0	.709	.197	.433	.591	.031	18	5	11	15	.8
160155*63F	1.5	.709	.197	.433	.591	.031	18	5	11	15	.8
160225*63G	2.2	.709	.295	.571	.591	.031	18	6	12	15	.8
160335*63M	3.3	1.043	.276	.630	.886	.031	26.5	7	16	22.5	.8
160475*63N	4.7	1.043	.335	.669	.886	.031	26.5	8.5	17	22.5	.8
160685*63O	6.8	1.043	.394	.748	.886	.031	26.5	10	19	22.5	.8
160106*63P	10	1.260	.433	.787	1.083	.031	32	11	20	27.5	.8
100 VDC/63 VAC											
# 160104*100C	.10	.512	.157	.374	.394	.031	13	4	9.5	10	.8
160124*100C	.12	.512	.157	.374	.394	.031	13	4	9.5	10	.8
160154*100C	.15	.512	.157	.374	.394	.031	13	4	9.5	10	.8
160184*100C	.18	.512	.157	.374	.394	.031	13	4	9.5	10	.8
160224*100D	.22	.512	.197	.433	.394	.031	13	5	11	10	.8
160274*100D	.27	.512	.197	.433	.394	.031	13	5	11	10	.8
160334*100E	.33	.512	.236	.472	.394	.031	13	6	12	10	.8
160334*100F	.33	.709	.197	.433	.591	.031	18	5	11	15	.8
160394*100D	.39	.512	.197	.433	.394	.031	13	5	11	10	.8
160394*100F	.39	.709	.197	.433	.591	.031	18	5	11	15	.8
160474*100E	.47	.512	.236	.472	.394	.031	13	6	12	10	.8
160474*100F	.47	.709	.197	.433	.591	.031	18	5	11	15	.8
160564*100G	.56	.709	.236	.472	.591	.031	18	6	12	15	.8
160684*100G	.68	.709	.236	.472	.591	.031	18	6	12	15	.8
160824*100H	.82	.709	.295	.531	.591	.031	18	7.5	13.5	15	.8
160105*100H	1.0	.709	.295	.531	.591	.031	18	7.5	13.5	15	.8
160155*100M	1.5	1.043	.276	.630	.886	.031	26.5	7	16	22.5	.8
160225*100N	2.2	1.043	.335	.669	.886	.031	26.5	8.5	17	22.5	.8
160335*100O	3.3	1.043	.394	.748	.886	.031	26.5	10	19	22.5	.8
160475*100P	4.7	1.260	.433	.787	1.083	.031	32	11	20	27.5	.8
160685*100Q	6.8	1.260	.512	.886	1.083	.031	32	13	22.5	27.5	.8
160106*100S	10	1.457	.709	1.299	1.083	.031	32	18	33	27.5	.8
250 VDC/160 VAC											
160333*250C	.033	.512	.157	.374	.394	.031	13	4	9.5	10	.8
160393*250C	.039	.512	.157	.374	.394	.031	13	4	9.5	10	.8
160473*250C	.047	.512	.157	.374	.394	.031	13	4	9.5	10	.8
160563*250C	.056	.512	.157	.374	.394	.031	13	4	9.5	10	.8
160683*250C	.068	.512	.157	.374	.394	.031	13	4	9.5	10	.8
160823*250C	.082	.512	.157	.374	.394	.031	13	4	9.5	10	.8
160104*250D	.10	.512	.197	.433	.394	.031	13	5	11	10	.8
160104*250F	.10	.709	.197	.433	.591	.031	18	5	11	15	.8
160124*250D	.12	.512	.197	.433	.394	.031	13	5	11	10	.8
160124*250F	.12	.709	.197	.433	.591	.031	18	5	11	15	.8
160154*250E	.15	.512	.236	.472	.394	.031	13	6	12	10	.8
160154*250F	.15	.709	.197	.433	.591	.031	18	5	11	15	.8
160184*250E	.18	.512	.236	.472	.394	.031	13	6	12	10	.8
160184*250F	.18	.709	.197	.433	.591	.031	18	5	11	15	.8
160224*250F	.22	.709	.197	.433	.591	.031	18	5	11	15	.8
160274*250G	.27	.709	.236	.472	.591	.031	18	6	12	15	.8
160334*250G	.33	.709	.236	.472	.591	.031	18	6	12	15	.8
160394*250H	.39	.709	.295	.531	.591	.031	18	7.5	13.5	15	.8
160474*250H	.47	.709	.295	.531	.591	.031	18	7.5	13.5	15	.8
160474*250L	.47	1.043	.236	.591	.886	.031	26.5	6	15	22.5	.8
160564*250I	.56	.709	.335	.571	.591	.031	18	8.5	14.5	15	.8
160564*250M	.56	1.043	.276	.630	.886	.031	26.5	7	16	22.5	.8
160684*250I	.68	.709	.335	.571	.591	.031	18	8.5	14.5	15	.8
160684*250M	.68	1.043	.276	.630	.886	.031	26.5	7	16	22.5	.8
160824*250M	.82	1.043	.276	.630	.886	.031	26.5	7	16	22.5	.8

* Indicate capacitance tolerance: J = \pm 5%, K = \pm 10%, M = \pm 20%

Also available in 160 VDC

North American Capacitor Company/P.O. Box 1284/Indianapolis IN 46206-1284/Phone: (317)273-0090/Fax: (317)273-2400

160 Series Metallized Polyester / Radial Leads

MALLORY

Catalog Number	Cap μ F	Inches					Millimeters				
		L	T	H	S	\varnothing d	L	T	H	S	\varnothing d
250 VDC/160 VAC											
160105*250N	1.0	1.043	.335	.669	.886	.031	26.5	8.5	17	22.5	.8
160155*250O	1.5	1.043	.394	.748	.886	.031	26.5	10	19	22.5	.8
160225*250P	2.2	1.260	.433	.787	1.083	.031	32	11	20	27.5	.8
160335*250Q	3.3	1.260	.512	.886	1.083	.031	32	13	22.5	27.5	.8
160475*250R	4.7	1.260	.591	1.181	1.083	.031	32	15	30	27.5	.8
160685*250S	6.8	1.457	.709	1.299	1.083	.031	32	18	33	27.5	.8
400 VDC/200 VAC											
160123*400C	.012	.512	.157	.374	.394	.031	13	4	9.5	10	.8
160153*400C	.015	.512	.157	.374	.394	.031	13	4	9.5	10	.8
160183*400C	.018	.512	.157	.374	.394	.031	13	4	9.5	10	.8
160223*400C	.022	.512	.157	.374	.394	.031	13	4	9.5	10	.8
160273*400C	.027	.512	.157	.374	.394	.031	13	4	9.5	10	.8
160333*400D	.033	.512	.197	.433	.394	.031	13	5	11	10	.8
160393*400D	.039	.512	.197	.433	.394	.031	13	5	11	10	.8
160473*400E	.047	.512	.236	.472	.394	.031	13	6	12	10	.8
160473*400F	.047	.709	.197	.433	.591	.031	18	5	11	15	.8
160563*400F	.056	.709	.197	.433	.591	.031	18	5	11	15	.8
160683*400F	.068	.709	.197	.433	.591	.031	18	5	11	15	.8
160823*400F	.082	.709	.197	.433	.591	.031	18	5	11	15	.8
160104*400G	.10	.709	.236	.472	.591	.031	18	6	12	15	.8
160124*400G	.12	.709	.236	.472	.591	.031	18	6	12	15	.8
160154*400H	.15	.709	.295	.531	.591	.031	18	7.5	13.5	15	.8
160154*400L	.15	1.043	.236	.591	.886	.031	26.5	6	15	22.5	.8
160184*400L	.18	1.043	.236	.591	.886	.031	26.5	6	15	22.5	.8
160224*400L	.22	1.043	.236	.591	.886	.031	26.5	6	15	22.5	.8
160274*400M	.27	1.043	.276	.630	.886	.031	26.5	7	16	22.5	.8
160334*400M	.33	1.043	.276	.630	.886	.031	26.5	7	16	22.5	.8
160394*400N	.39	1.043	.335	.669	.886	.031	26.5	8.5	17	22.5	.8
160474*400N	.47	1.043	.335	.669	.886	.031	26.5	8.5	17	22.5	.8
160564*400O	.56	1.043	.394	.748	.886	.031	26.5	10	19	22.5	.8
160684*400P	.68	1.260	.433	.787	1.083	.031	32	11	20	27.5	.8
160824*400P	.82	1.260	.433	.787	1.083	.031	32	11	20	27.5	.8
160105*400P	1.0	1.260	.433	.787	1.083	.031	32	11	20	27.5	.8
630 VDC/220 VAC											
160392*630C	.0039	.512	.157	.374	.394	.031	13	4	9.5	10	.8
160472*630C	.0047	.512	.157	.374	.394	.031	13	4	9.5	10	.8
160562*630C	.0056	.512	.157	.374	.394	.031	13	4	9.5	10	.8
160682*630C	.0068	.512	.157	.374	.394	.031	13	4	9.5	10	.8
160822*630C	.0082	.512	.157	.374	.394	.031	13	4	9.5	10	.8
160103*630C	.010	.512	.157	.374	.394	.031	13	4	9.5	10	.8
160123*630D	.012	.512	.197	.433	.394	.031	13	5	11	10	.8
160153*630D	.015	.512	.197	.433	.394	.031	13	5	11	10	.8
160183*630D	.018	.512	.197	.433	.394	.031	13	5	11	10	.8
160223*630E	.022	.512	.236	.472	.394	.031	13	6	12	10	.8
160273*630F	.027	.709	.197	.433	.591	.031	18	5	11	15	.8
160333*630F	.033	.709	.197	.433	.591	.031	18	5	11	15	.8
160393*630G	.039	.709	.236	.472	.591	.031	18	6	12	15	.8
160473*630G	.047	.709	.236	.472	.591	.031	18	6	12	15	.8
160563*630G	.056	.709	.236	.472	.591	.031	18	6	12	15	.8
160683*630H	.068	.709	.295	.531	.591	.031	18	7.5	13.5	15	.8
160683*630L	.068	1.043	.236	.591	.886	.031	26.5	6	15	22.5	.8
160823*630L	.082	1.043	.236	.591	.886	.031	26.5	6	15	22.5	.8
160104*630L	.10	1.043	.236	.591	.886	.031	26.5	6	15	22.5	.8
160124*630M	.12	1.043	.276	.630	.886	.031	26.5	7	16	22.5	.8
160154*630M	.15	1.043	.276	.630	.886	.031	26.5	7	16	22.5	.8
160184*630N	.18	1.043	.335	.669	.886	.031	26.5	8.5	17	22.5	.8
160224*630N	.22	1.043	.335	.669	.886	.031	26.5	8.5	17	22.5	.8
160274*630Q	.27	1.260	.512	.886	1.083	.031	32	13	22.5	27.5	.8
160334*630P	.33	1.260	.433	.787	1.083	.031	32	11	20	27.5	.8
160394*630P	.39	1.260	.433	.787	1.083	.031	32	11	20	27.5	.8
160474*630Q	.47	1.260	.512	.886	1.083	.031	32	13	22.5	27.5	.8

* Indicate capacitance tolerance: J = $\pm 5\%$, K = $\pm 10\%$, M = $\pm 20\%$

General Purpose Film

160 Series Metallized Polyester / Radial Leads



Catalog Number	Cap μ F	Inches					Millimeters				
		L	T	H	S	\varnothing d	L	T	H	S	\varnothing d
1000 VDC/250 VAC											
160222*1000C	.0022	.512	.157	.374	.394	.031	13	4	9.5	10	.8
160272*1000C	.0027	.512	.157	.374	.394	.031	13	4	9.5	10	.8
160332*1000C	.0033	.512	.157	.374	.394	.031	13	4	9.5	10	.8
160392*1000D	.0039	.512	.197	.433	.394	.031	13	5	11	10	.8
160472*1000D	.0047	.512	.197	.433	.394	.031	13	5	11	10	.8
160562*1000D	.0056	.512	.197	.433	.394	.031	13	5	11	10	.8
160682*1000D	.0068	.512	.197	.433	.394	.031	13	5	11	10	.8
160822*1000D	.0082	.512	.197	.433	.394	.031	13	5	11	10	.8
160103*1000F	.010	.709	.197	.433	.591	.031	18	5	11	15	.8
160123*1000F	.012	.709	.197	.433	.591	.031	18	5	11	15	.8
160153*1000F	.015	.709	.197	.433	.591	.031	18	5	11	15	.8
160183*1000G	.018	.709	.236	.472	.591	.031	18	6	12	15	.8
160223*1000G	.022	.709	.236	.472	.591	.031	18	6	12	15	.8
160273*1000H	.027	.709	.295	.531	.591	.031	18	7.5	13.5	15	.8
160333*1000L	.033	1.043	.236	.591	.886	.031	26.5	6	15	22.5	.8
160393*1000L	.039	1.043	.236	.591	.886	.031	26.5	6	15	22.5	.8
160473*1000L	.047	1.043	.236	.591	.886	.031	26.5	6	15	22.5	.8
160563*1000M	.056	1.043	.276	.630	.886	.031	26.5	7	16	22.5	.8
160683*1000M	.068	1.043	.276	.630	.886	.031	26.5	7	16	22.5	.8
160823*1000N	.082	1.043	.335	.669	.886	.031	26.5	8.5	17	22.5	.8
160104*1000N	.10	1.043	.335	.669	.886	.031	26.5	8.5	17	22.5	.8
160124*1000O	.12	1.043	.394	.748	.886	.031	26.5	10	19	22.5	.8
160154*1000P	.15	1.260	.433	.787	1.083	.031	32	11	20	27.5	.8
160184*1000Q	.18	1.260	.512	.886	1.083	.031	32	13	22.5	27.5	.8
160224*1000Q	.22	1.260	.512	.886	1.083	.031	32	13	22.5	27.5	.8

* Indicate capacitance tolerance: J = \pm 5%, K = \pm 10%, M = \pm 20%

General Purpose Film

167/184 Series Metallized Polyester / Radial Leads

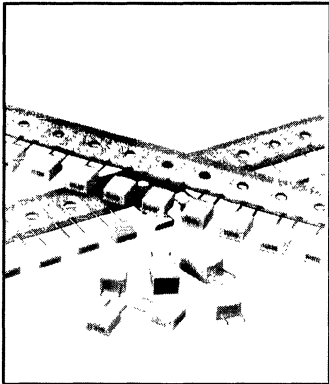

- Low Leakage
- Radial Leaded (7.5mm)
- 167 Series Bulk Packaging
- 184 Series Available Reel or Ammo Pack
- Non-Polar
- Flame Retardant Case Meets UL94V0
- Epoxy Encapsulant Meets UL94V0
- Lead Material
Tinned Copper Wire
Minimum Lead Content 5%

GENERAL SPECIFICATIONS

Operating Temperature:
-55°C to +125°C with voltage derating above 85°C

Voltage Range:
63 VDC to 630 VDC

Capacitance Range:
0.001 μ F to 1.0 μ F

Capacitance Tolerance:
 \pm 5%, \pm 10%, \pm 20%

CECC Approval:
Detail Specification 30401-009

Total Self Inductance:
Approximately 8nH

Dielectric Withstand Voltage:
1.6 x rated voltage for 2 sec
at +25°C \pm 5°C

Dissipation Factor (DF):
 $\text{tg}\delta \times 10^{-4}$ at +25°C \pm 5°C

KHz	$\text{tg}\delta \times 10^{-4}$
1	≤ 100
10	≤ 150

Excellent choice for general purpose applications such as bypass, decoupling, smoothing and some timing, energy storage/discharge and arc suppression.

Maximum Pulse Rise Time (dv/dt)

Vn	V/ μ Sec
63	5
100	6
250	15
400	30
630	40

If the working voltage (V) is less than the nominal voltage (Vn), the capacitor can work at higher dv/dt. In this case, the maximum value allowed is obtained by multiplying the above value (See table dv/dt) with the ratio Vn/V.

Test Method and Performance

Insulation Resistance	
Test Conditions	
Temperature	25°C \pm 5°C
Voltage Charge Time	1 minute
Voltage Charge	50 VDC for Vn < 100 VDC 100 VDC for Vn \geq 100 VDC
Performance	
For Vn > 100 VDC	$\geq 30,000 \text{ M}\Omega$ (50,000 M Ω typical)
For Vn \leq 100 VDC	$\geq 10,000 \text{ M}\Omega$ for C $\leq 0.1 \mu\text{F}$ $\geq 1,000 \text{ M}\Omega \times \mu\text{F}$ for C > 0.1 μF
Damp Heat Test	
Test Conditions	
Temperature	+40°C
Relative Humidity	95%
Test Duration	21 days
Performance	
Capacitance Change $\Delta\text{C}/\text{C}$	$\leq \pm 5\%$
DF Change $\Delta\text{tg}\delta$	$\leq 50 \times 10^{-4}$ at 1KHz
Insulation Resistance	$\geq 50\%$ of limit value
Life Test	
Test Conditions	
Temperature	+85°C
Test Duration	1000 h
Voltage Applied	1.25 x Vn
Performance	
Capacitance Change $\Delta\text{C}/\text{C}$	$\leq \pm 5\%$
DF Change $\Delta\text{tg}\delta$	$\leq 30 \times 10^{-4}$ at 10KHz
Insulation Resistance	$\geq 50\%$ of limit value
Soldering	
Test Conditions	
Soldering Temperature	260°C \pm 5°C
Soldering Duration	10 sec \pm 1 sec
Performance	
Capacitance Change $\Delta\text{C}/\text{C}$	$\leq \pm 2\%$
DF Change $\Delta\text{tg}\delta$	$\leq 30 \times 10^{-4}$ at 10 KHz
Insulation Resistance	\geq limit value
Long Term Stability (after two years)	
Storage Performance	Standard Environmental Conditions
Capacitance Change $\Delta\text{C}/\text{C}$	$\leq \pm 3\%$ for C $\leq 0.1 \mu\text{F}$ $\leq \pm 2\%$ for C > 0.1 μF

Outline Dimensions

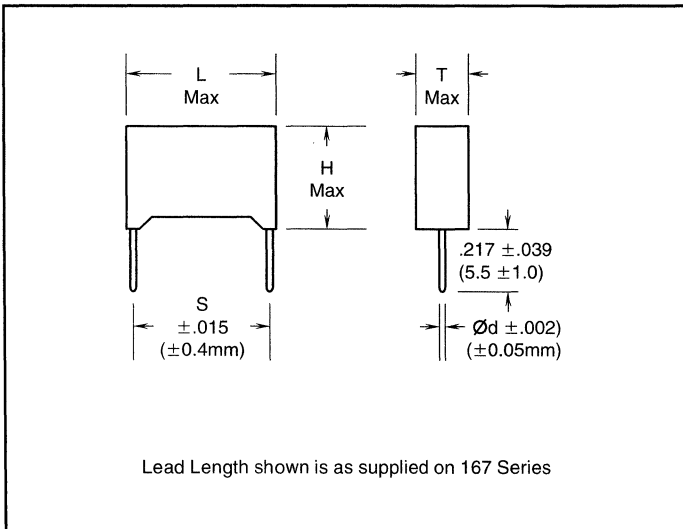

167/184 Series Metallized Polyester / Radial Leads

MALLY

Tape Specifications - 7.5 mm Lead Spacing

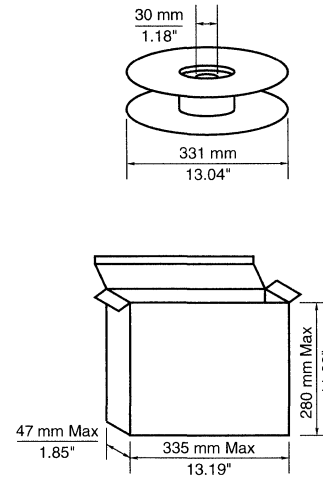
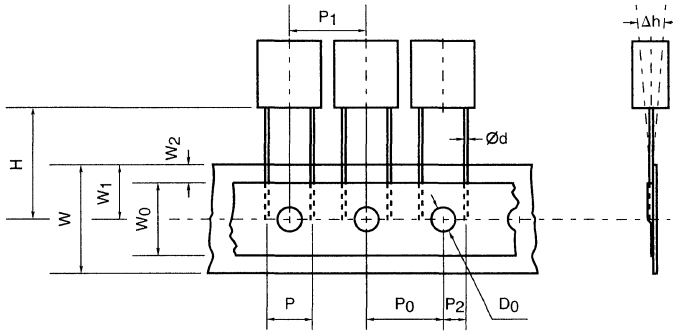

Reel
Packing

Ammo Box
Packing

Dimensions

Item	Code	Millimeters	Inches
Lead-Wire Diameter	Ød	0.6 ^{+0.04-0.01}	.024 ^{±.001}
Lead-to-Lead Distance	P	7.5 ^{+0.6-0.2}	.295 ^{+0.024-.040}
Feed Hole Pitch	p ₀	12.7 ^{±0.3}	.5 ^{±.012}
Pitch of Component	p ₁	12.7 ^{±1.0}	.5 ^{±.039}
Hole Center to Lead	p ₂	8.95 ^{±0.7}	.352 ^{±.028}
Feed Hole Center to Component Center	p ₃	12.7 ^{±1.3}	.5 ^{±.051}
Component Alignment, F-R	Δh	0 ^{±2.0}	0 ^{±.079}
Tape Width	W	18 ^{+1.0-0.1}	.709 ^{+0.039-.004}
Hold-down Tape Width	W ₀	6.0 min	.236 min
Hole Position	W ₁	9.0 ^{+0.75-0.05}	.355 ^{+0.030-0.01}
Hold-down Tape Position	W ₂	3.0 Max	.118 Max
Height of Component from Tape Center	H	>	>
Feed Hole Diameter	D ₀	4.0 ^{±0.3}	.157 ^{±.012}

Component Quantity Per Reel

Case Code	Quantity Reeled	Quantity Ammo Pack
A	1800	1500
B	1500	1500
C	1200	1000
D	1000	1000

> The H dimension depends on the insertion equipment used. Specify the proper tooling code as indicated below.

Tooling Code	H Dimension	
	Millimeters	Inches
A	16.5 ^{±0.75}	.679 ^{±.030}
B	18.5 ^{±0.75}	.728 ^{±.030}
C	16.0 ^{±0.75}	.630 ^{±.030}

General Purpose Film

167/184 Series Metallized Polyester / Radial Leads



Catalog Number		Cap μF	Inches					Millimeters				
Bulk Pack	Tape and Reel Ammo Pack		L Length	T Thickness	H Height	S Spacing	Ød	L Length	T Thickness	H Height	S Spacing	Ød
63 VDC/40 VAC												
167683*63A	184683*63#A>	.068	.413	.138	.276	.295	.024	10.5	3.5	7.0	7.5	.6
167104*63A	184104*63#A>	.10	.413	.138	.276	.295	.024	10.5	3.5	7.0	7.5	.6
167154*63A	184154*63#A>	.15	.413	.138	.276	.295	.024	10.5	3.5	7.0	7.5	.6
167224*63A	184224*63#A>	.22	.413	.138	.276	.295	.024	10.5	3.5	7.0	7.5	.6
167274*63A	184274*63#A>	.27	.413	.138	.276	.295	.024	10.5	3.5	7.0	7.5	.6
167334*63A	184334*63#A>	.33	.413	.138	.276	.295	.024	10.5	3.5	7.0	7.5	.6
167474*63B	184474*63#B>	.47	.413	.157	.354	.295	.024	10.5	4.0	9.0	7.5	.6
167684*63C	184684*63#C>	.68	.413	.197	.433	.295	.024	10.5	5.0	11.0	7.5	.6
167105*63C	184105*63#C>	1	.413	.197	.433	.295	.024	10.5	5.0	11.0	7.5	.6
100 VDC/63 VAC												
167333*100A	184333*100#A>	.033	.413	.138	.276	.295	.024	10.5	3.5	7.0	7.5	.6
167473*100A	184473*100#A>	.047	.413	.138	.276	.295	.024	10.5	3.5	7.0	7.5	.6
167683*100A	184683*100#A>	.068	.413	.138	.276	.295	.024	10.5	3.5	7.0	7.5	.6
167104*100A	184104*100#A>	.10	.413	.138	.276	.295	.024	10.5	3.5	7.0	7.5	.6
167124*100B	184124*100#B>	.12	.413	.157	.354	.295	.024	10.5	4.0	9.0	7.5	.6
167154*100B	184154*100#B>	.15	.413	.157	.354	.295	.024	10.5	4.0	9.0	7.5	.6
167224*100C	184224*100#C>	.22	.413	.197	.433	.295	.024	10.5	5.0	11.0	7.5	.6
167334*100C	184334*100#C>	.33	.413	.197	.433	.295	.024	10.5	5.0	11.0	7.5	.6
250 VDC/160 VAC												
167103*250A	184103*250#A>	.01	.413	.138	.276	.295	.024	10.5	3.5	7.0	7.5	.6
167153*250A	184153*250#A>	.015	.413	.138	.276	.295	.024	10.5	3.5	7.0	7.5	.6
167183*250A	184183*250#A>	.018	.413	.138	.276	.295	.024	10.5	3.5	7.0	7.5	.6
167223*250A	184223*250#A>	.022	.413	.138	.276	.295	.024	10.5	3.5	7.0	7.5	.6
167273*250B	184273*250#B>	.027	.413	.157	.354	.295	.024	10.5	4.0	9.0	7.5	.6
167333*250B	184333*250#B>	.033	.413	.157	.354	.295	.024	10.5	4.0	9.0	7.5	.6
167393*250B	184393*250#B>	.039	.413	.157	.354	.295	.024	10.5	4.0	9.0	7.5	.6
167473*250B	184473*250#B>	.047	.413	.157	.354	.295	.024	10.5	4.0	9.0	7.5	.6
167683*250C	184683*250#C>	.068	.413	.197	.433	.295	.024	10.5	5.0	11.0	7.5	.6
167104*250C	184104*250#C>	.10	.413	.197	.433	.295	.024	10.5	5.0	11.0	7.5	.6
400 VDC/200 VAC												
167472*400A	184472*400#A>	.0047	.413	.138	.276	.295	.024	10.5	3.5	7.0	7.5	.6
167472*400B	184472*400#B>	.0047	.413	.157	.354	.295	.024	10.5	4.0	9.0	7.5	.6
167562*400A	184562*400#A>	.0056	.413	.138	.276	.295	.024	10.5	3.5	7.0	7.5	.6
167682*400A	184682*400#A>	.0068	.413	.138	.276	.295	.024	10.5	3.5	7.0	7.5	.6
167103*400A	184103*400#A>	.01	.413	.138	.276	.295	.024	10.5	3.5	7.0	7.5	.6
167153*400B	184153*400#B>	.015	.413	.157	.354	.295	.024	10.5	4.0	9.0	7.5	.6
167223*400C	184223*400#C>	.022	.413	.197	.433	.295	.024	10.5	5.0	11.0	7.5	.6
167333*400C	184333*400#C>	.033	.413	.197	.433	.295	.024	10.5	5.0	11.0	7.5	.6
630 VDC/220 VAC												
167102*630B	184102*630#B>	.001	.413	.157	.354	.295	.024	10.5	4.0	9.0	7.5	.6
167152*630A	184152*630#A>	.0015	.413	.138	.276	.295	.024	10.5	3.5	7.0	7.5	.6
167222*630A	184222*630#A>	.0022	.413	.138	.276	.295	.024	10.5	3.5	7.0	7.5	.6
167332*630A	184332*630#A>	.0033	.413	.138	.276	.295	.024	10.5	3.5	7.0	7.5	.6
167472*630B	184472*630#B>	.0047	.413	.157	.354	.295	.024	10.5	4.0	9.0	7.5	.6
167682*630B	184682*630#B>	.0068	.413	.157	.354	.295	.024	10.5	4.0	9.0	7.5	.6
167103*630C	184103*630#C>	.01	.413	.197	.433	.295	.024	10.5	5.0	11.0	7.5	.6
167153*630D	184153*630#D>	.015	.413	.236	.472	.295	.024	10.5	6.0	12.0	7.5	.6

* Indicate capacitance tolerance:
J = ±5%, K = ±10%, M = ±20%

Indicate packaging type:
R = Tape and Reel, A = Ammo Pack

> Indicate tooling code:
A = 16.5mm, B = 18.5mm, C = 16.0mm
(See H dimension in taping specifications)

General Purpose Film

168/185 Series Metallized Polyester / Radial Leads

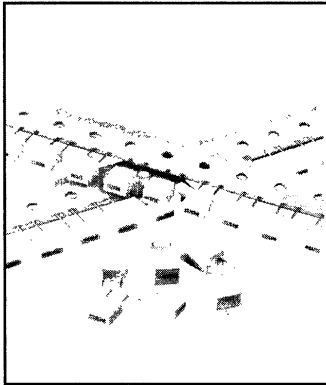

- Low Leakage
- Radial Leaded (5.0mm)
- 168 Series Bulk Packaging
- 185 Series Available Reel or Ammo Pack
- Non-Polar
- Flame Retardant Case Meets UL94V0
- Epoxy Encapsulant Meets UL94V0
- Lead Material
Tinned Copper Wire
Minimum Lead Content 5%

GENERAL SPECIFICATIONS

Operating Temperature:
-55°C to +125°C with voltage derating above 85°C

Voltage Range:
50, 63, 100, 250 and 400 VDC

Capacitance Range:
0.0010 μ F to 1.0 μ F

Capacitance Tolerance:
 \pm 5%, \pm 10%, \pm 20%

CECC Approval:
Detail Specification 30401-009

Total Self Inductance:
Approximately 7nH

Dielectric Withstand Voltage:
1.6 x rated voltage for 2 sec
at +25°C \pm 5°C

Dissipation Factor (DF):
 $\text{tg}\delta \times 10^{-4}$ at +25°C \pm 5°C

KHz	C \leq 0.1 μ F	C > 0.1 μ F
1	\leq 100	\leq 100
10	\leq 150	\leq 150
100	\leq 300	\leq 150

Excellent choice for general purpose applications such as bypass, decoupling, smoothing and some timing, energy storage/discharge and arc suppression.

Maximum Pulse Rise Time (dv/dt)

Vn	Capacitance	V/ μ Sec
50	C > .0068 μ F .0033 μ F < C < .0068 μ F C \leq .0033 μ F	4
63		8
100		10
250		15
400		30
		44
		100

If the working voltage (V) is less than the nominal voltage (Vn), the capacitor can work at higher dv/dt. In this case, the maximum value allowed is obtained by multiplying the above value (See table dv/dt) with the ratio Vn/V.

Test Method and Performance

Insulation Resistance	
Test Conditions	25°C \pm 5°C
Temperature	1 minute
Voltage Charge Time	50 VDC for Vn < 100 VDC
Voltage Charge	100 VDC for Vn \geq 100 VDC
Performance	
For Vn > 100 VDC	\geq 30,000 M Ω
For Vn \leq 100 VDC	\geq 10,000 M Ω for C \leq 0.1 μ F
	\geq 1,000 M Ω x μ F for C > 0.1 μ F
Damp Heat Test	
Test Conditions	+40°C
Temperature	95%
Relative Humidity	21 days
Test Duration	
Performance	
Capacitance Change Δ C/C	\leq \pm 5%
DF Change Δ tg δ	\leq 50 x 10 ⁻⁴ at 1KHz
Insulation Resistance	\geq 50% of limit value
Life Test	
Test Conditions	+85°C
Temperature	1000 h
Test Duration	1.25 x Vn
Voltage Applied	
Performance	
Capacitance Change Δ C/C	\leq \pm 5%
DF Change Δ tg δ	\leq 30 x 10 ⁻⁴ at 10 KHz
Insulation Resistance	\geq 50% of limit value
Soldering	
Test Conditions	260°C \pm 5°C
Soldering Temperature	10 sec \pm 1 sec
Soldering Duration	
Performance	
Capacitance Change Δ C/C	\leq \pm 2%
DF Change Δ tg δ	\leq 30 x 10 ⁻⁴ at 10 KHz
Insulation Resistance	\geq limit value
Long Term Stability (after two years)	
Storage Performance	Standard Environmental Conditions
Capacitance Change Δ C/C	\leq \pm 3%

Outline Dimensions

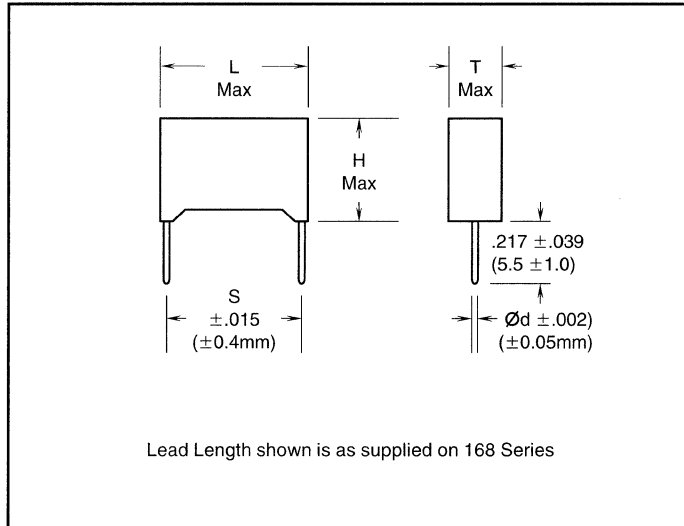

Tape Specifications - 5.0 mm Lead Spacing

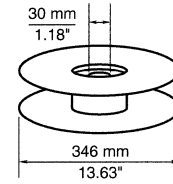
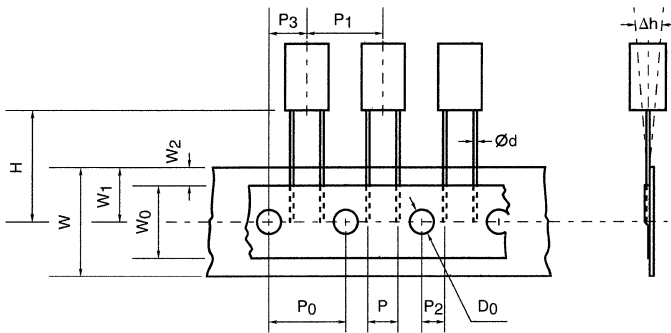

Reel Packing

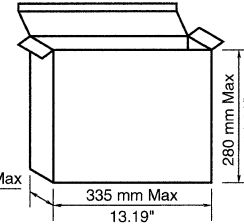

Ammo Box Packing

Dimensions

Item	Code	Millimeters	Inches
Lead-Wire Diameter	Ød	0.6 ^{+0.04-0.01}	.024 ^{±.001}
Lead-to-Lead Distance	P	5.0 ^{+0.6-0.2}	.197 ^{+0.24-.040}
Feed Hole Pitch	p ₀	12.7 ^{±0.3}	.5 ^{±.012}
Pitch of Component	p ₁	12.7 ^{±1.0}	.5 ^{±.039}
Hole Center to Lead	p ₂	3.85 ^{±0.7}	.152 ^{±.028}
Feed Hole Center to Component Center	p ₃	6.35 ^{±1.3}	.250 ^{±.051}
Component Alignment, F-R	Δh	0 ^{±2.0}	0 ^{±.079}
Tape Width	W	18 ^{+1.0-0.1}	.709 ^{+0.39-.004}
Hold-Down Tape Width	W ₀	6.0 min	.236 min
Hole Position	W ₁	9.0 ^{+0.75-0.05}	.355 ^{+0.30-0.01}
Hold-Down Tape Position	W ₂	3.0 Max	.118 Max
Height of Component from Tape Center	H	>	>
Feed Hole Diameter	D ₀	4.0 ^{±0.3}	.157 ^{±.012}

Component Quantity Per Reel

Case Code	Quantity Reeled	Quantity Ammo Pack
A	2500	3500
C	1800	1500
F	1200	1800
G	1000	1000
H	1400	1400

> The H dimension depends on the insertion equipment used. Specify the proper tooling code as indicated below.

Tooling Code	H Dimension	
	Millimeters	Inches
A	16.5 ^{±0.75}	.679 ^{±.030}
B	18.5 ^{±0.75}	.728 ^{±.030}
C	16.0 ^{±0.75}	.630 ^{±.030}

Catalog Number		Cap µF	Inches					Millimeters				
Bulk Pack	Tape and Reel Ammo Pack		L Length	T Thickness	H Height	S Spacing	Ød	L Length	T Thickness	H Height	S Spacing	Ød
50 VDC/30 VAC												
168104*50A	185104*50#A>	.10	.283	.098	.256	.197	.024	7.2	2.5	6.5	5.0	.6
168154*50A	185154*50#A>	.15	.283	.098	.256	.197	.024	7.2	2.5	6.5	5.0	.6
168224*50C	185224*50#C>	.22	.283	.138	.295	.197	.024	7.2	3.5	7.5	5.0	.6
168334*50C	185334*50#C>	.33	.283	.138	.295	.197	.024	7.2	3.5	7.5	5.0	.6
168474*50H	185474*50#H>	.47	.283	.177	.335	.197	.024	7.2	4.5	8.5	5.0	.6
168684*50F	185684*50#F>	.68	.283	.197	.394	.197	.024	7.2	5.0	10.0	5.0	.6
168824*50G	185824*50#G>	.82	.283	.236	.433	.197	.024	7.2	6.0	11.0	5.0	.6
168105*50G	185105*50#G>	1	.283	.236	.433	.197	.024	7.2	6.0	11.0	5.0	.6

* Indicate capacitance tolerance:
J = ±5%, K = ±10%, M = ±20%

Indicate packaging type:
R = tape and reel, A = ammo pack

> Indicate tooling code:
A = 16.5mm, B = 18.5mm, C = 16.0mm
(See H dimension in taping specifications)

General Purpose Film

168/185 Series Metallized Polyester / Radial Leads



Catalog Number		Cap μF	Inches					Millimeters				
Bulk Pack	Tape and Reel Ammo Pack		L Length	T Thickness	H Height	S Spacing	Ød	L Length	T Thickness	H Height	S Spacing	Ød
63 VDC/40 VAC												
168473*63A	185473*63#A>	.047	.283	.098	.256	.197	.024	7.2	2.5	6.5	5.0	.6
168563*63A	185563*63#A>	.056	.283	.098	.256	.197	.024	7.2	2.5	6.5	5.0	.6
168683*63A	185683*63#A>	.068	.283	.098	.256	.197	.024	7.2	2.5	6.5	5.0	.6
168823*63A	185823*63#A>	.082	.283	.098	.256	.197	.024	7.2	2.5	6.5	5.0	.6
168104*63A	185104*63#A>	.10	.283	.098	.256	.197	.024	7.2	2.5	6.5	5.0	.6
168154*63C	185154*63#C>	.15	.283	.138	.295	.197	.024	7.2	3.5	7.5	5.0	.6
168184*63C	185184*63#C>	.18	.283	.138	.295	.197	.024	7.2	3.5	7.5	5.0	.6
168224*63C	185224*63#C>	.22	.283	.138	.295	.197	.024	7.2	3.5	7.5	5.0	.6
168274*63C	185274*63#C>	.27	.283	.138	.295	.197	.024	7.2	3.5	7.5	5.0	.6
168334*63H	185334*63#H>	.33	.283	.177	.335	.197	.024	7.2	4.5	8.5	5.0	.6
168474*63H	185474*63#H>	.47	.283	.177	.335	.197	.024	7.2	4.5	8.5	5.0	.6
168684*63F	185684*63#F>	.68	.283	.197	.394	.197	.024	7.2	5.0	10.0	5.0	.6
168105*63G	185105*63#G>	1	.283	.236	.433	.197	.024	7.2	6.0	11.0	5.0	.6
100 VDC/63 VAC												
168102*100A	185102*100#A>	.001	.283	.098	.256	.197	.024	7.2	2.5	6.5	5.0	.6
168152*100A	185152*100#A>	.0015	.283	.098	.256	.197	.024	7.2	2.5	6.5	5.0	.6
168222*100A	185222*100#A>	.0022	.283	.098	.256	.197	.024	7.2	2.5	6.5	5.0	.6
168272*100A	185272*100#A>	.0027	.283	.098	.256	.197	.024	7.2	2.5	6.5	5.0	.6
168332*100A	185332*100#A>	.0033	.283	.098	.256	.197	.024	7.2	2.5	6.5	5.0	.6
168392*100A	185392*100#A>	.0039	.283	.098	.256	.197	.024	7.2	2.5	6.5	5.0	.6
168472*100A	185472*100#A>	.0047	.283	.098	.256	.197	.024	7.2	2.5	6.5	5.0	.6
168562*100A	185562*100#A>	.0056	.283	.098	.256	.197	.024	7.2	2.5	6.5	5.0	.6
168682*100A	185682*100#A>	.0068	.283	.098	.256	.197	.024	7.2	2.5	6.5	5.0	.6
168822*100A	185822*100#A>	.0082	.283	.098	.256	.197	.024	7.2	2.5	6.5	5.0	.6
168103*100A	185103*100#A>	.010	.283	.098	.256	.197	.024	7.2	2.5	6.5	5.0	.6
168153*100A	185153*100#A>	.015	.283	.098	.256	.197	.024	7.2	2.5	6.5	5.0	.6
168183*100A	185183*100#A>	.018	.283	.098	.256	.197	.024	7.2	2.5	6.5	5.0	.6
168223*100A	185223*100#A>	.022	.283	.098	.256	.197	.024	7.2	2.5	6.5	5.0	.6
168273*100A	185273*100#A>	.027	.283	.098	.256	.197	.024	7.2	2.5	6.5	5.0	.6
168333*100C	185333*100#C>	.033	.283	.138	.295	.197	.024	7.2	3.5	7.5	5.0	.6
168393*100C	185393*100#C>	.039	.283	.138	.295	.197	.024	7.2	3.5	7.5	5.0	.6
168473*100C	185473*100#C>	.047	.283	.138	.295	.197	.024	7.2	3.5	7.5	5.0	.6
168683*100H	185683*100#H>	.068	.283	.177	.335	.197	.024	7.2	4.5	8.5	5.0	.6
168104*100H	185104*100#H>	.10	.283	.177	.335	.197	.024	7.2	4.5	8.5	5.0	.6
168154*100F	185154*100#F>	.15	.283	.197	.394	.197	.024	7.2	5.0	10.0	5.0	.6
168224*100G	185224*100#G>	.22	.283	.236	.433	.197	.024	7.2	6.0	11.0	5.0	.6
250 VDC/160 VAC												
168332*250A	185332*250#A>	.0033	.283	.098	.256	.197	.024	7.2	2.5	6.5	5.0	.6
168472*250A	185472*250#A>	.0047	.283	.098	.256	.197	.024	7.2	2.5	6.5	5.0	.6
168682*250A	185682*250#A>	.0068	.283	.098	.256	.197	.024	7.2	2.5	6.5	5.0	.6
168103*250A	185103*250#A>	.010	.283	.098	.256	.197	.024	7.2	2.5	6.5	5.0	.6
168153*250A	185153*250#A>	.015	.283	.098	.256	.197	.024	7.2	2.5	6.5	5.0	.6
168223*250C	185223*250#C>	.022	.283	.138	.295	.197	.024	7.2	3.5	7.5	5.0	.6
168333*250C	185333*250#C>	.033	.283	.138	.295	.197	.024	7.2	3.5	7.5	5.0	.6
168473*250H	185473*250#H>	.047	.283	.177	.335	.197	.024	7.2	4.5	8.5	5.0	.6
168683*250H	185683*250#H>	.068	.283	.177	.335	.197	.024	7.2	4.5	8.5	5.0	.6
168104*250G	185104*250#G>	.10	.283	.236	.433	.197	.024	7.2	6.0	11.0	5.0	.6
400 VDC/200 VAC												
168102*400A	185102*400#A>	.0010	.283	.098	.256	.197	.024	7.2	2.5	6.5	5.0	.6
168152*400A	185152*400#A>	.0015	.283	.098	.256	.197	.024	7.2	2.5	6.5	5.0	.6
168222*400A	185222*400#A>	.0022	.283	.098	.256	.197	.024	7.2	2.5	6.5	5.0	.6
168332*400C	185332*400#C>	.0033	.283	.138	.295	.197	.024	7.2	3.5	7.5	5.0	.6
168472*400C	185472*400#C>	.0047	.283	.138	.295	.197	.024	7.2	3.5	7.5	5.0	.6
168682*400C	185682*400#C>	.0068	.283	.138	.295	.197	.024	7.2	3.5	7.5	5.0	.6
168103*400H	185103*400#H>	.010	.283	.177	.335	.197	.024	7.2	4.5	8.4	5.0	.6
168153*400F	185153*400#F>	.015	.283	.197	.394	.197	.024	7.2	5.0	10.0	5.0	.6
168223*400G	185223*400#G>	.022	.283	.236	.433	.197	.024	7.2	6.0	11.0	5.0	.6

* Indicate capacitance tolerance:
J = ±5%, K = ±10%, M = ±20%

Indicate packaging type:
R = Tape and Reel, A = Ammo Pack

> Indicate tooling code:
A = 16.5mm, B = 18.5mm, C = 16.0mm
(See H dimension in taping specifications)

General Purpose Film

170 Series Metallized Polypropylene / Axial Leads

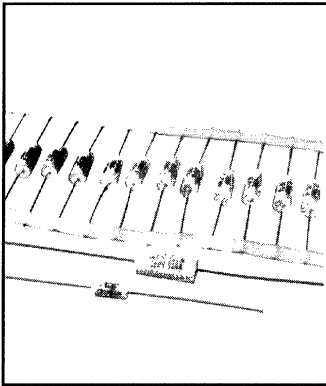

- Axial Leads
- Available Tape and Reel For Automatic Insertion
- Non Inductively Wound
- Non-Polar
- Flame Retardant Polyester Wrap Meets UL510
- Epoxy Encapsulant Meets UL94V0
- Lead Material
Tinned Copper Wire
Minimum Lead Content 5%

GENERAL SPECIFICATIONS

Operating Temperature:
-55°C to +105°C with voltage derating above 85°C

Voltage Range:
160 VDC (90 VAC) to
630 VDC (250 VAC)

Capacitance Range:
0.001 μ F to 4.7 μ F

Capacitance Tolerance:
 \pm 5%, \pm 10%, \pm 20%

Total Self Inductance (L):
1nH maximum per 1mm lead
and capacitor length

Test Voltage Between Terminations:
1.6Vn applied for 2 sec
at +25°C \pm 5°C

Dissipation Factor (DF)
 $tg \delta \times 10^{-4}$ at +25°C \pm 5°C

	C	C	C
KHz	<0.1 μ F	0.1 μ F to 1 μ F	>1 μ F
1	\leq 6	\leq 6	\leq 6
10	\leq 10	\leq 20	
100	\leq 30		

Excellent choice for applications requiring low dielectric losses, high voltage capability and stable characteristics.

General Purpose Film

Maximum Pulse Rise Time dv/dt (V/ μ sec)

Vn	L max				
	11	16.5	20.5	28	33
160	5	5	3	2	1
250	11	10	7	4	2.5
400	—	13.5	10	6.5	4
630	—	20	15	10	6

If the working voltage (V) is less than the nominal voltage (Vn), the capacitor can work at higher dv/dt. In this case, the maximum value allowed is obtained by multiplying the above value (See table dv/dt) with the ratio Vn/V.

Tape and Reel Specifications[^]

L Max (Body Length)		Lead Spacing		Distance Between Reel Flanges		Class
Inches	mm	Inches	mm	Inches	mm	
\leq .433	\leq 11	2.06	52.4	3.0	75	1
.551 - .808	14 - 20.5	2.5	63.6	3.4	86	2
\geq 1.03	\geq 26	2.87	73	3.7	95	3

[^] Add class number (1, 2, or 3) to Catalog Number to indicate tape and reel

Diameter		Quantity per Reel
Inches	mm	
.197	5	3,000
.236 thru .256	6.0 thru 6.5	1,200
.276	7	1,100
.315 thru .346	8 thru 8.5	800
.354 thru .413	9 thru 10.5	500
.433 thru .512	11 thru 13	300
.551 thru .571	14 thru 14.5	200
>.571	>14.5	Not available

Outline Dimensions

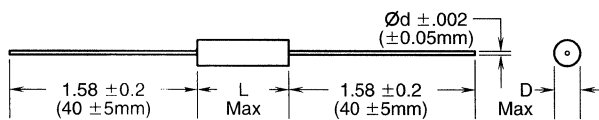

Test Method and Performance

Insulation Resistance	
Test Conditions	
Temperature	25°C \pm 5°C
Voltage Charge Time	1 minute
Voltage Charge	100 VDC
Performance	
For C \leq 0.33 μ F	\geq 1 x 10 ⁵ M Ω
For C > 0.33 μ F	\geq 30,000 M Ω x μ F
Damp Heat Test	
Test Conditions	
Temperature	+40°C
Relative Humidity	95%
Test Duration	21 days
Performance	
Capacitance Change Δ C/C	\leq \pm 2%
DF Change Δ tg δ	\leq 10 x 10 ⁻⁴ at 1 KHz
Insulation Resistance	\geq 50% of limit value
Life Test	
Test Conditions	
Temperature	+85°C
Test Duration	1000 h
Voltage Applied	1.25 x Vn
Performance	
Capacitance Change Δ C/C	\leq \pm 3%
DF Change Δ tg δ	\leq 10 x 10 ⁻⁴ for C > 1 μ F at 1 KHz \leq 10 x 10 ⁻⁴ for C \leq 1 μ F at 10 KHz
Insulation Resistance	\geq 50% of limit value
Soldering	
Test Conditions	
Soldering Temperature	+260°C \pm 5°C
Soldering Duration	10 sec \pm 1 sec
Performance	
Capacitance Change Δ C/C	\leq \pm 1%
DF Change Δ tg δ	\leq 10 x 10 ⁻⁴ for C > 1 μ F at 1 KHz \leq 10 x 10 ⁻⁴ for C \leq 1 μ F at 10 KHz
Insulation Resistance	\geq 50% of limit value
Long Term Stability (after two years)	
Storage Performance	Standard Environmental Conditions
Capacitance Change Δ C/C	\leq \pm 0.5%

170 Series Metallized Polypropylene / Axial Leads



Catalog Number	Cap μ F	Inches			Millimeters			ESR (mOhms) 20KHz to 100KHz	IRMS (Amps)		
		D Max	L Max	\varnothing d	D Max	L Max	\varnothing d		25°C	45°C	85°C
160 VDC/90 VAC											
170223*160AA^	.022	.197	.433	.020	5.0	11.0	.5				
170273*160AA^	.027	.197	.433	.020	5.0	11.0	.5				
170333*160AA^	.033	.197	.433	.020	5.0	11.0	.5				
170393*160AA^	.039	.197	.433	.020	5.0	11.0	.5				
170473*160AA^	.047	.197	.433	.020	5.0	11.0	.5				
170563*160BB^	.056	.236	.650	.024	6.0	16.5	.6				
170683*160BB^	.068	.236	.650	.024	6.0	16.5	.6				
170823*160BB^	.082	.236	.650	.024	6.0	16.5	.6				
170104*160BB^	.10	.236	.650	.024	6.0	16.5	.6				
170124*160DB^	.12	.276	.650	.024	7.0	16.5	.6				
170154*160DB^	.15	.276	.650	.024	7.0	16.5	.6				
170184*160EB^	.18	.315	.650	.031	8.0	16.5	.8				
170224*160EB^	.22	.315	.650	.031	8.0	16.5	.8				
170274*160EC^	.27	.315	.807	.031	8.0	20.5	.8				
170334*160EC^	.33	.315	.807	.031	8.0	20.5	.8				
170394*160HC^	.39	.374	.807	.031	9.5	20.5	.8				
170474*160HC^	.47	.374	.807	.031	9.5	20.5	.8	37.0	8.7	3.1	1.4
170564*160GE^	.56	.354	1.102	.031	9.0	28.0	.8	35.0	3.9	3.3	1.5
170684*160GE^	.68	.354	1.102	.031	9.0	28.0	.8	33.0	4.1	3.5	1.6
170824*160JE^	.82	.413	1.102	.031	10.5	28.0	.8	31.0	4.3	3.6	1.7
170105*160JE^	1.0	.413	1.102	.031	10.5	28.0	.8	26.0	5.5	4.7	2.6
170155*160ME^	1.5	.492	1.102	.031	12.5	28.0	.8	20.0	6.1	5.1	3.1
170225*160PF^	2.2	.531	1.299	.031	13.5	33.0	.8	18.0	6.8	5.7	3.3
170335*160TF^	3.3	.630	1.299	.039	16.0	33.0	1.0	16.0	7.4	6.4	3.6
170475*160XF^	4.7	.709	1.299	.039	18.0	33.0	1.0	15.0	8.1	6.8	3.9
250 VDC/200 VAC											
170103*250AA^	.010	.197	.433	.020	5.0	11.0	.5				
170123*250AA^	.012	.197	.433	.020	5.0	11.0	.5				
170153*250AA^	.015	.197	.433	.020	5.0	11.0	.5				
170183*250BB^	.018	.236	.650	.024	6.0	16.5	.6				
170223*250BB^	.022	.236	.650	.024	6.0	16.5	.6				
170273*250BB^	.027	.236	.650	.024	6.0	16.5	.6				
170333*250BB^	.033	.236	.650	.024	6.0	16.5	.6				
170393*250CB^	.039	.256	.650	.024	6.5	16.5	.6				
170473*250CB^	.047	.256	.650	.024	6.5	16.5	.6				
170563*250EB^	.056	.295	.650	.031	7.5	16.5	.8				
170683*250EB^	.068	.295	.650	.031	7.5	16.5	.8				
170823*250FB^	.082	.335	.650	.031	8.5	16.5	.8				
170104*250FB^	.10	.335	.650	.031	8.5	16.5	.8				
170124*250FC^	.12	.335	.807	.031	8.5	20.5	.8				
170154*250FC^	.15	.335	.807	.031	8.5	20.5	.8				
170184*250HC^	.18	.374	.807	.031	9.5	20.5	.8				
170224*250HC^	.22	.374	.807	.031	9.5	20.5	.8				
170274*250GE^	.27	.354	1.102	.031	9.0	28.0	.8				
170334*250GE^	.33	.354	1.102	.031	9.0	28.0	.8				
170394*250JE^	.39	.413	1.102	.031	10.5	28.0	.8				
170474*250JE^	.47	.413	1.102	.031	10.5	28.0	.8	35.0	3.8	3.6	1.7
170564*250ME^	.56	.472	1.102	.031	12.0	28.0	.8	33.0	3.9	3.7	1.8
170684*250ME^	.68	.472	1.102	.031	12.0	28.0	.8	32.0	4.0	3.8	1.9
170824*250NF^	.82	.512	1.299	.031	13.0	33.0	.8	31.0	4.2	4.0	2.0
170105*250NF^	1.0	.512	1.299	.031	13.0	33.0	.8	28.0	4.4	4.4	3.2
170155*250TF^	1.5	.610	1.299	.031	15.5	33.0	.8	26.0	5.1	4.9	3.5
170225*250XF^	2.2	.709	1.299	.039	18.0	33.0	1.0	20.0	8.4	7.0	4.1
170335*250ZF^	3.3	.846	1.299	.039	21.5	33.0	1.0	18.0	9.0	7.8	4.5

Not applicable. These capacitance values are not customarily used in switched-mode power supplies.

Not applicable. These capacitance values are not customarily used in switched-mode power supplies.

* Indicate capacitance tolerance
J = $\pm 5\%$, K = $\pm 10\%$, M = $\pm 20\%$

^ If ordering Tape & Reel, insert 1, 2, or 3
(See page 156 to determine which class applies)

General Purpose Film

170 Series Metallized Polypropylene / Axial Leads

MALLORY

General Purpose Film

Catalog Number	Cap μ F	Inches			Millimeters			ESR (mOhms) 20KHz to 100KHz	IRMS (Amps)		
		D Max	L Max	\varnothing d	D Max	L Max	\varnothing d		25°C	45°C	85°C
400 VDC/220 VAC											
170153*400BB [^]	.015	.236	.650	.024	6.0	16.5	.6	Not applicable. These capacitance values are not customarily used in switched-mode power supplies.			
170183*400CB [^]	.018	.256	.650	.024	6.5	16.5	.6				
170223*400CB [^]	.022	.256	.650	.024	6.5	16.5	.6				
170273*400DB [^]	.027	.276	.650	.024	7.0	16.5	.6				
170333*400DB [^]	.033	.276	.650	.024	7.0	16.5	.6				
170393*400EB [^]	.039	.315	.650	.031	8.0	16.5	.8				
170473*400EB [^]	.047	.315	.650	.031	8.0	16.5	.8				
170563*400EC [^]	.056	.315	.807	.031	8.0	20.5	.8				
170683*400EC [^]	.068	.315	.807	.031	8.0	20.5	.8				
170823*400GC [^]	.082	.354	.807	.031	9.0	20.5	.8				
170104*400GC [^]	.10	.354	.807	.031	9.0	20.5	.8				
170124*400FE [^]	.12	.335	1.102	.031	8.5	28.0	.8				
170154*400FE [^]	.15	.335	1.102	.031	8.5	28.0	.8				
170184*400IE [^]	.18	.394	1.102	.031	10.0	28.0	.8				
170224*224IE [^]	.22	.394	1.102	.031	10.0	28.0	.8				
170274*400LE [^]	.27	.453	1.102	.031	11.5	28.0	.8				
170334*400LE [^]	.33	.453	1.102	.031	11.5	28.0	.8				
170394*400NE [^]	.39	.512	1.102	.031	13.0	28.0	.8				
170474*400NE [^]	.47	.512	1.102	.031	13.0	28.0	.8	32.0	5.7	5.0	2.2
170564*400QF [^]	.56	.571	1.299	.031	14.5	33.0	.8	31.0	5.7	5.3	2.3
170684*400QF [^]	.68	.571	1.299	.031	14.5	33.0	.8	30.0	5.7	5.5	2.4
170824*400VF [^]	.82	.669	1.299	.039	17.0	33.0	1.0	28.0	5.7	5.6	2.6
170105*400VF [^]	1.0	.669	1.299	.039	17.0	33.0	1.0	27.0	5.7	5.7	4.3
170155*400YF [^]	1.5	.709	1.299	.039	18.0	33.0	1.0	25.0	7.0	6.7	4.7
630 VDC/250 VAC											
170102*630BB [^]	.0010	.236	.650	.024	6.0	16.5	.6	Not applicable. These capacitance values are not customarily used in switched-mode power supplies.			
170122*630BB [^]	.0012	.236	.650	.024	6.0	16.5	.6				
170152*630BB [^]	.0015	.236	.650	.024	6.0	16.5	.6				
170182*630BB [^]	.0018	.236	.650	.024	6.0	16.5	.6				
170222*630BB [^]	.0022	.236	.650	.024	6.0	16.5	.6				
170272*630BB [^]	.0027	.236	.650	.024	6.0	16.5	.6				
170332*630BB [^]	.0033	.236	.650	.024	6.0	16.5	.6				
170392*630BB [^]	.0039	.236	.650	.024	6.0	16.5	.6				
170472*630BB [^]	.0047	.236	.650	.024	6.0	16.5	.6				
170562*630BB [^]	.0056	.236	.650	.024	6.0	16.5	.6				
170682*630CB [^]	.0068	.236	.650	.024	6.0	16.5	.6				
170822*630CB [^]	.0082	.256	.650	.024	6.5	16.5	.6				
170103*630CB [^]	.010	.256	.650	.024	6.5	16.5	.6				
170123*630EB [^]	.012	.295	.650	.031	7.5	16.5	.8				
170153*630EB [^]	.015	.295	.650	.031	7.5	16.5	.8				
170183*630FB [^]	.018	.335	.650	.031	8.5	16.5	.8				
170223*630FB [^]	.022	.335	.650	.031	8.5	16.5	.8				
170273*630FC [^]	.027	.335	.807	.031	8.5	20.5	.8				
170333*630FC [^]	.033	.335	.807	.031	8.5	20.5	.8				
170393*630HC [^]	.039	.374	.807	.031	9.5	20.5	.8				
170473*630HC [^]	.047	.374	.807	.031	9.5	20.5	.8				
170563*630GE [^]	.056	.354	1.102	.031	9.0	28.0	.8				
170683*630GE [^]	.068	.354	1.102	.031	9.0	28.0	.8				
170823*630IE [^]	.082	.394	1.102	.031	10.0	28.0	.8				
170104*630IE [^]	.10	.394	1.102	.031	10.0	28.0	.8				
170124*630ME [^]	.12	.472	1.102	.031	12.0	28.0	.8				
170154*630ME [^]	.15	.472	1.102	.031	12.0	28.0	.8				
170184*630NF [^]	.18	.512	1.299	.031	13.0	33.0	.8				
170224*630NF [^]	.22	.512	1.299	.031	13.0	33.0	.8				
170274*630TF [^]	.27	.610	1.299	.031	15.5	33.0	.8				
170334*630TF [^]	.33	.610	1.299	.031	15.5	33.0	.8				
170394*630XF [^]	.39	.709	1.299	.039	18.0	33.0	1.0				
170474*630XF [^]	.47	.709	1.299	.039	18.0	33.0	1.0		28.0	6.8	5.8
170564*630ZF [^]	.56	.827	1.299	.039	21.0	33.0	1.0	26.0	7.4	6.3	2.8
170684*630ZF [^]	.68	.827	1.299	.039	21.0	33.0	1.0	25.0	7.8	6.8	2.9

* Indicate capacitance tolerance, J = $\pm 5\%$, K = $\pm 10\%$, M = $\pm 20\%$

[^] If ordering Tape & Reel, insert 1, 2, or 3
(See page 156 to determine which class applies)

171 Series Metallized Polypropylene / Radial Leads

MALLORY

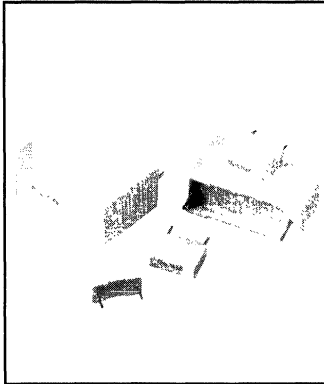

- Low Leakage
- Radial Leaded (7.5 mm to 27.4 mm)
- Non Inductively Wound
- Non-Polar
- Flame Retardant Case Meets UL94V0
- Epoxy Encapsulant Meets UL94V0
- Lead Material
Tinned Copper Wire
Minimum Lead Content 5%

GENERAL SPECIFICATIONS

Operating Temperature:
-55°C to +105°C with voltage derating above 85°C

Voltage Range:
160 VDC (90 VAC) to 630 VDC (250 VAC)

Capacitance Range:
0.0022 μF to 3.3 μF

Capacitance Tolerance:
±5%, ±10%, ±20%

Total Self Inductance
(2mm lead length)

Dielectric Withstand:
1.6 x Vn applied for 2 sec at +25°C ±5°C

Dissipation Factor (DF):
tgδ x 10⁻⁴ at +25°C ±5°C

	C	C	C
KHz	≤0.1μF	0.1μF to 1μF	>1μF
1	≤6	≤6	≤6
10	≤10	≤20	
100	≤30		

pitch (mm)	7.5	10	15	22.5	27.5
L (nH) ≈	8	9	10	18	18

Excellent choice for applications requiring low dielectric losses, high insulation resistance, high voltage capability and stable characteristics.

Maximum Pulse Rise Time dv/dt (V/μsec)

Vn	Pitch (mm)				
	7.5	10	15	22.5	27.5
160	5.5	4	2	1.5	1
250	15	11	7	4	3
400	35	20	10	5.5	5
630	55	30	15	8	7

If the working voltage (V) is less than the nominal voltage (Vn), the capacitor can work at higher dv/dt. In this case, the maximum value allowed is obtained by multiplying the above value (See table dv/dt) with the ratio Vn/V.

Test Method and Performance

Insulation Resistance	
Test Conditions	
Temperature	+25°C ± 5°C
Voltage Charge Time	1 minute
Voltage Charge	100VDC
Performance	
For C ≤ 0.33 μF	≥ 100,000 MΩ
For C > 0.33 μF	≥ 30,000 MΩ x μF
Damp Heat Test	
Test Conditions	
Temperature	+40°C
Relative Humidity	93% ± 2%
Test Duration	56 days
Performance	
Capacitance Change ΔC/C	≤ ± 2%
DF Change Δtgδ	≤ 10 x 10 ⁻⁴ at 1 KHz
Insulation Resistance	≥ 50% of limit value
Life Test	
Test Conditions	
Temperature	+85°C
Test Duration	2000h
Voltage Applied	1.25 x Vn
Performance	
Capacitance Change ΔC/C	≤ ± 3%
DF Change Δtgδ	≤ 10 x 10 ⁻⁴ for C > 1μF at 1 KHz ≤ 10 x 10 ⁻⁴ for C ≤ 1μF at 10 KHz
Insulation Resistance	≥ 50% of limit value
Soldering	
Test Conditions	
Soldering Temperature	+260°C ± 5°C
Soldering Duration	10 sec ± 1 sec
Performance	
Capacitance Change ΔC/C	≤ ± 1%
DF Change Δtgδ	≤ 10 x 10 ⁻⁴ for C > 1μF at 1 KHz ≤ 10 x 10 ⁻⁴ for C ≤ 1μF at 10 KHz
Long Term Stability (after two years)	
Storage Performance	Standard Environmental Conditions
Capacitance Change ΔC/C	≤ ± 0.5%
Corona (Partial Discharge Inception Voltage)	200 VAC for 160 VDC, 250 VDC 250 VAC for 400 VDC, 630 VDC

Outline Dimensions

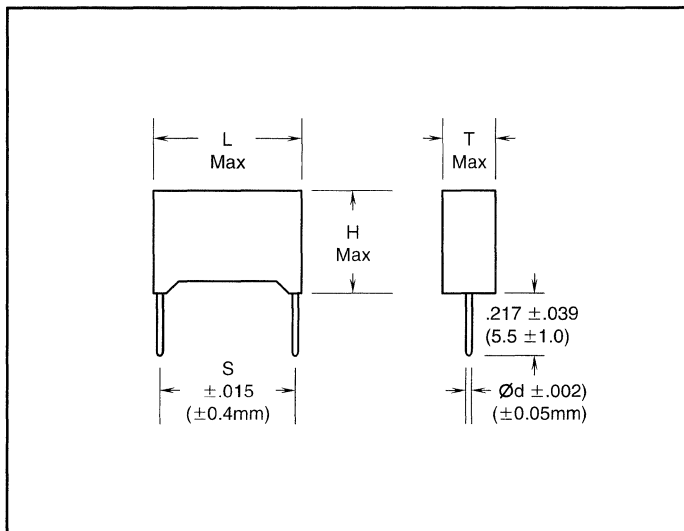

Catalog Number	Cap μF	Inches (Max)					Millimeters (Max)					ESR (mOhms) 20KHz to 100KHz	IRMS		
		L Length	T Thickness	H Height	S Spacing	Ød	L Length	T Thickness	H Height	S Spacing	Ød		25°C	45°C	85°C
160 VDC/90 VAC															
171333*160B	.033	.413	.157	.374	.295	.024	10.5	4.0	9.5	7.5	.6	Not applicable. These capacitance values are not customarily used in switched-mode power supplies.	25°C	45°C	85°C
171473*160B	.047	.413	.157	.374	.295	.024	10.5	4.0	9.5	7.5					
171473*160C	.047	.512	.157	.374	.394	.031	13.0	4.0	9.5	10.0					
171683*160C7	.068	.413	.197	.433	.295	.024	10.5	5.0	11.0	7.5					
171683*160D	.068	.512	.197	.433	.394	.031	13.0	5.0	11.0	10.0					
171104*160C7	.10	.413	.197	.433	.295	.031	10.5	5.0	11.0	7.5					
171104*160E	.10	.512	.236	.472	.394	.031	13.0	6.0	12.0	10.0					

* Indicate capacitance tolerance: J = ±5%, K = ±10%, M = ±20%

171 Series Metallized Polypropylene / Radial Leads



General Purpose Film

Catalog Number	Cap μ F	Inches (Max)					Millimeters (Max)					ESR (mOhms) 20KHz to 100KHz	IRMS						
		L Length	T Thickness	H Height	S Spacing	ϕ d	L Length	T Thickness	H Height	S Spacing	ϕ d		25°C	45°C	85°C				
160 VDC/90 VAC																			
171154*160D7	.15	.413	.236	.472	.295	.031	10.5	6.0	12.0	7.5	.8	Not applicable. These capacitance values are not customarily used in switched-mode power supplies.							
171154*160E	.15	.512	.236	.472	.394	.031	13.0	6.0	12.0	10.0	.8								
171224*160F	.22	.709	.197	.433	.591	.031	18.0	5.0	11.0	15.0	.8								
171334*160G	.33	.709	.236	.472	.591	.031	18.0	6.0	12.0	15.0	.8								
171474*160H	.47	.709	.295	.531	.591	.031	18.0	7.5	13.5	15.0	.8								
171684*160L	.68	1.039	.236	.591	.886	.031	26.5	6.0	15.0	22.5	.8								
171105*160N	1.0	1.039	.335	.669	.886	.031	26.5	8.5	17.0	22.5	.8								
171155*160O	1.5	1.039	.394	.748	.886	.031	26.5	10.0	19.0	22.5	.8								
171225*160P	2.2	1.260	.433	.787	1.083	.031	32.0	11.0	20.0	27.5	.8	18	6.3	5.7	3.3				
171335*160Q	3.3	1.260	.512	.886	1.083	.031	32.0	13.0	22.5	27.5	.8	16	7.4	6.4	3.6				
250 VDC/200 VAC																			
171153*250B	.015	.413	.157	.374	.295	.024	10.5	4.0	9.5	7.5	.6	Not applicable. These capacitance values are not customarily used in switched-mode power supplies.							
171223*250C	.022	.512	.157	.374	.394	.024	13.0	4.0	9.5	10.0	.8								
171333*250C	.033	.512	.157	.374	.394	.031	13.0	4.0	9.5	10.0	.8								
171473*250D	.047	.512	.197	.433	.394	.031	13.0	5.0	11.0	10.0	.8								
171683*250E	.068	.512	.236	.472	.394	.031	13.0	6.0	12.0	10.0	.8								
171104*250F	.10	.709	.197	.433	.591	.031	18.0	5.0	11.0	15.0	.8								
171154*250G	.15	.709	.236	.472	.591	.031	18.0	6.0	12.0	15.0	.8								
171224*250H	.22	.709	.295	.531	.591	.031	18.0	7.5	13.5	15.0	.8								
171334*250L	.33	1.043	.236	.591	.886	.031	26.5	6.0	15.0	22.5	.8								
171474*250M	.47	1.043	.276	.630	.886	.031	26.5	7.0	16.0	22.5	.8								
171684*250Q	.68	1.260	.512	.886	.886	.031	32.0	13.0	22.5	22.5	.8					35	3.8	3.6	1.7
171105*250P	1.0	1.260	.433	.787	1.083	.031	32.0	11.0	20.0	27.5	.8					28	4.4	4.4	3.2
171155*250Q	1.5	1.260	.512	.886	1.083	.031	32.0	13.0	22.5	27.5	.8					26	5.1	4.9	3.5
400 VDC/220 VAC																			
171682*400B	.0068	.413	.157	.374	.295	.024	10.5	4.0	9.5	7.5	.6					Not applicable. These capacitance values are not customarily used in switched-mode power supplies.			
171103*400B	.01	.413	.157	.374	.295	.024	10.5	4.0	9.5	7.5	.6								
171103*400C	.01	.512	.157	.374	.394	.024	13.0	4.0	9.5	10.0	.6								
171153*400D	.015	.512	.197	.433	.394	.024	13.0	5.0	11.0	10.0	.6								
171223*400D	.022	.512	.197	.433	.394	.031	13.0	5.0	11.0	10.0	.8								
171333*400E	.033	.512	.236	.472	.394	.031	13.0	6.0	12.0	10.0	.8								
171473*400F	.047	.709	.197	.433	.591	.031	18.0	5.0	11.0	15.0	.8								
171683*400G	.068	.709	.236	.472	.591	.031	18.0	6.0	12.0	15.0	.8								
171104*400H	.10	.709	.295	.531	.591	.031	18.0	7.5	13.5	15.0	.8								
171154*400I	.15	.709	.335	.571	.591	.031	18.0	8.5	14.5	15.0	.8								
171224*400N	.22	1.039	.335	.669	.886	.031	26.5	8.5	17.0	22.5	.8								
171334*400O	.33	1.039	.394	.748	.886	.031	26.5	10.0	19.0	22.5	.8								
171474*400P	.47	1.260	.433	.787	1.083	.031	32.0	11.0	20.0	27.5	.8	32	5.7	5.0	2.2				
171684*400Q	.68	1.260	.512	.886	1.083	.031	32.0	13.0	22.5	27.5	.8	30	5.7	5.5	2.4				
630 VDC/250 VAC																			
171222*630B	.0022	.413	.157	.374	.295	.024	10.5	4.0	9.5	7.5	.6	Not applicable. These capacitance values are not customarily used in switched-mode power supplies.							
171222*630C	.0022	.512	.157	.374	.394	.031	13.0	4.0	9.5	10.0	.8								
171332*630B	.0033	.413	.157	.374	.295	.024	10.5	4.0	9.5	7.5	.6								
171332*630C	.0033	.512	.157	.374	.394	.031	13.0	4.0	9.5	10.0	.8								
171472*630B	.0047	.413	.157	.374	.295	.024	10.5	4.0	9.5	7.5	.6								
171472*630C	.0047	.512	.157	.374	.394	.031	13.0	4.0	9.5	10.0	.8								
171682*630D	.0068	.512	.197	.433	.394	.031	13.0	5.0	11.0	10.0	.8								
171103*630D	.01	.512	.197	.433	.394	.031	13.0	5.0	11.0	10.0	.8								
171153*630E	.015	.512	.236	.472	.394	.031	13.0	6.0	12.0	10.0	.8								
171223*630F	.022	.709	.197	.433	.591	.031	18.0	5.0	11.0	15.0	.8								
171333*630G	.033	.709	.236	.472	.591	.031	18.0	6.0	12.0	15.0	.8								
171473*630H	.047	.709	.295	.531	.591	.031	18.0	7.5	13.5	15.0	.8								
171683*630I	.068	.709	.335	.571	.591	.031	18.0	8.5	14.5	15.0	.8								
171104*630N	.10	1.043	.335	.669	.886	.031	26.5	8.5	17.0	22.5	.8								
171154*630O	.15	1.043	.394	.748	.886	.031	26.5	10.0	19.0	22.5	.8								
171224*630P	.22	1.260	.433	.787	1.083	.031	32.0	11.0	20.0	27.5	.8								
171334*630Q	.33	1.260	.512	.886	1.083	.031	32.0	13.0	22.5	27.5	.8								

* Indicate capacitance tolerance
 J = $\pm 5\%$
 K = $\pm 10\%$
 M = $\pm 20\%$

PVC Series - Polyester Film / Foil (to 1000V) Polypropylene Film / Foil (1200 - 2000V)

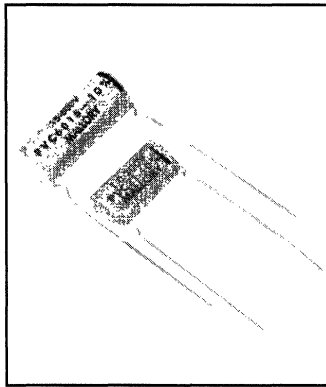

- Radial Leaded
- Wire Leads Crimped to Provide Seating on Printed Circuit Boards
- Non Inductively Wound
- Non-Polar
- 100 - 600 VDC meets UL94V0*
1000 - 2000 VDC meets UL94V2
(*PVC4047 and PVC6015 to PVC6033 meets UL94V2)
- Adaptable to all electronic circuit applications calling for bypass and coupling
- Lead Material
Tinned Copper Clad Steel

GENERAL SPECIFICATIONS

Operating Temperature:
100 - 1000 VDC:
-55°C to +125°C *
1200 - 2000 VDC:
-55°C to 105°C *
(*Provided the working voltage is reduced to 50% of the 85°C rating.)

Voltage Range:
100 VDC to 2000 VDC

Capacitance Range:
0.001 μ F to 1.0 μ F

Capacitance Tolerance (1KHz):
 \pm 10%

CECC Approval:
Detail Specification 30401-009

Dielectric Withstand:
Capacitors <1000 volts can withstand a DC potential of 250% of rated voltage between terminals of not more than 5 seconds. However, \geq 1000 volts the DC potential is 200%

Dissipation Factor (DF):
At +25°C ratings
1200-2000 VDC are 0.1% Max
All others are 0.75% Max

Insulation Resistance (IR)

After a two minute charge at rated voltage or 500 V whichever is less at 25°C	
100 - 1000 VDC	
For C \leq 0.25 μ F	100,000 M Ω
For C > 0.25 μ F	25,000 M Ω x μ F
1200 - 2000 VDC	
For C \leq 0.50 μ F	400,000 M Ω
For C > 0.50 μ F	200,000 M Ω x μ F

Outline Dimensions

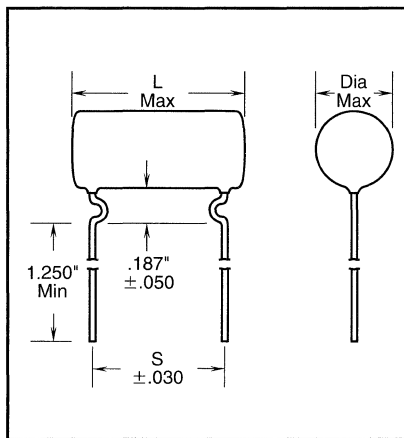

Test Method and Performance

Lead Pull Test
Capacitor leads shall withstand a steady pull of 5lbs. applied radially to the capacitor body for 1 minute.
Lead Bend Test
Capacitor leads shall be bent without breakage below the lead crimp, first 90° in one direction, then back to the original position and then 90° in the opposite direction.
Life Test
Conducted at +85°C: 500 hours with 1.5 times rated voltage DC.

General Purpose Film

Catalog Number	Cap μ F	Inches				Millimeters			
		L Max	Dia Max	S Lead Spacing	ϕ d	L Max	Dia Max	S Lead Spacing	ϕ d
100VDC/70VAC									
PVC118	.018	.700	.330	.500	.032	17.8	8.4	12.7	.8
PVC1122	.022	.700	.350	.500	.032	17.8	8.9	12.7	.8
PVC1127	.027	.700	.350	.500	.032	17.8	8.9	12.7	.8
PVC1133	.033	.700	.350	.500	.032	17.8	8.9	12.7	.8
PVC114	.040	.700	.350	.500	.032	17.8	8.9	12.7	.8
PVC1147	.047	.700	.350	.500	.032	17.8	8.9	12.7	.8
PVC1156	.056	.700	.380	.500	.032	17.8	9.7	12.7	.8
PVC1168	.068	.700	.380	.500	.032	17.8	9.7	12.7	.8
PVC1182	.082	.900	.400	.688	.032	22.9	10.2	17.5	.8
PVC101	.10	.900	.400	.688	.032	22.9	10.2	17.5	.8
PVC1015	.15	.900	.450	.688	.032	22.9	11.4	17.5	.8
PVC1022	.22	1.200	.450	.969	.032	30.5	11.4	24.6	.8
PVC1025	.25	1.200	.500	.969	.032	30.5	12.7	24.6	.8
PVC1033	.33	1.200	.500	.969	.032	30.5	12.7	24.6	.8
PVC1039	.39	1.600	.500	1.344	.032	40.6	12.7	34.1	.8
PVC1047	.47	1.600	.500	1.344	.032	40.6	12.7	34.1	.8
PVC105	.50	1.600	.600	1.344	.032	40.6	15.2	34.1	.8
PVC1056	.56	1.600	.600	1.344	.032	40.6	15.2	34.1	.8
PVC1068	.68	1.600	.600	1.344	.032	40.6	15.2	34.1	.8
PVC1082	.82	1.600	.700	1.344	.032	40.6	17.8	34.1	.8
PVC11	1.00	1.600	.700	1.344	.032	40.6	17.8	34.1	.8
200VDC/140VAC									
PVC211	.010	.700	.330	.500	.032	17.8	8.4	12.7	.8
PVC2115	.015	.700	.330	.500	.032	17.8	8.4	12.7	.8
PVC2118	.018	.700	.330	.500	.032	17.8	8.4	12.7	.8
PVC212	.020	.700	.330	.500	.032	17.8	8.4	12.7	.8
PVC2122	.022	.700	.330	.500	.032	17.8	8.4	12.7	.8

PVC Series - Polyester Film / Foil (to 1000V) Polypropylene Film / Foil (1200 - 2000V)

MALLORY

Catalog Number	Cap μ F	Inches				Millimeters			
		L Max	Dia Max	S Lead Spacing	\emptyset d	L Max	Dia Max	S Lead Spacing	\emptyset d
200VDC/140VAC									
PVC2133	.033	.900	.380	.688	.032	22.9	9.7	17.5	.8
PVC2139	.039	.900	.380	.688	.032	22.9	9.7	17.5	.8
PVC214	.040	.900	.380	.688	.032	22.9	9.7	17.5	.8
PVC2147	.047	.900	.380	.688	.032	22.9	9.7	17.5	.8
PVC215	.050	.900	.380	.688	.032	22.9	9.7	17.5	.8
PVC2156	.056	1.200	.380	.969	.032	30.5	9.7	24.6	.8
PVC2168	.068	1.200	.380	.969	.032	30.5	9.7	24.6	.8
PVC2182	.082	1.200	.400	.969	.032	30.5	10.2	24.6	.8
PVC201	.10	1.200	.400	.969	.032	30.5	10.2	24.6	.8
PVC2015	.15	1.200	.450	.969	.032	30.5	11.4	24.6	.8
PVC2022	.22	1.200	.500	.969	.032	30.5	12.7	24.6	.8
PVC2025	.25	1.600	.500	.969	.032	40.6	12.7	24.6	.8
PVC2027	.27	1.600	.500	1.344	.032	40.6	12.7	34.1	.8
PVC2033	.33	1.600	.500	1.344	.032	40.6	12.7	34.1	.8
PVC2047	.47	1.600	.560	1.344	.032	40.6	14.2	34.1	.8
PVC205	.50	1.600	.560	1.344	.032	40.6	14.2	34.1	.8
400VDC/200VAC									
PVC421	.0010	.700	.300	.500	.032	17.8	7.6	12.7	.8
PVC4222	.0022	.700	.300	.500	.032	17.8	7.6	12.7	.8
PVC4233	.0033	.700	.300	.500	.032	17.8	7.6	12.7	.8
PVC4247	.0047	.700	.300	.500	.032	17.8	7.6	12.7	.8
PVC4268	.0068	.700	.330	.500	.032	17.8	8.4	12.7	.8
PVC411	.010	.700	.350	.500	.032	17.8	8.9	12.7	.8
PVC412	.020	.900	.390	.688	.032	22.9	9.9	17.5	.8
PVC4133	.033	.900	.400	.688	.032	22.9	10.2	17.5	.8
PVC4147	.047	1.200	.400	.969	.032	30.5	10.2	24.6	.8
PVC415	.050	1.200	.450	.969	.032	30.5	11.4	24.6	.8
PVC4156	.056	1.200	.450	.969	.032	30.5	11.4	24.6	.8
PVC4168	.068	1.200	.450	.969	.032	30.5	11.4	24.6	.8
PVC4182	.082	1.200	.520	.969	.032	30.5	13.2	24.6	.8
PVC401	.10	1.200	.530	.969	.032	30.5	13.5	24.6	.8
PVC4015	.15	1.200	.570	.969	.032	30.5	14.5	24.6	.8
PVC4018	.18	1.600	.600	1.344	.032	40.6	15.2	34.1	.8
PVC4022	.22	1.600	.600	1.344	.032	40.6	15.2	34.1	.8
PVC4025	.25	1.600	.650	1.344	.032	40.6	16.5	34.1	.8
PVC4033	.33	1.600	.650	1.344	.032	40.6	16.5	34.1	.8
PVC4039	.39	1.600	.720	1.344	.032	40.6	18.3	34.1	.8
PVC4047	.47	1.600	.800	1.344	.032	40.6	20.3	34.1	.8
600VDC/200VAC									
PVC621	.0010	.700	.300	.500	.032	17.8	7.6	12.7	.8
PVC6212	.0012	.700	.340	.500	.032	17.8	8.6	12.7	.8
PVC6215	.0015	.700	.340	.500	.032	17.8	8.6	12.7	.8
PVC6218	.0018	.700	.330	.500	.032	17.8	8.4	12.7	.8
PVC622	.0020	.700	.340	.500	.032	17.8	8.6	12.7	.8
PVC6222	.0022	.700	.340	.500	.032	17.8	8.6	12.7	.8
PVC6225	.0025	.700	.340	.500	.032	17.8	8.6	12.7	.8
PVC6227	.0027	.700	.350	.500	.032	17.8	8.9	12.7	.8
PVC623	.0030	.700	.350	.500	.032	17.8	8.9	12.7	.8
PVC6233	.0033	.700	.350	.500	.032	17.8	8.9	12.7	.8
PVC6239	.0039	.700	.390	.500	.032	17.8	9.9	12.7	.8
PVC624	.0040	.700	.390	.500	.032	17.8	9.9	12.7	.8
PVC6247	.0047	.700	.390	.500	.032	17.8	9.9	12.7	.8
PVC625	.0050	.700	.390	.500	.032	17.8	9.9	12.7	.8
PVC6256	.0056	.700	.400	.500	.032	17.8	10.2	12.7	.8
PVC626	.006	.700	.400	.500	.032	17.8	10.2	12.7	.8
PVC6268	.0068	.700	.400	.500	.032	17.8	10.2	12.7	.8
PVC6275	.0075	.700	.400	.500	.032	17.8	10.2	12.7	.8
PVC628	.0080	.900	.400	.688	.032	22.9	10.2	17.5	.8
PVC6282	.0082	.900	.400	.688	.032	22.9	10.2	17.5	.8
PVC611	.010	.900	.400	.688	.032	22.9	10.2	17.5	.8
PVC6112	.012	.900	.400	.688	.032	22.9	10.2	17.5	.8
PVC6115	.015	.900	.400	.688	.032	22.9	10.2	17.5	.8
PVC6118	.018	.900	.450	.688	.032	22.9	11.4	17.5	.8
PVC612	.020	.900	.450	.688	.032	22.9	11.4	17.5	.8
PVC6122	.022	.900	.450	.688	.032	22.9	11.4	17.5	.8
PVC6125	.025	.900	.450	.688	.032	22.9	11.4	17.5	.8

General Purpose Film

PVC Series - Polyester Film / Foil (to 1000V) Polypropylene Film / Foil (1200 - 2000V)

MALLORY

Catalog Number	Cap μ F	Inches				Millimeters			
		L Max	Dia Max	S Lead Spacing	\varnothing d	L Max	Dia Max	S Lead Spacing	\varnothing d
600VDC/200VAC									
PVC6127	.027	1.200	.450	.969	.032	30.5	11.4	24.6	.8
PVC613	.030	1.200	.450	.969	.032	30.5	11.4	24.6	.8
PVC6133	.033	1.200	.450	.969	.032	30.5	11.4	24.6	.8
PVC6139	.039	1.200	.560	.969	.032	30.5	14.2	24.6	.8
PVC614	.040	1.200	.560	.969	.032	30.5	14.2	24.6	.8
PVC6147	.047	1.200	.560	.969	.032	30.5	14.2	24.6	.8
PVC615	.050	1.200	.560	.969	.032	30.5	14.2	24.6	.8
PVC6156	.056	1.200	.600	.969	.032	30.5	15.2	24.6	.8
PVC6168	.068	1.200	.600	.969	.032	30.5	15.2	24.6	.8
PVC6182	.082	1.200	.650	.969	.032	30.5	16.5	24.6	.8
PVC601	.10	1.200	.650	.969	.032	30.5	16.5	24.6	.8
PVC6012	.12	1.600	.700	1.344	.032	40.6	17.8	34.1	.8
PVC6015	.15	1.600	.700	1.344	.032	40.6	17.8	34.1	.8
PVC6018	.18	1.600	.800	1.344	.032	40.6	20.3	34.1	.8
PVC602	.20	1.600	.800	1.344	.032	40.6	20.3	34.1	.8
PVC6022	.22	1.600	.800	1.344	.032	40.6	20.3	34.1	.8
PVC6025	.25	1.600	.800	1.344	.032	40.6	20.3	34.1	.8
PVC6033	.33	1.810	.890	1.531	.032	46.0	22.6	38.9	.8
1000VDC/200VAC									
PVC1021	.0010	.700	.330	.500	.032	17.8	8.4	12.7	.8
PVC10215	.0015	.700	.330	.500	.032	17.8	8.4	12.7	.8
PVC10218	.0018	.700	.350	.500	.032	17.8	8.9	12.7	.8
PVC10222	.0022	.700	.350	.500	.032	17.8	8.9	12.7	.8
PVC10233	.0033	.900	.350	.688	.032	22.9	8.9	17.5	.8
PVC10247	.0047	.900	.400	.688	.032	22.9	10.2	17.5	.8
PVC10256	.0056	.900	.430	.688	.032	22.9	10.9	17.5	.8
PVC10268	.0068	.900	.430	.688	.032	22.9	10.9	17.5	.8
PVC10282	.0082	.900	.480	.688	.032	22.9	12.2	17.5	.8
PVC1011	.010	.900	.480	.688	.032	22.9	12.2	17.5	.8
PVC10115	.015	1.200	.480	.969	.032	30.5	12.2	24.6	.8
PVC10118	.018	1.200	.580	.969	.032	30.5	14.7	24.6	.8
PVC10122	.022	1.200	.580	.969	.032	30.5	14.7	24.6	.8
PVC10127	.027	1.200	.650	.969	.032	30.5	16.5	24.6	.8
PVC10133	.033	1.200	.650	.969	.032	30.5	16.5	24.6	.8
PVC10139	.039	1.600	.650	1.344	.032	40.6	16.5	34.1	.8
PVC10147	.047	1.600	.650	1.344	.032	40.6	16.5	34.1	.8
PVC10156	.056	1.600	.750	1.344	.032	40.6	19.1	34.1	.8
PVC10168	.068	1.600	.750	1.344	.032	40.6	19.1	34.1	.8
PVC10182	.082	1.600	.850	1.344	.032	40.6	21.6	34.1	.8
PVC10010	.10	1.600	.850	1.344	.032	40.6	21.6	34.1	.8
1200VDC/475VAC									
PVC1221	.0010	1.300	.500	.969	.032	33.0	12.7	24.6	.8
PVC12212	.0012	1.300	.500	.969	.032	33.0	12.7	24.6	.8
PVC12215	.0015	1.300	.500	.969	.032	33.0	12.7	24.6	.8
PVC12218	.0018	1.300	.500	.969	.032	33.0	12.7	24.6	.8
PVC12222	.0022	1.300	.500	.969	.032	33.0	12.7	24.6	.8
PVC12227	.0027	1.300	.500	.969	.032	33.0	12.7	24.6	.8
PVC12233	.0033	1.300	.500	.969	.032	33.0	12.7	24.6	.8
PVC12239	.0039	1.300	.500	.969	.032	33.0	12.7	24.6	.8
PVC12247	.0047	1.300	.500	.969	.032	33.0	12.7	24.6	.8
PVC12256	.0056	1.300	.550	.969	.032	33.0	14.0	24.6	.8
PVC12268	.0068	1.300	.550	.969	.032	33.0	14.0	24.6	.8
PVC12282	.0082	1.300	.600	.969	.032	33.0	15.2	24.6	.8
PVC1211	.010	1.300	.600	.969	.032	33.0	15.2	24.6	.8
PVC12112	.012	1.300	.650	.969	.032	33.0	16.5	24.6	.8
PVC12115	.015	1.300	.650	.969	.032	33.0	16.5	24.6	.8
PVC12118	.018	1.700	.650	1.344	.032	43.2	16.5	34.1	.8
PVC12122	.022	1.700	.650	1.344	.032	43.2	16.5	34.1	.8
PVC12127	.027	1.700	.750	1.344	.032	43.2	19.1	34.1	.8
PVC12133	.033	1.700	.750	1.344	.032	43.2	19.1	34.1	.8
PVC12139	.039	1.700	.850	1.344	.032	43.2	21.6	34.1	.8
PVC12147	.047	1.700	.850	1.344	.032	43.2	21.6	34.1	.8

General Purpose Film

PVC Series - Polyester Film / Foil (to 1000V) Polypropylene Film / Foil (1200 - 2000V)



General Purpose Film

Catalog Number	Cap μ F	Inches				Millimeters			
		L Max	Dia Max	S Lead Spacing	\emptyset d	L Max	Dia Max	S Lead Spacing	\emptyset d
1600VDC/475VAC									
PVC1621	.0010	1.300	.500	.969	.032	33.0	12.7	24.6	.8
PVC16215	.0015	1.300	.500	.969	.032	33.0	12.7	24.6	.8
PVC16222	.0022	1.300	.500	.969	.032	33.0	12.7	24.6	.8
PVC16227	.0027	1.300	.500	.969	.032	33.0	12.7	24.6	.8
PVC1623	.0030	1.300	.500	.969	.032	33.0	12.7	24.6	.8
PVC16233	.0033	1.300	.500	.969	.032	33.0	12.7	24.6	.8
PVC1624	.0040	1.300	.500	.969	.032	33.0	12.7	24.6	.8
PVC16247	.0047	1.300	.500	.969	.032	33.0	12.7	24.6	.8
PVC1625	.0050	1.300	.500	.969	.032	33.0	12.7	24.6	.8
PVC1626	.0060	1.300	.550	.969	.032	33.0	14.0	24.6	.8
PVC16268	.0068	1.300	.550	.969	.032	33.0	14.0	24.6	.8
PVC1627	.0070	1.300	.550	.969	.032	33.0	14.0	24.6	.8
PVC16275	.0075	1.300	.550	.969	.032	33.0	14.0	24.6	.8
PVC1628	.0080	1.300	.600	.969	.032	33.0	15.2	24.6	.8
PVC16282	.0082	1.300	.600	.969	.032	33.0	15.2	24.6	.8
PVC1611	.010	1.300	.600	.969	.032	33.0	15.2	24.6	.8
PVC16115	.015	1.300	.650	1.344	.032	33.0	16.5	34.1	.8
PVC1612	.020	1.700	.650	1.344	.032	43.2	16.5	34.1	.8
PVC16122	.022	1.700	.650	1.344	.032	43.2	16.5	34.1	.8
PVC16133	.033	1.700	.750	1.344	.032	43.2	19.1	34.1	.8
PVC16147	.047	1.700	.850	1.344	.032	43.2	21.6	34.1	.8
PVC1615	.050	1.700	.850	1.344	.032	43.2	21.6	34.1	.8
2000VDC/500VAC									
PVC2X21	.0010	1.300	.500	.969	.032	33.0	12.7	24.6	.8
PVC2X212	.0012	1.300	.500	.969	.032	33.0	12.7	24.6	.8
PVC2X215	.0015	1.300	.500	.969	.032	33.0	12.7	24.6	.8
PVC2X218	.0018	1.300	.500	.969	.032	33.0	12.7	24.6	.8
PVC2X222	.0022	1.300	.500	.969	.032	33.0	12.7	24.6	.8
PVC2X227	.0027	1.300	.550	.969	.032	33.0	14.0	24.6	.8
PVC2X233	.0033	1.300	.550	.969	.032	33.0	14.0	24.6	.8
PVC2X239	.0039	1.300	.600	.969	.032	33.0	15.2	24.6	.8
PVC2X247	.0047	1.300	.600	.969	.032	33.0	15.2	24.6	.8
PVC2X256	.0056	1.300	.650	.969	.032	33.0	16.5	24.6	.8
PVC2X268	.0068	1.300	.650	.969	.032	33.0	16.5	24.6	.8
PVC2X282	.0082	1.300	.700	.969	.032	33.0	17.8	24.6	.8
PVC2X11	.010	1.300	.700	.969	.032	33.0	17.8	24.6	.8
PVC2X112	.012	1.700	.750	1.344	.032	43.2	19.1	34.1	.8
PVC2X115	.015	1.700	.750	1.344	.032	43.2	19.1	34.1	.8
PVC2X118	.018	1.700	.850	1.344	.032	43.2	21.6	34.1	.8
PVC2X122	.022	1.700	.850	1.344	.032	43.2	21.6	34.1	.8
PVC2X127	.027	1.700	.950	1.344	.032	43.2	24.1	34.1	.8
PVC2X133	.033	1.700	.950	1.344	.032	43.2	24.1	34.1	.8

SX Series Polystyrene-Foil / Axial Leads

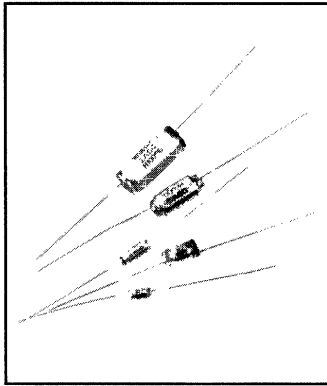

- Axial Leads
- High Q and Excellent Stability
- High Insulation, Low Absorption
- Low Dissipation Factor, Tight Temperature Coefficient
- Lead Material
Solder Coated or Tinned
Solid Wire

The colored band at one side of the body serves as a color guide for rated voltage, and indicates the lead attached to the outside foil.

GENERAL SPECIFICATIONS

Operating Temperature:
-40°C to +70°C (Derate 0.67% per °C above 40°C)

Voltage Range:
40°C - 33 VDC to 630 VDC
70°C - 25 VDC to 500 VDC

Capacitance Range:
20 pF to 0.1 μF

Capacitance Tolerance:
±2.5% (SXX, SXL, SXM)
±5.0% (SX)

Total Self Inductance:
Body: 10 to 30 nH, function of the body length
Leads: 10 nH/cm of length

Dielectric Withstand:
2.5 x V rated for 5 seconds
Charge and discharge current ≤ 50 mA

Dissipation Factor (DF):
Shall not be > .05%

Ideally suited for precision circuits such as sample and hold, dual Slope Integration and Temperature Compensation

Temperature Coefficient

For 33 VDC:	
	-125 ± 75 PPM/°C
For 63, 160, 630 VDC	
Capacitance Values ≤ 500 pF	-175 ± 75 PPM/°C
Capacitance Values > 500 PF	-125 ± 75 PPM/°C

Specifications

Insulation Resistance (IR) Shall be less than: 50,000 MΩ or 1000/C (MΩ) (C in MFD) whichever is lower for 33 VDC at 10 VDC 100,000 MΩ or 2000/C (MΩ) (C in MFD) whichever is lower for 63 VDC at 10 VDC 500,000 MΩ or 10,000/C (MΩ) (C in MFD) whichever is lower for 160 to 630 VDC at 100 VDC
Dielectric Absorption: Equal to or less than .02%
Capacitance Drift: Equal to or less than ± 0.3% + 0.4 pF after thermal cycle from +25°C to -25°C to +70°C and back to +25°C
Storage: ΔC/C ≤ ± 0.5% +.4pF for SXX, SXL ΔC/C ≤ ± 0.2% +.4PF for SXM, SX When stored in constant climate ≤ 70% RH within operating temperature range and stabilized at 40% RH 25°C ± 5°C for 24 hours before measurements
Life Test: 125% of rated voltage for 250 hrs at 70°C
Soldering Conditions: Not recommended for wave soldering For manual soldering: Solder Temperature: 270°C Time: 4 seconds maximum Distance from body: .236 inches minimum Caution: Exposure to temperatures > 70°C will result in serious degradation Clean with de-ionized water only. Do not expose to solvents.

Outline Dimensions

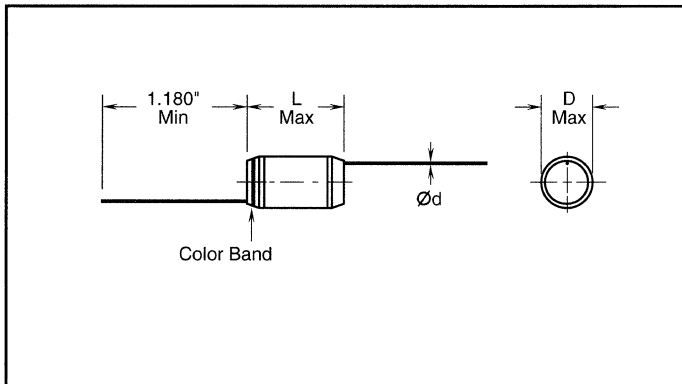

SX Series Polystyrene-Foil / Axial Leads



Precision Film

Catalog Number	Cap pF	Inches			Millimeters		
		D Max	L Max	Ød	D Max	L Max	Ød
33 WVDC @ +40°C 25 WVDC @ +85°C (Blue Color Band)							
SXK310	100	.180	.315	.012	4.6	8.0	.3
SXK312	120	.180	.315	.012	4.6	8.0	.3
SXK315	150	.180	.315	.012	4.6	8.0	.3
SXK318	180	.180	.315	.012	4.6	8.0	.3
SXK322	220	.180	.315	.012	4.6	8.0	.3
SXK327	270	.180	.315	.012	4.6	8.0	.3
SXK333	330	.180	.315	.012	4.6	8.0	.3
SXK339	390	.180	.315	.012	4.6	8.0	.3
SXK347	470	.180	.315	.012	4.6	8.0	.3
SXK356	560	.180	.315	.012	4.6	8.0	.3
SXK368	680	.180	.315	.012	4.6	8.0	.3
SXK382	820	.180	.315	.012	4.6	8.0	.3
SXK210	1,000	.180	.315	.012	4.6	8.0	.3
SXK212	1,200	.260	.473	.016	6.6	12.0	.4
SXK215	1,500	.260	.473	.016	6.6	12.0	.4
SXK218	1,800	.260	.473	.016	6.6	12.0	.4
SXK222	2,200	.260	.473	.016	6.6	12.0	.4
SXK227	2,700	.260	.473	.016	6.6	12.0	.4
SXK233	3,300	.260	.473	.016	6.6	12.0	.4
SXK239	3,900	.260	.473	.016	6.6	12.0	.4
SXK247	4,700	.260	.473	.016	6.6	12.0	.4
SXK256	5,600	.470	.670	.020	11.9	17.0	.5
SXK268	6,800	.470	.670	.020	11.9	17.0	.5
SXK282	8,200	.470	.670	.020	11.9	17.0	.5
SXK110	10,000	.470	.670	.020	11.9	17.0	.5
SXK112	12,000	.470	.670	.020	11.9	17.0	.5
SXK115	15,000	.470	.670	.020	11.9	17.0	.5
SXK118	18,000	.470	.670	.020	11.9	17.0	.5
SXK122	22,000	.470	.670	.020	11.9	17.0	.5
SXK125	25,000	.470	.670	.020	11.9	17.0	.5
SXK127	27,000	.470	.670	.020	11.9	17.0	.5
SXK133	33,000	.709	.867	.020	18.0	22.0	.5
SXK139	39,000	.709	.867	.020	18.0	22.0	.5
SXK147	47,000	.709	.867	.020	18.0	22.0	.5
SXK156	56,000	.709	.867	.020	18.0	22.0	.5
SXK168	68,000	.709	.867	.020	18.0	22.0	.5
SXK182	82,000	.709	.867	.020	18.0	22.0	.5
SXK010	100,000	.709	.867	.020	18.0	22.0	.5

Catalog Number	Cap pF	Inches			Millimeters		
		D Max	L Max	Ød	D Max	L Max	Ød
63 WVDC @ +40°C 50 WVDC @ +85°C (Yellow Color Band)							
SXL482	82	.190	.315	.012	4.8	8.0	.3
SXL310	100	.190	.315	.012	4.8	8.0	.3
SXL315	150	.190	.315	.012	4.8	8.0	.3
SXL318	180	.190	.315	.012	4.8	8.0	.3
SXL322	220	.190	.315	.012	4.8	8.0	.3
SXL327	270	.190	.315	.012	4.8	8.0	.3
SXL333	330	.190	.315	.012	4.8	8.0	.3
SXL347	470	.190	.315	.012	4.8	8.0	.3
SXL356	560	.190	.315	.012	4.8	8.0	.3
SXL368	680	.190	.315	.012	4.8	8.0	.3
SXL210	1,000	.330	.473	.016	8.4	12.0	.4
SXL212	1,200	.330	.473	.016	8.4	12.0	.4
SXL215	1,500	.330	.473	.016	8.4	12.0	.4
SXL218	1,800	.330	.473	.016	8.4	12.0	.4
SXL222	2,200	.330	.473	.016	8.4	12.0	.4
SXL227	2,700	.330	.473	.016	8.4	12.0	.4
SXL233	3,300	.330	.473	.016	8.4	12.0	.4
SXL239	3,900	.330	.473	.016	8.4	12.0	.4
SXL247	4,700	.330	.473	.016	8.4	12.0	.4
SXL256	5,600	.340	.670	.020	8.6	17.0	.5
SXL268	6,800	.340	.670	.020	8.6	17.0	.5
SXL282	8,200	.340	.670	.020	8.6	17.0	.5
SXL110	10,000	.340	.670	.020	8.6	17.0	.5
SXL112	12,000	.430	.867	.020	10.9	22.0	.5
SXL115	15,000	.430	.867	.020	10.9	22.0	.5
SXL116	16,000	.430	.867	.020	10.9	22.0	.5
SXL118	18,000	.430	.867	.020	10.9	22.0	.5
SXL120	20,000	.430	.867	.020	10.9	22.0	.5
SXL122	22,000	.430	.867	.020	10.9	22.0	.5
SXL125	25,000	.430	.867	.020	10.9	22.0	.5

SX Series Polystyrene-Foil / Axial Leads



Catalog Number	Cap pF	Inches			Millimeters		
		D Max	L Max	Ød	D Max	L Max	Ød
160 WVDC @ +40°C 125 WVDC @ +85°C (Red Color Band)							

SXM420	20	.240	.315	.012	6.1	8.0	.3
SXM427	27	.240	.315	.012	6.1	8.0	.3
SXM433	33	.240	.315	.012	6.1	8.0	.3
SXM439	39	.240	.315	.012	6.1	8.0	.3
SXM447	47	.240	.315	.012	6.1	8.0	.3
SXM456	56	.240	.315	.012	6.1	8.0	.3
SXM468	68	.240	.315	.012	6.1	8.0	.3
SXM482	82	.240	.315	.012	6.1	8.0	.3
SXM310	100	.240	.315	.012	6.1	8.0	.3
SXM312	120	.240	.315	.012	6.1	8.0	.3
SXM315	150	.240	.315	.012	6.1	8.0	.3
SXM318	180	.240	.315	.012	6.1	8.0	.3
SXM322	220	.240	.315	.012	6.1	8.0	.3
SXM327	270	.240	.315	.012	6.1	8.0	.3
SXM330	300	.240	.315	.012	6.1	8.0	.3
SXM333	330	.240	.315	.012	6.1	8.0	.3
SXM336	360	.240	.315	.012	6.1	8.0	.3
SXM339	390	.240	.315	.012	6.1	8.0	.3
SXM343	430	.240	.315	.012	6.1	8.0	.3
SXM347	470	.240	.315	.012	6.1	8.0	.3
SXM350	500	.240	.315	.012	6.1	8.0	.3
SXM351	510	.240	.315	.012	6.1	8.0	.3
SXM356	560	.240	.315	.012	6.1	8.0	.3
SXM360	600	.240	.315	.012	6.1	8.0	.3
SXM362	620	.300	.473	.016	7.6	12.0	.4
SXM368	680	.300	.473	.016	7.6	12.0	.4
SXM375	750	.300	.473	.016	7.6	12.0	.4
SXM382	820	.300	.473	.016	7.6	12.0	.4
SXM391	910	.300	.473	.016	7.6	12.0	.4
SXM210	1,000	.300	.473	.016	7.6	12.0	.4
SXM211	1,100	.300	.473	.016	7.6	12.0	.4
SXM212	1,200	.300	.473	.016	7.6	12.0	.4
SXM213	1,300	.300	.473	.016	7.6	12.0	.4
SXM215	1,500	.300	.473	.016	7.6	12.0	.4
SXM216	1,600	.300	.473	.016	7.6	12.0	.4
SXM218	1,800	.300	.473	.016	7.6	12.0	.4
SXM220	2,000	.300	.473	.016	7.6	12.0	.4
SXM222	2,200	.370	.670	.020	9.4	17.0	.5
SXM224	2,400	.370	.670	.020	9.4	17.0	.5
SXM227	2,700	.370	.670	.020	9.4	17.0	.5
SXM230	3,000	.370	.670	.020	9.4	17.0	.5
SXM233	3,300	.370	.670	.020	9.4	17.0	.5
SXM236	3,600	.370	.670	.020	9.4	17.0	.5
SXM239	3,900	.370	.670	.020	9.4	17.0	.5
SXM243	4,300	.370	.670	.020	9.4	17.0	.5
SXM247	4,700	.370	.670	.020	9.4	17.0	.5
SXM250	5,000	.370	.670	.020	9.4	17.0	.5
SXM251	5,100	.470	.867	.020	11.9	22.0	.5
SXM256	5,600	.470	.867	.020	11.9	22.0	.5
SXM262	6,200	.470	.867	.020	11.9	22.0	.5
SXM268	6,800	.470	.867	.020	11.9	22.0	.5
SXM275	7,500	.470	.867	.020	11.9	22.0	.5
SXM282	8,200	.470	.867	.020	11.9	22.0	.5
SXM110	10,000	.470	.867	.020	11.9	22.0	.5
SXM112	12,000	.470	.867	.020	11.9	22.0	.5
SXM113	13,000	.470	.867	.020	11.9	22.0	.5
SXM115	15,000	.470	.867	.020	11.9	22.0	.5
SXM118	18,000	.530	1.260	.020	13.5	32.0	.5
SXM122	22,000	.530	1.260	.020	13.5	32.0	.5
SXM124	24,000	.530	1.260	.020	13.5	32.0	.5

Catalog Number	Cap pF	Inches			Millimeters		
		D Max	L Max	Ød	D Max	L Max	Ød
630 WVDC @ +40°C 500 WVDC @ +85°C (Black Color Band)							

SX420	20	.280	.473	.016	7.1	12.0	.4
SX422	22	.280	.473	.016	7.1	12.0	.4
SX424	24	.280	.473	.016	7.1	12.0	.4
SX330	30	.280	.473	.016	7.1	12.0	.4
SX430	30	.280	.473	.016	7.1	12.0	.4
SX433	33	.280	.473	.016	7.1	12.0	.4
SX436	36	.280	.473	.016	7.1	12.0	.4
SX439	39	.280	.473	.016	7.1	12.0	.4
SX443	43	.280	.473	.016	7.1	12.0	.4
SX447	47	.280	.473	.016	7.1	12.0	.4
SX456	56	.280	.473	.016	7.1	12.0	.4
SX462	62	.280	.473	.016	7.1	12.0	.4
SX468	68	.280	.473	.016	7.1	12.0	.4
SX475	75	.280	.473	.016	7.1	12.0	.4
SX482	82	.280	.473	.016	7.1	12.0	.4
SX491	91	.280	.473	.016	7.1	12.0	.4
SX310	100	.280	.473	.016	7.1	12.0	.4
SX311	110	.280	.473	.016	7.1	12.0	.4
SX312	120	.280	.473	.016	7.1	12.0	.4
SX313	130	.280	.473	.016	7.1	12.0	.4
SX315	150	.280	.473	.016	7.1	12.0	.4
SX316	160	.280	.473	.016	7.1	12.0	.4
SX318	180	.280	.473	.016	7.1	12.0	.4
SX320	200	.280	.473	.016	7.1	12.0	.4
SX322	220	.280	.473	.016	7.1	12.0	.4
SX324	240	.280	.473	.016	7.1	12.0	.4
SX327	270	.280	.473	.016	7.1	12.0	.4
SX333	330	.280	.473	.016	7.1	12.0	.4
SX336	360	.280	.473	.016	7.1	12.0	.4
SX339	390	.280	.473	.016	7.1	12.0	.4
SX343	430	.280	.473	.016	7.1	12.0	.4
SX347	470	.280	.473	.016	7.1	12.0	.4
SX351	510	.400	.670	.020	10.2	17.0	.5
SX356	560	.400	.670	.020	10.2	17.0	.5
SX362	620	.400	.670	.020	10.2	17.0	.5
SX368	680	.400	.670	.020	10.2	17.0	.5
SX375	750	.400	.670	.020	10.2	17.0	.5
SX382	820	.400	.670	.020	10.2	17.0	.5
SX210	1,000	.400	.670	.020	10.2	17.0	.5
SX211	1,100	.400	.670	.020	10.2	17.0	.5
SX212	1,200	.400	.670	.020	10.2	17.0	.5
SX213	1,300	.400	.670	.020	10.2	17.0	.5
SX215	1,500	.400	.670	.020	10.2	17.0	.5
SX218	1,800	.400	.670	.020	10.2	17.0	.5
SX220	2,000	.400	.670	.020	10.2	17.0	.5
SX222	2,200	.400	.670	.020	10.2	17.0	.5
SX224	2,400	.400	.670	.020	10.2	17.0	.5
SX225	2,500	.400	.670	.020	10.2	17.0	.5
SX227	2,700	.400	.670	.020	10.2	17.0	.5
SX230	3,000	.400	.670	.020	10.2	17.0	.5
SX233	3,300	.590	.867	.020	15.0	22.0	.5
SX236	3,600	.590	.867	.020	15.0	22.0	.5
SX239	3,900	.590	.867	.020	15.0	22.0	.5
SX243	4,300	.590	.867	.020	15.0	22.0	.5
SX247	4,700	.590	.867	.020	15.0	22.0	.5
SX250	5,000	.590	.867	.020	15.0	22.0	.5
SX251	5,100	.590	.867	.020	15.0	22.0	.5
SX256	5,600	.590	.867	.020	15.0	22.0	.5
SX262	6,200	.590	.867	.020	15.0	22.0	.5
SX268	6,800	.590	.867	.020	15.0	22.0	.5
SX275	7,500	.590	.867	.020	15.0	22.0	.5
SX282	8,200	.590	.867	.020	15.0	22.0	.5
SX291	9,100	.590	.867	.020	15.0	22.0	.5
SX110	10,000	.590	.867	.020	15.0	22.0	.5
SX122	22,000	.710	1.260	.020	18.0	32.0	.5

Precision Film

158X Series — Type X2 Suppressor Capacitors Metallized Polyester / Radial Leads

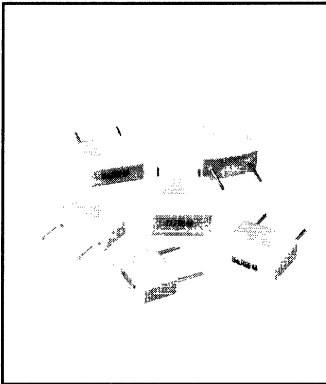

- Radial Leads in Two Lengths
- UL 1414 and CSA Approved
- Flame Retardant Case Meets UL94V0
- Polyurethane End Fill Meets UL94V0
- Used in applications where damage to the capacitor will not lead to the danger of electrical shock
- Lead Material Tinned Copper Clad Steel

For other X type capacitors see our UN Series Ceramic on page 123

GENERAL SPECIFICATIONS

Operating Temperature: -40°C to +100°C
 Voltage Range: 250 vrms
 Capacitance Range: 0.01 μ F to 2.2 μ F
 Capacitance Tolerance: \pm 20% (Standard) \pm 10% (Special)
 Dissipation Factor (DF) $\text{tg}\delta$ 0.01 Max at 1,000 \pm 100KHz

Insulation Resistance (IR) (@ 500 VDC and 20°C)
 Terminal to Terminal:
 $\leq 0.33\mu\text{F}$ 15,000 M Ω min
 $\geq 0.47\mu\text{F}$ 5,000 M Ω x μF min
 Both Terminals to Body: 100,000 M Ω min

Maximum Pulse Rise Time

μF	V/ μs	μF	V/ μs
.01	2800	.22	1200
.022	2400	.47	1000
.033	2400	.68	1000
.047	2000	1.0	800
.068	2000	1.5	800
.100	1600	2.2	600

International Approvals

Safety Agency	Standard	File Number
UL	UL-1414	E151554
UL	UL-1283	E151553
CSA	C22 2, No. 8-M1986	LR37404-33M
VDE	VDE0565-1	18022-4670-1700
SEMKO	SS443-04-01	9308002
SEV	SEV1055	92.552158.01
EI	E384/14-82 (IEC384-14, 1981)	164090-01
DEMKO	Heavy Current Regulations Section 21 and IEC384-14	112398EC/121
NEMKO	NEMKO132/85	M70107

Outline Dimensions

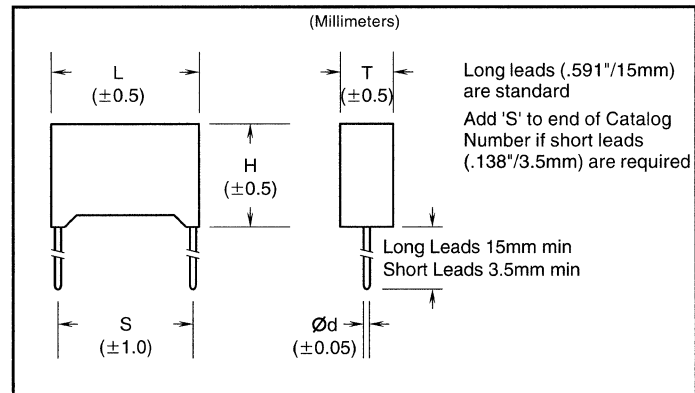

Catalog Number	Cap μF	Inches					Millimeters				
		L	T	H	S	Ød	L	T	H	S	Ød
158X103	.01	.669	.197	.472	.591	.024	17.0	5.0	12.0	15.0	.6
158X123	.012	.669	.197	.472	.591	.024	17.0	5.0	12.0	15.0	.6
158X153	.015	.669	.197	.472	.591	.024	17.0	5.0	12.0	15.0	.6
158X183	.018	.669	.197	.472	.591	.024	17.0	5.0	12.0	15.0	.6
158X223	.022	.669	.197	.472	.591	.024	17.0	5.0	12.0	15.0	.6
158X273	.027	.669	.197	.472	.591	.024	17.0	5.0	12.0	15.0	.6
158X333	.033	.669	.197	.472	.591	.024	17.0	5.0	12.0	15.0	.6
158X393	.039	.669	.217	.492	.591	.031	17.0	5.5	12.5	15.0	.8
158X473	.047	.669	.217	.492	.591	.031	17.0	5.5	12.5	15.0	.8
158X563	.056	.669	.256	.531	.591	.031	17.0	6.5	13.5	15.0	.8
158X683	.068	.669	.256	.531	.591	.031	17.0	6.5	13.5	15.0	.8
158X823	.082	.669	.315	.591	.591	.031	17.0	8.0	15.0	15.0	.8
158X104	.1	.669	.315	.591	.591	.031	17.0	8.0	15.0	15.0	.8
158X124	.12	.984	.256	.630	.886	.031	25.0	6.5	16.0	22.5	.8
158X154	.15	.984	.256	.630	.886	.031	25.0	6.5	16.0	22.5	.8
158X184	.18	.984	.315	.689	.886	.031	25.0	8.0	17.5	22.5	.8
158X224	.22	.984	.315	.689	.886	.031	25.0	8.0	17.5	22.5	.8
158X274	.27	1.181	.335	.669	1.083	.031	30.0	8.5	17.0	27.5	.8
158X334	.33	.984	.394	.768	.886	.031	25.0	10.0	19.5	22.5	.8
158X394	.39	1.181	.433	.866	1.083	.031	30.0	11.0	22.0	27.5	.8
158X474	.47	1.181	.433	.866	1.083	.031	30.0	11.0	22.0	27.5	.8
158X564	.56	1.181	.531	.965	1.083	.031	30.0	13.5	24.5	27.5	.8
158X684	.68	1.181	.531	.965	1.083	.031	30.0	13.5	24.5	27.5	.8
158X824	.82	1.201	.630	1.102	1.083	.039	30.5	16.0	28.0	27.5	1.0
158X105	1.0	1.201	.630	1.102	1.083	.039	30.5	16.0	28.0	27.5	1.0
158X125	1.2	1.614	.610	1.102	1.476	.039	41.0	15.5	28.0	37.5	1.0
158X155	1.5	1.614	.610	1.102	1.476	.039	41.0	15.5	28.0	37.5	1.0
158X185	1.8	1.614	.689	1.280	1.476	.039	41.0	17.5	32.5	37.5	1.0
158X225	2.2	1.614	.689	1.280	1.476	.039	41.0	17.5	32.5	37.5	1.0

NOTE: If \pm 10% tolerance is required, add 'K' to end of Catalog Number

NOTE: Parts are normally supplied with long leads (15mm / .591")
 If short leads (3.5mm / .138") are required, add 'S' to end of Catalog Number

Q/QRL Series - (QUENCHARC®) Metallized Polyester Arc Suppressor/Snubber Network

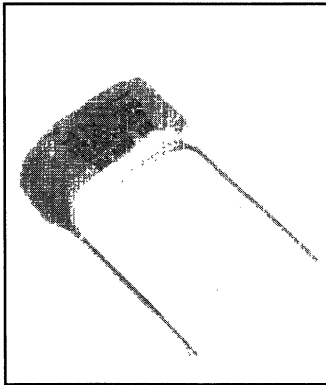

- Noise and Arc Suppression
- RC Snubber Network
- Relay Contact Protection
- Noise Reduction on Controllers/Drivers
- EMI/RFI Reduction
- Type QRL - UL/CSA Version

GENERAL SPECIFICATIONS

Operating Temperature:
-55°C to +85°C at full rated voltage

Voltage Range:
200 VDC (125VAC) to
600 VDC (250VAC)

Capacitance Values:
0.1, 0.5, 1.0 μ F

Resistor Values:
22, 47, 100, 150, 220 Ohms

Tolerance:
Capacitance - \pm 20%
Resistance - \pm 10%

Construction:
Metallized polyester in series with a carbon composition resistor

Case:
Coated with a flame retardant epoxy

Dielectric Withstand:
Units shall withstand a DC potential of 1.6 times the DC voltage rating. Testing conducted at +25°C

Outline Dimensions

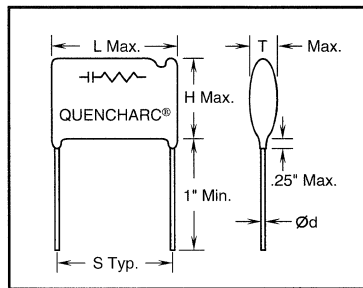

Test Method and Performance

DC Life Test

Units shall withstand a test potential of 125°C of the rated voltage for a period of 500 hours at 85°C. A failure shall consist of:
— Capacitance change >5%
— DF greater than original limits

Long Term Stability

The capacitance shall not change more than 2% when stored at ambient temperature and humidity for a period of two years or less.

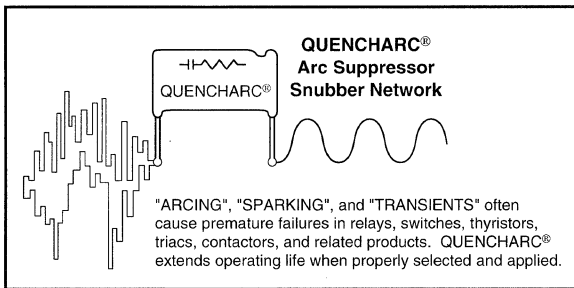

Catalog Number	Cap μ F	Resistor		Inches					Millimeters				
		Watts	Ohms \pm 10%	L Max	T Max	H Max	S Typ	ϕ d	L Max	T Max	H Max	S Typ	ϕ d
200VDC/125VAC													
504M02QA100	.50	1/2	100	1.080	.370	.640	.820	.032	27.4	9.4	16.3	20.8	.8
504M02QA220	.50	1/2	220	1.080	.370	.640	.820	.032	27.4	9.4	16.3	20.8	.8
105M02QB47	1.00	1/2	47	1.450	.390	.660	1.200	.032	36.8	9.9	16.8	30.5	.8
600VDC/250VAC													
104M06QC22	.10	1/2	22	1.080	.390	.660	.820	.032	27.4	9.9	16.8	20.8	.8
104M06QC47	.10	1/2	47	1.080	.390	.660	.820	.032	27.4	9.9	16.8	20.8	.8
104M06QC100	.10	1/2	100	1.080	.390	.660	.820	.032	27.4	9.9	16.8	20.8	.8
104M06QC150	.10	1/2	150	1.080	.390	.660	.820	.032	27.4	9.9	16.8	20.8	.8

Note: Other ratings are available by special request.
Contact NACC for availability and price.

UL/CSA Recognized Across-the-Line Application (Complies with UL1414/CSA-C22.2 No. 1)

Catalog Number	Cap μ F	Resistor		Inches					Millimeters				
		Watts	Ohms \pm 10%	L Max	T Max	H Max	S Typ	ϕ d	L Max	T Max	H Max	S Typ	ϕ d
125VAC													
104MACQRL150	.10	1/2	150	1.080	.440	.660	.820	.032	27.4	11.2	16.8	20.8	.8

Type QRL: UL File No. E33628
CSA File No. LR32208

Suppressor Film

Porcelain Capacitors

Series	Type	Features	Capacitance Range	Voltage Range	Capacitance Tolerances	Operating Temperature	Temperature Coefficient of Capacitance	Terminations	Size
MPR	Unencapsulated Multilayer Porcelain	To 10 GHz High-Q	0.2 pF to 1,000 pF	50 WVDC to 500 WVDC	$\pm 0.1\text{pF}, \pm 0.25\text{pF}, \pm 0.5\text{pF}, \pm 1\%, \pm 2\%, \pm 5\%, \pm 10\%, \pm 20\%$	-55°C to +200°C (Derated)	+90 \pm 20 ppm/°C	Chip & Pellet, Gold Termination, Leaded on special order	1.4mm L x W 1.45mm max T & 2.79mm L x W 2.79mm max T
		To 10 GHz High-Q NPO					0 \pm 30 ppm/°C		
		To 20 GHz High-Q High Temperature	1 pF to 100 pF	100 WVDC to 500 WVDC		-55°C to +175°C Without Derating	+90 \pm 20 ppm/°C		
		To 10 GHz NPO	0.1 pF to 5,100 pF	50 WVDC to 500 WVDC		-55°C to +125°C Without Derating	0 \pm 30 ppm/°C		
		Wide Capacitance Range X7R	510 pF to 0.1 μ F	50 WVDC to 500 WVDC		-55°C to +85°C Without Derating	$\pm 15\%$ Max		
		General Purpose Hi-Q	0.5 pF to 1,000 pF	50 WVDC to 500 WVDC		-55°C to +200°C (Derated)	+90 \pm 20 ppm/°C		
MPV	Glass Encapsulated Multilayer Porcelain	Designed Primarily for RF Medium Power Applications	10 pF to 1000 pF	500 VDC to 1000 VDC 500 VAC to 2000 VAC	$\pm 0.1\text{pF}, \pm 0.25\text{pF}, \pm 0.5\text{pF}, \pm 1\%, \pm 2\%, \pm 5\%, \pm 10\%$	-55°C to +85°C Without Derating	+90 \pm 20 ppm/°C and 0 \pm 40 ppm/°C	Axial and Radial Leads	(L x W) 8.3mm x 5.1mm to 23.5mm x 12.5mm (T) 3.2mm to 5.0mm

Multilayer Ceramic Capacitors

Series	Type	Features	Capacitance Range	Voltage Range	Capacitance Tolerances	Operating Temperature	Terminations	Size
MHQ	High Q Ceramic	To 1000 MHz Glass Encapsulated High-Q	0.5 pF to 3,000 pF	200 VDC and 300 VDC	$\pm 0.1\text{pF}, \pm 0.25\text{pF}, \pm 0.5\text{pF}, \pm 1\%, \pm 2\%, \pm 5\%$	-55°C to +125°C	Chip Axial Ribbons Radial Leads	2.75mm L x W - 1.55mm T to 10.79mm L x W - 2.29mm T
MHP	High Power Ceramic	To 100 MHz Glass Encapsulated Custom Product Available	10 pF to 3,000 pF	to 7KVDC to 5KVrms	$\pm .05\text{pF}, \pm 5\%, \pm 10\%$	-55°C to +125°C	Wide Fine Silver Axial Ribbons	13.85mm x 13.85mm 26.95mm x 13.85mm 26.95mm x 20.95mm
MHK	High K Ceramic	Very High Capacitance per Unit Volume	.001 μ F to 1.0 μ F	25 WVDC to 50 WVDC	$\pm 10\%, \pm 20\%, +80\%-20\%$	-55°C to +125°C	Axial or Radial Leads	3.55mm L x W - 1.50mm T to 10.40mm L x W - 2.00mm T

Trimmer Capacitors

Series	Type	Features	Capacitance Range	Voltage Range	Capacitance Tolerances	Operating Temperature	Terminations	Size
MAV	Air Trimmer	To 3 GHz Gold Plated Terminals	0.4 pF to 30 pF @ 1 MHz	250 WVDC and 500 WVDC	Not Applicable	-55°C to +125°C	Panel and PC board	See Specialized Catalog
MTR	Microwave Trimmer Sapphire Dielectric	To 13 GHz Gold Plated Terminals	0.3 pF to 8.0 pF	500 WVDC	Not Applicable	-65°C to +125°C	Panel and PC Board	See Specialized Catalog
MPT	Glass and Quartz Dielectric Tubular Piston Trimmers	To 100 Mhz Solder Coated Electrodes & Leads	0.6 pF to 120 pF	750 WVDC and 5000 WVDC	Not Applicable	-55°C to +150°C	Panel and PC Board	See Specialized Catalog
MVC	Miniature Monolithic Multilayer Disc Ceramic	Wide Capacitance Ranges Excellent Stability	1.6 pF to 60 pF	50 WVDC to 500 WVDC	Not Applicable	-55°C to +125°C	PC Board	See Specialized Catalog
MTD	Metallic microwave tuning devices consisting of a mounting bushing and a tuning rotor. These devices offer convenient means for the tuning of waveguides and microwave cavities.							

**Ask for the comprehensive MICROELECTRONICS catalog
for details on the vast assortment of microwave devices
briefly described above**

PSU Series AC Motor Start Capacitors

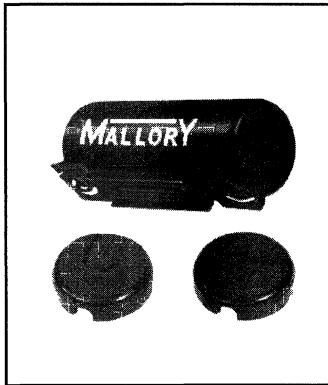

- For Motor Starting and other Intermittent Duty AC Applications
- Dual Quick Connect Terminals
- Rugged Bakelite Case
- Compact Size
- Easily Mounted

GENERAL SPECIFICATIONS

Operating Temperature: -40°C to +65°C
 Storage Temperature: -55°C to +85°C
 Voltage Range: 110 to 330 VAC
 Capacitance Range: 21 μ F to 1280 μ F
 Operating Frequency: 50 to 60 Hz
 Power Factor: 10% max (12% \leq 30 μ F)
 Meets EIA RS-463 Type 2 (Normal Performance)

ACR15KT Motor Start Resistor

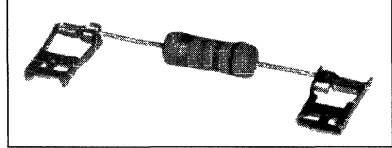

15KOhm 2 watt bleeder resistor for AC motor start applications. Saves relay switch contacts and capacitor, particularly in capacitor start-run applications. 1/4" quick connect terminals eliminate need for soldering.

Cap μ F	VAC	Case Code	Diameter (Inches)	Length (Inches)	Catalog Number
21-25	110/125	1	1 7/16	2 3/4	PSU2115
25-30	110/125	1	1 7/16	2 3/4	PSU2515
30-36	110/125	1	1 7/16	2 3/4	PSU3015
36-43	110/125	1	1 7/16	2 3/4	PSU3615
43-52	110/125	1	1 7/16	2 3/4	PSU4315
47-56	110/125	1	1 7/16	2 3/4	PSU4715
53-64	110/125	1	1 7/16	2 3/4	PSU5315
64-77	110/125	1	1 7/16	2 3/4	PSU6415
72-86	110/125	1	1 7/16	2 3/4	PSU7215
88-106	110/125	1	1 7/16	2 3/4	PSU8815
108-130	110/125	1	1 7/16	2 3/4	PSU10815
124-149	110/125	1	1 7/16	2 3/4	PSU12415
130-156	110/125	1	1 7/16	2 3/4	PSU13015
145-174	110/125	1	1 7/16	2 3/4	PSU14515
161-193	110/125	1	1 7/16	2 3/4	PSU16115
189-227	110/125	1	1 7/16	2 3/4	PSU18915A
200-240	110/125	2	1 7/16	3 3/8	PSU20015
216-259	110/125	2	1 7/16	3 3/8	PSU21615
233-280	110/125	2	1 7/16	3 3/8	PSU23315A
243-292	110/125	2	1 7/16	3 3/8	PSU24315A
270-324	110/125	2	1 7/16	3 3/8	PSU27015A
300-360	110/125	4	1 13/16	3 3/8	PSU30015
324-389	110/125	3	1 7/16	4 3/8	PSU32415A
340-408	110/125	4	1 13/16	3 3/8	PSU34015
378-454	110/125	4	1 13/16	3 3/8	PSU37815
400-480	110/125	4	1 13/16	3 3/8	PSU40015
430-516	110/125	4	1 13/16	3 3/8	PSU43015A
460-552	110/125	4	1 13/16	3 3/8	PSU46015A
540-648	110/125	4	1 13/16	3 3/8	PSU54015A
540-648	110/125	5	1 13/16	4 3/8	PSU54015B
590-708	110/125	5	1 13/16	4 3/8	PSU59015A
645-774	110/125	5	1 13/16	4 3/8	PSU64515
708-850	110/125	5	1 13/16	4 3/8	PSU70815
720-864	110/125	5	1 13/16	4 3/8	PSU72015
800-960	110/125	5	1 13/16	4 3/8	PSU80015
815-978	110/125	5	1 13/16	4 3/8	PSU81515
829-995	110/125	5	1 13/16	4 3/8	PSU82915A
850-1020	110/125	5	1 13/16	4 3/8	PSU85015
1000-1200	110/125	7	2 1/16	4 3/8	PSU100015A
1020-1224	110/125	7	2 1/16	4 3/8	PSU102015
1175-1410	110/125	7	2 1/16	4 3/8	PSU117515
1280-1536	110/125	7	2 1/16	4 3/8	PSU128015
21-25	165	1	1 7/16	2 3/4	PSU2165A
25-30	165	1	1 7/16	2 3/4	PSU2565A
30-36	165	1	1 7/16	2 3/4	PSU3065A
36-43	165	1	1 7/16	2 3/4	PSU3665A
43-52	165	1	1 7/16	2 3/4	PSU4365A
47-56	165	1	1 7/16	2 3/4	PSU4765A
53-64	165	1	1 7/16	2 3/4	PSU5365A
64-77	165	1	1 7/16	2 3/4	PSU6465A
72-86	165	1	1 7/16	2 3/4	PSU7265A
88-106	165	2	1 7/16	3 3/8	PSU8865
108-130	165	2	1 7/16	3 3/8	PSU10865
124-149	165	2	1 7/16	3 3/8	PSU12465
130-154	165	2	1 7/16	3 3/8	PSU13065

Cap μ F	VAC	Case Code	Diameter (Inches)	Length (Inches)	Catalog Number
145-174	165	2	1 7/16	3 3/8	PSU14565
161-193	165	2	1 7/16	3 3/8	PSU16165
189-227	165	2	1 7/16	3 3/8	PSU18965B
216-259	165	4	1 13/16	3 3/8	PSU21665A
233-280	165	3	1 7/16	4 3/8	PSU23365
243-292	165	3	1 7/16	4 3/8	PSU24365
270-324	165	3	1 7/16	4 3/8	PSU27065A
324-389	165	5	1 13/16	4 3/8	PSU32465
340-408	165	5	1 13/16	4 3/8	PSU34065
378-454	165	5	1 13/16	4 3/8	PSU37865
400-480	165	5	1 13/16	4 3/8	PSU40065
430-516	165	5	1 13/16	4 3/8	PSU43065
460-552	165	5	1 13/16	4 3/8	PSU46065
540-648	165	7	2 1/16	4 3/8	PSU54065
21-25	220/250	1	1 7/16	2 3/4	PSU2135
25-30	220/250	1	1 7/16	2 3/4	PSU2535
30-36	220/250	1	1 7/16	2 3/4	PSU3035
36-43	220/250	1	1 7/16	2 3/4	PSU3635
43-52	220/250	2	1 7/16	3 3/8	PSU4335B
47-56	220/250	2	1 7/16	3 3/8	PSU4735
53-64	220/250	2	1 7/16	3 3/8	PSU5335
64-77	220/250	2	1 7/16	3 3/8	PSU6435
72-86	220/250	4	1 13/16	3 3/8	PSU7235
88-106	220/250	4	1 13/16	3 3/8	PSU8835
108-130	220/250	4	1 13/16	3 3/8	PSU10835A
124-149	220/250	5	1 13/16	4 3/8	PSU12435
130-156	220/250	5	1 13/16	4 3/8	PSU13035
145-174	220/250	5	1 13/16	4 3/8	PSU14535
161-193	220/250	7	2 1/16	4 3/8	PSU16135A
189-227	220/250	7	2 1/16	4 3/8	PSU18935A
216-259	220/250	7	2 1/16	4 3/8	PSU21635A
233-280	220/250	7	2 1/16	4 3/8	PSU23335A
243-292	220/250	7	2 1/16	4 3/8	PSU24335
270-324	220/250	7	2 1/16	4 3/8	PSU27035A
21-25	330	1	1 7/16	2 3/4	PSU2130
25-30	330	2	1 7/16	3 3/8	PSU2530
30-36	330	2	1 7/16	3 3/8	PSU3030
36-43	330	2	1 7/16	3 3/8	PSU3630
43-52	330	2	1 7/16	3 3/8	PSU4330
47-56	330	4	1 13/16	3 3/8	PSU4730
53-64	330	4	1 13/16	3 3/8	PSU5330B
64-77	330	4	1 13/16	3 3/8	PSU6430
72-86	330	5	1 13/16	4 3/8	PSU7230B
88-106	330	5	1 13/16	4 3/8	PSU8830A
108-130	330	7	2 1/16	4 3/8	PSU10830B
124-149	330	8	2 9/16	4 3/8	PSU12430
124-149	330	7	2 1/16	4 3/8	PSU12430A
130-156	330	7	2 1/16	4 3/8	PSU13030
145-174	330	7	2 1/16	4 3/8	PSU14530A
161-193	330	8	2 9/16	4 3/8	PSU16130
189-227	330	8	2 9/16	4 3/8	PSU18930
216-259	330	8	2 9/16	4 3/8	PSU21630
270-324	330	8	2 9/16	4 3/8	PSU27030
378-454	330	8	2 9/16	4 3/8	PSU37830
460-552	330	8	2 9/16	4 3/8	PSU46030

See page 200 for Capacitor Hardware

AC Products

Type MPF AC Metallized Polypropylene Motor Run Capacitors

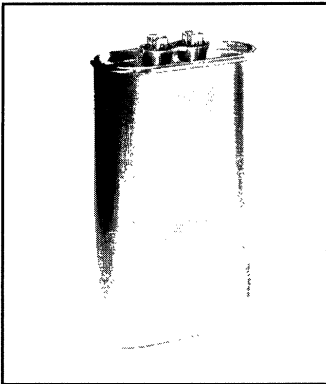

- Internal Protector
- Environmentally Safe
- Light Weight
- Small Size
- Long Life and High Reliability
- Double Rolled Seams
- Applications:
 - Lighting
 - Motors
 - Power Factor Correction
 - Phase Shifting
 - Air Conditioning
 - Refrigeration

GENERAL SPECIFICATIONS

Operating Temperature:
-40°C to +70°C (Case)

Voltage Range:
330, 370 and 440 VAC

Capacitance Range:
1 μ F to 80 μ F

Capacitance Tolerance:
 \pm 10%

Operating Frequency:
50 to 60 Hz

Dissipation Factor:
0.1% max @ 60 Hz

UL Recognized: Yellow Card
Number E65270

Meets EIA RS-456 Char. E

Round and Flat Oval Cans

Metallized polypropylene film dielectric capacitors offer a new option for alternating current applications. All devices have metal cases and 4-prong* quick disconnect terminals. These capacitors pack the same capacitance and voltage capabilities of a conventional paper capacitor into a smaller case of considerably lighter weight. In addition, these parts have extremely low dissipation factors. They offer high reliability and long life and meet EIA Standard RS-456 Characteristic 'E'. Allow 1/2 inch clearance above the terminals on fluid-filled capacitors for interrupter operation.

* 21 Style round units are 3-prong.

OUTLINE DIMENSIONS (MPF and MSF) (Inches)

Flat Oval Containers					
Style	A	B	H	D	Industry Type
32	1-5/16	2-5/32	*	13/16	1-1/4 F.O.
37	1-29/32	2-29/32	*	13/16	1-3/4 F.O.
38	1-31/32	3-21/32	*	13/16	2 F.O.

* See Rating Tables for 'H' Dimension

Round Containers					
Style	A	B	H	D	Industry Type
21	1-3/4	1-7/8	*	13/16	1-3/4" Round
23	2	2-1/8	*	13/16	2" Round
24	2-1/2	2-5/8	*	13/16	2-1/2" Round

* See Rating Tables for 'H' Dimension

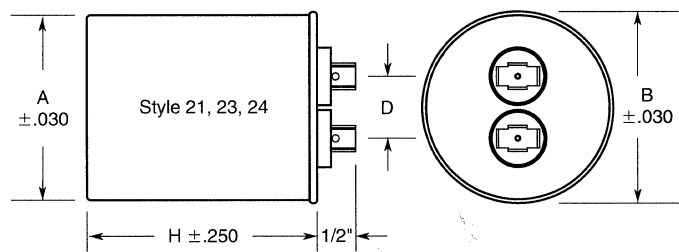
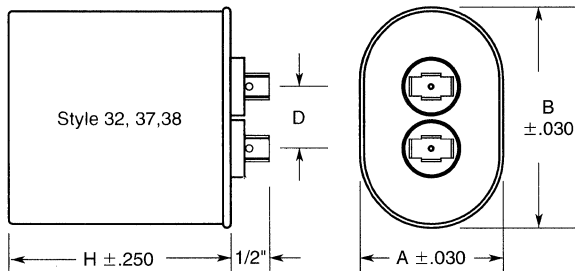

FLAT OVAL (SINGLE) STYLE

Cap μ F	VAC	Base Style	Height (Inches)	Catalog Number
1	370	32	2.13	32FD3701
2	370	32	2.13	32FD3702
3	370	32	2.13	32FD3703
4	370	32	2.13	32FD3704
5	370	32	2.38	32FD3705
6	370	32	2.38	32FD3706
7.5	370	32	2.38	32FD37075
10	370	32	2.63	32FD3710
12.5	370	37	2.63	37FD37125
15	370	37	2.63	37FD3715
17.5	370	37	2.63	37FD37175
20	370	37	2.63	37FD3720
22.5	370	37	2.63	37FD37225
25	370	37	2.63	37FD3725

Cap μ F	VAC	Base Style	Height (Inches)	Catalog Number
27.5	370	38	3.00	38FD37275
30	370	38	3.00	38FD3730
35	370	38	3.00	38FD3735
40	370	38	3.00	38FD3740
45	370	38	3.00	38FD3745
50	370	38	3.00	38FD3750
1	440	32	2.13	32FB4401
2	440	32	2.13	32FB4402
3	440	32	2.38	32FB4403
4	440	32	2.38	32FB4404
5	440	32	2.63	32FB4405
6	440	32	2.63	32FB4406
7.5	440	37	2.63	37FB44075

Cap μ F	VAC	Base Style	Height (Inches)	Catalog Number
10	440	37	2.63	37FB4410
12.5	440	37	2.63	37FB44125
15	440	37	2.63	37FB4415
17.5	440	37	2.63	37FB44175
20	440	38	3.00	38FB4420
25	440	38	3.75	38FB4425
30	440	38	3.75	38FB4430
35	440	38	3.75	38FB4435
40	440	38	3.75	38FB4440
45	440	38	3.75	38FB4445
50	440	38	3.75	38FB4450
55	440	38	4.75	38FB4455
60	440	38	4.75	38FB4460

FLAT OVAL (DUAL) STYLE

Cap μ F	VAC	Base Style	Height (Inches)	Catalog Number
15+4	370	37	2.63	37FD371504
15+5	370	37	2.63	37FD371505
15+10	370	37	2.63	37FD371510
20+5	370	37	2.63	37FD372005
20+15	370	38	2.63	38FD372015
25+5	370	38	2.63	38FD372505

Cap μ F	VAC	Base Style	Height (Inches)	Catalog Number
30+5	370	38	3.00	38FD373005
35+3	370	38	3.00	38FD373503
35+4	370	38	3.00	38FD373504
35+5	370	38	3.00	38FD373505
40+5	370	38	3.75	38FD374005
40+7.5	370	38	3.75	38FD3740075

Cap μ F	VAC	Base Style	Height (Inches)	Catalog Number
45+5	370	38	3.75	38FD374505
45+7.5	370	38	3.75	38FD3745075
45+10	370	38	3.75	38FD374510
25+5	440	37	3.00	37FB442505
30+5	440	38	3.75	38FB443005
35+5	440	38	3.75	38FB443505

See pages 200 & 201 for Capacitor Hardware

Type MPF AC Metallized Polypropylene Motor Run Capacitors



ROUND STYLE

Cap μ F	VAC	Base Style	Height (Inches)	Catalog Number
3	330	23	2.63	23FD3303
4	330	23	2.63	23FD3304
5	330	23	2.63	23FD3305
6	330	23	2.63	23FD3306
7	330	23	2.63	23FD3307
8	330	23	2.63	23FD3308
10	330	23	2.63	23FD3310
3	370	21	2.63	21FD3703
4	370	21	2.63	21FD3704
5	370	21	2.63	21FD3705
6	370	21	2.63	21FD3706
7	370	21	2.63	21FD3707
8	370	21	2.63	21FD3708
10	370	21	2.63	21FD3710
12.5	370	21	2.63	21FD37125
15.0	370	21	2.63	21FD3715
17.5	370	21	2.63	21FD37175
20	370	21	2.63	21FD3720

Cap μ F	VAC	Base Style	Height (Inches)	Catalog Number
25	370	21	3.00	21FD3725
25	370	23	3.00	23FD3725
30	370	21	3.00	21FD3730
30	370	23	3.00	23FD3730
35	370	21	3.75	21FD3735
35	370	23	3.00	23FD3735
40	370	21	3.75	21FD3740
40	370	23	3.00	23FD3740
45	370	23	3.75	23FD3745
45	370	24	3.00	24FD3745
50	370	23	3.75	23FD3750
50	370	24	3.00	24FD3750
55	370	23	3.75	23FD3755
55	370	24	3.00	24FD3755
60	370	23	3.75	23FD3760
60	370	24	3.00	24FD3760
65	370	24	3.75	24FD3765
70	370	24	3.75	24FD3770

Cap μ F	VAC	Base Style	Height (Inches)	Catalog Number
80	370	24	4.75	24FD3780
15	440	21	2.63	21FB4415
20	440	21	3.00	21FB4420
20	440	23	3.00	23FB4420
22.5	440	21	3.00	21FB44225
22.5	440	23	3.00	23FB44225
25	440	21	3.75	21FB4425
25	440	23	3.0	23FB4425
30	440	23	3.75	23FB4430
30	440	24	3.00	24FB4430
35	440	23	3.75	23FB4435
35	440	24	3.00	24FB4435
40	440	23	3.75	23FB4440
40	440	24	3.75	24FB4440
45	440	24	3.75	24FB4445
50	440	24	3.75	24FB4450
55	440	24	3.75	24FB4455
60	440	24	4.75	24FB4460

See pages 200 & 201 for Capacitor Hardware

Type MSF AC Power Supply Capacitors

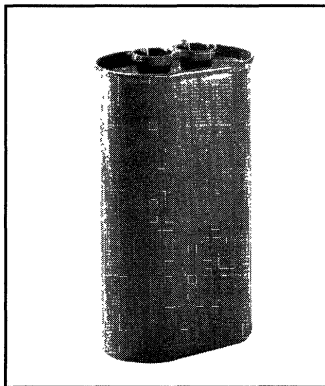

- Internal Protector
- Environmentally Safe
- Low Dissipation Factor
- Small Size
- Long Life and High Reliability
- Self Healing
- Applications:
 - Lighting
 - Power Supplies
 - Motor Run
 - Power Factor Correction
 - Phase Conversion

GENERAL SPECIFICATIONS

Operating Temperature:
-40°C to +70°C (Case)

Voltage:
660 VAC

Capacitance Range:
1 μ F to 30 μ F

Capacitance Tolerance:
 \pm 6%

Operating Frequency:
50 to 60 Hz

Dissipation Factor:
0.1% max @ 60 Hz

AC Leakage:
 \leq 20 μ A

UL Recognized: Yellow Card
Number E65270

Meets EIA RS-495 Characteristics X & Y
Flat oval 1-1/4", 1-3/4", 2" industry types

Metallized Paper-Polypropylene
Metallized paper-polypropylene capacitors are suitable for use in ferroresonant power supplies as well as other AC continuous duty applications. They are supplied in the same rigid metal cases as the AC Motor Run series, have biodegradable oil, and are UL recognized:

Cap μ F	VAC	Base Style	Height (Inches)	Catalog Number
1	660	32	2.0	32KB6601
2	660	32	2.0	32KC6602
3	660	32	2.0	32KE6603
3	660	37	2.0	37KE6603
4	660	32	2.25	32KE6604
4	660	37	2.0	37KE6604
5	660	32	2.5	32KE6605

Cap μ F	VAC	Base Style	Height (Inches)	Catalog Number
5	660	37	2.25	37KE6605
6	660	32	2.75	32KE6606
6	660	37	2.75	37KE6606
7	660	32	3.0	32KD6607
7.5	660	37	2.75	37KD66075
8	660	32	3.5	32KD6608
8	660	37	2.75	37KD6608

Cap μ F	VAC	Base Style	Height (Inches)	Catalog Number
10	660	37	3.0	37KD6610
12	660	37	3.0	37KD6612
15	660	37	3.38	37KD6615
18	660	37	3.88	37KD6618
20	660	38	3.38	38KC6620
25	660	38	4.13	38KC6625
30	660	38	4.25	38KD6630

See pages 200 & 201 for Capacitor Hardware

Series	Mounting	Frequency ±500 Hz	Voltage	Loudness	Current	Function	Page
--------	----------	----------------------	---------	----------	---------	----------	------

Sonalert® Audible Signal Devices (Commercial and Industrial)

SC	Classic Panel (Screw Neck)	1900 Hz 2900 Hz 4500 Hz	1 - 250 V AC & DC	Loud: 80 - 95 dB Med: 65 - 80 dB Soft: 50 - 65 dB	1 - 28 mA	Continuous Pulse Dual Mode Chime Chirp Warble Siren	176
SBM	Printed Circuit Board	2900 Hz	1 - 28 VDC	Med: 55 - 78 dB	3 - 16 mA	Continuous Pulse Dual Mode	176
SNP	Panel (Snap in)	2900 Hz	4 - 28 VDC	Med: 55 - 76 dB	3 - 18 mA	Continuous Pulse	176

Sonalert® Multi-Tone

SC	Classic Panel (Screw Neck)	1750 Hz 3000 Hz	6 - 16 VDC	Med: 60 - 72 dB	2 - 27 mA	Multi-Tone WY = 3 Mode WXY = 5 Mode	181
-----------	-------------------------------	--------------------	------------	-----------------	-----------	---	------------

Sonalert® for Military Applications

SC	Classic Panel (Screw Neck)	1900 Hz 2900 Hz 4500 Hz	6 - 250 V AC & DC	Loud: 80 - 90 dB Med: 68 - 80 dB	3 - 18 mA	Continuous Pulse Dual Mode Warble	184
-----------	-------------------------------	-------------------------------	----------------------	-------------------------------------	-----------	--	------------

Sonalert II™

MSR MSO	Printed Circuit Board (15 mm Pitch)	3000 Hz (MSR) 3150 Hz (MSO)	3 - 20 VDC	Med: 55 - 74 dB	3 - 20 mA	Continuous	185
--------------------	---	--------------------------------	------------	-----------------	-----------	------------	------------

Piezoelectric Transducer Units

PT	Printed Circuit & Flange	Various	30 V. Max	Medium	Requires Drive Circuitry	Continuous	187
-----------	-----------------------------	---------	-----------	--------	-----------------------------	------------	------------

Technical Information on Sound

186

Sonalert® Accessories

SCMB — Electrical Mounting Box	183
SCVC — Manual Volume Control	
BNR1 — Anodized Black Aluminum Mounting Ring (Standard on Military units)	
CNR1 — Anodized Clear Aluminum Mounting Ring	
PNR1 — Black Plastic (Nylon 6/6) Mounting Ring (Standard on Commercial and Industrial units)	

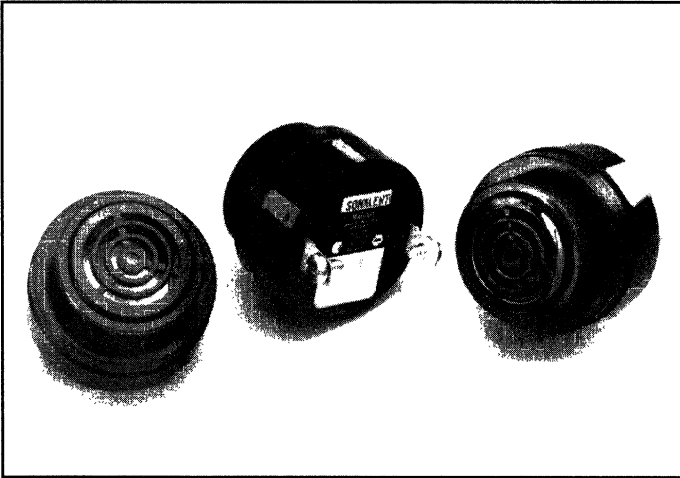

The Mallory Sonalert® produces an audible tone by internally creating an oscillating signal which drives a piezo ceramic transducer mounted in a sound chamber. Various types of continuous and intermittent tones are available from the Mallory Sonalert® product line.

Self driven piezo ceramic transducers are superior to electromagnetic buzzers because they produce no arcing, electrical noise, or mechanical wear during operation. They are more reliable and operate more consistently during their operating life and are able to produce many more types of tones compared to buzzers.

The Mallory Sonalert® can be actuated by AC and DC power signals and has several mounting configurations and terminations available.

Criteria for Selecting Mallory Sonalert® Products

There are a multitude of Sonalert models listed in this catalog. The following factors should be considered before selecting a Sonalert from the list of models available:

1. **Continuous or Intermittant tone?**
Intermittant tones are more discernable than continuous tones.
2. **Magnitude of sound required?**
Loud, medium, and soft sounds are available for many versions.
3. **What type of actuation signal is available?**
Sonalerts are available which operate with various AC and DC voltages from 1V to 250V.
4. **What type of mounting configuration and termination is required?**
Many types are available and outlined on the next few pages.
5. **Can't find exactly what you require?**
Contact the Sonalert Product Marketing Manager to see if a custom design can be produced for your application. Special continuous and intermittent tones can be created for your unique application. Special mounting configurations and terminations can also be developed.

Because the operation of the Sonalert audible signal device is dependent upon the circuit in which it is used, it is advisable to thoroughly test the selected device in the specific circuit and application to assure mechanical and electrical compatibility and verify system performance.

Underwriters Laboratories			
The following models are listed as recognized components - Audible Signal Appliances			
SBM2	SC110K	SC628	SC628P
SBM428	SC110N	SC628A	SC628-9B
SC110	SC110P	SC628D	SC648
SC110D	SC110Q	SC628H	SC648AD
SC110H	SC416	SC628J	SNP428
SC110J			

Guide Number UCST2, Yellow Card Number S1290.

Mallory Sonalerts are covered by one or more of the following U.S. Patent Numbers: **3,815,219 - 3,879,726 - 3,922,672 - 4,104,628 - 4,213,121 - 4,225,856 - 4,626,799.**

Catalog Number	Loudness Category	Mounting Method	Case Style	Frequency ± 500 Hz	Minimum Sound Pressure dB (A) at Two Feet		Operating Voltage * AC/DC Non-Polar All Others DC Only		Typical Operating Current (mA)	
					At Min V	At Max V	■ Min	Max	At Min V	At Max V
Continuous Tones										
Bold Type Denotes New Products										
• SC110N	Loud	Panel	D	2900	80	95	* 30	120	8	28
SC307N	Loud	Panel	C	2900	80	90	3	7	3	8
SC616N	Loud	Panel	C	2900	80	95	6	16	4	16
SC616NL	Loud	Panel	C-3	2900	80	95	6	16	4	16
SC628N	Loud	Panel	C	2900	80	90	6	28	3	14
SC616N-3	Loud	Printed Board	G	2900	80	95	6	16	4	16
SC628NL	Loud	Panel	C-3	2900	80	90	6	28	3	14
SC628AN	Loud	Panel	D	2900	80	95	* 6	28	8	28
SC648AN	Loud	Panel	D	2900	80	95	* 10	48	8	28
SC648ND	Loud	Panel	D	1900	80	90	10	48	10	30
• SBM2	Medium	Printed Board	F	2900	55	68	1	5	3	16
• SBM428	Medium	Printed Board	F	2900	64	78	4	28	3	16
SNP2	Medium	Snap In Panel	B	2900	55	68	1	5	2	12
• SNP428	Medium	Snap In Panel	B	2900	64	76	4	28	3	18
SC105	Medium	Panel	C	2900	60	75	1	5	3	16
• SC110	Medium	Panel	D	2900	68	80	* 30	120	6	21
• SC110D	Medium	Panel	D	1900	60	75	* 30	120	6	21
• SC110H	Medium	Panel	D	4500	68	80	* 30	120	6	21
SC250	Medium	Panel	D	2900	68	80	* 60	250	4	16
SC250D	Medium	Panel	D	1900	60	72	* 60	250	4	16
SC250H	Medium	Panel	D	4500	68	80	* 60	250	4	16
• SC416	Medium	Panel	C	2900	68	80	4	16	4	14
• SC628	Medium	Panel	C	2900	68	80	6	28	3	18
• SC628A	Medium	Panel	D	2900	68	80	* 6	28	6	23
SC628AD	Medium	Panel	D	1900	60	75	* 6	28	4	16
SC628AH	Medium	Panel	D	4500	68	80	* 6	28	4	16
• SC628D	Medium	Panel	C	1900	60	75	6	28	6	23
• SC628H	Medium	Panel	C	4500	68	80	6	28	6	23
SC628L	Medium	Panel	C-3	2900	68	80	6	28	3	14
▲ ST628	Medium	Panel	C	2900	60	80	6	28	1.5	12
• SC648	Medium	Panel	C	2900	68	80	10	48	5	22
SC648A	Medium	Panel	D	2900	68	80	* 10	48	4	16
• SC648AD	Medium	Panel	D	1900	60	75	* 10	48	4	16
SC648AH	Medium	Panel	D	4500	68	80	* 10	48	4	16
SC648D	Medium	Panel	C	1900	60	75	10	48	3	17
SC648H	Medium	Panel	C	4500	68	80	10	48	3	14
SC1.5	Soft	Twist Tab	A	3500	60@1.5V		1	4	4@1.5V	
SC6	Soft	Twist Tab	A	3500	68@6V		4	8	12@6V	
SC12	Soft	Twist Tab	A	3500	70@12V		8	15	14@12V	
SC18	Soft	Twist Tab	A	3500	70@18V		14	20	16@18V	
SC24	Soft	Twist Tab	A	3500	70@24V		20	30	16@24V	
SNP428F	Soft	Snap In Panel	B	2900	52	68	4	28	0.5	3
SC110E	Soft	Panel	D	1900	55	65	* 30	120	3	14
SC110F	Soft	Panel	D	2900	55	65	* 30	120	1	4
SC250E	Soft	Panel	D	1900	55	65	* 60	250	3	14
SC250F	Soft	Panel	D	2900	55	65	* 60	250	1	4
SC628AE	Soft	Panel	D	1900	50	65	* 6	28	3	14
SC628AF	Soft	Panel	D	2900	50	65	* 6	28	1	4
SC628E	Soft	Panel	C	1900	55	68	6	28	3	8
SC628F	Soft	Panel	C	2900	55	70	6	28	0.5	3
SC648AE	Soft	Panel	D	1900	55	65	* 10	48	3	14

▲ Denotes High Trigger Model (Start Up Voltage Approximately 3 V).
• Denotes UL Models

* For both DC or AC Operation
(AC Voltage is RMS for 50 or 60 Hz Power Line)

■ Minimum voltage specified for sound test does not represent sound turn-on or turn-off points. Units will sound at lower voltages.

Commercial and Industrial Sonalert® Audible Signal Devices



Catalog Number	Loudness Category	Mounting Method	Case Style	Frequency ± 500 Hz	Minimum Sound Pressure dB (A) at Two Feet		Operating Voltage * AC/DC Non-Polar All Others DC Only		Typical Operating Current (mA)	
					At Min V	At Max V	■ Min	Max	At Min V	At Max V
Short Pulse										
Turns on and off at .5 to 2 pulses per second depending upon voltage at 10% duty cycle.										
• SC110K	Medium	Panel	E	2900	68	80	* 30	120	6	22
SC250K	Medium	Panel	E	2900	68	80	* 60	250	5	18
SC628K	Medium	Panel	D	2900	68	80	6	28	3	14
SC628AK	Medium	Panel	E	2900	68	80	* 6	28	4	16
SC648AK	Medium	Panel	E	2900	68	80	* 10	48	6	24
SC110FK	Soft	Panel	E	2900	55	65	* 30	120	4	16
SC250FK	Soft	Panel	E	2900	52	65	* 60	250	4	16
SC628FK	Soft	Panel	D	2900	50	65	6	28	3	14
SC628AFK	Soft	Panel	E	2900	55	70	* 6	28	2	8

Catalog Number	Loudness Category	Mounting Method	Case Style	Frequency ± 500 Hz	Minimum Sound Pressure dB (A) at Two Feet		Operating Voltage * AC/DC Non-Polar All Others DC Only		Typical Operating Current (mA)	
					At Min V	At Max V	■ Min	Max	At Min V	At Max V

Intermittant Tones

Fast Pulse (1) Slow Pulse (2) **Bold Type Denotes New Products**

SC110NP	SC110NJ	Loud	Panel	D	2900	80	95	* 30	120	8	28
SC616NP	SC616NJ	Loud	Panel	C	2900	80	95	6	16	4	16
▶ SC616NP-10	—	Loud	Panel	D-4	2900	80	95	6	16	6	18
SC628ANP	SC628ANJ	Loud	Panel	D	2900	80	95	* 6	28	8	28
SC648NP	SC648NJ	Loud	Panel	C	2900	80	95	10	48	8	28
SC648ANP	SC648ANJ	Loud	Panel	D	2900	80	95	* 10	48	8	28
SBM616P	SBM616J	Medium	Printed Board	F	2900	68	78	6	16	1	4
SC110DP	SC110DJ	Medium	Panel	E	1900	60	75	* 30	120	4	16
SC110HP	SC110HJ	Medium	Panel	E	4500	68	80	* 30	120	4	16
• SC110P	• SC110J	Medium	Panel	E	2900	68	80	* 30	120	6	21
SC250DP	SC250DJ	Medium	Panel	E	1900	60	72	* 60	250	4	16
SC250HP	SC250HJ	Medium	Panel	E	4500	68	80	* 60	250	4	16
SC250P	SC250J	Medium	Panel	E	2900	68	78	* 60	250	4	16
SNP616P	SNP616J	Medium	Snap In Panel	B-1	2900	65	75	6	16	1	5
SC616P	SC616J	Medium	Panel	C-1	2900	68	78	6	16	1	4
SC616P-1	SC616J-1	Medium	Panel	C-11	2900	68	78	6	16	1	4
SC628ADP	SC628ADJ	Medium	Panel	E	1900	60	75	* 6	28	4	16
SC628AHP	SC628AHJ	Medium	Panel	E	4500	68	80	* 6	28	4	16
SC628AP	SC628AJ	Medium	Panel	E	2900	68	80	* 6	28	4	16
SC628DP	SC628DJ	Medium	Panel	D	1900	60	75	6	28	3	14
SC628HP	SC628HJ	Medium	Panel	D	4500	68	80	6	28	3	14
• SC628P	• SC628J	Medium	Panel	D	2900	68	80	6	28	6	26
SC648ADP	SC648ADJ	Medium	Panel	E	1900	60	75	* 10	48	4	16
SC648AP	SC648AJ	Medium	Panel	E	2900	68	80	* 10	48	4	16
SC110EP	SC110EJ	Soft	Panel	E	1900	55	65	* 30	120	3	14
SC110FP	SC110FJ	Soft	Panel	E	2900	55	65	* 30	120	4	16
SC250EP	SC250EJ	Soft	Panel	E	1900	55	68	* 60	250	3	14
SC250FP	SC250FJ	Soft	Panel	E	2900	55	65	* 60	250	4	16
SC628AEP	SC628AEJ	Soft	Panel	E	1900	50	65	* 6	28	3	14
SC628AFP	SC628AFJ	Soft	Panel	E	2900	50	65	* 6	28	4	16
SC628EP	SC628EJ	Soft	Panel	D	1900	50	65	6	28	3	8
SC628FP	SC628FJ	Soft	Panel	D	2900	50	65	6	28	3	14

(1) Turns on and off at 2 to 10 pulses per second depending upon voltage at 50% duty cycle.
 (2) Turns on and off at .5 to 2 pulses per second depending upon voltage at 50% duty cycle.

▶ Pulse rate 2 to 10 pps with 10 second shutoff
 • Denotes UL Models

* For both DC or AC Operation
 (AC Voltage is RMS for 50 or 60 Hz Power Line)

■ Minimum voltage specified for sound test does not represent sound turn-on or turn-off points. Units will sound at lower voltages.

Catalog Number	Loudness Category	Mounting Method	Case Style	Frequency ± 500 Hz	Minimum Sound Pressure dB (A) at Two Feet		Operating Voltage * AC/DC Non-Polar All Others DC Only		Typical Operating Current (mA)		
					At Min V	At Max V	■ Min	Max	At Min V	At Max V	
Dual Mode Operation											
Continuous or Fast Pulse (1)	Continuous or Slow Pulse (2)	When power terminals are connected, third terminal may be switched to open to select a continuous sound or switched to positive (+) to select a pulsing sound. Switching current is less than 2.0 milliamp.									
SC616NPU		Loud	Panel	D-1	2900	80	90	6	16	4	16
SBM616PU	SBM616JU	Medium	Printed Board	F	2900	68	78	6	16	3	12
SC616PU	SC616JU	Medium	Panel	C-7	2900	68	78	6	16	3	12
SC616PU-1	SC616JU-1	Medium	Panel	C-7	2900	68	80	6	16	3	12
Warble											
Fast Warble (1)	Slow Warbl(2)										
— —	SC616JW	Medium	Panel	C	1800-2800	68	80	6	16	6	18
Single package warbler. Pulse rate is 1.5pps (typical) @ 50% duty cycle.											
SC628W	SC628JW	Medium	Panel	D-1	2900	68	80	6	28	3	16
Produces two tones alternately when used with additional continuous tone unit (Use with SC628D or SC628H)											
SC628FW	SC628FJW	Soft	Panel	D-1	2900	55	70	6	28	3	14
Produces two tones alternately when used with additional continuous tone unit (Use with SC628E)											
Chime Tone											
										A pleasant sound which chimes every one or two seconds as long as voltage is applied. Pulse rate is 0.3 to 2 pps at 50% duty cycle.	
SC110CP		Medium	Panel	E	2900	68	78	* 30	120	4	16
SC616CP		Medium	Panel	D	2900	68	78	6	16	3	8
SC616CPN		Loud	Panel	D	2900	76	86	6	16	6	16
Chirp											
										A unique sound which pulses at 20 to 60 pps.	
• SC110Q (AC Only)		Medium	Panel	C	2900	68	80	30 AC	120 AC	6	22
SC616Q		Medium	Panel	C-1	2900	68	78	6	16	1	4
Siren Tone											
SC648S		Loud	Panel	D	1800-2800	80	90	10	48	15	30
Sweep rate @ 5Hz (typical)											

- (1) Turns on and off at 2 to 10 pulses per second depending upon voltage at 50% duty cycle.
 (2) Turns on and off at .5 to 2 pulses per second depending upon voltage at 50% duty cycle.

• Denotes UL Models

* For both DC or AC Operation
 (AC Voltage is RMS for 50 or 60 Hz Power Line)

■ Minimum voltage specified for sound test does not represent sound turn-on or turn-off points. Units will sound at lower voltages.

Case Style A

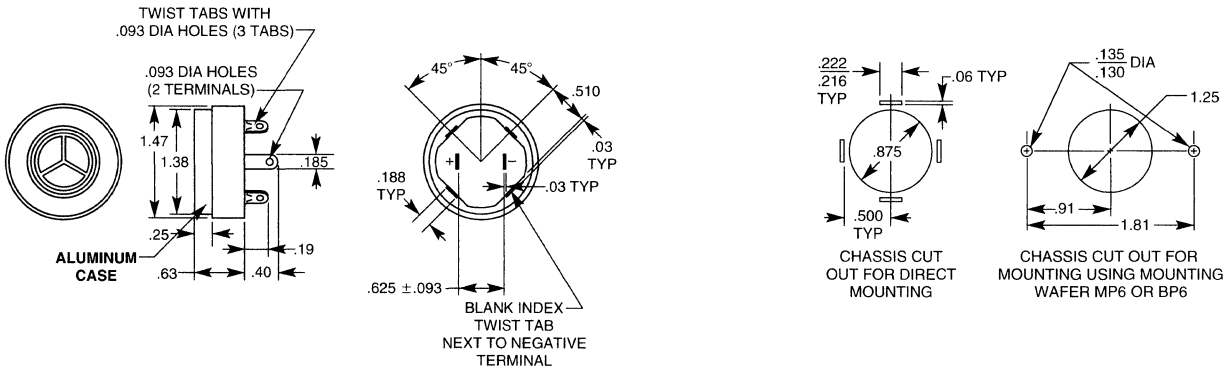

Terminals - .032 steel, tin plated with .093 dia. wire hole, will accept standard 3/16" quick disconnect.

Mounting - Four Twist Tabs per EIA std. RS395 are provided for mounting. Terminals are electrically isolated from case and Twist Tabs.

Also may be mounted using mounting wafer.

MP6 for uninsulated mounting
BP6 to insulate case from chassis.

**Bakelite
Mounting Wafer
Catalog No. BP6**

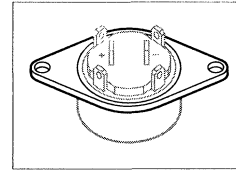

Case Style B

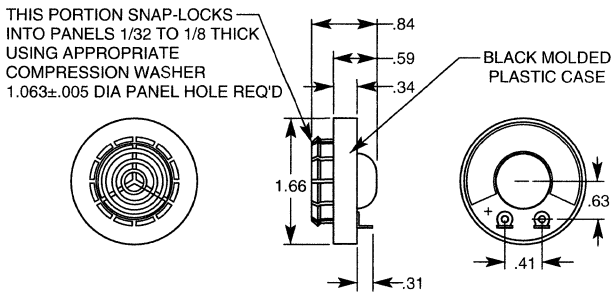

Case Style B - 1

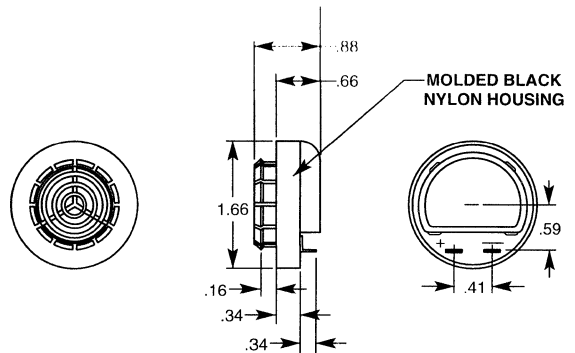

Terminals - .020 brass, hot tin finish with .065 wire hole. Terminal will accept standard 1/8" quick disconnect.

Typical Panel Installation Case Style B

Mounting - Panel hole 1.063 ± .005 diameter should be punched from the back side so that locking fingers enter on the slightly rounded edge of the hole. Assemble proper **compression washer** and press into panel hole until locking fingers snap over hole edge. Installation pressure should be applied only at the circumference of the device.

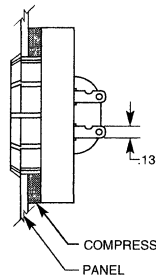

Compression Washer

Catalog Number	Thickness	Panel Thickness
PW1	.063	11-12 GA (.125-.109)
PW2	.125	13-17 GA (.093-.056)
PW3	.187	18-22 GA (.050-.031)

Material: Black ester foam Compression 5:1
Size: 1.06" I.D. x 1.50" O.D. (Ref.)

Case Style C

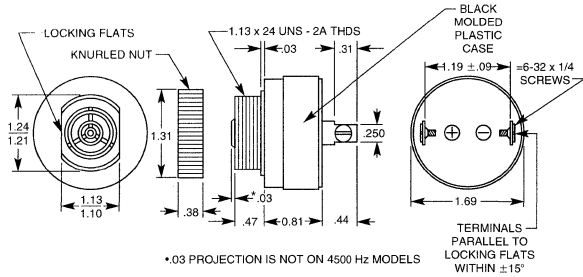

C-8: Same as Style C except terminal spacing is 1.31".

Case Style C-1

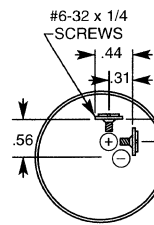

C-2

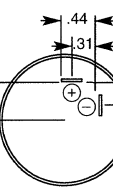

C-3

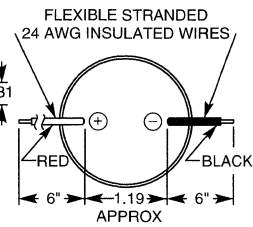

C-11: Same as Style C-2 except terminal height is .56".

Case Style D

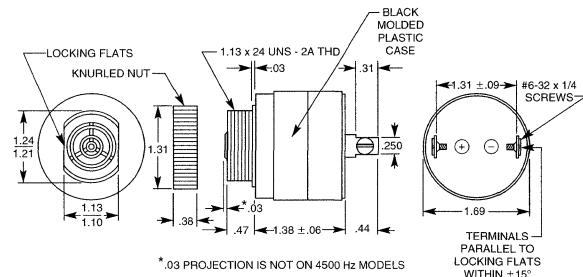

Terminals - .032 brass, tin plated, tapped for #6-32 screw. Two #6-32 nickel plated brass screws included. Will accept 1/4" quick disconnect with 3/16" opening.

Mounting - Remove black plastic nut and insert threaded front through 1.25" hole punched in panel. If orientation is needed, note locking flats on drawing. Screw nut back on. Do not overtighten.

Optional Mounting Nuts - To substitute natural finished aluminum or anodized black aluminum nut for the standard plastic nut, purchase catalog numbers 'CNR1' or 'BNR1' respectively as shown on page 184.

Case Style D-1 and C-7

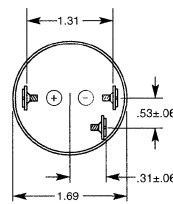

Case Style D-4

Same as Style D except no screws

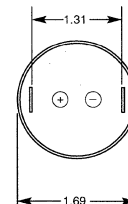

Case Style E

Outline dimensions are the same as case style D except length is changed to 1.94" ± .094" (1-15/16 ± 3/32).

Case Style F

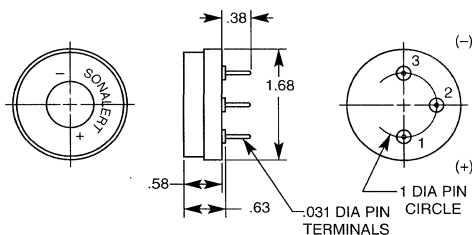

Terminals - .031 dia. soldercoated copperclad steel

Mounting - Insert into printed circuit board and hand or machine solder.

Electrical Connections - SBM2, SBM428, SBM616P, SBM616J - When pin 1 is connected to + voltage and pin 3 is connected to common (-), unit will sound. Pin 2 is for mechanical support only and is not connected internally.

SBM616PU, SBM616JU - When pin 1 is connected to + voltage, and pin 3 is connected to common (-), and the voltage on pin 2 is within 1.25V of pin 1 or higher, the unit will sound a pulsing tone. When the voltage on pin 2 is within .9V of pin 3 or lower, the unit will sound a continuous tone. The maximum voltage which may be applied to pin 2 before damage may occur is ± 16V referenced to pin 3. Pin 2 input impedance is 110K ohm.

Case Style G

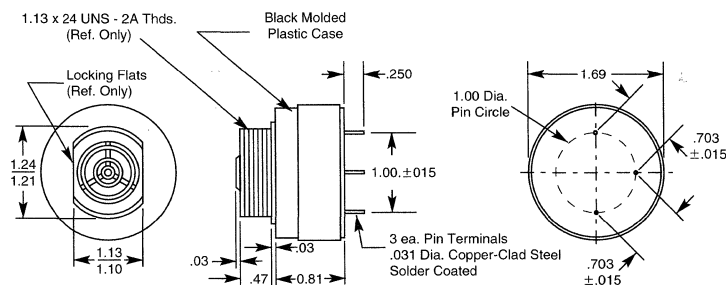

Mounting - Insert Pin Terminals into Circuit Board and Solder

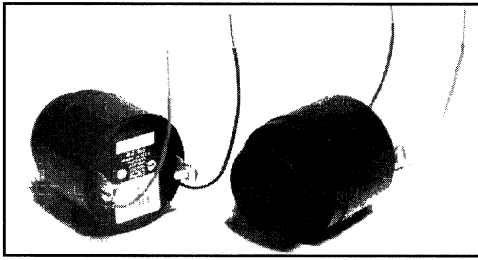

Models SC616WY & SC616WXY

Key Features

The Multi-Tone Sonalert models SC616WY and SC616WXY are piezoelectric signaling devices with several functions. When operated and controlled from a 6-16 VDC source, they produce distinctive tone patterns. The SC616WY tone patterns are pulsate high frequency, pulsate low frequency and warble. The SC616WXY has two additional tones - continuous high and low frequency. Operating modes are determined by the connection of two control wires.

The Multi-Tone Sonalert employs all solid state circuitry. When driven at the maximum supply voltage, a sound pressure of 72 dB at 2 feet is obtained. Both models have a low current drain (27 mA max).

Mechanical

Outline drawing and dimensions - See below.

Case Material: Nylon
 Mounting method: Panel
 Terminals: .032 brass, tin plated, tapped for #6-32 screw.
 Two #6-32 nickel plated brass screws included.
 Will accept 1/4" quick disconnect terminals (non-standard).

Control wire size: 24AWG, stranded, 6" long

Operating temperature: -30°C to +65°C

Control Functions

The red and black leads control the several functions. A logic "Low" is a voltage less than 1/3 of supply voltage. A logic "High" is a voltage greater than 1/2 supply voltage. A red or black input lead left unconnected is considered an open state.

Typical Performance

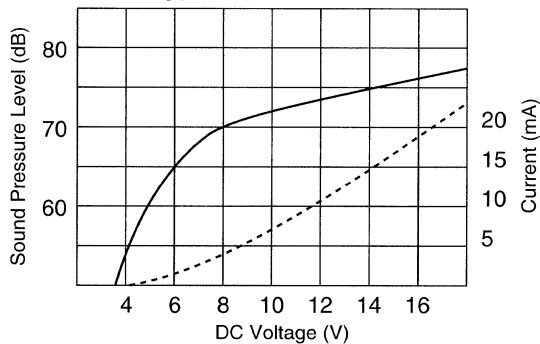

Dimensions

(Case Style D-2)

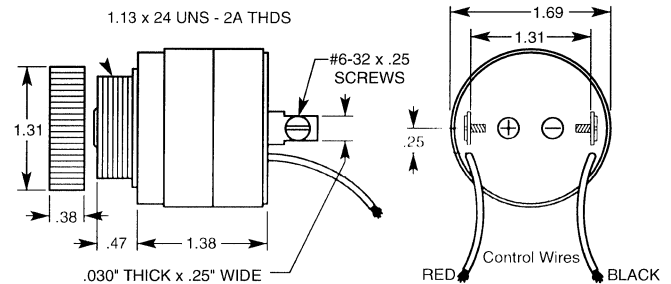

Electrical

Catalog Number	Voltage		Typical Current mA		High Tone Frequency ± 500	Low Tone Frequency ± 500	Pulse Rate Per Second *	Minimum Sound Pressure dB at Two Feet	
	Min.	Max.	At Min. V	At Max. V				At Min. V	At Max. V
SC616WY	6	16	2	18	3000	1750	.5 - 1.2	60	72
SC616WXY	6	16	2	18	3000	1750	.5 - 1.2	60	72

* 50% Duty Cycle

Truth Table for SC616WY

Control Lead		Function Mode
Red	Black	
Low	Low	Off
High	Low	High Pulse
Low	High	Low Pulse
High	High	Warble

Truth Table for SC616WXY

Control Lead		Function Mode
Red	Black	
High	Low	Off
Open	High	High Continuous
Open	Low	Low Continuous
High	Open	High Pulse
Low	Open	Low Pulse
Open	Open	Warble

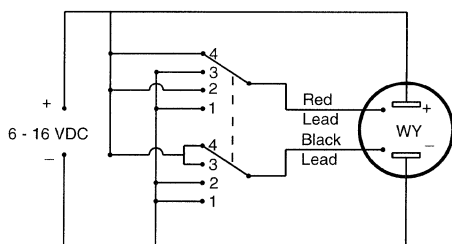

Schematics: Set to Warble

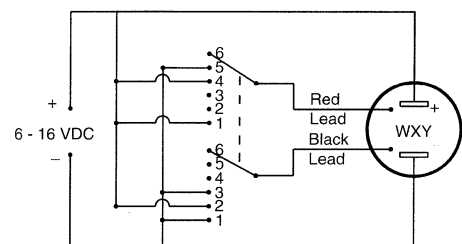

Typical Performance Curves Sonalert® Audible Signal Devices

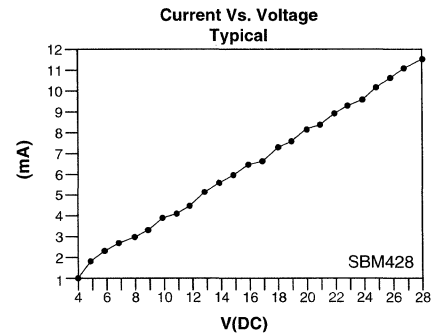
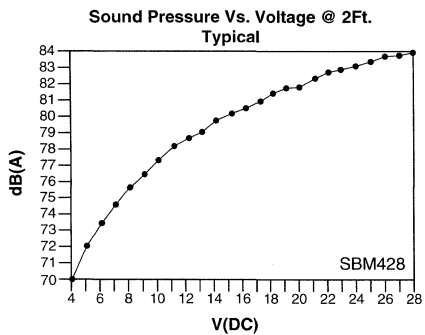
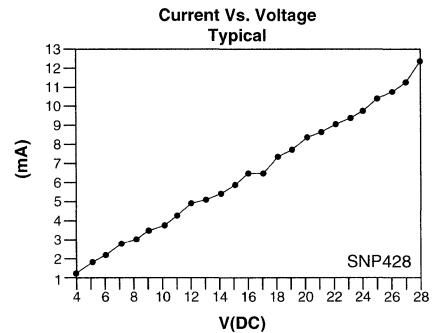
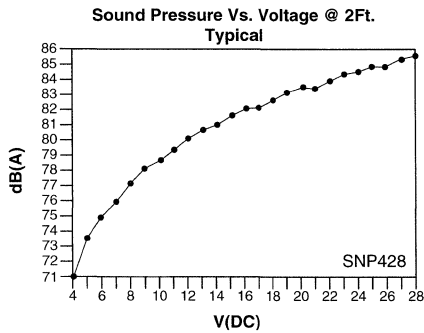
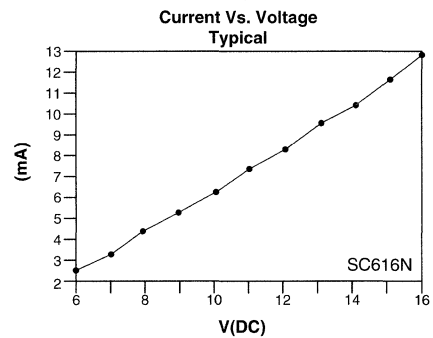
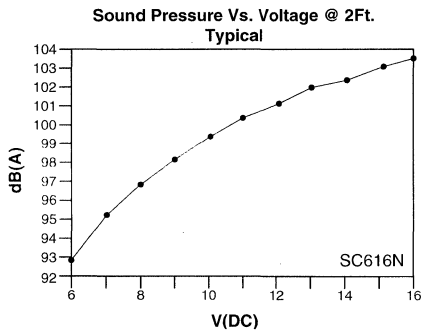
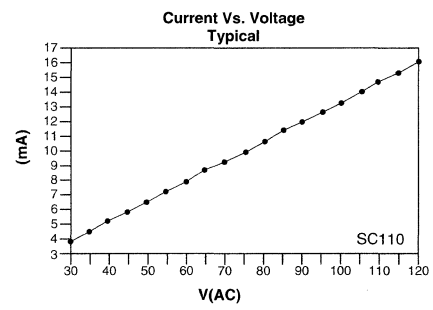
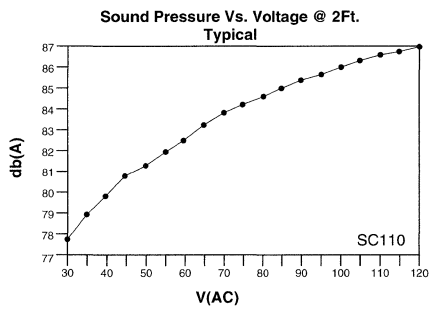
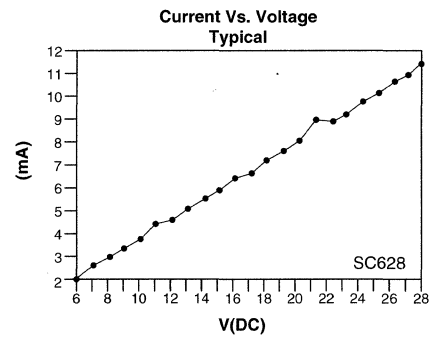
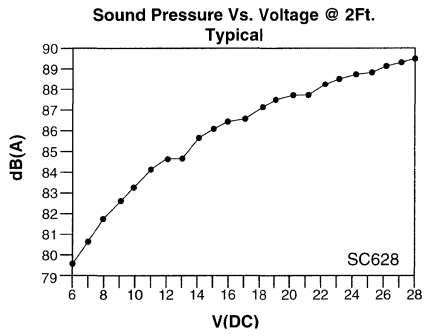

Environmental Specifications

Surge Voltage

15% over maximum rated voltage applied for less than one minute.

Reverse Voltage – DC Models

Maximum reverse polarity equal to rated voltage for one minute. Some models may sound softly when subjected to reversed polarity voltage.

Life Specification

Continuous – 250 hours continuous operation at 65°C with maximum rated voltage applied.

Intermittent – A duty cycle of 1 minute on, 5 minutes off, a minimum of 10,000 times at room temperature and maximum rated voltage applied.

Life Expectancy

7 years under normal operating conditions

Storage Temperature

-40°C to +85°C

Operating Temperature

-30°C to +65°C

Humidity

The Sonalert® signal should operate after having been subjected to 95% Relative Humidity at +40°C continuously for 100 hours. After removal from test, the unit should be allowed to dry a minimum of 4 hours at room temperature before operation. Units should deliver original output characteristics.

Vibration

The Sonalert signal should be mounted in the standard manner on a mounting panel. The specimens should be subjected to a harmonic motion having an amplitude of 0.03 inch (0.06 inch maximum total excursion). The frequency should be varied uniformly between a limit of 10 and 55 Hertz. The entire frequency range from 10 to 55 Hertz and return to 10 Hertz should be traversed in approximately one minute. Motion should be applied for two hours in each of 3 mutually perpendicular planes (total 6 hours). This test should be conducted while the Sonalert signal is not operating. After completion of test, Sonalert signals should meet specifications.

Salt Spray

The Sonalert signal should meet specified operating conditions after completing 96 hours in an atomized salt spray while not operating. The spray should consist of a 5% salt solution atomized by a forced air supply. The solution should be sprayed through a nozzle into a chamber maintained at 35°C. After salt spray, the unit should be removed and washed in running water not warmer than 40°C. A soft hairbrush or plastic bristle brush should be used, lightly brushing to remove salt deposits from the unit. The cleaned Sonalert signals should be placed on absorbent material with the nose pointed downward and allowed to dry at room temperature for 24 hours prior to use.

Terminal Strength

5 pounds, applied axially for a period of 5 minutes. This is considered a destructive test.

Accessories Sonalert® Audible Signal Devices

Manual Volume Control

Consisting of 3 component parts

Catalog Number SCVC

Electrical Mounting Box

Used to mount Sonalert® signal case styles C and D on standard 3/4" electrical conduit. 3 - 1/2" diameter, 2" deep ABS plastic.

Catalog Number SCMB

Sonalert® Mounting Nuts

Material	Catalog Number
Anodized Black Aluminum (standard on Military units)	BNR1
Anodized Clear Aluminum	CNR1
Black Plastic (Nylon 6/6) (Standard on industrial and commercial units)	PNR1

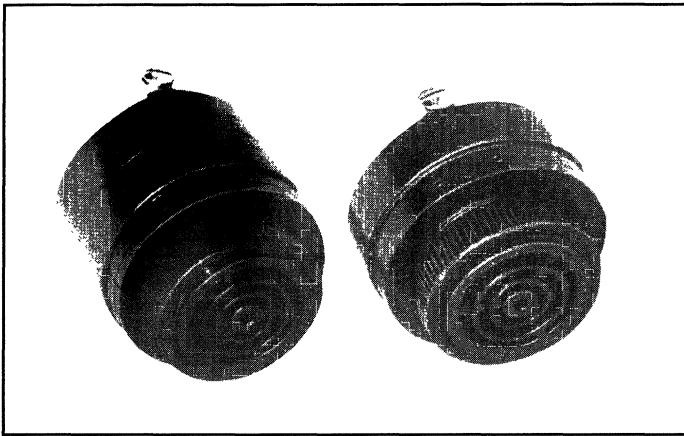

Quality Specifications

Operating

100% measurement of sound output and frequency at +25°C. Data is supplied with parts. Operation of each part confirmed at -40°C and +85°C.

Environmental

MIL Std. 105D Level II single normal inspection .65 AQL

Life Specifications

500 hours continuous operation at 85°C and maximum rated voltage applied. 10,000 cycles one minute on, 5 minutes off at 25°C and maximum rated voltage applied.

Life Expectancy

10 years under normal operating conditions

Operating Temperature

-40°C to +85°C

Storage Temperature

-65°C to +85°C

Altitude Change

10,000 feet per minute maximum

Environmental Specifications

Test	MIL-STD-202 Method	Test Condition
Thermal shock	107	A
Humidity	103	B
Salt spray	101	A
Shock	213	H
Vibration	201	None
Terminal strength	211	A (5 lbs.)

Because the operation of the Sonalert audible signal device is dependent upon the circuit in which it is used, it is advisable to thoroughly test the selected device in the specific circuit and application to assure mechanical and electrical compatibility and verify system performance.

For applications requiring operation over extended temperature ranges, or in extreme environmental conditions, military models are recommended. These special units use MIL approved components if available. Exposed surface of the sound transducer is treated with a corrosion protective coating. Mounting nut is anodized aluminum. Terminals are tin plated brass with nickel plated 6-32 screws. All units are marked with Mallory logo, part number, polarity and date code per MIL-STD-1285. Marking is permanently preserved by a layer of clear epoxy. Customer part number may be included on label if desired. A certificate of compliance to NACC specifications will be supplied if requested.

Black plastic case and black anodized aluminum mounting nut is standard. To specify olive drab case and mounting nut, add G to part number.

Example: SC628MG. To specify black case and clear anodized mounting nut, add C to part number. *Example:* SC628MC.

North American Capacitor Co. Cage Code - 37942

Catalog Number	Loudness Category	Mounting Method	Case Style	Frequency ± 500 Hz	Minimum Sound Pressure dB (A) at Two Feet		Operating Voltage * AC/DC Non-Polar All Others DC Only		Typical Operating Current (mA)	
					At Min. V	At Max. V	Min.	Max.	At Min. V	At Max. V

Bold Type Denotes New Products

Continuous Tones

SC616MN	Loud	Panel	C-8	2900	80	95	6	16	6	22
SC628MN	Loud	Panel	C	2900	80	90	6	28	4	16
SC628M	Medium	Panel	C	2900	68	80	6	28	3	14
SC628MD	Medium	Panel	C	1900	60	75	6	28	3	14
SC628MH	Medium	Panel	C	4500	68	80	6	28	3	14
SC648M	Medium	Panel	C	2900	68	80	10	48	3	14
SC648MD	Medium	Panel	C	1900	60	75	10	48	3	14
SC628MA	Medium	Panel	D	2900	68	80	* 6	28	4	16
SC628MAH	Medium	Panel	D	4500	68	80	* 6	28	4	16
SC648MA	Medium	Panel	D	2900	68	80	* 10	48	4	16
SC648MAH	Medium	Panel	D	4500	68	80	* 10	48	4	16
SC110M	Medium	Panel	D	2900	68	80	* 30	120	4	16
SC110MH	Medium	Panel	D	4500	68	80	* 30	120	4	16
SC250M	Medium	Panel	D	2900	68	80	* 60	250	4	16

Fast Pulse

Turns on and off at 2 to 9 pulses per second depending upon voltage at 50% duty cycle.

SC628MNP	Loud	Panel	D	2900	80	90	6	28	4	16
SC628MP	Medium	Panel	D	2900	68	80	6	28	3	14
SC628MHP	Medium	Panel	D	4500	68	80	6	28	3	14

Fast Warble

Produces two tones alternately when used with additional continuous unit.

SC628MW	Medium	Panel	D-1	2900	68	80	6	28	3	16
---------	--------	-------	-----	------	----	----	---	----	---	----

Continuous or Fast Pulse

Dual mode operation.

SC616MPU	Medium	Panel	C-7	2900	68	78	6	16	3	12
----------	--------	-------	-----	------	----	----	---	----	---	----

* For both DC or AC Operation (AC Voltage is RMS for 50 or 60 Hz Power Line)

■ Minimum voltage specified for sound test does not represent sound turn-on or turn-off points. Units will sound at lower voltages.

Models MSR320 & MSO320 Sonalert II™ Audible Signal Devices

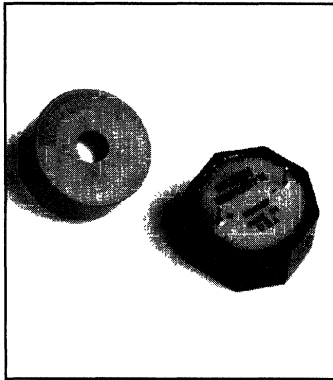

- Made in USA
- Low Power Consumption
- Low Cost
- Low Profile and Compact
- Piezo Tone Quality
- Wave Solderable

GENERAL SPECIFICATION

Resonant Frequency:
 3.0 ±.5 KHz (MSR)
 3.15 ±.5 KHz (MSO)

Min. Sound Pressure (dB/2 Ft.)
 75 @ 12 V

Rated Voltage:
 3-20 VDC to +65°C

Max. Current:
 3-16 mA @ 3-20 VDC

Operating Temperature:
 -20°C to +65°C

Storage Temperature:
 -30°C to +80°C

Solder Temperature:
 +270°C for 3 seconds

Case Material (Black):
 VALOX (UL-94V0)

Weight (Typical):
 3.5 grams

APPLICATIONS

Fire Alarm,
 Crime Prevention Alarm,
 Call Buzzer,
 Automotive,
 Clocks,
 Cash Registers & P.O.S.
 Equipment,
 Medical Instruments,
 Electrical Instruments

Shape and Dimensions (mm)

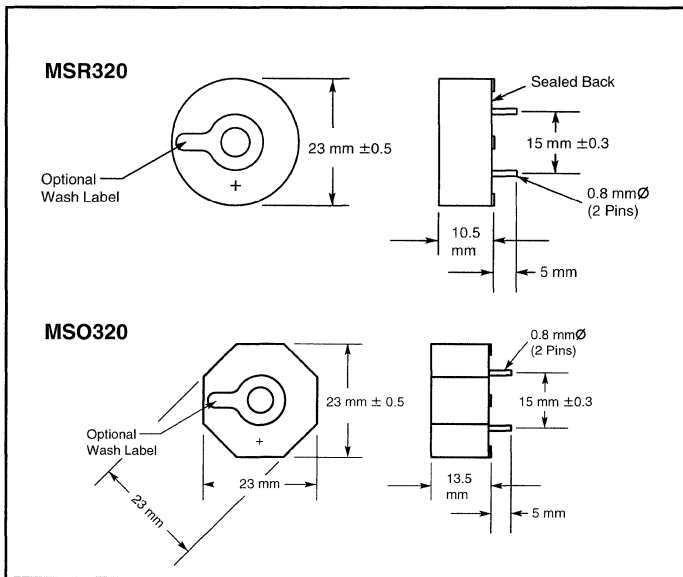

The MSR320 and MSO320 are piezoelectric audible signal devices with a built-in oscillator circuit. They are suitable replacements for the MCP320B2 and MCP320.

The MSR320 and MSO320 are suitable for wave soldering when ordered with the sound emission hole covered with a wash label. The recommended maximum temperature and exposure time for wave soldering is +270°C and 3 seconds respectively.

Optional wash label may be ordered by adding 'S' to model number.

Example: MSR320S
 MSO320S

The MSR320 has passed ESD (ElectroStatic Discharge) testing to levels 1, 2 & 3 per MIL-STD-883D.

Because the operation of the Sonalert II audible signal device is dependent upon the circuit in which it is used, it is advisable to thoroughly test the selected device in the specific circuit and application to assure mechanical and electrical compatibility and verify system performance.

Characteristics

dB Vs. Voltage

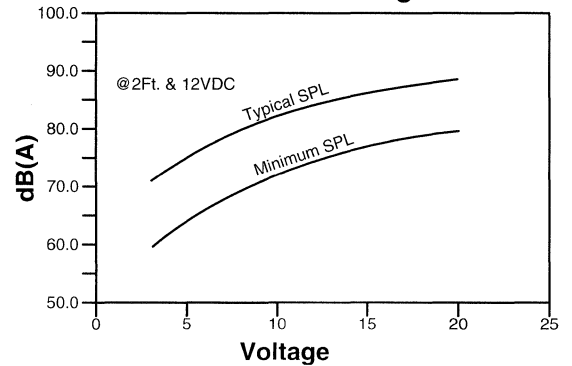

Current Vs. Voltage

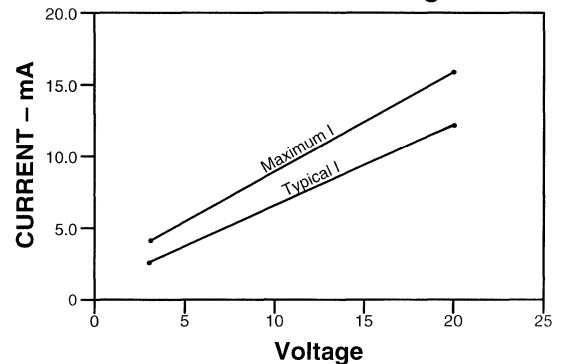

Loudness

The loudness of sound heard from a Sonalert signal depends upon, among other things, the hearing sensitivity of the listener, the frequency of the sound, the distance to the listener, the density and humidity of the air, the design of the Sonalert signal and the voltage applied. Technically, loudness as perceived by the human ear, is measured in sones and this unit may be used to judge the relative loudness between sounds. For example, a sound with a loudness of 4 sones will sound about 4 times louder than a sound of 1 sone. Because loudness at the listener's location is dependent upon the environment, it is not specified for Sonalert signals.

Sound Pressure

Sonalert signals generate air pressure waves which travel through the air to the listener's ear where they produce a sensation of sound. The amount of pressure produced depends upon the loudness and the frequency ratings of the Sonalert signal. Sonalert signal frequencies have been selected for maximum loudness with minimum amount of sound pressure.

Measurements of sound air pressure are expressed as a ratio compared to a pressure of .0002 dynes per square centimeter. This is the smallest sound pressure heard by the average person. The largest pressure that can be heard before pain is felt is about 3 million times higher. For measurement convenience, this wide pressure range is converted to a logarithmic ratio and expressed decibels (dB) according to the formula:

$$dB = 20 \text{ Log } \frac{\text{measured pressure}}{.0002 \text{ dynes/cm}^2}$$

The threshold of hearing has a ratio of 1:1, or a dB of 0. The threshold of pain has a ratio of 3 million:1, or a dB of 130.

Sound Pressure Change with Distance

When the sound pressure leaves the Sonalert signal, it radiates in all directions and is about 2 or 3 dB greater in the direction the open grill is facing. As the sound pressure travels towards the listener, it covers a greater area with a corresponding reduction in pressure at any one point until it is below the threshold of hearing.

For distances shorter than 50 meters, sound pressure drops 6 dB each time the distance traveled is doubled. Variations as much as ±8 dB may occur inside a room or around large objects such as buildings due to echo cancellation and reinforcement effects.

For distances longer than 2KM, air friction reduces sound air pressure about 10 dB/KM @ 1500 Hz, and 20 dB/KM @ 3000 Hz. Of course, the reduction in sound pressure between stationary points also depends upon wind direction and turbulence.

Perhaps the loudest known sound was caused by the eruption of Mt. Krakatau in 1883 which was estimated at 170 dB at 3 miles.

Sound Pressure Specifications

Since sound pressure decreases as it travels from the Sonalert® signal, standard measurements must be made at a standard distance. Standard measurements are made at a distance of 2 feet in an anechoic chamber; or 10 feet above the ground in an open area with no wind. Sound pressure specifications for all Sonalert signal models are shown in the Catalog Number lists.

Frequency

Each Sonalert signal model has its own frequency (tone) which cannot be changed. Models are available to provide frequencies from 1900 to 4500 Hz. For equal sound pressure, 1900 Hz Sonalert signals sound softer and more pleasant than 2900 Hz and 4500 Hz Sonalert signals.

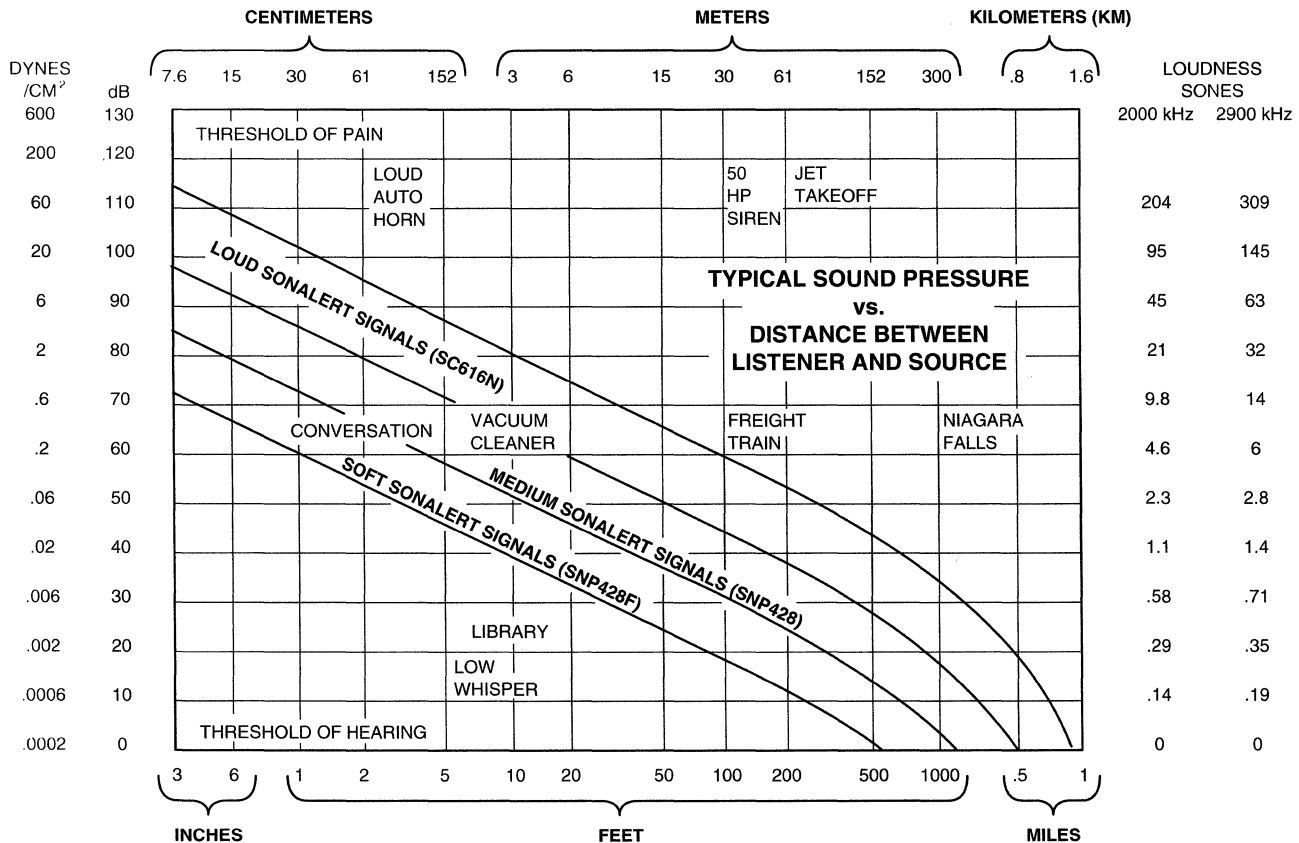

Sound Devices

Type PT Piezoelectric Transducer Units

MALLORY

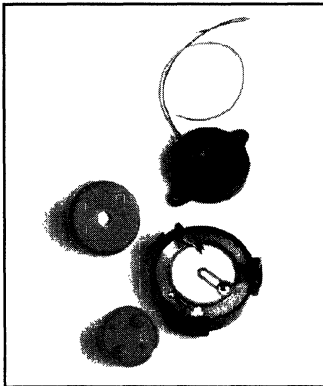

- Low Cost
- Small Size
- High Reliability
- Low Power Input
- Easy Assembly

ENVIRONMENTAL SPECIFICATIONS

Storage Temperature:
-30°C to +70°C

Operating Temperature:
-20°C to +60°C

APPLICATIONS

- Alarm Clocks
- Business Machines
- Calculators
- Medical Equipment
- Cameras
- Refrigerators
- Microwave Ovens

— Made in Taiwan —

EXTERNAL DRIVE (Without Feedback)

Catalog Number	Input Voltage Max.	Resonant Frequency KHz ± 0.5	Minimum Sound Output @ 10 cm	Current Consumption Max.	Capacitance pF $\pm 30\%$
PT-1540P	25V p-p	4.0	80 dB @ 5 V. Square Wave	1.5 mA	10,000
PT-2040P	30V p-p	4.0	90 dB @ 5 V. Square Wave	1.5 mA	20,000
PT-2060W	30V p-p	6.0	95 dB @ 5 V. Square Wave	1.0 mA	12,000

SELF Drive (With Feedback)

Catalog Number	Input Voltage Max.	Resonant Frequency KHz ± 0.5	Minimum Sound Output @ 10 cm	Current Consumption Max.	Capacitance pF $\pm 30\%$
PT-2065FW	3 ~ 28 VDC	6.5	94 dB @ 12 Vdc	8.0 mA	N/A
PT-2735FPL	3 ~ 28 VDC	3.5	97 dB @ 12 vdc	10.0 mA	N/A

Typical Drive Circuits

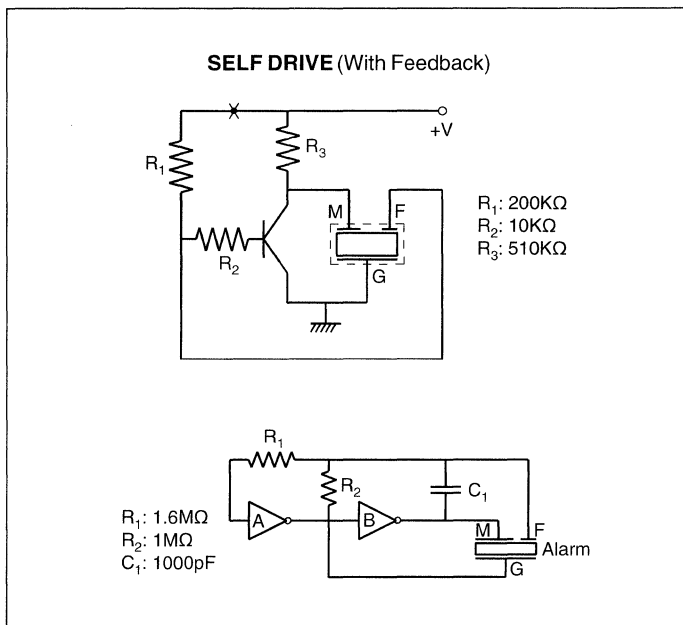

(M) Red + (G) Black - (F) Blue Feedback

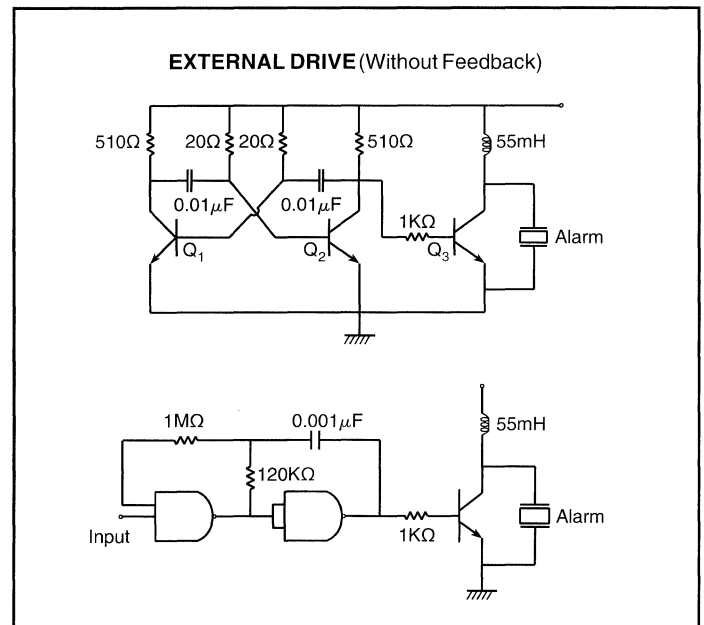

The Piezoelectric Transducer Unit consists of a piezoelectric ceramic element in a housing that provides acoustic enhancement and a convenient mounting vehicle. Models are provided for direct mounting on a chassis or soldering onto a P.C. board. When activated with a typical drive circuit, the unit will produce a clear, audible tone requiring very low electronic power input for the acoustic output.

Shape and Dimensions (millimeters)

PT-1540P — External Drive Unit (Without Feedback)
(Replaces PKM17EPP-4001)

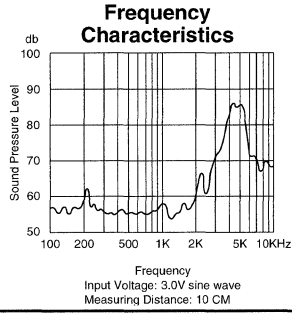
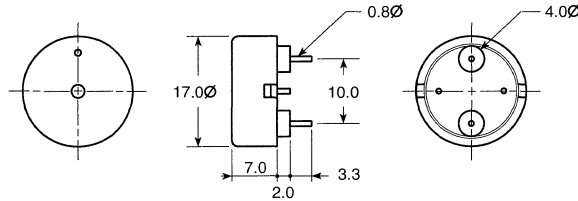

PT-2040P — External Drive Unit (Without Feedback)
(Replaces EFB-RD)

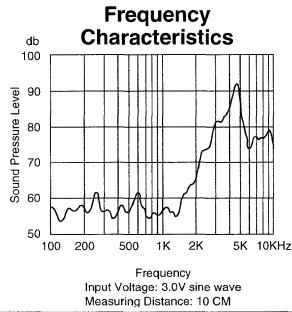
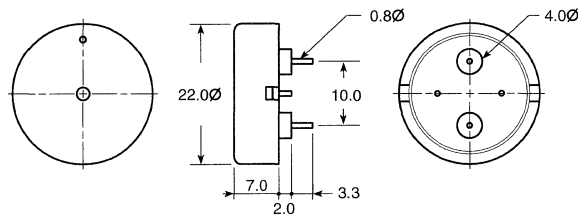

PT-2060W — External Drive Unit (Without Feedback)
(Replaces EFB-RC)

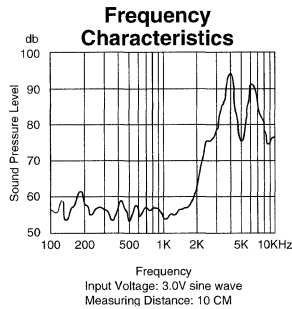
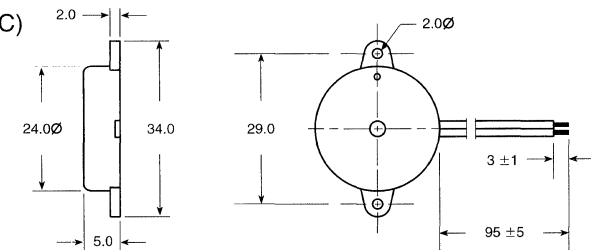

PT-2065FW — Self Drive Unit (With Feedback)
(Replaces EFB-RN)

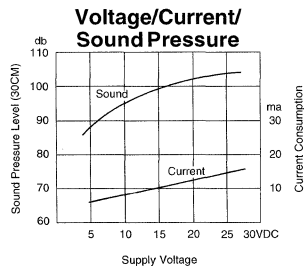
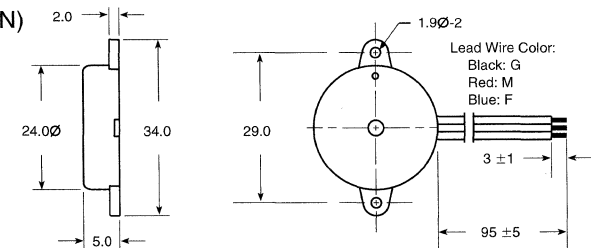

PT-2735FPL — Self Drive Unit (With Feedback)
(Replaces EFB-RL)

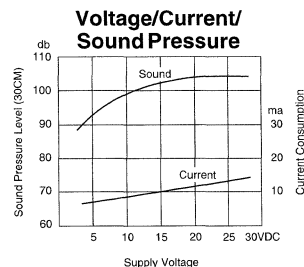
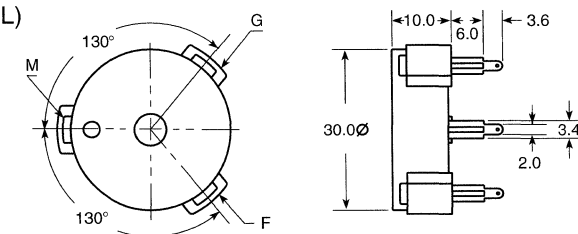

Type JF DC Voltage Rotary Fans



DC Voltage Rotary Fans

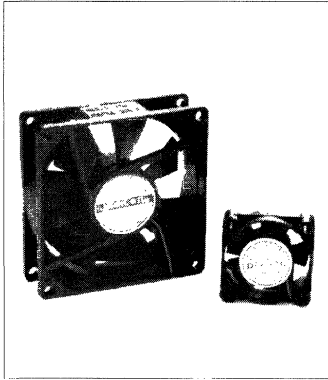

- Solid state brushless DC motors
- Low current, low noise and low interference
- Ball or sleeve bearings available
- CPU cooling module available for the 40mm fan

GENERAL SPECIFICATIONS
 Operating Temperature:
 -10°C +65°C
 @ 65% Relative Humidity
 Storage Temperature:
 -40°C +75°C
 @ 65% Relative Humidity
 Operating Voltage:
 @ 12VDC (8 to 13.5 Range)
 @ 24VDC (14 to 27.6 Range)
JF0510S only
 @ 12Vdc (9 to 13.8 Range)
 Insulation Resistance:
 10MΩ min. @ 500VDC between frame and positive terminal

Dielectric Strength:
 5 mA max @ 500VAC between frame and positive terminal
 Expected Life:
 30,000 Hours at 40°C - Sleeve
 50,000 Hours at 40°C - Ball
 Rotation: Clockwise
 Plastic Material:
 Impeller - PBT UL94V-0 or ABS UL94HB
 Frame - PBT UL94V-0
 Wire Material:
 Red (+) UL1007, AWG22
 Black (-) UL1007, AWG22
JF0510S only
 Red (+) UL1007, AWG26-28
 Black (-) UL1007, AWG26-28
 Blue (-) UL 1007, AWG26-28

International Approvals

Safety Agency	File Number	Model
TUV # R9152817	946-AK/YY E9152816E01	JF-060 JF-080
C-UL # E156480	94SC05394	JF-040 JF-060 JF-080 JF-090
Approvals pending at time of publication		JF-020 JF05

Cooling Module Assembly Chart

Heat sink and power supply connector are optional on models JF7M040 and JF0510S only

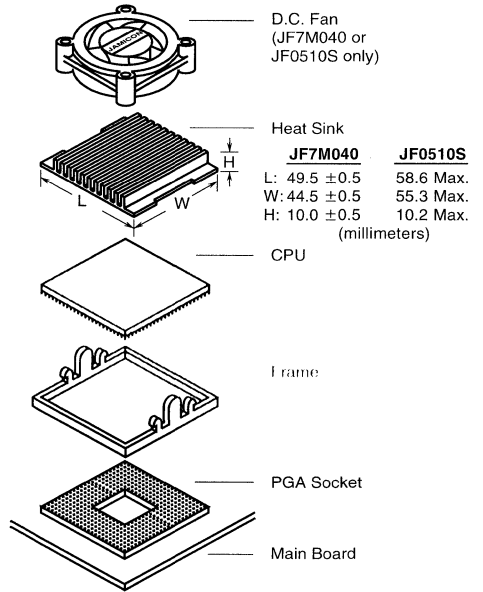

Part Number Nonmenclature

JF7 M 040 13 S 12 * *
 (1) (2) (3) (4) (5) (6) (7) (8)

1. Series
2. RPM (See list for letter code)
3. Dimension (Width & Length)
4. Thickness
5. Shaft (S= Sleeve, B= Ball)
6. Voltage (12= 12VDC, 24= 24 VDC)
7. Optional
8. Optional

(* Optional Heat Sink and/or Connectors - See Catalog Number list)

Catalog Number	Fan Outline Dimensions (Millimeters)					Rated Voltage (DCV)	Start Voltage (DCV)	Rated Current (A)	Input Power (W)	Air Flow (CFM)	Static Pressure (inches-H2O)	Noise Level (dB)	Maximum Rotary Speed RPM (code)	Approx. Weight (g)	Optional Heat Sink Dimensions (mm)		
	W	L	T	P	I										L	W	H
JF7M02010*12	25	25	10	22.1	300	12	5	0.07	0.84	1.25	0.100	29	11,000 (M)	8	-	-	-
JF7M04013*12++	40	40	13	32	300	12	7	0.06	0.72	5.10	0.190	26	5000 (M)	20	49.5	44.5	10
JF7M06025*12	60	60	25	50	300	12	5	0.11	1.32	11.40	0.150	24	3900 (M)	65	-	-	-
JF7M06025*24	60	60	25	50	300	24	10	0.11	2.64	11.40	0.150	24	3900 (M)	65	-	-	-
JF7H06025*12	60	60	25	50	300	12	5	0.13	1.51	13.70	0.165	28	4500 (H)	65	-	-	-
JF7H06025*24	60	60	25	50	300	24	10	0.13	3.12	13.70	0.165	28	4500 (H)	65	-	-	-
JF7L08025*12	80	80	25	71.5	300	12	5	0.07	.84	23.10	0.101	22	2000 (L)	80	-	-	-
JF7L08025*24	80	80	25	71.5	300	24	10	0.07	1.68	23.10	0.101	22	2000 (L)	80	-	-	-
JF7M08025*12	80	80	25	71.5	300	12	5	0.12	1.44	30.20	0.127	26	2500 (M)	80	-	-	-
JF7M08025*24	80	80	25	71.5	300	24	10	0.10	2.40	30.20	0.127	26	2500 (M)	80	-	-	-
JF7H08025*12	80	80	25	71.5	300	12	5	0.16	1.92	37.80	0.177	31	3000 (H)	80	-	-	-
JF7H08025*24	80	80	25	71.5	300	24	10	0.12	2.88	37.80	0.177	31	3000 (H)	80	-	-	-
JF7M09025*12	90	90	25	82.5	300	12	5	0.17	2.04	36.00	0.140	34	2100 (M)	95	-	-	-
JF7H09025*24	90	90	25	82.5	300	24	10	0.16	3.84	42.00	0.180	37	3200 (H)	95	-	-	-

* Indicate bearing: S = Sleeve, B = Ball + Optional: H = Heat Sink for JFM04 only.
 + Optional: C = Connectors to connect CPU cooling module to power supply for JFM04 only.

Power DC Fan (PENTIUM®)

JF0510S-##	52	52	10	42	250	12	5	0.08	.96	6.35	0.189	24	4000	22	58.6	55.3	10.2
------------	----	----	----	----	-----	----	---	------	-----	------	-------	----	------	----	------	------	------

Sleeve Bearing only # Optional: C = Connectors to connect CPU cooling module to power supply for JF0510S only.
 # Optional: M = Heat Sink for JF0510S only

Measuring Noise: A microphone is placed one meter from the end of the fan with the air flowing outward. It is measured under rated voltage in a semi-anechoic chamber with a sound meter.

PENTIUM® is a registered trademark of Intel Corp.

Type JF DC Voltage Rotary Fans



DC Voltage Rotary Fans

JF7-02010

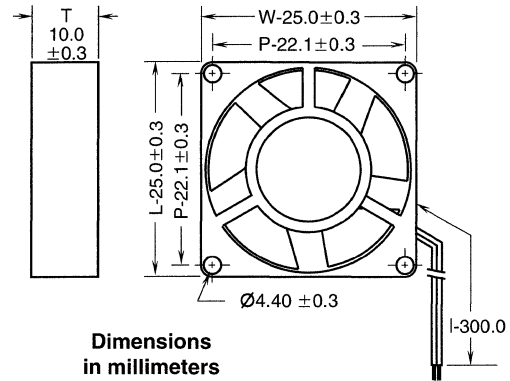
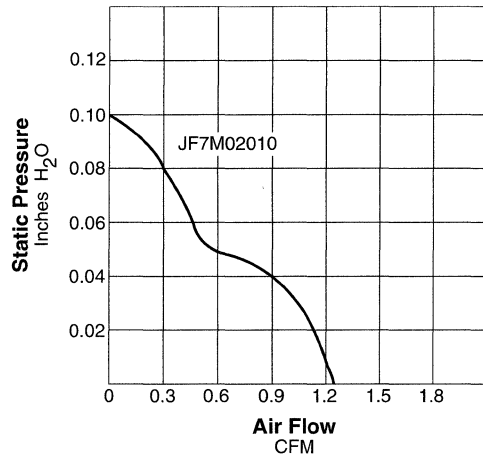

JF7-04013

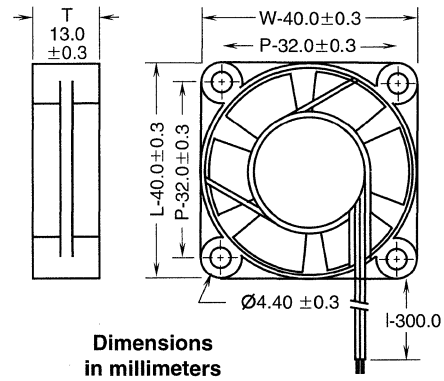
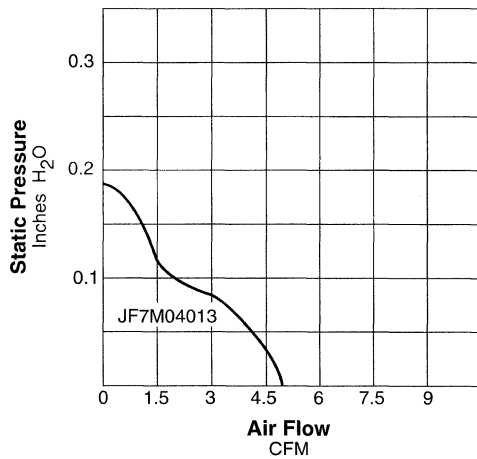

JF7-06025

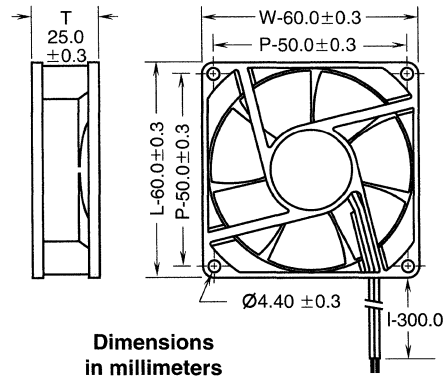
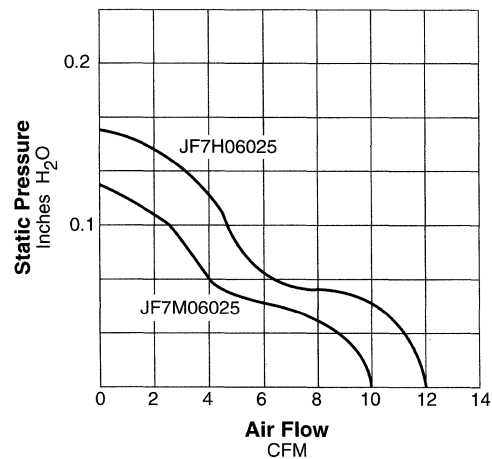

JF7-08025

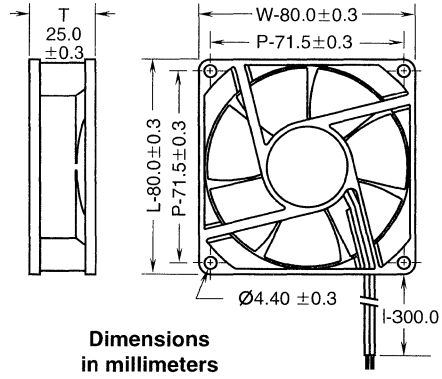
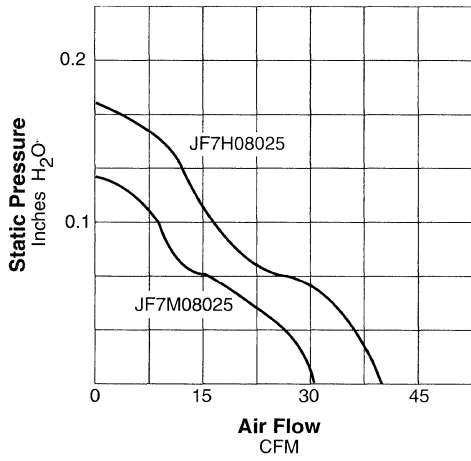

JF7-09025

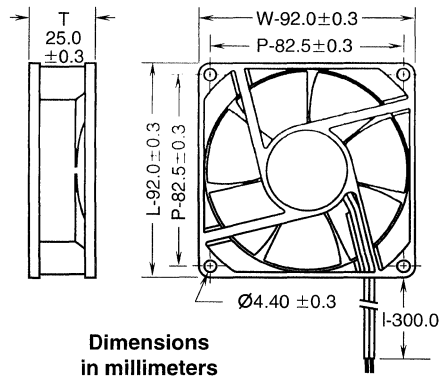
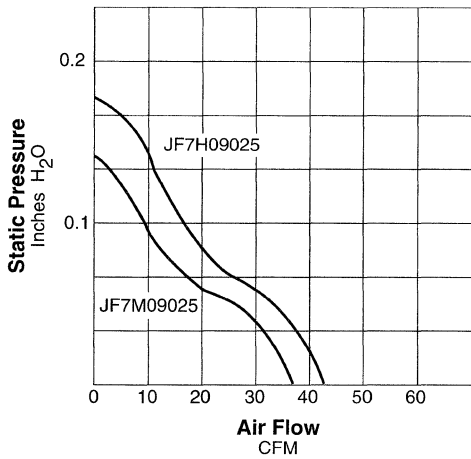

JF0510S

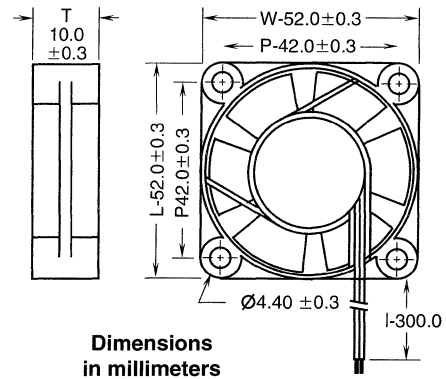
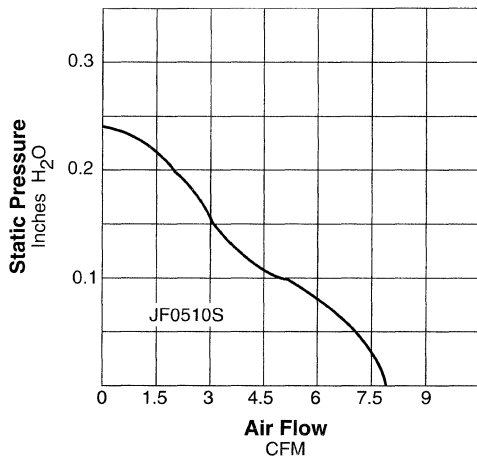

Type	Description	Features	Page Number
Wirewound Controls			
MR	3 Watt Multiple Mounting	Wirewound — Linear Taper	193
M LW MG R	3 to 12.5 Watt	Wirewound Miniature — Bushing Mount	194-195
VW VWS	5 Watt - Rugged Construction	Wirewound Subminiature — Linear Taper	194-195

Wirewound Audio Attenuators			
L Pad	15 Watts — Mono	Wirewound — 2 section	196
MGL Pad	50 Watts — Mono	Wirewound — 2 Sections — Glass Elements	196
LL Pad	15 Watts — Stereo	Wirewound — 4 Sections	196
MGLL Pad	50 Watts — Stereo	Wirewound — 4 Sections — Glass Elements	196
T Pad	15 Watts — Mono	Wirewound — 3 Sections	197
RT Pad	10 Watts — Mono	Wirewound — 3 Sections	197

T pads are used where it is important that the insertion of the attenuator in the circuit and the amount of the attenuation have no effect upon the impedance relations existing in the circuit. This is achieved by making the image impedance of the T pad equal the generator and load resistance. In the case of the T pad where input impedance is equal to the output impedance, the network is said to be symmetrical about a vertical center line.

L attenuators, or pads, are less expensive than the T type since only two instead of three variable resistors are required to control the attenuation. At the same time, the L attenuator maintains impedance independent of attenuation at only one pair of terminals; whereas the T attenuator maintains constant impedance at both input and output terminals.

L pads are generally used where a number of loads are associated with a common generator and it is necessary to control the power delivered to each load without altering the impedance reflected to the generator. In L pads, one input and one output terminal are connected directly together and the pad is grounded or unbalanced. The variable L pad is composed of two controls on a common shaft with the contact arms externally tied together. As one unit increases in resistance, the other decreases thereby maintaining the impedance, as seen by the source, constant. These L pads may be obtained to match impedances from two ohms to four thousand ohms.

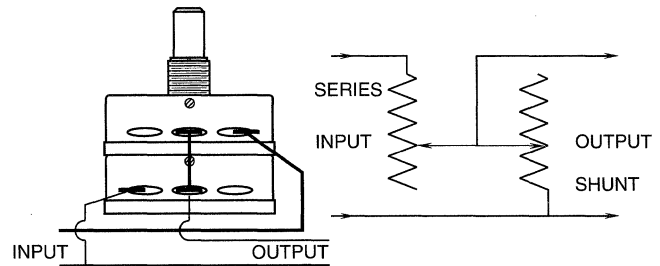
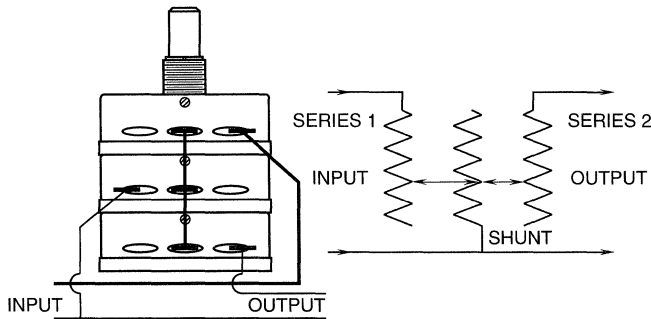

Type	Description	Features	Page Number
Stereo Level Control			
RR Pad	10 Watt — Stereo — For lower priced 4 and 8 Ohm speakers	Wirewound — 2 Sections	197
Rotary Switch			
3000 Series	Multiple Poles and Positions	General purpose — Bushing mount	198
Hardware			
Switch & Control	Knob, Dial Plates, Brackets, Shafts, Nuts & Washers	Wide variety	199

Type MR - 3 Watt Wirewound Controls



Power Rating: 3 Watts @ 55°C
Derate linearly to 0 @ 105°C

Ohms Tolerance: ±20% (Standard)
(Other tolerances available)

Dielectric Strength: Mounting plate to terminals,
high pot test for 1 minute
@ 900 VAC

Stop Strength: 12 inch pounds (Minimum)

Operating Torque: 1/2 - 10 inch ounces

Resistance Taper: Linear only

Mechanical Rotation: 240

Electrical Rotation: 215

Contact Arm: Insulated from case.

PC Mount - No Snap

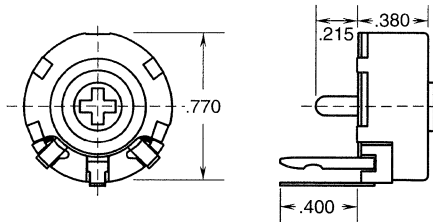

Ohms Rating	Max Amperes	Catalog Number
15	.450	MR15P
100	.170	MR100P
600	.071	MR600P
1K	.055	MR1000P
1.5K	.045	MR1500P
3K	.032	MR3000P
5K	.024	MR5000P

Tab Mount

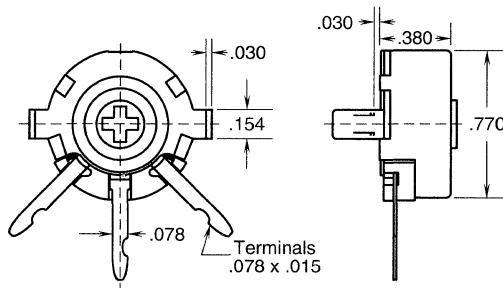

Ohms Rating	Max Amperes	Catalog Number
50	.240	MR50T
10K	.017	MR10KT

.154 Twist Tab, .246 Long
Center-to-center mounting dimension: - .925

Flange Mount

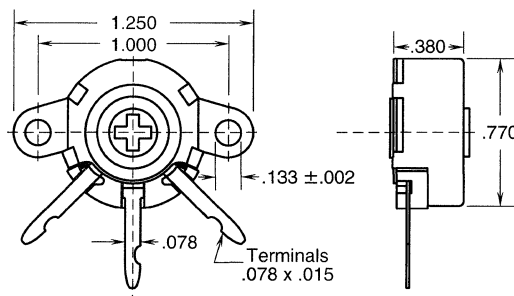

Ohms Rating	Max Amperes	Catalog Number
100	.170	MR100F
500	.077	MR500F
1K	.055	MR1000F
2.5K	.035	MR2500F

Mounting ear holes - .130 Dia. on 1" centers

Bushing Mount

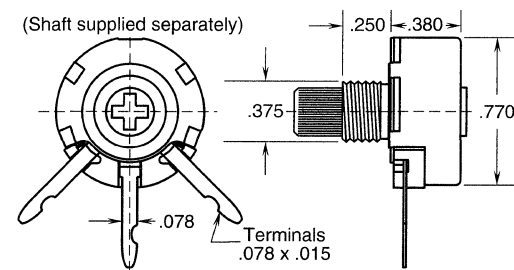

Ohms Rating	Max Amperes	Catalog Number
100	.170	MR100B

Bushing 3/8-32 x 1/4"

3 Watt - R Series

Power Rating: 3 Watts @ 40°C
Derated linearly to 0 @ 105°C

Ohms Tolerance: ± 10% (Standard)
(Other tolerances available)

Dielectric Strength: Mounting plate to terminals,
high pot test for 1 minute
@ 900 VAC

Insulation Resistance: 1000 megohms minimum
(50% relative humidity @ 25°C)

Operating Temperature: -30°C to +105°C

Operating Life: 10,000 cycles standard

Resistance Taper: Linear
(Other tapers available)

Mechanical Rotation: 297° ± 5°

Bushing Information: Thread: 3/8-32 NEF-2A

Contact Arm: Insulated from case

Ohms Rating	Max. Amperes	Catalog Number
10	.548	R10L
500	.077	R500L
1K	.055	R1000L
2.5K	.035	R2500L

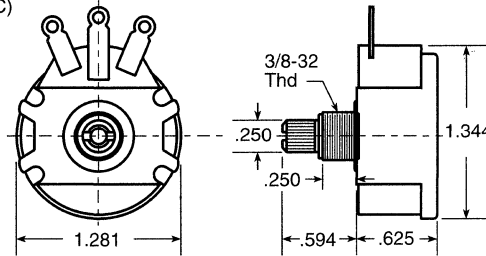

4 Watt - M Series

Power Rating: 4 Watts @ 40°C

Ohms Tolerance: ± 10% (Standard)
(Other tolerances available)

Dielectric Strength: Mounting plate to terminals,
high pot test for 1 minute
@ 900 VAC

Insulation Resistance: 1000 megohms minimum
(50% relative humidity @ 25°C)

Operating Temperature: -55°C to +105°C

Operating Life: 10,000 cycles standard

Resistance Taper: Linear
(Other tapers available)

Mechanical Rotation: 294° ± 5°

Bushing Information: Thread: 3/8-32 NEF-2A

Contact Arm: Insulated from case

Ohms Rating	Max. Amperes	Catalog Number
1	2.000	M1PK
3	1.150	M3PK
6	.816	M6PK
15	.516	M15PK
25	.400	M25PK
50	.280	M50PK
100	.200	M100PK
200	.140	M200PK
300	.116	M300PK
500	.090	M500PK
1K	.063	M1MPK
2K	.045	M2MPK
5K	.028	M5MPK
10K	.020	M10MPK
20K	.014	M20MPK
25K	.013	M25MPK
50K	.009	M50MPK
100K	.0062	M100MPK

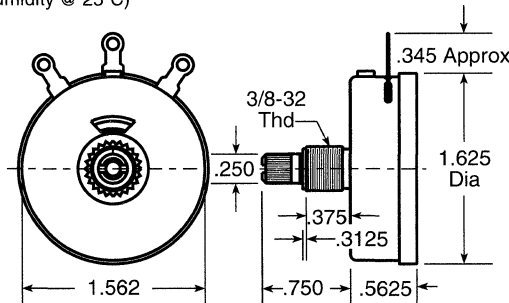

5 Watt - VW Series

Power Rating: 5 Watts @ 35°C

Ohms Tolerance: ± 10% (Standard)
(Other tolerances available)

Dielectric Strength: Mounting plate to terminals,
high pot test for 1 minute
@ 900 VAC

Insulation Resistance: 1000 megohms minimum
(50% relative humidity @ 25°C)

Operating Temperature: -30°C to +105°C

Operating Life: 10,000 cycles standard

Resistance Taper: Linear
(Others available)

Mechanical Rotation: 305° ± 5°

Bushing Information: Thread: 3/8-32 NEF-2A

Contact Arm: Insulated from case

Ohms Rating	Max. Amperes	Catalog Number
1	2.2	VW1
2	1.6	VW2
5	1.0	VW5
8	.750	VW8
10	.710	VW10
15	.580	VW15
20	.500	VW20
25	.450	VW25
50	.320	VW50
100	.220	VW100
200	.160	VW200
250	.140	VW250
300	.130	VW300
500	.100	VW500
1K	.071	VW1K
2K	.050	VW2K
2.5K	.045	VW2P5K
3K	.041	VW3K
4K	.035	VW4K
5K	.032	VW5K
10K	.022	VW10K
20K	.016	VW20K
25K	.014	VW25K

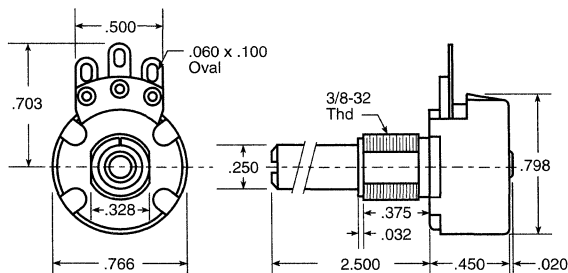

Bushing Mount Wirewound Controls

MALLORY

5 Watt - VWS Series

Power Rating: 5 Watts @ 35°C
 Ohms Tolerance: ± 10% (Standard)
 Dielectric Strength: Mounting plate to terminals, high pot test for 1 minute @ 900 VAC
 Insulation Resistance: 1000 megohms minimum (50% relative humidity @ 25°C)

Operating Temperature: -30°C to +105°C
 Operating Life: 10,000 cycles standard
 Resistance Taper: Linear
 Mechanical Rotation: 305° ± 5°
 Bushing Information: Thread: 3/8-32 NEF-2A
 Contact Arm: Insulated from case

Ohms Rating	Max. Amperes	Catalog Number
1	2.200	VWS1
50	.320	VWS50
100	.220	VWS100
200	.160	VWS200
1K	.071	VWS1K
5K	.032	VWS5K
20K	.016	VWS20K

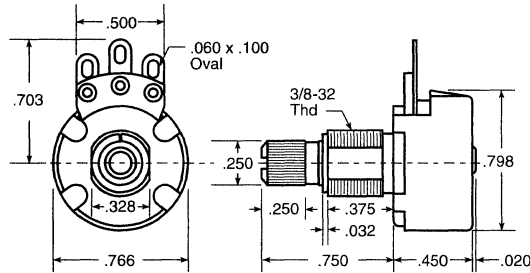

5 Watts - LW Series

Power Rating: 5 Watts @ 25°C
 4 Watts @ 55°C
 Ohms Tolerance: ± 10% (Standard)
 Dielectric Strength: Mounting plate to terminals, high pot test for 1 minute @ 900 VAC
 Insulation Resistance: 1000 megohms minimum (50% relative humidity @ 25°C)

Operating Temperature: -30°C to +105°C
 Operating Life: 10,000 cycles standard
 Resistance Taper: Linear only
 Mechanical Rotation: 300° ± 5°
 Bushing Information: Thread: 3/8-32 NEF-2A
 Contact Arm: Insulated from case

Ohms Rating	Max. Amperes	Catalog Number
5	.890	LW5
8	.710	LW8
10	.630	LW10
25	.450	LW25
50	.280	LW50
100	.200	LW100
250	.130	LW250
500	.089	LW500
1K	.063	LW1K
1.5K	.058	LW1P5K
2.5K	.040	LW2P5K
5K	.028	LW5K
10K	.020	LW10K

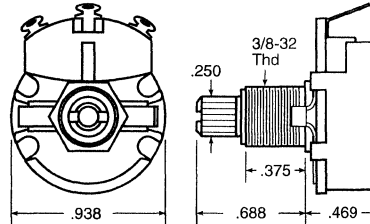

12.5 Watts - MG Series

Power Rating: 12.5 Watts @ 40°C
 Derated linearly to 0°C @ 250°C
 Ohms Tolerance: ± 10% (Standard)
 Dielectric Strength: Mounting plate to terminals, high pot test for 1 minute @ 900 VAC
 Insulation Resistance: 1000 megohms minimum (50% relative humidity @ 25°C)

Operating Temperature: -55°C to +250°C
 Operating Life: 10,000 cycles standard
 Resistance Taper: Linear
 Mechanical Rotation: 294° ± 5°
 Bushing Information: Thread: 3/8-32 NEF-2A
 Contact Arm: Insulated from case

Ohms Rating	Max. Amperes	Catalog Number
10	1.100	MG10
25	.710	MG25
50	.550	MG50
500	.160	MG500
1K	.110	MG1000
2.5K	.070	MG2500
25K	.022	MG25K

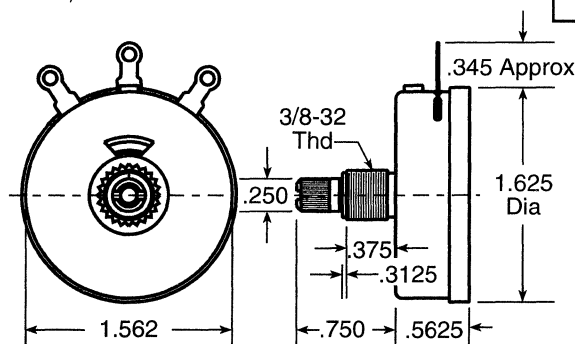

L Pad Attenuator

Presents constant impedance to source (Amplifier). Used in audio circuits where output (Speaker) impedance is not critical

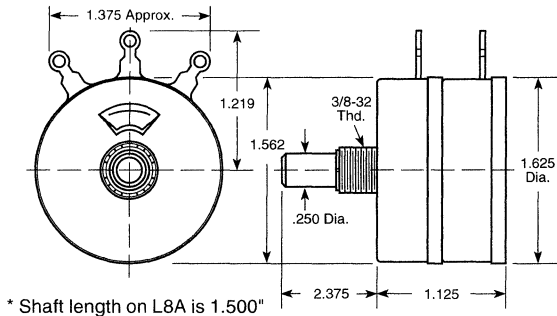

Power Rating: 4 Watts
 Continuous Audio: 15 Watts
 Dielectric Strength: Mounting plate to terminals, high pot test for 1 minute @ 900 VAC
 Insulation Resistance: 1000 megohms minimum (50% relative humidity @ 25°C)
 Operating Temperature: -55°C to +105°C
 Operating Life: 10,000 cycles standard
 Mechanical Rotation: 294° ±5°
 Bushing Information: Thread: 3/8-32 NEF-2A
 Contact Arm: Insulated from case
 Terminals: Solder Lug

Ohms Rating	Catalog Number
4	L4
8	L8
8	L8A *
15	L15
50	L50
600	L600
2000	L2000

MGL Pad Attenuator

Same as L Pad but with glass element for higher wattage

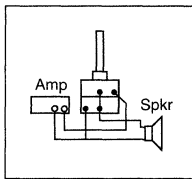

Power Rating: 12.5 Watts
 Continuous Audio: 50 Watts
 Dielectric Strength: Mounting plate to terminals, high pot test for 1 minute @ 900 VAC
 Insulation Resistance: 1000 megohms minimum (50% relative humidity @ 25°C)
 Operating Temperature: -55°C to +250°C
 Operating Life: 10,000 cycles standard
 Mechanical Rotation: 294° ±5°
 Bushing Information: Thread: 3/8-32 NEF-2A
 Contact Arm: Insulated from case
 Terminals: Solder Lug

Ohms Rating	Catalog Number
8	MGL8
16	MGL16

LL Pad Attenuator

Two L pads in tandem for Stereo Level Control

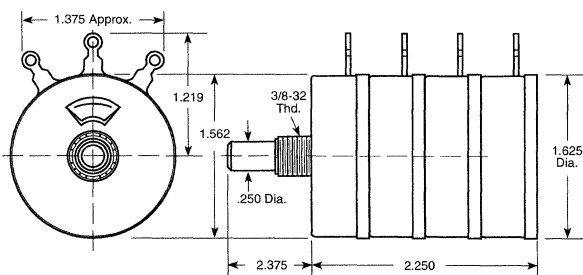

Power Rating: 4 Watts
 Continuous Audio: 15 Watts
 Dielectric Strength: Mounting plate to terminals, high pot test for 1 minute @ 900 VAC
 Insulation Resistance: 1000 megohms minimum (50% relative humidity @ 25°C)
 Operating Temperature: -55°C to +105°C
 Operating Life: 10,000 cycles standard
 Mechanical Rotation: 294° ±5°
 Bushing Information: Thread: 3/8-32 NEF-2A
 Contact Arm: Insulated from case
 Terminals: Solder Lug

Ohms Rating	Catalog Number
4	LL4
8	LL8
16	LL16

MGLL Pad Attenuator

Same as LL Pad but with glass element for higher wattage

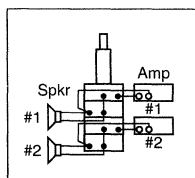

Power Rating: 12.5 Watts
 Continuous Audio: 50 Watts
 Dielectric Strength: Mounting plate to terminals, high pot test for 1 minute @ 900 VAC
 Insulation Resistance: 1000 megohms minimum (50% relative humidity @ 25°C)
 Operating Temperature: -55°C to +105°C
 Operating Life: 10,000 cycles standard
 Mechanical Rotation: 294° ±5°
 Bushing Information: Thread: 3/8-32 NEF-2A
 Contact Arm: Insulated from case
 Terminals: Solder Lug

Ohms Rating	Catalog Number
8	MGLL8

All Audio Attenuators are supplied with palnut and dial plate.
 Dial Plate 395 for Mono and Dial Plate 495 for Stereo.

T Pad Attenuator

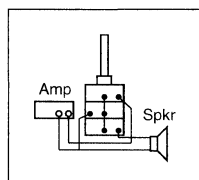
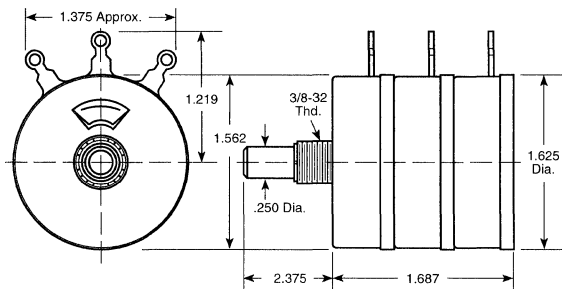

Presents constant impedance to both source (Amplifier) and output (Speaker)

Power Rating: 4 Watts
 Continuous Audio: 15 Watts
 Dielectric Strength: Mounting plate to terminals, high pot test for 1 minute @ 900 VAC
 Insulation Resistance: 1000 megohms minimum. (50% relative humidity @ 25°C)
 Operating Temperature: -55°C to +105°C
 Operating Life: 10,000 cycles standard.
 Mechanical Rotation: 294° ±5°
 Bushing Information: Thread: 3/8-32 NEF-2A
 Contact Arm: Insulated from case
 Terminals: Solder Lug

Ohms Rating	Catalog Number
8	T8
50	T50
600	T600

RT Pad Attenuator

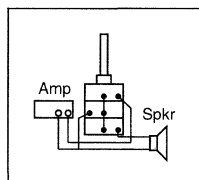
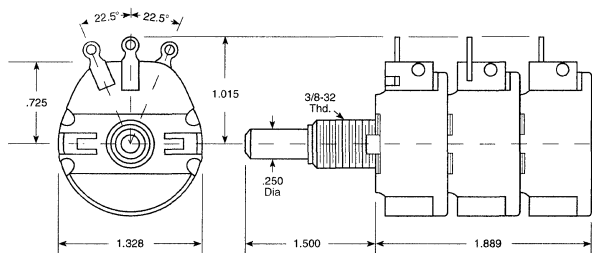

Presents constant impedance to both source (Amplifier) and output (Speaker)

Power Rating: 3 Watts
 Continuous Audio: 10 Watts
 Dielectric Strength: Mounting plate to terminals, high pot test for 1 minute @ 900 VAC
 Insulation Resistance: 1000 megohms minimum (50% relative humidity @ 25°C)
 Operating Temperature: -30°C to +105°C
 Operating Life: 10,000 cycles standard
 Mechanical Rotation: 300° ±5°
 Bushing Information: Thread: 3/8-32 NEF-2A
 Contact Arm: Insulated from case
 Terminals: Solder Lug

Ohms Rating	Catalog Number
8	RT8

Stereo Level Control

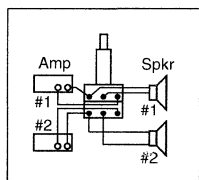
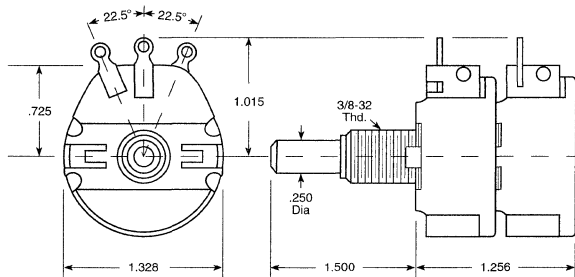

50 Ohm tandem dual level control for lower priced 4 and 8 Ohm stereo speakers

Power Rating: 3 Watts
 Continuous Audio: 10 Watts
 Dielectric Strength: Mounting plate to terminals, high pot test for 1 minute @ 900 VAC
 Insulation Resistance: 1000 megohms minimum (50% relative humidity @ 25°C.)
 Operating Temperature: -30°C to +105°C.
 Operating Life: 10,000 cycles standard
 Mechanical Rotation: 300° ±5°
 Bushing Information: Thread: 3/8-32 NEF-2A
 Contact Arm: Insulated from case
 Terminals: Solder Lug

Ohms Rating	Catalog Number
50	RR50

All Audio Attenuators are supplied with palnut and dial plate.
 Dial Plate 395 for Mono and Dial Plate 495 for Stereo.

General Purpose Rotary Switches

Positions (Max.): 12
Maximum number of poles: 4
Indexing Angle: 30°
Contact Resistance (initial): Less than .010 ohms
Dielectric Strength: 500 volts AC or 500 volts DC between terminals or terminals to ground
Operating Life: 10,000 cycles
Insulation Resistance: 1000 megohms minimum @ 25°C and 40% relative humidity
Sections: One only
Detent Type: Hill and valley
Terminals: Silver plated high quality non-ferrous material
Ground Rings: Silver plated brass
Insulation: High grade phenolic

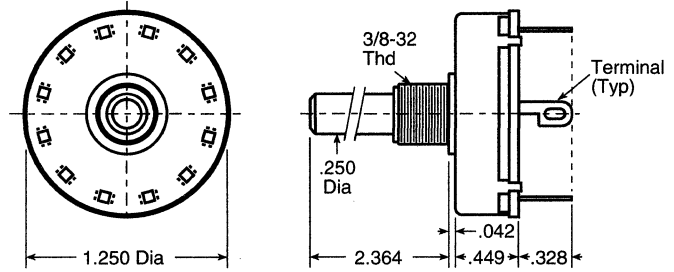

Shaft can be snapped off to desired length

Number of Poles	Maximum Positions	Catalog Number	
		Shorting	Non-Shorting
1	5	—	3215J
1	12	31112J	32112J
2	2	—	3222J
2	3	3123J	3223J
2	6	3126J	3226J
3	4	3134J	3234J
4	2	—	3242J
4	3	3143J	3243J

Electrical Limits @ Voltage			
300 VDC	.2 Amp	300 VAC	.25 Amp
100 VDC	.4 Amp	100 VAC	.5 Amp
50 VDC	1 Amp	50 VAC	1 Amp
25 VDC	2 Amp	25 VAC	2 Amp
12 VDC	4 Amp	12 VAC	4 Amp
6 VDC	5 Amp	6 VAC	6 Amp

DIAL PLATES

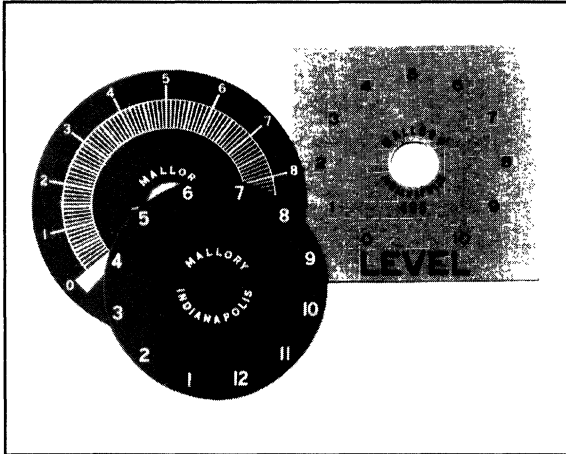

30° Marking

Aluminum dial plates with figures etched on solid black background. Diameter is 1-13/16", with a 7/16" hole. Lettering is 7/16" high, .020" wide.

Markings	Catalog Number
1 to 2	372
1 to 3	373
1 to 4	374
1 to 6	376
1 to 7	377
1 to 8	378
1 to 9	379
1 to 10	380
1 to 11	381
1 to 12	382
OFF 1 to 3	383
OFF 1 to 9	389
OFF 1 to 10	390

Other Marking

Aluminum dial plates with figures etched on solid black background. Similar to dial plates at left, but with various spacing and markings.

Size (Diameter)	Markings	Degrees Spacing	Catalog Number
1-13/16"	1 to 24	15	394
2-1/4"	0 to 10	330	369
2-1/4"	0 to 10	275	395
2-1/4"	0 to 10	260	397
2-1/4"	0 to 10	305	399
1-13/16"	1 to 17	20	467
2" (Square)	Level		495

SWITCH and CONTROL KNOBS

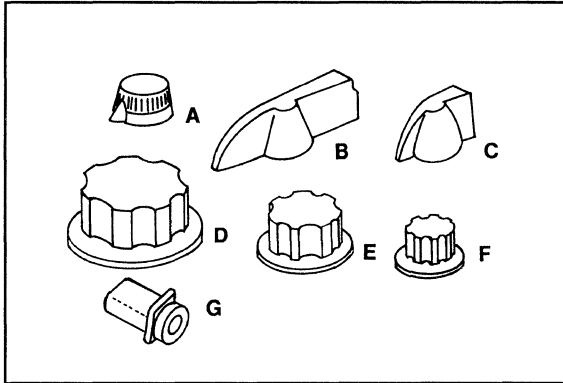
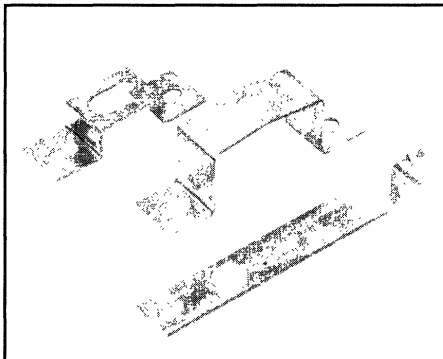

Figure	Description	Shaft Size	Catalog Number
A	11/16" Black Pointer	1/4"	364
B	2" Black Bar	1/4"	365-1
C	1-1/4" Black	1/4"	366-1
D	1-1/2" Black	1/4"	367-1
E	1-1/8" Black	1/4"	368-1
F	3/4" Black	1/8"	1910K
G	9/16" x 13/16" Black for lever switches		GS5149A

ADJUSTABLE MOUNTING BRACKETS



Description	Catalog Number
1-1/4" mounting centers	RB248
2-1/2" mounting centers	RB249
Universal	RB254

SHAFTS FOR MR CONTROLS

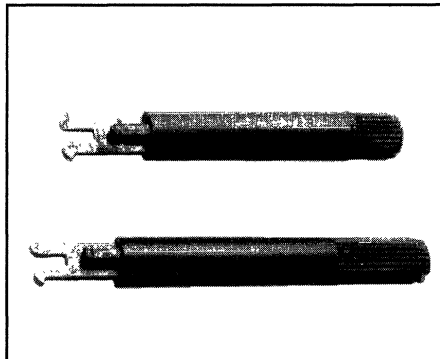

Description	Catalog Number
1/4" dia x 1-1/4" from front of mounting surface. Knurled and slotted nylon. Plugs into either end of MR controls.	MRS1250
1/4" dia x 1-9/16" from front of mounting surface. Knurled and slotted nylon. Plugs into either end of MR controls.	MRS1563

HEX NUTS AND WASHERS

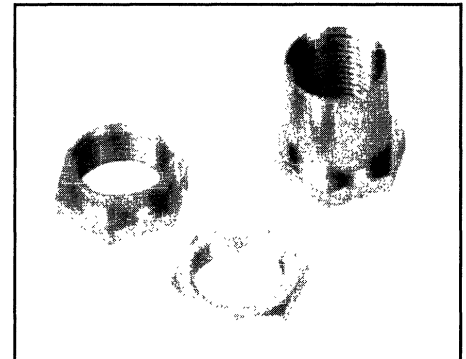

Description	Catalog Number
3/8"-32 Hex Nut	232
.218 shoulder length	255
.328 shoulder length	A1126012
.578 shoulder length	A112602
3/8" I.D. metal washer	225

TYPE VR VERTICAL MOUNTING CLAMP

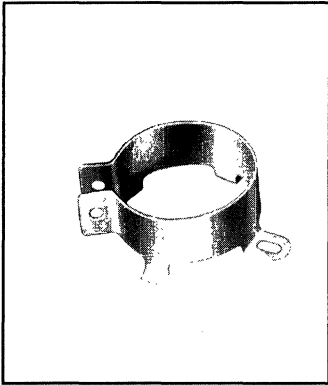

Diameter of Part to be Mounted	Catalog Number			Dimensions		
	Without Screw & Nut	Unassembled Screw & Nut Included	Assembled with Screw & Nut	A	B	C
1" to 1-1/16"	VR1B	VR1	VR1A	1"	1-7/16"	1-7/8**
1-3/8" to 1-7/16"	VR3B	VR3	VR3A	1-3/8"	1-25/32"	2-7/32"
1-1/2" to 1-9/16"	VR4B	VR4	VR4A	1-1/2"	1-15/16"	2-11/32"
1-3/4" to 1-13/16"	VR6B	VR6	VR6A	1-3/4"	2-1/4"	2-9/16"
2" to 2-1/16"	VR8B	VR8	VR8A	2"	2-1/2"	2-13/16"
2-1/2" to 2-9/16"	VR10B	VR10	VR10A	2-1/2"	3"	3-5/16"
3" to 3-1/8"	VR12B	VR12	VR12A	3"	3-7/16"	3-13/16"
Screw	VRSCREW	—	—	9/16" long 6-32 thread NC-2A		
Nut	VRNUT	—	—	Standard hex nut to fit screw		

NACC VR mounting clamps may be used to mount any cylindrical capacitor with a 1" to 3" diameter that is to be mounted in a vertical position. Material is 1010 CRS, commercial grade #4 temper ASI-scale. Parts are finished with .0001 (nominal) zinc chromate plating. Use for mounting CG types, PSU, HC/NP and MPD/MPF types. Material thickness is .035"

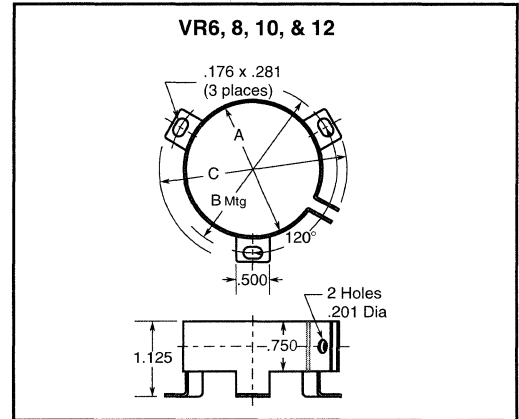
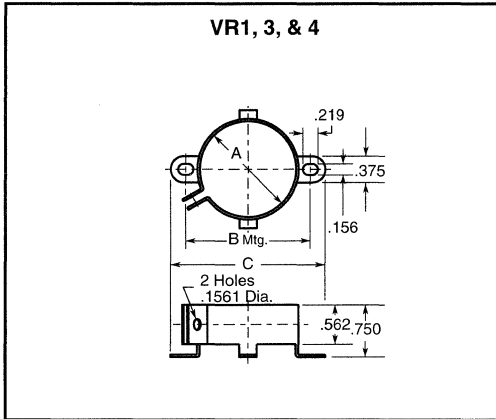

Capacitor Hardware

MOUNTING ACCESSORIES FOR PSU AND HC/NP TYPE CAPACITORS

Type HB Horizontal Mounting Bracket

EIA Case Code	Dimensions				Catalog Number
	A	B	C*	D	
1	3-3/8"	1-11/64"	7/8"	1.258	HB2
2-4-6	4-1/64"	1-13/16"	1-1/2"	1-37/64	HB4
3-5-7-8	5-1/64"	2-23/32"	1-25/32"	2-5/64"	HB8

HB brackets are used with PL or PLA end caps. The bracket is assembled to the motor or any suitable surface by two screws in line at any convenient position within the center-to-center dimension (C) shown in the chart.

Material: .042 spring steel with black parkerized finish

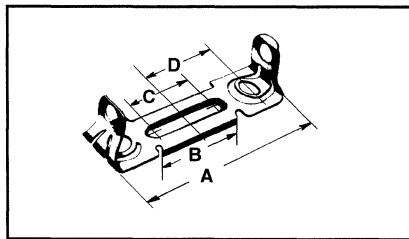

*C dimension = max mounting hole center
Use 10-32" flat head screws

Type PL and PLA End Caps

EIA Case Code	A Dimension	Catalog Number	
		Wire Hole Toward Bracket	Wire Hole Away From Bracket
1-2-3	1-7/16"	PL3	PLA3
4-5	1-13/16"	PL6	PLA6
6-7	2-1/16"	PL8	PLA8
8	2-9/16"	PL10	PLA10

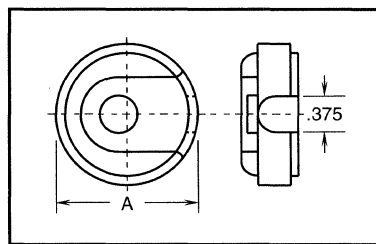

PL and PLA end caps are usually used with HB type brackets. The drawing shown at left is type PL for use with the wiring through the bracket to the motor. For off motor mounting, use type PLA. See page 173 for a photo showing a capacitor and end cap mounted in a bracket.

TYPE TH HORIZONTAL MOUNTING CLIP

Nominal Diameter of Part to be Mounted	Dimensions		Catalog Number
	A	B	
.375	.250	.470	TH13
.500	.250	.620	TH15
.625	.312	.720	TH17
.750	.312	.890	TH19
.875	.312	1.000	TH21
1.000	.312	1.060	TH23
1.375	.312	1.500	TH25

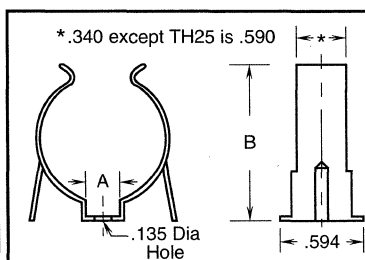

These clips, though designed for capacitors, have varied applications to retain many cylindrical components. They are used extensively in the electrical and electronic industries to hold spindles, condensers, capacitors, tubes, rods and conduit. Clips have phosphate and oil finish. Material thickness TH13 thru TH17 is .016". TH19 thru TH25 is .020"

MOUNTING ACCESSORIES FOR AC TYPE CAPACITORS

Type RB Cylindrical Capacitor Mounting Clamp

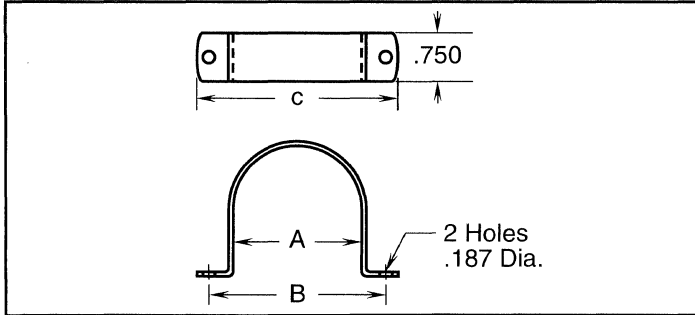

This clamp has a galvanized finish and is designed for use with the round base style motor run capacitor, types MPF. Material thickness is .035"

Base Style	Dimensions			Catalog Number
	A Nominal Diameter	B	C	
21	1.750	2.500	2.875	RB175
23	2.000	2.750	3.125	RB200
24	2.500	3.250	3.625	RB250
21	1.750	2.500	3.250	RB175A
23	2.000	2.750	3.500	RB200A
24	2.500	3.250	4.000	RB250A

Type OB Oval Capacitor Mounting Clamp

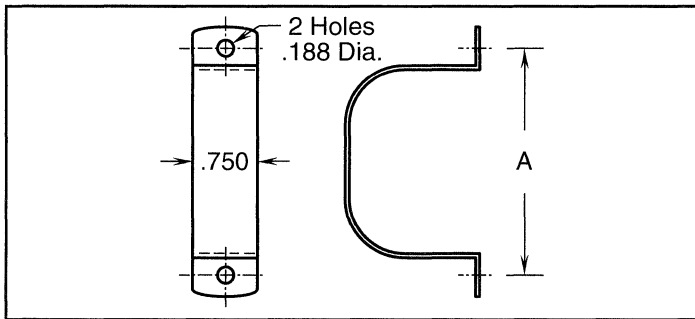

This clamp has a galvanized finish and is designed for use with the flat oval base style AC capacitors, types MPF/MSF. Material thickness is .036"

Base Style	Dimensions		Catalog Number
	Base Size	A	
32	1-5/16" x 2-5/32"	2-9/16"	OB2
37	1-31/32" x 2-29/32"	3-5/16"	OB4
38	1-31/32" x 3-21/32"	4-1/16"	OB3

Neoprene Terminal Insulator

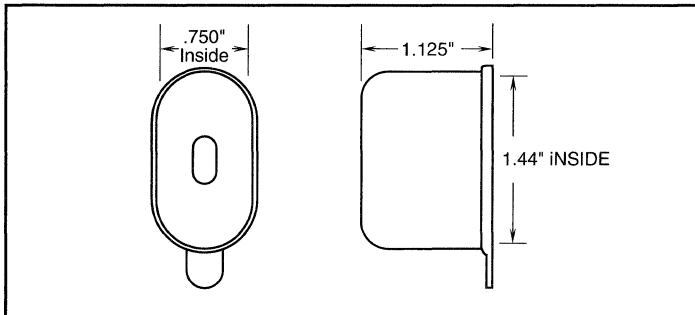

For use on capacitor types MPF/MSF, this neoprene terminal insulator, or 'boot', is used to insulate and protect the terminal area of single section units only. Material is classified 94V-1 when tested per UL94.

Order catalog number: **OC1**

Capacitor Hardware

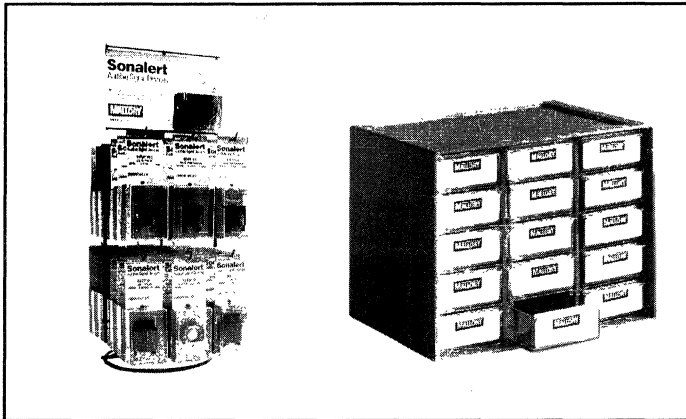

NACC components are available in popular Mallobin Merchandisers. The Mallobin is a handsome, easy to stack display case designed for quick access to a variety of electronic components. The Mallobin is a sturdy, metal cabinet containing fifteen drawers.

When you choose a Mallobin, you can rest assured you will receive the component reliability you have come to expect from NACC. Quantity per each drawer differs for each individual Mallobin kit.

Contact NACC for detailed information or to discuss other possible Mallobin configurations.

The 'SONAK' kit comes complete with 8 of the most popular SONALERT® Audible Signal devices (36 pieces total), individually packaged in see-through hard plastic display boxes. Included is an attractive display rack with a built-in Audible Signal demonstrator.

Catalog Number	Cap μF	Voltage	Description
DISC151M	1 pf to $.1 \mu\text{F}$	50 VDC to 1000 VDC	An assortment of general purpose disc ceramic capacitors
MONO151A	22 pf to $1 \mu\text{F}$	Up to 200 VDC	A collection of monolithic ceramic capacitors
RPE60	$.001 \mu\text{F}$ to $3.3 \mu\text{F}$	63 VDC to 1000 VDC	An assortment of radial leaded metallized polyester film 160 series capacitors
RPE6768	$.001 \mu\text{F}$ to $1.0 \mu\text{F}$	63 VDC to 250 VDC	A mix of radial leaded metallized polyester film 167 and 168 capacitor series
SKR151	$1 \mu\text{F}$ to $6800 \mu\text{F}$	10 VDC to 100 VDC	A selection of single ended aluminum electrolytic capacitors.
SMT CER	22 pF to $.33 \mu\text{F}$	50 VDC to 100 VDC	An offering of ceramic chip capacitors in three different case sizes to include the 0805, 1206 and 1210 sizes
SMTKIT	1-33 μF , $.1$ - $22 \mu\text{F}$, 22pF- $.1 \mu\text{F}$	10 - 35 VDC, 50VDC, 50 - 100 VDC	Surface mount capacitors: Solid tantalum chips and Multilayer ceramic chips
SX301	22 pF to 10,000 pF	33 VDC to 630 VDC	This kit includes polystyrene axial leaded capacitors with standard tolerance ratings
TAC151	$.1 \mu\text{F}$ to $47 \mu\text{F}$	10 VDC to 50 VDC	A selection of fully precision axial leaded molded solid tantalum capacitors in high impact resistance epoxy cases

Catalog Number	Cap μF	Voltage	Description
TC151	$10 \mu\text{F}$ to $500 \mu\text{F}$	Up to 450 VDC	Assorted axial leaded aluminum electrolytic capacitors
TC151A	$20 \mu\text{F}$ to $2000 \mu\text{F}$	Up to 450 VDC	An assortment of axial leaded aluminum electrolytic capacitors similar to TC151
TCG151	$100 \mu\text{F}$ to $10,000 \mu\text{F}$	10 VDC to 450 VDC	A selection of tubular computer grade capacitors
TDC151A	$.1 \mu\text{F}$ to $200 \mu\text{F}$	Up to 50 VDC	An assortment of epoxy dipped solid tantalum capacitors with capacitance tolerance of $\pm 10\%$
T491KIT	$.47 \mu\text{F}$ to $68 \mu\text{F}$	6 VDC to 35 VDC	This kit consists of tantalum chip capacitors in precision molded cases to offer dimensional consistency and uniform surfaces for pick and place equipment
VPR151	$130 \mu\text{F}$ to $5900 \mu\text{F}$	10 VDC to 100 VDC	An assortment of vertical single ended aluminum electrolytic capacitors

SONAK consists of:	6 ea: BSBM428	3 ea: BSC616NL
	3 ea: BSC110	6 ea: BSC628
	6 ea: BSC616N	3 ea: BSC628P
	3 ea: BSC616NJ	6 ea: BSNP428

Competitive Cross Reference - Capacitors

MALLORY

Competitive Series	Competitor Name	NACC Series	Competitive Series	Competitor Name	NACC Series	Competitive Series	Competitor Name	NACC Series
100	Maida	AT/ATR/ASR	40YW	Philips	MTP	C315	Kemet	M15
101	Sangamo	CGR	40ZS	Philips	THF	C320	Kemet	M20
101R	Sangamo	CGR	41GS	Philips	TDC	C322	Kemet	M22
101X	Sangamo	CGO	41PS	Philips	TIM	C330	Kemet	M30
109D/130D	Sprague	TLH/TL5	432D	Sprague	SFC	C340	Kemet	M40
135D	Sprague	THT	43XW	Philips	XTL/XTH/XTV	C350	Kemet	M50
137D	Sprague	TLW	49MC	Philips	T491	C410	Kemet	P10
138D	Sprague	TXX	4C	Sprague	M50	C420	Kemet	P20
139R	Sangamo	CGO	500	Sangamo	CG	C430	Kemet	P30
140D	Sprague	XTL/XTH	500D	Sprague	TA/TC/SKA	C440	Kemet	P40
141D	Sprague	XTV	500R	Sangamo	CG	CE02W	Marcon	TC/TT/SKA
146D	Sprague	MTP	500X	Sangamo	CG	CE04W	Marcon	LKX/LPW
147D	Sprague	MTP	501D	Sprague	TC/TT/SKA	CEAUF	Marcon	LP, HPW(1)
148D	Sprague	TAP	511D	Sprague	VPR/TKR	CEAWF	Marcon	LPX/LPW
149D	Sprague	MTP	515D	Sprague	SKR	CEBPM	Marcon	NKR
150D	Sprague	TAS	516D	Sprague	SKA	CEDSM	Marcon	SKR
173D	Sprague	TAC	517D	Sprague	VPR/TKR	CEHPW-N	Marcon	KLR(1)
196D	Sprague	TDC	52	Johanson	MAV	CESSM	Marcon	SSR
199D	Sprague	TDL	53D	Sprague	TC/TCG/SKA	CETSU	Marcon	LP, HPW(1)
1C	Sprague	M20	54	Johanson	MAV	CETSW	Marcon	LPX/LPW
202D	Sprague	TMX	55	Johanson	MAV	CEUFM	Marcon	WGR
210	Electrocube	150	56	Johanson	MAV	CEUSM	Marcon	TKR
230	Electrocube	150	57	Johanson	MAV	CEUST	Marcon	TKA(1)
232	Electrocube	160	58	Johanson	MAV	CKS	Illinois Cap	SKR
250	Electrocube	152	592C (B)	Sprague	P10	CPR	Cornell Dubilier	21
272	Johanson	MTR	592C (C)	Sprague	P20	CRC115	Corning	M15
293D	Sprague	T491	592C (D)	Sprague	P30	CRC120	Corning	M20
2C	Sprague	M30	592C (E)	Sprague	P40	CRC220	Corning	M22
3070	Philips	TC/TT/SKA	601	Sprague	TCX	CRC230	Corning	M30
30D	Sprague	TT, TKA(1)	602D	Sprague	CGR	CRS	Cornell Dubilier	23
3120	Philips	CGR	602DX	Sprague	CGR	CRT	Cornell Dubilier	24
3186	Philips	CGS	622D	Sprague	CGO	CWT	Hilton	MTP
3188	Philips	CG/CGR	636D	Sprague	CG	D	Maida	G, C, S, H, L
3191	Philips	CGO	672D	Sprague	VPR	DD05-DD112	Murata	C, S, H, L
325P	Sprague	21/23/24	673D	Sprague	VPR	ECCF	Panasonic	G, C, L
325P,OV	Sprague	32/37/38	678D	Sprague	VPR	ECEA-K	Panasonic	SSR
32D	Sprague	CG	69	Johanson	MTD	ECEA-U	Panasonic	SKR
32DR	Sprague	CG	703E1	Philips	172	ECEA-V-S	Panasonic	SKR
32DX	Sprague	CG	712A1	Philips	160	ECEB-U	Panasonic	TT/SKA
3476	Philips	SKR	719A1	Philips	160/167/184, 168/185	ECEB-V	Panasonic	SKA
3480	Philips	TKR	719F1	Philips	171	ECED-V-S	Panasonic	TT/SKA SKR
3481	Philips	VPR	719J1	Philips	158	ECES-G	Panasonic	LPX/LPW
3487	Philips	LPX/LPW	80	Johanson	MAV	ECES-U (1)	Panasonic	LP, HPW(1)
3488	Philips	LP, HPW(1)	80D	Sprague	LPX/LPW	ECKF	Panasonic	H/S
3489	Philips	LPX/LPW	81D	Sprague	LP, HPW(1)	ECQ-E	Panasonic	160/167/184, 168/185
3534	Philips	PSU	82D	Sprague	LPX/LPW	ECQ-EW	Panasonic	158X
3534B	Philips	PSU	910	Electrocube	170	ECQ-P	Panasonic	173
35F	G.E.	PSU	912	Electrocube	171	ECQ-T	Panasonic	150
36D	Sprague	CGS	952	Electrocube	173	ECQ-Z	Panasonic	152
36DY	Sprague	CGS	A	Philips	P10-P40	ECU-M	Panasonic	1206
39D	Sprague	TC/TCG/SKA	AQ	Tansitor	TLT	ECU-N	Panasonic	0805
3C	Sprague	M40	AR	Tansitor	TXT	G	Sprague	MPT
40AW	Philips	TLT	AREM	Aerovox	150	GCR	Illinois Cap	G
40BW	Philips	TXT	ARPK	Aerovox	152	GL	Panasonic	UN
40CS	Philips	TAC	ARPM	Aerovox	170	GR40	Murata	0805
40CW	Philips	MTP	AS	Tansitor	TXT	GR42-2	Murata	1210
40ES	Philips	TAC	AT	Tansitor	TLT	GR42-6	Murata	1206
40EW	Philips	TLH	ATC	ATC	MPR	GR43-2	Murata	1812
40EW	Philips	TLW	AU	RMC	UN	H50	Aerovox	32
40JW	Philips	TL	B1W	Rubycon	NKR	H62	Aerovox	38
40LW	Philips	TLS	BCR	Illinois Cap	C	H64	Aerovox	37
40SS	Philips	TAS/TER(CSR13)	BFA	Illinois Cap	NKA(1)	HAQ	Tansitor	THT
40SW	Philips	TLX	BPS	Illinois Cap	NKR	HD (1)	Rubycon	UKR(1)
40TW	Philips	THT	C	RMC	C	HFR (1)	Richey	TKR, TMR(1)
40XS	Philips	TXA/TXE(CSR13)				K	Phillips	M15-M50
40XW	Philips	XTH/XTV/ XTM/XTK						
40YS	Philips	TXR						

(1) Items found in MALLORY/JAMICON Catalog.

All other items found in
MALLORY General Catalog

This Cross Reference does not warrant exact interchangeability of components.
In most cases, the terminal configuration, performance specifications, and basic dimensions are similar.
The end user must make the ultimate decision for suitability of the component in their application.

Competitive Cross Reference - Capacitors

MALLORY

Competitive Series	Competitor Name	NACC Series	Competitive Series	Competitor Name	NACC Series	Competitive Series	Competitor Name	NACC Series
KBN+SF	Cornell Dubilier	38	P64	Aerovox	37	T110	Kemet	TAS
KKN+SF	Cornell Dubilier	32	PA	Elpac	170	T140	Kemet	TXA
KME (T)	United Chemi-Con	TKA(1), TMA(1)	PFR	Rifa/Evox	173	T242	Kemet	TXE(CSR23)
KME (VB)	United Chemi-Con	TKR	PH (VB)	UCC	FSR(1)	T252	Kemet	TXR(CSR33)
KME (VB)	United Chemi-Con	TMR(1)	PMR	Rifa/Evox	171	T262	Kemet	THF
KME(VB)	United Chemi-Con	TKR	PMR10...27.5	Evox	171	T322	Kemet	TAC
KMG-VN	United Chemi-Con	LP, HPW(1)	PMWA	Rifa/Evox	170	T330	Kemet	TIM
KP173	Saha	173	PP	Paktron	172	T350	Kemet	TDL
KP173Y	Saha	173Y	PR	Elpac	171	T351	Kemet	TDL
KS130	Saha	130	PSA	Aero-M	PSU	T352	Kemet	TDL
KSA-BP	UCC	UKR(1)	PSR	Richey	WGR	T353	Kemet	TDL
KTN+SF	Cornell Dubilier	37	PT	Paktron	152	T354	Kemet	TDC
			PZ	Richey	VPR	T355	Kemet	TDC
						T356	Kemet	TDL
LBA	Illinois Cap	LPX/LPW	R09	Johanson	0403	T361	Kemet	TDL
LC	Richey	SKR	R11	Johanson	0504	T362	Kemet	TDC
LCL	Richey	LKR(1)	R15	Johanson	0805	T368	Kemet	TDC
LCT	Richey	KLR(1)	R18	Johanson	1206	TA	MALLORY	SKA
LGK	Nichicon	LP, HPW(1)	R29	Johanson	1808	TAP	Avx	TDL
LGQ	Nichicon	LP, HPW(1)	RA	Tansitor	TLT	TE	Sprague	TT/SKA
LLA	UCC	LKR(1)	RB	Paktron	160	TLB	Nichicon	TC/TT/SKA
LLK	Nichicon	LPX/LPW	RBEN	Aerovox	168/185	TR	Richey	LPR
LLQ	Nichicon	LPX/LPW	RBEO	Aerovox	167/184	TTA	Illinois Cap	TT/SKA
LMU	Illinois Cap	LP, HPW(1)	RBEP	Aerovox	160	TTMS	Rubycon	TC/TT/SKA
LNR	Nichicon	CGS	RBEX	Aerovox	158X	TTS	Rubycon	TC/SKA
LP	Rubycon	LPX/LPW	RLR	Illinois Cap	LKR(1)	TVA	Sprague	TC/SKA
LP	Richey	EKR(1)	RMR	Illinois Cap	TKR	TVX	Nichicon	TC/TSSKA
			RPA10	Murata	P10	TWMS	Rubycon	SKR
MA	Murata	MAV	RPA20	Murata	P20			
MCH21	Rohm	0805	RPA30	Murata	P30	UFP	Murata	MHP
MCH31	Rohm	1206	RPA40	Murata	P40	UHA	Nichicon	UKR(1)
MCH32	Rohm	1210	RPE110	Murata	M15	ULB	Nichicon	SKR
MDA	Elpac	152	RPE113	Murata	M30	UPF	Nichicon	WGR
MDI	Richey	TC/TT/SKA	RPE114	Murata	M40	UPR	Nichicon	VPR
MF	Paktron	160	RPE117	Murata	M50	USK	Nichicon	SSR
MFWA	Rifa/Evox	152	RPE121	Murata	M20	UVF	Nichicon	NKR
MHA	Rubycon	VTH/TKR (1)	RPE122	Murata	M22	UVX	Nichicon	SKR
MKP171	Saha	171	RSC	Illinois Cap	EKR(1)			VPR/TKR
MKP1839	Roederstein	170	RW	Tansitor	TL	UW	Maida	UN
MKP1840	Roederstein	171	RWC	Paktron	150	UW	Tansitor	TLH
MKT158X	Saha	158X	RWP	Paktron	170	UY	Murata	MHK/MHP
MKT160	Saha	160	RZM	Illinois Cap	WGR			
MKT167	Saha	167/184	RZS	Illinois Cap	WGR(1)	VAJ	Murata	MAV
MKT1813	Roederstein	150				VFR	Nichicon	TMR(1)
MKT1817	Roederstein	168/185	S41	Johanson	1210	VJ0805	Vitramon	0805
MKT1818	Roederstein	167/184	S43	Johanson	1812	VJ1206	Vitramon	1206
MKT1822	Roederstein	160	S47	Johanson	2221	VJ1210	Vitramon	1210
MKT185	Saha	168/185	SA10	AVX	P10	VTH	MALLORY	TKR
MMK	Rifa/Evox	160	SA20	AVX	P20	VTL	MALLORY	SKR
MMK10...27.5	Evox	160	SA30	AVX	P30	VTN	MALLORY	NKR
MMK5	Rifa/Evox	168/185	SA40	AVX	P40	VTM	MALLORY	SSR
MMK5	Evox	168	SKG (V)	United Chemi-Con	VPR	VTZ	MALLORY	WGR
MMK7.5	Rifa/Evox	167/184	SM	Richey	SSR			
MMK7.5	Evox	167	SME (T)	United Chemi-Con	TC/TT/SKA	WC	Tansitor	TLS
MMW	Cornell Dubilier	150	SME (VB)	United Chemi-Con	SKR	WC	Paktron	150
MMWA	Rifa/Evox	150	SME(T)	United Chemi-Con	SKA	WH	Tansitor	TLW
MMX	Rifa/Evox	158	SME-BP	United Chemi-Con	NKR	WP	Paktron	170
MP	Paktron	171	SMG-VN	United Chemi-Con	LPX/LPW	WT	Tansitor	TLX
MPR	Saha	150	SMX	Saha	198	WY	Murata	MHQ
MS16	Rubycon	EKR(1)	SM-BP	United Chemi-Con	NKA(1)			
MS7	Rubycon	SSR	SR15	AVX	M15	X3865,D	ASC	21,23,24
MV	Murata	MAV	SR20	AVX	M20	X3875,D	ASC	32,37,38
			SR21	AVX	M22			
N50	Aerovox	32	SR30	AVX	M30	Z23	Aerovox	21
N62	Aerovox	38	SR40	AVX	M40	Z24	Aerovox	23
N64	Aerovox	37	SR50	AVX	M50	Z26	Aerovox	24
NC	Richey	NKR(1)	SRAC	United Chemi-Con	SSR	Z50	Aerovox	32
NC(TV)	Richey	UKR(1)	SRC (VB)	UCC	EKR(1)	Z62	Aerovox	38
NTT	Rubycon	NKA(1)	ST	Paktron	198	Z64	Aerovox	37
			SWT	Hilton	MTP	ZA	Elpac	150
P50	Aerovox	32	SXE (VB)	UCC	KLR(1)	ZDR	Elpac	160
P62	Aerovox	38						

(1) Items found in MALLORY/JAMICON Catalog.

All other items found in
MALLORY General Catalog

This Cross Reference does not warrant exact interchangeability of components.

In most cases, the terminal configuration, performance specifications, and basic dimensions are similar.
The end user must make the ultimate decision for suitability of the component in their application.

Competitive Cross Reference - DC Rotary Fans

Competitive Part Number	Competitor Name	NACC/Jamicon Part Number	Competitive Part Number	Competitor Name	NACC/Jamicon Part Number	Competitive Part Number	Competitor Name	NACC/Jamicon Part Number
2408PL-04W-B30	NMB	JF7M06025*12	DA120825H	Elina/Indek	JF7H08025*12	FL12G306 032271	Rotron	JF7M06025*12
2408PL-04W-B40	NMB	JF7M06025*12	DA120825L	Elina/Indek	JF7L08025*12	FL12G308 032260	Rotron	JF7M08025*12
2408PL-05W-B30	NMB	JF7M06025*24	DA120825M	Elina/Indek	JF7M08025*12	FL24A306 032270	Rotron	JF7H06025*24
2408PL-05W-B40	NMB	JF7M06025*24	DA120925L	Elina/Indek	JF7M09025*12	FL24A308 032259	Rotron	JF7M08025*24
2410NL-04W-B10	NMB	JF7M06025*12	DA240625H	Elina/Indek	JF7H06025*24	FL24G306 032272	Rotron	JF7M06025*24
2410NL-04W-B20	NMB	JF7M06025*12	DA240625L	Elina/Indek	JF7M06025*24	FL24G308 032261	Rotron	JF7M08025*24
2410NL-04W-B30	NMB	JF7H06025*12	DA240825H	Elina/Indek	JF7M08025*24	FN12F3 031172	Rotron	JF7M09025*12
2410NL-05W-B10	NMB	JF7M06025*24	DA240825L	Elina/Indek	JF7L08025*24	FS12F3 031160	Rotron	JF7M06025*12
2410NL-05W-B20	NMB	JF7M06025*24	DA240825M	Elina/Indek	JF7M08025*24	FS12H3 031158	Rotron	JF7H06025*12
2410NL-05W-B30	NMB	JF7H06025*24	DA240925H	Elina/Indek	JF7M09025*24	FS24F3 031161	Rotron	JF7H06025*24
2410PL-04W-B20	NMB	JF7M06025*12	DFA0612L	Delta	JF7H06025*12	FS24H3 031159	Rotron	JF7H06025*24
2410PL-04W-B30	NMB	JF7H06025*12	DFA062H	Delta	JF7H06025*24			
2410PL-05W-B20	NMB	JF7M06025*24	DFA0812H	Delta	JF7H08025*12	KD1206PTS1	Sunon	JF7H06025*12
2410PL-05W-B30	NMB	JF7H06025*24	DFA0812L	Delta	JF7L08025*12	KD1206PTS3	Sunon	JF7H08025*12
			DFA0812M	Delta	JF7M08025*12	KD1208PTB1	Sunon	JF7H08025*12
3110NL-04W-B10	NMB	JF7M08025*12	DFA0824H	Delta	JF7M08025*24	KD1208PTB2	Sunon	JF7H08025*12
3110NL-04W-B20	NMB	JF7M08025*12	DFA0824L	Delta	JF7L08025*24	KD1208PTB3	Sunon	JF7M08025*12
3110PL-04W-B20	NMB	JF7M08025*12	DFA0824M	Delta	JF7M08025*24			
3110PL-04W-B30	NMB	JF7M08025*12	DFA0912L	Delta	JF7M09025*12	M33402	Nidec	JF7M06025*12
3110PL-04W-B40	NMB	JF7H08025*12	DFA0924H	Delta	JF7M09025*24	M33403	Nidec	JF7M06025*24
3110PL-05W-B40	NMB	JF7M08025*24				M33404	Nidec	JF7H06025*12
3-15-8101	Howard	JF7M06025*12	FB24B3 031169	Rotron	JF7M09025*24	M33405	Nidec	JF7H06025*24
3-15-8102	Howard	JF7M06025*24	FBH-06A12HN	Panasonic	JF7H06025*12	M33418	Nidec	JF7M09025*12
3-15-8103	Howard	JF7H06025*12	FBH-06A12LN	Panasonic	JF7M06025*12	M33423	Nidec	JF7M09025*24
3-15-8104	Howard	JF7H06025*24	FBH-06A24HN	Panasonic	JF7H06025*24	MMF-06C12DH	Mitsubishi	JF7H06025*12
3-15-8301	Howard	JF7L08025*12	FBH-06A24LN	Panasonic	JF7M06025*24	MMF-06C12DL	Mitsubishi	JF7M06025*12
3-15-8302	Howard	JF7L08025*24	FBK-06A12H	Panasonic	JF7H06025*12	MMF-06C12DM	Mitsubishi	JF7M06025*12
3-15-8303	Howard	JF7L08025*12	FBK-06A12L	Panasonic	JF7M06025*12	MMF-06C12DS	Mitsubishi	JF7H06025*12
3-15-8304	Howard	JF7L08025*24	FBK-06A24H	Panasonic	JF7H06025*24	MMF-06C24DH	Mitsubishi	JF7H06025*24
3-15-8305	Howard	JF7M08025*12	FBK-06A24L	Panasonic	JF7M06025*24	MMF-06C24DL	Mitsubishi	JF7M06025*24
3-15-8306	Howard	JF7M08025*24	FBK-08A12H	Panasonic	JF7H08025*12	MMF-06C24DM	Mitsubishi	JF7M06025*24
3-15-8501	Howard	JF7M09025*12	FBK-08A12L	Panasonic	JF7L08025*12	MMF-06C24DS	Mitsubishi	JF7H06025*24
3-15-8502	Howard	JF7M09025*24	FBK-08A12M	Panasonic	JF7M08025*12	MMF-06D12DH	Mitsubishi	JF7H06025*12
3412L	Papst	JF7M09025*12	FBK-08A24H	Panasonic	JF7M08025*24	MMF-06D12DL	Mitsubishi	JF7M06025*12
3414	Papst	JF7M09025*24	FBK-08A24L	Panasonic	JF7L08025*24	MMF-06D12DM	Mitsubishi	JF7M06025*12
3610NL-04W-B10	NMB	JF7M09025*12	FBK-08A24M	Panasonic	JF7M08025*24	MMF-06D12DM	Mitsubishi	JF7H06025*12
3610NL-04W-B20	NMB	JF7M09025*12	FBK-09A12L	Panasonic	JF7M09025*12	MMF-06D24DH	Mitsubishi	JF7H06025*24
3610NL-05W-B40	NMB	JF7M09025*24	FBK-09A24H	Panasonic	JF7M09025*24	MMF-06D24DM	Mitsubishi	JF7H06025*24
3610PL-04W-B20	NMB	JF7M09025*12	FBN-08A12HN	Panasonic	JF7H08025*12	MMF-08C12DH	Mitsubishi	JF7H08025*12
3610PL-05W-B30	NMB	JF7M09025*24	FBN-08A12LN	Panasonic	JF7L08025*12	MMF-08C12DL	Mitsubishi	JF7M08025*12
			FBN-08A12MN	Panasonic	JF7M08025*12	MMF-08C12DM	Mitsubishi	JF7H08025*12
612L	Papst	JF7M06025*12	FBN-08A24HN	Panasonic	JF7M08025*24	MMF-08C24DS	Mitsubishi	JF7H08025*12
612M	Papst	JF7H06025*12	FBN-09A12LN	Panasonic	JF7M09025*12	MMF-08C24DL	Mitsubishi	JF7M08025*24
614L	Papst	JF7M06025*24	FBN-09A24HN	Panasonic	JF7M09025*24	MMF-09B12DL	Mitsubishi	JF7M09025*12
614M	Papst	JF7H06025*24	FDC60-12L	Elina/Indek	JF7M06025*12	MMF-09B24DH	Mitsubishi	JF7M09025*24
			FDC60-24H	Elina/Indek	JF7H06025*24			
8412	Papst	JF7H08025*12	FDC60-24L	Elina/Indek	JF7M06025*24	PO012-12D-2B	Interfan	JF7M06025*12
8412L	Papst	JF7L08025*12	FDC60S-12H	Elina/Indek	JF7H06025*12	PO025-12D-3B	Interfan	JF7M08025*12
8412M	Papst	JF7M08025*12	FDC60S-12L	Elina/Indek	JF7M06025*12	PO025-24D-3B	Interfan	JF7M08025*24
8414	Papst	JF7H08025*24	FDC60S-12M	Elina/Indek	JF7H06025*12	PO034-12D-3B	Interfan	JF7M09025*12
8414L	Papst	JF7L08025*24	FDC60S-24H	Elina/Indek	JF7H06025*24	PO034-24D-2B	Interfan	JF7M06025*24
8414M	Papst	JF7M08025*24	FDC60S-24L	Elina/Indek	JF7M06025*24	PO034-24D-3B	Interfan	JF7M09025*24
			FDC60S-24M	Elina/Indek	JF7H06025*24			
A32100	Nidec	JF7L08025*12	FDC80-24H	Elina/Indek	JF7M08025*24	TF-DD-60-12-RXA	Toyo	JF7H06025*12
A32140	Nidec	JF7H08025*12	FDC80-24L	Elina/Indek	JF7L08025*24	TF-DD-60-12-RXAL	Toyo	JF7M06025*12
A32858	Nidec	JF7L08025*24	FDC80-24M	Elina/Indek	JF7M08025*24	TF-DD-60-24-RXA	Toyo	JF7H06025*24
A32859	Nidec	JF7H08025*24	FE12B3 031162	Rotron	JF7H08025*12	TF-DD-60-24-RXAL	Toyo	JF7M06025*24
			FE12F3 031166	Rotron	JF7L08025*12	TF-DD-80-12-RXA	Toyo	JF7H08025*12
C33244	Nidec	JF7M04013*12	FE12H3 031164	Rotron	JF7M08025*12	TF-DD-80-12-RXAL	Toyo	JF7M08025*12
C33246	Nidec	JF7M04013*12	FE24B3 031163	Rotron	JF7M08025*24	TF-DD-80-24-RXA	Toyo	JF7M08025*24
			FE24H3 031165	Rotron	JF7M08025*24	TF-DD-80-24-RXAL	Toyo	JF7M08025*24
DA120625H	Elina/Indek	JF7H06025*12	FL12A306 032269	Rotron	JF7H06025*12	TF-DD-92-24-RXA	Toyo	JF7M09025*24
DA120625L	Elina/Indek	JF7M06025*12	FL12A308 032258	Rotron	JF7H08025*12			

* Shaft Bearing - Insert S for sleeve, B for ball.

This Cross Reference does not warrant exact interchangeability of components. In most cases, the terminal configuration, performance specifications, and basic dimensions are similar. The end user must make the ultimate decision for suitability of the component in their application.

AUSTRALIA

K.D. FISHER
18 BENJAMIN ST, P.O. BOX 170
ST MARYS, ADELAIDE, S. AUSTRALIA
AUSTRALIA 5042

FAX: 61-8-276-4024
PHONE: 61-8-277-3288

AUSTRIA

O. SAUSENG OHG
LIENFELDERGASSE 32
VIENNA, AUSTRIA 1160

TELEX: 3221103
FAX: 43-222-458611-21 or 43-1-45-86-11-21
PHONE: 43-222-458611

BELGIUM

SERVOTRONICS PVBA
WASSERIJSTRAAT 3
B - 2900 SCHOTEN
BELGIUM

TELEX: 72-294
FAX: 32-3-326-1393
PHONE: 32-3-326-4666

CHILE

ANDREW GOLDFLAM
CASILLA 2852
SANTIAGO
CHILE

TELEX: 340412
FAX: 562-232-8002
PHONE: 2325425

COLOMBIA

CENTRO De ACCESORIOS, LTDA.
APARTADO AEREO 100-147, ZONA 10
SANTA FE DE BOGOTA D.C.
COLOMBIA

FAX: 571-211-4318
PHONE: 571-310-5199

DENMARK

K. KAMUK APS
P.O. BOX 149
BREDEBOVEJ 31
DK-2800 LYNGBY
DENMARK

FAX: 45-45-88 40 77
PHONE: 45-45-88 38 33

EGYPT

INDOMAR TRADING CO.
P.O. BOX 94 SHUBRAMISR
CAIRO 11231
EGYPT

TELEX: 20682
FAX: 202-45-54-305
PHONE: 202-43-061

UNITED KINGDOM

H-SQUARED ELECTRONICS
CONIFER HOUSE
OLD BRIDGE WAY
SHEFFORD, BEDFORDSHIRE
SG17 5HQ ENGLAND

TELEX: 826052
FAX: 44-462-815-187
PHONE: 44-462-815-115 or 462-851-155

FINLAND

COMODO OY
RALSSINTIE 6
00720 HELSINKI FINLAND

FAX: 358-0-351-5355
PHONE: 358-0-351-5100

FRANCE

TOTEM S.A.
39 RUE DE VERDUN
94170 LE PERREUX-SUR MARNE
FRANCE

TELEX: 264924
FAX: 33-1-48-711395
PHONE: 33-1-48-72-4204

GERMANY

ADELCO ELEKTRONIK GMBH
BOXHOMSTR. 5
D25451 QUICKBORN/HAMBURG
GERMANY

TELEX: 2180619
FAX: 49-4106-3852
PHONE: 49-4106-2024

GUATEMALA

PRESTELECTRO
APARTADO POSTAL 219-A
01909 GUATEMALA
CENTRAL AMERICA

FAX: 502-2-320-997
PHONE: 502-2-320997 or 320941

HOLLAND

NEDELKO B.V. ELECTRONICS
SHEFFIELD STRAAT 2
3047AP ROTTERDAM
HOLLAND

TELEX: 23057
FAX: 31-10-437-4589
PHONE: 31-10-437-4333

HONG KONG

PATRICK TRADING CORP.
1608-1611 SHUI ON CENTRE
6-8 HARBOUR RD, WANCHAI
HONG KONG

TELEX: 75472
FAX: +852-519-6180
PHONE: 852-827-9977

INDIA

HINDCO CORPORATION
SHIV-E-NUMH
205-A DR. ANNIE BESANT RD.
WORLI NAKA
BOMBAY 400-018
INDIA

TELEX: 011-75172
FAX: 91-22-493-6948 or 91-22-493-7945
PHONE: 91-22-493-1544 or 493-6948
CABLE: HINDCOMEL' WORLI-BOMBAY

ISRAEL

BORAN TECHNOLOGIES LTD.
P.O. BOX 2627
PETAH-TIKVA 49125
ISRAEL

TELEX: 381512
FAX: 972-3-934-4235
PHONE: 972-3-934-5171

ITALY

LED S.R.L.
TURIN HDQ
VIA AMEDEO RAVINA 36
10153 TURIN, ITALY

FAX: 39-11-238782
PHONE: 39-11-2482186

DIMAC RED SRL
(Wet Tantalum Only)
VIA GIOVANNI XXXIII N.25
20046 BIASSOND(MI)
ITALY

FAX: 39-39-491-773
PHONE: 39-39-491514

KOREA

SANAM TECHNOLOGY INC.
YEOIDO P.O.B 1093
SEOUL, KOREA

FAX: 82-2-784-4966
PHONE: 82-784-4961

NEW ZEALAND

TOWER AGENCY LTT
P.O. BOX 12816
33 FAIRFAX AVE.
PENROSE, AUCKLAND 6
NEW ZEALAND

FAX: 64-9-525-0648
PHONE: 64-9-579-8868

NORWAY

BEXAB NORGE A.S.
VESTVOLLVEIEN 10, POB 84
N-20-20 SKEDSMOKORSET
NORWAY

FAX: 47-63-87-5900
PHONE: 47-63-87-4900

PHILIPPINES

CARR INTERNATIONAL
P.O. BOX 1849
SUITE 612-613
BANK OF P.I. BLDG.
150 PLAZA CERVANTES
MANILA, PHILIPPINES

TELEX: 40669
FAX: 632-815-2809
PHONE: 632-483629

PORTUGAL

ANATRONICS SA
RUE PADRE ANTONIO VIEIRA NR. 31-B
POVA DE SANTO ADRIAO
2675 ODIVELAS, PORTUGAL

FAX: 351-193-71834
PHONE: 351-193-76267 & 87

SAUDI ARABIA

SEGAM TRADING SERVICES
POB 8510, DAMMAN PORT
DAMMAN 31492
SAUDI ARABIA

FAX: 966-3-833-8929
PHONE: 966-3-833-4133

**SINGAPORE-MALAYSIA
INDONESIA**

KULTHORN ENGINEERING LTD. PART.
7500A BEACH ROAD
28-309 THE PLAZA
SINGAPORE 0719

TELEX: 42320
FAX: 65-788-7106
PHONE: 65-788-9874

REP. SOUTH AFRICA

TALTRONICS (PTY) LTD.
99 VAN RIE BEECK AVE
P.O. BOX 2578 EDENVALE, 1610
REP. OF SOUTH AFRICA

TELEX: 4-22154
FAX: 27-11-452-6159
PHONE: 27-11-452-6155

SPAIN

ANATRONIC SA
AVENIDA VALLADOLID 27
MADRID 8
SPAIN

TELEX: 47397
FAX: 34-559-6975
PHONE: 34-542-4455 OR 542-5566

SWEDEN

AB SWEDECO
RINGVAGEN 18
S-18133 LIDINGO
SWEDEN

TELEX: 14440
FAX: 46-8-767-3027
PHONE: 46-8-767-6989

SWITZERLAND

NOVITRONIC AG
ELEKTR BAUELEMENTE
THURGAUERSTRASSE 74
CH-8050 ZURICH
SWITZERLAND

TELEX: 823417
FAX: 41-1-302-1818
PHONE: 41-1-302-2121

TAIWAN

HELM ENG & TRADING CO.
TEN YUN CO. LTD.
4F 658 TUN HUA SOUTH ROAD
TAIPEI, TAIWAN

TELEX: 28204
FAX: 886-2-706-0465
PHONE: 886-2-709-1888

**THAILAND - MALAYSIA
INDONESIA - SINGAPORE**

KULTHORN ENGINEERING LTD. PART.
237 LARN LUANG RD.
P.O. BOX 2790
BANGKOK 10100
THAILAND

TELEX: 82363
FAX: 662-280-1444
PHONE: 662-282-1513

TURKEY

RADEL ELEKTRONIK DIS TICARET
VE SANAY, A.S.
NECATIBEY CAD No. 119
80030 KARAKOY
ISTANBUL - TURKEY

TELEX: 30386
FAX: 90-1-243-7443
PHONE: 90-1-243-1538, 243-1539

VENEZUELA

UNION ANDINA C.A.
AVENIDA 12, NO64A-50
MARACAIBO
VENEZUELA

FAX: 58-61-427242
PHONE: 58-61-80146

Capacitance

(μ F) Micro-farad	(nF) Nano-farad	(pF) Pico-farad
.0001	.10	100
.00012	.12	120
.00015	.15	150
.00018	.18	180
.0002	.20	200
.00022	.22	220
.00025	.25	250
.00027	.27	270
.0003	.30	300
.00033	.33	330
.00039	.39	390
.0004	.40	400
.00047	.47	470
.0005	.50	500
.00056	.56	560
.00068	.68	680
.00075	.75	750
.00082	.82	820

(μ F) Micro-farad	(nF) Nano-farad	(pF) Pico-farad
.001	1.0	1,000
.0012	1.2	1,200
.0015	1.5	1,500
.002	2.0	2,000
.0022	2.2	2,200
.0025	2.5	2,500
.0027	2.7	2,700
.003	3.0	3,000
.0033	3.3	3,300
.0039	3.9	3,900
.0047	4.7	4,700
.0056	5.6	5,600
.0068	6.8	6,800
.0082	8.2	8,200

(μ F) Micro-farad	(nF) Nano-farad	(pF) Pico-farad
.01	10	10,000
.012	12	12,000
.015	15	15,000
.018	18	18,000
.022	22	22,000
.027	27	27,000
.033	33	33,000
.039	39	39,000
.047	47	47,000
.056	56	56,000
.068	68	68,000
.082	82	82,000
.1	100	100,000
1.0	1,000	1,000,000

Dimensions

Inch	Decimal	mm
	.008	.203
1/64	.0156	.397
	.023	.584
1/32	.0312	.794
	.039	.991
3/64	.0469	1.191
	.054	1.372
1/16	.0625	1.588
	.070	1.778
5/64	.0781	1.984
	.086	2.184
3/32	.0937	2.381
	.102	2.591
7/64	.1094	2.778
	.117	2.978
1/8	.125	3.175
	.133	3.378
9/64	.1406	3.572
	.148	3.759
5/32	.1562	3.969
	.164	4.166
11/64	.1719	4.366
	.180	4.572
3/16	.1875	4.763
	.195	4.953
13/64	.2031	5.159
	.211	5.359
7/32	.2187	5.556
	.227	5.766
15/64	.2344	5.953
	.242	6.147
1/4	.250	6.350

Inch	Decimal	mm
7/64	.258	6.553
	.2656	6.747
	.273	6.934
9/32	.2812	7.144
	.289	7.341
19/64	.2969	7.541
	.305	7.747
5/16	.3125	7.938
	.320	8.128
21/64	.3281	8.334
	.336	8.534
11/32	.3437	8.731
	.352	8.941
23/64	.3594	9.128
	.367	9.322
3/8	.375	9.525
	.383	9.728
25/64	.3906	9.922
	.398	10.109
13/32	.4062	10.318
	.414	10.516
27/64	.4219	10.716
	.430	10.922
7/16	.4375	11.113
	.445	11.303
29/64	.4531	11.509
	.461	11.709
15/32	.4687	11.906
	.477	12.116
31/64	.4844	12.303
	.492	12.497
1/2	.500	12.700

Inch	Decimal	mm
33/64	.508	12.903
	.5156	13.097
	.523	13.284
17/32	.5312	13.494
	.539	13.691
35/64	.5469	13.891
	.555	14.097
9/16	.5625	14.288
	.570	14.478
37/64	.5781	14.684
	.586	14.884
19/32	.5937	15.081
	.602	15.291
39/64	.6094	15.478
	.617	15.672
5/8	.625	15.875
	.633	16.078
41/64	.6406	16.272
	.648	16.459
21/32	.6562	16.669
	.6640	16.866
43/64	.6719	17.066
	.680	17.272
11/16	.6875	17.463
	.695	17.653
45/64	.7031	17.859
	.711	18.059
23/32	.7187	18.256
	.727	18.466
47/64	.7344	18.653
	.742	18.847
3/4	.750	19.050

Inch	Decimal	mm
49/64	.756	19.202
	.7656	19.447
	.773	19.634
25/32	.7812	19.843
	.789	20.041
51/64	.7969	20.240
	.805	20.447
13/16	.8125	20.638
	.820	20.828
53/64	.8281	21.034
	.836	21.234
27/32	.8437	21.431
	.852	21.641
55/64	.8594	21.828
	.867	22.022
7/8	.8750	22.225
	.883	22.428
57/64	.8906	22.622
	.898	22.809
29/32	.9062	23.019
	.914	23.216
59/64	.9219	23.416
	.930	23.622
15/16	.9375	23.813
	.945	24.003
61/64	.9531	24.209
	.961	24.409
31/32	.9687	24.606
	.977	24.816
63/64	.9844	25.003
	.992	25.197
1.000	1.000	25.400

Product	Description	Page
CLR90	MIL-C-39006/30 - Tantalum Case Capacitors Higher Ripple - Lower ESR - Superior to CLR79	41
CLR91	MIL-C-39006/31 - Tantalum Case Capacitors Higher Ripple - Lower ESR - Superior to CLR81	44
TBS	All Tantalum, Pin Mount (Formerly W13)	20
T491 / T495	New Tantalum Chip Capacitors	69/71
HES	High Energy Storage Aluminum Electrolytic Capacitors	85
MALLORY/JAMICON	Miniature Aluminum Capacitors Snap-Mount Capacitors DC Voltage Rotary Fans	Index on Page 72 Index on Page 72 189
C0805 / C1206 / C1210	New Multilayer Ceramic Chip Capacitors	134
Q/QRL	RC Snubber Networks	169
MALLORY/ MICROELECTRONICS	High Frequency Ceramic, Porcelain and Trimmer Capacitors	170
SC648S	Loud Siren Classic Sonalert® (Also See Other New Classic Sonalerts Identified by Bold Type)	178
SCVC	Sound Device Volume Control	183
PT	New Piezoelectric Transducers	187



To deliver competitive products and services that meet or exceed customer expectations, North American Capacitor Company pursues ongoing programs for advancement. This is achieved through a system of identifying, controlling, documenting, and continuously improving critical elements throughout all operations.

ISO9002 registration of NACC's Indianapolis and Greencastle, IN facilities was obtained in 1994.

This General Catalog is not a contract. Its contents are limited by size. The information contained herein has been obtained from sources believed to be reliable, but no guarantee or warranty with respect to accuracy, completeness or results is implied and no liability is assumed. Nothing herein is to be construed as advising or authorizing practice of any invention covered by existing patents owned by North American Capacitor Company or others without license from the owners thereof. In the interest of improved design and performance, NACC reserves the right to make changes in any specification, data, or material contained herein without notice. It is the user's responsibility to see that the product is proper for use in user's application. NACC's warranty for its products is subject to the limitations, exclusions, terms and conditions of its express warranty, a copy of which is available upon request.

MALLORY

NORTH AMERICAN CAPACITOR COMPANY



7545 ROCKVILLE ROAD, INDIANAPOLIS, IN 46214
PHONE: 317-273-0090 • FAX: 317-273-2400