

NEC

Preliminary User's Manual

VR4111™

64/32-bit Microprocessor

μPD30111

Document No. U13137EJ2V0UM00 (2nd edition)

Date Published April 1998 N CP(K)

© NEC Corporation 1998

© MIPS Technologies, Inc. 1998

Printed in Japan

[MEMO]

NOTES FOR CMOS DEVICES

① PRECAUTION AGAINST ESD FOR SEMICONDUCTORS

Note:

Strong electric field, when exposed to a MOS device, can cause destruction of the gate oxide and ultimately degrade the device operation. Steps must be taken to stop generation of static electricity as much as possible, and quickly dissipate it once, when it has occurred. Environmental control must be adequate. When it is dry, humidifier should be used. It is recommended to avoid using insulators that easily build static electricity. Semiconductor devices must be stored and transported in an anti-static container, static shielding bag or conductive material. All test and measurement tools including work bench and floor should be grounded. The operator should be grounded using wrist strap. Semiconductor devices must not be touched with bare hands. Similar precautions need to be taken for PW boards with semiconductor devices on it.

② HANDLING OF UNUSED INPUT PINS FOR CMOS

Note:

No connection for CMOS device inputs can be cause of malfunction. If no connection is provided to the input pins, it is possible that an internal input level may be generated due to noise, etc., hence causing malfunction. CMOS devices behave differently than Bipolar or NMOS devices. Input levels of CMOS devices must be fixed high or low by using a pull-up or pull-down circuitry. Each unused pin should be connected to V_{DD} or GND with a resistor, if it is considered to have a possibility of being an output pin. All handling related to the unused pins must be judged device by device and related specifications governing the devices.

③ STATUS BEFORE INITIALIZATION OF MOS DEVICES

Note:

Power-on does not necessarily define initial status of MOS device. Production process of MOS does not define the initial operation status of the device. Immediately after the power source is turned ON, the devices with reset function have not yet been initialized. Hence, power-on does not guarantee out-pin levels, I/O settings or contents of registers. Device is not initialized until the reset signal is received. Reset operation must be executed immediately after power-on for devices having reset function.

V_R3000, V_R4000, V_R4100, V_R4102, V_R4110, V_R4111, V_R4300, V_R4400, and V_R Series are trademarks of NEC Corporation.

MIPS is a trademark of MIPS Technologies, Inc.

HSP is a trademark of PC-TEL, Inc.

iAPX is a trademark of Intel Corporation.

DEC VAX is a trademark of Digital Equipment Corporation.

UNIX is a registered trademark in the United States and other countries, licensed exclusively through X/Open Company, Ltd.

Exporting this product or equipment that include this product may require a governmental license from the U.S.A. for some countries because this product utilizes technologies limited by the export control regulations of the U.S.A.

The information in this document is subject to change without notice.

No part of this document may be copied or reproduced in any form or by any means without the prior written consent of NEC Corporation. NEC Corporation assumes no responsibility for any errors which may appear in this document.

NEC Corporation does not assume any liability for infringement of patents, copyrights or other intellectual property rights of third parties by or arising from use of a device described herein or any other liability arising from use of such device. No license, either express, implied or otherwise, is granted under any patents, copyrights or other intellectual property rights of NEC Corporation or others.

While NEC Corporation has been making continuous effort to enhance the reliability of its semiconductor devices, the possibility of defects cannot be eliminated entirely. To minimize risks of damage or injury to persons or property arising from a defect in an NEC semiconductor device, customers must incorporate sufficient safety measures in its design, such as redundancy, fire-containment, and anti-failure features.

NEC devices are classified into the following three quality grades:

"Standard", "Special", and "Specific". The Specific quality grade applies only to devices developed based on a customer designated "quality assurance program" for a specific application. The recommended applications of a device depend on its quality grade, as indicated below. Customers must check the quality grade of each device before using it in a particular application.

Standard: Computers, office equipment, communications equipment, test and measurement equipment, audio and visual equipment, home electronic appliances, machine tools, personal electronic equipment and industrial robots

Special: Transportation equipment (automobiles, trains, ships, etc.), traffic control systems, anti-disaster systems, anti-crime systems, safety equipment and medical equipment (not specifically designed for life support)

Specific: Aircrafts, aerospace equipment, submersible repeaters, nuclear reactor control systems, life support systems or medical equipment for life support, etc.

The quality grade of NEC devices is "Standard" unless otherwise specified in NEC's Data Sheets or Data Books. If customers intend to use NEC devices for applications other than those specified for Standard quality grade, they should contact an NEC sales representative in advance.

Anti-radioactive design is not implemented in this product.

Regional Information

Some information contained in this document may vary from country to country. Before using any NEC product in your application, please contact the NEC office in your country to obtain a list of authorized representatives and distributors. They will verify:

- Device availability
- Ordering information
- Product release schedule
- Availability of related technical literature
- Development environment specifications (for example, specifications for third-party tools and components, host computers, power plugs, AC supply voltages, and so forth)
- Network requirements

In addition, trademarks, registered trademarks, export restrictions, and other legal issues may also vary from country to country.

NEC Electronics Inc. (U.S.)

Santa Clara, California
Tel: 408-588-6000
800-366-9782
Fax: 408-588-6130
800-729-9288

NEC Electronics (Germany) GmbH

Duesseldorf, Germany
Tel: 0211-65 03 02
Fax: 0211-65 03 490

NEC Electronics (UK) Ltd.

Milton Keynes, UK
Tel: 01908-691-133
Fax: 01908-670-290

NEC Electronics Italiana s.r.l.

Milano, Italy
Tel: 02-66 75 41
Fax: 02-66 75 42 99

NEC Electronics (Germany) GmbH

Benelux Office
Eindhoven, The Netherlands
Tel: 040-2445845
Fax: 040-2444580

NEC Electronics (France) S.A.

Velizy-Villacoublay, France
Tel: 01-30-67 58 00
Fax: 01-30-67 58 99

NEC Electronics (France) S.A.

Spain Office
Madrid, Spain
Tel: 01-504-2787
Fax: 01-504-2860

NEC Electronics (Germany) GmbH

Scandinavia Office
Taeby, Sweden
Tel: 08-63 80 820
Fax: 08-63 80 388

NEC Electronics Hong Kong Ltd.

Hong Kong
Tel: 2886-9318
Fax: 2886-9022/9044

NEC Electronics Hong Kong Ltd.

Seoul Branch
Seoul, Korea
Tel: 02-528-0303
Fax: 02-528-4411

NEC Electronics Singapore Pte. Ltd.

United Square, Singapore 1130
Tel: 65-253-8311
Fax: 65-250-3583

NEC Electronics Taiwan Ltd.

Taipei, Taiwan
Tel: 02-719-2377
Fax: 02-719-5951

NEC do Brasil S.A.

Cumbica-Guarulhos-SP, Brasil
Tel: 011-6465-6810
Fax: 011-6465-6829

MAJOR REVISIONS IN THIS EDITION

Page	Description
P.57	Addition of Table 1-19 Relationships Between CLKSEL Pin Settings and Clock Frequencies
P.67	Addition of a description to MPOWER function in Table 2-4 Initialization Interface Signals
P.68	Addition and change of descriptions of TxD/CLKSEL2, RTS#/CLKSEL1, and DTR#/CLKSEL0 functions in Table 2-5 RS-232C Interface Signals
P.71	Change of descriptions of GPIO49 function in Table 2-11 General-purpose I/O Signals
P.72	Change of descriptions of MIPS16EN function in Table 2-14 Initial Setting Signals
P.73	Addition of a caution to Table 2-15 Dedicated V_{DD} and GND Signals
P.76	Change of the DBUS32/GPIO48 pin state in the Suspend mode in Table 2-16 Pin Status upon Specific States
P.101, 102	Addition of descriptions about an ERET instruction to 4.4 ISA MODE
P.230	Addition of descriptions about the 2.5-V power supply system to 8.1.1 RTC Reset
P.233	Addition of descriptions about the 2.5-V power supply system to 8.1.4 Software Shutdown
P.234	Addition of descriptions about the 2.5-V power supply system to 8.1.5 HALTimer Shutdown
P.235	Addition of descriptions about the 2.5-V power supply system to 8.2 POWER-ON SEQUENCE
p.240	Addition of descriptions to 8.4.1 Power Modes (4) Hibernate Mode
P.289	Correction of Figure 11-7 1-Byte Access to Even Address Using 16-Bit Bus (WISAA[2:0] = 101)
P.290	Addition of descriptions and corrections to Figure 11-8 2-Byte Access When Sampling IOCHRDY at High Level Using 16-Bit Bus (WISAA[2:0] = 101)
P.291	Correction of Figure 11-9 1-Byte Access to Odd Address Using 16-Bit Bus (WISAA[2:0] = 101) and Figure 11-10 1-Byte Access to Odd Address Using 8-Bit Bus (WISAA[2:0] = 101)
P.292	Addition of corrections, descriptions, and a caution to Figure 11-11 2-Byte Access When Sampling ZWS# at Low Level Using 16-Bit Bus (WISAA[2:0] = 101)
P.292	Correction of Figure 11-12 2-Byte Access When Sampling ZWS# at Low Level Using 8-Bit Bus (WISAA[2:0] = 101)
P.293	Addition of a description to 11.5.2 (3) Bus Operations in High-Speed System Bus
P.294	Correction of Figure 11-13 2-Byte Access Using 16-Bit Bus (WLCD/M[2:0] = 101) and Figure 11-14 1-Byte Access Using 8-Bit Bus (WLCD/M[2:0] = 101)
P.295	Correction of Figure 11-15 2-Byte Access When Sampling ZWS# at Low Level Using 16-Bit Bus (WLCD/M[2:0] = 101) and Figure 11-16 1-Byte Access When Sampling ZWS# at Low Level Using 8-Bit Bus (WLCD/M[2:0] = 101)
P.296	Correction of Figure 11-17 2-Byte Access to LCD Controller (WLCD/M[2:0] = 010)
P.297	Correction of Figure 11-18 2-Byte Access to LCD Controller (WLCD/M[2:0] = 011) and Figure 11-19 Access to LCD Controller When Data Bus Size Is 32 Bits
P.315	Addition of a description to 13.2 DMA PROIRITY CONTROL
p.355	Addition of a description about the 2.5-V power supply system to 16.1.3 Power-on Control
P.362	Change of descriptions in 16.1.4 (3) Suspend Mode
P.365	Addition of descriptions to 16.2.1 PMUINTREG (0x0B00 00A0)
P.397	Addition of descriptions to 19.1 General
P.425, 426	Change of descriptions about functions of bits 13 to 10 and addition of a description to 20.3.1 PIUCNTREG (0x0B00 0122)
P.428	Addition of descriptions and a caution to 20.3.2 PIUINTREG (0x0b00 0124)
P.463	Change of descriptions about functions of bits 9 to 4 in 22.2.2 KIUSCANREP (0x0B00 0190)
P.470	Change of a description about a function of bit 4 in 25.2.8 SIULC (0x0C00 0003)
P.622, 625 to 628	Addition of descriptions about the ISA mode bit in each Description and Operation of ERET, JAL, JALR, JALX, and JR instructions
P.766	Addition of a description about the 2.5-V power supply system to A.2.7 PMU

The mark ★ shows major revised points.

PREFACE

- Readers** This manual targets users who intend to understand the functions of the VR4111 and to design application systems using this microprocessor.
- Purpose** This manual introduces the architecture and hardware functions of the VR4111 to users, following the organization described below.
- Organization** This manual consists of the following contents:
- Introduction
 - Pipeline operation
 - Cache organization and memory management system
 - Exception processing
 - Initialization interface
 - Interrupts
 - Peripheral units
 - Instruction set details
- How to read this manual** It is assumed that the reader of this manual has general knowledge in the fields of electric engineering, logic circuits, and microcomputers.
- The VR4000™ in this manual includes the VR4400™.
- To learn in detail about the function of a specific instruction,
→ Read **CHAPTER 3 MIPS™ III INSTRUCTION SET SUMMARY, CHAPTER 4 MIPS16 INSTRUCTION SET, CHAPTER 28 MIPS™ III INSTRUCTION SET DETAILS**, and **CHAPTER 29 MIPS16 INSTRUCTION SET FORMAT**.
- To learn about the overall functions of the VR4111,
→ Read this manual in sequential order.
- To learn about electrical specifications,
→ Refer to **Data Sheet** which is separately available.
- Conventions**
- | | |
|--|---|
| Data significance: | Higher on left and lower on right |
| Active low: | XXX# (trailing # after pin and signal names) |
| Note: | Description of item marked with Note in the text |
| Caution: | Information requiring particular attention |
| Remark: | Supplementary information |
| Numeric representation: | binary/decimal ... XXXX
hexadecimal ... 0XXXXX |
| Prefixes representing an exponent of 2 (for address space or memory capacity): | |
| K (kilo) | $2^{10} = 1024$ |
| M (mega) | $2^{20} = 1024^2$ |
| G (giga) | $2^{30} = 1024^3$ |
| T (tera) | $2^{40} = 1024^4$ |
| P (peta) | $2^{50} = 1024^5$ |
| E (exa) | $2^{60} = 1024^6$ |

Related Documents

The related documents indicated here may include preliminary version. However, preliminary versions are not marked as such.

- User's manual
 - VR4111 User's Manual This manual
 - VR4102™ User's Manual U12739
- Data sheet
 - μPD30111 (VR4111) Data Sheet Under preparation
- Application note
 - VR Series™ Application Note programming guide Under preparation

CONTENTS

CHAPTER 1 INTRODUCTION	31
1.1 FEATURES	31
1.2 ORDERING INFORMATION	32
1.3 64-BIT ARCHITECTURE	32
1.4 VR4111 PROCESSOR	32
1.4.1 Internal Block Structure	33
1.4.2 I/O Registers.....	35
1.5 VR4110 CPU CORE	45
1.5.1 Internal Block Configuration	45
1.5.2 CPU Registers.....	47
1.5.3 CPU Instruction Set Overview	48
1.5.4 Data Formats and Addressing.....	50
1.5.5 Coprocessors (CP0)	52
1.5.6 Floating-Point Unit (FPU)	54
1.6 CPU CORE MEMORY MANAGEMENT SYSTEM (MMU)	55
1.6.1 Translation Lookaside Buffer (TLB).....	55
1.6.2 Operating Modes	55
1.6.3 Cache	56
1.7 INSTRUCTION PIPELINE	56
1.8 CLOCK INTERFACE	56
CHAPTER 2 PIN FUNCTIONS	59
2.1 PIN CONFIGURATION	59
2.2 PIN FUNCTION DESCRIPTION	63
2.2.1 System Bus Interface Signals.....	64
2.2.2 Clock Interface Signals.....	66
2.2.3 Battery Monitor Interface Signals	66
2.2.4 Initialization Interface Signals	67
2.2.5 RS-232C Interface Signals	68
2.2.6 IrDA Interface Signals.....	69
2.2.7 Debug Serial Interface Signals	69
2.2.8 Keyboard Interface Signals	70
2.2.9 Audio Interface Signals.....	70
2.2.10 Touch Panel/General Purpose A/D Interface Signals	70
2.2.11 General-purpose I/O Signals	71
2.2.12 HSP MODEM Interface Signals.....	72
2.2.13 LED Interface Signal.....	72
2.2.14 Initial Setting Signals	72
2.2.15 Dedicated V _{DD} and GND Signals	73
2.3 PIN STATUS	74
2.3.1 Pin Status upon Specific States	74
2.3.2 Connection of Unused Pins and Pin I/O Circuits	77
2.3.3 Pin I/O Circuits.....	80

CHAPTER 3 MIPS III INSTRUCTION SET SUMMARY.....	81
3.1 CPU INSTRUCTION FORMATS.....	81
3.2 INSTRUCTION CLASSES.....	82
3.2.1 Load and Store Instructions.....	82
3.2.2 Computational Instructions.....	86
3.2.3 Jump and Branch Instructions.....	92
3.2.4 Special Instructions.....	96
3.2.5 System Control Coprocessor (CP0) Instructions.....	97
CHAPTER 4 MIPS16 INSTRUCTION SET.....	99
4.1 OUTLINE.....	99
4.2 FEATURES.....	99
4.3 REGISTER SET.....	100
4.4 ISA MODE.....	101
4.4.1 Changing ISA Mode Bit by Software.....	101
4.4.2 Changing ISA Mode Bit by Exception.....	101
4.4.3 Enabling Change ISA Mode Bit.....	102
4.5 TYPES OF INSTRUCTIONS.....	102
4.6 INSTRUCTION FORMAT.....	104
4.7 MIPS16 OPERATION CODE BIT ENCODING.....	108
4.8 OUTLINE OF INSTRUCTIONS.....	111
4.8.1 PC-Relative Instructions.....	111
4.8.2 Extend Instruction.....	112
4.8.3 Delay Slots.....	114
4.8.4 Instruction Details.....	115
CHAPTER 5 Vr4111 PIPELINE.....	129
5.1 PIPELINE STAGES.....	129
5.1.1 Pipeline Activities.....	130
5.2 BRANCH DELAY.....	132
5.3 LOAD DELAY.....	132
5.4 PIPELINE OPERATION.....	132
5.5 INTERLOCK AND EXCEPTION HANDLING.....	139
5.5.1 Exception Conditions.....	142
5.5.2 Stall Conditions.....	143
5.5.3 Slip Conditions.....	144
5.5.4 Bypassing.....	145
5.6 CODE COMPATIBILITY.....	145
CHAPTER 6 MEMORY MANAGEMENT SYSTEM.....	147
6.1 TRANSLATION LOOKASIDE BUFFER (TLB).....	147
6.2 VIRTUAL ADDRESS SPACE.....	147
6.2.1 Virtual-to-Physical Address Translation.....	148
6.2.2 32-bit Mode Address Translation.....	149

6.2.3	64-bit Mode Address Translation.....	150
6.2.4	Operating Modes	151
6.2.5	User Mode Virtual Addressing.....	151
6.2.6	Supervisor-mode Virtual Addressing.....	154
6.2.7	Kernel-mode Virtual Addressing.....	157
6.3	PHYSICAL ADDRESS SPACE.....	165
6.3.1	ROM Space	167
6.3.2	System Bus Space	169
6.3.3	Internal I/O Space.....	170
6.3.4	LCD Space	171
6.3.5	DRAM Space.....	171
6.4	SYSTEM CONTROL COPROCESSOR.....	173
6.4.1	Format of a TLB Entry	174
6.5	CP0 REGISTERS	175
6.5.1	Index Register (0).....	175
6.5.2	Random Register (1)	175
6.5.3	EntryLo0 (2) and EntryLo1 (3) Registers.....	176
6.5.4	PageMask Register (5).....	177
6.5.5	Wired Register (6)	178
6.5.6	EntryHi Register (10).....	179
6.5.7	Processor Revision Identifier (PRId) Register (15).....	180
6.5.8	Config Register (16)	181
6.5.9	Load Linked Address (LLAddr) Register (17).....	182
6.5.10	Cache Tag Registers (TagLo (28) and TagHi (29)).....	182
6.5.11	Virtual-to-Physical Address Translation.....	183
6.5.12	TLB Misses.....	185
6.5.13	TLB Instructions.....	185
CHAPTER 7	EXCEPTION PROCESSING.....	187
7.1	EXCEPTION PROCESSING OPERATION.....	187
7.2	PRECISION OF EXCEPTIONS.....	188
7.3	EXCEPTION PROCESSING REGISTERS	189
7.3.1	Context Register (4)	190
7.3.2	BadVAddr Register (8)	191
7.3.3	Count Register (9)	191
7.3.4	Compare Register (11).....	192
7.3.5	Status Register (12).....	192
7.3.6	Cause Register (13)	195
7.3.7	Exception Program Counter (EPC) Register (14).....	197
7.3.8	WatchLo (18) and WatchHi (19) Registers.....	198
7.3.9	XContext Register (20).....	199
7.3.10	Parity Error Register (26).....	200
7.3.11	Cache Error Register (27)	200
7.3.12	ErrorEPC Register (30).....	201
7.4	DETAILS OF EXCEPTIONS	203
7.4.1	Exception Types	203
7.4.2	Exception Vector Locations	203

7.4.3	Priority of Exceptions	205
7.4.4	Cold Reset Exception	206
7.4.5	Soft Reset Exception	207
7.4.6	NMI Exception	208
7.4.7	Address Error Exception	209
7.4.8	TLB Exceptions.....	210
7.4.9	Bus Error Exception	213
7.4.10	System Call Exception.....	214
7.4.11	Breakpoint Exception.....	215
7.4.12	Coprocessor Unusable Exception	216
7.4.13	Reserved Instruction Exception	217
7.4.14	Trap Exception.....	218
7.4.15	Integer Overflow Exception.....	219
7.4.16	Watch Exception.....	219
7.4.17	Interrupt Exception.....	220
7.5	EXCEPTION PROCESSING AND SERVICING FLOWCHARTS	221
 CHAPTER 8 INITIALIZATION INTERFACE		229
8.1	RESET FUNCTION.....	229
8.1.1	RTC Reset	230
8.1.2	RSTSW	231
8.1.3	Deadman's Switch	232
8.1.4	Software Shutdown.....	233
8.1.5	HALTimer Shutdown.....	234
8.2	POWER-ON SEQUENCE.....	235
8.3	RESET OF THE CPU CORE.....	237
8.3.1	Cold Reset	237
8.3.2	Soft Reset.....	238
8.4	V_R4111 PROCESSOR MODES.....	239
8.4.1	Power Modes	239
8.4.2	Privilege Mode	240
8.4.3	Reverse Endian	240
8.4.4	Bootstrap Exception Vector (BEV).....	240
8.4.5	Cache Error Check	241
8.4.6	Parity Error Prohibit	241
8.4.7	Interrupt Enable (IE)	241
 CHAPTER 9 CACHE MEMORY.....		243
9.1	MEMORY ORGANIZATION	243
9.2	CACHE ORGANIZATION.....	244
9.2.1	Organization of the Instruction Cache (I-Cache)	244
9.2.2	Organization of the Data Cache (D-Cache)	245
9.2.3	Accessing the Caches	246
9.3	CACHE OPERATIONS.....	247
9.3.1	Cache Write Policy	247
9.4	CACHE STATES	248

9.5	CACHE STATE TRANSITION DIAGRAMS.....	249
9.5.1	Data Cache State Transition	249
9.5.2	Instruction Cache State Transition	249
9.6	CACHE DATA INTEGRITY	250
9.7	MANIPULATION OF THE CACHES BY AN EXTERNAL AGENT.....	258
 CHAPTER 10 CPU CORE INTERRUPTS.....		 259
10.1	NON-MASKABLE INTERRUPT (NMI).....	259
10.2	ORDINARY INTERRUPTS.....	259
10.3	SOFTWARE INTERRUPTS GENERATED IN CPU CORE.....	260
10.4	TIMER INTERRUPT	260
10.5	ASSERTING INTERRUPTS.....	260
10.5.1	Detecting Hardware Interrupts.....	260
10.5.2	Masking Interrupt Signals.....	262
 CHAPTER 11 BCU (BUS CONTROL UNIT).....		 263
11.1	GENERAL	263
11.2	REGISTER SET.....	263
11.2.1	BCUCNTREG1 (0x0B00 0000)	264
11.2.2	BCUCNTREG2 (0x0B00 0002)	266
11.2.3	BCUSPEEDREG (0x0B00 000A)	267
11.2.4	BCUERRSTREG (0x0B00 000C).....	269
11.2.5	BCURFCNTREG (0x0B00 000E)	270
11.2.6	REVIDREG (0x0B00 0010)	271
11.2.7	BCURFCOUNTREG (0x0B00 0012)	272
11.2.8	CLKSPEEDREG (0x0B00 0014)	273
11.2.9	BCUCNTREG3 (0x0B00 0016)	274
11.3	CONNECTION OF ADDRESS PINS.....	275
11.3.1	Connection to DRAM.....	275
11.3.2	Connection to ROM.....	277
11.4	NOTES ON USING BCU.....	279
11.4.1	CPU Core Bus Modes	279
11.4.2	Access Data Size	279
11.4.3	ROM Interface	280
11.4.4	Flash Memory Interface.....	281
11.4.5	LCD Control Interface.....	282
11.4.6	Illegal Access Notification.....	284
11.5	BUS OPERATIONS.....	285
11.5.1	ROM Access.....	285
11.5.2	System Bus Access.....	288
11.5.3	LCD Interface	296
11.5.4	DRAM Access (EDO Type)	298
11.5.5	Refresh	302
11.5.6	Bus Hold.....	303

CHAPTER 12 DMAAU (DMA ADDRESS UNIT)	305
12.1 GENERAL	305
12.2 REGISTER SET	306
12.2.1 AIU IN DMA Base Address Registers.....	307
12.2.2 AIU IN DMA Address Registers.....	309
12.2.3 AIU OUT DMA Base Address Registers.....	310
12.2.4 AIU OUT DMA Address Registers.....	312
12.2.5 FIR DMA Base Address Registers.....	313
12.2.6 FIR DMA Address Registers.....	314
CHAPTER 13 DCU (DMA CONTROL UNIT)	315
13.1 GENERAL	315
13.2 DMA PRIORITY CONTROL	315
13.3 REGISTER SET	315
13.3.1 DMARSTREG (0x0B00 0040).....	316
13.3.2 DMAIDLEREG (0x0B00 0042).....	317
13.3.3 DMASENREG (0x0B00 0044).....	318
13.3.4 DMAMSKREG (0x0B00 0046).....	319
13.3.5 DMAREQREG (0x0B00 0048).....	320
13.3.6 TDREG (0x0B00 004A).....	321
CHAPTER 14 CMU (CLOCK MASK UNIT)	323
14.1 GENERAL	323
14.2 REGISTER SET	323
14.2.1 CMUCLKMSK (0x0B00 0060).....	324
CHAPTER 15 ICU (INTERRUPT CONTROL UNIT)	325
15.1 GENERAL	325
15.2 REGISTER SET	328
15.2.1 SYSINT1REG (0x0B00 0080).....	329
15.2.2 PIUINTREG (0x0B00 0082).....	331
15.2.3 AIUINTREG (0x0B00 0084).....	332
15.2.4 KIUINTREG (0x0B00 0086).....	333
15.2.5 GIUINTLREG (0x0B00 0088).....	334
15.2.6 DSIUINTREG (0x0B00 008A).....	335
15.2.7 MSYSINT1REG (0x0B00 008C).....	336
15.2.8 MPIUINTREG (0x0B00 008E).....	338
15.2.9 MAIUINTREG (0x0B00 0090).....	339
15.2.10 MKIUINTREG (0x0B00 0092).....	340
15.2.11 MGIUINTLREG (0x0B00 0094).....	341
15.2.12 MDSIUINTREG (0x0B00 0096).....	342
15.2.13 NMIREG (0x0B00 0098).....	343
15.2.14 SOFTINTREG (0x0B00 009A).....	344
15.2.15 SYSINT2REG (0x0B00 0200).....	345

15.2.16	GIUINTHREG (0x0B00 0202).....	346
15.2.17	FIRINTREG (0x0B00 0204).....	347
15.2.18	MSYSINT2REG (0x0B00 0206)	348
15.2.19	MGIUINTHREG (0x0B00 0208).....	349
15.2.20	MFIRINTREG (0x0B00 020A)	350
15.3	NOTES FOR REGISTER SETTING	351
CHAPTER 16 PMU (POWER MANAGEMENT UNIT).....		353
16.1	GENERAL	353
16.1.1	Reset Control.....	353
16.1.2	Shutdown Control.....	354
16.1.3	Power-on Control.....	355
16.1.4	Power Mode	360
16.2	REGISTER SET.....	363
16.2.1	PMUINTREG (0x0B00 00A0)	364
16.2.2	PMUCNTREG (0x0B00 00A2).....	366
16.2.3	PMUINT2REG (0x0B00 00A4)	368
16.2.4	PMUCNT2REG (0x0B00 00A6).....	369
16.2.5	PMUWAITREG (0x0B00 00A8).....	370
CHAPTER 17 RTC (REALTIME CLOCK UNIT).....		371
17.1	GENERAL	371
17.2	REGISTER SET.....	372
17.2.1	Elapsed Time Registers	373
17.2.2	Elapsed Time Compare Registers.....	375
17.2.3	RTC Long 1 Registers	377
17.2.4	RTC Long 1 Count Registers	379
17.2.5	RTC Long 2 Registers	381
17.2.6	RTC Long 2 Count Registers	383
17.2.7	TClock Counter Registers	385
17.2.8	TClock Counter Count Registers.....	387
17.2.9	RTC Interrupt Register	389
CHAPTER 18 DSU (DEADMAN'S SWITCH UNIT).....		391
18.1	GENERAL	391
18.2	REGISTER SET.....	392
18.2.1	DSUCNTREG (0x0B00 00E0)	392
18.2.2	DSUSETREG (0x0B00 00E2)	393
18.2.3	DSUCLRREG (0x0B00 00E4)	394
18.2.4	DSUTIMREG (0x0B00 00E6)	395
18.3	REGISTER SETTING FLOW	396

CHAPTER 19 GIU (GENERAL PURPOSE I/O UNIT)	397
19.1 GENERAL	397
19.2 REGISTER SET	398
19.2.1 GIUIOSELL (0x0B00 0100)	399
19.2.2 GIUIOSELH (0x0B00 0102).....	400
19.2.3 GIUIODL (0x0B00 0104)	401
19.2.4 GIUIODH (0x0B00 0106).....	402
19.2.5 GIUINTSTATL (0x0B00 0108)	403
19.2.6 GIUINTSTATH (0x0B00 010A)	404
19.2.7 GIUINTENL (0x0B00 010C).....	405
19.2.8 GIUINTENH (0x0B00 010E)	406
19.2.9 GIUINTTYPL (0x0B00 0110)	407
19.2.10 GIUINTTYPH (0x0B00 0112).....	408
19.2.11 GIUINTALSELL (0x0B00 0114)	409
19.2.12 GIUINTALSELH (0x0B00 0116)	410
19.2.13 GIUINTHTSELL (0x0B00 0118).....	411
19.2.14 GIUINTHTSELH (0x0B00 011A).....	412
19.2.15 GIUPODATL (0x0B00 011C)	414
19.2.16 GIUPODATH (0x0B00 011E).....	416
19.2.17 GIUUSEUPDN (0x0B00 02E0)	417
19.2.18 GIUTERMUPDN (0x0B00 02E02)	418
CHAPTER 20 PIU (TOUCH PANEL INTERFACE UNIT)	419
20.1 GENERAL	419
20.1.1 Block Diagrams.....	420
20.2 SCAN SEQUENCER STATE TRANSITION	422
20.3 REGISTER SET	424
20.3.1 PIUCNTREG (0x0B00 0122)	425
20.3.2 PIUINTREG (0x0B00 0124).....	428
20.3.3 PIUSIVLREG (0x0B00 0126).....	429
20.3.4 PIUSTBLREG (0x0B00 0128).....	430
20.3.5 PIUCMDREG (0x0B00 012A)	431
20.3.6 PIUASCNREG (0x0B00 0130).....	433
20.3.7 PIUAMSKREG (0x0B00 0132)	435
20.3.8 PIUCIVLREG (0x0B00 013E)	436
20.3.9 PIUPBnmREG (0x0B00 02A0 to 0x0B00 02AE, 0x0B00 02BC to 0x0B00 02BE)	437
20.3.10 PIUABnREG (0x0B00 02B0 to 0x0B00 02B6).....	438
20.4 REGISTER SETTING FLOW	439
20.5 RELATIONSHIPS AMONG TPX, TPY, ADIN, AND AUDIOIN PINS AND STATES	441
20.6 TIMING	442
20.6.1 Touch/Release Detection Timing.....	442
20.6.2 A/D Port Scan Timing	442
20.7 DATA LOSS INTERRUPT CONDITIONS	443

CHAPTER 21 AIU (AUDIO INTERFACE UNIT)	445
21.1 GENERAL	445
21.2 REGISTER SET	445
21.2.1 MDMADATREG (0x0B00 0160)	446
21.2.2 SDMADATREG (0x0B00 0162).....	447
21.2.3 SODATREG (0x0B00 0166).....	447
21.2.4 SCNTREG (0x0B00 0168).....	448
21.2.5 SCNVRREG (0x0B00 016A)	449
21.2.6 MIDATREG (0x0B00 0170)	450
21.2.7 MCNTREG (0x0B00 0172)	451
21.2.8 MCNVRREG (0x0B00 0174)	452
21.2.9 DVALIDREG (0x0B00 0178)	453
21.2.10 SEQREG (0x0B00 017A)	454
21.2.11 INTREG (0x0B00 017C).....	455
21.3 OPERATION SEQUENCE	456
21.3.1 Output (Speaker).....	456
21.3.2 Input (MIC).....	457
CHAPTER 22 KIU (KEYBOARD INTERFACE UNIT)	459
22.1 GENERAL	459
22.2 REGISTER SET	459
22.2.1 KIUDATn (0x0B00 0180 to 0x0B00 018A)	460
22.2.2 KIUSCANREP (0x0B00 0190).....	463
22.2.3 KIUSCANS (0x0B00 0192).....	465
22.2.4 KIUWKS (0x0B00 0194).....	466
22.2.5 KIUWKI (0x0B00 0196)	467
22.2.6 KIUINT (0x0B00 0198)	468
22.2.7 KIURST (0x0B00 019A).....	469
22.2.8 KIUGPEN (0x0B00 019C)	470
22.2.9 SCANLINE (0x0B00 019E).....	472
CHAPTER 23 DSIU (DEBUG SERIAL INTERFACE UNIT)	477
23.1 GENERAL	477
23.2 REGISTER SET	477
23.2.1 PORTREG (0x0B00 01A0)	478
23.2.2 MODEMREG (0x0B00 01A2)	479
23.2.3 ASIM00REG (0x0B00 01A4)	480
23.2.4 ASIM01REG (0x0B00 01A6)	481
23.2.5 RXBORREG (0x0B00 01A8).....	482
23.2.6 RXBOLREG (0x0B00 01AA)	482
23.2.7 TXSORREG (0x0B00 01AC).....	483
23.2.8 TXSOLREG (0x0B00 01AE).....	483
23.2.9 ASIS0REG (0x0B00 01B0).....	484
23.2.10 INTR0REG (0x0B00 01B2).....	485
23.2.11 BPRM0REG (0x0B00 01B6).....	486

23.2.12	DSIURESETREG (0x0B00 01B8).....	487
23.3	DESCRIPTION OF OPERATIONS	488
23.3.1	Data Format.....	488
23.3.2	Transmission	489
23.3.3	Reception.....	490
CHAPTER 24	LED (LED CONTROL UNIT).....	493
24.1	GENERAL.....	493
24.2	REGISTER SET	493
24.2.1	LEDHTSREG (0x0B00 0240)	494
24.2.2	LEDLTSREG (0x0B00 0242)	495
24.2.3	LEDCNTREG (0x0B00 0248)	496
24.2.4	LEDASTCREG (0x0B00 024A).....	497
24.2.5	LEDINTREG (0x0B00 024C)	498
24.3	OPERATION FLOW	499
CHAPTER 25	SIU (SERIAL INTERFACE UNIT).....	501
25.1	GENERAL.....	501
25.2	REGISTER SET	501
25.2.1	SIURB (0x0C00 0000: LCR[7] = 0, Read)	502
25.2.2	SIUTH (0x0C00 0000: LCR[7] = 0, Write).....	502
25.2.3	SIUDLL (0x0C00 0000: LCR[7] = 1)	502
25.2.4	SIUIE (0x0C00 0001: LCR[7] = 0)	503
25.2.5	SIUDLM (0x0C00 0001: LCR[7] = 1)	504
25.2.6	SIUIID (0x0C00 0002: Read).....	505
25.2.7	SIUFC (0x0C00 0002: Write).....	507
25.2.8	SIULC (0x0C00 0003).....	510
25.2.9	SIUMC (0x0C00 0004).....	511
25.2.10	SIULS (0x0C00 0005).....	512
25.2.11	SIUMS (0x0C00 0006).....	514
25.2.12	SIUSC (0x0C00 0007)	515
25.2.13	SIUIRSEL (0x0C00 0008).....	516
25.2.14	SIURESET (0x0C00 0009)	518
25.2.15	SIUCSEL (0x0C00 000A)	518
CHAPTER 26	HSP (MODEM INTERFACE UNIT).....	519
26.1	GENERAL.....	519
26.2	REGISTER SET	521
26.2.1	HSP Initialize Register	522
26.2.2	HSP Data Register, HSP Index Register.....	523
26.2.3	HSP ID Register, HSP I/O Address Program Confirmation Register.....	531
26.2.4	HSP Signature Checking Port.....	531
26.3	POWER CONTROL.....	532

CHAPTER 27 FIR (FAST IrDA INTERFACE UNIT)	535
27.1 GENERAL	535
27.2 REGISTER SET	535
27.2.1 FRSTR (0x0C00 0040)	536
27.2.2 DPINTR (0x0C00 0042).....	537
27.2.3 DPCNTR (0x0C00 0044)	538
27.2.4 TDR (0x0C00 0050)	539
27.2.5 RDR (0x0C00 0052)	540
27.2.6 IMR (0x0C00 0054)	541
27.2.7 FSR (0x0C00 0056).....	542
27.2.8 IRSR1 (0x0C00 0058)	544
27.2.9 CRCSR (0x0C00 005C).....	545
27.2.10 FIRCR (0x0C00 005E).....	546
27.2.11 MIRCR (0x0C00 0060)	548
27.2.12 DMACR (0x0C00 0062).....	549
27.2.13 DMAER (0x0C00 0064).....	550
27.2.14 TXIR (0x0C00 0066).....	551
27.2.15 RXIR (0x0C00 0068)	552
27.2.16 IFR (0x0C00 006A).....	553
27.2.17 RXSTS (0x0C00 006C)	555
27.2.18 TXFL (0x0C00 006E).....	557
27.2.19 MRXF (0x0C00 0070).....	558
27.2.20 RXFL (0x0C00 0074).....	559
CHAPTER 28 MIPS III INSTRUCTION SET DETAILS	561
28.1 INSTRUCTION NOTATION CONVENTIONS	561
28.2 LOAD AND STORE INSTRUCTIONS	563
28.3 JUMP AND BRANCH INSTRUCTIONS	564
28.4 SYSTEM CONTROL COPROCESSOR (CP0) INSTRUCTIONS	565
28.5 CPU INSTRUCTION	565
28.6 CPU INSTRUCTION OPCODE BIT ENCODING	711
CHAPTER 29 MIPS16 INSTRUCTION SET FORMAT	713
CHAPTER 30 VR4111 COPROCESSOR 0 HAZARDS	753
CHAPTER 31 PLL PASSIVE COMPONENTS	759
APPENDIX A DIFFERENCES BETWEEN VR4111 AND VR4102	761
A.1 SUMMARY OF DIFFERENCES	761
A.2 DETAILS OF DIFFERENCES	762
A.2.1 Cache Memory	762
A.2.2 Instruction Set	762
A.2.3 Pin Function	763
A.2.4 Memory Capacity	765

A.2.5 BCU.....	766
A.2.6 DMA.....	766
A.2.7 PMU.....	766
A.2.8 GIU.....	767
A.2.9 AIU.....	767
A.2.10 KIU.....	767
A.2.11 DSIU.....	767
A.2.12 HSP.....	768
A.2.13 FIR.....	768

APPENDIX B INDEX.....	769
------------------------------	------------

LIST OF FIGURES (1/5)

Fig. No.	Title	Page
1-1	VR4111 Internal Block Diagram and Example of Connection to External Blocks.....	32
1-2	VR4110 CPU Core Internal Block Diagram	45
1-3	VR4111 CPU Registers	47
1-4	CPU Instruction Formats (32-bit length instruction)	48
1-5	CPU Instruction Formats (16-bit length instruction)	49
1-6	Little-Endian Byte Ordering in Word Data	50
1-7	Little-Endian Byte Ordering in Double Word Data.....	51
1-8	Misaligned Word Accessing (Little-Endian).....	51
1-9	CP0 Registers	52
1-10	External Circuit of Clock Oscillator.....	57
1-11	Examples of Oscillator with Bad Connection	58
2-1	VR4111 Signal Classification.....	63
3-1	MIPS III ISA CPU Instruction Formats	81
3-2	Byte Specification Related to Load and Store Instructions	83
5-1	Pipeline Stages	129
5-2	Instruction Execution in the Pipeline	130
5-3	Pipeline Activities	130
5-4	Branch Delay.....	132
5-5	Add Instruction Pipeline Activities	133
5-6	JALR Instruction Pipeline Activities.....	134
5-7	BEQ Instruction Pipeline Activities	135
5-8	TLT Instruction Pipeline Activities	136
5-9	LW Instruction Pipeline Activities	137
5-10	SW Instruction Pipeline Activities.....	138
5-11	Interlocks, Exceptions, and Faults	139
5-12	Exception Detection	142
5-13	Data Cache Miss Stall.....	143
5-14	CACHE Instruction Stall	143
5-15	Load Data Interlock	144
5-16	MD Busy Interlock.....	144
6-1	Virtual-to-Physical Address Translation	148
6-2	32-bit Mode Virtual Address Translation	149
6-3	64-bit Mode Virtual Address Translation	150
6-4	User Mode Address Space	152
6-5	Supervisor Mode Address Space.....	155
6-6	Kernel Mode Address Space	158
6-7	xkphys Area Address Space	159
6-8	VR4111 Physical Address Space	165
6-9	CP0 Registers and the TLB	173
6-10	Format of a TLB Entry.....	174

LIST OF FIGURES (2/5)

Fig. No.	Title	Page
6-11	Index Register	175
6-12	Random Register	175
6-13	EntryLo0 and EntryLo1 Registers	176
6-14	Page Mask Register	177
6-15	Positions Indicated by the Wired Register.....	178
6-16	Wired Register.....	178
6-17	EntryHi Register	179
6-18	PRId Register	180
6-19	Config Register Format	181
6-20	LAddr Register	182
6-21	TagLo Register.....	182
6-22	TagHi Register	183
6-23	TLB Address Translation.....	184
7-1	Context Register Format	190
7-2	BadVAddr Register Format	191
7-3	Count Register Format	191
7-4	Compare Register Format.....	192
7-5	Status Register Format	192
7-6	Status Register Diagnostic Status Field.....	193
7-7	Cause Register Format	195
7-8	EPC Register Format (When MIPS16 ISA Is Disabled)	197
7-9	EPC Register Format (When MIPS16 ISA Is Enabled)	198
7-10	WatchLo Register Format	198
7-11	WatchHi Register Format.....	198
7-12	XContext Register Format.....	199
7-13	Parity Error Register Format	200
7-14	Cache Error Register Format	200
7-15	ErrorEPC Register Format (When MIPS16 ISA Is Disabled)	202
7-16	ErrorEPC Register Format (When MIPS16 ISA Is Enabled)	202
7-17	Common Exception Handling.....	222
7-18	TLB/XTLB Refill Exception Handling.....	224
7-19	Cold Reset Exception Handling.....	226
7-20	Soft Reset and NMI Exception Handling	227
8-1	RTC Reset.....	230
8-2	RSTSW	231
8-3	Deadman's Switch.....	232
8-4	Software Shutdown	233
8-5	HALTimer Shutdown	234
8-6	VR4111 Activation Sequence (When Battery Check Is OK)	236
8-7	VR4111 Activation Sequence (When Battery Check Is NG)	236
8-8	Cold Reset.....	237
8-9	Soft Reset.....	238

LIST OF FIGURES (3/5)

Fig. No.	Title	Page
9-1	Logical Hierarchy of Memory	243
9-2	Cache Support	244
9-3	Instruction Cache Line Format	245
9-4	Data Cache Line Format	245
9-5	Cache Data and Tag Organization.....	246
9-6	Data Cache State Diagram	249
9-7	Instruction Cache State Diagram	249
9-8	Data Check Flow on Instruction Fetch	250
9-9	Data Check Flow on Load Operations	250
9-10	Data Check Flow on Store Operations.....	251
9-11	Data Check Flow on Index_Invalidate Operations	251
9-12	Data Check Flow on Index_Writeback_Invalidate Operations	252
9-13	Data Check Flow on Index_Load_Tag Operations	252
9-14	Data Check Flow on Index_Store_Tag Operations.....	253
9-15	Data Check Flow on Create_Dirty Operations	253
9-16	Data Check Flow on Hit_Invalidate Operations	254
9-17	Data Check Flow on Hit_Writeback_Invalidate Operations	254
9-18	Data Check Flow on Fill Operations.....	255
9-19	Data Check Flow on Hit_Writeback Operations.....	255
9-20	Writeback Flow.....	256
9-21	Refill Flow.....	256
9-22	Writeback & Refill Flow	257
10-1	Non-maskable Interrupt Signal.....	259
10-2	Hardware Interrupt Signals	261
10-3	Masking of the Interrupt Request Signals	262
11-1	Example of 32-Bit LCD Controller Interface Connection.....	283
11-2	ROM 4-Byte Read, 16-Bit Mode (WROMA[2:0] = 110)	286
11-3	ROM 4-Byte Read, 32-Bit Mode (WROMA[2:0] = 110)	286
11-4	PageROM 4-Word Read, 16-Bit Mode (WROMA[2:0] = 111, WPROM[1:0] = 10)	287
11-5	PageROM 4-Word Read, 32-Bit Mode (WROMA[2:0] = 111, WPROM[1:0] = 10)	287
11-6	Flash Memory Mode, 2-Byte Access	288
11-7	1-Byte Access to Even Address Using 16-Bit Bus (WISAA[2:0] = 101)	289
11-8	2-Byte Access When Sampling IOCHRDY at High Level Using 16-Bit Bus (WISAA[2:0] = 101).....	290
11-9	1-Byte Access to Odd Address Using 16-Bit Bus (WISAA[2:0] = 101)	291
11-10	1-Byte Access to Odd Address Using 8-Bit Bus (WISAA[2:0] = 101)	291
11-11	2-Byte Access When Sampling ZWS# at Low Level Using 16-Bit Bus (WISAA[2:0] = 101)	292
11-12	2-Byte Access When Sampling ZWS# at Low Level Using 8-Bit Bus (WISAA[2:0] = 101)	292
11-13	2-Byte Access Using 16-Bit Bus (WLCD/M[2:0] = 101)	294
11-14	1-Byte Access Using 8-Bit Bus (WLCD/M[2:0] = 101)	294
11-15	2-Byte Access When Sampling ZWS# at Low Level Using 16-Bit Bus (WLCD/M[2:0] = 101)	295
11-16	1-Byte Access When Sampling ZWS# at Low Level Using 8-Bit Bus (WLCD/M[2:0] = 101)	295
11-17	2-Byte Access to LCD Controller (WLCD/M[2:0] = 010)	296

LIST OF FIGURES (4/5)

Fig. No.	Title	Page
11-18	2-Byte Access to LCD Controller (WLCD/M[2:0] = 011).....	297
11-19	Access to LCD Controller When Data Bus Size Is 32 Bits	297
11-20	4-Byte Access to DRAM (16-Bit Mode)	298
11-21	8-Byte Access to DRAM (32-Bit Mode)	298
11-22	Byte Read of Odd Address in DRAM (16-Bit Mode).....	299
11-23	Byte Read of Even Address in DRAM (16-Bit Mode)	299
11-24	Byte Write to Odd Address in DRAM (16-Bit Mode).....	300
11-25	Byte Write to Even Address in DRAM (16-Bit Mode)	300
11-26	Read Cycle for DRAM (in 32-Bit Mode).....	301
11-27	Write Cycle for DRAM (in 32-Bit Mode).....	301
11-28	CBR Refresh (16-Bit Mode).....	302
11-29	Self Refresh (16-Bit Mode).....	302
11-30	Bus Hold in Fullspeed Mode and Standby Mode	303
11-31	Bus Hold in Suspend Mode.....	304
12-1	DMA Space Used in DMA Transfers	305
14-1	Block Diagram of CMU and Peripheral Blocks	323
15-1	Interrupt Control Outline	327
16-1	Activation via Power Switch Interrupt (BATTINH/BATTINT# = 1)	356
16-2	Activation via Power Switch Interrupt (BATTINH/BATTINT# = 0)	356
16-3	Activation via GPIO Activation Interrupt (BATTINH/BATTINT# = 1).....	357
16-4	Activation via GPIO Activation Interrupt (BATTINH/BATTINT# = 0).....	357
16-5	Activation via DCD Interrupt (BATTINH/BATTINT# = 1)	358
16-6	Activation via DCD Interrupt (BATTINH/BATTINT# = 0)	358
16-7	Activation via Alarm Interrupt (BATTINH/BATTINT# = 1).....	359
16-8	Activation via Alarm Interrupt (BATTINH/BATTINT# = 0).....	359
16-9	Power Mode State Transition	361
20-1	PIU Peripheral Block Diagram.....	420
20-2	Coordinate Detection Equivalent Circuits.....	421
20-3	Internal Block Diagram of PIU	421
20-4	Scan Sequencer State Transition Diagram	422
20-5	Interval Times and States.....	429
20-6	Touch/Release Detection Timing	442
20-7	A/D Port Scan Timing	442
21-1	Speaker Output and AUDIOOUT Pin	456
21-2	AUDIOIN Pin and MIC Operation	457
22-1	Scan Operation and Key Data Store Register.....	462
22-2	Connection of Keyboard Interface Pin.....	471

LIST OF FIGURES (5/5)

Fig. No.	Title	Page
22-3	Transition of Sequencer Status.....	473
22-4	Basic Operation Timing Chart.....	474
23-1	Data Format for Transmission and Reception	488
23-2	Transmit Complete Interrupt Timing.....	489
23-3	Receive Complete Interrupt Timing.....	490
23-4	Receive Error Timing	491
25-1	Connection Example Between the VR4111 and IrDA Module	517
26-1	HSP Unit Block Diagram.....	519
26-2	Circuit Configuration Block Diagram Examples	520
26-3	Block Diagram of HSP Interface Power Control.....	532
28-1	VR4111 Opcode Bit Encoding	711
31-1	Example of Connection of PLL Passive Components.....	759

LIST OF TABLES (1/4)

Table No.	Title	Page
1-1	BCU Registers.....	35
1-2	DMAAU Registers	35
1-3	DCU Registers	36
1-4	CMU Register.....	36
1-5	ICU Registers.....	37
1-6	PMU Registers	37
1-7	RTC Registers.....	38
1-8	DSU Registers.....	39
1-9	GIU Registers.....	39
1-10	PIU Registers	40
1-11	AIU Registers	41
1-12	KIU Registers	42
1-13	DSIU Registers.....	42
1-14	LED Registers	43
1-15	SIU Registers	43
1-16	HSP Registers.....	43
1-17	FIR Registers	44
1-18	System Control Coprocessor (CPO) Register Definitions.....	53
1-19	Relationships Between CLKSEL Pin Settings and Clock Frequencies	57
2-1	System Bus Interface Signals	64
2-2	Clock Interface Signals.....	66
2-3	Battery Monitor Interface Signals	66
2-4	Initialization Interface Signals.....	67
2-5	RS-232C Interface Signals.....	68
2-6	IrDA Interface Signals	69
2-7	Debug Serial Interface Signals.....	69
2-8	Keyboard Interface Signals	70
2-9	Audio Interface Signals	70
2-10	Touch Panel/General Purpose A/D Interface Signals	70
2-11	General-purpose I/O Signals.....	71
2-12	HSP MODEM Interface Signals.....	72
2-13	LED Interface Signal	72
2-14	Initial Setting Signals.....	72
2-15	Dedicated V _{DD} and GND Signals.....	73
2-16	Pin Status upon Specific States	74
2-17	Connection of Unused Pins and Pin I/O Circuit Type.....	77
3-1	Number of Delay Slot Cycles Necessary for Load and Store Instructions	82
3-2	Load/Store Instruction	84
3-3	Load/Store Instruction (Extended ISA).....	85
3-4	ALU Immediate Instruction	86
3-5	ALU Immediate Instruction (Extended ISA).....	87
3-6	Three-Operand Type Instruction	87
3-7	Three-Operand Type Instruction (Extended ISA).....	88

LIST OF TABLES (2/4)

Table No.	Title	Page
3-8	Shift Instruction	88
3-9	Shift Instruction (Extended ISA)	89
3-10	Multiply/Divide Instructions	90
3-11	Multiply/Divide Instructions (Extended ISA)	90
3-12	Number of Stall Cycles in Multiply and Divide Instructions	91
3-13	Number of Delay Slot Cycles in Jump and Branch Instructions	92
3-14	Jump Instruction	93
3-15	Branch Instructions	94
3-16	Branch Instructions (Extended ISA)	95
3-17	Special Instructions	96
3-18	Special Instructions (Extended ISA)	96
3-19	System Control Coprocessor (CP0) Instructions	97
4-1	General-Purpose Registers	100
4-2	Special Registers	101
4-3	MIPS16 Instruction Set Outline	103
4-4	Field Definition	104
4-5	Bit Encoding of Major Operation Code (op)	108
4-6	RR Minor Operation Code (RR-Type Instruction)	108
4-7	RRR Minor Operation Code (RRR-Type Instruction)	109
4-8	RRRI-A Minor Operation Code (RRI-Type ADD Instruction)	109
4-9	SHIFT Minor Operation Code (SHIFT-Type Instruction)	109
4-10	I8 Minor Operation Code (I8-Type Instruction)	109
4-11	I64 Minor Operation Code (64-bit Only, I64-Type Instruction)	110
4-12	Base PC Address Setting	111
4-13	Extendable MIPS16 Instructions	113
4-14	Load and Store Instructions	115
4-15	ALU Immediate Instructions	118
4-16	Two-/Three-Operand Register Type	120
4-17	Shift Instructions	122
4-18	Multiply/Divide Instructions	124
4-19	Jump and Branch Instructions	126
4-20	Special Instructions	127
5-1	Description of Pipeline Activities During Each Stage	131
5-2	Correspondence of Pipeline Stage to Interlock and Exception Conditions	140
5-3	Pipeline Interlock	141
5-4	Description of Pipeline Exception	141
6-1	Comparison of useg and xuseg	152
6-2	32-bit and 64-bit Supervisor Mode Segments	156
6-3	32-bit Kernel Mode Segments	160
6-4	64-bit Kernel Mode Segments	162
6-5	Cacheability and the xkphys Address Space	163

LIST OF TABLES (3/4)

Table No.	Title	Page
6-6	V _R 4111 Physical Address Space	166
6-7	ROM Addresses (When Using 16-bit Data Bus)	167
6-8	ROM Addresses (When Using 32-bit Data Bus)	168
6-9	Internal I/O Space 1	170
6-10	Internal I/O Space 2	170
6-11	DRAM Addresses (When Using 16-bit Data Bus)	171
6-12	DRAM Addresses (When Using 32-bit Data Bus)	172
6-13	Cache Algorithm.....	177
6-14	Mask Values and Page Sizes.....	177
7-1	CP0 Exception Processing Registers.....	189
7-2	Cause Register Exception Code Field	196
7-3	64-Bit Mode Exception Vector Base Addresses.....	204
7-4	32-Bit Mode Exception Vector Base Addresses.....	204
7-5	Exception Priority Order	205
11-1	BCU Registers.....	263
11-2	Example of DRAM Connection and Address Output from V _R 4111.....	275
11-3	Example of ROM Connection and Address Output from V _R 4111.....	277
11-4	Access Size Restrictions for Address Spaces.....	279
11-5	ROM Mode Settings and Access-Enabled Devices	280
11-6	Example of Bit Inversion in Data in V _R 4111 and at DATA[15:0] Pins.....	282
11-7	Illegal Access Notification Methods.....	284
11-8	Access Times During Ordinary ROM Read Mode.....	285
11-9	PageROM Read Mode Access Time.....	287
11-10	System Bus Access Times.....	288
11-11	High-Speed System Bus Access Times.....	293
11-12	Access Times for LCD Interface.....	296
12-1	DMAAU Registers	306
13-1	DMA Priority Levels.....	315
13-2	DCU Registers	315
14-1	CMU Register.....	323
15-1	ICU Registers	328
16-1	Bit Operations During Reset.....	353
16-2	Bit Operations During Shutdown.....	354
16-3	Power Mode	361
16-4	PMU Registers	363
17-1	RTC Registers.....	372

LIST OF TABLES (4/4)

Table No.	Title	Page
18-1	DSU Registers	392
19-1	GPIO Pin Functions	397
19-2	GIU Registers.....	398
19-3	Correspondences Between Interrupt Mask and Interrupt Hold	413
19-4	Correspondences Between GPIO[47..32] and Function Pins	415
19-5	Correspondence Between GPIO[48] and Function Pin.....	416
20-1	PIU Registers	424
20-2	PIUCNTREG Bit Manipulation and States	427
20-3	PIUASCNREG Bit Manipulation and States.....	434
20-4	Detected Coordinates and Page Buffers.....	437
20-5	A/D Ports and Data Buffers.....	438
20-6	Mask Clear During Scan Sequence Operation	439
21-1	AIU Registers	445
22-1	KIU Registers	459
23-1	DSIU Registers	477
23-2	Receive Error Causes	491
24-1	LED Registers	493
25-1	SIU Registers	501
25-2	Correspondence Between Baud Rates and Divisors	504
25-3	Interrupt Function.....	506
26-1	HSP Registers.....	521
26-2	Control Register Definitions	523
27-1	FIR Registers	535
28-1	CPU Instruction Operation Notations	562
28-2	Load and Store Common Functions	563
28-3	Access Type Specifications for Loads/Stores.....	564
30-1	VR4111 Coprocessor 0 Hazards	754
30-2	Calculation Example of CP0 Hazard and Number of Instructions Inserted.....	757

[MEMO]

CHAPTER 1 INTRODUCTION

This chapter describes the outline of the VR4111 (μ PD30111), which is a 64-/32-bit RISC microprocessor.

1.1 FEATURES

The VR4111, which is a high-performance 64-/32-bit microprocessor employing the RISC (reduced instruction set computer) architecture developed by MIPS, is one of the RISC microprocessor VR-Series™ products manufactured by NEC.

The VR4111 is ideally suited for battery-driven high-performance portable information equipment.

It mainly consists of the high-performance ultra-low-power consumption VR4111™ CPU core, and has various peripheral functions including a DMA controller, software modem interface, serial interface, keyboard interface, IrDA interface, touch panel interface, real-time clock, A/D converter, and D/A converter.

The external bus width of this device can be selected between 32 bits and 16 bits. This function enables the VR4111 to process voluminous data at high speed.

This processor supports instruction set architecture (ISA) of MIPS I, MIPS II, MIPS III, and MIPS16. It does not support LL, LLD, SC, SCD, and floating point instructions.

The features of the VR4111 are described below.

- ◇ Employs 64-bit RISC CPU Core (VR4110 equivalent)
- ◇ Internal 64-bit processing
- ◇ Optimized 5-stage pipeline
- ◇ Conforms to MIPS I, II, III instruction sets (with the FPU, LL, LLD, SC, and SCD instructions left out)
- ◇ Supports high-speed product-sum operation instructions to execute applications in high speed
- ◇ On-chip 16-Kbyte instruction cache and 8-Kbyte data cache
- ◇ 32-double-entry translation lookaside buffer (TLB) for virtual address management
- ◇ 32-bit physical address space and 40-bit virtual address space
- ◇ On-chip peripheral units suited for portable equipment
 - Memory controller (supports ROM, EDO-type DRAM, and flash memory)
 - ISA-bus interface
 - Keyboard interface
 - Touch panel interface (on-chip 4-channel A/D converter)
 - Controller complying with IrDA 1.1 (FIR)
 - Software modem interface supporting the HSP modem™ of PC-TEL
 - DMA controller
 - Serial interface
 - Debug serial interfaces
 - Interrupt controller
 - Audio interface (on-chip digital I/O, A/D and D/A converters)
 - General-purpose A/D converter: 3 channels
 - General-purpose ports
- ◇ Effective power management features, which include the following four operating modes:
 - Fullspeed mode: normal operating mode in which all clocks operate
 - Standby mode: all internal clocks stop except for interrupt-related clocks
 - Suspend mode: bus clock and all internal clocks stop except for interrupt-related clocks
 - Hibernate mode: all clocks generated by the CPU core stop

- ◇ External input clock: 32.768 kHz, 18.432 MHz (for internal CPU core and peripheral unit operation), 48 MHz (dedicated for FIR IrDA interface)
- ◇ Supports ISA bus subset
- ◇ Clock supply management function for each on-chip peripheral unit to implement low-power consumption
- ◇ Operation supply voltage: $V_{DD} = 3.0$ to 3.6 V

1.2 ORDERING INFORMATION

	Part Number	Package	Maximum Operation Frequency
★	μ PD30111S1-80-3C	224-pin fine-pitch BGA (16 × 16 mm)	80 MHz
	μ PD30111S1-100-3C	224-pin fine-pitch BGA (16 × 16 mm)	100 MHz

1.3 64-BIT ARCHITECTURE

The Vr4111 microprocessor has a 64-bit architecture. However, it can also run 32-bit applications.

1.4 Vr4111 PROCESSOR

The Vr4111 consists of the Vr4110 CPU core and seventeen peripheral units. It can connect external controllers directly.

Figure 1-1 is an internal block diagram of the Vr4111 processor.

Figure 1-1. Vr4111 Internal Block Diagram and Example of Connection to External Blocks

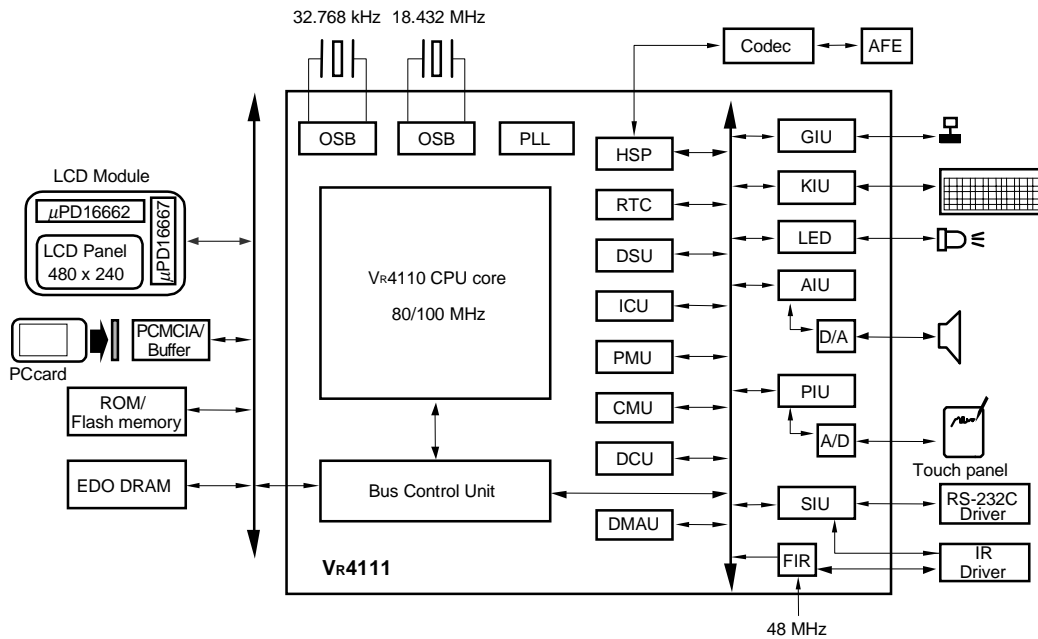

1.4.1 Internal Block Structure

The following provides an outline of the peripheral units.

For the CPU core, refer to **1.5 VR4110 CPU CORE**.

(1) Bus Control Unit (BCU)

In the VR4111, the bus control unit (BCU) transfers data between the VR4110 CPU core and SysAD bus. It also controls external circuits, such as the LCD controller connected to the system bus, DRAM, ROM (flash memory or masked ROM), and PCMCIA controller, and transfers data between the VR4111 and these external devices, using the address and data buses.

(2) Real-time Clock Unit (RTC)

The real-time clock (RTC) is provided with an accurate counter that operates on a 32.768-kHz clock pulse supplied from the clock generator. It is also provided with several counters and Compare registers for controlling various interrupts.

(3) Deadman's Switch Unit (DSU)

The Deadman's switch unit (DSU) is used to check whether the processor is running normally. If the register of this unit is not cleared by software within a specified period, the system is shut down.

(4) Interrupt Control Unit (ICU)

The interrupt control unit (ICU) controls interrupt requests that are caused by factors either internal or external to the VR4111, and informs the VR4110 CPU core when an interrupt request occurs.

(5) Power Management Unit (PMU)

The power management unit (PMU) outputs signals necessary to control the power of the entire system including the VR4111. The signals are used to control the PLL of the VR4110 CPU core and the internal clocks (pipeline clock, TClock, and MasterOut) in low-power modes.

(6) Direct Memory Access Address Unit (DMAAU)

The direct memory access address unit (DMAAU) controls the address of three different DMA transfers.

(7) Direct Memory Access Control Unit (DCU)

The direct memory access control unit (DCU) controls the arbitration of three different DMA transfers.

(8) Clock Mask Unit (CMU)

The clock mask unit (CMU) controls the way the clocks TClock and MasterOut are supplied from the VR4110 CPU core to internal peripheral units.

(9) General Purpose I/O Unit (GIU)

The general purpose I/O unit (GIU) controls 49 GPIO pins.

(10) Audio Interface Unit (AIU)

The audio interface unit (AIU) executes mic-input sampling and audio signal output by controlling the internal A/D converter and D/A converter.

(11) Keyboard Interface Unit (KIU)

The keyboard interface unit (KIU) has 12 scan lines and 8 detection lines. It can detect when any of 64/80/96 keys are pressed. It supports key rollover for two to three continuous strokes.

(12) Touch Panel Interface Unit (PIU)

The touch panel interface unit (PIU) detects when the touch panel is touched, by controlling the internal A/D converter.

(13) Debug Serial Interface Unit (DSIU)

The debug serial interface unit (DSIU) is a serial interface for debugging. It supports a maximum transfer rate of 115 kbps.

(14) Serial Interface Unit (SIU)

The serial interface unit (SIU) conforms to the RS-232-C specification and is compatible with NS16550. It supports a maximum transfer rate of 1.15 Mbps. Also available is an IrDA serial interface supporting a maximum transfer rate of 115 kbps, but this interface and the RS-232-C interface are mutually exclusive.

(15) Fast IrDA Interface Unit (FIR)

The FIR unit is a unit for performing 0.5- to 4-Mbps IrDA communication. This unit operates based on a dedicated 48-MHz clock input.

(16) Host Signal Processing Unit (HSP)

The HSP unit is used to realize a software modem. It interfaces the CPU core with an external codec device, and controls them.

(17) Light Emitting Diode Unit (LED)

The LED unit is used to control the lighting of external LED.

1.4.2 I/O Registers

The I/O registers are used for peripheral unit control.

Table 1-1. BCU Registers

Register symbols	Function	Address
BCUCNTREG1	BCU Control Register 1	0x0B00 0000
BCUCNTREG2	BCU Control Register 2	0x0B00 0002
BCUSPEEDREG	BCU Access Cycle Change Register	0x0B00 000A
BCUERRSTREG	BCU BUS ERROR Status Register	0x0B00 000C
BCURFCNTREG	BCU Refresh Control Register	0x0B00 000E
REVIDREG	Peripheral Unit Revision ID Register	0x0B00 0010
BCURFCOUNTREG	BCU Refresh Cycle Count Register	0x0B00 0012
CLKSPEEDREG	Clock Setting Register	0x0B00 0014
BCUCNTREG3	BCU Control Register 3	0x0B00 0016

Table 1-2. DMAAU Registers

Register symbols	Function	Address
AIUIBALREG	AIU IN DMA Base Address Register Low	0x0B00 0020
AIUIBAHREG	AIU IN DMA Base Address Register High	0x0B00 0022
AIUIALREG	AIU IN DMA Address Register Low	0x0B00 0024
AIUIAHREG	AIU IN DMA Address Register High	0x0B00 0026
AIUOBALREG	AIU OUT DMA Base Address Register Low	0x0B00 0028
AIUOBHREG	AIU OUT DMA Base Address Register High	0x0B00 002A
AIUOALREG	AIU OUT DMA Address Register Low	0x0B00 002C
AIUOAHREG	AIU OUT DMA Address Register High	0x0B00 002E
FIRBALREG	FIR DMA Base Address Register Low	0x0B00 0030
FIRBAHREG	FIR DMA Base Address Register High	0x0B00 0032
FIRALREG	FIR DMA Address Register Low	0x0B00 0034
FIRAHREG	FIR DMA Address Register High	0x0B00 0036

Table 1-3. DCU Registers

Register symbols	Function	Address
DMARSTREG	DMA Reset Register	0x0B00 0040
DMAIDLEREG	DMA Sequencer Status Register	0x0B00 0042
DMASENREG	DMA Sequencer Enable Register	0x0B00 0044
DMAMSKREG	DMA Mask Register	0x0B00 0046
DMAREQREG	DMA Request Register	0x0B00 0048
TDREG	Transfer Direction Setting Register	0x0B00 004A

Table 1-4. CMU Register

Register symbol	Function	Address
CMUCLKMSK	CMU Clock Mask Register	0x0B00 0060

Table 1-5. ICU Registers

Register symbols	Function	Address
SYSINT1REG	Level 1 System Interrupt Register 1	0x0B00 0080
PIUINTREG	Level 2 PIU Interrupt Register	0x0B00 0082
AIUINTREG	Level 2 AIU Interrupt Register	0x0B00 0084
KIUINTREG	Level 2 KIU Interrupt Register	0x0B00 0086
GIUINTLREG	Level 2 GIU Interrupt Register Low	0x0B00 0088
DSIUINTREG	Level 2 DSIU Interrupt Register	0x0B00 008A
MSYSINT1REG	Level 1 Mask System Interrupt Register 1	0x0B00 008C
MPIUINTREG	Level 2 Mask PIU Interrupt Register	0x0B00 008E
MAIUINTREG	Level 2 Mask AIU Interrupt Register	0x0B00 0090
MKIUINTREG	Level 2 Mask KIU Interrupt Register	0x0B00 0092
MGIUINTLREG	Level 2 Mask GIU Interrupt Register Low	0x0B00 0094
MDSIUINTREG	Level 2 Mask DSIU Interrupt Register	0x0B00 0096
NMIREG	Battery Interrupt Select Register	0x0B00 0098
SOFTINTREG	Software Interrupt Register	0x0B00 009A
SYSINT2REG	Level 1 System Interrupt Register 2	0x0B00 0200
GIUINTHREG	Level 2 GIU Interrupt Register High	0x0B00 0202
FIRINTREG	Level 2 FIR Interrupt Register	0x0B00 0204
MSYSINT2REG	Level 1 Mask System Interrupt Register 2	0x0B00 0206
MGIUINTHREG	Level 2 Mask GIU Interrupt Register High	0x0B00 0208
MFIRINTREG	Level 2 Mask FIR Interrupt Register	0x0B00 020A

Table 1-6. PMU Registers

Register symbols	Function	Address
PMUINTREG	PMU Interrupt/Status Register	0x0B00 00A0
PMUCNTREG	PMU Control Register	0x0B00 00A2
PMUINT2REG	PMU Interrupt Register 2	0x0B00 00A4
PMUCNT2REG	PMU Control Register 2	0x0B00 00A6
PMUWAITREG	PMU Wait Count Register	0x0B00 00A8

Table 1-7. RTC Registers

Register symbols	Function	Address
ETIMELREG	Elapsed Time L Register	0x0B00 00C0
ETIMEMREG	Elapsed Time M Register	0x0B00 00C2
ETIMEHREG	Elapsed Time H Register	0x0B00 00C4
ECMPLREG	Elapsed Compare L Register	0x0B00 00C8
ECMPMREG	Elapsed Compare M Register	0x0B00 00CA
ECMPHREG	Elapsed Compare H Register	0x0B00 00CC
RTCL1LREG	RTC Long 1 L Register	0x0B00 00D0
RTCL1HREG	RTC Long 1 H Register	0x0B00 00D2
RTCL1CNTLREG	RTC Long 1 Count L Register	0x0B00 00D4
RTCL1CNTHREG	RTC Long 1 Count H Register	0x0B00 00D6
RTCL2LREG	RTC Long 2 L Register	0x0B00 00D8
RTCL2HREG	RTC Long 2 H Register	0x0B00 00DA
RTCL2CNTLREG	RTC Long 2 Count L Register	0x0B00 00DC
RTCL2CNTHREG	RTC Long 2 Count H Register	0x0B00 00DE
TCLKLREG	TClock L Register	0x0B00 01C0
TCLKHREG	TClock H Register	0x0B00 01C2
TCLKCNTLREG	TClock Count L Register	0x0B00 01C4
TCLKCNTHREG	TClock Count H Register	0x0B00 01C6
RTCINTREG	RTC Interrupt Register	0x0B00 01DE

Table 1-8. DSU Registers

Register symbols	Function	Address
DSUCNTREG	DSU Control Register	0x0B00 00E0
DSUSETREG	DSU Cycle (Dead Time) Set Register	0x0B00 00E2
DSUCLRREG	DSU Clear Register	0x0B00 00E4
DSUTIMREG	DSU Elapsed Time Register	0x0B00 00E6

Table 1-9. GIU Registers

Register symbols	Function	Address
GIUIOSELL	GPIO Input/Output Select Register L	0x0B00 0100
GIUIOSELH	GPIO Input/Output Select Register H	0x0B00 0102
GIUIODL	GPIO Port Input/Output Data Register L	0x0B00 0104
GIUIODH	GPIO Port Input/Output Data Register H	0x0B00 0106
GIUINTSTATL	GPIO Interrupt Status Register L	0x0B00 0108
GIUINTSTATH	GPIO Interrupt Status Register H	0x0B00 010A
GIUINTENL	GPIO Interrupt Enable Register L	0x0B00 010C
GIUINTENH	GPIO Interrupt Enable Register H	0x0B00 010E
GIUINTTYPL	GPIO Interrupt Type (Edge or Level) Select Register L	0x0B00 0110
GIUINTTYPH	GPIO Interrupt Type (Edge or Level) Select Register H	0x0B00 0112
GIUINTALSELL	GPIO Interrupt Active Level Select Register L	0x0B00 0114
GIUINTALSELH	GPIO Interrupt Active Level Select Register H	0x0B00 0116
GIUINTHTSELL	GPIO Interrupt Hold/Through Select Register L	0x0B00 0118
GIUINTHTSELH	GPIO Interrupt Hold/Through Select Register H	0x0B00 011A
GIUPODATH	GPIO Port Output Data Register L	0x0B00 011C
GIUPODATH	GPIO Port Output Data Register H	0x0B00 011E
GIUUSEUPDN	GPIO Pull-up/Pull-down Enable Register	0x0B00 02E0
GIUTERMUPDN	GPIO Pull-up/Pull-down Set Register	0x0B00 02E2

Table 1-10. PIU Registers

Register symbols	Function	Address
PIUCNTREG	PIU Control Register	0x0B00 0122
PIUINTREG	PIU Interrupt Cause Register	0x0B00 0124
PIUSIVLREG	PIU Data Sampling Interval Register	0x0B00 0126
PIUSTBLREG	PIU A/D Converter Start Delay Register	0x0B00 0128
PIUCMDREG	PIU A/D Command Register	0x0B00 012A
PIUASCNREG	PIU A/D Port Scan Register	0x0B00 0130
PIUAMSKREG	PIU A/D Scan Mask Register	0x0B00 0132
PIUCIVLREG	PIU Check Interval Register	0x0B00 013E
PIUPB00REG	PIU Page 0 Buffer 0 Register	0x0B00 02A0
PIUPB01REG	PIU Page 0 Buffer 1 Register	0x0B00 02A2
PIUPB02REG	PIU Page 0 Buffer 2 Register	0x0B00 02A4
PIUPB03REG	PIU Page 0 Buffer 3 Register	0x0B00 02A6
PIUPB10REG	PIU Page 1 Buffer 0 Register	0x0B00 02A8
PIUPB11REG	PIU Page 1 Buffer 1 Register	0x0B00 02AA
PIUPB12REG	PIU Page 1 Buffer 2 Register	0x0B00 02AC
PIUPB13REG	PIU Page 1 Buffer 3 Register	0x0B00 02AE
PIUAB0REG	PIU AD Scan Buffer 0 Register	0x0B00 02B0
PIUAB1REG	PIU AD Scan Buffer 1 Register	0x0B00 02B2
PIUAB2REG	PIU AD Scan Buffer 2 Register	0x0B00 02B4
PIUAB3REG	PIU AD Scan Buffer 3 Register	0x0B00 02B6
PIUPB04REG	PIU Page 0 Buffer 4 Register	0x0B00 02BC
PIUPB14REG	PIU Page 1 Buffer 4 Register	0x0B00 02BE

Table 1-11. AIU Registers

Register symbols	Function	Address
MDMADATREG	Mike Input DMA Data Register	0x0B00 0160
SDMADATREG	Speaker Output DMA Data Register	0x0B00 0162
SODATREG	Speaker Output Data Register	0x0B00 0166
SCNTREG	Speaker Output Control Register	0x0B00 0168
SCNVRREG	Speaker Conversion Rate Register	0x0B00 016A
MIDATREG	Mike Input Data Register	0x0B00 0170
MCNTREG	Mike Input Control Register	0x0B00 0172
MCNVRREG	Mike Conversion Rate Register	0x0B00 0174
DVALIDREG	Data Valid Register	0x0B00 0178
SEQREG	Sequential Operation Enable Register	0x0B00 017A
INTREG	AIU Interrupt Register	0x0B00 017C

Table 1-12. KIU Registers

Register symbols	Function	Address
KIUDAT0	KIU Data0 Register	0x0B00 0180
KIUDAT1	KIU Data1 Register	0x0B00 0182
KIUDAT2	KIU Data2 Register	0x0B00 0184
KIUDAT3	KIU Data3 Register	0x0B00 0186
KIUDAT4	KIU Data4 Register	0x0B00 0188
KIUDAT5	KIU Data5 Register	0x0B00 018A
KIUSCANREP	KIU Scan/Repeat Register	0x0B00 0190
KIUSCANS	KIU Scan Status Register	0x0B00 0192
KIUWKS	KIU Wait Keyscan Stable Register	0x0B00 0194
KIUWKI	KIU Wait Keyscan Interval Register	0x0B00 0196
KIUINT	KIU Interrupt Register	0x0B00 0198
KIURST	KIU Reset Register	0x0B00 019A
KIUGPEN	KIU General Purpose Output Enable Register	0x0B00 019C
SCANLINE	KIU Scan Line Register	0x0B00 019E

Table 1-13. DSIU Registers

Register symbols	Function	Address
PORTREG	Port Change Register	0x0B00 01A0
MODEMREG	Modem Control Register	0x0B00 01A2
ASIM00REG	Asynchronous Mode 0 Register	0x0B00 01A4
ASIM01REG	Asynchronous Mode 1 Register	0x0B00 01A6
RXB0RREG	Receive Buffer Register (Extended)	0x0B00 01A8
RXB0LREG	Receive Buffer Register	0x0B00 01AA
TXS0RREG	Transmit Data Register (Extended)	0x0B00 01AC
TXS0LREG	Transmit Data Register	0x0B00 01AE
ASIS0REG	Status Register	0x0B00 01B0
INTR0REG	Debug SIU Interrupt Register	0x0B00 01B2
BPRM0REG	Baud-rate Generator Prescaler Mode Register	0x0B00 01B6
DSIURESETREG	Debug SIU Reset Register	0x0B00 01B8

Table 1-14. LED Registers

Register symbols	Function	Address
LEDHTSREG	LED H Time Set Register	0x0B00 0240
LEDLTSREG	LED L Time Set Register	0x0B00 0242
LEDCNTREG	LED Control Register	0x0B00 0248
LEDASTCREG	LED Auto Stop Time Count Register	0x0B00 024A
LEDINTREG	LED Interrupt Register	0x0B00 024C

Table 1-15. SIU Registers

Register symbols	Function	LCR[7]	Address
SIURB	Receiver Buffer Register (Read)	0	0x0C00 0000
SIUTH	Transmitter Holding Register (Write)		
SIUDLL	Divisor Latch (Least Significant Byte) Register	1	
SIUIE	Interrupt Enable Register	0	0x0C00 0001
SIUDLM	Divisor Latch (Most Significant Byte) Register	1	
SIUIID	Interrupt Identification Register (Read)	-	0x0C00 0002
SIUFC	FIFO Control Register (Write)		
SIULC	Line Control Register	-	0x0C00 0003
SIUMC	MODEM Control Register	-	0x0C00 0004
SIULS	Line Status Register	-	0x0C00 0005
SIUMS	MODEM Status Register	-	0x0C00 0006
SIUSC	Scratch Register	-	0x0C00 0007
SIURSEL	SIU/FIR IrDA Selector	-	0x0C00 0008
SIURESET	SIU Reset Register	-	0x0C00 0009
SIUCSEL	SIU Echo Back Control Register	-	0x0C00 000A

Remark LCR[7] is bit 7 of the SIULC register.

Table 1-16. HSP Registers

Register symbols	Function	Address
HSPINIT	HSP Initialize Register	0x0C00 0020
HSPDATA[7:0]	HSP Data Register [7:0]	0x0C00 0022
HSPDATA[15:8]	HSP Data Register [15:8]	0x0C00 0023
HSPINDEX	HSP Index Register	0x0C00 0024
HSPID[7:0]	HSP ID Register	0x0C00 0028
HSPPCS[7:0]	HSP I/O Address Program Confirmation Register	0x0C00 0029
HSPCTEL[7:0]	HSP Signature Checking Port	0x0C00 0029

Table 1-17. FIR Registers

Register symbols	Function	Address
FRSTR	FIR Reset Register	0x0C00 0040
DPINTR	DMA Page Interrupt Register	0x0C00 0042
DPCNTR	DMA Page Control Register	0x0C00 0044
TDR	Transmit Data Register	0x0C00 0050
RDR	Receive Data Register	0x0C00 0052
IMR	Interrupt Mask Register	0x0C00 0054
FSR	FIFO Setup Register	0x0C00 0056
IRSR1	IR Setup Register 1	0x0C00 0058
CRCSR	CRC Setup Register	0x0C00 005C
FIRCR	FIR Control Register	0x0C00 005E
MIRCR	MIR Control Register	0x0C00 0060
DMACR	DMA Control Register	0x0C00 0062
DMAER	DMA Enable Register	0x0C00 0064
TXIR	Transmission Indicate Register	0x0C00 0066
RXIR	Reception Indicate Register	0x0C00 0068
IFR	Interrupt Flag Register	0x0C00 006A
RXSTS	Reception Status Register	0x0C00 006C
TXFL	Transmit Frame Length Register	0x0C00 006E
MRXF	Maximum Receive Frame Length Register	0x0C00 0070
RXFL	Receive Frame Length Register	0x0C00 0074

1.5 VR4110 CPU CORE

Figure 1-2 shows the internal block diagram of the VR4110 CPU core.

In addition to the conventional high-performance integer operation units, this CPU core has the full-associative format translation look aside buffer (TLB), which has 32 entries that provide mapping to 2- page pairs (odd and even) for one entry. Moreover, it also has instruction caches, data caches, and bus interface.

Figure 1-2. VR4110 CPU Core Internal Block Diagram

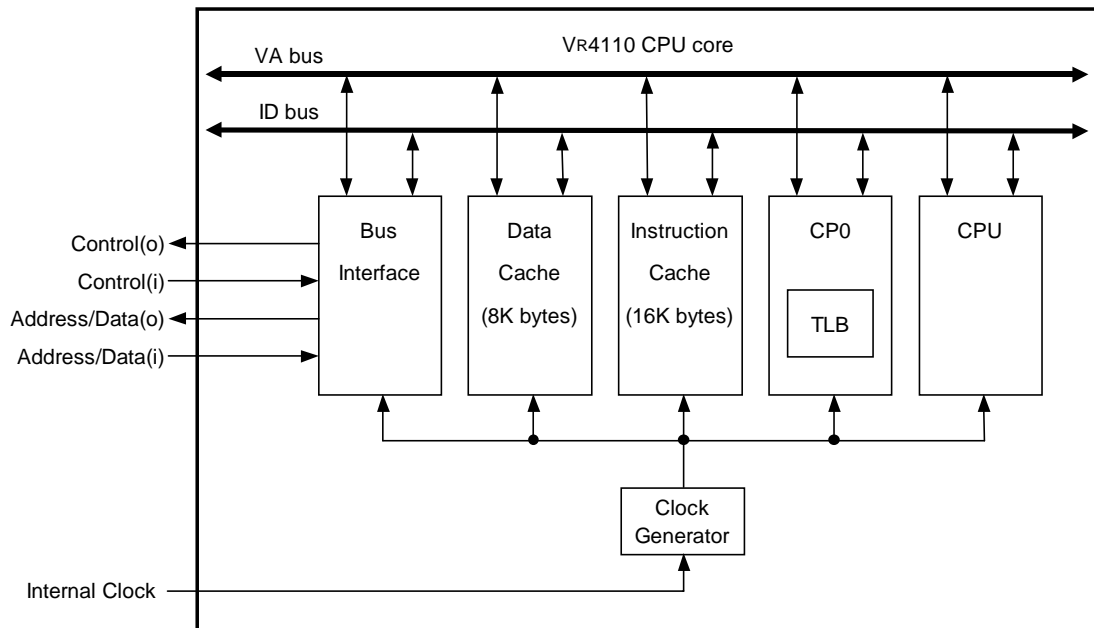

1.5.1 Internal Block Configuration

(1) CPU

CPU has hardware resources to process an integer instruction. They are the 64-bit register file, 64-bit integer data bus, and multiply-and-accumulate operation unit.

(2) Coprocessor 0 (CP0)

CP0 incorporates a memory management unit (MMU) and exception handling function. MMU checks whether there is an access between different memory segments (user, supervisor, and kernel) by executing address conversion. The translation lookaside buffer (TLB) converts virtual addresses to physical addresses.

(3) Instruction cache

The instruction cache employs direct mapping, virtual index, and physical tag. Its capacity is 16K bytes.

(4) Data cache

The data cache employs direct mapping, virtual index, physical tag, and write back. Its capacity is 8K bytes.

(5) CPU bus interface

The CPU bus interface controls data transmission/reception between the V_R4110 CPU core and the BCU, which is one of peripheral units. The V_R4110 CPU interface consists of two 32-bit multiplexed address/data buses (one is for input, and another is for output), clock signals, and control signals such as interrupts.

(6) Clock generator

The following clock inputs are oscillated and supplied to internal units.

- 32.768-kHz clock for RTC unit:
oscillating a 32.768-kHz crystal resonator input via an internal oscillator to supply to the RTC unit.
- 18.432-MHz clock for serial interface and the V_R4111's reference operating clock:
oscillating an 18.432-MHz crystal resonator input via an internal oscillator, and then multiplying it by phase-locked loop (PLL) to generate a pipeline clock (PClock). The internal bus clock (TClock) is generated from PClock and supplied to peripheral units.

1.5.2 CPU Registers

The VR4110 CPU core has thirty two 64-bit general-purpose registers (GPRs).

In addition, the processor provides the following special registers:

- ✧ 64-bit Program Counter (PC)
- ✧ 64-bit HI register, containing the integer multiply and divide upper doubleword result
- ✧ 64-bit LO register, containing the integer multiply and divide lower doubleword result

Two of the general-purpose registers have assigned the following functions:

- ✧ r0 is hardwired to a value of zero, and can be used as the target register for any instruction whose result is to be discarded. r0 can also be used as a source when a zero value is needed.
- ✧ r31 is the link register used by link instruction, such as JAL (Jump and Link) instructions. This register can be used for other instructions. However, be careful that use of the register by a link instruction will not coincide with use of the register for other operations.

The register group is provided within the CP0, to process exceptions and to manage addresses.

CPU registers can operate as either 32-bit or 64-bit registers, depending on the VR4111 processor mode of operation.

The operation of the CPU register differs depending on what instructions are executed: 32-bit instructions or MIPS16 instructions. For details, refer to **CHAPTER 4 MIPS16 INSTRUCTION SET SUMMARY**.

Figure 1-3 shows the CPU registers.

Figure 1-3. VR4111 CPU Registers

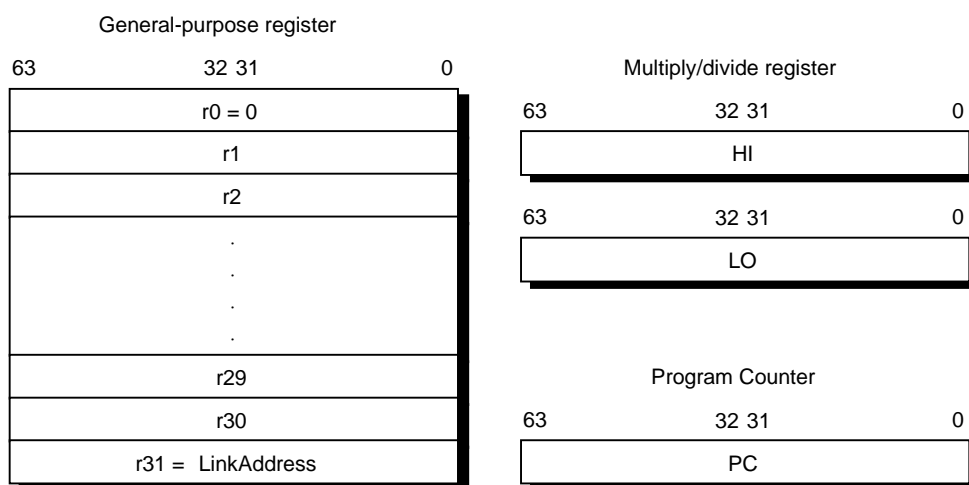

The VR4111 has no Program Status Word (PSW) register as such; this is covered by the Status and Cause registers incorporated within the System Control Coprocessor (CP0).

The CP0 registers are used for exception handling or address management. The overview of these registers is described in **1.5.5 Coprocessors (CP0)**.

1.5.3 CPU Instruction Set Overview

For CPU instructions, there are two types of instructions – 32-bit length instruction (MIPS III) and 16-bit length instruction (MIPS16).

(1) MIPS III Instruction

All the CPU instructions are 32-bit length when executing MIPS III instructions, and they are classified into three instruction formats as shown in Figure 1-4: immediate (I-type), jump (J-type), and register (R-type). The field of each instruction format is described in **CHAPTER 3 MIPS III INSTRUCTION SET SUMMARY**.

Figure 1-4. CPU Instruction Formats (32-bit length instruction)

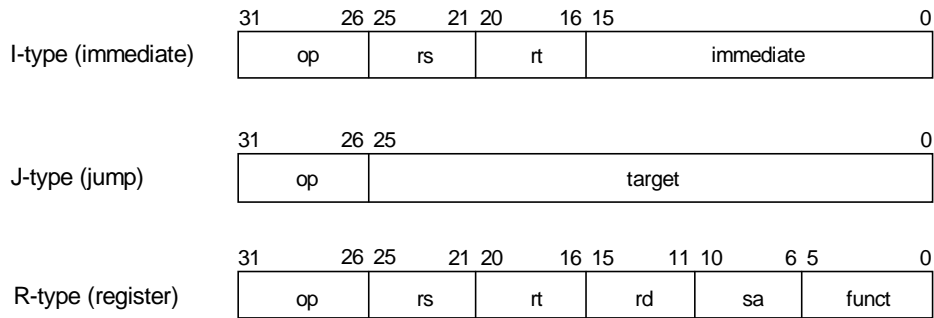

The instruction set can be further divided into the following five groupings:

- (1) Load and store instructions move data between memory and general-purpose registers. They are all immediate (I-type) instructions, since the only addressing mode supported is base register plus 16-bit, signed immediate offset.
- (2) Computational instructions perform arithmetic, logical, shift, multiply, and divide operations on values in registers. They include R-type (in which both the operands and the result are stored in registers) and I-type (in which one operand is a 16-bit signed immediate value) formats.
- (3) Jump and branch instructions change the control flow of a program. Jumps are always made to an absolute address formed by combining a 26-bit target address with the high-order bits of the Program Counter (J-type format) or register address (R-type format). The format of the branch instructions is I type. Branches have 16-bit offsets relative to the Program Counter. JAL instructions save their return address in register 31.
- (4) Coprocessor 0 (System Control Coprocessor, CP0) instructions perform operations on CP0 registers to control the memory-management and exception-handling facilities of the processor.
- (5) Special instructions perform system calls and breakpoint operations, or cause a branch to the general exception-handling vector based upon the result of a comparison. These instructions occur in both R-type (both the operands and the result are stored in registers) and I-type (one operand is a 16-bit signed immediate value) formats.

For the operation of each instruction, refer to **CHAPTER 3 MIPS III INSTRUCTION SET SUMMARY** and **CHAPTER 28 MIPS III INSTRUCTION SET DETAILS**.

(2) MIPS16 Instruction

All the CPU instructions except for JAL and JALX are 16-bit length when executing MIPS16 instructions, and they are classified into thirteen instruction formats as shown in Figure 1-5.

The field of each instruction format is described in **CHAPTER 4 MIPS 16 INSTRUCTION SET**.

Figure 1-5. CPU Instruction Formats (16-bit length instruction)

I-type	15	11 10	0		
	op		immediate		
RI-type	15	11 10	8 7	0	
	op		rx	immediate	
RR-type	15	11 10	8 7	5 4	0
	op		rx	ry	funct
RRI-type	15	11 10	8 7	5 4	0
	RRI		rx	ry	immediate
RRR-type	15	11 10	8 7	5 4	2 1 0
	RRR		rx	ry	rz F
RRIA-type	15	11 10	8 7	5 4 3	0
	RRR-A		rx	ry	F immediate
Shift-type	15	11 10	8 7	5 4	2 1 0
	SHIFT		rx	ry	Shamt F
I8-type	15	11 10	8 7	0	
	I8		funct	immediate	
I8_MOVR32-type	15	11 10	8 7	5 4	0
	I8		funct	ry	r32[4:0]
I8_MOV32R-type	15	11 10	8 7	4 3	0
	I8		funct	r32[2:0, 4:3]	rz
I64-type	15	11 10	8 7	0	
	I64		funct	immediate	
RI64-type	15	11 10	8 7	5 4	0
	I64		funct	ry	immediate
JAL, JALX-type					
	31	27 26 25	21 20	16 15	0
	JAL		X	immediate 20:16	immediate 25:21
	immediate 15:0				

The instruction set can be further divided into the following four groupings:

- (a) Load and store instructions move data between memory and general-purpose registers. They include RRI-, RI-, I8-, and RI64-types.
- (b) Computational instructions perform arithmetic, logical, shift, multiply, and divide operations on values in registers. They include RI-, RRIA-, I8-, RI64-, I64-, RR-, RRR-, I8_MOVR32-, and I8_MOV32R-types.
- (c) Jump and branch instructions change the control flow of a program. They include JAL-/JALX-, RR-, RI-, I8-, and I-types.
- (d) Special instructions are break and extend instructions. The break instruction transfers control to an exception handler. The extend instruction extends the immediate field of the next instruction. They are RR- and I-types. When extending the immediate field of the next instruction by using the extend instruction, one cycle is needed for executing the extend instruction, and another cycle is needed for executing the next instruction.

For more details of each instruction’s operation, refer to **CHAPTER 4 MIPS16 INSTRUCTION SET** and **CHAPTER 29 MIPS16 INSTRUCTION SET FORMAT**.

1.5.4 Data Formats and Addressing

The VR4111 uses following four data formats:

- ◇ Doubleword (64 bits)
- ◇ Word (32 bits)
- ◇ Halfword (16 bits)
- ◇ Byte (8 bits)

For the VR4110 CPU core, byte ordering within all of the larger data formats - halfword, word, doubleword - can be configured in either big-endian or little-endian order. **However, the VR4111 supports the little-endian order only.**

Endianness refers to the location of byte 0 within the multi-byte data structure.

When configured as a little-endian system, byte 0 is always the least-significant (rightmost) byte, which is compatible with iAPX™ and DEC VAX™ conventions. Figures 1-6 and 1-7 show this configuration.

Figure 1-6. Little-Endian Byte Ordering in Word Data

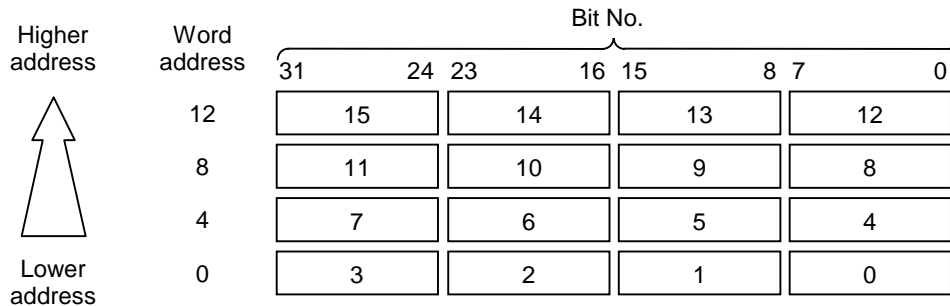

- Remarks 1.** The lowest byte is the lowest address.
- 2.** The address of word data is specified by the lowest byte’s address.

In this manual, bit 0 is always the least-significant (rightmost) bit; thus, bit designations are always little-endian. Figure 1-7 shows little-endian byte ordering in doublewords.

Figure 1-7. Little-Endian Byte Ordering in Double Word Data

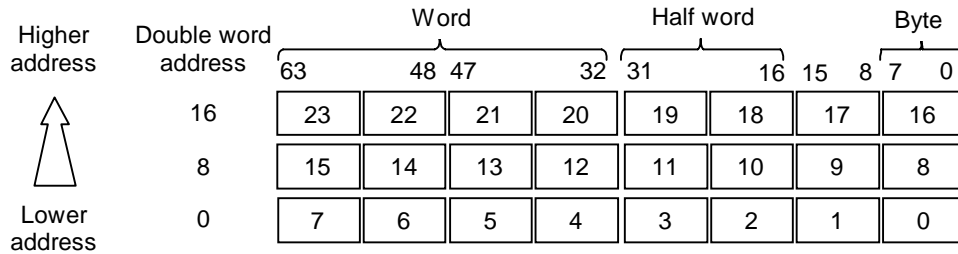

- Remarks 1.** The lowest byte is the lowest address.
2. The address of word data is specified by the lowest byte's address.

The CPU core uses the following byte boundaries for halfword, word, and doubleword accesses:

- ◇ Halfword: An even byte boundary (0, 2, 4...)
- ◇ Word: A byte boundary divisible by four (0, 4, 8...)
- ◇ Doubleword: A byte boundary divisible by eight (0, 8, 16...)

The following special instructions to load and store data that are not aligned on 4-byte (word) or 8-byte (doubleword) boundaries:

LWL	LWR	SWL	SWR
LDL	LDR	SDL	SDR

These instructions are used in pairs to provide an access to misaligned data. Accessing misaligned data incurs one additional instruction cycle over that required for accessing aligned data.

Figure 1-8 shows the access of a misaligned word that has byte address 3 for the little-endian conventions.

Figure 1-8. Misaligned Word Accessing (Little-Endian)

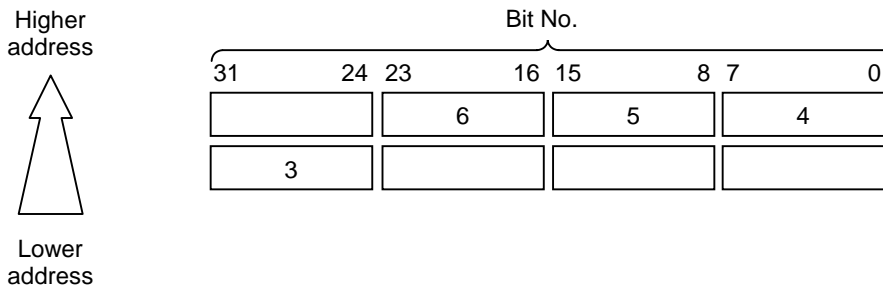

1.5.5 Coprocessors (CP0)

MIPS ISA defines 4 types of coprocessors (CP0 to CP3).

- CP0 translates virtual addresses to physical addresses, switches the operating mode (kernel, supervisor, or user mode), and manages exceptions. It also controls the cache subsystem to analyze a cause and to return from the error state.
- CP1 is reserved for floating-point instructions.
- CP2 is reserved for future definition by MIPS.
- CP3 is no longer defined. CP3 instructions are reserved for future extensions.

Figure 1-9 shows the definitions of the CP0 register, and Table 1-18 shows simple descriptions of each register. For the detailed descriptions of the registers related to the virtual system memory, refer to Chapter 6. For the detailed descriptions of the registers related to exception handling, refer to Chapter 7.

Figure 1-9. CP0 Registers

Register No.	Register name	Register No.	Register name
0	Index*	16	Config*
1	Random*	17	LLAddr*
2	EntryLo0*	18	WatchLo**
3	EntryLo1*	19	WatchHi**
4	Context**	20	XContext**
5	PageMask*	21	–
6	Wired*	22	–
7	–	23	–
8	BadVAddr**	24	–
9	Count**	25	–
10	EntryHi*	26	PErr**
11	Compare**	27	CacheErr**
12	Status**	28	TagLo*
13	Cause**	29	TagHi*
14	EPC**	30	ErrorEPC**
15	PRId*	31	–

* for Memory management

** for Exception handling

- Reserved

Table 1-18. System Control Coprocessor (CP0) Register Definitions

Number	Register	Description
0	Index	Programmable pointer to TLB array
1	Random	Pseudo-random pointer to TLB array (read only)
2	EntryLo0	Low half of TLB entry for even VPN
3	EntryLo1	Low half of TLB entry for odd VPN
4	Context	Pointer to kernel virtual PTE in 32-bit mode
5	PageMask	TLB page mask
6	Wired	Number of wired TLB entries
7	—	Reserved for future use
8	BadVAddr	Virtual address where the most recent error occurred
9	Count	Timer count
10	EntryHi	High half of TLB entry (including ASID)
11	Compare	Timer compare
12	Status	Status register
13	Cause	Cause of last exception
14	EPC	Exception Program Counter
15	PRId	Processor revision identifier
16	Config	Configuration register (specifying memory mode system)
17	LLAddr	Reserved for future use
18	WatchLo	Memory reference trap address low bits
19	WatchHi	Memory reference trap address high bits
20	XContext	Pointer to kernel virtual PTE in 64-bit mode
21 to 25	—	Reserved for future use
26	PErr ^{Note}	Cache parity bits
27	CacheErr ^{Note}	Index and status of cache error
28	TagLo	Cache Tag register (low)
29	TagHi	Cache Tag register (high)
30	ErrorEPC	Error Exception Program Counter
31	—	Reserved for future use

Note This register is defined to maintain compatibility with the VR4100™. This register is not used in the VR4111 hardware.

1.5.6 Floating-Point Unit (FPU)

The VR4111 does not support the floating-point unit (FPU). Coprocessor Unusable exception will occur if any FPU instructions are executed. If necessary, FPU instructions should be emulated by software in an exception handler.

1.6 CPU CORE MEMORY MANAGEMENT SYSTEM (MMU)

The Vr4111 has a 32-bit physical addressing range of 4 Gbytes. However, since it is rare for systems to implement a physical memory space as large as that memory space, the CPU provides a logical expansion of memory space by translating addresses composed in the large virtual address space into available physical memory addresses. The Vr4111 supports the following two addressing modes:

- ◇ 32-bit mode, in which the virtual address space is divided into 2 Gbytes for user process and 2 Gbytes for the kernel.
- ◇ 64-bit mode, in which the virtual address is expanded to 1 Tbyte (2^{40} bytes) of user virtual address space.

A detailed description of these address spaces is given in Chapter 6.

1.6.1 Translation Lookaside Buffer (TLB)

Virtual memory mapping is performed using the translation lookaside buffer (TLB). The TLB converts virtual addresses to physical addresses. It runs by a full-associative method. It has 32 entries, each mapping a pair of pages having a variable size (1 KB to 256 KB).

(1) Joint TLB (JTLB)

JTLB holds both an instruction address and data address.

For fast virtual-to-physical address decoding, the Vr4111 uses a large, fully associative TLB (joint TLB) that translates 64 virtual pages to their corresponding physical addresses. The TLB is organized as 32 pairs of even-odd entries, and maps a virtual address and address space identifier (ASID) into the 4-Gbyte physical address space.

The page size can be configured, on a per-entry basis, to map a page size of 1 KB to 256 KB. A CP0 register stores the size of the page to be mapped, and that size is entered into the TLB when a new entry is written. Thus, operating systems can provide special purpose maps; for example, a typical frame buffer can be memory-mapped using only one TLB entry.

Translating a virtual address to a physical address begins by comparing the virtual address from the processor with the physical addresses in the TLB; there is a match when the virtual page number (VPN) of the address is the same as the VPN field of the entry, and either the Global (G) bit of the TLB entry is set, or the ASID field of the virtual address is the same as the ASID field of the TLB entry.

This match is referred to as a TLB hit. If there is no match, a TLB Miss exception is taken by the processor and software is allowed to refill the TLB from a page table of virtual/physical addresses in memory.

1.6.2 Operating Modes

The Vr4111 has three operating modes:

- ◇ User mode
- ◇ Supervisor mode
- ◇ Kernel mode

The manner in which memory addresses are translated or mapped depends on these operating modes. Refer to **CHAPTER 6 MEMORY MANAGEMENT SYSTEM** for details.

1.6.3 Cache

The VR4111 chip incorporates instruction and data caches, which are independent of each other. This configuration enables high-performance pipeline operations. Both caches have a 64-bit data bus, enabling a one-clock access. These buses can be accessed in parallel. The instruction cache of the VR4111 has a storage capacity of 4 KB, while the data cache has a capacity of 1 KB.

A detailed description of caches is given in **CHAPTER 9 CACHE ORGANIZATION AND OPERATION**.

1.7 INSTRUCTION PIPELINE

The VR4111 has a 5-stage instruction pipeline. Under normal circumstances, one instruction is issued each cycle.

A detailed description of pipeline is provided in Chapter 5.

1.8 CLOCK INTERFACE

The VR4111 has the following nine clocks.

✧ **CLKX1, CLKX2 (input)**

These are oscillation inputs of 18.432 MHz, and used to generate operation clocks for the CPU core, serial interface, and touch panel interface.

✧ **RTCX1, RTCX2 (input)**

These are oscillation inputs of 32.768 kHz, and used for PMU and RTC.

✧ **FIRCLK (input)**

This is a 48-MHz clock input, and used for FIR.

✧ **PClock (internal)**

This clock is used to control the pipeline used in the VR4110 CPU core, and for units relating to the pipeline. This clock is generated from the clock input of CLKX1 and CLKX2 pins. Its frequency is determined by CLKSEL[2..0] pins.

✧ **MasterOut (internal)**

- ★ This is a bus clock of the VR4110 CPU core, and used for interrupt control. The contents of the CP0's count register are incremented synchronously with this clock. Its frequency is 1/8, 1/12, or 1/16 of PClock frequency, and is determined by the CLKSEL[2..0] pins.

✧ **TClock (internal)**

This is an operation clock for VR4110 CPU core bus, internal bus of the VR4111, and on-chip peripheral unit. Its frequency is 1/2, 1/3, or 1/4 of the PClock frequency, and is determined by the CLKSEL[2..0] pins.

✧ **BUSCLK (output)**

This clock is supplied to the controller on the system bus. Its frequency is determined by CLKSEL[2..0] pins.

✧ **HSPMCLK (output)**

This clock is supplied to the external CODEC. Its frequency is determined by the HSPMCLKD register.

✧ **HSPSCLK (input)**

This is an operation clock for the external CODEC and the modem interface.

★

Table 1-19. Relationships Between CLKSEL Pin Settings and Clock Frequencies

CLKSEL[2:0]	PClock	TClock	MasterOut	BUSCLK
111	98.1 MHz	24.5 MHz	6.13 MHz	6.13 MHz
110	90.5 MHz	22.7 MHz	5.67 MHz	5.67 MHz
101	84.1 MHz	28.0 MHz	7.01 MHz	7.01 MHz
100	78.5 MHz	26.2 MHz	6.54 MHz	6.54 MHz
011	69.3 MHz	23.1 MHz	5.77 MHz	5.77 MHz
010	65.4 MHz	21.8 MHz	5.45 MHz	5.45 MHz
001	62.0 MHz	20.7 MHz	5.17 MHz	5.17 MHz
000	49.1 MHz	24.5 MHz	6.13 MHz	6.13 MHz

Figure 1-10 shows an external circuit of the clock oscillator.

Figure 1-10. External Circuit of Clock Oscillator

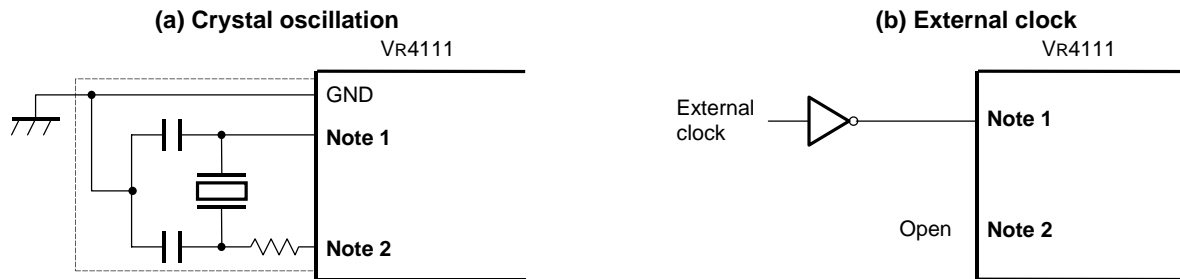

- Notes**
1. CLKX1, RTCX1
 2. CLKX2, RTCX2

Cautions

1. When using a clock oscillator, run wires in the area of this figure shown by broken lines, according to the following rules, to avoid effects such as stray capacitance:

- Minimize the wire.
- Never cause the wires to cross other signal lines or run near a line carrying a large varying current.
- Cause the grounding point of the capacitor of the oscillator circuit to have the same potential as GND. Never connect the capacitor to a ground pattern carrying a large current.
- Never extract a signal from the oscillator.

2. Take it into consideration that no load such as wiring capacity is applied to the CLKX2 or RTCX2 pin when inputting an external clock.

Figure 1-11 shows examples of oscillator having bad connection.

Figure 1-11. Examples of Oscillator with Bad Connection

(a) Connection circuit wiring is too long.

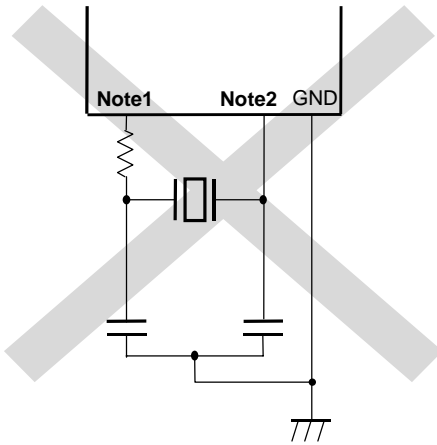

(b) There is another signal line crossing.

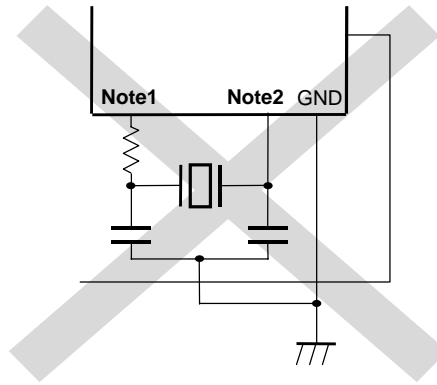

(c) A high varying current flows near a signal line.

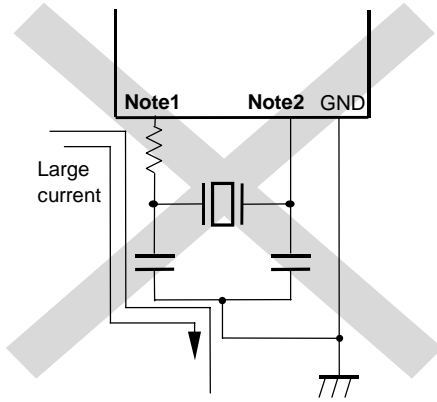

(d) A current flows over the ground line of the generator circuit (The potentials of points A, B, and C change).

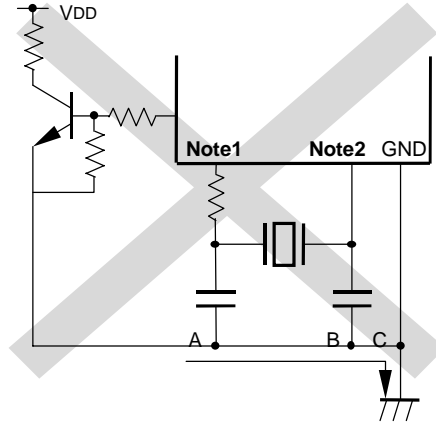

(e) A signal is extracted.

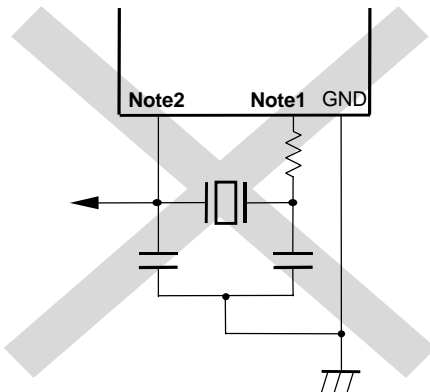

- Notes 1. CLKX2, RTCX2
2. CLKX1, RTCX1

CHAPTER 2 PIN FUNCTIONS

2.1 PIN CONFIGURATION

- ★ • 224-pin fine-pitch GBA (16 × 16 mm)

μPD30111S1-80-3C

μPD30111S1-100-3C

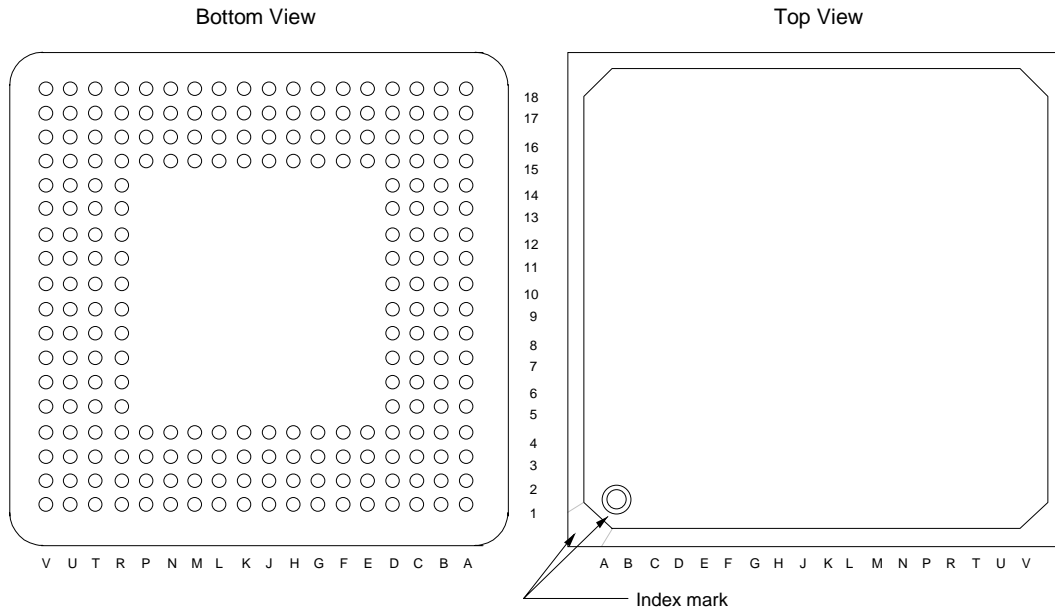

CHAPTER 2 PIN FUNCTIONS

Pin No.	Power System	Pin Name	Pin No.	Power System	Pin Name	Pin No.	Power System	Pin Name
A1	3.3 V	V _{DD3}	C15	3.3 V	RTS#/CLKSEL1	H15	3.3 V	GND3
A2	3.3 V	SHB#	C16	3.3 V	GND3	H16	3.3 V	KPORT6
A3	3.3 V	BUSCLK	C17	3.3 V	ILCSENSE	H17	3.3 V	KPORT4
A4	3.3 V	HLDACK#	C18	3.3 V	AFERST#	H18	2.5 V	V _{DD2}
A5	3.3 V	IOCHRDY	D1	3.3 V	DATA5	J1	3.3 V	DATA20/GPIO20
A6	3.3 V	MEMW#	D2	3.3 V	DATA3	J2	3.3 V	DATA17/GPIO17
A7	3.3 V	ADD23	D3	3.3 V	DATA6	J3	3.3 V	DATA22/GPIO22
A8	3.3 V	V _{DD3}	D4	3.3 V	GND3	J4	3.3 V	DATA19/GPIO19
A9	3.3 V	ADD18	D5	3.3 V	MEMCS16#	J15	3.3 V	KSCAN9/GPIO41
A10	3.3 V	ADD15	D6	3.3 V	ADD25	J16	3.3 V	V _{DD3}
A11	3.3 V	ADD8	D7	3.3 V	GND3	J17	2.5 V	GND2
A12	3.3 V	ADD7	D8	3.3 V	ADD19	J18	3.3 V	KSCAN11/GPIO43
A13	2.5 V	V _{DD2}	D9	3.3 V	ADD16	K1	3.3 V	DATA23/GPIO23
A14	3.3 V	DCD#/GPIO15	D10	3.3 V	ADD14	K2	3.3 V	DATA26/GPIO26
A15	3.3 V	TxD/CLKSEL2	D11	3.3 V	V _{DD3}	K3	3.3 V	DATA25/GPIO25
A16	3.3 V	IRDOUT#	D12	3.3 V	GND3	K4	3.3 V	DATA21/GPIO21
A17	3.3 V	IRING	D13	3.3 V	ADD4	K15	3.3 V	KSCAN7/GPIO39
A18	3.3 V	V _{DD3}	D14	3.3 V	CTS#	K16	3.3 V	KSCAN10/GPIO42
B1	3.3 V	DATA1	D15	3.3 V	GND3	K17	3.3 V	KSCAN5/GPIO37
B2	3.3 V	IOR#	D16	3.3 V	GND3	K18	3.3 V	KSCAN8/GPIO40
B3	3.3 V	IOW#	D17	3.3 V	SDI	L1	3.3 V	DATA27/GPIO27
B4	3.3 V	LEDOUT#	D18	3.3 V	SDO	L2	3.3 V	DATA31/GPIO31
B5	3.3 V	FIRCLK	E1	3.3 V	DATA9	L3	3.3 V	DATA29/GPIO29
B6	3.3 V	HLDRQ#	E2	3.3 V	DATA4	L4	3.3 V	DATA24/GPIO24
B7	3.3 V	ZWS#	E3	3.3 V	DATA7	L15	3.3 V	KSCAN3/GPIO35
B8	3.3 V	ADD24	E4	3.3 V	DATA10	L16	3.3 V	KSCAN6/GPIO38
B9	3.3 V	ADD21	E15	3.3 V	OPD#	L17	3.3 V	KSCAN0/GPIO32
B10	3.3 V	ADD12	E16	3.3 V	HSPSCLK	L18	3.3 V	KSCAN4/GPIO36
B11	3.3 V	ADD6	E17	3.3 V	FS	M1	3.3 V	DATA30/GPIO30
B12	2.5 V	GND2	E18	3.3 V	HC0	M2	3.3 V	V _{DD3}
B13	3.3 V	DSR#	F1	3.3 V	DATA13	M3	3.3 V	GND3
B14	3.3 V	IRDIN	F2	3.3 V	DATA8	M4	3.3 V	DATA28/GPIO28
B15	3.3 V	FIRDIN#/SEL	F3	3.3 V	DATA11	M15	3.3 V	KSCAN2/GPIO34
B16	3.3 V	BATTINH/BATTINT#	F4	3.3 V	DATA14	M16	3.3 V	MIPS16EN
B17	3.3 V	OFFHOOK	F15	3.3 V	KPORT3	M17	3.3 V	GND3
B18	3.3 V	MUTE	F16	3.3 V	HSPMCLK	M18	3.3 V	KSCAN1/GPIO33
C1	3.3 V	DATA2	F17	3.3 V	TELCON	N1	2.5 V	V _{DD2}
C2	3.3 V	DATA0	F18	3.3 V	KPORT1	N2	3.3 V	ADD3
C3	3.3 V	GND3	G1	2.5 V	V _{DD2}	N3	3.3 V	ADD10
C4	3.3 V	GND3	G2	3.3 V	DATA12	N4	3.3 V	GND2
C5	3.3 V	GND3	G3	3.3 V	DATA15	N15	3.3 V	GND3
C6	3.3 V	IOCS16#	G4	3.3 V	GND3	N16	3.3 V	V _{DD3}
C7	3.3 V	MEMR#	G15	3.3 V	KPORT7	N17	2.5 V	V _{DDP}
C8	3.3 V	ADD22	G16	3.3 V	KPORT2	N18	3.3 V	GND3
C9	3.3 V	ADD20	G17	3.3 V	KPORT0	P1	3.3 V	ADD9
C10	3.3 V	ADD17	G18	3.3 V	KPORT5	P2	3.3 V	ADD0
C11	3.3 V	ADD13	H1	3.3 V	DATA16/GPIO16	P3	3.3 V	ADD2
C12	3.3 V	ADD5	H2	2.5 V	GND2	P4	3.3 V	ADD11
C13	3.3 V	RxD	H3	3.3 V	DATA18/GPIO18	P15	2.5 V	V _{DD2} (V _{DDPD})
C14	3.3 V	DTR#/CLKSEL0	H4	3.3 V	V _{DD3}	P16	2.5 V	GNDP

CHAPTER 2 PIN FUNCTIONS

Pin No.	Power System	Pin Name	Pin No.	Power System	Pin Name	Pin No.	Power System	Pin Name
P17	3.3 V	CLKX2	T6	3.3 V	AVDD	U13	3.3 V	GPIO9
P18	2.5 V	GND2 (GNDPD)	T7	3.3 V	LCAS#	U14	3.3 V	GPIO6
R1	3.3 V	ADD1	T8	3.3 V	ROMCS2#	U15	3.3 V	GPIO5
R2	3.3 V	POWER	T9	3.3 V	RD#	U16	3.3 V	GPIO1
R3	3.3 V	GND3	T10	3.3 V	WR#	U17	3.3 V	GPIO2
R4	3.3 V	GND3	T11	3.3 V	DBUS32/GPIO48	U18	3.3 V	CGND
R5	3.3 V	AUDIOIN	T12	3.3 V	DDOUT/GPIO44	V1	3.3 V	VDD3
R6	3.3 V	DVDD	T13	3.3 V	GPIO11	V2	3.3 V	PIUGND
R7	3.3 V	MRAS2#/ULCAS#	T14	3.3 V	GPIO8	V3	3.3 V	TPX0
R8	3.3 V	MRAS1#	T15	3.3 V	GND3	V4	3.3 V	TPY1
R9	3.3 V	ROMCS1#	T16	3.3 V	GND3	V5	3.3 V	ADIN2
R10	3.3 V	RSTOUT	T17	3.3 V	GPIO0	V6	3.3 V	AUDIOOUT
R11	3.3 V	GND3	T18	3.3 V	RTCX1	V7	3.3 V	MRAS3#/UUCAS#
R12	3.3 V	GPIO49	U1	3.3 V	MPOWER	V8	3.3 V	MRAS0#
R13	3.3 V	DDIN/GPIO45	U2	3.3 V	RTCRST#	V9	3.3 V	ROMCS0#
R14	3.3 V	GPIO12	U3	3.3 V	AGND	V10	3.3 V	VDD3
R15	3.3 V	GND	U4	3.3 V	TPX1	V11	3.3 V	LCDCS#
R16	3.3 V	CVDD	U5	3.3 V	TPY0	V12	3.3 V	DCTS#/GPIO47
R17	3.3 V	RTCX2	U6	3.3 V	ADIN1	V13	3.3 V	GPIO14
R18	3.3 V	CLKX1	U7	3.3 V	DGND	V14	3.3 V	GPIO10
T1	3.3 V	POWERON	U8	3.3 V	UCAS#	V15	3.3 V	GPIO7
T2	3.3 V	RSTSW#	U9	3.3 V	ROMCS3#	V16	3.3 V	GPIO4
T3	3.3 V	GND3	U10	3.3 V	LDCRDY	V17	3.3 V	GPIO3
T4	3.3 V	PIUVDD	U11	3.3 V	DRTS#/GPIO46	V18	3.3 V	VDD3
T5	3.3 V	ADIN0	U12	3.3 V	GPIO13			

PIN IDENTIFICATION

ADD [0:25]	: Address Bus	IRDOUT#	: IrDA Data Output
ADIN [0:2]	: General Purpose Input for A/D	IRING	: Input Ring
AFERST#	: AFE Reset	KPORT [0:7]	: Key Code Data Input
AGND	: GND for A/D	KSCAN [0:11]	: Key Scan Line
AUDIOIN	: Audio Input	LCAS#	: Lower Column Address Strobe
AUDIOOUT	: Audio Output	LCDCS#	: LCD Chip Select
AVDD	: VDD for A/D	LCDRDY	: LCD Ready
BATTINH	: Battery Inhibit	LEDOUT#	: LED Output
BATTINT	: Battery Interrupt Request	MEMCS16#	: Memory Chip Select 16
BUSCLK	: System Bus Clock	MEMR#	: Memory Read
CGND	: GND for Oscillator	MEMW#	: Memory Write
CLKSEL [0:2]	: Clock Select	MIPS16EN	: MIPS16 Enable
CLKX1	: Clock X1	MPOWER	: Main Power
CLKX2	: Clock X2	MRAS [0:3]#	: DRAM Row Address Strobe
CTS#	: Clear to Send	MUTE	: Mute
CVDD	: VDD for Oscillator	OFFHOOK	: Off Hook
DATA [0:31]	: Data Bus	OPD#	: Output Power Down
DBUS32	: Data Bus 32	PIUGND	: GND for Touch Panel Interface
DCD#	: Data Carrier Detect	PIUVDD	: VDD for Touch Panel Interface
DCTS#	: Debug Serial Clear to Send	POWER	: Power Switch
DDIN	: Debug Serial Data Input	POWERON	: Power On State
DDOUT	: Debug Serial Data Output	RD#	: Read
DGND	: GND for D/A	ROMCS [0:3]#	: ROM Chip Select
DRTS#	: Debug Serial Request to Send	RSTOUT	: System Bus Reset Output
DSR#	: Data Set Ready	RSTSW#	: Reset Switch
DTR#	: Data Terminal Ready	RTCST#	: Real-time Clock Reset
DVDD	: VDD for D/A	RTCX1	: Real-time Clock X1
FIRCLK	: FIR Clock	RTCX2	: Real-time Clock X2
FIRDIN#	: FIR Data Input	RTS#	: Request to Send
FS	: Frame Synchronization	RxD	: Receive Data
GND2, GND3	: Ground	SDI	: HSP Serial Data Input
GNDP, GNDPD	: Ground for PLL	SDO	: HSP Serial Data Output
GPIO [0:49]	: General Purpose I/O	SEL	: IrDA Module Select
HC0	: Hardware Control 0	SHB#	: System Hi-Byte Enable
HLDACK#	: Hold Acknowledge	TELCON	: Telephone Control
HLDRQ#	: Hold Request	TPX [0:1]	: Touch Panel X I/O
HSPMCLK	: HSP Codec Master Clock	TPY [0:1]	: Touch Panel Y I/O
HSPSCLK	: HSP Codec Serial Clock	TxD	: Transmit Data
ILCSENSE	: Input Loop Current Sensing	UCAS#	: Upper Column Address Strobe
IOCHRDY	: I/O Channel Ready	ULCAS#	: Lower Byte of Upper Column Address Strobe
IOCS16#	: I/O Chip Select 16	UUCAS#	: Upper Byte of Upper Column Address Strobe
IOR#	: I/O Read	VDD2, VDD3	: Power Supply Voltage
IOW#	: I/O Write	VDDP, VDDPD	: VDD for PLL
IRDIN	: IrDA Data Input	WR#	: Write
		ZWS#	: Zero Wait State

Remark # indicates active low.

2.2 PIN FUNCTION DESCRIPTION

The functional classification of the VR4111 pins is listed below.

Remark # indicates active low.

Figure 2-1. VR4111 Signal Classification

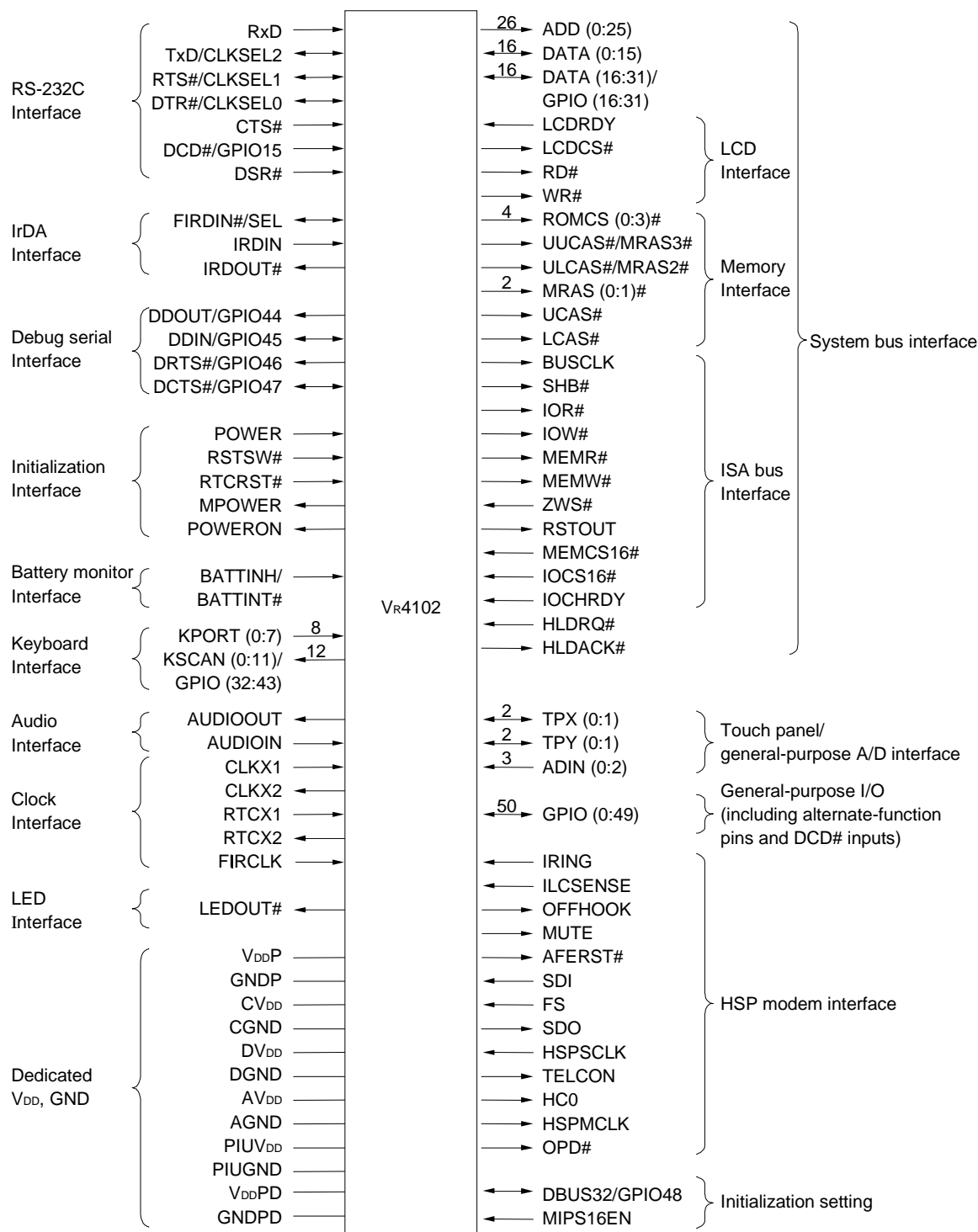

2.2.1 System Bus Interface Signals

These signals are used when the VR4111 is connected to a DRAM, ROM, or LCD, or other devices in the system through the system bus.

Table 2-1. System Bus Interface Signals (1/2)

Signal	I/O	Description of function
ADD[25..0]	O	This is a 26-bit address bus. The VR4111 uses this to specify addresses for the DRAM, ROM, LCD, or system bus (ISA).
DATA[15..0]	I/O	This is a 16-bit data bus. The VR4111 uses this to transmit and receive data with a DRAM, ROM, LCD, or system bus.
DATA[31..16]/ GPIO[31..16]	I/O	This function differs depending on how the DBUS32 pin is set. <When DBUS32 = 1> : DATA[31..16] It is the high-order 16 bits of the 32-bit data bus. This bus is used for transmitting and receiving data between the VR4111 and the DRAM and ROM. <When DBUS32 = 0> : GPIO[31..16] It is a general-purpose I/O (GPIO) port.
LDCS#	O	This is the LCD chip select signal. This signal is active when the VR4111 is performing LCD access using the ADD/DATA bus.
RD#	O	This is active when the VR4111 is reading data from the LCD, RAM, or ROM.
WR#	O	This is active when the VR4111 is writing data to the LCD, RAM, or ROM.
LCDRDY	I	This is the LCD ready signal. Set this signal as active when the LCD controller is ready to receive access from the VR4111.
ROMCS[3..2]#	O	The function differs with the setting of the DBUS32 pin. <When DBUS32 = 1> This becomes the chip select signal for the extended ROM or DRAM. <When DBUS32 = 0> This is the ROM chip select signal.
ROMCS[1..0]#	O	This is the ROM chip select signal.
UUCAS#/ MRAS[3]#	O	This function differs depending on how the DBUS32 pin is set. <When DBUS32 = 1> : UUCAS# This signal is active when a valid column address is output via the ADD bus during access of DATA[31:24] in the 32-bit data bus. When the access bus size to the LCD is 32 bits, this also becomes active when a valid address is output to the ADD bus while accessing DATA[31:24]. <When DBUS32 = 0> : MRAS[3]# This is the DRAM's RAS signal. Up to four DRAM units can be connected, and this signal is active when a valid row address is output via the ADD bus for the DRAM connected to the high-order address.
ULCAS#/ MRAS[2]#	O	This function differs depending on how the DBUS32 pin is set. <When DBUS32 = 1> ULCAS# This signal is active when a valid column address is output via the ADD bus during access of DATA[23:16] in the 32-bit data bus. When the access bus size to the LCD is 32 bits, this also becomes active when a valid address is output to the ADD bus while accessing DATA[23:16]. <When DBUS32 = 0> MRAS[2]# This is the DRAM's RAS signal. This signal is active when a valid row address is output via the ADD bus for the DRAM connected to the next-highest address after the highest high-order address.

Table 2-1. System Bus Interface Signals (2/2)

Signal	I/O	Description of function
MRAS[1..0]#	O	This is the DRAM's RAS signal.
UCAS#	O	This is the DRAM's CAS signal. This signal is active when a valid column address is output via the ADD bus during access of DATA[15:8] in the DRAM. When the access bus size to the LCD is 32 bits, this also becomes active when a valid address is output to the ADD bus while accessing DATA[15:8].
LCAS#	O	This is the DRAM's CAS signal. This signal is active when a valid column address is output via the ADD bus during access of DATA[7:0] in the DRAM. When the access bus size to the LCD is 32 bits, this also becomes active when a valid address is output to the ADD bus while accessing DATA[7:0].
BUSCLK	O	This is the system bus clock. It is used to output the clock that is supplied to the controller on the system bus. Its frequency is determined by the state of the CLKSEL2/TxD, CLKSEL1/RTS#, and CLKSEL0/DTR# pins. (See 2.2.5 RS-232C Interface Signals.)
SHB#	O	This is the system bus high-byte enable signal. During system bus access, this signal is active when the high-order byte is valid on the data bus.
IOR#	O	This is the system bus I/O read signal. It is active when the Vr4111 accesses the system bus to read data from an I/O port.
IOW#	O	This is the system bus I/O write signal. It is active when the Vr4111 accesses the system bus to write data to an I/O port.
MEMR#	O	This is the system bus memory read signal. It is active when the Vr4111 accesses the system bus to read data from memory.
MEMW#	O	This is the system bus memory write signal. It is active when the Vr4111 accesses the system bus to write data to memory.
ZWS#	I	This is the system bus zero wait state signal. Set this signal as active to enable the controller on the system bus to be accessed by the Vr4111 without a wait interval.
RSTOUT	O	This is the system bus reset signal. It is active when the Vr4111 resets the system bus controller.
MEMCS16#	I	This is a dynamic bus sizing request signal. Set this signal as active when system bus memory accesses data in 16-bit width.
IOCS16#	I	This is a dynamic bus sizing request signal. Set this signal as active when system bus I/O accesses data in 16-bit width.
IOCHRDY	I	This is the system bus ready signal. Set this signal as active when the system bus controller is ready to be accessed by the Vr4111.
HLDRQ#	I	This is a hold request signal for the system bus and DRAM bus that is sent from an external bus master.
HLDAK#	O	This is a hold acknowledge signal for the system bus and DRAM bus that is sent to an external bus master.

2.2.2 Clock Interface Signals

These signals are used to supply clocks. Table 2-2 lists functions of these signals.

Table 2-2. Clock Interface Signals

Signal	I/O	Description of function
RTCX1	I	This is the 32.768-kHz oscillator's input pin. It is connected to one side of a crystal resonator.
RTCX2	O	This is the 32.768-kHz oscillator's output pin. It is connected to one side of a crystal resonator.
CLKX1	I	This is the 18.432-MHz oscillator's input pin. It is connected to one side of a crystal resonator.
CLKX2	O	This is the 18.432-MHz oscillator's output pin. It is connected to one side of a crystal resonator.
FIRCLK	I	This is the 48-MHz clock input pin. Fix this at high level when FIR is not used.

The operating frequency of CPUCORE can be set by the CLKSEL2/TxD, CLKSEL1/RTS#, and CLKSEL0/DTR# signals.

For details of these signals, refer to **2.2.5 RS-232C Interface Signals**.

2.2.3 Battery Monitor Interface Signals

These signals indicate when an external agent is able to provide enough power for system operations. Table 2-3 describes the functions of these signals.

Table 2-3. Battery Monitor Interface Signals

Signal	I/O	Description of function
BATTINH/ BATTINT#	I	This function differs depending on how the MPOWER pin is set. <When MPOWER = 0> BATTINH function This signal enables/prohibits activation due to power-on. 1 : Enable activation (power-on) 0 : Prohibit activation (power on) <When MPOWER = 1> BATTINT# function This is an interrupt signal that is output when remaining power is low during normal operations. The external agent checks the remaining battery power. Activate the signal at this pin if voltage sufficient for operations cannot be supplied.

2.2.4 Initialization Interface Signals

These signals are used when an external agent initializes the processor operation parameters. Table 2-4 describes the functions of these signals.

Table 2-4. Initialization Interface Signals

Signal	I/O	Description of function
★ MPOWER	O	This signal indicates the VR4111 is operating. This signal is inactive during Hibernate mode.
POWERON	O	This signal indicates the VR4111 is ready to operate. It becomes active when a power-on factor is detected and becomes inactive when the BATTINH/BATTINT# signal check operation is completed.
POWER	I	This signal indicates that the POWER ON switch has been pressed.
RSTSW#	I	This signal indicates that the RESET switch has been pressed.
RTCST#	I	This signal resets RTC. When power is first supplied to a device, the external agent must assert the signal at this pin for about 600 ms.

2.2.5 RS-232C Interface Signals

These signals control data transmission and reception between the VR4111 and an RS-232C controller. Table 2-5 describes the functions of these signals.

Table 2-5. RS-232C Interface Signals

Signal	I/O	Description of function																																													
RxD	I	This is a receive data signal. It is used when the RS-232C controller sends serial data to the VR4111.																																													
CTS#	I	This is the transmit enable (“clear-to-send”) signal. This signal is asserted when the RS-232C controller is ready to receive transmission of serial data.																																													
DCD#/ GPIO[15]	I	This is a carrier detection signal. This signal is asserted when valid serial data is being received. It is also used when detecting a power-on factor for the VR4111. When this pin is not used for DCD# signal, this pin can be used as an interrupt detection function for the GIU unit.																																													
DSR#	I	This is the data set ready signal. Assert this signal to set up transmission and reception of serial data between the RS-232C controller and the VR4111.																																													
TxD/ CLKSEL[2], RTS#/ CLKSEL[1], DTR#/ CLKSEL[0]	I/O	<p>This function differs depending on the operating status.</p> <ul style="list-style-type: none"> During normal operation (output) <p>Signals used for serial communication</p> <p>TxD signal (output): This is a transmit data signal. It is used when the VR4111 sends serial data to the RS-232C controller.</p> <p>RTS# signal (output): This is a transmit request signal. This signal is asserted when the VR4111 is ready to receive serial data from the RS-232C controller.</p> <p>DTR# signal (output): This is a terminal equipment ready signal. This signal is asserted when the VR4111 is ready to transmit or receive serial data.</p> When RTC reset (input) <p>Signals (CLKSEL[2:0]) used to set the CPU core operation frequency, BUSCLK frequency, and internal bus clock frequency. These signals are sampled when the RTCRST# signal changes from low level to high level.</p> <p>The relationships between the CLK pin setting and each clock frequency are shown below.</p> <table border="1"> <thead> <tr> <th>CLKSEL[2:0]</th> <th>CPU core operation frequency</th> <th>BUSCLK output frequency</th> <th>Internal bus clock frequency</th> <th>Interrupt control clock frequency</th> </tr> </thead> <tbody> <tr> <td>111</td> <td>98.1 MHz</td> <td>6.13 MHz</td> <td>24.5 MHz</td> <td>6.13 MHz</td> </tr> <tr> <td>110</td> <td>90.5 MHz</td> <td>5.67 MHz</td> <td>22.6 MHz</td> <td>5.67 MHz</td> </tr> <tr> <td>101</td> <td>84.1 MHz</td> <td>7.01 MHz</td> <td>28.0 MHz</td> <td>7.01 MHz</td> </tr> <tr> <td>100</td> <td>78.5 MHz</td> <td>6.54 MHz</td> <td>26.2 MHz</td> <td>6.54 MHz</td> </tr> <tr> <td>011</td> <td>69.3 MHz</td> <td>5.77 MHz</td> <td>23.1 MHz</td> <td>5.77 MHz</td> </tr> <tr> <td>010</td> <td>65.4 MHz</td> <td>5.45 MHz</td> <td>21.8 MHz</td> <td>5.45 MHz</td> </tr> <tr> <td>001</td> <td>62.0 MHz</td> <td>5.17 MHz</td> <td>20.7 MHz</td> <td>5.17 MHz</td> </tr> <tr> <td>000</td> <td>49.1 MHz</td> <td>6.13 MHz</td> <td>24.5 MHz</td> <td>6.13 MHz</td> </tr> </tbody> </table> <p>Caution Some of these frequency settings may not be selectable in the future.</p>	CLKSEL[2:0]	CPU core operation frequency	BUSCLK output frequency	Internal bus clock frequency	Interrupt control clock frequency	111	98.1 MHz	6.13 MHz	24.5 MHz	6.13 MHz	110	90.5 MHz	5.67 MHz	22.6 MHz	5.67 MHz	101	84.1 MHz	7.01 MHz	28.0 MHz	7.01 MHz	100	78.5 MHz	6.54 MHz	26.2 MHz	6.54 MHz	011	69.3 MHz	5.77 MHz	23.1 MHz	5.77 MHz	010	65.4 MHz	5.45 MHz	21.8 MHz	5.45 MHz	001	62.0 MHz	5.17 MHz	20.7 MHz	5.17 MHz	000	49.1 MHz	6.13 MHz	24.5 MHz	6.13 MHz
CLKSEL[2:0]	CPU core operation frequency	BUSCLK output frequency	Internal bus clock frequency	Interrupt control clock frequency																																											
111	98.1 MHz	6.13 MHz	24.5 MHz	6.13 MHz																																											
110	90.5 MHz	5.67 MHz	22.6 MHz	5.67 MHz																																											
101	84.1 MHz	7.01 MHz	28.0 MHz	7.01 MHz																																											
100	78.5 MHz	6.54 MHz	26.2 MHz	6.54 MHz																																											
011	69.3 MHz	5.77 MHz	23.1 MHz	5.77 MHz																																											
010	65.4 MHz	5.45 MHz	21.8 MHz	5.45 MHz																																											
001	62.0 MHz	5.17 MHz	20.7 MHz	5.17 MHz																																											
000	49.1 MHz	6.13 MHz	24.5 MHz	6.13 MHz																																											

★

2.2.6 IrDA Interface Signals

These signals are used to control data transmission and reception between the VR4111 and an IrDA controller. Table 2-6 describes the functions of these signals.

Table 2-6. IrDA Interface Signals

Signal	I/O	Description of function
IRDIN	I	This is the IrDA serial data input signal. It is used when the VR4111 sends serial data to the IrDA controller, for both FIR and SIR. If the IrDA controller used is an HP product, however, this signal should be used for only SIR.
FIRDIN#/SEL	I/O	This function differs according to the IrDA controller used (for how to switch a controller, refer to 24.2.13). <ul style="list-style-type: none"> • HP's controller FIRDIN#: It is an FIR receive data input signal. • TEMIC's controller SEL: It is an output port for external FIR/SIR switching. • SHARP's controller Use is prohibited.
IRDOUT#	O	This is the IrDA serial data output signal for both SIR and FIR. It is used when the IrDA controller sends serial data to the VR4111.

2.2.7 Debug Serial Interface Signals

These signals are used to control data transmission and reception between the VR4111 and a external debug serial controller. Table 2-7 describes the functions of these signals.

Table 2-7. Debug Serial Interface Signals

Signal	I/O	Description of function
DDOUT/ GPIO[44]	O	This is the debug serial data output signal. It is used when an external debug serial data controller sends serial data to the VR4111. When this pin is not used for the DDOUT signal, it can be used as a general-purpose output port.
DDIN/ GPIO[45]	I/O	This is the debug serial data input signal. It is used when the VR4111 sends serial data to an external debug serial controller. When this pin is not used for the DDIN signal, it can be used as a general-purpose output port.
DRTS#/ GPIO[46]	O	This is a transmission request signal. The VR4111 asserts this signal before sending serial data. When this pin is not used for the DRTS# signal, it can be used as a general-purpose output port.
DCTS#/ GPIO[47]	I/O	This is a transmit acknowledge signal. The VR4111 asserts this signal when it is ready to receive transmitted serial data. When this pin is not used for the DCTS# signal, it can be used as a general-purpose output port.

2.2.8 Keyboard Interface Signals

These signals are used to control a keyboard circuit to the VR4111. Table 2-8 describes the functions of these signals.

Table 2-8. Keyboard Interface Signals

Signal	I/O	Description of function
KPORT[7..0]	I	This is a keyboard scan data input signal. It is used to scan for pressed keys on the keyboard.
KSCAN[11..0]/ GPIO[43..32]	O	These signal are used as keyboard scan data output signals and a general-purpose output port. The scan line is set as active when scanning for pressed keys on the keyboard. Pins that are not used for the key scan operation can be used as a general-purpose output port.

2.2.9 Audio Interface Signals

This signal is used to input/output audio signals. Table 2-9 describes the functions of this signal.

Table 2-9. Audio Interface Signals

Signal	I/O	Description of function
AUDIOOUT	O	This is an audio output signal. Analog signals that have been converted via the on-chip 10-bit D/A converter are output.
AUDIOIN	I	This pin is the audio input pin.

2.2.10 Touch Panel/General Purpose A/D Interface Signals

These are the signals to the on-chip A/D converter of the VR4111. Four of these signals are used for a touch panel, and the remaining three are used as general-purpose input pins. Table 2-10 describes the functions of these signals.

Table 2-10. Touch Panel/General Purpose A/D Interface Signals

Signal	I/O	Description of function
TPX[1..0]	I/O	This is an I/O signal that is used for the touch panel. It uses the voltage applied to the X coordinate and the voltage input to the Y coordinate to detect which coordinates on the touch panel are being pressed.
TPY[1..0]	I/O	This is an I/O signal that is used for the touch panel. It uses the voltage applied to the Y coordinate and the voltage input to the X coordinate to detect which coordinates on the touch panel are being pressed.
ADIN[2..0]	I	This is a general-purpose A/D input signal.

2.2.11 General-purpose I/O Signals

These are general-purpose I/O pins of the VR4111. Ordinary, 33 of the 49 GPIO pins are used as alternate-function pins. Table 2-11 describes the functions of these signals.

Table 2-11. General-purpose I/O Signals

Signal	I/O	Description of function
GPIO[3..0]	I/O	These are maskable power-on factors. After start-up, they are used as ordinary GPIO pins.
GPIO[8..4]	I/O	These are ordinary GPIO pins.
GPIO[12..9]	I/O	These are maskable power-on factors. After start-up, they are used as ordinary GPIO pins.
GPIO[14..13]	I/O	These are ordinary GPIO pins.
DATA[31..16]/ GPIO[31..16]	I/O	See 2.2.1 System Bus Interface Signals .
KSCAN[11..0]/ GPIO[43..32]	O	See 2.2.8 Keyboard Interface Signals .
DDOUT/ GPIO[44]	O	See 2.2.7 Debug Serial Interface Signals .
DDIN/GPIO[45]	I/O	See 2.2.7 Debug Serial Interface Signals .
DRTS#/ GPIO[46]	O	See 2.2.7 Debug Serial Interface Signals .
DCTS#/ GPIO[47]	I/O	See 2.2.7 Debug Serial Interface Signals .
DBUS32/ GPIO[48]	I/O	See 2.2.14 Initialization Setting Signals .
GPIO[49]	O	This function differs depending on the operating status. <ul style="list-style-type: none"> • During normal operation It can be used as a general-purpose output port. • When RTC reset This signal is sampled when the RTCRTS# signal changes from low level to high level.

★

2.2.12 HSP MODEM Interface Signals

Table 2-12. HSP MODEM Interface Signals

Signal	I/O	Function
IRING	I	RING signal detect signal. This pin becomes active when the RING signal is detected.
ILCSENSE	I	Handset detect signal.
OFFHOOK	O	On-hook relay control signal.
MUTE	O	Modem speaker mute control signal.
AFERST#	O	CODEC reset signal.
SDI	I	Serial input signal from CODEC.
FS	I	Frame synchronization signal from CODEC.
SDO	O	Serial output signal to CODEC.
HSPSCLK	I	Operation clock input of modem interface block for CODEC.
TELCON	O	Handset relay control signal.
HC0	O	CODEC control signal.
HSPMCLK	O	Clock output to CODEC.
OPD#	O	Use this pin for controlling power of CODEC and DAA. This signal is set as active when to set power supply to them ON.

2.2.13 LED Interface Signal

Table 2-13. LED Interface Signal

Signal	I/O	Description of function
LEDOUT#	O	This is an output signal for lighting LEDs.

2.2.14 Initial Setting Signals

Table 2-14. Initial Setting Signals

Signal Name	I/O	Function Description
★ DBUS32/ GPIO[48]	I/O	<p>The function differs with the state of the RTCRST# signal</p> <ul style="list-style-type: none"> • During normal operation (output) This can be used as a general-purpose output port. • When RTC reset (input) This is the switching signal for the data bus width. This signal is sampled when the RTCRST# signal changes from low level to high level. 1: The data bus has a 32-bit width. 0: The data bus has a 16-bit width.
MIPS16EN	I	<p>This pin enables the use of MIPS16 instructions. This signal is sampled when the RTCRST# signal changes from low level to high level.</p> <p>1: Enables the use of MIPS16 instructions 0: Disables the use of MIPS16 instructions</p>

2.2.15 Dedicated V_{DD} and GND SignalsTable 2-15. Dedicated V_{DD} and GND Signals

Signal Name	Power-Supply System	Function Description
V _{DDP}	2.5 V	Dedicated V _{DD} for the PLL analog unit.
GNDP	2.5 V	Dedicated GND for the PLL analog unit.
V _{DDPD}	2.5 V	Dedicated V _{DD} for the PLL digital unit. Its function is identical to V _{DD2} .
GNDPD	2.5 V	Dedicated GND for the PLL digital unit. Its function is identical to GND2.
CV _{DD}	3.3 V	Dedicated V _{DD} for the oscillator.
CGND	3.3 V	Dedicated GND for the oscillator.
DV _{DD}	3.3 V	Dedicated V _{DD} for the D/A converter. The voltage applied to this pin becomes the maximum of the analog output of AUDIOOUT.
DGND	3.3 V	Dedicated GND for D/A converter. The voltage applied to this pin becomes the minimum of the analog output of AUDIOOUT.
AV _{DD}	3.3 V	Dedicated V _{DD} for the A/D converter. The voltage applied to this pin becomes the maximum voltage that can be detected by the A/D interface signals (8 lines).
AGND	3.3 V	Dedicated GND for the A/D converter. The voltage applied to this pin becomes the minimum voltage that can be detected by the A/D interface signals (8 lines).
PIUV _{DD}	3.3 V	Dedicated V _{DD} for touch-sensitive panel interface.
PIUGND	3.3 V	Dedicated GND for touch-sensitive panel interface.
V _{DD2}	2.5 V	Normal 2.5-V system V _{DD} .
GND2	2.5 V	Normal 2.5-V system GND.
V _{DD3}	3.3 V	Normal 3.3-V system V _{DD} .
GND3	3.3 V	Normal 3.3-V system GND.

- ★ **Caution** The V_R4111 has two types of power supplies. There are no restrictions as to the sequence in which these power supplies are applied. However, do not apply one type of power for more than one second while the other power supply is not applied.

2.3 PIN STATUS

2.3.1 Pin Status upon Specific States

Table 2-16 lists the pin states after the VR4111 is reset or when it is in the power mode.

Table 2-16. Pin Status upon Specific States (1/3)

Signal Name	After Reset by the RTCRST	After Reset by the Deadman's Switch or RSTSW	In the Suspend Mode	In the Hibernate Mode or Shut Down by the HAL Timer	During a Bus Hold
ADD[25..0]	0	0	Note 1	0	Hi-Z
DATA[15..0]	0	0	Note 1	0	Hi-Z
DATA[31..16]/ GPIO[31..16]	0/ Hi-Z	0/ Hi-Z	Note 1	0/ Hi-Z	Hi-Z/ Note 1
LCDCS#	Hi-Z	1	1	Hi-Z	1
RD#	Hi-Z	1	1	Hi-Z	Hi-Z
WR#	Hi-Z	1	1	Hi-Z	Hi-Z
LCDRDY	—	—	—	—	—
ROMCS#[3..2]	Hi-Z	Note 2	Note 2	Note 2	Note 2
ROMCS#[1..0]	Hi-Z	1	1	Hi-Z	1
UUCAS#/MRAS#[3]	Note 3	Note 4	0	0	Hi-Z
ULCAS#/MRAS#[2]	Note 3	Note 4	0	0	Hi-Z
MRAS#[1..0]	1	Note 4	0	0	Hi-Z
UCAS#	0	Note 4	0	0	Hi-Z
LCAS#	0	Note 4	0	0	Hi-Z
BUSCLK	0	0	Note 1	0	Note 5
SHB#	Hi-Z	1	1	Hi-Z	Hi-Z
IOR#	Hi-Z	1	1	Hi-Z	Hi-Z
IOW#	Hi-Z	1	1	Hi-Z	Hi-Z
MEMR#	Hi-Z	1	1	Hi-Z	Hi-Z
MEMW#	Hi-Z	1	1	Hi-Z	Hi-Z
ZWS#	—	—	—	—	—
RSTOUT	Hi-Z	1	0	Hi-Z	Note 6

- Notes**
1. Maintains the state of the previous Full-Speed Mode.
 2. When used as the chip select for the ROM or extended ROM, this is the same as ROMCS[1..0]#. When used as the RAS for the extended DRAM, this is the same as MRAS[1..0]#.
 3. When DBUS32 = 1, the low level is output. When DBUS32 = 0, the high level is output.
 4. Reset by the RSTSW# signal: The pin outputs a low level. (Self refresh)
Reset by the Deadman's switch: The pin outputs a high level.
 5. Bus hold from the Suspend Mode: The state of the previous Full-Speed Mode is maintained. Bus hold from Full-Speed Mode or Standby Mode: Outputs clocks.
 6. Normal operation proceeds.

Table 2-16. Pin Status upon Specific States (2/3)

Signal Name	After Reset by the RTCRST	After Reset by the Deadman's Switch or RSTSW	In the Suspend Mode	In the Hibernate Mode or Shut Down by the HAL Timer	During a Bus Hold
IOCS16#	—	—	—	—	—
MEMCS16#	—	—	—	—	—
IOCHRDY	—	—	—	—	—
HLDRQ#	—	—	—	—	—
HLDACK#	Hi-Z	1	Note 1	Hi-Z	Note 1
RTCX1	—	—	—	—	—
RTCX2	—	—	—	—	—
CLKX1	—	—	—	—	—
CLKX2	—	—	—	—	—
FIRCLK	—	—	—	—	—
BATTINH/BATTINT #	—	—	—	—	—
MPOWER	0	1	1	0	1
POWERON	0	0	0	0	0
POWER	—	—	—	—	—
RSTSW#	—	—	—	—	—
RTCRST#	—	—	—	—	—
RxD	—	—	—	—	—
TxD/CLKSEL[2]	Hi-Z	1	1	1	Note 1
RTS#/CLKSEL[1]	Hi-Z	1	1	1	Note 1
CTS#	—	—	—	—	—
DCD#/GPIO[15]	—	—	—	—	—
DTR#/CLKSEL[0]	Hi-Z	1	1	1	Note 1
DSR#	—	—	—	—	—
IRDIN#	—	—	—	—	—
IRDOUT	0	0	0	0	Note 1
FIRDIN#/SEL	Hi-Z	Hi-Z	Note 2	Hi-Z	Note 2
DDIN#/ GPIO[45] ^{Note 3}	—/ Hi-Z	—/ Note 2	—/ Note 2	—/ Note 2	—/ Note 2
DDOUT#/ GPIO[44] ^{Note 3}	1/ 1	1/ Note 2	1/ Note 2	1/ Note 2	1/ Note 2
DRTS#/ GPIO[46] ^{Note 3}	1/ 1	1/ Note 2	1/ Note 2	1/ Note 2	1/ Note 2
DCTS#/ GPIO[47] ^{Note 3}	—/ Hi-Z	—/ Note 2	—/ Note 2	—/ Note 2	—/ Note 2

Notes 1. Normal operation proceeds.

2. The state of the previous Full-Speed Mode is maintained.

3. Software can switch the function pin and the output port.

Table 2-16. Pin Status upon Specific States (3/3)

Signal Name	After Reset by the RTCRST	After Reset by the Deadman's Switch or RSTSW	In the Suspend Mode	In the Hibernate Mode or Shut Down by the HAL Timer	During a Bus Hold
KPORT[7..0]	—	—	—	—	—
KSCAN[11..0]/ GPIO[43..32] ^{Note 1}	Hi-Z/ Hi-Z	Hi-Z/ Note 2	Note 2 / Note 2	Hi-Z/ Note 2	Note 3
AUDIOOUT	0	0	Note 2	0	Note 3
TPX[1..0]	1	1	Note 2	1	Note 3
TPY[1..0]	Hi-Z	Hi-Z	Note 2	Hi-Z	Note 3
ADIN[2..0]	—	—	—	—	—
AUDIOIN	—	—	—	—	—
GPIO[14..0]	Hi-Z	Hi-Z	Note 2	Hi-Z	Note 3
IRING	—	—	—	—	—
ILCSENSE	—	—	—	—	—
OFFHOOK ^{Note 4}	Hi-Z	Hi-Z	Note 2	Hi-Z	Note 2
MUTE ^{Note 4}	Hi-Z	Hi-Z	Note 2	Hi-Z	Note 2
AFERST ^{Note 4}	0	0	Note 2	0	Note 2
SDI	—	—	—	—	—
FS	—	—	—	—	—
SDO	0	0	Note 2	0	Note 2
HSPSCLK	—	—	—	—	—
TELCON ^{Note 4}	Hi-Z	Hi-Z	Note 2	Hi-Z	Note 2
HCO ^{Note 4}	0	0	Note 2	0	Note 2
HSPMCLK ^{Note 4}	0	0	Note 2	0	Note 2
OPD#	0	0	Note 2	0	Note 2
LEDOUT#	1	Note 3	Note 3	Note 3	Note 3
★ DBUS32/ GPIO[48] ^{Note 5}	Hi-Z/ Hi-Z	Hi-Z/ Note 2	Note 2 / Note 2	Hi-Z/ Note 2	Note 2 / Note 2
MIPS16EN	Hi-Z	Hi-Z	Hi-Z	Hi-Z	Hi-Z
GPIO[49] ^{Note 5}	Note 6	Note 2	Note 2	Note 2	Note 2

- Notes**
1. Software can switch the function pin and the output port.
 2. The state of the previous Full-Speed Mode is maintained.
 3. Normal operation proceeds.
 4. When initializing, always set BSC bit (D1) in the HSPINT register (0x0c000020) to one.
 5. After the RTC reset is released, this functions as an output port.
 6. Input state. Input low level.

2.3.2 Connection of Unused Pins and Pin I/O Circuits

Table 2-17. Connection of Unused Pins and Pin I/O Circuit Type (1/3)

Signal	Internal processing	External processing	Drive capability	I/O circuit type
ADD[25..0]	Slew rate buffer	–	120 pF	A
DATA[15..0]	–	–	40 pF	A
DATA[31..16]/ GPIO[31..16]	–	Note 1	40 pF	A
LDCS#	Slew rate buffer	–	40 pF	A
RD#	Slew rate buffer	Note 2	120 pF	A
WR#	Slew rate buffer	Note 2	120 pF	A
LCDRDY	–	Note 3	–	A
ROMCS[3..2]#	Slew rate buffer	Note 4	40 pF	A
ROMCS[1..0]#	Slew rate buffer	–	40 pF	A
UUCAS#/MRAS[3]#	Slew rate buffer	Note 2	120 pF	A
ULCAS#/MRAS[2]#	Slew rate buffer	Note 2	120 pF	A
MRAS[1..0]#	Slew rate buffer	Note 2	40 pF	A
UCAS#	Slew rate buffer	Note 2	120 pF	A
LCAS#	Slew rate buffer	Note 2	120 pF	A
BUSCLK	Slew rate buffer	–	40 pF	A
SHB#	Slew rate buffer	Note 2	40 pF	A
IOR#	Slew rate buffer	Note 2	40 pF	A
IOW#	Slew rate buffer	Note 2	40 pF	A
MEMR#	Slew rate buffer	Note 2	40 pF	A
MEMW#	Slew rate buffer	Note 2	40 pF	A
ZWS#	Note 5	Note 3	–	A
RSTOUT	Slew rate buffer	Pull up	40 pF	A
IOCS16#	Note 5	Note 3	–	A
MEMCS16#	Note 5	Note 3	–	A
IOCHRDY	Note 5	Note 3	–	A

- Notes**
1. Pins DATA[31...16] in the V_R4111 function as GPIO[31...16] when using the 16-bit data bus. When using these pins as GPIO[31...16], pull them up or pull down so as not to input an intermediate-level signal.
 2. When the bus hold function is used, pull-ups are recommended outside the V_R4111.
 3. Do not input an intermediate-level signal.
 4. When used as the RAS signal of extended DRAM, external pull-up is recommended for the V_R4111.
 5. When the MPOWER pin outputs the low-level, intermediate-level input is enabled.

Table 2-17. Connection of Unused Pins and Pin I/O Circuit Type (2/3)

Signal	Internal processing	External processing	Drive capability	I/O circuit type
HLDRQ#	Note 1	Note 2	–	A
HLDAK#	Slew rate buffer	–	40 pF	A
RTCX1	–	Resonator	–	–
RTCX2	–	Resonator	–	–
CLKX1	–	Resonator	–	–
CLKX2	–	Resonator	–	–
FIRCLK	–	Note 3	–	A
BATTINH/ BATTINT#	Schmitt	–	–	B
MPOWER	–	–	40 pF	A
POWERON	–	–	40 pF	A
POWER	Schmitt	–	–	B
RSTSW#	Schmitt	–	–	B
RTCST#	Schmitt	–	–	B
RxD	–	–	–	A
TxD/CLKSEL[2]	–	Pull up/ Pull down	40 pF	A
RTS#/CLKSEL[1]	–	Pull up/ Pull down	40 pF	A
CTS#	–	–	–	A
DCD#/GPIO[15]	Schmitt	Pull up	–	B
DTR#/CLKSEL[0]	–	Pull up/ Pull down	40 pF	A
DSR#	–	–	–	A
IRDIN	–	Pull up	–	A
IRDOUT#	–	–	40 pF	A
FIRDIN#/SEL	–	Pull up/ Pull down	40 pF	A
DDIN#/ GPIO[45]	–	–	40 pF	A
DDOUT/ GPIO[44]	–	–	40 pF	A
DRTS#/ GPIO[46]	–	–	40 pF	A
DCTS#/ GPIO[47]	–	–	40 pF	A

- Notes**
- Intermediate-level input is enabled when the MPOWER pin is set for low-level output.
 - When the bus hold function is used : Pull up.
When the bus hold function is not used : Connect to V_{DD}.
 - When FIR unit is used : Attach an oscillator.
When FIR unit is not used : Connect to V_{DD}.

Table 2-17. Connection of Unused Pins and Pin I/O Circuit Type (3/3)

Signal	Internal processing	External processing	Drive capability	I/O circuit type
KPORT[7..0]	Schmitt, Pull down	–	–	B
KSCAN[11..0]/ GPIO[43..32]	–	–	40 pF	A
AUDIOOUT	–	Note 1	–	F
TPX[1..0]	–	–	120 pF or more	C
TPY[1]	–	–	120 pF or more	D
TPY[0]	–	–	120 pF or more	C
ADIN[2..0]	–	–	–	E
AUDIOIN	–	–	–	E
GPIO[14..0]	Schmitt Note 2	Note 2	40 pF	B
IRING	Schmitt	Pull down	–	B
ILCSENSE	–	Pull down	–	A
OFFHOOK	–	–	40 pF	A
MUTE	–	–	40 pF	A
AFERST#	–	–	40 pF	A
SDI	–	Pull up/ Pull down	–	A
FS	–	Pull up/ Pull down	–	A
SDO	–	–	40 pF	A
HSPSCLK	–	–	–	A
TELCON	–	–	40 pF	A
HC0	–	–	40 pF	A
HSPMCLK	–	–	40 pF	A
OPD#	–	–	40 pF	A
LEDOUT#	–	–	40 pF	A
DBUS32/ GPIO[48]	–	Pull up/ Pull down	40 pF	A
MIPS16EN	–	Pull up/ Pull down	40 pF	A
GPIO[49]	–	Pull down	–	A

- Notes 1.** Connect an operation amplifier which has high-impedance input characteristics, since the output level of AUDIOOUT pin varies according to the external impedance.
- 2.** If internal pull-ups or pull-downs are used in GPIO[14:0], software can switch between pull up, pull down, and open.
If an internal pull-up or pull-down resistor is not used, then provide an external pull-up or pull-down resistor.

2.3.3 Pin I/O Circuits

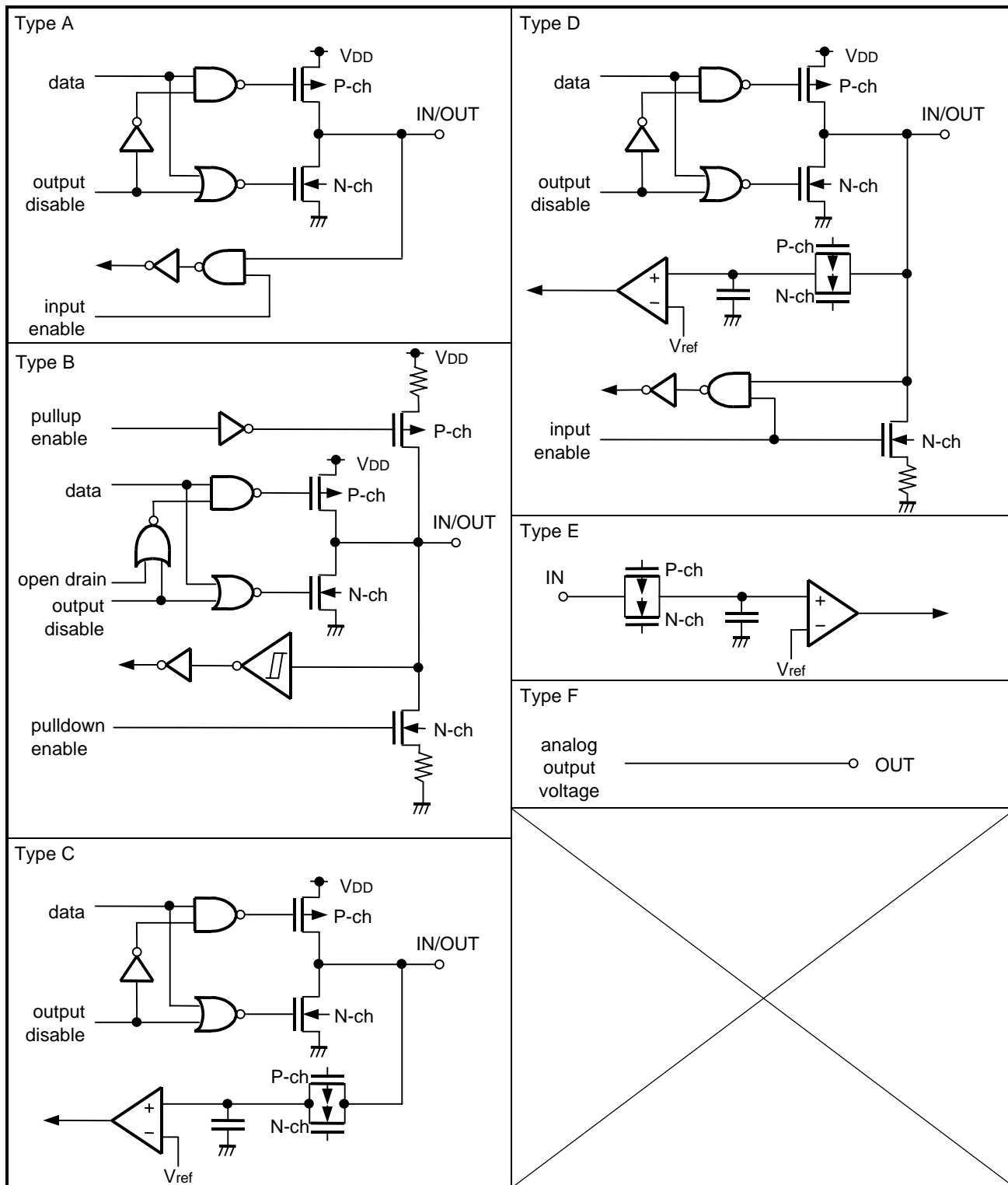

CHAPTER 3 MIPS III INSTRUCTION SET SUMMARY

This chapter is an overview of the MIPS III ISA central processing unit (CPU) instruction set; refer to the **Chapter 28 MIPS III INSTRUCTION SET DETAILS** for detailed descriptions of individual CPU instructions.

3.1 CPU INSTRUCTION FORMATS

Each MIPS III ISA CPU instruction consists of a single 32-bit word, aligned on a word boundary. There are three instruction formats - immediate (I-type), jump (J-type), and register (R-type) - as shown in Figure 3-1. The use of a small number of instruction formats simplifies instruction decoding, allowing the compiler to synthesize more complicated and less frequently used instruction and addressing modes from these three formats as needed.

Figure 3-1. MIPS III ISA CPU Instruction Formats

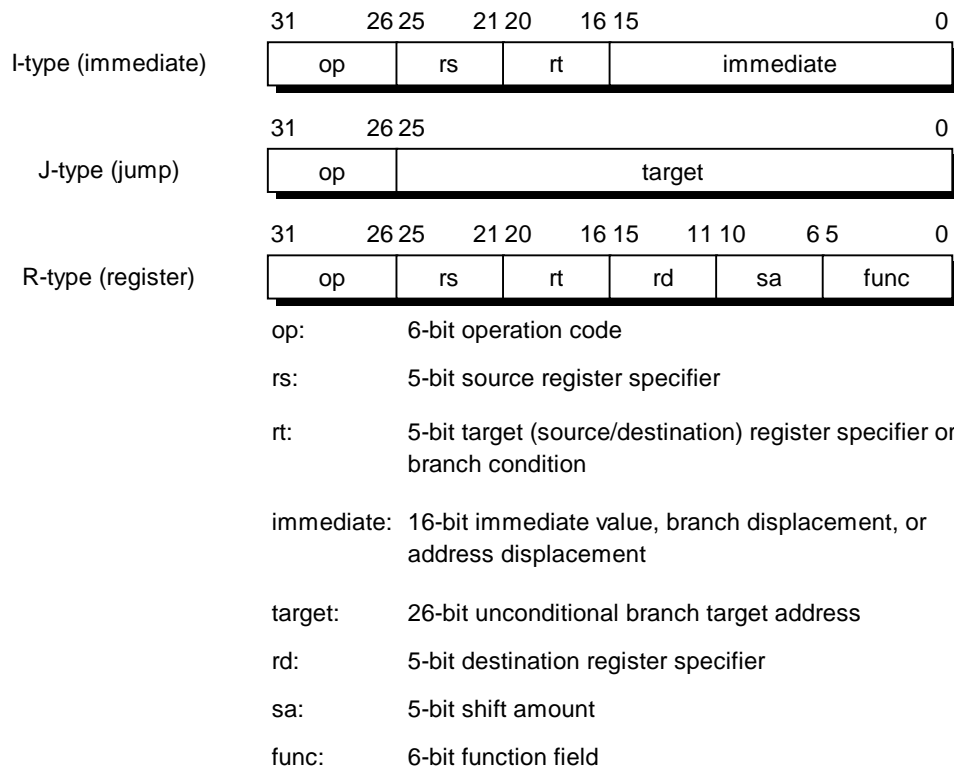

(1) Support of the MIPS ISA

The VR4111 does not support a multiprocessor operating environment. Thus the synchronization support instructions defined in the MIPS II and MIPS III ISA - the load linked and store conditional instructions - cause reserved instruction exception. The load/link (LL) bit is eliminated.

Note that the SYNC instruction is handled as a NOP instruction since all load/store instructions in this processor are executed in program order.

3.2 INSTRUCTION CLASSES

The CPU instructions are classified into five classes.

3.2.1 Load and Store Instructions

Load and store are immediate (I-type) instructions that move data between memory and the general-purpose registers. The only addressing mode that load and store instructions directly support is base register plus 16-bit signed immediate offset.

(1) Scheduling a Load Delay Slot

A load instruction that does not allow its result to be used by the instruction immediately following is called a delayed load instruction. The instruction slot immediately following this delayed load instruction is referred to as the load delay slot.

In the VR4000 Series, a load instruction can be followed directly by an instruction that accesses a register that is loaded by the load instruction. In this case, however, an interlock occurs for a necessary number of cycles. Any instruction can follow a load instruction, but the load delay slot should be scheduled appropriately for both performance and compatibility with the VR Series microprocessors. For detail, see **CHAPTER 5 Vr4111 PIPELINE**.

(2) Store Delay Slot

When a store instruction is writing data to a cache, the data cache is kept busy at the DC and WB stages. If an instruction (such as load) that follows directly the store instruction accesses the data cache in the DC stage, a hardware-driven interlock occurs. To overcome this problem, the store delay slot should be scheduled.

Table 3-1. Number of Delay Slot Cycles Necessary for Load and Store Instructions

Instruction	Necessary number of PCycles
Load	1
Store	1

(3) Defining Access Types

Access type indicates the size of a Vr4111 processor data item to be loaded or stored, set by the load or store instruction opcode. Access types and accessed byte are shown in Table 3-2.

Regardless of access type or byte ordering (endianness), the address given specifies the low-order byte in the addressed field. For a little-endian configuration, the low-order byte is the least-significant byte.

The access type, together with the three low-order bits of the address, define the bytes accessed within the addressed doubleword (shown in Table 3-2). Only the combinations shown in Table 3-2 are permissible; other combinations cause address error exceptions.

Tables 3-2 and 3-3 list the ISA-defined load/store instructions and extended-ISA instructions, respectively.

Figure 3-2. Byte Specification Related to Load and Store Instructions

Access type (value)	Low-order address bit			Accessed byte (Little endian)									
	2	1	0	63									0
Doubleword (7)	0	0	0	7	6	5	4	3	2	1	0		
7-byte (6)	0	0	0		6	5	4	3	2	1	0		
	0	0	1	7	6	5	4	3	2	1			
6-byte (5)	0	0	0			5	4	3	2	1	0		
	0	1	0	7	6	5	4	3	2				
5-byte (4)	0	0	0				4	3	2	1	0		
	0	1	1	7	6	5	4	3					
Word (3)	0	0	0					3	2	1	0		
	1	0	0	7	6	5	4						
Triple byte (2)	0	0	0						2	1	0		
	0	0	1					3	2	1			
	1	0	0		6	5	4						
	1	0	1	7	6	5							
Halfword (1)	0	0	0							1	0		
	0	1	0					3	2				
	1	0	0			5	4						
	1	1	0	7	6								
Byte (0)	0	0	0										0
	0	0	1								1		
	0	1	0						2				
	0	1	1					3					
	1	0	0				4						
	1	0	1			5							
	1	1	0		6								
	1	1	1	7									

Table 3-2. Load/Store Instruction

Instruction	Format and Description				
		op	base	rt	offset
Load Byte	LB rt, offset (base) The offset is sign extended and then added to the contents of the register base to form the virtual address. The bytes of the memory location specified by the address are sign extended and loaded into register rt.				
Load Byte Unsigned	LBU rt, offset (base) The offset is sign extended and then added to the contents of the register base to form the virtual address. The bytes of the memory location specified by the address are zero extended and loaded into register rt.				
Load Halfword	LH rt, offset (base) The offset is sign extended and then added to the contents of the register base to form the virtual address. The halfword of the memory location specified by the address is sign extended and loaded to register rt.				
Load Halfword Unsigned	LHU rt, offset (base) The offset is sign extended and then added to the contents of the register base to form the virtual address. The halfword of the memory location specified by the address is zero extended and loaded to register rt.				
Load Word	LW rt, offset (base) The offset is sign extended and then added to the contents of the register base to form the virtual address. The word of the memory location specified by the address is sign extended and loaded to register rt. In the 64-bit mode, it is further sign extended to 64 bits.				
Load Word Left	LWL rt, offset (base) The offset is sign extended and then added to the contents of the register base to form the virtual address. Shifts to the left the word whose address is specified so that the address-specified byte is at the left-most position of the word. The result of the shift operation is merged with the contents of register rt and loaded to register rt. In the 64-bit mode, it is further sign extended to 64 bits.				
Load Word Right	LWR rt, offset (base) The offset is sign extended and then added to the contents of the register base to form the virtual address. Shifts to the right the word whose address is specified so that the address-specified byte is at the right-most position of the word. The result of the shift operation is merged with the contents of register rt and loaded to register rt. In the 64-bit mode, it is further sign extended to 64 bits.				
Store Byte	SB rt, offset (base) The offset is sign extended and then added to the contents of the register base to form the virtual address. The least significant byte of register rt is stored to the memory location specified by the address.				
Store Halfword	SH rt, offset (base) The offset is sign extended and then added to the contents of the register base to form the virtual address. The least significant halfword of register rt is stored to the memory location specified by the address.				
Store Word	SW rt, offset (base) The offset is sign extended and then added to the contents of the register base to form the virtual address. The lower word of register rt is stored to the memory location specified by the address.				
Store Word Left	SWL rt, offset (base) The offset is sign extended and then added to the contents of the register base to form the virtual address. Shifts to the right the contents of register rt so that the left-most byte of the word is in the position of the address-specified byte. The result is stored to the lower word in memory.				
Store Word Right	SWR rt, offset (base) The offset is sign extended and then added to the contents of the register base to form the virtual address. Shifts to the left the contents of register rt so that the right-most byte of the word is in the position of the address-specified byte. The result is stored to the upper word in memory.				

Table 3-3. Load/Store Instruction (Extended ISA)

Instruction	Format and Description				
		op	base	rt	offset
Load Doubleword	LD rt, offset (base) The offset is sign extended and then added to the contents of the register base to form the virtual address. The doubleword of the memory location specified by the address are loaded into register rt.				
Load Doubleword Left	LDL rt, offset (base) The offset is sign extended and then added to the contents of the register base to form the virtual address. Shifts to the left the double word whose address is specified so that the address-specified byte is at the left-most position of the double word. The result of the shift operation is merged with the contents of register rt and loaded to register rt.				
Load Doubleword Right	LDR rt, offset (base) The offset is sign extended and then added to the contents of the register base to form the virtual address. Shifts to the right the double word whose address is specified so that the address-specified byte is at the right-most position of the double word. The result of the shift operation is merged with the contents of register rt and loaded to register rt.				
Load Word Unsigned	LWU rt, offset (base) The offset is sign extended and then added to the contents of the register base to form the virtual address. The word of the memory location specified by the address are zero extended and loaded into register rt				
Store Doubleword	SD rt, offset (base) The offset is sign extended and then added to the contents of the register base to form the virtual address. The contents of register rt are stored to the memory location specified by the address.				
Store Doubleword Left	SDL rt, offset (base) The offset is sign extended and then added to the contents of the register base to form the virtual address. Shifts to the right the contents of register rt so that the left-most byte of the double word is in the position of the address-specified byte. The result is stored to the lower doubleword in memory.				
Store Doubleword Right	SDR rt, offset (base) The offset is sign extended and then added to the contents of the register base to form the virtual address. Shifts to the left the contents of register rt so that the right-most byte of the double word is in the position of the address-specified byte. The result is stored to the upper doubleword in memory.				

3.2.2 Computational Instructions

Computational instructions perform arithmetic, logical, and shift operations on values in registers. Computational instructions can be either in register (R-type) format, in which both operands are registers, or in immediate (I-type) format, in which one operand is a 16-bit immediate.

Computational instructions are classified as:

- (1) ALU immediate instructions (Tables 3-4 and 3-5)
- (2) Three-operand type instructions (Tables 3-6 and 3-7)
- (3) Shift instructions (Tables 3-8 and 3-9)
- (4) Multiply/divide instructions (Table 3-10 and 3-11)

To maintain data compatibility between the 64- and 32-bit modes, it is necessary to sign-extend 32-bit operands correctly. If the sign extension is not correct, the 32-bit operation result is meaningless.

Table 3-4. ALU Immediate Instruction

Instruction	Format and Description				
		op	rs	rt	immediate
Add Immediate	ADDI rt, rs, immediate The 16-bit immediate is sign extended and then added to the contents of register rs to form a 32-bit result. The result is stored into register rt. In the 64-bit mode, the operand must be sign extended. An exception occurs on the generation of 2's complement overflow.				
Add Immediate Unsigned	ADDIU rt, rs, immediate The 16-bit immediate is sign extended and then added to the contents of register rs to form a 32-bit result. The result is stored into register rt. In the 64-bit mode, the operand must be sign extended. No exception occurs on the generation of integer overflow.				
Set On Less Than Immediate	SLTI rt, rs, immediate The 16-bit immediate is sign extended and then compared to the contents of register rt treating both operands as signed integers. If rs is less than the immediate, the result is set to 1; otherwise, the result is set to 0. The result is stored to register rt.				
Set On Less Than Immediate Unsigned	SLTIU rt, rs, immediate The 16-bit immediate is sign extended and then compared to the contents of register rt treating both operands as unsigned integers. If rs is less than the immediate, the result is set to 1; otherwise, the result is set to 0. The result is stored to register rt.				
And Immediate	ANDI rt, rs, immediate The 16-bit immediate is zero extended and then ANDed with the contents of the register. The result is stored into register rt.				
Or Immediate	ORI rt, rs, immediate The 16-bit immediate is zero extended and then ORed with the contents of the register. The result is stored into register rt.				
Exclusive Or Immediate	XORI rt, rs, immediate The 16-bit immediate is zero extended and then Ex-ORed with the contents of the register. The result is stored into register rt.				
Load Upper Immediate	LUI rt, immediate The 16-bit immediate is shifted left by 16 bits to set the lower 16 bits of word to 0. The result is stored into register rt. In the 64-bit mode, the operand must be sign extended.				

Table 3-5. ALU Immediate Instruction (Extended ISA)

Instruction	Format and Description	op	rs	rt	immediate
Doubleword Add Immediate	DADDI rt, rs, immediate The 16-bit immediate is sign extended to 64 bits and then added to the contents of register rs to form a 64-bit result. The result is stored into register rt. An exception occurs on the generation of integer overflow.				
Doubleword Add Immediate Unsigned	DADDIU rt, rs, immediate The 16-bit immediate is sign extended to 64 bits and then added to the contents of register rs to form a 64-bit result. The result is stored into register rt. No exception occurs on the generation of overflow.				

Table 3-6. Three-Operand Type Instruction

Instruction	Format and Description	op	rs	rt	rd	sa	funct
Add	ADD rd, rs, rt The contents of registers rs and rt are added together to form a 32-bit result. The result is stored into register rd. In the 64-bit mode, the operand must be sign extended. An exception occurs on the generation of integer overflow.						
Add Unsigned	ADDU rd, rs, rt The contents of registers rs and rt are added together to form a 32-bit result. The result is stored into register rd. In the 64-bit mode, the operand must be sign extended. No exception occurs on the generation of integer overflow.						
Subtract	SUB rd, rs, rt The contents of register rt are subtracted from the contents of register rs. The 32-bit result is stored into register rd. In the 64-bit mode, the operand must be sign extended. An exception occurs on the generation of integer overflow.						
Subtract Unsigned	SUBU rd, rs, rt The contents of register rt are subtracted from the contents of register rs. The 32-bit result is stored into register rd. In the 64-bit mode, the operand must be sign extended. No exception occurs on the generation of integer overflow.						
Set On Less Than	SLT rd, rs, rt The contents of registers rs and rt are compared, treating both operands as signed integers. If the contents of register rs is less than that of register rt, the result is set to 1; otherwise, the result is set to 0. The result is stored to register rd.						
Set On Less Than Unsigned	SLTU rd, rs, rt The contents of registers rs and rt are compared treating both operands as unsigned integers. If the contents of register rs is less than that of register rt, the result is set to 1; otherwise, the result is set to 0. The result is stored to register rd.						
And	AND rd, rt, rs The contents of register rs are logical ANDed with that of general register rt bit-wise. The result is stored to register rd.						
Or	OR rd, rt, rs The contents of register rs are logical ORed with that of general register rt bit-wise. The result is stored to register rd.						
Exclusive Or	XOR rd, rt, rs The contents of register rs are logical Ex-ORed with that of general register rt bit-wise. The result is stored to register rd.						
Nor	NOR rd, rt, rs The contents of register rs are logical NORed with that of general register rt bit-wise. The result is stored to register rd.						

Table 3-7. Three-Operand Type Instruction (Extended ISA)

Instruction	Format and Description						
		op	rs	rt	rd	sa	funct
Doubleword Add	DADD rd, rt, rs The contents of register rs are added to that of register rt. The 64-bit result is stored into register rd. An exception occurs on the generation of integer overflow.						
Doubleword Add Unsigned	DADDU rd, rt, rs The contents of register rs are added to that of register rt. The 64-bit result is stored into register rd. No exception occurs on the generation of integer overflow.						
Doubleword Subtract	DSUB rd, rt, rs The contents of register rt are subtracted from that of register rs. The 64-bit result is stored into register rd. An exception occurs on the generation of integer overflow.						
Doubleword Subtract Unsigned	DSUBU rd, rt, rs The contents of register rt are subtracted from that of register rs. The 64-bit result is stored into register rd. No exception occurs on the generation of integer overflow.						

Table 3-8. Shift Instruction

Instruction	Format and Description						
		op	rs	rt	rd	sa	funct
Shift Left Logical	SLL rd, rs, sa The contents of register rt are shifted left by sa bits and zeros are inserted into the emptied lower bits. The 32-bit result is stored into register rd. In the 64-bit mode, the operand must be sign extended.						
Shift Right Logical	SRL rd, rs, sa The contents of register rt are shifted right by sa bits and zeros are inserted into the emptied higher bits. The 32-bit result is stored into register rd. In the 64-bit mode, the operand must be sign extended.						
Shift Right Arithmetic	SRA rd, rt, sa The contents of register rt are shifted right by sa bits and the emptied higher bits are sign extended. The 32-bit result is stored into register rd. In the 64-bit mode, the operand must be sign extended.						
Shift Left Logical Variable	SLLV rd, rt, rs The contents of register rt are shifted left and zeros are inserted into the emptied lower bits. The lower five bits of register rs specify the shift count. The 32-bit result is stored into register rd. In the 64-bit mode, the operand must be sign extended.						
Shift Right Logical Variable	SRLV rd, rt, rs The contents of register rt are shifted right and zeros are inserted into the emptied higher bits. The lower five bits of register rs specify the shift count. The 32-bit result is stored into register rd. In the 64-bit mode, the operand must be sign extended.						
Shift Right Arithmetic Variable	SRAV rd, rt, rs The contents of register rt are shifted right and the emptied higher bits are sign extended. The lower five bits of register rs specify the shift count. The 32-bit result is stored into register rd. In the 64-bit mode, the operand must be sign extended.						

Table 3-9. Shift Instruction (Extended ISA)

Instruction	Format and Description	op	rs	rt	rd	sa	funct
Doubleword Shift Left Logical	DSLL rd, rs, sa The contents of register rt are shifted left by sa bits and zeros are inserted into the emptied lower bits. The 64-bit result is stored into register rd.						
Doubleword Shift Right Logical	DSRL rd, rs, sa The contents of register rt are shifted right by sa bits and zeros are inserted into the emptied higher bits. The 64-bit result is stored into register rd.						
Doubleword Shift Right Arithmetic	DSRA rd, rt, sa The contents of register rt are shifted right by sa bits and the emptied higher bits are sign extended. The 64-bit result is stored into register rd.						
Doubleword Shift Left Logical Variable	DSLLV rd, rt, rs The contents of register rt are shifted left and zeros are inserted into the emptied lower bits. The lower six bits of register rs specify the shift count. The 64-bit result is stored into register rd.						
Doubleword Shift Right Logical Variable	DSRLV rd, rt, rs The contents of register rt are shifted right and zeros are inserted into the emptied higher bits. The lower six bits of register rs specify the shift count. The 64-bit result is stored into register rd.						
Doubleword Shift Right Arithmetic Variable	DSRAV rd, rt, rs The contents of register rt are shifted right and the emptied higher bits are sign extended. The lower six bits of register rs specify the shift count. The 64-bit result is stored into register rd.						
Doubleword Shift Left Logical + 32	DSLL32 rd, rt, sa The contents of register rt are shifted left by 32 + sa bits and zeros are inserted into the emptied lower bits. The 64-bit result is stored into register rd.						
Doubleword Shift Right Logical + 32	DSRL32 rd, rt, sa The contents of register rt are shifted right by 32 + sa bits and zeros are inserted into the emptied higher bits. The 64-bit result is stored into register rd.						
Doubleword Shift Right Arithmetic + 32	DSRA32 rd, rt, sa The contents of register rt are shifted right by 32 + sa bits and the emptied higher bits are sign extended. The 64-bit result is stored into register rd.						

Table 3-10. Multiply/Divide Instructions

Instruction	Format and Description	op	rs	rt	rd	sa	funct
Multiply	MULT rs, rt The contents of registers rt and rs are multiplied, treating both operands as 32-bit signed integers. The 64-bit result is stored into special registers HI and LO. In the 64-bit mode, the operand must be sign extended.						
Multiply Unsigned	MULTU rs, rt The contents of registers rt and rs are multiplied, treating both operands as 32-bit unsigned integers. The 64-bit result is stored into special registers HI and LO. In the 64-bit mode, the operand must be sign extended.						
Divide	DIV rs, rt The contents of register rs are divided by that of register rt, treating both operands as 32-bit signed integers. The 32-bit quotient is stored into special register LO, and the 32-bit remainder is stored into special register HI. In the 64-bit mode, the operand must be sign extended.						
Divide Unsigned	DIVU rs, rt The contents of register rs are divided by that of register rt, treating both operands as 32-bit unsigned integers. The 32-bit quotient is stored into special register LO, and the 32-bit remainder is stored into special register HI. In the 64-bit mode, the operand must be sign extended.						
Move From HI	MFHI rd The contents of special register HI are loaded into register rd.						
Move From LO	MFLO rd The contents of special register LO are loaded into register rd.						
Move To HI	MTHI rs The contents of register rs are loaded into special register HI.						
Move To LO	MTLO rs The contents of register rs are loaded into special register LO.						

Table 3-11. Multiply/Divide Instructions (Extended ISA) (1/2)

Instruction	Format and Description	op	rs	rt	rd	sa	funct
Doubleword Multiply	DMULT rs, rt The contents of registers rt and rs are multiplied, treating both operands as signed integers. The 128-bit result is stored into special registers HI and LO.						
Doubleword Multiply Unsigned	DMULTU rs, rt The contents of registers rt and rs are multiplied, treating both operands as unsigned integers. The 128-bit result is stored into special registers HI and LO.						
Doubleword Divide	DDIV rs, rt The contents of register rs are divided by that of register rt, treating both operands as signed integers. The 64-bit quotient is stored into special register LO, and the 64-bit remainder is stored into special register HI.						
Doubleword Divide Unsigned	DDIVU rs, rt The contents of register rs are divided by that of register rt, treating both operands as unsigned integers. The 64-bit quotient is stored into special register LO, and the 64-bit remainder is stored into special register HI.						

Table 3-11. Multiply/Divide Instructions (Extended ISA) (2/2)

Instruction	Format and Description	op	rs	rt	rd	sa	funct
Multiply and Add 16-bit Integer	MADD16 rs, rt The contents of registers rt and rs are multiplied, treating both operands as 16-bit signed integers (by sign extending to 64 bits). The result is added to the combined value of special registers HI and LO. The 64-bit result is stored into special registers HI and LO.						
Doubleword Multiply and Add 16-bit Integer	DMADD16 rs, rt The contents of registers rt and rs are multiplied, treating both operands as 16-bit signed integers (by sign extending to 64 bits). The result is added to value of special register LO. The 64-bit result is stored into special register LO.						

MFHI and MFLO instructions after a multiply or divide instruction generate interlocks to delay execution of the next instruction, inhibiting the result from being read until the multiply or divide instruction completes.

Table 3-12 gives the number of processor cycles (PCycles) required to resolve interlock or stall between various multiply or divide instructions and a subsequent MFHI or MFLO instruction.

Table 3-12. Number of Stall Cycles in Multiply and Divide Instructions

Instruction	Number of instruction cycles
MULT	1
MULTU	1
DIV	35
DIVU	35
DMULT	4
DMULTU	4
DDIV	67
DDIVU	67
MADD16	1
DMADD16	1

3.2.3 Jump and Branch Instructions

Jump and branch instructions change the control flow of a program. All jump and branch instructions occur with a delay of one instruction: that is, the instruction immediately following the jump or branch instruction (this is known as the instruction in the delay slot) always executes while the target instruction is being fetched from memory.

For instructions involving a link (such as JAL and BLTZAL), the return address is saved in register r31.

Table 3-13. Number of Delay Slot Cycles in Jump and Branch Instructions

Instruction	Necessary number of cycles
Branch instruction	1
Jump instruction	1

(1) Overview of jump instructions

Subroutine calls in high-level languages are usually implemented with J or JAL instructions, both of which are J-type instructions. In J-type format, the 26-bit target address shifts left 2 bits and combines with the high-order 4 bits of the current program counter to form a 32-bit or 64-bit absolute address.

Returns, dispatches, and cross-page jumps are usually implemented with the JR or JALR instructions. Both are R-type instructions that take the 32-bit or 64-bit byte address contained in one of the general-purpose registers.

For more information, refer to **Chapter 28 MIPS III INSTRUCTION SET DETAILS**.

(2) Overview of branch instructions

A branch instruction has a PC-related signed 16-bit offset.

Tables 3-14 through 3-16 show the lists of Jump, Branch, and Extended ISA instructions, respectively.

Table 3-14. Jump Instruction

Instruction	Format and Description	op	target
Jump	J target The contents of 26-bit target address is shifted left by two bits and combined with the high-order four bits of the PC. The program jumps to this calculated address with a delay of one instruction.		
Jump And Link	JAL target The contents of 26-bit target address is shifted left by two bits and combined with the high-order four bits of the PC. The program jumps to this calculated address with a delay of one instruction. The address of the instruction following the delay slot is stored into r31 (link register).		

Instruction	Format and Description	op	target
Jump And Link Exchange	JALX target The contents of 26-bit target address is shifted left by two bits and combined with the high-order four bits of the PC. The program jumps to this calculated address with a delay of one instruction, and then the ISA mode bit is reversed. The address of the instruction following the delay slot is stored into r31 (link register).		

Instruction	Format and Description	op	rs	rt	rd	sa	funct
Jump Register	JR rs The program jumps to the address specified in register rs with a delay of one instruction.						
Jump And Link Register	JALR rs, rd The program jumps to the address specified in register rs with a delay of one instruction. The address of the instruction following the delay slot is stored into rd.						

There are the following common restrictions for Tables 3-15 and 3-16.

(1) Branch address

All branch instruction target addresses are computed by adding the address of the instruction in the delay slot to the 16-bit offset (shifted left by 2 bits and sign-extended to 64 bits). All branches occur with a delay of one instruction.

(2) Operation when unbranched

If the branch condition does not meet in executing a Likely instruction, the instruction in its delay slot is nullified. For all other branch instructions, the instruction in its delay slot is unconditionally executed.

Remark The target instruction of the branch is fetched at the EX stage of the branch instruction. Comparison of the operands of the branch instruction and calculation of the target address is performed at phase 2 of the RF stage and phase 1 of the EX stage of the instruction. Branch instructions require one cycle of the branch delay slot defined by the architecture. Jump instructions also require one cycle of delay slot. If the branch condition is not satisfied in a branch likely instruction, the instruction in its delay slot is nullified.

There are special symbols used in the instruction formats of Tables 3-15 through 3-19.

- REGIMM : Opcode
- Sub : Sub-operation code
- CO : Sub-operation identifier
- BC : BC sub-operation code
- br : Branch condition identifier
- op : Operation code

Table 3-15. Branch Instructions

Instruction	Format and Description	op	rs	rt	offset
Branch On Equal	BEQ rs, rt, offset If the contents of register rs are equal to that of register rt, the program branches to the target address.				
Branch On Not Equal	BNE rs, rt, offset If the contents of register rs are not equal to that of register rt, the program branches to the target address.				
Branch On Less Than Or Equal To Zero	BLEZ rs, offset If the contents of register rs are less than or equal to zero, the program branches to the target address.				
Branch On Greater Than Zero	BGTZ rs, offset If the contents of register rs are greater than zero, the program branches to the target address.				

Instruction	Format and Description	REGIMM	rs	sub	offset
Branch On Less Than Zero	BLTZ rs, offset If the contents of register rs are less than zero, the program branches to the target address.				
Branch On Greater Than Or Equal To Zero	BGEZ rs, offset If the contents of register rs are greater than or equal to zero, the program branches to the target address.				
Branch On Less Than Zero And Link	BLTZAL rs, offset The address of the instruction that follows delay slot is stored to register r31 (link register). If the contents of register rs are less than zero, the program branches to the target address.				
Branch On Greater Than Or Equal To Zero And Link	BGEZAL rs, offset The address of the instruction that follows delay slot is stored to register r31 (link register). If the contents of register rs are greater than or equal to zero, the program branches to the target address.				

Instruction	Format and Description	COPO	BC	br	offset
Branch On Coprocessor 0 True	BC0T offset Adds the 16-bit offset (shifted left by two bits and sign extended to 32 bits) to the address of the instruction in the delay slot to calculate out the branch target address. If the conditional signal of the coprocessor 0 is true, the program branches to the target address with one-instruction delay.				
Branch On Coprocessor 0 False	BC0F offset Adds the 16-bit offset (shifted left by two bits and sign extended to 32 bits) to the address of the instruction in the delay slot to calculate out the branch target address. If the conditional signal of the coprocessor 0 is false, the program branches to the target address with one-instruction delay.				

Table 3-16. Branch Instructions (Extended ISA)

Instruction	Format and Description				
		op	rs	rt	offset
Branch On Equal Likely	BEQL rs, rt, offset If the contents of register rs are equal to that of register rt, the program branches to the target address. If the branch condition is not met, the instruction in the delay slot is discarded.				
Branch On Not Equal Likely	BNEL rs, rt, offset If the contents of register rs are not equal to that of register rt, the program branches to the target address. If the branch condition is not met, the instruction in the delay slot is discarded.				
Branch On Less Than Or Equal To Zero Likely	BLEZL rs, offset If the contents of register rs are less than or equal to zero, the program branches to the target address. If the branch condition is not met, the instruction in the delay slot is discarded.				
Branch On Greater Than Zero	BGTZL rs, offset If the contents of register rs are greater than zero, the program branches to the target address. If the branch condition is not met, the instruction in the delay slot is discarded.				

Instruction	Format and Description				
		REGIMM	rs	sub	offset
Branch On Less Than Zero Likely	BLTZL rs, offset If the contents of register rs are less than zero, the program branches to the target address. If the branch condition is not met, the instruction in the delay slot is discarded.				
Branch On Greater Than Or Equal To Zero Likely	BGEZL rs, offset If the contents of register rs are greater than or equal to zero, the program branches to the target address. If the branch condition is not met, the instruction in the delay slot is discarded.				
Branch On Less Than Zero And Link Likely	BLTZALL rs, offset The address of the instruction that follows delay slot is stored to register r31 (link register). If the contents of register rs are less than zero, the program branches to the target address. If the branch condition is not met, the instruction in the delay slot is discarded.				
Branch On Greater Than Or Equal To Zero And Link Likely	BGEZALL rs, offset The address of the instruction that follows delay slot is stored to register r31 (link register). If the contents of register rs are greater than or equal to zero, the program branches to the target address. If the branch condition is not met, the instruction in the delay slot is discarded.				

Instruction	Format and Description				
		COP0	BC	br	offset
Branch On Coprocessor 0 True Likely	BC0TL offset Adds the 16-bit offset (shifted left by two bits and sign extended to 32 bits) to the address of the instruction in the delay slot to calculate out the branch target address. If the conditional signal of the coprocessor 0 is true, the program branches to the target address with one-instruction delay. If the branch condition is not met, the instruction in the delay slot is discarded.				
Branch On Coprocessor 0 False Likely	BC0FL offset Adds the 16-bit offset (shifted left by two bits and sign extended to 32 bits) to the address of the instruction in the delay slot to calculate out the branch target address. If the conditional signal of the coprocessor 0 is false, the program branches to the target address with one-instruction delay. If the branch condition is not met, the instruction in the delay slot is discarded.				

3.2.4 Special Instructions

Special instructions generate software exceptions. Their formats are R-type (Syscall, Break). The Trap instruction is available only for the VR4000 Series. All the other instructions are available for all VR Series.

Table 3-17. Special Instructions

Instruction	Format and Description	SPECIAL	rs	rt	rd	sa	funct
Synchronize	SYNC Completes the load/store instruction executing in the current pipeline before the next load/store instruction starts execution.						
System Call	SYSCALL Generates a system call exception, and then transits control to the exception handling program.						
Breakpoint	BREAK Generates a break point exception, and then transits control to the exception handling program.						

Table 3-18. Special Instructions (Extended ISA) (1/2)

Instruction	Format and Description	SPECIAL	rs	rt	rd	sa	funct
Trap If Greater Than Or Equal	TGE rs, rt The contents of register rs are compared with that of register rt, treating both operands as signed integers. If the contents of register rs are greater than or equal to that of register rt, an exception occurs.						
Trap If Greater Than Or Equal Unsigned	TGEU rs, rt The contents of register rs are compared with that of register rt, treating both operands as unsigned integers. If the contents of register rs are greater than or equal to that of register rt, an exception occurs.						
Trap If Less Than	TLT rs, rt The contents of register rs are compared with that of register rt, treating both operands as signed integers. If the contents of register rs are less than that of register rt, an exception occurs.						
Trap If Less Than Unsigned	TLTU rs, rt The contents of register rs are compared with that of register rt, treating both operands as unsigned integers. If the contents of register rs are less than that of register rt, an exception occurs.						
Trap If Equal	TEQ rs, rt If the contents of registers rs and rt are equal, an exception occurs.						
Trap If Not Equal	TNE rs, rt If the contents of registers rs and rt are not equal, an exception occurs.						

Table 3-18. Special Instructions (Extended ISA) (2/2)

Instruction	Format and Description	REGIMM	rs	sub	immediate
Trap If Greater Than Or Equal Immediate	TGEI rs, immediate The contents of register rs are compared with 16-bit sign-extended immediate data, treating both operands as signed integers. If the contents of register rs are greater than or equal to 16-bit sign-extended immediate data, an exception occurs.				
Trap If Greater Than Or Equal Immediate Unsigned	TGEIU rs, immediate The contents of register rs are compared with 16-bit zero-extended immediate data, treating both operands as unsigned integers. If the contents of register rs are greater than or equal to 16-bit sign-extended immediate data, an exception occurs.				
Trap If Less Than Immediate	TLTI rs, immediate The contents of register rs are compared with 16-bit sign-extended immediate data, treating both operands as signed integers. If the contents of register rs are less than 16-bit sign-extended immediate data, an exception occurs.				
Trap If Less Than Immediate Unsigned	TLTIU rs, immediate The contents of register rs are compared with 16-bit zero-extended immediate data, treating both operands as unsigned integers. If the contents of register rs are less than 16-bit sign-extended immediate data, an exception occurs.				
Trap If Equal Immediate	TEQI rs, immediate If the contents of register rs and immediate data are equal, an exception occurs.				
Trap If Not Equal Immediate	TNEI rs, immediate If the contents of register rs and immediate data are not equal, an exception occurs.				

3.2.5 System Control Coprocessor (CP0) Instructions

System control coprocessor (CP0) instructions perform operations specifically on the CP0 registers to manipulate the memory management and exception handling facilities of the processor.

Table 3-19. System Control Coprocessor (CP0) Instructions (1/2)

Instruction	Format and Description	COP0	sub	rt	rd	0
Move To System Control Coprocessor	MTC0 rt, rd The word data of general-purpose register rt in the CPU are loaded into general-purpose register rd in the CP0.					
Move From System Control Coprocessor	MFC0 rt, rd The word data of general-purpose register rd in the CP0 are loaded into general-purpose register rt in the CPU.					
Doubleword Move To System Control Coprocessor 0	DMTC0 rt, rd The doubleword data of general-purpose register rt in the CPU are loaded into general-purpose register rd in the CP0.					
Doubleword Move From System Control Coprocessor 0	DMFC0 rt, rd The doubleword data of general-purpose register rd in the CP0 are loaded into general-purpose register rt in the CPU.					

Table 3-19. System Control Coprocessor (CP0) Instructions (2/2)

Instruction	Format and Description	COP0		
		CO	funct	
Read Indexed TLB Entry	TLBR The TLB entry indexed by the index register is loaded into the entryHi, entryLo0, entryLo1, or page mask register.			
Write Indexed TLB Entry	TLBWI The contents of the entryHi, entryLo0, entryLo1, or page mask register are loaded into the TLB entry indexed by the index register.			
Write Random TLB Entry	TLBWR The contents of the entryHi, entryLo0, entryLo1, or page mask register are loaded into the TLB entry indexed by the random register.			
Probe TLB For Matching Entry	TLBP The address of the TLB entry that matches with the contents of entryHi register is loaded into the index register.			
Return From Exception	ERET The program returns from exception, interrupt, or error trap.			

Instruction	Format and Description	COP0		
		CO	funct	
STANDBY	STANDBY The processor's operating mode is transited from fullspeed mode to standby mode.			
SUSPEND	SUSPEND The processor's operating mode is transited from fullspeed mode to suspend mode.			
HIBERNATE	HIBERNATE The processor's operating mode is transited from fullspeed mode to hibernate mode.			

Instruction	Format and Description	CACHE	base	op	offset
		Cache Operation	Cache op, offset (base) The 16-bit offset is sign extended to 32 bits and added to the contents of the register case, to form virtual address. This virtual address is translated to physical address with TLB. For this physical address, cache operation that is indicated by 5-bit sub-opcode is performed.		

CHAPTER 4 MIPS16 INSTRUCTION SET

4.1 OUTLINE

If the MIPS16 ASE (Application-Specific Extension), which is an expanded function for MIPS ISA (Instruction Set Architecture), is used, system costs can be considerably reduced by lowering the memory capacity requirement of embedded hardware. MIPS16 is an instruction set that uses the 16-bit instruction length, and is compatible with MIPS I, II, III, IV, and V^{Note} instruction sets in any combination. Moreover, 32-bit instruction length binary data can be executed with the VR4111.

Note The VR4100 Series currently supports the MIPS I, II, and III instruction sets.

4.2 FEATURES

- 16-bit length instruction format
- Reduces memory capacity requirements to lower overall system cost
- MIPS16 instructions can be used with MIPS instruction binary
- Compatibility with MIPS I, II, III, IV, and V instruction sets
- Used with switching between MIPS16 instruction length mode and 32-bit MIPS instruction length mode.
- Supports 8-bit, 16-bit, 32-bit, and 64-bit data formats
- Provides 8 general-purpose registers and special registers
- Improved code generation efficiency using special 16-bit dedicated instructions

4.3 REGISTER SET

Tables 4-1 and 4-2 show the MIPS16 register sets. These register sets form part of the register sets that can be accessed in 32-bit instruction length mode. MIPS16 ASE can directly access 8 of the 32 registers that can be used in the 32-bit instruction length mode.

In addition to these 8 general-purpose registers, the special instructions of MIPS16 ASE reference the stack pointer register (sp), return address register (ra), condition code register (t8), and program counter (pc). sp and ra are mapped by fixing to the general-purpose registers in the 32-bit instruction length mode.

MIPS16 has 2 move instructions that are used in addressing 32 general-purpose registers.

Table 4-1. General-Purpose Registers

MIPS16 register encoding	32-bit MIPS register encoding	Symbol	Comment
0	16	s0	General-purpose register
1	17	s1	General-purpose register
2	2	v0	General-purpose register
3	3	v1	General-purpose register
4	4	a0	General-purpose register
5	5	a1	General-purpose register
6	6	a2	General-purpose register
7	7	a3	General-purpose register
N/A	24	t8	MIPS16 condition code register. BTEQZ, BTNEZ, CMP, CMPI, SLT, SLTU, SLTI, and SLTIU instructions are implicitly referenced.
N/A	29	sp	Stack pointer register
N/A	31	ra	Return address register

- Notes**
1. The symbols are the general assembler symbols.
 2. The MIPS register encoding numbers 0 to 7 correspond to the MIPS16 binary encoding of the registers, and are used to show the relationship between this encoding and the MIPS registers. The numbers 0 to 7 are not used to reference registers, except within binary MIPS16 instructions. Registers are referenced from the assembler using the MIPS name (\$16, \$17, \$2, etc.) or the symbol name (s0, s1, v0, etc.). For example, when register number 17 is accessed with the register file, the programmer references either \$17 or s1 even if the MIPS16 encoding of this register is 001.
 3. The general-purpose registers not shown in this table cannot be accessed with a MIPS16 instruction set other than the Move instruction. The Move instruction of MIPS16 can access all 32 general-purpose registers.
 4. To reference the MIPS16 condition code registers with this manual, either T, t8, or \$24 has to be used, depending on the case. These three names reference the same physical register.

Table 4-2. Special Registers

Symbol	Description
PC	Program counter. The PC-relative Add instruction and Load instruction can access this register.
HI	The upper word of the multiply or divide result is inserted
LO	The lower word of the multiply or divide result is inserted

4.4 ISA MODE

MIPS16 ASE supports procedure calling, and returns from the MIPS16 instruction length mode or the 32-bit MIPS instruction length mode to the MIPS16 instruction length mode or the 32-bit MIPS instruction length mode.

- The JAL instruction supports calling to the same ISA.
- The JALX instruction supports calling that inverses ISA.
- The JALR instruction supports calling to either ISA.
- The JR instruction supports also returning to either ISA.

★ MIPS16 ASE also supports a return operation from exception processing.

- The ERET instruction, which is defined only in 32-bit instruction length mode, supports returning to ISA when an exception has not occurred.

The ISA mode bit defines the instruction length mode to be executed. If the ISA mode bit is 0, the processor executes only 32-bit MIPS instructions. If the ISA mode bit is 1, the processor executes only MIPS16 instructions.

4.4.1 Changing ISA Mode Bit by Software

Only the JALX, JR, and JALR instructions change the ISA mode bit between the MIPS16 instruction mode and the 32-bit instruction length mode. The ISA mode bit cannot be directly overwritten by software. The JALX changes the ISA mode bit to select another ISA mode. The JR instruction and JALR instruction load the ISA mode bit from bit 0 of the general-purpose register that holds the target address. Bit 0 is not a part of the target address. Bit 0 of the target address is always 0, and no address exception is generated.

Moreover, the JAL, JALR, and JALX instructions save the ISA mode bit to bit 0 of the general-purpose register that acquires the return address. The contents of this general-purpose register are later used by the JR and JALR instruction for return and restoration of the ISA mode.

★ 4.4.2 Changing ISA Mode Bit by Exception

Even if an exception occurs, the ISA mode does not change. When an exception occurs, the ISA mode bit is cleared to 0 so that the exception is serviced with 32-bit code. Then the ISA mode status before the exception occurred is saved to the least significant bit of the EPC register or the error EPC register. During return from an exception, the ISA mode before the exception occurred is returned to by executing the JR or ERET instruction with the contents of this register. Moreover, the ISA mode bit is cleared to 0 after cold reset and soft reset of the CPU core, and the 32-bit instruction length mode returns to its initial state.

★ 4.4.3 Enabling Change ISA Mode Bit

Changing the ISA mode bit is valid only MIPS16EN is set to active when the RTCRST is selected, and the MIPS16 instruction mode is enabled. The operation of the JALX, JALR, JR, and ERET instructions in the 32-bit instruction mode, differs depending on whether the MIPS16 instruction mode is enabled or prohibited. If the MIPS16 instruction mode is prohibited, the JALX instruction generates a reserved instruction exception. The JR and JALR instructions generate an address exception when bit 0 of the source register is 1. The ERET instruction generates an address exception when bit 0 of the EPC or error EPC register is 1. If the MIPS16 instruction mode is enabled, the JALX instruction executes JAL, and the ISA mode bit is inverted. The JR and JALR instructions load the ISA mode from bit 0 of the source register. The ERET instruction loads the ISA mode from bit 0 of the EPC or error EPC register. Bit 0 of the target address is always 0, and no address exception is generated even when bit 0 of the source register is 1.

4.5 TYPES OF INSTRUCTIONS

This section describes the different types of instructions, and indicates the MIPS16 instructions included in each group.

Instructions are divided into the following types.

- Load and Store instructions : Move data between memory and the general-purpose registers.
- Computational instructions : Perform arithmetic operations, logical operations, and shift operations on values in registers.
- Jump and Branch instructions: Change the control flow of a program.
- Special instructions : Break instructions and Extend instructions. Break transfers control to an exception handler. Extend enlarges the immediate field of the next instruction. Instructions that can be extended with Extend are indicated as **Note 1** in Table 4-3 MIPS16 Instruction Set Outline.

Table 4-3. MIPS16 Instruction Set Outline

Op	Description	Op	Description
Load and Store instructions		Multiply/Divide instructions	
LB ^{Note 1}	Load Byte	MULT	Multiply
LBU ^{Note 1}	Load Byte Unsigned	MULTU	Multiply Unsigned
LH ^{Note 1}	Load Halfword	DIV	Divide
LHU ^{Note 1}	Load Halfword Unsigned	DIVU	Divide Unsigned
LW ^{Note 1}	Load Word	MFHI	Move From HI
LWU ^{Notes 1, 2}	Load Word Unsigned	MFLO	Move From LO
LD ^{Notes 1, 2}	Load Doubleword	DMULT ^{Note 2}	Doubleword Multiply
SB ^{Note 1}	Store Byte	DMULTU ^{Note 2}	Doubleword Multiply Unsigned
SH ^{Note 1}	Store Halfword	DDIV ^{Note 2}	Doubleword Divide
SW ^{Note 1}	Store Word	DDIVU ^{Note 2}	Doubleword Divide Unsigned
SD ^{Notes 1, 2}	Store Doubleword		
		Jump/Branch instructions	
Arithmetic instructions: ALU immediate instructions		JAL	Jump and Link
LI ^{Note 1}	Load Immediate	JALX	Jump and Link Exchange
ADDIU ^{Note 1}	Add Immediate Unsigned	JR	Jump Register
DADDIU ^{Notes 1, 2}	Doubleword Add Immediate Unsigned	JALR	Jump and Link Register
SLTI ^{Note 1}	Set on Less Than Immediate	BEQZ ^{Note 1}	Branch on Equal to Zero
SLTIU ^{Note 1}	Set on Less Than Immediate Unsigned	BNEZ ^{Note 1}	Branch on Not Equal to Zero
CMPI ^{Note 1}	Compare Immediate	BTEQZ ^{Note 1}	Branch on T Equal to Zero
		BTNEZ ^{Note 1}	Branch on T Not Equal to Zero
Arithmetic instructions: 2/3 operand register instructions		B ^{Note 1}	Branch Unconditional
ADDU	Add Unsigned		
SUBU	Subtract Unsigned	Shift instructions	
DADDU ^{Note 2}	Doubleword Add Unsigned	SLL ^{Note 1}	Shift Left Logical
DSUBU ^{Note 2}	Doubleword Subtract Unsigned	SRL ^{Note 1}	Shift Right Logical
SLT	Set on Less Than	SRA ^{Note 1}	Shift Right Arithmetic
SLTU	Set on Less Than Unsigned	SLLV	Shift Left Logical Variable
CMP	Compare	SRLV	Shift Right Logical Variable
NEG	Negate	SRAV	Shift Right Arithmetic Variable
AND	AND	DSLL ^{Notes 1, 2}	Doubleword Shift Left Logical
OR	OR	DSRL ^{Notes 1, 2}	Doubleword Shift Right Logical
XOR	Exclusive OR	DSRA ^{Notes 1, 2}	Doubleword Shift Right Arithmetic
NOT	Not	DSLLV ^{Note 2}	Doubleword Shift Left Logical Variable
MOVE	Move	DSRLV ^{Note 2}	Doubleword Shift Right Logical Variable
		DSRAV ^{Note 2}	Doubleword Shift Right Arithmetic Variable
Special instructions			
EXTEND	Extend		
BREAK	Breakpoint		

Notes 1. Extendable instruction. For details, see 4.8.2 Extend instructions.

2. Can be used in 64-bit mode and 32-bit kernel mode.

4.6 INSTRUCTION FORMAT

The MIPS16 instruction set has a length of 16 bits and is located at the half-word boundary. One part of Jump instructions and instructions for which the Extend instruction extends immediate become 32 bits in length, but crossing the word boundary does not represent a problem.

The instruction format is shown below. Variable subfields are indicated with lower case letters (rx, ry, rz, immediate, etc.).

In the case of special functions, constants are input to the two instruction subfields op and funct. These values are indicated by upper case mnemonics. For example, in the case of the Load Byte instruction, op is LB, and in the case of the Add instruction, op is SPECIAL, and function is ADD.

The constants of the fields used in the instruction formats are shown below.

Table 4-4. Field Definition

Field	Definition
op	5-bit major operation code
rx	3-bit source/destination register specification
ry	3-bit source/destination register specification
immediate or imm	4-bit, 5-bit, 8-bit, or 11-bit immediate value, branch displacement, or address displacement
rz	3-bit source/destination register specification
Funct or F	Function field

I-type (immediate) instruction format

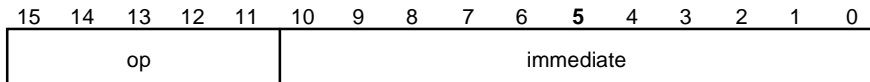

RI-type instruction format

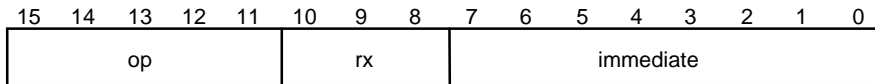

RR-type instruction format

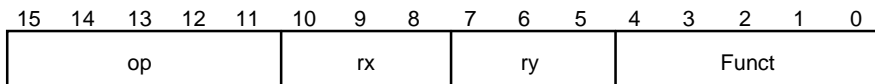

RRI-type instruction format

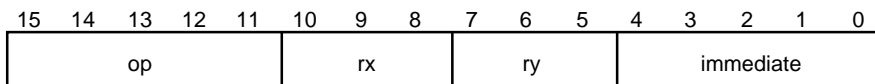

RRR-type instruction format

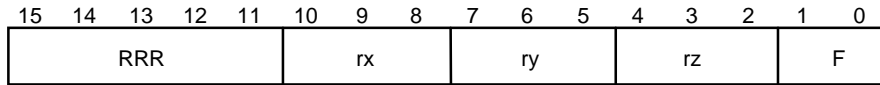

RRI-A type instruction format

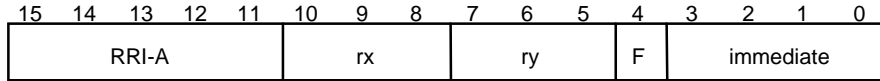

SHIFT instruction format

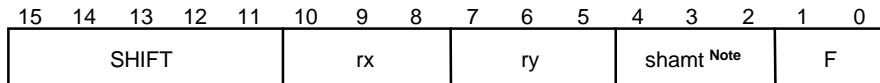

Note The 3-bit shamt field can encode shift count numbers from 0 to 7. 0-bit shift (NOP) cannot be executed. 0 is regarded as shift count 8.

I8-type instruction format

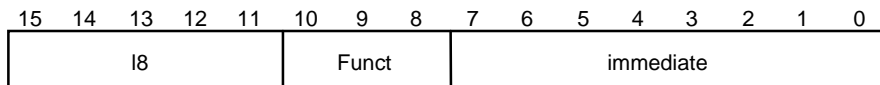

I8_MOVR32 instruction format (used only with MOVR32 instruction)

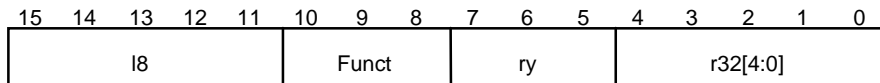

I8_MOV32R instruction format (used only with MOV32R instruction)

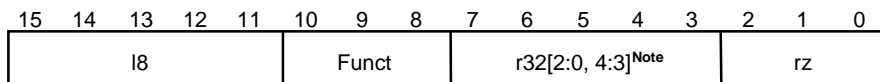

Note The r32 field uses special bit encoding. For example, encoding of \$7 (00111) is 11100 in the r32 field.

I64-type I instruction format

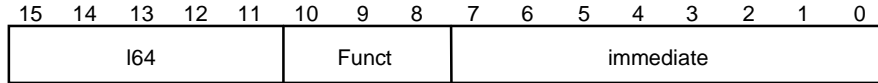

RI64-type instruction format

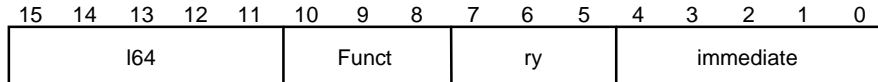

JAL and JALX instruction format

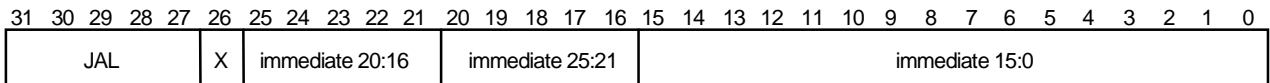

JAL in case of X = 0 instruction

JALX in case of X = 1 instruction

EXT-I instruction format

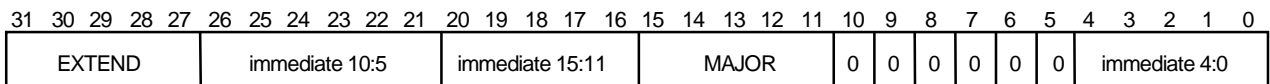

EXT-RI instruction format

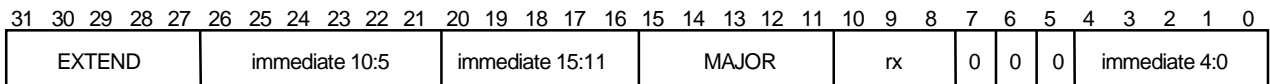

EXT-RRI instruction format

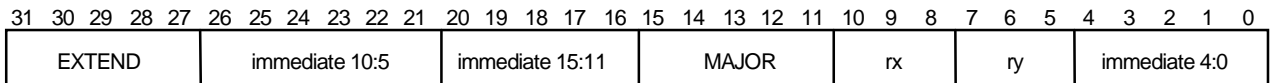

EXT-RRI-A instruction format

31	30	29	28	27	26	25	24	23	22	21	20	19	18	17	16	15	14	13	12	11	10	9	8	7	6	5	4	3	2	1	0
EXTEND				immediate 10:4						imm 14:11				RRI-A				rx		ry		F	imm 3:0								

EXT-SHIFT instruction format

31	30	29	28	27	26	25	24	23	22	21	20	19	18	17	16	15	14	13	12	11	10	9	8	7	6	5	4	3	2	1	0
EXTEND				immediate 4:0						\$S ^{Note}	0	0	0	0	0	0	SHIFT				rx		ry		0	0	0	F			

Note Only in the case of DSLL, the S5 bit is the most significant bit of the 6-bit shift count field (shamt). In the case of all 32-bit extended shifts, S5 must be 0. For a normal shift instruction, the display of shift count 0 is considered as shift count 8, but the extended shift instruction does not perform such mapping changes. Therefore, 0-bit shift using the extended format is possible.

EXT-I8 instruction format

31	30	29	28	27	26	25	24	23	22	21	20	19	18	17	16	15	14	13	12	11	10	9	8	7	6	5	4	3	2	1	0
EXTEND				immediate 10:5						immediate 15:11						I8				Funct		0	0	0	immediate 4:0						

EXT-I64 instruction format

31	30	29	28	27	26	25	24	23	22	21	20	19	18	17	16	15	14	13	12	11	10	9	8	7	6	5	4	3	2	1	0
EXTEND				immediate 10:5						immediate 15:11						I64				Funct		0	0	0	immediate 4:0						

EXT-RI64 instruction format

31	30	29	28	27	26	25	24	23	22	21	20	19	18	17	16	15	14	13	12	11	10	9	8	7	6	5	4	3	2	1	0
EXTEND				immediate 10:5						immediate 15:11						I64				Funct		ry		immediate 4:0							

EXT-SHIFT64 instruction format

31	30	29	28	27	26	25	24	23	22	21	20	19	18	17	16	15	14	13	12	11	10	9	8	7	6	5	4	3	2	1	0
EXTEND				shamt 4:0						\$S ^{Note}	0	0	0	0	0	0	RR				0		0	0	ry		Function				

Note The S5 bit is the most significant bit of the 6-bit shift count field (shamt). In the case of a normal shift instruction, the display of shift count 0 is considered as shift count 8, but the extended shift instruction does not perform such mapping changes. Therefore, 0-bit shift using the extended format is possible.

4.7 MIPS16 OPERATION CODE BIT ENCODING

This section describes encoding for major operation code and minor operation code. Table 4-5 shows bit encoding of the MIPS16 major operation code. Tables 4-6 to 4-11 show bit encoding of the minor operation code. The italic operation codes in the tables are instructions for the extended ISA.

Table 4-5. Bit Encoding of Major Operation Code (op)

Instruction bits [15:14]	Instruction bits [13:11]							
	000	001	010	011	100	101	110	111
00	<i>addi</i> sp ^{Note 1}	<i>addi</i> pc ^{Note 2}	b	jal(x) ^{Note 3}	beqz	bnez	SHIFT	<i>ld</i>
01	RRI-A	<i>addi</i> 8 ^{Note 4}	slti	sltiu	l8	li	cmpi	<i>sd</i>
10	lb	lh	lwsp	lw	lbu	lhu	lwpc	<i>lwu</i>
11	sb	sh	swsp	sw	RRR	RR	extend	<i>l64</i>

- Notes**
1. *addi*sp : *addi* rx, sp, immediate
 2. *addi*pc : *addi* rx, pc, immediate
 3. jal(x) : jal instruction and jalx instruction
 4. *addi*8 : *addi* rx, immediate

Table 4-6. RR Minor Operation Code (RR-Type Instruction)

Instruction bits [4:3]	Instruction bits [2:0]							
	000	001	010	011	100	101	110	111
00	j(al)r ^{Note 1}	*	slt	sltu	sllv	break	srlv	srav
01	<i>dsrl</i> ^{Note 2}	ϕ	cmp	neg	and	or	xor	not
10	Mfhi	*	mflo	<i>dsra</i> ^{Note 2}	<i>dsllv</i>	*	<i>dsrlv</i>	<i>dsrav</i>
11	mult	multu	div	divu	<i>dmult</i>	<i>dmultu</i>	<i>ddiv</i>	<i>ddivu</i>

- Notes**
1. J(al)r: jr rx instruction (ry = 000)
jr ra instruction (ry = 001, rx = 000)
jalr ra, rx instruction (ry = 010)
 2. *dsrl* and *dsra* use the rx register field to encode the shift count (8-digit shift for 0). In the case of the extended version of these two instructions, the EXT-SHIFT64 format is used. Only these two RR instructions can be extended.

Remarks The symbols in the figures have the following meaning.

- * : Execution of operation code with an asterisk on the current V_R4111 causes a reserved instruction exception to be generated. This code is reserved for future extension.
- ϕ : Operation code with ϕ is invalid, but no reserved instruction exception is generated in the V_R4111.

Table 4-7. RRR Minor Operation Code (RRR-Type Instruction)

Instruction bits [1:0]			
00	01	10	11
<i>daddu</i>	<i>addu</i>	<i>dsubu</i>	<i>subu</i>

Table 4-8. RRRI-A Minor Operation Code (RRI-Type ADD Instruction)

Instruction bit [4]	
0	1
<i>addiu</i> ^{Note 1}	<i>daddiu</i> ^{Note 2}

- Notes**
1. *addiu* : *addiu* ry, rx, immediate
 2. *daddiu*: *daddiu* ry, rx immediate

Table 4-9. SHIFT Minor Operation Code (SHIFT-Type Instruction)

Instruction bits [1:0]			
00	01	10	11
<i>sll</i>	<i>dsll</i>	<i>srl</i>	<i>sra</i>

Table 4-10. I8 Minor Operation Code (I8-Type Instruction)

Instruction bits [10:8]							
000	001	010	011	100	101	110	111
<i>bteqz</i>	<i>btnez</i>	<i>swrasp</i> ^{Note 1}	<i>adjsp</i> ^{Note 2}	*	<i>mov32r</i> ^{Note 3}	*	<i>movr32</i> ^{Note 4}

- Notes**
1. *swrasp* : *sw* ra, immediate(sp)
 2. *adjsp* : *addiu* sp, immediate
 3. *mov32r*: *move* r32, rz
 4. *movr32*: *move* ry, r32

Remark The symbols used in the figures have the following meaning.

- * : Execution of operation code with an asterisk on the current Vr4111 causes a reserved instruction exception to be generated. This code is reserved for future extension.

Table 4-11. I64 Minor Operation Code (64-bit Only, I64-Type Instruction)

Instruction bits [10:8]							
000	001	010	011	100	101	110	111
<i>ldsp</i> ^{Note 1}	<i>sdsp</i> ^{Note 2}	<i>sdrasp</i> ^{Note 3}	<i>dadjsp</i> ^{Note 4}	<i>ldpc</i> ^{Note 5}	<i>daddiu5</i> ^{Note 6}	<i>dadiupc</i> ^{Note 7}	<i>dadiusp</i> ^{Note 8}

- Notes**
1. *ldsp* : ld ry, immediate
 2. *sdsp* : sd ry, immediate
 3. *sdrasp* : sd ra, immediate
 4. *dadjsp* : daddiu sp, immediate
 5. *ldpc* : ld ry, immediate
 6. *daddiu5*: daddiu ry, immediate
 7. *dadiupc*: daddiu ry, pc, immediate
 8. *dadiusp*: daddiu ry, sp, immediate

4.8 OUTLINE OF INSTRUCTIONS

This section describes the assembler syntax and defines each instruction. Instructions can be divided into the following four types.

- Load and Store instructions
- Computational instructions
- Jump and Branch instructions
- Special instructions

4.8.1 PC-Relative Instructions

PC-relative instructions is the instruction format first defined among the MIPS16 instruction set. MIPS16 supports both extension and non-extension through the Extend instruction for four PC-relative instructions.

Load Word	LW rx, offset(pc)
Load Doubleword	LD ry, offset(pc)
Add Immediate Unsigned	ADDIU rx, pc, immediate
Doubleword Add Immediate Unsigned	DADDIU ry, pc, immediate

All these instructions calculate the PC value of a PC-relative instruction or the PC value of the instruction immediately preceding as the base address. The address calculation base using various function combinations is shown next.

Table 4-12. Base PC Address Setting

Instruction	Base PC value
Non-extension PC-relative instructions not located in Jump delay slot	PC of instruction
Extension PC-relative instruction	PC of Extend instruction
Non-extension PC-relative instruction in Jump delay slot of JR or JALR	PC of JR instruction or JALR instruction
Non-extension PC-relative instruction in Jump delay slot of JAL or JALX	PC of initial halfword of JAL or JALX ^{Note}

Note Because the JAL and JALX instruction length is 32 bits.

The PC value used as the base for address calculation for the PC-relative instruction outlines shown in tables 4-14 and 4-15 is called base PC value. The base PC value is defined so as to be equivalent to the exception program counter (EPC) value related to the PC-relative instruction.

4.8.2 Extend Instruction

The Extend instruction can extend the immediate fields of MIPS16 instructions, which have fewer immediate fields than equivalent 32-bit MIPS instructions. The Extend instruction must always precede (by one instruction) the instruction whose immediate field you want to extend. Every extended instruction consumes four bytes in program memory instead of two bytes (two bytes for Extend and two bytes for the instruction being extended), and it can cross a word boundary.

For example, the MIPS16 instruction

```
lw ry, offset (rx)
```

contains a five-bit immediate. The immediate expands to 16 bits (000000000 | offset | 00) before execution in the pipeline. This allows 32 different offset values of 0, 4, 8, and up through 124. Once extended, this instruction can hold any of the normal 65,536 values in the range -32768 through 32767.

Shift instructions are extended to 5-bit unsigned immediate values. All other immediate instructions expand to either signed or unsigned 16-bit immediate values. The only exceptions are

```
addiu ry, rx, immediate  
daddiu ry, rx, immediate
```

which can be extended only to a 15-bit signed immediate.

There is only one restriction. Extended instructions should not be placed in jump delay slots. Otherwise, the results are unpredictable because the pipeline would attempt to execute one half the instruction.

Table 4-13 lists the MIPS16 extendable instructions, the size of their immediate, and how much each immediate can be extended when preceded with the Extend instruction.

For the instruction format of the Extend instruction, see **4.6 Instruction Format**.

Table 4-13. Extendable MIPS16 Instructions

MIPS16 Instruction	MIPS16 Immediate	Instruction Format	Extended Immediate	Instruction Format
Load Byte	5	RRI	16	EXT-RRI
Load Byte Unsigned	5	RRI	16	EXT-RRI
Load Halfword	5	RRI	16	EXT-RRI
Load Halfword Unsigned	5	RRI	16	EXT-RRI
Load Word	5 8	RRI RI	16 16	EXT-RRI EXT-RI
Load Word Unsigned	5	RRI	16	EXT-RRI
Load Doubleword	5	RRI	16	EXT-RRI
Store Byte	5	RRI	16	EXT-RRI
Store Halfword	5	RRI	16	EXT-RRI
Store Word	5 (Other) 8 (SW rx, offset(sp)) 8 (SW ra, offset(sp))	RRI RI I8	16 16 16	EXT-RRI EXT-RI EXT-I8
Store Doubleword	5 (SD ry, offset(rx)) 8 (Other)	RRI I64	16 16	EXT-RRI EXT-I64
Load Immediate	8	RI	16	EXT-RI
Add Immediate Unsigned	4 (ADDIU ry, rx, imm) 8 (ADDIU sp, imm) 8 (Other)	RRI-A I8 RI	15 16 16	EXT-RRI-A EXT-I8 EXT-RI
Doubleword Add Immediate Unsigned	4 (DADDIU ry, rx, imm) 5 (DADDIU ry, pc, imm) 8 (Other)	RRI-A RI64 I64	15 16 16	EXT-RRI-A EXT-RI64 EXT-I64
Set on Less Than Immediate	8	RI	16	EXT-RI
Set on Less Than Immediate Unsigned	8	RI	16	EXT-RI
Compare Immediate	8	RI	16	EXT-RI
Shift Left Logical	3	SHIFT	5	EXT-SHIFT
Shift Right Logical	3	SHIFT	5	EXT-SHIFT
Shift Right Arithmetic	3	SHIFT	5	EXT-SHIFT
Doubleword Shift Left Logical	3	SHIFT	6	EXT-SHIFT
Doubleword Shift Right Logical	3	RR	6	EXT-SHIFT64
Doubleword Shift Right Arithmetic	3	RR	6	EXT-SHIFT64
Branch on Equal to Zero	8	RI	16	EXT-RI
Branch on Not Equal to Zero	8	RI	16	EXT-RI
Branch on T Equal to Zero	8	I8	16	EXT-I8
Branch on T Not Equal to Zero	8	I8	16	EXT-I8
Branch Unconditional	11	I	16	EXT-I

4.8.3 Delay Slots

MIPS16 instructions normally execute in one cycle. However, some instructions have special requirements that must be met to assure optimum instruction flow. The instructions include All Load, Branch, and Multiply/Divide instructions.

(1) Load delay slots

MIPS16 operates with delayed loads. This is similar to the method used by 32-bit MIPS instruction sets. If another instruction references the load destination register before the load operation is completed, one cycle occurs automatically. To assure the best performance, the compiler should always schedule load delay slots as early as possible.

(2) Branch delay slots not supported

Unlike for 32-bit MIPS instructions, there are no branch delay slots for branch instructions in MIPS16. If a branch is taken, the instruction that immediately follows the branch (instruction corresponding to 32-bit MIPS delay slot) is cancelled. There are no restrictions on the instruction that follows a branch instruction, and such instruction is executed only when a branch is not taken. Branches, jumps, and extended instructions are permitted in the instruction slot after a branch.

(3) Jump delay slots

With MIPS16, there is a delay of one cycle after each jump instruction. The processor executes any instruction in the jump delay slot before it executes the jump target instruction. Two restrictions apply to any instruction placed in the jump delay slot:

1. Do not specify a branch or jump in the delay slot.
2. Do not specify an extended instruction (32-bits) in the delay slot. Doing so will make the results unpredictable.

(4) Multiply and divide scheduling

Multiply and divide latency depends on the hardware implementation. If an MFLO or MFHI instruction references the Multiply or Divide result registers before the result is ready, the pipeline stalls until the operation is complete and the result is available. However, to assure the best performance, the compiler should always schedule Multiply and Divide instructions as early as possible.

MIPS16 requires that all MFHI and MFLO instructions be followed by two instructions that do not write to the HI or LO registers. Otherwise, the data read by MFLO or MFHI will be undefined. The Extend instruction is counted singly as one instruction.

4.8.4 Instruction Details

(1) Load and Store Instructions

Load and Store instructions move data between memory and the general-purpose registers. The only addressing mode that is supported is the mode for adding immediate offset to the base register.

Table 4-14. Load and Store Instructions (1/3)

Instruction	Format and Description
Load Byte	<p>LB ry, offset (rx)</p> <p>The 5-bit immediate is zero extended and then added to the contents of general-purpose register rx to form the virtual address. The bytes of the memory location specified by the address are sign extended and loaded into general-purpose register ry.</p>
Load Byte Unsigned	<p>LBU ry, offset (rx)</p> <p>The 5-bit immediate is zero extended and then added to the contents of general-purpose register rx to form the virtual address. The bytes of the memory location specified by the address are zero extended and loaded into general-purpose register ry.</p>
Load Halfword	<p>LH ry, offset (rx)</p> <p>The 5-bit immediate is shifted left one bit, zero extended, and then added to the contents of general-purpose register rx to form the virtual address. The halfword of the memory location specified by the address is sign extended and loaded to general-purpose register ry.</p> <p>If the least significant bit of the address is not 0, an address error exception is generated.</p>
Load Halfword Unsigned	<p>LHU ry, offset (rx)</p> <p>The 5-bit immediate is shifted left one bit, zero extended, and then added to the contents of general-purpose register rx to form the virtual address. The halfword of the memory location specified by the address is zero extended and loaded to general-purpose register ry.</p> <p>If the least significant bit of the address is not 0, an address error exception is generated.</p>
Load Word	<p>LW ry, offset (rx)</p> <p>The 5-bit immediate is shifted left two bits, zero extended, and then added to the contents of general-purpose register rx to form the virtual address. The word of the memory location specified by the address is loaded to general-purpose register ry. In the 64-bit mode, it is further sign extended to 64 bits.</p> <p>If either of the lower two bits is not 0, an address error exception is generated.</p>
	<p>LW rx, offset (pc)</p> <p>The two lower bits of the BasePC value associated with the instruction are cleared to form the masked BasePC value. The 8-bit immediate is shifted left two bits, zero extended, and then added to the masked BasePC to form the virtual address. The contents of the word at the memory location specified by the address are loaded to general-purpose register rx. In the 64-bit mode, it is further sign extended to 64 bits.</p>
	<p>LW rx, offset (sp).</p> <p>The 8-bit immediate is shifted left two bits, zero extended, and then added to the contents of general-purpose register sp to form the virtual address. The contents of the word at the memory location specified by the address are loaded to general-purpose register rx. In the 64-bit mode, it is further sign extended to 64 bits.</p> <p>If either of the two lower bits of the address is 0, an address error exception is generated.</p>

Table 4-14. Load and Store Instructions (2/3)

Instruction	Format and Description
Load Word Unsigned	<p>LWU ry, offset (rx)</p> <p>The 5-bit immediate is shifted left two bits, zero extended to 64 bits, and then added to the contents of general-purpose register rx to form the virtual address. The word of the memory location specified by the address is zero extended and loaded to general-purpose register ry.</p> <p>If either of the two lower bits of the address is not 0, an address error exception is generated.</p> <p>This operation is defined in the 64-bit mode and the 32-bit kernel mode. When this instruction is executed in the 32-bit user/supervisor mode, a reserved instruction exception is generated.</p>
Load Doubleword	<p>LD ry, offset (rx)</p> <p>The 5-bit immediate is shifted left three bits, zero extended to 64 bits, and then added to the contents of general-purpose register rx to form the virtual address. The 64-bit doubleword of the memory location specified by the address is loaded to general-purpose register ry.</p> <p>If any of the lower three bits of the address is not 0, an address error exception is generated.</p> <p>This operation is defined in the 64-bit mode and the 32-bit kernel mode. When this instruction is executed in the 32-bit user/supervisor mode, a reserved instruction exception is generated.</p>
	<p>LD ry, offset (pc)</p> <p>The lower three bits of the base PC value related to the instruction are cleared to form the masked BasePC value.</p> <p>The 5-bit immediate is shifted left three bits, zero extended to 64 bits, and then added to the masked BasePC to form the virtual address. The 64-bit doubleword at the memory location specified by the address is loaded to general-purpose register ry.</p> <p>This operation is defined in the 64-bit mode and the 32-bit kernel mode. When this instruction is executed in the 32-bit user/supervisor mode, a reserved instruction exception is generated.</p>
	<p>LD ry, offset (sp)</p> <p>The 5-bit immediate is shifted left three bits, zero extended to 64 bits, and added to the contents of general-purpose register sp to form the virtual address. The 64-bit doubleword at the memory location specified by the address is loaded to general-purpose register ry.</p> <p>If any of the three lower bits of the address is not 0, an address error exception is generated.</p> <p>This operation is defined in the 64-bit mode and the 32-bit kernel mode. When this instruction is executed in the 32-bit user/supervisor mode, a reserved instruction exception is generated.</p>

Table 4-14. Load and Store Instructions (3/3)

Instruction	Format and Description
Store Byte	<p>SB ry, offset (rx)</p> <p>The 5-bit immediate is zero extended and then added to the contents of general-purpose register rx to form the virtual address. The least significant byte of general-purpose register ry is stored to the memory location specified by the address.</p>
Store Halfword	<p>SH ry, offset (rx)</p> <p>The 5-bit immediate is shifted left one bit, zero extended, and then added to the contents of general-purpose register rx to form the virtual address. The lower halfword of general-purpose register ry is stored to the memory location specified by the address.</p> <p>If the least significant bit of the address is not 0, an address error exception is generated.</p>
Store Word	<p>SW ry, offset (rx)</p> <p>The 5-bit immediate is shifted left two bits, zero extended, and then added to the contents of general-purpose register rx to form a virtual address. The contents of general-purpose register ry are stored to the memory location specified by the address. If either of the two lower bits of the address is not 0, an address error exception is generated.</p>
	<p>SW rx, offset (sp)</p> <p>The 8-bit immediate is shifted left two bits, zero extended, and then added to the contents of general-purpose register sp to form the virtual address. The contents of general-purpose register rx are stored to the memory location specified by the address. If either of the two lower bits of the address is not 0, and address error exception is generated.</p>
	<p>SW ra, offset (sp)</p> <p>The 8-bit immediate is shifted left two bits, zero extended, and then added to the contents of general-purpose register sp to form the virtual address. The contents of general-purpose register ra are stored to the memory location specified by the address. If either of the two lower bits of the address is not 0, an address error exception is generated.</p>
Store Doubleword	<p>SD ry, offset (rx)</p> <p>The 5-bit immediate is shifted left three bits, zero extended to 64 bits, and then added to the contents of general-purpose register rx to form the virtual address. The 64 bits of general-purpose register ry are stored to the memory location specified by the address. If any of the lower three bits of the address is not 0, an address error exception is generated.</p> <p>This operation is defined in the 64-bit mode and the 32-bit kernel mode. When this instruction is executed in the 32-bit user/supervisor mode, a reserved instruction exception is generated.</p>
	<p>SD ry, offset (sp)</p> <p>The 5-bit immediate is shifted left three bits, zero extended to 64 bits, and then added to the contents of general-purpose register sp to form the virtual address. The 64 bits of general-purpose register ry are stored to the memory location specified by the address.</p> <p>If any of the lower three bits of the address is not 0, an address error exception is generated.</p> <p>This operation is defined in the 64-bit mode and the 32-bit kernel mode. When this instruction is executed in the 32-bit user/supervisor mode, a reserved instruction exception is generated.</p>
	<p>SD ra, offset (sp).</p> <p>The 8-bit immediate is shifted left three bits, zero extended to 64 bits, and then added to the contents of general-purpose register sp to form the virtual address. The 64 bits of general-purpose register ra are stored to the memory location specified by the memory. If any of the three lower bits of the address is not 0, an address error exception is generated.</p> <p>This operation is defined in the 64-bit mode and the 32-bit kernel mode. When this instruction is executed in the 32-bit user/supervisor mode, a reserved instruction exception is generated.</p>

(2) Computational instructions

Computational instructions perform arithmetic, logical, and shift operations on values in registers. There are four categories of Computational instructions: ALU Immediate, Two/Three-Operand Register-Type, Shift, and Multiply/Divide.

Table 4-15. ALU Immediate Instructions (1/2)

Instruction	Format and Description
Load Immediate	LI rx, immediate The 8-bit immediate is zero extended and loaded to general-purpose register rx.
Add Immediate Unsigned	ADDIU ry, rx, immediate The 4-bit immediate is sign extended and then added to the contents of general-purpose register rx to form a 32-bit result. The result is placed into general-purpose register ry. No integer overflow exception occurs under any circumstances. In the 64-bit mode, the operand must be a 64-bit value formed by sign-extending a 32-bit value.
	ADDIU rx, immediate The 8-bit immediate is sign extended and then added to the contents of general-purpose register rx to form a 32-bit result. The result is placed into general-purpose register rx. No integer overflow exception occurs under any circumstances. In the 64-bit mode, the operand must be a 64-bit value formed by sign-extending a 32-bit value.
	ADDIU sp, immediate The 8-bit immediate is shifted left three bits, sign extended, and then added to the contents of general-purpose register sp to form a 32-bit result. The result is placed into general-purpose register sp. No integer overflow exception occurs under any circumstances. In the 64-bit mode, the operand must be a 64-bit value formed by sign-extending a 32-bit value.
	ADDIU rx, pc, immediate The two lower bits of the BasePC value associated with the instruction are cleared to form the masked BasePC value. The 8-bit immediate is shifted left two bits, zero extended, and then added to the masked BasePC value to form the virtual address. This address is placed into general-purpose register rx. No integer overflow exception occurs under any circumstances.
	ADDIU rx, sp, immediate The 8-bit immediate is shifted left two bits, zero extended, and then added to the contents of register sp to form a 32-bit result. The result is placed into general-purpose register rx. No integer overflow exception occurs under any circumstance. In the 64-bit mode, the operand must be a 64-bit value formed by sign-extending a 32-bit value.

Table 4-15. ALU Immediate Instructions (2/2)

Instruction	Format and Description
Doubleword Add Immediate Unsigned	<p>DADDIU ry, rx, immediate</p> <p>The 4-bit immediate is sign extended to 64 bits, and then added to the contents of register rx to form a 64-bit result. The result is placed into general-purpose register ry. No integer overflow exception occurs under any circumstances.</p> <p>This operation is defined in the 64-bit mode and the 32-bit kernel mode. When this instruction is executed in the 32-bit user/supervisor mode, a reserved instruction exception is generated.</p>
	<p>DADDIU ry, immediate</p> <p>The 5-bit immediate is sign extended to 64 bits, and then added to the contents of register ry to form a 64-bit result. The result is placed into general-purpose register ry. No integer overflow exception occurs under any circumstances.</p> <p>This operation is defined in the 64-bit mode and the 32-bit kernel mode. When this instruction is executed in the 32-bit user/supervisor mode, a reserved instruction exception is generated.</p>
	<p>DADDIU sp, immediate</p> <p>The 8-bit immediate is shifted left three bits, sign extended to 64 bits, and then added to the contents of register sp to form a 64-bit result. The result is placed into general-purpose register sp. No integer overflow exception occurs under any circumstances.</p> <p>This operation is defined in the 64-bit mode and the 32-bit kernel mode. When this instruction is executed in the 32-bit user/supervisor mode, a reserved instruction exception is generated.</p>
	<p>DADDIU ry, pc, immediate</p> <p>The two lower bits of the BasePC value associated with the instruction are cleared to form the masked BasePC value. The 5-bit immediate is shifted left two bits, zero extended, and added to the masked BasePC value to form the virtual address. This address is placed into general-purpose register ry. No integer overflow exception occurs under any circumstances.</p> <p>This operation is defined in the 64-bit mode and the 32-bit kernel mode. When this instruction is executed in the 32-bit user/supervisor mode, a reserved instruction exception is generated.</p>
	<p>DADDIU ry, sp, immediate</p> <p>The 5-bit immediate is shifted left two bits, zero extended to 64 bits, and then added to the contents of register sp to form a 64-bit result. This result is placed into register ry. No integer overflow exception occurs under any circumstances.</p> <p>This operation is defined in the 64-bit mode and the 32-bit kernel mode. When this instruction is executed in the 32-bit user/supervisor mode, a reserved instruction exception is generated.</p>
Set on Less Than Immediate	<p>SLTI rx, immediate</p> <p>The 8-bit immediate is zero extended and subtracted from the contents of general-purpose register rx. Considering both quantities as signed integers, if rx is less than the zero-extended immediate, the result is set to 1; otherwise, the result is set to 0. The result is placed into register T (\$24).</p>
Set on Less Than Immediate Unsigned	<p>SLTIU rx, immediate</p> <p>The 8-bit immediate is zero extended and subtracted from the contents of general-purpose register rx. Considering both quantities as signed integers, if rx is less than the zero-extended immediate, the result is set to 1; otherwise, the result is set to 0. The result is placed into register T (\$24).</p>
Compare Immediate	<p>CMPI rx, immediate</p> <p>The 8-bit immediate is zero extended and exclusive ORed in 1-bit units with the contents of general-purpose register rx. The result is placed into register T (\$24).</p>

Table 4-16. Two-/Three-Operand Register Type (1/2)

Instruction	Format and Description
Add Unsigned	<p>ADDU rz, rx, ry</p> <p>The contents of general-purpose registers rx and ry are added together to form a 32-bit result. The result is placed into general-purpose register rz. No integer overflow exception occurs under any circumstances. In the 64-bit mode, the operand must be a 64-bit value formed by sign-extending a 32-bit value.</p>
Subtract Unsigned	<p>SUBU rz, rx, ry</p> <p>The contents of general-purpose register ry are subtracted from the contents of general-purpose register rx. The 32-bit result is placed into general-purpose register rz. No integer overflow exception occurs under any circumstances. In the 64-bit mode, the operand must be a 64-bit value formed by sign-extending a 32-bit value.</p>
Doubleword Add Unsigned	<p>DADDU rz, rx, ry</p> <p>The contents of general-purpose register ry are added to the contents of general-purpose register rx. The 64-bit result is placed into register rz. No integer overflow exception occurs under any circumstances.</p> <p>This operation is defined in the 64-bit mode and the 32-bit kernel mode. When this instruction is executed in the 32-bit user/supervisor mode, a reserved instruction exception is generated.</p>
Doubleword Subtract Unsigned	<p>DSUBU rz, rx, ry</p> <p>The contents of general-purpose register ry are subtracted from the contents of general-purpose register rx. The 64-bit result is placed into general-purpose register rz. No integer overflow exception occurs under any circumstances.</p> <p>This operation is defined in the 64-bit mode and the 32-bit kernel mode. When this instruction is executed in the 32-bit user/supervisor mode, a reserved instruction exception is generated.</p>
Set on Less Than	<p>SLT rx, ry</p> <p>The contents of general-purpose register ry are subtracted from the contents of general-purpose register rx. Considering both quantities as signed integers, if the contents of rx are less than the contents of ry, the result is set to 1; otherwise, the result is set to 0. The result is placed into register T (\$24).</p> <p>No integer overflow exception occurs. The comparison is valid even if the subtraction overflows.</p>
Set on Less Than Unsigned	<p>SLTU rx, ry</p> <p>The contents of general-purpose register ry are subtracted from the contents of general-purpose register rx. Considering both quantities as unsigned integers, if the contents of rx are less than the contents of ry, the result is set to 1; otherwise, the result is set to 0. The result is placed in register T (\$24).</p> <p>No integer overflow exception occurs. The comparison is valid even if the subtraction overflows.</p>

Table 4-16. Two-/Three-Operand Register Type (2/2)

Instruction	Format and Description
Compare	<p>CMP rx, ry</p> <p>The contents of general-purpose register ry are Exclusive-ORed with the contents of general-purpose register rx. The result is placed into register T (\$24).</p>
Negate	<p>NEG rx, ry</p> <p>The contents of general-purpose register ry are subtracted from zero to form a 32-bit result. The result is placed in general-purpose register rx.</p>
AND	<p>AND rx, ry</p> <p>The contents of general-purpose register ry are logical ANDed with the contents of general-purpose register rx in 1-bit units. The result is placed in general-purpose register rx.</p>
OR	<p>OR rx, ry</p> <p>The contents of general-purpose register ry are logical ORed with the contents of general-purpose register ry. The result is placed in general-purpose register rx.</p>
Exclusive OR	<p>XOR rx, ry</p> <p>The contents of general-purpose register ry are Exclusive-ORed with the contents of general-purpose register rx in 1-bit units. The result is placed in general-purpose register rx.</p>
NOT	<p>NOT rx, ry</p> <p>The contents of general-purpose register ry are inverted in 1-bit units and placed in general-purpose register rx.</p>
Move	<p>MOVE ry, r32</p> <p>The contents of general-purpose register r32 are moved to general-purpose register ry. R32 can specify any one of the 32 general-purpose registers.</p>
Move	<p>MOVE r32, rz</p> <p>The contents of general-purpose register rz are moved to general-purpose register r32. r32 can specify any one of the 32 general-purpose registers</p>

Table 4-17. Shift Instructions (1/2)

Instruction	Format and Description
Shift Left Logical	<p>SLL rx, ry, immediate</p> <p>The 32-bit contents of general-purpose register ry are shifted left and zeros are inserted into the emptied low-order bits. The 3-bit immediate specifies the shift count. A shift count of 0 is interpreted as a shift count of 8. The result is placed in general-purpose register rx. In the 64-bit mode, the value that is formed by sign-extending shifted 32-bit value is stored as the result.</p>
Shift Right Logical	<p>SLR rx, ry, immediate</p> <p>The 32-bit contents of general-purpose register ry are shifted right, and zeros are inserted into the emptied high-order bits. The 3-bit immediate specifies the shift count. A shift count of 0 is interpreted as a shift count of 8. The result is placed in general-purpose register rx. In the 64-bit mode, the value that is formed by sign-extending shifted 32-bit value is stored as the result.</p>
Shift Right Arithmetic	<p>SRA rx, ry, immediate</p> <p>The 32-bit contents of general-purpose register ry are shifted right and the emptied high-order bits are sign extended. The 3-bit immediate specifies the shift count. A shift count of 0 is interpreted as a shift count of 8. In the 64-bit mode, the value that is formed by sign-extending shifted 32-bit value is stored as the result.</p>
Shift Left Logical Variable	<p>SLLV ry, rx</p> <p>The 32-bit contents of general-purpose register ry are shifted left, and zeros are inserted into the emptied low-order bits. The five low-order bits of general-purpose register rx specify the shift count. The result is placed in general-purpose register ry. In the 64-bit mode, the value that is formed by sign-extending shifted 32-bit value is stored as the result.</p>
Shift Right Logical Variable	<p>SRLV ry, rx</p> <p>The 32-bit contents of general-purpose register ry are shifted right, and the emptied high-order bits are sign extended. The five lower-order bits of general-purpose register rx specify the shift count. The register is placed in general-purpose register ry. In the 64-bit mode, the value that is formed by sign-extending shifted 32-bit value is stored as the result.</p>
Shift Right Arithmetic Variable	<p>SRAV ry, rx</p> <p>The 32-bit contents of general-purpose register ry are shifted right, and the emptied high-order bits are sign extended. The five low-order bits of general-purpose register rx specify the shift count. The result is placed in general-purpose register ry. In the 64-bit mode, the value that is formed by sign-extending shifted 32-bit value is stored as the result.</p>

Table 4-17. Shift Instructions (2/2)

Instruction	Format and Description
Doubleword Shift Left Logical	<p>DSLl rx, ry, immediate</p> <p>The 64-bit doubleword contents of general-purpose register ry are shifted left, and zeros are inserted into the emptied low-order bits. The 3-bit immediate specifies the shift count. A shift count of 0 is interpreted as a shift count of 8. The 64-bit result is placed in general-purpose register rx.</p> <p>This operation is defined in the 64-bit mode and the 32-bit kernel mode. When this instruction is executed in the 32-bit user/supervisor mode, a reserved instruction exception is generated.</p>
Doubleword Shift Right Logical	<p>DSRL ry, immediate</p> <p>The 64-bit doubleword contents of general-purpose register ry are shifted right, and zeros are inserted into the emptied high-order bits. The 3-bit immediate specifies the shift count. A shift count of 0 is interpreted as a shift count of 8.</p> <p>This operation is defined in the 64-bit mode and the 32-bit kernel mode. When this instruction is executed in the 32-bit user/supervisor mode, a reserved instruction exception is generated.</p>
Doubleword Shift Right Arithmetic	<p>DSRA ry, immediate</p> <p>The 64-bit doubleword contents of general-purpose register ry are shifted right, and the emptied high-order bits are sign extended. The 3-bit immediate specifies the shift count. A shift count of 0 is interpreted as a shift count of 8.</p> <p>This operation is defined in the 64-bit mode and the 32-bit kernel mode. When this instruction is executed in the 32-bit user/supervisor mode, a reserved instruction exception is generated.</p>
Doubleword Shift Left Logical Variable	<p>DSLlV ry, rx</p> <p>The 64-bit doubleword contents of general-purpose register ry are shifted left, and zeros are inserted into the emptied low-order bits. The six low-order bits of general-purpose register rx specify the shift count. The result is placed in general-purpose register ry.</p> <p>This operation is defined in the 64-bit mode and the 32-bit kernel mode. When this instruction is executed in the 32-bit user/supervisor mode, a reserved instruction exception is generated.</p>
Doubleword Shift Right Logical Variable	<p>DSRLV ry, rx</p> <p>The 64-bit doubleword contents of general-purpose register ry are shifted right, and zeros are inserted into the emptied high-order bits. The six low-order bits of general-purpose register rx specify the shift count. The result is placed in general-purpose register ry.</p> <p>This operation is defined in the 64-bit mode and the 32-bit kernel mode. When this instruction is executed in the 32-bit user/supervisor mode, a reserved instruction exception is generated.</p>
Doubleword Shift Right Arithmetic Variable	<p>DSRAV ry, rx</p> <p>The 64-bit doubleword contents of general-purpose register ry are shifted right, and the emptied high-order bits are sign extended. The six low-order bits of general-purpose register rx specify the shift count. The result is placed in general-purpose register ry.</p> <p>This operation is defined in the 64-bit mode and the 32-bit kernel mode. When this instruction is executed in the 32-bit user/supervisor mode, a reserved instruction exception is generated.</p>

Table 4-18. Multiply/Divide Instructions (1/2)

Instruction	Format and Description
Multiply	<p>MULT rx, ry</p> <p>The contents of general-purpose registers rx and ry are multiplied, treating both operands as 32-bit two's complement values. No integer overflow exception occurs.</p> <p>In the 64-bit mode, the operand must be a 64-bit value formed by sign-extending a 32-bit value. The low-order 32-bit word of the result are placed in special register LO, and the high-order 32-bit word is placed in special register HI. In the 64-bit mode, each result is sign extended and then stored.</p> <p>If either of the two immediately preceding instructions is MFHI or MFLO, their transfer instruction execution result becomes undefined. To obtain the correct result, insert two or more other instructions between the MFHI, MFLO instructions, and the MULT instruction.</p>
Multiply Unsigned	<p>MULTU rx, ry</p> <p>The contents of general-purpose registers rx and ry are multiplied, treating both operands as 32-bit unsigned values. No integer overflow exception occurs. In the 64-bit mode, the operand must be a 64-bit value formed by sign-extending a 32-bit value. The low-order 32-bit word of the result is placed in special register LO, and the high-order 32-bit word is placed in special register HI. In the 64-bit mode, each result is sign extended and stored.</p> <p>If either of the two immediately preceding instructions is MFHI or MFLO, the result of execution of these transfer instructions is undefined. To obtain the correct result, insert two or more other instructions between the MFHI, MFLO instructions and the MULTU instruction.</p>
Divide	<p>DIV rx, ry</p> <p>The contents of general-purpose register rx are divided by the contents of general-purpose register ry, treating both operands as 32-bit two's complement values. No integer overflow exception occurs. The result when the divisor is 0 is undefined. The 32-bit quotient is placed in special register LO, and the 32-bit remainder is placed in special register HI. In the 64-bit mode, the result is sign extended.</p> <p>Normally, this instruction is executed after instructions checking for division by zero and overflow.</p> <p>If either of the two immediately preceding instructions is MFHI or MFLO, the result of execution of these transfer instructions is undefined. To obtain the correct result, insert two or more other instructions between the MFHI, MFLO instructions and the DIV instruction.</p>
Divide Unsigned	<p>DIVU rx, ry</p> <p>The contents of general-purpose register rx are divided by the contents of general-purpose register ry, treating both operands as unsigned values. No integer overflow exception occurs. The result when the divisor is 0 is undefined. The 32-bit quotient is placed in special register LO, and the 32-bit remainder is placed in special register HI. In the 64-bit mode, the result is sign extended.</p> <p>Normally, this instruction is executed after instructions checking for division by zero.</p> <p>If either of the two immediately preceding instructions is MFHI or MFLO, the result of execution of these transfer instructions is undefined. To obtain the correct result, insert two or more other instructions between the MFHI, MFLO instructions and the DIVU instruction.</p>
Move From HI	<p>MFHI rx</p> <p>The contents of special register HI are loaded into general-purpose register rx.</p> <p>To ensure correct operation when an interrupt occurs, do not use an instruction that changes the HI register (MULT, MULTU, DIV, DIVU, DMULT, DMULTU, DDIV, DDIVU) for the two instructions after the MFHI instruction.</p>

Table 4-18. Multiply/Divide Instructions (2/2)

Instruction	Format and Description
Move From LO	<p>MFLO rx</p> <p>The contents of special register LO are loaded into general-purpose register rx.</p> <p>To ensure correct operation when an interrupt occurs, do not use an instruction that changes the HI register (MULT, MULTU, DIV, DIVU, DMULT, DMULTU, DDIV, DDIVU) for the two instructions after the MFLO instruction.</p>
Doubleword Multiply	<p>DMULT rx, ry</p> <p>The 64-bit contents of general-purpose register rx and ry are multiplied, treating both operands as two's complement values. No integer overflow exception occurs. The low-order 64 bits of the result are placed in special register LO, and the high-order 64 bits are placed in special register HI.</p> <p>If either of the two immediately preceding instructions is MFHI or MFLO, the result of execution of these transfer instructions is undefined. To obtain the correct result, insert two or more other instructions between the MFHI, MFLO instructions and the DMULT instruction.</p> <p>This operation is defined in the 64-bit mode and the 32-bit kernel mode. When this instruction is executed in the 32-bit user/supervisor mode, a reserved instruction exception is generated.</p>
Doubleword Multiply Unsigned	<p>DMULTU rx, ry</p> <p>The 64-bit contents of general-purpose registers rx and ry are multiplied, treating both operands as unsigned values. No integer overflow exception occurs. The low-order 64 bits of the result are placed in special register LO, and the high-order 64 bits of the result are placed in special register HI.</p> <p>If either of the two immediately preceding instructions is MFHI or MFLO, the result of execution of these transfer instructions is undefined. To obtain the correct result, insert two or more other instructions between the MFHI, MFLO instructions and the DMULTU instruction.</p> <p>This operation is defined in the 64-bit mode and the 32-bit kernel mode. When this instruction is executed in the 32-bit user/supervisor mode, a reserved instruction exception is generated.</p>
Doubleword divide	<p>DDIV rx, ry</p> <p>The 64-bit contents of general-purpose registers rx are divided by the contents of general-purpose register ry, treating both operands as two's complement values. No integer overflow exception occurs. The result when the divisor is 0 is undefined. The 64-bit quotient is placed in special register LO, and the 64-bit remainder is placed in special register HI. Normally, this instruction is executed after instructions checking for division by zero and overflow.</p> <p>If either of the two immediately preceding instructions is MFHI or MFLO, the result of execution of these transfer instructions is undefined. To obtain the correct result, insert two or more other instructions between the MFHI, MFLO instructions and the DDIV instruction.</p> <p>This operation is defined in the 64-bit mode and the 32-bit kernel mode. When this instruction is executed in the 32-bit user/supervisor mode, a reserved instruction exception is generated.</p>
Doubleword Divide Unsigned	<p>DDIVU rx, ry</p> <p>The 64-bit contents of general-purpose register rx are divided by the contents of general-purpose register ry, treating both operands as unsigned values. No integer overflow exception occurs. The result when the divisor is 0 is undefined. The 64-bit quotient is placed in special register LO, and the 64-bit remainder is placed in special register HI. Normally, this instruction is executed after an instruction checking for division by zero.</p> <p>If either of the two immediately preceding instructions is MFHI or MFLO, the result of execution of these transfer instructions is undefined. To obtain the correct result, insert two or more other instructions between the MFHI, MFLO instructions and the DDIVU instruction.</p> <p>This operation is defined in the 64-bit mode and the 32-bit kernel mode. When this instruction is executed in the 32-bit user/supervisor mode, a reserved instruction exception is generated.</p>

(3) Jump and Branch Instructions

Jump and Branch instructions change the control flow of a program.

All Jump instructions occur with a one-instruction delay. That is, the instruction immediately following the jump is always executed.

Branch instructions do not have a delay slot. If a branch is taken, the instruction immediately following the branch is never executed. If the branch is not taken, the instruction immediately following the branch is always executed.

Table 4-19 shows the MIPS16 Jump and Branch instructions.

Table 4-19. Jump and Branch Instructions (1/2)

Instruction	Format and Description
Jump and Link	<p>JAL target</p> <p>The 26-bit target address is shifted left two bits and combined with the high-order four bits of the address of the delay slot. The program unconditionally jumps to this calculated address with a delay of one instruction. The address of the instruction immediately following the delay slot is placed in register ra. The ISA Mode bit is left unchanged. The value stored in ra bit 0 will reflect the current ISA Mode bit.</p>
Jump and Link Exchange	<p>JALX target</p> <p>The 26-bit target address is shifted left two bits and combined with the high-order four bits of the address of the delay slot. The program unconditionally jumps to this calculated address with a delay of one instruction. The address of the instruction immediately following the delay slot is placed in register ra. The ISA Mode bit is inverted with a delay of one instruction. The value stored in ra bit 0 will reflect the ISA Mode bit before execution of the Jump execution.</p>
Jump Register	<p>JR rx</p> <p>The program unconditionally jumps to the address specified in general-purpose register rx, with a delay of one instruction. The instruction sets the ISA Mode bit to the value in rx bit 0. If the Jump target address is in the MIPS16 instruction length mode, no address exception occurs when bit 0 of the source register is 1 because bit 0 of the target address is 0 so that the instruction is located at the halfword boundary.</p> <p>If the 32-bit length instruction mode is changed, an address exception occurs when the jump target address is fetched if the two low-order bits of the target address are not 0.</p>
	<p>JR ra</p> <p>The program unconditionally jumps to the address specified in register ra, with a delay of one instruction. The instruction sets the ISA Mode bit to the value in ra bit 0. If the Jump target address is in the MIPS16 instruction length mode, no address exception occurs when bit 0 of the source register is 1 because bit 0 of the target address is 0 so that the instruction is located at the halfword boundary.</p> <p>If the 32-bit length instruction mode is changed, an address exception occurs when the jump target address is fetched if the two low-order bits of the target address are not 0.</p>
Jump and Link Register	<p>JALR ra, rx</p> <p>The program unconditionally jumps to the address contained in register rx, with a delay of one instruction. This instruction sets the ISA Mode bit to the value in rx bit 0. The address of the instruction immediately following the delay slot is placed in register ra. The value stored in ra bit 0 will reflect the ISA mode bit before the jump execution is executed.</p> <p>If the Jump target address is in the MIPS16 instruction length mode, no address exception occurs when bit 0 of the source register is 1 because bit 0 of the target address is 0 so that the instruction is located at the halfword boundary.</p> <p>If the 32-bit length instruction mode is changed, an address exception occurs when the jump target address is fetched if the two low-order bits of the target address are not 0.</p>

Table 4-19. Jump and Branch Instructions (2/2)

Instruction	Format and Description
Branch on Equal to Zero	BEQZ rx, immediate The 8-bit immediate is shifted left one bit, sign extended, and then added to the address of the instruction after the branch to form the target address. If the contents of general-purpose register rx are equal to zero, the program branches to the target address. No delay slot is generated.
Branch on Not Equal to Zero	BNEZ rx, immediate The 8-bit immediate is shifted left one bit, sign extended, and then added to the address of the instruction after the branch to form the target address. If the contents of general-purpose register rx are not equal to zero, the program branches to the target address. No delay slot is generated.
Branch on T Equal to Zero	BTEQZ immediate The 8-bit immediate is shifted left one bit, sign extended, and then added to the address of the instruction after the branch to form the target address. If the contents of special register T (\$24) are not equal to zero, the program branches to the target address. No delay slot is generated.
Branch on T Not Equal to Zero	BTNEZ immediate The 8-bit immediate is shifted left one bit, sign extended, and then added to the address of the instruction after the branch to form the target address. If the contents of special register T (\$24) are not equal to zero, the program branches to the target address. No delay slot is generated.
Branch Unconditional	B immediate The 11-bit immediate is shifted left one bit, sign extended, and then added to the address of the instruction after the branch to form the target address. The program branches to the target address unconditionally.

(4) Special Instructions

Special instructions unconditionally perform branching to general exception vectors. Special instructions are of the R type. Table 4-20 shows two special instructions.

Table 4-20. Special Instructions

Instruction	Format and Description
Breakpoint	BREAK immediate A breakpoint trap occurs, immediately and unconditionally transferring control to the exception handler. By using a 6-bit code area, parameters can be sent to the exception handler. If the exception handler uses this parameter, the contents of memory including instructions must be loaded as data.
Extend	EXTEND immediate The 11-bit immediate is combined with the immediate in the next instruction to form a larger immediate equivalent to 32-bit MIPS. The Extend instruction must always precede (by one instruction) the instruction whose immediate field you want to extend. Every extended instruction consumes four bytes in program memory instead of two bytes (two bytes for Extend and two bytes for the instruction being extended), and it can cross a word boundary. (For details, see 4.8.2 Extend Instruction.)

[MEMO]

CHAPTER 5 VR4111 PIPELINE

This chapter describes the basic operation of the VR4111 processor pipeline, which includes descriptions of the delay slots (instructions that follow a branch or load instruction in the pipeline), interrupts to the pipeline flow caused by interlocks and exceptions, and CP0 hazards.

5.1 PIPELINE STAGES

The VR4111 has a five-stage instruction pipeline; each stage takes one PCycle (one cycle of Pclock), and each PCycle has two phases: $\Phi 1$ and $\Phi 2$, as shown in Figure 5-1. Thus, the execution of each instruction takes at least 5 PCycles. An instruction can take longer - for example, if the required data is not in the cache, the data must be retrieved from main memory. Once the pipeline has been filled, five instructions are executed simultaneously.

Figure 5-1. Pipeline Stages

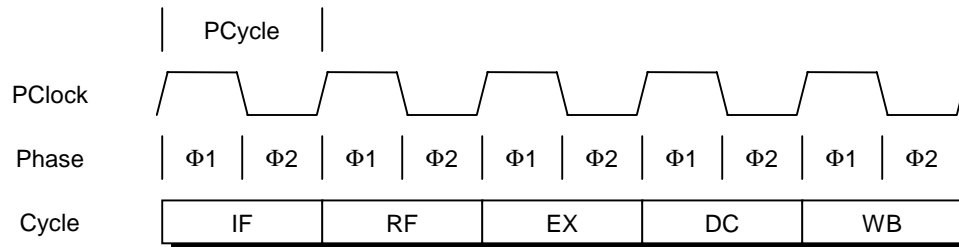

The five pipeline stages are:

- ◇ IF - Instruction cache fetch
- ◇ RF - Register fetch
- ◇ EX - Execution
- ◇ DC - Data cache fetch
- ◇ WB - Write back

Figure 5-2 shows the five stages of the instruction pipeline. In this figure, a row indicates the execution process of each instruction, and a column indicates the processes executed simultaneously.

Figure 5-2. Instruction Execution in the Pipeline

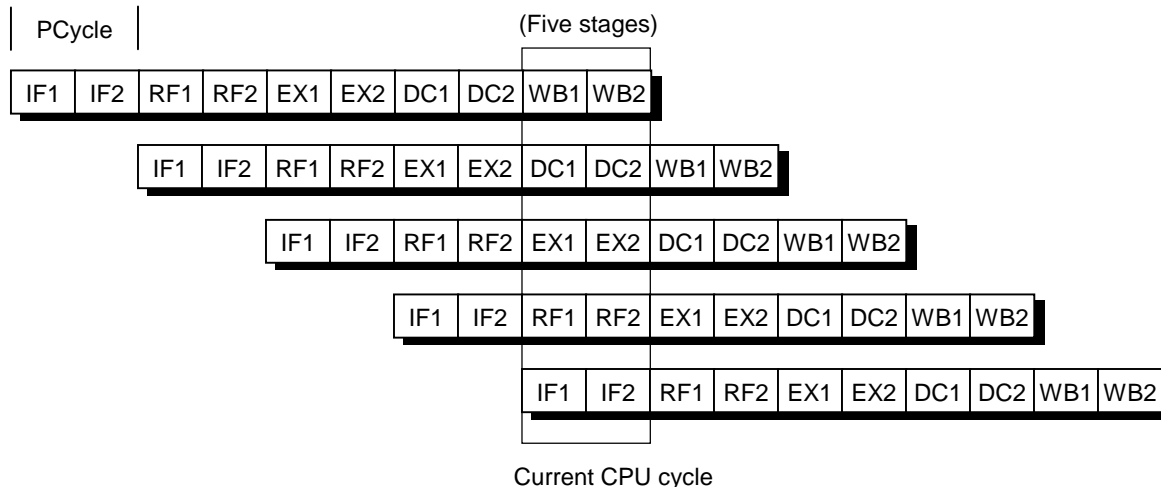

5.1.1 Pipeline Activities

Figure 5-3 shows the activities that can occur during each pipeline stage; Table 5-1 describes these pipeline activities.

Figure 5-3. Pipeline Activities

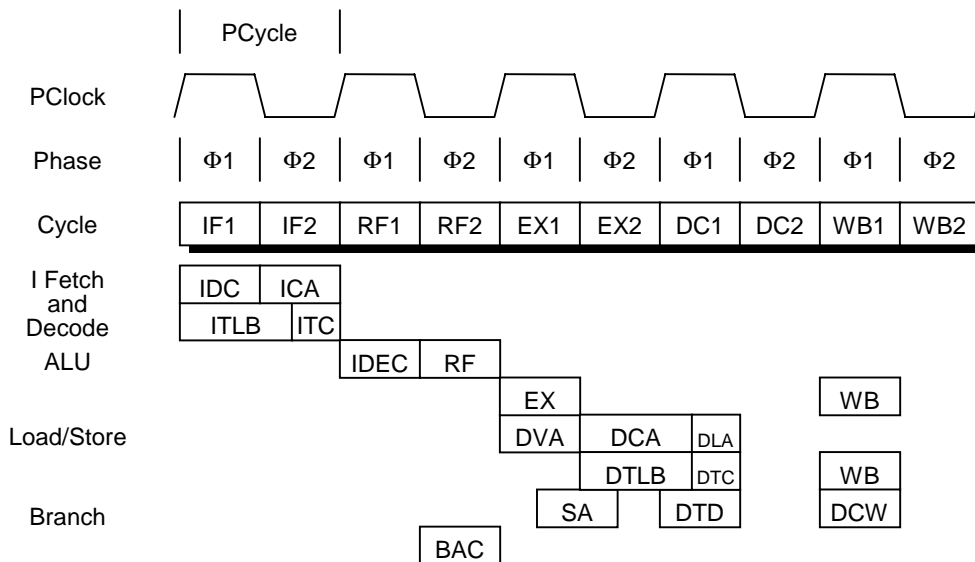

Table 5-1. Description of Pipeline Activities During Each Stage

Cycle	Phase	Mnemonic	Description
IF	Φ1	IDC	Instruction cache address decode
		ITLB	Instruction address translation
	Φ2	ICA	Instruction cache array access
		ITC	Instruction tag check
RF	Φ1	IDEC	Instruction decode
	Φ2	RF	Register operand fetch
		BAC	Branch address calculation
EX	Φ1	EX	Execution stage
		DVA	Data virtual address calculation
		SA	Store align
	Φ2	DCA	Data cache address decode/array access
		DTLB	Data address translation
DC	Φ1	DLA	Data cache load align
		DTC	Data tag check
		DTD	Data transfer to data cache
WB	Φ1	DCW	Data cache write
		WB	Write back to register file

5.2 BRANCH DELAY

During a VR4111's pipeline operation, a one-cycle branch delay occurs when:

- Target address is calculated by a Jump instruction
- Branch condition of branch instruction is met and then logical operation starts for branch-destination comparison

The instruction address generated at the EX stage in the Jump/Branch instruction are available in the IF stage, two instructions later. No branch delay slot due to a branch instruction occurs in MIPS16 ISA. When a branch condition is met, the instruction representing a delay slot is discarded.

Figure 5-4 illustrates the branch delay and the location of the branch delay slot.

Figure 5-4. Branch Delay

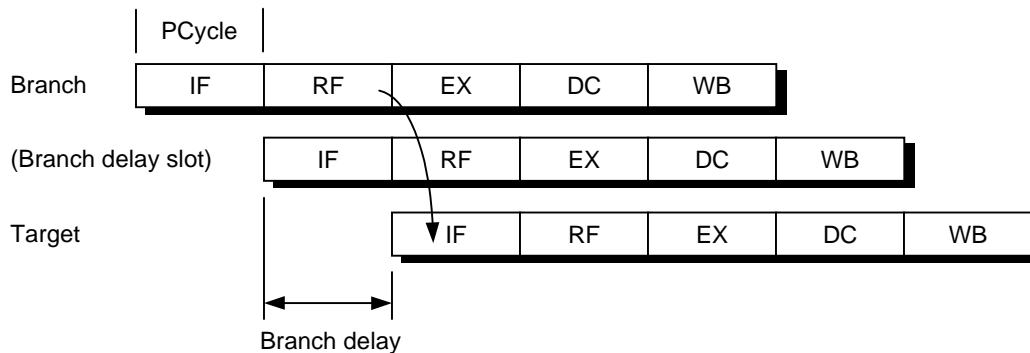

5.3 LOAD DELAY

A load instruction that does not allow its result to be used by the instruction immediately following is called a delayed load instruction. The instruction immediately following this delayed load instruction is referred to as the load delay slot.

In the VR4111, the instruction immediately following a load instruction can use the contents of the loaded register, however in such cases hardware interlocks insert additional delay cycles. Consequently, scheduling load delay slots can be desirable, both for performance and VR-Series processor compatibility.

5.4 PIPELINE OPERATION

The operation of the pipeline is illustrated by the following examples that describe how typical instructions are executed. The instructions described are: ADD, JALR, BEQ, TLT, LW, and SW. Each instruction is taken through the pipeline and the operations that occur in each relevant stage are described.

(1) Add instruction (Add rd, rs, rt)

- IF stage In $\Phi 1$ of the IF stage, the eleven least-significant bits of the virtual address are used to access the instruction cache. In $\Phi 2$ of the IF stage, the cache index is compared with the page frame number and the cache data is read out. The virtual PC is incremented by 4 so that the next instruction can be fetched.

- RF stage During $\Phi 2$, the 2-port register file is addressed with the rs and rt fields and the register data is valid at the register file output. At the same time, bypass multiplexers select inputs from either the EX- or DC-stage output in addition to the register file output, depending on the need for an operand bypass.

- EX stage The ALU controls are set to do an A + B operation. The operands flow into the ALU inputs, and the ALU operation is started. The result of the ALU operation is latched into the ALU output latch during $\Phi 1$.

- DC stage This stage is a NOP for this instruction. The data from the output of the EX stage (the ALU) is moved into the output latch of the DC.

- WB stage During $\Phi 1$, the WB latch feeds the data to the inputs of the register file, which is accessed by the rd field. The file write strobe is enabled. By the end of $\Phi 1$, the data is written into the file.

Figure 5-5. Add Instruction Pipeline Activities

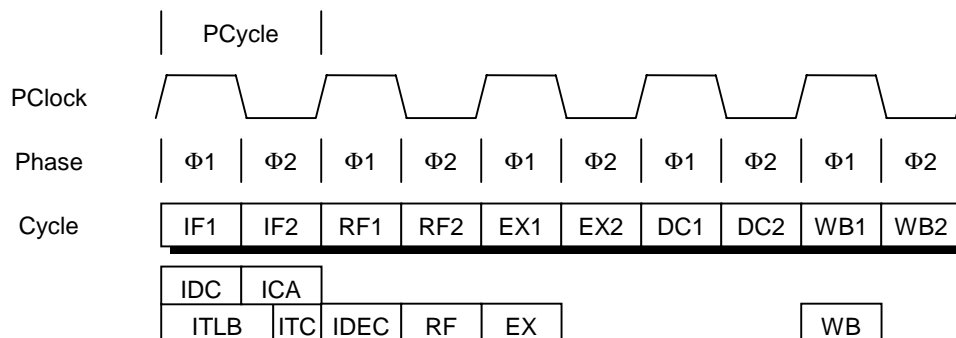

(2) Jump and Link Register instruction (JALR rd, rs)

- IF stage Same as the IF stage for the ADD instruction.

- RF stage A register specified in the rs field is read from the file during $\Phi 2$ at the RF stage, and the value read from the rs register is input to the virtual PC latch synchronously. This value is used to fetch an instruction at the jump destination. The value of the virtual PC incremented during the IF stage is incremented again to produce the link address $PC + 8$ where PC is the address of the JALR instruction. The resulting value is the PC to which the program will eventually return. This value is placed in the Link output latch of the Instruction Address unit.

- EX stage The $PC + 8$ value is moved from the Link output latch to the output latch of the EX stage.

- DC stage The $PC + 8$ value is moved from the output latch of the EX stage to the output latch of the DC stage.

- WB stage Refer to the ADD instruction. Note that if no value is explicitly provided for rd then register 31 is used as the default. If rd is explicitly specified, it cannot be the same register addressed by rs; if it is, the result of executing such an instruction is undefined.

Figure 5-6. JALR Instruction Pipeline Activities

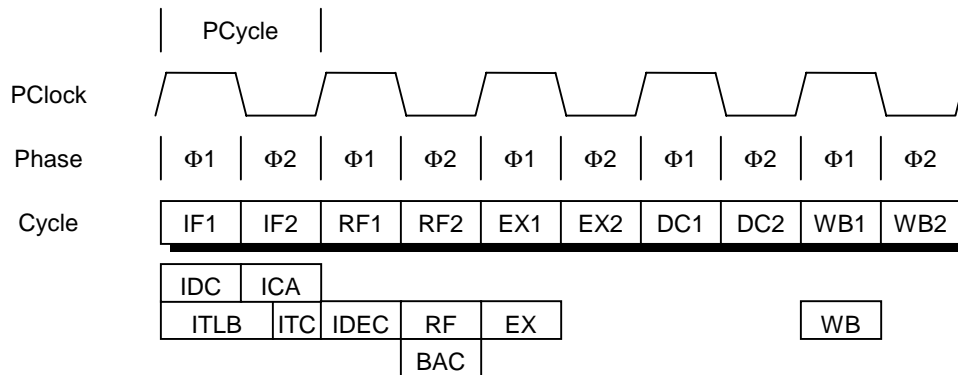

(3) Branch on Equal instruction (BEQ rs, rt, offset)

- IF stage Same as the IF stage for the ADD instruction.

- RF stage During $\Phi 2$, the register file is addressed with the rs and rt fields. A check is performed to determine if each corresponding bit position of these two operands has equal values. If they are equal, the PC is set to PC + target, where target is the sign-extended offset field. If they are not equal, the PC is set to PC + 4.

- EX stage The next PC resulting from the branch comparison is valid at the beginning of $\Phi 2$ for instruction fetch.

- DC stage This stage is a NOP for this instruction.

- WB stage This stage is a NOP for this instruction.

Figure 5-7. BEQ Instruction Pipeline Activities

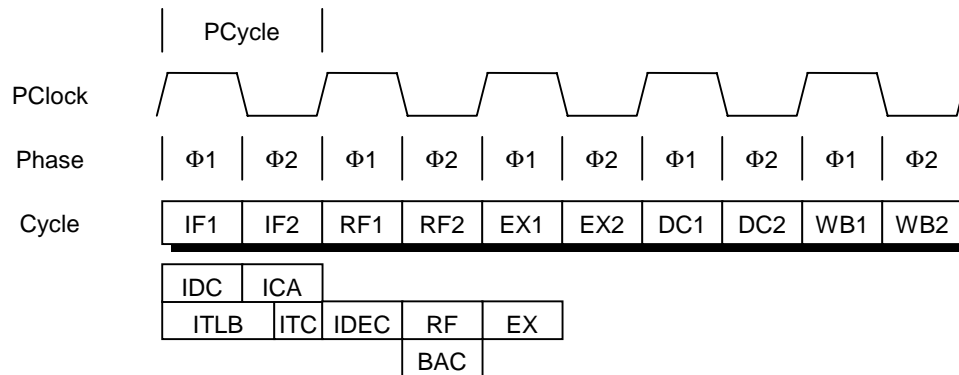

(4) Trap if Less Than instruction (TLT rs, rt)

- IF stage Same as the IF stage for the ADD instruction.

- RF stage Same as the RF stage for the ADD instruction.

- EX stage ALU controls are set to do an A – B operation. The operands flow into the ALU inputs, and the ALU operation is started. The result of the ALU operation is latched into the ALU output latch during $\Phi 1$. The sign bits of operands and of the ALU output latch are checked to determine if a less than condition is true. If this condition is true, a Trap exception occurs. The value in the PC register is used as an exception vector value, and from now on any instruction will be invalid.

- DC stage No operation

- WB stage The EPC register is loaded with the value of the PC if the less than condition was met in the EX stage. The Cause register ExCode field and BD bit are updated appropriately, as is the EXL bit of the Status register. If the less than condition was not met in the EX stage, no activity occurs in the WB stage.

Figure 5-8. TLT Instruction Pipeline Activities

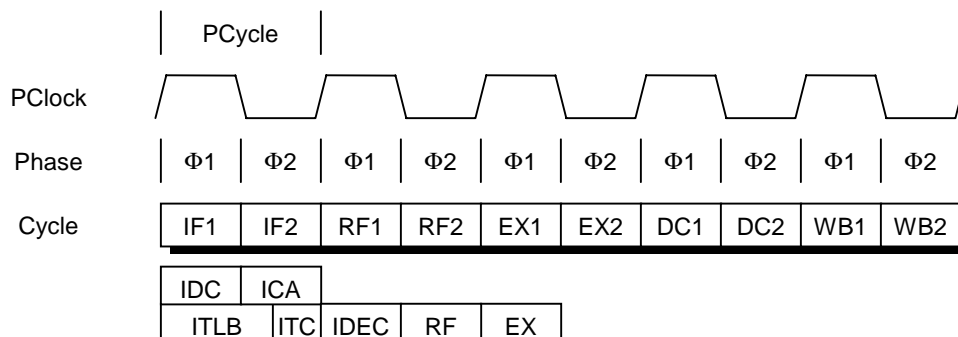

(5) Load Word instruction (LW rt, offset (base))

- IF stage Same as the IF stage for the ADD instruction.

- RF stage Same as the RF stage for the ADD instruction. Note that the base field is in the same position as the rs field.

- EX stage Refer to the EX stage for the ADD instruction. For LW, the inputs to the ALU come from GPR[base] through the bypass multiplexer and from the sign-extended offset field. The result of the ALU operation that is latched into the ALU output latch in $\Phi 1$ represents the effective virtual address of the operand (DVA).

- DC stage The cache tag field is compared with the Page Frame Number (PFN) field of the TLB entry. After passing through the load aligner, aligned data is placed in the DC output latch during $\Phi 2$.

- WB stage During $\Phi 1$, the cache read data is written into the register file addressed by the rt field.

Figure 5-9. LW Instruction Pipeline Activities

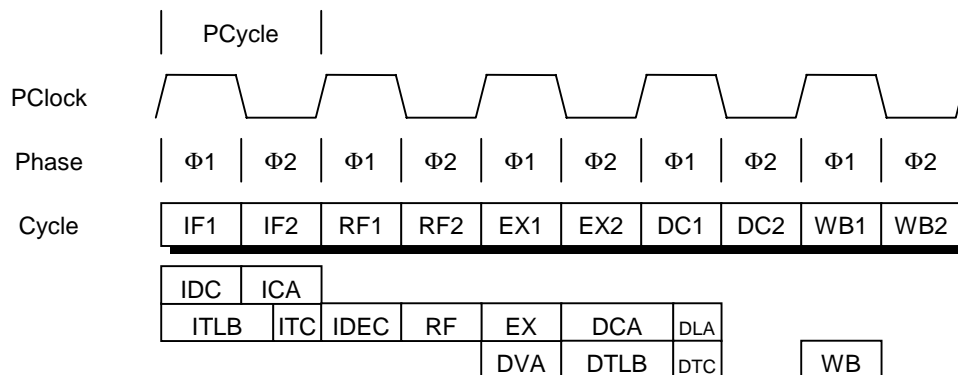

(6) Store Word instruction (SW rt, offset (base))

- IF stage Same as the IF stage for the ADD instruction.

- RF stage Same as the RF stage for the LW instruction.

- EX stage Refer to the LW instruction for a calculation of the effective address. From the RF output latch, the GPR[rt] is sent through the bypass multiplexer and into the main shifter, where the shifter performs the byte-alignment operation for the operand. The results of the ALU are latched in the output latches during $\Phi 1$. The shift operations are latched in the output latches during $\Phi 2$.

- DC stage Refer to the LW instruction for a description of the cache access.

- WB stage If there was a cache hit, the content of the store data output latch is written into the data cache at the appropriate word location.
 Note that all store instructions use the data cache for two consecutive PCycles. If the following instruction requires use of the data cache, the pipeline is slipped for one PCycle to complete the writing of an aligned store data.

Figure 5-10. SW Instruction Pipeline Activities

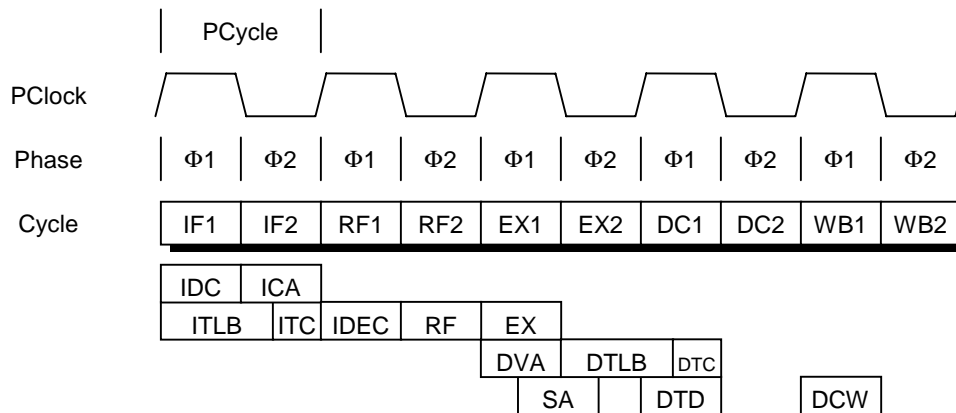

5.5 INTERLOCK AND EXCEPTION HANDLING

Smooth pipeline flow is interrupted when cache misses or exceptions occur, or when data dependencies are detected. Interruptions handled using hardware, such as cache misses, are referred to as interlocks, while those that are handled using software are called exceptions. As shown in Figure 5-11, all interlock and exception conditions are collectively referred to as faults.

Figure 5-11. Interlocks, Exceptions, and Faults

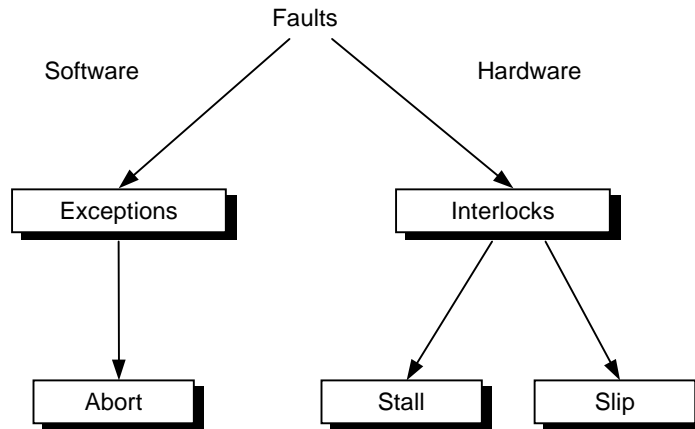

At each cycle, exception and interlock conditions are checked for all active instructions.

Because each exception or interlock condition corresponds to a particular pipeline stage, a condition can be traced back to the particular instruction in the exception/interlock stage, as shown in Table 5-2. For instance, an LDI Interlock is raised in the Register Fetch (RF) stage.

Tables 5-2 to 5-4 describe the pipeline interlocks and exceptions listed in Table 5-2.

Table 5-2. Correspondence of Pipeline Stage to Interlock and Exception Conditions

Status \ Stage		IF	RF	EX	DC	WB
Interlock	Stall	–	ITM ICM	–	DTM DCM DCB	–
	Slip	–	LDI MDI SLI CP0	–	–	–
Exception		IAErr	NMI ITLB IPErr INTr IBE SYSC BP Cun RSVD	Trap OVF DAErr	Reset DTLB TMod DPErr WAT DBE	–

Remark In the above table, exception conditions are listed up in higher priority order.

Table 5-3. Pipeline Interlock

Interlock	Description
ITM	Interrupt TLB Miss
ICM	Interrupt Cache Miss
LDI	Load Data Interlock
MDI	MD Busy Interlock
SLI	Store-Load Interlock
CP0	Coprocessor 0 Interlock
DTM	Data TLB Miss
DCM	Data Cache Miss
DCB	Data Cache Busy

Table 5-4. Description of Pipeline Exception

Exception	Description
IAErr	Instruction Address Error exception
NMI	Non-maskable Interrupt exception
ITLB	ITLB exception
IPErr	Instruction Parity Error exception
INTR	Interrupt exception
IBE	Instruction Bus Error exception
SYSC	System Call exception
BP	Breakpoint exception
CUn	Coprocessor Unusable exception
RSVD	Reserved Instruction exception
Trap	Trap exception
OVF	Overflow exception
DAErr	Data Address Error exception
Reset	Reset exception
DTLB	DTLB exception
DTMod	DTLB Modified exception
WAT	Watch exception
DBE	Data Bus Error exception

5.5.1 Exception Conditions

When an exception condition occurs, the relevant instruction and all those that follow it in the pipeline are cancelled. Accordingly, any stall conditions and any later exception conditions that may have referenced this instruction are inhibited; there is no benefit in servicing stalls for a cancelled instruction.

When an exceptional conditions is detected for an instruction, the Vr4111 will kill it and all following instructions. When this instruction reaches the WB stage, the exception flag and various information items are written to CP0 registers. The current PC is changed to the appropriate exception vector address and the exception bits of earlier pipeline stages are cleared.

This implementation allows all preceding instructions to complete execution and prevents all subsequent instructions from completing. Thus the value in the EPC is sufficient to restart execution. It also ensures that exceptions are taken in the order of execution; an instruction taking an exception may itself be killed by an instruction further down the pipeline that takes an exception in a later cycle.

Figure 5-12. Exception Detection

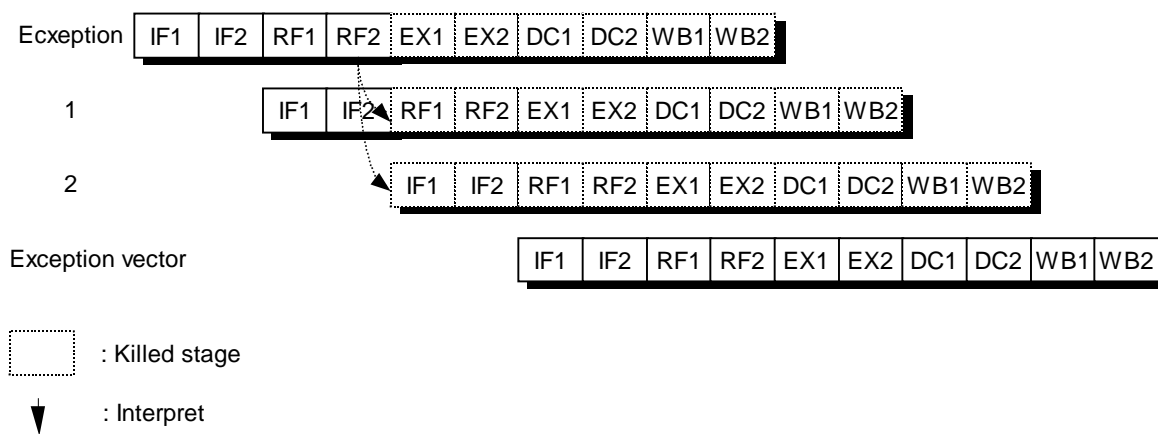

5.5.2 Stall Conditions

Stalls are used to stop the pipeline for conditions detected after the RF stage. When a stall occurs, the processor will resolve the condition and then the pipeline will continue. Figure 5-13 shows a data cache miss stall, and Figure 5-14 shows a CACHE instruction stall.

Figure 5-13. Data Cache Miss Stall

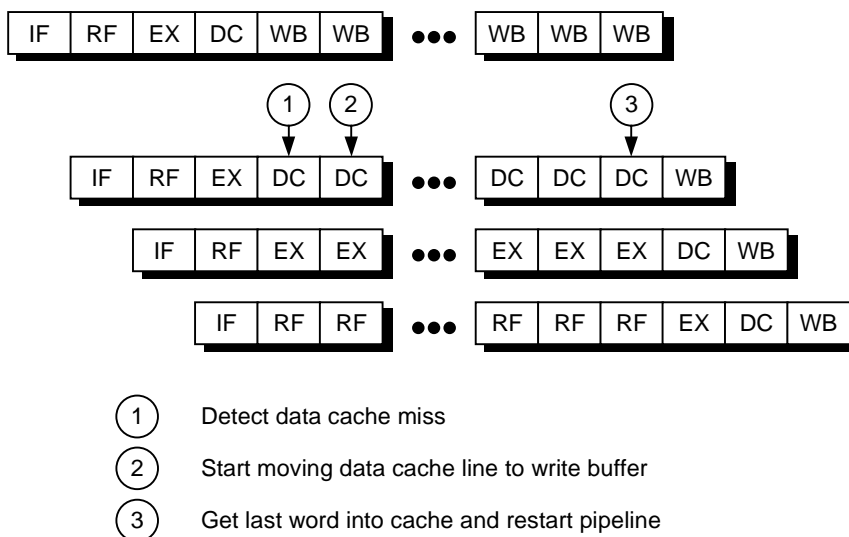

If the cache line to be replaced is dirty — the W bit is set — the data is moved to the internal write buffer in the next cycle. The write-back data is returned to memory. The last word in the data is returned to the cache at 3, and pipelining restarts.

Figure 5-14. CACHE Instruction Stall

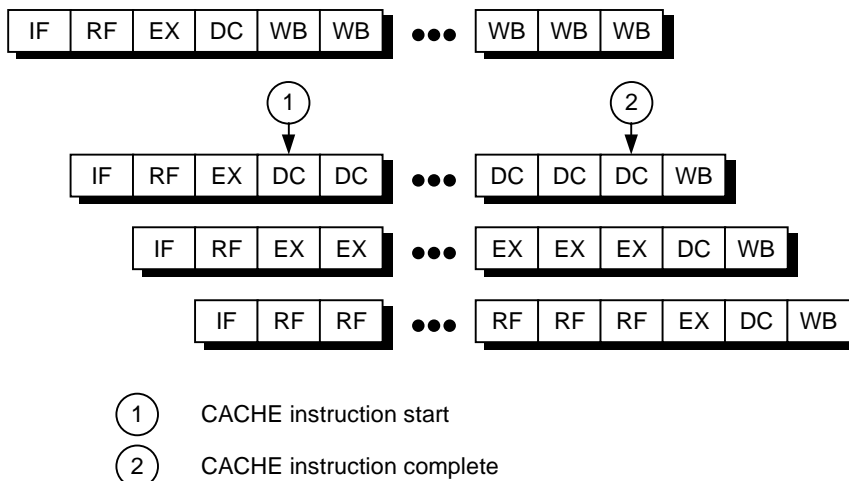

When the CACHE instruction enters the DC pipe-stage, the pipeline stalls while the CACHE instruction is executed. The pipeline begins running again when the CACHE instruction is completed, allowing the instruction fetch to proceed.

5.5.3 Slip Conditions

During $\Phi 2$ of the RF stage and $\Phi 1$ of the EX stage, internal logic will determine whether it is possible to start the current instruction in this cycle. If all of the source operands are available (either from the register file or via the internal bypass logic) and all the hardware resources necessary to complete the instruction will be available whenever required, then the instruction “run”; otherwise, the instruction will “slip”. Slipped instructions are retired on subsequent cycles until they issue. The backend of the pipeline (stages DC and WB) will advance normally during slips in an attempt to resolve the conflict. NOPs will be inserted into the bubble in the pipeline. Instructions killed by branch likely instructions, ERET or exceptions will not cause slips.

Figure 5-15. Load Data Interlock

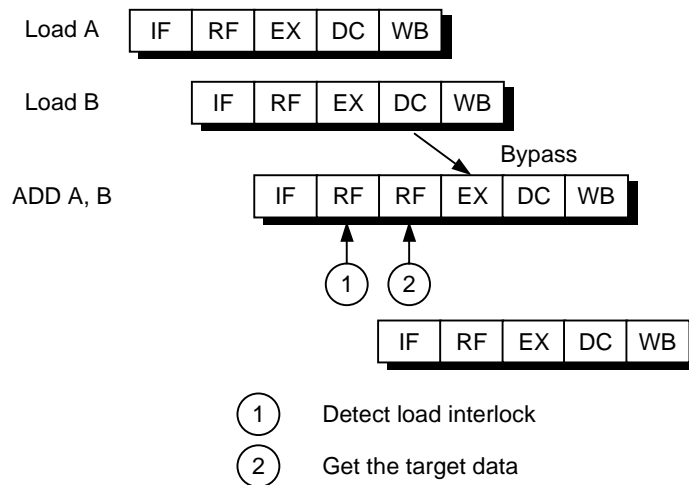

Load Data Interlock is detected in the RF stage shown in as Figure 5-15 and also the pipeline slips in the stage. Load Data Interlock occurs when data fetched by a load instruction and data moved from HI, LO or CP0 register is required by the next immediate instruction. The pipeline begins running again when the clock after the target of the load is read from the data cache, HI, LO and CP0 registers. The data returned at the end of the DC stage is input into the end of the RF stage, using the bypass multiplexers.

Figure 5-16. MD Busy Interlock

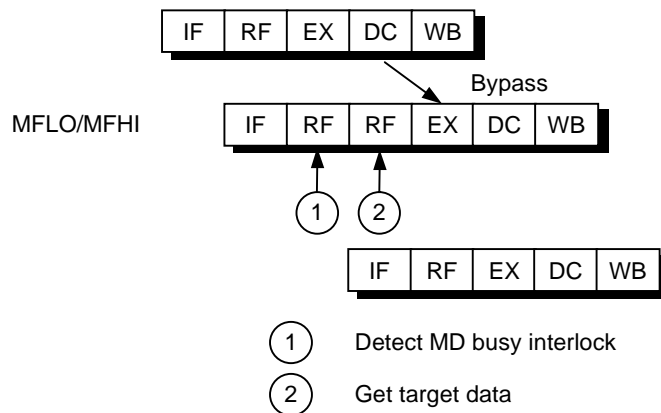

MD Busy Interlock is detected in the RF stage as shown in Figure 5-16 and also the pipeline slips in the stage. MD Busy Interlock occurs when Hi/Lo register is required by MFHi/Lo instruction before finishing Mult/Div execution. The pipeline begins running again the clock after finishing Mult/Div execution. The data returned from the Hi/Lo register at the end of the DC stage is input into the end of the RF stage, using the bypass multiplexers.

Store-Load Interlock is detected in the EX stage and the pipeline slips in the RF stage. Store-Load Interlock occurs when store instruction followed by load instruction is detected. The pipeline begins running again one clock after.

Coprocessor 0 Interlock is detected in the EX stage and the pipeline slips in the RF stage. A coprocessor interlock occurs when an MTC0 instruction for the Configuration or Status register is detected.

The pipeline begins running again one clock after.

5.5.4 Bypassing

In some cases, data and conditions produced in the EX, DC and WB stages of the pipeline are made available to the EX stage (only) through the bypass data path.

Operand bypass allows an instruction in the EX stage to continue without having to wait for data or conditions to be written to the register file at the end of the WB stage. Instead, the Bypass Control Unit is responsible for ensuring data and conditions from later pipeline stages are available at the appropriate time for instructions earlier in the pipeline.

The Bypass Control Unit is also responsible for controlling the source and destination register addresses supplied to the register file.

5.6 CODE COMPATIBILITY

The VR4110 CPU core can execute all programs that can be executed in other VR-Series processors. But the reverse is not necessarily true. Programs compiled using a standard MIPS compiler can be executed in both types of processors. When using manual assembly, however, write programs carefully so that compatibility with other VR-series processors can be maintained. Matters which should be paid attention to when porting programs between the VR4110 CPU core and other VR-Series processors are listed below.

- The VR4110 CPU core does not support floating-point instructions since it has no Floating-Point Unit (FPU).
- Multiply-add instructions (DMADD16, MADD16) are added in the VR4110 CPU core.
- Instructions for power modes (HIBERNATE, STANDBY, SUSPEND) are added in the VR4110 CPU core to support power modes.
- The VR4110 CPU core does not have the LL bit to perform synchronization of multiprocessing. Therefore, the CPU core does not support instructions which manipulate the LL bit (LL, LLD, SC, SCD).
- A 16-bit length MIPS16 instruction set is added in the VR4110 CPU core.
- The CP0 hazards of the VR4110 CPU core are equally or less stringent than those of other processors (see Chapter 30 for details).

For more information, refer to Chapter 4, Chapter 28, *the VR4000, VR4400 User's Manual*, or *the VR4300™ User's Manual*.

[MEMO]

CHAPTER 6 MEMORY MANAGEMENT SYSTEM

The VR4111 provides a memory management unit (MMU) which uses a translation lookaside buffer (TLB) to translate virtual addresses into physical addresses. This chapter describes the virtual and physical address spaces, the virtual-to-physical address translation, the operation of the TLB in making these translations, and the CP0 registers that provide the software interface to the TLB.

6.1 TRANSLATION LOOKASIDE BUFFER (TLB)

Virtual addresses are translated into physical addresses using an on-chip TLB. The on-chip TLB is a fully-associative memory that holds 32 entries, which provide mapping to odd/even page pairs for one entry. The pages can have five different sizes, 1 K, 4 K, 16 K, 64 K, and 256 K, and can be specified in each entry. If it is supplied with a virtual address, each of the TLB entries is checked simultaneously to see whether they match the virtual addresses that are provided with the ASID field and saved in the EntryHi register.

If there is a virtual address match, or “hit,” in the TLB, the physical page number is extracted from the TLB and concatenated with the offset to form the physical address.

If no match occurs (TLB “miss”), an exception is taken and software refills the TLB from the page table resident in memory. The software writes to an entry selected using the Index register or a random entry indicated in the Random register.

If more than one entry in the TLB matches the virtual address being translated, the operation is undefined and the TLB may be disabled. In this case, the TLB-Shutdown (TS) bit of the Status register is set to 1, and the TLB becomes unusable (an attempt to access the TLB results in a TLB Mismatch exception regardless of whether there is an entry that hits). The TS bit can be cleared only by a reset.

Note that virtual addresses may be converted to physical addresses without using a TLB, depending on the address space that is being subjected to address translation. For example, address translation for the kseg0 or kseg1 address space does not use mapping. The physical addresses of these address spaces are determined by subtracting the base address of the address space from the virtual addresses.

6.2 VIRTUAL ADDRESS SPACE

The address space of the CPU is extended in memory management system, by converting (translating) huge virtual memory addresses into physical addresses.

The physical address space of the VR4111 is 4 Gbytes and 32-bit width addresses are used.

For the virtual address space, up to 2 Gbytes (2^{31}) are provided as a user's area and 32-bit width addresses are used in the 32-bit mode. In the 64-bit mode, up to 1 Tbyte (2^{40}) is provided as a user's area and 64-bit width addresses are used. For the format of the TLB entry in each mode, refer to 6.4.1.

As shown in Figures 6-2 and 6-3, the virtual address is extended with an address space identifier (ASID), which reduces the frequency of TLB flushing when switching contexts. This 8-bit ASID is in the CP0 EntryHi register, and the Global (G) bit is in the EntryLo0 and EntryLo1 registers, described later in this chapter.

Figure 6-1. Virtual-to-Physical Address Translation

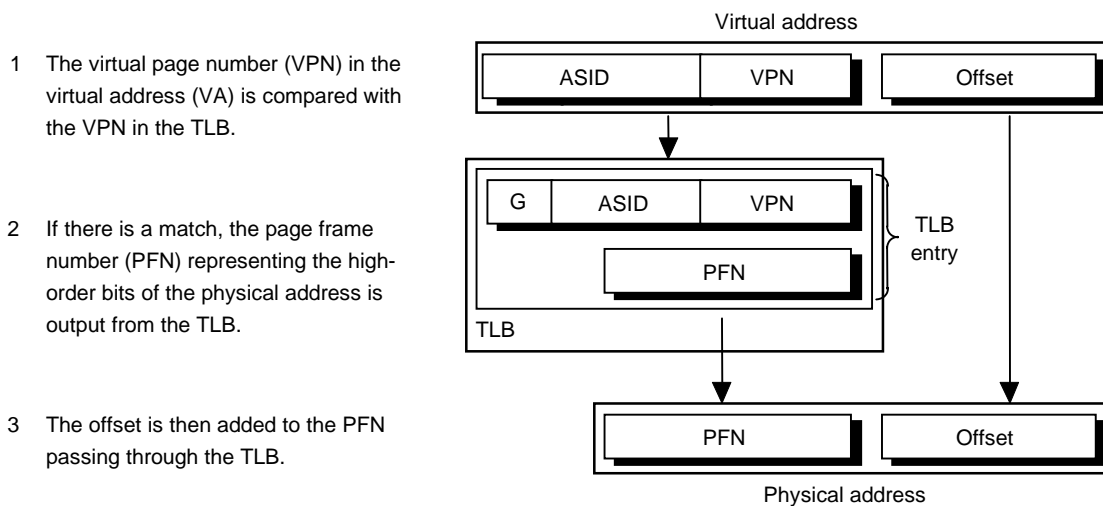

6.2.1 Virtual-to-Physical Address Translation

Converting a virtual address to a physical address begins by comparing the virtual address from the processor with the virtual addresses in the TLB; there is a match when the virtual page number (VPN) of the address is the same as the VPN field of the entry, and either:

- ✧ the Global (G) bit of the TLB entry is set to 1, or
- ✧ the ASID field of the virtual address is the same as the ASID field of the TLB entry.

This match is referred to as a TLB hit. If there is no match, a TLB Mismatch exception is taken by the processor and software is allowed to refill the TLB from a page table of virtual/physical addresses in memory.

If there is a virtual address match in the TLB, the physical address is output from the TLB and concatenated with the offset, which represents an address within the page frame space. The offset does not pass through the TLB. Instead, the low-order bits of the virtual address are output without being translated. See descriptions about the virtual address space for details. For details about the physical address, see **6.5.11 Virtual-to-Physical Address Translation**.

The next two sections describe the 32-bit and 64-bit mode address translations.

6.2.2 32-bit Mode Address Translation

Figure 6-2 shows the virtual-to-physical-address translation of a 32-bit mode address. The pages can have five different sizes between 1 Kbyte (10 bits) and 256 Kbytes (18 bits), each being 4 times as large as the preceding one in ascending order, that is 1 K, 4 K, 16 K, 64 K, and 256 K.

- ✧ Shown at the top of Figure 6-2 is the virtual address space in which the page size is 1 Kbyte and the offset is 10 bits. The 22 bits excluding the ASID field represents the virtual page number (VPN), enabling selecting a page table of 4 M entries.
- ✧ Shown at the bottom of Figure 6-2 is the virtual address space in which the page size is 256 Kbytes and the offset is 18 bits. The 14 bits excluding the ASID field represents the VPN, enabling selecting a page table of 16 K entries.

Figure 6-2. 32-bit Mode Virtual Address Translation

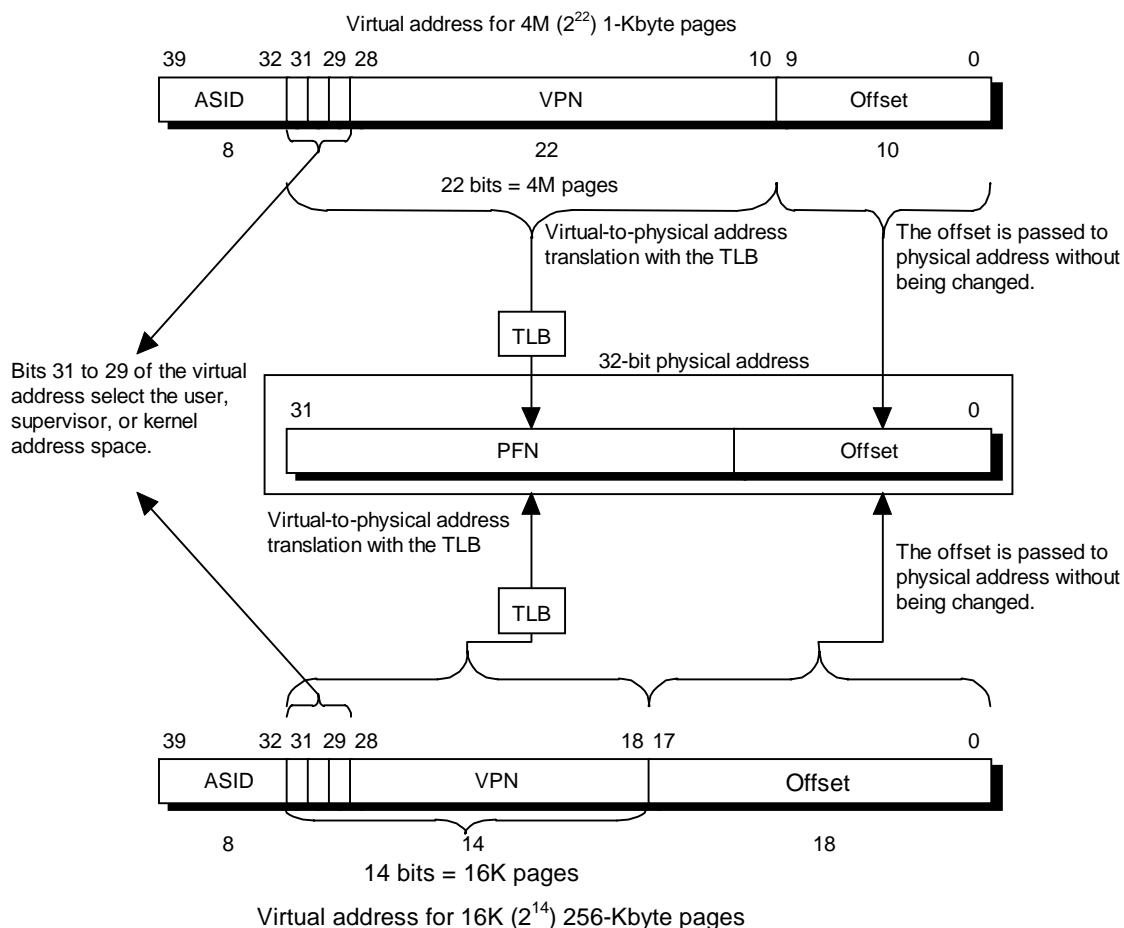

6.2.3 64-bit Mode Address Translation

Figure 6-3 shows the virtual-to-physical-address translation of a 64-bit mode address. The pages can have five different sizes between 1 Kbyte (10 bits) and 256 Kbytes (18 bits), each being 4 times as large as the preceding one in ascending order, that is 1K, 4K, 16K, 64K, and 256K. This figure illustrates the two possible page sizes: a 1-Kbyte page (10 bits) and a 256-Kbyte page (18 bits).

- ◇ Shown at the top of Figure 6-3 is the virtual address space in which the page size is 1 Kbyte and the offset is 10 bits. The 30 bits excluding the ASID field represents the virtual page number (VPN), enabling selecting a page table of 1 G entry.
- ◇ Shown at the bottom of Figure 6-3 is the virtual address space in which the page size is 256 Kbytes and the offset is 18 bits. The 22 bits excluding the ASID field represents the VPN, enabling selecting a page table of 4 M entries.

Figure 6-3. 64-bit Mode Virtual Address Translation

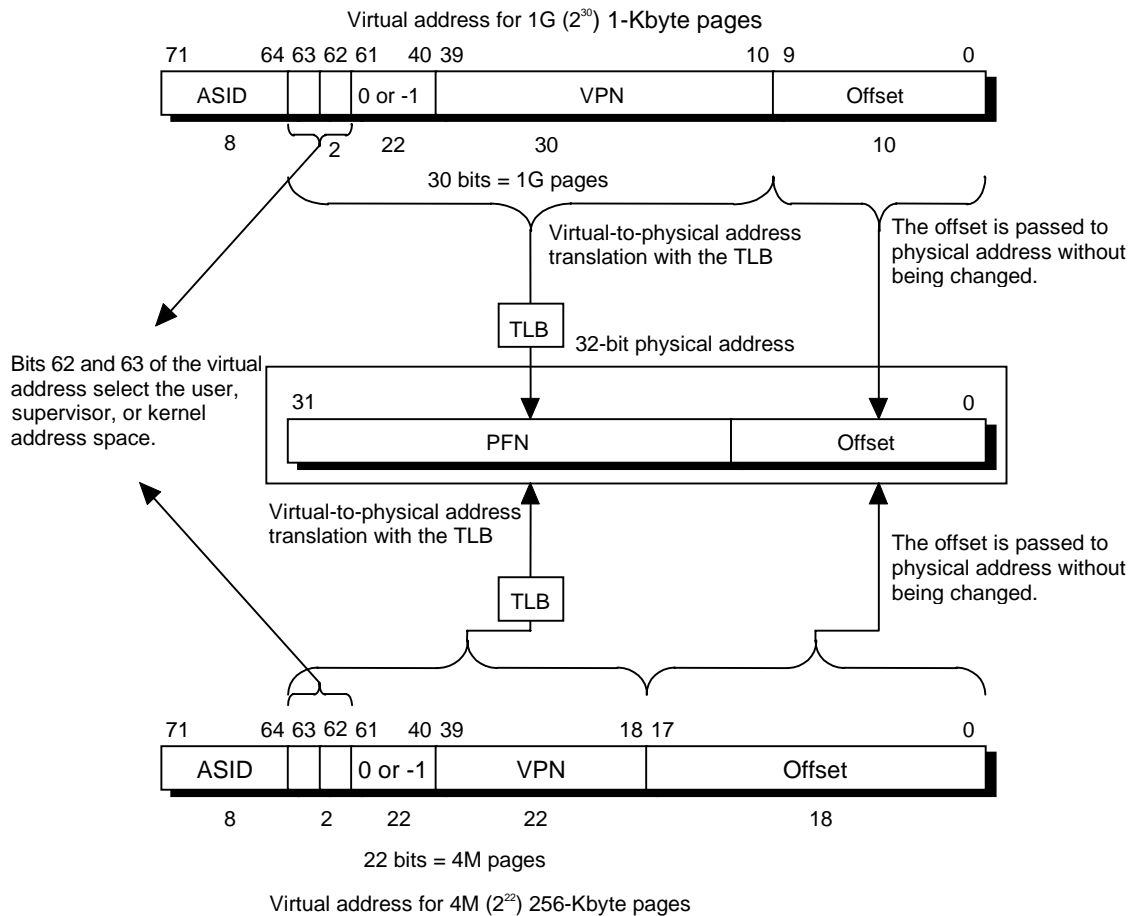

6.2.4 Operating Modes

The processor has three operating modes that function in both 32- and 64-bit operations:

- ◇ User mode
- ◇ Supervisor mode
- ◇ Kernel mode

User and Kernel modes are common to all V_R-Series processors. Generally, Kernel mode is used to executing the operating system, while User mode is used to run application programs. The V_R4000 series processors have a third mode, which is called Supervisor mode and categorized in between User and Kernel modes. This mode is used to configure a high-security system.

When an exception occurs, the CPU enters Kernel mode, and remains in this mode until an exception return instruction (ERET) is executed. The ERET instruction brings back the processor to the mode in which it was just before the exception occurs.

These modes are described in the next three sections.

6.2.5 User Mode Virtual Addressing

During the single user mode, a 2-Gbyte (2^{31} bytes) virtual address space (useg) can be used in the 32-bit mode. In the 64-bit mode, a 1-Tbyte (2^{40} bytes) virtual address space (xuseg) can be used.

As shown in Tables 6-2 and 6-3, each virtual address is extended independently as another virtual address by setting an 8-bit address space ID area (ASID), to support user processes of up to 256. The contents of TLB can be retained after context switching by allocating each process by ASID. useg and xuseg can be referenced via TLB. Whether a cache is used or not is determined for each page by the TLB entry (depending on the C bit setting in the TLB entry).

The User segment starts at address 0 and the current active user process resides in either useg (in 32-bit mode) or xuseg (in 64-bit mode). The TLB identically maps all references to useg/xuseg from all modes, and controls cache accessibility.

The processor operates in User mode when the Status register contains the following bit-values:

- ◇ KSU = 10
- ◇ EXL = 0
- ◇ ERL = 0

In conjunction with these bits, the UX bit in the Status register selects 32- or 64-bit User mode addressing as follows:

- ◇ When UX = 0, 32-bit useg space is selected.
- ◇ When UX = 1, 64-bit xuseg space is selected.

Table 6-1 lists the characteristics of each user segment (useg and xuseg).

Figure 6-4. User Mode Address Space

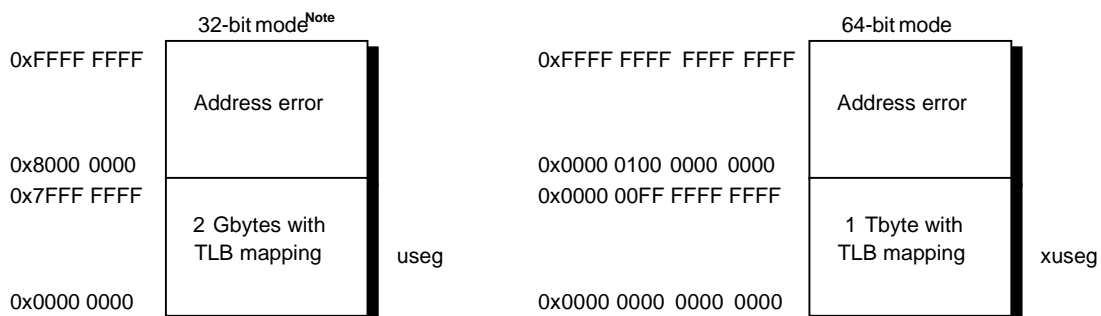

Note The VR4111 uses 64-bit addresses within it. When the processor is running in Kernel mode, it saves the contents of each register or restores their previous contents to initialize them before switching the context. For 32-bit mode addressing, bit 31 is sign-extended to bits 32 to 63, and the resulting 32 bits are used for addressing. Usually, it is impossible for 32-bit mode programs to generate invalid addresses. If context switching occurs and the processor enters Kernel mode, however, an attempt may be made to save an address other than the sign-extended 32-bit address mentioned above to a 64-bit register. In this case, user-mode programs are likely to generate an invalid address.

Table 6-1. Comparison of useg and xuseg

Address bit value	Status register bit value				Segment name	Address range	Size
	KSU	EXL	ERL	UX			
32-bit A[31] = 0	10	0	0	0	useg	0x0000 0000 to 0x7FFF FFFF	2 Gbytes (2 ³¹ bytes)
64-bit A[63..40] = 0	10	0	0	1	xuseg	0x0000 0000 0000 0000 to 0x0000 00FF FFFF FFFF	1 Tbyte (2 ⁴⁰ bytes)

(1) useg (32-bit mode)

In User mode, when UX = 0 in the Status register and the most significant bit of the virtual address is 0, this virtual address space is labeled useg.

Any attempt to reference an address with the most-significant bit set while in User mode causes an Address Error exception (see **CHAPTER 7 EXCEPTION PROCESSING**).

The TLB Mismatch exception vector is used for TLB misses.

(2) xuseg (64-bit mode)

In User mode, when UX = 1 in the Status register and bits 63 to 40 of the virtual address are all 0, this virtual address space is labeled xuseg.

Any attempt to reference an address with bits 63:40 equal to 1 causes an Address Error exception (see **CHAPTER 7 EXCEPTION PROCESSING**).

The XTLB Mismatch exception vector is used for TLB misses.

6.2.6 Supervisor-mode Virtual Addressing

Supervisor mode shown in Figure 6-5 is designed for layered operating systems in which a true kernel runs in Kernel mode, and the rest of the operating system runs in Supervisor mode.

All of the suseg, sseg, xsuseg, xsseg, and csseg spaces are referenced via TLB. Whether cache can be used or not is determined by bit C of each page's TLB entry.

The processor operates in Supervisor mode when the Status register contains the following bit-values:

- ✧ KSU = 01
- ✧ EXL = 0
- ✧ ERL = 0

In conjunction with these bits, the SX bit in the Status register selects 32- or 64-bit Supervisor mode addressing:

- ✧ When SX = 0, 32-bit supervisor space is selected.
- ✧ When SX = 1, 64-bit supervisor space is selected.

Figure 6-5 shows the supervisor mode address space, and Table 6-2 lists the characteristics of the Supervisor mode segments.

Figure 6-5. Supervisor Mode Address Space

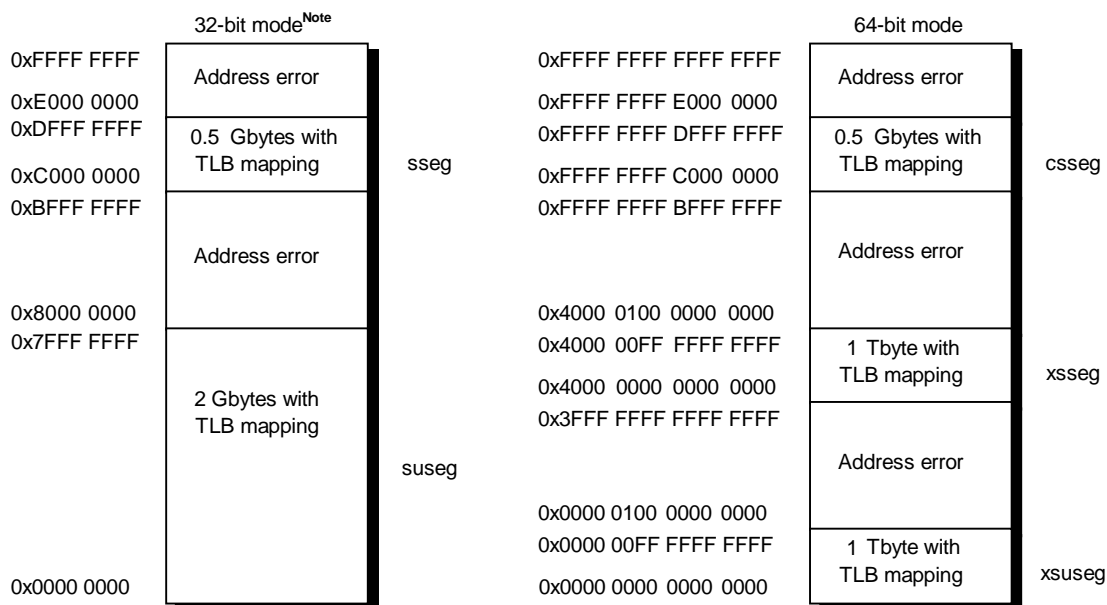

Note The VR4111 uses 64-bit addresses within it. For 32-bit mode addressing, bit 31 is sign-extended to bits 32 to 63, and the resulting 32 bits are used for addressing. Usually, it is impossible for 32-bit mode programs to generate invalid addresses. In an operation of base register + offset for addressing, however, a two's complement overflow may occur, causing an invalid address. Note that the result becomes undefined. Two factors that can cause a two's complement follow:

- ◇ When offset bit 15 is 0, base register bit 31 is 0, and bit 31 of the operation “base register + offset” is 1
- ◇ When offset bit 15 is 1, base register bit 31 is 1, and bit 31 of the operation “base register + offset” is 0

Table 6-2. 32-bit and 64-bit Supervisor Mode Segments

Address bit value	Status register bit value				Segment name	Address range	Size
	KSU	EXL	ERL	SX			
32-bit A[31] = 0	01	0	0	0	suseg	0x0000 0000 to 0x7FFF FFFF	2 Gbytes (2^{31} bytes)
32-bit A[31..29] = 110	01	0	0	0	sseg	0xC000 0000 to 0xDFFF FFFF	512 Mbytes (2^{29} bytes)
64-bit A[63..62] = 00	01	0	0	1	xsuseg	0x0000 0000 0000 0000 to 0x0000 00FF FFFF FFFF	1 Tbyte (2^{40} bytes)
64-bit A[63..62] = 01	01	0	0	1	xsseg	0x4000 0000 0000 0000 to 0x4000 00FF FFFF FFFF	1 Tbyte (2^{40} bytes)
64-bit A[63..62] = 11	01	0	0	1	csseg	0xFFFF FFFF C000 0000 to 0xFFFF FFFF DFFF FFFF	512 Mbytes (2^{29} bytes)

(1) suseg (32-bit Supervisor mode, user space)

When SX = 0 in the Status register and the most-significant bit of the virtual address space is set to 0, the suseg virtual address space is selected; it covers 2 Gbytes (2^{31} bytes) of the current user address space. The virtual address is extended with the contents of the 8-bit ASID field to form a unique virtual address. This mapped space starts at virtual address 0x0000 0000 and runs through 0x7FFF FFFF.

(2) sseg (32-bit Supervisor mode, supervisor space)

When SX = 0 in the Status register and the three most-significant bits of the virtual address space are 110, the sseg virtual address space is selected; it covers 512 Mbytes (2^{29} bytes) of the current supervisor virtual address space. The virtual address is extended with the contents of the 8-bit ASID field to form a unique virtual address. This mapped space begins at virtual address 0xC000 0000 and runs through 0xDFFF FFFF.

(3) xsuseg (64-bit Supervisor mode, user space)

When SX = 1 in the Status register and bits 63 and 62 of the virtual address space are set to 00, the xsuseg virtual address space is selected; it covers 1 Tbyte (2^{40} bytes) of the current user address space. The virtual address is extended with the contents of the 8-bit ASID field to form a unique virtual address. This mapped space starts at virtual address 0x0000 0000 0000 0000 and runs through 0x0000 00FF FFFF FFFF.

(4) xsseg (64-bit Supervisor mode, current supervisor space)

When $SX = 1$ in the Status register and bits 63 and 62 of the virtual address space are set to 01, the xsseg virtual address space is selected; it covers 1 Tbyte (2^{40} bytes) of the current supervisor virtual address space. The virtual address is extended with the contents of the 8-bit ASID field to form a unique virtual address. This mapped space begins at virtual address 0x4000 0000 0000 0000 and runs through 0x4000 00FF FFFF FFFF.

(5) csseg (64-bit Supervisor mode, separate supervisor space)

When $SX = 1$ in the Status register and bits 63 and 62 of the virtual address space are set to 11, the csseg virtual address space is selected; it covers 512 Mbytes (2^{29} bytes) of the separate supervisor virtual address space. The virtual address is extended with the contents of the 8-bit ASID field to form a unique virtual address. This mapped space begins at virtual address 0xFFFF FFFF C000 0000 and runs through 0xFFFF FFFF DFFF FFFF.

6.2.7 Kernel-mode Virtual Addressing

If the Status register satisfies any of the following conditions, the processor runs in Kernel mode.

- ◇ $KSU = 00$
- ◇ $EXL = 1$
- ◇ $ERL = 1$

The addressing width in Kernel mode varies according to the state of the KX bit of the Status register, as follows:

- ◇ When $KX = 0$, 32-bit kernel space is selected.
- ◇ When $KX = 1$, 64-bit kernel space is selected.

The processor enters Kernel mode whenever an exception is detected and it remains in Kernel mode until an exception return (ERET) instruction is executed and results in ERL and/or $EXL = 0$. The ERET instruction restores the processor to the mode existing prior to the exception.

Kernel mode virtual address space is divided into regions differentiated by the high-order bits of the virtual address, as shown in Figure 6-6. Table 6-3 lists the characteristics of the 32-bit Kernel mode segments, and Table 6-4 lists the characteristics of the 64-bit Kernel mode segments.

Figure 6-6. Kernel Mode Address Space

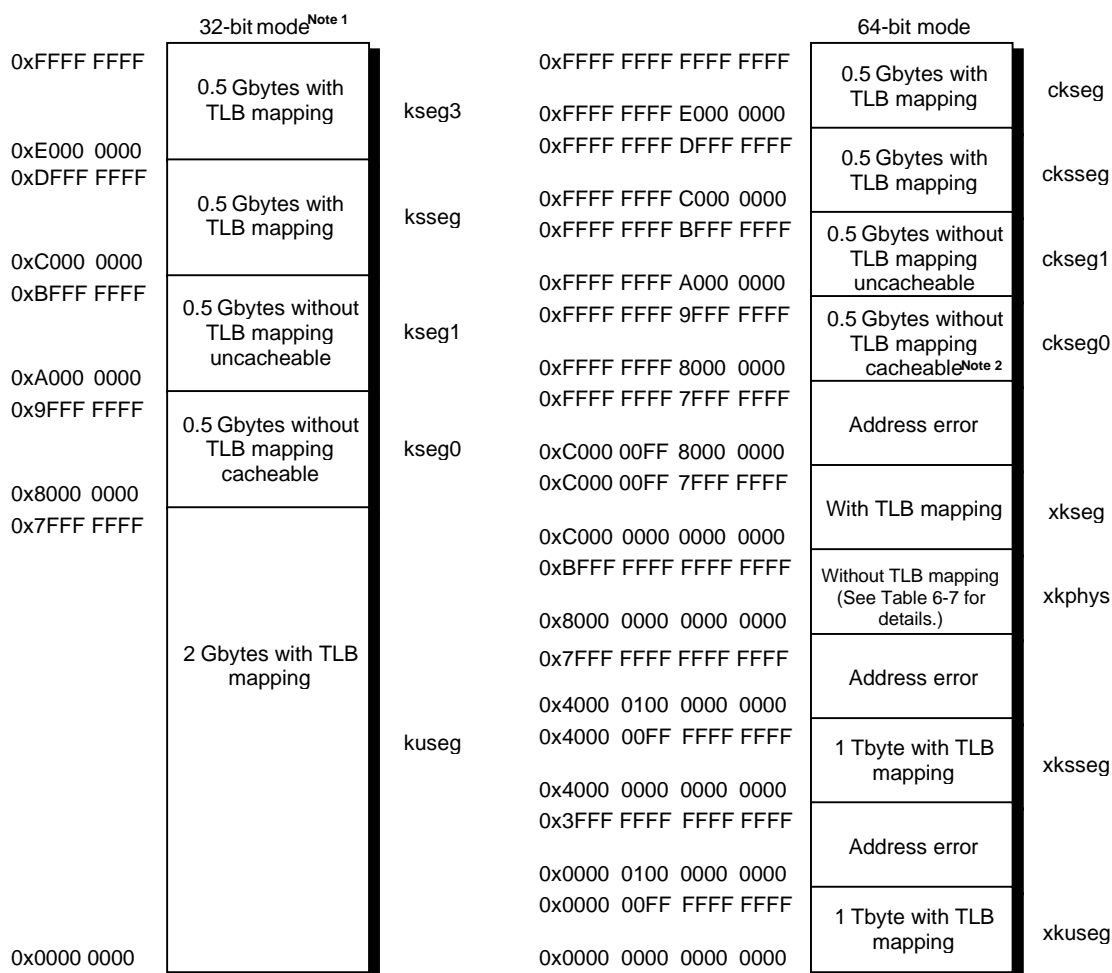

Notes 1. The VR4111 uses 64-bit addresses within it. For 32-bit mode addressing, bit 31 is sign-extended to bits 32 to 63, and the resulting 32 bits are used for addressing. Usually, a 64-bit instruction is used for the program in 32-bit mode. In an operation of base register + offset for addressing, however, a two's complement overflow may occur, causing an invalid address. Note that the result becomes undefined. Two factors that can cause a two's complement follow:

- ◇ When offset bit 15 is 0, base register bit 31 is 0, and bit 31 of the operation “base register + offset” is 1
- ◇ When offset bit 15 is 1, base register bit 31 is 1, and bit 31 of the operation “base register + offset” is 0

2. The K0 field of the Config register controls cacheability of kseg0 and ckseg0.

Figure 6-7. xkphys Area Address Space

0xBFFF FFFF FFFF FFFF	Address error
0xB800 0001 0000 0000	4 Gbytes without TLB mapping cacheable
0xB800 0000 FFFF FFFF	
0xB800 0000 0000 0000	Address error
0xB7FF FFFF FFFF FFFF	
0xB000 0001 0000 0000	4 Gbytes without TLB mapping cacheable
0xB000 0000 FFFF FFFF	
0xB000 0000 0000 0000	Address error
0xAFFF FFFF FFFF FFFF	
0xA800 0001 0000 0000	4 Gbytes without TLB mapping cacheable
0xA800 0000 FFFF FFFF	
0xA800 0000 0000 0000	Address error
0xA7FF FFFF FFFF FFFF	
0xA000 0001 0000 0000	4 Gbytes without TLB mapping cacheable
0xA000 0000 FFFF FFFF	
0xA000 0000 0000 0000	Address error
0x9FFF FFFF FFFF FFFF	
0x9800 0001 0000 0000	4 Gbytes without TLB mapping cacheable
0x9800 0000 FFFF FFFF	
0x9800 0000 0000 0000	Address error
0x97FF FFFF FFFF FFFF	
0x9000 0001 0000 0000	4 Gbytes without TLB mapping cacheable
0x9000 0000 FFFF FFFF	
0x9000 0000 0000 0000	Address error
0x8FFF FFFF FFFF FFFF	
0x8800 0001 0000 0000	4 Gbytes without TLB mapping cacheable
0x8800 0000 FFFF FFFF	
0x8800 0000 0000 0000	Address error
0x87FF FFFF FFFF FFFF	
0x8000 0001 0000 0000	4 Gbytes without TLB mapping cacheable
0x8000 0000 FFFF FFFF	
0x8000 0000 0000 0000	

Table 6-3. 32-bit Kernel Mode Segments

Address bit value	Status register bit value				Segment name	Virtual address	Physical address	Size
	KSU	EXL	ERL	KX				
32-bit A[31] = 0	KSU = 00 or EXL = 1 or ERL = 1	0	kuseg	0x0000 0000 to 0x7FFF FFFF	TLB map	2 Gbytes (2 ³¹ bytes)		
32-bit A[31..29] = 100			kseg0	0x8000 0000 to 0x9FFF FFFF	0x0000 0000 to 0x1FFF FFFF	512 Mbytes (2 ²⁹ bytes)		
32-bit A[31..29] = 101			kseg1	0xA000 0000 to 0xBFFF FFFF	0x0000 0000 to 0x1FFF FFFF	512 Mbytes (2 ²⁹ bytes)		
32-bit A[31..29] = 110			ksseg	0xC000 0000 to 0xDFFF FFFF	TLB map	512 Mbytes (2 ²⁹ bytes)		
32-bit A[31..29] = 111			kseg3	0xE000 0000 to 0xFFFF FFFF	TLB map	512 Mbytes (2 ²⁹ bytes)		

(1) kuseg (32-bit Kernel mode, user space)

When KX = 0 in the Status register, and the most-significant bit of the virtual address space is 0, the kuseg virtual address space is selected; it is the current 2-Gbyte (2³¹-byte) user address space.

The virtual address is extended with the contents of the 8-bit ASID field to form a unique virtual address.

References to kuseg are mapped through TLB. Whether cache can be used or not is determined by bit C of each page's TLB entry.

If the ERL bit of the Status register is 1, the user address space is assigned 2 Gbytes (2³¹ bytes) without TLB mapping and becomes unmapped (with virtual addresses being used as physical addresses) and uncached so that the cache error handler can use it. This allows the Cache Error exception code to operate uncached using r0 as a base register.

(2) kseg0 (32-bit Kernel mode, kernel space 0)

When KX = 0 in the Status register and the most-significant three bits of the virtual address space are 100, the kseg0 virtual address space is selected; it is the current 512-Mbyte (2²⁹-byte) physical space.

References to kseg0 are not mapped through TLB; the physical address selected is defined by subtracting 0x8000 0000 from the virtual address.

The K0 field of the Config register controls cacheability (see **CHAPTER 7 EXCEPTION PROCESSING**).

(3) kseg1 (32-bit Kernel mode, kernel space 1)

When $KX = 0$ in the Status register and the most-significant three bits of the virtual address space are 101, the kseg1 virtual address space is selected; it is the current 512-Mbyte (2^{29} -byte) physical space.

References to kseg1 are not mapped through TLB; the physical address selected is defined by subtracting 0xA000 0000 from the virtual address.

Caches are disabled for accesses to these addresses, and main memory (or memory-mapped I/O device registers) is accessed directly.

(4) ksseg (32-bit Kernel mode, supervisor space)

When $KX = 0$ in the Status register and the most-significant three bits of the virtual address space are 110, the ksseg virtual address space is selected; it is the current 512-Mbyte (2^{29} -byte) virtual address space. The virtual address is extended with the contents of the 8-bit ASID field to form a unique virtual address.

References to ksseg are mapped through TLB. Whether cache can be used or not is determined by bit C of each page's TLB entry.

(5) kseg3 (32-bit Kernel mode, kernel space 3)

When $KX = 0$ in the Status register and the most-significant three bits of the virtual address space are 111, the kseg3 virtual address space is selected; it is the current 512-Mbyte (2^{29} -byte) kernel virtual space. The virtual address is extended with the contents of the 8-bit ASID field to form a unique virtual address.

References to kseg3 are mapped through TLB. Whether cache can be used or not is determined by bit C of each page's TLB entry.

Table 6-4. 64-bit Kernel Mode Segments

Address bit value	Status register bit value				Segment name	Virtual address	Physical address	Size
	KSU	EXL	ERL	KX				
64-bit A[63..62] = 00	KSU = 00 or EXL = 1 or ERL = 1			1	xkuseg	0x0000 0000 0000 0000 to 0x0000 00FF FFFF FFFF	TLB map	1 Tbyte (2^{40} bytes)
64-bit A[63..62] = 01					xksseg	0x4000 0000 0000 0000 to 0x4000 00FF FFFF FFFF	TLB map	1 Tbyte (2^{40} bytes)
64-bit A[63..62] = 10					xkphys	0x8000 0000 0000 0000 to 0xBFFF FFFF FFFF FFFF	0x0000 0000 to 0xFFFF FFFF	4 Gbytes (2^{32} bytes)
64-bit A[63..62] = 11					xkseg	0xC000 0000 0000 0000 to 0xC000 00FF 7FFF FFFF	TLB map	$2^{40} - 2^{31}$ bytes
64-bit A[63..62] = 11 A[63..31] = -1					ckseg0	0xFFFF FFFF 8000 0000 to 0xFFFF FFFF 9FFF FFFF	0x0000 0000 to 0x1FFF FFFF	512 Mbytes (2^{29} bytes)
64-bit A[63..62] = 11 A[63..31] = -1					ckseg1	0xFFFF FFFF A000 0000 to 0xFFFF FFFF BFFF FFFF	0x0000 0000 to 0x1FFF FFFF	512 Mbytes (2^{29} bytes)
64-bit A[63..62] = 11 A[63..31] = -1					cksseg	0xFFFF FFFF C000 0000 to 0xFFFF FFFF DFFF FFFF	TLB map	512 Mbytes (2^{29} bytes)
64-bit A[63..62] = 11 A[63..31] = -1					ckseg3	0xFFFF FFFF E000 0000 to 0xFFFF FFFF FFFF FFFF	TLB map	512 Mbytes (2^{29} bytes)

(6) xkuseg (64-bit Kernel mode, user space)

When KX = 1 in the Status register and bits 63 and 62 of the virtual address space are 00, the xkuseg virtual address space is selected; it is the 1-Tbyte (2^{40} bytes) current user address space. The virtual address is extended with the contents of the 8-bit ASID field to form a unique virtual address.

References to xkuseg are mapped through TLB. Whether cache can be used or not is determined by bit C of each page's TLB entry.

If the ERL bit of the Status register is 1, the user address space is assigned 2 Gbytes (2^{31} bytes) without TLB mapping and becomes unmapped (with virtual addresses being used as physical addresses) and uncached so that the cache error handler can use it. This allows the Cache Error exception code to operate uncached using r0 as a base register.

(7) xksseg (64-bit Kernel mode, current supervisor space)

When KX = 1 in the Status register and bits 63 and 62 of the virtual address space are 01, the xksseg address space is selected; it is the 1-Tbyte (2^{40} bytes) current supervisor address space. The virtual address is extended with the contents of the 8-bit ASID field to form a unique virtual address.

References to xksseg are mapped through TLB. Whether cache can be used or not is determined by bit C of each page's TLB entry.

(8) xkphys (64-bit Kernel mode, physical spaces)

When the KX = 1 in the Status register and bits 63 and 62 of the virtual address space are 10, the virtual address space is called xkphys and selected as either cached or uncached. If any of bits 58 to 32 of the address is 1, an attempt to access that address results in an address error.

Whether cache can be used or not is determined by bits 59 to 61 of the virtual address. Table 6-5 shows cacheability corresponding to 8 address spaces.

Table 6-5. Cacheability and the xkphys Address Space

Bits 61-59	Cacheability	Start address
0	Cached	0x8000 0000 0000 0000 to 0x8000 0000 FFFF FFFF
1	Cached	0x8800 0000 0000 0000 to 0x8800 0000 FFFF FFFF
2	Uncached	0x9000 0000 0000 0000 to 0x9000 0000 FFFF FFFF
3	Cached	0x9800 0000 0000 0000 to 0x9800 0000 FFFF FFFF
4	Cached	0xA000 0000 0000 0000 to 0xA000 0000 FFFF FFFF
5	Cached	0xA800 0000 0000 0000 to 0xA800 0000 FFFF FFFF
6	Cached	0xB000 0000 0000 0000 to 0xB000 0000 FFFF FFFF
7	Cached	0xB800 0000 0000 0000 to 0xB800 0000 FFFF FFFF

(9) xkseg (64-bit Kernel mode, physical spaces)

When the KX = 1 in the Status register and bits 63 and 62 of the virtual address space are 11, the virtual address space is called xkseg and selected as either of the following:

- kernel virtual space xkseg, the current kernel virtual space; the virtual address is extended with the contents of the 8-bit ASID field to form a unique virtual address
References to xkseg are mapped through TLB. Whether cache can be used or not is determined by bit C of each page's TLB entry.
- one of the four 32-bit kernel compatibility spaces, as described in the next section.

(10) 64-bit Kernel mode compatible spaces (ckseg0, ckseg1, cksseg, and ckseg3)

If the conditions listed below are satisfied in Kernel mode, ckseg0, ckseg1, cksseg, or ckseg3 (each having 512 Mbytes) is selected as a compatible space according to the state of the bits 30 and 29 (two low-order bits) of the address.

- ◇ The KX bit of the Status register is 1.
- ◇ Bits 63 and 62 of the 64-bit virtual address are 11.
- ◇ Bits 61 to 31 of the virtual address are all 1.

(i) ckseg0

This space is an unmapped region, compatible with the 32-bit mode kseg0 space. The K0 field of the Config register controls cacheability and coherency.

(ii) ckseg1

This space is an unmapped and uncached region, compatible with the 32-bit mode kseg1 space.

(iii) cksseg

This space is the current supervisor virtual space, compatible with the 32-bit mode ksseg space. References to cksseg are mapped through TLB. Whether cache can be used or not is determined by bit C of each page's TLB entry.

(iv) ckseg3

This space is the current supervisor virtual space, compatible with the 32-bit mode kseg3 space. References to ckseg3 are mapped through TLB. Whether cache can be used or not is determined by bit C of each page's TLB entry.

6.3 PHYSICAL ADDRESS SPACE

Using a 32-bit address, the processor physical address space encompasses 4 Gbytes. The V_R4111 uses this 4-Gbyte physical address space as shown in Figure 6-8.

Figure 6-8. V_R4111 Physical Address Space

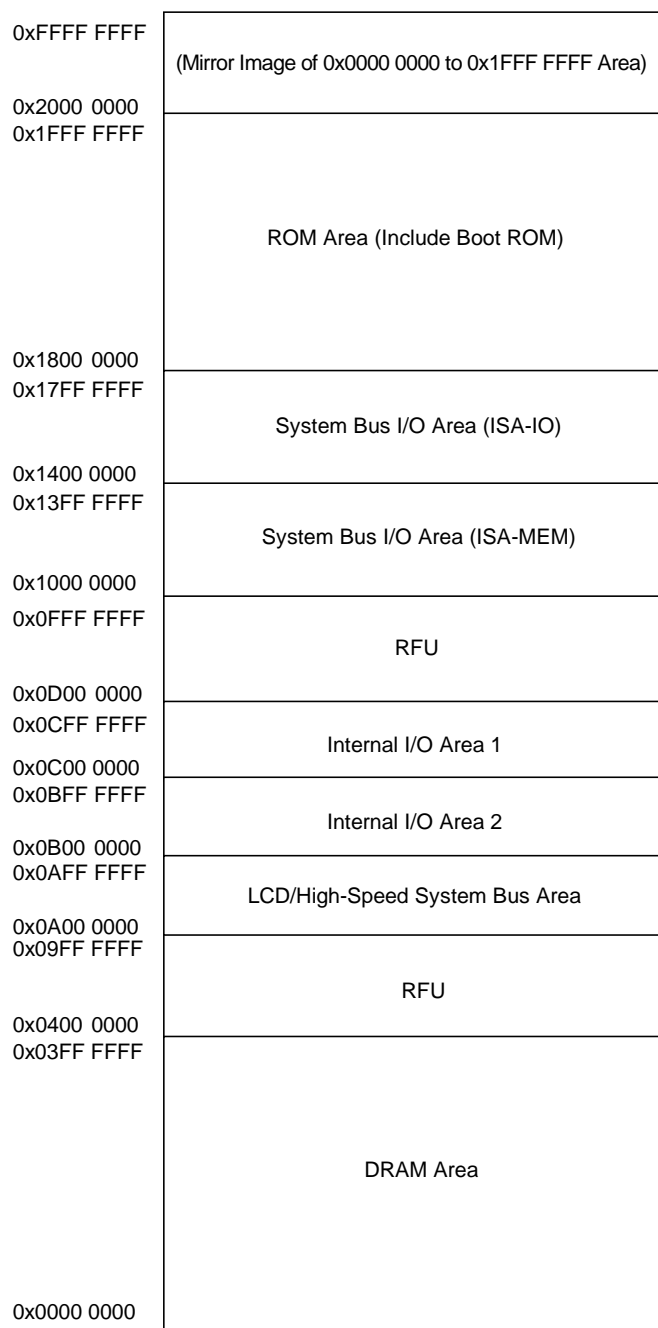

Table 6-6. VR4111 Physical Address Space

Physical address	Space	Capacity (bytes)
0xFFFF FFFF to 0x2000 0000	Mirror image of 0x1FFF FFFF to 0x0000 0000	3.5 G
0x1FFF FFFF to 0x1800 0000	ROM space	128 M
0x17FF FFFF to 0x1400 0000	System bus I/O space (ISA-IO)	64 M
0x13FF FFFF to 0x1000 0000	System bus memory space (ISA-MEM)	64 M
0x0FFF FFFF to 0x0D00 0000	Space reserved for future use	48 M
0x0CFF FFFF to 0x0C00 0000	Internal I/O space 1	16 M
0x0BFF FFFF to 0x0B00 0000	Internal I/O space 2	16 M
0x0AFF FFFF to 0x0A00 0000	LCD/high-speed system bus memory space	16 M
0x09FF FFFF to 0x0400 0000	Space reserved for future use	96 M
0x03FF FFFF to 0x0000 0000	DRAM space	64 M

6.3.1 ROM Space

The ROM space differs depending on the data bus' bit width and the capacity of the ROM being used.

- The data bus' bit width is set via the DBUS32 pin.
- The ROM capacity is set via the BCUNREG1's ROM64 bit and EXT_ROM64 bit.

The physical addresses of the ROM space are listed below.

Table 6-7. ROM Addresses (When Using 16-bit Data Bus)

Physical address	ADD[25:0] pin	When using 32-M ROM (DBUS32=0, ROM64=0)	When using 64-M ROM (DBUS32=0, ROM64=1)
0x1FFF FFFF to 0x1FC0 0000	0x3FF FFFF to 0x3C0 0000	Bank 3 (ROMCS[3]#)	Bank 3 (ROMCS[3]#)
0x1FBF FFFF to 0x1F80 0000	0x3BF FFFF to 0x380 0000	Bank 2 (ROMCS[2]#)	
0x1F7F FFFF to 0x1F40 0000	0x37F FFFF to 0x340 0000	Bank 1 (ROMCS[1]#)	Bank 2 (ROMCS[2]#)
0x1F3F FFFF to 0x1F00 0000	0x33F FFFF to 0x300 0000	Bank 0 (ROMCS[0]#)	
0x1EFF FFFF to 0x1E80 0000	0x2FF FFFF to 0x280 0000	ROM space reserved for future use	Bank 1 (ROMCS[1]#)
0x1E7F FFFF to 0x1E00 0000	0x27F FFFF to 0x200 0000		Bank 0 (ROMCS[0]#)
0x1DFF FFFF to 0x1800 0000	0x1FF FFFF to 0x000 0000		ROM space reserved for future use

Table 6-8. ROM Addresses (when using 32-bit data bus)

(a) When using 32-Mbit extended ROM

Physical address	ADD[25:0] pin	When using 32-Mbit ROM (DBUS32 = 1, ROM64 = 0, EXT_ROM64 = 0)	When using 64-Mbit ROM (DBUS32 = 1, ROM64 = 1, EXT_ROM64 = 0)
0x1FFFFFFF to 0x1F800000	0x3FFFFFFF to 0x38000000	Bank 1 (ROMCS#[1])	Bank 1 (ROMCS#[1])
0x1F7FFFFFFF to 0x1F000000	0x37FFFFFFF to 0x30000000	Bank 0 (ROMCS#[0])	
0x1EFFFFFFF to 0x1E800000	0x2FFFFFFF to 0x28000000	Bank 3 (ROMCS#[3])	Bank 0 (ROMCS#[0])
0x1E7FFFFFFF to 0x1E000000	0x27FFFFFFF to 0x20000000	Bank 2 (ROMCS#[2])	
0x1DFFFFFFF to 0x1D800000	0x1FFFFFFF to 0x18000000	ROM space reserved for future use	Bank 3 (ROMCS#[3]) ^{Note}
0x1D7FFFFFFF to 0x1D000000	0x17FFFFFFF to 0x10000000		Bank 2 (ROMCS#[2]) ^{Note}
0x1CFFFFFFF to 0x18000000	0x0FFFFFFF to 0x00000000		ROM space reserved for future use

(b) When using 64-Mbit extended ROM

Physical address	ADD[25:0] pin	When using 32-M ROM (DBUS32 = 1, ROM64 = 0, EXT_ROM64 = 1)	When using 64-M ROM (DBUS32 = 1, ROM64 = 1, EXT_ROM64 = 1)
0x1FFFFFFF to 0x1F800000	0x3FFFFFFF to 0x38000000	Bank 1 (ROMCS#[1])	Bank 1 (ROMCS#[1])
0x1F7FFFFFFF to 0x1F000000	0x37FFFFFFF to 0x30000000	Bank 0 (ROMCS#[0])	
0x1EFFFFFFF to 0x1E000000	0x2FFFFFFF to 0x20000000	Bank 3 (ROMCS#[3])	Bank 0 (ROMCS#[0])
0x1DFFFFFFF to 0x1D000000	0x1FFFFFFF to 0x10000000	Bank 2 (ROMCS#[2])	Bank 3 (ROMCS#[3]) ^{Note}
0x1CFFFFFFF to 0x1C000000	0x0FFFFFFF to 0x00000000	ROM space reserved for future use	Bank 2 (ROMCS#[2]) ^{Note}
0x1BFFFFFFF to 0x18000000	0x3FFFFFFF to 0x00000000		ROM space reserved for future use

Note Can be used exclusively from the extension DRAM.

6.3.2 System Bus Space

The following three types of system bus space are available.

- System bus I/O space
This corresponds to the ISA's I/O space.
- System bus memory space
This corresponds to the ISA's memory space.
- High-speed system bus memory space
The access speed can be set independently of the system bus memory space.
There are 16 Mbytes of high-speed system bus memory space. Therefore, the ADD[25:24] pin is fixed as 10.
When system bus memory has been accessed from the high-speed system bus memory space, the LCDCS# pin becomes active.
The high-speed system bus memory space is used exclusively from the LCD space. To switch between these two types of space, set the ISAM/LCD bit in BCUCNTREG1.

6.3.3 Internal I/O Space

The VR4111 has two internal I/O spaces. Each of these spaces are described below.

Table 6-9. Internal I/O Space 1

Physical address	Internal I/O
0x0CFF FFFF to 0x0C00 0080	Reserved for future use
0x0C00 007F to 0x0C00 0060	FIR2
0x0C00 005F to 0x0C00 0040	FIR
0x0C00 003F to 0x0C00 0020	HSP (Software modem interface)
0x0C00 001F to 0x0C00 0000	SIU (equivalent to 16550)

Table 6-10. Internal I/O Space 2

Physical address	Internal I/O
0x0BFF FFFF to 0x0B00 0300	Reserved for future use
0x0B00 02FF to 0x0B00 02E0	GIU2
0x0B00 02DF to 0x0B00 02C0	PMU2
0x0B00 02BF to 0x0B00 02A0	PIU2
0x0B00 029F to 0x0B00 0280	Reserved for future use
0x0B00 027F to 0x0B00 0260	A/D test
0x0B00 025F to 0x0B00 0240	LED
0x0B00 023F to 0x0B00 0220	Reserved for future use
0x0B00 021F to 0x0B00 0200	ICU2
0x0B00 01FF to 0x0B00 01E0	Reserved for future use
0x0B00 01DF to 0x0B00 01C0	RTC2
0x0B00 01BF to 0x0B00 01A0	DSIU
0x0B00 019F to 0x0B00 0180	KIU
0x0B00 017F to 0x0B00 0160	AIU
0x0B00 015F to 0x0B00 0140	Reserved for future use
0x0B00 013F to 0x0B00 0120	PIU1
0x0B00 011F to 0x0B00 0100	GIU1
0x0B00 00FF to 0x0B00 00E0	DSU
0x0B00 00DF to 0x0B00 00C0	RTC1
0x0B00 00BF to 0x0B00 00A0	PMU
0x0B00 009F to 0x0B00 0080	ICU1
0x0B00 007F to 0x0B00 0060	CMU
0x0B00 005F to 0x0B00 0040	DCU
0x0B00 003F to 0x0B00 0020	DMAA
0x0B00 001F to 0x0B00 0000	BCU

6.3.4 LCD Space

This space is used to access the external LCD controller.

The data bus's bit width is set via the DBUS32 pin and the BCUCNTREG3's LCD 32 bit.

DBUS32 pin == 0: 16 bits

DBUS32 pin == 1

BCUCNTREG3's LCD32 == 0: 16 bits

BCUCNTREG3's LCD32 == 1: 32 bits

The data accessed via this space can be bit-inverted/bit-reinverted by the GMODE bit of BCUCNTREG2.

The LCD space is used exclusively from the high-speed system bus memory space. To switch between these two types of space, set the ISAM/LCD bit in BCUCNTREG1.

6.3.5 DRAM Space

The DRAM space differs depending on the data bus' bit width and the capacity of the DRAM being used.

- The data bus' bit width is set via the DBUS32 pin.
- The DRAM capacity is set via the BCUCNTREG1's DRAM64 bit and EX_DRAM64 bit.

The physical addresses of the DRAM space are listed below.

For details of ADD[25:0] pin connection, refer to **11.3 CONNECTION OF ADDRESS PINS**.

Table 6-11. DRAM Addresses (When Using 16-bit Data Bus)

Physical address	When using 16-Mbit DRAM (DBUS32 = 0, DRAM64 = 0)	When using 64-Mbit DRAM (DBUS32 = 0, DRAM64 = 1)
0x03FF FFFF to 0x02000000	DRAM space reserved for future use	DRAM space reserved for future use
0x01FF FFFF to 0x01800000		Bank 3 (UUCAS#/MRAS#[3])
0x017F FFFF to 0x01000000		Bank 2 (ULCAS#/MRAS#[2])
0x00FF FFFF to 0x00800000		Bank 1 (MRAS#[1])
0x007F FFFF to 0x00600000	Bank 3 (UUCAS#/MRAS#[3])	Bank 0 (MRAS#[0])
0x005F FFFF to 0x00400000	Bank 2 (ULCAS#/MRAS#[2])	
0x003F FFFF to 0x00200000	Bank 1 (MRAS#[1])	
0x001F FFFF to 0x00000000	Bank 0 (MRAS#[0])	

Table 6-12. DRAM Addresses (When Using 32-bit Data Bus)

(a) When using 16-M bit extended DRAM

Physical address	When using 16-M DRAM (DBUS32 = 1, DRAM64 = 0, EXT_DRAM64 = 0)	When using 64-M DRAM (DBUS32 = 1, DRAM64 = 1, EXT_DRAM64 = 0)
0x03FFFFFF to 0x28000000	DRAM space reserved for future use	DRAM space reserved for future use
0x027FFFFFF to 0x02400000		Bank 3 (ROMCS#[3]) ^{Note}
0x023FFFFFF to 0x02000000		Bank 2 (ROMCS#[2]) ^{Note}
0x017FFFFFF to 0x01800000		Bank 1 (MRAS#[1])
0x017FFFFFF to 0x01000000		
0x00FFFFFF to 0x00e00000	Bank 3 (ROMCS#[3])	Bank 0 (MRAS#[0])
0x00dFFFFFF to 0x00c00000		
0x00bFFFFFF to 0x00a00000	Bank 2 (ROMCS#[2])	
0x009FFFFFF to 0x00800000		
0x007FFFFFF to 0x00600000	Bank 1 (MRAS#[1])	
0x005FFFFFF to 0x00400000		
0x003FFFFFF to 0x00200000	Bank 0 (MRAS#[0])	
0x001FFFFFF to 0x00000000		

(b) When using 64-M bit extended DRAM

Physical address	When using 16-M DRAM (DBUS32 = 1, DRAM64 = 0, EXT_DRAM64 = 1)	When using 64-M DRAM (DBUS32 = 1, DRAM64 = 1, EXT_DRAM64 = 1)
0x03FFFFFF to 0x03000000	DRAM space reserved for future use	Bank 3 (ROMCS#[3]) ^{Note}
0x02FFFFFF to 0x02800000		Bank 2 (ROMCS#[2]) ^{Note}
0x027FFFFFF to 0x02000000	Bank 3 (ROMCS#[3])	Bank 1 (MRAS #[1])
0x017FFFFFF to 0x01800000		
0x017FFFFFF to 0x01000000	Bank 2 (ROMCS #[2])	Bank 0 (MRAS #[0])
0x00FFFFFF to 0x00800000		
0x007FFFFFF to 0x00600000	Bank 1 (MRAS#[1])	
0x005FFFFFF to 0x00400000		
0x003FFFFFF to 0x00200000	Bank 0 (MRAS #[0])	
0x001FFFFFF to 0x00000000		

Note Can be used exclusively from the extension ROM

6.4 SYSTEM CONTROL COPROCESSOR

The System Control Coprocessor (CP0) is implemented as an integral part of the CPU, and supports memory management, address translation, exception handling, and other privileged operations. The CP0 contains the registers and a 32-entry TLB shown in Figure 6-9. The sections that follow describe how the processor uses each of the memory management-related registers.

Remark Each CP0 register has a unique number that identifies it; this number is referred to as the register number. See Chapter 1 for details. Also see Chapter 7 for the CP0 functions and the relationships between exception processing and registers.

Figure 6-9. CP0 Registers and the TLB

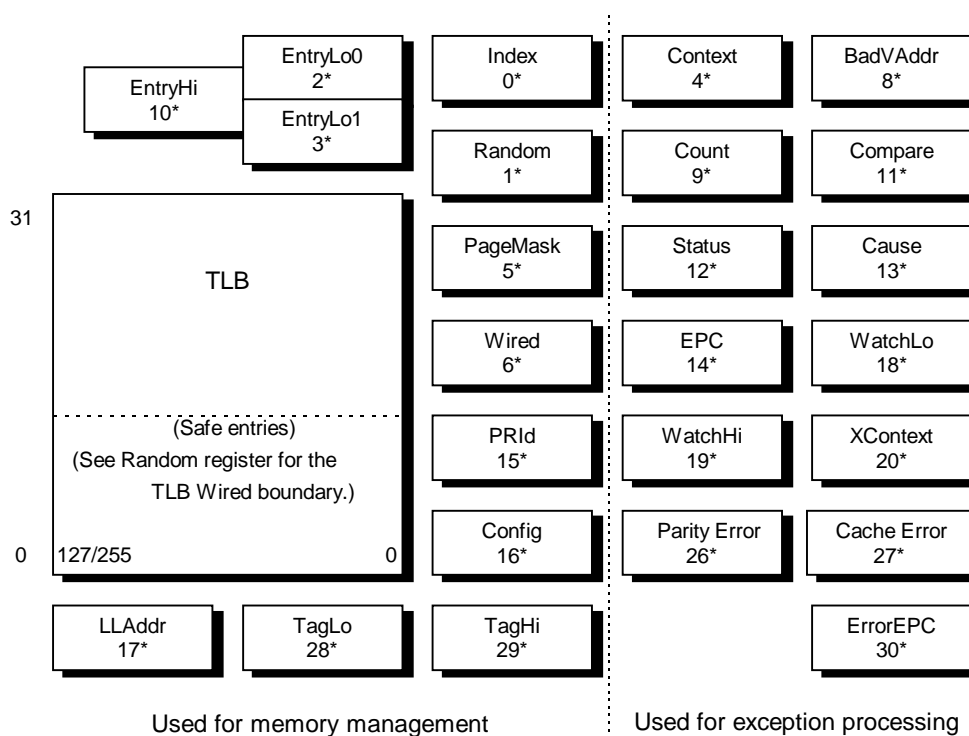

Remark *: Register number

Caution When accessing the CP0 register, some instructions require consideration of the interval time until the next instruction is executed, because it takes a while from when the contents of the CP0 register change to when this change is reflected on the CPU operation. This time lag is called CP0 hazard. For details, see Chapter 30.

6.4.1 Format of a TLB Entry

Figure 6-10 shows the TLB entry formats for both 32- and 64-bit modes. Each field of an entry has a corresponding field in the EntryHi, EntryLo0, EntryLo1, or PageMask registers.

Figure 6-10. Format of a TLB Entry

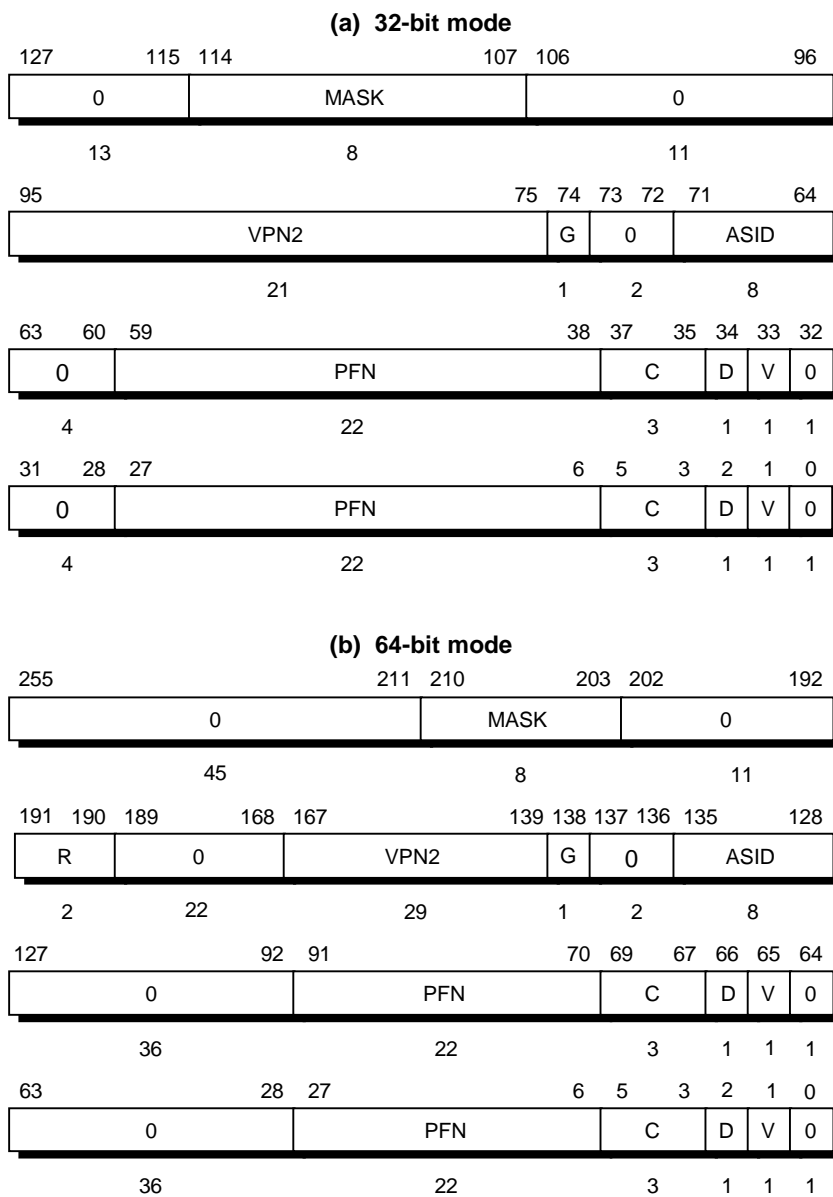

The format of the EntryHi, EntryLo0, EntryLo1, and PageMask registers are nearly the same as the TLB entry. However, it is unknown what bit of the EntryHi register corresponds to the TLB G bit.

6.5 CP0 REGISTERS

The CP0 registers explained below are accessed by the memory management system and software. The parenthesized number that follows each register name is the register number.

6.5.1 Index Register (0)

The Index register is a 32-bit, read/write register containing five low-order bits to index an entry in the TLB. The most-significant bit of the register shows the success or failure of a TLBP instruction.

The Index register also specifies the TLB entry affected by TLB read (TLBR) or TLB write index (TLBWI) instructions.

Figure 6-11. Index Register

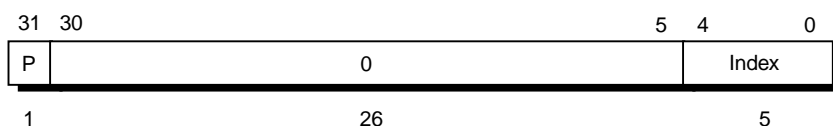

P : Indicates whether probing is successful or not. It is set to 1 if the latest TLBP instruction fails. It is cleared to 0 when the TLBP instruction is successful.

Index : Specifies an index to a TLB entry that is a target of the TLBR or TLBWI instruction.

0 : Reserved for future use. Write 0 in a write operation. When this field is read, 0 is read.

6.5.2 Random Register (1)

The Random register is a read-only register. The low-order 5 bits are used in referencing a TLB entry. This register is decremented each time an instruction is executed. The values that can be set in the register are as follows:

- ✧ The lower bound is the content of the Wired register.
- ✧ The upper bound is 31.

The Random register specifies the entry in the TLB that is affected by the TLBWR instruction. The register is readable to verify proper operation of the processor.

The Random register is set to the value of the upper bound upon Cold Reset. This register is also set to the upper bound when the Wired register is written. Figure 6-12 shows the format of the Random register.

Figure 6-12. Random Register

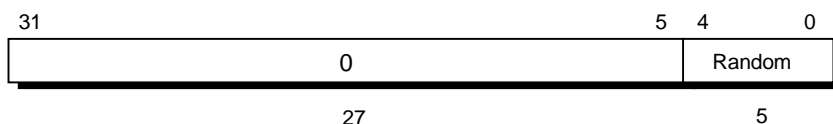

Random : TLB random index

0 : Reserved for future use. Write 0 in a write operation. When this field is read, 0 is read.

6.5.3 EntryLo0 (2) and EntryLo1 (3) Registers

The EntryLo register consists of two registers that have identical formats: EntryLo0, used for even virtual pages and EntryLo1, used for odd virtual pages. The EntryLo0 and EntryLo1 registers are both read-/write-accessible. They are used to access the built-in TLB. When a TLB read/write operation is carried out, the EntryLo0 and EntryLo1 registers hold the contents of the low-order 32 bits of TLB entries at even and odd addresses, respectively.

Figure 6-13. EntryLo0 and EntryLo1 Registers

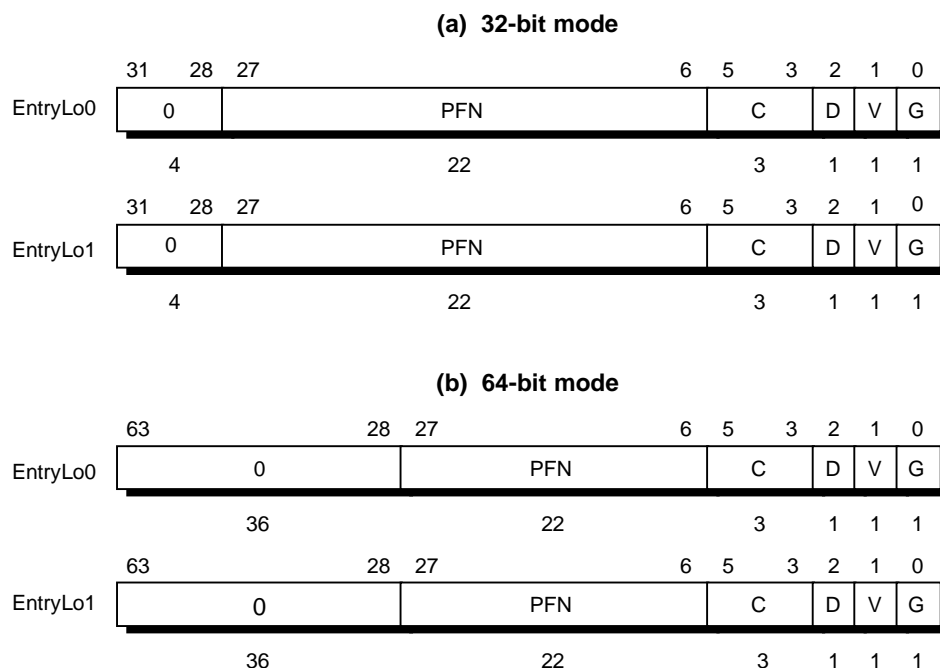

- PFN : Page frame number; high-order bits of the physical address.
- C : Specifies the TLB page attribute (see Table 6-13).
- D : Dirty. If this bit is set to 1, the page is marked as dirty and, therefore, writable. This bit is actually a write-protect bit that software can use to prevent alteration of data.
- V : Valid. If this bit is set to 1, it indicates that the TLB entry is valid; otherwise, a TLB Invalid exception (TLBL or TLBS) occurs.
- G : Global. If this bit is set in both EntryLo0 and EntryLo1, then the processor ignores the ASID during TLB lookup.
- 0 : Reserved for future use. Write 0 in a write operation. When this field is read, 0 is read.

The coherency attribute (C) bits are used to specify whether to use the cache in referencing a page. When the cache is used, whether the page attribute is “cached” or “uncached” is selected by algorithm.

Table 6-13 lists the page attributes selected according to the value in the C bits.

Table 6-13. Cache Algorithm

C bit value	Cache algorithm
0	Cached
1	Cached
2	Uncached
3	Cached
4	Cached
5	Cached
6	Cached
7	Cached

6.5.4 PageMask Register (5)

The PageMask register is a read/write register used for reading from or writing to the TLB; it holds a comparison mask that sets the page size for each TLB entry, as shown in Table 6-14. Page sizes must be from 1 Kbyte to 256 Kbytes.

TLB read and write instructions use this register as either a source or a destination; Bits 18 to 11 that are targets of comparison are masked during address translation.

Figure 6-14. Page Mask Register



MASK : Page comparison mask, which determines the virtual page size for the corresponding entry.

0 : Reserved for future use. Write 0 in a write operation. When this field is read, 0 is read.

Table 6-14 lists the mask pattern for each page size. If the mask pattern is one not listed below, the TLB behaves unexpectedly.

Table 6-14. Mask Values and Page Sizes

Page size	Bit							
	18	17	16	15	14	13	12	11
1 Kbyte	0	0	0	0	0	0	0	0
4 Kbytes	0	0	0	0	0	0	1	1
16 Kbytes	0	0	0	0	1	1	1	1
64 Kbytes	0	0	1	1	1	1	1	1
256 Kbytes	1	1	1	1	1	1	1	1

6.5.5 Wired Register (6)

The Wired register is a read/write register that specifies the lower boundary of the random entry of the TLB as shown in Figure 6-15. Wired entries cannot be overwritten by a TLBWR instruction. They can, however, be overwritten by a TLBWI instruction. Random entries can be overwritten by both instructions.

Figure 6-15. Positions Indicated by the Wired Register

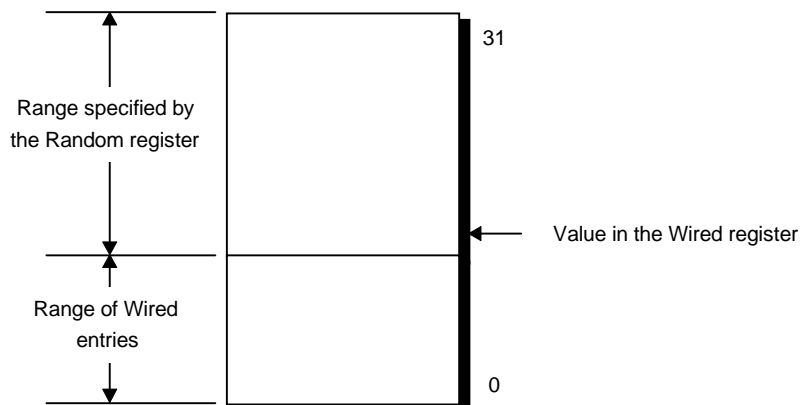

The Wired register is set to 0 upon Cold Reset. Writing this register also sets the Random register to the value of its upper bound (see **6.5.2 Random Register (1)**). Figure 6-16 shows the format of the Wired register.

Figure 6-16. Wired Register

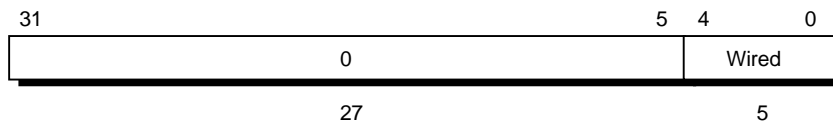

Wired : TLB wired boundary

0 : Reserved for future use. Write 0 in a write operation. When this field is read, 0 is read.

6.5.6 EntryHi Register (10)

The EntryHi register is write-accessible. It is used to access the on-chip TLB. The EntryHi register holds the high-order bits of a TLB entry for TLB read and write operations. If a TLB Mismatch, TLB Invalid, or TLB Modified exception occurs, the EntryHi register holds the high-order bit of the TLB entry. The EntryHi register is also set with the virtual page number (VPN2) for a virtual address where an exception occurred and the ASID. See Chapter 7 for details of the TLB exception.

The ASID is used to read from or write to the ASID field of the TLB entry. It is also checked with the ASID of the TLB entry as the ASID of the virtual address during address translation.

The EntryHi register is accessed by the TLBP, TLBWR, TLBWI, and TLBR instructions.

Figure 6-17. EntryHi Register

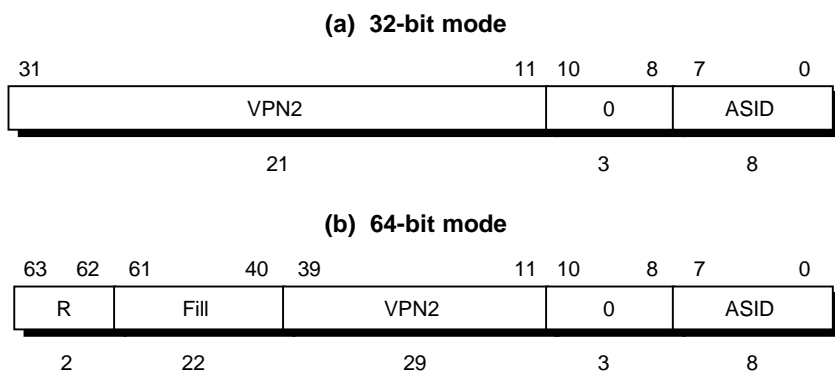

VPN2: Virtual page number divided by two (mapping to two pages)

ASID : Address space ID. An 8-bit ASID field that lets multiple processes share the TLB; each process has a distinct mapping of otherwise identical virtual page numbers.

R : Space type (00 → user, 01 → supervisor, 11 → kernel). Matches bits 63 and 62 of the virtual address.

Fill : Reserved. Ignored on write. When read, returns zero.

0 : Reserved for future use. Write 0 in a write operation. When this field is read, 0 is read.

6.5.7 Processor Revision Identifier (PRId) Register (15)

The 32-bit, read-only Processor Revision Identifier (PRId) register contains information identifying the implementation and revision level of the CPU and CP0. Figure 6-18 shows the format of the PRId register.

Figure 6-18. PRId Register

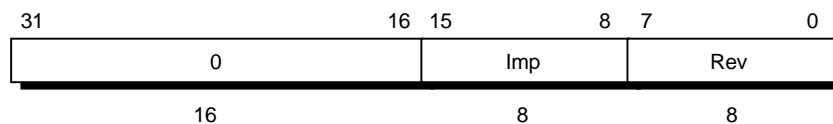

Imp : CPU core processor ID number (0x0C for the VR4111)

Rev : CPU core processor revision number

0 : Reserved for future use. Write 0 in a write operation. When this field is read, 0 is read.

The low-order byte (bits 7:0) of the PRId register is interpreted as a revision number, and the high-order byte (bits 15:8) is interpreted as an implementation number. The processor revision number is stored as a value in the form y.x, where y is a major revision number in bits 7 to 4 and x is a minor revision number in bits 3 to 0.

The processor revision number can distinguish some CPU core revisions, however there is no guarantee that changes to the CPU core will necessarily be reflected in the PRId register, or that changes to the revision number necessarily reflect real CPU core changes. Therefore, create a program that does not depend on the processor revision number area.

6.5.8 Config Register (16)

The Config register specifies various configuration options selected on VR4111 processors.

Some configuration options, as defined by the EC and BE fields, are set by the hardware during Cold Reset and are included in the Config register as read-only status bits for the software to access. Other configuration options are read/write (AD, EP, and K0 fields) and controlled by software; on Cold Reset these fields are undefined. Since only a subset of the VR4000 Series options are available in the VR4111, some bits are set to constants (e.g., bits 14:13) that were variable in the VR4000 Series. The Config register should be initialized by software before caches are used. Figure 6-19 shows the format of the Config register.

Figure 6-19. Config Register Format

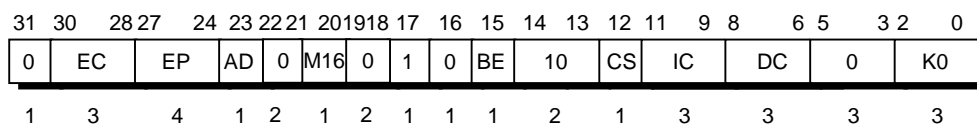

EC : System interface clock (TClock) frequency ratio (read only)

- 0 → Processor clock frequency divided by 2
- 1 → Processor clock frequency divided by 3
- 2 → Processor clock frequency divided by 4
- 3 to 7 → Reserved

EP : Transfer data pattern (cache write-back pattern) setting

- 0 → DD: 1 word/1 cycle
- Others → Reserved

AD : Accelerate data mode

- 0 → VR4000 Series compatible mode
- 1 → Reserved

M16: MIPS16 ISA mode enable/disable indication (read only)

- 0 → MIPS16 instruction cannot be executed
- 1 → MIPS16 instruction can be executed.

BE : BigEndianMem. Endian mode of memory and a kernel.

- 0 → Little endian
- 1 → Reserved

CS : Cache size mode indication (fixed to 1)

- 0 → IC = $2^{(n+12)}$ Byte/DC = $2^{(n+12)}$
- 1 → IC = $2^{(n+10)}$ Byte/DC = $2^{(n+10)}$

IC : Instruction cache size indication. In the VR4111, $2^{(IC+10)}$ bytes.

- 100 → 16 Kbytes
- Others → Reserved

DC : Data cache size indication. In the VR4111, $2^{(DC+10)}$ bytes.

- 011 → 8 Kbytes
- Others → Reserved

K0 : kseg0 cache coherency algorithm

- 010 → Uncached
- Others → Cached

1 : 1 is returned when read.

0 : 0 is returned when read.

Caution Be sure to set the EP field and the AD bit to 0. If they are set with any other values, the processor may behave unexpectedly.

6.5.9 Load Linked Address (LLAddr) Register (17)

The read/write Load Linked Address (LLAddr) register is not used with the VR4111 processor except for diagnostic purpose, and serves no function during normal operation.

LLAddr register is implemented just for compatibility between the VR4111 and VR4000/VR4400.

Figure 6-20 LLAddr Register

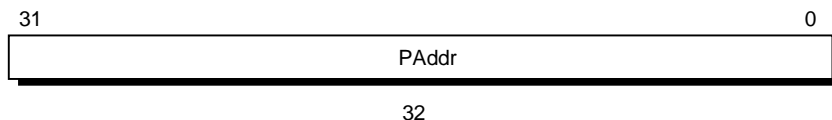

PAddr: 32-bit physical address

6.5.10 Cache Tag Registers (TagLo (28) and TagHi (29))

The TagLo and TagHi registers are 32-bit read/write registers that hold the primary cache tag during cache initialization, cache diagnostics, or cache error processing. The Tag registers are written by the CACHE and MTC0 instructions.

Figures 6-21 and 6-22 show the format of these registers.

Figure 6-21. TagLo Register

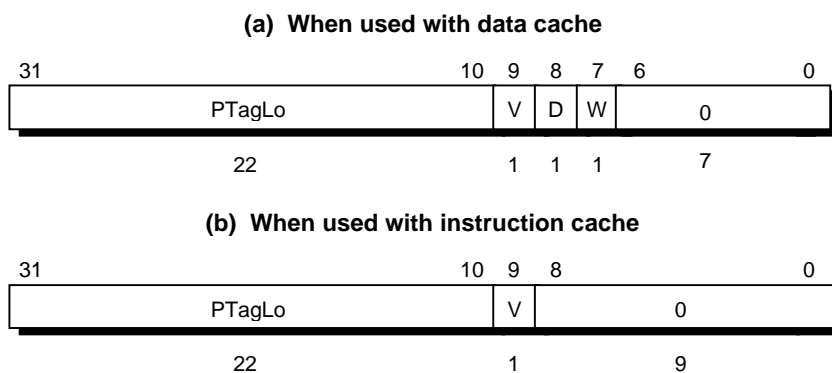

PTagLo: Specifies physical address bits 31 to 10.

V : Valid bit

D : Dirty bit. However, this bit is defined only for the compatibility with the VR4000 Series processors, and does not indicate the status of cache memory in spite of its readability and writability. This bit cannot change the status of cache memory.

W : Write-back bit (set if cache line has been updated)

0 : Reserved for future use. Write 0 in a write operation. When this field is read, 0 is read.

Figure 6-22. TagHi Register

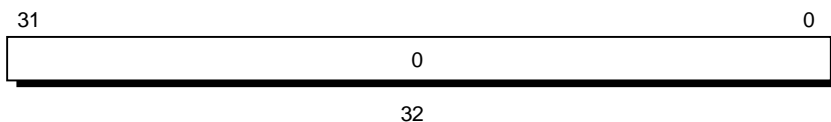

0: Reserved for future use. Write 0 in a write operation. When this field is read, 0 is read.

6.5.11 Virtual-to-Physical Address Translation

During virtual-to-physical address translation, the CPU compares the 8-bit ASID (when the Global bit, G, is not set to 1) of the virtual address to the ASID of the TLB entry to see if there is a match. One of the following comparisons are also made:

- ✧ In 32-bit mode, the high-order bits^{Note} of the 32-bit virtual address are compared to the contents of the VPN2 (virtual page number divided by two) of each TLB entry.
- ✧ In 64-bit mode, the high-order bits^{Note} of the 64-bit virtual address are compared to the contents of the VPN2 (virtual page number divided by two) of each TLB entry.

If a TLB entry matches, the physical address and access control bits (C, D, and V) are retrieved from the matching TLB entry. While the V bit of the entry must be set to 1 for a valid address translation to take place, it is not involved in the determination of a matching TLB entry.

Figure 6-23 illustrates the TLB address translation flow.

Note The number of bits differs from page sizes. The table below shows the examples of high-order bits of the virtual address in page size of 256 Kbytes and 1 Kbytes.

Page size Mode	256 Kbytes	1 Kbyte
32-bit mode	bits 31 to 19	bits 31 to 11
64-bit mode	bits 63, 62, 39 to 19	bits 63, 62, 39 to 11

Figure 6-23. TLB Address Translation

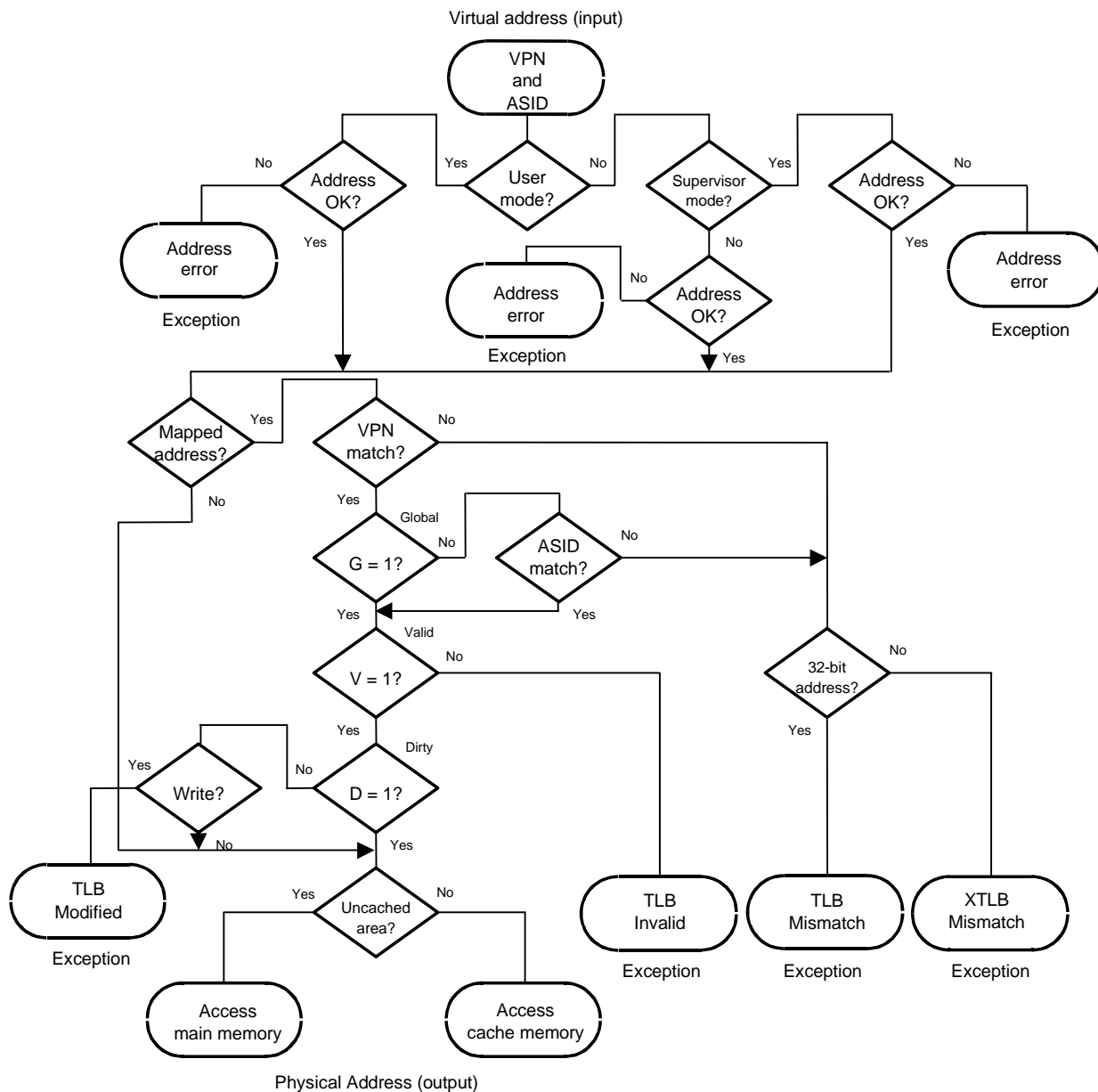

6.5.12 TLB Misses

If there is no TLB entry that matches the virtual address, a TLB Refill (miss) exception occurs^{Note}. If the access control bits (D and V) indicate that the access is not valid, a TLB Modified or TLB Invalid exception occurs. If the C bit is 010, the retrieved physical address directly accesses main memory, bypassing the cache.

Note See Chapter 7 for details of the TLB Miss exception.

6.5.13 TLB Instructions

The instructions used for TLB control are described below.

(a) Translation lookaside buffer probe (TLBP)

The translation lookaside buffer probe (TLBP) instruction loads the Index register with a TLB number that matches the content of the EntryHi register. If there is no TLB number that matches the TLB entry, the highest-order bit of the Index register is set.

(b) Translation lookaside buffer read (TLBR)

The translation lookaside buffer read (TLBR) instruction loads the EntryHi, EntryLo0, EntryLo1, and PageMask registers with the content of the TLB entry indicated by the content of the Index register.

(c) Translation lookaside buffer write index (TLBWI)

The translation lookaside buffer write index (TLBWI) instruction writes the contents of the EntryHi, EntryLo0, EntryLo1, and PageMask registers to the TLB entry indicated by the content of the Index register.

(d) Translation lookaside buffer write random (TLBWR)

The translation lookaside buffer write random (TLBWR) instruction writes the contents of the EntryHi, EntryLo0, EntryLo1, and PageMask registers to the TLB entry indicated by the content of the Random register.

[MEMO]

CHAPTER 7 EXCEPTION PROCESSING

This chapter describes CPU exception processing, including an explanation of hardware that processes exceptions, followed by the format and use of each CPU exception register.

7.1 EXCEPTION PROCESSING OPERATION

The processor receives exceptions from a number of sources, including translation lookaside buffer (TLB) misses, arithmetic overflows, I/O interrupts, and system calls. When the CPU detects an exception, the normal sequence of instruction execution is suspended and the processor enters Kernel mode (see Chapter 6 for a description of system operating modes). If an exception occurs while executing a MIPS16 instruction, the processor stops the MIPS16 instruction execution, and shifts to the 32-bit instruction execution mode.

The processor then disables interrupts and transfers control for execution to the exception handler (located at a specific address as an exception handling routine implemented by software). The handler saves the context of the processor, including the contents of the program counter, the current operating mode (User or Supervisor), statuses, and interrupt enabling. This context is saved so it can be restored when the exception has been serviced.

When an exception occurs, the CPU loads the Exception Program Counter (EPC) register with a location where execution can restart after the exception has been serviced. The restart location in the EPC register is the address of the instruction that caused the exception or, if the instruction was executing in a branch delay slot, the address of the branch instruction immediately preceding the delay slot. Note that no branch delay slot generated by executing a branch instruction exists when the processor operates in the MIPS16 mode.

When MIPS16 instructions are enabled to be executed, bit 0 of the EPC register indicates the operating mode in which an exception occurred. It indicates 1 when in the MIPS16 instruction mode, and indicates 0 when in the MIPS III instruction mode.

The Vr4111 processor supports a Supervisor mode and fast TLB refill for all address spaces. The Vr4111 also provides the following functions:

- ◇ Interrupt enable (IE) bit
- ◇ Operating mode (User, Supervisor, or Kernel)
- ◇ Exception level (normal or exception is indicated by the EXL bit in the Status register)
- ◇ Error level (normal or error is indicated by the ERL bit in the Status register).

Interrupts are enabled when the following conditions are satisfied:

(1) Interrupt enable

An interrupt is enabled when the following conditions are satisfied.

- Interrupt enable bit (IE) = 1
- EXL bit = 0, ERL bit = 0
- Corresponding IM field bits in the Status register = 1

(2) Operating mode

The operating mode is specified by KSU bit in the Status register when both the exception level and error level are normal (0). The operation enters Kernel mode when either EXL bit or ERL bit in the Status register is set to 1.

(3) Exception/error levels

Returning from an exception resets the exception level to normal (0) (for details, see Chapter 28).

The registers that retain address, cause, and status information during exception processing are described in **7.3 EXCEPTION PROCESSING REGISTERS**. For a description of the exception process, see **7.4 DETAILS OF EXCEPTIONS**.

7.2 PRECISION OF EXCEPTIONS

VR4111 exceptions are logically precise; the instruction that causes an exception and all those that follow it are aborted and can be re-executed after servicing the exception. When succeeding instructions are killed, exceptions associated with those instructions are also killed. Exceptions are not taken in the order detected, but in instruction fetch order.

The exception handler can still determine exception and its origin. The cause of the program can be restarted by rewriting the destination register - not automatically, however, as in the case of all the other precise exceptions where no status change occurs.

7.3 EXCEPTION PROCESSING REGISTERS

This section describes the CP0 registers that are used in exception processing. Table 7-1 lists these registers, along with their number—each register has a unique identification number that is referred to as its register number. The CP0 registers not listed in the table are used in memory management (see Chapter 6 for details).

The exception handler examines the CP0 registers during exception processing to determine the cause of the exception and the state of the CPU at the time the exception occurred.

The registers in Table 7-1 are used in exception processing, and are described in the sections that follow.

Table 7-1. CP0 Exception Processing Registers

Register name	Register number
Context register	4
BadVAddr register	8
Count register	9
Compare register	11
Status register	12
Cause register	13
EPC register	14
WatchLo register	18
WatchHi register	19
XContext register	20
Parity Error register	26
Cache Error register	27
ErrorEPC register	30

This register is prepared to maintain compatibility with the VR4100. This register is not used in the VR4111 hardware.

7.3.1 Context Register (4)

The Context register is a read/write register containing the pointer to an entry in the page table entry (PTE) array on the memory; this array is a table that stores virtual-to-physical address translations. When there is a TLB miss, the operating system loads the unsuccessfully translated entry from the PTE array to the TLB. The Context register is used by the TLB Refill exception handler for loading TLB entries. The Context register duplicates some of the information provided in the BadVAddr register, but the information is arranged in a form that is more useful for a software TLB exception handler. Figure 7-1 shows the format of the Context register.

Figure 7-1. Context Register Format

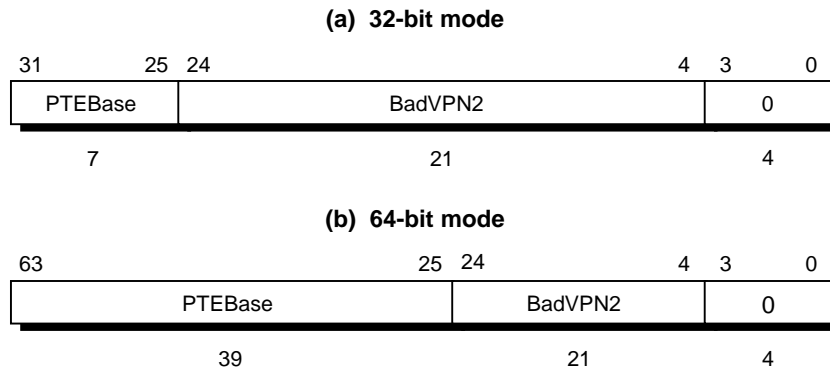

- PTEBase : The PTEBase field is a base address of the PTE entry table.
- BadVPN2 : The BadVPN2 field is written by hardware if a TLB miss occurs. This field holds the value (VPN2) obtained by halving the virtual page number of the most recent virtual address for which translation failed.
- 0 : Reserved for future use. Write 0 in a write operation. When this field is read, 0 is read.

The PTEBase field is used by software as the pointer to the base address of the PTE table in the current user address space.

The 21-bit BadVPN2 field contains bits 31-11 of the virtual address that caused the TLB miss; bit 10 is excluded because a single TLB entry maps to an even-odd page pair. For a 1-Kbyte page size, this format can directly address the pair-table of 8-byte PTEs. When the page size is 4 Kbytes or more, shifting or masking this value produces the correct PTE reference address.

7.3.2 BadVAddr Register (8)

The Bad Virtual Address (BadVAddr) register is a read-only register that saves the most recent virtual address that failed to have a valid translation, or that had an addressing error. Figure 7-2 shows the format of the BadVAddr register.

Caution This register saves no information after a bus error exception, because it is not an address error exception.

Figure 7-2. BadVAddr Register Format

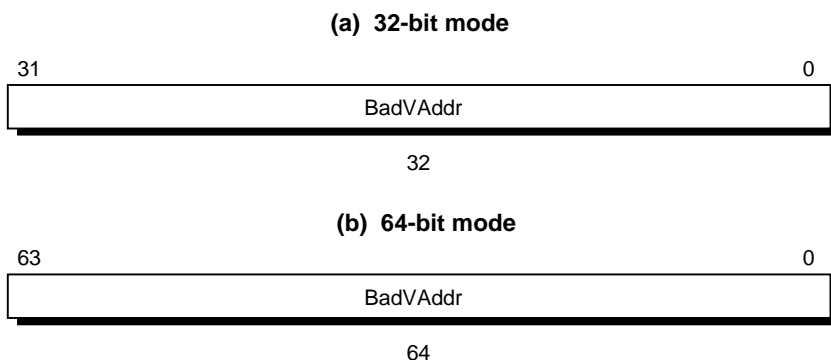

BadVAddr: Most recent virtual address for which an addressing error occurred, or for which address translation failed.

7.3.3 Count Register (9)

The read/write Count register acts as a timer. It is incremented in synchronization with the MasterOut clock (1/8, 1/12, or 1/16 frequencies of the PClock), regardless of whether instructions are being executed, retired, or any forward progress is actually made through the pipeline.

This register is a free-running type. When the register reaches all ones, it rolls over to zero and continues counting. This register is used for self-diagnostic test, system initialization, or the establishment of inter-process synchronization.

Figure 7-3 shows the format of the Count register.

Figure 7-3. Count Register Format

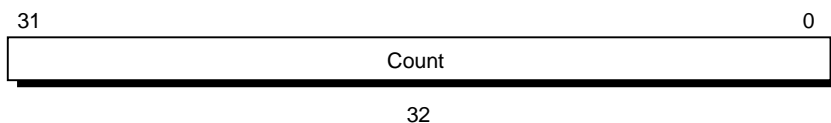

Count: 32-bit up-date count value that is compared with the value of the Compare register.

7.3.4 Compare Register (11)

The Compare register causes a timer interrupt; it maintains a stable value that does not change on its own.

When the value of the Count register (see 7.3.3 Count Register (9)) equals the value of the Compare register, the IP(7) bit in the Cause register is set. This causes an interrupt as soon as the interrupt is enabled.

Writing a value to the Compare register, as a side effect, clears the timer interrupt request.

For diagnostic purposes, the Compare register is a read/write register. Normally, this register should be only used for a write. Figure 7-4 shows the format of the Compare register.

Figure 7-4. Compare Register Format

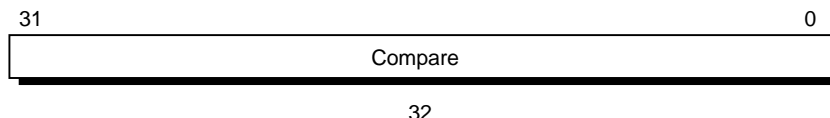

Compare: Value that is compared with the count value of the Count register.

7.3.5 Status Register (12)

The Status register is a read/write register that contains the operating mode, interrupt enabling, and the diagnostic states of the processor. Figure 7-5 shows the format of the Status register.

Figure 7-5. Status Register Format

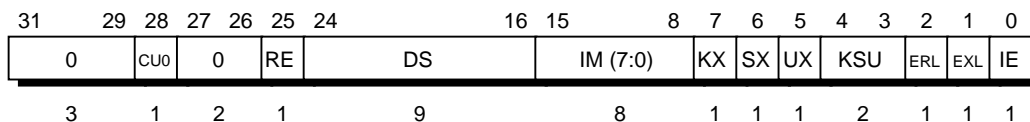

CU0 : Enables/disables the use of the coprocessor (1 → Enabled, 0 → Disabled).

CP0 can be used by the kernel at all times.

0 : Reserved for future use. Write 0 in a write operation. When this bit is read, 0 is read.

RE : Enables/disables reversing of the endian setting in User mode (0 → Disabled, 1 → Enabled). This bit must be set to 0 since the VR4111 supports the little-endian order only.

DS : Diagnostic Status field (see Figure 7-6).

IM : Interrupt Mask field used to enable/disable interrupts (0 → Disabled, 1 → Enabled). This field consists of 8 bits that are used to control eight interrupts. The bits are assigned to interrupts as follows:

IM7 : Masks a timer interrupt.

IM(6:2) : Mask ordinary interrupts (Int(4:0)^{Note}). However, Int4^{Note} never occur in the VR4111.

IM(1:0) : Software interrupts.

Note Int(4:0) are internal signals of the VR4110 CPU core. For details about connection to the on-chip peripheral units, refer to Chapter 15.

- KX : Enables 64-bit addressing in Kernel mode (0 → 32-bit, 1 → 64-bit). If this bit is set, an XTLB Refill exception occurs if a TLB miss occurs in the Kernel mode address space.
- SX : Enables 64-bit addressing and operation in Supervisor mode (0 → 32-bit, 1 → 64-bit). If this bit is set, an XTLB Refill exception occurs if a TLB miss occurs in the Supervisor mode address space.
- UX: : Enables 64-bit addressing and operation in User mode (0 → 32-bit, 1 → 64-bit). If this bit is set, an XTLB Refill exception occurs if a TLB miss occurs in the User mode address space.
- KSU : Sets and indicates the operating mode (10 → User, 01 → Supervisor, 00 → Kernel).
- ERL : Sets and indicates the error level (0 → Normal, 1 → Error).
- EXL : Sets and indicates the exception level (0 → Normal, 1 → Exception).
- IE : Sets and indicates interrupt enabling/disabling (0 → Disabled, 1 → Enabled).

Figure 7-6 shows the details of the Diagnostic Status (DS) field. All DS field bits other than the TS bit are writable.

Figure 7-6. Status Register Diagnostic Status Field

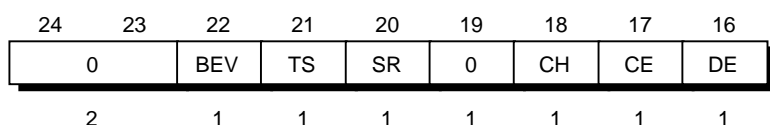

- BEV : Specifies the base address of a TLB Refill exception vector and common exception vector (0 → Normal, 1 → Bootstrap).
- TS : Occurs the TLB to be shut down (read-only) (0 → Not shut down, 1 → Shut down). This bit is used to avoid any problems that may occur when multiple TLB entries match the same virtual address. After the TLB has been shut down, reset the processor to enable restart. Note that the TLB is shut down even if a TLB entry matching a virtual address is marked as being invalid (with the V bit cleared).
- SR : Occurs a Soft Reset or NMI exception (0 → Not occurred, 1 → Occurred).
- CH : CP0 condition bit (0 → False, 1 → True). This bit can be read and written by software only; it cannot be accessed by hardware.
- CE, DE: These are prepared to maintain compatibility with the VR4100, and are not used in the VR4111 hardware.
- 0 : Reserved for future use. Write 0 in a write operation. When this field is read, 0 is read.

The status register has the following fields where the modes and access status are set.

(1) Interrupt enable

Interrupts are enabled when all of the following conditions are true:

- ◇ IE is set to 1.
- ◇ EXL is cleared to 0.
- ◇ ERL is cleared to 0.
- ◇ The appropriate bit of the IM is set to 1.

(2) Operating modes

The following Status register bit settings are required for User, Kernel, and Supervisor modes.

- ◇ The processor is in User mode when $KSU = 10$, $EXL = 0$, and $ERL = 0$.
- ◇ The processor is in Supervisor mode when $KSU = 01$, $EXL = 0$, and $ERL = 0$.
- ◇ The processor is in Kernel mode when $KSU = 00$, $EXL = 1$, or $ERL = 1$.

(3) 32- and 64-bit modes

The following Status register bit settings select 32- or 64-bit operation for User, Kernel, and Supervisor operating modes. Enabling 64-bit operation permits the execution of 64-bit opcodes and translation of 64-bit addresses. 64-bit operation for User, Kernel and Supervisor modes can be set independently.

- ◇ 64-bit addressing for Kernel mode is enabled when KX bit = 1. 64-bit operations are always valid in Kernel mode.
- ◇ 64-bit addressing and operations are enabled for Supervisor mode when SX bit = 1.
- ◇ 64-bit addressing and operations are enabled for User mode when UX bit = 1.

(4) Kernel address space accesses

Access to the kernel address space is allowed when the processor is in Kernel mode.

(5) Supervisor address space accesses

Access to the supervisor address space is allowed when the processor is in Supervisor or Kernel mode.

(6) User address space accesses

Access to the user address space is allowed in any of the three operating modes.

(7) Status after reset

The contents of the Status register are undefined after Cold resets, except for the following bits in the diagnostic status field.

- TS and SR are cleared to 0.
- ERL and BEV are set to 1.
- SR is 0 after Cold reset, and is 1 after Soft reset or NMI interrupt.

Remark Cold reset and Soft reset are CPU core reset (see **8.3 RESET OF THE CPU CORE**). For the reset of all the V_R4111 including peripheral units, refer to **CHAPTER 8 INITIALIZATION INTERFACE** and **CHAPTER 16 PMU**.

7.3.6 Cause Register (13)

The 32-bit read/write Cause register holds the cause of the most recent exception. A 5-bit exception code indicates one of the causes (see Table 7-2). Other bits hold the detailed information of the specific exception. All bits in the Cause register, with the exception of the IP1 and IP0 bits, are read-only; IP1 and IP0 are used for software interrupts. Figure 7-7 shows the fields of this register; Table 7-2 describes the Cause register codes.

Figure 7-7. Cause Register Format

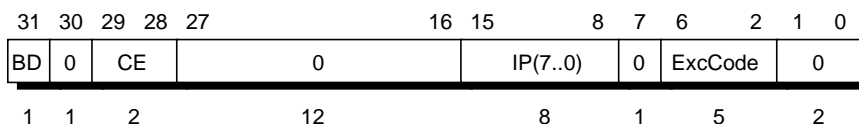

- BD : Indicates whether the most recent exception occurred in the branch delay slot (1 → In delay slot, 0 → Normal).
- CE : Indicates the coprocessor number in which a Coprocessor Unusable exception occurred. This field will remain undefined for as long as no exception occurs.
- IP : Indicates whether an interrupt is pending (1 → Interrupt pending, 0 → No interrupt pending).
 - IM7 : A timer interrupt.
 - IM(6:2) : Ordinary interrupts (Int(4:0)^{Note}). However, Int4^{Note} never occurs in the VR4111.
 - IM(1:0) : Software interrupts. Only these bits cause an interrupt exception, when they are set to 1 by means of software.

Note Int(4:0) are internal signals of the VR4110 CPU core. For details about connection to the on-chip peripheral units, refer to Chapter 15.

ExcCode: Exception code field (refer to Table 7-2 for details).

0 : Reserved for future use. Write 0 in a write operation. When this field is read, 0 is read.

Table 7-2. Cause Register Exception Code Field

Exception code	Mnemonic	Description
0	Int	Interrupt exception
1	Mod	TLB Modified exception
2	TLBL	TLB Refill exception (load or fetch)
3	TLBS	TLB Refill exception (store)
4	AdEL	Address Error exception (load or fetch)
5	AdES	Address Error exception (store)
6	IBE	Bus Error exception (instruction fetch)
7	DBE	Bus Error exception (data load or store)
8	Sys	System Call exception
9	Bp	Breakpoint exception
10	RI	Reserved Instruction exception
11	CpU	Coprocessor Unusable exception
12	Ov	Integer Overflow exception
13	Tr	Trap exception
14 to 22	—	Reserved for future use
23	WATCH	Watch exception
24 to 31	—	Reserved for future use

The VR4111 has eight interrupt request sources, IP7 to IP0.
For the detailed description of interrupts, refer to Chapter 10.

(1) IP7

This bit indicates whether there is a timer interrupt request.
It is set when the values of Count register and Compare register match.

(2) IP6 to IP2

IP6 to IP2 reflect the state of the interrupt request signal of the CPU core.

(3) IP1 and IP0

These bits are used to set/clear a software interrupt request.

7.3.7 Exception Program Counter (EPC) Register (14)

The Exception Program Counter (EPC) is a read/write register that contains the address at which processing resumes after an exception has been serviced. The contents of this register change depending on whether execution of MIPS16 instructions is enabled or disabled. Setting the MIPS16EN pin after RTC reset specifies whether execution of the MIPS16 instructions is enabled or disabled.

When the MIPS16 instruction execution is disabled, the EPC register contains either:

- Virtual address of the instruction that caused the exception.
- Virtual address of the immediately preceding branch or jump instruction (when the instruction associated with the exception is in a branch delay slot, and the BD bit in the Cause register is set to 1).

When the MIPS16 instruction execution is enabled, the EPC register contains either:

- Virtual address of the instruction that caused the exception and ISA mode at which an exception occurs.
- Virtual address of the immediately preceding branch or jump instruction and ISA mode at which an exception occurs (when the instruction associated with the exception is in a branch delay slot of the jump instruction, and the BD bit in the Cause register is set to 1).

When the 16-bit instruction is executed, the EPC register contains either:

- Virtual address of the instruction that caused the exception and ISA mode at which an exception occurs.
- Virtual address of the immediately preceding Extend or jump instruction and ISA mode at which an exception occurs (when the instruction associated with the exception is in a branch delay slot of the jump instruction or in the instruction following the Extend instruction, and the BD bit in the Cause register is set to 1).

The EXL bit in the Status register is set to 1 to keep the processor from overwriting the address of the exception-causing instruction contained in the EPC register in the event of another exception.

Figure 7-8 shows the EPC register format when MIPS16 ISA is disabled, and Figure 7-9 shows the EPC register format when MIPS16 ISA is enabled.

Figure 7-8. EPC Register Format (When MIPS16 ISA Is Disabled)

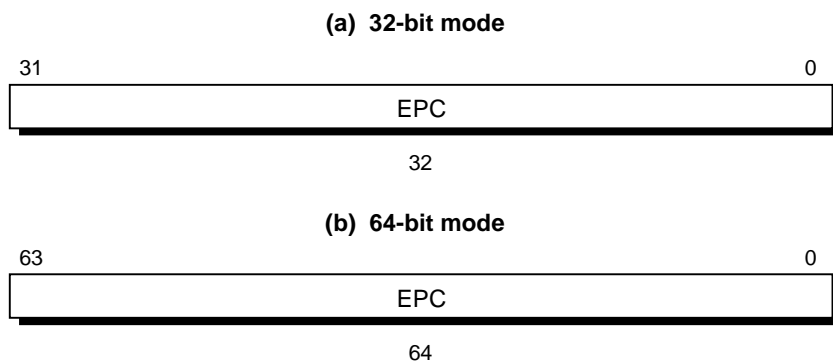

EPC: Restart address after exception processing.

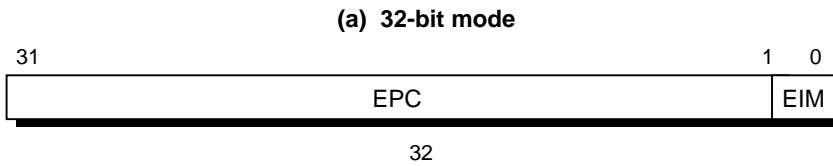
Figure 7-9. EPC Register Format (When MIPS16 ISA Is Enabled)

EPC: Restart address after exception processing [31:1].

EIM: ISA mode at which an exception occurs.

(1: when MIPS16 SIA instruction is executed, 0: when MIPS III ISA instruction is executed.)

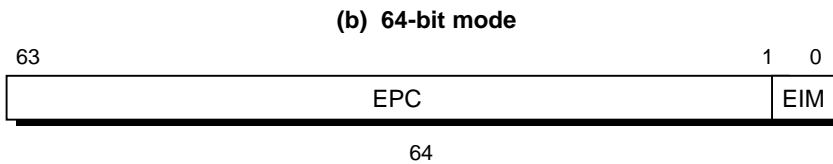

EPC: Restart address after exception processing [63:1].

EIM: ISA mode at which an exception occurs.

(1: when MIPS16 SIA instruction is executed, 0: when MIPS III ISA instruction is executed.)

7.3.8 WatchLo (18) and WatchHi (19) Registers

The VR4111 processor provides a debugging feature to detect references to a selected physical address; load and store instructions to the location specified by the WatchLo and WatchHi registers cause a Watch exception.

Figures 7-10 and 7-11 show the format of the WatchLo and WatchHi registers.

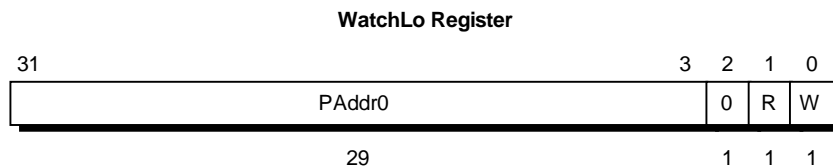
Figure 7-10. WatchLo Register Format

PAddr0 : Specifies physical address bits 31 to 3.

R : If this bit is set to 1, an exception will occur when a load instruction is executed.

W : If this bit is set to 1, an exception will occur when a store instruction is executed.

0 : Reserved for future use. Write 0 in a write operation. When this field is read, 0 is read.

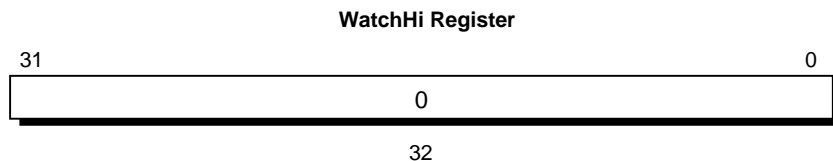
Figure 7-11. WatchHi Register Format

0 : Reserved for future use. Write 0 in a write operation. When this field is read, 0 is read.

7.3.9 XContext Register (20)

The read/write XContext register contains a pointer to an entry in the page table entry (PTE) array, an operating system data structure that stores virtual-to-physical address translations. If a TLB miss occurs, the operating system loads the untranslated data from the PTE into the TLB to handle the software error.

The XContext register is used by the XTLB Refill exception handler to load TLB entries in 64-bit addressing mode.

The XContext register duplicates some of the information provided in the BadVAddr register, and puts it in a form useful for the XTLB exception handler.

This register is included solely for operating system use. The operating system sets the PTEBase field in the register, as needed. Figure 7-12 shows the format of the XContext register.

Figure 7-12. XContext Register Format

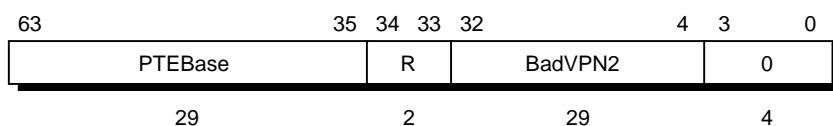

PTEBase : The PTEBase field is a base address of the PTE entry table.

BadVPN2 : This field holds the value (VPN2) obtained by halving the virtual page number of the most recent virtual address for which translation failed.

R : Space type (00 → User, 01 → Supervisor, 11 → Kernel). The setting of this field matches virtual address bits 63 and 62.

0 : Reserved for future use. Write 0 in a write operation. When this field is read, 0 is read.

The 29-bit BadVPN2 field has bits 39 to 11 of the virtual address that caused the TLB miss; bit 10 is excluded because a single TLB entry maps to an even-odd page pair. For a 1-Kbyte page size, this format may be used directly to address the pair-table of 8-byte PTEs. For 4-Kbyte-or-more page and PTE sizes, shifting or masking this value produces the appropriate address.

7.3.10 Parity Error Register (26)

The Parity Error (PErr) register is a readable/writable register. This register is defined to maintain software-compatibility with the VR4100, and is not used in hardware because the VR4111 has no parity.

Figure 7-13 shows the format of the PErr register.

Figure 7-13. Parity Error Register Format

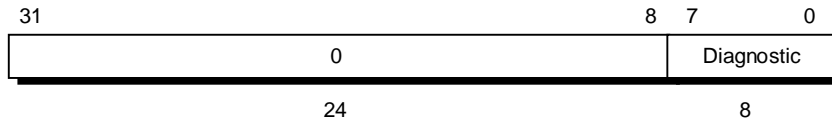

Diagnostic : 8-bit self diagnostic field.

0 : Reserved for future use. Write 0 in a write operation. When this field is read, 0 is read.

7.3.11 Cache Error Register (27)

The Cache Error register is a readable/writable register. This register is defined to maintain software-compatibility with the VR4100, and is not used in hardware because the VR4111 has no parity.

Figure 7-14 shows the format of the Cache Error register.

Figure 7-14. Cache Error Register Format

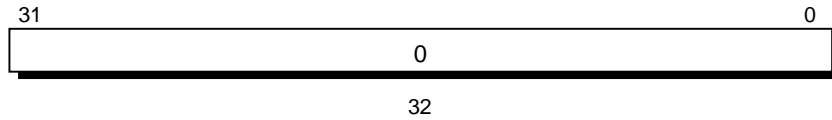

0 : Reserved for future use. Write 0 in a write operation. When this field is read, 0 is read.

7.3.12 ErrorEPC Register (30)

The Error Exception Program Counter (ErrorEPC) register is similar to the EPC register. It is used to store the Program Counter value at which the Cache Error, Cold Reset, Soft Reset, or NMI exception has been serviced.

The read/write ErrorEPC register contains the virtual address at which instruction processing can resume after servicing an error. The contents of this register change depending on whether execution of MIPS16 instructions is enabled or disabled. Setting the MIPS16EN pin after RTC reset specifies whether the execution of MIPS16 instructions is enabled or disabled.

When the MIPS16 ISA is disabled, this address can be:

- Virtual address of the instruction that caused the exception.
- Virtual address of the immediately preceding branch or jump instruction, when the instruction associated with the error exception is in a branch delay slot.

When the MIPS16 instruction execution is enabled during a 32-bit instruction execution, this address can be:

- Virtual address of the instruction that caused the exception and ISA mode at which an exception occurs.
- Virtual address of the immediately preceding branch or jump instruction and ISA mode at which an exception occurs when the instruction associated with the exception is in a branch delay slot.

When the MIPS16 instruction execution is enabled during a 16-bit instruction execution, this address can be:

- Virtual address of the instruction that caused the exception and ISA mode at which an exception occurs.
- Virtual address of the immediately preceding jump instruction or Extend instruction and ISA mode at which an exception occurs when the instruction associated with the exception is in a branch delay slot of the jump instruction or is the instruction following the Extend instruction.

The contents of the ErrorEPC register do not change when the ERL bit of the Status register is set to 1. This prevents the processor when other exceptions occur from overwriting the address of the instruction in this register which causes an error exception.

There is no branch delay slot indication for the ErrorEPC register.

Figure 7-15 shows the format of the ErrorEPC register when the MIPS16ISA is disabled. Figure 7-16 shows the format of the ErrorEPC register when the MIPS16ISA is enabled.

Figure 7-15. ErrorEPC Register Format (When MIPS16 ISA Is Disabled)

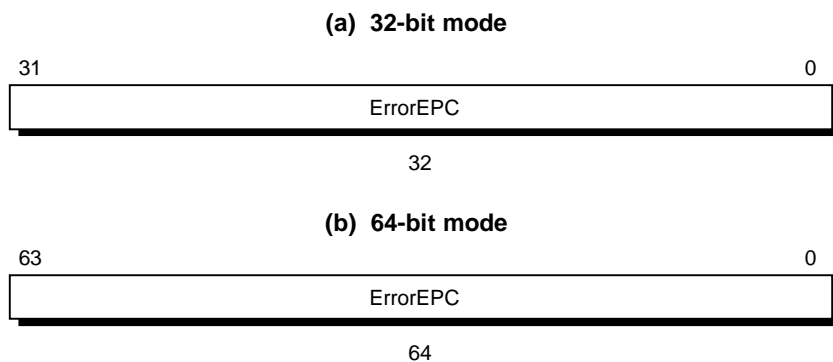

ErrorEPC: Program counter that indicates the restart address after Cold reset, Soft reset, or NMI exception.

Figure 7-16. ErrorEPC Register Format (When MIPS16 ISA Is Enabled)

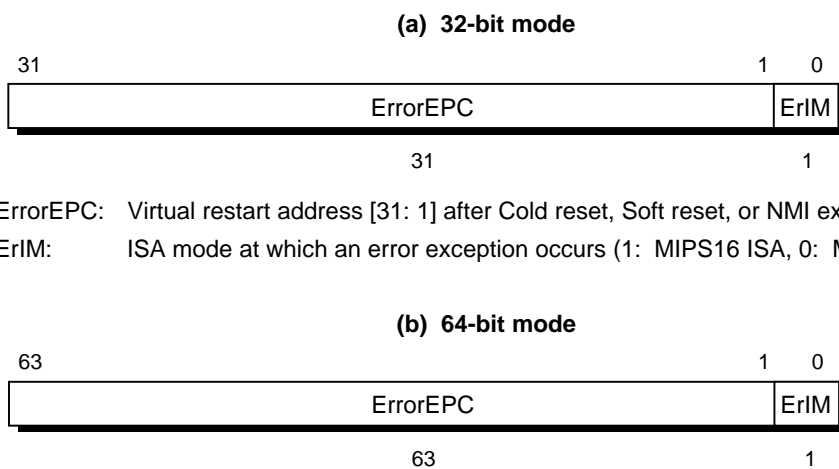

ErrorEPC: Virtual restart address [31: 1] after Cold reset, Soft reset, or NMI exception.

ErIM: ISA mode at which an error exception occurs (1: MIPS16 ISA, 0: MIPS III ISA).

ErrorEPC: Virtual restart address [63: 1] after Cold reset, Soft reset, or NMI exception.

ErIM: ISA mode at which an error exception occurs (1: MIPS16 ISA, 0: MIPS III ISA).

7.4 DETAILS OF EXCEPTIONS

This section describes causes, processes, and services of the V_R4111's exceptions.

7.4.1 Exception Types

This section gives sample exception handler operations for the following exception types:

- ◇ Cold Reset
- ◇ Soft Reset
- ◇ NMI
- ◇ Remaining processor exceptions

When the EXL and ERL bits in the Status register are 0, either User, Supervisor, or Kernel operating mode is specified by the KSU bits in the Status register. When either the EXL or ERL bit is set to 1, the processor is in Kernel mode.

When the processor takes an exception, the EXL bit is set to 1, meaning the system is in Kernel mode. After saving the appropriate state, the exception handler typically resets the EXL bit back to 0. The exception handler sets the EXL bit to 1 so that the saved state is not lost upon the occurrence of another exception while the saved state is being restored.

Returning from an exception also resets the EXL bit to 0. For details, see **Chapter 28 MIPS III INSTRUCTION SET DETAILS**.

7.4.2 Exception Vector Locations

The Cold Reset, Soft Reset, and NMI exceptions are always branched to the following reset exception vector address (virtual). This address is in an uncached, unmapped space.

- ◇ 0xBFC0 0000 in 32-bit mode
- ◇ 0xFFFF FFFF BFC0 0000 in 64-bit mode

Addresses for the remaining exceptions are a combination of a vector offset and a base address. 64-/32-bit mode exception vectors and their offsets are shown below.

Table 7-3. 64-Bit Mode Exception Vector Base Addresses

	Vector base address (virtual)	Vector offset
Cold Reset Soft Reset NMI	0xFFFF FFFF BFC0 0000 (BEV is automatically set to 1)	0x0000
TLB Refill (EXL = 0)	0xFFFF FFFF 8000 0000 (BEV = 0) 0xFFFF FFFF BFC0 0200 (BEV = 1)	0x0000
XTLB Refill (EXL = 0)		0x0080
Other exceptions		0x0180

Table 7-4. 32-Bit Mode Exception Vector Base Addresses

	Vector base address (virtual)	Vector offset
Cold Reset Soft Reset NMI	0xBFC0 0000 (BEV is automatically set to 1)	0x0000
TLB Refill (EXL = 0)	0x8000 0000 (BEV = 0) 0xBFC0 0200 (BEV = 1)	0x0000
XTLB Refill (EXL = 0)		0x0080
Other exceptions		0x0180

(1) TLB Refill Exception Vector

When BEV bit = 0, the vector base address (virtual) for the TLB Refill exception is in kseg0 (unmapped) space.

- ✧ 0x8000 0000 in 32-bit mode
- ✧ 0xFFFF FFFF 8000 0000 in 64-bit mode

When BEV bit = 1, the vector base address (virtual) for the TLB Refill exception is in kseg1 (uncached, unmapped) space.

- ✧ 0xBFC0 0200 in 32-bit mode
- ✧ 0xFFFF FFFF BFC0 0200 in 64-bit mode

This is an uncached, non-TLB-mapped space, allowing the exception handler to bypass the cache and TLB.

7.4.3 Priority of Exceptions

While more than one exception can occur for a single instruction, only the exception with the highest priority is reported. Table 7-5 lists the priorities.

Table 7-5. Exception Priority Order

Priority	Exceptions
High	Cold Reset
↑	Soft Reset
	NMI
	Address Error (instruction fetch)
	TLB/XTLB Refill (instruction fetch)
	TLB Invalid (instruction fetch)
	Bus Error (instruction fetch)
	System Call
	Breakpoint
	Coprocessor Unusable
	Reserved Instruction
	Trap
	Integer Overflow
	Address Error (data access)
	TLB/XTLB Refill (data access)
	TLB Invalid (data access)
	TLB Modified (data write)
	Watch
↓	Bus Error (data access)
Low	Interrupt (other than NMI)

Hereafter, handling exceptions by hardware is referred to as “process”, and handling exception by software is referred to as “service”.

7.4.4 Cold Reset Exception

Cause

The Cold Reset exception occurs when the ColdReset# signal (internal) is asserted and then deasserted. This exception is not maskable. The Reset# signal (internal) must be asserted along with the ColdReset# signal (for details, see Chapter 8).

Processing

The CPU provides a special interrupt vector for this exception:

- ◇ 0xBFC0 0000 (virtual) in 32-bit mode
- ◇ 0xFFFF FFFF BFC0 0000 (virtual) in 64-bit mode

The Cold Reset vector resides in unmapped and uncached CPU address space, so the hardware need not initialize the TLB or the cache to process this exception. It also means the processor can fetch and execute instructions while the caches and virtual memory are in an undefined state.

The contents of all registers in the CPU are undefined when this exception occurs, except for the following register fields:

- When the MIPS16 instruction execution is disabled while the ERL of Status register is 0, the PC value at which an exception occurs is set to the ErrorEPC register.
When the MIPS16 instruction execution is enabled while the ERL of Status register is 0, the PC value at which an exception occurs is set to the ErrorEPC register and the ISA mode in which an exception occurs is set to the least significant bit of the ErrorEPC register.
- TS and SR of the Status register are cleared to 0.
- ERL and BEV of the Status register are set to 1.
- The Random register is initialized to the value of its upper bound (31).
- The Wired register is initialized to 0.
- Bits 31 to 28 and bits 22 to 3 of the Config register are set to fixed values.
- All other bits are undefined.

Servicing

The Cold Reset exception is serviced by:

- Initializing all processor registers, coprocessor registers, TLB, caches, and the memory system
- Performing diagnostic tests
- Bootstrapping the operating system

7.4.5 Soft Reset Exception

Cause

A Soft Reset (sometimes called Warm Reset) occurs when the ColdReset# signal remains deasserted while the Reset# signal goes from assertion to deassertion (for details, see Chapter 8).

A Soft Reset immediately resets all state machines, and sets the SR bit of the Status register. Execution begins at the reset vector when the reset is deasserted. This exception is not maskable.

Caution In the Vr4111, a soft reset never occurs.

Processing

The CPU provides a special interrupt vector for this exception (same location as Cold Reset):

- ◇ 0xBFC0 0000 (virtual) in 32-bit mode
- ◇ 0xFFFF FFFF BFC0 0000 (virtual) in 64-bit mode

This vector is located within unmapped and uncached address space, so that the cache and TLB need not be initialized to process this exception. The SR bit of the Status register is set to 1 to distinguish this exception from a Cold Reset exception.

When this exception occurs, the contents of all registers are preserved except for the following registers:

- When the MIPS16 instruction execution is disabled, the PC value at which an exception occurs is set to the ErrorEPC register.
When the MIPS16 instruction execution is enabled, the PC value at which an exception occurs is set to the ErrorEPC register and the ISA mode in which an exception occurs is set to the least significant bit of the ErrorEPC register.
- TS bit of the Status register is cleared to 0.
- ERL, SR, and BEV bits of the Status register are set to 1.

During a soft reset, access to the operating cache or system interface may be aborted. This means that the contents of the cache and memory will be undefined if a Soft Reset occurs.

Servicing

The Soft Reset exception is serviced by:

- Preserving the current processor states for diagnostic tests
- Reinitializing the system in the same way as for a Cold Reset exception

7.4.6 NMI Exception

Cause

The Nonmaskable Interrupt (NMI) exception occurs when the NMI signal (internal) becomes active. This interrupt is not maskable; it occurs regardless of the settings of the EXL, ERL, and the IE bits in the Status register (for details, see Chapters 10 and 15).

Processing

The CPU provides a special interrupt vector for this exception:

- ◇ 0xBFC0 0000 (virtual) in 32-bit mode
- ◇ 0xFFFF FFFF BFC0 0000 (virtual) in 64-bit mode

This vector is located within unmapped and uncached address space so that the cache and TLB need not be initialized to process an NMI interrupt. The SR bit of the Status register is set to 1 to distinguish this exception from a Cold Reset exception.

Unlike Cold Reset and Soft Reset, but like other exceptions, NMI is taken only at instruction boundaries. The states of the caches and memory system are preserved by this exception.

When this exception occurs, the contents of all registers are preserved except for the following registers:

- When the MIPS16 instruction execution is disabled, the PC value at which an exception occurs is set to the ErrorEPC register.
When the MIPS16 instruction execution is enabled, the PC value at which an exception occurs is set to the ErrorEPC register and the ISA mode in which an exception occurs is set to the least significant bit of the ErrorEPC register.
- The TS bit of the Status register is cleared to 0.
- The ERL, SR, and BEV bits of the Status register are set to 1.

Servicing

The NMI exception is serviced by:

- Preserving the current processor states for diagnostic tests
- Reinitializing the system in the same way as for a Cold Reset exception

7.4.7 Address Error Exception

Cause

The Address Error exception occurs when an attempt is made to execute one of the following. This exception is not maskable.

- Execution of the LW, LWU, SW, or CACHE instruction for word data that is not located on a word boundary
- Execution of the LH, LHU, or SH instruction for half-word data that is not located on a half-word boundary
- Execution the LD or SD instruction for double-word data that is not located on a double-word boundary
- Referencing the kernel address space in User or Supervisor mode
- Referencing the supervisor space in User mode
- Referencing an address that does not exist in the kernel, user, or supervisor address space in 64-bit Kernel, User, or Supervisor mode
- Branching to an address that was not located on a word boundary when the MIPS16 instruction is disabled
- Branching to address whose least-significant 2 bits are 10 when the MIPS16 instruction is enabled

Processing

The common exception vector is used for this exception. The AdEL or AdES code in the Cause register is set. If this exception has been caused by an instruction reference or load operation, AdEL is set. If it has been caused by a store operation, AdES is set.

When this exception occurs, the BadVAddr register stores the virtual address that was not properly aligned or was referenced in protected address space. The contents of the VPN field of the Context and EntryHi registers are undefined, as are the contents of the EntryLo register.

When the MIPS16 instruction is disabled, the EPC register contains the address of the instruction that caused the exception. However, if this instruction is in a branch delay slot, the EPC register contains the address of the preceding jump or branch instruction, and the BD bit of the Cause register is set to 1.

When the MIPS16 instruction is enabled, the EPC register contains the address of the instruction that caused the exception, and the least significant bit stores the ISA mode in which an exception occurs. However, if this instruction is in a branch delay slot or is the instruction following the Extend instruction, the EPC register contains the address of the preceding jump or Extend instruction, and the BD bit of the Cause register is set to 1.

Servicing

The kernel reports the UNIX™ SIGSEGV (segmentation violation) signal to the current process, and this exception is usually fatal.

7.4.8 TLB Exceptions

Three types of TLB exceptions can occur:

- TLB Refill exception occurs when there is no TLB entry that matches a referenced address.
- A TLB Invalid exception occurs when a TLB entry that matches a referenced virtual address is marked as being invalid (with the V bit set to 0).
- The TLB Modified exception occurs when a TLB entry that matches a virtual address referenced by the store instruction is marked as being valid (with the V bit set to 1).

The following three sections describe these TLB exceptions.

(1) TLB Refill Exception (32-bit Space Mode)/XTLB Refill Exception (64-bit Space Mode)

Cause

The TLB Refill exception occurs when there is no TLB entry to match a reference to a mapped address space. This exception is not maskable.

Processing

There are two special exception vectors for this exception; one for references to 32-bit address spaces, and one for references to 64-bit address spaces. The UX, SX, and KX bits of the Status register determine whether the user, supervisor or kernel address spaces referenced are 32-bit or 64-bit spaces. When the EXL bit of the Status register is set to 0, either of these two special vectors is referenced. When the EXL bit is set to 1, the common exception vector is referenced.

This exception sets the TLBL or TLBS code in the ExcCode field of the Cause register. If this exception has been caused by an instruction reference or load operation, TLBL is set. If it has been caused by a store operation, TLBS is set.

When this exception occurs, the BadVAddr, Context, XContext and EntryHi registers hold the virtual address that failed address translation. The EntryHi register also contains the ASID from which the translation fault occurred. The Random register normally contains a valid location in which to place the replacement TLB entry. The contents of the EntryLo register are undefined.

When the MIPS16 instruction is disabled, the EPC register contains the address of the instruction that caused the exception. However, if this instruction is in a branch delay slot, the EPC register contains the address of the preceding jump or branch instruction, and the BD bit of the Cause register is set to 1.

When the MIPS16 instruction is enabled, the EPC register contains the address of the instruction that caused the exception, and the least significant bit stores the ISA mode in which an exception occurs. However, if this instruction is in a branch delay slot or is the instruction following the Extend instruction, the EPC register contains the address of the preceding jump or Extend instruction, and the BD bit of the Cause register is set to 1.

Servicing

To service this exception, the contents of the Context or XContext register are used as a virtual address to fetch memory words containing the physical page frame and access control bits for a pair of TLB entries. The memory word is written into the TLB entry by using the EntryLo0, EntryLo1, or EntryHi register.

It is possible that the physical page frame and access control bits are placed in a page where the virtual address is not resident in the TLB. This condition is processed by allowing a TLB Refill exception in the TLB Refill exception handler. In this case, the common exception vector is used because the EXL bit of the Status register is set to 1.

(2) TLB Invalid Exception**Cause**

The TLB Invalid exception occurs when the TLB entry that matches with the virtual address to be referenced is invalid (the V bit is set to 0). This exception is not maskable.

Processing

The common exception vector is used for this exception. The TLBL or TLBS code in the ExcCode field of the Cause register is set. If this exception has been caused by an instruction reference or load operation, TLBL is set. If it has been caused by a store operation, TLBS is set.

When this exception occurs, the BadVAddr, Context, Xcontext, and EntryHi registers contain the virtual address that failed address translation. The EntryHi register also contains the ASID from which the translation fault occurred. The Random register normally stores a valid location in which to place the replacement TLB entry. The contents of the EntryLo register are undefined.

When the MIPS16 instruction is disabled, the EPC register contains the address of the instruction that caused the exception. However, if this instruction is in a branch delay slot, the EPC register contains the address of the preceding jump or branch instruction, and the BD bit of the Cause register is set to 1.

When the MIPS16 instruction is enabled, the EPC register contains the address of the instruction that caused the exception, and the least significant bit stores the ISA mode in which an exception occurs. However, if this instruction is in a branch delay slot or is the instruction following the Extend instruction, the EPC register contains the address of the preceding jump or Extend instruction, and the BD bit of the Cause register is set to 1.

Servicing

Usually, the V bit of a TLB entry is cleared in the following cases:

- ◇ When a virtual address does not exist
- ◇ When the virtual address exists, but is not in main memory (a page fault)
- ◇ When a trap is required on any reference to the page (for example, to maintain a reference bit)

After servicing the cause of a TLB Invalid exception, the TLB entry is located with a TLBP (TLB Probe) instruction, and replaced by an entry with its Valid bit set to 1.

(3) TLB Modified Exception

Cause

The TLB Modified exception occurs when the TLB entry that matches with the virtual address referenced by the store instruction is valid (bit V is 1) but is not writable (bit D is 0). This exception is not maskable.

Processing

The common exception vector is used for this exception, and the Mod code in the ExcCode field of the Cause register is set.

When this exception occurs, the BadVAddr, Context, Xcontext, and EntryHi registers contain the virtual address that failed address translation. The EntryHi register also contains the ASID from which the translation fault occurred. The contents of the EntryLo register are undefined.

When the MIPS16 instruction is disabled, the EPC register contains the address of the instruction that caused the exception. However, if this instruction is in a branch delay slot, the EPC register contains the address of the preceding jump or branch instruction, and the BD bit of the Cause register is set to 1.

When the MIPS16 instruction is enabled, the EPC register contains the address of the instruction that caused the exception, and the least significant bit stores the ISA mode in which an exception occurs. However, if this instruction is in a branch delay slot or is the instruction following the Extend instruction, the EPC register contains the address of the preceding jump or Extend instruction, and the BD bit of the Cause register is set to 1.

Servicing

The kernel uses the failed virtual address or virtual page number to identify the corresponding access control bits. The page identified may or may not permit write accesses; if writes are not permitted, a write protection violation occurs.

If write accesses are permitted, the page frame is marked dirty (/writable) by the kernel in its own data structures. The TLBP instruction places the index of the TLB entry that must be altered into the Index register. The word data containing the physical page frame and access control bits (with the D bit set to 1) is loaded to the EntryLo register, and the contents of the EntryHi and EntryLo registers are written into the TLB.

7.4.9 Bus Error Exception

Cause

A Bus Error exception is raised by board-level circuitry for events such as bus time-out, local bus parity errors, and invalid physical memory addresses or access types. This exception is not maskable.

A Bus Error exception occurs only when a cache miss refill, uncached reference, or unbuffered write occurs synchronously. In other words, it occurs when an illegal access is detected during BCU read.

For details of illegal accesses, refer to **11.4.6 Illegal Access Notification**.

Processing

The common interrupt vector is used for a Bus Error exception. The IBE or DBE code in the ExcCode field of the Cause register is set, signifying whether the instruction caused the exception by an instruction reference, load operation, or store operation.

When the MIPS16 instruction is disabled, the EPC register contains the address of the instruction that caused the exception. However, if this instruction is in a branch delay slot, the EPC register contains the address of the preceding jump or branch instruction, and the BD bit of the Cause register is set to 1.

When the MIPS16 instruction is enabled, the EPC register contains the address of the instruction that caused the exception, and the least significant bit stores the ISA mode in which an exception occurs. However, if this instruction is in a branch delay slot or is the instruction following the Extend instruction, the EPC register contains the address of the preceding jump or Extend instruction, and the BD bit of the Cause register is set to 1.

Servicing

The physical address at which the fault occurred can be computed from information available in the System Control Coprocessor (CP0) registers.

- If the IBE code in the Cause register is set (indicating an instruction fetch), the virtual address is contained in the EPC register (or 4 + the contents of the EPC register if the BD bit of the Cause register is set to 1).
- If the DBE code is set (indicating a load or store), the virtual address of the instruction that caused the exception is saved to the EPC register.

The virtual address of the load and store instruction can then be obtained by interpreting the instruction. The physical address can be obtained by using the TLBP instruction and reading the EntryLo register to compute the physical page number.

At the time of this exception, the kernel reports the UNIX SIGBUS (bus error) signal to the current process, but the exception is usually fatal.

7.4.10 System Call Exception

Cause

A System Call exception occurs during an attempt to execute the SYSCALL instruction. This exception is not maskable.

Processing

The common exception vector is used for this exception, and the Sys code in the ExcCode field of the Cause register is set.

The EPC register contains the address of the SYSCALL instruction unless it is in a branch delay slot, in which case the EPC register contains the address of the preceding branch instruction.

If the SYSCALL instruction is in a branch delay slot, the BD bit of the Status register is set to 1; otherwise this bit is cleared.

Servicing

When this exception occurs, control is transferred to the applicable system routine.

To resume execution, the EPC register must be altered so that the SYSCALL instruction does not re-execute; this is accomplished by adding a value of 4 to the EPC register before returning.

If a SYSCALL instruction is in a branch delay slot, interpretation of the branch instruction is required to resume execution.

7.4.11 Breakpoint Exception

Cause

A Breakpoint exception occurs when an attempt is made to execute the BREAK instruction. This exception is not maskable.

Processing

The common exception vector is used for this exception, and the BP code in the ExcCode field of the Cause register is set.

When the MIPS16 instruction is disabled, the EPC register contains the address of the instruction that caused the exception. However, if this instruction is in a branch delay slot, the EPC register contains the address of the preceding jump or branch instruction, and the BD bit of the Cause register is set to 1.

When the MIPS16 instruction is enabled, the EPC register contains the address of the instruction that caused the exception, and the least significant bit stores the ISA mode in which an exception occurs. However, if this instruction is in a branch delay slot or is the instruction following the Extend instruction, the EPC register contains the address of the preceding jump or Extend instruction, and the BD bit of the Cause register is set to 1.

Servicing

When the Breakpoint exception occurs, control is transferred to the applicable system routine. Additional distinctions can be made by analyzing the unused bits of the BREAK instruction (bits 25 to 6), and loading the contents of the instruction whose address the EPC register contains. A value of 4 must be added to the contents of the EPC register to locate the instruction if it resides in a branch delay slot.

To resume execution, the EPC register must be altered so that the BREAK instruction does not re-execute; this is accomplished by adding a value of 4 to the EPC register before returning.

When a Breakpoint exception occurs while executing the MIPS16 instruction, a value of 2 should be added to the EPC register before returning.

If a BREAK instruction is in a branch delay slot, interpretation (decoding) of the branch instruction is required to resume execution.

7.4.12 Coprocessor Unusable Exception

Cause

The Coprocessor Unusable exception occurs when an attempt is made to execute a coprocessor instruction for either:

- ◇ a corresponding coprocessor unit that has not been marked usable (Status register bit, CU[0] = 0), or
- ◇ CP0 instructions, when the unit has not been marked usable (Status register bit, CU[0] = 0) and the process executes in User or Supervisor mode.

This exception is not maskable.

Processing

The common exception vector is used for this exception, and the CPU code in the ExcCode field of the Cause register is set. The CE bit of the Cause register indicates which of the four coprocessors was referenced.

When the MIPS16 instruction is disabled, the EPC register contains the address of the instruction that caused the exception. However, if this instruction is in a branch delay slot, the EPC register contains the address of the preceding jump or branch instruction, and the BD bit of the Cause register is set to 1.

When the MIPS16 instruction is enabled, the EPC register contains the address of the instruction that caused the exception, and the least significant bit stores the ISA mode in which an exception occurs. However, if this instruction is in a branch delay slot or is the instruction following the Extend instruction, the EPC register contains the address of the preceding jump or Extend instruction, and the BD bit of the Cause register is set to 1.

Servicing

The coprocessor unit to which an attempted reference was made is identified by the CE bit of the Cause register. One of the following processing is performed by the handler:

- ◇ If the process is entitled access to the coprocessor, the coprocessor is marked usable and the corresponding state is restored to the coprocessor.
- ◇ If the process is entitled access to the coprocessor, but the coprocessor does not exist or has failed, interpretation of the coprocessor instruction is possible.
- ◇ If the BD bit in the Cause register is set to 1, the branch instruction must be interpreted; then the coprocessor instruction can be emulated and execution resumed with the EPC register advanced past the coprocessor instruction.
- ◇ If the process is not entitled access to the coprocessor, the kernel reports UNIX SIGILL/ILL_PRIVIN_FAULT (illegal instruction/privileged instruction fault) signal to the current process, and this exception is fatal.

7.4.13 Reserved Instruction Exception

Cause

The Reserved Instruction exception occurs when an attempt is made to execute one of the following instructions:

- Instruction with an undefined major opcode (bits 31 to 26)
- SPECIAL instruction with an undefined minor opcode (bits 5 to 0)
- REGIMM instruction with an undefined minor opcode (bits 20 to 16)
- 64-bit instructions in 32-bit User or Supervisor mode
- RR instruction with an undefined minor op code (bits 4 to 0) when executing the MIPS16 instruction
- I8 instruction with an undefined minor op code (bits 10 to 8) when executing the MIPS16 instruction

64-bit operations are always valid in Kernel mode regardless of the value of the KX bit in the Status register. This exception is not maskable.

Processing

The common exception vector is used for this exception, and the RI code in the ExcCode field of the Cause register is set.

When the MIPS16 instruction is disabled, the EPC register contains the address of the instruction that caused the exception. However, if this instruction is in a branch delay slot, the EPC register contains the address of the preceding jump or branch instruction, and the BD bit of the Cause register is set to 1.

When the MIPS16 instruction is enabled, the EPC register contains the address of the instruction that caused the exception, and the least significant bit stores the ISA mode in which an exception occurs. However, if this instruction is in a branch delay slot or is the instruction following the Extend instruction, the EPC register contains the address of the preceding jump or Extend instruction, and the BD bit of the Cause register is set to 1.

Servicing

All currently defined MIPS ISA instructions can be executed. The process executing at the time of this exception is handled by a UNIX SIGILL/ILL_RESOP_FAULT (illegal instruction/reserved operand fault) signal. This error is usually fatal.

7.4.14 Trap Exception

Cause

The Trap exception occurs when a TGE, TGEU, TLT, TLTU, TEQ, TNE, TGEI, TGEUI, TLTI, TLTI, TEQI, or TNEI instruction results in a TRUE condition. This exception is not maskable.

Processing

The common exception vector is used for this exception, and the Tr code in the ExcCode field of the Cause register is set.

The EPC register contains the address of the trap instruction causing the exception unless the instruction is in a branch delay slot, in which case the EPC register contains the address of the preceding branch instruction and the BD bit of the Cause register is set to 1.

Servicing

At the time of a Trap exception, the kernel reports the UNIX SIGFPE/FPE_INTOVF_TRAP (floating-point exception/integer overflow) signal to the current process, but the exception is usually fatal.

7.4.15 Integer Overflow Exception

Cause

An Integer Overflow exception occurs when an ADD, ADDI, SUB, DADD, DADDI, or DSUB instruction results in a 2's complement overflow. This exception is not maskable.

Processing

The common exception vector is used for this exception, and the Ov code in the ExcCode field of the Cause register is set.

The EPC register contains the address of the instruction that caused the exception unless the instruction is in a branch delay slot, in which case the EPC register contains the address of the preceding branch instruction and the BD bit of the Cause register is set to 1.

Servicing

At the time of the exception, the kernel reports the UNIX SIGFPE/FPE_INTOVF_TRAP (floating-point exception/integer overflow) signal to the current process, and this exception is usually fatal.

7.4.16 Watch Exception

Cause

A Watch exception occurs when a load or store instruction references the physical address specified by the WatchLo/WatchHi registers. The WatchLo/WatchHi registers specify whether a load or store or both could have initiated this exception.

- When the R bit of the WatchLo register is set to 1: Load instruction
- When the W bit of the WatchLo register is set to 1: Store instruction
- When both the R bit and W bit of the WatchLo register are set to 1: Load instruction or store instruction

The CACHE instruction never causes a Watch exception.

The Watch exception is postponed while the EXL bit in the Status register is set to 1, and Watch exception is only maskable by setting the EXL bit in the Status register to 1.

Processing

The common exception vector is used for this exception, and the WATCH code in the ExcCode field of the Cause register is set.

When the MIPS16 instruction is disabled, the EPC register contains the address of the instruction that caused the exception. However, if this instruction is in a branch delay slot, the EPC register contains the address of the preceding jump or branch instruction, and the BD bit of the Cause register is set to 1.

When the MIPS16 instruction is enabled, the EPC register contains the address of the instruction that caused the exception, and the least significant bit stores the ISA mode in which an exception occurs. However, if this instruction is in a branch delay slot or is the instruction following the Extend instruction, the EPC register contains the address of the preceding jump or Extend instruction, and the BD bit of the Cause register is set to 1.

Servicing

The Watch exception is a debugging aid; typically the exception handler transfers control to a debugger, allowing the user to examine the situation. To continue, once the Watch exception must be disabled to execute the faulting instruction. The Watch exception must then be reenabled. The faulting instruction can be executed either by the debugger or by setting breakpoints.

7.4.17 Interrupt Exception**Cause**

The Interrupt exception occurs when one of the eight interrupt conditions^{Note} is asserted. In the V_R4111, interrupt requests from internal peripheral units first enter the ICU and are then notified to the CPU core via one of four interrupt sources (Int [3:0]) or NMI.

Each of the eight interrupts can be masked by clearing the corresponding bit in the IM field of the Status register, and all of the eight interrupts can be masked at once by clearing the IE bit of the Status register or setting the EXL/ERL bit.

Note: They are 1 timer interrupt, 5 ordinary interrupts, and 2 software interrupts.

Of the five ordinary interrupts, Int4 is never asserted active.

Processing

The common exception vector is used for this exception, and the Int code in the ExcCode field of the Cause register is set.

The IP field of the Cause register indicates current interrupt requests. It is possible that more than one of the bits can be simultaneously set (or cleared) if the interrupt request signal is asserted and then deasserted before this register is read.

When the MIPS16 instruction is disabled, the EPC register contains the address of the instruction that caused the exception. However, if this instruction is in a branch delay slot, the EPC register contains the address of the preceding jump or branch instruction, and the BD bit of the Cause register is set to 1.

When the MIPS16 instruction is enabled, the EPC register contains the address of the instruction that caused the exception, and the least significant bit stores the ISA mode in which an exception occurs. However, if this instruction is in a branch delay slot or is the instruction following the Extend instruction, the EPC register contains the address of the preceding jump or Extend instruction, and the BD bit of the Cause register is set to 1.

Servicing

If the interrupt is caused by one of the two software-generated exceptions (SW0 or SW1), the interrupt condition is cleared by setting the corresponding Cause register bit to 0.

If the interrupt is caused by hardware, the interrupt condition is cleared by deactivating the corresponding interrupt request signal.

7.5 EXCEPTION PROCESSING AND SERVICING FLOWCHARTS

The remainder of this chapter contains flowcharts for the following exceptions and guidelines for their handlers:

- ✧ Common exceptions and a guideline to their exception handler
- ✧ TLB/XTLB Refill exception and a guideline to their exception handler
- ✧ Cold Reset, Soft Reset and NMI exceptions, and a guideline to their handler.

Generally speaking, the exceptions are "processed" by hardware (HW); the exceptions are then "serviced" by software (SW).

Figure 7-17. Common Exception Handling (1/2)

(a) Handling exceptions other than Cold reset, Soft reset, NMI, and TLB/XTLB Refill (hardware)

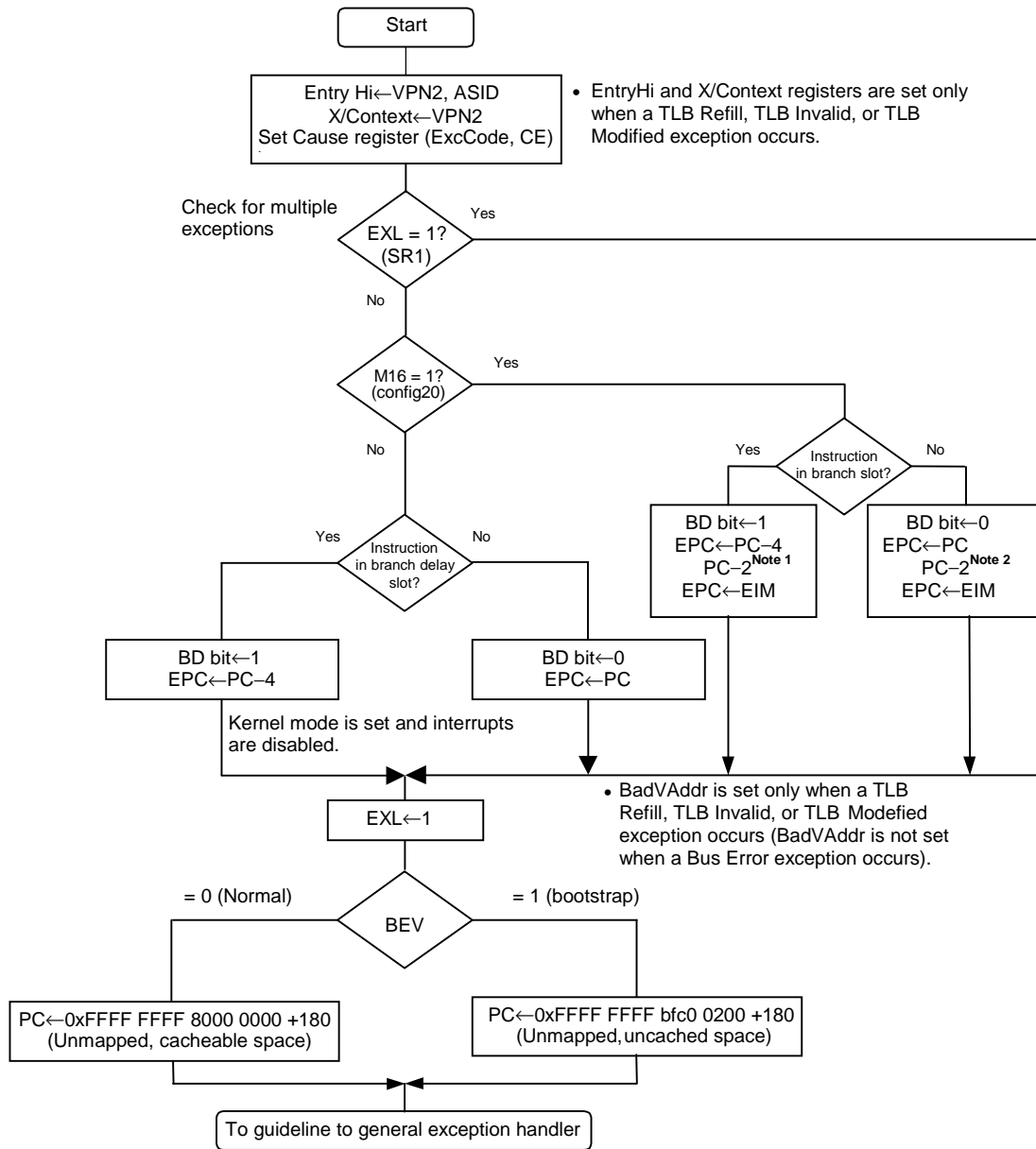

- Notes 1.** When the JR or JALR instruction of MIPS16 instructions
- 2.** When the Extend instruction of MIPS16 instructions

Caution The interrupts can be masked by setting the IE or IM bit. The Watch exception can be set to pending state by setting the EXL bit.

Figure 7-17. Common Exception Handling (2/2)

(b) Servicing common exceptions (software)

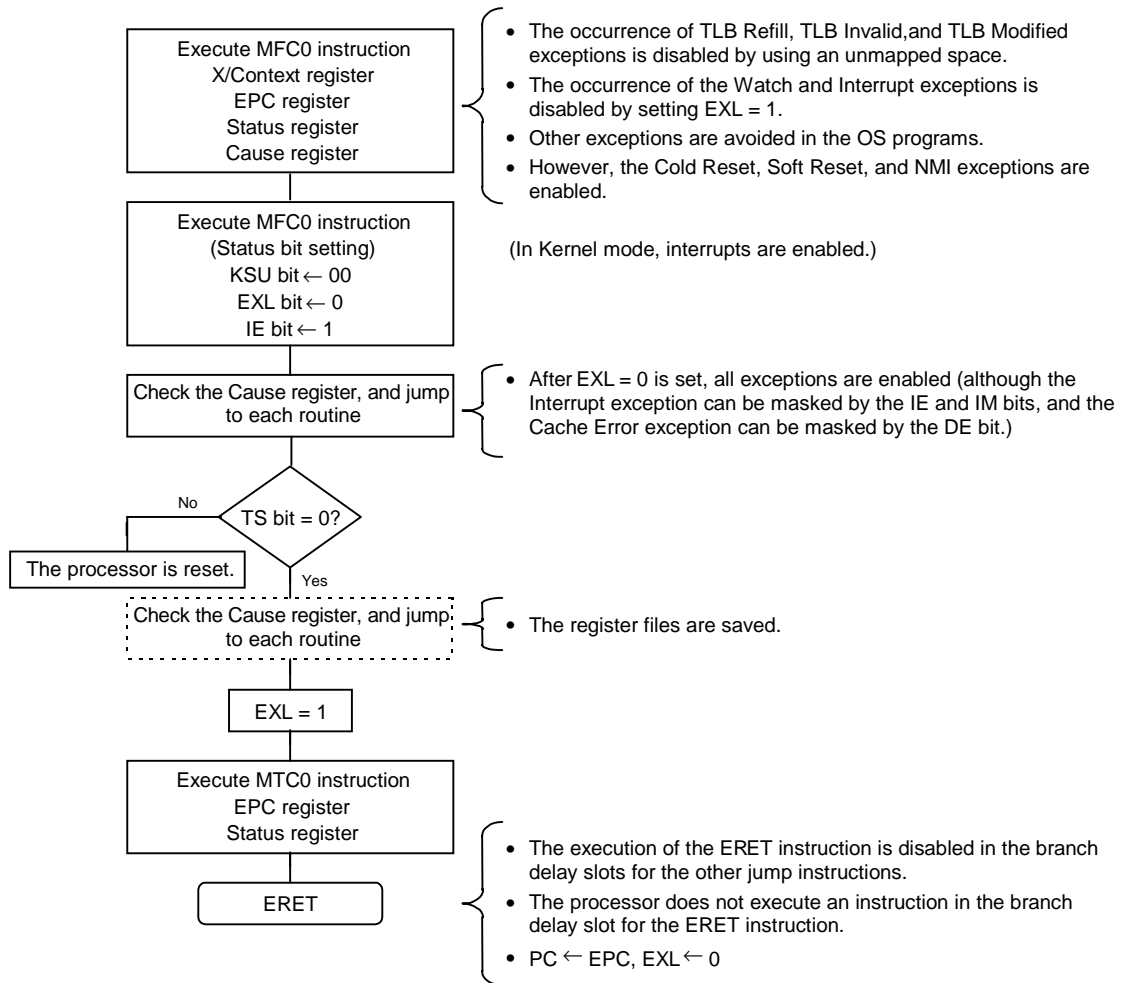
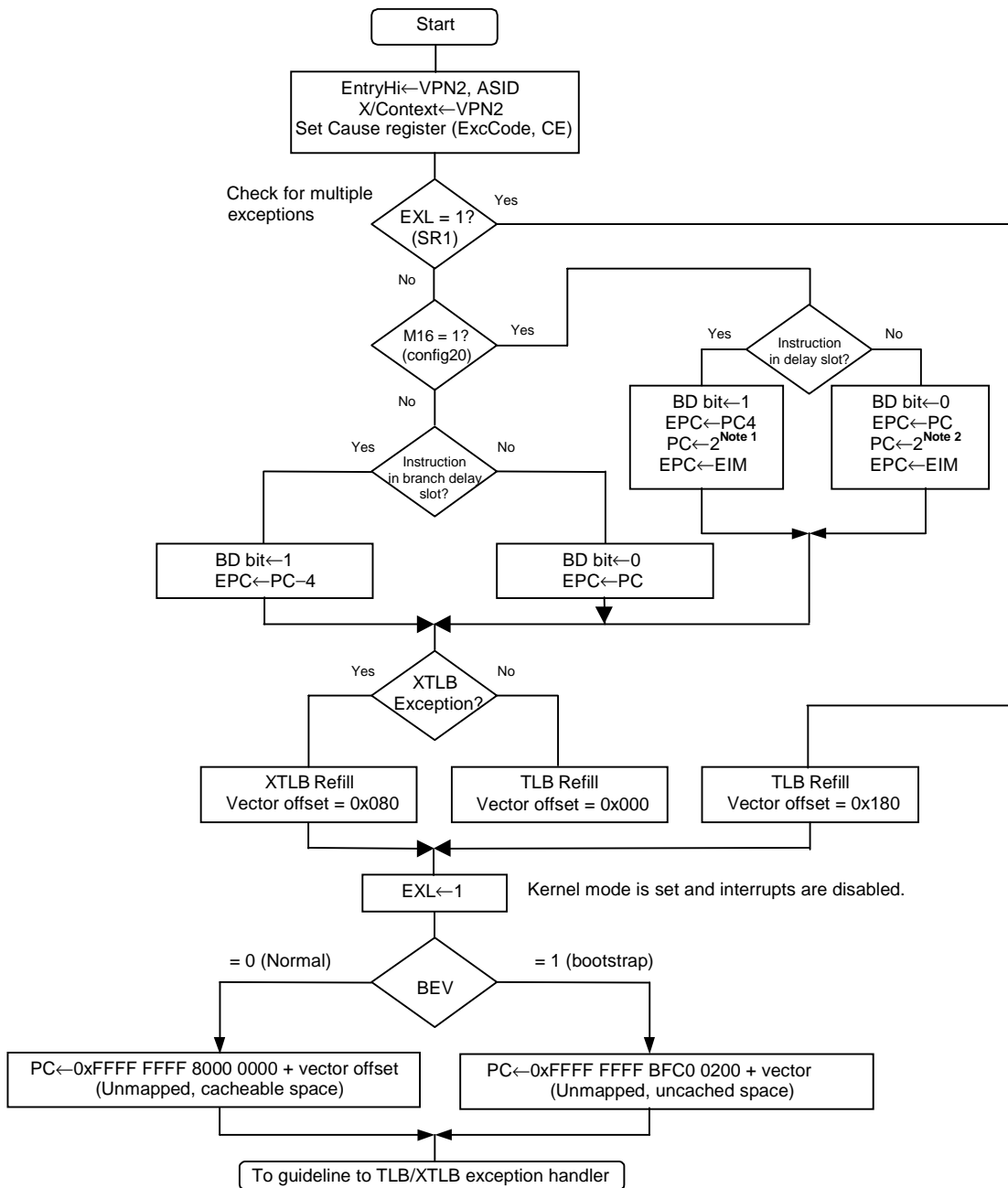

Figure 7-18. TLB/XTLB Refill Exception Handling (1/2)

(a) Handling TLB/XTLB Refill exceptions (hardware)



Notes 1. When the JR or JALR instruction of MIPS16 instructions

2. When the Extend instruction of MIPS16 instructions

Figure 7-18. TLB/XTLB Refill Exception Handling (2/2)

(b) Servicing TLB/XTLB Refill exceptions (software)

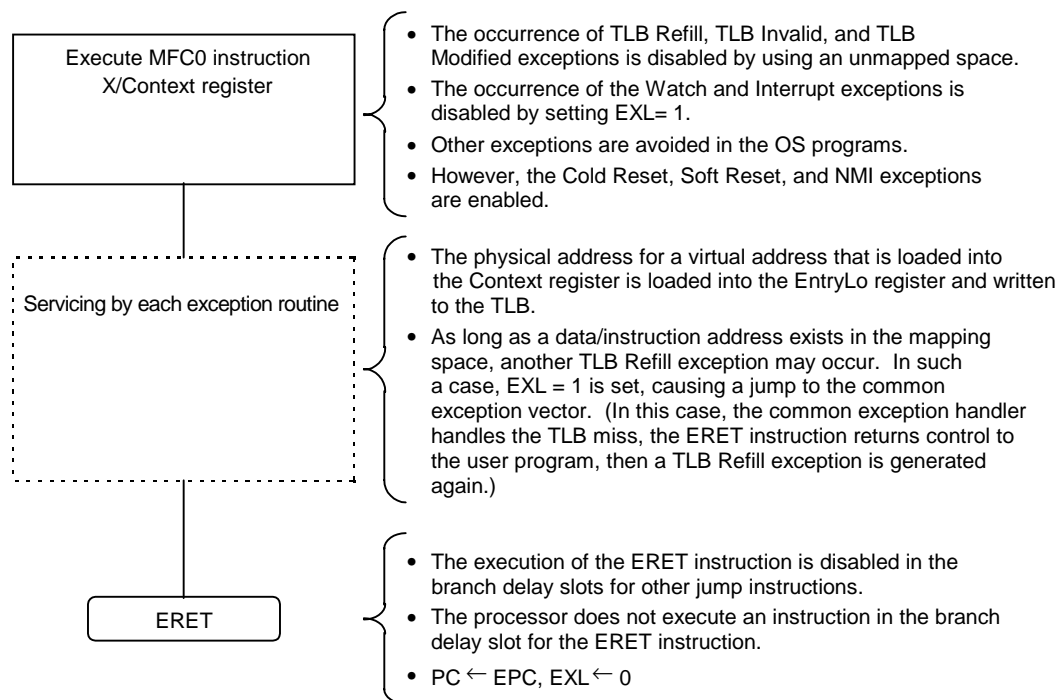
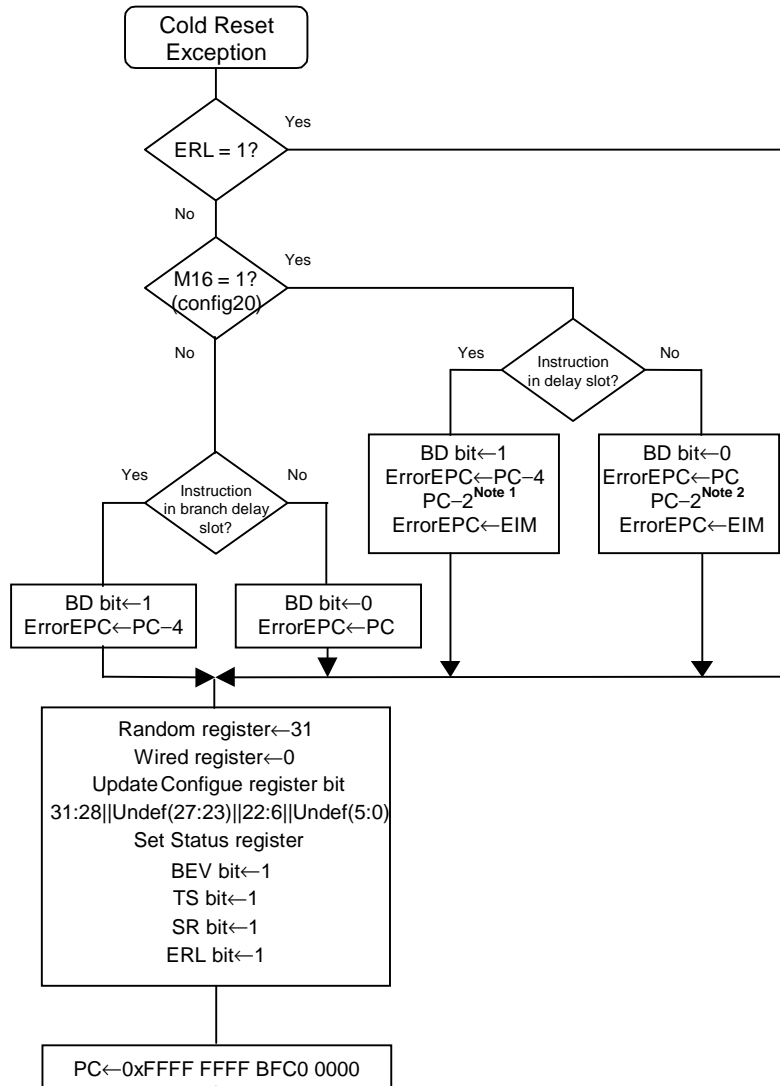
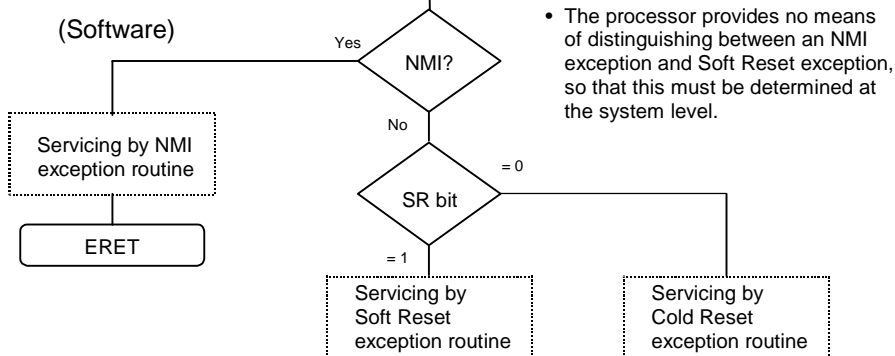

Figure 7-19. Cold Reset Exception Handling

(Hardware)



(Software)



Notes 1. When the JR or JALR instruction of MIPS16 instructions

2. When the Extend instruction of MIPS16 instructions

Figure 7-20. Soft Reset and NMI Exception Handling

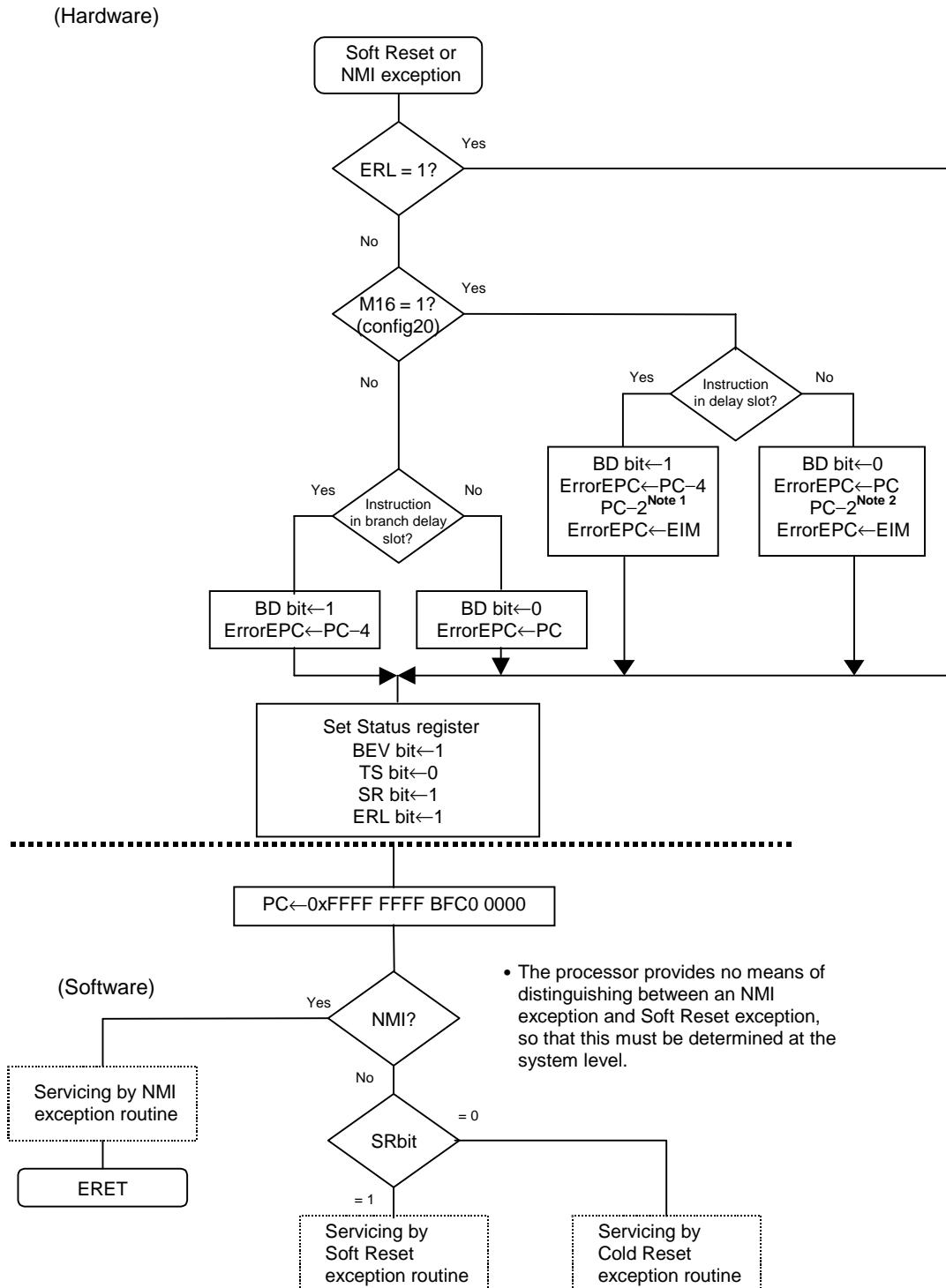

Notes 1. When the JR or JALR instruction of MIPS16 instructions

2. When the Extend instruction of MIPS16 instructions

[MEMO]

CHAPTER 8 INITIALIZATION INTERFACE

This chapter describes the initialization interface and processor modes. It also explains the reset signal descriptions and types, signal- and timing-related dependence, and the initialization sequence during each mode that can be selected by the user.

Remark # that follows signal names indicates active low.

8.1 RESET FUNCTION

There are five ways to reset the VR4111. Each is summarized below.

8.1.1 RTC Reset

During power-on, set the RTCRST# pin as active. After waiting (about 600 ms) for the 32.768-kHz oscillator to begin oscillating when the power supply is stable at 3.0 V or above, setting the RTCRST# pin as inactive causes the RTC unit to begin counting. Then, the states of the DBUS32/GPIO48, MIPS16EN, CLKSEL2/TxD, CLKSEL1/RTS#, and CLKSEL0/DTR# pins are read after one RTC cycle. Next, when the POWER pin, DCD# pin, or GPIO[3] pin becomes inactive, the VR4111 asserts the POWERON pin and uses the BATTINH/BATTINT# signal to perform a battery level check. If the battery check's result is OK, the VR4111 asserts the MPOWER pin and waits for the stabilization time period (about 350 ms) for the external agent's DC/DC converter, then begins PLL oscillation and starts all clocks (a period of about 16 ms following the start of PLL oscillation is required for stabilization of PLL oscillation).

- ★ During an RTC reset, supplying voltage to the 2.5-V power-supply systems (V_{DD2}, V_{DDP}, V_{DDPD}) can be stopped to reduce the leak current. The following operation will not be affected by supplying voltage of 2.3 V or more to these power supplies within the period from when the MPOWER pin becomes active to when PLL starts oscillation. However, this function is available from version 2.0.

An RTC reset does not save any of the status information and it completely initializes the processor's internal state. Since the DRAM is not switched to self refresh mode, the contents of DRAM after an RTC reset are not at all guaranteed.

After a reset, the processor becomes the system bus master and it begins the Cold reset exception sequence to access the reset vectors in the ROM space. Since only part of the internal status is reset when a reset occurs in the VR4111, the processor should be completely initialized by software.

After Power-On, the processor's pin statuses are undefined since the RTCRST# becomes active, until the 32.768-kHz clock oscillator starts oscillation. The pin statuses after oscillation starts are described in **CHAPTER 2 PIN FUNCTION**.

★ **Figure 8-1. RTC Reset**

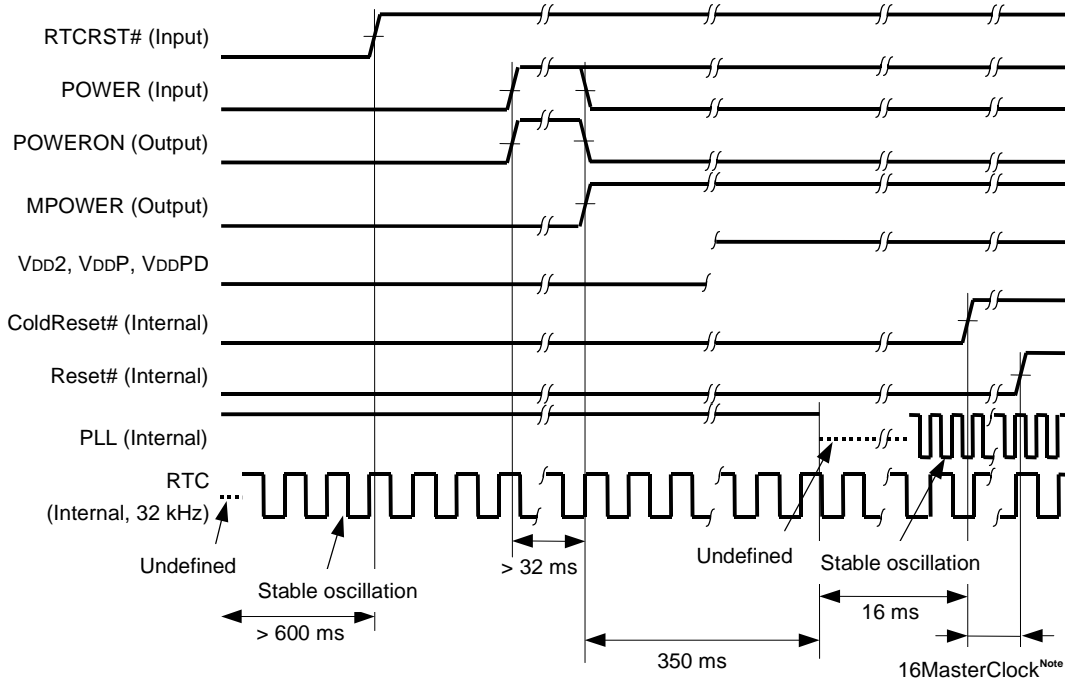

Note MasterClock is the basic clock used in the CPU core.

8.1.2 RSTSW

After the RSTSW# pin becomes active and then becomes inactive 100 μ s later, the VR4111 starts PLL oscillation and starts all clocks (a period of about 16 ms following the start of PLL oscillation is required for stabilization of PLL oscillation).

A reset by RSTSW initializes the entire internal state except for the RTC timer and the PMU.

After a reset, the processor becomes the system bus master and it begins the Cold reset exception sequence to access the reset vectors in the ROM space. Since only part of the internal status is reset when a reset occurs in the VR4111, the processor should be completely initialized by software.

Figure 8-2. RSTSW

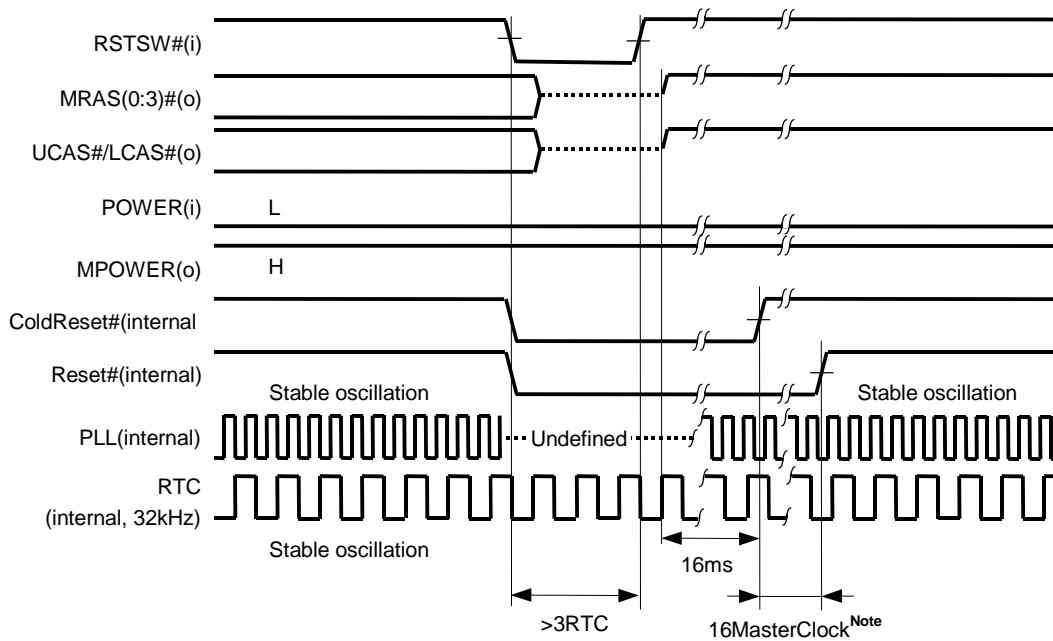

Note MasterClock is the basic clock used in the CPU core.

Caution If the RSTSW# signal becomes active at the same time the CPU transits to the Hibernate mode, the CPU may be activated without asserting the POWER signal after the MPOWER signal becomes inactive.

8.1.3 Deadman's Switch

After the Deadman's switch unit is enabled, if the Deadman's switch is not cleared within the specified time period, the VR4111 is immediately returned to reset status. Setting and clearing of the Deadman's switch is performed by software.

A reset by the Deadman's switch initializes the entire internal state except for the RTC timer and the PMU. Since the DRAM is not switched to self refresh mode, the contents of DRAM after a Deadman's switch reset are not at all guaranteed.

After a reset, the processor becomes the system bus master and it begins the Cold reset exception sequence to access the reset vectors in the ROM space. Since only part of the internal status is reset when a reset occurs in the VR4111, the processor should be completely initialized by software.

Figure 8-3. Deadman's Switch

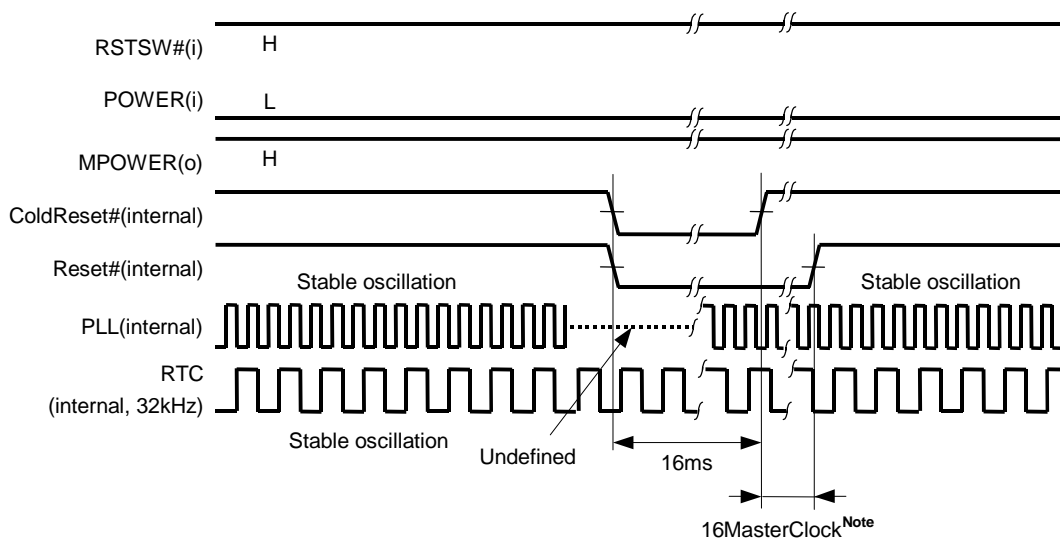

Note MasterClock is the basic clock used in the CPU core.

8.1.4 Software Shutdown

When the software executes the HIBERNATE instruction, the VR4111 sets the DRAM to self refresh mode and sets the MPOWER pin as inactive, then enters reset status. Recovery from reset status occurs when the POWER pin is asserted, when a WakeUpTimer interrupt occurs, when the DCD# pin is asserted, or when the GPIO[0:3], GPIO[9:12] pins are asserted.

- ★ During a software shutdown, supplying voltage to the 2.5-V power-supply systems (V_{DD2}, V_{DDP}, V_{DDPD}) can be stopped to reduce the leak current. The following operation will not be affected by supplying voltage of 2.3 V or more to these power supplies within the period from when the MPOWER pin becomes active to when PLL starts oscillation. However, this function is available from version 2.0.

A reset by software shutdown initializes the entire internal state except for the RTC timer and the PMU.

After a reset, the processor becomes the system bus master and it begins the Cold reset exception sequence to access the reset vectors in the ROM space. Since only part of the internal status is reset when a reset occurs in the VR4111, the processor should be completely initialized by software.

★ **Figure 8-4. Software Shutdown**

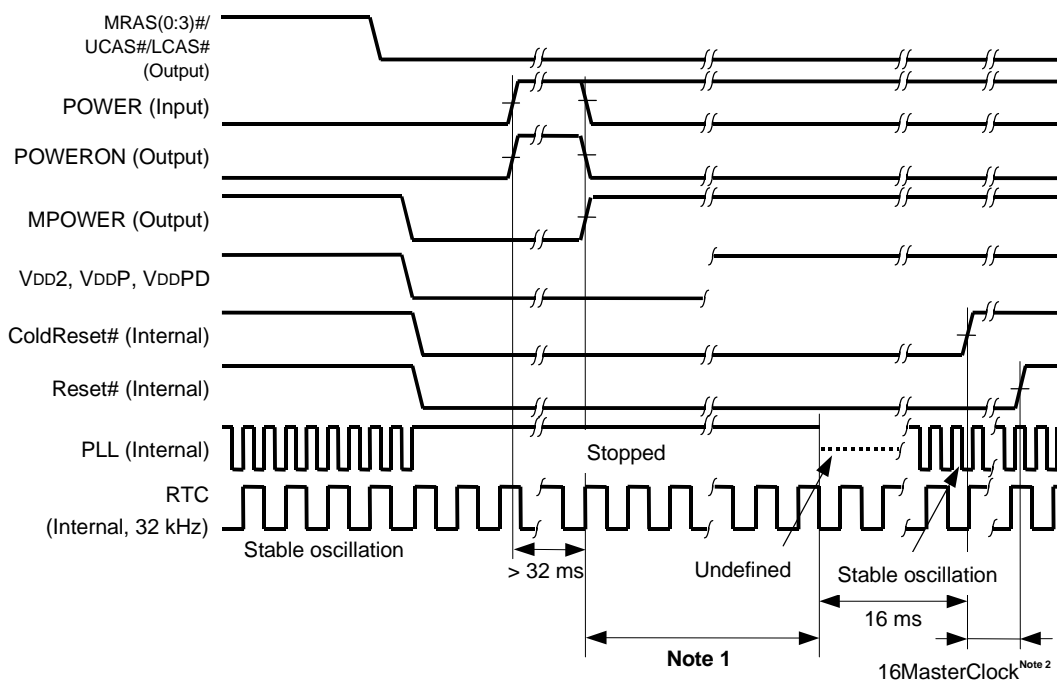

Notes 1. Wait time for activation. It can be changed by setting PMUWAITREG (see 16.2.5 PMUWAITREG (0x0B00 00A8)).

2. MasterClock is the basic clock used in the CPU core.

8.1.5 HALTimer Shutdown

After an RTC reset is canceled, if the HAL timer is not canceled by software within about four seconds (the HALTIMERRST bit of the PMUCNTREG register is not set to 1), the VR4111 enters reset status (see **16.1.2 Shutdown Control**). Recovery from reset status occurs when the POWER pin is asserted or when a WakeUpTimer interrupt occurs.

- ★ During a HALTimer shutdown, supplying voltage to the 2.5-V power-supply systems (V_{DD2} , V_{DDP} , V_{DDPD}) can be stopped to reduce the leak current. The following operation will not be affected by supplying voltage of 2.3 V or more to these power supplies within the period from when the MPOWER pin becomes active to when PLL starts oscillation. However, this function is available from version 2.0.

A reset by HAL timer initializes the entire internal state except for the RTC timer and the PMU.

After a reset, the processor becomes the system bus master and it begins the Cold reset exception sequence to access the reset vectors in the ROM space. Since only part of the internal status is reset when a reset occurs in the VR4111, the processor should be completely initialized by software.

★ **Figure 8-5. HALTimer Shutdown**

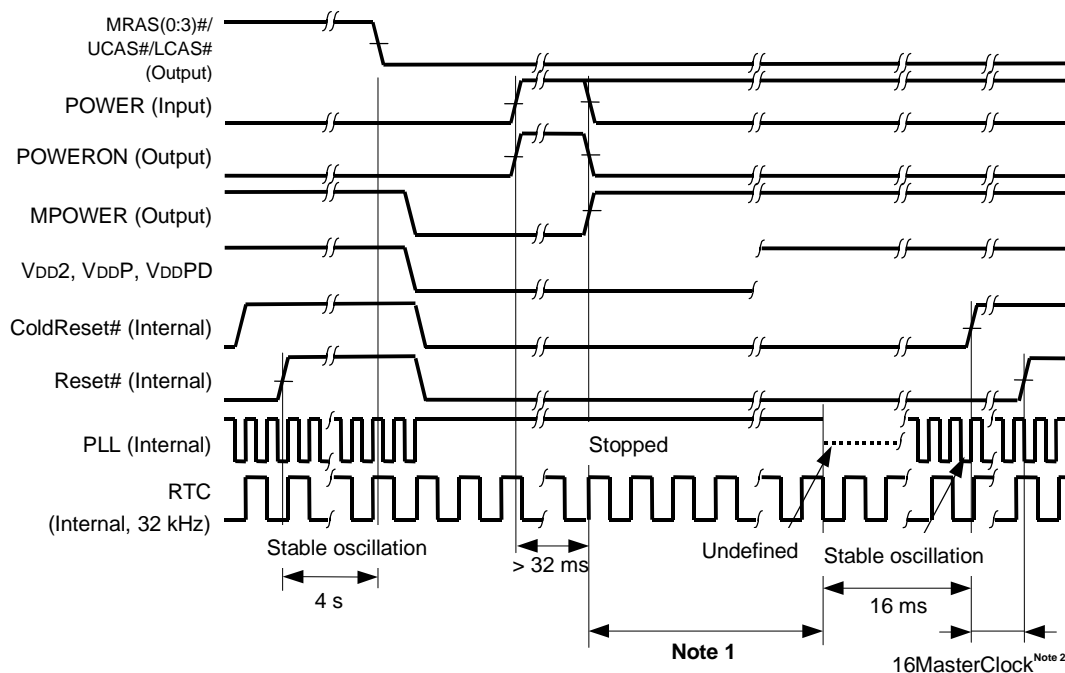

Notes 1. Wait time for activation. It can be changed by setting PMUWAITREG (see **16.2.5 PMUWAITREG (0x0B00 00A8)**).

2. MasterClock is the basic clock used in the CPU core.

8.2 POWER-ON SEQUENCE

The factors that cause the VR4111 to switch from hibernate mode or shutdown mode to full speed mode are called power-on factors. There are four power-on factors: assertion of the POWERON pin, assertion of the DCD# pin, activation of the wakeup timer, and assertion of the GPIO pins (GPIO[3..0], GPIO[12..9]). When an activation factor occurs, the VR4111 asserts the POWERON pin, then provides notification to external agents that the VR4111 is ready for power-on. Three RTC clocks after the POWERON pin is asserted, the VR4111 checks the state of the BATTINH/BATTINT# pin. If the BATTINH/BATTINT# pin's state is low, the POWERON pin is deasserted one RTC clock after the BATTINH/BATTINT# pin check is completed, then the VR4111 is not activated. If the BATTINH/BATTINT# pin's state is high, the POWERON pin is deasserted three RTC clocks after the BATTINH/BATTINT# pin check is completed, then the MPOWER pin is asserted and the VR4111 is activated.

- ★ While the MPOWER pin is inactive, supplying voltage to the 2.5-V power-supply systems (V_{DD2} , V_{DDP} , V_{DDPD}) can be stopped to reduce the leak current. The following operation will not be affected by supplying voltage of 2.3 V or more to these power supplies within the period from when the MPOWER pin becomes active to when PLL starts oscillation. However, this function is available from version 2.0.

Figure 8-6 shows a timing chart of VR4111 activation and Figure 8-7 shows a timing chart of when activation fails due to the BATTINH/BATTINT# pin's "low" state.

★ **Figure 8-6. VR4111 Activation Sequence (When Battery Check Is OK)**

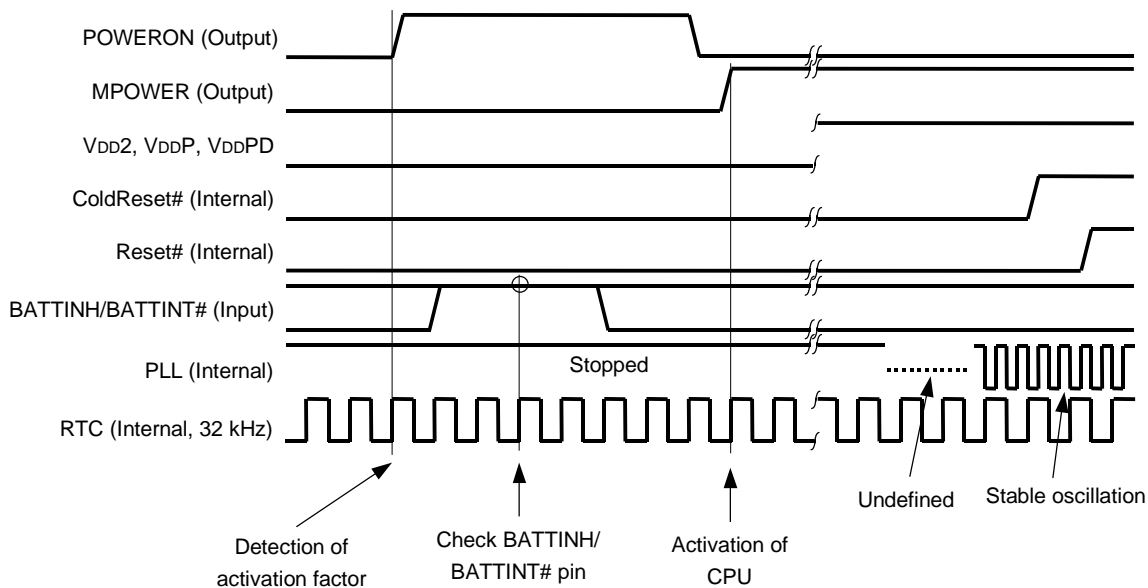

★ **Figure 8-7. VR4111 Activation Sequence (When Battery Check Is NG)**

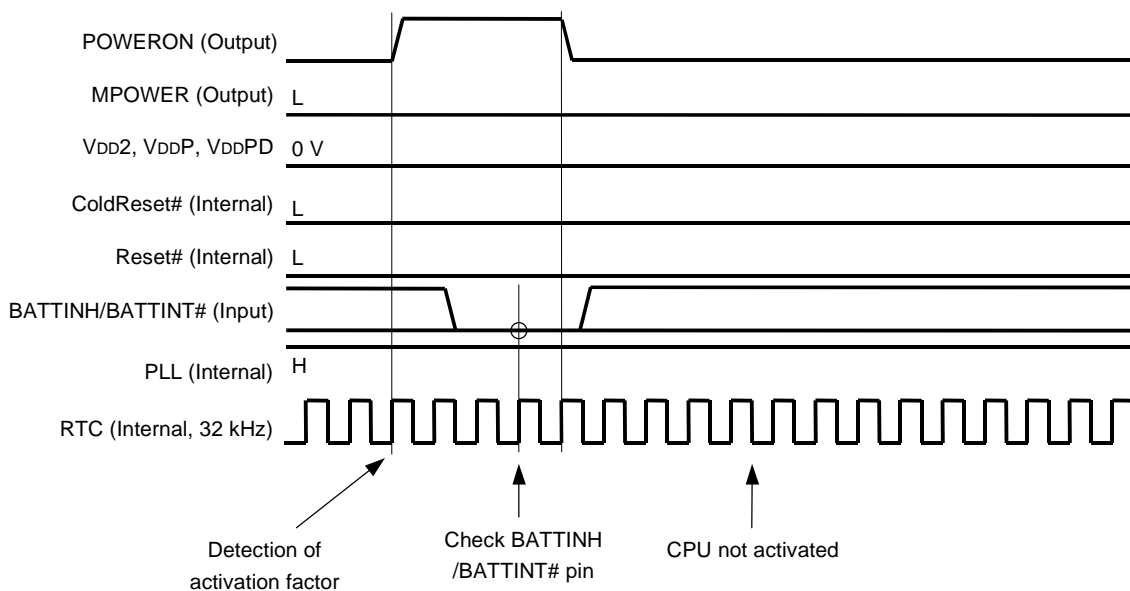

8.3 RESET OF THE CPU CORE

This section describes the reset sequence of the VR4110 CPU core. For details about factors of reset or reset of the whole VR4111, refer to **8.1 RESET FUNCTION** and Chapter 16.

8.3.1 Cold Reset

In the VR4111, a cold reset sequence is executed in the CPU core in the following cases:

- RTC reset
- RSTSW reset
- Deadman's SW shutdown
- Software shutdown
- HAL Timer shutdown
- Battery low shutdown
- Battery lock release shutdown

A Cold Reset completely initializes the CPU core, except for the following register bits.

- The TS and SR bits of the Status register are cleared to 0.
- The ERL and BEV bits of the Status register are set to 1.
- The upper limit value (31) is set in the Random register.
- The Wired register is initialized to 0.
- Bits 31 to 28 of the Config register are set to 0 and bits 22 to 3 to 0x04800; the other bits are undefined.
- The values of the other registers are undefined.

Once power to the processor is established, the ColdReset# (internal) and the Reset# (internal) signals are asserted and a Cold Reset is started. After approximately 2 ms assertion, the ColdReset# signal is deasserted synchronously with MasterOut. Then the Reset# signal is deasserted synchronously with MasterOut, and the Cold Reset is completed.

Upon reset, the CPU core becomes bus master and drives the SysAD bus (internal). After Reset# is deasserted, the CPU core branches to the Reset exception vector and begins executing the reset exception code.

Figure 8-8. Cold Reset

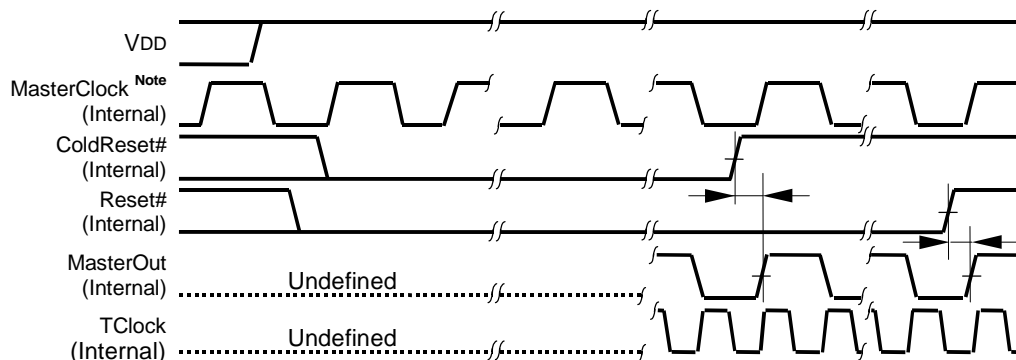

Note MasterClock is the basic clock used in the CPU core.

8.3.2 Soft Reset

Caution Soft Reset is not supported in the present Vr4111.

A Soft Reset initializes the CPU core without affecting the clocks; in other words, a Soft Reset is a logic reset. In a Soft Reset, the CPU core retains as much state information as possible; all state information except for the following is retained:

- The TS bit of the Status register is cleared to 0.
- The SR, ERL and BEV bits of the Status register are set to 1.
- The Count register is initialized to 0.
- The IP7 bit of the Cause register is cleared to 0.
- Any Interrupts generated on the SysAD bus are cleared.
- NMI is cleared.
- The Config register is initialized.

A Soft Reset is started by assertion of the Reset# signal, and is completed at the deassertion of the Reset# signal synchronized with MasterOut. In general, data in the CPU core is preserved for debugging purpose.

Upon reset, the CPU core becomes bus master and drives the SysAD bus (internal). After Reset# is deasserted, the CPU core branches to the Reset exception vector and begins executing the reset exception code.

Figure 8-9. Soft Reset

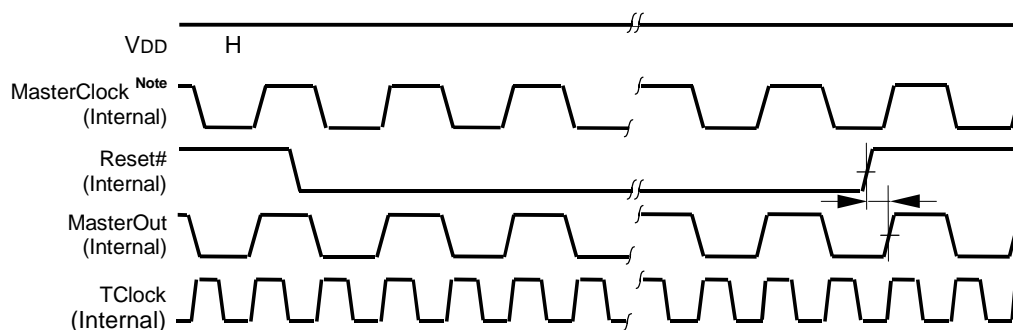

Note MasterClock is the basic clock used in the CPU core.

8.4 VR4111 PROCESSOR MODES

The VR4111 supports various modes, which can be selected by the user. The CPU core mode is set each time a write occurs in the Status register and Config register. The on-chip peripheral unit mode is set by writing to the I/O register.

This section describes the CPU core's operation modes. For operation modes of on-chip peripheral units, see the chapters describing the various units.

8.4.1 Power Modes

The VR4111 supports four power modes: Fullspeed mode, Standby mode, Suspend mode, and Hibernate mode.

(1) Fullspeed Mode

This is the normal operation mode.

The VR4111's default status sets operation under Fullspeed mode. After the processor is reset, the VR4111 returns to Fullspeed mode.

(2) Standby Mode

When a STANDBY instruction has been executed, the processor can be set to Standby mode. During Standby mode, all of the internal clocks in the CPU core except for the timer and interrupt clocks are held at high level. The peripheral units all operate as they do during Fullspeed mode. This means that DMA operations are enabled during Standby mode.

When the STANDBY instruction completes the WB stage, the VR4111 remains idle until the SysAD internal bus enters the idle state. Next, the clocks in the CPU core are shut down and pipeline operation is stopped. However, the PLL, timer, and interrupt clocks continue to operate, as do the internal bus clocks (TClock and MasterOut).

During Standby mode, the processor is returned to Fullspeed mode if any interrupt occurs, including a timer interrupt that occurs internally.

(3) Suspend Mode

When the SUSPEND instruction has been executed, the processor can be set to Suspend mode. During Suspend mode, the processor stalls the pipeline and supplying all of the internal clocks in the CPU core except for PLL timer and interrupt clocks are stopped. The VR4111 stops supplying TClock to peripheral units. Accordingly, during Suspend mode peripheral units can only be activated by a special interrupt unit (DCD# control, etc.). While in this mode, the register and cache contents are retained.

When the SUSPEND instruction completes the WB stage, the VR4111 switches the DRAM to self refresh mode and then waits for the SysAD internal bus to enter the idle state. Next, the clocks in the CPU core are shut down and pipeline operation is stopped. The VR4111 then stops supplying TClock to peripheral units. However, the PLL, timer, and interrupt clocks continue to operate, as do the MasterOut.

The processor remains in Suspend mode until an interrupt is received, at which time it returns to Fullspeed mode.

(4) Hibernate Mode

When the HIBERNATE instruction has been executed, the processor can be set to Hibernate mode. During Hibernate mode, the processor stops supplying clocks to all units. The register and cache contents are retained and output of TClock and MasterOut is stopped. The processor remains in Hibernate mode until the POWER pin is asserted or a WakeUpTimer interrupt occurs at which the processor returns to Fullspeed mode.

- ★ In this mode, supplying voltage to the 2.5-V power-supply systems (VDD2, VDDP, VDDPD) can be stopped. When the voltage of the 2.5-V power supplies becomes 0 V, the power dissipation becomes almost 0 W (it is not exactly 0 V because there are a 32.768-kHz oscillator and on-chip peripheral circuits operating at 32.768 kHz). However, this function is available from version 2.0.

8.4.2 Privilege Mode

The VR4111 supports three system modes: kernel expanded addressing mode, supervisor expanded addressing mode, and user expanded addressing mode. These three modes are described below.

(1) Kernel Expanded Addressing Mode

When the Status register's KX bit has been set, an expanded TLB miss exception vector is used when a TLB miss occurs for the kernel address. While in kernel mode, the MIPS III operation code can always be used, regardless of the KX bit.

(2) Supervisor Expanded Addressing Mode

When the Status register's SX bit has been set, the MIPS III operation code can be used when in supervisor mode and an expanded TLB miss exception vector is used when a TLB miss occurs for the supervisor address.

(3) User Expanded Addressing Mode

When the Status register's UX bit has been set, the MIPS III operation code can be used when in user mode, and an expanded TLB miss exception vector is used when a TLB miss occurs for the user address. When this bit is cleared, the MIPS I and II operation codes can be used, as can 32-bit virtual addresses.

8.4.3 Reverse Endian

When the Status register's RE bit has been set, the endian ordering is reversed to adopt the user software's perspective. However, the RE bit of the Status register must be set to 0 since the VR4111 supports the little-endian order only.

8.4.4 Bootstrap Exception Vector (BEV)

The BEV bit is used to generate an exception during operation testing (diagnostic testing) of the cache and main memory system. This bit is automatically set to 1 after reset or NMI exception.

When the Status register's BEV bit has been set, the address of the TLB miss exception vector is changed to the virtual address 0xFFFF FFFF BFC0 0200 and the ordinary execution vector is changed to address 0xFFFF FFFF BFC0 0380.

When the BEV bit is cleared, the TLB miss exception vector's address is changed to 0xFFFF FFFF 8000 0000 and the ordinary execution vector is changed to address 0xFFFF FFFF 8000 0180.

8.4.5 Cache Error Check

The Status register's CE bit has no meaning because the Vr4111 does not support cash parity.

8.4.6 Parity Error Prohibit

When the Status register's DE bit has been set, the processor does not issue any cache parity error exceptions.

8.4.7 Interrupt Enable (IE)

When the Status register's IE bit has been cleared, no interrupts can be received except for reset interrupts and nonmaskable interrupts.

[MEMO]

CHAPTER 9 CACHE MEMORY

This chapter describes in detail the cache memory: its place in the VR4110 CPU core memory organization, and individual organization of the caches.

This chapter uses the following terminology:

- ✧ The data cache may also be referred to as the D-cache.
- ✧ The instruction cache may also be referred to as the I-cache.

These terms are used interchangeably throughout this book.

9.1 MEMORY ORGANIZATION

Figure 9-1 shows the VR4110 CPU core system memory hierarchy. In the logical memory hierarchy, the caches lie between the CPU and main memory. They are designed to make the speedup of memory accesses transparent to the user.

Each functional block in Figure 9-1 has the capacity to hold more data than the block above it. For instance, physical main memory has a larger capacity than the caches. At the same time, each functional block takes longer to access than any block above it. For instance, it takes longer to access data in main memory than in the CPU on-chip registers.

Figure 9-1. Logical Hierarchy of Memory

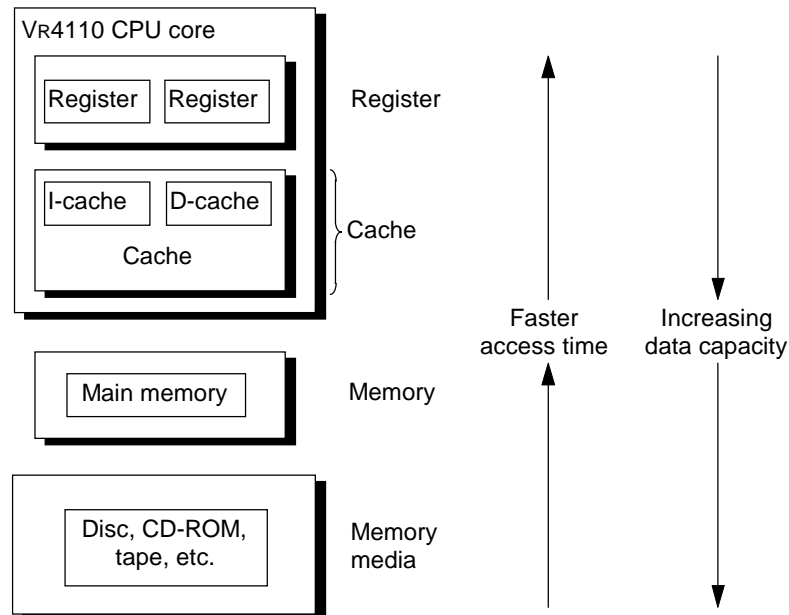

The VR4110 CPU core has two on-chip caches: one holds instructions (the instruction cache), the other holds data (the data cache). The instruction and data caches can be read in one PClock cycle.

2 PCycles are needed to write data. However, data writes are pipelined and can complete at a rate of one per PClock cycle. In the first stage of the cycle, the store address is translated and the tag is checked; in the second stage, the data is written into the data RAM.

9.2 CACHE ORGANIZATION

This section describes the organization of the on-chip data and instruction caches. Figure 9-2 provides a block diagram of the VR4110 CPU core cache and memory model.

Figure 9-2. Cache Support

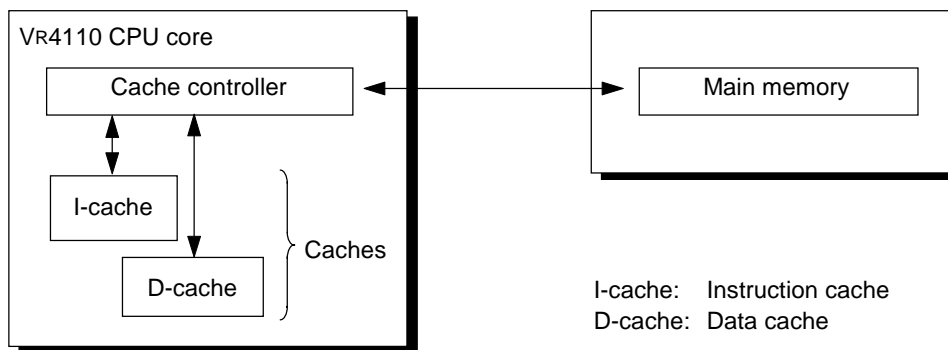

(1) Cache Line Lengths

A cache line is the smallest unit of information that can be fetched from main memory for the cache, and that is represented by a single tag.

The line size for the instruction/data cache is 4 words (16 bytes).

For the cache tag, see 9.2.1 and 9.2.2.

(2) Cache Sizes

The instruction cache in the VR4110 CPU core is 16 Kbytes; the data cache is 8 Kbytes.

9.2.1 Organization of the Instruction Cache (I-Cache)

Each line of I-cache data (although it is actually an instruction, it is referred to as data to distinguish it from its tag) has an associated 23-bit tag that contains a 22-bit physical address, and a single valid bit.

The VR4110 CPU core I-cache has the following characteristics:

- ✧ direct-mapped
- ✧ indexed with a virtual address
- ✧ checked with a physical tag
- ✧ organized with a 4-word (16-byte) cache line.

Figure 9-3 shows the format of a 4-word (16-byte) I-cache line.

Figure 9-3. Instruction Cache Line Format

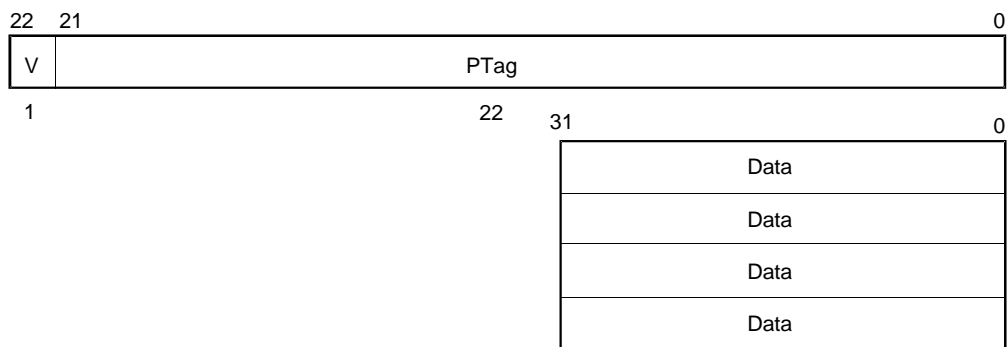

Ptag : Physical tag (bits 31 to 10 of physical address)

V : Valid bit

Data : Cache data

9.2.2 Organization of the Data Cache (D-Cache)

Each line of D-cache data has an associated 25-bit tag that contains a 22-bit physical address, a Valid bit, a Dirty bit, and a Write-back bit.

The VR4110 CPU core D-cache has the following characteristics :

- ✧ write-back
- ✧ direct-mapped
- ✧ indexed with a virtual address
- ✧ checked with a physical tag
- ✧ organized with a 4-word (16-byte) cache line.

Figure 9-4 shows the format of a 4-word (16-byte) D-cache line.

Figure 9-4. Data Cache Line Format

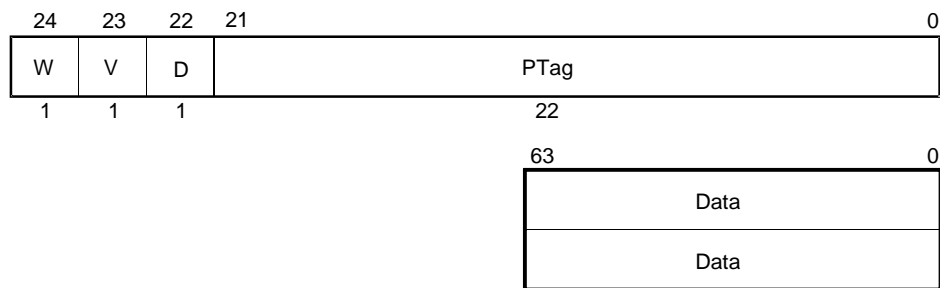

W : Write-back bit (set if cache line has been written)

D : Dirty bit

V : Valid bit

Ptag : Physical tag (bits 31 to 10 of physical address)

Data : D-cache data

9.2.3 Accessing the Caches

Figure 9-5 shows the virtual address (VA) index into the caches. The number of virtual address bits used to index the instruction and data caches depends on the cache size.

(1) Data cache addressing

Using VA (12:4). The most-significant bit is VA12 because the cache size is 8 Kbytes.

The least-significant bit is VA4 because the line size is 4 words (16 bytes).

(2) Instruction cache addressing

Using VA (13:4). The most-significant bit is VA13 because the cache size is 16 Kbytes.

The least-significant bit is VA4 because the line size is 4 words (16 bytes).

Figure 9-5. Cache Data and Tag Organization

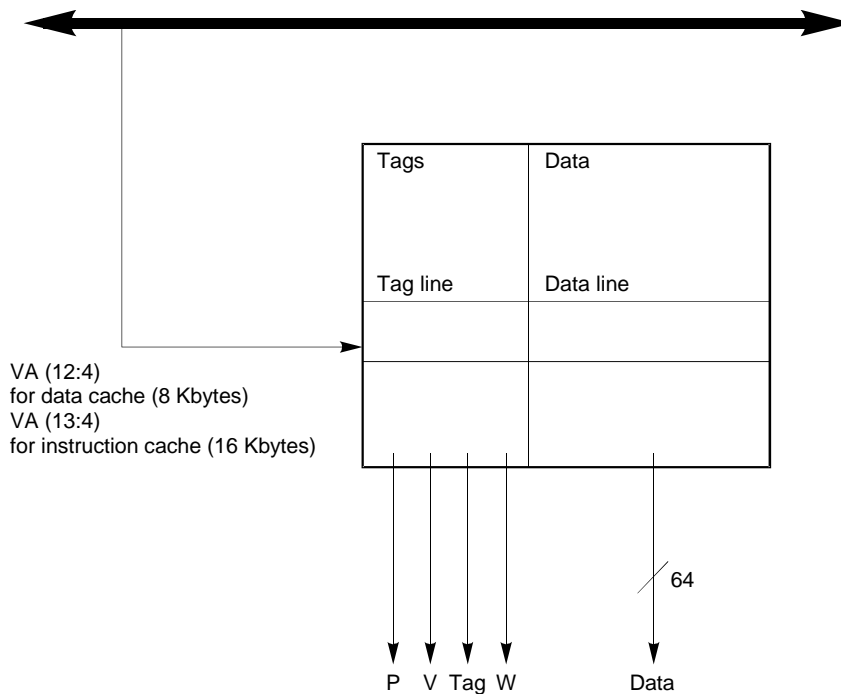

9.3 CACHE OPERATIONS

As described earlier, caches provide fast temporary data storage, and they make the speedup of memory accesses transparent to the user. In general, the CPU core accesses cache-resident instructions or data through the following procedure:

1. The CPU core, through the on-chip cache controller, attempts to access the next instruction or data in the appropriate cache.
2. The cache controller checks to see if this instruction or data is present in the cache.
 - ✧ If the instruction/data is present, the CPU core retrieves it. This is called a cache hit.
 - ✧ If the instruction/data is not present in the cache, the cache controller must retrieve it from memory. This is called a cache miss.
3. The CPU core retrieves the instruction/data from the cache and operation continues.

It is possible for the same data to be in two places simultaneously: main memory and cache. This data is kept consistent through the use of a write-back methodology; that is, modified data is not written back to memory until the cache line is to be replaced.

Instruction and data cache line replacement operations are described in the following sections.

9.3.1 Cache Write Policy

The VR4110 CPU core manages its data cache by using a write-back policy; that is, it stores write data into the cache, instead of writing it directly to memory^{Note}. Some time later this data is independently written into memory. In the VR4111 implementation, a modified cache line is not written back to memory until the cache line is to be replaced either in the course of satisfying a cache miss, or during the execution of a write-back CACHE instruction.

When the CPU core writes a cache line back to memory, it does not ordinarily retain a copy of the cache line, and the state of the cache line is changed to invalid.

Note Contrary to the write-back, the write-through cache policy stores write data into the memory and cache simultaneously.

9.4 CACHE STATES

(1) Cache line

The three terms below are used to describe the state of a cache line:

- ✧ Dirty: a cache line containing data that has changed since it was loaded from memory.
- ✧ Clean: a cache line that contains data that has not changed since it was loaded from memory.
- ✧ Invalid: a cache line that does not contain valid information must be marked invalid, and cannot be used. For example, after a Soft Reset, software sets all cache lines to invalid. A cache line in any other state than invalid is assumed to contain valid information. Neither Cold reset nor Soft reset makes the cache state invalid. Software makes the cache state invalid.

(2) Data cache

The data cache supports three cache states:

- ✧ invalid
- ✧ valid clean
- ✧ valid dirty

(3) Instruction cache

The instruction cache supports two cache states:

- ✧ invalid
- ✧ valid

The state of a valid cache line may be modified when the processor executes a CACHE operation. CACHE operations are described in Chapter 28.

9.5 CACHE STATE TRANSITION DIAGRAMS

The following section describes the cache state diagrams for the data and instruction cache lines. These state diagrams do not cover the initial state of the system, since the initial state is system-dependent.

9.5.1 Data Cache State Transition

The following diagram illustrates the data cache state transition sequence. A load or store operation may include one or more of the atomic read and/or write operations shown in the state diagram below, which may cause cache state transitions.

- ✧ Read (1) indicates a read operation from main memory to cache, inducing a cache state transition.
- ✧ Write (1) indicates a write operation from CPU core to cache, inducing a cache state transition.
- ✧ Read (2) indicates a read operation from cache to the CPU core, which induces no cache state transition.
- ✧ Write (2) indicates a write operation from CPU core to cache, which induces no cache state transition.

Figure 9-6. Data Cache State Diagram

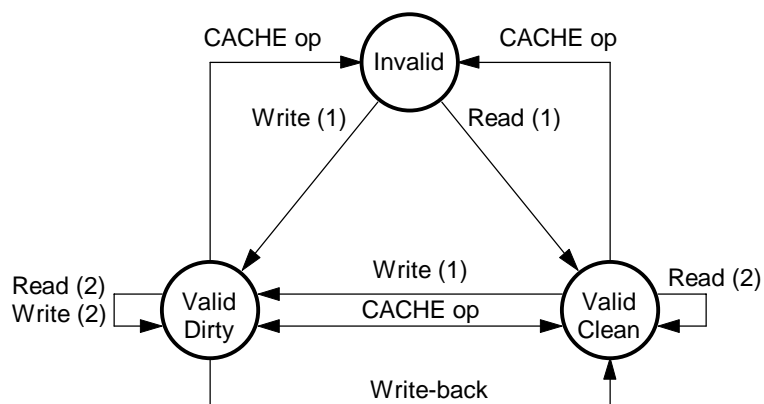

9.5.2 Instruction Cache State Transition

The following diagram illustrates the instruction cache state transition sequence.

- ✧ Read (1) indicates a read operation from main memory to cache, inducing a cache state transition.
- ✧ Read (2) indicates a read operation from cache to the CPU core, which induces no cache state transition.

Figure 9-7. Instruction Cache State Diagram

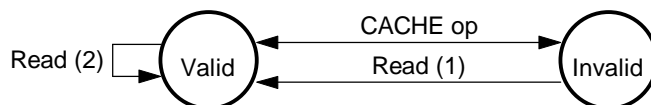

9.6 CACHE DATA INTEGRITY

Figures 9-8 to 9-22 shows checking operations for various cache accesses.

Figure 9-8. Data Check Flow on Instruction Fetch

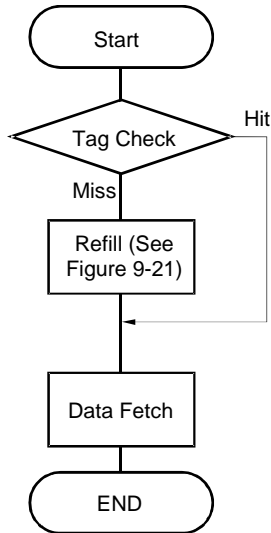

Figure 9-9. Data Check Flow on Load Operations

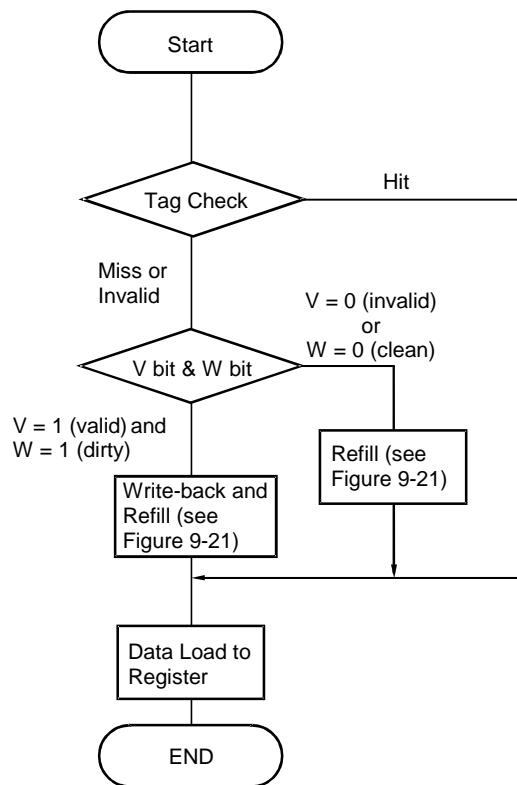

Figure 9-10. Data Check Flow on Store Operations

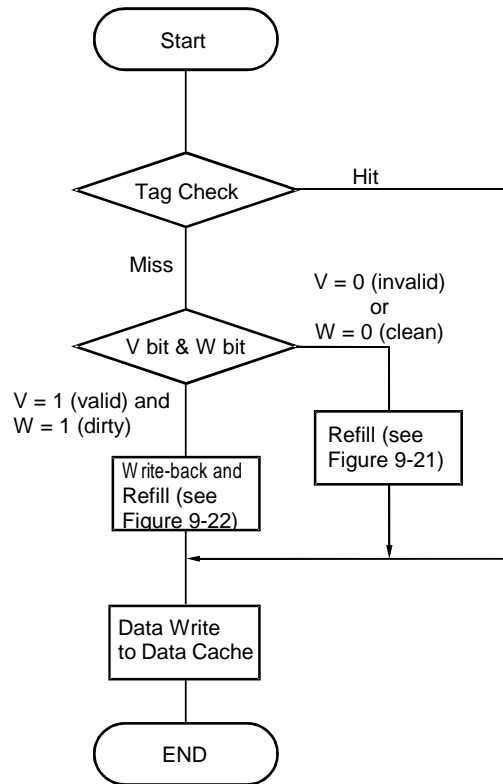

Figure 9-11. Data Check Flow on Index_Invalidate Operations

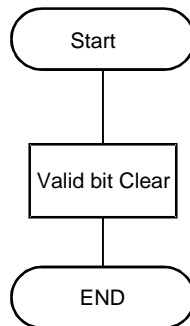

Figure 9-12. Data Check Flow on Index_Writeback_Invalidate Operations

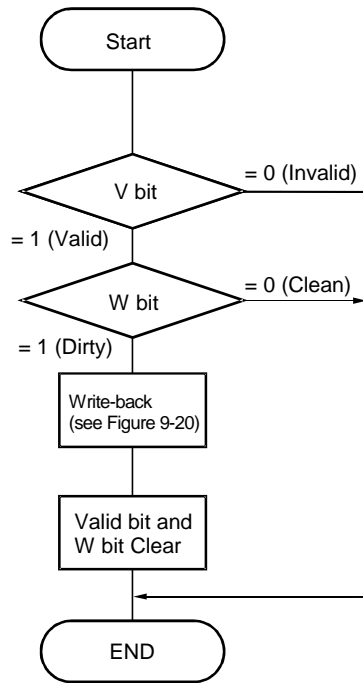

Figure 9-13. Data Check Flow on Index_Load_Tag Operations

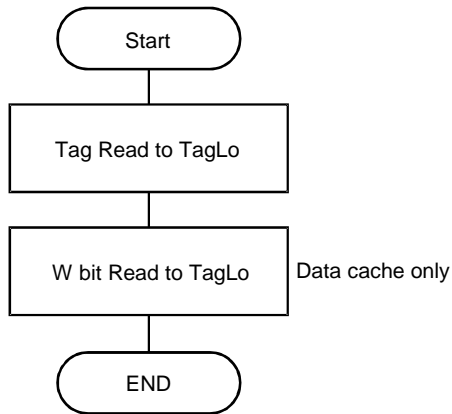

Figure 9-14. Data Check Flow on Index_Store_Tag Operations

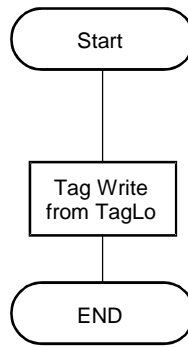

Figure 9-15. Data Check Flow on Create_Dirty Operations

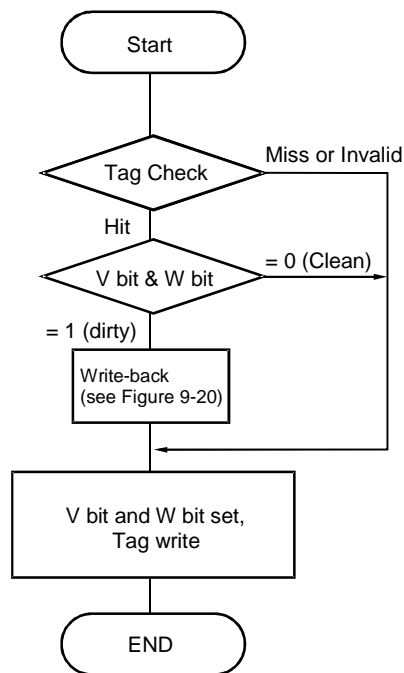

Figure 9-16. Data Check Flow on Hit_Invalidate Operations

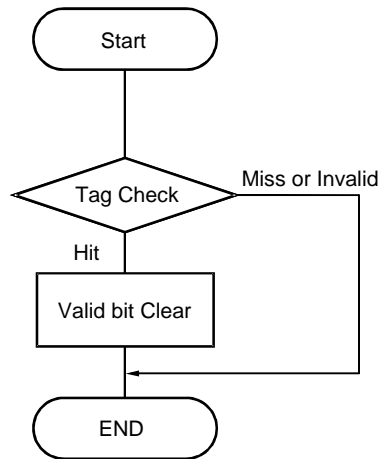

Figure 9-17. Data Check Flow on Hit_Writeback_Invalidate Operations

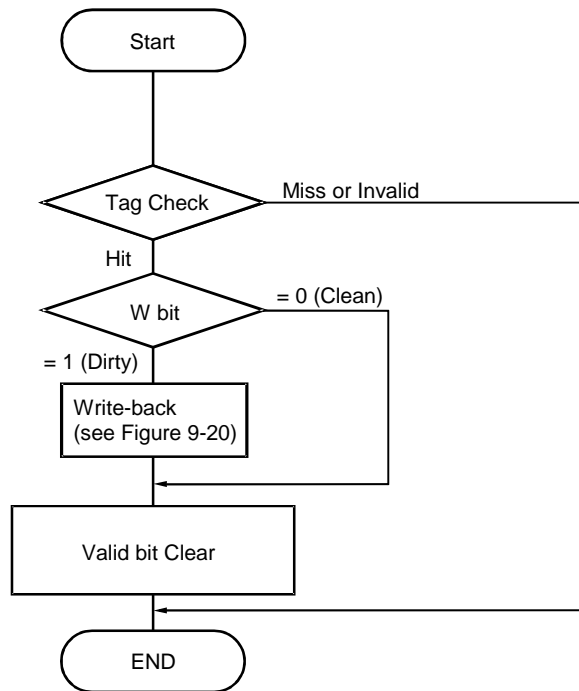

Figure 9-18. Data Check Flow on Fill Operations

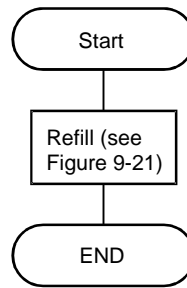

Figure 9-19. Data Check Flow on Hit_Writeback Operations

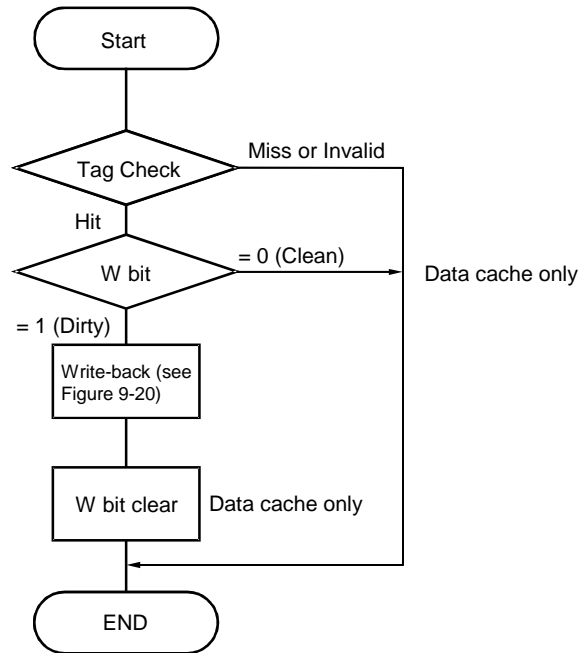

Figure 9-20. Writeback Flow

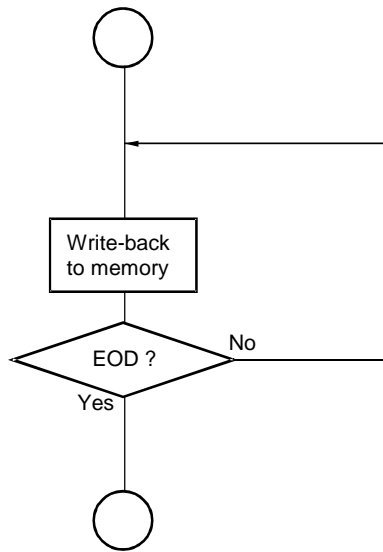

Figure 9-21. Refill Flow

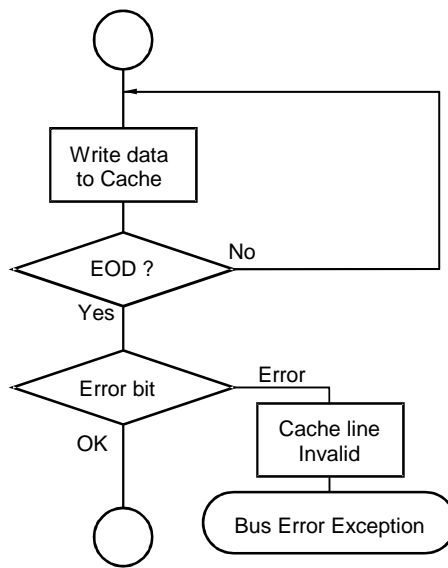
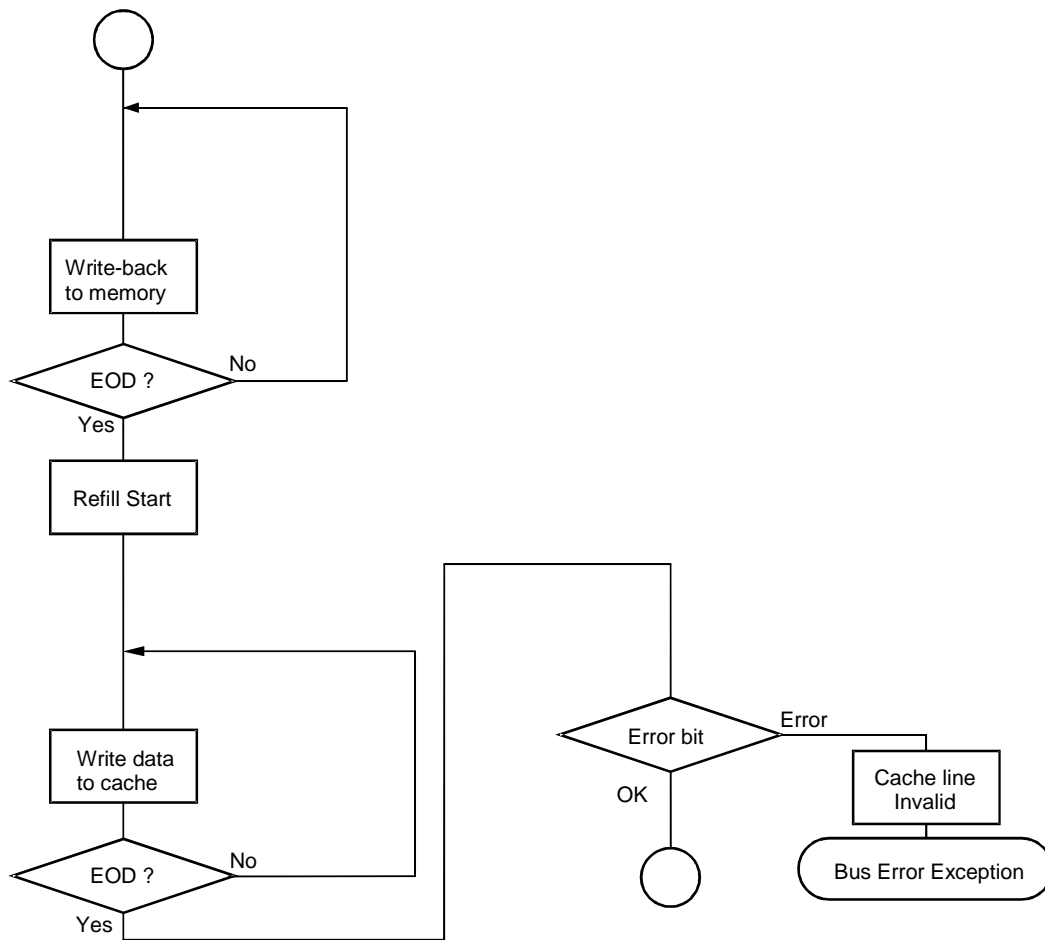

Figure 9-22. Writeback & Refill Flow

**Remark** Write-back Procedure:

On a store miss write-back, data tag is checked and data is transferred to the write buffer. If an error is detected in the data field, the write back is not terminated; the erroneous data is still written out to main memory. If an error is detected in the tag field, the write-back bus cycle is not issued.

The cache data may not be checked during CACHE operation.

9.7 MANIPULATION OF THE CACHES BY AN EXTERNAL AGENT

The Vr4111 does not provide any mechanisms for an external agent to examine and manipulate the state and contents of the caches.

CHAPTER 10 CPU CORE INTERRUPTS

Four types of interrupt are available on the CPU core. These are:

- ✧ one non-maskable interrupt, NMI
- ✧ five ordinary interrupts
- ✧ two software interrupts
- ✧ one timer interrupt

For the interrupt request input to the CPU core, see **Chapter 15**.

10.1 NON-MASKABLE INTERRUPT (NMI)

The non-maskable interrupt is acknowledged by asserting the NMI signal (internal), forcing the processor to branch to the Reset Exception vector. This signal is latched into an internal register at the rising edge of MasterOut, as shown in Figure 10-1.

NMI only takes effect when the processor pipeline is running.

This interrupt cannot be masked.

Figure 10-1 shows the internal service of the NMI signal. The NMI signal is latched into an internal register by the rising edge of MasterOut. The latched signal is inverted to be transferred to inside the device as an NMI request.

Figure 10-1. Non-maskable Interrupt Signal

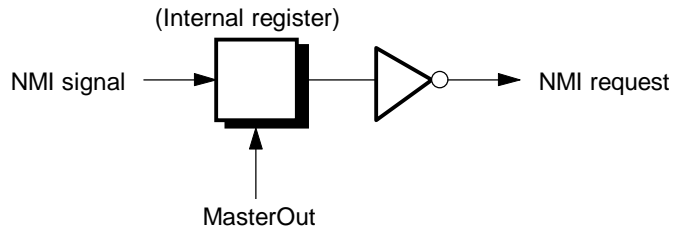

10.2 ORDINARY INTERRUPTS

Ordinary interrupts are acknowledged by asserting the Int(4:0) signals (internal). **However, Int4 never occurs in the VR4111.**

This interrupt request can be masked with the IM (6:2), IE, and EXL fields of the Status register.

10.3 SOFTWARE INTERRUPTS GENERATED IN CPU CORE

Software interrupts generated in the CPU core use bits 1 and 0 of the IP (interrupt pending) field in the Cause register. These may be written by software, but there is no hardware mechanism to set or clear these bits.

After the processing of a software interrupt exception, corresponding bit of the IP field in the Cause register must be cleared before returning to ordinary routine or enabling multiple interrupts until the operation returns to normal routine.

This interrupt request is maskable through the IM (1:0), IE, and EXL fields of the Status register.

10.4 TIMER INTERRUPT

The timer interrupt uses bit 7 of the IP (interrupt pending) field of the Cause register. This bit is set automatically whenever the value of the Count register equals the value of the Compare register, and an interrupt request is acknowledged.

This interrupt is maskable through IM7 of the IM field of the Status register.

10.5 ASSERTING INTERRUPTS

10.5.1 Detecting Hardware Interrupts

Figure 10-2 shows how the hardware interrupts are readable through the Cause register.

- ✧ The timer interrupt signal, IP7, is directly readable as bit 15 of the Cause register.
- ✧ Bits 4:0 of the Interrupt register are bit-wise ORed with the current value of the Int(4:0) signals and the result is directly readable as bits 14:10 of the Cause register.

IP(1:0) of the Cause register, which are described in Chapter 7, are software interrupts. There is no hardware mechanism for setting or clearing the software interrupts.

Figure 10-2. Hardware Interrupt Signals

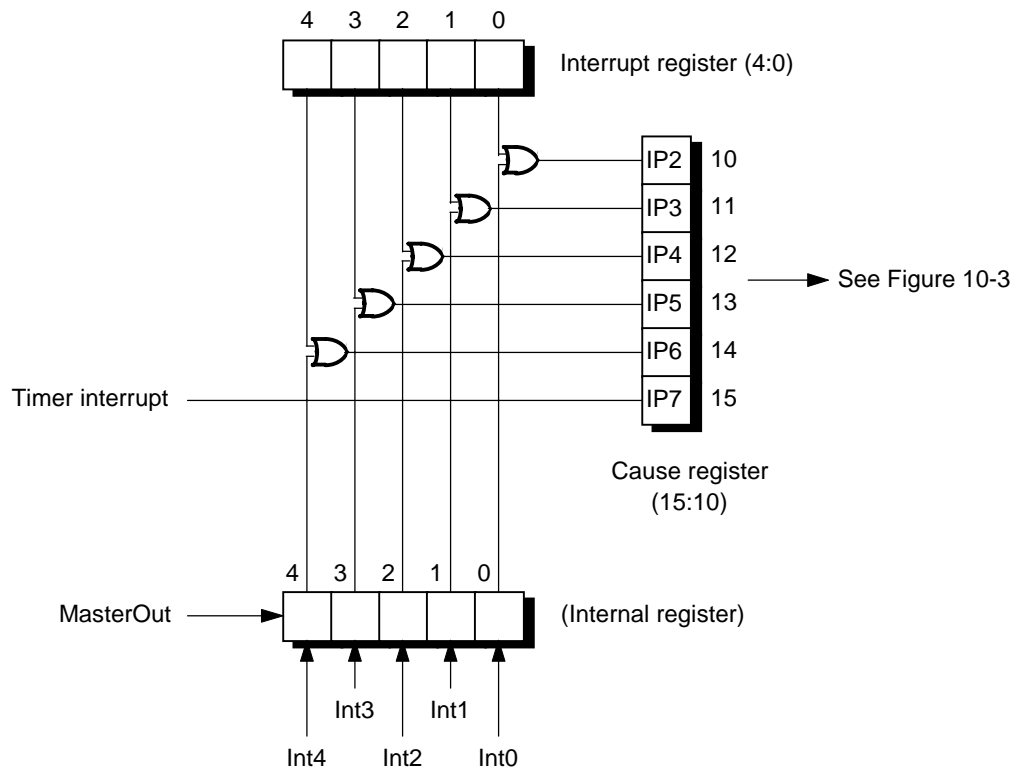

Remark Int4 never occurs in the VR4111.

10.5.2 Masking Interrupt Signals

Figure 10-3 shows the masking of the CPU core interrupt signals.

- ✧ Cause register bits 15 to 8 (IP7 to IP0) are AND-ORed with Status register interrupt mask bits 15 to 8 (IM7 to IM0) to mask individual interrupts.
- ✧ Status register bit 0 is a global Interrupt Enable (IE). It is ANDed with the output of the AND-OR logic to produce the CPU core interrupt signal. The EXL bit in the Status register also enables these interrupts.

Figure 10-3. Masking of the Interrupt Request Signals

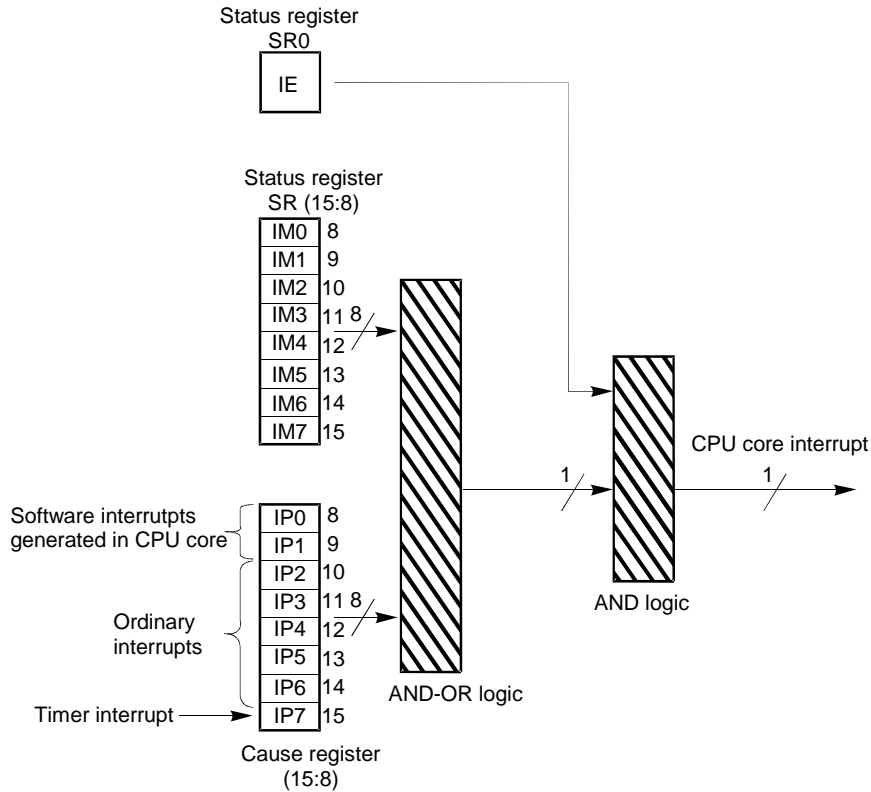

Bit	Function	Setting
IE	Whole interrupts enable	1 : Enable 0 : Disable
IM(7:0)	Interrupt mask	Each bit 1 : Enable 0 : Disable
IP(7:0)	Interrupt request	Each bit 1 : Pending 0 : Not pending

CHAPTER 11 BCU (BUS CONTROL UNIT)

This chapter describes the BCU's operations and register settings.

11.1 GENERAL

In the VR4111, the BCU receives data that has passed via the VR4110 CPU core and the SysAD bus. The BCU also controls external agents via the system bus, such as an LCD controller, DRAM, ROM (Flash memory or masked ROM), or PCMCIA controller, and it transmits and receives data with these external agents via the ADD bus and DATA bus.

11.2 REGISTER SET

The BCU registers are listed below.

Table 11-1. BCU Registers

Address	R/W	Register symbols	Function
0x0B00 0000	R/W	BCUCNTREG1	BCU Control Register 1
0x0B00 0002	R/W	BCUCNTREG2	BCU Control Register 2
0x0B00 000A	R/W	BCUSPEEDREG	BCU Access Cycle Change Register
0x0B00 000C	R/W	BCUERRSTREG	BCU BUS ERROR Status Register
0x0B00 000E	R/W	BCURFCNTREG	BCU Refresh Control Register
0x0B00 0010	R	REVIDREG	Revision ID Register
0x0B00 0012	R/W	BCURFCOUNTREG	BCU Refresh Count Register
0x0B00 0014	R	CLKSPEEDREG	Clock Speed Register
0x0B00 0016	R/W	BCUCNTREG3	BCU Control Register 3

Each register is described in detail as follows.

11.2.1 BCUCNTREG1 (0x0B00 0000)

(1/2)

Bit	D15	D14	D13	D12	D11	D10	D9	D8
Name	ROM64	DRAM64	ISAM/LCD	PAGE128	Reserved	PAGEROM2	Reserved	PAGEROM0
R/W	R/W	R/W	R/W	R/W	R	R/W	R	R/W
RTCRST	0	0	0	0	0	0	0	0
Other resets	0	0	0	0	0	0	0	0

Bit	D7	D6	D5	D4	D3	D2	D1	D0
Name	Reserved	ROMWEN2	Reserved	ROMWEN0	Reserved	Reserved	BUSHERREN	RSTOUT
R/W	R	R/W	R	R/W	R	R	R/W	R/W
RTCRST	0	0	0	0	0	0	0	0
Other resets	0	0	0	0	0	0	0	0

Bit	Name	Function
D[15]	ROM64	Sets the capacity of the ROM to be used 1: 64M-bit ROM 0: 32M-bit ROM
D[14]	DRAM64	Sets the capacity of the DRAM to be used 1 : 64M-bit DRAM 0 : 16M-bit DRAM
D[13]	ISAM/LCD	Assigns space from 0x0A00 0000 to 0x0AFF FFFF as the physical address space. 1 : As ISA high-speed memory space 0 : As LCD space
D[12]	PAGE128	Sets the maximum burst access size for Page ROM. 1 : 128-bit (16 byte) 0 : 64-bit (8 byte)
D[11]	Reserved	Write 0 to this bit. 0 is returned after a read.
D[10]	PAGEROM2	This is the page ROM access enable bit for the ROM space in banks 3 and 2 (16-bit mode) or in bank 1 (32-bit mode). 1 : Page ROM 0 : Ordinary ROM
D[9]	Reserved	Write 0 to this bit. 0 is returned after a read.
D[8]	PAGEROM0	This is the page ROM access enable bit for the ROM space in banks 1 and 0 (16-bit mode) or in bank 0 (32-bit mode). 1 : Page ROM 0 : Ordinary ROM

Bit	Name	Function
D[7]	Reserved	Write 0 to this bit. 0 is returned after a read.
D[6]	ROMWEN2	This enables flash memory write and issues a flash memory register read-only bus cycle for the ROM space in banks 3 and 2 (16-bit mode) or in bank 1 (32-bit mode). 1 : Enable (Not affected by PAGEROM2) 0 : Prohibit
D[5]	Reserved	Write 0 to this bit. 0 is returned after a read.
D[4]	ROMWEN0	This enables flash memory write and issues a flash memory register read-only bus cycle for the ROM space in banks 1 and 0 (16-bit mode) or in bank 0 (32-bit mode). 1 : Enable (Not affected by PAGEROM0) 0 : Prohibit
D[3..2]	Reserved	Write 0 to these bits. 0 is returned after a read.
D[1]	BUSHERREN	This is the bus timeout detection enable bit, which is used when a bus hold has been received. 1 : Performs timeout detection when a bus hold has been received. 0 : Does not perform timeout detection when a bus hold has been received.
D[0]	RSTOUT	RSTOUT control bit 1 : High level 0 : Low level

This register is used to set parameters such as the bus interface's bus cycle and memory type to be used.

For the setting of the PAGEROM2 and ROMWEN2 bits, the target ROM area differs depending on the data bus mode. The access target ROM area is banks 3 and 2 in 16-bit data bus mode, and is banks 3, 2, and 1 in 32-bit data bus mode.

For the setting of the PAGEROM0 and ROMWEN0 bits, the target ROM area differs depending on the data bus mode. The access target ROM area is banks 3 and 2 in 16-bit data bus mode, and is banks 3, 2, and 1 in 32-bit data bus mode.

For details of the bank assignment in the ROM area and DRAM area, refer to **6.3.1 ROM Space** and **6.3.5 DRAM Space**, respectively.

When a timeout is detected while the BUSHERREN bit is set to 1, the RSTOUT pin is set to high to request bus release from the external bus master (in this case, the HLDRQ# pin of the bus master should be set to high). An interrupt request is then sent to the CPU by setting the bit BERRST of the BCUERRSTREG register to 1. Write 0 to the RSTOUT bit to make the RSTOUT pin low. Detection is not performed in the suspend mode.

11.2.2 BCUCNTREG2 (0x0B00 0002)

Bit	D15	D14	D13	D12	D11	D10	D9	D8
Name	Reserved	Reserved	Reserved	Reserved	Reserved	Reserved	Reserved	Reserved
R/W	R	R	R	R	R	R	R	R
RTCRST	0	0	0	0	0	0	0	0
Other resets	0	0	0	0	0	0	0	0

Bit	D7	D6	D5	D4	D3	D2	D1	D0
Name	Reserved	Reserved	Reserved	Reserved	Reserved	Reserved	Reserved	GMODE
R/W	R	R	R	R	R	R	R	R/W
RTCRST	0	0	0	0	0	0	0	0
Other resets	0	0	0	0	0	0	0	0

Bit	Name	Function
D[15..1]	Reserved	Write 0 to these bits. 0 is returned after a read.
D[0]	GMODE	This is the access data control bit for LCD space. 1 : Do not invert the access data for LCD space 0 : Invert the access data for LCD space

This register is used to specify whether data is inverted (translated to 2's complement) or not when accessing the LCD space.

The LCD space is accessed when the ISAM/LCD bit of BCUCNTREG1 is 0. When it is 1, this address space is used as the ISA high-speed memory space. In this case, the contents of the BCUCNTREG2 register are invalid, and inversion of access data is not performed.

11.2.3 BCUSPEEDREG (0x0B00 000A)

(1/2)

Bit	D15	D14	D13	D12	D11	D10	D9	D8
Name	Reserved	Reserved	WPROM[1]	WPROM[0]	Reserved	WLCD/M[2]	WLCD/M[1]	WLCD/M[0]
R/W	R	R	R/W	R/W	R	R/W	R/W	R/W
RTCRST	0	0	0	0	0	0	0	0
Other resets	0	0	0	0	0	0	0	0

Bit	D7	D6	D5	D4	D3	D2	D1	D0
Name	Reserved	WISAA [2]	WISAA [1]	WISAA [0]	Reserved	WROMA[2]	WROMA[1]	WROMA[0]
R/W	R	R/W	R/W	R/W	R	R/W	R/W	R/W
RTCRST	0	0	0	0	0	0	0	0
Other resets	0	0	0	0	0	0	0	0

Bit	Name	Function
D[15..14]	Reserved	Write 0 to these bits. 0 is returned after a read.
D[13..12]	WPROM[1..0]	Page ROM access speed 11 : RFU 10 : 1TClock 01 : 2TClock 00 : 3TClock
D[11]	Reserved	Write 0 to this bit. 0 is returned after a read.
D[10..8]	WLCD/M[2..0]	Access speed to physical address space from 0x0A00 0000 to 0x0AFF FFFF LCD(ISAM/LCD=0) ISA-MEM(ISAM/LCD=1) 111 : RFU 1TClock 110 : RFU 2TClock 101 : RFU 3TClock 100 : RFU 4TClock 011 : 2TClock 5TClock 010 : 4TClock 6TClock 001 : 6TClock 7TClock 000 : 8TClock 8TClock
D[7]	Reserved	Write 0 to this bit. 0 is returned after a read.

Bit	Name	Function
D[6..4]	WISAA[2..0]	System bus access speed 111 : RFU. Operation is not guaranteed when this value has been set. 110 : RFU. Operation is not guaranteed when this value has been set. 101 : 3TClock ^{Note} 100 : 4TClock ^{Note} 011 : 5TClock 010 : 6TClock 001 : 7TClock 000 : 8TClock
D[3]	Reserved	Write 0 to this bit. 0 is returned after a read.
D[2..0]	WROMA[2..0]	ROM access speed 111 : 2TClock 110 : 3TClock 101 : 4TClock 100 : 5TClock 011 : 6TClock 010 : 7TClock 001 : 8TClock 000 : 9TClock

Note When the WISAA [2:0] bits are set to 101 or 100, the AC characteristics between BUSCLK and the system bus interface signals (ADD [25:0], SHB#, MEMR#, MEMW#, IOR#, and IOW#) are not guaranteed.

This register is used to set the access speed for the LCD, system bus, page ROM, and ROM.

The lowest speed is set when "0" is set to all of the following bits: WLCD/M[2..0], WPROM[1..0], WISAA[2..0], and WROMA[2..0]. Setting "1" to all of these bits sets the highest speed.

The value set to WPROM[1..0] is valid only when "1" has been set to the PAGEROM bit in BCUCNTREG1.

11.2.4 BCUERRSTREG (0x0B00 000C)

Bit	D15	D14	D13	D12	D11	D10	D9	D8
Name	Reserved	Reserved	Reserved	Reserved	Reserved	Reserved	Reserved	Reserved
R/W	R	R	R	R	R	R	R	R
RTCRST	0	0	0	0	0	0	0	0
Other resets	0	0	0	0	0	0	0	0

Bit	D7	D6	D5	D4	D3	D2	D1	D0
Name	Reserved	Reserved	Reserved	Reserved	Reserved	Reserved	Reserved	BERRST
R/W	R	R	R	R	R	R	R	R/W1C
RTCRST	0	0	0	0	0	0	0	0
Other resets	0	0	0	0	0	0	0	0

Bit	Name	Function
D[15..1]	Reserved	Write 0 to these bits. 0 is returned after a read.
D[0]	BERRST	Bus error status. Clear to 0 when 1 is written. 1 : Bus error 0 : Normal

This register is used to indicate when a bus error interrupt request has occurred.
The bus error interrupt can be cleared by setting BERRST to 1.

11.2.5 BCURFCNTREG (0x0B00 000E)

Bit	D15	D14	D13	D12	D11	D10	D9	D8
Name	Reserved	Reserved	BRF[13]	BRF[12]	BRF[11]	BRF[10]	BRF[9]	BRF[8]
R/W	R	R	R/W	R/W	R/W	R/W	R/W	R/W
RTCRST	0	0	0	0	0	0	1	0
Other resets	0	0	Undefined	Undefined	Undefined	Undefined	Undefined	Undefined

Bit	D7	D6	D5	D4	D3	D2	D1	D0
Name	BRF[7]	BRF[6]	BRF[5]	BRF[4]	BRF[3]	BRF[2]	BRF[1]	BRF[0]
R/W	R/W	R/W	R/W	R/W	R/W	R/W	R/W	R/W
RTCRST	0	0	0	0	0	0	0	0
Other resets	Undefined	Undefined	Undefined	Undefined	Undefined	Undefined	Undefined	Undefined

Bit	Name	Function
D[15..14]	Reserved	Write 0 to these bits. 0 is returned after a read.
D[13..0]	BRF[13..0]	Use this bit to set the number of DRAM refresh cycles (with TClock cycle).

The refresh interval can be obtained by calculating the following expression:

$$\text{Refresh interval} = \text{BRF}[13..0] \times \text{TClock}$$

Therefore, the setting value should be obtained by calculating the number of used DRAM refresh cycles (ex. 4,096 cycles/128 ms in the μ PD42S16165) and the bus access cycles (each address space/bus hold cycle). For TClock, see **10.2.8 CLKSPEEDREG**.

If a bus timeout occurs, one DRAM refresh cycle is lost. It occurs when the ready signal and HLDRQ# signal do not become high level in a certain period during the system bus I/O MEM, LCD/high-speed bus, or bus hold cycle.

11.2.6 REVIDREG (0x0B00 0010)

Bit	D15	D14	D13	D12	D11	D10	D9	D8
Name	RID[3]	RID[2]	RID[1]	RID[0]	MJREV[3]	MJREV[2]	MJREV[1]	MJREV[0]
R/W	R	R	R	R	R	R	R	R
RTCRST	0	0	0	1	0	0	0	0
Other resets	0	0	0	1	Undefined	Undefined	Undefined	Undefined

Bit	D7	D6	D5	D4	D3	D2	D1	D0
Name	Reserved	Reserved	Reserved	Reserved	MNREV[3]	MNREV[2]	MNREV[1]	MNREV[0]
R/W	R	R	R	R	R	R	R	R
RTCRST	0	0	0	0	0	0	0	0
Other resets	0	0	0	0	Undefined	Undefined	Undefined	Undefined

Bit	Name	Function
D[15..12]	RID[3:0]	This is the processor revision ID. 0x02 indicates the Vr4111.
D[11..8]	MJREV[3..0]	Major revision number
D[7..4]	Reserved	Write 0 to these bits. 0 is returned after a read.
D[3..0]	MNREV[3..0]	Minor revision number

This register is used to indicate revisions of the Vr4111's peripheral units.

The revision number is stored as a value in the form $y.x$, where y is a major revision number and x is a minor revision number.

Major revision number and minor revision number can distinguish the revision of the CPU and the peripheral units, however there is no guarantee that changes to the CPU and the peripheral units will necessarily be reflected in this register, or that changes to the revision number necessarily reflect real CPU's and units' changes. For this reason, these values are not listed and software should not rely on the revision number in PREVIDREG to characterize the units.

11.2.7 BCURFCOUNTREG (0x0B00 0012)

Bit	D15	D14	D13	D12	D11	D10	D9	D8
Name	Reserved	Reserved	BRFC[13]	BRFC[12]	BRFC[11]	BRFC[10]	BRFC[9]	BRFC[8]
R/W	R	R	R/W	R/W	R/W	R/W	R/W	R/W
RTCRST	0	0	0	0	0	0	0	0
Other resets	0	0	Undefined	Undefined	Undefined	Undefined	Undefined	Undefined

Bit	D7	D6	D5	D4	D3	D2	D1	D0
Name	BRFC[7]	BRFC[6]	BRFC[5]	BRFC[4]	BRFC[3]	BRFC[2]	BRFC[1]	BRFC[0]
R/W	R/W	R/W	R/W	R/W	R/W	R/W	R/W	R/W
RTCRST	0	0	0	0	0	0	0	1
Other resets	Undefined	Undefined	Undefined	Undefined	Undefined	Undefined	Undefined	Undefined

Bit	Name	Function
D[15..14]	Reserved	Write 0 to these bits. 0 is returned after a read.
D[13..0]	BRFC[13..0]	Number of the current DRAM refresh cycle.

This register is used to indicate the current refresh cycle count value.

When the value of this register is 0x0000, a refresh cycle request is generated and the BCURFCNTREG (0x0B00 000E) value is set. The counter operates irrespective of refresh cycle generation.

Even after the refresh cycle request is generated, if no refresh cycle is generated because of other bus cycles (system bus I/O MEM, LCD/high-speed system bus, or bus hold) and if this register is 0x0000, bus timeout occurs (during bus hold cycle, this depends on the setting of BCUCNTREG1's bit 1).

11.2.8 CLKSPEEDREG (0x0B00 0014)

Bit	D15	D14	D13	D12	D11	D10	D9	D8
Name	DIV2B	DIV3B	DIV4B	Reserved	Reserved	Reserved	Reserved	Reserved
R/W	R	R	R	R	R	R	R	R
RTCRST	Undefined	Undefined	Undefined	0	0	0	0	0
Other resets	Undefined	Undefined	Undefined	0	0	0	0	0

Bit	D7	D6	D5	D4	D3	D2	D1	D0
Name	Reserved	Reserved	Reserved	CLKSP[4]	CLKSP[3]	CLKSP[2]	CLKSP[1]	CLKSP[0]
R/W	R	R	R	R	R	R	R	R
RTCRST	0	0	0	Undefined	Undefined	Undefined	Undefined	Undefined
Other resets	0	0	0	Undefined	Undefined	Undefined	Undefined	Undefined

Bit	Name	Function
D[15]	DIV2B	Used to calculate the operating clock (TClock) of peripheral unit.
D[14]	DIV3B	Used to calculate the operating clock (TClock) of peripheral unit.
D[13]	DIV4B	Used to calculate the operating clock (TClock) of peripheral unit.
D[12..5]	Reserved	RFU. Write 0 to these bits. 0 is returned after a read.
D[4..0]	CLKSP[4..0]	Used to calculate the operating clock (PClock) of the CPU core.

The following expression is used to calculate the operating clock (TClock) of peripheral unit.

When DIV2B = 0,

$$TClock = (18.432 \text{ MHz}/CLKSP[4:0]) \times 32$$

When DIV3B = 0,

$$TClock = (18.432 \text{ MHz}/CLKSP[4:0]) \times 21.33$$

When DIV4B = 0,

$$TClock = (18.432 \text{ MHz}/CLKSP[4:0]) \times 16$$

The following expression is used to calculate the operating clock (PClock) of the CPU core.

$$PClock = (18.432 \text{ MHz}/CLKSP[4:0]) \times 64$$

11.2.9 BCUCNTREG3 (0x0B00 0016)

Bit	D15	D14	D13	D12	D11	D10	D9	D8
Name	EXT_ROM64	EXT_DRAM64	EXT_ROMCS[3]	EXT_ROMCS[2]	EXT_MEM	Reserved	Reserved	Reserved
R/W	R/W	R/W	R/W	R/W	R/W	R	R	R
RTCRST	0	0	0	0	0	0	0	0
Other resets	—	—	—	—	—	0	0	0

Bit	D7	D6	D5	D4	D3	D2	D1	D0
Name	LCD32	Reserved	Reserved	Reserved	Reserved	Reserved	Reserved	Reserved
R/W	R/W	R	R	R	R	R	R	R
RTCRST	0	0	0	0	0	0	0	0
Other resets	—	0	0	0	0	0	0	0

Bit	Name	Function
D[15]	EXT_ROM64	Sets the capacity of the expansion ROM to be used. 1: 64M-bit ROM 0: 32M-bit ROM
D[14]	EXT_DRAM64	Sets the capacity of the expansion DRAM to be used. 1: 64M-bit DRAM 0: 16M-bit DRAM
D[13..12]	EXT_ROMCS[3..2]	Assigns space of banks 3 and 2 (32-bit mode). 11: Bank 3 = ROM, bank 2 = ROM 10: Bank 3 = ROM, bank 2 = DRAM 01: RFU 00: Bank 3 = DRAM, bank 2 = DRAM
D[11]	EXT_MEM	Enables/Disables an access to expansion memory (ROM/DRAM). 1: Enable 0: Disable
D[10..8]	Reserved	Write 0 to these bits. 0 is returned after a read.
D[7]	LCD32	Sets the data bus size of LCD space (32-bit mode). 1: 32 bits 0: 16 bits
D[6..0]	Reserved	Write 0 to these bits. 0 is returned after a read.

This register can be set only in 32-bit data bus mode (DBUS32 = 1).
The data bus size of high-speed system bus is fixed to 16 bits.

11.3 CONNECTION OF ADDRESS PINS

11.3.1 Connection to DRAM

Table 11-2 shows the connection example between the V_R4111 and DRAM.

The data of row address and column address that correspond to RAS signal (MRAS[3:0]#) and CAS signal (UUCAS#, ULCAS#, UCAS#, and LCAS#), respectively, are output to DRAM (multiplexed-addressing supported), via the V_R4111's ADD pin (ADD[23:9]).

See the table below for the physical address corresponding to each address.

Table 11-2. Example of DRAM Connection and Address Output from V_R4111 (1/2)

(a) In 16-bit data bus mode (DBUS32 = 0)

DRAM address pin	16M-bit DRAM (1 Mbit × 16)			64M-bit DRAM (4 Mbits × 16)		
	ADD pin	Row	Column	ADD pin	Row	Column
A12/NC ^{Note 1}				ADD20	adr20	
A11/NC ^{Note 2}	ADD20	adr20		ADD22	adr22	
A10/NC ^{Note 2}	ADD19	adr19		ADD21	adr21	
A9	ADD18	adr18	adr20	ADD18	adr18	adr20
A8	ADD17	adr17	adr19	ADD17	adr17	adr19
A7	ADD16	adr16	adr8	ADD16	adr16	adr8
A6	ADD15	adr15	adr7	ADD15	adr15	adr7
A5	ADD14	adr14	adr6	ADD14	adr14	adr6
A4	ADD13	adr13	adr5	ADD13	adr13	adr5
A3	ADD12	adr12	adr4	ADD12	adr12	adr4
A2	ADD11	adr11	adr3	ADD11	adr11	adr3
A1	ADD10	adr10	adr2	ADD10	adr10	adr2
A0	ADD9	adr9	adr1	ADD9	adr9	adr1

Notes 1. μ PD42S64165/ μ PD42S65165

2. μ PD42S16165/ μ PD42S18165

Remark adr[22:1]: CPU Core or DMAAU physical address bit.

Table 11-2. Example of DRAM Connection and Address Output from VR4111 (2/2)

(b) In 32-bit data bus mode (DBUS32 = 1)

DRAM address pin	16M-bit DRAM (1 Mbit × 16)			64M-bit DRAM (4 Mbits × 16)		
	ADD pin	Row	Column	ADD pin	Row	Column
A12/NC ^{Note 1}				ADD20	adr20	
A11/NC ^{Note 2}	ADD20	adr20		ADD23	adr23	
A10/NC ^{Note 2}	ADD19	adr19		ADD22	adr22	
A9	ADD18	adr18	adr20	ADD18	adr18	adr20
A8	ADD17	adr17	adr19	ADD17	adr17	adr19
A7	ADD16	adr16	adr8	ADD16	adr16	adr8
A6	ADD15	adr15	adr7	ADD15	adr15	adr7
A5	ADD14	adr14	adr6	ADD14	adr14	adr6
A4	ADD13	adr13	adr5	ADD13	adr13	adr5
A3	ADD12	adr12	adr4	ADD12	adr12	adr4
A2	ADD11	adr11	adr3	ADD11	adr11	adr3
A1	ADD10	adr10	adr2	ADD10	adr10	adr2
A0	ADD9	adr9	adr21	ADD9	adr9	adr21

Notes 1. μ PD42S64165/ μ PD42S65165**2.** μ PD42S16165/ μ PD42S18165**Remark** adr[23:2]: CPU Core or DMAAU physical address bit.

11.3.2 Connection to ROM

Table 11-3 shows a connection example between the VR4111 and ROM.

Table 11-3. Example of ROM Connection and Address Output from Vr4111 (1/2)

(a) In 16-bit data bus mode (DBUS32 = 0)

ROM address pin	32M-bit ROM (2 Mbits × 16)		64M-bit DRAM (4 Mbits × 16)	
	ADD pin	adr	ADD pin	adr
A21			ADD22	adr22
A20	ADD21	adr21	ADD21	adr21
A19	ADD20	adr20	ADD20	Adr20
A18	ADD19	adr19	ADD19	adr19
A17	ADD18	adr18	ADD18	Adr18
A16	ADD17	adr17	ADD17	Adr17
A15	ADD16	adr16	ADD16	adr16
A14	ADD15	adr15	ADD15	Adr15
A13	ADD14	adr14	ADD14	adr14
A12	ADD13	adr13	ADD13	Adr13
A11	ADD12	adr12	ADD12	adr12
A10	ADD11	adr11	ADD11	Adr11
A9	ADD10	adr10	ADD10	adr10
A8	ADD9	adr9	ADD9	adr9
A7	ADD8	adr8	ADD8	adr8
A6	ADD7	adr7	ADD7	adr7
A5	ADD6	adr6	ADD6	adr6
A4	ADD5	adr5	ADD5	Adr5
A3	ADD4	adr4	ADD4	adr4
A2	ADD3	adr3	ADD3	adr3
A1	ADD2	adr2	ADD2	Adr2
A0	ADD1	adr1	ADD1	adr1

Remark adr[22:1]: CPU Core or DMAAU physical address bit.

Table 11-3. Example of ROM Connection and Address Output from Vr4111 (2/2)

(b) In 32-bit data bus mode (DBUS32 = 1)

ROM address pin	32M-bit ROM (2 Mbits × 16)		64M-bit DRAM (4 Mbits × 16)	
	ADD pin	adr	ADD pin	Adr
A21			ADD23	Adr23
A20	ADD22	adr22	ADD22	Adr22
A19	ADD21	adr21	ADD21	Adr21
A18	ADD20	adr20	ADD20	adr20
A17	ADD19	adr19	ADD19	adr19
A16	ADD18	adr18	ADD18	adr18
A15	ADD17	adr17	ADD17	adr17
A14	ADD16	adr16	ADD16	adr16
A13	ADD15	adr15	ADD15	adr15
A12	ADD14	adr14	ADD14	adr14
A11	ADD13	adr13	ADD13	adr13
A10	ADD12	adr12	ADD12	adr12
A9	ADD11	adr11	ADD11	adr11
A8	ADD10	adr10	ADD10	adr10
A7	ADD9	adr9	ADD9	adr9
A6	ADD8	adr8	ADD8	adr8
A5	ADD7	adr7	ADD7	adr7
A4	ADD6	adr6	ADD6	adr6
A3	ADD5	adr5	ADD5	adr5
A2	ADD4	adr4	ADD4	adr4
A1	ADD3	adr3	ADD3	adr3
A0	ADD2	adr2	ADD2	adr2

Remark adr[23:2]: CPU Core or DMAAU physical address bit.

11.4 NOTES ON USING BCU

11.4.1 CPU Core Bus Modes

The VR4111 is designed on the assumption that the CPU core is set to the following mode.

- Writeback data rate : D
- Accelerate data ratio : VR4x00 compatible mode

Therefore, set the Config Register as below:

- EP : 0000
- AD : 0

11.4.2 Access Data Size

In the VR4111, access size is restricted for each address space. Access sizes for the following address spaces are listed below.

Table 11-4. Access Size Restrictions for Address Spaces

Address space	R/W	Access size (bytes)						Remark
		16	8	4	3	2	1	
ROM/PageROM	R	○	○	○	○	○	○	
Flash memory	W	×	×	△	×	△	×	Note 1
System bus I/O space	R/W	○	○	○	×	○	○	
System bus memory space	R/W	○	○	○	×	○	○	
On-chip I/O space 1	R/W	○	○	○	×	○	○	
On-chip I/O space 2	R/W	×	○	○	×	○	×	
LCD space	R/W	×	○	○	×	○	○	Notes 2, 3
High-speed system bus memory space	R/W	×	○	○	×	○	○	Note 3
DRAM	R/W	○	○	○	○	○	○	

- Notes 1.** The access size when writing to flash memory must be the same as the data bus width such as below;
 In 32-bit mode: 4 bytes
 In 16-bit mode: 2 bytes
- 2.** Use as uncached.
- 3.** The LCD space and high-speed system bus memory space are mapped to the same physical address.
 Use BCUCNTREG1's ISAM/LCD bit to switch between the two.

Remark ○, △ : accessible, × : not accessible

11.4.3 ROM Interface

(1) Switching among ROM, PageROM, and Flash Memory Modes

The VR4111 supports three modes (ROM, PageROM and Flash Memory). The mode setting in ROM bank is set via BCUCNTREG1's ROMWEN and PAGEROM bits.

Table 11-5. ROM Mode Settings and Access-Enabled Devices

Mode	Setting		Access-enabled devices		
	ROMWEN2/0	PAGEROM2/0	Memory read	Flash Memory register read	Flash Memory write
Ordinary ROM	0	0	Ordinary ROM PageROM Flash Memory	N/A	N/A
PageROM	0	1	PageROM	N/A	N/A
Flash Memory	1	don't care	Ordinary ROM PageROM Flash Memory	Flash Memory	Flash Memory

Remark The initial setting is Ordinary ROM mode.

(2) Access Speed Setting

The VR4111 enables the access speed to be changed when operating in Ordinary ROM mode or PageROM mode.

For details, see **11.5.1 ROM Access**.

11.4.4 Flash Memory Interface

(1) Notes for Specific Modes

The following two modes are available for flash memory.

- Ordinary ROM mode (memory read only)
- Flash Memory mode (supports memory write and register read)

The following notes apply to these modes.

(a) Notes for Ordinary ROM mode

- Write is prohibited
The WR# pin is not asserted even when a write operation is attempted.
- Flash memory register read is prohibited
The Ordinary ROM mode is the mode in which bus cycles suite for memory read operations are issued. Since the AC characteristics of flash memory are different for register read and memory read operations, accurate data cannot be obtained by reading the flash memory register while in this mode.

(b) Notes for Flash Memory mode

- Be sure to access in 2-byte units or 4-byte units (depending on data bus width) when writing to flash memory.

(2) Example of write sequence for flash memory

An example of a write sequence for flash memory is shown below.

Caution This example's operations have not been confirmed using an actual system.

- 1 Using GPIO as an output port, apply the flash memory write voltage (V_{PP}).
If the VR4111's on-chip GPIOs cannot be used, set up an external output port and then control the write voltage.
- 2 Set the VR4111 to flash memory mode (Set "1" to the BCUCNTREG's ROMWEN bit).
- 3 Wait until the flash memory write voltage become stable.
- 4 Issue the flash memory write command from the VR4111.
- 5 Write data from the VR4111 to flash memory.
- 6 Wait until the flash memory write completion signal (ry/by) becomes stable.
- 7 Wait until the flash memory write completion signal gives notification of write completion.
After write to flash memory is completed, notification can be obtained by receiving an interrupt from the flash memory write completion signal (ry/by) or by polling the flash memory register.
- 8 Read the flash memory register.
 - If write succeeded, start processing from "9".
 - If write failed, start processing from "12".
- 9 If writing new data to flash memory, start processing from "4".
If write to flash memory is completed, start processing from "10".

- 10 Compare the data written to flash memory with the original data.
 - If the data matches, perform processing at “11”.
 - If the data does not match
 - Start processing from “1” when rewriting.
 - If processing is interrupted, start processing from “11”.
- 11 Apply the write voltage (V_{PP}) to the flash memory, and end processing after flash memory mode has been canceled.
- 12 Clear any error data in the flash memory register.
 - If writing again
 - If the write voltage is too low, start processing from “1”.
 - In all other cases, start processing from “4”.
 - If processing is completed, perform processing at “11”.

(3) Notes for Using Memory Capacity

The capacity of the memory (ROM and DRAM) to be used can be set by using the ROM64 and DRAM64 bits of the BCUCNTREG1 register. In this case, take into consideration that the physical addresses and banks of the ROM differ depending on the setting of the ROM64 and DRAM64 bits of BCUCNTREG1, as shown in **6.3.1 ROM Space** and **6.3.5 DRAM Space**.

(4) Usage of Expansion Memory when Data Bus Size is 32 bits

In 32-bit data bus size mode, the expansion memory (ROM and DRAM) can be used by setting the proper values to the EXT_ROM64, EXT_DRAM64, EXT_ROMCS[3:2], and EXT_MEM of BCUCNTREG3. In this case, set EXT_ROM64, EXT_DRAM64, and EXT_ROMCS[3:2] before setting EXT_MEM (access enable). When manipulating these settings, take into consideration that the physical addresses and banks of the memory differ as shown in **6.3.1 ROM Space** and **6.3.5 DRAM Space**.

11.4.5 LCD Control Interface

(1) Access Size

Available access sizes for accessing the LCD controller interface are 1 byte, 2 bytes, 4 bytes, and 8 bytes.

(2) Data Inversion

When “0” has been set to the BCUCNTREG1’s ISAM/LCD bit and to BCUCNTREG2’s GMODE bit, the Vr4111 inverts the bits in the data being read or written via the LCD controller interface.

Table 11-6. Example of Bit Inversion in Data in Vr4111 and at DATA[15:0] Pins

Data in Vr4111	Data at DATA [15:0] Pins
0x0000	0xFFFF
0xA5A5	0x5A5A
0x1234	0xEDCB

(3) Data Bus Size

In the V_R4111, if the LCD32 bit of BCUCNTREG3 is set to 1 during the 32-bit data bus mode (DBUS32 = 1), the data bus size of the LCD controller interface is expanded to 32 bits (16 bits as default). In this case, the signals UUCAS#/MRAS3#, ULCAS#/MRAS2#, UCAS#, and LCAS# are used to indicate the effective data on the DATA[31:0] pins, not SHB# nor ADD0.

Figure 11-1. Example of 32-bit LCD Controller Interface Connection

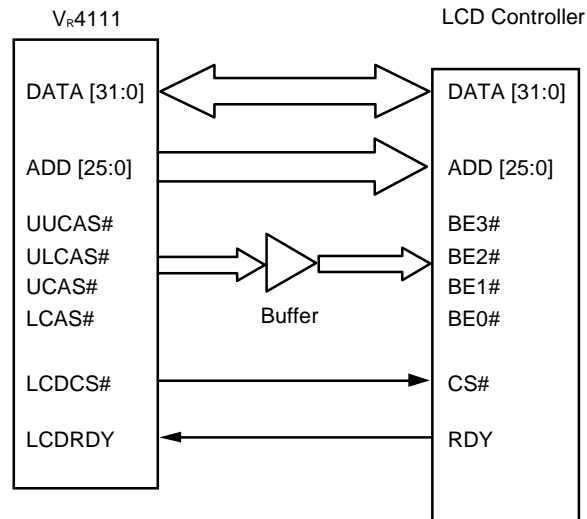

Caution Take sufficient consideration for the countermeasure against noises (such as undershoot, overshoot, or cross talk) for the UUCAS#/MRAS3#, ULCAS#/MRAS2#, UCAS#, and LCAS# signals, because they also function as the DRAM's CAS signals.

Using buffers is recommended for long lines — for example, use cables to connect an LCD controller.

11.4.6 Illegal Access Notification

(1) Types of Illegal Access

Under the following circumstances, the V_R4111 provides notification concerning illegal access of the CPU core, by the unmaskable interrupt request (bus error exception) during a read operation, and by the maskable interrupt request (Int0) set with the BCUERRSTREG's BERRST bit during a write operation.

- **Bus deadlock**

A deadlock is judged when a bus timeout (DRAM refresh interval + α) occurs due to the non-return of a ready signal via the system bus or LCD controller interface, in which case notification of illegal access is given. ($0 < \alpha < \text{DRAM refresh interval}$)

- **Address space reserved for future use**

Notification of illegal access is given when the processor has accessed any of the following addresses.

0x0FFF FFFF to 0x0C00 0000

0x09FF FFFF to 0x0400 0000

(2) Notification Method for Illegal Access

The methods used to notify the CPU core are listed below.

Table 11-7. Illegal Access Notification Methods

Access type	Illegal access notification method
Processor read request	Notification by bus error caused by SysCmd
Processor write request	Notification by interrupt exception (Int0)

Remark To clear the interrupt source caused by a processor write request, write "1" to BCUERRSTREG's bit1.

11.5 BUS OPERATIONS

The bus operations of buses controlled by the BCU are described below.

The BCU's operating clock (TClock, internal) appears in the timing chart for each bus operation.

TClock is determined within a range of 20 to 28 MHz by CLKSEL[2:0] pin settings.

Remark # that follows signal names indicates active low.

11.5.1 ROM Access

The VR4111 supports the following three modes for ROM access.

Use BCUCNTREG1's PAGEROM bits and ROMWEN bits to set the mode.

- Ordinary ROM read mode (ROMWEN, PAGEROM = 00)
- PageROM read mode (ROMWEN, PAGEROM = 01)
- Flash Memory mode (ROMWEN = 1)

(1) Ordinary ROM Read Mode

Set ROMWEN = 0 and PAGEROM = 0.

WROMA[2:0] (BCUSPEEDREG [2:0]) can be used to set the access time during the ordinary ROM read mode, as shown in Table 11-8.

Figures 11-2 and 11-3 show 4-byte read timing chart data for when WROMA [2:0] is set to "110". If access uses a data size larger than 4 bytes, the Trom cycle is continued until the required access size is reached.

Table 11-8. Access Times During Ordinary ROM Read Mode

WROMA [2:0]	Trom (TClock)
000	9
001	8
010	7
011	6
100	5
101	4
110	3
111	2

Figure 11-2. ROM 4-Byte Read, 16-Bit Mode (WROMA[2:0] = 110)

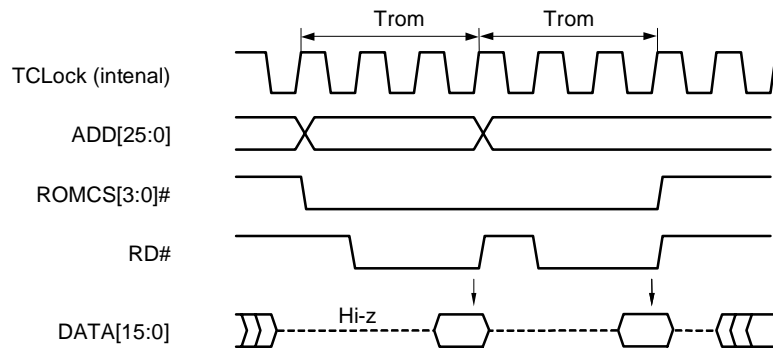
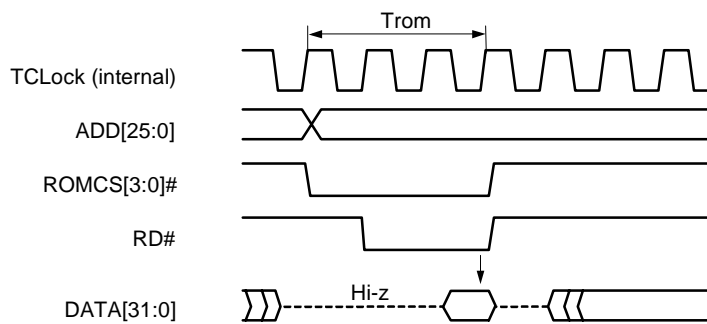

Figure 11-3. ROM 4-Byte Read, 32-Bit Mode (WROMA[2:0] = 110)



Data is sampled at the rising edge of the TCLK following the last Trom-state TCLK.
The bus operation types for ordinary ROM are as follows.

1-byte read, 2-byte read, 3-byte read, 1-word read, 2-word read, and 4-word read (1 word = 4 bytes)

(2) PageROM Read Mode

Set ROMWEN = 0 and PAGEROM = 1.

WROMA[2:0] (BCUSPEEDREG [2:0]) and WPROM[1:0] (BCUSPEEDREG [13:12]) can be used to set the access time of the Page ROM read cycle (T_{prom}).

Figures 11-4 and 11-5 show 16-byte read timing charts for when WROMA [2:0] is set to “111” and WPROM [1:0] is set to “10”. The ROMCS[3:0]# and RD# pins are held at low level during T_{rom} cycles.

Table 11-9. PageROM Read Mode Access Time

WROMA [2:0]	T_{rom} (TClock)	WPROM [1:0]	T_{prom} (TClock)
000	9	00	3
001	8	01	2
010	7	10	1
011	6	11	RFU
100	5		
101	4		
110	3		
111	2		

Figure 11-4. PageROM 4-Word Read, 16-Bit Mode (WROMA[2:0] = 111, WPROM[1:0] = 10)

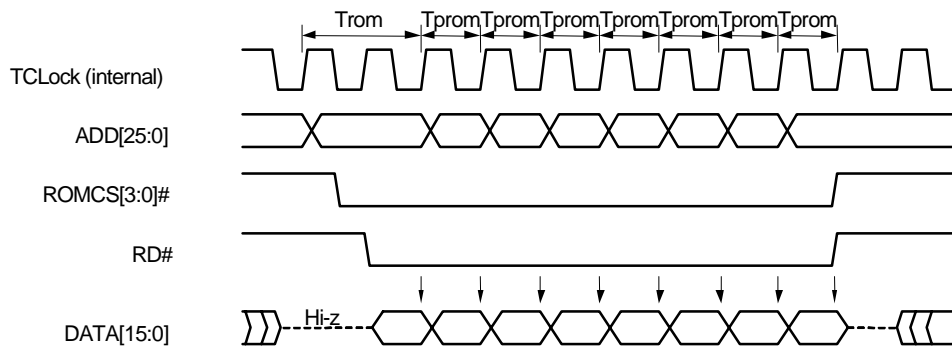
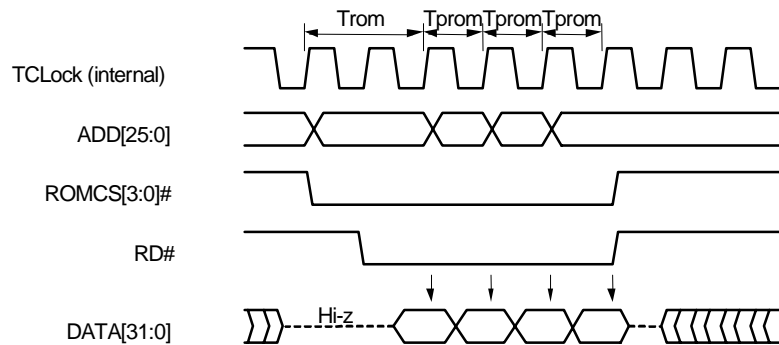

Figure 11-5. PageROM 4-Word Read, 32-Bit Mode (WROMA[2:0] = 111, WPROM[1:0] = 10)



(3) Flash Memory Mode

Set ROMWEN = 1.

This mode is used to meet the electrical characteristics required for writing to flash memory and for accessing the flash memory register. This mode can also be used to read to flash memory.

Note that the access time is constant when in this mode.

Figure 11-6. Flash Memory Mode, 2-Byte Access

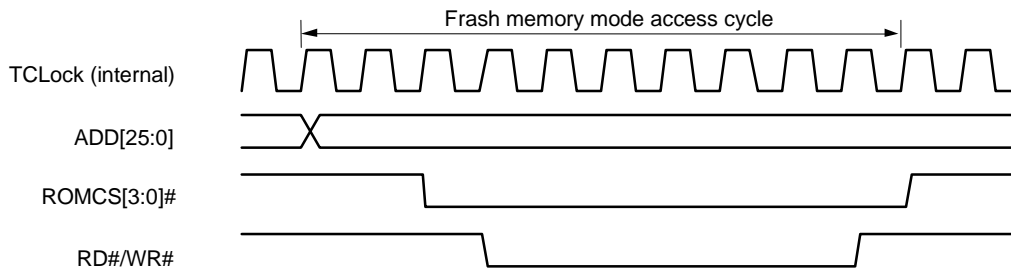

11.5.2 System Bus Access

(1) Bus Operations in System Bus of ISA Memory Space and ISA I/O Space

WISAA[2:0] (BCUSPEEDREG [6:4]) can be used to set the access time.

Table 11-10. System Bus Access Times

WISAA [2:0]	Tisa (TClock)
000	8
001	7
010	6
011	5
100	4
101	3
110	RFU
111	RFU

(2) Access to System Bus of ISA Memory Space and ISA I/O Space

The relationships between the data bus and SHB#, ADD0 signals during 16-/8-bit access to the system bus are shown below.

SHB#	ADD[0]	IOCS16#	Write		Read		Remark
			MEMCS16#	DATA[15:8]	DATA[7:0]	DATA[15:8]	
0	0	0	○	○	⊙	⊙	
1	0	0	×	○	—	⊙	
0	1	0	○	Copy of DATA[15:8]	⊙	—	
1	1	0	×	×	—	—	Note 1
—	0	1	×	○	—	⊙	Note 2
—	1	1	×	○	—	⊙	Note 3

- Notes**
1. This combination is never output.
 2. Byte access to even addresses
 3. Byte access to odd addresses

- Remarks**
- ‘○’ indicates the system bus outputs invalid data.
 - ‘×

★ **Figure 11-7. 1-Byte Access to Even Address Using 16-Bit Bus (WISAA[2:0] = 101)**

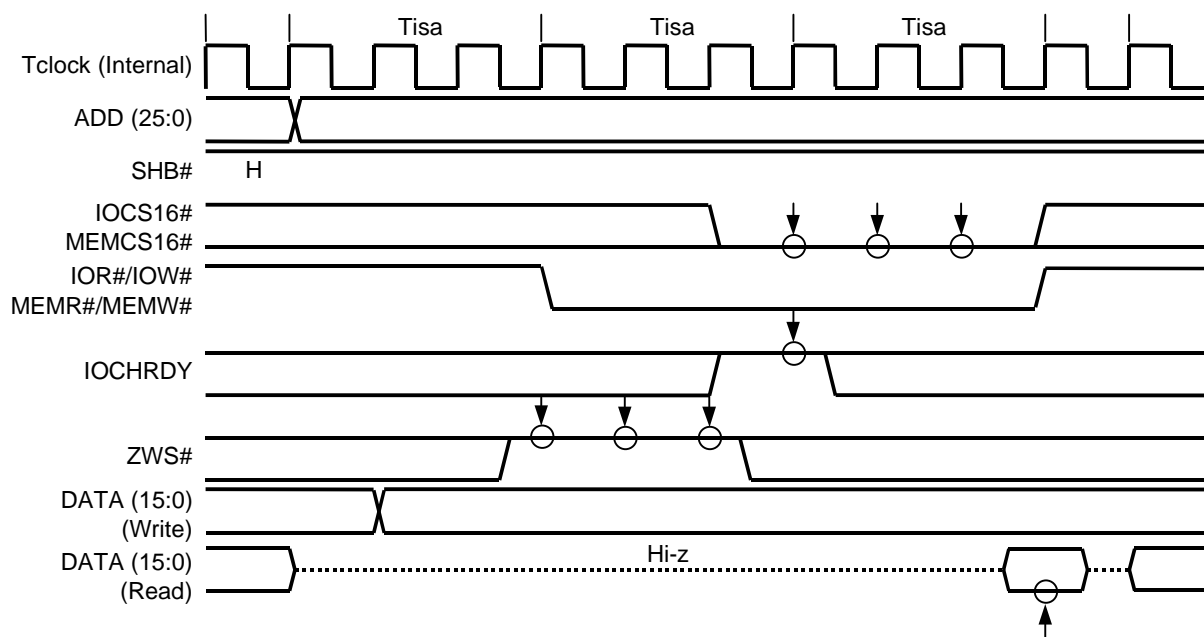

Figure 11-8 illustrates 2-byte access when sampling IOCHRDY at high level.

- ★ The IOCHRDY signal is sampled 1-Tisa cycle later from the falling edge of the IOR#/IOW# or MEMR#/MEMW# signal. When IOCHRDY is active, data becomes valid 1-Tisa cycle later. When IOCHRDY is inactive, one more wait of 1-Tisa cycle is inserted.

If the system bus access time has been set as three TClocks (WISAA[2:0] = 101), the bus cycle will end after waiting for at least three TClocks (Tisa periods) after the ready signal is sampled using IOCHRDY.

- ★ If high-level IOCHRDY is sampled, the IOCS16# or MEMCS16# signal is sampled for 1-Tisa cycle from sampling IOCHRDY.

★ **Figure 11-8. 2-Byte Access When Sampling IOCHRDY at High Level Using 16-Bit Bus (WISAA[2:0] = 101)**

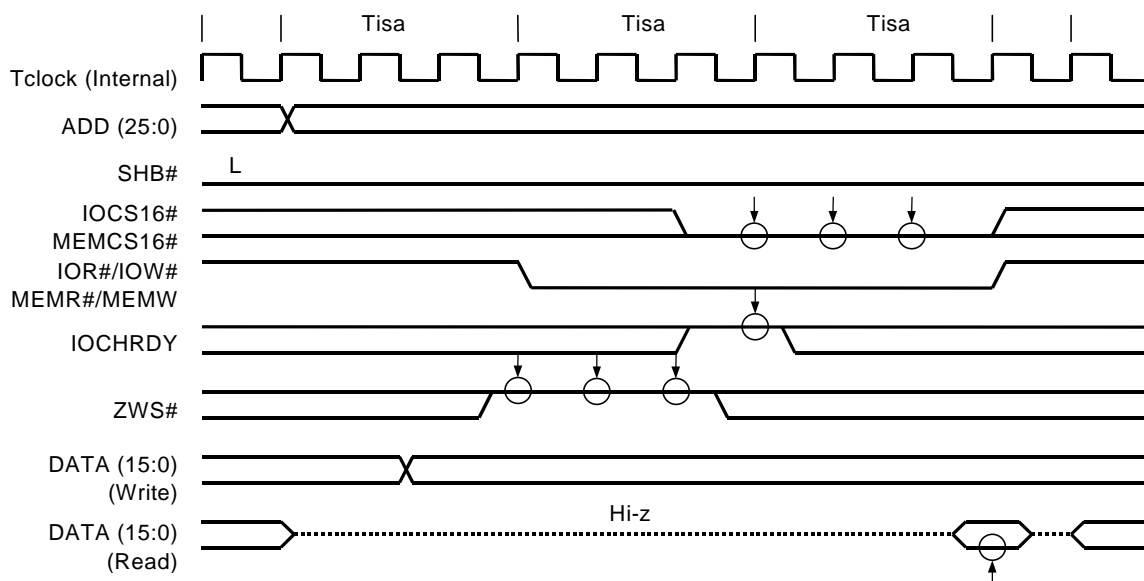

Figures 11-9 and 11-10 show timing charts for 1-byte access.

★ **Figure 11-9. 1-Byte Access to Odd Address Using 16-Bit Bus (WISAA[2:0] = 101)**

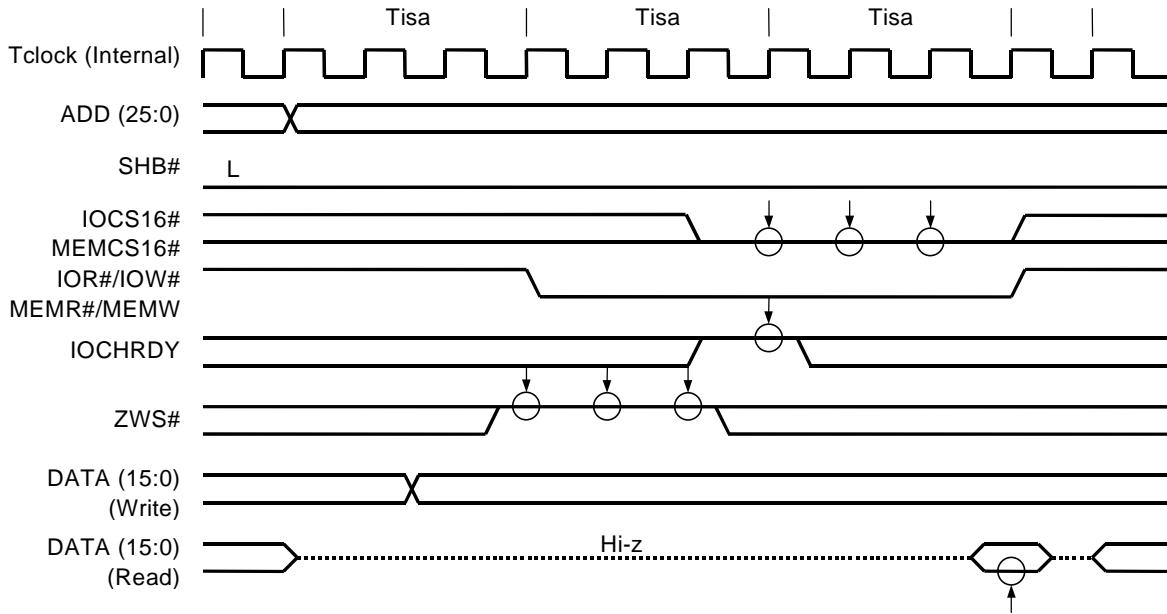

★ **Figure 11-10. 1-Byte Access to Odd Address Using 8-Bit Bus (WISAA[2:0] = 101)**

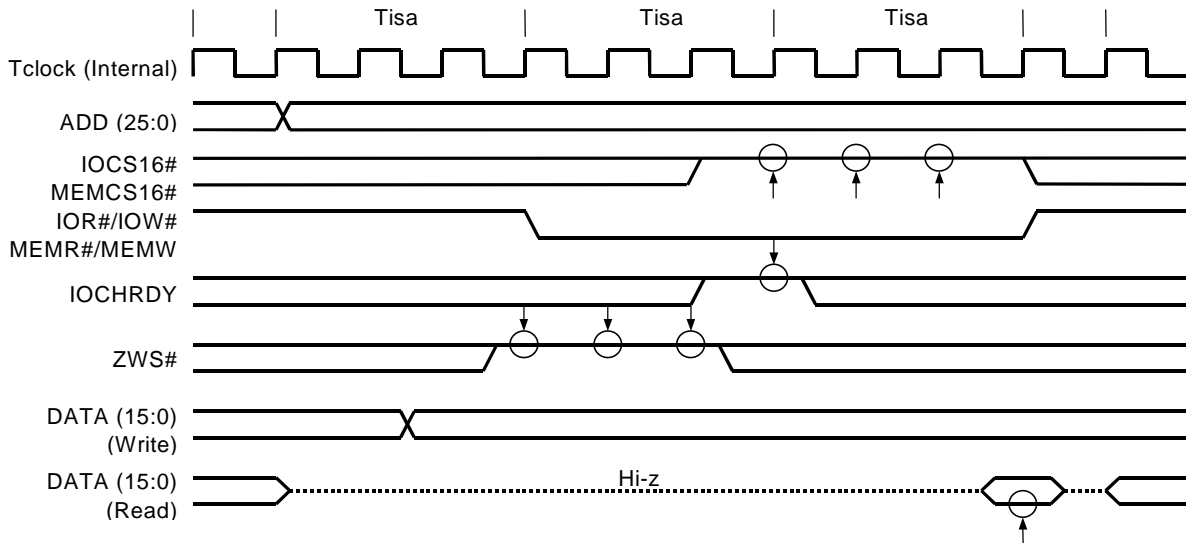

Figures 11-11 and 11-12 illustrate 2-byte access when sampling ZWS# at low level.

- ★ The bus cycle will end after waiting for at least 3 TClocks (1-Tisa cycle) after the ready signal is sampled using ZWS#.
- ★ The ZWS# signal is sampled at every rising edge of TClock in the second and later Tisa periods.
- ★ If high-level ZWS# is sampled, one more wait of 1-Tisa cycle is inserted.

★ **Caution** Be sure not to change the level of the ZWS# signal in 1-Tisa cycle.

★ **Figure 11-11. 2-Byte Access When Sampling ZWS# at Low Level Using 16-Bit Bus (WISAA[2:0] = 101)**

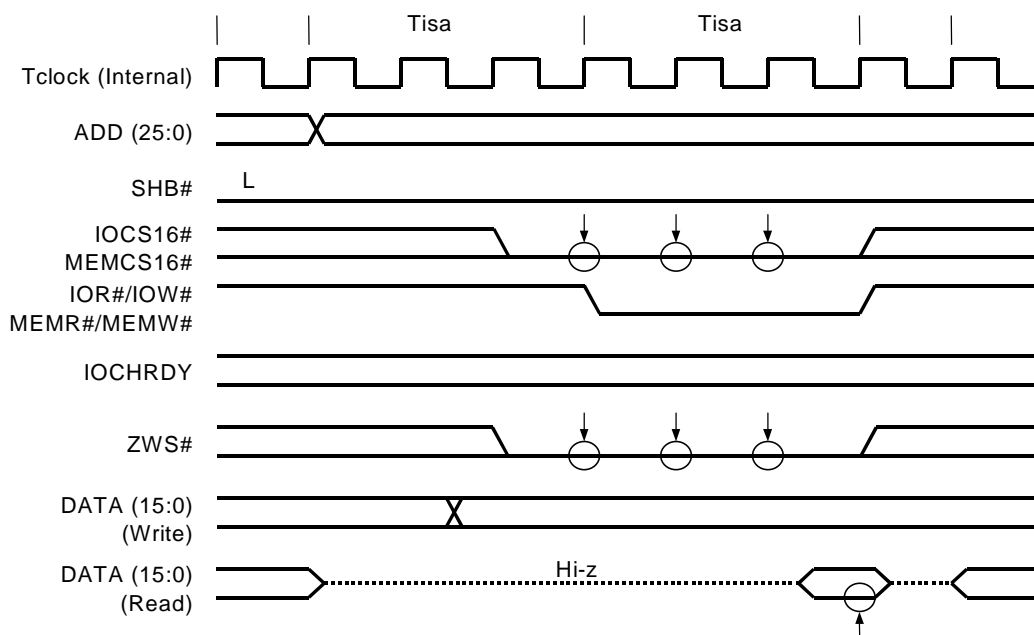

★ **Figure 11-12. 2-Byte Access When Sampling ZWS# at Low Level Using 8-Bit Bus (WISAA[2:0] = 101)**

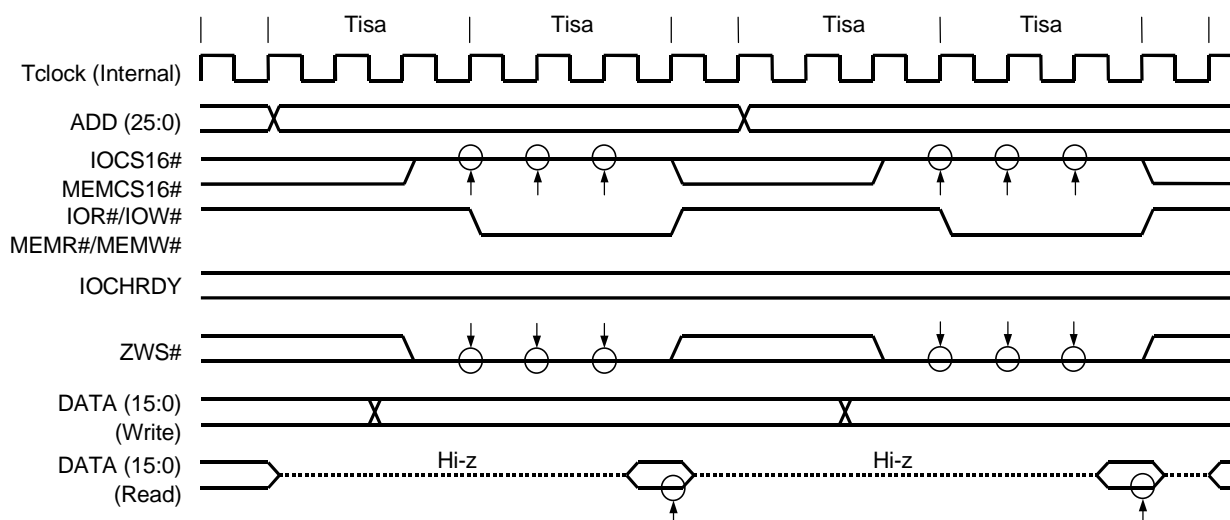

(3) Bus Operations in High-Speed System Bus

The space of physical address from 0x0A00 0000 to 0x0AFF FFFF can be used as the high-speed system bus memory space by setting the ISAM/LCD bit of BCUCNTREG1. WLCD/M [2:0] (BCUSPEEDREG [10:8]) can be used to set the access time for access to this space, as shown in the table below.

The operation of the high-speed system bus is the same as that of system bus in the ISA memory space or ISA I/O space, except for access time settings and LCDCS# signal activation.

Table 11-11. High-Speed System Bus Access Times

WLCD/W [2:0]	Tisa (TClock)
000	8
001	7
010	6
011	5
100	4
101	3
110	2
111	1

★ **Figure 11-13. 2-Byte Access Using 16-Bit Bus (WLCD/M[2:0] = 101)**

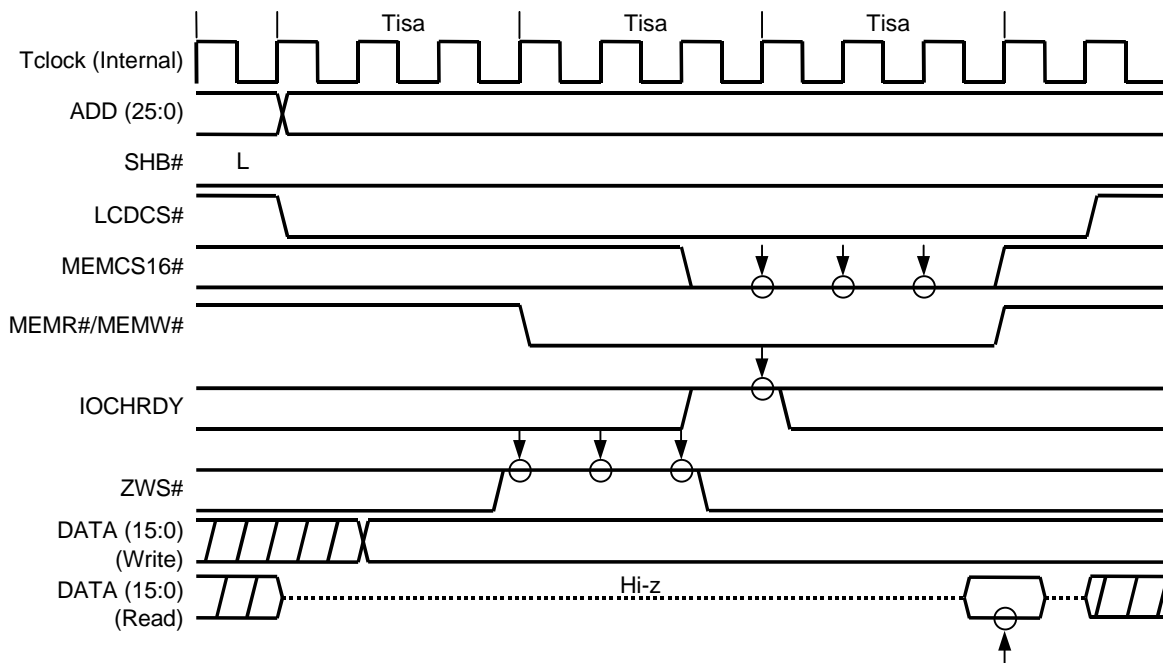

★ **Figure 11-14. 1-Byte Access Using 8-Bit Bus (WLCD/M[2:0] = 101)**

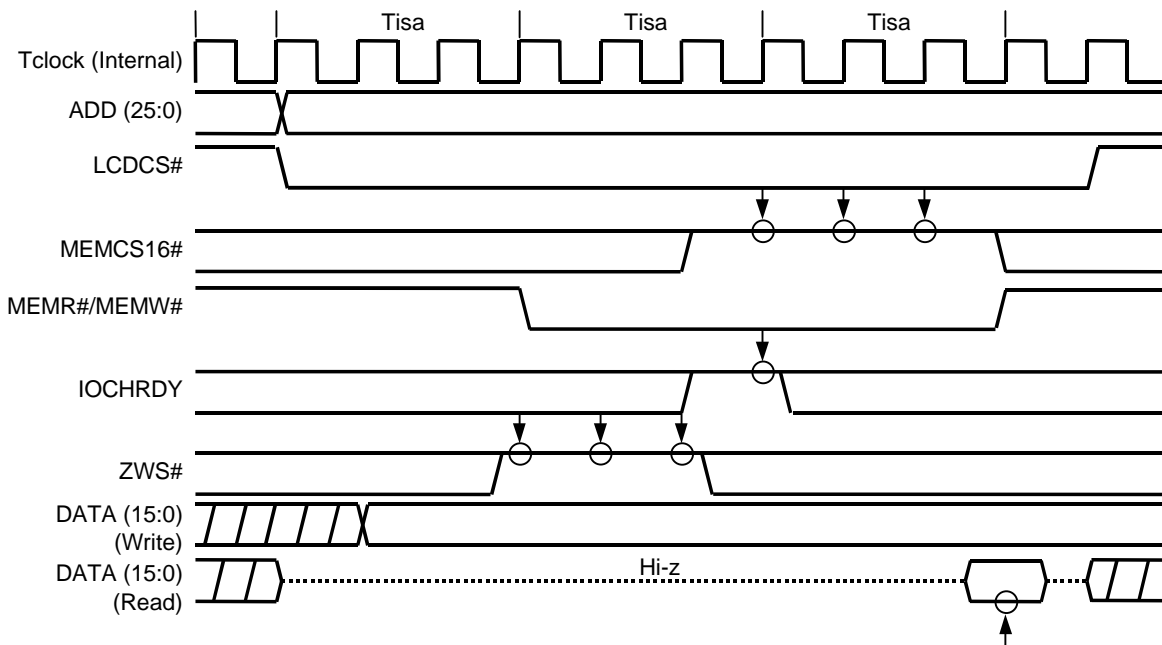

★

**Figure 11-15. 2-Byte Access When Sampling ZWS# at Low Level
Using 16-Bit Bus (WLCD/M[2:0] = 101)**

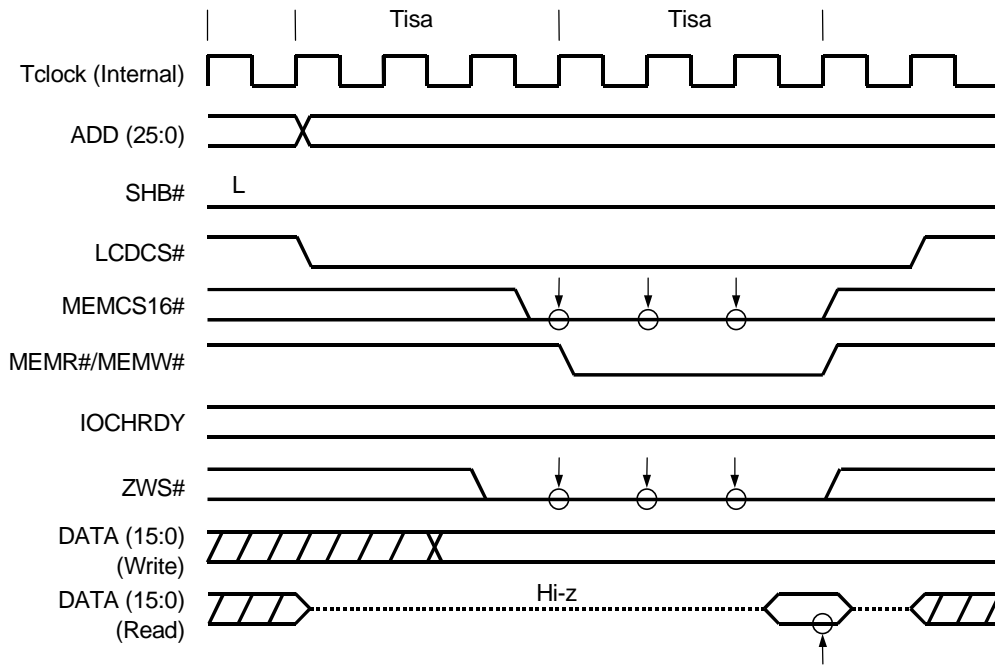

★

**Figure 11-16. 1-Byte Access When Sampling ZWS# at Low Level
Using 8-Bit Bus (WLCD/M[2:0] = 101)**

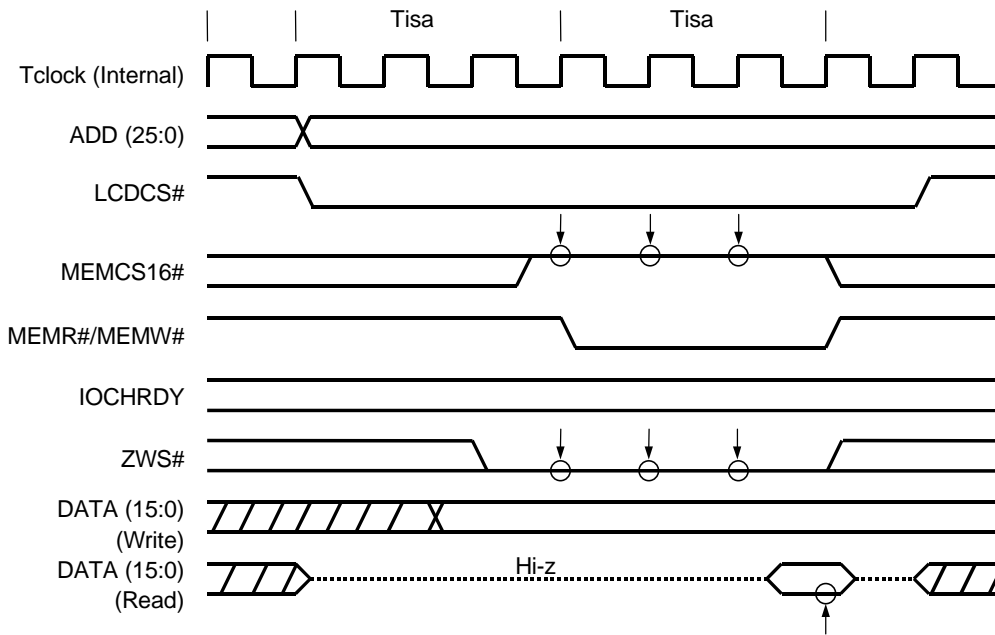

11.5.3 LCD Interface

The space of the physical address, from 0x0A00 0000 to 0x0AFF FFFF can be used as the LCD space by setting the ISM/LCD bit of the BCUCNTREG1 to 0. WLCD/M[2:0] (BCUSPEEDREG [10:8]) can be used to set the access time.

Table 11-12. Access Times for LCD Interface

WLCD/M [2:0]	Tlcd (TClock)
000	8
001	6
010	4
011	2
100 - 111	RFU

When the LCD interface is used in 16-bit bus width, SHB# and ADD0 are used to specify bytes. When the LCD interface is used in 32-bit bus width, UUCAS#, ULCAS#, UCAS#, and LCAS# are used to specify bytes.

★

Figure 11-17. 2-Byte Access to LCD Controller (WLCD/M[2:0] = 010)

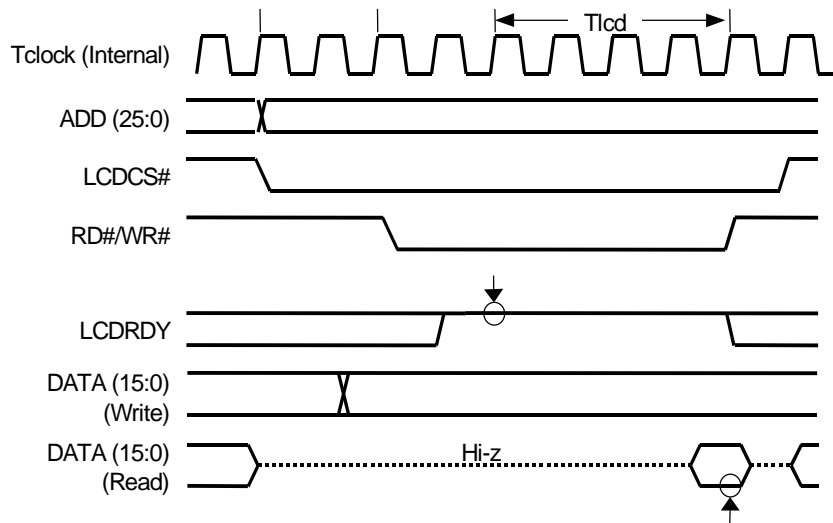

★

Figure 11-18. 2-Byte Access to LCD Controller (WLCD/M[2:0] = 011)

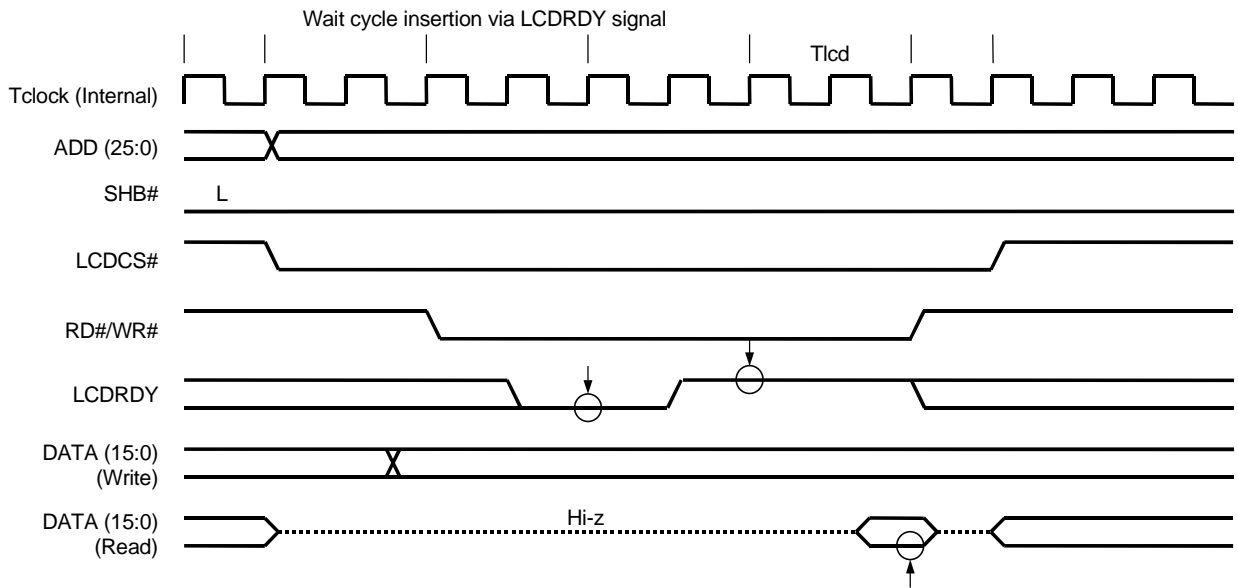

★

Figure 11-19. Access to LCD Controller When Data Bus Size Is 32 Bits

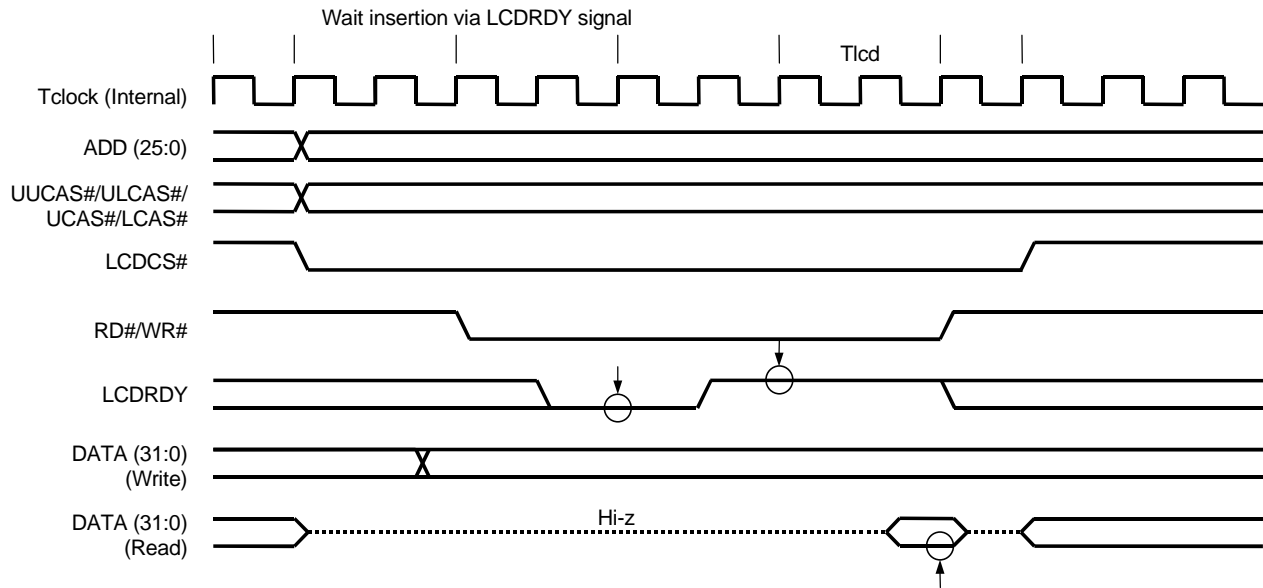

11.5.4 DRAM Access (EDO Type)

The access time is constant for DRAM.

Figure 11-20. 4-Byte Access to DRAM (16-Bit Mode)

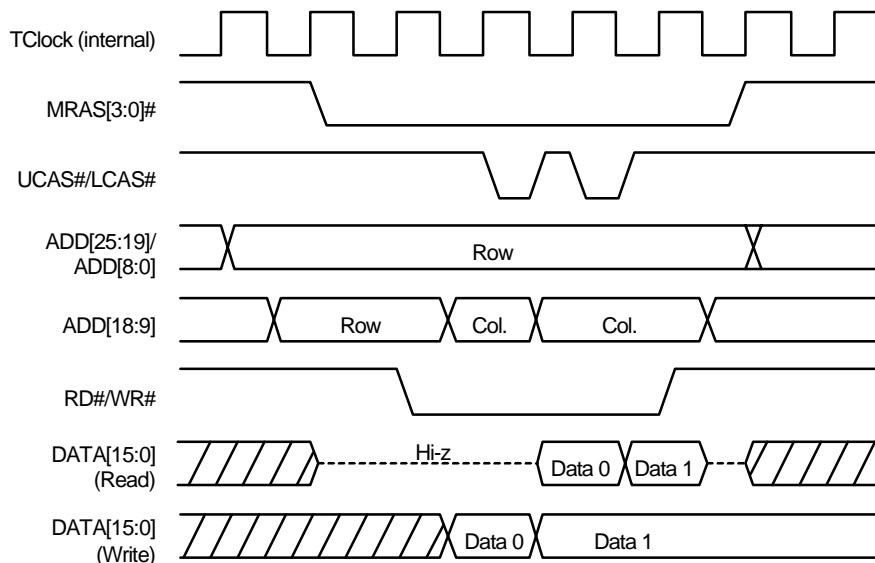

Figure 11-21. 8-Byte Access to DRAM (32-Bit Mode)

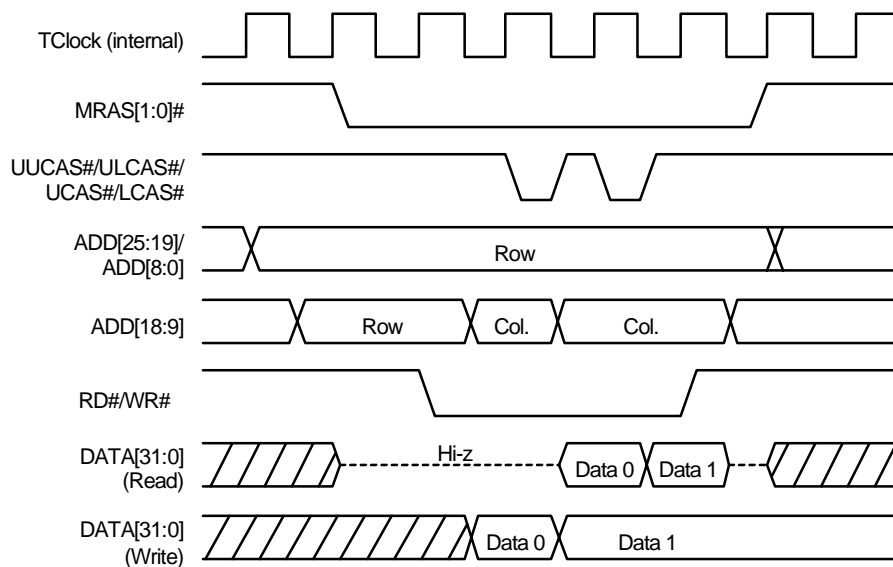

Figure 11-22. Byte Read of Odd Address in DRAM (16-Bit Mode)

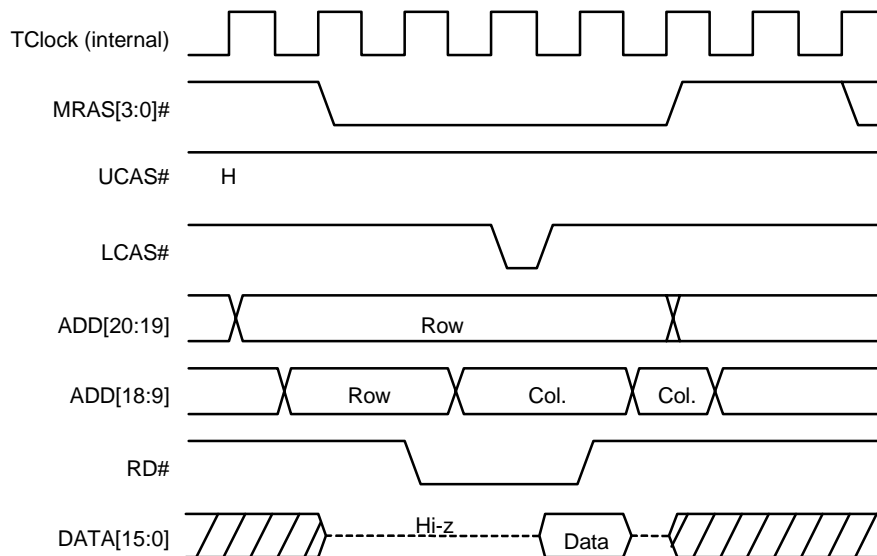

Figure 11-23. Byte Read of Even Address in DRAM (16-Bit Mode)

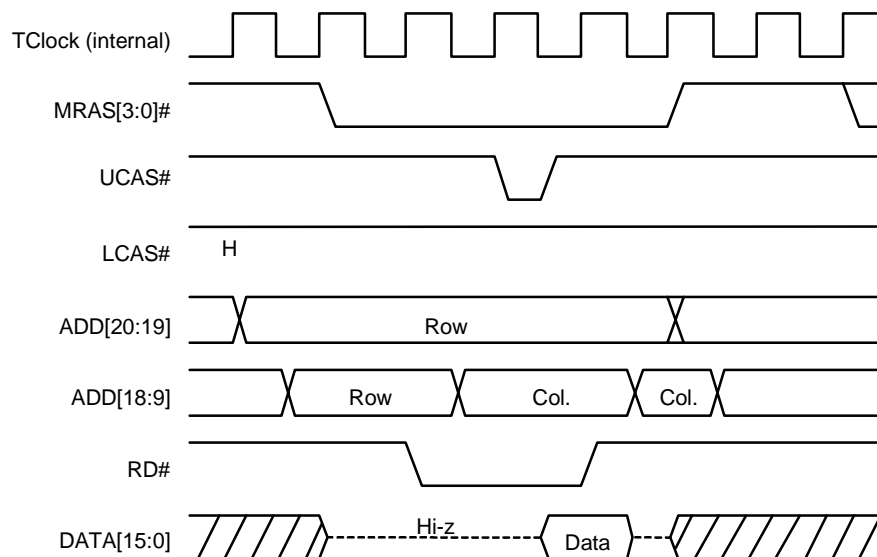

Figure 11-24. Byte Write to Odd Address in DRAM (16-Bit Mode)

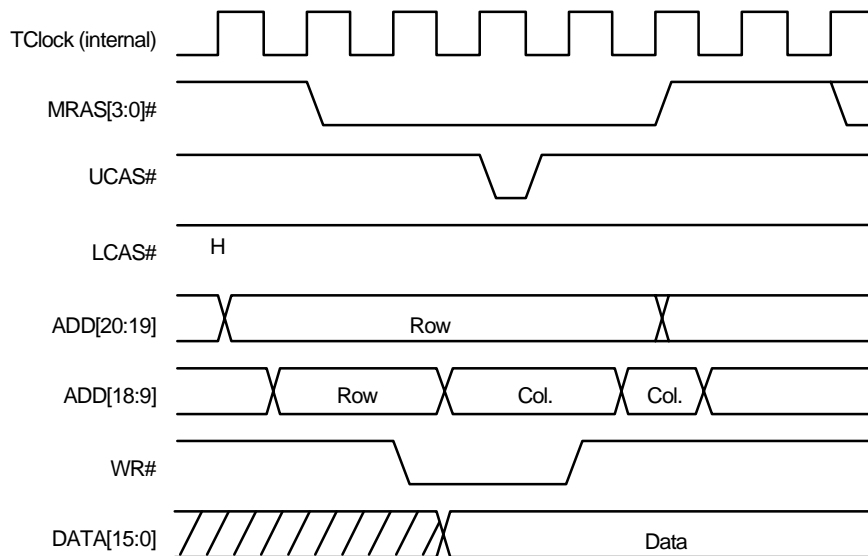

Figure 11-25. Byte Write to Even Address in DRAM (16-Bit Mode)

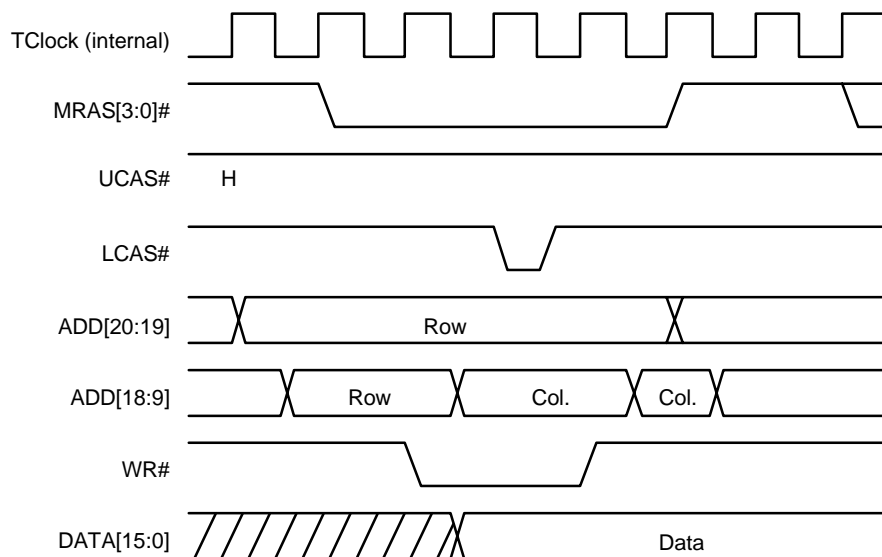
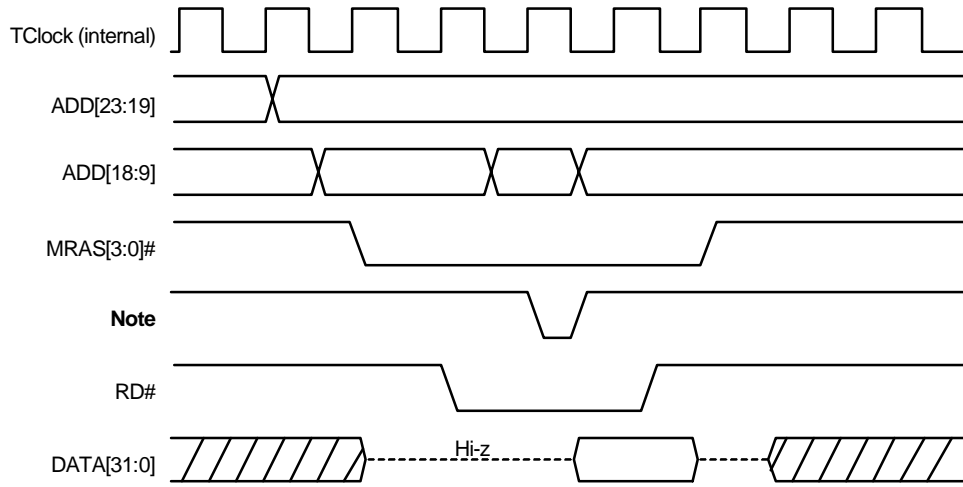
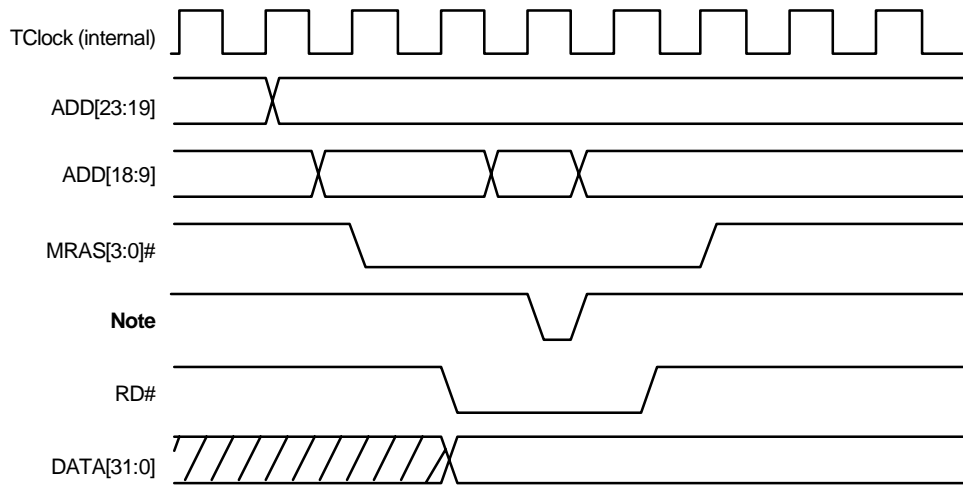

Figure 11-26. Read Cycle for DRAM (in 32-Bit Mode)



Note When accessing DATA[31:24]: UUCAS#
 When accessing DATA[23:16]: ULCAS#
 When accessing DATA[15:8]: UCAS#
 When accessing DATA[7:0]: LCAS#

Figure 11-27. Write Cycle for DRAM (in 32-Bit Mode)



Note When accessing DATA[31:24]: UUCAS#
 When accessing DATA[23:16]: ULCAS#
 When accessing DATA[15:8]: UCAS#
 When accessing DATA[7:0]: LCAS#

11.5.5 Refresh

The VR4111 supports CBR refresh and self refresh.

(1) CBR Refresh

Figure 11-28. CBR Refresh (16-Bit Mode)

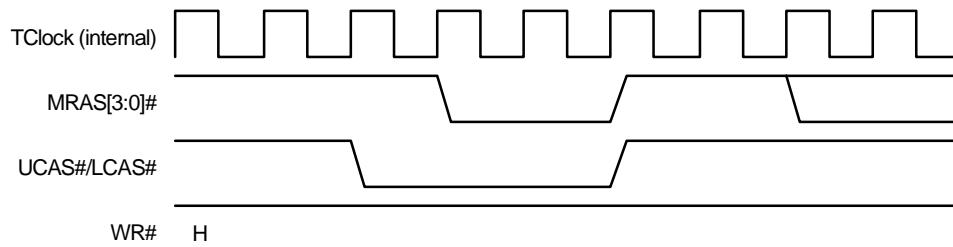

(2) Self Refresh

Figure 11-29. Self Refresh (16-Bit Mode)

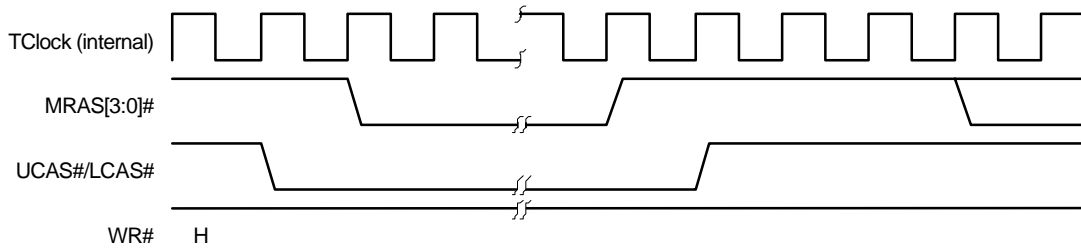

11.5.6 Bus Hold

If the external bus master wants to obtain the system bus mastership during the Full Speed/Standby/Suspend mode, it makes the HLD $\overline{RQ\#}$ signal active to start the bus hold function. Once it is allowed, the Vr4111 asserts the HLD $\overline{ACK\#}$ signal, makes system bus signals high-impedance state, then passes the bus mastership to the external bus master.

Note that the bus hold function is disabled during the Hibernate mode. Bus mastership requirement is not acknowledged in the Hibernate mode even the HLD $\overline{RQ\#}$ signal is asserted.

Figure 11-30. Bus Hold in Fullspeed Mode and Standby Mode

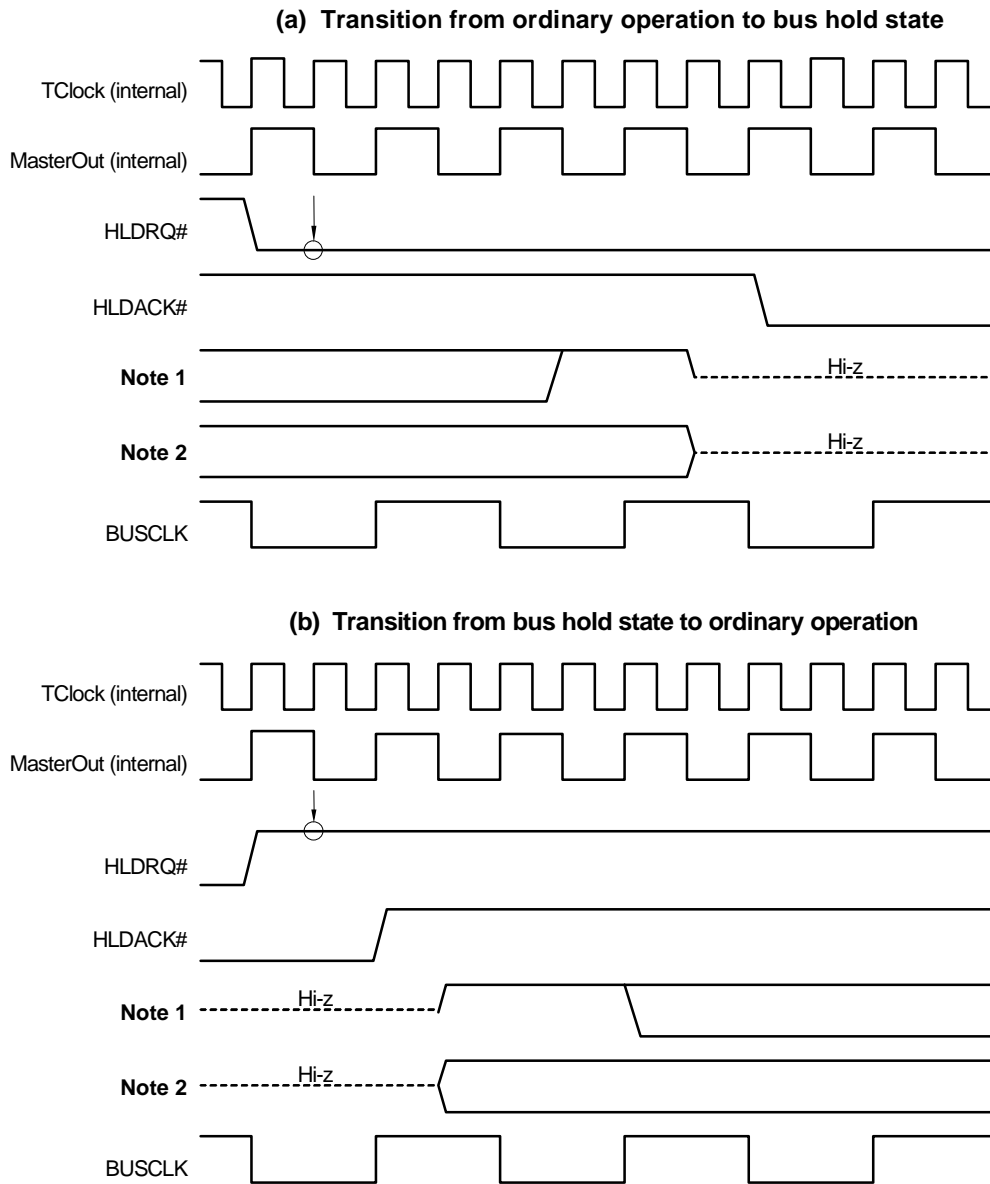

- Notes**
1. UUCAS#/MRAS[3]#, ULCAS#/MRAS[2]#, MRAS[1..0]#, UCAS#, LCAS#
 2. SHB#, IOR#, IOW#, MEMR#, MEMW#, RD#, WR#, ADD[25..0], DATA[15..0], DATA[31..16]/GPIO[31..16] (in 32-bit data bus mode)

Figure 11-31. Bus Hold in Suspend Mode

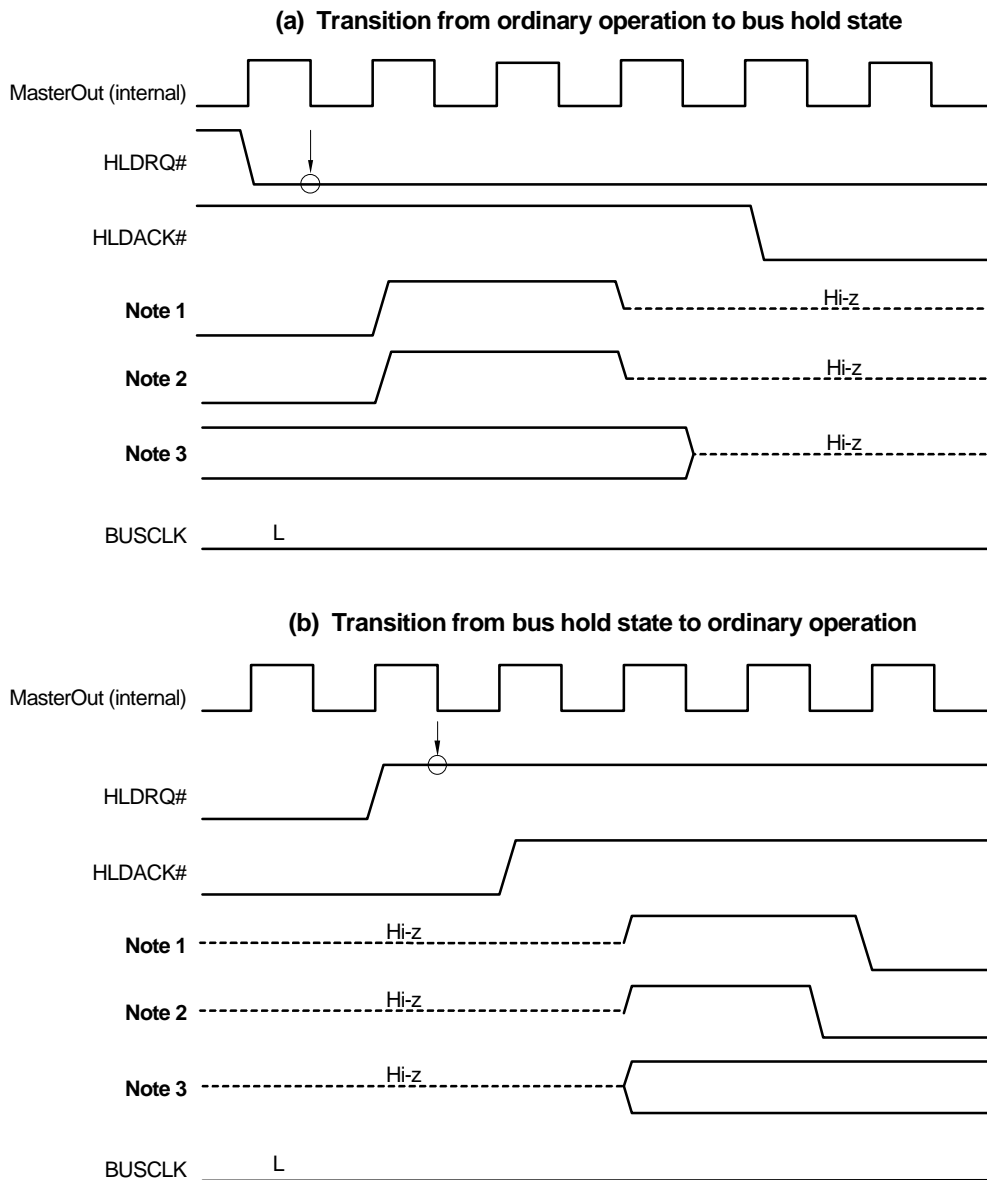

- Notes**
1. UUCAS#/MRAS[3]#, ULCAS#/MRAS[2]#, MRAS[1..0]# (in 16-bit data bus mode)
MRAS[1..0]# (in 32-bit data bus mode)
 2. UCAS#, LCAS# (in 16-bit data bus mode)
UUCAS#/MRAS#[3], ULCAS#/MRAS[2]#, UCAS#, LCAS# (in 32-bit data bus mode)
 3. SHB#, IOR#, IOW#, MEMR#, MEMW#, RD#, WR#, ADD[25..0], DATA[15..0],
DATA[31..16]/GPIO[31..16] (in 32-bit data bus mode)

CHAPTER 12 DMAAU (DMA ADDRESS UNIT)

This chapter describes the DMAAU register's operations and settings.

12.1 GENERAL

The DMAAU register controls the DMA addresses for the AIU and IrDA 4-Mbps communication module (FIR).

The DMA channel used for each unit can set a DMA start address as any half-word address in the physical address from 0x0000 0000 to 0x01FF FFFE, and is retained in DRAM as a 2-Kbyte block that starts at the address which is generated by masking the low-order 10 bits of the DMA start address.

Caution DMA operations are not guaranteed if an address overlaps with another DMA buffer.

After a DMA start address is set to the DMA base address register, the VR4111 performs DMA transfer using the registers of DMAAU as below.

(1) When the DMA start address is included in the first page of the DMA space

1. The VR4111 starts a DMA transfer after writing the start address to the DMA address register.
2. When the DMA transfer reaches the first page boundary, the VR4111 adds 1 Kbyte to the contents of the DMA base address register, writes the value to the DMA address register, and continues the DMA transfer.
3. When the DMA transfer reaches the second page boundary, the VR4111 writes the contents of the DMA base address register to the DMA address register and continues the DMA transfer.
4. The VR4111 repeats 2. and 3. until all the data is transferred.

(2) When the DMA start address is included in the second page of the DMA space

1. The VR4111 starts a DMA transfer after writing the start address to the DMA address register.
2. When the DMA transfer reaches the second page boundary, the VR4111 subtracts 1 Kbyte from the contents of the DMA base address register, writes the value to the DMA address register, and continues the DMA transfer.
3. When the DMA transfer reaches the first page boundary, the VR4111 writes the contents of the DMA base address register to the DMA address register and continues the DMA transfer.
4. The VR4111 repeats 2. and 3. until all the data is transferred.

Figure 12-1. DMA Space Used in DMA Transfers

(a) When the DMA start address is included in the first page of the DMA space

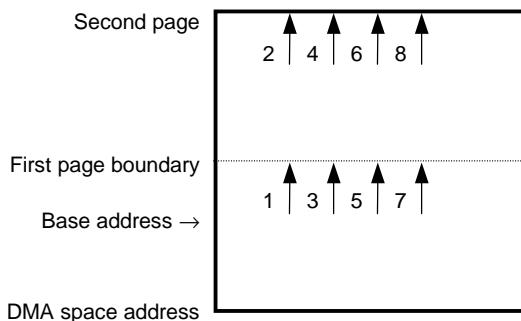

(b) When the DMA start address is included in the second page of the DMA space

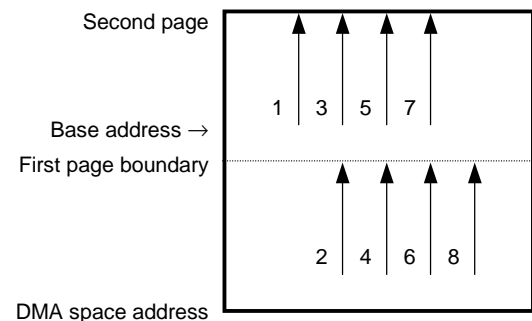

12.2 REGISTER SET

The DMAAU registers are listed below.

Table 12-1. DMAAU Registers

Address	R/W	Register Symbols	Function
0x0B00 0020	R/W	AIUIBALREG	AIU IN DMA Base Address Register Low
0x0B00 0022	R/W	AIUIBAHREG	AIU IN DMA Base Address Register High
0x0B00 0024	R/W	AIUIALREG	AIU IN DMA Address Register Low
0x0B00 0026	R/W	AIUIAHREG	AIU IN DMA Address Register High
0x0B00 0028	R/W	AIUOBALREG	AIU OUT DMA Base Address Register Low
0x0B00 002A	R/W	AIUOBHREG	AIU OUT DMA Base Address Register High
0x0B00 002C	R/W	AIUOALREG	AIU OUT DMA Address Register Low
0x0B00 002E	R/W	AIUOAHREG	AIU OUT DMA Address Register High
0x0B00 0030	R/W	FIRBALREG	FIR DMA Base Address Register Low
0x0B00 0032	R/W	FIRBAHREG	FIR DMA Base Address Register High
0x0B00 0034	R/W	FIRALREG	FIR DMA Address Register Low
0x0B00 0036	R/W	FIRAHREG	FIR DMA Address Register High

These registers are described in detail below.

12.2.1 AIU IN DMA Base Address Registers

(1) AIUIBALREG (0x0B00 0020)

Bit	D15	D14	D13	D12	D11	D10	D9	D8
Name	AIUIBA[15]	AIUIBA[14]	AIUIBA[13]	AIUIBA[12]	AIUIBA[11]	AIUIBA[10]	AIUIBA[9]	AIUIBA[8]
R/W	R/W	R/W	R/W	R/W	R/W	R/W	R/W	R/W
RTCRST	1	1	1	1	1	0	0	0
Other resets	1	1	1	1	1	0	0	0

Bit	D7	D6	D5	D4	D3	D2	D1	D0
Name	AIUIBA[7]	AIUIBA[6]	AIUIBA[5]	AIUIBA[4]	AIUIBA[3]	AIUIBA[2]	AIUIBA[1]	AIUIBA[0]
R/W	R/W	R/W	R/W	R/W	R/W	R/W	R/W	R
RTCRST	0	0	0	0	0	0	0	0
Other resets	0	0	0	0	0	0	0	0

Bit	Name	Function
D[15:1]	AIUIBA[15:1]	DMA base address [15:1] for AIU input
D[0]	AIUIBA[0]	DMA base address [0] for AIU input Write 0 to this bit. 0 is returned after a read.

(2) AIUIBAHREG (0x0B00 0022)

Bit	D15	D14	D13	D12	D11	D10	D9	D8
Name	AIUIBA[31]	AIUIBA[30]	AIUIBA[29]	AIUIBA[28]	AIUIBA[27]	AIUIBA[26]	AIUIBA[25]	AIUIBA[24]
R/W	R	R	R	R	R	R	R/W	R/W
RTCRST	0	0	0	0	0	0	0	1
Other resets	0	0	0	0	0	0	0	1

Bit	D7	D6	D5	D4	D3	D2	D1	D0
Name	AIUIBA[23]	AIUIBA[22]	AIUIBA[21]	AIUIBA[20]	AIUIBA[19]	AIUIBA[18]	AIUIBA[17]	AIUIBA[16]
R/W	R/W	R/W	R/W	R/W	R/W	R/W	R/W	R/W
RTCRST	1	1	1	1	1	1	1	1
Other resets	1	1	1	1	1	1	1	1

Bit	Name	Function
D[15:10]	AIUIBA[31:26]	DMA base address [31:26] for AIU input Write 0 to these bits. 0 is returned after a read.
D[9:0]	AIUIBA[25:16]	DMA base address [25:16] for AIU input

AIUIBALREG and AIUIBAHREG are used to set the base addresses for the DMA channel used for audio input (recording).

The addresses set to this register become DMA transfer start addresses.

The DMA channel used for audio input is retained in DRAM as a 2-Kbyte buffer that starts at the address which is generated by masking the low-order 10 bits of the DMA start address.

12.2.2 AIU IN DMA Address Registers

(1) AIUIALREG (0x0B00 0024)

Bit	D15	D14	D13	D12	D11	D10	D9	D8
Name	AIUIA[15]	AIUIA[14]	AIUIA[13]	AIUIA[12]	AIUIA[11]	AIUIA[10]	AIUIA[9]	AIUIA[8]
R/W	R/W	R/W	R/W	R/W	R/W	R/W	R/W	R/W
RTCRST	1	1	1	1	1	0	0	0
Other resets	1	1	1	1	1	0	0	0

Bit	D7	D6	D5	D4	D3	D2	D1	D0
Name	AIUIA[7]	AIUIA[6]	AIUIA[5]	AIUIA[4]	AIUIA[3]	AIUIA[2]	AIUIA[1]	AIUIA[0]
R/W	R/W	R/W	R/W	R/W	R/W	R/W	R/W	R/W
RTCRST	0	0	0	0	0	0	0	0
Other resets	0	0	0	0	0	0	0	0

Bit	Name	Function
D[15:0]	AIUIA[15:0]	Next DMA address [15:0] to be accessed for AIU input channel

(2) AIUIAHREG (0x0B00 0026)

Bit	D15	D14	D13	D12	D11	D10	D9	D8
Name	AIUIA[31]	AIUIA[30]	AIUIA[29]	AIUIA[28]	AIUIA[27]	AIUIA[26]	AIUIA[25]	AIUIA[24]
R/W	R	R	R	R	R	R	R/W	R/W
RTCRST	0	0	0	0	0	0	0	1
Other resets	0	0	0	0	0	0	0	1

Bit	D7	D6	D5	D4	D3	D2	D1	D0
Name	AIUIA[23]	AIUIA[22]	AIUIA[21]	AIUIA[20]	AIUIA[19]	AIUIA[18]	AIUIA[17]	AIUIA[16]
R/W	R/W	R/W	R/W	R/W	R/W	R/W	R/W	R/W
RTCRST	1	1	1	1	1	1	1	1
Other resets	1	1	1	1	1	1	1	1

Bit	Name	Function
D[15:0]	AIUIA[31:16]	Next DMA address [31:16] to be accessed for AIU input channel

12.2.3 AIU OUT DMA Base Address Registers

(1) AIUOBALREG (0x0B00 0028)

Bit	D15	D14	D13	D12	D11	D10	D9	D8
Name	AIUOBA[15]	AIUOBA[14]	AIUOBA[13]	AIUOBA[12]	AIUOBA[11]	AIUOBA[10]	AIUOBA[9]	AIUOBA[8]
R/W	R/W	R/W	R/W	R/W	R/W	R/W	R/W	R/W
RTCRST	1	1	1	1	1	0	0	0
Other resets	1	1	1	1	1	0	0	0

Bit	D7	D6	D5	D4	D3	D2	D1	D0
Name	AIUOBA[7]	AIUOBA[6]	AIUOBA[5]	AIUOBA[4]	AIUOBA[3]	AIUOBA[2]	AIUOBA[1]	AIUOBA[0]
R/W	R/W	R/W	R/W	R/W	R/W	R/W	R/W	R
RTCRST	0	0	0	0	0	0	0	0
Other resets	0	0	0	0	0	0	0	0

Bit	Name	Function
D[15:1]	AIUOBA[15:1]	DMA base address [15:1] for AIU output
D[0]	AIUOBA[0]	DMA base address [0] for AIU output Write 0 to this bit. 0 is returned after a read.

(2) AIUOBAREG (0x0B00 002A)

Bit	D15	D14	D13	D12	D11	D10	D9	D8
Name	AIUOBA[31]	AIUOBA[30]	AIUOBA[29]	AIUOBA[28]	AIUOBA[27]	AIUOBA[26]	AIUOBA[25]	AIUOBA[24]
R/W	R	R	R	R	R	R	R/W	R/W
RTCRST	0	0	0	0	0	0	0	1
Other resets	0	0	0	0	0	0	0	1

Bit	D7	D6	D5	D4	D3	D2	D1	D0
Name	AIUOBA[23]	AIUOBA[22]	AIUOBA[21]	AIUOBA[20]	AIUOBA[19]	AIUOBA[18]	AIUOBA[17]	AIUOBA[16]
R/W	R/W	R/W	R/W	R/W	R/W	R/W	R/W	R/W
RTCRST	1	1	1	1	1	1	1	1
Other resets	1	1	1	1	1	1	1	1

Bit	Name	Function
D[15:10]	AIUOBA[31:26]	DMA base address [31:26] for AIU output Write 0 to these bits. 0 is returned after a read.
D[9:0]	AIUOBA[25:16]	DMA base address [25:16] for AIU output

AIUOBALREG and AIUOBAREG are used to set the base addresses for the DMA channel used for audio output (playback).

The addresses set to this register become DMA transfer start addresses.

The DMA channel used for audio output is retained in DRAM as a 2-Kbyte buffer that starts at the address which is generated by masking the low-order 10 bits of the DMA start address.

12.2.4 AIU OUT DMA Address Registers

(1) AIUOALREG (0x0B00 002C)

Bit	D15	D14	D13	D12	D11	D10	D9	D8
Name	AIUOA[15]	AIUOA[14]	AIUOA[13]	AIUOA[12]	AIUOA[11]	AIUOA[10]	AIUOA[9]	AIUOA[8]
R/W	R/W	R/W	R/W	R/W	R/W	R/W	R/W	R/W
RTCRST	1	1	1	1	1	0	0	0
Other resets	1	1	1	1	1	0	0	0

Bit	D7	D6	D5	D4	D3	D2	D1	D0
Name	AIUOA[7]	AIUOA[6]	AIUOA[5]	AIUOA[4]	AIUOA[3]	AIUOA[2]	AIUOA[1]	AIUOA[0]
R/W	R/W	R/W	R/W	R/W	R/W	R/W	R/W	R/W
RTCRST	0	0	0	0	0	0	0	0
Other resets	0	0	0	0	0	0	0	0

Bit	Name	Function
D[15:0]	AIUOA[15:0]	Next DMA address [15:0] to be accessed for AIU output channel

(2) AIUOAHREG (0x0B00 002E)

Bit	D15	D14	D13	D12	D11	D10	D9	D8
Name	AIUOA[31]	AIUOA[30]	AIUOA[29]	AIUOA[28]	AIUOA[27]	AIUOA[26]	AIUOA[25]	AIUOA[24]
R/W	R	R	R	R	R	R	R/W	R/W
RTCRST	0	0	0	0	0	0	0	1
Other resets	0	0	0	0	0	0	0	1

Bit	D7	D6	D5	D4	D3	D2	D1	D0
Name	AIUOA[23]	AIUOA[22]	AIUOA[21]	AIUOA[20]	AIUOA[19]	AIUOA[18]	AIUOA[17]	AIUOA[16]
R/W	R/W	R/W	R/W	R/W	R/W	R/W	R/W	R/W
RTCRST	1	1	1	1	1	1	1	1
Other resets	1	1	1	1	1	1	1	1

Bit	Name	Function
D[15:0]	AIUOA[31:16]	Next DMA address [31:16] to be accessed for AIU output channel

12.2.5 FIR DMA Base Address Registers

(1) FIRBALREG (0x0B00 0030)

Bit	D15	D14	D13	D12	D11	D10	D9	D8
Name	FIRBA[15]	FIRBA[14]	FIRBA[13]	FIRBA[12]	FIRBA[11]	FIRBA[10]	FIRBA[9]	FIRBA[8]
R/W	R/W	R/W	R/W	R/W	R/W	R/W	R/W	R/W
RTCRST	1	1	1	1	1	0	0	0
Other resets	1	1	1	1	1	0	0	0

Bit	D7	D6	D5	D4	D3	D2	D1	D0
Name	FIRBA[7]	FIRBA[6]	FIRBA[5]	FIRBA[4]	FIRBA[3]	FIRBA[2]	FIRBA[1]	FIRBA[0]
R/W	R/W	R/W	R/W	R/W	R/W	R/W	R/W	R/W
RTCRST	0	0	0	0	0	0	0	0
Other resets	0	0	0	0	0	0	0	0

Bit	Name	Function
D[15:0]	FIRBA[15:0]	FIR DMA base address [15:0]

(2) FIRBAHREG (0x0B00 0032)

Bit	D15	D14	D13	D12	D11	D10	D9	D8
Name	FIRBA[31]	FIRBA[30]	FIRBA[29]	FIRBA[28]	FIRBA[27]	FIRBA[26]	FIRBA[25]	FIRBA[24]
R/W	R	R	R	R	R	R	R/W	R/W
RTCRST	0	0	0	0	0	0	0	1
Other resets	0	0	0	0	0	0	0	1

Bit	D7	D6	D5	D4	D3	D2	D1	D0
Name	FIRBA[23]	FIRBA[22]	FIRBA[21]	FIRBA[20]	FIRBA[19]	FIRBA[18]	FIRBA[17]	FIRBA[16]
R/W	R/W	R/W	R/W	R/W	R/W	R/W	R/W	R/W
RTCRST	1	1	1	1	1	1	1	1
Other resets	1	1	1	1	1	1	1	1

Bit	Name	Function
D[15:10]	FIRBA[31:26]	FIR DMA base address [31:26] Write 0 to these bits. 0 is returned after a read.
D[9:0]	FIRBA[25:16]	FIR DMA base address [25:16]

FIRBALREG and FIRBAHREG are used to set the base addresses for the FIR DMA channel.

The addresses set to this register become DMA transfer start addresses.

The FIR DMA channel is retained in DRAM as a 2-Kbyte buffer that starts at the address that is generated by masking the low-order 10 bits of the DMA start address.

12.2.6 FIR DMA Address Registers

(1) FIRALREG (0x0B00 0034)

Bit	D15	D14	D13	D12	D11	D10	D9	D8
Name	FIRA[15]	FIRA[14]	FIRA[13]	FIRA[12]	FIRA[11]	FIRA[10]	FIRA[9]	FIRA[8]
R/W	R/W	R/W	R/W	R/W	R/W	R/W	R/W	R/W
RTCRST	1	1	1	1	1	0	0	0
Other resets	1	1	1	1	1	0	0	0

Bit	D7	D6	D5	D4	D3	D2	D1	D0
Name	FIRA[7]	FIRA[6]	FIRA[5]	FIRA[4]	FIRA[3]	FIRA[2]	FIRA[1]	FIRA[0]
R/W	R/W	R/W	R/W	R/W	R/W	R/W	R/W	R/W
RTCRST	0	0	0	0	0	0	0	0
Other resets	0	0	0	0	0	0	0	0

Bit	Name	Function
D[15:0]	FIRA[15:0]	Next DMA address [15:0] to be accessed by FIR channel

(2) FIRAHREG (0x0B00 0036)

Bit	D15	D14	D13	D12	D11	D10	D9	D8
Name	FIRA[31]	FIRA[30]	FIRA[29]	FIRA[28]	FIRA[27]	FIRA[26]	FIRA[25]	FIRA[24]
R/W	R	R	R	R	R	R	R/W	R/W
RTCRST	0	0	0	0	0	0	0	1
Other resets	0	0	0	0	0	0	0	1

Bit	D7	D6	D5	D4	D3	D2	D1	D0
Name	FIRA[23]	FIRA[22]	FIRA[21]	FIRA[20]	FIRA[19]	FIRA[18]	FIRA[17]	FIRA[16]
R/W	R/W	R/W	R/W	R/W	R/W	R/W	R/W	R/W
RTCRST	1	1	1	1	1	1	1	1
Other resets	1	1	1	1	1	1	1	1

Bit	Name	Function
D[15:0]	FIRA[31:16]	Next DMA address [31:16] to be accessed by FIR channel

CHAPTER 13 DCU (DMA CONTROL UNIT)

This chapter describes the DCU register's operations and settings.

13.1 GENERAL

The DCU register is used for DMA control. Specifically, it controls acknowledgment from the BCU that handles bus arbitration and DMA requests from the on-chip peripheral I/O units (AIU and FIR). It also controls DMA enable/prohibit settings.

13.2 DMA PRIORITY CONTROL

When a conflict occurs between DMA requests sent from on-chip peripheral I/O units, the following priority levels are used to resolve the conflict. These priority levels cannot be changed.

Table 13-1. DMA Priority Levels

Priority level	Type of DMA operation
High	Audio input (recording)
↑	Audio output (playback)
Low	FIR transmission/reception

- ★ When a conflict occurs among a DMA request from on-chip peripheral I/O units, a DRAM refresh request, and a bus hold request, the processing is executed in the order of DRAM refresh, bus hold, and DMA. When a DRAM refresh request occurs during a DMA transfer, DRAM refresh is performed after one DMA transfer has been completed.

13.3 REGISTER SET

The DCU register set is described below.

Table 13-2. DCU Registers

Address	R/W	Register symbols	Function
0x0B00 0040	R/W	DMARSTREG	DMA Reset Register
0x0B00 0042	R	DMAIDLEREG	DMA Idle Register
0x0B00 0044	R/W	DMASENREG	DMA Sequencer Enable Register
0x0B00 0046	R/W	DMAMSKREG	DMA Mask Register
0x0B00 0048	R	DMAREQREG	DMA Request Register
0x0B00 004A	R/W	TDREG	Transfer Direction Register

These registers are described in detail below.

13.3.1 DMARSTREG (0x0B00 0040)

Bit	D15	D14	D13	D12	D11	D10	D9	D8
Name	Reserved	Reserved	Reserved	Reserved	Reserved	Reserved	Reserved	Reserved
R/W	R	R	R	R	R	R	R	R
RTCRST	0	0	0	0	0	0	0	0
Other resets	0	0	0	0	0	0	0	0

Bit	D7	D6	D5	D4	D3	D2	D1	D0
Name	Reserved	Reserved	Reserved	Reserved	Reserved	Reserved	Reserved	DMARST
R/W	R	R	R	R	R	R	R	R/W
RTCRST	0	0	0	0	0	0	0	0
Other resets	0	0	0	0	0	0	0	0

Bit	Name	Function
D[15..1]	Reserved	Write 0 to these bits. 0 is returned after a read.
D[0]	DMARST	Reset DMA controller 0 : Reset 1 : Normal

This register is used to reset the DMA controller.

13.3.2 DMAIDLEREG (0x0B00 0042)

Bit	D15	D14	D13	D12	D11	D10	D9	D8
Name	Reserved	Reserved	Reserved	Reserved	Reserved	Reserved	Reserved	Reserved
R/W	R	R	R	R	R	R	R	R
RTCRST	0	0	0	0	0	0	0	0
Other resets	0	0	0	0	0	0	0	0

Bit	D7	D6	D5	D4	D3	D2	D1	D0
Name	Reserved	Reserved	Reserved	Reserved	Reserved	Reserved	Reserved	DMAISTAT
R/W	R	R	R	R	R	R	R	R
RTCRST	0	0	0	0	0	0	0	0
Other resets	0	0	0	0	0	0	0	0

Bit	Name	Function
D[15..1]	Reserved	Write 0 to these bits. 0 is returned after a read.
D[0]	DMAISTAT	Display DMA sequencer status 1 : D_IDLE status 0 : DMA busy

This register is used to display the DMA sequencer status.

13.3.3 DMASENREG (0x0B00 0044)

Bit	D15	D14	D13	D12	D11	D10	D9	D8
Name	Reserved	Reserved	Reserved	Reserved	Reserved	Reserved	Reserved	Reserved
R/W	R	R	R	R	R	R	R	R
RTCRST	0	0	0	0	0	0	0	0
Other resets	0	0	0	0	0	0	0	0

Bit	D7	D6	D5	D4	D3	D2	D1	D0
Name	Reserved	Reserved	Reserved	Reserved	Reserved	Reserved	Reserved	DMASEN
R/W	R	R	R	R	R	R	R	R/W
RTCRST	0	0	0	0	0	0	0	0
Other resets	0	0	0	0	0	0	0	0

Bit	Name	Function
D[15..1]	Reserved	Write 0 to these bits. 0 is returned after a read.
D[0]	DMASEN	Enable DMA sequencer 1 : Enable 0 : Prohibit

This register is used to enable/prohibit the DMA sequencer.

13.3.4 DMAMSKREG (0x0B00 0046)

Bit	D15	D14	D13	D12	D11	D10	D9	D8
Name	Reserved	Reserved	Reserved	Reserved	Reserved	Reserved	Reserved	Reserved
R/W	R	R	R	R	R	R	R	R
RTCRST	0	0	0	0	0	0	0	0
Other resets	0	0	0	0	0	0	0	0

Bit	D7	D6	D5	D4	D3	D2	D1	D0
Name	Reserved	Reserved	Reserved	Reserved	DMAMSKAIN	DMAMSKAOUT	Reserved	DMAMSKFOUT
R/W	R	R	R	R	R/W	R/W	R	R/W
RTCRST	0	0	0	0	0	0	0	0
Other resets	0	0	0	0	0	0	0	0

Bit	Name	Function
D[15..4]	Reserved	Write 0 to these bits. 0 is returned after a read.
D[3]	DMAMSKAIN	Audio input DMA transfer enable/prohibit 1 : Enable 0 : Prohibit
D[2]	DMAMSKAOUT	Audio output DMA transfer enable/prohibit 1 : Enable 0 : Prohibit
D[1]	Reserved	Write 0 to this bit. 0 is returned after a read.
D[0]	DMAMSKFOUT	FIR transmission DMA transfer enable/prohibit 1 : Enable 0 : Prohibit

This register is used to enable/prohibit various types of DMA transfers.

The DMA transfer enable bits should be set when the units that receive DMA service have been stopped or when there are no pending DMA requests. If any of the above bits are set to a unit while a DMA request is pending for that unit, the CPU's operation will be undefined.

13.3.5 DMAREQREG (0x0B00 0048)

Bit	D15	D14	D13	D12	D11	D10	D9	D8
Name	Reserved	Reserved	Reserved	Reserved	Reserved	Reserved	Reserved	Reserved
R/W	R	R	R	R	R	R	R	R
RTCRST	0	0	0	0	0	0	0	0
Other resets	0	0	0	0	0	0	0	0

Bit	D7	D6	D5	D4	D3	D2	D1	D0
Name	Reserved	Reserved	Reserved	Reserved	DRQAIN	DRQAOUT	Reserved	DRQFOUT
R/W	R	R	R	R	R	R	R	R
RTCRST	0	0	0	0	0	0	0	0
Other resets	0	0	0	0	0	0	0	0

Bit	Name	Function
D[15..4]	Reserved	Write 0 to these bits. 0 is returned after a read.
D[3]	DRQAIN	Audio input DMA transfer request 1 : Request pending 0 : No request
D[2]	DRQAOUT	Audio output DMA transfer request 1 : Request pending 0 : No request
D[1]	Reserved	Write 0 to this bit. 0 is returned after a read.
D[0]	DRQFOUT	FIR transmission DMA transfer request 1 : Request pending 0 : No request

This register is used to indicate whether or not there are any DMA transfer requests.

13.3.6 TDREG (0x0B00 004A)

Bit	D15	D14	D13	D12	D11	D10	D9	D8
Name	Reserved	Reserved	Reserved	Reserved	Reserved	Reserved	Reserved	Reserved
R/W	R	R	R	R	R	R	R	R
RTCRST	0	0	0	0	0	0	0	0
Other resets	0	0	0	0	0	0	0	0

Bit	D7	D6	D5	D4	D3	D2	D1	D0
Name	Reserved	Reserved	Reserved	Reserved	Reserved	Reserved	Reserved	FIR
R/W	R	R	R	R	R	R	R	R/W
RTCRST	0	0	0	0	0	0	0	0
Other resets	0	0	0	0	0	0	0	0

Bit	Name	Function
D[15..1]	Reserved	Write 0 to these bits. 0 is returned after a read.
D[0]	FIR	Transfer direction of DMA channel for FIR transmission 1 : I/O → MEM 0 : MEM → I/O

This register is used to set the data transfer direction of DMA channel for FIR transmission.

[MEMO]

CHAPTER 14 CMU (CLOCK MASK UNIT)

This chapter describes the CMU register's operations and settings.

14.1 GENERAL

As various input clocks (ctclock, i_seclk, firclock) are supplied from the CPU to each unit, a masking method enables power consumption to be curtailed in units that are not used.

The units for which this masking method are used are the KIU, PIU, AIU, SIU, DSIU, FIR, and HSP (software modem interface) units.

The basic functions are described below.

1. Control of TClock supplied to PIU, AIU, SIU, KIU, DSIU, and FIR
2. Control of internal clock (18.432 MHz) supplied to SIU and HSP
3. Control of internal clock (48 MHz) supplied to FIR

The initial value is "0", which specifies masking all supplied clocks. No clock is supplied unless the CPU writes "1" to CMUCLKMSK register.

Figure 14-1. Block Diagram of CMU and Peripheral Blocks

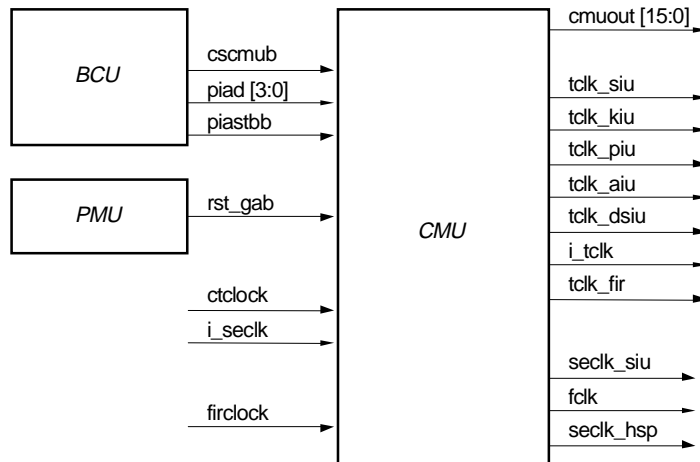

14.2 REGISTER SET

The CMU register is listed below.

Table 14-1. CMU Register

Address	R/W	Register symbol	Function
0x0B00 0060	R/W	CMUCLKMSK	CMU Clock Mask Register

This register is described in detail below.

14.2.1 CMUCLKMSK (0x0B00 0060)

Bit	D15	D14	D13	D12	D11	D10	D9	D8
Name	Reserved	Reserved	Reserved	Reserved	Reserved	MSKFFIR	MSKSHSP	MSKSSIU
R/W	R	R	R	R	R	R/W	R/W	R/W
RTCRST	0	0	0	0	0	0	0	0
Other resets	0	0	0	0	0	0	0	0

Bit	D7	D6	D5	D4	D3	D2	D1	D0
Name	Reserved	Reserved	MSKDSIU	MSKFIR	MSKKIU	MSKAIU	MSKSIU	MSKPIU
R/W	R	R	R/W	R/W	R/W	R/W	R/W	R/W
RTCRST	0	0	0	0	0	0	0	0
Other resets	0	0	0	0	0	0	0	0

Bit	Name	Function
D[15:11]	Reserved	Write 0 to these bits. 0 is returned after a read.
D[10]	MSKFFIR	Supply/mask 48-MHz clock to FIR unit 1 : Supply 0 : Mask
D[9]	MSKSHSP	Supply/mask 18.432-MHz clock to HSP unit 1 : Supply 0 : Mask
D[8]	MSKSSIU	Supply/mask 18.432-MHz clock to SIU unit 1 : Supply 0 : Mask
D[7:6]	Reserved	Write 0 to these bits. 0 is returned after a read.
D[5]	MSKDSIU	Supply/mask TClock to DSIU unit 1 : Supply 0 : Mask
D[4]	MSKFIR	Supply/mask TClock to FIR unit 1 : Supply 0 : Mask
D[3]	MSKKIU	Supply/mask TClock to KIU unit 1 : Supply 0 : Mask
D[2]	MSKAIU	Supply/mask TClock to AIU unit 1 : Supply 0 : Mask
D[1]	MSKSIU	Supply/mask TClock to SIU unit 1 : Supply 0 : Mask
D[0]	MSKPIU	Supply/mask TClock to PIU unit 1 : Supply 0 : Mask

This register is used to mask the clocks that are supplied to the KIU, PIU, AIU, SIU, DSIU, FIR, and HSP units.

CHAPTER 15 ICU (INTERRUPT CONTROL UNIT)

This chapter describes the ICU register's operations and settings.

15.1 GENERAL

The ICU collects interrupt requests from the various on-chip peripheral units and transfers these interrupt request signals (Int0, Int1, Int2, Int3, and NMI) to the CPU core.

The functions of the ICU's internal blocks are briefly described below.

- ADDECICU ... Decodes read/write addresses from the CPU that are used for ICU registers.
- REGICU ... This includes a register for interrupt masking. The initial value is "0", which specifies masking. No interrupt signal is supplied to CPU core unless the CPU writes "1" to this register.
- OUTICU ... This block collects interrupt requests after masking them, and generates an interrupt request signal to output to the CPU core.
During Suspend mode, it also controls the masking of interrupt requests, output of the int_all signal that is the general interrupt source signal, and the memdrv output timing signal that is used when returning from Suspend mode.

The signals used to notice interrupt request to the CPU are as below.

NMI : battint_intr only

Switching between NMI and Int0 is enabled according to this register's settings.

Because NMI's interrupt masking cannot be controlled by means of software, switch to Int0 to mask battint_intr.

Int3 : hsp_intr only

Int2 : rtc_long2_intr only

Int1 : rtc_long1_intr only

The IT (interval timer) and HSP interrupts require more responsiveness than do other interrupt sources.

Int0 : All other interrupts

For details of the interrupt sources, see **15.2 REGISTER SET**.

How an interrupt request is notified to the CPU core is shown below.

If an interrupt request occurs in the peripheral units, the corresponding bit in the interrupt indication register of Level 2 (xxxINTREG) is set to 1. The interrupt indication register is ANDed bit-wise with the corresponding interrupt mask register of Level 2 (MxxxINTREG). If the occurred interrupt request is enabled (set to 1) in the mask register, the interrupt request is notified to the interrupt indication register of Level 1 (SYSINTREG) and the corresponding bit is set to 1. At this time, the interrupt requests from the same register of Level 2 are notified to the SYSINTREG as a single interrupt request.

Interrupt requests from some units directly set their corresponding bits in the SYSINTREG.

The SYSINTREG is ANDed bit-wise with the interrupt mask register of Level 1 (MSYSINTREG). If the interrupt request is enabled by MSYSINTREG (set to 1), a corresponding interrupt request signal is output from the ICU to the CPU core. battint is connected to the NMI or Int0 signal of the CPU core (selected by setting of NMIREG). rtc_long signals are connected to the Int3 signal of the CPU core. The other interrupt requests are connected to the Int0 signal of the CPU core as a one interrupt request.

The following figure shows an outline of interrupt control in the ICU.

Figure 15-1. Interrupt Control Outline

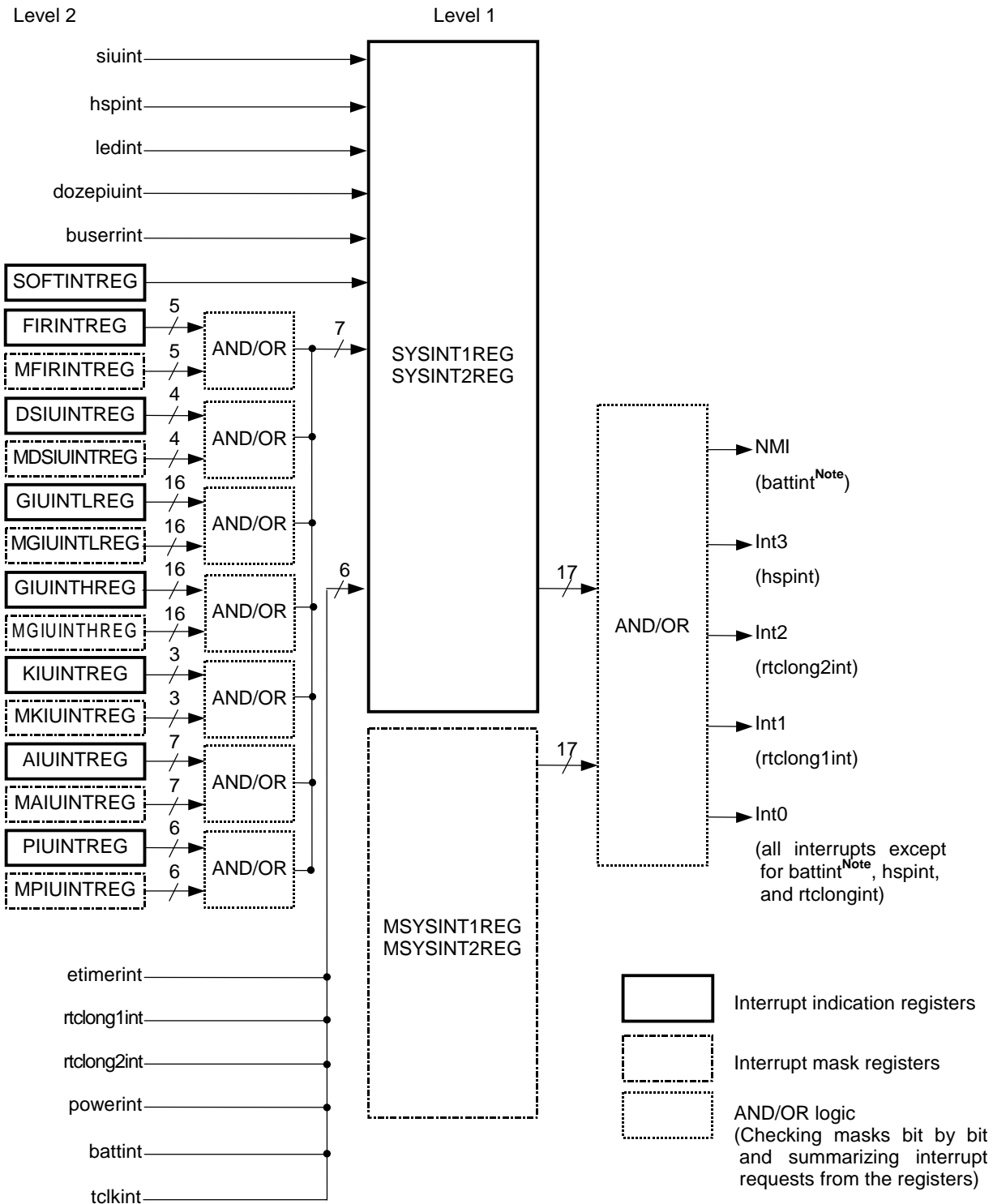

Note Which of NMI or Int0 is used for *battint* is selected by setting of *NMIREG*.

15.2 REGISTER SET

The ICU registers are listed below.

Table 15-1. ICU Registers

Address	R/W	Register symbols	Function
0x0B00 0080	R	SYSINT1REG	Level 1 System interrupt register 1
0x0B00 0082	R	PIUINTREG	Level 2 PIU interrupt register
0x0B00 0084	R	AIUINTREG	Level 2 AIU interrupt register
0x0B00 0086	R	KIUINTREG	Level 2 KIU interrupt register
0x0B00 0088	R	GIUINTLREG	Level 2 GIU interrupt register Low
0x0B00 008A	R	DSIUINTREG	Level 2 DSIU interrupt register
0x0B00 008C	R/W	MSYSINT1REG	Level 1 mask system interrupt register 1
0x0B00 008E	R/W	MPIUINTREG	Level 2 mask PIU interrupt register
0x0B00 0090	R/W	MAIUINTREG	Level 2 mask AIU interrupt register
0x0B00 0092	R/W	MKIUINTREG	Level 2 mask KIU interrupt register
0x0B00 0094	R/W	MGIUINTLREG	Level 2 mask GIU interrupt register Low
0x0B00 0096	R/W	MDSIUINTREG	Level 2 mask DSIU interrupt register
0x0B00 0098	R/W	NMIREG	NMI register
0x0B00 009A	R/W	SOFTINTREG	Software interrupt register
0x0B00 0200	R	SYSINT2REG	Level 1 System interrupt register 2
0x0B00 0202	R	GIUINTHREG	Level 2 GIU interrupt register High
0x0B00 0204	R	FIRINTREG	Level 2 FIR interrupt register
0x0B00 0206	R/W	MSYSINT2REG	Level 1 mask system interrupt register 2
0x0B00 0208	R/W	MGIUINTHREG	Level 2 mask GIU interrupt register High
0x0B00 020A	R/W	MFIRINTREG	Level 2 mask FIR interrupt register

These registers are described in detail below.

15.2.1 SYSINT1REG (0x0B00 0080)

(1/2)

Bit	D15	D14	D13	D12	D11	D10	D9	D8
Name	Reserved	Reserved	DOZE PIUINTR	Reserved	SOFTINTR	WRBER RINTR	SIUINTR	GIUINTR
R/W	R	R	R	R	R	R	R	R
RTCRST	0	0	0	0	0	0	0	0
Other resets	0	0	0	0	0	0	0	0

Bit	D7	D6	D5	D4	D3	D2	D1	D0
Name	KIUINTR	AIUINTR	PIUINTR	Reserved	ETIMER INTR	RTCL1INTR	POWER INTR	BATINTR
R/W	R	R	R	R	R	R	R	R
RTCRST	0	0	0	0	0	0	0	0
Other resets	0	0	0	0	0	0	0	0

Bit	Name	Function
D[15..14]	Reserved	Write 0 to these bits. 0 is returned after a read.
D[13]	DOZEPIUINTR	PIU interrupt during Suspend mode 1 : Occurred 0 : Normal
D[12]	Reserved	Write 0 to this bit. 0 is returned after a read.
D[11]	SOFTINTR	Software interrupt (occurs by setting the SOFTINTREG) 1 : Occurred 0 : Normal
D[10]	WRBERRINTR	Bus error interrupt 1 : Occurred 0 : Normal
D[9]	SIUINTR	SIU interrupt 1 : Occurred 0 : Normal
D[8]	GIUINTR	GIU interrupt 1 : Occurred 0 : Normal
D[7]	KIUINTR	KIU interrupt 1 : Occurred 0 : Normal
D[6]	AIUINTR	AIU interrupt 1 : Occurred 0 : Normal

Bit	Name	Function
D[5]	PIUINTR	PIU interrupt 1 : Occurred 0 : Normal
D[4]	Reserved	Write 0 to this bit. 0 is returned after a read.
D[3]	ETIMERINTR	ETIMER interrupt 1 : Occurred 0 : Normal
D[2]	RTCL1INTR	RTCLong1 interrupt 1 : Occurred 0 : Normal
D[1]	POWERINTR	PowerSW interrupt 1 : Occurred 0 : Normal
D[0]	BATINTR	Battery interrupt 1 : Occurred 0 : Normal

This register indicates when various interrupts occur in the VR4111 system.

15.2.2 PIUINTREG (0x0B00 0082)

Bit	D15	D14	D13	D12	D11	D10	D9	D8
Name	Reserved	Reserved	Reserved	Reserved	Reserved	Reserved	Reserved	Reserved
R/W	R	R	R	R	R	R	R	R
RTCRST	0	0	0	0	0	0	0	0
Other resets	0	0	0	0	0	0	0	0

Bit	D7	D6	D5	D4	D3	D2	D1	D0
Name	Reserved	PADCMD INTR	PADADP INTR	PADPAGE1 INTR	PADPAGE0 INTR	PADDLOST INTR	Reserved	PENCHG INTR
R/W	R	R	R	R	R	R	R	R
RTCRST	0	0	0	0	0	0	0	0
Other resets	0	0	0	0	0	0	0	0

Bit	Name	Function
D[15..7]	Reserved	Write 0 to these bits. 0 is returned after a read.
D[6]	PADCMDINTR	PIU command scan interrupt. This interrupt occurs when command scan found valid data. 1 : Occurred 0 : Normal
D[5]	PADADPINTR	PIU AD port scan interrupt. This interrupt occurs when AD port scan found a set of valid data. 1 : Occurred 0 : Normal
D[4]	PADPAGE1INTR	PIU data buffer page 1 interrupt. This interrupt occurs when a set of valid data is stored in page 1 of data buffer. 1 : Occurred 0 : Normal
D[3]	PADPAGE0INTR	PIU data buffer page 0 interrupt. This interrupt occurs when a set of valid data is stored in page 0 of data buffer. 1 : Occurred 0 : Normal
D[2]	PADDLOSTINTR	A/D data timeout interrupt. This interrupt occurs when a set of data did not found within specified time. 1 : Occurred 0 : Normal
D[1]	Reserved	Write 0 to this bit. 0 is returned after a read.
D[0]	PENCHGINTR	Touch panel contact status change interrupt 1: Change has occurred 0: No change

This register indicates when various PIU-related interrupts occur.

15.2.3 AIUINTREG (0x0B00 0084)

Bit	D15	D14	D13	D12	D11	D10	D9	D8
Name	Reserved	Reserved	Reserved	Reserved	INTMEND	INTM	INTMIDDLE	INTMST
R/W	R	R	R	R	R	R	R	R
RTCRST	0	0	0	0	0	0	0	0
Other resets	0	0	0	0	0	0	0	0

Bit	D7	D6	D5	D4	D3	D2	D1	D0
Name	Reserved	Reserved	Reserved	Reserved	INTSEND	INTS	INTSIDLE	Reserved
R/W	R	R	R	R	R	R	R	R
RTCRST	0	0	0	0	0	0	0	0
Other resets	0	0	0	0	0	0	0	0

Bit	Name	Function
D[15:12]	Reserved	Write 0 to these bits. 0 is returned after a read.
D[11]	INTMEND	Audio input (MIC) DMA buffer 2 page interrupt 1 : Occurred 0 : Normal
D[10]	INTM	Audio input (MIC) DMA buffer 1 page interrupt 1 : Occurred 0 : Normal
D[9]	INTMIDDLE	Audio input (MIC) idle interrupt (received data is lost). This interrupt occurs if valid data exists in MIDATREG when data was received from A/D converter. 1 : Occurred 0 : Normal
D[8]	INTMST	Audio input (MIC) receive completion interrupt. This interrupt occurs when 10-bit converted data was received from the A/D converter. 1 : Occurred 0 : Normal
D[7:4]	Reserved	Write 0 to these bits. 0 is returned after a read
D[3]	INTSEND	Audio output (speaker) DMA buffer 2 page interrupt 1 : Occurred 0 : Normal
D[2]	INTS	Audio output (speaker) DMA buffer 1 page interrupt 1 : Occurred 0 : Normal
D[1]	INTSIDLE	Audio output (speaker) idle interrupt (mute). This interrupt occurs if there is no valid data in SODATREG when data was transferred to D/A. 1 : Occurred 0 : Normal
D[0]	Reserved	Write 0 to this bit. 0 is returned after a read

This register indicates when various AIU-related interrupts occur.

15.2.4 KIUINTEG (0x0B00 0086)

Bit	D15	D14	D13	D12	D11	D10	D9	D8
Name	Reserved	Reserved	Reserved	Reserved	Reserved	Reserved	Reserved	Reserved
R/W	R	R	R	R	R	R	R	R
RTCRST	0	0	0	0	0	0	0	0
Other resets	0	0	0	0	0	0	0	0

Bit	D7	D6	D5	D4	D3	D2	D1	D0
Name	Reserved	Reserved	Reserved	Reserved	Reserved	KDATLOST	KDATRDY	SCANINT
R/W	R	R	R	R	R	R	R	R
RTCRST	0	0	0	0	0	0	0	0
Other resets	0	0	0	0	0	0	0	0

Bit	Name	Function
D[15..3]	Reserved	Write 0 to these bits. 0 is returned after a read.
D[2]	KDATLOST	Key scan data lost interrupt 1 : Occurred 0 : Normal
D[1]	KDATRDY	Key scan data complete interrupt 1 : Occurred 0 : Normal
D[0]	SCANINT	Key input detect interrupt 1 : Occurred 0 : Normal

This register indicates when various KIU-related interrupts occur.

15.2.5 GIUINTLREG (0x0B00 0088)

Bit	D15	D14	D13	D12	D11	D10	D9	D8
Name	INTS[15]	INTS[14]	INTS[13]	INTS[12]	INTS[11]	INTS[10]	INTS[9]	INTS[8]
R/W	R	R	R	R	R	R	R	R
RTCST	0	0	0	0	0	0	0	0
Other resets	0	0	0	0	0	0	0	0

Bit	D7	D6	D5	D4	D3	D2	D1	D0
Name	INTS[7]	INTS[6]	INTS[5]	INTS[4]	INTS[3]	INTS[2]	INTS[1]	INTS[0]
R/W	R	R	R	R	R	R	R	R
RTCST	0	0	0	0	0	0	0	0
Other resets	0	0	0	0	0	0	0	0

Bit	Name	Function
D[15..0]	INTS[15..0]	Interrupt to GPIO[15..0] pin 1 : Occurred 0 : Normal

This register indicates when various GIU-related interrupts occur.

15.2.6 DSIUINTREG (0x0B00 008A)

Bit	D15	D14	D13	D12	D11	D10	D9	D8
Name	Reserved	Reserved	Reserved	Reserved	INTDCTS	INTSER0	INTSR0	INTST0
R/W	R	R	R	R	R	R	R	R
RTCRST	0	0	0	0	0	0	0	0
Other resets	0	0	0	0	0	0	0	0

Bit	D7	D6	D5	D4	D3	D2	D1	D0
Name	Reserved	Reserved	Reserved	Reserved	Reserved	Reserved	Reserved	Reserved
R/W	R	R	R	R	R	R	R	R
RTCRST	0	0	0	0	0	0	0	1
Other resets	0	0	0	0	0	0	0	1

Bit	Name	Function
D[15..12]	Reserved	Write 0 to these bits. 0 is returned after a read.
D[11]	INTDCTS	DCTS# change interrupt 1 : Occurred 0 : Normal
D[10]	INTSER0	Debug serial receive error interrupt 1 : Occurred 0 : Normal
D[9]	INTSR0	Debug serial receive complete interrupt 1 : Occurred 0 : Normal
D[8]	INTST0	Debug serial transmit complete interrupt 1 : Occurred 0 : Normal
D[7..1]	Reserved	Write 0 to these bits. 0 is returned after a read.
D[0]	Reserved	Write 1 to this bit. 1 is returned after a read.

This register indicates when various DSIU-related interrupts occur.

15.2.7 MSYSINT1REG (0x0B00 008C)

(1/2)

Bit	D15	D14	D13	D12	D11	D10	D9	D8
Name	Reserved	Reserved	DOZE PIUINTR	Reserved	SOFTINTR	WRBERR INTR	SIUINTR	GIUINTR
R/W	R	R	R/W	R	R/W	R/W	R/W	R/W
RTCRST	0	0	0	0	0	0	0	0
Other resets	0	0	0	0	0	0	0	0

Bit	D7	D6	D5	D4	D3	D2	D1	D0
Name	KIUINTR	AIUINTR	PIUINTR	Reserved	ETIMER INTR	RTCL1INTR	POWER INTR	BATINTR
R/W	R/W	R/W	R/W	R	R/W	R/W	R/W	R/W
RTCRST	0	0	0	0	0	0	0	0
Other resets	0	0	0	0	0	0	0	0

Bit	Name	Function
D[15..14]	Reserved	Write 0 to these bits. 0 is returned after a read.
D[13]	DOZEPIUINTR	PIU interrupt enable during suspend mode 1 : Enable 0 : Prohibit
D[12]	Reserved	Write 0 to this bit. 0 is returned after a read.
D[11]	SOFTINTR	Software interrupt (occurs by setting the SOFTINTREG) enable 1 : Enable 0 : Prohibit
D[10]	WRBERRINTR	Bus error interrupt enable 1 : Enable 0 : Prohibit
D[9]	SIUINTR	SIU interrupt enable 1 : Enable 0 : Prohibit
D[8]	GIUINTR	GIU interrupt enable 1 : Enable 0 : Prohibit
D[7]	KIUINTR	KIU interrupt enable 1 : Enable 0 : Prohibit
D[6]	AIUINTR	AIU interrupt enable 1 : Enable 0 : Prohibit

(2/2)

Bit	Name	Function
D[5]	PIUINTR	PIU interrupt enable 1 : Enable 0 : Prohibit
D[4]	Reserved	Write 0 when writing. 0 is returned after a read.
D[3]	ETIMERINTR	ETIMER interrupt enable 1 : Enable 0 : Prohibit
D[2]	RTCL1INTR	RTCLong1 timer interrupt enable 1 : Enable 0 : Prohibit
D[1]	POWERINTR	PowerSW interrupt enable 1 : Enable 0 : Prohibit
D[0]	BATINTR	Battery interrupt enable 1 : Enable 0 : Prohibit

This register is used to mask various interrupts that occur in the VR4111 system.

15.2.8 MPIUINTREG (0x0B00 008E)

Bit	D15	D14	D13	D12	D11	D10	D9	D8
Name	Reserved	Reserved	Reserved	Reserved	Reserved	Reserved	Reserved	Reserved
R/W	R	R	R	R	R	R	R	R
RTCRST	0	0	0	0	0	0	0	0
Other resets	0	0	0	0	0	0	0	0

Bit	D7	D6	D5	D4	D3	D2	D1	D0
Name	Reserved	PADCMD INTR	PADADP INTR	PADPAGE1 INTR	PADPAGE0 INTR	PADDLOST INTR	Reserved	PENCHG INTR
R/W	R	R/W	R/W	R/W	R/W	R/W	R	R/W
RTCRST	0	0	0	0	0	0	0	0
Other resets	0	0	0	0	0	0	0	0

Bit	Name	Function
D[15..7]	Reserved	Write 0 to these bits. 0 is returned after a read.
D[6]	PADCMDINTR	PIU command scan interrupt enable 1 : Enable 0 : Prohibit
D[5]	PADADPINTR	PIU A/D port scan interrupt enable 1 : Enable 0 : Prohibit
D[4]	PADPAGE1INTR	PIU data buffer page 1 interrupt enable 1 : Enable 0 : Prohibit
D[3]	PADPAGE0INTR	PIU data buffer page 0 interrupt enable 1 : Enable 0 : Prohibit
D[2]	PADDLOSTINTR	A/D data timeout interrupt enable 1 : Enable 0 : Prohibit
D[1]	Reserved	Write 0 to this bit. 0 is returned after a read.
D[0]	PENCHGINTR	Touch panel contact status change interrupt enable 1 : Enable 0 : Prohibit

This register is used to mask various PIU-related interrupts.

15.2.9 MAIUINTREG (0x0B00 0090)

Bit	D15	D14	D13	D12	D11	D10	D9	D8
Name	Reserved	Reserved	Reserved	Reserved	INTMEND	INTM	INTMIDDLE	INTMST
R/W	R	R	R	R	R/W	R/W	R/W	R/W
RTCRST	0	0	0	0	0	0	0	0
Other resets	0	0	0	0	0	0	0	0

Bit	D7	D6	D5	D4	D3	D2	D1	D0
Name	Reserved	Reserved	Reserved	Reserved	INTSEND	INTS	INTSIDLE	Reserved
R/W	R	R	R	R	R/W	R/W	R/W	R
RTCRST	0	0	0	0	0	0	0	0
Other resets	0	0	0	0	0	0	0	0

Bit	Name	Function
D[15:12]	Reserved	Write 0 to these bits. 0 is returned after a read.
D[11]	INTMEND	Audio input (MIC) DMA buffer 2 page interrupt enable 1 : Enable 0 : Prohibit
D[10]	INTM	Audio input (MIC) DMA buffer 1 page interrupt enable 1 : Enable 0 : Prohibit
D[9]	INTMIDDLE	Audio input (MIC) idle interrupt (received data is lost) enable 1 : Enable 0 : Prohibit
D[8]	INTMST	Audio input (MIC) receive complete interrupt 1 : Enable 0 : Prohibit
D[7:4]	Reserved	Write 0 to these bits. 0 is returned after a read.
D[3]	INTSEND	Audio output (speaker) DMA buffer 2 page interrupt enable 1 : Enable 0 : Prohibit
D[2]	INTS	Audio output (speaker) DMA buffer 1 page interrupt enable 1 : Enable 0 : Prohibit
D[1]	INTSIDLE	Audio output (speaker) idle interrupt (mute) enable 1 : Enable 0 : Prohibit
D[0]	Reserved	Write 0 to this bit. 0 is returned after a read.

This register is used to mask various AIU-related interrupts.

15.2.10 MKIUINTREG (0x0B00 0092)

Bit	D15	D14	D13	D12	D11	D10	D9	D8
Name	Reserved	Reserved	Reserved	Reserved	Reserved	Reserved	Reserved	Reserved
R/W	R	R	R	R	R	R	R	R
RTCRST	0	0	0	0	0	0	0	0
Other resets	0	0	0	0	0	0	0	0

Bit	D7	D6	D5	D4	D3	D2	D1	D0
Name	Reserved	Reserved	Reserved	Reserved	Reserved	KDATLOST	KDATRDY	SCANINT
R/W	R	R	R	R	R	R/W	R/W	R/W
RTCRST	0	0	0	0	0	0	0	0
Other resets	0	0	0	0	0	0	0	0

Bit	Name	Function
D[15..3]	Reserved	Write 0 to these bits. 0 is returned after a read.
D[2]	KDATLOST	Key data scan lost interrupt enable 1 : Enable 0 : Prohibit
D[1]	KDATRDY	Key scan data complete interrupt enable 1 : Enable 0 : Prohibit
D[0]	SCANINT	Key input detect interrupt enable 1 : Enable 0 : Prohibit

This register is used to mask various KIU-related interrupts.

15.2.11 MGIUINTLREG (0x0B00 0094)

Bit	D15	D14	D13	D12	D11	D10	D9	D8
Name	INTS[15]	INTS[14]	INTS[13]	INTS[12]	INTS[11]	INTS[10]	INTS[9]	INTS[8]
R/W	R/W	R/W	R/W	R/W	R/W	R/W	R/W	R/W
RTCRST	0	0	0	0	0	0	0	0
Other resets	0	0	0	0	0	0	0	0

Bit	D7	D6	D5	D4	D3	D2	D1	D0
Name	INTS[7]	INTS[6]	INTS[5]	INTS[4]	INTS[3]	INTS[2]	INTS[1]	INTS[0]
R/W	R/W	R/W	R/W	R/W	R/W	R/W	R/W	R/W
RTCRST	0	0	0	0	0	0	0	0
Other resets	0	0	0	0	0	0	0	0

Bit	Name	Function
D[15..0]	INTS[15..0]	GPIO[15..0] pin interrupt enable 1 : Enable 0 : Prohibit

This register is used to mask various GIU-related interrupts.

15.2.12 MDSIUINTREG (0x0B00 0096)

Bit	D15	D14	D13	D12	D11	D10	D9	D8
Name	Reserved	Reserved	Reserved	Reserved	INTDCTS	INTSER0	INTSR0	INTST0
R/W	R	R	R	R	R/W	R/W	R/W	R/W
RTCRST	0	0	0	0	0	0	0	0
Other resets	0	0	0	0	0	0	0	0

Bit	D7	D6	D5	D4	D3	D2	D1	D0
Name	Reserved	Reserved	Reserved	Reserved	Reserved	Reserved	Reserved	Reserved
R/W	R	R	R	R	R	R	R	R
RTCRST	0	0	0	0	0	0	0	0
Other resets	0	0	0	0	0	0	0	0

Bit	Name	Function
D[15..12]	Reserved	Write 0 to these bits. 0 is returned after a read.
D[11]	INTDCTS	DCTS# change interrupt enable 1 : Enable 0 : Prohibit
D[10]	INTSER0	Debug serial data receive error interrupt enable 1 : Enable 0 : Prohibit
D[9]	INTSR0	Debug serial data receive complete interrupt enable 1 : Enable 0 : Prohibit
D[8]	INTST0	Debug serial data transmit complete interrupt enable 1 : Enable 0 : Prohibit
D[7..0]	Reserved	Write 0 to these bits. 0 is returned after a read.

This register is used to mask various DSIU-related interrupts.

15.2.13 NMIREG (0x0B00 0098)

Bit	D15	D14	D13	D12	D11	D10	D9	D8
Name	Reserved	Reserved	Reserved	Reserved	Reserved	Reserved	Reserved	Reserved
R/W	R	R	R	R	R	R	R	R
RTCRST	0	0	0	0	0	0	0	0
Other resets	0	0	0	0	0	0	0	0

Bit	D7	D6	D5	D4	D3	D2	D1	D0
Name	Reserved	Reserved	Reserved	Reserved	Reserved	Reserved	Reserved	NMIORINT
R/W	R	R	R	R	R	R	R	R/W
RTCRST	0	0	0	0	0	0	0	0
Other resets	0	0	0	0	0	0	0	0

Bit	Name	Function
D[15..1]	Reserved	Write 0 to these bits. 0 is returned after a read.
D[0]	NMIORINT	Low battery detect interrupt type setting 1 : Int0 0 : NMI

This register is used to set the type of interrupt used to notify the Vr4110 CPU core when a low battery detect interrupt has occurred.

15.2.14 SOFTINTREG (0x0B00 009A)

Bit	D15	D14	D13	D12	D11	D10	D9	D8
Name	Reserved	Reserved	Reserved	Reserved	Reserved	Reserved	Reserved	Reserved
R/W	R	R	R	R	R	R	R	R
RTCRST	0	0	0	0	0	0	0	0
Other resets	0	0	0	0	0	0	0	0

Bit	D7	D6	D5	D4	D3	D2	D1	D0
Name	Reserved	Reserved	Reserved	Reserved	SOFTINTR[3]	SOFTINTR[2]	SOFTINTR[1]	SOFTINTR[0]
R/W	R	R	R	R	R/W	R/W	R/W	R/W
RTCRST	0	0	0	0	0	0	0	0
Other resets	0	0	0	0	0	0	0	0

Bit	Name	Function
D[15..4]	Reserved	Write 0 to these bits. 0 is returned after a read.
D[3..0]	SOFTINTR[3..0]	Set/clear software interrupt 1 : Set 0 : Clear

This register is used to set software interrupts. Each bit can be set separately, and can cause four types of interrupts.

15.2.15 SYSINT2REG (0x0B00 0200)

Bit	D15	D14	D13	D12	D11	D10	D9	D8
Name	Reserved	Reserved	Reserved	Reserved	Reserved	Reserved	Reserved	Reserved
R/W	R	R	R	R	R	R	R	R
RTCRST	0	0	0	0	0	0	0	0
Other resets	0	0	0	0	0	0	0	0

Bit	D7	D6	D5	D4	D3	D2	D1	D0
Name	Reserved	Reserved	DSIUINTR	FIRINTR	TCLKINTR	HSPINTR	LEDINTR	RTCL2INTR
R/W	R	R	R	R	R	R	R	R
RTCRST	0	0	0	0	0	0	0	0
Other resets	0	0	0	0	0	0	0	0

Bit	Name	Function
D[15..6]	Reserved	Write 0 to these bits. 0 is returned after a read.
D[5]	DSIUINTR	DSIU interrupt 1 : Occurred 0 : Normal
D[4]	FIRINTR	FIR interrupt 1 : Occurred 0 : Normal
D[3]	TCLKINTR	TClock counter interrupt 1 : Occurred 0 : Normal
D[2]	HSPINTR	HSP interrupt 1 : Occurred 0 : Normal
D[1]	LEDINTR	LED interrupt 1 : Occurred 0 : Normal
D[0]	RTCL2INTR	RTCLong2 timer interrupt 1 : Occurred 0 : Normal

This register indicates when various interrupts occur in the VR4111 system.

15.2.16 GIUINTHREG (0x0B00 0202)

Bit	D15	D14	D13	D12	D11	D10	D9	D8
Name	INTS[31]	INTS[30]	INTS[29]	INTS[28]	INTS[27]	INTS[26]	INTS[25]	INTS[24]
R/W	R	R	R	R	R	R	R	R
RTCST	0	0	0	0	0	0	0	0
Other resets	0	0	0	0	0	0	0	0

Bit	D7	D6	D5	D4	D3	D2	D1	D0
Name	INTS[23]	INTS[22]	INTS[21]	INTS[20]	INTS[19]	INTS[18]	INTS[17]	INTS[16]
R/W	R	R	R	R	R	R	R	R
RTCST	0	0	0	0	0	0	0	0
Other resets	0	0	0	0	0	0	0	0

Bit	Name	Function
D[15..0]	INTS[31..16]	GPIO[31..16] pin interrupt 1 : Occurred 0 : Normal

This register indicates when various GIU-related interrupts occur.

15.2.17 FIRINTREG (0x0B00 0204)

Bit	D15	D14	D13	D12	D11	D10	D9	D8
Name	Reserved	Reserved	Reserved	Reserved	Reserved	Reserved	Reserved	Reserved
R/W	R	R	R	R	R	R	R	R
RTCRST	0	0	0	0	0	0	0	0
Other resets	0	0	0	0	0	0	0	0

Bit	D7	D6	D5	D4	D3	D2	D1	D0
Name	Reserved	Reserved	Reserved	FIRINT	FDPINT[4]	FDPINT[3]	FDPINT[2]	FDPINT[1]
R/W	R	R	R	R	R	R	R	R
RTCRST	0	0	0	0	0	0	0	0
Other resets	0	0	0	0	0	0	0	0

Bit	Name	Function
D[15..5]	Reserved	Write 0 to these bits. 0 is returned after a read.
D[4]	FIRINT	Interrupt from FIR unit 1 : Occurred 0 : Normal
D[3]	FDPINT[4]	FIR DMA buffer (receive side) 2 page interrupt 1 : Occurred 0 : Normal
D[2]	FDPINT[3]	FIR DMA buffer (transmit side) 2 page interrupt 1 : Occurred 0 : Normal
D[1]	FDPINT[2]	FIR DMA buffer (receive side) 1 page interrupt 1 : Occurred 0 : Normal
D[0]	FDPINT[1]	FIR DMA buffer (transmit side) 1 page interrupt 1 : Occurred 0 : Normal

This register indicates when various FIR-related interrupts occur.

When FDPINT[4] or FDPINT[3] is set to 1, the VR4111 stops the DMA requests. When FDPINT[2] or FDPINT[1] is set to 1 during the FDPCNT bit of the DPCNTR register (0x0C00 0044) is set to 1 (DMA buffer 1 page interrupt is enabled), the VR4111 stops the DMA requests.

15.2.18 MSYSINT2REG (0x0B00 0206)

Bit	D15	D14	D13	D12	D11	D10	D9	D8
Name	Reserved	Reserved	Reserved	Reserved	Reserved	Reserved	Reserved	Reserved
R/W	R	R	R	R	R	R	R	R
RTCRST	0	0	0	0	0	0	0	0
Other resets	0	0	0	0	0	0	0	0

Bit	D7	D6	D5	D4	D3	D2	D1	D0
Name	Reserved	Reserved	DSIUINTR	FIRINTR	TCLKINTR	HSPINTR	LEDINTR	RTCL2INTR
R/W	R	R	R/W	R/W	R/W	R/W	R/W	R/W
RTCRST	0	0	0	0	0	0	0	0
Other resets	0	0	0	0	0	0	0	0

Bit	Name	Function
D[15..6]	Reserved	Write 0 to these bits. 0 is returned after a read.
D[5]	DSIUINTR	DSIU interrupt enable 1 : Enable 0 : Prohibit
D[4]	FIRINTR	FIR interrupt enable 1 : Enable 0 : Prohibit
D[3]	TCLKINTR	TClock counter interrupt enable 1 : Enable 0 : Prohibit
D[2]	HSPINTR	HSP interrupt enable 1 : Enable 0 : Prohibit
D[1]	LEDINTR	LED interrupt enable 1 : Enable 0 : Prohibit
D[0]	RTCL2INTR	RTCLong2 timer interrupt enable 1 : Enable 0 : Prohibit

This register is used to mask various interrupts in the VR4111 system.

15.2.19 MGIUINTHREG (0x0B00 0208)

Bit	D15	D14	D13	D12	D11	D10	D9	D8
Name	INTS[31]	INTS[30]	INTS[29]	INTS[28]	INTS[27]	INTS[26]	INTS[25]	INTS[24]
R/W	R/W	R/W	R/W	R/W	R/W	R/W	R/W	R/W
RTCRST	0	0	0	0	0	0	0	0
Other resets	0	0	0	0	0	0	0	0

Bit	D7	D6	D5	D4	D3	D2	D1	D0
Name	INTS[23]	INTS[22]	INTS[21]	INTS[20]	INTS[19]	INTS[18]	INTS[17]	INTS[16]
R/W	R/W	R/W	R/W	R/W	R/W	R/W	R/W	R/W
RTCRST	0	0	0	0	0	0	0	0
Other resets	0	0	0	0	0	0	0	0

Bit	Name	Function
D[15..0]	INTS[31..16]	Enable GPIO[31..16] pin interrupt 1 : Enable 0 : Prohibit

This register is used to mask various GIU-related interrupts.

15.2.20 MFIRINTREG (0x0B00 020A)

Bit	D15	D14	D13	D12	D11	D10	D9	D8
Name	Reserved	Reserved	Reserved	Reserved	Reserved	Reserved	Reserved	Reserved
R/W	R	R	R	R	R	R	R	R
RTCRST	0	0	0	0	0	0	0	0
Other resets	0	0	0	0	0	0	0	0

Bit	D7	D6	D5	D4	D3	D2	D1	D0
Name	Reserved	Reserved	Reserved	FIRINT	FDPINT[4]	FDPINT[3]	FDPINT[2]	FDPINT[1]
R/W	R	R	R	R/W	R/W	R/W	R/W	R/W
RTCRST	0	0	0	0	0	0	0	0
Other resets	0	0	0	0	0	0	0	0

Bit	Name	Function
D[15..5]	Reserved	Write 0 to these bits. 0 is returned after a read.
D4	FIRINT	FIR unit interrupt enable 1 : Enable 0 : Prohibit
D[3]	FDPINT[4]	FIR DMA buffer 2 page interrupt (receive side) enable 1 : Enable 0 : Prohibit
D[2]	FDPINT[3]	FIR DMA buffer 2 page interrupt (transmit side) enable 1 : Enable 0 : Prohibit
D[1]	FDPINT[2]	FIR DMA buffer 1 page interrupt (receive side) enable 1 : Enable 0 : Prohibit
D[0]	FDPINT[1]	FIR DMA buffer 1 page interrupt (transmit side) enable 1 : Enable 0 : Prohibit

This register is used to mask various FIR-related interrupts.

15.3 NOTES FOR REGISTER SETTING

There is no register setting flow in relation to the ICU.

With regard to the interrupt mask registers, the initial setting is “initial = 0= mask” after start up. Therefore, enough masks must be cleared to provide sufficient interrupts for the CPU’s start-up processing. This is always necessary when `battint_intr = NMI`.

The initial setting for `battint_intr` is “initial = 0 = NMI”. A “1” must be written to the register to switch this setting to `Int0`.

`soft_intr` is a software interrupt request that is output to `Int0` by setting 1 to the `SOFTINTREG` register. Writing a “0” clears the interrupt.

[MEMO]

CHAPTER 16 PMU (POWER MANAGEMENT UNIT)

This chapter describes the PMU's operation and register settings.

16.1 GENERAL

The PMU performs power management within the VR4111 and controls the power supply throughout the system which includes the VR4111.

- Reset control
- Shutdown control
- Power-on control
- Low-power consumption mode control

The PMU also performs settings to use the GPIO[12:9] and GPIO[3:0] signals as a startup factor.

16.1.1 Reset Control

The operations of the RTC, peripheral units, CPU core, and PMUINTREG bit settings during a reset are listed below.

Table 16-1. Bit Operations During Reset

Reset type	RTC	Peripheral units	CPU core	PMUINTREG
RTC reset	Reset	Reset	Cold reset	RTCRST=1
RSTSW reset	Active	Reset	Cold reset	RSTSW=1

(1) RTC Reset

When the RTCRST# signal is asserted, the PMU asserts the rtrcstb and rst_gab signals (internal) and resets all peripheral units including the RTC unit. It also asserts the ccoldresetb and creset signals (internal) and resets the CPU core.

In addition, the RTCRST bit in PMUINTREG is set (to "1"). After the CPU is restarted, the RTCRST bit must be checked and cleared (to "0") by means of software.

For details of the timing of RTC reset, refer to **8.1.1 RTC Reset**.

(2) RSTSW Reset

When the RSTSW# signal is asserted, the PMU asserts the rst_gab signal (internal) and resets all peripheral units except for RTC and PMU. Next, it asserts the ccoldresetb and creset signals (internal) and resets the CPU core.

In addition, the RSTSW bit in PMUINTREG is set (to "1"). After the CPU is restarted, the RSTSW bit must be checked and cleared (to "0") by means of software.

For details of the timing of RSTSW reset, refer to **8.1.2 RSTSW**.

16.1.2 Shutdown Control

The operations of the RTC, peripheral units, CPU core, and PMUINTREG bit settings during a reset are listed below.

Table 16-2. Bit Operations During Shutdown

Shutdown type	RTC	Peripheral units	CPU core	PMUINTREG
HALTimer shutdown	Active	Reset	Cold reset	HALTIMERRST=1
Deadman's SW shutdown	Active	Reset	Cold reset	TIMOUTRST=1
Hibernate shutdown	Active	Reset	Cold reset	-
BATTINH shutdown	Active	Reset	Cold reset	BATTINH = 1

(1) HAL Timer Shutdown

After the CPU is activated (following the mode change from Shutdown or Hibernate mode to Fullspeed mode), the software must write "1" to PMUCNTREG's HALTIMERRST bit within about four seconds to clear the HAL timer.

If the HAL timer is not cleared within about four seconds after the CPU is activated, the PMU asserts the rst_gab signal (internal) and resets all peripheral units except for RTC and PMU. Next, it asserts the ccoldresetb and creset signals (internal) and resets the CPU core.

In addition, the TIMOUTRST bit in PMUINTREG is set (to "1"). After the CPU is restarted, the TIMOUTRST bit must be checked and cleared (to "0") by means of software.

For details of the timing of HALTimer shutdown, refer to **8.1.5 HALTimer Shutdown**.

(2) Deadman's SW Shutdown

When the Deadman's SW function is enabled, the software must write "1" to DSUCLRREG's DSWCLR bit each specified time, to clear the Deadman's SW counter (for details, see Chapter 18).

If the Deadman's SW counter is not cleared within a specified time, the PMU asserts the rst_gab signal (internal) and resets all peripheral units except for RTC and PMU. Next, it asserts the ccoldresetb and creset signals (internal) and resets the CPU core.

In addition, the DMSRST bit in PMUINTREG is set (to "1"). After the CPU is restarted, the DMSRST bit must be checked and cleared (to "0") by means of software.

For details of the timing of Deadman's SW shutdown, refer to **8.1.3 Deadman's SW**.

(3) Hibernate Shutdown

When the HIBERNATE instruction is executed, the PMU checks for currently pending interrupts. If there are no pending interrupts, it asserts the cclockstopen (internal) signal to stop the CPU clock. It then asserts the rst_gab signal (internal) and resets all peripheral units except for RTC and PMU.

The PMU register contents do not change.

For details of the timing of software shutdown, refer to **8.1.4 Software Shutdown**.

(4) BATTINH Shutdown

If the BATTINH/BATTINT# signal is low when the CPU is going to be activated, PMU stops CPU activation, asserts the rst_gab signal (internal), and resets all peripheral units except for RTC and PMU. Next, it asserts the coldresetb and creset signals (internal) and resets the CPU core.

In addition, the TIMOUTRST bit in PMUINTREG is set (to “1”). After the CPU is restarted, the TIMOUTRST bit must be checked and cleared (to “0”) by means of software.

For details of the timing of BATTINH shutdown, see **16.1.3 Power-on Control** below.

16.1.3 Power-on Control

The causes of CPU activation (mode change from shutdown mode or Hibernate mode to Fullspeed mode) are called startup factors. There are twelve startup factors: a power switch interrupt (POWER), eight types of GPIO activation interrupts (GPIO[12..9], [3..0]), a DCD interrupt (DCD#), a touch panel interrupt, and an alarm interrupt.

Battery low detection (BATTINH/BATTINT# pin check) is a factor that prevents CPU activation.

The period (power-on wait time), in which the POWERON pin is active at power-on, can be specified by using PMUWAITREG. After RTCRST, by which the CPU is initialized, the period is 343.75 ms. Power-on wait time can be specified when activation is caused by sources other than RTCRST.

- ★ During CPU activation, supplying voltage to the 2.5-V power-supply systems (VDD2, VDDP, VDDPD) can be stopped to reduce the leak current. This means that these power supplies become 0 V while the MPOWER pin is inactive. The following operation will not be affected by supplying voltage of 2.3 V or more to these power supplies within the period from when the MPOWER pin becomes active to when PLL starts oscillation.

Caution When the CPU moves to the Hibernate mode by executing the Hibernate instruction, if an activation factor occurs simultaneously, the CPU may be activated without asserting the POWERON signal after the MPOWER signal is once deasserted. Moreover, if RSTSW, which is not an activation factor from the Hibernate mode, is asserted at the same time as the activation factor occurs, the CPU may be activated without asserting the POWERON signal after the MPOWER signal is deasserted once.

(1) Activation via Power Switch Interrupt

When the POWER signal is asserted, the PMU asserts the POWERON signal and provides external notification that the CPU is being activated. After asserting the POWERON signal, the PMU checks the BATTINH/BATTINT# signal and then de-asserts the POWERON signal.

If the BATTINH/BATTINT# signal is high (“1”), the PMU cancels peripheral unit reset, then starts the Cold Reset sequence to activate the CPU core.

If the BATTINH/BATTINT# signal is low (“0”), the PMU sets “1” to PMUINTREG’s BATTINH bit and then performs another shutdown. After the CPU is restarted, the BATTINH bit must be checked and cleared (to “0”) by means of software.

Activation via power switch interrupt never sets PMUINTREG’s POWERSWINTR bit (to 1).

Figure 16-1. Activation via Power Switch Interrupt (BATTINH/BATTINT# = 1)

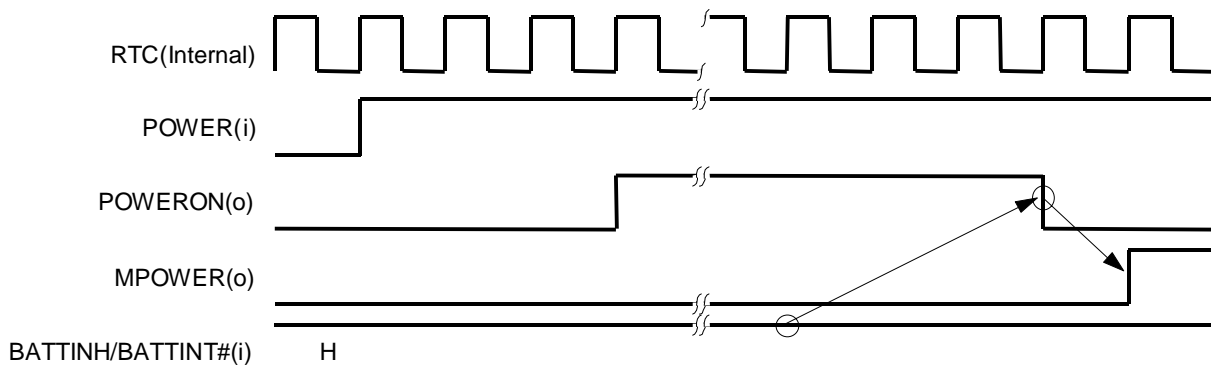
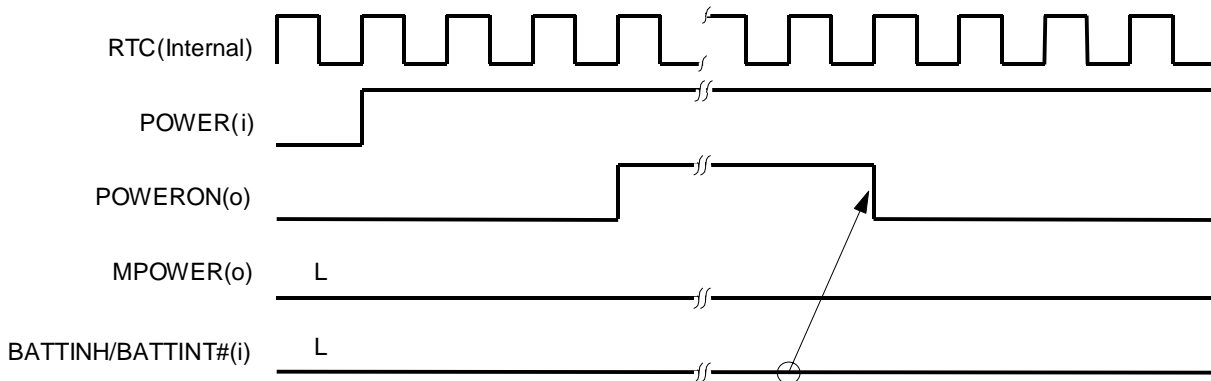

Figure 16-2. Activation via Power Switch Interrupt (BATTINH/BATTINT# = 0)



(2) Activation via GPIO Activation Interrupt

When the GPIO[12..9], [3..0] signal is asserted, the PMU checks the GPIO[12..9], [3..0]'s activation interrupt enable bit. If GPIO[12..9], [3..0] activation interrupts are enabled, the PMU asserts the POWERON signal and provides external notification that the CPU is being activated (since the GPIO[12..9], [2..0] activation enable interrupt bit is cleared after an RTC is reset, the GPIO[12..9], [2..0] signal cannot be used for activation immediately after an RTC reset. However, activation can occur at the falling edge of the GPIO[3] signal immediately after an RTC reset for GPIO[3] only). The PMU asserts the POWERON signal, then checks the BATTINH/BATTINT# signal and de-asserts the POWERON signal.

When the BATTINH/BATTINT# signal is high ("1"), the PMU cancels peripheral unit reset, then starts the Cold Reset sequence to activate the CPU core.

When the BATTINH/BATTINT# signal is low ("0"), the PMU sets "1" to PMUINTREG's BATTINH bit and then performs another shutdown. After the CPU is restarted, the BATTINH bit must be checked and cleared (to "0") by means of software.

The CPU sets "1" to the corresponding GPIOINTR bit in the PMUINTREG or PMUINT2REG regardless of whether activation succeeds or fails.

Caution The changes in the GPIO signal are ignored while POWERON signal is active.

Figure 16-3. Activation via GPIO Activation Interrupt (BATTINH/BATTINT# = 1)

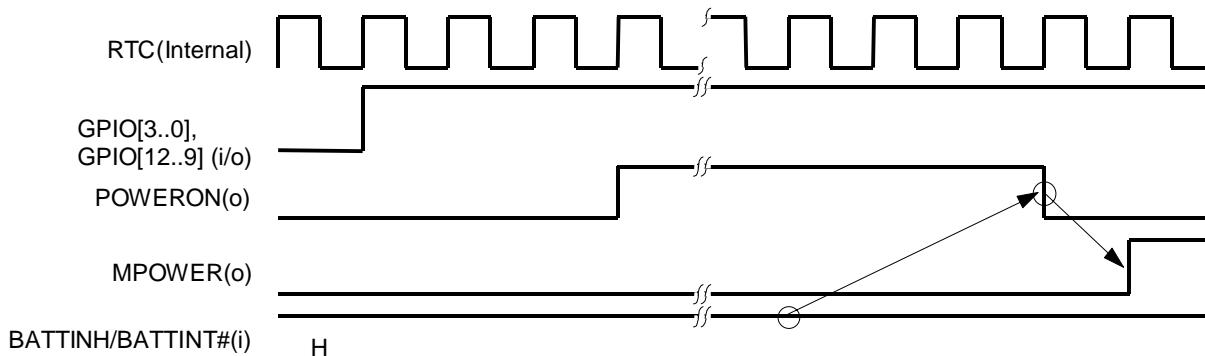
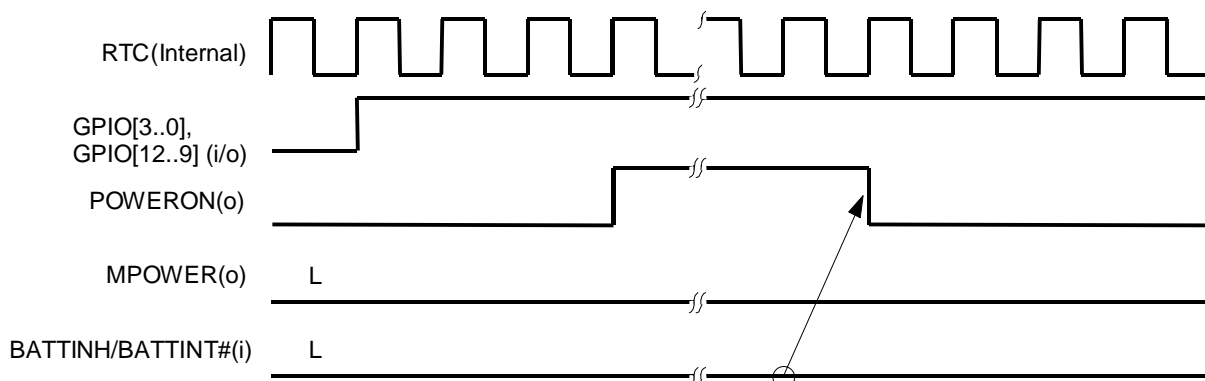

Figure 16-4. Activation via GPIO Activation Interrupt (BATTINH/BATTINT# = 0)



(3) Activation via DCD Interrupt

When the DCD# signal is asserted (it means, the falling edge of DCD# signal is detected by PMU), the PMU asserts the POWERON signal and provides external notification that the CPU is being activated. After asserting the POWERON signal, the PMU checks the BATTINH/BATTINT# signal and then de-asserts the POWERON signal.

If the BATTINH/BATTINT# signal is high ("1"), the PMU cancels peripheral unit reset, then starts the Cold Reset sequence to activate the CPU core.

If the BATTINH/BATTINT# signal is low ("0"), the PMU sets "1" to PMUINTREG's BATTINH bit and then performs another shutdown. After the CPU is restarted, the BATTINH bit must be checked and cleared (to "0") by means of software.

The PMUINTREG's DCDST bit does not indicate whether a DCD interrupt has occurred, but instead reflects the current status of the DCD# pin.

- Cautions**
1. Once POWERSW has been asserted, the PMU cannot recognize changes in the DCD# signal. If the DCD# state when POWERSW is asserted is different from the DCD# state when POWERSW is de-asserted, the change in the DCD# signal is detected only after POWERSW is de-asserted. However, if the DCD# state when POWERSW is asserted is the same as the DCD# state when POWERSW is de-asserted, any changes in the DCD# signal that occur while POWERSW is asserted are not detected.
 2. The changes in the DCD# signal are ignored while POWERON signal is active.

Figure 16-5. Activation via DCD Interrupt (BATTINH/BATTINT# = 1)

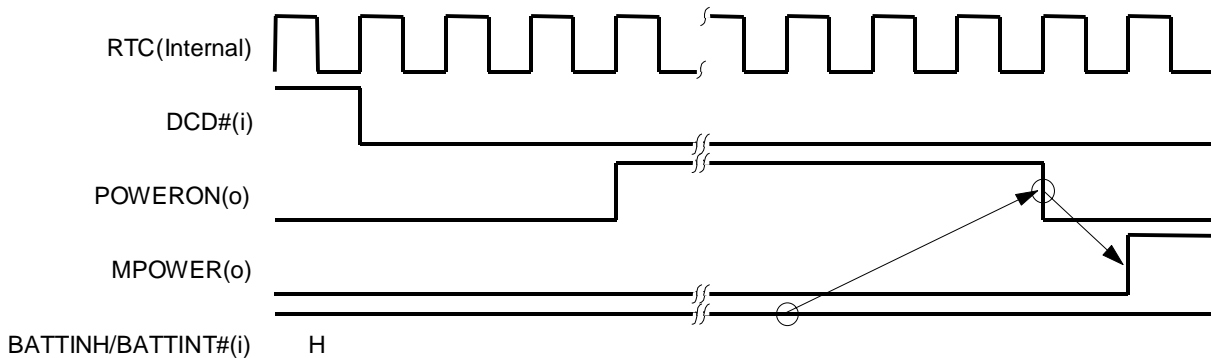
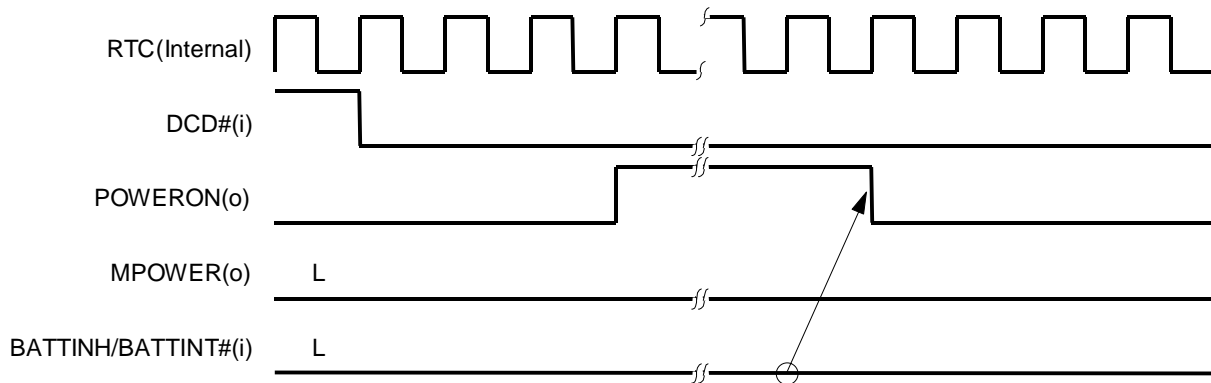

Figure 16-6. Activation via DCD Interrupt (BATTINH/BATTINT# = 0)



(4) Activation via Elapsed Timer Interrupt (Alarm Interrupt)

When the alarm interrupt (alarm_intr) signal generated from the elapsed timer is asserted, the PMU asserts the POWERON signal and provides external notification that the CPU is being activated. After asserting the POWERON signal, the PMU checks the BATTINH/BATTINT# signal and then de-asserts the POWERON signal. If the BATTINH/BATTINT# signal is high (“1”), the PMU cancels peripheral unit reset, then starts the Cold Reset sequence to activate the CPU core.

If the BATTINH/BATTINT# signal is low (“0”), the PMU sets “1” to PMUINTREG’s BATTINH bit and then performs another shutdown. After the CPU is restarted, the BATTINH bit must be checked and cleared (to “0”) by means of software.

Caution The alarm interrupt is ignored while the POWERON signal is active. After the POWERON signal becomes inactive, it is notified to PMU.

Figure 16-7. Activation via Alarm Interrupt (BATTINH/BATTINT# = 1)

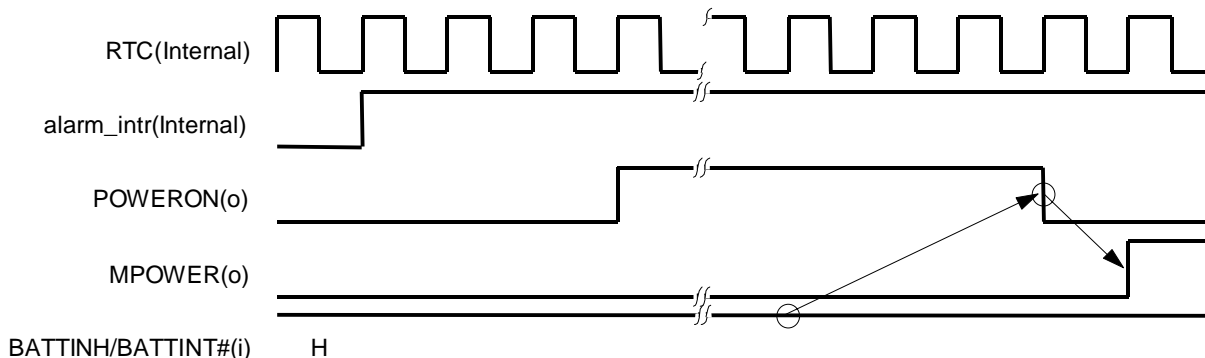
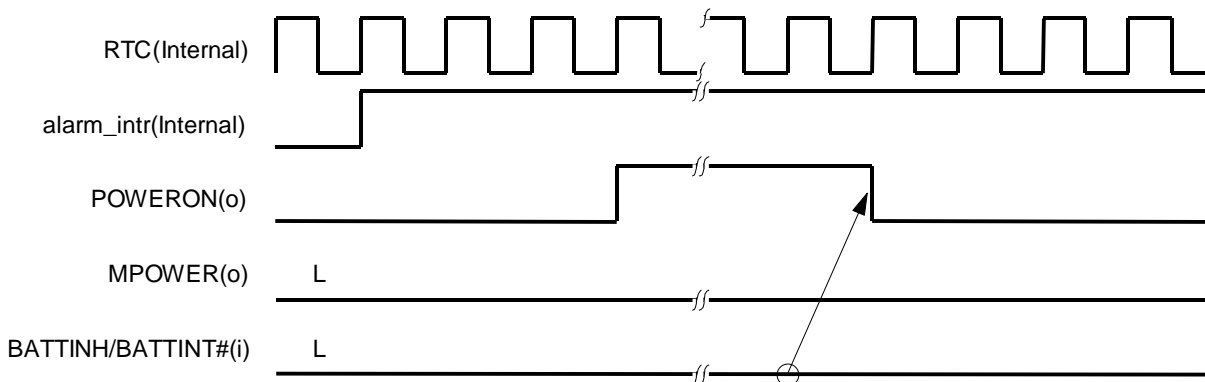

Figure 16-8. Activation via Alarm Interrupt (BATTINH/BATTINT# = 0)



16.1.4 Power Mode

The VR4111 supports the following four power modes.

- ✧ Fullspeed mode
- ✧ Standby mode
- ✧ Suspend mode
- ✧ Hibernate mode

To set Standby, Suspend, or Hibernate mode from Fullspeed mode, execute a STANDBY, SUSPEND, or HIBERNATE instruction, respectively. RTCRST is always valid in every mode, and initializes (resets) units in the CPU including RTC. However, the CPU does not restart by RTCRST.

The power mode state transition and its outlines are shown below.

Figure 16-9. Power Mode State Transition

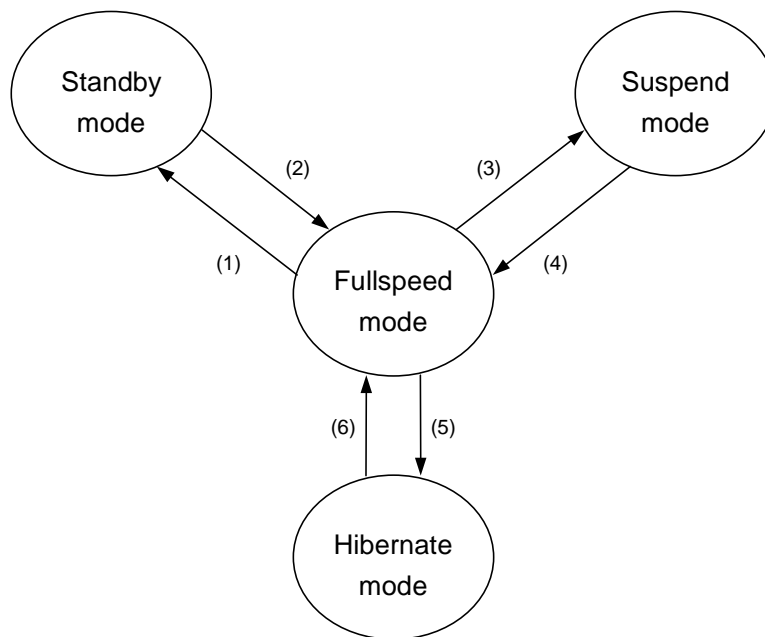

(1)	(2)	(3)	(4)	(5)	(6)
STANDBY instruction & pipeline flash & SysAD idle & PClock high	All interrupts	SUSPEND instruction & pipeline flash & SysAD idle & PClock high & TClock high & DRAM self refresh	POWER RSTSW Elapsed Time RTCLong1 RTCLong2 KeyTouch PenTouch GPIO[14..9] DCD# (GPIO, SIU) BATTINTR	HIBERNATE instruction & pipeline flash & SysAD idle & PClock high & TClock high & MasterOut high & DRAM self refresh	POWER Elapsed Time DCD# GPIO[3..0] GPIO[12:9]

Table 16-3. Power Mode

Mode	Internal peripheral unit				CPU core
	RTC	ICU	DCU	others	
Fullspeed	On	On	On	Selectable ^{Note}	On
Standby	On	On	On	Selectable ^{Note}	Off
Suspend	On	On	Off	Off	Off
Hibernate	On	Off	Off	Off	Off
Off	Off	Off	Off	Off	Off

Note See CHAPTER 14 CMU for details.

(1) Fullspeed Mode

In Fullspeed mode, all internal clocks and the bus clock operate. In this mode, all the functions of the VR4111 can be executed.

(2) Standby Mode

In Standby mode, all internal clocks, other than those provided to the internal peripheral units and the internal timer/interrupt unit of the CPU core, are fixed to high level.

To switch to Standby mode from Fullspeed mode, first execute the STANDBY instruction. The VR4111 waits until the SysAD bus (internal) enters idle status after the completion of the WB stage of the STANDBY instruction. Then, the internal clock is shut down, and the pipeline stops. PLL, timer/interrupt clock, internal bus clocks (TClock, MasterOut), and RTC continue to operate.

In Standby mode, the processor returns to Fullspeed mode when an interrupt occurs. At this time, the contents of bits indicating the states of pins in the peripheral unit's registers are undefined. The contents of other fields are retained.

(3) Suspend Mode

In Suspend mode, all internal clocks (including TClock) other than those supplied to the RTC/ICU/PMU internal peripheral units and the internal timer/interrupt unit of the CPU core are fixed to high level.

To switch to Suspend mode from Fullspeed mode, first execute the SUSPEND instruction. The VR4111 waits until the SysAD bus (internal) enters idle status after the completion of the WB stage of the SUSPEND instruction and DRAM has entered self-refresh mode. Then, the internal clocks (including TClock) are shut down, and the pipeline stops. PLL, timer interrupt clock, MasterOut, and RTC continue to operate.

★ If the SUSPEND instruction is executed during DMA transfer, the DRAM transfer is suspended, and the operation is undefined.

In Suspend mode, the processor returns to Fullspeed mode when an interrupt request from the peripheral units or any resets occur. At this time, the contents of bits indicating the states of pins in the peripheral unit's registers are undefined. The contents of other fields are retained.

(4) Hibernate Mode

In Hibernate mode, all the clocks supplied to internal peripheral units other than RTC/ICU/PMU and to the CPU core are fixed to high level.

To switch to Hibernate mode from Fullspeed mode, first execute the HIBERNATE instruction. The VR4111 waits until the SysAD bus (internal) enters idle status after the completion of the WB stage of the HIBERNATE instruction, DRAM has entered self-refresh mode, and the MPOWER pin has been made inactive. Then, the internal clocks (including TClock and MasterOut) are shut down, and the pipeline stops. PLL also stops, but RTC continue to operate.

In Hibernate mode, the processor returns to Fullspeed mode when it is alarmed from the RTC, the power-on switch is pressed, or DCD# pin is asserted. At this time, the contents of bits indicating the states of pins in the peripheral unit's registers and caches in the CPU core are undefined. The contents of other fields are retained.

16.2 REGISTER SET

The PMU registers are listed below.

Table 16-4. PMU Registers

Address	R/W	Register symbols	Function
0x0B00 00A0	R/W	PMUINTREG	PMU Interrupt/Status Register
0x0B00 00A2	R/W	PMUCNTREG	PMU Control Register
0x0B00 00A4	R/W	PMUINT2REG	PMU Interrupt/Status 2 Register
0x0B00 00A6	R/W	PMUCNT2REG	PMU Control 2 Register
0x0B00 00A8	R/W	PMUWAITREG	PMU Wait Counter Register

Each register is described in detail below.

16.2.1 PMUINTREG (0x0B00 00A0)

(1/2)

Bit	D15	D14	D13	D12	D11	D10	D9	D8
Name	GPIO3INTR	GPIO2INTR	GPIO1INTR	GPIO0INTR	Reserved	DCDST	RTCINTR	BATTINH
R/W	R/W	R/W	R/W	R/W	R	R	R/W	R/W
RTCRST	0	0	0	0	0	0	0	0
Other resets	0	0	0	0	0	0	0	0

Bit	D7	D6	D5	D4	D3	D2	D1	D0
Name	memo[1]	memo[0]	TIMOUTRST	RTCRST	RSTSW	DMSRST	BATTINTR	POWERSW INTR
R/W	R/W	R/W	R/W	R/W	R/W	R/W	R/W	R/W
RTCRST	0	0	0	1	0	0	0	0
Other resets	0	0	0	0	0	0	0	0

Bit	Name	Function
D[15]	GPIO3INTR	GPIO[3] activation interrupt detection. Cleared to 0 when 1 is written. 1: Detected 0: Not detected
D[14]	GPIO2INTR	GPIO[2] activation interrupt detection. Cleared to 0 when 1 is written. 1: Detected 0: Not detected
D[13]	GPIO1INTR	GPIO[1] activation interrupt detection. Cleared to 0 when 1 is written. 1: Detected 0: Not detected
D[12]	GPIO0INTR	GPIO[0] activation interrupt detection. Cleared to 0 when 1 is written. 1: Detected 0: Not detected
D[11]	Reserved	Write 0 to this bit. 0 is returned after a read.
D[10]	DCDST	DCD# pin state. 1: High 0: Low
D[9]	RTCINTR	RTC alarm interrupt detection. Cleared to 0 when 1 is written. 1: Detected 0: Not detected
D[8]	BATTINH	Battery low (BATTINH/BATTINT# signal low level) detection during activation. Cleared to 0 when 1 is written. 1: Detected 0: Not detected

Bit	Name	Function
D[7..6]	memo[1..0]	These bits are readable/writable, and can be used by users freely.
D[5]	TIMOUTRST	HAL timer reset detection. Cleared to 0 when 1 is written. 1 : Detected 0 : Not detected
D[4]	RTCST	RTC reset detection. Cleared to 0 when 1 is written. 1 : Detected 0 : Not detected
D[3]	RSTSW	RESET switch interrupt detection. Cleared to 0 when 1 is written. 1 : Detected 0 : Not detected
D[2]	DMSRST	Deadman's switch interrupt detection. Cleared to 0 when 1 is written. 1 : Detected 0 : Not detected
D[1]	BATTINTR	Battery low detection during normal operation. Cleared to 0 when 1 is written. 1 : Detected 0 : Not detected
D[0]	POWERSWINTR	POWER switch interrupt detection. Cleared to 0 when 1 is written. 1 : Detected 0 : Not detected

This register is used to set whether the CPU detects a power-on factor and reset.

It also indicates the status of the DCD# pin.

- ★ The BATTINTR bit is set to 1 when the BATTINH/BATTINT# signal becomes low and a battery-low interrupt request occurs in modes other than the Hibernate mode (MPOWER = 1).

The POWERSWINTR bit is set to 1 when the POWER signal becomes high and a power switch request occurs in modes other than the Hibernate mode. However, this bit is not set to 1 when the POWER signal becomes high in the Hibernate mode (MPOWER = 0).

16.2.2 PMUCNTREG (0x0B00 00A2)

(1/2)

Bit	D15	D14	D13	D12	D11	D10	D9	D8
Name	GPIO3MSK	GPIO2MSK	GPIO1MSK	GPIO0MSK	GPIO3TRG	GPIO2TRG	GPIO1TRG	GPIO0TRG
R/W	R/W	R/W	R/W	R/W	R/W	R/W	R/W	R/W
RTCRST	1	0	0	0	1	0	0	0
Other resets	Note	Note	Note	Note	Note	Note	Note	Note

Bit	D7	D6	D5	D4	D3	D2	D1	D0
Name	STANDBY	Reserved	Reserved	Reserved	Reserved	HALTIMER RST	Reserved	Reserved
R/W	R/W	R	R	R	R	R/W	R	R
RTCRST	0	0	0	0	0	0	1	0
Other resets	0	0	0	0	0	0	1	0

Bit	Name	Function
D[15]	GPIO3MSK	GPIO[3] activation enable 1: Enable 0: Prohibit
D[14]	GPIO2MSK	GPIO[2] activation enable 1: Enable 0: Prohibit
D[13]	GPIO1MSK	GPIO[1] activation enable 1: Enable 0: Prohibit
D[12]	GPIO0MSK	GPIO[0] activation enable 1: Enable 0: Prohibit
D[11]	GPIO3TRG	GPIO[3] activation interrupt type 1: Falling edge detection 0: Rising edge detection
D[10]	GPIO2TRG	GPIO[2] activation interrupt type 1: Falling edge detection 0: Rising edge detection
D[9]	GPIO1TRG	GPIO[1] activation interrupt type 1: Falling edge detection 0: Rising edge detection
D[8]	GPIO0TRG	GPIO[0] activation interrupt type 1: Falling edge detection 0: Rising edge detection
D[7]	STANDBY	Standby mode setting. This setting is performed only for software, and does not affect hardware in any way. 1: Standby mode 0: Normal mode

Note Holds the value before reset.

Bit	Name	Function
D[6..3]	Reserved	Write 0 to these bits. 0 is returned after a read.
D[2]	HALTIMERRST	HAL timer reset 1 : Reset 0 : Set
D[1]	Reserved	Write 1 to this bit. 1 is returned after a read.
D[0]	Reserved	Write 0 to this bit. 0 is returned after a read.

This register is used to set CPU shutdown and overall system management operations.

The HALTIMERRST bit must be reset within about four seconds after activation. Resetting of the HALTIMERRST bit indicates that the Vr4111 itself has been activated normally. If the HALTIMERRST bit is not reset within about four seconds after activation, program execution is regarded as abnormal (possibly due to a runaway) and an automatic shutdown is performed.

The GPIO[3..0]MSK bits are used to set enable/prohibit for activation from Hibernate mode when the corresponding interrupt (GPIO[3..0]) occurs. The GPIO3MSK bit is set to 1 by RTCRST, and the other bits are cleared to "0" (prohibit). Accordingly, the GPIO[2..0] cannot be used for activation immediately after an RTCRST reset. The GPIO activation interrupt is valid only when the CPU is in the Hibernate mode.

16.2.3 PMUINT2REG (0x0B00 00A4)

Bit	D15	D14	D13	D12	D11	D10	D9	D8
Name	GPIO12INTR	GPIO11INTR	GPIO10INTR	GPIO9INTR	Reserved	Reserved	Reserved	Reserved
R/W	R/W	R/W	R/W	R/W	R	R	R	R
RTC	0	0	0	0	0	0	0	0
Other resets	0	0	0	0	0	0	0	0

Bit	D7	D6	D5	D4	D3	D2	D1	D0
Name	Reserved	Reserved	Reserved	Reserved	Reserved	Reserved	Reserved	Reserved
R/W	R	R	R	R	R	R	R	R
RTC	0	0	0	0	0	0	0	0
Other resets	0	0	0	0	0	0	0	0

Bit	Name	Function
D[15]	GPIO12INTR	GPIO[12] activation interrupt detection. Cleared to 0 when 1 is written. 1: Detected 0: Not detected
D[14]	GPIO11INTR	GPIO[11] activation interrupt detection. Cleared to 0 when 1 is written. 1: Detected 0: Not detected
D[13]	GPIO10INTR	GPIO[10] activation interrupt detection. Cleared to 0 when 1 is written. 1: Detected 0: Not detected
D[12]	GPIO9INTR	GPIO[9] activation interrupt detection. Cleared to 0 when 1 is written. 1: Detected 0: Not detected
D[11..0]	Reserved	RFU. Write 0 to these bits. 0 is returned after a read.

This register is used to specify whether the GPIO[12..9] interrupts are detected as power-on factors.

16.2.4 PMUCNT2REG (0x0B00 00A6)

Bit	D15	D14	D13	D12	D11	D10	D9	D8
Name	GPIO12MSK	GPIO11MSK	GPIO10MSK	GPIO9MSK	GPIO12TRG	GPIO11TRG	GPIO10TRG	GPIO9TRG
R/W	R/W	R/W	R/W	R/W	R/W	R/W	R/W	R/W
RTC	0	0	0	0	0	0	0	0
Other resets	Note	Note	Note	Note	Note	Note	Note	Note

Bit	D7	D6	D5	D4	D3	D2	D1	D0
Name	Reserved	Reserved	Reserved	Reserved	Reserved	Reserved	Reserved	Reserved
R/W	R	R	R	R	R	R	R	R
RTC	0	0	0	0	0	0	0	0
Other resets	0	0	0	0	0	0	0	0

Bit	Name	Function
D[15]	GPIO12MSK	GPIO[12] activation enable 1: Enable 0: Prohibit
D[14]	GPIO11MSK	GPIO[11] activation enable 1: Enable 0: Prohibit
D[13]	GPIO10MSK	GPIO[10] activation enable 1: Enable 0: Prohibit
D[12]	GPIO9MSK	GPIO[9] activation enable 1: Enable 0: Prohibit
D[11]	GPIO12TRG	GPIO[12] activation interrupt type 1: Falling edge detection 0: Rising edge detection
D[10]	GPIO11TRG	GPIO[11] activation interrupt type 1: Falling edge detection 0: Rising edge detection
D[9]	GPIO10TRG	GPIO[10] activation interrupt type 1: Falling edge detection 0: Rising edge detection
D[8]	GPIO9TRG	GPIO[9] activation interrupt type 1: Falling edge detection 0: Rising edge detection
D[7..0]	Reserved	RFU. Write 0 to these bits. 0 is returned after a read.

Note Hold the value before reset.

This register is used to set the CPU activation by means of the GPIO interrupt.

The GPIO[12..9]MSK bits are used to set enable/prohibit for activation from Hibernate mode when the corresponding interrupt (GPIO[12..9]) occurs. All mask bits are cleared to 0 (prohibit) after RTCRST reset. Therefore, GPIO[12..9] interrupts cannot be used for activation immediately after RTCRST reset. Additionally, the GPIO activation interrupt is valid only when the CPU is in the Hibernate mode.

16.2.5 PMUWAITREG (0x0B00 00A8)

Bit	D15	D14	D13	D12	D11	D10	D9	D8
Name	Reserved	Reserved	WCOUNT [13]	WCOUNT [12]	WCOUNT [11]	WCOUNT [10]	WCOUNT [9]	WCOUNT [8]
R/W	R	R	R/W	R/W	R/W	R/W	R/W	R/W
RTC	0	0	1	0	1	1	0	0
Other resets	0	0	Note	Note	Note	Note	Note	Note

Bit	D7	D6	D5	D4	D3	D2	D1	D0
Name	WCOUNT [7]	WCOUNT [6]	WCOUNT [5]	WCOUNT [3]	WCOUNT [3]	WCOUNT [2]	WCOUNT [1]	WCOUNT [0]
R/W	R/W	R/W	R/W	R/W	R/W	R/W	R/W	R/W
RTC	0	0	0	0	0	0	0	0
Other resets	Note	Note	Note	Note	Note	Note	Note	Note

Bit	Name	Function
D[15..14]	Reserved	RFU. Write 0 to these bits. 0 is returned after a read.
D[13..0]	WCOUNT [13..0]	Activation wait time timer count value Activation wait time = WCOUNT[13..0] × (1/32.768) ms

Note Hold the value before reset.

This register is used to set the activation wait time when the CPU is activated.

This register is set to 0x2C00 (it sets 343.75-ms activation wait time) after RTC reset. Therefore, the 343.75-ms wait time is always inserted as an activation wait time, when the CPU is activated immediately after RTC reset. The activation wait time can be changed by setting this register for the CPU activation from the Hibernate mode.

When this register is set to 0x0, 0x1, 0x2, 0x3, or 0x4, the operation is not guaranteed. Be sure to set a value greater than or 0x4 to this register.

CHAPTER 17 RTC (REALTIME CLOCK UNIT)

This chapter describes the RTC unit's operations and register settings.

17.1 GENERAL

The RTC unit has a total of four timers, including the following three types.

- RTCLong This is a 24-bit programmable counter that counts down using 32.768-kHz frequency. Cycle interrupts occur for up to 512 seconds.
- TClockCount..... This is a 25-bit programmable counter that counts down using TClock cycles. Cycle interrupts occur for up to 1 to 2 seconds. This counter is used for performance evaluation.
- ElapsedTime..... This is a 48-bit up counter that counts up using 32.768-kHz frequency. It counts up to 272 years before returning to zero. It includes 48-bit comparators (ECMPHREG, ECMPREG, and ECMPMREG) and 48-bit alarm time registers (ETIMELREG, ETIMEMREG, and ETIMEHREG) to enable interrupts to occur at specified times.

17.2 REGISTER SET

The RTC registers are listed below.

Table 17-1. RTC Registers

Address	R/W	Register Symbols	Function
0x0B00 00C0	R/W	ETIMELREG	Elapsed Time L Register
0x0B00 00C2	R/W	ETIMEMREG	Elapsed Time M Register
0x0B00 00C4	R/W	ETIMEHREG	Elapsed Time H Register
0x0B00 00C8	R/W	ECMPLREG	Elapsed Compare L Register
0x0B00 00CA	R/W	ECMPMREG	Elapsed Compare M Register
0x0B00 00CC	R/W	ECMPHREG	Elapsed Compare H Register
0x0B00 00D0	R/W	RTCL1LREG	RTC Long 1 L Register
0x0B00 00D2	R/W	RTCL1HREG	RTC Long 1 H Register
0x0B00 00D4	R	RTCL1CNTLREG	RTC Long 1 Count L Register
0x0B00 00D6	R	RTCL1CNTHREG	RTC Long 1 Count H Register
0x0B00 00D8	R/W	RTCL2LREG	RTC Long 2 L Register
0x0B00 00DA	R/W	RTCL2HREG	RTC Long 2 H Register
0x0B00 00DC	R	RTCL2CNTLREG	RTC Long 2 Count L Register
0x0B00 00DE	R	RTCL2CNTHREG	RTC Long 2 Count H Register
0x0B00 01C0	R/W	TCLKLREG	TCLK L Register
0x0B00 01C2	R/W	TCLKHREG	TCLK H Register
0x0B00 01C4	R	TCLKCNTLREG	TCLK Count L Register
0x0B00 01C6	R	TCLKCNTHREG	TCLK Count H Register
0x0B00 01DE	R/W	RTCINTREG	RTC Interrupt Register

Each register is described in detail below.

17.2.1 Elapsed Time Registers

(1) ETIMELREG (0x0B00 00C0)

Bit	D15	D14	D13	D12	D11	D10	D9	D8
Name	ETIME[15]	ETIME[14]	ETIME[13]	ETIME[12]	ETIME[11]	ETIME[10]	ETIME[9]	ETIME[8]
R/W	R/W	R/W	R/W	R/W	R/W	R/W	R/W	R/W
RTCRST	0	0	0	0	0	0	0	0
Other resets	Note	Note	Note	Note	Note	Note	Note	Note

Bit	D7	D6	D5	D4	D3	D2	D1	D0
Name	ETIME[7]	ETIME[6]	ETIME[5]	ETIME[4]	ETIME[3]	ETIME[2]	ETIME[1]	ETIME[0]
R/W	R/W	R/W	R/W	R/W	R/W	R/W	R/W	R/W
RTCRST	0	0	0	0	0	0	0	0
Other resets	Note	Note	Note	Note	Note	Note	Note	Note

Bit	Name	Function
D[15:0]	ETIME[15:0]	ElapsedTime bit [15:0]

Note Continues counting.

(2) ETIMEMREG (0x0B00 00C2)

Bit	D15	D14	D13	D12	D11	D10	D9	D8
Name	ETIME[31]	ETIME[30]	ETIME[29]	ETIME[28]	ETIME[27]	ETIME[26]	ETIME[25]	ETIME[24]
R/W	R/W	R/W	R/W	R/W	R/W	R/W	R/W	R/W
RTCRST	0	0	0	0	0	0	0	0
Other resets	Note	Note	Note	Note	Note	Note	Note	Note

Bit	D7	D6	D5	D4	D3	D2	D1	D0
Name	ETIME[23]	ETIME[22]	ETIME[21]	ETIME[20]	ETIME[19]	ETIME[18]	ETIME[17]	ETIME[16]
R/W	R/W	R/W	R/W	R/W	R/W	R/W	R/W	R/W
RTCRST	0	0	0	0	0	0	0	0
Other resets	Note	Note	Note	Note	Note	Note	Note	Note

Bit	Name	Function
D[15:0]	ETIME[31:16]	ElapsedTime bit [31:16]

Note Continues counting.

(3) ETIMEHREG (0x0B00 00C4)

Bit	D15	D14	D13	D12	D11	D10	D9	D8
Name	ETIME[47]	ETIME[46]	ETIME[45]	ETIME[44]	ETIME[43]	ETIME[42]	ETIME[41]	ETIME[40]
R/W	R/W	R/W	R/W	R/W	R/W	R/W	R/W	R/W
RTCRST	0	0	0	0	0	0	0	0
Other resets	Note	Note	Note	Note	Note	Note	Note	Note

Bit	D7	D6	D5	D4	D3	D2	D1	D0
Name	ETIME[39]	ETIME[38]	ETIME[37]	ETIME[36]	ETIME[35]	ETIME[34]	ETIME[33]	ETIME[32]
R/W	R/W	R/W	R/W	R/W	R/W	R/W	R/W	R/W
RTCRST	0	0	0	0	0	0	0	0
Other resets	Note	Note	Note	Note	Note	Note	Note	Note

Bit	Name	Function
D[15:0]	ETIME[47:32]	ElapsedTime bit [47:32]

Note Continues counting

These registers indicate the elapsed timer's value. They count up using a 32.768-kHz frequency and when a match occurs with the elapsed compare registers, an alarm (elapsed time interrupt) occurs (and the count-up continues). A write operation is valid once values have been written to all registers (ETIMELREG, ETIMEMREG, and ETIMEHREG).

These registers have no buffers for read. Therefore, an illegal data may be read if the counter value changes during a read operation. When using a read data, be sure to read a value twice and check that two read values are the same.

When setting these registers again, wait until at least 100 μ s (\cong 32.768-kHz clock \times 3) have elapsed before doing so.

17.2.2 Elapsed Time Compare Registers

(1) ECMPPLREG (0x0B00 00C8)

Bit	D15	D14	D13	D12	D11	D10	D9	D8
Name	ECMP[15]	ECMP[14]	ECMP[13]	ECMP[12]	ECMP[11]	ECMP[10]	ECMP[9]	ECMP[8]
R/W	R/W	R/W	R/W	R/W	R/W	R/W	R/W	R/W
RTCRST	0	0	0	0	0	0	0	0
Other resets	Note	Note	Note	Note	Note	Note	Note	Note

Bit	D7	D6	D5	D4	D3	D2	D1	D0
Name	ECMP[7]	ECMP[6]	ECMP[5]	ECMP[4]	ECMP[3]	ECMP[2]	ECMP[1]	ECMP[0]
R/W	R/W	R/W	R/W	R/W	R/W	R/W	R/W	R/W
RTCRST	0	0	0	0	0	0	0	0
Other resets	Note	Note	Note	Note	Note	Note	Note	Note

Bit	Name	Function
D[15:0]	ECMP[15:0]	Value to be compared with ElapsedTime bit [15:0]

Note Previous value is retained.

(2) ECMPMREG (0x0B00 00CA)

Bit	D15	D14	D13	D12	D11	D10	D9	D8
Name	ECMP[31]	ECMP[30]	ECMP[29]	ECMP[28]	ECMP[27]	ECMP[26]	ECMP[25]	ECMP[24]
R/W	R/W	R/W	R/W	R/W	R/W	R/W	R/W	R/W
RTCRST	0	0	0	0	0	0	0	0
Other resets	Note	Note	Note	Note	Note	Note	Note	Note

Bit	D7	D6	D5	D4	D3	D2	D1	D0
Name	ECMP[23]	ECMP[22]	ECMP[21]	ECMP[20]	ECMP[19]	ECMP[18]	ECMP[17]	ECMP[16]
R/W	R/W	R/W	R/W	R/W	R/W	R/W	R/W	R/W
RTCRST	0	0	0	0	0	0	0	0
Other resets	Note	Note	Note	Note	Note	Note	Note	Note

Bit	Name	Function
D[15:0]	ECMP[31:16]	Value to be compared with ElapsedTime bit [31:16]

Note Previous value is retained.

(3) ECMPHREG (0x0B00 00CC)

Bit	D15	D14	D13	D12	D11	D10	D9	D8
Name	ECMP[47]	ECMP[46]	ECMP[45]	ECMP[44]	ECMP[43]	ECMP[42]	ECMP[41]	ECMP[40]
R/W	R/W	R/W	R/W	R/W	R/W	R/W	R/W	R/W
RTCRST	0	0	0	0	0	0	0	0
Other resets	Note	Note	Note	Note	Note	Note	Note	Note

Bit	D7	D6	D5	D4	D3	D2	D1	D0
Name	ECMP[39]	ECMP[38]	ECMP[37]	ECMP[36]	ECMP[35]	ECMP[34]	ECMP[33]	ECMP[32]
R/W	R/W	R/W	R/W	R/W	R/W	R/W	R/W	R/W
RTCRST	0	0	0	0	0	0	0	0
Other resets	Note	Note	Note	Note	Note	Note	Note	Note

Bit	Name	Function
D[15:0]	ECMP[47:32]	Value to be compared with ElapsedTime bit [47:32]

Note Previous value is retained.

Use these registers to set the values to be compared with values in the elapsed time registers.

A write operation is valid once values have been written to all registers (ECMPLREG, ECMPMREG, and ECMPHREG).

When setting these registers again, wait until at least 100 μ s (\cong 32.768-kHz clock \times 3) have elapsed before doing so.

17.2.3 RTC Long 1 Registers

(1) RTCL1LREG (0x0B00 00D0)

Bit	D15	D14	D13	D12	D11	D10	D9	D8
Name	RTCL1P[15]	RTCL1P[14]	RTCL1P[13]	RTCL1P[12]	RTCL1P[11]	RTCL1P[10]	RTCL1P[9]	RTCL1P[8]
R/W	R/W	R/W	R/W	R/W	R/W	R/W	R/W	R/W
RTCRST	0	0	0	0	0	0	0	0
Other resets	Note	Note	Note	Note	Note	Note	Note	Note

Bit	D7	D6	D5	D4	D3	D2	D1	D0
Name	RTCL1P[7]	RTCL1P[6]	RTCL1P[5]	RTCL1P[4]	RTCL1P[3]	RTCL1P[2]	RTCL1P[1]	RTCL1P[0]
R/W	R/W	R/W	R/W	R/W	R/W	R/W	R/W	R/W
RTCRST	0	0	0	0	0	0	0	0
Other resets	Note	Note	Note	Note	Note	Note	Note	Note

Bit	Name	Function
D[15:0]	RTCL1P[15:0]	[15:0] for RTCLong1 counter cycle

Note Previous value is retained.

(2) RTCL1HREG (0x0B00 00D2)

Bit	D15	D14	D13	D12	D11	D10	D9	D8
Name	Reserved	Reserved	Reserved	Reserved	Reserved	Reserved	Reserved	Reserved
R/W	R	R	R	R	R	R	R	R
RTCRST	0	0	0	0	0	0	0	0
Other resets	Note	Note	Note	Note	Note	Note	Note	Note

Bit	D7	D6	D5	D4	D3	D2	D1	D0
Name	RTCL1P[23]	RTCL1P[22]	RTCL1P[21]	RTCL1P[20]	RTCL1P[19]	RTCL1P[18]	RTCL1P[17]	RTCL1P[16]
R/W	R/W	R/W	R/W	R/W	R/W	R/W	R/W	R/W
RTCRST	0	0	0	0	0	0	0	0
Other resets	Note	Note	Note	Note	Note	Note	Note	Note

Bit	Name	Function
D[15:8]	Reserved	Write 0 when writing. 0 is returned after a read.
D[7:0]	RTCL1P[23:16]	[23:16] for RTCLong1 counter cycle

Note Previous value is retained.

Use these registers to set the RTCLong1 counter cycle. The RTCLong1 counter begins its countdown at the value written to these registers.

A write operation is valid once values have been written to both registers (RTCL1LREG and RTCL1HREG).

When setting these registers again, wait until at least 100 μ s (\cong 32.768-kHz clock \times 3) have elapsed before doing so.

Cautions 1. The RTC unit is stopped when all zeros are written.

2. Any combined setting of “RTCL1HREG = 0x0000” and “RTCL1LREG = 0x0001, 0x0002, 0x0003, 0x0004” is prohibited.

17.2.4 RTC Long 1 Count Registers

(1) RTCL1CNTLREG (0x0B00 00D4)

Bit	D15	D14	D13	D12	D11	D10	D9	D8
Name	RTCL1C[15]	RTCL1C[14]	RTCL1C[13]	RTCL1C[12]	RTCL1C[11]	RTCL1C[10]	RTCL1C[9]	RTCL1C[8]
R/W	R	R	R	R	R	R	R	R
RTCRST	0	0	0	0	0	0	0	0
Other resets	Note	Note	Note	Note	Note	Note	Note	Note

Bit	D7	D6	D5	D4	D3	D2	D1	D0
Name	RTCL1C[7]	RTCL1C[6]	RTCL1C[5]	RTCL1C[4]	RTCL1C[3]	RTCL1C[2]	RTCL1C[1]	RTCL1C[0]
R/W	R	R	R	R	R	R	R	R
RTCRST	0	0	0	0	0	0	0	0
Other resets	Note	Note	Note	Note	Note	Note	Note	Note

Bit	Name	Function
D[15:0]	RTCL1C[15:0]	RTCLong1 counter bit [15:0]

Note Continues counting.

(2) RTCL1CNTHREG (0x0B00 00D6)

Bit	D15	D14	D13	D12	D11	D10	D9	D8
Name	Reserved	Reserved	Reserved	Reserved	Reserved	Reserved	Reserved	Reserved
R/W	R	R	R	R	R	R	R	R
RTCRST	0	0	0	0	0	0	0	0
Other resets	Note	Note	Note	Note	Note	Note	Note	Note

Bit	D7	D6	D5	D4	D3	D2	D1	D0
Name	RTCL1C[23]	RTCL1C[22]	RTCL1C[21]	RTCL1C[20]	RTCL1C[19]	RTCL1C[18]	RTCL1C[17]	RTCL1C[16]
R/W	R	R	R	R	R	R	R	R
RTCRST	0	0	0	0	0	0	0	0
Other resets	Note	Note	Note	Note	Note	Note	Note	Note

Bit	Name	Function
D[15:8]	Reserved	Write 0 to these bits. 0 is returned after a read.
D[7:0]	RTCL1C[23:16]	RTCLong1 counter bit [23:16]

Note Continues counting.

These registers indicate the RTCLong1 counter's values. The countdown uses a 32.768-kHz frequency and begins at the value set to the RTCLong1 registers. An RTCLong1 interrupt occurs when the counter reaches 0x00 0001 (at which point the counter returns to the start value and continues counting).

These registers have no buffers for read. Therefore, an illegal data may be read if the counter value changes during a read operation. When using a read data, be sure to read a value twice and check that two read values are the same.

When setting these registers again, wait until at least 100 μ s (\cong 32.768-kHz clock \times 3) have elapsed before doing so.

17.2.5 RTC Long 2 Registers

(1) RTCL2LREG (0x0B00 00D8)

Bit	D15	D14	D13	D12	D11	D10	D9	D8
Name	RTCL2P[15]	RTCL2P[14]	RTCL2P[13]	RTCL2P[12]	RTCL2P[11]	RTCL2P[10]	RTCL2P[9]	RTCL2P[8]
R/W	R/W	R/W	R/W	R/W	R/W	R/W	R/W	R/W
RTCRST	0	0	0	0	0	0	0	0
Other resets	Note	Note	Note	Note	Note	Note	Note	Note

Bit	D7	D6	D5	D4	D3	D2	D1	D0
Name	RTCL2P[7]	RTCL2P[6]	RTCL2P[5]	RTCL2P[4]	RTCL2P[3]	RTCL2P[2]	RTCL2P[1]	RTCL2P[0]
R/W	R/W	R/W	R/W	R/W	R/W	R/W	R/W	R/W
RTCRST	0	0	0	0	0	0	0	0
Other resets	Note	Note	Note	Note	Note	Note	Note	Note

Bit	Name	Function
D[15:0]	RTCL2P[15:0]	[15:0] for RTCLong2 counter cycle

Note Previous value is retained.

(2) RTCL2HREG (0x0B00 00DA)

Bit	D15	D14	D13	D12	D11	D10	D9	D8
Name	Reserved	Reserved	Reserved	Reserved	Reserved	Reserved	Reserved	Reserved
R/W	R	R	R	R	R	R	R	R
RTCRST	0	0	0	0	0	0	0	0
Other resets	Note	Note	Note	Note	Note	Note	Note	Note

Bit	D7	D6	D5	D4	D3	D2	D1	D0
Name	RTCL2P[23]	RTCL2P[22]	RTCL2P[21]	RTCL2P[20]	RTCL2P[19]	RTCL2P[18]	RTCL2P[17]	RTCL2P[16]
R/W	R/W	R/W	R/W	R/W	R/W	R/W	R/W	R/W
RTCRST	0	0	0	0	0	0	0	0
Other resets	Note	Note	Note	Note	Note	Note	Note	Note

Bit	Name	Function
D[15:8]	Reserved	Write 0 to these bits. 0 is returned after a read.
D[7:0]	RTCL2P[23:16]	[23:16] for RTCLong2 counter cycle

Note Previous value is retained.

Use these registers to set the RTCLong2 counter cycle. The RTCLong2 counter begins its countdown at the value written to these registers.

A write operation is valid once values have been written to both registers (RTCL2LREG and RTCL2HREG).

When setting these registers again, wait until at least 100 μ s (\cong 32.768-kHz clock \times 3) have elapsed before doing so.

Cautions 1. The RTC unit is stopped when all zeros are written.

2. Any combined setting of “RTCL2HREG = 0x0000” and “RTCL2LREG = 0x0001, 0x0002, 0x0003, 0x0004” is prohibited.

17.2.6 RTC Long 2 Count Registers

(1) RTCL2CNTLREG (0x0B00 00DC)

Bit	D15	D14	D13	D12	D11	D10	D9	D8
Name	RTCL2C[15]	RTCL2C[14]	RTCL2C[13]	RTCL2C[12]	RTCL2C[11]	RTCL2C[10]	RTCL2C[9]	RTCL2C[8]
R/W	R	R	R	R	R	R	R	R
RTCRST	0	0	0	0	0	0	0	0
Other resets	Note	Note	Note	Note	Note	Note	Note	Note

Bit	D7	D6	D5	D4	D3	D2	D1	D0
Name	RTCL2C[7]	RTCL2C[6]	RTCL2C[5]	RTCL2C[4]	RTCL2C[3]	RTCL2C[2]	RTCL2C[1]	RTCL2C[0]
R/W	R	R	R	R	R	R	R	R
RTCRST	0	0	0	0	0	0	0	0
Other resets	Note	Note	Note	Note	Note	Note	Note	Note

Bit	Name	Function
D[15:0]	RTCL2C[15:0]	RTCLong2 counter bit [15:0]

Note Continues counting.

(2) RTCL2CNTHREG (0x0B00 00DE)

Bit	D15	D14	D13	D12	D11	D10	D9	D8
Name	Reserved	Reserved	Reserved	Reserved	Reserved	Reserved	Reserved	Reserved
R/W	R	R	R	R	R	R	R	R
RTCRST	0	0	0	0	0	0	0	0
Other resets	Note	Note	Note	Note	Note	Note	Note	Note

Bit	D7	D6	D5	D4	D3	D2	D1	D0
Name	RTCL2C[23]	RTCL2C[22]	RTCL2C[21]	RTCL2C[20]	RTCL2C[19]	RTCL2C[18]	RTCL2C[17]	RTCL2C[16]
R/W	R	R	R	R	R	R	R	R
RTCRST	0	0	0	0	0	0	0	0
Other resets	Note	Note	Note	Note	Note	Note	Note	Note

Bit	Name	Function
D[15:8]	Reserved	Write 0 to these bits. 0 is returned after a read.
D[7:0]	RTCL2C[23:16]	RTCLong2 counter bit [23:16]

Note Continues counting.

These registers indicate the RTCLong2 counter's values. The countdown uses a 32.768-kHz frequency and begins at the value set to the RTCLong2 registers. An RTCLong2 interrupt occurs when the counter reaches 0x00 0001 (at which point the counter returns to the start value and continues counting).

These registers have no buffers for read. Therefore, an illegal data may be read if the counter value changes during a read operation. When using a read data, be sure to read a value twice and check that two read vales are the same.

17.2.7 TClock Counter Registers

(1) TCLKLREG (0x0B00 01C0)

Bit	D15	D14	D13	D12	D11	D10	D9	D8
Name	TCLKP[15]	TCLKP[14]	TCLKP[13]	TCLKP[12]	TCLKP[11]	TCLKP[10]	TCLKP[9]	TCLKP[8]
R/W	R/W	R/W	R/W	R/W	R/W	R/W	R/W	R/W
RTCRST	0	0	0	0	0	0	0	0
Other resets	0	0	0	0	0	0	0	0

Bit	D7	D6	D5	D4	D3	D2	D1	D0
Name	TCLKP[7]	TCLKP[6]	TCLKP[5]	TCLKP[4]	TCLKP[3]	TCLKP[2]	TCLKP[1]	TCLKP[0]
R/W	R/W	R/W	R/W	R/W	R/W	R/W	R/W	R/W
RTCRST	0	0	0	0	0	0	0	0
Other resets	0	0	0	0	0	0	0	0

Bit	Name	Function
D[15:0]	TCLKP[15:0]	[15:0] for TClock counter cycle

(2) TCLKHREG (0x0B00 01C2)

Bit	D15	D14	D13	D12	D11	D10	D9	D8
Name	Reserved	Reserved	Reserved	Reserved	Reserved	Reserved	Reserved	TCLKP[24]
R/W	R	R	R	R	R	R	R	R/W
RTCRST	0	0	0	0	0	0	0	0
Other resets	0	0	0	0	0	0	0	0

Bit	D7	D6	D5	D4	D3	D2	D1	D0
Name	TCLKP[23]	TCLKP[22]	TCLKP[21]	TCLKP[20]	TCLKP[19]	TCLKP[18]	TCLKP[17]	TCLKP[16]
R/W	R/W	R/W	R/W	R/W	R/W	R/W	R/W	R/W
RTCRST	0	0	0	0	0	0	0	0
Other resets	0	0	0	0	0	0	0	0

Bit	Name	Function
D[15:9]	Reserved	Write 0 to these bits. 0 is returned after a read.
D[8:0]	TCLKP[24:16]	[24:16] for TClock counter cycle

Use these registers to set the TCLK counter cycle. The TCLK counter begins its countdown at the value written to these registers.

A write operation is valid once values have been written to both registers (TCLKLREG and TCLKHREG).

Caution The TCLK unit is stopped when all zeros are written.

17.2.8 TClock Counter Count Registers

(1) TCLKCNTLREG (0x0B00 01C4)

Bit	D15	D14	D13	D12	D11	D10	D9	D8
Name	TCLKC[15]	TCLKC[14]	TCLKC[13]	TCLKC[12]	TCLKC[11]	TCLKC[10]	TCLKC[9]	TCLKC[8]
R/W	R	R	R	R	R	R	R	R
RTCRST	0	0	0	0	0	0	0	0
Other resets	0	0	0	0	0	0	0	0

Bit	D7	D6	D5	D4	D3	D2	D1	D0
Name	TCLKC[7]	TCLKC[6]	TCLKC[5]	TCLKC[4]	TCLKC[3]	TCLKC[2]	TCLKC[1]	TCLKC[0]
R/W	R	R	R	R	R	R	R	R
RTCRST	0	0	0	0	0	0	0	0
Other resets	0	0	0	0	0	0	0	0

Bit	Name	Function
D[15:0]	TCLKC[15:0]	TClock counter [15:0]

(2) TCLKCNTHREG (0x0B00 01C6)

Bit	D15	D14	D13	D12	D11	D10	D9	D8
Name	Reserved	Reserved	Reserved	Reserved	Reserved	Reserved	Reserved	TCLKC[24]
R/W	R	R	R	R	R	R	R	R
RTCRST	0	0	0	0	0	0	0	0
Other resets	0	0	0	0	0	0	0	0

Bit	D7	D6	D5	D4	D3	D2	D1	D0
Name	TCLKC[23]	TCLKC[22]	TCLKC[21]	TCLKC[20]	TCLKC[19]	TCLKC[18]	TCLKC[17]	TCLKC[16]
R/W	R	R	R	R	R	R	R	R
RTCRST	0	0	0	0	0	0	0	0
Other resets	0	0	0	0	0	0	0	0

Bit	Name	Function
D[15:9]	Reserved	Write 0 to these bits. 0 is returned after a read.
D[8:0]	TCLKC[24:16]	TClock counter [24:16]

Use these registers to set the TCLK counter value. The TCLKCNT counter begins its countdown at the value written to the TCLK counter registers. An TCLK counter interrupt occurs when the counter reaches 0x000 0001 (at which point the counter returns to the start value and continues counting).

These registers have no buffers for read. Therefore, an illegal data may be read if the counter value changes during a read operation. When using a read data, be sure to read a value twice and check that two read vales of the higher 9 bits are the same.

17.2.9 RTC Interrupt Register

(1) RTCINTREG (0x0B00 01DE)

Bit	D15	D14	D13	D12	D11	D10	D9	D8
Name	Reserved	Reserved	Reserved	Reserved	Reserved	Reserved	Reserved	Reserved
R/W	R	R	R	R	R	R	R	R
RTCRST	0	0	0	0	0	0	0	0
Other resets	0	0	0	0	0	0	0	0

Bit	D7	D6	D5	D4	D3	D2	D1	D0
Name	Reserved	Reserved	Reserved	Reserved	RTCINTR3	RTCINTR2	RTCINTR1	RTCINTR0
R/W	R	R	R	R	R/W	R/W	R/W	R/W
RTCRST	0	0	0	0	0	0	0	0
Other resets	0	0	0	0	0	Note	Note	Note

Bit	Name	Function
D[15:4]	Reserved	Write 0 to these bits. 0 is returned after a read.
D[3]	RTCINTR3	TClock counter interrupt. Cleared to 0 when 1 is written. 1 : Occurred 0 : Normal
D[2]	RTCINTR2	RTCLong2 interrupt. Cleared to 0 when 1 is written. 1 : Occurred 0 : Normal
D[1]	RTCINTR1	RTCLong1 interrupt. Cleared to 0 when 1 is written. 1 : Occurred 0 : Normal
D[0]	RTCINTR0	Status bit for elapsed time interrupt. Cleared to 0 when 1 is written. 1 : Occurred 0 : Normal

Note Previous value is retained.

This register is used to set/indicate the occurrences of interrupt requests of RTC.

[MEMO]

CHAPTER 18 DSU (DEADMAN'S SWITCH UNIT)

This chapter describes the DSU (Deadman's Switch Unit)'s operations and register settings.

18.1 GENERAL

The DSU detects when the VR4111 is in runaway (endless loop) state and resets the VR4111 to minimize runaway time. The use of the DSU to minimize runaway time effectively minimizes data loss that can occur due to software-related runaway states.

18.2 REGISTER SET

The DSU registers are listed below.

Table 18-1. DSU Registers

Address	R/W	Symbol	Function
0x0B00 00E0	R/W	DSUCNTREG	DSU Control Register
0x0B00 00E2	R/W	DSUSETREG	DSU Dead Time Set Register
0x0B00 00E4	W	DSUCLRREG	DSU Clear Register
0x0B00 00E6	R/W	DSUTIMREG	DSU Elapsed Time Register

Each register is described in detail below.

18.2.1 DSUCNTREG (0x0B00 00E0)

Bit	D15	D14	D13	D12	D11	D10	D9	D8
Name	Reserved	Reserved	Reserved	Reserved	Reserved	Reserved	Reserved	Reserved
R/W	R	R	R	R	R	R	R	R
RTCRST	0	0	0	0	0	0	0	0
Other resets	0	0	0	0	0	0	0	0

Bit	D7	D6	D5	D4	D3	D2	D1	D0
Name	Reserved	Reserved	Reserved	Reserved	Reserved	Reserved	Reserved	DSWEN
R/W	R	R	R	R	R	R	R	R/W
RTCRST	0	0	0	0	0	0	0	0
Other resets	0	0	0	0	0	0	0	0

Bit	Name	Function
D[15..1]	Reserved	Write 0 to these bits. 0 is returned after a read.
D[0]	DSWEN	Deadman's Switch function enable 1: Enable 0: Prohibit

This register is used to enable use of the Deadman's Switch functions.

18.2.2 DSUSETREG (0x0B00 00E2)

Bit	D15	D14	D13	D12	D11	D10	D9	D8
Name	Reserved	Reserved	Reserved	Reserved	Reserved	Reserved	Reserved	Reserved
R/W	R	R	R	R	R	R	R	R
RTCRST	0	0	0	0	0	0	0	0
Other resets	0	0	0	0	0	0	0	0

Bit	D7	D6	D5	D4	D3	D2	D1	D0
Name	Reserved	Reserved	Reserved	Reserved	DEDTIME[3]	DEDTIME[2]	DEDTIME[1]	DEDTIME[0]
R/W	R	R	R	R	R/W	R/W	R/W	R/W
RTCRST	0	0	0	0	0	0	0	0
Other resets	0	0	0	0	0	0	0	0

Bit	Name	Function
D[15..4]	Reserved	Write 0 to these bits. 0 is returned after a read.
D[3..0]	DEDTIME[3..0]	Deadman's Switch cycle setting 1111 15 sec 1110 14 sec : 0010 2 sec 0001 1 sec 0000 RFU

This register sets the cycle for Deadman's Switch functions.

The Deadman's Switch cycle can be set in 1-second increments in a range from 1 to 15 seconds. However, the Vr4111's operation is undefined when 0x0 has been set to DEDTIME[3..0]. The DSUCLRREG's DSWCLR bit must be set by means of software within the specified cycle time.

18.2.3 DSUCLRREG (0x0B00 00E4)

Bit	D15	D14	D13	D12	D11	D10	D9	D8
Name	Reserved	Reserved	Reserved	Reserved	Reserved	Reserved	Reserved	Reserved
R/W	R	R	R	R	R	R	R	R
RTCRST	0	0	0	0	0	0	0	0
Other resets	0	0	0	0	0	0	0	0

Bit	D7	D6	D5	D4	D3	D2	D1	D0
Name	Reserved	Reserved	Reserved	Reserved	Reserved	Reserved	Reserved	DSWCLR
R/W	R	R	R	R	R	R	R	W
RTCRST	0	0	0	0	0	0	0	0
Other resets	0	0	0	0	0	0	0	0

Bit	Name	Function
D[15..1]	Reserved	Write 0 to these bits. 0 is returned after a read.
D[0]	DSWCLR	Deadman's Switch counter clear. Cleared to 0 when 1 is written. 1 : Clear 0 : Don't clear

This register clears the Deadman's Switch counter by setting the DSWCLR bit in this register to 1. The Vr4111 automatically shuts down if 1 is not written to this register within the period specified in DSUSETREG.

18.2.4 DSUTIMREG (0x0B00 00E6)

Bit	D15	D14	D13	D12	D11	D10	D9	D8
Name	Reserved	Reserved	Reserved	Reserved	Reserved	Reserved	Reserved	Reserved
R/W	R	R	R	R	R	R	R	R
RTCRST	0	0	0	0	0	0	0	0
Other resets	0	0	0	0	0	0	0	0

Bit	D7	D6	D5	D4	D3	D2	D1	D0
Name	Reserved	Reserved	Reserved	Reserved	CRTTIME[3]	CRTTIME[2]	CRTTIME[1]	CRTTIME[0]
R/W	R	R	R	R	R/W	R/W	R/W	R/W
RTCRST	0	0	0	0	0	0	0	0
Other resets	0	0	0	0	0	0	0	0

Bit	Name	Function
D[15..4]	Reserved	Write 0 to these bits. 0 is returned after a read.
D[3..0]	CRTTIME[3..0]	Current Deadman's Switch timer value (elapsed time) 1111 15 sec 1110 14 sec : 0010 2 sec 0001 1 sec 0000 RFU

This register indicates the elapsed time for the current Deadman's Switch timer.

18.3 REGISTER SETTING FLOW

The DSU register setting flow is described below.

1. Set the DSU's count-up value (From 1 to 15 seconds).

The CPU will be reset if it does not clear (1 is not written to DSUCLRREG) the timer within this time period.

DSUDTMREG address : 0x0B00 00E2 data : 0x000x

2. Enable the DSU

DSUCNTREG address : 0x0B00 00E0 data : 0x0001

3. Clear the timer within the time period specified in step 1 above.

DSUCLRREG address : 0x0B00 00E4 data : 0x0001

For normal use, repeat step 3. To obtain the current elapsed time:

DSITIMREG address : 0x0B00 00E6 read (4 bits)

4. Disable the DSU for DOZE mode or a shutdown.

DSUCNTREG address : 0x0B00 00E0 data : 0x0000

CHAPTER 19 GIU (GENERAL PURPOSE I/O UNIT)

This chapter describes the GIU's operations and register settings.

19.1 GENERAL

The GIU controls GPIO and DCD# pins. GPIO pins are ports that support output functions and input functions (including three types of interrupt trigger detection functions). The interrupts occur in response to an input signal change (rising edge or falling edge of signal), low level, or high level.

The clocks and input buffer types used for interrupt detection at a GPIO pin are listed below.

Table 19-1. GPIO Pin Functions

Pin	Interrupt detection clock (internal)	Input buffer type
GPIO[49..32]	–	–
GPIO[31..16]	TClock	Normal
GPIO[15](DCD#)	MasterOut	Normal
GPIO[14..9]	MasterOut	Normal
GPIO[8..4]	TClock	Schmitt
GPIO[3..0]	RTC	Schmitt

Cautions The function of GPIO[15] is fixed as DCD# input signal. This pin cannot be used as a general-purpose input/output pin.

When not used for an interrupt, the registers corresponding to these pins can be written to output a low-level or high-level signal. Each register can be read to check the state of the signal currently being input to the corresponding pin.

- ★ The GPIO pins can be used as transition factors from the Standby, Suspend, or Hibernate mode to the Fullspeed mode. With the setting of generating an interrupt request for these pins, when the GPIO[31:0] or GPIO[14:9] pins become active, the Fullspeed mode returns from the Standby or Suspend mode, respectively. When these pins are specified as activation factors by the PMU registers and the GPIO[12:9] and GPIO[3:0] pins become active, the operation shifts from Hibernate mode to Fullspeed mode.

The GPIO[15] (DCD#) pin is also notified of an interrupt by SIU. Therefore, mask either GIU or SIU according to your requirements.

19.2 REGISTER SET

The GIU registers are listed below.

Table 19-2. GIU Registers

Address	R/W	Register Symbols	Function
0x0B00 0100	R/W	GIUIOSELL	GPIO Input/Output Select Register L
0x0B00 0102	R/W	GIUIOSELH	GPIO Input/Output Select Register H
0x0B00 0104	R/W	GIUIODL	GPIO Port Input/Output Data Register L
0x0B00 0106	R/W	GIUIODH	GPIO Port Input/Output Data Register H
0x0B00 0108	R/W	GIUINTSTATL	GPIO Interrupt Status Register L
0x0B00 010A	R/W	GIUINTSTATH	GPIO Interrupt Status Register H
0x0B00 010C	R/W	GIUINTENL	GPIO Interrupt Enable Register L
0x0B00 010E	R/W	GIUINTENH	GPIO Interrupt Enable Register H
0x0B00 0110	R/W	GIUINTTYPL	GPIO Interrupt Type (Edge or Level) Select Register L
0x0B00 0112	R/W	GIUINTTYPH	GPIO Interrupt Type (Edge or Level) Select Register H
0x0B00 0114	R/W	GIUINTALSELL	GPIO Interrupt Active Level Select Register L
0x0B00 0116	R/W	GIUINTALSELH	GPIO Interrupt Active Level Select Register H
0x0B00 0118	R/W	GIUINTHTSELL	GPIO Interrupt Hold/Through Select Register L
0x0B00 011A	R/W	GIUINTHTSELH	GPIO Interrupt Hold/Through Select Register H
0x0B00 011C	R/W	GIUPODATL	GPIO Port Output Data Register L
0x0B00 011E	R/W	GIUPODATH	GPIO Port Output Data Register H
0x0B00 02E0	R/W	GIUUSEUPDN	GPIO Pullup/Down User Register
0x0B00 02E2	R/W	GIUTERMUPDN	GPIO Terminal Pullup/Down Register

19.2.1 GIUISELL (0x0B00 0100)

Bit	D15	D14	D13	D12	D11	D10	D9	D8
Name	IOS[15]	IOS[14]	IOS[13]	IOS[12]	IOS[11]	IOS[10]	IOS[9]	IOS[8]
R/W	R	R/W	R/W	R/W	R/W	R/W	R/W	R/W
RTCST	0	0	0	0	0	0	0	0
Other resets	0	0	0	0	0	0	0	0

Bit	D7	D6	D5	D4	D3	D2	D1	D0
Name	IOS[7]	IOS[6]	IOS[5]	IOS[4]	IOS[3]	IOS[2]	IOS[1]	IOS[0]
R/W	R/W	R/W	R/W	R/W	R/W	R/W	R/W	R/W
RTCST	0	0	0	0	0	0	0	0
Other resets	0	0	0	0	0	0	0	0

Bit	Name	Function
D[15]	IOS[15]	GPIO[15] (DCD#) pin input/output select 1 : RFU 0 : Input
D[14..0]	IOS[14..0]	GPIO[14..0] pin input/output select 1 : Output 0 : Input

This register is used to set input/output modes for GPIO[15..0] pins. The IOS [15..0] bits correspond to the GPIO[15..0] pins.

When the IOS bit is set to "1", the corresponding GPIO pin is set for output and the value that has been written to the corresponding PIOD bit in the GIUPIODL (GPIO Port Input/Output Data Register) is output.

When this bit is set to "0", the corresponding GPIO pin is set for input.

Caution Since GPIO[15] (DCD#) is fixed as input, IOS[15] cannot be set for output.

19.2.2 GIUIOSELH (0x0B00 0102)

Bit	D15	D14	D13	D12	D11	D10	D9	D8
Name	IOS[31]	IOS[30]	IOS[29]	IOS[28]	IOS[27]	IOS[26]	IOS[25]	IOS[24]
R/W	R/W	R/W	R/W	R/W	R/W	R/W	R/W	R/W
RTCRST	0	0	0	0	0	0	0	0
Other resets	0	0	0	0	0	0	0	0

Bit	D7	D6	D5	D4	D3	D2	D1	D0
Name	IOS[23]	IOS[22]	IOS[21]	IOS[20]	IOS[19]	IOS[18]	IOS[17]	IOS[16]
R/W	R/W	R/W	R/W	R/W	R/W	R/W	R/W	R/W
RTCRST	0	0	0	0	0	0	0	0
Other resets	0	0	0	0	0	0	0	0

Bit	Name	Function
D[15..0]	IOS[31..16]	GPIO[31..16] pin input/output select 1 : Output 0 : Input

This register is used to set input/output modes for GPIO[31..16] pins. The IOS[31..16] pins correspond to the GPIO[31..16] pins.

When the IOS bit is set to "1", the corresponding GPIO pin is set for output and the value that has been written to the corresponding PIOD bit in the GIUPIODH (GPIO Port Input/Output Data Register) is output.

When this bit is set to "0", the corresponding GPIO pin is set for input.

19.2.3 GIUPIODL (0x0B00 0104)

Bit	D15	D14	D13	D12	D11	D10	D9	D8
Name	PIOD[15]	PIOD[14]	PIOD[13]	PIOD[12]	PIOD[11]	PIOD[10]	PIOD[9]	PIOD[8]
R/W	R	R/W	R/W	R/W	R/W	R/W	R/W	R/W
RTCRST	0	0	0	0	0	0	0	0
Other resets	0	0	0	0	0	0	0	0

Bit	D7	D6	D5	D4	D3	D2	D1	D0
Name	PIOD[7]	PIOD[6]	PIOD[5]	PIOD[4]	PIOD[3]	PIOD[2]	PIOD[1]	PIOD[0]
R/W	R/W	R/W	R/W	R/W	R/W	R/W	R/W	R/W
RTCRST	0	0	0	0	0	0	0	0
Other resets	0	0	0	0	0	0	0	0

Bit	Name	Function
D[15]	PIOD[15]	GPIO15 (DCD#) pin output data specification 1 : RFU 0 : Low
D[14..0]	PIOD[14..0]	GPIO pin output data specification 1 : High 0 : Low

This register is used to read GPIO pins and write data. The PIOD[15..0] bits correspond to the GPIO[15..0] pins.

When “1” is set to the corresponding IOS bit in the GIUIOSELL register (GPIO Input/Output Select Register), the data written to the PIOD bit is output via the corresponding GPIO pin.

When the value of the corresponding IOS bit in the GIUIOSELL register (GPIO Input/Output Select Register) is “0”, writing a value to the PIOD bit does not affect the GPIO pin (the write data is ignored).

When the value of the IOS bit in the GIUIOSELL register (GPIO Input/Output Select Register) is “0”, reading the PIOD bit enables the corresponding GPIO pin’s state to be read.

Caution Since GPIO[15] (DCD#) pin is fixed as input, data cannot be written to PIOD15.

19.2.4 GIUPIODH (0x0B00 0106)

Bit	D15	D14	D13	D12	D11	D10	D9	D8
Name	PIOD[31]	PIOD[30]	PIOD[29]	PIOD[28]	PIOD[27]	PIOD[26]	PIOD[25]	PIOD[24]
R/W	R/W	R/W	R/W	R/W	R/W	R/W	R/W	R/W
RTCRST	0	0	0	0	0	0	0	0
Other resets	0	0	0	0	0	0	0	0

Bit	D7	D6	D5	D4	D3	D2	D1	D0
Name	PIOD[23]	PIOD[22]	PIOD[21]	PIOD[20]	PIOD[19]	PIOD[18]	PIOD[17]	PIOD[16]
R/W	R/W	R/W	R/W	R/W	R/W	R/W	R/W	R/W
RTCRST	0	0	0	0	0	0	0	0
Other resets	0	0	0	0	0	0	0	0

Bit	Name	Function
D[15..0]	PIOD[31..16]	GPIO pin output data specification 1 : High 0 : Low

This register is used to read GPIO pins and write data. The PIOD[31..16] bits correspond to the GPIO[31..16] pins.

When “1” is set to the corresponding IOS bit in the GIUIOSELH register (GPIO Input/Output Select Register), the data written to the PIOD bit is output via the corresponding GPIO pin.

When the value of the corresponding IOS bit in the GIUIOSELH register (GPIO Input/Output Select Register) is “0”, writing a value to the PIOD bit does not affect the GPIO pin (the write data is ignored).

When the value of the IOS bit in the GIUIOSELH register (GPIO Input/Output Select Register) is “0”, reading the PIOD bit enables the corresponding GPIO pin’s state to be read.

19.2.5 GIUINTSTATL (0x0B00 0108)

Bit	D15	D14	D13	D12	D11	D10	D9	D8
Name	INTS[15]	INTS[14]	INTS[13]	INTS[12]	INTS[11]	INTS[10]	INTS[9]	INTS[8]
R/W	R/W	R/W	R/W	R/W	R/W	R/W	R/W	R/W
RTCRST	0	0	0	0	0	0	0	0
Other resets	0	0	0	0	0	0	0	0

Bit	D7	D6	D5	D4	D3	D2	D1	D0
Name	INTS[7]	INTS[6]	INTS[5]	INTS[4]	INTS[3]	INTS[2]	INTS[1]	INTS[0]
R/W	R/W	R/W	R/W	R/W	R/W	R/W	R/W	R/W
RTCRST	0	0	0	0	0	0	0	0
Other resets	0	0	0	0	0	0	0	0

Bit	Name	Function
D[15..0]	INTS[15..0]	Interrupt to GPIO pin. Cleared to 0 when 1 is written. 1 : Interrupt occurred 0 : No interrupt

This register indicates the interrupt status of GPIO pins.

The INTS[15..0] bits correspond to the GPIO[15..0] pins.

“1” is set to the corresponding INTS bit when the signal input to the GPIO pin meets the condition set via the GIUINTTYPL register (0x0B00 0110: GPIO Interrupt Type (Edge or Level) Select Register) or the GIUINTALSELL register (0x0B00 0114: GPIO Interrupt Active Level Select Register).

Even if the corresponding bit is set to “1”, however, no interrupt occurs when the GIUINTENL register (0x0B00 010C: GPIO Interrupt Enable Register) is set to prohibit interrupt.

If a GIPO pin is low at default status, it is judged that the condition is met, and the corresponding bit is set to “1”.

When using this register, it should be cleared to 0 once after the GIUINTTYPL and GIUINTALSELL registers are set to enable interrupt.

Caution The function of GPIO15 is fixed as the DCD# signal input.

19.2.6 GIUINTSTATH (0x0B00 010A)

Bit	D15	D14	D13	D12	D11	D10	D9	D8
Name	INTS[31]	INTS[30]	INTS[29]	INTS[28]	INTS[27]	INTS[26]	INTS[25]	INTS[24]
R/W	R/W	R/W	R/W	R/W	R/W	R/W	R/W	R/W
RTCRST	0	0	0	0	0	0	0	0
Other resets	0	0	0	0	0	0	0	0

Bit	D7	D6	D5	D4	D3	D2	D1	D0
Name	INTS[23]	INTS[22]	INTS[21]	INTS[20]	INTS[19]	INTS[18]	INTS[17]	INTS[16]
R/W	R/W	R/W	R/W	R/W	R/W	R/W	R/W	R/W
RTCRST	0	0	0	0	0	0	0	0
Other resets	0	0	0	0	0	0	0	0

Bit	Name	Function
D[15..0]	INTS[31..16]	Interrupt to GPIO pin. Cleared to 0 when 1 is written. 1 : Interrupt occurred 0 : No interrupt

This register indicates the interrupt status of GPIO pins.

The INTS[31..16] bits correspond to the GPIO[31..16] pins.

“1” is set to the corresponding INTS bit when the signal input to the GPIO pin meets the condition set via the GIUINTTYPH register (0x0B00 0112: GPIO Interrupt Type (Edge or Level) Select Register) or GIUINTALSELH register (0x0B00 0116: GPIO Interrupt Active Level Select Register).

Even if the corresponding bit is set to “1”, however, no interrupt occurs when the GIUINTENH register (0x0B00 010E: GPIO Interrupt Enable Register) is set to prohibit interrupt.

If a GPIO pin is low at default status, it is judged that the condition is met, and the corresponding bit is set to “1”.

When using this register, it should be cleared to 0 once after the GIUINTTYPH and GIUINTALSELH registers are set to enable interrupt.

19.2.7 GIUINTENL (0x0B00 010C)

Bit	D15	D14	D13	D12	D11	D10	D9	D8
Name	INTE[15]	INTE[14]	INTE[13]	INTE[12]	INTE[11]	INTE[10]	INTE[9]	INTE[8]
R/W	R/W	R/W	R/W	R/W	R/W	R/W	R/W	R/W
RTCRST	0	0	0	0	0	0	0	0
Other resets	0	0	0	0	0	0	0	0

Bit	D7	D6	D5	D4	D3	D2	D1	D0
Name	INTE[7]	INTE[6]	INTE[5]	INTE[4]	INTE[3]	INTE[2]	INTE[1]	INTE[0]
R/W	R/W	R/W	R/W	R/W	R/W	R/W	R/W	R/W
RTCRST	0	0	0	0	0	0	0	0
Other resets	0	0	0	0	0	0	0	0

Bit	Name	Function
D[15..0]	INTE[15..0]	Interrupt enable to GPIO pin 1 : Interrupt enable 0 : Interrupt prohibit

This register is used to set interrupt enable status for GPIO pins. The INTE[15..0] bits correspond to the GPIO[15..0] pins.

When “1” is set to the corresponding INTE bit, interrupts are enabled for the corresponding GPIO pins.

Caution The function of GPIO15 is fixed as the DCD# signal input.

19.2.8 GIUINTENH (0x0B00 010E)

Bit	D15	D14	D13	D12	D11	D10	D9	D8
Name	INTE[31]	INTE[30]	INTE[29]	INTE[28]	INTE[27]	INTE[26]	INTE[25]	INTE[24]
R/W	R/W	R/W	R/W	R/W	R/W	R/W	R/W	R/W
RTCRST	0	0	0	0	0	0	0	0
Other resets	0	0	0	0	0	0	0	0

Bit	D7	D6	D5	D4	D3	D2	D1	D0
Name	INTE[23]	INTE[22]	INTE[21]	INTE[20]	INTE[19]	INTE[18]	INTE[17]	INTE[16]
R/W	R/W	R/W	R/W	R/W	R/W	R/W	R/W	R/W
RTCRST	0	0	0	0	0	0	0	0
Other resets	0	0	0	0	0	0	0	0

Bit	Name	Function
D[15..0]	INTE[31..16]	Interrupt enable to GPIO[31..16] pin 1 : Interrupt enable 0 : Interrupt prohibit

This register is used to set interrupt enable status for GPIO pins. The INTE[31..16] bits correspond to the GPIO[31..16] pins.

When “1” is set to the corresponding INTE bit, interrupts are enabled for the corresponding GPIO pins.

19.2.9 GIUINTTYPL (0x0B00 0110)

Bit	D15	D14	D13	D12	D11	D10	D9	D8
Name	INTT[15]	INTT[14]	INTT[13]	INTT[12]	INTT[11]	INTT[10]	INTT[9]	INTT[8]
R/W	R/W	R/W	R/W	R/W	R/W	R/W	R/W	R/W
RTCRST	0	0	0	0	0	0	0	0
Other resets	0	0	0	0	0	0	0	0

Bit	D7	D6	D5	D4	D3	D2	D1	D0
Name	INTT[7]	INTT[6]	INTT[5]	INTT[4]	INTT[3]	INTT[2]	INTT[1]	INTT[0]
R/W	R/W	R/W	R/W	R/W	R/W	R/W	R/W	R/W
RTCRST	0	0	0	0	0	0	0	0
Other resets	0	0	0	0	0	0	0	0

Bit	Name	Function
D[15..0]	INTT[15..0]	Interrupt detection trigger 1 : Edge 0 : Level

This register is used to set the trigger to detect an interrupt request for GPIO pins. The INTT[15..0] bits correspond to the GPIO[15..0] pins.

When “1” is set to the corresponding INTT bit, the edge detection method is used for the interrupt signal at the corresponding GPIO pin (an interrupt is triggered when the signal state changes from low to high or from high to low).

The level detection method is used when “0” is set, in which case the level set to the corresponding bit in the GIUINTALSELL register (GPIO Interrupt Active Level Select Register) is detected.

Caution The function of GPIO[15] is fixed as DCD# signal input.

19.2.10 GIUINTTYPH (0x0B00 0112)

Bit	D15	D14	D13	D12	D11	D10	D9	D8
Name	INTT[31]	INTT[30]	INTT[29]	INTT[28]	INTT[27]	INTT[26]	INTT[25]	INTT[24]
R/W	R/W	R/W	R/W	R/W	R/W	R/W	R/W	R/W
RTCRST	0	0	0	0	0	0	0	0
Other resets	0	0	0	0	0	0	0	0

Bit	D7	D6	D5	D4	D3	D2	D1	D0
Name	INTT[23]	INTT[22]	INTT[21]	INTT[20]	INTT[19]	INTT[18]	INTT[17]	INTT[16]
R/W	R/W	R/W	R/W	R/W	R/W	R/W	R/W	R/W
RTCRST	0	0	0	0	0	0	0	0
Other resets	0	0	0	0	0	0	0	0

Bit	Name	Function
D[15..0]	INTT[31..16]	Interrupt detection trigger 1 : Edge 0 : Level

This register is used to set the detection method for interrupts to GPIO pins. The INTT[31..16] bits correspond to the GPIO[31..16] pins.

When “1” is set to the corresponding INTT bit, the edge detection method is used for the interrupt request signal at the corresponding GPIO pin (an interrupt request is triggered when the signal state changes from low to high or from high to low).

The level detection method is used when “0” is set, in which case the level set to the corresponding bit in the GIUINTALSELH register (GPIO Interrupt Active Level Select Register) is detected.

19.2.11 GIUINTALSELL (0x0B00 0114)

Bit	D15	D14	D13	D12	D11	D10	D9	D8
Name	INTL[15]	INTL[14]	INTL[13]	INTL[12]	INTL[11]	INTL[10]	INTL[9]	INTL[8]
R/W	R/W	R/W	R/W	R/W	R/W	R/W	R/W	R/W
RTCRST	0	0	0	0	0	0	0	0
Other resets	0	0	0	0	0	0	0	0

Bit	D7	D6	D5	D4	D3	D2	D1	D0
Name	INTL[7]	INTL[6]	INTL[5]	INTL[4]	INTL[3]	INTL[2]	INTL[1]	INTL[0]
R/W	R/W	R/W	R/W	R/W	R/W	R/W	R/W	R/W
RTCRST	0	0	0	0	0	0	0	0
Other resets	0	0	0	0	0	0	0	0

Bit	Name	Function
D[15..0]	INTL[15..0]	Interrupt request detection level 1 : High active 0 : Low active

This register is used to set the active level when using the level detection method for interrupts to GPIO pins. The INTL[15..0] bits correspond to the GPIO[15..0] pins.

The contents of this register are not reflected when the edge detection method is selected via the GIUINTTYPL register (GPIO Interrupt Type (Edge or Level) Select Register). When using this register, be sure to set the level detection method via the GIUINTTYPL register (GPIO Interrupt Type (Edge or Level) Select Register).

Caution The function of GPIO15 is fixed as the DCD# signal input.

19.2.12 GIUINTALSELH (0x0B00 0116)

Bit	D15	D14	D13	D12	D11	D10	D9	D8
Name	INTL[31]	INTL[30]	INTL[29]	INTL[28]	INTL[27]	INTL[26]	INTL[25]	INTL[24]
R/W	R/W	R/W	R/W	R/W	R/W	R/W	R/W	R/W
RTCRST	0	0	0	0	0	0	0	0
Other resets	0	0	0	0	0	0	0	0

Bit	D7	D6	D5	D4	D3	D2	D1	D0
Name	INTL[23]	INTL[22]	INTL[21]	INTL[20]	INTL[19]	INTL[18]	INTL[17]	INTL[16]
R/W	R/W	R/W	R/W	R/W	R/W	R/W	R/W	R/W
RTCRST	0	0	0	0	0	0	0	0
Other resets	0	0	0	0	0	0	0	0

Bit	Name	Function
D[15..0]	INTL[31..16]	Interrupt request detection level 1 : High active 0 : Low active

This register is used to set the active level when using the level detection method for interrupts to GPIO pins. The INTL[31..16] bits correspond to the GPIO[31..16] pins.

The contents of this register are not reflected when the edge detection method is selected via the GIUINTTYPH register (GPIO Interrupt Type (Edge or Level) Select Register). When using this register, be sure to set the level detection method via the GIUINTTYPH register (GPIO Interrupt Type (Edge or Level) Select Register).

19.2.13 GIUINTHSELL (0x0B00 0118)

Bit	D15	D14	D13	D12	D11	D10	D9	D8
Name	INTH[15]	INTH[14]	INTH[13]	INTH[12]	INTH[11]	INTH[10]	INTH[9]	INTH[8]
R/W	R/W	R/W	R/W	R/W	R/W	R/W	R/W	R/W
RTCRST	0	0	0	0	0	0	0	0
Other resets	0	0	0	0	0	0	0	0

Bit	D7	D6	D5	D4	D3	D2	D1	D0
Name	INTH[7]	INTH[6]	INTH[5]	INTH[4]	INTH[3]	INTH[2]	INTH[1]	INTH[0]
R/W	R/W	R/W	R/W	R/W	R/W	R/W	R/W	R/W
RTCRST	0	0	0	0	0	0	0	0
Other resets	0	0	0	0	0	0	0	0

Bit	Name	Function
D[15..0]	INTH[15..0]	GPIO[15..0] pin interrupt signal hold/through 1 : Hold 0 : Through

This register is used to set whether or not interrupt signals to the GPIO pins should be held. The INTH[15..0] bits correspond to the GPIO[15..0] pins.

When “1” is set to the corresponding INTH bit, any interrupt signal input to the corresponding GPIO pin is held.

When “0” is set to this bit, any interrupt signal input to the corresponding GPIO pin is not held and is instead allowed to pass through.

Any held interrupt signal is cleared when “1” is set to the corresponding bit in the GIUINTSTATL register (GPIO Interrupt Status Register).

INTH[15..0] are not affected by GIUINTENL (interrupt enable register).

If “1” (hold) is set to the INTH bit while the interrupt enable bit is set to 0 (prohibit interrupts), any change in the pin state is retained as change data. Therefore, an interrupt still occurs when the interrupt enable bit is again set to enable interrupts.

Caution The function of GPIO15 is fixed as the DCD# signal input.

19.2.14 GIUINTHTSELH (0x0B00 011A)

Bit	D15	D14	D13	D12	D11	D10	D9	D8
Name	INTH[31]	INTH[30]	INTH[29]	INTH[28]	INTH[27]	INTH[26]	INTH[25]	INTH[24]
R/W	R/W	R/W	R/W	R/W	R/W	R/W	R/W	R/W
RTCRST	0	0	0	0	0	0	0	0
Other resets	0	0	0	0	0	0	0	0

Bit	D7	D6	D5	D4	D3	D2	D1	D0
Name	INTH[23]	INTH[22]	INTH[21]	INTH[20]	INTH[19]	INTH[18]	INTH[17]	INTH[16]
R/W	R/W	R/W	R/W	R/W	R/W	R/W	R/W	R/W
RTCRST	0	0	0	0	0	0	0	0
Other resets	0	0	0	0	0	0	0	0

Bit	Name	Function
D[15..0]	INTH[31..16]	GPIO[31..16] pin interrupt signal hold/through 1 : Hold 0 : Through

This register is used to set whether or not interrupt signals to the GPIO pins should be held. The INTH[31..16] bits correspond to the GPIO[31..16] pins.

When “1” is set to the corresponding INTH bit, any interrupt signal input to the corresponding GPIO pin is held.

When “0” is set to this bit, any interrupt signal input to the corresponding GPIO pin is not held and is instead allowed to pass through.

Any held interrupt signal is cleared when “1” is set to the corresponding bit in the GIUINTSTATH register (GPIO Interrupt Status Register).

INTH[31..16] are not affected by GIUINTENH (interrupt enable register).

If “1” (hold) is set to the INTH bit while the interrupt enable bit is set to 0 (prohibit interrupts), any change in the pin state is retained as change data. Therefore, an interrupt still occurs when the interrupt enable bit is again set to enable interrupts.

The relationship between settings of GPIO interrupts enable/prohibit and hold/through is as below.

Table 19-3. Correspondences Between Interrupt Mask and Interrupt Hold

Interrupt trigger	Setting of GIUINTHSEL	Setting of GIUINTEN	Hold in GIU	Notation to ICU
Level	Hold	Masked	Held	Not noticed
		Not masked	Held	Noticed
		Masked → canceled	Held	Noticed
	Through	Masked	Through	Not noticed
		Not masked	Through	Noticed
		Masked → canceled	Through	Not noticed
Edge	Hold	Masked	Held	Not noticed
		Not masked	Held	Noticed
		Masked → canceled	Held	Noticed
	Through	Masked	Through	Not noticed
		Not masked	Prohibited	Prohibited
		Masked → canceled	Through	Not noticed

19.2.15 GIUPODATL (0x0B00 011C)

Bit	D15	D14	D13	D12	D11	D10	D9	D8
Name	PIOD[47]	PIOD[46]	PIOD[45]	PIOD[44]	PIOD[43]	PIOD[42]	PIOD[41]	PIOD[40]
R/W	R/W	R/W	R/W	R/W	R/W	R/W	R/W	R/W
RTCRST	0	0	0	0	1	1	1	1
Other resets	Note	Note	Note	Note	Note	Note	Note	Note

Bit	D7	D6	D5	D4	D3	D2	D1	D0
Name	PIOD[39]	PIOD[38]	PIOD[37]	PIOD[36]	PIOD[35]	PIOD[34]	PIOD[33]	PIOD[32]
R/W	R/W	R/W	R/W	R/W	R/W	R/W	R/W	R/W
RTCRST	1	1	1	1	1	1	1	1
Other resets	Note	Note	Note	Note	Note	Note	Note	Note

Bit	Name	Function
D[15..0]	PIOD[47..32]	GPIO[47..32] pin output data specification 1 : High 0 : Low

Note Previous value is retained.

This register is used to set the output level for GPIO[47..32] pins. The PIOD[47..32] bits correspond to the GPIO[47..32] pins.

The data written to the PIOD bit is output via the corresponding GPIO pin. The set value can be read by reading the PIOD bit.

Pins set by this register are output-only. Pins set by this register are used exclusively from other function pins. Therefore, when using this register, set the enable bit to prohibit in the corresponding unit.

The correspondences between PIOD bits and function pins are listed in the table on the next page.

Table 19-4. Correspondences Between GPIO[47..32] and Function Pins

PIOD Bit	GPIO pin	Function pin
PIOD[47]	GPIO[47]	DCTS#
PIOD[46]	GPIO[46]	DRTS#
PIOD[45]	GPIO[45]	DDIN
PIOD[44]	GPIO[44]	DDOUT
PIOD[43]	GPIO[43]	KSCAN[11]
PIOD[42]	GPIO[42]	KSCAN[10]
PIOD[41]	GPIO[41]	KSCAN[9]
PIOD[40]	GPIO[40]	KSCAN[8]
PIOD[39]	GPIO[39]	KSCAN[7]
PIOD[38]	GPIO[38]	KSCAN[6]
PIOD[37]	GPIO[37]	KSCAN[5]
PIOD[36]	GPIO[36]	KSCAN[4]
PIOD[35]	GPIO[35]	KSCAN[3]
PIOD[34]	GPIO[34]	KSCAN[2]
PIOD[33]	GPIO[33]	KSCAN[1]
PIOD[32]	GPIO[32]	KSCAN[0]

19.2.16 GIUPODATH (0x0B00 011E)

Bit	D15	D14	D13	D12	D11	D10	D9	D8
Name	Reserved	Reserved	Reserved	Reserved	Reserved	Reserved	PIOEN[1]	PIOEN[0]
R/W	R	R	R	R	R	R	R/W	R/W
RTCRST	0	0	0	0	0	0	0	0
Other resets	Note	Note	Note	Note	Note	Note	Note	Note

Bit	D7	D6	D5	D4	D3	D2	D1	D0
Name	Reserved	Reserved	Reserved	Reserved	Reserved	Reserved	PIOD[49]	PIOD[48]
R/W	R	R	R	R	R	R	R/W	R/W
RTCRST	0	0	0	0	0	0	0	0
Other resets	Note	Note	Note	Note	Note	Note	Note	Note

Bit	Name	Function
D[15..0]	Reserved	Write 0 to these bits. 0 is returned after a read.
D[9]	PIOEN[1]	GPIO[49] pin output control 1: Enable 0: Disable
D[8]	PIOEN[0]	GPIO[48]/DBUS32 pin output control 1: Enable 0: Disable
D[7..2]	Reserved	Write 0 to these bits. 0 is returned after a read.
D[1..0]	PIOD[49..48]	GPIO[49..48] pin output data specification 1: High 0: Low

Note Previous value is retained.

This register is used to enable/disable the output to the GPIO[49..48] pins and to set the output level for GPIO[49..48] pins. The PIOEN[1..0] bits or the PIOD[49..48] bits correspond to the GPIO[49..48].

The data written to the PIOD bit is output via the corresponding GPIO pin. The set value can be read by reading the PIOD bit.

Pins set by this register are output-only. Pins set by this register are used exclusively from other function pins. Therefore, when using this register, set the enable bit to prohibit in the corresponding unit.

The correspondence between PIOD bit and function pin is listed below.

Table 19-5. Correspondence Between GPIO[48] and Function Pin

PIOD Bit	GPIO pin	Function pin
PIOD[48]	GPIO[48]	DBUS32

Caution Input the low-level to the GPIO[49] pin because it is in the input state during RTCRST. This pin should be pulled down when this pin is not used, because this pin functions as an output pin in the operating modes other than RTCRST.

19.2.17 GIUUSEUPDN (0x0B00 02E0)

Bit	D15	D14	D13	D12	D11	D10	D9	D8
Name	Reserved	USEUPDN [14]	USEUPDN [13]	USEUPDN [12]	USEUPDN [11]	USEUPDN [10]	USEUPDN [9]	USEUPDN [8]
R/W	R	R/W	R/W	R/W	R/W	R/W	R/W	R/W
RTCRST	0	0	0	0	0	0	0	0
Other resets	Note	Note	Note	Note	Note	Note	Note	Note

Bit	D7	D6	D5	D4	D3	D2	D1	D0
Name	USEUPDN [7]	USEUPDN [6]	USEUPDN [5]	USEUPDN [4]	USEUPDN [3]	USEUPDN [2]	USEUPDN [1]	USEUPDN [0]
R/W	R/W	R/W	R/W	R/W	R/W	R/W	R/W	R/W
RTCRST	0	0	0	0	0	0	0	0
Other resets	Note	Note	Note	Note	Note	Note	Note	Note

Bit	Name	Function
D[15]	Reserved	Write 0 to this bit. 0 is returned after a read.
D[14..0]	USEUPDN[14..0]	GPIO pin pull-up/pull-down usage specification 1: Use pull-up/pull-down function 0: Does not use pull-up/pull-down function

Note Previous value is retained.

This register is used to specify whether the pull-up/pull-down function is used or not for the GPIO[14..0] pins. The USEUPDN[14..0] bits correspond to the GPIO[14..0] pins.

Setting “1” to the USEUPDN bit enables to use the pull-up/pull-down function for the corresponding GPIO pin.

The setting of the corresponding TERMUPDN bit of the GIUTERMUPDN register (0x0B00 02E2: GPIO Terminal Pullup/Down Register) determines whether the corresponding pin is pulled up or pulled down.

This function is valid only when all the bits of the GIUIOSELL register (0x0B00 0100: GPIO Input/Output Select Register) are set to 0 (setting for input).

Caution GPIO15 is not provided with this function because its function is fixed as the DCD# signal input.

19.2.18 GIUTERMUPDN (0x0B00 02E02)

Bit	D15	D14	D13	D12	D11	D10	D9	D8
Name	Reserved	TERMUPDN [14]	TERMUPDN [13]	TERMUPDN [12]	TERMUPDN [11]	TERMUPDN [10]	TERMUPDN [9]	TERMUPDN [8]
R/W	R	R/W	R/W	R/W	R/W	R/W	R/W	R/W
RTCRST	0	0	0	0	0	0	0	0
Other resets	Note	Note	Note	Note	Note	Note	Note	Note

Bit	D7	D6	D5	D4	D3	D2	D1	D0
Name	TERMUPDN [7]	TERMUPDN [6]	TERMUPDN [5]	TERMUPDN [4]	TERMUPDN [3]	TERMUPDN [2]	TERMUPDN [1]	TERMUPDN [0]
R/W	R/W	R/W	R/W	R/W	R/W	R/W	R/W	R/W
RTCRST	0	0	0	0	0	0	0	0
Other resets	Note	Note	Note	Note	Note	Note	Note	Note

Bit	Name	Function
D[15]	Reserved	Write 0 to this bit. 0 is returned after a read.
D[14..0]	TERMUPDN[14..0]	GPIO[14..0] pin pull-up/pull-down selection 1: Pull-up 0: Pull-down

Note Previous value is retained.

This register is used to specify whether the pull-up or pull-down function is used for the GPIO[14..0] pins. The TERMUPDN[14..0] bits correspond to the GPIO[14..0] pins.

When the corresponding bit of the GIUUSEUPNL register (0x0B00 02E0: GPIO Pullup/Down Register) is 1, setting “1” to the TERMUPDN bit specifies the pull-up function for the corresponding pin, and setting “0” does the pull-down function.

Caution GPIO15 is not provided with this function because its function is fixed as the DCD# signal input.

CHAPTER 20 PIU (TOUCH PANEL INTERFACE UNIT)

This chapter describes the PIU's operations and register settings.

20.1 GENERAL

The PIU uses an on-chip A/D converter and detects the X and Y coordinates of pen contact locations on the touch panel and scans the general-purpose A/D input port. Since the touch panel control circuit and the A/D converter (conversion precision: 10 bits) are both on-chip, the touch panel is connected directly to the V_{R4111} .

The PIU's function, namely the detection of X and Y coordinates, is performed partly by hardware and partly by software.

Hardware tasks :

- Touch panel applied voltage control
- Reception of coordinate data

Software task : • Processing of coordinate data based on data sampled by hardware

Features of the PIU's hardware tasks are described below.

- Can be directly connected to touch panel with four-pin resistance layers (on-chip touch panel driver)
- Interface for on-chip A/D converter
- Voltage detection at three general-purpose AD ports and one audio input port
- Operation of A/D converter based on various settings and control of voltage applied to touch panel
- Sampling of X-coordinate and Y-coordinate data
- Variable coordinate data sampling interval
- Interrupt is triggered if pen touch occurs regardless of CPU operation mode (interrupts do not occur when in CPU hibernate mode)
- Four dedicated buffers for up to two pages each of coordinate data
- Four buffers for A/D port scan
- Auto/manual options for coordinate data sampling start/stop control

20.1.1 Block Diagrams

Figure 20-1. PIU Peripheral Block Diagram

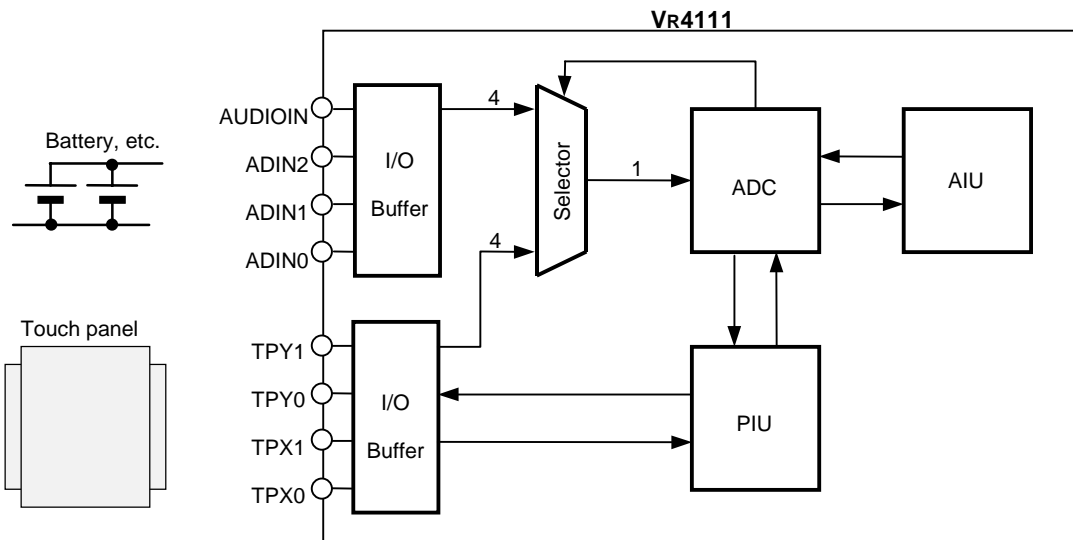

- **Touch panel**

A set of four pins are located at the edges of the X-axis and Y-axis resistance layers, and the two layers have high resistance when there is no pen contact and low resistance when there is pen contact. The resistance between the two edges of the resistance layers is about 1 k Ω . When a voltage is applied to both edges of the Y-axis resistance layer, the voltage (V_{Y1} and V_{Y2} in the figure below) is measured at the X-axis resistance layer's pins to determine the Y coordinate. Similarly, when a voltage is applied to both edges of the X-axis resistance layer, the voltage (V_{X1} and V_{X2} in the figure below) is measured at the Y-axis resistance layer's pins to determine the X coordinate. For greater precision, voltage applied to individual resistance-layer pins can be measured to obtain X and Y coordinate data based on four voltage measurements. The obtained data is stored into the PIUBPnmREG register ($n = 0$ or 1, $m = 0$ to 3).

Figure 20-2. Coordinate Detection Equivalent Circuits

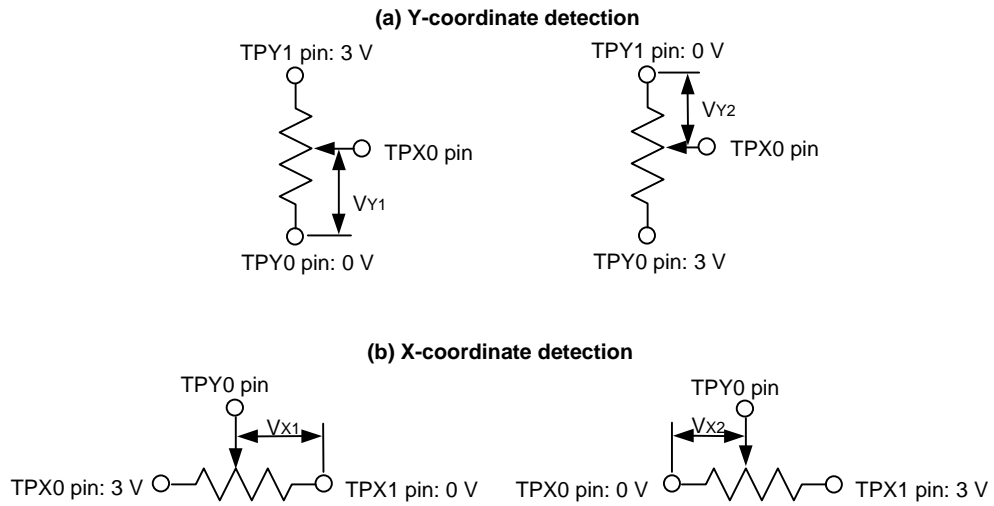
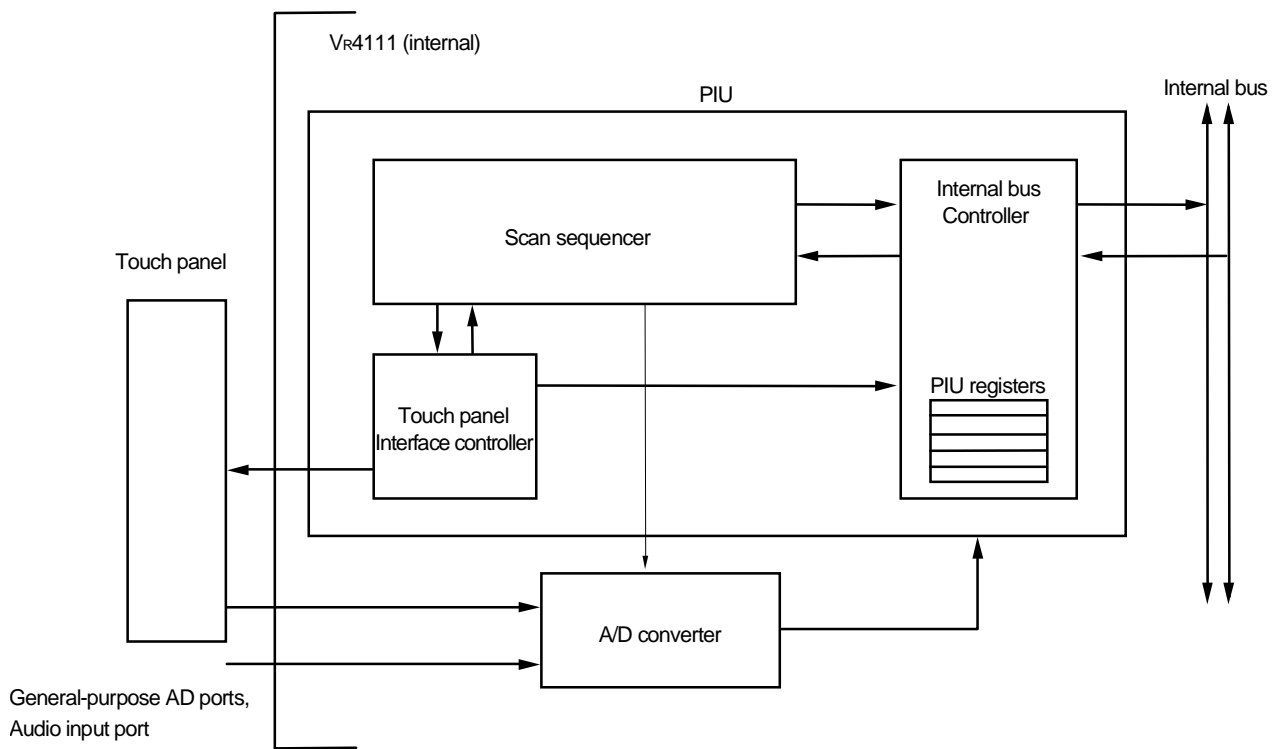

Figure 20-3. Internal Block Diagram of PIU



The PIU includes three blocks: an internal bus controller, a scan sequencer, and a touch panel interface controller.

- Internal bus controller
The internal bus controller controls the internal bus, the PIU registers, and interrupts and performs serial/parallel conversion of data from the A/D converter.
- Scan sequencer
The scan sequencer is used for PIU state management.
- Touch panel interface controller
The touch panel interface controller is used to control the touch panel.

20.2 SCAN SEQUENCER STATE TRANSITION

Figure 20-4. Scan Sequencer State Transition Diagram

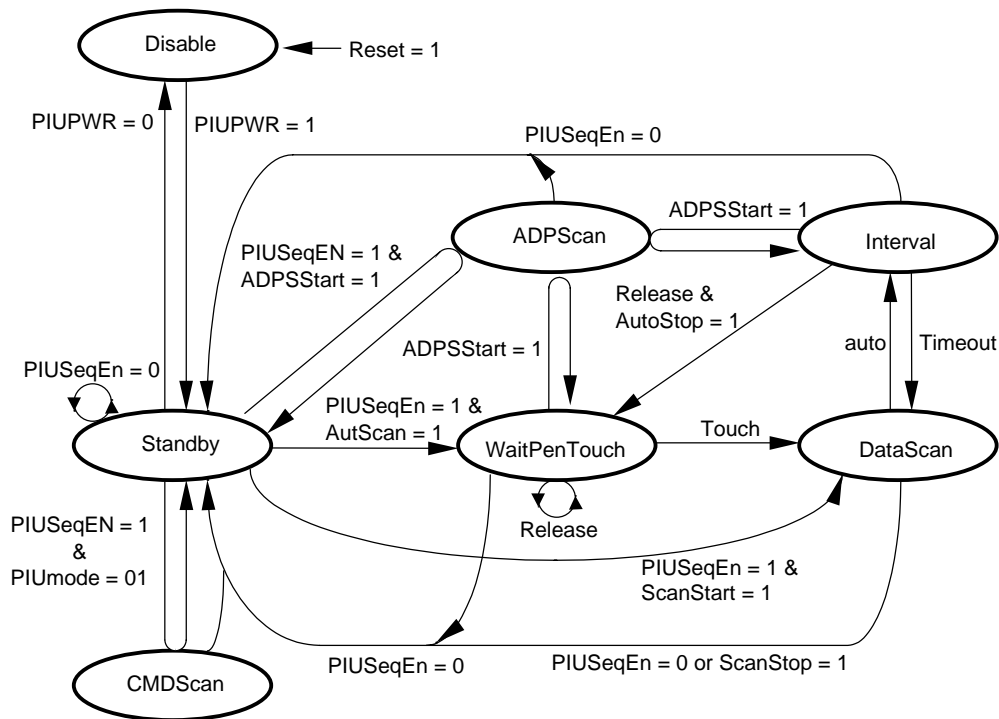

- Disable state

In this state, the A/D converter is in standby mode, the output pins are in touch detection mode (no PIU interrupt), and the input pins are in mask mode (to prevent misoperation when an undefined input is applied).

- Standby state

In this state, the unit is in scan idle mode. The touch panel is in low-power mode (0-V voltage is applied to the touch panel and the A/D converter is in disable mode). Normally, this is the state from which various mode settings are made.

Caution State transitions occur when the PIUSEQEN bit is active, so the PIUSEQEN bit must be set as active after each mode setting has been completed.

- ADPortScan state

This is the state in which voltage is measured at the A/D converter's three general-purpose ports and one audio input port. After the A/D converter is activated and voltage data is obtained, the data is stored in the PIU's internal data buffer (PIUABxREG). After the four ports are scanned, a PadCMDIntr interrupt occurs. After this interrupt occurs, the ADPSSTART bit is automatically set as inactive and the state changes to the state in which the ADPSSTART bit was active.

- CMDScan state

When in this state, the A/D converter operates using various settings. Voltage data from one port only is fetched based on a combination of the touch panel pin setting (TPX[1:0], TPY[1:0]) and the selection of an input port (TPX[1:0], TPY[1:0], AUDIOIN, ADIN[2:0]) to the A/D converter. Use PIUCMDREG to make the touch panel pin setting and to select the input port.

- WaitPenTouch state

This is the standby state that waits for a touch panel "touch" state. When the PIU detects a touch panel "touch" state, PenChgIntr (an internal interrupt in the PIU) occurs. At this point, if the PADATSCAN bit is active, the state changes to the PenDataScan state. During the WaitPenTouch state, it is possible to change to Suspend mode because the panel state can be detected even when TClock has been stopped.

- PenDataScan state

This is the state in which touch panel coordinates are detected. The A/D converter is activated and the four sets of data for each coordinate are sampled.

Caution If one complete pair of coordinates is not obtained during the interval between one pair of coordinates and the next coordinate data, a PadDataLostIntr interrupt occurs.

- IntervalNextScan state

This is the standby state that waits for the next coordinate sampling period and the touch panel's "Release" state. After the touch panel state is detected, the time period specified via PIUSIVLREG elapses before the transition to the PenDataScan state. If the PIU detects the "Release" state within the specified time period, PenChgIntr (an internal interrupt in the PIU) occurs. At this point, the state changes to the WaitPenTouch state if the PADAUTOSTOP bit is active. If the PADATSTOP bit is inactive, it changes to the PenDataScan state after the specified time period has elapsed.

20.3 REGISTER SET

The PIU registers are listed below.

Table 20-1. PIU Registers

Address	R/W	Register symbols	Function
0x0B00 0122	R/W	PIUCNTREG	PIU Control register
0x0B00 0124	R/W	PIUINTREG	PIU Interrupt cause register
0x0B00 0126	R/W	PIUSIVLREG	PIU Data sampling interval register
0x0B00 0128	R/W	PIUSTBLREG	PIU A/D converter start delay register
0x0B00 012A	R/W	PIUCMDREG	PIU A/D command register
0x0B00 0130	R/W	PIUASCNREG	PIU A/D port scan register
0x0B00 0132	R/W	PIUAMSKREG	PIU A/D scan mask register
0x0B00 013E	R	PIUCIVLREG	PIU Check interval register
0x0B00 02A0	R/W	PIUPB00REG	PIU Page 0 Buffer 0 register
0x0B00 02A2	R/W	PIUPB01REG	PIU Page 0 Buffer 1 register
0x0B00 02A4	R/W	PIUPB02REG	PIU Page 0 Buffer 2 register
0x0B00 02A6	R/W	PIUPB03REG	PIU Page 0 Buffer 3 register
0x0B00 02A8	R/W	PIUPB10REG	PIU Page 1 Buffer 0 register
0x0B00 02AA	R/W	PIUPB11REG	PIU Page 1 Buffer 1 register
0x0B00 02AC	R/W	PIUPB12REG	PIU Page 1 Buffer 2 register
0x0B00 02AE	R/W	PIUPB13REG	PIU Page 1 Buffer 3 register
0x0B00 02B0	R/W	PIUAB0REG	PIU A/D scan Buffer 0 register
0x0B00 02B2	R/W	PIUAB1REG	PIU A/D scan Buffer 1 register
0x0B00 02B4	R/W	PIUAB2REG	PIU A/D scan Buffer 2 register
0x0B00 02B6	R/W	PIUAB3REG	PIU A/D scan Buffer 3 register
0x0B00 02BC	R/W	PIUPB04REG	PIU Page 0 Buffer 4 register
0x0B00 02BE	R/W	PIUPB14REG	PIU Page 1 Buffer 4 register

These registers are described in detail below.

20.3.1 PIUCNTREG (0x0B00 0122)

(1/2)

Bit	D15	D14	D13	D12	D11	D10	D9	D8
Name	Reserved	Reserved	PENSTC	PADSTATE[2]	PADSTATE[1]	PADSTATE[0]	PADATSTOP	PADATSTART
R/W	R	R	R	R	R	R	R/W	R/W
RTCRST	0	0	0	0	0	0	0	0
Other resets	0	0	0	0	0	0	0	0

Bit	D7	D6	D5	D4	D3	D2	D1	D0
Name	PADSCAN STOP	PADSCAN START	PADSCAN TYPE	PIUMODE[1]	PIUMODE[0]	PIUSEQEN	PIUPWR	PADRST
R/W	R/W	R/W	R/W	R/W	R/W	R/W	R/W	W
RTCRST	0	0	0	0	0	0	0	0
Other resets	0	0	0	0	0	0	0	0

Bit	Name	Function
D[15..14]	Reserved	Write 0 to these bits. 0 is returned after a read.
★ D[13]	PENSTC	Touch/release when touch panel contact state changes 1 : Touch 0 : Release
★ D[12..10]	PADSTATE	Scan sequencer status 111 : CmdScan 110 : IntervalNextScan 101 : PenDataScan 100 : WaitPenTouch 011 : RFU 010 : ADPortScan 001 : Standby 000 : Disable
D[9]	PADATSTOP	Sequencer auto stop setting during touch panel release state 1 : Auto stop after sampling data for one set of coordinates during release state 0 : No auto stop (even during release state)
D[8]	PADATSTART	Sequencer auto start setting during touch panel touch state 1 : Auto start during touch state 0 : No auto start during touch state
D[7]	PADSCANSTOP	Forced stop setting for touch panel sequencer 1 : Forced stop after sampling data for one set of coordinates 0 : Do not stop

Bit	Name	Function
D[6]	PADSCANSTART	Start setting for touch panel sequencer 1 : Forced start 0 : Do not start
D[5]	PADSCANTYPE	Touch pressure sampling enable 1 : Enable 0 : Prohibit
D[4..3]	PIUMODE[1..0]	PIU mode setting 11 : RFU 10 : RFU 01 : Operate A/D converter using any command 00 : Sample coordinate data
D[2]	PIUSEQEN	Scan sequencer operation enable 1 : Enable 0 : Prohibit
D[1]	PIUPWR	PIU power mode setting 1 : Set PIU output as active and change to standby mode 0 : Set panel to touch detection state and set PIU operation stop enabled mode
D[0]	PADRST	PIU reset. Once the PADRST bit is set to "1", it is automatically cleared to 0 after four TClock cycles. 1 : Reset 0 : Normal

This register is used to make various settings for the PIU.

- ★ The PENSTC bit indicates the touch panel contact state at the time when the PENCHGINTR bit of PIUINTREG is set to 1. This bit's state remains as it is until PENCHGINTR is cleared to 0. Also, when PENCHGINTR is cleared to 0, PENSTC indicates the touch panel contact state. However, PENSTC does not change while PENCHGINTR is set to 1, even if the touch panel contact state changes between release and touch.

Some bits in this register cannot be set in a specific state of scan sequencer. The combination of the setting of this register and the sequencer state is as follows.

Table 20-2. PIUCNTREG Bit Manipulation and States

PIUCNTREG bit manipulation		Scan sequencer's state			
		Disable	Standby	WaitPenTouch	PenData Scan
PADRST	0 → 1	– ^{Note1}	Disable ^{Note1}	Disable ^{Note1}	Disable ^{Note1}
PIUPWR	0 → 1	Standby	?	×	×
	1 → 0	?	Disable	×	×
PIUSEQEN	0 → 1	×	WaitPenTouch	?	?
	1 → 0	?	?	Standby	Standby
PADATSTART	0 → 1	×	–	PenDataScan ^{Note2}	×
	1 → 0	×	–	–	×
PADATSTOP	0 → 1	×	–	×	×
	1 → 0	×	–	×	×
PADSCANSTART	0 → 1	×	PenDataScan ^{Note3}	×	×
	1 → 0	×	–	×	×
PADSCANSTOP	0 → 1	×	–	×	Standby ^{Note4}
	1 → 0	×	–	×	–

PIUCNTREG bit manipulation		Scan sequencer's state		
		IntervalNextScan	ADPortScan	CmdScan
PADRST	0 → 1	Disable ^{Note1}	Disable ^{Note1}	Disable ^{Note1}
PIUPWR	0 → 1	?	?	?
	1 → 0	×	×	×
PIUSEQEN	0 → 1	?	?	?
	1 → 0	Standby	Standby	Standby
PADATSTART	0 → 1	×	×	×
	1 → 0	×	×	×
PADATSTOP	0 → 1	×	×	×
	1 → 0	×	×	×
PADSCANSTART	0 → 1	×	×	×
	1 → 0	×	×	×
PADSCANSTOP	0 → 1	Standby	Standby ^{Note4}	Standby ^{Note4}
	1 → 0	?	–	–

- Notes**
1. After “1” is written, the bit is automatically cleared to 0 after four TClock cycles.
 2. State transition occurs during touch state
 3. State transition occurs when PIUSEQEN = 1
 4. State transition occurs after one set of data is sampled. This bit is cleared to 0 after the state transition occurs.

Remarks

- : The bit change is retained but there is no state transition.
- × : Setting prohibited (operation not guaranteed)
- ? : Combination of state and bit status before setting does not exist

20.3.2 PIUINTREG (0x0B00 0124)

Bit	D15	D14	D13	D12	D11	D10	D9	D8
Name	OVP	Reserved	Reserved	Reserved	Reserved	Reserved	Reserved	Reserved
R/W	R/W	R	R	R	R	R	R	R
RTCRST	0	0	0	0	0	0	0	0
Other resets	0	0	0	0	0	0	0	0

Bit	D7	D6	D5	D4	D3	D2	D1	D0
Name	Reserved	PADCMD INTR	PADADP INTR	PADPAGE1 INTER	PADPAGE0 INTER	PADDLOST INTR	Reserved	PENCHG INTR
R/W	R	R/W	R/W	R/W	R/W	R/W	R	R/W
RTCRST	0	0	0	0	0	0	0	0
Other resets	0	0	0	0	0	0	0	0

Bit	Name	Function
D[15]	OVP	Valid page ID bit (older valid page) 1 : Valid data older than page 1 buffer data is retained 0 : Valid data older than page 0 buffer data is retained
D[14..7]	Reserved	Write 0 to these bits. 0 is returned after a read.
D[6]	PADCMDINTR	PIU command scan interrupt. Cleared to 0 when 1 is written. 1 : Indicates that command scan found valid data 0 : Indicates that command scan did not find valid data in buffer
D[5]	PADADPINTR	PIU A/D port scan interrupt . Cleared to 0 when 1 is written. 1 : Indicates that A/D port scan found valid data with "1" value in buffer 0 : Indicates that A/D port scan did not find valid data with "1" value in buffer
D[4]	PADPAGE1INTER	PIU data buffer page 1 interrupt. Cleared to 0 when 1 is written. 1 : Valid data with "1" value is stored in page 1 of data buffer 0 : No valid data with "1" value in page 1 of data buffer
D[3]	PADPAGE0INTER	PIU data buffer page 0 interrupt. Cleared to 0 when 1 is written. 1 : Valid data with "1" value is stored in page 0 of data buffer 0 : No valid data with "1" value in page 0 of data buffer
D[2]	PADDLOSTINTR	A/D data timeout. Cleared to 0 when 1 is written. 1 : Not data with "1" value found within specified time 0 : No timeout
D[1]	Reserved	Write 0 to this bit. 0 is returned after a read.
D[0]	PENCHGINTR	Change in touch panel contact state. Cleared to 0 when 1 is written. 1 : Change has occurred 0 : No change

This register sets and indicates the interrupt request generation of PIU.

- ★ When the PENCHGINTR bit is set to 1, the PENSTC bit indicates the touch panel contact state (touch or release) when a contact state changes. The PENSTC bit's state remains until PENCHGINTR bit is cleared to 0. Also, when PENCHGINTR is cleared to 0, PENSTC indicates the touch panel contact state. However, PENSTC does not change while PENCHGINTR is set to 1, even if the touch panel contact state changes between release and touch.

★ **Caution** In the Hibernate mode, the V_{R4111} retains the touch panel state. Therefore, if the Hibernate mode has been entered while the touch panel is touched, the contact state may be mistakenly recognized as having changed, when the Fullspeed mode returns.

This may result in $PENCHGINTR$ being set to 1, when a touch panel state change interrupt occurs immediately after the Fullspeed mode returns from the Hibernate mode. Similarly, other bits of $PINUINTREG$ may be set to 1 on returning from the Hibernate mode. Therefore, set each bit of $PIUINTREG$ to 1 to clear an interrupt request, immediately after the Fullspeed mode returns from the Hibernate mode.

20.3.3 PIUSIVLREG (0x0B00 0126)

Bit	D15	D14	D13	D12	D11	D10	D9	D8
Name	Reserved	Reserved	Reserved	Reserved	Reserved	SCANINT VAL[10]	SCANINT VAL[9]	SCANINT VAL[8]
R/W	R	R	R	R	R	R/W	R/W	R/W
RTCRST	0	0	0	0	0	0	0	0
Other resets	0	0	0	0	0	0	0	0

Bit	D7	D6	D5	D4	D3	D2	D1	D0
Name	SCANINT VAL[7]	SCANINT VAL[6]	SCANINT VAL[5]	SCANINT VAL[4]	SCANINT VAL[3]	SCANINT VAL[2]	SCANINT VAL[1]	SCANINT VAL[0]
R/W	R/W	R/W	R/W	R/W	R/W	R/W	R/W	R/W
RTCRST	1	0	1	0	0	1	1	1
Other resets	1	0	1	0	0	1	1	1

Bit	Name	Function
D[15..11]	Reserved	Write 0 to these bits. 0 is returned after a read.
D[10..0]	SCANINTVAL[10..0]	Coordinate data scan sampling interval setting Interval = $SCANINTVAL[10..0] \times 30 \mu s$

This register sets the sampling interval for coordinate data sampling.

The sampling interval for one pair of coordinate data is the value set via $SCANINTVAL[10..0]$ multiplied by $30 \mu s$. Accordingly, the logical range of sampling intervals that can be set in $30\text{-}\mu s$ units is from $0 \mu s$ to $60,810 \mu s$ (about 60 ms). Actually, if the sampling interval setting is shorter than the time required for obtaining a pair of coordinate data or ADPortScan data, a $PIULostIntr$ interrupt will occur. If $PIULostIntr$ interrupts occur frequently, set a longer interval time.

Figure 20-5. Interval Times and States

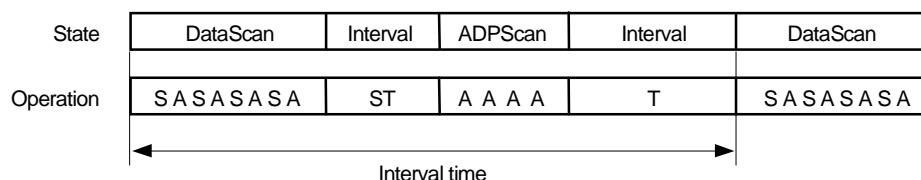

S: Voltage stabilization standby time (STABLE[5:0] in PIUSTBLREG)
 A: A/D converter
 T: Touch/release detection

20.3.4 PIUSTBLREG (0x0B00 0128)

Bit	D15	D14	D13	D12	D11	D10	D9	D8
Name	Reserved	Reserved	Reserved	Reserved	Reserved	Reserved	Reserved	Reserved
R/W	R	R	R	R	R	R	R	R
RTCRST	0	0	0	0	0	0	0	0
Other resets	0	0	0	0	0	0	0	0

Bit	D7	D6	D5	D4	D3	D2	D1	D0
Name	Reserved	Reserved	STABLE[5]	STABLE[4]	STABLE[3]	STABLE[2]	STABLE[1]	STABLE[0]
R/W	R	R	R/W	R/W	R/W	R/W	R/W	R/W
RTCRST	0	0	0	0	0	1	1	1
Other resets	0	0	0	0	0	1	1	1

Bit	Name	Function
D[15..6]	Reserved	Write 0 to these bits. 0 is returned after a read.
D[5..0]	STABLE[5..0]	Panel applied voltage stabilization standby time (DataScan, CmdScan state) A/D scan timeout time (ADPScan state) Standby time = STABLE[5..0] × 30 μs (Disable, WaitPenTouch, Interval state) During A/D scan, this can be used as a timeout counter.

The voltage stabilization standby time for the voltage applied to the touch panel can be set via STABLE[5..0] in 30-μs units between 0 μs and 1,890 μs.

20.3.5 PIUCMDREG (0x0B00 012A)

(1/2)

Bit	D15	D14	D13	D12	D11	D10	D9	D8
Name	Reserved	Reserved	Reserved	STABLEON	TPYEN1	TPYEN0	TPXEN1	TPXEN0
R/W	R	R	R	R/W	R/W	R/W	R/W	R/W
RTCRST	0	0	0	0	0	0	0	0
Other resets	0	0	0	0	0	0	0	0

Bit	D7	D6	D5	D4	D3	D2	D1	D0
Name	TPYD1	TPYD0	TPXD1	TPXD0	ADCMD[3]	ADCMD[2]	ADCMD[1]	ADCMD[0]
R/W	R/W	R/W	R/W	R/W	R/W	R/W	R/W	R/W
RTCRST	0	0	0	0	1	1	1	1
Other resets	0	0	0	0	1	1	1	1

Bit	Name	Function
D[15..13]	Reserved	Write 0 to these bits. 0 is returned after a read.
D[12]	STABLEON	Touch panel applied voltage stabilization time set during command scan (STABLE[5..0] of PIUSTBLREG) enable 1 : Retain panel voltage stabilization time 0 : Ignore panel voltage stabilization time (voltage stabilization standby time = 0)
D[11..10]	TPYEN[1..0]	TPY port input/output switching during command scan 00 : TPY1 input, TPY0 input 01 : TPY1 input, TPY0 output 10 : TPY1 output, TPY0 input 11 : TPY1 output, TPY0 output
D[9..8]	TPXEN[1..0]	TPX port input/output switching during command scan 00 : TPX1 input, TPX0 input 01 : TPX1 input, TPX0 output 10 : TPX1 output, TPX0 input 11 : TPX1 output, TPX0 output
D[7..6]	TPYD[1..0]	TPY output level during command scan 00 : TPY1 = "L", TPY0 = "L" 01 : TPY1 = "L", TPY0 = "H" 10 : TPY1 = "H", TPY0 = "L" 11 : TPY1 = "H", TPY0 = "H" TPYD value is ignored when TPYEN is set for input.
D[5..4]	TPXD[1..0]	TPX output level during command scan 00 : TPX1 = "L", TPX0 = "L" 01 : TPX1 = "L", TPX0 = "H" 10 : TPX1 = "H", TPX0 = "L" 11 : TPX1 = "H", TPX0 = "H" TPXD value is ignored when TPXEN is set for input.

(2/2)

Bit	Name	Function
D[3..0]	ADCMD[3..0]	A/D converter input port selection for command scan 1111 : A/D converter standby mode request 1110 : RFU : 1000 : RFU 0111 : AUDIOIN port 0110 : ADIN2 port 0101 : ADIN1 port 0100 : ADIN0 port 0011 : TPY1 port 0010 : TPY0 port 0001 : TPX1 port 0000 : TPX0 port

This register switches input/output and sets output level for each port during a command scanning operation.

20.3.6 PIUASCNREG (0x0B00 0130)

Bit	D15	D14	D13	D12	D11	D10	D9	D8
Name	Reserved	Reserved	Reserved	Reserved	Reserved	Reserved	Reserved	Reserved
R/W	R	R	R	R	R	R	R	R
RTCRST	0	0	0	0	0	0	0	0
Other resets	0	0	0	0	0	0	0	0

Bit	D7	D6	D5	D4	D3	D2	D1	D0
Name	Reserved	Reserved	Reserved	Reserved	Reserved	Reserved	TPPSCAN	ADPS START
R/W	R	R	R	R	R	R	R/W	R/W
RTCRST	0	0	0	0	0	0	0	0
Other resets	0	0	0	0	0	0	0	0

Bit	Name	Function
D[15..2]	Reserved	Write 0 to these bits. 0 is returned after a read.
D[1]	TPPSCAN	Port selection for ADPortScan 1 : Select TPX[1:0], TPY[1:0] (for touch panel) as A/D port 0 : Select ADIN[2:0] (general-purpose) as A/D port and AUDIOIN as audio input port The bit manipulation is valid only in the Standby state. In the other states, the operation is not guaranteed.
D[0]	ADPSSTART	ADPortScan start 1 : Start ADPortScan 0 : Do not perform ADPortScan

This register is used for ADPScan setting

The ADPortScan begins when the ADPSSTART bit is set. After the ADPortScan is completed, the state returns to the state when ADPortScan was started.

If the ADPortScan is not completed within the time period set via PIUSTBLREG's STABLE bits, a PIULostIntr interrupt occurs as a timeout interrupt.

Some bits in this register cannot be set in a specific state of scan sequencer. The combination of the setting of this register and the sequencer state is as follows.

Table 20-3. PIUASCNREG Bit Manipulation and States

PIUASCNREG bit manipulation		Scan sequencer's state			
		Disable	Standby	WaitPenTouch	PenData Scan
ADPSSTART	0 → 1	×	ADPortScan ^{Note}	×	×
	1 → 0	×	Disable	×	×
TPPSCAN	0 → 1	–	–	–	–
	1 → 0	–	–	–	–

PIUCNTREG bit manipulation		Scan sequencer's state		
		IntervalNextScan	ADPortScan	CmdScan
ADPSSTART	0 → 1	×	ADPortScan ^{Note}	×
	1 → 0	×	Disable	×
TPPSCAN	0 → 1	×	WaitPenTouch	?
	1 → 0	?	?	Standby

Note After ADPortScan is completed, the bit is automatically cleared to 0.

Remarks – : The bit change is retained but there is no state transition.
 × : Setting prohibited (operation not guaranteed)
 ? : Combination of state and bit status before setting does not exist

20.3.7 PIUAMSKREG (0x0B00 0132)

Bit	D15	D14	D13	D12	D11	D10	D9	D8
Name	Reserved	Reserved	Reserved	Reserved	Reserved	Reserved	Reserved	Reserved
R/W	R	R	R	R	R	R	R	R
RTCRST	0	0	0	0	0	0	0	0
Other resets	0	0	0	0	0	0	0	0

Bit	D7	D6	D5	D4	D3	D2	D1	D0
Name	ADINM3	ADINM2	ADINM1	ADINM0	TPYM1	TPYM0	TPXM1	TPXM0
R/W	R/W	R/W	R/W	R/W	R/W	R/W	R/W	R/W
RTCRST	0	0	0	0	0	0	0	0
Other resets	0	0	0	0	0	0	0	0

Bit	Name	Function
D[15..8]	Reserved	Write 0 to these bits. 0 is returned after a read.
D[7]	ADINM[3]	Audio input port mask Valid only during A/D scan. If masked, A/D conversions are not performed for the corresponding port. 1 : Mask 0 : Normal
D[6..4]	ADINM[2..0]	General-purpose A/D port mask Valid only during A/D scan. If masked, A/D conversions are not performed for the corresponding port. 1 : Mask 0 : Normal
D[3..2]	TPYM[1..0]	Touch panel A/D port TPY mask Valid only during A/D scan. If masked, A/D conversions are not performed for the corresponding port. 1 : Mask 0 : Normal
D[1..0]	TPXM[1..0]	Touch panel A/D port TPX mask Valid only during A/D scan. If masked, A/D conversions are not performed for the corresponding port. 1 : Mask 0 : Normal

This register is used to set masking each A/D port.

20.3.8 PIUCIVLREG (0x0B00 013E)

Bit	D15	D14	D13	D12	D11	D10	D9	D8
Name	Reserved	Reserved	Reserved	Reserved	Reserved	CHECKIN TVAL[10]	CHECKIN TVAL[9]	CHECKIN TVAL[8]
R/W	R	R	R	R	R	R	R	R
RTCRST	0	0	0	0	0	0	0	0
Other resets	0	0	0	0	0	0	0	0

Bit	D7	D6	D5	D4	D3	D2	D1	D0
Name	CHECKIN TVAL[7]	CHECKIN TVAL[6]	CHECKIN TVAL[5]	CHECKIN TVAL[4]	CHECKIN TVAL[3]	CHECKIN TVAL[2]	CHECKIN TVAL[1]	CHECKIN TVAL[0]
R/W	R	R	R	R	R	R	R	R
RTCRST	1	0	1	0	0	1	1	1
Other resets	1	0	1	0	0	1	1	1

Bit	Name	Function
D[15..11]	Reserved	Write 0 to these bits. 0 is returned after a read.
D[10..0]	CHKINTVAL[10..0]	Interval count value. CHKINTVAL[10..0] = Interval count value

This register is used for real-time reading of internal register values being counted down based on the PIUSIVLREG setting.

20.3.9 PIUPBnmREG (0x0B00 02A0 to 0x0B00 02AE, 0x0B00 02BC to 0x0B00 02BE)

Remark n = 0, 1, m = 0 to 4

PIUPB00REG	(0x0B00 02A0)	PIUPB10REG	(0x0B00 02A8)
PIUPB01REG	(0x0B00 02A2)	PIUPB11REG	(0x0B00 02AA)
PIUPB02REG	(0x0B00 02A4)	PIUPB12REG	(0x0B00 02AC)
PIUPB03REG	(0x0B00 02A6)	PIUPB13REG	(0x0B00 02AE)
PIUPB04REG	(0x0B00 02BC)	PIUPB14REG	(0x0B00 02BE)

Bit	D15	D14	D13	D12	D11	D10	D9	D8
Name	VALID	Reserved	Reserved	Reserved	Reserved	Reserved	PADDATA[9]	PADDATA[8]
R/W	R/W	R	R	R	R	R	R/W	R/W
RTCRST	0	0	0	0	0	0	0	0
Other resets	0	0	0	0	0	0	0	0

Bit	D7	D6	D5	D4	D3	D2	D1	D0
Name	PADDATA[7]	PADDATA[6]	PADDATA[5]	PADDATA[4]	PADDATA[3]	PADDATA[2]	PADDATA[1]	PADDATA[0]
R/W	R/W	R/W	R/W	R/W	R/W	R/W	R/W	R/W
RTCRST	0	0	0	0	0	0	0	0
Other resets	0	0	0	0	0	0	0	0

Bit	Name	Function
D[15]	VALID	Indicates validity of data in PADDATA 1 : Valid 0 : Invalid
D[14..10]	Reserved	Write 0 to these bits. 0 is returned after a read.
D[9..0]	PADDATA[9..0]	A/D converter's sampling data

These registers are used to store coordinate data or touch pressure data. There are four coordinate data buffers and one touch pressure data buffer, each of which holds two pages of coordinate data or pressure data, and the addresses (register addresses) where the coordinate data or the pressure data is stored are fixed. Read coordinate data from the corresponding register in a valid page.

The VALID bit, which indicates when the data is valid, is automatically rendered invalid when the page buffer interrupt source (PIUPAGE0INTR or PIUPAGE1INTR in PIUINTREG) is cleared.

Table 20-4 shows correspondences between the sampled data and the register in which the sampled data is stored.

Table 20-4. Detected Coordinates and Page Buffers

Detected data	Page0 Buffer	Page1 Buffer
X-	PIUPB00REG	PIUPB10REG
X+	PIUPB01REG	PIUPB11REG
Y-	PIUPB02REG	PIUPB12REG
Y+	PIUPB03REG	PIUPB13REG
Z (Touch pressure)	PIUPB04REG	PIUPB14REG

20.3.10 PIUABnREG (0x0B00 02B0 to 0x0B00 02B6)

Remark n = 0 to 3

PIUAB0REG	(0x0B00 02B0)
PIUAB1REG	(0x0B00 02B2)
PIUAB2REG	(0x0B00 02B4)
PIUAB3REG	(0x0B00 02B6)

Bit	D15	D14	D13	D12	D11	D10	D9	D8
Name	VALID	Reserved	Reserved	Reserved	Reserved	Reserved	PADDATA[9]	PADDATA[8]
R/W	R/W	R	R	R	R	R	R/W	R/W
RTCRST	0	0	0	0	0	0	0	0
Other resets	0	0	0	0	0	0	0	0

Bit	D7	D6	D5	D4	D3	D2	D1	D0
Name	PADDATA[7]	PADDATA[6]	PADDATA[5]	PADDATA[4]	PADDATA[3]	PADDATA[2]	PADDATA[1]	PADDATA[0]
R/W	R/W	R/W	R/W	R/W	R/W	R/W	R/W	R/W
RTCRST	0	0	0	0	0	0	0	0
Other resets	0	0	0	0	0	0	0	0

Bit	Name	Function
D[15]	VALID	Indicates validity of data in PADDATA 1: Valid 0: Invalid
D[14..10]	Reserved	Write 0 to these bits. 0 is returned after a read.
D[9..0]	PADDATA[9..0]	A/D converter's sampling data

These registers are used to store general-purpose A/D port/audio input port sampling data or command scan data. There are four data buffers and the addresses (register address) where the data is stored are fixed.

The VALID bit, which indicates when the data is valid, is automatically rendered invalid when the page buffer interrupt cause (PIUADPINTR in PIUINTREG) is cleared.

Table 20-5 shows correspondences between the sampled data and the register in which the sampled data is stored.

Table 20-5. A/D Ports and Data Buffers

Register	During ADPortScan		During CMDScan
	TPPScan = 0	TPPScan = 1	
PIUAB0REG	ADIN0	TPX0	CMDScanDATA
PIUAB1REG	ADIN1	TPX1	–
PIUAB2REG	ADIN2	TPY0	–
PIUAB3REG	AUDIOIN	TPY1	–

20.4 REGISTER SETTING FLOW

Be sure to reset the PIU before operating the scan sequencer. Setting initial values via a reset sets particular values for the sequence interval, etc., that are required.

The following registers require initial settings.

PIUSITVLREG	SCANINTVAL [10:0]
PIUSTBLREG	STABLE [3:0]

Interrupt mask cancellation settings are required for registers other than the PIU registers.

Table 20-6. Mask Clear During Scan Sequence Operation

Setting	Unit	Register	Bit	Value
Interrupt mask clear	ICU	MSYSINT1REG	PIUINTR	1
	ICU	MPIUINTRREG	bits 6:0	0x7F
Clock mask clear	CMU	CMUCLKMSK	MSKPIU	1

(1) Register Setting Flow for Voltage Detection at A/D General-purpose Ports and Audio Input Port

Standby, WaitPenTouch, or Interval state

<1> PIUAMSKREG Mask setting for A/D port and audio input port

<2> PIUASCNREG ADPSSTART = 1

↓

ADPortScan state

<3> PIUASCNREG ADPSSTART = 0

↓

Standby, WaitPenTouch, or Interval state

(2) Register Setting Flow for Auto Scan Coordinate Detection

Standby state

<1> PIUCNTREG PIUMODE [1:0] = 00

PADATSCAN = 1

PADATSTOP = 1

<2> PIUCNTREG PIUSEQEN = 1

↓

WaitPenTouch state

(3) Register Setting Flow for Manual Scan Coordinate Detection

Disable state
 <1> PIUCNTREG PIUPWR=1
 ↓
 Standby state
 <2> PIUCNTREG PIUMODE [1:0]=00
 PADSCANSTART=1
 <3> PIUCNTREG PIUSEQEN=1
 ↓
 PenDataScan state

(4) Register Setting Flow during Suspend Mode Transition

Standby, WaitPenTouch, or Interval state
 <1> PIUCNTREG PIUSEQEN=0
 ↓
 Standby state
 <2> PIUCNTREG PIUPWR=1
 ↓
 Disable state

(5) Register Setting Flow when Returning from Suspend Mode Transition

Disable state
 <1> PIUCNTREG PIUPWR=1
 ↓
 Standby state
 <2> PIUCNTREG PIUMODE [1:0]=00
 PADATSCAN=1
 PADATSTOP=1
 <3> PIUCNTREG PIUSEQEN=1
 ↓
 WaitPenTouch state
 Touch detected
 ↓
 PenDataScan state

(6) Register Setting Flow for Command Scan

Disable state
 <1> PIUCNTREG PIUPWR=1
 ↓
 Standby state
 <2> PIUCNTREG PIUMODE [1:0]=01
 <3> PIUCNTREG Set touch panel pins, select input port
 <4> PIUCNTREG PIUSEQEN=1
 ↓
 CMDScan state

20.5 RELATIONSHIPS AMONG TPX, TPY, ADIN, AND AUDIOIN PINS AND STATES

State	PadState[2:0]	TPX[1:0]	TPY[1:0]	ADIN[3:0]
PIU disable (pen status detection)	Disable ^{Note}	HH	D-	---
Low-power standby	Standby	00	00	---
Pen status detection	WaitPenTouch/Interval	HH	D-	---
Voltage detection at general-purpose AD0 port	ADPortScan	00	00	---I
Voltage detection at general-purpose AD1 port	ADPortScan	00	00	--I-
Voltage detection at general-purpose AD2 port	ADPortScan	00	00	-I--
Voltage detection at audio input port	ADPortScan	00	00	I---
TPY1=H, TPY0=L, TPX0=samp (X+)	PadDataScan	-I	HL	---
TPY1=L, TPY0=H, TPX0=samp (X-)	PadDataScan	-I	LH	---
TPX1=H, TPX0=L, TPY0=samp (Y+)	PadDataScan	HL	-I	---
TPX1=L, TPX0=H, TPY0=samp (Y-)	PadDataScan	LH	-I	---
Touch pressure detection (Z)	PadDataScan	HH	d-	---

Note The states of pins are not guaranteed when the PadState [2:0] that precedes the CPU's Suspend or Hibernate instruction execution is in a state other than the Disable state.

Remarks

- 0 : Low level input
- 1 : High level input
- L : Low level output
- H : High level output
- I : A/D converter input
- D : Touch interrupt input (with a pull-down resistor)
- d : No touch interrupt input (with a pull-down resistor)
- : Don't care
- Z : Hi-Z (high-impedance)

20.6 TIMING

20.6.1 Touch/Release Detection Timing

Touch/release detection does not use the A/D converter but instead uses the voltage level of the TPY1 pin to determine the panel's touch/release state. The following figure shows a touch/release detection timing diagram.

Figure 20-6. Touch/Release Detection Timing

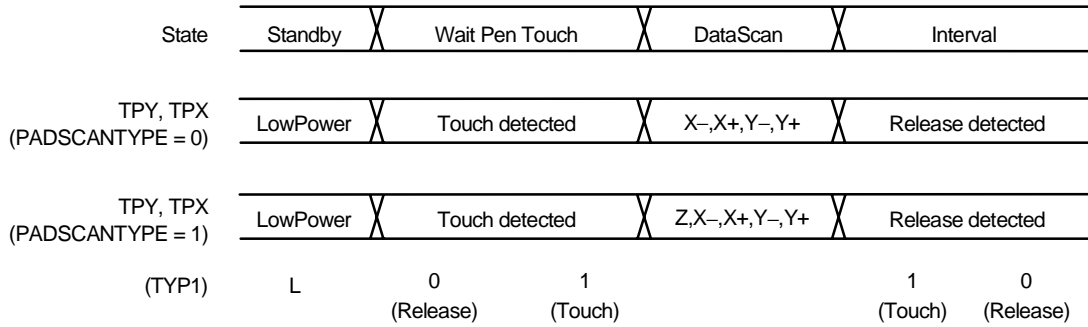

20.6.2 A/D Port Scan Timing

The A/D port scan function sequentially scans the A/D converter's four input channel port pins and stores the data in the data buffer used for A/D port scanning.

The following figure shows an A/D port scan timing diagram.

Figure 20-7. A/D Port Scan Timing

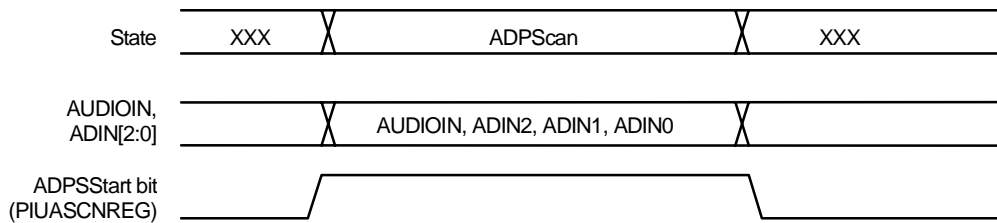

XXX state: Standby or WaitPenTouch or Interval

20.7 DATA LOSS INTERRUPT CONDITIONS

The PIU issues a PIUDataLostIntr interrupt when any of the following four conditions exist.

Once a PIUDataLostIntr interrupt occurs, the sequencer is forcibly changed to the Standby state.

1. Data for one coordinate has not been obtained within the interval period
2. The A/D port scan has not been completed within the time set via PIUSTBLREG
3. Transfer of the next coordinate data has begun while valid data for both pages remains in the buffer
4. The next data transfer starts while there is valid data in the ADPortScan buffer

(1) When data for one coordinate has not been obtained within the interval period

Cause

This condition occurs when the AIU has exclusive use of the A/D converter and the PIU is therefore unable to use the A/D converter.

If this data loss condition occurs frequently, implement a countermeasure that temporarily prohibits the AIU's use of the A/D converter.

Response

After clearing the cause of the PIUDataLostIntr interrupt, set PIUCIUCNTREG's PADATSTART bit or PADSCANSTART bit to restart the coordinate detection operation. Once the PIUDataLostIntr interrupt is cleared, the page in which the loss occurred becomes invalid. If the valid data prior to the data loss is needed, be sure to save the data that is being stored in the page buffer before clearing the PIUDataLostIntr interrupt.

(2) When the A/D port scan has not been completed within the time set via PIUSTBLREG

Cause

Same as cause of condition 1

Response

After clearing the cause of the PIUDataLostIntr interrupt, set PIUASCNREG's ADPSSTART bit to restart the A/D port scan operation. Once the PIUDataLostIntr interrupt is cleared, the page in which the loss occurred becomes invalid. If the valid data prior to the data loss is needed, be sure to save the data that is being stored in the page buffer before clearing the PIUDataLostIntr interrupt.

(3) When transfer of the next coordinate data has begun while valid data for both pages remains in the buffer

Cause

This condition is caused when the data buffer contains two pages of valid data (both the PIUPAGE1INTR and PIUPAGE0INTR interrupts have occurred) but the valid data has not been processed. If the A/D converter is used frequently, this may shorten the time that would normally be required from when both pages become full until when the data loss occurs.

Response

In condition 3, valid data contained in the pages when the PIUDataLostIntr interrupt occurs is never overwritten.

After two pages of valid data are processed, clear the causes of the three interrupts (PIUDataLostIntr, PIUPAGE1INTR, and PIUPAGE0INTR).

After clearing these interrupt causes, set the PADATSTART bit or PADSCANSTART bit of PIUCIUCNTREG to restart the coordinate detection operation.

(4) When the next data transfer starts while there is valid data in the ADPortScan buffer**Cause**

This condition is caused when valid data is not processed even while the ADPortScan buffer holds valid data (PADADPINTR interrupt occurrence).

Response

In condition 4, valid data contained in the buffer when the PIUDataLostIntr interrupt occurs is never overwritten.

After valid data in the buffer is processed, clear the causes of the two interrupts (PIUDataLostIntr, PADADPINTR).

After clearing these interrupt causes, set the ADPSSTART bit of PIUASCNREG to restart the general-purpose A/D port scan.

CHAPTER 21 AIU (AUDIO INTERFACE UNIT)

This chapter describes the AIU's operations and register settings.

21.1 GENERAL

The AIU supports speaker output and MIC input operations. The resolution of the D/A converter used for a speaker or microphone is usually 10 bits.

21.2 REGISTER SET

The AIU registers are listed below.

Table 21-1. AIU Registers

Address	R/W	Register Symbols	Function
0x0B00 0160	R/W	MDMADATREG	Mike DMA Data Register
0x0B00 0162	R/W	SDMADATREG	Speaker DMA Data Register
0x0B00 0166	R/W	SODATREG	Speaker Output Data Register
0x0B00 0168	R/W	SCNTREG	Speaker Output Control Register
0x0B00 016A	R/W	SCNVRREG	Speaker Conversion Rate Register
0x0B00 0170	R/W	MIDATREG	Mike Input Data Register
0x0B00 0172	R/W	MCNTREG	Mike Input Control Register
0x0B00 0174	R/W	MCNVRREG	Mike Conversion Rate Register
0x0B00 0178	R/W	DVALIDREG	Data Valid Register
0x0B00 017A	R/W	SEQREG	Sequential Register
0x0B00 017C	R/W	INTREG	Interrupt Register

These registers are described in detail below.

21.2.1 MDMADATREG (0x0B00 0160)

Bit	D15	D14	D13	D12	D11	D10	D9	D8
Name	Reserved	Reserved	Reserved	Reserved	Reserved	Reserved	MDMA[9]	MDMA[8]
R/W	R	R	R	R	R	R	R/W	R/W
RTCRST	0	0	0	0	0	0	1	0
Other resets	0	0	0	0	0	0	1	0

Bit	D7	D6	D5	D4	D3	D2	D1	D0
Name	MDMA[7]	MDMA[6]	MDMA[5]	MDMA[4]	MDMA[3]	MDMA[2]	MDMA[1]	MDMA[0]
R/W	R/W	R/W	R/W	R/W	R/W	R/W	R/W	R/W
RTCRST	0	0	0	0	0	0	0	0
Other resets	0	0	0	0	0	0	0	0

Bit	Name	Function
D[15:10]	Reserved	Write 0 to these bits. 0 is returned after a read.
D[9:0]	MDMA[9:0]	MIC input DMA data (from MIDATREG to buffer)

This register is used prior to DMA transfer to store 10-bit data that has been converted by the A/D converter and stored in MIDATREG. Write is used for debugging and is enabled when AIUMEN bit of SEQREG is set to 1. This register is cleared (0x0200) by resetting AIUMEN bit of SEQREG to 0. Therefore, if the AIUMEN bit is set to 0 during DMA transfer, invalid data may be transferred.

21.2.2 SDMATREG (0x0B00 0162)

Bit	D15	D14	D13	D12	D11	D10	D9	D8
Name	Reserved	Reserved	Reserved	Reserved	Reserved	Reserved	SDMA[9]	SDMA[8]
R/W	R	R	R	R	R	R	R/W	R/W
RTCRST	0	0	0	0	0	0	1	0
Other resets	0	0	0	0	0	0	1	0

Bit	D7	D6	D5	D4	D3	D2	D1	D0
Name	SDMA[7]	SDMA[6]	SDMA[5]	SDMA[4]	SDMA[3]	SDMA[2]	SDMA[1]	SDMA[0]
R/W	R/W	R/W	R/W	R/W	R/W	R/W	R/W	R/W
RTCRST	0	0	0	0	0	0	0	0
Other resets	0	0	0	0	0	0	0	0

Bit	Name	Function
D[15:10]	Reserved	Write 0 to these bits. 0 is returned after a read.
D[9:0]	SDMA[9:0]	Speaker output DMA data (from buffer to SODATREG)

This register is used to store 10-bit DMA data for speaker output. When SODATREG is empty, the data is transferred to SODATREG. Write is used for debugging and is enabled when AIUSEN bit of SEQREG is set to 1. This register is cleared (0x0200) by resetting AIUSEN bit of SEQREG to 0.

21.2.3 SODATREG (0x0B00 0166)

Bit	D15	D14	D13	D12	D11	D10	D9	D8
Name	Reserved	Reserved	Reserved	Reserved	Reserved	Reserved	SODAT[9]	SODAT[8]
R/W	R	R	R	R	R	R	R/W	R/W
RTCRST	0	0	0	0	0	0	1	0
Other resets	0	0	0	0	0	0	1	0

Bit	D7	D6	D5	D4	D3	D2	D1	D0
Name	SODAT[7]	SODAT[6]	SODAT[5]	SODAT[4]	SODAT[3]	SODAT[2]	SODAT[1]	SODAT[0]
R/W	R/W	R/W	R/W	R/W	R/W	R/W	R/W	R/W
RTCRST	0	0	0	0	0	0	0	0
Other resets	0	0	0	0	0	0	0	0

Bit	Name	Function
D[15:10]	Reserved	Write 0 to these bits. 0 is returned after a read.
D[9:0]	SODAT[9:0]	Speaker output data (from SDMATREG to D/A converter)

This register is used to store 10-bit DMA data for speaker output. Data is received from the D/A converter and is sent to SDMATREG. Write is used for debugging and is enabled when AIUSEN bit of SEQREG is set to 1. This register is cleared (0x0200) by resetting AIUSEN bit of SEQREG to 0.

21.2.4 SCNTREG (0x0B00 0168)

Bit	D15	D14	D13	D12	D11	D10	D9	D8
Name	DAENAIU	Reserved	Reserved	Reserved	Reserved	Reserved	Reserved	Reserved
R/W	R/W	R	R	R	R	R	R	R
RTCRST	0	0	0	0	0	0	0	0
Other resets	0	0	0	0	0	0	0	0

Bit	D7	D6	D5	D4	D3	D2	D1	D0
Name	Reserved	Reserved	Reserved	Reserved	SSTATE	Reserved	SSTOPEN	Reserved
R/W	R	R	R	R	R	R	R/W	R
RTCRST	0	0	0	0	0	0	0	0
Other resets	0	0	0	0	0	0	0	0

Bit	Name	Function
D[15]	DAENAIU	This is the speaker D/A enable bit. 1 : Vref ON 0 : Vref OFF
D[14:4]	Reserved	Write 0 to these bits. 0 is returned after a read.
D[3]	SSTATE	Indicates speaker operation state 1 : In operation 0 : Stopped
D[2]	Reserved	Write 0 to this bit. 0 is returned after a read.
D[1]	SSTOPEN	Speaker output DMA transfer 1-page boundary interrupt stop 1 : Stop DMA request at 1-page boundary 0 : Stop DMA request at 2-page boundary
D[0]	Reserved	Write 0 to this bit. 0 is returned after a read.

This register is used to control the AIU's speaker block.

The DAENAIU bit controls the connection of DVDD and Vref input to ladder type resistors in the D/A converter. Setting this bit to 0 (OFF) allows low power consumption when not using the D/A converter. When using the D/A converter, this bit must be set following the sequence described in **21.3 OPERATION SEQUENCE**.

The content of the SSTATE bit is valid only when the AIUSEN bit of SEQREG is set to 1.

21.2.5 SCNVRREG (0x0B00 016A)

Bit	D15	D14	D13	D12	D11	D10	D9	D8
Name	Reserved	Reserved	Reserved	Reserved	Reserved	Reserved	Reserved	Reserved
R/W	R	R	R	R	R	R	R	R
RTCST	0	0	0	0	0	0	0	0
Other resets	0	0	0	0	0	0	0	0

Bit	D7	D6	D5	D4	D3	D2	D1	D0
Name	Reserved	Reserved	Reserved	Reserved	Reserved	SCNVR[2]	SCNVR[1]	SCNVR[0]
R/W	R	R	R	R	R	R/W	R/W	R/W
RTCST	0	0	0	0	0	0	0	0
Other resets	0	0	0	0	0	0	0	0

Bit	Name	Function
D[15:3]	Reserved	Write 0 to these bits. 0 is returned after a read.
D[2:0]	SCNVR[2:0]	D/A Conversion Rate 111 : RFU 1 101 : RFU 100 : 8 ksps 011 : RFU 010 : 44.1 ksps 001 : 22.05 ksps 000 : 11.025 ksps

This register is used to select a conversion rate for the D/A converter.

21.2.6 MIDATREG (0x0B00 0170)

Bit	D15	D14	D13	D12	D11	D10	D9	D8
Name	Reserved	Reserved	Reserved	Reserved	Reserved	Reserved	MIDAT[9]	MIDAT[8]
R/W	R	R	R	R	R	R	R/W	R/W
RTCRST	0	0	0	0	0	0	1	0
Other resets	0	0	0	0	0	0	1	0

Bit	D7	D6	D5	D4	D3	D2	D1	D0
Name	MIDAT[7]	MIDAT[6]	MIDAT[5]	MIDAT[4]	MIDAT[3]	MIDAT[2]	MIDAT[1]	MIDAT[0]
R/W	R/W	R/W	R/W	R/W	R/W	R/W	R/W	R/W
RTCRST	0	0	0	0	0	0	0	0
Other resets	0	0	0	0	0	0	0	0

Bit	Name	Function
D[15:10]	Reserved	Write 0 to these bits. 0 is returned after a read.
D[9:0]	MIDAT[9:0]	MIC input data (from A/D to MDMADATREG)

This register is used to store 10-bit speaker input data that has been converted by the A/D converter. Data is sent to MDMADATREG and is received from the A/D converter. Write is used for debugging and is enabled when AIUMEN bit of SEQREG is set to 1. This register is cleared (0x0200) by resetting AIUMEN bit of SEQREG to 0.

21.2.7 MCNTREG (0x0B00 0172)

Bit	D15	D14	D13	D12	D11	D10	D9	D8
Name	ADENAIU	Reserved	Reserved	Reserved	Reserved	Reserved	Reserved	Reserved
R/W	R/W	R	R	R	R	R	R	R
RTCRST	0	0	0	0	0	0	0	0
Other resets	0	0	0	0	0	0	0	0

Bit	D7	D6	D5	D4	D3	D2	D1	D0
Name	Reserved	Reserved	Reserved	Reserved	MSTATE	Reserved	MSTOPEN	ADREQAIU
R/W	R	R	R	R	R	R	R/W	R
RTCRST	0	0	0	0	0	0	0	0
Other resets	0	0	0	0	0	0	0	0

Bit	Name	Function
D[15]	ADENAIU	This is the MIC A/D enable bit. 1 : Vref ON 0 : Vref OFF
D[14:4]	Reserved	Write 0 to these bits. 0 is returned after a read.
D[3]	MSTATE	Indicates MIC operation state (= AIUMEN) 1 : In operation 0 : Stopped
D[2]	Reserved	Write 0 to this bit. 0 is returned after a read.
D[1]	MSTOPEN	MIC input DMA transfer 1-page boundary interrupt stop 1 : Stop DMA request at 1-page boundary 0 : Stop DMA request at 2-page boundary
D[0]	ADREQAIU	A/D use request bit 1 : Request 0 : Normal

This register is used to control the AIU's MIC block.

The ADENAIU bit controls the connection of AVDD and Vref input to ladder type resistors in the A/D converter. Setting this bit to 0 (OFF) allows low power consumption when not using the A/D converter. When using the A/D converter, this bit must be set following the sequence described in **21.3 OPERATION SEQUENCE**.

The content of the MSTATE bit is valid only when the AIUMEN bit of SEQREG is set to 1.

This unit has priority when a conflict occurs with the PIU in relation to A/D conversion requests.

21.2.8 MCNVRREG (0x0B00 0174)

Bit	D15	D14	D13	D12	D11	D10	D9	D8
Name	Reserved	Reserved	Reserved	Reserved	Reserved	Reserved	Reserved	Reserved
R/W	R	R	R	R	R	R	R	R
RTCRST	0	0	0	0	0	0	0	0
Other resets	0	0	0	0	0	0	0	0

Bit	D7	D6	D5	D4	D3	D2	D1	D0
Name	Reserved	Reserved	Reserved	Reserved	Reserved	MCNVR[2]	MCNVR[1]	MCNVR[0]
R/W	R	R	R	R	R	R/W	R/W	R/W
RTCRST	0	0	0	0	0	0	0	0
Other resets	0	0	0	0	0	0	0	0

Bit	Name	Function
D[15:3]	Reserved	Write 0 to these bits. 0 is returned after a read.
D[2:0]	MCNVR[2:0]	A/D Conversion Rate 111 : RFU 1 101 : RFU 100 : 8 ksps 011 : RFU 010 : 44.1 ksps 001 : 22.05 ksps 000 : 11.025 ksps

This register is used to select a conversion rate for the A/D converter.

21.2.9 DVALIDREG (0x0B00 0178)

Bit	D15	D14	D13	D12	D11	D10	D9	D8
Name	Reserved	Reserved	Reserved	Reserved	Reserved	Reserved	Reserved	Reserved
R/W	R	R	R	R	R	R	R	R
RTCRST	0	0	0	0	0	0	0	0
Other resets	0	0	0	0	0	0	0	0

Bit	D7	D6	D5	D4	D3	D2	D1	D0
Name	Reserved	Reserved	Reserved	Reserved	SODATV	SDMAV	MIDATV	MDMAV
R/W	R	R	R	R	R/W	R/W	R/W	R/W
RTCRST	0	0	0	0	0	0	0	0
Other resets	0	0	0	0	0	0	0	0

Bit	Name	Function
D[15:4]	Reserved	Write 0 to these bits. 0 is returned after a read
D[3]	SODATV	This indicates when valid data has been stored in SODATREG. 1 : Valid data exists 0 : No valid data
D[2]	SDMAV	This indicates when valid data has been stored in SDMATATREG. 1 : Valid data exists 0 : No valid data
D[1]	MIDATV	This indicates when valid data has been stored in MIDATREG. 1 : Valid data exists 0 : No valid data
D[0]	MDMAV	This indicates when valid data has been stored in MDMADATREG. 1 : Valid data exists 0 : No valid data

This register indicates when valid data has been stored in SODATREG, SDMATATREG, MIDATREG, or MDMADATREG.

If data has been written directly to SODATREG, SDMATATREG, MIDATREG, or MDMADATREG via software, the bits in this register are not active, so write “1” via software.

Write is used for debugging and is enabled when AIUSEN or AIUMEN bit of SEQREG is set to 1.

If AIUSEN = 0 or AIUMEN = 0 in SEQREG, then SODATV = SDMAV = 0 or MIDATV = MDMAV = 0.

21.2.10 SEQREG (0x0B00 017A)

Bit	D15	D14	D13	D12	D11	D10	D9	D8
Name	AIURST	Reserved	Reserved	Reserved	Reserved	Reserved	Reserved	Reserved
R/W	R/W	R	R	R	R	R	R	R
RTCRST	0	0	0	0	0	0	0	0
Other resets	0	0	0	0	0	0	0	0

Bit	D7	D6	D5	D4	D3	D2	D1	D0
Name	Reserved	Reserved	Reserved	AIUMEN	Reserved	Reserved	Reserved	AIUSEN
R/W	R	R	R	R/W	R	R	R	R/W
RTCRST	0	0	0	0	0	0	0	0
Other resets	0	0	0	0	0	0	0	0

Bit	Name	Function
D[15]	AIURST	AIU reset via software 1 : Reset 0 : Normal
D[14:5]	Reserved	Write 0 to these bits. 0 is returned after a read.
D[4]	AIUMEN	MIC block operation enable, DMA enable 1 : Enable operation 0 : Disable operation
D[3:1]	Reserved	Write 0 to these bits. 0 is returned after a read.
D[0]	AIUSEN	Speaker block operation enable, DMA enable 1 : Enable operation 0 : Disable operation

This register is used to enable/disable the AIU's operation.

21.2.11 INTREG (0x0B00 017C)

Bit	D15	D14	D13	D12	D11	D10	D9	D8
Name	Reserved	Reserved	Reserved	Reserved	MENDINTR	MINTR	MIDLEINTR	MSTINTR
R/W	R	R	R	R	R/W	R/W	R/W	R/W
RTCRST	0	0	0	0	0	0	0	0
Other resets	0	0	0	0	0	0	0	0

Bit	D7	D6	D5	D4	D3	D2	D1	D0
Name	Reserved	Reserved	Reserved	Reserved	SENDINTR	SINTR	SIDLEINTR	Reserved
R/W	R	R	R	R	R/W	R/W	R/W	R
RTCRST	0	0	0	0	0	0	0	0
Other resets	0	0	0	0	0	0	0	0

Bit	Name	Function
D[15:12]	Reserved	Write 0 to these bits. 0 is returned after a read.
D[11]	MENDINTR	MIC DMA 2 page interrupt. Cleared to 0 when 1 is written. 1 : Occurred 0 : Normal
D[10]	MINTR	MIC DMA 1 page interrupt. Cleared to 0 when 1 is written. 1 : Occurred 0 : Normal
D[9]	MIDLEINTR	MIC idle interrupt (receive data loss). Cleared to 0 when 1 is written. 1 : Occurred 0 : Normal
D[8]	MSTINTR	MIC receive complete interrupt. Cleared to 0 when 1 is written. 1 : Occurred 0 : Normal
D[7:4]	Reserved	Write 0 to these bits. 0 is returned after a read.
D[3]	SENDINTR	SPEAKER DMA 2 page interrupt. Cleared to 0 when 1 is written. 1 : Occurred 0 : Normal
D[2]	SINTR	SPEAKER DMA 1 page interrupt. Cleared to 0 when 1 is written. 1 : Occurred 0 : Normal
D[1]	SIDLEINTR	SPEAKER idle interrupt (mute). Cleared to 0 when 1 is written. 1 : Occurred 0 : Normal
D[0]	Reserved	Write 0 to this bit. 0 is returned after a read.

When data is received from the A/D converter, MIDLEINTR is set if valid data still exists in MIDATREG (MIDATV = 1). In this case, MIDATREG is overwritten.

MSTINTR is set when data is received in MDMADATREG.

When data is passed to the D/A converter, SIDLEINTR is set if there is no valid data in SODATREG (SODATV = 0). However, this interrupt is valid only after AIUSEN = 1, after which SODATV = 1 in DVALID REG.

21.3 OPERATION SEQUENCE

21.3.1 Output (Speaker)

1. Set conversion rate (0x0B00 016A: SCNVR = any value)
2. Set output data area to DMAAU
3. DMA enable in DCU
4. Set D/A converter's Vref to ON (0x0B00 0168: DAENAIU = 1)
5. Wait for Vref resistor stabilization time (about 5 μ s) (use the RTC counter)

Even if speaker power is set to ON and speaker operation is enabled (AIUSEN = 1) without waiting for Vref resistor stabilization time, speaker output starts after the period calculated with the formula below.

$$5 + 1/\text{conversion rate (44.1, 22.05, 11.025, or 8 ksps) } (\mu\text{s})$$

In this case, however, a noise may occur when speaker power is set to ON.
6. Set speaker power ON via GPIO.
7. Speaker operation enable (0x0B00 017A: AIUSEN = 1)

DMA request
Receive acknowledge and DMA data from DMA
0x0B00 0178: SDMAV = SODATV = 1
Output 10-bit data (0x0B00 0166: SODAT) to D/A converter
SODATV = 0, SDMAV = 1
Send SDMATATREG data to SODATREG.
SODATV = 1, SDMAV = 0
Output DMA request and store the data after the next into SDMATATREG.
SODATV = 1, SDMAV = 1
Refresh data at each conversion timing interval (becomes SIDLEINTR = 1 when DMA is slow and SODATV = 0 during conversion timing interval, and (mute) interrupt occurs)
DMA page boundary interrupt occurs at page boundary
Clear the page interrupt request to continue output.
8. Speaker operation to disable (0x0B00 017A: AIUSEN = 0)
9. Set speaker power OFF via GPIO.
10. Set D/A converter's Vref to OFF (0x0B00 0168: AIUDAEN = 0)
11. DMA disable in DCU

Figure 21-1. Speaker Output and AUDIOOUT Pin

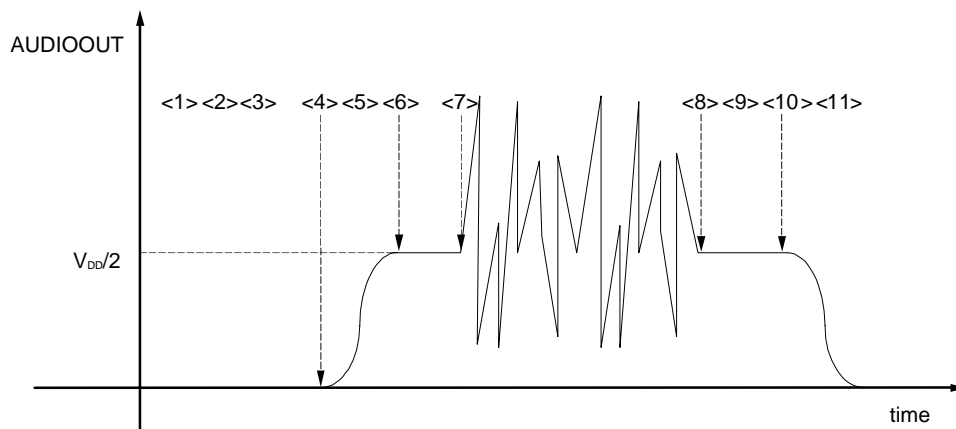

21.3.2 Input (MIC)

1. Set conversion rate (0x0B00 0174: MCNVR = any value)
2. Set input data area in DMAAU
3. DMA enable in DCU
4. Set A/D converter's Vref to ON (0x0B00 0172: ADENAIU = 1)
 - MIC power can be set ON and MIC operation can be enabled without waiting for Vref resistor stabilization time (about 5 μ s). However, in such a case, sampling starts after the period calculated with the formula below.
 - $5 + 1/\text{conversion rate (44.1, 22.05, 11.025, or 8 ksp)} (\mu\text{s})$
5. Set MIC power ON via GPIO.
6. MIC operation enable (0x0B00 017A: AIUMEN = 1)
 - Output A/D request (AIUADREQ) to A/D converter
 - Return acknowledge (aiuadack) and 10-bit conversion data from A/D converter.
 - Store data in MIDATREG.
 - 0x0B00 0178: MDMAV = 0, MIDATV = 1
 - Transfer data from MIDATREG to MDMADATREG.
 - MDMAV = 1, MIDATV = 0
 - The INTMST value becomes "1" and an interrupt (receive complete) occurs.
 - Issue DMA request and store MIDMADATREG data to memory.
 - MDMAV = 0, MIDATV = 0
 - An A/D request is issued once per conversion timing interval and 10-bit data is received (becomes MIDDLEINTR = 1 when DMA is slow and MIDATV = 1 during conversion timing interval, and (data loss) interrupt occurs)
 - DMA page boundary interrupt occurs at page boundary
 - Clear the page interrupt request to continue output.
7. MIC operation to disable (0x0B00 017A: AIUMEN = 0)
8. Set MIC power OFF via GPIO.
9. Set A/D converter's Vref to OFF (0x0B00 0172: AIUADEN = 0)
10. DMA disable in DCU

Figure 21-2. AUDIOIN Pin and MIC Operation

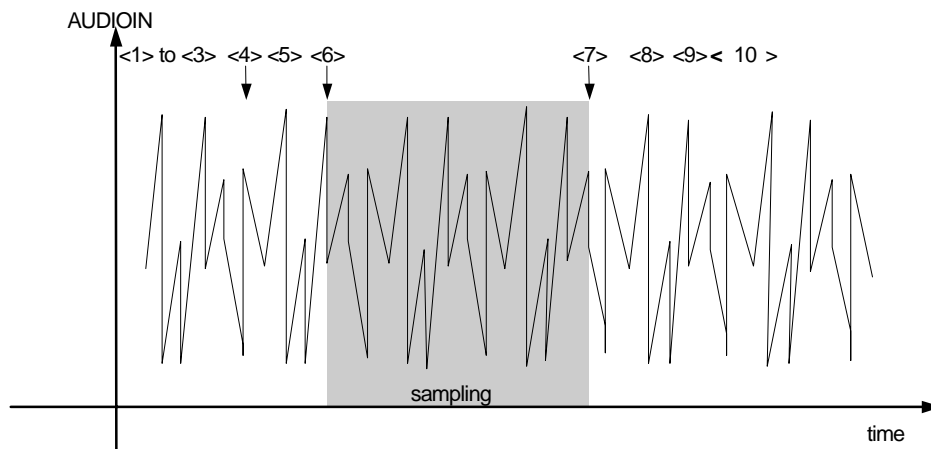

[MEMO]

CHAPTER 22 KIU (KEYBOARD INTERFACE UNIT)

This chapter describes the KIU's operations and register settings.

22.1 GENERAL

The KIU includes 12 scan lines and 8 detection lines. The number of key inputs to be detected can be selected from 96/80/64, by switching the number of scan lines from 12/10/8.

The register can be set to enable the 12 scan lines to be used as a general-purpose output port.

22.2 REGISTER SET

The KIU registers are listed below.

Table 22-1. KIU Registers

Address	R/W	Register Symbols	Function
0x0B00 0180	R/W	KIUDAT0	KIU Data0 Register
0x0B00 0182	R/W	KIUDAT1	KIU Data1 Register
0x0B00 0184	R/W	KIUDAT2	KIU Data2 Register
0x0B00 0186	R/W	KIUDAT3	KIU Data3 Register
0x0B00 0188	R/W	KIUDAT4	KIU Data4 Register
0x0B00 018A	R/W	KIUDAT5	KIU Data5 Register
0x0B00 0190	R/W	KIUSCANREP	KIU Scan/Repeat Register
0x0B00 0192	R	KIUSCANS	KIU Scan Status Register
0x0B00 0194	R/W	KIUWKS	KIU Wait Keyscan Stable Register
0x0B00 0196	R/W	KIUWKI	KIU Wait Keyscan Interval Register
0x0B00 0198	R/W	KIUINT	KIU Interrupt Register
0x0B00 019A	W	KIURST	KIU Reset Register
0x0B00 019C	R/W	KIUGPEN	KIU General Purpose Output Enable
0x0B00 019E	R/W	SCANLINE	KIU Scan Line Register

22.2.1 KIUDATn (0x0B00 0180 to 0x0B00 018A)

Remark n = 0 to 5
 KIUDAT0 (0x0B00 0180)
 KIUDAT1 (0x0B00 0182)
 KIUDAT2 (0x0B00 0184)
 KIUDAT3 (0x0B00 0186)
 KIUDAT4 (0x0B00 0188)
 KIUDAT5 (0x0B00 018A)

Bit	D15	D14	D13	D12	D11	D10	D9	D8
Name	KEYDAT[15]	KEYDAT[14]	KEYDAT[13]	KEYDAT[12]	KEYDAT[11]	KEYDAT[10]	KEYDAT[9]	KEYDAT[8]
R/W	R/W	R/W	R/W	R/W	R/W	R/W	R/W	R/W
RTCRST	0	0	0	0	0	0	0	0
Other resets	0	0	0	0	0	0	0	0

Bit	D7	D6	D5	D4	D3	D2	D1	D0
Name	KEYDAT[7]	KEYDAT[6]	KEYDAT[5]	KEYDAT[4]	KEYDAT[3]	KEYDAT[2]	KEYDAT[1]	KEYDAT[0]
R/W	R/W	R/W	R/W	R/W	R/W	R/W	R/W	R/W
RTCRST	0	0	0	0	0	0	0	0
Other resets	0	0	0	0	0	0	0	0

Bit	Name	Function
D[15..8]	KEYDAT[15..8]	Scan data from odd-numbered scans
D[7..0]	KEYDAT[7..0]	Scan data from even-numbered scans

These registers are used to hold key scan data.
 Each KIU data register is able to hold the data from one scan operation.
 How scan data is input to the registers is as below. Figure 22-1 shows a scan operation and storing timing.

Register

KIUDAT00[7..0]	Stores the data scanned by the KSCAN0 pin.
KIUDAT00[15..8]	Stores the data scanned by the KSCAN1 pin.
KIUDAT01[7..0]	Stores the data scanned by the KSCAN2 pin.
KIUDAT01[15..8]	Stores the data scanned by the KSCAN3 pin.
KIUDAT02[7..0]	Stores the data scanned by the KSCAN4 pin.
KIUDAT02[15..8]	Stores the data scanned by the KSCAN5 pin.
KIUDAT03[7..0]	Stores the data scanned by the KSCAN6 pin.
KIUDAT03[15..8]	Stores the data scanned by the KSCAN7 pin.
KIUDAT04[7..0]	Stores the data scanned by the KSCAN8 pin.
KIUDAT04[15..8]	Stores the data scanned by the KSCAN9 pin.
KIUDAT05[7..0]	Stores the data scanned by the KSCAN10 pin.
KIUDAT05[15..8]	Stores the data scanned by the KSCAN11 pin.

See also the figure “**Scan Operation and Key Data Store Register**” on the next page.

The data in the KIUDAT00 to KIUDAT05 registers should be read out in the interval time between two key scan operations (see **KIUWKI**). Scan interval is set by the KIUWKI register.

When data is not read before the next key scan operation starts, the key scan data lost interrupt occurs (see **KIUINT**).

The data registers KIUDAT00 through KIUDAT05 overwrite the following scan data.

Figure 22-1. Scan Operation and Key Data Store Register

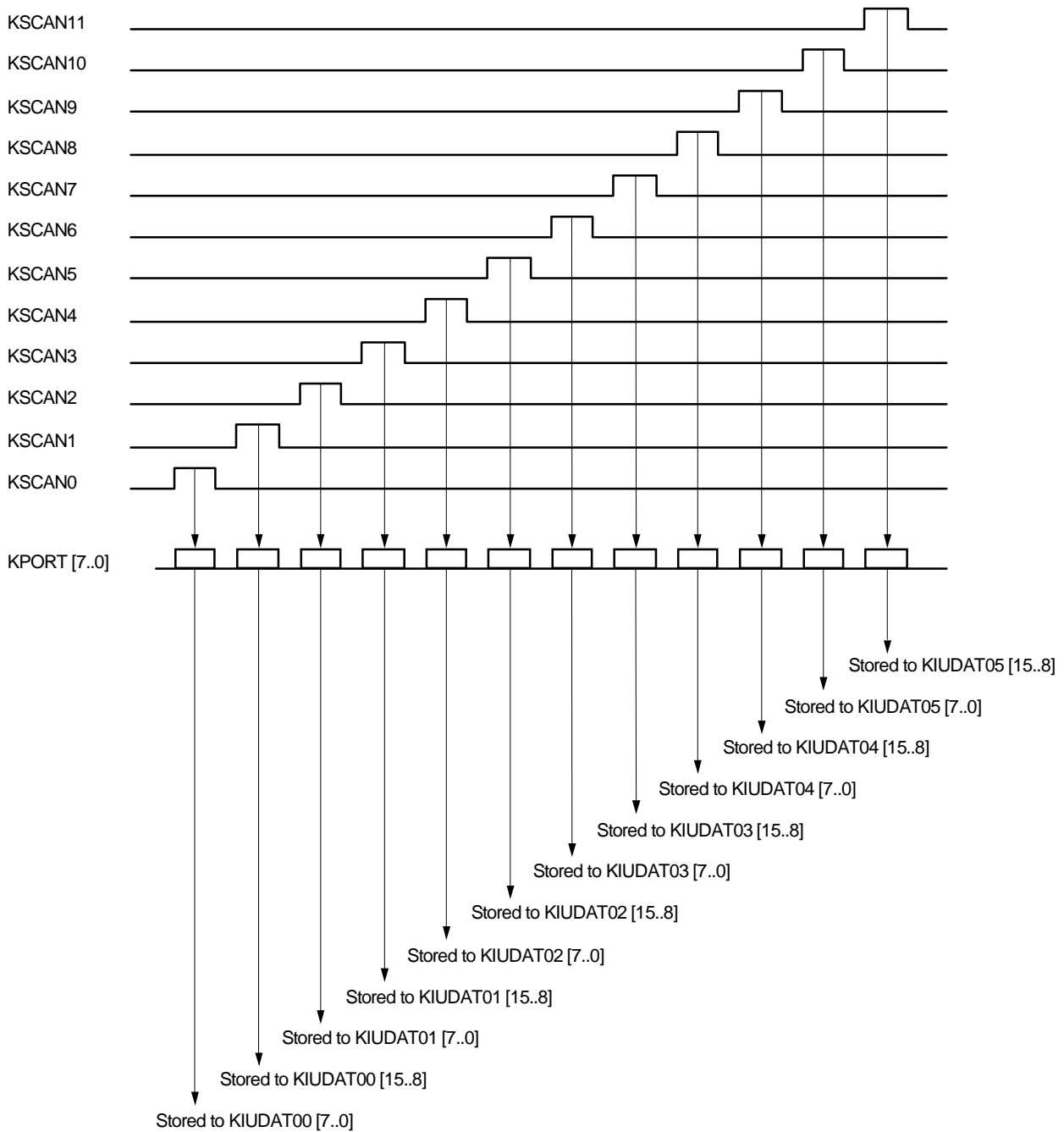

22.2.2 KIUSCANREP (0x0B00 0190)

Bit	D15	D14	D13	D12	D11	D10	D9	D8
Name	KEYEN	Reserved	Reserved	Reserved	Reserved	Reserved	STPREP[5]	STPREP[4]
R/W	R/W	R	R	R	R	R	R/W	R/W
RTCRST	0	0	0	0	0	0	0	0
Other resets	0	0	0	0	0	0	0	0

Bit	D7	D6	D5	D4	D3	D2	D1	D0
Name	STPREP[3]	STPREP[2]	STPREP[1]	STPREP[0]	SCANSTP	SCANSTART	ATSTP	ATSCAN
R/W	R/W	R/W	R/W	R/W	R/W	R/W	R/W	R/W
RTCRST	0	0	0	0	0	0	0	1
Other resets	0	0	0	0	0	0	0	1

Bit	Name	Function
D[15]	KEYEN	Key scan This enables/prohibits a scan operation. When this bit is set to 1, Key scan start or Key auto scan operation is enabled. However, this bit cannot be set to "1" while the number of scan lines is set to 0 by the SCANLINE register. 1 : Enable 0 : Prohibit (Key scan operation cannot be started.)
D[14..10]	Reserved	Write 0 to these bits. 0 is returned after a read.
D[9..4]	STPREP[5..0]	Key scan sequencer stop count setting 111111 : 63 times : STPREP[5..0] times 000001 : 1 time 000000 : RFU
D[3]	SCANSTP	Key scan stop Set to 1 to stop a scan operation. 1 : Stop 0 : Operate
D[2]	SCANSTART	Key scan start When this bit is set to 1, the key scan operation starts immediately. 1 : Start 0 : Stop
D[1]	ATSTP	Key auto stop setting When this bit is set to 1, the key scan operation stops automatically when the data remains all zeros for the number of key scan times specified by the STPREP[5..0] bits. 1 : Auto stop 0 : Not auto stop
D[0]	ATSCAN	Key auto scan setting When this bit is set to 1 (default), the key scan operation starts after any of the KPORT[7..0] bits is set to 1 (key contact). 1 : Auto scan 0 : Not auto scan

★

This register is used to enable operation of the key scan unit and to make settings for key scan and the key scan sequencer.

- Key scan sequencer stop count setting
This sets the number of key scan sequencer stops when no keys are being pressed.
- Key scan stop
The SCANSTP bit should be set to 1 when the KIUSCANS register stops the key scan operation in Scanning or Interval Next Scan mode.
When this bit is set to “1”, the key scan sequencer stops. However, if this bit is set to “1” during a key scan operation, the key scan sequencer stops after the current set of key data is received.
This bit becomes 0 when the key scan sequencer stops.
When the key scan operation is started by setting this bit to 1 during Stopped or WaitKeyIn state, the key scan operation stops immediately after a set of key scan operation is completed.
- Key scan start
When the SCANSTART bit is set to “1”, the key scan sequencer starts regardless of key contact detection.
This bit becomes 0 when the key scan operation starts.
This bit cannot be set while the KEYEN bit is 0.
- Key scan auto stop setting
In the key scan auto stop mode, the key scan operation stops automatically when the data of all zeros is input to the KPORT [7:0] pins (no key contact is detected).
The number of zeros is set by the STPREP [5..0] bits.
- Key auto scan setting
When the ATSCAN bit is set to 1, the key touch wait state is entered, and key scan operation starts automatically upon a key touch (“1” is input to any of the KPORT input pins).
When the KEYEN bit is 0, the key touch wait state is not entered even if this bit is set to 1. The key wait state is entered and the key auto scan mode is set from the point when the KEYEN bit is set to 1.

For details, see **Figure 22-3 Transition of Sequencer Status** and **Figure 22-4 Basic Operation Timing Chart**.

22.2.3 KIUSCANS (0x0B00 0192)

Bit	D15	D14	D13	D12	D11	D10	D9	D8
Name	Reserved	Reserved	Reserved	Reserved	Reserved	Reserved	Reserved	Reserved
R/W	R	R	R	R	R	R	R	R
RTCRST	0	0	0	0	0	0	0	0
Other resets	0	0	0	0	0	0	0	0

Bit	D7	D6	D5	D4	D3	D2	D1	D0
Name	Reserved	Reserved	Reserved	Reserved	Reserved	Reserved	SSTAT[1]	SSTAT[0]
R/W	R	R	R	R	R	R	R	R
RTCRST	0	0	0	0	0	0	0	0
Other resets	0	0	0	0	0	0	0	0

Bit	Name	Function
D[15..2]	Reserved	Write 0 to these bits. 0 is returned after a read.
D[1..0]	SSTAT[1..0]	KIU sequencer status (see figures Basic Operation Timing Chart and Transition of Sequencer Status) 11 : Scanning 10 : Interval Next Scan 01 : WaitKeyIn 00 : Stopped

This register indicates the current KIU sequencer status.

Details of the status of the KIU sequencer are described below.

- Scanning: This is the state where the scan sequencer performs key scan to load key data.
- Interval next scan: This is the state where the scan of a set of key data has completed and waiting for the start of the next key scan.
- Wait Key in: This is the state of waiting for key input in the key auto scan mode.
- Stopped: This is the state where the sequencer is disabled.

22.2.4 KIUWKS (0x0B00 0194)

Bit	D15	D14	D13	D12	D11	D10	D9	D8
Name	Reserved	T3CNT[4]	T3CNT[3]	T3CNT[2]	T3CNT[1]	T3CNT[0]	T2CNT[4]	T2CNT[3]
R/W	R	R/W	R/W	R/W	R/W	R/W	R/W	R/W
RTCRST	0	1	1	1	1	1	1	1
Other resets	0	1	1	1	1	1	1	1

Bit	D7	D6	D5	D4	D3	D2	D1	D0
Name	T2CNT[2]	T2CNT[1]	T2CNT[0]	T1CNT[4]	T1CNT[3]	T1CNT[2]	T1CNT[1]	T1CNT[0]
R/W	R/W	R/W	R/W	R/W	R/W	R/W	R/W	R/W
RTCRST	1	1	1	1	1	1	1	1
Other resets	1	1	1	1	1	1	1	1

Bit	Name	Function
D[15]	Reserved	Write 0 to this bit. 0 is returned after a read.
D[14..10]	T3CNT[4..0]	Wait time setting ((T3CNT[4..0] + 1) x 30 μ s) 11111 : 960 μ s : 00001 : 60 μ s 00000 : RFU
D[9..5]	T2CNT[4..0]	Off time setting ((T2CNT[4..0] + 1) x 30 μ s) 11111 : 960 μ s : 00001 : 60 μ s 00000 : RFU
D[4..0]	T1CNT[4..0]	Stabilization time setting ((T1CNT[4..0] + 1) x 30 μ s) 11111 : 960 μ s : 00001 : 60 μ s 00000 : RFU

This register is used to set the wait time between when the key scan sequencer sets the KSCAN pin active during a key matrix scan and when the status is read from the KPORT pin.

The T1CNT bit is used to set the stabilization time between when the KSCAN pin becomes high and when the key scan data is read.

The T2CNT bit is used to set the time between when the key data is read and when the KSCAN pin becomes low.

The T3CNT bit is used to set the time between when the KSCAN pin becomes low and when it becomes high again.

The status of output from the KSCAN pins and the timing of KPORT sampling are shown below.

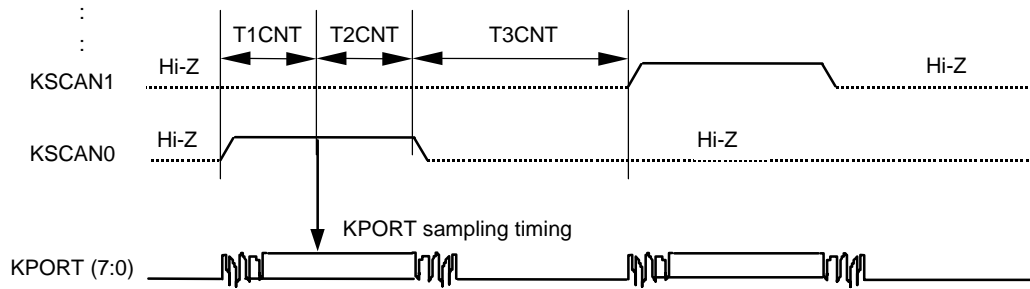

22.2.5 KIUWKI (0x0B00 0196)

Bit	D15	D14	D13	D12	D11	D10	D9	D8
Name	Reserved	Reserved	Reserved	Reserved	Reserved	Reserved	WINTVL[9]	WINTVL[8]
R/W	R	R	R	R	R	R	R/W	R/W
RTCRST	0	0	0	0	0	0	0	0
Other resets	0	0	0	0	0	0	0	0

Bit	D7	D6	D5	D4	D3	D2	D1	D0
Name	WINTVL[7]	WINTVL[6]	WINTVL[5]	WINTVL[4]	WINTVL[3]	WINTVL[2]	WINTVL[1]	WINTVL[0]
R/W	R/W	R/W	R/W	R/W	R/W	R/W	R/W	R/W
RTCRST	0	0	0	0	0	0	0	0
Other resets	0	0	0	0	0	0	0	0

Bit	Name	Function
D[15..10]	Reserved	Write 0 to these bits. 0 is returned after a read.
D[9..0]	WINTVL[9..0]	Key scan interval time setting (WINTVL[9..0] x 30 μ s) 1111111111 : 30690 μ s : 0000000001 : 30 μ s 0000000000 : No Wait

This register is used to set the interval time between when one set of key data is obtained by the key scan sequencer and when the next set of key data is obtained. The following figure shows the key scan interval time.

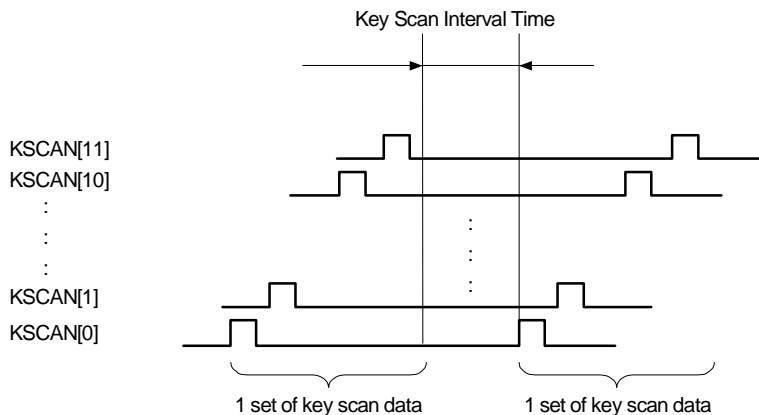

22.2.6 KIUINT (0x0B00 0198)

Bit	D15	D14	D13	D12	D11	D10	D9	D8
Name	Reserved	Reserved	Reserved	Reserved	Reserved	Reserved	Reserved	Reserved
R/W	R	R	R	R	R	R	R	R
RTCRST	0	0	0	0	0	0	0	0
Other resets	0	0	0	0	0	0	0	0

Bit	D7	D6	D5	D4	D3	D2	D1	D0
Name	Reserved	Reserved	Reserved	Reserved	Reserved	KDATLOST	KDATRDY	SCANINT
R/W	R	R	R	R	R	R/W	R/W	R/W
RTCRST	0	0	0	0	0	0	0	0
Other resets	0	0	0	0	0	0	0	0

Bit	Name	Function
D[15..3]	Reserved	Write 0 to these bits. 0 is returned after a read.
D[2]	KDATLOST	Key scan data lost interrupt. Cleared to 0 when 1 is written. This interrupt occurs when data is not read out from the data register (KIUDAT00 through KIUDAT05) between when data is input to the data register (KIUDAT00 through KIUDAT05) after a key scan and when the next scan operation starts. The data registers (KIUDAT00 through KIUDAT05) overwrite the following scan data. 1: Yes 0: No
D[1]	KDATRDY	Key data scan complete interrupt. Cleared to 0 when 1 is written. This interrupt occurs when all the key data is input after one scan operation is completed. 1: Yes 0: No
D[0]	SCANINT	Key input detection interrupt. Cleared to 0 when 1 is written. In the auto key scan mode, this interrupt occurs when a key touch is detected in the key touch wait state ("1" is detected from any of the KPORT[7..0] bits), when a key scan operation starts after setting the start of key scan, or when a key scan operation starts after returning from the Suspend mode upon key touch detection. 1: Yes 0: No

This register indicates the type of interrupt that has occurred in the KIU.

22.2.7 KIURST (0x0B00 019A)

Bit	D15	D14	D13	D12	D11	D10	D9	D8
Name	Reserved	Reserved	Reserved	Reserved	Reserved	Reserved	Reserved	Reserved
R/W	R	R	R	R	R	R	R	R
RTCRST	0	0	0	0	0	0	0	0
Other resets	0	0	0	0	0	0	0	0

Bit	D7	D6	D5	D4	D3	D2	D1	D0
Name	Reserved	Reserved	Reserved	Reserved	Reserved	Reserved	Reserved	KIURST
R/W	R	R	R	R	R	R	R	W
RTCRST	0	0	0	0	0	0	0	0
Other resets	0	0	0	0	0	0	0	0

Bit	Name	Function
D[15..1]	Reserved	Write 0 to these bits. 0 is returned after a read.
D[0]	KIURST	KIU reset. Cleared to 0 when 1 is written. 1 : Reset 0 : Normal operation

This register is used to forcibly reset the KIU registers, except for the KIUGPEN register.

22.2.8 KIUGPEN (0x0B00 019C)

Bit	D15	D14	D13	D12	D11	D10	D9	D8
Name	Reserved	Reserved	Reserved	Reserved	KGPEN[11]	KGPEN[10]	KGPEN[9]	KGPEN[8]
R/W	R	R	R	R	R/W	R/W	R/W	R/W
RTCRST	0	0	0	0	0	0	0	0
Other resets	0	0	0	0	Note	Note	Note	Note

Bit	D7	D6	D5	D4	D3	D2	D1	D0
Name	KGPEN[7]	KGPEN[6]	KGPEN[5]	KGPEN[4]	KGPEN[3]	KGPEN[2]	KGPEN[1]	KGPEN[0]
R/W	R/W	R/W	R/W	R/W	R/W	R/W	R/W	R/W
RTCRST	0	0	0	0	0	0	0	0
Other resets	Note	Note	Note	Note	Note	Note	Note	Note

Bit	Name	Function
D[15..12]	Reserved	Write 0 to these bits. 0 is returned after a read.
D[11..0]	KGPEN[11..0]	SCAN pin function 1 : Use as output port 0 : Use as SCAN pin

Note The value before reset is retained.

This register is used to set whether or not the KSCAN[11:0] pins will function as a general-purpose output port. The KGPEN[11:0] bits correspond to the KSCAN[11:0] pins bitwise.

Setting a “1” to each bit in this register enables the KSCAN pin to function as a general-purpose output port.

The output port setting are made via the GIU’s GIUPODATL register (0x0B00 011C).

The correspondences between KSCAN and GPIO pins are as below.

Bit	Pin
KGPEN[11]	KSCAN[11]/GPIO[43]
KGPEN[10]	KSCAN[10]/GPIO[42]
KGPEN[9]	KSCAN[9]/GPIO[41]
KGPEN[8]	KSCAN[8]/GPIO[40]
KGPEN[7]	KSCAN[7]/GPIO[39]
KGPEN[6]	KSCAN[6]/GPIO[38]
KGPEN[5]	KSCAN[5]/GPIO[37]
KGPEN[4]	KSCAN[4]/GPIO[36]
KGPEN[3]	KSCAN[3]/GPIO[35]
KGPEN[2]	KSCAN[2]/GPIO[34]
KGPEN[1]	KSCAN[1]/GPIO[33]
KGPEN[0]	KSCAN[0]/GPIO[32]

However, the number of pins used as SCAN pin or output port is limited by the SCANLINE register’s setting. For details, refer to 22.2.9.

KIU controls enable/disable of the output buffer of the KSCAN[11:0]/GPIO[43:32] pins with the internal signal en_kscan[11:0] according to the setting of the KGPEN[11:0] bits.

One en_kscan signal corresponds to each KGPEN bit. The en_kscan signal that is set for a KSCAN pin by the KGPEN bit outputs the high level during a scan, and outputs the low level during a wait time. On the other hand, the en_kscan signal that is set for a general output port by the KGPEN bit always outputs the high level.

Figure 22-2. Connection of Keyboard Interface Pin

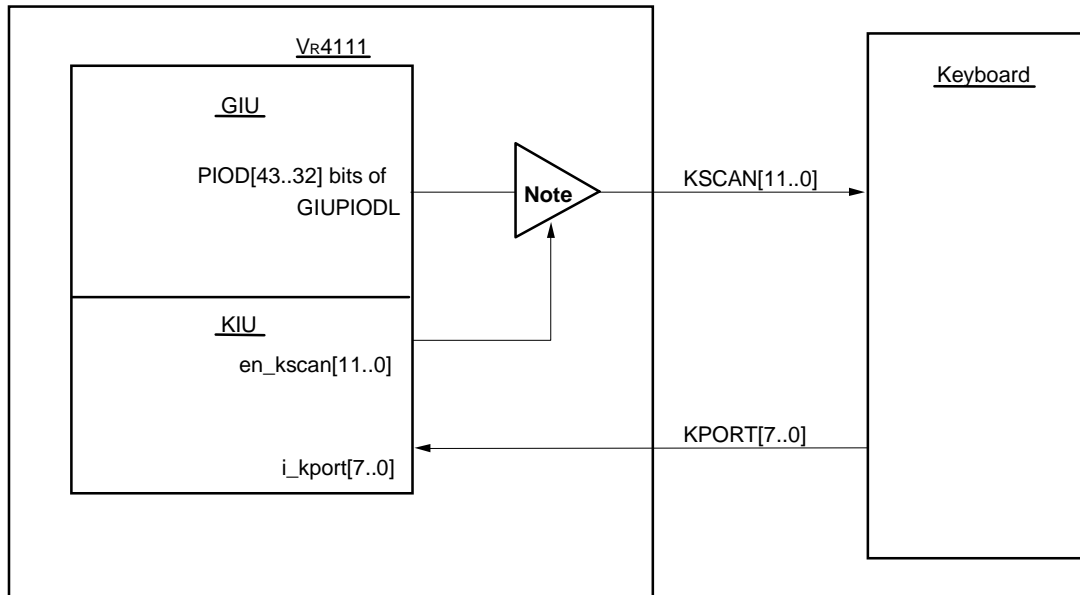

Note The output of this buffer is enabled with a high-level signal (active-high).
 When en_kscan is high, this buffer outputs data to the KSCAN pin.
 When en_kscan is low, the KSCAN pin goes into the high-impedance state.

22.2.9 SCANLINE (0x0B00 019E)

Bit	D15	D14	D13	D12	D11	D10	D9	D8
Name	Reserved	Reserved	Reserved	Reserved	Reserved	Reserved	Reserved	Reserved
R/W	R	R	R	R	R	R	R	R
RTCRST	0	0	0	0	0	0	0	0
Other resets	0	0	0	0	0	0	0	0

Bit	D7	D6	D5	D4	D3	D2	D1	D0
Name	Reserved	Reserved	Reserved	Reserved	Reserved	Reserved	LINE[1]	LINE[0]
R/W	R	R	R	R	R	R	R/W	R/W
RTCRST	0	0	0	0	0	0	0	0
Other resets	0	0	0	0	0	0	0	0

Bit	Name	Function
D[15..2]	Reserved	Write 0 to these bits. 0 is returned after a read.
D[1..0]	LINE[1..0]	<p>SCAN pin use/do not use setting</p> <p>11 : Do not use SCAN pins for key scan All the KIU's SCAN pins are used as output ports.</p> <p>10 : Use eight key scan pins (KSCAN[7..0]) Key scan uses eight key scan pins (supports 64 keys) Set the KGPEN[7..0] bits in the KIUGPEN register to 0. The remaining four pins can be used as an output port.</p> <p>01 : Use ten key scan pins (KSCAN[9..0]) Key scan uses ten key scan pins (supports 80 keys) Set the KGPEN[9..0] bits in the KIUGPEN register to 0. The remaining two pins can be used as an output port.</p> <p>00 : Use twelve key scan pins (KSCAN[11..0]) Key scan uses twelve key scan pins (supports 96 keys) Set the KGPEN[11..0] bits in the KIUGPEN register to 0. No pins can be used as an output port.</p>

This register is used to switch the number of scan lines.

Figure 22-3. Transition of Sequencer Status

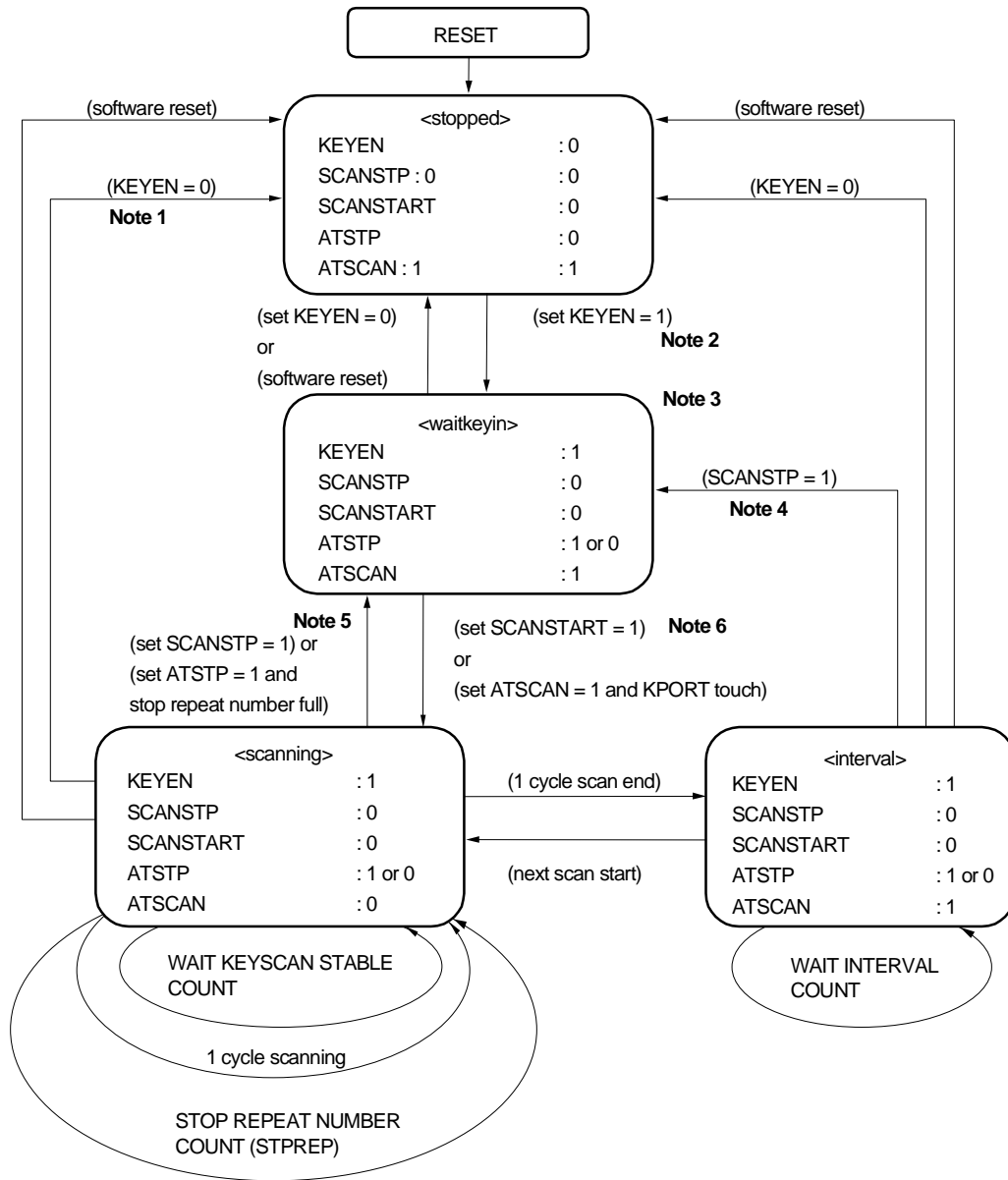

<Description>
 <stopped> : KIUSCAN register bit 1 = 0, bit 0 = 0
 <waitkeyin> : KIUSCAN register bit 1 = 0, bit 0 = 1
 <interval> : KIUSCAN register bit 1 = 1, bit 0 = 0
 <scanning> : KIUSCAN register bit 1 = 1, bit 0 = 1
 KEYEN : KIUSCANREP register bit 15
 STPREP : KIUSCANREP register bits 9, 8, 7, 6, 5, 4
 SCANSTP : KIUSCANREP register bit 3
 SCANSTART : KIUSCANREP register bit 2
 ATSTP : KIUSCANREP register bit 1
 ATSCAN : KIUSCANREP register bit 0
 software reset : KIURST bit 0 = 1 write
 KPORT touch : When any of KPORT[7..0] pins is "1"
 stop repeat number full : When the scan data is "0" for the number of times specified by the STPREP register

- Notes**
1. When the KETEN is set to 0 during a scanning operation, the status changes to the stopped status after that scanning operation has completed.
 2. The KETEN bit cannot be set to 1 while both bits 1 and 0 of the SCANLINE register are 1.
 3. When the status changes from the waitkeyin mode to the scanning mode after the SCANSTP bit is set to 1, the status returns to the waitkeyin mode again after scanning a set of data.
 4. When the SCANSTP bit is set to 1 in the interval mode, the status changes to the waitkeyin mode and the SCANSTP bit becomes 0 automatically.
 5. If the SCANSTP bit is set to 1 during a scanning operation, that one set of data scanning is continued. After this scanning is completed, the status changes to the waitkeyin mode and the SCANSTP bit becomes 0 automatically.
 6. The SCANSTART bit becomes automatically 0 when the status changes to the scanning mode, except if the SCANSTART bit was set to 1 during the interval or scanning mode.

Figure 22-4. Basic Operation Timing Chart (1/2)
 (a) Auto Start/Auto Stop

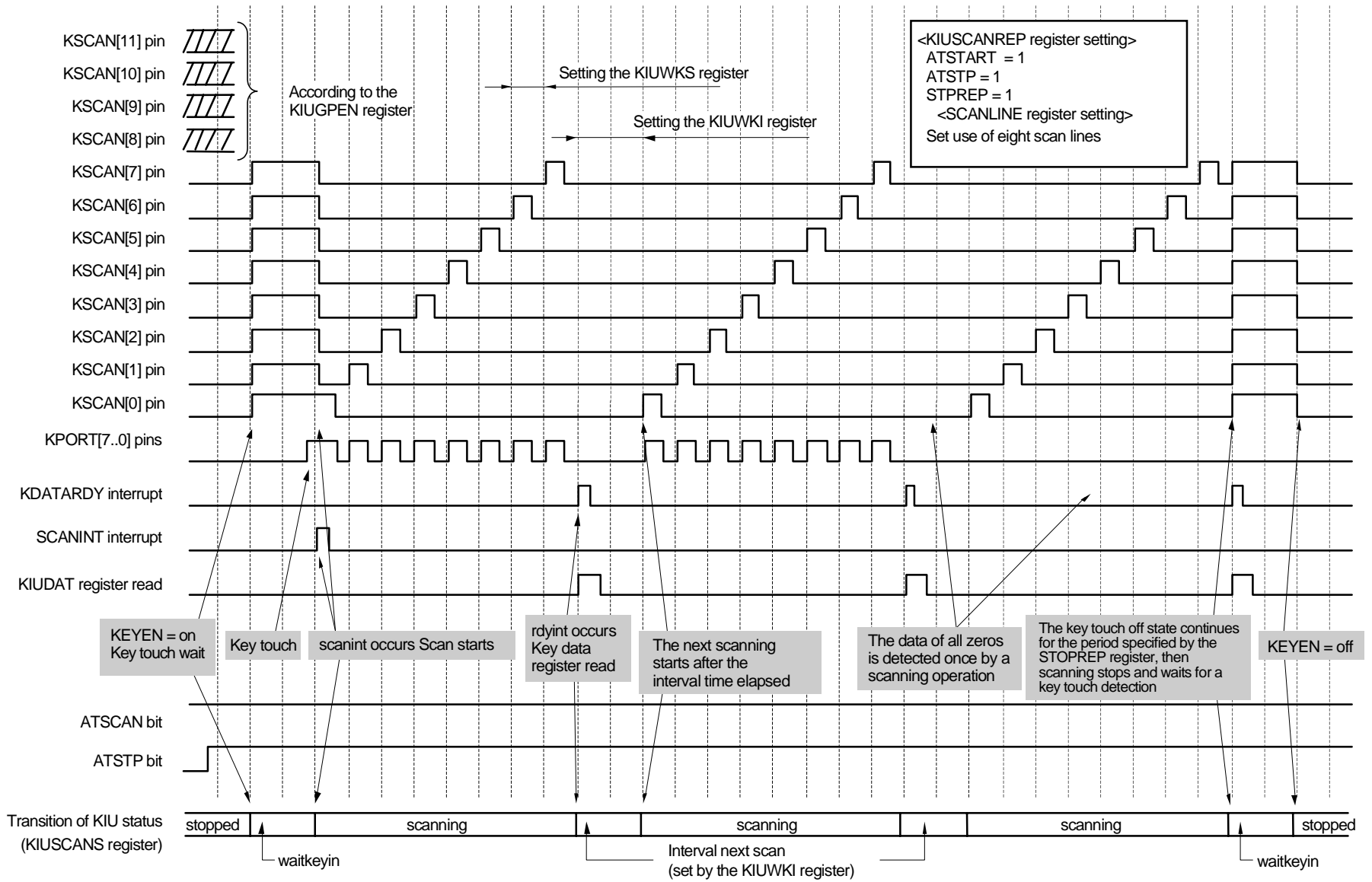
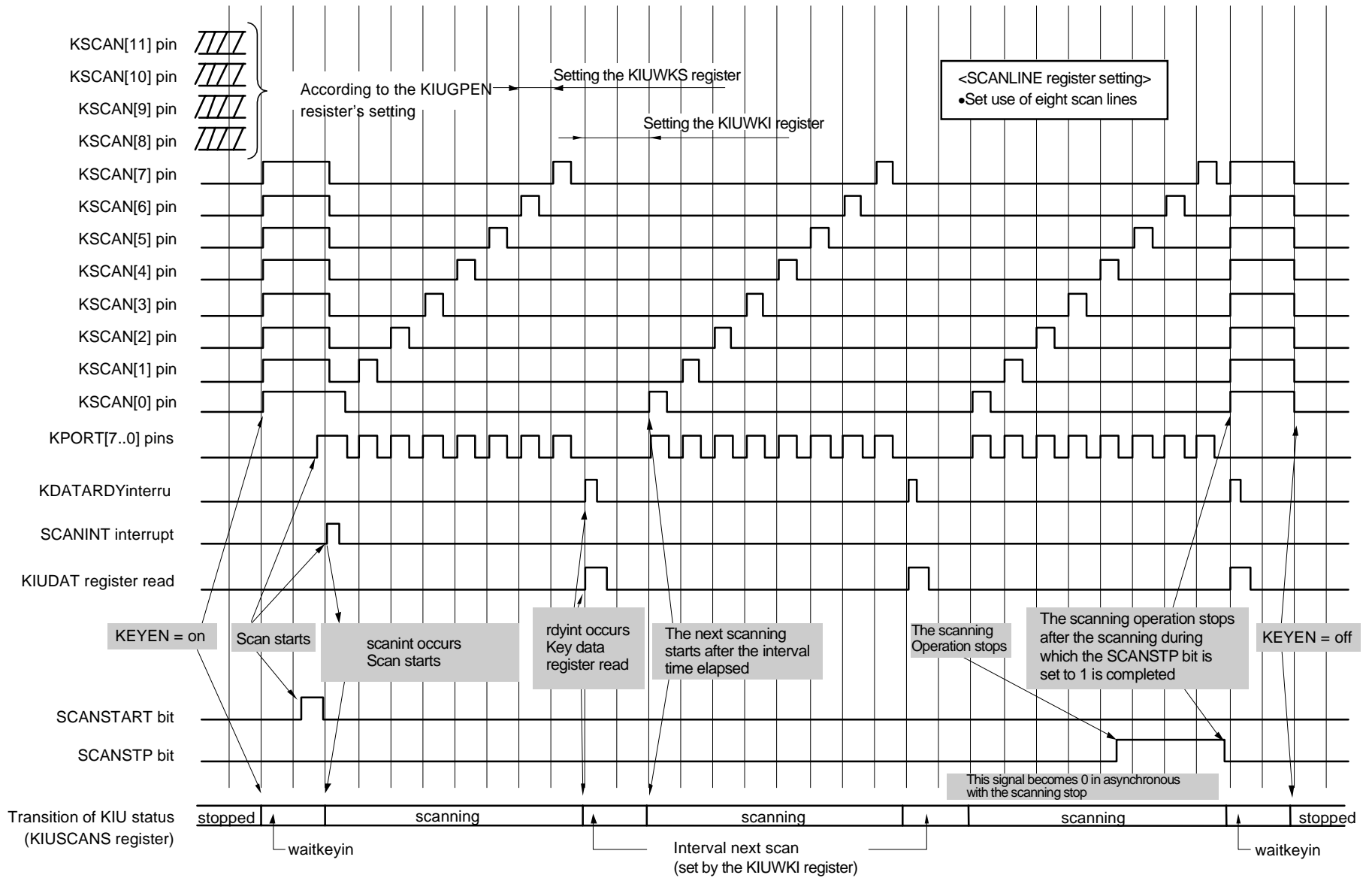

Figure 22-4. Basic Operation Timing Chart (2/2)
 (b) Auto Start/Auto Stop



[MEMO]

CHAPTER 23 DSIU (DEBUG SERIAL INTERFACE UNIT)

This chapter describes the DSIU's operations and register settings.

23.1 GENERAL

The DSIU (debug serial interface unit) supports transfer rates of up to 115 kbps. In addition to the DDIN and DDOUT input/output pins, the DSIU supports the DCTS# and DRTS# pins that are used for hardware flow control.

23.2 REGISTER SET

The DSIU registers are listed below.

Table 23-1. DSIU Registers

Address	R/W	Register Symbols	Function
0x0B00 01A0	R/W	PORTREG	Port Change Register
0x0B00 01A2	R	MODEMREG	Modem Control Register
0x0B00 01A4	R/W	ASIM00REG	Asynchronous Mode 0 Register
0x0B00 01A6	R/W	ASIM01REG	Asynchronous Mode 1 Register
0x0B00 01A8	R	RXB0RREG	Receive Buffer Register (Extended)
0x0B00 01AA	R	RXB0LREG	Receive Buffer Register
0x0B00 01AC	R/W	TXS0RREG	Transmit Data Register (Extended)
0x0B00 01AE	R/W	TXS0LREG	Transmit Data Register
0x0B00 01B0	R	ASIS0REG	Status Register
0x0B00 01B2	R/W	INTR0REG	Debug SIU Interrupt Register
0x0B00 01B6	R/W	BPRM0REG	Baud rate Generator Prescaler Mode Register
0x0B00 01B8	R/W	DSIURESETREG	Debug SIU Reset Register

These registers are described in detail below.

23.2.1 PORTREG (0x0B00 01A0)

Bit	D15	D14	D13	D12	D11	D10	D9	D8
Name	Reserved	Reserved	Reserved	Reserved	Reserved	Reserved	Reserved	Reserved
R/W	R	R	R	R	R	R	R	R
RTCRST	0	0	0	0	0	0	0	0
Other resets	0	0	0	0	0	0	0	0

Bit	D7	D6	D5	D4	D3	D2	D1	D0
Name	Reserved	Reserved	Reserved	Reserved	CDDIN	CDDOUT	CDRTS	CDCTS
R/W	R	R	R	R	R/W	R/W	R/W	R/W
RTCRST	0	0	0	0	0	0	0	0
Other resets	0	0	0	0	Note	Note	Note	Note

Bit	Name	Function
D[15:4]	Reserved	Write 0 to these bits. 0 is returned after a read.
D[3]	CDDIN	This pin is used to switch the DDIN pin for use as a general-purpose output pin. 1 : General-purpose output 0 : DDIN
D[2]	CDDOUT	This pin is used to switch the DDOUT pin for use as a general-purpose output pin. 1 : General-purpose output 0 : DDOUT
D[1]	CDRTS	This pin is used to switch the DRTS# pin for use as a general-purpose output pin. 1 : General-purpose output 0 : DRTS#
D[0]	CDCTS	This pin is used to switch the DCTS# pin for use as a general-purpose output pin. 1 : General-purpose output 0 : DCTS#

Note Previous value is retained.

This register is used to switch the DSIU pin for use as a general-purpose output pin.

Note that the output value should be set in the GIU when the DSIU pins are set to general-purpose outputs.

23.2.2 MODEMREG (0x0B00 01A2)

Bit	D15	D14	D13	D12	D11	D10	D9	D8
Name	Reserved	Reserved	Reserved	Reserved	Reserved	Reserved	Reserved	Reserved
R/W	R	R	R	R	R	R	R	R
RTCRST	0	0	0	0	0	0	0	0
Other resets	0	0	0	0	0	0	0	0

Bit	D7	D6	D5	D4	D3	D2	D1	D0
Name	Reserved	Reserved	Reserved	Reserved	Reserved	Reserved	DRTS	DCTS
R/W	R	R	R	R	R	R	R	R
RTCRST	0	0	0	0	0	0	1	1
Other resets	0	0	0	0	0	0	1	1

Bit	Name	Function
D[15:2]	Reserved	Write 0 to these bits. 0 is returned after a read.
D[1]	DRTS	DRTS# pin output 1: High level 0: Low level
D[0]	DCTS	DCTS# pin input 1: High level 0: Low level

This register is used for flow control and can be used to pass signals between the V_{R4111} and external agents. The setting of the RXE0 bit in ASIM00REG reflects on the DRTS#'s output.

23.2.3 ASIM00REG (0x0B00 01A4)

Bit	D15	D14	D13	D12	D11	D10	D9	D8
Name	Reserved	Reserved	Reserved	Reserved	Reserved	Reserved	Reserved	Reserved
R/W	R	R	R	R	R	R	R	R
RTCRST	0	0	0	0	0	0	0	0
Other resets	0	0	0	0	0	0	0	0

Bit	D7	D6	D5	D4	D3	D2	D1	D0
Name	Reserved	RXE0	PS0[1]	PS0[0]	CL0	SL0	Reserved	Reserved
R/W	R	R/W	R/W	R/W	R/W	R/W	R	R
RTCRST	1	0	0	0	0	0	0	0
Other resets	1	0	0	0	0	0	0	0

Bit	Name	Function
D[15:8]	Reserved	Write 0 to these bits. 0 is returned after a read.
D[7]	Reserved	Write 1 to this bit. 1 is returned after a read.
D[6]	RXE0	Debug serial reception enable 1 : Enable 0 : Prohibit
D[5:4]	PS0[1:0]	Debug serial parity select 11 : Even parity 10 : Odd parity 01 : Zero parity bits during transmit No parity during receive 00 : No parity. Set to 00 for extended-bit operations
D[3]	CL0	Debug serial character length setting 1 : 8 bits 0 : 7 bits
D[2]	SL0	Debug serial stop bit setting 1 : 2 bits 0 : 1 bit
D[1:0]	Reserved	Write 0 to these bits. 0 is returned after a read.

This register is used to make various serial communication settings for debugging.

The setting of RXE0 reflects on the DRTS#'s output. Setting this bit to 1 (reception enable) makes the DRTS# pin output 0, and clearing to 0 (reception prohibit) makes DRTS# output 1.

If this register is changed during transmission or reception of serial data for debugging, the DSIU's operations cannot be guaranteed.

23.2.4 ASIM01REG (0x0B00 01A6)

Bit	D15	D14	D13	D12	D11	D10	D9	D8
Name	Reserved	Reserved	Reserved	Reserved	Reserved	Reserved	Reserved	Reserved
R/W	R	R	R	R	R	R	R	R
RTCRST	0	0	0	0	0	0	0	0
Other resets	0	0	0	0	0	0	0	0

Bit	D7	D6	D5	D4	D3	D2	D1	D0
Name	Reserved	Reserved	Reserved	Reserved	Reserved	Reserved	Reserved	EBS0
R/W	R	R	R	R	R	R	R	R/W
RTCRST	0	0	0	0	0	0	0	0
Other resets	0	0	0	0	0	0	0	0

Bit	Name	Function
D[15:1]	Reserved	Write 0 to these bits. 0 is returned after a read.
D[0]	EBS0	Extended bit operation enable 1 : Enable 0 : Prohibit

This register is used to set extended bit operations for the DSIU.

When “1” is set to the EBS0 bit, one bit is added to the 8-bit data length for transmission and reception to enable operations using 9-bit data. Extended-bit operations are valid only when “00” has been set to ASIM00REG’s PS[1:0] bits. If a value other than “00” has been set to ASIM00REG’s PS[1:0] bits, the EBS0 bit specification is ignored and extended-bit operations cannot be performed.

23.2.5 RXB0RREG (0x0B00 01A8)

Bit	D15	D14	D13	D12	D11	D10	D9	D8
Name	Reserved	Reserved	Reserved	Reserved	Reserved	Reserved	Reserved	RXB0[8]
R/W	R	R	R	R	R	R	R	R
RTCRST	0	0	0	0	0	0	0	0
Other resets	0	0	0	0	0	0	0	0

Bit	D7	D6	D5	D4	D3	D2	D1	D0
Name	RXB0[7]	RXB0[6]	RXB0[5]	RXB0[4]	RXB0[3]	RXB0[2]	RXB0[1]	RXB0[0]
R/W	R	R	R	R	R	R	R	R
RTCRST	0	0	0	0	0	0	0	0
Other resets	0	0	0	0	0	0	0	0

Bit	Name	Function
D[15:9]	Reserved	Write 0 to these bits. 0 is returned after a read.
D[8:0]	RXB0[8:0]	Receive data [8:0]

This register is used to store debug serial receive data.

The RXB0[8] bit stores the extended bit during extended-bit operations and stores a zero during 7- or 8-bit character reception. The RXB0[7] bit stores a zero during 7-bit character reception.

23.2.6 RXB0LREG (0x0B00 01AA)

Bit	D15	D14	D13	D12	D11	D10	D9	D8
Name	Reserved	Reserved	Reserved	Reserved	Reserved	Reserved	Reserved	Reserved
R/W	R	R	R	R	R	R	R	R
RTCRST	0	0	0	0	0	0	0	0
Other resets	0	0	0	0	0	0	0	0

Bit	D7	D6	D5	D4	D3	D2	D1	D0
Name	RXB0L[7]	RXB0L[6]	RXB0L[5]	RXB0L[4]	RXB0L[3]	RXB0L[2]	RXB0L[1]	RXB0L[0]
R/W	R	R	R	R	R	R	R	R
RTCRST	0	0	0	0	0	0	0	0
Other resets	0	0	0	0	0	0	0	0

Bit	Name	Function
D[15:8]	Reserved	Write 0 to these bits. 0 is returned after a read.
D[7:0]	RXB0L[7:0]	Receive data [7:0]

This register is used to store debug serial receive data.

The RXB0L[7] bit stores a zero during 7-bit character reception.

The only difference between this register and RXB0RREG is that this register does not support extended-bit operations.

23.2.7 TXS0RREG (0x0B00 01AC)

Bit	D15	D14	D13	D12	D11	D10	D9	D8
Name	Reserved	Reserved	Reserved	Reserved	Reserved	Reserved	Reserved	TXS0[8]
R/W	R	R	R	R	R	R	R	R/W
RTCRST	0	0	0	0	0	0	0	1
Other resets	0	0	0	0	0	0	0	1

Bit	D7	D6	D5	D4	D3	D2	D1	D0
Name	TXS0[7]	TXS0[6]	TXS0[5]	TXS0[4]	TXS0[3]	TXS0[2]	TXS0[1]	TXS0[0]
R/W	R/W	R/W	R/W	R/W	R/W	R/W	R/W	R/W
RTCRST	1	1	1	1	1	1	1	1
Other resets	1	1	1	1	1	1	1	1

Bit	Name	Function
D[15:9]	Reserved	Write 0 to these bits. 0 is returned after a read.
D[8:0]	TXS0[8:0]	Transmit data [8:0]

This register is used to store debug serial transmit data.

The TXS0[8] bit is used to transmit the extended bit during extended-bit operations.

23.2.8 TXS0LREG (0x0B00 01AE)

Bit	D15	D14	D13	D12	D11	D10	D9	D8
Name	Reserved	Reserved	Reserved	Reserved	Reserved	Reserved	Reserved	Reserved
R/W	R	R	R	R	R	R	R	R
RTCRST	0	0	0	0	0	0	0	0
Other resets	0	0	0	0	0	0	0	0

Bit	D7	D6	D5	D4	D3	D2	D1	D0
Name	TXS0L[7]	TXS0L[6]	TXS0L[5]	TXS0L[4]	TXS0L[3]	TXS0L[2]	TXS0L[1]	TXS0L[0]
R/W	R/W	R/W	R/W	R/W	R/W	R/W	R/W	R/W
RTCRST	1	1	1	1	1	1	1	1
Other resets	1	1	1	1	1	1	1	1

Bit	Name	Function
D[15:8]	Reserved	Write 0 to these bits. 0 is returned after a read.
D[7:0]	TXS0L[7:0]	Transmit data [7:0]

This register is used to store debug serial transmit data.

The only difference between this register and TXS0RREG is that this register does not support extended-bit operations.

23.2.9 ASIS0REG (0x0B00 01B0)

Bit	D15	D14	D13	D12	D11	D10	D9	D8
Name	Reserved	Reserved	Reserved	Reserved	Reserved	Reserved	Reserved	Reserved
R/W	R	R	R	R	R	R	R	R
RTCRST	0	0	0	0	0	0	0	0
Other resets	0	0	0	0	0	0	0	0

Bit	D7	D6	D5	D4	D3	D2	D1	D0
Name	SOT0	Reserved	Reserved	Reserved	Reserved	PE0	FE0	OVE0
R/W	R	R	R	R	R	R	R	R
RTCRST	0	0	0	0	0	0	0	0
Other resets	0	0	0	0	0	0	0	0

Bit	Name	Function
D[15:8]	Reserved	Write 0 to these bits. 0 is returned after a read.
D[7]	SOT0	Transmit mode status 1: Transmission start 0: Transmission complete
D[6:3]	Reserved	Write 0 to these bits. 0 is returned after a read.
D[2]	PE0	Parity error status 1: Parity error 0: Normal
D[1]	FE0	Framing error status 1: Framing error 0: Normal
D[0]	OVE0	Overrun error status 1: Overrun error status 0: Normal

This register indicates the debug serial transmit/receive status.

A write to the TXS0RREG or TXS0LREG register sets “1” to the SOT0 bit. When the transmission is completed, “1” is set to the INTR0REG register’s INTST0 bit and the SOT0 bit is cleared to zero. This bit can be used as a means of determining whether or not it is possible to write to the transmission shift register when transmitting data in debug serial mode.

If the received data contains a parity error, “1” is set to the PE0 bit. If the stop bit is not detected, “1” is set to the FE0 bit.

An overrun error occurs and “1” is set to the OVE0 bit if the sequencer completes the next receive processing before receive data is read from the receive buffer. When an overrun error occurs, the old data in the receive buffer is overwritten by the newly received data.

23.2.10 INTR0REG (0x0B00 01B2)

Bit	D15	D14	D13	D12	D11	D10	D9	D8
Name	Reserved	Reserved	Reserved	Reserved	Reserved	Reserved	Reserved	Reserved
R/W	R	R	R	R	R	R	R	R
RTCRST	0	0	0	0	0	0	0	0
Other resets	0	0	0	0	0	0	0	0

Bit	D7	D6	D5	D4	D3	D2	D1	D0
Name	Reserved	Reserved	Reserved	Reserved	INTDCD	INTSER0	INTSR0	INTST0
R/W	R	R	R	R	R/W	R/W	R/W	R/W
RTCRST	0	0	0	0	0	0	0	0
Other resets	0	0	0	0	0	0	0	0

Bit	Name	Function
D[15:4]	Reserved	Write 0 to these bits. 0 is returned after a read.
D[3]	INTDCD	CTS# change interrupt. Cleared to 0 when 1 is written. 1 : CTS change interrupt 0 : Normal
D[2]	INTSER0	Debug serial receive error interrupt. Cleared to 0 when 1 is written. 1 : Error interrupt 0 : Normal
D[1]	INTSR0	Debug serial receive complete interrupt. Cleared to 0 when 1 is written. 1 : Receive complete 0 : Other
D[0]	INTST0	Debug serial transmit complete interrupt. Cleared to 0 when 1 is written. 1 : Transmit complete 0 : Other

This register indicates interrupt events that occur during debug serial transfer.

When debug serial operations are in the reception-enable mode, and either the PE0 bit, FE0 bit, or OVE0 bit in the ASIS0REG has been set, "1" is set to the INTSER0 bit.

When debug serial operations are in the reception-enable mode, and receive data is transferred to the receive buffer, "1" is set to the INTSR0 bit. When one frame of transmit data is sent from the transmit register, "1" is set to the INTST0 bit.

When CTS# (flow control signal from an external agent) is changed, "1" is set to the INTDCD bit.

23.2.11 BPRM0REG (0x0B00 01B6)

Bit	D15	D14	D13	D12	D11	D10	D9	D8
Name	Reserved	Reserved	Reserved	Reserved	Reserved	Reserved	Reserved	Reserved
R/W	R	R	R	R	R	R	R	R
RTCRST	0	0	0	0	0	0	0	0
Other resets	0	0	0	0	0	0	0	0

Bit	D7	D6	D5	D4	D3	D2	D1	D0
Name	BRCE0	Reserved	Reserved	Reserved	Reserved	BPR0[2]	BPR0[1]	BPR0[0]
R/W	R/W	R	R	R	R	R/W	R/W	R/W
RTCRST	0	0	0	0	0	0	0	0
Other resets	0	0	0	0	0	0	0	0

Bit	Name	Function
D[15:8]	Reserved	Write 0 to these bits. 0 is returned after a read.
D[7]	BRCE0	Baud rate generator count enable 1 : Enable 0 : Prohibit
D[6:3]	Reserved	Write 0 to these bits. 0 is returned after a read.
D[2:0]	BPR0[2:0]	Debug serial baud rate setting 111 : 115200 bps 110 : 57600 bps 101 : 38400 bps 100 : 19200 bps 011 : 9600 bps 010 : 4800 bps 001 : 2400 bps 000 : 1200 bps

This register is used to set the baud rate for debug serial communications.
DSIU's operations are not guaranteed if the baud rate is changed during transmission or reception.

23.2.12 DSIURESETREG (0x0B00 01B8)

Bit	D15	D14	D13	D12	D11	D10	D9	D8
Name	Reserved	Reserved	Reserved	Reserved	Reserved	Reserved	Reserved	Reserved
R/W	R	R	R	R	R	R	R	R
RTCRST	0	0	0	0	0	0	0	0
Other resets	0	0	0	0	0	0	0	0

Bit	D7	D6	D5	D4	D3	D2	D1	D0
Name	Reserved	Reserved	Reserved	Reserved	Reserved	Reserved	Reserved	DSIURST
R/W	R	R	R	R	R	R	R	R/W
RTCRST	0	0	0	0	0	0	0	0
Other resets	0	0	0	0	0	0	0	0

Bit	Name	Function
D[15:1]	Reserved	Write 0 to these bits. 0 is returned after a read.
D[0]	DSIURST	DSIU reset. Cleared to 0 when 1 is written. 1 : Reset 0 : Normal

This register is used to reset DSIU forcibly.

23.3 DESCRIPTION OF OPERATIONS

23.3.1 Data Format

Serial data is transmitted and received in full-duplex mode.

The format of the transmit and receive data is shown in the following figure. Each frame includes a start bit, character bits, parity bit, and stop bit(s). Specification of the character bit length in one data frame, along with the parity setting, and stop bit length specification are all made via the mode registers (ASIM00REG and ASIM01REG).

Figure 23-1. Data Format for Transmission and Reception

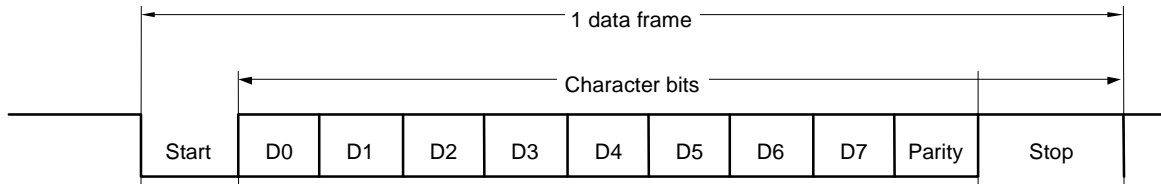

- Start bit (Start) : 1 bit
- Character bits (Dn) : 7, 8, or 9 bits (when using extended bit)
- Parity bit (Parity) : Even parity, odd parity, zero parity, or no parity
- Stop bit(s) (Stop) : 1 bit or 2 bits

23.3.2 Transmission

After the SOT0 pin value is confirmed as “0”, writing data to a transmission shift register (TXS0REG or TXS0LREG) activates transmission via the DDOUT pin. Use the transmit complete interrupt (Dsiu_Intst0) service routine to write the next data to TXS0REG or TXS0LREG.

Transmission enable status

The DSIU unit is always set to transmission enable status. The DCTS# pin is used when it is necessary to confirm that the remote side is ready to receive.

Activation of transmit operation

Writing data to a transmission shift register (TXS0REG or TXS0LREG) activates the transmit operation. The transmit data is sent in LSB-first order, beginning with the start bit. The start bit, parity bit, and stop bit(s) are added automatically.

Transmit complete interrupt request

Once one frame of data has been sent, a transmit complete interrupt request (Dsiu_Intst0) occurs. If the next data to be transmitted is then not written to TXS0REG or TXS0LREG, the transmit operation is halted and the transmission rate is lowered.

- Cautions**
1. Normally, the transmit complete interrupt request (Dsiu_Intst0) occurs when the TXS0REG or TXS0LREG register is empty. However, if a reset is input, the transmit complete interrupt request (Dsiu_Intst0) will not occur even when the transmission shift register (TXS0REG or TXS0LREG) is empty.
 2. Writing to either TXS0REG or TXS0LREG is prohibited during a transmit operation until Dsiu_Intst0 occurs.

Figure 23-2. Transmit Complete Interrupt Timing

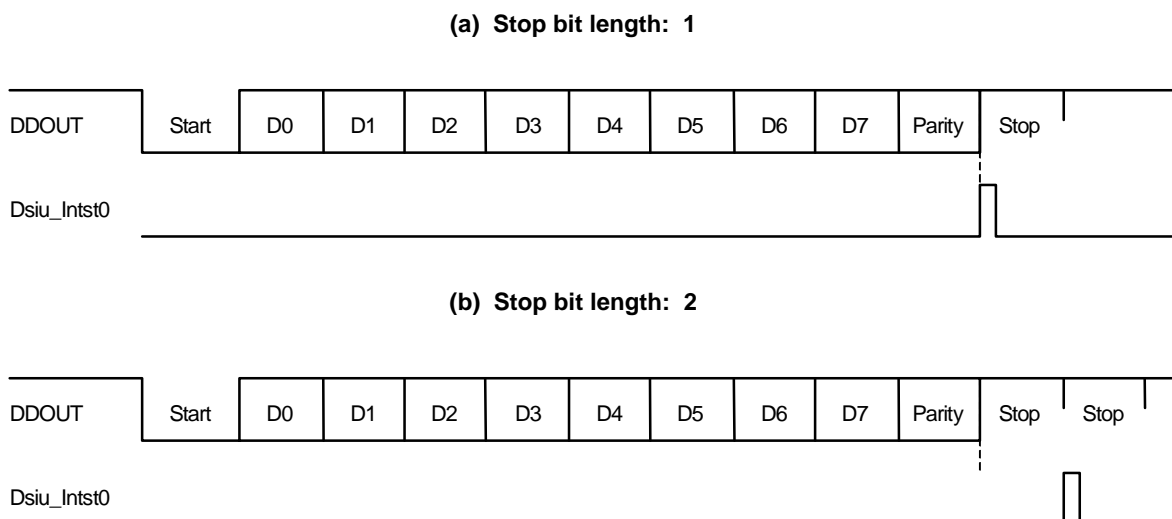

23.3.3 Reception

Once reception is enabled, sampling of the DDIN pin begins and, when a start bit is detected, data reception begins. A receive complete interrupt request (Dsiu_Intst0) occurs each time reception of one frame of data is completed. Normally, this interrupt service is used to transfer receive data from a receive buffer (RXB0REG or RXB0LREG) to memory.

Reception enable status

Setting the ASIM00REG's bit[6] sets enable status for the receive operation, and a zero is output to DRTS#.

RXE0 = 1: Reception enable status DRTS# = 0
 RXE0 = 0: Reception prohibit status DRTS# = 1

The reception hardware is initialized and enters idle mode when reception prohibit status has been set. Once that happens, receive complete interrupts and receive error interrupts are not issued and the contents of the receive buffer are retained.

Activation of receive operation

The receive operation is activated when a start bit is detected.

The DDIN pin is sampled at the interval set by the serial clock specified via ASIM00REG. Once a signal's falling edge is detected at the DDIN pin, the DDIN pin is again sampled after an interval of eight serial clocks. This time, when a low-level state is detected it is recognized as a start bit and control is passed to the receive operation, after which the DDIN pin input continues to be sampled using an interval of 16 serial clocks.

After eight serial clocks have elapsed since a signal's falling edge was detected at the DDIN pin, when sampling recognizes a high-level state it does not recognize the signal's falling edge as a start bit. Instead, the serial clock counter used for the sampling timing is initialized and the receive operation is halted until the next edge input.

Receive complete interrupt request

When RXE0 = 1 and one frame of data has been received, the receive data in the shift register is transferred to a receive buffer (RXB0REG or RXB0LREG) and a receive complete interrupt request (Dsiu_Intsr0) is issued. Even when an error has occurred, the receive data for which the error occurred is still transferred to a receive buffer (RXB0REG or RXB0LREG) and two interrupts; a receive complete interrupt (Dsiu_Intsr0) and a receive error interrupt (Dsiu_Intser0), occur at the same time.

If the RXE0 bit is reset (to "0") during a receive operation, the receive operation is halted immediately. At that point, the contents of the receive buffer (RXB0REG or RXB0LREG) and ASIS0REG are not changed and neither the receive complete interrupt (Dsiu_Intsr0) nor the receive error interrupt (Dsiu_Intser0) occur.

Figure 23-3. Receive Complete Interrupt Timing

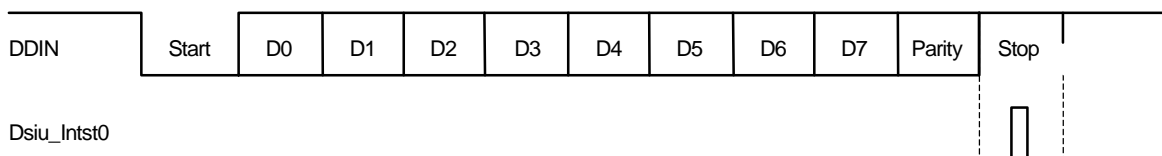

Receive error flag

Receive operations can be affected by three types of error flags that are set during the receive operations: a parity error flag, a framing error flag, and an overrun error flag.

A receive error interrupt request is issued after these three types of error flags are ORed.

During receive error interrupt service (Dsiu_Intser0), the contents of ASIS0REG can be read to detect which kind of error occurred during reception.

The contents of ASIS0REG are reset (to “0”) when the receive buffer (RXB0REG or RXB0LREG) is read or when the next data is received (another error flag is set if the next data also contains an error).

Table 23-2. Receive Error Causes

Receive error	Cause
Parity error	Parity specified during reception does not match parity of receive data
Framing error	Stop bit is not detected
Overrun error	Reception of the next data is completed before data is read from the receive buffer

Figure 23-4. Receive Error Timing

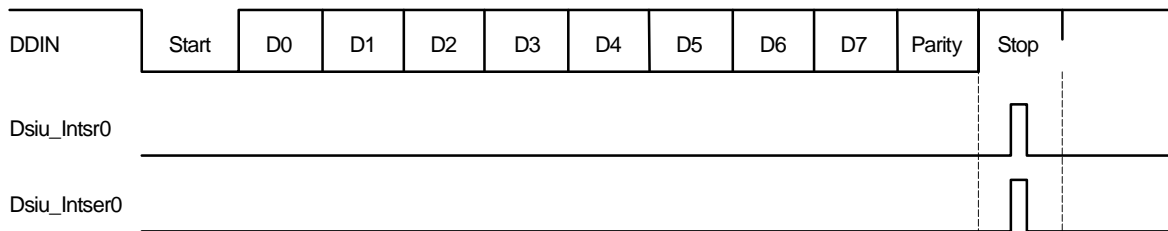

[MEMO]

CHAPTER 24 LED (LED CONTROL UNIT)

This chapter describes LED operations and register settings.

24.1 GENERAL

LEDs are switched on and off at a regular interval. The interval can be set as programmable.

24.2 REGISTER SET

The LED registers are listed below.

Table 24-1. LED Registers

Address	R/W	Register Symbols	Function
0x0B00 0240	R/W	LEDHRSREG	LED H Time Set register
0x0B00 0242	R/W	LEDLSREG	LED L Time Set register
0x0B00 0248	R/W	LEDCNTREG	LED Control register
0x0B00 024A	R/W	LEDASTCREG	LED Auto Stop Time Count register
0x0B00 024C	R/W	LEDINTREG	LED Interrupt register

These registers are described in detail below.

24.2.1 LEDHTSREG (0x0B00 0240)

Bit	D15	D14	D13	D12	D11	D10	D9	D8
Name	Reserved	Reserved	Reserved	Reserved	Reserved	Reserved	Reserved	Reserved
R/W	R	R	R	R	R	R	R	R
RTCRST	0	0	0	0	0	0	0	0
Other resets	0	0	0	0	0	0	0	0

Bit	D7	D6	D5	D4	D3	D2	D1	D0
Name	Reserved	Reserved	Reserved	HTS[4]	HTS[3]	HTS[2]	HTS[1]	HTS[0]
R/W	R	R	R	R/W	R/W	R/W	R/W	R/W
RTCRST	0	0	0	1	0	0	0	0
Other resets	0	0	0	Note	Note	Note	Note	Note

Bit	Name	Function
D[15..5]	Reserved	Write 0 to these bits. 0 is returned after a read.
D[4..0]	HTS[4..0]	Values compared to bits 15 to 11 of LED HL Time Count. 11111 : 1.9375 seconds : 10000 : 1 second : 01000 : 0.5 seconds : 00100 : 0.25 seconds : 00010 : 0.125 seconds 00001 : 0.0625 seconds 00000 : Prohibit

Note Previous value is retained.

This register is used to set the LED's ON time (high level width of LEDOUT#).

The ON time ranges from 0.0625 to 1.9375 seconds and can be set in 0.0625-second units. The initial value is 1 second.

This register must not be changed once the LEDENABLE bit of LEDCNTREG has been set to 1 as "enable". The operation is not guaranteed if a change is made after that point.

24.2.2 LEDLTSREG (0x0B00 0242)

Bit	D15	D14	D13	D12	D11	D10	D9	D8
Name	Reserved	Reserved	Reserved	Reserved	Reserved	Reserved	Reserved	Reserved
R/W	R	R	R	R	R	R	R	R
RTCRST	0	0	0	0	0	0	0	0
Other resets	0	0	0	0	0	0	0	0

Bit	D7	D6	D5	D4	D3	D2	D1	D0
Name	Reserved	LTS[6]	LTS[5]	LTS[4]	LTS[3]	LTS[2]	LTS[1]	LTS[0]
R/W	R	R/W	R/W	R/W	R/W	R/W	R/W	R/W
RTCRST	0	0	1	0	0	0	0	0
Other resets	0	Note	Note	Note	Note	Note	Note	Note

Bit	Name	Function
D[15..7]	Reserved	Write 0 to these bits. 0 is returned after a read.
D[6..0]	LTS[6..0]	Values compared to bits 17 to 11 of LED HL Time Count. 1111111 : 7.9375 seconds : 1000000 : 4 seconds : 0100000 : 2 seconds : 0010000 : 1 second : 0001000 : 0.5 seconds : 0000100 : 0.25 seconds : 0000010 : 0.125 seconds 0000001 : 0.0625 seconds 0000000 : Prohibit

Note Previous value is retained.

This register is used to set the LED's OFF time (low level width of LEDOUT#).

The OFF time ranges from 0.0625 to 7.9375 seconds and can be set in 0.0625-second units. It should be set by means of software. The initial value is 2 seconds.

This register must not be changed once the LEDENABLE bit of LEDCNTREG has been set as "enable". The operation is not guaranteed if a change is made after that point.

24.2.3 LEDCNTREG (0x0B00 0248)

Bit	D15	D14	D13	D12	D11	D10	D9	D8
Name	Reserved	Reserved	Reserved	Reserved	Reserved	Reserved	Reserved	Reserved
R/W	R	R	R	R	R	R	R	R
RTCST	0	0	0	0	0	0	0	0
Other resets	0	0	0	0	0	0	0	0

Bit	D7	D6	D5	D4	D3	D2	D1	D0
Name	Reserved	Reserved	Reserved	Reserved	Reserved	Reserved	LEDSTOP	LEDENABLE
R/W	R	R	R	R	R	R	R/W	R/W
RTCST	0	0	0	0	0	0	1	0
Other resets	0	0	0	0	0	0	Note	Note

Bit	Name	Function
D[15..2]	Reserved	Write 0 to these bits. 0 is returned after a read.
D[1]	LEDSTOP	LED ON/OFF auto stop setting 1: ON 0: OFF
D[0]	LEDENABLE	LED ON/OFF (blink) setting 1: Blink 0: Do not blink

Note Previous value is retained.

This register is used to make various LED settings.

Caution When setting up LED activation, make sure that a value other than zero has already been set to the LEDHTSREG, LEDLTSREG, and LEDASTCREG. The operation is not guaranteed if zero is set to these registers.

24.2.4 LEDASTCREG (0x0B00 024A)

Bit	D15	D14	D13	D12	D11	D10	D9	D8
Name	ASTC[15]	ASTC[14]	ASTC[13]	ASTC[12]	ASTC[11]	ASTC[10]	ASTC[9]	ASTC[8]
R/W	R/W	R/W	R/W	R/W	R/W	R/W	R/W	R/W
RTCRST	0	0	0	0	0	1	0	0
Other resets	0	0	0	0	0	1	0	0

Bit	D7	D6	D5	D4	D3	D2	D1	D0
Name	ASTC[7]	ASTC[6]	ASTC[5]	ASTC[4]	ASTC[3]	ASTC[2]	ASTC[1]	ASTC[0]
R/W	R/W	R/W	R/W	R/W	R/W	R/W	R/W	R/W
RTCRST	1	0	1	1	0	0	0	0
Other resets	1	0	1	1	0	0	0	0

Bit	Name	Function
D[15..0]	ASTC[15..0]	LED auto stop time count bit

This register is a 16-bit down counter that sets the number of ON/OFF times prior to automatic stopping of LED activation. The set value is read during a read. The initial setting is 1,200 times (ON/OFF pairs) in which each time includes one second of ON time and two seconds of OFF time.

The pair of operations in which the LED is switched ON once and OFF once is counted as “1” by this counter. The counter counts down from the set value and an LEDINT interrupt occurs when it reaches zero.

Caution Setting a zero to this register is prohibited. The operation is not guaranteed if zero is set to this register.

24.2.5 LEDINTREG (0x0B00 024C)

Bit	D15	D14	D13	D12	D11	D10	D9	D8
Name	Reserved	Reserved	Reserved	Reserved	Reserved	Reserved	Reserved	Reserved
R/W	R	R	R	R	R	R	R	R
RTCRST	0	0	0	0	0	0	0	0
Other resets	0	0	0	0	0	0	0	0

Bit	D7	D6	D5	D4	D3	D2	D1	D0
Name	Reserved	Reserved	Reserved	Reserved	Reserved	Reserved	Reserved	LEDINT
R/W	R	R	R	R	R	R	R	R/W
RTCRST	0	0	0	0	0	0	0	0
Other resets	0	0	0	0	0	0	0	0

Bit	Name	Function
D[15..1]	Reserved	Write 0 to these bits. 0 is returned after a read.
D[0]	LEDINT	Auto stop interrupt request. Cleared to 0 when 1 is written. 1: Yes 0: No

This register indicates when an auto stop interrupt request has occurred.

An auto stop interrupt request occurs if “1” has already been set to the LEDSTOP bit and the LEDENABLE bit of LEDCNTREG when LEDASTCREG is cleared to “0”. When this interrupt occurs, the LEDSTOP bit and the LEDENABLE bit of LEDCNTREG are both cleared to “0”.

24.3 OPERATION FLOW

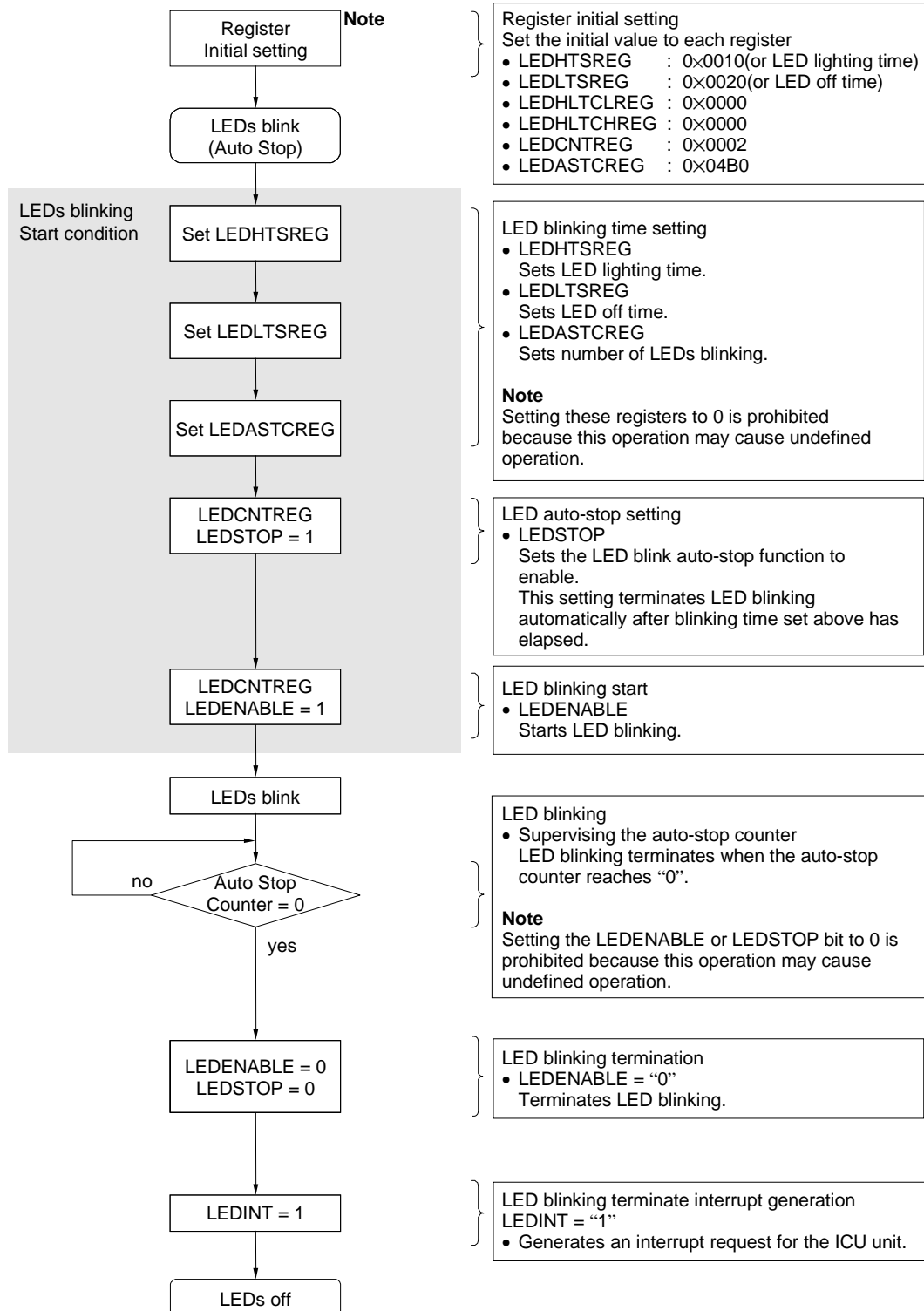

Note Initial setting for each register must be performed only when a power is supplied to device for the first time, regardless whether LEDs blinking function is used or not.

[MEMO]

CHAPTER 25 SIU (SERIAL INTERFACE UNIT)

This chapter describes the SIU's operations and register settings.

25.1 GENERAL

The SIU is a serial interface that conforms to the RS-232-C communication standard and is equipped with two one-channel interfaces, one for transmission and one for reception.

This unit is functionally compatible with the NS16550.

25.2 REGISTER SET

The SIU registers are listed below.

Table 25-1. SIU Registers

Address	LCR[7]	R/W	Register Symbols	Function
0x0C00 0000	0	R	SIURB	Receiver Buffer Register (Read)
		W	SIUTH	Transmitter Holding Register (Write)
	1	R/W	SIUDLL	Divisor Latch (Least Significant Byte)
0x0C00 0001	0	R/W	SIUIE	Interrupt Enable
	1	R/W	SIUDLM	Divisor Latch (Most Significant Byte)
0x0C00 0002	—	R	SIUIID	Interrupt Identification Register (Read)
	—	W	SIUFC	FIFO Control Register (Write)
0x0C00 0003	—	R/W	SIULC	Line Control Register
0x0C00 0004	—	R/W	SIUMC	MODEM Control Register
0x0C00 0005	—	R/W	SIULS	Line Status Register
0x0C00 0006	—	R/W	SIUMS	MODEM Status Register
0x0C00 0007	—	R/W	SIUSC	Scratch Register
0x0C00 0008	—	R/W	SIUIRSEL	SIU/FIR IrDA Selector
0x0C00 0009	—	R/W	SIURESET	SIU Reset Register
0x0C00 000A	—	R/W	SIUCSEL	SIU Echo-Back Control Register

Remark LCR[7] is the bit 7 of SIULC register.

25.2.1 SIURB (0x0C00 0000: LCR[7] = 0, Read)

Bit	D7	D6	D5	D4	D3	D2	D1	D0
Name	RXD[7]	RXD[6]	RXD[5]	RXD[4]	RXD[3]	RXD[2]	RXD[1]	RXD[0]
R/W	R	R	R	R	R	R	R	R
RTCRST	0	0	0	0	0	0	0	0
Other resets	0	0	0	0	0	0	0	0

Bit	Name	Function
D[7..0]	RXD[7..0]	Serial receive data

This register stores receive data used in serial communications.
To access this register, set LCR[7] (bit 7 of SIULC register) to 0.

25.2.2 SIUTH (0x0C00 0000: LCR[7] = 0, Write)

Bit	D7	D6	D5	D4	D3	D2	D1	D0
Name	TXD[7]	TXD[6]	TXD[5]	TXD[4]	TXD[3]	TXD[2]	TXD[1]	TXD[0]
R/W	W	W	W	W	W	W	W	W
RTCRST	0	0	0	0	0	0	0	0
Other resets	0	0	0	0	0	0	0	0

Bit	Name	Function
D[7..0]	TXD[7..0]	Serial transmit data

This register stores transmit data used in serial communications.
To access this register, set LCR[7] (bit 7 of SIULC register) to 0.

25.2.3 SIUDLL (0x0C00 0000: LCR[7] = 1)

Bit	D7	D6	D5	D4	D3	D2	D1	D0
Name	DLL[7]	DLL[6]	DLL[5]	DLL[4]	DLL[3]	DLL[2]	DLL[1]	DLL[0]
R/W	R/W	R/W	R/W	R/W	R/W	R/W	R/W	R/W
RTCRST	0	0	0	0	0	0	0	0
Other resets	0	0	0	0	0	0	0	0

Bit	Name	Function
D[7..0]	DLL[7..0]	Baud rate generator divisor (low-order byte)

This register is used to set the divisor (division rate) for the baud rate generator.
The data in this register and the upper 8-bit data in SIUDLM register are together handled as 16-bit data.
To access this register, set LCR[7] (bit 7 of SIULC register) to 1.

25.2.4 SIUIE (0x0C00 0001: LCR[7] = 0)

Bit	D7	D6	D5	D4	D3	D2	D1	D0
Name	Reserved	Reserved	Reserved	Reserved	IE[3]	IE[2]	IE[1]	IE[0]
R/W	R	R	R	R	R/W	R/W	R/W	R/W
RTCRST	0	0	0	0	0	0	0	0
Other resets	0	0	0	0	0	0	0	0

Bit	Name	Function
D[7..4]	Reserved	Write 0 to these bits. 0 is returned after read.
D[3]	IE[3]	Modem status interrupt 1 : Interrupt enable 0 : Interrupt prohibit
D[2]	IE[2]	Receive status interrupt 1 : Interrupt enable 0 : Interrupt prohibit
D[1]	IE[1]	Transmitter holding register empty interrupt 1 : Interrupt enable 0 : Interrupt prohibit
D[0]	IE[0]	Receive data interrupt or timeout interrupt in FIFO mode 1 : Interrupt enable 0 : Interrupt prohibit

This register is used to specify interrupt enable/prohibit settings for the five types of interrupt used by SIU.

Each interrupt can be used by setting the corresponding bit to 1.

Overall use of interrupt functions can be halted by setting bits 0 to 3 of this register (IER) to zero.

When interrupts are prohibited, "pending" is not displayed in the IIR[0] bit even when the interrupt condition has been met and INTR output does not become active.

Other functions in the system are not affected even though interrupts are prohibited and the settings in the line status register and modem status register are valid.

To access this register, set LCR[7] (bit 7 of SIULC register) to 0.

25.2.5 SIUDLM (0x0C00 0001: LCR[7] = 1)

Bit	D7	D6	D5	D4	D3	D2	D1	D0
Name	DLM[7]	DLM[6]	DLM[5]	DLM[4]	DLM[3]	DLM[2]	DLM[1]	DLM[0]
R/W	R/W	R/W	R/W	R/W	R/W	R/W	R/W	R/W
RTCRST	0	0	0	0	0	0	0	0
Other resets	0	0	0	0	0	0	0	0

Bit	Name	Function
D[7..0]	DLM[7..0]	Baud rate generator divisor (high-order byte)

This register is used to set the divisor (division rate) for the baud rate generator.

The data in this register and the lower 8-bit data in SIUDLL register are together handled as 16-bit data.

To access this register, set LCR[7] (bit 7 of SIULC register) to 1.

Table 25-2. Correspondence Between Baud Rates and Divisors

Baud rate	Divisor	1-clock width
50	23040	20000
75	15360	13333
110	10473	9091
134.5	8565	7435
150	7680	6667
300	3840	3333
600	1920	1667
1200	920	833
1800	640	556
2000	573	500
2400	480	417
3600	320	278
4800	240	208
7200	160	139
9600	120	104
19200	60	52.1
38400	30	26.0
56000	21	17.9
128000	9	7.81
144000	8	6.94
192000	6	5.21
230400	5	4.34
288000	4	3.47
384000	3	2.60
576000	2	1.74
1152000	1	0.868

25.2.6 SIUIID (0x0C00 0002: Read)

Bit	D7	D6	D5	D4	D3	D2	D1	D0
Name	IIR[7]	IIR[6]	Reserved	Reserved	IIR[3]	IIR[2]	IIR[1]	IIR[0]
R/W	R	R	R	R	R	R	R	R
RTCRST	0	0	0	0	0	0	0	1
Other resets	0	0	0	0	0	0	0	1

Bit	Name	Function
D[7..6]	IIR[7..6]	Becomes 11 when FCR0 = 1
D[5..4]	Reserved	Write 0 to these bits. 0 is returned after read.
D[3]	IIR[3]	Pending character timeout interrupt (in FIFO mode) 1 : No pending interrupt 0 : Pending interrupt
D[2..1]	IIR[2..1]	Indicates the priority level of pending interrupt. See the following table.
D[0]	IIR[0]	Pending interrupts 1 : No pending interrupt 0 : Pending interrupt

This register indicates priority levels for interrupts and existence of pending interrupt.

From highest to lowest priority, these interrupts are receive line status, receive data ready, character timeout, transmit holding register empty, and modem status.

The contents of IIR[3] bit is valid only in FIFO mode, and it is always 0 in 16550 mode.

IIR[2] bit becomes 1 when IIR[3] bit is set to 1.

Table 25-3. Interrupt Function

SIUID register			Interrupt set/reset function			
Bit 3 (Note)	Bit 2	Bit 1	Priority level	Interrupt type	Interrupt source	Interrupt reset control
0	1	1	Highest (1st)	Receive line status	Overrun error, parity error, framing error, or break interrupt	Read line status register
0	1	0	2nd	Receive data ready	Receive data exists or has reached the trigger level.	Read the receive buffer register or lower trigger level via FIFO.
1	1	0	2nd	Character timeout	During the time period for the four most recent characters, not one character has been read from the receive FIFO nor has a character been input to the receive FIFO. During this period, at least one character has been held in the receive FIFO.	Read receive buffer register
0	0	1	3rd	Transmit holding register empty	Transmit register is empty	Read IIR (if it is the interrupt source) or write to transmit holding register
0	0	0	4th	Modem status	CTS#, DSR#, or DCD#	Read modem status register

Note FIFO mode only.

25.2.7 SIUFC (0x0C00 0002: Write)

Bit	D7	D6	D5	D4	D3	D2	D1	D0
Name	FCR[7]	FCR[6]	Reserved	Reserved	FCR[3]	FCR[2]	FCR[1]	FCR[0]
R/W	W	W	R	R	W	W	W	W
RTCRST	0	0	0	0	0	0	0	0
Other resets	0	0	0	0	0	0	0	0

Bit	Name	Function
D[7..6]	FCR[7..6]	Receive FIFO trigger level 11 : 14 bytes 10 : 8 bytes 01 : 4 bytes 00 : 0 bytes
D[5..4]	Reserved	Write 0 to these bits. 0 is returned after read.
D[3]	FCR[3]	Switch between 16550 mode and FIFO mode 1 : From 16550 mode to FIFO mode 0 : From FIFO mode to 16550 mode
D[2]	FCR[2]	Transmit FIFO clear/counter clear. Cleared to 0 when 1 is written. 1 : FIFO clear/counter clear 0 : Normal
D[1]	FCR[1]	Receive FIFO clear/counter clear. Cleared to 0 when 1 is written. 1 : FIFO clear/counter clear 0 : Normal
D[0]	FCR[0]	Receive/Transmit FIFO enable 1 : Enable 0 : Disable

This register is used to control the FIFOs: enable FIFO, clear FIFO, and set the receive FIFO trigger level.

- **FIFO interrupt modes**

When receive FIFO is enabled and receive interrupts are enabled, receive interrupts can occur as described below.

1. When the FIFO is reached to the specified trigger level, a receive data ready interrupt occurs to inform the CPU.
This interrupt is cleared when the FIFO goes below the trigger level.
2. When the FIFO is reached to the specified trigger level, the SIUID register indicates a receive data ready interrupt.
As with the interrupt above, SUIII is cleared when the FIFO goes below the trigger level.
3. Receive line status interrupts are assigned a higher priority level than are receive data ready interrupts.
4. When characters are transferred from the shift register to the receive FIFO, "1" is set to the LSR0 bit.
The value of this bit returns to "0" when the FIFO becomes empty.

When receive FIFO is use-enabled and receive interrupts are enabled, receive FIFO timeout interrupts can occur as described below.

1. The following are conditions under which FIFO timeout interrupts occur.
 - At least one character is being stored in the FIFO.
 - The time required for sending four characters has elapsed since the serial reception of the last character (includes the time for two stop bits in cases where a stop bit has been specified).
 - The time required for sending four characters has elapsed since the CPU last accessed the FIFO.

The time between receiving the last character and issuing a timeout interrupt is a maximum of 160 ms when operating at 300 baud and receiving 12-bit data.
2. The transfer time for a character is calculated based on the baud rate clock for reception (internal) input as clock signals (which is why the elapsed time is in proportion to the baud rate).
3. Once a timeout interrupt has occurred, the timeout interrupt is cleared and the timer is reset as soon as the CPU reads one character from the receive FIFO.
4. If no timeout interrupt has occurred, the timer is reset when a new character is received or when the CPU reads the receive FIFO.

When transmit FIFO is enabled and transmit interrupts are enabled, transmit interrupts can occur as described below.

1. When the transmit FIFO becomes empty, a transmit holding register empty interrupt occurs. This interrupt is cleared when a character is written to the transmit holding register (from one to 16 characters can be written to the transmit FIFO during servicing of this interrupt), or when SIUID (interrupt ID register) is read.
2. If there are not at least two bytes of character data in the transmit FIFO between one time when LSR[5] = 1 (transmit FIFO is empty) and the next time when LSR[5] = 1, empty transmit FIFO status is reported to the IIR after a delay period calculated as “the time for one character – the time for the last stop bit(s)”. When transmit interrupts are enabled, the first transmit interrupt that occurs after the FCR0 (FIFO enable bit) is overwritten is indicated immediately.

The priority level of the character timeout interrupt and receive FIFO trigger level interrupt is the same as that of the receive data ready interrupt.

The priority level of the transmit FIFO empty interrupt is the same as that of the transmit holding register empty interrupt.

Whether data to be transmitted exists or not in the transmit FIFO and the transmit shift register, check the transmit block empty bit (bit 6) of the SIULS register. It cannot be checked by the transmit holding register empty bit (bit 5) of the SIULS register, because this bit is used to check whether data to be transferred exists or not in the transmit FIFO. Therefore, this bit cannot check if there is data in the transmit shift register.

- **FIFO polling mode**

When FCR0 = 1 (FIFO is enabled), if the value of any or all of the interrupt enable register (SIUIE) bits 3 to 0 becomes “0”, SIU enters FIFO polling mode. Because the transmit block and receive blocks are controlled separately, polling mode can be set for either or both blocks.

When in this mode, the status of the transmit block and/or receive block can be checked by reading the line status register (SIULS) via a user program.

When in the FIFO polling mode, there is no notification when the trigger level is reached or when a timeout occurs, but the receive FIFO and transmit FIFO can still store characters as they normally do.

25.2.8 SIULC (0x0C00 0003)

Bit	D7	D6	D5	D4	D3	D2	D1	D0
Name	LCR[7]	LCR[6]	LCR[5]	LCR[4]	LCR[3]	LCR[2]	LCR[1]	LCR[0]
R/W	R/W	R/W	R/W	R/W	R/W	R/W	R/W	R/W
RTCRST	0	0	0	0	0	0	0	0
Other resets	0	0	0	0	0	0	0	0

Bit	Name	Function
D[7]	LCR[7]	Divisor latch access bit specification 1 : Divisor latch access 0 : Receive buffer, transmit holding register, interrupt enable register
D[6]	LCR[6]	Break control 1 : Set break 0 : Clear break
D[5]	LCR[5]	Parity fixing 1 : Fixed parity 0 : Parity not fixed
★ D[4]	LCR[4]	Parity setting 1 : Set one bit as even bit 0 : Set one bit as odd bit
D[3]	LCR[3]	Parity enable 1 : Create parity (during transmission) or check parity (during reception) 0 : No parity (during transmission) or no checking (during reception)
D[2]	LCR[2]	Stop bit specification 1 : 1.5 bits (character length is 5 bits) 2 bits (character length is 6, 7, or 8 bits) 0 : 1 bit
D[1..0]	LCR[1..0]	Specifies the length of one character (number of bits) 11 : 8 Bits 10 : 7 Bits 01 : 6 Bits 00 : 5 Bits

This register is used to specify the format for asynchronous communication and exchange and to set the divisor latch access bit.

Bit 6 is used to send the break status to the receive side's UART. When bit 6 = 1, the serial output (TxD) is forcibly set to the spacing (0) state.

The setting of bit 5 becomes valid according to settings in bits 4 and 3.

25.2.9 SIUMC (0x0C00 0004)

Bit	D7	D6	D5	D4	D3	D2	D1	D0
Name	Reserved	Reserved	Reserved	MCR[4]	MCR[3]	MCR[2]	MCR[1]	MCR[0]
R/W	R	R	R	R/W	R/W	R/W	R/W	R/W
RTCRST	0	0	0	0	0	0	0	0
Other resets	0	0	0	0	0	0	0	0

Bit	Name	Function
D[7..5]	Reserved	Write 0 to these bits. 0 is returned after read.
D[4]	MCR[4]	For diagnostic testing (local loopback) 1 : Enable use of local loopback 0 : Disable use of local loopback
D[3]	MCR[3]	OUT2 signal (internal) specification 1 : Output the low-level signal from the OUT2 pin 0 : Output the high-level signal from the OUT2 pin
D[2]	MCR[2]	OUT1 signal (internal) specification 1 : Output the low-level signal from the OUT1 pin 0 : Output the high-level signal from the OUT1 pin
D[1]	MCR[1]	RTS# output control 1 : Output the low-level signal from the RTS pin 0 : Output the high-level signal from the RTS pin
D[0]	MCR[0]	DTR# output control 1 : Output the low-level signal from the DTR pin 0 : Output the high-level signal from the DTR pin

This register is used for interface control with a modem or data set (or a peripheral device that emulates a modem).

The settings of bit 3 and bit 2 become valid only when bit 4 is set to 1 (enable use of local loopback).

- **Local Loopback**

The local loopback can be used to test the transmit/receive data path in SIU.

The following operation (local loopback) is executed when bit 4 value = 1.

The transmit block's serial output (TxD) enters the marking state (logical 1) and the serial input (RxD) to the receive block is cut off. The transmit shift register's output is looped back to the receive shift register's input.

The four modem control inputs (DSR#, CTS#, RI (internal), and DCD#) are cut off and the four modem control outputs (DTR#, RTS#, OUT1 (internal), and OUT2 (internal)) are internally connected to the corresponding modem control inputs.

The modem control output pins are forcibly set as inactive (high level). During this kind of loopback mode, transmitted data can be immediately and directly received.

This function can be used to check on the transmit/receive data bus within SIU.

When in loopback mode, both transmission and receive interrupts can be used. The interrupt sources are external sources in relation to the transmit and receive blocks.

Although modem control interrupts can be used, the low-order four bits of the modem control register can be used instead of the four modem control inputs as interrupt sources.

As usual, each interrupt is controlled by an interrupt enable register.

25.2.10 SIULS (0x0C00 0005)

Bit	D7	D6	D5	D4	D3	D2	D1	D0
Name	LSR[7]	LSR[6]	LSR[5]	LSR[4]	LSR[3]	LSR[2]	LSR[1]	LSR[0]
R/W	R/W	R/W	R/W	R/W	R/W	R/W	R/W	R/W
RTCRST	0	1	1	0	0	0	0	0
Other resets	0	1	1	0	0	0	0	0

Bit	Name	Function
D[7]	LSR[7]	Error detection in (FIFO mode) 1 : Parity error, framing error, or break is detected in the FIFO. 0 : Normal
D[6]	LSR[6]	Transmit block empty 1 : No data in transmit holding register or transmit shift register No data in transmit FIFO (during FIFO mode) 0 : Data exists in transmit holding register or transmit shift register Data exists in transmit FIFO (during FIFO mode)
D[5]	LSR[5]	Transmit holding register empty 1 : Character is transferred to transmit shift register (during 16550 mode) Transmit FIFO is empty (during FIFO mode) 0 : Character is stored in transmit holding register (during 16550 mode) Transmit data exists in transmit FIFO (during FIFO mode)
D[4]	LSR[4]	Break interrupt 1 : Break interrupt detected 0 : Normal
D[3]	LSR[3]	Framing error 1 : Framing error detected 0 : Normal
D[2]	LSR[2]	Parity error 1 : Parity error detected 0 : Normal
D[1]	LSR[1]	Overrun error 1 : Overwrite receive data 0 : Normal
D[0]	LSR[0]	Receive data ready 1 : Receive data exists in FIFO 0 : No receive data in FIFO

The CPU uses this register to get information related to data transfers.

When LSR[7] and LSR[4..1] are 1, reading this register clears these bits to 0.

Caution The receive data ready bit (bit 0) is set before the serial data reception is completed. Therefore, the receive data ready bit may not be cleared if the serial receive data is read from the SIURB register immediately after this bit is set.

When reading data from the SIURB register, wait for the stop bit width time since the receive data ready bit is set.

LSR[7] bit is valid only in FIFO mode, and it indicates always 0 in 16550 mode.

The value of LSR[4] becomes 1 when the spacing mode (logical 0) is held longer than the time required for transmission of one word of receive data input (start bit + data bits + parity bit + stop bit).

This bit value returns "0" when the CPU reads the contents of the line status register. When in FIFO mode, if a break interrupt is detected for one character in the FIFO, the character is regarded as an error character and the CPU is notified of a break interrupt when that character reaches the highest position in the FIFO.

When a break occurs, one "zero" character is sent to the FIFO. The SIU enters marking mode, and when the next valid start bit is received, the next character can be transmitted.

The value of LSR[3] becomes 1 when a zero (spacing level) stop bit is detected following the final data bit or parity bit. This bit value returns to 0 when the CPU reads the contents of the line status register.

When in FIFO mode, if a framing error is detected for one character in the FIFO, the character is regarded as an error character and the CPU is notified of a framing error when that character reaches the highest position in the FIFO.

When a framing error occurs, the SIU prepares for further synchronization. The next start bit is assumed to be the cause of the framing error and further data is not accepted until the next start bit has been sampled twice.

The value of LSR[2] becomes 1 when a parity error is detected. This bit value returns to 0 when the CPU reads the contents of the line status register.

When in FIFO mode, if a parity error is detected for one character within the FIFO, the character is regarded as an error character and the CPU is notified of a parity error when that character reaches the highest position in the FIFO.

The value of LSR[1] becomes 1 when overrun status is detected and returns to "0" when the CPU reads the contents of the line status register.

When in FIFO mode, if the data exceeds the trigger level as it continues to be transferred to the FIFO, even after the FIFO becomes full an overrun error will not occur until all characters are stored in the shift register.

The CPU is notified as soon as an overrun error occurs. The characters in the shift register are overwritten and are not transferred to the FIFO.

25.2.11 SIUMS (0x0C00 0006)

Bit	D7	D6	D5	D4	D3	D2	D1	D0
Name	MSR[7]	MSR[6]	MSR[5]	MSR[4]	MSR[3]	MSR[2]	MSR[1]	MSR[0]
R/W	R	R	R	R	R/W	R/W	R/W	R/W
RTCRST	Undefined	Undefined	Undefined	Undefined	0	0	0	0
Other resets	Undefined	Undefined	Undefined	Undefined	0	0	0	0

Bit	Name	Function
D[7]	MSR[7]	Complement of DCD# signal 1 : High level 0 : Low level
D[6]	MSR[6]	Complement of RI signal (internal) 1 : High level 0 : Low level
D[5]	MSR[5]	Complement of DSR# input 1 : High level 0 : Low level
D[4]	MSR[4]	Complement of CTS# input 1 : High level 0 : Low level
D[3]	MSR[3]	DCD# signal change 1 : Change in DCD# signal 0 : No change
D[2]	MSR[2]	RI signal (internal) change 1 : Change in RI signal (internal) 0 : No change
D[1]	MSR[1]	DSR# signal change 1 : Change in DSR# signal 0 : No change
D[0]	MSR[0]	CTS# signal change 1 : Change in CTS# signal 0 : No change

This register indicates the current status of various control signals that are input to the CPU from a modem or other peripheral device.

MSR[3..0] bits are cleared to 0 when they are read.

25.2.12 SIUSC (0x0C00 0007)

Bit	D7	D6	D5	D4	D3	D2	D1	D0
Name	SCR[7]	SCR[6]	SCR[5]	SCR[4]	SCR[3]	SCR[2]	SCR[1]	SCR[0]
R/W	R/W	R/W	R/W	R/W	R/W	R/W	R/W	R/W
RTCRST	0	0	0	0	0	0	0	0
Other resets	0	0	0	0	0	0	0	0

Bit	Name	Function
D[7..0]	SCR[7..0]	Can be freely applied by user

This register is a readable/writable 8-bit register, and can be used freely by users.
It does not affect control of the SIU.

25.2.13 SIURSEL (0x0C00 0008)

Bit	D7	D6	D5	D4	D3	D2	D1	D0
Name	Reserved	Reserved	TMICMODE	TMICTX	IRMSEL[1]	IRMSEL[0]	IRUSESEL	SIRSEL
R/W	R	R	R/W	R/W	R/W	R/W	R/W	R/W
RTCRST	0	0	0	0	0	0	0	0
Other resets	0	0	0	0	0	0	0	0

Bit	Name	Function
D[7..6]	Reserved	Write 0 to these bits. 0 is returned after read.
D[5]	TMICMODE	This bit is used when the emitter/receptor module is a module manufactured by TEMIC. The mode of the emitter/receptor module is set by changing this bit from low to high, and then back to low. Refer to the TMICTX bit below.
D[4]	TMICTX	This bit is used when the emitter/receptor module is a module manufactured by TEMIC. Reset this bit to 0 after any setting is done. 1 : Communication at 4 Mbps 0 : Communication at 1.15 Mbps or less
D[3..2]	IRMSEL[1..0]	Sets the type of emitter/receptor module to be used 11 : Setting prohibited 10 : HP model (HSDL-1100 is assumed) 01 : TEMIC model (TFDS6000 is assumed) 00 : SHARP model (RY5FD01D is assumed)
D[1]	IRUSESEL	Selects SIU or FIR for use with IrDA emitter/receptor module 1 : FIR uses IrDA module 0 : SIU uses IrDA module
D[0]	SIRSEL	Selects whether the SIU uses the IrDA module or the RS-232-C pins during communications 1 : Use IrDA module 0 : Use RS-232-C interface

This register is used to set the IrDA module settings, IrDA module access privileges, and the SIU's communication format (IrDA or serial).

The connection examples of the V_R4111 and IrDA modules are shown below.

Figure 25-1. Connection Example Between the VR4111 and IrDA Module

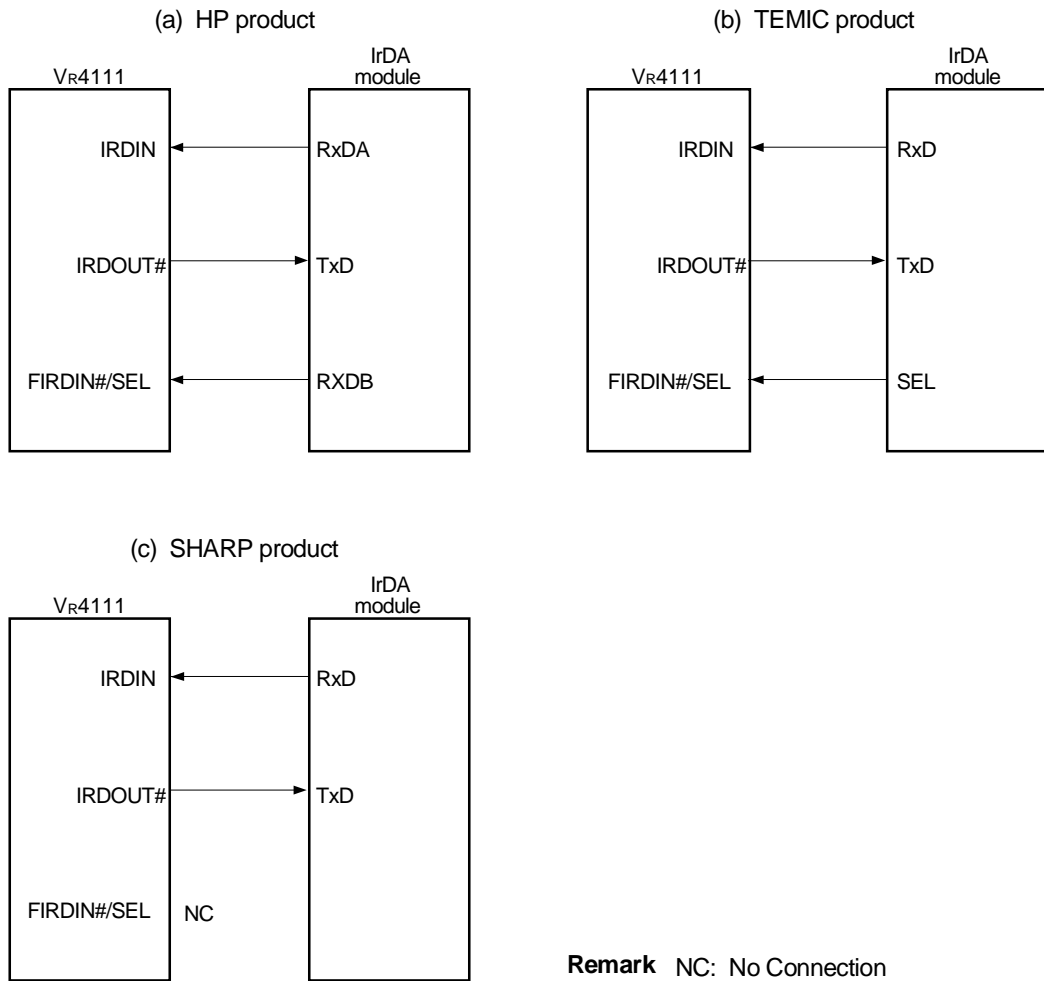

25.2.14 SIURESET (0x0C00 0009)

Bit	D7	D6	D5	D4	D3	D2	D1	D0
Name	Reserved	Reserved	Reserved	Reserved	Reserved	Reserved	Reserved	SIU RESET
R/W	R	R	R	R	R	R	R	R/W
RTCRST	0	0	0	0	0	0	0	0
Other resets	0	0	0	0	0	0	0	0

Bit	Name	Function
D[7..1]	Reserved	Write 0 to these bits. 0 is returned after a read.
D[0]	SIURESET	This bit is used to reset SIU. 1: Reset SIU 0: Release SIU reset

This register is used to reset SIU forcibly.

25.2.15 SIUCSEL (0x0C00 000A)

Bit	D7	D6	D5	D4	D3	D2	D1	D0
Name	Reserved	Reserved	Reserved	Reserved	Reserved	Reserved	Reserved	CSEL
R/W	R	R	R	R	R	R	R	R/W
RTCRST	0	0	0	0	0	0	0	0
Other resets	0	0	0	0	0	0	0	0

Bit	Name	Function
D[7..1]	Reserved	Write 0 to these bits. 0 is returned after a read.
D[0]	SCEL	This bit is used to specify masking for echo-back prevention. 1: Mask 0: Do not mask

This register is used to specify whether masking is done for echo-back prevention when using SIR.

CHAPTER 26 HSP (MODEM INTERFACE UNIT)

This chapter describes the HSP unit's operations and register settings.

26.1 GENERAL

The core of the HSP unit uses an NEC56K chip made by PCTEL. The main functions of this core are as follows:

- <1> CODEC device control and serial ↔ parallel conversion of the CODEC transmit/receive data
- <2> Control of relay lines, hook lines, and other signal lines in the data access arrangement (DAA) block

Block diagrams of HSP unit and an example of connection between the Vr4111 and external agents are shown below.

Figure 26-1. HSP Unit Block Diagram

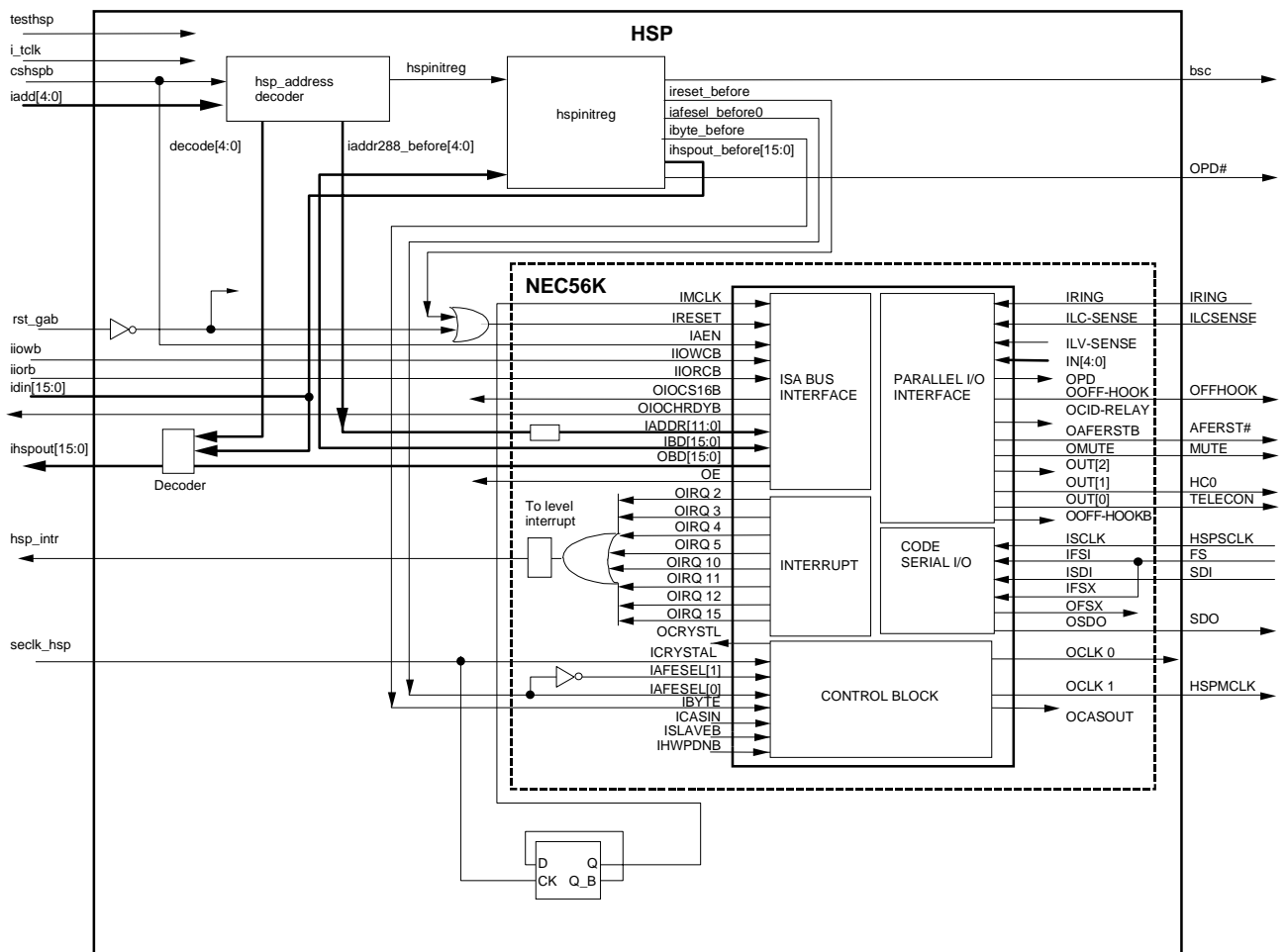
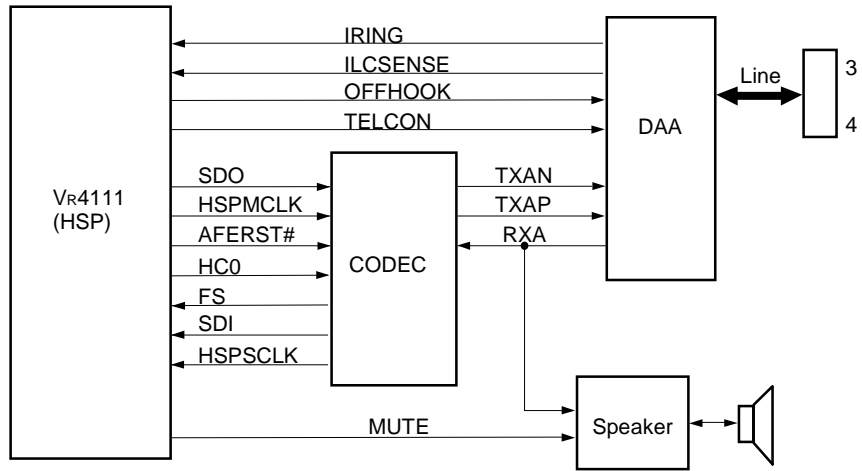

Figure 26-2. Circuit Configuration Block Diagram Examples



26.2 REGISTER SET

The HSP registers are listed below.

The data registers can be accessed as the control registers by specifying the INDEX number and then reading from or writing to.

The HSPINIT register is added for the Vr4111, and other registers are original to the NEC56K.

Table 26-1. HSP Registers

Address	R/W	Register Symbols	Name
0x0C00 0020	R/W	HSPINIT[7:0]	HSP Initialize Register
0x0C00 0022	R/W	HSPDATA[7:0]	HSP Data Register L
0x0C00 0023	R/W	HSPDATA[15:8]	HSP Data Register H
0x0C00 0024	W	HSPINDEX[7:0]	HSP Index Register
0x0C00 0028	R	HSPID[7:0]	HSP ID Register
0x0C00 0029	R	HSPPCS[7:0]	HSP I/O Address Program Confirmation Register
0x0C00 0029	W	HSPPCTEL[7:0]	HSP Signature Checking Port

26.2.1 HSP Initialize Register

(1) HSPINIT (0x0C00 0020)

Bit	D15	D14	D13	D12	D11	D10	D9	D8
Name	Reserved	Reserved	Reserved	Reserved	Reserved	Reserved	Reserved	Reserved
R/W	R	R	R	R	R	R	R	R
RTCRST	0	0	0	0	0	0	0	0
Other resets	0	0	0	0	0	0	0	0

Bit	D7	D6	D5	D4	D3	D2	D1	D0
Name	Reserved	Reserved	Reserved	OPD	AFESEL	BYTE	BSC	HSPRST
R/W	R	R	R	R/W	R/W	R/W	R/W	R/W
RTCRST	0	0	0	0	0	0	0	0
Other resets	0	0	0	0	0	0	0	0

Bit	Name	Function
D[15:5]	Reserved	Write 0 to these bits. 0 is returned after read.
D[4]	OPD	Power-down CODEC (indicates OPD# pin's state) 1: High level 0: Low level
D[3]	AFESEL	CODEC interface mode switch 1: ST7546, STLC7546(SGS), T7525(AT) 0: TLC320C44, TLC320AC01/02(TI)
D[2]	BYTE	HSP data bus width setting 1: 8 bits 0: 16 bits
D[1]	BSC	CODEC interface control 1: Normal 0: Initial value, or bus is high-impedance
D[0]	HSPRST	HSP reset 1: Reset 0: Do not reset

This register is used to control the HSP.

BSC is used to control the CODEC interface. This bit must be set to 1 when using the HSP.

The reset by HSPRST is not effective on the HSPINIT register settings. The HSPRST bit does not automatically become 0 after it is set to 1. Therefore, be sure to set 0 to this bit to release the reset.

26.2.2 HSP Data Register, HSP Index Register

HSPDATA[15..0] is a 16-bit data port. This register can be accessed as control registers according to the HSPINDEX[15..0] setting.

HSPINDEX[15..0] is a write-only index register. The role of the data register changes according to the values set to this register.

The correspondence between INDEX numbers and registers is shown below.

Table 26-2. Control Register Definitions

INDEX	WRITE		READ	
	Higher Byte	Lower Byte	Higher Byte	Lower Byte
0	HSPTxData[15..8]	HSPTxData[7..0]	HSPRxData[15..8]	HSPRxData[7..0]
1	HSPCNTL[9..8]	HSPCNTL[7..0]	HSPSTS[15..8]	HSPSTS[7..0]
2	Reserved	HSPEXTOUT[7..0]	HSPID[7..0]	HSPEXTIN[7..0]
3	HSPTOC[3..0]	HSPMCLK[4..0]	HSPERRCNT[11..8]	HSPERRCNT[7..0]
4	Reserved	HSPFFSZ[7..0]	Reserved	
5 to 15	Reserved		Reserved	
16 to 255	Not Accessible		Not Accessible	

The control registers are described below.

(1) HSPTxData (0x0C00 0022: Index 0, Write)

Bit	D15	D14	D13	D12	D11	D10	D9	D8
Name	TxData[15]	TxData[14]	TxData[13]	TxData[12]	TxData[11]	TxData[10]	TxData[9]	TxData[8]
R/W	W	W	W	W	W	W	W	W
RTCST	Undefined	Undefined	Undefined	Undefined	Undefined	Undefined	Undefined	Undefined
Other resets	Undefined	Undefined	Undefined	Undefined	Undefined	Undefined	Undefined	Undefined

Bit	D7	D6	D5	D4	D3	D2	D1	D0
Name	TxData[7]	TxData[6]	TxData[5]	TxData[4]	TxData[3]	TxData[2]	TxData[1]	TxData[0]
R/W	W	W	W	W	W	W	W	W
RTCST	Undefined	Undefined	Undefined	Undefined	Undefined	Undefined	Undefined	Undefined
Other resets	Undefined	Undefined	Undefined	Undefined	Undefined	Undefined	Undefined	Undefined

Bit	Name	Function
D[15:0]	TxData[15:0]	Transmit data

This register is used to store transmission data when the index number is 0.

(2) HSPCNTL 0x0C00 0022: Index 1, Write)

Bit	D15	D14	D13	D12	D11	D10	D9	D8
Name	Reserved	Reserved	Reserved	Reserved	Reserved	Reserved	Reserved	Reserved
R/W	W	W	W	W	W	W	W	W
RTCRST	0	0	Undefined	Undefined	Undefined	Undefined	Undefined	Undefined
Other resets	0	0	Undefined	Undefined	Undefined	Undefined	Undefined	Undefined

Bit	D7	D6	D5	D4	D3	D2	D1	D0
Name	NTORST	ENIRQ	START	Reserved	ENTX	IRQS2	IRQS1	IRQS0
R/W	W	W	W	W	W	W	W	W
RTCRST	0	0	0	0	0	0	0	0
Other resets	0	0	0	0	0	0	0	0

Bit	Name	Function
D[15:8]	Reserved	Write 0 to these bits.
D[7]	NTORST	Disable timeout reset When this bit is "0", it enables a timeout to occur when a specified number of errors have been counted, at which point HSP resets itself. 1: Disable 0: Enable
D[6]	ENIRQ	Interrupt enable 1: Enable 0: Disable
D[5]	START	RX/TX FIFO pointer initialization When this bit is set to "1", the RX/TX FIFO pointer is set to its initial position. 1: Initialize (at rising edge) 0: Status hold
D[4]	Reserved	Write 0 to this bit.
D[3]	ENTX	Transfer enable 1: Enable 0: Disable
D[2:0]	IRQS[2:0]	Interrupt signal select. However, IRQ signal is always selected whatever value is set to these bits (000 through 111).

This register is used to set several settings to control HSP when the index number is 1.

Caution If 1 is set to ENTX bit, the setting cannot be changed after that. The only way to stop the operation is by resetting the NEC56K.

(3) HSPEXTOUT (0x0C00 0022: Index 2, Write)

Bit	D15	D14	D13	D12	D11	D10	D9	D8
Name	Reserved	Reserved	Reserved	Reserved	Reserved	Reserved	Reserved	Reserved
R/W	W	W	W	W	W	W	W	W
RTCRST	Undefined	Undefined	Undefined	Undefined	Undefined	Undefined	Undefined	Undefined
Other resets	Undefined	Undefined	Undefined	Undefined	Undefined	Undefined	Undefined	Undefined

Bit	D7	D6	D5	D4	D3	D2	D1	D0
Name	Reserved	HC0	TELECON	Reserved	MUTE	AFERST	Reserved	OFFHOOK
R/W	W	W	W	W	W	W	W	W
RTCRST	Undefined	0	0	0	0	1	0	0
Other resets	Undefined	0	0	0	0	1	0	0

Bit	Name	Function
D[15:7]	Reserved	Write 0 to these bits.
D[6]	HC0	Select CODEC mode This bit is connected to the HC0 pin. 1 : High-level signal output 0 : Low-level signal output
D[5]	TELECON	Hand set relay control This bit is connected to the TELECON pin. 1 : High-level signal output 0 : Low-level signal output
D[4]	Reserved	Write 0 to this bit.
D[3]	MUTE	Mute speaker This bit is connected to the MUTE pin. 1 : High-level signal output 0 : Low-level signal output
D[2]	AFERST	CODEC reset This bit is connected to the AFERST# pin. 1 : High-level signal output 0 : Low-level signal output
D[1]	Reserved	Write 0 to this bit.
D[0]	OFFHOOK	OFF HOOK relay control This bit is connected to the OFFHOOK pin. 1 : High-level signal output 0 : Low-level signal output

This register is used to set output values of the HSP signals when the index number is 2.

(4) HSPTOC and HSPMCLKD (0x0C00 0022: Index 3, Write)

Bit	D15	D14	D13	D12	D11	D10	D9	D8
Name	Reserved	Reserved	Reserved	Reserved	TOC3	TOC2	TOC1	TOC0
R/W	W	W	W	W	W	W	W	W
RTCRST	Undefined	Undefined	Undefined	Undefined	0	0	0	0
Other resets	Undefined	Undefined	Undefined	Undefined	0	0	0	0

Bit	D7	D6	D5	D4	D3	D2	D1	D0
Name	Reserved	Reserved	Reserved	MCLKD4	MCLKD3	MCLKD2	MCLKD1	MCLKD0
R/W	W	W	W	W	W	W	W	W
RTCRST	Undefined	Undefined	Undefined	1	1	1	1	0
Other resets	Undefined	Undefined	Undefined	1	1	1	1	0

Bit	Name	Function
D[15:12]	Reserved	Write 0 to these bits.
D[11:8]	TOC[3:0]	High-order 4 bits of timeout count
D[7:5]	Reserved	Write 0 to these bits.
D[4:0]	MCLKD[4:0]	HSPMCLK divisor to clock input HSPMCLK frequency = 18.432 MHz / (MCLKD[4:0] + 2)

The upper byte of this register sets the timeout counter value and lower byte sets the HSPMCLK's division ratio when the INDEX number is 3.

TOC[3:0] is used to set the high-order four bits of the final count of the timeout counter. The timeout counter is a 12-bit counter and is incremented once for each interrupt signal that is not serviced. The low-order 8 bits are automatically set to 0 when TOC[3:0] is set. When the specified timeout count value is reached, the TO bit of HSPSTS register is set to 1. The user is responsible for resetting the HSP core to prevent a system hang-up.

MCLKD[4:0] is used to set the division ratio when the clock is supplied to the HSPMCLK pin. If MCLKD[4:0] is "0", there is no clock division and the 18.432-MHz clock is output. Note that an even number must be set to MCLKD[4:0].

(5) HSPFFSZ (0x0C00 0022: Index 4, Write)

Bit	D15	D14	D13	D12	D11	D10	D9	D8
Name	Reserved	Reserved	Reserved	Reserved	Reserved	Reserved	Reserved	Reserved
R/W	W	W	W	W	W	W	W	W
RTCRST	Undefined	Undefined	Undefined	0	0	0	0	0
Other resets	Undefined	Undefined	Undefined	0	0	0	0	0

Bit	D7	D6	D5	D4	D3	D2	D1	D0
Name	FFSZ7	FFSZ6	FFSZ5	FFSZ4	FFSZ3	FFSZ2	FFSZ1	FFSZ0
R/W	W	W	W	W	W	W	W	W
RTCRST	0	0	1	0	0	0	0	0
Other resets	0	0	1	0	0	0	0	0

Bit	Name	Function
D[15:8]	Reserved	Write 0 to these bits.
D[7:0]	FFSZ[7:0]	FIFO size control

When the index number is 4, this register is used to set the transmit/receive buffer size, and can be set up to 96 words word-wise (16 bits). If buffer-full interrupt is enabled, an interrupt will occur when the data in the transmit/receive buffer reaches to the size set in this register.

(6) HSPRxData (0x0C00 0022: Index 0, Read)

Bit	D15	D14	D13	D12	D11	D10	D9	D8
Name	RxData[15]	RxData[14]	RxData[13]	RxData[12]	RxData[11]	RxData[10]	RxData[9]	RxData[8]
R/W	R	R	R	R	R	R	R	R
RTCRST	Undefined	Undefined	Undefined	Undefined	Undefined	Undefined	Undefined	Undefined
Other resets	Undefined	Undefined	Undefined	Undefined	Undefined	Undefined	Undefined	Undefined

Bit	D7	D6	D5	D4	D3	D2	D1	D0
Name	RxData[7]	RxData[6]	RxData[5]	RxData[4]	RxData[3]	RxData[2]	RxData[1]	RxData[0]
R/W	R	R	R	R	R	R	R	R
RTCRST	Undefined	Undefined	Undefined	Undefined	Undefined	Undefined	Undefined	Undefined
Other resets	Undefined	Undefined	Undefined	Undefined	Undefined	Undefined	Undefined	Undefined

Bit	Name	Function
D[15:0]	RxData[15:0]	Receive data from the receive FIFO

This register is used to store the receive data sent from the receive FIFO when the index number is 0.

(7) HSPSTS (0x0C00 0022: Index 1, Read)

Bit	D15	D14	D13	D12	D11	D10	D9	D8
Name	Reserved	Reserved	Reserved	Reserved	Reserved	Reserved	Reserved	Reserved
R/W	R	R	R	R	R	R	R	R
RTCRST	0	0	0	0	0	Undefined	Undefined	Undefined
Other resets	0	0	0	0	0	Undefined	Undefined	Undefined

Bit	D7	D6	D5	D4	D3	D2	D1	D0
Name	AFESEL1	AFESEL0	IBYTE	TO	CFGCP	IRQS	RxOVRUN	TxUDRUN
R/W	R	R	R	R	R	R	R	R
RTCRST	Undefined	Undefined	Undefined	0	0	0	0	0
Other resets	Undefined	Undefined	Undefined	0	0	0	0	0

Bit	Name	Function
D[15:8]	Reserved	Write 0 to these bits. 0 is returned after a read.
D[7:6]	AFESEL[1:0]	Indicates the AFESEL[1:0] signal (internal) state
D[5]	IBYTE	Indicates the BYTE signal (internal) state
D[4]	TO	Error-related timeout 1 : Timeout occurred 0 : No timeout
D[3]	CFGCP	CODEC initialization complete 1 : Complete 0 : Not complete
D[2]	IRQS	Pending interrupt request exists 1 : Exists 0 : No pending interrupt requests
D[1]	RxOVRUN	Receive buffer overrun occurred 1 : Occurred 0 : No receive overruns
D[0]	TxUDRUN	Transmit buffer underrun occurred 1 : Occurred 0 : No transmit overruns

This register is used to indicate various states during a communication when the index number is 1.

TO bit is set (to "1") when the timeout counter reaches the value specified by the TOC bit of HSPTOC.

CFGCP bit indicates whether or not CODEC initialization has been completed. Actually, this bit is set (to "1") when the START bit of HSPCNT has been set as active to reset the FIFO pointer and then 9-word data has been transmitted (1 word = 16 bits).

IRQS bit indicates whether or not any pending interrupt request exists. When an interrupt request from HSP to the CPU core is in pending, the request is cleared after this register is read.

IRQS, RxOVRUN, and TxUDRUN bits are cleared (to "0") when read.

(8) HSPID and HSPEXTIN (0x0C00 0022: Index 2, Read)

Bit	D15	D14	D13	D12	D11	D10	D9	D8
Name	ID7	ID6	ID5	ID4	ID3	ID2	ID1	ID0
R/W	R	R	R	R	R	R	R	R
RTCRST	0	0	1	0	0	1	1	0
Other resets	0	0	1	0	0	1	1	0

Bit	D7	D6	D5	D4	D3	D2	D1	D0
Name	Reserved	Reserved	Reserved	Reserved	Reserved	Reserved	ILCS	IRING
R/W	R	R	R	R	R	R	R	R
RTCRST	Undefined	Undefined	Undefined	Undefined	Undefined	Undefined	Undefined	Undefined
Other resets	Undefined	Undefined	Undefined	Undefined	Undefined	Undefined	Undefined	Undefined

Bit	Name	Function
D[15:8]	ID[7:0]	Indicates HSP unit's ID and revision number
D[7:2]	Reserved	Write 0 to these bits. 0 is returned after a read.
D[1]	ILCS	ILCSENSE input pin state indication
D[0]	IRING	IRING input pin state indication

When the index number is 2, this register indicates the HSP unit's ID and revision number in the higher byte and the HSP input signal's state in the lower byte.

ID[7:0] is divided into two parts. The high-order 4 bits of ID[7:0] indicate the ID number of HSP, and the low-order 4 bits indicate the revision number of HSP.

(9) HSPERRCNT (0x0C00 0022: Index 3, Read)

Bit	D15	D14	D13	D12	D11	D10	D9	D8
Name	Reserved	Reserved	Reserved	Reserved	ERRCNT11	ERRCNT10	ERRCNT9	ERRCNT8
R/W	R	R	R	R	R	R	R	R
RTCRST	0	0	0	0	0	0	0	0
Other resets	0	0	0	0	0	0	0	0

Bit	D7	D6	D5	D4	D3	D2	D1	D0
Name	ERRCNT7	ERRCNT6	ERRCNT5	ERRCNT4	ERRCNT3	ERRCNT2	ERRCNT1	ERRCNT0
R/W	R	R	R	R	R	R	R	R
RTCRST	0	0	0	0	0	0	0	0
Other resets	0	0	0	0	0	0	0	0

Bit	Name	Function
D[15:12]	Reserved	0 is returned after a read.
D[11:0]	ERRCNT[11:0]	Error count

This register indicates the number of errors when the index number is 3.

This register indicates the number of overrun or underrun errors that have occurred. This is used for synchronizing software and hardware.

26.2.3 HSP ID Register, HSP I/O Address Program Confirmation Register

The specific values are displayed to HSPID[7:0] and HSPPCS[7:0] registers following normal access of HSPPCTEL register.

26.2.4 HSP Signature Checking Port

HSPPCTEL[7:0] register must be accessed when to start using HSP unit. 0xA5 can be read from the HSPPCS register by writing a certain value. Other HSP registers cannot be accessed unless this processing is executed. It must be executed during initialization.

26.3 POWER CONTROL

Power control of the CODEC and AFE can be performed using the OPD# pin and the BSC bit (HSPINIT). The following is an example of a control method using these units.

Figure 26-3. Block Diagram of HSP Interface Power Control

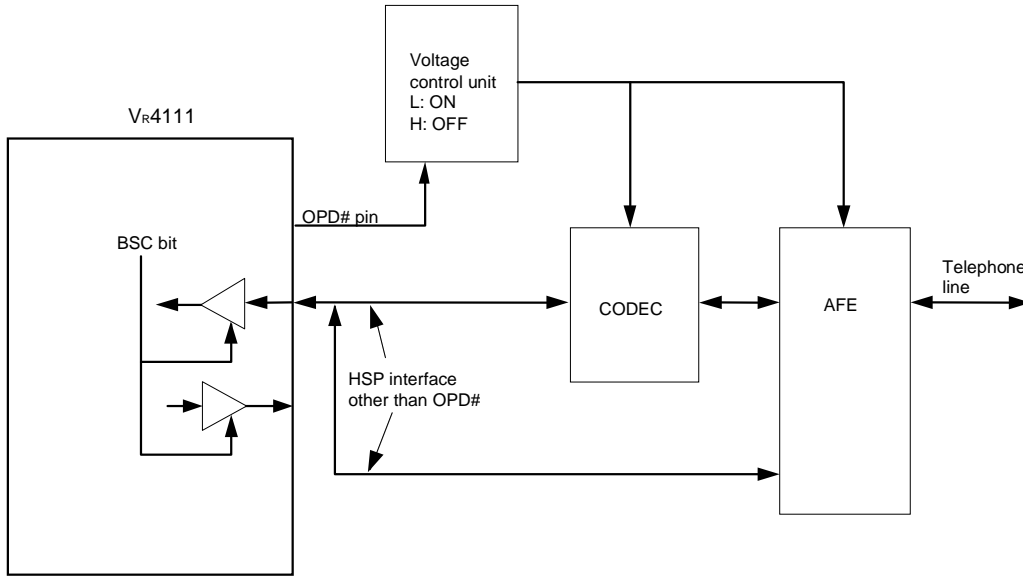

(1) After RTC reset

Item	OPD# pin	BSC bit	HSP bus state	VR4111 power	CODEC/AFE power
1 When initialized	L	0	Note	ON	OFF
2 During power-on of CODEC or AFE	H	0	Note	ON	ON
3 When HSP bus's gate is set to "ON"	H	1	Normal	ON	ON
4 Software modem control	H	1	Normal	ON	ON

Note Refer to 2.3.1 Pin Status upon Specific States.

(2) During power-down (VR4111: Fullspeed/Standby/Suspend mode)

Item	OPD# pin	BSC bit	HSP bus state	VR4111 power	CODEC/AFE power
1 Complete operation	H	1	Normal	ON	ON
2 When HSP bus's gate is set to "OFF"	H	0	Note	ON	ON
3 When CODEC or AFE power is set to "OFF"	L	0	Note	ON	OFF
4 If necessary, issue STANDBY/ SUSPEND command	L	0	Note	ON	OFF

Note Refer to 2.3.1 Pin Status upon Specific States.

(3) During recovery from power-down (V_R4111: Fullspeed/Standby/Suspend mode)

	Item	OPD# pin	BSC bit	HSP bus state	V _R 4111 power	CODEC/AFE power
1	Power down status	L	0	Note	ON	OFF
2	During power-on of CODEC or AFE	H	0	Note	ON	ON
3	When HSP bus's gate is set to "ON"	H	1	Normal	ON	ON
4	Use HSP unit	H	1	Normal	ON	ON

Note Refer to 2.3.1 Pin Status upon Specific States.

(4) When changing to Hibernate mode (the following processing must occur before entering Hibernate mode)

	Item	OPD# pin	BSC bit	HSP bus state	V _R 4111 power	CODEC/AFE power
1	Complete operation	H	1	Normal	ON	ON
2	When HSP bus's gate is set to "OFF"	H	0	Note	ON	ON
3	When CODEC or AFE power is set to "OFF"	L	0	Note	ON	OFF
4	Issue HIBERNATE command	L	0	Note	ON	OFF

Note Refer to 2.3.1 Pin Status upon Specific States.

(5) During recovery from Hibernate mode to use HSP unit

	Item	OPD# pin	BSC bit	HSP bus state	V _R 4111 power	CODEC/AFE power
1	During Hibernate mode	L	0	Note	ON	OFF
2	During power-on of CODEC or AFE	H	0	Note	ON	ON
3	When HSP bus's gate is set to "ON"	H	1	Normal	ON	ON
4	Use HSP unit	H	1	Normal	ON	ON

Note Refer to 2.3.1 Pin Status upon Specific States.

[MEMO]

CHAPTER 27 FIR (FAST IrDA INTERFACE UNIT)

The FIR operation and register settings are described below.

27.1 GENERAL

This unit supports the IrDA 1.1 high-speed infrared communication physical layer standard. Supported FIR (FAST SIR) transfer rates include 0.576 Mbps, 1.152 Mbps, and 4 Mbps. SIR (up to 1.152 kbps) is not supported.

27.2 REGISTER SET

The FIR registers are listed below.

Table 27-1. FIR Registers

Address	R/W	Register symbols	Function
0x0C00 0040	R/W	FRSTR	FIR Reset register
0x0C00 0042	R/W	DPINTR	DMA Page Interrupt register
0x0C00 0044	R/W	DPCNTR	DMA Control register
0x0C00 0050	W	TDR	Transmit Data register
0x0C00 0052	R	RDR	Receive Data register
0x0C00 0054	R/W	IMR	Interrupt Mask register
0x0C00 0056	R/W	FSR	FIFO Setup register
0x0C00 0058	R/W	IRSR1	Infrared Setup register 1
0x0C00 005C	R/W	CRCSR	CRC Setup register
0x0C00 005E	R/W	FIRCR	FIR Control register
0x0C00 0060	R/W	MIRCR	MIR Control register
0x0C00 0062	R/W	DMACR	DMA Control register
0x0C00 0064	R/W	DMAER	DMA Enable register
0x0C00 0066	R	TXIR	Transmit Indication register
0x0C00 0068	R	RXIR	Receive Indication register
0x0C00 006A	R	IFR	Interrupt Flag register
0x0C00 006C	R	RXSTS	Receive Status
0x0C00 006E	R/W	TXFL	Transmit Frame Length
0x0C00 0070	R/W	MRXF	Maximum Receive Frame Length
0x0C00 0074	R	RXFL	Receive Frame Length

These registers are described in detail below.

27.2.1 FRSTR (0x0C00 0040)

Bit	D15	D14	D13	D12	D11	D10	D9	D8
Name	Reserved	Reserved	Reserved	Reserved	Reserved	Reserved	Reserved	Reserved
R/W	R	R	R	R	R	R	R	R
RTC	0	0	0	0	0	0	0	0
Other resets	0	0	0	0	0	0	0	0

Bit	D7	D6	D5	D4	D3	D2	D1	D0
Name	Reserved	Reserved	Reserved	Reserved	Reserved	Reserved	Reserved	FRST
R/W	R	R	R	R	R	R	R	R/W
RTC	0	0	0	0	0	0	0	0
Other resets	0	0	0	0	0	0	0	0

Bit	Name	Function
D15 to D1	Reserved	Write 0 to these bits. 0 is returned after a read.
D0	FRST	FIR reset 0: Normal 1: Reset (write 0 when releasing reset)

27.2.2 DPINTR (0x0C00 0042)

Bit	D15	D14	D13	D12	D11	D10	D9	D8
Name	Reserved	Reserved	Reserved	Reserved	Reserved	Reserved	Reserved	Reserved
R/W	R	R	R	R	R	R	R	R
RTC	0	0	0	0	0	0	0	0
Other resets	0	0	0	0	0	0	0	0

Bit	D7	D6	D5	D4	D3	D2	D1	D0
Name	Reserved	Reserved	Reserved	FDPINT5	FDPINT4	FDPINT3	FDPINT2	FDPINT1
R/W	R	R	R	R/W	R/W	R/W	R/W	R/W
RTC	0	0	0	0	0	0	0	0
Other resets	0	0	0	0	0	0	0	0

Bit	Name	Function
D15 to D5	Reserved	Write 0 to these bits. 0 is returned after a read.
D4	FDPINT5	This bit indicates an FIR interrupt occurs. 0: Normal 1: Occurred
D3	FDPINT4 (Note 1)	This bit indicates that the DMA buffer (receive side) becomes full (2 pages). Cleared to 0 when 1 is written. 0: Normal 1: Occurred (DMA request is stopped)
D2	FDPINT3 (Note 1)	This bit indicates that the DMA buffer (transmit side) becomes full (2 pages). Cleared to 0 when 1 is written. 0: Normal 1: Occurred (DMA request is stopped)
D1	FDPINT2 (Note 2)	This bit indicates that the DMA buffer (receive side) becomes full (1 page). Cleared to 0 when 1 is written. 0: Normal 1: Occurred (when bit 0 of DPCNTR is 1, DMA request is stopped)
D0	FDPINT1 (Note 2)	This bit indicates that the DMA buffer (transmit side) becomes full (1 page). Cleared to 0 when 1 is written. 0: Normal 1: Occurred (when bit 0 of DPCNTR is 1, DMA request is stopped)

- Notes 1.** If FDPINT[4..3] is set to 1, the last data of transmit data is not guaranteed.
- 2.** If FDPINY[2..1] is set to 1 while bit 0 of DPCNTR register is set to 1, the last data of transfer data is not guaranteed.

27.2.3 DPCNTR (0x0C00 0044)

Bit	D15	D14	D13	D12	D11	D10	D9	D8
Name	Reserved	Reserved	Reserved	Reserved	Reserved	Reserved	Reserved	Reserved
R/W	R	R	R	R	R	R	R	R
RTC	0	0	0	0	0	0	0	0
Other resets	0	0	0	0	0	0	0	0

Bit	D7	D6	D5	D4	D3	D2	D1	D0
Name	Reserved	Reserved	Reserved	Reserved	Reserved	Reserved	Reserved	FDP CNT
R/W	R	R	R	R	R	R	W	R/W
RTC	0	0	0	0	0	0	0	0
Other resets	0	0	0	0	0	0	0	0

Bit	Name	Function
D15 to D1	Reserved	Write 0 to these bits. 0 is returned after a read.
D0	FDP CNT	DMA transfer stopping boundary. 0: 2-page boundary (the last data of the second page is not guaranteed) 1: 1-page boundary (the last data of the first page is not guaranteed)

27.2.4 TDR (0x0C00 0050)

Bit	D15	D14	D13	D12	D11	D10	D9	D8
Name	Reserved	Reserved	Reserved	Reserved	Reserved	Reserved	Reserved	Reserved
R/W	W	W	W	W	W	W	W	W
RTC	0	0	0	0	0	0	0	0
Other resets	0	0	0	0	0	0	0	0

Bit	D7	D6	D5	D4	D3	D2	D1	D0
Name	TDR7	TDR6	TDR5	TDR4	TDR3	TDR2	TDR1	TDR0
R/W	W	W	W	W	W	W	W	W
RTC	0	0	0	0	0	0	0	0
Other resets	0	0	0	0	0	0	0	0

Bit	Name	Function
D15 to D8	Reserved	Write 0 to these bits. 0 is returned after a read.
D7 to D0	TDR7 to 0	Transmit FIFO

[Function]

This register is used to store the address to which data is written to the transmit data store FIFO.

Up to 64- or 32-byte data (determined by bit 3 of FSR) is stored to the transmit data store FIFO.

(1) Write

Data is written to the transmit data store FIFO while the IrDA is operating.

When a write operation is completed, the write pointer of the transmit data store FIFO is incremented. However, if data is written when this write pointer is full, it is not incremented.

After the data of frame size is written to the TXFL register in a status other than the transmit busy status (start enable), if the data written to this register reaches frame size, data transfer starts even if the number of write to this register is short of the threshold. This is Start 1.

After that, data is always transferred if it reaches frame size, even if it is short of the threshold. This is Start 2.

(2) Read

After frame transmission is completed, the sequencer reads the transmit data during the data transfer sequence, and the read pointer is incremented.

If read is done while the transmit FIFO is empty, a transmit underrun error occurs. This stops the current frame transmission and then starts the abort frame transmission. The following frames scheduled to be transmitted next are not transferred.

27.2.5 RDR (0x0C00 0052)

Bit	D15	D14	D13	D12	D11	D10	D9	D8
Name	Reserved	Reserved	Reserved	Reserved	Reserved	Reserved	Reserved	Reserved
R/W	R	R	R	R	R	R	R	R
RTC	0	0	0	0	0	0	0	0
Other resets	0	0	0	0	0	0	0	0

Bit	D7	D6	D5	D4	D3	D2	D1	D0
Name	RDR7	RDR6	RDR5	RDR4	RDR3	RDR2	RDR1	RDR0
R/W	R	R	R	R	R	R	R	R
RTC	0	0	0	0	0	0	0	0
Other resets	0	0	0	0	0	0	0	0

Bit	Name	Function
D15 to D8	Reserved	Write 0 to these bits. 0 is returned after a read.
D7 to D0	RDR7 to 0	Receive FIFO

[Function]

This register is used to store the address from which data is read from the receive data store FIFO.

Up to 64- or 32-byte data (determined by bit 3 of FSR) is stored to the receive data store FIFO.

(1) Write

During a frame data reception, the sequencer writes the receive data during the data transfer sequence, and the write pointer is incremented.

If data is written when the unread data in the receive FIFO reaches the maximum volume, the receive overrun error occurs and the current frame reception is ended.

The write pointer is not incremented.

After the receive FIFO is cleared, if the number of received frames is less than 7 frames, it is possible to continue frame reception.

To receive 8 or more frames, read all the data and frames that are already received from the receive FIFO, then clear the receive FIFO and restart reception.

(2) Read

Data is read from the receive data store FIFO while the IrDA is operating.

When a read operation is completed, the read pointer of the receive data store FIFO is incremented. However, it is not incremented when the receive FIFO is empty.

When the number of read frames reaches the receive frame size, an interrupt occurs and bit 7 of the RXSTS register is set to 1.

[Caution]

If data is read when the receive FIFO is empty (read pointer = write pointer), it may contend with the sequencer's write operation. This may cause undefined data.

The error generated by read underrun is not reported in this macro.

27.2.6 IMR (0x0C00 0054)

Bit	D15	D14	D13	D12	D11	D10	D9	D8
Name	Reserved	Reserved	Reserved	Reserved	Reserved	Reserved	Reserved	Reserved
R/W	R	R	R	R	R	R	R	R
RTC	0	0	0	0	0	0	0	0
Other resets	0	0	0	0	0	0	0	0

Bit	D7	D6	D5	D4	D3	D2	D1	D0
Name	IMR7	IMR6	IMR5	IMR4	IMR3	IMR2	IMR1	IMR0
R/W	R/W	R/W	R/W	R/W	R/W	R/W	R/W	R/W
RTC	0	0	0	0	0	0	0	0
Other resets	0	0	0	0	0	0	0	0

Bit	Name	Function	
D15 to D8	Reserved	Write 0 to these bits. 0 is returned after a read.	
D7 to D0	IMR7 to 0	These bits are used to enable/prohibit interrupt output. Each bit corresponds to the equivalent IFR register bit. When interrupt output is enabled and corresponding bit is 1, interrupt output is active.	
		IMRn	Interrupt output
		0	Prohibit
		1	Enable

[Caution]

The IFR register is set irrespective of this register's setting.

27.2.7 FSR (0x0C00 0056)

Bit	D15	D14	D13	D12	D11	D10	D9	D8
Name	Reserved	Reserved	Reserved	Reserved	Reserved	Reserved	Reserved	Reserved
R/W	R	R	R	R	R	R	R	R
RTC	0	0	0	0	0	0	0	0
Other resets	0	0	0	0	0	0	0	0

Bit	D7	D6	D5	D4	D3	D2	D1	D0
Name	RX_TH1	RX_TH0	TX_TH1	TX_TH0	F_SIZE	TXF_CLR	RXF_CLR	TX_STOP
R/W	R/W	R/W	R/W	R/W	R/W	R/W	R/W	R/W
RTC	0	0	0	0	0	0	0	0
Other resets	0	0	0	0	0	0	0	0

Bit	Name	Function			
D15 to D8	Reserved	Write 0 to these bits. 0 is returned after a read.			
D7 and D6	RX_TH1, 0	These bits are used to specify the receive FIFO's threshold.			
		RX_TH 1, 0	F_SIZE = 0	F_SIZE = 1	
		00	1 byte	1 byte	
		01	4 bytes	8 bytes	
		10	16 bytes	32 bytes	
		11	26 bytes	48 bytes	
D5 and D4	TX_TH1, 0	These bits are used to specify the transmit FIFO's threshold.			
		TX_TH 1, 0	F_SIZE = 0	F_SIZE = 1	
		00	1 byte	1 byte	
		01	8 bytes	16 bytes	
		10	16 bytes	32 bytes	
		11	26 bytes	48 bytes	
D3	F_SIZE	This bit is used to specify the maximum size of transmit/receive FIFO.			
		F_SIZE	FIFO maximum size		
		0	32 bytes		
		1	64 bytes		
D2	TXF_CLR	Transmit FIFO clear trigger (read value = 0)			
D1	RXF_CLR	Receive FIFO clear trigger (read value = 0)			
D0	TX_STOP	Transmission stop trigger (read value = 0)			

This register is used to make various settings for the transmit/receive FIFO.

When the TXF_CLR bit is set, the pointers of the transmit data FIFO and transmit frame size FIFO are initialized.

When the RXF_CLR bit is set, the pointers of the receive data FIFO, receive frame size FIFO, and receive status FIFO are initialized.

When the TX_STOP bit is set, the current frame transmission is stopped and the abort frame transmission starts.

The following frames scheduled to be transmitted next are not transferred. Also, setting this bit to 1 causes DMA operation to be stopped, and then a DMA completion interrupt to be output.

- Cautions**
1. During transmission/reception, the contents of bits 7 through 3 of the FSR register must not be changed (refresh is possible).
 2. The data in the FIFO is not cleared even if the TXF_CLR or RXF_CLR bit is set (clearing the pointer).
 3. Set the TX_STOP bit to stop DMA operation after data transfer is completed, regardless of whether the DMA operation is transmission or reception. In the case of reception, however, the DMA should be stopped after confirming the command bit of the transferred data.

27.2.8 IRSR1 (0x0C00 0058)

Bit	D15	D14	D13	D12	D11	D10	D9	D8
Name	Reserved	Reserved	Reserved	Reserved	Reserved	Reserved	Reserved	Reserved
R/W	R	R	R	R	R	R	R	R
RTC	0	0	0	0	0	0	0	0
Other resets	0	0	0	0	0	0	0	0

Bit	D7	D6	D5	D4	D3	D2	D1	D0
Name	IRDA_EN	Reserved	Reserved	Reserved	Reserved	Reserved	IRDA_MD	MIR_MD
R/W	R/W	R	R	R	R	R	R/W	R/W
RTC	0	0	0	0	0	0	0	0
Other resets	0	0	0	0	0	0	0	0

Bit	Name	Function																				
D15 to D8	Reserved	Write 0 to these bits. 0 is returned after a read.																				
D7	IRDA_EN	This bit is used to control (enable/prohibit) IrDA macro operation. When this bit is set to 1, peripheral main block's reset is released and clock supply starts. 0: Prohibit 1: Enable																				
D6 to D2	Reserved	Write 0 to these bits. 0 is returned after a read.																				
D1 and D0	IRDA_MD/ MIR_MD	These bits are used to specify the IrDA/MIR mode.																				
		<table border="1"> <thead> <tr> <th>IRDA_MD</th> <th>MIR_MD</th> <th>Operation mode</th> <th>Frequency</th> <th>Modulation method</th> </tr> </thead> <tbody> <tr> <td>0</td> <td>1 or 0</td> <td>FIR mode</td> <td>8 MHz</td> <td>4 PPM</td> </tr> <tr> <td>1</td> <td>0</td> <td>MIR full mode</td> <td>1.152MHz</td> <td>Bit stream/stuff</td> </tr> <tr> <td>1</td> <td>1</td> <td>MIR half mode</td> <td>0.576 MHz</td> <td>Bit stream/stuff</td> </tr> </tbody> </table>	IRDA_MD	MIR_MD	Operation mode	Frequency	Modulation method	0	1 or 0	FIR mode	8 MHz	4 PPM	1	0	MIR full mode	1.152MHz	Bit stream/stuff	1	1	MIR half mode	0.576 MHz	Bit stream/stuff
		IRDA_MD	MIR_MD	Operation mode	Frequency	Modulation method																
0	1 or 0	FIR mode	8 MHz	4 PPM																		
1	0	MIR full mode	1.152MHz	Bit stream/stuff																		
1	1	MIR half mode	0.576 MHz	Bit stream/stuff																		

Pulse output level changes according to operation mode changes by IRDA_MD and MIR_MD.

The operation mode should be changed after changing the IrDA operation to prohibit state (by setting the IRDAEN bit (bit 7) to 0). The output level does not change because output latch is reset.

Once the mode is changed, be sure to switch bit inversion of I/O data ON/OFF by setting bit 0 of the CRCSR register.

Example) Sequence of changing operation mode from FIR mode to MIR full mode

```

clr1    0x7, IRSR1    Prohibit IrDA operation
set1    0x1, IRSR1    Change the mode
set1    0x0, CRCSR    Set bit inversion
set1    0x7, IRSR1    Enable IrDA operation
    
```

[Caution]

During transmission/reception, this register must not be changed (refresh is possible).

27.2.9 CRC5R (0x0C00 005C)

Bit	D15	D14	D13	D12	D11	D10	D9	D8
Name	Reserved	Reserved	Reserved	Reserved	Reserved	Reserved	Reserved	Reserved
R/W	R	R	R	R	R	R	R	R
RTC	0	0	0	0	0	0	0	0
Other resets	0	0	0	0	0	0	0	0

Bit	D7	D6	D5	D4	D3	D2	D1	D0
Name	TX_EN	RX_EN	4PPM_DIS	DPLL_DIS	Reserved	NON_CRC	CRC_INV	DATA_INV
R/W	R/W	R/W	R/W	R/W	R	R/W	R/W	R/W
RTC	0	0	0	0	0	0	0	0
Other resets	0	0	0	0	0	0	0	0

Bit	Name	Function
D15 to D8	Reserved	Write 0 to these bits. 0 is returned after a read.
D7	TX_EN	This bit is used to control (enable/prohibit) masking of transmit start enable flag. Masking sequence transition to transmission enable state entered by writing the TXFL register is: 0: Prohibited 1: Enabled
D6	RX_EN	This bit is used to control (enable/prohibit) receive operation. Releasing masking of receive line, sampling data, and generating receive clocks are: 0: Prohibited 1: Enabled
D5	4PPM_DIS	This bit is used to control (enable/prohibit) the 4PPM modulation (for debugging). The 4PPM modulation of transmit data is: 0: Enabled 1: Prohibited
D4	DPLL_DIS	This bit is used to control (enable/prohibit) the bit correction (for debugging). Bit correction of received data is: 0: Enabled 1: Prohibited
D3	Reserved	Write 0 to this bit. 0 is returned after a read.
D2	NON_CRC	This bit is used to control whether or not a CRC is added for frames to be transmitted (for debugging). 0: Add CRC 1: Do not add CRC

Bit	Name	Function
D1	CRC_INV	This bit is used to set whether or not a CRC is inverted to create an incorrect CRC in the normal routine. 0: Normal CRC (not inverted) 1: Inverted CRC
D0	DATA_INV	This bit is used to set whether or not received/transmitted data I/O is inverted. 0: Normal (not inverted) 1: Inverted Be sure to set as normal in FIR, and set as inverted in MIR.

[Caution]

During transmission/reception, the data in this register must not be changed (refresh is possible).

27.2.10 FIRCR (0x0C00 005E)

Bit	D15	D14	D13	D12	D11	D10	D9	D8
Name	Reserved	Reserved	Reserved	Reserved	Reserved	Reserved	Reserved	Reserved
R/W	R	R	R	R	R	R	R	R
RTC	0	0	0	0	0	0	0	0
Other resets	0	0	0	0	0	0	0	0

Bit	D7	D6	D5	D4	D3	D2	D1	D0
Name	PA_LEN2	PA_LEN1	PA_LEN0	W_PULSE1	W_PULSE0	F_WIDTH2	F_WIDTH1	F_WIDTH0
R/W	R/W	R/W	R/W	R	R	R/W	R/W	R/W
RTC	1	0	0	0	0	1	0	1
Other resets	1	0	0	0	0	1	0	1

Bit	Name	Function		
D15 to D8	Reserved	Write 0 to these bits. 0 is returned after a read.		
D7 to D5	PA_LEN2 to PA_LEN0	These bits are used to specify the number of PA (preamble) added to FIR's transmit frame.		
		PA_LEN2 to 0	Number of PA	
		001	1	
		010	2	
		011	4	
	100 (default)	16		
	111	32		
	Others	RFU (reserved)		
D4 and D3	W_PULSE1 and W_PULSE0	These bits are used to specify the undefined receive pulse width area. Pulse width within the undefined receive pulse width area = recognized as single pulse Pulse width within other than the undefined receive pulse width area = recognized as double pulse		
		W_PULSE 1 and 0	Undefined receive pulse width area	
		00	7 or 8 clocks	
		01 (default)	8 or 9 clocks	
		10	9 or 10 clocks	
	11	10 or 11 clocks		
D2 to D0	F_WIDTH2 to F_WIDTH0	These bits are used to specify FIR pulse modulation width. The FIR's output pulse is modulated to a pulse consisting of the number of reference clocks (48 MHz) specified by these bits.		
		F_WIDTH2 to 0	Single pulse	Double pulse
		000	1 clock	7 clocks
		001	2 clocks	8 clocks
		010	3 clocks	9 clocks
		011	4 clocks	10 clocks
		100	5 clocks	11 clocks
101 (default)	6 clocks	12 clocks		
	Others	Setting prohibited		

[Function]

Controls the FIR operation.

[Caution]

During transmission/reception, the contents of this register must not be changed.

27.2.11 MIRCR (0x0C00 0060)

Bit	D15	D14	D13	D12	D11	D10	D9	D8
Name	Reserved	Reserved	Reserved	Reserved	Reserved	Reserved	Reserved	Reserved
R/W	R	R	R	R	R	R	R	R
RTC	0	0	0	0	0	0	0	0
Other resets	0	0	0	0	0	0	0	0

Bit	D7	D6	D5	D4	D3	D2	D1	D0
Name	STA_LEN2	STA_LEN1	STA_LEN0	M_WIDTH4	M_WIDTH3	M_WIDTH2	M_WIDTH1	M_WIDTH0
R/W	R/W	R/W	R/W	R/W	R/W	R/W	R/W	R/W
RTC	0	1	0	0	1	0	0	1
Other resets	0	1	0	0	1	0	0	1

Bit	Name	Function																		
D15 to D8	Reserved	Write 0 to these bits. 0 is returned after a read.																		
D7 to D5	STA_LEN2 to STA_LEN0	These bits are used to specify the number of STA (start flag) added to MIR's transmit frame.																		
		<table border="1"> <thead> <tr> <th>STA_LEN2 to 0</th> <th>Number of STA</th> </tr> </thead> <tbody> <tr> <td>001</td> <td>1</td> </tr> <tr> <td>010 (default)</td> <td>2</td> </tr> <tr> <td>011</td> <td>4</td> </tr> <tr> <td>100</td> <td>16</td> </tr> <tr> <td>111</td> <td>32</td> </tr> <tr> <td>Others</td> <td>2 (reserved)</td> </tr> </tbody> </table>	STA_LEN2 to 0	Number of STA	001	1	010 (default)	2	011	4	100	16	111	32	Others	2 (reserved)				
		STA_LEN2 to 0	Number of STA																	
		001	1																	
		010 (default)	2																	
011	4																			
100	16																			
111	32																			
Others	2 (reserved)																			
D4 to D0	M_WIDTH4 to M_WIDTH0	These bits are used to specify the MIR pulse modulation width. The MIR's output pulse is modulated to a pulse consisting of the number of reference clocks (48 MHz) specified by these bits.																		
		<table border="1"> <thead> <tr> <th>F_WIDTH4 to 0</th> <th>Single pulse</th> </tr> </thead> <tbody> <tr> <td>00000</td> <td>1 clock</td> </tr> <tr> <td>00001</td> <td>2 clocks</td> </tr> <tr> <td>:</td> <td>:</td> </tr> <tr> <td>01001 (default)</td> <td>10 clocks</td> </tr> <tr> <td>:</td> <td>:</td> </tr> <tr> <td>10100</td> <td>21 clocks</td> </tr> <tr> <td>:</td> <td>:</td> </tr> <tr> <td>11111</td> <td>32 clocks</td> </tr> </tbody> </table>	F_WIDTH4 to 0	Single pulse	00000	1 clock	00001	2 clocks	:	:	01001 (default)	10 clocks	:	:	10100	21 clocks	:	:	11111	32 clocks
		F_WIDTH4 to 0	Single pulse																	
		00000	1 clock																	
		00001	2 clocks																	
:	:																			
01001 (default)	10 clocks																			
:	:																			
10100	21 clocks																			
:	:																			
11111	32 clocks																			

[Function]

Controls the MIR operation.

The nominal pulse width of MIR is 1/4. Therefore, be sure to set as follows:

MIR full mode (1.152 MHz) = 01001 (rate 10/42)

MIR half mode (0.576 MHz) = 10100 (rate 21/83)

[Caution]

During transmission/reception, the contents of this register must not be changed.

27.2.12 DMACR (0x0C00 0062)

Bit	D15	D14	D13	D12	D11	D10	D9	D8
Name	Reserved	Reserved	Reserved	Reserved	Reserved	Reserved	Reserved	Reserved
R/W	R	R	R	R	R	R	R	R
RTC	0	0	0	0	0	0	0	0
Other resets	0	0	0	0	0	0	0	0

Bit	D7	D6	D5	D4	D3	D2	D1	D0
Name	ACES_MD	TRANS_MD	Reserved	Reserved	Reserved	DEMAND2	DEMAND1	DEMAND0
R/W	R/W	R/W	R	R	R	R/W	R/W	R/W
RTC	0	0	0	0	0	0	0	0
Other resets	0	0	0	0	0	0	0	0

Bit	Name	Function																		
D15 to D8	Reserved	Write 0 to these bits. 0 is returned after a read.																		
D7	ACES_MD	This bit is used to select the access mode. Write 0 when writing. 0 is returned after a read.																		
D6	TRANS_MD	This bit is used to specify the transfer direction.																		
		<table border="1"> <thead> <tr> <th>TRANS_MD</th> <th>Transfer direction</th> </tr> </thead> <tbody> <tr> <td>0</td> <td>Memory → TDR</td> </tr> <tr> <td>1</td> <td>RDR → Memory</td> </tr> </tbody> </table>	TRANS_MD	Transfer direction	0	Memory → TDR	1	RDR → Memory												
		TRANS_MD	Transfer direction																	
0	Memory → TDR																			
1	RDR → Memory																			
D5 to D3	Reserved	Write 0 to these bits. 0 is returned after a read.																		
D2 to D0	DEMAND2 to DEMAND0	These bits are used to specify the demand size.																		
		<table border="1"> <thead> <tr> <th>DEMAND2 to 0</th> <th>Demand size</th> </tr> </thead> <tbody> <tr> <td>000</td> <td>1</td> </tr> <tr> <td>001</td> <td>2</td> </tr> <tr> <td>010</td> <td>3</td> </tr> <tr> <td>011</td> <td>4</td> </tr> <tr> <td>100</td> <td>5</td> </tr> <tr> <td>101</td> <td>6</td> </tr> <tr> <td>110</td> <td>7</td> </tr> <tr> <td>111</td> <td>Free size</td> </tr> </tbody> </table>	DEMAND2 to 0	Demand size	000	1	001	2	010	3	011	4	100	5	101	6	110	7	111	Free size
		DEMAND2 to 0	Demand size																	
		000	1																	
		001	2																	
		010	3																	
		011	4																	
		100	5																	
101	6																			
110	7																			
111	Free size																			

[Caution]

During the DMA operation (both the master side and IrDA side), the contents of this register must not be changed.

27.2.13 DMAER (0x0C00 0064)

Bit	D15	D14	D13	D12	D11	D10	D9	D8
Name	Reserved	Reserved	Reserved	Reserved	Reserved	Reserved	Reserved	Reserved
R/W	R	R	R	R	R	R	R	R
RTC	0	0	0	0	0	0	0	0
Other resets	0	0	0	0	0	0	0	0

Bit	D7	D6	D5	D4	D3	D2	D1	D0
Name	Reserved	Reserved	Reserved	Reserved	Reserved	Reserved	DMA_BUSY	DMA_EN
R/W	R	R	R	R	R	R	R	R/W
RTC	0	0	0	0	0	0	0	0
Other resets	0	0	0	0	0	0	0	0

Bit	Name	Function
D15 to D2	Reserved	Write 0 to these bits. 0 is returned after a read.
D1	DMA_BUSY	This bit is used to indicate the busy status.
		DMA_BUSY DMA busy
		0 No Indicates that the DMA is not in operation enable state.
		1 Yes Indicates that the DMA is in operation enable state.
D0	DMA_EN	This bit is used as a DMA operation enable trigger. 1: Enable 0: Disable

[Function]

The DMA_BUSY bit is set automatically by setting the DMA_EN bit to 1, and is cleared by setting bit 0 of the FSR register (TX_STOP) to 1.

Even if 0 is written to DMA_EN during DMA operation, DMA ignores this and continues its operation.

27.2.14 TXIR (0x0C00 0066)

Bit	D15	D14	D13	D12	D11	D10	D9	D8
Name	Reserved	Reserved	Reserved	Reserved	Reserved	Reserved	Reserved	Reserved
R/W	R	R	R	R	R	R	R	R
RTC	0	0	0	0	0	0	0	0
Other resets	0	0	0	0	0	0	0	0

Bit	D7	D6	D5	D4	D3	D2	D1	D0
Name	TX_BUSY	Reserved	LAST_TFL	TX_TH_OV	Reserved	TXF_UNDR	TXF_FULL	TXF_EMP
R/W	R	R	R	R	R	R	R	R
RTC	0	0	0	0	0	0	0	0
Other resets	0	0	0	0	0	0	0	0

Bit	Name	Function
D15 to D8	Reserved	Write 0 to these bits. 0 is returned after a read.
D7	TX_BUSY	Transmission busy. This bit is set to 1 during the period between PA (in FIR) or STA (in MIR) transmission and abort transmission. 0: Not in transmission 1: In transmission
D6	Reserved	Write 0 to this bit. 0 is returned after a read.
D5	LAST_TFL	Last transmission frame status. This bit indicates whether data exists or not in the transmission frame size FIFO. This bit changes when the STA transmission sequence ends. Its initial value is 1. 0: Normal 1: Exists
D4	TX_TH_OV	Transmission FIFO threshold over status. This bit indicates whether or not the data size within the transmission FIFO exceeds the threshold. 0: Normal 1: Excesses
D3	Reserved	Write 0 to this bit. 0 is returned after a read.
D2	TXF_UNDR	Transmission FIFO underrun status. This bit indicates whether or not data is read when there is no data in the transmission FIFO. 0: Normal 1: Data is read
D1	TXF_FULL	Transmission FIFO full status. This bit indicates that there is no writable space in the transmission FIFO. 0: Normal 1: FIFO is full
D0	TXF_EMP	Transmission FIFO empty status. This bit indicates whether or not data to be read exists in the transmission FIFO. 0: Normal 1: Exists

27.2.15 RXIR (0x0C00 0068)

Bit	D15	D14	D13	D12	D11	D10	D9	D8
Name	Reserved	Reserved	Reserved	Reserved	Reserved	Reserved	Reserved	Reserved
R/W	R	R	R	R	R	R	R	R
RTC	0	0	0	0	0	0	0	0
Other resets	0	0	0	0	0	0	0	0

Bit	D7	D6	D5	D4	D3	D2	D1	D0
Name	RX_BUSY	END_DATA	LAST_RFL	RX_TH_OV	Reserved	Reserved	RXF_FULL	RXF_EMP
R/W	R	R	R	R	R	R	R	R
RTC	0	0	0	0	0	0	0	0
Other resets	0	0	0	0	0	0	0	0

Bit	Name	Function
D15 to D8	Reserved	Write 0 to these bits. 0 is returned after a read.
D7	RX_BUSY	Reception busy. This bit is set to 1 during the period between when PA (in FIR) or STA (in MIR) is detected and when reception ends. 0: Not in reception 1: In reception
D6	END_DATA	Frame last data status. This bit indicates whether the last data of frame that is received completely exists or not in the FIFO. 0: Normal 1: Exists
D5	LAST_RFL	Last reception frame status. This bit is set (to 1) when the reception result (frame size and status) of the 7th frame is stored. 0: Normal 1: Result is stored
D4	RX_TH_OV	Reception FIFO threshold over status. This bit indicates whether or not the data size within the reception FIFO exceeds the threshold. 0: Normal 1: Excesses
D3 and D2	Reserved	Write 0 to these bits. 0 is returned after a read.
D1	RXF_FULL	Reception FIFO full status. This bit indicates that there is no writable space in the reception FIFO. 0: Normal 1: FIFO is full
D0	RXF_EMP	Reception FIFO empty status. This bit indicates whether or not data to be read exists in the reception FIFO. 0: Normal 1: Exists

[Caution]

This register can be read only in IrDA mode.

[Remark]

This register's initial value is the value immediately after the IrDA operation is enabled or after the reception FIFO is cleared. 0x00 is read while the operation stops.

27.2.16 IFR (0x0C00 006A)

Bit	D15	D14	D13	D12	D11	D10	D9	D8
Name	Reserved	Reserved	Reserved	Reserved	Reserved	Reserved	Reserved	Reserved
R/W	R	R	R	R	R	R	R	R
RTC	0	0	0	0	0	0	0	0
Other resets	0	0	0	0	0	0	0	0

Bit	D7	D6	D5	D4	D3	D2	D1	D0
Name	TX_ABORT	TX_ERR	RX_VALID	DMA_END	RX_END	TX_END	TX_WR_RQ	RX_RD_RQ
R/W	R	R	R	R	R	R	R	R
RTC	0	0	0	0	0	0	0	0
Other resets	0	0	0	0	0	0	0	0

Bit	Name	Function
D15 to D8	Reserved	Write 0 to these bits. 0 is returned after a read.
D7	TX_ABORT	Abort frame transmission end interrupt. This bit indicates that abort frame is transmitted and the following frame's transfer reservation is cancelled. 0: Normal 1: Cancelled
D6	TX_ERR	Transmission error interrupt. This bit indicates that the transmission error (such as a forcible stop) occurs. 0: Normal 1: Occurs
D5	RX_VALID	Reception result valid interrupt. This bit indicates that the last data of frame is read from the reception FIFO and the received status becomes valid. 0: Normal 1: Valid
D4	DMA_END	DMA end interrupt. This bit indicates that the DMA operation ends. 0: Normal 1: Ends
D3	RX_END	Reception end interrupt. This bit indicates that STO is detected for each reception frame. 0: Normal 1: Detected
D2	TX_END	Transmission end interrupt. This bit indicates that STO is transmitted for each transmission frame. 0: Normal 1: Detected

Bit	Name	Function
D1	TX_WR_RQ	Transmission data write request interrupt. This bit indicates that a transmission data write request interrupt has occurred. 0: Normal 1: Occurs
D0	RX_RD_RQ	Reception data read request interrupt. This bit indicates that a reception data read request interrupt has occurred. 0: Normal 1: Occurs

[Caution]

If bits 7 through 2 of the IFR register are set, the flags that are set to 1 before a read are all cleared to 0.

27.2.17 RXSTS (0x0C00 006C)

Bit	D15	D14	D13	D12	D11	D10	D9	D8
Name	Reserved	Reserved	Reserved	Reserved	Reserved	Reserved	Reserved	Reserved
R/W	R	R	R	R	R	R	R	R
RTC	0	0	0	0	0	0	0	0
Other resets	0	0	0	0	0	0	0	0

Bit	D7	D6	D5	D4	D3	D2	D1	D0
Name	Valid	Reserved	Reserved	RXF_OV	CRC_ERR	ABORT	MRXF_OV	Reserved
R/W	R	R	R	R	R	R	R	R
RTC	0	0	0	0	0	0	0	0
Other resets	0	0	0	0	0	0	0	0

Bit	Name	Function
D15 to D8	Reserved	Write 0 to these bits. 0 is returned after a read.
D7	Valid	Valid status in the indication status. This bit is set to 1 when received data of one frame is read completely. 0: Not completed 1: Completed
D6 and D5	Reserved	Write 0 to these bits. 0 is returned after a read.
D4	RXF_OV	Receive FIFO overrun error. This bit is set to 1 when a receive operation is stopped by receive FIFO's overrun. 0: Normal 1: Overrun
D3	CRC_ERR	CRC Error. This bit is set to 1 when the receive result CRC does not match with expected value. 0: Normal 1: CRC error
D2	ABORT	Abort detection error. This bit is set to 1 when a receive operation is stopped by abort frame detection. 0: Normal 1: Abort error
D1	MRXF_OV	Maximum receive frame size error. This bit is set to 1 when a receive operation is stopped by maximum receive frame size overrun. 0: Normal 1: Overrun
D0	Reserved	Write 0 to this bit. 0 is returned after a read.

[Function]

Reads data from the receive status store FIFO, in which data of up to 7 frames can be stored.

The FIFO is initialized by setting bit 1 of the FSR register.

The receive status FIFO is used as follows.

(1) Write (bits 4 to 1)

The receive status is written to this register at the same timing of writing data to the receive frame length register. This register shares the write pointer with the receive frame length register.

(2) Write (bit 7)

This bit is set to 1 when the data of receive frame size is read from the FIFO. While this bit is 1, data is recognized as valid.

(3) Read

This register shares the read pointer with the receive frame length register.

The read pointer is incremented by reading the RXFL (receive frame length) register after valid data is read from this register.

27.2.18 TXFL (0x0C00 006E)

Bit	D15	D14	D13	D12	D11	D10	D9	D8
Name	Reserved	Reserved	Reserved	TXFL12	TXFL11	TXFL10	TXFL9	TXFL8
R/W	R	R	R	R/W	R/W	R/W	R/W	R/W
RTC	0	0	0	0	0	0	0	0
Other resets	0	0	0	0	0	0	0	0

Bit	D7	D6	D5	D4	D3	D2	D1	D0
Name	TXFL7	TXFL6	TXFL5	TXFL4	TXFL3	TXFL2	TXFL1	TXFL0
R/W	R/W	R/W	R/W	R/W	R/W	R/W	R/W	R/W
RTC	0	0	0	0	0	0	0	0
Other resets	0	0	0	0	0	0	0	0

Bit	Name	Function
D15 to D13	Reserved	Write 0 to these bits. 0 is returned after a read.
D12 to D0	TXFL12 to TXFL0	Transmit frame size.

[Function]

This register functions as prebuffer address for data write to the transmit frame size data store FIFO, in which data of up to 7 frames can be stored.

Setting value = transmit size – 1

Setting range = 1 to 2 Kbytes

The FIFO is initialized by setting bit 2 of the FSR register.

(1) Write

The data transmit size of frames to be transferred is written to this register.

Transmission is enabled when data is written to this register in the state other than transmission busy state (after FIFO initialization and after transmission completion).

The frames whose number is specified by this register are transferred continuously (back-to-back transfer).

During the single frame transfer, FIFO should be initialized at each 1-frame transfer completion to restart transmit operation.

(2) Read

The sequencer reads the transmission size from this register after the STA flag of transmission frame is transmitted completed. Then, the read pointer is incremented.

[Caution]

If data exists in the FIFO when the STO transmit sequence is completed, continuous transfer mode is entered. When multiple frames are transferred, be sure to write data to the TXFL register before the STO transmit sequence is completed.

27.2.19 MRXF (0x0C00 0070)

Bit	D15	D14	D13	D12	D11	D10	D9	D8
Name	Reserved	Reserved	Reserved	MRXF12	MRXF11	MRXF10	MRXF9	MRXF8
R/W	R	R	R	R/W	R/W	R/W	R/W	R/W
RTC	0	0	0	0	0	0	0	0
Other resets	0	0	0	0	0	0	0	0

Bit	D7	D6	D5	D4	D3	D2	D1	D0
Name	MRXF7	MRXF6	MRXF5	MRXF4	MRXF3	MRXF2	MRXF1	MRXF0
R/W	R/W	R/W	R/W	R/W	R/W	R/W	R/W	R/W
RTC	0	0	0	0	0	0	0	0
Other resets	0	0	0	0	0	0	0	0

Bit	Name	Function	
D15 to D13	Reserved	Write 0 to these bits. 0 is returned after a read.	
D12 to D0	MRXF12 to MRXF0	Specifies receivable maximum frame size.	
		MRXF	MAX Tx Frame length
		0x0000	1 byte
		0x0001	2 bytes
		:	:
	0x1FFF	2 Kbytes	

[Function]

The maximum frame size is stored in this register.

When a 1-frame receive data is transferred to the receive FIFO exceeding the receivable maximum frame size set by this register, an error occurs even under frame reception to end the current frame reception. This sets bit 1 of the RXSTS register.

After the receive FIFO is cleared, if the number of received frames is less than 7 frames, it is possible to continue frame reception.

To receive 8 or more frames, read all the data and frames that are already received from the receive FIFO, then clear the receive FIFO and restart reception.

When receiving data via the DMA operation, set the transfer size value by the following expression:

$$\text{DMA receivable capacitance} = \text{set value} \times 7 \text{ frames}$$

[Caution]

The data exceeding the maximum size cannot be transferred to the FIFO.

27.2.20 RXFL (0x0C00 0074)

Bit	D15	D14	D13	D12	D11	D10	D9	D8
Name	Reserved	Reserved	Reserved	RXFL12	RXFL11	RXFL10	RXFL9	RXFL8
R/W	R	R	R	R	R	R	R	R
RTC	0	0	0	0	0	0	0	0
Other resets	0	0	0	0	0	0	0	0

Bit	D7	D6	D5	D4	D3	D2	D1	D0
Name	RXFL7	RXFL6	RXFL5	RXFL4	RXFL3	RXFL2	RXFL1	RXFL0
R/W	R	R	R	R	R	R	R	R
RTC	0	0	0	0	0	0	0	0
Other resets	0	0	0	0	0	0	0	0

Bit	Name	Function
D15 to D13	Reserved	Write 0 to these bits. 0 is returned after a read.
D12 to D0	RXFL12 to RXFL0	Receive frame size.

[Function]

This register functions as prebuffer address for data read from the receive frame size data store FIFO, in which data of up to 7 frames can be stored.

Setting value = transmit size – 1

Setting range = 1 to 2 Kbytes

The FIFO is initialized by setting bit 1 of the FSR register.

(1) Write

When the frame reception is completed after its data is transferred (even if only 1 byte) to the receive FIFO, the sequencer writes the current transfer data size to this register, and the write pointer is incremented.

When the frame reception is completed before its data is transferred to the receive FIFO, write operation is not performed (lost frame).

(2) Read

The read pointer is enabled to be incremented by reading valid data from the RXSTS register, and the next data can be read.

[Caution]

If a receive operation ends abnormally, the data size transferred to the receive FIFO at that time is written to this register.

When the data of 7 frames are stored, the receive line is automatically masked. Therefore, the frame whose receive result cannot be stored is not transferred to the FIFO.

The update condition of the read pointer of the receive frame size store FIFO is also valid in the test mode.

[MEMO]

CHAPTER 28 MIPS III INSTRUCTION SET DETAILS

This chapter provides a detailed description of the operation of each Vr4111 instruction in both 32- and 64-bit modes. The instructions are listed in alphabetical order.

28.1 INSTRUCTION NOTATION CONVENTIONS

In this chapter, all variable subfields in an instruction format (such as *rs*, *rt*, *immediate*, etc.) are shown in lowercase names.

For the sake of clarity, we sometimes use an alias for a variable subfield in the formats of specific instructions. For example, we use *rs = base* in the format for load and store instructions. Such an alias is always lower case, since it refers to a variable subfield.

Figures with the actual bit encoding for all the mnemonics are located at the end of this chapter (**28.6 CPU INSTRUCTION OPCODE BIT ENCODING**), and the bit encoding also accompanies each instruction.

In the instruction descriptions that follow, the Operation section describes the operation performed by each instruction using a high-level language notation. The Vr4111 can operate as either a 32- or 64-bit microprocessor and the operation for both modes is included with the instruction description.

Special symbols used in the notation are described in Table 28-1.

Table 28-1. CPU Instruction Operation Notations

Symbol	Meaning
<-	Assignment.
	Bit string concatenation.
x^y	Replication of bit value x into a y -bit string. x is always a single-bit value.
$xy:z$	Selection of bits y through z of bit string x . Little-endian bit notation is always used. If y is less than z , this expression is an empty (zero length) bit string.
+	2's complement or floating-point addition.
-	2's complement or floating-point subtraction.
*	2's complement or floating-point multiplication.
div	2's complement integer division.
mod	2's complement modulo.
/	Floating-point division.
<	2's complement less than comparison.
and	Bit-wise logical AND.
or	Bit-wise logical OR.
xor	Bit-wise logical XOR.
nor	Bit-wise logical NOR.
GPR [x]	General-Register x . The content of GPR [0] is always zero. Attempts to alter the content of GPR [0] have no effect.
CPR [z, x]	Coprocessor unit z , general register x .
CCR [z, x]	Coprocessor unit z , control register x .
COC [z]	Coprocessor unit z condition signal.
BigEndianMem	Big-endian mode as configured at reset (0 → Little, 1 → Big). Specifies the endianness of the memory interface (see LoadMemory and StoreMemory), and the endianness of Kernel and Supervisor mode execution. However, this value is always 0 since the V_{R4111} supports the little endian order only.
ReverseEndian	Signal to reverse the endianness of load and store instructions. This feature is available in User mode only, and is effected by setting the RE bit of the Status register. Thus, ReverseEndian may be computed as (SR25 and User mode). However, this value is always 0 since the V_{R4111} supports the little endian order only.
BigEndianCPU	The endianness for load and store instructions (0 → Little, 1 → Big). In User mode, this endianness may be reversed by setting SR25. Thus, BigEndianCPU may be computed as BigEndianMem XOR ReverseEndian. However, this value is always 0 since the V_{R4111} supports the little endian order only.
$T + i$.	Indicates the time steps between operations. Each of the statements within a time step are defined to be executed in sequential order (as modified by conditional and loop constructs). Operations which are marked $T + i$ are executed at instruction cycle i relative to the start of execution of the instruction. Thus, an instruction which starts at time j executes operations marked $T + i$ at time $i + j$. The interpretation of the order of execution between two instructions or two operations that execute at the same time should be pessimistic; the order is not defined.

(1) Instruction Notation Examples

The following examples illustrate the application of some of the instruction notation conventions:

Example #1:

$$\text{GPR [rt]} \leftarrow \text{immediate} \parallel 0^{16}$$

Sixteen zero bits are concatenated with an immediate value (typically 16 bits), and the 32-bit string (with the lower 16 bits set to zero) is assigned to General-purpose register *rt*.

Example #2:

$$(\text{immediate}_{15})^{16} \parallel \text{immediate}_{15..0}$$

Bit 15 (the sign bit) of an immediate value is extended for 16 bit positions, and the result is concatenated with bits 15 through 0 of the immediate value to form a 32-bit sign extended value.

28.2 LOAD AND STORE INSTRUCTIONS

In the Vr4111 implementation, the instruction immediately following a load may use the loaded contents of the register. In such cases, the hardware interlocks, requiring additional real cycles, so scheduling load delay slots is still desirable, although not required for functional code.

In the load and store descriptions, the functions listed in Table 28-2 are used to summarize the handling of virtual addresses and physical memory.

Table 28-2. Load and Store Common Functions

Function	Meaning
Address Translation	Uses the TLB to find the physical address given the virtual address. The function fails and an exception is taken if the required translation is not present in the TLB.
Load Memory	Uses the cache and main memory to find the contents of the word containing the specified physical address. The low-order three bits of the address and the Access Type field indicate which of each of the four bytes within the data word need to be returned. If the cache is enabled for this access, the entire word is returned and loaded into the cache. If the specified data is short of word length, the data position to which the contents of the specified data is stored is determined considering the endian mode and reverse endian mode.
Store Memory	Uses the cache, write buffer, and main memory to store the word or part of word specified as data in the word containing the specified physical address. The low-order three bits of the address and the Access Type field indicate which of each of the four bytes within the data word should be stored. If the specified data is short of word length, the data position to which the contents of the specified data is stored is determined considering the endian mode and reverse endian mode.

As shown in Table 28-3, the Access Type field indicates the size of the data item to be loaded or stored. Regardless of access type or byte-numbering order (endianness), the address specifies the byte that has the smallest byte address in the addressed field. This is the rightmost byte in the VR4111 since it supports the little-endian order only.

Table 28-3. Access Type Specifications for Loads/Stores

Access Type Mnemonic	Value	Meaning
DOUBLEWORD	7	8 bytes (64 bits)
SEPTIBYTE	6	7 bytes (56 bits)
SEXTIBYTE	5	6 bytes (48 bits)
QUINTIBYTE	4	5 bytes (40 bits)
WORD	3	4 bytes (32 bits)
TRIPLEBYTE	2	3 bytes (24 bits)
HALFWORD	1	2 bytes (16 bits)
BYTE	0	1 byte (8 bits)

The bytes within the addressed doubleword that are used can be determined directly from the access type and the three low-order bits of the address.

28.3 JUMP AND BRANCH INSTRUCTIONS

All jump and branch instructions have an architectural delay of exactly one instruction. That is, the instruction immediately following a jump or branch (that is, occupying the delay slot) is always executed while the target instruction is being fetched from storage. A delay slot may not itself be occupied by a jump or branch instruction; however, this error is not detected and the results of such an operation are undefined.

If an exception or interrupt prevents the completion of a legal instruction during a delay slot, the hardware sets the EPC register to point at the jump or branch instruction that precedes it. When the code is restarted, both the jump or branch instructions and the instruction in the delay slot are reexecuted.

Because jump and branch instructions may be restarted after exceptions or interrupts, they must be restartable. Therefore, when a jump or branch instruction stores a return link value, register *r31* (the register in which the link is stored) may not be used as a source register.

Since instructions must be word-aligned, a Jump Register or Jump and Link Register instruction must use a register which contains an address whose two low-order bits (low-order one bit in the 16-bit mode) are zero. If these low-order bits are not zero, an address exception will occur when the jump target instruction is subsequently fetched.

28.4 SYSTEM CONTROL COPROCESSOR (CP0) INSTRUCTIONS

There are some special limitations imposed on operations involving CP0 that is incorporated within the CPU. Although load and store instructions to transfer data to/from coprocessors and to move control to/from coprocessor instructions are generally permitted by the MIPS architecture, CP0 is given a somewhat protected status since it has responsibility for exception handling and memory management. Therefore, the move to/from coprocessor instructions are the only valid mechanism for writing to and reading from the CP0 registers.

Several CP0 instructions are defined to directly read, write, and probe TLB entries and to modify the operating modes in preparation for returning to User mode or interrupt-enabled states.

28.5 CPU INSTRUCTION

This section describes the functions of CPU instructions in detail for both 32-bit address mode and 64-bit address mode.

The exception that may occur by executing each instruction is shown in the last of each instruction's description. For details of exceptions and their processes, see **CHAPTER 7 EXCEPTION PROCESSING**.

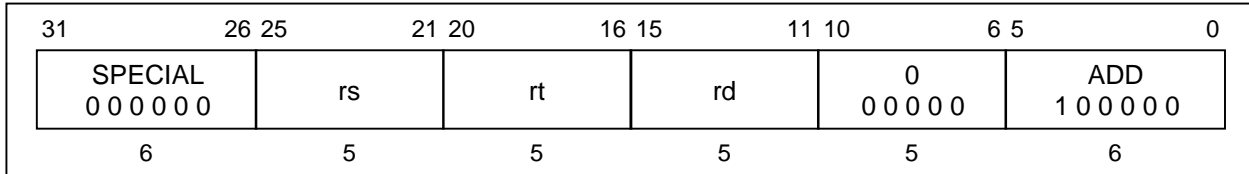
ADD**Add****ADD****Format:**

ADD rd, rs, rt

Description:

The contents of general register *rs* and the contents of general register *rt* are added to form the result. The result is placed into general register *rd*. In 64-bit mode, the operands must be valid sign-extended, 32-bit values.

An overflow exception occurs if the carries out of bits 30 and 31 differ (2's complement overflow). The destination register *rd* is not modified when an integer overflow exception occurs.

Operation:

32	T: GPR [rd] ← GPR [rs] + GPR [rt]
64	T: temp ← GPR [rs] + GPR [rt] GPR [rd] ← (temp ³¹) ³² temp ^{31...0}

Exceptions:

Integer overflow exception

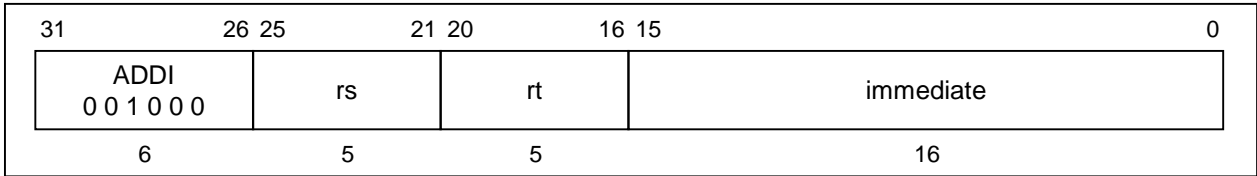
ADDI**Add Immediate****ADDI****Format:**

ADDI rt, rs, immediate

Description:

The 16-bit *immediate* is sign-extended and added to the contents of general register *rs* to form the result. The result is placed into general register *rt*. In 64-bit mode, the operand must be valid sign-extended, 32-bit values.

An overflow exception occurs if carries out of bits 30 and 31 differ (2's complement overflow). The destination register *rt* is not modified when an integer overflow exception occurs.

Operation:

32	T: $GPR[rt] \leftarrow GPR[rs] + (immediate_{15})^{16} \parallel immediate_{15..0}$
64	T: $temp \leftarrow GPR[rs] + (immediate_{15})^{48} \parallel immediate_{15..0}$ $GPR[rt] \leftarrow (temp_{31})^{32} \parallel temp_{31..0}$

Exceptions:

Integer overflow exception

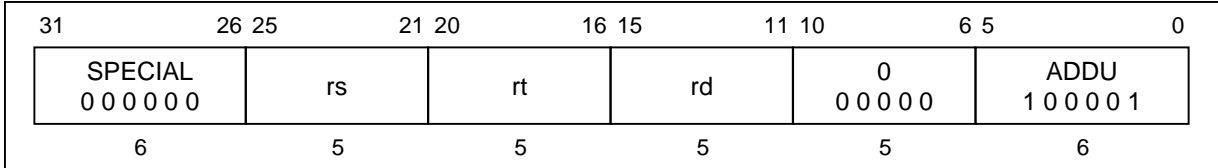
ADDU**Add Unsigned****ADDU****Format:**

ADDU rd, rs, rt

Description:

The contents of general register *rs* and the contents of general register *rt* are added to form the result. The result is placed into general register *rd*. No integer overflow exception occurs under any circumstances. In 64-bit mode, the operands must be valid sign-extended, 32-bit values.

The only difference between this instruction and the ADD instruction is that ADDU never causes an integer overflow exception.

Operation:

32	T:	$GPR[rd] \leftarrow GPR[rs] + GPR[rt]$
64	T:	temp $\leftarrow GPR[rs] + GPR[rt]$ GPR[rd] $\leftarrow (temp_{31})^{32} temp_{31...0}$

Exceptions:

None

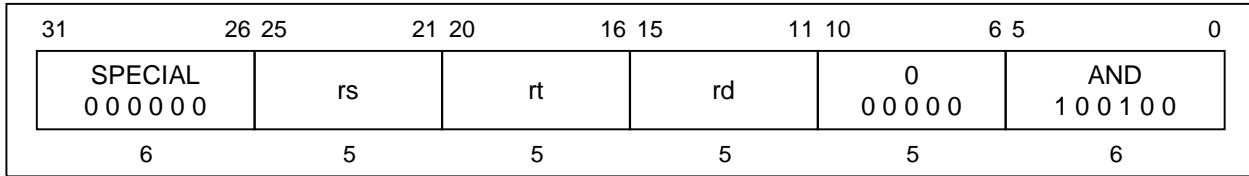
AND**And****AND****Format:**

AND rd, rs, rt

Description:

The contents of general register *rs* are combined with the contents of general register *rt* in a bit-wise logical AND operation. The result is placed into general register *rd*.

Operation:

32	T:	GPR [rd] ← GPR [rs] and GPR [rt]
64	T:	GPR [rd] ← GPR [rs] and GPR [rt]

Exceptions:

None

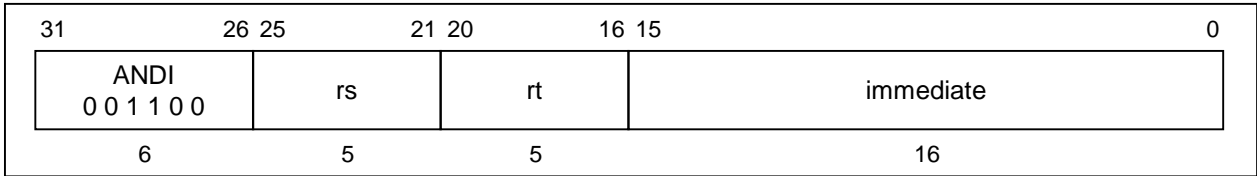
ANDI**And Immediate****ANDI****Format:**

ANDI rt, rs, immediate

Description:

The 16-bit *immediate* is zero-extended and combined with the contents of general register *rs* in a bit-wise logical AND operation. The result is placed into general register *rt*.

Operation:

32	T: $\text{GPR [rt]} \leftarrow 0^{16} \parallel (\text{immediate and GPR [rs]}_{15..0})$
64	T: $\text{GPR [rt]} \leftarrow 0^{48} \parallel (\text{immediate and GPR [rs]}_{15..0})$

Exceptions:

None

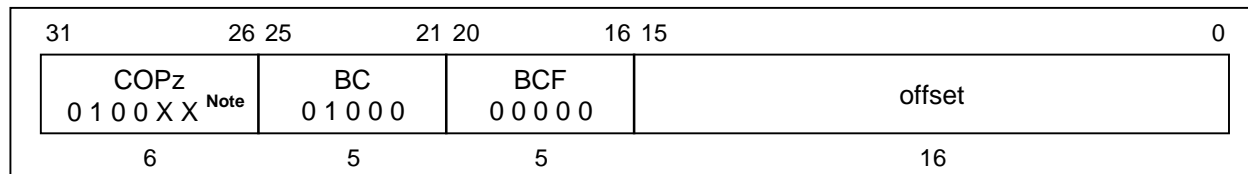
BC0F**Branch On Coprocessor 0 False****BC0F****Format:**

BC0F offset

Description:

A branch target address is computed from the sum of the address of the instruction in the delay slot and the 16-bit *offset*, shifted left two bits and sign-extended. If coprocessor 0's condition signal (CpCond: Status register bit-18 CH field), as sampled during the previous instruction, is false, then the program branches to the target address with a delay of one instruction.

Because the condition line is sampled during the previous instruction, there must be at least one instruction between this instruction and a coprocessor instruction that changes the condition line.

Operation:

```

32  T-1: condition ← not SR18
    T:   target ← (offset15)14 || offset || 02
    T+1: if condition then
        PC ← PC + target
    endif

64  T-1: condition ← not SR18
    T:   target ← (offset15)46 || offset || 02
    T+1: if condition then
        PC ← PC + target
    endif

```

Exceptions:

Coprocessor unusable exception

Note See the opcode table below, or **28.6 CPU INSTRUCTION OPCODE BIT ENCODING**.

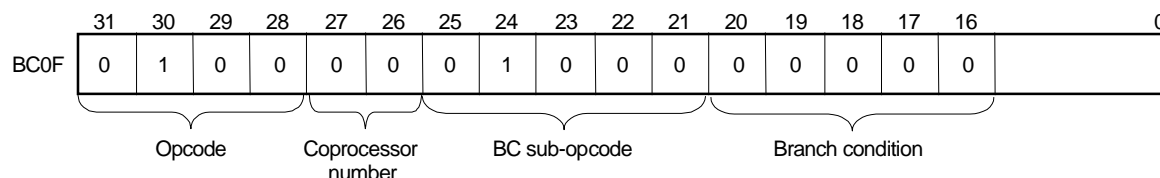
Opcode Table:

BC0FL Branch On Coprocessor 0 False Likely BC0FL

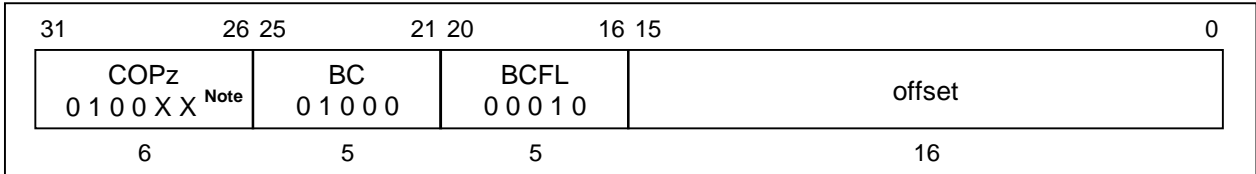
**Format:**

BC0FL offset

Description:

A branch target address is computed from the sum of the address of the instruction in the delay slot and the 16-bit *offset*, shifted left two bits and sign-extended. If the contents of coprocessor 0's condition line, as sampled during the previous instruction, is false, the target address is branched to with a delay of one instruction.

If the conditional branch is not taken, the instruction in the branch delay slot is nullified.

Because the condition line is sampled during the previous instruction, there must be at least one instruction between this instruction and a coprocessor instruction that changes the condition line.

Operation:

```

32  T-1: condition ← not SR18
    T:   target ← (offset15)14 || offset || 02
    T+1: if condition then
            PC ← PC + target
        else
            NullifyCurrentInstruction
        endif

64  T-1: condition ← not SR18
    T:   target ← (offset15)46 || offset || 02
    T+1: if condition then
            PC ← PC + target
        else
            NullifyCurrentInstruction
        endif

```

Exceptions:

Coprocessor unusable exception

Note See the opcode table below, or **28.6 CPU INSTRUCTION OPCODE BIT ENCODING**.

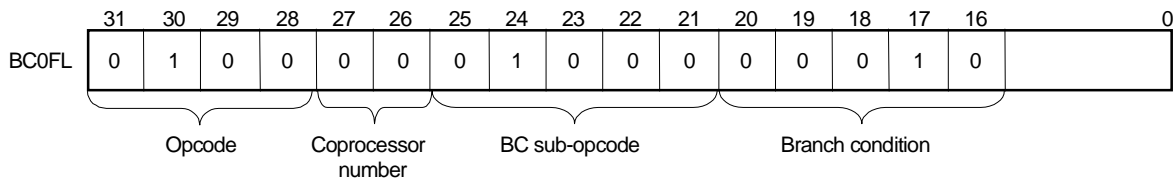
Opcode Table:

BC0T

Branch On Coprocessor 0 True

BC0T

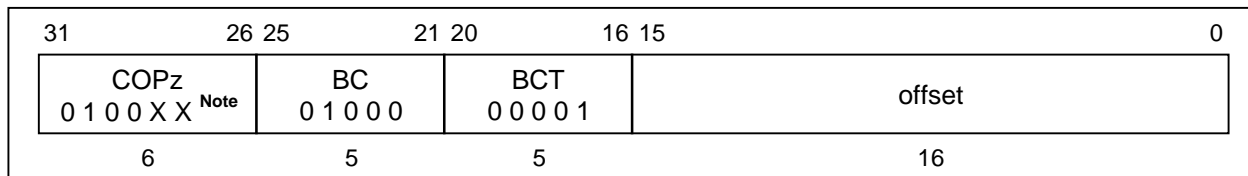

Format:

BC0T offset

Description:

A branch target address is computed from the sum of the address of the instruction in the delay slot and the 16-bit *offset*, shifted left two bits and sign-extended. If the coprocessor 0's condition signal (CpCond: Status register bit-18 CH field) is true, then the program branches to the target address, with a delay of one instruction.

Because the condition line is sampled during the previous instruction, there must be at least one instruction between this instruction and a coprocessor instruction that changes the condition line.

Operation:

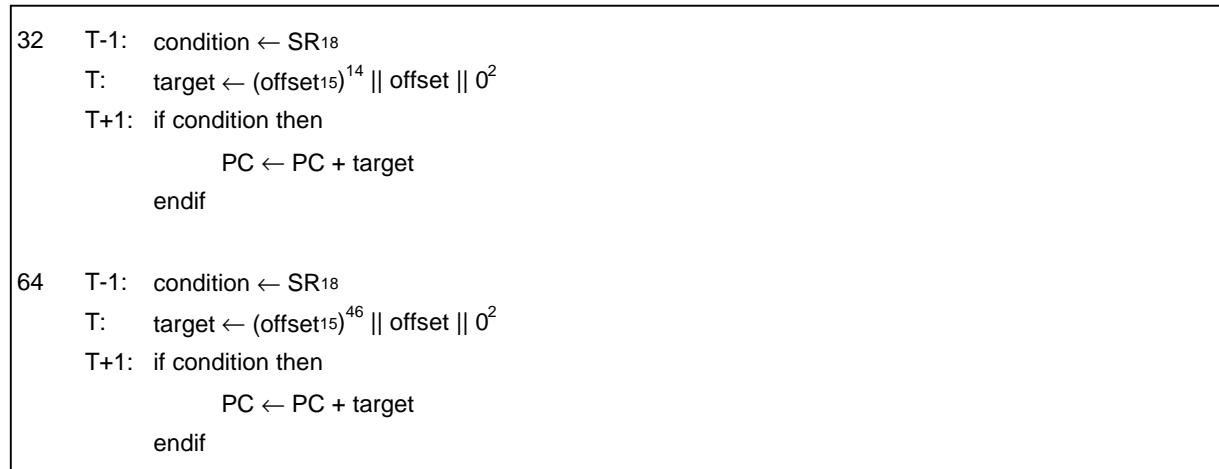

Exceptions:

Coprocessor unusable exception

Note See the opcode table below, or **28.6 CPU INSTRUCTION OPCODE BIT ENCODING**.

Opcode Table:

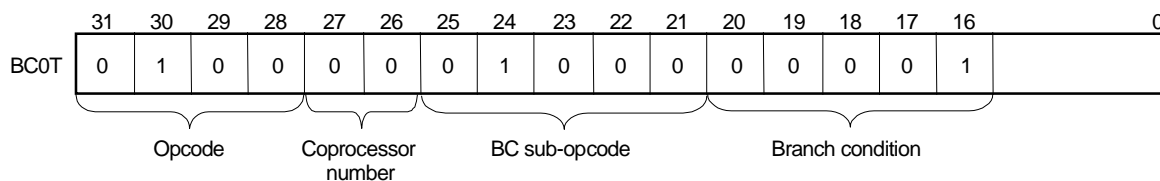

BC0TL Branch On Coprocessor 0 True Likely BC0TL

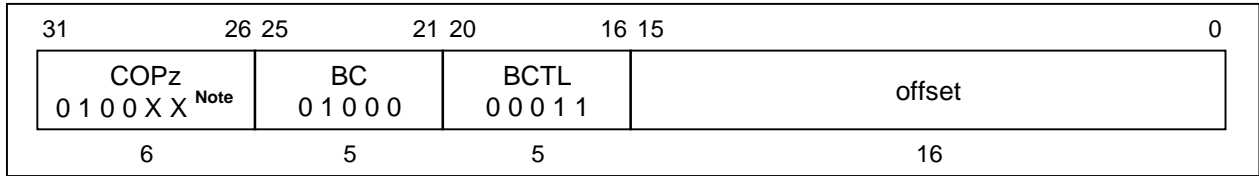

Format:

BC0TL offset

Description:

A branch target address is computed from the sum of the address of the instruction in the delay slot and the 16-bit *offset*, shifted left two bits and sign-extended. If the contents of coprocessor 0's condition line, as sampled during the previous instruction, is true, the target address is branched to with a delay of one instruction.

If the conditional branch is not taken, the instruction in the branch delay slot is nullified.

Because the condition line is sampled during the previous instruction, there must be at least one instruction between this instruction and a coprocessor instruction that changes the condition line.

Operation:

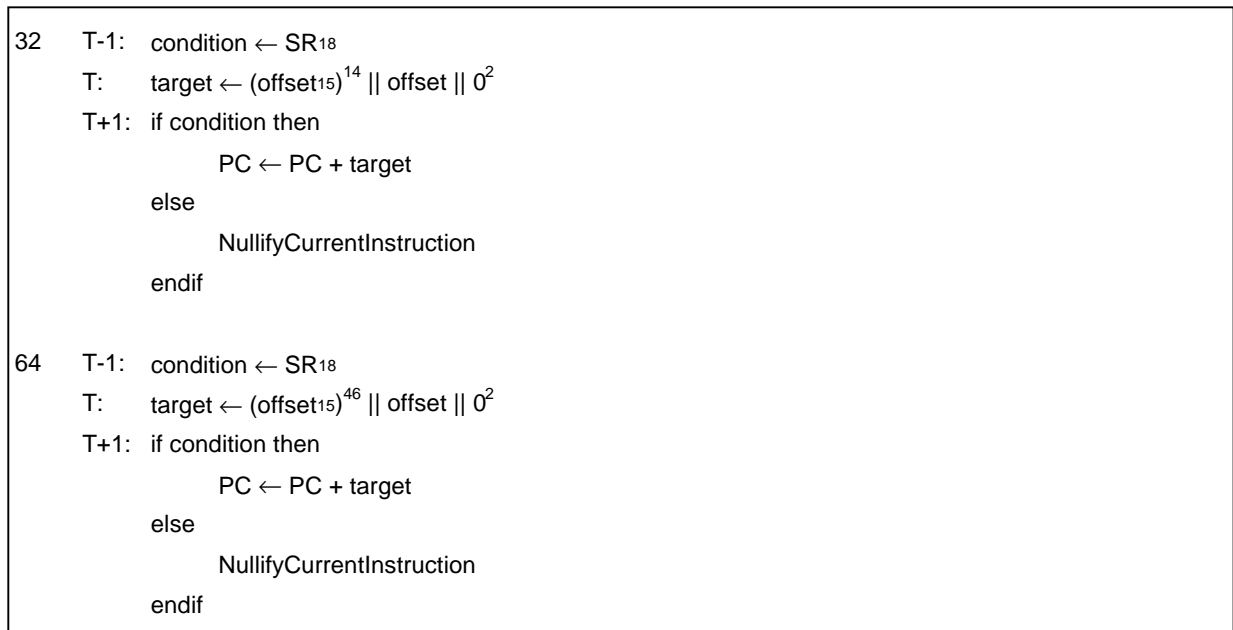

Exceptions:

Coprocessor unusable exception

Note See the opcode table below, or **28.6 CPU INSTRUCTION OPCODE BIT ENCODING**.

Opcode Table:

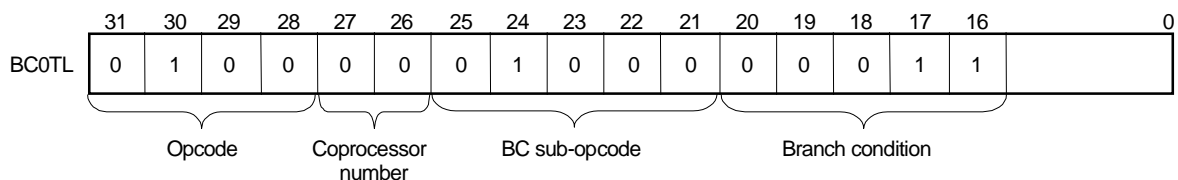

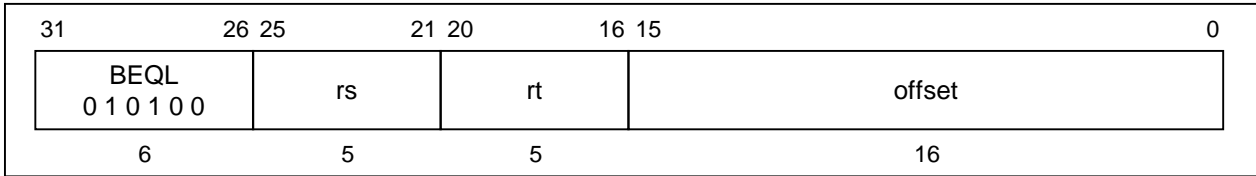
BEQL**Branch On Equal Likely****BEQL****Format:**

BEQL rs, rt, offset

Description:

A branch target address is computed from the sum of the address of the instruction in the delay slot and the 16-bit offset, shifted left two bits and sign-extended. The contents of general register *rs* and the contents of general register *rt* are compared. If the two registers are equal, the target address is branched to, with a delay of one instruction. If the conditional branch is not taken, the instruction in the branch delay slot is nullified.

Operation:

```

32  T:  target ← (offset15)14 || offset || 02
      condition ← (GPR [rs] = GPR [rt])
      T+1: if condition then
            PC ← PC + target
          else
            NullifyCurrentInstruction
          endif

64  T:  target ← (offset15)46 || offset || 02
      condition ← (GPR [rs] = GPR [rt])
      T+1: if condition then
            PC ← PC + target
          else
            NullifyCurrentInstruction
          endif

```

Exceptions:

None

BGEZ Branch On Greater Than Or Equal To Zero BGEZ

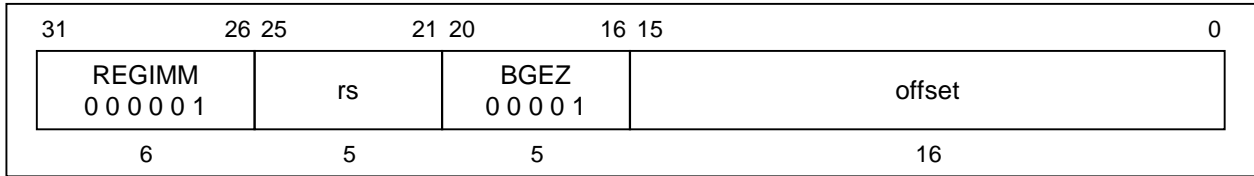
**Format:**

BGEZ rs, offset

Description:

A branch target address is computed from the sum of the address of the instruction in the delay slot and the 16-bit *offset*, shifted left two bits and sign-extended. If the contents of general register *rs* have the sign bit cleared, then the program branches to the target address, with a delay of one instruction.

Operation:

```

32  T:  target ← (offset15)14 || offset || 02
      condition ← (GPR [rs]31 = 0)
      T+1: if condition then
            PC ← PC + target
          endif

64  T:  target ← (offset15)46 || offset || 02
      condition ← (GPR [rs]63 = 0)
      T+1: if condition then
            PC ← PC + target
          endif

```

Exceptions:

None

BGEZALL Branch On Greater Than Or Equal To Zero And Link Likely BGEZALL

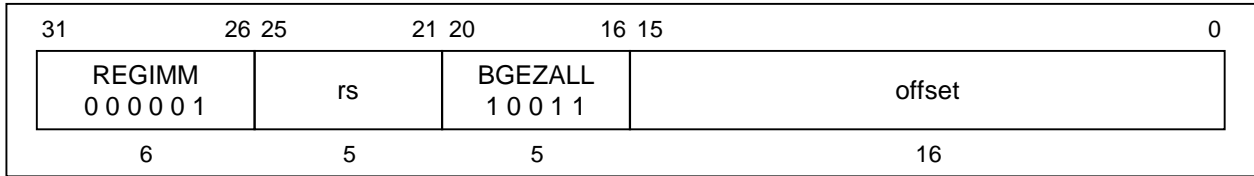
**Format:**

BGEZALL rs, offset

Description:

A branch target address is computed from the sum of the address of the instruction in the delay slot and the 16-bit *offset*, shifted left two bits and sign-extended. Unconditionally, the address of the instruction after the delay slot is placed in the link register, *r31*. If the contents of general register *rs* have the sign bit cleared, then the program branches to the target address, with a delay of one instruction. General register *rs* may not be general register *31*, because such an instruction is not restartable. An attempt to execute this instruction is not trapped, however. If the conditional branch is not taken, the instruction in the branch delay slot is nullified.

Operation:

```

32  T:  target ← (offset15)14 || offset || 02
      condition ← (GPR [rs]31 = 0)
      GPR [31] ← PC + 8
      T+1: if condition then
            PC ← PC + target
          else
            NullifyCurrentInstruction
          endif

64  T:  target ← (offset15)46 || offset || 02
      condition ← (GPR [rs]63 = 0)
      GPR [31] ← PC + 8
      T+1: if condition then
            PC ← PC + target
          else
            NullifyCurrentInstruction
          endif

```

Exceptions:

None

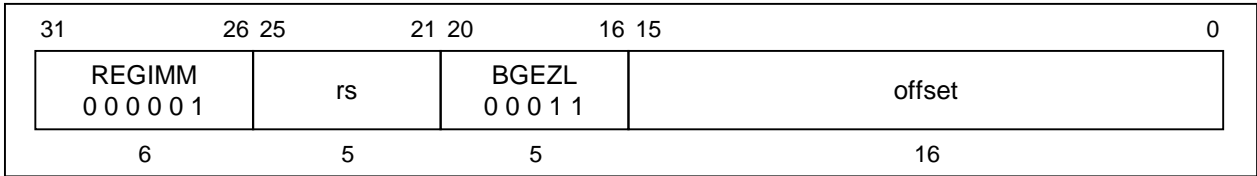
BGEZL Branch On Greater Than Or Equal To Zero Likely **BGEZL****Format:**

BGEZL rs, offset

Description:

A branch target address is computed from the sum of the address of the instruction in the delay slot and the 16-bit *offset*, shifted left two bits and sign-extended. If the contents of general register *rs* have the sign bit cleared, then the program branches to the target address, with a delay of one instruction. If the conditional branch is not taken, the instruction in the branch delay slot is nullified.

Operation:

```

32  T:  target ← (offset15)14 || offset || 02
      condition ← (GPR [rs]31 = 0)
      T+1: if condition then
            PC ← PC + target
          else
            NullifyCurrentInstruction
          endif

64  T:  target ← (offset15)46 || offset || 02
      condition ← (GPR [rs]63 = 0)
      T+1: if condition then
            PC ← PC + target
          else
            NullifyCurrentInstruction
          endif

```

Exceptions:

None

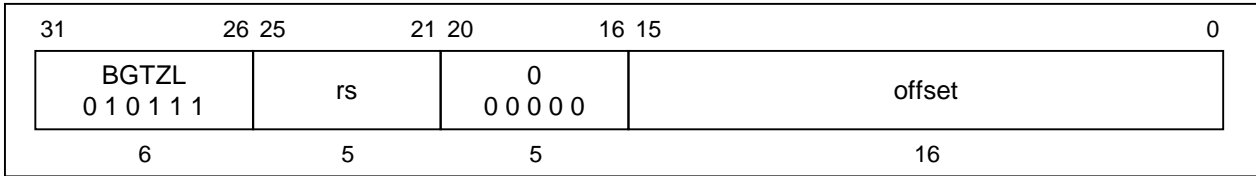
BGTZL**Branch On Greater Than Zero Likely****BGTZL****Format:**

BGTZL rs, offset

Description:

A branch target address is computed from the sum of the address of the instruction in the delay slot and the 16-bit *offset*, shifted left two bits and sign-extended. The contents of general register *rs* are compared to zero. If the contents of general register *rs* have the sign bit cleared and are not equal to zero, then the program branches to the target address, with a delay of one instruction. If the conditional branch is not taken, the instruction in the branch delay slot is nullified.

Operation:

```

32  T:  target ← (offset15)14 || offset || 02
      condition ← (GPR [rs]31 = 0) and (GPR [rs] ≠ 032)
      T+1: if condition then
            PC ← PC + target
          else
            NullifyCurrentInstruction
          endif

64  T:  target ← (offset15)46 || offset || 02
      condition ← (GPR [rs]63 = 0) and (GPR [rs] ≠ 064)
      T+1: if condition then
            PC ← PC + target
          else
            NullifyCurrentInstruction
          endif

```

Exceptions:

None

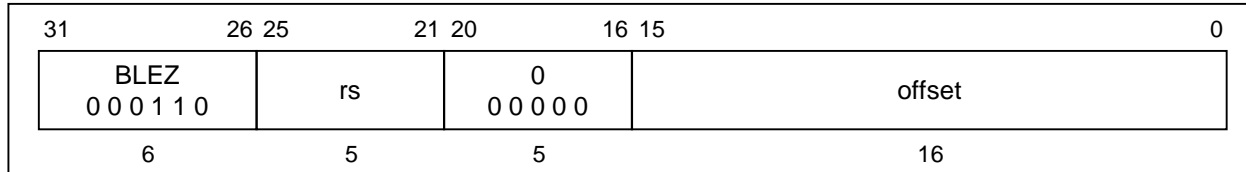
BLEZ**Branch On Less Than Or Equal To Zero****BLEZ****Format:**

BLEZ rs, offset

Description:

A branch target address is computed from the sum of the address of the instruction in the delay slot and the 16-bit *offset*, shifted left two bits and sign-extended. The contents of general register *rs* are compared to zero. If the contents of general register *rs* have the sign bit set, or are equal to zero, then the program branches to the target address, with a delay of one instruction.

Operation:

```

32  T:  target ← (offset15)14 || offset || 02
      condition ← (GPR [rs]31 = 1) or (GPR [rs] = 032)
      T+1: if condition then
            PC ← PC + target
            endif

64  T:  target ← (offset15)46 || offset || 02
      condition ← (GPR [rs]63 = 1) or (GPR [rs] = 064)
      T+1: if condition then
            PC ← PC + target
            endif

```

Exceptions:

None

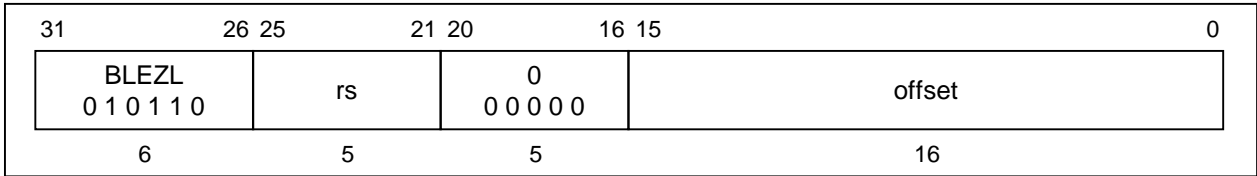
BLEZL Branch On Less Than Or Equal To Zero Likely **BLEZL****Format:**

BLEZL rs, offset

Description:

A branch target address is computed from the sum of the address of the instruction in the delay slot and the 16-bit *offset*, shifted left two bits and sign-extended. The contents of general register *rs* is compared to zero. If the contents of general register *rs* have the sign bit set, or are equal to zero, then the program branches to the target address, with a delay of one instruction.

If the conditional branch is not taken, the instruction in the branch delay slot is nullified.

Operation:

```

32  T:  target ← (offset15)14 || offset || 02
      condition ← (GPR [rs]31 = 1) or (GPR [rs] = 032)
      T+1: if condition then
            PC ← PC + target
          else
            NullifyCurrentInstruction
          endif

64  T:  target ← (offset15)46 || offset || 02
      condition ← (GPR [rs]63 = 1) or (GPR [rs] = 064)
      T+1: if condition then
            PC ← PC + target
          else
            NullifyCurrentInstruction
          endif

```

Exceptions:

None

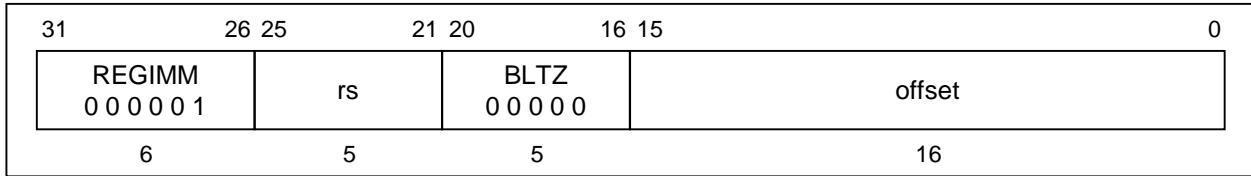
BLTZ**Branch On Less Than Zero****BLTZ****Format:**

BLTZ rs, offset

Description:

A branch target address is computed from the sum of the address of the instruction in the delay slot and the 16-bit *offset*, shifted left two bits and sign-extended. If the contents of general register *rs* have the sign bit set, then the program branches to the target address, with a delay of one instruction.

Operation:

```

32  T:  target ← (offset15)14 || offset || 02
      condition ← (GPR [rs]31 = 1)
      T+1: if condition then
            PC ← PC + target
          endif

64  T:  target ← (offset15)46 || offset || 02
      condition ← (GPR [rs]63 = 1)
      T+1: if condition then
            PC ← PC + target
          endif

```

Exceptions:

None

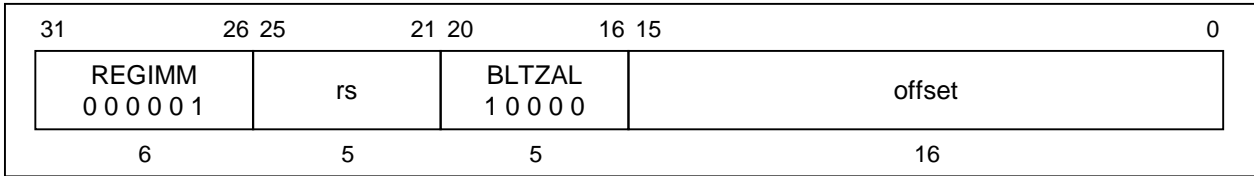
BLTZAL**Branch On Less Than Zero And Link****BLTZAL****Format:**BLTZAL *rs*, *offset***Description:**

A branch target address is computed from the sum of the address of the instruction in the delay slot and the 16-bit *offset*, shifted left two bits and sign-extended. Unconditionally, the address of the instruction after the delay slot is placed in the link register, *r31*. If the contents of general register *rs* have the sign bit set, then the program branches to the target address, with a delay of one instruction.

General register *rs* may not be general register 31, because such an instruction is not restartable. An attempt to execute this instruction with register 31 specified as *rs* is not trapped, however.

Operation:

```

32 T: target ← (offset15)14 || offset || 02
      condition ← (GPR [rs]31 = 1)
      GPR [31] ← PC + 8
      T+1: if condition then
            PC ← PC + target
          endif

64 T: target ← (offset15)46 || offset || 02
      condition ← (GPR [rs]63 = 1)
      GPR [31] ← PC + 8
      T+1: if condition then
            PC ← PC + target
          endif

```

Exceptions:

None

BLTZALL Branch On Less Than Zero And Link Likely BLTZALL

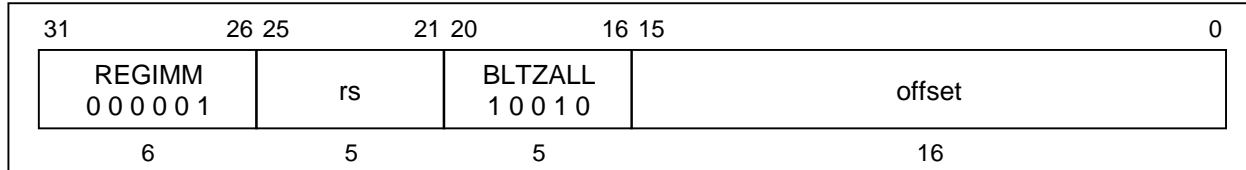
**Format:**

BLTZALL rs, offset

Description:

A branch target address is computed from the sum of the address of the instruction in the delay slot and the 16-bit *offset*, shifted left two bits and sign-extended. Unconditionally, the address of the instruction after the delay slot is placed in the link register, *r31*. If the contents of general register *rs* have the sign bit set, then the program branches to the target address, with a delay of one instruction.

General register *rs* may not be general register *31*, because such an instruction is not restartable. An attempt to execute this instruction with register *31* specified as *rs* is not trapped, however. If the conditional branch is not taken, the instruction in the branch delay slot is nullified.

Operation:

```

32  T:  target ← (offset15)14 || offset || 02
      condition ← (GPR [rs]31 = 1)
      GPR [31] ← PC + 8
      T+1: if condition then
            PC ← PC + target
          else
            NullifyCurrentInstruction
          endif

64  T:  target ← (offset15)46 || offset || 02
      condition ← (GPR [rs]63 = 1)
      GPR [31] ← PC + 8
      T+1: if condition then
            PC ← PC + target
          else
            NullifyCurrentInstruction
          endif

```

Exceptions:

None

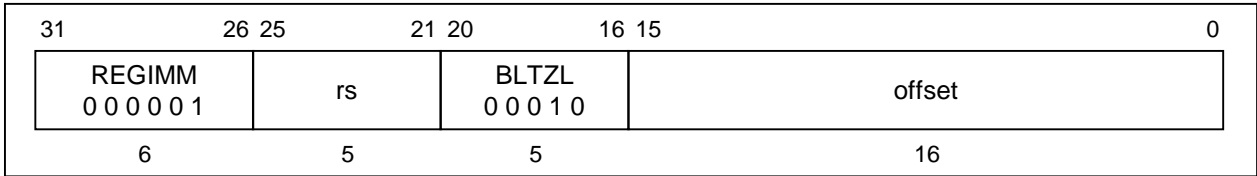
BLTZL**Branch On Less Than Zero Likely****BLTZL****Format:**

BLTZ rs, offset

Description:

A branch target address is computed from the sum of the address of the instruction in the delay slot and the 16-bit *offset*, shifted left two bits and sign-extended. If the contents of general register *rs* have the sign bit set, then the program branches to the target address, with a delay of one instruction. If the conditional branch is not taken, the instruction in the branch delay slot is nullified.

Operation:

```

32  T:  target ← (offset15)14 || offset || 02
      condition ← (GPR [rs]31 = 1)
      T+1: if condition then
            PC ← PC + target
          else
            NullifyCurrentInstruction
          endif

64  T:  target ← (offset15)46 || offset || 02
      condition ← (GPR [rs]63 = 1)
      T+1: if condition then
            PC ← PC + target
          else
            NullifyCurrentInstruction
          endif

```

Exceptions:

None

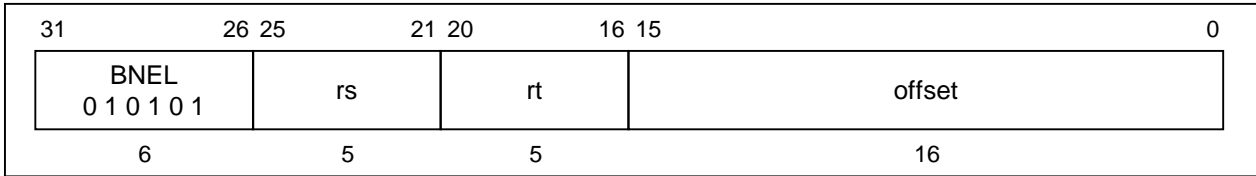
BNEL**Branch On Not Equal Likely****BNEL****Format:**

BNEL rs, rt, offset

Description:

A branch target address is computed from the sum of the address of the instruction in the delay slot and the 16-bit *offset*, shifted left two bits and sign-extended. The contents of general register *rs* and the contents of general register *rt* are compared. If the two registers are not equal, then the program branches to the target address, with a delay of one instruction.

If the conditional branch is not taken, the instruction in the branch delay slot is nullified.

Operation:

```

32  T:  target ← (offset15)14 || offset || 02
      condition ← (GPR [rs] ≠ GPR [rt])
      T+1: if condition then
            PC ← PC + target
          else
            NullifyCurrentInstruction
          endif

64  T:  target ← (offset15)46 || offset || 02
      condition ← (GPR [rs] ≠ GPR [rt])
      T+1: if condition then
            PC ← PC + target
          else
            NullifyCurrentInstruction
          endif

```

Exceptions:

None

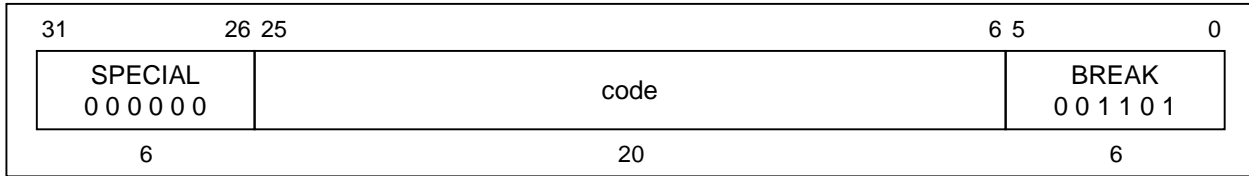
BREAK**Breakpoint****BREAK****Format:**

BREAK

Description:

A breakpoint trap occurs, immediately and unconditionally transferring control to the exception handler.

The code field is available for use as software parameters, but is retrieved by the exception handler only by loading the contents of the memory word containing the instruction.

Operation:

32, 64 T: BreakpointException

Exceptions:

Breakpoint exception

CACHE**Cache
(Continued)****CACHE**

Write back from a primary cache goes to memory. The address to be written is specified by the cache tag and not the translated physical address.

TLB Refill and TLB Invalid exceptions can occur on any operation. For Index operations (where the physical address is used to index the cache but need not match the cache tag) unmapped addresses may be used to avoid TLB exceptions. This operation never causes a TLB Modified exception.

Bits 17...16 of the instruction specify the cache as follows:

Code	Name	Cache
0	I	Instruction cache
1	D	Data cache
2	—	Reserved
3	—	Reserved

CACHE

Cache
(Continued)

CACHE

Bits 20...18 (this value is listed under the **Code** column) of the instruction specify the operation as follows:

Code	Cache	Name	Operation
0	I	Index_Invalidate	Set the cache state of the cache block to Invalid.
0	D	Index_Write_Back_Invalidate	Examine the cache state and W bit of the primary data cache block at the index specified by the virtual address. If the state is not Invalid and the W bit is set, then write back the block to memory. The address to write is taken from the primary cache tag. Set cache state of primary cache block to Invalid.
1	I, D	Index_Load_Tag	Read the tag for the cache block at the specified index and place it into the TagLo CP0 registers, ignoring parity errors. Also load the data parity bits into the ECC register.
2	I, D	Index_Store_Tag	Write the tag for the cache block at the specified index from the TagLo and TagHi CP0 registers.
3	D	Create_Dirty_Exclusive	This operation is used to avoid loading data needlessly from memory when writing new contents into an entire cache block. If the cache block does not contain the specified address, and the block is dirty, write it back to the memory. In all cases, set the cache state to Dirty.
4	I, D	Hit_Invalidate	If the cache block contains the specified address, mark the cache block invalid.
5	D	Hit_Write_Back_Invalidate	If the cache block contains the specified address, write back the data if it is dirty, and mark the cache block invalid.
5	I	Fill	Fill the primary instruction cache block from memory. If the CE bit of the Status register is set, the contents of the ECC register is used instead of the computed parity bits for addressed doubleword when written to the instruction cache.
6	D	Hit_Write_Back	If the cache block contains the specified address, and the W bit is set, write back the data to memory and clear the W bit.
6	I	Hit_Write_Back	If the cache block contains the specified address, write back the data unconditionally.

CACHE**Cache
(Continued)****CACHE****Operation:**

<p>32, 64 T: $vAddr \leftarrow ((offset_{15})^{48} offset_{15...0}) + GPR [base]$ $(pAddr, uncached) \leftarrow AddressTranslation (vAddr, DATA)$ CacheOp (op, vAddr, pAddr)</p>

Exceptions:

- Coprocessor unusable exception
- TLB Refill exception
- TLB Invalid exception
- Bus Error exception
- Address Error exception
- Cache Error exception

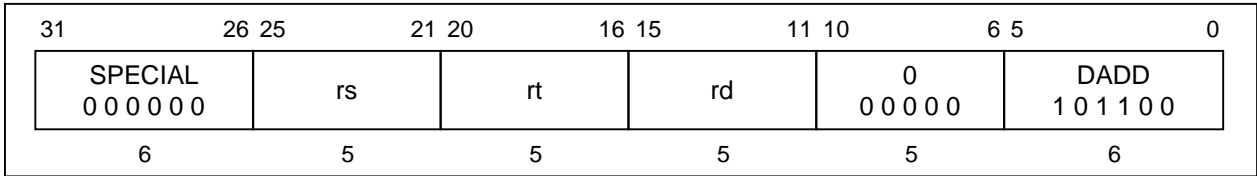
DADD**Doubleword Add****DADD****Format:**

DADD rd, rs, rt

Description:

The contents of general register *rs* and the contents of general register *rt* are added to form the result. The result is placed into general register *rd*.

An overflow exception occurs if the carries out of bits 62 and 63 differ (2's complement overflow). The destination register *rd* is not modified when an integer overflow exception occurs.

This operation is defined for the VR4111 operating in 64-bit mode or in 32-bit kernel mode. Execution of this instruction in 32-bit user or supervisor mode causes a reserved instruction exception.

Operation:

64 T: GPR [rd] ← GPR [rs] + GPR [rt]
--

Exceptions:

Integer overflow exception

Reserved instruction exception (VR4111 in 32-bit user mode, VR4111 in 32-bit supervisor mode)

DADDIU Doubleword Add Immediate Unsigned DADDIU

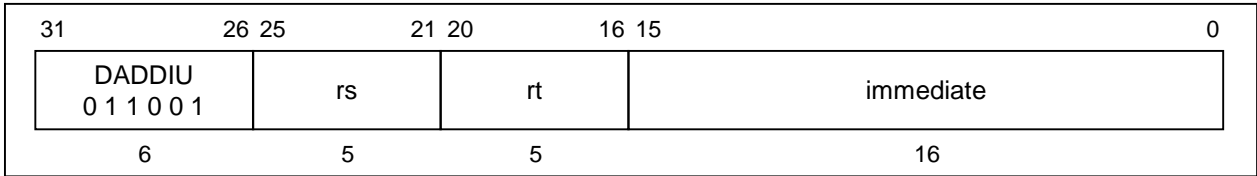
**Format:**

DADDIU *rt*, *rs*, *immediate*

Description:

The 16-bit *immediate* is sign-extended and added to the contents of general register *rs* to form the result. The result is placed into general register *rt*. No integer overflow exception occurs under any circumstances.

The only difference between this instruction and the DADDI instruction is that DADDIU never causes an overflow exception.

This operation is defined for the VR4111 operating in 64-bit mode or in 32-bit kernel mode. Execution of this instruction in 32-bit user or supervisor mode causes a reserved instruction exception.

Operation:

64	T:	$\text{GPR}[rt] \leftarrow \text{GPR}[rs] + (\text{immediate}_{15})^{48} \parallel \text{immediate}_{15..0}$
----	----	--

Exceptions:

Reserved instruction exception (VR4111 in 32-bit user mode, VR4111 in 32-bit supervisor mode)

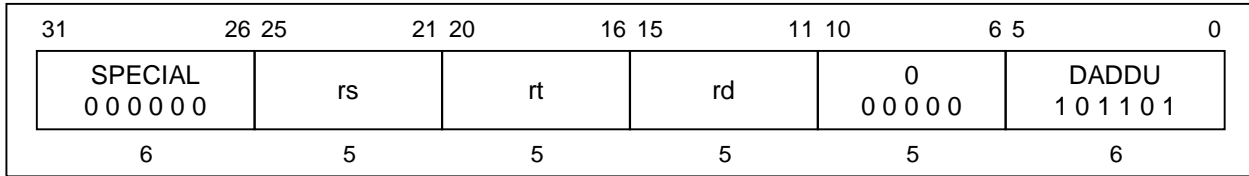
DADDU**Doubleword Add Unsigned****DADDU****Format:**

DADDU rd, rs, rt

Description:

The contents of general register *rs* and the contents of general register *rt* are added to form the result. The result is placed into general register *rd*.

No overflow exception occurs under any circumstances.

The only difference between this instruction and the DADD instruction is that DADDU never causes an overflow exception.

This operation is defined for the VR4111 operating in 64-bit mode or in 32-bit kernel mode. Execution of this instruction in 32-bit user or supervisor mode causes a reserved instruction exception.

Operation:

64 T: $\text{GPR}[\text{rd}] \leftarrow \text{GPR}[\text{rs}] + \text{GPR}[\text{rt}]$

Exceptions:

Reserved instruction exception (VR4111 in 32-bit user mode, VR4111 in 32-bit supervisor mode)

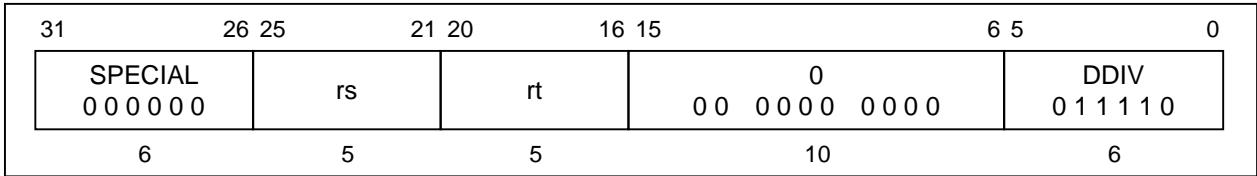
DDIV**Doubleword Divide****DDIV****Format:**

DDIV rs, rt

Description:

The contents of general register *rs* are divided by the contents of general register *rt*, treating both operands as 2's complement values. No overflow exception occurs under any circumstances, and the result of this operation is undefined when the divisor is zero.

This instruction is typically followed by additional instructions to check for a zero divisor and for overflow.

When the operation completes, the quotient word of the double result is loaded into special register *LO*, and the remainder word of the double result is loaded into special register *HI*.

If either of the two preceding instructions is MFHI or MFLO, the results of those instructions are undefined. Correct operation requires separating reads of *HI* or *LO* from writes by two or more instructions.

This operation is defined for the Vr4111 operating in 64-bit mode or in 32-bit kernel mode. Execution of this instruction in 32-bit user or supervisor mode causes a reserved instruction exception.

Operation:

64	T-2:	LO	← undefined
		HI	← undefined
	T-1:	LO	← undefined
		HI	← undefined
	T:	LO	← GPR [rs] div GPR [rt]
		HI	← GPR [rs] mod GPR [rt]

Exceptions:

Reserved instruction exception (Vr4111 in 32-bit user mode, Vr4111 in 32-bit supervisor mode)

DDIVU Doubleword Divide Unsigned DDIVU

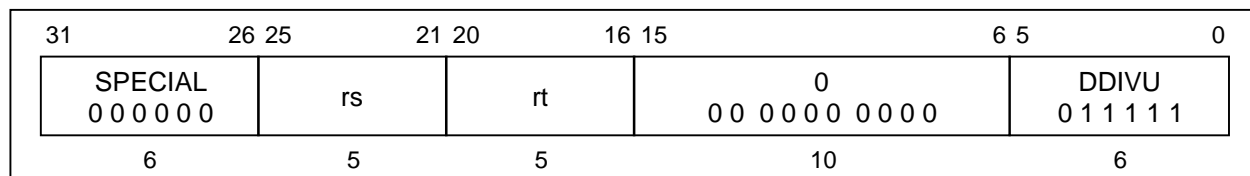
**Format:**

DDIVU rs, rt

Description:

The contents of general register *rs* are divided by the contents of general register *rt*, treating both operands as unsigned values. No integer overflow exception occurs under any circumstances, and the result of this operation is undefined when the divisor is zero.

This instruction may be followed by additional instructions to check for a zero divisor, inserted by the programmer.

When the operation completes, the quotient word of the double result is loaded into special register *LO*, and the remainder word of the double result is loaded into special register *HI*.

If either of the two preceding instructions is MFHI or MFLO, the results of those instructions are undefined. Correct operation requires separating reads of *HI* or *LO* from writes by two or more instructions.

This operation is defined for the VR4111 operating in 64-bit mode or in 32-bit kernel mode. Execution of this instruction in 32-bit user or supervisor mode causes a reserved instruction exception.

Operation:

64	T-2:	LO	← undefined
		HI	← undefined
	T-1:	LO	← undefined
		HI	← undefined
	T:	LO	← (0 GPR [rs]) div (0 GPR [rt])
		HI	← (0 GPR [rs]) mod (0 GPR [rt])

Exceptions:

Reserved instruction exception (VR4111 in 32-bit user mode, VR4111 in 32-bit supervisor mode)

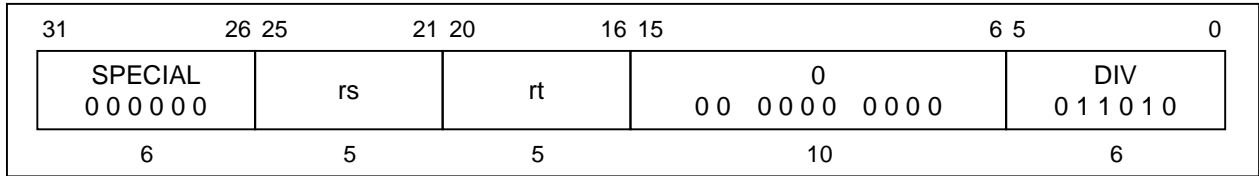
DIV**Divide****DIV****Format:**

DIV rs, rt

Description:

The contents of general register *rs* are divided by the contents of general register *rt*, treating both operands as 2's complement values. No overflow exception occurs under any circumstances, and the result of this operation is undefined when the divisor is zero.

In 64-bit mode, the operands must be valid sign-extended, 32-bit values.

This instruction is typically followed by additional instructions to check for a zero divisor and for overflow.

When the operation completes, the quotient word of the double result is loaded into special register *LO*, and the remainder word of the double result is loaded into special register *HI*.

If either of the two preceding instructions is MFHI or MFLO, the results of those instructions are undefined. Correct operation requires separating reads of *HI* or *LO* from writes by two or more instructions.

Operation:

32	T-2:	LO	← undefined		
		HI	← undefined		
	T-1:	LO	← undefined		
		HI	← undefined		
	T:	LO	← GPR [rs] div GPR [rt]		
		HI	← GPR [rs] mod GPR [rt]		
64	T-2:	LO	← undefined		
		HI	← undefined		
	T-1:	LO	← undefined		
		HI	← undefined		
	T:	q	← GPR [rs] _{31..0} div GPR [rt] _{31..0}		
		r	← GPR [rs] _{31..0} mod GPR [rt] _{31..0}		
		LO	← (q ₃₁) ³² q _{31..0}		
		HI	← (r ₃₁) ³² r _{31..0}		

Exceptions:

None

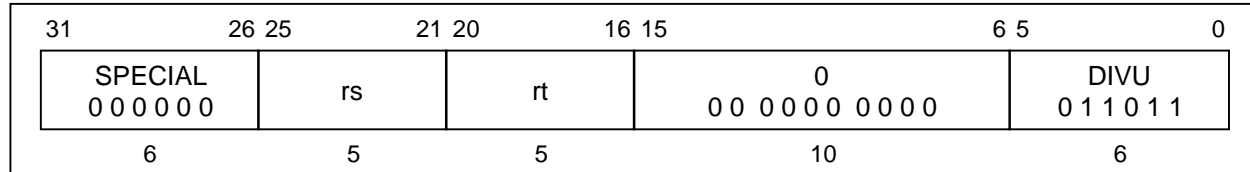
DIVU**Divide Unsigned****DIVU****Format:**

DIVU rs, rt

Description:

The contents of general register *rs* are divided by the contents of general register *rt*, treating both operands as unsigned values. No integer overflow exception occurs under any circumstances, and the result of this operation is undefined when the divisor is zero.

In 64-bit mode, the operands must be valid sign-extended, 32-bit values.

This instruction is typically followed by additional instructions to check for a zero divisor.

When the operation completes, the quotient word of the double result is loaded into special register *LO*, and the remainder word of the double result is loaded into special register *HI*.

If either of the two preceding instructions is MFHI or MFLO, the results of those instructions are undefined. Correct operation requires separating reads of *HI* or *LO* from writes by two or more instructions.

Operation:

32	T-2:	LO	←	undefined
		HI	←	undefined
	T-1:	LO	←	undefined
		HI	←	undefined
	T:	LO	←	(0 GPR [rs]) div (0 GPR [rt])
		HI	←	0 GPR [rs] mod (0 GPR [rt])
64	T-2:	LO	←	undefined
		HI	←	undefined
	T-1:	LO	←	undefined
		HI	←	undefined
	T:	q	←	(0 GPR [rs] _{31..0}) div (0 GPR [rt] _{31..0})
		r	←	(0 GPR [rs] _{31..0}) mod (0 GPR [rt] _{31..0})
		LO	←	(q ₃₁) ³² q _{31..0}
		HI	←	(r ₃₁) ³² r _{31..0}

Exceptions:

None

DMADD16 Doubleword Multiply and Add 16-bit integer DMADD16

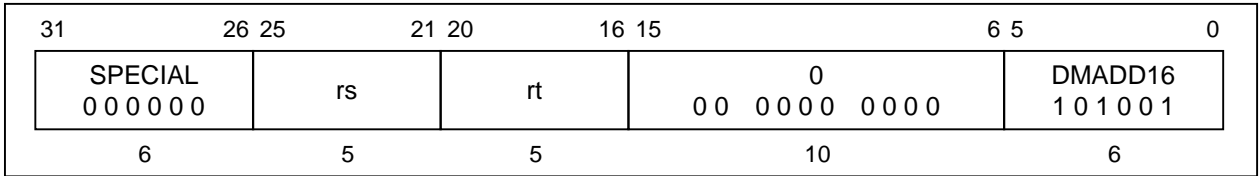

Format:

DMADD16 *rs*, *rt*

Description:

The contents of general registers *rs* and *rt* are multiplied, treating both operands as 16-bit 2's complement values. The operand[62:15] must be valid 15-bit, sign-extended values. If not, the result is unpredictable.

This multiplied result and the 64-bit data joined of special register *LO* is added to form the result as a signed integer. When the operation completes, the doubleword result is loaded into special register *LO*.

No integer overflow exception occurs under any circumstances.

This operation is defined for the V_R4111 operating in 64-bit mode or in 32-bit kernel mode. Execution of this instruction in 32-bit user or supervisor mode causes a reserved instruction exception.

The following table shows hazard cycles between DMADD16 and other instructions.

Instruction sequence	No. of cycles
MULT/MULTU → DMADD16	1 Cycle
DMULT/DMULTU → DMADD16	4 Cycles
DIV/DIVU → DMADD16	36 Cycles
DDIV/DDIVU → DMADD16	68 Cycles
MFHI/MFLO → DMADD16	2 Cycles
MADD16 → DMADD16	0 Cycles
DMADD16 → DMADD16	0 Cycles

DMADD16 Doubleword Multiply and Add 16-bit integer DMADD16 (Continued)

Operation:

64	T-2:	LO	← undefined
		HI	← undefined
	T-1:	LO	← undefined
		HI	← undefined
	T:	temp	← GPR [rs] * GPR [rt]
		temp	← temp + LO
		LO	← temp
		HI	← undefined

Exceptions:

Reserved instruction exception (V_{R4111} in 32-bit user mode, V_{R4111} in 32-bit supervisor mode)

DMFC0 Doubleword Move From System Control Coprocessor DMFC0

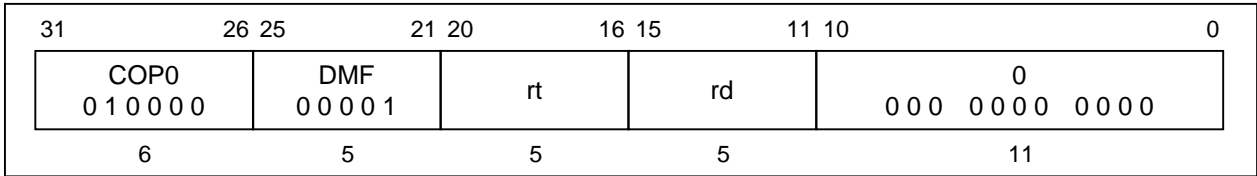

Format:

DMFC0 *rt*, *rd*

Description:

The contents of coprocessor register *rd* of the CP0 are loaded into general register *rt*.

This operation is defined for the VR4111 operating in 64-bit mode or in 32-bit kernel mode. Execution of this instruction in 32-bit user or supervisor mode causes a reserved instruction exception. All 64-bits of the general register destination are written from the coprocessor register source. The operation of DMFC0 on a 32-bit coprocessor 0 register is undefined.

Operation:

64 T: data ← CPR [0, <i>rd</i>] T+1: GPR [<i>rt</i>] ← data

Exceptions:

Coprocessor unusable exception (user mode and supervisor mode if CP0 not enabled)
 Reserved instruction exception (VR4111 in 32-bit user mode, VR4111 in 32-bit supervisor mode)

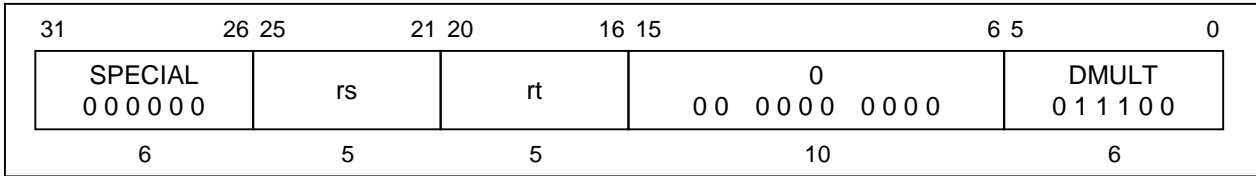
DMULT**Doubleword Multiply****DMULT****Format:**

DMULT rs, rt

Description:

The contents of general registers *rs* and *rt* are multiplied, treating both operands as 2's complement values. No integer overflow exception occurs under any circumstances.

When the operation completes, the low-order word of the double result is loaded into special register *LO*, and the high-order word of the double result is loaded into special register *HI*.

If either of the two preceding instructions is MFHI or MFLO, the results of these instructions are undefined. Correct operation requires separating reads of *HI* or *LO* from writes by a minimum of two other instructions.

This operation is defined for the VR4111 operating in 64-bit mode or in 32-bit kernel mode. Execution of this instruction in 32-bit user or supervisor mode causes a reserved instruction exception.

Operation:

64	T-2:	LO	← undefined
		HI	← undefined
	T-1:	LO	← undefined
		HI	← undefined
	T:	t	← GPR [rs] * GPR [rt]
		LO	← t63..0
		HI	← t127..64

Exceptions:

Reserved instruction exception (VR4111 in 32-bit user mode, VR4111 in 32-bit supervisor mode)

DMULTU Doubleword Multiply Unsigned DMULTU

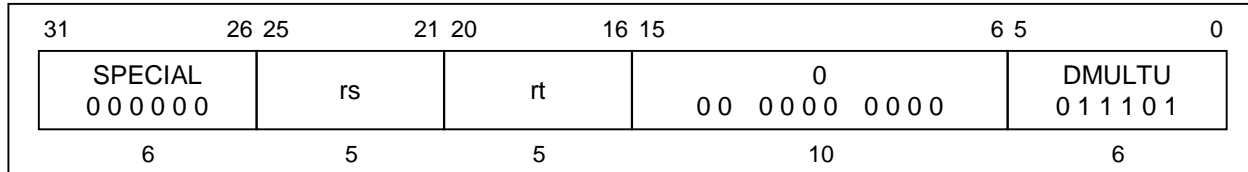
**Format:**DMULTU *rs*, *rt***Description:**

The contents of general register *rs* and the contents of general register *rt* are multiplied, treating both operands as unsigned values. No overflow exception occurs under any circumstances.

When the operation completes, the low-order word of the double result is loaded into special register *LO*, and the high-order word of the double result is loaded into special register *HI*.

If either of the two preceding instructions is MFHI or MFLO, the results of these instructions are undefined. Correct operation requires separating reads of *HI* or *LO* from writes by a minimum of two instructions.

This operation is defined for the VR4111 operating in 64-bit mode or in 32-bit kernel mode. Execution of this instruction in 32-bit user or supervisor mode causes a reserved instruction exception.

Operation:

64	T-2:	LO	← undefined
		HI	← undefined
	T-1:	LO	← undefined
		HI	← undefined
	T:	t	← (0 GPR [<i>rs</i>]) * (0 GPR [<i>rt</i>])
		LO	← t _{63..0}
		HI	← t _{127..64}

Exceptions:

Reserved instruction exception (VR4111 in 32-bit user mode, VR4111 in 32-bit supervisor mode)

DSLL

Doubleword Shift Left Logical

DSLL

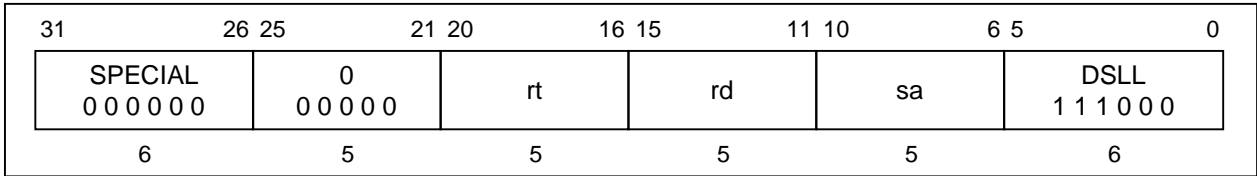

Format:

DSLL rd, rt, sa

Description:

The contents of general register *rt* are shifted left by *sa* bits, inserting zeros into the low-order bits. The result is placed in register *rd*.

This operation is defined for the VR4111 operating in 64-bit mode or in 32-bit kernel mode. Execution of this instruction in 32-bit user or supervisor mode causes a reserved instruction exception.

Operation:



Exceptions:

Reserved instruction exception (VR4111 in 32-bit user mode, VR4111 in 32-bit supervisor mode)

DSLLV Doubleword Shift Left Logical Variable DSLLV

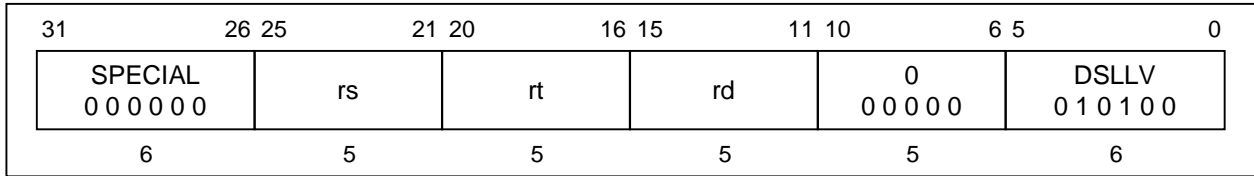
**Format:**

DSLLV rd, rt, rs

Description:

The contents of general register *rt* are shifted left by the number of bits specified by the low-order six bits contained in general register *rs*, inserting zeros into the low-order bits. The result is placed in register *rd*.

This operation is defined for the VR4111 operating in 64-bit mode or in 32-bit kernel mode. Execution of this instruction in 32-bit user or supervisor mode causes a reserved instruction exception.

Operation:

64 T: $s \leftarrow \text{GPR}[rs]_{5..0}$
 $\text{GPR}[rd] \leftarrow \text{GPR}[rt]_{(63-s)..0} \parallel 0^s$

Exceptions:

Reserved instruction exception (VR4111 in 32-bit user mode, VR4111 in 32-bit supervisor mode)

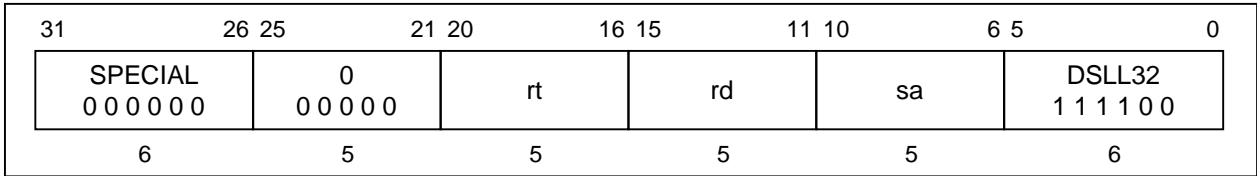
DSLL32**Doubleword Shift Left Logical + 32****DSLL32****Format:**

DSLL32 rd, rt, sa

Description:

The contents of general register *rt* are shifted left by $32 + sa$ bits, inserting zeros into the low-order bits. The result is placed in register *rd*.

This operation is defined for the VR4111 operating in 64-bit mode or in 32-bit kernel mode. Execution of this instruction in 32-bit user or supervisor mode causes a reserved instruction exception.

Operation:

64 T: $s \leftarrow 1 \parallel sa$
 $GPR [rd] \leftarrow GPR [rt]_{(63-s)..0} \parallel 0^s$

Exceptions:

Reserved instruction exception (VR4111 in 32-bit user mode, VR4111 in 32-bit supervisor mode)

DSRA Doubleword Shift Right Arithmetic DSRA

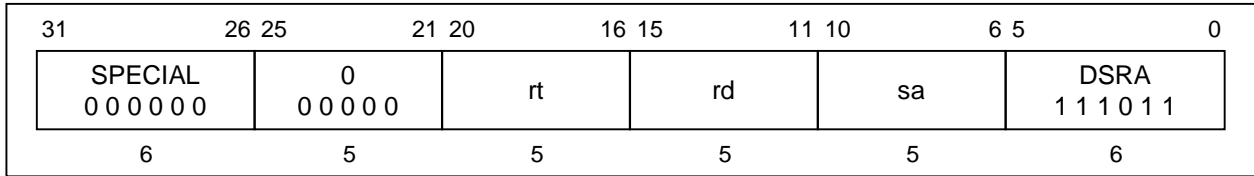
**Format:**

DSRA rd, rt, sa

Description:

The contents of general register *rt* are shifted right by *sa* bits, sign-extending the high-order bits. The result is placed in register *rd*.

This operation is defined for the VR4111 operating in 64-bit mode or in 32-bit kernel mode. Execution of this instruction in 32-bit user or supervisor mode causes a reserved instruction exception.

Operation:

64 T: $s \leftarrow 0 \parallel sa$
 $GPR [rd] \leftarrow (GPR [rt]_{63})^s \parallel GPR [rt]_{63..s}$

Exceptions:

Reserved instruction exception (VR4111 in 32-bit user mode, VR4111 in 32-bit supervisor mode)

DSRAV Doubleword Shift Right Arithmetic Variable DSRAV

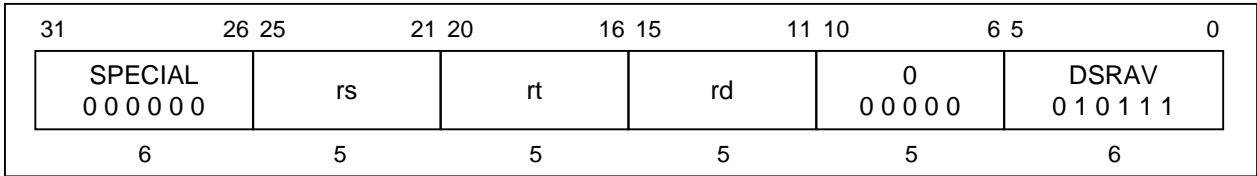
**Format:**

DSRAV rd, rt, rs

Description:

The contents of general register *rt* are shifted right by the number of bits specified by the low-order six bits of general register *rs*, sign-extending the high-order bits. The result is placed in register *rd*.

This operation is defined for the VR4111 operating in 64-bit mode or in 32-bit kernel mode. Execution of this instruction in 32-bit user or supervisor mode causes a reserved instruction exception.

Operation:

64 T: $s \leftarrow \text{GPR}[rs]_{5..0}$
 $\text{GPR}[rd] \leftarrow (\text{GPR}[rt]_{63})^s \parallel \text{GPR}[rt]_{63..s}$

Exceptions:

Reserved instruction exception (VR4111 in 32-bit user mode, VR4111 in 32-bit supervisor mode)

DSRA32 Doubleword Shift Right Arithmetic + 32 DSRA32

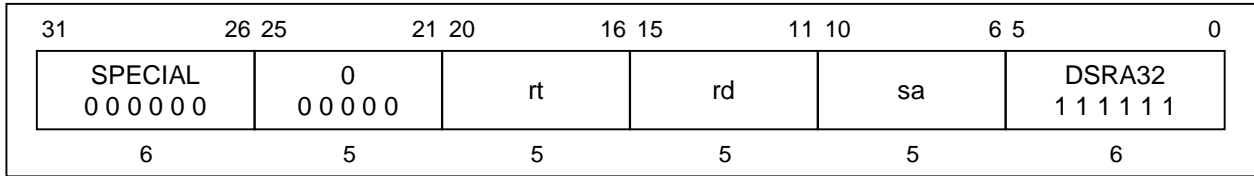
**Format:**

DSRA32 rd, rt, sa

Description:

The contents of general register *rt* are shifted right by $32 + sa$ bits, sign-extending the high-order bits. The result is placed in register *rd*.

This operation is defined for the VR4111 operating in 64-bit mode or in 32-bit kernel mode. Execution of this instruction in 32-bit user or supervisor mode causes a reserved instruction exception.

Operation:

64 T: $s \leftarrow 1 \parallel sa$
 $GPR [rd] \leftarrow (GPR [rt]_{63})^s \parallel GPR [rt]_{63..s}$

Exceptions:

Reserved instruction exception (VR4111 in 32-bit user mode, VR4111 in 32-bit supervisor mode)

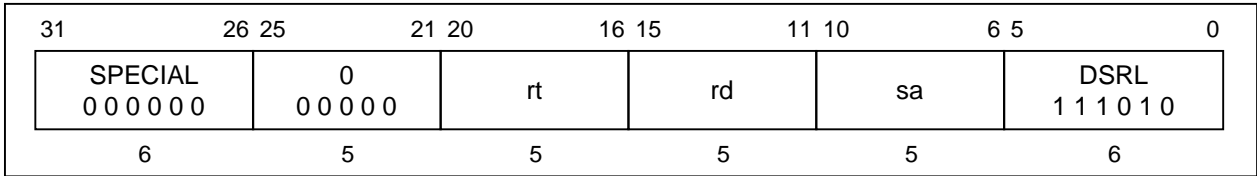
DSRL**Doubleword Shift Right Logical****DSRL****Format:**

DSRL rd, rt, sa

Description:

The contents of general register *rt* are shifted right by *sa* bits, inserting zeros into the high-order bits. The result is placed in register *rd*.

This operation is defined for the VR4111 operating in 64-bit mode or in 32-bit kernel mode. Execution of this instruction in 32-bit user or supervisor mode causes a reserved instruction exception.

Operation:

64 T: $s \leftarrow 0 \parallel sa$
 $GPR [rd] \leftarrow 0^s \parallel GPR [rt]_{63..s}$

Exceptions:

Reserved instruction exception (VR4111 in 32-bit user mode, VR4111 in 32-bit supervisor mode)

DSRLV Doubleword Shift Right Logical Variable DSRLV

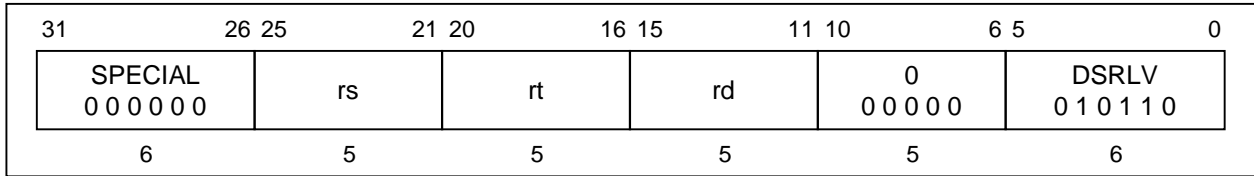
**Format:**

DSRLV rd, rt, rs

Description:

The contents of general register *rt* are shifted right by the number of bits specified by the low-order six bits of general register *rs*, inserting zeros into the high-order bits. The result is placed in register *rd*.

This operation is defined for the VR4111 operating in 64-bit mode or in 32-bit kernel mode. Execution of this instruction in 32-bit user or supervisor mode causes a reserved instruction exception.

Operation:

64 T: $s \leftarrow \text{GPR}[rs]_{5..0}$
 $\text{GPR}[rd] \leftarrow 0^s \parallel \text{GPR}[rt]_{63..s}$

Exceptions:

Reserved instruction exception (VR4111 in 32-bit user mode, VR4111 in 32-bit supervisor mode)

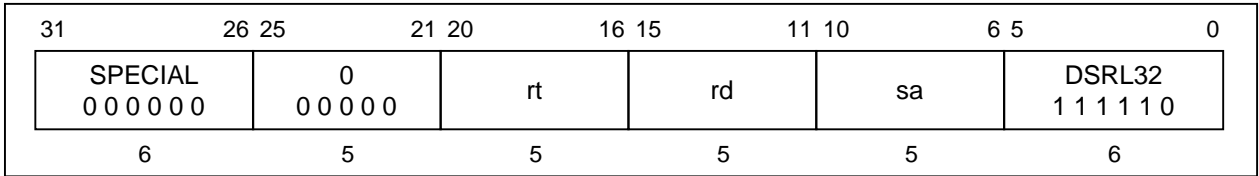
DSRL32**Doubleword Shift Right Logical + 32****DSRL32****Format:**

DSRL32 rd, rt, sa

Description:

The contents of general register *rt* are shifted right by $32 + sa$ bits, inserting zeros into the high-order bits. The result is placed in register *rd*.

This operation is defined for the VR4111 operating in 64-bit mode or in 32-bit kernel mode. Execution of this instruction in 32-bit user or supervisor mode causes a reserved instruction exception.

Operation:

64 T: $s \leftarrow 1 \parallel sa$
 $GPR [rd] \leftarrow 0^s \parallel GPR [rt]_{63..s}$

Exceptions:

Reserved instruction exception (VR4111 in 32-bit user mode, VR4111 in 32-bit supervisor mode)

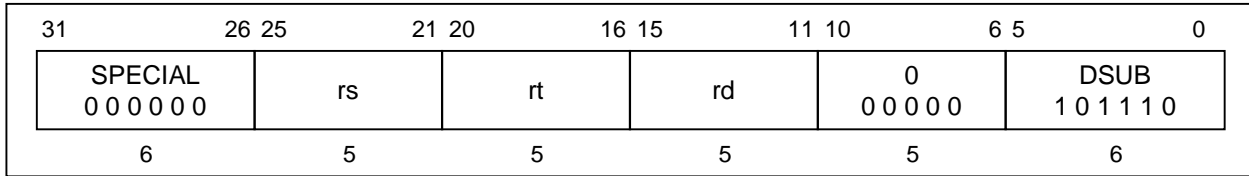
DSUB**Doubleword Subtract****DSUB****Format:**

DSUB rd, rs, rt

Description:

The contents of general register *rt* are subtracted from the contents of general register *rs* to form a result. The result is placed into general register *rd*.

The only difference between this instruction and the DSUBU instruction is that DSUBU never traps on overflow.

An integer overflow exception takes place if the carries out of bits 62 and 63 differ (2's complement overflow). The destination register *rd* is not modified when an integer overflow exception occurs.

This operation is defined for the VR4111 operating in 64-bit mode or in 32-bit kernel mode. Execution of this instruction in 32-bit user or supervisor mode causes a reserved instruction exception.

Operation:

64	T:	$GPR [rd] \leftarrow GPR [rs] - GPR [rt]$
----	----	---

Exceptions:

Integer overflow exception

Reserved instruction exception (VR4111 in 32-bit user mode, VR4111 in 32-bit supervisor mode)

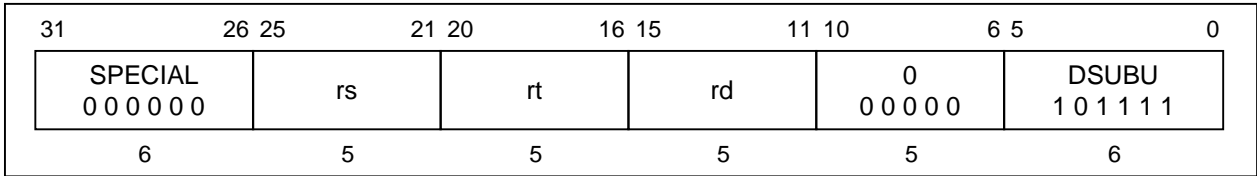
DSUBU**Doubleword Subtract Unsigned****DSUBU****Format:**

DSUBU rd, rs, rt

Description:

The contents of general register *rt* are subtracted from the contents of general register *rs* to form a result. The result is placed into general register *rd*.

The only difference between this instruction and the DSUB instruction is that DSUBU never traps on overflow. No integer overflow exception occurs under any circumstances.

This operation is defined for the VR4111 operating in 64-bit mode or in 32-bit kernel mode. Execution of this instruction in 32-bit user or supervisor mode causes a reserved instruction exception.

Operation:

64 T: $GPR[rd] \leftarrow GPR[rs] - GPR[rt]$

Exceptions:

Reserved instruction exception (VR4111 in 32-bit user mode, VR4111 in 32-bit supervisor mode)

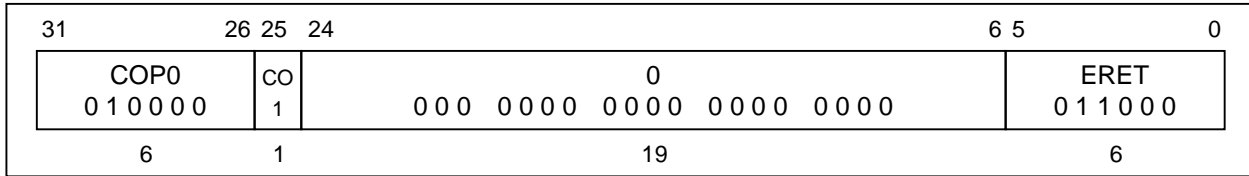
ERET**Exception Return****ERET****Format:**

ERET

Description:

ERET is the V_{R4111} instruction for returning from an interrupt, exception, or error trap. Unlike a branch or jump instruction, ERET does not execute the next instruction.

ERET must not itself be placed in a branch delay slot.

If the processor is servicing an error trap ($SR_2 = 1$), then load the PC from the ErrorEPC register and clear the *ERL* bit of the Status register (SR_2). Otherwise ($SR_2 = 0$), load the PC from the EPC register, and clear the *EXL* bit of the Status register ($SR_1 = 0$).

- ★ When a MIPS16 instruction can be executed, the value of clearing the least significant bit of the EPC or error EPC register to 0 is loaded to PC. This means the content of the least significant bit is reflected on the ISA mode bit (internal).

★ Operation:

```

32, 64 T: if  $SR_2 = 1$  then
    if MIPS16EN = 1 then
        PC ← ErrorEPC63..1 || 0
        ISA MODE ← ErrorEPC0
    else
        PC ← ErrorEPC
    endif
    SR ←  $SR_{31..3}$  || 0 ||  $SR_{1..0}$ 
else
    if MIPS16EN = 1 then
        PC ← EPC63..1 || 0
        ISA MODE ← EPC0
    else
        PC ← EPC
    endif
    SR ←  $SR_{31..2}$  || 0 ||  $SR_0$ 
endif

```

Exceptions:

Coprocessor unusable exception

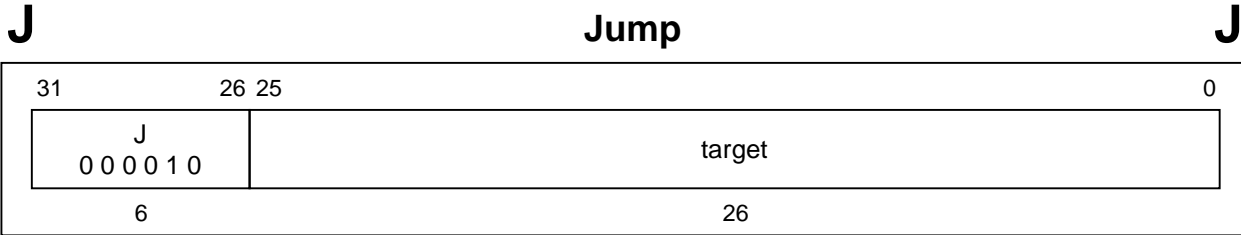
**Format:**

J target

Description:

The 26-bit target address is shifted left two bits and combined with the high-order four bits of the address of the delay slot. The program unconditionally jumps to this calculated address with a delay of one instruction.

Operation:

32	T: temp ← target T+1: PC ← PC _{31..28} temp 0 ²
64	T: temp ← target T+1: PC ← PC _{63..28} temp 0 ²

Exceptions:

None

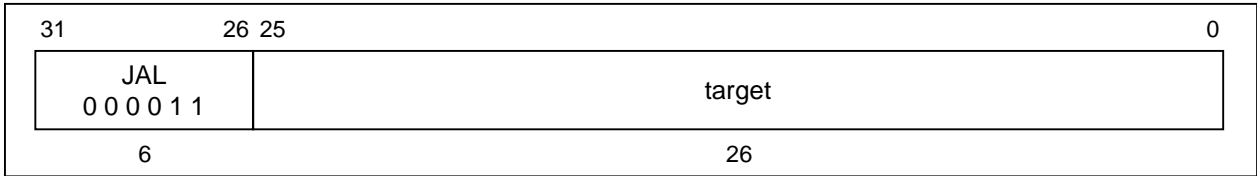
JAL**Jump And Link****JAL****Format:**

JAL target

Description:

The 26-bit target address is shifted left two bits and combined with the high-order four bits of the address of the delay slot. The program unconditionally jumps to this calculated address with a delay of one instruction. The address of the instruction after the delay slot is placed in the link register, *r31*. The address of the instruction immediately after a delay slot is placed in the link register (*r31*). When a MIPS16 instruction can be executed, the value of bit 0 of *r31* indicates the ISA mode bit before jump.

★

★ **Operation:**

32	T:	temp ← target If MIPS16En = 1 then GPR[31] ← (PC+8) _{31..1} ISA MODE else GPR[31] ← PC+8 endif T+1: PC ← PC _{31..28} temp 0 ²
64	T:	temp ← target If MIPS16En = 1 then GPR[31] ← (PC+8) _{63..1} ISA MODE else GPR[31] ← PC+8 endif T+1: PC ← PC _{63..28} temp 0 ²

Exceptions:

None

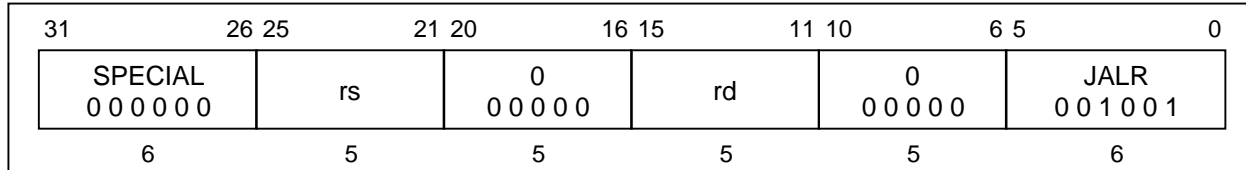
JALR**Jump And Link Register****JALR****Format:**

JALR rs
JALR rd, rs

Description:

- ★ The program unconditionally jumps to the address contained in general register *rs*, with a delay of one instruction. When a MIPS16 instruction can be executed, the program unconditionally jumps with a delay of one instruction to the address indicated by the value of clearing the least significant bit of the general-purpose register *rs* to 0. Then, the content of the least significant bit of the general-purpose register *rs* is set to the ISA mode bit (internal).
 - ★ The address of the instruction after the delay slot is placed in general register *rd*. The default value of *rd*, if omitted in the assembly language instruction, is 31. When a MIPS16 instruction can be executed, the value of bit 0 of *rd* indicates the ISA mode bit before jump.
- Register specifiers *rs* and *rd* may not be equal, because such an instruction does not have the same effect when re-executed. Because storing a link address destroys the contents of *rs* if they are equal. However, an attempt to execute this instruction is *not* trapped, and the result of executing such an instruction is undefined.
- Since 32-bit length instructions must be word-aligned, a **Jump and Link Register (JALR)** instruction must specify a target register (*rs*) that contains an address whose two low-order bits are zero when a MIPS16 instruction can be executed. If these low-order bits are not zero, an address error exception will occur when the jump target instruction is subsequently fetched.

★ Operation:

```

32, 64 T:   temp ← GPR [rs]
           If MIPS16EN = 1 then
               GPR [rd] ← (PC + 8)63..1 || ISA MODE
           else
               GPR [rd] ← PC + 8
           endif
T+1:   If MIPS16EN = 1 then
           PC ← temp63..1 || 0
           ISA MODE ← temp0
       else
           PC ← temp
       endif

```

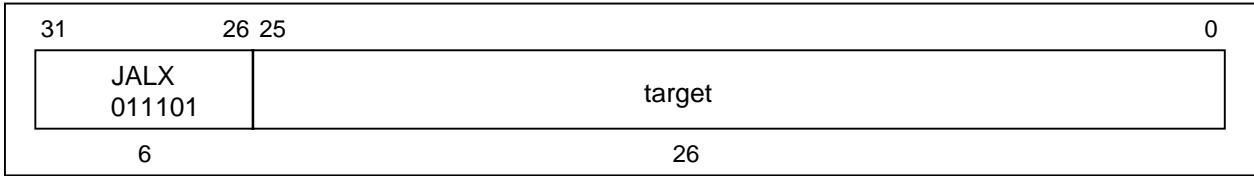
JALX**Jump And Link Exchange****JALX****Format:**

JALX target

Description:

- ★ When a MIPS16 instruction can be executed, a 26-bit target is shifted to left by 2 bits and then added to higher 4 bits of the delay slot's address to make a target address. The program unconditionally jumps to the target address with a delay of one instruction. The address of the instruction that follows the delay slot is stored to the link register (r31). The ISA mode bit is inverted with a delay of one instruction. The value of bit 0 of the link register (r31) indicates the ISA mode bit before jump.

★ Operation:

32	T:	temp ← target
		GPR [31] ← (PC + 8) _{31..1} ISA MODE
	T+1:	PC ← PC _{31..28} temp 0 ²
		ISA MODE toggle
64	T:	temp ← target
		GPR [31] ← (PC + 8) _{63..1} ISA MODE
	T+1:	PC ← PC _{63..28} temp 0 ²
		ISA MODE toggle

Exceptions:

Reserved instruction exception (when MIPS16 instruction execution disabled)

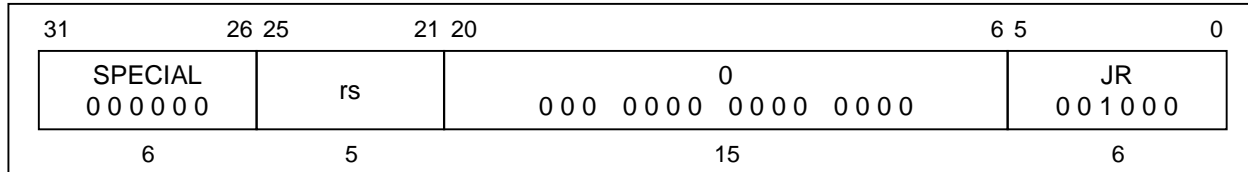
JR**Jump Register****JR****Format:**JR *rs***Description:**

The program unconditionally jumps to the address contained in general register *rs*, with a delay of one instruction.

- ★ When a MIPS16 instruction can be executed, the program unconditionally jumps with a delay of one instruction to the address indicated by the value of clearing the least significant bit of the general-purpose register *rs* to 0. Then, the content of the least significant bit of the general-purpose register *rs* is set to the ISA mode bit (internal).

Since 32-bit length instructions must be word-aligned, a **Jump Register (JR)** instruction must specify a target register (*rs*) that contains an address whose two low-order bits are zero when a MIPS16 instruction can be executed. If these low-order bits are not zero, an address error exception will occur when the jump target instruction is subsequently fetched.

★ Operation:

```

32, 64 T:   temp ← GPR [rs]
        T+1: If MIPS16EN = 1 then
                PC ← temp63..1 || 0
                ISA MODE ← temp0
        else
                PC ← temp
        endif

```

Exceptions:

None

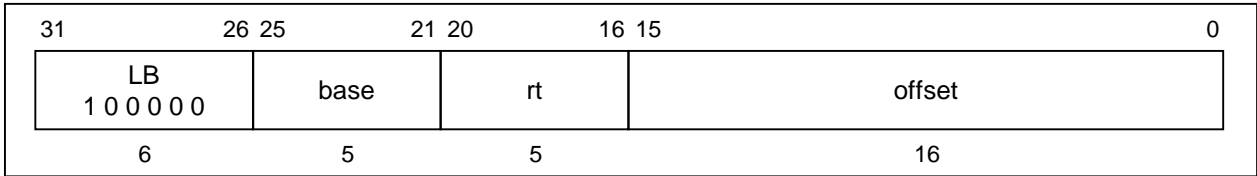
LB**Load Byte****LB****Format:**LB *rt*, *offset* (*base*)**Description:**

The 16-bit *offset* is sign-extended and added to the contents of general register *base* to form a virtual address. The contents of the byte at the memory location specified by the effective address are sign-extended and loaded into general register *rt*.

Operation:

32	T:	$vAddr \leftarrow ((offset_{15})^{16} \parallel offset_{15..0}) + GPR [base]$ $(pAddr, uncached) \leftarrow AddressTranslation (vAddr, DATA)$ $pAddr \leftarrow pAddr_{PSIZE - 1..3} \parallel (pAddr_{2..0} \text{ xor } ReverseEndian^3)$ $mem \leftarrow LoadMemory (uncached, BYTE, pAddr, vAddr, DATA)$ $byte \leftarrow vAddr_{2..0} \text{ xor } BigEndianCPU^3$ $GPR [rt] \leftarrow (mem_{7 + 8 * byte})^{24} \parallel mem_{7 + 8 * byte..8 * byte}$
64	T:	$vAddr \leftarrow ((offset_{15})^{48} \parallel offset_{15..0}) + GPR [base]$ $(pAddr, uncached) \leftarrow AddressTranslation (vAddr, DATA)$ $pAddr \leftarrow pAddr_{PSIZE - 1..3} \parallel (pAddr_{2..0} \text{ xor } ReverseEndian^3)$ $mem \leftarrow LoadMemory (uncached, BYTE, pAddr, vAddr, DATA)$ $byte \leftarrow vAddr_{2..0} \text{ xor } BigEndianCPU^3$ $GPR [rt] \leftarrow (mem_{7 + 8 * byte})^{56} \parallel mem_{7 + 8 * byte..8 * byte}$

Exceptions:

- TLB refill exception
- TLB invalid exception
- Bus error exception
- Address error exception

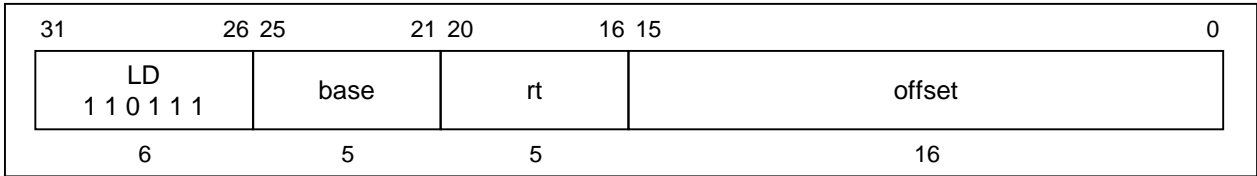
LD**Load Doubleword****LD****Format:**LD *rt*, *offset* (*base*)**Description:**

The 16-bit *offset* is sign-extended and added to the contents of general register *base* to form a virtual address. The contents of the 64-bit doubleword at the memory location specified by the effective address are loaded into general register *rt*.

If any of the three least-significant bits of the effective address are non-zero, an address error exception occurs.

This operation is defined for the VR4111 operating in 64-bit mode or in 32-bit kernel mode. Execution of this instruction in 32-bit user or supervisor mode causes a reserved instruction exception.

Operation:

```

64   T:   vAddr ← ((offset15)48 || offset15..0) + GPR [base]
        (pAddr, uncached) ← AddressTranslation (vAddr, DATA)
        data ← LoadMemory (uncached, DOUBLEWORD, pAddr, vAddr, DATA)
        GPR [rt] ← data

```

Exceptions:

TLB refill exception

TLB invalid exception

Bus error exception

Address error exception

Reserved instruction exception (VR4111 in 32-bit user mode, VR4111 in 32-bit supervisor mode)

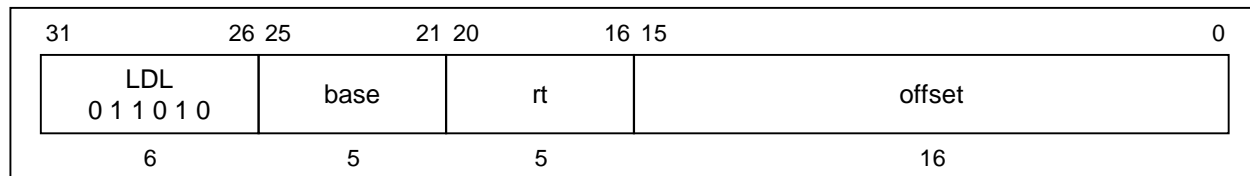
LDL**Load Doubleword Left****LDL****Format:**

LDL rt, offset (base)

Description:

This instruction can be used in combination with the LDR instruction to load a register with eight consecutive bytes from memory, when the bytes cross a doubleword boundary. LDL loads the left portion of the register with the appropriate part of the high-order doubleword; LDR loads the right portion of the register with the appropriate part of the low-order doubleword.

The LDL instruction adds its sign-extended 16-bit *offset* to the contents of general register *base* to form a virtual address that can specify an arbitrary byte. It reads bytes only from the doubleword in memory that contains the specified starting byte. From one to eight bytes will be loaded, depending on the starting byte specified.

Conceptually, it starts at the specified byte in memory and loads that byte into the high-order (left-most) byte of the register; then it loads bytes from memory into the register until it reaches the low-order byte of the doubleword in memory. The least-significant (right-most) byte(s) of the register will not be changed.

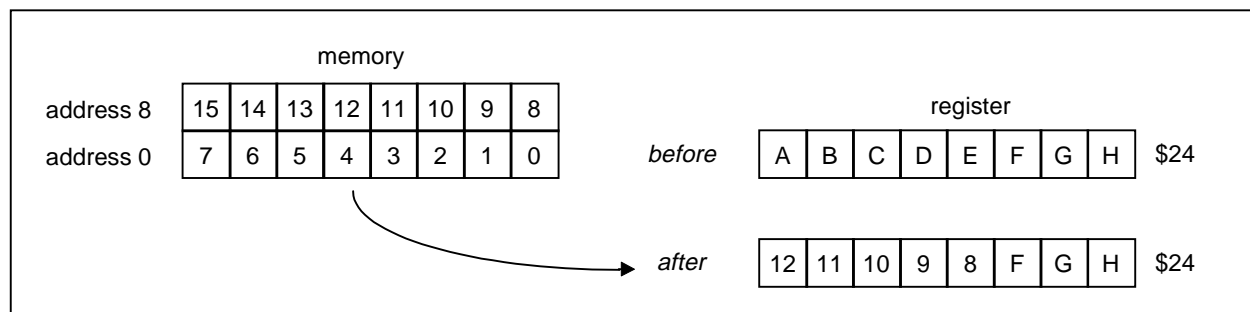

LDL**Load Doubleword Left
(Continued)****LDL**

The contents of general register *rt* are internally bypassed within the processor so that no NOP is needed between an immediately preceding load instruction which specifies register *rt* and a following LDL (or LDR) instruction which also specifies register *rt*.

No address error exceptions due to alignment are possible.

This operation is defined for the VR4111 operating in 64-bit mode or in 32-bit kernel mode. Execution of this instruction in 32-bit user or supervisor mode causes a reserved instruction exception.

Operation:

```

64   T:   vAddr ← ((offset15)48 || offset15..0) + GPR [base]
        (pAddr, uncached) ← AddressTranslation (vAddr, DATA)
        pAddr ← pAddrPSIZE - 1..3 || (pAddr2..0 xor ReverseEndian3)
        if BigEndianMem = 0 then
            pAddr ← pAddrPSIZE - 1..3 || 03
        endif
        byte ← vAddr2..0 xor BigEndianCPU3
        mem ← LoadMemory (uncached, byte, pAddr, vAddr, DATA)
        GPR [rt] ← mem7 + 8 * byte..0 || GPR [rt]55 - 8 * byte..0

```

LDL

Load Doubleword Left (Continued)

LDL

Given a doubleword in a register and a doubleword in memory, the operation of LDL is as follows:

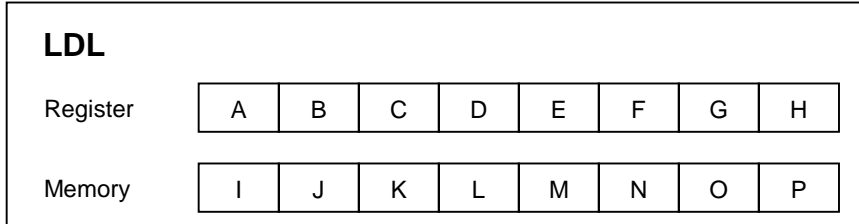

vAddr _{2,0}	BigEndianCPU = 0		
	destination	type	offset (LEM)
0	P B C D E F G H	0	0
1	O P C D E F G H	1	0
2	N O P D E F G H	2	0
3	M N O P E F G H	3	0
4	L M N O P F G H	4	0
5	K L M N O P G H	5	0
6	J K L M N O P H	6	0
7	I J K L M N O P	7	0

LEM Little-endian memory (BigEndianMem = 0)
Type AccessType (see Table 3-2) sent to memory
Offset pAddr_{2,0} sent to memory

Exceptions:

- TLB refill exception
- TLB invalid exception
- Bus error exception
- Address error exception
- Reserved instruction exception (VR4111 in 32-bit user mode, VR4111 in 32-bit supervisor mode)

LDR Load Doubleword Right LDR

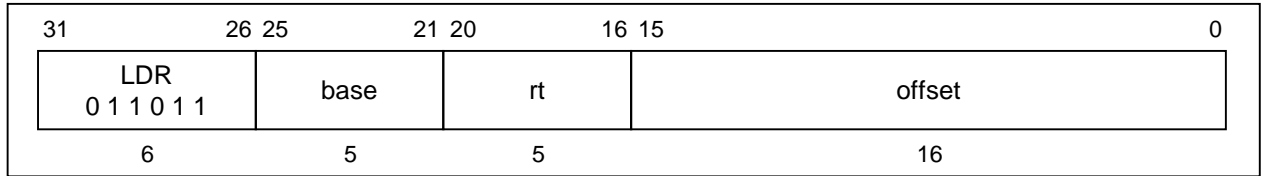
**Format:**

LDR rt, offset (base)

Description:

This instruction can be used in combination with the LDL instruction to load a register with eight consecutive bytes from memory, when the bytes cross a doubleword boundary. LDR loads the right portion of the register with the appropriate part of the low-order doubleword; LDL loads the left portion of the register with the appropriate part of the high-order doubleword.

The LDR instruction adds its sign-extended 16-bit *offset* to the contents of general register *base* to form a virtual address that can specify an arbitrary byte. It reads bytes only from the doubleword in memory that contains the specified starting byte. From one to eight bytes will be loaded, depending on the starting byte specified.

Conceptually, it starts at the specified byte in memory and loads that byte into the low-order (right-most) byte of the register; then it loads bytes from memory into the register until it reaches the high-order byte of the doubleword in memory. The most significant (left-most) byte(s) of the register will not be changed.

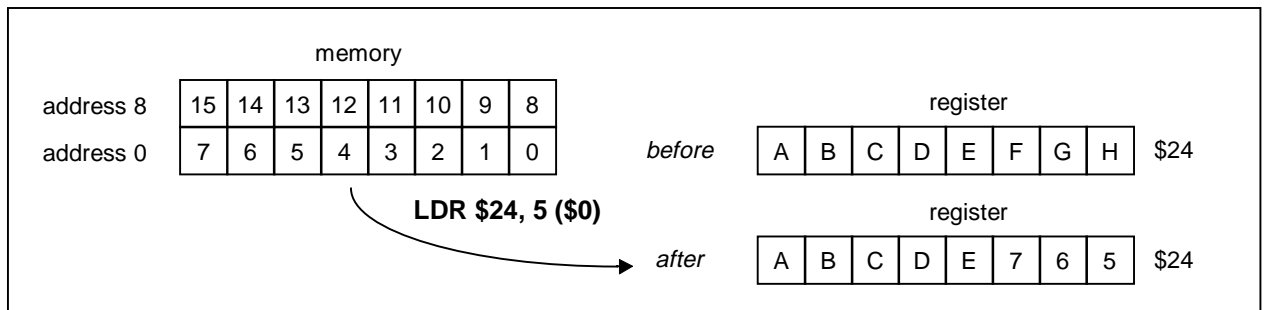

LDR**Load Doubleword Right
(Continued)****LDR**

The contents of general register *rt* are internally bypassed within the processor so that no NOP is needed between an immediately preceding load instruction which specifies register *rt* and a following LDR (or LDL) instruction which also specifies register *rt*.

No address error exceptions due to alignment are possible.

This operation is defined for the VR4111 operating in 64-bit mode or in 32-bit kernel mode. Execution of this instruction in 32-bit user or supervisor mode causes a reserved instruction exception.

Operation:

```

64  T:  vAddr ← ((offset15)48 || offset15..0) + GPR [base]
      (pAddr, uncached) ← AddressTranslation (vAddr, DATA)
      pAddr ← pAddrPSIZE - 1..3 || (pAddr2..0 xor ReverseEndian3)
      if BigEndianMem = 1 then
          pAddr ← pAddrPSIZE - 1..3 || 03
      endif
      byte ← vAddr2..0 xor BigEndianCPU3
      mem ← LoadMemory (uncached, DOUBLEWORD-byte, pAddr, vAddr, DATA)
      GPR [rt] ← GPR [rt]63..64 - 8 * byte || mem63..8 * byte

```

LDR

Load Doubleword Right (Continued)

LDR

Given a doubleword in a register and a doubleword in memory, the operation of LDR is as follows:

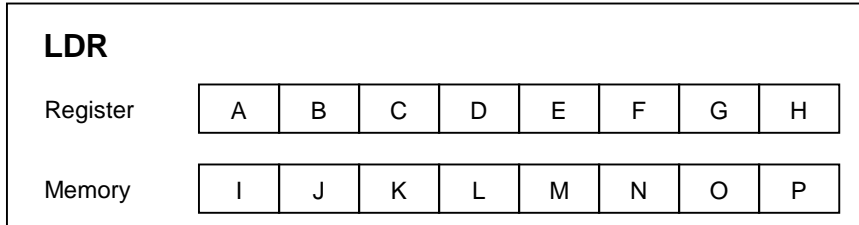

vAddr _{2,0}	BigEndianCPU = 0		
	destination	type	offset (LEM)
0	I J K L M N O P	7	0
1	A I J K L M N O	6	1
2	A B I J K L M N	5	2
3	A B C I J K L M	4	3
4	A B C D I J K L	3	4
5	A B C D E I J K	2	5
6	A B C D E F I J	1	6
7	A B C D E F G I	0	7

LEM Little-endian memory (BigEndianMem = 0)
Type AccessType (see Table 3-2) sent to memory
Offset pAddr_{2,0} sent to memory

Exceptions:

- TLB refill exception
- TLB invalid exception
- Bus error exception
- Address error exception
- Reserved instruction exception (VR4111 in 32-bit user mode, VR4111 in 32-bit supervisor mode)

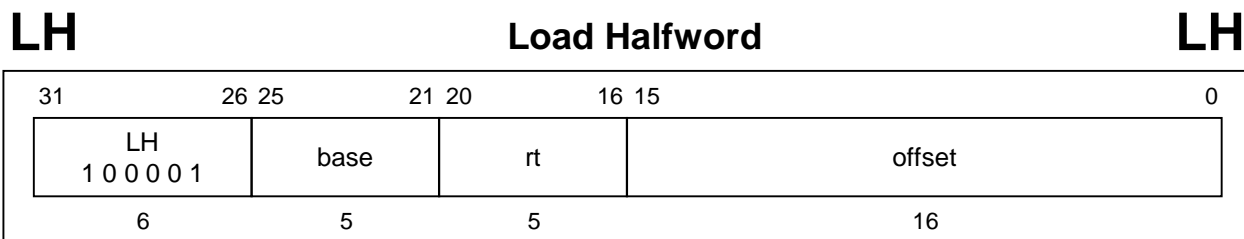
**Format:**LH *rt*, *offset* (*base*)**Description:**

The 16-bit *offset* is sign-extended and added to the contents of general register *base* to form a virtual address. The contents of the halfword at the memory location specified by the effective address are sign-extended and loaded into general register *rt*.

If the least-significant bit of the effective address is non-zero, an address error exception occurs.

Operation:

```

32   T:   vAddr ← ((offset15)16 || offset15...0) + GPR [base]
        (pAddr, uncached) ← AddressTranslation (vAddr, DATA)
        pAddr ← pAddrPSIZE - 1...3 || (pAddr2...0 xor (ReverseEndian2 || 0))
        mem ← LoadMemory (uncached, HALFWORD, pAddr, vAddr, DATA)
        byte ← vAddr2...0 xor (BigEndianCPU2 || 0)
        GPR [rt] ← (mem15 + 8 * byte)16 || mem15 + 8 * byte...8 * byte

64   T:   vAddr ← ((offset15)48 || offset15...0) + GPR [base]
        (pAddr, uncached) ← AddressTranslation (vAddr, DATA)
        pAddr ← pAddrPSIZE - 1...3 || (pAddr2...0 xor (ReverseEndian2 || 0))
        mem ← LoadMemory (uncached, HALFWORD, pAddr, vAddr, DATA)
        byte ← vAddr2...0 xor (BigEndianCPU2 || 0)
        GPR [rt] ← (mem15 + 8 * byte)48 || mem15 + 8 * byte...8 * byte

```

Exceptions:

- TLB refill exception
- TLB invalid exception
- Bus error exception
- Address error exception

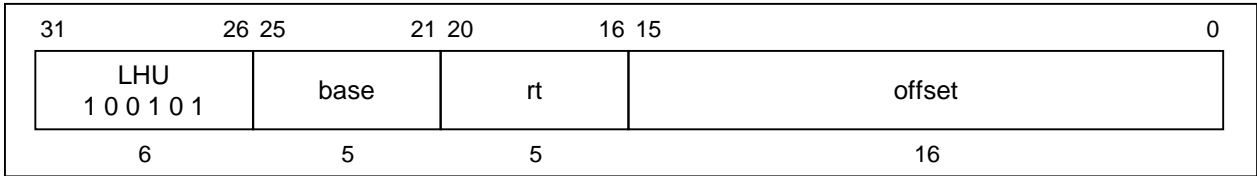
LHU**Load Halfword Unsigned****LHU****Format:**LHU *rt*, *offset* (*base*)**Description:**

The 16-bit *offset* is sign-extended and added to the contents of general register *base* to form a virtual address. The contents of the halfword at the memory location specified by the effective address are zero-extended and loaded into general register *rt*.

If the least-significant bit of the effective address is non-zero, an address error exception occurs.

Operation:

32	T:	$vAddr \leftarrow ((offset_{15})^{16} \parallel offset_{15...0}) + GPR [base]$ $(pAddr, uncached) \leftarrow AddressTranslation (vAddr, DATA)$ $pAddr \leftarrow pAddr_{PSize - 1...3} \parallel (pAddr_{2...0} \text{ xor } (ReverseEndian^2 \parallel 0))$ $mem \leftarrow LoadMemory (uncached, HALFWORD, pAddr, vAddr, DATA)$ $byte \leftarrow vAddr_{2...0} \text{ xor } (BigEndianCPU^2 \parallel 0)$ $GPR [rt] \leftarrow 0^{16} \parallel mem_{15 + 8 * byte...8 * byte}$
64	T:	$vAddr \leftarrow ((offset_{15})^{48} \parallel offset_{15...0}) + GPR [base]$ $(pAddr, uncached) \leftarrow AddressTranslation (vAddr, DATA)$ $pAddr \leftarrow pAddr_{PSize - 1...3} \parallel (pAddr_{2...0} \text{ xor } (ReverseEndian^2 \parallel 0))$ $mem \leftarrow LoadMemory (uncached, HALFWORD, pAddr, vAddr, DATA)$ $byte \leftarrow vAddr_{2...0} \text{ xor } (BigEndianCPU^2 \parallel 0)$ $GPR [rt] \leftarrow 0^{48} \parallel mem_{15 + 8 * byte...8 * byte}$

Exceptions:

- TLB refill exception
- TLB invalid exception
- Bus Error exception
- Address error exception

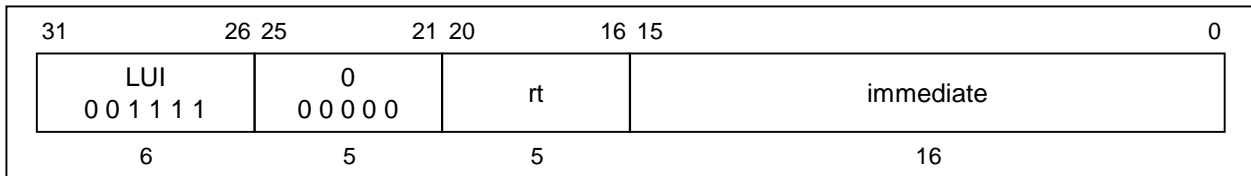
LUI**Load Upper Immediate****LUI****Format:**LUI *rt*, *immediate***Description:**

The 16-bit *immediate* is shifted left 16 bits and concatenated to 16 bits of zeros. The result is placed into general register *rt*. In 64-bit mode, the loaded word is sign-extended.

Operation:

32	T:	$\text{GPR}[rt] \leftarrow \text{immediate} \ll 16$
64	T:	$\text{GPR}[rt] \leftarrow (\text{immediate}_{15})^{32} \ll 16 \ll \text{immediate}$

Exceptions:

None

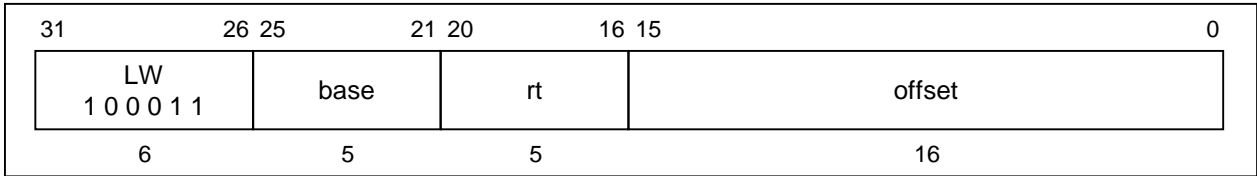
LW**Load Word****LW****Format:**LW *rt*, *offset* (*base*)**Description:**

The 16-bit *offset* is sign-extended and added to the contents of general register *base* to form a virtual address. The contents of the word at the memory location specified by the effective address are loaded into general register *rt*. In 64-bit mode, the loaded word is sign-extended.

If either of the two least-significant bits of the effective address is non-zero, an address error exception occurs.

Operation:

32	T:	$vAddr \leftarrow ((offset_{15})^{16} \parallel offset_{15...0}) + GPR [base]$ $(pAddr, uncached) \leftarrow AddressTranslation (vAddr, DATA)$ $pAddr \leftarrow pAddr_{PSIZE-1...3} \parallel (pAddr_{2...0} \text{ xor } (ReverseEndian \parallel 0^2))$ $mem \leftarrow LoadMemory (uncached, WORD, pAddr, vAddr, DATA)$ $byte \leftarrow vAddr_{2...0} \text{ xor } (BigEndianCPU \parallel 0^2)$ $GPR [rt] \leftarrow mem_{31+8*byte...8*byte}$
64	T:	$vAddr \leftarrow ((offset_{15})^{48} \parallel offset_{15...0}) + GPR [base]$ $(pAddr, uncached) \leftarrow AddressTranslation (vAddr, DATA)$ $pAddr \leftarrow pAddr_{PSIZE-1...3} \parallel (pAddr_{2...0} \text{ xor } (ReverseEndian \parallel 0^2))$ $mem \leftarrow LoadMemory (uncached, WORD, pAddr, vAddr, DATA)$ $byte \leftarrow vAddr_{2...0} \text{ xor } (BigEndianCPU \parallel 0^2)$ $GPR [rt] \leftarrow (mem_{31+8*byte})^{32} \parallel mem_{31+8*byte...8*byte}$

Exceptions:

- TLB refill exception
- TLB invalid exception
- Bus error exception
- Address error exception

LWL Load Word Left LWL

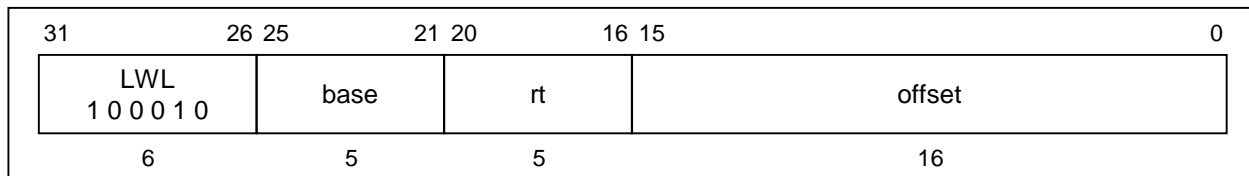

Format:

LWL rt, offset (base)

Description:

This instruction can be used in combination with the LWR instruction to load a register with four consecutive bytes from memory, when the bytes cross a word boundary. LWL loads the left portion of the register with the appropriate part of the high-order word; LWR loads the right portion of the register with the appropriate part of the low-order word.

The LWL instruction adds its sign-extended 16-bit *offset* to the contents of general register *base* to form a virtual address that can specify an arbitrary byte. It reads bytes only from the word in memory that contains the specified starting byte. From one to four bytes will be loaded, depending on the starting byte specified. In 64-bit mode, the loaded word is sign-extended.

Conceptually, it starts at the specified byte in memory and loads that byte into the high-order (left-most) byte of the register; then it loads bytes from memory into the register until it reaches the low-order byte of the word in memory. The least-significant (right-most) byte(s) of the register will not be changed.

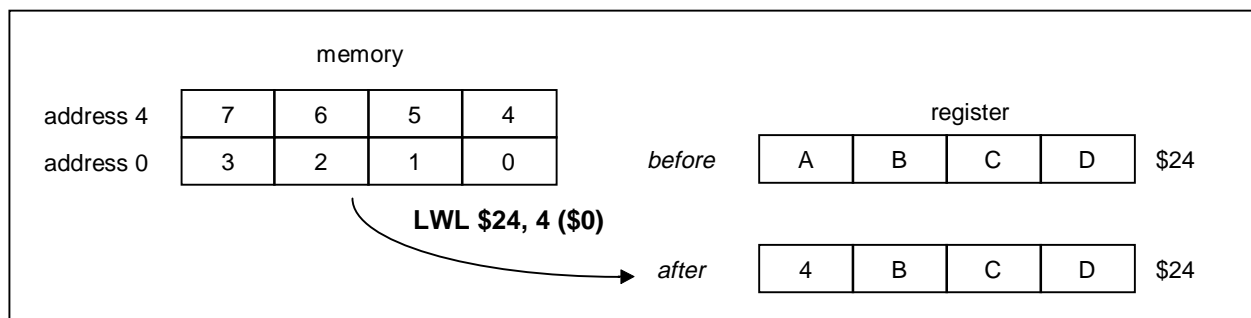

LWL**Load Word Left
(Continued)****LWL**

The contents of general register *rt* are internally bypassed within the processor so that no NOP is needed between an immediately preceding load instruction which specifies register *rt* and a following LWL (or LWR) instruction which also specifies register *rt*.

No address error exceptions due to alignment are possible.

Operation:

```

32  T:  vAddr ← ((offset15)16 || offset15...0) + GPR [base]
      (pAddr, uncached) ← AddressTranslation (vAddr, DATA)
      pAddr ← pAddrPSIZE - 1...3 || (pAddr2...0 xor ReverseEndian3)
      if BigEndianMem = 0 then
          pAddr ← pAddrPSIZE - 1...2 || 02
      endif
      byte ← vAddr1...0 xor BigEndianCPU2
      word ← vAddr2 xor BigEndianCPU
      mem ← LoadMemory (uncached, byte, pAddr, vAddr, DATA)
      temp ← mem32 * word + 8 * byte + 7...32 * word || GPR [rt]23 - 8 * byte...0
      GPR [rt] ← temp

64  T:  vAddr ← ((offset15)48 || offset15...0) + GPR [base]
      (pAddr, uncached) ← AddressTranslation (vAddr, DATA)
      pAddr ← pAddrPSIZE - 1...3 || (pAddr2...0 xor ReverseEndian3)
      if BigEndianMem = 0 then
          pAddr ← pAddrPSIZE - 1...2 || 02
      endif
      byte ← vAddr1...0 xor BigEndianCPU2
      word ← vAddr2 xor BigEndianCPU
      mem ← LoadMemory (uncached, 0 || byte, pAddr, vAddr, DATA)
      temp ← mem32 * word + 8 * byte + 7...32 * word || GPR [rt]23 - 8 * byte...0
      GPR [rt] ← (temp31)32 || temp

```

LWL**Load Word Left
(Continued)****LWL**

Given a doubleword in a register and a doubleword in memory, the operation of LWL is as follows:

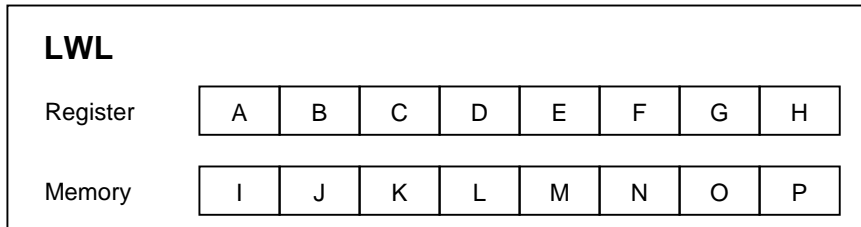

vAddr _{2..0}	BigEndianCPU = 0		
	destination	type	offset (LEM)
0	S S S S P F G H	0	0
1	S S S S O P G H	1	0
2	S S S S N O P H	2	0
3	S S S S M N O P	3	0
4	S S S S L F G H	0	4
5	S S S S K L G H	1	4
6	S S S S J K L H	2	4
7	S S S S I J K L	3	4

LEM Little-endian memory (BigEndianMem = 0)
Type AccessType (see Table 3-2) sent to memory
Offset pAddr_{2..0} sent to memory
S sign-extend of destination₃₁

Exceptions:

TLB refill exception
 TLB invalid exception
 Bus error exception
 Address error exception

LWR

Load Word Right

LWR

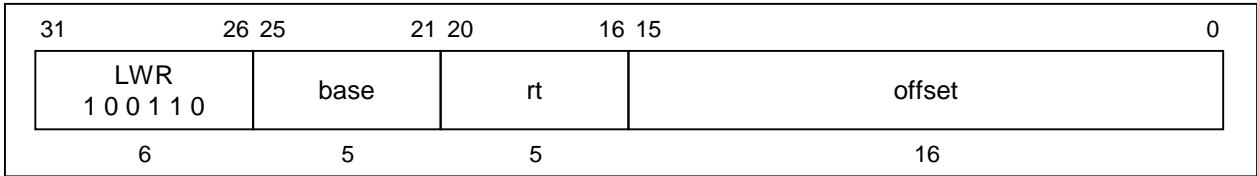

Format:

LWR rt, offset (base)

Description:

This instruction can be used in combination with the LWL instruction to load a register with four consecutive bytes from memory, when the bytes cross a word boundary. LWR loads the right portion of the register with the appropriate part of the low-order word; LWL loads the left portion of the register with the appropriate part of the high-order word.

The LWR instruction adds its sign-extended 16-bit *offset* to the contents of general register *base* to form a virtual address that can specify an arbitrary byte. It reads bytes only from the word in memory that contains the specified starting byte. From one to four bytes will be loaded, depending on the starting byte specified. In 64-bit mode, the loaded word is sign-extended.

Conceptually, it starts at the specified byte in memory and loads that byte into the low-order (right-most) byte of the register; then it loads bytes from memory into the register until it reaches the high-order byte of the word in memory. The most significant (left-most) byte(s) of the register will not be changed.

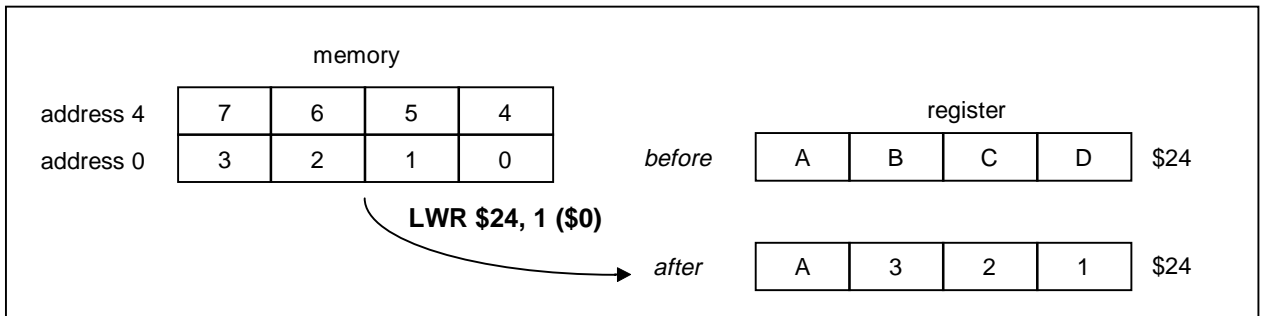

LWR**Load Word Right
(Continued)****LWR**

The contents of general register *rt* are internally bypassed within the processor so that no NOP is needed between an immediately preceding load instruction which specifies register *rt* and a following LWR (or LWL) instruction which also specifies register *rt*.

No address error exceptions due to alignment are possible.

Operation:

```

32  T:  vAddr ← ((offset15)16 || offset15...0) + GPR [base]
      (pAddr, uncached) ← AddressTranslation (vAddr, DATA)
      pAddr ← pAddrPSIZE - 1...3 || (pAddr2...0 xor ReverseEndian3)
      if BigEndianMem = 1 then
          pAddr ← pAddrPSIZE - 1...3 || 03
      endif
      byte ← vAddr1...0 xor BigEndianCPU2
      word ← vAddr2 xor BigEndianCPU
      mem ← LoadMemory (uncached, 0 || byte, pAddr, vAddr, DATA)
      temp ← GPR [rt]31...32 - 8 * byte || mem31 + 32 * word...32 * word + 8 * byte
      GPR [rt] ← temp

64  T:  vAddr ← ((offset15)48 || offset15...0) + GPR [base]
      (pAddr, uncached) ← AddressTranslation (vAddr, DATA)
      pAddr ← pAddrPSIZE - 1...3 || (pAddr2...0 xor ReverseEndian3)
      if BigEndianMem = 1 then
          pAddr ← pAddrPSIZE - 1...3 || 03
      endif
      byte ← vAddr1...0 xor BigEndianCPU2
      word ← vAddr2 xor BigEndianCPU
      mem ← LoadMemory (uncached, WORD-byte, pAddr, vAddr, DATA)
      temp ← GPR [rt]31...32 - 8 * byte || mem31 + 32 * word...32 * word + 8 * byte
      GPR [rt] ← (temp31)32 || temp

```

LWR

Load Word Right (Continued)

LWR

Given a word in a register and a word in memory, the operation of LWR is as follows:

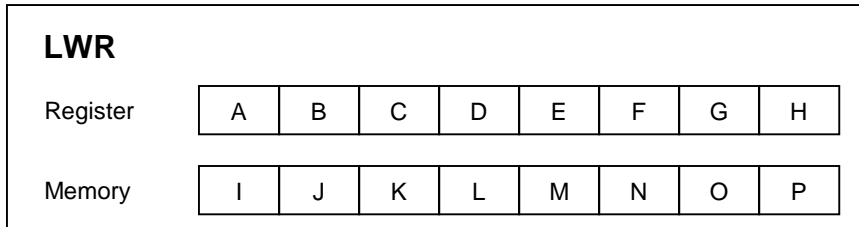

vAddr _{2,0}	BigEndianCPU = 0		
	destination	type	offset (LEM)
0	S S S S M N O P	3	0
1	S S S S E M N O	2	1
2	S S S S E F M N	1	2
3	S S S S E F G M	0	3
4	S S S S I J K L	3	4
5	S S S S E I J K	2	5
6	S S S S E F I J	1	6
7	S S S S E F G I	0	7

- LEM* Little-endian memory (BigEndianMem = 0)
- Type* AccessType (see Table 3-2) sent to memory
- Offset* pAddr_{2,0} sent to memory
- S* sign-extend of destination₃₁

Exceptions:

- TLB refill exception
- TLB invalid exception
- Bus error exception
- Address error exception

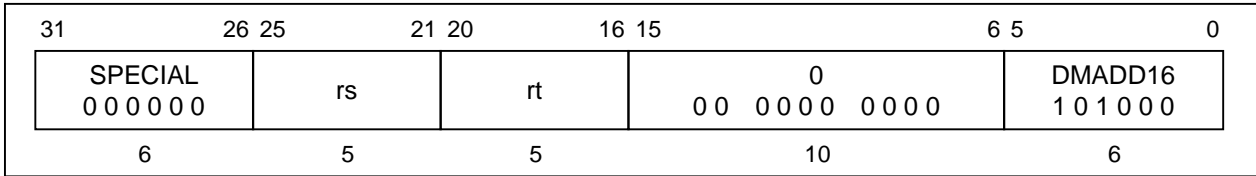
MADD16**Multiply and Add 16-bit integer****MADD16****Format:**

MADD16 rs, rt

Description:

The contents of general registers *rs* and *rt* are multiplied, treating both operands as 16-bit 2's complement values. The operand[62:15] must be valid 15-bit, sign-extended values. If not, the results is unpredictable.

This multiplied result and the 64-bit data joined special register *HI* to *LO* are added to form the result.

No integer overflow exception occurs under any circumstances.

When the operation completes, the low-order word of the double result is loaded into special register *LO*, and the high-order word of the double result is loaded into special register *HI*.

The following Table are hazard cycles between MADD16 and other instructions.

Instruction sequence	No. of cycles
MULT/MULTU → MADD16	1 Cycle
DMULT/DMULTU → MADD16	4 Cycles
DIV/DIVU → MADD16	36 Cycles
DDIV/DDIVU → MADD16	68 Cycles
MFHI/MFLO → MADD16	2 Cycles
DMADD16 → MADD16	0 Cycles
MADD16 → MADD16	0 Cycles

Operation:

```

32, 64 T: temp1 ← GPR [rs] * GPR [rt]
          temp2 ← temp1 + (HI31...0 || LO31...0)
          LO ← (temp131)32 || temp231...0
          HI ← (temp263)32 || temp263...32

```

Exceptions:

None

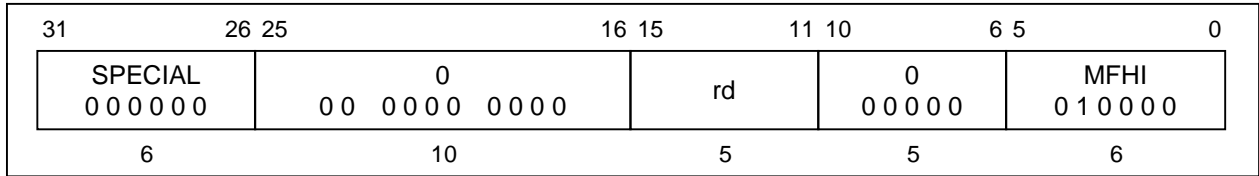
MFHI**Move From HI****MFHI****Format:**

MFHI rd

Description:

The contents of special register *HI* are loaded into general register *rd*.

To ensure proper operation in the event of interruptions, the two instructions which follow a MFHI instruction may not be any of the instructions which modify the *HI* register: MULT, MULTU, DIV, DIVU, MTHI, DMULT, DMULTU, DDIV, DDIVU.

Operation:

32, 64 T: GPR [rd] ← HI

Exceptions:

None

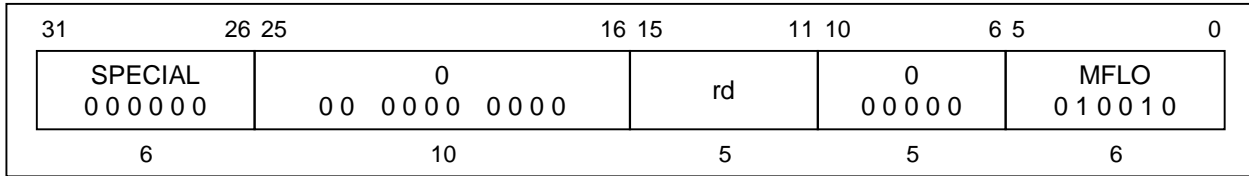
MFLO**Move From LO****MFLO****Format:**

MFLO rd

Description:

The contents of special register *LO* are loaded into general register *rd*.

To ensure proper operation in the event of interruptions, the two instructions which follow a MFLO instruction may not be any of the instructions which modify the *LO* register: MULT, MULTU, DIV, DIVU, MTLO, DMULT, DMULTU, DDIV, DDIVU.

Operation:

32, 64 T: GPR [rd] ← LO

Exceptions:

None

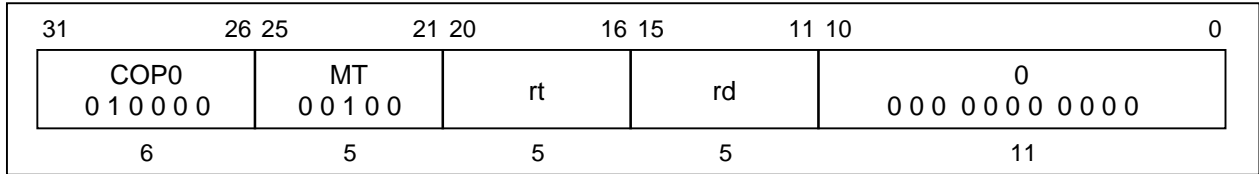
MTC0**Move To Coprocessor0****MTC0****Format:**MTC0 *rt*, *rd***Description:**

The contents of general register *rt* are loaded into coprocessor register *rd* of coprocessor 0.

Because the state of the virtual address translation system may be altered by this instruction, the operation of load instructions, store instructions, and TLB operations immediately prior to and after this instruction are undefined.

When using a register used by the MTC0 by means of instructions before and after it, refer to Chapter 28 and place the instructions in the appropriate location.

Operation:

32, 64 T: data ← GPR [*rt*]
 T+1: CPR [0, *rd*] ← data

Exceptions:

Coprocessor unusable exception (user and supervisor mode if CP0 not enabled)

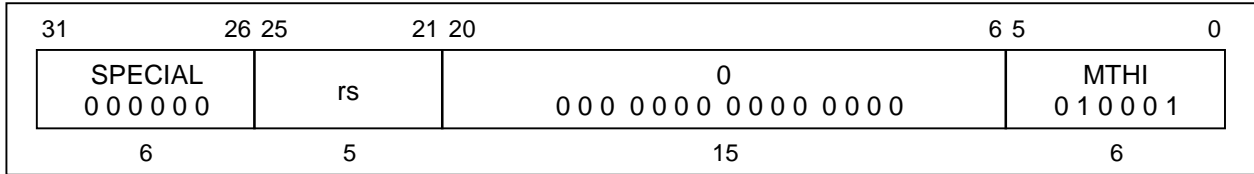
MTHI**Move To HI****MTHI****Format:**

MTHI rs

Description:

The contents of general register *rs* are loaded into special register *HI*.

If a MTHI operation is executed following a MULT, MULTU, DIV, or DIVU instruction, but before any MFLO, MFHI, MTLO, or MTHI instructions, the contents of special register *HI* are undefined.

Operation:

32, 64 T-2: HI ← undefined
 T-1: HI ← undefined
 T: HI ← GPR [rs]

Exceptions:

None

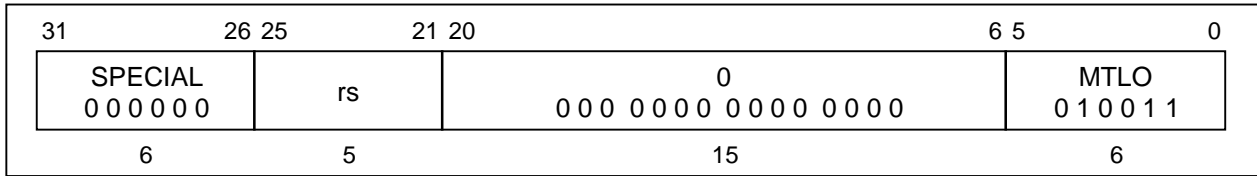
MTLO**Move To LO****MTLO****Format:**

MTLO rs

Description:

The contents of general register *rs* are loaded into special register *LO*.

If an MTLO operation is executed following a MULT, MULTU, DIV, or DIVU instruction, but before any MFLO, MFHI, MTLO, or MTHI instructions, the contents of special register *LO* are undefined.

Operation:

32, 64 T-2: LO ← undefined
 T-1: LO ← undefined
 T: LO ← GPR [rs]

Exceptions:

None

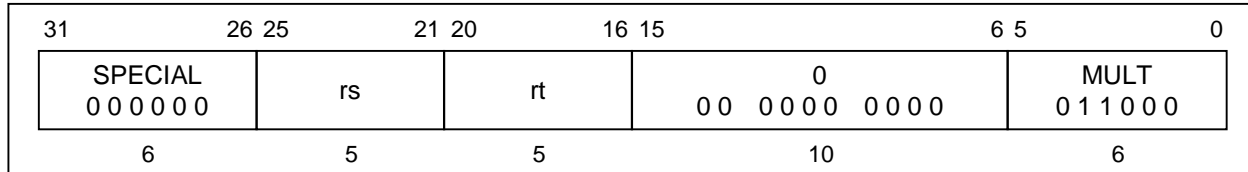
MULT**Multiply****MULT****Format:**MULT *rs*, *rt***Description:**

The contents of general registers *rs* and *rt* are multiplied, treating both operands as signed 32-bit integer. No integer overflow exception occurs under any circumstances. In 64-bit mode, the operands must be valid 32-bit, sign-extended values.

When the operation completes, the low-order word of the double result is loaded into special register *LO*, and the high-order word of the double result is loaded into special register *HI*.

If either of the two preceding instructions is MFHI or MFLO, the results of these instructions are undefined. Correct operation requires separating reads of *HI* or *LO* from writes by a minimum of two other instructions.

Operation:

32	T-2: LO ← undefined
	HI ← undefined
	T-1: LO ← undefined
	HI ← undefined
	T: t ← GPR [<i>rs</i>] * GPR [<i>rt</i>]
	LO ← $t_{31..0}$
	HI ← $t_{63..32}$
64	T-2: LO ← undefined
	HI ← undefined
	T-1: LO ← undefined
	HI ← undefined
	T: t ← GPR [<i>rs</i>] _{31...0} * GPR [<i>rt</i>] _{31...0}
	LO ← $(t_{31})^{32} t_{31..0}$
	HI ← $(t_{63})^{32} t_{63..32}$

Exceptions:

None

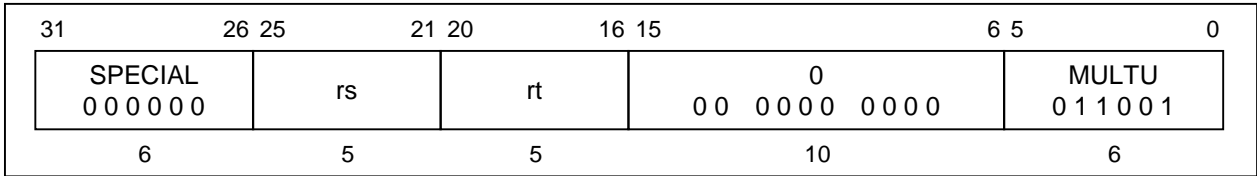
MULTU**Multiply Unsigned****MULTU****Format:**

MULTU rs, rt

Description:

The contents of general register *rs* and the contents of general register *rt* are multiplied, treating both operands as unsigned values. No overflow exception occurs under any circumstances. In 64-bit mode, the operands must be valid 32-bit, sign-extended values.

When the operation completes, the low-order word of the double result is loaded into special register *LO*, and the high-order word of the double result is loaded into special register *HI*.

If either of the two preceding instructions is MFHI or MFLO, the results of these instructions are undefined. Correct operation requires separating reads of *HI* or *LO* from writes by a minimum of two instructions.

Operation:

32	T-2:	LO	← undefined
		HI	← undefined
	T-1:	LO	← undefined
		HI	← undefined
	T:	t	← (0 GPR [rs]) * (0 GPR [rt])
		LO	← t _{31...0}
		HI	← t _{63...32}
64	T-2:	LO	← undefined
		HI	← undefined
	T-1:	LO	← undefined
		HI	← undefined
	T:	t	← (0 GPR [rs] _{31...0}) * (0 GPR [rt] _{31...0})
		LO	← (t ₃₁) ³² t _{31...0}
		HI	← (t ₆₃) ³² t _{63...32}

Exceptions:

None

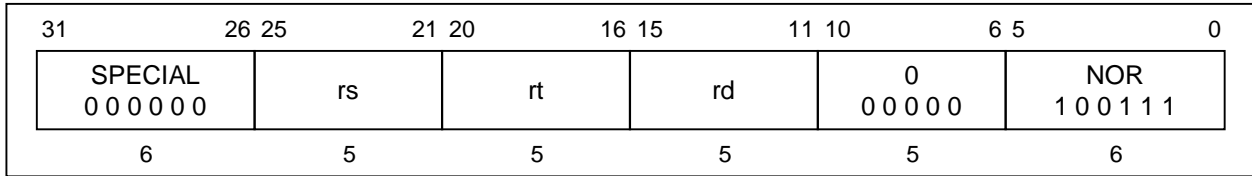
NOR**Nor****NOR****Format:**

NOR rd, rs, rt

Description:

The contents of general register *rs* are combined with the contents of general register *rt* in a bit-wise logical NOR operation. The result is placed into general register *rd*.

Operation:

32, 64 T: $\text{GPR}[rd] \leftarrow \text{GPR}[rs] \text{ nor } \text{GPR}[rt]$

Exceptions:

None

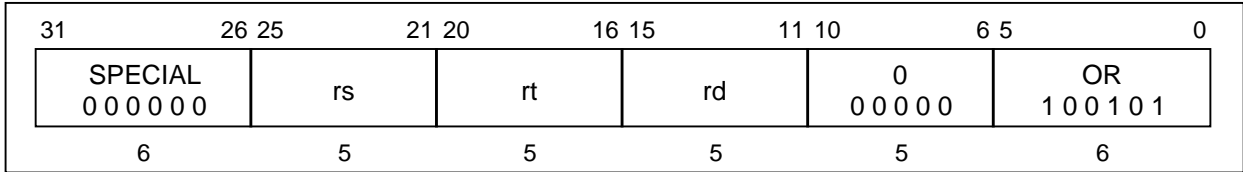
OR**Or****OR****Format:**

OR rd, rs, rt

Description:

The contents of general register *rs* are combined with the contents of general register *rt* in a bit-wise logical OR operation. The result is placed into general register *rd*.

Operation:

32, 64 T: GPR [rd] ← GPR [rs] or GPR [rt]

Exceptions:

None

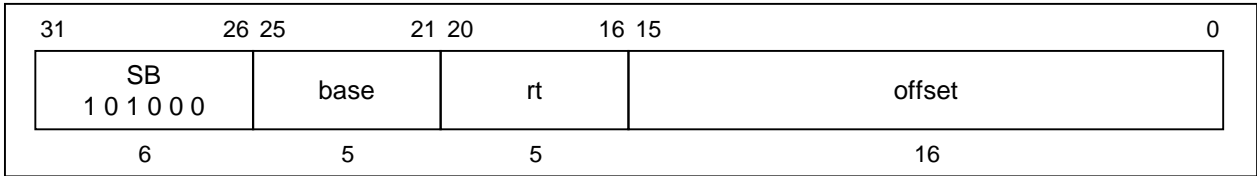
SB**Store Byte****SB****Format:**

SB rt, offset (base)

Description:

The 16-bit *offset* is sign-extended and added to the contents of general register *base* to form a virtual address. The least-significant byte of register *rt* is stored at the effective address.

Operation:

```

32  T:  vAddr ← ((offset15)16 || offset15...0) + GPR [base]
        (pAddr, uncached) ← AddressTranslation (vAddr, DATA)
        pAddr ← pAddrPSIZE - 1...3 || (pAddr2...0 xor (ReverseEndian3))
        byte ← vAddr2...0 xor BigEndianCPU3
        data ← GPR [rt]63 - 8 * byte...0 || 08 * byte
        StoreMemory (uncached, BYTE, data, pAddr, vAddr, DATA)

64  T:  vAddr ← ((offset15)48 || offset15...0) + GPR [base]
        (pAddr, uncached) ← AddressTranslation (vAddr, DATA)
        pAddr ← pAddrPSIZE - 1...3 || (pAddr2...0 xor (ReverseEndian3))
        byte ← vAddr2...0 xor BigEndianCPU3
        data ← GPR [rt]63 - 8 * byte...0 || 08 * byte
        StoreMemory (uncached, BYTE, data, pAddr, vAddr, DATA)

```

Exceptions:

- TLB refill exception
- TLB invalid exception
- TLB modification exception
- Bus error exception
- Address error exception

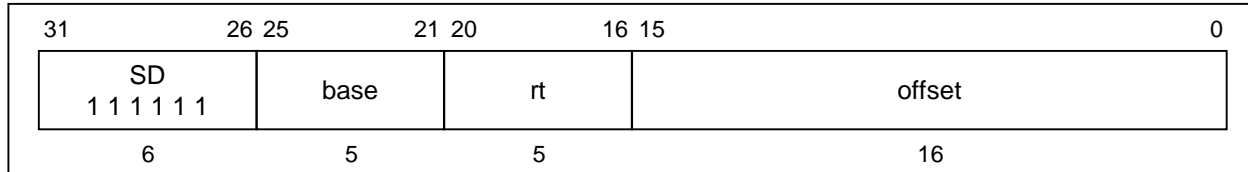
SD**Store Doubleword****SD****Format:**SD *rt*, *offset* (*base*)**Description:**

The 16-bit *offset* is sign-extended and added to the contents of general register *base* to form a virtual address. The contents of general register *rt* are stored at the memory location specified by the effective address.

If either of the three least-significant bits of the effective address are non-zero, an address error exception occurs.

This operation is defined for the VR4111 operating in 64-bit mode or in 32-bit kernel mode. Execution of this instruction in 32-bit user or supervisor mode causes a reserved instruction exception.

Operation:

```

64   T:   vAddr ← ((offset15)48 || offset15...0) + GPR [base]
      (pAddr, uncached) ← AddressTranslation (vAddr, DATA)
      data ← GPR [rt]
      StoreMemory (uncached, DOUBLEWORD, data, pAddr, vAddr, DATA)

```

Exceptions:

- TLB refill exception
- TLB invalid exception
- TLB modification exception
- Bus error exception
- Address error exception
- Reserved instruction exception (VR4111 in 32-bit user mode, VR4111 in 32-bit supervisor mode)

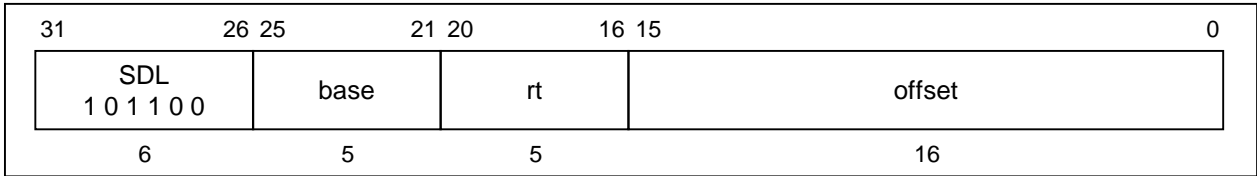
SDL**Store Doubleword Left****SDL****Format:**

SDL rt, offset (base)

Description:

This instruction can be used with the SDR instruction to store the contents of a register into eight consecutive bytes of memory, when the bytes cross a doubleword boundary. SDL stores the left portion of the register into the appropriate part of the high-order doubleword of memory; SDR stores the right portion of the register into the appropriate part of the low-order doubleword.

The SDL instruction adds its sign-extended 16-bit *offset* to the contents of general register *base* to form a virtual address that may specify an arbitrary byte. It alters only the word in memory that contains that byte. From one to four bytes will be stored, depending on the starting byte specified.

Conceptually, it starts at the most-significant byte of the register and copies it to the specified byte in memory; then it copies bytes from register to memory until it reaches the low-order byte of the word in memory.

No address error exceptions due to alignment are possible.

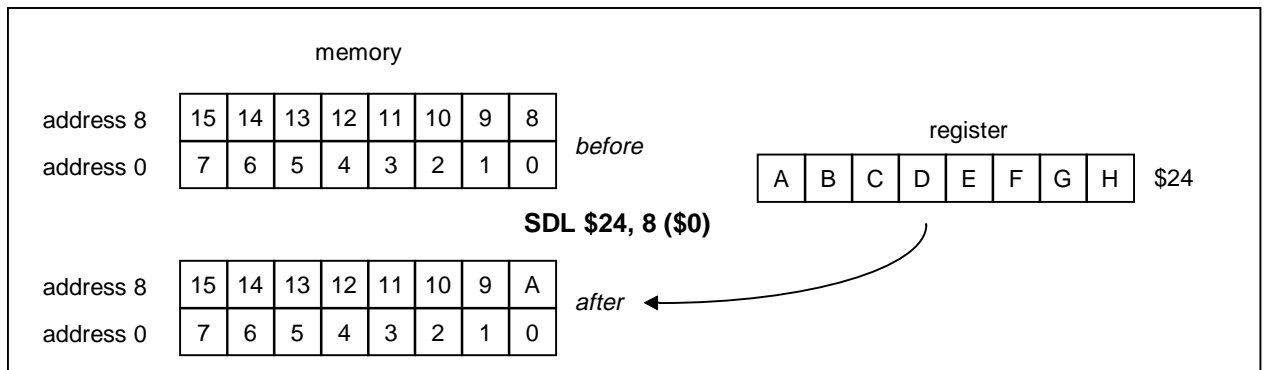

SDL**Store Doubleword Left
(Continued)****SDL**

This operation is defined for the VR4111 operating in 64-bit mode or in 32-bit kernel mode. Execution of this instruction in 32-bit user or supervisor mode causes a reserved instruction exception.

Operation:

```

64  T:  vAddr ← ((offset15)48 || offset15...0) + GPR [base]
      (pAddr, uncached) ← AddressTranslation (vAddr, DATA)
      pAddr ← pAddrPSIZE - 1...3 || (pAddr2...0 xor ReverseEndian3)
      if BigEndianMem = 0 then
          pAddr ← pAddrPSIZE - 1...3 || 03
      endif
      byte ← vAddr2...0 xor BigEndianCPU3
      data ← 056 - 8 * byte || GPR [rt]63...56 - 8 * byte
      StoreMemory (uncached, byte, data, pAddr, vAddr, DATA)

```

SDL**Store Doubleword Left
(Continued)****SDL**

Given a doubleword in a register and a doubleword in memory, the operation of SDL is as follows:

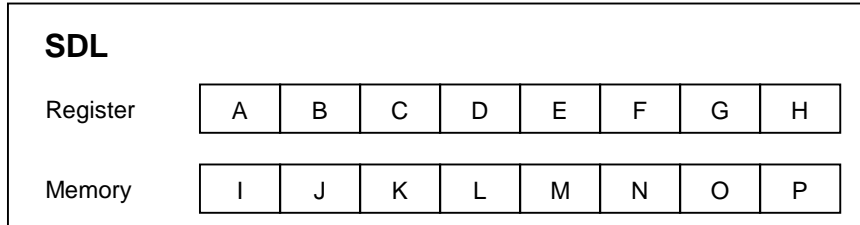

vAddr _{2..0}	BigEndianCPU = 0		
	destination	type	offset (LEM)
0	I J K L M N O A	0	0
1	I J K L M N A B	1	0
2	I J K L M A B C	2	0
3	I J K L A B C D	3	0
4	I J K A B C D E	4	0
5	I J A B C D E F	5	0
6	I A B C D E F G	6	0
7	A B C D E F G H	7	0

LEM Little-endian memory (BigEndianMem = 0)
Type AccessType (see Table 3-2) sent to memory
Offset pAddr_{2..0} sent to memory

Exceptions:

- TLB refill exception
- TLB invalid exception
- TLB modification exception
- Bus error exception
- Address error exception
- Reserved instruction exception (VR4111 in 32-bit user mode, VR4111 in 32-bit supervisor mode)

SDR **Store Doubleword Right** **SDR**

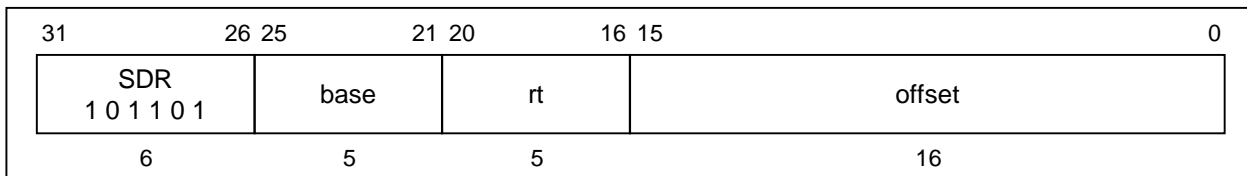

Format:

SDR rt, offset (base)

Description:

This instruction can be used with the SDL instruction to store the contents of a register into eight consecutive bytes of memory, when the bytes cross a boundary between two doublewords. SDR stores the right portion of the register into the appropriate part of the low-order doubleword; SDL stores the left portion of the register into the appropriate part of the low-order doubleword of memory.

The SDR instruction adds its sign-extended 16-bit *offset* to the contents of general register *base* to form a virtual address that may specify an arbitrary byte. It alters only the word in memory that contains that byte. From one to eight bytes will be stored, depending on the starting byte specified.

Conceptually, it starts at the least-significant (rightmost) byte of the register and copies it to the specified byte in memory; then it copies bytes from register to memory until it reaches the high-order byte of the word in memory. No address error exceptions due to alignment are possible.

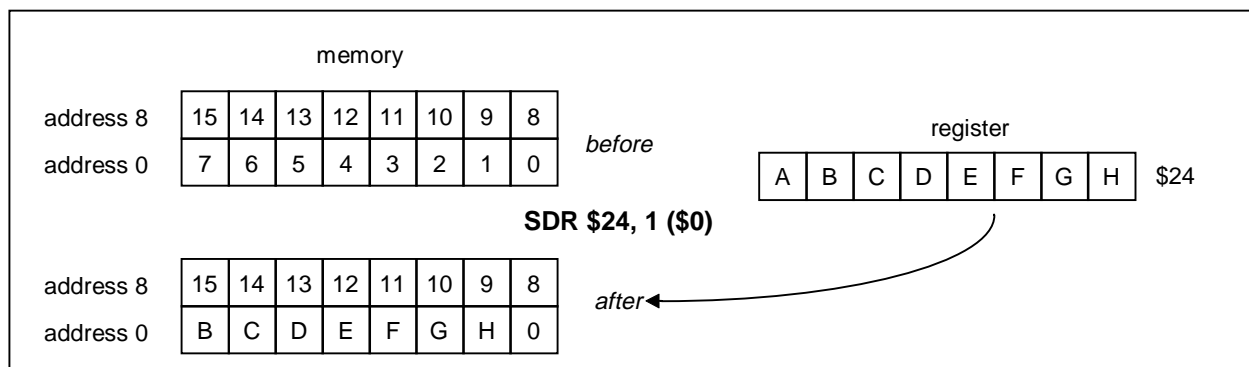

SDR**Store Doubleword Right
(Continued)****SDR**

This operation is defined for the VR4111 operating in 64-bit mode or in 32-bit kernel mode. Execution of this instruction in 32-bit user or supervisor mode causes a reserved instruction exception.

Operation:

```

64   T:   vAddr ← ((offset15)48 || offset15...0) + GPR [base]
        (pAddr, uncached) ← AddressTranslation (vAddr, DATA)
        pAddr ← pAddrPSIZE - 1...3 || (pAddr2...0 xor ReverseEndian3)
        if BigEndianMem = 0 then
            pAddr ← pAddrPSIZE - 1...3 || 03
        endif
        byte ← vAddr2...0 xor BigEndianCPU3
        data ← GPR [rt]63 - 8 * byte || 08 * byte
        StoreMemory (uncached, DOUBLEWORD-byte, data, pAddr, vAddr, DATA)

```

SDR**Store Doubleword Right
(Continued)****SDR**

Given a doubleword in a register and a doubleword in memory, the operation of SDR is as follows:

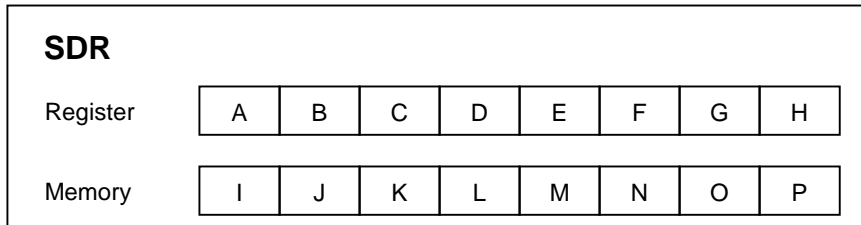

vAddr _{2..0}	BigEndianCPU = 0		
	destination	type	offset (LEM)
0	A B C D E F G H	7	0
1	B C D E F G H P	6	1
2	C D E F G H O P	5	2
3	D E F G H N O P	4	3
4	E F G H M N O P	3	4
5	F G H L M N O P	2	5
6	G H K L M N O P	1	6
7	H J K L M N O P	0	7

LEM Little-endian memory (BigEndianMem = 0)
Type AccessType (see Table 3-2) sent to memory
Offset pAddr_{2..0} sent to memory

Exceptions:

- TLB refill exception
- TLB invalid exception
- TLB modification exception
- Bus error exception
- Address error exception
- Reserved instruction exception (VR4111 in 32-bit user mode, VR4111 in 32-bit supervisor mode)

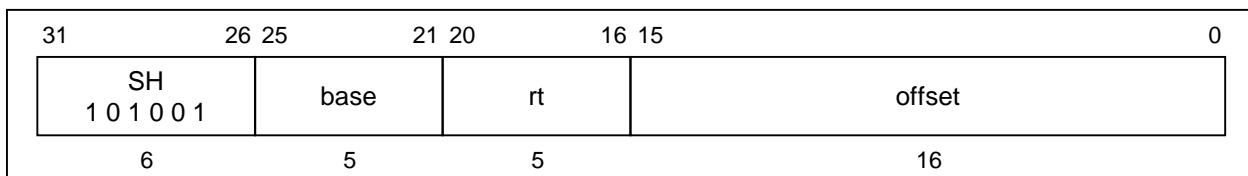
SH**Store Halfword****SH****Format:**SH *rt*, *offset* (*base*)**Description:**

The 16-bit *offset* is sign-extended and added to the contents of general register *base* to form an unsigned effective address. The least-significant halfword of register *rt* is stored at the effective address. If the least-significant bit of the effective address is non-zero, an address error exception occurs.

Operation:

32	<p>T: $vAddr \leftarrow ((offset_{15})^{16} \parallel offset_{15...0}) + GPR [base]$ $(pAddr, uncached) \leftarrow AddressTranslation (vAddr, DATA)$ $pAddr \leftarrow pAddr_{PSIZE - 1...3} \parallel (pAddr_{2...0} \text{ xor } (ReverseEndian^2 \parallel 0))$ $byte \leftarrow vAddr_{2...0} \text{ xor } (BigEndianCPU^2 \parallel 0)$ $data \leftarrow GPR [rt]_{63 - 8 * byte...0} \parallel 0^{8 * byte}$ StoreMemory (uncached, HALFWORD, data, pAddr, vAddr, DATA)</p>
64	<p>T: $vAddr \leftarrow ((offset_{15})^{48} \parallel offset_{15...0}) + GPR [base]$ $(pAddr, uncached) \leftarrow AddressTranslation (vAddr, DATA)$ $pAddr \leftarrow pAddr_{PSIZE - 1...3} \parallel (pAddr_{2...0} \text{ xor } (ReverseEndian^2 \parallel 0))$ $byte \leftarrow vAddr_{2...0} \text{ xor } (BigEndianCPU^2 \parallel 0)$ $data \leftarrow GPR [rt]_{63 - 8 * byte...0} \parallel 0^{8 * byte}$ StoreMemory (uncached, HALFWORD, data, pAddr, vAddr, DATA)</p>

Exceptions:

- TLB refill exception
- TLB invalid exception
- TLB modification exception
- Bus error exception
- Address error exception

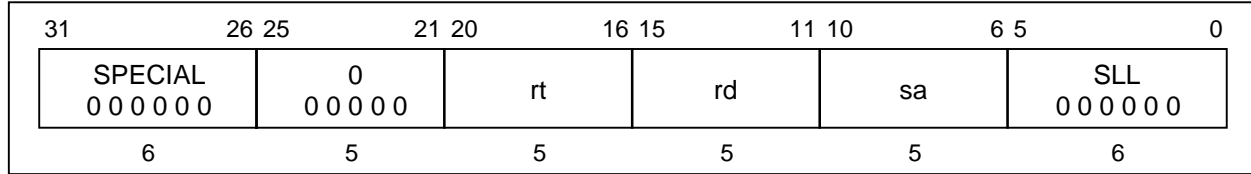
SLL**Shift Left Logical****SLL****Format:**

SLL rd, rt, sa

Description:

The contents of general register *rt* are shifted left by *sa* bits, inserting zeros into the low-order bits.

The result is placed in register *rd*.

In 64-bit mode, the 32-bit result is sign-extended when placed in the destination register. It is sign extended for all shift amounts, including zero; SLL with zero shift amount truncates a 64-bit value to 32 bits and then sign extends this 32-bit value. SLL, unlike nearly all other word operations, does not require an operand to be a properly sign-extended word value to produce a valid sign-extended word result.

Operation:

32	T: $GPR[rd] \leftarrow GPR[rt]_{31-sa..0} \parallel 0^{sa}$
64	T: $s \leftarrow 0 \parallel sa$ $temp \leftarrow GPR[rt]_{31-s..0} \parallel 0^s$ $GPR[rd] \leftarrow (temp_{31})^{32} \parallel temp$

Exceptions:

None

Remark SLL with a shift amount of zero may be treated as a NOP by some assemblers, at some optimization levels. If using SLL with a zero shift to truncate 64-bit values, check the assembler you are using.

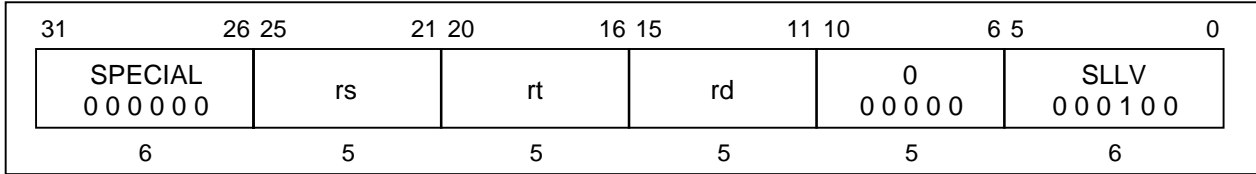
SLLV**Shift Left Logical Variable****SLLV****Format:**

SLLV rd, rt, rs

Description:

The contents of general register *rt* are shifted left the number of bits specified by the low-order five bits contained in general register *rs*, inserting zeros into the low-order bits.

The result is placed in register *rd*.

In 64-bit mode, the 32-bit result is sign-extended when placed in the destination register. It is sign extended for all shift amounts, including zero; SLLV with zero shift amount truncates a 64-bit value to 32 bits and then sign extends this 32-bit value. SLLV, unlike nearly all other word operations, does not require an operand to be a properly sign-extended word value to produce a valid sign-extended word result.

Operation:

32	T:	$s \leftarrow \text{GPR}[rs]_{4..0}$ $\text{GPR}[rd] \leftarrow \text{GPR}[rt]_{(31-s)..0} \parallel 0^s$
64	T:	$s \leftarrow 0 \parallel \text{GPR}[rs]_{4..0}$ $\text{temp} \leftarrow \text{GPR}[rt]_{(31-s)..0} \parallel 0^s$ $\text{GPR}[rd] \leftarrow (\text{temp}_{31})^{32} \parallel \text{temp}$

Exceptions:

None

Remark SLLV with a shift amount of zero may be treated as a NOP by some assemblers, at some optimization levels. If using SLLV with a zero shift to truncate 64-bit values, check the assembler you are using.

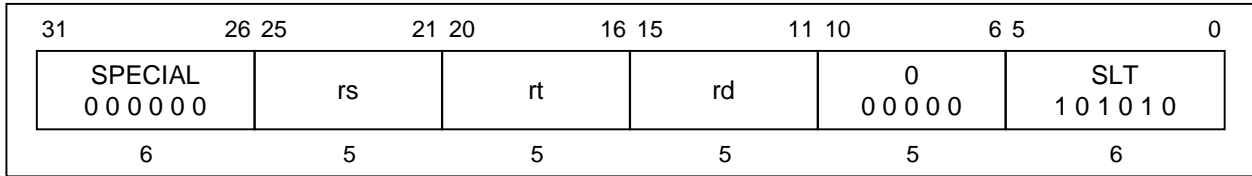
SLT**Set On Less Than****SLT****Format:**

SLT rd, rs, rt

Description:

The contents of general register *rt* are subtracted from the contents of general register *rs*. Considering both quantities as signed integers, if the contents of general register *rs* are less than the contents of general register *rt*, the result is set to one; otherwise the result is set to zero.

The result is placed into general register *rd*.

No integer overflow exception occurs under any circumstances. The comparison is valid even if the subtraction used during the comparison overflows.

Operation:

```

32  T:  if GPR [rs] < GPR [rt] then
        GPR [rd] ← 031 || 1
    else
        GPR [rd] ← 032
    endif

64  T:  if GPR [rs] < GPR [rt] then
        GPR [rd] ← 063 || 1
    else
        GPR [rd] ← 064
    endif

```

Exceptions:

None

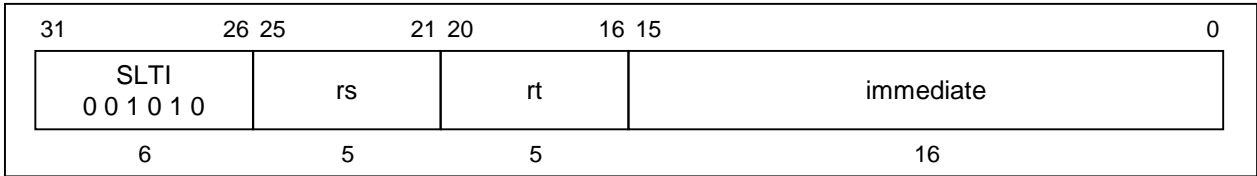
SLTI**Set On Less Than Immediate****SLTI****Format:**

SLTI rt, rs, immediate

Description:

The 16-bit *immediate* is sign-extended and subtracted from the contents of general register *rs*. Considering both quantities as signed integers, if *rs* is less than the sign-extended immediate, the result is set to 1; otherwise the result is set to 0.

The result is placed into general register *rt*.

No integer overflow exception occurs under any circumstances. The comparison is valid even if the subtraction used during the comparison overflows.

Operation:

```

32  T:  if GPR [rs] < (immediate15)16 || immediate15...0 then
        GPR [rt] ← 031 || 1
    else
        GPR [rt] ← 032
    endif

64  T:  if GPR [rs] < (immediate15)48 || immediate15...0 then
        GPR [rt] ← 063 || 1
    else
        GPR [rt] ← 064
    endif

```

Exceptions:

None

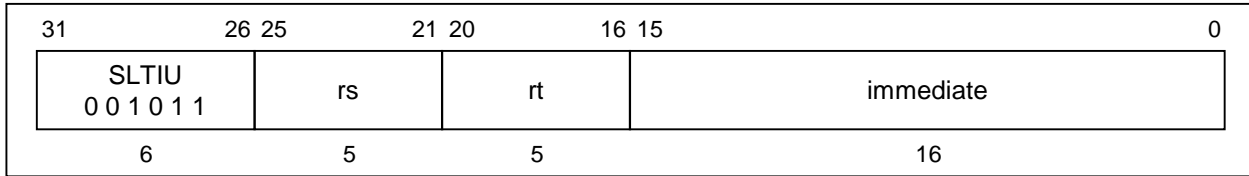
SLTIU**Set On Less Than Immediate Unsigned****SLTIU****Format:**SLTIU *rt*, *rs*, *immediate***Description:**

The 16-bit *immediate* is sign-extended and subtracted from the contents of general register *rs*. Considering both quantities as unsigned integers, if *rs* is less than the sign-extended *immediate*, the result is set to 1; otherwise the result is set to 0.

The result is placed into general register *rt*.

No integer overflow exception occurs under any circumstances. The comparison is valid even if the subtraction used during the comparison overflows.

Operation:

```

32  T:  if (0 || GPR [rs]) < (0 || (immediate15)16 || immediate15...0) then
        GPR [rt] ← 031 || 1
    else
        GPR [rt] ← 032
    endif

64  T:  if (0 || GPR [rs]) < (0 || (immediate15)48 || immediate15...0) then
        GPR [rt] ← 063 || 1
    else
        GPR [rt] ← 064
    endif

```

Exceptions:

None

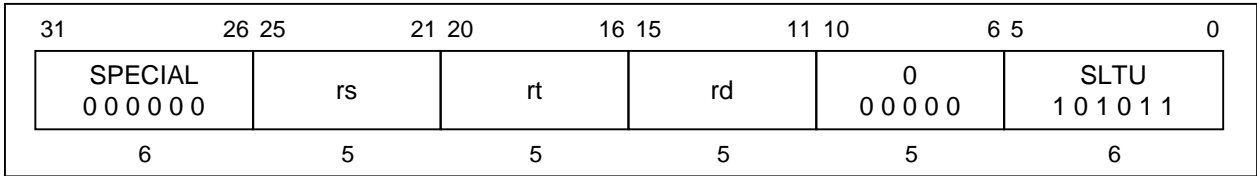
SLTU**Set On Less Than Unsigned****SLTU****Format:**

SLTU rd, rs, rt

Description:

The contents of general register *rt* are subtracted from the contents of general register *rs*. Considering both quantities as unsigned integers, if the contents of general register *rs* are less than the contents of general register *rt*, the result is set to 1; otherwise the result is set to 0.

The result is placed into general register *rd*.

No integer overflow exception occurs under any circumstances. The comparison is valid even if the subtraction used during the comparison overflows.

Operation:

```

32  T:  if (0 || GPR [rs]) < 0 || GPR [rt] then
        GPR [rd] ← 031 || 1
        else
        GPR [rd] ← 032
        endif

64  T:  if (0 || GPR [rs]) < 0 || GPR [rt] then
        GPR [rd] ← 063 || 1
        else
        GPR [rd] ← 064
        endif

```

Exceptions:

None

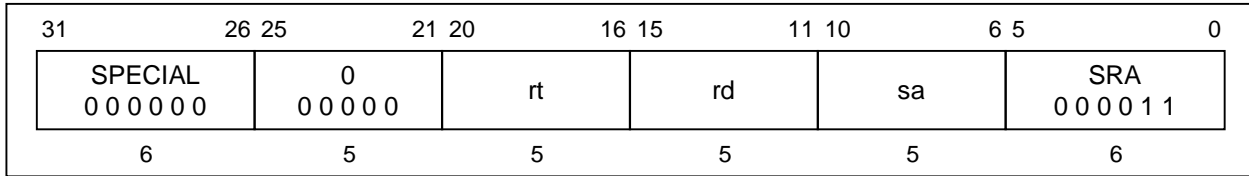
SRA**Shift Right Arithmetic****SRA****Format:**

SRA rd, rt, sa

Description:

The contents of general register *rt* are shifted right by *sa* bits, sign-extending the high-order bits.

The result is placed in register *rd*.

In 64-bit mode, the operand must be a valid sign-extended, 32-bit value.

Operation:

32 T: $\text{GPR}[\text{rd}] \leftarrow (\text{GPR}[\text{rt}]_{31})^{\text{sa}} \parallel \text{GPR}[\text{rt}]_{31 \dots \text{sa}}$

64 T: $s \leftarrow 0 \parallel \text{sa}$
 $\text{temp} \leftarrow (\text{GPR}[\text{rt}]_{31})^s \parallel \text{GPR}[\text{rt}]_{31 \dots s}$
 $\text{GPR}[\text{rd}] \leftarrow (\text{temp}_{31})^{32} \parallel \text{temp}$

Exceptions:

None

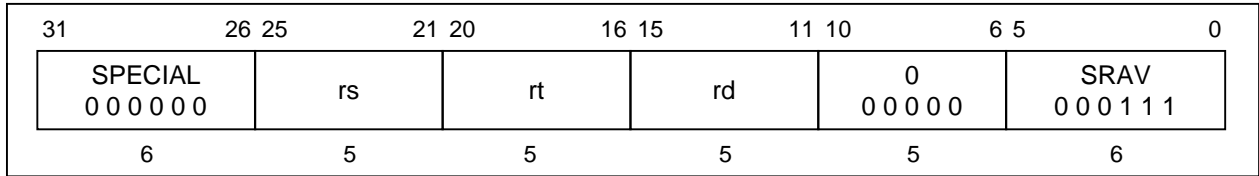
SRAV**Shift Right Arithmetic Variable****SRAV****Format:**

SRAV rd, rt, rs

Description:

The contents of general register *rt* are shifted right by the number of bits specified by the low-order five bits of general register *rs*, sign-extending the high-order bits.

The result is placed in register *rd*.

In 64-bit mode, the operand must be a valid sign-extended, 32-bit value.

Operation:

32	T:	$s \leftarrow \text{GPR}[rs]_{4..0}$ $\text{GPR}[rd] \leftarrow (\text{GPR}[rt]_{31})^s \parallel \text{GPR}[rt]_{31..s}$
64	T:	$s \leftarrow \text{GPR}[rs]_{4..0}$ $\text{temp} \leftarrow (\text{GPR}[rt]_{31})^s \parallel \text{GPR}[rt]_{31..s}$ $\text{GPR}[rd] \leftarrow (\text{temp}_{31})^{32} \parallel \text{temp}$

Exceptions:

None

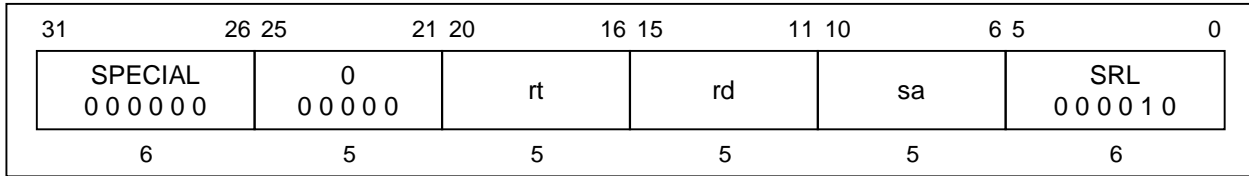
SRL**Shift Right Logical****SRL****Format:**

SRL rd, rt, sa

Description:

The contents of general register *rt* are shifted right by *sa* bits, inserting zeros into the high-order bits.

The result is placed in register *rd*.

In 64-bit mode, the operand must be a valid sign-extended, 32-bit value.

Operation:

32 T: $\text{GPR}[rd] \leftarrow 0^{sa} \parallel \text{GPR}[rt]_{31 \dots sa}$

64 T: $s \leftarrow 0 \parallel sa$
 $\text{temp} \leftarrow 0^s \parallel \text{GPR}[rt]_{31 \dots s}$
 $\text{GPR}[rd] \leftarrow (\text{temp}_{31})^{32} \parallel \text{temp}$

Exceptions:

None

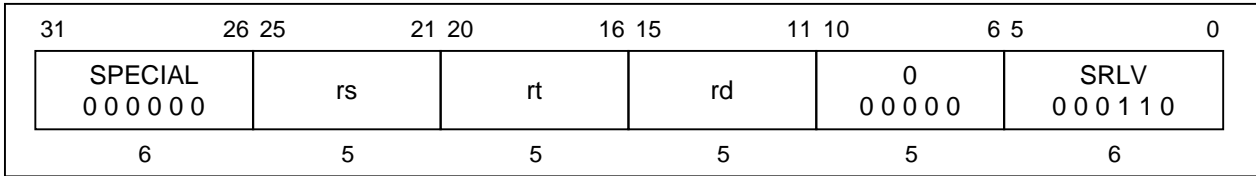
SRLV**Shift Right Logical Variable****SRLV****Format:**

SRLV rd, rt, rs

Description:

The contents of general register *rt* are shifted right by the number of bits specified by the low-order five bits of general register *rs*, inserting zeros into the high-order bits.

The result is placed in register *rd*.

In 64-bit mode, the operand must be a valid sign-extended, 32-bit value.

Operation:

32	T:	$s \leftarrow \text{GPR}[rs]_{4..0}$ $\text{GPR}[rd] \leftarrow 0^s \parallel \text{GPR}[rt]_{31..s}$
64	T:	$s \leftarrow \text{GPR}[rs]_{4..0}$ $\text{temp} \leftarrow 0^s \parallel \text{GPR}[rt]_{31..s}$ $\text{GPR}[rd] \leftarrow (\text{temp}_{31})^{32} \parallel \text{temp}$

Exceptions:

None

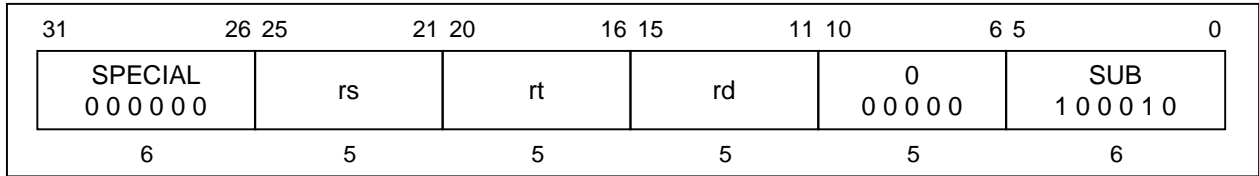
SUB**Subtract****SUB****Format:**

SUB rd, rs, rt

Description:

The contents of general register *rt* are subtracted from the contents of general register *rs* to form a result. The result is placed into general register *rd*. In 64-bit mode, the operands must be valid sign-extended, 32-bit values.

The only difference between this instruction and the SUBU instruction is that SUBU never traps on overflow.

An integer overflow exception takes place if the carries out of bits 30 and 31 differ (2's complement overflow). The destination register *rd* is not modified when an integer overflow exception occurs.

Operation:

32	T:	$GPR[rd] \leftarrow GPR[rs] - GPR[rt]$
64	T:	temp $\leftarrow GPR[rs] - GPR[rt]$ GPR[rd] $\leftarrow (temp_{31})^{32} temp_{31..0}$

Exceptions:

Integer overflow exception

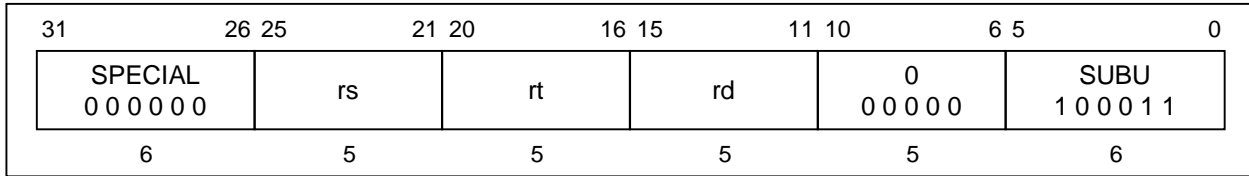
SUBU**Subtract Unsigned****SUBU****Format:**

SUBU rd, rs, rt

Description:

The contents of general register *rt* are subtracted from the contents of general register *rs* to form a result.

The result is placed into general register *rd*.

In 64-bit mode, the operands must be valid sign-extended, 32-bit values.

The only difference between this instruction and the SUB instruction is that SUBU never traps on overflow. No integer overflow exception occurs under any circumstances.

Operation:

32	T:	$\text{GPR}[\text{rd}] \leftarrow \text{GPR}[\text{rs}] - \text{GPR}[\text{rt}]$
64	T:	$\text{temp} \leftarrow \text{GPR}[\text{rs}] - \text{GPR}[\text{rt}]$ $\text{GPR}[\text{rd}] \leftarrow (\text{temp}_{31})^{32} \parallel \text{temp}_{31\dots 0}$

Exceptions:

None

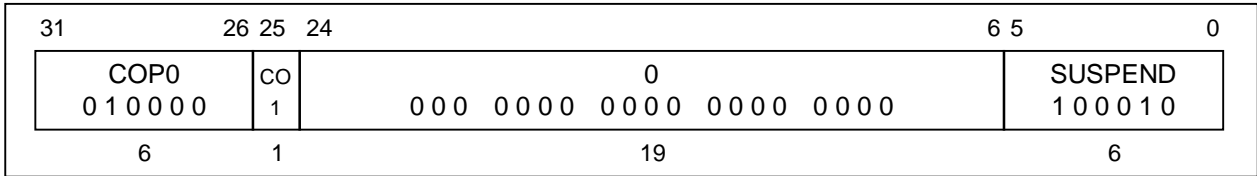
SUSPEND**Suspend****SUSPEND****Format:**

SUSPEND

Description:

SUSPEND instruction starts mode transition from Fullspeed mode to Suspend mode.

When the SUSPEND instruction finishes the WB stage, the V_R4111 wait by the SysAD bus is idle state, after then the internal clocks including the TClock will shut down, thus freezing the pipeline. The PLL, Timer/Interrupt clocks and MasterOut, will continue to run.

Once the V_R4111 is in Suspend mode, any interrupt, including the internally generated timer interrupt, NMI, Soft Reset and Cold Reset will cause the V_R4111 to exit Suspend mode and to enter Fullspeed mode.

Operation:

32, 64 T:
T+1: Suspend operation ()

Exceptions:

Coprocessor unusable exception

Remark Refer to Chapter 16 for details about the operation of the peripheral units at mode transition.

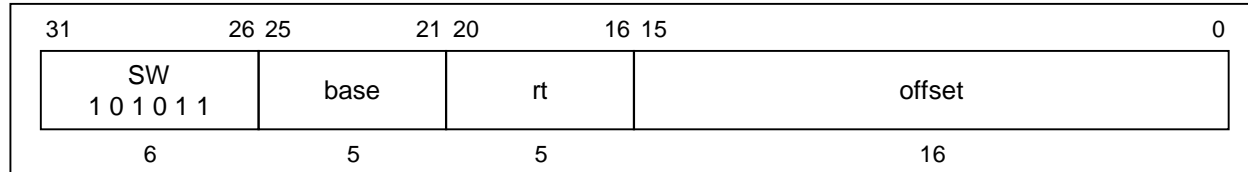
SW**Store Word****SW****Format:**

SW rt, offset (base)

Description:

The 16-bit *offset* is sign-extended and added to the contents of general register *base* to form a virtual address. The contents of general register *rt* are stored at the memory location specified by the effective address.

If either of the two least-significant bits of the effective address are non-zero, an address error exception occurs.

Operation:

```

32  T:  vAddr ← ((offset15)16 || offset15...0) + GPR [base]
      (pAddr, uncached) ← AddressTranslation (vAddr, DATA)
      pAddr ← pAddrPSIZE - 1...3 || (pAddr2...0 xor (ReverseEndian || 02))
      byte ← vAddr2...0 xor (BigEndianCPU || 02)
      data ← GPR [rt]63 - 8 * byte || 08 * byte
      StoreMemory (uncached, WORD, data, pAddr, vAddr, DATA)

64  T:  vAddr ← ((offset15)48 || offset15...0) + GPR [base]
      (pAddr, uncached) ← AddressTranslation (vAddr, DATA)
      pAddr ← pAddrPSIZE - 1...3 || (pAddr2...0 xor (ReverseEndian || 02))
      byte ← vAddr2...0 xor (BigEndianCPU || 02)
      data ← GPR [rt]63 - 8 * byte || 08 * byte
      StoreMemory (uncached, WORD, data, pAddr, vAddr, DATA)

```

Exceptions:

- TLB refill exception
- TLB invalid exception
- TLB modification exception
- Bus error exception
- Address error exception

SWL

Store Word Left

SWL

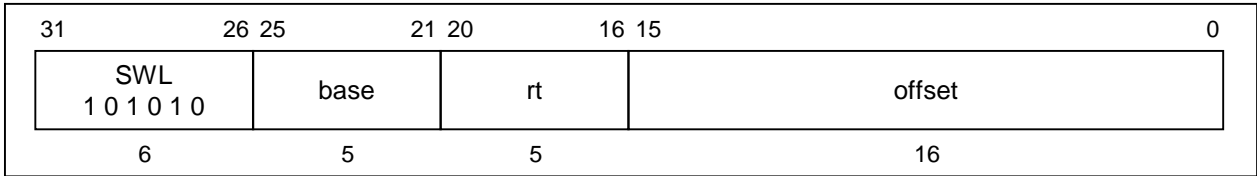

Format:

SWL rt, offset (base)

Description:

This instruction can be used with the SWR instruction to store the contents of a register into four consecutive bytes of memory, when the bytes cross a word boundary. SWL stores the left portion of the register into the appropriate part of the high-order word of memory; SWR stores the right portion of the register into the appropriate part of the low-order word.

The SWL instruction adds its sign-extended 16-bit *offset* to the contents of general register *base* to form a virtual address that may specify an arbitrary byte. It alters only the word in memory that contains that byte. From one to four bytes will be stored, depending on the starting byte specified.

Conceptually, it starts at the most-significant byte of the register and copies it to the specified byte in memory; then it copies bytes from register to memory until it reaches the low-order byte of the word in memory.

No address error exceptions due to alignment are possible.

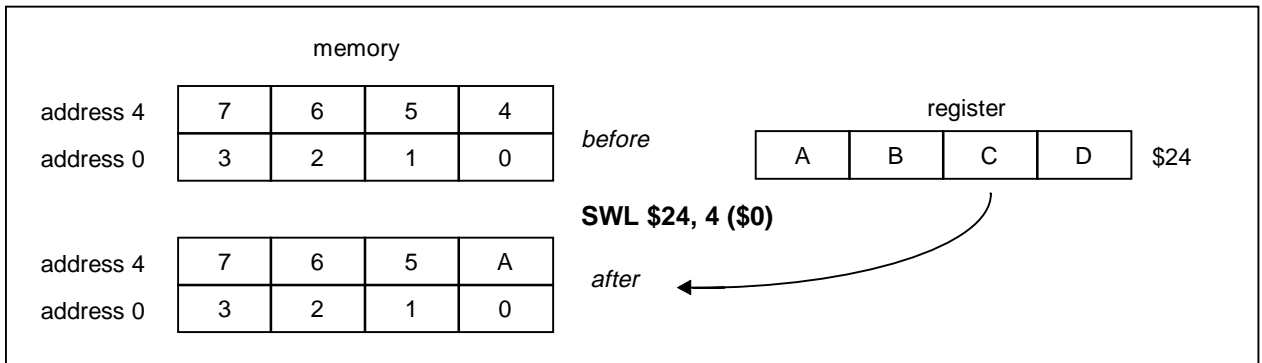

SWL

Store Word Left
(Continued)

SWL

Operation:

```

32  T:  vAddr ← ((offset15)16 || offset15...0) + GPR [base]
      (pAddr, uncached) ← AddressTranslation (vAddr, DATA)
      pAddr ← pAddrPSIZE - 1...3 || (pAddr2...0 xor ReverseEndian3)
      if BigEndianMem = 0 then
        pAddr ← pAddrPSIZE - 1...2 || 02
      endif
      byte ← vAddr1...0 xor BigEndianCPU2
      if (vAddr2 xor BigEndianCPU) = 0 then
        data ← 032 || 024 - 8 * byte || GPR [rt]31...24 - 8 * byte
      else
        data ← 024 - 8 * byte || GPR [rt]31...24 - 8 * byte || 032
      endif
      StoreMemory (uncached, byte, data, pAddr, vAddr, DATA)

64  T:  vAddr ← ((offset15)48 || offset15...0) + GPR [base]
      (pAddr, uncached) ← AddressTranslation (vAddr, DATA)
      pAddr ← pAddrPSIZE - 1...3 || (pAddr2...0 xor ReverseEndian3)
      if BigEndianMem = 0 then
        pAddr ← pAddrPSIZE - 1...2 || 02
      endif
      byte ← vAddr1...0 xor BigEndianCPU2
      if (vAddr2 xor BigEndianCPU) = 0 then
        data ← 032 || 024 - 8 * byte || GPR [rt]31...24 - 8 * byte
      else
        data ← 024 - 8 * byte || GPR [rt]31...24 - 8 * byte || 032
      endif
      StoreMemory (uncached, byte, data, pAddr, vAddr, DATA)

```

SWL**Store Word Left
(Continued)****SWL**

Given a doubleword in a register and a doubleword in memory, the operation of SWL is as follows:

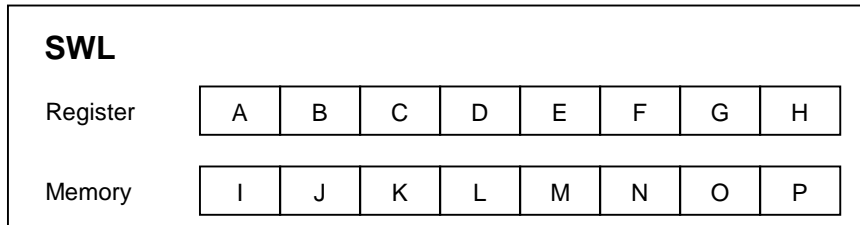

vAddr _{2..0}	BigEndianCPU = 0		
	destination	type	offset (LEM)
0	I J K L M N O E	0	0
1	I J K L M N E F	1	0
2	I J K L M E F G	2	0
3	I J K L E F G H	3	0
4	I J K E M N O P	0	4
5	I J E F M N O P	1	4
6	I E F G M N O P	2	4
7	E F G H M N O P	3	4

LEM Little-endian memory (BigEndianMem = 0)
Type AccessType (see Table 3-2) sent to memory
Offset pAddr_{2..0} sent to memory

Exceptions:

- TLB refill exception
- TLB invalid exception
- TLB modification exception
- Bus error exception
- Address error exception

SWR**Store Word Right
(Continued)****SWR****Operation:**

```

32  T:  vAddr ← ((offset15)16 || offset15...0) + GPR [base]
      (pAddr, uncached) ← AddressTranslation (vAddr, DATA)
      pAddr ← pAddrPSIZE - 1...3 || (pAddr2...0 xor ReverseEndian3)
      if BigEndianMem = 1 then
          pAddr ← pAddrPSIZE - 1...2 || 02
      endif
      byte ← vAddr1...0 xor BigEndianCPU2
      if (vAddr2 xor BigEndianCPU) = 0 then
          data ← 032 || GPR [rt]31 - 8 * byte...0 || 08 * byte
      else
          data ← GPR [rt]31 - 8 * byte || 08 * byte || 032
      endif
      StoreMemory (uncached, WORD-byte, data, pAddr, vAddr, DATA)

64  T:  vAddr ← ((offset15)48 || offset15...0) + GPR [base]
      (pAddr, uncached) ← AddressTranslation (vAddr, DATA)
      pAddr ← pAddrPSIZE - 1...3 || (pAddr2...0 xor ReverseEndian3)
      if BigEndianMem = 1 then
          pAddr ← pAddrPSIZE - 1...2 || 02
      endif
      byte ← vAddr1...0 xor BigEndianCPU2
      if (vAddr2 xor BigEndianCPU) = 0 then
          data ← 032 || GPR [rt]31 - 8 * byte...0 || 08 * byte
      else
          data ← GPR [rt]31 - 8 * byte || 08 * byte || 032
      endif
      StoreMemory (uncached, WORD-byte, data, pAddr, vAddr, DATA)

```

SWR**Store Word Right
(Continued)****SWR**

Given a doubleword in a register and a doubleword in memory, the operation of SWR is as follows:

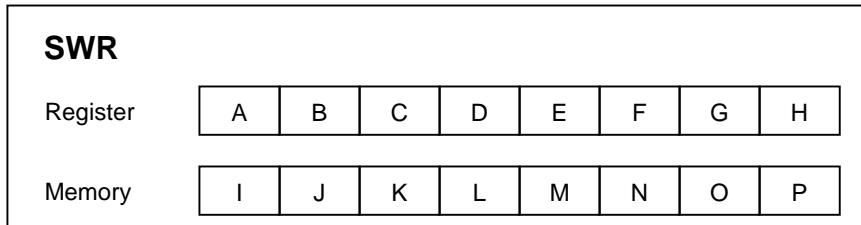

vAddr _{2..0}	BigEndianCPU = 0		
	destination	type	offset (LEM)
0	I J K L E F G H	3	0
1	I J K L F G H P	2	1
2	I J K L G H O P	1	2
3	I J K L H N O P	0	3
4	E F G H M N O P	3	4
5	F G H L M N O P	2	5
6	G H K L M N O P	1	6
7	H J K L M N O P	0	7

LEM Little-endian memory (BigEndianMem = 0)
Type AccessType (see Table 3-2) sent to memory
Offset pAddr_{2..0} sent to memory

Exceptions:

- TLB refill exception
- TLB invalid exception
- TLB modification exception
- Bus error exception
- Address error exception

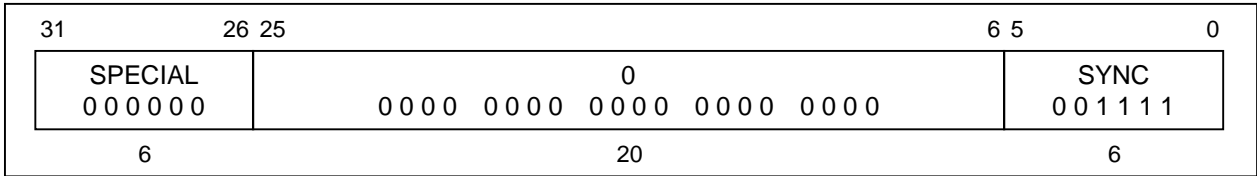
SYNC**Synchronize****SYNC****Format:**

SYNC

Description:

The SYNC instruction is executed as a NOP on the Vr4111. This operation maintains compatibility with code compiled for the Vr4100.

Operation:

32, 64 T: SyncOperation ()

Exceptions:

None

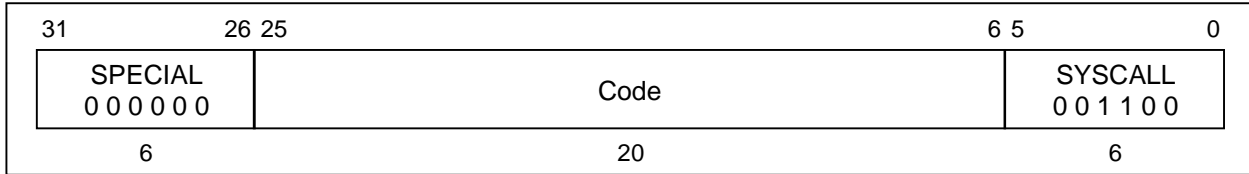
SYSCALL**System Call****SYSCALL****Format:**

SYSCALL

Description:

A system call exception occurs, immediately and unconditionally transferring control to the exception handler.

The code field is available for use as software parameters, but is retrieved by the exception handler only by loading the contents of the memory word containing the instruction.

Operation:

32, 64 T: SystemCallException

Exceptions:

System Call exception

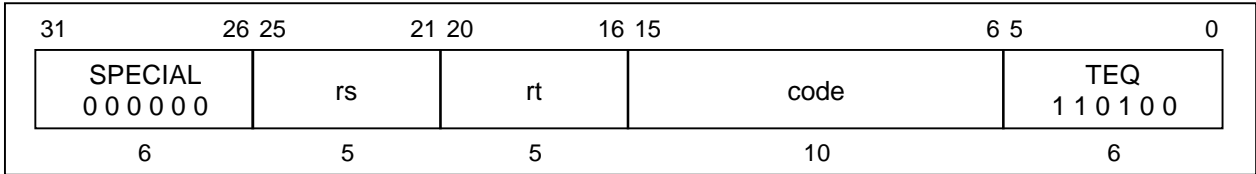
TEQ**Trap If Equal****TEQ****Format:**TEQ *rs*, *rt***Description:**

The contents of general register *rt* are compared to general register *rs*. If the contents of general register *rs* are equal to the contents of general register *rt*, a trap exception occurs.

The code field is available for use as software parameters, but is retrieved by the exception handler only by loading the contents of the memory word containing the instruction.

Operation:

```

32, 64 T:  if GPR [rs] = GPR [rt] then
            TrapException
            endif

```

Exceptions:

Trap exception

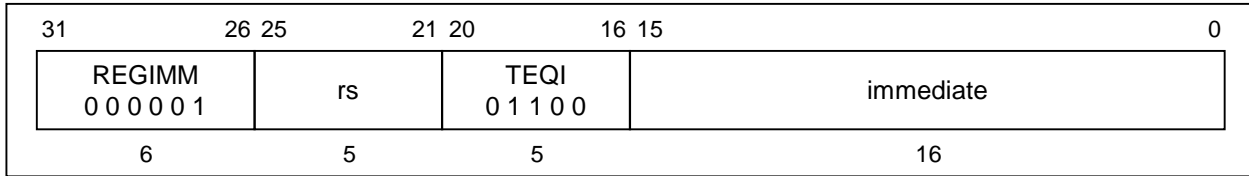
TEQI**Trap If Equal Immediate****TEQI****Format:**

TEQI rs, immediate

Description:

The 16-bit *immediate* is sign-extended and compared to the contents of general register *rs*. If the contents of general register *rs* are equal to the sign-extended *immediate*, a trap exception occurs.

Operation:

```

32  T:  if GPR [rs] = (immediate15)16 || immediate15...0 then
           TrapException
        endif

64  T:  if GPR [rs] = (immediate15)48 || immediate15...0 then
           TrapException
        endif

```

Exceptions:

Trap exception

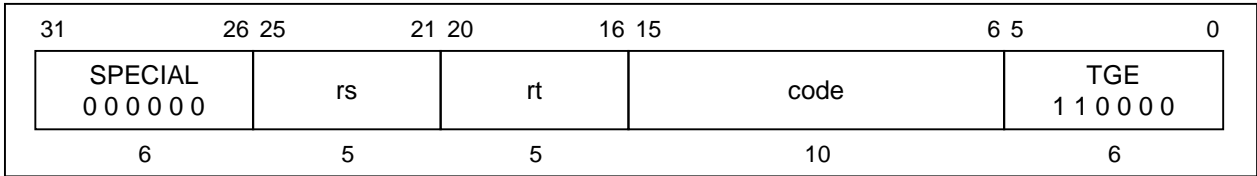
TGE**Trap If Greater Than Or Equal****TGE****Format:**TGE *rs*, *rt***Description:**

The contents of general register *rt* are compared to the contents of general register *rs*. Considering both quantities as signed integers, if the contents of general register *rs* are greater than or equal to the contents of general register *rt*, a trap exception occurs.

The code field is available for use as software parameters, but is retrieved by the exception handler only by loading the contents of the memory word containing the instruction.

Operation:

```

32, 64 T:  if GPR [rs] ≥ GPR [rt] then
            TrapException
        endif

```

Exceptions:

Trap exception

TGEU Trap If Greater Than Or Equal Unsigned TGEU

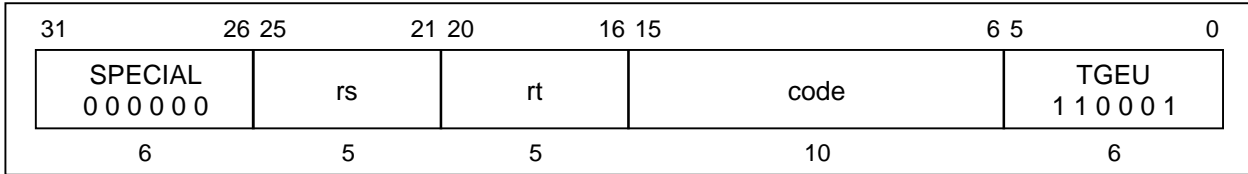
**Format:**TGEU *rs*, *rt***Description:**

The contents of general register *rt* are compared to the contents of general register *rs*. Considering both quantities as unsigned integers, if the contents of general register *rs* are greater than or equal to the contents of general register *rt*, a trap exception occurs.

The code field is available for use as software parameters, but is retrieved by the exception handler only by loading the contents of the memory word containing the instruction.

Operation:

```
32, 64 T:  if (0 || GPR [rs] ≥ (0 || GPR [rt]) then
           TrapException
           endif
```

Exceptions:

Trap exception

TLBP

Probe TLB For Matching Entry

TLBP

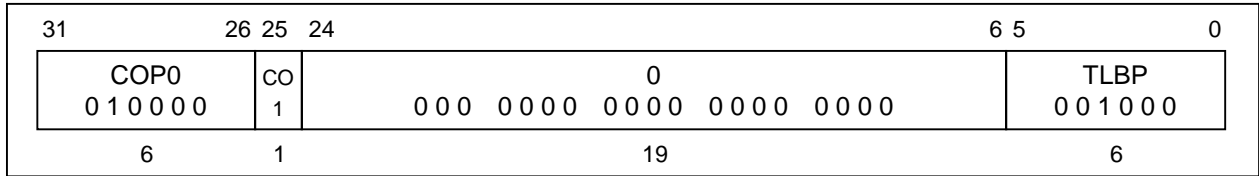

Format:

TLBP

Description:

The Index register is loaded with the address of the TLB entry whose contents match the contents of the EntryHi register. If no TLB entry matches, the high-order bit of the Index register is set.

The architecture does not specify the operation of memory references associated with the instruction immediately after a TLBP instruction, nor is the operation specified if more than one TLB entry matches.

Operation:

```

32  T:  Index ← 1 || 025 || Undefined6
      for i in 0...TLBEntries - 1
          if (TLB [i]95...77 = EntryHi31...13) and (TLB [i]76 or
              (TLB [i]71...64 = EntryHi7...0)) then
              Index ← 026 || i5...0
          endif
      endfor

64  T:  Index ← 1 || 025 || Undefined6
      for i in 0...TLBEntries - 1
          if (TLB [i]167...141 and not (015 || TLB [i]216...205))
              = (EntryHi39...13) and not (015 || TLB [i]216...205) and
              (TLB [i]140 or (TLB [i]135...128 = EntryHi7...0)) then
              Index ← 026 || i5...0
          endif
      endfor
    
```

Exceptions:

Coprocessor unusable exception

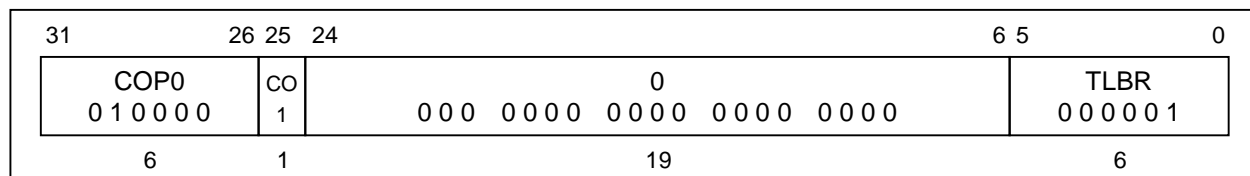
TLBR**Read Indexed TLB Entry****TLBR****Format:**

TLBR

Description:

The EntryHi and EntryLo registers are loaded with the contents of the TLB entry pointed at by the contents of the TLB Index register.

The *G* bit (which controls ASID matching) read from the TLB is written into both of the EntryLo0 and EntryLo1 registers. The operation is invalid (and the results are unspecified) if the contents of the TLB Index register are greater than the number of TLB entries in the processor.

Operation:

32	T: PageMask \leftarrow TLB [Index5...0] _{127...96} EntryHi \leftarrow TLB [Index5...0] _{95...64} and not TLB [Index5...0] _{127...96} EntryLo1 \leftarrow TLB [Index5...0] _{63...33} TLB [Index5...0] ₇₆ EntryLo0 \leftarrow TLB [Index5...0] _{31...1} TLB [Index5...0] ₇₆
64	T: PageMask \leftarrow TLB [Index5...0] _{255...192} EntryHi \leftarrow TLB [Index5...0] _{191...128} and not TLB [Index5...0] _{255...192} EntryLo1 \leftarrow TLB [Index5...0] _{127...65} TLB [Index5...0] ₁₄₀ EntryLo0 \leftarrow TLB [Index5...0] _{63...1} TLB [Index5...0] ₁₄₀

Exceptions:

Coprocessor unusable exception

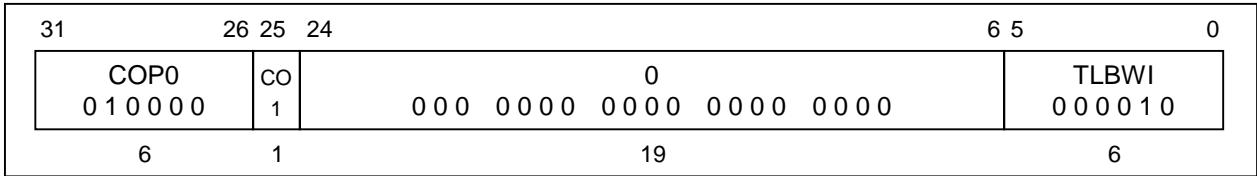
TLBWI**Write Indexed TLB Entry****TLBWI****Format:**

TLBWI

Description:

The TLB entry pointed at by the contents of the TLB Index register is loaded with the contents of the EntryHi and EntryLo registers.

The *G* bit of the TLB is written with the logical AND of the *G* bits in the EntryLo0 and EntryLo1 registers.

The operation is invalid (and the results are unspecified) if the contents of the TLB Index register are greater than the number of TLB entries in the processor.

Operation:

32, 64 T: TLB [Index_{5..0}] ←
PageMask || (EntryHi and not PageMask) || EntryLo1 || EntryLo0

Exceptions:

Coprocessor unusable exception

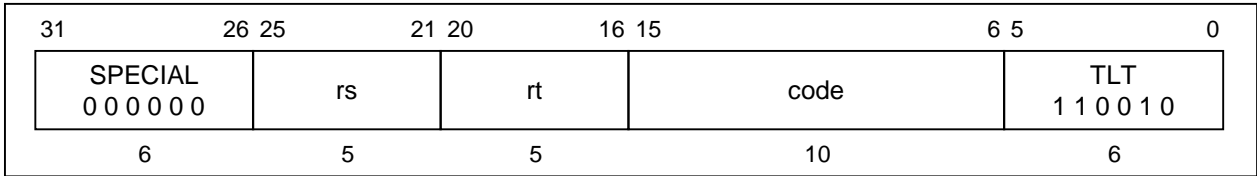
TLT**Trap If Less Than****TLT****Format:**

TLT rs, rt

Description:

The contents of general register *rt* are compared to general register *rs*. Considering both quantities as signed integers, if the contents of general register *rs* are less than the contents of general register *rt*, a trap exception occurs.

The code field is available for use as software parameters, but is retrieved by the exception handler only by loading the contents of the memory word containing the instruction.

Operation:

```

32, 64 T:  if GPR [rs] < GPR [rt] then
           TrapException
           endif

```

Exceptions:

Trap exception

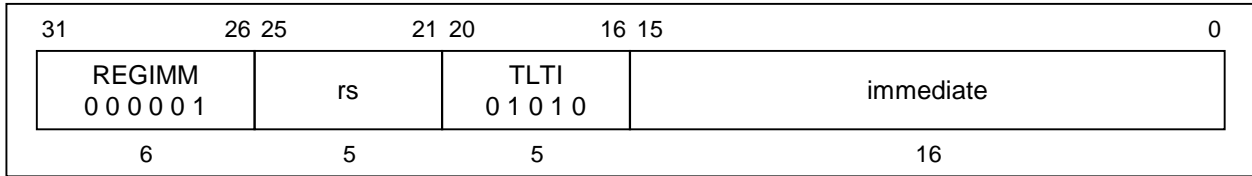
TLTI**Trap If Less Than Immediate****TLTI****Format:**

TLTI rs, immediate

Description:

The 16-bit *immediate* is sign-extended and compared to the contents of general register *rs*. Considering both quantities as signed integers, if the contents of general register *rs* are less than the sign-extended *immediate*, a trap exception occurs.

Operation:

```

32  T:  if GPR [rs] < (immediate15)16 || immediate15...0 then
        TrapException
        endif

64  T:  if GPR [rs] < (immediate15)48 || immediate15...0 then
        TrapException
        endif

```

Exceptions:

Trap exception

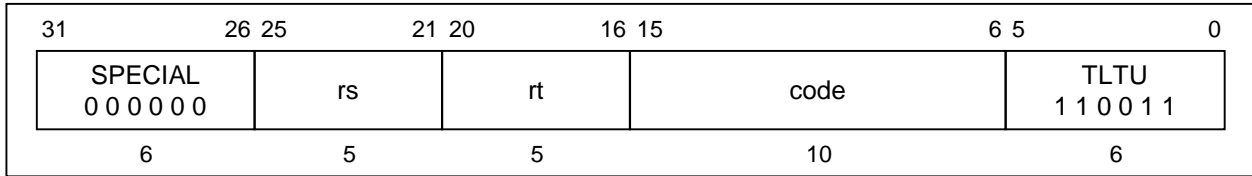
TLTU**Trap If Less Than Unsigned****TLTU****Format:**TLTU *rs*, *rt***Description:**

The contents of general register *rt* are compared to general register *rs*. Considering both quantities as unsigned integers, if the contents of general register *rs* are less than the contents of general register *rt*, a trap exception occurs.

The code field is available for use as software parameters, but is retrieved by the exception handler only by loading the contents of the memory word containing the instruction.

Operation:

```

32, 64 T:  if (0 || GPR [rs]) < (0 || GPR [rt]) then
            TrapException
            endif

```

Exceptions:

Trap exception

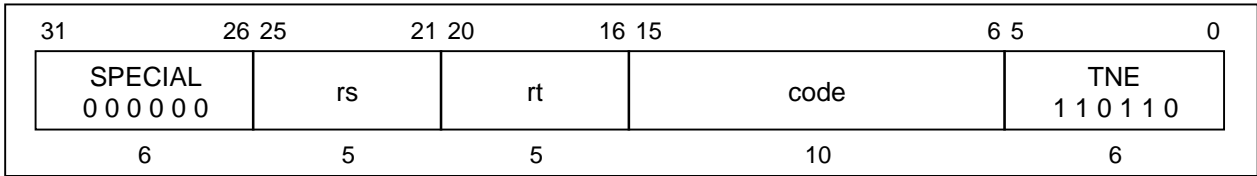
TNE**Trap If Not Equal****TNE****Format:**

TNE rs, rt

Description:

The contents of general register *rt* are compared to general register *rs*. If the contents of general register *rs* are not equal to the contents of general register *rt*, a trap exception occurs.

The code field is available for use as software parameters, but is retrieved by the exception handler only by loading the contents of the memory word containing the instruction.

Operation:

```

32, 64 T:  if GPR [rs] ≠ GPR [rt] then
           TrapException
           endif

```

Exceptions:

Trap exception

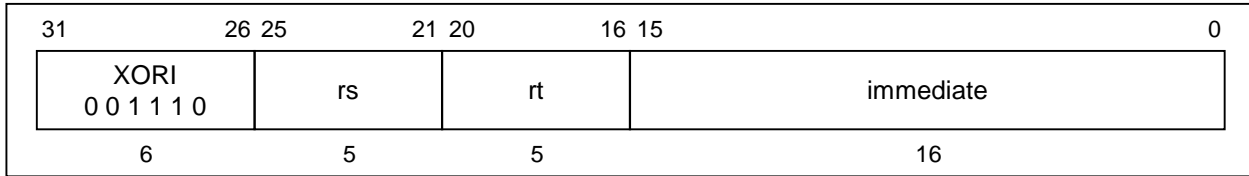
XORI**Exclusive OR Immediate****XORI****Format:**

XORI rt, rs, immediate

Description:

The 16-bit *immediate* is zero-extended and combined with the contents of general register *rs* in a bit-wise logical exclusive OR operation.

The result is placed into general register *rt*.

Operation:

32 T: $\text{GPR}[rt] \leftarrow \text{GPR}[rs] \text{ xor } (0^{16} \parallel \text{immediate})$

64 T: $\text{GPR}[rt] \leftarrow \text{GPR}[rs] \text{ xor } (0^{48} \parallel \text{immediate})$

Exceptions:

None

28.6 CPU INSTRUCTION OPCODE BIT ENCODING

The remainder of this chapter presents the opcode bit encoding for the CPU instruction set (ISA and extensions), as implemented by the Vr4111. Figure 28-2 lists the Vr4111 Opcode Bit Encoding.

Figure 28-1. Vr4111 Opcode Bit Encoding (1/2)

28...26		Opcode							
31...29	0	1	2	3	4	5	6	7	
0	SPECIAL	REGIMM	J	JAL	BEQ	BNE	BLEZ	BGTZ	
1	ADDI	ADDIU	SLTI	SLTIU	ANDI	ORI	XORI	LUI	
2	COP0	π	π	*	BEQL	BNEL	BLEZL	BGTZL	
3	DADDI ϵ	DADDIU ϵ	LDL ϵ	LDR ϵ	*	JALX θ	*	*	
4	LB	LH	LWL	LW	LBU	LHU	LWR	LWU ϵ	
5	SB	SH	SWL	SW	SDL ϵ	SDR ϵ	SWR	CACHE δ	
6	*	π	π	*	*	π	π	LD ϵ	
7	*	π	π	*	*	π	π	SD ϵ	

2...0		SPECIAL function							
5...3	0	1	2	3	4	5	6	7	
0	SLL	*	SRL	SRA	SLLV	*	SRLV	SRAV	
1	JR	JALR	*	*	SYSCALL	BREAK	*	SYNC	
2	MFHI	MTHI	MFLO	MTLO	DSLLV ϵ	*	DSRLV ϵ	DSRAV ϵ	
3	MULT	MULTU	DIV	DIVU	DMULT ϵ	DMULTU ϵ	DDIV ϵ	DDIVU ϵ	
4	ADD	ADDU	SUB	SUBU	AND	OR	XOR	NOR	
5	MADD16	DMADD16	SLT	SLTU	DADD ϵ	DADDU ϵ	DSUB ϵ	DSUBU ϵ	
6	TGE	TGEU	TLT	TLTU	TEQ	*	TNE	*	
7	DSLL ϵ	*	DSRL ϵ	DSRA ϵ	DSLL32 ϵ	*	DSRL32 ϵ	DSRA32 ϵ	

18...16		REGIMM rt							
20...19	0	1	2	3	4	5	6	7	
0	BLTZ	BGEZ	BLTZL	BGEZL	*	*	*	*	
1	TGEI	TGEIU	TLTI	TLTIU	TEQI	*	TNEI	*	
2	BLTZAL	BGEZAL	BLTZALL	BGEZALL	*	*	*	*	
3	*	*	*	*	*	*	*	*	

Figure 28-1. VR4111 Opcode Bit Encoding (2/2)

23...21		COP0 rs							
25, 24	0	1	2	3	4	5	6	7	
0	MF	DMF ϵ	γ	γ	MT	DMT ϵ	γ	γ	
1	BC	γ	γ	γ	γ	γ	γ	γ	
2	CO								
3									

18...16		COP0 rt							
20...19	0	1	2	3	4	5	6	7	
0	BCF	BCT	BCFL	BCTL	γ	γ	γ	γ	
1	γ	γ	γ	γ	γ	γ	γ	γ	
2	γ	γ	γ	γ	γ	γ	γ	γ	
3	γ	γ	γ	γ	γ	γ	γ	γ	

2...0		COP0 Function							
5...3	0	1	2	3	4	5	6	7	
0	ϕ	TLBR	TLBWI	ϕ	ϕ	ϕ	TLBWR	ϕ	
1	TLBP	ϕ	ϕ	ϕ	ϕ	ϕ	ϕ	ϕ	
2	ξ	ϕ	ϕ	ϕ	ϕ	ϕ	ϕ	ϕ	
3	ERET χ	ϕ	ϕ	ϕ	ϕ	ϕ	ϕ	ϕ	
4	ϕ	STANDBY	SUSPEND	HIBERNATE	ϕ	ϕ	ϕ	ϕ	
5	ϕ	ϕ	ϕ	ϕ	ϕ	ϕ	ϕ	ϕ	
6	ϕ	ϕ	ϕ	ϕ	ϕ	ϕ	ϕ	ϕ	
7	ϕ	ϕ	ϕ	ϕ	ϕ	ϕ	ϕ	ϕ	

Key:

- * Operation codes marked with an asterisk cause reserved instruction exceptions in all current implementations and are reserved for future versions of the architecture.
- γ Operation codes marked with a gamma cause a reserved instruction exception. They are reserved for future versions of the architecture.
- δ Operation codes marked with a delta are valid only for VR4400 Series processors with CP0 enabled, and cause a reserved instruction exception on other processors.
- ϕ Operation codes marked with a phi are invalid but do not cause reserved instruction exceptions in VR4111 implementations.
- ξ Operation codes marked with a xi cause a reserved instruction exception on VR4111 processor.
- χ Operation codes marked with a chi are valid on VR4000 Series only.
- ϵ Operation codes marked with epsilon are valid when the processor operating as a 64-bit processor. These instructions will cause a reserved instruction exception if 64-bit operation is not enabled.
- π Operation codes marked with a pi are invalid and cause coprocessor unusable exception.
- θ Operation codes marked with a theta are valid when MIPS16 instruction execution is enabled, and cause a reserved instruction exception when MIPS16 instruction execution is disabled.

CHAPTER 29 MIPS16 INSTRUCTION SET FORMAT

This chapter describes the format of each MIPS16 instruction, and the format of the MIPS instructions that are made by converting MIPS16 instructions in alphabetical order. For details of MIPS16 instruction conversion and opcode, refer to **CHAPTER 4 MIPS16 INSTRUCTION SET**.

Caution For some instructions, their format or syntax may become ineffective after they are converted to a 32-bit instruction. For details of formats and syntax of 32-bit instructions, refer to **CHAPTER 3 MIPS III INSTRUCTION SET SUMMARY** and **CHAPTER 28 MIPS III INSTRUCTION SET DETAILS**.

ADDIU

Add Immediate Unsigned

(1/2)

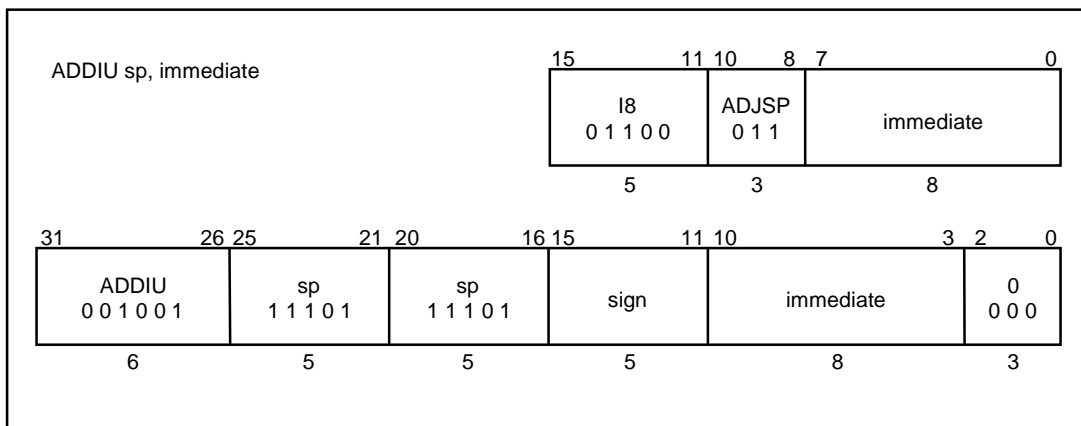
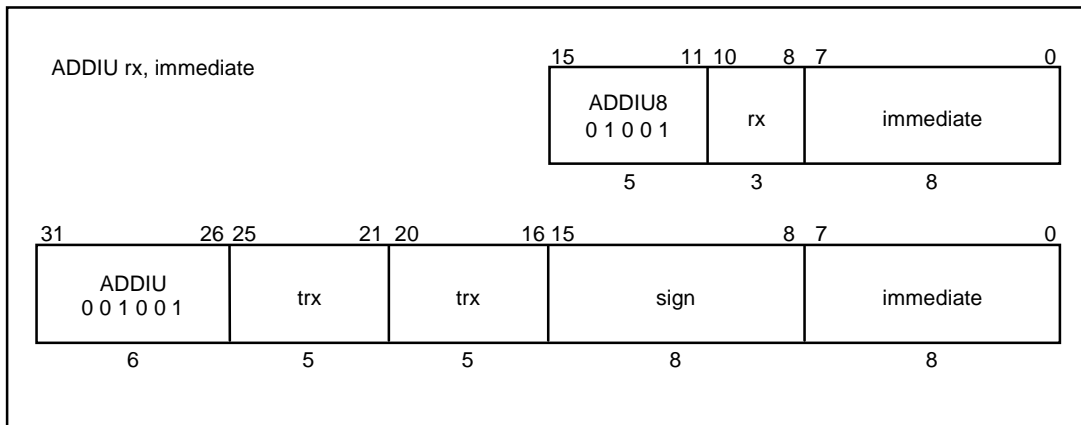
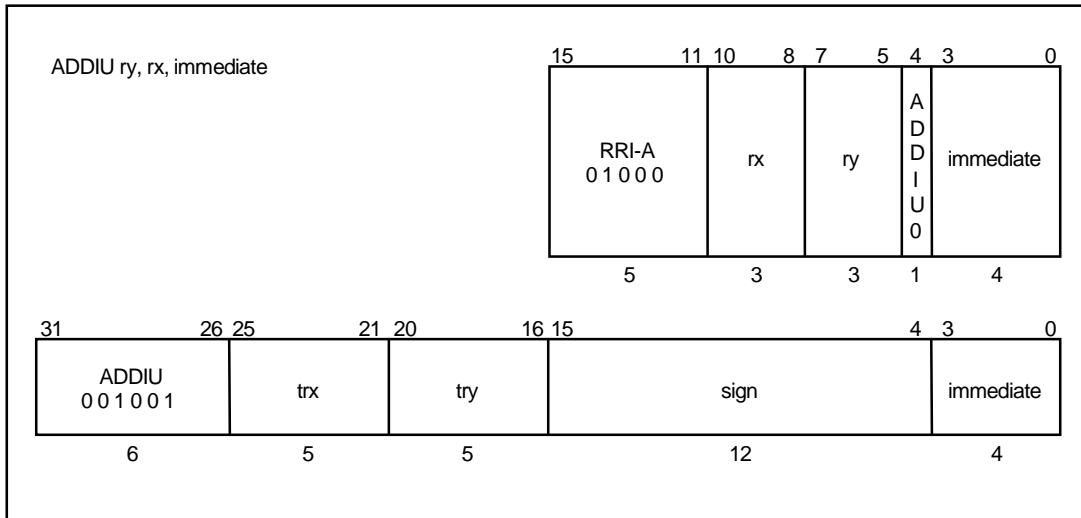

ADDIU

Add Immediate Unsigned

(2/2)

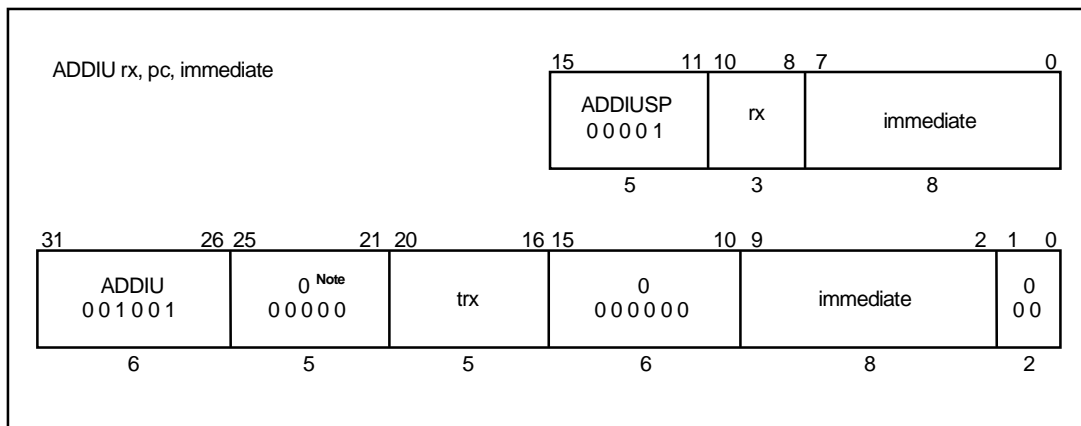

Note Zeros are shown in the field of bits 21 to 25 as placeholders. The 32-bit PC-relative instruction format shown above is provided here only to make the description complete; it is not a valid 32-bit MIPS instruction. Please see CHAPTER 4 for a complete definition of the semantics of the MIPS16 PC-relative instructions.

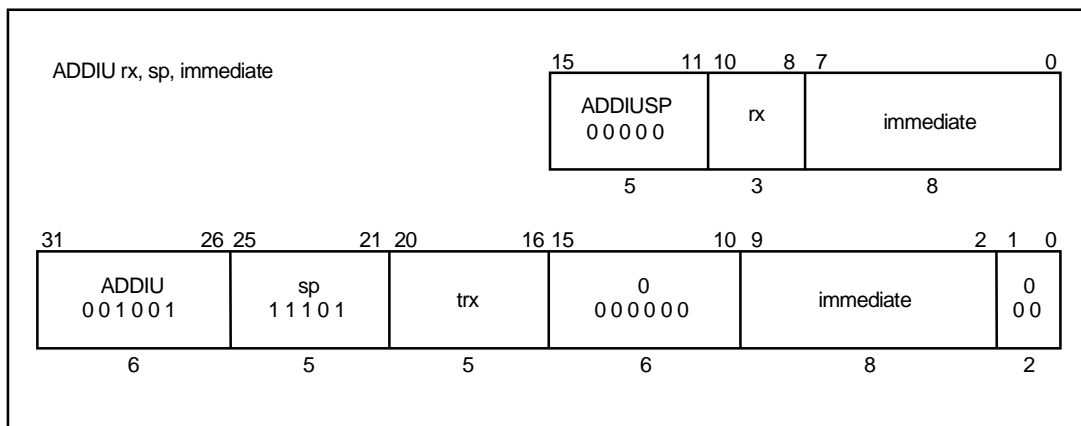

ADDU

Add Unsigned

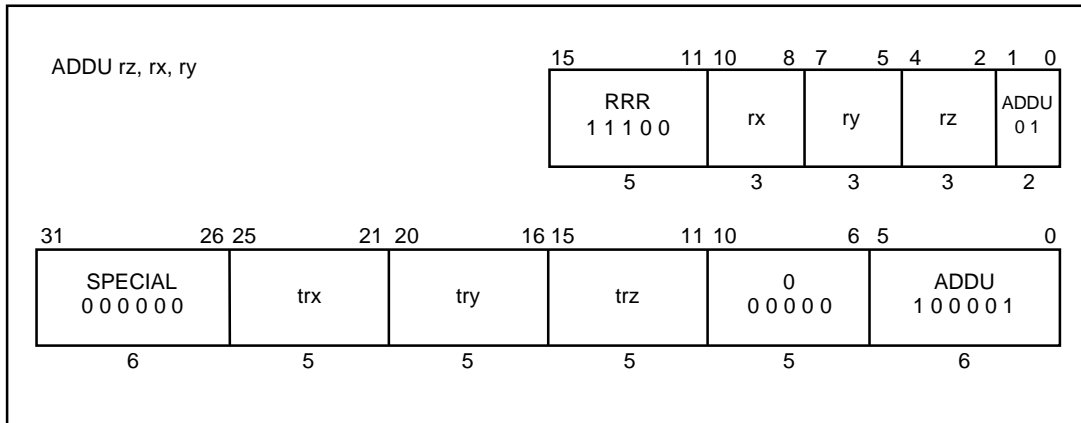

AND

AND

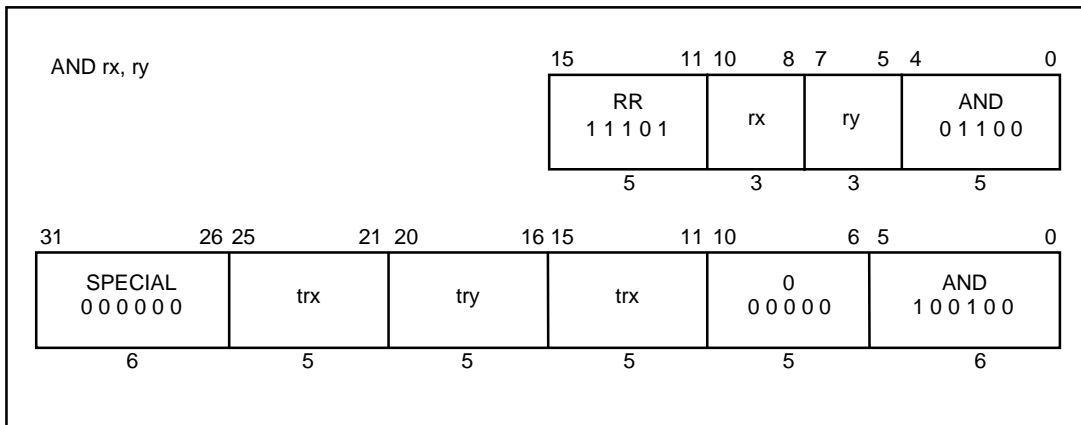

B

Branch Unconditional

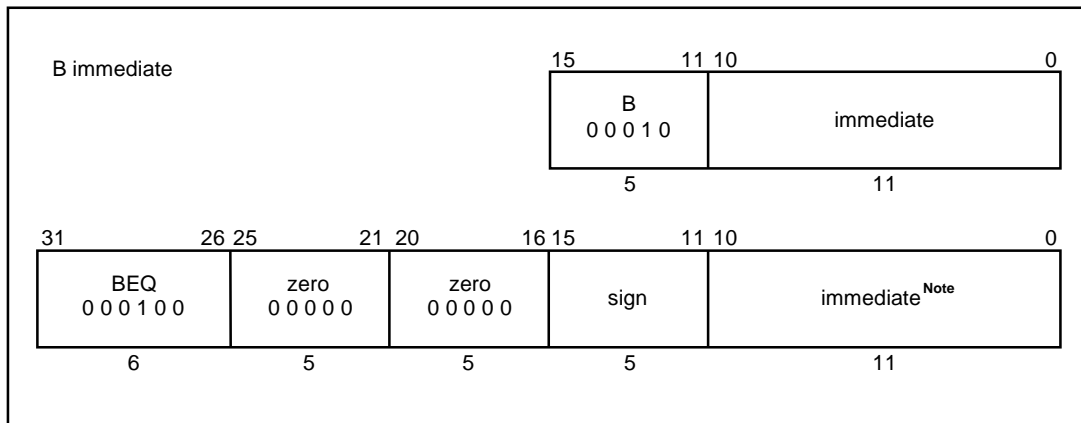

Note In MIPS16 mode, the branch offset is interpreted as halfword aligned. This is unlike 32-bit MIPS mode which interprets the offset value as word aligned. The 32-bit branch instruction format shown above is provided here only to make the description complete; it is not a valid 32-bit MIPS instruction. Please see CHAPTER 3 and CHAPTER 28 for a complete definition of the semantics of the MIPS16 branch instructions.

BEQZ

Branch On Equal to Zero

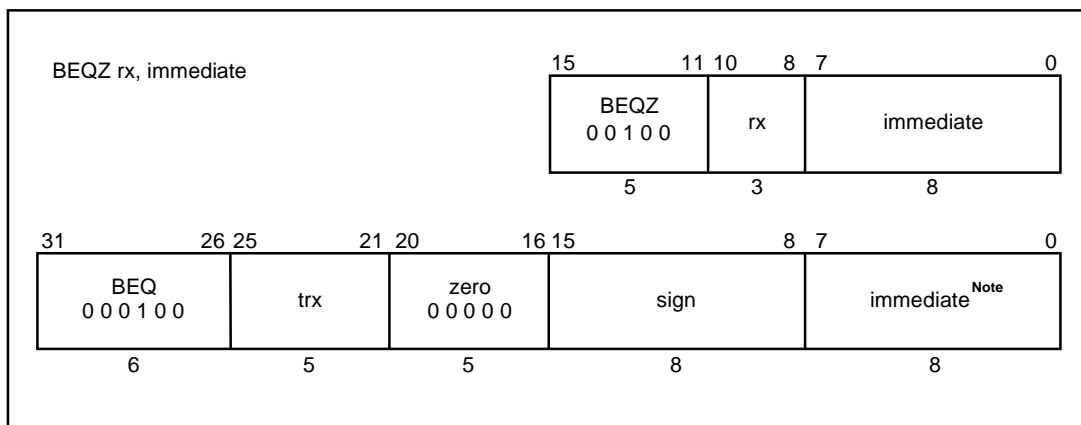

Note In MIPS16 mode, the branch offset is interpreted as halfword aligned. This is unlike 32-bit MIPS mode which interprets the offset value as word aligned. The 32-bit branch instruction format shown above is provided here only to make the description complete; it is not a valid 32-bit MIPS instruction. Please see CHAPTER 3 and CHAPTER 28 for a complete definition of the semantics of the MIPS16 branch instructions.

BNEZ

Branch Not Equal to Zero

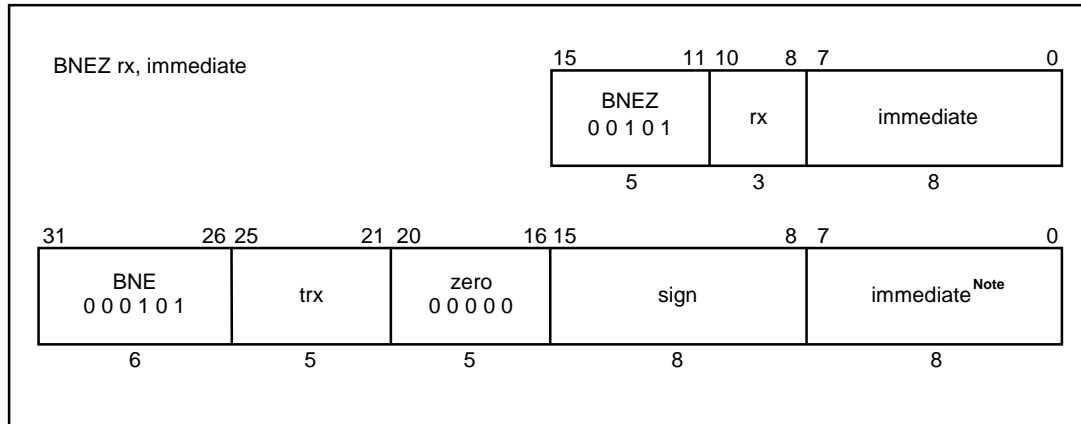

Note In MIPS16 mode, the branch offset is interpreted as halfword aligned. This is unlike 32-bit MIPS mode which interprets the offset value as word aligned. The 32-bit branch instruction format shown above is provided here only to make the description complete; it is not a valid 32-bit MIPS instruction. Please see CHAPTER 3 and CHAPTER 28 for a complete definition of the semantics of the MIPS16 branch instructions.

BREAK

Breakpoint

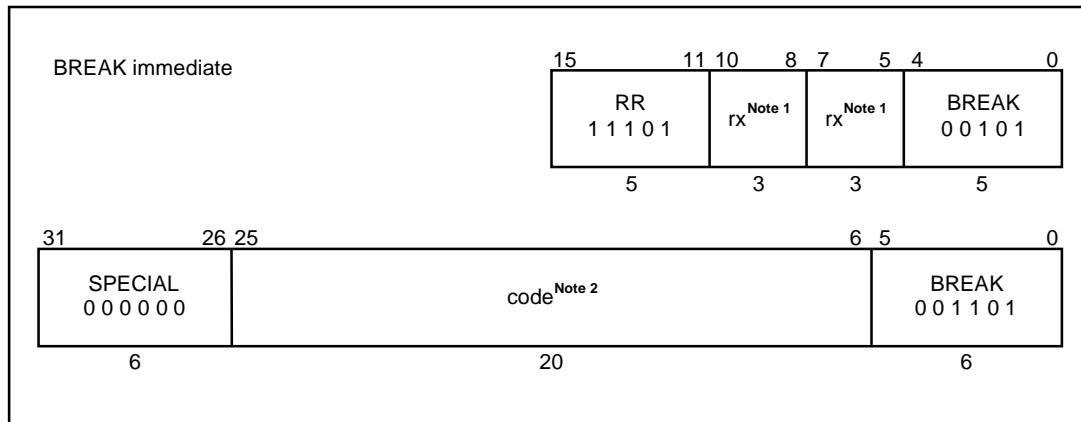

- Notes 1.** The two register fields in the MIPS16 break instruction may be used as a 6-bit code (immediate) field for software parameters. The 6-bit code can be retrieved by the exception handler.
- 2.** The 32-bit break instruction format shown above is provided here only to make the description complete; it is not a valid 32-bit MIPS instruction. The code field is entirely ignored by the pipeline, and it is not visible in any way to the software executing on the processor.

BTEQZ

Branch On T Equal to Zero

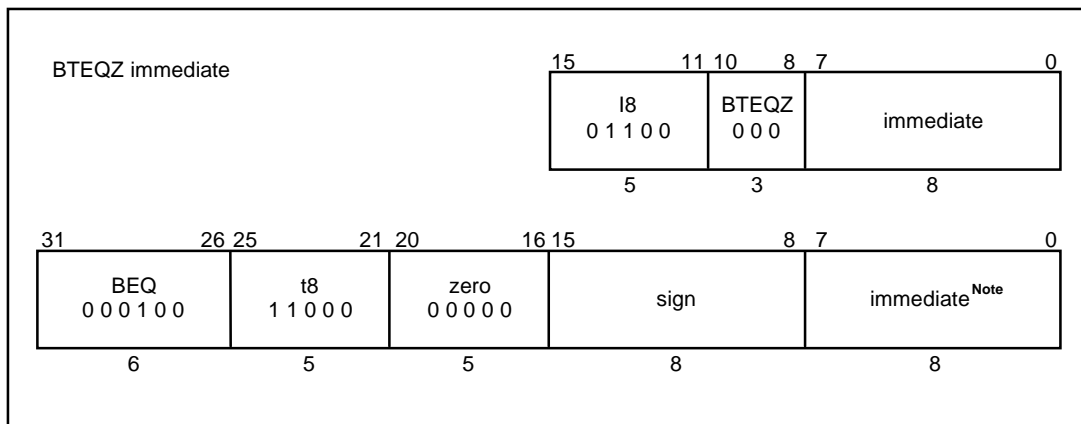

Note In MIPS16 mode, the branch offset is interpreted as halfword aligned. This is unlike 32-bit MIPS mode which interprets the offset value as word aligned. The 32-bit branch instruction format shown above is provided here only to make the description complete; it is not a valid 32-bit MIPS instruction. Please see CHAPTER 3 and CHAPTER 28 for a complete definition of the semantics of the MIPS16 branch instructions.

BTNEZ

Branch On T Not Equal to Zero

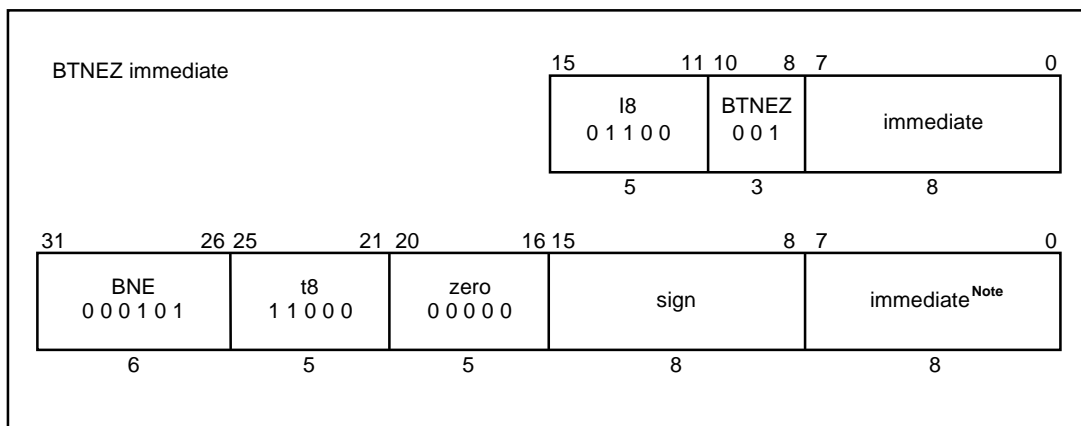

Note In MIPS16 mode, the branch offset is interpreted as halfword aligned. This is unlike 32-bit MIPS mode which interprets the offset value as word aligned. The 32-bit branch instruction format shown above is provided here only to make the description complete; it is not a valid 32-bit MIPS instruction. Please see CHAPTER 3 and CHAPTER 28 for a complete definition of the semantics of the MIPS16 branch instructions.

CMP

Compare

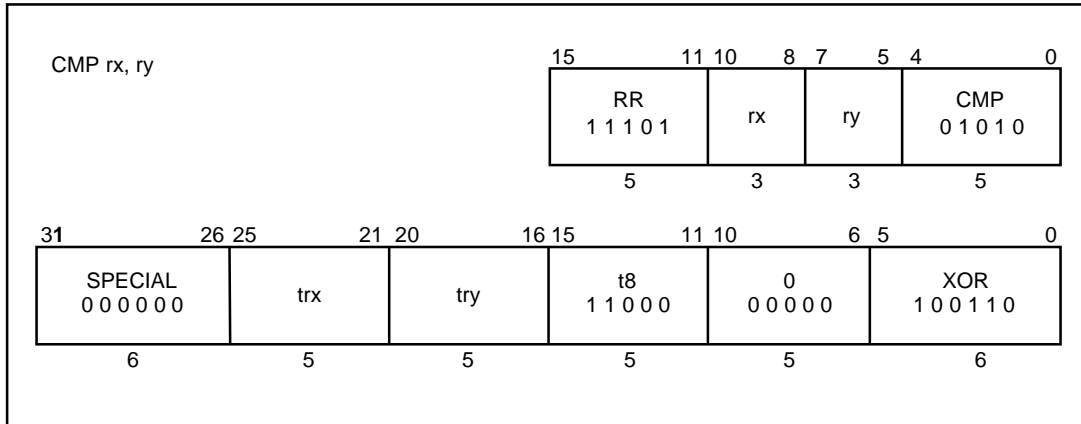

CMPI

Compare Immediate

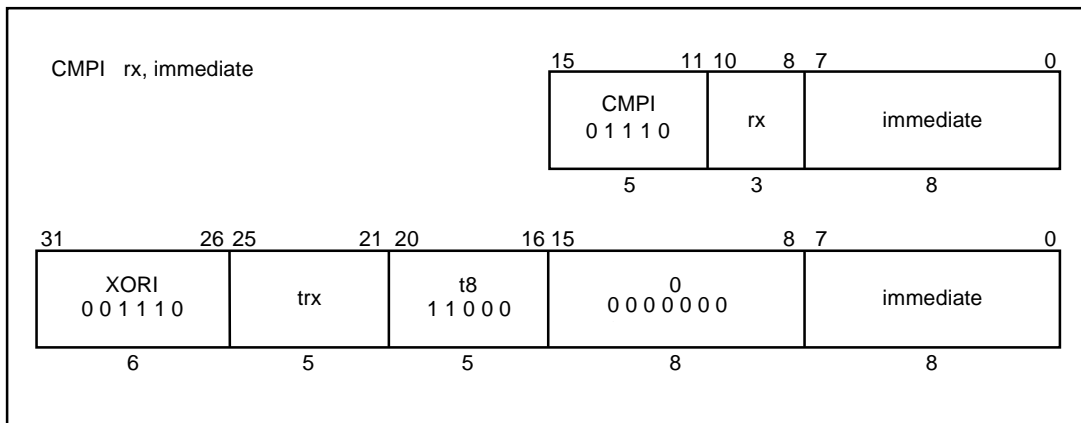

DADDIU

Doubleword Add Immediate Unsigned

(1/2)

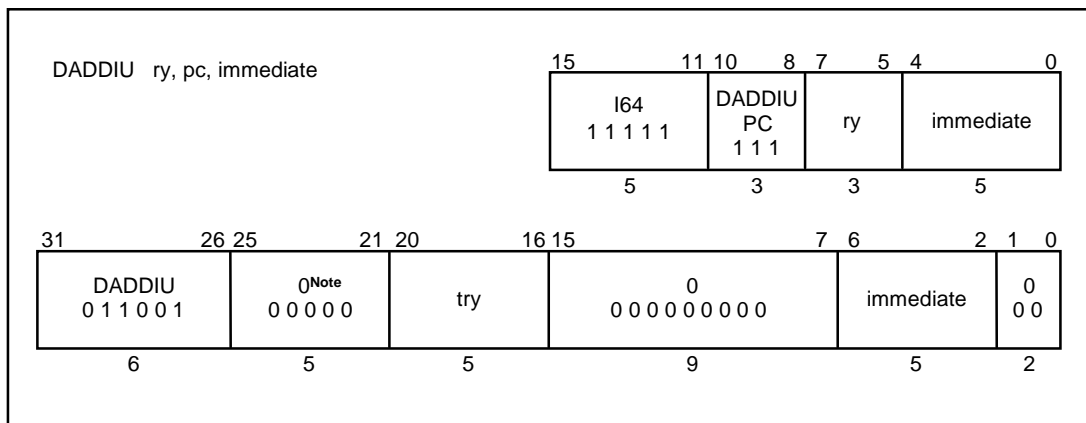
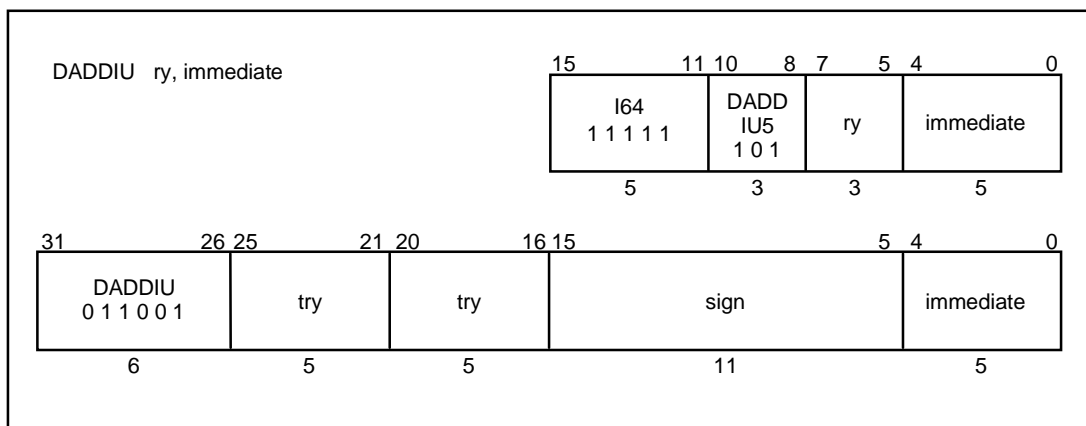
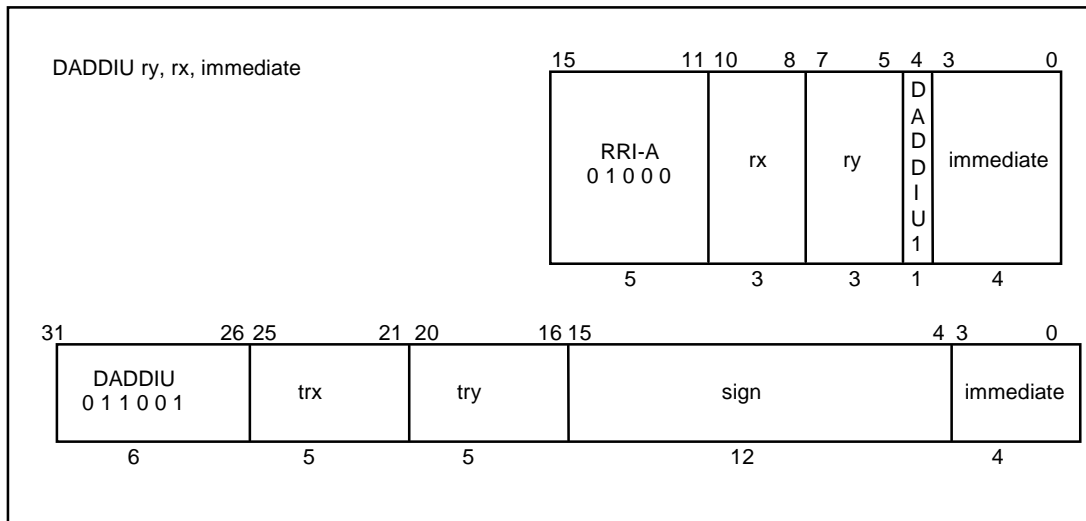

Note Zeros are shown in the field of bits 21 to 25 as placeholders. The 32-bit PC-relative instruction format shown above is provided here only to make the description complete; it is not a valid 32-bit MIPS instruction. Please see CHAPTER 4 for a complete definition of the semantics of the MIPS16 PC-relative instructions.

DADDIU

Doubleword Add Immediate Unsigned

(2/2)

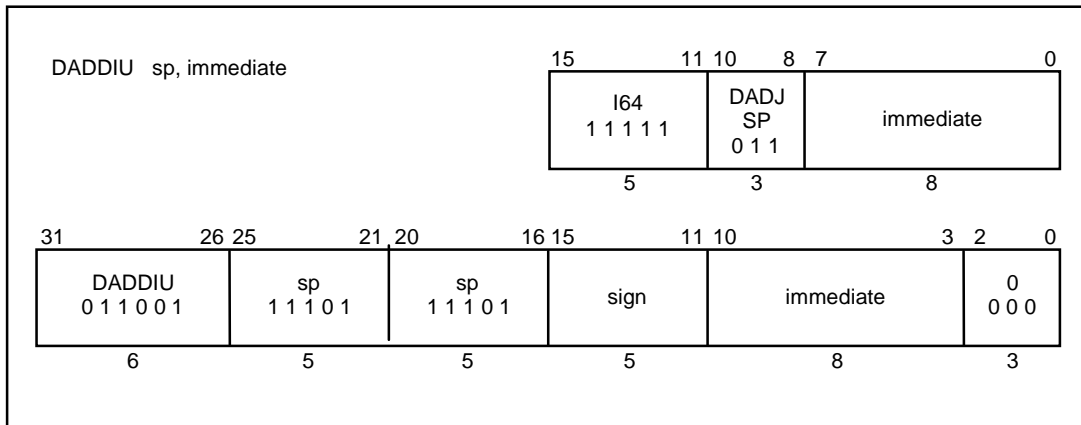
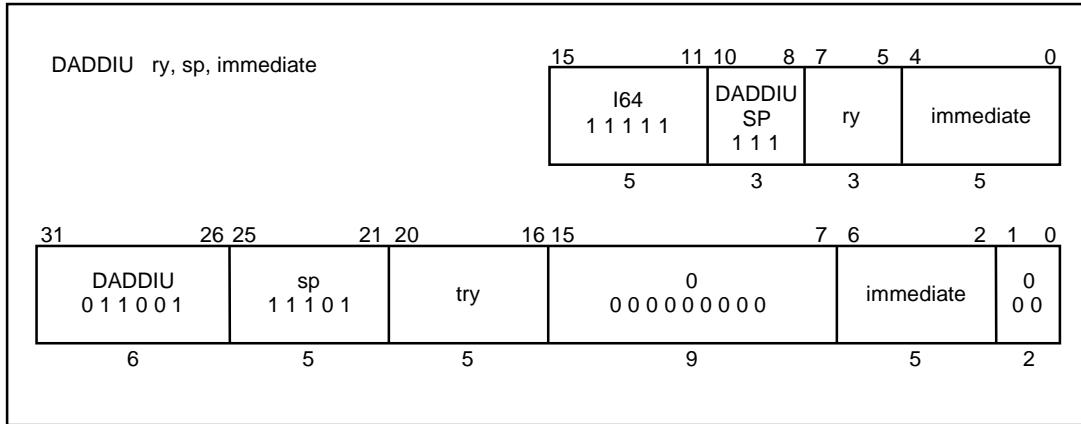

DADDU

Doubleword Add Unsigned

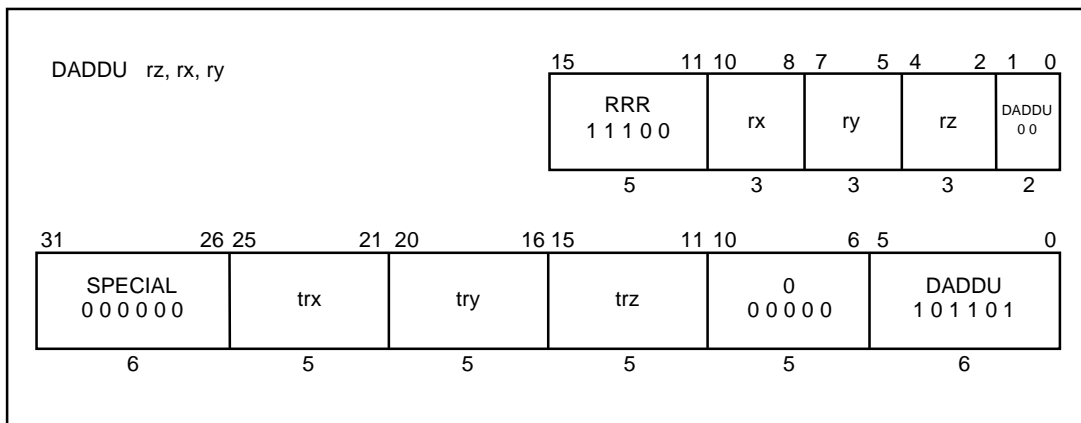

DDIV

Doubleword Divide

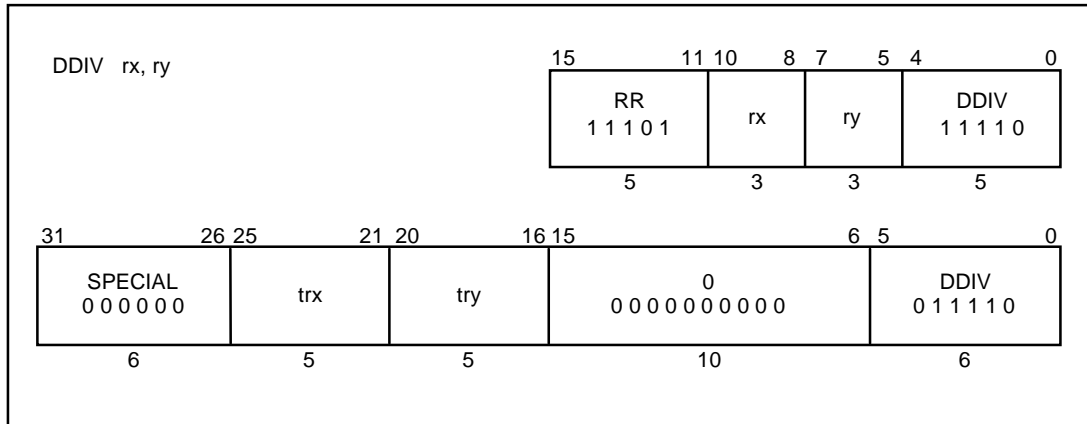

DDIVU

Doubleword Divide Unsigned

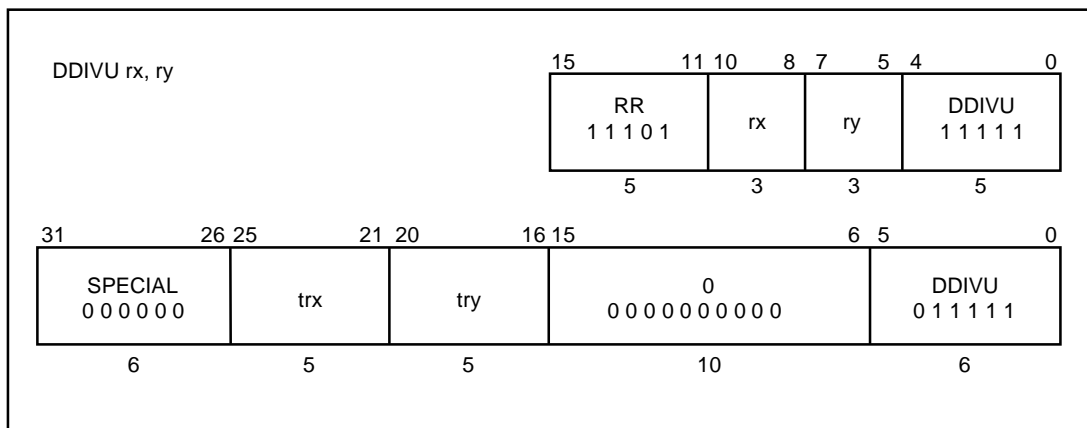

DIV

Divide

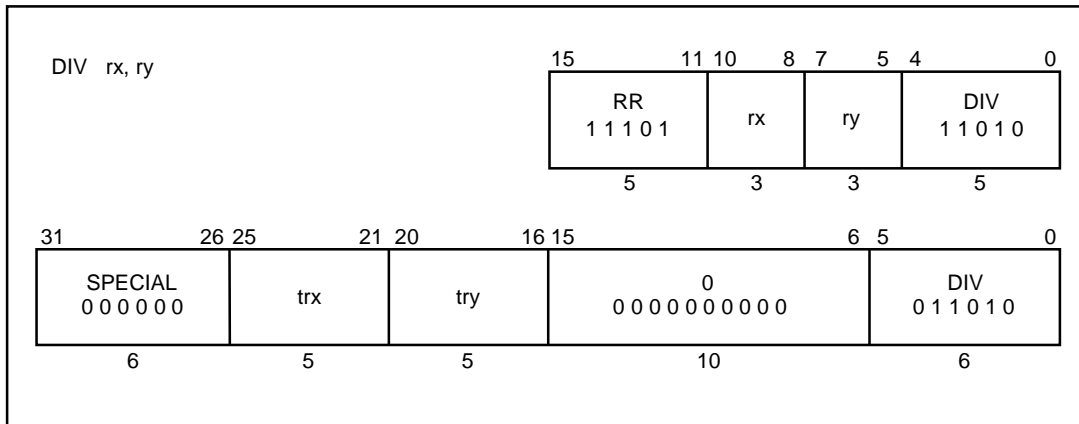

DIVU

Divide Unsigned

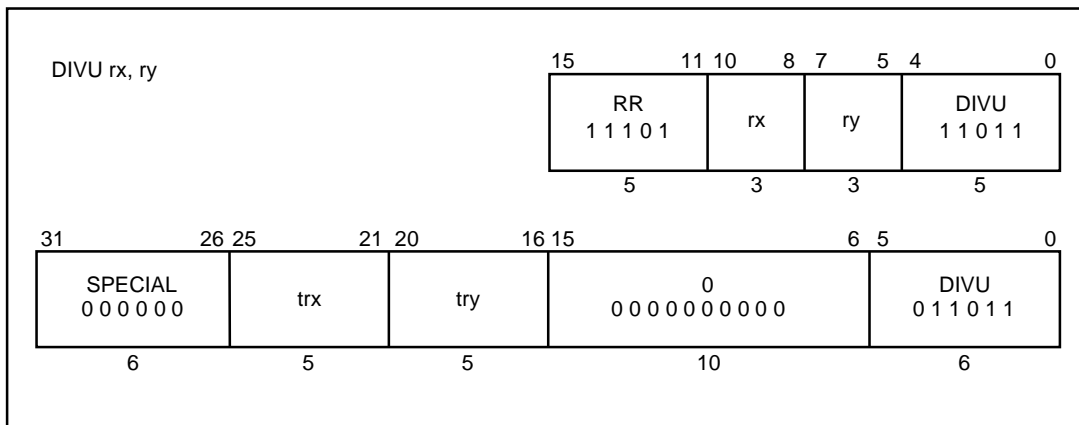

DMULT

Doubleword Multiply

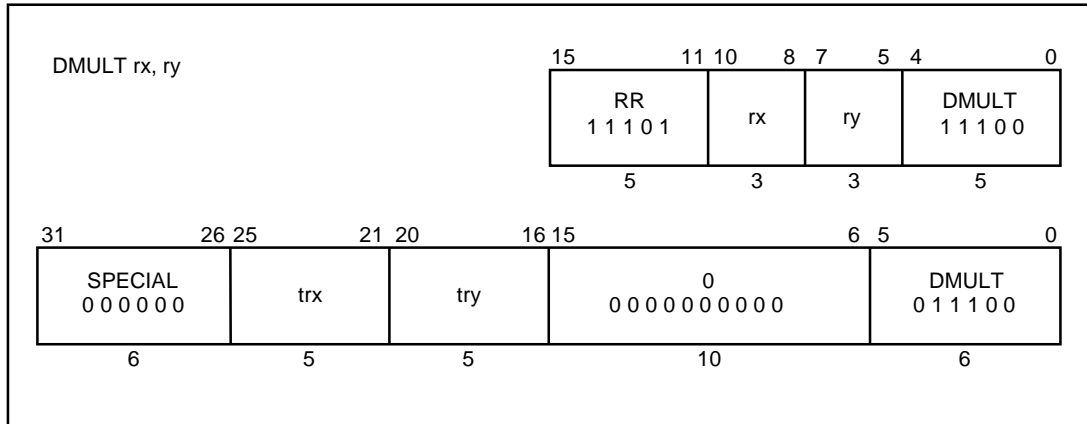

DMULTU

Doubleword Multiply Unsigned

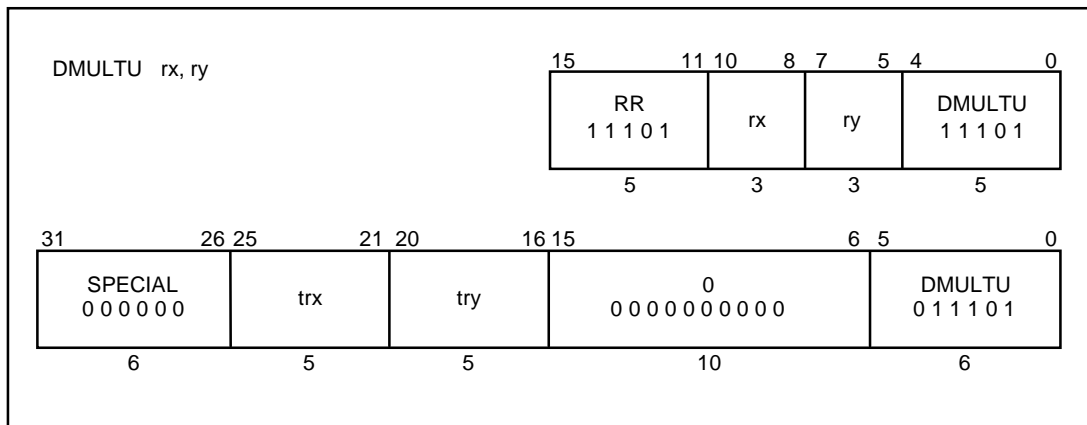

DSLL

Doubleword Shift Left Logical

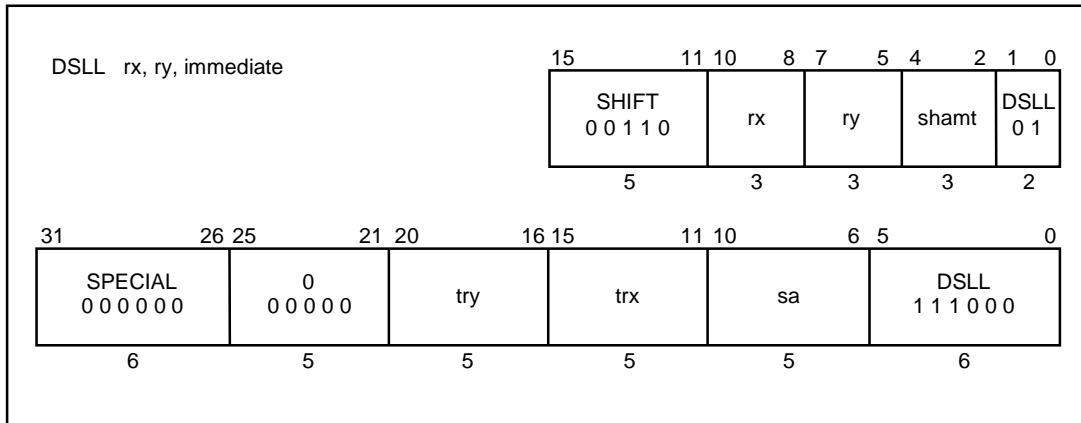

DSLLV

Doubleword Shift Left Logical Variable

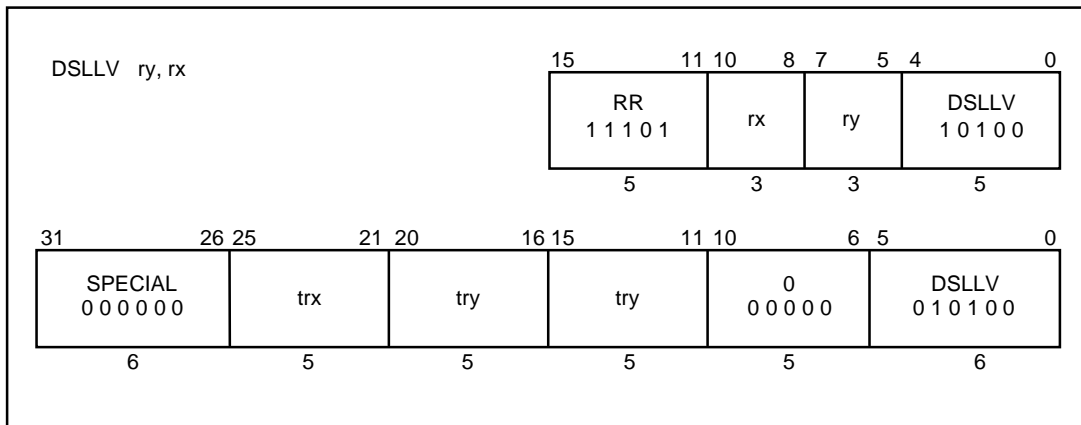

DSRA

Doubleword Shift Right Arithmetic

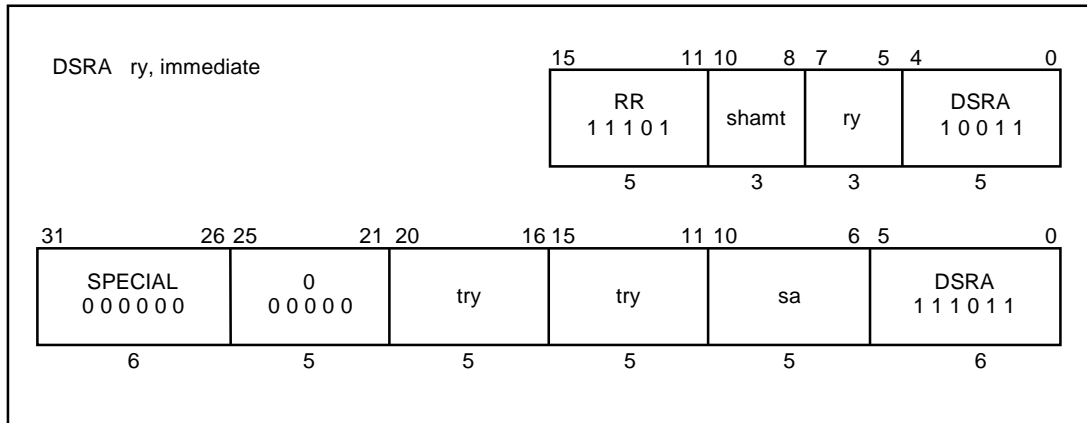

DSRAV

Doubleword Shift Right Arithmetic Variable

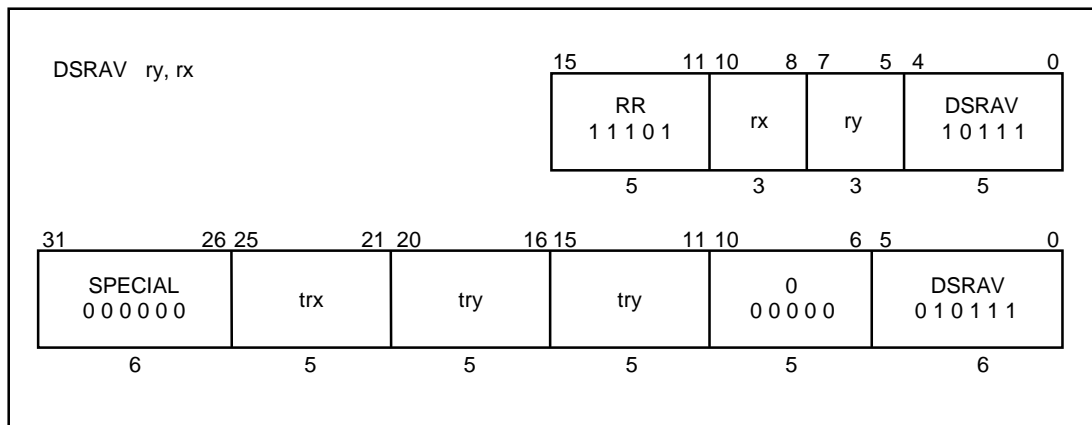

DSRL

Doubleword Shift Right Logical

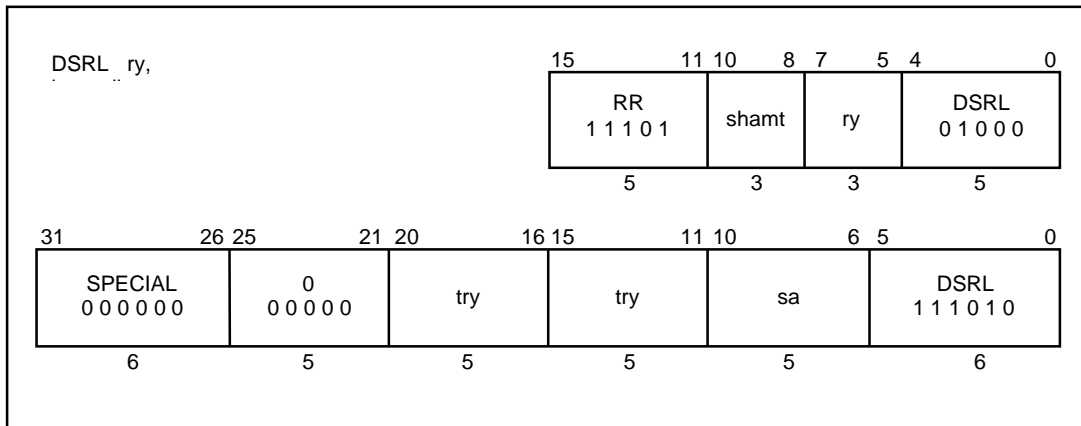

DSRLV

Doubleword Shift Right Logical Variable

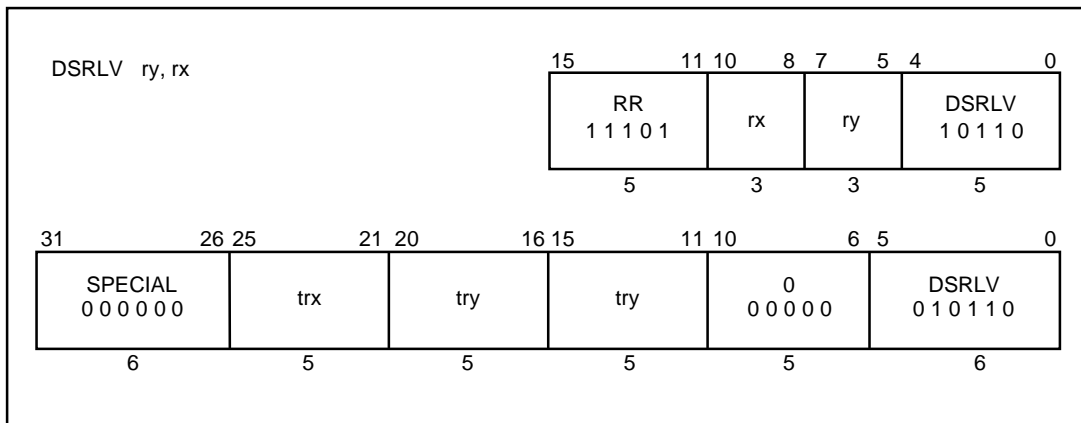

DSUBU

Doubleword Subtract Unsigned

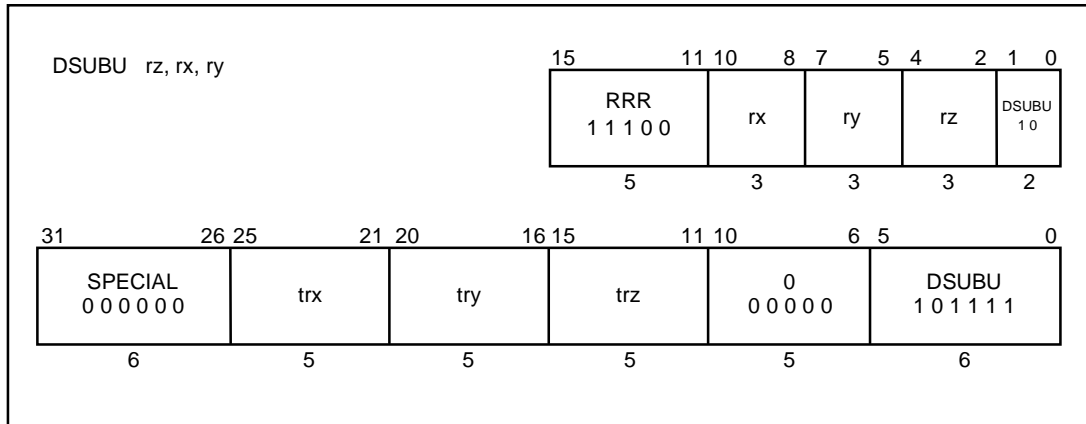

JAL

Jump and Link

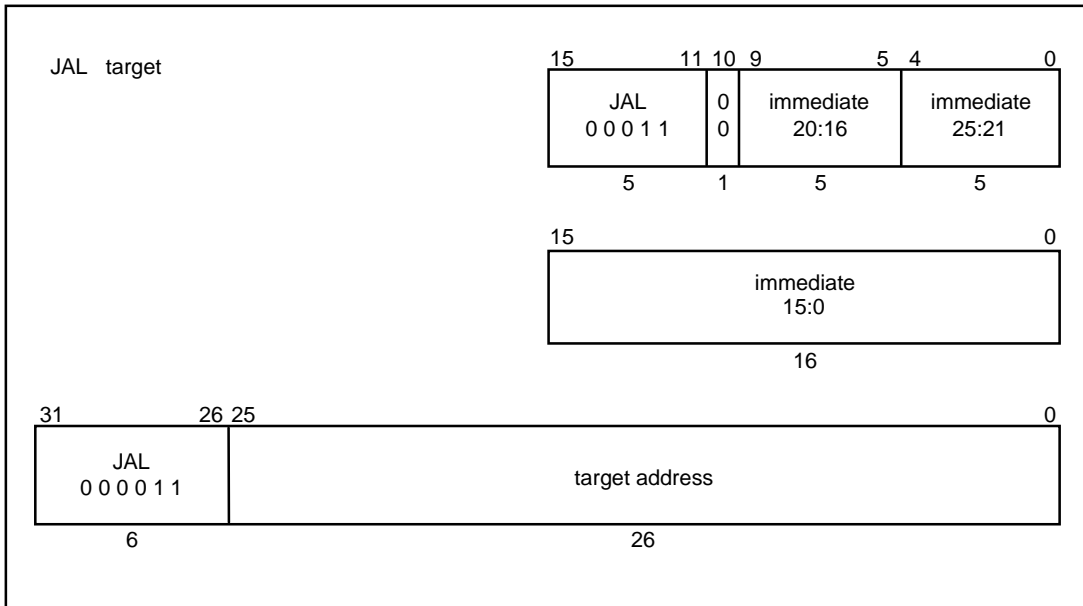

JALR

Jump and Link Register

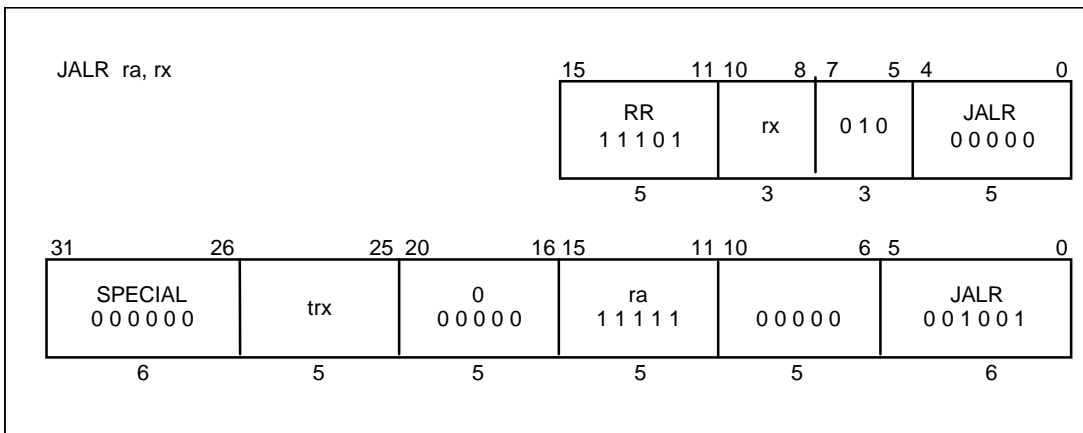

JALX

Jump and Link Exchange

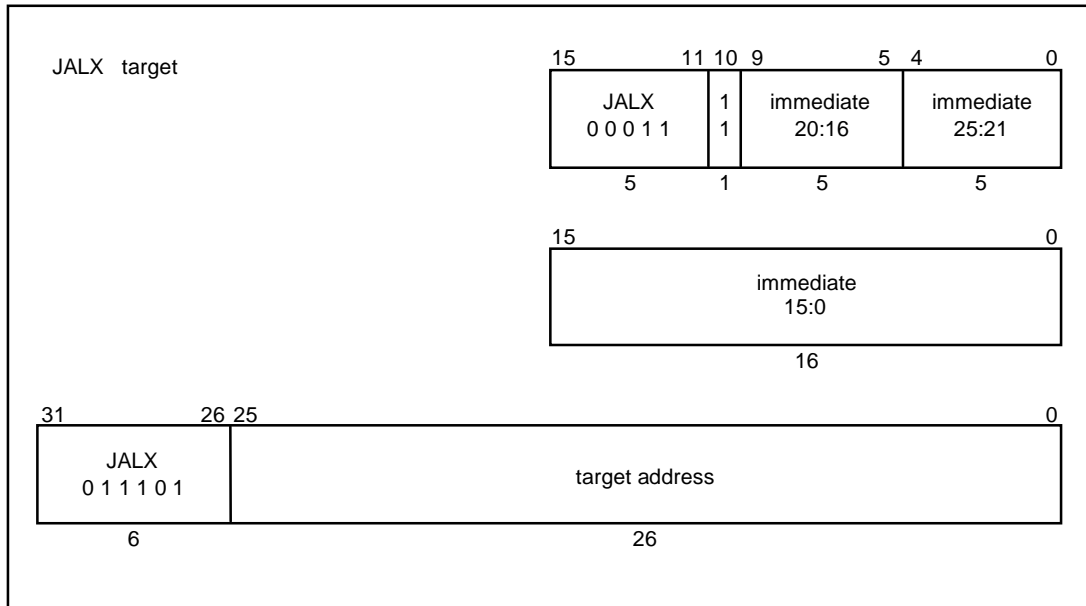

JR

Jump Register

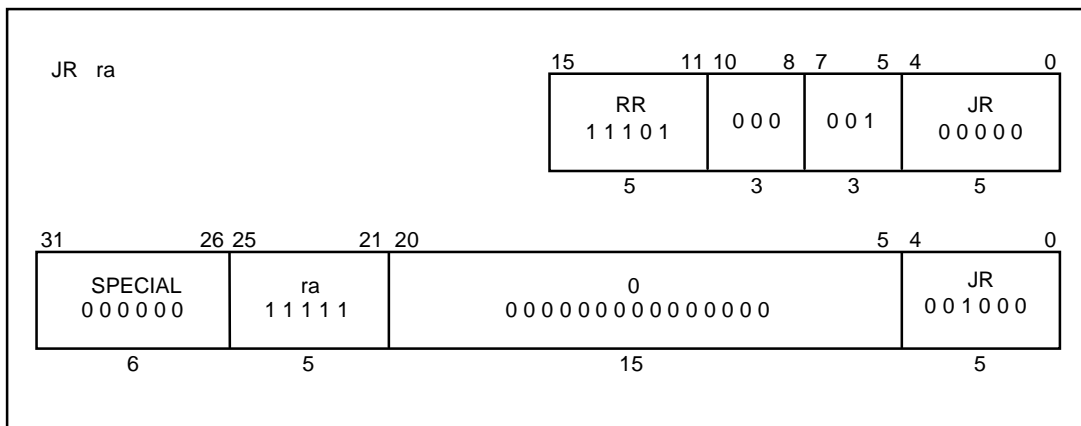
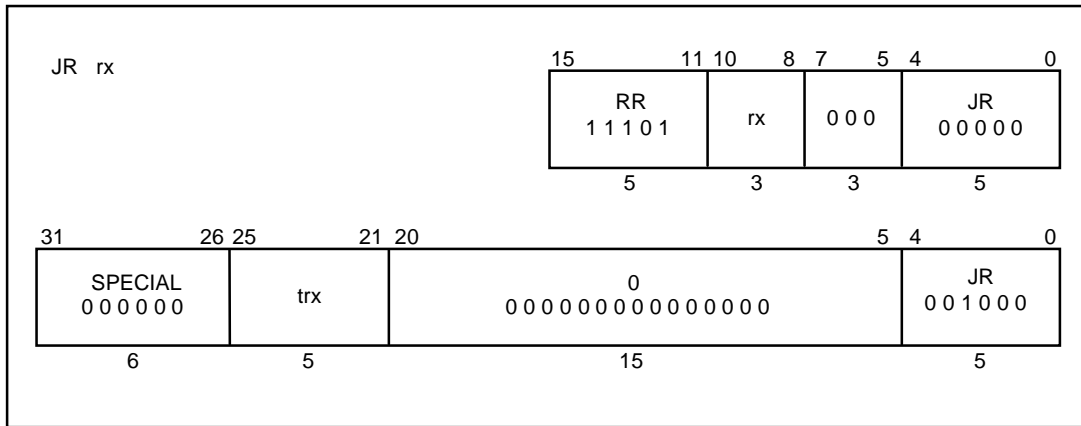

LB

Load Byte

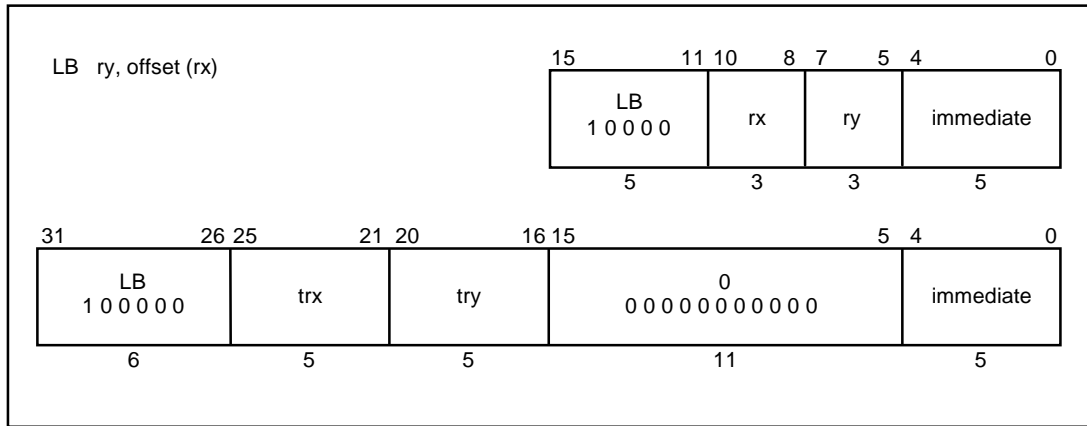

LBU

Load Byte Unsigned

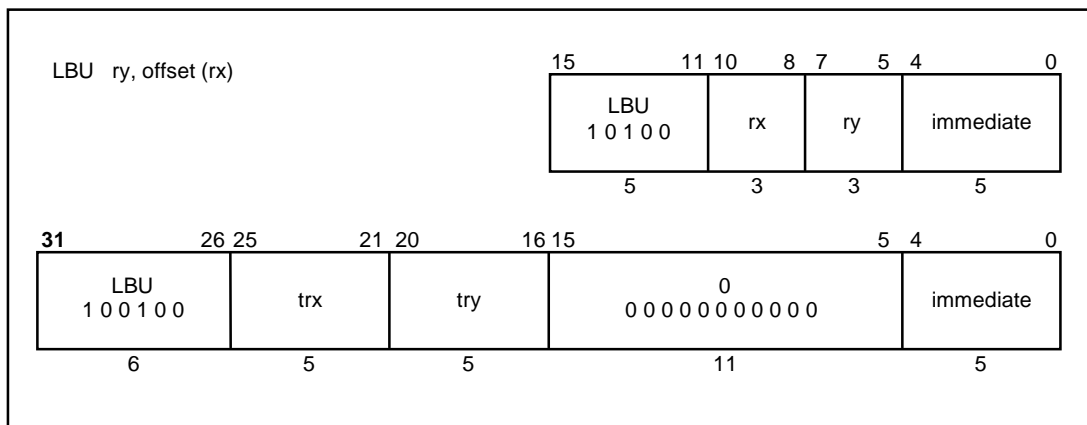

LD

Load Doubleword

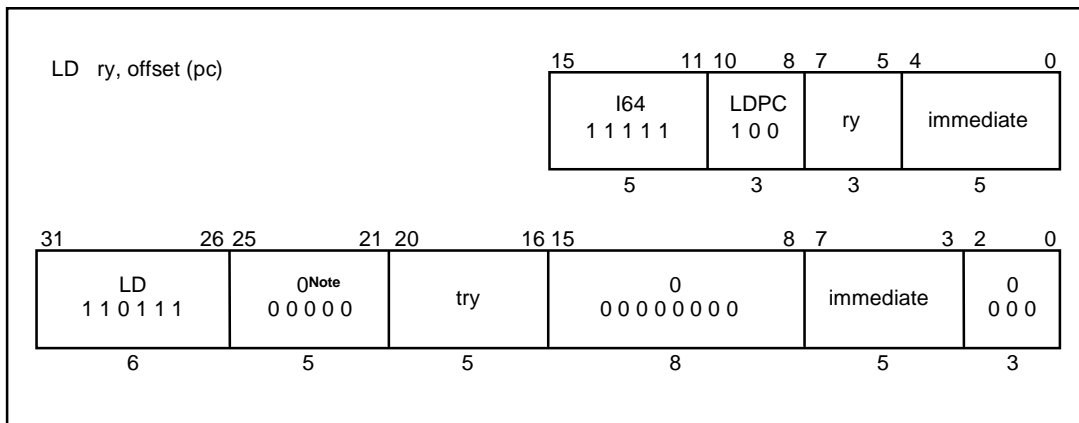
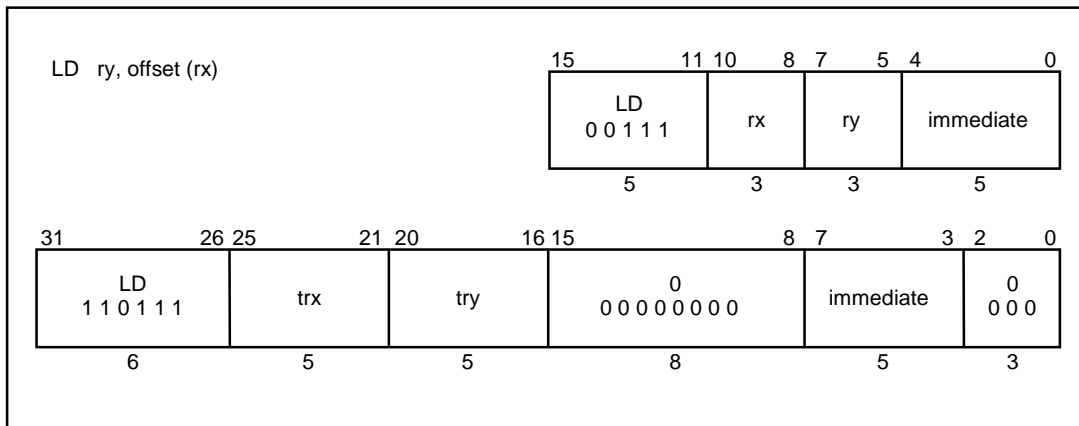

Note Zeros are shown in the field of bits 21 to 25 as placeholders. The 32-bit PC-relative instruction format shown above is provided here only to make the description complete; it is not a valid 32-bit MIPS instruction. Please see CHAPTER 4 for a complete definition of the semantics of the MIPS16 PC-relative instructions.

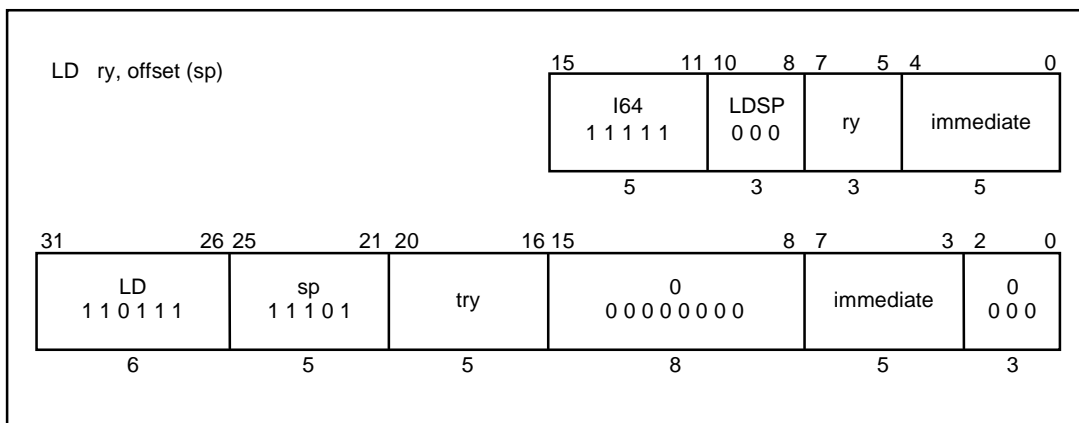

LH

Load Halfword

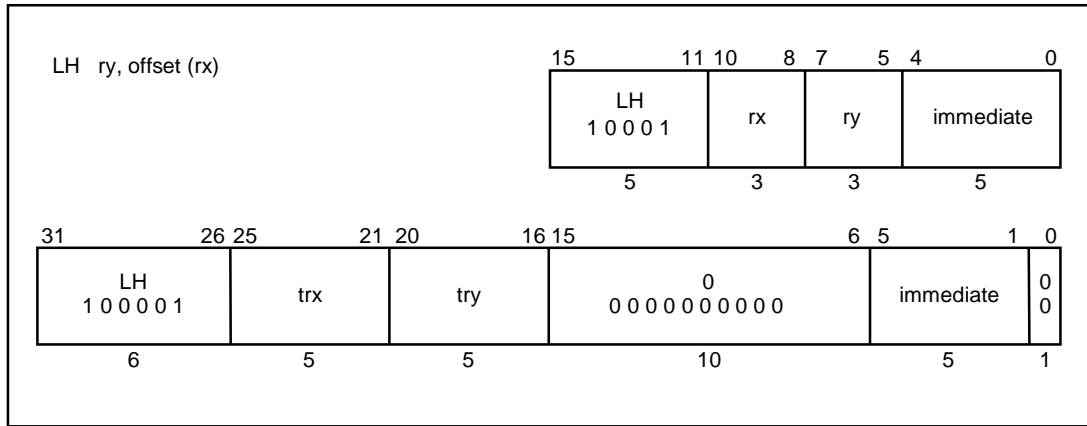

LHU

Load Halfword Unsigned

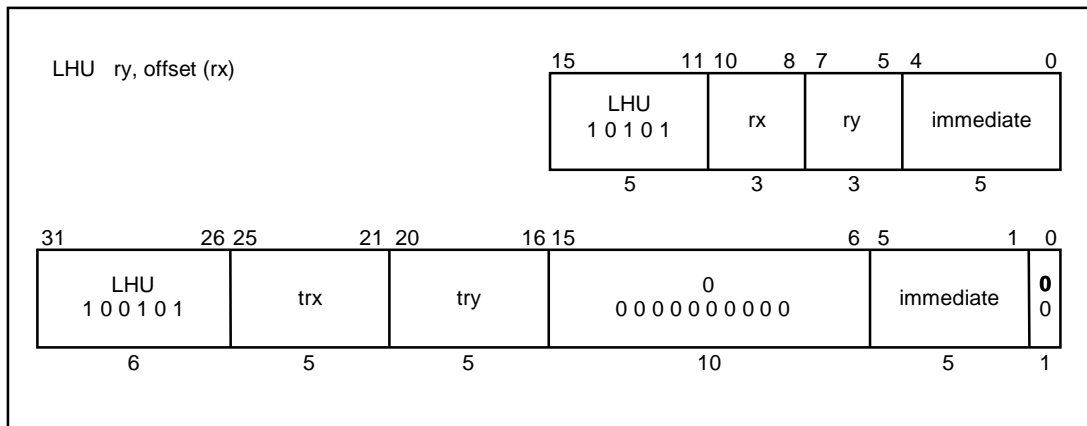

LI

Load Immediate

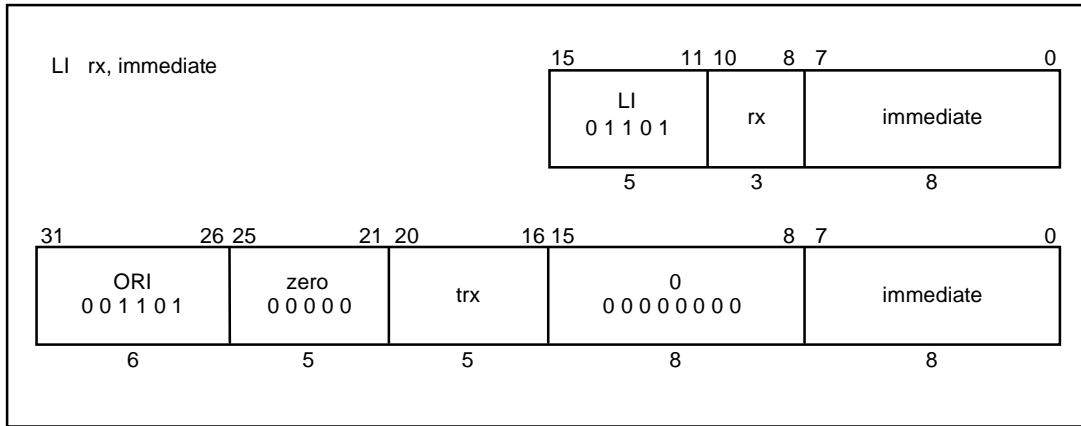

LW

Load Word

(1/2)

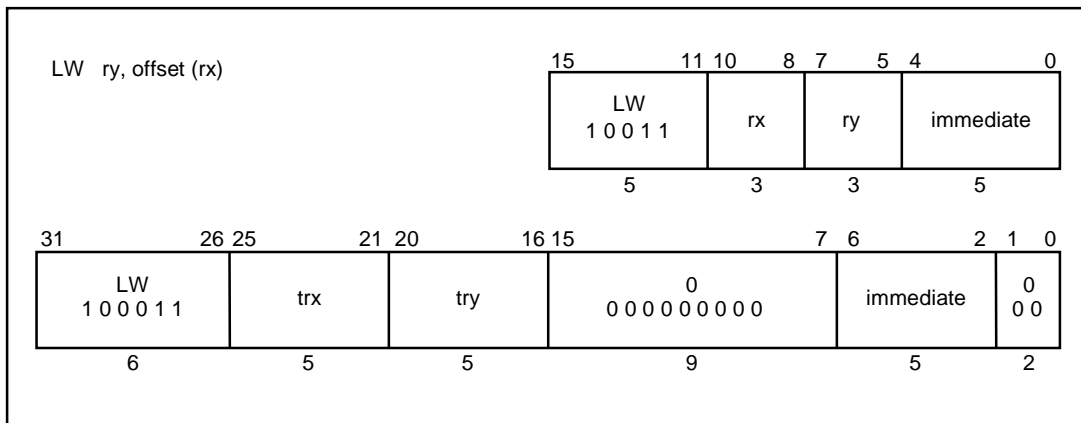

LW

Load Word

(2/2)

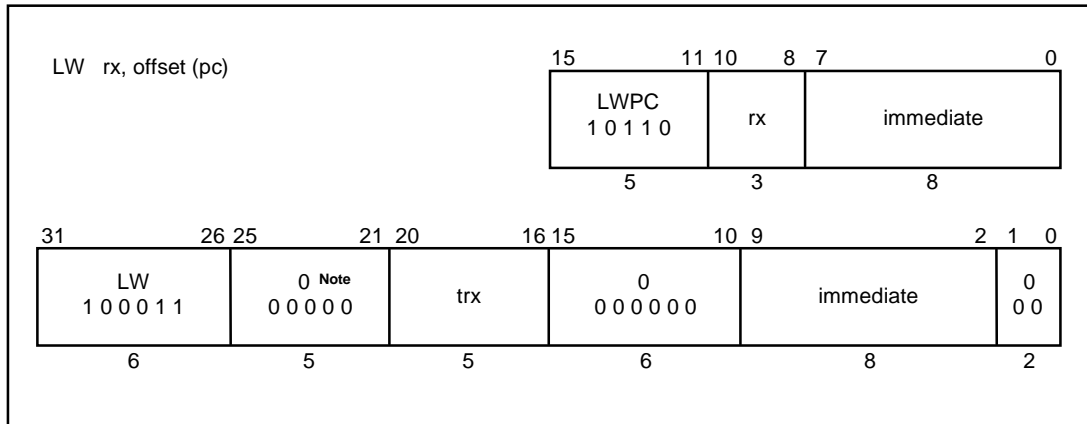

Note Zeros are shown in the field of bits 21 to 25 as placeholders. The 32-bit PC-relative instruction format shown above is provided here only to make the description complete; it is not a valid 32-bit MIPS instruction. Please see CHAPTER 4 for a complete definition of the semantics of the MIPS16 PC-relative instructions.

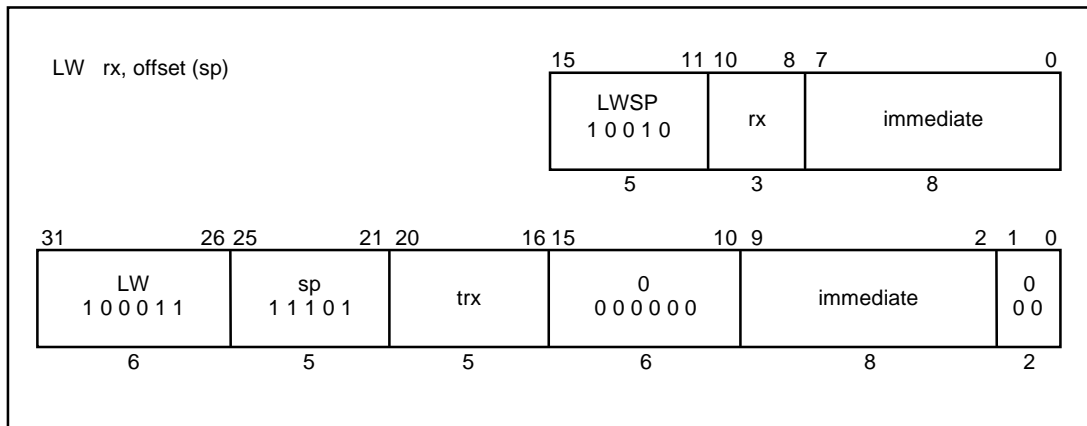

LWU

Load Word Unsigned

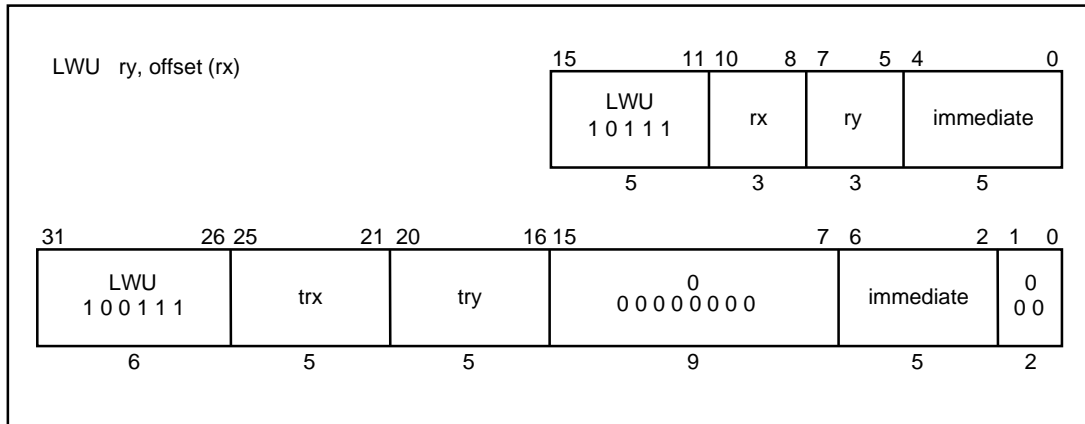

MFHI

Move From HI Register

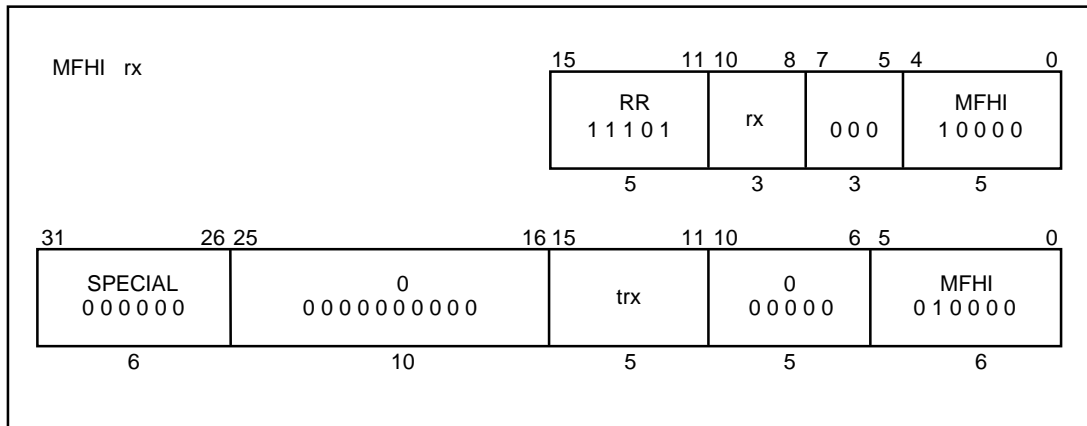

MFLO

Move From LO Register

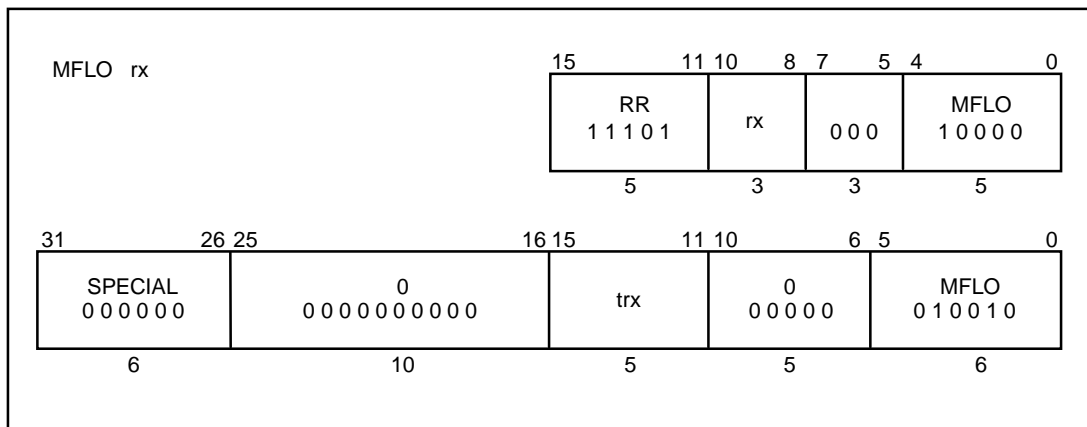

MOVE

Move

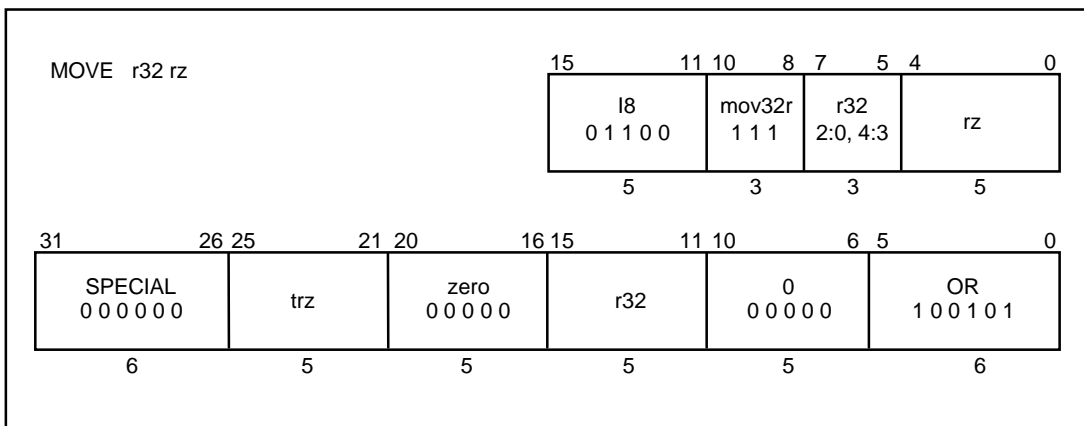
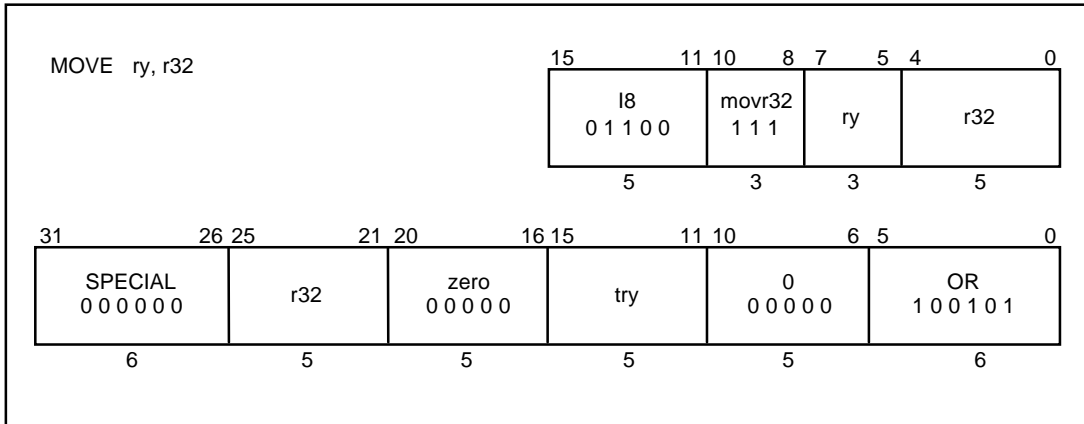

MULT

Multiply

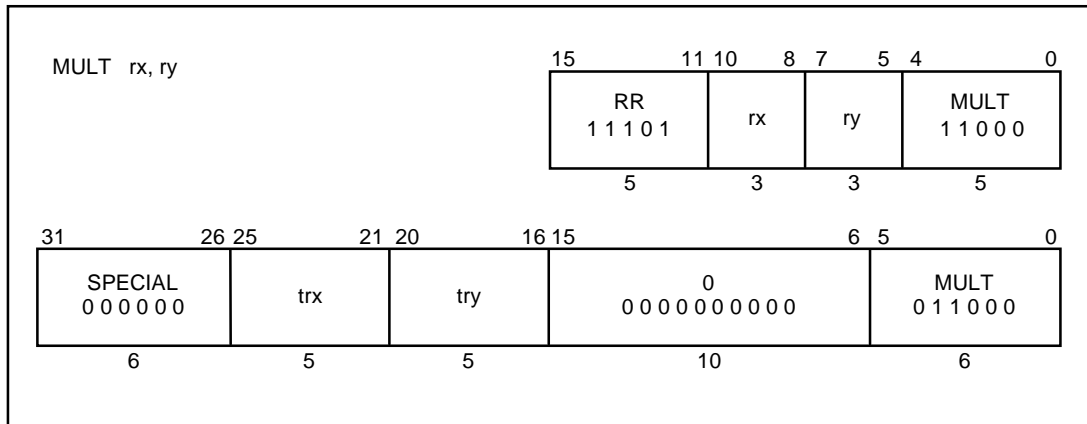

MULTU

Multiply Unsigned

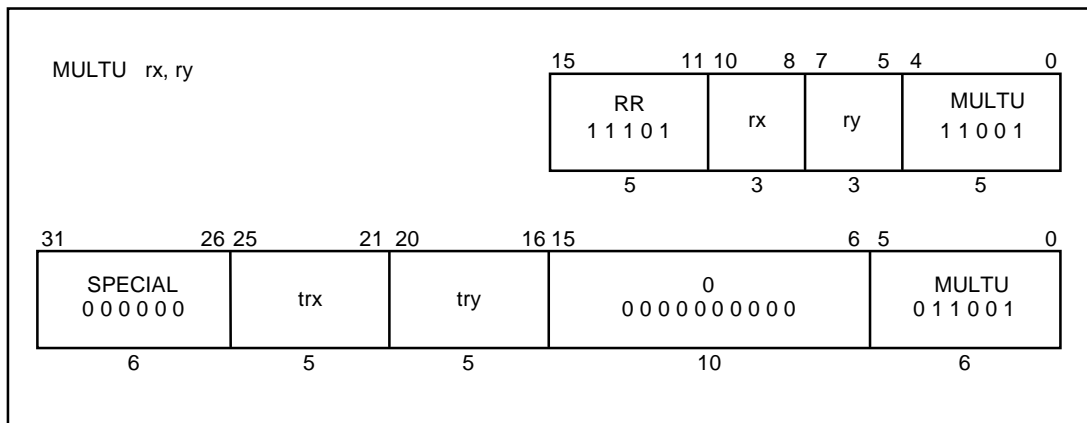

NEG

Negate

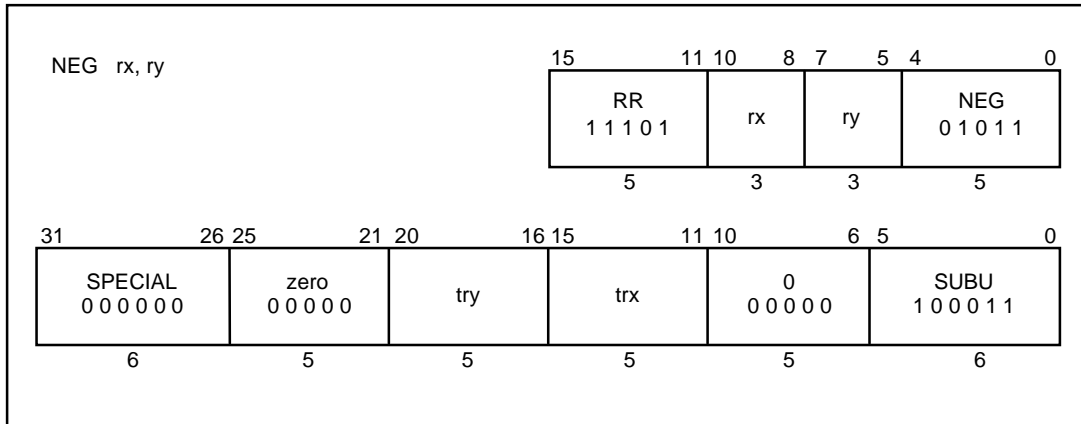

NOT

NOT

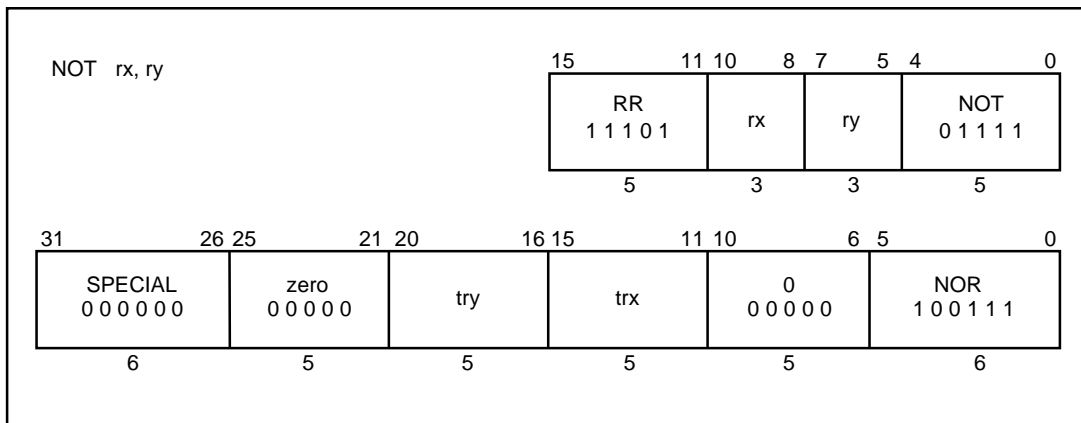

OR

OR

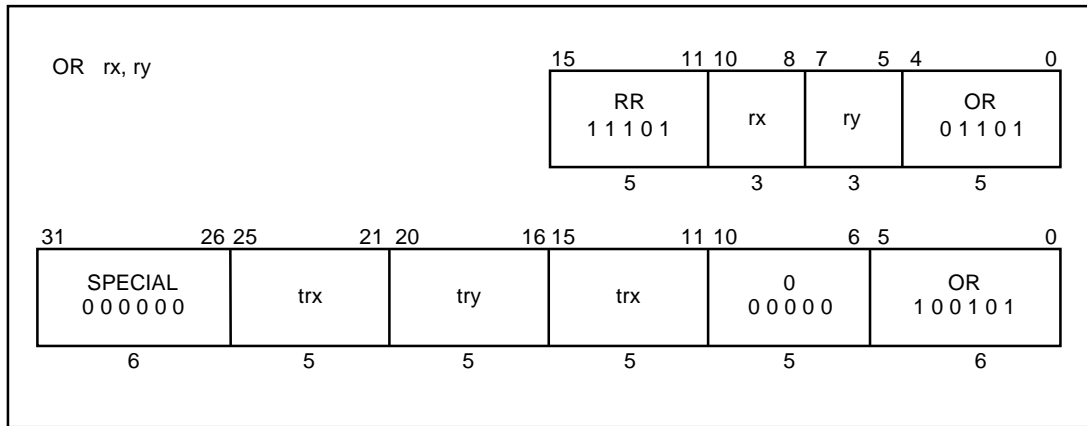

SB

Store Byte

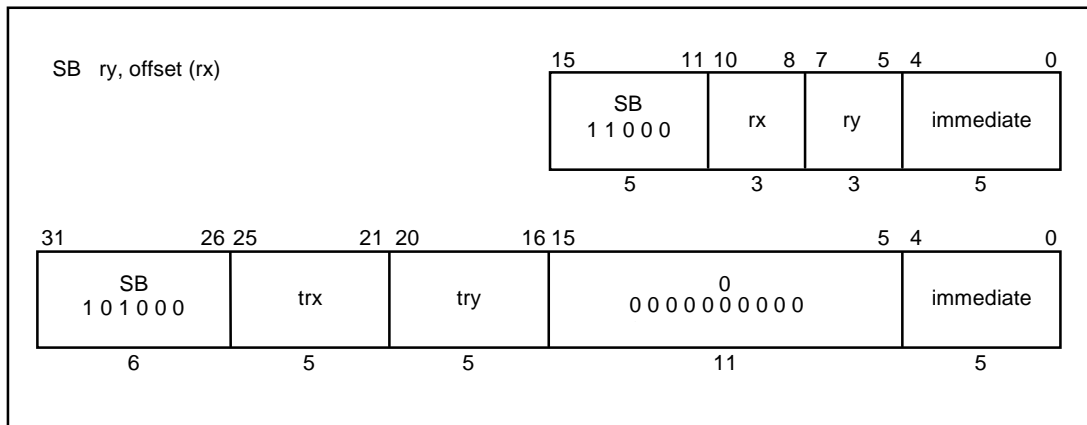

SD

Store Doubleword

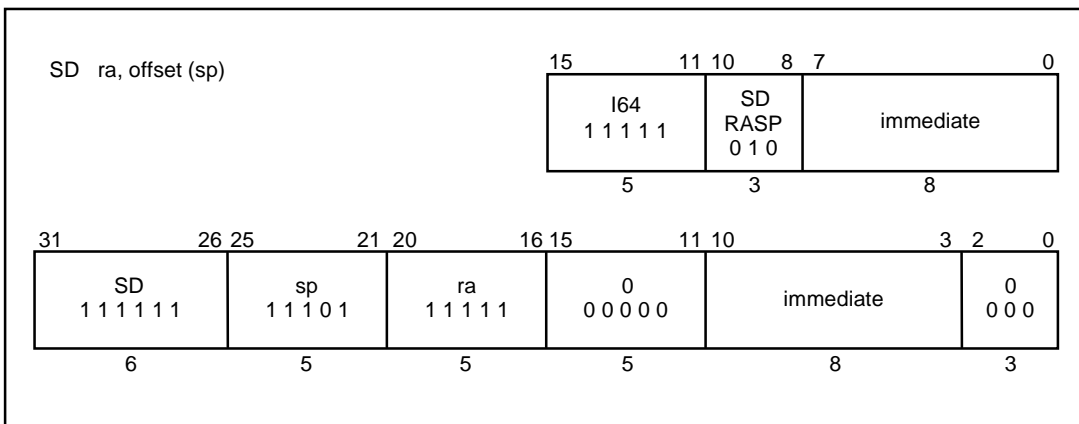
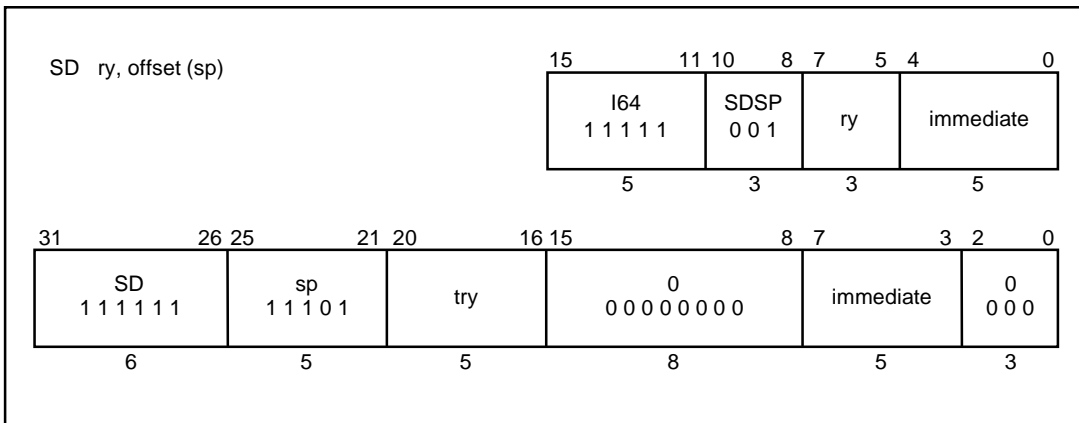
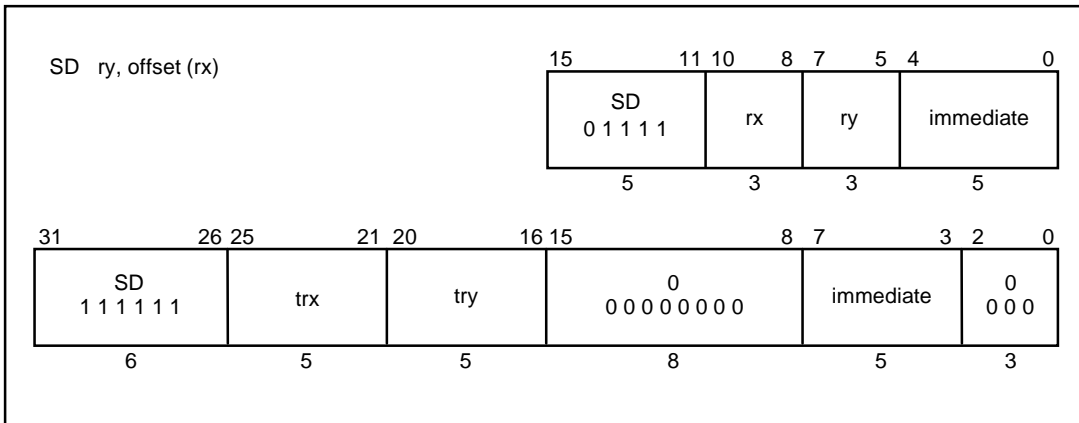

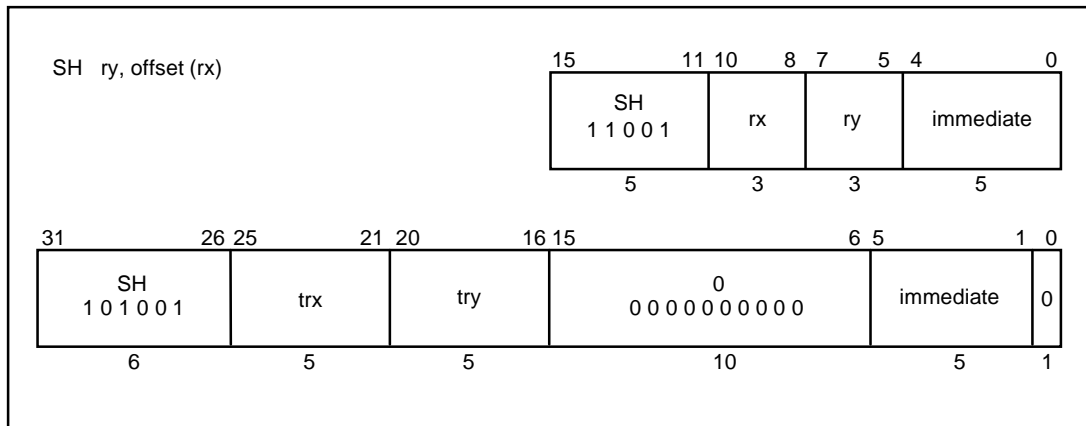
SH**Store Halfword**

SLL

Shift Left Logical

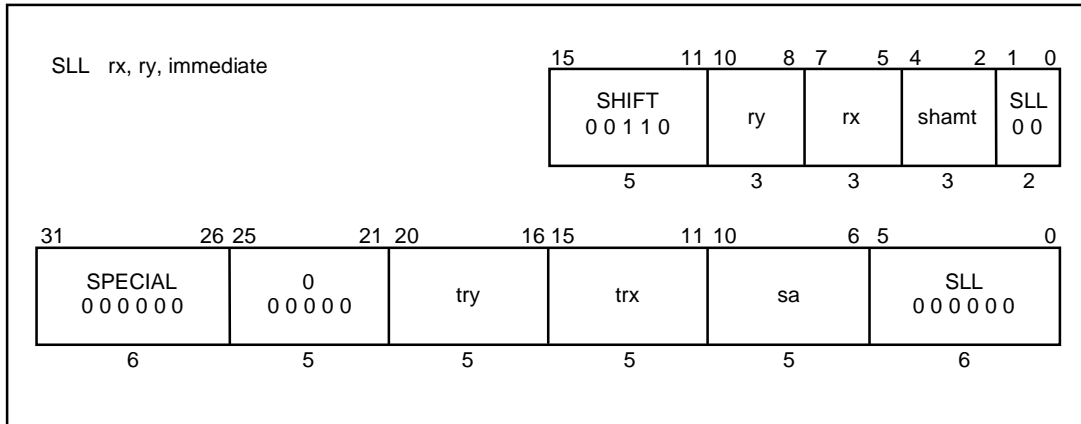

SLLV

Shift Left Logical Variable

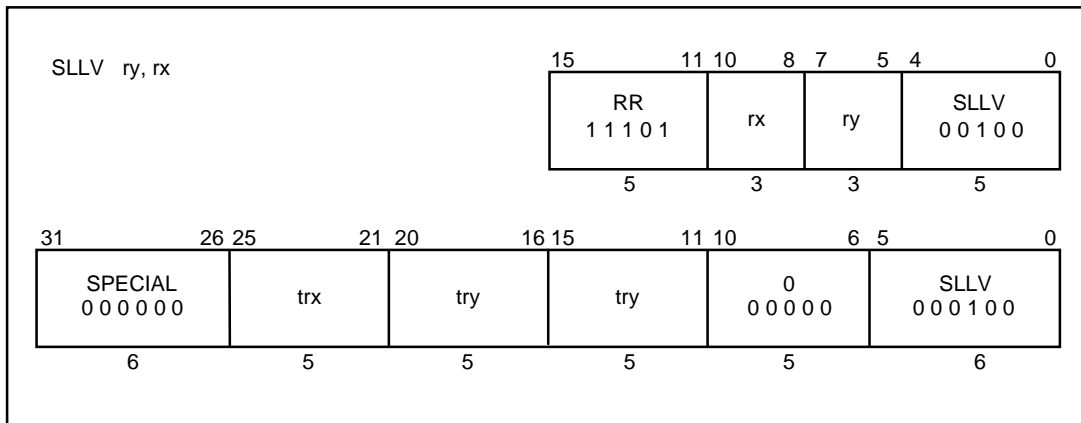

SLT

Set on Less Than

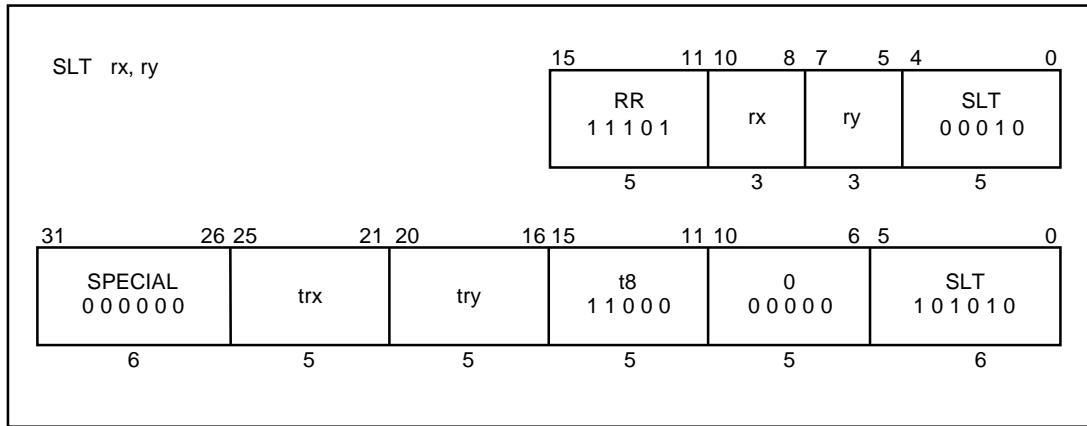

SLTI

Set on Less Than Immediate

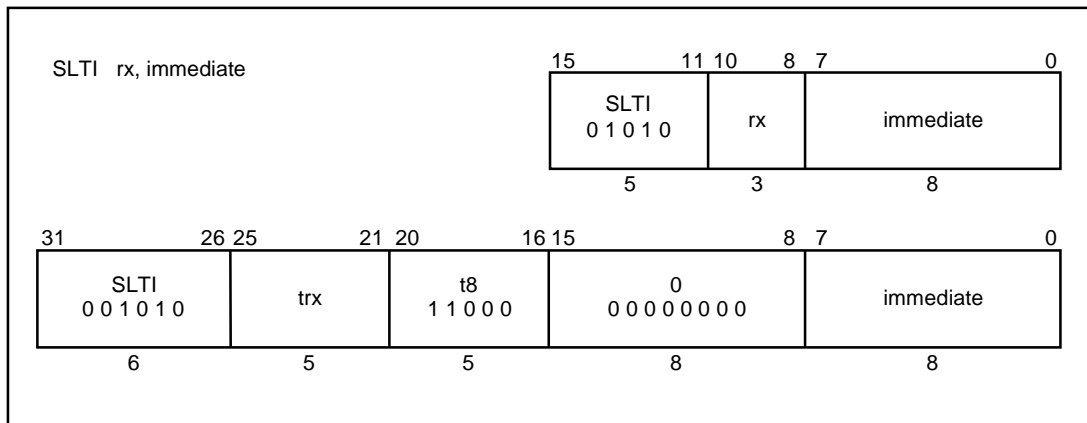

SLTIU

Set on Less Than Immediate Unsigned

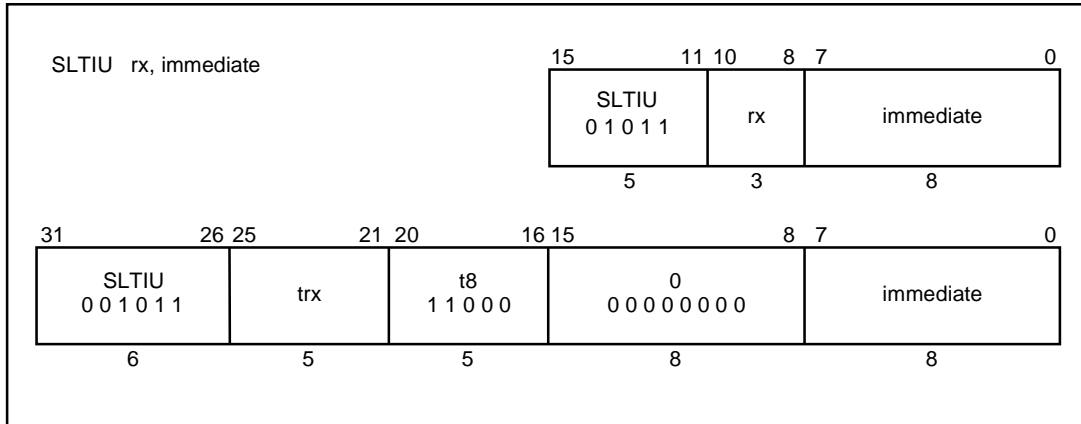

SLTU

Set on Less Than Unsigned

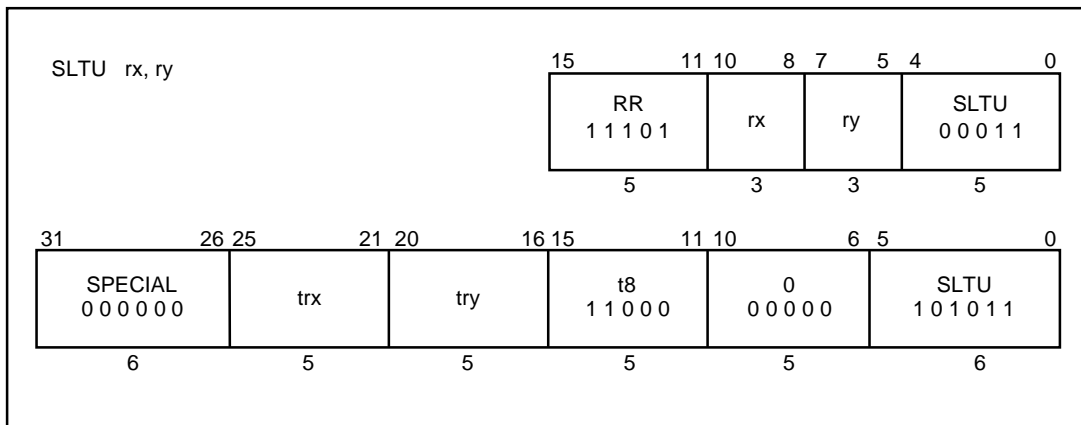

SRA

Shift Right Arithmetic

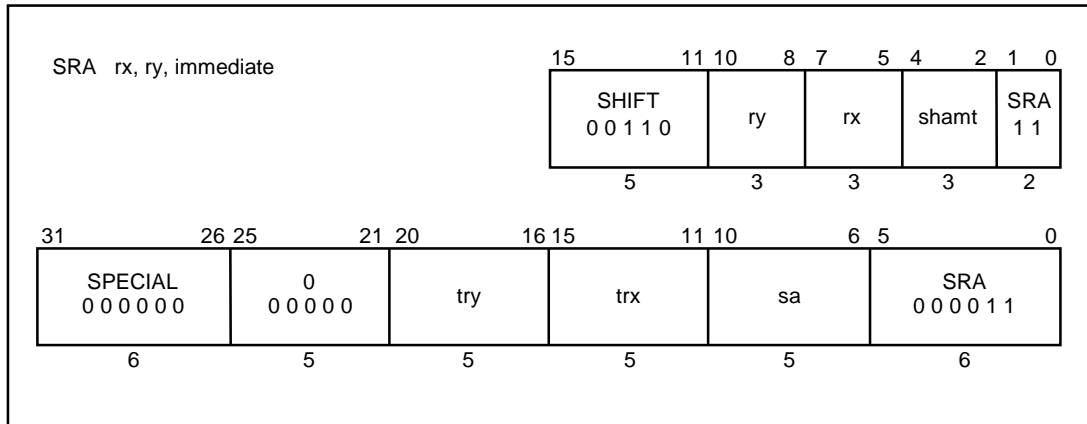

SRAV

Shift Right Arithmetic Variable

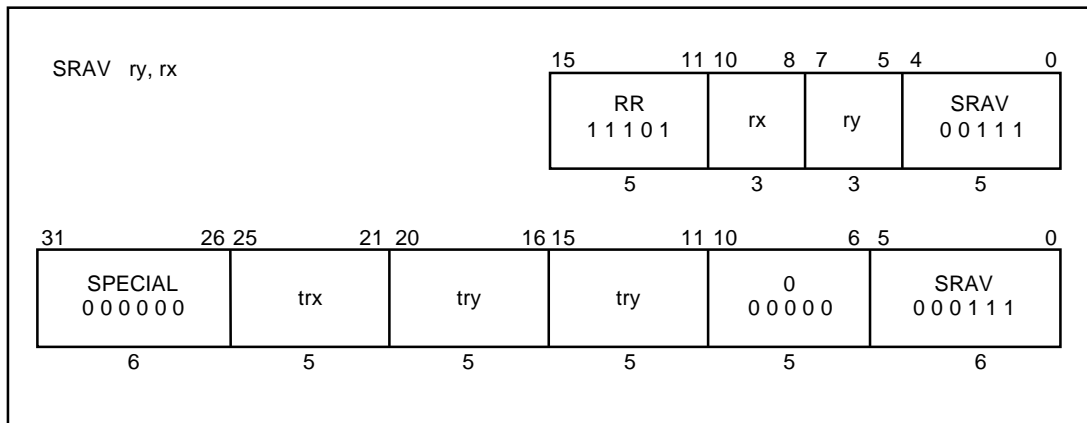

SRL

Shift Right Logical

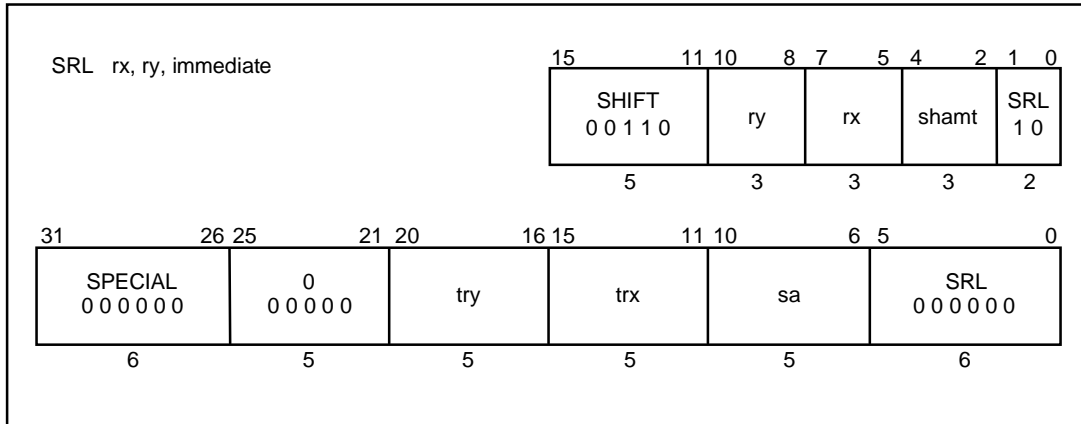

SRLV

Shift Right Logical Variable

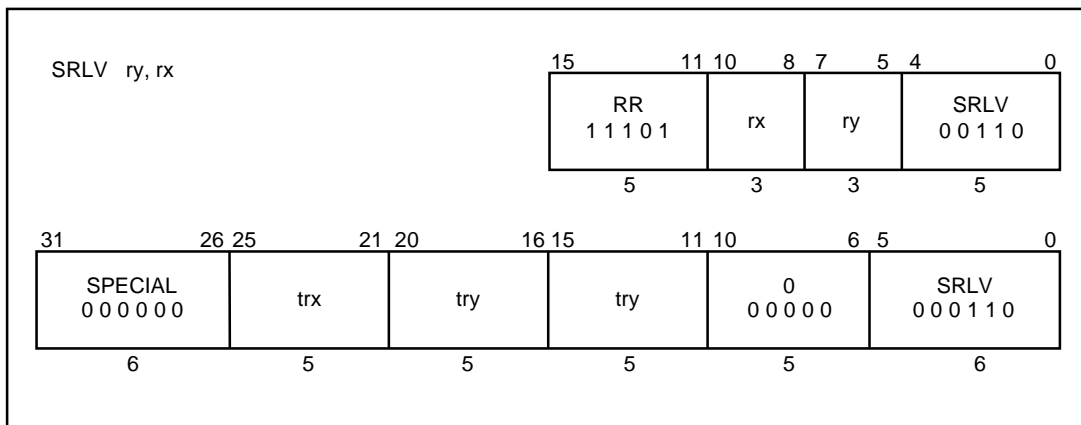

SW

Store Word

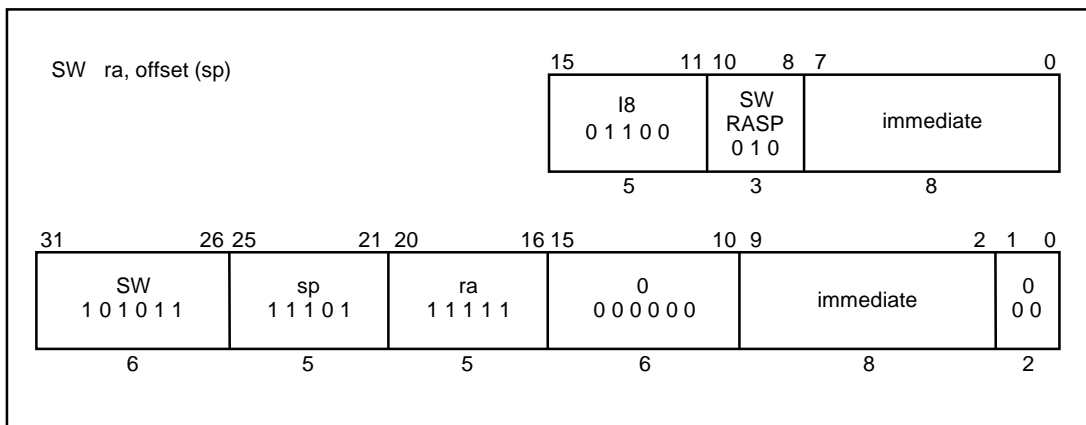
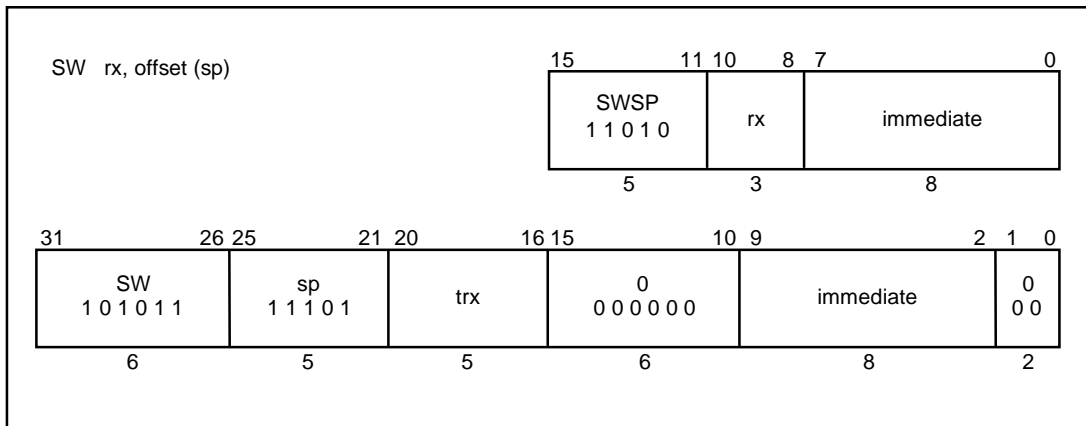
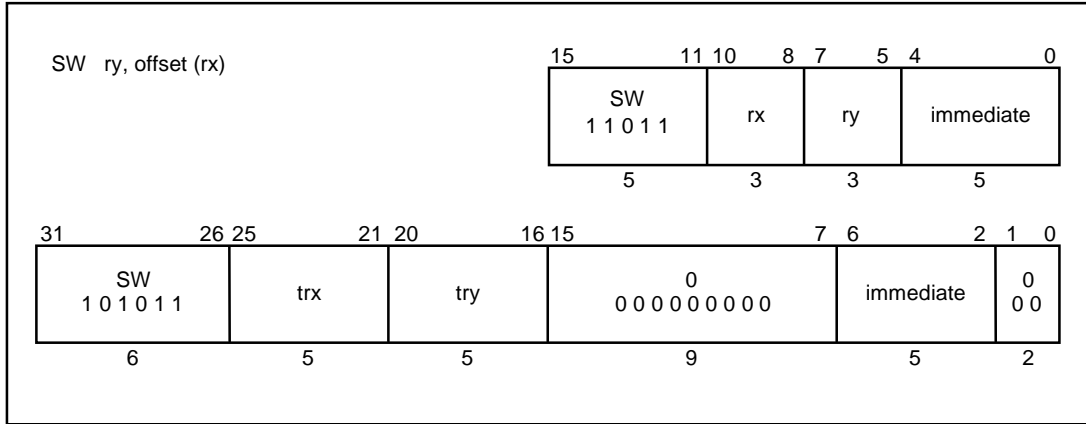

SUBU

Subtract Unsigned

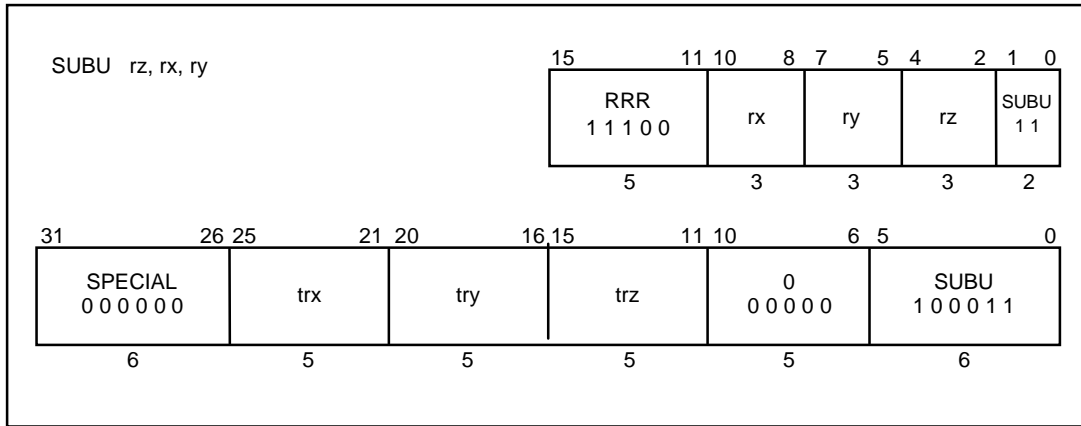

XOR

Exclusive OR

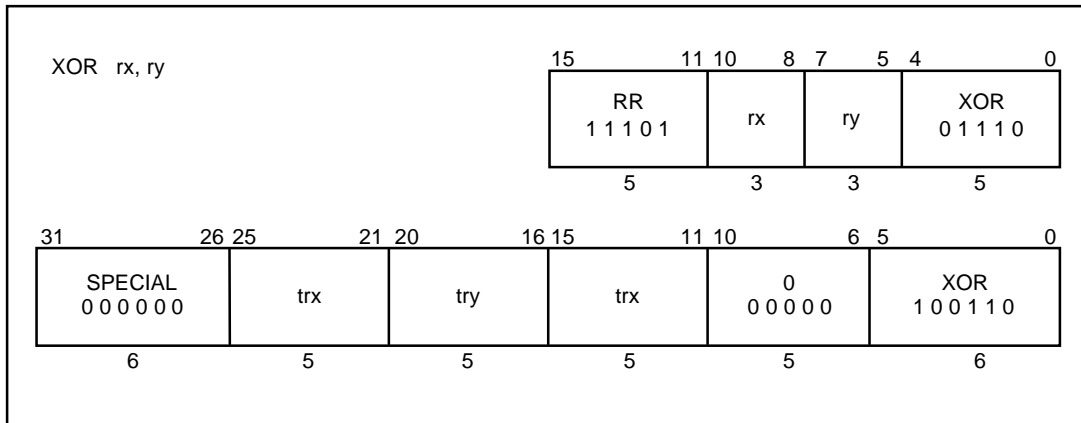

CHAPTER 30 VR4111 COPROCESSOR 0 HAZARDS

The VR4110 CPU core avoids contention of its internal resources by causing a pipeline interlock in such cases as when the contents of the destination register of an instruction are used as a source in the succeeding instruction. Therefore, instructions such as NOP must not be inserted between instructions.

However, interlocks do not occur on the operations related to the CP0 registers and the TLB. Therefore, contention of internal resources should be considered when composing a program that manipulates the CP0 registers or the TLB. The CP0 hazards define the number of NOP instructions that is required to avoid contention of internal resources, or the number of instructions unrelated to contention. This chapter describes the CP0 hazards.

The CP0 hazards of the VR4110 CPU core are as or less stringent than those of the VR4000. Table 30-1 lists the Coprocessor 0 hazards of the VR4110 CPU core. Code that complies with these hazards will run without modification on the VR4000.

The contents of the CP0 registers or the bits in the “Source” column of this table can be used as a source after they are fixed.

The contents of the CP0 registers or the bits in the “Destination” column of this table can be available as a destination after they are stored.

Based on this table, the number of NOP instructions required between instructions related to the TLB is computed by the following formula, and so is the number of instructions unrelated to contention:

$$(\text{Destination Hazard number of A}) - [(\text{Source Hazard number of B}) + 1]$$

As an example, to compute the number of instructions required between an MTC0 and a subsequent MFC0 instruction, this is:

$$(5) - (3 + 1) = 1 \text{ instruction}$$

The CP0 hazards do not generate interlocks of pipeline. Therefore, the required number of instruction must be controlled by program.

Table 30-1. VR4111 Coprocessor 0 Hazards

Operation	Source		Destination	
	Source Name	No. of cycles	Destination Name	No. of cycles
MTC0			cpr rd	5
MFC0	cpr rd	3		
TLBR	Index, TLB	2	PageMask, EntryHi, EntryLo0, EntryLo1	5
TLBWI TLBWR	Index or Random, PageMask, EntryHi, EntryLo0, EntryLo1	2	TLB	5
TLBP	PageMask, EntryHi	2	Index	6
ERET	EPC or ErrorEPC, TLB	2	Status.EXL, Status.ERL	4
	Status	2		
CACHE Index Load Tag			TagLo, TagHi, PErr	5
CACHE Index Store Tag	TagLo, TagHi, PErr	3		
CACHE Hit ops.	cache line	3	cache line	5
Coprocessor usable test	Status.CU, Status.KSU, Status.EXL, Status.ERL	2		
Instruction fetch	EntryHi.ASID, Status.KSU, Status.EXL, Status.ERL, Status.RE, Config.K0C	2		
	TLB	2		
Instruction fetch exception			EPC, Status	4
			Cause, BadVAddr, Context, XContext	5
Interrupt signals	Cause.IP, Status.IM, Status.IE, Status.EXL, Status.ERL	2		
Load/Store	EntryHi.ASID, Status.KSU, Status.EXL, Status.ERL, Status.RE, Config.K0C, TLB	3		
	Config.AD, Config.EP	3		
	WatchHi, WatchLo	3		
Load/Store exception			EPC, Status, Cause, BadVAddr, Context, XContext	5
TLB shutdown			Status.TS	2 (Inst.), 4 (Data)

- Cautions**
1. If the setting of the K0 bit in the Config register is changed to uncached mode by MTC0, the accessed memory area is switched to the uncached one at the instruction fetch of the third instruction after MTC0.
 2. A stall of several instructions occurs if a jump or branch instruction is executed immediately after the setting of the ITS bit in the Status register.

- Remarks**
1. The instruction following MTC0 must not be MFC0.
 2. The five instructions following MTC0 to Status register that changes KSU and sets EXL and ERL may be executed in the new mode, and not kernel mode. This can be avoided by setting EXL first, leaving KSU set to kernel, and later changing KSU.
 3. There must be two non-load, non-CACHE instructions between a store and a CACHE instruction directed to the same primary cache line as the store.

The status during execution of the following instruction for which CP0 hazards must be considered is described below.

(1) MTC0

Destination: The completion of writing to a destination register (CP0) of MTC0.

(2) MFC0

Source: The confirmation of a source register (CP0) of MFC0.

(3) TLBR

Source: The confirmation of the status of TLB and the Index register before the execution of TLBR.

Destination: The completion of writing to a destination register (CP0) of TLBR.

(4) TLBWI, TLBWR

Source: The confirmation of a source register of these instructions and registers used to specify a TLB entry.

Destination: The completion of writing to TLB by these instructions.

(5) TLBP

Source: The confirmation of the PageMask register and the EntryHi register before the execution of TLBP.

Destination: The completion of writing the result of execution of TLBP to the Index register.

(6) ERET

Source: The confirmation of registers containing information necessary for executing ERET.

Destination: The completion of the processor state transition by the execution of ERET.

(7) CACHE Index Load Tag

Destination: The completion of writing the results of execution of this instruction to the related registers.

(8) CACHE Index Store Tag

Source: The confirmation of registers containing information necessary for executing this instruction.

(9) Coprocessor Usable Test

Source: The confirmation of modes set by the bits of the CP0 registers in the "Source" column.

- Examples**
1. When accessing the CP0 registers in User mode after the contents of the CU0 bit of the Status register are modified, or when executing an instruction such as TLB instructions, CACHE instructions, or branch instructions that use the resource of the CP0.
 2. When accessing the CP0 registers in the operating mode set in the Status register after the KSU, EXL, and ERL bits of the Status register are modified.

(10) Instruction Fetch

Source: The confirmation of the operating mode and TLB necessary for instruction fetch.

- Examples**
1. When changing the operating mode from User to Kernel and fetching instructions after the KSU, EXL, and ERL bits of the Status register are modified.
 2. When fetching instructions using the modified TLB entry after TLB modification.

(11) Instruction Fetch Exception

Destination: The completion of writing to registers containing information related to the exception when an exception occurs on instruction fetch.

(12) Interrupts

Source: The confirmation of registers judging the condition of occurrence of interrupt when an interrupt factor is detected.

(13) Loads/Stores

Source: The confirmation of the operating mode related to the address generation of Load/Store instructions, TLB entries, the cache mode set in the K0 bit of the Config register, and the registers setting the condition of occurrence of a Watch exception.

Example When Loads/Stores are executed in the kernel field after changing the mode from User to Kernel.

(14) Load/Store Exception

Destination: The completion of writing to registers containing information related to the exception when an exception occurs on load or store operation.

(15) TLB Shutdown

Destination: The completion of writing to the TS bit of the Status register when a TLB shutdown occurs.

Table 30-2 indicates examples of calculation.

Table 30-2. Calculation Example of CP0 Hazard and Number of Instructions Inserted

Destination	Source	Contending internal resource	Number of instructions inserted	Formula
TLBWR/TLBWI	TLBP	TLB Entry	2	$5 - (2 + 1)$
TLBWR/TLBWI	Load or Store using newly modified TLB	TLB Entry	1	$5 - (3 + 1)$
TLBWR/TLBWI	Instruction fetch using newly modified TLB	TLB Entry	2	$5 - (2 + 1)$
MTC0, Status [CU]	Coprocessor instruction that requires the setting of CU	Status [CU]	2	$5 - (2 + 1)$
TLBR	MFC0 EntryHi	EntryHi	1	$5 - (3 + 1)$
MTC0 EntryLo0	TLBWR/TLBWI	EntryLo0	2	$5 - (2 + 1)$
TLBP	MFC0 Index	Index	2	$6 - (3 + 1)$
MTC0 EntryHi	TLBP	EntryHi	2	$5 - (2 + 1)$
MTC0 EPC	ERET	EPC	2	$5 - (2 + 1)$
MTC0 Status	ERET	Status	2	$5 - (2 + 1)$
MTC0 Status [IE] ^{Note}	Instruction that causes an interrupt	Status [IE]	2	$5 - (2 + 1)$

Note The number of hazards is undefined if the instruction execution sequence is changed by exceptions. In such a case, the minimum number of hazards until the IE bit value is confirmed may be the same as the maximum number of hazards until an interrupt request occurs that is pending and enabled.

[MEMO]

CHAPTER 31 PLL PASSIVE COMPONENTS

The Phase Locked Loop circuit requires several passive components for proper operation, which are connected to V_{DDP} as illustrated in Figure 31-1.

Figure 31-1. Example of Connection of PLL Passive Components

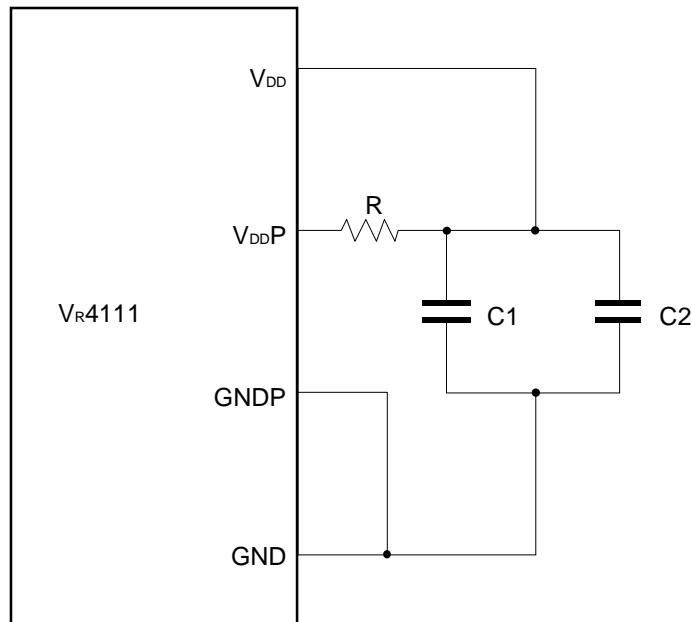

- Remarks1.** Capacitors C1 and C2 and resistor R are mounted on the printed circuit board.
2. Since the value for the components depends upon the application system, the optimum values for each system should be decided after repeated experimentation.

It is essential to isolate the analog power and ground for the PLL circuit (V_{DDP}) from the regular power and ground (V_{DD}/GND). Initial evaluations have yielded good results with the following values:

$$R = 100 \Omega \quad C1 = 0.1 \mu F \quad C2 = 1.0 \mu F$$

Since the optimum values for the filter components depend upon the application and the system noise environment, these values should be considered as starting points for further experimentation within your specific application. In addition, the choke (inductor: L) can be considered for use as an alternative to the resistor (R) for use in filtering the power supply.

[MEMO]

APPENDIX A DIFFERENCES BETWEEN VR4111 AND VR4102

The VR4111 is similar to the VR4102 in many points, including functions and pins. On the contrary, however, there are also differences between these two devices, as shown in this chapter. This means that when replacing the VR4111 with the VR4102, or vice versa, the following differences should be taken into consideration.

For the functions of the VR4102, refer to **VR4102 User's Manual**.

A.1 SUMMARY OF DIFFERENCES

Item		VR4111	VR4102
Cache size		Instruction: 16 Kbytes, data: 8 Kbytes	Instruction: 4 Kbytes, data: 1 Kbyte
Instruction set		MIPS III + high-speed product-sum operation + MIPS16	MIPS III + high-speed product-sum operation
LCD interface bus width		16-bit/32-bit width	16-bit width
Memory controller	Maximum of DRAM capacity (EDO type)	64 Mbytes	32 Mbytes
	Maximum of ROM capacity	64 Mbytes	32 Mbytes
Power-on factor		4 factors, 12 sources	4 factors, 8 sources
Audio interface		Conversion rate: 44.1, 22.05, 11.25, 8.0 ksps	Conversion rate: 44.1, 22.05, 11.25 ksps
MODEM interface		Transmit/receive FIFO: 96 bytes	Transmit/receive FIFO: 32 bytes
Internal operating frequency (max.)		80/100 MHz	54 MHz
Supply voltage		Internal: 2.5 V, External: 3.3 V	3.3 V
Package		224-pin FBGA	216 pin LQFP, 224-pin FBGA

A.2 DETAILS OF DIFFERENCES

A.2.1 Cache Memory

(1) Cache memory size

The instruction cache of the VR4111 is 16 Kbytes in size, and the size of the data cache of the VR4111 is 8 Kbytes. Both of them are greater than that of the VR4102.

The IC and DC bits in the Config register in the CPU core indicate 100 and 011 respectively, and the index address used in cache tag access is VA[13..4] for instruction cache, and VA[12..4] for data cache.

For details, refer to **CHAPTER 9 CACHE MEMORY** and **6.5.8 Config Register (16)**.

(2) Cache parity check

In the VR4102, data check is performed in word parity for instruction cache, and in byte parity for data cache. But the VR4111 does not execute data check by parity.

Therefore, the functions in the bits P and W' of the TagLo register and that in the bits CE and DE of the Status register are deleted in the VR4111. And in the VR4111, the parity error register of the VR4102 is changed to the register used for self-diagnostic, and the cache error register is changed to the register whose bits are all reserved fields.

The VR4111 does not generate a cache error exception, because a parity error never occurs in this device.

For details, refer to **6.5.10 Cache Tag Registers (TagLo (28) and TagHi (29))**, **Status Register (12)**, **7.3.10 Parity Error Register (26)**, and **7.3.11 Cache Error Register (27)**.

A.2.2 Instruction Set

The VR4102 has the MIPS III instruction set, product-sum operation instructions, and power mode transition instructions. On the other hand, the VR4111 has the MIPS16 instruction set, as well as the above three types of instructions. For details about the MIPS16 instructions, refer to **CHAPTER 4 MIPS16 INSTRUCTION SET** and **CHAPTER 29 MIPS16 INSTRUCTION SET FORMAT**.

An MIPS16 instruction can be specified whether it is executed after RTCRST by setting the MIPS16EN pin. Whether the execution is enabled or not is indicated in the bit M16 in the Config register in the CPU core.

The contents indicated in the EPC register and error EPC register in the CPU core differ depending on whether the MIPS16 instruction execution after RTCRST is enabled or disabled. If it is enabled, bits 0 of these registers (EPS register and error EPC register) indicate whether the instruction executed immediately before exception generation is a MIPS16 instruction or not.

For details, refer to **7.3.7 Exception Program Counter (EPC) Register (14)**, **7.3.12 Error EPC Register (30)**, and **7.5 EXCEPTION PROCESSING AND SERVICING FLOWCHARTS**.

A.2.3 Pin Function

(1) Power Supply

In the VR4102, the power is supplied in single 3.3 V. However, the VR4111 has two power supply systems, 2.5 V for internal operation and 3.3 V for external interface.

For details, refer to **2.1 PIN CONFIGURATION** and **2.2.15 Dedicated V_{DD} and GND Signals**.

(2) Setting of Internal Operation Frequency

The operation clock for the CPU core is generated from 18.432-MHz clock input for both the VR4111 and the VR4102. However, the setting by the CLKSEL [2..0] pins differs in each device, because the operation frequency of the CPU core of the VR4111 is different to that of the VR4102. The following table shows the relationships between CLKSEL [2..0] pins and clock frequencies of these two devices.

CLKSEL (2:0)	CPU Core		Tclock Frequency		BUSCLK Frequency	
	VR4111	VR4102	VR4111	VR4102	VR4111	VR4102
111	98.1 MHz	RFU	24.5 MHz	RFU	6.13 MHz	RFU
110	90.6 MHz	RFU	22.7 MHz	RFU	5.67 MHz	RFU
101	84.1 MHz	53.6 MHz	28.0 MHz	26.8 MHz	7.01 MHz	6.7 MHz
100	78.5 MHz	49.2 MHz	26.2 MHz	24.6 MHz	6.54 MHz	6.1 MHz
011	69.3 MHz	45.4 MHz	23.1 MHz	22.7 MHz	5.77 MHz	5.7 MHz
010	65.4 MHz	42.1 MHz	21.8 MHz	21.1 MHz	5.45 MHz	5.3 MHz
001	62.0 MHz	36.9 MHz	20.7 MHz	18.5 MHz	5.17 MHz	9.2 MHz
000	49.1 MHz	32.8 MHz	24.6 MHz	16.4 MHz	6.13 MHz	8.2 MHz

The internal operation frequency that is set is indicated in the CLKSPEEDREG register in the bus control unit (BCU).

For details, refer to **2.2.5 RS-232C Interface Signals** and **11.2.8 CLKSPEEDREG (0x0B00 0014)**.

Caution Some frequencies in this table may be unusable when the VR4111 or VR4102 is mass-produced.

(3) Enable/Disable of MIPS16 Instruction

For the VR4111, the MIPS16EN pin is provided to specify whether MIPS16 instructions can be executed or not. The VR4102 does not have this pin because it does not support MIPS16 instructions.

For details, refer to **2.2.14 Initial Setting Signals**.

(4) Buffer Type of Output Pin

In the Vr4111, the following output pins incorporate a slew-rate buffer. On the other hand, the Vr4102 has no such output pins.

ADD (25:0)	LCAS#
LCDCDS#	BUSCLK
RD#	SHB#
WR#	IOR#
ROMCS (3:0)#	IOW#
UUCAS#/MRAS3#	MEMR#
ULCAS#/MRAS2#	MEMW#
MRAS (1:0)#	RSTOUT
UCAS#	HLDACK#

For details, refer to **2.3.2 Connection of Unused Pins and Pin I/O Circuits**.

(5) Buffer Type of Input Pin

Compared to the Vr4102, the Schmitt-input pins are added to the Vr4111. The following lists the Schmitt-input pins.

Vr4111	Vr4102
BATTINH/BATTINT#	BATTINH/BATTINT#
POWER#	POWER#
RSTSW#	RSTSW#
RSTRST#	RSTRST#
IRING	IRING
GPIO[14..0]	GPIO[14..0]
DCD#/GPIO15	
KPORT[7..0]	

For details, refer to **2.3.2 Connection of Unused Pins and Pin I/O Circuits**.

(6) Pin Status upon Specific States

When a pin is in a specific state indicated as follows, the states of the pins GPIO[49:32] and GPIO[14:0] are different between the Vr4111 and the Vr4102.

Pin Name	In the Hibernate Mode or Shut Down by the HALTimer		Shut Down by Deadman's Switch or by RSTSW	
	Vr4111	Vr4102	Vr4111	Vr4102
GPIO49	The state of the previous Full-Speed Mode is retained	Hi-Z	The state of the previous Full-Speed Mode is retained	Hi-Z
GPIO48/DBUS32	The state of the previous Full-Speed Mode is retained/Hi-Z	Hi-Z	The state of the previous Full-Speed Mode is retained/Hi-Z	Hi-Z
GPIO47/DCTS#	The state of the previous Full-Speed Mode is retained/Hi-Z	Hi-Z	The state of the previous Full-Speed Mode is retained/Hi-Z	Hi-Z
GPIO46/DRTS#	The state of the previous Full-Speed Mode is retained/1	1	The state of the previous Full-Speed Mode is retained/1	1
GPIO45/DDIN	The state of the previous Full-Speed Mode is retained/Hi-Z	Hi-Z	The state of the previous Full-Speed Mode is retained/Hi-Z	Hi-Z
GPIO44/DDOUT	The state of the previous Full-Speed Mode is retained/1	1	The state of the previous Full-Speed Mode is retained/1	1
GPIO (43:32)/KSCAN (11:0)	The state of the previous Full-Speed Mode is retained/Hi-Z	Hi-Z	The state of the previous Full-Speed Mode is retained/Hi-Z	Hi-Z
GPIO (14:0)	The state of the previous Full-Speed Mode is retained (Note)	Hi-Z	The state of the previous Full-Speed Mode is retained/Hi-Z	Hi-Z

Note While HALTimer shut down, pull-up/pull-down registers cannot be used and enter into input state.

A.2.4 Memory Capacity

(1) DRAM

The DRAM size of the Vr4102 is 32 Mbytes maximum and that of the Vr4111 is 64 Mbytes maximum. When the Vr4111 is in the 32-bit bus mode, the DRAM size can be expanded by setting the BCUCNTREG3 register in the bus control unit (BCU) to select the expand DRAM to be used. But the expand DRAM space and the expand ROM space must be used exclusively.

For details, refer to **6.3.5 DRAM Space** and **11.2.9 BCUCNTREG3 (0x0B00 0016)**.

(2) ROM

The ROM size of the Vr4102 is 32 Mbytes maximum and that of the Vr4111 is 64 Mbytes maximum. When the Vr4111 is in the 32-bit bus mode, the ROM size can be expanded by setting the BCUCNTREG3 register in the bus control unit (BCU) to select the expand ROM to be used. However, the expand ROM space and the expand DRAM space must be used exclusively.

For details, refer to **6.3.1 ROM Space** and **11.2.9 BCUCNTREG3 (0x0B00 0016)**.

A.2.5 BCU

(1) LCD Space

For the VR4111's LCD interface, its bus width can be selected from 16 bits and 32 bits, while the bus width of the VR4102's interface is fixed to 16 bits.

For details, refer to **6.3.4 LCD Space**, **11.2.9 BCUCNTREG3 (0x0B00 0016)**, and **11.4.5 LCD Controller Interface**.

(2) Processor Revision Number Indication

The RID bits in the REVIDREG register indicate the processor's revision number. 0x01 means the VR4102, and 0x02 means the VR4111.

For details, refer to **11.2.6 REVIDREG (0x0B00 0010)**.

A.2.6 DMA

Compared to the VR4102, the DRAM space of the VR4111 is expanded. Therefore the DMA address of the VR4111 is 26 bits, while that of the VR4102 is 25 bits. In addition to that, bit 9 of the following registers can be read/write in the VR4111, while that of the VR4102 is read only.

AIUBAHREG	AIUAHREG
AIUOB AHREG	AIUOAHREG
FIRBAHREG	FIRAHREG

For details, refer to **12.2 REGISTER SET**.

A.2.7 PMU

For the VR4111, the power-on wait time after reset can be changed by setting PMUWAITREG, while that of the VR4102 is fixed to 350 ms. It is initialized to 350 ms after RTCRST.

- ★ In Hibernate mode, the VR4111 can stop supplying voltage to the 2.5-V power-supply systems to reduce the leak current. This makes 2.5-V power supplies 0 V while the MPOWER pin is inactive. The following operation is not affected if a voltage of 2.3 V or more is supplied to these power supplies within the period from when the MPOWER pin becomes active to when PLL starts oscillating. However, this function is only available for version 2.0 and higher.

For details, refer to **CHAPTER 8 INITIALIZATION INTERFACE** or **16.1.3 Power-on Control**.

A.2.8 GIU

The GPIO[14..0] pins of the Vr4111 have a pull-up/pull-down function, while the Vr4102 is not provided with this function. Whether this function can be used or not, and if usable, whether the pin is pulled up or down, are set by means of software independently.

For details, refer to **2.3.2 Connection of Unused Pins and Pin I/O Circuits**, **19.2.17 GIUSEUPDN (0x0B00 02E0)**, and **19.2.18 GIUTERMUPDN (0x0B00 02E2)**.

A.2.9 AIU

If the AIUMEN bit in the SEQREG register is set to 0 (mike and DMA operation disable), nothing occurs in the Vr4111 (Rev.2.0) and Vr4102 (Rev.2.0). However, if this setting is done in the Vr4111 (Rev.1.1) or the Vr4102 (Rev.1.4), silent data is transferred.

For details, refer to **21.2.1 MDMADATREG (0x0B00 0160)** and **21.2.10 SEQREG (0x0B00 017A)**.

A.2.10 KIU

The KSCAN[11..0]/GPIO[43..32] pins can be specified whether they are used as key scan pins or as general-purpose I/O ports, by setting the KIUGPEN register. In the Vr4102, when it is activated from the Hibernate mode or from the shut down by Deadman's SW or RSTSW, the KIUGPEN register is initialized, and the all KSCAN[11..0]/GPIO[43..32] pins are set to be used as key scan pins. On the other hand, the KIUGPEN register in the Vr4111 retains the previous value before the shut down even if the same situation was occurred.

For details, refer to **22.2.8 KIUGPEN (0x0B00 019C)**.

A.2.11 DSIU

The DDOUT/GPIO44, DDIN/GPIO45, DRTS#/GPIO46, and DCTS#/GPIO47 pins can be specified whether they are used as the debug serial communication pins or as the general-purpose output ports, by setting the PORTREG register. In the Vr4102, when it is activated from the Hibernate mode or from the shut down by Deadman's SW or RSTSW, the PORTREG register is initialized, and all these pins are set to be used as the debug serial communication pins. On the other hand, the PORTREG register in the Vr4111 retains the previous value before the shutdown even if the same situation has occurred.

For details, refer to **23.2.1 PORTREG (0x0B00 01A0)**.

A.2.12 HSP

(1) Calculating HSPMCLK Frequency

The formula to calculate the HSPMCLK frequency by using the HSPMCLK register's setting differs between the VR4102 and the VR411, as follows.

VR4102: HSPMCLK frequency = 18.432 MHz/(MCLKD (4:0) + 2)

VR4111: HSPMCLK frequency = 18.432 MHz/(MCLKD (4:0) + 1)

For details, refer to **26.2.2 (4) HSPTOC and HSPMCLKD (0x0C00 0022: Index 3, Write)**.

(2) Transmit/Receive FIFO Buffer Size

In the VR4102, the transmit/receive FIFO buffer size can be set up to 32 words in 1-word (= 16 bits) units, while up to 96 words can be set in 1-word units for that of the VR4111.

For details, refer to **26.2.2 (5) HSPFFSZ (0x0C00 0022: Index 4, Write)**.

A.2.13 FIR

The specifications of this unit are changed substantially among the VR4102 (Rev.1.4), VR4102 (Rev.2.0), and VR4111, resulting differences in register formats, etc.

For details, refer to **CHAPTER 27 FIR (FAST IrDA INTERFACE UNIT)**.

APPENDIX B INDEX

A

A/D port scan	442
Access data size	279
Address error exception	209
Address pin connection	275
Address translation	149, 150
Addressing	50
AIU	33, 445
AIU registers	41, 445
AIUIAHREG	309
AIUIALREG	309
AIUIBAHREG	307
AIUIBALREG	307
AIUINTREG	332
AIUOAHREG	312
AIUOALREG	312
AIUOBABHREG	310
AIUOBALREG	310
ASIM00REG	480
ASIM01REG	481
ASIS0REG	484
Audio Interface Unit (AIU)	33, 445

B

BadVAddr register	191
BATTINH shut down	355
Baud rates and divisors	504
BCU	33, 263
BCU registers	35, 263
BCUCNTREG 1	264
BCUCNTREG 2	266
BCUCNTREG 3	274
BCUERRSTREG	269
BCURFCNTREG	270
BCURFCOUNTREG	272
BCUSPEEDREG	267
BEV	240
Bootstrap exception vector (BEV)	240
BPRM0REG	486
Branch	92, 126, 564
Branch address	93
Branch delay	132
Branch delay slot	114
Breakpoint exception	215
Bus Control Unit (BCU)	33, 263
Bus error exception	213
Bus hold	303
Bypassing	145

C

Cache algorithm	177
Cache data integrity	250

Cache error check	241
Cache error register	200
Cache line	244, 248
Cache memory	243
Cache operations	247
Cache organization	244
Cache state transition	249
Cache states	248
Cause register	195
CBR refresh	302
CLKSPEEDREG	273
Clock generator	46
Clock interface	56
Clock Mask Unit (CMU)	33, 323
CMU	33, 323
CMU register	36, 323
CMUCLKMSK	324
Code compatibility	145
Cold reset	237
Cold reset exception	206
Compare register	192
Computational instructions	86, 118
Config register	181
Connection of address pins	275
Connection of unused pins	77
Context register	190
Coordinate detection	421
Coprocessor 0	45
Coprocessor Unusable exception	216
Count register	191
CP0 hazards	753
CP0 registers	52, 53, 175
CPU core	45
CPU instruction opcode bit encoding	711
CPU Instruction Set	565
CPU registers	47
CRCSR	545
Crystal oscillation	57

D

Data cache	45, 245, 248
Data cache addressing	246
Data formats	50
Data loss	443
DCU	33, 315
DCU registers	36, 315
Deadman's SW shutdown	354
Deadman's Switch	232
Deadman's Switch Unit (DSU)	33, 391
Debug Serial Interface Unit (DSIU)	34, 477
Defining access types	82

- Direct Memory Access (DMA) space..... 305
Direct Memory Access Address Unit (DMAAU)
..... 33, 305
Direct Memory Access Control Unit (DCU)
..... 33, 315
DMA priority levels 315
DMAAU 33, 305
DMAAU registers 35, 306
DMACR 549
DMAER 550
DMAIDLEREG 316
DMAMSKREG 319
DMAREQREG 320
DMARSTREG 316
DMASENREG 318
DPCNTR 538
DPINTR 537
DRAM access 298
DRAM connection 275
DRAM space 171
DSIU 34, 477
DSIU registers 42, 477
DSIUINTREG 335
DSIURESETREG 487
DSU 33, 391
DSU registers 33, 392
DSUCLRREG 394
DSUCNTREG 392
DSUSETREG 393
DSUTIMREG 395
DVALIDREG 453
- E**
- ECMPHREG 376
ECMPLREG 375
ECMPMREG 375
Elapsed Timer 371
EntryHi register 179
EntryLo0 register 176
EntryLo1 register 176
EPC register 197
ErrorEPC register 201
ETIMEHREG 374
ETIMELREG 373
ETIMEMREG 373
Exception 139, 187
Exception conditions 142
Exception processing 187
Exception processing registers 189
Exception Program Counter (EPC) register . 197
Exception vector locations 203
Extend instruction 112
External clock 57
- F**
- Fast IrDA Interface Unit (FIR) 34, 535
FIFO interrupt modes 508
FIFO polling mode 509
FIR 34, 535
FIR registers 44, 535
FIRAHREG 314
FIRALREG 314
FIRBAHREG 313
FIRBALREG 313
FIRCR 546
FIRINTREG 347
Flash memory 281, 288
Flash memory interface 281
FRSTR 536
FSR 542
Fullspeed mode 239, 362
- G**
- General Purpose I/O Unit (GIU) 33, 397
General-purpose register 100
GIU 33, 397
GIU registers 39, 398
GIUINTSELH 410
GIUINTSELL 409
GIUINTENH 406
GIUINTENL 405
GIUINTHREG 346
GIUINTHTSELH 412
GIUINTHTSELL 411
GIUINTLREG 334
GIUINTSTATH 404
GIUINTSTATL 403
GIUINTTYPH 408
GIUINTTYPL 407
GIUIOSELH 400
GIUIOSELL 399
GIUIODH 402
GIUIODL 401
GIUIODATH 416
GIUIODATL 414
GIUTERMUPDN 418
GIUUSEUPDN 417
- H**
- HALTimer shutdown 234, 354
Hardware interrupts 260
Hibernate mode 240, 362
High-speed system bus 243
Host Signal Processing Unit (HSP) 293
Hierarchy of memory 34, 519
HSP 34, 519
HSP register 43, 521
HSPCNTL 524
HSPDATA 523

HSPERRCNT	531	Keyboard Interface Unit (KIU)	34, 459
HSPEXTIN	530	KIU	34, 459
HSPEXTOUT	525	KIU registers	42, 459
HSPFFSZ	527	KIUDATn (n = 0 to 5)	460
HSPID	530, 531	KIUGPEN	470
HSPINDEX	523	KIUINT	468
HSPINIT	522	KIUINTREG	333
HSPMCLKD	526	KIURST	469
HSPPCS	531	KIUSCANREP	463
HSPPCTEL	531	KIUSCANS	465
HSPRxData	528	KIUWKI	467
HSPSTS	529	KIUWKS	466
HSPTOC	526		
HSPTxData	523		
		L	
I		LCD control interface	282
I/O registers	35	LCD interface	296
ICU	33, 325	LCD space	171
ICU registers	37, 328	LED	34, 493
IE bit	241	LED Control Unit (LED)	493
IFR	553	LED registers	43, 493
Illegal access notification	284	LEDASTCREG	497
IMR	541	LEDCNTREG	496
Index register	175	LEDHTSREG	494
Initialization interface	229	LEDINTREG	498
Input (MIC)	457	LEDLTSREG	495
Instruction cache	45, 244, 248	Light Emitting Diode Unit (LED)	34, 493
Instruction cache addressing	246	LLAddr register	182
Instruction formats	81, 104	Load delay	132
Integer overflow exception	219	Load delay slot	82, 114
Interlock	139	Load instruction	82, 115, 563
Internal I/O space	170	Local loopback	511
Interrupt	259		
Interrupt control	327	M	
Interrupt Control Unit (ICU)	33, 325	MAIUINTREG	339
Interrupt enable (IE)	194, 241	MasterOut	56
Interrupt exception	220	MCNTREG	451
INTR0REG	485	MCNVRREG	452
INTREG	455	MDMADATREG	446
IrDA module	517	MDSIUINTREG	342
IRSR1	544	Memory management system (MMU)	147
ISA I/O space	289	MFIRINTREG	350
ISA memory space	289	MGIUINTHREG	349
ISA mode	101	MGIUINTLREG	341
		MIDATREG	450
J		MIPS III instruction set	81, 561
Joint TLB	55	MIPS16 instruction set	99, 713
JTLB	55	MIRCR	548
Jump delay slot	114	MKIUINTREG	340
Jump instruction	92, 126, 564	MODEM Interface Unit (HSP)	519
		MODEMREG	479
K		MPIUINRTG	338
Kernel expanded addressing mode	240	MRXF	558
Kernel mode	157	MSYSINT1REG	336
Kernel mode address space	194	MSYSINT2REG	348

N			
NMI	259	Priority of exceptions	205
NMI exception	208	Privilege mode	240
NMIREG	343	Processor Revision Identifier (PRId) register	180
Non-maskable Interrupt (NMI)	259		
O		R	
Opcode bit encoding	108	Random register	175
Operating modes	151, 194	RDR	540
Operation when unbranched	93	Real-time Clock Unit (RTC)	33, 371
Ordinary interrupts	259	Refresh	302
Ordinary ROM	281, 285	Reserved Instruction exception	217
Output (Speaker)	456	Reset control	353
		Reverse endian	240
		REVIDREG	271
		ROM connection	277
		ROM interface	280
		ROM space	167
P		RSTSW	231
PageMask register	177	RSTSW reset	353
PageROM	281, 287	RTC	33, 371
Parity error prohibit	241	RTC registers	38, 372
Parity error register	200	RTC reset	230, 353
PClock	56	RTCINTREG	389
PC-relative instruction	111	RTCL1CNTHREG	380
Physical address	165	RTCL1CNTLREG	379
Pin configuration	59	RTCL1HREG	378
Pin functions	59	RTCL1LREG	377
Pin I/O circuit	80	RTCL2CNTHREG	384
Pin status	74	RTCL2CNTLREG	383
Pipeline	129	RTCL2HREG	382
PIU	34, 419	RTCL2LREG	381
PIU registers	40, 424	RTCLong timer	371
PIUABnREG (n = 0 to 3)	438	RXB0LREG	482
PIUAMSKREG	435	RXB0RREG	482
PIUASCNREG	433	RXFL	559
PIUCIVLREG	436	RXIR	552
PIUCMDREG	431	RXSTS	555
PIUCNTREG	425		
PIUINTRTG (ICU)	331	S	
PIUINTREG (PIU)	428	Scan sequencer	422
PIUPBnmREG (n = 0 or 1, m = 0 to 4)	437	SCANLINE	472
PIUSIVLREG	429	SCNTREG	448
PIUSTBLREG	430	SCNVRREG	449
PLL passive components	759	SDMADATREG	447
PMU	33, 353	Self refresh	302
PMU registers	37, 363	SEQREG	454
PMUCNT2REG	369	Serial Interface Unit (SIU)	34, 501
PMUCNTREG	366	Shutdown control	354
PMUINT2REG	368	SIU	34, 501
PMUINTREG	364	SIU registers	43, 501
PMUWAITREG	370	SIUCSEL	518
PORTREG	478	SIUDLL	502
Power Management Unit (PMU)	33, 353	SIUDLM	504
Power mode	239, 360	SIUFC	507
Power mode state transition	361	SIUIE	503
Power-on control	355	SIUID	505
Power-on sequence	235		
Precision of exceptions	188		

SIURSEL	516
SIULC	510
SIULS	512
SIUMC	511
SIUMS	514
SIURB	502
SIURESET	518
SIUSC	515
SIUTH	502
Slip conditions	144
SODATREG	447
Soft reset	238
Soft reset exception	207
SOFTINTREG	344
Software interrupts	260
Software shutdown	233, 354
Special instructions	96, 127
Stall conditions	143
Standby mode	239, 362
Status after reset	194
Status register	192
Store delay slot	82
Store instruction	82, 115, 563
Supervisor expanded addressing mode	240
Supervisor mode	154
Supervisor mode address space	194
Suspend mode	239, 362
SYSINT1REG	329
SYSINT2REG	345
System bus access	289
System bus space	169
System Call exception	214
System Control Coprocessor (CP0)	52, 173
System Control Coprocessor (CP0) instructions	97, 565
T	
TagHi register	182
TagLo register	182
TCLKCNTHREG	388
TCLKCNTLREG	387
TCLKHREG	386
TCLKLREG	385
TClock	56
TClock Counter	371
TDR	539
TDREG	321
Timer interrupt	260
TLB	55, 147
TLB entry	174
TLB exceptions	210
TLB instructions	185
TLB Invalid exception	211
TLB Misses	185
TLB Modified exception	212
TLB Refill exception	210
Touch panel	420
Touch Panel Interface controller	422
Touch Panel Interface Unit (PIU)	34, 419
Touch/release detection	442
Translation Lookaside Buffer (TLB)	55, 147
Trap exception	218
TXFL	557
TXIR	551
TXSOLREG	483
TXSORREG	483
U	
User expanded addressing mode	240
User mode	154
User mode address space	194
V	
Virtual address	147
Virtual-to-physical address translation	183
W	
Watch exception	219
WatchHi register	198
WatchLo register	198
Wired register	178
X	
XContext register	199
TLB Refill exception	210

[MEMO]

Facsimile Message

Although NEC has taken all possible steps to ensure that the documentation supplied to our customers is complete, bug free and up-to-date, we readily accept that errors may occur. Despite all the care and precautions we've taken, you may encounter problems in the documentation. Please complete this form whenever you'd like to report errors or suggest improvements to us.

From:

Name

Company

Tel.

FAX

Address

Thank you for your kind support.

North America

NEC Electronics Inc.
Corporate Communications Dept.
Fax: 1-800-729-9288
1-408-588-6130

Hong Kong, Philippines, Oceania

NEC Electronics Hong Kong Ltd.
Fax: +852-2886-9022/9044

Asian Nations except Philippines

NEC Electronics Singapore Pte. Ltd.
Fax: +65-250-3583

Europe

NEC Electronics (Europe) GmbH
Technical Documentation Dept.
Fax: +49-211-6503-274

Korea

NEC Electronics Hong Kong Ltd.
Seoul Branch
Fax: 02-528-4411

Japan

NEC Semiconductor Technical Hotline
Fax: 044-548-7900

South America

NEC do Brasil S.A.
Fax: +55-11-6465-6829

Taiwan

NEC Electronics Taiwan Ltd.
Fax: 02-719-5951

I would like to report the following error/make the following suggestion:

Document title: _____

Document number: _____ Page number: _____

If possible, please fax the referenced page or drawing.

Document Rating	Excellent	Good	Acceptable	Poor
Clarity	<input type="checkbox"/>	<input type="checkbox"/>	<input type="checkbox"/>	<input type="checkbox"/>
Technical Accuracy	<input type="checkbox"/>	<input type="checkbox"/>	<input type="checkbox"/>	<input type="checkbox"/>
Organization	<input type="checkbox"/>	<input type="checkbox"/>	<input type="checkbox"/>	<input type="checkbox"/>