

PA05

FILM CAPACITORS

1993

PASSIVE COMPONENTS

DATA HANDBOOK

Film Capacitors

B | 0 | 0 | K | P | A | 0 | 5 | 1 | 9 | 6 | 1 | 9 | 6 | 3

Philips Components



PHILIPS

CONTENTS

Introduction	5
Selection Guide	15
Packaging	29
Product Data	
General Purpose	45
Interference Suppression	145
AC and Pulse	185
Precision	249
Specific Applications	315

DEFINITIONS

Data sheet status	
Objective specification	This data sheet contains target or goal specifications for product development.
Preliminary specification	This data sheet contains preliminary data; supplementary data may be published later.
Product specification	This data sheet contains final product specifications.
Application information	
Where application information is given, it is advisory and does not form part of the specification.	

INTRODUCTION

FILM CAPACITORS

Film capacitors are capacitors where the dielectric material is a plastic film or a paper film. In the table below, an overview is given of the most commonly used film dielectrics in Philips film capacitor products.

Dielectrics:	P	KT	KC	KPS	KS	KP
Dielectric constant at 1 kHz	3	3.3	3	3	2.4	2.2
Dissipation factor (x 10 ⁻⁴)						
at 1 kHz	50	50	12	3	2	1
at 10 kHz	120	110	50	6	2	2
at 100 kHz	200	170	100	12	2	2
at 1 MHz	300	200	110	18	4	4
Volume resistivity in ohm cm		1.E + 17	1.E + 17	1.E + 17	1.E + 18	1.E + 18
Dielectric strength in V/μm	100	400	300	250	500	600
Maximum application temperature (°C)	100	125	125	150	85	100
Power density 10 kHz in W/cm ³	67	50	21	2.5	0.67	0.6

P = Paper
 KC = polycarbonate
 KS = polystyrene

KT = polyethyleneterephthalate
 KPS = polyphenylene sulphide
 KP = polypropylene

Because of their typical properties, the polyester and polycarbonate dielectrics are used in general purpose applications, where a small bias DC voltage and small AC voltages at low frequency are usual. High capacitance per volume for polyester, and capacitance stability over a wide temperature range for polycarbonate are the most important properties.

A rather new dielectric for general purpose applications is polyphenylene sulphide (PPS). With its low dissipation factor and excellent ability to withstand wave soldering temperatures, this dielectric is very important for SMD technology.

Polypropylene and polystyrene films are used in high frequency or high voltage applications due to their very low dissipation factor and high dielectric strength.

Paper film is still used in capacitors for mains applications.

Typical properties as a function of temperature or frequency are illustrated in the following figures.

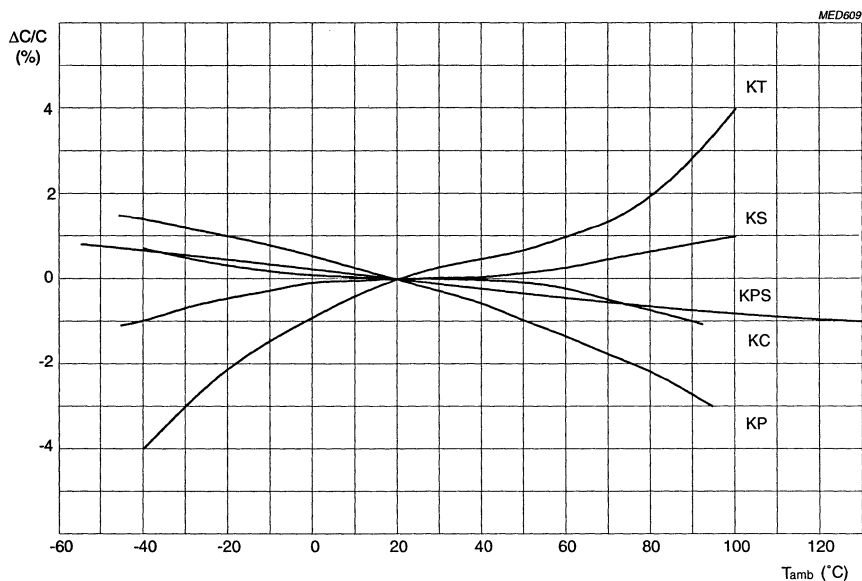

Capacitance as a function of ambient free air temperature; typical curves.

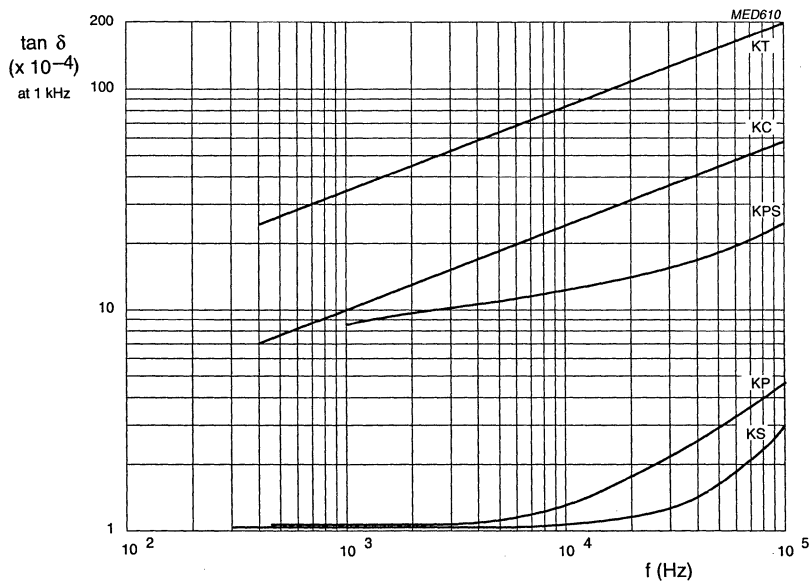

Dissipation factor as a function of frequency; typical curves.

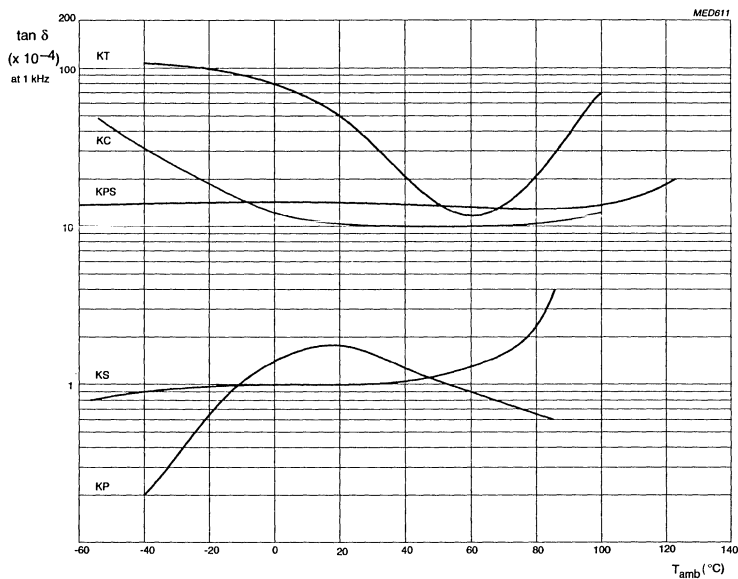

Dissipation factor as a function of ambient free air temperature; typical curves.

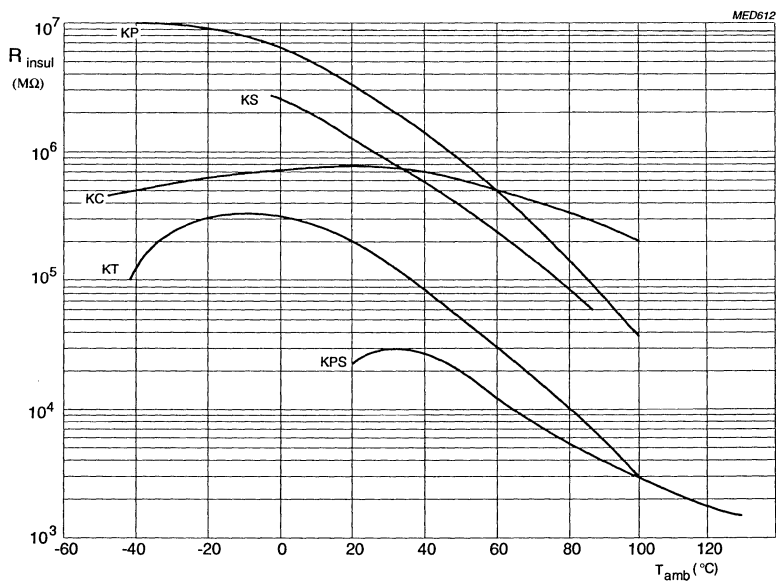

Insulation resistance as a function of ambient free air temperature; typical curves.

CONSTRUCTIONS OF THE CAPACITOR CELL

All capacitor cells are low inductive wound sections, except for the SMD's. These are stacked film capacitors.

Depending on the AC voltage, single section or series constructions are used. A single section capacitor is used for voltages up to 250 V AC, while series constructions are used for higher voltages.

Capacitors with foil as electrode can withstand high peak currents. For metallized film capacitors, the voltage pulse slope has always to be limited.

GENERAL DEFINITIONS**Rated voltage (U_{Rdc})**

The maximum DC voltage (in V) which may be applied continuously to a capacitor at any operating ambient temperature below the rated temperature.

Category voltage (U_c)

The maximum voltage which may be applied continuously to a capacitor at its upper category temperature. The category voltage is dependent on the ambient temperature.

Rated AC voltage (U_{Rac})

The maximum RMS voltage (in V), of specified frequency, which may be applied continuously to a film capacitor at any operating ambient temperature below the rated temperature.

Capacitance

The capacitance of a capacitor is the capacitive part of the equivalent circuit composed of capacitance, series resistance and inductance.

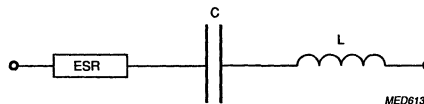
**Rated capacitance**

The capacitance value for which the capacitor has been designed and which is usually indicated upon it.

Capacitance tolerance

The allowed deviation of the capacitance from the rated capacitance at a free air ambient temperature of 23 ± 1 °C and RH of $50 \pm 2\%$.

This can be coded as follows: (ref.: IEC 62)

$\pm 1.0\%$	F
$\pm 2.0\%$	G
$\pm 5.0\%$	J
$\pm 10.0\%$	K
$\pm 20.0\%$	M

A letter "A" indicates that the tolerance is defined in the type specification or customer detail specification.

Temperature coefficient and cycle drift of capacitance

The terms characterizing these two properties apply to capacitors of which the variations of capacitance as a function of temperature are linear or approximately linear and can be expressed with a certain precision.

Temperature coefficient of capacitance

The rate of change of capacitance with temperature measured over the specified range of temperature. It is normally expressed in parts per million per degree Celsius ($10^{-6}/^{\circ}\text{C}$).

Temperature cyclic drift of capacitance

The maximum irreversible variation of capacitance observed at room temperature during or after the completion of a number of specified temperature cycles. It is expressed normally as a percentage of the capacitance related to a reference temperature. This is normally 20 °C.

Dissipation factor and equivalent series resistance

The equivalent series resistance is the resistive part of the equivalent circuit composed of capacitance, series resistance and inductance.

The dissipation factor or tangent of the loss angle ($\tan \delta$) is the power loss of the capacitor divided by the reactive power of the capacitor at a sinusoidal voltage of specified frequency.

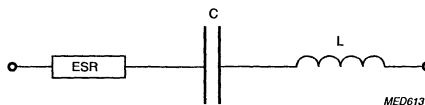

Rated voltage pulse slope (dV/dt)

The maximum voltage pulse slope that the capacitor can withstand with a pulse voltage equal to the rated voltage.

For other pulse voltages than the rated voltage, the maximum voltage pulse slope may be multiplied by U_{Rdc} and divided by the applied voltage.

The voltage pulse slope multiplied by the capacitance gives the peak current for the capacitor.

Insulation resistance and time constant

The insulation resistance is defined by the applied DC voltage divided by the leakage current after a well defined minimum time.

The time constant is the minimum product (in seconds) of the nominal capacitance and the insulation resistance between terminals.

Ambient temperature

The ambient temperature is the temperature of the air surrounding the component.

Climatic category

The climatic code (e.g. 50/100/56) indicates to which climatic category a film capacitor type belongs.

The category is indicated by a series of three sets of digits separated by oblique strokes corresponding respectively to the minimum ambient temperature of operation, the maximum temperature of operation and the number of days of exposure to damp heat (Steady state - test Ca) that they will withstand.

Category temperature range

The range of ambient temperatures for which the capacitor has been designed to operate continuously. This is defined by the temperature limits of the appropriate category.

Upper category temperature

The maximum ambient temperature for which a capacitor has been designed to operate continuously.

Lower category temperature

The minimum ambient temperature for which a capacitor has been designed to operate continuously.

Rated temperature

The maximum ambient temperature at which the rated voltage may be applied continuously.

Self-healing

The process by which the electrical properties of a metallized capacitor, after a local breakdown are rapidly and essentially restored to the values before the breakdown.

Temperature characteristic of capacitance

The term characterizing this property applies mainly to capacitors of which the variations of capacitance as a function of temperature, linear or non-linear, cannot be expressed with precision and certainty.

The temperature characteristic of capacitance is the maximum reversible variation of capacitance produced over a given temperature range within the category temperature range.

It is expressed normally as a percentage of the capacitance related to a reference temperature of 20 °C.

Storage temperature

The temperature range with a RH of maximum 80% without condensation at which the initial characteristics can be guaranteed for at least 2 years.

Maximum Power Dissipation

The power dissipated by a capacitor is a function of the voltage U_{esr} across or the current I through the series resistance ESR and is expressed by:

$$P = \frac{U_{esr}^2}{ESR}$$

$$P = ESR \times I^2$$

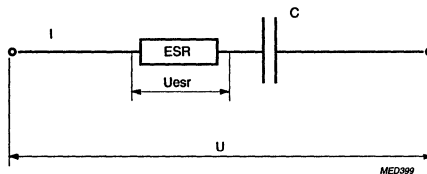

$$U_{esr}^2 = \frac{ESR^2}{ESR^2 + 1/\omega^2 C^2} \times U^2$$

Given that for film capacitors $\tan \delta = \omega C \times ESR \ll 0.1$, the formula can be simplified to

$$U_{esr}^2 = ESR^2 \times \omega^2 C^2 \times U^2$$

or with $ESR = \tan \delta / \omega C$, the formula becomes:

$$P = \omega C \times \tan \delta \times U^2$$

$$P = \frac{\tan \delta}{\omega C} \times I^2$$

For the $\tan \delta$ we take the maximum value found in the specification, C is in farads and $\omega = 2\pi f$.

U or I are assumed to be known.

The maximum permissible power dissipation (P_{max}), which depends on the dimensions of the capacitor and on the ambient free air temperature are given in the specification.

In applications where sinewaves occur, we have to take for U the RMS voltage or for I the RMS current of the sinewave.

In applications where periodic signals occur, the signal has to be expressed in Fourier-terms :

$$U = U_0 + \sum_{k=1}^{\infty} U_k \times \sin(k\omega t + \Phi_k)$$

$$I = \sum_{k=1}^{\infty} I_k \times \sin(k\omega t + \Phi_k)$$

with U_0 the DC voltage, U_k and I_k (the voltage and current of the k -th harmonic resp.) the formulae become for the dissipated power:

$$P = \sum_{k=1}^{\infty} k\omega C \times \tan \delta_k \times \frac{U_k^2}{2}$$

$$P = \sum_{k=1}^{\infty} \frac{\tan \delta_k \times I_k^2}{2k\omega C}$$

and $\tan \delta_k$ is the $\tan \delta$ at the k -th harmonic.

TEST INFORMATION**Robustness of terminations**

Tensile strength of terminations (Ua)
(Load in wire axis direction)

wire diameter 0.5, 0.6 and 0.8 mm:	load 10N, 10 s
1.0 mm	load 20N, 20 s

Bending (Ub)

wire diameter 0.5, 0.6 and 0.8 mm :	load 5 N, 4 x 90°
1.0 mm	load 10N, 4 x 90°

Torsion (Uc) (For axial capacitors only)

Severity 1:	three rotations of 360°
Severity 2:	two rotations of 180°

Rapid change of temperature (Na)

The rapid change of temperature test is intended to determine the effect on capacitors of a change of temperature or a succession of changes of temperature and consists of 5 cycles of 30 minutes at lower category temperature and 30 minutes at higher category temperature.

Dry heat (Ba)

The object of this test is to determine the ability of the capacitors to be used or stored at high temperature. The standard test is 16 hours at upper category temperature.

Damp heat cyclic (Db)

The object of this test is to determine the suitability of capacitors for use and storage under conditions of high humidity when combined with cyclic temperature changes and in general, producing condensation on the surface of the capacitor.

One cycle consists of 24 hour exposure to 55 °C and 95 - 100% relative humidity.

Cold (Aa)

The object of this test is to determine the ability of the capacitors to be used or stored at low temperature. The standard test is 2 hours at the lower category temperature.

Damp heat steady state (Ca)

The object of this test is to determine the suitability of capacitors for use and storage under conditions of high humidity. This test is primarily intended to permit the observations of the effects of high humidity at constant temperature over a prescribed period.

The capacitors are exposed to a damp heat environment which is maintained at a temperature of 40 °C and a R.H. of 90 to 95% for the number of days specified by the third set of digits of the climatic category code.

	page
GENERAL PURPOSE	16
INTERFERENCE SUPPRESSION	18
AC & PULSE	20
PRECISION	22
SPECIFIC APPLICATIONS	24

GENERAL PURPOSE

Selection guide

MKT-370/371/372/373

Page 47



Dielectric	metallized polyester
Encapsulation	potted with epoxy resin
Qualified to	CECC 30401-801
Temp. range	-55 to 100 °C
Packaging	loose, taped
Tolerance	±20%, ±10%, ±5%

Capacitance (µF)*	U _{Rdc}					
	63 V	100 V	250 V	400 V	63 V	100 V
0.00022						
0.00033						
0.00047						
0.00068						
0.001						
0.0015						
0.0022						
0.0033						
0.0047						
0.0068						
0.01						
0.015						
0.022						
0.033						
0.047						
0.068						
0.1						
0.15						
0.22						
0.33						
0.47						
0.68						
1.0						
1.5						
2.2						
3.3						
4.7						
6.8						
10						
15						

* Intermediate values of E12 series are also available.

pitch sizes:

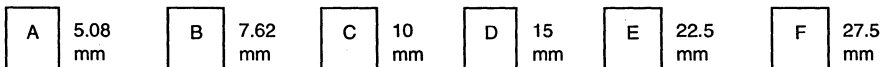

GENERAL PURPOSE

Selection guide

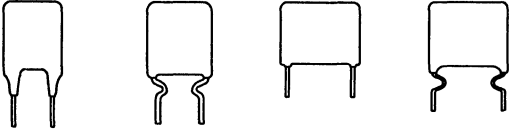
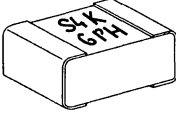
MKT-365/366/367/368/369				PPS-390/391/392/393/394		
Page 89				Page 137		
						
metallized polyester				metallized polyphenylene sulphide		Dielectric
epoxy lacquered						Encapsulation
IEC 384-2				EN 132500 (DRAFT)		Qualified to
-55 to 100 °C				-55 to 125 °C		Temp. range
loose, taped				taped		Packaging
±20%, ±10%, ±5%				±10%, ±5%		Tolerance
U_{Rdc}				U_{Rdc}		Capacitance (µF)*
100 V	250 V	400 V	630 V	25 V	160 V	
						0.00022
						0.00033
						0.00047
						0.00068
						0.001
						0.0015
						0.0022
						0.0033
						0.0047
						0.0068
						0.01
						0.015
						0.022
						0.033
						0.047
						0.068
						0.1
						0.15
						0.22
						0.33
						0.47
						0.68
						1.0
						1.5
						2.2
						3.3
						4.7
						6.8
						10
						15

* Intermediate values of E12 series are also available.

pitch sizes:



A 5.08 mm



B 7.62 mm



C 10 mm



D 15 mm



E 22.5 mm



F 27.5 mm

INTERFERENCE SUPPRESSION

Selection guide

	MKT-P 330 4 Page 147	MKT/MKT 331 6 Page 155	MKP 335 1 Page 165	MP-KT 333 4 Page 175
Class	X2*	X2	X2	X2
Dielectric	metallized polyester and paper	metallized polyester	metallized polypropylene	metallized paper and polyester
Encapsulation	potted with epoxy resin	potted with epoxy resin	potted with epoxy resin	potted with epoxy resin
Qualified to	IEC 384-14	IEC 40-secr. 792	IEC 40-792	IEC 40-secr. 611
Approvals				
Temp. range	-40 to 85 °C	-55 to 100 °C	-40 to 85 °C	-40 to 85 °C
Packaging	loose, taped	loose, taped	loose, taped	loose, taped
Tolerance	±20%, ±10%	±20%	±20%, ±10%	±10%
Capacitance (µF)	U_{Rac} 250 V	U_{Rac} 300 V	U_{Rac} 250 V	U_{Rac} 250 V
0.0068				
0.01				
0.015				
0.022				
0.033	D	D	D	D
0.047				
0.068				
0.1				
0.15				E
0.22	E	E	E	
0.33				
0.47				F
0.68			F	
1.0				
1.5				

* In accordance with the new IEC 384-14 capacitors will be classified X3 for new designs.

pitch sizes:

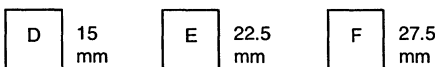

This page intentionally left blank.

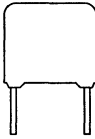
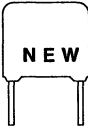
	(MKP) MKP/MKP-378						MKP-379			
	Page 187						Page 211			
										
Dielectric	metallized polypropylene						metallized polypropylene			
Encapsulation	potted with epoxy resin						potted with epoxy resin			
Qualified to	IEC 384-17						IEC 384-16			
Temp. range	-55 to 85 °C						-55 to 85 °C			
Packaging	loose, taped						loose, taped			
Tolerance	±5%						±5%			
Capacitance (µF)*	U_{Rdc}						U_{Rdc}			
	250	400	630	1000	1600	2000	160 V	250 V	400 V	630 V
0.001										
0.0015										
0.0022										
0.0033										
0.0047										
0.0068				D						
0.01										
0.015										
0.022			D							
0.033				E					C	
0.047										
0.068								C		
0.1			E						D	
0.15										
0.22								D		
0.33		E								
0.47	E			F			D			
0.68								E		
1.0									F	
1.5		F					E			
2.2	F							F		
3.3										
4.7							F			
6.8										

* Intermediate values of E24 series are also available.

** For new design see 2222 379 series.

pitch sizes:

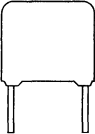

KP/MMKP-376				
Page 229				
				
metallized polypropylene			Dielectric	
potted with epoxy resin			Encapsulation	
IEC 384-17			Qualified to	
-55 to 100 °C			Temp. range	
loose, taped			Packaging	
±5%, ±3.5%			Tolerance	
U_{Rdc}			Capacitance (μF)*	
630 V	1000 V	1600 V	2000 V	
			D	0.001
			D	0.0015
				0.0022
		D		0.0033
	D		E	0.0047
		E		0.0068
D				0.01
				0.015
				0.022
	E		F	0.033
				0.047
				0.068
	F			0.1
		E		0.15
				0.22
				0.33
				0.47
				0.68
		F		1.0
				1.5
				2.2
				3.3
				4.7
				6.8

* Intermediate values of E24 series are also available.

pitch sizes:



15 mm





22.5 mm



27.5 mm

PRECISION

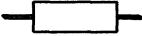
Selection guide

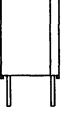
	KS-424/431 Page 251				KP-460/464 Page 271					KS-444/447 Page 289				KS-443 Page 301
														
Dielectric	polystyrene				polypropylene					polystyrene				polystyrene
Encapsulation					epoxy lacquered					epoxy lacquered				potted with epoxy resin
Qualified to	IEC 384-7				IEC 384-13					IEC 384-7				IEC 384-7
Temp. range	-40 to 85 °C				-40 to 100 °C					-40 to 70 °C (63V) -40 to 85 °C (≥160V)				-55 to 70 °C -55 to 85 °C
Packaging	loose, taped				loose, taped					loose				loose
Tolerance	±5%, ±2%, ±1%				5%, 2%, 1%					±5%, ±2%, ±1%				±1%
Capacitance (pF)*	U _{Rdc} (V)				U _{Rdc} (V)					U _{Rdc} (V)				U _{Rdc} (V)
	63	160	250	630	63	160	250	400	630	63	160	250	630	63
47														
68									H					
100														
150														
220				G										
330									G					
470														
680														J
1000				G										K
1500														L
2200	G	G							G					
3300					H									
4700														
6800														
10 000														
15 000														
22 000		H												
33 000														
47 000														
68 000														
100 000														
150 000														
162 000														

* Intermediate values of E24-series (with ±5%, ±2% or 1% tolerance), E48-series (with ±2% or ±1% tolerance) and E96-series (with ±1% tolerance) are also available.

Code for body length KS-424/431; KP-460/464; KS-444/447

G 11 mm

H 15 mm

I 25 mm

Code for box dimensions KS-443

J 5.0 x 7.5 mm

K 7.5 x 7.5 mm

L 6.25 x 6.25 mm

M 10 x 10 mm

SPECIFIC APPLICATIONS

Selection guide

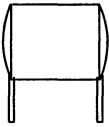
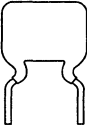
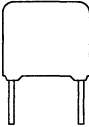
	KT 90028/29 Page 317	KT 90032 Page 323	MKC-344 Page 329			
						
Dielectric	polyester	polyester	metallized polycarbonate			
Encapsulation		epoxy lacquered	potted with epoxy resin			
Qualified to	IEC 384-11	IEC 384-11	IEC 384-6			
Temp. range	-40 to 100 °C	-40 to 125 °C	-55 to 100 °C			
Packaging	loose, taped	loose	loose, taped			
Tolerance		±20%	10%, 5%			
Capacitance (µF)*	U_{Rac}	U_{Rac}	U_{Rdc}			
	250 V	250 V	100 V	250 V	400 V	630 V
0.0012						
0.0056						
0.001						
0.0015						
0.0022						
0.0033						
0.0047						
0.0068						
0.01						
0.015						C
0.022					C	
0.033						D
0.047				C		
0.068					D	
0.1			C			
0.15				D		E
0.22					E	
0.33						F
0.47			D			
0.68				E		
1.0					F	
1.5						
2.2			E		F	
3.3						
5.6				F		
8.2						

* Intermediate values of E 12 series are also available.

for pitch sizes:

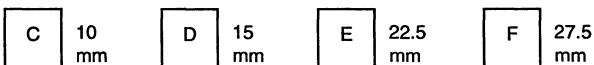

SPECIFIC APPLICATIONS

Selection guide

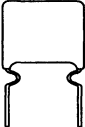
KT-347				
Page 345				
				
polyester			Dielectric	
lacquered			Encapsulation	
IEC 384-11			Qualified to	
-40 to 100 °C			Temp. range	
loose			Packaging	
±20%, ±10%			Tolerance	
U_{Rdc}				Capacitance (μF)*
100 V	250 V	400 V	630 V	
				1200
				5600
				0.001
				0.0015
			C	0.0022
				0.0033
				0.0047
		C		0.0068
	C			0.01
			D	0.015
C				0.022
		D		0.033
	D			0.047
			E	0.068
D				0.1
		E		0.15
			F	0.22
	E			0.33
		F		0.47
	F			0.68
				1.0
				1.5
				2.2
				3.3
				5.6
				8.2

* Intermediate values of E12 series are also available.

pitch sizes:



PACKAGING

Taping specification for film CHIP capacitors

Packaging

FILM CHIP CAPACITORS

390....394 types

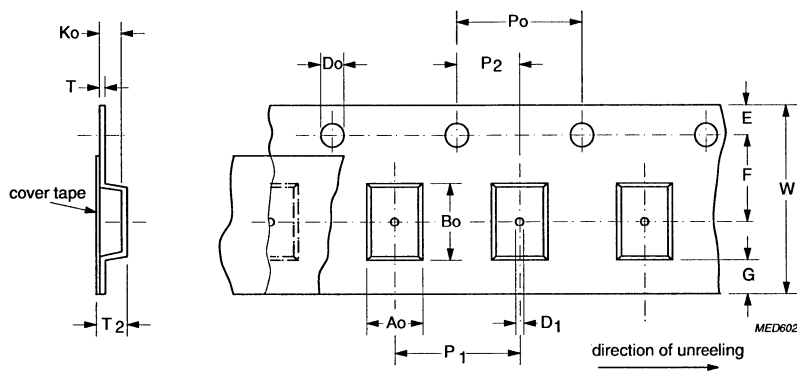

CASE SIZE REFERENCE	W ± 0.3 mm	A _o ± 0.1 mm	B _o ± 0.1 mm	K _o max. mm	F ± 0.05 mm	P ₁ ± 0.1 mm	D ₁ min. mm	T ₂ max. mm
1206	8	2.0	3.6	1.4	3.5	4.0	1.0	2.5
1210	8	2.9	3.6	2.2	3.5	4.0	1.0	3.0
1812	12	3.6	4.9	2.7	5.5	8.0	1.5	3.5
2220	12	5.5	6.1	4.2	5.5	8.0	1.5	5.0
2824	16	6.6	7.6	5.0	7.5	8.0	1.5	6.0

Feed hole diameter	D _o = 1.5 \pm 0.1 mm
Feed hole position	E = 1.75 \pm 0.1 mm
Margin to component window	G = 0.75 mm min.
Feed hole spacing	P _o = 4 \pm 0.1 mm
Hole centre to component centre	P ₂ = 2 \pm 0.05 mm
Tape thickness	T = 0.6 mm max.

Taping specification for film CHIP capacitors

Packaging

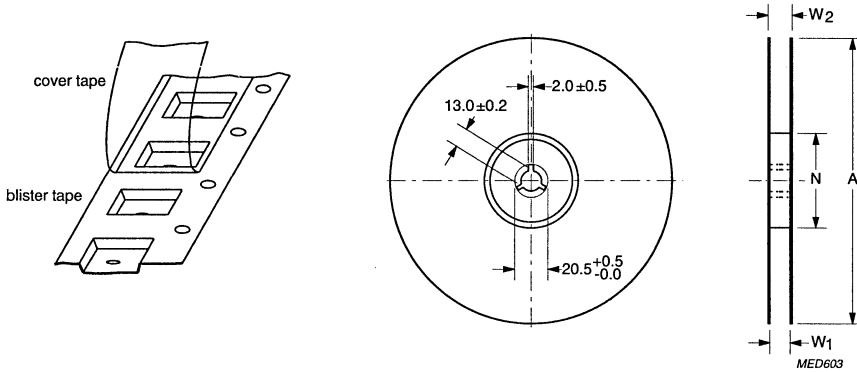

Dimensions in mm.

Break-off force of cover tape in direction of unreeling $\geq 10N$.

Peel-off force of cover tape shall be between 0.2 and 1.0 N.

Speed 300 mm/min; angle of cover tape during peel-off and direction of unreeling between 165° and 180°.

At least 40 positions at the beginning and at the end of the tape are not used. The tape has a 400 mm leader. (According to IEC 286-3)

Reel dimensions

Tape width (W) (mm)	W_1 (mm)	W_2 max. (mm)	A (mm)	N (mm)
8	8.4 +0/+1.5	14.4	180 -2/+0	62 ±1.5
12	12.4 +0/+2.0	18.4	330 -2/+0	62 ±1.5
16	16.4 +0/+2.0	22.4	330 -2/+0	62 ±2.0

Taping specification for AXIAL film capacitors

AXIAL UNIDIRECTIONEL FILM CAPACITORS (dimensions in mm)

460 ... 464 types

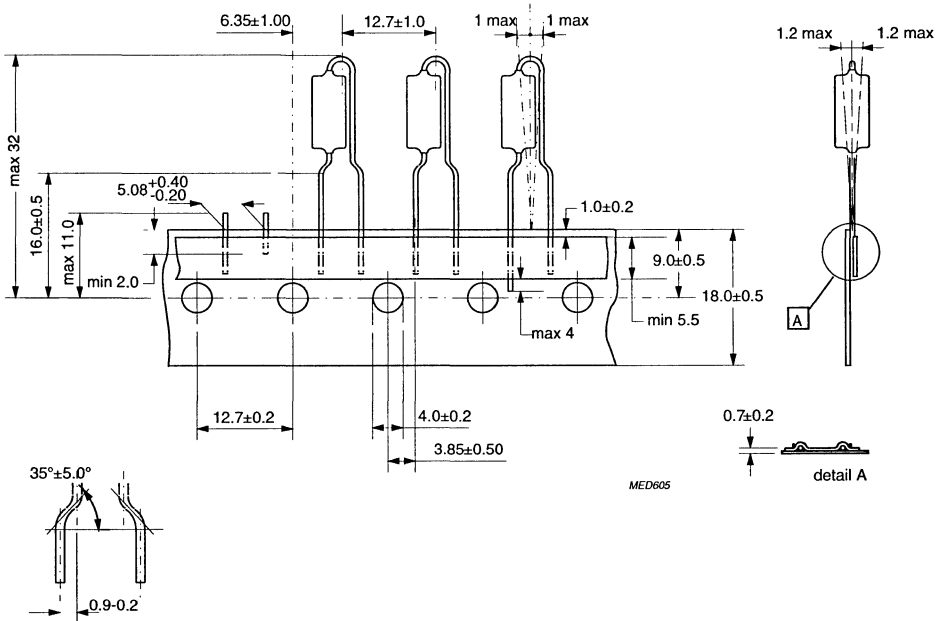

* Cumulative pitch error: 1.0 mm per 20 spacings
0.5 mm per 4 spacings

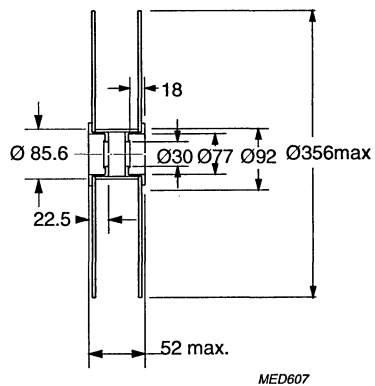
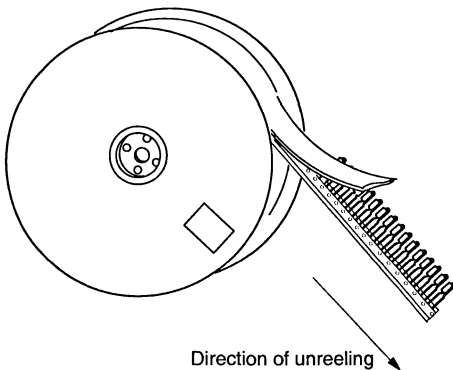

Taping specification for AXIAL film capacitors

Packaging

AXIAL FILM CAPACITORS (dimensions in mm)

424...431, 460...464 types

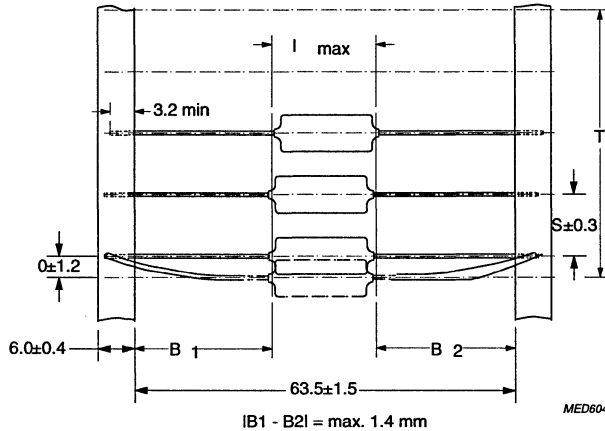

d_{max} (mm)	S (mm)	T for number (n) of capacitors	
		n < 50	50 < n < 100
≤ 4.5	5	5(n-1) ±2	5(n-1) ±4
>4.5	10	10(n-1) ±2	10(n-1) ±4

Characteristics of taped products

For axial leads		For radial leads	
Pull-out force of the component	2N	Pull-out force of the component	≥5N
Pull-off force of adhesive tape	≥6N	Pull-off force of adhesive tape	≥6N
Tearing force of tape	≥10N	Tearing force of tape	≥15N
Storage conditions			
Storage temperature range	-25 °C to +40 °C		
Relative humidity	max. 80% without condensation		

Taping specification for AXIAL film capacitors

Outlines of packing for axial products (dimensions in mm)

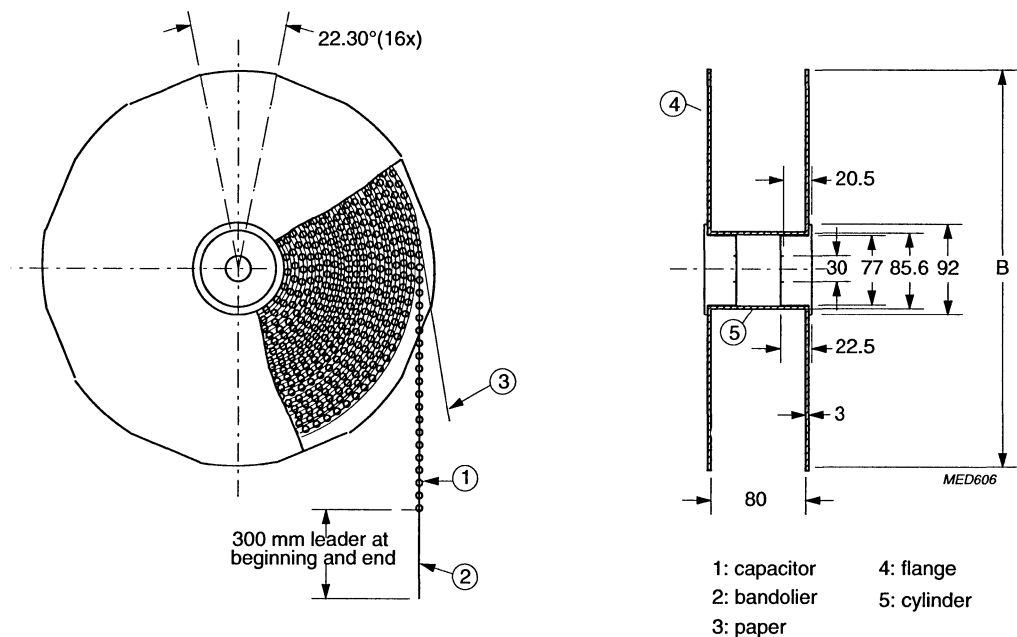

Reel \varnothing B as a function of maximum body thickness d_{max}

d_{max} (mm)	B (mm)
≤ 5.0	305
> 5.0	356

Taping specification for film CHIP capacitors

Packaging

Ammunition packing for 460/461/462/463/464

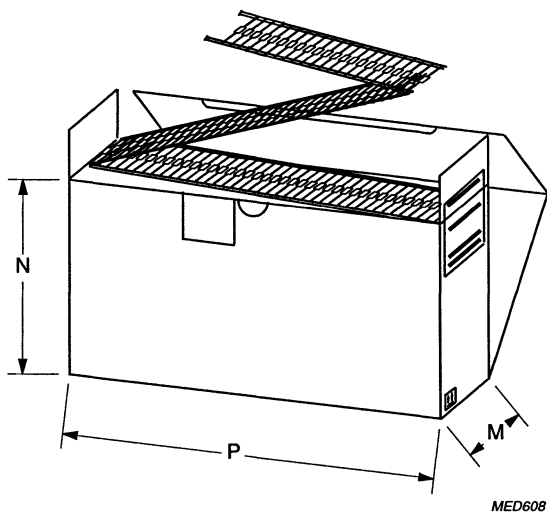

Box dimensions as a function of body thickness d_{max}

d_{max} (mm)	M x N x P (mm)
≤ 6	97 x 155 x 265
> 6	97 x 135 x 265

Taping specification for RADIAL POTTED film capacitors

RADIAL POTTED FILM CAPACITORS (dimensions in mm)

Capacitors with pitch = 5 mm

370 types

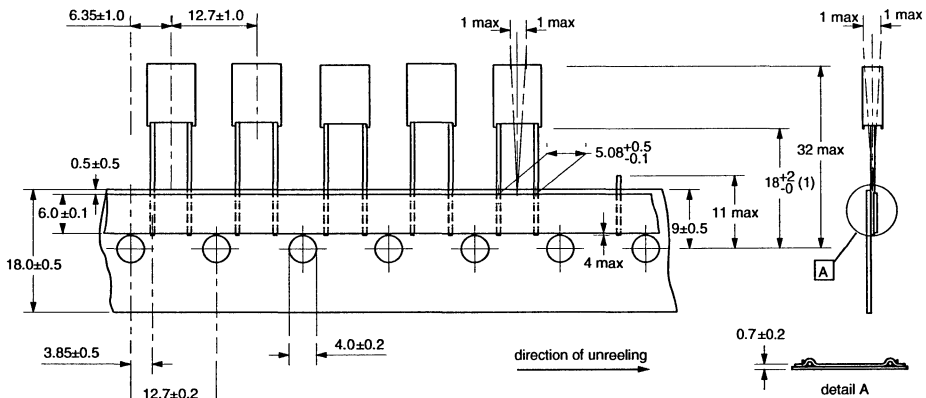

(1) $16^{+0.3}_{-0.5}$ or 18^{+2}_{-0} for ammunition packing

MED599

Capacitors with pitch = 7.5 mm

371 types

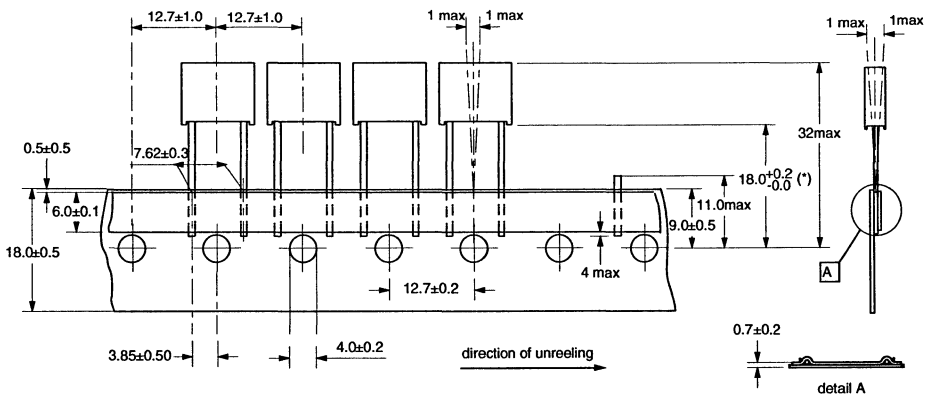

(*) also available with intape height 16.5 ± 0.3

MED600

Taping specification for RADIAL POTTED film capacitors

Capacitors with pitch = 10 mm

344, 372, 379 types

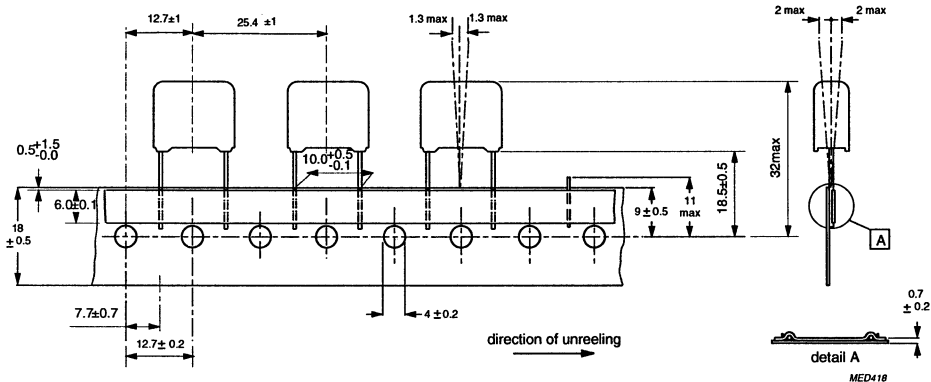

Capacitors with pitch = 15 mm

330 4, 331 6, 333 4, 335 1, 344, 373, 376, 378, 379 types

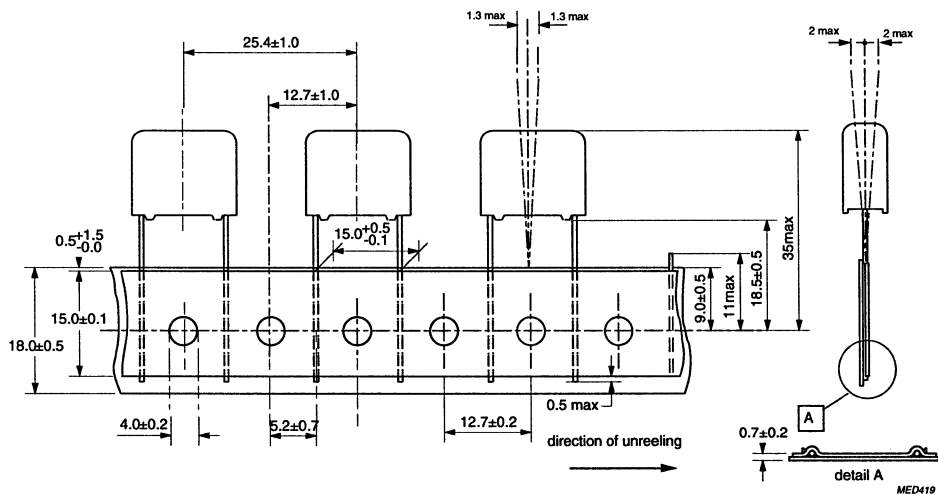

Taping specification for RADIAL POTTED film capacitors

Capacitors with pitch = 22.5 or 27.5 mm

330 4, 331 6, 333 4, 335 1, 344, 373, 376, 378, 379 types

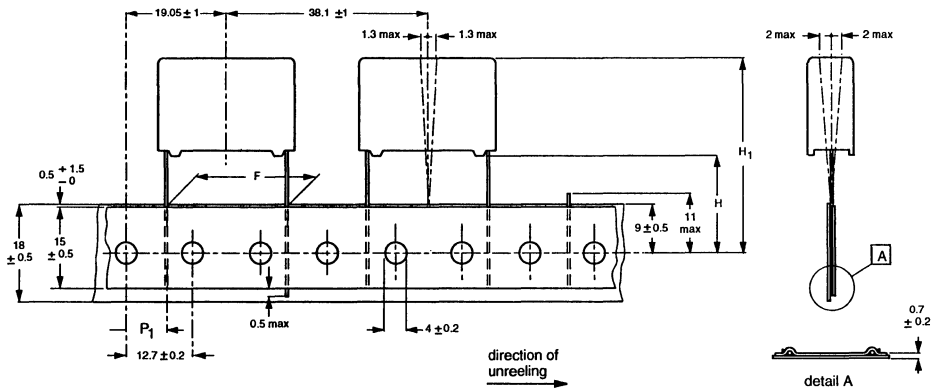

ITEM	SYMBOL	VALUE	VALUE	TOLERANCE
LEAD TO LEAD DISTANCE	F	22.5	27.5	+0.5/-0.1
HEIGHT OF COMPONENT FROM TAPE CENTER TO SEATING PLANE	H	18.5		± 0.5
COMPONENT HEIGHT FROM TAPE CENTER	H ₁	40 max	48 max	
FEED HOLE TO LEAD CENTER	P ₁	7.8	5.33	± 0.7

MED420

Characteristics of taped products

Pull-out force of the component ≥5N
 Pull-off force of the adhesive tape ≥6N
 Tearing force of tape ≥15N
 Storage conditions:

Storage temperature -25 °C to +40 °C
 Relative humidity max. 80% without condensation

Taping specification for RADIAL POTTED film capacitors

Outlines of reel and ammunition packing (dimensions in mm)

370 and 371 types

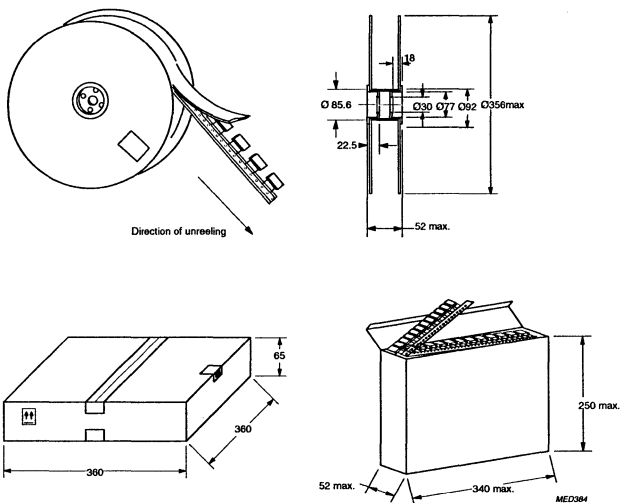

330 4, 331 6, 333 4, 335 1, 344, 372, 373, 376, 378, 379 types

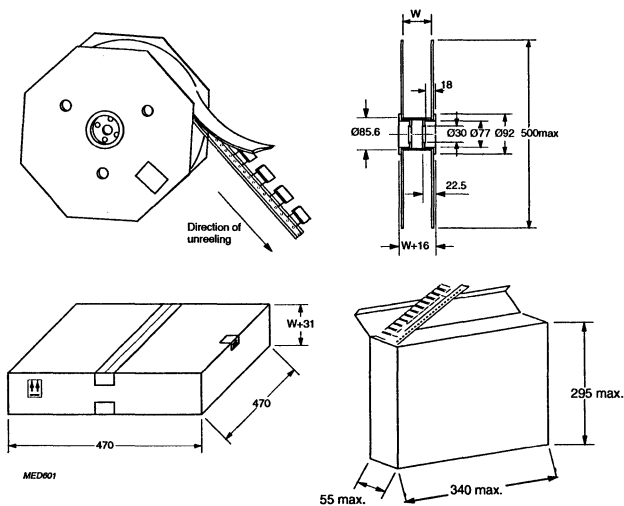

Taping specification for RADIAL POTTED film capacitors

Packaging

W as a function of product dimensions (l_{max} and b_{max})

$l_{max} = 12.5 \text{ or } 17.5 \text{ mm}$		$l_{max} = 26 \text{ or } 31 \text{ mm}$	
$b_{max} \text{ (mm)}$	W $\pm 2 \text{ mm}$	$b_{max} \text{ (mm)}$	W $\pm 2 \text{ mm}$
4	40	6	45
5	40	7	45
6	45	8.5	50
7	45	9	50
8.5	45	10	50
		11	50
		13	55
		15	55
		18	60
		21	60

Cumulative pitch error 1.0 mm/20 pitches.

The maximum number of empty places per reel shall not exceed 0.5% (*) of the total number of components per reel, and no more than 2 consecutive positions may be vacant.

(*) 5% for capacitors with $b_{max} = 4.5 - 5 \text{ or } 6 \text{ mm}$ in ammunition pack.

The maximum number of empty places per reel shall not exceed 0.5% of the total number of components per reel, but a maximum of 2 consecutive components may be missing provided this gap is followed by 6 consecutive components.

Taping specification for RADIAL LACQUERED film capacitors

RADIAL LACQUERED FILM CAPACITORS (dimensions in mm)

Capacitors with pitch = 5 mm

365 types

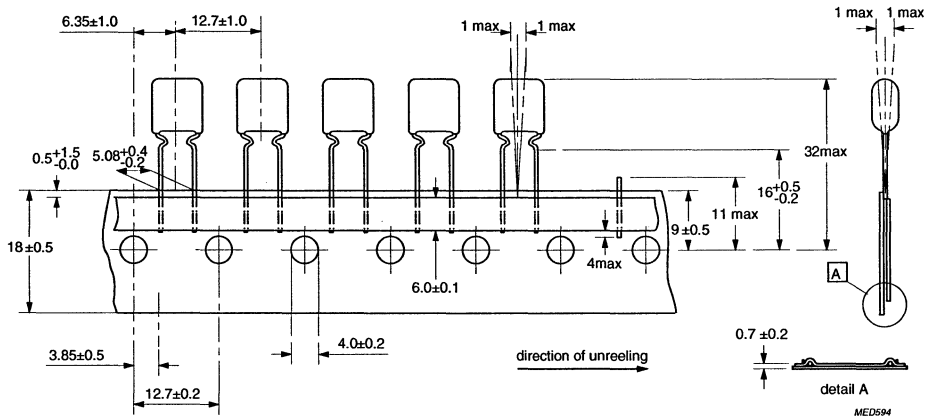

Capacitors with pitch = 10 mm

369 types

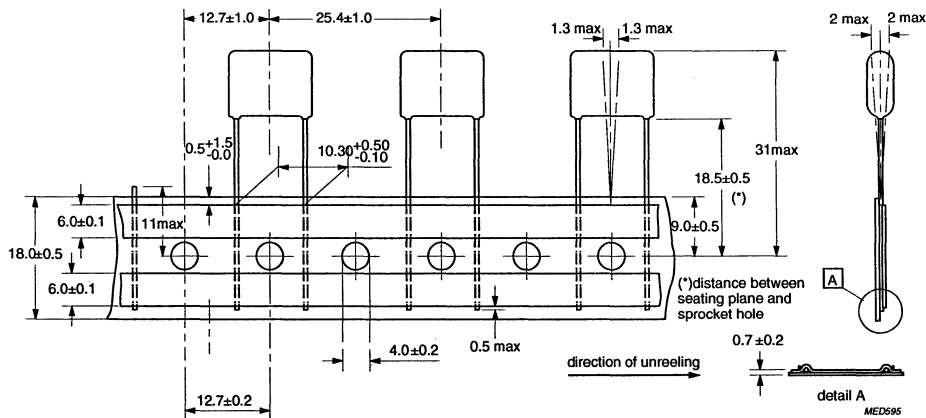

Taping specification for RADIAL LACQUERED film capacitors

Capacitors with pitch = 10 mm

368 types

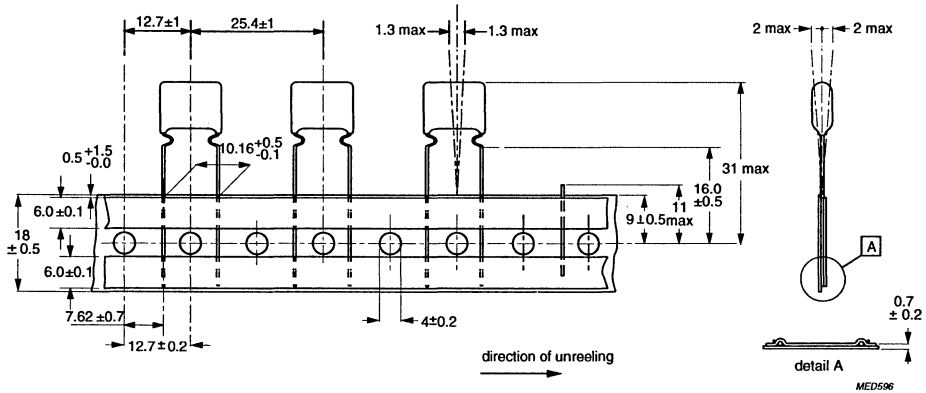

Capacitors with pitch = 15 mm

368 types

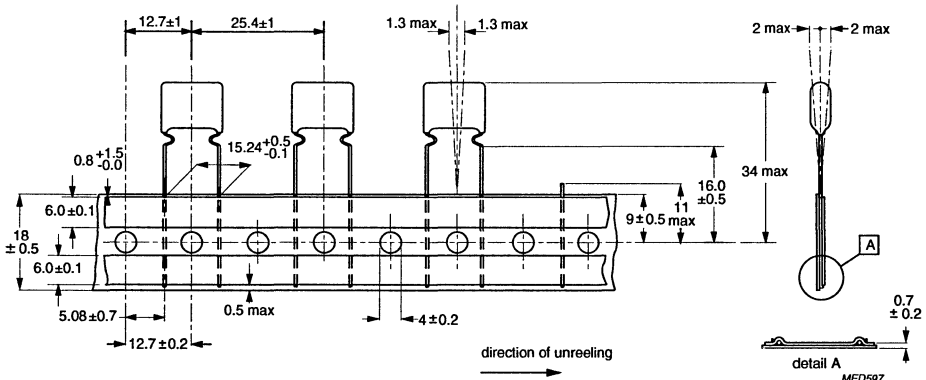

Taping specification for RADIAL LACQUERED film capacitors

Capacitors with pitch = 22.5 and 27.5 mm

368 types

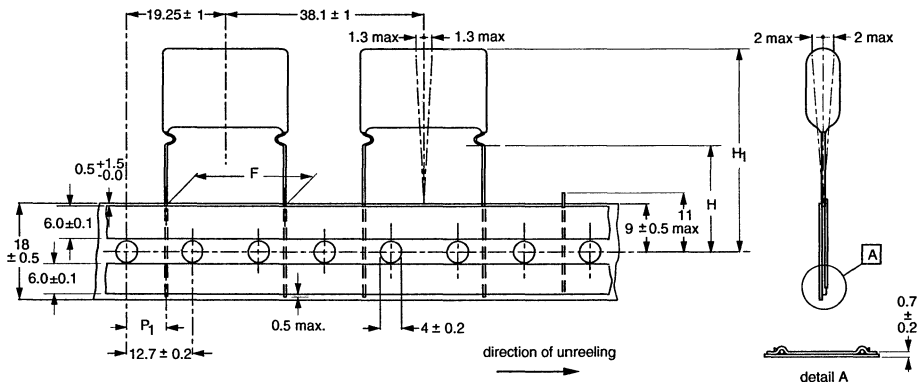

ITEM	SYMBOL	VALUE	VALUE	TOLERANCE
LEAD TO LEAD DISTANCE	F	22.86	27.94	+0.5/-0.1
HEIGHT OF COMPONENT FROM TAPE CENTER TO SEATING PLANE	H	16.0		± 0.5
COMPONENT HEIGHT FROM TAPE CENTER	H ₁	38.0 max	41.0 max	
FEED HOLE TO LEAD CENTER	P ₁	7.8	5.3	± 0.7

MED598

Characteristics concerning taped products

- Pull-out force of the component ≥5N
- Pull-off force of the adhesive tape ≥6N
- Tearing force of tape ≥15N
- Storage conditions:

- Storage temperature -25 °C to +40 °C
- Relative humidity max. 80% without condensation

Taping specification for RADIAL LACQUERED film capacitors

Outlines of reel and ammunition packing (dimensions in mm)

365 types

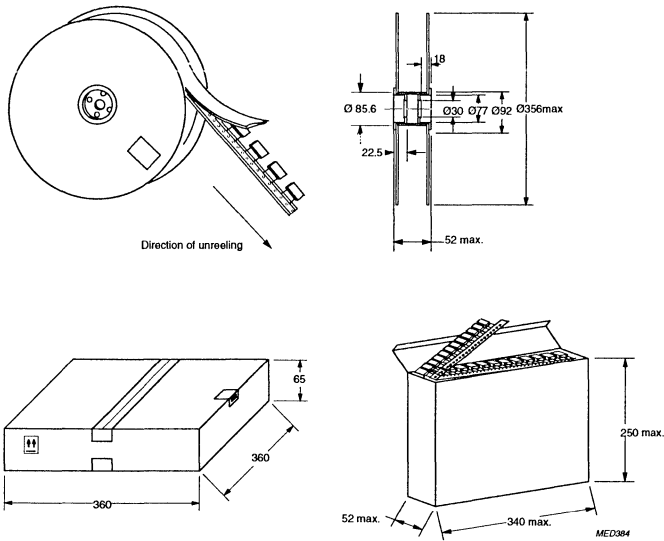

368, 369 types

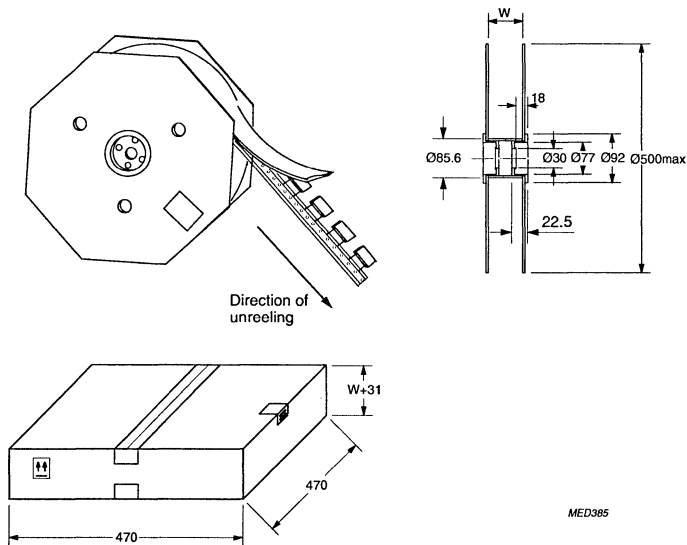

Taping specification for RADIAL LACQUERED film capacitors

Packaging

W as a function of product dimensions (l_{max} and b_{max})

b_{max} (mm)	$l_{max} = 12.5$ mm		$l_{max} = 17.5$ mm		$l_{max} = 26$ or 30 mm	
	W ± 2 mm		b_{max} (mm)	W ± 2 mm	b_{max} (mm)	W ± 2 mm
	2222 368	2222 369				
4	40	40	4		5	45
4.5	40	40	4.5		5.5	45
5	40	45	5	45	6	50
5.5	40	45	5.5	45	6.5	50
6	45	45	6	45	7	50
6.5	45	45	6.5	45	7.5-8	50
7			7	45	8.5-9	50
7.5			7.5	45	9.5-10	50
8			8	45	10.5	50
					11-12	55

Cumulative pitch error: 1.0 mm/20 pitches.

The maximum number of empty places per reel shall not exceed 0.5% of the total number of components per reel, and no more than 2 consecutive positions may be vacant.

GENERAL PURPOSE

E Metallized POLYESTER MKT 370/371/372/373 film capacitors

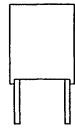

MKT RADIAL POTTED CAPACITORS

Pitch 5/7.5/10/15/22.5/27.5

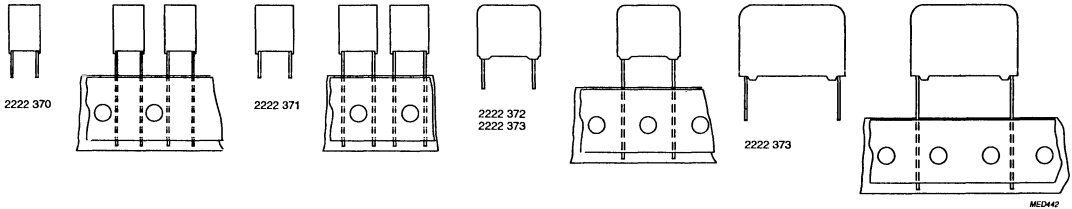

QUICK REFERENCE DATA

Capacitance range (E12)	0.001 to 15 μ F
Capacitance tolerance	\pm 20%, \pm 10%, \pm 5%
Rated voltage U_{Rdc}	63 V, 100 V, 250 V, 400 V
Climatic category	55/100/56
Maximum application temperature	100 °C
Rated temperature	85 °C
Tangent of loss angle at 10 kHz	100×10^{-4}
Reference specification	IEC 384-2, DIN 44122, DIN 45910 Draft
Performance grade	Grade 1 (long life)
Qualified in accordance with	CECC 30 401-801

FEATURES

- Low-inductive wound cell of metallized (PETP) film
- Potted with blue epoxy resin in a blue flame retardant case
- Radial leads of solder-coated wire
- Withstand solvents and rinsing liquids
- Small stand-off pips to allow removal of solder flux
- Suitable for high density packaging.

APPLICATIONS

- Blocking and coupling
- Bypass and energy reservoir applications.

Metallized POLYESTER
film capacitors

MKT 370

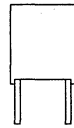

Pitch 5

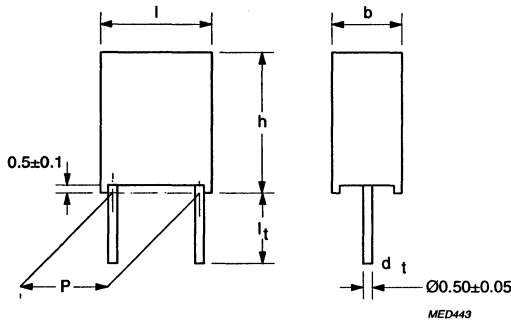

$U_{Rdc} = 63 V$

$U_{Rac} = 40 V$

loose in box

Cap. (μF)	$b_{max} \times h_{max} \times l_{max}$ (mm)	mass (g)	CATALOGUE NUMBER 2222 370					
			$l_t = 4 +1/-0.5 \text{ mm}$			$l_t = 26 \pm 1 \text{ mm}$		
			C-tol $\pm 20\%$	C-tol $\pm 10\%$	C-tol $\pm 5\%$	C-tol $\pm 20\%$	C-tol $\pm 10\%$	C-tol $\pm 5\%$
Pitch = 5.08 \pm 0.3 mm								
0.056	2.5 x 6.5 x 7.2	0.25	10563	11563	12563	14563	15563	16563
0.068			10683	11683	12683	14683	15683	16683
0.082			10823	11823	12823	14823	15823	16823
0.1			10104	11104	12104	14104	15104	16104
0.12	3.5 x 8.0 x 7.2	0.35	10124	11124	12124	14124	15124	16124
0.15			10154	11154	12154	14154	15154	16154
0.18			10184	11184	12184	14184	15184	16184
0.22			10224	11224	12224	14224	15224	16224
0.27			10274	11274	12274	14274	15274	16274
0.33			10334	11334	12334	14334	15334	16334
0.39	4.5 x 9.0 x 7.2	0.45	10394	11394	12394	14394	15394	16394
0.47			10474	11474	12474	14474	15474	16474
0.56	5.0 x 10.0 x 7.2	0.50	10564	11564	12564	14564	15564	16564
0.68			10684	11684	12684	14684	15684	16684
0.82	6.0 x 11.0 x 7.2	0.60	10824	11824	12824	14824	15824	16824
1			10105	11105	12105	14105	15105	16105

SMALLEST PACKING QUANTITIES (SPQ)	$l_t = 4 \text{ mm}$	$l_t = 26 \text{ mm}$
DIMENSIONS	SPQ	SPQ
all dimensions	2000	1000

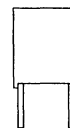

Pitch 5

SPECIFIC REFERENCE DATA FOR 63 V DC

Tangent of loss angle	at 1 kHz	at 10 kHz	at 100 kHz
$C \leq 0.1 \mu\text{F}$	$\leq 75 \cdot 10^{-4}$	$\leq 130 \cdot 10^{-4}$	$\leq 250 \cdot 10^{-4}$
$0.1 \mu\text{F} < C \leq 0.47 \mu\text{F}$	$\leq 75 \cdot 10^{-4}$	$\leq 130 \cdot 10^{-4}$	$\leq 300 \cdot 10^{-4}$
$0.47 \mu\text{F} < C \leq 1.0 \mu\text{F}$	$\leq 75 \cdot 10^{-4}$	$\leq 130 \cdot 10^{-4}$	
Rated voltage pulse slope $(dU/dt)_R$ at U_{Rdc} (see also application note)	60 V/ μs		
R between terminations, for $C \leq 0.33 \mu\text{F}$	>15 000 M Ω		
RC between terminations, for $C > 0.33 \mu\text{F}$	>5000 s		

 $U_{Rdc} = 63 \text{ V}$ **$U_{Rac} = 40 \text{ V}$** **taped versions**

Cap. (μF)	$b_{\text{max}} \times h_{\text{max}} \times l_{\text{max}}$ (mm)	mass (g)	CATALOGUE NUMBER 2222 370								
			taped on reel			ammopack					
			H = 18 mm *			H = 16 mm *			H = 18 mm *		
			C-tol $\pm 20\%$	C-tol $\pm 10\%$	C-tol $\pm 5\%$	C-tol $\pm 20\%$	C-tol $\pm 10\%$	C-tol $\pm 5\%$	C-tol $\pm 20\%$	C-tol $\pm 10\%$	C-tol $\pm 5\%$
Pitch = 5.08 \pm 0.3 mm											
0.056	2.5 x 6.5 x 7.2	0.25	17563	18563	19563	77563	78563	79563	74563	75563	76563
0.068			17683	18683	19683	77683	78683	79683	74683	75683	76683
0.082			17823	18823	19823	77823	78823	79823	74823	75823	76823
0.1			17104	18104	19104	77104	78104	79104	74104	75104	76104
0.12	3.5 x 8.0 x 7.2	0.35	17124	18124	19124	77124	78124	79124	74124	75124	76124
0.15			17154	18154	19154	77154	78154	79154	74154	75154	76154
0.18			17184	18184	19184	77184	78184	79184	74184	75184	76184
0.22			17224	18224	19224	77224	78224	79224	74224	75224	76224
0.27			17274	18274	19274	77274	78274	79274	74274	75274	76274
0.33			17334	18334	19334	77334	78334	79334	74334	75334	76334
0.39	4.5 x 9.0 x 7.2	0.45	17394	18394	19394	77394	78394	79394	74394	75394	76394
0.47			17474	18474	19474	77474	78474	79474	74474	75474	76474
0.56	5.0 x 10.0 x 7.2	0.50	17564	18564	19564	77564	78564	79564	74564	75564	76564
0.68			17684	18684	19684	77684	78684	79684	74684	75684	76684
0.82	6.0 x 11.0 x 7.2	0.60	17824	18824	19824	77824	78824	79824	74824	75824	76824
1			17105	18105	19105	77105	78105	79105	74105	75105	76105

SMALLEST PACKING QUANTITIES (SPQ)	reel	ammopack
DIMENSIONS	SPQ	SPQ
2.5 x 6.5 x 7.2	2000	2000
3.5 x 8.0 x 7.2	1500	1500
4.5 x 9.0 x 7.2	1000	1000
5.0 x 10.0 x 7.2	1000	1000
6.0 x 11.0 x 7.2	1000	750

* H: intape height; for detailed specification refer to chapter PACKAGING.

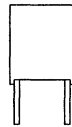

Pitch 5

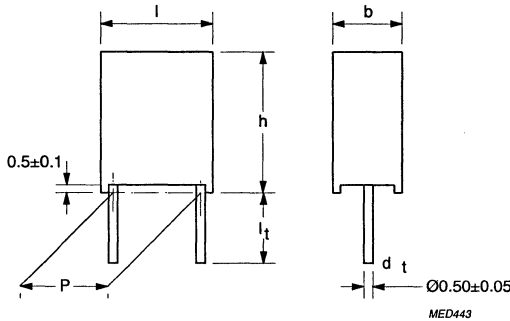

$U_{Rdc} = 100 V$

$U_{Rac} = 63 V$

loose in box

Cap. (μF)	$b_{max} \times h_{max} \times l_{max}$ (mm)	mass (g)	CATALOGUE NUMBER 2222 370					
			$l_t = 4 +1/-0.5$ mm			$l_t = 26 \pm 1$ mm		
			C-tol $\pm 20\%$	C-tol $\pm 10\%$	C-tol $\pm 5\%$	C-tol $\pm 20\%$	C-tol $\pm 10\%$	C-tol $\pm 5\%$
Pitch = 5.08 ± 0.3 mm								
0.012	2.5 x 6.5 x 7.2	0.25	20123	21123	22123	24123	25123	26123
0.015			20153	21153	22153	24153	25153	26153
0.018			20183	21183	22183	24183	25183	26183
0.022			20223	21223	22223	24223	25223	26223
0.027			20273	21273	22273	24273	25273	26273
0.033			20333	21333	22333	24333	25333	26333
0.039			20393	21393	22393	24393	25393	26393
0.047			20473	21473	22473	24473	25473	26473
0.056			3.5 x 8.0 x 7.2	0.35	20563	21563	22563	24563
0.068	20683	21683			22683	24683	25683	26683
0.082	20823	21823			22823	24823	25823	26823
0.10	20104	21104			22104	24104	25104	26104
0.12	4.5 x 9.0 x 7.2	0.45	20124	21124	22124	24124	25124	26124
0.15			20154	21154	22154	24154	25154	26154
0.18	5.0 x 10.0 x 7.2	0.50	20184	21184	22184	24184	25184	26184
0.22			20224	21224	22224	24224	25224	26224
0.27	6.0 x 11.0 x 7.2	0.65	20274	21274	22274	24274	25274	26274
0.33			20334	21334	22334	24334	25334	26334
0.39 **			20394	21394	22394	24394	25394	26394
0.47 **			20474	21474	22474	24474	25474	26474

** marked capacitance values are not CECC qualified

SMALLEST PACKING QUANTITIES (SPQ)	$l_t = 4$ mm	$l_t = 26$ mm
DIMENSIONS	SPQ	SPQ
all dimensions	2000	1000

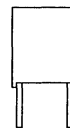

Pitch 5

SPECIFIC REFERENCE DATA FOR 100 V DC

Tangent of loss angle	at 1 kHz	at 10 kHz	at 100 kHz
$C \leq 0.1 \mu\text{F}$	$\leq 75 \cdot 10^{-4}$	$\leq 130 \cdot 10^{-4}$	$\leq 250 \cdot 10^{-4}$
$0.1 \mu\text{F} < C \leq 0.47 \mu\text{F}$	$\leq 75 \cdot 10^{-4}$	$\leq 130 \cdot 10^{-4}$	$\leq 300 \cdot 10^{-4}$
Rated voltage pulse slope $(dU/dt)_R$ at U_{Rdc} (see also application note)	110 V/ μs		
R between terminations	>15 000 M Ω		

 $U_{Rdc} = 100 \text{ V}$ **$U_{Rac} = 63 \text{ V}$** **taped versions**

Cap. (μF)	$b_{\text{max}} \times h_{\text{max}} \times l_{\text{max}}$ (mm)	mass (g)	CATALOGUE NUMBER 2222 370								
			taped on reel			ammopack					
			H = 18 mm *			H = 16 mm *			H = 18 mm *		
			C-tol $\pm 20\%$	C-tol $\pm 10\%$	C-tol $\pm 5\%$	C-tol $\pm 20\%$	C-tol $\pm 10\%$	C-tol $\pm 5\%$	C-tol $\pm 20\%$	C-tol $\pm 10\%$	C-tol $\pm 5\%$
Pitch = 5.08 \pm 0.3 mm											
0.012	2.5 x 6.5 x 7.2	0.25	27123	28123	29123	87123	88123	89123	84123	85123	86123
0.015			27153	28153	29153	87153	88153	89153	84153	85153	86153
0.018			27183	28183	29183	87183	88183	89183	84183	85183	86183
0.022			27223	28223	29223	87223	88223	89223	84223	85223	86223
0.027			27273	28273	29273	87273	88273	89273	84273	85273	86273
0.033			27333	28333	29333	87333	88333	89333	84333	85333	86333
0.039			27393	28393	29393	87393	88393	89393	84393	85393	86393
0.047	27473	28473	29473	87473	88473	89473	84473	85473	86473		
0.056	3.5 x 8.0 x 7.2	0.35	27563	28563	29563	87563	88563	89563	84563	85563	86563
0.068			27683	28683	29683	87683	88683	89683	84683	85683	86683
0.082			27823	28823	29823	87823	88823	89823	84823	85823	86823
0.10			27104	28104	29104	87104	88104	89104	84104	85104	86104
0.12	4.5 x 9.0 x 7.2	0.45	27124	28124	29124	87124	88124	89124	84124	85124	86124
0.15			27154	28154	29154	87154	88154	89154	84154	85154	86154
0.18	5.0 x 10.0 x 7.2	0.50	27184	28184	29184	87184	88184	89184	84184	85184	86184
0.22			27224	28224	29224	87224	88224	89224	84224	85224	86224
0.27	6.0 x 11.0 x 7.2	0.65	27274	28274	29274	87274	88274	89274	84274	85274	86274
0.33			27334	28334	29334	87334	88334	89334	84334	85334	86334
0.39 **			27394	28394	29394	87394	88394	89394	84394	85394	86394
0.47 **			27474	28474	29474	87474	88474	89474	84474	85474	86474

**** marked capacitance values are not CECC qualified**

SMALLEST PACKING QUANTITIES (SPQ)	reel	ammopack
DIMENSIONS	SPQ	SPQ
2.5 x 6.5 x 7.2	2000	2000
3.5 x 8.0 x 7.2	1500	1500
4.5 x 9.0 x 7.2	1000	1000
5.0 x 10.0 x 7.2	1000	1000
6.0 x 11.0 x 7.2	1000	750

* H: intape height; for detailed specifications refer to chapter PACKAGING.

E Metallized POLYESTER
film capacitors

MKT 370

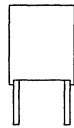

Pitch 5

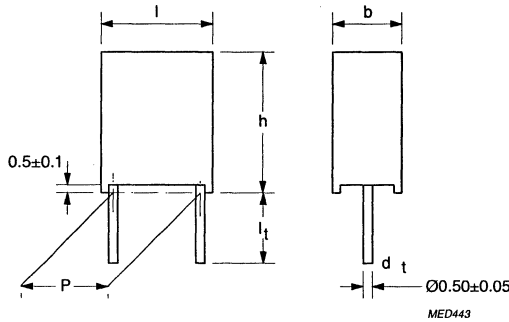

$U_{Rdc} = 250 V$

$U_{Rac} = 160 V$

loose in box

Cap. (μF)	$b_{max} \times h_{max} \times l_{max}$ (mm)	mass (g)	CATALOGUE NUMBER 2222 370					
			$l_t = 4 +1/-0.5$ mm			$l_t = 26 \pm 1$ mm		
			C-tol $\pm 20\%$	C-tol $\pm 10\%$	C-tol $\pm 5\%$	C-tol $\pm 20\%$	C-tol $\pm 10\%$	C-tol $\pm 5\%$
Pitch = 5.08 \pm 0.3 mm								
0.0039 **	2.5 x 6.5 x 7.2	0.25	40392	41392	42392	44392	45392	46392
0.0047 **			40472	41472	42472	44472	45472	46472
0.0056 **			40562	41562	42562	44562	45562	46562
0.0068 **			40682	41682	42682	44682	45682	46682
0.0082			40822	41822	42822	44822	45822	46822
0.01			40103	41103	42103	44103	45103	46103
0.012			40123	41123	42123	44123	45123	46123
0.015	3.5 x 8.0 x 7.2	0.35	40153	41153	42153	44153	45153	46153
0.018			40183	41183	42183	44183	45183	46183
0.022			40223	41223	42223	44223	45223	46223
0.027			40273	41273	42273	44273	45273	46273
0.033			40333	41333	42333	44333	45333	46333
0.039	4.5 x 9.0 x 7.2	0.45	40393	41393	42393	44393	45393	46393
0.047			40473	41473	42473	44473	45473	46473
0.056			40563	41563	42563	44563	45563	46563
0.068	5.0 x 10.0 x 7.2		40683	41683	42683	44683	45683	46683
0.082	6.0 x 11.0 x 7.2	0.60	40823	41823	42823	44823	45823	46823
0.1			40104	41104	42104	44104	45104	46104

** marked capacitance values are not CECC qualified.

SMALLEST PACKING QUANTITIES (SPQ)	$l_t = 4$ mm	$l_t = 26$ mm
DIMENSIONS	SPQ	SPQ
all dimensions	2000	1000

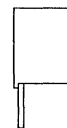

Pitch 5

SPECIFIC REFERENCE DATA FOR 250 V DC

Tangent of loss angle	at 1 kHz	at 10 kHz	at 100 kHz
$C \leq 0.1 \mu\text{F}$	$\leq 75 \cdot 10^{-4}$	$\leq 130 \cdot 10^{-4}$	$\leq 250 \cdot 10^{-4}$
Rated voltage pulse slope $(dU/dt)_R$ at U_{Rdc} (see also application note)	330 V/ μs		
R between terminations	>30 000 M Ω		

 $U_{Rdc} = 250 \text{ V}$ **$U_{Rac} = 160 \text{ V}$** **taped versions**

Cap. (μF)	$b_{\text{max}} \times h_{\text{max}} \times l_{\text{max}}$ (mm)	mass (g)	CATALOGUE NUMBER 2222 370								
			taped on reel			ammopack					
			H = 18 mm *			H = 16 mm *			H = 18 mm *		
			C-tol $\pm 20\%$	C-tol $\pm 10\%$	C-tol $\pm 5\%$	C-tol $\pm 20\%$	C-tol $\pm 10\%$	C-tol $\pm 5\%$	C-tol $\pm 20\%$	C-tol $\pm 10\%$	C-tol $\pm 5\%$
Pitch = 5.08 \pm 0.3 mm											
0.0039**	2.5 x 6.5 x 7.2	0.25	47392	48392	49392	37392	38392	39392	34392	35392	36392
0.0047**			47472	48472	49472	37472	38472	39472	34472	35472	36472
0.0056**			47562	48562	49562	37562	38562	39562	34562	35562	36562
0.0068**			47682	48682	49682	37682	38682	39682	34682	35682	36682
0.0082			47822	48822	49822	37822	38822	39822	34822	35822	36822
0.01			47103	48103	49103	37103	38103	39103	34103	35103	36103
0.012	47123	48123	49123	37123	38123	39123	34123	35123	36123		
0.015	3.5 x 8.0 x 7.2	0.35	47153	48153	49153	37153	38153	39153	34153	35153	36153
0.018			47183	48183	49183	37183	38183	39183	34183	35183	36183
0.022			47223	48223	49223	37223	38223	39223	34223	35223	36223
0.027			47273	48273	49273	37273	38273	39273	34273	35273	36273
0.033			47333	48333	49333	37333	38333	39333	34333	35333	36333
0.039	4.5 x 9.0 x 7.2	0.45	47393	48393	49393	37393	38393	39393	34393	35393	36393
0.047			47473	48473	49473	37473	38473	39473	34473	35473	36473
0.056			47563	48563	49563	37563	38563	39563	34563	35563	36563
0.068	5.0 x 10.0 x 7.2		47683	48683	49683	37683	38683	39683	34683	35683	36683
0.082	6.0 x 11.0 x 7.2	0.60	47823	48823	49823	37823	38823	39823	34823	35823	36823
0.1			47104	48104	49104	37104	38104	39104	34104	35104	36104

** marked capacitance values are not CECC qualified.

SMALLEST PACKING QUANTITIES (SPQ)	reel	ammopack
DIMENSIONS	SPQ	SPQ
2.5 x 6.5 x 7.2	2000	2000
3.5 x 8.0 x 7.2	1500	1500
4.5 x 9.0 x 7.2	1000	1000
5.0 x 10.0 x 7.2	1000	1000
6.0 x 11.0 x 7.2	1000	750

* H: intape height; for detailed specifications refer to chapter PACKAGING.

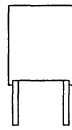

Pitch 5

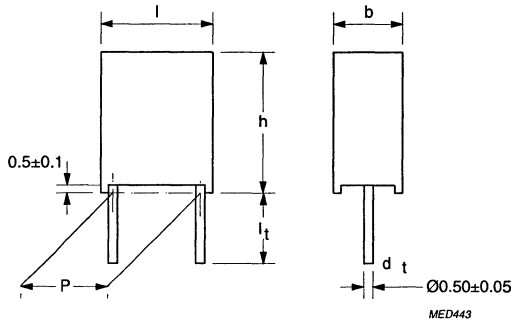

U_{Rdc} = 400 V

U_{Rac} = 220 V

loose in box

Cap. (µF)	b _{max} x h _{max} x l _{max} (mm)	mass (g)	CATALOGUE NUMBER 2222 370					
			l _t = 4 +1/-0.5 mm			l _t = 26 ±1 mm		
			C-tol ±20%	C-tol ±10%	C-tol ±5%	C-tol ±20%	C-tol ±10%	C-tol ±5%
Pitch = 5.08 ±0.3 mm								
0.001 **	2.5 x 6.5 x 7.2	0.25	50102	51102	52102	54102	55102	56102
0.0012 **			50122	51122	52122	54122	55122	56122
0.0015 **			50152	51152	52152	54152	55152	56152
0.0018 **			50182	51182	52182	54182	55182	56182
0.0022 **			50222	51222	52222	54222	55222	56222
0.0027 **			50272	51272	52272	54272	55272	56272
0.0033 **			50332	51332	52332	54332	55332	56332
0.0039			50392	51392	52392	54392	55392	56392
0.0047			50472	51472	52472	54472	55472	56472
0.0056			3.5 x 8.0 x 7.2	0.35	50562	51562	52562	54562
0.0068	50682	51682			52682	54682	55682	56682
0.0082	50822	51822			52822	54822	55822	56822
0.01	50103	51103			52103	54103	55103	56103
0.012	4.5 x 9.0 x 7.2	0.45	50123	51123	52123	54123	55123	56123
0.015			50153	51153	52153	54153	55153	56153
0.018	5.0 x 10.0 x 7.2	0.50	50183	51183	52183	54183	55183	56183
0.022			50223	51223	52223	54223	55223	56223
0.027	6.0 x 11.0 x 7.2	0.60	50273	51273	52273	54273	55273	56273
0.033			50333	51333	52333	54333	55333	56333

** marked capacitance values are not CECC qualified.

SMALLEST PACKING QUANTITIES (SPQ)	l _t = 4 mm	l _t = 26 mm
DIMENSIONS	SPQ	SPQ
all dimensions	2000	1000

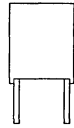

Pitch 5

SPECIFIC REFERENCE DATA FOR 400 V DC

Tangent of loss angle	at 1 kHz	at 10 kHz	at 100 kHz
$C \leq 0.1 \mu\text{F}$	$\leq 75 \cdot 10^{-4}$	$\leq 130 \cdot 10^{-4}$	$\leq 250 \cdot 10^{-4}$
Rated voltage pulse slope $(dU/dt)_R$ at U_{Rdc} (see also application note)	630 V/ μs		
R between terminations, for $C \leq 0.33 \mu\text{F}$	>30 000 M Ω		

 $U_{Rdc} = 400 \text{ V}$ $U_{Rac} = 220 \text{ V}$

taped versions

Cap. (μF)	$b_{\text{max}} \times h_{\text{max}} \times l_{\text{max}}$ (mm)	mass (g)	CATALOGUE NUMBER 2222 370								
			taped on reel			ammopack					
			H = 18 mm *			H = 16 mm *			H = 18 mm *		
			C-tol $\pm 20\%$	C-tol $\pm 10\%$	C-tol $\pm 5\%$	C-tol $\pm 20\%$	C-tol $\pm 10\%$	C-tol $\pm 5\%$	C-tol $\pm 20\%$	C-tol $\pm 10\%$	C-tol $\pm 5\%$
Pitch = 5.08 \pm 0.3 mm											
0.001 **	2.5 x 6.5 x 7.2	0.25	57102	58102	59102	67102	68102	69102	64102	65102	66102
0.0012 **			57122	58122	59122	67122	68122	69122	64122	65122	66122
0.0015 **			57152	58152	59152	67152	68152	69152	64152	65152	66152
0.0018 **			57182	58182	59182	67182	68182	69182	64182	65182	66182
0.0022 **			57222	58222	59222	67222	68222	69222	64222	65222	66222
0.0027 **			57272	58272	59272	67272	68272	69272	64272	65272	66272
0.0033 **			57332	58332	59332	67332	68332	69332	64332	65332	66332
0.0039			57392	58392	59392	67392	68392	69392	64392	65392	66392
0.0047			57472	58472	59472	67472	68472	69472	64472	65472	66472
0.0056	3.5 x 8.0 x 7.2	0.35	57562	58562	59562	67562	68562	69562	64562	65562	66562
0.0068			57682	58682	59682	67682	68682	69682	64682	65682	66682
0.0082			57822	58822	59822	67822	68822	69822	64822	65822	66822
0.01			57103	58103	59103	67103	68103	69103	64103	65103	66103
0.012	4.5 x 9.0 x 7.2	0.45	57123	58123	59123	67123	68123	69123	64123	65123	66123
0.015			57153	58153	59153	67153	68153	69153	64153	65153	66153
0.018	5.0 x 10.0 x 7.2	0.50	57183	58183	59183	67183	68183	69183	64183	65183	66183
0.022			57223	58223	59223	67223	68223	69223	64223	65223	66223
0.027	6.0 x 11.0 x 7.2	0.60	57273	58273	59273	67273	68273	69273	64273	65273	66273
0.033			57333	58333	59333	67333	68333	69333	64333	65333	66333

** marked capacitance values are not CECC qualified.

SMALLEST PACKING QUANTITIES (SPQ)	reel	ammopack
DIMENSIONS	SPQ	SPQ
2.5 x 6.5 x 7.2	2000	2000
3.5 x 8.0 x 7.2	1500	1500
4.5 x 9.0 x 7.2	1000	1000
5.0 x 10.0 x 7.2	1000	1000
6.0 x 11.0 x 7.2	1000	750

* H: intape height; for detailed specifications refer to chapter PACKAGING.

E Metallized POLYESTER
film capacitors

MKT 371

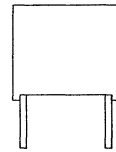

Pitch 7.5

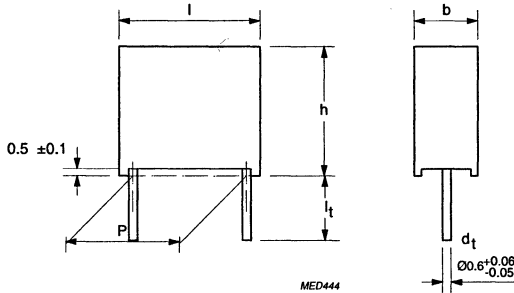

U_{Rdc} = 63 V

U_{Rac} = 40 V

loose in box

Cap. (μ F)	$b_{max} \times h_{max} \times l_{max}$ (mm)	mass (g)	CATALOGUE NUMBER 2222 371			
			$l_t = 4 \pm 1/-0.5$ mm		$l_t = 26 \pm 1$ mm	
			C-tol $\pm 10\%$	C-tol $\pm 5\%$	C-tol $\pm 10\%$	C-tol $\pm 5\%$
Pitch = 7.62 +0.3/-0.4 mm						
0.056	2.5 x 6.5 x 10.0	0.3	11563	12563	15563	16563
0.068			11683	12683	15683	16683
0.082			11823	12823	15823	16823
0.1			11104	12104	15104	16104
0.12	3.0 x 8.0 x 10.0	0.40	11124	12124	15124	16124
0.15			11154	12154	15154	16154
0.18			11184	12184	15184	16184
0.22			11224	12224	15224	16224
0.27	4.0 x 9.0 x 10.0	0.50	11274	12274	15274	16274
0.33			11334	12334	15334	16334
0.39			11394	12394	15394	16394
0.47			11474	12474	15474	16474
0.56	5.0 x 10.5 x 10.0	0.65	11564	12564	15564	16564
0.68			11684	12684	15684	16684
0.82			11824	12824	15824	16824
1			11105	12105	15105	16105

SMALLEST PACKING QUANTITIES (SPQ)	$l_t = 4$ mm	$l_t = 26$ mm
	DIMENSIONS	SPQ
all dimensions	1000	1000

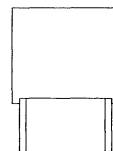

Pitch 7.5

SPECIFIC REFERENCE DATA FOR 63 V DC

Tangent of loss angle	at 1 kHz	at 10 kHz	at 100 kHz
$C \leq 0.1 \mu\text{F}$	$\leq 75 \cdot 10^{-4}$	$\leq 130 \cdot 10^{-4}$	$\leq 250 \cdot 10^{-4}$
$0.1 \mu\text{F} < C \leq 0.47 \mu\text{F}$	$\leq 75 \cdot 10^{-4}$	$\leq 130 \cdot 10^{-4}$	$\leq 300 \cdot 10^{-4}$
$0.47 \mu\text{F} < C \leq 1.0 \mu\text{F}$	$\leq 75 \cdot 10^{-4}$	$\leq 130 \cdot 10^{-4}$	
Rated voltage pulse slope $(dU/dt)_R$ at U_{Rdc} (see also application note)	18 V/ μs		
R between terminations, for $C \leq 0.33 \mu\text{F}$	>15 000 M Ω		
RC between terminations, for $C > 0.33 \mu\text{F}$	>5000 s		

 $U_{Rdc} = 63 \text{ V}$ **$U_{Rac} = 40 \text{ V}$** **taped versions**

Cap. (μF)	$b_{\text{max}} \times h_{\text{max}} \times l_{\text{max}}$ (mm)	mass (g)	CATALOGUE NUMBER 2222 371					
			taped on reel				ammopack	
			H = 16 mm *		H = 18 mm *		H = 18 mm *	
			C-tol $\pm 10\%$	C-tol $\pm 5\%$	C-tol $\pm 10\%$	C-tol $\pm 5\%$	C-tol $\pm 10\%$	C-tol $\pm 5\%$
Pitch = 7.62 +0.3/-0.4 mm								
0.056	2.5 x 6.5 x 10.0	0.30	18563	19563	35563	36563	38563	39563
0.068			18683	19683	35683	36683	38683	39683
0.082			18823	19823	35823	36823	38823	39823
0.1			18104	19104	35104	36104	38104	39104
0.12	3.0 x 8.0 x 10.0	0.40	18124	19124	35124	36124	38124	39124
0.15			18154	19154	35154	36154	38154	39154
0.18			18184	19184	35184	36184	38184	39184
0.22			18224	19224	35224	36224	38224	39224
0.27	4.0 x 9.0 x 10.0	0.50	18274	19274	35274	36274	38274	39274
0.33			18334	19334	35334	36334	38334	39334
0.39			18394	19394	35394	36394	38394	39394
0.47			18474	19474	35474	36474	38474	39474
0.56	5.0 x 10.5 x 10.0	0.65	18564	19564	35564	36564	38564	39564
0.68			18684	19684	35684	36684	38684	39684
0.82			18824	19824	35824	36824	38824	39824
1			18105	19105	35105	36105	38105	39105

SMALLEST PACKING QUANTITIES (SPQ)	reel	ammopack
DIMENSIONS	SPQ	SPQ
2.5 x 6.5 x 10.0	2000	2000
3.0 x 8.0 x 10.0	1500	1500
4.0 x 9.0 x 10.0	1500	1500
5.0 x 10.5 x 10.0	1000	1000

* H: intape height; for detailed specifications refer to chapter PACKAGING.

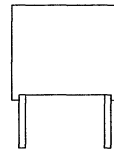

Pitch 7.5

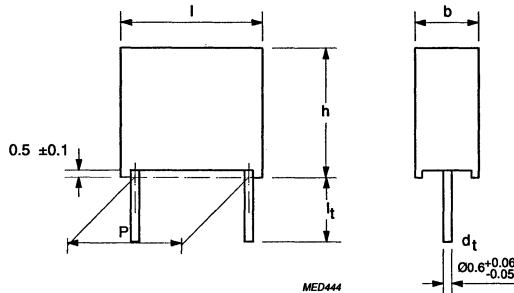

$U_{Rdc} = 100 \text{ V}$

$U_{Rac} = 63 \text{ V}$

loose in box

Cap. (μF)	$b_{\text{max}} \times h_{\text{max}} \times l_{\text{max}}$ (mm)	mass (g)	CATALOGUE NUMBER 2222 371			
			$l_t = 4 \pm 1/0.5 \text{ mm}$		$l_t = 26 \pm 1 \text{ mm}$	
			C-tol $\pm 10\%$	C-tol $\pm 5\%$	C-tol $\pm 10\%$	C-tol $\pm 5\%$
Pitch = 7.62 +0.3/-0.4 mm						
0.018	2.5 x 6.5 x 10.0	0.30	21183	22183	25183	26183
0.022			21223	22223	25223	26223
0.027			21273	22273	25273	26273
0.033			21333	22333	25333	26333
0.039			21393	22393	25393	26393
0.047			21473	22473	25473	26473
0.056	3.0 x 8.0 x 10.0	0.40	21563	22563	25563	26563
0.068			21683	22683	25683	26683
0.082			21823	22823	25823	26823
0.10			21104	22104	25104	26104
0.12	4.0 x 9.0 x 10.0	0.50	21124	22124	25124	26124
0.15			21154	22154	25154	26154
0.18			21184	22184	25184	26184
0.22			21224	22224	25224	26224
0.27	5.0 x 10.5 x 10.0	0.70	21274	22274	25274	26274
0.33			21334	22334	25334	26334
0.39			21394	22394	25394	26394
0.47			21474	22474	25474	26474

SMALLEST PACKING QUANTITIES (SPQ)	$l_t = 4 \text{ mm}$		$l_t = 26 \text{ mm}$	
	DIMENSIONS		SPQ	
	all dimensions		1000	

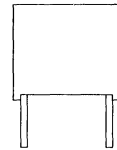

Pitch 7.5

SPECIFIC REFERENCE DATA FOR 100 V DC

Tangent of loss angle	at 1 kHz	at 10 kHz	at 100 kHz
$C \leq 0.1 \mu\text{F}$	$\leq 75 \cdot 10^{-4}$	$\leq 130 \cdot 10^{-4}$	$\leq 250 \cdot 10^{-4}$
$0.1 \mu\text{F} < C \leq 0.47 \mu\text{F}$	$\leq 75 \cdot 10^{-4}$	$\leq 130 \cdot 10^{-4}$	$\leq 300 \cdot 10^{-4}$
Rated voltage pulse slope $(dU/dt)_R$ at U_{Rdc} (see also application note)	36 V/ μs		
R between terminations, for $C \leq 0.33 \mu\text{F}$	$>15\ 000 \text{ M}\Omega$		
RC between terminations, for $C > 0.33 \mu\text{F}$	$>5000 \text{ s}$		

 $U_{Rdc} = 100 \text{ V}$ $U_{Rac} = 63 \text{ V}$

taped versions

Cap. (μF)	$b_{\text{max}} \times h_{\text{max}} \times l_{\text{max}}$ (mm)	mass (g)	CATALOGUE NUMBER 2222 371					
			taped on reel				ammopack	
			H = 16 mm *		H = 18 mm *		H = 18 mm *	
			C-tol $\pm 10\%$	C-tol $\pm 5\%$	C-tol $\pm 10\%$	C-tol $\pm 5\%$	C-tol $\pm 10\%$	C-tol $\pm 5\%$
Pitch = 7.62 +0.3/-0.4 mm								
0.018	2.5 x 6.5 x 10.0	0.30	28183	29183	65183	66183	68183	69183
0.022			28223	29223	65223	66223	68223	69223
0.027			28273	29273	65273	66273	68273	69273
0.033			28333	29333	65333	66333	68333	69333
0.039			28393	29393	65393	66393	68393	69393
0.047			28473	29473	65473	66473	68473	69473
0.056	3.0 x 8.0 x 10.0	0.40	28563	29563	65563	66563	68563	69563
0.068			28683	29683	65683	66683	68683	69683
0.082			28823	29823	65823	66823	68823	69823
0.10			28104	29104	65104	66104	68104	69104
0.12	4.0 x 9.0 x 10.0	0.50	28124	29124	65124	66124	68124	69124
0.15			28154	29154	65154	66154	68154	69154
0.18			28184	29184	65184	66184	68184	69184
0.22			28224	29224	65224	66224	68224	69224
0.27	5.0 x 10.5 x 10.0	0.70	28274	29274	65274	66274	68274	69274
0.33			28334	29334	65334	66334	68334	69334
0.39			28394	29394	65394	66394	68394	69394
0.47			28474	29474	65474	66474	68474	69474

SMALLEST PACKING QUANTITIES (SPQ)	reel	ammopack
DIMENSIONS	SPQ	SPQ
2.5 x 6.5 x 10.0	2000	2000
3.0 x 8.0 x 10.0	1500	1500
4.0 x 9.0 x 10.0	1500	1500
5.0 x 10.5 x 10.0	1000	1000

* H: intape height; for detailed specifications refer to chapter PACKAGING.

E Metallized POLYESTER
film capacitors

MKT 371

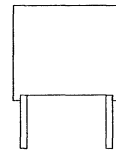

Pitch 7.5

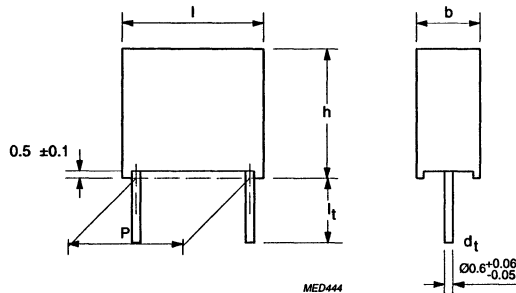

$U_{Rdc} = 250 V$

$U_{Rac} = 160 V$

loose in box

Cap. (μF)	$b_{max} \times h_{max} \times l_{max}$ (mm)	mass (g)	CATALOGUE NUMBER 2222 371					
			$l_t = 4 \pm 1/-0.5 \text{ mm}$		$l_t = 26 \pm 1 \text{ mm}$			
			C-tol $\pm 10\%$	C-tol $\pm 5\%$	C-tol $\pm 10\%$	C-tol $\pm 5\%$		
Pitch = 7.62 +0.3/-0.4 mm								
0.0082	2.5 x 6.5 x 10.0	0.30	41822	42822	45822	46822		
0.010			41103	42103	45103	46103		
0.012			41123	42123	45123	46123		
0.015			41153	42153	45153	46153		
0.018			3.0 x 8.0 x 10.0	0.40	41183	42183	45183	46183
0.022	41223	42223			45223	46223		
0.027	41273	42273			45273	46273		
0.033	41333	42333			45333	46333		
0.039	41393	42393			45393	46393		
0.047	41473	42473			45473	46473		
0.056	4.0 x 9.0 x 10.0	0.50			41563	42563	45563	46563
0.068					41683	42683	45683	46683
0.082	5.0 x 10.5 x 10.0	0.60	41823	42823	45823	46823		
0.10			41104	42104	45104	46104		

SMALLEST PACKING QUANTITIES (SPQ)	$l_t = 4 \text{ mm}$	$l_t = 26 \text{ mm}$
	SPQ	SPQ
	all dimensions	1000

E Metallized POLYESTER
film capacitors

MKT 371

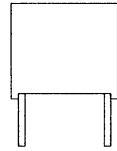

Pitch 7.5

SPECIFIC REFERENCE DATA FOR 250 V DC

Tangent of loss angle	at 1 kHz	at 10 kHz	at 100 kHz
	$\leq 75 \cdot 10^{-4}$	$\leq 130 \cdot 10^{-4}$	$\leq 250 \cdot 10^{-4}$
Rated voltage pulse slope $(dU/dt)_R$ at U_{Rdc} (see also application note)	70 V/ μ s		
R between terminations	>30 000 M Ω		

 $U_{Rdc} = 250$ V $U_{Rac} = 160$ V

taped versions

Cap. (μ F)	$b_{max} \times h_{max} \times l_{max}$ (mm)	mass (g)	CATALOGUE NUMBER 2222 371							
			taped on reel				ammopack			
			H = 16 mm *		H = 18 mm *		H = 18 mm *			
			C-tol $\pm 10\%$	C-tol $\pm 5\%$	C-tol $\pm 10\%$	C-tol $\pm 5\%$	C-tol $\pm 10\%$	C-tol $\pm 5\%$		
Pitch = 7.62 +0.3/-0.4 mm										
0.0082	2.5 x 6.5 x 10.0	0.30	48822	49822	75822	76822	78822	79822		
0.010			48103	49103	75103	76103	78103	79103		
0.012			48123	49123	75123	76123	78123	79123		
0.015			48153	49153	75153	76153	78153	79153		
0.018			3.0 x 8.0 x 10.0	0.40	48183	49183	75183	76183	78183	79183
0.022	48223	49223			75223	76223	78223	79223		
0.027	48273	49273			75273	76273	78273	79273		
0.033	48333	49333			75333	76333	78333	79333		
0.039	48393	49393			75393	76393	78393	79393		
0.047	48473	49473			75473	76473	78473	79473		
0.056	4.0 x 9.0 x 10.0	0.50			48563	49563	75563	76563	78563	79563
0.068					48683	49683	75683	76683	78683	79683
0.082	5.0 x 10.5 x 10.0	0.70	48823	49823	75823	76823	78823	79823		
0.10			48104	49104	75104	76104	78104	79104		

SMALLEST PACKING QUANTITIES (SPQ)	reel	ammopack
DIMENSIONS	SPQ	SPQ
2.5 x 6.5 x 10.0	2000	2000
3.0 x 8.0 x 10.0	1500	1500
4.0 x 9.0 x 10.0	1500	1500
5.0 x 10.5 x 10.0	1000	1000

* H: intape height; for detailed specifications refer to chapter PACKAGING.

E Metallized POLYESTER
film capacitors

MKT 371

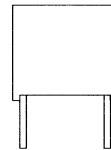

Pitch 7.5

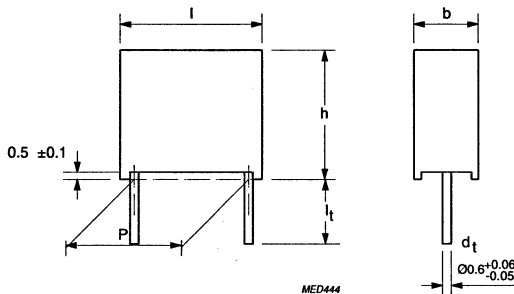

$U_{Rdc} = 400 \text{ V}$

$U_{Rac} = 220 \text{ V}$

loose in box

Cap. (μF)	$b_{\text{max}} \times h_{\text{max}} \times l_{\text{max}}$ (mm)	mass (g)	CATALOGUE NUMBER 2222 371			
			$l_t = 4 \text{ } +1/-0.5 \text{ mm}$		$l_t = 26 \pm 1 \text{ mm}$	
			C-tol $\pm 10\%$	C-tol $\pm 5\%$	C-tol $\pm 10\%$	C-tol $\pm 5\%$
Pitch = $7.62 \text{ } +0.3/-0.4 \text{ mm}$						
0.0039	2.5 x 6.5 x 10.0	0.30	51392	52392	55392	56392
0.0047			51472	52472	55472	56472
0.0056			51562	52562	55562	56562
0.0068			51682	52682	55682	56682
0.0082	3.0 x 8.0 x 10.0	0.40	51822	52822	55822	56822
0.01			51103	52103	55103	56103
0.012	4.0 x 9.0 x 10.0	0.50	51123	52123	55123	56123
0.015			51153	52153	55153	56153

SMALLEST PACKING QUANTITIES (SPQ)	$l_t = 4 \text{ mm}$	$l_t = 26 \text{ mm}$
DIMENSIONS	SPQ	SPQ
all dimensions	1000	1000

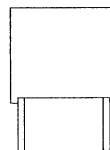

Pitch 7.5

SPECIFIC REFERENCE DATA FOR 400 V DC

Tangent of loss angle	at 1 kHz	at 10 kHz	at 100 kHz
	$\leq 75 \cdot 10^{-4}$	$\leq 130 \cdot 10^{-4}$	$\leq 250 \cdot 10^{-4}$
Rated voltage pulse slope $(dU/dt)_R$ at U_{Rdc} (see also application note)	190 V/ μ s		
R between terminations	>30 000 M Ω		

 $U_{Rdc} = 400$ V **$U_{Rac} = 220$ V****taped versions**

Cap. (μ F)	$b_{max} \times h_{max} \times l_{max}$ (mm)	mass (g)	CATALOGUE NUMBER 2222 371					
			taped on reel				ammopack	
			H = 16 mm *		H = 18 mm *		H = 18 mm *	
			C-tol $\pm 10\%$	C-tol $\pm 5\%$	C-tol $\pm 10\%$	C-tol $\pm 5\%$	C-tol $\pm 10\%$	C-tol $\pm 5\%$
Pitch = 7.62 +0.3/-0.4 mm								
0.0039	2.5 x 6.5 x 10.0	0.30	58392	59392	85392	86392	88392	89392
0.0047			58472	59472	85472	86472	88472	89472
0.0056			58562	59562	85562	86562	88562	89562
0.0068			58682	59682	85682	86682	88682	89682
0.0082	3.0 x 8.0 x 10.0	0.40	58822	59822	85822	86822	88822	89822
0.01			58103	59103	85103	86103	88103	89103
0.012	4.0 x 9.0 x 10.0	0.50	58123	59123	85123	86123	88123	89123
0.015			58153	59153	85153	86153	88153	89153

SMALLEST PACKING QUANTITIES (SPQ)	reel	ammopack
DIMENSIONS	SPQ	SPQ
2.5 x 6.5 x 10.0	2000	2000
3.0 x 8.0 x 10.0	1500	1500
4.0 x 9.0 x 10.0	1500	1500

* H: intape height; for detailed specifications refer to chapter PACKAGING.

Metallized POLYESTER
film capacitors

MKT 372

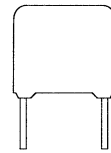

Pitch 10

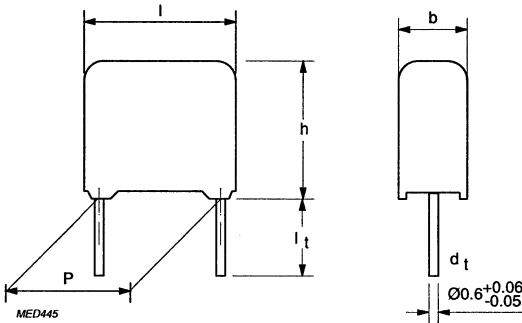

$U_{Rdc} = 100 V$

$U_{Rac} = 63 V$

loose and taped

Cap. (μF)	$b_{max} \times h_{max} \times l_{max}$ (mm)	mass (g)	CATALOGUE NUMBER 2222 372					
			loose in box		taped on reel		ammopack	
			$l_t = 4 \pm 1/-0.5 \text{ mm}$		$H = 18 \text{ mm}^*$		$H = 18 \text{ mm}^*$	
			C-tol $\pm 10\%$	C-tol $\pm 5\%$	C-tol $\pm 10\%$	C-tol $\pm 5\%$	C-tol $\pm 10\%$	C-tol $\pm 5\%$
Pitch = $10 \pm 0.4 \text{ mm}$								
0.1	4.0 x 9.0 x 12.5	0.55	21104	22104	25104	26104	28104	29104
0.12			21124	22124	25124	26124	28124	29124
0.15			21154	22154	25154	26154	28154	29154
0.18			21184	22184	25184	26184	28184	29184
0.22			21224	22224	25224	26224	28224	29224
0.27	4.0 x 10.0 x 12.5	0.60	21274	22274	25274	26274	28274	29274
0.33			21334	22334	25334	26334	28334	29334
0.39	5.0 x 11.0 x 12.5	0.85	21394	22394	25394	26394	28394	29394
0.47			21474	22474	25474	26474	28474	29474

SMALLEST PACKING QUANTITIES (SPQ)	loose in box	reel	ammopack
DIMENSIONS	SPQ	SPQ	SPQ
4.0 x 9.0 x 12.5	1000	1400	1400
4.0 x 10.0 x 12.5	1000	1400	1400
5.0 x 11.0 x 12.5	1000	1100	1100

* H: intape height; for detailed specifications refer to chapter PACKAGING.

Metallized POLYESTER film capacitors

MKT 372

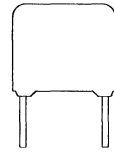

Pitch 10

SPECIFIC REFERENCE DATA FOR 100 V DC and 250 V DC

Tangent of loss angle	at 1 kHz	at 10 kHz	at 100 kHz
	$\leq 75 \cdot 10^{-4}$	$\leq 130 \cdot 10^{-4}$	$\leq 250 \cdot 10^{-4}$
Rated voltage pulse slope $(dU/dt)_R$ at U_{Rdc} (see also application note)	100 V version 34 V/ μ s	250 V version 50 V/ μ s	
R between terminations, for $C \leq 0.33 \mu F$	15 000 M Ω		30 000 M Ω
RC between terminations, for $C > 0.33 \mu F$	> 5000 s		$> 10\,000$ s

 $U_{Rdc} = 250$ V $U_{Rac} = 160$ V

loose and taped

Cap. (μF)	$b_{max} \times h_{max} \times l_{max}$ (mm)	mass (g)	CATALOGUE NUMBER 2222 372					
			loose in box		taped on reel		ammopack	
			$l_t = 4 +1/-0.5$ mm		H = 18 mm *		H = 18 mm *	
			C-tol $\pm 10\%$	C-tol $\pm 5\%$	C-tol $\pm 10\%$	C-tol $\pm 5\%$	C-tol $\pm 10\%$	C-tol $\pm 5\%$
Pitch = 10 ± 0.4 mm								
0.047	4.0 x 9.0 x 12.5	0.55	41473	42473	45473	46473	48473	49473
0.056			41563	42563	45563	46563	48563	49563
0.068			41683	42683	45683	46683	48683	49683
0.082	4.0 x 10.0 x 12.5	0.60	41823	42823	45823	46823	48823	49823
0.10			41104	42104	45104	46104	48104	49104
0.12	5.0 x 11.0 x 12.5	0.85	41124	42124	45124	46124	48124	49124
0.15			41154	42154	45154	46154	48154	49154

SMALLEST PACKING QUANTITIES (SPQ)	loose in box	reel	ammopack
DIMENSIONS	SPQ	SPQ	SPQ
4.0 x 9.0 x 12.5	1000	1400	750
4.0 x 10.0 x 12.5	1000	1400	750
5.0 x 11.0 x 12.5	1000	1100	600

* H: intape height; for detailed specifications refer to chapter PACKAGING.

E Metallized POLYESTER
film capacitors

MKT 372

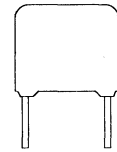

Pitch 10

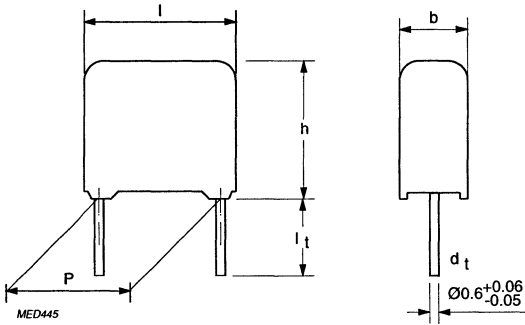

SPECIFIC REFERENCE DATA FOR 400 V DC

Tangent of loss angle	at 1 kHz	at 10 kHz	at 100 kHz
	$\leq 75 \cdot 10^{-4}$	$\leq 130 \cdot 10^{-4}$	$\leq 250 \cdot 10^{-4}$
Rated voltage pulse slope $(dU/dt)_R$ at U_{Rdc} (see also application note)	80 V/ μ s		
R between terminations, for $C \leq 0.33 \mu F$	30 000 M Ω		
RC between terminations, for $C > 0.33 \mu F$	>10 000 s		

SMALLEST PACKING QUANTITIES (SPQ)	loose in box	reel	ammopack
DIMENSIONS	SPQ	SPQ	SPQ
4.0 x 9.0 x 12.5	1000	1400	750
4.0 x 10.0 x 12.5	1000	1400	750
5.0 x 11.0 x 12.5	1000	1100	600

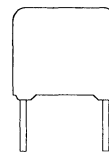

Pitch 10

 $U_{Rdc} = 400 \text{ V}$ $U_{Rac} = 220 \text{ V}$ **loose and taped**

Cap. (μF)	$b_{\max} \times h_{\max} \times l_{\max}$ (mm)	mass (g)	CATALOGUE NUMBER 2222 372					
			loose in box		taped on reel		ammopack	
			$l_1 = 4 \pm 1/-0.5 \text{ mm}$		$H = 18 \text{ mm}^*$		$H = 18 \text{ mm}^*$	
			C-tol $\pm 10\%$	C-tol $\pm 5\%$	C-tol $\pm 10\%$	C-tol $\pm 5\%$	C-tol $\pm 10\%$	C-tol $\pm 5\%$
Pitch = $10 \pm 0.4 \text{ mm}$								
0.0047	4.0 x 9.0 x 12.5	0.55	51472	52472	55472	56472	58472	59472
0.0056			51562	52562	55562	56562	58562	59562
0.0068			51682	52682	55682	56682	58682	59682
0.0082			51822	52822	55822	56822	58822	59822
0.010			51103	52103	55103	56103	58103	59103
0.012			51123	52123	55123	56123	58123	59123
0.015			51153	52153	55153	56153	58153	59153
0.018			51183	52183	55183	56183	58183	59183
0.022	51223	52223	55223	56223	58223	59223		
0.027	4.0 x 10.0 x 12.5	0.60	51273	52273	55273	56273	58273	59273
0.033			51333	52333	55333	56333	58333	59333
0.039	5.0 x 11.0 x 12.5	0.85	51393	52393	55393	56393	58393	59393
0.047			51473	52473	55473	56473	58473	59473

* H: intape height; for detailed specifications refer to chapter PACKAGING.

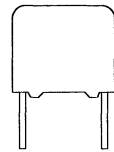

Pitch 15/22.5/27.0

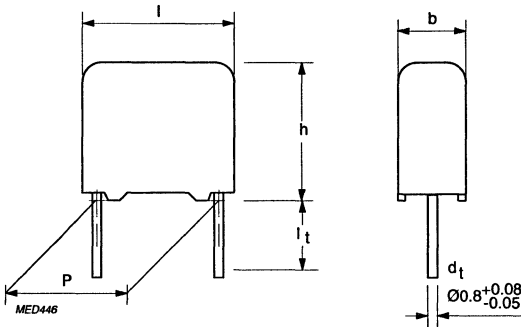

SPECIFIC REFERENCE DATA FOR 100 V DC

Tangent of loss angle	at 1 kHz	at 10 kHz	at 100 kHz
$C \leq 0.47 \mu\text{F}$	$\leq 75 \cdot 10^{-4}$	$\leq 130 \cdot 10^{-4}$	$\leq 300 \cdot 10^{-4}$
$0.47 \mu\text{F} < C \leq 1.0 \mu\text{F}$	$\leq 75 \cdot 10^{-4}$	$\leq 130 \cdot 10^{-4}$	
$1 \mu\text{F} < C \leq 10 \mu\text{F}$	$\leq 75 \cdot 10^{-4}$	$\leq 150 \cdot 10^{-4}$	
$C > 10 \mu\text{F}$	$\leq 75 \cdot 10^{-4}$		
Rated voltage pulse slope $(dU/dt)_R$ at U_{Rdc} (see also application note)	$P = 15 \text{ mm}$ $14 \text{ V}/\mu\text{s}$	$P = 22.5 \text{ mm}$ $5 \text{ V}/\mu\text{s}$	$P = 27.5 \text{ mm}$ $4 \text{ V}/\mu\text{s}$
R between terminations, for $C \leq 0.33 \mu\text{F}$	$> 15\,000 \text{ M}\Omega$		
RC between terminations, for $C > 0.33 \mu\text{F}$	$> 5000 \text{ s}$		

SMALLEST PACKING QUANTITIES (SPQ)	loose in box	taped on reel
DIMENSIONS	SPQ	SPQ
5.0 x 11.0 x 17.5	1000	1100
6.0 x 12.0 x 17.5	1000	900
7.0 x 13.5 x 17.5	1000	800
8.5 x 15.0 x 17.5	1000	650
8.5 x 18.0 x 26.0	200	450
10.0 x 19.5 x 26.0	200	350
9.0 x 19.0 x 26.0	200	400
11.0 x 21.0 x 31.0	100	300
13.0 x 23.0 x 31.0	100	250
18.0 x 28.0 x 31.0	100	150

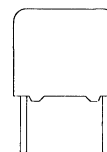
**U_{Rdc} = 100 V****U_{Rac} = 63 V****loose and taped**

Cap. (μ F)	$b_{max} \times h_{max} \times l_{max}$ (mm)	mass (g)	CATALOGUE NUMBER 2222 373			
			loose in box		taped on reel	
			It = 5 \pm 1 mm		H = 18.5 mm *	
			C-tol \pm 10%	C-tol \pm 5%	C-tol \pm 10%	C-tol \pm 5%
Pitch = 15 \pm 0.4 mm						
0.33	5.0 x 11.0 x 17.5	1.1	21334	22334	25334	26334
0.39			21394	22394	25394	26394
0.47			21474	22474	25474	26474
0.56			21564	22564	25564	26564
0.68			21684	22684	25684	26684
0.82	6.0 x 12.0 x 17.5	1.4	21824	22824	25824	26824
1			21105	22105	25105	26105
1.2	7.0 x 13.5 x 17.5	1.9	21125	22125	25125	26125
1.5			21155	22155	25155	26155
1.8	8.5 x 15.0 x 17.5	2.6	21185	22185	25185	26185
2.2 **			21225	22225	25225	26225
Pitch = 22.5 \pm 0.4 mm						
2.7	8.5 x 18.0 x 26.0	4.4	21275	22275	25275	26275
3.3			21335	22335	25395	26395
3.9	10.0 x 19.5 x 26.0	5.5	21395	22395	25395	26395
4.7 **			21475	22475	25475	26475
Pitch = 27.5 \pm 0.4 mm						
5.6	11.0 x 21.0 x 31.0	8.0	21565	22565	25565	26565
6.8			21685	22685	25685	26565
8.2	13.0 x 23.0 x 31.0	10.5	21825	22825	25825	26825
10			21106	22106	25106	26106
12	18.0 x 28.0 x 31.0	17.5	21126	22126	25126	26126
15			21156	22156	25156	26156

Capacitors available on special request

Pitch = 22.5 \pm 0.4 mm						
1.5	6.0 x 15.5 x 26.0	2.5	90012	90013	90018	90019
1.8	7.0 x 16.5 x 26.0	3.2	90022	90023	90028	90029
2.2			90002	90003	90008	90009
Pitch = 27.5 \pm 0.4 mm						
4.7	9.0 x 19.0 x 31.0	5.8	90032	90033	90034	90035

* H: intape height; for detailed specifications refer to chapter PACKAGING.

**** marked capacitance values are not CECC qualified.**

E Metallized POLYESTER
film capacitors

MKT 373

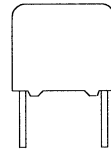

Pitch 15/22.5/27.5

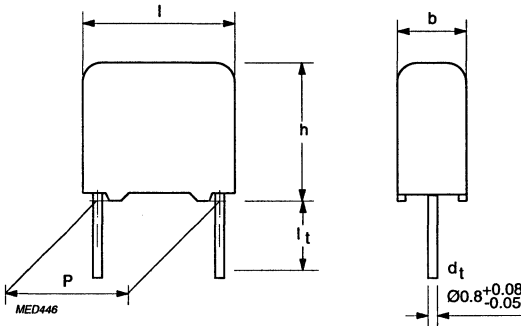

SPECIFIC REFERENCE DATA FOR 250 V DC

Tangent of loss angle	at 1 kHz	at 10 kHz	at 100 kHz
0.15 $\mu\text{F} < C \leq 0.47 \mu\text{F}$	$\leq 75 \cdot 10^{-4}$	$\leq 130 \cdot 10^{-4}$	$\leq 300 \cdot 10^{-4}$
0.47 $\mu\text{F} < C \leq 1.0 \mu\text{F}$	$\leq 75 \cdot 10^{-4}$	$\leq 130 \cdot 10^{-4}$	
1 $\mu\text{F} < C \leq 4.7 \mu\text{F}$	$\leq 75 \cdot 10^{-4}$	$\leq 150 \cdot 10^{-4}$	
Rated voltage pulse slope (dU/dt) at U_{Rdc} (see also application note)	P = 15 mm 16 V/ μs	P = 22.5 mm 7 V/ μs	P = 27.5 mm 6 V/ μs
R between terminations, for $C \leq 0.33 \mu\text{F}$	> 30000 $\text{M}\Omega$		
RC between terminations, for $C > 0.33 \mu\text{F}$	> 10000 s		

SMALLEST PACKING QUANTITIES (SPQ)	loose in box	taped on reel
	SPQ	SPQ
5.0 x 11.0 x 17.5	1000	1100
6.0 x 12.0 x 17.5	1000	900
7.0 x 13.5 x 17.5	1000	800
8.5 x 15.0 x 17.5	1000	650
6.0 x 15.5 x 26.0	200	600
7.0 x 16.5 x 26.0	200	550
8.5 x 18.0 x 26.0	200	450
10.0 x 19.5 x 26.0	200	350
9.0 x 19.0 x 31.0	100	400
11.0 x 21.0 x 31.0	100	300
13.0 x 25.0 x 31.0	100	250
15.0 x 25.0 x 31.0	100	200

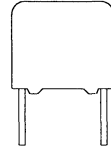
**U_{Rdc} = 250 V****U_{Rac} = 160 V****loose and taped**

Cap. (μ F)	$b_{max} \times h_{max} \times l_{max}$ (mm)	mass (g)	CATALOGUE NUMBER 2222 373			
			loose in box		taped on reel	
			$l_t = 5 \pm 1$ mm		H = 18 mm *	
			C-tol $\pm 10\%$	C-tol $\pm 5\%$	C-tol $\pm 10\%$	C-tol $\pm 5\%$
Pitch = 15 \pm 0.4 mm						
0.15 0.18 0.22	5.0 x 11.0 x 17.5	1.1	41154 41184 41224	42154 42184 42224	45154 45184 45224	46154 46184 46224
0.27 0.33 0.39 0.47	6.0 x 12.0 x 17.5	1.4	41274 41334 41394 41474	42274 42334 42394 42474	45274 45334 45394 45474	46274 46334 46394 46474
0.56 0.68	7.0 x 13.5 x 17.5	1.9	41564 41684	42564 42684	45564 45684	46564 46684
0.82 1	8.5 x 15.0 x 17.5	2.6	41824 41105	42824 42105	45824 45105	46824 46105
Pitch = 22.5 \pm 0.4 mm						
1.2 1.5	8.5 x 18.0 x 26.0	4.4	41125 41155	42125 42155	45125 45155	46125 46155
1.8 2.2	10.0 x 19.5 x 26.0	5.5	41185 41225	42185 42225	45185 45225	46185 46225
Pitch = 27.5 \pm 0.4 mm						
2.7 3.3	13.0 x 23.0 x 31.0	10.4	41275 41335	42275 42335	45275 45335	46275 46335
3.9 4.7	15.0 x 25.0 x 31.0	12.5	41395 41475	42395 42475	45395 45475	46395 46475

Capacitors available on special request

Pitch = 22.5 \pm 0.4 mm						
0.47 0.56 0.68	6.0 x 15.5 x 26.0	2.5	90042 90052 90062	90043 90053 90063	90048 90058 90068	90049 90059 90069
0.82 1	7.0 x 16.5 x 26.0	3.2	90072 90082	90073 90083	90078 90088	90079 90089
Pitch = 27.5 \pm 0.4 mm						
1.2 1.5	9.0 x 19.0 x 31.0	5.8	90172 90092	90173 90093	90174 90098	90175 90099
1.8 2.2	11.0 x 21.0 x 31.0	7.8	90102 90112	90103 90113	90108 90118	90109 90119

* H: intape height; for detailed specifications refer to chapter PACKAGING.

** marked capacitance values are not CECC qualified.

E Metallized POLYESTER
film capacitors

MKT 373

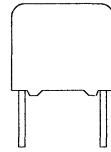

Pitch 15/22.5/27.5

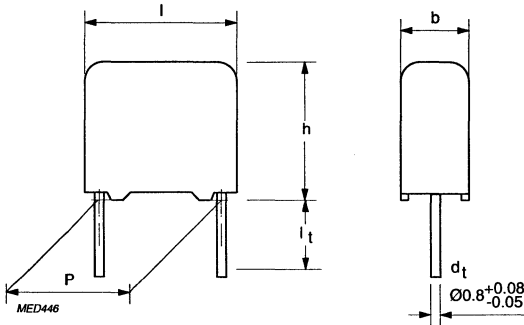

SPECIFIC REFERENCE DATA FOR 400 V DC

Tangent of loss angle	at 1 kHz	at 10 kHz	at 100 kHz
$C \leq 0.1 \mu\text{F}$	$\leq 75 \cdot 10^{-4}$	$\leq 130 \cdot 10^{-4}$	$\leq 250 \cdot 10^{-4}$
$0.1 \mu\text{F} < C \leq 0.47 \mu\text{F}$	$\leq 75 \cdot 10^{-4}$	$\leq 130 \cdot 10^{-4}$	$\leq 300 \cdot 10^{-4}$
$0.47 \mu\text{F} < C \leq 1.0 \mu\text{F}$	$\leq 75 \cdot 10^{-4}$	$\leq 130 \cdot 10^{-4}$	
$1 \mu\text{F} < C \leq 1.5 \mu\text{F}$	$\leq 75 \cdot 10^{-4}$	$\leq 150 \cdot 10^{-4}$	
Rated voltage pulse slope $(dU/dt)_R$ at U_{Rdc} (see application note)	P = 15 mm 34 V/ μs	P = 22.5 mm 14 V/ μs	P = 27.5 mm 12 V/ μs
R between terminations, for $C \leq 0.33 \mu\text{F}$	>30 000 M Ω		
RC between terminations, for $C > 0.33 \mu\text{F}$	>10 000 s		

SMALLEST PACKING QUANTITIES (SPQ)	loose in box	taped on reel
	SPQ	SPQ
5.0 x 11.0 x 17.5	1000	1100
6.0 x 12.0 x 17.5	1000	900
7.0 x 13.5 x 17.5	1000	800
8.5 x 15.0 x 17.5	1000	650
6.0 x 15.5 x 26.0	200	600
7.0 x 16.5 x 26.0	200	550
8.5 x 18.0 x 26.0	200	450
10.0 x 19.5 x 26.0	200	350
9.0 x 19.0 x 31.0	100	400
11.0 x 21.0 x 31.0	100	300
15.0 x 25.0 x 31.0	100	200

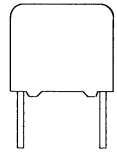
 **$U_{Rdc} = 400 V$** **$U_{Rac} = 220 V$** **loose and taped**

Cap. (μF)	$b_{max} \times h_{max} \times l_{max}$ (mm)	mass (g)	CATALOGUE NUMBER 2222 373			
			loose in box		taped on reel	
			$l_1 = 5 \pm 1$ mm		H = 18.5 mm *	
			C-tol $\pm 10\%$	C-tol $\pm 5\%$	C-tol $\pm 10\%$	C-tol $\pm 5\%$
Pitch = 15 ± 0.4 mm						
0.047	5.0 x 11.0 x 17.5	1.1	51473	52473	55473	56473
0.056			51563	52563	55563	56563
0.068			51683	52683	55683	56683
0.082			51823	52823	55823	56823
0.1			51104	52104	55104	56104
0.12	6.0 x 12.0 x 17.5	1.4	51124	52124	55124	56124
0.15			51154	52154	55154	56154
0.18	7.0 x 13.5 x 17.5	1.9	51184	52184	55184	56184
0.22 **			51224	52224	55224	56224
0.27 **	8.5 x 15.0 x 17.5	2.6	51274	52274	55274	56274
0.33 **			51334	52334	55334	56334
Pitch = 22.5 ± 0.4 mm						
0.39	8.5 x 18.0 x 26.0	4.4	51394	52394	55394	56394
0.56	10.0 x 19.5 x 26.0	4.4	51564	52564	55564	56564
0.68		5.5	51684	52684	55684	56684
Pitch = 27.5 ± 0.4 mm						
0.82	11.0 x 21.0 x 31.0	7.8	51824	52824	55824	56824
1			51105	52105	55105	56105
1.2	15.0 x 25.0 x 31.0	12.8	51125	52125	55125	56125
1.5			51155	52155	55155	56155

Capacitors available on special request

Pitch = 22.5 ± 0.4 mm						
0.22	6.0 x 15.5 x 26.0	2.5	90122	90123	90128	90129
0.27	7.0 x 16.5 x 26.0	3.2	90132	90133	90138	90139
0.33			90142	90143	90148	90149
Pitch = 27.5 ± 0.4 mm						
0.68	9.0 x 19.0 x 31.0	5.8	90152	90153	90158	90159

* H: intape height; for detailed specifications refer to chapter PACKAGING.

**** marked capacitance values are not CECC qualified.**

RATINGS AND CHARACTERISTICS

Unless otherwise specified, all electrical values apply to an ambient free air temperature of $23 \pm 1 \text{ }^\circ\text{C}$, an atmospheric pressure of 86 to 106 kPa and a relative humidity of $50 \pm 2\%$.

CAPACITANCE

- all capacitance values are specified at 1 kHz

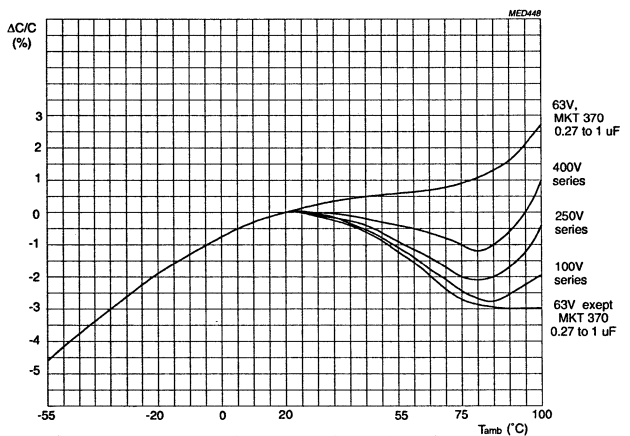
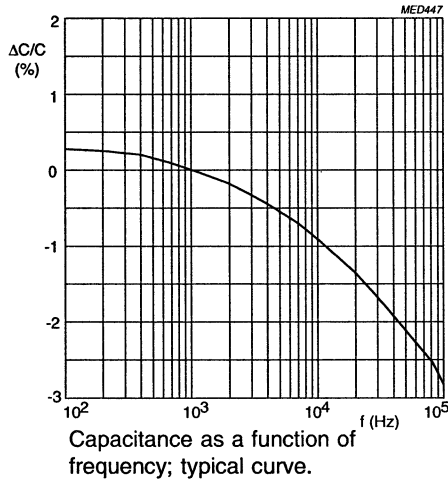

TEMPERATURE

- Storage temperature: $T_{stg} = -25\text{ }^{\circ}\text{C}$ to $+40\text{ }^{\circ}\text{C}$ with RH maximum 80% without condensation.

VOLTAGE

- Category voltage: $U_c = 0.8 \times U_{Rdc}$
- Test voltage between terminations: $1.6 \times U_{Rdc}$
- Test voltage between interconnected terminations and case (foil method): $2 \times U_{Rdc}$ (min. 200 V)
- Maximum RMS voltage (sinewave) as a function of frequency: for $T_{amb} \leq 85\text{ }^{\circ}\text{C}$ (see graphs below)

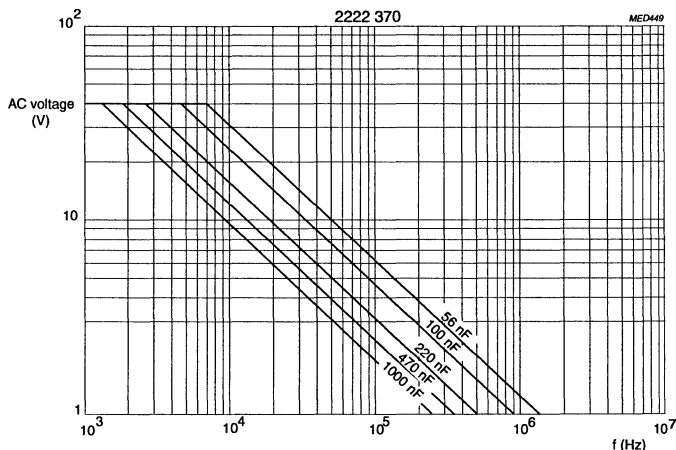

AC voltage (RMS value) as a function of frequency at $T_{amb} \leq 85\text{ }^{\circ}\text{C}$, for $U_{Rdc} = 63\text{ V}$.

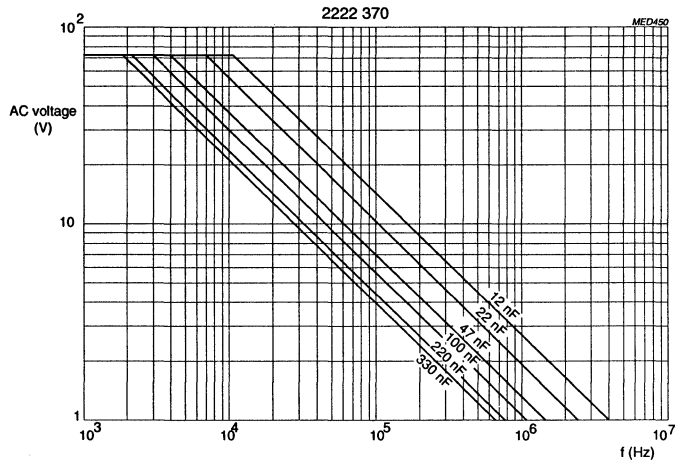

AC voltage (RMS value) as a function of frequency
at $T_{amb} \leq 85^\circ\text{C}$, for $U_{Rdc} = 100\text{ V}$.

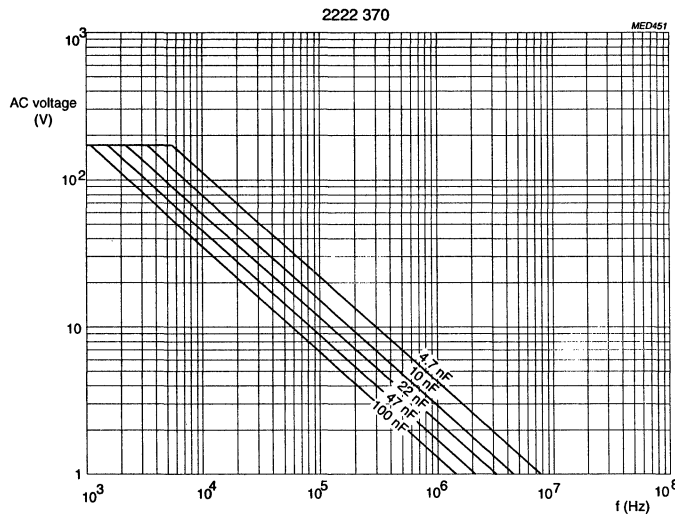

AC voltage (RMS value) as a function of frequency
at $T_{amb} \leq 85^\circ\text{C}$, for $U_{Rdc} = 250\text{ V}$.

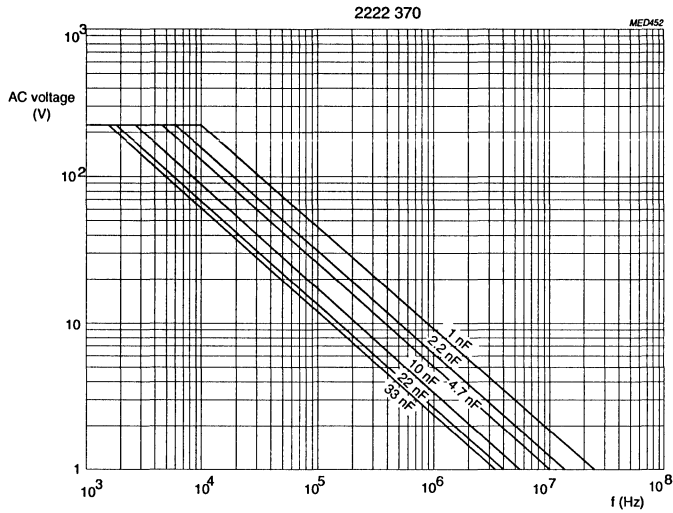

AC voltage (RMS value) as a function of frequency
at $T_{amb} \leq 85^\circ\text{C}$, for $U_{Rdc} = 400\text{ V}$.

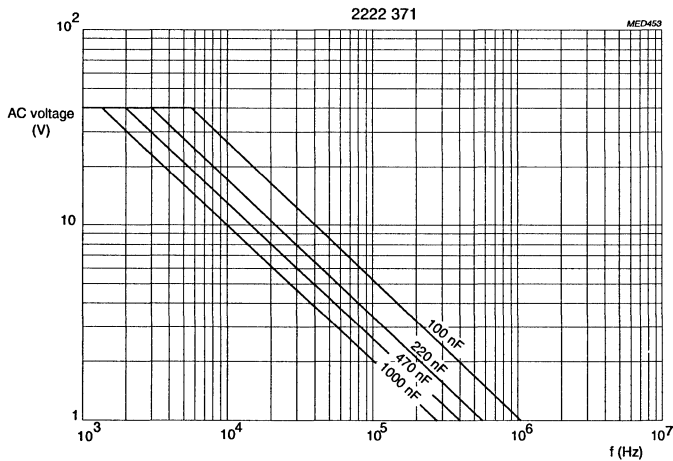

AC voltage (RMS value) as a function of frequency
at $T_{amb} \leq 85^\circ\text{C}$, for $U_{Rdc} = 63\text{ V}$.

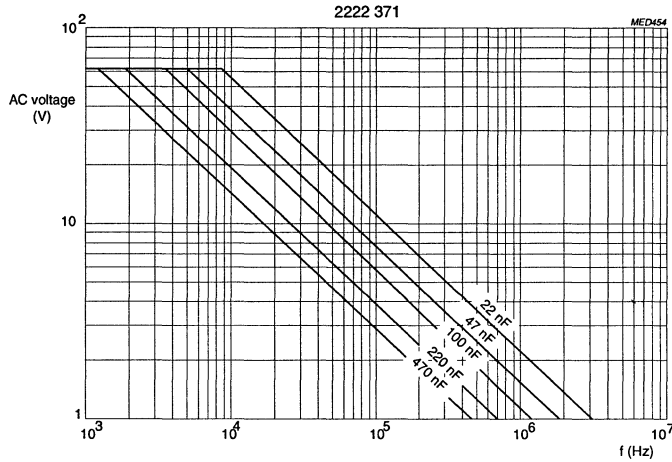

AC voltage (RMS value) as a function of frequency
at $T_{amb} \leq 85^\circ\text{C}$, for $U_{Rdc} = 100\text{ V}$.

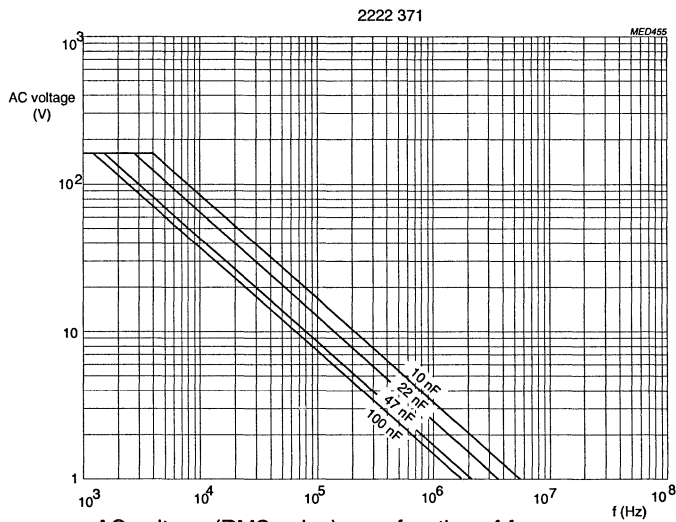

AC voltage (RMS value) as a function of frequency
at $T_{amb} \leq 85^\circ\text{C}$, for $U_{Rdc} = 250\text{ V}$.

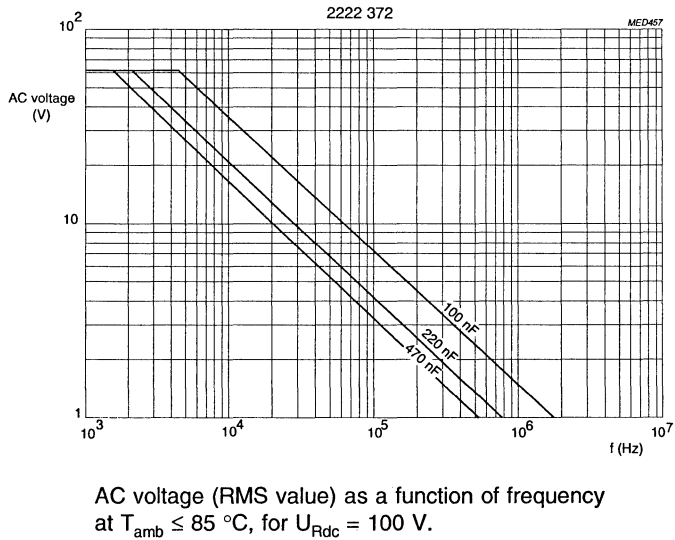
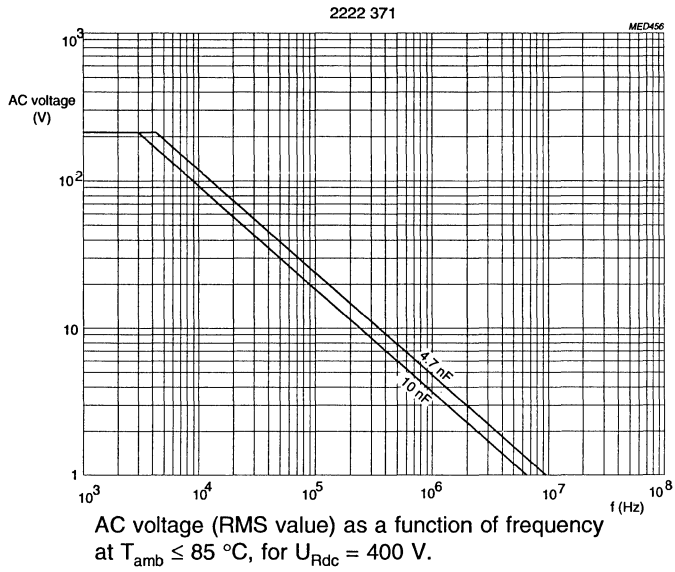

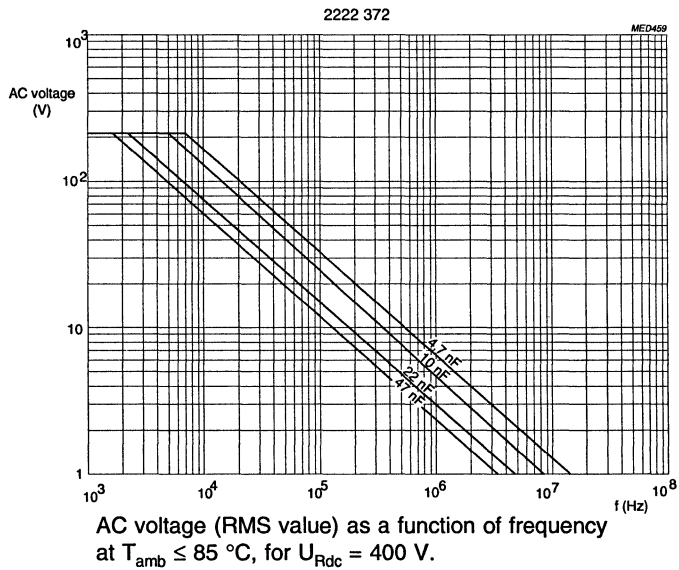
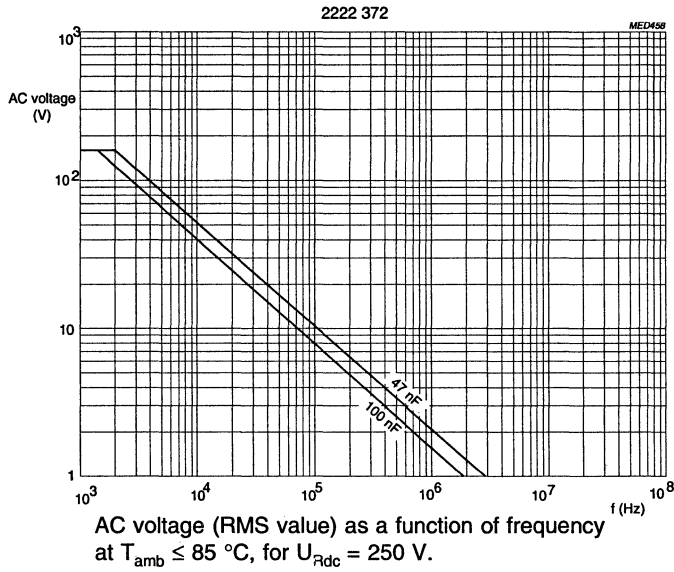

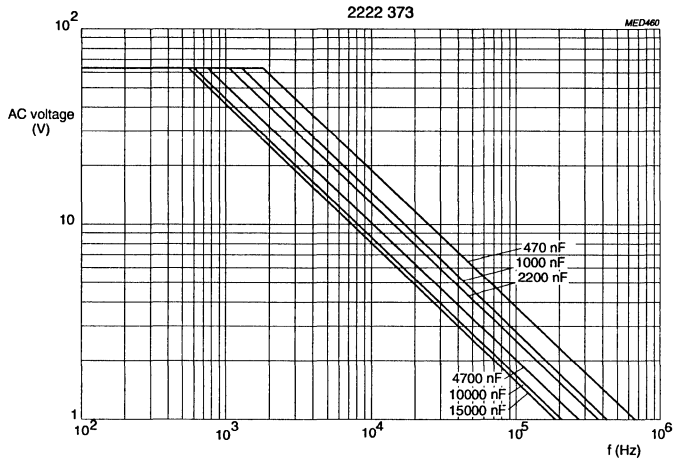

AC voltage (RMS value) as a function of frequency
at $T_{amb} \leq 85\text{ }^{\circ}\text{C}$, for $U_{Rdc} = 100\text{ V}$.

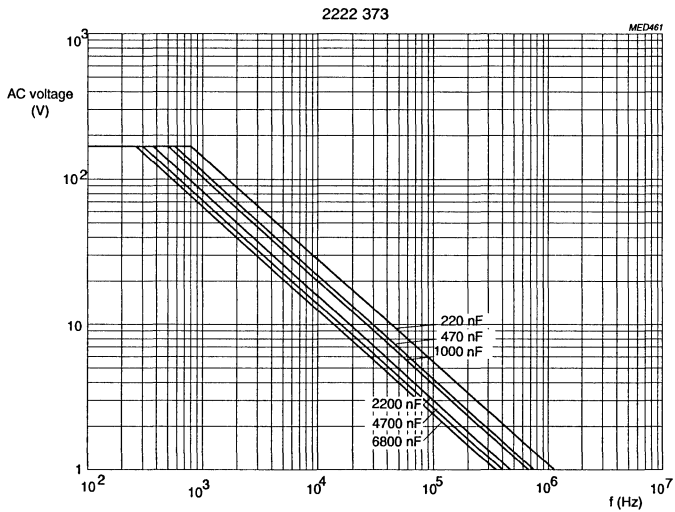

AC voltage (RMS value) as a function of frequency
at $T_{amb} \leq 85\text{ }^{\circ}\text{C}$, for $U_{Rdc} = 250\text{ V}$.

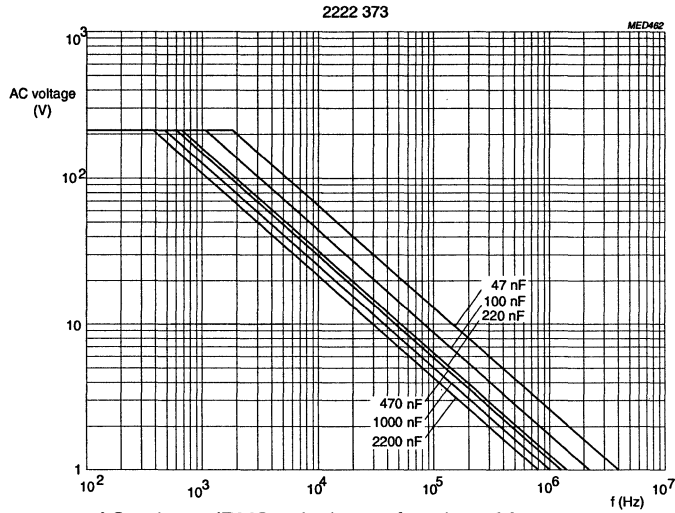

AC voltage (RMS value) as a function of frequency
at $T_{amb} \leq 85^\circ\text{C}$, for $U_{Rdc} = 400\text{ V}$.

TANGENT OF LOSS ANGLE

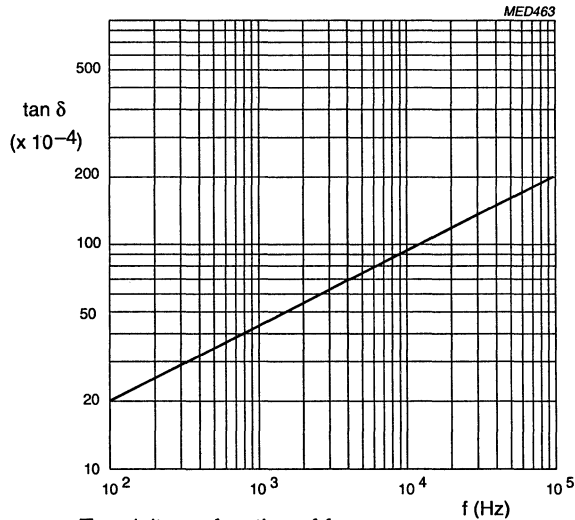

Tan-delta as function of frequency;
typical curve.

RATED VOLTAGE PULSE SLOPE

The maximum pulse load values are valid for pulse voltages equal to the rated voltage. For lower pulse voltages the given values may be multiplied by U_{Rdc} and divided by the applied voltage.

Note: If the pulse load requirement is satisfied, a check must be made to ascertain that the maximum dissipation is not exceeded.

INSULATION RESISTANCE

The insulation resistance is measured after a voltage has been applied for 1 minute ± 5 seconds, the voltage being 10 ± 1 V for the 63 V version and $100 \text{ V} \pm 15$ V for the 100 V, 250 V and 400 V versions.

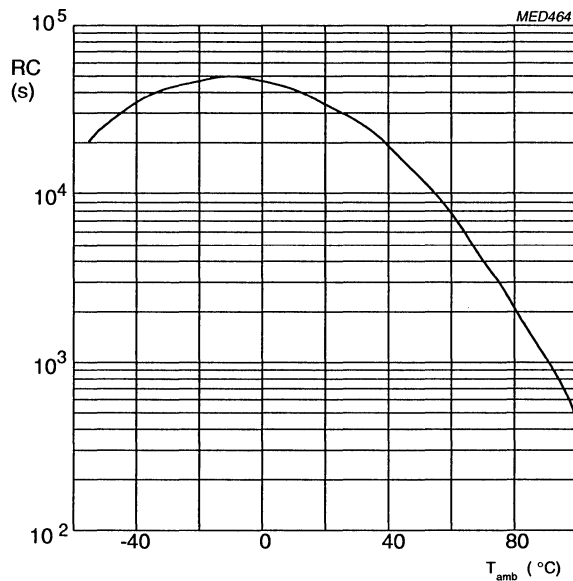

RC product as a function of ambient free air temperature; typical curve.

R between terminations: for value see specific reference data

R between interconnected terminations and case (foil method): >30 000 M Ω

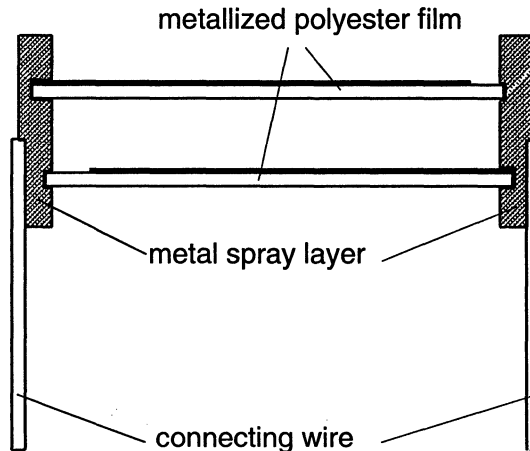
GENERAL DATA**CONSTRUCTION**

MED375

DESCRIPTION

- Low-inductive wound cell of metallized polyethyleneterephthalate (PETP) film, potted with blue epoxy resin in a blue flame retardent case
- Radial leads, solder-coated
- Small stand-off pips allow removal of solder flux etc. during cleaning of the printed-wiring board.

MOUNTING**Normal use**

The capacitors are designed for mounting on printed-wiring boards. The capacitors packed in bandoliers are designed for mounting on printed-wiring boards by automatic insertion machines. For detailed specifications refer to chapter PACKAGING.

Specific method of mounting to withstand vibration and shock test. It must be ensured that the stand-off pips are in good contact with the printing-wiring board.

- For cases sizes up to and including a mass of 6 g the capacitors shall be mechanically fixed by the leads.
- For larger pitches the capacitors shall be mounted in the same way and the body clamped.

MAXIMUM DISSIPATION

Curve	Dimensions (mm)		
	b_{max}	h_{max}	l_{max}
1	2.5	6.5	7.2
2	2.5	6.5	10.0
3	3.5	8.0	7.2
4	3.0	8.0	10.0
	4.5	9.0	7.2
5	5.0	10.0	7.2
	4.0	9.0	10.0
6	6.0	11.0	7.2
7	5.0	10.5	10.0
	4.0	9.0	12.5
8	4.0	10.0	12.5
9	6.0	12.0	10.0
10	5.0	11.0	12.5
11	6.0	12.0	12.5
12	5.0	11.0	17.5
13	6.0	12.0	17.5
14	7.0	13.5	17.5
15	8.5	15.0	17.5
16	6.0	15.5	26.0
17	7.0	16.5	26.0
18	8.5	18.0	26.0
19	10.0	19.5	26.0
20	11.0	21.0	31.0
21	13.0	23.0	31.0
22	15.0	25.0	31.0
23	18.0	28.0	31.0

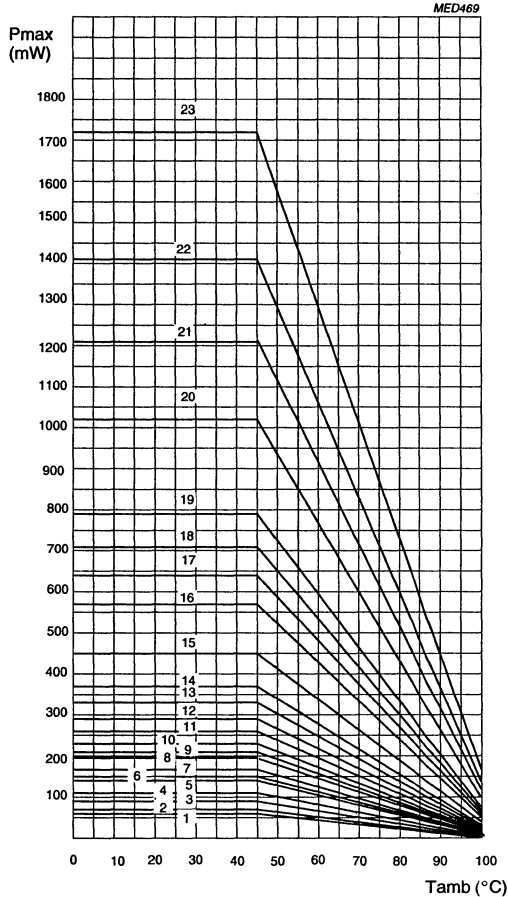

Maximum dissipation as a function of ambient free air temperature.

APPLICATION NOTE

To select this capacitor for a certain application, 6 conditions must be checked:

1. The peak voltage (U_p) shall not be greater than the rated DC voltage.
2. The peak to peak voltage (U_{pp}) shall not be greater than $2 \cdot \sqrt{2}$ times the rated AC voltage to avoid the ionisation inception level.
3. The peak current (I_p) shall not exceed the maximum peak current, defined as maximum voltage pulse slope (dU/dt) multiplied by the capacitance.





$$I_p \text{ max} = C \left(\frac{dU}{dt} \right) \text{ max.}$$

Or the voltage pulse slope shall not exceed the rated voltage pulse slope. If the pulse voltage is lower than the rated voltage, the values of the table may be multiplied by U_{Rdc} and divided by the applied voltage.

4. The dissipated power shall not be greater than the maximum permissible power dissipation stated in the graph on the preceding page.
5. The free air ambient temperature for the capacitor is not exceeding the category temperature.
6. In applications where voltages higher than 50 V are applied, it is recommended that the power in the capacitor be limited to 2.5 VA in case of a capacitor failure.

Package marking

The package containing the capacitors is marked as shown.

PHILIPS COMPONENTS	LINE	MARKING EXPLANATION
MADE IN BELGIUM	1	Manufacturer's name
METAL. PETP FILM CAPACITOR	2	Country of origin
MKT RADIAL POTTED TYPE	3	Sub-family
0.47 μ F \pm 10% 63V= 55/100/56	4	Type description
CECC 30401-801	5	Capacitance value, tolerance, voltage and climatic category (IEC)
F 0.5	6	-
 ORIG A170 RPC HQ	7	Preference origin code: A Country of origin in code: 170 (Belgium) Responsible production centre: HQ (Roeselare) WO: work order
 TYPE MKT 370	8	Product type description
-	9	Quantity and production period, year and week code
 QTY 8000 DATE 9238	10	Product code (12NC)
 CODENO 2222 370 11474		

Metallized POLYESTER MKT 365/366/367/368/369 film capacitors

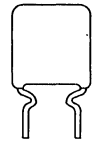

MKT RADIAL EPOXY LACQUERED CAPACITORS

Pitch 5/7.5/10/15/22.5/27.5

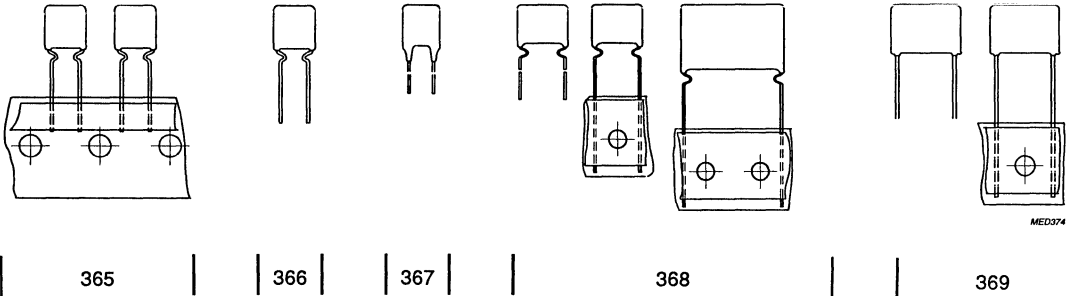

QUICK REFERENCE DATA

Capacitance range (E12 series)	0.001 to 6.8 μF
Capacitance tolerance	$\pm 20\%$, $\pm 10\%$, $\pm 5\%$
Rated voltage U_{Rdc}	63 V, 100 V, 250 V, 400 V, 630 V
Climatic category	55/100/56
Rated temperature	85 °C
Maximum application temperature	100 °C
Tangent of loss angle at 10 kHz	100×10^{-4}
Reference specifications	IEC 384-2
Performance grade	Grade 1 (long life)

<p>FEATURES</p> <ul style="list-style-type: none"> • Low-inductive wound cell of metallized (PETP) film • Cell protected by epoxy lacquer • Radial leads of solder-coated wire • Withstand solvents and rinsing liquids • Small stand-off pips allow removal of solder flux. 	<p>APPLICATIONS</p> <ul style="list-style-type: none"> • Blocking and coupling • Bypass and energy reservoir applications.
--	---

**Metallized POLYESTER
film capacitors**

MKT 365

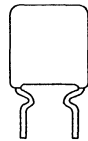

Pitch 5

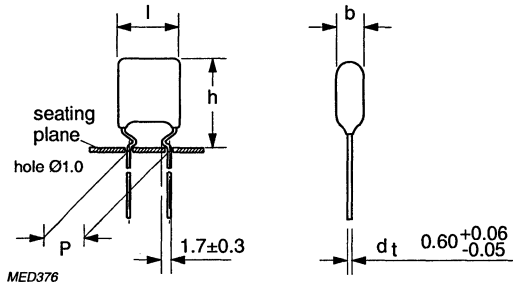

$U_{Rdc} = 63 V$

$U_{Rac} = 40 V$

taped versions

Cap. (μF)	$b_{max} \times h_{max} \times l_{max}$ (mm)	mass (g)	CATALOGUE NUMBER 2222 365					
			taped on reel			ammopack		
			H = 16 mm *			H = 16 mm *		
			C-tol $\pm 20\%$	C-tol $\pm 10\%$	C-tol $\pm 5\%$	C-tol $\pm 20\%$	C-tol $\pm 10\%$	C-tol $\pm 5\%$
Pitch = 5.08 \pm 0.3 mm								
0.047	3.5 x 12.5 x 7.5	0.3	70473	71473	72473	74473	75473	76473
0.056			70563	71563	72563	74563	75563	76563
0.068			70683	71683	72683	74683	75683	76683
0.082			70823	71823	72823	74823	75823	76823
0.1			70104	71104	72104	74104	75104	76104
0.12	70124	71124	72124	74124	75124	76124		
0.15	4.0 x 13.0 x 7.5	0.3	70154	71154	72154	74154	75154	76154
0.18	4.5 x 13.5 x 7.5		70184	71184	72184	74184	75184	76184
0.22			70224	71224	72224	74224	75224	76224
0.27	5.0 x 14.0 x 7.5	0.4	70274	71274	72274	74274	75274	76274
0.33	5.5 x 14.5 x 7.5	0.4	70334	71334	72334	74334	75334	76334
0.39			70394	71394	72394	74394	75394	76394
0.47	6.0 x 15.5 x 7.5	0.4	70474	71474	72474	74474	75474	76474
0.56	5.5 x 14.0 x 7.5	0.4	70564	71564	72564	74564	75564	76564
0.68	5.5 x 14.5 x 7.5	0.4	70684	71684	72684	74684	75684	76684
0.82	6.0 x 15.0 x 7.5	0.5	70824	71824	72824	74824	75824	76824
1	6.5 x 15.5 x 7.5	0.5	70105	71105	72105	74105	75105	76105

SMALLEST PACKING QUANTITIES (SPQ)	reel	ammopack
DIMENSIONS	SPQ	SPQ
3.5 x 12.5 x 7.5	1500	1500
4.0 x 13.0 x 7.5	1500	1500
4.5 x 13.5 x 7.5	1000	1000
5.0 x 14.0 x 7.5	1000	1000
5.5 x 14.5 x 7.5	1000	1000
6.0 x 15.5 x 7.5	1000	1000
6.0 x 15.0 x 7.5	1000	1000

* H: intape height; for detailed specifications refer to chapter PACKAGING.

Metalized POLYESTER film capacitors

MKT 365

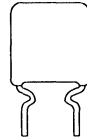

Pitch 5

SPECIFIC REFERENCE DATA FOR 63 V DC and 100 V DC

Tangent of loss angle	at 1 kHz	at 10 kHz	at 100 kHz
$C \leq 0.1 \mu\text{F}$	$\leq 75 \cdot 10^{-4}$	$\leq 130 \cdot 10^{-4}$	$\leq 225 \cdot 10^{-4}$
$0.1 \mu\text{F} < C \leq 0.47 \mu\text{F}$	$\leq 75 \cdot 10^{-4}$	$\leq 130 \cdot 10^{-4}$	$\leq 300 \cdot 10^{-4}$
$0.47 \mu\text{F} < C \leq 1.0 \mu\text{F}$	$\leq 75 \cdot 10^{-4}$	$\leq 130 \cdot 10^{-4}$	-
Rated voltage pulse slope (dU/dt)R at U_{Rdc} (see also application note)	110 V/ μs		
R between terminations, for $C \leq 0.33 \mu\text{F}$	>15 000 M Ω		
RC between terminations, for $C > 0.33 \mu\text{F}$	>5000 s		
R between interconnected terminations and case (foil method)	>30 000 M Ω		

 $U_{\text{Rdc}} = 100 \text{ V}$ $U_{\text{Rac}} = 63 \text{ V}$

taped versions

Cap. (μF)	$b_{\text{max}} \times h_{\text{max}} \times l_{\text{max}}$ (mm)	mass (g)	CATALOGUE NUMBER 2222 365					
			taped on reel			ammopack		
			H = 16 mm *			H = 16 mm *		
			C-tol $\pm 20\%$	C-tol $\pm 10\%$	C-tol $\pm 5\%$	C-tol $\pm 20\%$	C-tol $\pm 10\%$	C-tol $\pm 5\%$
Pitch = 5.08 \pm 0.3 mm								
0.01	3.5 x 12.5 x 7.5	0.3	80103	81103	82103	84103	85103	86103
0.012			80123	81123	82123	84123	85123	86123
0.015			80153	81153	82153	84153	85153	86153
0.018			80183	81183	82183	84183	85183	86183
0.022			80223	81223	82223	84223	85223	86223
0.027			80273	81273	82273	84273	85273	86273
0.033			80333	81333	82333	84333	85333	86333
0.039			80393	81393	82393	84393	85393	86393
0.047			80473	81473	82473	84473	85473	86473
0.056			80563	81563	82563	84563	85563	86563
0.068			80683	81683	82683	84683	85683	86683
0.082	4.0 x 13.0 x 7.5	0.3	80823	81823	82823	84823	85823	86823
0.10	4.5 x 13.5 x 7.5	0.4	80104	81104	82104	84104	85104	86104

SMALLEST PACKING QUANTITIES (SPQ)	reel	ammopack
DIMENSIONS	SPQ	SPQ
3.5 x 12.5 x 7.5	1500	1500
4.0 x 13.0 x 7.5	1500	1500
4.5 x 13.5 x 7.5	1000	1000

* H: intape height; for detailed specifications refer to chapter PACKAGING.

Metallized POLYESTER film capacitors

MKT 365

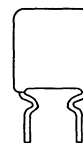

Pitch 5 (bent back leads)

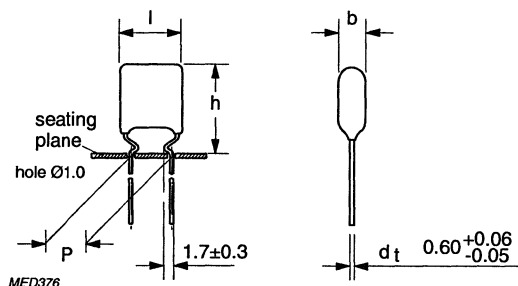

$U_{Rdc} = 63 V$

$U_{Rac} = 40 V$

taped versions

Cap. (μF)	$b_{max} \times h_{max} \times l_{max}$ (mm)	mass (g)	CATALOGUE NUMBER 2222 365			
			taped on reel		ammopack	
			H = 16 mm *		H = 16 mm *	
			C-tol $\pm 10\%$	C-tol $\pm 5\%$	C-tol $\pm 10\%$	C-tol $\pm 5\%$
Pitch = 5.08 \pm 0.3 mm						
0.12	4.0 x 13.5 x 10.0	0.4	11124	12124	15124	16124
0.15			11154	12154	15154	16154
0.18			11184	12184	15184	16184
0.22			11224	12224	15224	16224
0.27	4.5 x 14.0 x 10.5	0.5	11274	12274	15274	16274
0.33	5.0 x 14.5 x 10.5	0.5	11334	12334	15334	16334
0.39		0.6	11394	12394	15394	16394
0.47	5.5 x 15.0 x 10.5	0.7	11474	12474	15474	16474
0.56			11564	12564	15564	16564
0.68			11684	12684	15684	16684
0.82			11824	12824	15824	16824
1			11105	12105	15105	16105

SMALLEST PACKING QUANTITIES (SPQ)	reel	ammopack
DIMENSIONS	SPQ	SPQ
4.0 x 13.5 x 10.0	1500	1500
4.5 x 14.0 x 10.5	1000	1000
5.0 x 14.5 x 10.5	1000	1000
5.5 x 15.0 x 10.5	1000	1000

* H: intape height; for detailed specifications refer to chapter PACKAGING.

Metallized POLYESTER film capacitors

MKT 365

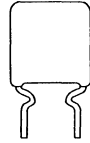

Pitch 5

SPECIFIC REFERENCE DATA FOR 63 V DC and 100 V DC

Tangent of loss angle	at 1 kHz	at 10 kHz	at 100 kHz
$C \leq 0.1 \mu\text{F}$	$\leq 75 \cdot 10^{-4}$	$\leq 130 \cdot 10^{-4}$	$\leq 225 \cdot 10^{-4}$
$0.1 \mu\text{F} < C \leq 0.47 \mu\text{F}$	$\leq 75 \cdot 10^{-4}$	$\leq 130 \cdot 10^{-4}$	$\leq 300 \cdot 10^{-4}$
$0.47 \mu\text{F} < C \leq 1.0 \mu\text{F}$	$\leq 75 \cdot 10^{-4}$	$\leq 130 \cdot 10^{-4}$	–
Rated voltage pulse slope $(dU/dt)_R$ at U_{Rdc} (see also application note)	63 V version 18 V/ μs		100 V version 36 V/ μs
R between terminations, for $C \leq 0.33 \mu\text{F}$	>15 000 M Ω		
RC between terminations, for $C > 0.33 \mu\text{F}$	>5000 s		
R between interconnected terminations and case (foil method)	>30 000 M Ω		

 $U_{Rdc} = 100 \text{ V}$ $U_{Rac} = 63 \text{ V}$

taped versions

Cap. (μF)	$b_{\text{max}} \times h_{\text{max}} \times l_{\text{max}}$ (mm)	mass (g)	CATALOGUE NUMBER 2222 365			
			taped on reel		ammopack	
			H = 16 mm *		H = 16 mm *	
			C-tol $\pm 10\%$	C-tol $\pm 5\%$	C-tol $\pm 10\%$	C-tol $\pm 5\%$
Pitch = 5.08 \pm 0.3 mm						
0.039	4.0 x 13.5 x 10.0	0.4	21393	22393	25393	26393
0.047			21473	22473	25473	26473
0.056			21563	22563	25563	26563
0.068			21683	22683	25683	26683
0.082			21823	22823	25823	26823
0.10			21104	22104	25104	26104
0.12	4.5 x 14.0 x 10.5	0.5	21124	22124	25124	26124
0.15	5.0 x 14.5 x 10.5	0.6	21154	22154	25154	26154
0.18			21184	22184	25184	26184
0.22	5.5 x 15.0 x 10.5	0.7	21224	22224	25224	26224
0.27	6.0 x 15.5 x 10.5	0.7	21274	22274	25274	26274
0.33			21334	22334	25334	26334
0.39			21394	22394	25394	26394
0.47			21474	22474	25474	26474

SMALLEST PACKING QUANTITIES (SPQ)	reel	ammopack
DIMENSIONS	SPQ	SPQ
4.0 x 13.5 x 10.0	1500	1500
4.5 x 14.0 x 10.5	1000	1000
5.0 x 14.5 x 10.5	1000	1000
5.5 x 15.0 x 10.5	1000	1000
6.0 x 15.5 x 10.5	1000	1000

* H: intape height; for detailed specifications refer to chapter PACKAGING.

**Metallized POLYESTER
film capacitors**

MKT 365

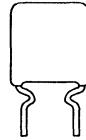

Pitch 5 (bent back leads)

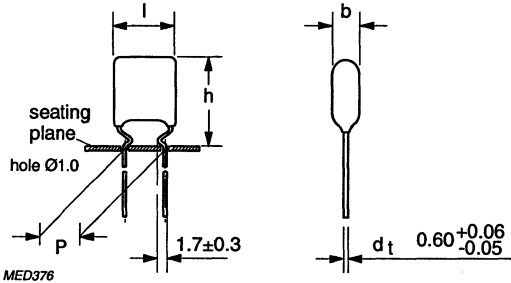

$U_{Rdc} = 250 V$

$U_{Rac} = 160 V$

taped versions

Cap. (μF)	$b_{max} \times h_{max} \times l_{max}$ (mm)	mass (g)	CATALOGUE NUMBER 2222 365			
			taped on reel		ammopack	
			H = 16 mm *		H = 16 mm *	
			C-tol $\pm 10\%$	C-tol $\pm 5\%$	C-tol $\pm 10\%$	C-tol $\pm 5\%$
Pitch = 5.08 \pm 0.3 mm						
0.018	4.0 x 13.5 x 10.0	0.4	41183	42183	45183	46183
0.022			41223	42223	45223	46223
0.027			41273	42273	45273	46273
0.033			41333	42333	45333	46333
0.039			41393	42393	45393	46393
0.047			41473	42473	45473	46473

SMALLEST PACKING QUANTITIES (SPQ)	reel	ammopack
DIMENSIONS	SPQ	SPQ
4.0 x 13.5 x 10.0	1500	1500

* H: intape height; for detailed specifications refer to chapter PACKAGING.

Metallized POLYESTER film capacitors

MKT 365

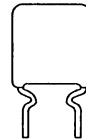

Pitch 5

SPECIFIC REFERENCE DATA FOR 250 V DC and 400 V DC

Tangent of loss angle	at 1 kHz	at 10 kHz	at 100 kHz
$C \leq 0.1 \mu\text{F}$	$\leq 75 \cdot 10^{-4}$	$\leq 130 \cdot 10^{-4}$	$\leq 225 \cdot 10^{-4}$
Rated voltage pulse slope $(dU/dt)_R$ at U_{Rdc} (see also application note)	250 V version 70 V/ μs		400 V version 110 V/ μs
R between terminations, for $C \leq 0.33 \mu\text{F}$	>30 000 M Ω		
R between interconnected terminations and case (foil method)	>30 000 M Ω		

 $U_{Rdc} = 400 \text{ V}$ $U_{Rac} = 220 \text{ V}$

taped versions

Cap. (μF)	$b_{\text{max}} \times h_{\text{max}} \times l_{\text{max}}$ (mm)	mass (g)	CATALOGUE NUMBER 2222 365			
			taped on reel		ammopack	
			H = 16 mm *		H = 16 mm *	
			C-tol $\pm 10\%$	C-tol $\pm 5\%$	C-tol $\pm 10\%$	C-tol $\pm 5\%$
Pitch = 5.08 \pm 0.3 mm						
0.0033	4.0 x 13.5 x 10.0	0.4	51332	52332	55332	56332
0.0039			51392	52392	55392	56392
0.0047			51472	52472	55472	56472
0.0056			51562	52562	55562	56562
0.0068			51682	52682	55682	56682
0.0082			51822	52822	55822	56822
0.010			51103	52103	55103	56103
0.012			51123	52123	55123	56123
0.015			51153	52153	55153	56153

SMALLEST PACKING QUANTITIES (SPQ)	reel	ammopack
DIMENSIONS	SPQ	SPQ
4.0 x 13.5 x 10.0	1500	1500

* H: intape height; for detailed specifications refer to chapter PACKAGING.

**Metallized POLYESTER
film capacitors**

MKT 366

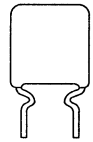

Pitch 5

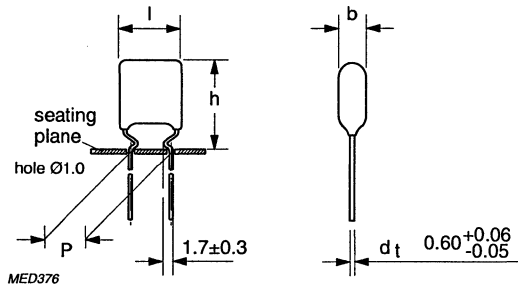

$U_{Rdc} = 63 V$

$U_{Rac} = 40 V$

loose in box

Cap. (μF)	$b_{max} \times h_{max} \times l_{max}$ (mm)	mass (g)	CATALOGUE NUMBER 2222 366					
			loose in box					
			$l_t = 17 \pm 4 \text{ mm}$			$l_t = 4 +1/-0.5 \text{ mm}$		
			C-tol $\pm 20\%$	C-tol $\pm 10\%$	C-tol $\pm 5\%$	C-tol $\pm 20\%$	C-tol $\pm 10\%$	C-tol $\pm 5\%$
Pitch = 5.08 \pm 0.3 mm								
0.047	3.5 x 12.5 x 7.5	0.3	70473	71473	72473	74473	75473	76473
0.056			70563	71563	72563	74563	75563	76563
0.068			70683	71683	72683	74683	75683	76683
0.082			70823	71823	72823	74823	75823	76823
0.1			70104	71104	72104	74104	75104	76104
0.12			70124	71124	72124	74124	75124	76124
0.15	4.0 x 13.0 x 7.5	0.3	70154	71154	72154	74154	75154	76154
0.18	4.5 x 13.5 x 7.5		70184	71184	72184	74184	75184	76184
0.22		70224	71224	72224	74224	75224	76224	
0.27	5.0 x 14.0 x 7.5	0.4	70274	71274	72274	74274	75274	76274
0.33	5.5 x 14.5 x 7.5		70334	71334	72334	74334	75334	76334
0.39		70394	71394	72394	74394	75394	76394	
0.47	6.0 x 15.5 x 7.5	0.5	70474	71474	72474	74474	75474	76474
0.56	5.5 x 14.0 x 7.5		70564	71564	72564	74564	75564	76564
0.68	5.5 x 14.5 x 7.5		70684	71684	72684	74684	75684	76684
0.82	6.0 x 15.0 x 7.5		70824	71824	72824	74824	75824	76824
1	6.5 x 15.5 x 7.5		70105	71105	72105	74105	75105	76105

SMALLEST PACKING QUANTITIES (SPQ)	$l_t = 17 \text{ mm}$	$l_t = 4 \text{ mm}$
	DIMENSIONS	
	SPQ	SPQ
all dimensions	1000	1000

Metallized POLYESTER film capacitors

MKT 366

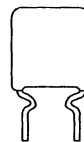

Pitch 5

SPECIFIC REFERENCE DATA FOR 63 V DC and 100 V DC

Tangent of loss angle	at 1 kHz	at 10 kHz	at 100 kHz
$C \leq 0.1 \mu\text{F}$	$\leq 75 \cdot 10^{-4}$	$\leq 130 \cdot 10^{-4}$	$\leq 225 \cdot 10^{-4}$
$0.1 \mu\text{F} < C \leq 0.47 \mu\text{F}$	$\leq 75 \cdot 10^{-4}$	$\leq 130 \cdot 10^{-4}$	$\leq 300 \cdot 10^{-4}$
$0.47 \mu\text{F} < C \leq 1.0 \mu\text{F}$	$\leq 75 \cdot 10^{-4}$	$\leq 130 \cdot 10^{-4}$	-
Rated voltage pulse slope $(dU/dt)_R$ at U_{Rdc} (see also application note)	10 V/ μs		
R between terminations, for $C \leq 0.33 \mu\text{F}$	>15 000 M Ω		
RC between terminations, for $C > 0.33 \mu\text{F}$	>5000 s		
R between interconnected terminations and case (foil method)	>30 000 M Ω		

 $U_{Rdc} = 100 \text{ V}$ $U_{Rac} = 63 \text{ V}$

loose in box

Cap. (μF)	$b_{\text{max}} \times h_{\text{max}} \times l_{\text{max}}$ (mm)	mass (g)	CATALOGUE NUMBER 2222 366					
			loose in box					
			$l_t = 17 \pm 4 \text{ mm}$			$l_t = 4 +1/-0.5 \text{ mm}$		
			C-tol $\pm 20\%$	C-tol $\pm 10\%$	C-tol $\pm 5\%$	C-tol $\pm 20\%$	C-tol $\pm 10\%$	C-tol $\pm 5\%$
Pitch = 5.08 \pm 0.3 mm								
0.01	3.5 x 12.5 x 7.5	0.3	80103	81103	82103	84103	85103	86103
0.012			80123	81123	82123	84123	85123	86123
0.015			80153	81153	82153	84153	85153	86153
0.018			80183	81183	82183	84183	85183	86183
0.022			80223	81223	82223	84223	85223	86223
0.027			80273	81273	82273	84273	85273	86273
0.033			80333	81333	82333	84333	85333	86333
0.039			80393	81393	82393	84393	85393	86393
0.047			80473	81473	82473	84473	85473	86473
0.056			80563	81563	82563	84563	85563	86563
0.068			80683	81683	82683	84683	85683	86683
0.082	4.0 x 13.0 x 7.5		80823	81823	82823	84823	85823	86823
0.10	4.5 x 13.5 x 7.5	0.4	80104	81104	82104	84104	85104	86104

SMALLEST PACKING QUANTITIES (SPQ)	$l_t = 17 \text{ mm}$	$l_t = 4 \text{ mm}$
DIMENSIONS	SPQ	SPQ
3.5 x 12.5 x 7.5	1000	1000
4.0 x 13.0 x 7.5	1000	1000
4.5 x 13.5 x 7.5	1000	1000

Metallized POLYESTER film capacitors

MKT 366



Pitch 7.5

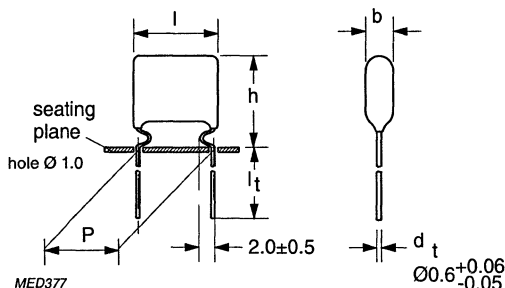

$U_{Rdc} = 63 V$

$U_{Rac} = 40 V$

loose in box

Cap. (μF)	$b_{max} \times h_{max} \times l_{max}$ (mm)	mass (g)	CATALOGUE NUMBER 2222 366			
			loose in box			
			$l_t = 17 \pm 4$ mm		$l_t = 4 +1/-0.5$ mm	
			C-tol $\pm 10\%$	C-tol $\pm 5\%$	C-tol $\pm 10\%$	C-tol $\pm 5\%$
Pitch = 7.62 \pm 0.3 mm						
0.12	4.0 x 12.0 x 10.0	0.4	11124	12124	15124	16124
0.15			11154	12154	15154	16164
0.18			11184	12184	15184	16184
0.22			11224	12224	15224	16224
0.27	4.5 x 13.0 x 10.5	0.5	11274	12274	15274	16274
0.33	5.0 x 13.5 x 10.5	0.6	11334	12334	15334	16334
0.39			11394	12394	15394	16394
0.47	5.5 x 14.0 x 10.5	0.7	11474	12474	15474	16474
0.56	5.5 x 14.5 x 10.5	0.8	11564	12564	15564	16564
0.68			11684	12684	15684	16684
0.82			11824	12824	15824	16824
1			11105	12105	15105	16105

Lead length 3 \pm 0.4 mm available with code 2222 366 18... for 10% and 2222 366 19... for 5% versions.

SMALLEST PACKING QUANTITIES (SPQ)	$l_t = 17$ mm	$l_t = 4$ mm
	SPQ	SPQ
DIMENSIONS		
4.0 x 12.0 x 10.0	1000	1000
4.5 x 13.0 x 10.5	1000	1000
5.0 x 13.5 x 10.5	1000	1000
5.5 x 14.5 x 10.5	1000	1000

**Metallized POLYESTER
film capacitors**

MKT 366

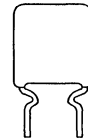

Pitch 7.5

SPECIFIC REFERENCE DATA FOR 63 V DC and 100 V DC

Tangent of loss angle	at 1 kHz	at 10 kHz	at 100 kHz
$C \leq 0.1 \mu\text{F}$	$\leq 75 \cdot 10^{-4}$	$\leq 130 \cdot 10^{-4}$	$\leq 225 \cdot 10^{-4}$
$0.1 \mu\text{F} < C \leq 0.47 \mu\text{F}$	$\leq 75 \cdot 10^{-4}$	$\leq 130 \cdot 10^{-4}$	$\leq 300 \cdot 10^{-4}$
$0.47 \mu\text{F} < C \leq 1.0 \mu\text{F}$	$\leq 75 \cdot 10^{-4}$	$\leq 130 \cdot 10^{-4}$	-
Rated voltage pulse slope $(dU/dt)_R$ at U_{Rdc} (see also application note)	63 V version 18 V/ μs		100 V version 36 V/ μs
R between terminations, for $C \leq 0.33 \mu\text{F}$	>15 000 M Ω		
RC between terminations, for $C > 0.33 \mu\text{F}$	>5000 s		
R between interconnected terminations and case (foil method)	>30 000 M Ω		

$U_{Rdc} = 100 \text{ V}$

$U_{Rac} = 63 \text{ V}$

loose in box

Cap. (μF)	$b_{\text{max}} \times h_{\text{max}} \times l_{\text{max}}$ (mm)	mass (g)	CATALOGUE NUMBER 2222 366			
			$l_t = 17 \pm 4 \text{ mm}$		$l_t = 4 +1/-0.5 \text{ mm}$	
			C-tol $\pm 10\%$	C-tol $\pm 5\%$	C-tol $\pm 10\%$	C-tol $\pm 5\%$
Pitch = 7.62 \pm 0.3 mm						
0.039	4.0 x 12.0 x 10.0	0.4	21393	22393	25393	26393
0.047			21473	22473	25473	26473
0.056			21563	22563	25563	26563
0.068			21683	22683	25683	26683
0.082			21823	22823	25823	26823
0.10	4.0 x 13.0 x 10.0	0.4	21104	22104	25104	26104
0.12	4.5 x 13.0 x 10.5	0.5	21124	22124	25124	26124
0.15	5.0 x 13.0 x 10.5	0.5	21154	22154	25154	26154
0.18	5.0 x 13.5 x 10.5	0.6	21184	22184	25184	26184
0.22	5.5 x 13.5 x 10.5	0.7	21224	22224	25224	26224
0.27	6.0 x 14.5 x 10.5	0.7	21274	22274	25274	26274
0.33	6.0 x 15.0 x 10.5	0.7	21334	22334	25334	26334
0.39			21394	22394	25394	26394
0.47			21474	22474	25474	26474

Lead length 3 \pm 0.4 mm available with code 2222 366 28... for 10% and 2222 366 29... for 5% versions.

SMALLEST PACKING QUANTITIES (SPQ)	$l_t = 17 \text{ mm}$	$l_t = 4 \text{ mm}$
DIMENSIONS	SPQ	SPQ
4.0 x 12.0 x 10.0	1000	1000
4.0 x 13.0 x 10.0	1000	1000
4.5 x 13.0 x 10.5	1000	1000
5.0 x 13.0 x 10.5	1000	1000
5.0 x 13.5 x 10.5	1000	1000
5.5 x 13.5 x 10.5	1000	1000
6.0 x 14.5 x 10.5	1000	1000
6.0 x 15.0 x 10.5	1000	1000

**Metallized POLYESTER
film capacitors**

MKT 366

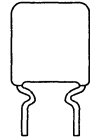

Pitch 7.5

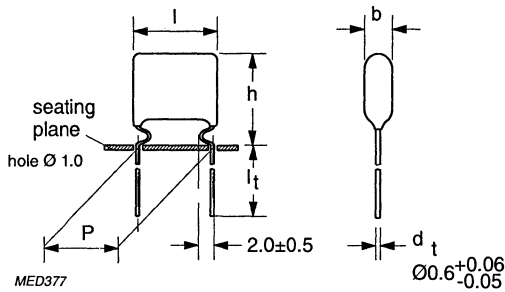

$U_{Rdc} = 250 V$

$U_{Rac} = 160 V$

loose in box

Cap. (μF)	$b_{max} \times h_{max} \times l_{max}$ (mm)	mass (g)	CATALOGUE NUMBER 2222 366			
			$l_t = 17 \pm 4 mm$		$l_t = 4 +1/-0.5 mm$	
			C-tol $\pm 10\%$	C-tol $\pm 5\%$	C-tol $\pm 10\%$	C-tol $\pm 5\%$
Pitch = 7.62 ± 0.3 mm						
0.018	4.0 x 13.0 x 10.0	0.4	41183	42183	45183	46183
0.022			41223	42223	45223	46223
0.027			41273	42273	45273	46273
0.033			41333	42333	45333	46333
0.039			41393	42393	45393	46393
0.047			41473	42473	45473	46473

Lead length 3 ± 0.4 mm available with code 2222 366 48... for 10% and 2222 366 49... for 5% version.

SMALLEST PACKING QUANTITIES (SPQ)	$l_t = 17 mm$	$l_t = 4 mm$
DIMENSIONS	SPQ	SPQ
4.0 x 13.0 x 10.0	1000	1000

Metallized POLYESTER film capacitors

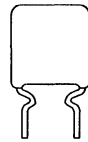
MKT 366

Pitch 7.5

SPECIFIC REFERENCE DATA FOR 250 V DC and 400 V DC

Tangent of loss angle	at 1 kHz	at 10 kHz	at 100 kHz
$C \leq 0.1 \mu\text{F}$	$\leq 75 \cdot 10^{-4}$	$\leq 130 \cdot 10^{-4}$	$\leq 225 \cdot 10^{-4}$
$0.1 \mu\text{F} < C \leq 0.47 \mu\text{F}$	$\leq 75 \cdot 10^{-4}$	$\leq 130 \cdot 10^{-4}$	$\leq 300 \cdot 10^{-4}$
$0.47 \mu\text{F} < C \leq 1.0 \mu\text{F}$	$\leq 75 \cdot 10^{-4}$	$\leq 130 \cdot 10^{-4}$	-
Rated voltage pulse slope $(dU/dt)_R$ at U_{Rdc} (see also application note)	250 V version 70 V/ μs 400 V version 110 V/ μs		
R between terminations, for $C \leq 0.33 \mu\text{F}$	>30 000 M Ω		
RC between terminations, for $C > 0.33 \mu\text{F}$	>10 000 s		
R between interconnected terminations and case (foil method)	>30 000 M Ω		

 $U_{Rdc} = 400 \text{ V}$ $U_{Rac} = 220 \text{ V}$ **loose in box**

Cap. (μF)	$b_{\max} \times h_{\max} \times l_{\max}$ (mm)	mass (g)	CATALOGUE NUMBER 2222 366			
			$l_1 = 17 \pm 4.0 \text{ mm}$		$l_1 = 4 + 10/-0.5 \text{ mm}$	
			C-tol $\pm 10\%$	C-tol $\pm 5\%$	C-tol $\pm 10\%$	C-tol $\pm 5\%$
Pitch = $7.62 \pm 0.3 \text{ mm}$						
0.0033	4.0 x 12.0 x 10.0	0.4	51332	52332	55332	56332
0.0039			51392	52392	55392	56392
0.0047			51472	52472	55472	56472
0.0056	4.0 x 13.0 x 10.0	0.4	51562	52562	55562	56562
0.0068			51682	52682	55682	56682
0.0082			51822	52822	55822	56822
0.010			51103	52103	55103	56103
0.012			51123	52123	55123	56123
0.015			51153	52153	55153	56153

Lead length $3 \pm 0.4 \text{ mm}$ available with code 2222 366 58... for 10% and 2222 366 59... for 5% version.

SMALLEST PACKING QUANTITIES (SPQ)	$l_1 = 17 \text{ mm}$	$l_1 = 4 \text{ mm}$
DIMENSIONS	SPQ	SPQ
4.0 x 12.0 x 10.0	1000	1000
4.0 x 13.0 x 10.0	1000	1000

Metallized POLYESTER film capacitors

MKT 367



Pitch 5

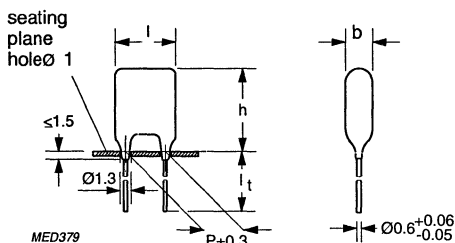

$U_{Rdc} = 63 V$

$U_{Rac} = 40 V$

loose in box

Cap. (μF)	$b_{max} \times h_{max} \times l_{max}$ (mm)	mass (g)	CATALOGUE NUMBER 2222 367					
			loose in box					
			$l_t = 22 \pm 4 \text{ mm}$			$l_t = 4 + 1.0/-0.5 \text{ mm}$		
			C-tol $\pm 20\%$	C-tol $\pm 10\%$	C-tol $\pm 5\%$	C-tol $\pm 20\%$	C-tol $\pm 10\%$	C-tol $\pm 5\%$
Pitch = $5.08 \pm 0.3 \text{ mm}$								
0.047	3.5 x 7.5 x 7.5	0.3	70473	71473	72473	74473	75473	76473
0.056			70563	71563	72563	74563	75563	76563
0.068			70683	71683	72683	74683	75683	76683
0.082			70823	71823	72823	74823	75823	76823
0.1			70104	71104	72104	74104	75104	76104
0.12			70124	71124	72124	74124	75124	76124
0.15	4.0 x 8.0 x 7.5	0.3	70154	71154	72154	74154	75154	76154
0.18	4.5 x 8.5 x 7.5	0.3	70184	71184	72184	74184	75184	76184
0.22			70224	71224	72224	74224	75224	76224
0.27	5.0 x 9.0 x 7.5	0.4	70274	71274	72274	74274	75274	76274
0.33	5.5 x 9.5 x 7.5	0.4	70334	71334	72334	74334	75334	76334
0.39	5.5 x 10.5 x 7.5	0.4	70394	71394	72394	74394	75394	76394
0.47	6.0 x 11.5 x 7.5	0.4	70474	71474	72474	74474	75474	76474
0.56	5.5 x 10.0 x 7.5	0.4	70564	71564	72564	74564	75564	76564
0.68	5.5 x 10.5 x 7.5	0.4	70684	71684	72684	74684	75684	76684
0.82	6.0 x 11.0 x 7.5	0.5	70824	71824	72824	74824	75824	76824
1	6.5 x 11.5 x 7.5	0.5	70105	71105	72105	74105	75105	76105

SMALLEST PACKING QUANTITIES (SPQ)	$l_t = 22 \text{ mm}$	$l_t = 4 \text{ mm}$
DIMENSIONS	SPQ	SPQ
all dimensions	1000	1000

Metallized POLYESTER film capacitors

MKT 367



Pitch 5

SPECIFIC REFERENCE DATA FOR 63 V DC and 100 V DC

Tangent of loss angle	at 1 kHz	at 10 kHz	at 100 kHz
$C \leq 0.1 \mu\text{F}$	$\leq 75 \cdot 10^{-4}$	$\leq 130 \cdot 10^{-4}$	$\leq 225 \cdot 10^{-4}$
$0.1 \mu\text{F} < C \leq 0.47 \mu\text{F}$	$\leq 75 \cdot 10^{-4}$	$\leq 130 \cdot 10^{-4}$	$\leq 300 \cdot 10^{-4}$
$0.47 \mu\text{F} < C \leq 1.0 \mu\text{F}$	$\leq 75 \cdot 10^{-4}$	$\leq 130 \cdot 10^{-4}$	–
Rated voltage pulse slope $(dU/dt)_R$ at U_{Rdc} (see also application note)	110 V/ μs		
R between terminations, for $C \leq 0.33 \mu\text{F}$	>15 000 M Ω		
RC between terminations, for $C > 0.33 \mu\text{F}$	>5000 s		
R between interconnected terminations and case (foil method)	>30 000 M Ω		

 $U_{Rdc} = 100 \text{ V}$ $U_{Rac} = 63 \text{ V}$

loose in box

Cap. (μF)	$b_{\text{max}} \times h_{\text{max}} \times l_{\text{max}}$ (mm)	mass (g)	CATALOGUE NUMBER 2222 367							
			loose in box							
			$l_t = 22 \pm 4 \text{ mm}$			$l_t = 4 +1/-0.5 \text{ mm}$				
			C-tol $\pm 20\%$	C-tol $\pm 10\%$	C-tol $\pm 5\%$	C-tol $\pm 20\%$	C-tol $\pm 10\%$	C-tol $\pm 5\%$		
Pitch = 5.08 \pm 0.3 mm										
0.01	3.5 x 7.5 x 7.5	0.3	80103	81103	82103	84103	85103	86103		
0.012			80123	81123	82123	84123	85123	86123		
0.015			80153	81153	82153	84153	85153	86153		
0.018			80183	81183	82183	84183	85183	86183		
0.022			80223	81223	82223	84223	85223	86223		
0.027			80273	81273	82273	84273	85273	86273		
0.033			80333	81333	82333	84333	85333	86333		
0.039			80393	81393	82393	84393	85393	86393		
0.047			80473	81473	82473	84473	85473	86473		
0.056			80563	81563	82563	84563	85563	86563		
0.068			80683	81683	82683	84683	85683	86683		
0.082			4.0 x 8.0 x 7.5	0.3	80823	81823	82823	84823	85823	86823
0.10			4.5 x 8.5 x 7.5	0.4	80104	81104	82104	84104	85104	86104

SMALLEST PACKING QUANTITIES (SPQ)	$l_t = 22 \text{ mm}$	$l_t = 4 \text{ mm}$
DIMENSIONS	SPQ	SPQ
3.5 x 7.5 x 7.5	1000	1000
4.0 x 8.0 x 7.5	1000	1000
4.5 x 8.5 x 7.5	1000	1000

**Metallized POLYESTER
film capacitors**

MKT 367



Pitch 7.5

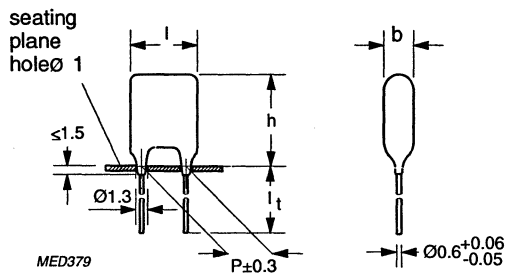

$U_{Rdc} = 63 V$

$U_{Rac} = 40 V$

loose in box

Cap. (μF)	$b_{max} \times h_{max} \times l_{max}$ (mm)	mass (g)	CATALOGUE NUMBER 2222 367			
			$l_t = 22 \pm 4.0$ mm		$l_t = 4 +1/-0.5$ mm	
			C-tol $\pm 10\%$	C-tol $\pm 5\%$	C-tol $\pm 10\%$	C-tol $\pm 5\%$
Pitch = 7.62 ± 0.3 mm						
0.12	4.0 x 8.0 x 10.0	0.4	11124	12124	15124	16124
0.15			11154	12154	15154	16154
0.18			11184	12184	15184	16184
0.22			11224	12224	15224	16224
0.27	4.5 x 8.5 x 10.5	0.5	11274	12274	15274	16274
0.33	5.0 x 9.0 x 10.5	0.5	11334	12334	15334	16334
0.39	5.0 x 9.0 x 10.5	0.6	11394	12394	15394	16394
0.47	5.5 x 9.5 x 10.5	0.7	11474	12474	15474	16474
0.56	5.5 x 10.0 x 10.5	0.7	11564	12564	15564	16564
0.68			11684	12684	15684	16684
0.82			11824	12824	15824	16824
1			11105	12105	15105	16105

SMALLEST PACKING QUANTITIES (SPQ)	$l_t = 17$ mm	$l_t = 4$ mm
DIMENSIONS	SPQ	SPQ
all dimensions	1000	1000

**Metalized POLYESTER
film capacitors**

MKT 367



Pitch 7.5

SPECIFIC REFERENCE DATA FOR 63 V DC and 100 V DC

Tangent of loss angle	at 1 kHz	at 10 kHz	at 100 kHz
$C \leq 0.1 \mu\text{F}$	$\leq 75 \cdot 10^{-4}$	$\leq 130 \cdot 10^{-4}$	$\leq 225 \cdot 10^{-4}$
$0.1 \mu\text{F} < C \leq 0.47 \mu\text{F}$	$\leq 75 \cdot 10^{-4}$	$\leq 130 \cdot 10^{-4}$	$\leq 300 \cdot 10^{-4}$
$0.47 \mu\text{F} < C \leq 1.0 \mu\text{F}$	$\leq 75 \cdot 10^{-4}$	$\leq 130 \cdot 10^{-4}$	-
Rated voltage pulse slope $(dU/dt)_R$ at U_{Rdc} (see also application note)	63 V version 18 V/ μs		100 V version 36 V/ μs
R between terminations, for $C \leq 0.33 \mu\text{F}$	>15 000 M Ω		
RC between terminations, for $C > 0.33 \mu\text{F}$	>5000 s		
R between interconnected terminations and case (foil method)	>30 000 M Ω		

$U_{Rdc} = 100 \text{ V}$

$U_{Rac} = 63 \text{ V}$

loose in box

Cap. (μF)	$b_{max} \times h_{max} \times l_{max}$ (mm)	mass (g)	CATALOGUE NUMBER 2222 367			
			$l_t = 22 \pm 4.0 \text{ mm}$		$l_t = 4 +1/-0.5 \text{ mm}$	
			C-tol $\pm 10\%$	C-tol $\pm 5\%$	C-tol $\pm 10\%$	C-tol $\pm 5\%$
Pitch = 7.62 \pm 0.3 mm						
0.039	4.0 x 8.0 x 10.0	0.4	21393	22393	25393	26393
0.047			21473	22473	25473	26473
0.056			21563	22563	25563	26563
0.068			21683	22683	25683	26683
0.082			21823	22823	25823	26823
0.10	4.0 x 8.5 x 10.0	0.4	21104	22104	25104	26104
0.12	4.5 x 9.0 x 10.5	0.5	21124	22124	25124	26124
0.15	5.0 x 9.5 x 10.5	0.5	21154	22154	25154	26154
0.18	5.0 x 9.5 x 10.5	0.6	21184	22184	25184	26184
0.22	5.5 x 10.0 x 10.5	0.6	21224	22224	25224	26224
0.27	6.0 x 10.5 x 10.5	0.7	21274	22274	25274	26274
0.33			21334	22334	25334	26334
0.39			21394	22394	25394	26394
0.47			21474	22474	25474	26474

SMALLEST PACKING QUANTITIES (SPQ)	$l_t = 22 \text{ mm}$	$l_t = 4 \text{ mm}$
DIMENSIONS	SPQ	SPQ
all dimensions	1000	1000

**Metallized POLYESTER
film capacitors**

MKT 367



Pitch 7.5

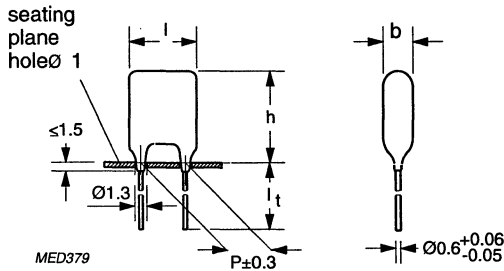

$U_{Rdc} = 250 V$

$U_{Rac} = 160 V$

loose in box

Cap. (μF)	$b_{max} \times h_{max} \times l_{max}$ (mm)	mass (g)	CATALOGUE NUMBER 2222 367			
			$l_t = 22 \pm 4.0$ mm		$l_t = 4 +1/-0.5$ mm	
			C-tol $\pm 10\%$	C-tol $\pm 5\%$	C-tol $\pm 10\%$	C-tol $\pm 5\%$
Pitch = 7.62 ± 0.3 mm						
0.018	4.0 x 8.5 x 10	0.4	41183	42183	45183	46183
0.022			41223	42223	45223	46223
0.027			41273	42273	45273	46273
0.033			41333	42333	45333	46333
0.039			41473	42473	45473	46473
0.047			41473	42473	45473	46473

SMALLEST PACKING QUANTITIES (SPQ)	$l_t = 22$ mm	$l_t = 4$ mm
DIMENSIONS	SPQ	SPQ
4.0 x 8.5 x 10.0	1000	1000

Metallized POLYESTER film capacitors

MKT 367



Pitch 7.5

SPECIFIC REFERENCE DATA FOR 250 V DC and 400 V DC

Tangent of loss angle	at 1 kHz	at 10 kHz	at 100 kHz
$C \leq 0.1 \mu\text{F}$	$\leq 75 \cdot 10^{-4}$	$\leq 130 \cdot 10^{-4}$	$\leq 225 \cdot 10^{-4}$
$0.1 \mu\text{F} < C \leq 0.47 \mu\text{F}$	$\leq 75 \cdot 10^{-4}$	$\leq 130 \cdot 10^{-4}$	$\leq 300 \cdot 10^{-4}$
$0.47 \mu\text{F} < C \leq 1.0 \mu\text{F}$	$\leq 75 \cdot 10^{-4}$	$\leq 130 \cdot 10^{-4}$	—
Rated voltage pulse slope $(dU/dt)_R$ at U_{Rdc} (see also application note)	250 V version 70 V/ μs		400 V version 110 V/ μs
R between terminations, for $C \leq 0.33 \mu\text{F}$	>30 000 M Ω		
R between interconnected terminations and case (foil method)	>30 000 M Ω		

 $U_{Rdc} = 400 \text{ V}$ $U_{Rac} = 220 \text{ V}$

loose in box

Cap. (μF)	$b_{\text{max}} \times h_{\text{max}} \times l_{\text{max}}$ (mm)	mass (g)	CATALOGUE NUMBER 2222 367			
			$l_t = 22 \pm 4.0 \text{ mm}$		$l_t = 4 +1/-0.5 \text{ mm}$	
			C-tol $\pm 10\%$	C-tol $\pm 5\%$	C-tol $\pm 10\%$	C-tol $\pm 5\%$
Pitch = $7.62 \pm 0.3 \text{ mm}$						
0.0033	4.0 x 8.5 x 10	0.4	51332	52332	55332	56332
0.0039			51392	52392	55392	56392
0.0047			51472	52472	55472	56472
0.0056			51562	52562	55562	56562
0.0068			51682	52682	55682	56682
0.0082			51822	52822	55822	56822
0.010			51103	52103	55103	56103
0.012			51123	52123	55123	56123
0.015			51153	52153	55153	56153

SMALLEST PACKING QUANTITIES (SPQ)	$l_t = 22 \text{ mm}$	$l_t = 4 \text{ mm}$
DIMENSIONS	SPQ	SPQ
4.0 x 8.5 x 10.0	1000	1000

**Metallized POLYESTER
film capacitors**

MKT 368



Pitch 10

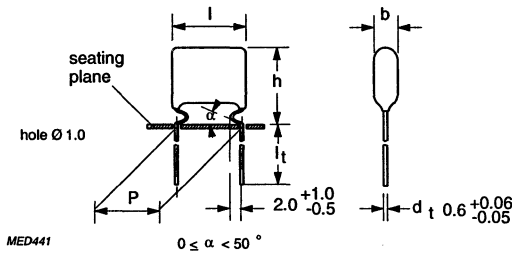

MED441

$U_{Rdc} = 63 V$

$U_{Rac} = 40 V$

loose and taped

Cap. (μF)	$b_{max} \times h_{max} \times l_{max}$ (mm)	mass (g)	CATALOGUE NUMBER 2222 368					
			loose in box				taped on reel	
			$l_t = 4 +1/-0.5 \text{ mm}$		$l_t = 19 \pm 4 \text{ mm}$		$H = 18.5 \text{ mm}^*$	
			C-tol $\pm 10\%$	C-tol $\pm 5\%$	C-tol $\pm 10\%$	C-tol $\pm 5\%$	C-tol $\pm 10\%$	C-tol $\pm 5\%$
Pitch = 10.16 \pm 0.3								
0.22	4.5 x 12.5 x 12.5	0.4	15224	16224	11224	12224	18224	19224
0.27			15274	16274	11274	12274	18274	19274
0.33			15334	16334	11334	12334	18334	19334
0.39			15394	16394	11394	12394	18394	19394
0.47	5.0 x 13.0 x 12.5	0.5	15474	16474	11474	12474	18474	19474
0.56			15564	16564	11564	12564	18564	19564
0.68	5.5 x 13.5 x 12.5	0.5	15684	16684	11684	12684	18684	19684
0.82	6.0 x 14.0 x 12.5	0.6	15824	16824	11824	12824	18824	19824
1.0	6.5 x 14.5 x 12.5	0.7	15105	16105	11105	12105	18105	19105

Lead length 3 \pm 0.4 mm available with code 2222 368 13... for 10% and 2222 368 17... for 5% version.

SMALLEST PACKING QUANTITIES (SPQ)	loose in box		taped on reel
DIMENSIONS	SPQ	SPQ	SPQ
4.5 x 12.5 x 12.5	1000	2000	1300
5.0 x 13.0 x 12.5	1000	2000	1200
5.5 x 13.5 x 12.5	1000	2000	1100
6.0 x 14.0 x 12.5	1000	2000	1000
6.5 x 14.5 x 12.5	1000	2000	900

* H: intape height; for detailed specifications refer to chapter PACKAGING.

Metallized POLYESTER film capacitors

MKT 368



SPECIFIC REFERENCE DATA FOR 63 V DC

Tangent of loss angle	at 1 kHz	at 10 kHz	at 100 kHz
$C \leq 0.1 \mu\text{F}$	$\leq 75 \cdot 10^{-4}$	$\leq 130 \cdot 10^{-4}$	$\leq 225 \cdot 10^{-4}$
$0.1 \mu\text{F} < C \leq 0.47 \mu\text{F}$	$\leq 75 \cdot 10^{-4}$	$\leq 130 \cdot 10^{-4}$	$\leq 300 \cdot 10^{-4}$
$0.47 \mu\text{F} < C \leq 1.0 \mu\text{F}$	$\leq 75 \cdot 10^{-4}$	$\leq 130 \cdot 10^{-4}$	-
Rated voltage pulse slope $(dU/dt)_R$ at URdc (see also application note)	30 V / μs		
R between terminations, for $C \leq 0.33 \mu\text{F}$	>15 000 M Ω		
RC between terminations, for $C > 0.33 \mu\text{F}$	>5000 s		
R between interconnected terminations and case (foil method)	>30 000 M Ω		

**Metallized POLYESTER
film capacitors**

MKT 368



Pitch 10/15/22.5/27.5

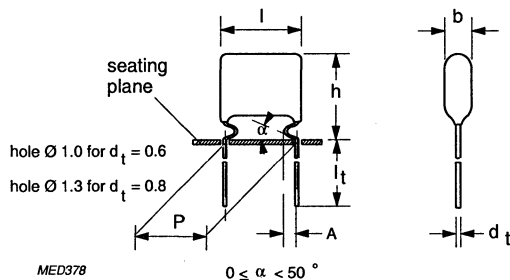

SPECIFIC REFERENCE DATA FOR 100 V DC

Tangent of loss angle	at 1 kHz	at 10 kHz	at 100 kHz
$C \leq 0.1 \mu\text{F}$	$\leq 75 \cdot 10^{-4}$	$\leq 130 \cdot 10^{-4}$	$\leq 250 \cdot 10^{-4}$
$0.1 \mu\text{F} < C \leq 0.47 \mu\text{F}$	$\leq 75 \cdot 10^{-4}$	$\leq 130 \cdot 10^{-4}$	$\leq 300 \cdot 10^{-4}$
$0.47 \mu\text{F} < C \leq 1.0 \mu\text{F}$	$\leq 75 \cdot 10^{-4}$	$\leq 130 \cdot 10^{-4}$	-
Rated voltage pulse slope $(dU/dt)_R$	$P = 10.0 \text{ mm}; 28 \text{ V}/\mu\text{s}$ $P = 22.5 \text{ mm}; 8 \text{ V}/\mu\text{s}$	$P = 15.0 \text{ mm}; 20 \text{ V}/\mu\text{s}$ $P = 27.5 \text{ mm}; 7 \text{ V}/\mu\text{s}$	
R between terminations, for $C \leq 0.33 \mu\text{F}$	$> 15\ 000 \text{ M}\Omega$		
RC between terminations, for $C > 0.33 \mu\text{F}$	$> 5000 \text{ s}$		

SMALLEST PACKING QUANTITIES (SPQ)	loose in box		taped on reel
	$l_t = 4 \text{ mm}$	$l_t = 19 \text{ mm}$	$H = 18.5 \text{ mm}$
DIMENSIONS	SPQ	SPQ	SPQ
4.0 x 12.0 x 12.5	2000	1000	1500
4.5 x 12.5 x 12.5	2000	1000	1300
5.0 x 13.0 x 12.5	2000	1000	1200
5.0 x 14.0 x 17.5	2000	1000	1200
5.5 x 14.5 x 17.5	2000	1000	1100
6.0 x 15.0 x 17.5	2000	1000	1000
6.5 x 15.5 x 17.5	2000	1000	900
7.5 x 16.5 x 17.5	2000	1000	800
6.0 x 18.0 x 26.0	1000	1000	650
6.5 x 19.5 x 26.0	1000	1000	600
7.0 x 20.0 x 26.0	1000	1000	500
8.5 x 21.0 x 26.0	1000	500	450
8.5 x 20.5 x 30.5	500	500	450
9.5 x 21.5 x 30.0	500	500	400
10.5 x 22.5 x 30.0	500	500	350
11.5 x 23.5 x 30.0	500	500	350

Metallized POLYESTER film capacitors

MKT 368

 $U_{Rdc} = 100 \text{ V}$ $U_{Rac} = 63 \text{ V}$

loose and taped

Cap. (μF)	$b_{\max} \times h_{\max} \times l_{\max}$ (mm)	mass (g)	CATALOGUE NUMBER 2222 368					
			loose in box				taped on reel	
			$l_1 = 4 \text{ +1/-0.5 mm}$		$l_1 = 19 \pm 4 \text{ mm}$		$H = 18.5 \text{ mm}^*$	
			C-tol $\pm 10\%$	C-tol $\pm 5\%$	C-tol $\pm 10\%$	C-tol $\pm 5\%$	C-tol $\pm 10\%$	C-tol $\pm 5\%$
Pitch = 10.16 ± 0.3 mm; $d_1 = 0.6 \text{ +0.06/-0.05 mm}$; $A = 2.0 \text{ +1/-0.5 mm}$								
0.056	4.0 x 12.0 x 12.5	0.4	25563	26563	21563	22563	28563	29563
0.068			25683	26683	21683	22683	28683	29683
0.082			25823	26823	21823	22823	28823	29823
0.10			25104	26104	21104	22104	28104	29104
0.12			25124	26124	21124	22124	28124	29124
0.15			25154	26154	21154	22154	28154	29154
0.18	4.5 x 12.5 x 12.5		25184	26184	21184	22184	28184	29184
0.22	5.0 x 13.0 x 12.5	0.5	25224	26224	21224	22224	28224	29224
Pitch = 15.24 ± 0.3 mm; $d_1 = 0.8 \text{ +0.08/-0.05 mm}$; $A = 2.5 \text{ +1.4/-0.5 mm}$								
0.27	5.0 x 14.0 x 17.5	0.6	25274	26274	21274	22274	28274	29274
0.33			25334	26334	21334	22334	28334	29334
0.39			25394	26394	21394	22394	28394	29394
0.47	5.5 x 14.5 x 17.5	0.7	25474	26474	21474	22474	28474	29474
0.56		0.8	25564	26564	21564	22564	28564	29564
0.68	6.0 x 15.0 x 17.5	1	25684	26684	21684	22684	28684	29684
0.82	6.5 x 15.5 x 17.5	1.1	25824	26824	21824	22824	28824	29824
1.0	7.5 x 16.5 x 17.5	1.3	25105	26105	21105	22105	28105	29105
Pitch = 22,86 ± 0.3 mm; $d_1 = 0.8 \text{ +0.08/-0.05 mm}$; $A = 2.5 \text{ +1.4/-0.5 mm}$								
1.2	6.0 x 18.0 x 26.0	1.8	25125	26125	21125	22125	28125	29125
1.5		2.0	25155	26155	21155	22155	28155	29155
1.8		2.3	25185	26185	21185	22185	28185	29185
2.2	6.5 x 19.5 x 26.0	2.8	25225	26225	21225	22225	28225	29225
2.7	7.5 x 20.0 x 26.0	3.2	25275	26275	21275	22275	28275	29275
3.3	8.5 x 21.0 x 26.0	4.0	25335	26335	21335	22335	28335	29335
Pitch = 27.94 ± 0.3 mm; $d_1 = 0.8 \text{ +0.08/-0.05 mm}$; $A = 2.5 \text{ +1.4/-0.5 mm}$								
3.9	8.5 x 20.5 x 30.0	4.5	25395	26395	21395	22395	28395	29395
4.7	9.5 x 21.5 x 30.0	5.2	25475	26475	21475	22475	28475	29475
5.6	10.5 x 22.5 x 30.0	6.0	25565	26565	21565	22565	28565	29565
6.8	11.5 x 23.5 x 30.0	6.5	25685	26685	21685	22685	28685	29685

* H: intape height; for detailed specifications refer to chapter PACKAGING.

Lead length 3 ± 0.4 mm available with code 2222 368 23... for 10% and 2222 368 27... for 5% version.

**Metallized POLYESTER
film capacitors**

MKT 368



Pitch 10/15/22.5/27.5

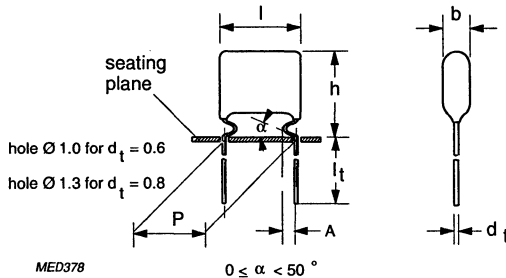

SPECIFIC REFERENCE DATA FOR 250 V DC

Tangent of loss angle	at 1 kHz	at 10 kHz	at 100 kHz
$C \leq 0.47 \mu\text{F}$	$\leq 75 \cdot 10^{-4}$	$\leq 130 \cdot 10^{-4}$	$\leq 225 \cdot 10^{-4}$
$0.47 \mu\text{F} < C \leq 1.0 \mu\text{F}$	$\leq 75 \cdot 10^{-4}$	$\leq 130 \cdot 10^{-4}$	$\leq 300 \cdot 10^{-4}$
$C > 1.0 \mu\text{F}$	$\leq 75 \cdot 10^{-4}$	$\leq 150 \cdot 10^{-4}$	-
Rated voltage pulse slope (dU/dt) _R	P = 10.0 mm; 70 V/μs P = 15.0 mm; 28 V/μs P = 22.5 mm; 12 V/μs P = 27.5 mm; 10 V/μs		
R between terminations, for C ≤ 0.33 μF	>30 000 MΩ		
RC between terminations, for C > 0.33 μF	>10 000 s		
R between interconnected terminations and case (foil method)	>30 000 MΩ		

SMALLEST PACKING QUANTITIES (SPQ)	loose in box		taped on reel
	l _t = 4 mm	l _t = 19 mm	H = 16 mm
DIMENSIONS	SPQ	SPQ	SPQ
4.0 x 12.0 x 12.5	2000	1000	1500
4.5 x 12.5 x 12.5	2000	1000	1300
5.0 x 13.0 x 12.5	2000	1000	1200
5.0 x 14.0 x 17.5	2000	1000	1200
5.5 x 14.5 x 17.5	2000	1000	1100
6.0 x 15.0 x 17.5	2000	1000	1000
6.5 x 15.5 x 17.5	2000	1000	900
7.0 x 16.0 x 17.5	2000	1000	800
5.0 x 17.0 x 26.0	1000	1000	800
5.5 x 17.5 x 26.0	1000	1000	750
6.0 x 18.0 x 26.0	1000	1000	650
6.5 x 18.5 x 26.0	1000	1000	600
7.0 x 19.0 x 26.0	1000	1000	550
7.5 x 19.5 x 26.0	1000	500	500
7.5 x 19.5 x 30.0	500	500	500
8.5 x 20.5 x 30.0	500	500	450
9.5 x 21.5 x 30.0	500	500	400
10.5 x 22.5 x 30.0	500	250	350

Metallized POLYESTER film capacitors

MKT 368

 $U_{Rdc} = 250 V$ $U_{Rac} = 160 V$

loose and taped

Cap. (μF)	$b_{max} \times h_{max} \times l_{max}$ (mm)	mass (g)	CATALOGUE NUMBER 2222 368					
			loose in box				taped on reel	
			$l_1 = 4 \pm 1/-0.5$ mm		$l_1 = 19.0 \pm 4.0$		H = 16.0 mm *	
			C-tol $\pm 10\%$	C-tol $\pm 5\%$	C-tol $\pm 10\%$	C-tol $\pm 5\%$	C-tol $\pm 10\%$	C-tol $\pm 5\%$
Pitch = 10.16 ± 0.3 mm; $d_1 = 0.6 +0.06/-0.05$ mm; A = 2.0 $+1/-0.5$ mm								
0.027	4.0 x 12.0 x 12.5	0.4	45273	46273	41273	42273	48273	49273
0.033			45333	46333	41333	42333	48333	49333
0.039			45393	46393	41393	42393	48393	49393
0.047			45473	46473	41473	42473	48473	49473
0.056	4.5 x 12.5 x 12.5	0.4	45563	46563	41563	42563	48563	49563
0.068			45683	46683	41683	42683	48683	49683
0.082	5.0 x 13.0 x 12.5	0.5	45823	46823	41823	42823	48823	49823
0.10			45104	46104	41104	42104	48104	49104
Pitch = 15.24 ± 0.3 mm; $d_1 = 0.8 +0.08/-0.05$ mm; A = 2.5 $+1.4/-0.5$ mm								
0.12	5.0 x 14.0 x 17.5	0.6	45124	46124	41124	42124	48124	49124
0.15		0.7	45154	46154	41154	42154	48154	49154
0.18	5.5 x 14.5 x 17.5	0.8	45184	46184	41184	42184	48184	49184
0.22	6.0 x 15.0 x 17.5	0.9	45224	46224	41224	42224	48224	49224
0.27	6.5 x 15.5 x 17.5	1.1	45274	46274	41274	42274	48274	49274
0.33	7.0 x 16.0 x 17.5	1.3	45334	46334	41334	42334	48334	49334
Pitch = 22.86 ± 0.3 mm; $d_1 = 0.8 +0.08/-0.05$ mm; A = 2.5 $+1.4/-0.5$ mm								
0.39	5.0 x 17.0 x 26.0	1.8	45394	46394	41394	42394	48394	49394
0.47	5.5 x 17.5 x 26.0	2.1	45474	46474	41474	42474	48474	49474
0.56	6.0 x 18.0 x 26.0	2.5	45564	46564	41564	42564	48564	49564
0.68	6.5 x 18.5 x 26.0	2.9	45684	46684	41684	42684	48684	49684
0.82	7.0 x 19.0 x 26.0	3.3	45824	46824	41824	42824	48824	49824
1.0	7.5 x 19.5 x 26.0	3.6	45105	46105	41105	42105	48105	49105
Pitch = 27.94 ± 0.3 mm; $d_1 = 0.8 +0.08/-0.05$ mm; A = 2.5 $+1.4/-0.5$ mm								
1.2	7.5 x 19.5 x 30.0	4.0	45125	46125	41125	42125	48125	49125
1.5	8.5 x 20.5 x 30.0	5.1	45155	46155	41155	42155	48155	49155
1.8	9.5 x 21.5 x 30.0	5.9	45185	46185	41185	42185	48185	49185
2.2	10.5 x 22.5 x 30.0	6.4	45225	46225	41225	42225	48225	49225

* H: intape height; for detailed specifications refer to chapter PACKAGING.

Lead length 3 ± 0.4 mm available with code 2222 368 43... for 10% and 2222 368 47... for 5% version.

**Metallized POLYESTER
film capacitors**

MKT 368



Pitch 10/15/22.5/27.5

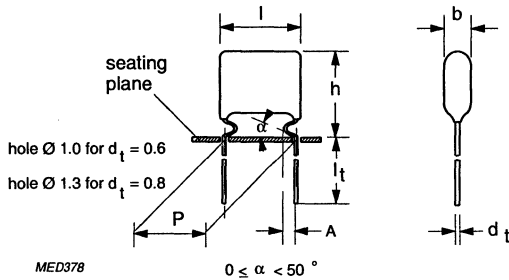

SPECIFIC REFERENCE DATA FOR 400 V DC

Tangent of loss angle	at 1 kHz	at 10 kHz	at 100 kHz
$C \leq 0.1 \mu\text{F}$	$\leq 75 \cdot 10^{-4}$	$\leq 130 \cdot 10^{-4}$	$\leq 225 \cdot 10^{-4}$
$0.1 \mu\text{F} < C \leq 0.47 \mu\text{F}$	$\leq 75 \cdot 10^{-4}$	$\leq 130 \cdot 10^{-4}$	$\leq 300 \cdot 10^{-4}$
$0.47 \mu\text{F} < C \leq 1.0 \mu\text{F}$	$\leq 75 \cdot 10^{-4}$	$\leq 130 \cdot 10^{-4}$	-
Rated voltage pulse slope $(dU/dt)_R$ at U_{Rdc} (see also application note)	P = 10.0 mm; 110 V/ μF P = 15.0 mm; 44 V/ μs P = 22.5 mm; 20 V/ μF P = 27.5 mm; 16 V/ μs		
R between terminations, for $C \leq 0.33 \mu\text{F}$	>30 000 M Ω		
RC between terminations, for $C > 0.33 \mu\text{F}$	>10 000 s		

SMALLEST PACKING QUANTITIES (SPQ)	loose in box		taped on reel
	$l_t = 4.0 \pm 1/-0.5 \text{ mm}$	$l_t = 19 \pm 4.0 \text{ mm}$	H = 16.0 mm
ALL DIMENSIONS	SPQ	SPQ	SPQ
4.0 x 12.0 x 12.5	2000	1000	1500
4.5 x 12.5 x 12.5	2000	1000	1300
5.0 x 14.0 x 17.5	2000	1000	1200
5.5 x 14.5 x 17.5	2000	1000	1100
6.0 x 15.0 x 17.5	2000	1000	1000
6.5 x 15.5 x 17.5	2000	1000	900
7.0 x 16.0 x 17.5	2000	1000	800
5.5 x 17.5 x 26.0	1000	1000	750
6.0 x 18.0 x 26.0	1000	1000	650
6.5 x 18.5 x 26.0	1000	1000	600
6.5 x 19.5 x 26.0	1000	1000	600
7.5 x 19.5 x 26.0	1000	500	500
7.5 x 19.5 x 30.0	500	500	500
8.5 x 20.5 x 30.0	500	500	450
9.0 x 21.0 x 30.0	500	500	400
10.0 x 22.0 x 30.0	500	250	350

Metallized POLYESTER film capacitors

MKT 368

 $U_{Rdc} = 400 V$ $U_{Rac} = 220 V$

loose and taped

Cap. (μF)	$b_{max} \times h_{max} \times l_{max}$ (mm)	mass (g)	CATALOGUE NUMBER 2222 368					
			loose in box				taped on reel	
			$l_1 = 4 \pm 1/-0.5$ mm		$l_1 = 19 \pm 4.0$ mm		$H = 16.0$ mm *	
			C-tol $\pm 10\%$	C-tol $\pm 5\%$	C-tol $\pm 10\%$	C-tol $\pm 5\%$	C-tol $\pm 10\%$	C-tol $\pm 5\%$
Pitch = 10.16 ± 0.3 mm; $d_1 = 0.6 \pm 0.06/-0.05$ mm; $A = 2.0 \pm 1/-0.5$ mm								
0.001	4.0 x 12.0 x 12.5	0.4	55102	56102	51102	52102	58102	59102
0.0012			55122	56122	51122	52122	58122	59122
0.0015			55152	56152	51152	52152	58152	59152
0.0018			55182	56182	51182	52182	58182	59182
0.0022			55222	56222	51222	52222	58222	59222
0.0027			55272	56272	51272	52272	58272	59272
0.0033			55332	56332	51332	52332	58332	59332
0.0039			55392	56392	51392	52392	58392	59392
0.0047			55472	56472	51472	52472	58472	59472
0.0056			55562	56562	51562	52562	58562	59562
0.0068			55682	56682	51682	52682	58682	59682
0.0082			55822	56822	51822	52822	58822	59822
0.010			55103	56103	51103	52103	58103	59103
0.012			55123	56123	51123	52123	58123	59123
0.015			55153	56153	51153	52153	58153	59153
0.018	55183	56183	51183	52183	58183	59183		
0.022	55223	56223	51223	52223	58223	59223		
0.027	4.5 x 12.5 x 12.5	0.4	55273	56273	51273	52273	58273	59273
0.033			55333	56333	51333	52333	58333	59333
Pitch = 15.24 ± 0.3 mm; $d_1 = 0.8 \pm 0.08/-0.05$ mm; $A = 2.5 \pm 1.4/-0.5$ mm								
0.039	4.5 x 13.5 x 17.5	0.6	55393	56393	51393	52393	58393	59393
0.047			55473	56473	51473	52473	58473	59473
0.056			55563	56563	51563	52563	58563	59563
0.068			55683	56683	51683	52683	58683	59683
0.082	5.0 x 14.0 x 17.5	0.8	55823	56823	51823	52823	58823	59823
0.10	5.5 x 14.5 x 17.5	0.9	55104	56104	51104	52104	58104	59104
0.12	6.0 x 15.0 x 17.5	1.1	55124	56124	51124	52124	58124	59124
0.15	6.5 x 15.5 x 17.5	1.3	55154	56154	51154	52154	58154	59154
Pitch = 22.86 ± 0.3 mm; $d_1 = 0.8 \pm 0.08/-0.05$ mm; $A = 2.5 \pm 1.4/-0.5$ mm								
0.18	5.5 x 17.5 x 26.0	1.6	55184	56184	51184	52184	58184	59184
0.22	6.0 x 18.0 x 26.0	1.9	55224	56224	51224	52224	58224	59224
0.27		2.3	55274	56274	51274	52274	58274	59274
0.33		2.6	55334	56334	51334	52334	58334	59334
0.39	6.5 x 18.5 x 26.0	3.0	55394	56394	51394	52394	58394	59394
0.47	7.5 x 19.5 x 26.0	3.4	55474	56474	51474	52474	58474	59474
Pitch = 27.94 ± 0.3 mm; $d_1 = 0.8 \pm 0.08/-0.05$ mm; $A = 2.5 \pm 1.4/-0.5$ mm								
0.56	7.5 x 19.5 x 30.0	3.5	55564	56564	51564	52564	58564	59564
0.68	8.5 x 20.5 x 30.0	4.0	55684	56684	51684	52684	58684	59684
0.82	9.0 x 21.0 x 30.0	4.5	55824	56824	51824	52824	58824	59824
1	10.0 x 22.0 x 30.0	5.0	55105	56105	51105	52105	58105	59105

* H: intape height; for detailed specifications refer to chapter PACKAGING.

Lead length 3 ± 0.4 mm available with code 2222 368 53... for 10% and 2222 368 57... for 5% version

Metallized POLYESTER film capacitors

MKT 368



Pitch 10/15/22.5/27.5

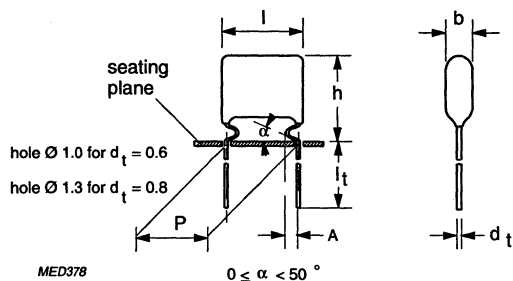

SPECIFIC REFERENCE DATA FOR 630 V DC

Tangent of loss angle	at 1 kHz	at 10 kHz	at 100 kHz
$C \leq 0.1 \mu\text{F}$	$\leq 75 \cdot 10^{-4}$	$\leq 130 \cdot 10^{-4}$	$\leq 250 \cdot 10^{-4}$
$0.1 \mu\text{F} < C \leq 0.47 \mu\text{F}$	$\leq 75 \cdot 10^{-4}$	$\leq 130 \cdot 10^{-4}$	$\leq 300 \cdot 10^{-4}$
Rated voltage pulse slope $(dU/dt)_R$ at U_{Rdc}	$P = 10.0 \text{ mm}; 70 \text{ V}/\mu\text{s}$ $P = 15.0 \text{ mm}; 70 \text{ V}/\mu\text{s}$ $P = 22.5 \text{ mm}; 28 \text{ V}/\mu\text{s}$ $P = 27.5 \text{ mm}; 24 \text{ V}/\mu\text{s}$		
R between terminations, for $C \leq 0.33 \mu\text{F}$	>30 000 M Ω		
RC between terminations, for $C > 0.33 \mu\text{F}$	>10 000 s		
R between interconnected terminations and case (foil method)	>30 000 M Ω		

SMALLEST PACKING QUANTITIES (SPQ)	loose in box		taped on reel
	SPQ		SPQ
	$l_1 = 4 \text{ mm}$	$l_1 = 19 \text{ mm}$	$H = 16 \text{ mm}$
4.5 x 12.5 x 12.5	2000	1000	1300
5.0 x 13.0 x 12.5	2000	1000	1200
5.5 x 13.5 x 12.5	2000	1000	1100
6.0 x 14.0 x 12.5	2000	1000	1000
6.5 x 14.5 x 12.5	2000	1000	900
5.5 x 14.5 x 17.5	2000	1000	1100
6.0 x 15.0 x 17.5	2000	1000	1000
6.5 x 15.5 x 17.5	2000	1000	900
7.0 x 16.0 x 17.5	2000	1000	800
7.5 x 16.5 x 17.5	2000	1000	800
8.0 x 17.0 x 17.5	2000	1000	750
5.5 x 17.5 x 26.0	1000	1000	750
6.0 x 18.0 x 26.0	1000	1000	650
7.0 x 19.0 x 26.0	1000	1000	550
7.5 x 19.5 x 26.0	1000	500	500
8.5 x 20.5 x 26.0	1000	500	450
9.5 x 21.5 x 26.0	1000	500	400
9.0 x 21.0 x 30.0	500	500	450
10.0 x 22.0 x 30.0	500	250	400
11.0 x 23.0 x 30.0	500	250	350
12.0 x 24.0 x 30.0	250	250	350

Metallized POLYESTER film capacitors

MKT 368

 $U_{Rdc} = 630 V$ $U_{Rac} = 220 V$

loose and taped

Cap. (μF)	$b_{max} \times h_{max} \times l_{max}$ (mm)	mass (g)	CATALOGUE NUMBER 2222 368					
			loose in box				taped on reel	
			$l_t = 4 \pm 1/-0.5 \text{ mm}$		$l_t = 19 \pm 4.0$		$H = 16.0 \text{ mm}^*$	
			C-tol $\pm 10\%$	C-tol $\pm 5\%$	C-tol $\pm 10\%$	C-tol $\pm 5\%$	C-tol $\pm 10\%$	C-tol $\pm 5\%$
Pitch = 10.16 ± 0.3 mm; $d_t = 0.6 \pm 0.06/-0.05$ mm; $A = 2.0 \pm 1/-0.5$ mm								
0.01	4.5 x 12.5 x 12.5	0.4	65103	66103	61103	62103	68103	69103
0.012	5.0 x 13.0 x 12.5	0.5	65123	66123	61123	62123	68123	69123
0.015	5.5 x 13.5 x 12.5		65153	66153	61153	62153	68153	69153
0.018	6.0 x 14.0 x 12.5	0.6	65183	66183	61183	62183	68183	69183
0.022	6.5 x 14.5 x 12.5	0.7	65223	66223	61223	62223	68223	69223
Pitch = 15.24 ± 0.3 mm; $d_t = 0.8 \pm 0.08/-0.05$ mm; $A = 2.5 \pm 1.4/-0.5$ mm								
0.027	5.5 x 14.5 x 17.5	0.9	65273	66273	61273	62273	68273	69273
0.033	6.0 x 15.0 x 17.5	1.0	65333	66333	61333	62333	68333	69333
0.039	6.5 x 15.5 x 17.5	1.1	65393	66393	61393	62393	68393	69393
0.047	7.0 x 16.0 x 17.5	1.2	65473	66473	61473	62473	68473	69473
0.056	7.5 x 16.5 x 17.5	1.3	65563	66563	61563	62563	68563	69563
0.068	8.0 x 17.0 x 17.5	1.4	65683	66683	61683	62683	68683	69683
Pitch = 22.86 ± 0.3 mm; $d_t = 0.8 \pm 0.08/-0.05$ mm; $A = 2.5 \pm 1.4/-0.5$ mm								
0.082	5.5 x 17.5 x 26.0	1.8	65823	66823	61823	62823	68823	69823
0.1	6.0 x 18.0 x 26.0	2.1	65104	66104	61104	62104	68104	69104
0.12	7.0 x 19.0 x 26.0	2.5	65124	66124	61124	62124	68124	69124
0.15	7.5 x 19.5 x 26.0	2.9	65154	66154	61154	62154	68154	69154
0.18	8.5 x 20.5 x 26.0	3.2	65184	66184	61184	62184	68184	69184
0.22	9.5 x 21.5 x 26.0	3.5	65224	66224	61224	62224	68224	69224
Pitch = 27.94 ± 0.3 mm; $d_t = 0.8 \pm 0.08/-0.05$ mm; $A = 2.5 \pm 1.4/-0.5$ mm								
0.27	9.0 x 21.0 x 30.0	4.3	65274	66274	61274	62274	68274	69274
0.33	10.0 x 22.0 x 30.0	5.0	65334	66334	61334	62334	68334	69334
0.39	11.0 x 23.0 x 30.0	5.6	65394	66394	61394	62394	68394	69394
0.47	12.0 x 24.0 x 30.0	6.5	65474	66474	61474	62474	68474	69474

* H: intape height; for detailed specifications refer to chapter PACKAGING.

Lead length 3 ± 4.0 mm available with code 2222 368 63... for 10% and 2222 368 67... for 5% version.

**Metallized POLYESTER
film capacitors**

MKT 369



Pitch 10

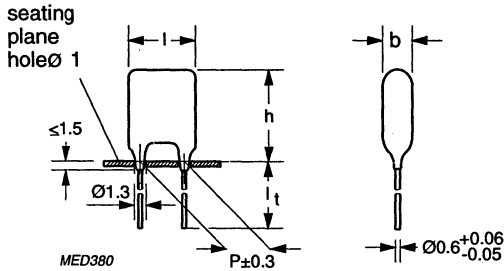

$U_{Rdc} = 63 V$

$U_{Rac} = 40 V$

loose and taped

Cap. (μF)	$b_{max} \times h_{max} \times l_{max}$ (mm)	mass (g)	CATALOGUE NUMBER 2222 369					
			loose in box				taped on reel	
			$l_t = 4 +1/-0.5 \text{ mm}$		$l_t = 22.0 \pm 4.0 \text{ mm}$		$H = 18.5 \text{ mm}^*$	
			C-tol $\pm 10\%$	C-tol $\pm 5\%$	C-tol $\pm 10\%$	C-tol $\pm 5\%$	C-tol $\pm 10\%$	C-tol $\pm 5\%$
Pitch = 10.16 \pm 0.3 mm								
0.22	4.5 x 10.0 x 12.5	0.4	15224	16224	11224	12224	18224	19224
0.27			15274	16274	11274	12274	18274	19274
0.33			15334	16334	11334	12334	18334	19334
0.39			15394	16394	11394	12394	18394	19394
0.47	5.0 x 10.5 x 12.5	0.5	15474	16474	11474	12474	18474	19474
0.56			15564	16564	11564	12564	18564	19564
0.68	5.5 x 11.0 x 12.5	0.5	15684	16684	11684	12684	18684	19684
0.82	6.0 x 11.5 x 12.5	0.6	15824	16824	11824	12824	18824	19824
1.0	6.5 x 12.0 x 12.5	0.7	15105	16105	11105	12105	18105	19105

SMALLEST PACKING QUANTITIES (SPQ)	loose in box		taped on reel
	DIMENSIONS		
	SPQ		SPQ
	$l_t = 4 \text{ mm}$	$l_t = 22 \text{ mm}$	$H = 18.5 \text{ mm}$
4.5 x 10.0 x 12.5	2000	1000	1300
5.0 x 10.5 x 12.5	2000	1000	1200
5.5 x 11.0 x 12.5	2000	1000	1100
6.0 x 11.5 x 12.5	2000	1000	1000
6.5 x 12.0 x 12.5	2000	1000	900

* H: intape height; for detailed specifications refer to chapter PACKAGING.

Metallized POLYESTER film capacitors

MKT 369



SPECIFIC REFERENCE DATA FOR 63 V DC and 100 V DC

Tangent of loss angle	at 1 kHz	at 10 kHz	at 100 kHz
$C \leq 0.1 \mu\text{F}$	$\leq 75 \cdot 10^{-4}$	$\leq 130 \cdot 10^{-4}$	$\leq 225 \cdot 10^{-4}$
$0.1 \mu\text{F} < C \leq 0.47 \mu\text{F}$	$\leq 75 \cdot 10^{-4}$	$\leq 130 \cdot 10^{-4}$	$\leq 300 \cdot 10^{-4}$
$0.47 \mu\text{F} < C \leq 1.0 \mu\text{F}$	$\leq 75 \cdot 10^{-4}$	$\leq 130 \cdot 10^{-4}$	–
Rated voltage pulse slope $(dU/dt)_R$ at U_{Rdc} (see also application note)	63 V version 30 V/ μs 100 V version 28 V/ μs		
R between terminations, for $C \leq 0.33 \mu\text{F}$	>15 000 M Ω		
RC between terminations, for $C > 0.33 \mu\text{F}$	>5000 s		
R between interconnected terminations and case (foil method)	>30 000 M Ω		

 $U_{Rdc} = 100 \text{ V}$ $U_{Rac} = 63 \text{ V}$

loose and taped

Cap. (μF)	$b_{\text{max}} \times h_{\text{max}} \times l_{\text{max}}$ (mm)	mass (g)	CATALOGUE NUMBER 2222 369					
			loose in box				taped on reel	
			$l_t = 4 \pm 1/-0.5 \text{ mm}$		$l_t = 22.0 \pm 4.0 \text{ mm}$		$H = 18.5 \text{ mm}^*$	
			C-tol $\pm 10\%$	C-tol $\pm 5\%$	C-tol $\pm 10\%$	C-tol $\pm 5\%$	C-tol $\pm 10\%$	C-tol $\pm 5\%$
Pitch = 10.16 \pm 0.3 mm								
0.056	4.0 x 9.5 x 12.5	0.4	25563	26563	21563	22563	28563	29563
0.068			25683	26683	21683	22683	28683	29683
0.082			25823	26823	21823	22823	28823	29823
0.10			25104	26104	21104	22104	28104	29104
0.12			25124	26124	21124	22124	28124	29124
0.15			25154	26154	21154	22154	28154	29154
0.18	4.5 x 10.0 x 12.5	0.5	25184	26184	21184	22184	28184	29184
0.22	5.0 x 10.5 x 12.5	0.5	25224	26224	21224	22224	28224	29224

SMALLEST PACKING QUANTITIES (SPQ)	loose in box		taped on reel
	SPQ		SPQ
	$l_t = 4 \text{ mm}$	$l_t = 22 \text{ mm}$	$H = 18.5 \text{ mm}$
4.0 x 9.5 x 12.5	2000	1000	1500
4.5 x 10.0 x 12.5	2000	1000	1300
5.0 x 10.5 x 12.5	2000	1000	1200

* H: intape height; for detailed specifications refer to chapter PACKAGING.

**Metallized POLYESTER
film capacitors**

MKT 369



Pitch 10

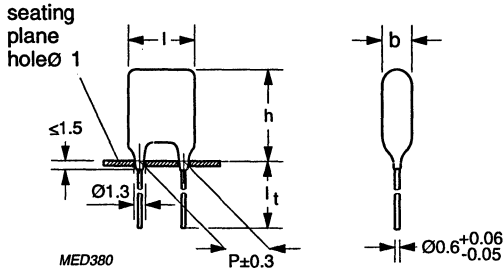

$U_{Rdc} = 250 V$

$U_{Rac} = 160 V$

loose and taped

Cap. (μF)	$b_{max} \times h_{max} \times l_{max}$ (mm)	mass (g)	CATALOGUE NUMBER 2222 369					
			loose in box				taped on reel	
			$l_t = 4 +1/-0.5 \text{ mm}$		$l_t = 22.0 \pm 4.0 \text{ mm}$		$H = 18.5 \text{ mm}^*$	
			C-tol $\pm 10\%$	C-tol $\pm 5\%$	C-tol $\pm 10\%$	C-tol $\pm 5\%$	C-tol $\pm 10\%$	C-tol $\pm 5\%$
Pitch = 10.16 ± 0.3 mm								
0.027	4.0 x 9.5 x 12.5	0.4	45273	46273	41273	42273	48273	49273
0.033			45333	46333	41333	42333	48333	49333
0.039			45393	46393	41393	42393	48393	49393
0.047			45473	46473	41473	42473	48473	49473
0.056	4.5 x 10.0 x 12.5	0.4	45563	46563	41563	42563	48563	49563
0.068			45683	46683	41683	42683	48683	49683
0.082	5.0 x 10.5 x 12.5	0.5	45823	46823	41823	42823	48823	49823
0.10			45104	46104	41104	42104	48104	49104

SMALLEST PACKING QUANTITIES (SPQ)	loose in box		taped on reel
DIMENSIONS	SPQ		SPQ
	$l_t = 4 \text{ mm}$	$l_t = 22 \text{ mm}$	$H = 18.5 \text{ mm}$
4.0 x 9.5 x 12.5	2000	1000	1500
4.5 x 10.0 x 12.5	2000	1000	1300
5.0 x 10.5 x 10.5	2000	1000	1200

* H: intape height; for detailed specifications refer to chapter PACKAGING.

Metallized POLYESTER film capacitors

MKT 369

SPECIFIC REFERENCE DATA FOR 250 V DC and 400 V DC

Tangent of loss angle	at 1 kHz	at 10 kHz	at 100 kHz
$C \leq 0.1 \mu\text{F}$	$\leq 75 \cdot 10^{-4}$	$\leq 130 \cdot 10^{-4}$	$\leq 225 \cdot 10^{-4}$
Rated voltage pulse slope $(dU/dt)_R$ at U_{Rdc} (see application note)	250 V version 70 V/ μs 400 V version 110 V/ μs		
R between terminations, for $C \leq 0.33 \mu\text{F}$	>15 000 M Ω		
RC between terminations, for $C > 0.33$	>5000 s		
R between interconnected terminations and case (foil method)	>30 000 M Ω		

 $U_{Rdc} = 400 \text{ V}$ $U_{Rac} = 220 \text{ V}$

loose and taped

Cap. (μF)	$b_{\text{max}} \times h_{\text{max}} \times l_{\text{max}}$ (mm)	mass (g)	CATALOGUE NUMBER 2222 369					
			loose in box				taped on reel	
			$l_1 = 4 \pm 1/-0.5 \text{ mm}$		$l_1 = 22.0 \pm 4.0 \text{ mm}$		$H = 18.5 \text{ mm}^*$	
			C-tol $\pm 10\%$	C-tol $\pm 5\%$	C-tol $\pm 10\%$	C-tol $\pm 5\%$	C-tol $\pm 10\%$	C-tol $\pm 5\%$
Pitch = 10.16 \pm 0.3 mm								
0.001	4.0 x 9.5 x 12.5	0.4	55102	56102	51102	52102	58102	59102
0.0012			55122	56122	51122	52122	58122	59122
0.0015			55152	56152	51152	52152	58152	59152
0.0018			55182	56182	51182	52182	58182	59182
0.0022			55222	56222	51222	52222	58222	59222
0.0027			55272	56272	51272	52272	58272	59272
0.0033			55332	56332	51332	52332	58332	59332
0.0039			55392	56392	51392	52392	58392	59392
0.0047			55472	56472	51472	52472	58472	59472
0.0056			55562	56562	51562	52562	58562	59562
0.0068			55682	56682	51682	52682	58682	59682
0.0082			55822	56822	51822	52822	58822	59822
0.010			55103	56103	51103	52103	58103	59103
0.012			55123	56123	51123	52123	58123	59123
0.015			55153	56153	51153	52153	58153	59153
0.018			55183	56183	51183	52183	58183	59183
0.022			55223	56223	51223	52223	58223	59223
0.027	4.5 x 10.0 x 12.5	0.4	55273	56273	51273	52273	58273	59273
0.033			55333	56333	51333	52333	58333	59333

SMALLEST PACKING QUANTITIES (SPQ)	loose in box		taped on reel
	SPQ		SPQ
	DIMENSIONS		H = 18.5 mm
	$l_1 = 4 \text{ mm}$	$l_1 = 22 \text{ mm}$	
4.0 x 9.5 x 12.5	2000	1000	1500
4.5 x 10.0 x 12.5	2000	1000	1300

* H: intape height; for detailed specifications refer to chapter PACKAGING.

**Metallized POLYESTER
film capacitors**

MKT 369



Pitch 10

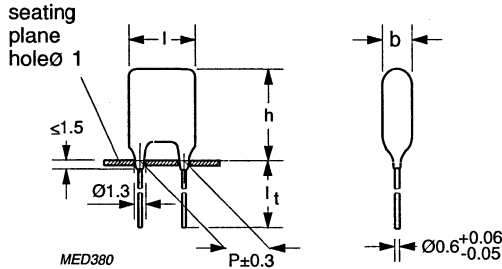

SPECIFIC REFERENCE DATA FOR 630 V DC

Tangent of loss angle	at 1 kHz	at 10 kHz	at 100 kHz
	$\leq 75 \cdot 10^{-4}$	$\leq 130 \cdot 10^{-4}$	$\leq 225 \cdot 10^{-4}$
Rated voltage pulse slope $(dU/dt)_R$ at U_{Rdc} (see application note)	70 V/ μ s		
R between terminations, for $C \leq 0.33 \mu F$	>30 000 M Ω		
RC between terminations, for $C > 0.33 \mu F$	>10 000 s		
R between interconnected terminations and case (foil method)	>30 000 M Ω		

$U_{Rdc} = 630 V$

$U_{Rac} = 220 V$

loose and taped

Cap. (μF)	$b_{max} \times h_{max} \times l_{max}$ (mm)	mass (g)	CATALOGUE NUMBER 2222 369					
			loose in box				taped on reel	
			$l_1 = 4 \pm 1/-0.5$ mm		$l_1 = 22.0 \pm 4.0$ mm		H = 18.5 mm *	
			C-tol $\pm 10\%$	C-tol $\pm 5\%$	C-tol $\pm 10\%$	C-tol $\pm 5\%$	C-tol $\pm 10\%$	C-tol $\pm 5\%$
Pitch = 10.16 \pm 0.3 mm								
0.010	4.5 x 10.0 x 12.5	0.4	65103	66103	61103	62103	68103	69103
0.012	5.0 x 10.5 x 12.5	0.5	65123	66123	61123	62123	68123	69123
0.015	5.5 x 11.0 x 12.5	0.5	65153	66153	61153	62153	68153	69153
0.018	6.0 x 11.5 x 12.5	0.6	65183	66183	61183	62183	68183	69183
0.022	6.5 x 12.0 x 12.5	0.7	65223	66223	61223	62223	68223	69223

SMALLEST PACKING QUANTITIES (SPQ)		loose in box		taped on reel
DIMENSIONS		SPQ		SPQ
		$l_1 = 4$ mm	$l_1 = 22$ mm	H = 18.5 mm
4.5 x 10.0 x 12.5		2000	1000	1300
5.0 x 10.5 x 12.5		2000	1000	1200
5.5 x 11.0 x 12.5		2000	1000	1100
6.0 x 11.5 x 12.5		2000	1000	1000
6.5 x 12.0 x 12.5		2000	1000	900

* H: intape height; for detailed specifications refer to chapter PACKAGING.

Metalized POLYESTER film capacitors

MKT 365/366/367/368/369

RATINGS AND CHARACTERISTICS

Unless otherwise specified all electrical values apply at an ambient temperature of 23 ± 1 °C, an atmospheric pressure of 86 to 106 kPa and a relative humidity of $50 \pm 2\%$.

CAPACITANCE

- All capacitance values are specified at 1 kHz.

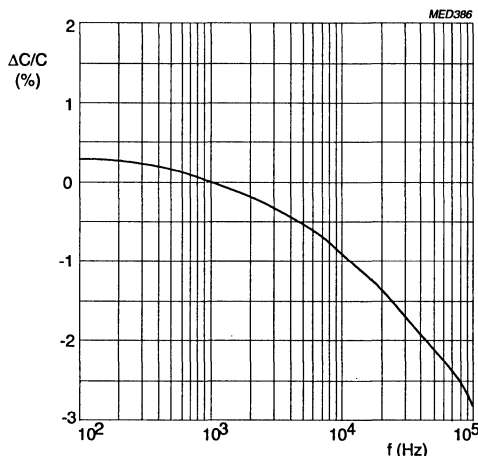

Capacitance as a function of frequency;
typical curve.

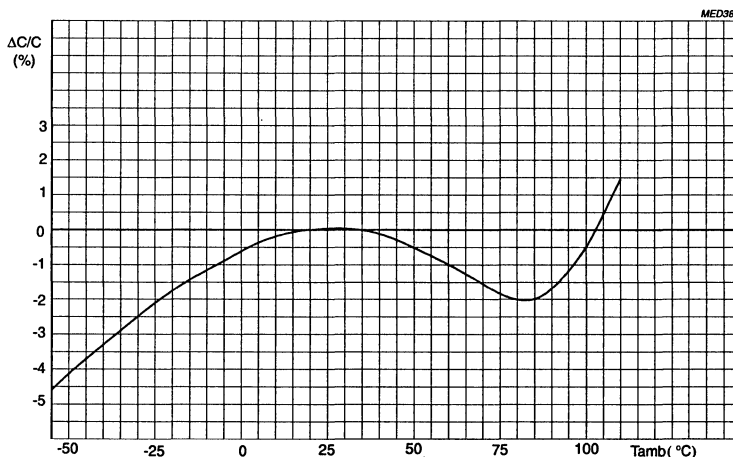

Capacitance as a function of ambient free air temperature,
measured at 1 kHz, 1 V; typical curve.

Metallized POLYESTER film capacitors

MKT 365/366/367/368/369

TEMPERATURE

- Storage temperature: $T_{stg} = -25\text{ °C}$ to $+40\text{ °C}$ with RH maximum 80% without condensation.

VOLTAGE

- Category voltage: $U_c = 0.8 \times U_{Rdc}$
- Test voltage between terminations: $1.6 \times U_{Rdc}$
- Test voltage between interconnected terminations and case (foil method): $2 \times U_{Rdc}$ (minimum 200 V)
- Maximum RMS voltage as a function of frequency: for $T_{amb} \leq 85\text{ °C}$ (see graphs below).

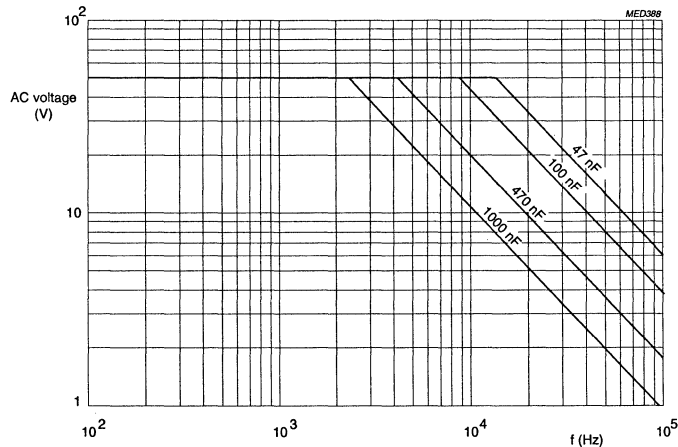

AC voltage (RMS value) as a function of frequency at
 $T_{amb} \leq 85\text{ °C}$ for $U_{Rdc} = 63\text{ V}$ (2222 365 - 366 - 367 types).

**Metallized POLYESTER
film capacitors**

MKT 365/366/367/368/369

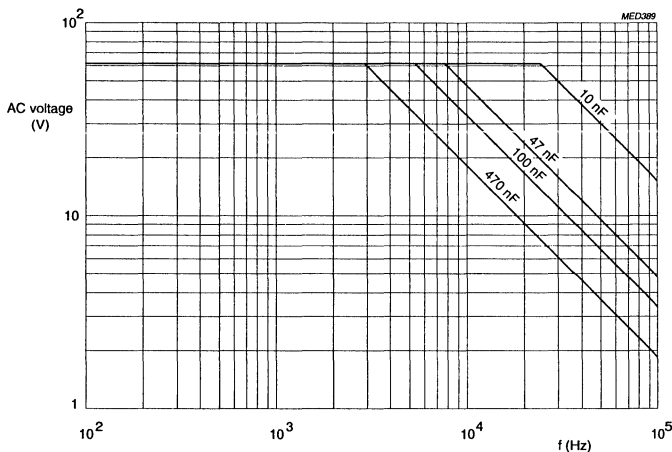

AC voltage (RMS value) as a function of frequency at
 $T_{amb} \leq 85\text{ }^{\circ}\text{C}$ for $U_{Rdc} = 100\text{ V}$ (2222 365 - 366 - 367 types).

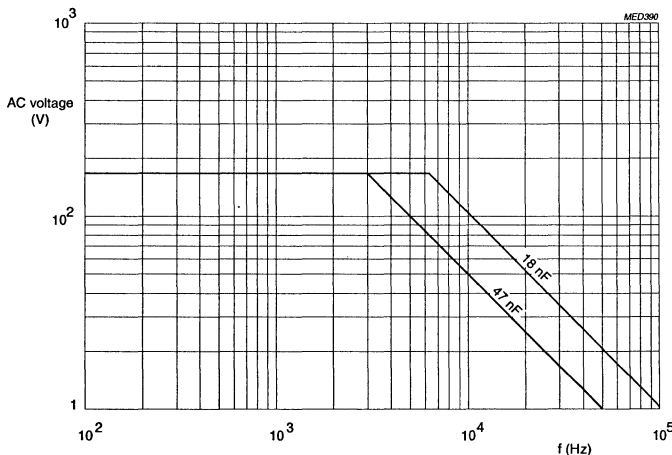

AC voltage (RMS value) as a function of frequency at
 $T_{amb} \leq 85\text{ }^{\circ}\text{C}$ for $U_{Rdc} = 250\text{ V}$ (2222 365 - 366 - 367 types).

**Metallized POLYESTER
film capacitors**

MKT 365/366/367/368/369

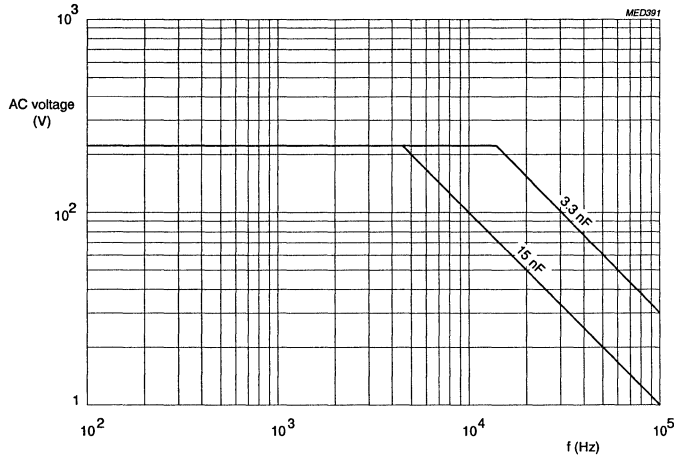

AC voltage (RMS value) as a function of frequency at
 $T_{amb} \leq 85^\circ\text{C}$ for $U_{Rdc} = 400\text{ V}$ (2222 365 - 366 - 367 types).

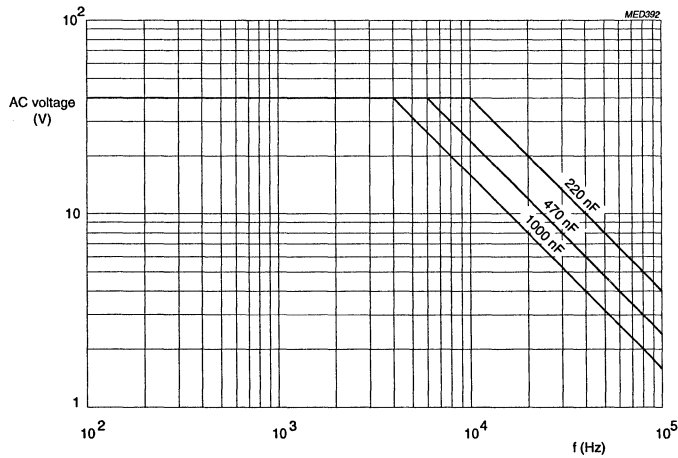

AC voltage (RMS value) as a function of frequency at
 $T_{amb} \leq 85^\circ\text{C}$ for $U_{Rdc} = 63\text{ V}$ (2222 368 - 369 types).

**Metallized POLYESTER
film capacitors**

MKT 365/366/367/368/369

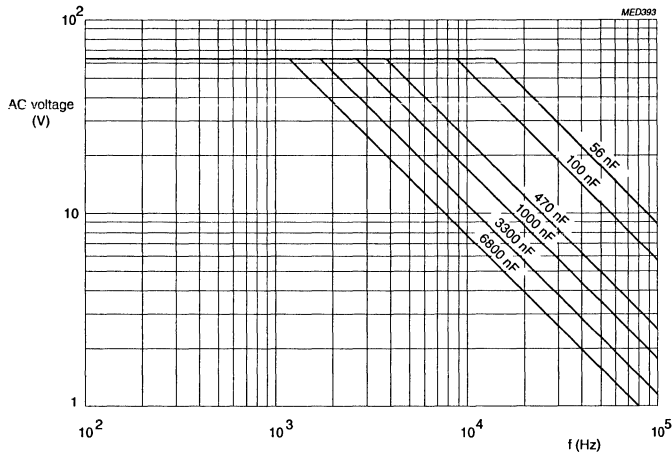

AC voltage (RMS value) as a function of frequency at $T_{amb} \leq 85^\circ\text{C}$ for $U_{Rdc} = 100\text{V}$ (2222 368 - 369 types).

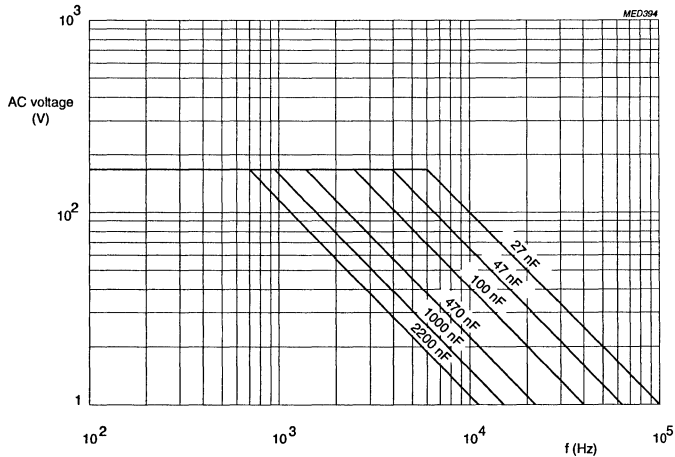

AC voltage (RMS value) as a function of frequency at $T_{amb} \leq 85^\circ\text{C}$ for $U_{Rdc} = 250\text{V}$ (2222 368 - 369 types).

**Metallized POLYESTER
film capacitors**

MKT 365/366/367/368/369

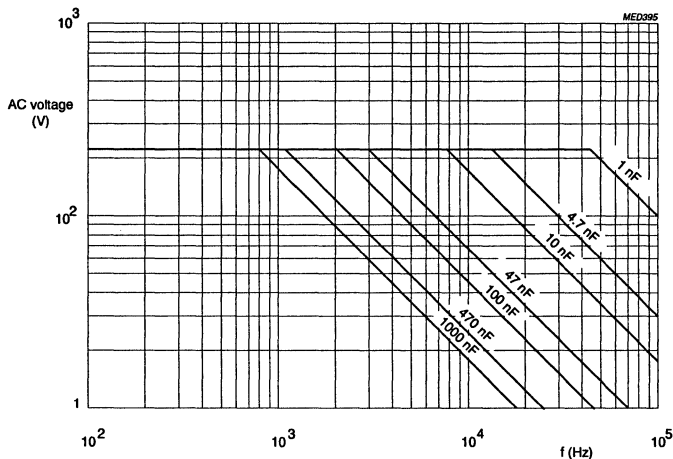

AC voltage (RMS value) as a function of frequency at
 $T_{amb} \leq 85^\circ\text{C}$ for $U_{Rdc} = 400\text{ V}$ (2222 368 - 369 types).

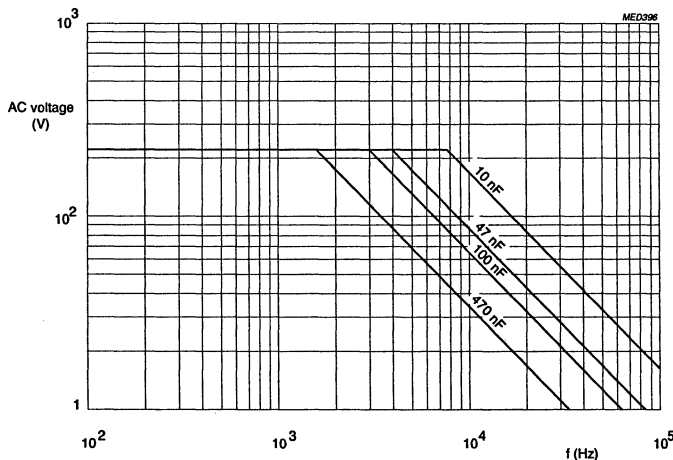

AC voltage (RMS value) as a function of frequency at
 $T_{amb} \leq 85^\circ\text{C}$ for $U_{Rdc} = 630\text{ V}$ (2222 368 - 369 types).

**Metalized POLYESTER
film capacitors**

MKT 365/366/367/368/369

TANGENT VOLTAGE PULSE SLOPE

- Refer to specific reference data for maximum values and measuring frequencies.

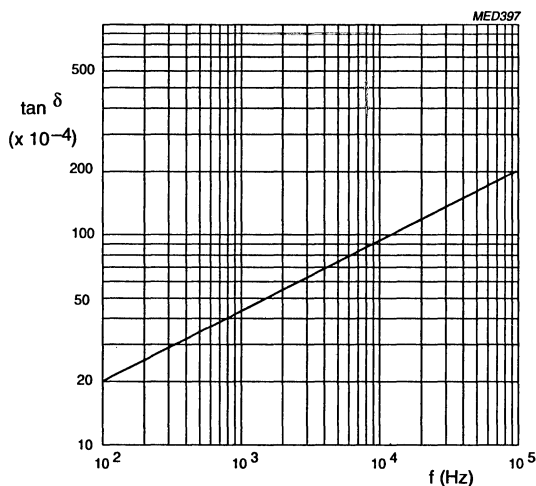

Tangent of the loss angle as a function of frequency; typical curve.

RATED VOLTAGE PULSE SLOPE (dU/dt)_R

The maximum pulse load values are valid for pulse voltages equal to the rated voltage. For lower pulse voltages the given values may be multiplied by U_{Rdc} and divided by the applied voltage.

**Metalized POLYESTER
film capacitors**

MKT 365/366/367/368/369

INSULATION RESISTANCE

The insulation resistance is measured after a voltage has been applied for 1 minute ± 5 seconds, the voltage being 10 ± 1 V for the 63 V version, $100 \text{ V} \pm 15$ V for the 100 V, 250 V and 400 V version and 500 ± 50 V for the 630 V version.

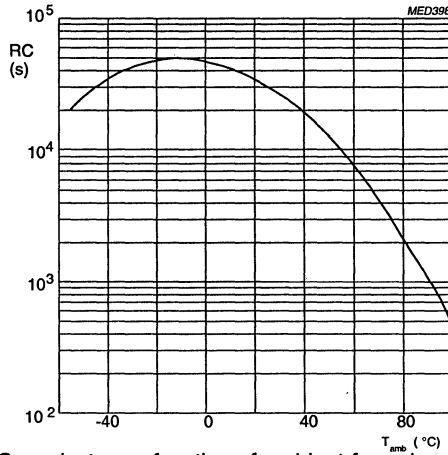

RC-product as a function of ambient free air temperature; typical curve.

R between terminations: for value see specific reference data
 R between interconnected terminations and case (foil method): $>30\,000 \text{ M}\Omega$

**Metallized POLYESTER
film capacitors**

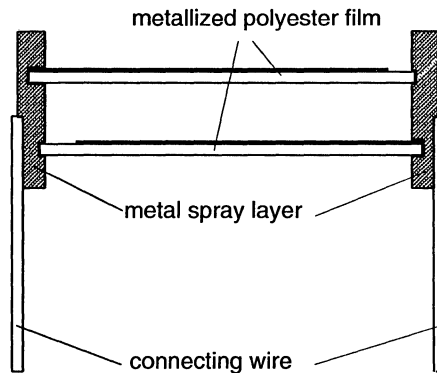
MKT 365/366/367/368/369**GENERAL DATA****CONSTRUCTION**

MED375

DESCRIPTION

- Low-inductive wound cell of metallized polyethyleneterephthalate film
- Protected by a hard, water repellent, solvent resistant epoxy lacquer
- Radial leads, solder-coated.

MOUNTING**Normal use**

The capacitors are designed for mounting on printed-wiring boards. The capacitors packed in bandoliers are designed for mounting on printed-wiring boards by means of automatic insertion machines. For detailed specifications refer to chapter PACKAGING.

Specified method of mounting to withstand vibration and shock

In order to withstand vibration and shock tests, it must be ensured that the underside of the crimps are in good contact with the printed-wiring board.

- For pitches of 15 mm the capacitors shall be mechanically fixed by the leads.
- For larger pitches the capacitors shall be mounted in the same way and the body clamped.

Metallized POLYESTER film capacitors

MKT 365/366/367/368/369

MAXIMUM DISSIPATION

2222 365 - 366 - 367

Curve	Dimensions (mm) $b_{\max} \times l_{\max}$
1	3.5 x 7.5
2	4.0 x 7.5
3	4.5 x 7.5
4	5.0 x 7.5
5	5.5 x 7.5
6	6.0 x 7.5
7	4.0 x 10.0
8	4.5 x 10.5
9	5.0 x 10.5
10	5.5 x 10.5
11	6.0 x 10.5

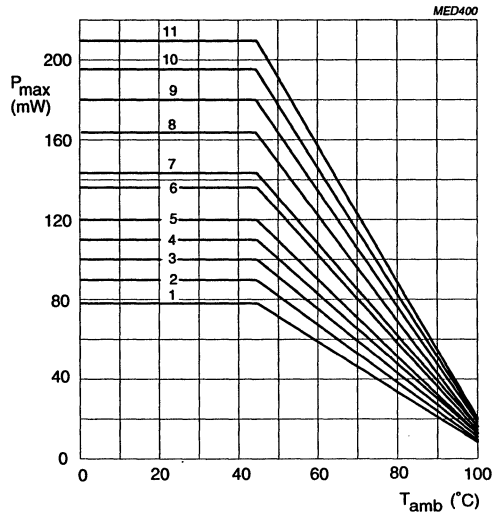

APPLICATION NOTE

To select this capacitor for a certain application, 6 conditions must be checked:

1. The peak voltage (U_p) shall not be greater than the rated DC voltage.
2. The peak to peak voltage (U_{pp}) shall not be greater than $2 \cdot \sqrt{2}$ times the rated AC voltage to avoid the ionisation inception level.
3. The peak current (I_p) shall not exceed the maximum peak current, defined as maximum voltage pulse slope (dU/dt) multiplied by the capacitance.

$$I_{Pmax} = C \left(\frac{dU}{dt} \right)_{\max}$$

Or the voltage pulse slope shall not exceed the rated voltage pulse slope. If the pulse voltage is lower than the rated voltage, the values of the table may be multiplied by U_{Rdc} and divided by the applied voltage.

4. The dissipated power shall not be greater than the maximum permissible power dissipation
5. The free air ambient temperature for the capacitor is not exceeding the category temperature.
6. Since all metallized film capacitors have an intrinsically active flammability risk, it is recommended that these capacitors should only be used in circuits where the power can be limited to less than 5 VA to the capacitor, should a failure occur.

**Metallized POLYESTER
film capacitors**

MKT 365/366/367/368/369

2222 368 - 369

Curve	Dimensions (mm) $b_{max} \times l_{max}$
1	4.0 x 12.5
2	4.5 x 12.5
3	5.0 x 12.5
4	5.5 x 12.5
5	6.0 x 12.5
6	6.5 x 12.5
7	4.5 x 17.5
8	5.5 x 17.5
9	6.0 x 17.5
10	6.5 x 17.5
11	7.0 x 17.5
12	7.5 x 17.5
13	8.0 x 17.5
14	8.5 x 17.5
15	5.0 x 26.0
16	5.5 x 26.0
17	6.0 x 26.0
18	6.5 x 26.0
19	7.0 x 26.0
20	7.5 x 26.0
21	8.0 x 26.0
22	8.5 x 26.0
23	9.0 x 26.0
24	9.5 x 26.0
25	10.0 x 26.0
26	10.5 x 26.0
27	11.0 x 26.0
28	11.5 x 26.0
29	12.0 x 26.0
30	12.5 x 26.0
31	13.0 x 26.0
32	13.5 x 26.0
33	14.0 x 26.0

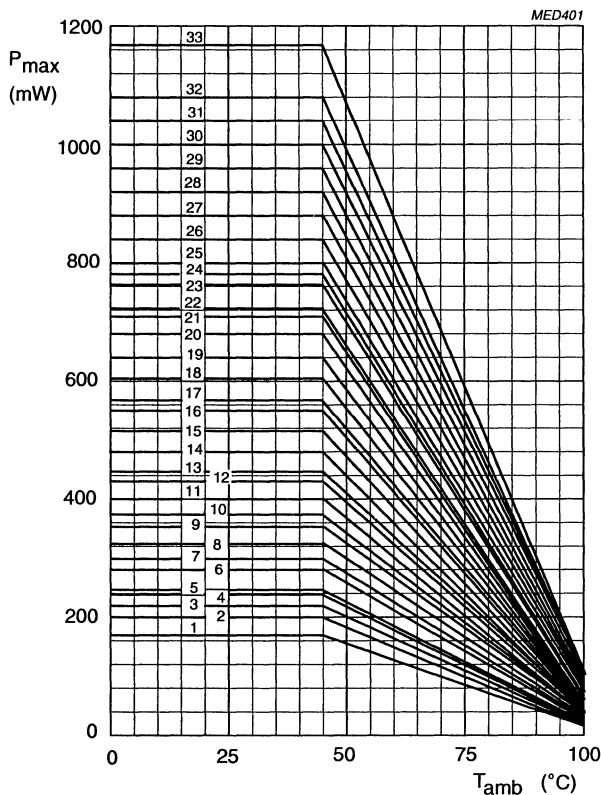

**Metallized POLYESTER
film capacitors**

MKT 365/366/367/368/369

MARKING

The capacitors with a body length ≤ 7.5 mm are marked on the top in black ink with the following information:

- Rated capacitance in pF or μF
- Tolerance on rated capacitance M: 20% K: 10% J: 5 %
- Rated (DC) voltage

Example: 0.047
 K 63

The capacitors with a body length of 10 or 10.5 mm are marked on the top in black ink with the following information:

- Rated capacitance in nF or μF
- Tolerance on rated capacitance M: 20% K: 10% J: 5%
- Rated (DC) voltage

Example: 470 K 100

The capacitors with a body length > 10.5 mm are marked on the top in black ink with the following information:

- Rated capacitance in nF or μF
- Tolerance on rated capacitance M: 20% K: 10% J: 5%
- Rated (DC) voltage
- Manufacturer's symbol





Example:  820 J 100

**Metallized POLYESTER
film capacitors**

MKT 365/366/367/368/369

Package marking

The package containing the capacitors is marked as follows:

PHILIPS COMPONENTS	LINE	MARKING EXPLANATION
MADE IN BELGIUM		
METAL. PETP FILM CAPACITOR	1	Manufacturer's name
MKT RADIAL EPOXY LACQUERED TYPE	2	Country of origin
0.47µF ± 10% 400V= 40/100/56	3	Sub-family
U _L C=0.8 × U _L R	4	Type description
	5	Capacitance value, tolerance, voltage and climatic category (IEC)
 WO: 13884002	6	-
ORIG A170 RPC HQ	7	Preference origin code: A Country of origin in code: 170 (Belgium) Responsible production centre: HQ (Roeselare) WO: work order
 TYPE MKT 368		
-	8	Product type description
 QTY 4000 DATE 9238	9	Quantity and production period, year and week code
 CODENO 2222 368 55474	10	Product code (12NC)

Metallized PPS film capacitors

MKPS 390/391/392/393/394

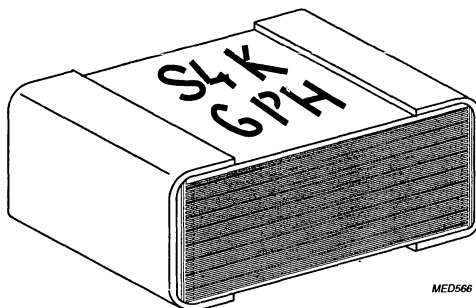
MKPS CHIP CAPACITOR
sizes 1206/1210/1812/2220/2824

MED566
QUICK REFERENCE DATA

Capacitance range (E12-series)	0.22 to 470 nF
Tolerance on capacitance	±5%; ±10%
Rated voltage U_{Rdc}	25 V, 160 V
Rated (AC) voltage	16 V, 100 V
Climatic category	55/125/56
Rated temperature	100 °C
Maximum application temperature	125 °C
Tangent of the loss angle at 100 kHz	$25 \cdot 10^{-4}$
Reference specification	IEC 384-1; 40(secr)644 EN 132500 (DRAFT)
Performance grade	Grade 2

FEATURES

- Self-encased chip capacitor for surface mounting
- Stacked metallized non-flammable film cell
- Solder coated terminations
- Can withstand solvents without damage
- Sizes 1206, 1210, 1812, 2220, 2824
- Taped versions for automatic placement.

APPLICATION

- Blocking and coupling
- Tuning; in data processing and telecommunication equipment.

**Metallized PPS
film capacitors**

MKPS 390/391/392/393/394

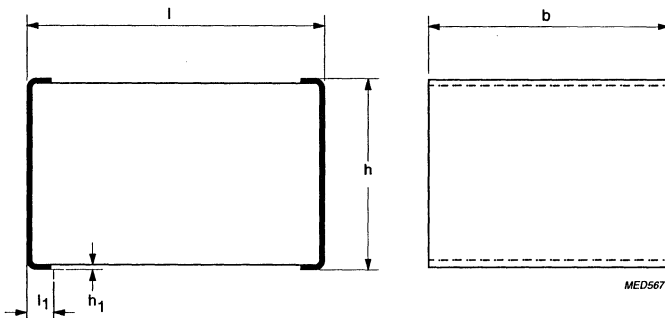

SPECIFIC REFERENCE DATA FOR 25 V AND 160 V DC

Tangent of loss angle	1 kHz	10 kHz	100 kHz
$C \leq 0.1 \mu\text{F}$	$\leq 20 \cdot 10^{-4}$	$\leq 25 \cdot 10^{-4}$	$\leq 35 \cdot 10^{-4}$
$C > 0.1 \mu\text{F}$	$\leq 20 \cdot 10^{-4}$	$\leq 25 \cdot 10^{-4}$	$\leq 50 \cdot 10^{-4}$
Rated voltage pulse slope $(dU/dt)_R$	size 1206 40 V/ μs	size 1210 40 V/ μs	size 1812 30 V/ μs
	size 2220 20 V/ μs	size 2824 15 V/ μs	
R between terminations, for $C \leq 0.33 \mu\text{F}$	>3750 M Ω		
RC between terminations, for $C > 0.33 \mu\text{F}$	>1250 s		

SMALLEST PACKING QUANTITIES (SPQ)	BLISTER TAPE ON REEL
CASE SIZES	SPQ
1206	3500
1210	3500
1812	3500
2220	2000
2824	1000

CASE SIZE REFERENCES, DIMENSIONS AND TOLERANCES

CASE SIZE REFERENCE	l (mm)	b (mm)	h_{max} (mm)	l_1 (mm)	h_1 (mm)
1206	3.2 \pm 0.2	1.6 \pm 0.2	1.2	0.7 \pm 0.3	0.10 \pm 0.05
1210	3.2 \pm 0.2	2.5 \pm 0.2	2.0	0.7 \pm 0.3	0.10 \pm 0.05
1812	4.5 \pm 0.2	3.2 \pm 0.2	2.5	0.7 \pm 0.3	0.10 \pm 0.05
2220	5.7 \pm 0.2	5.0 \pm 0.2	4.0	0.7 \pm 0.3	0.10 \pm 0.05
2824	7.2 \pm 0.2	6.1 \pm 0.2	4.8	1.0 \pm 0.3	0.10 \pm 0.05

**Metallized PPS
film capacitors**
MKPS 390/391/392/393/394

 $U_{Rdc} = 25 \text{ V}$
 $U_{Rac} = 16 \text{ V}$
blister tape on reel

CAPACITANCE (μF)	CATALOGUE NUMBER 2222						
	390	391	392	393	394	LAST DIGITS OF CATALOGUE NUMBER	
	CASE SIZE					C-tol $\pm 10\%$	C-tol $\pm 5\%$
	1206 *	1210 *	1812	2220	2824		
h_{max}	h_{max}	h_{max}	h_{max}	h_{max}			
0.00047	1.2					28471	29471
0.00068	1.2					28681	29681
0.0010	1.2	1.4	1.8			28102	29102
0.0015	1.2	1.4	1.8			28152	29152
0.0022	1.2	1.4	1.8			28222	29222
0.0033	1.2	1.4	1.8			28332	29332
0.0047	1.2	1.4	1.8			28472	29472
0.0068		1.4	1.8			28682	29682
0.010		1.4	1.8			28103	29103
0.015		1.8	1.8			28153	29153
0.022			1.8			28223	29223
0.033			1.8	1.8		28333	29333
0.047			2.3	1.8		28473	29473
0.068				1.8		28683	29683
0.10				2.1	1.8	28104	29104
0.15				2.9	1.9	28154	29154
0.22				4.0	2.5	28224	29224
0.33					3.5	28334	29334
0.47					4.8	28474	29474

 $U_{Rdc} = 160 \text{ V}$
 $U_{Rac} = 100 \text{ V}$
blister tape on reel

CAPACITANCE (μF)	CATALOGUE NUMBER 2222						
	390	391	392	393	394	LAST DIGITS OF CATALOGUE NUMBER	
	CASE SIZE					C-tol $\pm 10\%$	C-tol $\pm 5\%$
	1206	1210	1812	2220	2824		
h_{max}	h_{max}	h_{max}	h_{max}	h_{max}			
0.00022	1.0					48221	49221
0.00033	1.0	1.0				48331	49331
0.00047	1.0	1.0				48471	49471
0.00068	1.3	1.0				48681	49681
0.0010		1.2	1.0			48102	49102
0.0015		1.6	1.0			48152	49152
0.0022		2.0	1.2	1.0		48222	49222
0.0033			1.5	1.0		48332	49332
0.0047			1.9	1.1	1.0	48472	49472
0.0068				1.4	1.0	48682	49682
0.010				1.8	1.3	48103	49103
0.015				2.4	1.6	48153	49153
0.022				3.2	2.1	48223	49223
0.033					2.9	48333	49333
0.047					3.9	48473	49473

* under development.

Note: The above table gives our standard range of high-voltage PPS capacitors.
Other combinations of capacitance, size and voltage rating are available on request.



RATINGS AND CHARACTERISTICS

Unless otherwise specified all electrical values apply at an ambient temperature of $23 \pm 1 \text{ }^\circ\text{C}$, an atmospheric pressure of 86 to 106 kPa and a relative humidity of $50 \pm 2\%$.

CAPACITANCE

- All capacitance values are specified at 1 kHz.

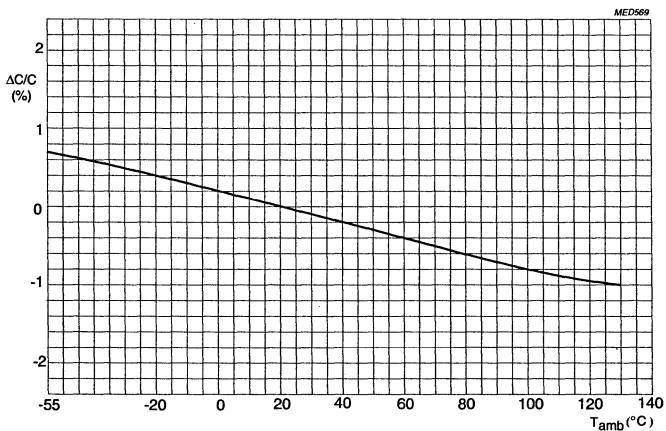
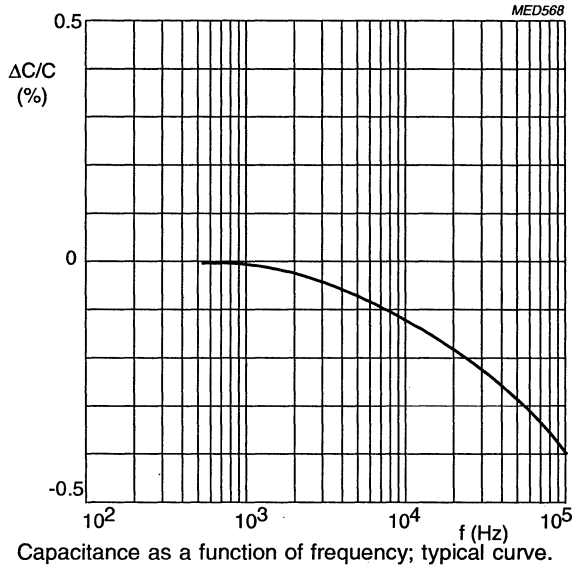

Capacitance as a function of ambient temperature; typical curve.

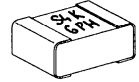

IMPEDANCE

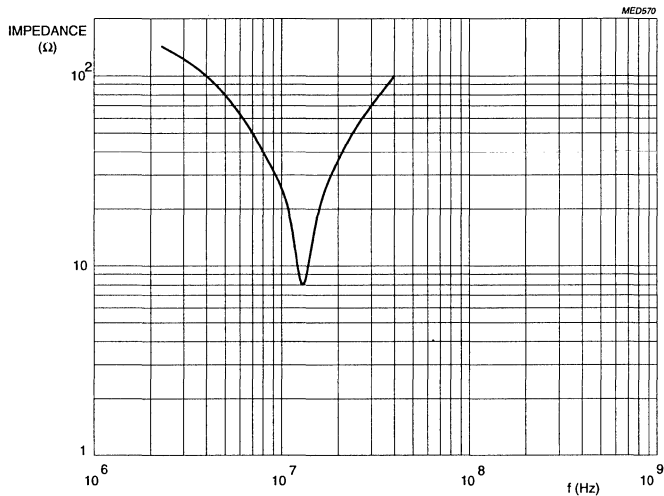

Impedance as a function of frequency: typical curve for 0.047 μF (1812 size).

TEMPERATURE

- Storage temperature: $T_{\text{stg}} = -25$ to $+40$ °C with RH maximum 80% without condensation.

VOLTAGE

- Category voltage: $U_C = 0.8 \times U_{\text{Rdc}}$
- Test voltage between terminations: $1.6 \times U_{\text{Rdc}}$

Note : The sum of the DC voltage and the peak value of the superimposed AC voltage must be $\leq U_{\text{Rdc}}$. For other than sinusoidal wave forms, the maximum dissipation must not be exceeded.



TANGENT OF THE LOSS ANGLE

- For maximum values and measuring frequencies: see specific reference data.

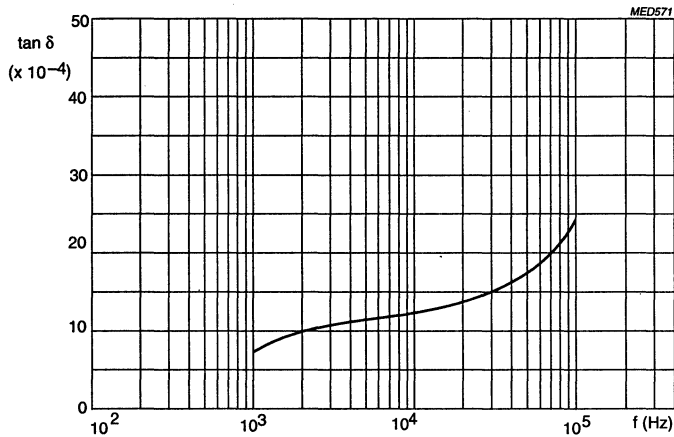

Tangent of the loss angle as a function of frequency;
typical curve.

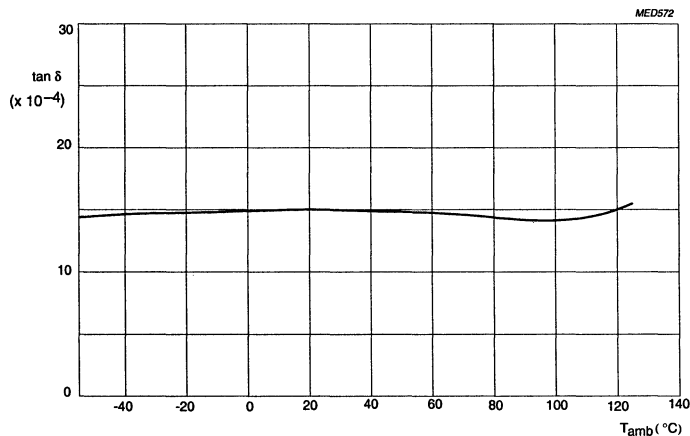

Tangent of the loss angle as a function of ambient
temperature.



RATED VOLTAGE PULSE SLOPE

The maximum pulse load values are valid for pulse voltages equal to the rated voltage. For lower pulse voltages the given values may be multiplied by U_R and divided by the applied voltage.

Note: If the pulse load requirement is satisfied, a check must be made to ascertain that the maximum dissipation is not exceeded.

INSULATION RESISTANCE

The insulation resistance is measured after a voltage of 10 ± 1 V has been applied for 1 minute ± 5 seconds.

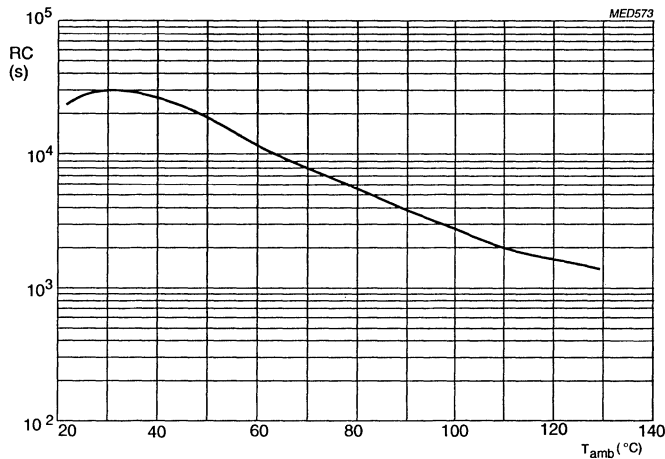

RC-product as a function of ambient free-air temperature;
typical curve.

MOUNTING

The capacitors are designed for surface mounting either by hand or by automatic placement. Soldering can be done by means of reflow or wave soldering.

INTERFERENCE SUPPRESSION

Interference suppression film capacitors

MKT-P 330 4

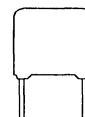

MKT-P RADIAL POTTED CAPACITORS

Pitch 15/22.5/27.5

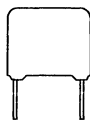

P=15 mm

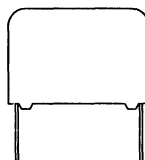
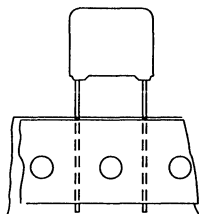

P = 22.5 to 27.5 mm

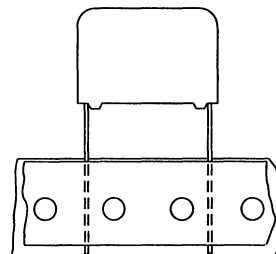

MED470

QUICK REFERENCE DATA

Capacitance range (E6 series) *	0.01 μ F to 1 μ F
Capacitance tolerance	\pm 20%, \pm 10%
Rated voltage U_{Rac} , 50 to 60 Hz	250 V
Climatic category	40/085/21
Application class according to DIN 40040	GPF
Rated temperature	85 °C
Maximum application temperature	85 °C
Reference specification	IEC 384-14
Approval marks	VDE 565-1, IMQ (CEI 40-7), Semko, UL 1283
Materials qualified according to UL	94V-0 (3.2), 94V-1(1.6)
Performance class	X2 **

* Intermediate values of the E12 series are available to special order.

** According to new IEC 384-14.

<p>FEATURES</p> <ul style="list-style-type: none"> • 15 to 27.5 mm terminal pitch • Supplied loose in box and taped on reel. 	<p>APPLICATIONS</p> <p>For radio interference suppression in:</p> <ul style="list-style-type: none"> • small household appliances, e.g. coffee grinders, mixers • general industrial applications, e.g. test and measuring equipment • audio and TV circuits.
---	---

Interference suppression film capacitors

MKT-P 330 4

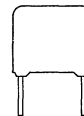

Pitch 15/22.5/27.5

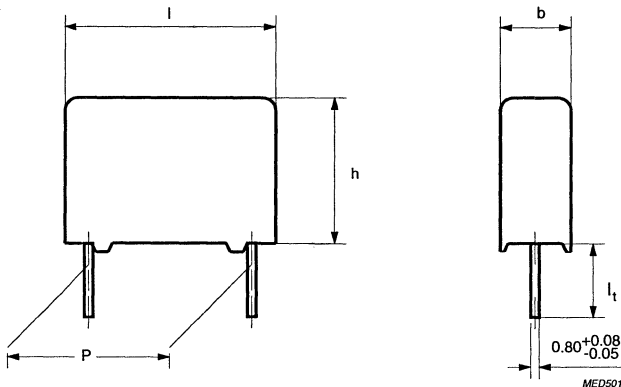

SPECIFIC REFERENCE DATA FOR 250 V AC

Tangent of loss angle	at 1 kHz	at 10 kHz
	$\leq 75 \cdot 10^{-4}$	$\leq 130 \cdot 10^{-4}$
Rated voltage pulse slope $(dU/dt)_R$	100 V/ μ s	
R between terminations, for $C \leq 0.33 \mu\text{F}$	$> 15\,000 \text{ M}\Omega$	
RC between terminations, for $C > 0.33 \mu\text{F}$	$> 5000 \text{ s}$	
Test (DC) voltage	1075 V, 1 s	

SMALLEST PACKING QUANTITIES (SPQ)	loose in box		taped on reel
	$l_t = 5 \text{ mm}$	$l_t = 25 \text{ mm}$	
DIMENSIONS	SPQ	SPQ	SPQ
5.0 x 11.0 x 17.5	1000	1000	1100
6.0 x 12.0 x 17.5	1000	1000	900
7.0 x 13.5 x 17.5	1000	500	800
8.5 x 15.0 x 17.5	1000	500	650
7.0 x 16.5 x 26.0	200	500	550
8.5 x 18.0 x 26.0	200	500	450
10.0 x 19.5 x 26.0	200	500	300
13.0 x 23.0 x 31.0	100	125	250
15.0 x 25.0 x 31.0	100	125	200
18.0 x 28.0 x 31.0	100	125	150

Interference suppression film capacitors

MKT-P 330 4

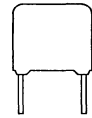
 $U_{Rac} = 250 V$

loose and taped

Cap. (μF)	$b_{max} \times h_{max} \times l_{max}$ (mm)	mass (g)	CATALOGUE NUMBER 2222 330					
			loose in box **				taped on reel	
			$l_1 = 5 \pm 1$		$l_1 = 25 \pm 2$		H = 18.5 mm *	
			C-tol $\pm 20\%$	C-tol $\pm 10\%$	C-tol $\pm 20\%$	C-tol $\pm 10\%$	C-tol $\pm 20\%$	C-tol $\pm 10\%$
Pitch = 15.0 \pm 0.4 mm								
0.010	5.0 x 11.0 x 17.5	1.2	40103	41103	44103	45103	42103	43103
0.015			40153	41153	44153	45153	42153	43153
0.022			40223	41223	44223	45223	42223	43223
0.033			40333	41333	44333	45333	42333	43333
0.047			40473	41473	44473	45473	42473	43473
0.068	7.0 x 13.5 x 17.5	2.0	40683	41683	44683	45683	42683	43683
0.10	8.5 x 15.0 x 17.5	2.6	40104	41104	44104	45104	42104	43104
Pitch = 22.5 \pm 0.4 mm								
0.15	7.0 x 16.5 x 26.0	3.0	40154	41154	44154	45154	42154	43154
0.22	8.5 x 18.0 x 26.0	3.7	40224	41224	44224	45224	42224	43224
0.33	10.0 x 19.5 x 26.0	5.4	40334	41334	44334	45334	42334	43334
Pitch = 27.5 \pm 0.4 mm								
0.47	13.0 x 23.0 x 31.0	10.8	40474	41474	44474	45474	42474	43474
0.68	15.0 x 25.0 x 31.0	12.9	40684	41684	44684	45684	42684	43684
1	18.0 x 28.0 x 31.0	18.2	40105	41105	44105	45105	42105	43105

* H: intape height; for detailed specifications refer to chapter PACKAGING.

** Leadlength between 3.2 mm and 35 mm also available on request.



MED500

APPROVALS

VDE 565-1 class X2	File. No 1016.30-4670-1010
UL 1283	File. No E 109565
SEMKO SS 443 04 14	Reg. No 8325176
IMQ CEI 40-7/1980	Reg. No V 1557

Interference suppression film capacitors

MKT-P 330 4

RATINGS AND CHARACTERISTICS

Unless otherwise specified, all electrical values apply to an ambient free air temperature of 23 ± 1 °C, an atmospheric pressure of 86 to 106 kPa and a relative humidity of $50 \pm 2\%$.

CAPACITANCE

- All capacitance values are specified at 1 kHz.

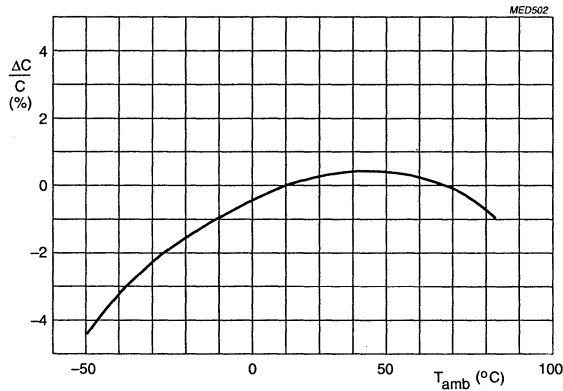

Capacitance as a function of ambient temperature; typical curve.

RESONANT FREQUENCY

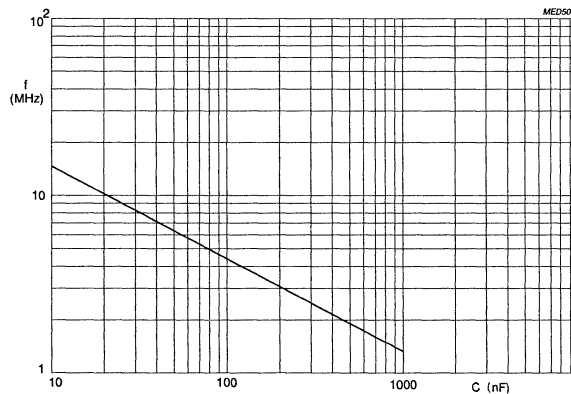

Resonant frequency as a function of capacitance; typical curve.

Interference suppression film capacitors

MKT-P 330 4

TEMPERATURE

- Storage temperature: $T_{stg} = -25\text{ °C}$ to $+40\text{ °C}$ with RH maximum 80% without condensation.

VOLTAGE

- Test voltage between terminations: 1075 V (DC) 100% on line for 1 second
- Test voltage between interconnected terminations and case (foil method): 2000 V (AC)

TANGENT OF THE LOSS ANGLE

- For maximum values and measuring frequencies: see specific reference data.

RATED VOLTAGE PULSE SLOPE $(dU/dt)_R$

For values see specific reference data.

If the pulse voltage is lower than the rated voltage, the values of the specific reference data may be multiplied by U_{Rdc} and divided by the applied voltage.

INSULATION RESISTANCE

The insulation resistance is measured after a voltage of $100\text{ V} \pm 15\text{ V}$ has been applied for 1 minute ± 5 seconds.

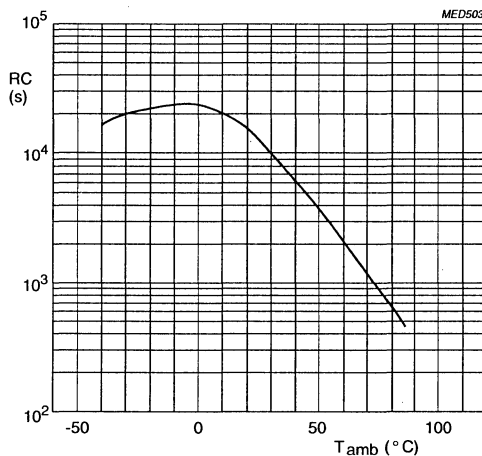

RC-product as a function of ambient free air temperature; typical curve.

R between terminations: for value see specific reference data

R between interconnected terminations and case (foil method): $>30\ 000\ \text{M}\Omega$

Interference suppression film capacitors

MKT-P 330 4

GENERAL DATA

CONSTRUCTION

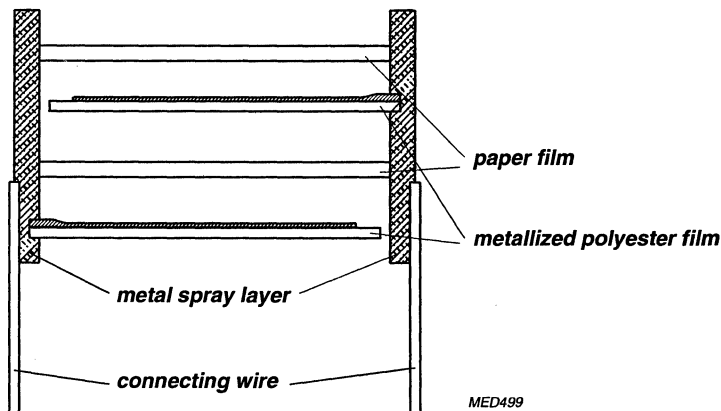

DESCRIPTION

- Low-inductive wound cell of metallized polyethyleneterephthalate (PETP) film and paper film, potted with blue epoxy resin in a blue flame retardent polypropylene case
- Radial leads, solder-coated
- Small stand-off pips allow removal of solder flux etc. during cleaning of the printed-wiring board.

MOUNTING

Normal use

The capacitors are designed for mounting on printed-wiring boards by automatic insertion machines. The capacitors are packed in bandoliers. For detailed specifications refer to chapter PACKAGING.

Specific method of mounting to withstand vibration and shock

In order to withstand vibration and shock tests, it must be ensured that the stand-off pips are in good contact with the printed-wiring board.

- For cases sizes up to and including a mass of 6 g, the capacitors shall be mechanically fixed by the leads.
- With larger case sizes the capacitors shall be mounted in the same way and the body clamped.

Interference suppression film capacitors

MKT-P 330 4

MARKING

Product marking

Capacitors with pitch $P = 15$ mm are marked on the top by embossed print.
Capacitors with pitch $P = 22.5$ mm or 27.5 mm are marked on the top by laser print with the following information:

Manufacturer (PHILIPS)

Manufacturer's type designation (330 4)

Rated capacitance in code according to IEC 62

Rated (AC) voltage (250V~)

Sub-class (X2)

Tolerance on rated capacitance $M = 20\%$

Code for diëlectric material (MKT-P)

Code for factory of origin (HQ)

Year and week of manufacture (e.g. 9210)

Safety approvals

Examples: Capacitors with pitch $P = 15$ mm

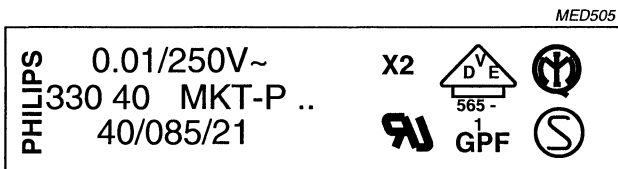

Capacitors with pitch $P = 22.5$ mm or 27.5 mm

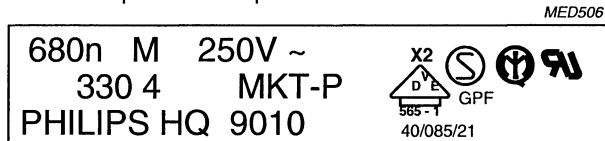

Interference suppression film capacitors

MKT-P 330 4

Package marking

The package containing the capacitors is marked as shown.

PHILIPS COMPONENTS

MADE IN BELGIUM

INTERF. SUPPR. FILM CAPACITOR

MKT-P RADIAL POTTED TYPE X2

0.1 μ F \pm 20% 250V \sim 40/085/21

ORIG A170 RPC HQ



TYPE MKT-P 330 4

-



QTY 4000 DATE 9238



CODENO 2222 330 40104

LINE	MARKING EXPLANATION
1	Manufacturer's name
2	Country of origin
3	Sub-family
4	Type description and sub-class X2
5	Capacitance value in tolerance, voltage and climatic category (IEC)
6	Safety approvals
7	Preference origin code: A Country of origin in code : 170 (Belgium) Responsible production centre : HQ (Roeselare) WO: work order
8	Product type description
9	Quantity and production period, year and week code
10	Product code (12NC)

Interference suppression film capacitors

MKT/MKT 331 6

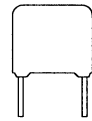

INTERFERENCE SUPPRESSION CAPACITORS

Pitch 15/22.5/27.5

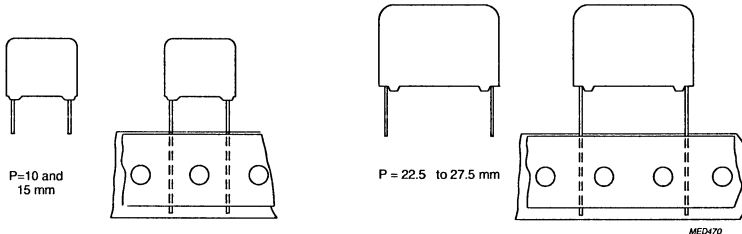

QUICK REFERENCE DATA

Capacitance range (E6 series) *	10 nF to 1 μ F
Capacitance tolerance	$\pm 10\%$, $\pm 20\%$
Rated (AC) voltage 50 to 60 Hz	300 V
Climatic category	55/100/56
Rated temperature	100 °C
Maximum application temperature	100 °C
Reference IEC specification **	40 (central office) 792 (1992-02-21)
Safety approvals ***	VDE 565-1, SEV 1055.1978, IMQ UL1283, N, D, S, FI
Materials qualified according to UL 94	94V-0
Safety class	X2

- Notes:**
- * Intermediate values of the E12 series are available to special order.
 - ** Will replace IEC 384-14 first edition 1981.
 - *** UL, N, D, S and FI pending; product will not be marked with (N,D).

<p>FEATURES</p> <ul style="list-style-type: none"> • 15 to 27.5 mm pitch • Supplied loose in box and taped on reel • Consist of a low-inductive wound cell of metallized polyester film • Potted in a flame retardent case • SEV approved for 3 kV pulse test. 	<p>APPLICATIONS</p> <ul style="list-style-type: none"> • For X2-electromagnetic interference suppression • Specially designed to meet the NEW REQUIREMENTS in accordance with 40 (C.O.) 792 the new IEC 384-14 specification, requiring a 2.5 KV peak pulse voltage test • Designed for 300 V AC applications.
--	--

**Interference suppression
film capacitors**

MKT/MKT 331 6

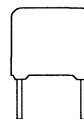

Pitch 15/22.5/27.5

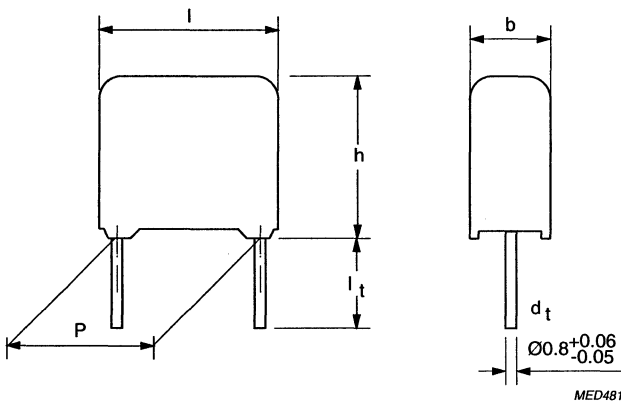

MED481

SPECIFIC REFERENCE DATA FOR 300 V AC

Tangent of loss angle	at 1 kHz	at 10 kHz	at 100 kHz
C ≤ 470 nF	≤75·10 ⁻⁴	≤130·10 ⁻⁴	≤300·10 ⁻⁴
C > 470 nF	≤75·10 ⁻⁴	≤130·10 ⁻⁴	
Rated voltage pulse slope (dU/dt) _R	P = 15 mm 200 V/μs	P = 22.5 mm 120 V/μs	P = 27.5 mm 100 V/μs
R between terminations for C ≤ 0.33 μF	>30 000 MΩ		
R between terminations for C > 0.33 μF	>10 000 s		
Test (DC) voltage	1075 V, 1 s		

SMALLEST PACKING QUANTITIES (SPQ)	loose in box		taped on reel
	l _t = 3.5 ±0.5 mm	l _t = 25 ±2.0 mm	
DIMENSIONS	SPQ	SPQ	SPQ
5.0 x 11.0 x 17.5	1000	1000	1100
6.0 x 12.0 x 17.5	1000	1000	900
7.0 x 13.5 x 17.5	1000	500	800
8.5 x 15.0 x 17.5	1000	500	650
7.0 x 16.5 x 26.0	200	100	550
8.5 x 18.0 x 26.0	200	100	450
11.0 x 21.0 x 31.0	100	125	300
13.0 x 23.0 x 31.0	100	125	250
15.0 x 25.0 x 31.0	100	125	200
18.0 x 28.0 x 31.0	100	125	150

Interference suppression film capacitors

MKT/MKT 331 6

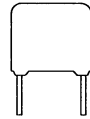
 $U_{Rac} = 300 V$

loose and taped

Cap. (μF)	$b_{max} \times h_{max} \times l_{max}$ (mm)	CATALOGUE NUMBER 2222 331		
		loose in box **		taped on reel
		$l_t = 3.5 \pm 0.5$ mm	$l_t = 25 \pm 2.0$ mm	H = 18.5 mm *
		C-tol *** $\pm 20\%$	C-tol *** $\pm 20\%$	C-tol *** $\pm 20\%$
Pitch = 15 ± 0.4 mm				
0.01	5.0 x 11.0 x 17.5	60103	64103	62103
0.015		60153	64153	62153
0.022		60223	64223	62223
0.033		60333	64333	62333
0.047	6.0 x 12.0 x 17.5	60473	64473	62473
0.068	7.0 x 13.5 x 17.5	60683	64683	62683
0.1	8.5 x 15.0 x 17.5	60104	64104	62104
Pitch = 22.5 ± 0.4 mm				
0.15	7.0 x 16.5 x 26.0	60154	64154	62154
0.22	8.5 x 18.0 x 26.0	60224	64224	62224
Pitch = 27.5 ± 0.4 mm				
0.33	11.0 x 21.0 x 31.0	60334	64334	62334
0.47	13.0 x 23.0 x 31.0	60474	64474	62474
0.68	15.0 x 25.0 x 31.0	60684	64684	62684
1	18.0 x 28.0 x 31.0	60105	64105	62105

* H: intape height: for detailed specifications refer to chapter PACKAGING.

** Lead length between 3.2 and 35 mm also available on special request.

*** $\pm 10\%$ available on request.

SAFETY APPROVALS

VDE 565-1 class X2

FI E384/14

SEV 1055.1978 class X

NEMKO 132

SEMKO SS 443 04 14

IMQ CEI 40-7/1980

UL1283

DEMKO

File No. 1016.30 - 4670 - 1015/A1D

Pending

Reg. No. 92.110908

Pending

Pending

Reg. No. V3416

Pending

Pending



MED472

Interference suppression film capacitors

MKT/MKT 331 6

RATINGS AND CHARACTERISTICS

Unless otherwise specified, all electrical values apply to an ambient free air temperature of 23 ± 1 °C, an atmospheric pressure of 86 to 106 kPa and a relative humidity of $50 \pm 2\%$.

CAPACITANCE

- All capacitance values are specified at 1 kHz.

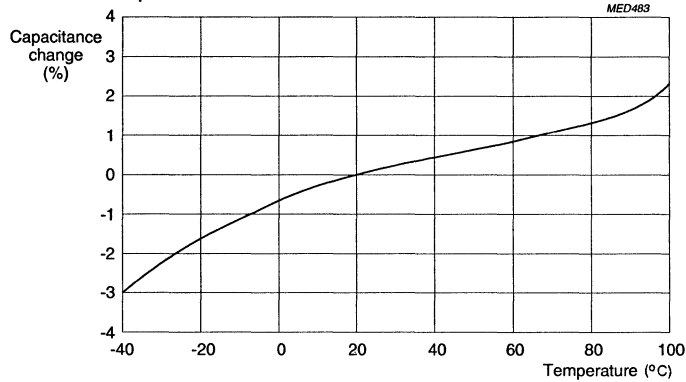

Capacitance change as a function of ambient free air temperature; typical curve.

IMPEDANCE

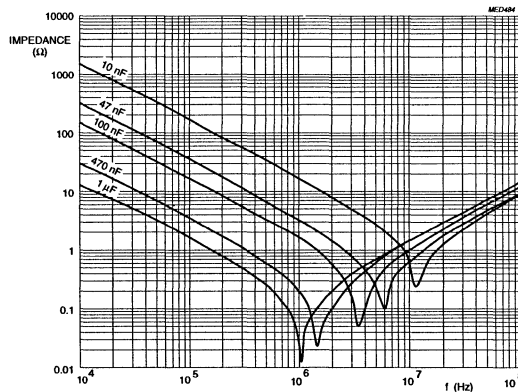

Impedance as a function of frequency; typical curves.

Interference suppression film capacitors

MKT/MKT 331 6

RESONANT FREQUENCY

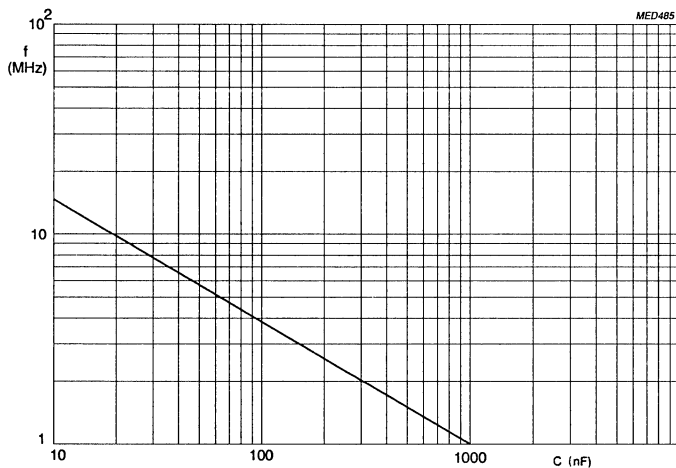

Resonant frequency as a function of capacitance;
typical curve.

TEMPERATURE

- Storage temperature: $T_{\text{stg}} = -25\text{ }^{\circ}\text{C}$ to $+40\text{ }^{\circ}\text{C}$ with RH maximum 80% without condensation.

VOLTAGE

- Test (DC) voltage between terminations, 100% on line for 1 second: 1075 V
- Test (AC) voltage between interconnected terminations and case (foil method): 2000 V.

Interference suppression film capacitors

MKT/MKT 331 6

TANGENT OF THE LOSS ANGLE

- For maximum values and measuring frequencies: see specific reference data.

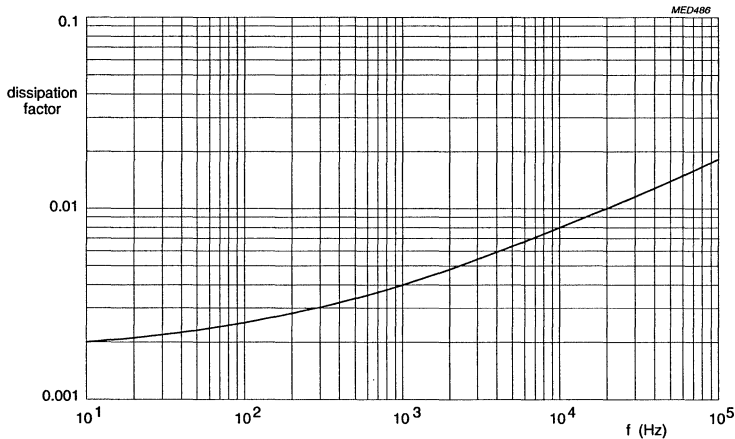

Tangent of the loss angle as a function of frequency; typical curve.

RATED VOLTAGE PULSE SLOPE $(dU/dt)_R$

For values see specific reference data.

If the pulse voltage is lower than the rated voltage, the values of the specific reference data may be multiplied by U_{Rdc} and divided by the applied voltage.

INSULATION RESISTANCE

The insulation resistance is measured after a voltage of 100 ± 15 V has been applied for 1 minute ± 5 seconds at $T_{amb} = 20$ °C.

- R between terminations: for value see specific reference data
- R between interconnected terminations and case (foil method): $>30\,000$ M Ω .

**Interference suppression
film capacitors**

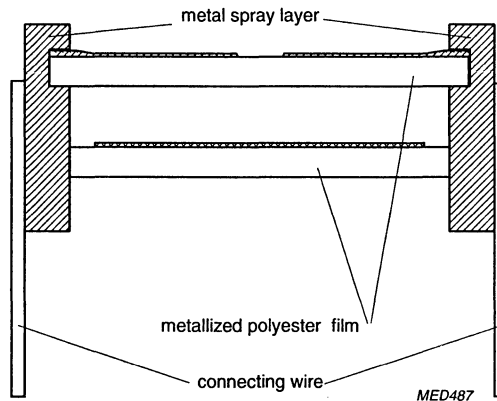
MKT/MKT 331 6**GENERAL DATA****CONSTRUCTION****DESCRIPTION**

- Low-inductive wound cell of metallized polyethyleneterephthalate (PETP) film, potted with blue epoxy resin in a blue flame retardant polypropylene case
- Radial leads, solder-coated wire
- Small stand-off pips allow removal of solder flux etc., during cleaning of the printed-wiring board.

MOUNTING**Normal use**

The capacitors are designed for mounting on printed-wiring boards. The capacitors packed in bandoliers are designed for mounting on printed-wiring boards by automatic insertion machines. For detailed specifications refer to chapter PACKAGING.

Specified method of mounting to withstand vibration and shock

In order to withstand vibration and shock tests, it must be ensured that the stand-off pips are in good contact with the printing-wiring board.

- For pitches of 15 mm capacitors shall be mechanically fixed by the leads.
- For larger pitches the capacitors shall be mounted in the same way and the body clamped.

Interference suppression film capacitors

MKT/MKT 331 6

MARKING

Product marking

Capacitors with a pitch of 15 mm are marked on the top and the side by laser print.
Capacitors with a pitch of 22.5 mm or 27.5 mm are marked on the top by laser print with the following information:

- Manufacturer (PHILIPS)
- Manufacturer's type designation (331 6)
- Rated capacitance in code according to IEC 62
- Rated (AC) voltage (300 V~)
- Sub-class (X2)
- Tolerance on rated capacitance M : 20%
- Code for dielectric material (MKT/MKT)
- Code for factory of origin (HQ)
- Year and week of manufacture (e.g. 9219)
- Safety approvals.

Example of marking for the capacitors with 15 mm pitch.

22n M 300V~X2
331 6 MKT/MKT

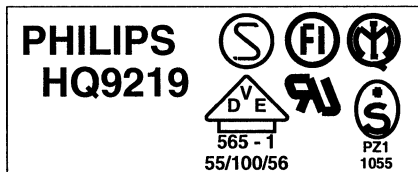

MED488

Marking on the top

Marking on the side

Example of marking for capacitors with 22.5 mm or 27.5 mm pitch.

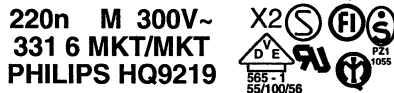

MED488

Marking on the top

**Interference suppression
film capacitors**

MKT/MKT 331 6

Package marking

The package containing the capacitors is marked as shown.

PHILIPS COMPONENTS

MADE IN BELGIUM

INTERF. SUPPR. FILM CAPACITOR

MKT/MKT RADIAL POTTED TYPE

0.01µF ± 20% 300V~ 55/100/56

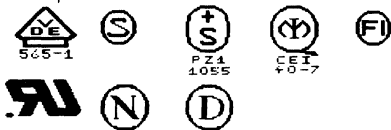

ORIG **A170** RPC **HQ**



TYPE **MKT/MKT 331**



QTY **4000** DATE **9243**



CODENO **2222 331 60103**

LINE	MARKING EXPLANATION
1	Manufacturer's name
2	Country of origin
3	Sub-family
4	Type description and sub-class X2
5	Capacitance value, tolerance, voltage and climatic category (IEC)
6	Safety approvals
7	Preference origin code: A Country of origin in code: 170 (Belgium) Responsible production centre: HQ (Roeselare) WO: work order
8	Product type description
9	Quantity and production period, year and week code
10	Product code (12NC)

Interference suppression film capacitors

MKP 335 1

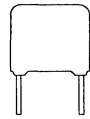

MKP RADIAL POTTED CAPACITORS

Pitch 15/22.5/27.5

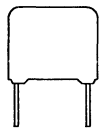

P=15 mm

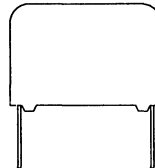
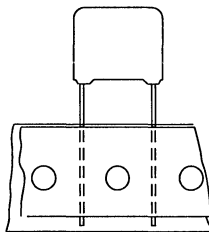

P = 22.5 to 27.5 mm

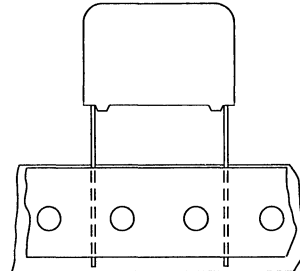

MED470

QUICK REFERENCE DATA

Capacitance range (E6 series) *	10 nF to 1 μ F
Capacitance tolerance	$\pm 10\%$, $\pm 20\%$
Rated (AC) voltage 50 to 60Hz	250 V
Climatic category	40/085/21
Rated temperature	85 °C
Maximum application temperature	85 °C
Reference IEC specification **	40 (Central office)792 (1992-02-21)
Safety approvals ***	VDE 565-1, S, FI, SEV 1055.1978 UL1283, N, D, ÖVE, IMQ
Materials qualified according UL 94	94V-0
Safety class	X2

Notes: * Intermediate values of the E12 series are available to special order

** Will replace IEC 384-14 - first edition 1981

*** Products will not be marked with (N, D and ÖVE) symbols.

FEATURES <ul style="list-style-type: none"> • 15 to 27.5 mm terminal pitch • Supplied loose in box and taped on reel • Consist of a low-inductive wound cell of metallized polypropylene film, potted in a flame retardent case. 	APPLICATIONS <ul style="list-style-type: none"> • For X2-electromagnetic interference suppression. • Specially designed to meet the NEW REQUIREMENTS in accordance with 40 (C.O.) 792 the new IEC 384-14 specification, requiring a 2.5 kV peak pulse voltage test. • SEV approved for 3 kV pulse test.
--	---

**Interference suppression
film capacitors**

MKP 335 1

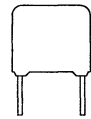

Pitch 15/22.5/27.5

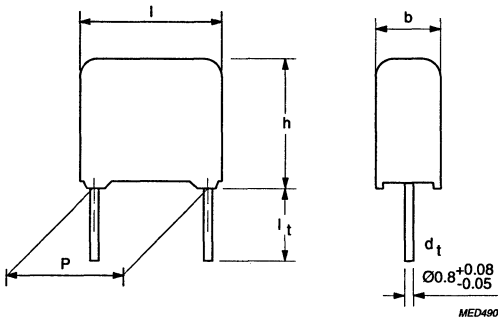

SPECIFIC REFERENCE DATA FOR 250 V AC

Tangent of loss angle	at 10 kHz	at 100 kHz
$C \leq 100 \text{ nF}$	$\leq 10 \cdot 10^{-4}$	$\leq 30 \cdot 10^{-4}$
$100 \text{ nF} < C \leq 470 \text{ nF}$	$\leq 20 \cdot 10^{-4}$	$\leq 70 \cdot 10^{-4}$
$C > 470 \text{ nF}$	$\leq 70 \cdot 10^{-4}$	-
Rated voltage pulse slope $(dU/dt)_R$	100 V/ μ s	
R between terminations, for $C \leq 0.33 \mu\text{F}$	>30 000 M Ω	
RC between terminations, for $C > 0.33 \mu\text{F}$	>10 000 s	
Test (DC) voltage	1075 V, 1 s	

SMALLEST PACKING QUANTITIES (SPQ)	loose in box		taped on reel
	$l_t = 3.5 \pm 0.5 \text{ mm}$	$l_t = 25 \pm 2.0 \text{ mm}$	
DIMENSIONS	SPQ	SPQ	SPQ
5.0 x 11.0 x 17.5	1000	1000	1100
6.0 x 12.0 x 17.5	1000	1000	900
7.0 x 13.5 x 17.5	1000	500	800
8.5 x 15.0 x 17.5	1000	500	650
7.0 x 16.5 x 26.0	200	100	550
8.5 x 18.0 x 26.0	200	100	450
10.0 x 19.5 x 26.0	200	100	350
11.0 x 21.0 x 31.0	100	125	300
15.0 x 25.0 x 31.0	100	125	200
18.0 x 28.0 x 31.0	100	125	150

Interference suppression film capacitors

MKP 335 1

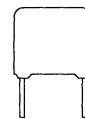
 $U_{Rac} = 250 V$

loose and taped

Cap. (μF)	$b_{max} \times h_{max} \times l_{max}$ (mm)	CATALOGUE NUMBER 2222 335		
		loose in box **		taped on reel
		$l_t = 3.5 \pm 0.5$ mm	$l_t = 25 \pm 2.0$ mm	H = 18.5 mm *
		C-tol *** $\pm 20\%$	C-tol *** $\pm 20\%$	C-tol *** $\pm 20\%$
Pitch = 15.0 \pm 0.4 mm				
0.010	5.0 x 11.0 x 17.5	10103	14103	12103
0.015		10153	14153	12153
0.022		10223	14223	12223
0.033		10333	14333	12333
0.047	6.0 x 12.0 x 17.5	10473	14473	12473
0.068	7.0 x 13.5 x 17.5	10683	14683	12683
0.1	8.5 x 15.0 x 17.5	10104	14104	12104
Pitch = 22.5 \pm 0.4 mm				
0.15	7.0 x 16.5 x 26.0	10154	14154	12154
0.22	8.5 x 18.0 x 26.0	10224	14224	12224
0.33	10.0 x 19.5 x 26.0	10334	14334	12334
Pitch = 27.5 \pm 0.4 mm				
0.47	11.0 x 21.0 x 31.0	10474	14474	12474
0.68	15.0 x 25.0 x 31.0	10684	14684	12684
1.00	18.0 x 28.0 x 31.0	10105	14105	12105

* H: intape height; for detailed specifications refer to chapter PACKAGING.

** Lead length between 3.2 and 35 mm also available on special request.

*** $\pm 10\%$ tolerance available on request.

SAFETY APPROVALS

VDE 565-1 class X2

FI E384/14

SEV 1055.1978 class X

NEMKO 132

SEMKO SS 443 04 14

IMQ CEI 40-7/1980

ÖVE

UL1283

DEMKO pending

File. No 1016.30-4670-1013

Reg. No 148517/148518-01..02

Reg. No 91.1 12391

Reg. No M68909

Reg. No 9211030

Reg. No V 3205

Reg. No PA21441/R

File No E 109565

Ref No 108282EC121



MED491

Interference suppression film capacitors

MKP 335 1

RATINGS AND CHARACTERISTICS

Unless otherwise specified all electrical values apply at an ambient temperature of 23 ± 1 °C, an atmospheric pressure of 86 to 106 kPa and a relative humidity of $50 \pm 2\%$.

CAPACITANCE

- All capacitance values are specified at 1 kHz.

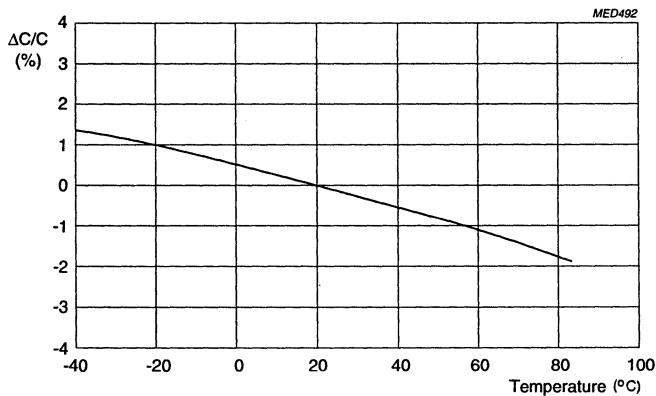

Capacitance change as a function of ambient temperature.

IMPEDANCE

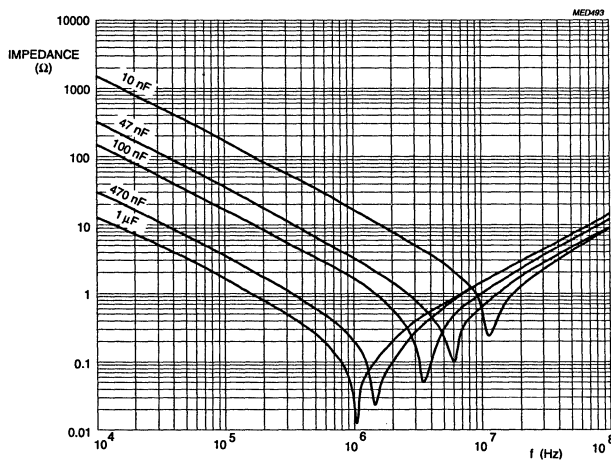

Impedance as a function of frequency; typical curve.

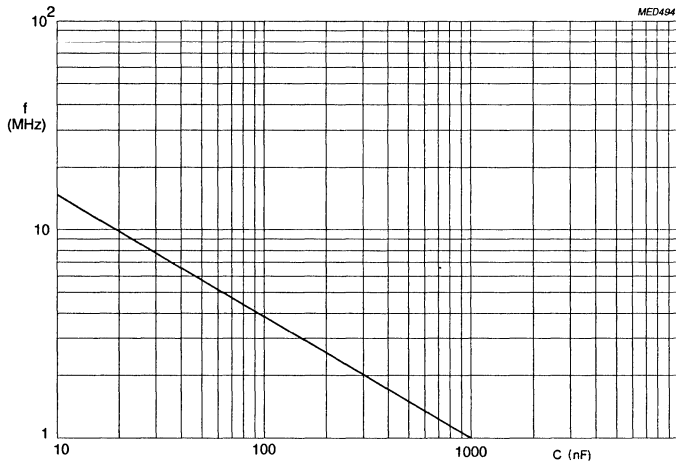
RESONANT FREQUENCY

Resonant frequency as a function of capacitance; typical curve.

TEMPERATURE

- Storage temperature : $T_{stg} = -25$ to $+40$ °C with RH maximum 80% without condensation.

VOLTAGE

- Test (DC) voltage between terminations, 100% on line for 1 second: 1075 V
- Test (AC) voltage between interconnected terminations and case (foil method): 2000 V.

Interference suppression film capacitors

MKP 335 1

GENERAL DATA

CONSTRUCTION

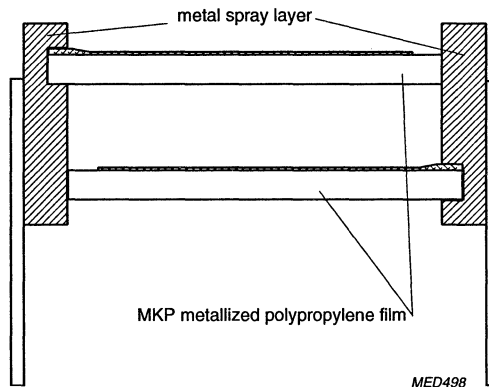

DESCRIPTION

- Low-inductive wound cell of metallized polypropylene (PP) film, potted with blue epoxy resin in a blue flame retardent polypropylene case.
- Radial leads, solder-coated
- Small stand-off pips allow removal of solder flux etc. during cleaning of the printed-wiring board.

MOUNTING

Normal use

The capacitors are designed for mounting on printed-wiring boards. The capacitors packed in bandoliers are designed for mounting on printed-wiring boards by means of automatic insertion machines. For detailed specifications refer to chapter PACKAGING.

Specific method of mounting to withstand vibration and shock

In order to withstand vibration and shock tests, it must be ensured that the stand-off pips are in good contact with the printing-wiring board.

- For pitches of 15 mm the capacitors shall be mechanically fixed by the leads.
- For larger pitches the capacitors shall be mounted in the same way and the body clamped.

Interference suppression film capacitors

MKP 335 1

TANGENT OF THE LOSS ANGLE

- For maximum values and measuring frequency see specific reference data.

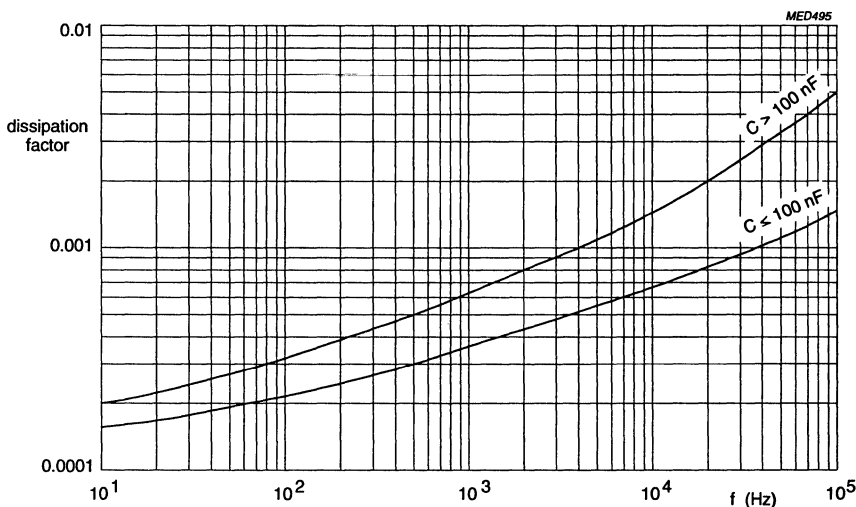

Tangent of the loss angle as a function of frequency; typical curves.

Rated voltage pulse slope $(dU/dt)_R$

INSULATION RESISTANCE

The insulation resistance is measured after a voltage of $100 \pm 15 \text{ V}$ has been applied for 1 minute ± 5 seconds at $T_{\text{amb}} = 20 \text{ }^\circ\text{C}$.

- For values see specific reference data and table.
- R between interconnected terminations and case (foil method): $>30\,000 \text{ M}\Omega$.

Interference suppression film capacitors

MKP 335 1

MARKING

Product marking

Capacitors with $l_{max} = 17.5$ mm are marked on the top and the side by laser print.
 Capacitors with $l_{max} = 26$ or 31 mm are marked on the top by laser print with the following information:

Manufacturer (PHILIPS)

Manufacturer's type designation (335 1)

Rated capacitance in code according to IEC 62

Rated (AC) voltage (250V)

Sub class (X2)

Tolerance on rated capacitance M = 20%

Code for dielectric material (MKP)

Code for factory of origin (HQ)

Year and week of manufacturing (e.g. 9219)

Safety approvals

Examples: pitch P = 15 mm

Head face

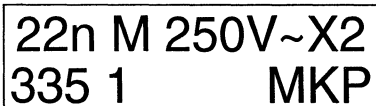

Front face

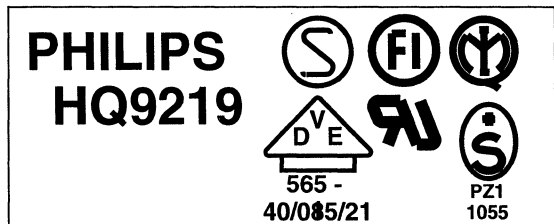

MED496

pitch P = 22.5 mm or 27.5 mm

Head face

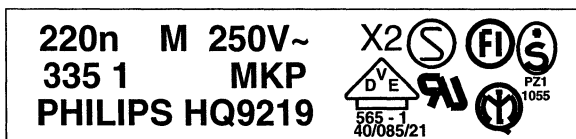

MED497



Interference suppression film capacitors

MKP 335 1

Package marking

The package containing the capacitors is marked as shown.

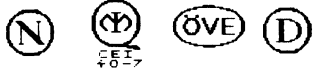
PHILIPS COMPONENTS
 MADE IN BELGIUM
 INTERF. SUPPR. FILM CAPACITOR
 MKP RADIAL POTTED TYPE X2
 0.01µF ± 20% 250V~ 40/085/21

ORIG **A170** RPC **HQ**



TYPE **MKP 335 1**



QTY **1000** DATE **9243**



CODENO **2222 335 14103**

LINE	MARKING EXPLANATION
1	Manufacturer's name
2	Country of origin
3	Sub-family
4	Type description and sub-class X2
5	Capacitance value, tolerance, voltage and climatic category (IEC)
6	Safety approvals
7	Preference origin code: A Country of origin in code: 170 (Belgium) Responsible production centre: HQ (Roeselare) WO: work order
8	Product type description
9	Quantity and production period, year and week code
10	Product code (12NC)

Interference suppression film capacitors

MP-KT 333 4

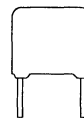

MP-KT RADIAL POTTED CAPACITORS

Pitch 15/22.5/27.5

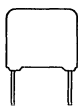

P=15 mm

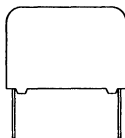
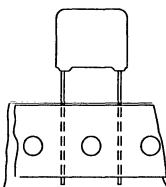

P = 22.5 to 27.5 mm

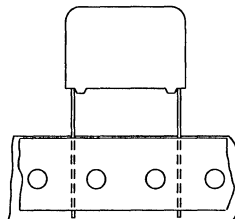

MEC470

QUICK REFERENCE DATA

Capacitance range (E6 series) *	10 nF to 680 nF
Capacitance tolerance	±10%
Rated (AC) voltage 50 to 60 Hz	250 V
Climatic category	40/085/21
Rated temperature	85 °C
Maximum application temperature	85 °C
Reference specification **	IEC 40-SECR.611 (Oct. 1990)
Safety approvals ***	VDE 565-1, S, N, D, ÖVE, IMQ, FI, SEV 1055.1978, UL1414, CSA
Materials qualified according UL	94V-0(3.2), 94V-1(1.6)
Safety class	X2

Notes: * Intermediate values of the E12 series are available to special order

** Will replace IEC 384-14

*** Products will not be marked with (N, D, ÖVE and IMQ) symbols.

<h4>FEATURES</h4> <ul style="list-style-type: none"> • 15 to 27.5 mm pitch • Supplied loose in box and taped on reel • Non-active flammability under fault conditions • Dual dielectric construction with metallized paper. 	<h4>APPLICATIONS</h4> <ul style="list-style-type: none"> • Consumer goods - coffee grinders, mixers, audio, TV, etc • Industry - test and measuring equipment • The capacitors can be used safely in these applications, where the equipment is connected continuously to the mains.
---	---

**Interference suppression
film capacitors**

MP-KT 333 4

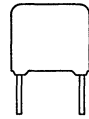

Pitch 15/22.5/27.5

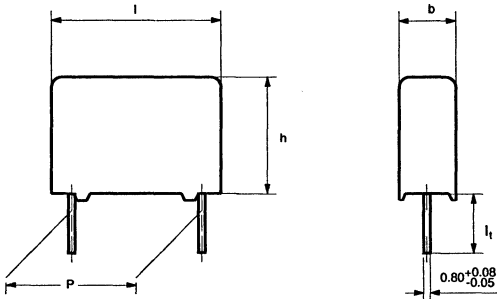

SPECIFIC REFERENCE DATA FOR 250 V AC

Tangent of loss angle	at 1 kHz	at 10 kHz	at 100 kHz
$C \leq 0.68 \mu\text{F}$	$\leq 100 \cdot 10^{-4}$	$\leq 200 \cdot 10^{-4}$	-
$C \leq 0.47 \mu\text{F}$	-	-	$\leq 350 \cdot 10^{-4}$
Rated voltage pulse slope $(dU/dt)_R$	P = 15.0 mm 1500 V/ μs	P = 27.5 mm	
	P = 22.5 mm 1000 V/ μs	220 nF < C \leq 330 nF = 500 V/ μs 330 nF < C \leq 680 nF = 250 V/ μs	
R between terminations, for $C \leq 0.33 \mu\text{F}$	>15 000 M Ω		
RC between terminations, for $C > 0.33 \mu\text{F}$	>5000 s		

SMALLEST PACKING QUANTITIES (SPQ)	loose in box		taped on reel
	$l_t = 5 \text{ mm}$	$l_t = 25 \text{ mm}$	H = 18.5 mm
DIMENSIONS	SPQ	SPQ	SPQ
5.0 x 11.0 x 17.5	1000	1000	1100
6.0 x 12.0 x 17.5	1000	1000	900
7.0 x 13.5 x 17.5	1000	500	800
8.5 x 15.0 x 17.5	1000	500	650
7.0 x 16.5 x 26.0	200	500	550
8.5 x 18.0 x 26.0	200	500	450
11.0 x 21.0 x 31.0	100	125	300
13.0 x 23.0 x 31.0	100	125	300
15.0 x 25.0 x 31.0	100	125	200
18.0 x 28.0 x 31.0	100	125	150

Interference suppression film capacitors

MP-KT 333 4

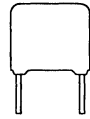

MED472

 $U_{\text{Rac}} = 250 \text{ V}$

loose and taped

Cap. (μF)	$b_{\text{max}} \times h_{\text{max}} \times l_{\text{max}}$ (mm)	mass (g)	CATALOGUE NUMBER 2222 333		
			loose in box		taped on reel
			$l_t = 5 \pm 1$ mm	$l_t = 25 \pm 2$ mm	H = 18.5 mm
			C-tol $\pm 10\%$	C-tol $\pm 10\%$	C-tol $\pm 10\%$
Pitch = 15.0 ± 0.4 mm					
0.010	5.0 x 11.0 x 17.5	1.4	41103	45103	43103
0.015			41153	45153	43153
0.022			41223	45223	43223
0.033	6.0 x 12.0 x 17.5	1.8	41333	45333	43333
0.047	7.0 x 13.5 x 17.5	2.4	41473	45473	43473
0.068	8.5 x 15.0 x 17.5	3.1	41683	41683	43683
Pitch = 22.5 ± 0.4 mm					
0.100	7.0 x 16.5 x 26.0	3.7	41104	45104	43104
0.150	8.5 x 18.0 x 26.0	5.0	41154	45154	43154
Pitch = 27.5 ± 0.4 mm					
0.220	11.0 x 21.0 x 31.0	8.0	41224	45224	43224
0.330	13.0 x 23.0 x 31.0	11.0	41334	45334	43334
0.470	15.0 x 25.0 x 31.0	13.7	41474	45474	43474
0.680	18.0 x 28.0 x 31.0	19.1	41684	45684	43684
Capacitors available on special request, C-tol $\pm 20\%$					
Pitch = 15.0 ± 0.4 mm					
0.100	10.0 x 16.5 x 17.5	3.5	94001	94004	94006
Pitch = 22.5 ± 0.4 mm					
0.220	10.0 x 19.5 x 26.0	3.5	94002	94005	94007

Interference suppression FILM capacitors

MP-KT 333 4

RATINGS AND CHARACTERISTICS

Unless otherwise specified, all electrical values apply at an ambient temperature of 23 ± 1 °C, an atmospheric pressure of 86 to 106 kPa and a relative humidity of $50 \pm 2\%$.

CAPACITANCE

- All capacitance values are specified at 1 kHz.

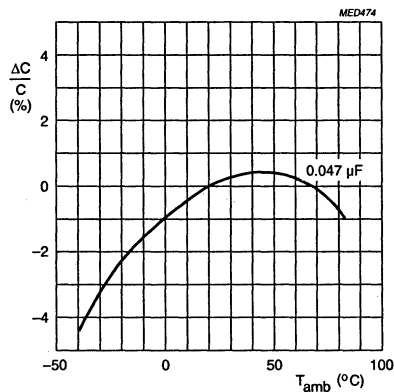

Capacitance change as a function of ambient temperature.

IMPEDANCE

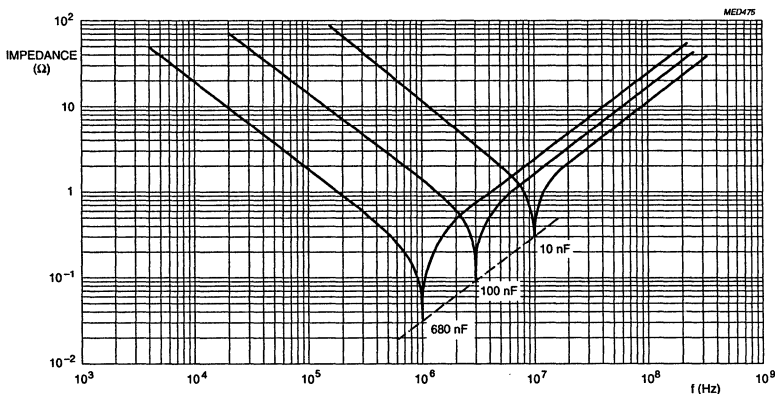

Impedance as a function of frequency; typical curves.

Interference suppression FILM capacitors

MP-KT 333 4

TEMPERATURE

- Storage temperature : $T_{Sg} = -25\text{ °C to }+40\text{ °C}$ with RH maximum 80% without condensation.

VOLTAGE

- Test (DC) voltage between terminations, 100% on line for 1 second: 2200 V
- Test (AC) voltage between interconnected terminations and case (foil method): 2000 V

TANGENT OF THE LOSS ANGLE

- For maximum values and measuring frequencies: see specific reference data.

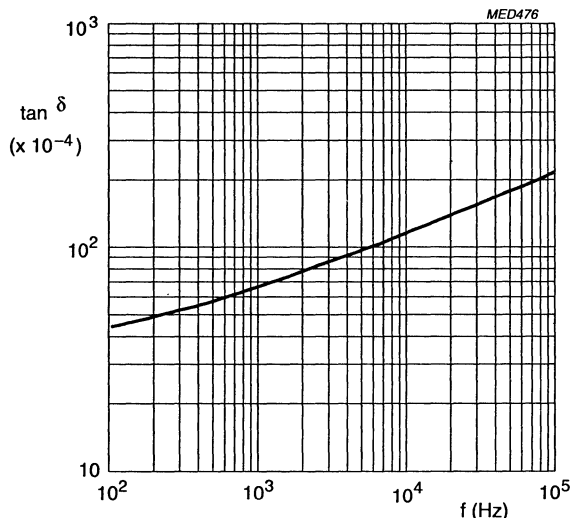

Tangent of the loss angle as a function of frequency; typical curve.

RATED VOLTAGE PULSE SLOPE $(dU/dt)_R$

For values see specific reference data.

If the pulse voltage is lower than the rated voltage, the values of the specific reference data may be multiplied by U_{Rdc} and divided by the applied voltage.

Interference suppression FILM capacitors

MP-KT 333 4**INSULATION RESISTANCE**

The insulation resistance is measured after a voltage of 100 ± 15 V has been applied for 1 minute ± 5 seconds at $T_{\text{amb}} = 20$ °C.

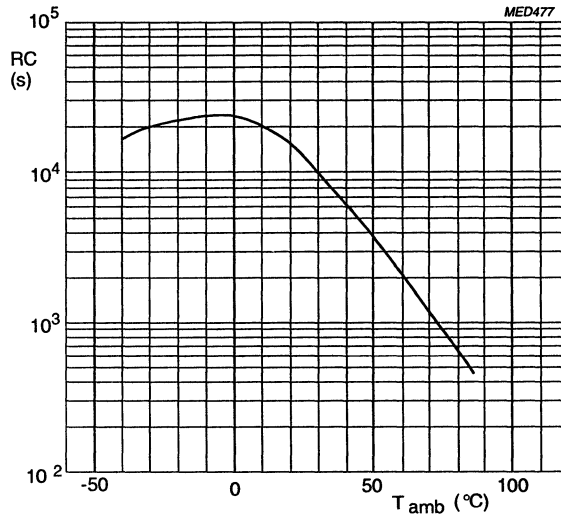

RC product as a function of ambient free air temperature; typical curve.

R between terminations: for value see specific reference data

R between interconnected terminations and case (foil method): $>30\ 000$ M Ω

Interference suppression FILM capacitors

MP-KT 333 4

GENERAL DATA

CONSTRUCTION

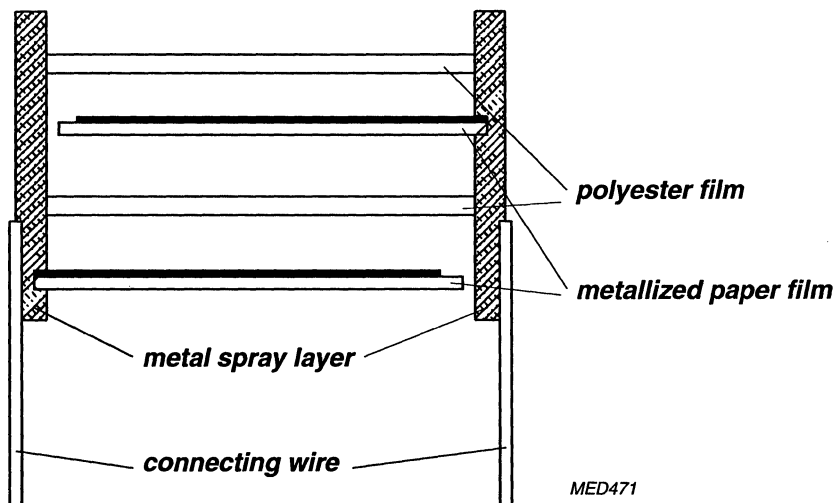

DESCRIPTION

- Low-inductive wound cell of metallized paper film and polyethyleneterephthalate (PETP) film, potted with blue epoxy resin in a blue flame retardent polypropylene case.
- Radial leads, solder coated
- Small stand-off pips allow removal of solder flux etc. during cleaning of the printed-wiring board.

MOUNTING

Normal use

The capacitors are designed for mounting on printed-wiring boards. The capacitors packed in bandoliers are designed for mounting on printed-wiring boards by means of automatic insertion machines. For detailed specifications refer to chapter PACKAGING.

Specific method of mounting to withstand vibration and shock

In order to withstand vibration and shock tests, it must be ensured that the stand-off pips are in good contact with the printed-wiring board.

- For pitches of 15 mm the capacitors shall be mechanically fixed by the leads.
- For larger pitches the capacitors shall be mounted in the same way and the body clamped.

Interference suppression FILM capacitors

MP-KT 333 4

MARKING

Product marking

Capacitors with a pitch of 15 mm are marked on the top and the side.

Capacitors with a pitch of 22.5 or 27.5 mm are marked on the top by laser print with the following information:

- Manufacturer (PHILIPS)
- Manufacturer's type designation (333 4)
- Capacitor class and subclass (X2)
- Safety approvals of National Testing Stations (e.g. FI)
- Rated capacitance $n = nF$
- Tolerance on rated capacitance K: 10% M: 20%
- Rated AC voltage (250V)
- Code for dielectric material (MP-KT)
- Code for factory of origin (HQ)
- Year and week of manufacture (e.g. 9125)
- Climatic category (40/085/21)

Example of marking for a capacitor with pitch = 15 mm.

10n K 250V ~ X2
333 4 MP-KT

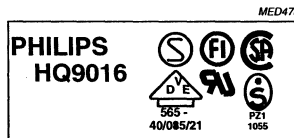

Marking on the top.

Marking on the side.

Example of marking for a capacitor with pitch = 22.5 mm or 27.5 mm.



Marking on the top.

**Interference suppression
FILM capacitors**

MP-KT 333 4

Package marking

The package containing the capacitors is marked as shown.

PHILIPS COMPONENTS

MADE IN BELGIUM

INTERF. SUPPR. FILM CAPACITOR

MP-KT RADIAL POTTED TYPE X2

0.1µF ± 10% 250V~ 40/085/21



ORIG **A170** RPC **HQ**



TYPE **MP-KT 333 4**



QTY **550** DATE **9238**



CODENO **2222 333 43104**

LINE	MARKING EXPLANATION
1	Manufacturer's name
2	Country of origin
3	Sub-family
4	Type description and safety class X2
5	Capacitance value, tolerance, voltage and climatic category (IEC)
6	Safety approvals
7	Preference origin code: A Country of origin in code: 170 (Belgium) Responsible production centre: HQ (Roeselare) WO: work order
8	Product type description
9	Quantity and production period, year and week code
10	Product code (12NC).



AC AND PULSE

AC and pulse metallized POLYPROPYLENE MKP 378 film capacitors

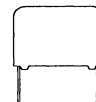

MKP RADIAL POTTED CAPACITORS

Pitch 15/22.5/27.5

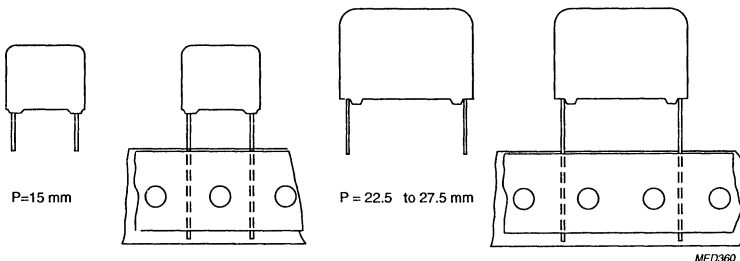

MED360

QUICK REFERENCE DATA

Capacitance range (E24 series)	0.0033 to 3.3 μ F
Capacitance tolerance	\pm 5%
Rated voltage U_{Rdc}	250 V, 400 V, 630 V, 1000 V, 1600 V, 2000 V
Rated (AC) voltage 50 to 60 Hz	160 V, 200 V, 300 V, 400 V, 500 V, 600 V
Rated peak to peak voltage	450 V, 560 V, 850 V, 1130 V, 1400 V, 1700 V
Climatic category	55/085/56
Rated temperature (DC)	85 °C
Rated temperature (AC)	70 °C
Maximum application temperature	85 °C
Reference specification	IEC 384-17
Performance grade	Grade 1 (long life)
Stability grade	Grade 2 Grade 1
	Pitch 15 mm Pitch 22.5 and 27.5

<h4>FEATURES</h4> <ul style="list-style-type: none"> • 15 to 27.5 mm terminal pitch • Low contact resistance • Low loss dielectric • Small dimensions for high density packaging • Supplied loose in box and taped on reel. 	<h4>APPLICATIONS</h4> <ul style="list-style-type: none"> • Where steep pulses occur e.g. SMPS (switch mode power supplies) • Motor control circuits.
--	--

AC and pulse metallized POLYPROPYLENE MKP 378 film capacitors

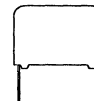

Pitch 22.5/27.5

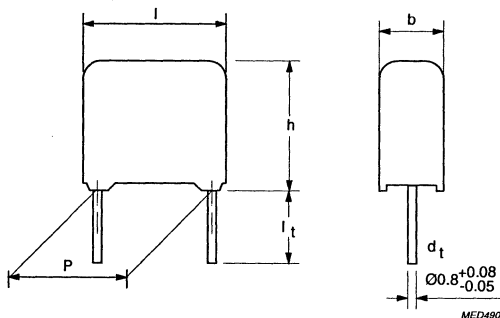

SPECIFIC REFERENCE DATA FOR 250 V DC

Tangent of loss angle	at 10 kHz	at 100 kHz
0.33 $\mu\text{F} \leq C \leq 0.43 \mu\text{F}$	$\leq 15 \cdot 10^{-4}$	$\leq 45 \cdot 10^{-4}$
0.47 $\mu\text{F} \leq C \leq 0.62 \mu\text{F}$	$\leq 15 \cdot 10^{-4}$	$\leq 55 \cdot 10^{-4}$
0.68 $\mu\text{F} \leq C \leq 0.82 \mu\text{F}$	$\leq 15 \cdot 10^{-4}$	$\leq 60 \cdot 10^{-4}$
0.91 $\mu\text{F} \leq C \leq 1.0 \mu\text{F}$	$\leq 20 \cdot 10^{-4}$	$\leq 90 \cdot 10^{-4}$
1.1 $\mu\text{F} \leq C \leq 3.3 \mu\text{F}$	$\leq 20 \cdot 10^{-4}$	$\leq 200 \cdot 10^{-4}$
Rated voltage pulse slope $(dU/dt)_R$ at U_{Rdc} (see also application note)	P = 22.5 mm: 90 V/ μs P = 27.5 mm: 60 V/ μs ($b_{max} < 15 \text{ mm}$) 30 V/ μs ($b_{max} \geq 15 \text{ mm}$)	
R between terminations, for $C \leq 1 \mu\text{F}$	$> 100\,000 \text{ M}\Omega$	
RC between terminations, for $C > 1 \mu\text{F}$	$> 100\,000 \text{ s}$	

SMALLEST PACKING QUANTITIES (SPQ)	loose in box	taped on reel
	SPQ	SPQ
7.0 x 16.5 x 26.0	200	550
8.5 x 18.0 x 26.0	200	450
10.0 x 19.5 x 26.0	200	350
11.0 x 21.0 x 31.0	100	300
13.0 x 23.0 x 31.0	100	250
15.0 x 25.0 x 31.0	100	200
18.0 x 28.0 x 31.0	100	150

AC and pulse metallized POLYPROPYLENE MKP 378 film capacitors

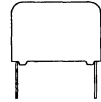
 $U_{Rdc} = 250 \text{ V}$
 $U_{Rac} = 160 \text{ V}$

loose and taped

Cap. (μF)	$b_{\text{max}} \times h_{\text{max}} \times l_{\text{max}}$ (mm)	mass (g)	CATALOGUE NUMBER 2222 378	
			loose in box	taped on reel
			$l_1 = 5 \pm 1 \text{ mm}$	$H = 18.5 \text{ mm}^*$
			C-tol $\pm 5\%$	C-tol $\pm 5\%$
Pitch = 22.5 ± 0.4 mm				
0.33	7.0 x 16.5 x 26.0	3.2	42334	45334
0.36			42364	45364
0.39			42394	45394
0.43	8.5 x 18.0 x 26.0	4.4	42434	45434
0.47			42474	45474
0.51			42514	45514
0.56			42564	45564
0.62			42624	45624
0.68	10.0 x 19.5 x 26.0	5.5	42684	45684
0.75			42754	45754
0.82			42824	45824
Pitch = 27.5 ± 0.4 mm				
0.91	11.0 x 21.0 x 31.0	7.8	42914	45914
1			42105	45105
1.1			42115	45115
1.2			42125	45125
1.3			42135	45135
1.5	13.0 x 23.0 x 31.0	10.4	42155	45155
1.6			42165	45165
1.8			42185	45185
2	15.0 x 25.0 x 31.0	12.8	42205	45205
2.2			42225	45225
2.4	18.0 x 28.0 x 31.0	17.2	42245	45245
2.7			42275	45275
3			42305	45305
3.3			42335	45335

* H: intape height; for detailed specifications refer to chapter PACKAGING.

- Maintenance type, for new design see 2222 379 4.... series
- Lead length 3.2 ± 0.5 mm available with code 2222 378 48...
- Extension with 15 mm pitch and lead length 3.5 ± 0.5 mm available in the 2222 379 4.... series

AC and pulse metallized POLYPROPYLENE MKP 378 film capacitors

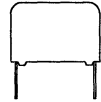

Pitch 22.5/27.5

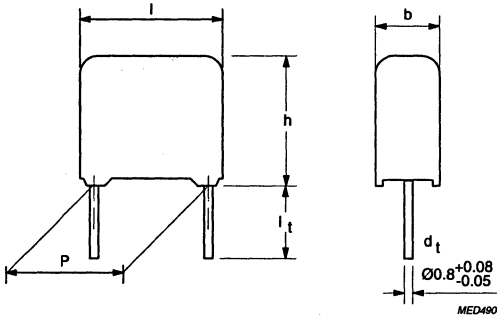

SPECIFIC REFERENCE DATA FOR 400 V DC

Tangent of loss angle	at 10 kHz	at 100 kHz
$C \leq 0.24 \mu\text{F}$	$\leq 10 \cdot 10^{-4}$	$\leq 30 \cdot 10^{-4}$
$0.27 \mu\text{F} \leq C \leq 0.36 \mu\text{F}$	$\leq 10 \cdot 10^{-4}$	$\leq 35 \cdot 10^{-4}$
$0.39 \mu\text{F} \leq C \leq 0.51 \mu\text{F}$	$\leq 10 \cdot 10^{-4}$	$\leq 40 \cdot 10^{-4}$
$0.56 \mu\text{F} \leq C \leq 0.68 \mu\text{F}$	$\leq 15 \cdot 10^{-4}$	$\leq 50 \cdot 10^{-4}$
$0.75 \mu\text{F} \leq C \leq 1.0 \mu\text{F}$	$\leq 15 \cdot 10^{-4}$	$\leq 70 \cdot 10^{-4}$
$1.1 \mu\text{F} \leq C \leq 2.0 \mu\text{F}$	$\leq 15 \cdot 10^{-4}$	$\leq 150 \cdot 10^{-4}$
Rated voltage pulse slope $(dU/dt)_R$ at U_{Rdc} (see also application note)	P = 22.5 mm: 100 V/ μs P = 27.5 mm: 70 V/ μs ($b_{max} < 15 \text{ mm}$) 35 V/ μs ($b_{max} \geq 15 \text{ mm}$)	
R between terminations, for $C \leq 1 \mu\text{F}$	>100 000 M Ω	
RC between terminations, for $C > 1 \mu\text{F}$	>100 000 s	

SMALLEST PACKING QUANTITIES (SPQ)	loose in box	taped on reel
	SPQ	SPQ
7.0 x 16.5 x 26.0	200	500
8.5 x 18.0 x 26.0	200	450
10.0 x 19.5 x 26.0	200	350
11.0 x 21.0 x 31.0	100	300
13.0 x 23.0 x 31.0	100	250
15.0 x 25.0 x 31.0	100	200
18.0 x 28.0 x 31.0	100	150

AC and pulse metallized POLYPROPYLENE MKP 378 film capacitors

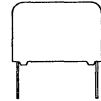
 $U_{Rdc} = 400 \text{ V}$
 $U_{Rac} = 200 \text{ V}$

loose and taped

Cap. (μF)	$b_{\text{max}} \times h_{\text{max}} \times l_{\text{max}}$ (mm)	mass (g)	CATALOGUE NUMBER 2222 378	
			loose in box	taped on reel
			$l_1 = 5 \pm 1 \text{ mm}$ C-tol $\pm 5\%$	$H = 18.5 \text{ mm}^*$ C-tol $\pm 5\%$
Pitch = $22.5 \pm 0.4 \text{ mm}$				
0.18	7.0 x 16.5 x 26.0	3.15	52184	55184
0.2			52204	55204
0.22			52224	55224
0.24	8.5 x 18.0 x 26.0	4.4	52244	55244
0.27			52274	55274
0.3			52304	55304
0.33			52334	55334
0.36	10.0 x 19.5 x 26.0	5.5	52364	55364
0.39			52394	55394
0.43			52434	55434
0.47			52474	55474
Pitch = $27.5 \pm 0.4 \text{ mm}$				
0.51	11.0 x 21.0 x 31.0	7.8	52514	55514
0.56			52564	55564
0.62			52624	55624
0.68			52684	55684
0.75	13.0 x 23.0 x 31.0	10.4	52754	55754
0.82			52824	55824
0.91			52914	55914
1			52105	55105
1.1	15.0 x 25.0 x 31.0	12.8	52115	55115
1.2			52125	55125
1.3			52135	55135
1.5	18.0 x 28.0 x 31.0	17.2	52155	55155
1.6			52165	55165
1.8			52185	55185
2			52205	55205

* H: intape height; for detailed specifications refer to chapter PACKAGING.

- Maintenance type, for new design see 2222 379 5.... series
- Lead length $3.2 \pm 0.5 \text{ mm}$ available with code 2222 378 58...
- Extension with 15 mm pitch and lead length $3.5 \pm 0.5 \text{ mm}$ available in the 2222 379 5.... series.

AC and pulse metallized POLYPROPYLENE MKP/MKP film capacitors

378

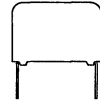

Pitch 15/22.5/27.5

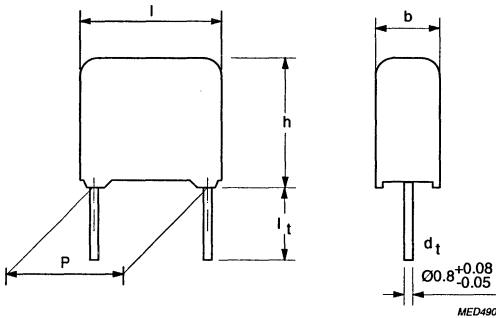

SPECIFIC REFERENCE DATA FOR 630 V DC

Tangent of loss angle	at 10 kHz	at 100 kHz
$C \leq 0.18 \mu\text{F}$	$\leq 8 \cdot 10^{-4}$	$\leq 20 \cdot 10^{-4}$
$0.20 \mu\text{F} \leq C \leq 0.30 \mu\text{F}$	$\leq 10 \cdot 10^{-4}$	$\leq 25 \cdot 10^{-4}$
$0.33 \mu\text{F} \leq C \leq 0.39 \mu\text{F}$	$\leq 10 \cdot 10^{-4}$	$\leq 30 \cdot 10^{-4}$
$0.43 \mu\text{F} \leq C \leq 0.51 \mu\text{F}$	$\leq 10 \cdot 10^{-4}$	$\leq 40 \cdot 10^{-4}$
$C > 0.51 \mu\text{F}$	$\leq 10 \cdot 10^{-4}$	$\leq 45 \cdot 10^{-4}$
Rated voltage pulse slope $(dU/dt)_R$ at U_{Rdc} (see also application note)	P = 15 mm: 500 V/ μs P = 22.5 mm: 370 V/ μs P = 27.5 mm: 230 V/ μs ($b_{\text{max}} < 15 \text{ mm}$) 120 V/ μs ($b_{\text{max}} \geq 15 \text{ mm}$)	
R between terminations, for $C \leq 1 \mu\text{F}$	>100 000 M Ω	

SMALLEST PACKING QUANTITIES (SPQ)	loose in box	taped on reel
	SPQ	SPQ
5.0 x 11.0 x 17.5	1000	1100
6.0 x 12.0 x 17.5	1000	900
7.0 x 13.5 x 17.5	500	800
8.5 x 15.0 x 17.5	500	650
7.0 x 16.5 x 26.0	200	550
8.5 x 18.0 x 26.0	200	450
10.0 x 19.5 x 26.0	200	350
11.0 x 21.0 x 31.0	100	300
13.0 x 23.0 x 31.0	100	250
15.0 x 25.0 x 31.0	100	200
18.0 x 28.0 x 31.0	100	150

AC and pulse metallized POLYPROPYLENE MKP/MKP film capacitors

378

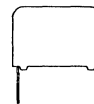
 $U_{Rdc} = 630 V$ $U_{Rac} = 300 V / U_{pp} = 850 V$

loose and taped

Cap. (μF)	$b_{max} \times h_{max} \times l_{max}$ (mm)	mass (g)	CATALOGUE NUMBER 2222 378	
			loose in box	taped on reel
			$l_1 = 3.5 \pm 0.5$ mm	H = 18.5 mm *
		C-tol $\pm 5\%$	C-tol $\pm 5\%$	
Pitch = 15.0 \pm 0.4 mm				
0.015	5.0 x 11.0 x 17.5		64153	65153
0.016			64163	65163
0.018			64183	65183
0.02			64203	65203
0.022			64223	65223
0.024	6.0 x 12.0 x 17.5		64243	65243
0.027			64273	65273
0.03			64303	65303
0.033			64333	65333
0.036			64363	65363
0.039	7.0 x 13.5 x 17.5		64393	65393
0.043			64433	65433
0.047			64473	65473
0.051	8.5 x 15.0 x 17.5		64513	65513
Pitch = 22.5 \pm 0.4 mm				
0.056	6.0 x 15.5 x 26.0	2.6	64563	65563
0.062			64623	65623
0.068	7.0 x 16.5 x 26.0	3.2	64683	65683
0.075			64753	65753
0.082			64823	65823
0.091			64913	65913
0.10			64104	65104
0.11	8.5 x 18.0 x 26.0	4.4	64114	65114
0.12			64124	65124
0.13			64134	65134
0.15			64154	65154
0.16			64164	65164
0.18	64184	65184		
Pitch = 27.5 \pm 0.4 mm				
0.20	11.0 x 21.0 x 31.0	7.8	64204	65204
0.22			64224	65224
0.24			64244	65244
0.27			64274	65274
0.30	13.0 x 23.0 x 31.0	10.4	64304	65304
0.33			64334	65334
0.36			64364	65364
0.39			64394	65394
0.43			64434	65434
0.47	15.0 x 25.0 x 31.0	12.8	64474	65474
0.51			64514	65514
0.56			64564	65564
0.62	18.0 x 28.0 x 31.0	17.2	64624	65624
0.68			64684	65684

* H: intape height; for detailed specifications refer to chapter PACKAGING.

- Lead length 5.0 \pm 1.0 mm available with code 2222 378 62...
- Lead length 3.2 \pm 0.5 mm available with code 2222 378 68...
- Capacitance values 0.056 and 0.062 μF in 15 mm pitch available on request.

AC and pulse metallized POLYPROPYLENE MKP/MKP film capacitors

378

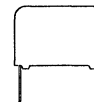

Pitch 15/22.5/27.5

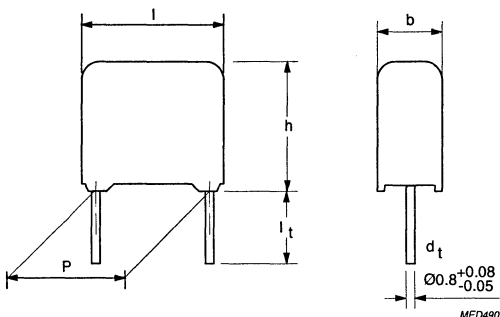

SPECIFIC REFERENCE DATA FOR 1000 V DC

Tangent of loss angle	at 10 kHz	at 100 kHz
$C \leq 0.051 \mu\text{F}$	$\leq 6 \cdot 10^{-4}$	$\leq 15 \cdot 10^{-4}$
$0.056 \mu\text{F} \leq C \leq 0.22 \mu\text{F}$	$\leq 8 \cdot 10^{-4}$	$\leq 20 \cdot 10^{-4}$
Rated voltage pulse slope $(dU/dt)_R$ at U_{Rdc} (see also application note)	P = 15 mm: 1300 V/ μs P = 22.5 mm: 1200 V/ μs P = 27.5 mm: 600 V/ μs ($b_{max} < 15 \text{ mm}$) 300 V/ μs ($b_{max} \leq 15 \text{ mm}$)	
R between terminations, for $C \leq 1 \mu\text{F}$	>100 000 M Ω	

SMALLEST PACKING QUANTITIES (SPQ)	loose in box	taped on reel
	SPQ	SPQ
DIMENSIONS		
5.0 x 11.0 x 17.5	1000	1100
6.0 x 12.0 x 17.5	1000	900
6.0 x 15.5 x 26.0	1000	900
7.0 x 16.5 x 26.0	200	550
8.5 x 18.0 x 26.0	200	450
10.0 x 19.5 x 26.0	200	350
11.0 x 21.0 x 31.0	100	300
13.0 x 23.0 x 31.0	100	250
15.0 x 25.0 x 31.0	100	200
18.0 x 28.0 x 31.0	100	150

AC and pulse metallized POLYPROPYLENE MKP/MKP film capacitors

378

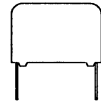
 $U_{Rdc} = 1000 \text{ V}$ $U_{Rac} = 400 \text{ V} / U_{pp} = 1130 \text{ V}$

loose and taped

Cap. (μF)	$b_{\text{max}} \times h_{\text{max}} \times l_{\text{max}}$ (mm)	mass (g)	CATALOGUE NUMBER 2222 378			
			loose in box	taped on reel		
			$l_1 = 3.5 \pm 0.5 \text{ mm}$	$H = 18.5 \text{ mm}$		
			C-tol $\pm 5\%$	C-tol $\pm 5\%$		
Pitch = 15.0 \pm 0.4 mm						
0.0030	5.0 x 11.0 x 17.5		74302	75302		
0.0033			74332	75332		
0.0036			74362	75362		
0.0039			74392	75392		
0.0043			74432	75432		
0.0047			74472	75472		
0.0051			74512	75512		
0.0056			74562	75562		
0.0062			74622	75622		
0.0068			74682	75682		
0.0075			74752	75752		
0.0082			6.0 x 12.0 x 17.5		74822	75822
0.0091					74912	75912
0.01					74103	75103
0.011	74113	75113				
Pitch = 22.5 \pm 0.4 mm						
0.012	6.0 x 15.5 x 26.0	2.6	74123	75123		
0.013			74133	75133		
0.015			74153	75153		
0.016			74163	75163		
0.018			74183	75183		
0.02	7.0 x 16.5 x 26.0	3.2	74203	75203		
0.022			74223	75223		
0.024			74243	75243		
0.027	8.5 x 18.0 x 26.0	4.4	74273	75273		
0.03			74303	75303		
0.033			74333	75333		
0.036			74363	75363		
0.039			74393	75393		
0.043	10.0 x 19.5 x 26.0	5.5	74433	75433		
0.047			74473	75473		
0.051			74513	75513		
Pitch = 27.5 \pm 0.4 mm						
0.056	11.0 x 21.0 x 31.0	7.8	74563	75563		
0.062			74623	75623		
0.068			74683	75683		
0.075			74753	75753		
0.082			74823	75823		
0.091			13.0 x 23.0 x 31.0	10.4	74913	75913
0.1	74104	75104				
0.11	74114	75114				
0.12	15.0 x 25.0 x 31.0	12.8	74124	75124		
0.13			74134	75134		
0.15			74154	75154		
0.16	18.0 x 28.0 x 31.0	17.5	74164	75164		
0.18			74184	75184		
0.2			74204	75204		
0.22			74224	75224		

- Lead length 5.0 \pm 1.0 mm available with code 2222 378 72...- Lead length 3.2 \pm 0.5 mm available with code 2222 378 78...- Capacitance values 0.012 to 0.018 μF in 15 mm pitch available on request.

AC and pulse metallized POLYPROPYLENE MKP/MKP film capacitors **378**

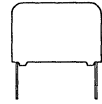

Pitch 22.5/27.5

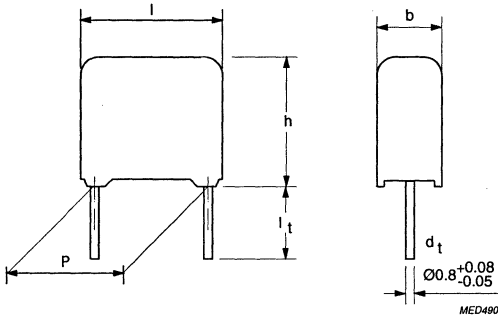

SPECIFIC REFERENCE DATA FOR 1600 V DC

Tangent of loss angle	at 10 kHz	at 100 kHz
$C \leq 0.022 \mu\text{F}$	$\leq 5 \cdot 10^{-4}$	$\leq 10 \cdot 10^{-4}$
$0.024 \mu\text{F} \leq C \leq 0.10 \mu\text{F}$	$\leq 6 \cdot 10^{-4}$	$\leq 15 \cdot 10^{-4}$
Rated voltage pulse slope $(dU/dt)_R$ at U_{Rdc} (see also application note)	$P = 22.5 \text{ mm: } 1600 \text{ V}/\mu\text{s}$ $P = 27.5 \text{ mm: } 900 \text{ V}/\mu\text{s} (b_{\text{max}} < 15 \text{ mm})$ $450 \text{ V}/\mu\text{s} (b_{\text{max}} \geq 15 \text{ mm})$	
R between terminations, for $C \leq 1 \mu\text{F}$	$> 100\,000 \text{ M}\Omega$	

SMALLEST PACKING QUANTITIES (SPQ)	loose in box	taped on reel
	SPQ	SPQ
DIMENSIONS		
6.0 x 15.5 x 26.0	1000	600
7.0 x 16.5 x 26.0	500	550
8.5 x 18.0 x 26.0	500	450
10.0 x 19.5 x 26.0	200	350
11.0 x 21.0 x 31.0	100	300
13.0 x 23.0 x 31.0	100	250
15.0 x 25.0 x 31.0	100	200
18.0 x 28.0 x 31.0	100	150

AC and pulse metallized POLYPROPYLENE MKP/MKP film capacitors

378

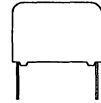
 $U_{Rdc} = 1600 \text{ V}$ $U_{Rac} = 500 \text{ V} / U_{pp} = 1400 \text{ V}$

loose and taped

Cap. (μF)	$b_{\max} \times h_{\max} \times l_{\max}$ (mm)	mass (g)	CATALOGUE NUMBER 2222 378	
			loose in box	taped on reel
			$l_1 = 3.5 \pm 0.5 \text{ mm}$	$H = 18.5 \text{ mm}^*$
			C-tol $\pm 5\%$	C-tol $\pm 5\%$
Pitch = 22.5 \pm 0.4 mm				
0.0056 0.0062 0.0068	6.0 x 15.5 x 26.0	2.6	84562 84622 84682	85562 85622 85682
0.0075 0.0082 0.0091 0.01	7.0 x 16.5 x 26.0	3.2	84752 84822 84912 84103	85752 85822 85912 85103
0.011 0.012 0.013 0.015 0.016	8.5 x 18.0 x 26.0	4.4	84113 84123 84133 84153 84163	85113 85123 85133 85153 85163
0.018 0.02 0.022	10.0 x 19.5 x 26.0	5.5	84183 84203 84223	85183 85203 85223
Pitch = 27.5 \pm 0.4 mm				
0.024 0.027 0.03 0.033 0.036	11.0 x 21.0 x 31.0	7.8	84243 84273 84303 84333 84363	85243 85273 85303 85333 85363
0.039 0.043 0.047 0.051	13.0 x 23.0 x 31.0	10.4	84393 84433 84473 84513	85393 85433 85473 85513
0.056 0.062 0.068	15.0 x 25.0 x 31.0	12.8	84563 84623 84683	85563 85623 85683
0.075 0.082 0.091 0.1	18.0 x 28.0 x 31.0	17.2	84753 84823 84913 84104	85753 85823 85913 85104

* H: intape height; for detailed specifications refer to chapter PACKAGING.

- Lead length 5.0 \pm 1.0 mm available with code 2222 378 82...
- Lead length 3.2 \pm 0.5 mm available with code 2222 378 88...

AC and pulse metallized POLYPROPYLENE MKP/MKP film capacitors

378

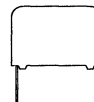

Pitch 22.5/27.5

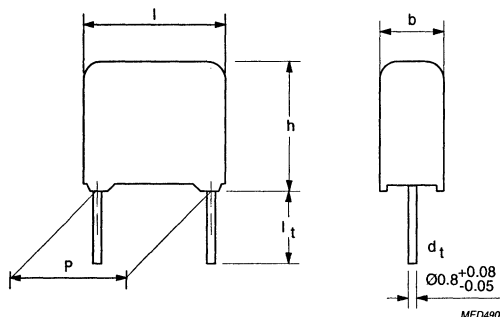

SPECIFIC REFERENCE DATA FOR 2000 V DC

Tangent of loss angle	at 10 kHz	at 100 kHz
$0.0033 \mu\text{F} \leq C \leq 0.051 \mu\text{F}$	$\leq 5 \cdot 10^{-4}$	$\leq 10 \cdot 10^{-4}$
Rated voltage pulse slope $(dU/dt)_R$ at U_{Rdc} (see also application note)	P = 22.5 mm: 2000 V/ μs P = 27.5 mm: 1200 V/ μs ($b_{\text{max}} < 15 \text{ mm}$) 600 V/ μs ($b_{\text{max}} \geq 15 \text{ mm}$)	
R between terminations, for $C \leq 1 \mu\text{F}$	>100 000 M Ω	

SMALLEST PACKING QUANTITIES (SPQ)	loose in box		taped on reel	
	DIMENSIONS		SPQ	SPQ
6.0 x 15.0 x 26.0	200	600		
7.0 x 16.5 x 26.0	200	550		
8.5 x 18.0 x 26.0	200	450		
10.0 x 19.5 x 26.0	200	350		
11.0 x 21.0 x 31.0	100	300		
13.0 x 23.0 x 31.0	100	250		
15.0 x 25.0 x 31.0	100	200		
18.0 x 28.0 x 31.0	100	150		

AC and pulse metallized POLYPROPYLENE MKP/MKP film capacitors

378

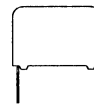
 $U_{Rdc} = 2000 \text{ V}$ $U_{Rac} = 600 \text{ V} / U_{pp} = 1700 \text{ V}$

loose and taped

Cap. (μF)	$b_{\max} \times h_{\max} \times l_{\max}$ (mm)	mass (g)	CATALOGUE NUMBER 2222 378	
			loose in box	taped on reel
			$l_1 = 3.5 \pm 0.5 \text{ mm}$	$H = 18.5 \text{ mm}^*$
			C-tol $\pm 5\%$	C-tol $\pm 5\%$
Pitch = $22.5 \pm 0.4 \text{ mm}$				
0.0033 0.0036	6.0 x 15.5 x 26.0	2.6	94332 94362	95332 95362
0.0039 0.0043 0.0047 0.0051	7.0 x 16.5 x 26.0	3.2	94392 94432 94472 94512	95392 95432 95472 95512
0.0056 0.0062 0.0068 0.0075 0.0082	8.5 x 18.0 x 26.0	4.4	94562 94622 94682 94752 94822	95562 95622 95682 95752 95822
0.0091 0.01 0.011 0.012	10.0 x 19.5 x 26.0	5.5	94912 94103 94113 94123	95912 95103 95113 95123
Pitch = $27.5 \pm 0.4 \text{ mm}$				
0.013 0.015 0.016 0.018 0.02	11.0 x 21.0 x 31.0	7.8	94133 94153 94163 94183 94203	95133 95153 95163 95183 95203
0.022 0.024 0.027	13.0 x 23.0 x 31.0		94223 94243 94273	95223 95243 95273
0.030 0.033 0.036	15.0 x 25.0 x 31.0		94303 94333 94363	95303 95333 95363
0.039 0.043 0.047 0.051	18.0 x 28.0 x 31.0		94393 94433 94473 94513	95393 95433 95473 95513

* H: intape height; for detailed specifications refer to chapter PACKAGING.

- Lead length $5.0 \pm 1.0 \text{ mm}$ available with code 2222 378 92...
- Lead length $3.2 \pm 0.5 \text{ mm}$ available with code 2222 378 98...

AC and pulse metallized POLYPROPYLENE film capacitors

MKP 378
MKP/MKP 378

RATINGS AND CHARACTERISTICS

Unless otherwise specified all electrical values apply at an ambient temperature of 23 ± 1 °C, an atmospheric pressure of 86 to 106 kPa and a relative humidity of $50 \pm 2\%$.

CAPACITANCE

- All capacitance values are specified at 1kHz.

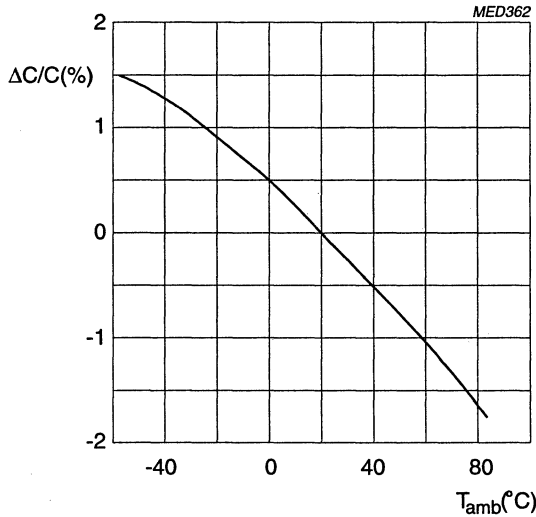

Capacitance as a function of ambient temperature; typical curve.

IMPEDANCE

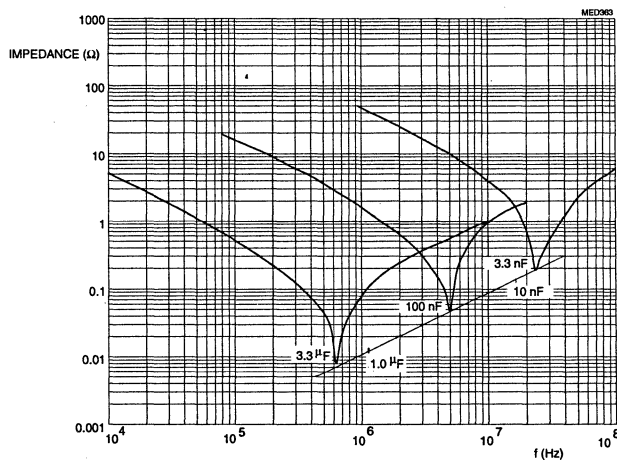

Impedance as a function of frequency; typical curves.

AC and pulse metallized POLYPROPYLENE film capacitors

MKP 378
MKP/MKP 378

TEMPERATURE

- Storage temperature : $T_{stg} = -25$ to $+40$ °C with RH maximum 80% without condensation.

VOLTAGE

- Category voltage: $U_C = U_R$ for $T = 85$ °C
- Test voltage between terminations: $1.6 \times U_{Rdc}$
- Test voltage between interconnected terminations and case (foil method): 2840 V DC
- Maximum RMS voltage (sinewave) as a function of frequency: for $T_{amb} \leq 70$ °C (see graphs below).

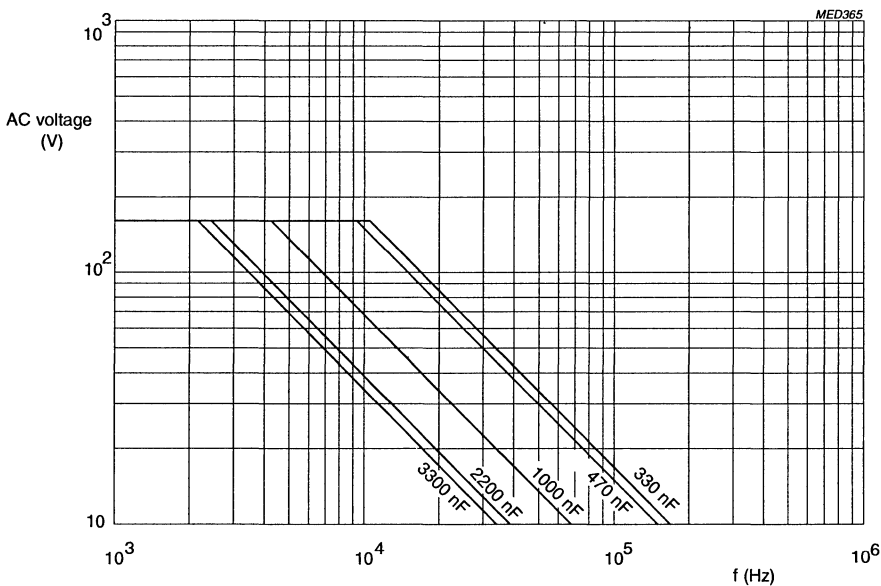

AC voltage as a function of frequency at $T_{amb} \leq 70$ °C, for $U_{Rdc} = 250$ V.

**AC and pulse metallized POLYPROPYLENE
film capacitors**

**MKP 378
MKP/MKP 378**

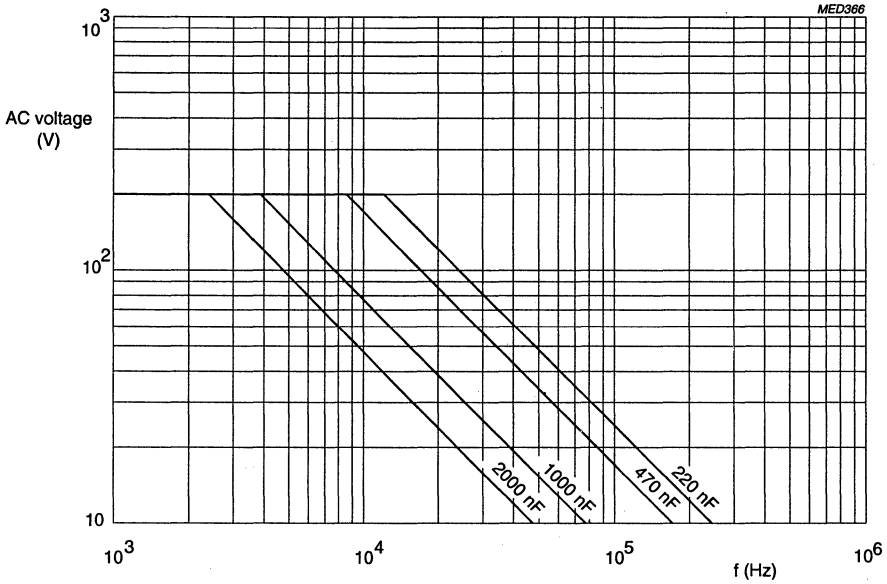

AC voltage as a function of frequency at $T_{amb} \leq 70 \text{ }^\circ\text{C}$, for $U_{Rdc} = 400 \text{ V}$.

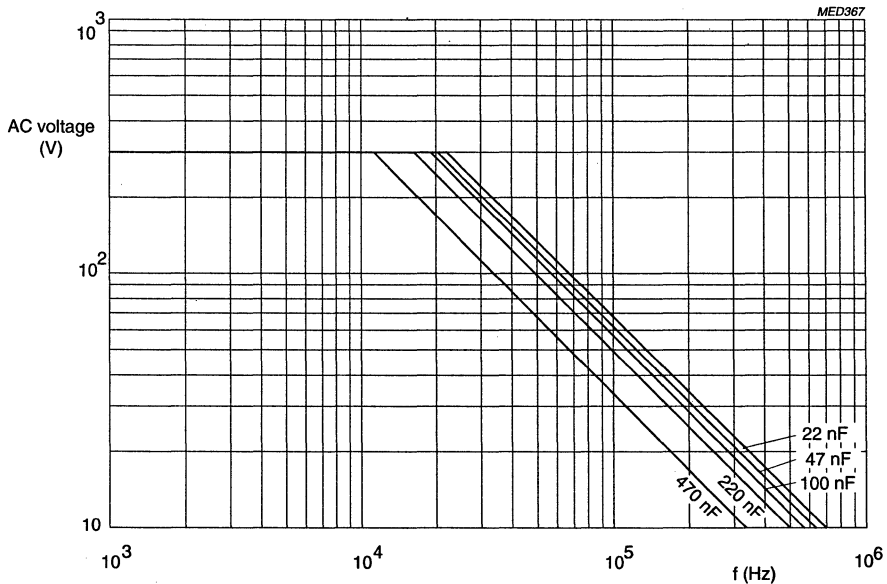

AC voltage as a function of frequency at $T_{amb} \leq 70 \text{ }^\circ\text{C}$, for $U_{Rdc} = 630 \text{ V}$.

**AC and pulse metallized POLYPROPYLENE
film capacitors**

**MKP 378
MKP/MKP 378**

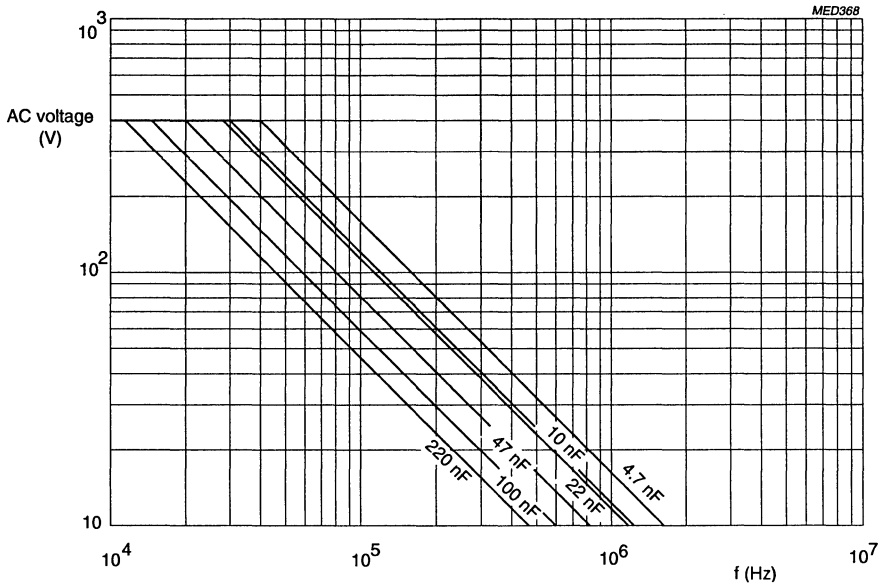

AC voltage as a function of frequency at $T_{amb} \leq 70^\circ \text{C}$, for $U_{Rdc} = 1000 \text{ V}$.

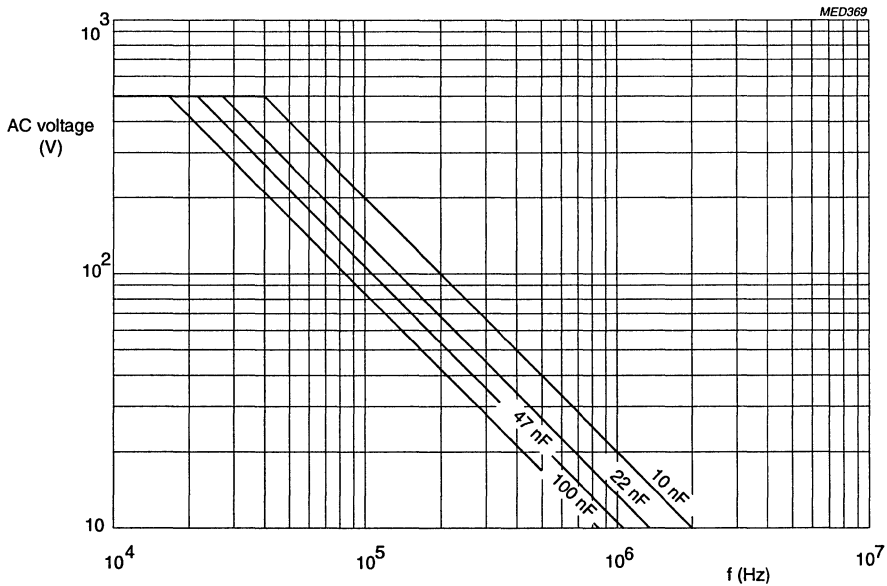

AC voltage as a function of frequency at $T_{amb} \leq 70^\circ \text{C}$, for $U_{Rdc} = 1600 \text{ V}$.

**AC and pulse metallized POLYPROPYLENE
film capacitors**

**MKP 378
MKP/MKP 378**

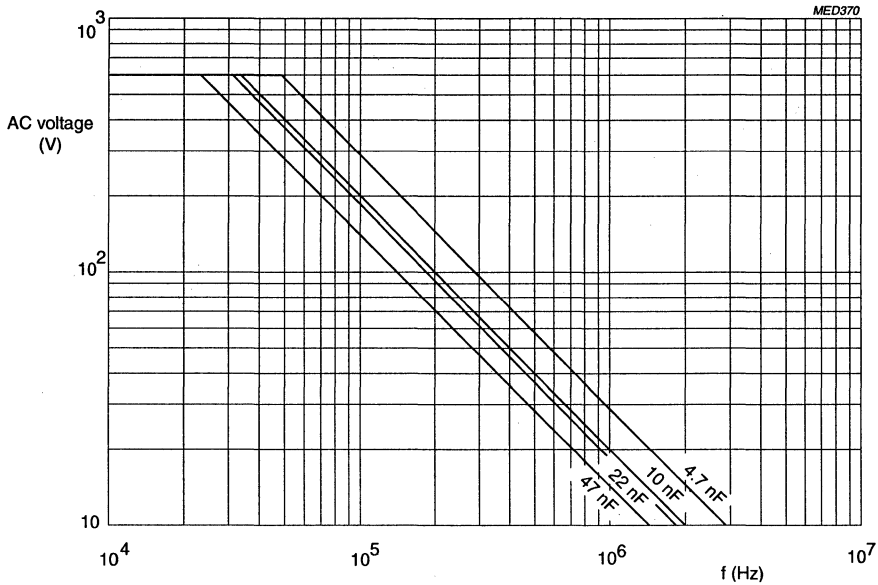

AC voltage as a function of frequency at $T_{amb} \leq 70 \text{ }^\circ\text{C}$, for $U_{Rdc} = 2000\text{V}$.

* Maximum RMS voltage as a function of frequency for $T > 70 \text{ }^\circ\text{C}$.

VOLTAGE DERATING

The maximum RMS voltage in graphs above has to be multiplied by a factor. (See graph below).

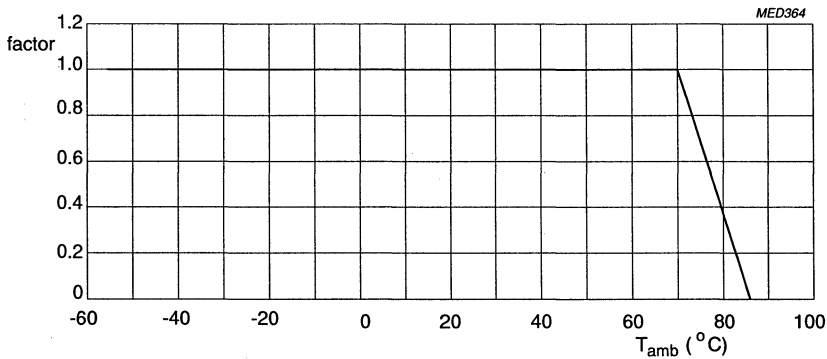

Multiplying factor as a function of temperature.

AC and pulse metallized POLYPROPYLENE film capacitors

MKP 378 MKP/MKP 378

TANGENT OF THE LOSS ANGLE

For maximum values and measuring frequencies see specific reference data.

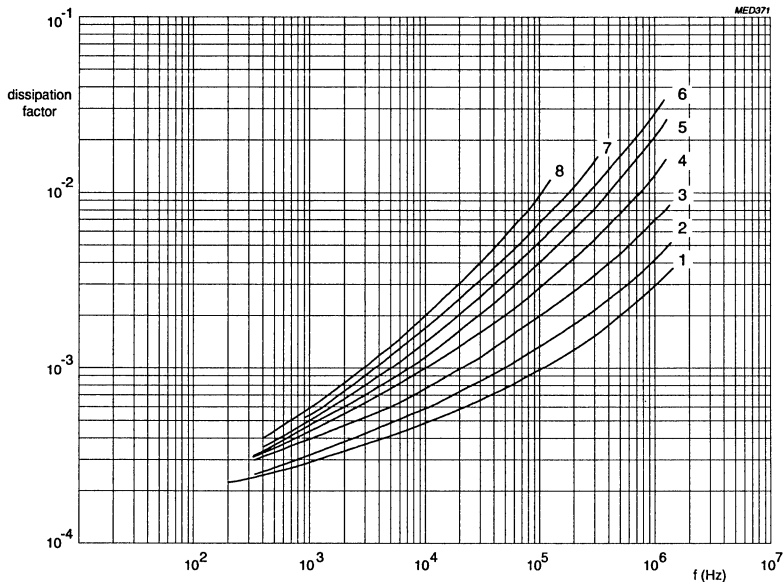

Tangent of the loss angle as a function of frequency; typical curve.

1) 2000 V version 1600 V version, $C \leq 22\text{nF}$	5) 630 V version, $0.34 \mu\text{F} \leq C \leq 0.51 \mu\text{F}$ 400 V version, $0.27 \mu\text{F} \leq C \leq 0.51 \mu\text{F}$
2) 1600 V version, $C \geq 24\text{nF}$ 1000 V version, $C \leq 51\text{nF}$ 630 V version, $C \leq 0.18 \mu\text{F}$	6) 630 V version, $C \leq 0.56 \mu\text{F}$ 400 V version, $0.56 \mu\text{F} \leq C \leq 0.68 \mu\text{F}$ 250 V version, $C \leq 0.43 \mu\text{F}$
3) 1000 V version, $C \geq 56\text{nF}$	7) 400 V version, $0.75 \mu\text{F} \leq C \leq 1 \mu\text{F}$ 250 V version, $0.47 \mu\text{F} \leq C \leq 0.82 \mu\text{F}$
4) 630 V version, $0.2 \mu\text{F} \leq C \leq 0.39 \mu\text{F}$ 400 V version, $C \leq 0.24 \mu\text{F}$	8) 400 V version, $C \geq 1.1 \mu\text{F}$ 250 V version, $C \geq 0.91 \mu\text{F}$

RATED VOLTAGE PULSE SLOPE $(dU/dt)_R$

For values see specific reference data.

If the pulse voltage is lower than the rated voltage, the values of the specific reference data may be multiplied by U_{Rdc} and divided by the applied voltage.

INSULATION RESISTANCE

The insulation resistance is measured after a voltage has been applied for 1 minute ± 5 seconds, the voltage being

100 ± 15 V for the 250 and 400 V versions, and 500 ± 50 V for the 630 V, 1000 V, 1600 V and 2000 V versions.

R between terminations: for value see specific reference data

R between interconnected terminations and case (foil method): $>100\,000 \text{ M}\Omega$

AC and pulse metallized POLYPROPYLENE film capacitors

MKP 378
MKP/MKP 378

GENERAL DATA

CONSTRUCTION

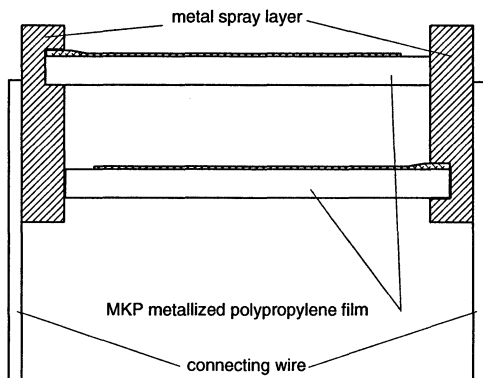

MKP 250 - 400 V versions

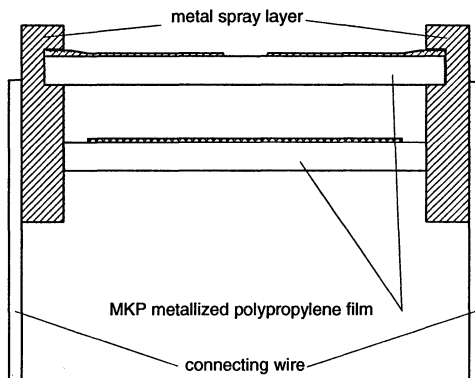

MED373

MKP/MKP 630 - 2000 V versions

DESCRIPTION

- Low-inductive wound cell of metallized polypropylene (PP) film, potted with blue epoxy resin in a blue flame retardent polypropylene case
- Radial leads, solder-coated
- Small stand-off pips allow removal of solder flux etc. during cleaning of the printed-wiring board.

MOUNTING

Normal use

The capacitors are designed for mounting on printed-wiring boards. The capacitors packed in bandoliers are designed for mounting on printed-wiring boards by means of automatic insertion machines. For detailed specifications refer to chapter PACKAGING.

Specific method of mounting to withstand vibration and shock.

In order to withstand vibration and shock tests, it must be ensured that the stand-off pips are in good contact with the printed-wiring board.

- For pitches of 15 mm the capacitors shall be mechanically fixed by the leads
- For larger pitches the capacitors shall be mounted in the same way and the body clamped.

AC and pulse metallized POLYPROPYLENE film capacitors

MKP 378 MKP/MKP 378

MAXIMUM DISSIPATION

Curve	Dimensions (mm)
	$b_{\max} \times h_{\max} \times l_{\max}$
1	5.0 x 11.0 x 17.5
2	6.0 x 12.0 x 17.5
3	7.0 x 13.5 x 17.5
4	8.5 x 15.0 x 17.5
5	6.0 x 15.5 x 26.0
6	7.0 x 16.5 x 26.0
7	8.5 x 18.0 x 26.0
8	10.0 x 19.5 x 26.0
9	11.0 x 21.0 x 31.0
10	13.0 x 23.0 x 31.0
11	15.0 x 25.0 x 31.0
12	18.0 x 28.0 x 31.0

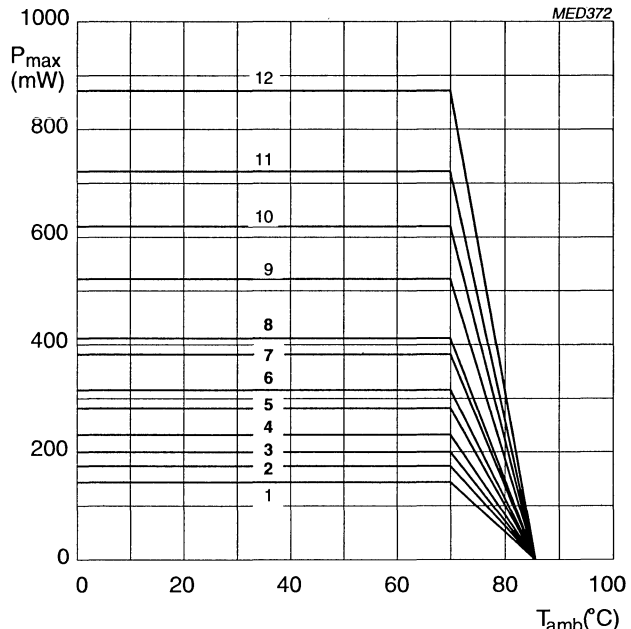

Maximum permissible power dissipation as a function of ambient free air temperature, at various capacitor dimensions.

APPLICATION NOTE

To select this capacitor for a certain application, 6 conditions must be checked:

1. The peak voltage (U_p) shall not be greater than the rated DC voltage.
2. The peak to peak voltage (U_{pp}) shall not be greater than $2\sqrt{2}$ times the rated AC voltage to avoid the ionisation inception level.
3. The peak current (I_p) shall not exceed the maximum peak current, defined as maximum voltage pulse slope (dU/dt) multiplied by the capacitance.

$$I_{P_{max}} = C \left(\frac{dU}{dt} \right)_{max}$$

Or the voltage pulse slope shall not exceed the rated voltage pulse slope. If the pulse voltage is lower than the rated voltage, the values of the table may be multiplied by U_{Rdc} and divided by the applied voltage.

4. The dissipated power shall not be greater than the maximum permissible power dissipation stated above.
5. The free air ambient temperature for the capacitor is not exceeding the category temperature.
6. It is recommended that the power in the capacitor be limited to 10 x the allowed power dissipation (P_{max}) in case of a capacitor failure.

**AC and pulse metallized POLYPROPYLENE
film capacitors**

**MKP 378
MKP/MKP 378****MARKING****Product marking**

Capacitors with a pitch of 10 mm and 15 mm are marked on the top and the side.

Capacitors with a pitch of 22.5 mm and 27.5 mm are marked on the top by laser print with the following information :

- Rated capacitance in code according to IEC 62
- Tolerance on rated capacitance J: 5%
- Rated DC voltage (e.g. 160V)
- Code for dielectric material (MKP or MKP/MKP)
- Code for factory of origin (HQ)
- Manufacturer's type designation (378)
- Manufacturer PHILIPS for pitches ≥ 15 mm or PH for pitch 10 mm
- Year and week of manufacture (e.g. 9225)

Example of marking for a capacitor with 15 mm pitch.

100n J	250V	PHILIPS
378	MKP	HQ 9225

Marking on the top

Marking on the side

Example of marking for a capacitor with 22.5 mm or 27.5 mm pitch.

4n7 J	2000V	PHILIPS	3 μ 3 J	250V	PHILIPS
378	MKP/MKP	HQ 9219	378	MKP	HQ 9219

Marking on the top

**AC and pulse metallized POLYPROPYLENE
film capacitors**

**MKP 378
MKP/MKP 378**

Package marking

The package containing the capacitors is marked as shown.

PHILIPS COMPONENTS

MADE IN BELGIUM

AC/PULSE POLYPROP. FILM CAPACITOR

MKP/MKP RADIAL POTTED TYPE

0.22µF ± 5% 1000V= 55/085/56



ORIG **A170** RPC **HQ**



TYPE **MKP/MKP 378**

—



QTY **500** DATE **9238**



CODENO **2222 378 72224**

LINE	MARKING EXPLANATION
1	Manufacturer's name
2	Country of origin
3	Sub-family
4	Type description
5	Capacitance value in µF, tolerance, voltage and climatic category (IEC)
6	—
7	Preference origin code: A Country of origin in code: 170 (Belgium) Responsible production centre: HQ (Roeselare) WO: work order
8	Product type description
9	Quantity and production period, year and week code
10	Product code (12NC)



Metallized POLYPROPYLENE film capacitors

MKP 379

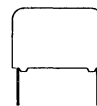

MKP RADIAL POTTED CAPACITORS

Pitch 10/15/22.5/27.5

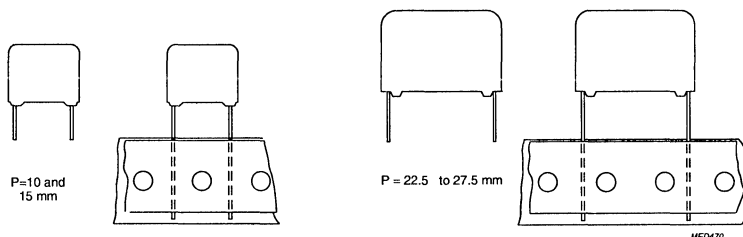

QUICK REFERENCE DATA

Capacitance range (E24 series)	0.010 to 6.2 μ F
Capacitance tolerance	\pm 5%
Rated voltage U_{Rdc}	160 V, 250 V, 400 V, 630 V
Rated (AC) voltage, 50 to 60 Hz	100 V, 160 V, 200 V, 250 V
Rated peak to peak voltage	280 V, 450 V, 560 V, 700 V
Climatic category	55/085/56
Rated temperature (DC)	85 °C
Rated temperature (AC)	70 °C
Maximum application temperature	85 °C
Reference specification	IEC 384-16
Performance grade	Grade 1 (long life)
Stability grade - 160 V version	Grade 2
- 250 V to 630 V version	Grade 2
Pitch 10 mm and 15 mm	Grade 2
Pitch 22.5 mm and 27.5 mm	Grade 1

FEATURES

- 10 to 27.5 mm terminal pitch
- Low contact resistance
- Low loss dielectric
- Small dimensions for high density packaging
- Supplied loose in box and taped on reel.

APPLICATIONS

- Where high currents at high frequencies occur.

Metallized POLYPROPYLENE film capacitors

MKP 379

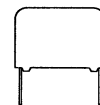

Pitch 10/15/22.5/27.5

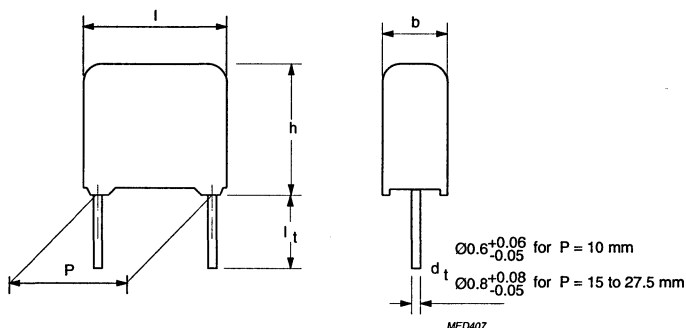

SPECIFIC REFERENCE DATA FOR 160 V DC

Tangent of loss angle	at 10 kHz	at 100 kHz
$C \leq 0.16 \mu\text{F}$	$\leq 25 \cdot 10^{-4}$	$\leq 80 \cdot 10^{-4}$
$0.16 \mu\text{F} < C \leq 0.75 \mu\text{F}$	$\leq 25 \cdot 10^{-4}$	$\leq 100 \cdot 10^{-4}$
$0.75 \mu\text{F} < C \leq 1.0 \mu\text{F}$	$\leq 30 \cdot 10^{-4}$	$\leq 150 \cdot 10^{-4}$
$C > 1.0 \mu\text{F}$	$\leq 30 \cdot 10^{-4}$	
Rated voltage pulse slope $(dU/dt)_R$	P = 10 mm: 60 V/ μs P = 15 mm: 50 V/ μs P = 22.5 mm: 25 V/ μs P = 27.5 mm: 15 V/ μs ($b_{\text{max}} < 15 \text{ mm}$) 7.5 V/ μs ($b_{\text{max}} \geq 15 \text{ mm}$)	
R between terminations, for $C \leq 1 \mu\text{F}$	>100 000 M Ω	
RC between terminations, for $C > 1 \mu\text{F}$	>100 000 s	

SMALLEST PACKING QUANTITIES (SPQ)	loose in box	taped on reel
	SPQ	SPQ
DIMENSIONS		
4.0 x 9.0 x 12.5	1000	1400
5.0 x 11.0 x 12.5	1000	1400
6.0 x 12.0 x 12.5	1000	1400
5.0 x 11.0 x 17.5	1000	1100
6.0 x 12.0 x 17.5	1000	900
7.0 x 13.5 x 17.5	500	800
8.5 x 15.0 x 17.5	500	650
7.0 x 16.5 x 26.0	200	550
8.5 x 18.0 x 26.0	200	450
10.0 x 19.5 x 26.0	200	350
11.0 x 21.0 x 31.0	100	300
13.0 x 23.0 x 31.0	100	250
15.0 x 25.0 x 31.0	100	200
18.0 x 28.0 x 31.0	100	150

Metallized POLYPROPYLENE film capacitors

MKP 379

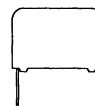
 $U_{Rdc} = 160 \text{ V}$ $U_{Rac} = 100 \text{ V} / U_{pp} = 280 \text{ V}$

loose and taped

Cap. (μF)	$b_{\max} \times h_{\max} \times l_{\max}$ (mm)	mass (g)	CATALOGUE NUMBER 2222 379.....	
			loose in box	taped on reel
			$l_1 = 3.5 \pm 0.5 \text{ mm}$ C-tol $\pm 5\%$	$H = 18.5 \text{ mm}^*$ C-tol $\pm 5\%$
Pitch = $10.0 \pm 0.4 \text{ mm}$		$d_1 = 0.6 \text{ mm}$	(+0.06 / -0.05)	
0.075 **	4.0 x 9.0 x 12.5		34753	35753
0.082 **			34823	35823
0.091 **			34913	35913
0.1 **			34104	35104
0.11 **	5.0 x 11.0 x 12.5		34114	35114
0.12 **			34124	35124
0.13 **			34134	35134
0.15 **			34154	35154
0.16 **	6.0 x 12.0 x 12.5		34164	35164
Pitch = $15.0 \pm 0.4 \text{ mm}$		$d_1 = 0.8 \text{ mm}$	(+0.08 / -0.05)	
0.18	5.0 x 11.0 x 17.5		34184	35184
0.2			34204	35204
0.22			34224	35224
0.24			34244	35244
0.27			34274	35274
0.30	6.0 x 12.0 x 17.5		34304	35304
0.33			34334	35334
0.36			34364	35364
0.39			34394	35394
0.43			34434	35434
0.47	7.0 x 13.5 x 17.5		34474	35474
0.51			34514	35514
0.56			34564	35564
0.62	8.5 x 15.0 x 17.5		34624	35624
0.68			34684	35684
0.75			34754	35754
Pitch = $22.5 \pm 0.4 \text{ mm}$		$d_1 = 0.8 \text{ mm}$	(+0.08 / -0.05)	
0.82	7.0 x 16.5 x 26.0		34824	35824
0.91			34914	35914
1.00	8.5 x 18.0 x 26.0		34105	35105
1.1			34115	35115
1.2			34125	35125
1.3			34135	35135
1.5			34155	35155
1.6	10.0 x 19.5 x 26.0		34165	35165
1.8			34185	35185
Pitch = $27.5 \pm 0.4 \text{ mm}$		$d_1 = 0.8 \text{ mm}$	(+0.08 / -0.05)	
2.0	11.0 x 21.0 x 31.0		34205	35205
2.2			34225	35225
2.4			34245	35245
2.7	13.0 x 23.0 x 31.0		34275	35275
3			34305	35305
3.3			34335	35335
3.6	15.0 x 25.0 x 31.0		34365	35365
3.9			34395	35395
4.3			34435	35435
4.7			34475	35475
5.1	18.0 x 28.0 x 31.0		34515	35515
5.6			34565	35565
6.2			34625	35625

* H: intape height; for detailed specifications refer to chapter PACKAGING.

** Under development.

**Metallized POLYPROPYLENE
film capacitors**

MKP 379

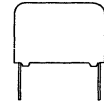

Pitch 10/15/22.5/27.5

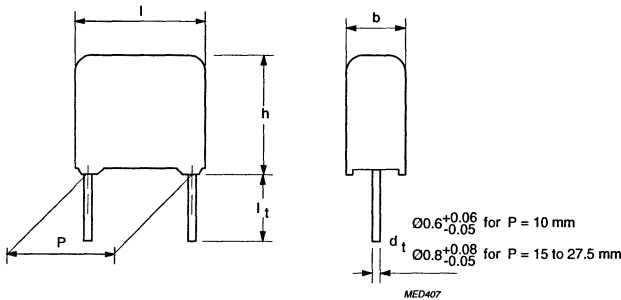

SPECIFIC REFERENCE DATA FOR 250 V DC

Tangent of loss angle	at 10 kHz	at 100 kHz
$C \leq 0.091 \mu\text{F}$	$\leq 15 \cdot 10^{-4}$	$\leq 40 \cdot 10^{-4}$
$0.091 \mu\text{F} < C \leq 0.47 \mu\text{F}$	$\leq 15 \cdot 10^{-4}$	$\leq 60 \cdot 10^{-4}$
$0.47 \mu\text{F} < C \leq 1.0 \mu\text{F}$	$\leq 20 \cdot 10^{-4}$	$\leq 120 \cdot 10^{-4}$
$1.0 \mu\text{F} < C \leq 3.9 \mu\text{F}$	$\leq 25 \cdot 10^{-4}$	
Rated voltage pulse slope (dU/dt) _R	P = 10 mm: 70 V/μs P = 15 mm: 60 V/μs P = 22.5 mm: 30 V/μs P = 27.5 mm: 20 V/μs ($b_{\text{max}} < 15 \text{ mm}$) 10 V/μs ($b_{\text{max}} \geq 15 \text{ mm}$)	
R between terminations, for $C \leq 1 \mu\text{F}$	>100 000 MΩ	
RC between terminations, for $C > 1 \mu\text{F}$	>100 000 s	

SMALLEST PACKING QUANTITIES (SPQ)	loose in box	taped on reel
DIMENSIONS	SPQ	SPQ
4.0 x 9.0 x 12.5	1000	1400
5.0 x 11.0 x 12.5	1000	1400
5.0 x 11.0 x 17.5	1000	1100
6.0 x 12.0 x 17.5	1000	900
7.0 x 13.5 x 17.5	500	800
8.5 x 15.0 x 17.5	500	650
7.0 x 16.5 x 26.0	200	550
8.5 x 18.0 x 26.0	200	450
10.0 x 19.5 x 26.0	200	350
11.0 x 21.0 x 31.0	100	300
13.0 x 23.0 x 31.0	100	250
15.0 x 25.0 x 31.0	100	200
18.0 x 28.0 x 31.0	100	150

Metallized POLYPROPYLENE film capacitors

MKP 379

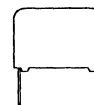
 $U_{Rdc} = 250 \text{ V}$ $U_{Rac} = 160 \text{ V} / U_{pp} = 450 \text{ V}$

loose and taped

Cap. (μF)	$b_{\max} \times h_{\max} \times l_{\max}$ (mm)	mass (g)	CATALOGUE NUMBER 2222 379.....	
			loose in box	taped on reel
			$l_1 = 3.5 \pm 0.5 \text{ mm}$	$H = 18.5 \text{ mm}^*$
	Pitch = $10.0 \pm 0.4 \text{ mm}$	$d_1 = 0.6 \text{ mm}$	(+0.06 / -0.05)	
0.047 **	4.0 x 9.0 x 12.5		44473	45473
0.051 **			44513	45513
0.056 **			44563	45563
0.062 **			44623	45623
0.068 **			44683	45683
0.075 **	5.0 x 11.0 x 12.5		44753	45753
0.082 **			44823	45823
0.091 **			44913	45913
	Pitch = $15.0 \pm 0.4 \text{ mm}$	$d_1 = 0.8 \text{ mm}$	(+0.08 / -0.05)	
0.10	5.0 x 11.0 x 17.5		44104	45104
0.11			44114	45114
0.12			44124	45124
0.13			44134	45134
0.15			44154	45154
0.16			44164	45164
0.18	6.0 x 12.0 x 17.5		44184	45184
0.2			44204	45204
0.22			44224	45224
0.24			44244	45244
0.27			44274	45274
0.3			44304	45304
0.33	8.5 x 15.0 x 17.5		44334	45334
0.36			44364	45364
0.39			44394	45394
0.43			44434	45434
0.47			44474	45474
			Pitch = $22.5 \pm 0.4 \text{ mm}$	$d_1 = 0.8 \text{ mm}$
0.51	7.0 x 16.5 x 26.0		44514	45514
0.56			44564	45564
0.62			44624	45624
0.68	8.5 x 18.0 x 26.0		44684	45684
0.75			44754	45754
0.82			44824	45824
0.91				
1	10.0 x 19.5 x 26.0		44105	45105
1.1			44115	45115
1.2			44125	45125
	Pitch = $27.5 \pm 0.4 \text{ mm}$	$d_1 = 0.8 \text{ mm}$	(+0.08 / -0.05)	
1.3	11.0 x 21.0 x 31.0		44135	45135
1.5			44155	45155
1.6			44165	45165
1.8	13.0 x 23.0 x 31.0		44185	45185
2.0			44205	45205
2.2			44225	45225
2.4			44245	45245
2.7	15.0 x 25.0 x 31.0		44275	45275
3.0			44305	45305
3.3			44335	45335
3.6	18.0 x 28.0 x 31.0		44365	45365
3.9			44395	45395

* H: intape height; for detailed specifications refer to chapter PACKAGING.

** Under development.

**Metallized POLYPROPYLENE
film capacitors**

MKP 379

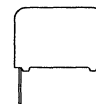

Pitch 10/15/22.5/27.5

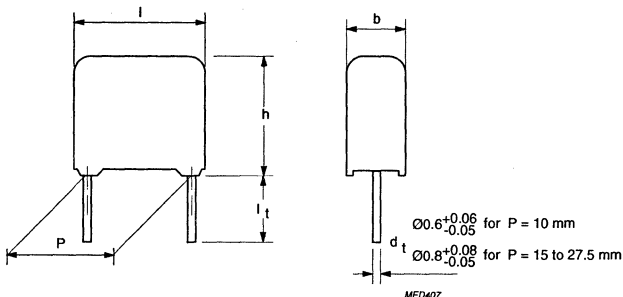

SPECIFIC REFERENCE DATA FOR 400 V DC

Tangent of loss angle	at 10 kHz	at 100 kHz
$C \leq 0.043 \mu\text{F}$	$\leq 10 \cdot 10^{-4}$	$\leq 30 \cdot 10^{-4}$
$0.043 \mu\text{F} < C \leq 0.22 \mu\text{F}$	$\leq 15 \cdot 10^{-4}$	$\leq 40 \cdot 10^{-4}$
$0.22 \mu\text{F} < C \leq 0.62 \mu\text{F}$	$\leq 15 \cdot 10^{-4}$	$\leq 60 \cdot 10^{-4}$
$0.62 \mu\text{F} < C \leq 1.0 \mu\text{F}$	$\leq 15 \cdot 10^{-4}$	$\leq 80 \cdot 10^{-4}$
$1.0 \mu\text{F} < C \leq 2.0 \mu\text{F}$	$\leq 20 \cdot 10^{-4}$	
Rated voltage pulse slope $(dU/dt)_R$ at U_{Rdc} (see application note)	P = 10 mm: 80 V/ μs P = 15 mm: 70 V/ μs P = 22.5 mm: 35 V/ μs P = 27.5 mm: 25 V/ μs ($b_{max} < 15 \text{ mm}$) 13 V/ μs ($b_{max} \geq 15 \text{ mm}$)	
R between terminations, for $C \leq 1 \mu\text{F}$	$> 100\ 000 \text{ M}\Omega$	
RC between terminations, for $C > 1 \mu\text{F}$	$> 100\ 000 \text{ s}$	

SMALLEST PACKING QUANTITIES (SPQ)	loose in box	taped on reel
	SPQ	SPQ
DIMENSIONS		
4.0 x 9.0 x 12.5	1000	1400
5.0 x 11.0 x 17.5	1000	1100
6.0 x 12.0 x 17.5	1000	900
7.0 x 13.5 x 17.5	500	800
8.5 x 15.0 x 17.5	500	650
7.0 x 16.5 x 26.0	200	550
8.5 x 18.0 x 26.0	200	450
10.0 x 19.5 x 26.0	200	350
11.0 x 21.0 x 31.0	100	300
13.0 x 23.0 x 31.0	100	250
15.0 x 25.0 x 31.0	100	200
18.0 x 28.0 x 31.0	100	150

Metallized POLYPROPYLENE film capacitors

MKP 379

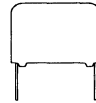
 $U_{Rdc} = 400 \text{ V}$ $U_{Rac} = 200 \text{ V} / U_{pp} = 560 \text{ V}$

loose and taped

Cap. (μF)	$b_{\max} \times h_{\max} \times l_{\max}$ (mm)	mass (g)	CATALOGUE NUMBER 2222 379.....	
			loose in box	taped on reel
			$l_t = 3.5 \pm 0.5 \text{ mm}$	$H = 18.5 \text{ mm}^*$
			C-tol $\pm 5\%$	C-tol $\pm 5\%$
Pitch = $10.0 \pm 0.4 \text{ mm}$		$d_t = 0.6 \text{ mm}$	(+0.06 / -0.05)	
0.022 **	4.0 x 9.0 x 12.5		54223	55223
0.024 **			54243	55243
0.027 **			54273	55273
0.030 **			54303	55303
0.033 **			54333	55333
0.036 **	5.0 x 11.0 x 12.5		54363	55363
0.039 **			54393	55393
0.043 **			54433	55433
Pitch = $15.0 \pm 0.4 \text{ mm}$		$d_t = 0.8 \text{ mm}$	(+0.08 / -0.05)	
0.047	5.0 x 11.0 x 17.5		54473	55473
0.051			54513	55513
0.056			54563	55563
0.062			54623	55623
0.068			54683	55683
0.075			54753	55753
0.082			54823	55823
0.091	6.0 x 12.0 x 17.5		54913	55913
0.1			54104	55104
0.11			54114	55114
0.12			54124	55124
0.13	7.0 x 13.5 x 17.5		54134	55134
0.15			54154	55154
0.16			54164	55164
0.18	8.5 x 15.0 x 17.5		54184	55184
0.2			54204	55204
0.22			54224	55224
Pitch = $22.5 \pm 0.4 \text{ mm}$		$d_t = 0.8 \text{ mm}$	(+0.08 / -0.05)	
0.24	7.0 x 16.5 x 26.0		54244	55244
0.27			54274	55274
0.3			54304	55304
0.33	8.5 x 18.0 x 26.0		54334	55334
0.36			54364	55364
0.39			54394	55394
0.43			54434	55434
0.47			54474	55474
0.51	10.0 x 19.5 x 26.0		54514	55514
0.56			54564	55564
0.62			54624	55624
Pitch = $27.5 \pm 0.4 \text{ mm}$		$d_t = 0.8 \text{ mm}$	(+0.08 / -0.05)	
0.68	11.0 x 21.0 x 31.0		54684	55684
0.75			54754	55754
0.82			54824	55824
0.91	13.0 x 23.0 x 31.0		54915	55915
1.0			54105	55105
1.1			54115	55115
1.2	15.0 x 25.0 x 31.0		54125	55125
1.3			54135	55135
1.5			54155	55155
1.6	18.0 x 28.0 x 31.0		54165	55165
1.8			54185	55185
2.0			54205	55205

* H : intape height; for detailed specifications refer to chapter PACKAGING.

** Under development.

**Metallized POLYPROPYLENE
film capacitors**

MKP 379

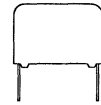

Pitch 10/15/22.5/27.5

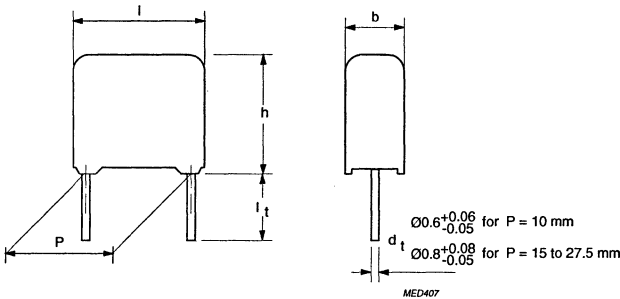

SPECIFIC REFERENCE DATA FOR 630 V DC

Tangent of loss angle	at 10 kHz	at 100 kHz
$C \leq 0.024 \mu\text{F}$	$\leq 10 \cdot 10^{-4}$	$\leq 20 \cdot 10^{-4}$
$0.024 \mu\text{F} < C \leq 0.11 \mu\text{F}$	$\leq 10 \cdot 10^{-4}$	$\leq 25 \cdot 10^{-4}$
$0.11 \mu\text{F} < C \leq 0.30 \mu\text{F}$	$\leq 10 \cdot 10^{-4}$	$\leq 35 \cdot 10^{-4}$
$0.33 \mu\text{F} < C \leq 1.0 \mu\text{F}$	$\leq 15 \cdot 10^{-4}$	$\leq 70 \cdot 10^{-4}$
Rated voltage pulse slope $(dU/dt)_R$ at U_{Rdc} (see application note)	P = 10 mm: 100 V/ μs P = 15 mm: 90 V/ μs P = 22.5 mm: 45 V/ μs P = 27.5 mm: 30 V/ μs ($b_{max} < 15 \text{ mm}$) 15 V/ μs ($b_{max} \geq 15 \text{ mm}$)	
R between terminations, for $C \leq 1 \mu\text{F}$	>100 000 M Ω	

SMALLEST PACKING QUANTITIES (SPQ)	loose in box	taped on reel
	SPQ	SPQ
DIMENSIONS		
4.0 x 9.0 x 12.5	1000	1400
5.0 x 11.0 x 12.5	1000	1100
5.0 x 11.0 x 17.5	1000	1100
6.0 x 12.0 x 17.5	1000	900
7.0 x 13.5 x 17.5	500	800
8.5 x 15.0 x 17.5	500	650
7.0 x 16.5 x 26.0	200	550
8.5 x 18.0 x 26.0	200	450
10.0 x 19.5 x 26.0	200	350
11.0 x 21.0 x 31.0	100	300
13.0 x 23.0 x 31.0	100	250
15.0 x 25.0 x 31.0	100	200
18.0 x 28.0 x 31.0	100	150

Metallized POLYPROPYLENE film capacitors

MKP 379

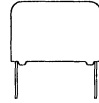
 $U_{Rdc} = 630 \text{ V}$ $U_{Rac} = 250 \text{ V} / U_{pp} = 700 \text{ V}$

loose and taped

Cap. (μF)	$b_{\max} \times h_{\max} \times l_{\max}$ (mm)	mass (g)	CATALOGUE NUMBER 2222 379.....			
			loose in box	taped on reel		
			$l_r = 3.5 \pm 0.5 \text{ mm}$	$H = 18.5 \text{ mm}^*$		
	Pitch = $10.0 \pm 0.4 \text{ mm}$	$d_r = 0.6 \text{ mm}$	(+0.06 / -0.05)			
0.010 **	4.0 x 9.0 x 12.5		64103	65103		
0.011 **			64113	65113		
0.012 **			64123	65123		
0.013 **			64133	65133		
0.015 **			64153	65153		
0.016 **			61163	65163		
0.018 **			5.0 x 11.0 x 12.5		64183	65183
0.02 **	64203	65203				
0.022 **	64223	65223				
0.024 **	64243	64243				
	Pitch = $15.0 \pm 0.4 \text{ mm}$	$d_r = 0.8 \text{ mm}$	(+0.08 / -0.05)			
0.027	5.0 x 11.0 x 17.5		64273	65273		
0.03			64303	65303		
0.033			64333	65333		
0.036			64363	65363		
0.039			64393	65393		
0.043			6.0 x 12.0 x 17.5		64433	65433
0.047	64473	65473				
0.051	64513	65513				
0.056	64563	65563				
0.062	64623	65623				
0.068	7.0 x 13.5 x 17.5				64683	65683
0.075					64753	65753
0.082					64823	62823
0.091			64913	65913		
0.1	8.5 x 15.0 x 17.5		64104	65104		
0.11			64114	65114		
	Pitch = $22.5 \pm 0.4 \text{ mm}$	$d_r = 0.8 \text{ mm}$	(+0.08 / -0.05)			
0.12	7.0 x 16.5 x 26.0		64124	65124		
0.13			64134	65134		
0.15			64154	65154		
0.16			64164	65164		
0.18	8.5 x 18.0 x 26.0		64184	65184		
0.2			64204	65204		
0.22			64224	65224		
0.24			64244	65244		
0.27	10.0 x 19.5 x 26.0		64274	65274		
0.3			64304	65304		
	Pitch = $27.5 \pm 0.4 \text{ mm}$	$d_r = 0.8 \text{ mm}$	(+0.08 / -0.05)			
0.33	11.0 x 21.0 x 31.0		64334	65334		
0.36			64364	65364		
0.39			64394	65394		
0.43			64434	65434		
0.47	13.0 x 23.0 x 31.0		64474	65474		
0.51			64514	65514		
0.56			64564	65564		
0.62			64624	65754		
0.68	15.0 x 25.0 x 31.0		64684	65684		
0.75			64754	65754		
0.82	18.0 x 28.0 x 31.0		64824	65824		
0.91			64914	65914		
1			64105	65105		

* H : intape height; for detailed specifications refer to chapter PACKAGING.

** Under development.

Metallized POLYPROPYLENE film capacitors

MKP 379

RATINGS AND CHARACTERISTICS

Unless otherwise specified all electrical values apply at an ambient temperature of 23 ± 1 °C, an atmospheric pressure of 86 to 106 kPa and a relative humidity of $50 \pm 2\%$.

CAPACITANCE

- All capacitance values are specified at 1 kHz.

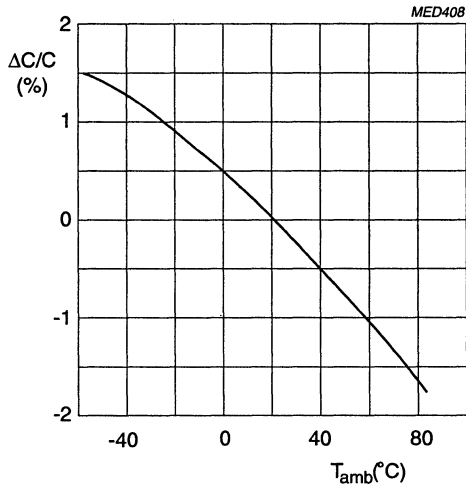

Capacitance as a function of temperature; typical curve.

IMPEDANCE

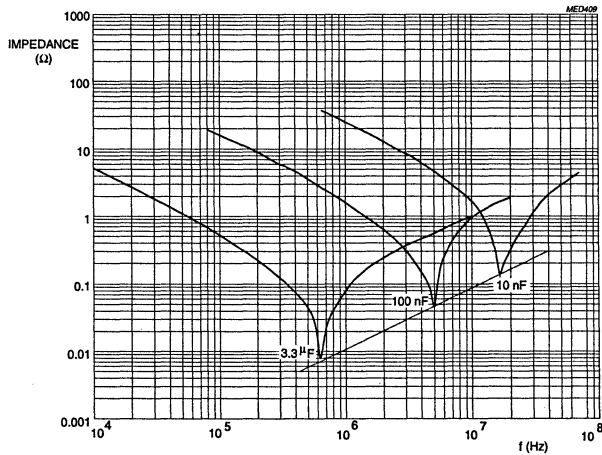

Impedance as a function of frequency; typical curves.

Metallized POLYPROPYLENE film capacitors

MKP 379**TEMPERATURE**

- Storage temperature: $T_{stg} = -25$ to $+40$ °C with RH maximum 80% without condensation.

VOLTAGE

- Category voltage: $U_c = U_R$ for $T = 85$ °C
- Test voltage between terminations: $1.6 \times U_{Rdc}$
- Test voltage between interconnected terminations and case (foil method): 2840 V DC
- Maximum RMS voltage (sinewave) as a function of frequency: for $T_{amb} \leq 70$ °C (see graphs below).

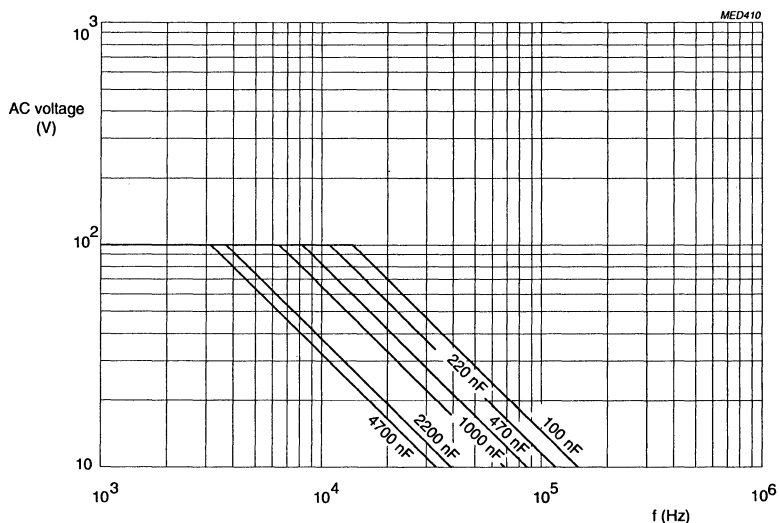

AC voltage as a function of frequency at $T_{amb} \leq 70$ °C, for $U_{Rdc} = 160$ V.

Metallized POLYPROPYLENE film capacitors

MKP 379

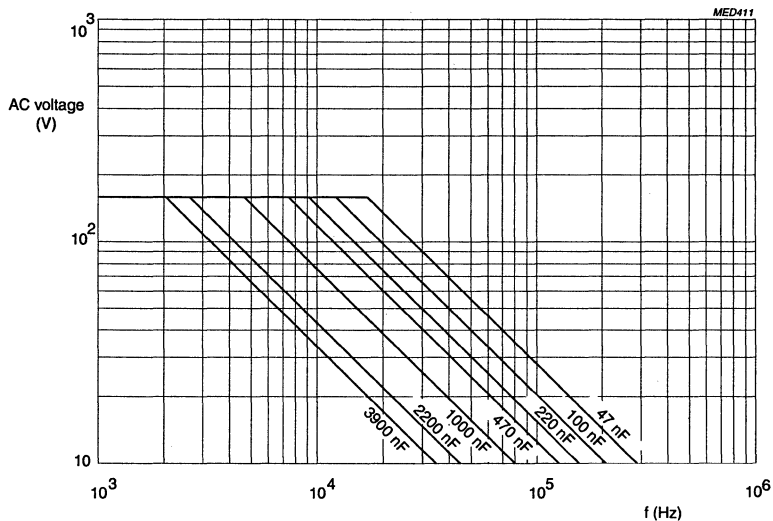

AC voltage as a function of frequency at $T_{amb} \leq 70 \text{ }^\circ\text{C}$, for $U_{Rdc} = 250 \text{ V}$.

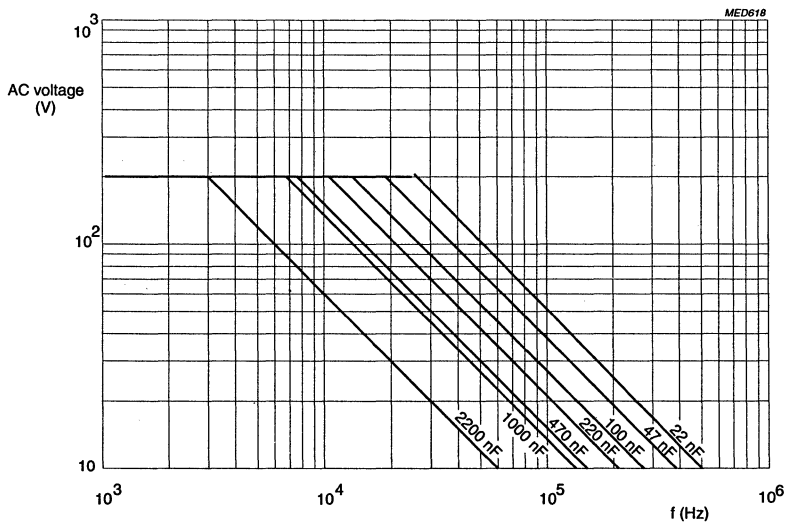

AC voltage as a function of frequency at $T_{amb} \leq 70 \text{ }^\circ\text{C}$, for $U_{Rdc} = 400 \text{ V}$.

Metallized POLYPROPYLENE film capacitors

MKP 379

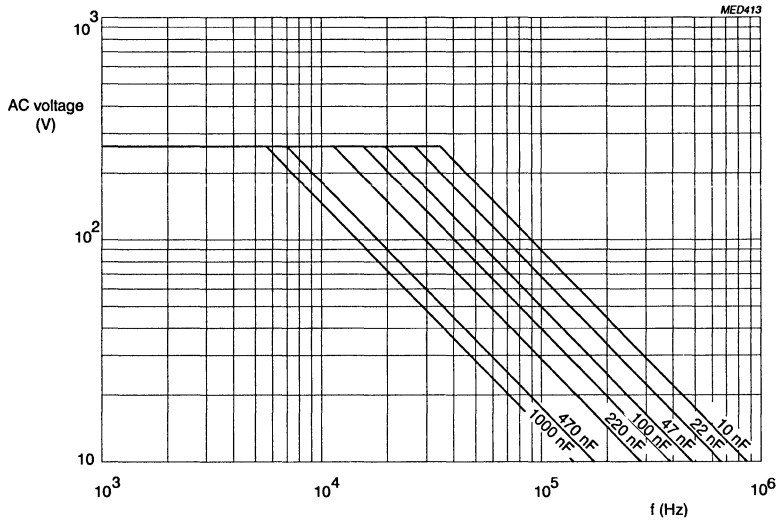

AC voltage as a function of frequency at $T_{amb} \leq 70 \text{ }^\circ\text{C}$, for $U_{Rdc} = 630 \text{ V}$.

- Maximum RMS voltage as a function of frequency for $T_{amb} > 70 \text{ }^\circ\text{C}$.

VOLTAGE DERATING

The maximum RMS voltage in graphs above has to be multiplied by a factor. (See graph below).

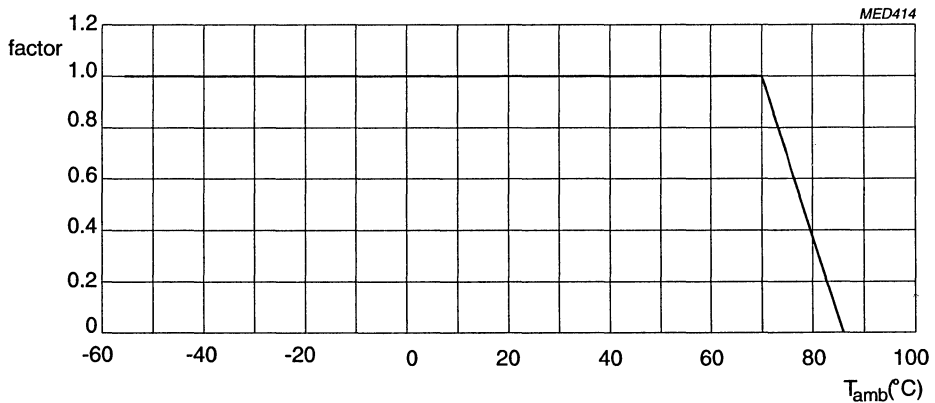

Multiplying factor as a function of temperature.

TANGENT OF THE LOSS ANGLE

- For maximum values and measuring frequencies: see specific reference data.

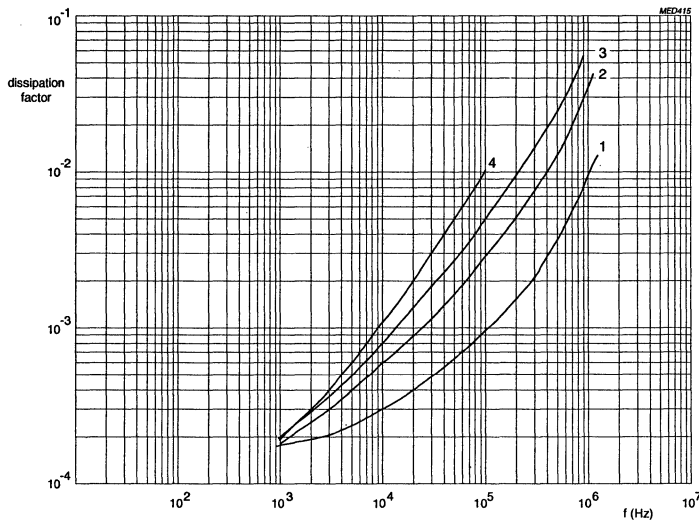

Tangent of the loss angle as a function of frequency; typical curves.

- | | |
|-------------------------------------|----------------------------------|
| 1) $C \leq 0.22 \mu\text{F}$ | 3) $0.47 < C \leq 1 \mu\text{F}$ |
| 2) $0.22 < C \leq 0.47 \mu\text{F}$ | 4) $C > 1 \mu\text{F}$ |

RATED VOLTAGE PULSE SLOPE $(dU/dt)_R$

For values see specific reference data.

If the pulse voltage is lower than the rated voltage, the values of the specific reference data may be multiplied by U_{Rdc} and divided by the applied voltage.

INSULATION RESISTANCE

The insulation resistance is measured after a voltage has been applied for 1 minute ± 5 seconds, the voltage being 100 ± 15 V for the 250 and 400 V versions, and 500 ± 50 V for the 630 V versions.

R between terminations: for value see specific reference data

R between interconnected terminations and case (foil method): $> 100\,000 \text{ M}\Omega$.

Metallized POLYPROPYLENE film capacitors

MKP 379

GENERAL DATA

CONSTRUCTION

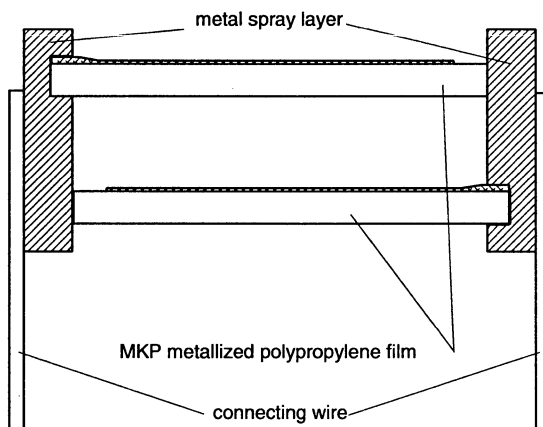

MED416

MKP 160 - 630 V versions

DESCRIPTION

- Low-inductive wound cell of metallized polypropylene (PP) film, potted with blue epoxy resin in a blue flame retardent polypropylene case
- Radial leads, solder-coated
- Small stand-off pips allow removal of solder flux etc. during cleaning of the printed-wiring board.

MOUNTING

Normal use

The capacitors are designed for mounting on printed-wiring boards. The capacitors packed in bandoliers are designed for mounting on printed-wiring boards by means of automatic insertion machines. For detailed specifications refer to chapter PACKAGING.

Specific method of mounting to withstand vibration and shock.

In order to withstand vibration and shock tests, it must be ensured that the stand-off pips are in good contact with the printing-wiring board.

- For pitches ≤ 15 mm the capacitors shall be mechanically fixed by the leads
- For larger pitches the capacitors shall be mounted in the same way and the body clamped.

Metallized POLYPROPYLENE film capacitors

MKP 379

MAXIMUM DISSIPATION

Curve	Dimensions (mm)
	$b_{\max} \times h_{\max} \times l_{\max}$
1	4.0 x 9.0 x 12.5
2	5.0 x 11.0 x 12.5
3	6.0 x 12.0 x 12.5
4	5.0 x 11.0 x 17.5
5	6.0 x 12.0 x 17.5
6	7.0 x 13.5 x 17.5
7	8.5 x 15.0 x 17.5
8	7.0 x 16.5 x 26.0
9	8.5 x 18.0 x 26.0
10	10.0 x 19.5 x 26.0
11	11.0 x 21.0 x 31.0
12	13.0 x 23.0 x 31.0
13	15.0 x 25.0 x 31.0
14	18.0 x 28.0 x 31.0

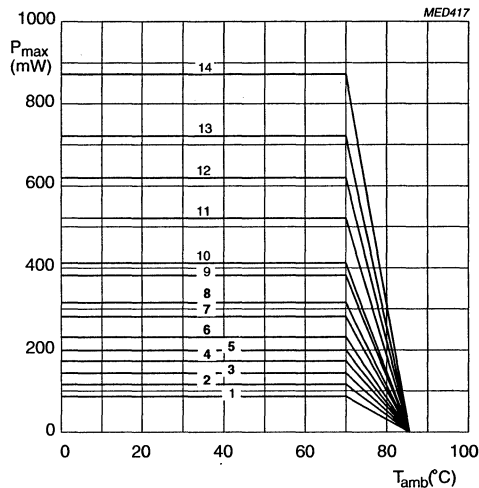

Maximum permissible power dissipation as a function of ambient temperature.

APPLICATION NOTE

To select this capacitor for a certain application, 6 conditions must be checked:

1. The peak voltage (U_p) shall not be greater than the rated DC voltage.
2. The peak to peak voltage (U_{pp}) shall not be greater than $2\sqrt{2}$ times the rated AC voltage to avoid the ionisation inception level.
3. The peak current (I_p) shall not exceed the maximum peak current, defined as maximum voltage pulse slope (dU/dt) multiplied by the capacitance.

$$I_{P_{\max}} = C \left(\frac{dU}{dt} \right)_{\max}$$

Or the voltage pulse slope shall not exceed the rated voltage pulse slope. If the pulse voltage is lower than the rated voltage, the values of the table may be multiplied by $U_{R_{dc}}$ and divided by the applied voltage.

4. The dissipated power shall not be greater than the maximum permissible power dissipation stated in the graph above.
5. The free air ambient temperature for the capacitor is not exceeding the category temperature.
6. It is recommended that the power in the capacitor be limited to 10 x the allowed power dissipation (P_{\max}) in case of a capacitor failure.

Metallized POLYPROPYLENE film capacitors

MKP 379

MARKING

Product marking

Capacitors with a pitch of 10 mm and 15 mm are marked on the top and the side.
Capacitors with a pitch of 22.5 mm and 27.5 mm are marked on the top by laser print with the following information :

- Rated capacitance in code according to IEC 62
- Tolerance on rated capacitance J: 5%
- Rated DC voltage (e.g. 160V)
- Code for dielectric material (MKP)
- Code for factory of origin (HQ)
- Manufacturer's type designation (379)
- Manufacturer PHILIPS for pitches ≥ 15 mm or PH for pitch 10 mm
- Year and week of manufacture (e.g. 9225)

Example of marking for a capacitor with 10 mm pitch.

7n5 J	250V
	MKP-HQ
	379-PH
	9225

Marking on the top

Marking on the side

Example of marking for a capacitor with 15 mm pitch.

100n J	250V	PHILIPS
379	MKP	HQ 9225

Marking on the top

Marking on the side

Example of marking for a capacitor with 22.5 mm or 27.5 mm pitch.

620n J	250V	PHILIPS
379	MKP	HQ 9225

Marking on the top

Metallized POLYPROPYLENE film capacitors

MKP 379**Package marking**

The package containing the capacitors is marked as shown.

PHILIPS COMPONENTS	LINE	MARKING EXPLANATION
MADE IN BELGIUM	1	Manufacturer's name
AC/PULSE POLYPROP. FILM CAPACITOR	2	Country of origin
MKP RADIAL POTTED TYPE	3	Sub-family
0.1µF ± 5% 160V= 55/085/56	4	Type description
	5	Capacitance value, tolerance, voltage and climatic category (IEC)
	6	-
	7	Preference origin code: A Country of origin in code: 170 (Belgium) Responsible production centre: HQ (Roeselare) WO: work order
	8	Product type description
	9	Quantity and production period, year and week code
	10	Product code (12NC)



**Metallized POLYPROPYLENE
film capacitors**

KP/MMKP 376

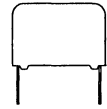

KP/MMKP RADIAL POTTED CAPACITORS

Pitch 15/22.5/27.5

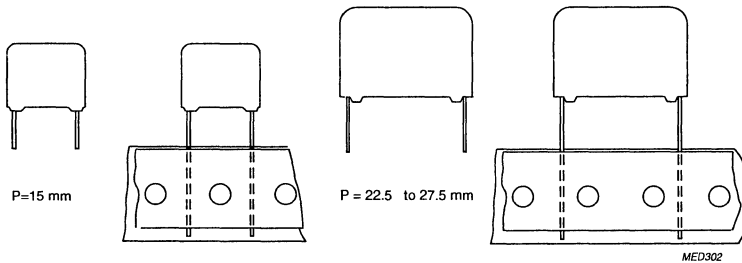

QUICK REFERENCE DATA

Capacitance range (E24 series)	0.001 to 0,27 μ F
Capacitance tolerance	\pm 5%, \pm 3.5%
Rated voltage U_{Rdc}	630 V, 1000 V, 1600 V, 2000 V
Rated voltage (AC)	300 V, 400 V, 500 V, 600 V
Climatic category	55/100/56
Rated temperature	85 °C
Reference specification	IEC 384-17
Performance grade 630 V to 2000 V versions for $C > 4.7$ nF for $C \leq 4.7$ nF	Grade 1 (long life) Grade 2 (general purpose)
Stability grade, 630 V to 2000 V versions	Grade 2

<p>FEATURES</p> <ul style="list-style-type: none"> • 15 mm to 27.5 mm terminal pitch • Supplied loose in box and taped on reel. 	<p>APPLICATION</p> <ul style="list-style-type: none"> • Where high currents and steep pulses occur • For deflection circuits in television receivers.
--	--

**Metallized POLYPROPYLENE
film capacitors**

KP/MMKP 376



Pitch 15/22.5/27.5

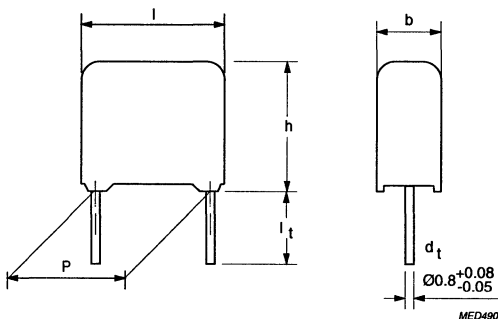

SPECIFIC REFERENCE DATA FOR 630 V DC

Tangent of loss angle	at 10 kHz	at 100 kHz
P = 15 mm	$3 \cdot 10^{-4}$	$10 \cdot 10^{-4}$
P = 22.5 mm	$3 \cdot 10^{-4}$	$15 \cdot 10^{-4}$
P = 27.5 mm	$4 \cdot 10^{-4}$	$20 \cdot 10^{-4}$
Rated voltage pulse slope $(dU/dt)_R$ at U_{Rdc} (see also application note)	>10 000 V/ μ s Limited by network conditions	
R between terminations	>100 000 M Ω	
R between interconnected terminations and case	>100 000 M Ω	

SMALLEST PACKING QUANTITIES (SPQ)	loose in box	taped on reel
	SPQ	SPQ
5.0 x 11.0 x 17.5	1000	1100
6.0 x 12.0 x 17.5	1000	900
7.0 x 13.5 x 17.5	1000	800
8.5 x 15.0 x 17.5	1000	650
6.0 x 15.5 x 26.0	200	600
7.0 x 16.5 x 26.0	200	550
8.5 x 18.0 x 26.0	200	450
9.0 x 19.0 x 31.0	100	400
11.0 x 21.0 x 31.0	100	300
13.0 x 23.0 x 31.0	100	250
15.0 x 25.0 x 31.0	100	200
18.0 x 28.0 x 31.0	100	150

Metallized POLYPROPYLENE film capacitors

KP/MMKP 376

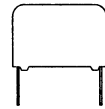
U_{Rdc} = 630 V
U_{Rac} = 300 V
loose and taped

Cap. (μ F)	$b_{max} \times h_{max} \times l_{max}$ (mm)	mass (g)	CATALOGUE NUMBER 222 376			
			loose in box		taped on reel	
			$l_1 = 5 \pm 1$ mm		H = 18.5 \pm 0.5 mm	
			C-tol $\pm 5\%$	C-tol $\pm 3.5\%$	C-tol $\pm 5\%$	C-tol $\pm 3.5\%$
Pitch = 15.0 \pm 0.4 mm						
0.0068	5.0 x 11.0 x 17.5	1.1	62682	63682	65682	66682
0.0075			62752	63752	65752	66752
0.0082			62822	63822	65822	66822
0.0091			62912	63912	65912	66912
0.010			6.0 x 12.0 x 17.5	1.4	62103	63103
0.011	62113	63113			65113	66113
0.012	62123	63123			65123	66123
0.013	62133	63133			65133	66133
0.015	7.0 x 13.5 x 17.5	1.8			62153	63153
0.016			62163	63163	65163	66163
0.018			62183	63183	65183	66183
0.020			8.5 x 15.0 x 17.5	2.6	62203	63203
0.022	62223	63223			65223	66223
Pitch = 22.5 \pm 0.4 mm						
0.024	6.0 x 15.5 x 26.0	2.8	62243	63243	65243	66243
0.027			62273	63273	65273	66273
0.030			62303	63303	65303	66303
0.033	7.0 x 16.5 x 26.0	3.5	62333	63333	65333	66333
0.036			62363	63363	65363	66363
0.039			62393	63393	65393	66393
0.043			8.5 x 18.0 x 26.0	4.4	62433	63433
0.047	62473	63473			65473	66473
0.051	62513	63513			65513	66513
0.056	62563	63563		65563	66563	
Pitch = 27.5 \pm 0.4 mm						
0.062	9.0 x 19.0 x 31.0	7.4	62623	63623	65623	66623
0.068			62683	63683	65683	66683
0.075			62753	63753	65753	66753
0.082	11.0 x 21.0 x 31.0	7.4	62823	63823	65823	66823
0.091			62913	63913	65913	66913
0.10			62104	63104	65104	66104
0.11			62114	63114	65114	66114
0.12	13.0 x 23.0 x 31.0	10.2	62124	63124	65124	66124
0.13			62134	63134	65134	66134
0.15			62154	63154	65154	66154
0.16			62164	63164	65164	66164
0.18			15.0 x 25.0 x 31.0	12.8	62184	63184
0.20	62204	63204			65204	66204
0.22	18.0 x 28.0 x 31.0	18.2	62224	63224	65224	66224
0.24			62244	63244	65244	66244
0.27			62274	63274	65274	66274

 Lead length 3.2 \pm 0.5 mm and tolerance $\pm 5\%$ available with code 222 376 68...

 Lead length 3.2 \pm 0.5 mm and tolerance $\pm 3.5\%$ available with code 222 376 69...

**Metallized POLYPROPYLENE
film capacitors**

KP/MMKP 376

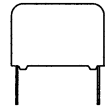

Pitch 15/22.5/27.5

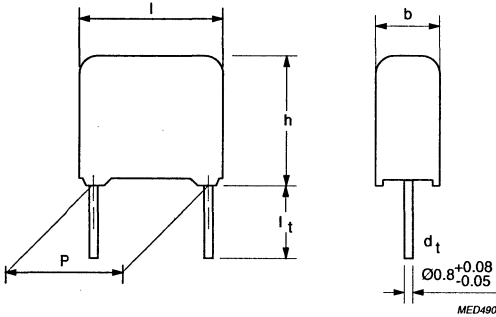

SPECIFIC REFERENCE DATA FOR 1000 V DC

Tangent of loss angle		at 10 kHz	at 100 kHz
	P = 15 mm	$3 \cdot 10^{-4}$	$10 \cdot 10^{-4}$
	P = 22.5 mm	$3 \cdot 10^{-4}$	$10 \cdot 10^{-4}$
	P = 27.5 mm	$3 \cdot 10^{-4}$	$15 \cdot 10^{-4}$
Rated voltage pulse slope $(dU/dt)_R$ at U_{Rdc} (see also application note)		>10 000 V/ μ s Limited by network conditions	
R between terminations		>100 000 M Ω	
R between interconnected terminations and case		>100 000 M Ω	

SMALLEST PACKING QUANTITIES (SPQ)	loose in box	taped on reel
DIMENSIONS	SPQ	SPQ
5.0 x 11.0 x 17.5	1000	1100
6.0 x 12.0 x 17.5	1000	900
7.0 x 13.5 x 17.5	1000	800
8.5 x 15.0 x 17.5	1000	650
6.0 x 15.5 x 26.0	200	600
7.0 x 16.5 x 26.0	200	550
8.5 x 18.0 x 17.5	200	450
10.0 x 19.5 x 26.0	200	350
9.0 x 19.0 x 31.0	100	400
11.0 x 21.0 x 31.0	100	300
13.0 x 23.0 x 31.0	100	250
15.0 x 25.0 x 31.0	100	200
18.0 x 28.0 x 31.0	100	150

Metallized POLYPROPYLENE film capacitors

KP/MMKP 376

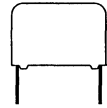
 $U_{Rdc} = 1000 \text{ V}$
 $U_{Rac} = 400 \text{ V}$
loose and taped

Cap. (μF)	$b_{\text{max}} \times h_{\text{max}} \times l_{\text{max}}$ (mm)	mass (g)	CATALOGUE NUMBER 2222 376			
			loose in box		taped on reel	
			$l_1 = 5 \pm 1 \text{ mm}$		$H = 18.5 \pm 0.5 \text{ mm}$	
			C-tol $\pm 5\%$	C-tol $\pm 3.5\%$	C-tol $\pm 5\%$	C-tol $\pm 3.5\%$
Pitch = $15 \pm 0.4 \text{ mm}$						
0.0047	5.0 x 11.0 x 17.5	1.1	72472	73472	75472	76472
0.0051			72512	73512	75512	76512
0.0056			72562	73562	75562	76562
0.0062	6.0 x 12.0 x 17.5	1.4	72622	73622	75622	76622
0.0068			72682	73682	75682	76682
0.0075			72752	73752	75752	76752
0.0082			72822	73822	75822	76822
0.0091	7.0 x 13.5 x 17.5	1.8	72912	73912	75912	76912
0.010			72103	73103	75103	76103
0.011			72113	73113	75113	76113
0.012	8.5 x 15.0 x 17.5	2.6	72123	73123	75123	76123
Pitch = $22.5 \pm 0.4 \text{ mm}$						
0.013	6.0 x 15.5 x 26.0	2.8	72133	73133	75133	76133
0.015	7.0 x 16.5 x 26.0	3.5	72153	73153	75153	76153
0.016			72163	73163	75163	76163
0.018			72183	73183	75183	76183
0.020	8.5 x 18.0 x 17.5	4.4	72203	73203	75203	76203
0.022			72223	73223	75223	76223
0.024			72243	73243	75243	76243
0.027			72273	73273	75273	76273
0.030			72303	73303	75303	76303
0.033			72333	73333	75333	76333
0.036			72363	73363	75363	76363
0.039			10.0 x 19.5 x 26.0	5.1	72393	73393
Pitch = $27.5 \pm 0.4 \text{ mm}$						
0.043	9.0 x 19.0 x 31.0	7.4	72433	73433	75433	76433
0.047			72473	73473	75473	76473
0.051			72513	73513	75513	76513
0.056	11.0 x 21.0 x 31.0	7.4	72563	73563	75563	76563
0.062			72623	73623	75623	76623
0.068			72683	73683	75683	76683
0.075			72753	73753	75753	76753
0.082	13.0 x 23.0 x 31.0	10.2	72823	73823	75823	76823
0.091			72913	73913	75913	76913
0.10			72104	73104	75104	76104
0.11			72114	73114	75114	76114
0.12	15.0 x 25.0 x 31.0	12.8	72124	73124	75124	76124
0.13			72134	73134	75134	76134
0.15			72154	73154	75154	76154
0.16	18.0 x 28.0 x 31.0	18.2	72164	73164	75164	76164
0.18			72184	73184	75184	76184

 Lead length $3.2 \pm 0.5 \text{ mm}$ and tolerance $\pm 5\%$ available with code 222 376 78...

 Lead length $3.2 \pm 0.5 \text{ mm}$ and tolerance $\pm 3.5\%$ available with code 222 376 79...

**Metallized POLYPROPYLENE
film capacitors**

KP/MMKP 376

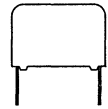

Pitch 15/22.5/27.5

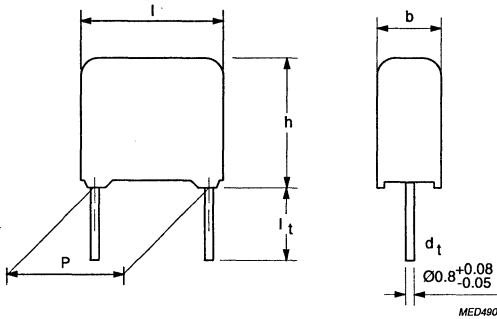

SPECIFIC REFERENCE DATA FOR 1600 V DC

Tangent of loss angle		at 10 kHz	at 100 kHz
	P = 15 mm	$3 \cdot 10^{-4}$	$10 \cdot 10^{-4}$
	P = 22.5 mm	$3 \cdot 10^{-4}$	$10 \cdot 10^{-4}$
	P = 27.5 mm	$3 \cdot 10^{-4}$	$15 \cdot 10^{-4}$
Rated voltage pulse slope $(dU/dt)_R$ at U_{Rdc} (see also application note)		>10 000 V/ μ s Limited by network conditions	
R between terminations		>100 000 M Ω	
R between interconnected terminations and case		>100 000 M Ω	

SMALLEST PACKING QUANTITIES (SPQ)	loose in box	taped on reel
	SPQ	SPQ
DIMENSIONS		
5.0 x 11.0 x 17.5	1000	1100
6.0 x 12.0 x 17.5	1000	900
7.0 x 13.5 x 17.5	1000	800
8.5 x 15.0 x 17.5	1000	650
6.0 x 15.5 x 26.0	200	600
7.0 x 16.5 x 26.0	200	550
8.5 x 18.0 x 26.0	200	450
10.0 x 19.5 x 26.0	200	350
9.0 x 19.0 x 31.0	100	400
11.0 x 21.0 x 31.0	100	300
13.0 x 23.0 x 31.0	100	250
15.0 x 25.0 x 31.0	100	200
18.0 x 28.0 x 31.0	100	150

Metallized POLYPROPYLENE film capacitors

KP/MMKP 376

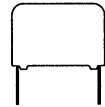
 $U_{Rdc} = 1600 \text{ V}$
 $U_{Rac} = 500 \text{ V}$
loose and taped

Cap. (μF)	$b_{\text{max}} \times h_{\text{max}} \times l_{\text{max}}$ (mm)	mass (g)	CATALOGUE NUMBER 2222 376			
			loose in box		taped on reel	
			$l_1 = 5 \pm 1 \text{ mm}$		$H = 18.5 \pm 0.5 \text{ mm}$	
			C-tol $\pm 5\%$	C-tol $\pm 3.5\%$	C-tol $\pm 5\%$	C-tol $\pm 3.5\%$
Pitch = $15 \pm 0.4 \text{ mm}$						
0.0018	5.0 x 11.0 x 17.5	1.1	82182	83182	85182	86182
0.0020	6.0 x 12.0 x 17.5	1.4	82202	83202	85202	86202
0.0022			82222	83222	85222	86222
0.0024			82242	83242	85242	86242
0.0027	7.0 x 13.5 x 17.5	1.8	82272	83272	85272	86272
0.0030			82302	83302	85302	86302
0.0033			82332	83332	85332	86332
0.0036	8.5 x 15.0 x 17.5	2.6	82362	83362	85362	86362
0.0039			82392	83392	85392	86392
0.0043			82432	83432	85432	86432
0.0047			82472	83472	85472	86472
Pitch = $22.5 \pm 0.4 \text{ mm}$						
0.0051	6.0 x 15.5 x 26.0	2.8	82512	83512	85512	86512
0.0056			82562	83562	85562	86562
0.0062			82622	83622	85622	86622
0.0068			82682	83682	85682	86682
0.0075	7.0 x 16.5 x 26.0	2.8	82752	83752	85752	86752
0.0082			82822	83822	85822	86822
0.0091			82912	83912	85912	86912
0.010	8.5 x 18.0 x 26.0	3.5	82103	83103	85103	86103
0.011			82113	83113	85113	86113
0.012			82123	83123	85123	86123
0.013			82133	83133	85133	86133
0.015	10.0 x 19.5 x 26.0	5.1	82153	83153	85153	86153
Pitch = $27.5 \pm 0.4 \text{ mm}$						
0.016	9.0 x 19.0 x 31.0	7.4	82163	83163	85163	86163
0.018	11.0 x 21.0 x 31.0	7.4	82183	83183	85183	86183
0.020			82203	83203	85203	86203
0.022			82223	83223	85223	86223
0.024			82243	83243	85243	86243
0.027	13.0 x 23.0 x 31.0	10.2	82273	83273	85273	86273
0.030			82303	83303	85303	86303
0.033			82333	83333	85333	86333
0.036			82363	83363	85363	86363
0.039	15.0 x 25.0 x 31.0	12.8	82393	83393	85393	86393
0.043			82433	83433	85433	86433
0.047			82473	83473	85473	86473
0.051	18.0 x 28.0 x 31.0	18.2	82513	83513	85513	86513
0.056			82563	83563	85563	86563

 Lead length $3.2 \pm 0.5 \text{ mm}$ and tolerance $\pm 5\%$ available with code 222 376 88...

 Lead length $3.2 \pm 0.5 \text{ mm}$ and tolerance $\pm 3.5\%$ available with code 222 376 89...

Metallized POLYPROPYLENE film capacitors

KP/MMKP 376

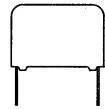

Pitch 15/22.5/27.5

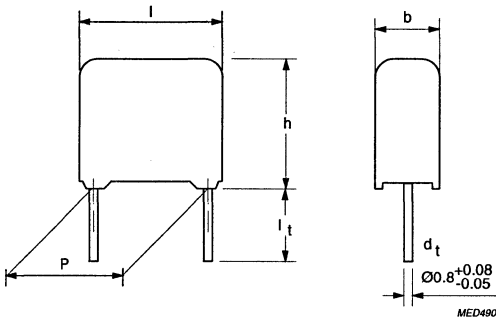

SPECIFIC REFERENCE DATA FOR 2000 V DC

Tangent of loss angle	at 10 kHz	at 100 kHz
P = 15 mm	$3 \cdot 10^{-4}$	$10 \cdot 10^{-4}$
P = 22.5 mm	$3 \cdot 10^{-4}$	$10 \cdot 10^{-4}$
P = 27.5 mm	$3 \cdot 10^{-4}$	$15 \cdot 10^{-4}$
Rated voltage pulse slope $(dU/dt)_R$ at U_{Rdc} (see also application note)	>10 000 V/ μ s Limited by network conditions	
R between terminations	>100 000 M Ω	
R between interconnected terminations and case	>100 000 M Ω	

SMALLEST PACKING QUANTITIES (SPQ)	loose in box	taped on reel
	SPQ	SPQ
DIMENSIONS		
5.0 x 11.0 x 17.5	1000	1100
6.0 x 12.0 x 17.5	1000	900
7.0 x 13.5 x 17.5	1000	800
8.5 x 15.0 x 17.5	1000	650
6.0 x 15.0 x 26.0	200	600
7.0 x 16.5 x 26.0	200	550
8.5 x 18.0 x 26.0	200	450
10.0 x 19.5 x 26.0	200	350
11.0 x 21.0 x 31.0	100	300
13.0 x 23.0 x 31.0	100	250
15.0 x 25.0 x 31.0	100	200
18.0 x 28.0 x 31.0	100	150

Metallized POLYPROPYLENE film capacitors

KP/MMKP 376

 $U_{Rdc} = 2000 \text{ V}$
 $U_{Rac} = 600 \text{ V}$

loose and taped

Cap. (μF)	$b_{\max} \times h_{\max} \times l_{\max}$ (mm)	mass (g)	CATALOGUE NUMBER 222 376			
			loose in box		taped on reel	
			$l_1 = 5 \pm 1 \text{ mm}$		$H = 18.5 \pm 0.5 \text{ mm}$	
			C-tol $\pm 5\%$	C-tol $\pm 3.5\%$	C-tol $\pm 5\%$	C-tol $\pm 3.5\%$
Pitch = $15 \pm 0.4 \text{ mm}$						
0.0010	5.0 x 11.0 x 17.5	1.1	92102	93102	95102	96102
0.0011			92112	93112	95112	96112
0.0012	6.0 x 12.0 x 17.5	1.4	92122	93122	95122	96122
0.0013			92132	93132	95132	96132
0.0015			92152	93152	95152	96152
0.0016			92162	93162	95162	96162
0.0018	7.0 x 13.5 x 17.5	1.8	92182	93182	95182	96182
0.0020			92202	93202	95202	96202
0.0022	8.5 x 15.0 x 17.5	2.6	92222	93222	95222	96222
0.0024			92242	93242	95242	96242
0.0027			92272	93272	95272	96272
0.0030			92302	93302	95302	96302
			Pitch = $22.5 \pm 0.4 \text{ mm}$			
0.0033	6.0 x 15.5 x 26.0	2.8	92332	93332	95332	96332
0.0036			92362	93362	95362	96362
0.0039			92392	93392	95392	96392
0.0043	7.0 x 16.5 x 26.0	2.8	92432	93432	95432	96432
0.0047			92472	93472	95472	96472
0.0051			92512	93512	95512	96512
0.0056	8.5 x 18.0 x 26.0	3.5	92562	93562	95562	96562
0.0062			92622	93622	95622	96622
0.0068			92682	93682	95682	96682
0.0075		4.4	92752	93752	95752	96752
			92822	93822	95822	96822
0.0091	10.0 x 19.5 x 26.0	5.1	92912	93912	95912	96912
0.010			92103	93103	95103	96103
Pitch = $27.5 \pm 0.4 \text{ mm}$						
0.011	11.0 x 21.0 x 31.0	7.4	92113	93113	95113	96113
0.012			92123	93123	95123	96123
0.013			92133	93133	95133	96133
0.015			92153	93153	95153	96153
0.016	13.0 x 23.0 x 31.0	10.2	92163	93163	95163	96163
0.018			92183	93183	95183	96183
0.020			92203	93203	95203	96203
0.022			92223	93223	95223	96223
			Pitch = $27.5 \pm 0.4 \text{ mm}$			
0.024	15.0 x 25.0 x 31.0	12.8	92243	93243	95243	96243
0.027			92273	93273	95273	96273
0.030	18.0 x 28.0 x 31.0	18.2	92303	93303	95303	96303
0.033			92333	93333	95333	96333

Lead length $3.2 \pm 0.5 \text{ mm}$ and tolerance $\pm 5\%$ available with code 222 376 98...Lead length $3.2 \pm 0.5 \text{ mm}$ and tolerance $\pm 3.5\%$ available with code 222 376 99...

Metallized POLYPROPYLENE film capacitors

KP/MMKP 376

RATINGS AND CHARACTERISTICS

Unless otherwise specified all electrical values apply at an ambient temperature of 23 ± 1 °C, an atmospheric pressure of 86 to 106 kPa and a relative humidity of $50 \pm 2\%$.

CAPACITANCE

- All capacitance values are specified at 1 kHz.

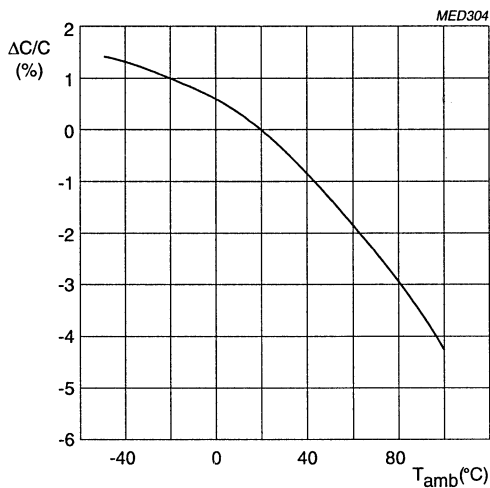

Capacitance as a function of ambient temperature: typical curve.

IMPEDANCE

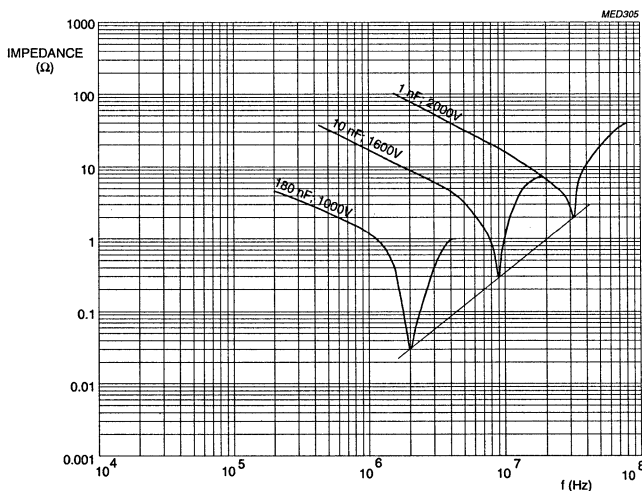

Impedance as a function of frequency: typical curve.

Metallized POLYPROPYLENE film capacitors

KP/MMKP 376

TEMPERATURE

- Storage temperature: $T_{stg} = -25$ to $+40$ °C with RH maximum 80% without condensation.

VOLTAGE

- Category voltage: $U_c = 0.7 \times U_{Rdc}$
- Test voltage between terminations: $1.6 \times U_{Rdc}$
- Test voltage between interconnected terminations and case (foil method) 2840 V DC
- Maximum RMS voltage (sinewave) as a function of frequency: for $T_{amb} \leq 85$ °C (see graphs below).

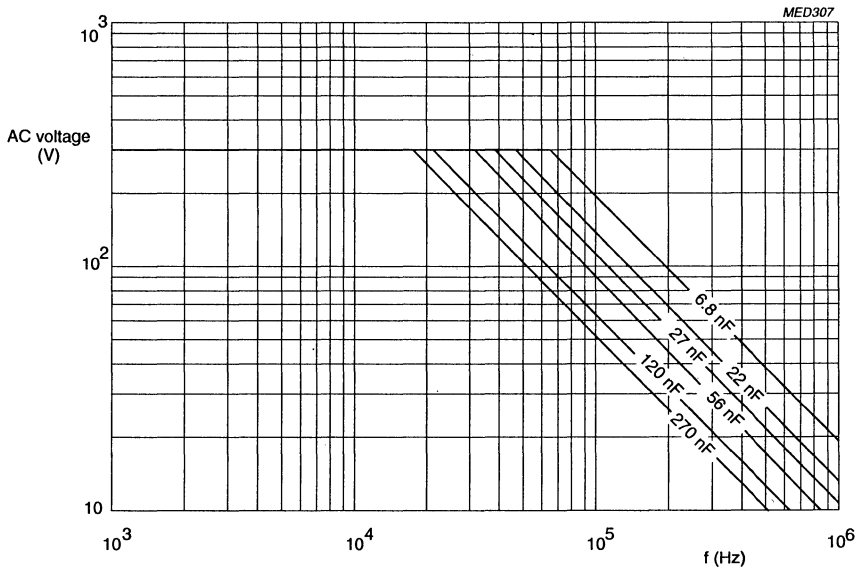

AC voltage (RMS value) as a function of frequency at $T_{amb} \leq 85$ °C, for $U_{Rdc} = 630$ V.

Metallized POLYPROPYLENE film capacitors

KP/MMKP 376

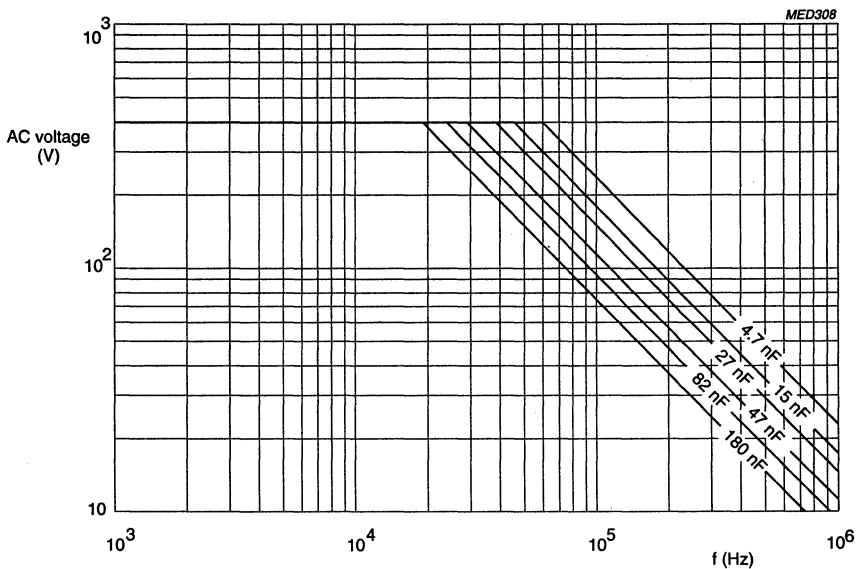

AC voltage (RMS value) as a function of frequency at $T_{amb} \leq 85^\circ\text{C}$, for $U_{Rdc} = 1000\text{ V}$.

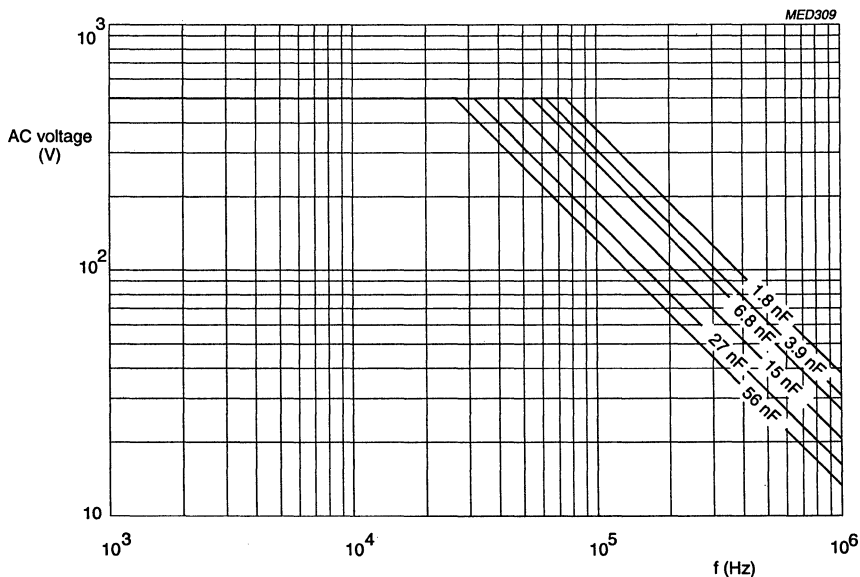

AC voltage (RMS value) as a function of frequency at $T_{amb} \leq 85^\circ\text{C}$, for $U_{Rdc} = 1600\text{ V}$.

Metalized POLYPROPYLENE film capacitors

KP/MMKP 376

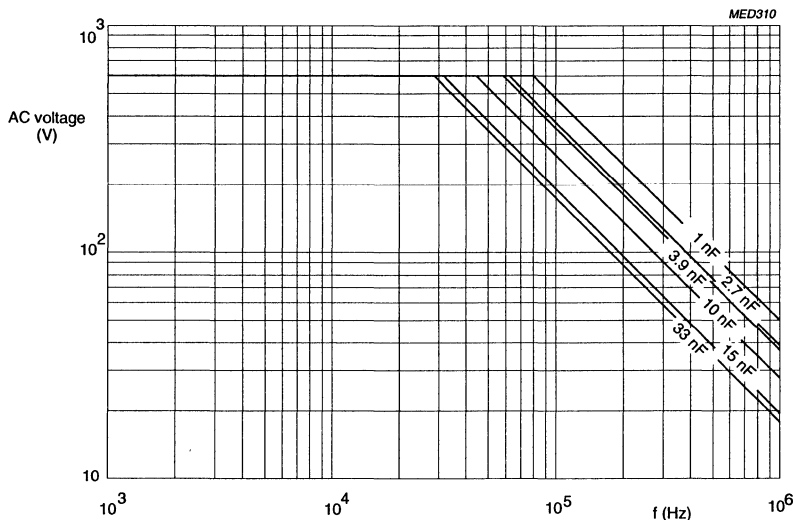

AC voltage (RMS value) as a function of frequency at $T_{amb} \leq 85^\circ\text{C}$ for $U_{Rdc} = 2000\text{ V}$.

- Maximum RMS voltage as a function of frequency for $T > 85^\circ\text{C}$
- The maximum RMS voltage in graphs above has to be multiplied by a factor. (See graph below)

VOLTAGE DERATING

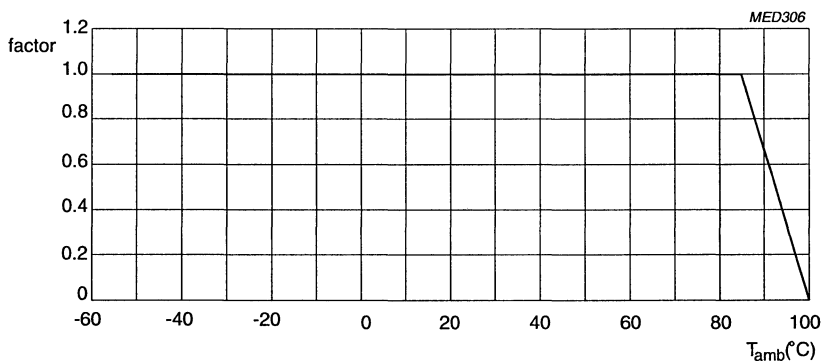

Multiplying factor as a function of temperature.

Metallized POLYPROPYLENE film capacitors

KP/MMKP 376

TANGENT OF THE LOSS ANGLE

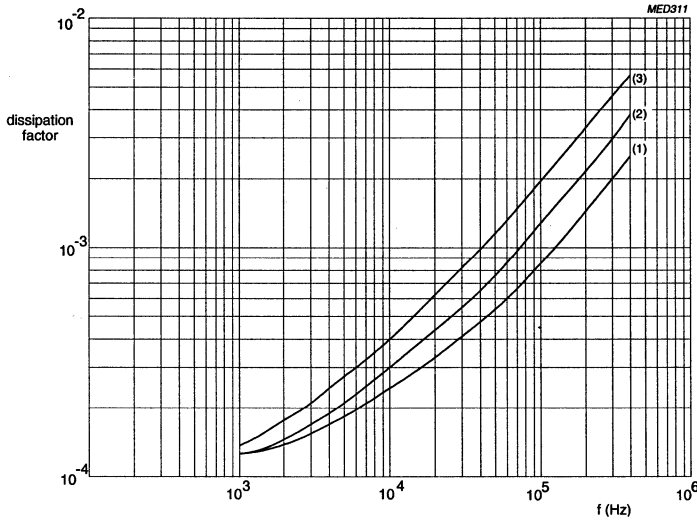

Tangent of the loss angle as a function of frequency; typical curve.

<p>Curve 1: 15.0 mm pitch, all series 22.5 mm pitch, 1000 V/1500 V/1600 V series 2000 V series</p>
<p>Curve 2: 22.5 mm pitch, 630 V series 27.5 mm pitch, 1000 V series 1500 V, 1600 V series 2000 V series</p>
<p>Curve 3: 27.5 mm pitch, 630 V series</p>

**Metallized POLYPROPYLENE
film capacitors****KP/MMKP 376****INSULATION RESISTANCE**

The insulation resistance is measured after a voltage has been applied for 1 minute ± 5 seconds, the voltage being 500 ± 50 V for the 630 V to 2000 V versions. $T_{\text{amb}} = 20$ °C.

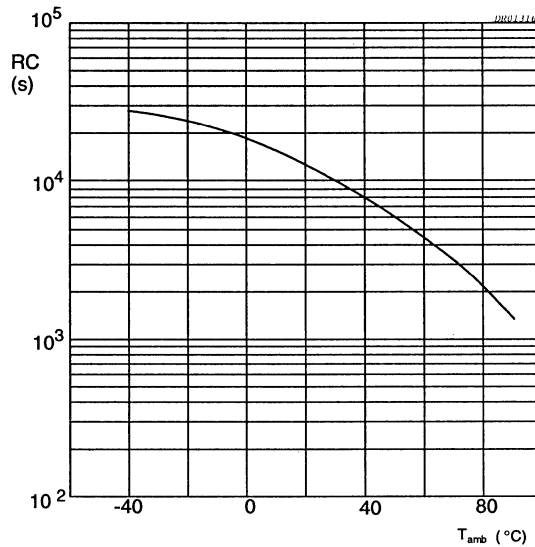

RC product as a function of ambient temperature: typical curve.

Metallized POLYPROPYLENE film capacitors

KP/MMKP 376

GENERAL DATA

CONSTRUCTION

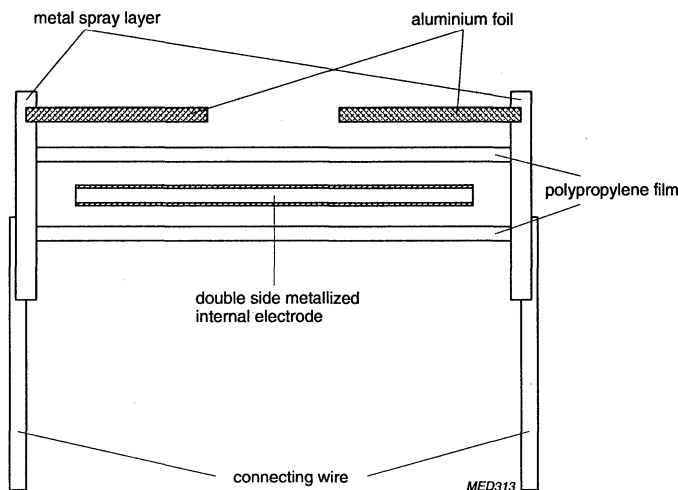

DESCRIPTION

- Low-inductive wound cell of aluminium foil and polypropylene film, potted with blue epoxy resin in a blue flame retardent polypropylene case
- Radial leads, solder-coated
- Small stand-off pips allow removal of solder flux etc. during cleaning of the printed-wiring board.

MOUNTING

Normal use

The capacitors are designed for mounting on printed-wiring boards. The capacitors packed in bandoliers are designed for mounting on printed-wiring boards by means of automatic insertion machines. For detailed specifications refer to chapter PACKAGING.

Specific method of mounting to withstand vibration and shock.

In order to withstand vibration and shock tests, it must be insured that the stand-off pips are in good contact with the printed-wiring board. For case sizes up to and including a mass of 6 g the capacitors shall be mechanically fixed by the leads. With larger case sizes the capacitors shall be mounted in the same way and the body clamped.

Metallized POLYPROPYLENE film capacitors

KP/MMKP 376

MAXIMUM DISSIPATION

Curve	Dimensions (mm)
	$b_{\max} \times h_{\max} \times l_{\max}$
1	5.0 x 11.0 x 17.5
2	6.0 x 12.0 x 17.5
3	7.0 x 13.5 x 17.5
4	8.5 x 15.0 x 17.5
5	6.0 x 15.5 x 26.0
6	7.0 x 16.5 x 26.0
7	8.5 x 18.0 x 26.0
8	10.0 x 19.5 x 26.0
9	9.0 x 19.0 x 31.0
10	11.0 x 21.0 x 31.0
11	13.0 x 23.0 x 31.0
12	15.0 x 25.0 x 31.0
13	18.0 x 28.0 x 31.0

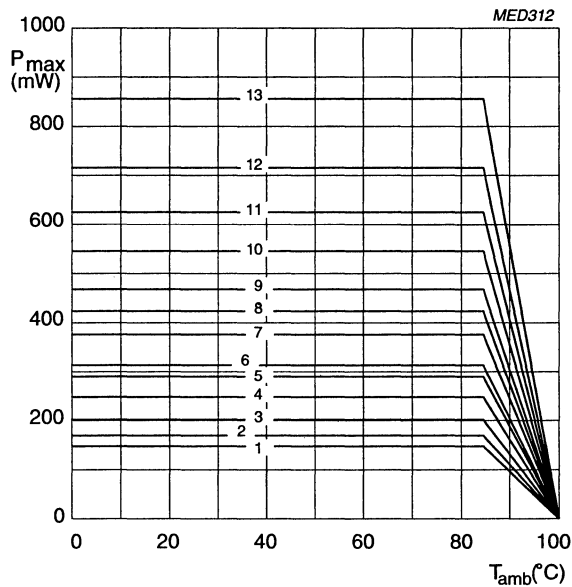

Maximum dissipation as a function of ambient temperature, at various capacitor dimensions.

APPLICATION NOTE

To select this capacitor for a certain application, 5 conditions must be checked:

1. The peak voltage (U_p) shall not be greater than the rated DC voltage.
2. The peak to peak voltage (V_{pp}) shall not be greater than $2\sqrt{2}$ times the rated AC voltage to avoid the ionisation inception level.
3. There is no limit for the peak current (I_p) or voltage slope (dU/dt) in the application.
4. The dissipated power shall not be greater than the maximum permissible power dissipation stated in the graph above.
5. The free air ambient temperature for the capacitor is not exceeding the category temperature.

Metallized POLYPROPYLENE film capacitors

KP/MMKP 376

MARKING

Product marking

Capacitors with pitch 15 mm

The capacitors are marked on the top by laser print with the following information:

- Rated capacitance in code according to IEC 62
- Tolerance on rated capacitance (e.g. 10)
- Rated (DC) voltage (e.g. 630V)
- Code for dielectric material (KP/MMKP)
- Manufacturer's type designation (376)

The capacitors are marked on the side by laser print with the following information:

- Code for factory of origin (HQ)
- Manufacturer (PHILIPS)
- Year and week of manufacture (e.g. 9238)

Example: 6800n J 630V PHILIPS
 376 KP/MMKP HQ 9238

Capacitors with pitch 22.5 mm or 27.5 mm

The capacitors are marked on the top by laser print with the following information:

- Capacitance in code according to IEC 62
- Capacitance tolerance J: 5% A: 3.5% K: 10%
- Rated voltage (e.g. 1000V)
- Manufacturer's type designation (376)
- Code for dielectric material (KP/MMKP) for 630 V to 2000 V versions
- Manufacturer (PHILIPS)
- Code for factory of origin (HQ)
- Year and week of manufacture (e.g. 9210)

Example: 33n J 1000 V PHILIPS
 376 KP/MMKP HQ 9210

Metallized POLYPROPYLENE film capacitors

KP/MMKP 376

Package marking

The package containing the capacitors is marked as shown.

PHILIPS COMPONENTS

MADE IN BELGIUM

AC/PULSE POLYPROP. FILM CAPACITOR

KP/MMKP RADIAL POTTED TYPE

8200_pF ± 5% 1600V= 55/100/56



ORIG **A170** RPC **HQ**



TYPE **KP/MMKP 376**



QTY **1000** DATE **9238**



CODENO **2222 376 82822**

LINE	MARKING EXPLANATION
1	Manufacturer's name
2	Country of origin
3	Sub-family
4	Type description
5	Capacitance value, tolerance, voltage and climatic category (IEC)
6	-
7	Preference origin code: A Country of origin in code: 170 (Belgium) Responsible production centre: HQ (Roeselare) WO: work order
8	Product type description
9	Quantity and production period, year and week code
10	Product code (12NC)

PRECISION

POLYSTYRENE film foil capacitors

KS 424 .. 431



KS AXIAL CAPACITORS

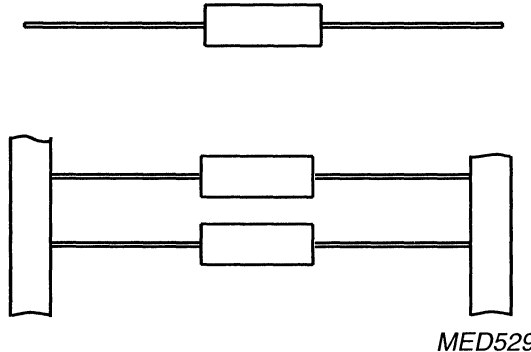

QUICK REFERENCE DATA

Capacitance range	47 to 39 000 pF
Capacitance tolerance	±5%, ±2%, ±1%
Rated voltage U_{Rdc}	63 V, 160 V, 250 V, 630 V
Climatic category	40/085/21
Rated temperature	85 °C
Reference specification	IEC 384-7
Stability class	Class 3

FEATURES

- Supplied loose in box and taped on reel.

APPLICATIONS

- For use in circuits where close tolerance, reliability and low losses are of prime importance, e.g. tuned circuits, filter networks, timing networks, etc.

POLYSTYRENE
film foil capacitors

KS 424 / 428

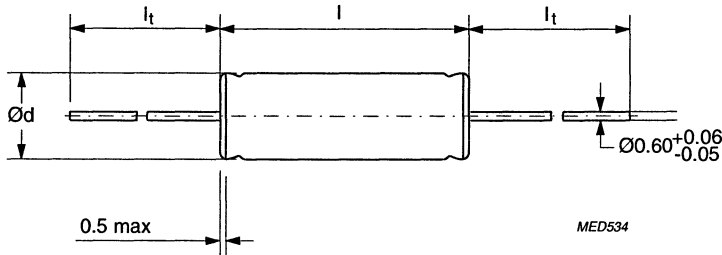
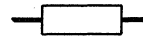

SPECIFIC REFERENCE DATA FOR 63 V DC

Tangent of loss angle	at 1 kHz	at 100 kHz	at 1 MHz
1000 pF < C ≤ 10 000 pF	≤5·10 ⁻⁴	≤10·10 ⁻⁴	-
10 000 pF < C ≤ 20 000 pF	≤5·10 ⁻⁴	≤15·10 ⁻⁴	-
C > 20 000 pF	≤5·10 ⁻⁴	≤25·10 ⁻⁴	-
R between terminations	>100 000 MΩ		

SMALLEST PACKING QUANTITIES (SPQ)	loose in box	taped on reel
DIMENSIONS	SPQ	SPQ
3.8 x 11.0	400	3000
4.0 x 11.0	400	2500
4.5 x 11.0	300	2500
5.0 x 11.0	250	1500
5.0 x 15.0	300	1500
5.5 x 15.0	250	1500
6.0 x 15.0	250	1500
6.5 x 15.0	200	1000
7.0 x 15.0	150	1000
7.5 x 15.0	150	1000
8.0 x 15.0	150	1000

POLYSTYRENE film foil capacitors

KS 424 / 428

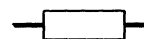
 $U_{Rdc} = 63 V$ $U_{Rac} = 25 V$

loose and taped

Cap. (E-24) (pF) *	$d_{max} \times l_{max}$ (mm)	mass (g)	CATALOGUE NUMBER					
			2222 424			2222 428		
			loose in box			taped on reel		
			C-tol $\pm 5\%$	C-tol $\pm 2\%$	C-tol $\pm 1\%$	C-tol $\pm 5\%$	C-tol $\pm 2\%$	C-tol $\pm 1\%$
$l_t = 30 \text{ mm}$								
2000 2200 2400	3.8 x 11.0	0.3	22002 22202 22402	32002 32202 32402	42002 42202 42402	62002 62202 62402	72002 72202 72402	82002 82202 82402
2700 3000 3300 3600 3900	4.0 X 11.0	0.4	22702 23002 23302 23602 23902	32702 33002 33302 33602 33902	42702 43002 43302 43602 43902	62702 63002 63302 63602 63902	72702 73002 73302 73602 73902	82702 83002 83302 83602 83902
4300 4700 5100 5600	4.5 x 11.0	0.5	24302 24702 25102 25602	34302 34702 35102 35602	44302 44702 45102 45602	64302 64702 65102 65602	74302 74702 75102 75602	84302 84702 85102 85602
6200 6800	5.0 x 11.0	0.6	26202 26802	36202 36802	46202 46802	66202 66802	76202 76802	86202 86802
$l_t = 28 \text{ mm}$								
7500 8200 9100 10000	5.0 x 15.0	0.6	27502 28202 29102 21003	37502 38202 39102 31003	47502 48202 49102 41003	67502 68202 69102 61003	77502 78202 79102 71003	87502 88202 89102 81003
11000 12000 13000 15000	5.5 x 15.0	0.8	21103 21203 21303 21503	31103 31203 31303 31503	41103 41203 41303 41503	61103 61203 61303 61503	71103 71203 71303 71503	81103 81203 81303 81503
16000 18000 20000	6.0 x 15.0	1.1	21603 21803 22003	31603 31803 32003	41603 41803 42003	61603 61803 62003	71603 71803 72003	81603 81803 82003
22000 24000	6.5 x 15.0	1.3	22203 22403	32203 32403	42203 42403	62203 62403	72203 72403	82203 82403
27000 30000	7.0 x 15.0	1.5	22703 23003	32703 33003	42703 43003	62703 63003	72703 73003	82703 83003
33000 36000	7.5 x 15.0	1.9	23303 23603	33303 33603	43303 43603	63303 63603	73303 73603	83303 83603
39000	8.0 x 15.0	2.0	23903	33903	43903	63903	73903	83903

* Besides the values of the E24-series as quoted, intermediate values of the E48-series (with a tolerance $\pm 2\%$ or $\pm 1\%$) and of the E96-series (with a tolerance $\pm 1\%$) are available. The specifications of these intermediate values are equal to the specifications of the next higher value of the E24-series.

On special request, these capacitors are also available in lacquered version. (See table composition of catalogue numbers for lacquered versions).

**POLYSTYRENE
film foil capacitors**

KS 425 / 429

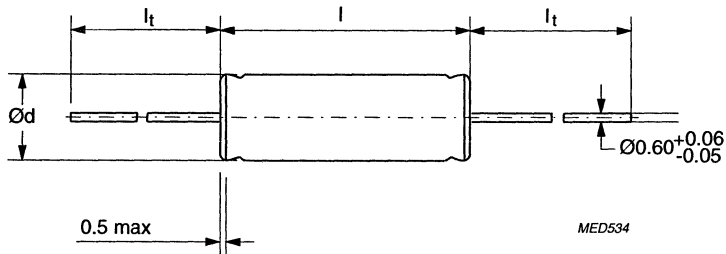

SPECIFIC REFERENCE DATA FOR 160 V DC

Tangent of loss angle	at 1 kHz	at 100 kHz	at 1 MHz
1000 pF < C ≤ 10 000 pF	≤5·10 ⁻⁴	≤10·10 ⁻⁴	-
10 000 pF < C ≤ 20 000 pF	≤5·10 ⁻⁴	≤15·10 ⁻⁴	-
R between terminations	>100 000 MΩ		

SMALLEST PACKING QUANTITIES (SPQ)	loose in box	taped on reel
	DIMENSIONS	SPQ
3.8 x 11.0	400	3000
4.0 x 11.0	400	2500
4.5 x 11.0	300	2500
5.0 x 11.0	250	1500
5.0 x 15.0	300	1500
5.5 x 15.0	250	1500
6.0 x 15.0	250	1500
6.5 x 15.0	200	1000
7.0 x 15.0	150	1000

POLYSTYRENE film foil capacitors

KS 425 / 429

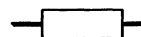
 $U_{Rdc} = 160 \text{ V}$ $U_{Rac} = 63 \text{ V}$

loose and taped

Cap. (E-24) (pF) *	$d_{max} \times l_{max}$ (mm)	mass (g)	CATALOGUE NUMBER						
			2222 425			2222 429			
			loose in box			taped on reel			
			C-tol $\pm 5\%$	C-tol $\pm 2\%$	C-tol $\pm 1\%$	C-tol $\pm 5\%$	C-tol $\pm 2\%$	C-tol $\pm 1\%$	
$l_t = 30 \text{ mm}$									
1100	3.8 x 11.0	0.3	21102	31102	41102	61102	71102	81102	
1200			21202	31202	41202	61202	71202	81202	
1300			21302	31302	41302	61302	71302	81302	
1500	4.0 x 11.0	0.4	21502	31502	41502	61502	71502	81502	
1600			21602	31602	41602	61602	71602	81602	
1800			21802	31802	41802	61802	71802	81802	
2000	4.5 x 11.0	0.4	22002	32002	42002	62002	72002	82002	
2200			22202	32202	42202	62202	72202	82202	
2400		0.5	22402	32402	42402	62402	72402	82402	
2700			22702	32702	42702	62702	72702	82702	
3000	5.0 x 11.0	0.5	23002	33002	43002	63002	73002	83002	
3300			23302	33302	43302	63302	73302	83302	
3600		0.6	23602	33602	43602	63602	73602	83602	
3900			23902	33902	43902	63902	73902	83902	
$l_t = 28 \text{ mm}$									
4300	5.0 x 15.0	0.6	24302	34302	44302	64302	74302	84302	
4700			24702	34702	44702	64702	74702	84702	
5100			25102	35102	45102	65102	75102	85102	
5600			25602	35602	45602	65602	75602	85602	
6200			26202	36202	46202	66202	76202	86202	
6800	5.5 x 15.0	0.8	26802	36802	46802	66802	76802	86802	
7500			27502	37502	47502	67502	77502	87502	
8200	6.0 x 15.0	0.9	28202	38202	48202	68202	78202	88202	
9100			29102	39102	49102	69102	79102	89102	
10000			21003	31003	41003	61003	71003	81003	
11000	6.5 x 15.0	1.1	21103	31103	41103	61103	71103	81103	
12000			21203	31203	41203	61203	71203	81203	
13000			21303	31303	41303	61303	71303	81303	
15000	7.0 x 15.0	1.4	21503	31503	41503	61503	71503	81503	
16000			21603	31603	41603	61603	71603	81603	

* Besides the values of the E24-series as quoted, intermediate values of the E48-series (with a tolerance $\pm 2\%$ or $\pm 1\%$) and of the E96-series (with a tolerance $\pm 1\%$) are available. The specifications of these intermediate values are equal to the specifications of the next higher value of the E24-series.

On special request, these capacitors are also available in lacquered version. (See table composition of catalogue numbers for lacquered versions).

**POLYSTYRENE
film foil capacitors**

KS 426 / 430

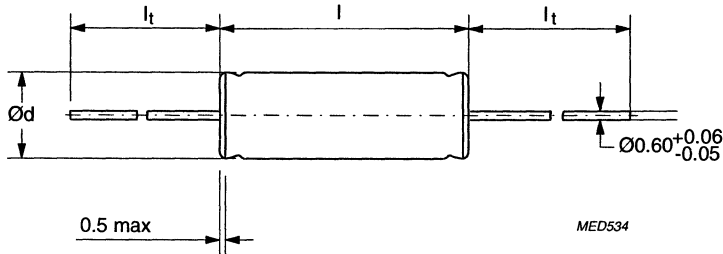
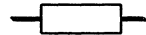

SPECIFIC REFERENCE DATA FOR 250 V DC

Tangent of loss angle	at 1 kHz	at 100 kHz	at 1 MHz
C ≤ 1000 pF	≤5·10 ⁻⁴	–	≤10·10 ⁻⁴
1000 pF < C ≤ 10 000 pF	≤5·10 ⁻⁴	≤10·10 ⁻⁴	–
10 000 pF < C ≤ 20 000 pF	≤5·10 ⁻⁴	≤15·10 ⁻⁴	–
R between terminations	>100 000 MΩ		

SMALLEST PACKING QUANTITIES (SPQ)	loose in box	taped on reel
	SPQ	SPQ
DIMENSIONS		
3.8 x 11.0	400	3000
4.0 x 11.0	400	2500
4.5 x 11.0	300	2500
5.0 x 11.0	250	1500
5.0 x 15.0	300	1500
5.5 x 15.0	250	1500
6.0 x 15.0	250	1500
6.5 x 15.0	200	1000
7.0 x 15.0	150	1000
7.5 x 15.0	150	1000

POLYSTYRENE film foil capacitors

KS 426 / 430

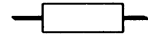
 $U_{Rdc} = 250 \text{ V}$ $U_{Rac} = 125 \text{ V}$

loose and taped

Cap. (E-24) (pF) *	$d_{max} \times l_{max}$ (mm)	mass (g)	CATALOGUE NUMBER					
			2222 426			2222 430		
			loose in box			taped on reel		
			C-tol $\pm 5\%$	C-tol $\pm 2\%$	C-tol $\pm 1\%$	C-tol $\pm 5\%$	C-tol $\pm 2\%$	C-tol $\pm 1\%$
$l_t = 30 \text{ mm}$								
560	3.8 x 11.0	0.3	25601	35601	45601	65601	75601	85601
620			26201	36201	46201	66201	76201	86201
680			26801	36801	46801	66801	76801	86801
750	4.0 x 11.0	0.3	27501	37501	47501	67501	77501	87501
820			28201	38201	48201	68201	78201	88201
910			29101	39101	49101	69101	79101	89101
1000			21002	31002	41002	61002	71002	81002
1100	4.5 x 11.0	0.4	21102	31102	41102	61102	71102	81102
1200			21202	31202	41202	61202	71202	81202
1300			21302	31302	41302	61302	71302	81302
1500			21502	31502	41502	61502	71502	81502
1600	5.0 x 11.0	0.5	21602	31602	41602	61602	71602	81602
1800			21802	31802	41802	61802	71802	81802
2000			22002	32002	42002	62002	72002	82002
2200			22202	32202	42202	62202	72202	82202
$l_t = 28 \text{ mm}$								
2400	5.0 x 15.0	0.6	22402	32402	42402	62402	72402	82402
2700			22702	32702	42702	62702	72702	82702
3000			23002	33002	43002	63002	73002	83002
3300			23302	33302	43302	63302	73302	83302
3600			23602	33602	43602	63602	73602	83602
3900			23902	33902	43902	63902	73902	83902
4300			24302	34302	44302	64302	74302	84302
4700	5.5 x 15.0	0.8	24702	34702	44702	64702	74702	84702
5100			25102	35102	45102	65102	75102	85102
5600	6.0 x 15.0	0.9	25602	35602	45602	65602	75602	85602
6200			26202	36202	46202	66202	76202	86202
6800	6.5 x 15.0	1.1	26802	36802	46802	66802	76802	86802
7500			27502	37502	47502	67502	77502	87502
8200	7.0 x 15.0	1.3	28202	38202	48202	68202	78202	88202
9100			29102	39102	49102	69102	79102	89102
10000	7.5 x 15.0	1.5	21003	31003	41003	61003	71003	81003
11000			21103	31103	41103	61103	71103	81103

* Besides the values of the E24-series as quoted, intermediate values of the E48-series (with a tolerance $\pm 2\%$ or $\pm 1\%$) and of the E96-series (with a tolerance $\pm 1\%$) are available. The specifications of these intermediate values are equal to the specifications of the next higher value of the E24-series.

On special request, these capacitors are also available in lacquered version. (See table composition of catalogue numbers for lacquered versions).

POLYSTYRENE
film foil capacitors

KS 427 / 431

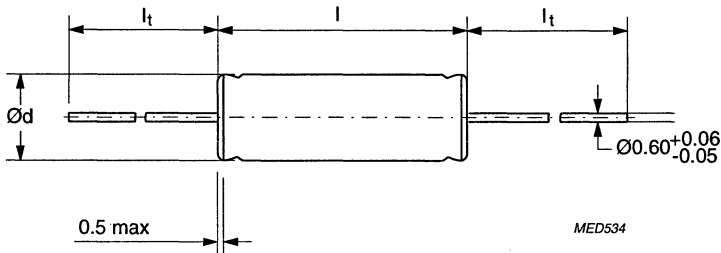
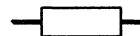

SPECIFIC REFERENCE DATA FOR 630 V DC

Tangent of loss angle		at 1 kHz	at 10 kHz	at 1 MHz
	$C \leq 1000 \text{ pF}$	$\leq 5 \cdot 10^{-4}$	-	$\leq 10 \cdot 10^{-4}$
	$1000 \text{ pF} < C \leq 10\,000 \text{ pF}$	$\leq 5 \cdot 10^{-4}$	$\leq 10 \cdot 10^{-4}$	-
R between terminations		$> 100\,000 \text{ M}\Omega$		

SMALLEST PACKING QUANTITIES (SPQ)	loose in box	taped on reel
DIMENSIONS	SPQ	SPQ
3.8 x 11.0	400	3000
4.0 x 11.0	400	2500
4.5 x 11.0	300	2500
5.0 x 11.0	250	1500
5.0 x 15.0	300	1500
5.5 x 15.0	250	1500
6.0 x 15.0	250	1500
6.5 x 15.0	200	1000
7.0 x 15.0	150	1000
7.5 x 15.0	150	1000
8.0 x 15.0	150	1000

POLYSTYRENE film foil capacitors

KS 427 / 431

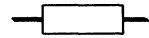
 $U_{Rdc} = 630 \text{ V}$ $U_{Rac} = 250 \text{ V}$

loose and taped

Cap. (E-24) (pF) *	$d_{max} \times l_{max}$ (mm)	mass (g)	CATALOGUE NUMBER							
			2222 427			2222 431				
			loose in box			taped on reel				
			C-tol $\pm 5\%$	C-tol $\pm 2\%$	C-tol $\pm 1\%$	C-tol $\pm 5\%$	C-tol $\pm 2\%$	C-tol $\pm 1\%$		
$l_t = 30 \text{ mm}$										
47	3.8 x 11.0	0.2	24709	34709	44709	64709	74709	84709		
51			25109	35109	45109	65109	75109	85109		
56			25609	35609	45609	65609	75609	85609		
62			26209	36209	46209	66209	76209	86209		
68			26809	36809	46809	66809	76809	86809		
75			27509	37509	47509	67509	77509	87509		
82			28209	38209	48209	68209	78209	88209		
91			29109	39109	49109	69109	79109	89109		
100			21001	31001	41001	61001	71001	81001		
110			21101	31101	41101	61101	71101	81101		
120			21201	31201	41201	61201	71201	81201		
130			21301	31301	41301	61301	71301	81301		
150			21501	31501	41501	61501	71501	81501		
160			21601	31601	41601	61601	71601	81601		
180			21801	31801	41801	61801	71801	81801		
200			22001	32001	42001	62001	72001	82001		
220			22201	32201	42201	62201	72201	82201		
240				0.3	22401	32401	42401	62401	72401	82401
270					22701	32701	42701	62701	72701	82701
300					23001	33001	43001	63001	73001	83001
330			4.0 x 11.0	0.3	23301	33301	43301	63301	73301	83301
360					23601	33601	43601	63601	73601	83601
390	23901	33901			43901	63901	73901	83901		
430	24301	34301			44301	64301	74301	84301		
470	4.5 x 11.0	0.3	24701	34701	44701	64701	74701	84701		
510			25101	35101	45101	65101	75101	85101		
560			25601	35601	45601	65601	75601	85601		
620			26201	36201	46201	66201	76201	86201		
680			26801	36801	46801	66801	76801	86801		
750	5.0 x 11.0	0.4	27501	37501	47501	67501	77501	87501		
820			28201	38201	48201	68201	78201	88201		
910			29101	39101	49101	69101	79101	89101		
1000			21002	31002	41002	61002	71002	81002		
1100			21102	31102	41102	61102	71102	81102		
1200			21202	31202	41202	61202	71202	81202		

* Besides the values of the E24-series as quoted, intermediate values of the E48-series (with a tolerance $\pm 2\%$ or $\pm 1\%$) and the E96-series (with a tolerance $\pm 1\%$) are available. The specifications of these intermediate values are equal to the specifications of the next higher value of the E24-series.

On special request, these capacitors are also available in lacquered version. (See table composition of catalogue numbers for lacquered versions).

POLYSTYRENE film foil capacitors

KS 427 / 431

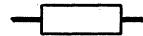
 $U_{Rdc} = 630 \text{ V}$ $U_{Rac} = 250 \text{ V}$

loose and taped

Cap. (E-24) (pF) *	$d_{max} \times l_{max}$ (mm)	mass (g)	CATALOGUE NUMBER					
			2222 427			2222 431		
			loose in box			taped on reel		
			C-tol $\pm 5\%$	C-tol $\pm 2\%$	C-tol $\pm 1\%$	C-tol $\pm 5\%$	C-tol $\pm 2\%$	C-tol $\pm 1\%$
$l_t = 28 \text{ mm}$								
1300	5.0 x 15.0	0.6	21302	31302	41302	61302	71302	81302
1500			21502	31502	41502	61502	71502	81502
1600			21602	31602	41602	61602	71602	81602
1800	5.5 x 15.0	0.8	21802	31802	41802	61802	71802	81802
2000			22002	32002	42002	62002	72002	82002
2200			22202	32202	42202	62202	72202	82202
2400			22402	32402	42402	62402	72402	82402
2700	6.0 x 15.0	1.1	22702	32702	42702	62702	72702	82702
3000	6.5 x 15.0	1.1	23002	33002	43002	63002	73002	83002
3300			23302	33302	43302	63302	73302	83302
3600	7.0 x 15.0	1.4	23602	33602	43602	63602	73602	83602
3900			23902	33902	43902	63902	73902	83902
4300	7.5 x 15.0	1.7	24302	34302	44302	64302	74302	84302
4700			24702	34702	44702	64702	74702	84702
5100	8.0 x 15.0	1.7	25102	35102	45102	65102	75102	85102
5600			25602	35602	45602	65602	75602	85602

* Besides the values of the E24-series as quoted, intermediate values of the E48-series (with a tolerance $\pm 2\%$ or $\pm 1\%$) and the E96-series (with a tolerance $\pm 1\%$) are available. The specifications of these intermediate values are equal to the specifications of the next higher value of the E24-series.

On special request, these capacitors are also available in lacquered version. (See table composition of catalogue numbers for lacquered versions).

POLYSTYRENE film foil capacitors

KS 424..431



COMPOSITION OF CATALOGUE NUMBERS FOR LACQUERED VERSIONS

63 V	5% 2% 1%	loose in box	2222 424 6.... 2222 424 7.... 2222 424 8....
	5% 2% 1%	taped on reel	2222 428 2.... 2222 428 3.... 2222 428 4....
160 V	5% 2% 1%	loose in box	2222 425 6.... 2222 425 7.... 2222 425 8....
	5% 2% 1%	taped on reel	2222 429 2.... 2222 429 3.... 2222 429 4....
250 V	5% 2% 1%	loose in box	2222 426 6.... 2222 426 7.... 2222 426 8....
	5% 2% 1%	taped on reel	2222 430 2.... 2222 430 3.... 2222 430 4....
630 V	5% 2% 1%	loose in box	2222 427 6.... 2222 427 7.... 2222 427 8....
	5% 2% 1%	taped on reel	2222 431 2.... 2222 431 3.... 2222 431 4....

POLYSTYRENE film foil capacitors

KS 424 .. 431

RATINGS AND CHARACTERISTICS

Unless otherwise specified all electrical values apply to an ambient temperature of 23 ± 1 °C, an atmospheric pressure of 86 to 106 kPa and a relative humidity of $50 \pm 2\%$.

CAPACITANCE

Capacitance tolerance: $\pm 5\%$, $\pm 2\%$ and $\pm 1\%$

Temperature coefficient: $-(125 \pm 60) \times 10^{-6}/^{\circ}\text{K}$

Capacitance dependence on frequency: none between 100 Hz and 1 MHz.

TEMPERATURE

Storage temperature: $T_{\text{stg}} = -25$ to $+40$ °C with RH maximum 80 % without condensation.

VOLTAGE

Category voltage: $U_c = U_{\text{Rdc}}$

Test voltage between terminations: $2 \times U_{\text{Rdc}}$

Maximum RMS voltage (sinewave) as a function of frequency for $T_{\text{amb}} \leq 70$ °C (see graphs below)

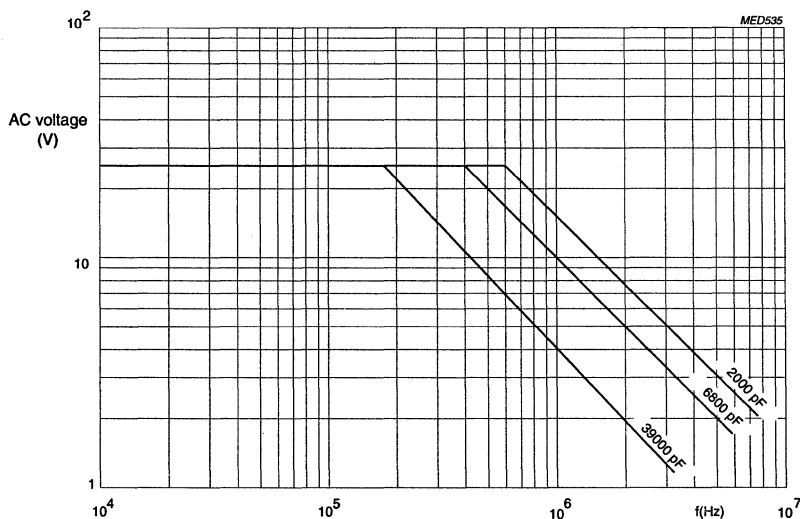

Maximum AC voltage (RMS value) as a function of frequency at $T_{\text{amb}} \leq 70$ °C, for 63 V version.

**POLYSTYRENE
film foil capacitors**

KS 424 .. 431

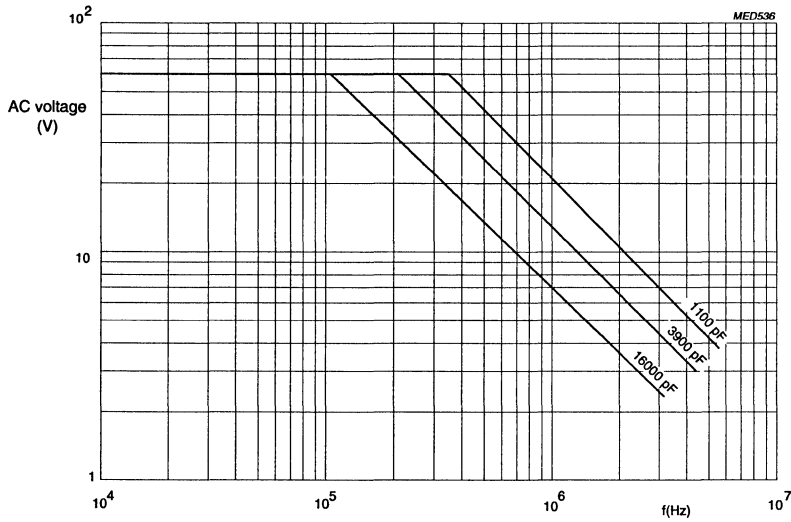

Maximum AC voltage (RMS value) as a function of frequency at $T_{amb} \leq 70\text{ }^{\circ}\text{C}$, for 160 V version.

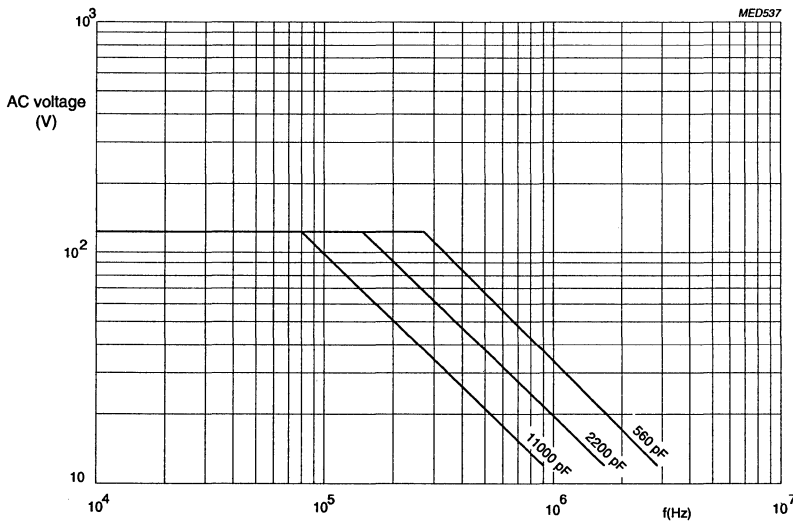

Maximum AC voltage (RMS value) as a function of frequency at $T_{amb} \leq 70\text{ }^{\circ}\text{C}$, for 250 V version.

POLYSTYRENE film foil capacitors

KS 424 .. 431

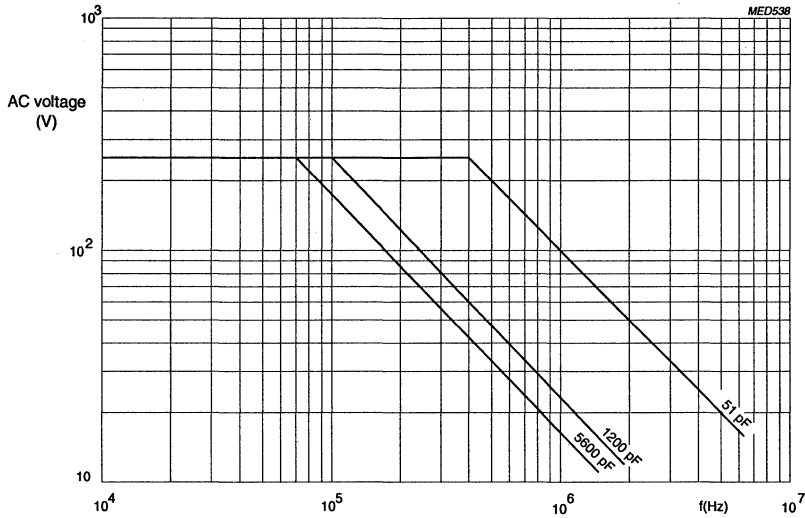

Maximum AC voltage (RMS value) as a function of frequency at $T_{amb} \leq 70^\circ\text{C}$, for 630 V version.

TANGENT OF LOSS ANGLE

For maximum values and measuring frequencies: see specific reference data.

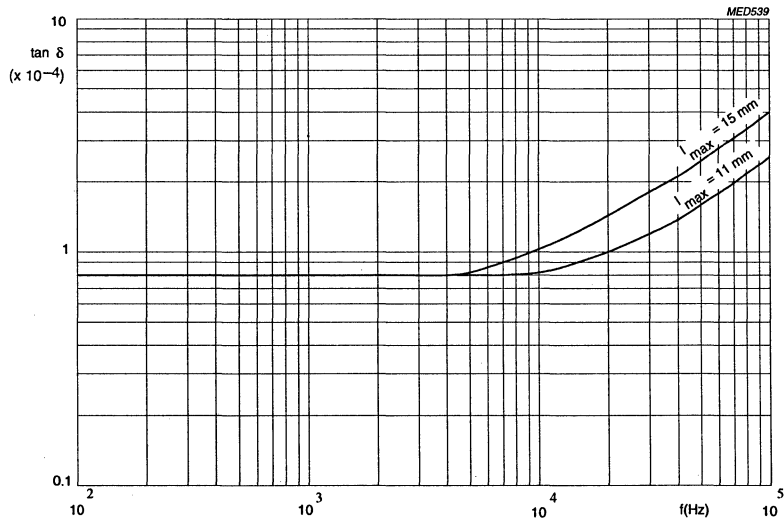

Tan-delta as a function of frequency; typical curves.

POLYSTYRENE film foil capacitors

KS 424 .. 431

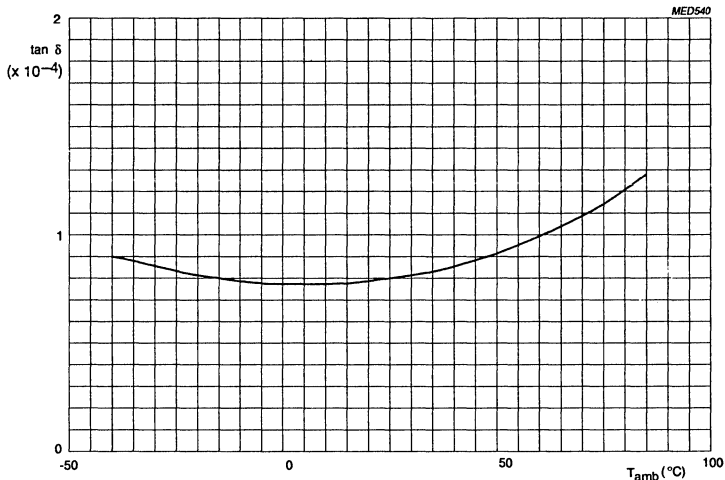

Tan-delta as a function of ambient free air temperature; typical curve.

INSULATION RESISTANCE

The insulation resistance is measured after a voltage has been applied for 1 minute ± 5 seconds, the voltage being 10 V ± 1 V for the 63 V version, 100 V ± 15 V for the 160 V and 250 V versions and 500 V ± 50 V for the 630 V version.

R between terminations: for value see specific reference data

R between interconnected terminations and case (foil method) >100 000 M Ω

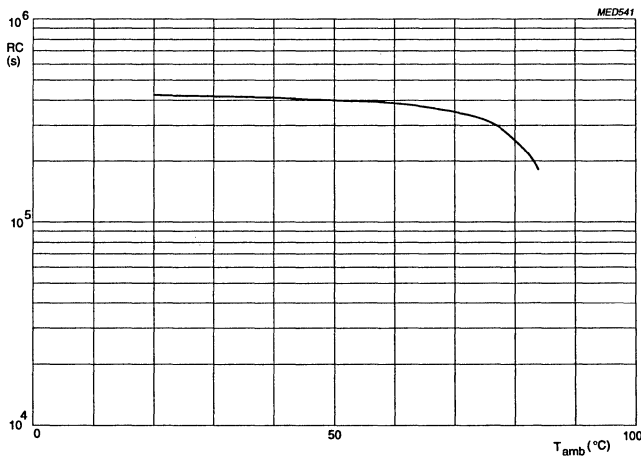

RC-product as a function of ambient free air temperature; typical curve.

INDUCTANCE

≤ 10 nH/cm lead and capacitor length.

POLYSTYRENE film foil capacitors

KS 424 .. 431

GENERAL DATA

CONSTRUCTION

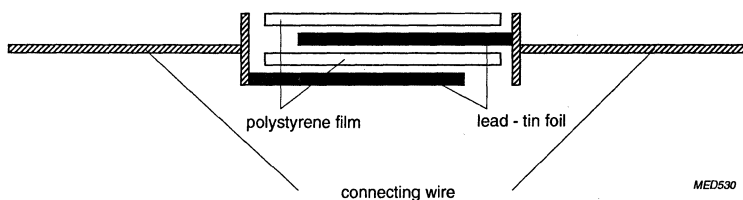

DESCRIPTION

Low-inductive wound cell of metal foil and a polystyrene film

Axial leads, solder-coated

The capacitors are available in a naked version or on special request with a blue epoxy lacquer.

MOUNTING

Normal use

The capacitors are suitable for vertical or horizontal mounting on printed-wiring boards.

The capacitors packed in bandoliers are designed for mounting on printed-wiring boards by means of automatic insertion machines. When soldering, the body temperature shall not exceed 100 °C.

Soldering conditions

The capacitance stability is dependent on the body dimensions and a function of soldering temperature, soldering time, preheating, mounting method, mounting height and mounting pitch.

In all of the following graphs the solder bath temperature is 260 ±5 °C.

The next figure shows the typical behaviour of $\Delta C/C$ with and without preheating as a function of soldering time. Preheating temperature is 80 °C (duration 1 hour). Mounting is directly on to the printed-wiring board.

POLYSTYRENE film foil capacitors

KS 424 .. 431

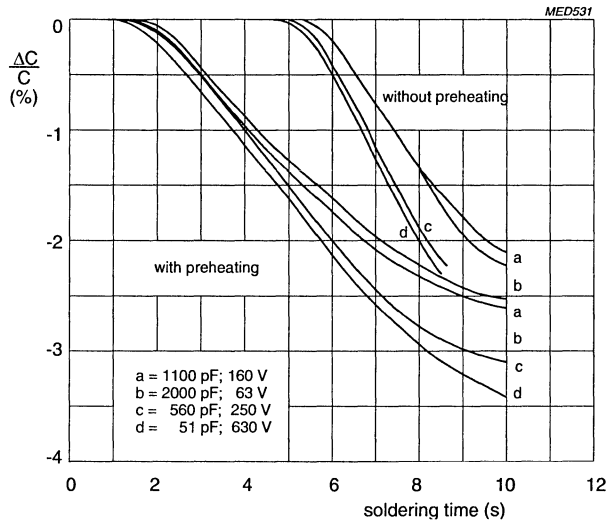

Typical effect on $\Delta C/C$ with and without preheating (worst case mounting).

The figure below shows the typical effect of higher mounting and minimum pitch, with and without preheating.

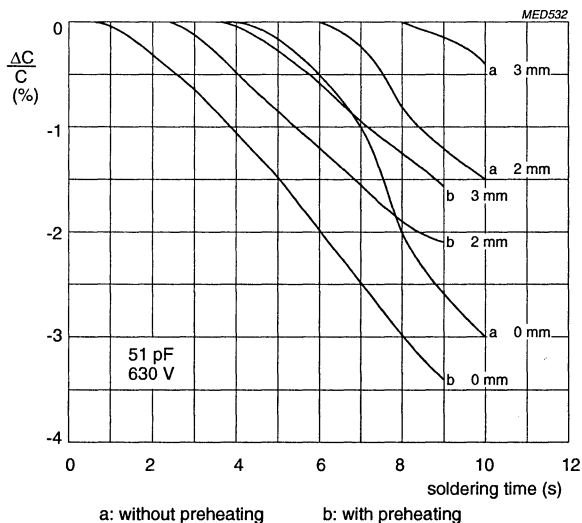

Typical effect of mounting height with and without preheating.

**POLYSTYRENE
film foil capacitors**

KS 424 .. 431

The figure below shows the effect of a wider mounting distance and close mounting on to the printed-wiring board with preheating of the capacitor.

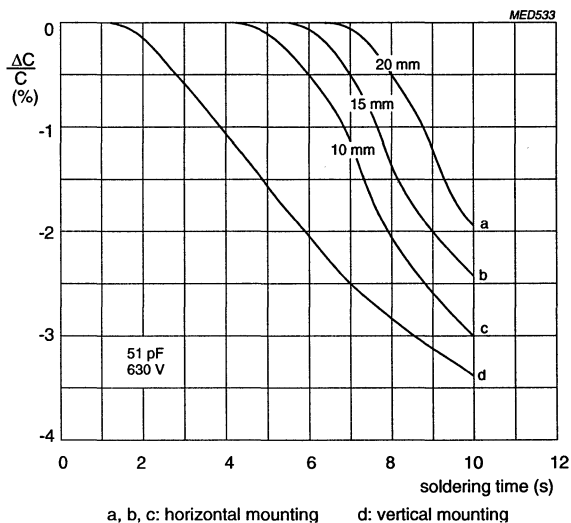

Typical effect of wider mounting distance and preheating.

Specific method of mounting to withstand vibration and shock

The capacitors shall be mechanically fixed by the leads.

POLYSTYRENE film foil capacitors

KS 424 .. 431

MAXIMUM DISSIPATION

Curve	dimensions (mm)
	$d_{max} \times l_{max}$
1	3.8 x 11.0
2	4.0 x 11.0
3	4.5 x 11.0
4	5.0 x 11.0
5	5.0 x 15.0
6	5.5 x 15.0
7	6.0 x 15.0
8	6.5 x 15.0
9	7.0 x 15.0
10	7.5 x 15.0
11	8.0 x 15.0

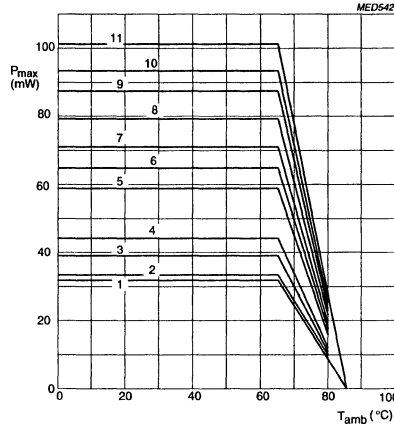

Maximum permissible power dissipation as a function of ambient free air temperature.

APPLICATION NOTE

To select this capacitor for a certain application, 5 conditions must be checked:

1. The peak voltage (U_p) shall not be greater than the rated DC voltage.
2. The peak to peak voltage (U_{pp}) shall not be greater than $2\sqrt{2}$ times the rated AC voltage to avoid the ionisation inception level.
3. There is no limit for the peak current (I_p) or voltage pulse slope (dU/dt) in the application.
4. The dissipated power shall not be greater than the maximum permissible power dissipation stated in graph above.
5. The free air ambient temperature for the capacitor is not exceeding the category temperature.

POLYSTYRENE film foil capacitors

KS 424 .. 431

MARKING

Product marking

The capacitors are marked with black ink with the following information :

- Rated capacitance in code according to IEC 62
- Tolerance on rated capacitance F: $\pm 1\%$ G: $\pm 2\%$ J: $\pm 5\%$
- Rated (DC) voltage (e.g. 63 V)
- Code for di electric material (KS)
- Production date code according to IEC 62, clause 5

Example: 9n1
G 63
KS D2

8n2

PACKAGE MARKING

The package containing the capacitors is marked as shown.

PHILIPS COMPONENTS

MADE IN BELGIUM

PS FILM FOIL CAPACITORS

KS AX SLEEVED CAP

200pF $\pm 1\%$ 63V= 40/070/21

ORIG A170 RPC HQ



TYPE KS 424

-



QTY 2400 DATE 9238



CODENO 2222 424 42002

LINE	MARKING EXPLANATION
1	Manufacturer's name
2	Country of origin
3	Sub-family
4	Type description
5	Capacitance value, tolerance, voltage and climatic category (IEC)
6	-
7	Preference origin code: A Country of origin in code: 170 (Belgium) Responsible production centre: HQ (Roeselare) WO: work order
8	Product type description
9	Quantity and production period, year and week code
10	Product code (12NC)

**POLYPROPYLENE
film foil capacitors**

KP 460 .. 464

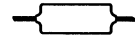

KP AXIAL EPOXY LACQUERED TYPES

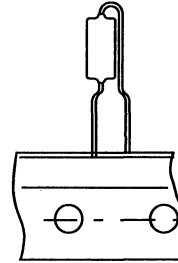
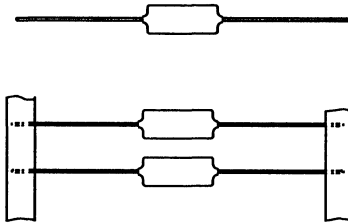

MED544

QUICK REFERENCE DATA

Capacitance range (E12 series)	47 to 62 000 pF
Capacitance tolerance	±5% (E24-series) ±2% (E24, E48-series) ±1% (E24, E48, E96-series)
Rated voltage U_{Rdc}	63 V, 160 V, 250 V, 400 V, 630 V
Climatic category	40/100/56
Rated temperature	85 °C
Maximum application temperature	100 °C
Reference specification	IEC 384-13
Stability class for 63 V, 160 V and 250 V versions for 400 V and 630 V versions	Class 1 Class 2

FEATURES

- Supplied loose in box, taped on reel or unidirectional.

APPLICATIONS

- For use in circuits where close tolerance, reliability and low losses are of prime importance, e.g. tuned circuits, filter networks, timing networks, etc.

**POLYPROPYLENE
film foil capacitors**

KP 460

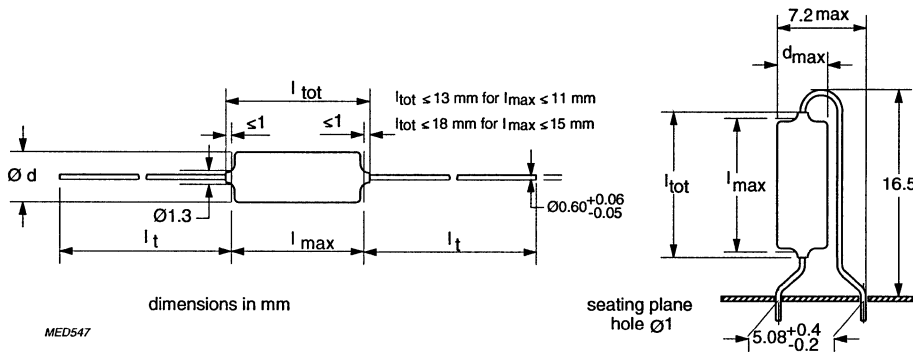
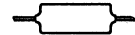

SPECIFIC REFERENCE DATA FOR 63 V DC

Tangent of loss angle	at 1 kHz	at 100 kHz	at 1 MHz
5000 pF < C ≤ 20 000 pF	≤ 5 · 10 ⁻⁴	≤ 15 · 10 ⁻⁴	-
20 000 pF < C ≤ 47 000 pF	≤ 5 · 10 ⁻⁴	≤ 25 · 10 ⁻⁴	-
C > 47 000 pF	≤ 5 · 10 ⁻⁴	≤ 40 · 10 ⁻⁴	-
R between terminations	> 100 000 MΩ		
R between interconnected terminations and case	> 100 000 MΩ		

SMALLEST PACKING QUANTITIES (SPQ)	loose in box	taped on reel	unidirectional
	SPQ	SPQ	SPQ
5.0 x 11.0	250	2500	1000
5.5 x 15.0	250	1500	-
6.0 x 15.0	250	1500	-
6.5 x 15.0	200	1000	-
7.0 x 15.0	150	1000	-
7.5 x 15.0	150	1000	-
8.0 x 15.0	150	1000	-

POLYPROPYLENE film foil capacitors

KP 460

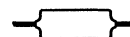
 $U_{Rdc} = 63 \text{ V}$
 $U_{Rac} = 40 \text{ V}$

loose, taped and unidirectional

Cap. (E-24) (pF) *	$d_{max} \times l_{max}$ (mm)	mass (g)	CATALOGUE NUMBER 2222 460							
			loose in box			taped on reel			unidirectional	
			C-tol $\pm 5\%$	C-tol $\pm 2\%$	C-tol $\pm 1\%$	C-tol $\pm 5\%$	C-tol $\pm 2\%$	C-tol $\pm 1\%$	C-tol $\pm 2\%$	C-tol $\pm 1\%$
$l_t = 30 \text{ mm}$										
6800	5.0 x 11.0	0.5	26802	36802	46802	66802	76802	86802	06802	16802
7500			27502	37502	47502	67502	77502	87502	07502	17502
8200			28202	38202	48202	68202	78202	88202	08202	18202
9100		29102	39102	49102	69102	79102	89102	09102	19102	
$l_t = 28 \text{ mm}$										
10000	5.5 x 15.0	0.6	21003	31003	41003	61003	71003	81003		
11000			21103	31103	41103	61103	71103	81103		
12000		0.7	21203	31203	41203	61203	71203	81203		
13000			21303	31303	41303	61303	71303	81303		
15000		0.8	21503	31503	41503	61503	71503	81503		
16000			21603	31603	41603	61603	71603	81603		
18000		0.7	21803	31803	41803	61803	71803	81803		
20000			22003	32003	42003	62003	72003	82003		
22000		0.8	22203	32203	42203	62203	72203	82203		
24000			22403	32403	42403	62403	72403	82403		
27000	6.0 x 15.0	1.0	22703	32703	42703	62703	72703	82703		
30000	6.5 x 15.0	1.1	23003	33003	43003	63003	73003	83003		
33000			23303	33303	43303	63303	73303	83303		
36000		1.2	23603	33603	43603	63603	73603	83603		
39000	7.0 x 15.0	1.3	23903	33903	43903	63903	73903	83903		
43000		1.4	24303	34303	44303	64303	74303	84303		
47000	7.5 x 15.0	1.5	24703	34703	44703	64703	74703	84703		
51000		1.6	25103	35103	45103	65103	75103	85103		
56000	8.0 x 15.0	1.7	25603	35603	45603	65603	75603	85603		
62000		1.8	26203	36203	46203	66203	76203	86203		

* Besides the values of the E24-series as quoted, intermediate values of the E48-series (with a tolerance $\pm 2\%$ or $\pm 1\%$) and the E96-series (with a tolerance $\pm 1\%$) are available.

The specifications of these intermediate values are equal to the specifications of the next higher value of the E24-series.

**POLYPROPYLENE
film foil capacitors**

KP 461

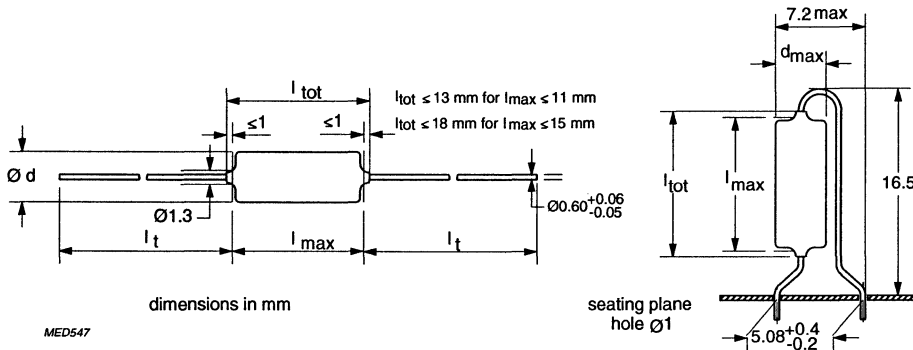
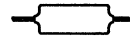

SPECIFIC REFERENCE DATA FOR 160 V DC

Tangent of loss angle	at 1 kHz	at 100 kHz	at 1 MHz
1000 pF < C ≤ 5000 pF	≤ 5 · 10 ⁻⁴	≤ 10 · 10 ⁻⁴	-
5000 pF < C ≤ 20 000 pF	≤ 5 · 10 ⁻⁴	≤ 15 · 10 ⁻⁴	-
20 000 pF < C ≤ 39 000 pF	≤ 5 · 10 ⁻⁴	≤ 25 · 10 ⁻⁴	-
R between terminations	> 100 000 MΩ		
R between interconnected terminations and case	> 100 000 MΩ		

SMALLEST PACKING QUANTITIES (SPQ)	loose in box	taped on reel	unidirectional
DIMENSIONS	SPQ	SPQ	SPQ
5.0 x 11.0	250	2500	1000
5.5 x 15.0	250	1500	-
6.0 x 15.0	250	1500	-
6.5 x 15.0	250	1000	-
7.0 x 15.0	250	1000	-
7.5 x 15.0	200	1000	-
8.0 x 15.0	200	1000	-

POLYPROPYLENE film foil capacitors

KP 461

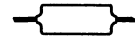
 $U_{Rdc} = 160 \text{ V}$
 $U_{Rac} = 63 \text{ V}$

loose, taped and unidirectional

Cap. (E-24) (pF) *	$d_{max} \times l_{max}$ (mm)	mass (g)	CATALOGUE NUMBER 2222 461							
			loose in box			taped on reel			unidirectional	
			C-tol $\pm 5\%$	C-tol $\pm 2\%$	C-tol $\pm 1\%$	C-tol $\pm 5\%$	C-tol $\pm 2\%$	C-tol $\pm 1\%$	C-tol $\pm 2\%$	C-tol $\pm 1\%$
$l_t = 30 \text{ mm}$										
3600	5.0 x 11.0	0.5	23602	33602	43602	63602	73602	83602	03602	13602
3900			23902	33902	43902	63902	73902	83902	03902	13902
4300			24302	34302	44302	64302	74302	84302	04302	14302
4700			24702	34702	44702	64702	74702	84702	04702	14702
5100			25102	35102	45102	65102	75102	85102	05102	15102
5600			25602	35602	45602	65602	75602	85602	05602	15602
6200			26202	36202	46202	66202	76202	86202	06202	16202
$l_t = 28 \text{ mm}$										
6800	5.5 x 15.0	0.4	26802	36802	46802	66802	76802	86802		
7500		0.7	27502	37502	47502	67502	77502	87502		
8200		0.6	28202	38202	48202	68202	78202	88202		
9100			29102	39102	49102	69102	79102	89102		
10000			21003	31003	41003	61003	71003	81003		
11000		0.7	21103	31103	41103	61103	71103	81103		
12000			21203	31203	41203	61203	71203	81203		
13000		0.8	21303	31303	41303	61303	71303	81303		
15000			21503	31503	41503	61503	71503	81503		
$l_t = 30 \text{ mm}$										
16000	6.0 x 15.0	0.9	21603	31603	41603	61603	71603	81603		
18000		1.0	21803	31803	41803	61803	71803	81803		
20000		22003	32003	42003	62003	72003	82003			
22000	6.5 x 15.0	1.1	22203	32203	42203	62203	72203	82203		
24000			22403	32403	42403	62403	72403	82403		
27000	7.0 x 15.0	1.2	22703	32703	42703	62703	72703	82703		
30000	7.5 x 15.0	1.3	23003	33003	43003	63003	73003	83003		
33000		1.4	23303	33303	43303	63303	73303	83303		
36000	8.0 x 15.0	1.5	23603	33603	43603	63603	73603	83603		
39000		1.6	23903	33903	43903	63903	73903	83903		

* Besides the values of the E24-series as quoted, intermediate values of the E48-series (with a tolerance $\pm 2\%$ or $\pm 1\%$) and the E96-series (with a tolerance $\pm 1\%$) are available.

The specifications of these intermediate values are equal to the specifications of the next higher value of the E24-series.

**POLYPROPYLENE
film foil capacitors**

KP 462

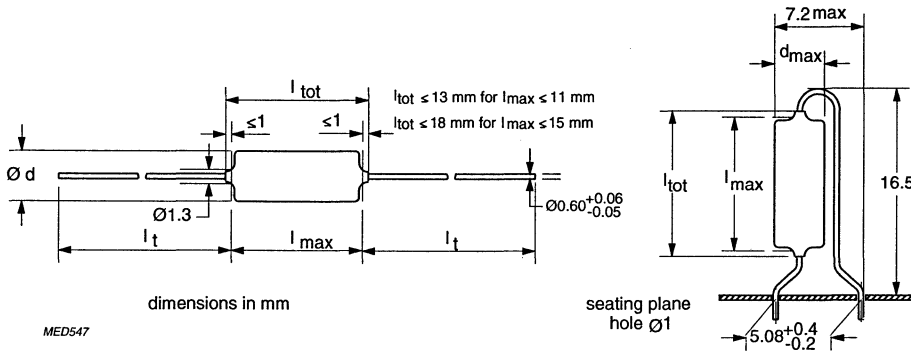
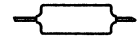

SPECIFIC REFERENCE DATA FOR 250 V DC

Tangent of loss angle	at 1 kHz	at 100 kHz	at 1 MHz
1000 pF < C ≤ 5000 pF	≤5·10 ⁻⁴	≤10·10 ⁻⁴	—
5000 pF < C ≤ 20 000 pF	≤5·10 ⁻⁴	≤15·10 ⁻⁴	—
20 000 pF < C ≤ 22 000 pF	≤5·10 ⁻⁴	≤25·10 ⁻⁴	—
R between terminations	>100 000 MΩ		
R between interconnected termination and case	>100 000 MΩ		

SMALLEST PACKING QUANTITIES (SPQ)	loose in box	taped on reel	unidirectional
DIMENSIONS	SPQ	SPQ	SPQ
5.0 x 11.0	250	2500	1000
5.5 x 15.0	250	1500	—
6.0 x 15.0	250	1500	—
6.5 x 15.0	200	1000	—
7.0 x 15.0	150	1000	—
7.5 x 15.0	150	1000	—
8.0 x 15.0	150	1000	—

POLYPROPYLENE film foil capacitors

KP 462

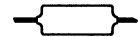
 $U_{Rdc} = 250 \text{ V}$
 $U_{Rac} = 125 \text{ V}$

loose, taped and unidirectional

Cap. (E-24) (pF) *	$d_{max} \times l_{max}$ (mm)	mass (g)	CATALOGUE NUMBER 2222 462								
			loose in box			taped on reel			unidirectional		
			C-tol $\pm 5\%$	C-tol $\pm 2\%$	C-tol $\pm 1\%$	C-tol $\pm 5\%$	C-tol $\pm 2\%$	C-tol $\pm 1\%$	C-tol $\pm 2\%$	C-tol $\pm 1\%$	
$l_1 = 30 \text{ mm}$											
1200	5.0 x 11.0	0.5	21202	31202	41202	61202	71202	81202	01202	11202	
1300			21302	31302	41302	61302	71302	81302	01302	11302	
1500			0.4	21502	31502	41502	61502	71502	81502	01502	11502
1600		21602		31602	41602	61602	71602	81602	01602	11602	
1800		0.6	21802	31802	41802	61802	71802	81802	01802	11802	
2000			22002	32002	42002	62002	72002	82002	02002	12002	
2200		0.5	22202	32202	42202	62202	72202	82202	02202	12202	
2400			22402	32402	42402	62402	72402	82402	02402	12402	
2700			22702	32702	42702	62702	72702	82702	02702	12702	
3000			23002	33002	43002	63002	73002	83002	03002	13002	
3300	23302		33302	43302	63302	73302	83302	03302	13302		
$l_1 = 28 \text{ mm}$											
3600	5.5 x 15.0		0.5	23602	33602	43602	63602	73602	83602		
3900		23902		33902	43902	63902	73902	83902			
4300		0.6		24302	34302	44302	64302	74302	84302		
4700			24702	34702	44702	64702	74702	84702			
5100			25102	35102	45102	65102	75102	85102			
5600			25602	35602	45602	65602	75602	85602			
6200		0.7	26202	36202	46202	66202	76202	86202			
6800			26802	36802	46802	66802	76802	86802			
7500			27502	37502	47502	67502	77502	87502			
8200			6.0 x 15.0	0.7	28202	38202	48202	68202	78202	88202	
9100	0.8	29102		39102	49102	69102	79102	89102			
10000	21003	31003		41003	61003	71003	81003				
11000	6.5 x 15.0	0.9	21103	31103	41103	61103	71103	81103			
12000		1.0	21203	31203	41203	61203	71203	81203			
13000		21303	31303	41303	61303	71303	81303				
15000	7.0 x 15.0	1.1	21503	31503	41503	61503	71503	81503			
16000		1.2	21603	31603	41603	61603	71603	81603			
18000	7.5 x 15.0	1.3	21803	31803	41803	61803	71803	81803			
20000	8.0 x 15.0	1.4	22003	32003	42003	62003	72003	82003			
22000		1.5	22203	32203	42203	62203	72203	82203			

* Besides the values of the E24-series as quoted, intermediate values of the E48-series (with a tolerance $\pm 2\%$ or $\pm 1\%$) and the E96-series (with a tolerance $\pm 1\%$) are available.

The specifications of these intermediate values are equal to the specifications of the next higher value of the E24-series.

POLYPROPYLENE
film foil capacitors

KP 463

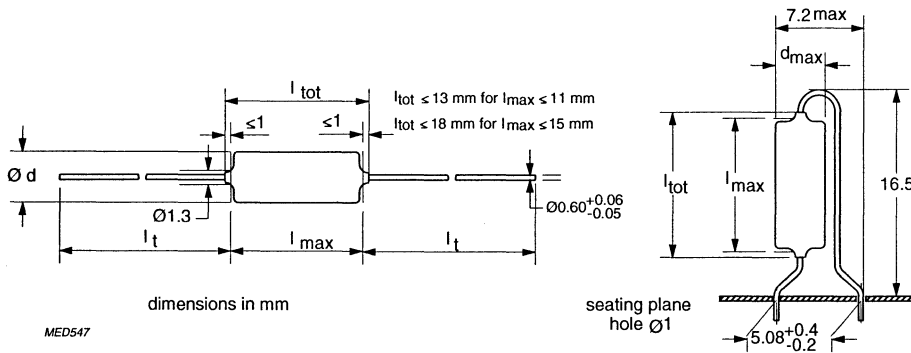
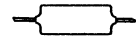

U_{Rdc} = 400 V

U_{Rac} = 160 V

loose, taped and unidirectional

Cap. (E-24) (pF) *	d _{max} x l _{max} (mm)	mass (g)	CATALOGUE NUMBER 2222 463							
			loose in box			taped on reel			unidirectional	
			C-tol ±5%	C-tol ±2%	C-tol ±1%	C-tol ±5%	C-tol ±2%	C-tol ±1%	C-tol ±2%	C-tol ±1%
l _t = 30 mm										
150	5.0 x 11.0	0.4	21501	31501	41501	61501	71501	81501	01501	11501
160			21601	31601	41601	61601	71601	81601	01601	11601
180			21801	31801	41801	61801	71801	81801	01801	11801
200		0.5	22001	32001	42001	62001	72001	82001	02001	12001
220			22201	32201	42201	62201	72201	82201	02201	12201
240			22401	32401	42401	62401	72401	82401	02401	12401
270		0.6	22701	32701	42701	62701	72701	82701	02701	12701
300			23001	33001	43001	63001	73001	83001	03001	13001
330			23301	33301	43301	63301	73301	83301	03301	13301
360		0.4	23601	33601	43601	63601	73601	83601	03601	13601
390			23901	33901	43901	63901	73901	83901	03901	13901
430			24301	34301	44301	64301	74301	84301	04301	14301
470		0.5	24701	34701	44701	64701	74701	84701	04701	14701
510			25101	35101	45101	65101	75101	85101	05101	15101
560			25601	35601	45601	65601	75601	85601	05601	15601
620		0.5	26201	36201	46201	66201	76201	86201	06201	16201
680			26801	36801	46801	66801	76801	86801	06801	16801
750			27501	37501	47501	67501	77501	87501	07501	17501
820		0.5	28201	38201	48201	68201	78201	88201	08201	18201
910	29101		39101	49101	69101	79101	89101	09101	19101	
1000	21002		31002	41002	61002	71002	81002	01002	11002	
1100			21102	31102	41102	61102	71102	81102	01102	11102

SMALLEST PACKING QUANTITIES (SPQ)	loose in box	taped on reel	unidirectional
DIMENSIONS	SPQ	SPQ	SPQ
5.0 x 11.0	250	2500	1000

POLYPROPYLENE film foil capacitors

KP 464

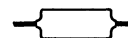

SPECIFIC REFERENCE DATA FOR 630 V DC

Tangent of loss angle	at 1 kHz	at 100 kHz	at 1 MHz
$C \leq 1000 \text{ pF}$	$\leq 5 \cdot 10^{-4}$	–	$\leq 10 \cdot 10^{-4} **$
$1000 \text{ pF} < C \leq 5000 \text{ pF}$	$\leq 5 \cdot 10^{-4}$	$\leq 10 \cdot 10^{-4}$	–
R between terminations	>100 000 M Ω		
R between interconnected termination and case	>100 000 M Ω		

** For unidirectional capacitors $\leq 13 \cdot 10^{-4}$

$U_{\text{Rdc}} = 630 \text{ V}$

$U_{\text{Rac}} = 200 \text{ V}$

**loose, taped and
unidirectional**

Cap. (E-24) (pF) *	$d_{\text{max}} \times l_{\text{max}}$ (mm)	mass (g)	CATALOGUE NUMBER 2222 464							
			loose in box			taped on reel			unidirectional	
			C-tol $\pm 5\%$	C-tol $\pm 2\%$	C-tol $\pm 1\%$	C-tol $\pm 5\%$	C-tol $\pm 2\%$	C-tol $\pm 1\%$	C-tol $\pm 2\%$	C-tol $\pm 1\%$
$l_t = 30 \text{ mm}$										
47	5.0 x 11.0	0.4	24709	34709	44709	64709	74709	84709	04709	14709
51			25109	35109	45109	65109	75109	85109	05109	15109
56			25609	35609	45609	65609	75609	85609	05609	15609
62			26209	36209	46209	66209	76209	86209	06209	16209
68			26809	36809	46809	66809	76809	86809	06809	16809
75			27509	37509	47509	67509	77509	87509	07509	17509
82			28209	38209	48209	68209	78209	88209	08209	18209
91			29109	39109	49109	69109	79109	89109	09109	19109
100			21001	31001	41001	61001	71001	81001	01001	11001
110			21101	31101	41101	61101	71101	81101	01101	11101
120			21201	31201	41201	61201	71201	81201	01201	11201
130			21301	31301	41301	61301	71301	81301	01301	11301

SMALLEST PACKING QUANTITIES (SPQ)	loose in box	taped on reel	unidirectional
DIMENSIONS	SPQ	SPQ	SPQ
5.0 x 11.0	250	2500	1000

* Besides the values of the E24-series as quoted, intermediate values of the E48-series (with a tolerance $\pm 2\%$ or $\pm 1\%$) and the E96-series (with a tolerance $\pm 1\%$) are available.
The specifications of these intermediate values are equal to the specifications of the next higher value of the E24-series.

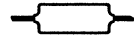
**POLYPROPYLENE
film foil capacitors****KP 460 .. 464****RATINGS AND CHARACTERISTICS**

Unless otherwise specified all electrical values apply at an ambient temperature of 23 ± 1 °C, an atmospheric pressure of 86 to 106 kPa and a relative humidity of $50 \pm 2\%$.

CAPACITANCE

- All capacitance values are specified at 1 kHz.

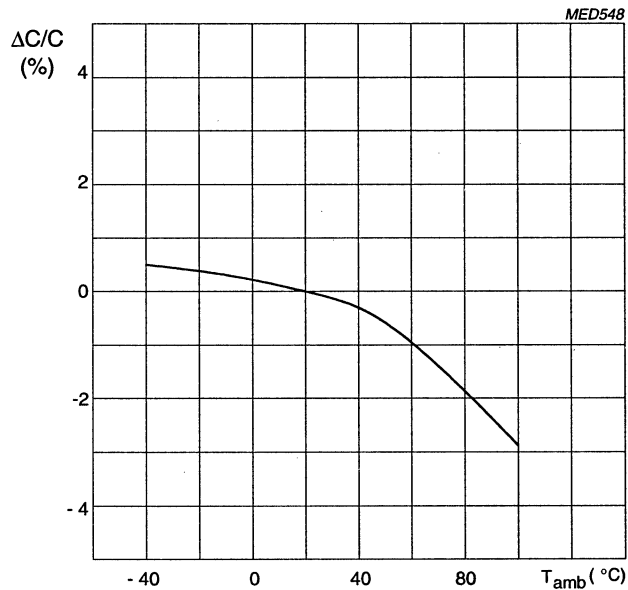

Capacitance as a function of ambient temperature; typical curve.

TEMPERATURE

- Storage temperature: $T_{Stg} = -25$ °C to $+40$ °C with RH maximum 80% without condensation.

POLYPROPYLENE film foil capacitors

KP 460 .. 464



VOLTAGE

- Category voltage: $U_c = 0.8 \times U_{Rdc}$
- Test voltage between terminations: $2 \times U_{Rdc}$
- Test voltage between interconnected terminations and case (foil method) : $2 \times U_{Rdc}$ (min. 400 V)
- Maximum RMS voltage (sine wave) as a function of frequency: for $T_{amb} \leq 70 \text{ }^\circ\text{C}$ (see graphs below).

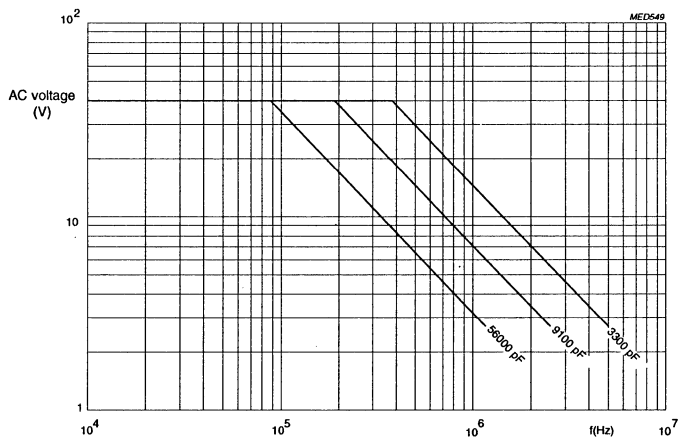

AC voltage as a function of frequency at $T_{amb} \leq 70 \text{ }^\circ\text{C}$,
for $U_{Rdc} = 63 \text{ V}$.

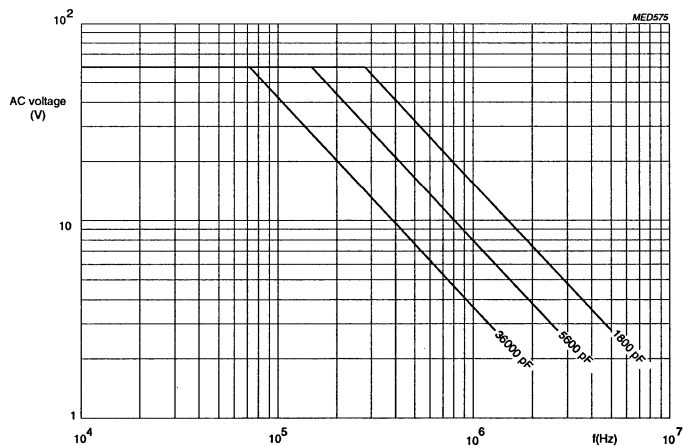

AC voltage as a function of frequency at $T_{amb} \leq 70 \text{ }^\circ\text{C}$,
for $U_{Rdc} = 160 \text{ V}$.

**POLYPROPYLENE
film foil capacitors**

KP 460 .. 464

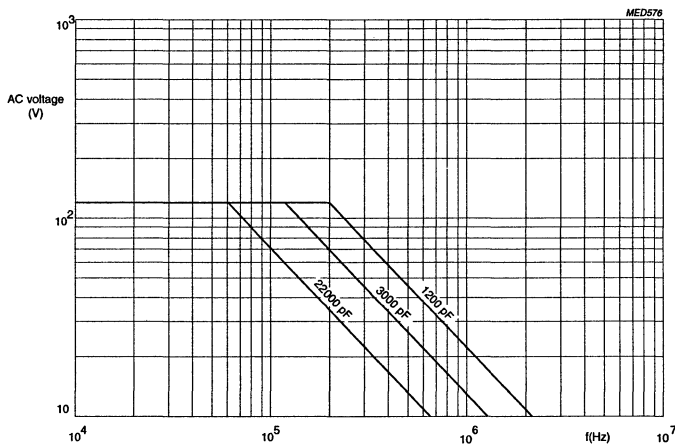
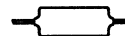

AC voltage as a function of frequency at $T_{amb} \leq 70\text{ }^{\circ}\text{C}$,
for $U_{Rdc} = 250\text{ V}$.

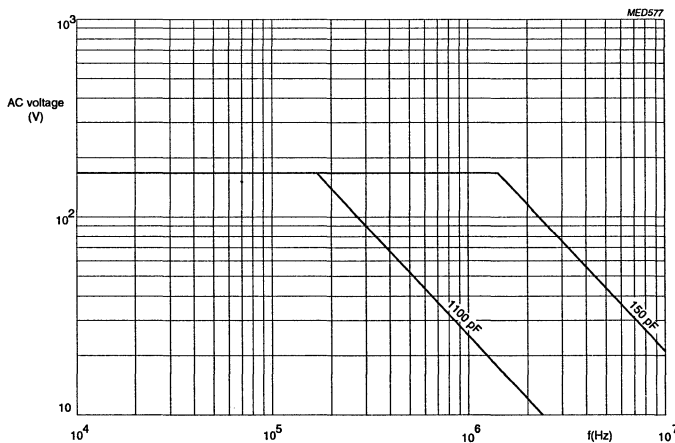

AC voltage as a function of frequency at $T_{amb} \leq 70\text{ }^{\circ}\text{C}$,
for $U_{Rdc} = 400\text{ V}$.

**POLYPROPYLENE
film foil capacitors**

KP 460 .. 464

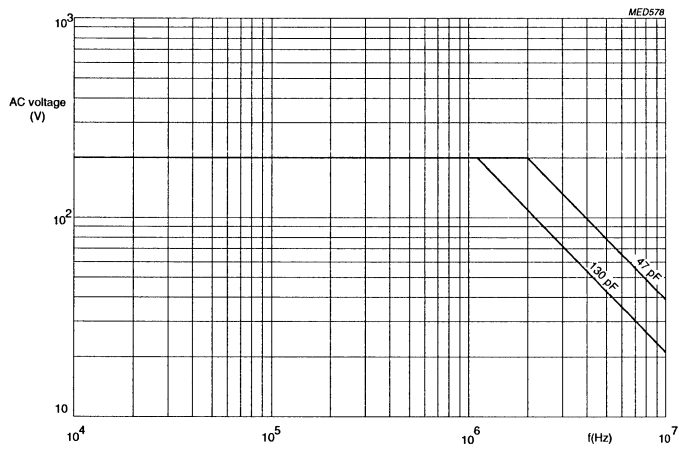
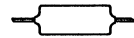

AC voltage as a function of frequency at $T_{amb} \leq 70 \text{ }^\circ\text{C}$,
for $U_{Rdc} = 630 \text{ V}$.

**POLYPROPYLENE
film foil capacitors**

KP 460 .. 464

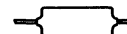

TANGENT OF THE LOSS ANGLE

- For maximum values and measuring frequencies: see specific reference data.

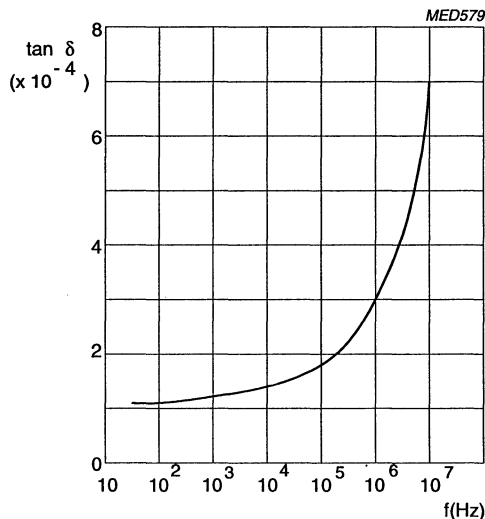

Tangent of the loss angle as a function of frequency; typical curve.

INSULATION RESISTANCE

The insulation resistance is measured after a voltage has been applied for 1 minute \pm 5 seconds, the voltage being 10 V \pm 1 V for the 63 V version, 100 V \pm 15 V for the 160 V, 250 V and 400 V versions and 500 V \pm 50 V for the 630 V version.

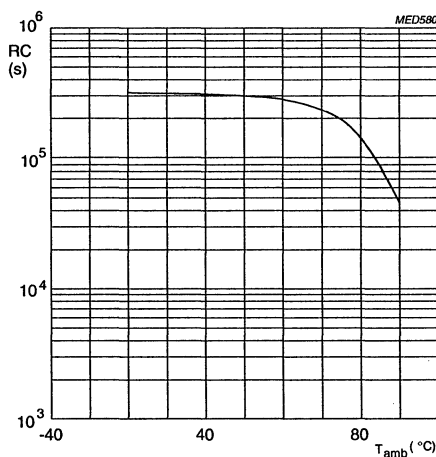

RC-product as a function of ambient free air temperature; typical curve.

INDUCTANCE: ≤ 10 nH/cm lead and capacitor length.

POLYPROPYLENE film foil capacitors

KP 460 .. 464

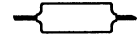

GENERAL DATA

CONSTRUCTION

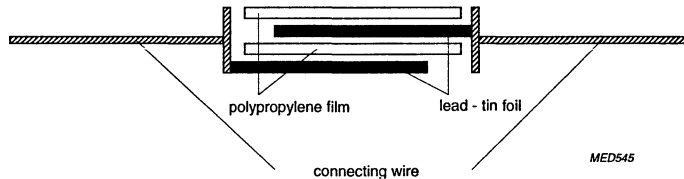

DESCRIPTION

- Low-inductive wound cell of metal foil and a polypropylene film
- Protected by a hard, water repellent solvent resistant blue epoxy lacquer
- Axial leads are solder-coated.

MOUNTING

Normal use

The capacitors are suitable for vertical or horizontal mounting on printed-wiring boards. The capacitors packed on bandoliers are designed for mounting on printed-wiring boards by means of automatic insertion machines. For detailed specifications refer to chapter PACKAGING.

Soldering conditions:

The capacitance stability is dependent on the maximum temperature the capacitor reaches during soldering. The figure below shows the typical effect of $\Delta C/C$ as a function of soldering time under worst possible mounting conditions (horizontal against the PWB, minimum possible pitch) and with 80 °C preheating.

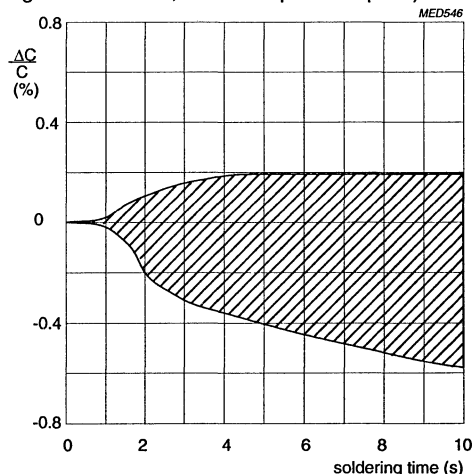

Specific method of mounting to withstand vibration and shock

The capacitors shall be mechanically fixed by the leads.

POLYPROPYLENE film foil capacitors

KP 460 .. 464

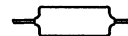

MAXIMUM DISSIPATION

Curve	Dimensions (mm)
	$d_{\max} \times l_{\max}$
1	5.0 x 11.0
2	5.5 x 15.0
3	6.0 x 15.0
4	6.5 x 15.0
5	7.0 x 15.0
6	7.5 x 15.0
7	8.0 x 15.0

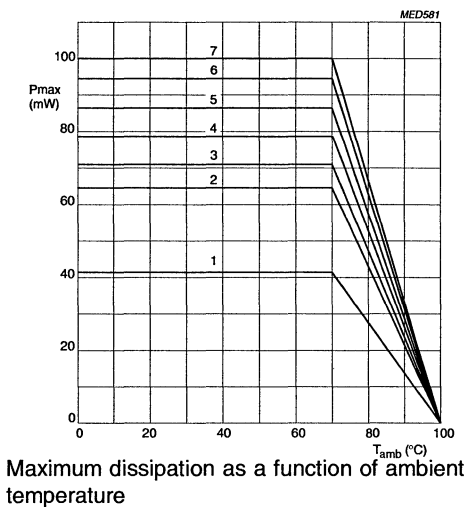

APPLICATION NOTE

To select this capacitor for a certain application, 5 conditions must be checked:

1. The peak voltage (U_p) shall not be greater than the rated DC voltage.
2. The peak to peak voltage (U_{pp}) shall not be greater than $2 \cdot \sqrt{2}$ times the rated AC voltage to avoid the ionisation inception level.
3. There is no limit for the peak current (I_p) or voltage pulse slope (dU/dt) in the application.
4. The dissipated power shall not be greater than the maximum permissible power dissipation stated above.
5. The free air ambient temperature for the capacitor is not exceeding the category temperature.

**POLYPROPYLENE
film foil capacitors**

KP 460 .. 464

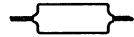

MARKING

The capacitors are marked in black ink with the following information :

- Rated capacitance in code according to IEC 62
- Rated (DC) voltage (e.g. 63 V)
- Tolerance on rated capacitance F: ±1% G: ±2% J: ±5%
- Code for dielectrical material (KP)
- Manufacturer (PHILIPS)
- Production date code according to IEC 62, clause 5

Example: 8n2
G63
KPD2
PHILIPS

PACKAGE MARKING

The package containing the capacitors is marked as shown.

PHILIPS COMPONENTS

MADE IN BELGIUM

PP FILM FOIL CAPACITORS

KP AX EPOXY LACQUERED CAP

47pF ± 1eF 630V= 40/100/56
ULC=0.8 x ULR



ORIG **A170** RPC **HQ**



TYPE **KP 464**

— —



QTY **1500** DATE **9238**



CODENO **2222 464 44709**

LINE	MARKING EXPLANATION
1	Manufacturer's name
2	Country of origin
3	Sub-family
4	Type description
5	Capacitance value, tolerance, voltage and climatic category (IEC)
6	—
7	Preference origin code: A Country of origin in code: 170 (Belgium) Responsible production centre: HQ (Roeselare) WO: work order
8	Product type description
9	Quantity and production period, year and week code
10	Product code (12NC)

**POLYSTYRENE
film foil capacitors**

KS 444 .. 447

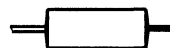

KS AXIAL WRAPPED END-FILLED CAPACITORS

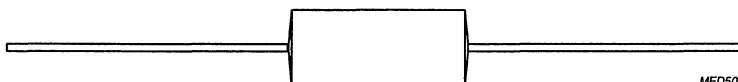

MED507

QUICK REFERENCE DATA

Capacitance range	6200 to 162 000 pF
Capacitance tolerance	±5%, ±2%, ±1%
Rated voltage U_{Rdc}	63 V, 160 V, 250 V, 630 V
Climatic category	
63 V version	40/070/56
160 V, 250 V, 630 V version	40/085/56
Rated temperature	
63 V version	70 °C
160 V, 250 V, 630 V version	85 °C
Reference specification	IEC 384-7
Stability class	Class 2

FEATURES

- Supplied loose in box.

APPLICATIONS

- For use in circuits where close tolerance, reliability and low losses are of prime importance, e.g. tuned circuits, filter networks, timing networks, etc.

**POLYSTYRENE
film foil capacitors**

KS 444

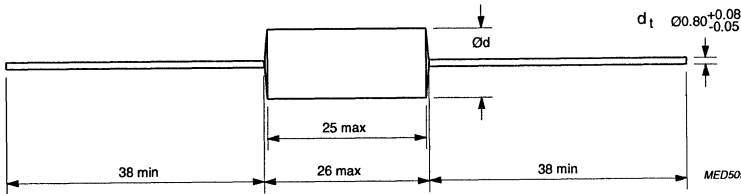
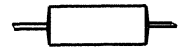

$U_{Rdc} = 63 \text{ V}$

$U_{Rac} = 25 \text{ V}$

loose in box

Cap. (E-24) (pF) *	d_{max} (mm)	mass (g)	CATALOGUE NUMBER 2222 444		
			loose in box		
			C-tol $\pm 5\%$	C-tol $\pm 2\%$	C-tol $\pm 1\%$
$d_t = 0.8 \text{ mm}$					
43000	7.0	3.1	24303	34303	44303
47000	7.5	3.2	24703	34703	44703
51000		3.4	25103	35103	45103
56000	8.0	3.7	25603	35603	45603
62000	8.5	4.0	26203	36203	46203
68000		4.4	26803	36803	46803
75000	9.0	4.7	27503	37503	47503
82000	9.5	5.1	28203	38203	48203
91000		5.5	29103	39103	49103
100000	10.0	5.9	21004	31004	41004
110000	10.5	6.4	21104	31104	41104
120000	11.0	6.9	21204	31204	41204
130000	11.5	7.5	21304	31304	41304
150000	12.0	8.2	21504	31504	41504
160000	12.5	9.0	21604	31604	41604
162000		9.1	21624	31624	41624

SMALLEST PACKING QUANTITIES (SPQ)	loose in box
DIMENSIONS	SPQ
$d_{max} \leq 8.0$	600
$d_{max} \leq 9.5$	500
$d_{max} \leq 11.5$	400
$d_{max} \leq 12.5$	300

* Besides the values of the E24-series as quoted, intermediate values of the E48-series (with a tolerance $\pm 2\%$ or $\pm 1\%$) and of the E96-series (with a tolerance $\pm 1\%$) are available. The specifications of these intermediate values are equal to the specifications of the next higher value of the E24-series.

POLYSTYRENE film foil capacitors

KS 445

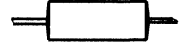

SPECIFIC REFERENCE DATA

Tangent of loss angle	at 1 kHz	at 100 kHz
6200 pF < C ≤ 10 000 pF	≤5·10 ⁻⁴	≤10·10 ⁻⁴
10 000 pF < C ≤ 20 000 pF	≤5·10 ⁻⁴	≤15·10 ⁻⁴
C > 20 000 pF	≤5·10 ⁻⁴	≤25·10 ⁻⁴
R between terminations	>500 000 MΩ	
R between interconnected terminations and case	>500 000 MΩ	

 $U_{Rdc} = 160 \text{ V}$
 $U_{Rac} = 63 \text{ V}$

loose in box

Cap. (E-24) (pF) *	d _{max} (mm)	mass (g)	CATALOGUE NUMBER 2222 445		
			loose in box		
			C-tol ±5%	C-tol ±2%	C-tol ±1%
d _t = 0.8 mm					
18000	6.5	2.3	21803	31803	41803
20000	7.0	2.4	22003	32003	42003
22000		2.5	22203	32203	42203
24000	7.5	2.6	22403	32403	42403
27000		2.8	22703	32703	42703
30000	8.0	3.1	23003	33003	43003
33000	8.5	3.4	23303	33303	43303
36000		3.8	23603	33603	43603
39000	9.0	4.1	23903	33903	43903
43000	9.5	4.4	24303	34303	44303
47000		4.7	24703	34703	44703
51000	10.0	5.1	25103	35103	45103
56000	10.5	5.5	25603	35603	45603
62000	11.0	5.9	26203	36203	46203
68000	11.5	6.4	26803	36803	46803
75000	12.0	7.0	27503	37503	47503
82000	12.5	7.6	28203	38203	48203

SMALLEST PACKING QUANTITIES (SPQ)	loose in box
DIMENSIONS	SPQ
d _{max} ≤ 8.0	600
d _{max} ≤ 9.5	500
d _{max} ≤ 11.5	400
d _{max} ≤ 12.5	300

* Besides the values of the E24-series as quoted, intermediate values of the E48-series (with a tolerance ±2% or ±1%) and of the E96-series (with a tolerance ±1%) are available. The specifications of these intermediate values are equal to the specifications of the next higher value of the E24-series.

POLYSTYRENE
film foil capacitors

KS 446

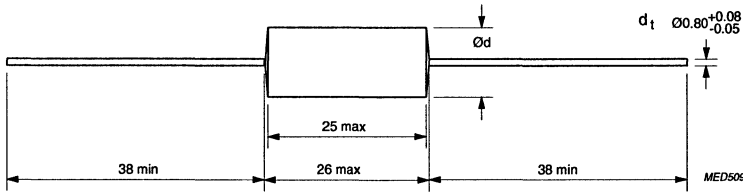
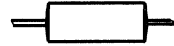

$U_{Rdc} = 250 V$

$U_{Rac} = 125 V$

loose in box

Cap. (E-24) (pF) *	d_{max} (mm)	mass (g)	CATALOGUE NUMBER 2222 446		
			loose in box		
			C-tol ±5%	C-tol ±2%	C-tol ±1%
$d_t = 0.8 \text{ mm}$					
12000	7.0	2.1	21203	31203	41203
13000		2.2	21303	31303	41303
15000	7.5	2.4	21503	31503	41503
16000		2.5	21603	31603	41603
18000	8.0	2.7	21803	31803	41803
20000	8.5	2.9	22003	32003	42003
22000		3.2	22203	32203	42203
24000	9.0	3.5	22403	32403	42403
27000	9.5	3.7	22703	32703	42703
30000	10.0	4.0	23003	33003	43003
33000	10.5	4.4	23303	33303	43303
36000		4.7	23603	33603	43603
39000	11.0	5.1	23903	33903	43903
43000	11.5	5.5	24303	34303	44303
47000	12.0	5.9	24703	34703	44703

SMALLEST PACKING QUANTITIES (SPQ)	loose in box
DIMENSIONS	SPQ
$d_{max} \leq 8.0$	600
$d_{max} \leq 9.5$	500
$d_{max} \leq 11.5$	400
$d_{max} = 12.5$	300

* Besides the values of the E24-series as quoted, intermediate values of the E48-series (with a tolerance ±2% or ±1%) and of the E96-series (with a tolerance ±1%) are available. The specifications of these intermediate values are equal to the specifications of the next higher value of the E24-series.

POLYSTYRENE film foil capacitors

KS 447

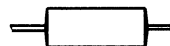

SPECIFIC REFERENCE DATA

Tangent of loss angle	at 1 kHz	at 100 kHz
6200 pF < C ≤ 10 000 pF	≤5·10 ⁻⁴	≤10·10 ⁻⁴
10 000 pF < C ≤ 20 000 pF	≤5·10 ⁻⁴	≤15·10 ⁻⁴
C > 20 000 pF	≤5·10 ⁻⁴	≤25·10 ⁻⁴
R between terminations for C ≤ 1 μF	>500 000 MΩ	
R between interconnected terminations and case	>500 000 MΩ	

 $U_{Rdc} = 630 \text{ V}$
 $U_{Rac} = 250 \text{ V}$

loose in box

Cap. (E-24) (pF) *	d _{max} (mm)	mass (g)	CATALOGUE NUMBER 2222 447		
			loose in box		
			C-tol ±5%	C-tol ±2%	C-tol ±1%
d _t = 0.8 mm					
6200	7.5	2.1	26202	36202	46202
6800		2.2	26802	36802	46802
7500	8.0	2.4	27502	37502	47502
8200		2.6	28202	38202	48202
9100	8.5	2.8	29102	39102	49102
10000	9.0	3.0	21003	31003	41003
11000		3.3	21103	31103	41103
12000	9.5	3.6	21203	31203	41203
13000	10.0	3.9	21303	31303	41303
15000	10.5	4.2	21503	31503	41503
16000	11.0	4.6	21603	31603	41603
18000	11.5	4.9	21803	31803	41803
20000	12.0	5.3	22003	32003	42003
22000	12.5	5.8	22203	32203	42203
24000		6.2	22403	32403	42403

SMALLEST PACKING QUANTITIES (SPQ)	loose in box
DIMENSIONS	SPQ
d _{max} ≤ 8.0	600
d _{max} ≤ 9.5	500
d _{max} ≤ 11.5	400
d _{max} ≤ 12.5	300

Besides the values of the E24-series as quoted, intermediate values of the E48-series (with a tolerance ±2% or ±1%) and of the E96-series (with a tolerance ±1%) are available. The specifications of these intermediate values are equal to the specifications of the next higher value of the E24-series.

POLYSTYRENE film foil capacitors

KS 444 .. 447

RATINGS AND CHARACTERISTICS

Unless otherwise specified all electrical values apply to an ambient free air temperature of 23 ± 1 °C, an atmospheric pressure of 86 to 106 kPa and a relative humidity of $50 \pm 2\%$.

CAPACITANCE

- Temperature coefficient: $-(125 \pm 60) \times 10^{-6}/^{\circ}\text{K}$
- Capacitance dependence on frequency: none between 100 Hz and 1 MHz.

TEMPERATURE

- Storage temperature: $T_{\text{Stg}} = -25$ °C to $+40$ °C with RH maximum 80% without condensation.

VOLTAGE

- Category voltage: $U_c = U_{\text{Rdc}}$
- Test voltage between terminations: $2 \times U_{\text{Rdc}}$
- Test voltage between interconnected terminations and case (foil method): $2 \times U_{\text{Rdc}}$ (min. 400 V)
- Maximum AC voltage (RMS value) as a function of frequency (see graphs below).

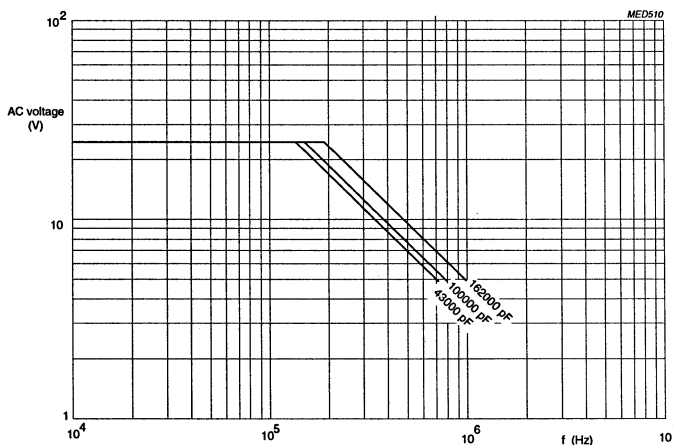

Maximum AC voltage (RMS value) as a function of frequency at $T_{\text{amb}} \leq 55$ °C, for $U_{\text{Rdc}} = 63$ V.

POLYSTYRENE film foil capacitors

KS 444 .. 447

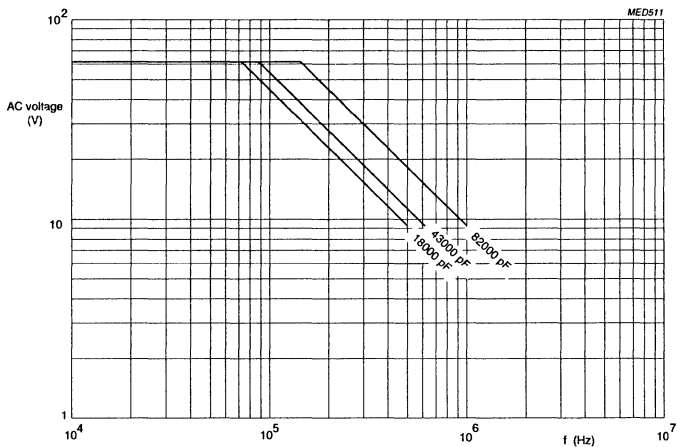

Maximum AC voltage (RMS value) as a function of frequency at $T_{amb} \leq 70\text{ }^{\circ}\text{C}$, for $U_{Rdc} = 160\text{ V}$.

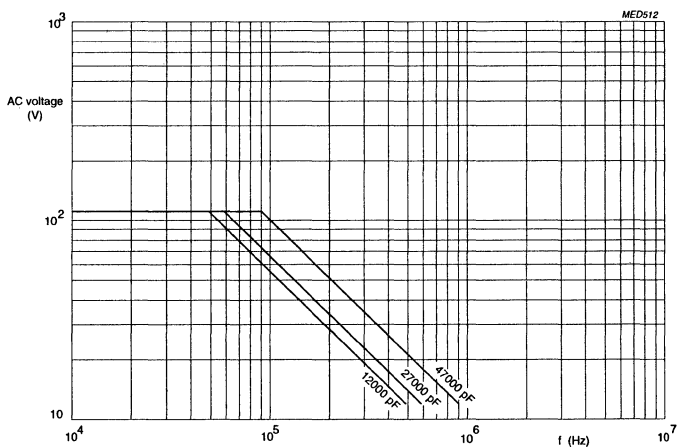

Maximum AC voltage (RMS value) as a function of frequency at $T_{amb} \leq 70\text{ }^{\circ}\text{C}$, for $U_{Rdc} = 250\text{ V}$.

**POLYSTYRENE
film foil capacitors**

KS 444 .. 447

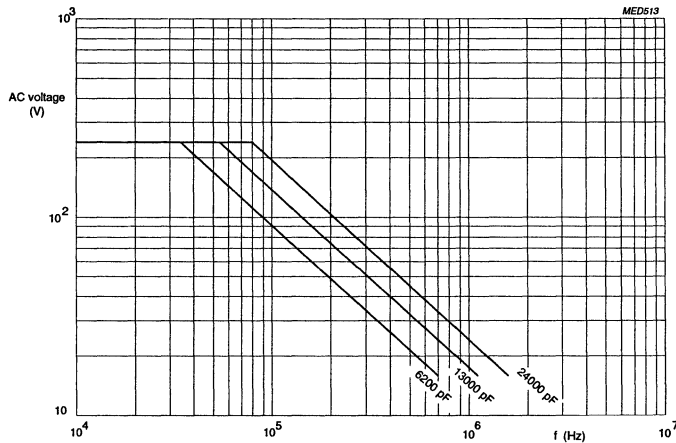

Maximum AC voltage (RMS value) as a function of frequency at $T_{amb} \leq 70 \text{ }^\circ\text{C}$, for $U_{Rdc} = 630 \text{ V}$.

TANGENT OF THE LOSS ANGLE

- For maximum values and measuring frequencies: see specific reference data.

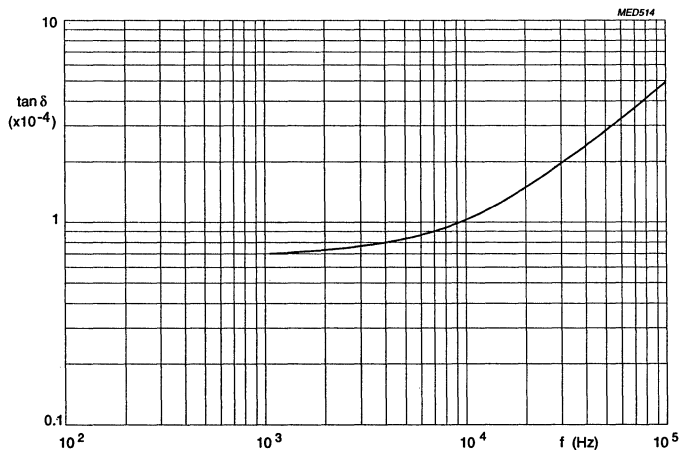

Tan-delta as a function of frequency; typical curve.

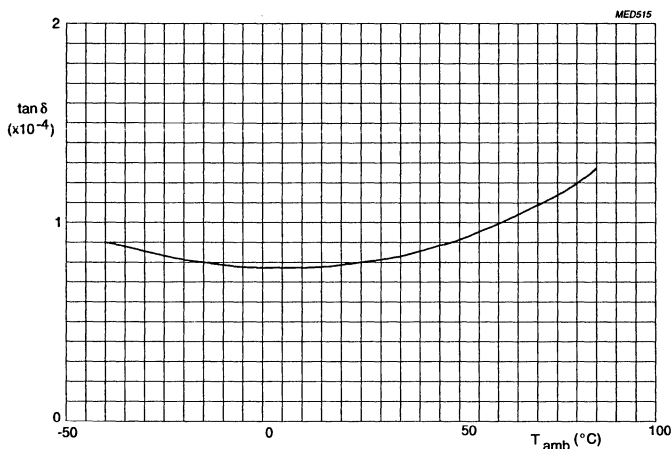
**POLYSTYRENE
film foil capacitors****KS 444 .. 447**

Tan-delta as a function of ambient free air temperature; typical curve.

INSULATION RESISTANCE

The insulation resistance is measured after a voltage has been applied for 1 minute ± 5 seconds, the voltage being 10 ± 1 V for the 63 V version, 100 ± 15 V for the 160 V and 250 V versions and 500 ± 50 V for the 630 V version.

R between terminations: $> 500\,000$ M Ω

R between interconnected terminations and case (foil method): for value see specific reference data

INDUCTANCE

≤ 10 nH/cm lead and capacitor length.

POLYSTYRENE film foil capacitors

KS 444 .. 447

GENERAL DATA

CONSTRUCTION

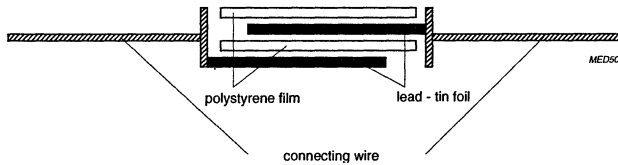

DESCRIPTION

- Low-inductive wound cell of metal foil and a polystyrene film
- The cell is wrapped in a polyester film, the ends are filled with epoxy resin
- Axial leads are of solder-coated wire.

MOUNTING

Normal use

The capacitors are suitable for vertical or horizontal mounting on printed-wiring boards and for point-to-point wiring.

Specific method of mounting to withstand vibration and shock.

- The capacitors shall be mechanically fixed by the leads and the body clamped.

POLYSTYRENE film foil capacitors

KS 444 .. 447

MAXIMUM DISSIPATION

Curve	Dimensions (mm) $d_{\max} \times l_{\max}$
1	6.5 x 25.0
2	7.0 x 25.0
3	7.5 x 25.0
4	8.0 x 25.0
5	8.5 x 25.0
6	9.0 x 25.0
7	9.5 x 25.0
8	10.0 x 25.0
9	10.5 x 25.0
10	11.0 x 25.0
11	11.5 x 25.0
12	12.0 x 25.0
13	12.5 x 25.0

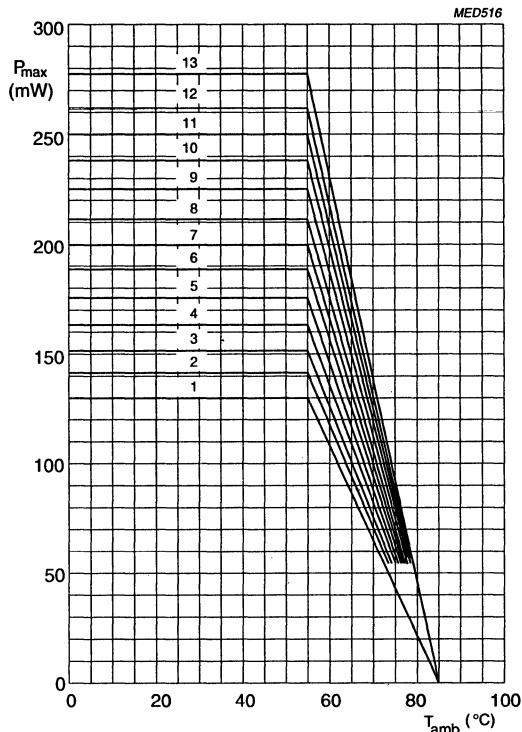

Maximum dissipation as a function of ambient free air temperature.

APPLICATION NOTE

To select this capacitor for a certain application, 5 conditions must be checked:

1. The peak voltage (U_p) shall not be greater than the rated DC voltage.
2. The peak to peak voltage (U_{pp}) shall not be greater than $2\sqrt{2}$ times the rated AC voltage to avoid the ionisation inception level.
3. There is no limit for the peak current (I_p) or voltage pulse slope (dU/dt) in the application.
4. The dissipated power shall not be greater than the maximum permissible power dissipation stated above.
5. The free air ambient temperature for the capacitor is not exceeding the category temperature.

**POLYSTYRENE
film foil capacitors**

KS 444 .. 447

MARKING

Product marking

The capacitors are marked in black ink on the top with the following information :

- Rated capacitance in code according to IEC 62
- Tolerance on rated capacitance (e.g. 1%)
- Rated (DC) voltage (e.g. 630 V)
- Code for dielectric material (KS)
- Manufacturer's type designation (e.g. 447)
- Production date code according to IEC 62, clause 5

The outer film connected is identified with a stroke.

Example : 8n1 1%
 630V = KS
 447 D2

PACKAGE MARKING

The package containing the capacitors is marked as shown.

PHILIPS COMPONENTS

MADE IN BELGIUM

PS FILM FOIL CAPACITORS

KS AX WRAPPED END-FILLED CAP

0.044µF ± 1% 63V= 40/070/56

ORIG **A170** RPC **HQ**

TYPE **KS 444**
—



QTY **1800** DATE **9238**

CODEND **2222 444 44403**

LINE	MARKING EXPLANATION
1	Manufacturer's name
2	Country of origin
3	Sub-family
4	Type description
5	Capacitance value, tolerance, voltage and climatic category (IEC)
6	—
7	Preference origin code: A Country of origin in code: 170 (Belgium) Responsible production centre: HQ (Roeselare) WO: work order
8	Product type description
9	Quantity and production period, year and week code
10	Product code (12NC)

POLYSTYRENE film foil capacitors

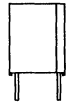
KS 443



KS RADIAL POTTED CAPACITORS

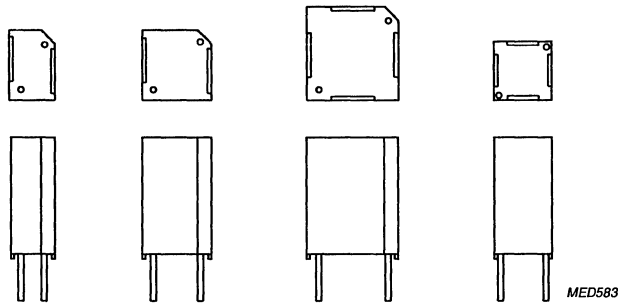

QUICK REFERENCE DATA

Capacitance range (E96-series)	100 to 34 000 pF
Capacitance tolerance	±1%
Rated voltage U_{Rdc}	63 V
Climatic category	55/070/56 (class 1) 55/085/56 (class 3)
Rated temperature	70 °C (class 1) 85 °C (class 3)
Reference specification	IEC 384-7
Stability class	Class 1 and 3

FEATURES

- 2.54 to 7.62 mm terminal pitch
- Supplied loose in box
- The dimensions are such that, in combination with currently available ferrites, a high package density is possible.

APPLICATIONS

- Use in LC filters, particularly in telephony equipment, where high requirements are imposed on precision, stability, humidity, dissipation factor and reliability.

**POLYSTYRENE
film foil capacitors**

KS 443

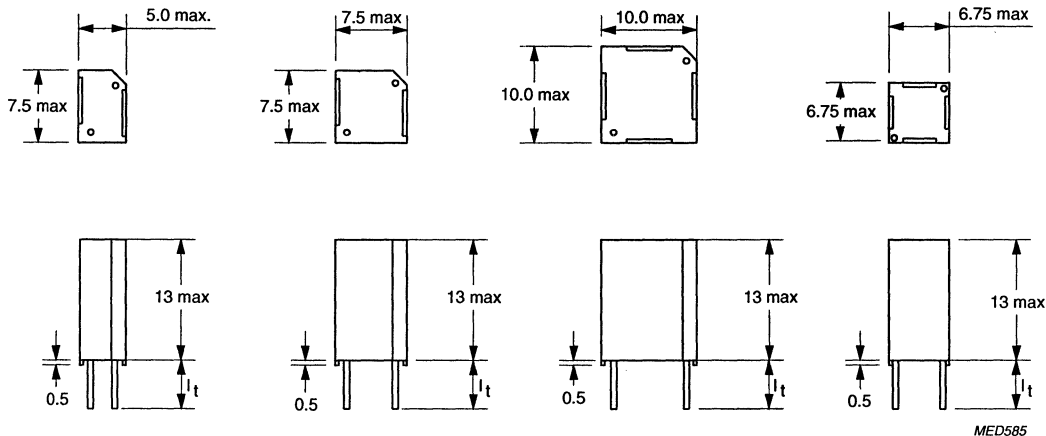

For all figures holds : $d_t = 0.6 \text{ mm } (+0.06/-0.05)$

SPECIFIC REFERENCE DATA

Tangent of loss angle	at 1 kHz	at 100 kHz	at 1 MHz
$C \leq 500 \text{ pF}$	$\leq 5 \cdot 10^{-4}$	—	$\leq 10 \cdot 10^{-4}$
$500 \text{ pF} < C \leq 1000 \text{ pF}$	$\leq 5 \cdot 10^{-4}$	—	$\leq 15 \cdot 10^{-4}$
$1000 \text{ pF} < C \leq 10\,000 \text{ pF}$	$\leq 5 \cdot 10^{-4}$	$\leq 10 \cdot 10^{-4}$	—
$10\,000 \text{ pF} < C \leq 15\,000 \text{ pF}$	$\leq 5 \cdot 10^{-4}$	$\leq 15 \cdot 10^{-4}$	—
$15\,000 \text{ pF} < C \leq 20\,000 \text{ pF}$	$\leq 5 \cdot 10^{-4}$	$\leq 25 \cdot 10^{-4}$	—
$20\,000 \text{ pF} < C \leq 30\,000 \text{ pF}$	$\leq 5 \cdot 10^{-4}$	$\leq 40 \cdot 10^{-4}$	—
$C > 30\,000 \text{ pF}$	$\leq 5 \cdot 10^{-4}$	$\leq 60 \cdot 10^{-4}$	—
R between terminations	$> 500\,000 \text{ M}\Omega$		
R between interconnected terminations and case	$> 500\,000 \text{ M}\Omega$		

SMALLEST PACKING QUANTITIES (SPQ)	loose in box
DIMENSIONS	SPQ
5.0 x 7.5	200
7.50 x 7.5	200
6.25 x 6.25	200
10.0 x 10.0	100

POLYSTYRENE film foil capacitors

KS 443

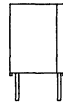
 $U_{Rdc} = 63 \text{ V}$ $U_{Rac} = 25 \text{ V}$

loose in box

Cap. (E96) (pF)*	$b_{max} \times l_{max}$ (mm)	Cat. number 2222 443		$b_{max} \times l_{max}$ (mm)	Cat. number 2222 443		$b_{max} \times l_{max}$ (mm)	Cat. number 2222 443.....
		$l_t = 3 \text{ mm}$	$l_t = 5 \text{ mm}$		$l_t = 3 \text{ mm}$	$l_t = 5 \text{ mm}$		$l_t = 5 \text{ mm}$
100	5.0 x 7.5	61001	41001	7.5 x 7.5	71001	81001	6.25 x 6.25	31001
102		61021	41021		71021	81021		31021
105		61051	41051		71051	81051		31051
107		61071	41071		71071	81071		31071
110		61101	41101		71101	81101		31101
113		61131	41131		71131	81131		31131
115		61151	41151		71151	81151		31151
118		61181	41181		71181	81181		31181
121		61211	41211		71211	81211		31211
124		61241	41241		71241	81241		31241
127		61271	41271		71271	81271		31271
130		61301	41301		71301	81301		31301
133		61331	41331		71331	81331		31331
137		61371	41371		71371	81371		31371
140		61401	41401		71401	81401		31401
143		61431	41431		71431	81431		31431
147		61471	41471		71471	81471		31471
150		61501	41501		71501	81501		31501
154		61541	41541		71541	81541		31541
158		61581	41581		71581	81581		31581
162		61621	41621		71621	81621		31621
165		61651	41651		71651	81651		31651
169		61691	41691		71691	81691		31691
174		61741	41741		71741	81741		31741
178		61781	41781		71781	81781		31781
182		61821	41821		71821	81821		31821
187		61871	41871		71871	81871		31871
191		61911	41911		71911	81911		31911
196		61961	41961		71961	81961		31961
200		62001	42001		72001	82001		32001
205		62051	42051		72051	82051		32051
210		62101	42101		72101	82101		32101
215		62151	42151		72151	82151		32151
221		62211	42211		72211	82211		32211
226		62261	42261		72261	82261		32261
232		62321	42321		72321	82321		32321
237		62371	42371		72371	82371		32371

* Besides the values of the E96 series as quoted, intermediate values of the E192 series (with a tolerance $\pm 1\%$) are available. The specifications of these intermediate values are equal to the specifications of the next higher value of the E96 series.

POLYSTYRENE film foil capacitors

KS 443

 $U_{Rdc} = 63 V$ $U_{Rac} = 25 V$

loose in box

Cap. (E96) (pF)*	$b_{max} \times l_{max}$ (mm)	Cat. number 2222 443		$b_{max} \times l_{max}$ (mm)	Cat. number 2222 443		$b_{max} \times l_{max}$ (mm)	Cat. number 2222 443.....
		$l_t = 3 \text{ mm}$	$l_t = 5 \text{ mm}$		$l_t = 3 \text{ mm}$	$l_t = 5 \text{ mm}$		$l_t = 5 \text{ mm}$
243	5.0 x 7.5	62431	42431	7.5 x 7.5	72431	82431	6.25 x 6.25	32431
249		62491	42491		72491	82491		32491
255		62551	42551		72551	82551		32551
261		62611	42611		72611	82611		32611
267		62671	42671		72671	82671		32671
274		62741	42741		72741	82741		32741
280		62801	42801		72801	82801		32801
287		62871	42871		72871	82871		32871
294		62941	42941		72941	82941		32941
301		63011	43011		73011	83011		33011
309		63091	43091		73091	83091		33091
316		63161	43161		73161	83161		33161
324		63241	43241		73241	83241		33241
332		63321	43321		73321	83321		33321
340		63401	43401		73401	83401		33401
348		63481	43481		73481	83481		33481
357		63571	43571		73571	83571		33571
365		63651	43651		73651	83651		33651
374		63741	43741		73741	83741		33741
383		63831	43831		73831	83831		33831
392		63921	43921		73921	83921		33921
402		64021	44021		74021	84021		34021
412		64121	44121		74121	84121		34121
422		64221	44221		74221	84221		34221
432		64321	44321		74321	84321		34321
442		64421	44421		74421	84421		34421
453		64531	44531		74531	84531		34531
464		64641	44641		74641	84641		34641
475		64751	44751		74751	84751		34751
487		64871	44871		74871	84871		34871
499		64991	44991		74991	84991		34991
511		65111	45111		75111	85111		35111
523		65231	45231		75231	85231		35231
536		65361	45361		75361	85361		35361
549		65491	45491		75491	85491		35491
562		65621	45621		75621	85621		35621
576		65761	45761		75761	85761		35761
590		65901	45901		75901	85901		35901
604		66041	46041		76041	86041		36041
619		66191	46191		76191	86191		36191
634	66341	46341	76341	86341	36341			
649	66491	46491	76491	86491	36491			
665	66651	46651	76651	86651	36651			
681	66811	46811	76811	86811	36811			
698	66981	46981	76981	86981	36981			
715	67151	47151	77151	87151	37151			
732	67321	47321	77321	87321	37321			
750	67501	47501	77501	87501	37501			
768	67681	47681	77681	87681	37681			
787	67871	47871	77871	87871	37871			

* Besides the values of the E96 series as quoted, intermediate values of the E192 series (with a tolerance $\pm 1\%$) are available. The specifications of these intermediate values are equal to the specifications of the next higher value of the E96 series.

POLYSTYRENE film foil capacitors

KS 443

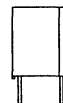
 $U_{Rdc} = 63 \text{ V}$ $U_{Rac} = 25 \text{ V}$

loose in box

Cap. (E96) (pF)*	$b_{max} \times l_{max}$ (mm)	Cat. number 2222 443		$b_{max} \times l_{max}$ (mm)	Cat. number 2222 443		$b_{max} \times l_{max}$ (mm)	Cat. number 2222 443.....
		$l_t = 3 \text{ mm}$	$l_t = 5 \text{ mm}$		$l_t = 5 \text{ mm}$			
806	5.0 x 7.5	68061	48061	7.5 x 7.5	78061	88061	6.25 x 6.25	38061
825		68251	48251		78251	88251		38251
845		68451	48451		78451	88451		38451
866		68661	48661		78661	88661		38661
877		68771	48771		78771	88771		38771
909		69091	49091		79091	89091		39091
931		69311	49311		79311	89311		39311
953		69531	49531		79531	89531		39531
976		69761	49761		79761	89761		39761
1000		61002	41002		71002	81002		31002
1020		61022	41022		71022	81022		31022
1050		61052	41052		71052	81052		31052
1070		61072	41072		71072	81072		31072
1100		61102	41102		71102	81102		31102
1130		61132	41132		71132	81132		31132
1150		61152	41152		71152	81152		31152
1180		61182	41182		71182	81182		31182
1210		61212	41212		71212	81212		31212
1240		61242	41242		71242	81242		31242
1270		61272	41272		71272	81272		31272
1300		61302	41302		71302	81302		31302
1330		61332	41332		71332	81332		31332
1370		61372	41372		71372	81372		31372
1400		61402	41402		71402	81402		31402
1430		61432	41432		71432	81432		31432
1470		61472	41472		71472	81472		31472
1500		61502	41502		71502	81502		31502
1540		61542	41542		71542	81542		31542
1580		61582	41582		71582	81582		31582
1620		61622	41622		71622	81622		31622
1650		61652	41652		71652	81652		31652
1690		61692	41692		71692	81692		31692
1740		61742	41742		71742	81742		31742
1780	61782	41782	71782	81782	31782			
1820	61822	41822	71822	81822	31822			
1870	61872	41872	71872	81872	31872			
1910	61912	41912	71912	81912	31912			
1960	61962	41962	71962	81962	31962			
2000	62002	42002	72002	82002	32002			
2050	62052	42052	72052	82052	32052			
2100	62102	42102	72102	82102	32102			
2150	62152	42152	72152	82152	32152			
2210	62212	42212	72212	82212	32212			
2260	62262	42262	72262	82262	32262			
2320	62322	42322	72322	82322	32322			
2370	62372	42372	72372	82372	32372			
2430	62432	42432	72432	82432	32432			
2490	62492	42492	72492	82492	32492			
2550	62552	42552	72552	82552	32552			

* Besides the values of the E96 series as quoted, intermediate values of the E192 series (with a tolerance $\pm 1\%$) are available. The specifications of these intermediate values are equal to the specifications of the next higher value of the E96 series.

POLYSTYRENE film foil capacitors

KS 443

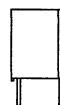
 $U_{Rdc} = 63 V$ $U_{Rac} = 25 V$

loose in box

Cap. (E96) (pF)*	$b_{max} \times l_{max}$ (mm)	Cat.number 2222 443		$b_{max} \times l_{max}$ (mm)	Cat. number 2222 443		$b_{max} \times l_{max}$ (mm)	Cat. number 2222 443.....
		$l_t = 3 \text{ mm}$	$l_t = 5 \text{ mm}$		$l_t = 3 \text{ mm}$	$l_t = 5 \text{ mm}$		$l_t = 5 \text{ mm}$
2610	5.0 x 7.5	62612	42612	7.5 x 7.5	72612	82612	6.25 x 6.25	32612
2670		62672	42672		72672	82672		32672
2740		62742	42742		72742	82742		32742
2800		62802	42802		72802	82802		32802
2870		62872	42872		72872	82872		32872
2940		62942	42942		72942	82942		32942
3010		63012	43012		73012	83012		33012
3090		63092	43092		73092	83092		33092
3160		63162	43162		73162	83162		33162
3240		63242	43242		73242	83242		33242
3320		63322	43322		73322	83322		33322
3400		63402	43402		73402	83402		33402
3480		63482	43482		73482	83482		33482
3570		63572	43572		73572	83572		33572
3650		63652	43652		73652	83652		33652
3740		63742	43742		73742	83742		33742
3830		63832	43832		73832	83832		33832
3920		63922	43922		73922	83922		33922

* Besides the values of the E96 series as quoted, intermediate values of the E192 series (with a tolerance $\pm 1\%$) are available. The specifications of these intermediate values are equal to the specifications of the next higher value of the E96 series.

POLYSTYRENE film foil capacitors

KS 443

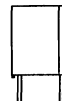
 $U_{Rdc} = 63 \text{ V}$ $U_{Rac} = 25 \text{ V}$

loose in box

Cap. (E96) (pF)*	$b_{max} \times l_{max}$ (mm)	Cat.number 2222 443		$b_{max} \times l_{max}$ (mm)	Cat. number 2222 443
		$l_t = 3 \text{ mm}$	$l_t = 5 \text{ mm}$		$l_t = 5 \text{ mm}$
4120	7.5 x 7.5	64122	44122	6.25 x 6.25	34122
4220		64222	44222		34222
4320		64322	44322		34322
4420		64422	44422		34422
4530		64532	44532		34532
4640		64642	44642		34642
4750		64752	44752		34752
4870		64872	44872		34872
4990		64992	44992		34992
5110		65112	45112		35112
5230		65232	45232		35232
5360		65362	45362		35362
5490		65492	45492		35492
5620		65622	45622		35622
5760		65762	45762		35762
5900		65902	45902		35902
6040		66042	46042		36042
6190		66192	46192		36192
6340		66342	46342		36342
6490		66492	46492		36492
6650		66652	46652		36652
6810		66812	46812		36812
6980		66982	46982		36982
7150		67152	47152		37152
7320		67322	47322		37322
7500		67502	47502		37502
7680		67682	47682		
7870		67872	47872		
8060		68062	48062		
8250		68252	48252		
8450		68452	48452		
8660		68662	48662		
8870		68872	48872		
9090		69092	49092		
9310		69312	49312		
9530		69532	49532		
9760		69762	49762		
10000		61003	41003		
10200		61023	41023		
10500		61053	41053		
10700	61073	41073			
11000	61103	41103			
11300	61133	41133			
11500	61153	41153			
11800	61183	41183			
12100	61213	41213			
12400	61243	41243			
12700	61273	41273			
13000	61303	41303			

* Besides the values of the E96 series as quoted, intermediate values of the E192 series (with a tolerance $\pm 1\%$) are available. The specifications of these intermediate values are equal to the specifications of the next higher value of the E96 series.

POLYSTYRENE film foil capacitors

KS 443

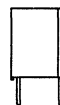
 $U_{Rdc} = 63 \text{ V}$
 $U_{Rac} = 25 \text{ V}$
loose in box

Cap. (E96) (pF)*	$b_{max} \times l_{max}$ (mm)	Cat.number 2222 443	
		$l_t = 3$	$l_t = 5$
13300	7.5 x 7.5	61333	41333
13700		61373	41373
14000		61403	41403
14300		61433	41433
14700		61473	41473
15000		61503	41503
15400		10.0 x 10.0	61543
15800	61583		41583
16200	61623		41623
16500	61653		41653
16900	61693		41693
17400	61743		41743
17800	61783		41783
18200	61823		41823
18700	61873		41873
19100	61913		41913
20000	62003		42003
21000	62103		42103
21500	62153		42153
22100	62213		42213
22600	62263		42263
23200	62323		42323
23700	62373		42373
24300	62433		42433
24900	62493		42493
25500	62553		42553
26100	62613		42613
27400	62743		42743
28000	62803		42803
28700	62873		42873
29400	62943		42943
30100	63013		43013
30900	63093		43093
31600	63163		43163
32400	63243		43243
33200	63323		43323
34000	63403		43403

* Besides the values of the E96 series as quoted, intermediate values of the E192 series (with a tolerance $\pm 1\%$) are available. The specifications of these intermediate values are equal to the specifications of the next higher value of the E96 series.

POLYSTYRENE FILM foil capacitors

KS 443

RATINGS AND CHARACTERISTICS

Unless otherwise specified all electrical values apply at an ambient temperature of 23 ± 1 °C, an atmospheric pressure of 86 to 106 kPa and a relative humidity of $50 \pm 2\%$.

CAPACITANCE

- All capacitance values are specified at 1 kHz
- Capacitance dependence on frequency: none between 100 Hz and 1 MHz
- Temperature coefficient $C \leq 15\,000$ pF $-(125 \pm 30) \times 10^{-6}/^{\circ}\text{K}$
 $C > 15\,000$ pF $-(160 \pm 40) \times 10^{-6}/^{\circ}\text{K}$

TEMPERATURE

- Storage temperature: $T_{\text{stg}} = -25$ to $+40$ °C with RH maximum 80% without condensation.

VOLTAGE

- Category voltage: $U_c = U_{\text{Rdc}}$
- Test voltage between terminations: $2 \times U_{\text{Rdc}}$
- Test voltage between interconnected terminations and case (foil method): 400 V
- Maximum RMS voltage as a function of frequency: for $T_{\text{amb}} \leq 55$ °C (see graph below).

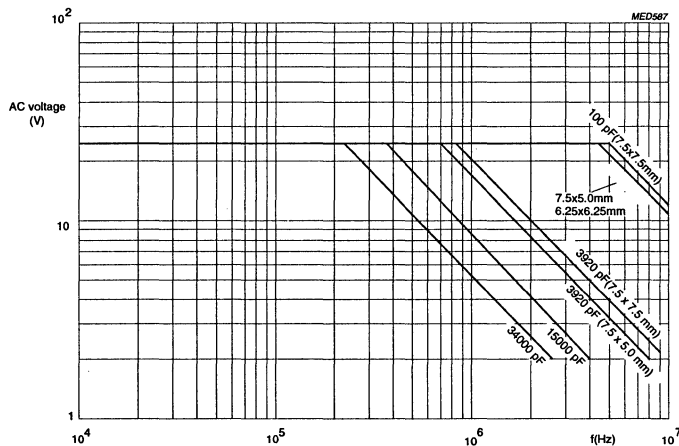

Maximum AC voltage (RMS value) as a function of frequency at $T_{\text{amb}} \leq 55$ °C.

**POLYSTYRENE FILM
foil capacitors**

KS 443

TANGENT OF THE LOSS ANGLE

- For maximum values and measuring frequencies: see specific reference data.

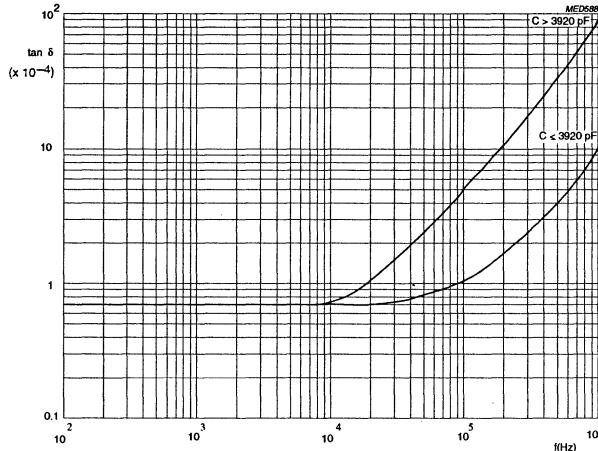

Tangent of the loss angle as a function of frequency; typical curve.

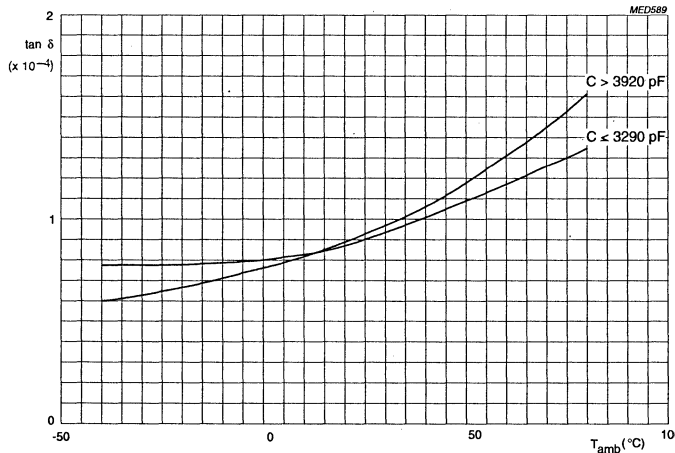

Tangent of the loss angle as a function of ambient free air temperature; typical curve.

INSULATION RESISTANCE

The insulation resistance is measured after a voltage of 10 ± 1 V has been applied for 1 minute ± 5 seconds at $T_{amb} = 20$ °C

R between terminations: $>500\,000$ M Ω

R between interconnected terminations: $>500\,000$ M Ω .

INDUCTANCE: ≤ 10 nH/cm lead and capacitor length.

POLYSTYRENE FILM foil capacitors

KS 443

GENERAL DATA

CONSTRUCTION

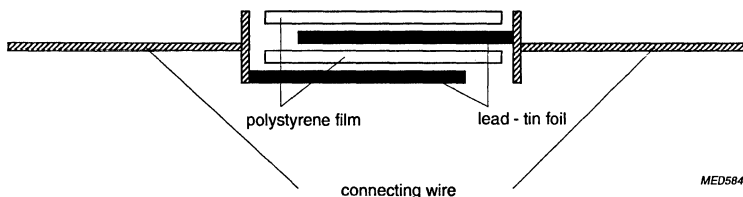

MED584

DESCRIPTION

- Low-inductance wound cell of polystyrene film and metal foil, potted with epoxy resin in a yellow flame retardent polypropylene case
- Low thermal conductivity of the radial leads provides optimum soldering conditions
- Stand-off ridges to give a clearance between the capacitor and the printed-wiring board.

MOUNTING

Normal use

The capacitors are designed for mounting on printed-wiring boards.

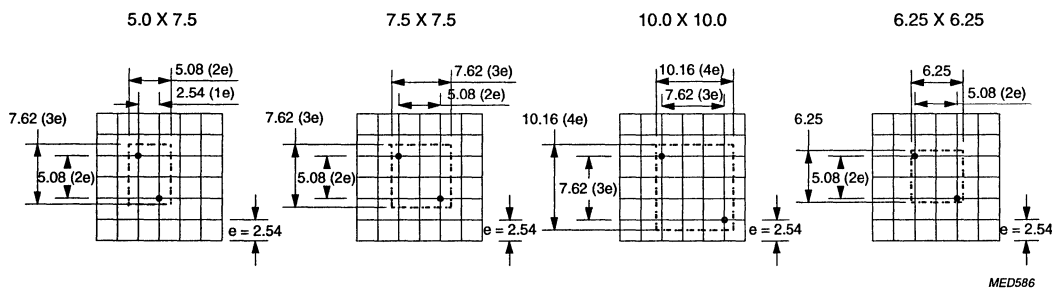

MED586

Space requirements on the printed-wiring board for a hole diameter of 1 mm.

**POLYSTYRENE FILM
foil capacitors**

KS 443

MAXIMUM DISSIPATION

Curve	Dimensions (mm)
	$b_{max} \times l_{max}$
1	5.0 x 7.5
1	6.25 x 6.25
2	7.5 x 7.50
3	10.0 x 10.0

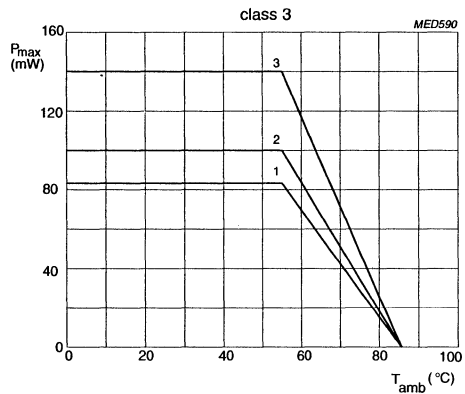
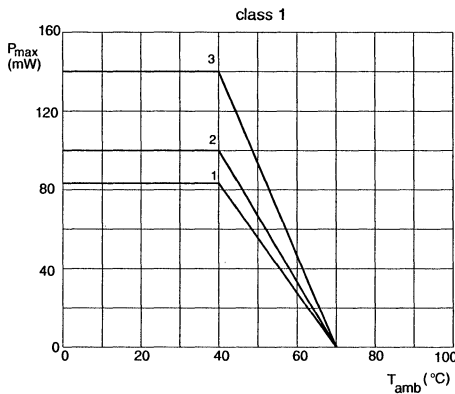

Maximum permissible power dissipation as a function of ambient free air temperature.

APPLICATION NOTE

To select this capacitor for a certain application 5 conditions must be checked:

1. The peak voltage (U_p) shall not be greater than the rated DC voltage.
2. The peak to peak voltage (U_{pp}) shall not be greater than $2 \cdot \sqrt{2}$ times the rated AC voltage to avoid the ionisation inception level.
3. There is no limit for the peak current (I_p) or voltage pulse slope (dU/dt) in the application.
4. The dissipated power shall not be greater than the maximum permissible power dissipation stated in the above graphs.
5. The free air ambient temperature for the capacitor is not exceeding the category temperature.

POLYSTYRENE FILM foil capacitors

KS 443

MARKING

Product marking

The capacitors with dimensions 5 x 7.5 mm and 6.25 x 6.25 mm are marked in black ink with the following information:

- Rated capacitance in code according to IEC 62
- Tolerance on rated capacitance F: $\pm 1\%$
- Rated (DC) voltage (e.g. 63)
- Production date code according to IEC 62, clause 5
- Code for dielectrical material (KS)

Note

The earth side is indicated by a vertical line to the left of the 2nd and 3rd lines of marking, or by the bevelled corner if applicable.

Example: 100
 | F63
 | D2KS

The capacitors with dimensions 7.5 x 7.5 mm and 10 x 10 mm are marked on the top in black ink with the following information :

- Rated capacitance in code according to IEC 62
- Tolerance on rated capacitance F: $\pm 1\%$
- Rated (DC) voltage (e.g. 63)
- Code for dielectric material (KS)
- Manufacturer's type designation (443)
- Production date code according to IEC 62, clause 5
- Manufacturer's identification symbol 

Note

The earth side is indicated by a vertical line to the left of the 2nd, 3rd and 4th lines of marking, and by the bevelled corner.

Example: 100
 | F63
 | 443
 | D2KS
 | 

**POLYSTYRENE FILM
foil capacitors**

KS 443

Package marking

The package containing the capacitors is marked as shown.

PHILIPS COMPONENTS

MADE IN BELGIUM

PS FILM FOIL CAPACITORS

KS RAD POTTED CAP

1000pF ± 1% 63V= 55/085/56



ORIG **A170** RPC **HQ**



TYPE **KS 443**



QTY **1200** DATE **9238**



CODENO **2222 443 41002**

LINE	MARKING EXPLANATION
1	Manufacturer's name
2	Country of origin
3	Sub-family
4	Type description
5	Capacitance value, tolerance, voltage and climatic category (IEC)
6	-
7	Preference origin code: A Country of origin in code: 170 (Belgium) Responsible production centre: HQ (Roeselare) WO: work order
8	Product type description
9	Quantity and production period, year and week code
10	Product code (12NC)

PRODUCTS FOR SPECIFIC APPLICATIONS

**Interference suppression
film capacitors**

KT 311 90028/90029

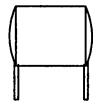

KT RADIAL CAPACITORS

Pitch 11.5

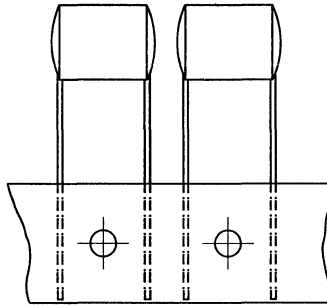
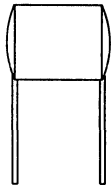

MED523

QUICK REFERENCE DATA

Capacitance value	5600 pF
Capacitance range	5000 - 7000 pF
Rated (AC) voltage, 50 to 60 Hz	250 V
Climatic category	40/100/21
Tangent of loss angle at 1 kHz	40×10^{-4}
Reference specification	IEC 384-11

<p>FEATURES</p> <ul style="list-style-type: none"> • 11.5 mm terminal pitch • Supplied loose in box and taped on reel. 	<p>APPLICATION</p> <ul style="list-style-type: none"> • The capacitors are suitable for radio interference suppression and incorporated in starters for fluorescent lamp circuits.
---	--

**Interference suppression
film capacitors**

KT 311 90028/90029

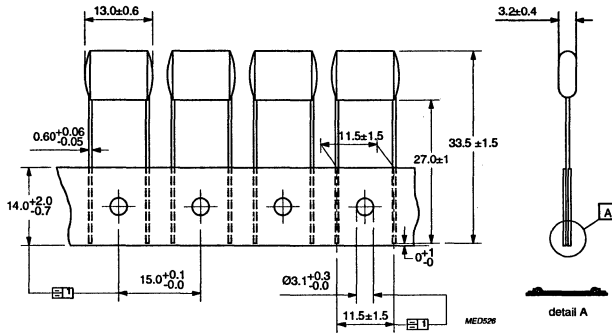
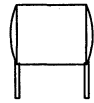

SPECIFIC REFERENCE DATA

Tangent of loss angle	at 1 kHz
	$\leq 60 \cdot 10^{-4}$
R between terminations	$\geq 50\ 000\ M\Omega$

Cap. (pF)	$b_{max} \times h_{max} \times l_{max}$ (mm)	mass (g)	CATALOGUE NUMBER 2222 311	
			loose in box	taped on reel
5600	3.6 x 9.0 x 13.6	0.46	90028	90029

SMALLEST PACKING QUANTITIES (SPQ)	loose in box	taped on reel
DIMENSIONS	SPQ	SPQ
3.6 x 9.0 x 13.6	5000	4000

Interference suppression film capacitors

KT 311 90028/90029

RATINGS AND CHARACTERISTICS

Unless otherwise specified, all electrical values apply at an ambient free air temperature of 23 ± 1 °C, an atmospheric pressure of 86 to 106 kPa and a relative humidity of $50 \pm 2\%$.

CAPACITANCE

All capacitance values are specified at 1 kHz.

TEMPERATURE

Storage temperature: $T_{stg} = -25$ to $+40$ °C with RH maximum 80% without condensation.

VOLTAGE

Rated (AC) voltage (RMS value), 50 to 60 Hz: 250 V

Test (DC) voltage between terminations, 100% on line for 1 second: 3000 V

TANGENT OF THE LOSS ANGLE

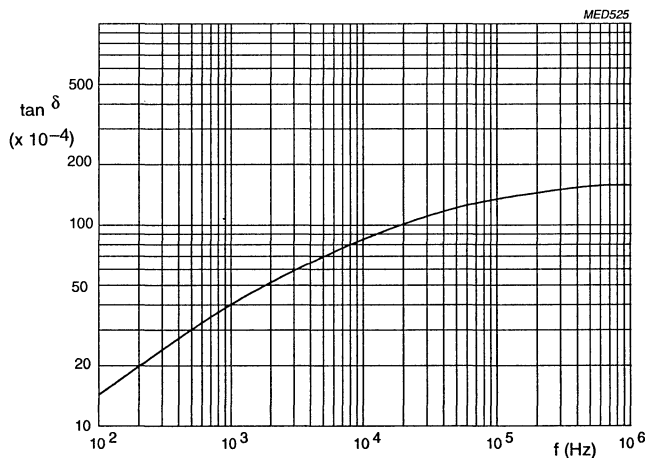

Tangent of the loss angle as a function of frequency; typical curve.

INSULATION RESISTANCE

The insulation resistance is measured after a voltage of 100 ± 15 V has been applied for 1 minute ± 5 seconds at $T_{amb} = 20$ °C.

R between terminations: for value see specific reference data.

Interference suppression film capacitors

KT 311 90028/90029

GENERAL DATA

CONSTRUCTION

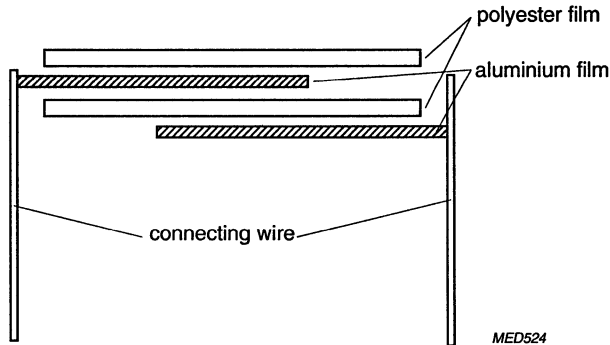

DESCRIPTION

- Impregnated non-inductive wound cell of aluminium foil with a polyethyleneterephthalate (PETP) film
- The ends of the cells are covered with a cyanoacrylate adhesive
- Radial leads, solder-coated.

MOUNTING

Normal use

The capacitors are designed for point-to-point wiring.

Specific method of mounting for vibration and bump

Not applicable.

**Interference suppression
film capacitors**

KT 311 90028/90029

MARKING

Product marking

The capacitors have no marking.

Package marking

The package containing the capacitors is marked as shown:

PHILIPS COMPONENTS
 MADE IN BELGIUM
 INTERF. SUPPR. FILM CAPACITOR
 KT RADIAL TYPE
 5600pF 250V~ 40/100/21

ZONE	MARKING EXPLANATION
1	Manufacturer's name
2	Country of origin
3	Sub-family
4	Type description
5	Capacitance value in pF, voltage and climatic category (IEC)
6	-
7	Preference origin code: A Country of origin in code: 170 (Belgium) Responsible production centre: HQ (Roeselare) WO: work order
8	Product type description
9	Quantity and production period, year and week code
10	Product code (12NC)

 ORIG **A170** RPC **HQ**



 TYPE **KT 311**
 -

 QTY **20000** DATE **9235**

 CODENO **2222 311 90028**

Interference suppression film capacitors

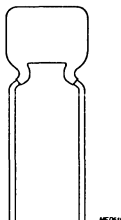
KT 311 90032

KT RADIAL EPOXY LACQUERED CAPACITORS
Pitch 7.5

QUICK REFERENCE DATA

Capacitance value	1200 pF
Capacitance tolerance	±20%
Rated (AC) voltage U_{RAC} , 50 to 60 Hz	250 V
Climatic category	40/125/56
Upper temperature	140 °C
Tangent of loss angle at 1 kHz	40×10^{-4}
Reference specification	IEC 384-11

FEATURES

- 7.5 mm terminal pitch
- Supplied loose in box.

APPLICATIONS

- The capacitors are suitable for radio interference suppression and incorporation in starters for fluorescent lamp circuits.

Interference suppression film capacitors

KT 311 90032

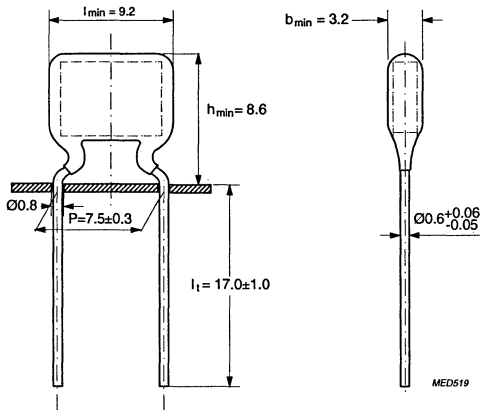

SPECIFIC REFERENCE DATA

Tangent of loss angle	1 kHz
	$\leq 60 \cdot 10^{-4}$
R between terminations	$\geq 50\,000\text{ M}\Omega$

Cap. (pF)	$b_{\max} \times h_{\max} \times l_{\max}$ (mm)	mass (g)	CATALOGUE NUMBER 2222 311
			loose in box $l_1 = 17 \pm 1\text{ mm}$
Pitch = $7.5 \pm 0.3\text{ mm}$			
1200	4.0 x 10.0 x 10.0	0.47	90032

SMALLEST PACKING QUANTITIES (SPQ)	loose in box
DIMENSIONS	SPQ
4.0 x 10.0 x 10.0	5000

Interference suppression film capacitors

KT 311 90032

RATINGS AND CHARACTERISTICS

Unless otherwise specified all electrical values apply at an ambient temperature of 23 ± 1 °C, an atmospheric pressure of 86 to 106 kPa and a relative humidity of $50 \pm 2\%$.

CAPACITANCE

- The capacitance value is specified at 1 kHz.

TEMPERATURE

- Storage temperature : $T_{stg} = -25$ °C to $+40$ °C with RH maximum 80% without condensation.

VOLTAGE

- Rated (AC) voltage (RMS value) 50 to 60 Hz: 250 V
- Test (DC) voltage between terminations, 100% on line for 1 second: 2000 V.

TANGENT OF THE LOSS ANGLE

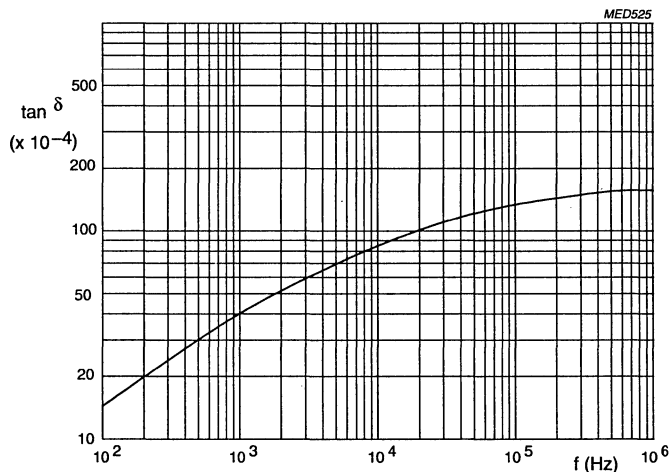

Tangent of the loss angle as a function of frequency; typical curve.

INSULATION RESISTANCE

The insulation resistance is measured after a voltage of 100 ± 15 V has been applied for 1 minute ± 5 seconds
 $T_{amb} = 20$ °C.

R between terminations: for value see specific reference data.

Interference suppression film capacitors

KT 311 90032

GENERAL DATA

CONSTRUCTION

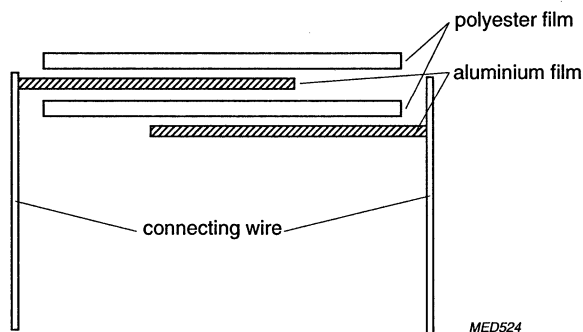

DESCRIPTION

- Impregnated non-inductive wound cell of aluminium foil with a polyethyleneterephthalate (PETP)
- Radial leads, solder-coated
- Protected by a hard, water repellent, solvent resistant epoxy lacquer.

MOUNTING

Normal use

The capacitors are designed for point-to point wiring.

Specific method of mounting for vibration and bump

Not applicable.

Interference suppression film capacitors

KT 311 90032

MARKING**Product marking**

The capacitors are marked on the top in black ink with the following information:

- Rated capacitance in code according to IEC 62
- Tolerance on rated capacitance M: 20%
- Rated (AC) voltage (e.g. 250~)

Example of marking: 1n2 M 250~

Package marking

The package containing the capacitors is marked as shown:

PHILIPS COMPONENTS

MADE IN BELGIUM

INTERF. SUPPR. FILM CAPACITOR

KT RADIAL EPOXY LACQUERED TYPE

0.0012 μ F \pm 20% 250V~ 40/125/56

ORIG A170 RPC HQ



TYPE KT 311

-



QTY 100 DATE 9243



CODENO 2222 311 90032

ZONE	MARKING EXPLANATION
1	Manufacturer's name
2	Country of origin
3	Sub-family
4	Type description
5	Capacitance value in pF, voltage and climatic category (IEC)
6	-
7	Preference origin code: A Country of origin in code: 170 (Belgium) Responsible production centre: HQ (Roeselare) WO: work order
8	Product type description
9	Quantity and production period, year and week code
10	Product code (12NC)

**Metallized POLYCARBONATE
film capacitors**

MKC 344

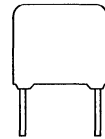

MKC RADIAL POTTED CAPACITORS

Pitch 10/15/22.5/27.5



P=10 and
15 mm

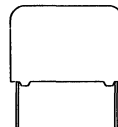
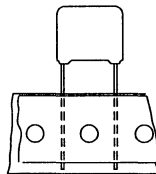

P = 22.5 to 27.5 mm

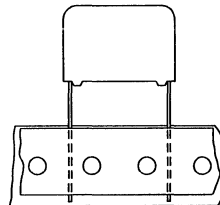

QUICK REFERENCE DATA

Capacitance range (E12 series)	0.010 to 6.8 μ F
Capacitance tolerance	$\pm 10\%$, $\pm 5\%$
Rated voltage U_{Rdc}	100 V, 250 V, 400 V, 630 V
Climatic category	55/100/56
Rated temperature	85 °C
Maximum application temperature	100 °C
Tangent of loss angle at 10 kHz	20×10^{-4}
Reference specification	IEC 384-6
Performance grade	Grade 1 (long life)

<p>FEATURES</p> <ul style="list-style-type: none"> • 10 to 27,5 mm terminal pitch • Small dimensions for high density packaging • Supplied loose in box and on tape. 	<p>APPLICATIONS</p> <ul style="list-style-type: none"> • In electronic circuits for blocking and coupling, bypass and energy reservoir applications.
--	--

**Metallized POLYCARBONATE
film capacitors**

MKC 344



Pitch 10/15/22.5/27.5

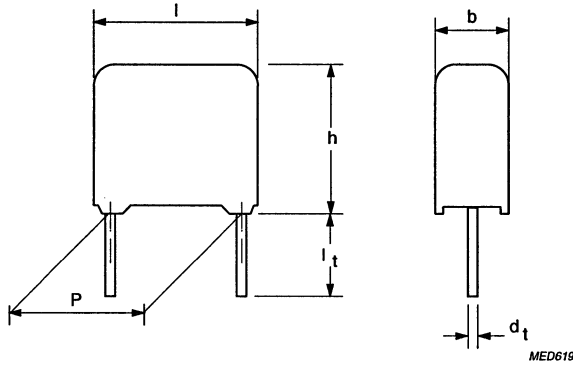

SPECIFIC REFERENCE DATA FOR 100 V DC

Tangent of loss angle	at 1 kHz	at 10 kHz	at 100 kHz	
C ≤ 0.1 μF	≤30·10 ⁻⁴	≤60·10 ⁻⁴	≤130·10 ⁻⁴	
0.1 μF < C ≤ 1.0 μF	≤30·10 ⁻⁴	≤60·10 ⁻⁴	-	
C > 1.0 μF	≤30·10 ⁻⁴	≤75·10 ⁻⁴	-	
Rated voltage pulse slope (dU/dt) _R at U _{Rdc} (see also application note)	P = 10 mm 60 V/μs	P = 15 mm 26 V/μs	P = 22.5 mm 12 V/μs	P = 27.5 mm 9 V/μs
R between terminations, for C ≤ 0.33 μF	>15 000 MΩ			
RC between terminations, for C > 0.33 μF	>5 000 s			

SMALLEST PACKING QUANTITIES (SPQ)	loose in box	taped on reel
DIMENSIONS	SPQ	SPQ
4.0 x 10.0 x 12.5	1000	1400
5.0 x 11.0 x 12.0	1000	1100
5.0 x 11.0 x 17.5	1000	1100
6.0 x 12.0 x 17.5	1000	900
7.0 x 13.5 x 17.5	1000	800
6.0 x 15.5 x 26.0	200	600
7.0 x 16.5 x 26.0	200	550
8.5 x 18.0 x 26.0	200	450
10.0 x 19.5 x 26.0	200	300
11.0 x 21.0 x 31.0	100	250
13.0 x 23.0 x 31.0	100	-

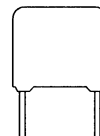
**Metallized POLYCARBONATE
film capacitors**
MKC 344

 $U_{Rdc} = 100 \text{ V}$
 $U_{Rac} = 63 \text{ V}$
loose and taped

Cap. (μF)	$b_{\text{max}} \times h_{\text{max}} \times l_{\text{max}}$ (mm)	mass (g)	CATALOGUE NUMBER 2222 344			
			loose in box		taped on reel	
			$l_1 = 5.0 \pm 1.0 \text{ mm}$		$H = 18.5 \text{ mm}^*$	
			C-tol $\pm 10\%$	C-tol $\pm 5\%$	C-tol $\pm 10\%$	C-tol $\pm 5\%$
Pitch = $10 \pm 0.4 \text{ mm}$; dt = 0.6 mm +0.06/-0.05 mm						
0.082	4.0 x 10.0 x 12.5	0.7	21823	22823	28823	29823
0.10			21104	22104	28104	29104
0.12			21124	22124	28124	29124
0.15			21154	22154	28154	29154
0.18	5.0 x 11.0 x 12.5	0.85	21184	22184	26184	29184
0.22			21224	22224	28224	29224
Pitch = $15 \pm 0.4 \text{ mm}$; dt = 0.8 mm +0.08/-0.05 mm						
0.27	5.0 x 11.0 x 17.5	1.05	21274	22274	28274	29274
0.33			21334	22334	28334	29334
0.39			21394	22394	28394	29394
0.47			21474	22474	28474	29474
0.56	6.0 x 12.0 x 17.5	1.4	21564	22564	28564	29564
0.68			21684	22684	28684	29684
0.82	7.0 x 13.5 x 17.5	1.8	21824	22824	28824	29824
1.0			21105	22105	28105	29105
Pitch = $22.5 \pm 0.4 \text{ mm}$; dt = 0.8 mm +0.08/-0.05 mm						
1.2	6.0 x 15.5 x 26.0	2.75	21125	22125	28125	29125
1.5			21155	22155	28155	29155
1.8	7.0 x 16.5 x 26.0	4.3	21185	22185	28185	29185
2.2	8.5 x 18.0 x 26.0	4.3	21225	22225	28225	29225
2.7			21275	22275	28275	29275
3.3	10.0 x 19.5 x 26.0	5.1	21335	22335	28335	29335
Pitch = $27.5 \pm 0.4 \text{ mm}$; dt = 0.8 mm +0.08/-0.05 mm						
3.9	11.0 x 21.0 x 31.0	7.4	21395	22395	28395	29395
4.7			21475	22475	28475	29475
5.6	13.0 x 23.0 x 31.0	10.2	21565	22565	28565	29565
6.8			21685	22685	28685	29685

* H: intape height; for detailed specifications refer to chapter PACKAGING.

**Metallized POLYCARBONATE
film capacitors**

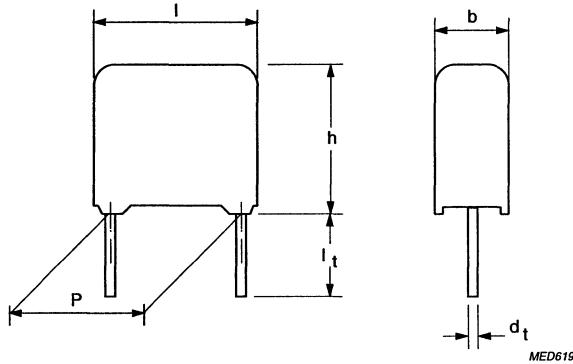
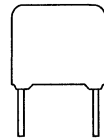
MKC 344



Pitch 10/15/22.5/27.5

SPECIFIC REFERENCE DATA FOR 250 V DC

Tangent of loss angle	at 1 kHz	at 10 kHz	at 100 kHz	
$C \leq 0.1 \mu\text{F}$	$\leq 30 \cdot 10^{-4}$	$\leq 60 \cdot 10^{-4}$	$\leq 130 \cdot 10^{-4}$	
$0.1 \mu\text{F} < C \leq 1.0 \mu\text{F}$	$\leq 30 \cdot 10^{-4}$	$\leq 60 \cdot 10^{-4}$	-	
$C > 1.0 \mu\text{F}$	$\leq 30 \cdot 10^{-4}$	$\leq 75 \cdot 10^{-4}$	-	
Rated voltage pulse slope $(dU/dt)_R$ at U_{Rdc} (see also application note)	P = 10 mm 90 V/ μs	P = 15 mm 36 V/ μs	P = 22.5 mm 16 V/ μs	P = 27.5 mm 14V/ μs
R between terminations, for $C \leq 0.33 \mu\text{F}$	>30 000 M Ω			
RC between terminations, for $C > 0.33 \mu\text{F}$	>10 000 s			

SMALLEST PACKING QUANTITIES (SPQ)	loose in box	taped on reel
DIMENSIONS	SPQ	SPQ
4.0 x 10.0 x 12.5	1000	1400
5.0 x 11.0 x 17.5	1000	1100
6.0 x 12.0 x 17.5	1000	900
7.0 x 13.5 x 17.5	1000	800
6.0 x 15.5 x 26.0	200	600
7.0 x 16.5 x 26.0	200	550
8.5 x 18.0 x 26.0	200	450
9.0 x 19.0 x 31.0	100	250
11.0 x 21.0 x 31.0	100	-
13.0 x 23.0 x 31.0	100	-

Metallized POLYCARBONATE film capacitors

MKC 344

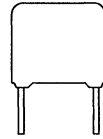

U_{Rdc} = 250 V
U_{Rac} = 160 V
loose and taped

Cap. (μ F)	$b_{max} \times h_{max} \times l_{max}$ (mm)	mass (g)	CATALOGUE NUMBER 2222 344			
			loose in box		taped on reel	
			$l_t = 5.0 \pm 1.0$ mm		H = 18.5 mm *	
			C-tol $\pm 10\%$	C-tol $\pm 5\%$	C-tol $\pm 10\%$	C-tol $\pm 5\%$
Pitch = 10 ± 0.4 mm; dt = 0.6 +0.06/-0.05 mm						
0.039	4.0 x 10.0 x 12.5	0.7	45393	43393	48393	49393
0.047			45473	43473	48473	49473
0.056			45563	43563	48563	49563
0.068			45683	43683	48683	49683
Pitch = 15 ± 0.4 mm; dt = 0.8 +0.08/-0.05 mm						
0.082	5.0 x 11.0 x 17.5	1.05	45823	43823	48823	49823
0.10			45104	43104	48104	49104
0.12			45124	43124	48124	49124
0.15			45154	43154	48154	49154
0.18	6.0 x 12.0 x 17.5	1.4	45184	43184	48184	49184
0.22			45224	43224	48224	49224
0.27	7.0 x 13.5 x 17.5	1.8	45274	43274	48274	49274
0.33			45334	43334	48334	49334
Pitch = 22.5 ± 0.4 mm; dt = 0.8 +0.08/-0.05 mm						
0.39	6.0 x 15.5 x 26.0	2.75	45394	43394	48394	49394
0.47			45474	43474	48474	49474
0.56	7.0 x 16.5 x 26.0	3.5	45564	43564	48564	49564
0.68			45684	43684	48684	49684
0.82	8.5 x 18.0 x 26.0	5.1	45824	43824	48824	49824
1.0			45105	43105	48105	49105
Pitch = 27.5 ± 0.4 mm; dt = 0.8 +0.08/-0.05 mm						
1.2	9.0 x 19.0 x 31.0	7.4	45125	43125	48125	49125
1.5	11.0 x 21.0 x 31.0	7.4	45155	43155	48155	49155
1.8		10.2	45185	43185	48185	49185
2.2	13.0 x 23.0 x 31.0	10.2	45225	43225	48225	49225

* H: intape height; for detailed specification refer to chapter PACKAGING.

**Metallized POLYCARBONATE
film capacitors**

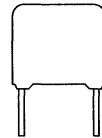
MKC 344



Pitch 10/15/22.5/27.5

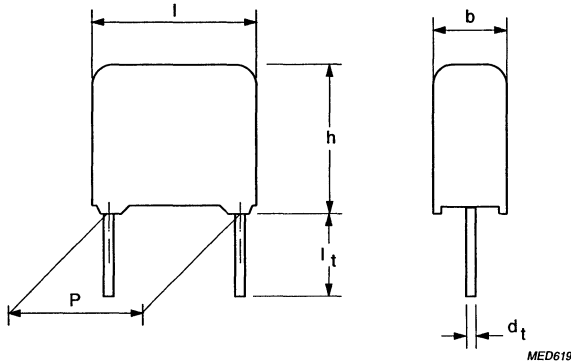

SPECIFIC REFERENCE DATA FOR 400 V DC

Tangent of loss angle	at 1 kHz	at 10 kHz	at 100 kHz	
$C \leq 0.1 \mu\text{F}$	$\leq 30 \cdot 10^{-4}$	$\leq 60 \cdot 10^{-4}$	$\leq 130 \cdot 10^{-4}$	
$0.1 \mu\text{F} < C \leq 1.0 \mu\text{F}$	$\leq 30 \cdot 10^{-4}$	$\leq 60 \cdot 10^{-4}$	-	
Rated voltage pulse slope $(dU/dt)_R$ at U_{Rdc} (see also application note)	P = 10 mm 140 V/ μs	P = 15 mm 60 V/ μs	P = 22.5 mm 26 V/ μs	P = 27.5 mm 22 V/ μs
R between terminations, for $C \leq 0.33 \mu\text{F}$	>30 000 M Ω			
RC between terminations, for $C > 0.33 \mu\text{F}$	>10 000 s			

SMALLEST PACKING QUANTITIES (SPQ)	loose in box	taped on reel
DIMENSIONS	SPQ	SPQ
4.0 x 10.0 x 12.5	1000	1400
5.0 x 11.0 x 17.5	1000	1100
6.0 x 12.0 x 17.5	1000	900
7.0 x 13.5 x 17.5	1000	800
6.0 x 15.5 x 26.0	200	600
7.0 x 16.5 x 26.0	200	550
8.5 x 18.0 x 26.0	200	450
10.0 x 19.5 x 26.0	200	300
11.0 x 21.0 x 31.0	100	250
13.0 x 23.0 x 31.0	100	-

Metallized POLYCARBONATE film capacitors

MKC 344

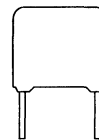

 $U_{Rdc} = 400 \text{ V}$
 $U_{Rac} = 220 \text{ V}$
loose and taped

Cap. (μF)	$b_{\text{max}} \times h_{\text{max}} \times l_{\text{max}}$ (mm)	mass (g)	CATALOGUE NUMBER 2222 344			
			loose in box		taped on reel	
			$l_t = 5.0 \pm 1.0 \text{ mm}$		H = 18.5 mm *	
			C-tol $\pm 10\%$	C-tol $\pm 5\%$	C-tol $\pm 10\%$	C-tol $\pm 5\%$
Pitch = 10.0 ± 0.4 mm; dt = 0.6 mm +0.06/-0.05 mm						
0.010	4.0 x 10.0 x 12.5	0.7	51103	52103	58103	59103
0.012			51123	52123	58123	59123
0.015			51153	52153	58153	59153
0.018			51183	52183	58183	59183
0.022			51223	52223	58223	59223
0.027			51273	52273	58273	59273
0.033			51333	52333	58333	59333
Pitch = 15.0 ± 0.4 mm; dt = 0.8 mm +0.08/-0.05 mm						
0.039	5.0 x 11.0 x 17.5	1.05	51393	52393	58393	59393
0.047			51473	52473	58473	59473
0.056			51563	52563	58563	59563
0.068			51683	52683	58683	59683
0.082	6.0 x 12.0 x 17.5	1.4	51823	52823	58823	59823
0.10			51104	52104	58104	59104
0.12	7.0 x 13.5 x 17.5	1.8	51124	52124	58124	59124
0.15			51154	52154	58154	59154
Pitch = 22.5 ± 0.3 mm; dt = 0.8 mm +0.08/-0.05 mm						
0.18	6.5 x 15.5 x 26.0	2.75	51184	52184	58184	59184
0.22			51224	52224	58224	59224
0.27	7.0 x 16.5 x 26.0	3.5	51274	52274	58274	59274
0.33	8.5 x 18.0 x 26.0	3.5	51334	52334	58334	59334
0.39			51394	52394	58394	59394
0.47	10.0 x 19.5 x 26.0	5.1	51474	52474	58474	59474
Pitch = 27.5 ± 0.3 mm; dt = 0.8 mm +0.08/-0.05 mm						
0.56	11.0 x 21.0 x 31.0	7.4	51564	52564	58564	59564
0.68			51684	52684	58684	59684
0.82	13.0 x 23.0 x 31.0	10.2	51824	52824	58824	59824
1.0			51105	52105	58105	59105

* H: intape height; for detailed specifications refer to chapter PACKAGING.

Metallized POLYCARBONATE film capacitors

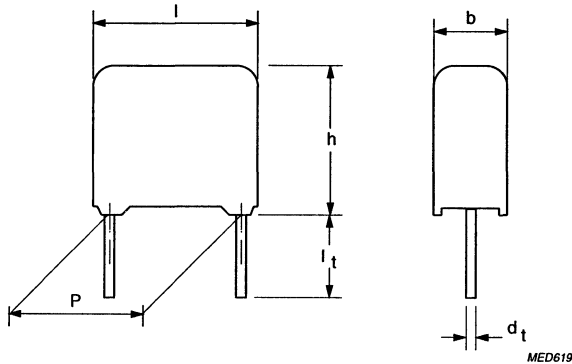
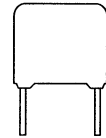
MKC 344



Pitch 10/15/22.5/27.5

SPECIFIC REFERENCE DATA FOR 630 V DC

Tangent of loss angle	at 1 kHz	at 10 kHz	at 100 kHz	
$C \leq 0.1 \mu\text{F}$	$\leq 30 \cdot 10^{-4}$	$\leq 60 \cdot 10^{-4}$	$\leq 130 \cdot 10^{-4}$	
$0.1 \mu\text{F} < C \leq 1.0 \mu\text{F}$	$\leq 30 \cdot 10^{-4}$	$\leq 60 \cdot 10^{-4}$	-	
Rated voltage pulse slope $(dU/dt)_R$ at U_{Rdc} (see also application note)	P = 10 mm 200 V/ μs	P = 15 mm 90 V/ μs	P = 22.5 mm 36 V/ μs	P = 27.5 mm 30 V/ μs
R between terminations, for $C \leq 0.33 \mu\text{F}$	>30 000 M Ω			
RC between terminations, for $C > 0.33 \mu\text{F}$	>10 000 s			

SMALLEST PACKING QUANTITIES (SPQ)	loose in box	taped on reel
DIMENSIONS	SPQ	SPQ
4.0 x 10.0 x 12.5	1000	1400
5.0 x 11.0 x 12.5	1000	1100
6.0 x 12.0 x 12.5	1000	900
5.0 x 11.0 x 17.5	1000	1100
6.0 x 12.0 x 17.5	1000	900
7.0 x 13.5 x 17.5	1000	800
8.5 x 15.0 x 17.5	1000	650
7.0 x 16.5 x 26.0	200	550
8.5 x 18.0 x 26.0	200	450
10.0 x 19.0 x 26.0	200	300
11.0 x 21.0 x 31.0	100	250
13.0 x 23.0 x 31.0	100	-

Metallized POLYCARBONATE film capacitors

MKC 344

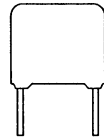
U_{Rdc} = 630V
U_{Rac} = 220 V
loose and taped

Cap. (μ F)	$b_{max} \times h_{max} \times l_{max}$ (mm)	mass (g)	CATALOGUE NUMBER 2222 344			
			loose in box		taped on reel	
			$l_t = 5.0 \pm 1.0$ mm		H = 18.5 mm *	
			C-tol $\pm 10\%$	C-tol $\pm 5\%$	C-tol $\pm 10\%$	C-tol $\pm 5\%$
Pitch = 10.0 \pm 0.4 mm; dt = 0.6 mm +0.06/-0.05 mm						
0.010	4.0 x 10.0 x 12.5	0.7	61103	62103	68103	69103
0.012 0.015	5.0 x 11.0 x 12.5	0.85	61123 61153	62123 62153	68123 68153	69123 69153
0.018 0.022	6.0 x 12.0 x 12.5	1	61183 61223	62183 62223	68183 68223	69183 69223
Pitch = 15.0 \pm 0.4 mm; dt = 0.8 mm +0.08/-0.05 mm						
0.027	5.0 x 11.0 x 17.5	1.4	61273	62273	68273	69273
0.033 0.039	6.0 x 12.0 x 17.5	1.4 1.8	61333 61393	62333 62393	68333 68393	69333 69393
0.047 0.056	7.0 x 13.5 x 17.5	1.8 2.55	61473 61563	62473 62563	68473 68563	69473 69563
0.068	8.5 x 15.0 x 17.5	2.55	61683	62683	68683	69683
Pitch = 22.5 \pm 0.4 mm; dt = 0.8 mm +0.08/-0.05 mm						
0.082 0.10 0.12	7.0 x 16.5 x 26.0	2.75 3.5	61823 61104 61124	62823 62104 62124	68823 68104 68124	69823 69104 69124
0.15	8.5 x 18.0 x 26.0	3.5	61154	62154	68154	69154
0.18 0.22	10.0 x 19.5 x 26.0	5.1	61184 61224	62184 62224	68184 68224	69184 69224
Pitch = 27.5 \pm 0.4 mm; dt = 0.8 mm +0.08/-0.05 mm						
0.27 0.33	11.0 x 21.0 x 31.0	7.4	61274 61334	62274 62334	68274 68334	69274 69334
0.39 0.47	13.0 x 23.0 x 31.0	10.2	61394 61474	62394 62474	68394 68474	69394 69474

* H: intape height; for detailed specifications refer to chapter PACKAGING.

Metallized POLYCARBONATE film capacitors

MKC 344

RATINGS AND CHARACTERISTICS

Unless otherwise specified all electrical values apply at an ambient temperature of 23 ± 1 °C, an atmospheric pressure of 86 to 106 kPa and a relative humidity of $50 \pm 2\%$.

CAPACITANCE

- All capacitance values are specified at 1 kHz.

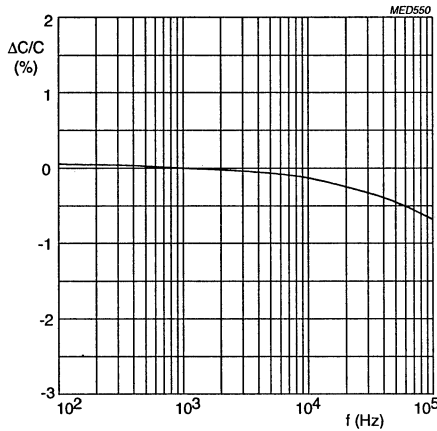

Capacitance as a function of frequency; typical curve.

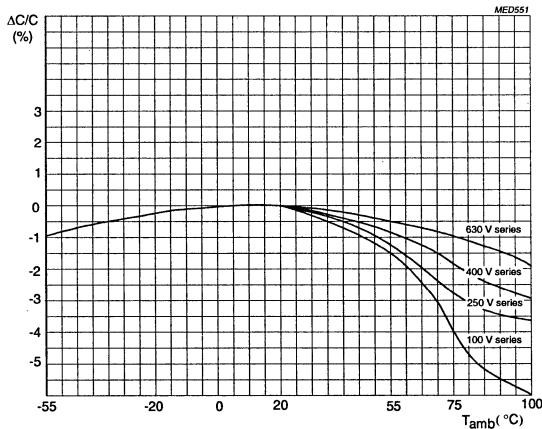

Capacitance as a function of ambient temperature; typical curves.

Metallized POLYCARBONATE film capacitors

MKC 344**TEMPERATURE**

- Storage temperature : $T_{stg} = -25\text{ }^{\circ}\text{C}$ to $+40\text{ }^{\circ}\text{C}$ with maximum 80% without condensation.

VOLTAGE

- Category voltage: $U_c = 0.8 \times U_{Rdc}$

- Test voltage between terminations: $1.6 \times U_{Rdc}$

- Test voltage between interconnected terminations and case (foil method): $2 \times U_{Rdc}$; min. 200 V.

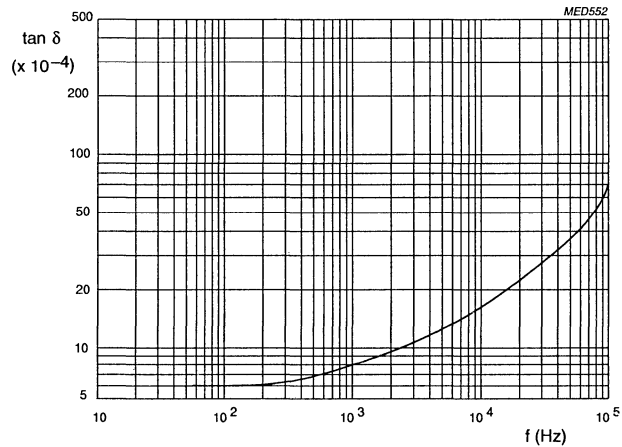
TANGENT OF THE LOSS ANGLE

Tangent of the loss angle as a function of frequency;
typical curve.

Metallized POLYCARBONATE film capacitors

MKC 344

RATED VOLTAGE PULSE SLOPE

The maximum pulse load values are valid for pulse voltages equal to the rated voltage. For lower pulse voltages the given values may be multiplied by U_{Rdc} and divided by the applied voltage.

Note: If the pulse load requirement is satisfied, a check must be made to ascertain that the maximum dissipation is not exceeded.

INSULATION RESISTANCE

The insulation resistance is measured after a voltage has been applied for 1 minute ± 5 seconds, the voltage being 100 V ± 15 V for the 100 V, 250 V and 400 V versions and 500 ± 50 V for the 630 V version.

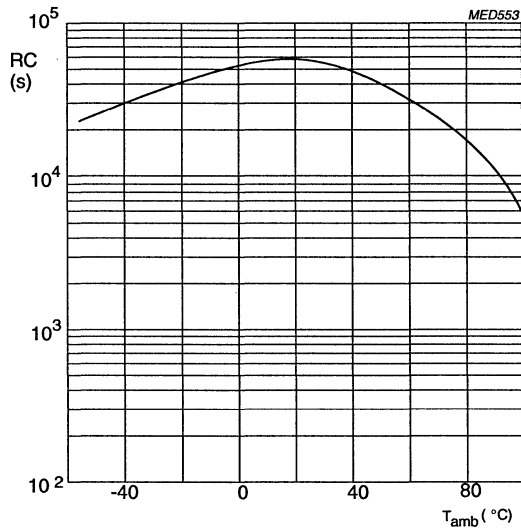

RC product as a function of ambient temperature; typical curve.

R between terminations : for value see specific reference data
R between interconnected terminations and case (foil method): $>30\ 000\ M\Omega$

Metallized POLYCARBONATE film capacitors

MKC 344

GENERAL DATA

CONSTRUCTION

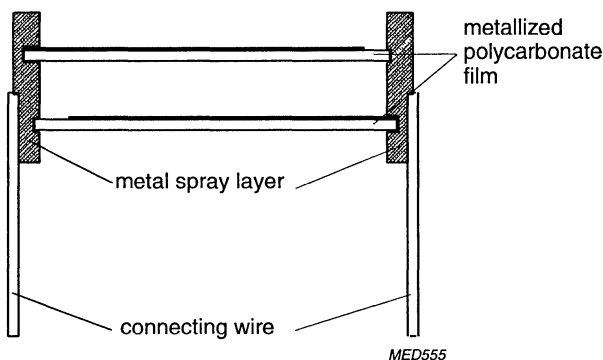

DESCRIPTION

- Low-inductive wound cell of metallized polycarbonate (PC) film, potted with blue epoxy resin in a flame retardant case
- Radial leads, solder-coated
- Small stand-off pips allow removal of solder flux etc. during cleaning of the printed-wiring board.

MOUNTING

Normal use

The capacitors are designed for mounting on printed-wiring boards. The capacitors packed in bandoliers are designed for mounting on printed-wiring boards by automatic insertion machines. For detailed specifications refer to chapter PACKAGING.

Specific method of mounting to withstand vibration and shock

In order to withstand vibration and shock tests, it must be ensured that the stand-off pips are in good contact with the printing-wiring board.

- For case sizes up to and including a mass of 6 g the capacitors shall be mechanically fixed by the leads.
- For pitches with larger case sizes the capacitors shall be mounted in the same way and the body clamped.

Metallized POLYCARBONATE film capacitors

MKC 344

MAXIMUM DISSIPATION

Curve	Dimensions (mm)
	$b_{max} \times h_{max} \times l_{max}$
1	4.0 x 10.0 x 12.5
2	5.0 x 11.0 x 12.5
3	6.0 x 12.0 x 12.5
4	5.0 x 11.0 x 17.5
5	6.0 x 12.0 x 17.5
6	7.0 x 13.5 x 17.5
7	8.5 x 15.0 x 17.5
8	6.5 x 15.5 x 26.0
9	7.5 x 16.5 x 26.0
10	8.5 x 17.5 x 26.0
11	10.0 x 19.5 x 26.0
12	9.0 x 19.0 x 31.0
13	11.0 x 21.0 x 31.0
14	13.0 x 23.0 x 31.0

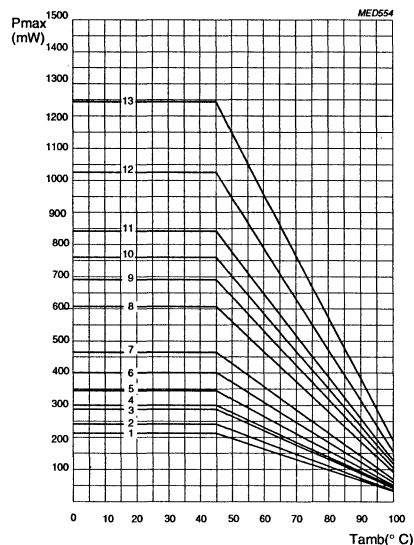

Maximum permissible power dissipation as a function of ambient temperature.

APPLICATION NOTE

To select this capacitor for a certain application, 6 conditions must be checked:

1. The peak voltage (U_p) shall not be greater than the rated DC voltage.
2. The peak to peak voltage (U_{pp}) shall not be greater than $2\sqrt{2}$ times the rated AC voltage to avoid the ionisation inception level.
3. The peak current (I_p) shall not exceed the maximum peak current, defined as maximum voltage pulse slope (dU/dt) multiplied by the capacitance.

$$I_{pmax} = C \left(\frac{dU}{dt} \right)_{max}$$

Or the voltage pulse slope shall not exceed the rated voltage pulse slope. If the pulse voltage is lower than the rated voltage, the values of the table may be multiplied by U_{Rdc} and divided by the applied voltage.

4. The dissipated power shall not be greater than the maximum permissible power dissipation stated in the graph above.
5. The free air ambient temperature for the capacitor is not exceeding the rated temperature.
6. In applications where voltages higher than 50 V are applied, it is recommended that the power in the capacitor be limited to 2.5 VA in case of a capacitor failure.

Metallized POLYCARBONATE film capacitors

MKC 344

Package marking

The package containing the capacitors is marked as shown.

PHILIPS COMPONENTS

MADE IN BELGIUM

METAL. POLYCARB. FILM CAPACITOR

MKC RADIAL POTTED TYPE

1 μ F \pm 10% 100V= 55/100/56



ORIG **A170** RPC **HQ**



TYPE **MKC 344**

—



QTY **4000** DATE **9238**



CODEND **2222 344 21105**

LINE	MARKING EXPLANATION
1	Manufacturer's name
2	Country of origin
3	Sub-family
4	Type description and safety class
5	Capacitance value, tolerance, voltage and climatic category (IEC)
6	—
7	Preference origin code: A Country of origin in code: 170 (Belgium) Responsible production centre: HQ (Roeselare) WO: work order
8	Product type description
9	Quantity and production period, year and week code
10	Product code (12NC)

POLYESTER film capacitors

KT 347

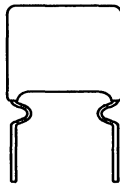
KT RADIAL PHENOLIC LACQUERED CAPACITORS
Pitch 10/15/22.5/27.5

MED556
QUICK REFERENCE DATA

Capacitance range (E12 series)	0.001 to 1 μ F
Capacitance tolerance	$\pm 20\%$, $\pm 10\%$
Rated voltage U_{Rdc}	100 V, 250 V, 400 V, 630 V
Rated voltage U_{Rac} at 50 to 60 Hz	50 V, 80 V, 125 V, 200 V,
Climatic category	40/100/21
Rated temperature	85 °C
Maximum application temperature	100 °C
Reference specification	IEC 384-11

FEATURES

- Low-inductive wound cell of metal foil and a polyethyleneterephthalate film
- Lacquered, which is self-extinguishing
- Radial leads of solder-coated wire.

APPLICATIONS

- Consumer and industrial applications
- Especially where high currents and/or steep pulses occur
- Suited for DC or AC.

**POLYESTER
film capacitors**

KT 347



Pitch 10/15/22.5/27.5

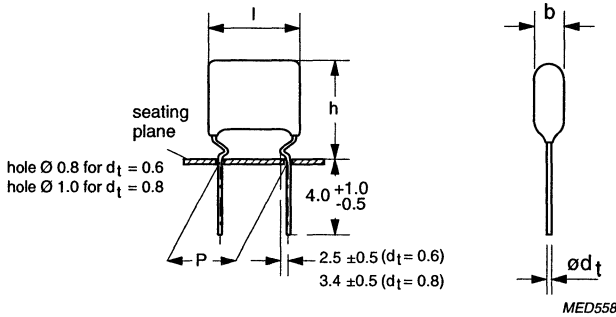

SPECIFIC REFERENCE DATA FOR 100 V DC

Tangent of loss angle	at 1 kHz	at 10 kHz
	$\leq 60 \cdot 10^{-4}$	$\leq 110 \cdot 10^{-4}$
Rated voltage pulse slope $(dU/dt)_R$ at U_{Rdc} (see also application note)	$> 10\,000 \text{ V}/\mu\text{s}$	
R between terminations, for $C \leq 0.33 \mu\text{F}$	$> 50\,000 \text{ M}\Omega$	
RC between terminations, for $C > 0.33 \mu\text{F}$	$> 16\,500 \text{ s}$	

SMALLEST PACKING QUANTITIES (SPQ)	loose in box
DIMENSIONS	SPQ
$< 5.5 \times 13.0 \times 14.0$	2000
$\geq 5.5 \times 13.0 \times 14.0$	2000
$\leq 7.5 \times 16.0 \times 19.5$	2000
$> 7.5 \times 16.0 \times 19.5$	1000
$\leq 7.5 \times 18.5 \times 27.5$	1000
$> 7.5 \times 18.5 \times 27.5$	500
$\leq 11.0 \times 22.5 \times 32.0$	500
$\geq 12.0 \times 23.5 \times 32.0$	200

POLYESTER
film capacitors
KT 347

 $U_{Rdc} = 100 \text{ V}$
 $U_{Rac} = 50 \text{ V}$
loose in box

Cap. (μF)	$b_{\text{max}} \times h_{\text{max}} \times l_{\text{max}}$ (mm)	mass (g)	CATALOGUE NUMBER 2222 347	
			C-tol $\pm 20\%$	C-tol $\pm 10\%$
Pitch = 10.16 \pm 0.3 mm; dt = 0.6 mm +0.06/-0.05 mm				
0.015	4.5 x 12.5 x 14.0	0.4	20153	21153
0.018	5.0 x 12.5 x 14.0	0.5	20183	21183
0.022 0.027	5.5 x 13.0 x 14.0	0.6 0.7	20223 20273	21223 21273
0.033	6.0 x 13.5 x 14.0	0.7	20333	21333
0.039	6.5 x 14.0 x 14.0	0.8	20393	21393
0.047	7.0 x 14.5 x 14.0	0.9	20473	21473
Pitch = 15.24 \pm 0.3 mm; dt = 0.8 mm +0.08/-0.05 mm				
0.056	5.5 x 14.0 x 19.5	1.2	20563	21563
0.068	6.0 x 14.5 x 19.5	1.3	20683	21683
0.082	6.5 x 15.0 x 19.5	1.5	20823	21823
0.10	7.0 x 15.5 x 19.5	1.7	20104	21104
0.12	7.5 x 16.0 x 19.5	1.9	20124	21124
0.15	8.0 x 16.5 x 19.5	2.3	20154	21154
Pitch = 22.86 \pm 0.3 mm; dt = 0.8 mm +0.08/-0.05 mm				
0.18	7.5 x 18.0 x 27.5	2.8	20184	21184
0.22	7.5 x 18.5 x 27.5	3.2	20224	21224
0.27	8.0 x 19.5 x 27.5	3.8	20274	21274
0.33	8.5 x 20.0 x 27.5	4.4	20334	21334
0.39	9.5 x 21.0 x 27.5	5.1	20394	21394
0.47	10.5 x 22.0 x 27.5	6.0	20474	21474
Pitch = 27.94 \pm 0.3 mm; dt = 0.8 mm +0.08/-0.05 mm				
0.56	10.0 x 21.5 x 32.5	7.0	20564	21564
0.68	11.0 x 22.5 x 32.5	8.4	20684	21684
0.82	12.0 x 23.5 x 32.5	10.2	20824	21824
1	13.5 x 25.0 x 32.5	12.5	20105	21105

**POLYESTER
film capacitors**

KT 347



Pitch 10/15/22.5/27.5

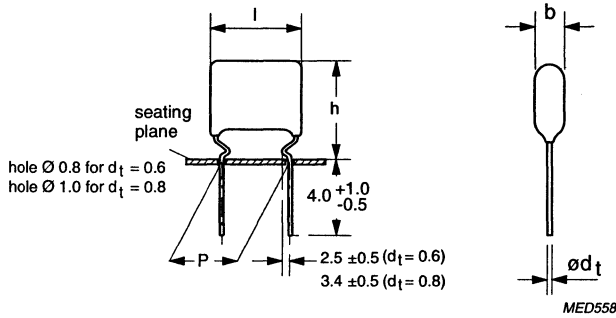

SPECIFIC REFERENCE DATA FOR 250 V DC

Tangent of loss angle	at 1 kHz	at 10 kHz
	$\leq 60 \cdot 10^{-4}$	$\leq 110 \cdot 10^{-4}$
Rated voltage pulse slope $(dU/dt)_R$ at U_{Rdc} (see also application note)	$> 10\,000$ V/ μ s	
R between terminations, for $C \leq 0.33$ μ F	$> 50\,000$ M Ω	
RC between terminations, for $C \leq 0.33$ μ F	$> 16\,500$ s	

SMALLEST PACKING QUANTITIES (SPQ)	loose in box
DIMENSIONS	SPQ
$< 5.5 \times 13.0 \times 13.5$	2000
$\geq 5.5 \times 13.0 \times 13.5$	2000
$\leq 7.5 \times 16.0 \times 19.0$	2000
$> 7.5 \times 16.0 \times 19.0$	1000
$\leq 7.5 \times 18.5 \times 27.0$	1000
$> 7.5 \times 18.5 \times 27.0$	500
$\leq 11.0 \times 22.5 \times 32.0$	500
$\geq 12.0 \times 23.5 \times 32.0$	250

POLYESTER
film capacitors
KT 347

 $U_{Rdc} = 250 \text{ V}$
 $U_{Rac} = 80 \text{ V}$
loose in box

Cap. (μF)	$b_{\max} \times h_{\max} \times l_{\max}$ (mm)	mass (g)	CATALOGUE NUMBER 2222 347	
			C-tol $\pm 20\%$	C-tol $\pm 10\%$
Pitch = 10.16 ± 0.3 mm; dt = 0.6 mm +0.06/-0.05 mm				
0.0082	4.5 x 12.0 x 13.5	0.4	40822	41822
0.010	5.0 x 12.5 x 13.5	0.5	40103	41103
0.012 0.015	5.5 x 13.0 x 13.5	0.5 0.6	40123 40153	41123 41153
0.018	6.0 x 13.5 x 13.5	0.7	40183	41183
0.022	6.5 x 14.0 x 13.5	0.8	40223	41223
0.027	7.0 x 14.5 x 13.5	0.9	40273	41273
Pitch = 15.24 ± 0.3 mm; dt = 0.8 mm +0.08/-0.05 mm				
0.033	5.5 x 14.0 x 19.0	1.1	40333	41333
0.039	6.0 x 14.5 x 19.0	1.3	40393	41393
0.047	6.5 x 15.0 x 19.0	1.4	40473	41473
0.056	7.0 x 15.5 x 19.0	1.6	40563	41563
0.068	7.5 x 16.0 x 19.0	1.8	40683	41683
0.082	8.0 x 16.5 x 19.0	2.1	40823	41823
Pitch = 22.86 ± 0.3 mm; dt = 0.8 mm +0.08/-0.05 mm				
0.10	7.5 x 18.0 x 27.0	2.7	40104	41104
0.12	7.5 x 18.5 x 27.0	3.0	40124	41124
0.15	8.0 x 19.5 x 27.0	3.5	40154	41154
0.18	8.5 x 20.0 x 27.0	4.0	40184	41184
0.22	9.5 x 21.0 x 27.0	4.5	40224	41224
0.27	10.5 x 22.0 x 27.0	5.3	40274	41274
Pitch = 27.94 ± 0.3 mm; dt = 0.8 mm +0.08/-0.05 mm				
0.33	10.0 x 21.5 x 32.0	6.3	40334	41334
0.39	11.0 x 22.5 x 32.0	7.6	40394	41394
0.47	12.0 x 23.5 x 32.0	9.1	40474	41474
0.56	13.5 x 25.0 x 32.0	10.8	40564	41564
0.68	15.0 x 26.5 x 32.0	13.1	40684	41684

**POLYESTER
film capacitors**

KT 347



Pitch 10/15/22.5/27.5

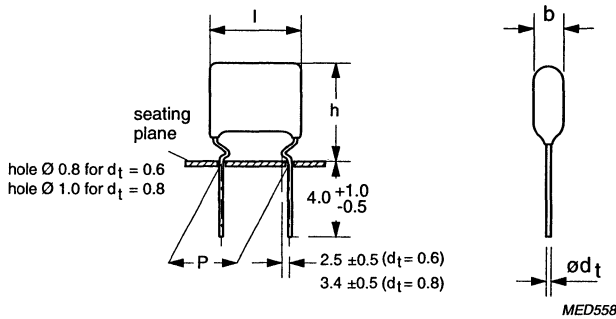

SPECIFIC REFERENCE DATA FOR 400 V DC

Tangent of loss angle	at 1 kHz	at 10 kHz
	$\leq 60 \cdot 10^{-4}$	$\leq 110 \cdot 10^{-4}$
Rated voltage pulse slope $(dU/dt)_R$ at U_{Rdc} (see also application note)	$> 10\,000 \text{ V}/\mu\text{s}$	
R between terminations, for $C \leq 0.33 \mu\text{F}$	$> 50\,000 \text{ M}\Omega$	
RC between terminations, for $C \leq 0.33 \mu\text{F}$	$> 16\,500 \text{ s}$	

SMALLEST PACKING QUANTITIES (SPQ)	loose in box
DIMENSIONS	SPQ
$< 5.5 \times 13.0 \times 13.5$	2000
$\geq 5.5 \times 13.0 \times 13.5$	2000
$\leq 7.5 \times 16.0 \times 19.0$	2000
$> 7.5 \times 16.0 \times 19.0$	1000
$\leq 7.5 \times 18.5 \times 27.0$	1000
$> 7.5 \times 18.5 \times 27.0$	500
$\leq 11.0 \times 22.5 \times 32.0$	500
$\geq 12.0 \times 23.5 \times 32.0$	250

POLYESTER
film capacitors
KT 347

 $U_{Rdc} = 400 \text{ V}$
 $U_{Rac} = 125 \text{ V}$
loose in box

Cap. (μF)	$b_{\max} \times h_{\max} \times l_{\max}$ (mm)	mass (g)	CATALOGUE NUMBER 2222 347	
			C-tol $\pm 20\%$	C-tol $\pm 10\%$
Pitch = 10.16 ± 0.3 mm; dt = 0.6 mm +0.06/-0.05 mm				
0.0047	4.5 x 12.0 x 13.5	0.4	50472	51472
0.0056	5.0 x 12.5 x 13.5	0.5	50562	51562
0.0068 0.0082	5.5 x 13.0 x 13.5	0.5 0.6	50682 50822	51682 51822
0.010	6.0 x 13.5 x 13.5	0.7	50103	51103
0.012	6.5 x 14.0 x 13.5	0.8	50123	51123
0.015	7.0 x 14.5 x 13.5	0.9	50153	51153
Pitch = 15.24 ± 0.3 mm; dt = 0.8 mm +0.08/-0.05 mm				
0.018	5.5 x 14.0 x 19.0	1.1	50183	51183
0.022	6.0 x 14.5 x 19.0	1.2	50223	51223
0.027	6.5 x 15.0 x 19.0	1.4	50273	51273
0.033	7.0 x 15.5 x 19.0	1.6	50333	51333
0.039	7.5 x 16.0 x 19.0	1.8	50393	51393
0.047	8.0 x 16.5 x 19.0	2.1	50473	51473
Pitch = 22.86 ± 0.3 mm; dt = 0.8 mm +0.08/-0.05 mm				
0.056	7.5 x 18.0 x 27.0	2.5	50563	51563
0.068	7.5 x 18.5 x 27.0	2.9	50683	51683
0.082	8.0 x 19.5 x 27.0	3.2	50823	51823
0.10	8.5 x 20.0 x 27.0	3.8	50104	51104
0.12	9.5 x 21.0 x 27.0	4.4	50124	51124
0.15	10.5 x 22.0 x 27.0	5.2	50154	51154
Pitch = 27.94 ± 0.3 mm; dt = 0.8 mm +0.08/-0.05 mm				
0.18	10.0 x 21.5 x 32.0	6.0	50184	51184
0.22	11.0 x 22.5 x 32.0	6.9	50224	51224
0.27	12.0 x 23.5 x 32.0	8.0	50274	51274
0.33	13.5 x 25.0 x 32.0	9.5	50334	51334

**POLYESTER
film capacitors**

KT 347



Pitch 10/15/22.5/27.5

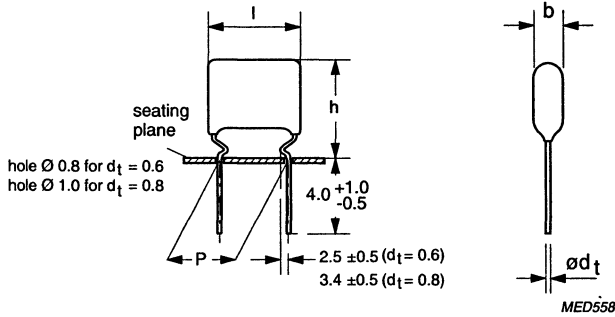

SPECIFIC REFERENCE DATA FOR 630 V DC

Tangent of loss angle	at 1 kHz	at 10 kHz
	$\leq 60 \cdot 10^{-4}$	$110 \cdot 10^{-4}$
Rated voltage pulse slope $(dU/dt)_R$ at U_{Rdc} (see also application note)	$> 10\,000 \text{ V}/\mu\text{s}$	
R between terminations, for $C \leq 0.33 \mu\text{F}$	$> 50\,000 \text{ M}\Omega$	
RC between terminations, for $C > 0.33 \mu\text{F}$	$> 16\,500 \text{ s}$	

SMALLEST PACKING QUANTITIES (SPQ)	loose in box
DIMENSIONS	SPQ
$< 5.5 \times 13.0 \times 13.5$	2000
$\geq 5.5 \times 13.0 \times 13.5$	2000
$\leq 7.5 \times 16.0 \times 19.0$	2000
$> 7.5 \times 16.0 \times 19.0$	1000
$\leq 7.5 \times 18.5 \times 27.0$	1000
$> 7.5 \times 18.5 \times 27.0$	500
$\leq 11.0 \times 22.5 \times 32.0$	500
$\geq 12.0 \times 23.5 \times 32.0$	250

POLYESTER film capacitors

KT 347

U_{Rdc} = 630 V
U_{Rac} = 200 V
loose in box

Cap. (μ F)	$b_{\max} \times h_{\max} \times l_{\max}$ (mm)	mass (g)	CATALOGUE NUMBER 2222 347	
			C-tol $\pm 20\%$	C-tol $\pm 10\%$
Pitch = 10.16 \pm 0.3 mm; dt = 0.6 mm +0.06/-0.05 mm				
0.001	5.5 x 13.0 x 13.5	0.5	60102	61102
0.0012		0.5	60122	61122
0.0015		0.6	60152	61152
0.0018		0.7	60182	61182
0.0022		0.5	60222	61222
0.0027		0.6	60272	61272
0.0033		0.5	60332	61332
0.0039		0.6	60392	61392
0.0047		6.0 x 13.5 x 13.5	0.7	60472
0.0056	6.5 x 14.0 x 13.5	0.8	60562	61562
0.0068	7.0 x 14.5 x 13.5	0.9	60682	61682
Pitch = 15.24 \pm 0.3 mm; dt = 0.8 mm +0.08/-0.05 mm				
0.0082	5.5 x 14.0 x 19.0	1.1	60822	61822
0.010	6.0 x 14.5 x 19.0	1.2	60103	61103
0.012	6.5 x 15.0 x 19.0	1.3	60123	61123
0.015	7.0 x 15.5 x 19.0	1.5	60153	61153
0.018	7.5 x 16.0 x 19.0	1.7	60183	61183
0.022	8.0 x 16.5 x 19.0	2.0	60223	61223
Pitch = 22.86 \pm 0.3 mm; dt = 0.8 mm +0.08/-0.05 mm				
0.027	7.5 x 18.0 x 27.0	2.5	60273	61273
0.033	7.5 x 18.5 x 27.0	2.8	60333	61333
0.039	8.0 x 19.5 x 27.0	3.0	60393	61393
0.047	8.5 x 20.0 x 27.0	3.5	60473	61473
0.056	9.5 x 21.0 x 27.0	3.8	60563	61563
0.068	10.5 x 22.0 x 27.0	4.4	60683	61683
Pitch = 27.94 \pm 0.3 mm; dt = 0.8 mm +0.08/-0.05 mm				
0.082	10.0 x 21.5 x 32.0	5.2	60823	61823
0.1	11.0 x 22.5 x 32.0	6.2	60104	61104
0.12	12.0 x 23.5 x 32.0	7.2	60124	61124
0.15	13.5 x 25.0 x 32.0	8.7	60154	61154

POLYESTER film capacitors

KT 347

RATINGS AND CHARACTERISTICS

Unless otherwise specified, all electrical values apply to an ambient free air temperature of $23 \pm 1 \text{ }^\circ\text{C}$, an atmospheric pressure of 86 to 106 kPa and a relative humidity of $50 \pm 2\%$.

CAPACITANCE

- All capacitance values are specified at 1 kHz.

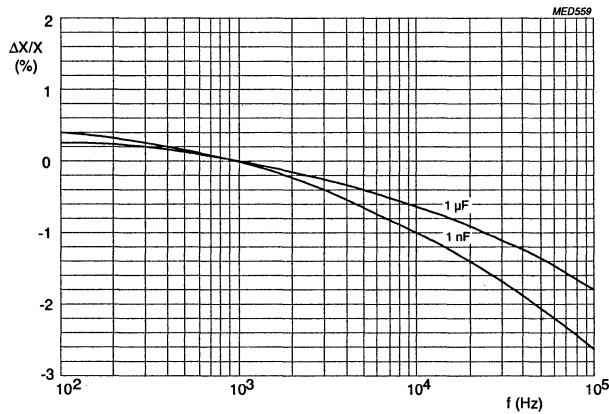

Capacitance as a function of frequency; typical curves.

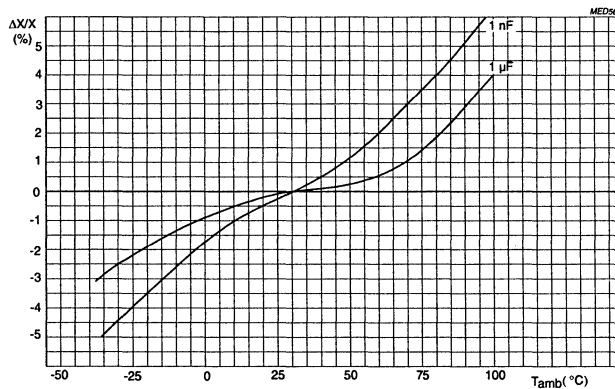

Capacitance as a function of ambient free air temperature at 1 kHz; typical curves.

POLYESTER film capacitors

KT 347**TEMPERATURE**

- Storage temperature : $T_{stg} = -25\text{ }^{\circ}\text{C}$ to $+40\text{ }^{\circ}\text{C}$ with RH maximum 80% without condensation.

VOLTAGE

- Category voltage: $U_c = 0.8 \times U_{Rdc}$
- Test voltage between terminations IEC 384-1, test A: $2 \times U_{Rdc}$
- Maximum AC voltage at 50 to 60 Hz: see specific reference data.

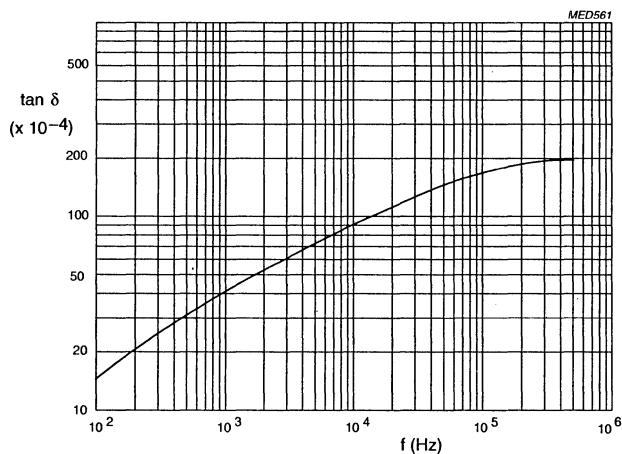
TANGENT OF THE LOSS ANGLE

Tan-delta as a function of frequency; typical curve.

**POLYESTER
film capacitors**

KT 347

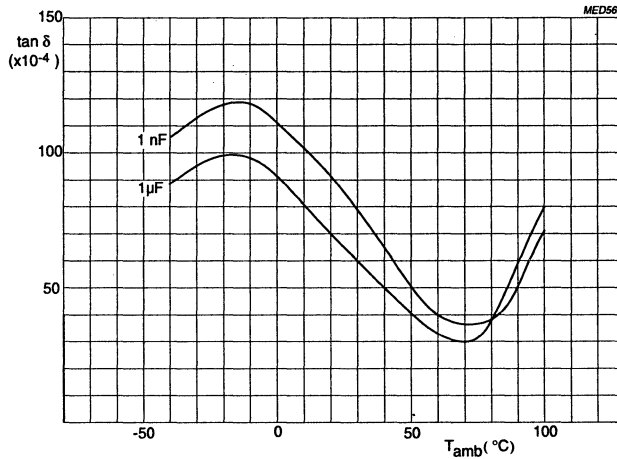

Tan-delta as a function of ambient free air temperature; typical curves. Measuring frequency is 10 kHz.

INSULATION RESISTANCE

The insulation resistance is measured after a voltage has been applied for 1 minute ±5 seconds, the voltage being 100 ±15 V for the 100 V, 250 V and 400 V versions and 500 V ±50 V for the 630 V version.

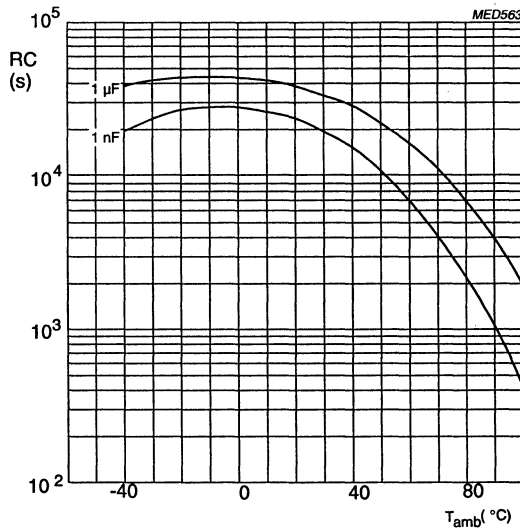

RC-product as a function of ambient free air temperature; typical curves.

POLYESTER film capacitors

KT 347

GENERAL DATA

CONSTRUCTION

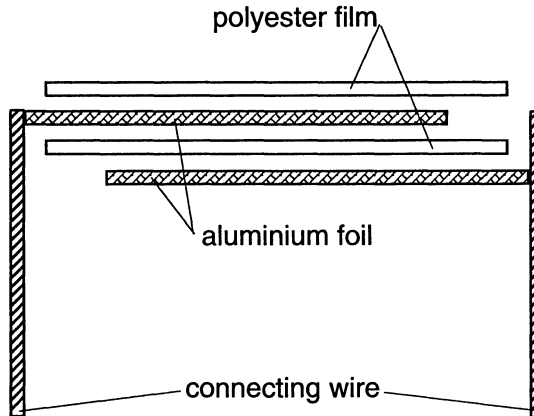

MED557

DESCRIPTION

- Low-inductive wound cell of metal foil and a polyethyleneterephthalate film
- Lacquered with self-extinguishing tan coloured lacquer
- Radial leads, solder-coated.

MOUNTING

Normal use

The capacitors are designed for mounting on printed-wiring boards.

Specific method of mounting to withstand vibration and shock.

In order to withstand vibration and shock tests, it must be ensured that the underside of the crimps are in good contact with the printed-wiring board. For case sizes up to and including a mass of 2 g the capacitors shall be mechanically fixed by the leads.

With larger case sizes the capacitors shall be mounted in the same way and the body clamped.

POLYESTER film capacitors

KT 347

MAXIMUM DISSIPATION

The power dissipated by a capacitor is a function of the voltage.

Curve	Dimensions (mm)
	$b_{max} \times h_{max} \times l_{max}$
1	4.5 x 12.0 x 14.0
2	5.0 x 12.5 x 14.0
3	5.5 x 13.0 x 14.0
4	6.0 x 13.5 x 14.0
5	6.5 x 14.0 x 14.0
6	7.0 x 14.5 x 14.0
7	5.5 x 14.0 x 19.5
8	6.0 x 14.5 x 19.5
9	6.5 x 15.0 x 19.5
10	7.0 x 15.5 x 19.5
11	7.5 x 16.0 x 19.5
12	8.0 x 16.5 x 19.5
13	6.5 x 18.5 x 27.5
14	7.0 x 18.5 x 27.5
15	8.0 x 19.5 x 27.5
16	8.5 x 20.0 x 27.5
17	9.5 x 21.0 x 27.5
18	10.5 x 22.0 x 27.5
19	10.0 x 21.5 x 32.5
20	11.0 x 22.5 x 32.5
21	12.0 x 23.5 x 32.5
22	13.5 x 25.0 x 32.5
23	15.0 x 26.5 x 32.5

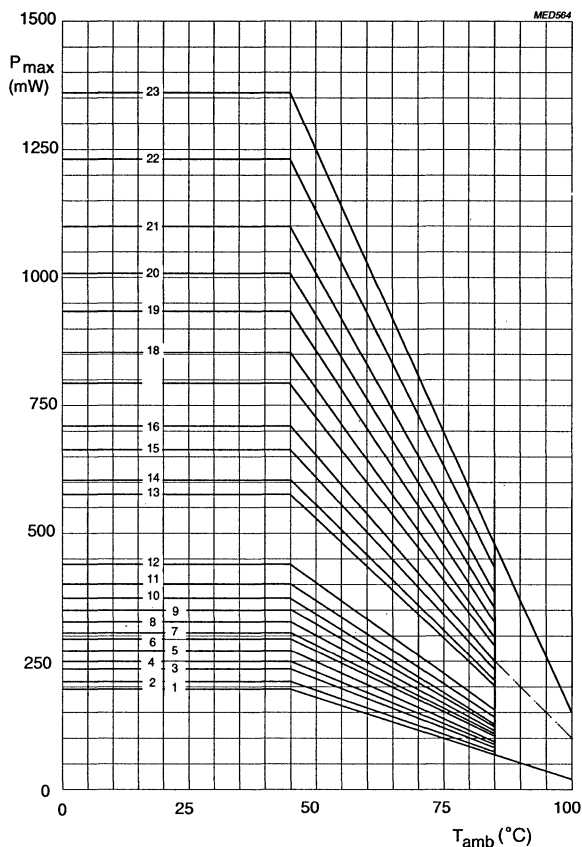

Maximum permissible power dissipation as a function of ambient free air temperature.

APPLICATION NOTE

To select this capacitor for a certain application, 5 conditions must be checked:

1. The peak voltage (U_p) shall not be greater than the rated DC voltage.
2. The peak to peak voltage (U_{pp}) shall not be greater than $2\sqrt{2}$ times the rated AC voltage, to avoid the ionisation inception level.
3. There is no limit for the peak current (I_p) or voltage pulse slope (dU/dt) in the application.
4. The dissipated power shall not be greater than the maximum permissible power dissipation.
5. The free air ambient temperature for the capacitor is not exceeding the category temperature.

**POLYESTER
film capacitors**

KT 347

MARKING

The capacitors are marked on the top in black ink with the following information:

- Capacitance in pF or μF
- Capacitance tolerance
- Rated voltage (e.g. 250V)
- Code for dielectric material (KT)
- Manufacturer (PHILIPS)
- Code for factory of origin (HQ)

Example:

PHILIPS 0.39 μF 20% |
250V- KT |
MED565

Package marking

The package containing the capacitors is marked as shown.

PHILIPS COMPONENTS

MADE IN BELGIUM

PETP FILM-FOIL CAPACITOR

KT RADIAL PHENOLIC LACQUERED TYPE

0.1 μF \pm 10% 400V= 40/100/21



ORIG **A170** RPC **HQ**



TYPE **KT 347**



QTY **2000** DATE **9238**



COEENO **2222 347 51104**

LINE	MARKING EXPLANATION
1	Manufacturer's name
2	Country of origin
3	Sub-family
4	Type description
5	Capacitance value, tolerance, voltage and climatic category (IEC)
6	-
7	Preference origin code: A Country of origin in code: 170 (Belgium) Responsible production centre: HQ (Roeselare) WO: work order
8	Product type description
9	Quantity and production period, year and week code
10	Product code (12NC)

NOTES

DATA HANDBOOK SYSTEM

PHILIPS COMPONENTS

DATA HANDBOOK SYSTEM

Philips Components data handbooks contain all pertinent data available at the time of publication and each is revised and reissued regularly.

Loose data sheets are sent to subscribers to keep them up-to-date on additions or alterations made during the lifetime of a data handbook.

Catalogues are available for selected product ranges (some catalogues are also on floppy discs).

Our data handbook titles are listed here.

Display components

<i>Book</i>	<i>Title</i>
DC01	Colour Display Components Colour TV Picture Tubes and Assemblies Colour Monitor Tube Assemblies
DC02	Monochrome Monitor Tubes and Deflection Units
DC03	Television Tuners, Coaxial Aerial Input Assemblies
DC05	Flyback Transformers, Mains Transformers and General-purpose FXC Assemblies

Liquid crystal displays

LCD01	Liquid Crystal Displays and Driver ICs for LCDs
-------	---

Magnetic products

MA01	Soft Ferrites
MA03	Piezoelectric Ceramics and Specialty Ferrites

Passive components

<i>Book</i>	<i>Title</i>
PA01	Electrolytic Capacitors
PA02	Varistors, Thermistors and Sensors
PA03	Potentiometers and Switches
PA04	Variable Capacitors
PA05	Film Capacitors
PA06	Ceramic Capacitors
PA07	Quartz Crystals for Special and Industrial Applications
PA08	Fixed Resistors
PA10	Quartz Crystals for Automotive and Standard Applications
PA11	Quartz Oscillators

Professional components

PC04	Photo Multipliers
PC05	Plumbicon Camera Tubes and Accessories
PC07	Vidicon and Newvicon Camera Tubes and Deflection Units
PC08	Image Intensifiers
PC09	Dry-reed Switches
PC12	Electron Multipliers

MORE INFORMATION FROM PHILIPS COMPONENTS?

For more information about Philips Components data handbooks, catalogues and subscriptions contact your nearest Philips Components national organization, select from the **address list on the back cover of this handbook**. Product specialists are at your service and enquiries are answered promptly.

PHILIPS SEMICONDUCTORS

OVERVIEW OF DATA HANDBOOKS

Our sister product division, Philips Semiconductors, also has a comprehensive data handbook system to support their products. Their data handbook titles are listed here.

Discrete semiconductors

<i>Book</i>	<i>Title</i>
SC01	Diodes
SC02	Power Diodes
SC03	Thyristors and Triacs
SC04	Small-signal Transistors
SC05	Low-frequency Power Transistors and Hybrid IC Power Modules
SC06	High-voltage and Switching NPN Power Transistors
SC07	Small-signal Field-effect Transistors
SC08a	RF Power Bipolar Transistors
SC08b	RF Power MOS Transistors
SC09	RF Power Modules
SC10	Surface Mounted Semiconductors
SC13	PowerMOS Transistors
SC14	RF Wideband Transistors, Video Transistors and Modules
SC15	Microwave Transistors
SC16	Wideband Hybrid IC Modules
SC17	Semiconductor Sensors

Integrated circuits

IC01	Semiconductors for Radio and Audio Systems
IC02	Semiconductors for Television and Video Systems
IC03	Semiconductors for Telecom Systems
IC04	CMOS HE4000B Logic Family
IC05	Advanced Low-power Schottky (ALS) Logic Series
IC06	High-speed CMOS Logic Family
IC08	ECL 100K ECL Logic Family
IC10	Memories
IC11	General-purpose/Linear ICs
IC12	Display Drivers and Microcontroller Peripherals (planned)
IC13	Programmable Logic Devices (PLD)
IC14	8048-based 8-bit Microcontrollers
IC15	FAST TTL Logic Series
IC16	ICs for Clocks and Watches
IC18	Semiconductors for In-Car Electronics and General Industrial Applications (planned)
IC19	Semiconductors for Datacom: LANs, UARTs, Multi-Protocol Controllers and Fibre Optics

Integrated circuits (continued)

IC20	8051-based 8-bit Microcontrollers
IC21	68000-based 16-bit Microcontrollers
IC22	ICs for Multi-Media Systems (planned)
IC23	QUBIC Advanced BiCMOS Interface Logic ABT, MULTIBYTE™
IC24	Low Voltage CMOS Logic

Professional components

PC01	High-power Klystrons and Accessories
PC06	Circulators and Isolators

MORE INFORMATION FROM PHILIPS SEMICONDUCTORS?

For more information contact your nearest Philips Semiconductors national organization shown in the following list.

Argentina: BUENOS AIRES, Tel. (541)786-76-35, Fax. (541)786-93-67
Australia: NORTH RYDE, Tel. (02)805 4455, Fax. (02)805 4466
Austria: WIEN, Tel. (0222)60 101-0, Fax. (0222)60 101-1975
Belgium: BRUXELLES, Tel. (02)525 6111, Fax. (02)525 7246
Brazil: SAO PAULO-SP, Tel. (011)829-1166, Fax. (011)829-1849
Canada: Discrete Semiconductors – SCARBOROUGH, Tel. (416)292-5161; Integrated Circuits – ETOBICOKE, Tel. (416)626-6676
Chile: SANTIAGO, Tel. (02)773 816
Colombia: BOGOTA, Tel. (01)249 7624
Denmark: COPENHAGEN, Tel. (32)883 333, Fax. (32)960 125
Finland: ESPOO, Tel. (0)50261, Fax. (0)520971
France: ISSY-LES-MOULINEAUX, Tel. (01)4093 8000, Fax. (01)4093 8127
Germany: HAMBURG, Tel. (040)3296-0, Fax. (040)3296 213
Greece: TAVROS, Tel. (01)4894 339/4894 911
Hong Kong: KWAI CHUNG, Tel. (0)4245 121, Fax. (0)4806 960
India: BOMBAY, Tel. (022)4938 541, Fax. (022)4941 595
Indonesia: JAKARTA, Tel. (021)5201122, Fax. (21)5205189
Ireland: DUBLIN, Tel. (01)693 355, Fax. (01)697 856
Italy: MILANO, Tel. (02)6752 2642, Fax. (02)6752 2648
Japan: TOKIO, Tel. (03)3740 5101, Fax. (03)37400 570
Korea: (Republic of) SEOUL, Tel. (02)794-5011, Fax. (02)798-8022
Malaysia: SELANGOR, Tel. (03)7755 1088, Fax. (03)757 4880
Mexico: CHI HUA HUA, Tel. (016)18-67-01/18-67-02
Netherlands: EINDHOVEN, Tel. (040)78 37 49, Fax. (040)78 83 99
New Zealand: AUCKLAND, Tel. (09)894-160, Fax. (09)897-811
Norway: OSLO, Tel. (02)74 8000, Fax. (02)74 8341
Pakistan: KARACHI, Tel. (021)725 772
Peru: LIMA, Tel. (014)350 059
Philippines: MANILA, Tel. (02)810-0161, Fax. (02)817 3474
Portugal: LISBOA, Tel. (019)683 121, Fax. (019)658 013
Singapore: SINGAPORE, Tel. (65)350 2000, Fax. (65)251 6500
South Africa: JOHANNESBURG, Tel. (011)8893 911, Fax. (011)8893 191
Spain: BARCELONA, Tel. (03)301 6312, Fax. (03)301 4243
Sweden: STOCKHOLM, Tel. (08)-782 1000, Fax. (08)-782 9002
Switzerland: ZÜRICH, Tel. (01)488 2211, Fax. (01)482 8595
Taiwan: TAIPEI, Tel. (2)509 7666, Fax. (2)500 5899
Thailand: BANGKOK, Tel. (2)399-3280 to 9, (2)398-2083, Fax. (2)398-2080
Turkey: ISTANBUL, Tel. (01)179 2770, Fax. (01)169 3094
United Kingdom: LONDON, (071)436 4144, Fax. (071)323 0342
United States: Discrete Semiconductors – RIVIERA BEACH, Tel. (407)881-3200, Fax. (407)881-3300.
 Integrated circuits – SUNNYVALE, Tel. (800)234-7381, Fax. (408)991-3581
Uruguay: MONTEVIDEO, Tel. (02)70-4044
Venezuela: CARACAS, Tel. (02)241 75 09
Zimbabwe: HARARE, Tel. (04)47 211
 For all other countries apply to: Philips Semiconductors, International Marketing and Sales, Building BAF-1, P.O. Box 218, 5600 MD, EINDHOVEN, The Netherlands, Telex 35000 phicnl, Fax. +31-40-724825

STANDARD SERIES OF VALUES IN A DECADE

for resistances and capacitances

according to IEC publication 63

E192	E96	E48	E192	E96	E48	E192	E96	E48	E192	E96	E48	E192	E96	E48
100	100	100	169	169	169	287	287	287	487	487	487	825	825	825
101			172			291			493			835		
102	102		174	174		294	294		499	499		845	845	
104			176			298			505			856		
105	105	105	178	178	178	301	301	301	511	511	511	866	866	866
106			180			305			517			876		
107	107		182	182		309	309		523	523		887	887	
109			184			312			530			898		
110	110	110	187	187	187	316	316	316	536	536	536	909	909	909
111			189			320			542			920		
113	113		191	191		324	324		549	549		931	931	
114			193			328			556			942		
115	115	115	196	196	196	332	332	332	562	562	562	953	953	953
117			198			336			569			965		
118	118		200	200		340	340		576	576		976	976	
120			203			344			583			988		
121	121	121	205	205	205	348	348	348	590	590	590			
123			208			352			597					
124	124		210	210		357	357		604	604				
126			213			361			612			E24	E12	E6 E3
127	127	127	215	215	215	365	365	365	619	619	619	10	10	10 10
129			218			370			626			11		
130	130		221	221		374	374		634	634		12	12	
132			223			379			642			13		
133	133	133	226	226	226	383	383	383	649	649	649	15	15	15
135			229			388			657			16		
137	137		232	232		392	392		665	665		18	18	
138			234			397			673			20		
140	140	140	237	237	237	402	402	402	681	681	681	22	22	22 22
142			240			407			690			24		
143	143		243	243		412	412		698	698		27	27	
145			246			417			706			30		
147	147	147	249	249	249	422	422	422	715	715	715	33	33	33
149			252			427			723			36		
150	150		255	255		432	432		732	732		39	39	
152			258			437			741			43		
154	154	154	261	261	261	442	442	442	750	750	750	47	47	47 47
156			264			448			759			51		
158	158		267	267		453	453		768	768		56	56	
160			271			459			777			62		
162	162	162	274	274	274	464	464	464	787	787	787	68	68	68
164			277			470			796			75		
165	165		280	280		475	475		806	806		82	82	
167			284			481			816			91		

Philips Components Sales Offices and Manufacturer's Representatives

AL	Huntsville, Over & Over, Inc.	(205) 837-7105	NY	Skaneateles, Empire Tech. Assoc., Inc.	(315) 685-5703
AZ	Tempe, Philips Components	(602) 820-2225	NY	East Rochester, Empire Tech. Assoc., Inc.	(716) 381-8500
CA	Santa Clara, Criterion Sales, Inc.	(408) 988-6300	NY	Edwell, Empire Tech. Assoc., Inc.	(607) 754-8756
CA	Signal Hill, Harper & Strong, Inc.	(310) 424-3030	OH	Dayton, Philips Components	(513) 436-0066
CA	Sunnyvale, Philips Components	(408) 991-2294	OH	Wickliffe, Philips Components	(216) 731-7721
CT	Ed Glass Associates, Inc.	(201) 592-0200	OR	Beaverton, Eclipse Market Group	(503) 642-1661
CO	Englewood, Philips Components	(303) 779-9696	PA	Willow Grove, Philips Components	(215) 659-6096
FL	Altamonte Springs, Over & Over, Inc.	(407) 332-1222	PR	Caparra Heights, M. Anderson Co., Inc.	(809) 783-6544
FL	Ft. Lauderdale, Over & Over, Inc.	(305) 485-0115	TN	Greenville, Philips Components	(615) 639-0251
GA	Norcross, Over & Over, Inc.	(404) 449-6205	TX	Austin, Philips Components	(512) 331-8828
GA	Roswell, Philips Components	(404) 992-0150	TX	Houston, Philips Components	(713) 272-8086
IA	Cedar Rapids, Lorenz Sales, Inc.	(319) 377-4666	TX	Richardson, Philips Components	(214) 231-8274
IL	Libertyville, GMR Sales, Inc.	(708) 367-8440	WA	Redmond, Eclipse Market Group	(206) 885-6991
IL	Rolling Meadows, Philips Components	(708) 670-9494	WI	New Berlin, Philips Components	(414) 785-6509
IN	Fort Wayne, Corrao Marsh, Inc.	(219) 482-2725	Canada	Scarborough, Ontario, Philips Components	(416) 292-5161
IN	Greenfield, Corrao Marsh, Inc.	(317) 462-4446	Mexico	El Paso, Philips Components	011+52-16-186701
IN	Kokomo, Philips Components	(317) 456-1615	Mexico	Mexico City, Philips Components	011+52-55-333858
KS	Overland Park, Lorenz Sales, Inc.	(913) 469-1312			
KS	Wichita, Lorenz Sales, Inc.	(316) 721-0500			
MA	Woburn, Philips Components	(617) 932-4748			
MI	Farmington Hills, Philips Components	(313) 553-6010			
MN	Minneapolis, Electric Components Sales, Inc.	(612) 933-2594			
MO	St. Louis, Lorenz Sales, Inc.	(314) 997-4558			
NC	Charlotte, Over & Over, Inc.	(704) 542-9111			
NC	Raleigh, Over & Over, Inc.	(919) 876-7338			
NE	Lincoln, Lorenz Sales, Inc.	(402) 475-4660			
NJ	Englewood Cliffs, Ed Glass Associates	(201) 592-0200			
NJ	Parsippany, Philips Components	(201) 455-1507			
NY	Ed Glass Associates, Inc.	(201) 592-0200			

Philips Components, Capacitor Operation

6071 St. Andrews Road, Columbia, SC 29212 Tel: (803) 772-2500

All rights are reserved. Reproduction in whole or in part is prohibited without prior written consent of the copyright owner.

The information presented in this document does not form part of any quotation or contract, is believed to be accurate and reliable and may be changed without notice. No liability will be accepted by the publisher for any consequences of its use. Publication thereof does not convey nor imply and license under patent or other industrial or intellectual property rights

Printed in the United States

Release Date: 11/92

Ordering Code: PC044

For Complimentary Literature, Call Our Literature Center Toll Free at 1-800-447-3762

Philips Components



PHILIPS