



# WRITE FOR 1962-1963 FILTER CATALOG

VOLUME 2 of 2

**IMMEDIATE DELIVERY  
FROM STOCK**

**ELECTRIC WAVE  
FILTERS  
HIGH Q COILS**

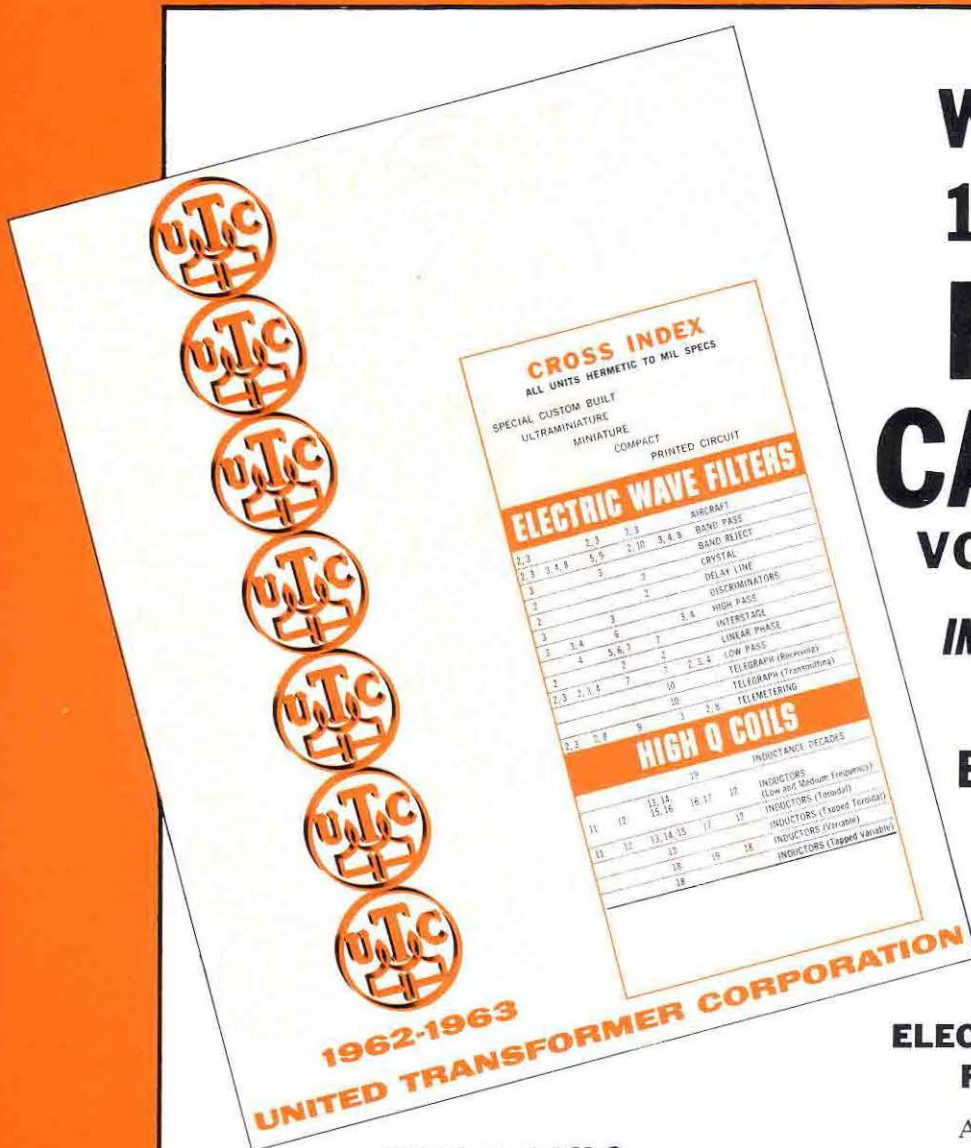

## HIGH Q COILS

INDUCTANCE DECADES  
LOW FREQUENCY  
TOROIDS  
TAPPED TOROIDS  
VARIABLE  
TAPPED VARIABLE

## LUMPED CONSTANT DELAY LINES

## ELECTRIC WAVE FILTERS

AIRCRAFT  
BAND PASS  
DISCRIMINATORS  
HIGH FREQUENCY  
HIGH PASS  
INTERSTAGE  
LINEAR PHASE  
LOW FREQUENCY  
LOW PASS  
TELEGRAPH (RECEIVING)  
TELEGRAPH (TRANSMITTING)  
TELEMETERING

## — AND CUSTOM BUILT SPECIALS —

The bulk of UTC's engineering and production facilities is geared to design and manufacture of special, custom built units to your specific requirements. Where unique designs are encountered, that are not covered by the standard items shown in this catalog, we will be pleased to quote on your requirements.

# IMMEDIATE DELIVERY ON ALL ITEMS

## INDEX AND NET PRICE LIST

QUANTITY PRICES AVAILABLE ON REQUEST

Type	Page	Net	Type	Page	Net	Type	Page	Net	Type	Page	Net	Type	Page	Net
<b>ULTRA COMPACT</b>			CG-305	47	\$63.00	New DI-T288	9	\$8.10	H-12	12	\$9.60	H-109	23	\$10.80
A-10	40	\$13.20	New CG-305W	47	69.00	DI-TSH	8	.90	H-13	12	9.00	H-110	25	27.00
A-11	40	12.00	CG-306	47	150.00	<b>DO-T'S</b>			H-14	12	9.00	New H-110W	25	29.70
A-12	40	12.00	New CG-306W	47	165.00	DO-T1	7	6.00	H-15	12	9.00	H-111	25	33.00
A-15	40	9.90	CG-307	47	138.00	DO-T2	7	5.40	H-16	12	9.00	New H-111W	25	36.00
A-16	40	9.90	CG-308	47	162.00	DO-T3	7	5.40	H-17	12	8.70	H-112	25	36.00
A-17	40	12.00	CG-309	47	360.00	DO-T4	7	5.40	H-18	12	8.70	New H-112W	25	39.60
A-18	40	12.00	CG-310	47	309.00	DO-T5	7	5.40	H-19A	13	16.50	H-113	25	54.00
A-19	40	12.00	CG-311	47	66.00	DO-T6	7	6.00	H-20	13	15.00	H-114	25	81.00
A-20	40	14.40	New CG-311W	47	69.00	DO-T7	7	6.60	H-21	13	18.00	H-115	25	81.00
A-21	40	12.00	CG-312	47	66.00	DO-T8	6	4.80	H-22	13	15.90	H-117	25	291.00
A-22	40	9.90	CG-315	47	14.40	DO-T9	7	6.60	H-23	13	16.20	New H-118	26	9.00
A-23	40	9.90	CG-316	47	21.00	DO-T10	7	6.60	H-24	13	10.80	New H-119	26	8.40
A-24	40	12.90	CG-333	46	9.00	DO-T11	7	6.60	H-25	13	15.00	H-120	26	13.80
A-25	40	12.00	CG-422	47	21.00	DO-T12	7	5.70	H-26	13	15.00	H-121	26	18.00
A-26	40	13.20	CG-428	47	24.90	DO-T13	7	5.70	H-27	13	15.00	H-122	26	21.00
A-27	40	12.00	CG-429	47	24.90	DO-T14	7	6.00	H-30	11	8.40	H-123	26	36.00
A-28	40	10.20	CG-431	47	36.00	DO-T15	7	6.00	H-31	11	8.40	H-124	26	12.00
A-30	41	10.20	CG-433	46	9.90	DO-T16	7	6.00	H-32	11	8.40	H-125	26	21.00
A-32	41	6.60	CG-710	46	12.00	DO-T17	7	6.00	H-33	11	8.40	H-126	26	27.00
A-33	41	2.70	CVA-1	47	12.00	DO-T18	7	6.30	H-35	11	6.90	H-127	26	45.00
A-34	40	10.20	CVA-2	47	14.10	DO-T19	7	6.00	H-36	11	7.50	H-128	26	81.00
A-35	40	9.90	CVA-3	47	18.00	DO-T20	7	6.00	H-37A	11	7.50	H-129	26	90.00
A-36	40	9.60	CVA-4	47	21.00	DO-T21	7	6.00	H-38	11	7.50	H-130	26	9.00
A-37	40	9.60	CVA-5	47	36.00	DO-T22	7	6.00	H-39	11	7.50	H-131	26	12.00
A-38	40	9.30	CVL-1	46	9.00	DO-T23	7	6.90	H-40A	11	7.50	H-132	26	19.20
A-39	40	11.10	CVL-2	46	10.50	DO-T24	7	7.50	H-41A	11	7.50	H-133	26	15.00
A-40	41	9.90	CVL-3	46	15.00	DO-T25	7	7.20	H-42A	11	8.40	H-134	26	16.80
A-41	41	6.30	CVM-0	46	10.50	DO-T26	6	5.70	H-45	37	6.75	H-135	26	21.00
New A-42	41	6.60	CVM-1	46	13.80	DO-T27	6	4.80	H-46	37	6.75	H-136	26	27.00
New A-43	40	14.10	CVM-2	46	18.00	DO-T28	6	4.80	H-47	37	6.00	H-137	26	12.00
<b>COMMERCIAL GRADE</b>			CVM-3	46	21.00	DO-T29	7	5.70	H-48	37	6.00	H-138	26	19.50
CG-1C	47	54.00	CVM-4	46	39.00	DO-T30	7	5.70	H-49	37	6.00	H-139	26	18.00
CG-1S	47	54.00	CVM-5	46	105.00	DO-T31	7	6.00	H-50	37	6.00	H-140	26	7.80
CG-2L6	46	13.80	CVP-1	46	13.20	DO-T32	7	6.00	H-51	37	6.00	H-141	28	10.20
CG-15	46	12.00	CVP-2	46	14.40	DO-T33	7	6.00	H-52	37	6.00	H-142	28	12.90
CG-16	46	12.00	CVP-3	46	21.00	DO-T34	7	6.00	H-53	37	6.00	H-143	28	18.60
CG-19	46	12.00	CVP-4	46	24.00	DO-T35	7	6.30	H-54	37	6.30	H-144	28	30.00
CG-20	46	15.00	CVP-5	46	39.00	DO-T36	7	7.50	H-55	37	6.30	H-145	28	45.90
CG-21	46	24.00	<b>DECADE INDUCTORS</b>			DO-T37	7	7.80	H-56	37	6.30	H-146	28	45.90
CG-30	47	18.90	DI-1	38	42.00	DO-T38	7	7.80	H-57	37	6.30	H-147	28	27.00
CG-31	47	42.00	DI-2	38	54.00	DO-T39	7	7.80	H-58	37	75.00	New H-164	23	6.60
CG-32	47	10.50	DI-3	38	57.00	DO-T40	7	8.40	H-60	36	6.60	New H-166	23	7.50
CG-33	47	9.00	DI-4	38	72.00	DO-T41	7	7.50	H-61	36	6.60	New H-168	23	8.40
CG-34	47	10.20	<b>DI-T'S</b>			DO-T42	7	7.50	H-62	36	6.60	H-170	23	10.20
CG-40	47	8.10	DI-T1	8	6.00	DO-T43	7	7.50	H-63	36	6.60	H-171	23	15.00
CG-44	47	6.90	DI-T2	8	5.40	DO-T44	7	7.50	H-64	36	6.60	New H-172	23	12.60
CG-45	47	6.00	DI-T3	8	5.40	New DO-T45	7	7.80	H-65	36	7.50	New H-173	23	21.00
CG-48C	47	7.50	DI-T5	8	5.40	New DO-T46	7	8.40	H-66	36	7.50	H-194	25	21.00
CG-51AX	46	9.00	DI-T8	8	4.80	New DO-T47	7	8.10	H-67	36	7.50	H-195	25	24.00
CG-53AX	46	10.50	DI-T9	8	6.60	New DO-T48	7	7.80	H-68	36	7.50	H-196	25	30.00
CG-59AX	46	10.80	DI-T10	8	6.60	New DO-T49	6	7.80	H-69	36	60.00	H-197	25	42.00
CG-100	47	9.00	DI-T11	8	6.60	New DO-T50	6	5.70	H-70	23	7.20	H-198	25	27.00
CG-101	47	9.00	DI-T19	8	6.00	New DO-T500	26	6.60	H-71	23	8.40	H-219	12	9.00
CG-102	47	13.20	DI-T20	8	6.00	DO-TSH	7	.90	H-72	23	9.00	H-220	12	8.70
CG-103	47	13.20	DI-T21	8	6.00	<b>FLAT HERMETIC</b>			H-73	23	11.40	H-221	12	8.70
CG-104	47	15.00	DI-T22	8	6.00	New FHA-15	11	8.10	H-74	23	12.90	New H-222	12	6.00
CG-105	47	15.00	DI-T23	8	6.90	New FHA-25	11	8.10	H-75	23	17.40	New H-224	12	6.00
CG-108	47	27.00	DI-T25	8	7.20	New FHI-3	11	6.00	H-76	23	24.00	H-280	13	12.00
CG-109	47	27.00	DI-T26	8	5.70	New FHI-7	11	6.00	H-77	23	27.00	H-281	13	12.00
CG-111	47	11.40	DI-T27	8	4.80	New FHI-11	11	6.00	H-78	23	34.50	H-282	13	12.60
CG-120	47	15.00	DI-T28	8	4.80	<b>FT FILAMENT</b>			H-79	23	90.00	New H-283	13	17.40
CG-121	47	18.00	DI-T36	8	7.50	FT-1	50	2.85	H-80	24	12.90	New H-284	13	7.20
CG-122	47	15.00	New DI-T37	8	7.80	FT-2	50	3.15	H-81	24	18.00	New H-286	13	7.50
CG-124	47	15.00	New DI-T38	8	7.80	FT-3	50	3.45	H-82	24	20.40	H-290	13	19.80
CG-125	47	18.00	New DI-T41	8	7.50	FT-4	50	3.45	H-83	24	21.00	H-291	13	28.80
CG-126	47	24.00	New DI-T43	8	7.50	FT-5	50	3.90	H-84	24	26.40	New H-300	23	6.30
CG-131	46	9.90	New DI-T44	8	7.50	FT-6	50	4.05	H-85	24	30.00	New H-461	37	6.75
CG-132	46	9.90	New DI-T204	9	6.00	FT-7	50	4.05	H-86	24	30.90	New H-501	37	6.00
CG-133	46	10.50	New DI-T208	9	6.00	FT-8	50	4.80	H-87	24	36.00	New H-531	37	6.00
CG-134	46	9.00	New DI-T212	9	6.00	FT-10	50	5.10	H-88	24	49.50	New H-561	37	6.30
CG-135	46	9.90	New DI-T216	9	6.90	FT-11	50	4.50	H-89	24	27.00	New H-611	36	6.60
CG-136	46	8.40	New DI-T225	9	8.40	FT-12	50	5.10	H-92	24	33.00	New H-641	36	6.60
CG-137	46	8.40	New DI-T230	9	7.20	New FT-13	50	3.30	H-93	25	49.50	New H-671	36	7.50
CG-140	46	7.80	New DI-T235	9	8.40	New FT-14	50	3.75	H-94	28	19.80	New H-915	28	11.70
CG-141	46	9.00	New DI-T245	9	8.40	<b>HERMETIC</b>			H-95	28	28.80	New H-925	28	12.90
CG-233	46	9.00	New DI-T250	9	7.20	H-1	12	9.00	H-96	28	48.00	New H-935	28	14.40
CG-235	46	12.00	New DI-T255	9	6.90	H-2	12	9.90	H-97	27	14.70	New H-965	28	20.40
CG-300	47	16.20	New DI-T260	9	7.20	H-3	12	7.80	H-98	27	15.90	<b>HIPERMALLOY</b>		
New CG-300W	47	17.70	New DI-T265	9	8.70	H-4	12	7.80	H-99	27	20.40	HA-100	42	17.40
CG-301	47	24.00	New DI-T270	9	7.80	H-5	12	8.40	H-100	27	21.00	HA-100X	42	17.40
New CG-301W	47	26.40	New DI-T273	9	7.80	H-6	12	10.20	H-101	26	14.10	HA-101	42	22.20
CG-302	47	30.00	New DI-T278	9	8.70	H-7	1							

# IMMEDIATE DELIVERY ON ALL ITEMS

## INDEX AND NET PRICE LIST QUANTITY PRICES AVAILABLE ON REQUEST

Type	Page	Net	Type	Page	Net	Type	Page	Net	Type	Page	Net	Type	Page	Net			
HA-108X	42	\$19.80	MH-4	10	\$8.40	O-25	16	\$8.10	R-112	50	\$9.00	SO-4	15	\$3.30			
HA-113	43	18.00	MH-5	10	8.70	O-26	16	8.10	R-113	50	13.20	SO-5	15	3.00			
HA-114	43	21.00	MH-6	10	8.70	O-27	16	8.40	R-220	50	4.20	SO-6	15	3.90			
HA-130X	42	21.00	MH-7	10	9.00	O-28	16	8.40	<b>SPECIAL SERIES</b>					SO-7	15	3.00	
HA-133	43	21.00	MH-8	10	9.00	O-29	16	8.70	S-1	48	4.80	SO-8	15	3.60			
HA-134	43	16.80	ML-1	10	8.40	O-30	16	8.10	S-2	48	6.00	SO-9	15	3.60			
HA-135	43	16.80	ML-2	10	8.40	O-31	16	8.10	S-3	48	4.50	SO-10	15	3.60			
HA-136	43	18.00	ML-3	10	8.40	O-32	16	8.10	S-5	48	5.10	SO-11	15	4.20			
HA-137	42	16.80	ML-4	10	8.40	O-33	16	8.10	S-6	48	4.50	SO-12	15	4.20			
HP-122	43	12.00	ML-5	10	8.40	New O-34	16	5.10	S-8	48	6.60	SO-13	15	4.20			
HP-123	43	12.00	ML-6	10	8.40	New O-36	16	5.10	S-9	48	8.70	SO-14	15	4.20			
<b>HERMETIC ISOLATION</b>			ML-7	10	8.40	<b>PLUG-IN</b>						S-10	48	6.60	New SO-2P	15	7.50
HIT-1	27	33.00	ML-8	10	8.40	P-1	17	9.00	S-11	48	5.10	New SO-3P	15	7.50			
HIT-2	27	48.00	ML-9	10	8.70	P-2	17	9.00	S-12	48	5.40	New SO-7P	15	7.20			
HIT-3	27	69.00	ML-10	10	9.90	P-3	17	8.40	S-13	48	7.80	New SO-8P	15	7.80			
New HIT-15	27	39.00	MM-1	10	7.50	P-6	17	8.40	S-14	48	6.60	New SO-9P	15	7.80			
<b>CIRCUIT DEVELOPMENT</b>			MM-2	10	7.50	P-7	17	8.40	S-15	48	7.20	New SO-14P	15	8.10			
New LAB-10	38	30.00	MM-3	10	7.80	P-8	17	9.00	S-16	48	8.40	SO-CH	15	.30			
New LAB-20	38	60.00	MM-4	10	7.80	P-9	17	9.00	S-17	48	12.00	<b>SUB-SUB OUNCER</b>					
<b>LINEAR STANDARD</b>			MM-5	10	8.10	P-10	17	9.00	S-18	48	7.20	SSO-1	14	4.50			
LS-6L1	45	36.00	MM-6	10	8.10	P-11	17	9.00	S-19	48	9.30	SSO-2	14	4.80			
LS-6L4	45	66.00	MM-7	10	8.40	P-12	17	9.00	S-20	48	15.00	SSO-3	14	4.20			
LS-10	44	24.00	MM-8	10	8.40	P-15	17	9.00	S-21	48	21.00	SSO-4	14	3.90			
LS-10X	44	24.00	New MO-15	10	6.30	P-16	17	11.40	S-22	48	33.00	SSO-5	14	3.90			
LS-12	44	27.00	New MO-3	10	6.30	<b>PHOTO-FLASH</b>						S-23	48	4.50	SSO-6	14	4.20
LS-12X	44	24.00	New MO-5	10	6.30	PF-1	51	8.40	S-24	49	5.10	SSO-7	14	3.30			
LS-14X	44	24.00	New MO-2	10	6.60	PF-3	51	6.00	S-25	49	3.90	SSO-8	14	3.90			
LS-19	44	19.50	New MO-5	10	6.60	PF-5	51	8.40	S-26	49	3.90	SSO-9	14	3.00			
LS-21	44	24.00	New MO-7.5	10	6.60	PF-6	51	5.10	S-27	49	5.10	SSO-10	14	3.00			
LS-25	44	27.00	New MO-20	10	6.60	PF-6	51	5.10	S-28	49	6.30	SSO-11	14	3.00			
LS-26	44	27.00	New MO-50	10	7.20	PF-7	51	3.60	S-29	49	5.10	SSO-12	14	3.00			
LS-27	45	24.00	New MO-100	10	7.20	<b>ULTRA MINIATURE PULSE</b>						S-30	49	5.10	SSO-13	14	4.50
LS-30	44	24.00	New MW-5	10	7.80	New PIP-1	35	6.00	S-31	49	6.90	SSO-14	14	4.20			
LS-30X	44	27.00	New MW-7.5	10	8.40	New PIP-2	35	6.00	S-32	49	6.90	SSO-15	14	4.20			
LS-31	44	24.00	New MW-1	10	8.70	New PIP-3	35	6.00	S-33	49	9.30	SSO-16	14	3.00			
LS-32	44	33.00	New MW-1.2	10	9.30	New PIP-4	35	6.00	S-34	49	9.60	SSO-17	14	3.30			
LS-33	45	24.00	New MW-2	10	10.80	New PIP-5	35	6.00	S-35	49	12.00	SSO-18	14	3.30			
LS-34	45	33.00	New MW-3	10	11.70	New PIP-6	35	6.00	S-36	49	12.00	SSO-19	14	3.30			
LS-35	45	24.00	New MW-5	10	13.50	New PIP-7	35	6.00	S-37	49	15.00	SSO-20	14	3.30			
LS-40	44	33.00	<b>MILITARY STANDARDS FILAMENT, POWER &amp; PLATE</b>			New PIP-8	35	6.00	S-38	49	15.00	SSO-21	14	4.80			
LS-47	44	24.00	N-583A	18	10.20	New PIP-9	35	6.00	S-39	49	16.50	SSO-22	14	3.90			
LS-48	44	60.00	N-584A	18	14.10	New PIP-10	35	6.00	S-40	49	18.00	SSO-23	14	3.00			
LS-50	45	24.00	N-585A	18	11.10	New PIP-11	35	6.00	S-41	49	18.00	SSO-24	14	3.00			
LS-51	45	27.00	N-586A	18	15.30	New PIP-12	35	6.00	S-42	49	19.50	SSO-25	14	5.10			
LS-52	45	24.00	N-587A	18	11.10	New PIP-100	35	51.00	S-44	49	25.80	SSO-26	14	5.10			
LS-54	45	21.00	N-588A	18	12.90	<b>REPLACEMENT TYPE</b>						S-45	49	21.00	New SSO-3P	14	8.10
LS-55	45	24.00	N-589A	18	17.70	R-14	50	1.95	S-46	49	24.00	New SSO-8P	14	8.10			
LS-56	45	27.00	N-590A	18	22.50	R-15	50	1.95	S-47	49	33.00	New SSO-14P	14	8.40			
LS-57	45	21.00	N-591A	18	18.00	R-16	50	1.95	S-48	49	39.00	New SSO-15P	14	8.40			
LS-58	45	57.00	N-592A	18	21.00	R-17	50	2.25	S-49	49	36.00	New SSO-19P	14	8.10			
LS-61	45	24.00	N-593A	18	20.70	R-18	50	2.52	S-50	49	60.00	New SSO-20P	14	8.10			
LS-63	45	21.00	N-594A	18	22.35	R-19	50	3.00	S-51	49	12.00	New SSO-21P	14	8.40			
LS-65	45	42.00	N-595A	18	25.35	R-20	50	3.60	S-52	49	15.60	New SSO-22P	14	7.80			
New LS-68	44	24.00	N-596A	18	27.30	R-21	50	3.60	S-53	49	6.30	SSO-CH	14	.30			
LS-140	44	27.00	N-597A	18	33.90	R-41	51	5.70	S-54	49	5.70	<b>VOLTAGE ADJUSTERS</b>					
LS-141	44	21.00	N-598A	18	19.80	R-42	51	6.00	S-55	49	5.40	V-1	50	20.00			
LS-150	45	21.00	N-599A	18	26.85	R-43	51	6.90	S-56	49	9.00	V-1-M	50	35.00			
LS-151	45	21.00	N-600A	18	37.50	R-44	51	8.40	S-57	49	9.00	<b>MILITARY STANDARDS AUDIO</b>					
LS-666	45	21.00	<b>OUNCER</b>			R-45	51	12.00	S-58	49	9.90	W-783	18	15.90			
LS-667	45	21.00	O-1	16	7.80	R-46	51	24.00	S-59	49	9.30	W-784	18	14.70			
LS-691	45	600.00	O-2	16	7.80	R-47	51	10.20	S-60	49	13.20	W-785	18	14.10			
LS-692	45	930.00	O-3	16	7.50	R-48	51	11.70	S-61	49	10.20	W-786	18	14.10			
<b>MAGAMPS</b>			O-4	16	6.60	R-49	51	12.00	S-62	49	9.30	W-787	18	12.75			
MAT-1	33	27.00	O-5	16	6.60	R-55	50	1.65	S-63	49	13.20	W-788	18	12.90			
MAT-2	33	30.00	O-6	16	7.50	R-64	51	45.00	S-64	49	10.80	W-789	18	12.45			
MAT-3	33	36.00	O-7	16	7.50	R-72	51	7.20	S-67	49	10.20	W-790	18	12.90			
MAT-4	33	39.00	O-8	16	7.80	R-73	51	9.00	S-68	49	10.50	W-791	18	12.45			
MAT-5	33	10.80	O-9	16	7.80	R-74	51	15.00	S-70	49	10.20	<b>MILITARY STANDARDS INDUCTORS</b>					
MAT-6	33	9.00	O-10	16	8.40	R-75	51	24.00	S-71	49	15.00	Z-848	18	11.40			
MAT-7	32	25.80	O-11	16	7.80	R-76	51	42.00	S-72	49	11.40	Z-849	18	14.10			
MAT-8	32	28.80	O-12	16	7.80	R-77	51	84.00	S-75	49	6.00	Z-850	18	21.30			
MAT-9	32	34.00	O-13	16	6.30	R-78	50	17.70	S-76	49	9.00	Z-851	18	16.50			
MAT-10	32	37.50	O-14	16	7.50	R-79	50	18.90	S-77	49	10.20	Z-852	18	24.30			
MAT-11	32	10.50	O-15	16	7.50	R-80	50	22.80	S-78	49	30.00	Z-853	18	29.40			
New MAT-60	32	54.00	O-16	16	10.20	R-81	50	33.00	S-80	49	3.90	Z-854	18	31.50			
New MAT-65	32	12.60	O-17	16	1.50	R-86	50	33.00	S-81	49	6.00	Z-855	18	36.90			
<b>MINIATURE INDUCTORS</b>			O-18	16	7.80	R-97	51	15.00	<b>SIGNAL</b>					Z-856	18	43.20	
MH-1	10	8.10	O-19	16	7.80	R-101	50	7.20	SC-3	51	7.50	Z-857	18	75.00			
MH-2	10	8.10	O-20	16	6.30	R-102	50	7.50	SC-4	51	9.00						
MH-3	10	8.40	O-21	16	5.40	R-103	50	8.40	SC-5	51	14.40						
			O-22	16	5.40	R-104	50	9.00	<b>SUBMINIATURE AUDIO INPUT</b>								
			O-23	16	5.10	R-105	50	11.40	New SML-70	15	8.40						
			O-24	16	5.10	R-110	50	7.20	<b>SUBOUNCER</b>								
						R-111	50	7.50	SO-1	15	3.60						
									SO-2	15	3.30						
									SO-3	15	3.30						

# CAPSULE DESCRIPTION OF PRODUCT LINES

ORANGE X = HERMETIC LINES • BLACK X = NON-HERMETIC LINES

	AUDIO	CHOPPER	INDUCTOR	POWER	PULSE	MAGAMP	
X	X						<b>A-Line (Audio)</b> Ultra compact wideband transistor & tube transformers & inductors—audio units cover 10 CPS—50KC & up, audio power range from low level to 5W. Size 1½ x 1¾ x 2" h. Wt ½ lb. Pgs 40, 41.
			X				<b>A-Line (Power)</b> Ultra compact power components, small and light in weight. Ideally suited for remote amplifier and similar compact equipment. Size & wt as above. Pg 41.
X							<b>CG (Audio)</b> High quality audio transformers for mixing, matching and tube circuit applications. Conservatively designed to AIEE commercial standards. Enclosed in rugged steel cases, vacuum impregnated and compound filled. Freq range 40 CPS—10KC. Power level from less than -28 dbm to 600 W. Size 1½ Sq x 2¼ h" to 7 x 12 x 9" h. Wt ½ lb to 60 lbs. Pg 46.
			X				<b>CG (Inductors)</b> High quality inductors. Conservatively designed to AIEE commercial standards. Enclosed in rugged drawn steel cases or end castings. Vacuum impregnated and compound filled. Ratings from 15 ma to 5 A. Size 2½ x 2½ x 3¼ h to 11½ x 4¾ x 6¾ h. Wt. 2½ lbs to 40 lbs. Pg 47.
				X			<b>CG (Power)</b> High quality power transformers for transistor, filament and plate types. Conservatively designed to AIEE commercial standards. Enclosed in rugged drawn steel cases or end castings. Vacuum impregnated and compound filled. Sizes 1½ x 1½ x 2½ h to 21 x 10 x 13¼ h. Wt 1 lb to 185 lbs. Pg 47.
X	X						<b>DI-T</b> Flexible leads ultra miniature transistor transformers & inductors, hermetically sealed to MIL-T-27A (grade 4 metal clad). Freq range 400 CPS—10KC & up. Power up to ½ W. Size ¾ dia x ¼ h. Wt approx ¼ oz. Pg 8.
X	X						<b>DI-T200 Series</b> Straight pin gold plated, Dumet leads. Ultra-miniature transistor transformers and inductors. Hermetically sealed to MIL-T-27A (Grade 4, metal cased). Freq range 400 CPS—100KC. Power up to 500 mw. Size ¾ dia x ¾ h. Wt approx ¼ oz. Pg 9.
X	X	X					<b>DO-T</b> Flexible leads ultra-miniature transistor transformers & inductors, hermetically sealed to MIL-T-27A (grade 4, Metal clad). Freq Range 300 CPS—10KC & up. Power up to ½ W. Size ¾ dia x 1¾ h. Wt approx ¼ oz. Pgs 6, 7.
X							<b>FHA</b> Flat hermetic audio units to grade 4, metal cased, MIL-T-27A specs. Straight 1" long pin terminals on a glass to metal seal header. Freq range 300 CPS—20KC. Power level +20 dbm (100mw). Size 2½ x 2½ x ¾ h. Wt 8 oz. Pg 11.
			X				<b>FHI</b> Flat hermetic inductors—split windings for series or parallel arrangements for multiplicity of inductance values. Straight 1" long pin terminals on a glass to metal seal header. Metal cased to grade 4 MIL Specs. Inductance range 15 mhs to 2.4 hys, DC 2 ma to 64 ma. Size 2½ x 2½ x ¾ h. Wt .8 oz. Pg 11.
				X			<b>FT</b> Channel frame, filament/transistor transformers. Designed for voltages between 2.5 Vct to 36 Vct. Current ratings .04A to 10 A. Size 2½ x 1½ x 1½ to 4½ x 2½ x 2½. Wt ¼ lb to 2½ lbs. Pg. 50.
X	X						<b>H (audio)</b> Hermetically sealed, metal clad transformers to MIL-T-27A grade 4 specs. Full line of input, interstage, output, mixing and matching and chopper transformers for both tube and transistor applications. Freq range 30 CPS—20KC. Power levels below 5 dbm (3mw) to 10 W. Size 1½ x 1½ x 2½ h to 1½ Sq x 2½ h. Wt .8 oz to 1 lb. Pgs 11, 12, 13.
			X				<b>H (Inductors)</b> Hermetic line of inductors to MIL-T-27A specs. Grade 4 and grade 5, inductance from .4mh to 450 hys, DC rating from 0.17 ma to 30 A. Size ¾ x 1 x 2½ to 7 x 7 x 8". Wt .05 lb to 60 lbs. Pgs 11, 12, 13, 23.
				X			<b>H (Power)</b> Hermetic line of power transformer to MIL-T-27A specs. 50 to 1000 cycles, grade 4 and grade 5. Transistor, filament, inverter and plate types. Metal clad and molded. Size ¾ x 1 x 2½ to 11 x 11 x 14¾. Wt .05 lb to 160 lbs. Pgs 24, 25, 26, 27, 28.
					X		<b>H (Pulse)</b> Molded precision miniature wide application pulse transformers to MIL Specs. Transistor and tube blocking oscillator and coupling service. Pulse widths from .05 µsec to 25 µsec. Sizes ¾ dia x ¾ to ¾ dia x ¾. Wt 1 gram to 6 grams. Pgs 36, 37.
X							<b>HA</b> Excellent quality, highly dependable commercial audio transformers. Full line of mixing, matching and tube applications. Fully vacuum impregnated and potted in high conductivity alloy cases. Many units incorporate hipermalloy nickel iron core and hum balanced structures. Freq range 20 CPS—50KC. Power levels from below +18dbm (63mw) to 20 W. Size 1½ x 2½ x 3¼ h to 21½ x 3½ x 3½ h. Wt 2 lbs to 5 lbs. Pgs 42, 43.
			X				<b>HIT</b> Ultrashielded power line isolation transformers. Hermetically sealed to MIL-T-27A Specs. 0.1 µf or less effective coupling. Power rating 50 to 480 W at 60 CPS. Size 4½ x 4½ x 3½ to 8 x 6½ x 5½. Wt 5 lbs to 30 lbs. Pg 27.
				X			<b>HP</b> Pre amplifier or tuner power supply transformers. Housed in rugged die cast case of high conductivity alloy. Specifically designed for portable and compact service. Size 2½ x 1½ x 3¼ to 3½ x 2½ x 3½. Wt 2 lbs to 5 lbs. Pg 43.
X							<b>LS</b> Linear standard audio transformers. High fidelity, highest quality commercial transformers. For tube, transistor, hybrid, modulation, and matching applications. Ultimate in low distortion, high efficiency, thorough shielding. Freq range 7 CPS to 50KC. Power from under +17 dbm to 2500 W. Size 2½ x 3¼ x 3¼ h to 13 x 15¼ x 28" h. Wt from 3 lbs to 520 lbs. Pgs 44, 45.
						X	<b>MAT</b> Hermetic line of magnetic amplifiers and associated transformers, for 60 and 400 cycle servo and other application, to MIL-T-27A specs. Tube and transistor inputs. 1 to 50 W. Size 1½ x ¾ x 1½ to 4½ x 4 x 4½. Wt 1.5 oz to 14 lbs. Pgs 32, 33.

	AUDIO	CHOPPER	INDUCTOR	POWER	PULSE	MAGAMP	
			X				<b>MH</b> Ultraminiature epoxy molded toroidal inductors similar to MM except maximum Q at 100 KC. Inductance range .6 mhy to 40 mhy. Pg 10.
			X				<b>ML</b> Ultraminiature hipermalloy cased inductors with epoxy board and pin terminals for printed circuit application. Maximum Q at 800 cps to 2 KC, depending on inductance. Inductance range .25 hy to 60 hy. Size ¾ x ¾ x ¾. Wt .2 oz. Pg 10.
			X				<b>MM</b> Ultraminiature epoxy molded toroidal inductors with pin terminals for printed circuit application. Maximum Q at 30 KC. Inductance range of 3 mhy to 120 mhy. Size ¾ dia x ¼ h. Wt .07 oz. Pg 10.
			X				<b>MO</b> Miniature epoxy molded inductors with pin terminals for printed circuit application. Maximum Q at 600 cps to 1500 cps depending on inductance. Inductance range .15 hy to 100 hy. Size ¾ x 1½ x 1½. Wt 1 oz. Pg 10.
			X				<b>MW</b> Miniature epoxy molded toroidal inductors with pin terminals for printed circuit application. Maximum Q at 5 to 10 KC. Inductance range .5 hy to 5 hy. Size 2½ dia x 1½ h. Wt .25 oz. Pg 10.
			X				<b>N</b> Military standard filament, power and plate transformers per MIL-T-27A Grade 4 (ruggedized) construction. Size 1½ x 1½ x 2½ to 5½ x 4½ x 5½. Wt 1½ lbs to 16½ lbs. Pg 18.
X	X	X					<b>O</b> Ouncer line—nonhermetic—best quality compact audio transformers—covers full range of tube and transistor transformer and inductor applications. Freq range 30 CPS—20KC and up. Power levels from under 8dbm to 1W. Size ¾ dia x ¾ h. Wt 1 oz. Pg 16.
X							<b>P</b> Plug in transformers to fit octal socket (P-16 fits nine pin socket). Best quality non hermetic compact audio transformers for tube mixing and matching applications. Freq range 30 CPS—20KC. Power +8 dbm (6.3mw). Size 1½ dia x 1½ h. Wt 2 ozs. Pg 17.
				X			<b>PF</b> Transformers for photoflash and similar applications. Line and transistor inputs. Power, inverter and trigger transformers. Size ¾ dia x 1½ to 2½ x 3¼ x 2½. Wt ½ oz to 2 lbs. Pg 51.
					X		<b>PIP</b> Hermetically sealed metal clad ultra miniature wide application pulse transformers, to MIL-T-21038B specifications. Size ¾ dia x ¾. Wt ½ oz. Pg 35.
			X				<b>R line inductors</b> Replacement type of inductors, channel frame construction. All are vacuum sealed against humidity and to prevent corrosion. Inductance from 2 mhs to 20 hys. DC current from 30 ma to 5 A. Sizes 2½ x 1½ x 1¾ to 4½ x 2½ x 2½. Wt ½ to 2½ lbs. Pg 50.
				X			<b>R Line Power</b> Replacement type line adjusting and isolation transformers. Provides high reliability. All are vacuum sealed against humidity to prevent corrosion. Units are housed in attractively finished shells. Size 2½ x 2½ x 3¼ to 12 x 7 x 9". Wt 2½ lbs to 70 lbs. Pgs 50, 51.
X							<b>SO</b> Small subouncer, open frame, flexible lead transformers and inductors, full line for applications to both tubes & transistor circuits. Freq range 200 CPS—20KC & up. Power to .25W. Size 1½ x 1½ x ¾. Wt .031 lb. Pg 15.
X							<b>SO-#P</b> Molded transistor & tube transformers to MIL-T-27A GR 5. Freq range 200 CPS—20KC & up. Power to .25W. Size ¾ x 1 x 2½. Wt .05 lb. Pg 15.
X	X						<b>SSO</b> Sub Sub uncner, small, open frame, flexible lead transformers and inductors for application to tube & transistor circuits. Freq range 300 CPS—10KC & up. Power to .1K. Size ¾ x ¾ x 1½. Wt .02 lb. Pg 14.
X							<b>SSO-#P</b> Molded transistor & tube transformers to MIL-T-27A GR 5. Freq range 300 CPS—10 KC & up. Power to .1 W. Size ¾ x ¾ x ¾. Wt .04 lb. Pg 14.
X							<b>S (audio)</b> Popular priced special series of audio transformers for matching and tube applications. All units vacuum impregnated and compound filled in drawn metal cases. Freq range 100 CPS—10KC. Power levels less than 10 dbm to 250 W. Size 1½ x 2½ x 1½ h to 5½ x 6¼ x 5¾ h. Wt 1 lb to 21 lbs. Pg 48.
			X				<b>S (Inductors)</b> Popular-priced special series of inductors. Ratings are based on ICAS intermittent use. Units are vacuum impregnated and compound filled. Inductance from 2 mhs to 500 hys. DC current ratings from 3ma to 5 A. Size ¾ x 2½ x 1½ to 4½ x 5½ x 5½. Wt 1 lb to 12 lbs. Pg 49.
				X			<b>S (Power)</b> Popular-priced special series of power transformers for filament, transistor and plate application. Ratings are based on ICAS intermittent use. Units are vacuum impregnated and compound filled. Size 1½ x 2½ x 1½ to 10¼ x 7¾ x 9¼. Wt 1 lb to 52 lbs. Pg 49.
				X			<b>SC</b> Signalling and control transformers, suitable for operating relays, sirens, horns, gongs, etc. Units have terminals for outputs of 4/8/12/16/20/24 volts. Screw type binding posts secondary terminals for easy connections. Ratings 50 to 250 W. Size 3 x 3½ x ¾ to 4 x 5 x 4¼. Wt 3 lbs to 10 lbs. Pg 51.
				X			<b>V</b> Varitran voltage adjuster. Output continually variable from 0-130V. Input 115V 50/60 CPS. Loads up to 570 W, 5A. Size 4¾ x 9¾ x 3¾. Wt 14 lbs. Pg 50.
X							<b>W (MIL STD)</b> Complete line of Military Standard audio transformers per MIL-T-27A Grade 4 (ruggedized) construction. Freq range 300 CPS—10KC. Power +15 dbm to 2W. Size MIL-AJ case (1½ sq x 2½ h) Wt. 6 lbs. Pg 18.
						X	<b>Z</b> Military standard inductors, per MIL-T-27A. Hermetically sealed construction. Series and parallel connections. Size 2½ x 2½ x 3½ to 4½ x 5½ x 7½. Wt from 2 lbs to 35 lbs. Pg 18.



In addition to the needs met by UTC stock audio components there are many unique applications which require special units. The illustrations below are intended to show some of the thousands of special units produced by UTC to customer's specifications. Range from .1 cycles to 400 MC . . . microwatts to 50 kw.



Molded carrier frequency transformer, + 8 dbm level. Within 3 db from 100 cycles to 100 KC. 4000:4000 ohms.  $\frac{3}{4}$  Dia. x  $\frac{5}{8}$  inches,  $\frac{1}{3}$  oz.

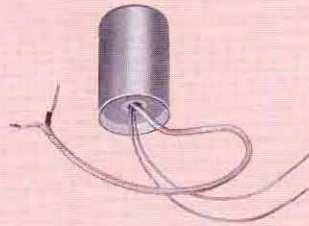

Microphone input transformer, double drawn hipermalloy shields. Shielded cable leads. Ratio 100:1.  $1\frac{3}{16}$  Dia. x  $1\frac{1}{2}$  high. Inductance greater than 1000 Hys. at 60 cycles.



DI-T tuned interstage transformer. 1,000 ohms to 1,000 ohms. Primary adjusted to 10% tolerance at 400 cycles for tuning with external capacitor. In hipermalloy shield.

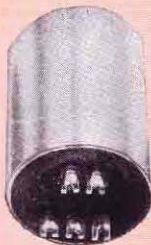

400 cycle bridging transformer. 100K to 400K, 80 db. electrostatic shielding, 1 oz.



Thirty cycle cathode follower output transformer to provide equal voltages to 4 loads and supply a half-wave rectifier. Primary inductance maintained to 5% with 20% change in DC unbalance and 30% change in AC voltages.

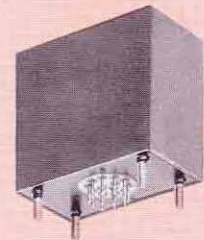

Bolometer transformer. Primary 10 ohms, secondary 530K ohms, 230:1 ratio, response from  $\frac{1}{2}$  cycle to 25 cycles. 120 db magnetic shielding, plus full electrostatic shielding.

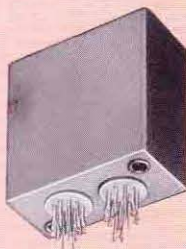

Matched hybrid transformers. Two transformers each 600 ohm primary. 40,000 ohm C.T. secondary 250 cycles to 5 KC within  $\frac{1}{4}$  db.  $\frac{1}{4}$ % C.T. tolerance,  $\frac{1}{2}$ % ratio tolerance, 40 db isolation over band.



Low distortion 2.5 KW output transformer, PP 450 TH's 18,500 ohms C.T. to 24/6 ohms, 20 KV hipot. 520 lbs.

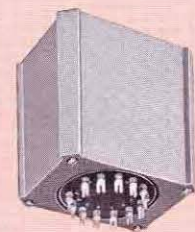

Hi Fidelity transistor output transformer to match any selection of primary transistors to 4, 8 or 16 ohm speakers. Primary 48 ohm CT. 36 ohm CT, 12 ohm CT; secondary 4, 8, 16 ohm. 40 watts. Frequency range: 20 cycles to 20 KC.



Carrier transformer humbucking, + 30 dbm level. Within .5 db 250 cycles to 110 KC. 600/135:600 centertapped to .1% tolerance. Electrostatic shield in  $1\frac{3}{4}$  X  $1\frac{1}{8}$  X 3 case, 14 oz.



Special chopper type transformer. Primary impedance greater than 200K ohms at .01V 60 cycles; ratio 1:3; electrostatically shielded; quadruple hipermeability magnetic shields. Size:  $2\frac{3}{4}$  x  $1\frac{1}{4}$  x  $2\frac{1}{2}$ " high.



Broad band input transformer. 30 ohms to 70K. 2 cycles to 6 KC within 1 db. High magnetic and electrostatic shielding, 1.5 lbs.



## SPECIAL CUSTOM BUILT AUDIO COMPONENTS TO YOUR SPECIFICATIONS

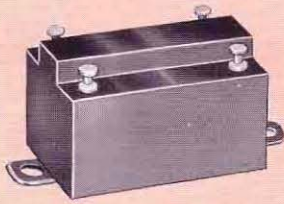

Small Grade 5 molded transformer with turret terminals below the lamination height. Constructed with mounting brackets. Reflected impedance maintained within 10% of required value. 500 V hipot. Insertion loss less than 1 db. Weight less than 1 ounce.



Output transformer for demodulator amplifier. Made to Signal Corps specs. Precisely controlled leakage inductance, turns ratio and interwinding capacitance. Electrostatically shielded. Cast in epoxy in metal case 29/32 x 1-3/8 x 2".

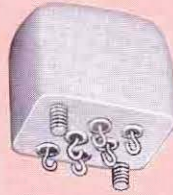

Ultra miniature, (17/32 x 21/32 x 5/8"), metal cased audio transformer to MIL-T-27A, Grade 4 Specs. 20K  $\Omega$  CT to 600  $\Omega$  CT, electrostatic shield between windings 300 ~ to 10 KC, + 10 DBM. Individual stud and glass to metal seal terminal construction.



High impedance 400 ~ input transformer to Grade 4 Class R MIL-T-27A Specs., open circuit impedances greater than 300,000 ohms. Each winding electrostatically box shielded for minimum interwinding capacitance. Magnetically shielded as well. Size MIL AH, weight less than 1/2 lb.

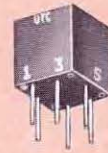

Molded, pin terminal unit. Packaging developed for and fully in accord with Micromodule program. Item shown is 10K ohms CT to 10K ohms CT. 100 mw from 400 cycles to 20 KC. Life tested per micromodule requirements with no failures.

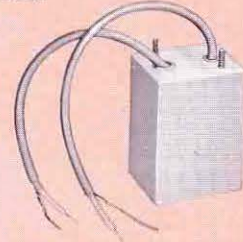

Chopper transformer with both magnetic and electrostatic shielding. Electrostatically shielded for voltage isolation of 2 x 10<sup>6</sup>. Shielded cable leads. Frequency range 60 cycles to 500 cycles. Primary impedance 200K ohms CT to within .1%. Secondary impedance 50K ohms.

## SPECIAL CUSTOM BUILT DO-T & DI-T TRANSFORMERS

There are always special situations which require mechanical or electrical modification of the DO-T & DI-T units (pgs. 6 through 9) despite the tremendous versatility already afforded in the wide ranging stock lines with their unique multiapplicable construction. Electrical changes are available on special order. These changes include different impedance ratings, addition of electrostatic or electromagnetic shields, or conversion to higher temperature insulation requirements, etc.

In addition, a variety of mechanical changes have already been produced to special order. Lead lengths up to 6" have been made with no loss in the ruggedness of construction and no deleterious effect upon the lead strain isolation, acknowledged by the industry as the best that exists for units of this size. Special pin terminals for printed circuit plug-in applications have been made with rectangular .1" grid spacings. Other spacings are available for your particular needs. The versatility of the DO-T & DI-T construction even extends to the ability to produce units of the same ruggedness and reliability with leads emerging from each end of the case.

Consult UTC for your special needs.

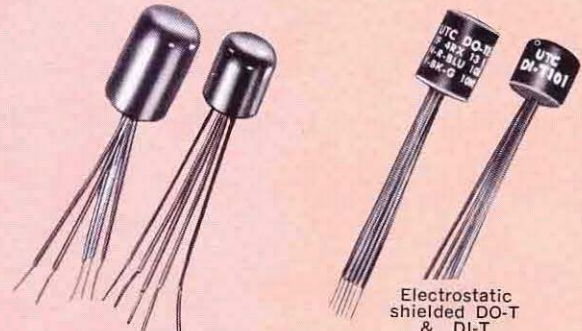

Units in Hipermalloy Shield  
DO-T: 23/64 O.D. x 35/64  
DI-T: 23/64 O.D. x 25/64



DO-T with pin terminals, for DI-T's see pg. 9



Variable Inductance DO-T & DI-T (Special Orders Only)



DO-T & DI-T with leads at both ends



Special long lead DO-T & DI-T (leads available to 6")



# DO-T TRANSISTOR\* TRANSFORMERS & INDUCTORS

HERMETICALLY SEALED

Conventional miniaturized transistor transformers have inherently poor electrical characteristics, perform with insufficient reliability and are woefully inadequate for many applications. The radical design of the new UTC DO-T (and DI-T see pgs. 8 & 9) transistor transformers provide unprecedented power handling capacity and reliability, coupled with extremely small size.

The exceptional reliability of DO-T (and DI-T) units is basic in their unique structure. The units are rugged, full hermetic seal, metal cased to MIL-T-27A grade 4. The bobbin is completely rigid eliminating stress and wire movement. The turns are circular in shape rather than square, eliminating turn corner stress and effecting uniform wire lay. The coil wire and external lead are rigidly anchored terminal board fashion employing no tapes and brought out through strain relief.

To fully appreciate DO-T (and DI-T) transistor transformers, the curves on this and pages 8 & 9 indicate their performance compared to that of similar size units now on the market. These curves show representative performance of all DO-T's and DI-T's except 200,000 ohm units. Higher performance is obtained when used in pushpull with balanced D.C. Other manufacturers' comparative performance is shown on these curves to put unjustified claims in perspective. For example, the UTC DO-T10 delivers 100 MW @ 5% distortion @ 300 cycles. Identical measurements were made on contemporary manufacturers' equivalent, rated at 50 MW @ 300 cycles. Actual delivered power was under 1 MW @ 7 1/2% distortion @ 300 cycles.

Units can be used for different impedances than those shown, keeping in mind that impedance ratio is constant. Lower source impedance will improve response and level ratings... higher source impedance will reduce them. Units may be used reversed, input to secondary.

The frequency response curve on this page is shown to 20 KC. This descriptive curve is not meant to be restrictive. Units can be used at frequencies well above 20 KC. Satisfactory applications for frequencies up to and above 100 KC have been developed.

The leads used on the stock DO-T transformers are tinned and insulated solid copper conductors. (Conductor size #24 AWG for 2, 4, and 5 lead units; size #26 AWG for 6 and 7 lead units.) The lead material can be changed to .017D. Dumet, tinned or gold plated or to your particular requirements on special order.

The stock DO-Ts are Grade 4 Class R units, for a maximum operating temperature of 105° C in accordance with MIL-T-27A Specs. On special order they can be designed to Class S requirements of MIL-T-27A (130° C maximum operating temperature). No additional life expectancy is gained by ordering Class S insulation systems for applications in the vicinity of Class R temperatures. Where the operating temperatures are above 105° C, the use of Class S insulations will afford greater life expectancy.

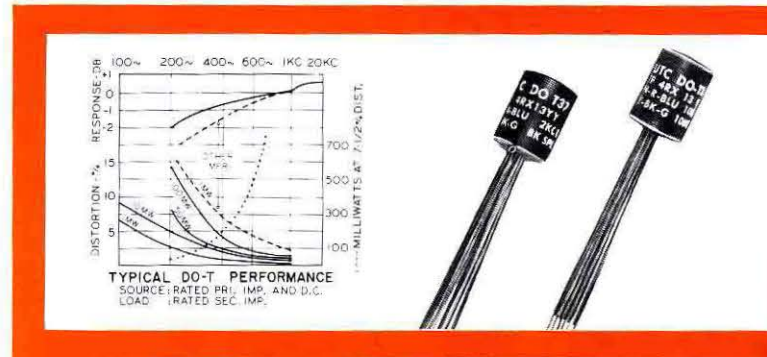

- High Power Rating.....up to 100 times greater.
- Excellent Response .....twice as good at low end.
- Low Distortion .....reduced 80%.
- High Efficiency .....up to 30% better . . . compare DCR.
- Moisture Proof .....hermetically sealed to MIL-T-27A.
- Rugged .....**Grade 4, completely metal cased.**
- Anchored Leads .....1 1/2" lead lengths
- Printed Circuit Use .....(solder melting) plastic insulated leads.
- Suited to Clip Mounting.....use Augat #6009-8A clip.

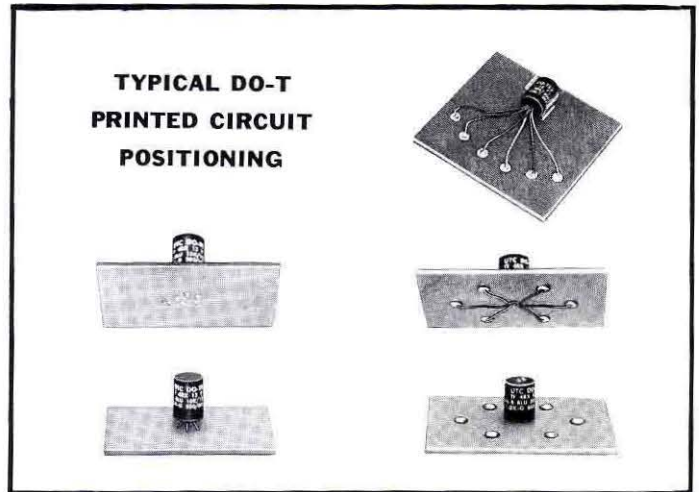

## INDUCTOR DO-T LISTING

Type No.	MIL Type	
NEW DO-T50 (2 wdgs.)	TF4RX20YY	Series connection: .075 Hy @ 10 ma DC, .06 Hy @ 30 ma DC, DCR 10.5 ohms Parallel connection: .018 Hys @ 20 ma DC, .015 Hys @ 60 ma DC, DCR 2.6 ohms
DO-T28	TF4RX20YY	.3 Hy @ 4 ma DC, .15 Hy @ 20 ma DC DCR 25 ohms
DO-T27	TF4RX20YY	1.25 Hys @ 2 ma DC, .5 Hy @ 11 ma DC DCR 100 ohms
DO-T8	TF4RX20YY	3.5 Hys @ 2 ma DC, 1 Hy @ 5 ma DC DCR 560 ohms
DO-T26	TF4RX20YY	6 Hys @ 2 ma DC, 1.5 Hys @ ma DC DCR 2100 ohms
NEW DO-T49 (2 wdgs.)	TF4RX20YY	Series connection: 20 Hys @ 1 ma DC, 8 Hys @ 3 ma DC, DCR 5100 ohms Parallel connection: 5 Hys @ 2 ma DC, 2 Hys @ 6 ma DC, DCR 1275 ohms

AND SPECIAL CUSTOM BUILT DO-T TRANSFORMERS  
Above stock units cover general purpose application



## TRANSFORMER DO-T LISTING

Locating Line	Type No.	MIL Type	Pri. Imp.	D.C. ma.† in Pri.	Sec. Imp.	Pri. Res.	Mw Level	Typical Application
1	DO-T44	TF4RX17YY	80 CT 100 CT	12 10	32 split 40 split	9.8	500	Interstage or matching or output
2	DO-T29	TF4RX17YY	120 CT 150 CT	10 10	3.2 4	10	500	Single or PP output
3	DO-T12	TF4RX17YY	150 CT 200 CT	10 10	12 16	11	500	Single or PP output
4	DO-T13	TF4RX17YY	300 CT 400 CT	7 7	12 16	20	500	Single or PP output
5	DO-T19	TF4RX17YY	300 CT	7	600	19	500	Output to line or matching
6	DO-T30	TF4RX17YY	320 CT 400 CT	7 7	3.2 4	20	500	Single or PP output
7	DO-T43	TF4RX17YY	400 CT 500 CT	8 6	40 split 50 split	46	500	Interstage or matching or output
8	DO-T42	TF4RX17YY	400 CT 500 CT	8 6	120 split 150 split	46	500	Interstage
9	DO-T41	TF4RX17YY	400 CT 500 CT	8 6	400 split 500 split	46	500	Interstage or output or matching (Ratio 2:1:1) also wide pulse application
10	DO-T2	TF4RX17YY	500 600	3 3	50 60	60	100	Output or matching
11	DO-T20	TF4RX17YY	500 CT	5.5	600	31	500	Output or line to line or mixing or matching
12	DO-T4	TF4RX17YY	600	3	3.2	60	100	Output or matching
13	DO-T14	TF4RX17YY	600 CT 800 CT	5 5	12 16	43	500	Single or PP output
14	DO-T31	TF4RX17YY	640 CT 800 CT	5 5	3.2 4	43	500	Single or PP output or matching
15	DO-T15	TF4RX17YY	800 CT 1070 CT	4 4	12 16	51	500	Single or PP output
16	DO-T32	TF4RX17YY	800 CT 1000 CT	4 4	3.2 4	51	500	Single or PP output
17	DO-T21	TF4RX17YY	900 CT	4	600	53	500	Output to line
18	DO-T3	TF4RX13YY	1000 1200	3 3	50 60	115	100	Output or matching
19	NEW DO-T45	TF4RX12YY	1000 CT 1250 CT	3.5 3.5	16,000 split 20,000 split	120	100	Interstage (Ratio 1:2:2) also wide pulse application
20	DO-T16	TF4RX13YY	1000 CT 1330 CT	3.5 3.5	12 16	71	500	Single or PP output
21	DO-T33	TF4RX13YY	1060 CT 1330 CT	3.5 3.5	3.2 4	71	500	Single or PP output
22	DO-T5	TF4RX13YY	1200	2	3.2	105	100	Output
23	DO-T17	TF4RX13YY	1500 CT 2000 CT	3 3	12 16	108	500	Single or PP output
24	DO-T22	TF4RX13YY	1500 CT	3	600	86	500	Output to line or matching
25	DO-T34	TF4RX13YY	1600 CT 2000 CT	3 3	3.2 4	109	500	Single or PP output
26	DO-T37	TF4RX13YY	2000 CT 2500 CT	3 3	8000 split 10,000 split	195	100	Isol. or Interstage (Ratio 1:1:1) also wide pulse application
27	DO-T18	TF4RX13YY	7500 CT 10,000 CT	1 1	12 16	505	100	Single or PP output
28	DO-T35	TF4RX13YY	8000 CT 10,000 CT	1 1	3.2 4	505	100	Single or PP output
29	NEW DO-T48	TF4RX13YY	8,000 CT 10,000 CT	1 1	1200 CT 1500 CT	640	100	Interstage, Includes electrostatic shield
30	NEW DO-T47	TF4RX13YY	9,000 CT 10,000 CT	1 1	9000 CT 10,000 CT	850	100	Isolation or interstage Includes electrostatic shield
31	DO-T6	TF4RX13YY	10,000	1	3.2	790	100	Output
32	DO-T9	TF4RX13YY	10,000 12,000	1 1	500 CT 600 CT	780	100	Output or driver
33	DO-T10	TF4RX13YY	10,000 12,500	1 1	1200 CT 1500 CT	780	100	Driver
34	DO-T25	TF4RX13YY	10,000 CT 12,000 CT	1 1	1500 CT 1800 CT	780	100	Interstage
35	DO-T11	TF4RX13YY	10,000 12,500	1 1	2000 CT 2500 CT	780	100	Driver
36	DO-T38	TF4RX13YY	10,000 CT 12,000 CT	1 1	2000 split 2400 split	560	100	Interstage
37	DO-T36	TF4RX13YY	10,000 CT 12,000 CT	1 1	10,000 CT 12,000 CT	975	100	Isol. or Interstage (Ratio 1:1) also wide pulse application
38	DO-T1	TF4RX13YY	20,000 30,000	.5 .5	800 1200	830	50	Interstage
39	DO-T23	TF4RX13YY	20,000 CT 30,000 CT	.5 .5	800 CT 1200 CT	830	100	Interstage
40	DO-T39	TF4RX13YY	20,000 CT 30,000 CT	.5 .5	1000 split 1500 split	800	100	Interstage
41	DO-T40	TF4RX13YY	40,000 CT 50,000 CT	.25 .25	400 split 500 split	1700	50	Interstage or output
42	NEW DO-T46	TF4RX16YY	100,000 CT	0	500 CT	7900	25	Input (usable for chopper service) Includes electrostatic shield
43	DO-T7	TF4RX16YY	200,000	0	1000	8500	25	Input
44	DO-T24	TF4RX16YY	200,000 CT	0	1000 CT	8500	25	Input (usable for chopper service)
45	DO-T500	TF4RX03YY	Power DO-T, see page 26					

**DO-TSH** Drawn Hipermalloy shield and cover for DO-T's provides 20 to 30 db shielding

†DCma shown is for single ended usage (under 5% distortion—100mw—1KC) . . . for push pull, DCma can be any balanced value taken by .5W transistors (under 5% distortion—500mw—1KC)

\*DO-T units have been designed for transistor application only . . . not for vacuum tube service. Pats. Pend. Where windings are listed as split, ¼ of the listed impedance is available by paralleling the winding.

### DO-T NOMINAL SIZE

5/16 Dia. x 13/32,  
1/10 Oz.

#### Unit Locating Key

Type No.	Located on Line
DO-T1	38
DO-T2	10
DO-T3	18
DO-T4	12
DO-T5	22
DO-T6	31
DO-T7	43
DO-T8	Pg. 6
DO-T9	32
DO-T10	33
DO-T11	35
DO-T12	3
DO-T13	4
DO-T14	13
DO-T15	15
DO-T16	20
DO-T17	23
DO-T18	27
DO-T19	5
DO-T20	11
DO-T21	17
DO-T22	24
DO-T23	39
DO-T24	44
DO-T25	34
DO-T26	Pg. 6
DO-T27	Pg. 6
DO-T28	Pg. 6
DO-T29	2
DO-T30	6
DO-T31	14
DO-T32	16
DO-T33	21
DO-T34	25
DO-T35	28
DO-T36	37
DO-T37	26
DO-T38	36
DO-T39	40
DO-T40	41
DO-T41	9
DO-T42	8
DO-T43	7
DO-T44	1
DO-T45	19
DO-T46	42
DO-T47	30
DO-T48	29
DO-T49	Pg. 6
DO-T50	Pg. 6
DO-T500	45



# DI-T TRANSISTOR\* TRANSFORMERS & INDUCTORS

HERMETICALLY SEALED

Manufactured & Guaranteed to MIL-T-27A by Full Environmental Testing, see back cover



The DI-T is of similar construction to the DO-T but a reduction of height has been afforded. The same rugged, reliable construction is used on both series. The leads are the same as the DO-T, and similarly may be changed to Dumet.

The electrical modifications of changed impedance ratios, additions of electrostatic and electromagnetic shields or conversions to higher temperature insulation requirements, etc., are, of course, available in this DI-T size. The Class R versus Class S information explained on the DO-T (pg. 6) also applies to the DI-T series.

Mechanical changes including printed circuit plug-in terminations, special lead lengths, or double ended configuration are also available in this size—see DO-T page 6 for further explanation.

### Unit Location Key

Type No.	Located on Line
DI-T1	18
DI-T2	5
DI-T3	8
DI-T5	9
DI-T8	22
DI-T9	12
DI-T10	13
DI-T11	16
DI-T19	2
DI-T20	6
DI-T21	7
DI-T22	10
DI-T23	19
DI-T25	14
DI-T26	23
DI-T27	21
DI-T28	20
DI-T36	17
DI-T37	11
DI-T38	15
DI-T41	4
DI-T43	3
DI-T44	1

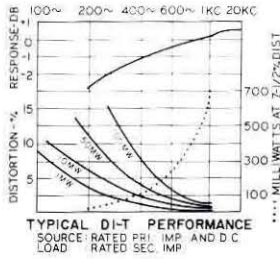

## COMPLETE DI-T LISTING

Locating Line	Type No	MIL Type	Pri. Imp.	D.C. ma <sup>‡</sup> in Pri.	Sec. Imp.	Pri. Res.	Mw Level	Application
1	NEW DI-T44	TF4RX17YY	80 CT 100 CT	12 10	32 split 40 split	11.5	500	Interstage
2	DI-T19	TF4RX17YY	300 CT	7	600	20	500	Output to line
3	NEW DI-T43	TF4RX17YY	400 CT 500 CT	8 6	40 split 50 split	50	500	Interstage
4	NEW DI-T41	TF4RX17YY	400 CT 500 CT	8 6	400 split 500 split	50	500	Interstage or output (Ratio 2:1:1) also wide pulse application
5	DI-T2	TF4RX17YY	500 600	3 3	50 60	65	100	Output
6	DI-T20	TF4RX17YY	500 CT	5.5	600	32	500	Output or line to line or mixing
7	DI-T21	TF4RX17YY	900 CT	4	600	53	500	Output to line
8	DI-T3	TF4RX13YY	1000 1200	3 3	50 60	110	100	Output
9	DI-T5	TF4RX13YY	1200	2	3.2	110	100	Output
10	DI-T22	TF4RX13YY	1500 CT	3	600	87	500	Output to line
11	NEW DI-T37	TF4RX13YY	2000 CT 2500 CT	3 3	8000 split 10,000 split	180	100	Isol. or Interstage (Ratio 1:1:1) also wide pulse application
12	DI-T9	TF4RX13YY	10,000 12,000	1 1	500 CT 600 CT	870	100	Output or driver
13	DI-T10	TF4RX13YY	10,000 12,500	1 1	1200 CT 1500 CT	870	100	Driver
14	DI-T25	TF4RX13YY	10,000 CT 12,000 CT	1 1	1500 CT 1800 CT	870	100	Interstage
15	NEW DI-T38	TF4RX13YY	10,000 CT 12,000 CT	1 1	2000 split 2400 split	620	100	Interstage
16	DI-T11	TF4RX13YY	10,000 12,500	1 1	2000 CT 2500 CT	870	100	Driver
17	DI-T36	TF4RX13YY	10,000 CT 12,000 CT	1 1	10,000 CT 12,000 CT	970	100	Isol. or Interstage (Ratio 1:1) also wide pulse application
18	DI-T1	TF4RX13YY	20,000 30,000	.5 .5	800 1200	815	50	Interstage
19	DI-T23	TF4RX13YY	20,000 CT 30,000 CT	.5 .5	800 CT 1200 CT	815	100	Interstage
20	DI-T28	TF4RX20YY	.1 Hy. @ 4 ma DC, .08 Hy. @ 10 ma DC			25		Inductor
21	DI-T27	TF4RX20YY	.9 Hy. @ 2 ma DC, .5 Hy. @ 6 ma DC			105		Inductor
22	DI-T8	TF4RX20YY	2.5 Hys. @ 2 ma DC, .9 Hy. @ 4 ma DC			630		Inductor
23	DI-T26	TF4RX20YY	4.5 Hys. @ 2 ma DC, 1.2 Hys. @ 4 ma DC			2300		Inductor
24	DI-TSH	Drawn Hipermalloy shield and cover for DI-T's provides 20 to 30 db shielding.						

<sup>‡</sup>DCma shown is for single ended usage (under 5% distortion—100mw—1KC)... for push pull, DCma can be any balanced value taken by .5W transistors (under 5% distortion—500mw—1KC)

\*DI-T units have been designed for transistor application only... not for vacuum tube service. Pats. Pend.

Where windings are listed as split, 1/4 of the listed impedance is available by paralleling the winding.

## AND SPECIAL CUSTOM BUILT DI-T TRANSISTOR TRANSFORMERS AND INDUCTORS TO YOUR SPECIFICATIONS

Above stock units cover general purpose applications. For specific applications cost reductions may be effected.



# DI-T200 TRANSISTOR\* TRANSFORMERS & INDUCTORS

**HERMETICALLY SEALED**

Manufactured & Guaranteed to MIL-T-27A by Full Environmental Testing, see back cover

The DI-T200 series embodies the same rugged reliable construction afforded by the unique winding and leading techniques that are used in the DO-T and DI-T transformers shown on the previous pages. This DI-T200 series differs in the lead material used and the way the leads emerge from the unit.

The lead material used is 1" long, .017D Dumet wire, gold plated, which is a weldable or solderable termination.

The uninsulated leads are spaced on a .1" radius circle to conform to the terminal spacing techniques of the "TO-5" cased semiconductors and micrologic elements. In the case of 4 lead or 2 lead transformers or inductors, the termination points are selected on the .1" R. circle to also conform to the rectangular .1" grid spacing commonly used for 4 or less terminals.

These units are built to the Grade 4 Class R Specifications of MIL-T-27A. They are rated for the Class R (105° C max. operating) temperature conditions. On special order they can be designed for Class S (130° C max. operating) specifications. No additional life expectancy is gained by using Class S insulation systems at Class R temperatures.

The electrical modifications of changed lead lengths, modified impedance ratios and additions of electrostatic shields, etc. are, of course, available in this DI-T construction.

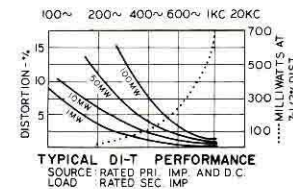
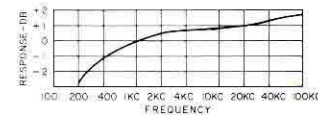

## COMPLETE NEW DI-T200 SERIES LISTING

Type No.	MIL Type	Pri. Imp.	DCma± in Pri.	Sec. Imp.	Pri. Res.	Mw Level	Application
DI-T225	TF4RX17YY	80 CT 100 CT	12 10	32 split 40 split	10	500	Interstage
DI-T230	TF4RX17YY	300 CT	7	600 CT	20	500	Output or line to line or matching
DI-T235	TF4RX17YY	400 CT 500 CT	8 6	40 split 50 split	50	500	Interstage
DI-T240	TF4RX17YY	400 CT 500 CT	8 6	400 split 500 split	50	500	Interstage or output (Ratio 2:1:1) also wide pulse application
DI-T245	TF4RX17YY	500 CT 600 CT	3 3	50 CT 60 CT	65	500	Output or matching
DI-T250	TF4RX17YY	500 CT	5.5	600 CT	35	500	Output or line to line or mixing or matching
DI-T255	TF4RX13YY	1,000 CT 1,200 CT	3 3	50 CT 60 CT	110	500	Output or matching
DI-T260	TF4RX13YY	1,500 CT	3	600 CT	90	500	Output to line or matching
DI-T265	TF4RX13YY	2,000 CT 2,500 CT	3 3	8,000 split 10,000 split	180	100	Isol. or interstage (Ratio 1:1:1) also wide pulse application
DI-T270	TF4RX13YY	10,000 CT 12,000 CT	1 1	500 CT 600 CT	870	100	Output or driver
DI-T273	TF4RX13YY	10,000 CT 12,500 CT	1 1	1,200 CT 1,500 CT	870	100	Output or driver
DI-T276	TF4RX13YY	10,000 CT 12,000 CT	1 1	2,000 CT 2,400 CT	870	100	Interstage or driver
DI-T278	TF4RX13YY	10,000 CT 12,500 CT	1 1	2,000 split 2,500 split	620	100	Interstage or driver
DI-T283	TF4RX13YY	10,000 CT 12,000 CT	1 1	10,000 CT 12,000 CT	970	100	Isol. or interstage (Ratio 1:1:1) also wide pulse application
DI-T288	TF4RX13YY	20,000 CT 30,000 CT	.5 .5	800 CT 1,200 CT	870	100	Interstage or driver
DI-T204	TF4RX20YY	Split Inductor (2 wdgs)		Series connected: .1 Hy @ 4 maDC, .08 Hys @ 10maDC, DCR 25Ω Parallel connected: .025 Hys @ 8 maDC, .02 Hys @ 20 maDC, DCR 6Ω			
DI-T208	TF4RX20YY	Split Inductor (2 wdgs)		Series connected: .9 Hys @ 2 maDC, .5 Hys @ 6 maDC, DCR 105Ω Parallel connected: .2 Hys @ 4 maDC, .1 Hys @ 12 maDC, DCR 26Ω			
DI-T212	TF4RX20YY	Split Inductor (2 wdgs)		Series connected: 2.5 Hys @ 2 maDC, .9 Hys @ 4 maDC, DCR 630Ω Parallel connected: .6 Hys @ 4 maDC, .2 Hys @ 8 maDC, DCR 157Ω			
DI-T216	TF4RX20YY	Split Inductor (2 wdgs)		Series connected: 4.5 Hys @ 2 maDC, 1.2 Hys @ 4 maDC, DCR 2300Ω Parallel connected: 1.1 Hys @ 4 maDC, .3 Hys @ 8 maDC, DCR 575Ω			

±DCma shown is for single ended usage (under 5% distortion—100MW—1KC) ... for push pull, DCma can be any balanced value taken by .5W transistors (under 5% distortion—500mw—1KC)

\*DI-T units have been designed for transistor application only ... not for vacuum tube service. Pats. Pend.

Where windings are listed as split, 1/4 of the listed impedance is available by paralleling the winding.

## AND SPECIAL CUSTOM BUILT DI-T200 NEW TRANSISTOR TRANSFORMERS AND INDUCTORS TO YOUR SPECIFICATIONS

Above stock units cover general purpose applications. For specific applications cost reductions may be effected.



# MINIATURE INDUCTORS

## HERMETICALLY SEALED

Manufactured & Guaranteed to MIL-T-27A by Full Environmental Testing, see back cover

### MINIDUCTORS

... all units MIL type TF5RX20ZZ

UTC Miniductors are ideal for transistor and printed circuit applications, providing high Q in miniature form. The ML-1 thru 4 and the MO-.15 thru 1 are for medium low frequencies adjusted at 1 V, 1 KC. The ML-5 thru 10 and the MO-2 thru 100 are for lower frequencies adjusted at 1 V, 400 cycles. The ML units are adjusted to a tolerance of  $\pm 3\%$  and the MO units are adjusted to a tolerance of  $\pm 2\%$ . The MM and the MW series are for medium frequencies. The MH series is for high frequencies. The MM and MH series are adjusted to a tolerance of  $\pm 2\%$ , the MW units are adjusted to  $\pm 1\%$ .

The MO-.15 has an inductance change of less than 3% for applied voltages at 1 KC from 0.1 V to 35 V. The MO-2 has an inductance change of less than 3% for applied voltages at 400 cycles from 0.1 V to 35 V. MW-.5 has an inductance change of less than 3% for applied voltages at 1 KC from 0.1 V to 32 V. Temperature stability is unequalled on all Miniductors, from  $-55^{\circ}\text{C}$ . to  $+100^{\circ}\text{C}$ . The ML units are in a Hipermalloy shield case, the MM, MH and MW coils are symmetrical toroid . . . for high coupling attenuation and low hum pickup. The ma DC Max. shown is for approximately 5% drop in inductance. All miniductors are equally well suited for vacuum tube application.



**ML CASE**  
 $\frac{3}{16} \times \frac{3}{16} \times \frac{3}{16}$ " high  
 Weight.... .2 oz.



**MM, MH CASE**  
 $\frac{3}{16}$ " Dia. x  $\frac{1}{4}$ " high  
 Weight.... .07 oz.

**MO TERMINAL LAYOUT**

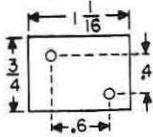

**MO CASE**  
 $\frac{3}{4} \times 1\frac{1}{16} \times 1\frac{1}{16}$ " high  
 Weight 1 oz.



**MW CASE**  
 $\frac{3}{32}$ " Dia. x  $1\frac{1}{32}$ " high  
 Weight .25 oz.

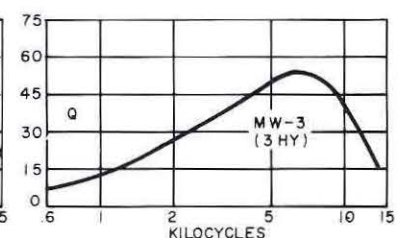
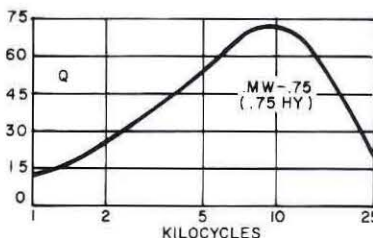
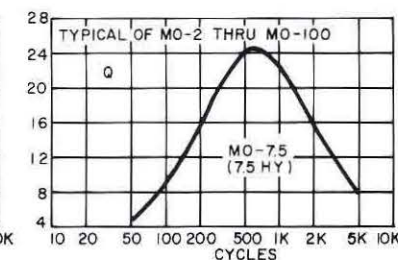
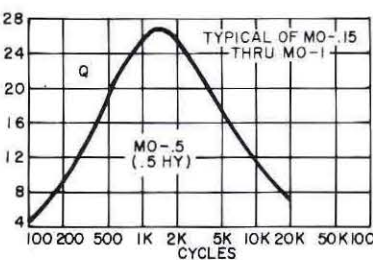
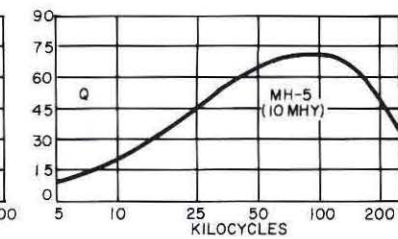
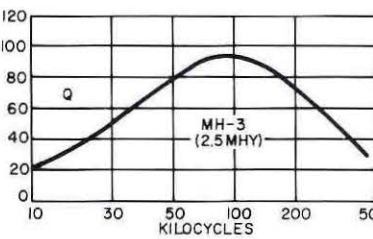
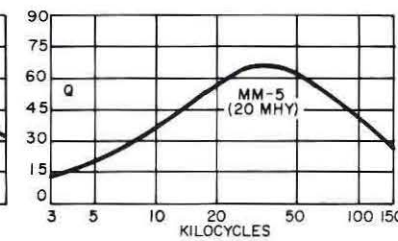
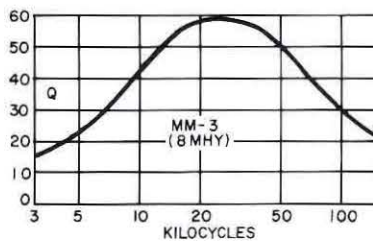
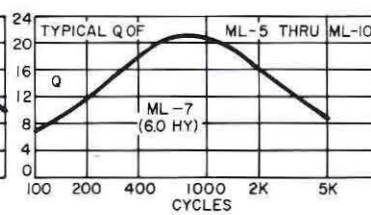
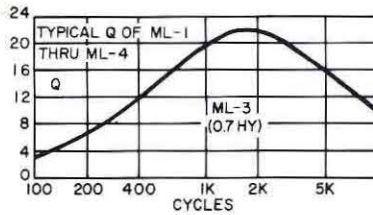

Type No.	Ind. Hy. (0 DC)	ma DC Max.	DCR% $\pm 20\%$
ML-1	.25	9	55
ML-2	.4	7	90
ML-3	.7	5	135
ML-4	1.4	3	210
ML-5	2.5	1	210
ML-6	4.0	.7	340
ML-7	6.0	.6	530
ML-8	10	.5	850
ML-9	25	.3	2300
ML-10	60	.2	5160

Type No.	Ind. Mhy. (0 DC)	ma DC Max.	DCR% $\pm 20\%$
MM-1	3	50	4.0
MM-2	5	40	6.7
MM-3	8	30	11
MM-4	12.5	25	16
MM-5	20	20	26
MM-6	30	16	39
MM-7	60	11	78
MM-8	120	8	155

Type No.	Ind. Mhy. (0 DC)	ma DC Max.	DCR% $\pm 20\%$
MH-1	.6	90	1.6
MH-2	1.5	57	4.1
MH-3	2.5	44	6.8
MH-4	6	28	16
MH-5	10	22	27
MH-6	15	18	41
MH-7	25	14	68
MH-8	40	11	108

Type No.	Ind. Hy. (0 DC)	ma DC Max.	DCR% $\pm 20\%$
New MO-.15	.15	45	22
New MO-.3	.3	28	34
New MO-.5	.5	23	54
New MO-1	1	16	130
New MO-2	2	8	130
New MO-5	5	5	340
New MO-7.5	7.5	4.5	517
New MO-20	20	2.7	1310
New MO-50	50	1.4	3180
New MO-100	100	1.1	8550

Type No.	Ind. Hy. (0 DC)	ma DC Max.	DCR% $\pm 20\%$
New MW-.5	.5	8	243
New MW-.75	.75	7	355
New MW-1	1.0	6	500
New MW-1.2	1.2	5	560
New MW-2	2	4	870
New MW-3	3	3.5	1340
New MW-5	5	3	2500

## AND SPECIAL CUSTOM BUILT MINIATURE INDUCTORS TO YOUR SPECIFICATIONS

Above stock units cover general purpose applications. For specific applications cost reductions may be effected.



# SUBMINIATURE INDUCTORS AND AUDIO TRANSFORMERS

**HERMETICALLY SEALED**

*Manufactured & Guaranteed to MIL-T-27A by Full Environmental Testing, see back cover*

## TRANSISTOR and TUBE TYPES

The stock Subminiature audio units, similar to the Miniature and Compact audio units on the next two pages, are manufactured in strict accordance with MIL-T-27A specifications. These small and lightweight units developed for miniaturization have been field proved for ruggedness and reliability. All meet the Grade 4, Class R, Life X military requirements.

Stock units are provided in hermetically sealed steel cases, with hooked pin headers and mounting stud (SM case), or with straight pin terminals for welding or printed circuit use (FH case). Units are a light gray with connection data printed on case. Special requirements for high permeability cases, different pins, higher temperatures, different impedance ratios, etc., can be met on special requests.

The frequency response ratings are based on military requirements. Units that do not carry DC are appreciably better in response than the range shown. Most are within 2 db from 30 to 20,000 cycles.

Transformers can be used for applications differing considerably from those shown, keeping in mind that impedance ratio is constant. Units may be reversed input to secondary.

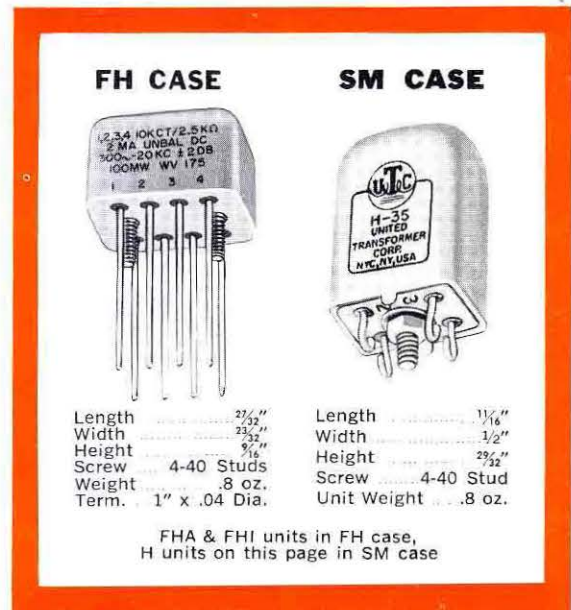

Type No.	Application	MIL Type	Pri. Imp. Ohms	Sec. Imp. Ohms	Pri. Unbal. DC ma	Response ±2 db (Cyc.)	Max. Level dbm	mw	
H-30	Input to grid	TF4RX10YY	50	62,500	0	150-10,000	+13	20	
H-31	Plate to single grid	TF4RX15YY	10,000	90,000	0	300-10,000	+13	20	
H-32	Single plate to line	TF4RX13YY	10,000*	200	3	300-10,000	+13	20	
H-33	Single plate to low imp.	TF4RX13YY	30,000	50	1	300-10,000	+15	30	
H-35	Inductor	TF4RX20YY	100 Henries-0 DC., 50 Henries-1 ma DC, 4,400 ohms.						
H-36	Transistor Interstage	TF4RX15YY	25,000 (DCR800)	1,000 (DCR110)	.5	300-10,000	+10	10	
H-37A	Transistor output	TF4RX17YY	500 CT (DCR50)	50 (DCR5)	3.5	300-10,000	+15	30	
H-38	Transistor Interstage	TF4RX13YY	10,000 CT (DCR600)	1,200 CT	2	300-10,000	+15	30	
H-39	Transistor Interstage	TF4RX13YY	10,000 CT (DCR600)	2,000 CT	2	300-10,000	+15	30	
H-40A	Transistor output	TF4RX17YY	500 CT (DCR26)	600 CT	10	300-10,000	+15	30	
H-41A	Transistor output	TF4RX13YY	1,500 CT (DCR71)	600 CT	7	300-10,000	+15	30	
H-42A	Isolation or Transistor Interstage	TF4RX13YY	10,000 CT	10,000 CT	1	300-10,000	+20	100	
New New New	FHA-15† FHA-25† FHI-3	Transistor Interstage Transistor Interstage Split Inductor	TF4RX13YY TF4RX13YY TF4RX04YY	10 KCT/2.5K (split) 20 KCT/5K (split) Series connection: 60 Mhys-32 ma DC, 6 ohms Parallel connection: 15 Mhys-64 ma DC, 1.5 ohms	200 CT/50 (split) 800 CT/200 (split)	2 1	300-20,000 300-20,000	+20 +20	100 100
New	FHI-7	Split Inductor	TF4RX04YY	Series connection: 1 Hy-8 ma DC, 100 ohms Parallel connection: .25 Hy-10 ma DC, 25 ohms					
New	FHI-11	Split Inductor	TF4RX04YY	Series connection: 2.4 Hys-2 ma DC, 160 ohms Parallel connection: .6 Hy-4 ma DC, 40 ohms					

†Electrostatic shield between primary and secondary.

\* Can be used for 500 ohm load . . . 25,000 ohm primary impedance . . . 1.5 ma DC.

## AND SPECIAL CUSTOM BUILT SUBMINIATURE INDUCTORS AND AUDIO TRANSFORMERS TO YOUR SPECIFICATIONS

*Above stock units cover general purpose applications. For specific applications cost reductions may be effected.*



# MINIATURE INDUCTORS AND AUDIO TRANSFORMERS

HERMETICALLY SEALED

Manufactured & Guaranteed to MIL-T-27A by Full Environmental Testing, see back cover

## TRANSISTOR and TUBE TYPES

The stock audio units listed below provide the high degree of reliability, in miniature size, which has made UTC the principal supplier of military transformers for over thirty years. All stock units employ compressed glass bead headers with hooked pin terminals. For printed circuit use, the hooked terminals can be straightened out without injury. Units with straight wire pin terminals are available on production orders.

These items are provided in steel drawn cases. For units requiring a high degree of magnetic shielding, same case manufactured of high permeability steel is available on production orders. These units are also available in MIL AG cases when desired, against production orders.

The frequency response ratings are based on military requirements. Units that do not carry DC are appreciably better in response than the range shown. Most are within 2 db from 30 to 20,000 cycles.

The level ratings are for low distortion at the lowest frequency specified. For higher frequencies, considerably higher levels are permissible. For example, the H-3 will handle + 21 dbm at 400 cycles.

Transformers can be used for applications differing considerably from those shown, keeping in mind that impedance ratio is constant. Units may be reversed input to secondary.

### RC-25 CASE

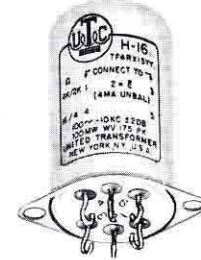

Length ..... 1 $\frac{3}{32}$ "  
 Width .....  $\frac{6}{64}$ "  
 Height ..... 1 $\frac{1}{16}$ "  
 Mtg. (slot center) 1 $\frac{1}{8}$ " to 1 $\frac{1}{2}$ "  
 Screws ..... 4-40 Fil.  
 Cutout .....  $\frac{7}{8}$ " Dia.  
 Unit Weight ..... 1.5 oz.

Type No.	Application	MIL Type	Pri. Imp. Ohms	Sec. Imp. Ohms	Pri. Unbal. DC ma	Response $\pm 2$ db (Cyc.)	Max. Level dbm	mw
H-1	Mike, line to grid	TF4RX10YY	50,200 CT, 500 CT*	50,000	0	50-10,000	+ 5	3
H-2	Mike to grid	TF4RX11YY	82	135,000	50	250-8,000	+18	63
H-3	Plate to single grid	TF4RX15YY	15,000	60,000	0	50-10,000	+ 6	4
H-4	Plate to single grid DC in Pri.	TF4RX15YY	15,000	60,000	4	200-10,000	+14	25
H-5	Plate to PP Grids	TF4RX15YY	15,000	95,000 CT	0	50-10,000	+ 5	3
H-6	Plate to PP Grids DC in Pri.	TF4RX15YY	15,000	95,000 split	4	200-10,000	+11	12
H-7	Plate or PP to line	TF4RX13YY	20,000 CT	600/150 split	4	200-10,000	+21	125
H-8	Mixing and matching	TF4RX16YY	600/150 split	600 CT	0	50-10,000	+ 8	6.3
H-9	82/41:1 input to grid	TF4RX10YY	600/150 split	1 MEG.	0	200-3,000 (4 db)	+10	10
H-10	10:1 plate to grid	TF4RX15YY	10,000	1 MEG.	0	200-3,000 (4 db)	+10	10
H-11	Inductor	TF4RX20YY	300 Hys. —0 DC, 50 Hys.-3ma. DC, 6,000 Ohms					
H-12	Mike, line to PP grids	TF4RX10YY	50, 200 CT, 500 CT*	50,000 CT	0	50-10,000	+ 5	3
H-13	Transistor Interstage	TF4RX13YY	10K/2.5K, split	2K/.5K split	4	100-10,000	+20	100
H-14	Transistor Interstage	TF4RX13YY	10K/2.5K, split	4K/1K split	4	100-10,000	+20	100
H-15	Transistor to line	TF4RX13YY	1,500 CT	500/125 split	8	100-10,000	+20	100
H-16	Transistor to V.C.	TF4RX13YY	2,000 CT 4,000 CT	8 16	4	100-10,000	+20	100
H-17	Transistor input	TF4RX16YY	600/150 split	2000/500 split	0	50-20,000	+15	31
H-18	Transistor Interstage	TF4RX13YY	10,000 CT	500/125 split	4	100-20,000	+20	100
H-219	Transistor Interstage	TF4RX13YY	50,000 CT	500/125 split	2	100-20,000	+20	100
H-220	Transistor Interstage	TF4RX17YY	500/125 split	500/125 split	20	100-20,000	+24	250**
H-221	Transistor Interstage	TF4RX17YY	500/125 split	150/37.5 split	20	100-20,000	+24	250**
New H-222 (2 wdgs.)	Split Inductor	TF4RX04YY	Series connection: 60 Mhy @ 80 ma DC, 4 ohms Parallel connection: 15 Mhy @ 160 ma DC, 1 ohm					
New H-224 (2 wdgs.)	Split Inductor	TF4RX04YY	Series connection: 1 Hy @ 20 ma DC, 60 ohms Parallel connection: .25 Hy @ 40 ma DC 15 ohms					

\*200 ohm termination can be used for 150 ohms or 250 ohms, 500 ohm termination for 600 ohms.

\*\*250 mw @ 100 cycles, 1 Watt @ 200 cycles.

## AND SPECIAL CUSTOM BUILT MINIATURE INDUCTORS AND AUDIO TRANSFORMERS TO YOUR SPECIFICATIONS

Above stock units cover general purpose applications. For specific applications cost reductions may be effected.



# COMPACT INDUCTORS AND AUDIO TRANSFORMERS

HERMETICALLY SEALED

Manufactured & Guaranteed to MIL-T-27A by Full Environmental Testing, see back cover

## TRANSISTOR and TUBE TYPES

These compact hermetically sealed, high reliability audio components encompass the broader range, higher powered, more heavily shielded types of transformers and inductors.

All are manufactured to meet MIL-T-27A, Grade 4, Class R, Life expectancy X specifications.

These compact units, along with the hermetic Miniature Audio units and the hermetic Subminiature Audio units (see two preceding pages) cover an extremely broad range of applications for both tube and transistor service.

Stock transformers are supplied with solder lug, glass to metal seal type terminals. Straight pin terminals or other special terminals are available on special orders.

Units are also available, against production order, in MIL AJ cases.

RC-50  
CASE



Length ..... 1 5/8"  
Width ..... 1 5/8"  
Height ..... 2 5/16"  
Mounting ..... 1 5/16"  
Screws ..... #6-32  
Cutout ..... 1 1/2" Dia.  
Unit Weight ..... 8 oz.

Type No.	Application	MIL Type	Pri. Imp. Ohms	Sec. Imp. Ohms	Pri. Unbal. DC ma	Response ±2 db (Cyc.)	Max. Level dbm	mw
H-19A	Balanced line to grid 1:14, multiple (75 db) shielding	TF4RX10YY	250 CT 500 CT	50,000 CT 100,000 CT	0	30-20,000	+ 6	4
H-20	Plate or PP to PP grids	TF4RX15YY	15,000 split	80,000 split	0	30-20,000	+12	15
H-21	Plate to PP grids DC in pri.	TF4RX15YY	15,000	80,000 split	8	100-20,000	+23	200
H-22	Plate to line	TF4RX13YY	15,000	50/200, 125/500*	8	50-20,000	+23	200
H-23	PP plates to line	TF4RX13YY	30,000 split	50/200, 125/500*	0	30-20,000	+19	80
H-24	Inductor	TF4RX20YY	450 Hys-0 DC, 250 Hys-5 ma DC, 6000 ohms 65 Hys-10 ma DC, 1500 ohms					
H-25	Mixing or trans. to line	TF4RX17YY	500 CT	500/125 split	20	40-20,000	—	1w
H-26	Transistor Interstage	TF4RX13YY	10,000/2,500 (split)	2,000/500 split	8	40-20,000	—	1w
H-27	Transistor to V.C.	TF4RX17YY	500 CT	16/4 split	20	40-20,000	—	1w
H-280	Transistor driver	TF4RX17YY	200 CT	400/100 split	20	40-20,000	—	1w
H-281	Transistor to V.C.	TF4RX17YY	48 CT	16, 8, 4	750 Bal	40-20,000	—	5w
H-282	Transistor to V.C. RC-62 case, Pg. 46.	TF4RX17YY	20 CT	16, 8, 4	1000 Bal	70-20,000	—	10w
New H-283†	Mixing or matching for line or transistor	TF4RX16YY	50, 125/150, 200/250, 333, 500/600	50, 125/150, 200/250, 333, 500/600	0	20-50,000	+15	30
New H-284	Soluit inductor	TF4RX04YY	Series connection: 4 Hys-50 ma DC, 100 ohms Parallel connection: 1 Hy-100 ma DC, 25 ohms					
New H-286	Split inductor	TF4RX04YY	Series connection: 40 Hys-15 ma DC, 1000 ohms Parallel connection: 10 Hys-30 ma DC, 250 ohms					

\* 200 ohm termination can be used for 150 ohms or 250 ohms, 125/500 ohm termination for 150/600 ohms.

†High electrostatic shielding



# CHOPPER TRANSFORMERS

HERMETICALLY SEALED

Manufactured & Guaranteed to MIL-T-27A by Full Environmental Testing, see back cover

Type No.	1/2 Pri. Imp. Ohms	Sec. Imp. Ohms	Turns Ratio 1/2 Pri. to Sec.	Max. Volts 1/2 Pri. -60~	Min. L Pri. 1V-60~	Pri. Res. Ohms	Sec. Res. Ohms	Case
H-290	2500	100,000	6.4	2.75	90 Hy	450	3,250	RC-50 (see above)
	High electrostatic shielding plus triple magnetic shield.							
H-291	2000/500	312,000	25/50	3.4/1.7	30/7.5 Hy	320/80	16,000	RC-62 (Pg. 46)
	Exceptional electrostatic shielding (10 db greater than H-290) plus hum-bucking structure and triple magnetic shield.							

## AND SPECIAL CUSTOM BUILT INDUCTORS, AUDIO AND CHOPPER TRANSFORMERS TO YOUR SPECIFICATIONS

Above stock units cover general purpose applications. For specific applications cost reductions may be effected.



# SUB-SUBOUNCER UNITS

## TRANSISTOR AND TUBE TYPES

### HERMETICALLY SEALED PRINTED CIRCUIT MOLDED TYPES TO MIL GRADE 5

Type No.	Application	Pri. Imp. ohms	Unbal. ma D C in Pri.	Sec. Imp. ohms	Pri. Res. ohms	Sec. Res. ohms	Max. dbm	Level mw
New SSO-3P	Plate to Line	10K 25K	3 1.5	200 500	2500	34	+20	100
New SSO-8P	Transistor to PP Sec.	10K	1	2000 CT	1200	45	+20	100
New SSO-14P	Transistor Interstage	10K CT 25K CT	2 1	200 CT 500 CT	650	22	+20	100
New SSO-15P	Transistor Interstage	20K CT 30K CT	1 1	800 CT 1200 CT	800	110	+20	100
New SSO-19P	Output matching	500 CT	10	600 CT	26	70	+20	100
New SSO-20P	Output	1.5K CT	7	600 CT	70	65	+20	100
New SSO-21P	Crystal/Chopper	200K CT	0	1000 CT	4000	200	+7	5
New SSO-22P	Interstage	10K CT 12K CT	4 4	1500 CT 1800 CT	800	300	+20	100

MIL TYPES: SSO-3P, TF5RX13ZZ; SSO-8P, TF5RX13ZZ; SSO-14P, TF5RX13ZZ; SSO-15P, TF5RX13ZZ; SSO-19P, TF5RX17ZZ; SSO-20P, TF5RX17ZZ; SSO-21P, TF5RX16ZZ; SSO-22P, TF5RX13ZZ.

### OPEN TYPES

SSO-1	Input	200 50	0	250 K 62.5 K	13.5	3600	+7	5
SSO-2	Interstage/3:1	10K	0-.25	90 K	710	3150	+15	30
SSO-3	Plate to Line	10K 25K	3 1.5	200 500	2500	34	+20	100
SSO-4	Output	30K	1.0	50	2875	4.6	+20	100
SSO-5	Inductor: 50 Hy. at 1 mil. D C, 4400 ohms D C Res.							
SSO-6	Output	100K	.5	60	3500	3.3	+20	100
SSO-7	Transistor Interstage	20K 30K	.5 .5	800 1200	800	110	+20	100
SSO-8	Transistor to PP Sec.	10K	1	2000 CT	1200	45	+20	100
SSO-9	Transistor to V.C.	10K	2	16	800	2.7	+20	100
SSO-10	Transistor to V.C.	10K	2	3.2	800	.65	+20	100
SSO-11	Transistor Output	500 600	3.5 3.5	50 60	50	5	+20	100
SSO-12	Transistor Output	1000 1200	3 3	50 60	90	5	+20	100
SSO-13	Crystal to Transistor	200K	0	1000	4000	190	+7	5
SSO-14	Transistor Interstage	10K CT 25K CT	2 1	200 CT 500 CT	650	22	+20	100
SSO-15	Transistor Interstage	20K CT 30K CT	1 1	800 CT 1200 CT	800	110	+20	100
SSO-16	Output	1200 1500	3 3	3.2 4	70	.45	+20	100
SSO-17	Output or driver	10K 12.5K	2 2	500 CT 600 CT	800	95	+20	100
SSO-18	Single or P P Output	7.5K CT 9.4K CT	4 4	3.2 4	770	.73	+20	100
SSO-19	Output matching	500 CT	10	600 CT	26	70	+20	100
SSO-20	Output	1.5K CT	7	600 CT	70	65	+20	100
SSO-21	Crystal/Chopper	200K CT	0	1000 CT	4000	200	+7	5
SSO-22	Interstage	10K CT 12K CT	4 4	1500 CT 1800 CT	800	300	+20	100
SSO-23	Inductor: 8 Hys. @ 2 ma D C, 4 Hys. @ 5 ma D C, 650 ohms							
SSO-24	Inductor: 3.5 Hys. @ 2 ma D C, 1.5 Hys. @ 5 ma D C, 160 ohms							
SSO-25	Transistor Interstage	10K CT 12K CT	1	10K CT 12K CT	560	650	+20	100
SSO-26	Transistor Interstage	40K CT 50K CT	.5	400 split 500 split	1900	43	+20	100
SSO-CH	Mounting channel for any of above SSO units							

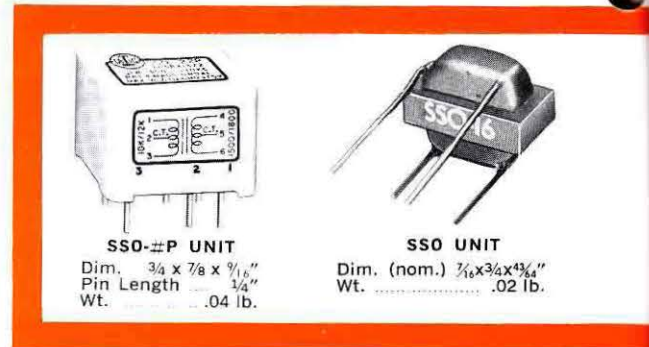

UTC Sub-subouncer units are ideal miniaturized components having high efficiency and wide frequency response. Through the use of special nickel iron core materials and winding methods, these miniature units provide exceptional performance and reliability. On the open type units, four inch color coded flexible leads are employed, securely anchored mechanically. Units are supplied without mounting facilities to provide maximum flexibility in location. However, suitable channels are available as a separate item (SSO-CH) which readily fit over the units. Units are vacuum processed and double (water proof) sealed.

The SSO-#P units are stock items, vacuum molded to MIL Grade 5. They employ 40 mil deeply anchored pin terminals ideally suited for printed circuit and transistor application. Terminals are strong enough to support these light weight units. Special type mounting facilities are available on production orders. Any unit in the SSO series is available in molded form on special orders.

The curves below indicate the excellent frequency response. Hermetic-SSO units (SM and FH case) listed on page 11. Units can be used for impedances, other than those shown, keeping in mind that the impedance ratio is constant. Units may be used reversed, input to secondary.

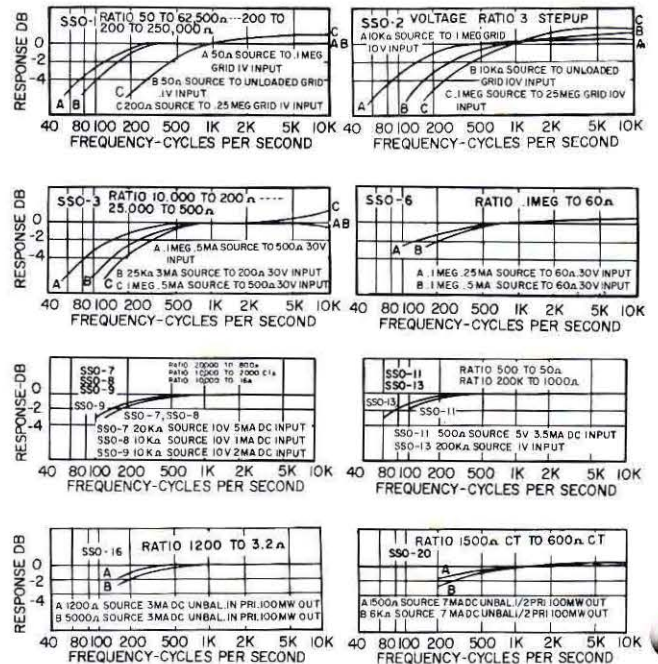







# OUNCER AUDIO UNITS

## TRANSISTOR and TUBE TYPES

UTC Ouncer components represent the acme in compact quality transformers. These units, which weigh one ounce, are fully impregnated and sealed in a drawn aluminum housing  $\frac{7}{8}$ " diameter . . . mounting opposite terminal board.

Ouncer items are ideal for portable broadcast, hearing aid, aircraft, concealed service, and similar applications. High fidelity characteristics are provided. "P" series units are identical to the UTC Ouncer units but are sealed in bakelite housings with plug-in base to fit standard octal socket. While of submersion proof design, these units weigh but two ounces. Oversize pins in the base make it impossible to dislodge these units from their sockets.

See page 20 for use of Ouncers with Printed Circuits. Hermetic Ouncers (RC-25 case) are listed on page 12.



**OUNCER CASE**

Dia. ....  $\frac{7}{8}$ "  
 Ht. ....  $1\frac{1}{2}$ "  
 Term. proj. ....  $\frac{3}{32}$ "  
 Mtg. ....  $\frac{1}{16}$ "  
 Scr. .... 2-56  
 Wt. .... 1 oz.

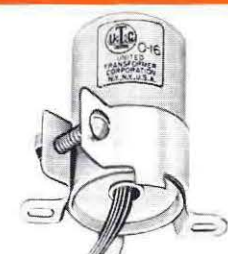

**0-16 CASE**

Dia. ....  $1\frac{1}{8}$ "  
 Ht. ....  $1\frac{1}{2}$ "  
 Mtg. ....  $\frac{1}{2}$ "  
 Scr. .... 6-32  
 Wt. .... 3 oz.  
 Clamp...  $1\frac{3}{8}$  X  $1\frac{7}{8}$ "

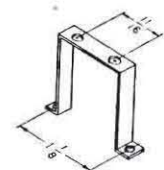

Ouncer chassis mount bracket available on production orders

### STANDARD TYPES

INPUT & MIXING TRANSFORMERS

INTERSTAGE TRANSFORMERS

OUTPUT TRANSFORMERS

INDUCTORS

SHIELD

Type No.	Application	Pri. Imp. Ohms	Unbal. maDC	Sec. Imp. Ohms	$\pm 1$ db Cycles	Max. Level dbm	mw	Pri. Resis. Ohms
0-1	Low imp. to grid	50, 200/250, 500/600		50,000	30-20,000	+ 8	6.3	52
0-2	Low imp. to PP grids	50, 200/250, 500/600		50,000 CT	30-20,000	+ 8	6.3	52
0-3	Low imp. to grid	7.5/30		50,000	30-20,000	+ 8	6.3	4.5
0-11	Crystal to line	50,000		50, 200/250, 500/600	30-20,000	+ 8	6.3	3900
0-12	Mixing, matching	50, 200/250,		Same as 0-11	30-20,000	+ 8	6.3	12
0-14	50:1 Low imp./grid	200		$\frac{1}{2}$ Megohm	50-5000	+ 8	6.3	10
0-16	Low imp. to grid	250 CT		50,000	30-20,000	+ 8	6.3	40
Uses two heavy gauge hipermalloy shields for very low hum pickup plus orientable mounting. Primary CT is balanced to 1%. Can be used for 150, 200, 250, 500, or 600 ohm sources . . . 200:1 impeded. ratio. 3 oz.								
0-25	Transistor input	600/150 split		2000/500 split	50-20,000	+15	-30	70
0-4	Plate to grid	15,000		60,000	30-20,000	+ 8	6.3	710
0-5	Plate to grid	15,000, 4 ma		60,000	200-10,000	+ 8	6.3	710
0-6	Plate to PP	15,000		95,000 CT	30-20,000	+ 8	6.3	690
0-7	Plate to PP	15,000, 4 ma		95,000 CT	200-10,000	+ 8	6.3	690
0-15	10:1 Pl. to grid	15,000		1 Megohm	100-3,000	+ 8	6.3	330
0-18	Transistor Int.	10K/2.5K split, 4 ma		2000/500 split	100-20,000	+20	100	800
0-19	Transistor Int.	10K/2.5K split, 4 ma		4K/1K split	100-20,000	+20	100	800
0-26	Transistor Int.	10,000 CT 4 ma		10,000 CT	100-20,000	+20	100	700
0-27	Transistor Int.	10,000 CT 4 ma		500/125 split	100-20,000	+20	100	750
0-28	Transistor Int.	50,000 CT 2 ma		500/125 split	100-20,000	+20	100	3200
0-29	" Int. or chopper	100,000 CT 1 ma		500/125 split	100-20,000	+20	100	3200
0-30	Transistor Int.	500/125 split 20 ma		500/125 split	100-20,000		1w*	37
0-31	Transistor Int.	500/125 split 20 ma		150/37.5 split	100-20,000		1w*	35
0-32	Transistor Int.	500/125 split 20 ma		50/12.5 split	100-20,000		1w*	37
0-33	Transistor Int.	100/25 split 40 ma		40/10 split	100-20,000		1w*	9
0-8	Plate to line	15,000		50, 200/250, 500/600	30-20,000	+ 8	6.3	950
0-9	Plate to line	15,000, 4 ma		Same as 0-8	200-10,000	+ 8	6.3	950
0-10	PP to line	30,000 CT		Same as 0-8	30-20,000	+ 8	6.3	1300
0-20	Transistor to line	1500 CT 8 ma		500/125 split	100-20,000	+20	100	100
0-21	Transistor to voice coil	2000 CT 4 ma 4000 CT		8 16	100-20,000	+20	100	200
0-22	Transistor to voice coil	400 CT 20 ma 500 CT		3.2 4	100-20,000		1w*	35
0-13	Inductor	300 Hys @ 0 DC; 50 Hys @ 3 maDC; 6000 ohms						
0-23	Inductor	7 Hys @ 3 maDC; 3.5 Hys @ 10 maDC; 230 ohms						
0-24	Inductor	1.6 Hys @ 3 maDC; .8 Hys @ 10 maDC; 25 ohms						
0-34	Split Inductor	Series connection: 60 Mhy @ 80 maDC; 4 ohms Parallel connection: 15 Mhy @ 160 maDC; 1 ohm						
0-36	Split Inductor	Series connection: 1 Hy @ 20 maDC; 60 ohms Parallel connection: .25 Hy @ 40 maDC; 15 ohms						
0-17	Hipermalloy shield, slip fit over ouncer, 1" O.D., provides 25 db shielding.							

\*At 200 cycles,  $\frac{1}{4}$  watt at 100 cycles.

## AND SPECIAL CUSTOM BUILT OUNCER

Above stock units cover general purpose applications.

## TRANSISTOR and TUBE TYPES



Hipermalloy Shield (0-17)  
shown slipping  
over oncer unit



**PLUG-IN CASE**  
Dia. ....1 3/8"  
Ht. ....1 15/32"  
Skt. ....St. Oct.  
Wt. ....2 oz.



**P-16 CASE**  
Dia. ....1 3/8"  
Ht. ....2 3/4"  
Wt. ....4 oz.

### PLUG-IN TYPES

#### INPUT & MIXING TRANSFORMERS

Type No.	Application	Pri. Imp. Ohms	Sec. Imp. Ohms	±1 db Cycles	Max. Level dbm mw	Pri. Resis. Ohms
P-1	Low imp. to grid	50, 200/250, 500/600	50,000	30-20,000	+ 8 6.3	52
P-2	Low imp. to PP grids	50, 200/250, 500/600	50,000 CT	30-20,000	+ 8 6.3	52
P-3	Low imp. to grid	7.5/30	50,000	30-20,000	+ 8 6.3	4.5
P-11	Crystal to line	50,000	50, 200/250, 500/600	30-20,000	+ 8 6.3	3900
P-12	Mixing, matching	50, 200/250,	50, 200/250, 500/600	30-20,000	+ 8 6.3	12
P-16	Same as 0-16 but with nine pin plug-in socket. 1 3/8 diam. x 2 3/4 high, 4 oz.					

#### INTERSTAGE TRANSFORMERS

Type No.	Application	Pri. Imp. Ohms	Unbal. maDC	Sec. Imp. Ohms	±1 db Cycles	Max. Level dbm mw	Pri. Resis. Ohms
P-6	Plate to PP	15,000		95,000 CT	30-20,000	+ 8 6.3	690
P-7	Plate to PP	15,000, 4 ma		95,000 CT	200-10,000	+ 8 6.3	690
P-15	10:1 Pl. to grid	15,000		1 Megohm	100-3,000	+ 8 6.3	330

#### OUTPUT TRANSFORMERS

Type No.	Application	Pri. Imp. Ohms	Unbal. maDC	Sec. Imp. Ohms	±1 db Cycles	Max. Level dbm mw	Pri. Resis. Ohms
P-8	Plate to line	15,000		50, 200/250, 500/600	30-20,000	+ 8 6.3	950
P-9	Plate to line	15,000, 4 ma		50, 200/250, 500/600	200-10,000	+ 8 6.3	950
P-10	PP to line	30,000 CT		50, 200/250, 500/600	30-20,000	+ 8 6.3	1300

CURVES SHOWN  
ON THIS PAGE  
DEPICT PERFORMANCE  
OF BOTH 0-TYPE  
AND P-TYPE UNITS

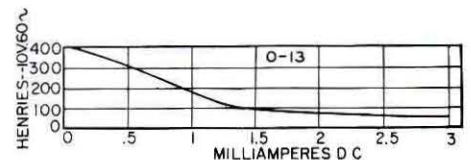
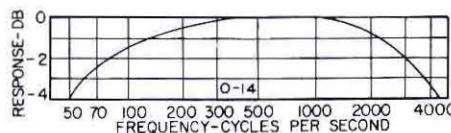
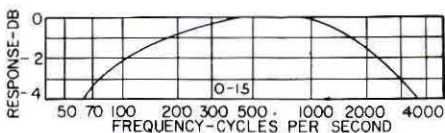
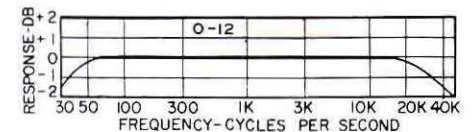
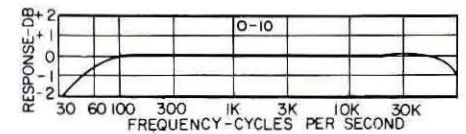
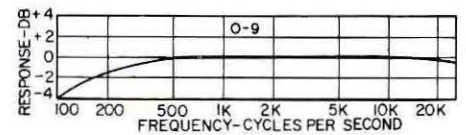
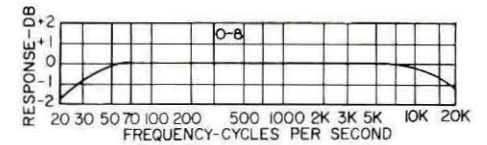
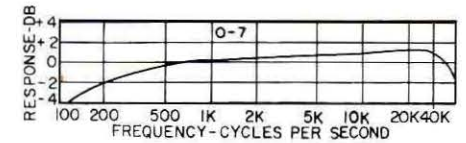
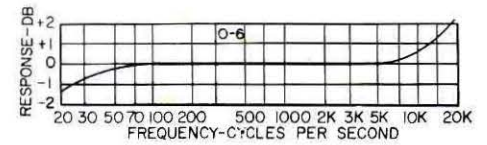
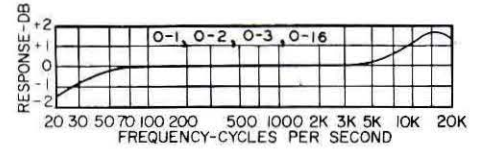



# MILITARY STANDARD TRANSFORMERS AND INDUCTORS

**HERMETICALLY SEALED**

Manufactured & Guaranteed to MIL-T-27A by Full Environmental Testing, see back cover

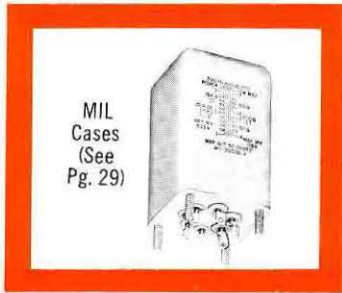

UTC MS audio units are now available as stock items from distributor shelves. Prices are shown in the Index and Net Price List.

**AUDIO** Transformers frequency response is 300 cycles to 10 KC,  $\pm 2$  db for all types. 600 ohm split provides for 600 ohm CT and 150 ohms. Secondaries of W-783 are center tapped, providing for 90K CT or 22.5K CT. Electrostatic shielding is provided on W-784, W-785, and W-786. All units are in MIL AJ case, weight .6 lbs.

**FILAMENT, POWER and PLATE** Transformer primaries are 105/115/125 V. 54/66 cycles. Current ratings for high voltage secondaries are DC, choke input filter. For condenser input, reduce current by 70% of rated values. The -2 after MS No. indicates grade 4 (ruggedized) which is equally usable where grade 1 is specified. All units are electrostatically shielded.

**INDUCTORS** consist of 2 windings that can be connected either in series of parallel for maximum flexibility. Higher inductance figure is for series connection, lower inductance figure is for parallel connection. All units except Z-857 are in Standard MIL Cases. For dimensions on Z-857 see pg. 29.

## MS AUDIO TRANSFORMER

UTC No.	MS No.	MIL IDENTIF.	APPLICATION	PRI. OHMS	PRI. ma DC	SEC. OHMS	LEVEL
W-783	90000	TF1RX15AJ001	PP Plates to PP Grids	10K CT	10 Unbal	90K Split	15 dbm
W-784	90001	TF1RX16AJ002	Line to V C	600 split		4/8/16	2 W
W-785	90002	TF1RX10AJ001	Line to PP Grids	600 split		135K CT	15 dbm
W-786	90003	TF1RX16AJ001	Line to Line	600 split		600 split	15 dbm
W-787	90004	TF1RX13AJ001	Plate to Line	7600/4800	40 Unbal	600 split	2 W
W-788	90005	TF1RX13AJ002	Plate to V C	7600/4800	40 Unbal	4/8/16	2 W
W-789	90006	TF1RX13AJ003	PP Plates to Line	15K CT	10 Unbal	600 split	2 W
W-790	90007	TF1RX13AJ004	PP Plates to Line	24K CT	20 Bal	600 split	1 W
W-791	90008	TF1RX13AJ005	PP Plates to Line	60K CT	20 Bal	600 split	.5 W

## MS FILAMENT, POWER, PLATE TRANSFORMERS

UTC No.	MS No.	MIL IDENTIFICATION	Secondary Ratings	MIL CASE	WT. LBS.
N-583A	90016-2	TF4RX01EB002	2.5V- 3A. 1000 WV	EB	1 $\frac{3}{8}$
N-584A	90017-2	TF4RX01GB003	2.5V-10A 1000 WV	GB	2 $\frac{3}{8}$
N-585A	90018-2	TF4RX01FB004	5V- 3A 1000 WV	FB	1 $\frac{3}{4}$
N-586A	90019-2	TF4RX01HB005	5V-10A 1000 WV	HB	3 $\frac{1}{2}$
N-587A	90020-2	TF4RX01FB006	6.3V- 2A 1000 WV	FB	1 $\frac{1}{2}$
N-588A	90021-2	TF4RX01GB007	6.3V- 5A 1000 WV	GB	2 $\frac{3}{4}$
N-589A	90022-2	TF4RX01JB008	6.3V-10A 1000 WV	JB	5
N-590A	90023-2	TF4RX01KB009	6.3V-20A 1000 WV	KB	7 $\frac{1}{2}$
N-591A	90024-2	TF4RX01JB012	2.5V-10A 6300 WV	JB	4 $\frac{1}{2}$
N-592A	90025-2	TF4RX01KB013	5V-10A 6300 WV	KB	6 $\frac{1}{4}$
N-593A	90026-2	TF4RX03HA001	200-100-0-100-200. 70 ma 6.3/5V-2A 6.3V-3A	HA	3 $\frac{3}{4}$
N-594A	90027-2	TF4RX03JB002	325-0-325, 70 ma 6.3/5V-2A 6.3V-4A	JB	5
N-595A	90028-2	TF4RX03KB006	325-0-325, 150 ma 5V-3A 6.3V-5A	KB	7 $\frac{1}{2}$
N-596A	90029-2	TF4RX03LB003	400-0-400, 175 ma 5V-3A 6.3V-8A	LB	9 $\frac{1}{2}$
N-597A	90030-2	TF4RX03MB004	450-0-450, 250 ma 5V-3A 6.3V-8A	MB	13
N-598A	90031-2	TF4RX02KB001	350-0-350, 250 ma	KB	7
N-599A	90032-2	TF4RX02LB002	550-0-550, 250 ma	LB	10
N-600A	90036-2	TF4RX02NB003	800-0-800, 250 ma	NB	16 $\frac{1}{2}$

## MS INDUCTORS

UTC No.	MS No.	MIL IDENTIFICATION	IND. HYS	ma DC	DCR OHMS	W.V.	MIL CASE	WT. LBS.
Z-848	90009-1	TF1RX04FA001	16 H 4	80 160	645 160	1000	FA	2
Z-849	90010-1	TF1RX04GA002	25 6.25	80 160	670 165	1000	GA	3
Z-850	90011-1	TF1RX04HA003	40 10	80 160	1020 250	1000	HA	4 $\frac{1}{4}$
Z-851	90013-1	TF1RX04HA005	16 4	125 250	330 82	2000	HA	4 $\frac{1}{4}$
Z-852	90014-1	TF1RX04JB006	25 6.25	125 250	460 115	2000	JB	6
Z-853	90037-1	TF1RX04KA007	40 10	125 250	535 133	3500	KA	8
Z-854	75000-2	TF4RX04LA009	16 4	200 400	180 44	3500	LA	11
Z-855	75001-2	TF4RX04MA010	25 6.25	200 400	210 52	3500	MA	16
Z-856	75002-2	TF4RX04NA012	16 4	315 630	105 25	3500	NA	18
Z-857	75003-2	TF4RX04YY013	25 6.25	315 630	150 37	3500	YY	35

# REGULATED VACUUM TUBE POWER SUPPLY CIRCUITS

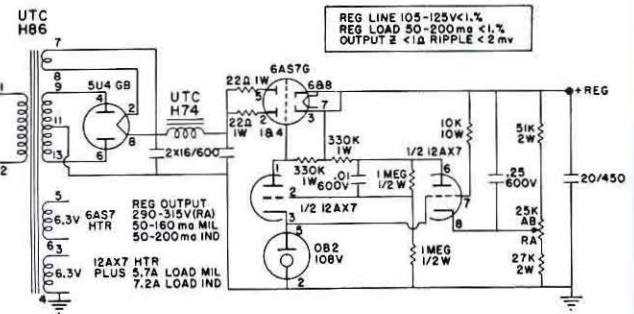
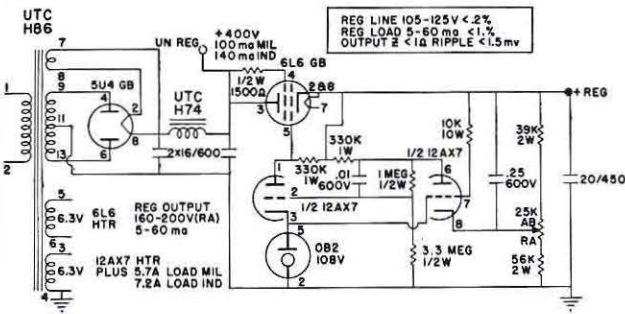
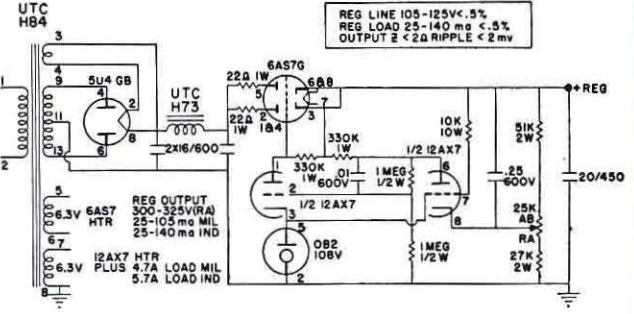
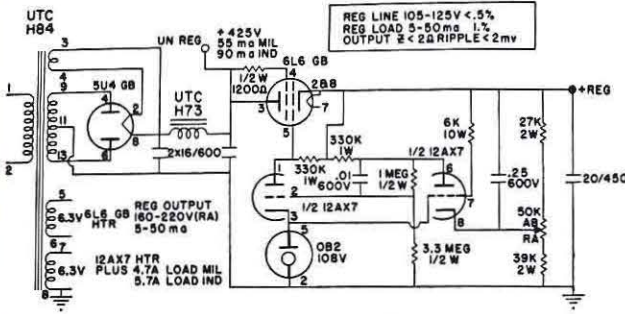

# RECOMMENDED VACUUM TUBE AMPLIFIER CIRCUITS

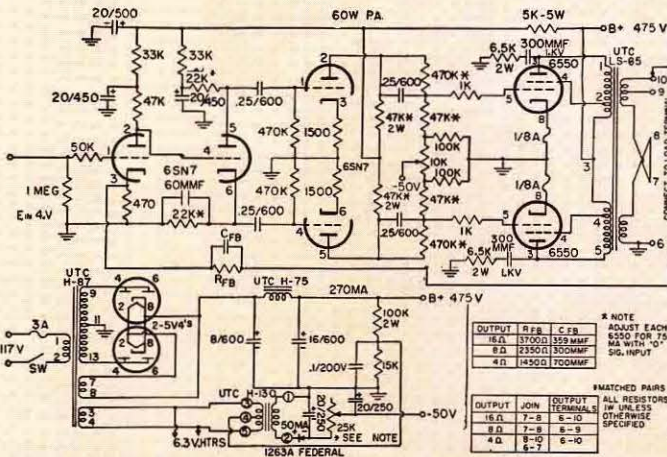

CIRCUIT PROVIDING 60 WATTS,  $\pm 1$  db from 15 cycles to 30 KC ...  
At 1 watt,  $\pm 1$  db 3 cycles to 80 KC.

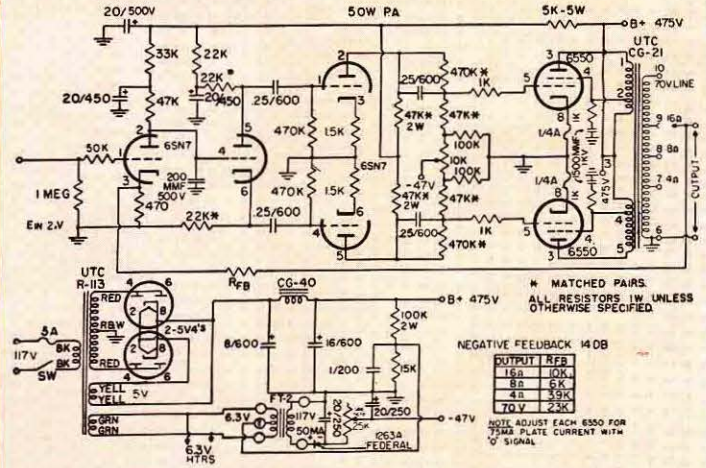

CIRCUIT PROVIDING 50 WATTS,  $\pm 1$  db 40 cycles to 10 KC ...  
At 1 watt,  $\pm 1$  db 20 cycles to 20 KC.

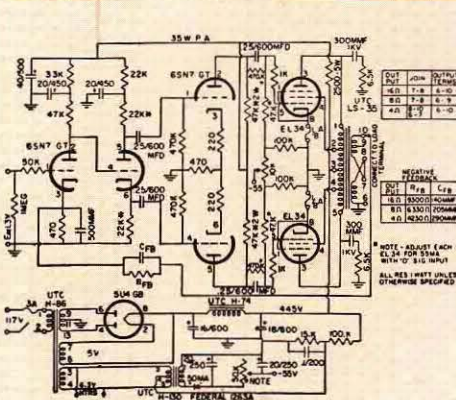

CIRCUIT PROVIDING 35 WATTS,  
 $\pm 1$  db from 15 cycles to 30 KC ...  
At 1 watt,  $\pm 1$  db 7 cycles to 100 KC.

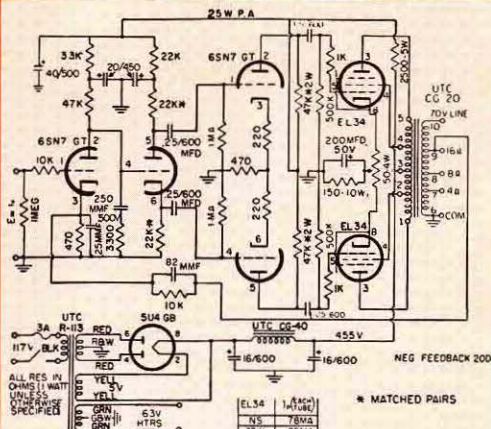

CIRCUIT PROVIDING 25 WATTS,  
 $\pm 1$  db 40 cycles to 10 KC ...  
At 1 watt,  $\pm 1$  db 20 cycles to 20 KC.

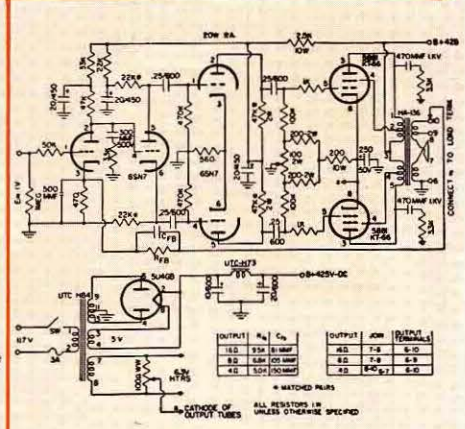

CIRCUIT PROVIDING 20 WATTS,  
 $\pm 1$  db 20 cycles to 30 KC ...  
At 1 watt,  $\pm 1$  db 7 cycles to 100 KC.

**FULL 8 1/2" x 11" SCHEMATICS AVAILABLE ON REQUEST**



# COMPONENTS FOR PRINTED CIRCUITS

With the increasing usage of printed circuitry in electronic equipment, a large part of the UTC stock components have been designed specifically with printed circuits in mind. Examples of these specifically designed groups are the DO-T and DI-T series (Pgs. 6, 7, 8 and 9), and the miniature pulse transformers (Pgs. 35, 36 and 37). For examples of the Miniductor see page 10. For Minifilter groups write for Filter Catalog. Other lines are readily adaptable. The hermetic miniature and subminiature audios listed on pages 11 and 12 are readily adapted to printed circuitry by straightening out the wire loop terminals.

where the units are not supplied with standard pin terminals. Hooked pin terminal units are available with straight terminals on production orders. The slotted terminals on UTC Ouncer (Pgs. 16 and 17) and Ultra-compact (Pgs. 40 and 41) transformers are finding increasing use in printed circuitry. When these units are used with a printed circuit, the prongs are slightly spread out after insertion in the printed circuit board holes. This provides good support for the unit, as well as rigid close contact between terminal and printed circuit before soldering. Special units are available in cased, molded, and open structures specifically for printed circuit use.

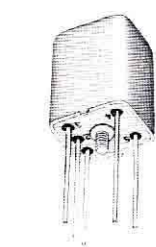

SOM CASE takes sub-ouncer units,  $\frac{1}{8} \times \frac{1}{8}$ " x  $1\frac{1}{4}$ " oz.

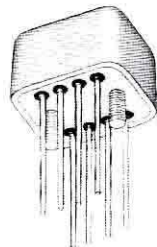

FLAT SM CASE takes sub subouncer units,  $\frac{7}{32} \times \frac{23}{32} \times \frac{3}{16}$ " x .8 oz.

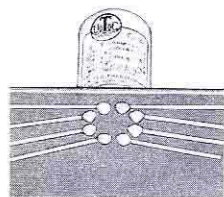

OUNCER.

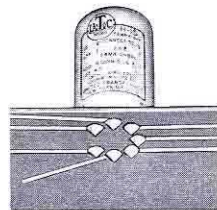

H AUDIO.

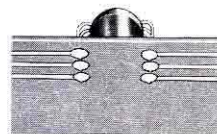

MINIATURE PULSE.

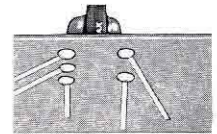

SUBOUNCER.

## TRANSFORMERS IN PRINTED CIRCUITS

## RECOMMENDED TRANSISTOR AMPLIFIER CIRCUITS

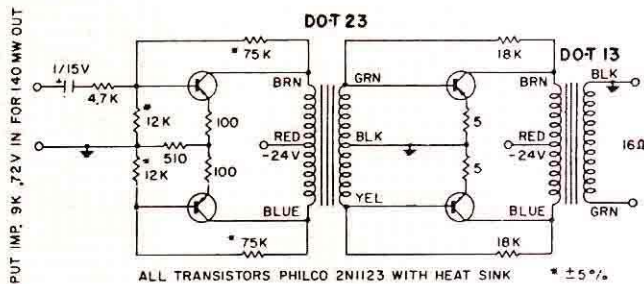

Circuit providing 140 MW, frequency range 300 cycles to 20 KC

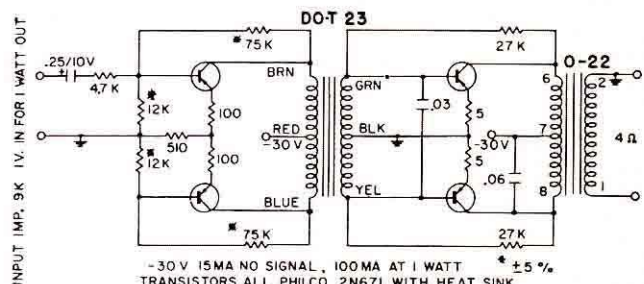

Circuit providing 1 watt, frequency range 200 cycles to 20 KC

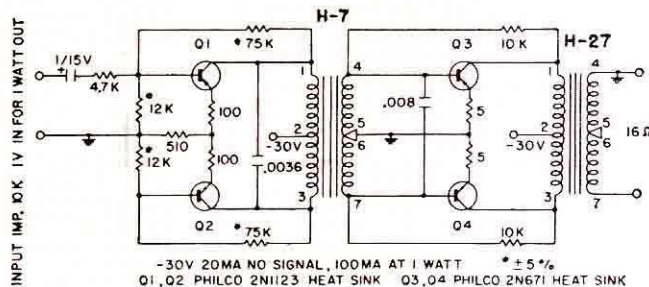

Circuit providing 1 watt, frequency range 100 cycles to 20 KC

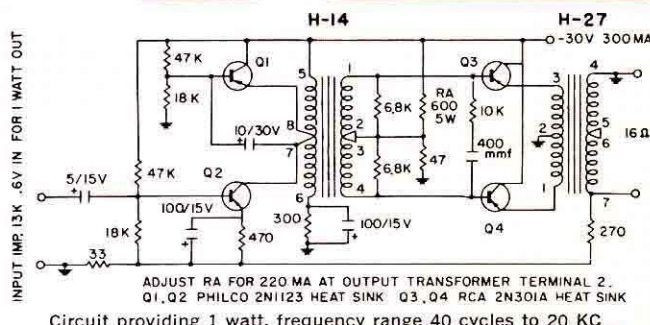

Circuit providing 1 watt, frequency range 40 cycles to 20 KC

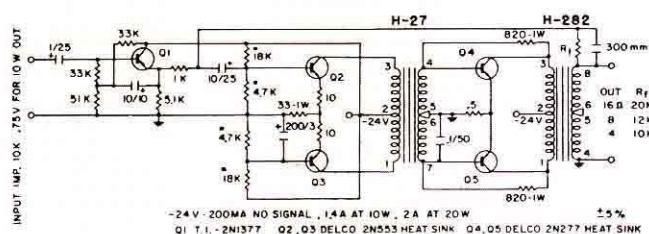

Circuit providing 20 watts, frequency range 50 cycles to 20 KC

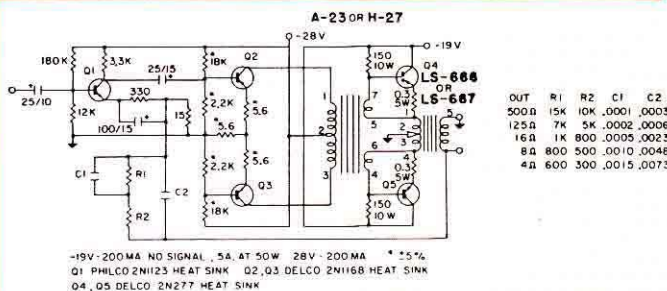

Circuit providing 50 watts, frequency range 20 cycles to 20 KC



## SPECIAL CUSTOM BUILT POWER TRANSFORMERS TO YOUR SPECIFICATIONS

In addition to the needs met by UTC stock power components, there are many unique applications which require special units. The units illustrated below are intended to show some of the thousands of special units produced by UTC and to help provide the equipment engineer with a concept of the possibilities in present special transformer design. Range covered is from milliwatts to 100 KVA.

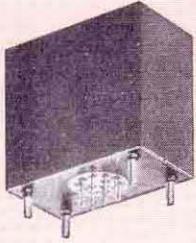

170° C. corona free power transformer. Primary 115 V., 400 cycles, 3 phase, to 400 V.-35 A., 250 V.-.25 A., 130 V.-.63 A. (320 V.A.). MIL-T-27A Grade 4 Class T Life X; 2 1/8 x 4 1/2 x 3 1/2", 4 1/4 lbs.



High temperature plate transformer. Primary 208 V., 3 phase 380/1000 cycles to 5100 V./leg, 1400 V. A. 200° C. MIL-T-27A; 6 x 3 x 4 1/2", 6 lbs.



High Current and High Voltage Transformer. Input 115 V 400 cycles to 7.5 V CT-51A, 22 KV hipot. MIL-T-27A, Grade 4; 6 1/2 x 6 7/8 x 6 3/8", 30 lbs.

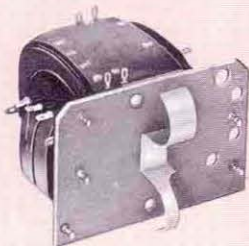

Scope power transformer with board for rectifiers. Primary 115 V., 400 cycles to two 14 KV filament windings, one 6.3 V. low capacity filament winding, 4.5 KV and 1.75 KV high voltage windings. 25 KV hipot when in oil; 2 7/8 x 3 1/2 x 2 5/8", 1 1/4 lbs.

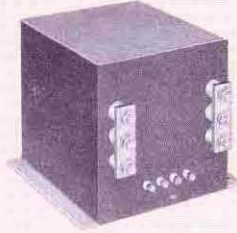

High current filament transformer. Primary 140/156 V., 47/63 cycles to 1.8 V.-1070 A. Current limiting through separate primary reactor, MIL-T-27A; 10 x 10 x 11 1/2", 150 lbs.

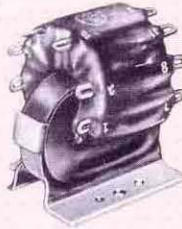

High temperature power transformer. Primary 115 V., 320/1000 cycles to four 6.3 V. and one 475 V. secondaries. 200° C. MIL-T-27A; 2 1/4 x 2 x 2", 9 ounce.



High voltage filament transformer. Primary 115V., 380/1600 cycles to 5 VCT.-10 A., 21 KV hipot. 160° C. MIL-T-27A Grade 5; 2 1/4 x 2 1/2 x 2 1/4", 10 ounce.

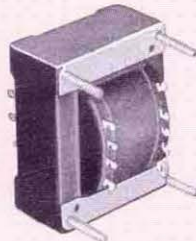

Molded power transformer. Primary 115/230 V., 50/420 cycles to 680 VCT.-.015 A., 6.3 VCT.-1.2 A., 6.3 V.-.6A. Commercial use; 2 1/2 x 3 x 2 7/8", 1.6 lbs.

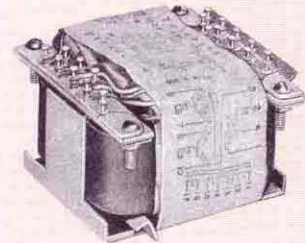

230° C. power transformer. Primary 115 V., 3 phase, 300/420 cycles to 200 V. and 20 V. secondaries, 525 V.A. 230° C. operating; 2 3/4 x 3 x 2", 1.8 lbs.



Low capacity current limiting filament transformer. Primary 118 V. 60 cycles to 6.3 V. at 3 A., 8 A. at short circuit. 25 MMFD capacity, 30 KV hipot and 200:1 capacity divider; 5 x 3 3/4 x 4 1/2", 9 lbs.

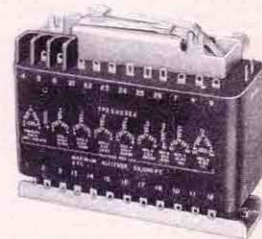

Molded Power Transformer 3 Phase. Input 200V, 380-420 cps. Electrostatic Shield, 8 output windings. 26 terminals. MIL-T-27A, Grade 2 Class S. Max. Alt. 50K Ft. Size 6 x 2 1/2 x 5", 8 lbs.

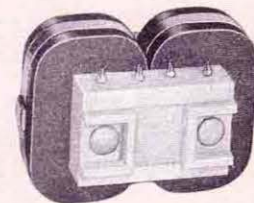

Molded High Temperature, High Voltage Transformer. Input 115 V 400 cycles, output 3400 V, 80 ma DC. Corona free molded terminals. MIL-T-27A Grade 5, Class T (170°C), 3 7/8 x 2 7/8 x 2 5/8", 2 lbs. 10 oz.



## HERMETIC POWER COMPONENTS

### IDEAL MILITARY UNITS

A tremendous advantage exists in using the standardized UTC hermetic power components for military equipment. These units have been fully tested to MIL-T-27A. This means that they can be used in prototypes without special test costs or delays. Similarly, they can be used in production without costs or delays for special MIL-T-27A testing. Minor deviations (elimination of terminals) do not effect the original test validity.

UTC hermetic power components are of rugged design with high safety factors in all characteristics. They exceed MIL-T-27A in many respects, taking into consideration the most severe conditions which may be encountered in service. In addition, however, an increasing number of industrial equipment manufacturers are becoming concerned with the reliability of components in their equipment, frequently turning to hermetically sealed components. The necessity for reliability in industrial service is clear when the cost of an hour's shutdown of a broadcast schedule or industrial control system is visualized. The series of hermetic transformers and inductors described on the following pages employ new concepts to provide units for a wide range of both military and industrial applications.

#### General Characteristics

UTC hermetic power components are rugged designs with high safety factor in all characteristics. Except for a few large sizes, all units are in standard drawn MIL cases with internal structure directly welded to the mounting studs. All units fully meet MIL-T-27A Specifications, and are suited for airborne ground communications, and marine service and missile service of every type. Their long life and reliability in structure also suit these units ideally to industrial equipment requiring high reliability.

### HIGHEST INDUSTRIAL AND MILITARY RELIABILITY

UTC hermetic power components have found wide acceptance for industrial electronics equipment where the highest reliability is important. The insulation operating temperature in a transformer considerably controls its life and reliability. This operating temperature is the sum of the transformer's temperature rise and the ambient temperature.

For Military application ambient is based on 65°C, for Class R units, because of the adverse conditions frequently encountered in Military service. This allows a 40°C rise for the maximum final temperature of 105°C

prescribed for Class R unit in MIL-T-27A.

The power transformers and inductors listed on page 20 thru 25 are available, on request, and may be shipped optionally, built to Class S specifications. These units are allowed a maximum final temperature of 130°C. *MIL-T-27A allows the use of a higher temperature class unit for a lower temperature application.* Therefore, a Class S unit may be used directly, without change, in a Class R application.

While Class S units should be used in applications in the vicinity of 130°C, they are equally as reliable if used in the vicinity of Class R temperatures, as units built to Class R specifications.

Industrial applications normally encounter ambients which are appreciably lower. As a result, the temperature rise in industrial applications can be approximately 15°C. higher (40°C. to 55°C. rise), still providing the same overall life and exceptional reliability. This results in the ability to operate the same components at somewhat greater ratings.

The listings of our "H" series power transformers, filament transformers, plate transformers, and filter inductors are given for both MIL-T-27A and industrial service, the latter in bold type.

These units exceed MIL-T-27A requirements in many respects. The insulations employed have exceptional safety factors. The use of special core materials provides high efficiency and small size. The transformer regulation has been a fundamental design consideration in all units to provide for diverse applications in which they may be employed.

#### Dual Voltage Ratings

UTC hermetic plate and power transformers incorporate a tapped high voltage winding to provide either of two secondary voltages for greatest versatility. For full understanding of the capabilities of these components, the DC voltage and permissible currents have been listed for both inductor and condenser input at both output voltages as well as for military and industrial service.

#### Multiple Rating Filter Inductors

Filter inductors have in the past been rated for one specific current value. To more fully meet today's electronic needs, the "H" series of filter inductors are designed and rated with inductance shown for four different current values. The industrial ratings are shown in bold type. In performance testing at our plant these units are 100% tested to exceed the inductance value specified at the maximum military current rating shown.

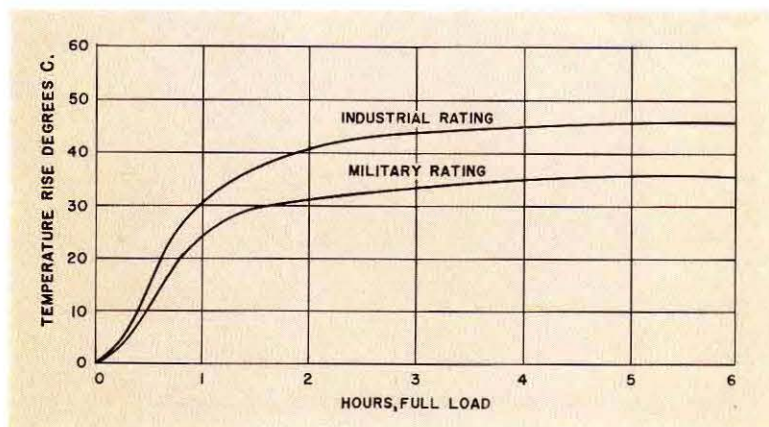





**FILTER INDUCTORS**  
HERMETICALLY SEALED

Manufactured & Guaranteed to MIL-T-27A by Full Environmental Testing, see back cover

**TRANSISTOR and TUBE TYPES**

The multiple ratings of the "H" series of filter inductors suits these units for the complete gamut of military and industrial applications. Transistor supply units have two windings to further add to their flexibility. These units are also made as swinging type to enhance the regulation of the power supply.

The use of grain-oriented core materials, to obtain the highest permeabilities, has produced inductors of exceptionally high inductance for a given size. MIL cases and cut-out dimensions on page 29. H-79 has terminals opposite mounting.

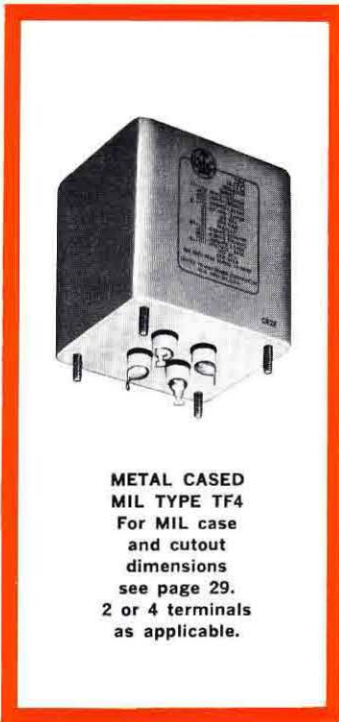

METAL CASED MIL TYPE TF4 For MIL case and cutout dimensions see page 29. 2 or 4 terminals as applicable.

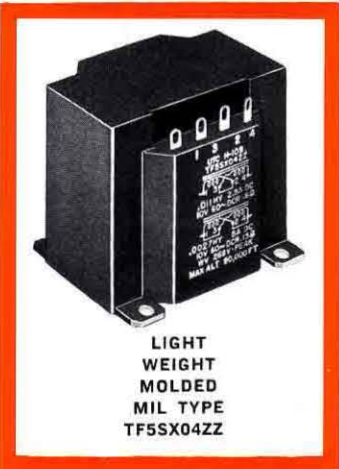

LIGHT WEIGHT MOLDED MIL TYPE TF5SX04ZZ

MIL-T-27A RATINGS IN REGULAR TYPE, INDUSTRIAL RATINGS IN BOLD TYPE

Type No.	MIL Type	Ind. @ Hys.	MA DC	Ind. @ Hys.	MA DC	Ind. @ Hys.	MA DC	Ind. @ Hys.	MA DC	Res. Ohms	Max. DCV Ch. Input	Test V. RMS	MIL Case Pg. 29
H-70	TF4RX04AH	20	20	18	25	14.5	30	10	35	925	350	1000	AH
H-71	TF4RX04FB	20	40	18.5	50	15.5	60	10	70	350	500	2500	FB
H-72	TF4RX04GB	13	70	11.5	85	9.5	105	7	125	215	500	2500	GB
H-73	TF4RX04HB	11	100	9.5	125	7.5	150	5.5	175	150	700	2500	HB
H-74	TF4RX04JB	11	150	10	170	8.5	195	<b>6.5</b>	<b>215</b>	135	700	2500	JB
H-75	TF4RX04KB	11	200	10	230	8.5	250	<b>6.5</b>	<b>300</b>	90	700	2500	KB
H-76	TF4RX04LB	11	200	10	230	8.5	250	<b>6.5</b>	<b>300</b>	85	1500	4500	LB
H-77	TF4RX04MB	10	300	9	350	<b>8</b>	<b>390</b>	<b>6.5</b>	<b>435</b>	60	2000	5500	MB
H-78	TF4RX04OA	7	400	<b>6.5</b>	<b>430</b>	<b>6</b>	<b>465</b>	<b>5.5</b>	<b>500</b>	48	2500	7000	OA
H-79	TF4RX04YY	7	800	6.5	900	6	1000	<b>5.5</b>	<b>1250</b>	20	3000	9000	7x7x8
New H-164	TF4SX04AG† (2 wdgs.) *	52‡ 13‡	35 70	40‡ 10‡	75 150	18‡ 4.5‡	350 700	9‡ 2.25‡	750 1.5A	1.0 .25		500	AG
New H-166	TF4SX04AH† (2 wdgs.) *	125‡ 31‡	50 100	80‡ 20‡	100 200	20‡ 5‡	500 1A	12‡ 3‡	1A 2A	1.2 .3		500	AH
New H-168	TF4SX04AJ† (2 WDG) *	68‡ 17‡	100 200	52‡ 13‡	200 400	20‡ 5‡	1A 2A	14‡ 3.5‡	2A 4A	.8 .2		750	AJ
H-170	TF4RX04GB† (2 wdgs.) *	.18 .045	125 250	.14 .035	250 500	25‡ 6.5‡	1.25A 2.5A	11‡ 3‡	2.5A 5.0A	.6 .15		1000	GB
H-171	TF4RX04JA† (2 wdgs.) *	9‡ 2.25‡	.75A 1.5A	5‡ 1.25‡	1.5A 3A	2.2‡ .55‡	7.5A 15A	1.6‡ .4‡	15A 30A	.03 .0075		1000	JA
New H-172	TF4RX04HA† (2 wdgs.) *	70‡ 17.5‡	.25A .5A	65‡ 16‡	.4A .8A	20‡ 5‡	2A 4A	9‡ 2.25‡	4A 8A	.22 .055		1000	HA
New H-173	TF4RX04KA† (2 wdgs.) *	90‡ 22.5‡	.5A 1A	80‡ 20‡	.8A 1.6A	18‡ 4.5‡	4A 8A	9‡ 2.25‡	8A 16A	.15 .038		1000	KA

Type No.	Inductance Henries @ DC MA	DCR, Ohms	Test Volts	L	W	H	Wgt. Lbs.
H-105	2.5 @ 25 ma, 2 @ 35 ma, 1.5 @ 45 ma	225	1000	1 1/4	1 1/16	1 1/16	.1
H-106	2.25 @ 60 ma, 1.75 @ 80 ma, 1.25 @ 100 ma	110	1000	1 3/8	1 1/16	1 3/8	.28
H-107	2 @ 120 ma, 1.5 @ 160 ma, 1 @ 200 ma	55	2500	2 3/8	1 3/4	1 5/16	.9
H-108	2 @ 220 ma, 1.5 @ 270 ma, 1 @ 325 ma	35	2500	2 7/8	2 1/2	2 1/32	1.7
H-109†	.2 @ 150 ma, .025 @ 1.25A, .011 @ 2.5A	.6	750	2 7/8	2 1/2	2 1/32	1.7
(2 wdgs.) *	.055 @ 250 ma, .00625 @ 2.5A, .0027 @ 5A	.15					
New H-300	1 @ 5MA, 2 @ 50MA, .16 @ 100MA	40	500	1	3/4	2 3/32	.05
(2 wdgs.) *	1.25 @ 10MA, .05 @ 100MA .04 @ 200MA	10					

† Split winding in series  
\* Split winding in parallel  
‡ Rated in millihenries

**MOUNTING DIMENSIONS**

Type No.	Mtg. Dim. and Studs
H-105	3/16 x 1/4 x two #4-40 Tap Diag.
H-106	1 3/16 x 1 3/16 1/4 Dia 4 holes
H-107	1 3/4 x 1 1/2 3/16 Dia 4 holes
H-108	2 3/16 x 2 1/16 3/32 x 3/32 slot 4 Req'd.
H-109	2 3/16 x 2 1/16 3/32 x 3/32 slot 4 Req'd.
H-300	(See SO-#P pg. 15)

**AND SPECIAL CUSTOM BUILT FILTER INDUCTORS TO YOUR SPECIFICATIONS**

Above stock units cover general purpose applications. For specific applications cost reductions may be effected.



# POWER AND PLATE TRANSFORMERS

Power transformers:  
primary 115V, 60 cycles suited  
to 50\*-1000 cycles service.

Plate transformers:  
primary 105/115/210/220  
volts, 50/60 cycles.

"L" ratings are choke input  
"C" ratings are condenser input

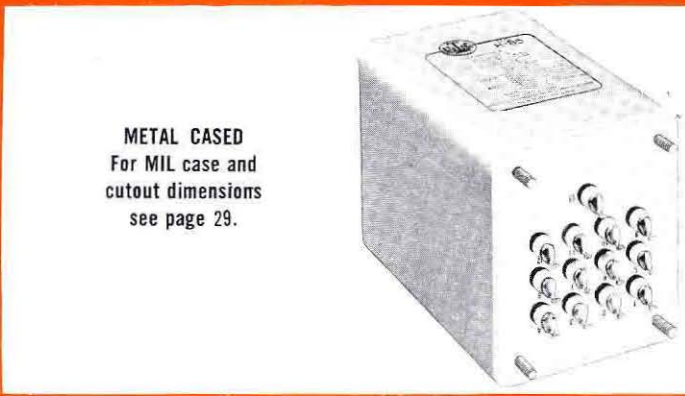

**METAL CASED**  
For MIL case and  
cutout dimensions  
see page 29.

## COMBINATION PLATE-FILAMENT TRANSFORMERS

MIL-T-27A RATINGS IN REGULAR TYPE, INDUSTRIAL RATINGS IN BOLD TYPE

Type No.	MIL Type	HV Sec. C T	Approx. DC Volts	MA DC	Fil. Wdg.	Approx. DC Volts	MA DC	Fil. Wdg.	MIL Case (See Pg. 29)
H-80	TF4RX03FA	450	C 240	30	6.3VCT-2A	C 215	38	6.3VCT-2.5A	FA
H-81	TF4RX03HA	500	L 170 C 270	95 55	6.3VCT-3A 5V-2A	L 160 C 245	110 75	6.3VCT-3A 5V-2A	HA
		550	L 200 C 310	85 50		L 180 C 280	105 65		
H-82	TF4RX03JB	550	L 180 C 290	145 90	6.3VCT-4A 5V-2A	L 160 C 270	190 115	6.3VCT-4.5A 5V-2A	JB
		600	L 215 C 330	135 85		L 190 C 315	180 100		
H-83	TF4RX03JA	600	L 215 C 315	165 100	6.3V-5A 5V-2A	L 200 C 320	210 120	6.3V-6A 5V-2A	JA
		670	L 250 C 400	150 90		L 230 C 380	200 110		
H-84	TF4RX03KA	700	L 245 C 390	225 135	6.3V-5A 6.3V-1A 5V-3A	L 240 C 375	255 160	6.3V-6A 6.3V-1.5A 5V-4A	KA
		750	L 275 C 430	205 125		L 270 C 410	230 150		
H-85	TF4RX03LA	700	L 245 C 390	300 190	6.3V-6A 6.3V-1.5A 5V-3A	L 230 C 355	370 230	6.3V-6A 6.3V-2A 5V-4A	LA
		750	L 270 C 425	280 170		L 250 C 395	350 210		
H-86	TF4RX03MB	720	L 270 C 425	310 180	6.3V-6A 6.3V-2A 5V-3A	L 250 C 395	360 225	6.3V-7.5A 6.3V-2A 5V-4A	MB
		790	L 295 C 475	300 160		L 280 C 440	350 210		
H-87	TF4RX03NB	730	L 245 C 390	420 275	6.3V-6A 6.3V-2A 5V-4A	L 230 C 390	515 300	6.3V-6A 6.3V-2A 5C-6A	NB
		800	L 275 C 440	400 250		L 275 C 430	480 290		
H-89	TF4RX03OA	850	L 305 C 460	430 280	6.3V-8A 6.3V-4A 5V-6A	L 275 C 445	550 340	6.3V-10A 6.3V-5A 5V-6A	OA
		1050	L 400 C 600	400 260		L 370 C 575	500 320		
H-91	TF4RX03KA	900	L 340 L 390	200 190	6.3V-5A 6.3V-1A 5V-3A	L 330 L 385	220 195	6.3V-6A 6.3V-1.5A 5V-4A	KA
		1000							
H-92	TF4RX03MB	900	L 340 L 400	265 240	6.3V-6A 6.3V-2A 5V-4A	L 330 L 395	310 290	6.3V-8A 6.3V-2A 5V-4A	MB
		1050							

Continued on facing page.

**HERMETICALLY SEALED**

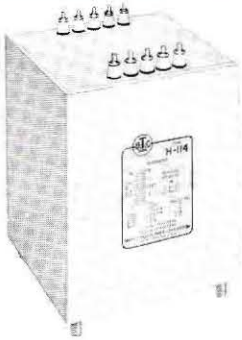

H-114, H-115, H-117 have terminals opposite mounting.

The "H" series of hermetic power and plate transformers are suited to a wide variety of electronic applications in both military and industrial service. Conservative design provides maximum reliability through low temperature use and high insulation factors. All units are in MIL cases with rugged internal construction. The use of grain-oriented core materials, combined with the latest winding techniques, has produced units of exceptional efficiency and reliability. Quality of workmanship and material, coupled with a high degree of quality control, yield units that are truly standards in the industry.

The tapped high voltage winding provides either of two secondary voltages for greatest versatility. The power transformer listings indicate DC voltages and permissible currents for both inductor and condenser input filters, as well as for military and industrial applications (see page 22).

Units with a W suffix have been designed to be used both in full wave center tap and full wave bridge application. In these units, center-tap of secondary winding may be disconnected from ground. All ratings are for inductor input filtering. Other electrical and mechanical parameters on "W" units are the same as the non-suffixed units.

CONTINUED FROM FACING PAGE

**COMBINATION PLATE-FILAMENT TRANSFORMERS**

MIL-T-27A RATINGS IN REGULAR TYPE, INDUSTRIAL RATINGS IN BOLD TYPE

Type No.	MIL Type	HV Sec. C T	Approx. DC	Approx. Volts	MA DC	Fil. Wdg.	Approx. DC	Approx. Volts	MA DC	Fil. Wdg.	MIL Case (See Pg. 29)
H-93	TF4RX03OA	1000 1200	L L	370 465	300 265	6.3V-8A 6.3V-4A 5V-6A	L L	340 455	390 350	6.3V-10A 6.3V-5A 5V-6A	OA
H-194**	TF4RX03HA	200 235	L C L C	170 275 200 325	140 85 125 75	6.3V-3.5A	L C L C	160 260 190 310	155 95 135 85	6.3V-4A	HA
H-195**	TF4RX03JA	215 265	L C L C	185 300 230 375	285 180 240 150	6.3V-5A	L C L C	175 285 220 360	300 195 255 165	6.3V-6A	JA
H-196**	TF4RX03KA	230 285	L C L C	200 320 250 400	445 280 380 235	6.3V-5A 6.3V-1.5A	L C L C	190 300 240 380	480 300 420 260	6.3V-6A 6.3V-2A	KA
H-197**	TF4RX03MB	260 320	L C L C	230 360 280 450	500 320 420 260	6.3V-6A 6.3V-2A	L C L C	220 340 270 430	550 350 470 290	6.3V-7A 6.3V-2A	MB
H-198 Highly shielded Scope transformer	TF4RX03HA	No CT 800 1600 2400		1000 2000 3000	5 5 5	1.25V—.2A connected to one end of HV winding. 6.3 V-.6A 5.2 KV RMS test voltage					HA
<b>PLATE TRANSFORMERS</b>											
<b>New</b>	H-110 W	TF4RX02MB	L L L L	1050	365	300		L	400		MB
				1200	430	275		L	385		
					730	210		L	280		
					860	190		L	265		
<b>New</b>	H-111 W	TF4RX02NA	L L L L	1050	415	500		L	600		NA
				1200	480	450		L	550		
					830	350		L	420		
					960	310		L	380		
<b>New</b>	H-112 W	TF4RX02NA	L L L L	1500	615	320		L	385		NA
				1900	790	275		L	330		
					1230	220		L	270		
					1580	190		L	230		
H-113	TF4RX02YY	2500 3000	L L	1050	310		L	375		Pg. 29	
				1275	275		L	330			
H-114	TF4RX02YY	2500 3000	L L	1050	475		L	525		Pg. 29	
				1265	425		L	475			
H-115	TF4RX02YY	3500 4400	L L	1500	275		L	375		Pg. 29	
				1900	235		L	320			
H-117	TF4RX02YY	5000 6000	L L	2125	950		L	1150		Pg. 29	
				2550	850		L	1050			

\*For 50 cycles, secondary current ratings reduced by 10%. \*\*DC ratings for bridge rectifier circuits.

**TRANSFORMERS TO YOUR SPECIFICATIONS**

For specific applications cost reductions may be effected.



# TRANSISTOR/FILAMENT SUPPLY TRANSFORMERS

HERMETICALLY SEALED

Manufactured & Guaranteed to MIL-T-27A by Full Environmental Testing, see back cover

These units are designed for a wide variety of Transistor/Filament circuit applications. The 50/60 cycle units can also be used for 400 cycle application, with no derating. Conservative design, of these components, has yielded unusually high reliability. Rugged mechanical construction for both the hermetic and molded units assures this high reliability under the most severe environmental conditions.

## 60 CYCLE TYPES

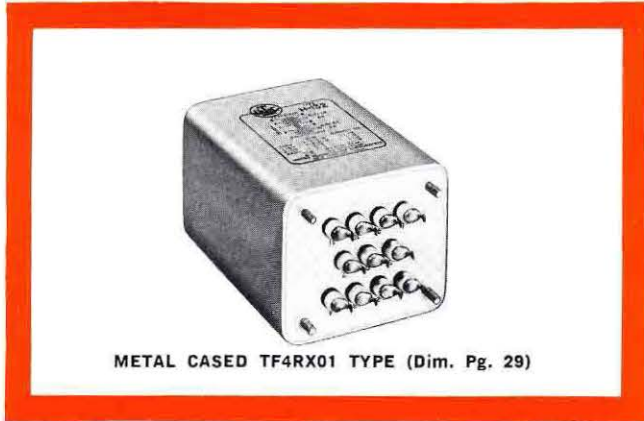

METAL CASED TF4RX01 TYPE (Dim. Pg. 29)

Primary: 105/115/210/220 volts, 50/60 cycles, except H-119, H-130, H-137, H-138, (115V.) and H-131 (115/220V.) All units designed for 50/60 cycles also suited for 400/1000 cycles service.

MIL-T-27A RATINGS IN REGULAR TYPE,  
INDUSTRIAL RATINGS IN BOLD TYPE.

Type No.	MIL Type	Sec. Volts	Amps (MIL)	Amps. (Indust.)	Sec. Test Volts RMS	MIL Case (See Pg. 29)
H-120	TF4RX01GB	2.5	10	12	4000	GB
H-121	TF4RX01JB	2.5	10	12	10000	JB
H-122	TF4RX01KB	2.5	20	26	10000	KB
H-123	TF4RX01NB	2.5	5	7.5	10000	NB
		2.5	5	7.5		
		2.5	10	15		
H-124	TF4RX01FB	5	3	3.8	2000	FB
H-125	TF4RX01KB	5	10	12	10000	KB
H-126	TF4RX01LA	5	20	25	10000	LA
H-127	TF4RX01NA Term. Opp. Mtg.	5	20	30	21000	NA
H-128	TF4RX01YY Term. Opp. Mtg.	5	60	75	21000	Pg. 29
H-129	TF4RX01YY Term. Opp. Mtg.	5	10	12	21000	Pg. 29
		5	10	12		
		5	20	24		
New H-119	TF4RX01AH	6.3CT	.3	.38	1500	AH
H-130	TF4RX01AJ	6.3CT	.6	.75	1500	AJ
H-131	TF4RX01FB	6.3CT	2	2.5	2500	FB
H-132	TF4RX01JA	6.3CT	6	7	2500	JA
		6.3CT	6	7		
H-133	TF4RX01HB	6.3CT	7	8	2500	HB
H-134	TF4RX01HA	6.3CT	10	12	2500	HA
H-135	TF4RX01JB	10 CT	10	13	2500	JB
H-136	TF4RX01LA	14, 12,	10	14	2500	LA
		11 CT				
H-137	TF4RX01EB	6.3	.6	.75	1500	EB
		6.3	.6	.75		
H-138	TF4RX01GA	12.6	2	2.5	1500	GA
		12.6	2	2.5		

## 400 CYCLE TYPES

NEW

DO-T500  
MIL TYPE TF4RX03YY  
(See Page 6 & 7)

Pri.	28V. 380-1000 Cycles
Sec.	6.3V. @ 60 ma



DO-T500  
ACTUAL SIZE

5/16 Dia. x 13/32"  
Wt. 1/10 oz.  
(See Pg. 6 & 7)

METAL CASED  
MIL TYPE  
TF4RX01  
(See Pg. 29)

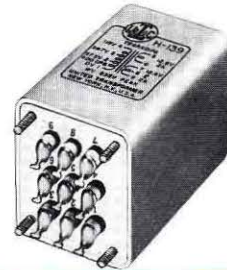

Type No.	MIL Type	Sec. Volts	(Amps. (MIL))	Amps. (Indust.)	Sec. Test Volts RMS	MIL Case
H-139*	TF4RX01FA Pri. 400 Cyc. 57.5, 99.7, 115V	12.6CT	2	2.5	1500	FA (Pg. 29)
		12.6	2	2.5		
H-140	TF4RX01YY Pri. 115V, 400 Cyc.	6.3	.6	.75	500	RC-25 (Pg. 12)

\*Two H-139's Scott connected provide 26 volt two phase from 115V. three phase 400 cycle input.

MOLDED TYPES  
MIL TF5SX01ZZ TYPES  
PRIMARY 105/115 VOLTS 380-1000 CYCLES

SEC: 6.3 VCT 2500V RMS TEST

Type No.	Sec. Amp.	L In.	W In.	H In.	Wt. Lbs.
H-101	3.5	1 <sup>25</sup> / <sub>32</sub>	1 <sup>1</sup> / <sub>32</sub>	2	.3
H-102	5.5	1 <sup>3</sup> / <sub>4</sub>	2	2 <sup>1</sup> / <sub>4</sub>	.44
H-103	10	2 <sup>5</sup> / <sub>16</sub>	2 <sup>1</sup> / <sub>8</sub>	2 <sup>1</sup> / <sub>2</sub>	.8
H-104	25	2 <sup>7</sup> / <sub>8</sub>	2 <sup>1</sup> / <sub>2</sub>	3 <sup>1</sup> / <sub>32</sub>	1.5

New H-118\* .3 SO-#P mold  
(See Pg. 15)

H-101 thru H-104 see pg. 29 for mounting dimensions

\*500V. RMS test.



MOLDED TYPES

## AND SPECIAL CUSTOM BUILT TRANSISTOR/FILAMENT SUPPLY TRANSFORMERS TO YOUR SPECIFICATIONS

Above stock units cover general purpose applications. For specific applications cost reductions may be effected.



## TRANSISTOR INVERTER AND CONVERTER TRANSFORMERS

HERMETICALLY SEALED

Manufactured & Guaranteed to MIL-T-27A by Full Environmental Testing, see back cover Type TF4SX40.

UTC inverter transformers are designed for high reliability and high efficiency in small size. The use of layer insulation gives reliabilities that are in sharp contrast to the random wound coil so often encountered in this field. Advanced coupling technique, between windings, has reduced the spikes that often endanger the driving transistors. A frequency of

approximately 1000 cycles was chosen for this inverter transformer for optimum results. Input voltages of 12/14 or 24/28 Volt can be used. With 6/7 V. input instead of 12/14 V., output voltage is halved, current rating remains the same. Dimensions on page 29. A converter application for standard UTC DO-T units is also shown.

FOR 12/14 OR  
24/28 VOLT BATTERY

Type No.	DC output, when used in circuit shown	MIL Case (see pg. 29)
H-97	250V.-60MA	AH
H-98	375V.-100MA	AJ
H-99	425V.-175MA	FA
H-100	550V.-200MA	GB

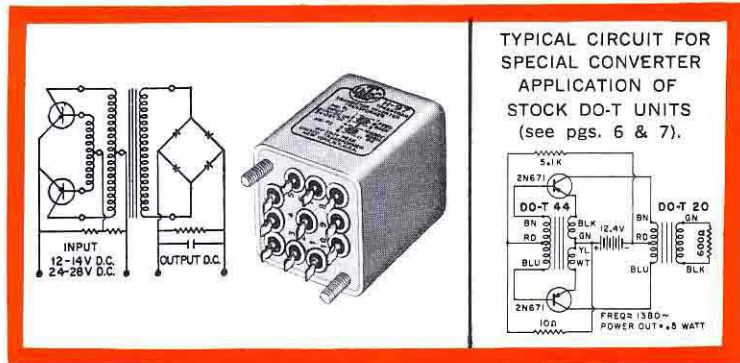

## ULTRASHIELDED POWER-LINE ISOLATION TRANSFORMERS

HERMETICALLY SEALED

Manufactured & Guaranteed to MIL-T-27A by Full Environmental Testing, see back cover Type TF4RX01YY

SIMULATES BATTERY OPERATION FOR CRITICAL CIRCUITS  
REQUIRING EXTREME ISOLATION FROM POWER LINE.

UTC hermetically sealed shielded isolation transformers are designed to give the ultimate in isolation for line-powered equipment. Isolation, which formerly could only be obtained from battery power, can now be realized by the use of these transformers. The effective capacity coupling between primary and secondary windings is less than 0.1 MMFD. (Even this minute capacitance can be substantially reduced by optimum circuit design suited to the individual application.) For this purpose shields are individually terminated to allow maximum flexibility. Input and output terminals are brought out on opposite sides of a special housing in order to maintain the excellent isolation between line and load.

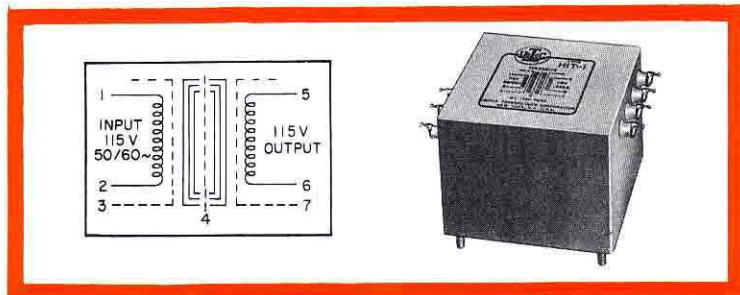

MIL-T-27A RATINGS IN REGULAR TYPE  
INDUSTRIAL RATINGS IN BOLD TYPE

PRIMARY 115 V 50/60 CYCLES  
SECONDARY 115 V

Type No.	Power Watt	Power Watts	Max. Case Size	Mounting Dim. and Studs
HIT-1	50	<b>60</b>	4 $\frac{1}{32}$ x 4 $\frac{1}{32}$ x 3 $\frac{1}{32}$ high	3 $\frac{3}{8}$ x 3 $\frac{3}{8}$ 10-32 x $\frac{1}{2}$ long
<b>New</b> HIT-15	120	<b>150</b>	5 $\frac{1}{32}$ x 5 x 3 $\frac{1}{2}$ high	4 $\frac{5}{8}$ x 4 $\frac{5}{8}$ 10-32 x $\frac{1}{2}$ long
HIT-2	160	<b>200</b>	5 $\frac{1}{32}$ x 5 $\frac{1}{32}$ x 4 $\frac{1}{32}$ high	4 $\frac{3}{16}$ x 4 $\frac{3}{16}$ 10-32 x $\frac{1}{2}$ long
HIT-3	400	<b>480</b>	8 x 6 $\frac{1}{32}$ x 5 $\frac{1}{32}$ high	7 $\frac{1}{16}$ x 5 $\frac{3}{8}$ 5 $\frac{1}{16}$ -18 x $\frac{1}{16}$ long

### AND SPECIAL CUSTOM BUILT INVERTER, CONVERTER AND ULTRASHIELDED TRANSFORMERS TO YOUR SPECIFICATIONS

Above stock units cover general purpose applications. For specific applications cost reductions may be effected.



# UNIVERSAL TRANSISTOR SUPPLY TRANSFORMERS

HERMETICALLY SEALED

Manufactured & Guaranteed to MIL-T-27A by Full Environmental Testing, see back cover

LOW VOLTAGE DC SUPPLY . . . TELEPHONE SUPPLY . . .  
BIAS SUPPLY . . . BATTERY CHARGERS . . . PLATING RECTIFIERS

UTC universal transistor supply transformers are high reliability units in drawn MIL cases. The chart below shows the secondary voltages available and the approximate DC voltages which result in typical silicon rectifier circuits (at MIL currents shown). Primary taps can modify nom. AC voltages by -6%, +6%, and +12%. Since the capacitor follows the rectifier effects the DC voltage, values used (in 1000 mfd) are shown, in parenthesis ( ), after each current rating. Case dimensions on page 29.



PRIMARY 115 VOLTS, 50/60 CYCLES  
NOMINAL SEC. VOLTS, 8.25 TO 40.5

TYPE NO.	MIL DC RANGE	INDUST. DC RANGE	MIL CASE (Pg. 29)
<b>New H-915</b>	6V-.065A to 53V-.02A	<b>6V-.085A to 53V-.025A</b>	AH
<b>New H-925</b>	6V.22A to 53V-.07A	<b>6V-.28A to 53V-.085A</b>	AJ
<b>New H-935</b>	6V-1.2A to 53V-.4A	<b>6V-1.52A to 53V-.48A</b>	FA
H-94	6V-3A to 53V-1A	<b>6V-3.8A to 53V-1.2A</b>	HA
H-95	6V-7.5A to 53V-2.5A	<b>6V-9A to 53V-3A</b>	KA
H-96	6V-18A to 53V-6A	<b>6V-23A to 53V-7.5A</b>	OA

PRIMARY 115 VOLTS, 50/60 CYCLES  
NOMINAL SEC. VOLTS, 16.5 TO 81

<b>New H-965</b>	12V-1.5A to 106V-.5A	<b>12V-1.9A to 106V-.6A</b>	HA
------------------	----------------------	-----------------------------	----

MIL-T-27A RATINGS IN REGULAR TYPE, INDUSTRIAL RATINGS IN BOLD TYPE

Nom. AC Volts*	FULL WAVE BRIDGE SILICON RECTIFIER							FULL WAVE CT			
	40.5	32.25	28.5	24	20.25	16.5	12	8.25	40.5 CT	24 CT	16.5 CT
Appr. DC Volts*	53	41	34	25	24	18	12	6	24	12	6.6
H-915 DC Amp.	.02 (.1)	.023(.1)	.025(.1)	.027(.1)	.042(.2)	.035(.2)	.055(.2)	.065(.2)	.035(.2)	.040(.2)	.055(.2)
<b>H-915 DC Amp.</b>	<b>.025(.1)</b>	<b>.035(.1)</b>	<b>.040(.1)</b>	<b>.042(.1)</b>	<b>.055(.2)</b>	<b>.042(.2)</b>	<b>.070(.2)</b>	<b>.085(.2)</b>	<b>.042(.2)</b>	<b>.055(.2)</b>	<b>.068(.2)</b>
H-925 DC Amp.	.07 (.1)	.08 (.1)	.085(.1)	.09 (.1)	.14 (.2)	.11 (.2)	.18 (.2)	.22 (.2)	.11 (.2)	.13 (.2)	.17 (.2)
<b>H-925 DC Amp.</b>	<b>.085(.1)</b>	<b>.12 (.1)</b>	<b>.13 (.1)</b>	<b>.14 (.1)</b>	<b>.18 (.2)</b>	<b>.14 (.2)</b>	<b>.23 (.2)</b>	<b>.28 (.2)</b>	<b>.14 (.2)</b>	<b>.17 (.2)</b>	<b>.21 (.2)</b>
H-935 DC Amp.	.4 (.5)	.44 (.5)	.48 (.5)	.52 (.5)	.8 (1.0)	.6 (1.0)	1.0 (2.0)	1.2 (2.0)	.6 (1)	.72 (1)	.92 (2)
<b>H-935 DC Amp.</b>	<b>.48 (.5)</b>	<b>.6 (.5)</b>	<b>.6 (.5)</b>	<b>.64 (.5)</b>	<b>1.0 (1.0)</b>	<b>.8 (1.0)</b>	<b>1.2 (2.0)</b>	<b>1.52 (2)</b>	<b>.8 (1)</b>	<b>.88 (1)</b>	<b>1.12 (2)</b>
H-94 DC Amp.	1 (.5)	1.1 (.5)	1.2 (.5)	1.3 (.5)	2 (1)	1.5 (1)	2.5 (2)	3 (2)	1.5 (1)	1.8 (1)	2.3 (2)
<b>H-94 DC Amp.</b>	<b>1.2 (.5)</b>	<b>1.5 (.5)</b>	<b>1.5 (.5)</b>	<b>1.6 (.5)</b>	<b>2.5 (1)</b>	<b>2 (1)</b>	<b>3 (2)</b>	<b>3.8 (2)</b>	<b>2 (1)</b>	<b>2.2 (1)</b>	<b>2.8 (2)</b>
H-95 DC Amp.	2.5 (1)	3 (1)	3 (1)	3.5 (1)	5 (2)	3.7 (2)	6 (4)	7.5 (4)	3.7 (2)	4.5 (2)	5.5 (4)
<b>H-95 DC Amp.</b>	<b>3 (1)</b>	<b>3.5 (1)</b>	<b>3.8 (1)</b>	<b>4 (1)</b>	<b>6 (2)</b>	<b>4.5 (2)</b>	<b>7.5 (4)</b>	<b>9 (4)</b>	<b>4.5 (2)</b>	<b>5.5 (2)</b>	<b>6.7 (4)</b>
H-96 DC Amp.	6 (4)	7 (4)	7.5 (4)	8 (4)	12 (6)	9 (6)	15 (12)	18 (12)	9 (6)	11 (6)	13.5 (12)
<b>H-96 DC Amp.</b>	<b>7.5 (4)</b>	<b>8.5 (4)</b>	<b>9.5 (4)</b>	<b>10 (4)</b>	<b>15 (6)</b>	<b>11 (6)</b>	<b>19 (12)</b>	<b>23 (12)</b>	<b>11 (6)</b>	<b>13.5 (6)</b>	<b>17 (12)</b>
Nom. AC Volts*	81	64.5	57	48	40.5	33	24	16.5	81 CT	48 CT	33 CT
Appr. DC Volts*	106	82	68	50	48	36	24	12	48	24	13
H-965 DC Amp.	0.5 (.125)	0.55 (.125)	0.6 (.125)	0.65 (.125)	1.0 (.25)	0.75 (.25)	1.25 (.5)	1.5 (.5)	0.75 (.25)	0.9 (.25)	1.15 (.5)
<b>H-965 DC Amp.</b>	<b>0.6 (.125)</b>	<b>0.75 (.125)</b>	<b>0.75 (.125)</b>	<b>0.8 (.125)</b>	<b>1.25 (.25)</b>	<b>1.0 (.25)</b>	<b>1.5 (.5)</b>	<b>1.9 (.5)</b>	<b>1.0 (.25)</b>	<b>1.1 (.25)</b>	<b>1.4 (.5)</b>

\*Nom. AC and DC volts are at 115 volt input . . . primary taps can modify -6%, +6%, and +12%.



# TRANSISTOR SUPPLY TRANSFORMERS

HERMETICALLY SEALED

Manufactured & Guaranteed to MIL-T-27A  
by Full Environmental Testing, see back cover

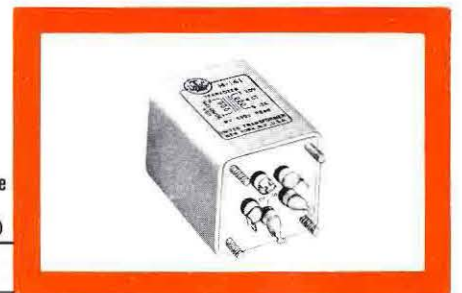

Type No.	MIL Type	Sec. V Rms	Sec. A Rms	Sec. in Parallel				Sec. in Series				Mil Case (see page 29)		
				Choke DCV	Input DCA	Cond. DCV	Input DCA	Choke DCV	Input DCA	Cond. DCV	Input DCA			
H-141	TF4RX02EB Full wave C.T.	20 CT	.3	16.5 8	.3 .43	26 12	.2 .3	.2 .5					EB	
H-142	TF4RX02EA Full wave C.T.	20 CT	.6	16.5 9	.6 .85	26 13	.4 .6	.4 1					EA	
H-143	TF4RX02HA	17/21.5 17/21.5	1.5 1.5	14/17.5	3	18.5/25	2	1	28/35	1.5	43/56	1	.5	HA
H-144	TF4RX02LA	17/21.5 17/21.5	4 4	14/17.5	8	18.5/25	5	2	28/35	4	43/56	2.5	1	LA
H-145	TF4RX02YY	17/21.5 17/21.5	9 9	14/17.5	18	18.5/25	12	6	28/35	9	43/56	6	4	RC-175 Pg. 46
H-146	TF4RX02YY	34/43 34/43	4.5 4.5	28/35	9	43/56	6	4	56/70	4.5	85/110	3	1	RC-175 Pg. 46
H-147	TF4RX02KA	10	20	8.2	20	10	13	12						KA

Primary 115V, 50/60 cycles (tapped on H-143 thru H-146 for dual secondary voltages). DC ratings are approximate, based on silicon bridge rectifier (except H-141, H-142 also shown F.W.C.T.). Choke input DCV is based on 10% voltage drop in choke. Condenser value, C, is in 1000 mfd. H-141, H-142, H-147 listing under "Sees in parallel" is single winding.

**AND SPECIAL CUSTOM BUILT  
TRANSISTOR SUPPLY TRANSFORMERS TO YOUR SPECIFICATIONS**

Above stock units cover general purpose applications. For specific applications cost reductions may be effected.



# HERMETIC POWER COMPONENT DIMENSIONS

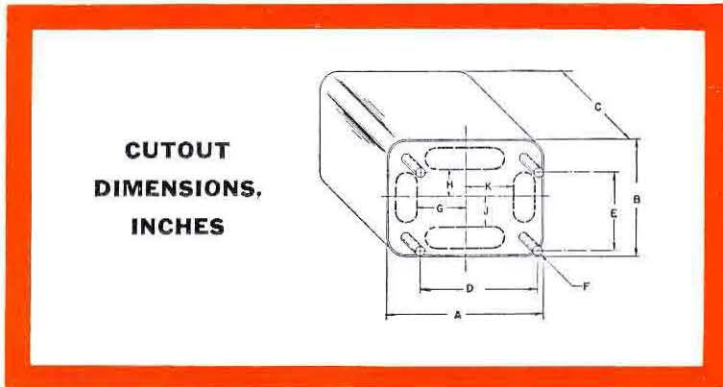

## MIL CASES, INCHES

Mil Case	A	B	C	D	E	Mtg. Studs	Wt. Lbs.
AF	3/4	3/4	1 1/8	Diagonal	3/8	4-40x3/8	.1
AG	1	1	1 3/8	Diagonal	3/4	4-40x3/8	.15
AH	1 1/8	1 1/8	1 3/4	Diagonal	1 1/4	6-32x3/8	3/8
AJ	1 1/8	1 1/8	2 3/8	1 1/8	1 1/8	6-32x3/8	3/4
EA	1 1/8	1 1/8	2 3/4	1 3/8	1 1/4	6-32x3/8	1
EB	1 1/8	1 1/8	2 1/8	1 3/8	1 1/4	6-32x3/8	7/8
FA	2 3/8	2 3/8	3 1/8	1 1/8	1 1/8	6-32x3/8	1 1/4
FB	2 3/8	2 3/8	2 1/2	1 1/8	1 1/8	6-32x3/8	1 1/2
GA	2 3/4	2 3/8	3 1/8	2 1/8	1 3/4	6-32x3/8	3 1/2
GB	2 3/4	2 3/8	2 1/8	2 1/8	1 3/4	6-32x3/8	2 1/2
HA	3 1/8	2 5/8	4 1/4	2 1/8	1 5/8	8-32x3/8	4 1/2
HB	3 1/8	2 5/8	3 3/8	2 1/8	1 5/8	8-32x3/8	3 1/2
JA	3 3/8	3 3/8	4 3/8	2 3/8	2 1/8	8-32x3/8	6
JB	3 3/8	3 3/8	3 3/8	2 3/8	2 1/8	8-32x3/8	5
KA	3 3/8	3 3/8	5 3/8	3	2 1/8	10-32x1/2	8 1/2
KB	3 3/8	3 3/8	4 3/8	3	2 1/8	10-32x1/2	7
LA	4 3/8	3 11/8	5 3/8	3 3/8	2 11/8	10-32x1/2	11
LB	4 3/8	3 11/8	4 1/2	3 3/8	2 11/8	10-32x1/2	10
MA	4 11/8	4	6	3 11/8	3	1/4-20x3/8	15
MB	4 11/8	4	4 11/8	3 11/8	3	1/4-20x3/8	14
NA	5 1/8	4 3/8	6 1/8	4 3/8	3 3/8	1/4-20x3/8	18
NB	5 1/8	4 3/8	5 1/2	4 3/8	3 3/8	1/4-20x3/8	15
OA	5 1/2	4 1/2	6 3/4	3 3/4	3	1/4-20x3/8	21

## UTC CASES, INCHES

Type No.	A	B	C	D	E	Mtg. Studs	Wt. Lbs.
H-79	7	7	8	5 3/8	5 3/8	3/8-16(6)	60
H-113	6	5 3/8	6 3/4	5	4 3/8	1/4-20	27
H-114	6 3/4	6 1/2	8	5 3/8	5 3/8	3/8-16	50
H-115	6 3/4	6 1/2	8	5 3/8	5 3/8	3/8-16	50
H-117	11	11	14 3/4	8 3/8	8 3/8	3/8-11	160
H-128	6 1/2	5 1/2	7 3/4	5 3/8	4 3/8	3/8-16	34
H-129	6 1/2	5 1/2	7 3/4	5 3/8	4 3/8	3/8-16	28
Z-857	5 11/8	4 11/8	7 1/2	4 3/8	3 3/8	1/4-20 x 3/8	35

## MOLDED UNITS, INCHES

Type No.	L	W	H	Mtg. Dim. and Studs	Wt. Lbs.
H-101	1 3/32	1 1/32	2	1 1/8 x 1 1/32 .157 Dia 4 holes	.3
H-102	1 3/4	2	2 1/4	1 1/8 x 1 1/32 .157 Dia 4 holes	.44
H-103	2 3/8	2 3/8	2 3/8	1 1/8 x 1 1/32 .157 Dia 4 holes	.8
H-104	2 3/8	2 1/2	3 3/32	2 3/8 x 1 1/32 .157 Dia 4 holes	1.5

UTC No.	Case (Dim. left)	Cutout Location	Cutout Dim.	Cutout Location	Cutout Dim.
H-70	AH	H=3/8	3/8x3/8		
H-71	FB	H=1/32	1/4x1/4		
H-72	OB	H=1/32	1/2x3/8		
H-73	HB	H=3/8	3/8x1 1/8		
H-74	JB	H=3/4	3/8x1 1/8		
H-75	KB	G=1 3/8	3/8x1 3/8		
H-76	LB	G=1 1/2	1 1/8x1 3/8		
H-77	MB	G=1 1/2	1 1/8x1 1/4		
H-78	OA	H=1	1x2		
H-80	FA	Centered	1 1/2 Dia		
H-81	HA	Centered	2 1/2 Dia		
H-82	JB	Centered	2 1/4 Dia		
H-83	JA	Centered	2 3/8 Dia		
*H-84	KA	Centered	2 3/8 Sq		
*H-85	LA	Centered	2 3/8 Sq		
H-86	MB	G=2 3/8	1 1/4x2 3/8	K=2 3/8	1 1/4x2 3/8
H-87	NB	Centered	2 3/8 Dia		
H-89	OA	H=3/8	1 1/4x2 1/2	J=3/8	1 1/4x2 1/2
*H-91	KA	Centered	2 3/8 Sq		
H-92	MB	G=2 3/8	1 1/4x2 3/8	K=2 3/8	1 1/4x2 3/8
H-93	OA	H=3/8	1 1/4x2 1/2	J=3/8	1 1/4x2 1/2
*H-94	HA	Centered	1 3/8x2		
H-95	KA	H=3/4	3/4x2 1/8	*J=3/8	1 1/8x2 1/4
H-96	OA	H=3/8	3/8x2 3/8	J=5/8	1 1/2x3 1/4
H-97	AH				
*H-98	AJ	Centered	1 1/8x1 1/8		
*H-99	FA	Centered	1 3/8 Sq		
H-100	GB	Centered	1 3/8 Sq		
H-110	MB	G=1 3/8	1 3/8x2 3/8	K=1 3/8	1 3/8x2 3/8
H-111	NA	H=1 3/8	7/8x3 1/4	J=1 3/8	5/8x3
H-112	NA	H=1 3/8	7/8x3 1/4	J=1 3/8	5/8x3
H-113		G=1 1/8	3/4x2 3/8	K=1 1/8	1 3/8x3 1/2
H-119	AH	Centered	1 Dia		
H-120	GB	H=3/8	3/4x1 1/8	J=3/8	5/8x1 1/8
H-121	JB	H=3/8	3/8x2	K=3/8	1 3/8x2 1/8
H-122	KB	G=1	5/8x2	K=3/8	1 3/8x2 1/8
*H-123	NB	Centered	3 1/4x4 3/8		
H-124	FB	H=3/8	3/8x1 1/4	J=3/8	1/2x1 1/8
H-125	KB	G=1	5/8x2	K=3/8	1 3/8x2 1/8
H-126	LA	H=3/8	1 3/8x2 3/8	J=3/8	1 3/8x2 3/8
H-130	AJ	Centered	1 1/4 Dia		
H-131	FB	H=3/8	3/8x1 1/4	J=3/8	5/8x1 1/4
*H-132	JA	Centered	2 3/8x2 1/8		
H-133	HB	H=5/8	5/8x1 3/8	J=5/8	5/8x2
H-134	HA	H=3/8	3/4x1 3/8	J=3/8	5/8x2
H-135	JB	G=1 1/8	3/4x1 3/8	K=1 1/8	3/4x1 3/8
H-136	LA	Centered	2 3/8 Dia		
H-137	EB		1 3/8 Dia		
H-138	GA		1 3/8 Dia		
H-139	FA	Centered	1 3/8*x1 1/8*		
H-141	EB		1 1/4 Dia		
H-142	EA		1 1/4 Dia		
H-143	HA		1 3/4 Dia		
H-144	LA		2 1/2 Dia		
H-145	RC-175 (see pg. 46)		2 1/2 Dia		
H-146	RC-175 (see pg. 46)		2 1/2 Dia		
H-164	AG	Diagonal	3/2x1 1/8*		
H-166	AH	Centered	7/8 Dia		
H-168	AJ	Centered	7/8 Dia		
H-147	KA		2 1/2 Dia		
H-170	GB		1 1/2 Dia		
H-171	JA		1 3/8 Dia		
H-172	HA	Centered	1 3/8 Sq		
H-173	KA	H=3/8	1 3/8x2	J=3/8	1 3/8x2
H-194	HA	Centered	1 3/4 Dia		
H-195	JA	Centered	2 3/8 Dia		
H-196	KA	H=3/8	1 1/8x3 3/8	J=3/8	1 1/8x2 3/8
H-197	MB	G=1 1/4	1x2 1/2	K=1 1/4	3/4x2 3/8
H-198	HA		2 3/8 Dia		
H-915	AH	Centered	2 3/8 Dia		
H-925	AJ	Centered	1 3/8 Dia		
H-935	FA	Centered	1 1/2x1 1/8		
H-965	HA	Centered	1 3/8x2 1/8		

\*Denotes 1/8 radius at corners of cutouts.

## TYPICAL REGULATED TRANSISTOR SUPPLIES

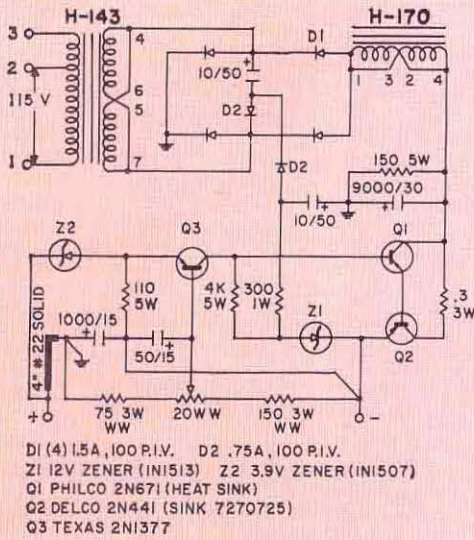

DI (4) 1.5A, 100 P.I.V. D2 .75A, 100 P.I.V.  
 Z1 12V ZENER (1N1513) Z2 3.9V ZENER (1N1507)  
 Q1 PHILCO 2N671 (HEAT SINK)  
 Q2 DELCO 2N441 (SINK 7270725)  
 Q3 TEXAS 2N1377

11 TO 13 VDC, 0 TO 2A, RIPPLE .35MV  
 .1% REG 105/125 V LINE, 0/2A LOAD

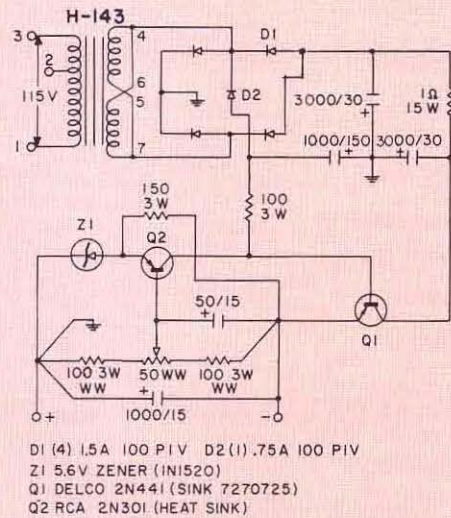

DI (4) 1.5A 100 P.I.V. D2 (1) .75A 100 P.I.V.  
 Z1 5.6V ZENER (1N1520)  
 Q1 DELCO 2N441 (SINK 7270725)  
 Q2 RCA 2N301 (HEAT SINK)

11.5 TO 12.5 VDC, 0 TO 2A, RIPPLE 5 MV  
 3.5% REG 105/125 V LINE, 0/2A LOAD

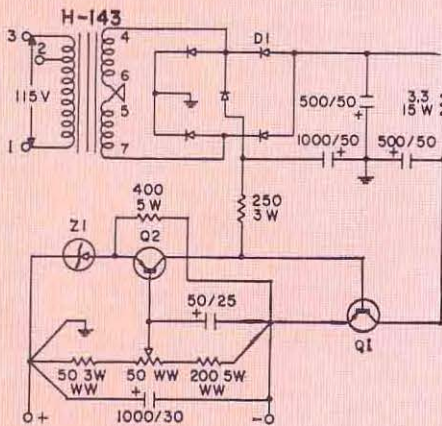

DI (5) .75A 100 P.I.V.  
 Z1 6.8V ZENER (1.5M 6.8Z)  
 Q1 DELCO 2N441 (SINK 7270725)  
 Q2 RCA 2N301 (HEAT SINK)

27 TO 29 VDC, 0 TO 1A, RIPPLE 1.5 MV  
 1% REG 105/125 V LINE, 0/1A LOAD

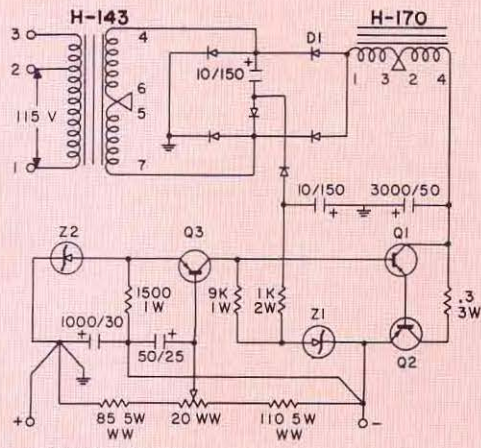

DI (6) .75A 100 P.I.V.  
 Z1 24V ZENER (1M24Z), Z2 12V ZENER (1N1513)  
 Q1 PHILCO 2N671 (HEAT SINK)  
 Q2 DELCO 2N441 (SINK 7270725)  
 Q3 TEXAS 2N1377

26 TO 30 VDC, 0 TO 1A, RIPPLE .12 MV  
 .1% REG 105/125 V LINE, 0/1A LOAD

## UNREGULATED SUPPLIES

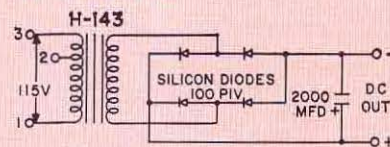
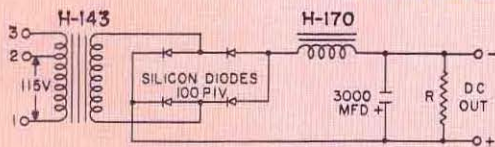

Pri. Term.	Sec. Term.	Choke Term.	Diode	R	D.C.V.	A.	0 Load Reg. %
1-3	Par.	Par.	1.5A	70	13	2.5	17
1-2	Par.	Par.	1.5A	60	16.5	2.5	12
1-3	Ser.	Ser.	.75A	300	27.5	1.25	13
1-2	Ser.	Ser.	.75A	250	34.5	1.25	12

Pri. Term.	Sec. Term.	Diode	D.C.V.	A.	0/Load Reg. %
1-3	Par.	1.5A	19.6	2	30
1-2	Par.	1.5A	25.5	2	26
1-3	Ser.	.75A	42	1	24
1-2	Ser.	.75A	53	1	20





## SPECIAL CUSTOM BUILT MAGAMPS, SATURABLE REACTORS REFERENCE UNITS ... TO YOUR SPECIFICATIONS

In addition to the many needs met by UTC stock components, there are a variety of unique applications which require special units. The illustrations below are intended to show some of the thousands of special units produced by UTC and to provide the equipment engineer with a concept of the possibilities in present special component design. Magamp range is from microwatts to 100 KVA.



Two self saturating magamps in one case. Output 250 V. into 750 ohms. Power gain 135,000. MIL-T-27A; 2 x 2 x 2½, 12 oz.

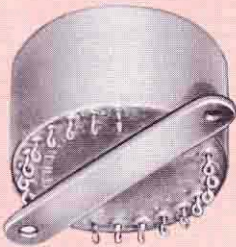

Multi Control Magamp. Power gain 400,000. Control Current .00003A. Output 25 V. DC into 1K. Six power windings, bias, feedback, and two control windings. MIL-T-27A; 2¼ dia. x 1¼ high, 8 oz.

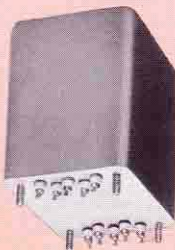

Magamp for 50 watt, 60 cycle servomotor. Two control windings. One feedback winding, one power winding, diode panel. Power gain 100. MIL-T-27A; 30 lbs.



Toroidal Transistor inverter transformer. Input 24 V DC. outputs 4 windings 150 V to 1050 V DC. Hipot 3800 V. Hermetically sealed. MIL-T-27A, 2¾ dia. x 1⅝", 15 oz.

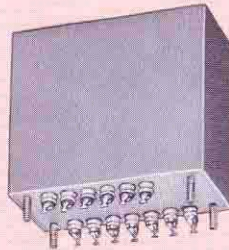

Servo reference transformer. Input 120 V., 380 to 420 cycles. Output ratios under load held to .005% tolerance. Phase shift .05° max. MIL-T-27A; 2¼ x 1¾ x 2, 12 oz.

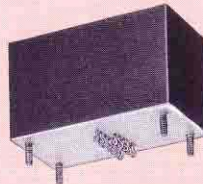

Precision Magnetic Modulator and Filter to produce sine wave output directly proportional to a DC control input. Temperature stabilized from -55°C to 85°C. Distortion and linearity less than 3% thru temperature and frequency range of 380-420 cycles. MIL-T-27A, 1⅝ x 1⅝ x 3⅝", 12 oz.

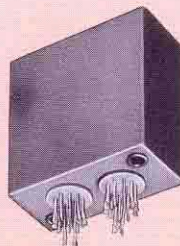

Precision reference transformer. Input 14 V., 400 cycles. Twelve secondaries held to low phase shift and .1% tolerance. MIL-T-27A; 1¾ x 2 x 1⅝, 4.5 oz.

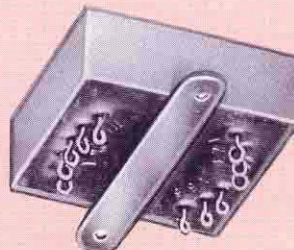

Instrument reference transformer. Input 50 V. 400 cycles. Three 5 V.-.025A. Outputs to .05% accuracy. Saturation characteristics and DCR balance to 3%. MIL-T-27A; 1½ x 1¾ x ¾, 2 oz.

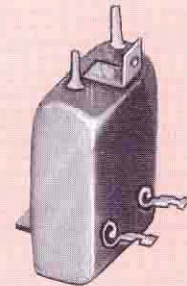

RF saturable inductor. 2 MA DC for sweep from 17 MC to 21 MC. MIL-T-27A; 2 oz.

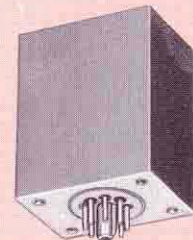

Magamp for 11 watt, 115 V., 400 cycle servomotor. Standard octal plug. MIL-T-27A; 1¾ x 2½ x 3, 1.7 lb.

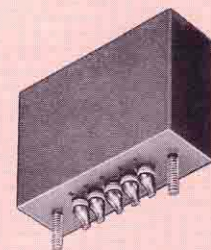

Saturable reactor. Input 50 V.-60 cycles. Output 10 V., 4 MA DC control current. MIL-T-27A; ¾ x 2½ x 1½, 6 oz.



Dual saturable reactor. Input 10 V. - 1 KC. Output 3.5 V. 2 MA DC control current. 130° C. MIL-T-27A; 1¾ x 1¾ x 1¼, 5 oz.



# MAGNETIC AMPLIFIERS FOR SERVO MOTOR APPLICATIONS

## HERMETICALLY SEALED

Manufactured & Guaranteed to MIL-T-27A by Full Environmental Testing, see back cover  
 . . . all units MIL type TF4SY40YY

### TRANSISTOR TYPE

#### 400 CYCLE MIL TYPE TF4SY40YY

UTC transistor MAT units are identical to their vacuum tube counterparts (details of which are given on facing page), but designed for low impedance control. Typical applications are illustrated in Figures 5, 6 and 7. The input transformer may be chosen by impedance ratio rather than precise rated impedance. For example, the DO-T11 can be used as the input in Figure 5 (7500 ohms to 1500 ohms), and would have 2.3° phase shift . . . the H-14 used as the input (3750 ohms to 1500 ohms) would have a phase shift of .6°.

#### 60 CYCLE MIL TYPE TF4SX40MB

The UTC MAT-60 unit is designed for the control of 2 phase 115 V 60 cycle servo motor in the 40 in.-oz. range.

Figure 7 shows the use of power transformer MAT-65, with this unit, in a typical application. The input transformer should be chosen by impedance ratio requirements. Input impedance, looking into a 1:1 transformer UTC H-25, in Figure 7, is 350 ohms.



#### 400 CYCLE TYPES

Type No. →	MAT-7	MAT-8	MAT-9	MAT-10
Power output	4 W.	8 W.	11 W.	18 W.
R <sub>L</sub> , ohms	3300	1600	1200	720
C <sub>L</sub> , mfd, approx.	.2	.3	.5	.7
Cont. Wind. Res.	38 Ω	52 Ω	30 Ω	36 Ω
Case Length, In.	2 <sup>5</sup> / <sub>16</sub>	2 <sup>1</sup> / <sub>2</sub>	2 <sup>3</sup> / <sub>4</sub>	2 <sup>2</sup> / <sub>32</sub>
Width, In.	1 <sup>1</sup> / <sub>16</sub>	2 <sup>1</sup> / <sub>4</sub>	2 <sup>1</sup> / <sub>2</sub>	2 <sup>2</sup> / <sub>32</sub>
Height, In.	1 <sup>1</sup> / <sub>32</sub>	1 <sup>1</sup> / <sub>16</sub>	2	2 <sup>1</sup> / <sub>4</sub>
Mtg. Dim., In.	1 <sup>3</sup> / <sub>8</sub> x 1 <sup>7</sup> / <sub>8</sub>	1 <sup>1</sup> / <sub>16</sub> x 2	1 <sup>5</sup> / <sub>16</sub> x 2 <sup>3</sup> / <sub>16</sub>	2 <sup>3</sup> / <sub>8</sub> x 2 <sup>3</sup> / <sub>8</sub>
Studs, stainless	4-40	6-32	8-32	8-32
Cutout, In.	1	1	1	1
Weights, lbs.	.65	1.1	1.7	2.75

MAT-11 115V-400 cyc. to two 28 Volt .2 A. windings for 56 VCT-.2 A. or 28 V .4 A. RC-37 case (Pg. 46). MIL type TF4SY02YY.

#### 60 CYCLE TYPES

NEW

Type No. →	MAT-60
Power Output	50 W.
R <sub>L</sub> , ohms	260 Ω
C <sub>L</sub> , mfd, approx.	7 Mfd.
Cont. Wind. Res.	50 Ω
Case and Wt.	MB (see pg. 29)

MAT-65 115V. 60 cyc. to 8.5 VCT @ 500 ma and 63 VCT @ 300 ma. FA case (see pg. 29) Mil Type TF4SX02FA

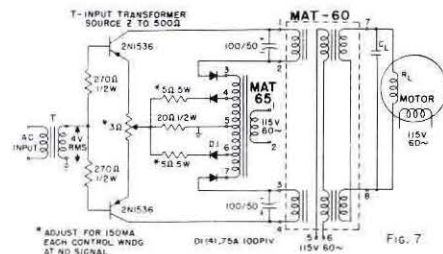
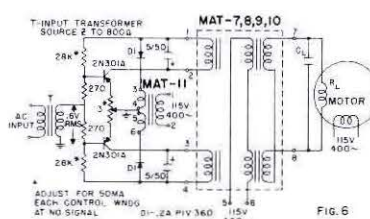
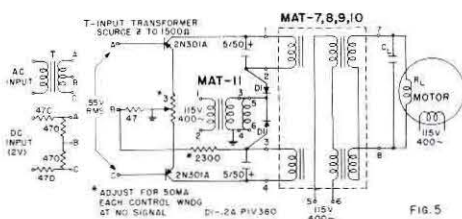



# MAGNETIC AMPLIFIERS FOR SERVO MOTOR APPLICATIONS

HERMETICALLY SEALED

Manufactured & Guaranteed to MIL-T-27A by Full Environmental Testing, see back cover  
... all units MIL type TF4SY40YY

## VACUUM TUBE TYPE

The MAT 1-4 Magnetic Amplifiers are exceptionally stable units designed for the control of 2 phase, 115V., 400 cycle servo motors. They are compact . . . hermetically sealed . . . magnetically shielded . . . and meet MIL-T-27A and MIL-E-5400 Specifications. The output is sinusoidal, amplitude variable, and phase reversible. Control is provided by a dual triode such as 12AU7 operating with a plate voltage of 115 volts, 400 cycles, or higher. The signal to the triode grids can be polarity reversible DC or phase reversible 400 cycles with or without suppressed carrier modulation. These units eliminate DC power requirements as well as temperature sensitive dry disc rectifiers. The high input impedance provides minimum loading on sensing elements and high power gain. Ringing at low load level has been reduced to a minimum through high internal damping factors. The power output figures are conservative . . . power gain of the *Magnetic Structure* is approximately 40 . . . response time approximately 7.5 milliseconds. The maximum null voltage is 3 volts RMS. For single phase supply voltage the load capacitor should effect 90° phase shift with motor load . . . for 3 phase, 30° phase shift.

For AC signal control the circuit of Figure 1 is employed. For DC signal control Figure 2 applies. Figure 3 shows the use of a power transformer (MAT-5) which provides higher plate voltages (230 volt supply data of chart) and eliminates the input transformer (MAT-6). The typical response curve of Figure 4 applies to all units, the larger units feeding heavier loads.

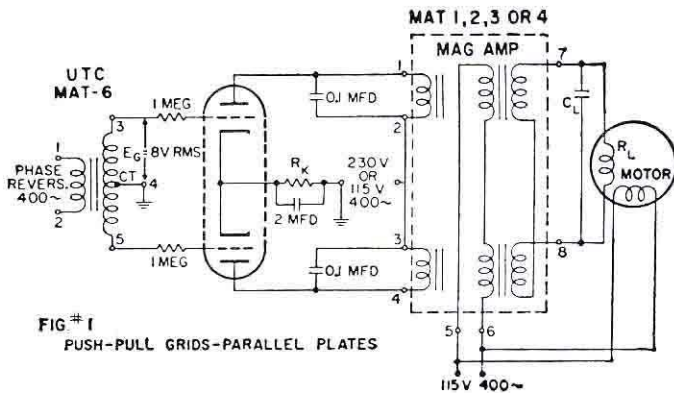
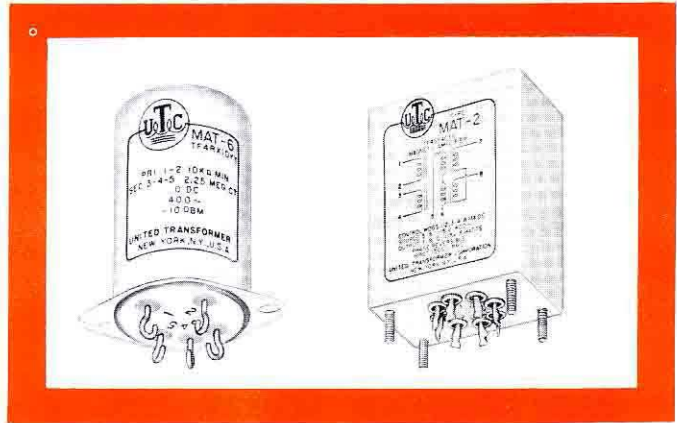

FIG #1  
PUSH-PULL GRIDS-PARALLEL PLATES

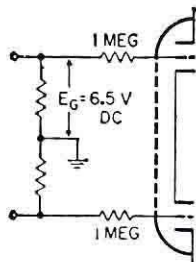

FIG #2  
GRID CIRCUIT  
MODIFICATION FOR  
DC INPUT

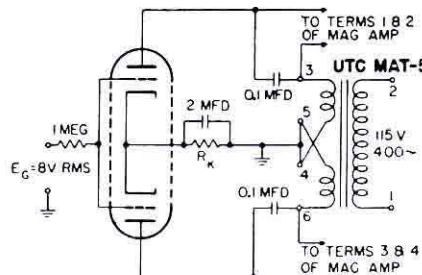

FIG #3  
PARALLEL GRIDS-PUSH-PULL PLATES

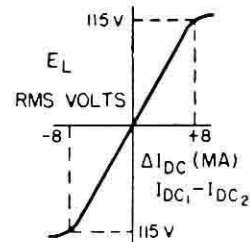

FIG #4

Type No. →	MAT-1	MAT-2	MAT-3	MAT-4
<b>230 Volt Supply</b>				
Power output	4 W	8 W	11 W	18 W
RL, ohms	3300	1600	1200	720
CL, mfd., approx.	.2	.3	.5	.7
<b>115 Volt Supply</b>				
Power output	2 W	4 W	6 W	9 W
RL, ohms	6500	3300	2200	1450
CL, mfd.	.13	.2	.3	.45
Reson. Freq.	40 cyc.	35 cyc.	35 cyc.	20 cyc.
Log-Decr.	.18	.23	.03	.65
Cont. Wdg. Res.	6200 ohms	8450 ohms	4750 ohms	5650 ohms
Case, Length, in.	1 1/4	1 1/2	1 3/4	2 1/8
Width, in.	1 15/16	2 1/8	2 1/2	3 1/8
Height, in.	2 5/16	2 3/4	2 15/16	3 3/8
Mtg. Dim., in.	1 3/16 x 1 1/2	1 x 1 5/8	1 1/8 x 1 7/8	1 1/2 x 2 1/2
Studs, stainless	4-40	6-32	8-32	8-32
Cutout, in.	1	1	1	1
Unit Weight, lbs.	.67	1.1	1.7	2.75

MAT-5 115V.-400 cyc. to 460 VCT; provides 230V. 48 ma DC or 460V. 24 ma DC. RC-37 Case (pg. 46). MIL type TF4SY02YY.

MAT-6 Input . . . 10,000 ohms pri. . . 1:15 C.T. ratio . . . phase shift under 1°. . . RC-25 case (pg. 12). MIL type TF4RX10YY.



## SPECIAL CUSTOM BUILT PULSE COMPONENTS TO YOUR SPECIFICATIONS

Because of the greatly varied nature of pulse component application, UTC stock items cover only low power transistor and tube requirements. The units illustrated below are intended to show some of the thousands of special units produced by UTC and to provide the equipment engineer with a concept of the possibilities in present special pulse circuit units. Range covered is from microwatts to 10 megawatts.

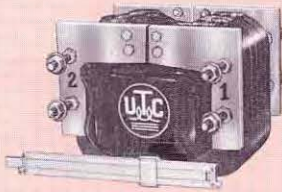

Impulse Transformer, discharge 37.5 mfd. Capacitor @ 5 KV DC. Peak Current 167,000 amps. Pulse width 2  $\mu$ sec, Rise time .2  $\mu$ sec, Energy level 470 watt-sec. MIL-T-27A Grade 5, Size 10 x 12 x 9 1/2", 135 lbs.



Output to 2J42 magnetron. Input 1300 V, 50 ohms. Output 6.5 KV to 1200 ohms and .6A. bifilar filament winding. .15  $\mu$ sec., 1000 PPS. Trigger winding. MIL-T-27A Grade 5; 1 1/2 x 2 1/2 x 2 3/4, 10 oz.



Pulse current transformer, Thyatron cathode to 50 ohms. Input 100A. Output 200 V. to 50 ohms. .5/2.4  $\mu$ sec. 2000 PPS. MIL-T-27A; 1 3/4 x 1 1/4 x 1 1/4, 2 oz.



Gaussian wave shape pulse output. Input 2 KV, 3.5  $\mu$ sec. Output 2.5 KV-5A., 80 KC rate. Corona free-35,000 feet. MIL-T-27A; 1 3/8 x 1 3/8 x 3 3/8, 1 lb.



Sonar Output Transformer. 36 KW pulses, 100 millisecc @ 5% duty cycle. Input 4K  $\Omega$  CT, output 120-180  $\Omega$ . Hipot 29 KV. Hermetic, MIL-T-27A Grade 4, 6 1/2 x 9 x 8", 37 lbs.

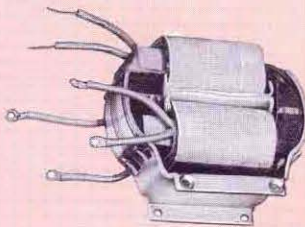

Output to magnetron. Input 6 KV peak 2.5  $\mu$ sec. or .5  $\mu$ sec. Output 28 KV-27 A. peak and 14.2A. bifilar magnetron filament winding. MIL-T-27A, 170° C.; 2 5/8 x 5 3/8 x 4 5/8, 7 1/2 lb.



Free running blocking oscillator transformer. 600 ohms, 1:1:1, 5  $\mu$ sec.  $\pm$  1, 12000  $\pm$  10% PPS. Output 600 V.  $\pm$  10%. Temperature stable -62° C. to 85° C. MIL-T-27A; 3/4 x 1 1/4 x 1 1/8; 1 1/2 oz.



Differentiating pulse transformer. Input 150 V. 40 MA peak, 6  $\mu$ sec., 3000 PPS. Output 30 V. .5  $\mu$ sec. Ferrite core. Rise, droop, and pulse duration held to 5%. MIL-T-27A, -55° C. to + 100° C.; 5/16 x 3/8 x 1, 7 grams.



Output to Klystron. 3.5  $\mu$ sec. pulses in group of pulse trains at high rep. rate. 1% droop over pulse train. 43 KV Hipot. MIL-T-27A; NA case; 4 1/4 x 5 x 6 3/4, 11 1/2 lb.



Linear charging reactor for line type pulser. 20 Hys., .11A. DC, 5 KV, 1000 PPS, 11 KV hipot. MIL-T-27A, 200° C.; 3 1/4 x 4 x 3 3/4, 3 lb.



DO-T Pulse Transformer, width 150  $\mu$ sec., ratio 1:1:1. Transistor output to gating circuits. -65° C to 105° C. MIL-T-27A. 5/16 Dia. x 13/32, 1/10 oz.



Ferrite core pulse transformer. 30 V. . . . three windings, 5-10  $\mu$ sec. Couples to magnetic tape head for high speed read in and out. Hipermalloy shield. Commercial; 5/8 x 1 1/4 x 1 5/8, 2 oz.



# PRECISION MINIATURE WIDE APPLICATION PULSE TRANSFORMERS

HERMETICALLY SEALED

Manufactured & Guaranteed to MIL-T-21038B (superseding MIL-T-27A) by Full Environmental Testing, see back cover

## NEW ITEMS

### PIP SERIES TRANSISTOR PULSE TRANSFORMERS

UTC's PIP series of subminiature transistor type pulse transformers is designed to supplement the transistor pulse transformers on page 36.

The underlying concept of physical design is based on the UTC DO-T and DI-T series. The exceptional reliability of the DO-T and DI-T transformers, proven in the field (see pages 6 thru 9), is now available in the PIP pulse transformers. These units are subminiaturized (5/16" diameter x 3/16" high, weight 1/20 oz.) to give a maximum component density in equipments. These units are checked and adjusted in the Transistor Test circuit to give the required pulse width.

All Units  
Individually Adjusted  
to Parameters  
Shown in Table

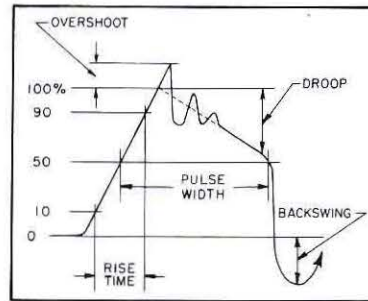
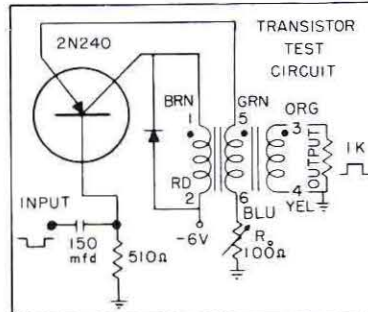

#### DEFINITIONS

**Amplitude:** Intersection of leading pulse edge with smooth curve approximating top of pulse.

**Pulse width:** Microseconds between 50% amplitude points on leading and trailing pulse edges.

**Rise Time:** Microseconds required to increase from 10% to 90% amplitude.

**Overshoot:** Percentage by which first excursion of pulse exceeds 100% amplitude.

**Droop:** Percentage reduction from 100% amplitude a specified time after 100% amplitude point.

**Backswing:** Negative swing after trailing edge as percentage of 100% amplitude.

#### ACTUAL SIZE

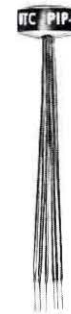

5/16" Dia. x 3/16" high  
Weight 1/20 oz.

#### RATIO 4:4:1 MIL TYPE TP6RX4410CZ

Type No.	APPROX. DCR, OHMS			BLOCKING OSCILLATOR PULSE					COUPLING CIRCUIT CHARACTERISTICS						
	1-Brn. 2-Rd	3-Org. 4-Yel	5-Grn 6-Blu	Width μ Sec.	Rise Time	% Over Shoot	Droop %	% Back Swing	P Width μSec.	Volt Out	Rise Time	% Over Shoot	Droop %	Back Swing	Imp. in/out
PIP-1	.18	.20	.07	.05	.02	0	0	37	.05	9	.018	0	0	12	50
PIP-2	.47	.56	.17	.1	.025	0	0	25	.1	8	.02	0	0	5	50
PIP-3	1.01	1.25	.37	.2	.030	2	0	15	.2	7	.035	0	0	5	100
PIP-4	1.5	1.85	.54	.5	.05	0	0	15	.5	7	.06	0	0	0	100
PIP-5	2.45	3.1	.9	1	.08	0	0	14	1	6.8	.15	0	0	5	100
PIP-6	3.0	3.7	1.1	2	.10	0	0	15	2	6.6	.18	0	2	10	100
PIP-7	4.9	6.05	1.8	3	.20	0	0	14	3	6.8	.20	0	2	10	100
PIP-8	8.0	9.7	2.9	5	.30	0	0	3	5	7.9	.22	0	13	25	200
PIP-9	13.1	15.9	4.7	10	.35	0	5	12	10	6.5	.4	0	15	20	200

PIP-100 Transistor pulse transformer kit, consisting of PIP-1 thru PIP-9 in plastic case.

#### RATIO 5:3:1 MIL TYPE TP6RX5310CZ

PIP-10	.55	.41	.15	.1	.01	0	0	20	.1	8	.01	0	0	5	140/50
PIP-11	2.9	2.2	.82	1	.02	4	4	6	1	6.6	.05	0	6	12	280/100
PIP-12	9.4	7.1	2.6	5	.05	0	12	12	5	8	.09	2	12	25	560/200

\* Input winding leads Brn-Rd (1-2); output winding leads Org-Yel (3-4); leads Grn-Blu (5-6) open.

## AND SPECIAL CUSTOM BUILT PULSE TRANSFORMERS TO YOUR SPECIFICATIONS

Above stock units cover general purpose applications. For specific applications cost reductions may be effected.



# PRECISION MINIATURE WIDE APPLICATION PULSE TRANSFORMERS

HERMETICALLY SEALED

/ Manufactured & Guaranteed to MIL-T-21038B (superseding MIL-T-27A) by Full Environmental Testing, see back cover

## TRANSISTOR PULSE TRANSFORMERS

All Units  
Individually Adjusted  
to Parameters  
Shown in Table

UTC miniature transistor pulse transformers are individually adjusted in standard test circuits to close tolerances. This series of pulse units are similar to the tube types listed on the opposite page, but specifically designed for transistor applications. These precision wound core units are hermetically sealed by vacuum molding and deliver high reliability service from  $-70^{\circ}\text{C}$  to  $+130^{\circ}\text{C}$ . A kit consisting of one of each of the 4:4:1 ratio series is available in a plastic case (H-69) . . . ideal for laboratory. Data based on 1V input trigger.

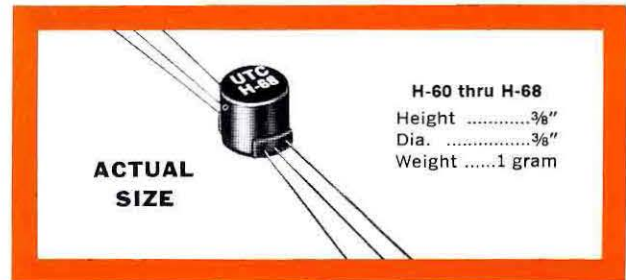

**DEFINITIONS**

**Amplitude:** Intersection of leading pulse edge with smooth curve approximating top of pulse.

**Pulse width:** Microseconds between 50% amplitude points on leading and trailing pulse edges.

**Rise Time:** Microseconds required to increase from 10% to 90% amplitude.

**Overshoot:** Percentage by which first excursion of pulse exceeds 100% amplitude.

**Drop:** Percentage reduction from 100% amplitude a specified time after 100% amplitude point.

**Backswing:** Negative swing after trailing edge as percentage of 100% amplitude.

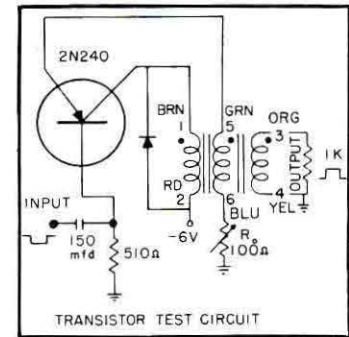
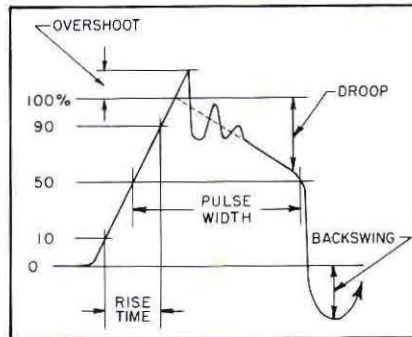

### RATIO 4:4:1 MIL TYPE TP7SX4410AZ

Type No.	APPROX. DCR, OHMS			BLOCKING OSCILLATOR PULSE					COUPLING CIRCUIT CHARACTERISTICS						
	1-2	3-4	5-6	Width $\mu$ Sec.	Rise Time	Over Shoot	Drop %	% Back Swing	P Width $\mu$ Sec.	Volts Out	Rise Time	Over Shoot	Drop %	% Back Swing	Imp. in/out, ohms
H-60	.124	.14	.05	.05	.016	0	0	30	.05	9.3	.012	0	0	20	50
H-61	.41	.48	.19	.1	.016	0	0	30	.1	8.2	.021	0	0	15	50
H-62	.78	.94	.33	.2	.022	0	0	18	.2	7.4	.034	0	5	12	100
H-63	1.86	2.26	.70	.5	.027	2	10	20	.5	7.5	.045	0	20	25	100
H-64	3.73	4.4	1.33	1	.033	0	12	25	1	7	.078	0	15	23	100
H-65	6.2	7.3	2.22	2	.066	0	15	25	2	6.6	.14	0	10	20	100
H-66	10.2	12	3.6	3	.087	0	18	30	3	6.8	.17	0	10	20	100
H-67	14.5	17.5	5.14	5	.097	0	23	28	5	7.9	.2	0	18	28	200
H-68	42.3	52.1	14.8	10	.14	0	15	28	10	6.5	.4	0	15	30	200
H-69	Transistor pulse transformer kit, consists of H-60 thru H-68 in plastic case.														

### RATIO 5:3:1 MIL TYPE TP7SX5310AZ

<b>New</b> H-611	.426	.32	.132	.1	.018	8	0	12	.1	8.2	.02	0	0	30	140/50
<b>New</b> H-641	5	3.6	1.4	1	.04	0	10	10	1	7	.07	0	20	30	280/100
<b>New</b> H-671	21	16	6	5	.08	0	14	12	5	8	.2	0	25	30	560/200

\* Input winding terminals 1-2; output winding terminals 3-4; terminals 5-6 open.

## AND SPECIAL CUSTOM BUILT PULSE TRANSFORMERS TO YOUR SPECIFICATIONS

Above stock units cover general purpose applications. For specific applications cost reductions may be effected.



# PRECISION MINIATURE WIDE APPLICATION PULSE TRANSFORMERS

HERMETICALLY SEALED

Manufactured & Guaranteed to MIL-T-21038B (superseding MIL-T-27A) by Full Environmental Testing, see back cover

## VACUUM TUBE PULSE TRANSFORMERS

All Units Individually Adjusted to Parameters Shown in Table

UTC miniature, wound core, pulse transformers are individually precision adjusted in standard test circuits to close tolerances. They are high reliability units, hermetically sealed by vacuum molding and suited for service from  $-70^{\circ}$  C. to  $+130^{\circ}$  C. Wound core structure provides excellent temperature stability (unlike ferrite). Designs are high inductance type to provide minimum of droop and assure true pulse width, as indicated on chart below. If used for coupling circuit where minimum rise time is important, use next lowest type number. Rise time will be that listed for this lower type number . . . droop will be that listed multiplied by ratio of actual pulse width to value listed for this type number. Blocking oscillator data listed is obtained in standard test circuits shown. Coupling data was obtained with H. P. 212A generator (correlated for H-55, H-56, H-57, H-561) and source/load impedance shown.

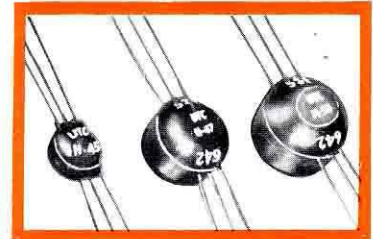
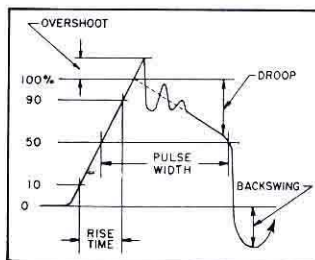
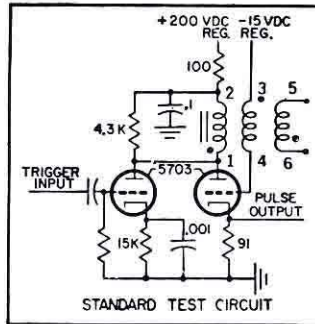

For Spring Clip Mounting, use Augat  
No. 6016-8A for AC(†)  
No. 6014-20A for AN(†)

### DEFINITIONS

**Amplitude:** Intersection of leading pulse edge with smooth curve approximating top of pulse.  
**Pulse width:** Microseconds between 50% amplitude points on leading and trailing pulse edges.  
**Rise Time:** Microseconds required to increase from 10% to 90% amplitude.  
**Overshoot:** Percentage by which first excursion of pulse exceeds 100% amplitude.  
**Droop:** Percentage reduction from 100% amplitude a specified time after 100% amplitude point.  
**Backswing:** Negative swing after trailing edge as percentage of 100% amplitude.

### RATIO 1:1:1 MIL TYPE TP7SX1110(†)

Type No.	APPROX. DCR, OHMS			BLOCKING OSCILLATOR PULSE					COUPLING CIRCUIT CHARACTERISTICS						DIMENSIONS				
	1-2	3-4	5-6	Width $\mu$ Sec.	Rise Time	% Over Shoot	% Droop	% Back Swing	P Width $\mu$ Sec.	Volts Out	Rise Time	% Over Shoot	% Droop	% Back Swing	Imp. in, ohms	L In.	W In.	Wt. † Gr.	Style & Envelope
H-45	3	3.5	4	.05	.022	0	20	10	.05	17	.01	20	0	35	250	3/8	3/8	1	AZ
H-46	5.5	6.5	7	.10	.024	0	25	10	.10	19	.01	30	10	50	250	3/8	3/8	1	AZ
H-47	3.7	4.0	4	.20	.026	0	25	8	.20	18	.01	30	15	65	500	5/8	5/8	4	AC
H-48	5.5	5.8	6	.50	.03	0	20	5	.50	20	.01	30	20	65	500	5/8	5/8	4	AC
H-49	8	8.5	9	1	.04	0	20	10	1	24	.02	15	15	65	500	5/8	5/8	4	AC
H-50	20	21	22	2	.05	0	20	10	2	27	.05	10	15	35	500	5/8	5/8	4	AC
H-51	28	31	33	3	.10	1	20	8	3	26	.07	10	10	35	500	5/8	5/8	4	AC
H-52	36	41	44	5	.13	1	25	8	5	23	.15	10	10	45	1000	5/8	5/8	4	AC
H-53	37	44	49	7	.28	0	25	8	7	24	.20	10	10	50	1000	5/8	5/8	6	AN
H-54	50	58	67	10	.30	0	20	8	10	24	.25	10	10	50	1000	5/8	5/8	6	AN
H-55	78	96	112	16	.75	0	20	10	16	23	.40	5	15	20	1000	5/8	5/8	6	AN
H-56	93	116	138	20	1.25	0	25	10	20	23	.6	5	10	10	1000	5/8	5/8	6	AN
H-57	104	135	165	25	2.0	0	30	10	25	24	1.5	5	10	10	1000	5/8	5/8	6	AN
H-58	Pulse transformer kit. Consists of one of each of the above units in partitioned plastic case.																		

### RATIO 5:3:1 MIL TYPE TP7SX5310(†)

New H-461	9.6	6.4	2.5	.1	.025	0	0	8	.1	19	.02	3	5	20	700 250	3/8	3/8	1	AZ
New H-501	30	20	7	2	.08	0	12	5	2	27	.06	12	15	35	1400 500	5/8	5/8	4	AC
New H-531	66	47	17	7	.32	0	12	3	7	24	.23	12	10	40	2800 1000	5/8	5/8	6	AN
New H-561	180	142	53	20	1.75	0	13	5	20	23	.7	5	10	10	2800 1000	5/8	5/8	6	AN

\* Input winding terminals 1-2; output winding terminals 3-4; terminals 5-6 open.

## AND SPECIAL CUSTOM BUILT PULSE TRANSFORMERS TO YOUR SPECIFICATIONS

Above stock units cover general purpose applications. For specific applications cost reductions may be effected.



## CIRCUIT DEVELOPMENT TRANSFORMERS FOR TRANSISTORS

The UTC Laboratory circuit development transformers aid the designer in selecting optimum impedances for best power and distortion results from his transistor circuit. The interstage and output transformers listed below are arranged for a multiplicity of possible impedance connections. Once the best selection of impedances is found, special or stock items are easily substituted for the best circuit performance. The LAB development units, representing extremely high efficiency, very wide band, high powered transformers, will usually be substantially larger and heavier than the transformers which replace them, since generally the designer will not need the full frequency range or maximum level afforded.

Screw type terminals are used to facilitate reconnecting for various impedances. Terminals are arranged so that shortest possible jumpers are always used regardless of impedance values desired.

### NEW LAB-10 20 Cycles to 20kc Up to 1W Continuous

Pri. Imp. $\Omega$ Range	Pri. to Sec. Ratio	Sec. Imp. $\Omega$ Range
1900 $\Omega$ to 14,400 $\Omega$	20:1 or 10:1	19 $\Omega$ to 36 $\Omega$
925 $\Omega$ to 7600 $\Omega$	10:1 or 5:1	37 $\Omega$ to 76 $\Omega$

Pri. & Sec. can be arranged for split, single ended or push-pull connections. Pri. up to 50 ma DC max unbalanced with full range response.

### NEW LAB-20 20 Cycles to 20kc Up to 50W Continuous

Pri. Imp. $\Omega$	Sec. Imp.
6, 12, 24, 40, 54, 70, 96	4, 8, 16, 64

On primaries, CT available on all impedances, split arrangement on most impedances.

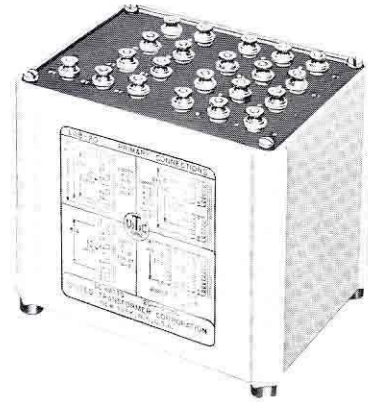

LAB-10 units in LS-1 case  
LAB-20 units in LS-3 case  
Terminal board as shown above  
(see page 45)



## HIGH Q PRECISION INDUCTANCE DECADES

UTC DI inductance decades are invaluable instruments for design and experimental work with tuned circuits, wave filters, and equalizers. They set new standards of Q, stability, frequency range, and convenience. The low hum pickup toroid coils employ a new permalloy dust core which, combined with special winding methods, provides very high Q, excellent voltage and temperature stability, and high self resonance frequency. The switch employed is a new low capacity type which lab tests have proven for low contact resistance after 100,000 operations. The inductance values are laboratory adjusted to better than 1% precision, with calibration noted on base.

DI inductance decades are housed in a compact, rugged, die cast case with control on a sloping panel, ideally suiting these units to laboratory use.

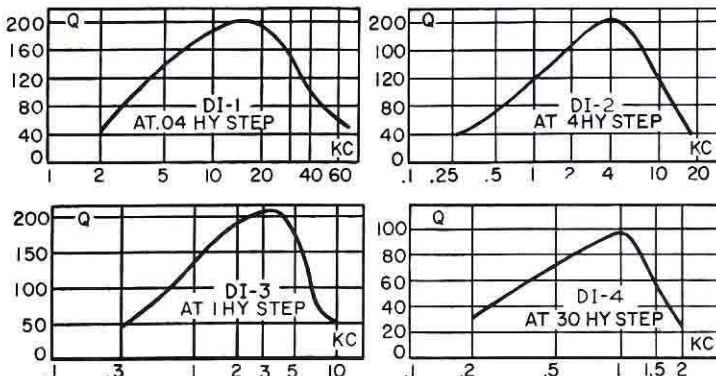

DI CASE

Length	4½"
Width	4¾"
Height	2¾"
Weight	2 lbs.

Type No.	Induct. Henries	Optimum Range	Max. Q	AC ma Max.	Volts RMS Ins. Test
DI-1	10 x .01	2-60 KC	200	500	500
DI-2	10 x .1	.25-20 KC	200	150	500
DI-3	10 x 1	.25-10 KC	200	50	500
DI-4	10 x 10	.2-1.5 KC	100	15	500





# LEADERSHIP IN HIGH FIDELITY

**FACTORS CONTROLLING FREQUENCY RESPONSE** The figures at the right indicate the basic story with reference to high fidelity audio transformers. Figure 1 represents an ideal transformer having 100% efficiency. Figure 2 shows the equivalent of a practical transformer with its varied reactances and capacities. Figure 3 is an equivalent "T" network of the same transformer, which can be further simplified to the basic elements illustrated in Figure 4. It is apparent from Figure 4 that  $L_m$  (primary inductance) represents a reactance which drops with frequency and, as a consequence, controls the low frequency response.  $L_l$  (the leakage reactance) and  $C$  (the distributed capacity) similarly control the high frequency response. Figures 5 and 6 respectively show the frequency attenuation curves for given primary inductance and distributed capacity.

**UTC FREQUENCY RESPONSE** It is obvious from the above that high primary inductance will provide good low frequency response. For a particular core structure this necessitates the use of a large number of turns in the transformer windings. Unfortunately, as the turns are increased, both leakage reactance and distributed capacitance increase, with a corresponding loss in the higher frequencies. This effect is minimized in UTC transformers by employing transformer core material of exceptional permeability, so that a minimum number of turns are required. In low level transformers we employ Hipermalloy, which is a stable nickel iron alloy selected for maximum characteristics. In high level transformers grain oriented silicon steels provide maximum permeability and minimum distortion. Uniquely low distributed capacity and leakage reactance are obtained through special winding methods. Output transformers will have as many as 16 interleaved windings to provide extremely low leakage reactance. Sectional windings are employed in input transformers to effect very low distributed capacity.

**WAVE FORM DISTORTION** Low wave form distortion requires great care in both design and manufacture. UTC high fidelity products provide a minimum of such distortion through the use of conservative flux densities, symmetrical coupling in push pull windings, low leakage reactance, and negligible resonance in coil structures. For example, low distortion in high level transformer designs, necessitates excellent response down to 7 cycles to assure negligible distortion at 20 to 30 cycles. For low distortion at high frequencies, in addition to primary and secondary windings being interleaved, excellent coupling is provided between primary halves. As an example, the LS-692 modulation transformer employs 10 sections in each primary half . . . with these sections individually cross-interleaved.

**SHIELDING** Inductive pickup in low level transformers is a basic circuit problem. The balanced coil structure, a development of the UTC engineering staff, is employed in the bulk of UTC low level transformers to provide very low pickup. This structure employs two accurately balanced astatic coils . . . virtually neutralizing stray pickup. In addition, the UTC high fidelity lines are housed in heavy high conductivity die castings, plus additional multiple alloy shields for many of the designs. While it is customary to make such shields of 47% nickel alloy, all UTC shields are 78% nickel to provide the greatest hum attenuation possible.

**FLEXIBILITY** The multi-tapped winding, a development of the UTC engineering staff, provides a wide range of impedances in high fidelity transformers with excellent coupling and balance. High efficiency and full response are obtained at any of the impedances specified.

**RELIABILITY** The designs of UTC high fidelity transformers are inherently centered around ruggedness and reliability. In addition, however, UTC quality control, which is accepted as the highest in the industry, assures the fulfillment of these design requirements in the ultimate manufactured product. The recognition of the dependability of UTC units is illustrated by their usage in the finest broadcast equipment, produced by such organizations as RCA, General Electric, etc.

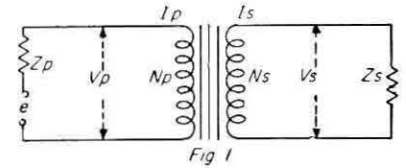

Fig 1  
ELECTRICAL CIRCUIT OF AN IDEAL TRANSFORMER WITH 100 PERCENT EFFICIENCY

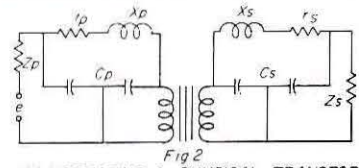

Fig 2  
ILLUSTRATING A PHYSICAL TRANSFORMER

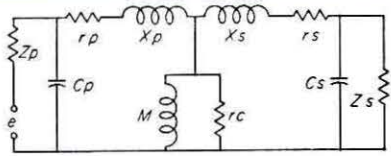

Fig 3  
EQUIVALENT T NETWORK OF THE SAME TRANSFORMER IN FIG 2

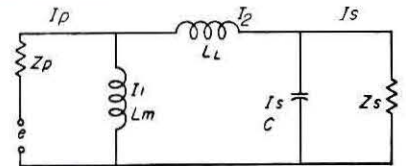

Fig 4  
A SIMPLIFICATION OF THE EQUIVALENT TRANSFORMER CIRCUIT SHOWN IN FIG 3

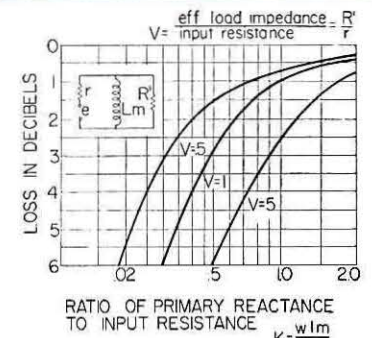

FIG 5 CURVES SHOWING THE LOSS DUE TO SHUNTING EFFECT OF THE PRIMARY OF A TRANSFORMER

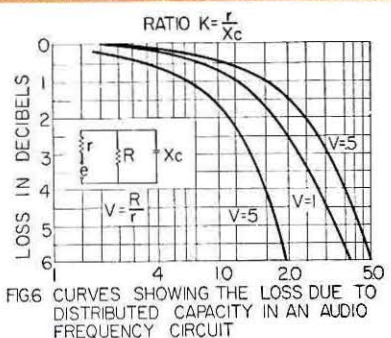

FIG 6 CURVES SHOWING THE LOSS DUE TO DISTRIBUTED CAPACITY IN AN AUDIO FREQUENCY CIRCUIT



# ULTRA COMPACT AUDIO UNITS

## TRANSISTOR AND TUBE TYPES

The UTC Ultra compact audio units are small and light in weight, ideally suited to remote amplifier and similar compact equipment. High fidelity is obtainable in all individual units, the frequency response being  $\pm 2$  db from 20 to 20,000 cycles, except where noted. Hermetic equivalents (RC-50 case) are listed on page 13. All units except those carrying DC in Primary employ a true hum balancing coil structure, which combined with a high conductivity outer case, effects good inductive shielding. The die-cast case provides for both top and bottom mounting. See page 20 for use in printed circuits.

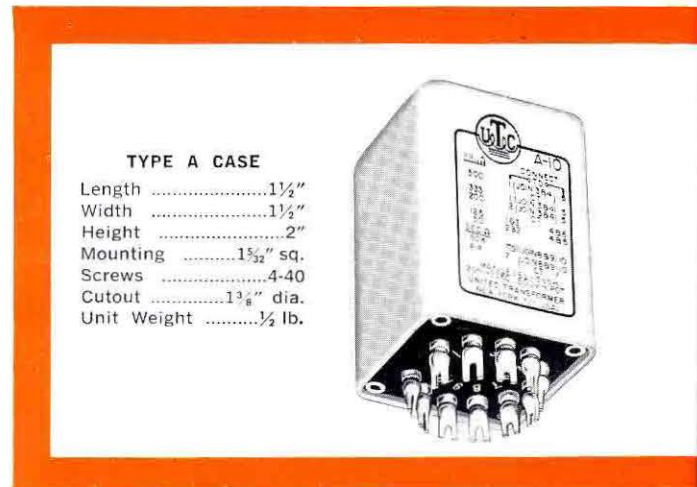

**TYPE A CASE**  
 Length .....1½"  
 Width .....1½"  
 Height .....2"  
 Mounting .....1½" sq.  
 Screws .....4-40  
 Cutout .....1¾" dia.  
 Unit Weight .....½ lb.

### INPUT TRANSFORMERS

Type No.	Application	Primary Imp. Ohms	Unbal DC	Secondary Imp. Ohms	$\pm 2$ db from	Pri Res. Ohms	Max. Level dbm	MW
A-10	Low imp. to grid	50, 125/150, 200/250 333, 500/600	0	50,000 (split)	20-20,000	59	+ 15	30
A-11*	Low imp. to 1 or 2 grids	50, 200, 500	0	50,000 CT	20-20,000	52	+ 5	3
A-12	Low imp. to PP grids	50, 125/150, 200/250 333, 500/600	0	80,000 (split)	20-20,000	60	+ 15	30
A-20†	Mixing, matching	50, 125/150, 200/250 333, 500/600	0	50, 125/150, 200/250 333,500/600	10-50,000	64	+ 15	30
A-21*†	Mixing, matching	50, 200/250, 500/600	0	50, 200/250, 500/600	30-30,000	28	+ 15	30
A-27	Xtal/hi. imp. to line	100,000 (split)	0	50, 125/150, 200/250 333,500/600	30-20,000 meas. with res. source	3700	+ 15	30
A-39*	Line to transistor	600/150 (split)	0	2000/500 (split)	20-20,000	70	+ 10	10
New A-43†	Mixing, matching line or transistor to 2 simultaneously loaded lines or transistors	600/150 (split)	0	2 secondaries each 600 150 (split)	20-30,000	45	+ 15	30

\* = Multiple alloy shield for extremely low hum pickup † = High electrostatic shielding

### INTERSTAGE AND OUTPUT TRANSFORMERS

Type No.	Application	Primary Ohms	Unbal DC	Secondary Inm. Ohms	$\pm 2$ db from	Pri Res. Ohms	Max. Level dbm	mw
A-15	Transistor interstage	10,000/2500 (split)	8 ma	2000/500 (split)	40-20,000	600	—	1w
A-16	Plate to grid	15,000	0	60,000	20-20,000	800	+ 15	30
A-17	Plate to grid	15,000	8 ma	60,000	40-20,000	3340	+ 15	30
A-18	Single or PP plates to PP grids	15,000 (split)	0	80,000 (split)	20-20,000	1040	+ 15	30
A-19	Plate to PP grids	15,000	8 ma	80,000 (split)	40-20,000	2900	+ 15	30
A-22	Tr. intstg. or output	500 CT	20 ma	500/125 (split)	40-20,000	36	—	1w
A-23	Tr. intstg. or output	500 CT	20 ma	16/4 (split)	40-20,000	36	—	1w
A-24	Single or PP plates to line	15,000 (split)	0	50, 125/150, 200/250 333, 500/600	20-40,000	1430	+ 15	30
A-25	Plate to line	15,000	8 ma	50, 125/150, 200/250 333, 500/600	40-20,000	1580	+ 15	30
A-26	Single or PP plates to line	30,000 (split)	0	50, 125/150, 200/250 333, 500/600	20-40,000	2520	+ 15	30
A-28	Transistor to V.C.	48 CT	750 ma Bal	16 (split) 8, 4	40-20,000	5	—	5w
A-34	Transistor interstage	25,000/6250 (split)	3 ma	500/125 (split)	30-20,000	1620	—	1w
A-35	Transistor interstage	10,000/2500 (split)	8 ma	500/125 (split)	30-20,000	610	—	1w
A-36	Transistor interstage	500/125 (split)	20 ma	150/37.5 (split)	40-20,000	36	—	1w
A-37	Transistor interstage	500/125 (split)	20 ma	50/12.5 (split)	40-20,000	36	—	1w
A-38	Transistor interstage	100/25 (split)	40 ma	40/10 (split)	40-20,000	6.2	—	1w

**AND SPECIAL CUSTOM BUILT ULTRA COMPACT**

Above stock units cover general purpose applications.

## TRANSISTOR AND TUBE TYPES



Hipermalloy Shield (A-33)  
shown slipping  
over "A"-line unit

A-33 SHIELD  
1<sup>19</sup>/<sub>32</sub> x 1<sup>19</sup>/<sub>32</sub> x 2<sup>1</sup>/<sub>32</sub>"

### INDUCTORS AND FILAMENT/TRANSISTOR SUPPLY TRANSFORMERS

Type No.	Application	
A-30	Audio inductor	450 Hys @ 0 ma, 250 Hys @ 5 ma, 6000 ohms DC; 65 Hys @ 10 ma, 1500 ohms DC
A-32	Filter inductor	60 Hys @ 15 ma, 2000 ohms DC; 15 Hys @ 30 ma, 500 ohms DC
A-40	Power transformer	115V 60 cycles to two 6.3V CT —.2A Secs.
A-41	Filter inductor	240 Mhy @ .2A, 6 ohms DC; 60 Mhy @ .4A, 1.5 ohms DC
<b>New</b> A-42 (2 Wdgs.)	Split filter inductor	Series conn't'd: 4 Hys @ 50 ma DC, 100 ohms Parallel conn't'd: 1 Hy @ 100 ma DC, 25 ohms
A-33	Hipermalloy shield, slip fit over "A" case, provides approximately 20 db shielding	

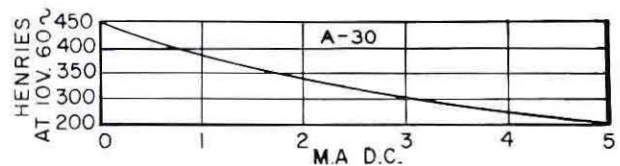
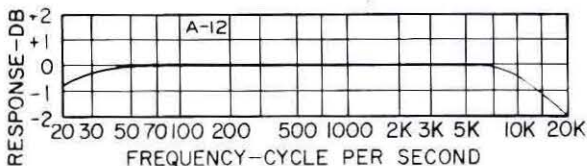
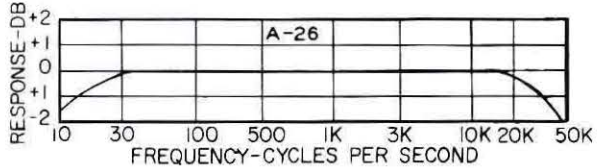
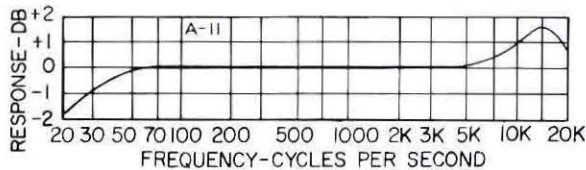
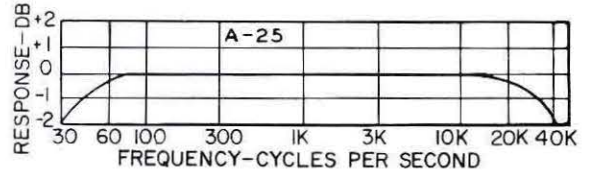
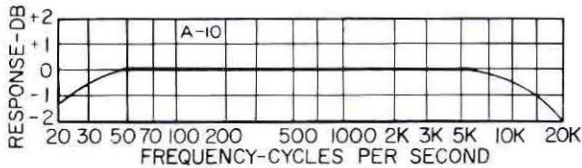
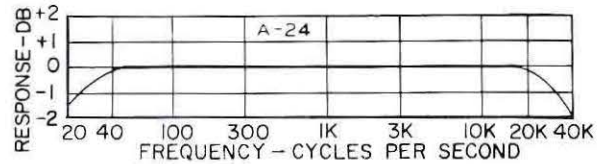
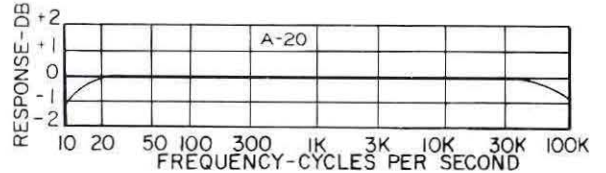
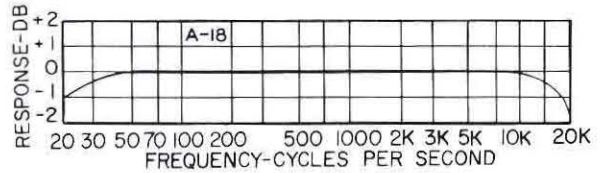

## AUDIO UNITS TO YOUR SPECIFICATIONS

For specific applications cost reductions may be effected.



# HIPERMALLOY TRANSFORMERS

The UTC Hipermalloy audio and power transformers are specifically designed for portable and compact service. While light in weight, neither dependability nor fidelity has been sacrificed. The frequency characteristic of the Hipermalloy audio units is uniform from 30 to 20,000 cycles. They incorporate a Hipermalloy nickel iron core and hum balanced coil structure. The rugged die cast case is of high conductivity alloy finished in grey, arranged for mounting with the terminals either up or down. DC in Primary shown is maximum unbalanced.

**TYPE H-1 CASE**

Length .....	2 $\frac{3}{8}$ "
Width .....	1 $\frac{5}{16}$ "
Height .....	3 $\frac{1}{8}$ "
Mounting .....	1 $\frac{3}{8}$ x 1 $\frac{13}{16}$ "
Screws .....	6-32
Cutout .....	1 $\frac{13}{16}$ " dia.
Unit Weight .....	2 lbs.

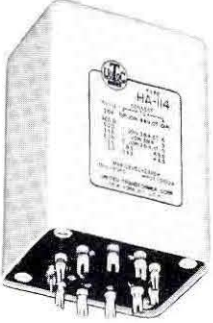

## LOW IMPEDANCE TO GRID AND MIXING TRANSFORMERS

Type No.	Application	Primary Imp. (ohms)	Secondary Impedance	± 1 db from	Max. Level dbm	mw	Unbal. DC in Prim'y	Case No.
HA-100	Low impedance mike, pickup, or multiple line to grid	50, 125/150, 200/250, 333, 500/600	60,000 ohms overall, split	30-20,000	+18	63	.5 ma	H-1
HA-100X	Same as above but with multiple alloy shields to effect very low hum pickup				+16	40		H-1
HA-101	Low impedance mike, pickup, or multiple line to P.P. grids	50, 125/150, 200/250, 333, 500/600	120,000 ohms overall, split	30-20,000	+18	63	.5 ma	H-1
HA-101X	As above but with multiple alloy shield to effect very low hum pickup		80,000 ohms overall, split	30-20,000	+16	40	.5 ma	H-1
HA-103A	Low impedance mike, pickup, or parallel mixer to grid	2.5, 5.5, 10, 15, 22, 30, 38, 60	60,000 ohms overall, split	30-20,000	+18	63	.5 ma	H-1
HA-108*	Mixing, low impedance mike, pickup, or multiple line	50, 125/150, 200/250, 333, 500/600	50, 125/150, 200/250, 333, 500/600	20-50,000	+20	100	.5 ma	H-1
HA-108X*	Same as above but with multiple alloy shields to effect very low hum pickup				+18	63		H-1
HA-130X	Three isolated lines or pads to one or two grids with tri-alloy internal shields	30, 50, 200/250 each primary	60,000 ohms overall, split	30-20,000	+18	63	.5 ma	H-1

\*High electrostatic shielding.

## INTERSTAGE AUDIO TRANSFORMERS

Type No.	Application	Primary Imp.	Secondary Impedance	± 1 db from	Max. Level dbm	mw	Unbal. DC in Prim'y	Case No.
HA-104	Single plate to P.P. grids like 2A3, 6L6 (split secondary)	15,000 ohms (split)	95,000 ohms 2.5:1	30-20,000	+20	100	0	H-1
HA-105	Single plate to single grid	15,000 ohms	60,000 ohms 2:1 turn ratio	30-20,000	+20	100	0	H-1
HA-106	Single plate to push pull grids (split secondary)	15,000 ohms (split)	135,000 ohms 3:1 ratio overall	30-20,000	+20	100	0	H-1
HA-107	Push pull plates to push pull grids (split primary and secondary)	30,000 ohms plate to plate	80,000 ohms 1.6:1 turn ratio overall	30-20,000	+28	600	.25 ma	H-2
HA-137	Push pull plates to push pull grids (split Pri. and Sec.)	30,000 ohms plate to plate	68,000 ohms 1.5:1 turn ratio	30-20,000	+20	100	0	H-1

## AND SPECIAL CUSTOM BUILT HIPERMALLOY

Above stock units cover general purpose applications.

## POWER TRANSFORMERS

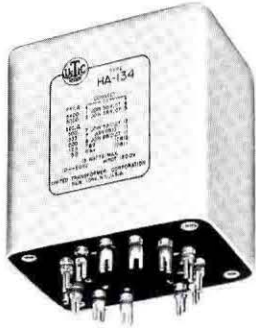

### TYPE H-2 CASE

Length ..... 3 $\frac{3}{16}$ "  
 Width ..... 2 $\frac{1}{16}$ "  
 Height ..... 3 $\frac{1}{2}$ "  
 Mounting ..... 2 x 2 $\frac{3}{4}$ "  
 Screws ..... 6-32  
 Cutout ..... 2 $\frac{1}{16}$ " dia.  
 Unit Weight ..... 5 lbs.

Type No.	Application	Primary Voltage 50/60 cycles	High Voltage	Filament Windings	Case No.
HP-122	pre-amp. power supply using 6X4, 6X5GT rectifier	115	220-0-220 15 ma	6.3 V.C.T.-.6A 6.3 V.C.T.-1.2A	H-1
HP-123	Pre amp. or tuner power supply using 6X4, 6X5GT rectifier	115	275-0-275 35 ma	6.3 V.C.T.-.6A 6.3 V.C.T.-2A	H-2

## PLATE TO LINE TRANSFORMERS

Type No.	Application	Primary Imp.	Secondary Imp. Ohms	$\pm 1$ db from	Max. Level dbm	Unbal. DC in Prim'y mw	Case No.	
HA-113	Single plate to multiple line	15,000 ohms (split)	50, 125/150, 200/250, 333, 500/600	30-40,000	+21	125	0 ma	H-1
HA-114	Push pull low level plates to multiple line	30,000 ohms plate to plate	50, 125/150, 200/250, 333, 500/600	30-40,000	+23	200	1 ma	H-1
HA-133	Single plate to mutiple line (DC in Pri.)	15,000 ohms (split)	50, 125/150, 200/250, 333, 500/600	30-40,000	+22	160	8 ma	H-1

## OUTPUT TRANSFORMERS

Type No.	Application	Primary Imp.	Secondary Imp. Ohms	$\pm 1$ db from	Max. Level	Case No.
HA-134	Push pull, 6L6, 6050, 7355, 7581 to line	5000/9400 ohms plate to plate	50, 125/150, 200/250, 333, 500/600	10-50,000	15 watts	H-2
HA-135	As above except to voice coil	3000/5000 ohms plate to plate	30, 20, 15, 10, 7.5, 5, 2.5, 1.2	10-50,000	18 watts	H-2
HA-136	5881's (KT-66's) in AB-feed back (see pg. 19 circuit)	6,600 ohms CT 43% screen taps	4, 8, 16	10-50,000	20 watts	H-2

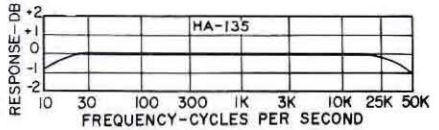
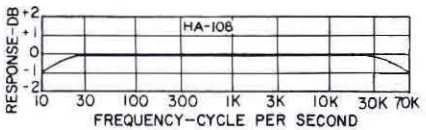
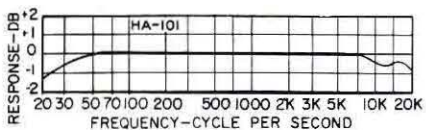
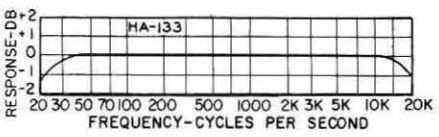
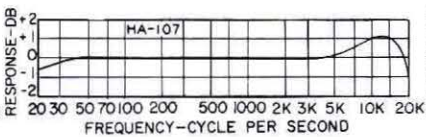
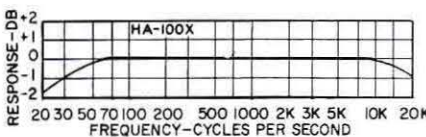
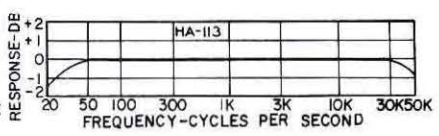
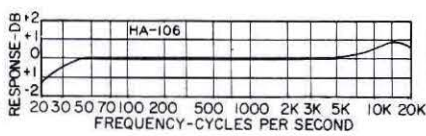
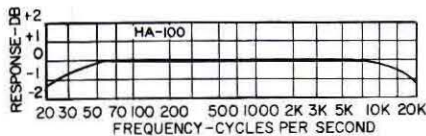

## TRANSFORMERS TO YOUR SPECIFICATIONS

For specific applications cost reductions may be effected.



# LINEAR STANDARD AUDIO TRANSFORMERS

The ever increasing use of wide range equipment has reached the point where the major limiting factor is the frequency range of the transformers employed. UTC Linear Standard components represent the closest approach to the ideal transformer from the standpoint of uniform frequency response, low wave form distortion, high efficiency, thorough shielding, and dependability.

## LOW IMPEDANCE TO GRID AND MIXING AND MATCHING TRANSFORMERS

Type No.	Application	Primary Impedance	Secondary Impedance	± 1 db from	Max. Level dbm	Relative* hum	Unbal. DC in primary	Case No.
LS-10	Low impedance mike, pickup, or multiple line to push pull grids	50, 125/150, 200/250, 333, 500/600 ohms	60,000 ohms in two sections	20-20,000	+19	-74 db	.5 ma	LS-1
LS-10X	As above	As above	50,000 ohms	20-20,000	+17	-92 db-Q	.5 ma	LS-1
LS-12	Low impedance mike, pickup or multiple line to push pull grids	50, 125/150, 200/250, 333, 500/600 ohms	120,000 ohms overall, in two sections	20-20,000	+19	-74 db	.5 ma	LS-1
LS-12X	As above	As above	80,000 ohms overall, split	20-20,000	+17	-92 db-Q	.5 ma	LS-1
LS-14X	Low impedance mike, pickup, or parallel mixer to grid	2.5, 5.5, 10, 15, 22, 30, 38, 60 ohms	50,000 ohms	20-20,000	+17	-92 db-Q	.5 ma	LS-1
LS-26	Bridging line to single or push pull grids	5,000 ohms	60,000 ohms in two sections	15-20,000	+23	-74 db	0 ma	LS-1
LS-30†	Mixing, low impedance mike, pickup or multiple line to multiple line	50, 125/150, 200/250, 333, 500/600 ohms	50, 125/150, 200/250, 333, 500/600 ohms	7-50,000	+23	-74 db	.5 ma	LS-1
LS-30X†	As above	As above	As above	20-20,000	+20	-92 db-Q	.3 ma	LS-1
LS-31	Three isolated lines or pads to multiple line	30/50, 200/250 ohms, each primary	50, 125/150, 200/250, 333, 500/600 ohms	20-20,000	+23	-74 db	.5 ma	LS-1
LS-32	Mixing, low impedance mike, pickup or parallel mixer to multiple line	2.5, 5.5, 10, 15, 22, 30, 38, 60 ohms	50, 125/150, 200/250, 333, 500/600 ohms	20-20,000	+23	-74 db	.5 ma	LS-1
LS-68 † <b>New</b>	Mixing, matching line or transistor to 2 simultaneously loaded lines or transistors	600/150 split	2 secondaries each 600/150 split	20-40,000	+15	-92 db-Q	0 ma	LS-1

† High electrostatic shielding.

## INTERSTAGE AND DRIVER TRANSFORMERS

Type No.	Application	Primary Impedance	Secondary Impedance	± 1 db from	Max. Level	Relative* hum	Unbal. DC in primary	Case No.
LS-19	Plate to PP grids like 6L6, 5881 Split secondary	15,000 ohms	95,000 ohms 1.25:1 each side	20-20,000	100 mw	-50 db	0 ma	LS-1
LS-21	Plate to PP grids Split pri. and sec.	15,000 ohms	135,000 ohms; 3:1 overall	10-20,000	100 mw	-74 db	0 ma	LS-1
LS-40	Plate to PP grids Split secondary	15,000 ohms	135,000 ohms; 3:1 overall	30-18,000 (± 2 db)	100 mw	-74 db	8 ma	LS-1
LS-25	PP plates to PP grids Med. level split pri. and sec.	30,000 ohms plate to plate	50,000 ohms; turn ratio 1.3:1 overall	20-20,000	200 mw	-74 db	1 ma	LS-1
LS-47	Driver from push pull 2A3's, or sim. to class B828's, 805's, or ZB120's	5,000 ohms plate to plate	.1 pri. impedance turns ratio, Pri./1/2 Sec. 3.2:1	20-20,000	20 Watts		5 ma	LS-2
LS-48	Driver trans. push pull 845's to 805 grids in class B	12,000 ohms plate to plate	.038 pri. impedance turns ratio, Pri./1/2 Sec. 5.1:1	20-20,000	40 Watts		15 ma	LS-3

## HYBRID AND REPEAT COILS

Type No.	Application	Pri and Sec. Impedances	± 1 db from	Max. Level dbm	Relative* hum	Max. Unbal. DC in primary	Case No.
LS-140	Line to line for isol. balanced and unbal. cir.; bal. for max. cross talk 70 db	500/600 ohms split 500/600 ohms split	30-20,000	+18	-92 db-Q	0 ma	LS-1
LS-141	Three sets of bal. wind. for hybrid service, centertapped	500/600 ohms 500/600 ohms	30-15,000	+18	-74 db	0 ma	LS-1

The values of unbalanced DC shown will effect approximately 1.5 db loss at 30 cycles.

\* Comparison of hum balanced unit with shielding to normal uncased type. Q = Multiple alloy magnetic shields.

## AND SPECIAL CUSTOM BUILT LINEAR STANDARD

Above stock units cover general purpose applications.

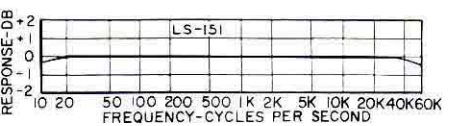
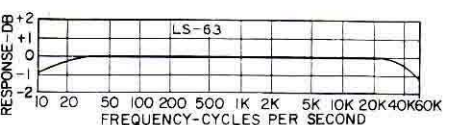
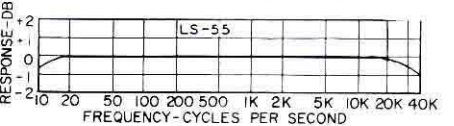
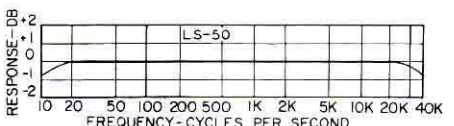
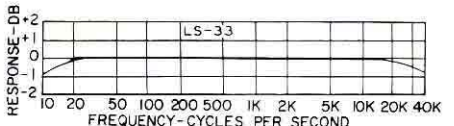
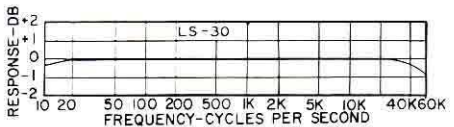
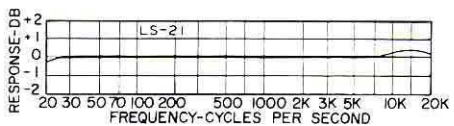
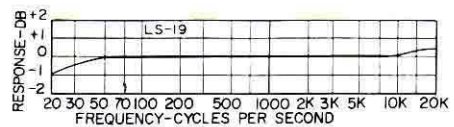
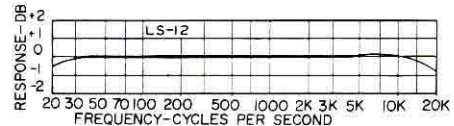
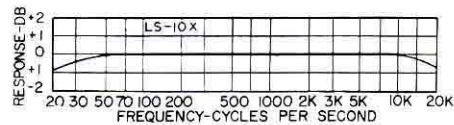
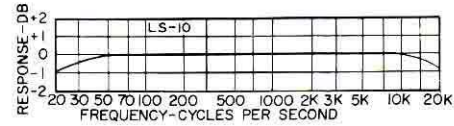



# LINEAR STANDARD AUDIO TRANSFORMERS

## PLATE, CRYSTAL, PHOTOCCELL, AND BRIDGING TO LINE TRANSFORMERS

Type No.	Application	Primary Impedance	Secondary Impedance	± 1 db from	Max. Level	Relative hum*	Unbal. DC in primary	Case No.
LS-27	Single pl. to multiple line	15,000 ohms	50, 125/150, 200/250, 333, 500/600	30-15,000	200 mw	-74 db	8 ma	LS-1
LS-50	Single pl. to multiple line	15,000 ohms	50, 125/150, 200/250, 333, 500/600	10-40,000	200 mw	-74 db	0 ma	LS-1
LS-51	Push pull low level pl. to multiple line	30,000 ohms plate to plate	50, 125/150, 200/250, 333, 500/600	10-40,000	250 mw	-74 db	1 ma	LS-1
LS-150	Bridging from 50 to 500 ohm line to line	4,000 ohms, bridging	50, 125/150, 200/250, 333, 500/600	7-50,000	200 mw	-74 db	1 ma	LS-1
LS-151	Bridging from 50 to 500 ohm line to line	16,000 ohms, bridging	50, 125/150, 200/250, 333, 500/600	7-50,000	400 mw	-74 db	1 ma	LS-1

## HIGH LEVEL MATCHING TRANSFORMERS

Type No.	Application	Primary Impedance	Secondary Impedance	± 1 db from	Max. Level	Case No.
LS-33	High level line matching	50, 125/150, 200/250, 333, 500/600 ohms	1.2, 2.5, 5, 7.5, 10, 15, 20, 30, 50, 125/150, 200/250, 333, 500/600	10-40,000	20 watts	LS-2
LS-34	High level line matching	50, 125/150, 200, 250, 333, 500/600 ohms	1.2, 2.5, 5, 7.5, 10, 15, 20, 30, 50, 125/150, 200/250, 333, 500/600	10-40,000	40 watts	LS-3

## OUTPUT TRANSFORMERS TO LINE AND VOICE COIL

Type No.	Primary will match typical tubes	Primary Impedance	Secondary Impedance	± 1 db from	Max. Level	Case No.
LS-52	Push pull 6AQ5, 6V6, 6L6, 5881, 6BQ5, 7189A	8,000 ohms	500, 333, 250/200, 125, 50, 30, 20, 15, 10, 7.5, 5, 2.5, 1.2	7-50,000	20 watts	LS-2
LS-54	Same as above	8,000 ohms	30, 20, 15, 10, 7.5, 5, 2.5, 1.2	7-50,000	20 watts	LS-2
LS-55	Push pull 300B, 6L6's, 6AS7G, 6080, 7581, 7355	5,000 ohms plate to plate and 3,000 ohms plate to plate	500, 333, 250/200, 125, 50, 30, 20, 15, 10, 7.5, 5, 2.5, 1.2	7-50,000	20 watts	LS-2
LS-57	Same as above	5,000 ohms plate to plate and 3,000 ohms plate to plate	30, 20, 15, 10, 7.5, 5, 2.5, 1.2	7-50,000	20 watts	LS-2
LS-58	Push pull parallel as above	2,500 ohms plate to plate and 1,500 ohms plate to plate	500, 333, 250/200, 125, 50, 30, 20, 15, 10, 7.5, 5, 2.5, 1.2	10-50,000	40 watts	LS-3
LS-61	Push pull triode; 6AS7G, 6080, 6L6, 5881, KT-66, 807, 1614	10,000 ohms pl. to plate and 6,000 ohms plate to plate	500, 333, 250/200, 125, 50, 30, 20, 15, 10, 7.5, 5, 2.5, 1.2	7-50,000	20 watts	LS-2
LS-63	Same as above	10,000 ohms pl. to plate and 6,000 ohms plate to plate	30, 20, 15, 10, 7.5, 5, 2.5, 1.2	7-50,000	20 watts	LS-2
LS-6L1	Self bias push pull 6L6's, 5881, KT-66, 6146 triode, 6159 triode	9,000 ohms plate to plate	500, 333, 250/200, 125, 50, 30, 20, 15, 10, 7.5, 5, 2.5, 1.2	7-50,000	30 watts	LS-3
LS-6L4	Push pull 6146, 6159, 6L6's fixed bias or push pull parallel 6L6's self bias, 7581	4,500 ohms plate to plate and 3,800 ohms plate to plate	500, 333, 250/200, 125, 50, 30, 20, 15, 10, 7.5, 5, 2.5, 1.2	12-50,000	55 watts	LS-3
LS-35	EL-34 in AB-feedback (see circuit pg. 19)	5,000 ohms CT 43% screen taps	4, 8, 16	7-50,000	35 watts	LS-3
LS-65	6550's in AB <sub>1</sub> feedback (see circuit pg. 19)	3,300 ohms CT 40% screen taps	4, 8, 16	7-50,000	60 watts	LS-3
LS-666	Push pull transistors class B (2N277 or equiv.) (see circuit pg. 20)	8 ohms split	500 ohms split	7-50,000	50 watts	LS-3
LS-667	Push pull transistors class B (2N277 or equiv.) (see circuit pg. 20)	8 ohms split	4, 8, 16	7-50,000	50 watts	LS-3

## MODULATION TRANSFORMERS

Type No.	Primary will match typical tubes	Primary Impedance	Secondary Impedance	± 1 db from	Max. Level	Case No.
LS-56	Push pull 6A5G's, 300B's, 6AS7G, 6L6 6080, 7335, 7581	5,000 ohms plate to plate and 3,000 ohms plate to plate	6000, 5000, 4000, 1800, 1500, 1000, 30, 20, 15, 10, 7.5, 5, 2.5, 1.2	10-50,000	20 watts	LS-2
LS-691	Class B, 833A, 250TH	10,400 ohms plate to plate	4500, 4000, 3500, 2750, 2000	20-40,000	1000 watts	LS-6
LS-692	Class B push pull parallel 833A's	4,750 ohms plate to plate	2500, 2000, 1750, 1500, 1250	20-40,000	2500 watts	LS-6

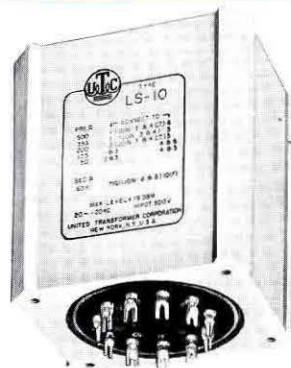

### LINEAR STANDARD HIGH SHIELDING DIE CAST CASES TOP & BOTTOM MTG.

#### LS-1 CASE

Length .....3 1/8"  
 Width .....2 5/8"  
 Height .....3 1/4"  
 Mounting .....1 3/8" x 2 1/8"  
 Screws .....6-32  
 Cutout .....1 1/8" dia.  
 Unit Weight .....3 lbs.

#### LS-2 CASE

Length .....4 7/8"  
 Width .....3 1/2"  
 Height .....4 3/8"  
 Mounting .....2 1/8" x 3 1/8"  
 Screws .....8-32  
 Cutout .....2 3/4" dia.  
 Unit Weight .....7.5 lbs.

#### LS-3 CASE

Length .....5 1/8"  
 Width .....5"  
 Height .....4 1/8"  
 Mounting .....4 3/8" x 5 1/8"  
 Screws .....10-24  
 Cutout .....3 3/4" dia.  
 Unit Weight .....15 lbs.

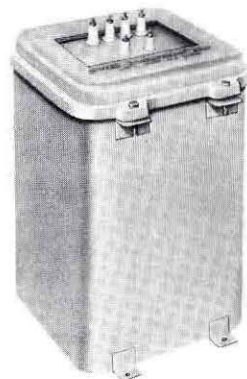

#### LS-6 CASE

Length .....15 3/8"  
 Width .....13"  
 Height—LS-691 .....24"  
 Height—LS-692 .....28"  
 Mounting Dimen .....7 3/8" x 14 1/8"  
 Mounting Hole .....3/8" dia.  
 Unit Weight .....350 lbs.  
 Unit Weight—LS-691 .....370 lbs.  
 Unit Weight—LS-692 .....520 lbs.



## COMMERCIAL GRADE COMPONENTS

The Commercial Grade series of transformers incorporate conservative design and rugged construction to assure dependability under continuous service operation in commercial grade equipment. These units are mounted in uniform drawn cases finished in light grey enamel, and intended for chassis mounting. All items are poured with special sealing compound in addition to vacuum impregnation of coil structures.

All audio components are linear  $\pm 1\frac{1}{2}$  db from 40 to 10,000 cycles (no unbalanced DC), except CVL and CVM units . . . 40 to 6000 cycles. CG-134, 135 and 136 are of the hum-bucking type to assure low hum pick-up. Parallel feed low level interstage units with 50,000 ohms and .25 mfd.; 200 ohm windings on input transformers are balanced and may be used for 150 to 250 ohm circuits.

### INPUT, INTERSTAGE, MIXING AND LOW LEVEL OUTPUT TRANSFORMERS

Type No.	Application	Primary Impedance Ohms	Max. Level dbm	Secondary Impedance Ohms	Case No.
CG-131	1 plate to 1 grid	15,000	+28	135,000 1:3 ratio	RC-50
CG-132	1 plate to 2 grids	15,000	+30	135,000 split 1:3 ratio overall	RC-62
CG-133	2 plate to 2 grids	30,000 P to P	+32	80,000 overall 1:1.6 ratio overall	RC-75
CG-134	Line to 1 grid hum-bucking	50, 200, 500	+30	80,000	RC-50
CG-135	Line to 2 grids hum-bucking	50, 200, 500	+30	120,000 overall	RC-50
CG-235	Line to 1 or 2 grids, hum-bucking; multiple alloy shielded for low hum pickup	50, 200, 500	+28	80,000 overall	RC-75
CG-136	Single plate and low impedance mike or line to 1 or 2 grids hum-bucking	15,000, 50, 200	+30	80,000 overall	RC-62
CG-137	Mixing	50, 200, 500	+28	50, 200, 500	RC-50
CG-140	Triode plate to line	15,000 8 ma DC	+30	50, 200, 500	RC-50
CG-141	PP triode plates to line	30,000 P to P	+32	50, 200, 500	RC-50
CG-233	PP 6C5, 12AU7, similar triodes to AB 45's, 2A3's, 6L6's, etc.	30,000 P to P	+35	25,000 overall 1:1.9 ratio overall	RC-87
CG-333	PP 6C5, 12AU7, similar triodes to fixed bias 6L6's	30,000 P to P	+35	3,300 overall 1:3.33 ratio overall	RC-87
CG-433	PP 45, 2A3, similar tubes to fixed bias 2 or 4 6L6's	5,000 P to P	10W.	800 overall 1:4 ratio overall	RC-100

### OUTPUT TRANSFORMERS

Secondary Impedances: 500, 200, 16, 8, 5, 3, 1.5 ohms

Type No.	Imped. P. P. Ohms, Overall	Typical Tubes	Max. Watts	Case No.
CG-15	8,000	6V6, 6AQ5, 6BQ5, 7189A	20	RC-100
CG-16	3,000/5,000	6AS7G, 6L6, 6080, 7581	20	RC-100
CG-19	6,000/10,000	6L6, 5881, 6DZ7	20	RC-100
CG-710	14,000/20,000	7B5, 6AK6, 6K6GT	20	RC-100
CG-2L6	9,000	6L6's, AB1, 5881	30	RC-125

### FEEDBACK OUTPUT TRANSFORMERS

(See page 19 for typical circuits)

Secondary Impedances: 4, 8, 16 ohms and 70 Volt line.

Type No.	Primary Impedance	Typical Tubes	Audio Watts	Case No.
CG-20	5,000 CT, 43% screen taps	EL-34 in AB	25	RC-125
CG-21	3,300 CT, 40% screen taps	6550's in AB <sub>1</sub>	50	RC-150

### CG VARIMATCH OUTPUTS FOR P. A.

Universal units designed to match any tubes within the rated output power, to line or voice coil. Output impedance 500, 200, 50, 16, 8, 5, 3, 1.5 ohms. Primary impedance 3000, 5000, 6000, 8,000, 10,000, 14,000 ohms, center tapped.

Type No.	Audio Watts	Typical Tubes	Case No.
CVP-1	12	6V6, 6AQ5, 6BQ5, 6DZ7, 7189	RC-100
CVP-2	30	6L6, 6V6, 807, 5881, 6DZ7, 7189, 7355, 7581	RC-125
CVP-3	60	300B's, 6L6's, 807, 1614, 5881, 1625	RC-150
CVP-4	125	807's, 4-6L6's, 845's, 4-1614's, 6146, 6159	RC-152
CVP-5	300	242A's, 838's, ZB-120's	RC-175



### COMMERCIAL GRADE CASE

Case No.	Base Dim. (Sq.)	Mounting Dim. (Sq.)	Mounting Screw	Height $+\frac{1}{8}, -\frac{1}{16}$	Cutout Dia.	Unit Weight Lbs.
RC-37	1 $\frac{1}{8}$	1 $\frac{1}{8}$	4-40	1 $\frac{1}{8}$	1 $\frac{1}{4}$	.35
RC-50	1 $\frac{1}{8}$	1 $\frac{1}{8}$	6-32	2 $\frac{1}{4}$	1 $\frac{1}{2}$	$\frac{1}{2}$
RC-62	1 $\frac{1}{8}$	1 $\frac{1}{2}$	6-32	2 $\frac{1}{2}$	1 $\frac{1}{2}$	1
RC-75	2 $\frac{1}{8}$	1 $\frac{3}{8}$	8-32	2 $\frac{1}{2}$	1 $\frac{1}{8}$	1 $\frac{1}{2}$
RC-87	2 $\frac{1}{8}$	2 $\frac{1}{2}$	8-32	3 $\frac{1}{4}$	2	2 $\frac{1}{2}$
RC-100	3	2 $\frac{1}{2}$	8-32	3 $\frac{1}{4}$	2 $\frac{1}{2}$	3 $\frac{1}{2}$
RC-112	3 $\frac{1}{8}$	2 $\frac{1}{8}$	10-32	4 $\frac{1}{8}$	2 $\frac{1}{8}$	5
RC-125	3 $\frac{1}{4}$	3	10-32	4 $\frac{1}{2}$	3	6 $\frac{1}{2}$
RC-150	4 $\frac{1}{2}$	3 $\frac{1}{8}$	12-28	5 $\frac{1}{2}$	3 $\frac{3}{4}$	11
RC-152	5 $\frac{1}{8}$	4 $\frac{1}{8}$	12-28	5 $\frac{1}{2}$	4	15 $\frac{1}{2}$
RC-175	5 $\frac{1}{4}$	4 $\frac{1}{8}$	$\frac{1}{4}$ -20	7	4	22

### CG VARIMATCH LINE TO VOICE COIL TRANSFORMERS

The UTC VARIMATCH line to voice coil transformers will match any voice coil or group of voice coils to a 500 ohm line. More than 50 voice coil combinations can be obtained, as follows:

.2, .4, .5, .62, 1, 1.25, 1.5, 2, 2.5, 3, 3.3, 3.8, 4, 4.5, 5, 5.5, 6, 6.25, 6.6, 7, 7.5, 8, 9, 10, 11, 12, 14, 15, 16, 18, 20, 25, 28, 30, 31, 40, 47, 50, 63, 69, 75 ohms.

Type No.	Audio Watts	Primary Impedance	Secondary Impedance	Case No.
CVL-1	15	500 ohms	.2 to 75 ohms	RC-87
CVL-2	40	500 ohms	.2 to 75 ohms	RC-125
CVL-3	75	500 ohms	.2 to 75 ohms	RC-150

### CG VARIMATCH DRIVER TRANSFORMERS

Type No.	Primary	Typical Output Tubes	Max. Level Watts	Case No.
CG-51AX	All single tubes like: 6C5, 6C4, 12AU7, 2A3, 5814A Ratios 2.8:1, 3.1:1, Pri. to $\frac{1}{2}$ sec.	2A3, 6L6	5	RC-87
CG-53AX	P. P. tube like: 2A3, 6L6, Ratios 2:1, 3:1, Pri. to $\frac{1}{2}$ sec.	841, 801A, 800, 838, 805	20	RC-112
CG-59AX	50, 200, 500 ohm line Ratios 1:1, 1.4:1, Pri. to $\frac{1}{2}$ sec.	805, 838, ZB-120, 100TH, 800, 55T	20	RC-112

### CG VARIMATCH MODULATION UNITS

Will match any modulator tubes to any RF load.

The UTC Varimatch transformer eliminates the power loss and high distortion caused by imprecise matching of RF load to a class B modulation through the use of a combination of tapped windings affording an extremely wide range in impedance matching. Designs provide that for any load impedance employed, full class C plate current can be carried by secondary winding.

Primary impedances from 500 to 20,000 ohms  
Secondary impedances from 30,000 to 300 ohms

Type No.	Max. Audio Watts	Max. Class C Input	Typical Modulator Tubes	Case No.
CVM-0	12	25	6BQ5, 6DZ7, 6V6, 7189	RC-100
CVM-1	30	60	6V6, 6L6, 807, 5881, 7189, 7355, 7581	RC-125
CVM-2	60	125	6L6, 809, T-20, 1608, 6159	RC-150
CVM-3	125	250	807, 845, TZ-20, RK-30, 35-T	RC-152
CVM-4	300	600	805, 838, T-55, ZB-120, 4-65A, 100TH	RC-175
CVM-5	600	1200	805, HF-300, HK-354, 205TH, 810, 4-125A	7x12x9H 82 lbs.

AND SPECIAL CUSTOM BUILT AUDIO AND POWER

Above stock units cover general purpose applications.





## COMMERCIAL GRADE COMPONENTS

UTC CG power transformers, Varimatch units and inductors are designed to A.I.E.E. commercial standards. Ratings are conservative for continuous duty. Units are tested for breakdown at twice maximum working voltage plus 1000 volts and surge tested at 250% normal voltage. All items are vacuum impregnated and sealed with special insulating compound. The conservative design and manufacturing procedure of these units make them suitable for virtually all types of commercial equipment as well as ideally suited for quality amateur and public address service.

### VARIPOWER AUTO-FORMERS

Boosting/Voltage Adjustment

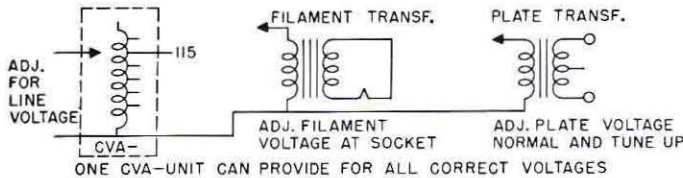

Type No.	Watts Output	Case No.
CVA-1	150	RC-112
CVA-2	250	RC-125
CVA-3	500	RC-150
CVA-4	1000	RC-152
CVA-5	2000	RC-175

Designed for line voltage control, filament control and reduced power operation. Output voltage from 0 to 130 volts, 50/60 cycles. Varipower units permit control of filament voltage at the tube socket to within 2½% of desired value simultaneously with line voltage control and plate voltage control. Can be used to reduce or increase voltages on filament transformers. Taps at 25, 55, 75, 95, 100, 105, 110, 115, 120, 125 and 130 volts permit output voltages from 0 to 130 volts in 5 volt steps... from 115V, 50/60 cycles.

### POWER AND BIAS TRANSFORMERS

Primary 115 volts 50/60 cycles

(DC ma is for choke input. Reduce to 70% for condenser input.)

Type No.	High Voltage	DC ma	Fil. 1	Fil. 2	Fil. 3	Fil. 4	Case No.
CG-422	435-365-0-365-435 125-0-125	125 25	5V-3A	5V-2A	6.3 VCT-3A	2.5 VCT-5A	RC-150
CG-428	500-0-500 80-0-80	250 100	5V-3A	5V-2A	6.3 VCT-4A	6.3 VCT-3A, tapped 2.5 VCT-3A	RC-152
CG-429	600-525-0-525-600	250	5V-3A	6.3VCT-3-A	7.5 VCT-3A, tapped 6.3 VCT-4A		RC-152
CG-431	500-400-0-400-500 80-0-80	500 100	5V-6A	5V-2A	6.3 VCT-5A	6.3 VCT-3A	RC-175
CG-315	Tapped for any DC voltage from 15 to 100 volts within 6%—250 MA						RC-125
CG-316	Tapped for any DC voltage from 75 to 400 volts within 6%—250 MA						RC-152

### TRANSISTOR/FILAMENT SUPPLY TRANSFORMERS

Primary 115 volts 50/60 cycles

See page 30 for typical applications.

Type No.	Sec. V RMS	Sec. A RMS	In Parallel			In Series			Case No.		
			Choke in DCV	C in DCA	C in DCV	Choke in DCV	C in DCA	C in DCV			
CG-30	17/21.5 17/21.5	1.5 1.5	14/17.5	3	18.5/25	2	28/35	1.5	43/56	1	RC-112
CG-31	34/43 34/43	4.5 4.5	28/35	9	43/56	6	56/70	4.5	85/110	3	RC-175
CG-32	6.3VCT	1.2									RC-62

### FILAMENT/TRANSISTOR SUPPLY TRANSFORMERS

Primary 105, 115, 210, 220, 230 volts, 50/60 cycles, except CG-34... 105, 115, 220, 230. These transformers may be used on 25 to 43 cycles if 220 volt primary is used on 110 volts. Secondary voltage is simultaneously reduced to half.

Type No.	Sec. Volts C T	Sec. Amps	Working Voltage	Sec. Test Volts RMS	Case No.
CG-33	6.3	4	500	2000	RC-75
CG-34	2.5	10	2500	6000	RC-112
CG-120	2.5	10	5000	11000	RC-125
CG-121	5	25	5000	11000	RC-150
CG-122	7.5/6.3	10	1500	4000	RC-125
CG-124	10	10	1500	4000	RC-150
CG-125	14/12/11	10	1500	4000	RC-150
CG-126	14/11/10 14/11/10	10 10	1500	4000	RC-152



### CG PLATE TRANSFORMERS

Primaries for 105, 115, 220, 230 volts, 50/60 cycles. For reduced power, secondary voltages can be reduced to half by using 220V. Pri. on 110 volts. These transformers may be used on 25 to 43 cycles if 220V. Pri. is used on 110 volts; secondary voltage is simultaneously halved. Units with a W suffix have been designed to be used both in full wave center tap and full wave bridge application. In these units, center-tap of secondary winding may be disconnected from ground. All ratings are for choke input filtering. Other electrical and mechanical parameters on "W" units are the same as the non-suffixed units.

Type No.	High Voltage	DC Voltage	DC ma	Case No.
CG-300	625-515-0-515-625	500/400	200	RC-150
CG-301	580-530-300-0-300-530-580	475/425/250	420	RC-152
CG-302	950-750-0-750-950	760/610	360	RC-175
CG-303	1500-1235-400-0-400-1235-1500	1250/1000 300	260* 175	RC-175

\* 300MA, if used without load on low voltage winding.

### END CASTING UNITS

Type No.	High Voltage	DC Voltage	DC ma	L	W	H	Mfg. Dim.	Wt. Lbs.
CG-304	1500-1235-0-1235-1500	1250/1000	800	14½"	8½"	10½"	7¼x13¾"	100
CG-304W		2500/2000	550		Same as above			
CG-305	2400-1750-0-1750-2400	2000/1500	300	10½"	4¾"	6¾"	3¾x9¾"	50
CG-305W		4000/3000	210		Same as above			
CG-306	2400-1750-0-1750-2400	2000/1500	500	13¾"	8½"	10¾"	7¼x12¾"	100
CG-306W		4000/3000	350		Same as above			
CG-307	3500-3000-2400-0-2400-3000-3500	3000/2500 2000	300	13¾"	8½"	10¾"	7¼x12¾"	90
CG-308	3500-3000-2400-0-2400-3000-3500	3000/2500 2000	500	15¾"	8½"	10¾"	7¼x14¼"	125
CG-309	3500-3000-2400-0-2400-3000-3500	3000/2500 2000	1000	21"	10"	13¾"	8½x20"	253
CG-310	4600-4050-3500-0-3500-4050-4600	4000/3500 3000	600	17¼"	10"	13¾"	8½x16¼"	150
CG-311	1500-1235-0-1235-1500	1250/1000	500	10½"	4¾"	6¾"	3¾x9¾"	50
CG-311W		2500/2000	350ma		Same as above			
CG-312	1800-1500-0-1500-1800	1500/1250	400	10½"	4¾"	6¾"	3¾x9¾"	38

### FILTER INDUCTORS

INDUCTANCE SHOWN IS AT RATED DC MA

Type No.	Inductance Henrys	DC ma	DC Res. Ohms	Test Volts RMS	Case No.
CG-40	10	200	110	1750	RC-112
CG-44	30	100	400	1750	RC-100
CG-45	250	15	5000	1750	RC-87
CG-48C	75	50	2200	1750	RC-87
CG-100	12	150	110	*2500	RC-125
CG-102	12	250	100	3000	RC-150
CG-104	10	350	90	5000	RC-152
CG-108	10	500	52	7000	RC-175
CG-1S	10	1000	40	9000	11½x4¾x 6¾ H, 40 lb.

### SWINGING INPUT INDUCTORS

INDUCTANCE SHOWN IS FROM 100% TO 10% OF RATED DC MA

Type No.	Inductance Henrys	DC ma	DC Res. Ohms	Test Volts RMS	Case No.
CG-101	25/5	150	110	2500	RC-125
CG-103	25/5	250	100	3000	RC-150
CG-105	25/5	350	90	5000	RC-152
CG-109	25/5	500	52	7000	RC-175
CG-111†	100/10 Mhy (2 Wdgs.)*	2.5A 5A	.6 .15	1500	RC-87
CG-1C	25/5	1000	40	9000	Same as CG-1S

† Split winding in series

\* Split winding in parallel



## SPECIAL SERIES AUDIO TRANSFORMERS

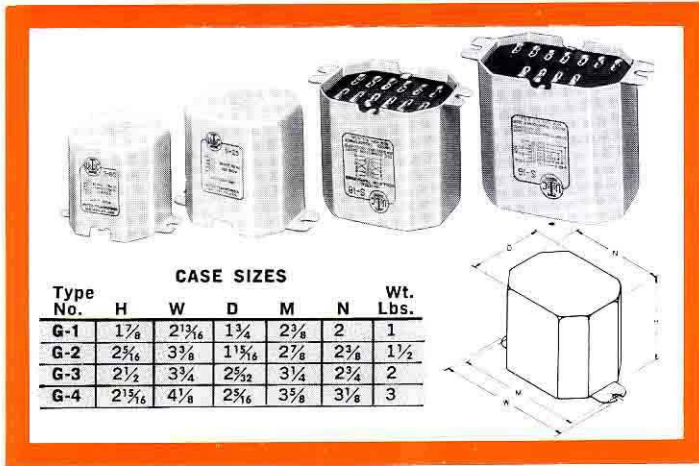

CASE SIZES						
Type No.	H	W	D	M	N	Wt. Lbs.
G-1	1 7/8	2 1/8	1 3/4	2 3/8	2	1
G-2	2 3/8	3 3/8	1 3/8	2 7/8	2 3/8	1 1/2
G-3	2 1/2	3 3/4	2 5/8	3 1/4	2 3/4	2
G-4	2 3/8	4 7/8	2 3/8	3 3/8	3 1/8	3

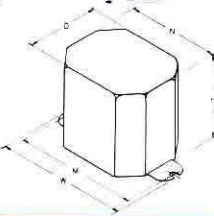

### CLASS A INPUT TRANSFORMERS

Type No.	Application	Ratio	Case
S-1	1 plate* to 1 grid	1:3	G-2
S-2	1 plate* to 2 grids	1:4	G-2
S-3	1 plate* to 1 or 2 grids compact type	1:4	G-1
S-5	Single or double button mike or line to 1 grid hum-bucking type	1:16	G-2
S-6	Single or double button mike or line to 1 grid, compact type	1:16	G-1

\*Will match tubes like 6J5, 6C4, 12AU7, etc. Can be used with high mu triodes with loss in low frequencies. Pri. DC to 8 ma

### UNIVERSAL DRIVER TRANSFORMERS (See modulator chart supplied with units for tube types, ratios are Pri. to 1/2 sec.)

Type No.	Application	Max. Watts	Case
S-8	Single driver plate to pushpull grids, 2.66:1, 5:1 ratios. Pri. DC to 45 ma.	5	G-3
S-9	Pushpull driver plates to grids of class B tubes up to 400 watts output, 2.66:1, 3.6:1, 5:1 ratios.	20	G-4
S-10	12AU7 or similar plates to 5881 or 6L6's, self or fixed bias, 2.25:1 ratio	5	G-3

### MATCHING TRANSFORMERS

Type No.	Application	Pri. Ohms	Sec. Ohms	Case
S-11	Single 6J5, 6C4, 12AU7 or similar tube to line	15,000 10 ma DC	200/500	G-2
S-12	Line to speaker 15 watts	500, 2000, 4000	2, 4, 8, 15	G-2
S-13	Line to speaker 30 watts	500, 2000, 4000	2, 4, 8, 15	G-4

### UNIVERSAL OUTPUT TRANSFORMERS TO LINE AND VOICE COIL

(Secondary Impedances: 500, 15, 8, 2 ohms)

Type No.	Primary Impedance	Typical Tubes	Case
<b>SINGLE-ENDED TUBES</b>			
S-14 10 W.	2500 ohms 4000 ohms 7000 ohms 10,000 ohms	35 ma DC 35L6GTG, 6V6, 12A6, 6AC5 2A3, 6B4, 6L6, 6Y6, 25L6GT 6F6, 7B5, 6K6GT, 1G5, 3C5 6A4, 6N7, 7189A, 7581, 7355	G-2
<b>PUSH-PULL TUBES</b>			
S-15 12 W.	4000 ohms 5000 ohms 10,000 ohms	6Y6, 25L6GT 2A3, 6AS7G 6080, 6BN8	G-2
S-16 30 W.	3000 ohms 6000 ohms 9000/10000 ohms	6AS7G, 6L6, 6DZ7 7189A, 7355, 7581 807-triode	G-4
S-17 55 W.	3800 ohms 4500/5000 ohms	6L6's 809, 6146, 7355, 7581	G-5

UTC Special Series audio units are specifically designed for amateur and popular-priced PA service. The Special Series units are finished in a rich, light gray enamel. A recessed terminal strip is provided permitting above chassis or breadboard wiring in addition to standard chassis type wiring. The universal windings provided on driver, matching and output transformers assure a maximum of flexibility. Large components are housed in formed cases with top or bottom mounting. All units are vacuum impregnated—compound filled.

### UNIVERSAL MODULATION TRANSFORMERS

(Secondary carries class C current)  
Any modulator tubes to any RF load.  
(see chart supplied with units)

Maximum efficiency and lowest distortion in a modulator stage are made possible by properly matching of impedances. These units cover every modulator combination. Full class C current can be carried. Primary impedances from 500 to 20,000 ohms... secondary from 200 to 22,000 ohms.

Type No.	Audio Power	Case
S-18	12 watts	G-3
S-19	30 watts	G-4
S-20	55 watts	G-5
S-21	110 watts	G-7
S-22	250 watts	G-9

### TYPICAL MODULATOR COMBINATIONS

S-18—12 WATTS MAX.

Typical driver tubes: 6C4, 12AU7, 6J5, 6SN7GT.

DRIVER Transf.	Sec. Term.	P. P. Tubes	Watts Output	P. P. Load	Plate Volts	Bias Volts
S-8	G'-G'	6AC5G	8	10,000	250	0
S-2	G-G	6V6, 6AQ5	12	6,000	250	15

S-19—30 WATTS MAX.

DRIVER Tube or Tubes	Transf.	Sec. Terms.	P. P. Tubes	Watts Output	P. P. Load	Plate Volts	Volts Bias
6C4	S-10	G-G	6L6 self bias	30	9,000	400	23

S-20—55 WATTS MAX.

DRIVER									
P. P. Tubes	Transf.	Sec. Terms.	P. P. Tubes	Watts Output	P. P. Load	Plate Volts	Plate Tr'sf.	Bias Volts	Bias Tr'sf.
12AU7	S-9	2-2	2E26	54	8000	500	S-41	15	S-51
12AU7	S-10	G-G	6L6, AB2	60	3800	400	S-39	25	S-51
12AU7	S-10	G-G	4-6L6	60	4500	400	S-40	23	S-51
2A3	S-9	3-3	809	60	5000	500	S-41	0	

S-21—115 WATTS MAX.

P. P.-2A3 Driver									
S-9 Transf.	Sec. Term.	P. P. Tubes	Watts Output	P. P. Load	Plate Volts	Plate Transf.	Bias Volts	Bias Tr'sf.	
1-1	807		80	6600	600	S-45	30	S-51	
2-2	6146		95	6000	600	S-46	50	S-51	
3-3	809		100	8400	750	S-45	5	S-51	
2-2	TZ-40		100	6000	750	S-45	0		
2-2	T-756		100	7000	850	S-46	30	S-51	
1-1	4-6L6		110	2000	400	S-44	25	S-51	
2-2	35-T		115	11000	1000	S-47	30	S-51	

S-22—250 WATTS MAX.

P. P.-2A3 Driver									
S-9 Transf.	Sec. Term.	P. P. Tubes	Watts Output	P. P. Load	Plate Volts	Plate Transf.	Bias Volts	Bias Tr'sf.	
1-1	T-55		175	6900	1000	S-47	40	S-51	
2-2	830 B		175	7600	1000	S-47	35	S-51	
2-2	808		190	12700	1250	S-47	15	S-51	
3-3	203 Z		200	6900	1000	S-47	0		
1-1	HK-354		220	15000	1500	S-49	100	S-51	
*	HK-154		225	11400	1250	S-47	210	S-52	
2-2	100 TH		250	7200	1250	S-47	0		
2-2	838		250	9000	1250	S-47	0		

\* Reverse S-9, using 2-2 for plates and P-P for grids.

**AND SPECIAL CUSTOM BUILT "S" LINE AUDIO AND POWER**

Above stock units cover general purpose applications.



## SPECIAL SERIES POWER TRANSFORMERS

UTC Special Series power supply components are designed specifically for amateur and popular-priced PA service. The ratings are based on such applications and recommended for ICAS intermittent use. For commercial application, CG or H grade components should be employed. Tapped coil structures on power and bias supply transformers afford maximum flexibility, permitting a given transformer to be used with many circuits and types of tubes. Stand by service should not be obtained by interrupting high voltage center tap.

### FILTER, SWINGING, AND AUDIO INDUCTORS

Type No.	Service	Inductance	Current	Resistance	Test Volts Rms	Case No.
S-23	Audio	300 Hy	5 ma	5000 ohms	1500 V	G-2
S-24	P. P. Inductor	500 Hy C T	3 ma	6000 ohms	1500 V	G-2
S-25	Filter	30 Hy	30 ma	800 ohms	1500 V	G-2
S-26	Filter	12 Hy	60 ma	250 ohms	1500 V	G-2
S-27	Filter	25 Hy	75 ma	350 ohms	1500 V	G-4
S-28	Filter	20 Hy	100 ma	350 ohms	1500 V	G-4
S-29	Filter	6 Hy	175 ma	90 ohms	1500 V	G-4
S-30	Swinging	20/4 Hy	175 ma	90 ohms	1500 V	G-4
S-31	Filter	6 Hy	225 ma	100 ohms	2700 V	G-5
S-32	Swinging	20/4 Hy	225 ma	100 ohms	2700 V	G-5
S-33	Filter	8 Hy	300 ma	100 ohms	4000 V	G-7
S-34	Swinging	20/4 Hy	300 ma	100 ohms	4000 V	G-7
S-35	Filter	8 Hy	400 ma	60 ohms	5000 V	G-8
S-36	Swinging	20/4 Hy	400 ma	60 ohms	5000 V	G-8
S-37	Filter	8 Hy	550 ma	60 ohms	6000 V	G-8
S-38	Swinging	20/4 Hy	550 ma	60 ohms	6000 V	G-8
S-80	Swinging	45/10 Mhy	1.75A	.5 ohm	500 V	G-1
S-81	Swinging† (2 Wdgs.)*	100/8 Mhy 25/2 Mhy	2.5A 5A	.6 ohm .15 ohm	1500 V	G-3

† Split winding in series  
\* Split windings in parallel

### FILAMENT TRANSFORMERS

Type No.	Primary Tapped 105, 115 Volts—50/60 Cycles	Secondary Volts	Secondary Current	Sec. Test Volts Rms	Case No.
S-53		2.5 VCT	10 A	1500 V	G-3
S-54		5 VCT	4 A	2500 V	G-3
S-55		6.3 VCT	3 A	1500 V	G-3
S-57		2.5 VCT	10 A	10,000 V	G-5
S-58		2.5 VCT	20 A	10,000 V	G-5
S-59		5 to 5.25 VCT	13 A	5000 V	G-5
S-60		5 to 5.25 VCT	22 A	10,000 V	G-7
S-61		6.3/7.5 VCT	10 A	3000 V	G-5
S-62		10 VCT	10 A	3000 V	G-5
S-63		11/12/14 VCT	10 A	5000 V	G-7

Type No.	Fil. 1	Fil. 2	Fil. 3	Sec. Test Volts Rms	Case No.
S-64	2.5 VCT-5A	2.5 VCT-5A	5 VCT-6A	3000 V	G-5
S-67	5 VCT-6A	6.3 VCT-5A		3000 V	G-5
S-68	5 VCT-3A	6.3 VCT-4A	7.5 VCT-5A	3000 V	G-5
S-70	6.3 VCT-5A	6.3 VCT-5A		3000 V	G-5
S-71	2.5 VCT-6A	2.5 VCT-6A	2.5 VCT-12A	10000 V	G-7
S-72	5 VCT-3A	5 VCT-3A	5 VCT-6A	5000 V	G-5

Primary 115 V. 50/60 cycles, tapped on S-77 and S-78 for dual secondary voltages.

DC voltages are approximate, based on Silicon bridge rectifier and 10% choke drop in choke input filter circuit.

C in condenser input values is in 1000 Mfd.

### TRANSISTOR/FILAMENT SUPPLY TRANSFORMERS

(See Pg. 30 for Typical Applications)

Type No.	Sec. V RMS	Sec. A RMS	Secs. in parallel				Secs. in series				Case No.		
			Choke Inp. DCV	Cond. Inp. DCV	Inp. DCA	C	Choke Inp. DCV	Cond. Inp. DCV	Inp. DCA	C			
S-75	6.3 6.3	.6 .6	5.2	1.2	7	0.80	5	10	0.6	14	0.40	1	G-1
S-76	12.6 12.6	2 2	10	4	12.6	3	3	20	2	26	1.4	1	G-4
S-77	17/21.5 17/21.5	1.5 1.5	14/17.5	3	18.5/25	2	1	28/35	1.5	43/56	1	.5	G-5
S-78	34/43 34/43	4.5 4.5	28/35	9	43/56	6	4	56/70	4.5	85/110	3	1	G-9

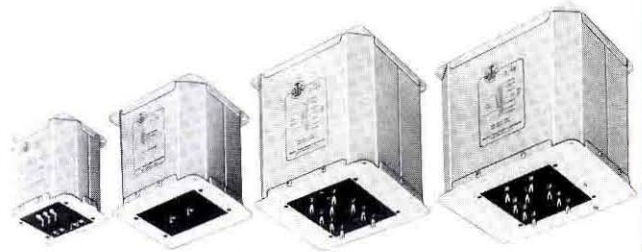

CASE SIZES  
(Will take 12-28 Mtg. Screw)

Type No.	H	W	D	M	N	Wt. Lbs.
G-5	3 3/4	3 1/4	4 1/2	3 3/8	2 1/4	4 1/2
G-7	4 5/8	4 3/8	5 1/2	4 3/32	3 3/32	8
G-8	4 5/8	5 3/8	5 3/8	4 3/32	4 3/4	12
G-9	5 7/8	5 3/8	6 3/4	6 3/32	4 13/32	21
G-10	5 7/8	6 1/4	6 3/4	5 13/16	5 13/32	24
G-11	5 7/8	6 13/32	7 3/4	6 3/32	5 23/32	31
G-12	10 1/4	7 3/8	9 1/4	8 1/2	6 5/8	52

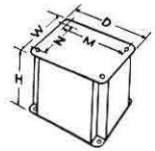

### COMBINED PLATE AND FILAMENT UNITS

Type No.	Voltage	Primary 115 V.—50/60 Cycles		Fil. No. 1	Fil. No. 2	Case No.
		Voltages* D. C.	Fil. Rectifier			
S-39	490-400-0-400-490 175 ma	400/310	5 V-3A	2.5 VCT -6A	6.3 VCT 4A	G-7
S-40	525-425-0-425-525 250 ma	400/310	5 V-3A	6.3 VCT -3A	6.3 VCT 3A	G-7
S-41	600-0-600 200 ma	475	5 V-3A	7.5 V tapped 6.3 V-3A	6.3 VCT 2A	G-7
S-42	600-525-0-525-600 300 ma	480/400	5 V-6A	7.5 V tapped 6.3 V 3A	6.3 VCT 3A	G-8

\* Based on two section filter, choke input.

### PLATE TRANSFORMERS — BIAS TRANSFORMERS

Type No.	High Voltage	Primary 115 V.—50/60 Cycles		DC Current	Case No.
		DC Voltages*	DC		
S-44	575-525-0-525-575	470/430	500 ma	G-9	
S-45	900-750-0-750-900	750/620	200 ma	G-8	
S-46	1000-750-0-750-1000	825/600	300 ma	G-9	
S-47	1500-1250-1000-0-1000-1250-1500	1275/1050/825	300 ma	G-10	
S-48	1500-1250-1000-0-1000-1250-1500	1300/1075/850	500 ma	G-11	
S-49	2100-1800-1500-0-1500-1800-2100	1815/1540/1275	300 ma	G-11	
S-50	3000-2500-0-2500-3000	2625/2175	300 ma	G-12	
S-51	Will supply any bias voltage from 15 to 100 volts DC within approximately 6% of desired value.		200 ma	G-5	
S-52	Will supply any bias voltage from 75 to 400 volts DC within approximately 6% of desired value.		200 ma	G-7	

\* Based on two section filter for 200 ma and 300 ma units, single section filter for 500 ma units, both inductor input.



# TRANSFORMERS FOR INDUSTRY WIDE APPLICATIONS

UTC industrial type transformers (Pri. 117 V. 50/60 cycles) provide the highest reliability in this field. All units are low temperature rise, vacuum sealed against humidity with special impregnating materials to prevent corrosion and electrolysis. Shells are finished in attractive high lustre black enamel.

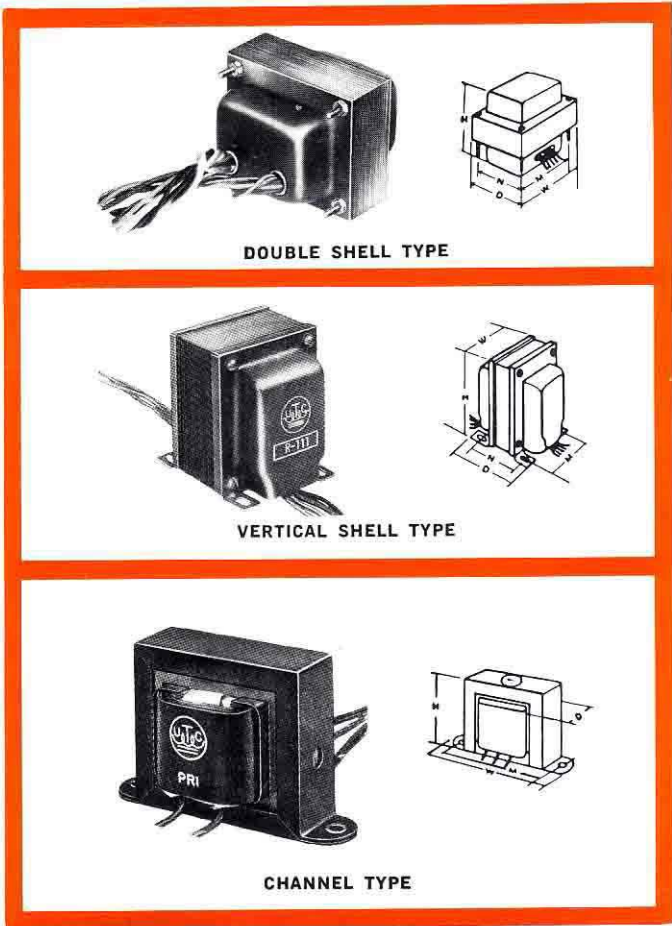

DOUBLE SHELL TYPE

VERTICAL SHELL TYPE

CHANNEL TYPE

## LINE VOLTAGE ADJUSTERS WITH METER

The perfect answer to abnormal or fluctuating line voltage. Adjust switch so that meter reads at red line and you know that your equipment is working at correct voltage. These units combine a tapped auto-transformer with a switch and meter in a compact, rugged assembly.

The nine tap switch provides for line voltage of 60 to 140 volts on 115 volt output models and 160 to 240 volts on 230 volt output model.

All units are designed for 50/60 cycle service and come complete with 6 foot input cord and plug and outlet receptacle.



Type No.	Primary Voltage	Volts Sec.	Watts Rating	L	W	H	Wgt. Lbs.
R-78	60, 70, 80, 90, 100, 110, 120, 130, 140	115	150	7	4	4 1/4	6
R-79	60, 70, 80, 90, 100, 110, 120, 130, 140	115	300	7	4	4 1/4	9
R-80	60, 70, 80, 90, 100, 110, 120, 130, 140	115	600	10 1/4	4	4 1/4	13
R-81	60, 70, 80, 90, 100, 110, 120, 130, 140	115	1200	10 1/4	4	4 1/4	21
R-86	160, 170, 180, 190, 200, 210, 220, 230, 240	230	1200	10 1/4	4	4 1/4	21

## CHANNEL FRAME FILAMENT / TRANSISTOR TRANSFS.

Pri. 115 V 50/60 Cycles—Test Volts RMS: 1500

Type No.	Secondary	W	D	H	M	Lbs.
FT-1	2.5 VCT-3A	2 1/8	1 3/8	1 1/16	2 3/8	3/4
FT-2	6.3 VCT-1.2A	2 1/8	1 3/8	1 1/16	2 3/8	3/4
FT-3	2.5 VCT-6A	3 3/8	1 7/8	2	2 1/16	1
FT-4	6.3 VCT-3A	3 3/8	1 7/8	2	2 1/16	1
FT-5	2.5 VCT-10A	3 3/4	2 1/8	2 3/8	3 3/8	1 1/2
FT-6	5 VCT-3A	3 3/4	2 1/8	2 3/8	3 3/8	1 1/2
FT-7	7.5 VCT-3A	3 3/4	2 1/8	2 3/8	3 3/8	1 1/2
FT-8	6.3 VCT-8A	4	2 1/2	2 3/8	3 3/8	2 1/2
FT-10	24 VCT-2A or 12V-4A	4	2 5/8	2 1/16	3 3/8	2 1/2
FT-11	24 VCT-1A or 12V-2A	3 3/4	2 1/8	2 3/8	3 3/8	1 1/2
FT-12	36 VCT-1.3A or 18V-2.6A	4	2 5/8	2 3/8	3 3/8	2 1/2

Taps on pri. of FT-13 & FT-14 to modify sec. nominal V, -6% +6%, +12%

Type No.	Secondary	W	D	H	M	Lbs.
FT-13	26 VCT-.04A	2 1/8	1 3/8	1 1/4	1 3/4	1/4
FT-14	26 VCT-.25A	2 1/8	1 3/8	1 1/16	2 3/8	3/4

## DOUBLE SHELL POWER TRANSFORMERS

Type No.	High V.	DC ma	5V. Fil.	6.3 VCT Fil.	W	D	H	M	N	Wt. Lbs.
R-101	275-0-275	50	2A	2.7A	3	2 1/2	3	2 1/2	2	2 1/2
R-102	350-0-350	70	3A	3A	3	2 1/2	3 3/8	2 1/2	2	3 1/2
R-103	350-0-350	90	3A	3.5A	3 3/4	2 7/8	3 1/16	2 3/16	2 1/4	4 1/4
R-104	350-0-350	120	3A	5A	3 3/4	3 1/4	3 3/8	3 3/8	2 1/2	5 1/2
R-105	385-0-385	160	3A	5A	3 3/4	3 3/8	4 3/8	3 3/8	2 1/2	7

## VERTICAL SHELL POWER TRANSFORMERS

Type No.	High V.	DC ma	5V. Fil.	6.3 VCT Fil.	W	D	H	M	N	Wt. Lbs.
R-110	300-0-300	50	2A	2.7A	2 3/8	2 1/16	3 1/4	2	1 3/4	2 1/2
R-111	350-0-350	70	3A	3A	2 3/8	3 3/16	3 3/4	2	2 3/8	3 1/2
R-112	350-0-350	120	3A	5A	3 3/8	3 1/16	4	2 1/2	2 3/8	5 1/2
R-113	400-0-400	200	3A	6A	3 3/8	4 3/8	4 3/8	3	3 3/8	8

## CHANNEL FRAME FILTER INDUCTORS

Inductance Shown is at Rated DC ma—Test Volts RMS: 1500

Type No.	Induct. Hys.	Current	Resistance Ohms	W	D	H	M	Wt. Lbs.
R-55	6	40ma	300	2 3/8	1 3/8	1 3/4	2	1/2
R-14	8	40ma	250	2 7/8	1 1/2	1 1/16	2 3/8	3/4
R-15	12	30ma	450	2 7/8	1 1/2	1 1/16	2 3/8	3/4
R-16	15	30ma	630	2 7/8	1 1/2	1 1/16	2 3/8	3/4
R-17	20	40ma	850	3 3/8	1 5/8	2	2 1/16	1
R-18	8	80ma	250	3 3/2	1 5/8	2	2 1/16	1
R-19	14	100ma	450	3 3/4	1 7/8	2 3/8	3 3/8	1 1/2
R-20	5	200ma	90	4 1/8	2 1/4	2 5/8	3 3/8	2 1/2
R-21	15/3	200ma	90	4 1/8	2 1/4	2 5/8	3 3/8	2 1/2
R-220	100/8 Mhy 25/2 Mhy	2.5A 5A	.6 .16	3 3/4	2	2 3/8	3 3/8	1 1/2

## VARITRAN VOLTAGE ADJUSTERS

Input 115 volts 50/60 cycles. Output continually adjustable from 0-130 Volts through roller contact on exposed autotransformer winding. Regulation and efficiency are excellent, no wave form distortion. Output voltage is independent of load. Complete with line cord, switch, and receptacle . . . for loads up to 570 Watts . . . 5 A.

Type No.		L	W	H	Wt. Lbs.
V-1-M	with meter	4 7/8	9 7/8	3 3/8	14
V-1	without meter	4 7/8	8	3 3/8	12



## AND SPECIAL CUSTOM BUILT TRANSFORMERS AND INDUCTORS

Above stock units cover general purpose applications.

## STEP DOWN AUTO-TRANSFORMERS

220/240 Volt to 110/120 Volts, 50/60 Cycles.

All units have 6 foot cord and female receptacle, except R-64.

Type No.	Rating Watts	L	W	H	Mtg. Dim.	Wgt. Lbs.
R-41	85	3 $\frac{1}{8}$	2 $\frac{3}{8}$	3 $\frac{1}{8}$	2x1 $\frac{1}{8}$	4
R-42	125	3 $\frac{1}{2}$	3	3 $\frac{1}{2}$	2 $\frac{1}{4}$ x2 $\frac{1}{4}$	5
R-43	175	3 $\frac{3}{4}$	3 $\frac{1}{4}$	3 $\frac{3}{8}$	2 $\frac{1}{2}$ x2 $\frac{1}{4}$	5 $\frac{1}{2}$
R-44	250	4 $\frac{3}{8}$	3 $\frac{1}{4}$	3 $\frac{3}{8}$	2 $\frac{1}{2}$ x2 $\frac{1}{4}$	6 $\frac{1}{2}$
R-45	500	4 $\frac{3}{8}$	3 $\frac{3}{8}$	4 $\frac{3}{8}$	3x3 $\frac{1}{4}$	12
R-46	1200	6 $\frac{1}{8}$	3 $\frac{3}{8}$	4 $\frac{3}{8}$	3x5 $\frac{1}{2}$	18
R-64	2500	10 $\frac{1}{2}$	4 $\frac{3}{4}$	6 $\frac{1}{4}$	3 $\frac{3}{8}$ x9 $\frac{1}{4}$	30



## ISOLATION TRANSFORMERS

Ideal for isolating line noise. AC-DC sets, etc. Excellent electrostatic shielding 1500 volt breakdown test. Six foot cord and female receptacle, except R-77.

Primary 110-120 volts 50/60 cycles—Secondary 110-120 volts  
Except R-97 220 volt Primary—120 volt Sec.

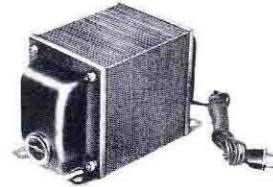

Type No.	Rating Watts	L	W	H	Mtg. Dim.	Wgt. Lbs.
R-72	40	3 $\frac{1}{8}$	2 $\frac{3}{8}$	3 $\frac{1}{8}$	2x1 $\frac{1}{8}$	4
R-73	100	3 $\frac{1}{4}$	3 $\frac{1}{4}$	3 $\frac{3}{8}$	2 $\frac{1}{4}$ x2 $\frac{3}{8}$	6
R-74	250	4 $\frac{3}{8}$	3 $\frac{3}{8}$	4 $\frac{3}{8}$	3x3 $\frac{1}{2}$	12
R-75	600	7 $\frac{1}{8}$	3 $\frac{3}{8}$	4 $\frac{3}{8}$	3x5 $\frac{7}{8}$	20
R-76	1200	8 $\frac{1}{2}$	4 $\frac{1}{2}$	5 $\frac{1}{8}$	3 $\frac{3}{8}$ x6 $\frac{5}{8}$	30
R-77	2500	12	7	9	6x11	70
R-97	250	4 $\frac{3}{8}$	3 $\frac{3}{8}$	4 $\frac{3}{8}$	3x3 $\frac{1}{2}$	12

## STANDARD PHOTOFLASH TRANSFORMERS

Can be used for either standard (Amglo type) or trigger (Sylvania type) multiple flash tubes. Circuit details included with transformer.

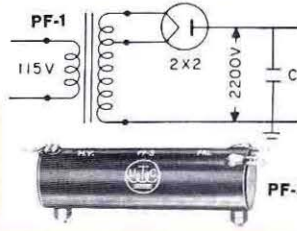

**PF-1** Primary for 115 volts, 50/60 cycles. Secondaries for power supply delivering 2200 volts DC to condenser up to 100 Mfd. Compound sealed in G-3 (p. 48) case 2 $\frac{3}{8}$  x 2 $\frac{3}{4}$  (3 $\frac{3}{4}$  including flanges) x 2 $\frac{1}{2}$  inches high. Weight 2 lbs.

**PF-3** Trigger Transformer 15 KV peak.  $\frac{7}{8}$  O.D. x 3 long. Weight 2 oz.



## TRANSISTOR PHOTOFLASH TRANSFORMERS

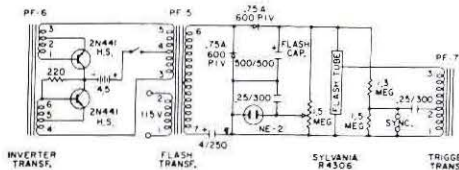

These are miniaturized light weight units for transistor type photoflash supply.

**PF-5** Primary for 115 volts 50/60 cycles or for 4 $\frac{1}{2}$  V battery switched by PF-6 inverter transformer. Output delivers 400 V DC when used in voltage doubler circuit to charge photoflash capacitor (typically 40 watt-sec.), G-1 case (See Pg. 48).

**PF-6** Inverter transformer transforms 4 $\frac{1}{2}$  V DC from battery to input for PF-5 stepup transformer. Ouncer case (See Pg. 16).

**PF-7** Trigger transformer. Shorting .25 mfd. capacitor (charged to approx. 225 V. DC) across terminals 1-2 produces 6 KV pulse at terminal 3 for triggering flash tube.  $\frac{7}{8}$ " Dia. x 1 $\frac{1}{8}$ " Wt.  $\frac{1}{2}$  oz.



PF-5



PF-6



PF-7

## SIGNALLING AND CONTROL TRANSFORMERS

Primary 110-120 volts, 50/60 cycles—Secondary 4/8/12/16/20/24 volts

High power transformers suitable for operating relays, sirens, horns, gongs, etc. from 115 V 50/60 cycle line. These units have four secondary terminals providing 4, 8, 12, 16, 20 and 24 volt output. The volt ampere rating is based on the 24 volt secondary tap with corresponding reduction at the lower voltages. Underwriters' approved primary leads are employed, and screw-type binding posts.

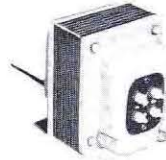

Type No.	Rating Watts	L	W	H	Mtg. Dim.	Wgt. Lbs.
SC-3	50	3	3 $\frac{1}{2}$	3 $\frac{3}{8}$	1 $\frac{7}{8}$ x 2 $\frac{1}{4}$	3
SC-4	100	3 $\frac{3}{4}$	4	4	2 $\frac{1}{8}$ x 2 $\frac{1}{2}$	5
SC-5	250	4	5	4 $\frac{3}{4}$	3 $\frac{1}{4}$ x 3	10

## EXPORT VOLTAGE ADAPTER

Complete with cord and plug and special locking switch providing for line voltages of 105, 115, 125, 135, 150, 210, 230, 250 volts; 42 to 60 cycles. Output voltage 115.

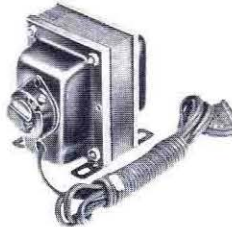

Type No.	Rating Watts	L	W	H	Mtg. Dim.	Wgt. Lbs.
R-47	85	4 $\frac{3}{8}$	3	3 $\frac{1}{2}$	2 $\frac{1}{4}$ x2 $\frac{1}{4}$	4 $\frac{1}{2}$
R-48	150	4 $\frac{3}{4}$	3 $\frac{1}{4}$	4	2 $\frac{1}{2}$ x2 $\frac{1}{2}$	5 $\frac{1}{2}$

## TV VOLTAGE REGULATOR

Complete with cord, plug, and special locking switch. Permits operation of 115 volt 50/60 cycle TV sets on line voltages of 85, 90, 95, 100, 105, 110, 120, 125 V.

Type No.	Rating Watts	L	W	H	Mtg. Dim.	Wgt. Lbs.
R-49	350	5	3 $\frac{1}{4}$	4	2 $\frac{1}{2}$ x2 $\frac{1}{4}$	5

UTC FOR THE HIGHEST IN QUALITY AND RELIABILITY

**CONSULT  
UTC  
FOR YOUR  
REQUIREMENTS**

Almost thirty years of pioneering by UTC's research, design, and engineering staffs assures you quality and reliability unexcelled in the industry. UTC's line of stock and special custom built items covers virtually every transformer and filter requirement for both military and commercial use.

Printed in U.S.A.

**FOR INDUSTRY WIDE APPLICATIONS TO YOUR SPECIFICATIONS**

For specific applications cost reductions may be effected.

# MIL-TYPE DESIGNATIONS

## MIL-T-27( ) MILITARY SPECIFICATION FOR TRANSFORMERS AND INDUCTORS (AUDIO & POWER)

### EXAMPLE OF TYPE DESIGNATION

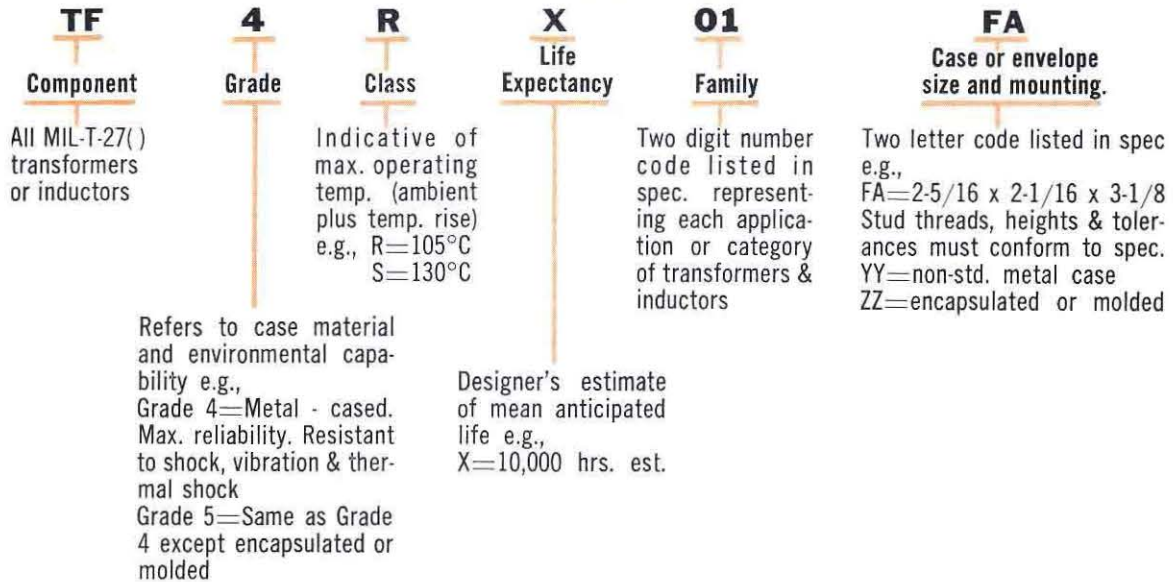

The Dept. of Defense has established military standards, (see page18). These are identified by a three digit code suffix to the applicable type designation.

## MIL-T-21038(B) MILITARY SPECIFICATION FOR PULSE TRANSFORMERS

### EXAMPLE OF TYPE DESIGNATION

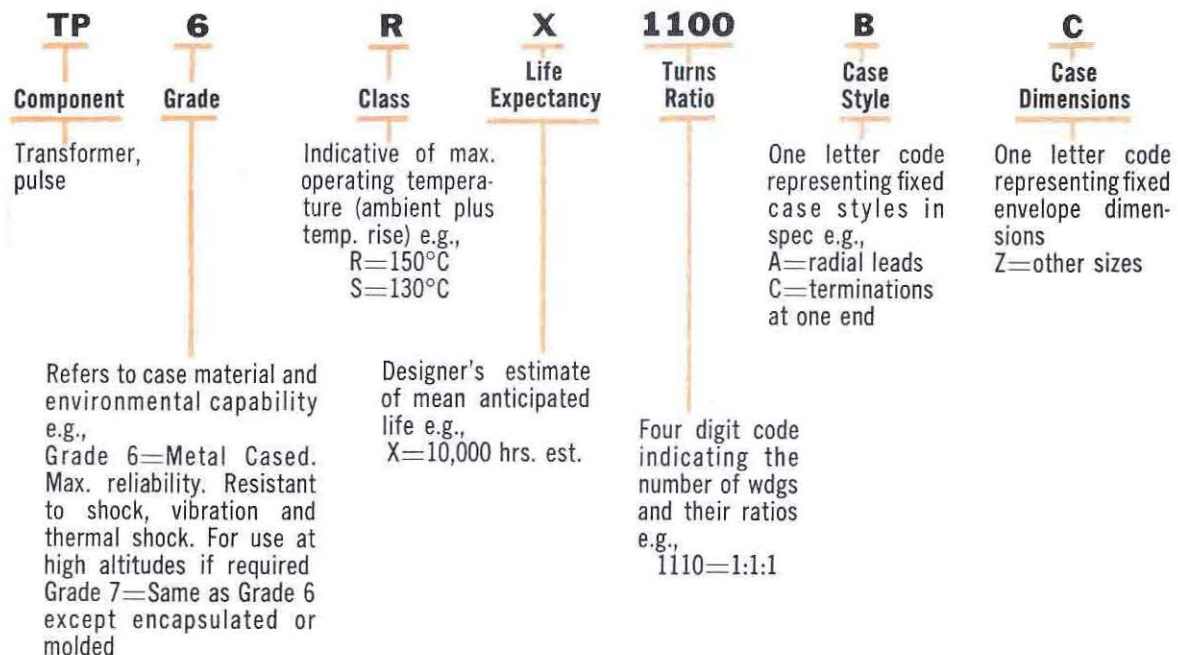

# UTC REPRESENTATIVES

(D) DISTRIBUTOR

(I) INDUSTRIAL

ALABAMA	(D) (I)	Millar-Hutto Assoc., Inc.	1036 Peachtree St., N.E., P.O. Box 7116, Station "C", Atlanta 9, Ga.	TR 6-0919
ARIZONA	(D)	Ellard E. Strassner	1865 N. Western Ave., Los Angeles 27, Calif.	HO 2-0916-7-8
ARIZONA	(I)	UTC Pacific Division	3630 Eastham Drive, Culver City, Calif.	UP 0-9755 (213)
ARKANSAS	(D) (I)	J. Y. Schoonmaker Co., Inc.	5328 Redfield, P.O. Box 35266, Dallas 35, Texas	ME 1-8480 (214)
CALIFORNIA	(D) Northern	Ellard E. Strassner	1667 Laurel St., San Carlos, Calif.	LY 3-7688
CALIFORNIA	(I) Northern	McKnight Co.	1436 El Camino Real, P.O. Box 36, Menlo Park, Calif.	DA 6-3762 (415)
CALIFORNIA	(D) Southern	Ellard E. Strassner	1865 N. Western Ave., Los Angeles 27, Calif.	HO 2-0916-7-8
CALIFORNIA	(I) Southern	UTC Pacific Division	3630 Eastham Drive, Culver City, Calif.	UP 0-9755 (213)
COLORADO	(D) (I)	Franklin Sales Co.	2149 South Clermont St., Denver 22, Colorado	SK 7-1371
CONNECTICUT	(D) (I)	Gerber Sales Co., Inc.	31 Broadway, New Haven, Conn.	SP 7-6279
DELAWARE	(D) (I)	L. D. Lowery, Inc.	2801 West Chester Pike, Broomall, Pa.	EL 6-5300
DIST. OF COLUMBIA	(D) (I)	L. D. Lowery, Inc.	4508 Annapolis Rd., Bladensburg, Md.	UN 4-4722
FLORIDA	(D) (I)	Millar-Hutto Assoc., Inc.	P.O. Box 1603, Winter Park, Fla.	MI 7-7407
GEORGIA	(D) (I)	Millar-Hutto Assoc., Inc.	1036 Peachtree St., N.E., P.O. Box 7116, Station "C", Atlanta 9, Ga.	TR 6-0919
IDAHO	(D) (I)	UTC New York	150 Varick St., New York 13, N. Y.	AL 5-3500 (212)
ILLINOIS	(D) Northern	Al Quackenbush	520 N. Michigan Ave., Chicago 11, Ill.	MO 4-1904 (312)
ILLINOIS	(I) Northern	Whitmore Associates	520 N. Michigan Ave., Chicago, 11 Ill.	MO 4-1904 (312)
ILLINOIS	(D) (I) Southern	W. N. Wellman	Box 166, Fenton, Mo.	DA 6-0313
INDIANA	(D)	Al Quackenbush	520 N. Michigan Ave., Chicago 11, Ill.	MO 4-1904 (312)
INDIANA	(I)	Whitmore Associates	520 N. Michigan Ave., Chicago 11, Ill.	MO 4-1904 (312)
IOWA	(I)	UTC New York	150 Varick St., New York 13, N. Y.	AL 5-3500 (212)
IOWA	(D)	Al Quackenbush	520 N. Michigan Ave., Chicago 11, Ill.	MO 4-1904 (312)
KANSAS	(D) (I)	W. N. Wellman	Box 166, Fenton, Mo.	DA 6-0313
KENTUCKY	(D) (I)	UTC New York	150 Varick St., New York 13, N. Y.	AL 5-3500 (212)
LOUISIANA	(D) (I)	J. Y. Schoonmaker Co., Inc.	5328 Redfield, P.O. Box 35266, Dallas 35, Texas	ME 1-8480 (214)
MAINE	(D) (I)	Gerber Sales Co., Inc.	48 Pearl St., Brookline 47, Mass.	BE 2-2425
MARYLAND	(D) (I)	L. D. Lowery, Inc.	4508 Annapolis Rd., Bladensburg, Md.	UN 4-4722
MASSACHUSETTS	(D) (I)	Gerber Sales Co., Inc.	48 Pearl St., Brookline 47, Mass.	BE 2-2425
MICHIGAN	(D) (I)	Edwin Frank Liddle	18925 Grand River Ave., Detroit 23, Michigan	VE 7-5310
MINNESOTA	(D) (I)	Fred B. Hill Co.	6110 Excelsior Blvd., Minneapolis 16, Minn.	WE 9-6727
MISSISSIPPI	(D) (I)	J. Y. Schoonmaker Co., Inc.	5328 Redfield, P.O. Box 35266, Dallas 35, Texas	ME 1-8480 (214)
MISSOURI	(D) (I)	W. N. Wellman	Box 166, Fenton, Mo.	DA 6-0313
MONTANA	(D) (I)	UTC New York	150 Varick St., New York 13, N. Y.	AL 5-3500 (212)
NEBRASKA	(D) (I)	UTC New York	150 Varick St., New York 13, N. Y.	AL 5-3500 (212)
NEVADA	(D) (I)	UTC New York	150 Varick St., New York 13, N. Y.	AL 5-3500 (212)
NEW HAMPSHIRE	(D) (I)	Gerber Sales Co., Inc.	48 Pearl St., Brookline 47, Mass.	BE 2-2425
NEW JERSEY	(D) Northern	UTC New York	150 Varick St., New York 13, N. Y.	AL 5-3500 (212)
NEW JERSEY	(I) Northern	Comtronic Associates	1551 Franklin Ave., Mineola 11, L.I., N. Y.	PI 1-8966
NEW JERSEY	(D) (I) Southern	L. D. Lowery, Inc.	2801 West Chester Pike, Broomall, Pa.	EL 6-5300
NEW JERSEY	(I) Spl. Accts.	Ben Miller	P.O. Box 72, Little Neck 63, N. Y.	BA 4-4673
NEW MEXICO	(D)	Ellard E. Strassner	1865 N. Western Ave., Los Angeles 27, Calif.	HO 2-0916-7-8
NEW MEXICO	(I)	UTC Pacific Division	3630 Eastham Drive, Culver City, Calif.	UP 0-9755 (213)
NEW YORK	(D) (I) Upstate	Frank W. Taylor Co. Inc.	4455 East Genesee St., P.O. Box 86, DeWitt 14, N. Y.	446-0422 (315)
NEW YORK	(D) Metropolitan	UTC New York	150 Varick St., New York 13, N. Y.	AL 5-3500 (212)
NEW YORK	(I) Metropolitan	Comtronic Associates	1551 Franklin Ave., Mineola 11, L.I., N. Y.	PI 1-8966
NEW YORK	(I) Spl. Accts.	Ben Miller	P.O. Box 72, Little Neck 63, N. Y.	BA 4-4673
NORTH CAROLINA	(D) (I)	Millar-Hutto Assoc., Inc.	4023 Arbor Way, Charlotte 7, N. C.	EM 6-2061
NORTH DAKOTA	(D) (I)	Fred B. Hill Co.	6110 Excelsior Blvd., Minneapolis 16, Minn.	WE 9 6727
OHIO	(D) (I)	Mike Roth Sales Co.	678 So. Green Rd., Cleveland 21, Ohio	EV 2-9090
OKLAHOMA	(D) (I)	J. Y. Schoonmaker Co., Inc.	5328 Redfield, P.O. Box 35266, Dallas 35, Texas	ME 1-8480 (214)
OREGON	(D) (I)	Samuel N. Stroum Co., Inc.	621 S. Michigan St., Seattle 8, Wash.	PA 3-7310
PENNSYLVANIA	(D) (I) Eastern	L. D. Lowery, Inc.	2801 West Chester Pike, Broomall, Pa.	EL 6 5300
PENNSYLVANIA	(D) (I) Western	Mike Roth Sales Co.	678 So. Green Rd., Cleveland 21, Ohio	EV 2-9090
PENNSYLVANIA	(I) Spl. Accts.	Ben Miller	P.O. Box 72, Little Neck 63, N. Y.	BA 4-4673
RHODE ISLAND	(D) (I)	Gerber Sales Co., Inc.	48 Pearl St., Brookline 47, Mass.	BE 2-2425
SOUTH CAROLINA	(D) (I)	Millar-Hutto Assoc., Inc.	1036 Peachtree St., N.E., P.O. Box 7116, Station "C", Atlanta 9, Ga.	TR 6-0919
SOUTH DAKOTA	(D) (I)	Fred B. Hill Co.	6110 Excelsior Blvd., Minneapolis 16, Minn.	WE 9-6727
TENNESSEE	(D) (I)	Millar-Hutto Assoc., Inc.	1036 Peachtree St., N.E., P.O. Box 7116, Station "C", Atlanta 9, Ga.	TR 6-0919
TEXAS	(D) (I)	J. Y. Schoonmaker Co., Inc.	5328 Redfield, P.O. Box 35266, Dallas 35, Texas	ME 1-8480 (214)
UTAH	(D) (I)	Franklin Sales Co.	2149 South Clermont St., Denver 22, Colorado	SK 7-1371
VERMONT	(D) (I)	Gerber Sales Co., Inc.	48 Pearl St., Brookline 47, Mass.	BE 2-2425
VIRGINIA	(D) (I)	L. D. Lowery, Inc.	4508 Annapolis Rd., Bladensburg, Md.	UN 4-4722
WASHINGTON	(D) (I)	Samuel N. Stroum Co., Inc.	621 S. Michigan St., Seattle 8, Wash.	PA 3-7310
WEST VIRGINIA	(D) (I)	Mike Roth Sales Co.	678 So. Green Rd., Cleveland 21, Ohio	EV 2-9090
WISCONSIN	(D)	Al Quackenbush	520 N. Michigan Ave., Chicago 11, Ill.	MO 4-1904 (312)
WISCONSIN	(I)	Whitmore Assoc.	520 N. Michigan Ave., Chicago 11, Ill.	MO 4-1904 (312)
WYOMING	(D) (I)	UTC New York	150 Varick St., New York 13, N. Y.	AL 5-3500 (212)
ALASKA	(D) (I)	UTC New York	150 Varick St., New York 13, N. Y.	AL 5-3500 (212)
HAWAII	(D) (I)	UTC New York	150 Varick St., New York 13, N. Y.	AL 5-3500 (212)
CANADA	(D) (I)	UTC New York	150 Varick St., New York 13, N. Y.	AL 5-3500 (212)

## UNITED TRANSFORMER CORPORATION

150 VARICK ST., New York 13, N. Y. Algonquin 5-3500

PACIFIC DIVISION: 3630 Eastham Drive, Culver City, Calif. Upton 0-9755

EXPORT DIVISION 13 East 40th St., New York 16, N. Y. Murray Hill 9-0200



**FOR MILITARY COMPONENTS**

**OUR 18 MILLIONTH MILITARY UNIT SHIPPED THIS YEAR**

THE UTC Laboratories include complete facilities for testing to MIL-T-27A, MIL-F-18327A and MIL-T-21038. These facilities are employed for continuous quality control of production as well as for proving new items. Virtually all hermetic items in this catalog have been proved to meet MIL-T-27A and/or MIL-F-18327A and/or MIL-T-21038 or are in process of proving tests. By using a UTC catalog item both costs and delays of initial testing to MIL-T-27A/MIL-F-18327A/MIL-T-21038 are eliminated . . . for prototype and production.

Shock Testing



Altitude Test and High Frequency Vibration for Airborne Units

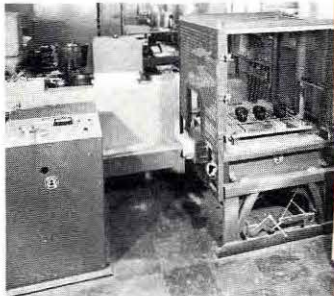

Automatic Programmed MIL-T-27A Vibration Test



Primary Standard Instrument Calibration

Accelerated Life Testing for Insulation Systems and Processes

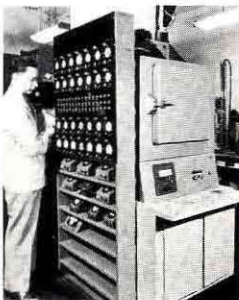

Automatic Programmed Humidity Testing

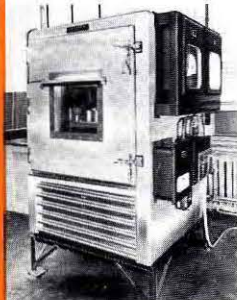

**IMMEDIATELY  
AVAILABLE  
THE  
MOST  
COMPLETE  
LINE  
OF  
TRANSFORMERS,  
INDUCTORS,  
MAGAMPS,  
PULSE UNITS,  
ELECTRIC WAVE  
FILTERS,  
HIGH Q COILS  
AND  
LUMPED CONSTANT  
DELAY LINES  
IN THE  
INDUSTRY**

**UNITED  
TRANSFORMER  
CORPORATION**

**150 VARICK STREET  
NEW YORK 13, N. Y.  
ALgonquin 5-3500**

UTC PACIFIC MFG. DIVISION  
3630 Eastham Drive, Culver City, Calif.  
UPTon 0-9755

UTC EXPORT DIVISION  
13 East 40th Street, New York 16, N. Y.