

'70



UNITED TRANSFORMER COMPANY DIVISION OF **TRW** INC.



THE UTC STORY—QUALITY and RELIABILITY at UTC

UNITED TRANSFORMER COMPANY, Division of TRW INC., with almost forty years of pioneering in the areas of research, design and engineering assures you quality and reliability unexcelled in the industry. UTC has in continuous production the most complete line of standard items ready for immediate delivery from the factory or authorized industrial distributor. This, coupled with UTC's broad capabilities in special (custom built) items, covers virtually every transformer and filter requirement for both military and industrial use.

ENGINEERING The knowledge and experience of the nation's top engineering talent create UTC products. All designs are fully laboratory proved before being released for production.

MATERIALS and LIFE TESTING The UTC Material and Chemical Laboratories analyze and evaluate the materials employed in all products. Special processes are introduced as required by material characteristics. Finished units, as well as insulation systems, are constantly undergoing life tests to provide reliability guides for present and future designs and manufacturing processes. The purpose of these tests is to extend the life of each design to the absolute maximum—usually far beyond customer requirements.

QUALITY CONTROL The Quality Control Department coordinates all statistics relating to materials and processes. All incoming materials are subjected to exhaustive testing, with individual lots of materials separately isolated in order to afford tight material control throughout production. Continuous surveillance is conducted to assure conformance of products to all requirements. If discrepancies are found or anticipated, corrective action is immediately instituted. Parts made within the UTC plant, such as drawn cans, stamped laminations, etc., are inspected and treated as though they were provided by an outside vendor.

PRODUCT TESTING Each individual transformer or filter is tested for its performance at least three times during successive stages of manufacture. In addition to this, a substantial sampling of each day's production is put through extensive humidity, vibration, thermal shock, and overload testing to assure exact performance and reliability.

MILITARY COMPONENTS The UTC Laboratories include complete "In House" DESC approved facilities for testing to MIL-T-27C, MIL-F-18327C, and MIL-T-21038B. These facilities are employed for quality control of production as well as for proving new items.

Virtually all hermetic items in this catalog have been proved to meet one or more of the MIL Specs, or are currently being tested.

A tremendous advantage exists in using the standardized UTC MIL components for military equipment. These units can be used in prototypes or full production without special tests, costs, or delays. Minor deviations from standard units do not affect the original test validity.

UTC hermetic components are of rugged design with high safety factors in all characteristics. They are either metal encased or molded and exceed MIL Specs in many respects, taking into consideration the most severe conditions which may be encountered in service. They are ideally suited for airborne, ground communications, marine, and missile service.

An increasing number of industrial equipment manufacturers, becoming concerned with the reliability of components in their equipment, are turning to hermetically sealed components. The necessity for reliability in industrial service is clear when the cost of an hour's shutdown of a broadcast schedule or industrial control system is visualized.

COMMERCIAL and INDUSTRIAL COMPONENTS UTC non-hermetic lines of components are designed for a wide range of applications, and have found acceptance in all types of commercial and industrial equipments. They are conservatively designed to assure highest reliability. Breakdown test voltages are used far in excess of maximum working voltages. All components are vacuum impregnated. Potted units are sealed with special insulating compounds for maximum environmental protection. Our quality control on these components is as stringent as on our military lines, requiring 100% testing on prime parameters.

SPECIAL DESIGNS In addition to the needs met by the standard components in this catalog, there are many unique applications which require special units. Special-design facilities are available for production of samples as well as large quantities. The close coordination between our design groups, sample shop, and factory assures production quality equal to sample quality.

THE END RESULT UTC's level of quality and reliability is unmatched in the industry—twenty times better than the industry average, based on available information.

For every phase of the art of iron core inductive devices, UTC is the first source for the highest reliability, the most varied types and the most sophisticated and advanced designs in the industry.



PRODUCT SERIES INDEX

PRODUCT SERIES DESCRIPTION PAGE

AUDIO TRANSFORMERS & INDUCTORS

General Information2
Product Selection Guide3

Military Types: Grade 4, Metal Encased

BIT-250 Transistor & flat pack styles4, 5
DI-T Ultraminiature transformers & inductors10
DI-T200 Plug-in ultraminiature transformers & inductors11
DO-T Ultraminiature transformers & inductors6, 7
DO-T200 Plug-in, ultraminiature transformers & inductors8
FHA Low profile audio transformers12
FHI Low profile inductors12
H Transformers & inductors. Full line. Hermetically sealed, metal encased12, 13, 14
PIL Ultraminiature transistor style units9
W Military Standards15

Military Types: Grade 5, Molded

SML Plug-in transformers16
SO-P Molded transformers17
SSO-P Molded transformers16

Industrial Types: Cased, non-hermetic

A Ultra compact wideband transformers & inductors...20, 21
CAT High copper efficiency for transistor use.....26
CG High quality transformers26
HA Excellent quality audio transformers24, 25
LAB Highest quality for laboratory circuit development15
LS Hi-fidelity, highest quality. Broadcast types22, 23
O Compact audio transformers & inductors18
P Octal socket plug-in types19
S Popular priced series27

Industrial Types: Open Frame, non-hermetic

SO Flexible lead types17
SSO Flexible lead types16

POWER TRANSFORMERS & INDUCTORS

General Information30
Product Selection Guide31

Military Types

DO-T400 Ultraminiature power transformers37
H Hermetically sealed inductors, Grades 4 & 5. 12, 13, 14, 36
H Hermetically sealed transformers, Grades 4 & 5. 32 thru 40
HIT Ultra-shielded power line isolation transformers.....40
MAT For magnetic amplifier and other applications48, 49
MET For 400 Hz application32, 33 & 37
N Military Standard transformers41
NV Miniature inverter transformers35
SRC Precision Scott-T reference40
Z Military Standard inductors41

Industrial and Commercial Types

A Ultra compact20, 21
CG Transformers & inductors. High quality transistor, filament and plate types42
FT Channel frame, filament/transistor transformers44
HP Pre-amplifier or tuner power supply transformers25
PF For photoflash and similar applications45
R Replacement type inductors44, 45
R Replacement type line adjusting and isolation transformers44, 45
S Popular-priced series transformers & inductors43
SC Signaling and control transformers45

MAGNETIC AMPLIFIERS

Product Selection Guide31
MAS High gain, solid state push pull types49
MAT For servo motors and other applications48, 49

PULSE TRANSFORMERS

General Information52, 53
Product Selection Guide53
BIT-P Metal encased transistor & flat pack types54, 55
H Molded:
Tube types, transistor types57, 58
PIP Metal encased transistor types56

PRODUCT SERIES DESCRIPTION PAGE

HIGH Q INDUCTORS

General Information60, 61
Product Selection Guide61

All MIL except VIC & DI

High Q Inductors—Fixed

FE Toroidal, molded64
FI Toroidal, molded64
FO Toroidal, molded64
HQA Toroidal, metal encased70
HQB Toroidal, metal encased70
HQC Toroidal, metal encased70
HQE Toroidal, metal encased70
MH Toroidal, molded63
ML Laminated, shielded62
MM Toroidal, molded63
MO Laminated, molded62
MQA Toroidal, metal encased66
MQB Toroidal, metal encased67
MQD Toroidal, metal encased66
MQE Toroidal, metal encased67
MQL Laminated, metal encased65
MQM Laminated, metal encased65
MS Toroidal, molded63
MW Toroidal, molded63
TQA Same as MQA, but centertapped66

High Q Inductors—Variable

HVC Wide range, +200%, -70% of nominal value68
HVV Vernier, narrow range $\pm 10\%$ of nominal value68
TVC Same as HVC, but centertapped68
VIC +85%, -45% of nominal value69
DI Inductance decades69

ELECTRIC WAVE FILTERS

General Information72, 73
Product Selection Guide74

Band Pass

BMI Miniature metal cased. Center frequency range 30 Hz to 10 kHz80
BML Similar to BMI. Center frequency range 400 Hz to 1 kHz.80
BPH Ultra miniaturized metal cased, pin terminals. Center frequency range 50 kHz to 100 kHz76
BPM Ultra miniaturized metal cased, pin terminals. Center frequency range 400 Hz to 20 kHz76
BTI Similar to BMI. Center frequency range 60 Hz to 120 Hz.80
FBH Flat construction, high frequency75
LBP Low Frequency83
MNF Ultraminiature telemetering metal cased, epoxy terminal board. Band Width $\pm 7.5\%$ 78
MWF Similar to MNF except Band Width $\pm 15\%$ 78
PLP 400 Hz line83
TGR Telegraph Tone Channel Receiving79
TGT Telegraph Tone Channel Transmitting79
TMN Miniature Telemetering metal cased. Band Width $\pm 7.5\%$ 78
TMW Similar to TMN except Band Width $\pm 15\%$ 78

Band Reject

BPM Ultra miniaturized metal cased, pin terminals. Center frequency range 400 Hz to 20 kHz76
LBP Low Frequency83

Low Pass

FLH Flat construction, metal cased with pin terminals. Cutoff frequency range 600 Hz to 5 kHz75
FLL Flat construction, metal cased. Cutoff frequency 3500 Hz to 50 kHz75
LLP Low frequency metal case. Cutoff frequency range 10 Hz to 15 Hz83
LMI Miniaturized metal cased. Cutoff frequency range 100 Hz to 10 kHz81
LML Miniaturized metal cased. Cutoff frequency range 1000 Hz to 12 kHz81
LPM Ultra miniaturized metal cased with pin terminals. Cutoff frequency range from 200 Hz to 15 kHz77
PLF 400 Hz line83

High Pass

FHH Flat construction, metal cased with pin terminals. Cutoff frequency 200 Hz75
HMI Miniature metal cased. Cutoff frequency range 50 Hz to 3 kHz82
HML Miniature metal cased. Cutoff frequency range 200 Hz to 1 kHz82
HPM Ultra miniaturized metal cased with pin terminals. Cutoff frequency range 500 Hz to 4 kHz77



GENERAL INFORMATION ON AUDIO AND HIGH FREQUENCY TRANSFORMERS & INDUCTORS

The audio transformer is defined by operation over a frequency band. Originally the audio band referred to the audible spectrum of frequencies, 15 Hz to 20 kHz. As it was found that the audio type transformer could be used successfully beyond this frequency range and for other functions, the applications broadened but the name "audio" stuck.

The basic functions of an audio transformer are impedance matching, output, driver, interstage, line, voice coil, etc. Basic operation information can be found on page 30 under Theory. The UTC catalog audio line represents close to 500 commercial and MIL grade components covering a frequency band from 5 Hz to 250 kHz, at levels of mWs to KWs and ranging in weight from 1/20 oz to 520 lbs. Custom designs cover an even broader range of frequencies and power ratings.

UTC has broad experience in custom designing transformers for special applications. Facilities are available for full engineering discussion to work out magnetics in early stages of equipment design. Fully equipped Electronics, Mechanical, and Chemical Laboratories with modern, accurate equipment are available to aid in the design of custom transformers.

Specifications

More problems are caused by improper transformer specifications than by any other reason. These problems typically affect price, manufacture, delivery and performance. Over-specification causes the price to be high and unrealistic, and makes manufacturing difficult and delivery long. Under-specification causes the performance to be inadequate.

Specification control stems from product knowledge and application understanding.

Catalog Specifications

1) The primary and secondary impedances listed in the catalog are the rated source and load resistances between which the transformer's performance ratings are determined. For instance, a unit rated at 500 ohms primary impedance and 500 ohms secondary impedance would yield the rated response limits when the part is driven by a 500 ohm source and is loaded with a 500 ohm load. Reductions in source and/or load impedances below the rated values would "push" the response characteristics toward lower frequencies. Conversely, higher than rated sources or loads edge the part ratings toward higher frequencies at the sacrifice of the lower portion of the rated frequency band.

2) A listing of "CT" after the impedance means that the winding has a termination midway toward the total winding turns (Center tap).

3) "Split" listing after the impedance rating means that the total impedance rating shown is composed of 2 separated windings, which when placed in series produce the larger of the two rated listings. When the windings are placed in parallel, the smaller of the winding ratings is achieved (1/4 of the larger).

4) The maDC rating shows the maximum unbalanced DC current which can be taken in the winding without disturbing the rated response limits. The maDC rating is not a measure of the maximum DC current which the part can tolerate. The maximum currents are a function of the wire sizes used in the part and the allowable heat rise for the part; the maximum AC power to be handled also affects the analysis. Because of the complicated interrelationships, maximum DC ratings are generally not listed as catalog values.

5) Milliwatt or maximum level is the power handling capability of the transformer in terms of power delivered to a matched load with a matched source impedance.

This power level is typically measured at 1 kHz with 5% maximum waveform distortion. In some of the product lines, this power is measured at the lowest frequency within the band pass. The DO-T, DI-T and PIL line are all measured at 1 kHz, while the H series transformers are measured at the lowest frequency. All other audio transformer products, because of specific applications, vary in terms of the frequency at which the maximum power level of operation is specified.

Custom Specifications

1) Electrostatic & Electromagnetic Shielding

Audio transformers require more shielding, in most cases, than any other type transformer. Because of the low power levels they operate at, they may be susceptible to radiated and line coupled interference.

Electrostatic shielding is commonly used between the primary and secondary of a transformer to reduce line coupled interference by reducing the interwinding capacity. This is accomplished by use of highly conductive materials, such as copper, silver or aluminum, as a wrap around or between the coils of a transformer.

Magnetic shielding is used to reduce radiated type interference from affecting a transformer. It is accomplished by encasing the transformer in a single high permeability nickel-iron can, or several nickel-iron cans, depending upon the intensity of the radiation.

2) Balance: Winding, Center Tap, Longitudinal, and Hybrid.

Many audio transformer applications require two matched windings or winding halves. Depending upon the parameters to be compared and the operating conditions, the type of balance required takes on a variety of names, as mentioned above.

Low frequency winding balance requirements are generally limited to accurate turns ratios and extremely well matched DCR's, while high frequency balance includes balancing of winding capacitances.

3) Insertion Loss and Efficiency

Insertion loss is the ratio of useful power delivered, to the input power supplied, the latter being a somewhat larger quantity to overcome losses inherent in the power transferring device. It is expressed in db.

Efficiency expresses the discrepancy between power supplied and power delivered. It is expressed as a percentage.

4) Transformer Phase Shift

A transformer is a series parallel network of complex impedances and will exhibit phase shift from primary to secondary as a function of frequency. Because its inductance is non-linear with applied voltage, phase shift will also be dependent on input voltage level.

5) Reflected Impedance and Return Loss

A transformer can be designed to reflect a specific impedance (within a reasonable tolerance) under a particular set of operating conditions. A measure of the accuracy of the impedance reflection is referred to as Return Loss.

6) Distortion

This is a measure of conformance between the transformer input and output signal waveshapes. Alternately it is a measure of the degradation of signal purity as it passes through a device.

By no means have we dealt with all of the terminology of audio transformers with regard to specifications. We have merely touched upon the surface as indicative of the variety of customer requirements that UTC frequently experiences. Specific requirements for tight performance characteristics are best discussed with our engineering department to arrive at practical solutions based on the state of the art.

STANDARD AUDIO TRANSFORMER & INDUCTOR SELECTION GUIDE

PRODUCT SERIES	DESCRIPTION	WEIGHT	SIZE (Nominal)	FREQ. RANGE	MAX. POWER	PAGE
Military Type: Grade 4, Metal Encased						
BIT-250	Ribbon style Kovar leads; compatible with transistor & IC flat pack styles. Transformers & inductors.	.04 oz	¼" d x ¼" h	300 Hz to 250 kHz	80 mW @ 1 kHz	4, 5
DO-T	Flexible 1½" Dumet leads, Goldplated. Ultraminiature transformers & inductors for transistor circuitry.	1/10 oz	5/16" d x 13/32" h	300 Hz to 20 kHz	500 mW @ 1 kHz	6, 7
DO-T200	Plug in—TO-5 pattern. Ultraminiature transformers & inductors for transistor style circuitry.	1/8 oz	.350" d x 9/16" h	300 Hz to 20 kHz	100 mW @ 1 kHz	8
DI-T	Flexible 1½" Dumet leads, Goldplated. Ultraminiature transformers & inductors for transistor circuitry.	1/15 oz	5/16" d x ¼" h	400 Hz to 100 kHz	500 mW @ 1 kHz	10
DI-T200	Plug in—TO-5 pattern. Ultraminiature transformers & inductors for transistor circuitry.	1/15 oz	5/16" d x 3/8" h	400 Hz to 100 kHz	500 mW @ 1 kHz	11
PIL	Ultraminiature transistor style unit. Flexible lead bundles, copper, tinned material. Transformers & inductors.	1/20 oz	23/64" d x ¼" h	800 Hz to 250 kHz	100 mW @ 1 kHz	9
H	Transformers —Full line of input, interstage & output types for transistor & tube use. Chopper type transformers. Inductors —range from .4 mHys to 450 Hys.	.8 oz to 1 lb	11/16" x ½" x 29/32" h to 13/16" x 13/16" x 2½" h	30 Hz to 20 kHz	1 mW to 10 mW	12, 13, 14
FHA	Low profile audio unit, straight 1" pin terminals for plug-in mounting.	.8 oz	23/32" x 27/32" d x 9/16" h	300 Hz to 20 kHz	100 mW @ 300 kHz	12
FHI	Low profile inductor, straight pin terminal for plug-in use. 15 mHys to 2.4 Hys.	.8 oz	23/32" x 27/32" d x 9/16" h	15 Mhy-64maDC to 2.4 Hys-2maDC		12
W (Mil Std)	Qualified to Mil Stds. print No.'s MS 90000-1 to 90008-1. Inputs, interstage & output types.	.6 lbs	1½" sq. x 23/8" h	300 Hz to 10 kHz	2 W @ 300 Hz	15
Military Type: Grade 5, Molded						
SML	Plug-in input or chopper type transformer.	.03 lbs	7/16" x 31/64" x 9/16" h	200 Hz to 20 kHz	10 mW @ 1 kHz	16
SSO-P	Transistor & tube type transformers. Input, interstage, output & inductors.	.04 lbs	¾" x 7/8" x 9/16" h	300 Hz to 20 kHz	100 mW @ 300 Hz	16
SO-P	Transistor & tube type transformers. Input, interstage, output & inductors.	.05 lbs	¾" x 1 x 23/32" h	200 Hz to 20 kHz	250 mW @ 200 Hz	17
Industrial Type: Cased, non-hermetic						
O	Excellent quality compact audio transformers & inductors, full range of transistor & tube applications.	1 oz	7/8" d x 13/16" h	300 Hz to 20 kHz	1 Watt	18
P	Octal socket plug in style unit. Tube application type.	2 oz	13/32" d x 15/32" h	300 Hz to 20 kHz	-8 DBM 6.3 mW	19
A	Ultra compact wideband transistor & tube type transformers & inductors, hybrids & choppers.	½ lb	1½" sq x 2" h	10 Hz to 50 kHz	5 Watt	20, 21
LS	Linear standard transformers. Hi-fidelity, highest quality. Tube & transistor types. Includes low dist. high efficiency, shielded types, hybrid transformers. Broadcast quality.	3 lbs to 520 lbs	25/8" x 33/8" x 33/4" h to 13" x 153/4" x 28" h	7 Hz to 50 kHz	Low level. to 2.5 KW	22, 23
HA	Excellent quality audio transformers for mixing, matching and tube application. Many units are of hum-bucking construction.	2 lbs to 5 lbs	15/16" x 23/8" x 31/8" h to 213/16" x 39/16" x 31/2" h	20 Hz to 50 kHz	+18 dbm to 20 W	24, 25
CG	High quality transformers for mixing, matching & tube circuit applications.	¼ lb to 82 lbs	15/8" sq x 21/4" h to 7" x 12" x 9" h	40 Hz to 15 kHz	+28 dbm to 600 W	26
CAT	High quality transformers designed with high copper efficiency for transistor use.	.5 lbs	15/8" sq. x 21/4" h	50 Hz to 15 kHz	5 W	26
S	Popular priced special series of transformers & inductors.	1 lb to 52 lbs	13/4" sq. x 211/16" h to 73/8" x 91/4" x 101/4" h	100 Hz to 10 kHz	0 dbm 250 W	27
LAB	Highest quality transformers designed for laboratory circuit development investigation. Input, interstage & output transformers terminated with solderless lugs for a multiplicity of connections for design aid use.	3 lbs to 15 lbs	31/8" x 35/8" x 33/4" to 513/16" x 5" x 411/16"	20 Hz to 20 kHz	50 mW to 50 W	15
Industrial Types: Open Frame, non-hermetic						
SSO	Flexible lead type transformers & inductors for tube & transistor application. Channel frame available.	.02 lbs	43/64" x 3/4" x 7/16" h	300 Hz to 20 kHz	100 mW	16
SO	Small, broadband type, flexible lead type. Transistor & tube types. Channel frame available.	.03 lbs	23/32" x 7/8" x 19/32" h	200 Hz to 20 kHz	250 mW	17



THE **BIT-250**TM LINE

A COMPLETELY NEW DEVELOPMENT IN TRANSFORMER TECHNOLOGY

PACKAGING Size reduction without loss of performance is achieved by major reduction of air gaps in the magnetic circuit. Core permeability closely approaches the theoretical maximum for material and structure.

Materials, dimensions, and surface finish are identical with IC Flat Pack standards. Removable support protects terminal alignment prior to final assembly. This insulated support allows testing in conventional jigs.

RELIABILITY Cylindrical bobbin-winding techniques eliminate corner stress normally found in fine-wire windings of conventional rectangular structures.

Lead arrangements and terminations have been designed to maximize reliability under thermal shock and temperature cycling.

FLEXIBILITY The stock units shown on facing page are designed to afford maximum flexibility of application.

Transformers are 7-terminal types, with center-tapped primaries and split secondaries. When connected in parallel, split-winding secondaries provide 1/4 the impedance and twice the DC current capability as series connections.

Inductors in the stock line include both single-winding and split-winding types.

SPECIALS BIT-250's not found in the stock line will be designed to customers' requirements:

- Special electrical parameters
- 10 or more leads
- Special termination arrangements, such as gold-plated straight pin leads, ribbon-style leads perpendicular to the terminal board for "dual in-line" packaging, etc.
- Operation to 130°C per MIL Class S.



NOTES

- **FREQUENCY RESPONSE** ± 2 db, 300 Hz—250,000 Hz, @ 1 MW Ref. level
- **DIELECTRIC STRENGTH** tested @ 200V RMS
- **MIL SPECS** To complete MIL-T-27C Specs. Metal encased, ruggedized, Grade 4, Class R, Life X. See pages 86, 87
- **SHIELDING** All units electromagnetically self-shielded
- **LEAD MATERIAL** Gold-plated ribbon-style Kovar, solderable and weldable—MIL-STD 1276 Type K

BIT - 250 TERMINATION ADAPTABILITY FOR PLUG-IN PC APPLICATIONS

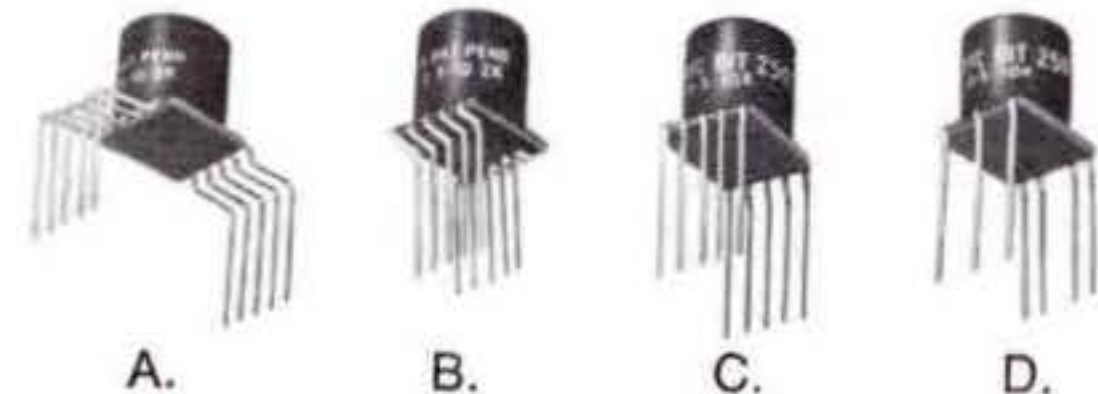

BIT-250 stock units are manufactured with Flat Pack type terminations extending outward. Terminations may be bent for adaptation to plug-in applications. Unique termination configuration isolates strain and affords safety during bending process. Variations of bends are pictured above.

- A. Right-angle bend outside the confines of the unit.
- B. Right-angle bend inside the confines of the unit.
- C. Right-angle bend at the confines of the unit.
- D. (As C, above) with three terminations eliminated.

Bending may be done by customer or by UTC on special order.

PLUG-IN PIN TERMINALS AND OTHER PROFILES AVAILABLE ON SPECIAL ORDER

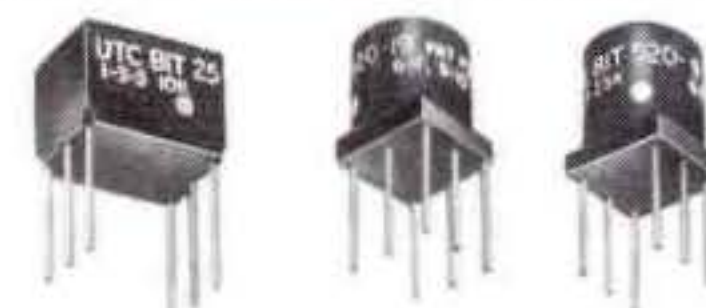

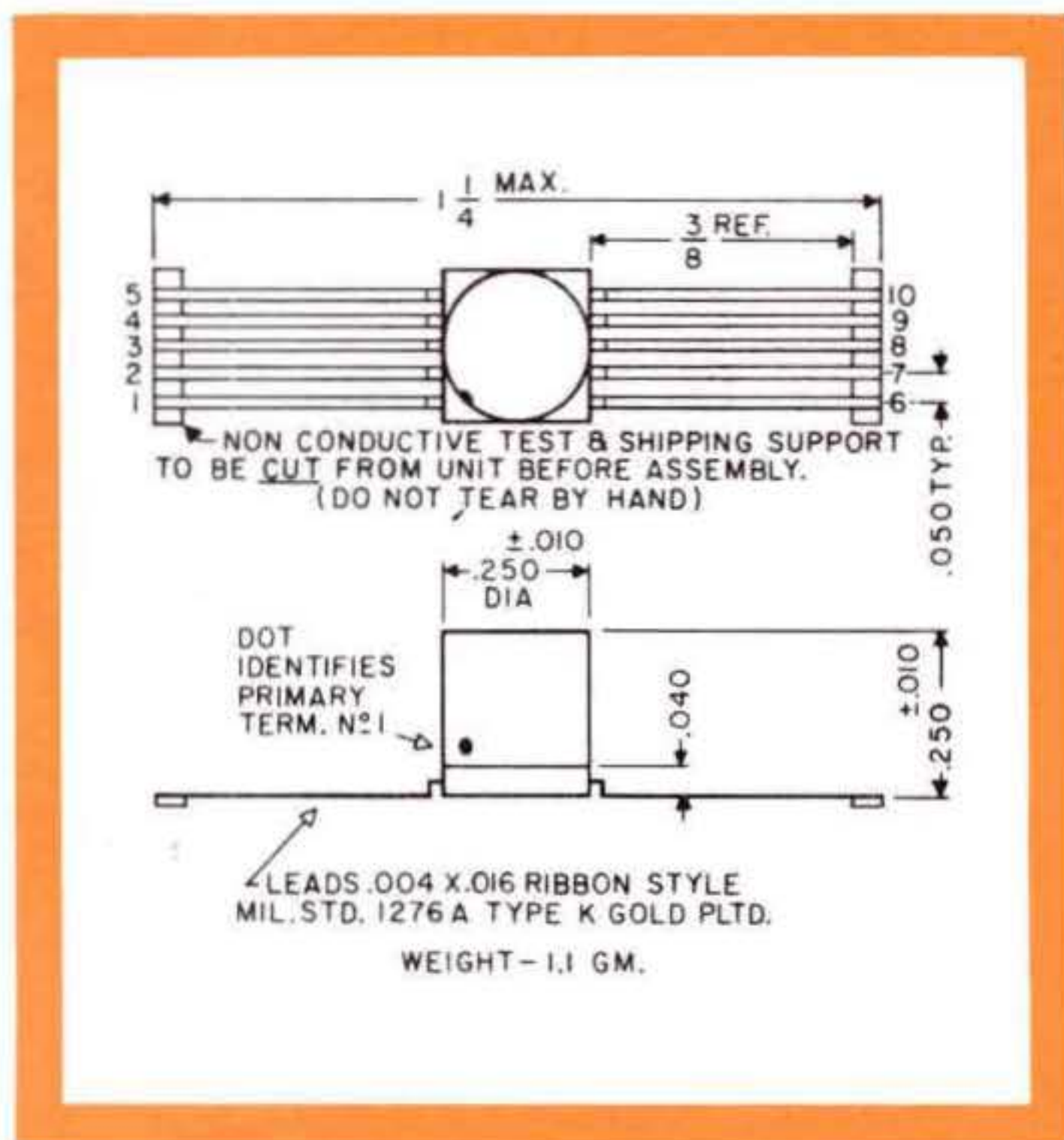

TRANSFORMERS

BIT-250 Type No.	MIL Type	Pri Imp Ω	Sec Imp Ω (Split Wdg) Series/Par	Power Level mW for 5% Max Dist @ 1 kHz	Pri DCR Ω	(Series Conn.) Sec DCR Ω	Turns Ratio		Typical Application
							Pri/Sec/Sec	Pri/Overall Sec	
BIT-250-14	TF4RX17YY	150 CT	12/3	80	16	1.85	7.1:1:1	3.54:1	Output
BIT-250-18	TF4RX17YY	300 CT	600/150	80	30	65	1.4:1:1	1:1.4	Output or Matching
BIT-250-20	TF4RX17YY	400 CT	400/100	80	45	45	2:1:1	1:1	Matching or Interstage
BIT-250-26	TF4RX17YY	500 CT	50/12.5	80	58	5.5	6.32:1:1	3.16:1:1	Output
BIT-250-30	TF4RX17YY	600 CT	600/150	80	65	65	2:1:1	1:1	Isolation or Matching
BIT-250-36	TF4RX17YY	1000 CT	1000/250	80	110	100	2:1:1	1:1	Output or Matching
BIT-250-40	TF4RX12YY	1500 CT	600/150	75	150	65	3.16:1:1	1.58:1	Output
BIT-250-48	TF4RX12YY	2000 CT	8000/2000	75	177	745	1:1:1	1:2	Isolation or Interstage
BIT-250-56	TF4RX12YY	10K CT	500/125	75	900	45	8.92:1:1	4.46:1	Output or Driver
BIT-250-60	TF4RX12YY	10K CT	1200/300	75	900	100	5.78:1:1	2.89:1	Driver
BIT-250-64	TF4RX12YY	10K CT	2000/500	75	900	160	4.48:1:1	2.24:1	Interstage
BIT-250-70	TF4RX12YY	10K CT	10K/2500	75	900	750	2:1:1	1:1	Isolation or Interstage
BIT-250-90	TF4RX12YY	25K CT	1000/250	40	2400	78	10:1:1	5:1	Interstage

INDUCTORS

BIT-250 Type No.	MIL Type	Connections	Inductance Hys Min @ 1 kHz 5V	@ ma DC	DC Res Ω	Ratio of Wdgs
BIT-250-03 (2 wdgs)	TF4RX20YY	Series	8.6 2.5	0 2	2260	1:1
		Parallel	2.4 .63	0 4		
BIT-250-05 (1 wdg)	TF4RX20YY		5.5 1.5	0 2	1000	
BIT-250-06 (1 wdg)	TF4RX20YY		.80 .25	1 6	250	
BIT-250-09 (2 wdgs)	TF4RX20YY	Series	.60 .15	0 5	146	1:1
		Parallel	.15 .038	0 10		

FOR FURTHER CHARACTERISTICS SEE NOTES ON OPPOSITE PAGE.



DO-T™ TRANSISTOR TRANSFORMERS & INDUCTORS

PACKAGING Hermetically sealed. A UTC pioneered structure. The bobbin is completely rigid eliminating stress and wire movement. The turns are circular in shape rather than square, eliminating turn corner stress and effecting uniform wire lay. No tapes are employed in connecting coil wire and external leads. They are rigidly anchored in secure terminal board fashion providing strain relief. The leads used on the stock DO-T transformers are insulated solid .016 diameter Dumet leads. For plug-in type see page 8.

MIL SPECS To complete MIL-T-27C Specs. Units are fully ruggedized, hermetically sealed, metal cased to Mil Grade 4, Class R, Life X. See pages 86, 87.

PERFORMANCE The radically designed UTC DO-T Family (see pgs. 6 thru 11) transistor transformers provide unprecedented power handling capacity and reliability, coupled with small size. Electrical parameters and areas of application exceed conventional transformer capabilities. Curves on this and pages 8, 10 & 11 indicate their performance compared to that of similar size units now on the market. These curves show representative performance of all DO-T's and DI-T's except 200,000 ohm units. Higher performance is obtained when used in pushpull with balanced DC. Other manufacturers' comparative performance is shown on these curves to put unjustified claims in perspective. For example, the UTC DO-T10 delivers 100 mw @ 5% distortion @ 300 Hz. *Identical measurements* were made on contemporary manufacturers' equivalent, rated at 50 mw @ 300 Hz. Actual delivered power was under 1 mw @ 7½% distortion @ 300 Hz.

FREQUENCY RESPONSE ± 3 db 300 Hz to 20 kHz.

APPLICATION Units can be used for different impedances from those shown, keeping in mind that impedance ratio is constant. Lower source impedance will improve hum bucking response and level ratings . . . higher source will reduce them. Units may be used reversed, input to secondary. The frequency response curve on this page is shown to 20 kHz. This descriptive curve is not meant to be restrictive. Units can be used at frequencies well above 20 kHz. Satisfactory applications for frequencies up to and above 100 kHz have been developed.

PULSE APPLICATION In pulse coupling impedance matching applications, (when measured with a 30 micro-second input pulse voltage wave), typical values for these transformers are: 5% or less droop, zero overshoot and less than 10% backswing.

RELIABILITY The exceptional reliability of DO-T family units, inherent in their unique structure, has been dynamically proven in the field.

SHIELDING Hipermalloy electromagnetic shield available from stock for all DO-T family units except PIL.

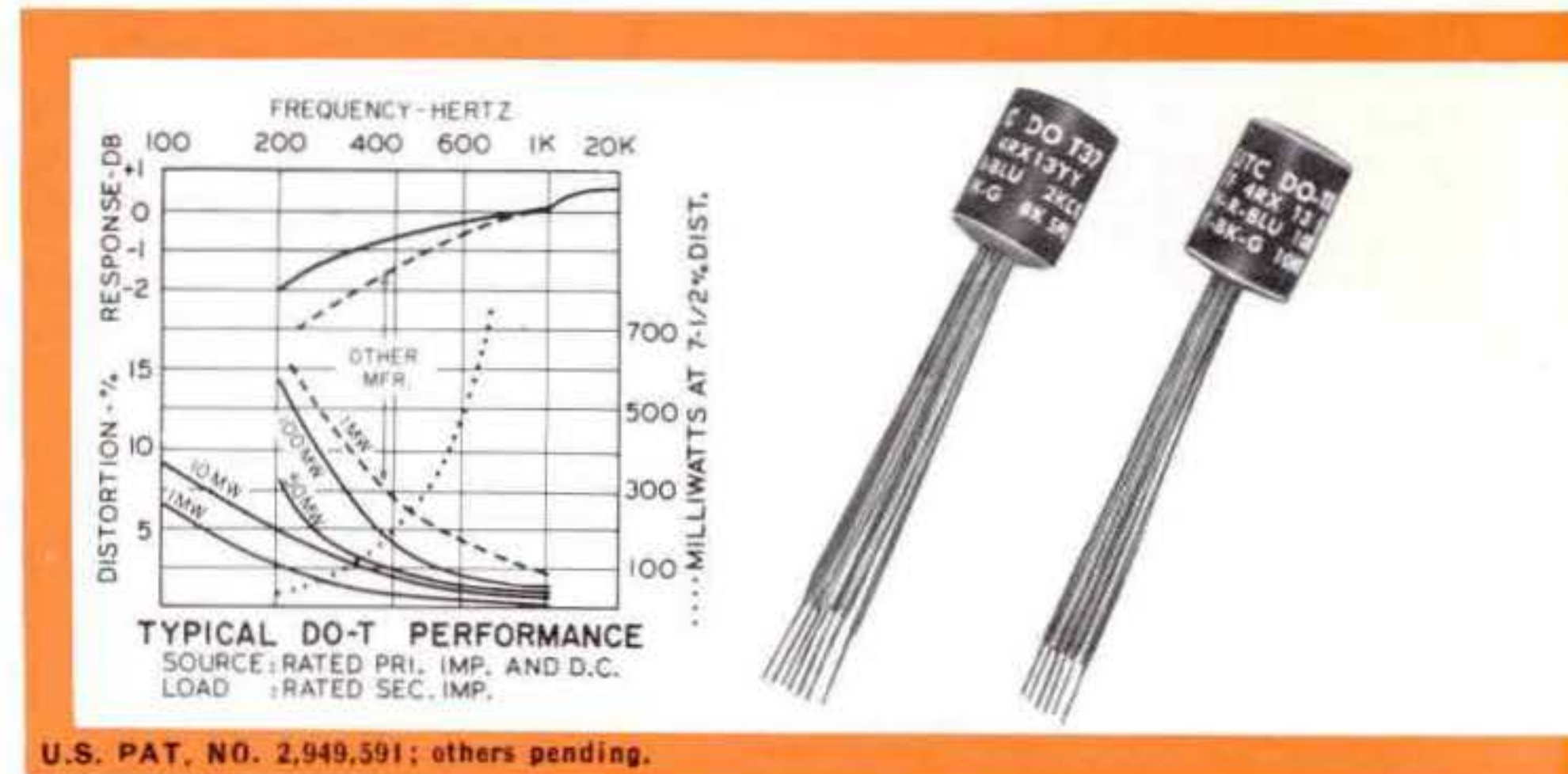

U.S. PAT. NO. 2,949,591; others pending.

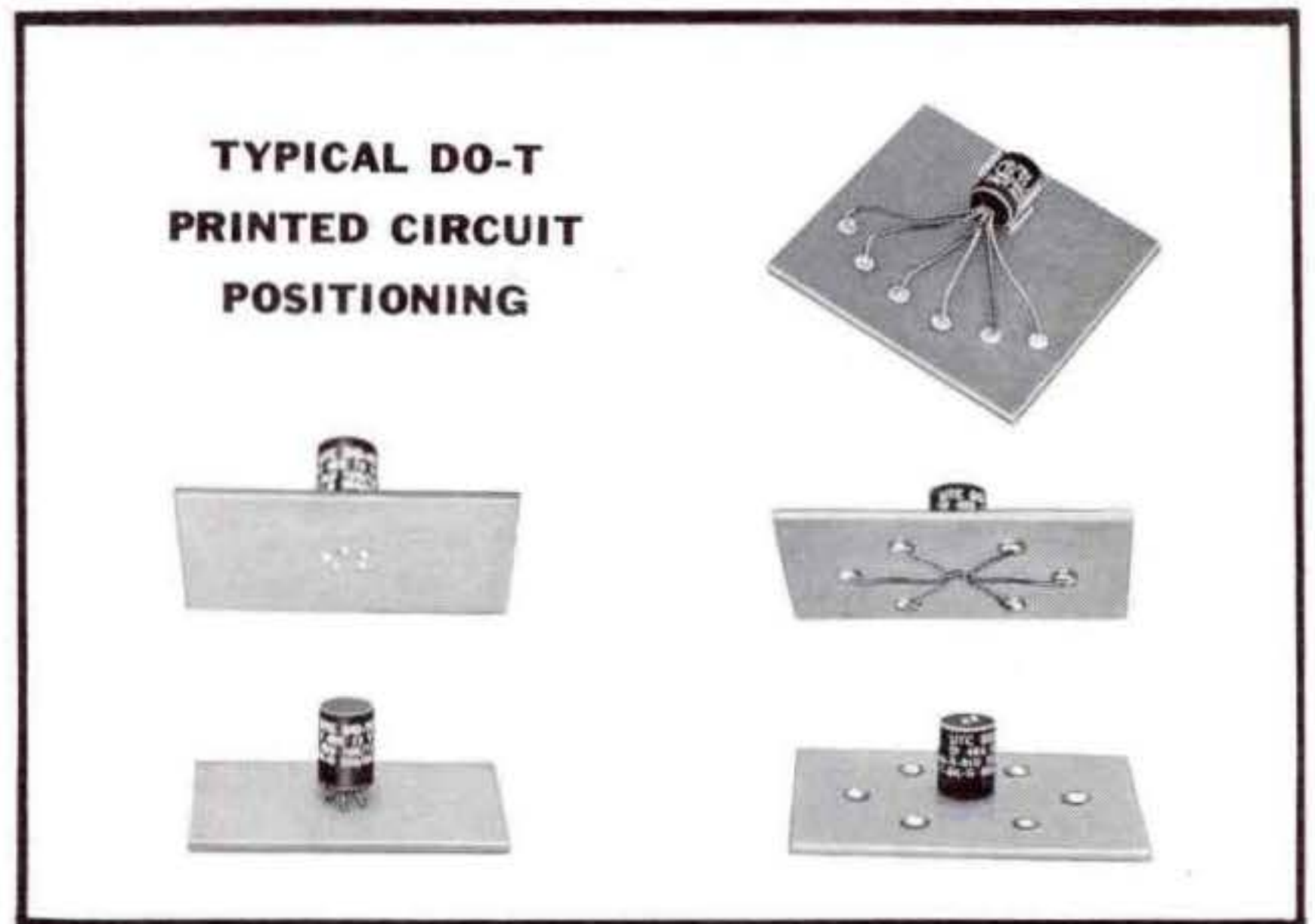

SPECIALS For indication of possibilities of DO-T Family units custom built to your special requirements, see special DO-T units on page 29.

The stock DO-T Family are Grade 4 Class R units, for a maximum operating temperature of 105° C in accordance with MIL-T-27C Specs. On special order they can be designed to Class S requirements of MIL-T-27C (130° C maximum operating temperature). No additional life expectancy is gained by ordering Class S insulation systems for applications in the vicinity of Class R temperatures. Where the operating temperatures are above 105° C, the use of Class S insulations will afford greater life expectancy.

Special units with electrical modifications of changed lead lengths, modified impedance ratios, and additions of electrostatic shields, etc., are available for all DO-T family units. Stock units cover general purpose applications. For specific applications cost reductions may be effected.

INDUCTOR DO-T™ LISTING

Type No.	MIL Type	
DO-T50 (2 wdgs.)	TF4RX20YY	Series connection: .075 Hy @ 10 ma DC, .06 Hy @ 30 ma DC, DCR 10.5 ohms Parallel connection: .018 Hys @ 20 ma DC, .015 Hys @ 60 ma DC, DCR 2.6 ohms
DO-T28	TF4RX20YY	.3 Hy @ 4 ma DC, DCR 25 ohms .15 Hy @ 20 ma DC
DO-T27	TF4RX20YY	1.25 Hys @ 2 ma DC, DCR 100 ohms .5 Hy @ 11 ma DC
DO-T8	TF4RX20YY	3.5 Hys @ 2 ma DC, DCR 560 ohms 1 Hy @ 5 ma DC
DO-T26	TF4RX20YY	6 Hys @ 2 ma DC, DCR 2100 ohms 1.5 Hys @ 5 ma DC
DO-T49 (2 wdgs.)	TF4RX20YY	Series connection: 20 Hys @ 1 ma DC, 8 Hys @ 3 ma DC, DCR 5100 ohms Parallel connection: 5 Hys @ 2 ma DC, 2 Hys @ 6 ma DC, DCR 1275 ohms

FOR POWER DO-T TRANSFORMERS (DO-T400 SERIES) SEE PAGE 37.

TRANSFORMER DO-T™ LISTING

Locating Line	Type No.	MIL Type	Pri. Imp.Ω	D.C. ma.‡ in Pri.	Sec. Imp.Ω	Pri. DCRΩ	Mw Level*	Typical Application
1	DO-T44	TF4RX17YY	80 CT 100 CT	12 10	32 split 40 split	9.8	500	Interstage or matching or output
2	DO-T29	TF4RX17YY	120 CT 150 CT	10 10	3.2 4	10	500	Single or PP output
3	DO-T12	TF4RX17YY	150 CT 200 CT	10 10	12 16	11	500	Single or PP output
4	DO-T13	TF4RX17YY	300 CT 400 CT	7 7	12 16	20	500	Single or PP output
5	DO-T19	TF4RX17YY	300 CT	7	600	19	500	Output to line or matching
6	DO-T30	TF4RX17YY	320 CT 400 CT	7 7	3.2 4	20	500	Single or PP output
7	DO-T43	TF4RX17YY	400 CT 500 CT	8 6	40 split 50 split	46	500	Interstage or matching or output
8	DO-T42	TF4RX17YY	400 CT 500 CT	8 6	120 split 150 split	46	500	Interstage
9	DO-T41	TF4RX17YY	400 CT 500 CT	8 6	400 split 500 split	46	500	Interstage or output or matching (Ratio 2:1:1) also wide pulse application
10	DO-T53	TF4RX17YY	400 CT 500 CT	8 6	4000 CT 5000 CT	46	500	Input or driver to low noise transistor
11	DO-T2	TF4RX17YY	500 600	3 3	50 60	60	100	Output or matching
12	DO-T20	TF4RX17YY	500 CT	5.5	600	31	500	Output or line to line or mixing or matching
13	DO-T4	TF4RX17YY	600	3	3.2	60	100	Output or matching
14	DO-T14	TF4RX17YY	600 CT 800 CT	5 5	12 16	43	500	Single or PP output
15	DO-T31	TF4RX17YY	640 CT 800 CT	5 5	3.2 4	43	500	Single or PP output or matching
16	DO-T32	TF4RX17YY	800 CT 1000 CT	4 4	3.2 4	51	500	Single or PP output
17	DO-T15	TF4RX17YY	800 CT 1070 CT	4 4	12 16	51	500	Single or PP output
18	DO-T21	TF4RX17YY	900 CT	4	600	53	500	Output to line
19	DO-T3	TF4RX13YY	1000 1200	3 3	50 60	115	100	Output or matching
20	DO-T45	TF4RX12YY	1000 CT 1250 CT	3.5 3.5	16,000 split 20,000 split	120	100	Interstage (ratio 1:2:2) also wide pulse application
21	DO-T16	TF4RX13YY	1000 CT 1330 CT	3.5 3.5	12 16	71	500	Single or PP output
22	DO-T33	TF4RX13YY	1060 CT 1330 CT	3.5 3.5	3.2 4	71	500	Single or PP output
23	DO-T5	TF4RX13YY	1200	2	3.2	105	100	Output
24	DO-T17	TF4RX13YY	1500 CT 2000 CT	3 3	12 16	108	500	Single or PP output
25	DO-T22	TF4RX13YY	1500 CT	3	600	86	500	Output to line or matching
26	DO-T34	TF4RX13YY	1600 CT 2000 CT	3 3	3.2 4	109	500	Single or PP output
27	DO-T51	TF4RX13YY	2000 CT 2500 CT	3 3	2000 split 2500 split	195	100	Isol. or interstage (Ratio 2:1:1) Also wide pulse application
28	DO-T37	TF4RX13YY	2000 CT 2500 CT	3 3	8000 split 10,000 split	195	100	Isol. or interstage (Ratio 1:1:1) also wide pulse application
29	DO-T52	TF4RX13YY	4000 CT 5000 CT	2 2	8000 CT 10,000 CT	320	100	Interstage Includes electrostatic shield
30	DO-T18	TF4RX13YY	7500 CT 10,000 CT	1 1	12 16	505	100	Single or PP output
31	DO-T35	TF4RX13YY	8000 CT 10,000 CT	1 1	3.2 4	505	100	Single or PP output
32	DO-T48	TF4RX13YY	8000 CT 10,000 CT	1 1	1200 CT 1500 CT	640	100	Interstage Includes electrostatic shield
33	DO-T47	TF4RX13YY	9000 CT 10,000 CT	1 1	9000 CT 10,000 CT	850	100	Isolation or interstage Includes electrostatic shield
34	DO-T6	TF4RX13YY	10,000	1	3.2	790	100	Output
35	DO-T9	TF4RX13YY	10,000 12,000	1 1	500 CT 600 CT	780	100	Output or driver
36	DO-T10	TF4RX13YY	10,000 12,500	1 1	1200 CT 1500 CT	780	100	Driver
37	DO-T25	TF4RX13YY	10,000 CT 12,000 CT	1 1	1500 CT 1800 CT	780	100	Interstage
38	DO-T38	TF4RX13YY	10,000 CT 12,000 CT	1 1	2000 split 2400 split	560	100	Interstage
39	DO-T11	TF4RX13YY	10,000 12,500	1 1	2000 CT 2500 CT	780	100	Driver
40	DO-T36	TF4RX13YY	10,000 CT 12,000 CT	1 1	10,000 CT 12,000 CT	975	100	Isol. or interstage (Ratio 1:1) also wide pulse application
41	DO-T1	TF4RX13YY	20,000 30,000	.5 .5	800 1200	830	50	Interstage
42	DO-T23	TF4RX13YY	20,000 CT 30,000 CT	.5 .5	800 CT 1200 CT	830	50	Interstage
43	DO-T39	TF4RX13YY	20,000 CT 30,000 CT	.5 .5	1000 split 1500 split	800	50	Interstage
44	DO-T40	TF4RX13YY	40,000 CT 50,000 CT	.25 .25	400 split 500 split	1700	50	Interstage or output
45	DO-T54	TF4RX13YY	40,000 CT 50,000 CT	.25 .25	4000 CT 5000 CT	1700	50	Interstage or isol. to low noise transistor
46	DO-T46	TF4RX16YY	100,000 CT	0	500 CT	7900	25	Input (usable for chopper service) Includes electrostatic shield
47	DO-T7	TF4RX16YY	200,000	0	1000	8500	25	Input
48	DO-T24	TF4RX16YY	200,000 CT	0	1000 CT	8500	25	Input (usable for chopper service)
49	DO-T400	TF4RX03YY	Power DO-T, see page 37					
50	DO-T410	TF4RX03YY	Power DO-T, see page 37					
51	DO-T420	TF4RX03YY	Power DO-T, see page 37					

DO-TSH Drawn Hipermalloy shield and cover for DO-T's provides 20 to 30 db shielding, ³⁵/₆₄ h x ²³/₆₄" dia, ¹/₈" hole in cover

*For 5% maximum distortion @ 1 kHz.
‡maDC shown is for single ended usage. For push pull, maDC can be any balanced value taken by .5W transistors.
Where windings are listed as split, ¼ of the listed impedance is available by paralleling the winding.

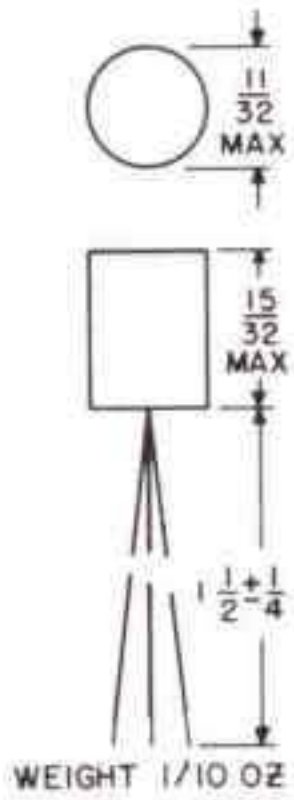

Unit Locating Key

Type No.	Located on Line
DO-T1	41
DO-T2	11
DO-T3	19
DO-T4	13
DO-T5	23
DO-T6	34
DO-T7	47
DO-T8	Pg. 6
DO-T9	35
DO-T10	36
DO-T11	39
DO-T12	3
DO-T13	4
DO-T14	14
DO-T15	17
DO-T16	21
DO-T17	24
DO-T18	30
DO-T19	5
DO-T20	12
DO-T21	18
DO-T22	25
DO-T23	42
DO-T24	48
DO-T25	37
DO-T26	Pg. 6
DO-T27	Pg. 6
DO-T28	Pg. 6
DO-T29	2
DO-T30	6
DO-T31	15
DO-T32	16
DO-T33	22
DO-T34	26
DO-T35	31
DO-T36	40
DO-T37	28
DO-T38	38
DO-T39	43
DO-T40	44
DO-T41	9
DO-T42	8
DO-T43	7
DO-T44	1
DO-T45	20
DO-T46	46
DO-T47	33
DO-T48	32
DO-T49	Pg. 6
DO-T50	Pg. 6
DO-T51	27
DO-T52	29
DO-T53	10
DO-T54	45
DO-T400	49
DO-T410	50
DO-T420	51



DO-T 200™ TRANSISTOR TRANSFORMERS & INDUCTORS

NEW DO-T 200™ SERIES

PACKAGING Hermetically sealed. DO-T family unit. See page 6.

MIL SPECS To complete MIL-T-27C Specs. Ruggedized, metal encased to Mil Grade 4, Class R, Life X. See pages 86, 87.

FREQUENCY RESPONSE ±3db, 300 Hz to 20 kHz.

TERMINALS Leads are .016 Dumet wire, gold plated, and may be either welded or soldered. They are uninsulated and are spaced on a .1" radius circle, conforming to the termination pattern of the "TO-5" cased semiconductors and micrologic elements.

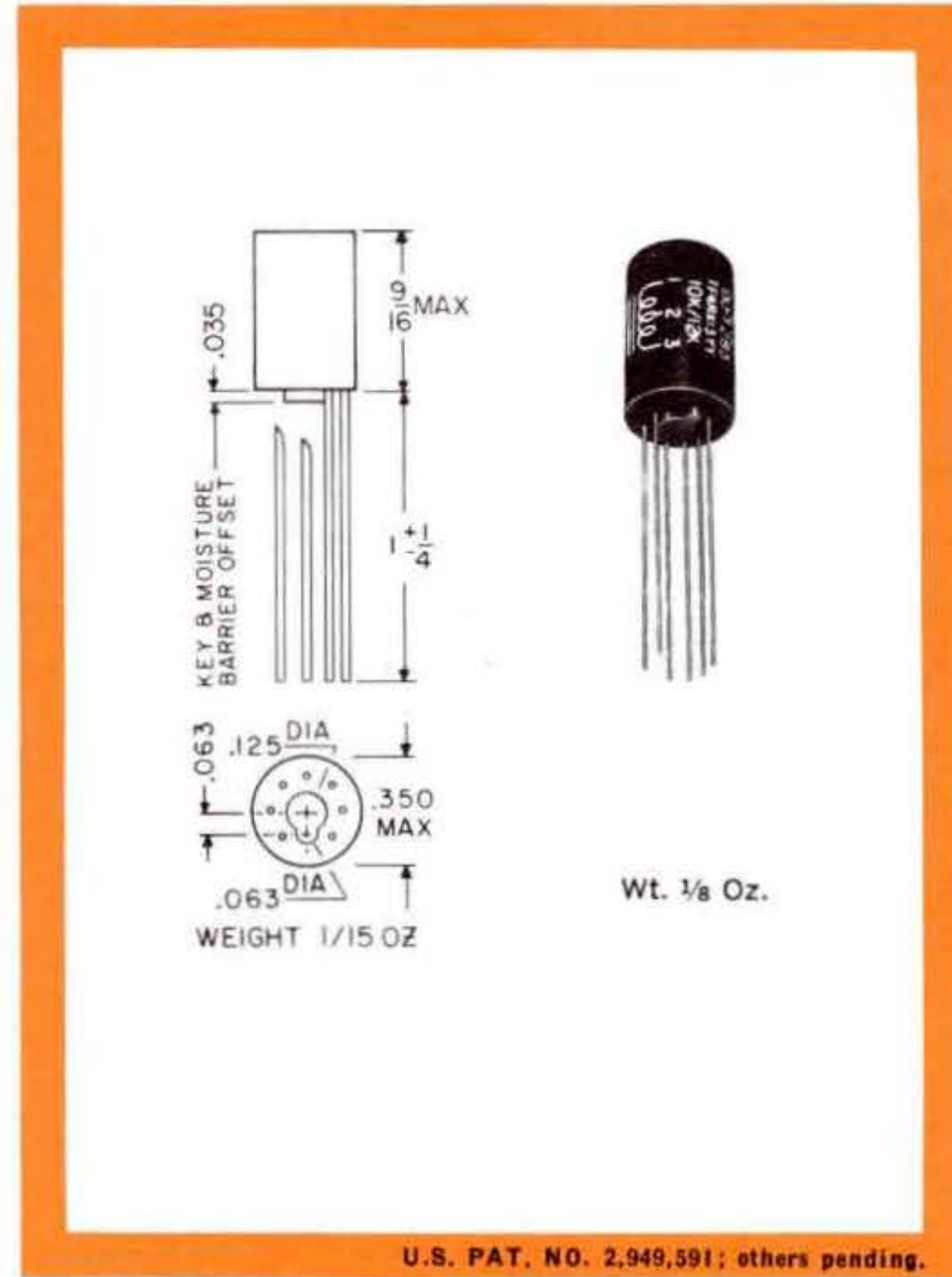
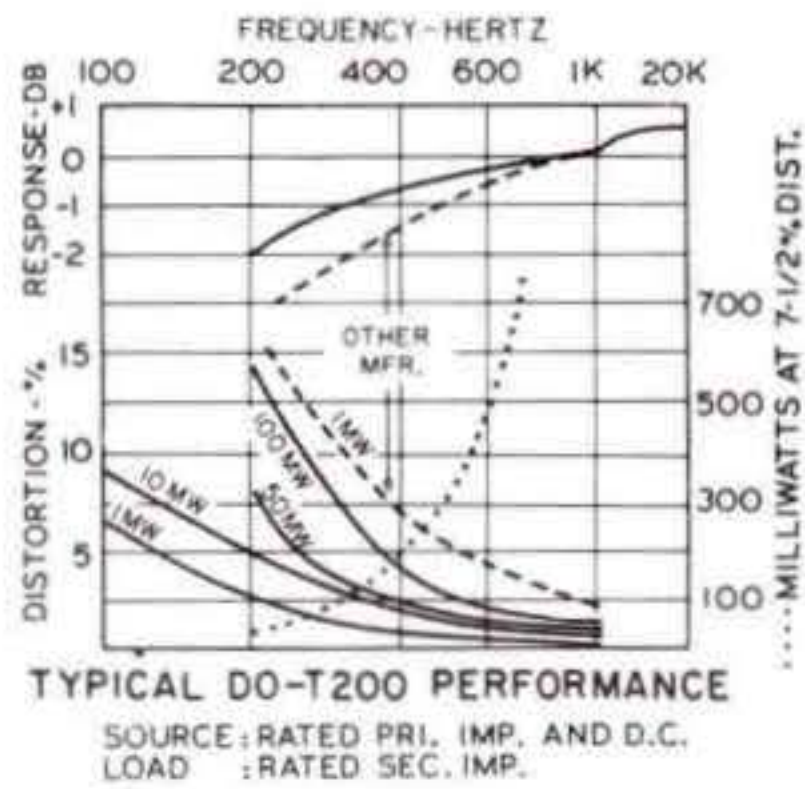

Type No.	MIL Type	Pri Imp Ω	ma D.C.‡ in Pri	Sec Imp Ω	Pri DCR Ω	Mw Level*	Application
DO-T255	TF4RX13YY	1000 CT 1200 CT	3 3	50 60	115	100	Output or matching
DO-T275	TF4RX13YY	10,000 CT 12,000 CT	1 1	1500 CT 1800 CT	780	100	Interstage
DO-T277	TF4RX13YY	10,000 CT 12,000 CT	1 1	2000 split 2400 split	560	100	Interstage
DO-T278	TF4RX13YY	10,000 12,500	1 1	2000 CT 2500 CT	780	100	Driver
DO-T283	TF4RX13YY	10,000 CT 12,000 CT	1 1	10,000 CT 12,000 CT	975	100	Isolation or Interstage (Ratio 1:1) also pulse appl.
DO-T288	TF4RX13YY	20,000 CT 30,000 CT	.5 .5	800 CT 1200 CT	830	50	Interstage
DO-T297	TF4RX16YY	200,000 CT	0	1000 CT	8500	25	Input and Chopper
DO-T200SH	Drawn Hipermalloy shield provides 15 to 20 db dshielding through side of case, 37/64 h x 3/8" dia, no cover						

*For 5% maximum distortion @ 1 kHz.
 ‡maDC shown is for single ended usage. For push pull, maDC can be any balanced value taken by .5W transistors.
 Where windings are listed as split, 1/4 of the listed impedance is available by paralleling the winding.



PIL™ ULTRAMINIATURE AUDIO TRANSFORMERS & INDUCTORS

PACKAGING DO-T family unit (except solid, tinned copper insulated leads). See page 6.

MIL SPECS To complete MIL-T-27C Specs. Ruggedized, metal encased to Mil Grade 4, Class R, Life X. See pages 86, 87.

FREQUENCY RESPONSE At 1 mw, ±3db, 800 Hz to 250 kHz.

SPECIALS Plug-in PIL available on special order. Maximum dimensions: 0.390" diameter x 0.350" high. For terminal arrangement see DI-T200, page 11.

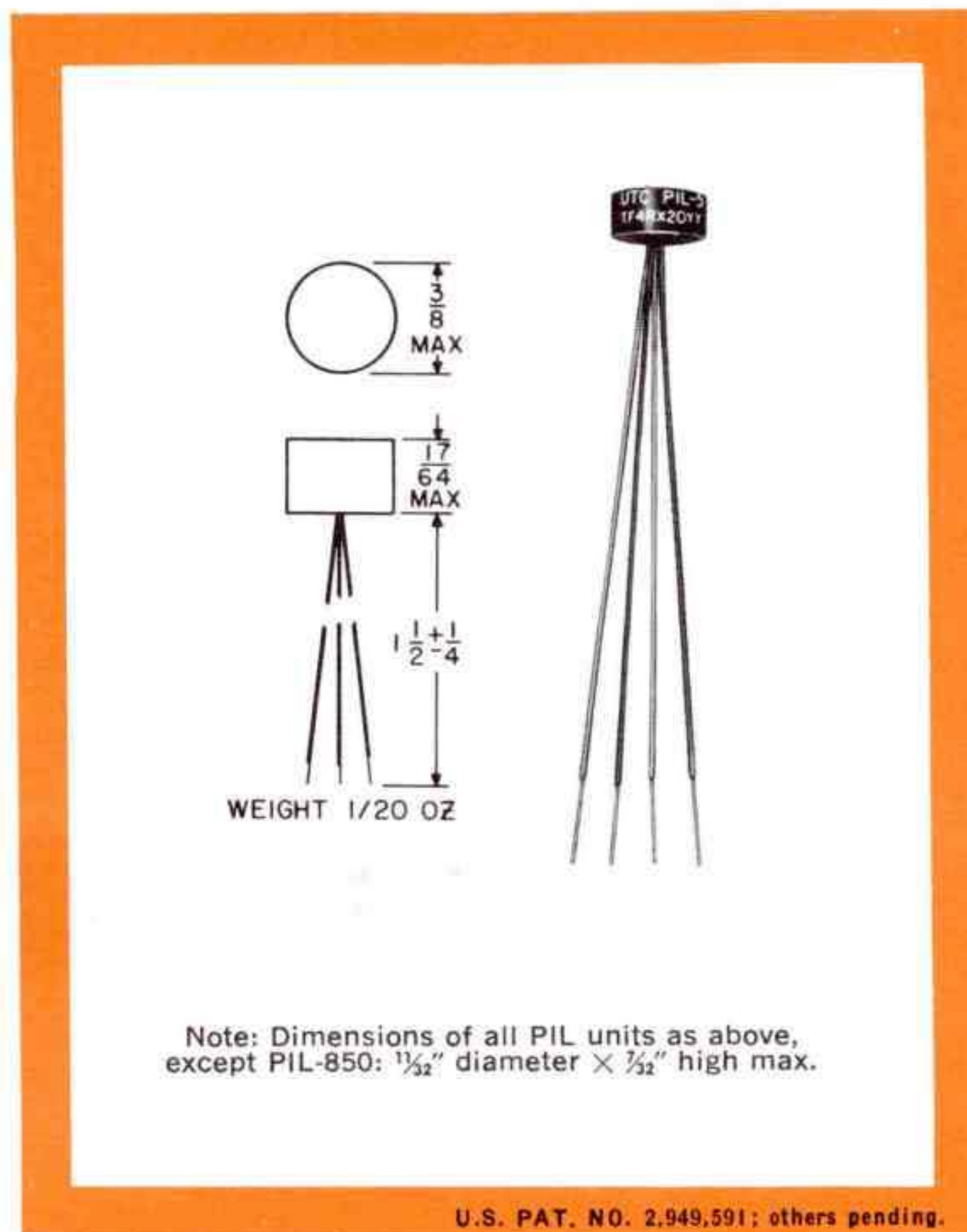
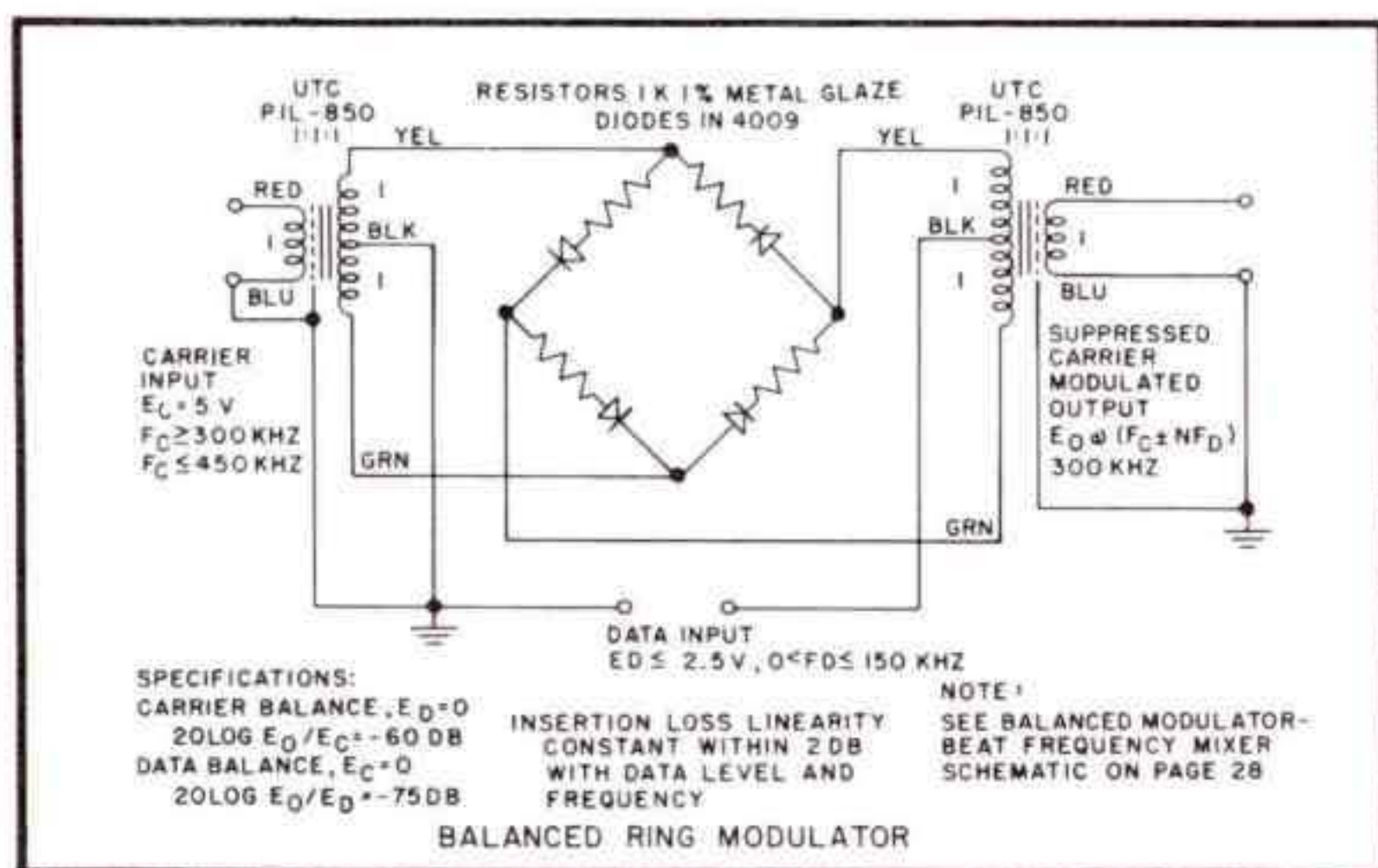

TRANSFORMER

Type No.	MIL Type	Pri Imp Ω	Unbal ma D.C. in Pri	Sec Imp Ω	Pri DCR Ω	Max Mw Level*
PIL-50	TF4RX17YY	500 CT	3	500 CT	40	100
PIL-70	TF4RX13YY	10K CT	1	500 CT	530	100
PIL-75	TF4RX13YY	10K CT	1	2K CT	530	100

BALANCED MODULATOR TRANSFORMER WITH ELECTROSTATIC SHIELD

Type No.	MIL Type	Pri. Imp Ω	Sec Imp Ω	Pri. DCR Ω ±25%	Sec DCR Ω ±25%	Frequency Range
PIL-850	TF4RX16YY	150	600 CT	3	7	300 kHz- 450 kHz

INDUCTORS— Hys (Min) @ 2V 1 kHz

Type No.	MIL Type	Conne- tion	Series	Parallel
PIL-5	TF4RX20YY	Series	.09 Hys @ 0 ma DC, .08 Hys @ 5 ma DC, DCR 43 ohms	.022 Hys @ 0 ma DC, .020 Hys @ 10 ma DC, DCR 10.7 ohms
		Parallel		
PIL-8	TF4RX20YY	Series	.26 Hys @ 0 ma DC, .18 Hys @ 5 ma DC, DCR 115 ohms	.06 Hys @ 0 ma DC, .05 Hys @ 10 ma DC, DCR 28 ohms
		Parallel		
PIL-12	TF4RX20YY	Series	.66 Hys @ 0 ma DC, .4 Hys @ 3 ma DC, DCR 300 ohms	.16 Hys @ 0 ma DC, .12 Hys @ 5 ma DC, DCR 75 ohms
		Parallel		

*For 5% maximum distortion @ 10 kHz.
‡maDC shown is for single ended usage. For push pull, maDC can be any balanced value taken by .5W transistors. Where windings are listed as split, 1/4 of the listed impedance is available by paralleling the winding.



DI-T™ TRANSISTOR TRANSFORMERS & INDUCTORS

Unit Location Key	
Type No.	Located on Line
DI-T1	21
DI-T2	6
DI-T3	9
DI-T5	10
DI-T8	25
DI-T9	15
DI-T10	16
DI-T11	19
DI-T19	2
DI-T20	7
DI-T21	8
DI-T22	11
DI-T23	22
DI-T25	17
DI-T26	26
DI-T27	24
DI-T28	23
DI-T36	20
DI-T37	13
DI-T38	18
DI-T41	4
DI-T43	3
DI-T44	1
DI-T51	12
DI-T52	14
DI-T53	5

PACKAGING DO-T family, see page 6.

MIL SPECS To complete MIL-T-27C Specs. Grade 4, Class R, Life X. See pages 86, 87.

FREQUENCY RESPONSE ±3db, 400 Hz to 100 kHz.

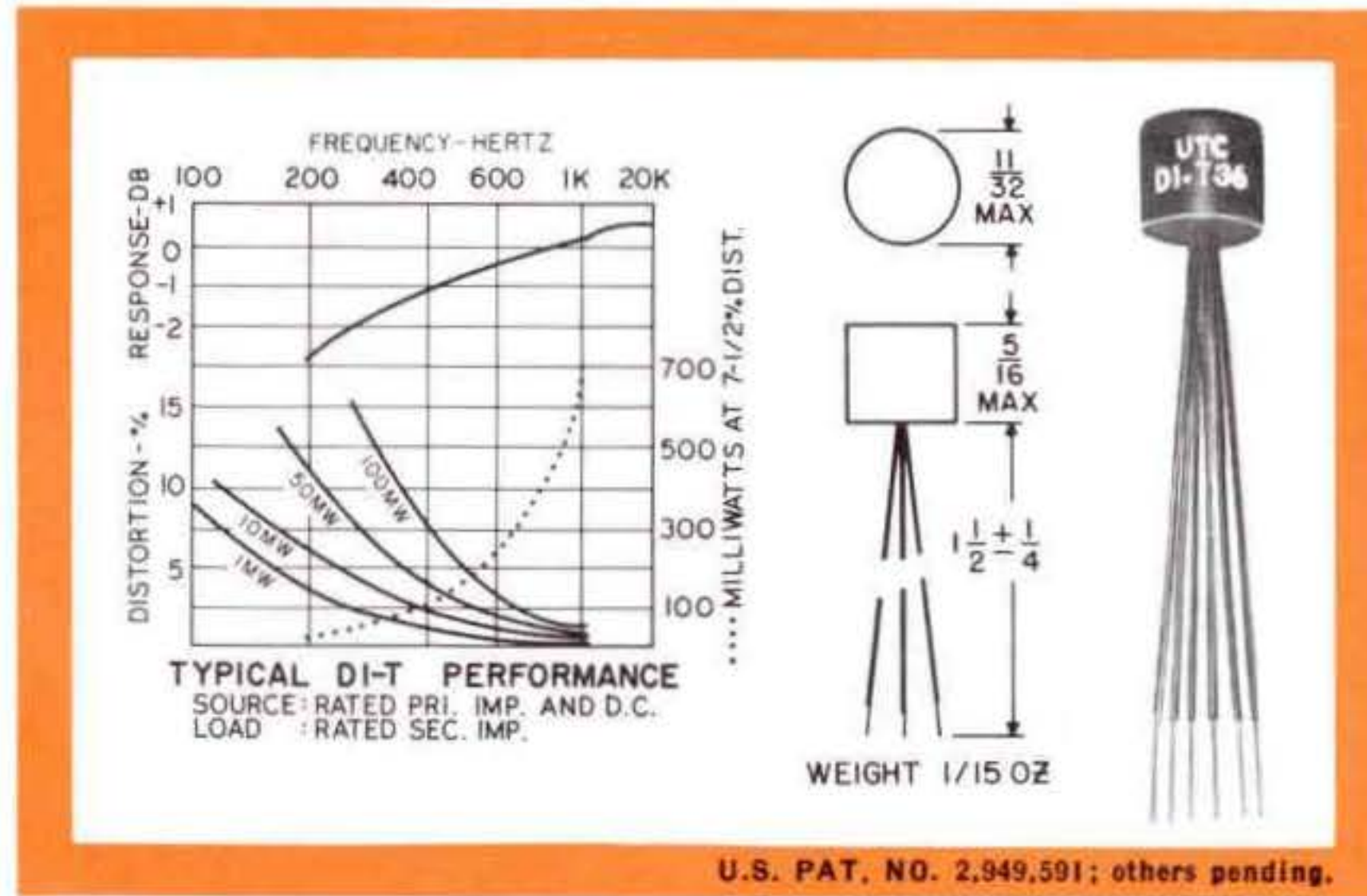

Locating Line	Type No.	MIL Type	Pri. Imp.Ω	ma D.C.‡ in Pri.	Sec. Imp.Ω	Pri. DCRΩ	Mw Level*	Application
1	DI-T44	TF4RX17YY	80 CT 100 CT	12 10	32 split 40 split	11.5	500	Interstage
2	DI-T19	TF4RX17YY	300 CT	7	600	20	500	Output to line
3	DI-T43	TF4RX17YY	400 CT 500 CT	8 6	40 split 50 split	50	500	Interstage
4	DI-T41	TF4RX17YY	400 CT 500 CT	8 6	400 split 500 split	50	500	Interstage or output (Ratio 2:1:1) also wide pulse application
5	DI-T53	TF4RX17YY	400 CT 500 CT	8 6	4000 CT 5000 CT	46	500	Input or driver to low noise transistor
6	DI-T2	TF4RX17YY	500 600	3 3	50 60	65	100	Output
7	DI-T20	TF4RX17YY	500 CT	5.5	600	32	500	Output or line to line or mixing
8	DI-T21	TF4RX17YY	900 CT	4	600	53	500	Output to line
9	DI-T3	TF4RX13YY	1000 1200	3 3	50 60	110	100	Output
10	DI-T5	TF4RX13YY	1200	2	3.2	110	100	Output
11	DI-T22	TF4RX13YY	1500 CT	3	600	87	500	Output to line
12	DI-T51	TF4RX13YY	2000 CT 2500 CT	3 3	2000 split 2500 split	180	100	Isol. or Interstage (Ratio 2:1:1) Also wide pulse application
13	DI-T37	TF4RX13YY	2000 CT 2500 CT	3 3	8000 split 10,000 split	180	100	Isol. or Interstage (Ratio 1:1:1) also wide pulse application
14	DI-T52	TF4RX13YY	4000 CT 5000 CT	2 2	8000 CT 10,000 CT	300	100	Interstage Includes electrostatic shield
15	DI-T9	TF4RX13YY	10,000 12,000	1 1	500 CT 600 CT	870	100	Output or driver
16	DI-T10	TF4RX13YY	10,000 12,500	1 1	1200 CT 1500 CT	870	100	Driver
17	DI-T25	TF4RX13YY	10,000 CT 12,000 CT	1 1	1500 CT 1800 CT	870	100	Interstage
18	DI-T38	TF4RX13YY	10,000 CT 12,000 CT	1 1	2000 split 2400 split	620	100	Interstage
19	DI-T11	TF4RX13YY	10,000 12,500	1 1	2000 CT 2500 CT	870	100	Driver
20	DI-T36	TF4RX13YY	10,000 CT 12,000 CT	1 1	10,000 CT 12,000 CT	970	100	Isol. or Interstage (Ratio 1:1) also wide pulse application
21	DI-T1	TF4RX13YY	20,000 30,000	.5 .5	800 1200	815	50	Interstage
22	DI-T23	TF4RX13YY	20,000 CT 30,000 CT	.5 .5	800 CT 1200 CT	815	50	Interstage
23	DI-T28	TF4RX20YY	.1 Hy. @ 4 ma DC, .08 Hy. @ 10 ma DC			25		Inductor
24	DI-T27	TF4RX20YY	.9 Hy. @ 2 ma DC, .5 Hy. @ 6 ma DC			105		Inductor
25	DI-T8	TF4RX20YY	2.5 Hys. @ 2 ma DC, .9 Hy. @ 4 ma DC			630		Inductor
26	DI-T26	TF4RX20YY	4.5 Hys. @ 2 ma DC, 1.2 Hys. @ 4 ma DC			2300		Inductor
27	DI-TSH	Drawn Hipermalloy shield and cover for DI-T's provides 20 to 30 db shielding, 25/64 h x 23/64" dia. 1/8" hole in cover						

*For 5% maximum distortion @ 1 kHz.
‡maDC shown is for single ended usage. For push pull, maDC can be any balanced value taken by .5W transistors. Where windings are listed as split, 1/4 of the listed impedance is available by paralleling the winding.



DI-T 200™ TRANSISTOR TRANSFORMERS & INDUCTORS

PACKAGING Hermetically sealed. DO-T family unit. See page 6.

MIL SPECS To complete MIL-T-27C Specs. Ruggedized, metal encased to Mil Grade 4, Class R, Life X. See pages 86, 87.

FREQUENCY RESPONSE ±3db, 400 Hz to 100 kHz.

TERMINALS Leads are .016 Dumet wire, gold plated, and may be either welded or soldered. They are uninsulated and are spaced on a .1" radius circle, conforming to the termination pattern of the "TO-5" cased semiconductors and micrologic elements.

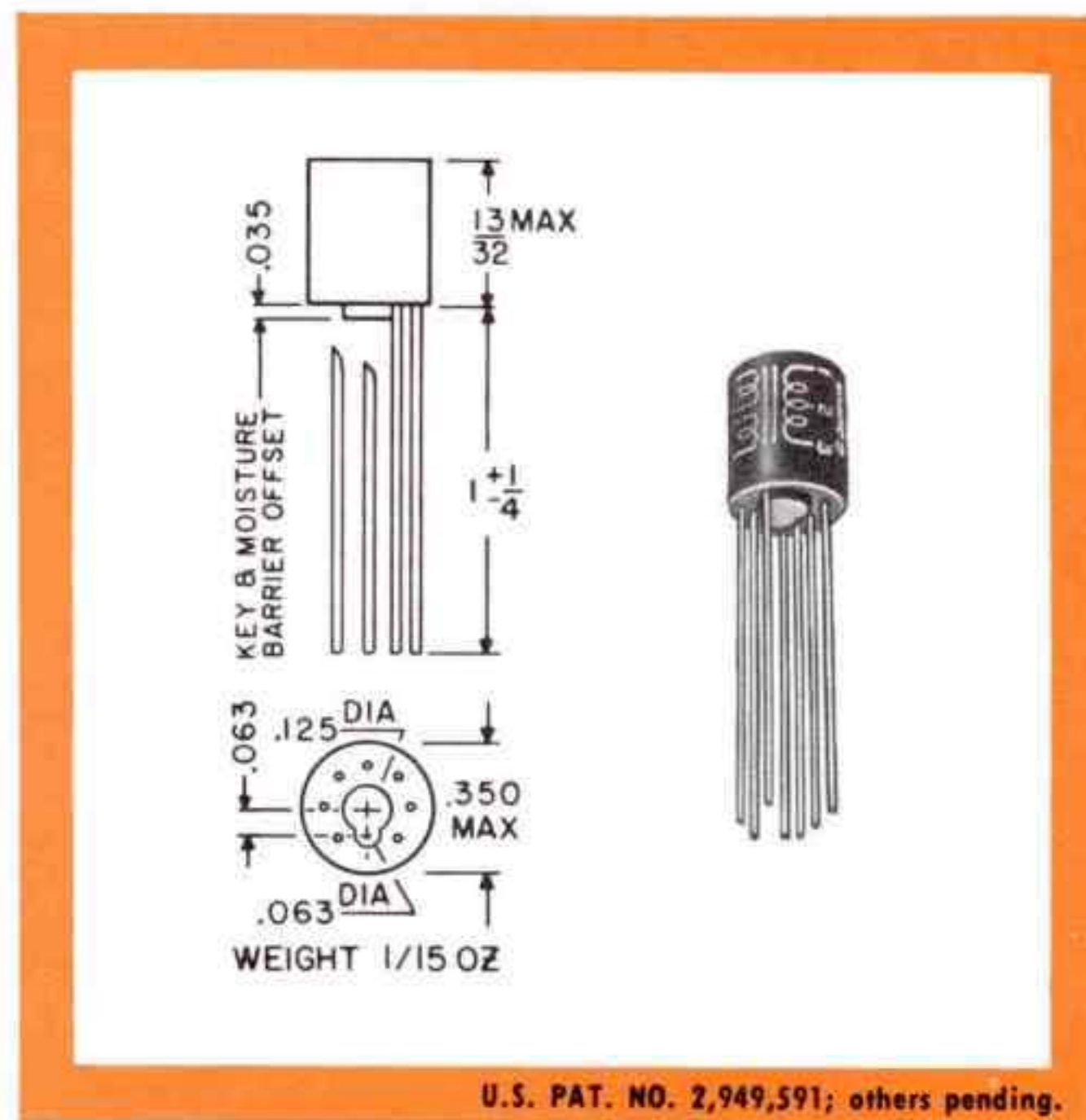
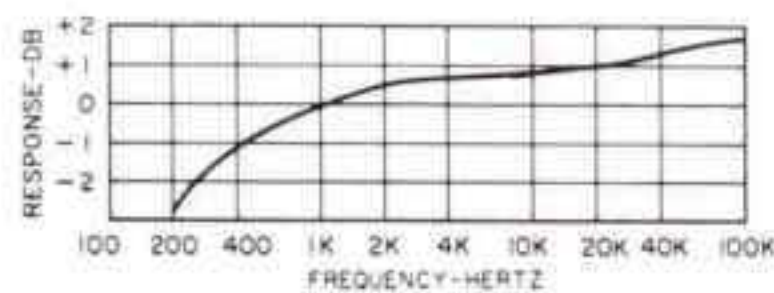
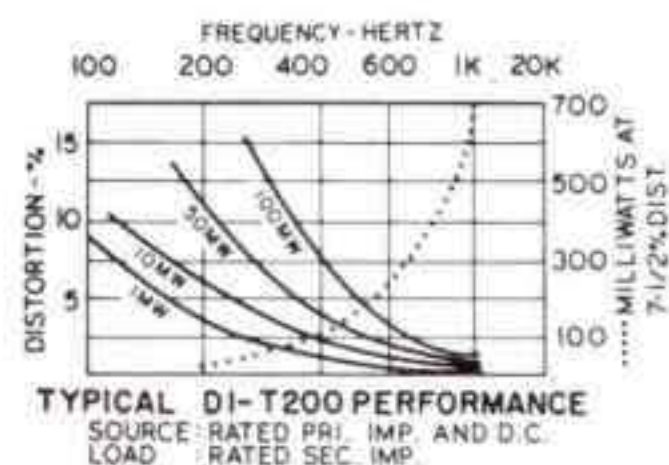

Type No.	MIL Type	Pri Imp Ω	ma D.C.‡ in Pri	Sec Imp Ω	Pri DCR Ω	Mw Level*	Application
DI-T225	TF4RX17YY	80 CT 100 CT	12 10	32 split 40 split	11.5	500	Interstage
DI-T230	TF4RX17YY	300 CT	7	600 CT	20	500	Output or line to line or matching
DI-T235	TF4RX17YY	400 CT 500 CT	8 6	40 split 50 split	50	500	Interstage
DI-T240	TF4RX17YY	400 CT 500 CT	8 6	400 split 500 split	50	500	Interstage or output (Ratio 2:1:1) also wide pulse application
DI-T245	TF4RX17YY	500 CT 600 CT	3 3	50 CT 60 CT	65	500	Output or matching
DI-T250	TF4RX17YY	500 CT	5.5	600 CT	32	500	Output or line to line or mixing or matching
DI-T255	TF4RX13YY	1,000 CT 1,200 CT	3 3	50 CT 60 CT	110	500	Output or matching
DI-T260	TF4RX13YY	1,500 CT	3	600 CT	87	500	Output to line or matching
DI-T265	TF4RX13YY	2,000 CT 2,500 CT	3 3	8,000 split 10,000 split	180	100	Isol. or interstage (Ratio 1:1:1) also wide pulse application
DI-T270	TF4RX13YY	10,000 CT 12,000 CT	1 1	500 CT 600 CT	870	100	Output or driver
DI-T273	TF4RX13YY	10,000 CT 12,500 CT	1 1	1,200 CT 1,500 CT	870	100	Output or driver
DI-T276	TF4RX13YY	10,000 CT 12,000 CT	1 1	2,000 CT 2,400 CT	870	100	Interstage or driver
DI-T278	TF4RX13YY	10,000 CT 12,500 CT	1 1	2,000 split 2,500 split	620	100	Interstage or driver
DI-T283	TF4RX13YY	10,000 CT 12,000 CT	1 1	10,000 CT 12,000 CT	970	100	Isol. or interstage (Ratio 1:1) also wide pulse application
DI-T288	TF4RX13YY	20,000 CT 30,000 CT	.5 .5	800 CT 1,200 CT	815	50	Interstage or driver
DI-T204	TF4RX20YY	Split Inductor (2 wdgs)		Series connected: .1 Hy @ 4 maDC, .08 Hys @ 10maDC, DCR 25Ω Parallel connected: .025 Hys @ 8 maDC, .02 Hys @ 20 maDC, DCR 6Ω			
DI-T208	TF4RX20YY	Split Inductor (2 wdgs)		Series connected: .9 Hys @ 2 maDC, .5 Hys @ 6 maDC, DCR 105Ω Parallel connected: .2 Hys @ 4 maDC, .1 Hys @ 12 maDC, DCR 26Ω			
DI-T212	TF4RX20YY	Split Inductor (2 wdgs)		Series connected: 2.5 Hys @ 2 maDC, .9 Hys @ 4 maDC, DCR 630Ω Parallel connected: .6 Hys @ 4 maDC, .2 Hys @ 8 maDC, DCR 157Ω			
DI-T216	TF4RX20YY	Split Inductor (2 wdgs)		Series connected: 4.5 Hys @ 2 maDC, 1.2 Hys @ 4 maDC, DCR 2300Ω Parallel connected: 1.1 Hys @ 4 maDC, .3 Hys @ 8 maDC, DCR 575Ω			
DI-T200SH	Drawn Hipermalloy shield provides 15 to 20 db shielding through side of case, ²⁷ / ₆₄ h x ³ / ₈ " dia, no cover						

*For 5% maximum distortion @ 1 kHz.
‡maDC shown is for single ended usage. For push pull, maDC can be any balanced value taken by .5W transistors. Where windings are listed as split, ¼ of the listed impedance is available by paralleling the winding.



SUBMINIATURE INDUCTORS AND AUDIO TRANSFORMERS

PACKAGING Hermetically sealed. Metal encased. Low profile types have straight pin terminals. Vertical, limited board area types have hooked pin headers. All have mounting studs.

MIL SPECS To complete MIL-T-27C Specs. Grade 4, Class R, Life X. See pages 86, 87.

SPECIALS High permeability cases, different pins, higher temperature, different impedance ratios, etc., to your specs.

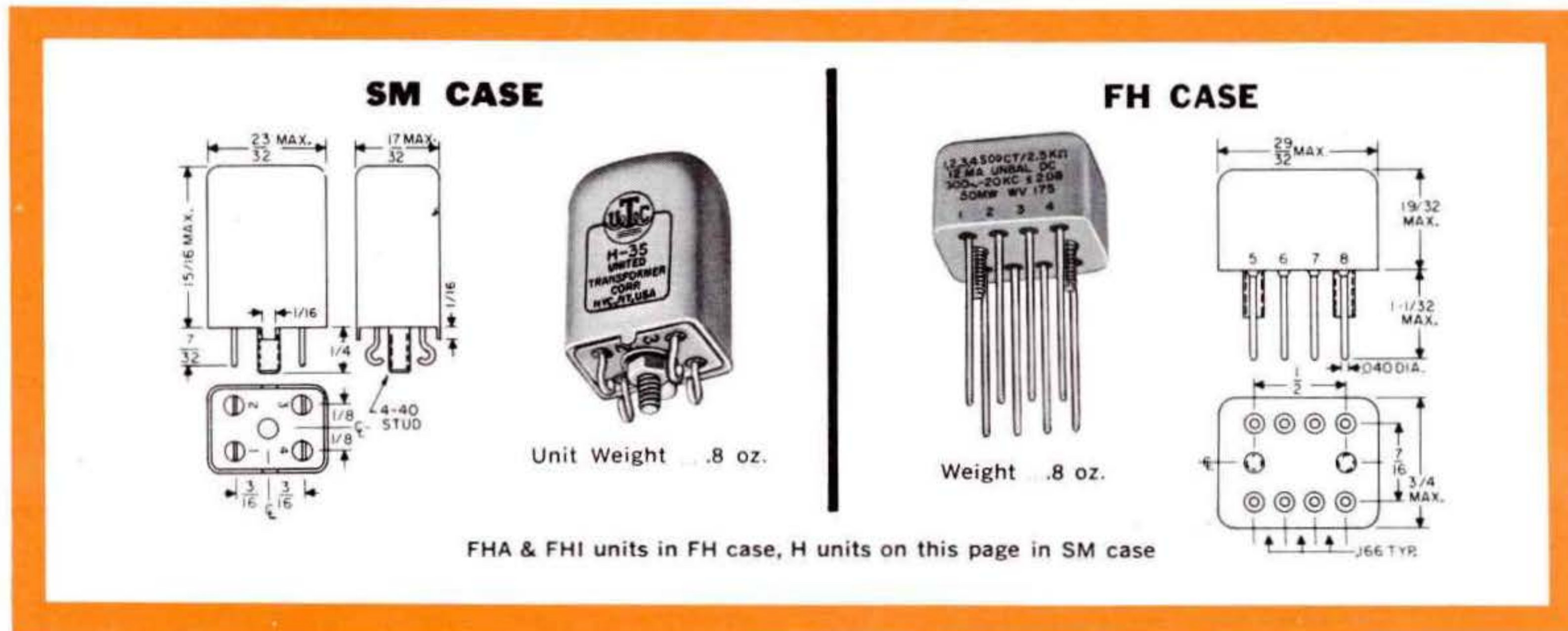

FHA & FHI units in FH case, H units on this page in SM case

Type No.	Application	MIL Type	Pri. Imp. Ohms	Sec. Imp. Ohms	Pri. Unbal. ma DC	Response ± 2 db (Hz)	Max. dbm	Level mw	
H-30	Input to grid	TF4RX10YY	50	62,500	0	150-10,000	+13	20	
H-31	Plate to single grid	TF4RX15YY	10,000	90,000	0	300-10,000	+13	20	
H-32	Single plate to line	TF4RX13YY	10,000*	200	3	300-10,000	+13	20	
H-33	Single plate to low imp.	TF4RX13YY	30,000	50	1	300-10,000	+15	30	
H-35	Inductor	TF4RX20YY	100 Henries-0 DC., 50 Henries-1 ma DC, 4,400 ohms.						
H-36	Transistor Interstage	TF4RX15YY	25,000 (DCR800)	1,000 (DCR110)	.5	300-10,000	+10	10	
H-37A	Transistor output	TF4RX17YY	500 CT (DCR50)	50 (DCR5)	3.5	300-10,000	+15	30	
H-38	Transistor Interstage	TF4RX13YY	10,000 CT (DCR600)	1,200 CT	2	300-10,000	+15	30	
H-39	Transistor Interstage	TF4RX13YY	10,000 CT (DCR600)	2,000 CT	2	300-10,000	+15	30	
H-40A	Transistor output	TF4RX17YY	500 CT (DCR26)	600 CT	10	300-10,000	+15	30	
H-41A	Transistor output	TF4RX13YY	1,500 CT (DCR71)	600 CT	7	300-10,000	+15	30	
H-42A	Isolation or Transistor Interstage	TF4RX13YY	10,000 CT	10,000 CT	1	300-10,000	+20	100	
FHA-5	Transistor Input	TF4RX17YY	500/125 (split)	5000/1250 (split)	12	300-20,000	+17	50	
FHA-10	Isolation or Transistor Interstage	TF4RX13YY	5000/1250 (split)	5000/1250 (split)	4	300-20,000	+17	50	
FHA-15†	Transistor Interstage	TF4RX13YY	10K CT/2.5K (split)	200 CT/50 (split)	2	300-20,000	+20	100	
FHA-25†	Transistor Interstage	TF4RX13YY	20K CT/5K (split)	800 CT/200 (split)	1	300-20,000	+20	100	
FHI-3	Split Inductor	TF4RX04YY	Series connection: 60 Mhys-32 ma DC, 6 ohms Parallel connection: 15 Mhys-64 ma DC, 1.5 ohms						
FHI-7	Split Inductor	TF4RX04YY	Series connection: 1 Hy-8 ma DC, 100 ohms Parallel connection: .25 Hy-16 ma DC, 25 ohms						
FHI-11	Split Inductor	TF4RX04YY	Series connection: 2.4 Hys-2 ma DC, 160 ohms Parallel connection: .6 Hy-4 ma DC, 40 ohms						

†Electrostatic shield between primary and secondary.

*Can be used for 500 ohm load . . . 25,000 ohm primary impedance . . . 1.5 ma DC.



MINIATURE AUDIO TRANSFORMERS AND INDUCTORS

PACKAGING Hermetically sealed. Steel drawn case. Compressed glass bead headers with hooked pin terminals.

MIL SPECS To complete MIL-T-27C Specs. Grade 4, Class R, Life X. See pages 86, 87.

NOTES For higher frequencies, considerably higher levels are permissible. For example, the H-3 will handle +21 dbm at 400 Hz.

SPECIALS Available on production order: High permeability steel case for high degree of magnetic shielding. Mil AG case (see page 51). Straight pin terminals.

RC-25 CASE

Unit Weight 2 oz.

Type No.	Application	MIL Type	Pri. Imp. Ohms	Sec. Imp. Ohms	Pri. Unbal. ma DC	Response ± 2 db (Hz)	Max. Level dbm	mw	
H-1	Mike, line to grid	TF4RX10YY	50,200 CT, 500 CT*	50,000	0	50-10,000	+ 5	3	
H-2	Mike to grid	TF4RX11YY	82	135,000	50	250-8,000	+18	63	
H-3	Plate to single grid	TF4RX10YY	15,000	60,000	0	50-10,000	+ 6	4	
H-4	Plate to single grid DC in Pri.	TF4RX15YY	15,000	60,000	4	200-10,000	+14	25	
H-5	Plate to PP Grids	TF4RX10YY	15,000	95,000 CT	0	50-10,000	+ 5	3	
H-6	Plate to PP Grids DC in Pri.	TF4RX15YY	15,000	95,000 split	4	200-10,000	+11	12	
H-7	Plate or PP to line	TF4RX13YY	20,000 CT	600/150 split	4	200-10,000	+21	125	
H-8	Mixing and matching	TF4RX16YY	600/150 split	600 CT	0	50-10,000	+ 8	6.3	
H-9	82/41:1 input to grid	TF4RX10YY	600/150 split	1 MEG.	0	200-3,000 (4 db)	+10	10	
H-10	10:1 plate to grid	TF4RX10YY	10,000	1 MEG.	0	200-3,000 (4 db)	+10	10	
H-11	Inductor	TF4RX20YY	300 Hys. —0 DC, 50 Hys.-3ma. DC, 6,000 Ohms						
H-12	Mike, line to PP grids	TF4RX10YY	50, 200 CT, 500 CT*	50,000 CT	0	50-10,000	+ 5	3	
H-13	Transistor Interstage	TF4RX13YY	10K/2.5K, split	2K/.5K split	4	100-10,000	+20	100	
H-14	Transistor Interstage	TF4RX13YY	10K/2.5K, split	4K/1K split	4	100-10,000	+20	100	
H-15	Transistor to line	TF4RX13YY	1,500 CT	500/125 split	8	100-10,000	+20	100	
H-16	Transistor to V.C.	TF4RX13YY	2,000 CT 4,000 CT	8 16	4	100-10,000	+20	100	
H-17	Transistor input	TF4RX16YY	600/150 split	2000/500 split	0	50-20,000	+15	31	
H-18	Transistor Interstage	TF4RX13YY	10,000 CT	500/125 split	4	100-20,000	+20	100	
H-219	Transistor Interstage	TF4RX13YY	50,000 CT	500/125 split	2	100-20,000	+20	100	
H-220	Transistor Interstage	TF4RX17YY	500/125 split	500/125 split	20	100-20,000	+24	250**	
H-221	Transistor Interstage	TF4RX17YY	500/125 split	150/37.5 split	20	100-20,000	+24	250**	
H-222 (2 wdgs.)	Split Inductor	TF4RX04YY	Series connection: 60 Mhy @ 80 ma DC, 4 ohms Parallel connection: 15 Mhy @ 160 ma DC, 1 ohm						
H-224 (2 wdgs.)	Split Inductor	TF4RX04YY	Series connection: 1 Hy @ 20 ma DC, 60 ohms Parallel connection: .25 Hy @ 40 ma DC, 15 ohms						
H-225	Transistor Interstage	TF4RX17YY	100/25 split	40/10 split	40	100-20,000	+24	250**	

*200 ohm termination can be used for 150 ohms or 250 ohms, 500 ohm termination for 600 ohms.
**250 mw @ 100 Hz, 1 Watt @ 200 Hz.



COMPACT™ AUDIO TRANSFORMERS AND INDUCTORS

PACKAGING Hermetically sealed. Metal encased.

TERMINALS Solder lug, glass to metal sealed type.

MIL SPECS To complete MIL-T-27C Specs. Grade 4, Class R, Life X. See pages 86, 87.

SPECIALS Available in MIL AJ case. H-282, H-291 available in MIL EB case; H-295 available in AH case (see page 51).

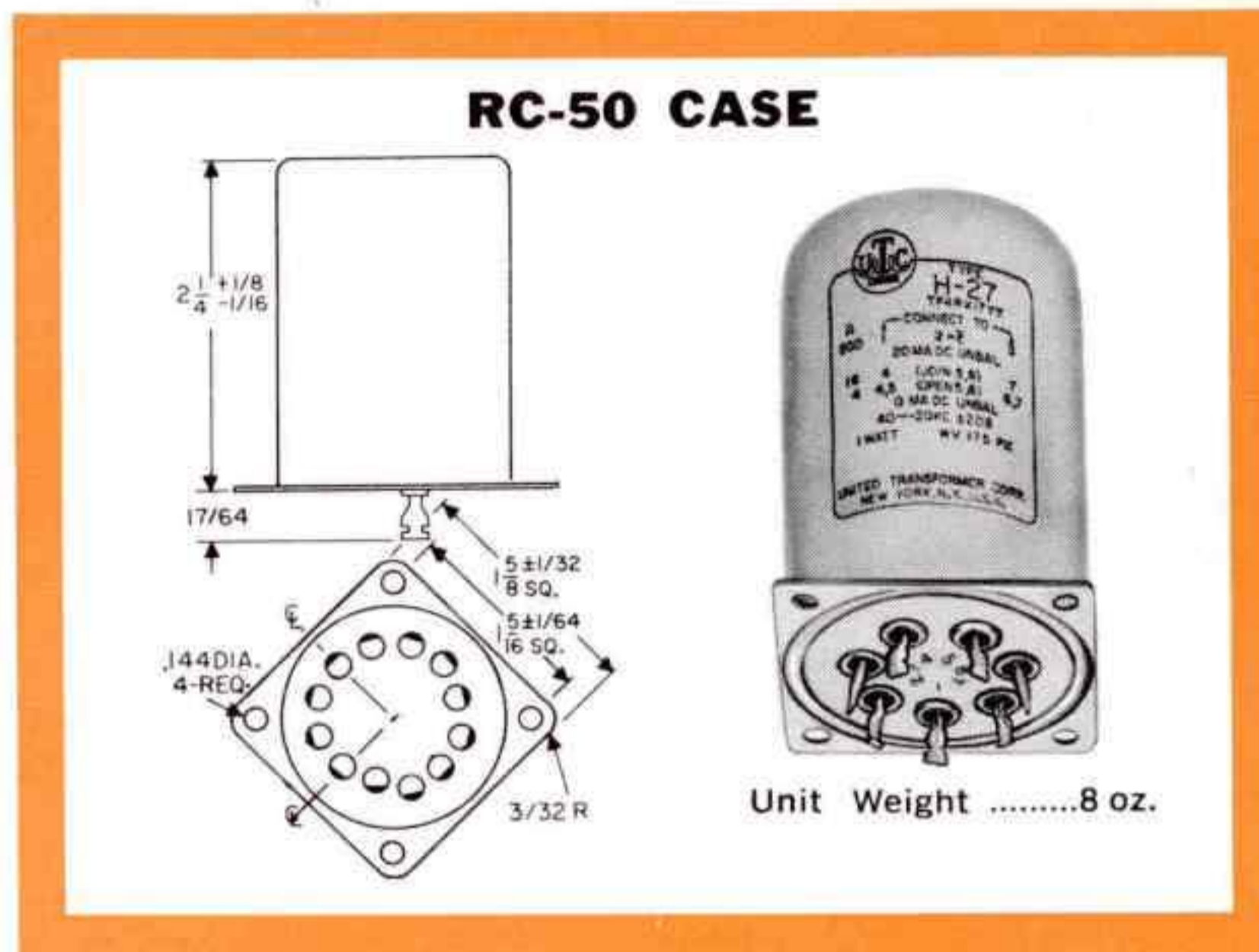

Type No.	Application	MIL Type	Pri. Imp. Ohms	Sec. Imp. Ohms	Pri. Unbal. DC ma	Response ±2 db (Hz)	Max. Level dbm	mw
H-19A	Balanced line to grid 1:14, multiple (75 db) shielding	TF4RX10YY	250 CT 500 CT	50,000 CT 100,000 CT	0	30-20,000	+ 6	4
H-20	1 or 2 plates to PP grids	TF4RX10YY	15,000 split	80,000 split	0	30-20,000	+12	15
H-21	Plate to PP grids DC in pri.	TF4RX15YY	15,000	80,000 split	8	100-20,000	+23	200
H-22	Plate to line	TF4RX13YY	15,000	50/200, 125/500*	8	50-20,000	+23	200
H-23	PP plates to line	TF4RX13YY	30,000 split	50/200, 125/500*	0	30-20,000	+19	80
H-24	Inductor	TF4RX20YY	450 Hys-0 DC, 250 Hys-5 ma DC, 6000 ohms 65 Hys-10 ma DC, 1500 ohms					
H-25	Mixing or trans. to line	TF4RX17YY	500 CT	500/125 split	20	40-20,000	—	1w
H-26	Transistor Interstage	TF4RX13YY	10,000/2,500 (split)	2,000/500 split	8	40-20,000	—	1w
H-27	Transistor to V.C.	TF4RX17YY	500 CT	16/4 split	20	40-20,000	—	1w
H-280	Transistor driver	TF4RX17YY	200 CT	400/100 split	20	40-20,000	—	1w
H-281	Transistor to V.C.	TF4RX17YY	48 CT	16, 8, 4	750 Bal	40-20,000	—	5w
H-282	Transistor to V.C. RC-62 case, Pg. 26	TF4RX17YY	20 CT	16, 8, 4	1000 Bal	75-20,000	—	10w
H-283†	Mixing or matching for line or transistor	TF4RX16YY	50, 125/150, 200/250, 333, 500/600	50, 125/150, 200/250, 333, 500/600	0	20-50,000	+15	30
H-284	Split inductor	TF4RX04YY	Series connection: 4 Hys-50 ma DC, 100 ohms Parallel connection: 1 Hy-100 ma DC, 25 ohms					
H-286	Split inductor	TF4RX04YY	Series connection: 40 Hys-15 ma DC, 1000 ohms Parallel connection: 10 Hys-30 ma DC, 250 ohms					

* 200 ohm termination can be used for 150 ohms or 250 ohms, 125/500 ohm termination for 150/600 ohms. †High electrostatic shielding



CHOPPER TRANSFORMERS

SHIELDING High electromagnetic and electrostatic shielding. All other characteristics same as in definitions above.

Type No.	½ Pri. Imp. Ohms	Sec. Imp. Ohms	Turns Ratio ½ Pri. to Sec.	Max. Volts ½ Pri.	Min. L Pri. IV-60 Hz	Pri. Res. Ohms	Sec. Res. Ohms	Case
H-290	2500	100,000	6.4	60 Hz 2.75	90 Hy	450	3,250	RC-50 (see above)
H-291	2000/500	312,000	25/50	60 Hz 3.4/1.7	30/7.5 Hy	320/80	16,000	RC-62 (Pg. 26)
H-295	10K/2.5K	50,000	2.2/4.4	60 Hz 4/2 400 Hz 24/12	200/50 Hy	1300/650	1900	RC-37 (Pg. 26)

High electrostatic shielding plus magnetic shielding and hum-bucking balanced structure



MILITARY STANDARD TRANSFORMERS AND INDUCTORS

PACKAGING Hermetically sealed. Metal encased.

MIL SPECS To complete MIL-T-27C Specs. Grade 4, Class R, Life X. See pages 86, 87.

FREQUENCY RESPONSE 300 Hz to 10 kHz, \pm 2db.

SHIELDING Electrostatic shielding provided on W-785 and W-786.

NOTE Secondaries of W-783 are center tapped, providing 90K CT or 22.5K CT. MIL AJ CASE 1 5/8 x 1 5/8 x 2 3/8" H. Weight 0.6 lbs. See page 51.



MIL AJ case, see page 51.

MS AUDIO TRANSFORMER

UTC No.	MS No.	MIL IDENTIF.	APPLICATION	PRI. OHMS	PRI. ma DC	SEC. OHMS	LEVEL
W-783	90000-A	TF4RX15AJ001	PP Plates to PP Grids	10K CT	10 Unbal	90K/22.5K Split	15 dbm
W-784	90001-A	TF4RX16AJ002	Line to V C	600/150 split		4/8/16	2 W
W-785	90002-A	TF4RX10AJ001	Line to PP Grids	600/150 split		135K CT	15 dbm
W-786	90003-A	TF4RX16AJ001	Line to Line	600/150 split		600/150 split	15 dbm
W-787	90004-A	TF4RX13AJ001	Plate to Line	7600/4800	40 Unbal	600/150 split	2 W
W-788	90005-A	TF4RX13AJ002	Plate to V C	7600/4800	40 Unbal	4/8/16	2 W
W-789	90006-A	TF4RX13AJ003	PP Plates to Line	15K CT	10 Unbal	600/150 split	2 W
W-790	90007-A	TF4RX13AJ004	PP Plates to Line	24K CT	20 Bal	600/150 split	1 W
W-791	90008-A	TF4RX13AJ005	PP Plates to Line	60K CT	20 Bal	600/150 split	.5 W



CIRCUIT DEVELOPMENT TRANSFORMERS FOR TRANSISTORS

LAB™ SERIES

The UTC LABoratory circuit development transformers aid the designer in selecting optimum impedances for power and distortion from his transistor circuit. The input, interstage, and output transformers listed below are arranged for a multiplicity of impedance connections. Once the best selection of impedances is found, special or stock items are easily substituted. The LAB development units, representing extremely high efficiency, very wide band, high powered transformers, will usually be substantially larger and heavier than the transformers which replace them, since the designer will not need the full frequency range or maximum level afforded. Solderless connection terminals are used to facilitate reconnecting for various impedances. Terminals are arranged so that shortest possible jumpers are always used regardless of impedance values desired.



LAB-5
20 Hz to 20 kHz
Up to 50mw Continuous

Pri. Imp. Ω	Sec. Imp. Ω
125	125
200 split	200 split
500 split	500 split
2000 split	2000 split

This unit contains high electrostatic shielding, multiple magnetic shielding and is constructed with humbucking balanced core and windings.

LAB-10
20 Hz to 20 kHz
Up to 1W Continuous

Pri. Imp. Ω	Pri. to Sec. Ratio	Sec. Imp. Ω
Range		Range
1900 Ω to 14,400 Ω	20:1 or 10:1	19 Ω to 36 Ω
925 Ω to 7600 Ω	10:1 or 5:1	37 Ω to 76 Ω

Pri. & Sec. can be arranged for split, single ended or push-pull connections. Pri. up to 50 ma DC unbalanced with full range response.

LAB-20
20 Hz to 20 kHz
Up to 50W Continuous

Pri. Imp. Ω	Sec. Imp. Ω
6, 12, 24, 40, 54, 70, 96	4, 8, 16, 64

On primaries, CT available on all impedances, split arrangement on most impedances.

CASE SIZES
LAB-5 & LAB-10 units in LS-1 case
LAB-20 units in LS-3 case
Terminal board as shown above (see page 23)

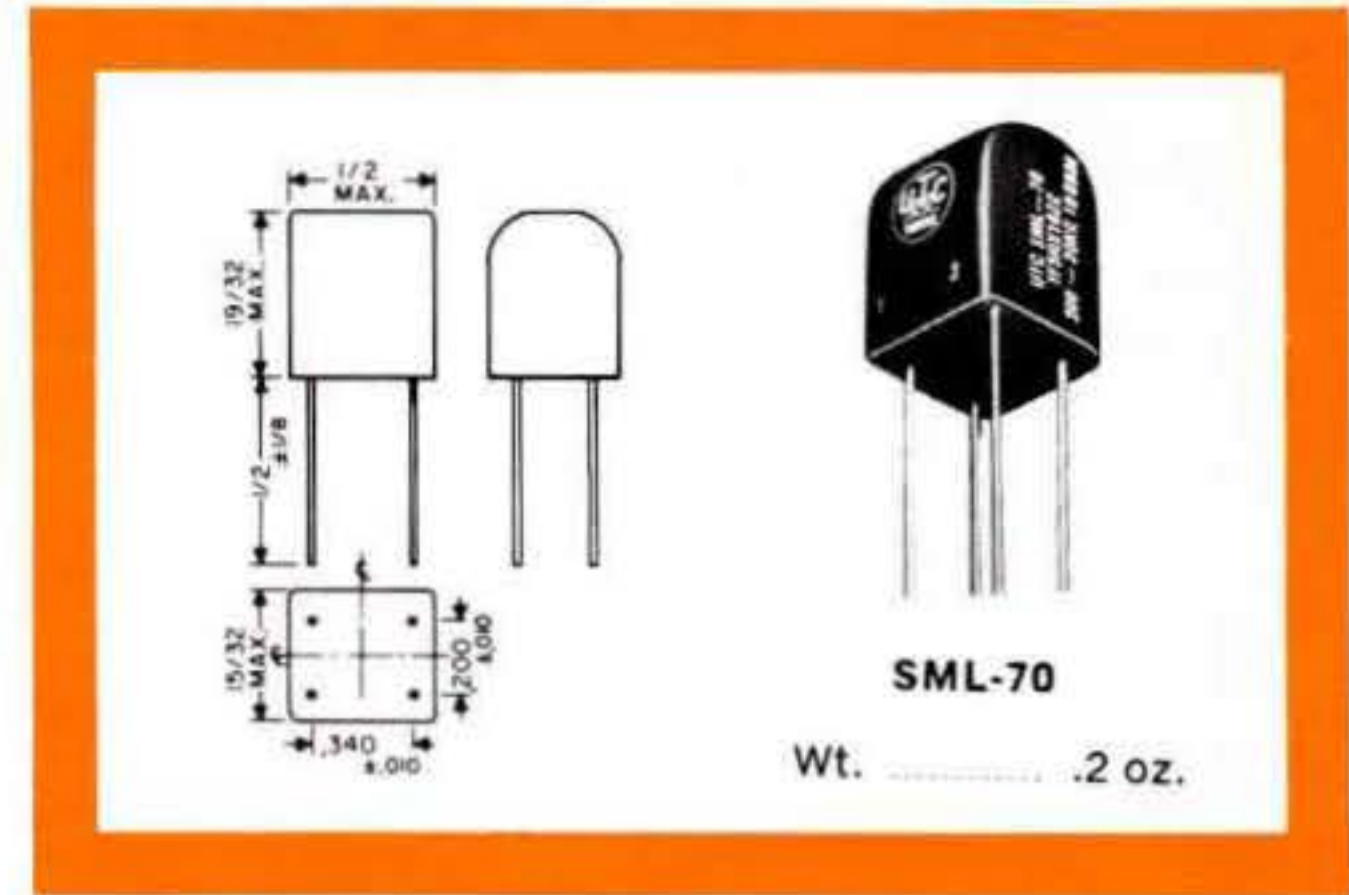
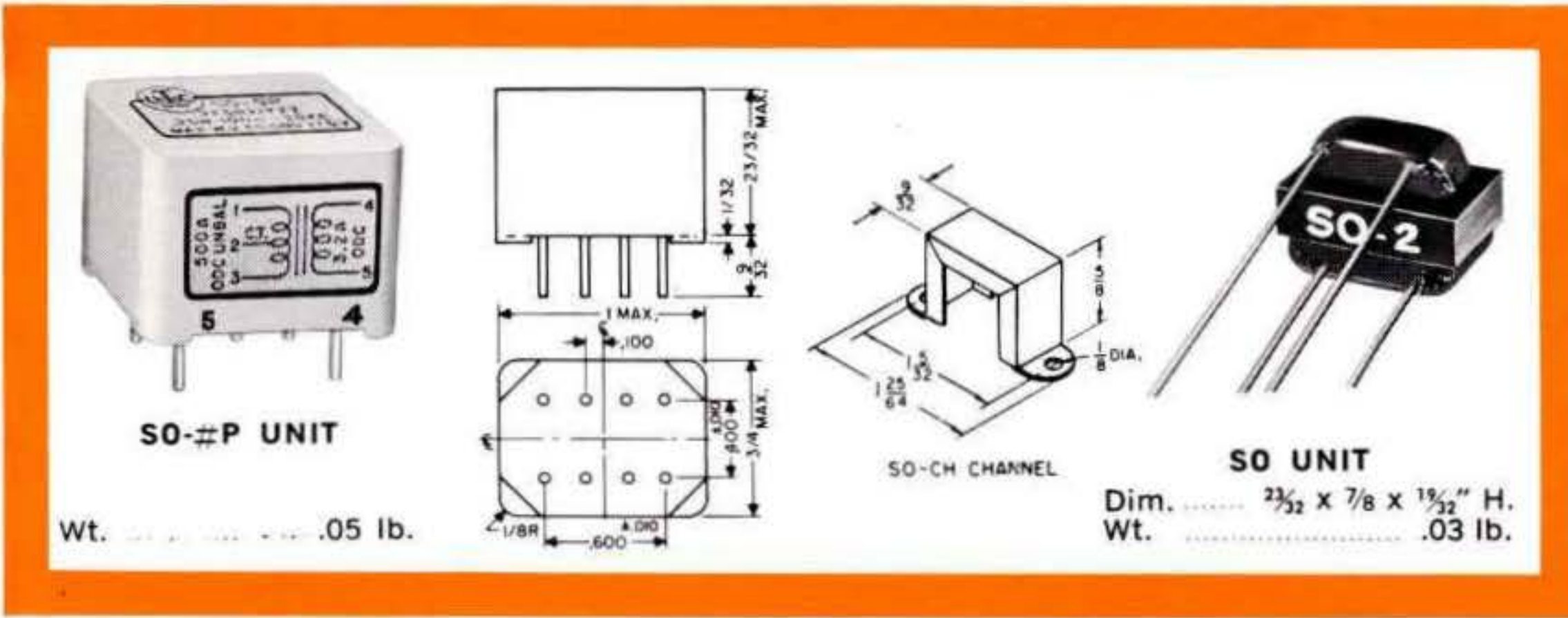

TYPES SO-#P, vacuum molded type. SO, open frame type.

PACKAGING SO-#P, hermetically sealed. SO, vacuum processed and double (water proof) sealed.

MIL SPECS SO-#P to complete MIL-T-27C Specs. Grade 5, Class R, Life X. See pages 86, 87.

TERMINALS & MOUNTINGS SO-#P, plug-in pin terminals, 40 mil diameter. Strong enough to support units without additional mounting facilities. SO, color coded flexible leads, 4 inches long; mounting channel (SO-CH) available separately from stock.

FREQUENCY RESPONSE 200 Hz to 20 kHz.

SPECIALS Any open frame type available molded. Metal encased type to Mil Grade 4 made to your specifications.

PRINTED CIRCUIT AUDIO UNIT

SML-70 HIPERMALLOY SHIELD CASE

PACKAGING Hermetically sealed. High permeability jacket provides electromagnetic shielding.

MIL SPECS To complete MIL-T-27C Specs. Grade 5, Class R, Life X. See pages 86, 87.

FREQUENCY RESPONSE 200 Hz to 20 kHz.

TERMINALS Gold-flashed dumet, plug-in terminals .025 diameter, strong enough to support unit without additional mounting facilities.

Type No.	Application	Pri Imp Ω	Unbal ma DC/Pri	Sec Imp Ω	Pri Res Ω	Sec Res Ω	Max Level dbm	mw
SML-70	Input or Chopper Service	200K	0	1K	4200	210	+10	10

MIL TYPE: TF5RX16ZZ.

PRINTED CIRCUIT MOLDED TYPES TO MIL GRADE 5

S0-2P	Interstage/3:1	10K	0-.25	90K	215	1850	+20	100
S0-3P*	Plate to Line	10K 25K	3 1.5	200 500	1225	30	+23	200
S0-5P	Split Inductor	Series: 40 Hys @ 1 ma DC, 20 Hys @ 2 ma DC, 2675 ohms Parallel: 10 Hys @ 2 ma DC, 5 Hys @ 4 ma DC, 670 ohms						
S0-7P*	Transistor Interstage	20K 30K	.5 .5	800 1200	450	32	+23	200
S0-8P	Transistor to PP Sec.	10K	1	2000 CT	1000	40	+23	200
S0-9P	PP Transistor to V.C.	500 CT	0	3.2	15	.35	+24	250
S0-14P	Transistor Interstage	80 CT 100 CT	16	32 split 40 split	4.9	3.2	+24	250
S0-15P	Matching or Tr. Output	600 CT	6	600 split	35	60	+24	250
S0-17P	Split Inductor	Series: 16 Hys @ 2 ma DC, 8 Hys @ 4 ma DC, 1100 ohms Parallel: 4 Hys @ 4 ma DC, 2 Hys @ 8 ma DC, 275 ohms						
S0-18P	Transistor Output	50K CT	1	600 split	2400	63	+24	250

MIL TYPES: S0-2P, TF5RX15ZZ; S0-3P, TF5RX13ZZ; S0-5P, TF5RX20ZZ; S0-7P, TF5RX13ZZ; S0-8P, TF5RX13ZZ; S0-9P, TF5RX17ZZ; S0-14P, TF5RX17ZZ; S0-15P, TF5RX17ZZ; S0-17P, TF5RX20ZZ; S0-18P, TF5RX13ZZ.

OPEN TYPES

Type No.	Application	Pri Imp Ω	Unbal ma DC/Pri	Sec Imp Ω	Pri Res Ω	Sec Res Ω	Max Level dbm	mw
*S0-1	Input	200 50	0	250K 62.5K	16	2500	+10	10
S0-2	Interstage/3:1	10K	0-.25	90K	215	1850	+20	100
*S0-3	Plate to Line	10K 25K	3 1.5	200 500	1225	30	+23	200
S0-4	Output	30K	1.0	50	1850	3.8	+23	200
S0-5	Inductor: 50 Hy. at 1 mil. DC, 2675 ohms DC Res.							
S0-6	Output	100K	.5	60	3400	3.7	+23	200
*S0-7	Transistor Interstage	20K 30K	.5 .5	800 1200	450	32	+23	200
S0-8	Transistor to PP Sec.	10K	1	2000 CT	1000	40	+23	200
S0-9	PP Transistor to V.C.	500 CT	0	3.2	15	.35	+24	250
*S0-10	Transistor output to V.C.	2000 CT 4000 CT	4 2	8 16	290	2	+24	250
S0-11	Transistor Interstage	400 CT 500 CT	8	400 split 500 split	20	45	+24	250
S0-12	Transistor Interstage	400 CT 500 CT	8	120 split 150 split	20	12.6	+24	250
S0-13	Transistor Interstage	400 CT 500 CT	8	40 split 50 split	20	4.5	+24	250
S0-14	Transistor Interstage	80 CT 100 CT	16	32 split 40 split	4.9	3.2	+24	250
S0-15	Matching or Tr. Output	600 CT	6	600 split	35	60	+24	250
S0-16	Matching or Tr. Interstage	2500 CT	4	2500 split	140	300	+24	250
S0-17	Split Inductor	Series: 16 Hys @ 2 ma DC, 8 Hys @ 4 ma DC, 1100 ohms Parallel: 4 Hys @ 4 ma DC, 2 Hys @ 8 ma DC, 275 ohms						
S0-18	Transistor Output	50K CT	1	600 split	2400	63	+24	250

SO-CH Mounting channel for any of above SO units

*Impedance ratio is fixed. 1250:1 for S0-1, etc. Any impedance between the values shown may be employed.

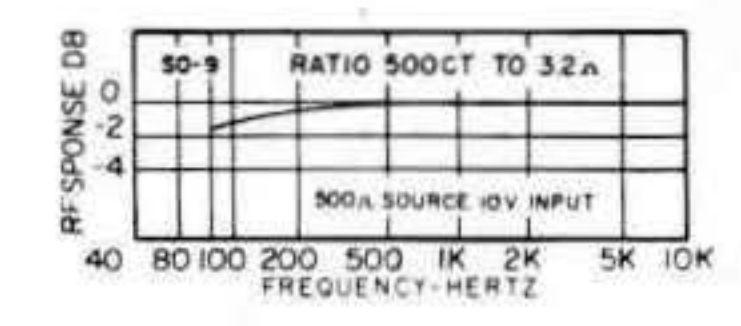
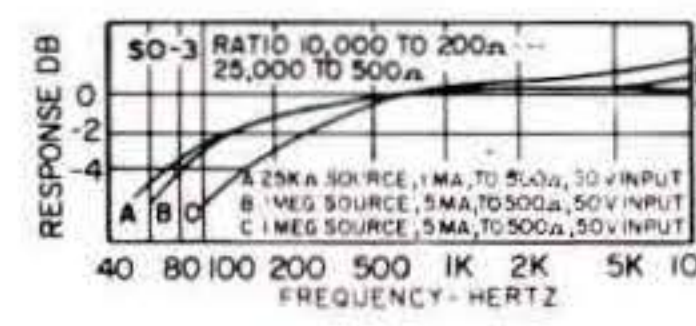
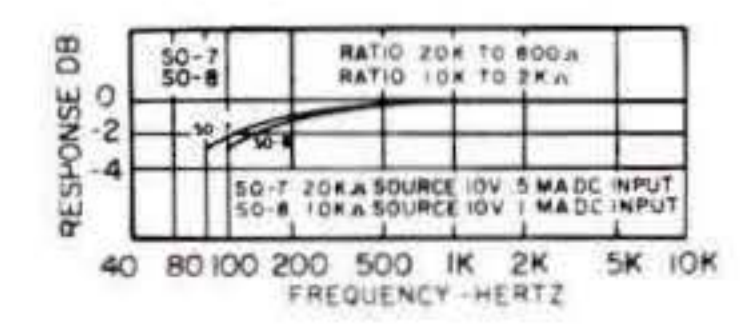
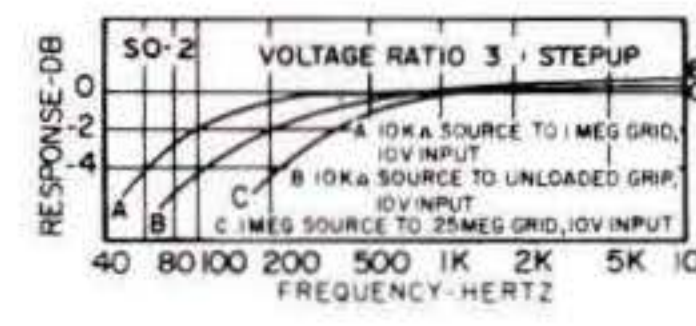
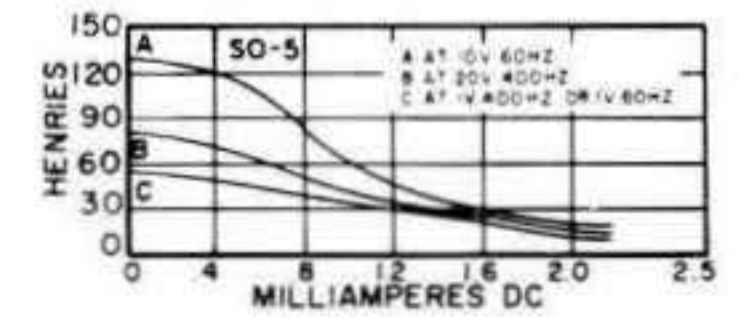
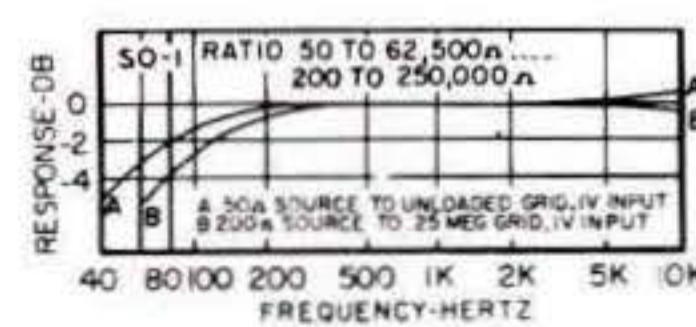



OUNCER™ AUDIO UNITS

PACKAGING Fully impregnated and sealed in a drawn aluminum housing. Mounting opposite terminal board.

APPLICATIONS Ideal for portable broadcast, aircraft, concealed service, and similar applications. High fidelity characteristics are provided.

TERMINALS Solder lug mounted in high quality phenolic board.

HERMETIC METAL CASED MIL TYPES Listed on page 13 (RC-25).

CURVES See facing page. "O" and "P" units have same electrical parameters for similar part number.



OUNCER CASE

Dia. 7/8"
Ht. 1 1/16"
Term proj. 5/32"
Mtg. 1/16"
Scr. 2-56
Wt. 1 oz.



O-16 CASE

Dia. 1 1/16"
Ht. 1 1/2"
Mtg. 1/2"
Scr. 6-32
Wt. 3 oz.
Clamp.... 1 3/16" x 1 1/8"



Hipermalloy Shield (0-17)

shown fitting over ouncer unit

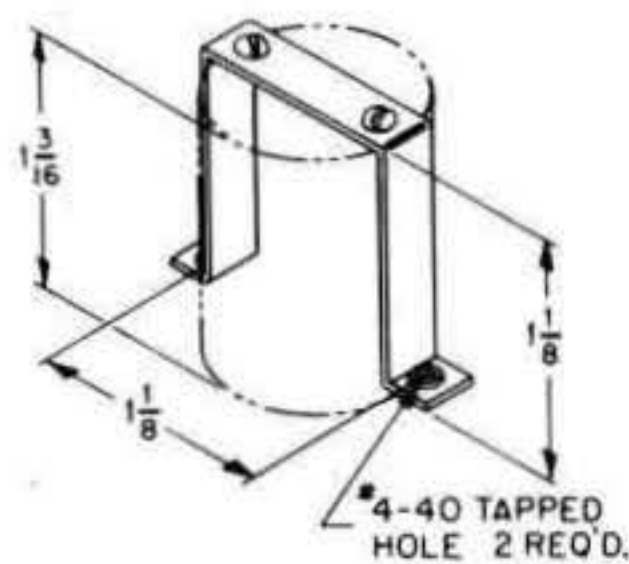

0-BR

Ouncer chassis mount bracket

INPUT & MIXING TRANSFORMERS

Type No.	Application	Pri. Imp. Ohms	Unbal. maDC	Sec. Imp. Ohms	±1 db (Hz)	Max. Level dbm	mw	Pri. Resis. Ohms
0-1	Low imp. to grid	50, 200/250, 500/600		50,000	30-20,000	+ 8	6.3	52
0-2	Low imp. to PP grids	50, 200/250 500/600		50,000 CT	30-20,000	+ 8	6.3	52
0-3	Low imp. to grid	7.5/30		50,000	30-20,000	+ 8	6.3	4.5
0-11	Crystal to transistor or line	50,000		50, 200/250, 500/600	30-20,000	+ 8	6.3	3900
0-12	Mixing, matching	50, 200/250,		Same as 0-11	30-20,000	+ 8	6.3	12
0-14	50:1 Low imp./grid	200		1/2 Megohm	50-5000	+ 8	6.3	10
0-16	Low imp. to grid	250 CT		50,000	30-20,000	+ 8	6.3	40
Uses two heavy gauge hipermalloy shields for very low hum pickup plus orientable mounting. Primary CT is balanced to 1%. Can be used for 150, 200, 250, 500, or 600 ohm sources... 200:1 impeded. ratio. 3 oz.								
0-25	Transistor input	600/150 split		2000/500 split	50-20,000	+15	30	70

INTERSTAGE TRANSFORMERS

0-4	Plate to grid	15,000		60,000	30-20,000	+ 8	6.3	710
0-5	Plate to grid	15,000, 4 ma		60,000	200-10,000	+ 8	6.3	710
0-6	Plate to PP grids	15,000		95,000 CT	30-20,000	+ 8	6.3	690
0-7	Plate to PP grids	15,000, 4 ma		95,000 CT	200-10,000	+ 8	6.3	690
0-15	10:1 Pl. to grid	10,000		1 Megohm	100-3,000	+ 8	6.3	330
0-18	Transistor Int.	10K/2.5K split, 4 ma		2000/500 split	100-20,000	+20	100	800
0-19	Transistor Int.	10K/2.5K split, 4 ma		4K/1K split	100-20,000	+20	100	800
0-26	Transistor Int.	10,000 CT 4 ma		10,000 CT	100-20,000	+20	100	700
0-27	Transistor Int.	10,000 CT 4 ma		500/125 split	100-20,000	+20	100	750
0-28	Transistor Int.	50,000 CT 2 ma		500/125 split	100-20,000	+20	100	3200
0-29	Tr. Int. or chopper	100,000 CT 1 ma		500/125 split	100-20,000	+20	100	3200
0-30	Transistor Int.	500/125 split 20 ma		500/125 split	100-20,000		1w*	37
0-31	Transistor Int.	500/125 split 20 ma		150/37.5 split	100-20,000		1w*	35
0-32	Transistor Int.	500/125 split 20 ma		50/12.5 split	100-20,000		1w*	37
0-33	Transistor Int.	100/25 split 40 ma		40/10 split	100-20,000		1w*	9

OUTPUT TRANSFORMERS

0-8	Plate to line	15,000		50, 200/250, 500/600	30-20,000	+ 8	6.3	950
0-9	Plate to line	15,000, 4 ma		Same as 0-8	200-10,000	+ 8	6.3	950
0-10	PP to line	30,000 CT		Same as 0-8	30-20,000	+ 8	6.3	1300
0-20	Transistor to line	1500 CT 8 ma		500/125 split	100-20,000	+20	100	100
0-21	Transistor to voice coil	2000 CT 4 ma 4000 CT		8 16	100-20,000	+20	100	200
0-22	Transistor to voice coil	400 CT 20 ma 500 CT		3.2 4	100-20,000		1w*	35
0-37	Transistor to line	4K/1K split, 4 ma		600/150 split	100-20,000		1w*	395
0-38	Autotransformer Speaker matching	0, 4, 8, 16. ODC			100-20,000		1w*	0.9

INDUCTORS

0-13	Inductor	300 Hys @ 0 DC; 50 Hys @ 3 maDC; 6000 ohms	
0-23	Inductor	7 Hys @ 3 maDC; 3.5 Hys @ 10 maDC; 230 ohms	
0-24	Inductor	1.6 Hys @ 3 maDC; .8 Hys @ 10 maDC; 25 ohms	
0-34	Split Inductor	Series connection: 60 Mhy @ 80 maDC; 4 ohms Parallel connection: 15 Mhy @ 160 maDC; 1 ohm	
0-36	Split Inductor	Series connection: 1 Hy @ 20 maDC; 60 ohms Parallel connection: .25 Hy @ 40 maDC; 15 ohms	

SHIELD

0-17 Hipermalloy shield, slip fit over ouncer, 1" O.D. provides 25 db shielding.

BRACKET

0-BR Mounting bracket, (see illustration)

* At 200 Hz, 1/4 watt at 100 Hz.



PLUG-IN TYPES

PACKAGING Fully impregnated and sealed in submer-sion proof bakelite housing. P-16 steel case contains high permeability magnetic shields.

TERMINALS Fits standard plug-in octal socket. P-16 fits standard plug-in 9-pin socket.

CURVES See below. "O" and "P" units have same elec-trical parameters for similar part numbers.



INPUT & MIXING TRANSFORMERS

Type No.	Application	Pri. Imp. Ohms	Sec. Imp. Ohms	±1 db (Hz)	Max. Level dbm mw	Pri. Resis. Ohms
P-1	Low imp. to grid	50, 200/250, 500/600	50,000	30-20,000	+ 8 6.3	52
P-2	Low imp. to PP grids	50, 200/250, 500/600	50,000 CT	30-20,000	+ 8 6.3	52
P-11	Crystal to transistor or line	50,000	50, 200/250, 500/600	30-20,000	+ 8 6.3	3900
P-12	Mixing, matching	50, 200/250,	50, 200/250, 500/600	30-20,000	+ 8 6.3	12
P-16	Same as O-16 but with nine pin plug-in socket. 1 3/8 diam. x 2 3/4 high, 4 oz.					

INTERSTAGE TRANSFORMERS

Type No.	Application	Pri. Imp. Ohms	Unbal. maDC	Sec. Imp. Ohms	±1 db (Hz)	Max. Level dbm mw	Pri. Resis. Ohms
P-6	Plate to PP grids	15,000		95,000 CT	30-20,000	+ 8 6.3	690
P-7	Plate to PP grids	15,000, 4 ma		95,000 CT	200-10,000	+ 8 6.3	690
P-15	10:1 Pl. to grid	15,000		1 Megohm	100-3,000	+ 8 6.3	330

OUTPUT TRANSFORMERS

Type No.	Application	Pri. Imp. Ohms	Unbal. maDC	Sec. Imp. Ohms	±1 db (Hz)	Max. Level dbm mw	Pri. Resis. Ohms
P-8	Plate to line	15,000		50, 200/250, 500/600	30-20,000	+ 8 6.3	950
P-9	Plate to line	15,000, 4 ma		50, 200/250, 500/600	200-10,000	+ 8 6.3	950
P-10	PP plates to line	30,000 CT		50, 200/250, 500/600	30-20,000	+ 8 6.3	1300

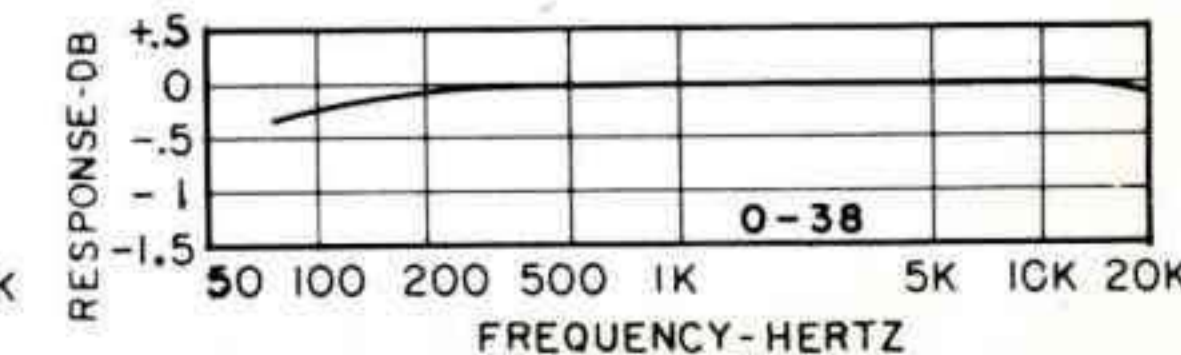
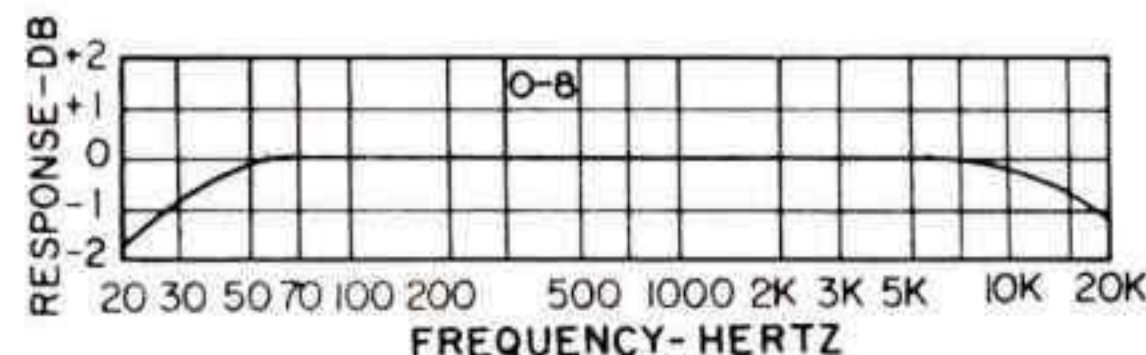
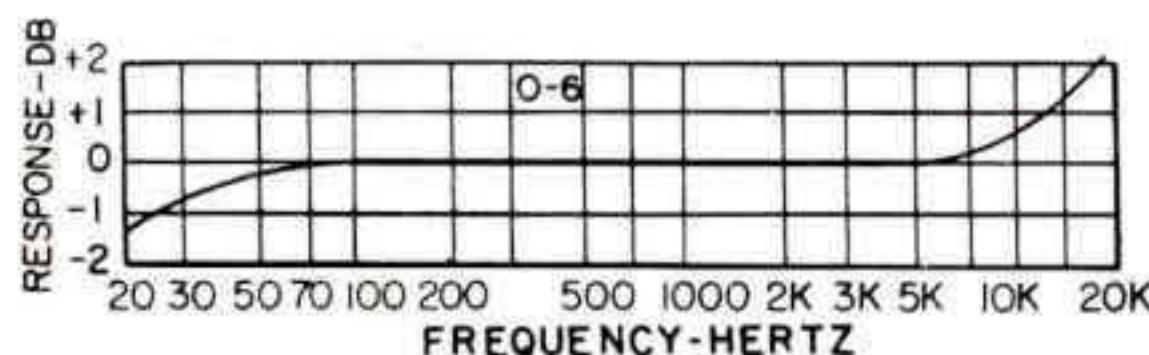
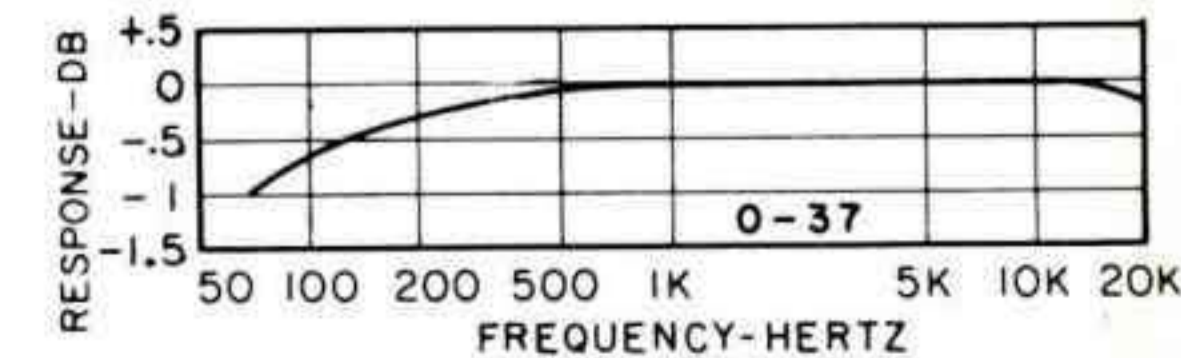
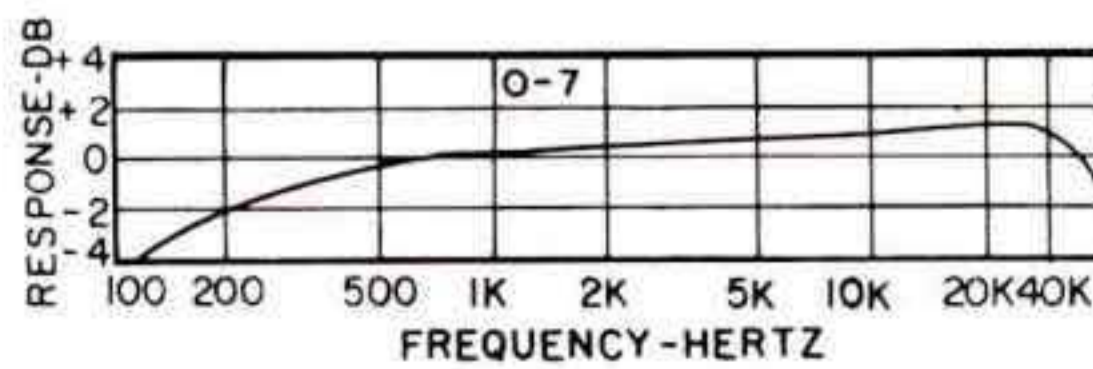
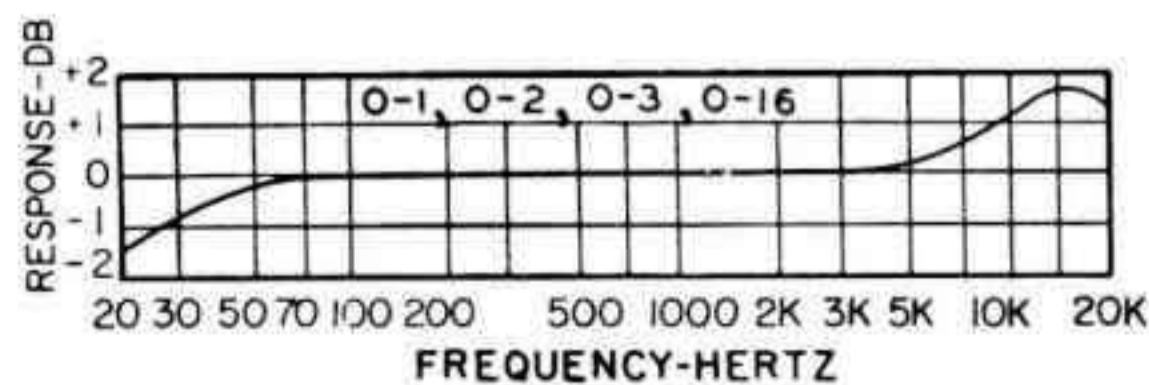
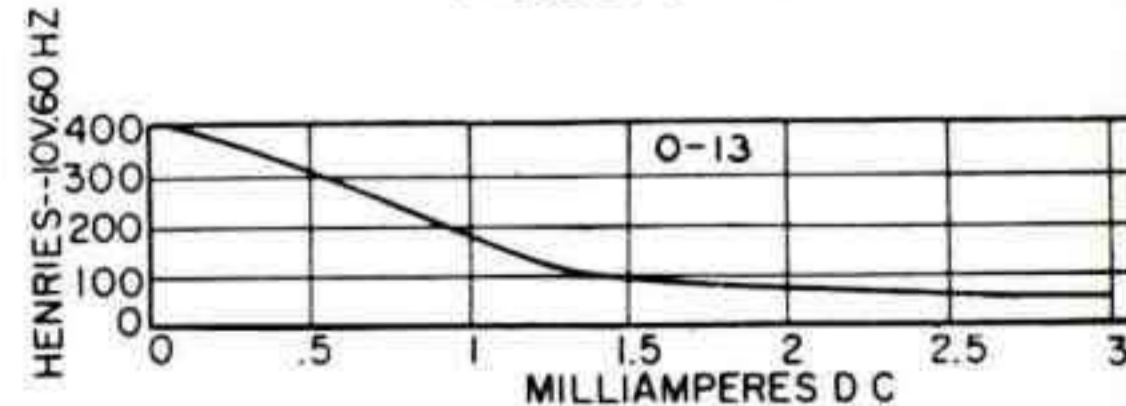
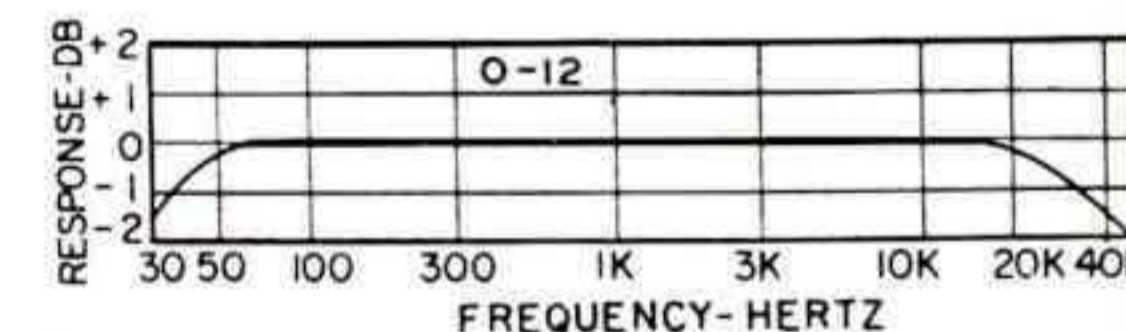
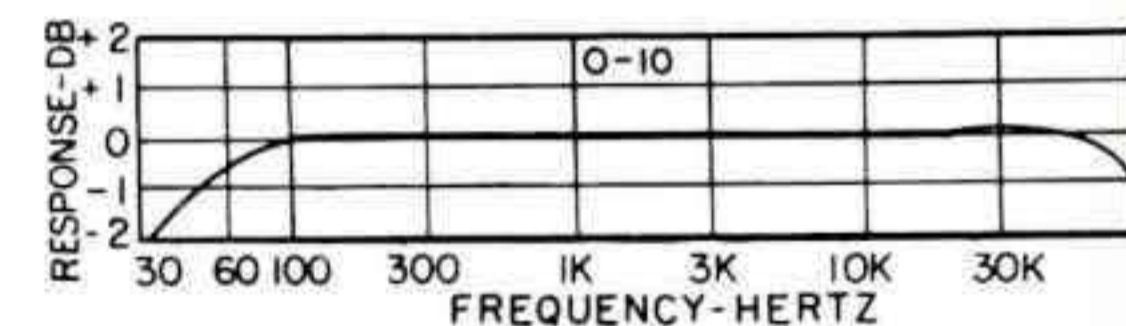
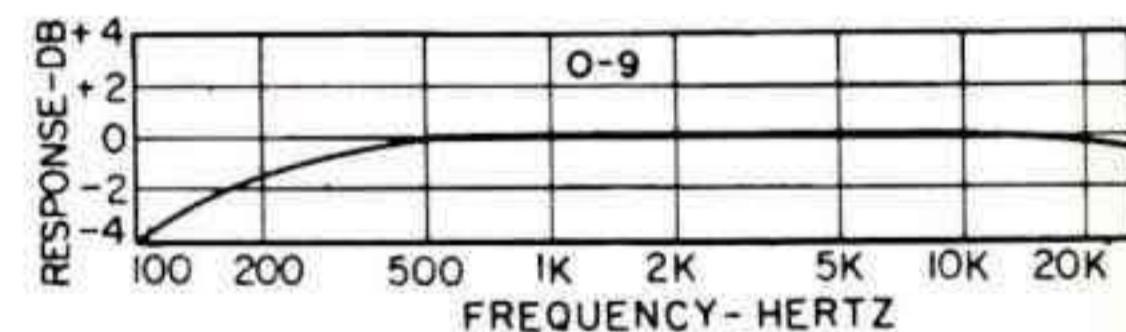



ULTRA-COMPACT™ AUDIO UNITS

PACKAGING High quality rugged die cast zinc alloy case with both top and bottom mounting facilities. Asterisked items (see Type No.) have multiple alloy shield.

APPLICATIONS Compact amplifiers and equipments.

APPLICATION NOTE Included in line are filament/transistor supply units.

HERMETIC METAL CASED MIL TYPES See page 14.

NOTE All units except those carrying DC in primary employ a true hum bucking coil structure, which provides electrical balance and effects good inductive shielding.

TYPE A CASE

- Length1½"
- Width1½"
- Height2"
- Mounting1½" sq.
- Screws4-40
- Cutout1¾" dia.
- Unit Weight½ lb.



INPUT & MATCHING TRANSFORMERS

Type No.	Application	Primary Imp. Ohms	Unbal DC	Secondary Imp. Ohms	Response ±2 db (Hz)	Pri Res. Ohms	Max. Level dbm	MW
A-10	Low imp. to grid	50, 125/150, 200/250, 333, 500/600	0	50,000 (split)	20-20,000	59	+ 15	30
A-11*	Low imp. to 1 or 2 grids	50, 200, 500	0	50,000 CT	20-20,000	52	+ 5	3
A-12	Low imp. to PP grids	50, 125/150, 200/250, 333, 500/600	0	80,000 (split)	20-20,000	60	+ 15	30
A-20†	Mixing, matching	50, 125/150, 200/250, 333, 500/600	0	50, 125/150, 200/250, 333,500/600	10-50,000	64	+ 15	30
A-21*†	Mixing, matching	50, 200/250, 500/600	0	50, 200/250, 500/600	30-30,000	28	+ 15	30
A-27	Xtal/hi. imp. to line	100,000 (split)	0	50, 125/150, 200/250, 333,500/600	30-20,000 meas. with res. source	3700	+ 15	30
A-39*	Line to transistor	600/150 (split)	0	2000/500 (split)	20-20,000	70	+ 10	10
A-43†	Mixing, matching line or transistor to 2 simultaneously loaded lines or transistors	600/150 (split)	0	2 secondaries each 600/150 (split)	20-30,000	45	+ 15	30

* = Multiple alloy shield for extremely low hum pickup † = High electrostatic shielding

INTERSTAGE AND OUTPUT TRANSFORMERS

Type No.	Application	Primary Imp. Ohms	Unbal DC	Secondary Imp. Ohms	Response ±2 db (Hz)	Pri Res. Ohms	Max. Level dbm	mw
A-15	Transistor interstage	10,000/2500 (split)	8 ma	2000/500 (split)	40-20,000	600	—	1w
A-16	Plate to grid	15,000	0	60,000	20-20,000	800	+ 15	30
A-18	Single or PP plates to PP grids	15,000 (split)	0	80,000 (split)	20-20,000	1040	+ 15	30
A-19	Plate to PP grids	15,000	8 ma	80,000 (split)	40-20,000	2900	+ 15	30
A-22	Tr. intstg. or output	500 CT	20 ma	500/125 (split)	40-20,000	36	—	1w
A-23	Tr. intstg. or output	500 CT	20 ma	16/4 (split)	40-20,000	36	—	1w
A-24	Single or PP plates to line	15,000 (split)	0	50, 125/150, 200/250, 333, 500/600	20-40,000	1430	+ 15	30
A-25	Plate to line	15,000	8 ma	50, 125/150, 200/250, 333, 500/600	40-20,000	1580	+ 15	30
A-26	Single or PP plates to line	30,000 (split)	0	50, 125/150, 200/250, 333, 500/600	20-40,000	2520	+ 15	30
A-28	Transistor to V.C.	48 CT	750 ma Bal	16 (split) 8, 4	40-20,000	5	—	5w
A-34	Transistor interstage	25,000/6250 (split)	3 ma	500/125 (split)	30-20,000	1620	—	1w
A-35	Transistor interstage	10,000/2500 (split)	8 ma	500/125 (split)	30-20,000	610	—	1w
A-36	Transistor interstage	500/125 (split)	20 ma	150/37.5 (split)	40-20,000	36	—	1w
A-37	Transistor interstage	500/125 (split)	20 ma	50/12.5 (split)	40-20,000	36	—	1w
A-38	Transistor interstage	100/25 (split)	40 ma	40/10 (split)	40-20,000	6.2	—	1w
A-44	Tr. intstg. or output	4K/1K (split)	12 ma	600/150 (split)	30-20,000	310	—	1w



Hipermalloy Shield (A-33)
shown slipping
over "A"-line unit

A-33 SHIELD
1 1/32" x 1 1/32" x 2 1/32"

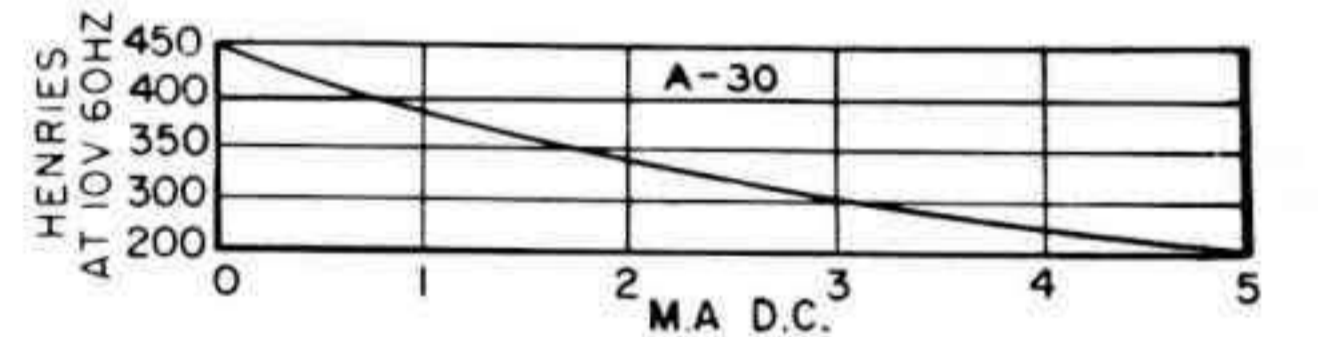
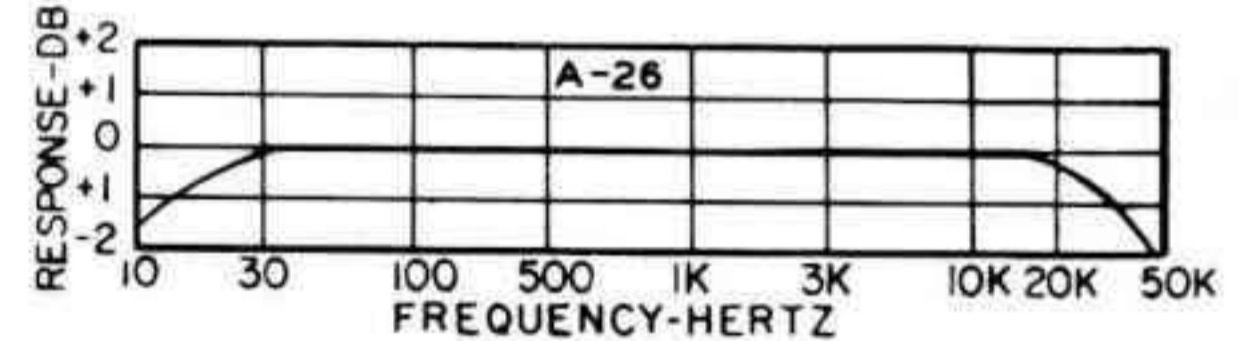
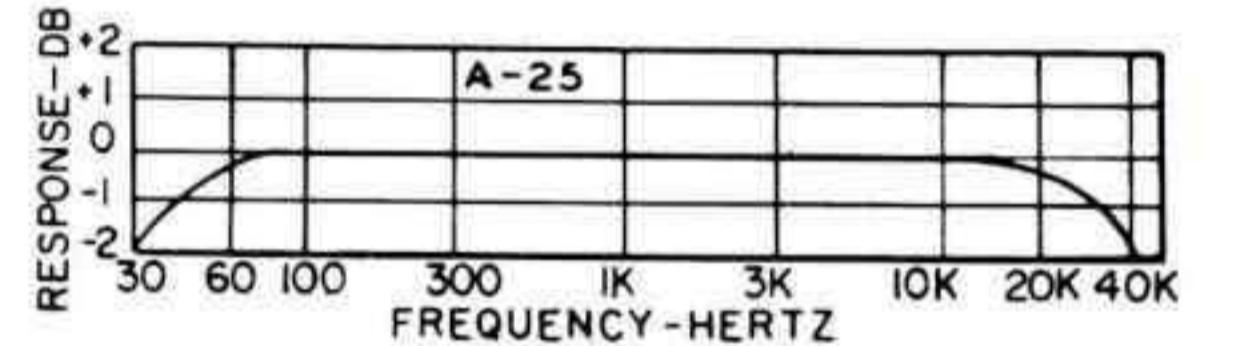
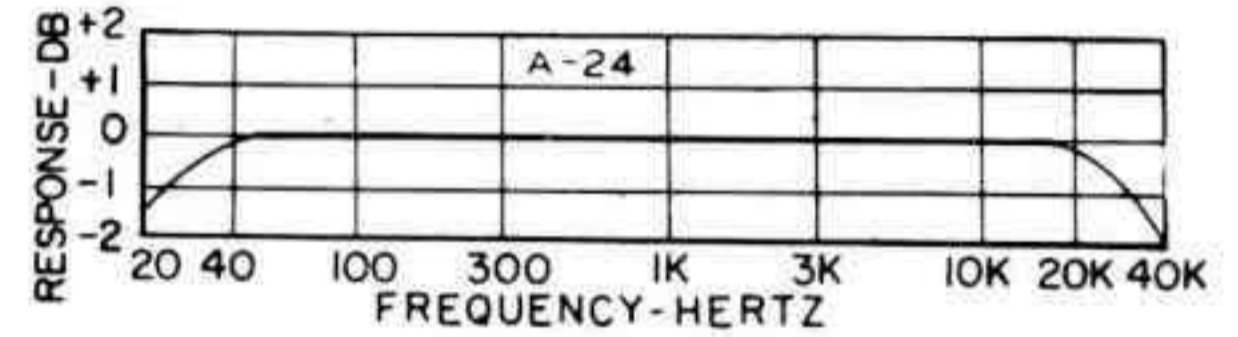
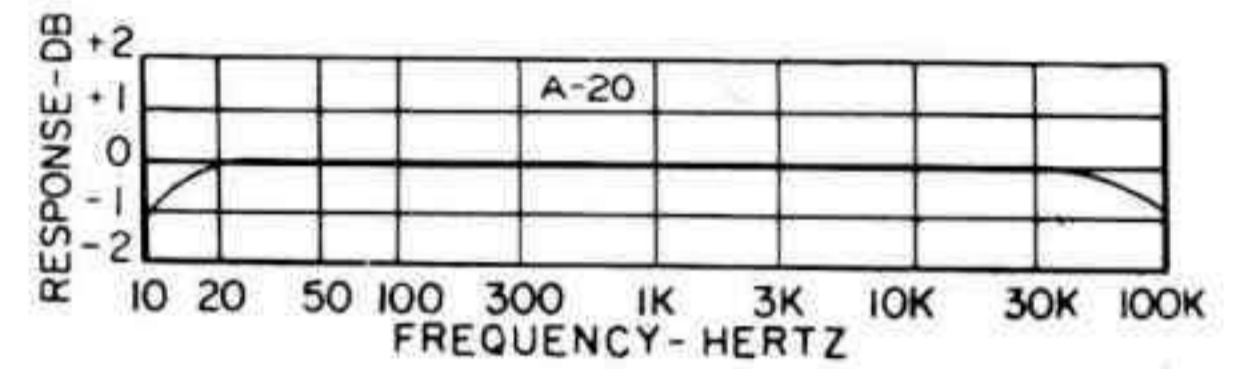
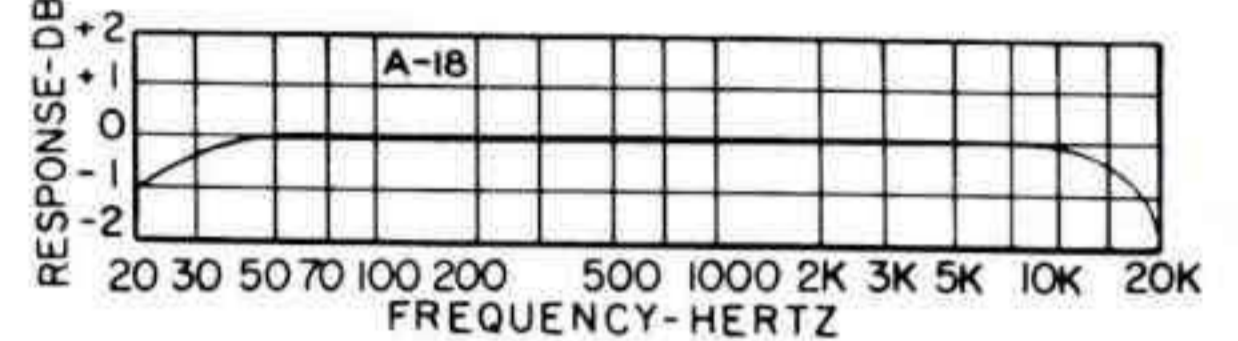
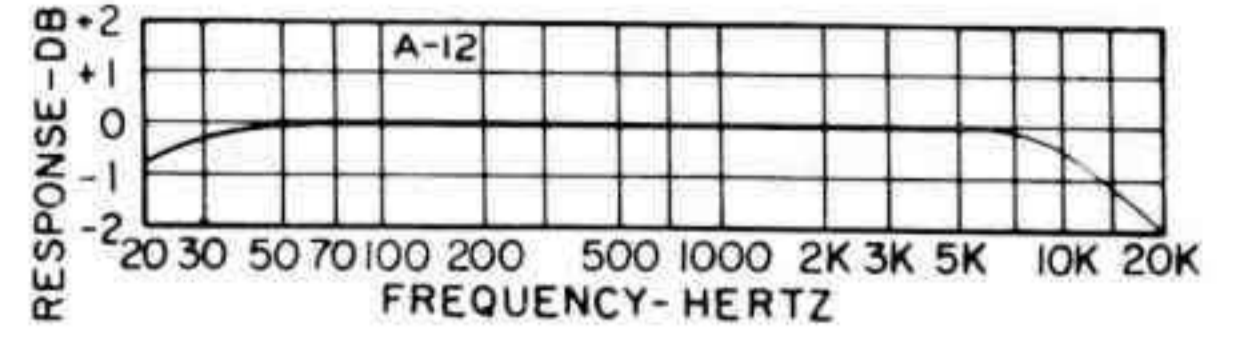
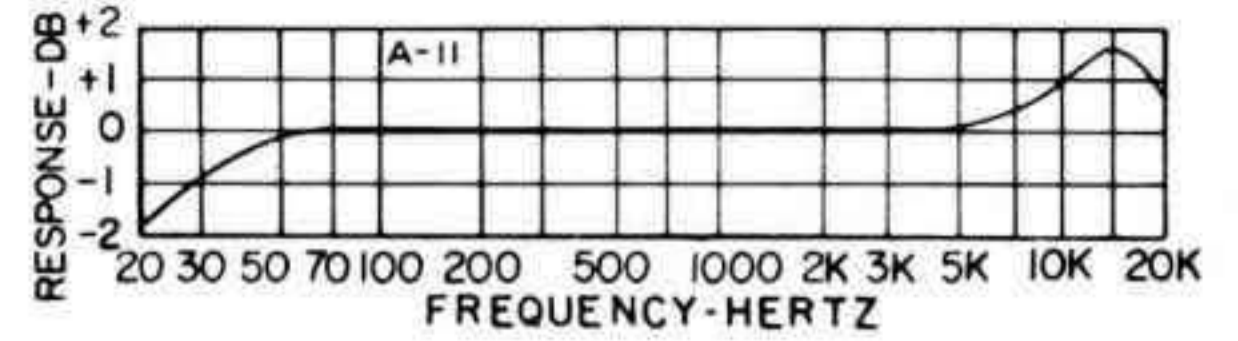
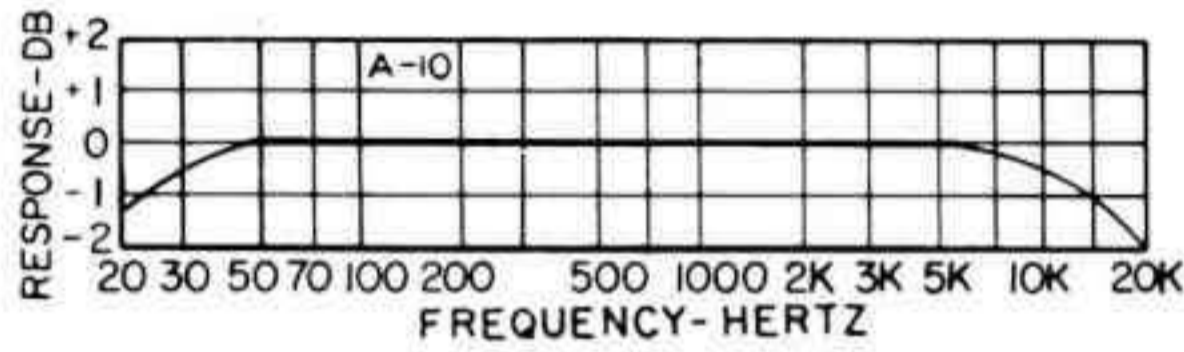

INDUCTORS AND FILAMENT/TRANSISTOR SUPPLY TRANSFORMERS

Type No.	Application	Specifications
A-30	Audio inductor	450 Hys @ 0 ma DC, 250 Hys @ 5 ma DC, 6000 ohms; 65 Hys @ 10 ma DC, 1500 ohms
A-32	Filter inductor	Series conn't'd: 60 Hys @ 15 ma DC, 2000 ohms Parallel conn't'd: 15 Hys @ 30 ma DC, 500 ohms
A-40	Power transformer	115V 60 cycles to two 6.3V CT—.2A Secs.
A-41	Filter inductor	Series conn't'd: 240 Mhy @ .2A DC, 6 ohms Parallel conn't'd: 60 Mhy @ .4A DC, 1.5 ohms
A-42	Split filter inductor	Series conn't'd: 4 Hys @ 50 ma DC, 100 ohms Parallel conn't'd: 1 Hy @ 100 ma DC, 25 ohms
A-33	Hipermalloy shield, slip fit over "A" case, provides approximately 20 db shielding	

SPECIAL APPLICATION TRANSFORMERS

Type No.	Application	Pri. Imp. Ohms	Unbal DC	± 2 db from	Pri. Res. Ohms	Max. Level
A-45	Autotransformer, speaker matching	4, 8, 16	0	40Hz-20kHz	1.2	1w @ 40 Hz; 4w @ 80 Hz

Type No.	Application	1/2 Pri. Imp.	Sec. Imp.	Turns Ratio 1/2 Pri. to Sec.	Max. Volts 1/2 Pri.	Min. L Pri. 1V 60 Hz	Pri. Res. Ohms
A-46	Chopper transformer High electrostatic shielding plus magnetic shielding plus humbucking balanced structure	10K/2.5K	50K	2.23/4.46	4/2 @ 60 Hz; 24/12 @ 400 Hz	200/50 Hy	1300/650

Type No.	Application	Pri. Imp. Ohms	Unbal. DC	Sec. Imp. Ohms	± 2 db from	Pri. Res. Ohms	Max. Level
A-47	Hybrid transformer 3 balanced windings CT	500/600 CT	0	500/600 CT 500/600 CT	40Hz-20kHz	39	+ 10 dbm, 10 mw

Type No.	Application	Pri. Imp. Ohms	Unbal. DC	Sec. Imp. Ohms	± 2 db from	Max. Level
A-48	"2 wire to 4 wire" hybrid circuit. Two transformers in one case for hybrid circuit use. Includes electromagnetic shielding. Hybrid circuit will provide 60 db minimum circuit isolation.	500/600	0	500/600 } 2 wdgs. 500/600 } plus winding for balance loading.	40 Hz—20 kHz	+10 dbm, 10 mw



LINEAR STANDARD™ AUDIO TRANSFORMERS

PACKAGING High quality rugged die cast zinc alloy case with both top and bottom mounting facilities (except LS-6).

APPLICATIONS High fidelity, broadcast applications. Closest approach to the ideal from the standpoint of uniform frequency response, low wave form distortion, high efficiency, thorough shielding and dependability.

LOW IMPEDANCE TO GRID AND MIXING AND MATCHING TRANSFORMERS

Type No.	Application	Primary Impedance	Secondary Impedance	± 1 db from	Max. Level dbm	Relative* hum	Unbal. DC in primary	Case No.
LS-10	Low impedance mike, pickup, or multiple line to push pull grids	50, 125/150, 200/250, 333, 500/600 ohms	60,000 ohms in two sections	20-20,000	+19	-74 db	.5 ma	LS-1
LS-10X	As above	As above	50,000 ohms	20-20,000	+17	-92 db-Q	.5 ma	LS-1
LS-12	Low impedance mike, pickup or multiple line to push pull grids	50, 125/150, 200/250, 333, 500/600 ohms	120,000 ohms overall, in two sections	20-20,000	+19	-74 db	.5 ma	LS-1
LS-12X	As above	As above	80,000 ohms overall, split	20-20,000	+17	-92 db-Q	.5 ma	LS-1
LS-14X	Low impedance mike, pickup, or parallel mixer to grid	2.5, 5.5, 10, 15, 22, 30, 38, 60 ohms	50,000 ohms	20-20,000	+17	-92 db-Q	.5 ma	LS-1
LS-26	Bridging line to single or push pull grids	5,000 ohms	60,000 ohms in two sections	15-20,000	+23	-74 db	0 ma	LS-1
LS-30+	Mixing, low impedance mike, pickup or multiple line to multiple line	50, 125/150, 200/250, 333, 500/600 ohms	50, 125/150, 200/250, 333, 500/600 ohms	7-50,000	+23	-74 db	.5 ma	LS-1
LS-30X+	As above	As above	As above	20-20,000	+20	-92 db-Q	.3 ma	LS-1
LS-31	Three isolated lines or pads to multiple line	30/50, 200/250 ohms each primary	50, 125/150, 200/250, 333, 500/600 ohms	20-20,000	+23	-74 db	.5 ma	LS-1
LS-32	Mixing, low impedance mike, pickup or parallel mixer to multiple line	2.5, 5.5, 10, 15, 22, 30, 38, 60 ohms	50, 125/150, 200/250, 333, 500/600 ohms	20-20,000	+23	-74 db	.5 ma	LS-1
LS-68 †	Mixing, matching line or transistor to 2 simultaneously loaded lines or transistors	600/150 split	2 secondaries each 600/150 split	20-40,000	+15	-92 db-Q	0 ma	LS-1

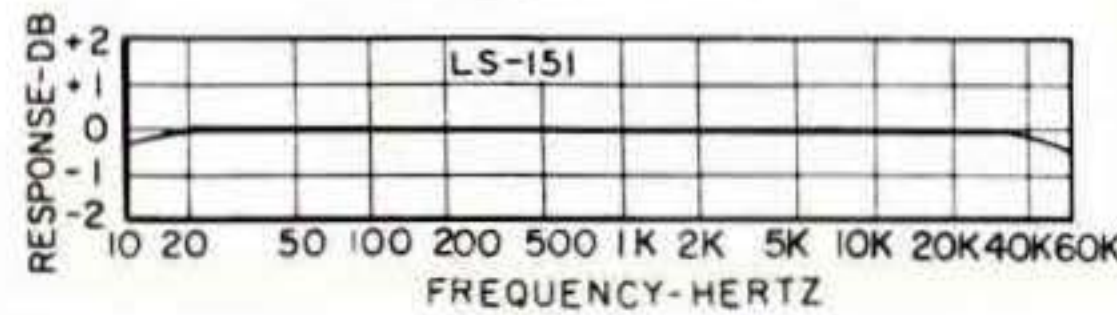
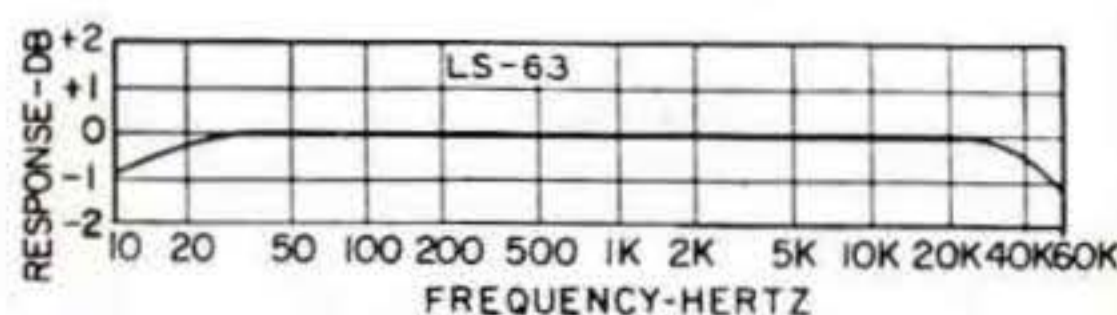
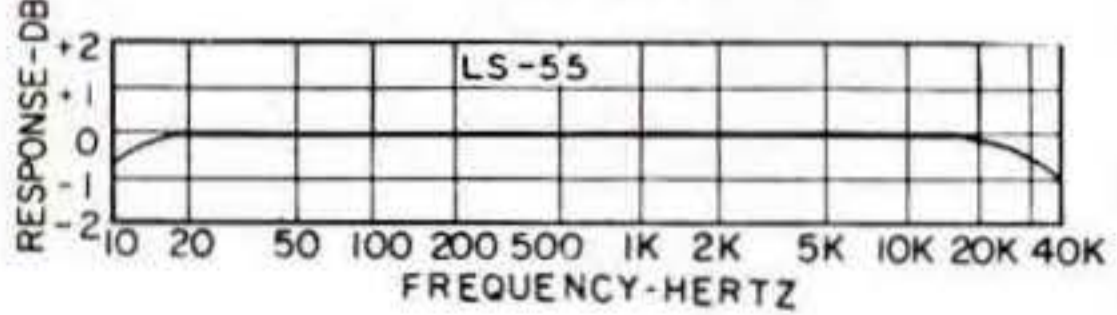
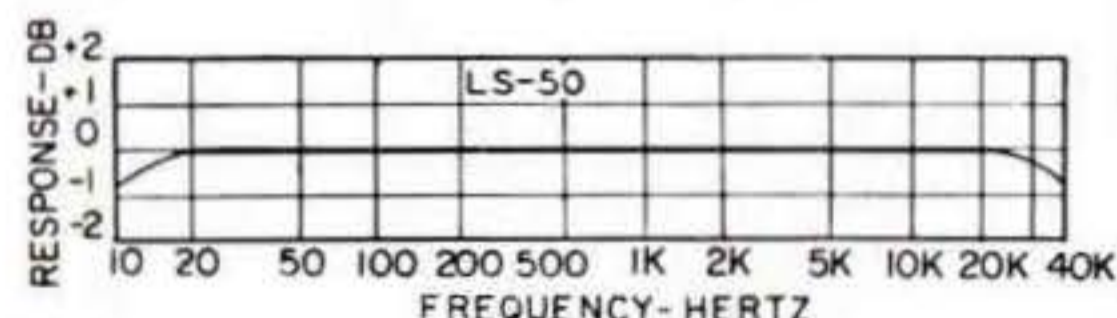
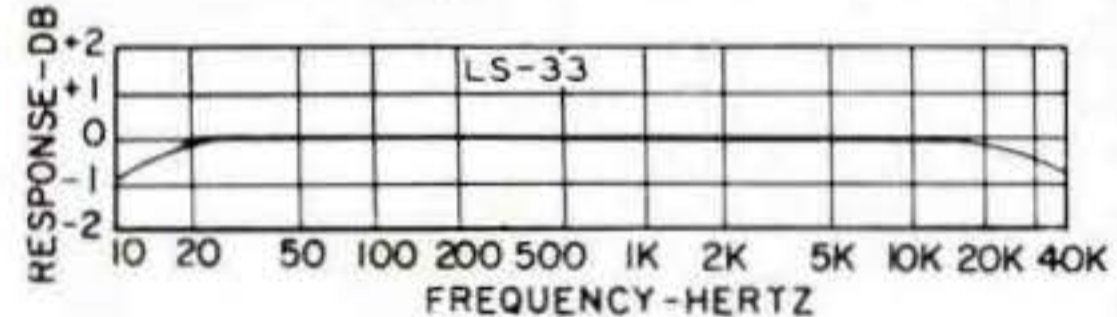
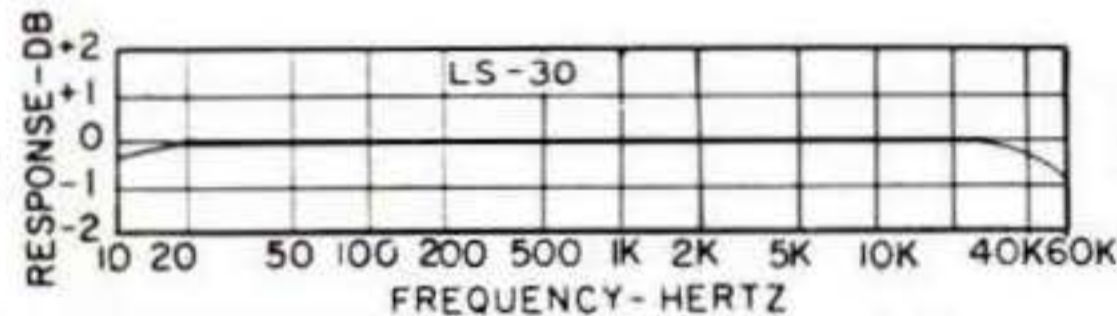
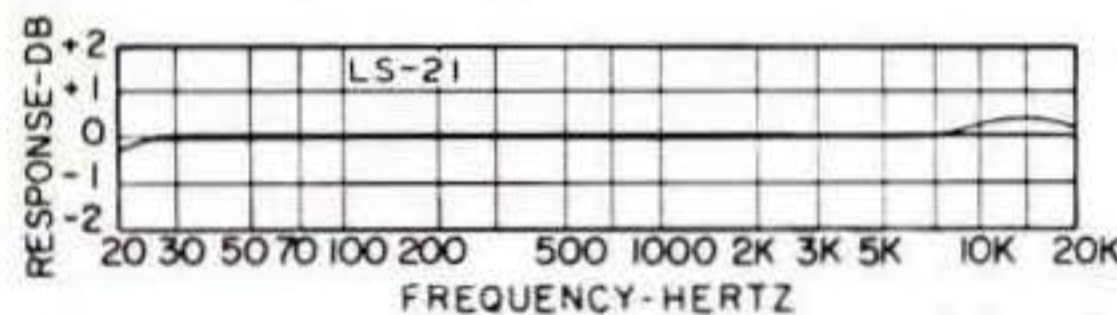
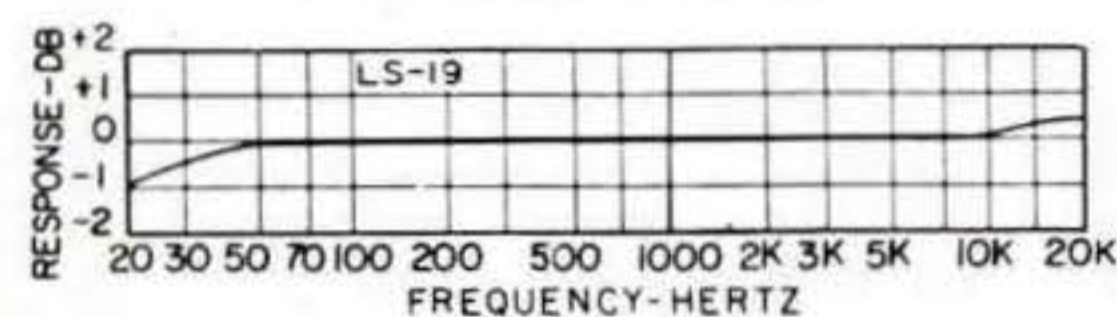
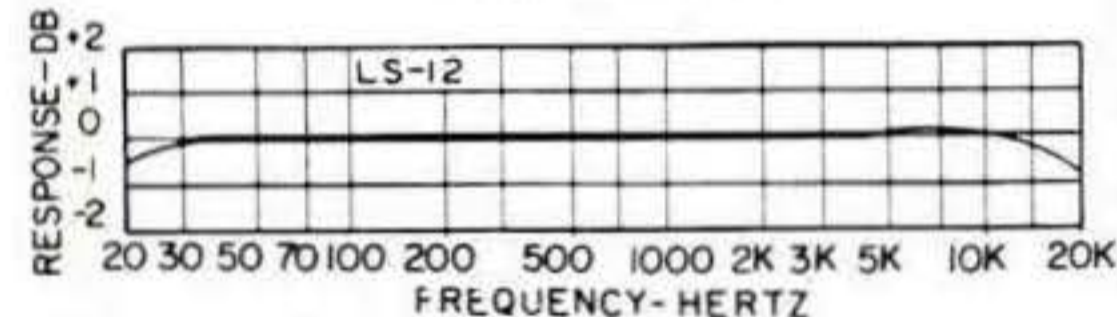
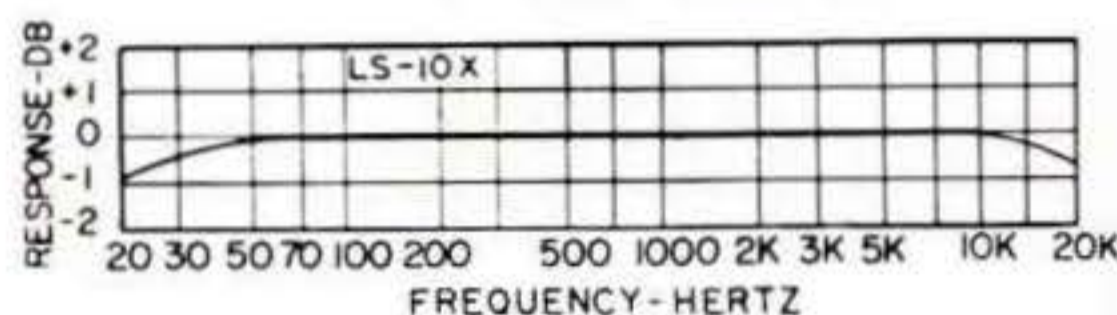
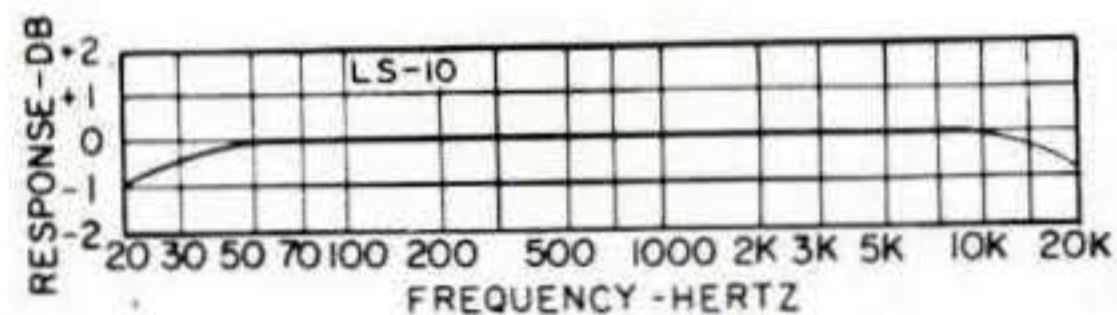

INTERSTAGE AND DRIVER TRANSFORMERS

Type No.	Application	Primary Impedance	Secondary Impedance	± 1 db from	Max. Level	Relative* hum	Unbal. DC in primary	Case No.
LS-19	Plate to PP grids like 6L6, 5881 Split secondary	15,000 ohms	95,000 ohms 1.25:1 each side	20-20,000	100 mw	-50 db	0 ma	LS-1
LS-21	Plate to PP grids Split pri. and sec.	15,000 ohms	135,000 ohms; 3:1 overall	10-20,000	100 mw	-74 db	0 ma	LS-1
LS-40	Plate to PP grids Split secondary	15,000 ohms	135,000 ohms; 3:1 overall	30-18,000 (± 2 db)	100 mw	-74 db	8 ma	LS-1
LS-25	PP plates to PP grids Med. level split pri. and sec.	30,000 ohms plate to plate	50,000 ohms; turn ratio 1.3:1 overall	20-20,000	200 mw	-74 db	1 ma	LS-1
LS-47	Driver from push pull 2A3's, or sim. to class B828's, 805's, or ZB120's	5,000 ohms plate to plate	.1 pri. impedance turns ratio, Pri./½ Sec. 3.2:1	20-20,000	20 Watts		5 ma	LS-2
LS-48	Driver trans. push pull 845's to 805 grids in class B	12,000 ohms plate to plate	.038 pri. impedance turns ratio, Pri./½ Sec. 5.1:1	20-20,000	40 Watts		15 ma	LS-3

HYBRID AND REPEAT COILS

Type No.	Application	Pri and Sec. Impedances	± 1 db from	Max. Level dbm	Relative* hum	Max. Unbal. DC in primary	Case No.
LS-68 †	Mixing, matching line or transistor to 2 simultaneously loaded lines or transistors	600/150 split 2 secondaries each 600/150 split	20-40,000	+15	-92 db-Q	0 ma	LS-1
LS-140 †	Line to line for Isol. balanced and unbal. cir.; bal. for max. cross talk 70 db	500/600 ohms split 500/600 ohms split	30-20,000	+18	-92 db-Q	0 ma	LS-1
LS-141	Three sets of bal. wind. for hybrid service, centertapped	500/600 ohms 500/600 ohms	30-15,000	+18	-74 db	0 ma	LS-1

The values of unbalanced DC shown will effect approximately 1.5 db loss at 30 Hz.
 * Comparison of hum balanced unit with shielding to normal uncased type. Q = Multiple alloy magnetic shields.
 † High electrostatic shielding.

PLATE, CRYSTAL, PHOTOCCELL, AND BRIDGING TO LINE TRANSFORMERS

Type No.	Application	Primary Impedance	Secondary Impedance	± 1 db from	Max. Level	Relative* hum	Unbal. DC in primary	Case No.
LS-27	Single pl. to multiple line	15,000 ohms	50, 125/150, 200/250, 333, 500/600	30-15,000	200 mw	-74 db	8 ma	LS-1
LS-50	Single pl. to multiple line	15,000 ohms	50, 125/150, 200/250, 333, 500/600	10-40,000	200 mw	-74 db	0 ma	LS-1
LS-51	Push pull low level pl. to multiple line	30,000 ohms plate to plate	50, 125/150, 200/250, 333, 500/600	10-40,000	250 mw	-74 db	1 ma	LS-1
LS-150	Bridging from 50 to 500 ohm line to line	4,000 ohms, bridging	50, 125/150, 200/250, 333, 500/600	7-50,000	200 mw	-74 db	1 ma	LS-1
LS-151	Bridging from 50 to 500 ohm line to line	16,000 ohms, bridging	50, 125/150, 200/250, 333, 500/600	7-50,000	400 mw	-74 db	1 ma	LS-1

HIGH LEVEL MATCHING TRANSFORMERS

Type No.	Application	Primary Impedance	Secondary Impedance	± 1 db from	Max. Level	Case No.
LS-33	High level line matching	50, 125/150, 200/250, 333, 500/600 ohms	1.2, 2.5, 5, 7.5, 10, 15, 20, 30, 50, 125/150, 200/250, 333, 500/600	10-40,000	20 watts	LS-2
LS-34	High level line matching	50, 125/150, 200, 250, 333, 500/600 ohms	1.2, 2.5, 5, 7.5, 10, 15, 20, 30, 50, 125/150, 200/250, 333, 500/600	10-40,000	40 watts	LS-3

OUTPUT TRANSFORMERS TO LINE AND VOICE COIL

Type No.	Primary will match typical tubes	Primary Impedance	Secondary Impedance	± 1 db from	Max. Level	Case No.
LS-52	Push pull 6AQ5, 6V6, 6L6, 5881, 6BQ5, 7189A 12BA5	8,000 ohms	500, 333, 250/200, 125, 50, 30, 20, 15, 10, 7.5, 5, 2.5, 1.2	7-50,000	20 watts	LS-2
LS-54	Same as above	8,000 ohms	30, 20, 15, 10, 7.5, 5, 2.5, 1.2	7-50,000	20 watts	LS-2
LS-55	Push pull 300B, 6L6's, 6AS7G, 6080, 7027, 7581, 7355, 7868	5,000 ohms plate to plate and 3,000 ohms plate to plate	500, 333, 250/200, 125, 50, 30, 20, 15, 10, 7.5, 5, 2.5, 1.2	7-50,000	20 watts	LS-2
LS-57	Same as above	5,000 ohms plate to plate and 3,000 ohms plate to plate	30, 20, 15, 10, 7.5, 5, 2.5, 1.2	7-50,000	20 watts	LS-2
LS-58	Push pull parallel as above	2,500 ohms plate to plate and 1,500 ohms plate to plate	500, 333, 250/200, 125, 50, 30, 20, 15, 10, 7.5, 5, 2.5, 1.2	10-50,000	40 watts	LS-3
LS-61	Push pull triode; 6AS7G, 6080, 6L6, 5881, KT-66, 807, 1614	10,000 ohms pl. to plate and 6,000 ohms plate to plate	500, 333, 250/200, 125, 50, 30, 20, 15, 10, 7.5, 5, 2.5, 1.2	7-50,000	20 watts	LS-2
LS-63	Same as above	10,000 ohms pl. to plate and 6,000 ohms plate to plate	30, 20, 15, 10, 7.5, 5, 2.5, 1.2	7-50,000	20 watts	LS-2
LS-6L1	Self bias push pull 6L6's, 5881, KT-66, 5146 triode, 6159 triode	9,000 ohms plate to plate	500, 333, 250/200, 125, 50, 30, 20, 15, 10, 7.5, 5, 2.5, 1.2	7-50,000	30 watts	LS-3
LS-6L4	Push pull 6146, 6159, 6L6's fixed bias or push pull parallel 6L6's self bias, 7581	4,500 ohms plate to plate and 3,800 ohms plate to plate	500, 333, 250/200, 125, 50, 30, 20, 15, 10, 7.5, 5, 2.5, 1.2	12-50,000	55 watts	LS-3
LS-35	EL-34 in AB-feedback (see circuit pg. 28)	5,000 ohms CT 43% screen taps	4, 8, 16	7-50,000	35 watts	LS-3
LS-65	6550's in AB ₁ feedback (see circuit pg. 28)	3,300 ohms CT 40% screen taps	4, 8, 16	7-50,000	60 watts	LS-3
LS-666	Push pull transistors class B (2N277 or equiv.) (see circuit pg. 28)	8 ohms split	500 ohms split	7-50,000	50 watts	LS-3
LS-667	Push pull transistors class B (2N277 or equiv.) (see circuit pg. 28)	8 ohms split	4, 8, 16	7-50,000	50 watts	LS-3

MODULATION TRANSFORMERS

Type No.	Primary will match typical tubes	Primary Impedance	Secondary Impedance	± 1 db from	Max. Level	Case No.
LS-56	Push pull 6A5G's, 300B's, 6AS7G, 6L6 6080, 7335, 7581	5,000 ohms plate to plate and 3,000 ohms plate to plate	6000, 5000, 4000, 1800, 1500, 1000, 30, 20, 15, 10, 7.5, 5, 2.5, 1.2	10-50,000	20 watts	LS-2
LS-691	Class B, 833A, 250TH 8163	10,400 ohms plate to plate	4500, 4000, 3500, 2750, 2000	20-40,000	1000 watts	LS-6
LS-692	Class B push pull parallel 833A's, 8164	4,750 ohms plate to plate	2500, 2000, 1750, 1500, 1250	20-40,000	2500 watts	LS-6



LINEAR STANDARD HIGH SHIELDING DIE CAST CASES TOP & BOTTOM MTG.

LS-1 CASE

Length3 1/8"
 Width2 3/8"
 Height3 3/4"
 Mounting1 1/8" x 2 1/8"
 Screws6-32
 Cutout1 1/8" dia.
 Unit Weight3 lbs.

LS-2 CASE

Length4 7/16"
 Width3 1/2"
 Height4 3/16"
 Mounting2 1/8" x 3 1/8"
 Screws8-32
 Cutout2 3/4" dia.
 Unit Weight7.5 lbs.

LS-3 CASE

Length5 13/16"
 Width5"
 Height4 11/16"
 Mounting4 3/16" x 5 1/2"
 Screws10-24
 Cutout3 3/4" dia.
 Unit Weight15 lbs.



LS-6 CASE

Length15 3/4"
 Width13"
 Height—LS-69124"
 Height—LS-69228"
 Mounting Dimen7 3/8" x 14 1/8"
 Mounting Hole3/8" dia.
 Unit Weight350 lbs.
 Unit Weight—LS-691370 lbs.
 Unit Weight—LS-692520 lbs.



HIPERMALLOY™ TRANSFORMERS

PACKAGING High quality zinc alloy rugged die cast case. Both top and bottom mounting facilities.

FREQUENCY RESPONSE ±1 db from 30 Hz to 20 kHz except where otherwise noted.

APPLICATION Ideal for portable compact equipments.

APPLICATION NOTE Included in line are power transformers.

NOTE Units employ a hipermalloy nickel iron core with a hum bucking coil structure which provides electrical balance and effects good inductive shielding.

TYPE H-1 CASE

Length 2³/₈"
 Width 1¹⁵/₁₆"
 Height 3¹/₈"
 Mounting 1³/₈ x 1¹³/₁₆"
 Screws 6-32
 Cutout 1¹³/₁₆" dia.
 Unit Weight 2 lbs.



LOW IMPEDANCE TO GRID AND MIXING TRANSFORMERS

Type No.	Application	Primary Imp. (ohms)	Secondary Impedance	± 1 db from	Max. Level dbm	mw	Unbal. DC in Prim'y	Case No.
HA-100	Low impedance mike, pickup, or multiple line to grid	50, 125/150, 200/250, 333, 500/600	60,000 ohms overall, split	30-20,000	+18	63	.5 ma	H-1
HA-100X	Same as above but with multiple alloy shields to effect		very low hum pickup		+16	40		H-1
HA-101	Low impedance mike, pickup, or multiple line to P.P. grids	50, 125/150, 200/250, 333, 500/600	120,000 ohms overall, split	30-20,000	+18	63	.5 ma	H-1
HA-101X	As above but with multiple alloy shield to effect		80,000 ohms overall, split	30-20,000	+16	40	.5 ma	H-1
HA-103A	Low impedance mike, pickup, or parallel mixer to grid	2.5, 5.5, 10, 15, 22, 30, 38, 60	60,000 ohms overall, split	30-20,000	+18	63	.5 ma	H-1
HA-108*	Mixing, low impedance mike, pickup, or multiple line	50, 125/150, 200/250, 333, 500/600	50, 125/150, 200/250, 333, 500/600	20-50,000	+20	100	.5 ma	H-1
HA-108X*	Same as above but with multiple alloy shields to effect		very low hum pickup		+18	63		H-1
HA-130X	Three isolated lines or pads to one or two grids with tri-alloy internal shields	30, 50, 200/250 each primary	60,000 ohms overall, split	30-20,000	+18	63	.5 ma	H-1

*High electrostatic shielding.

INTERSTAGE AUDIO TRANSFORMERS

Type No.	Application	Primary Imp.	Secondary Impedance	± 1 db from	Max. Level dbm	mw	Unbal. DC in Prim'y	Case No.
HA-104	Single plate to P.P. grids like 2A3, 6L6 (split secondary)	15,000 ohms (split)	95,000 ohms 1:2.5 ratio overall	30-20,000	+20	100	0	H-1
HA-105	Single plate to single grid	15,000 ohms	60,000 ohms 1:2 turn ratio	30-20,000	+20	100	0	H-1
HA-106	Single plate to push pull grids (split secondary)	15,000 ohms (split)	135,000 ohms 1:3 ratio overall	30-20,000	+20	100	0	H-1
HA-107	Push pull plates to push pull grids (split primary and secondary)	30,000 ohms plate to plate	80,000 ohms 1:1.6 ratio overall	30-20,000	+28	600	.25 ma	H-2
HA-137	Push pull plates to push pull grids (split Pri. and Sec.)	30,000 ohms plate to plate	68,000 ohms 1:1.5 ratio overall	30-20,000	+20	100	0	H-1



TYPE H-2 CASE

Length 3¹/₁₆"
 Width 2¹/₁₆"
 Height 3¹/₂"
 Mounting 2 x 2³/₄"
 Screws 6-32
 Cutout 2¹/₁₆" dia.
 Unit Weight 5 lbs.

POWER TRANSFORMERS

Type No.	Application	Primary Voltage 50/60 Hz	High Voltage	Filament Windings	Case No.
HP-122	pre-amp. power supply using 6x4 6X5GT rectifier	115	220-0-220 15 ma	6.3 V.C.T.-.6A 6.3 V.C.T.-1.2A	H-1
HP-123	Pre amp. or tuner power supply using 6X4, 6X5GT rectifier	115	275-0-275 35 ma	6.3 V.C.T.-.6A 6.3 V.C.T.-2A	H-2

PLATE TO LINE TRANSFORMERS

Type No.	Application	Primary Imp.	Secondary Imp. Ohms	± 1 db from	Max. Level dbm mw	Unbal. DC in Prim'y	Case No.
HA-113	Single plate to multiple line	15,000 ohms (split)	50, 125/150, 200/250, 333, 500/600	30-40,000	+21 125	0 ma	H-1
HA-114	Push pull low level plates to multiple line	30,000 ohms plate to plate	50, 125/150, 200/250, 333, 500/600	30-40,000	+23 200	1 ma	H-1
HA-133	Single plate to multiple line (DC in Pri.)	15,000 ohms (split)	50, 125/150, 200/250, 333, 500/600	30-40,000	+22 160	8 ma	H-1

OUTPUT TRANSFORMERS

Type No.	Application	Primary Imp.	Secondary Imp. Ohms	± 1 db from	Max. Level	Case No.
HA-134	Push pull, 6L6, 6W6, 6050, 7355, 7581, 12BA5 to line	5000/9400 ohms plate to plate	50, 125/150, 200/250, 333, 500/600	10-50,000	15 watts	H-2
HA-135	As above except to voice coil	3000/5000 ohms plate to plate	30, 20, 15, 10, 7.5, 5, 2.5, 1.2	10-50,000	18 watts	H-2
HA-136	5881's (KT-66's) in AB-feed back (see pg. 28 circuit)	6,600 ohms CT 43% screen taps	4, 8, 16	10-50,000	20 watts	H-2



EXPERIMENTER/HOBBY CIRCUIT TRANSFORMER

The New UTC HCA-308 is a hi-fi, low distortion, IC or transistor output to voice coil transformer. Circuit shown is from RCA's KD-2117 kit.

Type No.	HCA-308
Primary impedance	200/125 Ω CT
Secondary impedance	4/3Ω
Frequency response	±1 db, 100 Hz to 10 kHz
Maximum level	1 watt

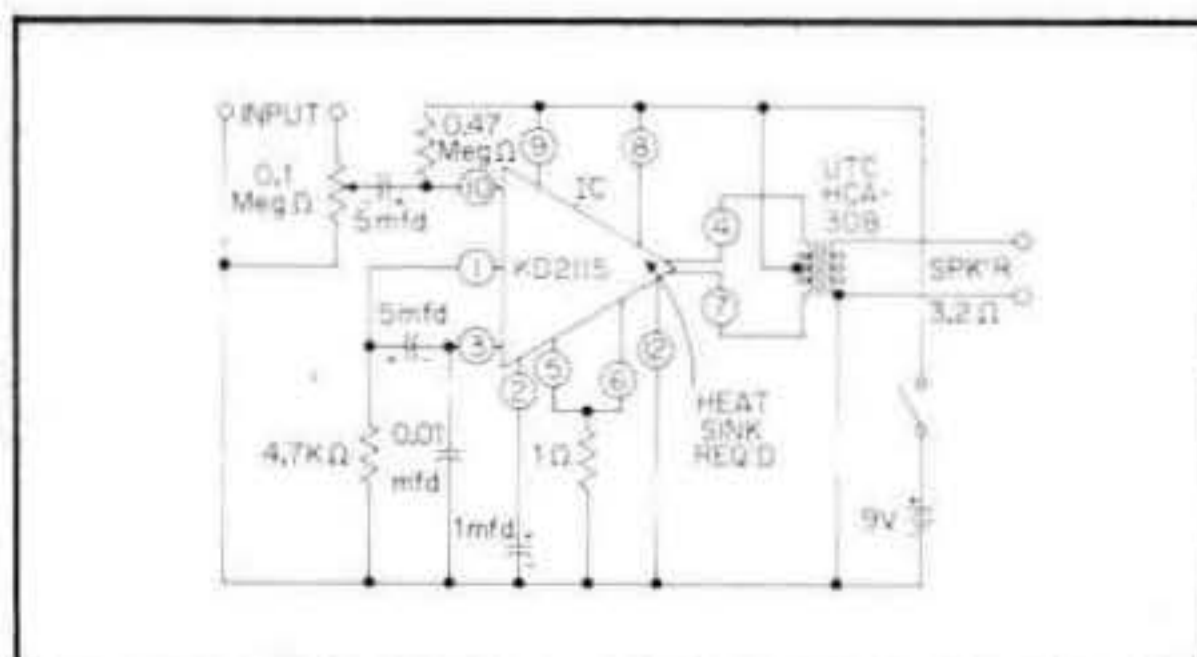

Height 1¹/₄" width 2¹/₈"
 depth 1¹/₈". Two 3/16" holes
 on 1³/₄" mounting center.
 Weight 0.2 lbs.



COMMERCIAL GRADE COMPONENTS

PACKAGING Drawn steel case. High quality phenolic terminal board. All items are poured with special sealing compound in addition to vacuum impregnation of coil structures.

APPLICATIONS Continuous commercial equipment service. The low level interstage units should be used with parallel feed of 50K ohms and .25 mfd. The input transformers' 200 ohm windings are balanced; they may be used for 150 to 250 ohm circuits.

FREQUENCY RESPONSE $\pm 1\frac{1}{2}$ db from 40 Hz to 10 kHz (no unbalanced DC); CVL and CVM units 40 Hz to 6 kHz, or unless otherwise specified.

NOTE CG-134, 135 and 136 are of the hum-bucking type to assure low hum pick-up.

INPUT, INTERSTAGE, MIXING AND LOW LEVEL OUTPUT TRANSFORMERS

Type No.	Application	Primary Impedance Ohms	Max. Level dbm	Secondary Impedance Ohms	Case No.
CG-131	1 plate to 1 grid	15,000	+28	135,000 1:3 ratio	RC-50
CG-132	1 plate to 2 grids	15,000	+30	135,000 split 1:3 ratio overall	RC-62
CG-133	2 plate to 2 grids	30,000 P to P	+32	80,000 overall 1:1.6 ratio overall	RC-75
CG-134	Line to 1 grid hum-bucking	50, 200, 500	+30	80,000	RC-50
CG-135	Line to 2 grids hum-bucking	50, 200, 500	+30	120,000 overall	RC-50
CG-235	Line to 1 or 2 grids, hum-bucking; multiple alloy shielded for low hum pickup	50, 200, 500	+28	80,000 overall	RC-75
CG-136	Single plate and low impedance mike or line to 1 or 2 grids hum-bucking	15,000, 50, 200	+30	80,000 overall	RC-62
CG-137	Mixing	50, 200, 500	+28	50, 200, 500	RC-50
CG-140	Triode plate to line	15,000 8 ma DC	+30	50, 200, 500	RC-50
CG-141	Dynamic mike or PP plates to line	30,000 P to P CT	+32	50, 200, 500	RC-50
CG-233	PP 6C5, 12AU7, similar triodes to AB 45's, 2A3's, 6L6's, etc.	30,000 P to P CT	+35	25,000 overall 1:1.9 ratio overall	RC-87
CG-333	PP 6C5, 12AU7, similar triodes to fixed bias 6L6's	30,000 P to P CT	+35	3,300 overall 1:1.33 ratio overall	RC-87
CG-433	PP 45, 2A3, similar tubes to fixed bias 2 or 4 6L6's	5,000 P to P CT	10W.	800 overall 1:1.4 ratio overall	RC-100

OUTPUT TRANSFORMERS

Secondary Impedances: 500, 200, 16, 8, 5, 3, 1.5 ohms

Type No.	Imped. P. P. Ohms, Overall	Typical Tubes	Max. Watts	Case No.
CG-15	8,000CT	6V6, 6AQ5, 6BQ5, 7189A	20	RC-100
CG-16	3,000/5,000CT	6AS7G, 6L6, 6080, 7581	20	RC-100
CG-19	6,000/10,000CT	6L6, 5881, 6DZ7	20	RC-100
CG-710	14,000/20,000CT	6AK6, 6K6GT, 7027	20	RC-100
CG-2L6	9,000CT	6L6's, AB1, 5881, 7868	30	RC-125

FEEDBACK OUTPUT TRANSFORMERS

(See page 28 for typical circuits)

Secondary Impedances: 4, 8, 16 ohms and 70 Volt line.

Type No.	Primary Impedance	Typical Tubes	Audio Watts	Case No.
CG-20	5,000 CT, 43% screen taps	EL-34 in AB	25	RC-125
CG-21	3,300 CT, 40% screen taps	6550's in AB ₁	50	RC-150

CG VARIMATCH™ OUTPUTS FOR P. A.

APPLICATION Universal units designed to match any tubes within the rated output power, to line or voice coil.

IMPEDANCES Output 500, 200, 50, 16, 8, 5, 3, 1.5 ohms. Primary 3K, 5K, 6K, 8K, 10K, 14K ohms, center tapped.

Type No.	Audio Watts	Typical Tubes	Case No.
CVP-1	12	6V6, 6AQ5, 6BQ5, 6DZ7, 7189	RC-100
CVP-2	30	6L6, 6V6, 807, 5881, 6DZ7, 7189, 7355, 7581	RC-125
CVP-3	60	300B's, 6L6's, 807, 1614, 5881, 1625	RC-150
CVP-4	125	807's, 4-6L6's, 845's, 4-1614's, 6146, 6159	RC-152
CVP-5	300	242A's, 838's, ZB-120's	RC-175

COMMERCIAL GRADE RC CASE DIMENSIONS



RC CASE

Case No.	Base Dim (Sq)	Mounting Dim (Sq)	Mounting Screw	Ht +1/8, -1/16	Cut-out Dia	Unit Weight Lbs
RC-37	1 3/8	1 1/8	4-40	1 3/8	1 1/4	.35
RC-50	1 5/8	1 5/16	6-32	2 1/4	1 1/2	1/2
RC-62	1 13/16	1 1/2	6-32	2 1/2	1 1/2	1
RC-75	2 3/16	1 13/16	8-32	2 7/8	1 7/8	1 1/2
RC-87	2 9/16	2 3/32	8-32	3 1/4	2	2 1/2
RC-100	3	2 3/8	8-32	3 3/4	2 3/8	3 1/2
RC-112	3 7/16	2 11/16	10-32	4 1/8	2 7/8	5
RC-125	3 3/4	3	10-32	4 1/2	3	6 1/2
RC-150	4 1/2	3 9/16	12-28	5 1/2	3 3/4	11
RC-152	5 1/8	4 1/8	12-28	5 1/2	4	15 1/2
RC-175	5 3/4	4 7/8	1/4-20	7	4	22

CAT™ SERIES

TRANSISTOR IMPEDANCE TYPE TRANSFORMERS

ALL UNITS IN RC-50 CASE

Type No.	Application	Pri. Imp.	Unbal. DC in Pri.	Sec. Imp.	Range +2 db	Power Level
CAT-15	Output	48/12 split	750 ma Bal.	16 split/8/4	50-15 kHz	5 w
CAT-20	Interstage or Output	500/125 split	20	16/4 split	50-15 kHz	1 w
CAT-25	Interstage Isol. or Output	500/125 split	20	500/125 split	50-15 kHz	1 w
CAT-30	Line Input or Interstage	500/125 split	20	2K/500 split	50-15 kHz	1 w
CAT-40	Interstage or Output	10K/2.5k split	8	2K/500 split	50-15 kHz	1 w

CG VARIMATCH™ LINE TO VOICE COIL TRANSFORMERS

APPLICATION Line to voice coil transformers will match any voice coil or group of voice coils to a line.

IMPEDANCES Primary 500 ohm line. Secondary .2, .4, .5, .62, 1, 1.25, 1.5, 2, 2.5, 3, 3.3, 3.8, 4, 4.5, 5, 5.5, 6, 6.25, 6.6, 7, 7.5, 8, 9, 10, 11, 12, 14, 15, 16, 18, 20, 25, 28, 30, 31, 40, 47, 50, 63, 69, 75 ohms.

Type No.	Audio Watts	Primary Impedance	Secondary Impedance	Case No.
CVL-1	15	500 ohms	.2 to 75 ohms	RC-87
CVL-2	40	500 ohms	.2 to 75 ohms	RC-125
CVL-3	75	500 ohms	.2 to 75 ohms	RC-150

CG VARIMATCH™ DRIVER TRANSFORMERS

Type No.	Primary	Typical Output Tubes	Max. Level Watts	Case No.
CG-51AX	All single tubes like: 6C5, 6C4, 12AU7, 2A3, 5814A Ratios 2.8:1, 3.1:1, Pri. to 1/2 sec.	2A3, 6L6	5	RC-87
CG-53AX	P. P. tube like: 2A3, 6L6, Ratios 2:1, 3:1, Pri. to 1/2 sec.	841, 801A, 800, 838, 805	20	RC-112
CG-59AX	50, 200, 500 ohm line Ratios 1:1, 1.4:1, Pri. to 1/2 sec.	805, 838, ZB-120, 100TH, 800, 55T	20	RC-112

CG VARIMATCH™ MODULATION UNITS

APPLICATIONS Will match any modulator tubes to any RF load. Eliminates the power loss and high distortion caused by imprecise matching of RF load to class B modulation through the use of a combination of tapped windings affording an extremely wide range in impedance matching. Designs provide that for any load impedance employed, full class C plate current can be carried by secondary winding.

IMPEDANCES Primary from 500 to 20,000 ohms. Secondary from 300 to 30,000 ohms.

NOTE CVM-5 is in end-casting package. See page 42.

Type No.	Max. Audio Watts	Max. Class C Input	Typical Modulator Tubes	Case No.
CVM-0	12	25	6BQ5, 6DZ7, 6V6, 7189	RC-100
CVM-1	30	60	6V6, 6L6, 807, 5881, 7189, 7355, 7581	RC-125
CVM-2	60	125	6L6, 809, T-20, 1608, 6159	RC-150
CVM-3	125	250	807, 845, TZ-20, RK-30, 35-T	RC-152
CVM-4	300	600	805, 838, T-55, ZB-120, 4-65A, 100TH	RC-175
CVM-5	600	1200	805, HF-300, HK-354, 205TH, 810, 4-125A	7x12x9H 82 lbs.



SPECIAL SERIES AUDIO TRANSFORMERS



G-1-G-4 CASES CASE SIZES (Will take 8-32 Mtg. Screw)						
Type No.	H	W	D	M	N	Wt. Lbs.
G-1	1 1/8	2 1/16	1 3/4	2 3/8	2	1
G-2	2 3/16	3 3/16	1 15/16	2 3/8	2 3/8	1 1/2
G-3	2 1/2	3 3/8	2 5/32	3 1/4	2 3/4	2
G-4	2 15/16	4 1/8	2 5/16	3 3/8	3 1/8	3

G-5-G-12 CASES CASE SIZES (Will take 12-28 Mtg. Screw)						
Type No.	H	W	D	M	N	Wt. Lbs.
G-5	3 3/4	3 1/8	4 1/2	3 7/8	2 7/16	4 1/2
G-7	4 5/8	4 3/8	5 1/2	4 27/32	3 25/32	8
G-8	4 3/8	5 3/8	5 3/8	4 25/32	4 3/4	12
G-9	5 1/8	5 3/8	6 3/4	6 3/32	4 19/32	21
G-10	5 7/8	6 1/8	6 3/8	5 1 1/16	5 13/32	24
G-11	5 7/8	6 19/32	7 3/8	6 21/32	5 29/32	31
G-12	10 1/4	7 3/8	9 1/4	8 1/2	6 3/8	52

CLASS A INPUT TRANSFORMERS

Type No.	Application	Ratio	Case
S-2	1 plate* to 2 grids	1:4	G-2
S-3	1 plate* to 1 or 2 grids compact type	1:4	G-1
S-5	Single or double button mike or line to 1 grid hum-bucking type	1:16	G-2
S-6	Single or double button mike or line to 1 grid, compact type	1:16	G-1

*Will match tubes like 6J5, 6C4, 12AU7, etc. Can be used with high mu triodes with loss in low frequencies. Pri. DC to 8 ma

UNIVERSAL DRIVER TRANSFORMERS

(See modulator chart supplied with units for tube types, ratios are Pri. to 1/2 sec.)

Type No.	Application	Max. Watts	Case
S-8	Single driver plate to pushpull grids, 2.66:1, 5:1 ratios. Pri. DC to 45 ma.	5	G-3
S-9	Pushpull driver plates to grids of class B tubes up to 400 watts output, 2.66:1, 3.6:1, 5:1 ratios.	20	G-4
S-10	12AU7 or similar plates to 5881 or 6L6's, self or fixed bias, 2.25:1 ratio	5	G-3

MATCHING TRANSFORMERS

Type No.	Application	Pri. Ohms	Sec. Ohms	Case
S-11	Single 6J5, 6C4, 12AU7 or similar tube to line	15,000 10 ma DC	200/500	G-2
S-12	Line to speaker 15 watts	500, 2000, 4000	2, 4, 8, 15	G-2
S-13	Line to speaker 30 watts	500, 2000, 4000	2, 4, 8, 15	G-4

UNIVERSAL OUTPUT TRANSFORMERS TO LINE AND VOICE COIL

(Secondary Impedances: 500, 15, 8, 2 ohms)

Type No.	Primary Impedance	Typical Tubes	Case
SINGLE-ENDED TUBES			
S-14 10 W.	2500 ohms 4000 ohms 7000 ohms 10,000 ohms	35 ma DC 35L6GTG, 6V6 2A3, 6B4, 6L6, 50L6, 6W6, 6AQ5, 6AS5, 6CA5, 6CM6, 12AB5, 6K6GT, 1G5, 3C5 6A4, 7189A, 7581, 7355	G-2
PUSH-PULL TUBES			
S-15 12 W.	4000 ohms 5000 ohms 10,000 ohms	6Y6, 12AB5, 6W6 2A3, 6AS7G, 6CU5 6080, 6BN8	G-2
S-16 30 W.	3000 ohms 6000 ohms 9000/10000 ohms	6AS7G, 6L6, 6DZ7 7189A, 7355, 7581 807-triode, 7027, 7868	G-4
S-17 55 W.	3800 ohms 4500/5000 ohms	6L6's, 7027, 7868 809, 6146, 7355, 7581	G-5

PACKAGING Drawn steel case. High quality phenolic recessed terminal strip. Permits above chassis or breadboard wiring in addition to chassis type wiring. Large units are housed in formed cases with top and bottom mounting. All units are vacuum impregnated—compound filled.

APPLICATION Amateur and popular-priced PA service.

NOTE The universal windings provided on driver, matching and output transformers assure a maximum of flexibility.

UNIVERSAL MODULATION TRANSFORMERS

(Secondary carries class C current)
Any modulator tubes to any RF load.
(see chart supplied with units)

Maximum efficiency and lowest distortion in a modulator stage are made possible by properly matching of impedances. These units cover every modulator combination. Full class C current can be carried. Primary impedances from 500 to 20,000 ohms... secondary from 200 to 22,000 ohms.

Type No.	Audio Power	Case
S-18	12 watts	G-3
S-19	30 watts	G-4
S-20	55 watts	G-5
S-21	110 watts	G-7
S-22	250 watts	G-9

TYPICAL MODULATOR COMBINATIONS

S-18—12 WATTS MAX.

Typical driver tubes: 6C4, 12AU7, 6J5, 6SN7GT.

DRIVER						
Transf.	Sec. Term.	P. P. Tubes	Watts Output	P. P. Load	Plate Volts	Bias Volts
S-8	G'-G'	6AC5G	8	10,000	250	0
S-2	G-G	6V6, 6AQ5	12	6,000	250	15

S-19—30 WATTS MAX.

DRIVER							
Tube or Tubes	Transf.	Sec. Terms.	P. P. Tubes	Watts Output	P. P. Load	Plate Volts	Volts Bias
6C4	S-10	G-G	6L6 self bias	30	9,000	400	23

S-20—55 WATTS MAX.

DRIVER									
P. P. Tubes	Transf.	Sec. Terms.	P. P. Tubes	Watts Output	P. P. Load	Plate Volts	Plate Tr'sf.	Bias Volts	Bias Tr'sf.
12AU7	S-9	2-2	2E26	54	8000	500	S-41	15	S-51
12AU7	S-10	G-G	6L6, AB2	60	3800	400	S-39	25	S-51
12AU7	S-10	G-G	4-6L6	60	4500	400	S-40	23	S-51
2A3	S-9	3-3	809	60	5000	500	S-41	0	

S-21—115 WATTS MAX.

P. P.-2A3 Driver								
S-9 Transf.	P. P. Sec. Term.	P. P. Tubes	Watts Output	P. P. Load	Plate Volts	Plate Transf.	Bias Volts	Bias Tr'sf.
1-1	807		80	6600	600	S-45	30	S-51
2-2	6146		95	6000	600	S-46	50	S-51
3-3	809		100	8400	750	S-45	5	S-51
2-2	TZ-40		100	6000	750	S-45	0	
2-2	T-756		100	7000	850	S-46	30	S-51
1-1	4-6L6		110	2000	400	S-44	25	S-51
2-2	35-T		115	11000	1000	S-47	30	S-51

S-22—250 WATTS MAX.

P. P.-2A3 Driver								
S-9 Transf.	P. P. Sec. Term.	P. P. Tubes	Watts Output	P. P. Load	Plate Volts	Plate Transf.	Bias Volts	Bias Transf.
1-1	T-55		175	6900	1000	S-47	40	S-51
2-2	830 B		175	7600	1000	S-47	35	S-51
2-2	808		190	12700	1250	S-47	15	S-51
3-3	203 Z		200	6900	1000	S-47	0	
1-1	HK-354		220	15000	1500	S-49	100	S-51
*	HK-154		225	11400	1250	S-47	210	S-52
2-2	100 TH		250	7200	1250	S-47	0	
2-2	838		250	9000	1250	S-47	0	

* Reverse S-9, using 2-2 for plates and P-P for grids.

RECOMMENDED TRANSISTOR AMPLIFIER CIRCUITS

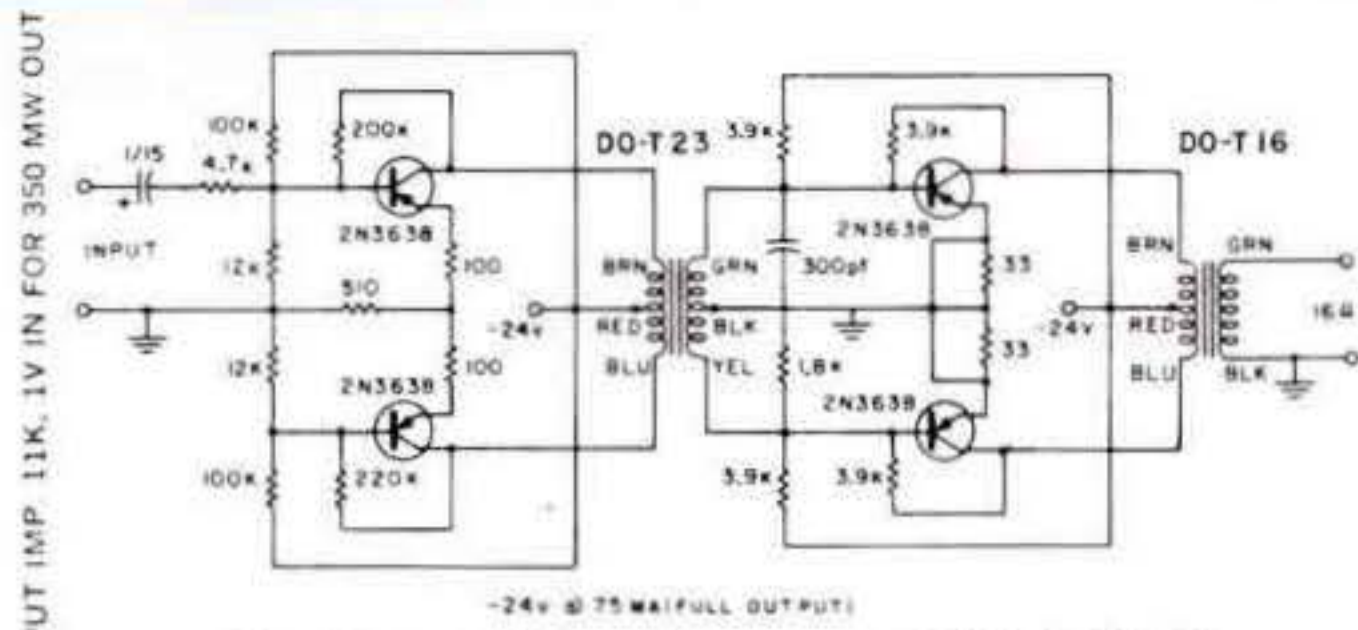

Circuit providing 350 mw, frequency range 900 Hz to 160 kHz

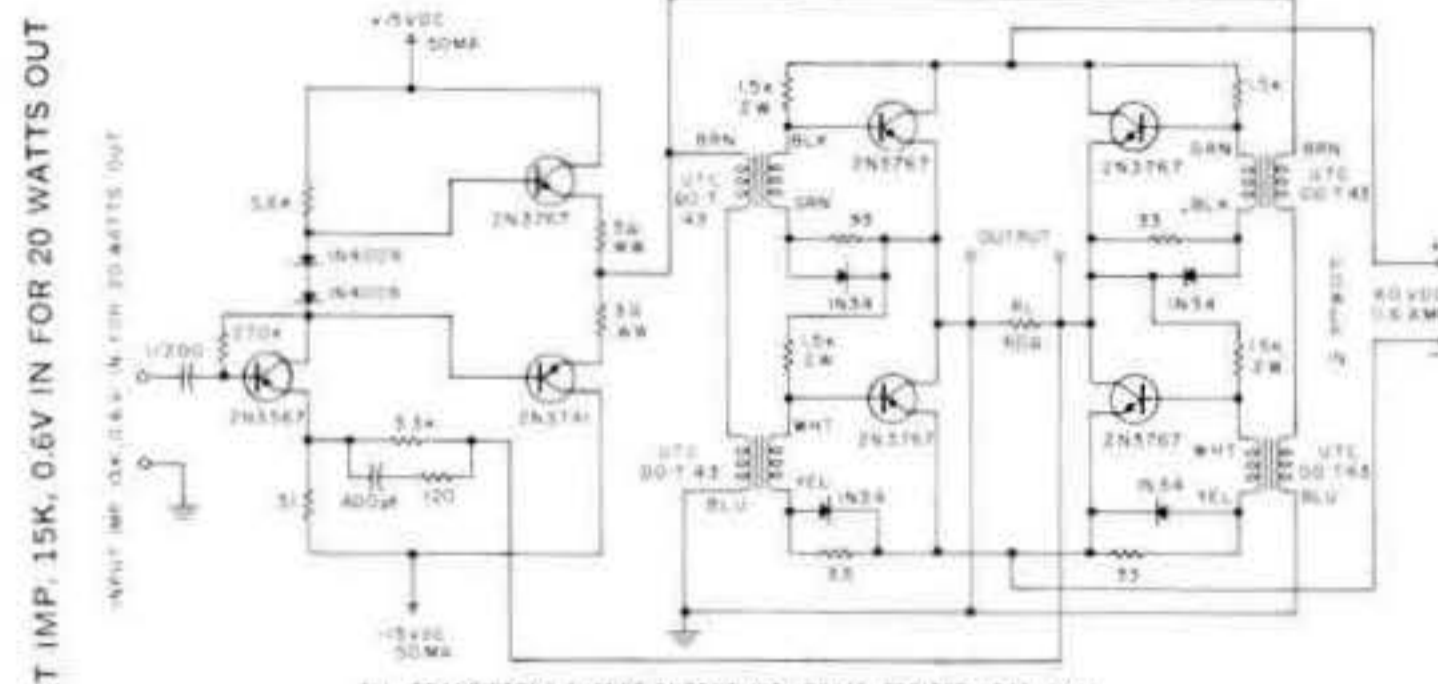

Circuit providing 20 watts, frequency range 50 Hz to 80 kHz

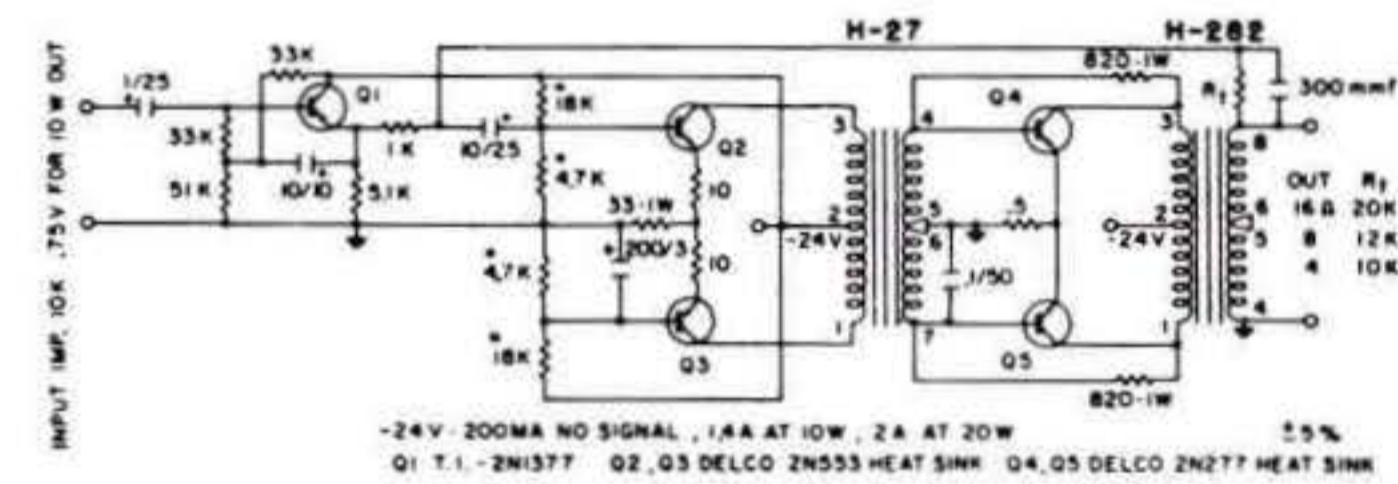

Circuit providing 20 watts, frequency range 50 Hz to 20 kHz

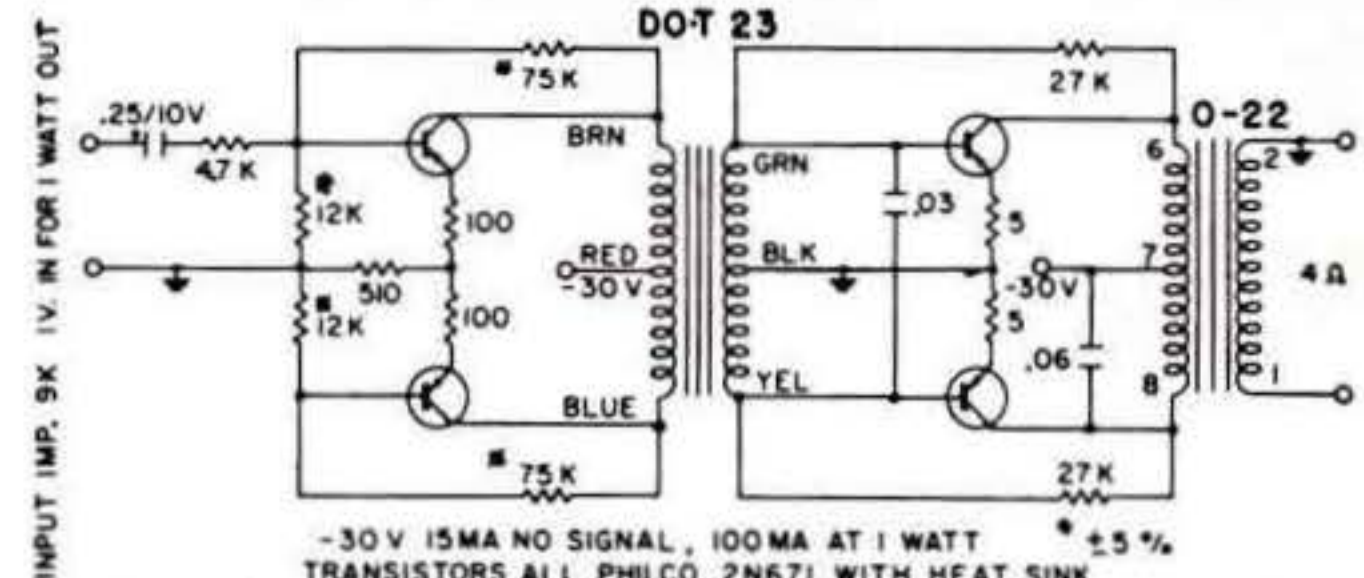

Circuit providing 1 watt, frequency range 200 Hz to 20 kHz

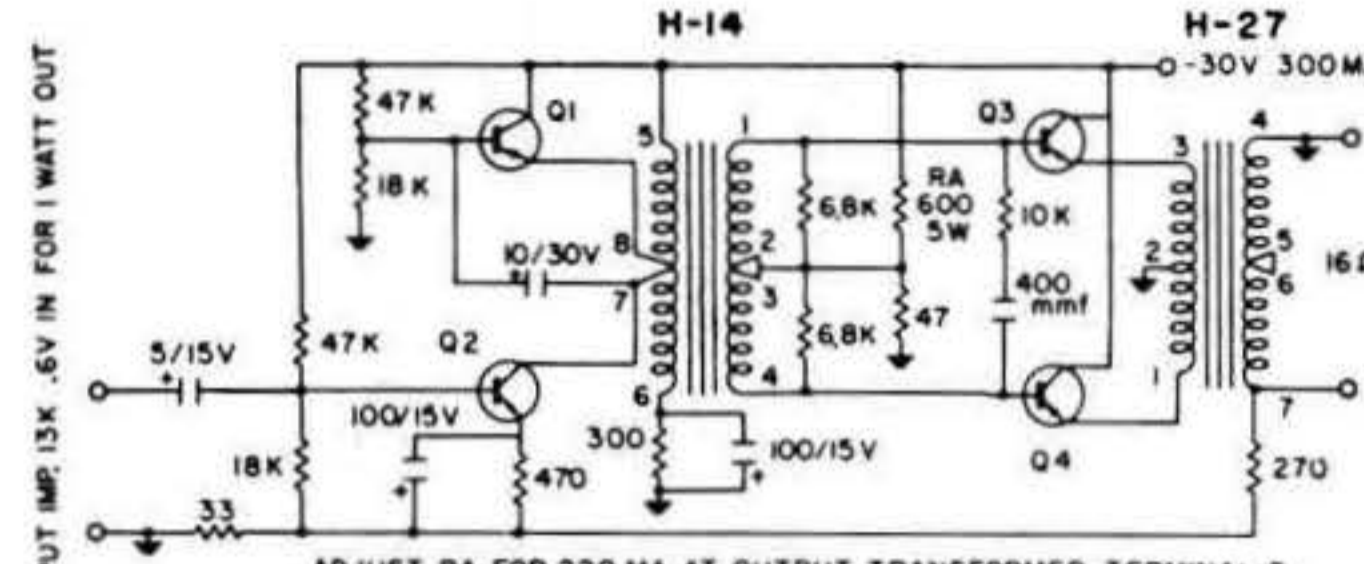

Circuit providing 1 watt, frequency range 40 Hz to 20 kHz

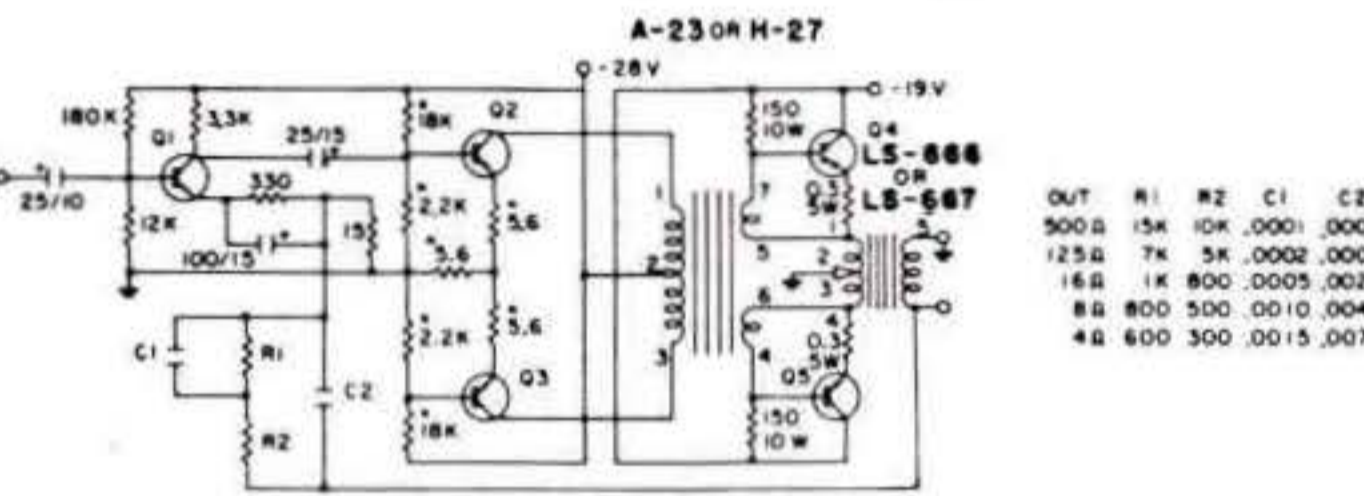

Circuit providing 50 watts, frequency range 20 Hz to 20 kHz

RECOMMENDED VACUUM TUBE AMPLIFIER CIRCUITS

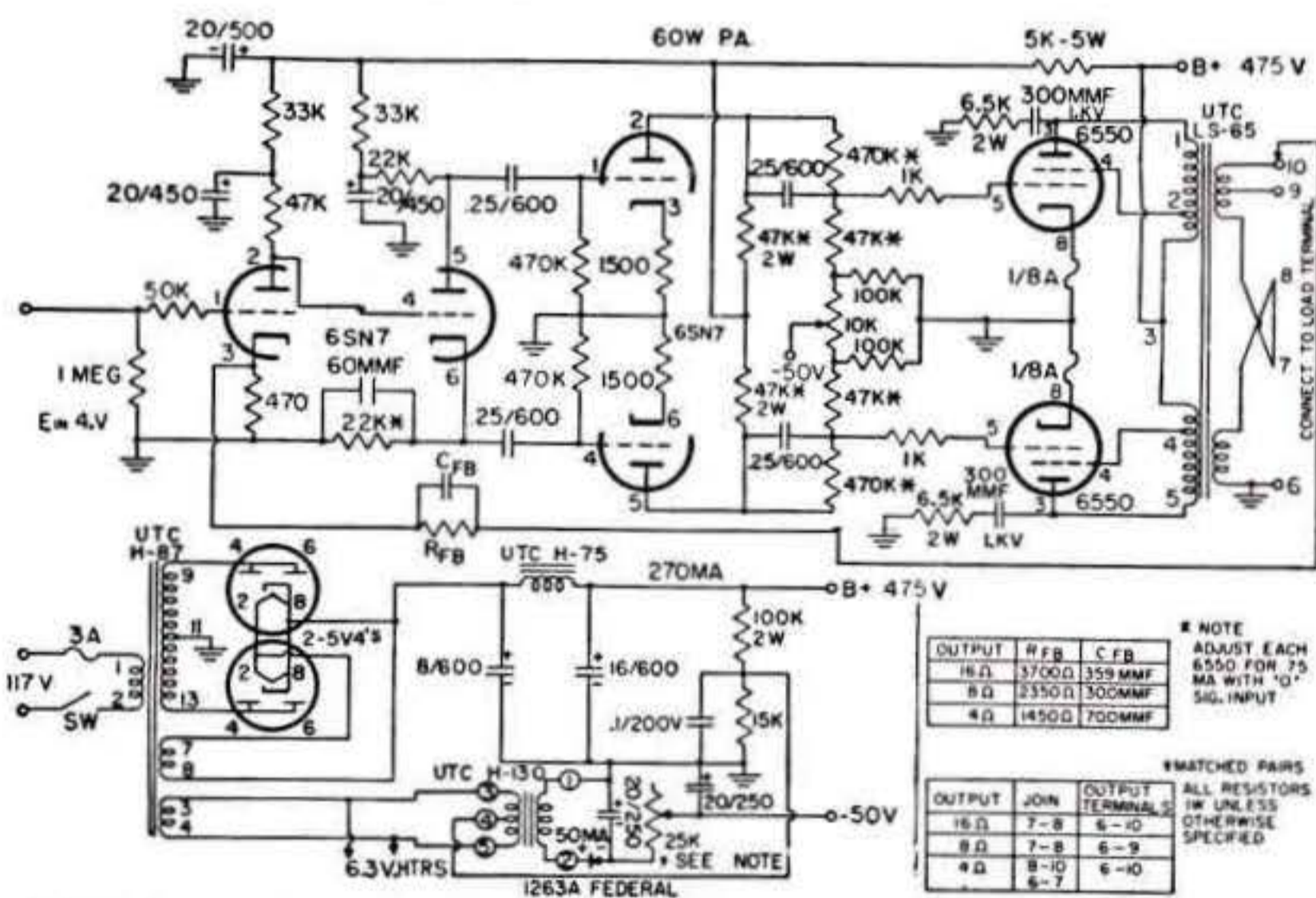

CIRCUIT PROVIDING 60 WATTS, ± 1 db from 15 Hz to 30 kHz ... At 1 watt, ± 1 db 3 Hz to 80 kHz.

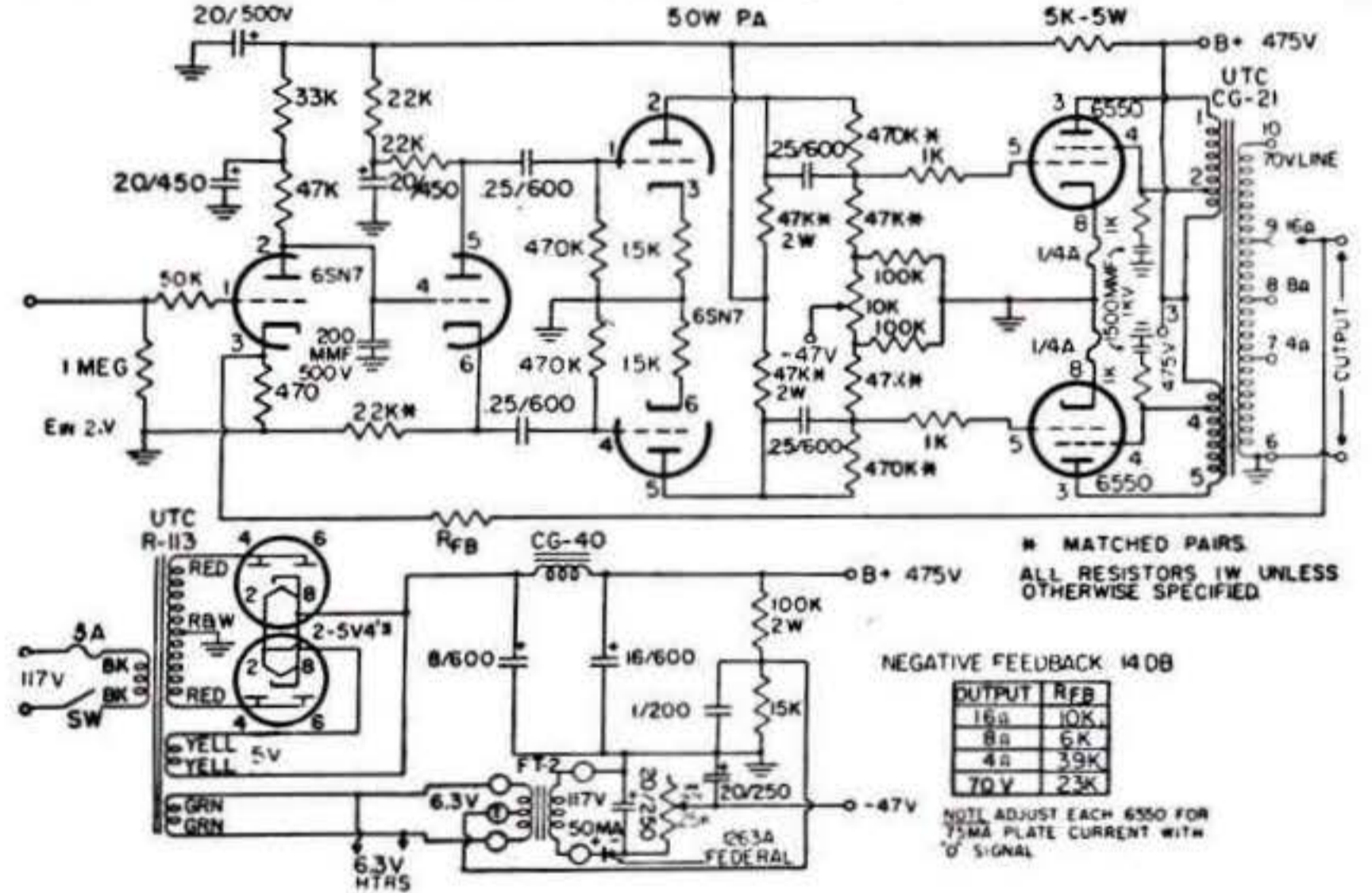

CIRCUIT PROVIDING 50 WATTS, ± 1 db 40 Hz to 10 kHz ... At 1 watt, ± 1 db 20 Hz to 20 kHz.

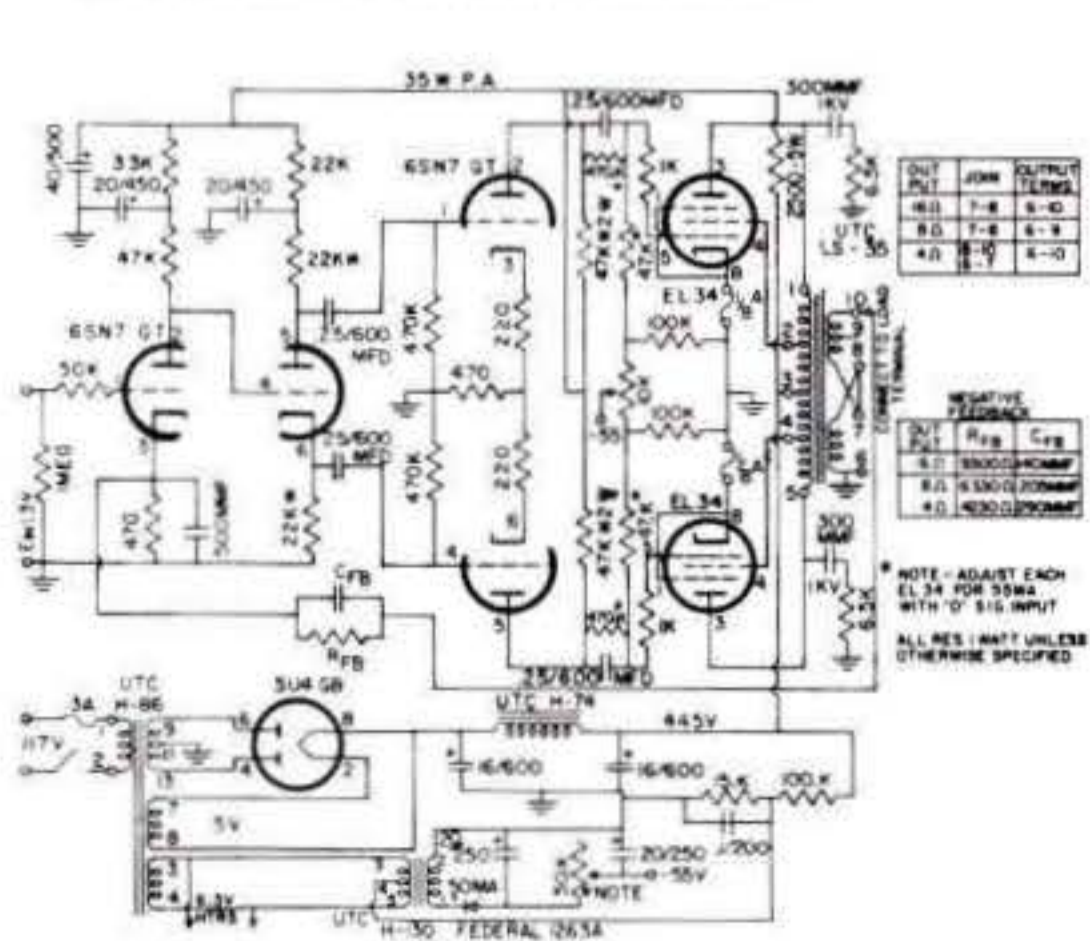

CIRCUIT PROVIDING 35 WATTS, ± 1 db from 15 Hz to 30 kHz ... At 1 watt, ± 1 db 7 Hz to 100 kHz.

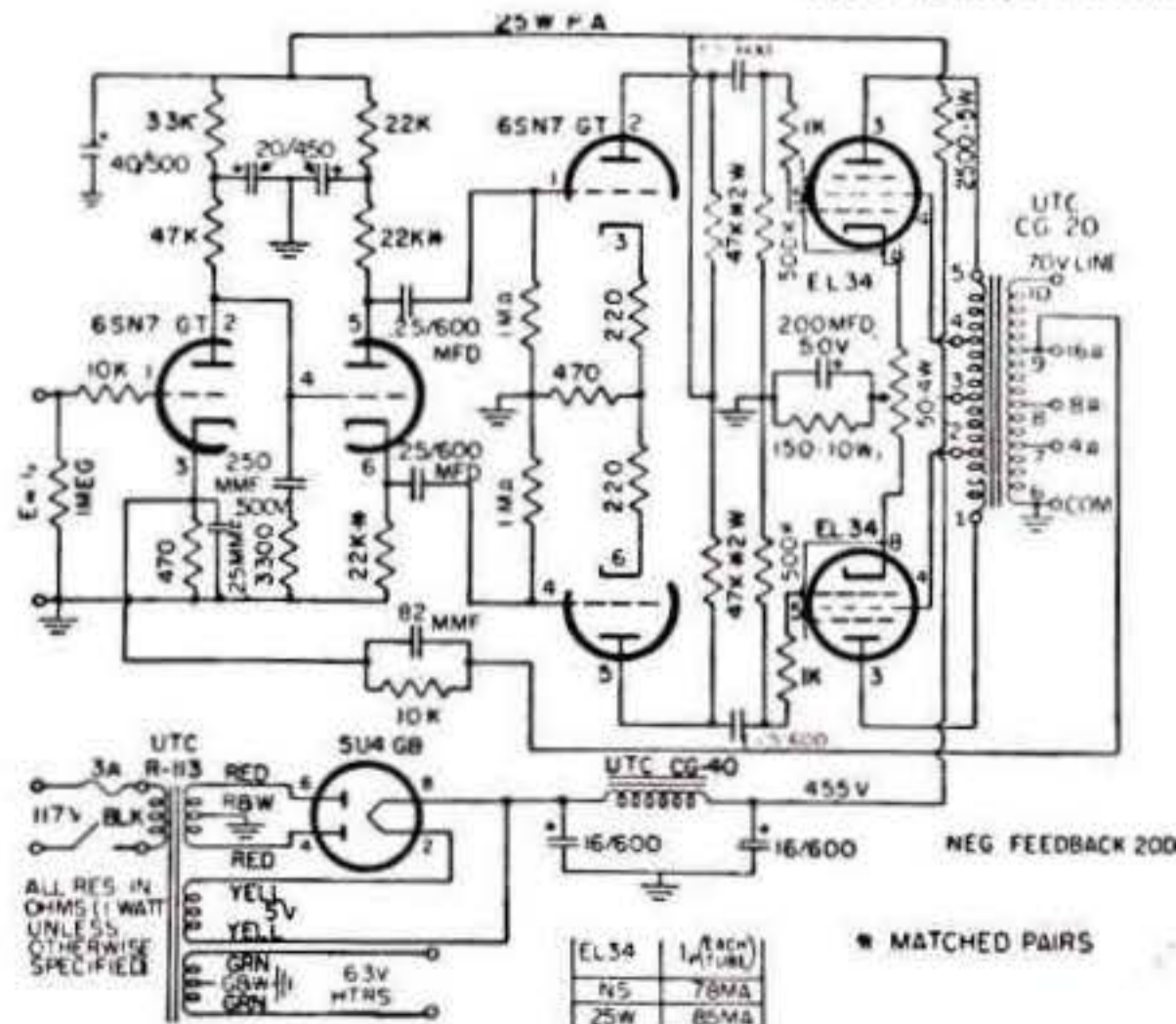

CIRCUIT PROVIDING 25 WATTS, ± 1 db 40 Hz to 10 kHz ... At 1 watt, ± 1 db 20 Hz to 20 kHz.

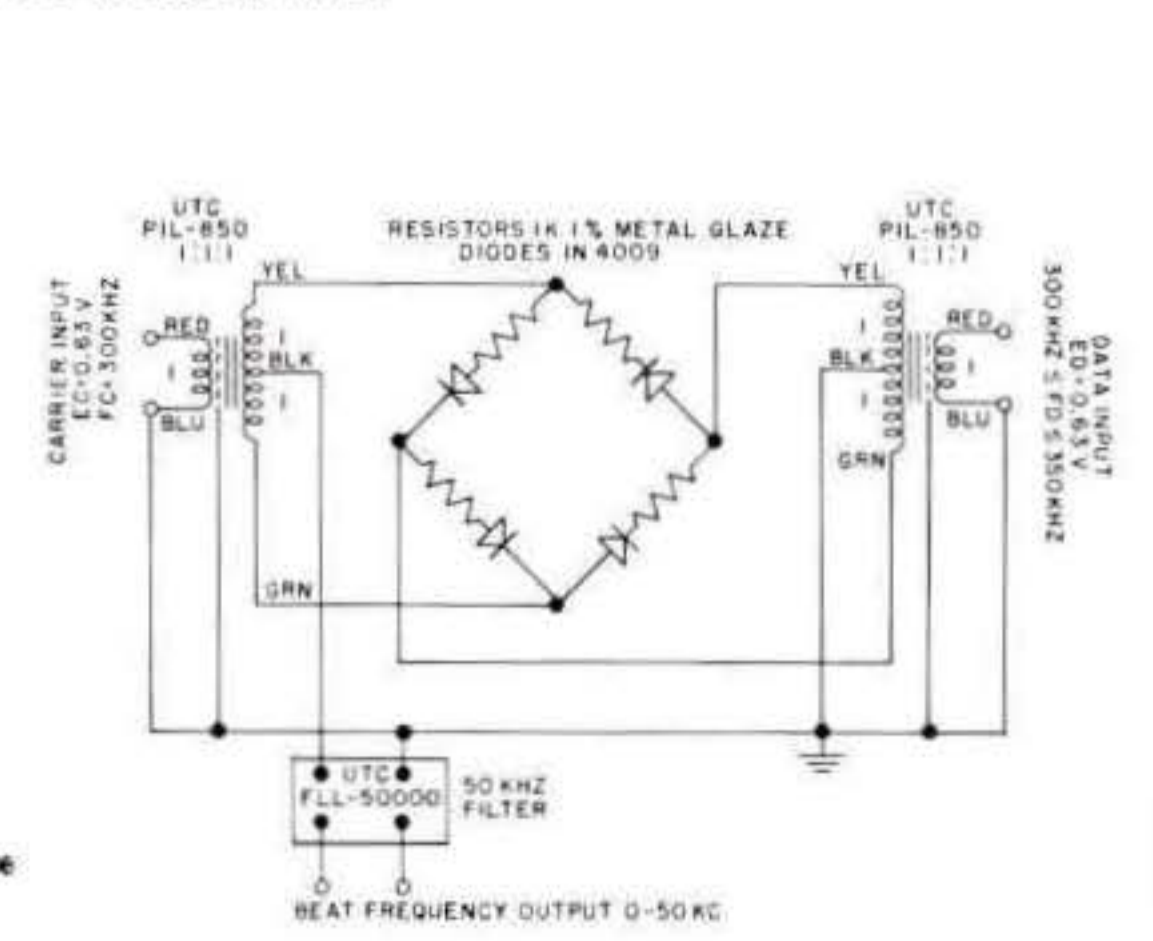

BALANCED MODULATOR—BEAT FREQUENCY MIXER



**SPECIAL CUSTOM BUILT
AUDIO COMPONENTS
TO YOUR SPECIFICATIONS**

In addition to the needs met by UTC stock audio components there are many unique applications which require special units. The illustrations below are intended to show some of the thousands of special units produced by UTC to customer's specifications. Range from .01 Hz to 400 MHz . . . microwatts to 50 KW.

Custom built variations of DO-T Family (pgs 6 through 11) units include: electrical changes of impedance ratings, electrostatic and/or electromagnetic shielding, high temperature insulation, lead length to 6 inches, units leaded at both ends, etc. These modifications can be made for any unit in the DO-T family.



DO-T leaded at both ends.

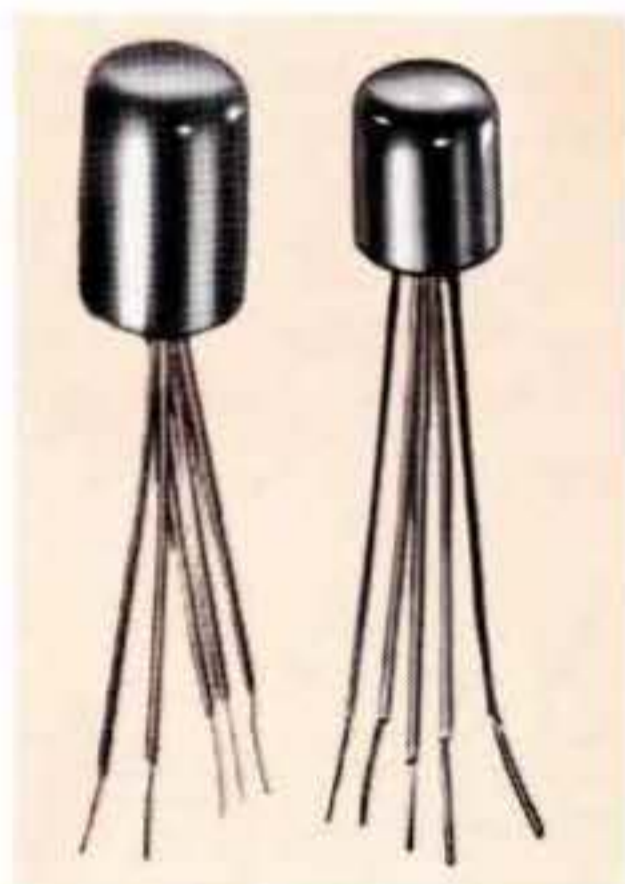

Units in Hipermalloy shields. See particular stock series (SH suffixed type no.) for size.

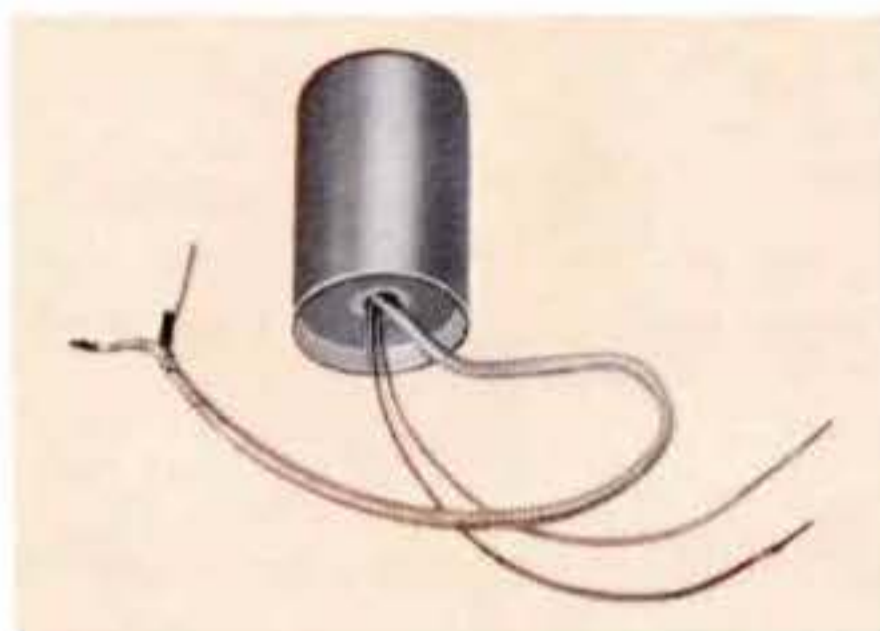

Microphone input transformer, double drawn hipermalloy shields. Shielded cable leads. Ratio 100:1. 1 5/16 Dia. x 1 1/32" high. Inductance greater than 1000 Hys. at 60 Hz.

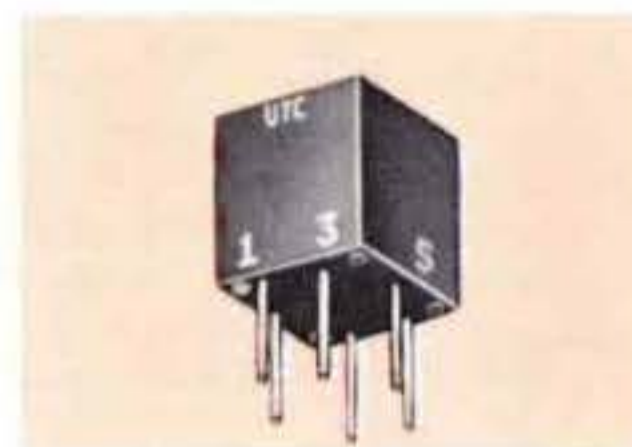

Molded, pin terminal unit. Packaging developed for and fully in accord with Micromodule program. Item shown is 10K ohms CT to 10K ohms CT, 100 mw from 400 Hz to 20 kHz. Life tested per micromodule requirements with no failures.



Thirty Hz cathode follower output transformer to provide equal voltages to 4 loads and supply a half-wave rectifier. Primary inductance maintained to 5% with 20% change in DC unbalance and 30% change in AC voltages.

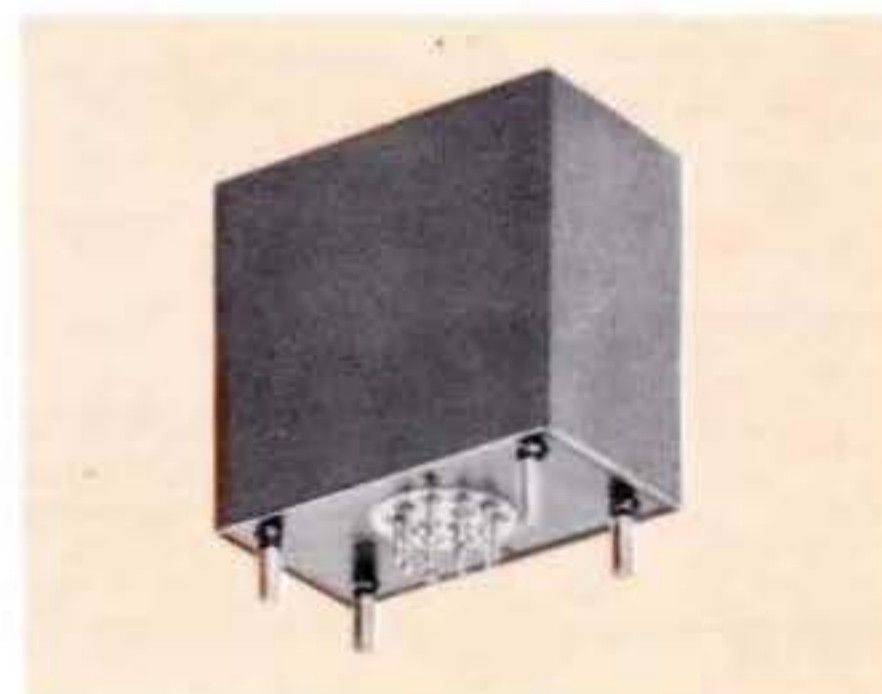

Bolometer transformer. Primary 10 ohms, secondary 530K ohms, 230:1 ratio, response from 1/2 Hz to 25 Hz. 120 db magnetic shielding, to 25 Hz. 120 db magnetic shield-plus full electrostatic shielding.



Toroidal transformer, primary 600 ohms, secondary 1200 ohms/split. From 1 kHz to 150 kHz, ±1 db at 10 mw max. Size: 1 1/8 Dia. x 3/8 inches. Weight: 25.6 grams. All types of toroidal transformers to specific requirements.



Low distortion 2.5 KW output transformer, PP 450 TH's 18,500 ohms CT to 24/6 ohms, 20 KV hipot. 520 lbs.



Current Transformer with 1 K load exhibits 1 V/amp/turn sensitivity. From 400 Hz to 30 kHz, ±0.1 db. Good linearity with both current, 1 mA-10 A; and turns, 1-5 T.



Molded carrier frequency transformer, + 8 dbm level. Within 3 db from 100 Hz to 100 kHz. 4000:4000 ohms. 3/4 Dia. x 5/8 inches, 1/3 oz.

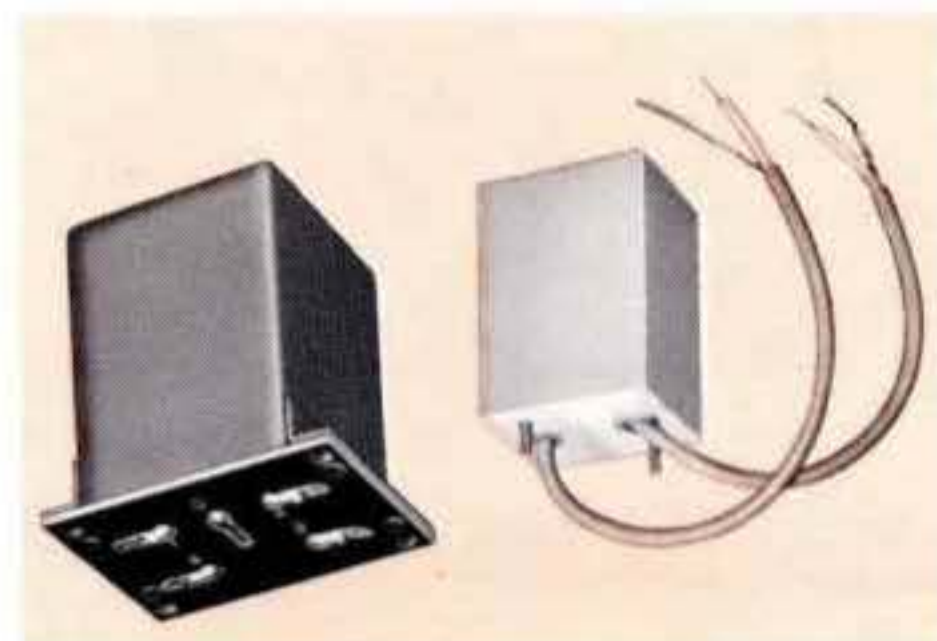

Special chopper type transformers with terminals or shielded leads; multiple high permeability magnetic shields; electrostatic shielding for voltage isolation of 2 x 10⁶.



Instrument reference transformer. To operate from 15 kHz to 20 kHz with 12.5 V on one half of primary and to deliver 9.0 V on each half of secondary; secondary halves loaded with different impedances. Size: 1.1 Dia. max. x .79" high max. Weight: 34 gms.



GENERAL INFORMATION ON POWER TRANSFORMERS & INDUCTORS

Power Transformers A power transformer transforms voltage and currents to higher or lower magnitudes with the purpose of converting prime supply voltages to specific application requirements.

UTC manufactures a wide variety of power transformers for military, space, industrial and commercial application.

Theory Basically, a transformer consists of two or more coils of wire inductively coupled to each other. When alternating current flows in one coil an alternating current of the same frequency is induced in the other coils. The magnitude of this voltage is a function of the relative number of turns on the coils and the degree of coupling. In a power transformer the coils are wound on a high permeability core, hence most of the flux is confined to the core and a high degree of coupling between coils is realized. This makes the voltage almost wholly dependent on the relative turns or the turns ratio.

Fundamentals The simplest transformer consists of two windings.

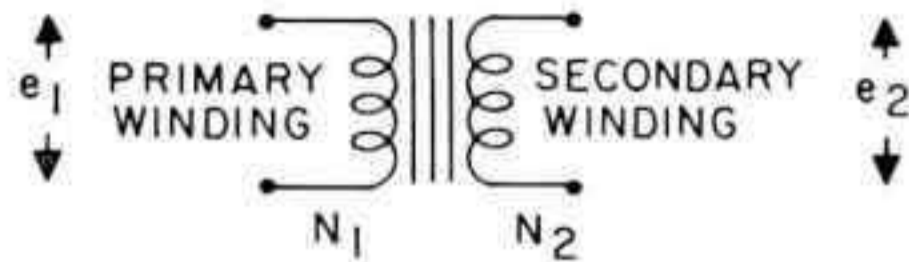

The primary winding is connected to the alternating current voltage source and the secondary winding is connected to the load.

The physical law governing induction in the windings is: $e = N \frac{d\phi}{dt} \times 10^{-8}$

This law can be stated: The voltage induced in a coil is proportional to the number of turns and to the time rate of change of magnetic flux in the coil.

In a power transformer the flux links between coil windings is almost perfect, consequently, $\frac{e_1}{e_2} = \frac{N_1}{N_2}$

where e_1 is the source of voltage and e_2 is the output voltage. $\frac{N_1}{N_2}$ is the turns ratio.

Equivalent Circuit For simplicity of analysis a transformer with a $\frac{N_1}{N_2} = 1$ is shown. This model can be extended to other turns ratios by the use of scaling factor $(\frac{N_1}{N_2})^2$.

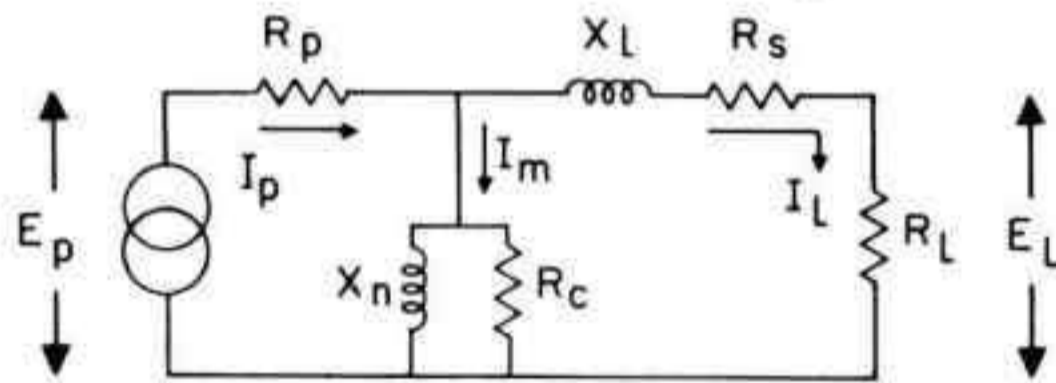

- R_p = Primary winding DC resistance
- R_s = Secondary winding DC resistance
- X_n = Represents an inductive reactance that causes a current to flow which produces the flux in the transformer magnetic core.
- R_c = Is a resistance that represents the losses in the magnetic core of the transformer. These losses are of two types: hysteresis and eddy currents. Hysteresis refers to losses due to movement of the core molecules. Eddy currents are the currents induced in the core due to core material conductivity.
- X_L = Represents an inductive reactance caused by the magnetic flux that does not couple both coils. It is shown as an inductance and is the result of imperfect coupling. This parameter is called leakage inductance.
- R_L = Load resistance represents the device that is being powered by the transformer and constitutes useful power.
- E_p = Input Voltage
- I_p = Input Current
- I_m = Current due to X_n and R_c called magnetization or exciting current.
- E_L = Load Voltage
- I_L = Load Current

Vector Diagram

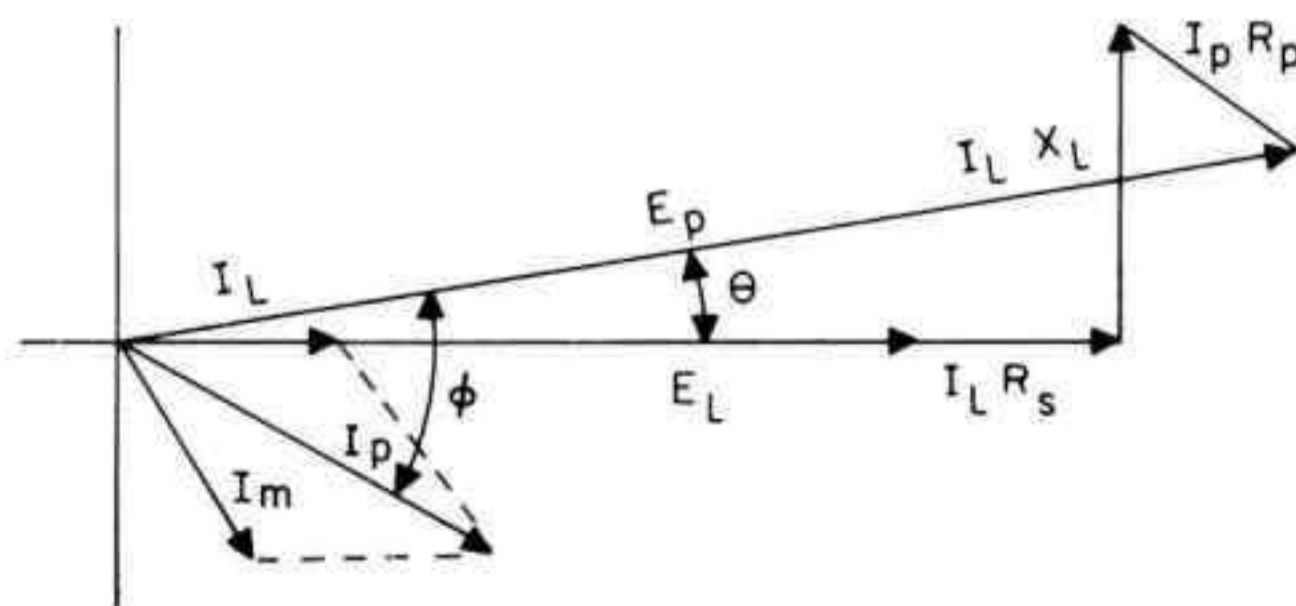

The diagram shows the result of the transformers parameters considered in the equivalent circuit and their terminology.

Although we assumed a $\frac{N_1}{N_2} = 1$ transformer E_L is smaller than E_p due to voltage drops $I_L R_s$, $I_p R_p$ & $I_L X_L$. In the unloaded transformer I_L would not exist and I_p would equal I_m , which normally is small compared to I_L . Consequently,

$$\frac{E_p}{E_L} = \frac{N_1}{N_2} \text{ very closely.}$$

Unloaded Loaded

1. Percent regulation = $100 \frac{(E_{NL} - E_L)}{E_L \text{ Loaded}}$
2. Power Factor = $\frac{\text{Output power plus losses}}{\text{Input volt-amps}}$ and is numerically equal to cosine ϕ .
3. Efficiency = $\frac{\text{Output power}}{\text{Output power plus losses}}$
4. Phase Shift between E_L & E_p sine wave shown as angle θ .

Actual losses which show up as heat in the transformer and cause a temperature rise shown up in the diagram at the following points:

1. Core loss = $I_m^2 R_c$
 2. Primary winding losses = $I_p^2 R_p$
 3. Secondary winding losses = $I_L^2 R_s$
- Total losses is the sum of these losses.

Power Inductors An inductor is used to impede the flow of AC current. They offer a high impedance to alternating currents but allow DC current to flow.

The principal purpose of these inductors is to reduce the AC ripple in rectifier power supplies in conjunction with capacitors. They are specified by inductance and DC current capability.

Hermetic Power Components

Highest Industrial and Military Reliability UTC hermetic power components have found wide acceptance for industrial electronics equipment where the highest reliability is important. The insulation operating temperature (ambient temperature plus transformer's temperature rise) in a transformer considerably controls its life and reliability.

For military application ambient is based on 65°C, for Class R units. This allows a 40°C rise for the maximum final temperature of 105°C prescribed for Class R units in MIL-T-27C.

The power transformers and inductors listed on pages 32 through 41 are available, on request, built to Class S specifications. These units are allowed a maximum final temperature of 130°C. MIL-T-27C allows the use of a higher temperature class unit for a lower temperature application. Therefore, a Class S unit may be used in a Class R application. Class S units are equally as reliable at Class R temperatures.

Industrial applications ambients are appreciably lower. As a result, the temperature rise can be approximately 15°C higher (40°C to 55°C rise), still providing the same overall life and reliability. This results in the ability to operate the same components at somewhat greater ratings.

The listings of our power transformers, filament transformers, plate transformers, and filter inductors are given for both MIL-T-27C and industrial service, the latter in bold type.

These units exceed MIL-T-27C requirements in many respects. The insulations employed have exceptional safety factors. The use of special core materials provides high efficiency and small size. The transformer regulation has been a fundamental design consideration in all units to provide for diverse applications in which they may be employed.

Dual Voltage Ratings UTC hermetic plate and power transformers incorporate a tapped high voltage winding to provide either of two secondary voltages for greatest versatility. For full understanding of the capabilities of these components, the DC voltage and permissible currents have been listed for both inductor and condenser input at both output voltages as well as for military and industrial service.

Multiple Rating Filter Inductors The "H" series of filter inductors are designed and rated with inductance shown for four different current values. The industrial ratings are shown in bold type. These units are 100% tested to exceed the inductance value specified at the maximum military current rating shown.

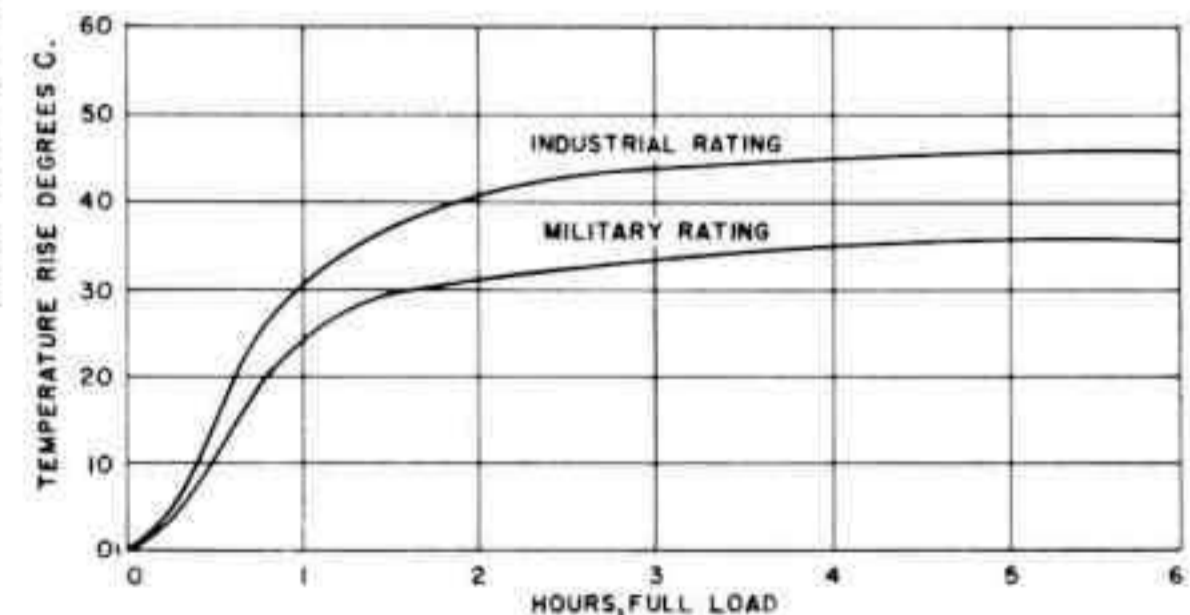

Special Designs In addition to the needs met by UTC stock power components, there are many unique applications which require special units. These custom designs, produced to customer specifications, range from milliwatts to 100 KVA capacity. They comprise temperature ranges from Class R (105°C) to Class U (higher than 170°C). All types of mechanical and electrical configurations are available. Special engineering emphasis is placed on customer requirement.

Our engineering and laboratory facilities are uniquely equipped to handle customer problems in tough design areas such as shielding, corona, reliability, high voltage, miniaturization, etc.

Facilities are available for production of samples as well as large quantities. The close coordination between our sample shop and production assures production quantity equal to sample quality.

STANDARD POWER TRANSFORMER & INDUCTOR SELECTION GUIDE

Product Series	Description	Size	Weight	Frequency	Power Range	Page
Military Type						
DO-T400	Flexible lead ultraminiature power transformer. Hermetically sealed to MIL-T-27C Grade 4, Metal Clad.	$\frac{5}{16}$ dia x $1\frac{13}{32}$ " long	1/10 oz	380 Hz to 2400 Hz	400 mW	37
H	Inductors. Hermetically sealed inductor to MIL-T-27C Grades 4 & 5.	$\frac{3}{4}$ x 1 x $2\frac{23}{32}$ " h to 7 x 7 x 8" h	.05 lb to 60 lbs	.017 A to 30 A*	0.4 mHy to 450 Hys†	12, 13 14, 36
H	Hermetically sealed to MIL-T-27C. Grades 4 & 5. Transistor, filament, inverter and plate type. Metal clad & molded.	$\frac{3}{4}$ x $\frac{7}{8}$ x $\frac{9}{16}$ " h to 11 x 11 x $14\frac{3}{4}$ " h	.04 lb to 160 lbs	50 Hz to 2500 Hz	1.2 VA to 5.0 KVA	32 thru 40
HIT	Ultra-shielded power line isolation transformers. Hermetically sealed to MIL-T-27C. Grade 4. 0.1 mfd or less, effective coupling.	$4\frac{1}{32}$ x $4\frac{1}{32}$ x $3\frac{1}{32}$ " h to 8 x $6\frac{17}{32}$ x $5\frac{17}{32}$ " h	5 lbs to 60 lbs	50 Hz to 400 Hz	50 W to 1200 W	40
MAT	Transformer, hermetically sealed; for magamp and other applications. MIL-T-27C, Grade 4.	1 d x $1\frac{3}{8}$ " h to $2\frac{5}{16}$ x $2\frac{1}{16}$ x $3\frac{3}{8}$ " h	1 oz to $1\frac{3}{4}$ lb	60 Hz to 400 Hz	100 mW to 20 VA	48, 49
MET	Hermetically sealed metal clad to MIL-T-27C. Grade 4. For 400 Hz application to give min size. Transistor, filament, universal types.	$\frac{61}{64}$ x $1\frac{13}{32}$ x $1\frac{17}{16}$ " h to $3\frac{1}{16}$ x $2\frac{5}{8}$ x $4\frac{1}{4}$ " h	$1\frac{1}{2}$ oz to $4\frac{1}{2}$ lbs	380 Hz to 2400 Hz	1.4 W to 240 W	32, 33 & 37
N	Mil. St'd. filament & plate transformers per MIL-T-27C. Grade 4 (ruggedized) construction.	$1\frac{15}{16}$ x $1\frac{13}{16}$ x $2\frac{7}{16}$ " h to $5\frac{1}{16}$ x $4\frac{5}{16}$ x $5\frac{1}{2}$ " h	$1\frac{5}{16}$ lbs to 16½ lbs	50 Hz to 400 Hz	7.5 W to 400 W	41
NV	Inverter transformer, miniature. Hermetically sealed to MIL-T-27C, Grade 4, Class V. Multiple outputs.	$1\frac{9}{16}$ x $1\frac{9}{16}$ x $1\frac{13}{16}$ " h to $1\frac{1}{4}$ x $1\frac{1}{4}$ x $1\frac{13}{16}$ " h	1.2 to 2.5 oz	10 kHz, 20 kHz, 50 kHz	32.5 VA to 89 VA	35
SRC	Transformer, hermetically sealed to MIL-T-27C, Grade 4. Precision Scott-T reference	$1\frac{5}{8}$ x $1\frac{5}{8}$ x $2\frac{3}{8}$ " h	2/3 lb	60 Hz to 400 Hz	6 VA	40
Z	Mil. St'd. inductors per MIL-T-27C. Hermetically sealed. Series & parallel connections.	$2\frac{5}{16}$ x $2\frac{1}{16}$ x $3\frac{1}{8}$ " h to $4\frac{13}{16}$ x $5\frac{15}{16}$ x $7\frac{1}{2}$ " h	2 lbs to 35 lbs	80 mA to 630 mA*	4 Hys to 40 Hys†	41
Industrial and Commercial Types						
A	Ultra compact components, small & light in weight. Ideal for remote amplifier and similar compact equipment.	$1\frac{1}{2}$ sq x 2" h	$\frac{1}{2}$ lb	60 Hz 15 ma to .4 A*	2.5 VA 60 mhy to 60 hys†	20, 21
CG	High quality. Transistor filament & plate use. Designed to AIEE. Rugged drawn steel cases or end castings. Vacuum impregnated & compound filled.	$1\frac{13}{16}$ sq x $2\frac{1}{2}$ " h to 21 x 10 x $13\frac{1}{4}$ " h	1 lb to 253 lbs	50/60 Hz	7.5 VA to 4950 VA	42
CG	(Inductor) High quality inductors. (As above)	$2\frac{9}{16}$ x $2\frac{3}{32}$ x $3\frac{1}{4}$ " h to $11\frac{1}{2}$ x $4\frac{3}{4}$ x $6\frac{7}{8}$ " h	$2\frac{1}{2}$ lbs to 40 lbs	15 ma to 5 A*	2.5 mhy to 250 hys†	42
FT	Channel frame, filament/transistor transformers. For 2.5 VCT to 48 VCT. From .04A to 10 A.	$2\frac{1}{8}$ x $1\frac{3}{8}$ x $1\frac{1}{4}$ " h to $4\frac{1}{8}$ x $2\frac{5}{8}$ x $2\frac{5}{8}$ " h	$\frac{1}{4}$ lb to $2\frac{1}{2}$ lbs	50/60 Hz	7.5 VA to 48 VA	44
HP	Pre-amplifier or tuner supply. Rugged die cast case of high conductivity alloy. For portable & compact service.	$2\frac{3}{8}$ x $1\frac{15}{16}$ x $3\frac{1}{8}$ " h to $3\frac{9}{16}$ x $2\frac{13}{16}$ x $3\frac{1}{2}$ " h	2 lbs to 5 lbs	50/60 Hz	18 VA to 35 VA	25
PF	For photoflash and similar applications. Line and transistor inputs. Power, inverter & trigger types.	$\frac{7}{8}$ d x $1\frac{5}{16}$ " h to $2\frac{1}{2}$ x $3\frac{3}{4}$ x $2\frac{5}{32}$ " h	$\frac{1}{2}$ oz to 2 lbs	Trigger DC Inverter $4\frac{1}{2}$ V DC 50/60 Hz	6 KV pulse to 15 KV pulse 40 Watt-Sec	45
R	(Inductors) Replacement types, channel frame construction. Vacuum sealed to prevent corrosion.	$2\frac{3}{8}$ x $1\frac{3}{8}$ x $1\frac{3}{8}$ " h to $4\frac{1}{8}$ x $2\frac{1}{4}$ x $2\frac{5}{8}$ " h	$\frac{1}{2}$ lb to $2\frac{1}{2}$ lbs	30 ma to 5 A*	2 mhys to 5 hys†	44, 45
R	Replacement type line adjusting and isolation transformers. High reliability. Vacuum sealed to prevent corrosion. Housed in protective shells.	$2\frac{5}{8}$ x $2\frac{13}{16}$ x $3\frac{1}{4}$ " h to 12 x 7 x 9" h	$2\frac{1}{2}$ lbs to 70 lbs	50/60 Hz	50 VA to 2500 VA	44, 45
S	Popular-priced series for filament transistor & plate use. Ratings are based on ICAS intermittent use. Vacuum impregnated & compound filled.	$1\frac{1}{8}$ x $2\frac{13}{16}$ x $1\frac{3}{4}$ " h to $10\frac{1}{4}$ x $7\frac{3}{8}$ x $9\frac{1}{4}$ " h	1 lb to 52 lbs	50/60 Hz	7.5 VA to 1400 VA	43
S	(Inductors) (As above)	$\frac{7}{8}$ x $2\frac{13}{16}$ x $1\frac{3}{4}$ " h to $4\frac{5}{8}$ x $5\frac{3}{8}$ x $5\frac{3}{8}$ " h	1 lb to 12 lbs	3 ma to 5 A*	2 mhys to 500 hys†	43
SC	Signalling & control transformers, for operating relays, sirens, horns, gongs, etc. 4/8/12/16/20/24 volts. Screw type binding posts secondary terminals for easy connections.	3 x $3\frac{1}{2}$ x $\frac{9}{16}$ " h to 4 x 5 x $4\frac{3}{4}$ " h	3 lbs to 10 lbs	50 Hz to 60 Hz	50 W to 250 W	45

* DC Current Rating.

† Inductance Range.

STANDARD MAGNETIC AMPLIFIER SELECTION GUIDE

Product Series	Description	Size	Weight	Frequency	Page
MAS	Solid state push pull magnetic amplifier. High gain, hermetically sealed. Plug-in octal header.	$1\frac{1}{2}$ d x 3" h	$\frac{1}{2}$ lb	400 Hz	49
MAT	Hermetically sealed. MIL-T-27C, Grade 4, for servo motors and other applications. Tube and transistor inputs.	$1\frac{1}{4}$ x $1\frac{15}{16}$ x $2\frac{5}{16}$ " h to $4\frac{11}{16}$ x 4 x $4\frac{15}{16}$ " h	.65 lb to 14 lbs	60 Hz & 400 Hz	48, 49



UNIVERSAL TRANSISTOR SUPPLY TRANSFORMERS

PACKAGING Hermetically sealed. Drawn metal case to Mil Grade 4.

MIL SPECS To complete MIL-T-27C Specs. See pages 86, 87. Mil Type: TF4SX02 plus two letter case code.

NOTES Chart, on facing page, shows the secondary AC voltages available, and the approximate DC voltages resulting, in typical capacitive filter silicon rectifier circuits (at the indicated currents). Since the capacitor following the rectifier affects the DC, voltage values used (in 1000 mfd) are shown in parenthesis () after each current rating. Case dimensions on page 51.

Primary taps can modify nominal AC voltages by -6%, +6%, and +12%.



INCLUDING MET™ SERIES

Primary 115 Volts, 50/60 Hz Nominal Sec. Volts, 8.25 to 40.5

Type No.	MIL DC Range	Indust. DC Range	MIL Case (Pg. 51)
H-915	6V-.065A to 53V-.02A	6V-.085A to 53V-.025A	AH
H-925	6V.22A to 53V-.07A	6V-.28A to 53V-.085A	AJ
H-935	6V-1.2A to 53V-.4A	6V-1.52A to 53V-.48A	FA
H-94	6V-3A to 53V-1A	6V-3.8A to 53V-1.2A	HA
H-95	6V-7.5A to 53V-2.5A	6V-9A to 53V-3A	KA
H-96	6V-18A to 53V-6A	6V-23A to 53V-7.5A	OA

Primary 115 Volts, 50/60 Hz Nominal Sec. Volts, 16.5 to 81

H-965	12V-1.5A to 106V.5A	12V-1.9A to 106V-.6A	HA
-------	---------------------	----------------------	----

Primary 115 Volts 400 Hz Nominal Sec. Volts, 8.25 to 40.5

MET-445	6V-.6A to 53V-.2A	6V-.75A to 53V-.24A	AH
MET-455	6V-1.2A to 53V-.4A	6V-1.52A to 53V-.48A	AJ
MET-465	6V-3A to 53V-1A	6V-3.8A to 53V-1.2A	FA
MET-475	6V-7.5A to 53V-2.5A	6V-9A to 53V-3A	HA

Primary 115 Volts, 400 Hz Nominal Sec. Volts, 16.5 to 81

MET-495	12V-.6A to 106V-.2A	12V-.76A to 106V-.24A	AJ
---------	---------------------	-----------------------	----

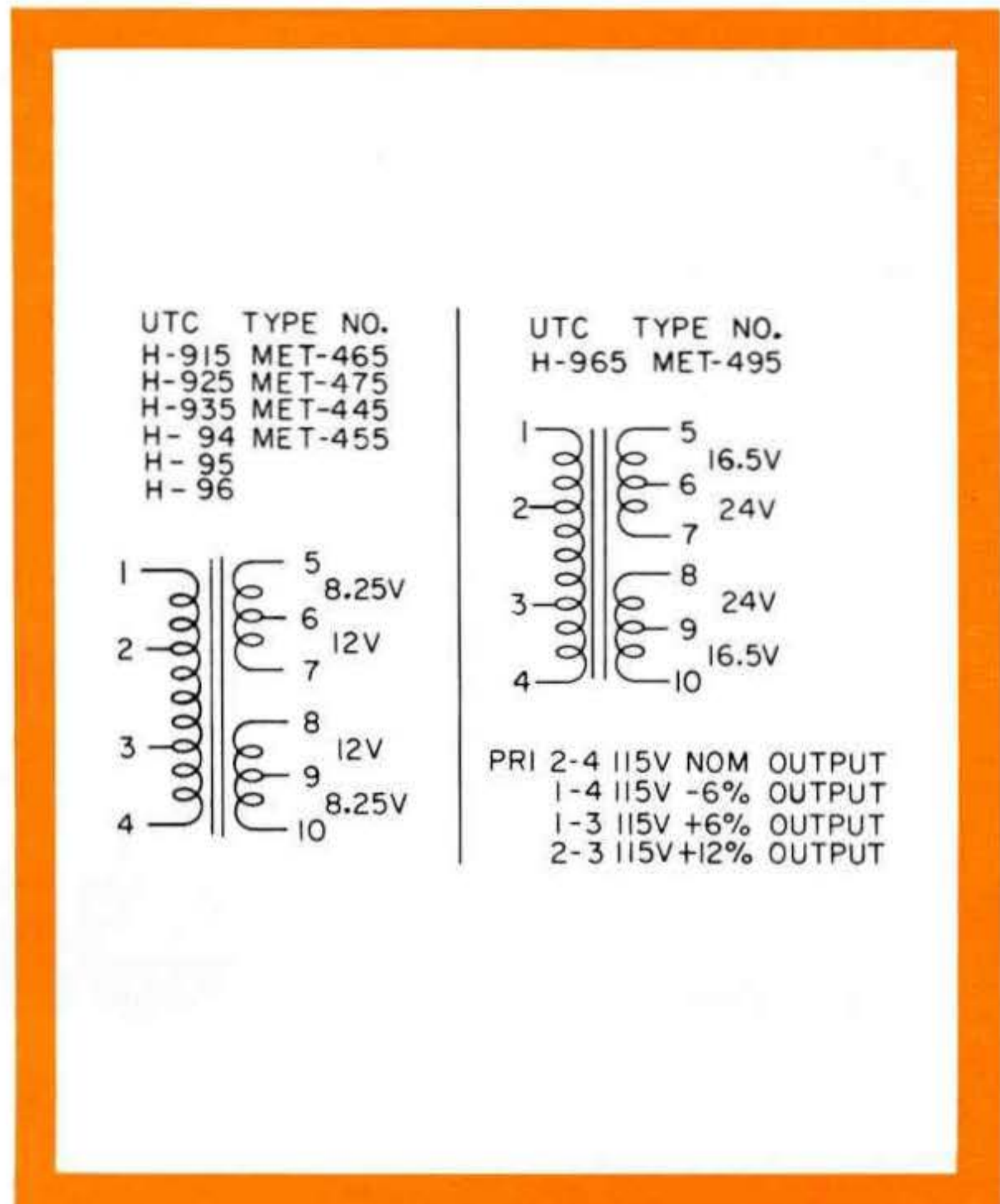

AC & DC VOLTAGES @ INDICATED CURRENTS

MIL-T-27C RATINGS IN REGULAR TYPE, INDUSTRIAL RATINGS IN BOLD TYPE

← FULL WAVE BRIDGE SILICON RECTIFIER → ← FULL WAVE CT →

SECONDARY AC VOLTAGES & APPROXIMATE DC VOLTAGES

Nom. AC Volts*	40.5	32.25	28.5	24	20.25	16.5	12	8.25	40.5 CT	24 CT	16.5 CT
Appr. DC Volts*	53	41	34	25	24	18	12	6	24	12	6.6

DC AMPERES (Capacitance in Parenthesis)
60 Hz TYPES

Type No.	40.5	32.25	28.5	24	20.25	16.5	12	8.25	40.5 CT	24 CT	16.5 CT
H-915	.02 (.1)	.023(.1)	.025(.1)	.027(.1)	.042(.2)	.035(.2)	.055(.2)	.065(.2)	.035(.2)	.040(.2)	.055(.2)
H-915	.025(.1)	.035(.1)	.040(.1)	.042(.1)	.055(.2)	.042(.2)	.070(.2)	.085(.2)	.042(.2)	.055(.2)	.068(.2)
H-925	.07 (.1)	.08 (.1)	.085(.1)	.09 (.1)	.14 (.2)	.11 (.2)	.18 (.2)	.22 (.2)	.11 (.2)	.13 (.2)	.17 (.2)
H-925	.085(.1)	.12 (.1)	.13 (.1)	.14 (.1)	.18 (.2)	.14 (.2)	.23 (.2)	.28 (.2)	.14 (.2)	.17 (.2)	.21 (.2)
H-935	.4 (.5)	.44 (.5)	.48 (.5)	.52 (.5)	.8 (1.0)	.6 (1.0)	1.0 (2.0)	1.2 (2.0)	.6 (1)	.72 (1)	.92 (2)
H-935	.48 (.5)	.6 (.5)	.6 (.5)	.64 (.5)	1.0 (1.0)	.8 (1.0)	1.2 (2.0)	1.52 (2)	.8 (1)	.88 (1)	1.12 (2)
H-94	1 (.5)	1.1 (.5)	1.2 (.5)	1.3 (.5)	2 (1)	1.5 (1)	2.5 (2)	3 (2)	1.5 (1)	1.8 (1)	2.3 (2)
H-94	1.2 (.5)	1.5 (.5)	1.5 (.5)	1.6 (.5)	2.5 (1)	2 (1)	3 (2)	3.8 (2)	2 (1)	2.2 (1)	2.8 (2)
H-95	2.5 (1)	3 (1)	3 (1)	3.5 (1)	5 (2)	3.7 (2)	6 (4)	7.5 (4)	3.7 (2)	4.5 (2)	5.5 (4)
H-95	3 (1)	3.5 (1)	3.8 (1)	4 (1)	6 (2)	4.5 (2)	7.5 (4)	9 (4)	4.5 (2)	5.5 (2)	6.7 (4)
H-96	6 (4)	7 (4)	7.5 (4)	8 (4)	12 (6)	9 (6)	15 (12)	18 (12)	9 (6)	11 (6)	13.5 (12)
H-96	7.5 (4)	8.5 (4)	9.5 (4)	10 (4)	15 (6)	11 (6)	19 (12)	23 (12)	11 (6)	13.5 (6)	17 (12)

400 Hz TYPES

MET-445	.2 (.15)	.22 (.15)	.24 (.15)	.26 (.15)	.4 (.25)	.3 (.25)	.5 (.5)	.6 (.5)	.3 (.25)	.36 (.25)	.46 (.5)
MET-445	.24 (.15)	.3 (.15)	.3 (.15)	.32 (.15)	.5 (.25)	.4 (.25)	.6 (.5)	.75 (.5)	.4 (.25)	.44 (.25)	.56 (.5)
MET-455	.4 (.15)	.44 (.15)	.48 (.15)	.52 (.15)	.8 (.25)	.6 (.25)	1.0 (.5)	1.2 (.5)	.6 (.25)	.72 (.25)	.92 (.5)
MET-455	.48 (.15)	.6 (.15)	.6 (.15)	.64 (.15)	1.0 (.25)	.8 (.25)	1.2 (.5)	1.52 (.5)	.8 (.25)	.88 (.25)	1.12 (.5)
MET-465	1 (.15)	1.1 (.15)	1.2 (.15)	1.3 (.15)	2 (.25)	1.5 (.25)	2.5 (.5)	3 (.5)	1.5 (.25)	1.8 (.25)	2.3 (.5)
MET-465	1.2 (.15)	1.5 (.15)	1.5 (.15)	1.6 (.15)	2.5 (.25)	2 (.25)	3 (.5)	3.8 (.5)	2 (.25)	2.2 (.25)	2.8 (.5)
MET-475	2.5 (.25)	3 (.25)	3 (.25)	3.5 (.25)	5 (.5)	3.7 (.5)	6 (1)	7.5 (1)	3.7 (.5)	4.5 (.5)	5.5 (1)
MET-475	3 (.25)	3.5 (.25)	3.8 (.25)	4 (.25)	6 (.5)	4.5 (.5)	7.5 (1)	9 (1)	4.5 (.5)	5.5 (.5)	6.7 (1)

SECONDARY AC VOLTAGES & APPROXIMATE DC VOLTAGES

Nom. AC Volts*	81	64.5	57	48	40.5	33	24	16.5	81 CT	48 CT	33 CT
Appr. DC Volts*	106	82	68	50	48	36	24	12	48	24	13

DC AMPERES (Capacitance in Parenthesis)
60 Hz TYPE

Type No.	81	64.5	57	48	40.5	33	24	16.5	81 CT	48 CT	33 CT
H-965	0.5 (.125)	0.55 (.125)	0.6 (.125)	0.65 (.125)	1.0 (.25)	0.75 (.25)	1.25 (.5)	1.5 (.5)	0.75 (.25)	0.9 (.25)	1.15 (.5)
H-965	0.6 (.125)	0.75 (.125)	0.75 (.125)	0.8 (.125)	1.25 (.25)	1.0 (.25)	1.5 (.5)	1.9 (.5)	1.0 (.25)	1.1 (.25)	1.4 (.5)

400 Hz TYPE

MET-495	.2 (.04)	.22 (.04)	.24 (.04)	.26 (.04)	.4 (.06)	.3 (.06)	.5 (.06)	.6 (.06)	.3 (.06)	.36 (.06)	.46 (.06)
MET-495	.24 (.04)	.3 (.04)	.3 (.04)	.32 (.04)	.5 (.06)	.4 (.06)	.6 (.06)	.76 (.06)	.4 (.06)	.44 (.06)	.56 (.06)

*Nom. AC and DC volts are at 115 volt input . . . primary taps can modify -6%, +6%, and +12%.



TRANSISTOR INVERTER AND CONVERTER TRANSFORMERS

PACKAGING Hermetically sealed. Metal cased Mil Grade 4.

CONSTRUCTION Layer construction instead of random wound coil gives highest reliability. Advanced coupling technique, between windings, reduce spikes that often endanger driving transistors.

FREQUENCY Approximately 1000 Hz.

INPUT VOLTAGE 12/14 V or 24/28 V. With 6/7 V instead of 12/14 V output voltage is halved, current rating remains the same.

MIL SPECS To complete MIL-T-27C Specs. Mil type: TF4SX40 plus two letter case code. See pages 86, 87.

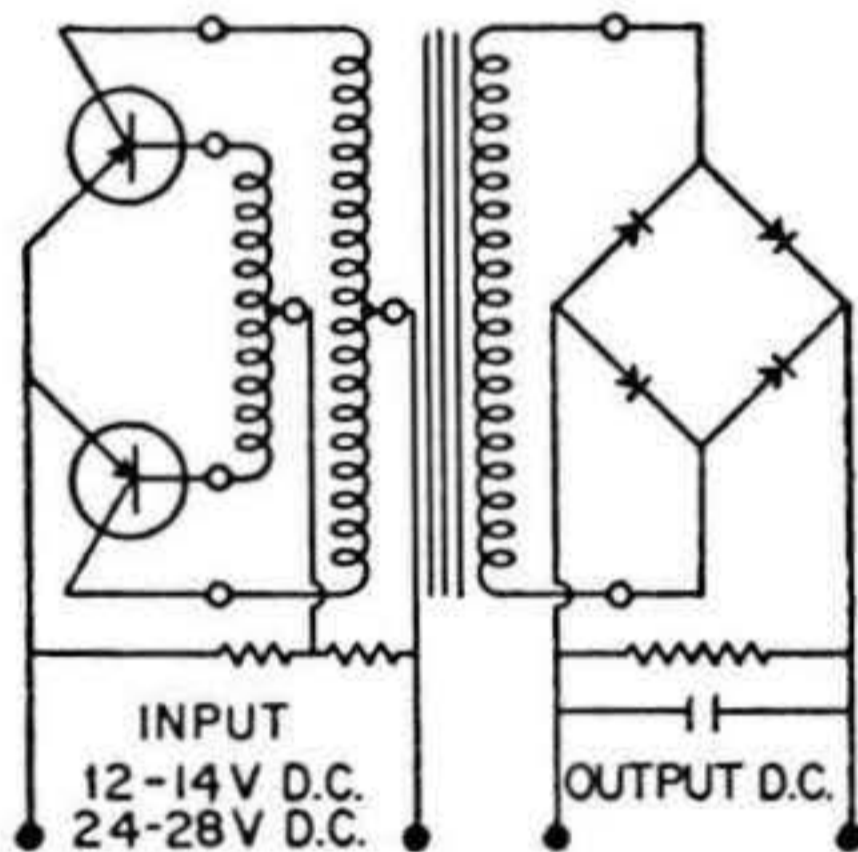

FOR 12/14 OR 24/28 VOLT BATTERY

Type No.	DC output, when used in circuit shown	MIL Case (see pg. 51)
H-97	250V.- 60ma	AH
H-98	375V.-100ma	AJ
H-99	425V.-175ma	FA
H-100	550V.-200ma	GB

TYPICAL CIRCUIT OF STOCK DO-T UNITS FOR SPECIAL CONVERTER APPLICATION (See page 6).

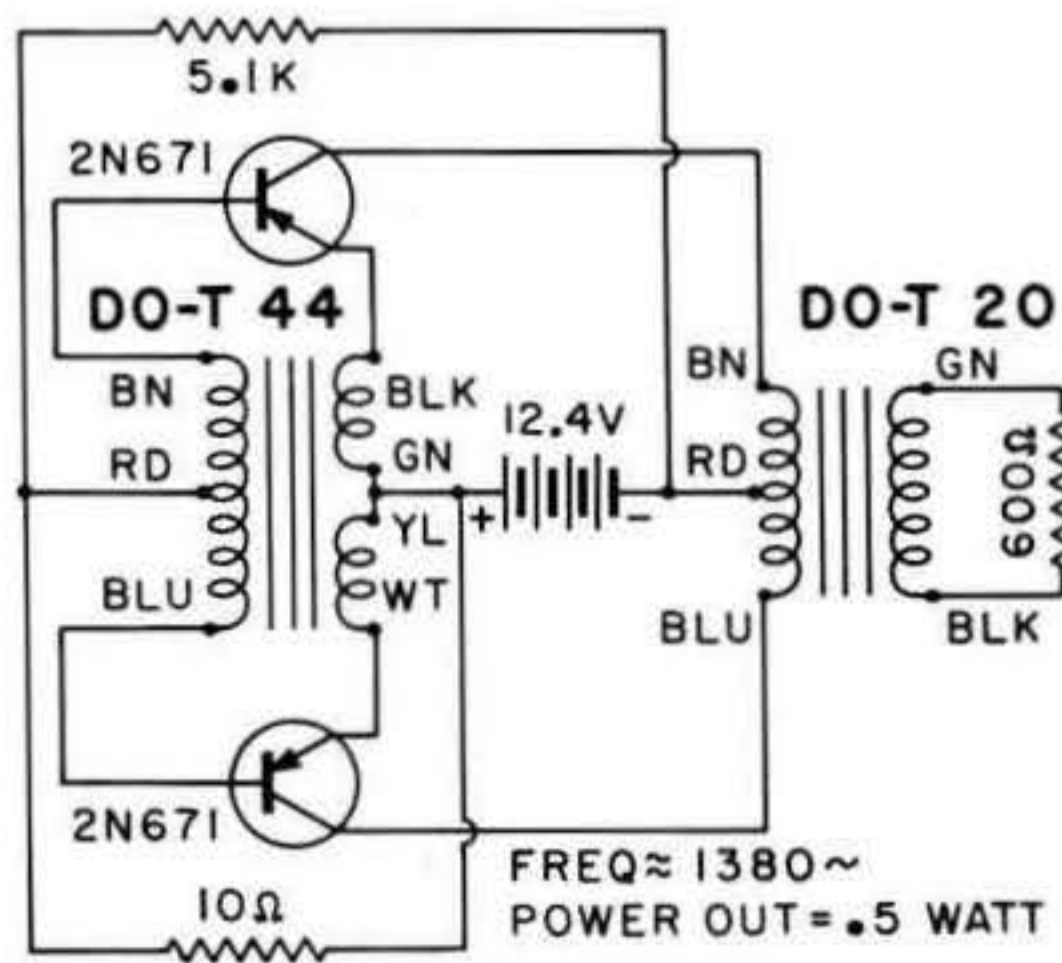

CAPACITOR DISCHARGE IGNITION SYSTEM

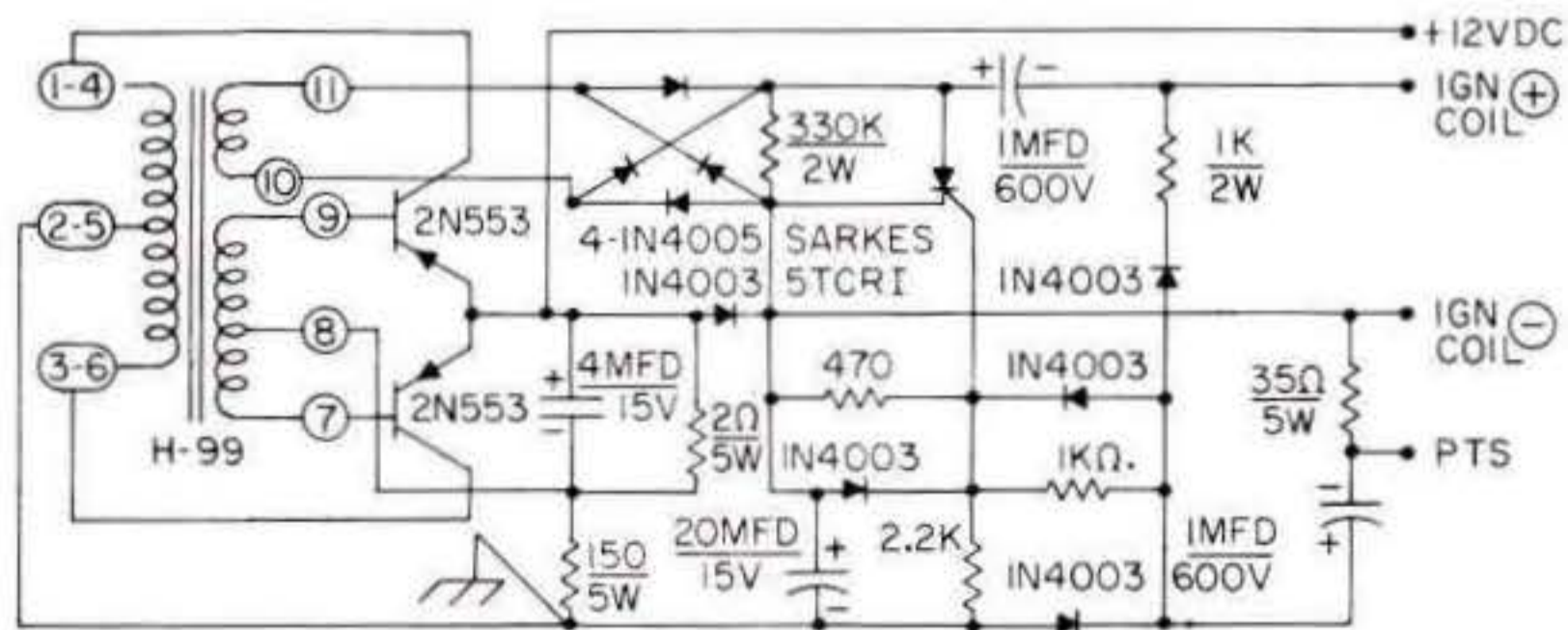

CIRCUIT PATENT PENDING BY DELTA PRODUCTS, INC. GRAND JUNCTION, COLORADO 81502



UNIVERSAL HIGH FREQUENCY INVERTER AND CONVERTER TRANSFORMERS

NEW NV™ SERIES

- Hermetically sealed
- Made to complete MIL-T-27C specs; Grade 4, Class V. See pages 86, 87.
- High efficiency
- Advanced winding coupling technique
- Reduced spiking assures transistor reliability
- Miniaturization due to the use of high efficiency core material
- Ease of rectifier filtering at high operating frequencies

DIMENSIONS

NV-520, NV-720, NV-920: 1 3/16 sq x 1 3/16" high max.
 NV-530, NV-730: 1 1/16 sq x 1 3/16" high max.
 Approximate weights: 1.5 oz & 2.5 oz.

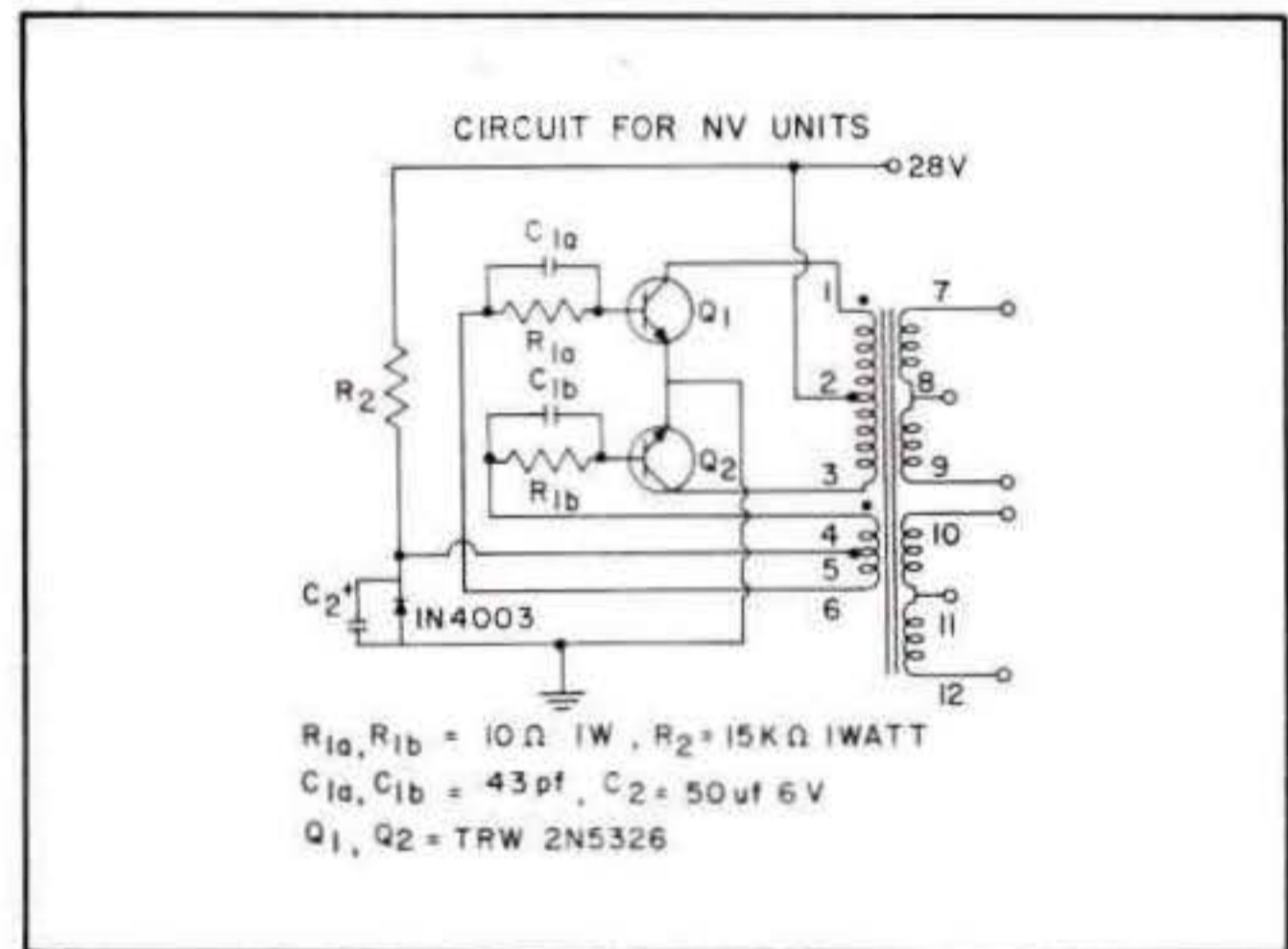
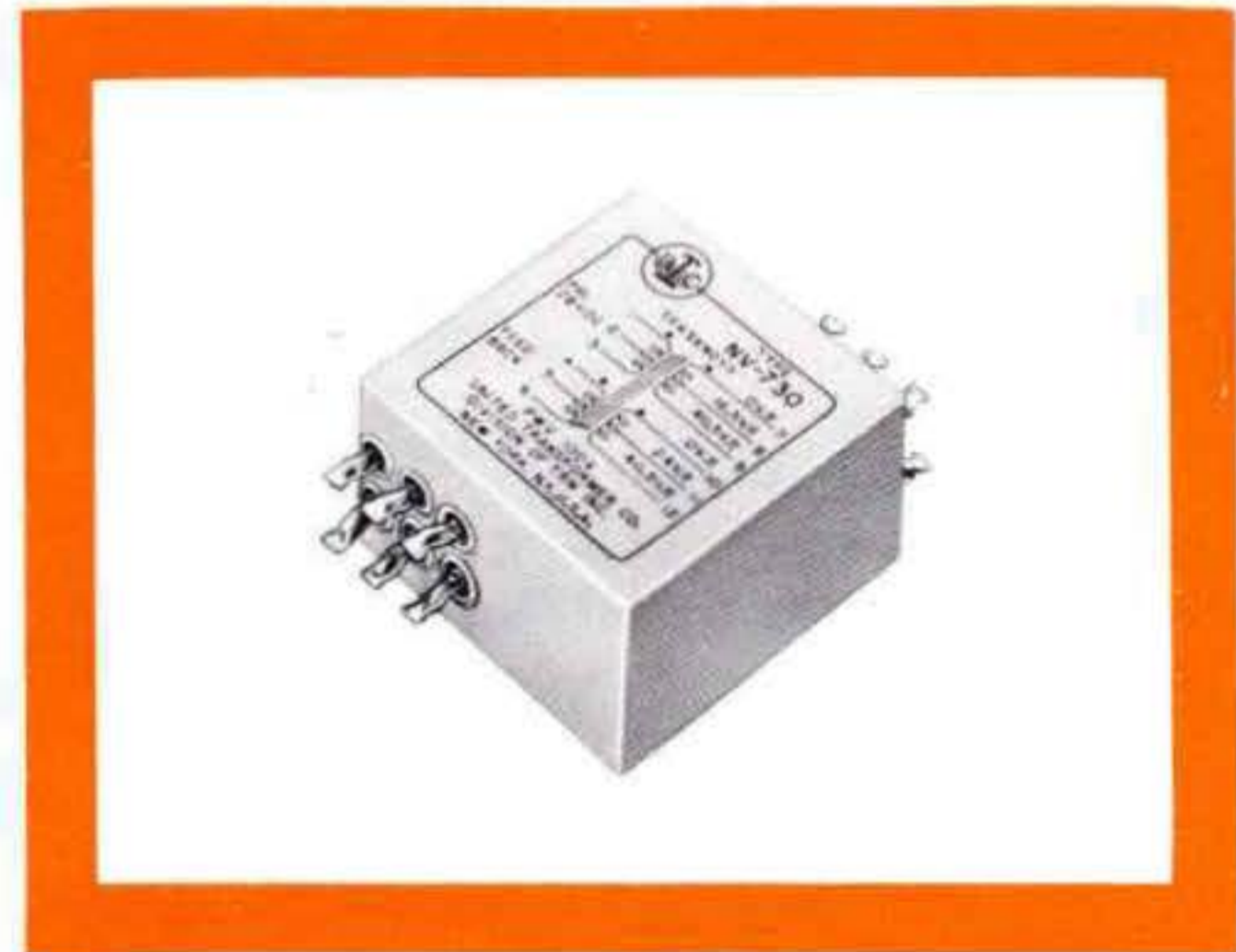

O to Peak Volts →	FULL WAVE BRIDGE							FULL WAVE CT				
	81	64.5	57	48	40.5	33	24	16.5	81 CT	48 CT	33 CT	
Type No.	Current in amperes RMS, at above voltages											
NV-520	10	.4	.45	.5	.55	.8	.6	1.05	1.2	.55	.65	.85
NV-530	10	.8	.9	1	1.1	1.6	1.2	2.1	2.4	1.1	1.3	1.7
NV-720	20	.55	.6	.65	.70	1.1	.8	1.3	1.6	.70	.85	1.05
NV-730	20	1.1	1.2	1.3	1.4	2.2	1.60	2.6	3.2	1.4	1.7	2.1
NV-920	50	1.0	1.1	1.2	1.3	2	1.5	2.5	3.0	1.3	1.55	2.0



FILTER INDUCTORS

PACKAGING Hermetically sealed. H-70 group—metal encased. H-105 group—molded.

APPLICATIONS Transistor supply units have two windings for wide flexibility. All are swinging types to enhance power supply regulation.

CONSTRUCTION Grain-oriented core materials impart highest permeabilities, producing exceptionally high inductance for size.

MIL SPECS To complete MIL-T-27C Specs. H-70 group (metal cased) Grade 4, Class S, Life X. H-105 group (molded) Grade 5, Class S, Life X. See pages 86, 87.



METAL CASED

MIL-T-27C RATINGS IN REGULAR TYPE, INDUSTRIAL RATINGS IN BOLD TYPE

Type No.	MIL Type	Ind. Hys. @ ma DC	Ind. Hys. @ ma DC	Ind. Hys. @ ma DC	Ind. Hys. @ ma DC	Res. Ohms	Max. DCV Ch. Input	Test V. RMS	MIL Case (See Pg. 51)				
H-70	TF4SX04AH	20	20	18	25	14.5	30	10	35	925	350	1000	AH
H-71	TF4SX04FB	20	40	18.5	50	15.5	60	10	70	350	500	2500	FB
H-72	TF4SX04GB	13	70	11.5	85	9.5	105	7	125	215	500	2500	GB
H-73	TF4SX04HB	11	100	9.5	125	7.5	150	5.5	175	150	700	2500	HB
H-74	TF4SX04JB	11	150	10	170	8.5	195	6.5	215	135	700	2500	JB
H-75	TF4SX04KB	11	200	10	230	8.5	250	6.5	300	90	700	2500	KB
H-76	TF4SX04LB	11	200	10	230	8.5	250	6.5	300	85	1500	4500	LB
H-77	TF4SX04MB	10	300	9	350	8	390	6.5	435	60	2000	5500	MB
H-78	TF4SX04OA	7	400	6.5	430	6	465	5.5	500	48	2500	7000	OA
H-79	TF4SX04YY	7	800	6.5	900	6	1000	5.5	1250	20	3000	9000	7x7x8**
H-164†	TF4SX04AG	45†	35	40†	75	18†	350	9†	750	1.2		500	AG
*	(2 wdgs.)	11.25†	70	10†	150	4.5†	700	2.25†	1.5A	.295			
H-166†	TF4SX04AH	125†	50	80†	100	20†	500	12†	1A	1.2		500	AH
*	(2 wdgs.)	31†	100	20†	200	5†	1A	3†	2A	.3			
H-168†	TF4SX04AJ	68†	100	52†	200	20†	1A	14†	2A	.8		750	AJ
*	(2 wdgs.)	17†	200	13†	400	5†	2A	3.5†	4A	.2			
H-170†	TF4SX04GB	180†	125	140†	250	25†	1.25A	11†	2.5A	.6		1000	GB
*	(2 wdgs.)	45†	250	35†	500	6.2†	2.5A	2.7†	5.0A	.15			
H-171†	TF4SX04JA	9†	.75A	5†	1.5A	2.2†	7.5A	1.6†	15A	.03		1000	JA
*	(2 wdgs.)	2.25†	1.25A	1.25†	3A	.55†	15A	.4†	30A	.0075			
H-172†	TF4SX04HA	70†	.25A	65†	.4A	20†	2A	9†	4A	.22		1000	HA
*	(2 wdgs.)	17.5†	.5A	16†	.8A	5†	4A	2.25†	8A	.055			
H-173†	TF4SX04KA	80†	.5A	72†	.8A	16.5†	4A	8.2†	8A	.15		1000	KA
*	(2 wdgs.)	20†	1A	18†	1.6A	4.1†	8A	2.1†	16A	.038			
H-174†	TF4SX04MB	50†	.65A	45†	1.3A	10†	6.5A	6.5†	13A	.08		1000	MB
*	(2 wdgs.)	12.5†	1.3A	11†	2.6A	2.5†	13A	1.6†	26A	.02			

MOLDED, MIL TYPE TF5SX04ZZ

Type No.	Inductance Henries @ ma DC	DCR, Ohms	Test Volts	L	W	H	Mtg. Dim. and Studs	Wgt. Lbs.
H-105	2.5 @ 25 ma, 2 @ 35 ma, 1.5 @ 45 ma	225	1000	1 1/4	15/16	15/16	9/16 x 7/8 two #4-40 Taps, Diag.	.1
H-106	2.25 @ 60 ma, 1.75 @ 80 ma, 1.25 @ 100 ma	110	1000	1 5/8	15/16	1 3/8	15/16 x 15/16 1/8 Dia 4 holes	.28
H-107	2 @ 120 ma, 1.5 @ 160 ma, 1 @ 200 ma	55	2500	2 1/8	1 3/4	1 5/8	1 3/4 x 1 11/32 5/32 Dia 4 holes	.9
H-108	2 @ 220 ma, 1.5 @ 270 ma, 1 @ 325 ma	35	2500	2 7/8	2 1/2	2 17/32	2 3/16 x 2 1/16 5/32 x 7/32 4 slots	1.7
H-109 †	.2 @ 125 ma, .025 @ 1.25A, 0.11 @ 2.5A	.6	750	2 7/8	2 1/2	2 17/32	2 3/16 x 2 1/16 5/32 x 7/32 4 slots	1.7
(2 wdgs.)*	.055 @ 250 ma, .00625 @ 2.5A, .0027 @ 5A	.15						
H-300 †	1 @ 5 ma, .2 @ 50 ma, .16 @ 100 ma	40	500	1	3/4	23/32	(See SO-#P pg. 17)	.05
(2 wdgs.)*	.25 @ 10 ma, .05 @ 100 ma, .04 @ 200 ma	10						

† Split winding in series
 * Split winding in parallel
 ‡ Rated in millihenries
 **Terminals opposite mounting.



400 Hz TRANSFORMERS

PACKAGING Hermetically Sealed. DO-T's & MET's metal encased. H-101 group—molded.

APPLICATION Transistor/filament and isolation.

SHIELDING All isolation transformers electrostatically shielded.

MIL SPECS To complete MIL-T-27C Specs. DO-T's: Grade 4, Class R, Life X. MET's: Grade 4, Class S, Life X. Molded units: Grade 5, Class S, Life X. See pages 86, 87.

MOLDED TYPES, GRADE 5



H-101
THRU
H-104

H-118
H-148
H-149

MIL TF5SX01ZZ TYPES
PRIMARY 105/115 VOLTS 380-1000 Hz
SEC: 6.3 VCT 2500V RMS TEST

Type No.	Sec. Amp.	L In.	W In.	H In.	Wt. Lbs.
H-101	3.5	1 ²⁵ / ₃₂	1 ²¹ / ₃₂	2	.3
H-102	5.5	1 ³ / ₄	2	2 ¹ / ₄	.44
H-103	10	2 ⁵ / ₁₆	2 ¹ / ₈	2 ¹ / ₂	.8
H-104	25	2 ⁷ / ₈	2 ¹ / ₂	3 ¹ / ₃₂	1.5

H-101 thru H-104 see pg. 51 for mounting dimensions

MIL TF5SX03ZZ TYPES
500V RMS TEST

Type No.	H-118	New H-148 †	New H-149
Application	Supply	Isolation	Supply
Primary	105/115V 380-1000 Hz	105/115V 400 Hz	28V 380-1000 Hz
Secondary	6.3VCT—.3A	115VCT-.02A	1) 6.3V-.08A 2) 6.3V-.08A 12.6V-.08A* 6.3V-.16A †
MIL Type	TF5SX01ZZ	TF5SX03ZZ	TF5SX03ZZ
Case Type	SO-#P	SO-#P	SSO-#P

(See Pgs. 16, 17)

*Series Connected.
†Parallel Connected.

‡ELECTROSTATICALLY SHIELDED

METAL ENCASED TYPES, GRADE 4

DO-T400™ SERIES

MIL TYPE TF4RX03YY

Pri 28V 380-1000 Hz
(See pages 6 & 7)

Type No.	Application/Secondary
DO-T400 (Was DO-T500)	6.3V @ 60 ma
DO-T410 (2-Secs.)	6.3V @ 30 ma 6.3V @ 30 ma
DO-T420	Isolation transformer 28V @ 10 ma Electrostatically shielded



5/16 Dia. x 13/32"
Wt. 1/10 oz.
(See Pg. 6 & 7)

U.S. PAT. NO. 2,949,591; others pending.



MET™ SERIES

Type No.	MIL Type	Pri Volt	Sec. Volts	(Amps. (MIL))	(Amps. (Indust.))	Sec. Test Volts RMS	MIL Case
MET-400 ‡	TF4SX03AH 380-1000 Hz 105/115/125V		115 CT 115 CT 230* 115†	.06 .06 .06 .12	.072 .072 .072 .144	1000	AH (Pg. 51)
MET-405 ‡	TF4SX01EA 380-1000 Hz 105/115/125V		115 CT 115 CT 230* 115†	0.2 0.2 0.2 0.4	.24 .24 .24 .48	1000	EA (Pg. 51)
MET-410	TF4SX01YY 115V, 400 Hz		6.3	.6	.75	500	RC-25 (Pg. 13)
MET-420	TF4SX01AH 380-1000 Hz 105/115/125V		6.3 CT	2	2.5	1500	AH (Pg. 51)
MET-430**	TF4SX01FA 400 Hz 57.5, 99.6, 115V		12.6 CT 12.6	2 2	2.5 2.5	1500	FA (Pg. 51)
MET-435	TF4SX01FA 380-1000 Hz 105/115/125 V		6.3 CT	10	12	2500	FA (Pg. 51)
MET-440	TF4SX01GB 380-1000 Hz 105/115/125V		6.3 CT 6.3 CT	6 6	7 7	2500	GB (Pg. 51)

*Series Connected.
†Parallel Connected.

**Two MET-430's Scott connected provide 26 volt two phase from 115V. three phase 400 Hz input.

‡ELECTROSTATICALLY SHIELDED



SUPPLY, REFERENCE & ULTRASHIELDED TRANSFORMERS

ALL HERMETICALLY SEALED, all to complete MIL-T-27C Specs, see pages 86, 87.

TRANSISTOR/FILAMENT SUPPLY TRANSFORMERS



Primary: 105/115/210/220 volts, 50/60 Hz, except H-119, H-130, H-137, H-138, (115V.) and H-131 (115/220V.) All units designed for 50/60 Hz also suited for 400/1000 Hz service.

MIL T-27C RATINGS IN REGULAR TYPE, INDUSTRIAL RATINGS IN BOLD TYPE.

Type No.	MIL Type	Sec. Volts	Amps (MIL)	Amps (Indust.)	Sec. Test Volts RMS	MIL Case (See Pg. 51)
H-120	TF4SX01GB	2.5	10	12	4000	GB
H-121	TF4SX01JB	2.5	10	12	10000	JB
H-122	TF4SX01KB	2.5	20	26	10000	KB
H-123	TF4SX01NB	2.5	5	7.5	10000	NB
		2.5	5	7.5		
		2.5	10	15		
H-124	TF4SX01FB	5	3	3.8	2000	FB
H-125	TF4SX01KB	5	10	12	10000	KB
H-126	TF4SX01LA	5	20	25	10000	LA
H-127	TF4SX01NA Term. Opp. Mtg.	5	20	30	21000	NA
H-128	TF4SX01YY Term. Opp. Mtg.	5	60	75	21000	Pg. 51
H-129	TF4SX01YY Term. Opp. Mtg.	5	10	12	21000	Pg. 51
		5	10	12		
		5	20	24		
H-119	TF4SX01AH	6.3CT	.3	.38	1500	AH
H-130	TF4SX01AJ	6.3CT	.6	.75	1500	AJ
H-131	TF4SX01FB	6.3CT	2	2.5	2500	FB
H-132	TF4SX01JA	6.3CT	6	7	2500	JA
		6.3CT	6	7		
H-133	TF4SX01HB	6.3CT	7	8	2500	HB
H-134	TF4SX01HA	6.3CT	10	12	2500	HA
H-135	TF4SX01JB	10 CT	10	13	2500	JB
H-136	TF4SX01LA	14, 12, 11 CT	10	14	2500	LA
H-137	TF4SX01EB	6.3	.6	.75	1500	EB
		6.3	.6	.75		
H-138	TF4SX01GA	12.6	2	2.5	1500	GA
		12.6	2	2.5		

HIT™ SERIES

ULTRASHIELDED POWER-LINE ISOLATION TRANSFORMERS

SIMULATES BATTERY OPERATION FOR CRITICAL CIRCUITS REQUIRING EXTREME ISOLATION FOR POWER LINE.

The effective capacity coupling between primary and secondary windings is less than 0.1 pf. Individually terminated shields allow maximum circuit design flexibility to further reduce this minute capacitance. Input and output terminals are on opposite sides of housing for excellent line/load isolation.

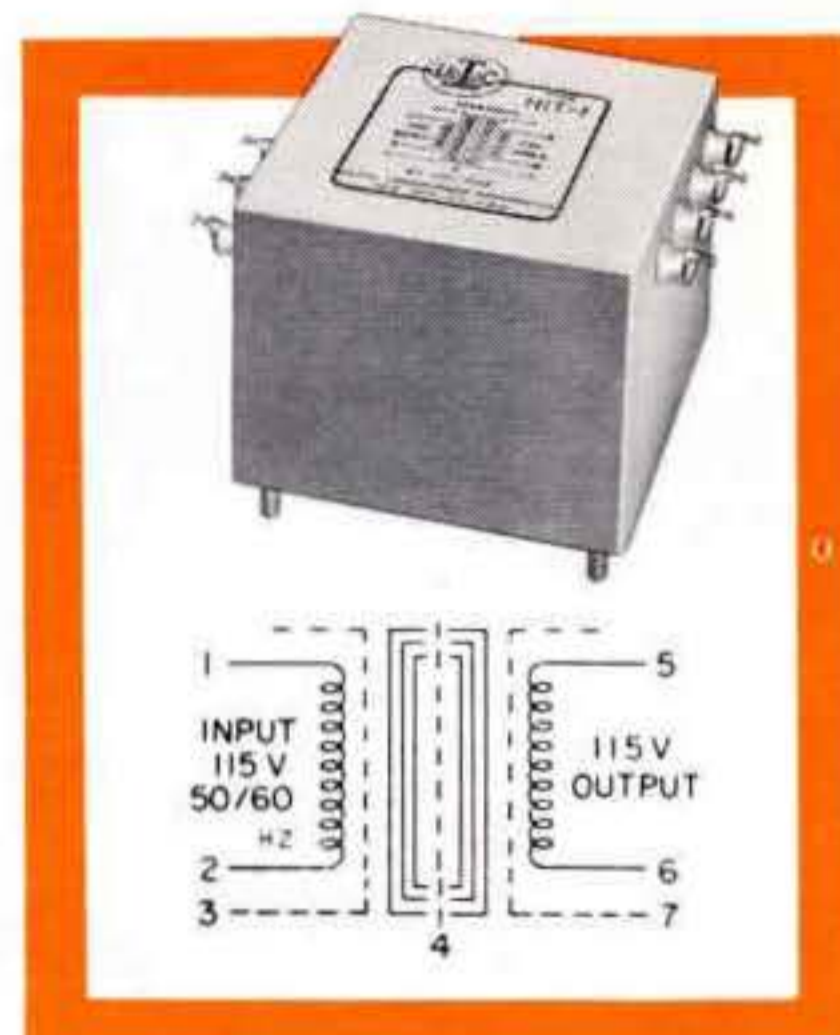

MIL-T-27C RATINGS IN REGULAR TYPE, INDUSTRIAL RATINGS IN BOLD TYPE

Type No.	Power Watts	Power Watts	Max. Case Size	Mounting Dim. and Studs	Wt. Lbs.
HIT-1	50	60	4 1/32 x 4 1/32 x 3 1/32 h	3 3/8 x 3 3/8 10-32 x 1/2 long	5 1/2
HIT-15	120	150	5 1/32 x 5 x 3 1/2 h	4 5/8 x 4 3/8 10-32 x 1/2 long	13
HIT-2	160	200	5 1/32 x 5 1/32 x 4 1/32 h	4 1/8 x 4 1/8 10-32 x 1/2 long	15 1/2
HIT-3	400	480	8 x 6 1/32 x 5 1/32 h	7 1/8 x 5 5/8 3/16-18 x 1 3/8 long	35
HIT-4	1000	1200	9 x 7 1/2 x 7 1/2 h	8 x 6 1/2 3/16-8 x 1 3/8 long	60

PRIMARY 115V 400 Hz, SECONDARY 115V

HIT-450	80	100	4 1/32 x 4 1/32 x 3 1/32 h	3 3/8 x 3 3/8 10 32 x 1/2 long	5 1/2
---------	----	------------	----------------------------	--------------------------------	-------

SRC-10™ PRECISION SCOTT-T REFERENCE TRANSFORMER

For precise conversion of three wire synchro information to equivalent resolver information. Two outputs 90° apart can be utilized in analog and digital computer or coordinate transformation applications. Mil type TF4SX09AJ. Input 90V 60/400 Hz 3 Phase high impedance for synchro output.

- Output 1) 3V @ .25 MA } 2 Phase Output.
 2) 3V @ .25 MA }
- a) Magnitudes of output voltage matched within 0.25%.
 b) Phase angle of output voltages is 90° ± .225°.

Other electrical values to your requirements.



TRANSISTOR SUPPLY TRANSFORMERS

Type No.	MIL Type	Sec. V Rms	Sec. A Rms	Sec. in Parallel				Sec. in Series				Mil Case (see page 51)		
				Choke DCV	Input DCA	Cond. DCV	Input DCA	Choke DCV	Input DCA	Cond. DCV	Input DCA			
H-141	TF4SX02EB Full wave C.T.	20 CT	.3	16.5 8	.3 .43	26 12	.2 .3	.2 .5					EB	
H-142	TF4SX02EA Full wave C.T.	20 CT	.6	16.5 9	.6 .85	26 13	.4 .6	.4 1					EA	
H-143	TF4SX02HA	17/21.5 17/21.5	1.5 1.5	14/17.5	3	18.5/25	2	1	28/35	1.5	43/56	1	.5	HA
H-144	TF4SX02LA	17/21.5 17/21.5	4 4	14/17.5	8	18.5/25	5	2	28/35	4	43/56	2.5	1	LA
H-145	TF4SX02YY	17/21.5 17/21.5	9 9	14/17.5	18	18.5/25	12	6	28/35	9	43/56	6	4	RC-175 Pg. 42.
H-146	TF4SX02YY	34/43 34/43	4.5 4.5	28/35	9	43/56	6	4	56/70	4.5	85/110	3	1	RC-175 Pg. 42.
H-147	TF4SX02KA	10	20	8.2	20	10	13	12					KA	



Primary 115V. 50/60 Hz (tapped on H-143 thru H-146 for dual secondary voltages). DC ratings are approximate, based on silicon bridge rectifier (except H-141, H-142 also shown F.W.C.T.). Choke input DCV is based on 10% voltage drop in choke. Condenser value, C, is in 1000 mfd. H-141, H-142, H-147 listing under "Secs in parallel" is single winding.



H-114, H-115, H-117 have terminals opposite mounting.

COMBINATION PLATE-FILAMENT TRANSFORMERS

MIL-T-27C RATINGS IN REGULAR TYPE, INDUSTRIAL RATINGS IN BOLD TYPE

Type No.	MIL Type	HV Sec. C T	Approx. DC	Volts	MA DC	Fil. Wdg.	Approx. DC	Volts	MA DC	Fil. Wdg.	MIL Case (see Pg. 51)
H-93	TF4SX030A	1000 1200	L L	370 465	300 265	6.3V-8A 6.3V-4A 5V-6A	L L	340 455	390 350	6.3V-10A 6.3V-5A 5V-6A	OA
H-194**	TF4SX03HA	200 235	L C L C	170 275 200 325	140 85 125 75	6.3V-3.5A	L C L C	160 260 190 310	155 95 135 85	6.3V-4A	HA
H-195**	TF4SX03JA	215 265	L C L C	185 300 230 375	285 180 240 150	6.3V-5A	L C L C	175 285 220 360	300 195 255 165	6.3V-6A	JA
H-196**	TF4SX03KA	230 285	L C L C	200 320 250 400	445 280 380 235	6.3V-5A 6.3V-1.5A	L C L C	190 300 240 380	480 300 420 260	6.3V-6A 6.3V-2A	KA
H-197**	TF4SX03MB	260 320	L C L C	230 360 280 450	500 320 420 260	6.3V-6A 6.3V-2A	L C L C	220 340 270 430	550 350 470 290	6.3V-7A 6.3V-2A	MB
H-198 Highly shielded Scope transformer	TF4SX03HA	No CT 800 1600 2400		1000 2000 3000	5 5 5	1.25V—.2A connected to one end of HV winding. 6.3 V-.6A 5.2 KV RMS test voltage					HA

PLATE TRANSFORMERS

H-110 W	TF4SX02MB	1050 1200	L	365	300	} FWCT	L	400		MB
			L	430	275		L	385		
			L	730	210	} FWB	L	280		
			L	860	190		L	265		
H-111 W	TF4SX02NA	1050 1200	L	415	500	} FWCT	L	600		NA
			L	480	450		L	550		
			L	830	350	} FWB	L	420		
			L	960	310		L	380		
H-112 W	TF4SX02NA	1500 1900	L	615	320	} FWCT	L	385		NA
			L	790	275		L	330		
			L	1230	220	} FWB	L	270		
			L	1580	190		L	230		
H-113	TF4SX02YY	2500 3000	L L	1050 1275	310 275		L L	375 330		Pg. 51
H-114	TF4SX02YY	2500 3000	L L	1050 1265	475 425		L L	525 475		Pg. 51
H-115	TF4SX02YY	3500 4400	L L	1500 1900	275 235		L L	375 320		Pg. 51
H-117	TF4SX02YY	5000 6000	L L	2125 2550	950 850		L L	1150 1050		Pg. 51

*For 50 Hz, secondary current ratings reduced by 10%. **DC ratings for bridge rectifier circuits.



SUPPLY, REFERENCE & ULTRASHIELDED TRANSFORMERS

ALL HERMETICALLY SEALED, all to complete MIL-T-27C Specs, see pages 86, 87.

TRANSISTOR/FILAMENT SUPPLY TRANSFORMERS



Primary: 105/115/210/220 volts, 50/60 Hz, except H-119, H-130, H-137, H-138, (115V.) and H-131 (115/220V.) All units designed for 50/60 Hz also suited for 400/1000 Hz service.

MIL T-27C RATINGS IN REGULAR TYPE, INDUSTRIAL RATINGS IN BOLD TYPE.

Type No.	MIL Type	Sec. Volts	Amps (MIL)	Amps. (Indust.)	Sec. Test Volts RMS	MIL Case (See Pg. 51)
H-120	TF4SX01GB	2.5	10	12	4000	GB
H-121	TF4SX01JB	2.5	10	12	10000	JB
H-122	TF4SX01KB	2.5	20	26	10000	KB
H-123	TF4SX01NB	2.5	5	7.5	10000	NB
		2.5	5	7.5		
		2.5	10	15		
H-124	TF4SX01FB	5	3	3.8	2000	FB
H-125	TF4SX01KB	5	10	12	10000	KB
H-126	TF4SX01LA	5	20	25	10000	LA
H-127	TF4SX01NA Term. Opp. Mtg.	5	20	30	21000	NA
H-128	TF4SX01YY Term. Opp. Mtg.	5	60	75	21000	Pg. 51
H-129	TF4SX01YY Term. Opp. Mtg.	5	10	12	21000	Pg. 51
		5	10	12		
		5	20	24		
H-119	TF4SX01AH	6.3CT	.3	.38	1500	AH
H-130	TF4SX01AJ	6.3CT	.6	.75	1500	AJ
H-131	TF4SX01FB	6.3CT	2	2.5	2500	FB
H-132	TF4SX01JA	6.3CT	6	7	2500	JA
		6.3CT	6	7		
H-133	TF4SX01HB	6.3CT	7	8	2500	HB
H-134	TF4SX01HA	6.3CT	10	12	2500	HA
H-135	TF4SX01JB	10 CT	10	13	2500	JB
H-136	TF4SX01LA	14, 12, 11 CT	10	14	2500	LA
H-137	TF4SX01EB	6.3	.6	.75	1500	EB
		6.3	.6	.75		
H-138	TF4SX01GA	12.6	2	2.5	1500	GA
		12.6	2	2.5		

HIT™ SERIES

ULTRASHIELDED POWER-LINE ISOLATION TRANSFORMERS

SIMULATES BATTERY OPERATION FOR CRITICAL CIRCUITS REQUIRING EXTREME ISOLATION FOR POWER LINE.

The effective capacity coupling between primary and secondary windings is less than 0.1 pf. Individually terminated shields allow maximum circuit design flexibility to further reduce this minute capacitance. Input and output terminals are on opposite sides of housing for excellent line/load isolation.

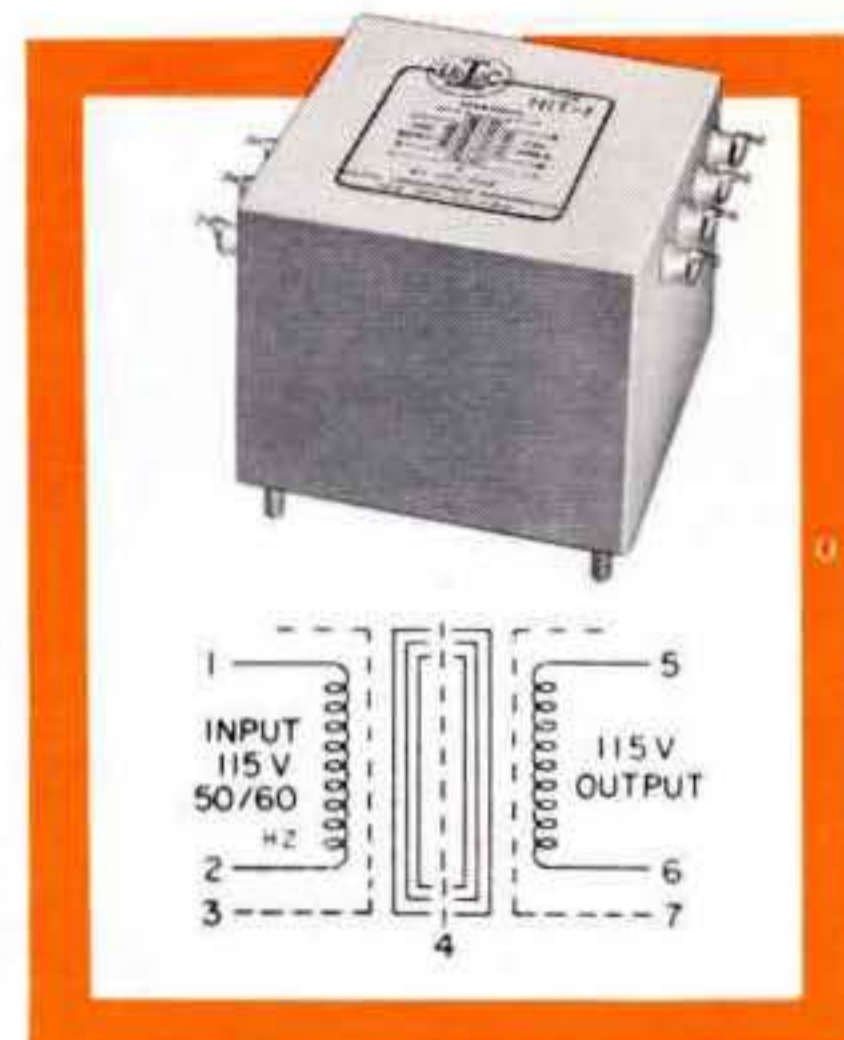

MIL-T-27C RATINGS IN REGULAR TYPE, INDUSTRIAL RATINGS IN BOLD TYPE

Type No.	Power Watts	Power Watts	Max. Case Size	Mounting Dim. and Studs	Wt. Lbs.
HIT-1	50	60	4 1/32 x 4 1/32 x 3 1/32 h	3 3/8 x 3 3/8 10-32 x 1/2 long	5 1/2
HIT-15	120	150	5 1/32 x 5 x 3 1/2 h	4 5/8 x 4 3/8 10-32 x 1/2 long	13
HIT-2	160	200	5 1/32 x 5 1/32 x 4 1/32 h	4 1/8 x 4 1/8 10-32 x 1/2 long	15 1/2
HIT-3	400	480	8 x 6 1/32 x 5 1/32 h	7 1/8 x 5 5/8 3/16-18 x 1 3/8 long	35
HIT-4	1000	1200	9 x 7 1/2 x 7 1/2 h	8 x 6 1/2 3/16-8 x 1 3/8 long	60

PRIMARY 115V 400 Hz, SECONDARY 115V

HIT-450	80	100	4 1/32 x 4 1/32 x 3 1/32 h	3 3/8 x 3 3/8 10 32 x 1/2 long	5 1/2
---------	----	------------	----------------------------	--------------------------------	-------

SRC-10™ PRECISION SCOTT-T REFERENCE TRANSFORMER

For precise conversion of three wire synchro information to equivalent resolver information. Two outputs 90° apart can be utilized in analog and digital computer or coordinate transformation applications. Mil type TF4SX09AJ. Input 90V 60/400 Hz 3 Phase high impedance for synchro output.

- Output 1) 3V @ .25 MA }
 2) 3V @ .25 MA } 2 Phase Output.
- a) Magnitudes of output voltage matched within 0.25%.
 b) Phase angle of output voltages is 90° ± .225°.

Other electrical values to your requirements.



TRANSISTOR SUPPLY TRANSFORMERS

Type No.	MIL Type	Sec. V Rms	Sec. A Rms	← Sec. in Parallel →				← Sec. in Series →				Mil Case (see page 51)		
				Choke DCV	Input DCA	Cond. DCV	Input DCA	Choke DCV	Input DCA	Cond. DCV	Input DCA			
H-141	TF4SX02EB Full wave C.T.	20 CT	.3	16.5 8	.3 .43	26 12	.2 .3	.2 .5					EB	
H-142	TF4SX02EA Full wave C.T.	20 CT	.6	16.5 9	.6 .85	26 13	.4 .6	.4 1					EA	
H-143	TF4SX02HA	17/21.5 17/21.5	1.5 1.5	14/17.5	3	18.5/25	2	1	28/35	1.5	43/56	1	.5	HA
H-144	TF4SX02LA	17/21.5 17/21.5	4 4	14/17.5	8	18.5/25	5	2	28/35	4	43/56	2.5	1	LA
H-145	TF4SX02YY	17/21.5 17/21.5	9 9	14/17.5	18	18.5/25	12	6	28/35	9	43/56	6	4	RC-175 Pg. 42.
H-146	TF4SX02YY	34/43 34/43	4.5 4.5	28/35	9	43/56	6	4	56/70	4.5	85/110	3	1	RC-175 Pg. 42.
H-147	TF4SX02KA	10	20	8.2	20	10	13	12					KA	

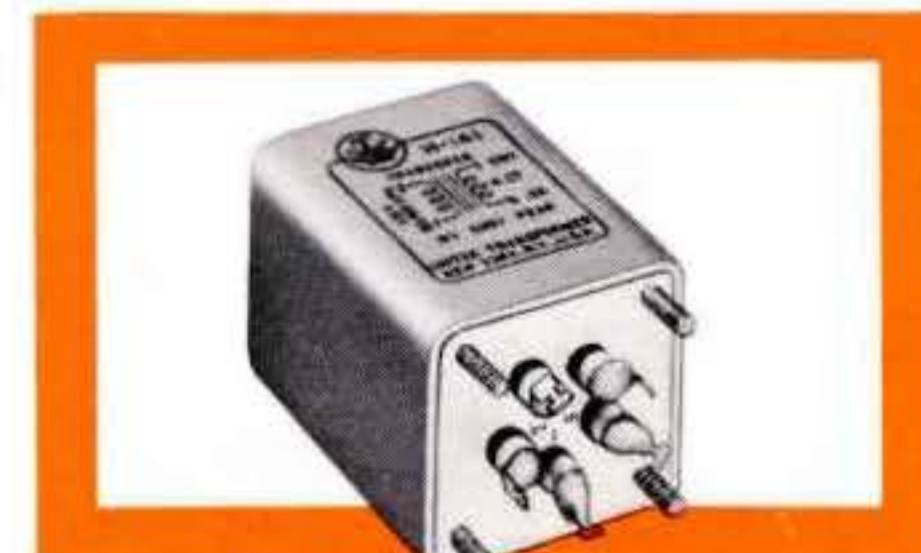

Primary 115V. 50/60 Hz (tapped on H-143 thru H-146 for dual secondary voltages). DC ratings are approximate, based on silicon bridge rectifier (except H-141, H-142 also shown F.W.C.T.). Choke input DCV is based on 10% voltage drop in choke. Condenser value, C, is in 1000 mfd. H-141, H-142, H-147 listing under "Secs in parallel" is single winding.



MILITARY STANDARD TRANSFORMERS AND INDUCTORS

PACKAGING Hermetically sealed. Metal cased to Military Standard Specifications.

MIL SPECS To complete MIL-T-27C Specs. See pages 86, 87.

FILAMENT, POWER AND PLATE Transformer primaries are 105/115/125 V. 54/66 Hz. Current ratings for high voltage secondaries are DC, choke input filter. For condenser input, reduce current to 70% of rated values. The -2 after MS No. indicates Grade 4 (ruggedized). All units are electrostatically shielded.

INDUCTORS Consist of 2 windings that can be connected either in series or parallel for maximum flexibility. Higher inductance figure is for series connection, lower inductance figure is for parallel connection.

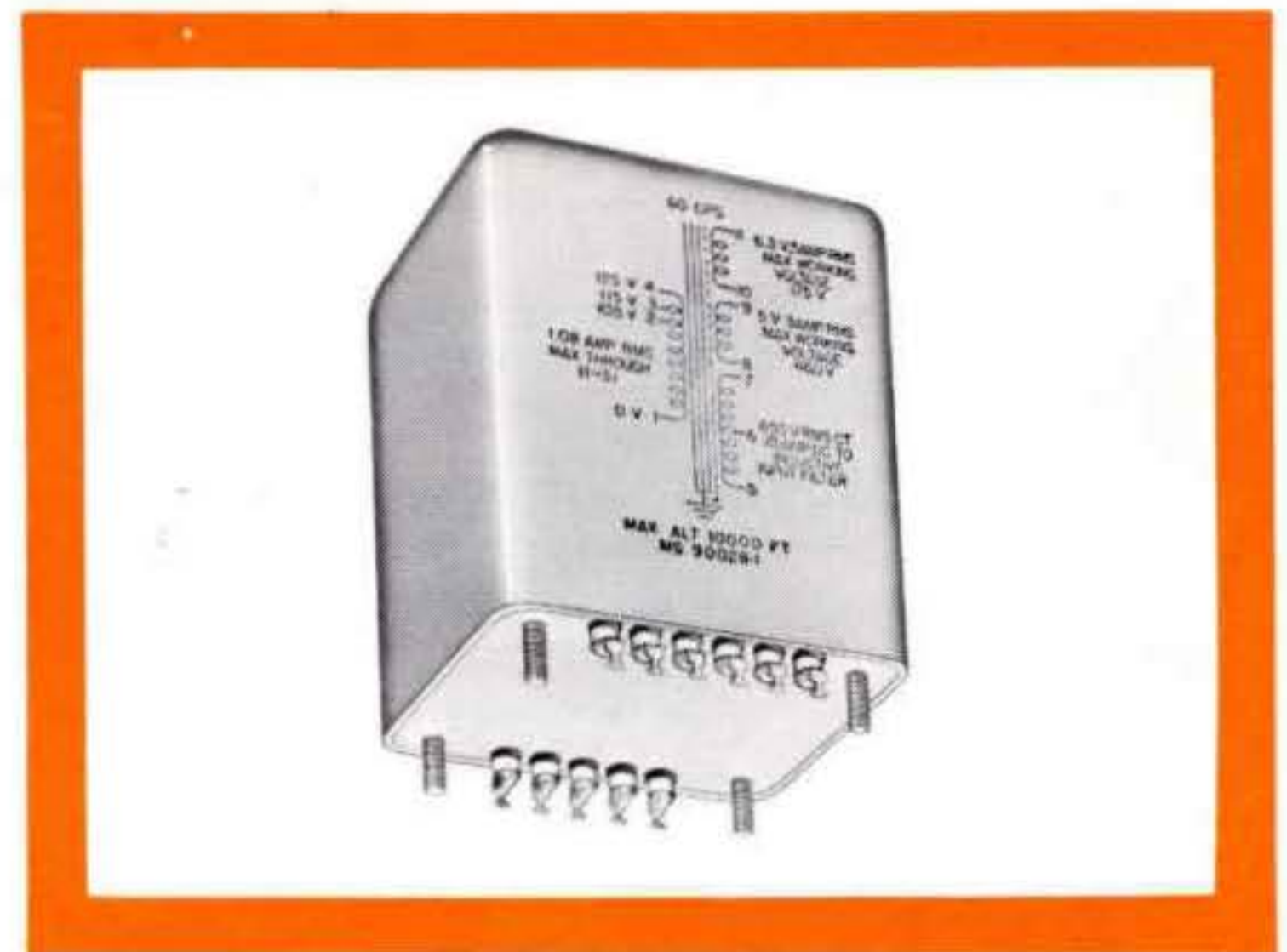

FILAMENT, POWER, PLATE TRANSFORMERS

UTC No.	MS No.	MIL IDENTIFICATION	Secondary Ratings	MIL CASE (see pg. 51)	WT. LBS.	
N-583A	90016-2	TF4RX01EB002	2.5V- 3A	1000 WV	EB	1 $\frac{3}{8}$
N-584A	90017-2	TF4RX01GB003	2.5V-10A	1000 WV	GB	2 $\frac{3}{8}$
N-585A	90018-2	TF4RX01FB004	5V- 3A	1000 WV	FB	1 $\frac{3}{4}$
N-586A	90019-2	TF4RX01HB005	5V-10A	1000 WV	HB	3 $\frac{1}{2}$
N-587A	90020-2	TF4RX01FB006	6.3V- 2A	1000 WV	FB	1 $\frac{1}{2}$
N-588A	90021-2	TF4RX01GB007	6.3V- 5A	1000 WV	GB	2 $\frac{3}{4}$
N-589A	90022-2	TF4RX01JB008	6.3V-10A	1000 WV	JB	5
N-590A	90023-2	TF4RX01KB009	6.3V-20A	1000 WV	KB	7 $\frac{1}{2}$
N-591A	90024-2	TF4RX01JB012	2.5V-10A	6300 WV	JB	4 $\frac{1}{2}$
N-592A	90025-2	TF4RX01KB013	5V-10A	6300 WV	KB	6 $\frac{1}{4}$
N-593A	90026-2	TF4RX03HA001	200-100-0-100-200, 70 ma 6.3/5V-2A 6.3V-3A	HA	3 $\frac{3}{4}$	
N-594A	90027-2	TF4RX03JB002	325-0-325, 70 ma 6.3/5V-2A 6.3V-4A	JB	5	
N-595A	90028-2	TF4RX03KB006	325-0-325, 150 ma 5V-3A 6.3V-5A	KB	7 $\frac{1}{2}$	
N-596A	90029-2	TF4RX03LB003	400-0-400, 175 ma 5V-3A 6.3V-8A	LB	9 $\frac{1}{2}$	
N-597A	90030-2	TF4RX03MB004	450-0-450, 250 ma 5V-3A 6.3V-8A	MB	13	
N-598A	90031-2	TF4RX02KB001	350-0-350, 250 ma	KB	7	
N-599A	90032-2	TF4RX02LB002	550-0-550, 250 ma	LB	10	
N-600A	90036-2	TF4RX02NB003	800-0-800, 250 ma	NB	16 $\frac{1}{2}$	

INDUCTORS

UTC No.	MS No.	MIL IDENTIFICATION	IND. HYS	ma DC	DCR OHMS	W.V.	MIL CASE (see pg. 51)	WT. LBS.
Z-848	90009-2	TF1RX04FA001	16 4	80 160	645 160	1000	FA	2
Z-849	90010-2	TF1RX04GA002	25 6.25	80 160	670 165	1000	GA	3
Z-850	90011-2	TF1RX04HA003	40 10	80 160	1020 250	1000	HA	4 $\frac{1}{4}$
Z-851	90013-2	TF1RX04HA005	16 4	125 250	330 82	2000	HA	4 $\frac{1}{4}$
Z-852	90014-2	TF1RX04JB006	25 6.25	125 250	460 115	2000	JB	6
Z-853	90037-2	TF1RX04KA007	40 10	125 250	535 133	3500	KA	8
Z-854	75000-2	TF4RX04LA009	16 4	200 400	180 44	3500	LA	11
Z-855	75001-2	TF4RX04MA010	25 6.25	200 400	210 52	3500	MA	16
Z-856	75002-2	TF4RX04NA012	16 4	315 630	105 25	3500	NA	18
Z-857	75003-2	TF4RX04YY013	25 6.25	315 630	150 37	3500	YY	35



COMMERCIAL GRADE COMPONENTS

PACKAGING Vacuum impregnated and sealed with special insulating compounds.

SPECIFICATIONS To IEEE commercial standards. Ratings conservative for continuous duty.

APPLICATIONS Commercial equipment, amateur and public address systems.

NOTE Tested at twice maximum working voltage plus 1000 V for breakdown. Surge tested at 250% normal voltage.



RC CASE



END CASTING UNIT

Case No.	Base Dim (Sq)	Mounting Dim (Sq)	Mounting Screw	Ht +1/16 -1/16	Cut-out Dia	Unit Weight Lbs
RC-37	1 3/8	1 1/8	4-40	1 1/8	1 1/4	.35
RC-50	1 5/8	1 5/16	6-32	2 1/4	1 1/2	1/2
RC-62	1 13/16	1 1/2	6-32	2 1/2	1 1/2	1
RC-75	2 3/16	1 13/16	8-32	2 3/8	1 3/8	1 1/2
RC-87	2 9/16	2 3/32	8-32	3 1/4	2	2 1/2
RC-100	3	2 3/8	8-32	3 3/4	2 5/8	3 1/2
RC-112	3 7/16	2 11/16	10-32	4 1/8	2 7/8	5
RC-125	3 3/4	3	10-32	4 1/2	3	6 1/2
RC-150	4 1/2	3 9/16	12-28	5 1/2	3 3/4	11
RC-152	5 1/8	4 1/8	12-28	5 1/2	4	15 1/2
RC-175	5 3/4	4 7/8	1/4-20	7	4	22

VARIPOWER™ AUTO-FORMERS

Boosting/Voltage Adjustment

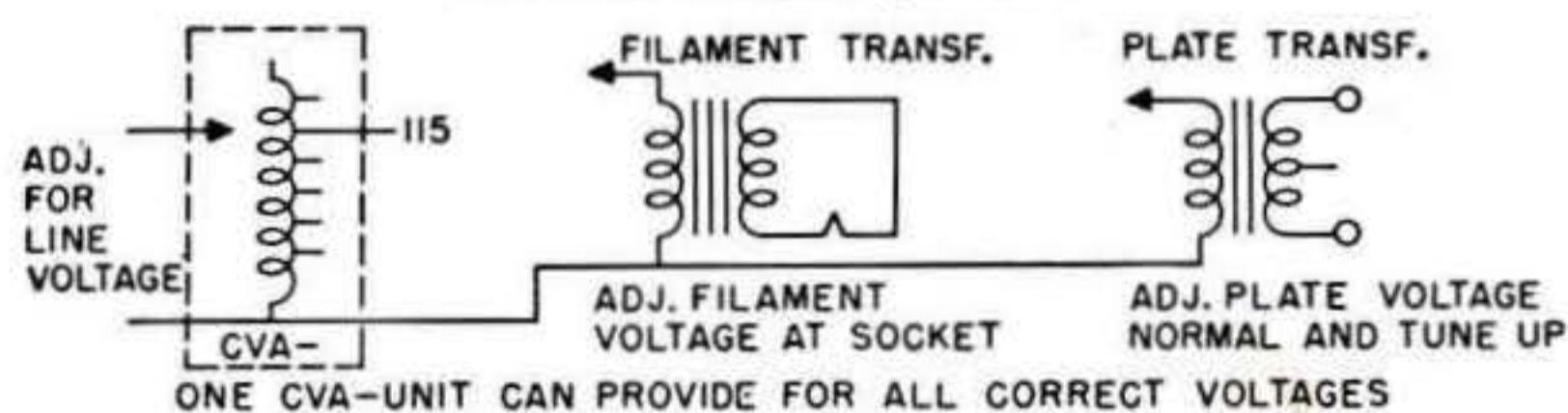

Type No.	Watts Output	Case No.
CVA-1	150	RC-112
CVA-2	250	RC-125
CVA-3	500	RC-150
CVA-4	1000	RC-152
CVA-5	2000	RC-175

Designed for line voltage control, filament control and reduced power operation. Output voltage from 0 to 130 volts, 50/60 Hz. Varipower units permit control of filament voltage at the tube socket to within 2 1/2% of desired value simultaneously with line voltage control and plate voltage control. Can be used to reduce or increase voltages on filament transformers. Taps at 25, 55, 75, 95, 100, 105, 110, 115, 120, 125 and 130 volts permit output voltages from 0 to 130 volts in 5 volt steps . . . from 115V, 50/60 Hz.

POWER AND BIAS TRANSFORMERS

Primary 115 volts 50/60 Hz

(DC ma is for choke input. Reduce to 70% for condenser input.)

Type No.	High Voltage	DC ma	Fil. 1	Fil. 2	Fil. 3	Fil. 4	Case No.
CG-422	435-365-0-365-435 125-0-125	125 25	5V-3A	5V-2A	6.3 VCT-3A	2.5 VCT-5A	RC-150
CG-428	500-0-500 80-0-80	250 100	5V-3A	5V-2A	6.3 VCT-4A	6.3 VCT-3A, tapped 2.5 VCT-3A	RC-152
CG-429	600-525-0-525-600	250	5V-3A	6.3VCT-3-A	7.5 VCT-3A, tapped 6.3 VCT-4A		RC-152
CG-431	500-400-0-400-500 80-0-80	500 100	5V-6A	5V-2A	6.3 VCT-5A	6.3 VCT-3A	RC-175
CG-315	Tapped for any DC voltage from 15 to 100 volts within 6%—250 MA						RC-125
CG-316	Tapped for any DC voltage from 75 to 400 volts within 6%—250 MA						RC-152

TRANSISTOR/FILAMENT SUPPLY TRANSFORMERS

Primary 115 volts 50/60 Hz

(See page 46 for typical applications)

Type No.	Sec. V RMS	Sec. A RMS	In Parallel				In Series				Case No.
			Choke in DCV	C in DCA	Choke in DCV	C in DCA	Choke in DCV	C in DCA	Choke in DCV	C in DCA	
CG-30	17/21.5 17/21.5	1.5 1.5	14/17.5	3	18.5/25	2	28/35	1.5	43/56	1	RC-112
CG-31	34/43 34/43	4.5 4.5	28/35	9	43/56	6	56/70	4.5	85/110	3	RC-175
CG-32	6.3VCT	1.2									RC-62

FILAMENT/TRANSISTOR SUPPLY TRANSFORMERS

Primary 105, 115, 210, 220, 230 volts, 50/60 Hz, except CG-34 . . . 105, 115, 220, 230. These transformers may be used on 25 to 43 Hz if 220 volt primary is used on 110 volts. Secondary voltage is simultaneously reduced to half.

Type No.	Sec. Volts C T	Sec. Amps	Working Voltage	Sec. Test Volts RMS	Case No.
CG-33	6.3	4	500	2000	RC-75
CG-34	2.5	10	2500	6000	RC-112
CG-35	6.3	6	500	2000	RC-87
CG-36	6.3 6.3	5 5	500	2000	RC-100
CG-120	2.5	10	5000	11000	RC-125
CG-121	5	25	5000	11000	RC-150
CG-122	7.5/6.3	10	1500	4000	RC-125
CG-124	10	10	1500	4000	RC-150
CG-125	14/12/11	10	1500	4000	RC-150
CG-126	14/11/10 14/11/10	10 10	1500	4000	RC-152

CG PLATE TRANSFORMERS

Primaries for 105, 115, 210, 220, 230 volts, 50/60 Hz. For reduced power, secondary voltages can be reduced to half by using 220V. Pri. on 110 volts. These transformers may be used on 25 to 43 Hz if 220V. Pri. is used on 110 volts; secondary voltage is simultaneously halved. Units with a W suffix have been designed to be used both in full wave center tap and full wave bridge application. In these units, center-tap of secondary winding may be disconnected from ground. All ratings are for choke input filtering. Other electrical and mechanical parameters on "W" units are the same as the nonsuffixed units.

Type No.	High Voltage	DC Voltage	ma DC	Case No.
CG-300W	625-515-0-515-625	500/400 FWCT 1000/800 FWB	200 140	RC-150
CG-301W	580-530-300-0-300-530-580	475/425/250 FWCT 950/850/500 FWB	420 290	RC-152
CG-302W	950-750-0-750-950	760/610 FWCT 1520/1220 FWB	360 250	RC-175
CG-303W	1500-1235-400-0-400-1235-1500	1250/1000/300 FWCT 2500/2000/600 FWB	260* 175 180/210	RC-175

* 300MA, if used without load on low voltage winding.

END CASTING UNITS

Type No.	High Voltage	DC Voltage	ma DC	L	W	H	Mtg. Dim.	Wt. Lbs.
CG-304W	1500-1235-0-1235-1500	1250/1000 FWCT 2500/2000 FWB	800 550	14 3/8	8 1/2	10 3/8	7 1/4 x 13 3/8	100
CG-305W	2400-1750-0-1750-2400	2000/1500 FWCT 4000/3000 FWB	300 210	10 1/2	4 3/4	6 7/8	3 7/8 x 9 7/8	50
CG-306W	2400-1750-0-1750-2400	2000/1500 FWCT 4000/3000 FWB	500 350	13 7/8	8 1/2	10 3/8	7 1/4 x 12 7/8	100
CG-307	3500-3000-2400-0-2400-3000-3500	3000/2500 2000	300	13 3/8	8 1/2	10 3/8	7 1/4 x 12 3/8	90
CG-308	3500-3000-2400-0-2400-3000-3500	3000/2500 2000	500	15 1/8	8 1/2	10 3/8	7 1/4 x 14 1/8	125
CG-309	3500-3000-2400-0-2400-3000-3500	3000/2500 2000	1000	21	10	13 1/4	8 1/2 x 20	253
CG-310	4600-4050-3500-0-3500-4050-4600	4000/3500 3000	600	19 1/4	10	13 1/4	8 1/2 x 18 1/4	150
CG-311W	1500-1235-0-1235-1500	1250/1000 FWCT 2500/2000 FWB	500 350	10 1/2	4 3/4	6 7/8	3 7/8 x 9 7/8	50
CG-312	1800-1500-0-1500-1800	1500/1250	400	10 1/2	4 3/4	6 7/8	3 7/8 x 9 7/8	38

FILTER INDUCTORS

INDUCTANCE SHOWN IS AT RATED DC MA

Type No.	Inductance Henrys	DC ma	DC Res. Ohms	Test Volts RMS	Case No.
CG-40	10	200	110	1750	RC-112
CG-44	30	100	400	1750	RC-100
CG-45	250	15	5000	1750	RC-87
CG-48C	75	50	2200	1750	RC-87
CG-100	12	150	110	2500	RC-125
CG-102	12	250	100	3000	RC-150
CG-104	10	350	90	5000	RC-152
CG-108	10	500	52	7000	RC-175
CG-1S	10	1000	40	9000	11 1/2 x 4 3/4 x 6 1/4 H, 40 lb.

SWINGING INPUT INDUCTORS

INDUCTANCE SHOWN IS FROM 100% TO 10% OF RATED DC MA

Type No.	Inductance Henrys	DC ma	DC Res. Ohms	Test Volts RMS	Case No.
CG-101	25/5	150	110	2500	RC-125
CG-103	25/5	250	100	3000	RC-150
CG-105	25/5	350	90	5000	RC-152
CG-109	25/5	500	52	7000	RC-175
CG-111† (2 Wdgs.)*	100/10 Mhy 25/2.5 Mhy	2.5A 5A	.6 .15	1500	RC-87
CG-112† (2 Wdgs.)*	40/10 Mhy 10/2.5 Mhy	6A 12A	.24 .06	1500	RC-112
CG-113† (2 Wdgs.)*	7/1.75 Mhy 1.8/.45 Mhy	17.5A 35A	.036 .009	1500	RC-125
CG-1C	25/5	1000	40	9000	Same as CG-1S

† Split winding in series

* Split winding in parallel



SPECIAL SERIES POWER & FILAMENT TRANSFORMERS & INDUCTORS

PACKAGING G-1 thru G-4 drawn cases with recessed terminal strip. G-5 thru G-12 formed cases with top and bottom mountings.

APPLICATIONS Designed for amateur and PA service, rating based on ICAS intermittent use. Tapped coils on power and bias transformers afford maximum flexibility with all types of circuits and tubes. For commercial and industrial application, CG and H grade components should be employed.

NOTE Standby service should not be obtained by interrupting high voltage center tap.

FILTER, SWINGING, AND AUDIO INDUCTORS

Inductance shown for swinging types are from 100% to 10% of rated DC ma

Type No.	Service	Inductance	Current	Resistance	Test Volts Rms	Case No.
S-23	Audio	300 Hy	5 ma	5000 ohms	1500 V	G-2
S-24	P. P. Inductor	500 Hy C T	3 ma	6000 ohms	1500 V	G-2
S-25	Filter	30 Hy	30 ma	800 ohms	1500 V	G-2
S-26	Filter	12 Hy	60 ma	250 ohms	1500 V	G-2
S-27	Filter	25 Hy	75 ma	350 ohms	1500 V	G-4
S-28	Filter	20 Hy	100 ma	350 ohms	1500 V	G-4
S-29	Filter	6 Hy	175 ma	90 ohms	1500 V	G-4
S-30	Swinging	20/4 Hy	175 ma	90 ohms	1500 V	G-4
S-31	Filter	6 Hy	225 ma	100 ohms	2700 V	G-5
S-32	Swinging	20/4 Hy	225 ma	100 ohms	2700 V	G-5
S-33	Filter	8 Hy	300 ma	100 ohms	4000 V	G-7
S-34	Swinging	20/4 Hy	300 ma	100 ohms	4000 V	G-7
S-35	Filter	8 Hy	400 ma	60 ohms	5000 V	G-8
S-36	Swinging	20/4 Hy	400 ma	60 ohms	5000 V	G-8
S-37	Filter	8 Hy	550 ma	60 ohms	6000 V	G-8
S-38	Swinging	20/4 Hy	550 ma	60 ohms	6000 V	G-8
S-80	Swinging	45/10 Mhy	1.75A	.5 ohm	500 V	G-1
S-81	Swinging† (2 Wdgs.)*	100/8 Mhy 25/2 Mhy	2.5A 5A	.6 ohm .15 ohm	1500 V	G-3

† Split winding in series
* Split windings in parallel

FILAMENT TRANSFORMERS

Primary Tapped 105, 115 Volts—50/60 Hz

Type No.	Secondary Volts	Secondary Current	Sec. Test Volts Rms	Case No.
S-53	2.5 VCT	10 A	1500 V	G-3
S-54	5 VCT	4 A	2500 V	G-3
S-55	6.3 VCT	3 A	1500 V	G-3
S-57	2.5 VCT	10 A	10,000 V	G-5
S-58	2.5 VCT	20 A	10,000 V	G-5
S-59	5 to 5.25 VCT	13 A	5000 V	G-5
S-60	5 to 5.25 VCT	22 A	10,000 V	G-7
S-61	6.3/7.5 VCT	10 A	3000 V	G-5
S-62	10 VCT	10 A	3000 V	G-5
S-63	11/12/14 VCT	10 A	5000 V	G-7

Type No.	Fil. 1	Fil. 2	Fil. 3	Sec. Test Volts Rms	Case No.
S-64	2.5 VCT-5A	2.5 VCT-5A	5 VCT-6A	3000 V	G-5
S-67	5 VCT-6A	6.3 VCT-5A		3000 V	G-5
S-68	5 VCT-3A	6.3 VCT-4A	7.5 VCT-5A	3000 V	G-5
S-70	6.3 VCT-5A	6.3 VCT-5A		3000 V	G-5
S-71	2.5 VCT-6A	2.5 VCT-6A	2.5 VCT-12A	10000 V	G-7
S-72	5 VCT-3A	5 VCT-3A	5 VCT-6A	5000 V	G-5

Primary 115 V. 50/60 Hz, tapped on S-77, S-78 and S-79 for dual secondary voltages.

DC voltages are approximate, based on Silicon bridge rectifier and 10% choke drop in choke input filter circuit.

C in condenser input values is in 1000 mfd.

TRANSISTOR/FILAMENT SUPPLY TRANSFORMERS

(See page 46 for typical applications)

Type No.	Sec. V RMS	Sec. A RMS	Secs. in parallel				Secs. in series				Case No.		
			Choke Inp. DCV	Cond. Inp. DCA	Choke Inp. DCV	Cond. Inp. DCA	Choke Inp. DCV	Cond. Inp. DCA					
S-75	6.3 6.3	.6 .6	5.2	1.2	7	0.80	5	10	0.6	14	0.40	1	G-1
S-76	12.6 12.6	2 2	10	4	12.6	3	3	20	2	26	1.4	1	G-4
S-77	17/21.5 17/21.5	1.5 1.5	14/17.5	3	18.5/25	2	1	28/35	1.5	43/56	1	.5	G-5
S-78	34/43 34/43	4.5 4.5	28/35	9	43/56	6	4	56/70	4.5	85/110	3	1	G-9
S-79	38.5/48 38.5/48	1.5 1.5	32/40	3	48/60	2	1	64/80	1.5	95/120	1	.5	G-7

G-1-G-4 CASES

(Will take 8-32 Mtg. Screw)

G-5-G-12 CASES

(Will take 12-28 Mtg. Screw)

CASE SIZES

Type No.	H	W	D	M	N	Wt. Lbs.
G-1	1 7/8	2 11/16	1 3/4	2 3/8	2	1
G-2	2 5/16	3 5/16	1 15/16	2 7/8	2 3/8	1 1/2
G-3	2 1/2	3 5/8	2 5/32	3 1/4	2 3/4	2
G-4	2 15/16	4 1/8	2 5/16	3 5/8	3 1/8	3
G-5	3 3/4	3 1/8	4 1/2	3 7/8	2 7/16	4 1/2
G-7	4 5/8	4 5/8	5 1/2	4 27/32	3 25/32	8
G-8	4 5/8	5 3/8	5 3/8	4 25/32	4 3/4	12
G-9	5 7/8	5 3/8	6 3/4	6 3/32	4 19/32	21
G-10	5 7/8	6 1/8	6 5/8	5 15/16	5 13/32	24
G-11	5 7/8	6 19/32	7 3/8	6 21/32	5 29/32	31
G-12	10 1/4	7 3/8	9 1/4	8 1/2	6 5/8	52

COMBINED PLATE AND FILAMENT UNITS

Type No.	Voltage	Primary 115 volts 50/60 Hz		Fil. No. 1	Fil. No. 2	Case No.
		Voltages* D. C.	Fil. Rectifier			
S-39	490-400-0-400-490 175 ma	400/310	5 V-3A	2.5 VCT -6A	6.3 VCT 4A	G-7
S-40	525-425-0-425-525 250 ma	400/310	5 V-3A	6.3 VCT -3A	6.3 VCT 3A	G-7
S-41	600-0-600 200 ma	475	5 V-3A	7.5 V tapped 6.3 V-3A	6.3 VCT 2A	G-7
S-42	600-525-0-525-600 300 ma	480/400	5 V-6A	7.5 V tapped 6.3 V 3A	6.3 VCT 3A	G-8

* Based on two section filter, choke input.

PLATE TRANSFORMERS — BIAS TRANSFORMERS

Type No.	High Voltage	DC Voltages*	DC Current	Case No.
S-44	575-525-0-525-575	470/430	500 ma	G-9
S-45	900-750-0-750-900	750/620	200 ma	G-8
S-46	1000-750-0-750-1000	825/600	300 ma	G-9
S-47	1500-1250-1000-0-1000-1250-1500	1275/1050/825	300 ma	G-10
S-48	1500-1250-1000-0-1000-1250-1500	1300/1075/850	500 ma	G-11
S-49	2100-1800-1500-0-1500-1800-2100	1815/1540/1275	300 ma	G-11
S-50	3000-2500-0-2500-3000	2625/2175	300 ma	G-12
S-51	Will supply any bias voltage from 15 to 100 volts DC within approximately 6% of desired value.			G-5
S-52	Will supply any bias voltage from 75 to 400 volts DC within approximately 6% of desired value.			G-7

* Based on two section filter for 200 ma and 300 ma units, single section filter for 500 ma units, both Inductor input.



TRANSFORMERS FOR INDUSTRY WIDE APPLICATIONS

PACKAGING High lustre black enamel.

APPLICATION Industrial type. Primary 117 V 50/60 Hz.

CONSTRUCTION Designed for low temperature rise. Vacuum sealed against humidity. Special impregnation prevents corrosion and electrolysis.

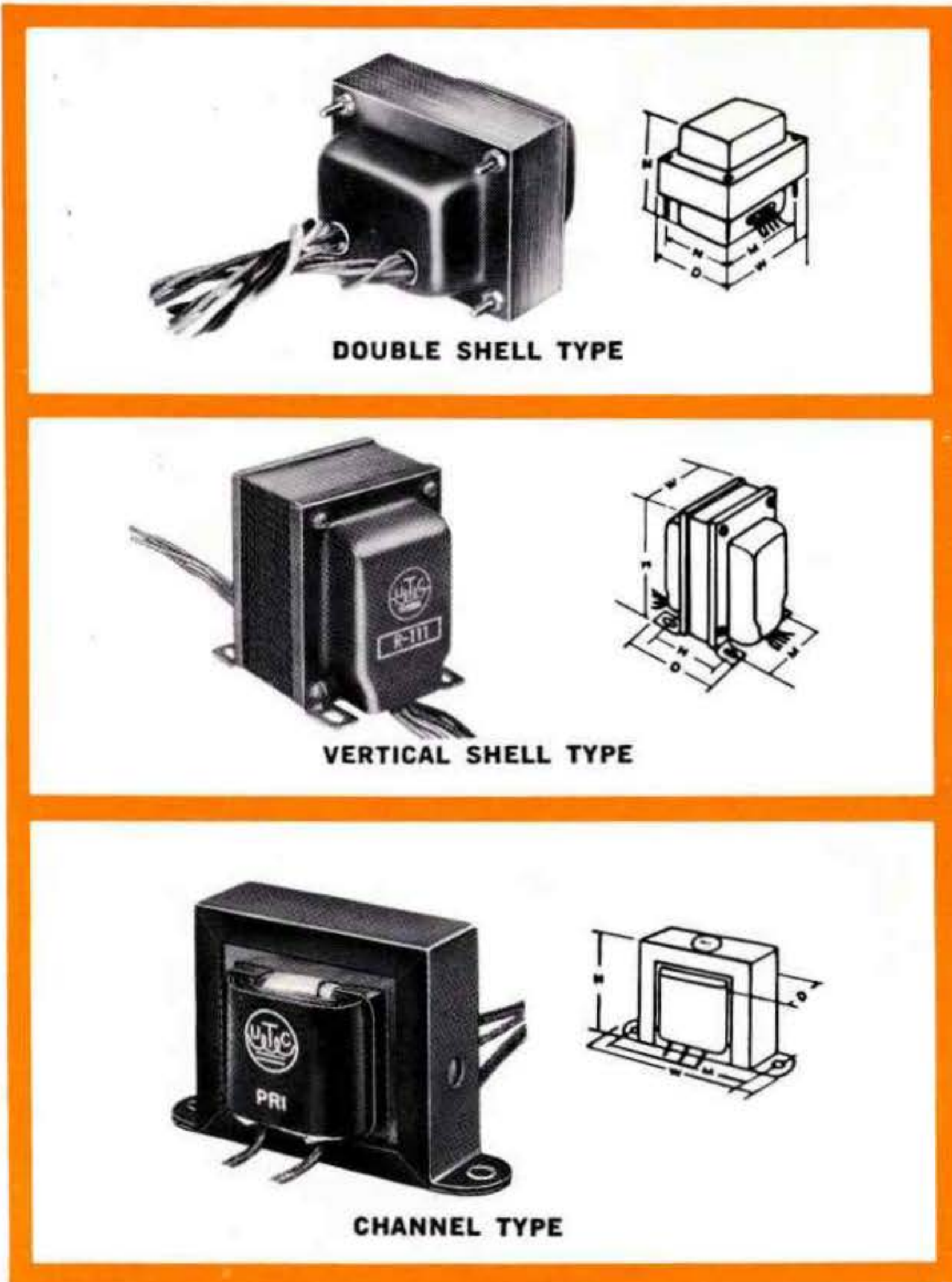

DOUBLE SHELL TYPE

VERTICAL SHELL TYPE

CHANNEL TYPE

LINE VOLTAGE ADJUSTERS WITH METER

APPLICATIONS For 50/60 Hz service. Corrects fluctuation of line voltage. Adjust switch so meter reads at red line and output voltage is correct. Nine tap switch provides for 60 to 140 V input on 115 V output model, and 160 to 240 V input on 230 V output model. Has 6 foot input plug-in cord and output receptacle.



Type No.	Primary Voltage	Volts Sec.	Watts Rating	Dim. L	Max. W	H	Mtg. Dim. L	W	Wgt. Lbs.
R-78		115	150	7 1/4	4 1/16	4 3/4	5 7/8	3	6
R-79	60, 70, 80	115	300	7 1/4	4 1/16	4 3/4	5 7/8	3	9
R-80	90, 100, 110	115	600	10 1/2	4 1/16	4 3/4	9 1/8	3	13
R-81	120, 130, 140	115	1200	10 1/2	4 1/16	4 3/4	9 1/8	3	21
R-86	160, 170, 180, 190, 200, 210, 220, 230, 240	230	1200	10 1/2	4 1/16	4 3/4	9 1/8	3	21

CHANNEL FRAME FILAMENT / TRANSISTOR TRANSFS.
Pri. 115 V 50/60 Hz—Test Volts RMS: 1500

Type No.	Secondary	W	D	H	M	Lbs.
FT-1	2.5 VCT-3A	2 7/8	1 5/8	1 11/16	2 3/8	3/4
FT-2	6.3 VCT-1.2A	2 7/8	1 5/8	1 11/16	2 3/8	3/4
FT-3	2.5 VCT-6A	3 5/16	1 7/8	2	2 13/16	1
FT-4	6.3 VCT-3A	3 5/16	1 7/8	2	2 13/16	1
FT-5	2.5 VCT-10A	3 3/4	2 1/8	2 5/8	3 1/8	1 1/2
FT-6	5 VCT-3A	3 3/4	2 1/8	2 5/8	3 1/8	1 1/2
FT-7	7.5 VCT-3A	3 3/4	2 1/8	2 5/16	3 1/8	1 1/2
FT-8	6.3 VCT-8A	4	2 1/2	2 5/8	3 3/16	2 1/2
FT-10	24 VCT-2A or 12V-4A	4	2 5/8	2 11/16	3 3/16	2 1/2
FT-11	24 VCT-1A or 12V-2A	3 3/4	2 1/8	2 5/16	3 1/8	1 1/2
FT-12	36 VCT-1.3A or 18V-2.6A	4	2 5/8	2 5/8	3 3/16	2 1/2

Taps on pri. of FT-13, FT-14, FT-15 & FT-16 to modify sec. nominal V, —6% +6%, +12%

FT-13	26 VCT-.04A	2 1/8	1 3/8	1 1/4	1 3/4	1/4
FT-14	26 VCT-.25A	2 7/8	1 5/8	1 11/16	2 3/8	3/4
FT-15	48 VCT-1A	4	2 1/2	2 5/8	3 3/16	2 1/2
FT-16*	11 VCT-2.5A or 5.5 V-5A	3 3/4	2 1/8	2 5/16	3 1/8	1 1/2

*For 120V input, use —6% tap.

DOUBLE SHELL POWER TRANSFORMERS

Type No.	High V.	DC ma	5V. Fil.	6.3 VCT Fil.	W	D	H	M	N	Wt. Lbs.
R-101	275-0-275	50	2A	2.7A	3	2 1/2	3	2 1/2	2 1/8	2 1/2
R-102	350-0-350	70	3A	3A	3	2 1/2	3 3/8	2 1/2	2 1/8	3 1/2
R-103	350-0-350	90	3A	3.5A	3 3/8	2 11/16	3 1/8	2 13/16	2 1/4	4 1/2
R-104	350-0-350	120	3A	5A	3 3/4	3 3/8	3 3/8	3 3/8	2 1/2	5 1/2
R-105	385-0-385	160	3A	5A	3 3/4	3 3/8	4 1/8	3 3/8	2 1/2	7

VERTICAL SHELL POWER TRANSFORMERS

Type No.	High V.	DC ma	5V. Fil.	6.3 VCT Fil.	W	D	H	M	N	Wt. Lbs.
R-110	300-0-300	50	2A	2.7A	2 5/8	2 13/16	3 1/4	2	1 3/4	2 1/2
R-111	350-0-350	70	3A	3A	2 5/8	3 1/16	3 1/4	2	2 3/8	3 1/2
R-112	350-0-350	120	3A	5A	3 3/8	3 11/16	4	2 1/2	2 3/8	5 1/2
R-113	400-0-400	200	3A	6A	3 3/8	4 1/8	4 3/8	3	3 1/8	8

CHANNEL FRAME FILTER INDUCTORS

Inductance Shown is at Rated DC ma—Test Volts RMS: 1500

Type No.	Induct. Hys.	Current	Resistance Ohms	W	D	H	M	Wt. Lbs.
R-55	6	40ma	300	2 3/8	1 3/8	1 3/8	2	1/2
R-14	8	40ma	250	2 7/8	1 1/2	1 11/16	2 3/8	3/4
R-15	12	30ma	450	2 7/8	1 1/2	1 11/16	2 3/8	3/4
R-16	15	30ma	630	2 7/8	1 1/2	1 11/16	2 3/8	3/4
R-17	20	40ma	850	3 3/8	1 5/8	2	2 13/16	1
R-18	8	80ma	250	3 3/2	1 5/8	2	2 13/16	1
R-19	14	100ma	450	3 3/4	1 7/8	2 5/8	3 3/8	1 1/2
R-20	5	200ma	90	4 1/8	2 1/4	2 5/8	3 3/8	2 1/2
R-21	15/3	200ma	90	4 1/8	2 1/4	2 5/8	3 3/8	2 1/2
R-220	100/8 Mhy 25/2 Mhy	2.5A 5A	.6 .16	3 3/4	2	2 5/8	3 3/8	1 1/2



TRANSFORMERS FOR INDUSTRY WIDE APPLICATIONS

STEP DOWN AUTO-TRANSFORMERS

220/240 Volts to 110/120 Volts, 50/60 Hz.

All units have 6 foot cord and female receptacle, except R-64.

Type No.	Rating Watts	L	W	H	Mtg. Dim.	Wgt. Lbs.
R-41	85	3 1/8	2 3/8	3 1/4	2x1 1/4	4
R-42	125	3 1/2	3	3 1/2	2 1/4 x 2 1/4	5
R-43	175	3 3/4	3 1/4	3 3/8	2 1/2 x 2 1/4	5 1/2
R-44	250	4 3/8	3 1/4	3 3/8	2 1/2 x 2 3/8	6 1/2
R-45	500	4 5/8	3 3/8	4 5/8	3x3 1/4	12
R-46	1200	6 7/8	3 3/8	4 5/8	3x5 1/2	18
R-64	2500	10 1/2	4 3/4	6 3/4	3 3/8 x 9 3/8	30



ISOLATION TRANSFORMERS

APPLICATION Isolates line noise. AC-DC sets, etc. Excellent electrostatic shielding, 1500 volt breakdown test. Six foot cord and female receptacle, except R-77. For optimum isolation see HIT's (pg. 40).

Primary 110-120 volts 50/60 Hz—Secondary 110-120 volts
Except R-97 220 volt Primary—120 volt Secondary



Type No.	Rating Watts	L	W	H	Mtg. Dim.	Wgt. Lbs.
R-72	40	3 1/8	2 3/8	3 1/4	2x1 1/4	4
R-73	100	3 3/4	3 1/4	3 3/8	2 1/2 x 2 3/8	6
R-74	250	4 7/8	3 3/8	4 3/8	3x3 1/2	12
R-75	600	7 3/8	3 3/8	4 5/8	3x5 7/8	20
R-76	1200	8 1/2	4 1/2	6 1/8	3 5/8 x 6 5/8	30
R-77	2500	12	7	9	6x11	70
R-97	250	4 3/8	3 3/8	4 3/8	3x3 1/2	12

STANDARD PHOTOFLASH TRANSFORMERS PHOTO & LASER APPLICATION

APPLICATION For either standard (Amglo type) or trigger (Sylvania type) multiple flash tubes. Circuit details included with transformer.

PF-1 Primary 115 volts, 50/60 Hz. Secondaries for power supply delivering 2200 volts DC to condenser up to 100 mfd. Compound sealed in G-3 case (see pg. 43).

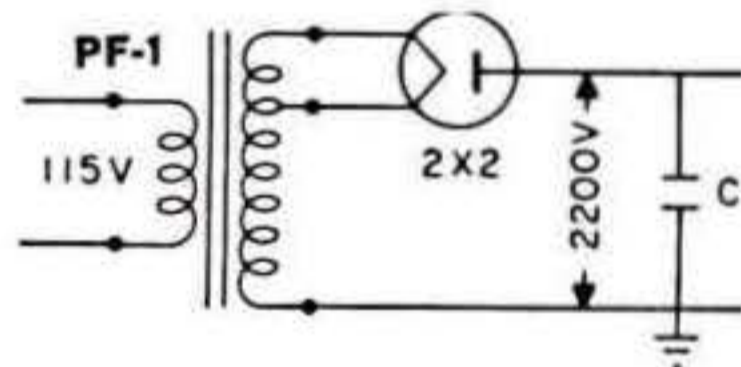

PF-3 Trigger transformer 15 KV peak. 7/8" dia x 3" long. Wt. 2 oz.



TRANSISTOR PHOTOFLASH TRANSFORMERS

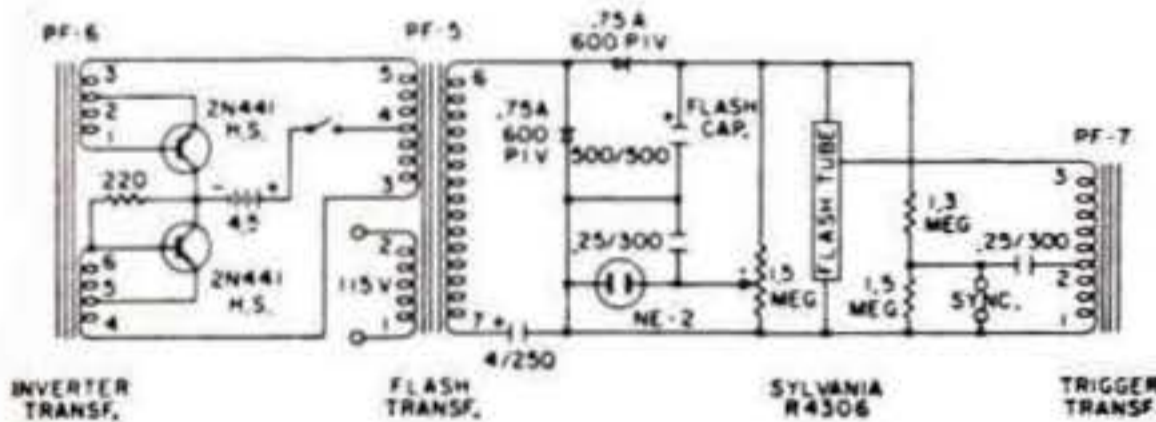

Miniaturized light weight units for transistor type photoflash supply.

PF-5 Primary for 115 volts 50/60 Hz or for 4 1/2 V battery switched by PF-6 inverter transformer. Output delivers 400 V DC when used in voltage doubler circuit to charge photoflash capacitor (typically 40 watt-Sec.). G-1 case (See Pg. 43).



PF-6 Inverter transformer transforms 4 1/2 V DC from battery to input for PF-5 stepup transformer. Ouncer case (See Pg. 18).

PF-7 Trigger transformer. Shorting .25 mfd. capacitor (charged to approx. 225 V DC) across terminals 1-2 produces 6 KV pulse at terminal 3 for triggering flash tube. 7/8" dia. x 15/16"; Wt. 1/2 oz.



SIGNALLING AND CONTROL TRANSFORMERS

Primary 110-120 volts, 50/60 Hz—Secondary 4/8/12/ 16/20/24 volts

APPLICATION Operating relays, sirens, horns, gongs, etc. from 115 V 50/60 Hz line. Four secondary terminals providing 4, 8, 12, 16, 20, and 24 volt output.

VOLT AMPERE RATING Based on 24 V secondary tap, corresponding reduction at lower voltages.

TERMINATIONS Primary: Underwriters' Approved leads. Secondary: Screw type binding posts.



Type No.	Rating Watts	L	W	H	Mtg. Dim.	Wgt. Lbs.
SC-3	50	3	3 1/8	3 3/8	1 3/4 x 2 1/4	3
SC-4	100	3 1/4	3 3/8	4	2 1/8 x 2 1/2	5
SC-5	250	4	4 5/8	4 3/4	3 3/8 x 3	10

EXPORT VOLTAGE ADAPTER

APPLICATION Switch provides line voltages of 105, 115, 125, 135, 150, 210, 230, 250; 42 to 60 Hz. Output 115 V.

TERMINATION Input, cord and plug. Output, female receptacle.

Type No.	Rating Watts	L	W	H	Mtg. Dim.	Wgt. Lbs.
R-47A	85	4 3/4	3	3 1/2	2 1/4 x 2 3/8	4 1/2
R-48A	150	4 3/4	3 1/4	4	2 1/2 x 2 3/4	5 1/2

APPLICATION Switch provides line voltages of 85, 90, 95, 100, 105, 110, 120, 125 V. 50/60 Hz. Output 115 V.

TERMINATION Input, cord and plug. Output, female receptacle.



Type No.	Rating Watts	L	W	H	Mtg. Dim.	Wgt. Lbs.
R-49A	350	4 1/2	3 1/4	4	2 1/2 x 2 1/4	5

TYPICAL REGULATED TRANSISTOR SUPPLIES

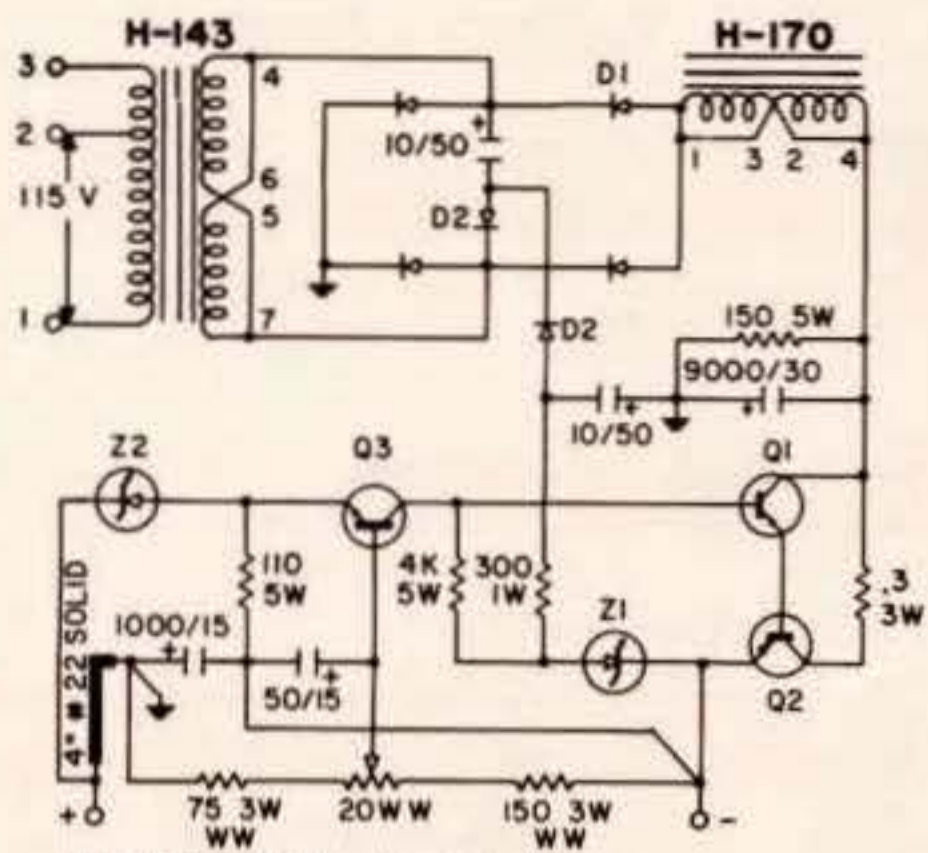

D1 (4) 1.5A, 100 P.I.V. D2 .75A, 100 P.I.V.
 Z1 12V ZENER (IN1513) Z2 3.9V ZENER (IN1507)
 Q1 DELCO 2N3214 (HEAT SINK)
 Q2 DELCO 2N441 (SINK 7270725)
 Q3 TEXAS 2N1377
 11 TO 13 VDC, 0 TO 2A, RIPPLE .35MV
 .1% REG 105/125 V LINE, 0/2A LOAD

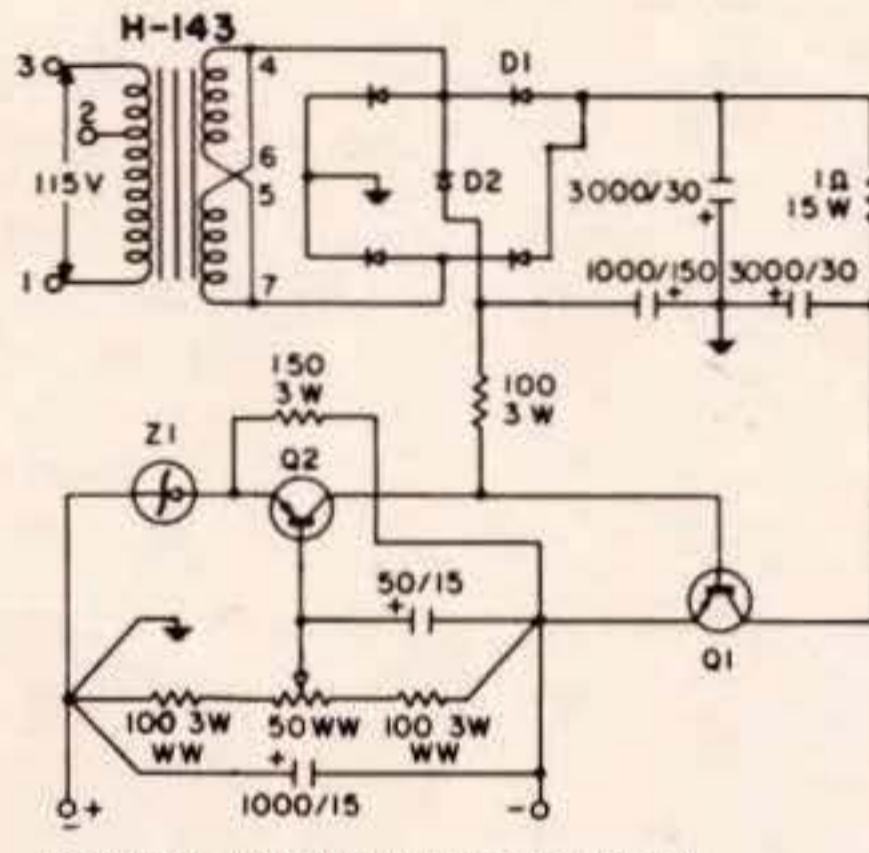

D1 (4) 1.5A 100 P.I.V. D2 (1) .75A 100 P.I.V.
 Z1 5.6V ZENER (IN1520)
 Q1 DELCO 2N441 (SINK 7270725)
 Q2 RCA 2N301 (HEAT SINK)
 11.5 TO 12.5 VDC, 0 TO 2A, RIPPLE 5 MV
 3.5% REG 105/125 V LINE, 0/2A LOAD

TYPICAL UNREGULATED TRANSISTOR SUPPLIES

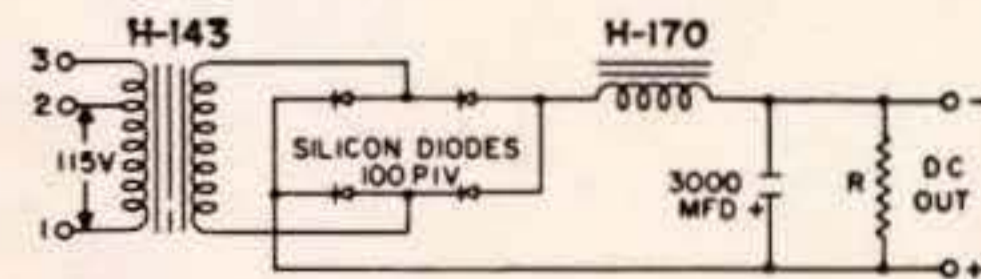

Pri. Term.	Sec. Term.	Choke Term.	Diode	R	D.C.V.	A.	O/Load Reg. %
1-3	Par.	Par.	1.5A	70	13	2.5	17
1-2	Par.	Par.	1.5A	60	16.5	2.5	12
1-3	Ser.	Ser.	.75A	300	27.5	1.25	13
1-2	Ser.	Ser.	.75A	250	34.5	1.25	12

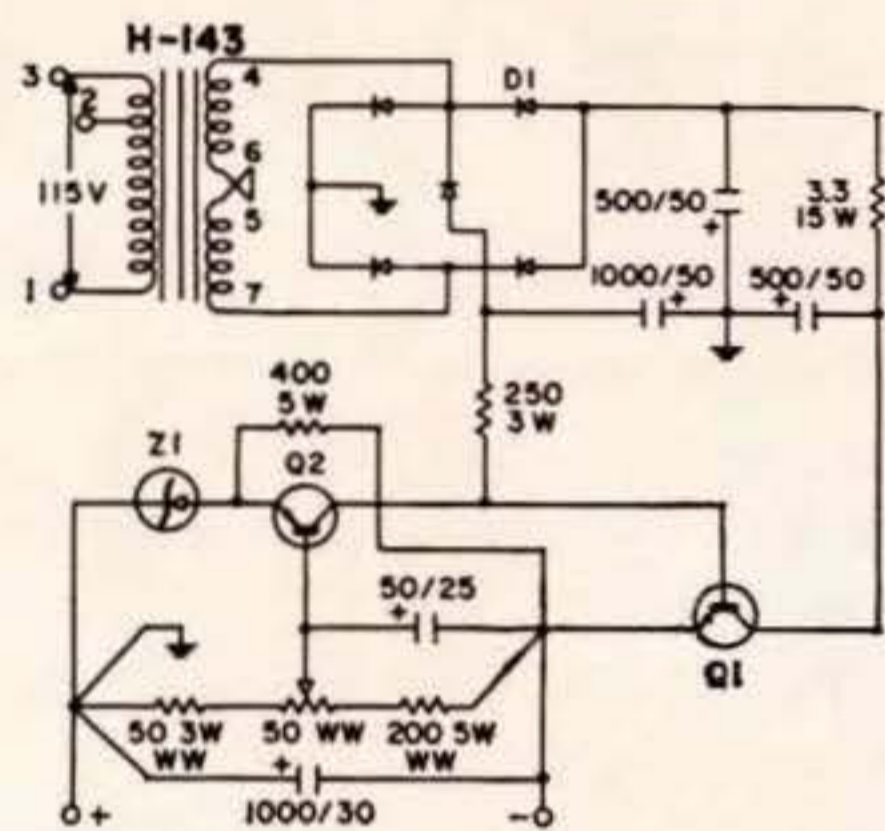

D1 (5) .75A 100 P.I.V.
 Z1 6.8V ZENER (1.5M 6.8Z)
 Q1 DELCO 2N441 (SINK 7270725)
 Q2 RCA 2N301 (HEAT SINK)

27 TO 29 VDC, 0 TO 1A, RIPPLE 1.5 MV
 1% REG 105/125 V LINE, 0/1A LOAD

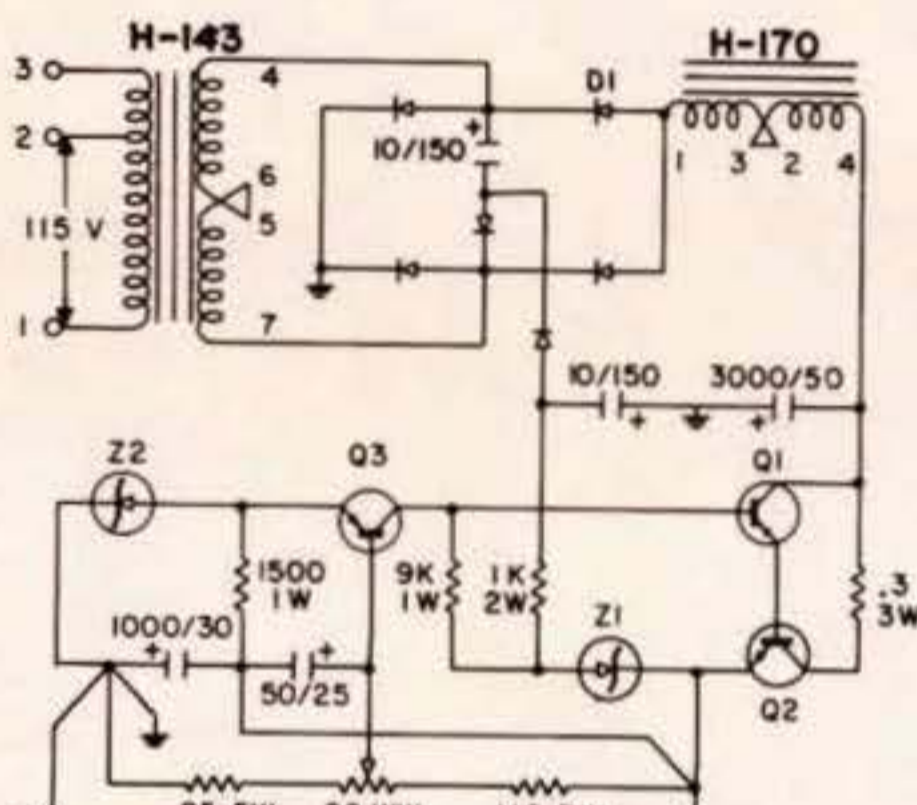

D1 (6) .75A 100 P.I.V.
 Z1 24V ZENER (1M24Z), Z2 12V ZENER (IN1513)
 Q1 DELCO 2N3214 (HEAT SINK)
 Q2 DELCO 2N441 (SINK 7270725)
 Q3 TEXAS 2N1377

26 TO 30 VDC, 0 TO 1A, RIPPLE .12 MV
 .1% REG 105/125 V LINE, 0/1A LOAD

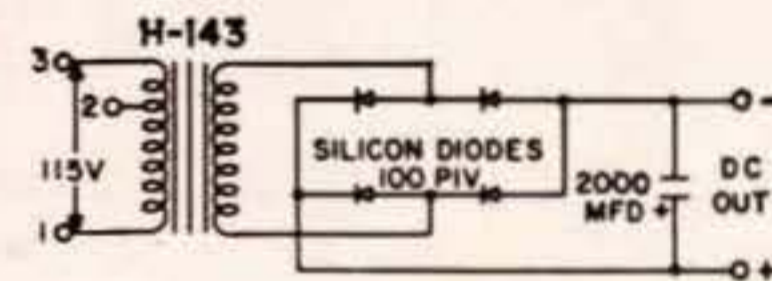

Pri. Term.	Sec. Term.	Diode	D.C.V.	A.	O/Load Reg. %
1-3	Par.	1.5A	19.6	2	30
1-2	Par.	1.5A	25.5	2	26
1-3	Ser.	.75A	42	1	24
1-2	Ser.	.75A	53	1	20

REGULATED VACUUM TUBE POWER SUPPLY CIRCUITS

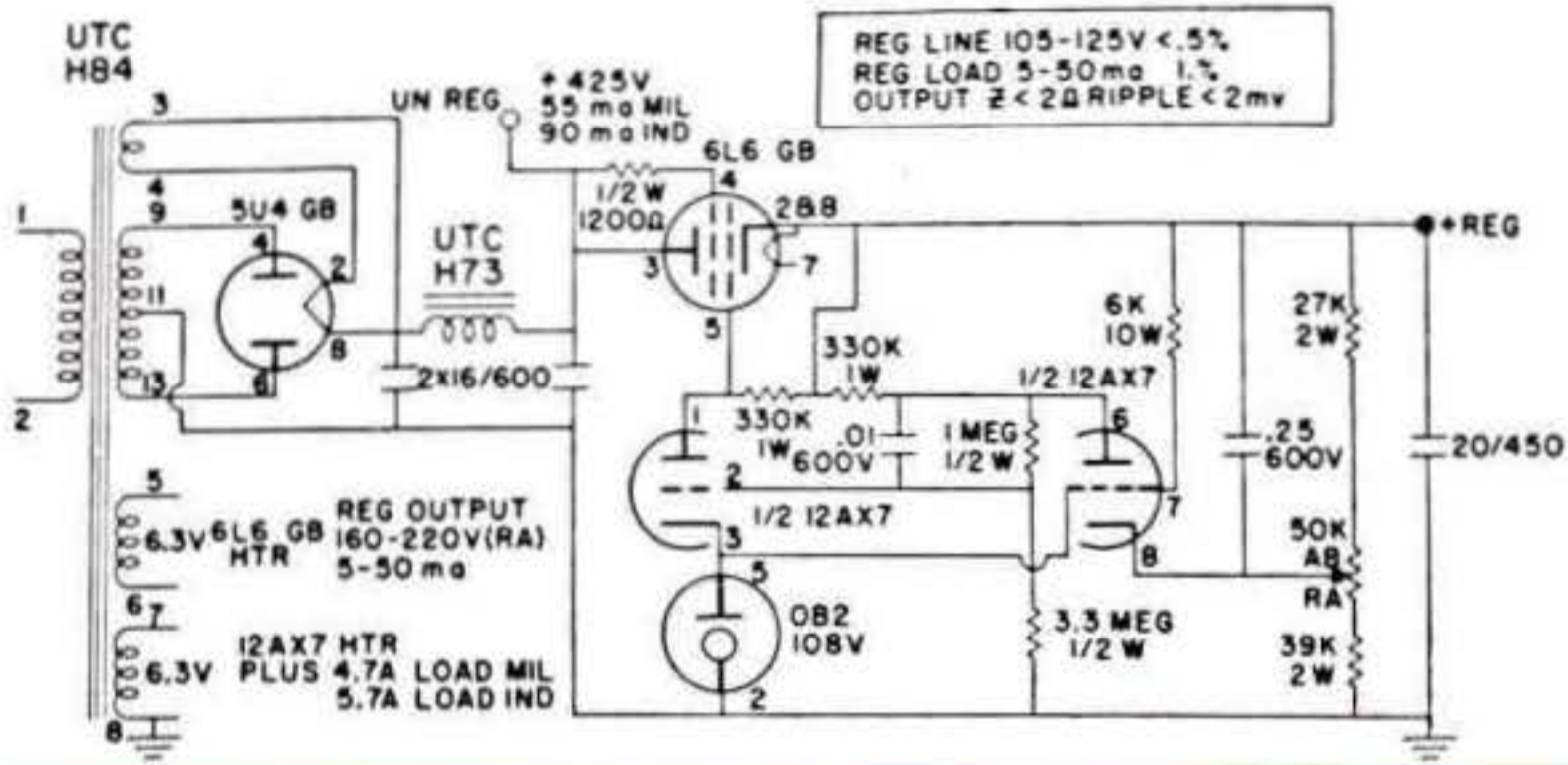

REG LINE 105-125V <.5%
 REG LOAD 5-50ma 1%
 OUTPUT Z < 2A RIPPLE < 2mv

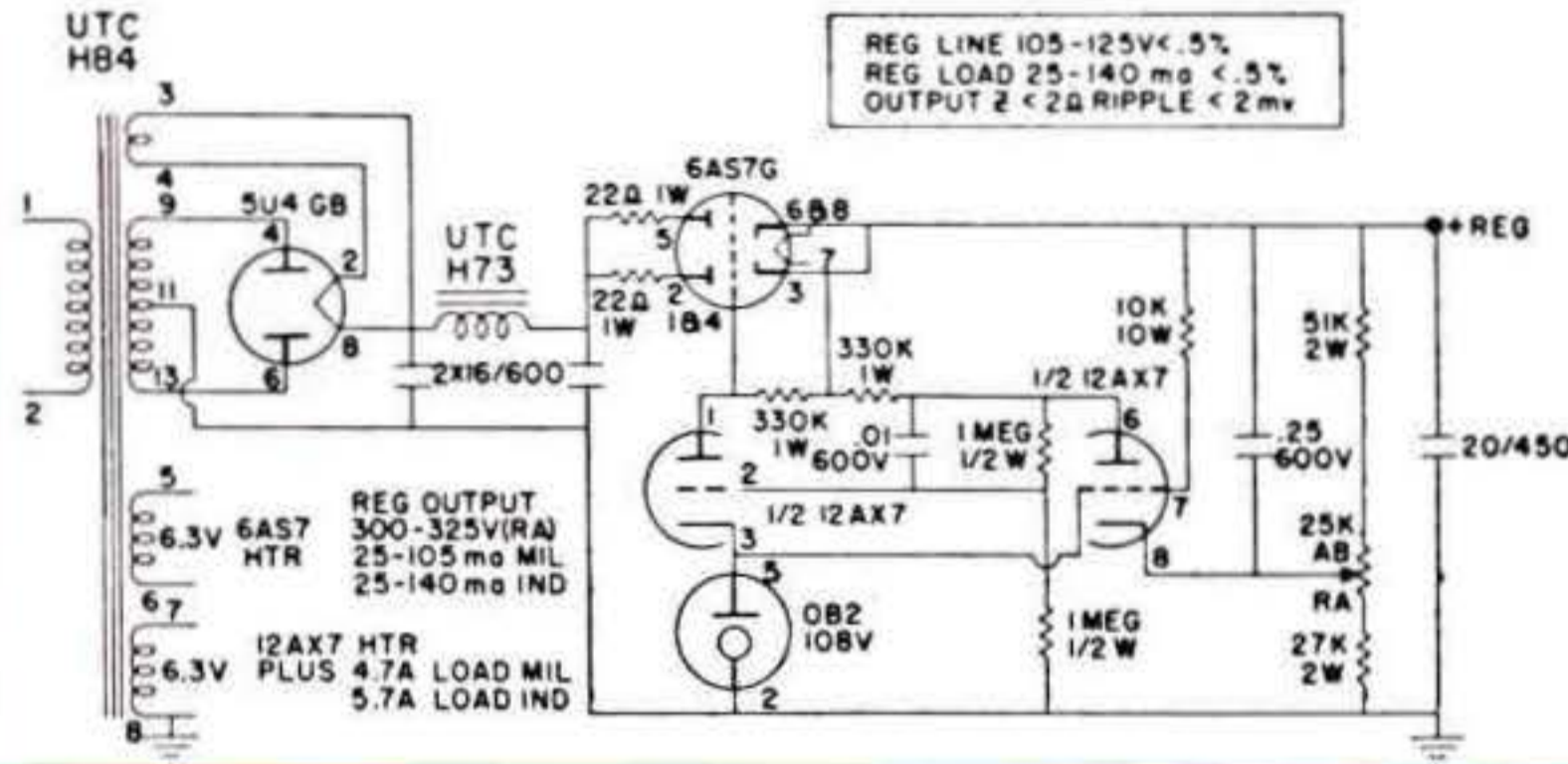

REG LINE 105-125V <.5%
 REG LOAD 25-140ma <.5%
 OUTPUT Z < 2A RIPPLE < 2mv

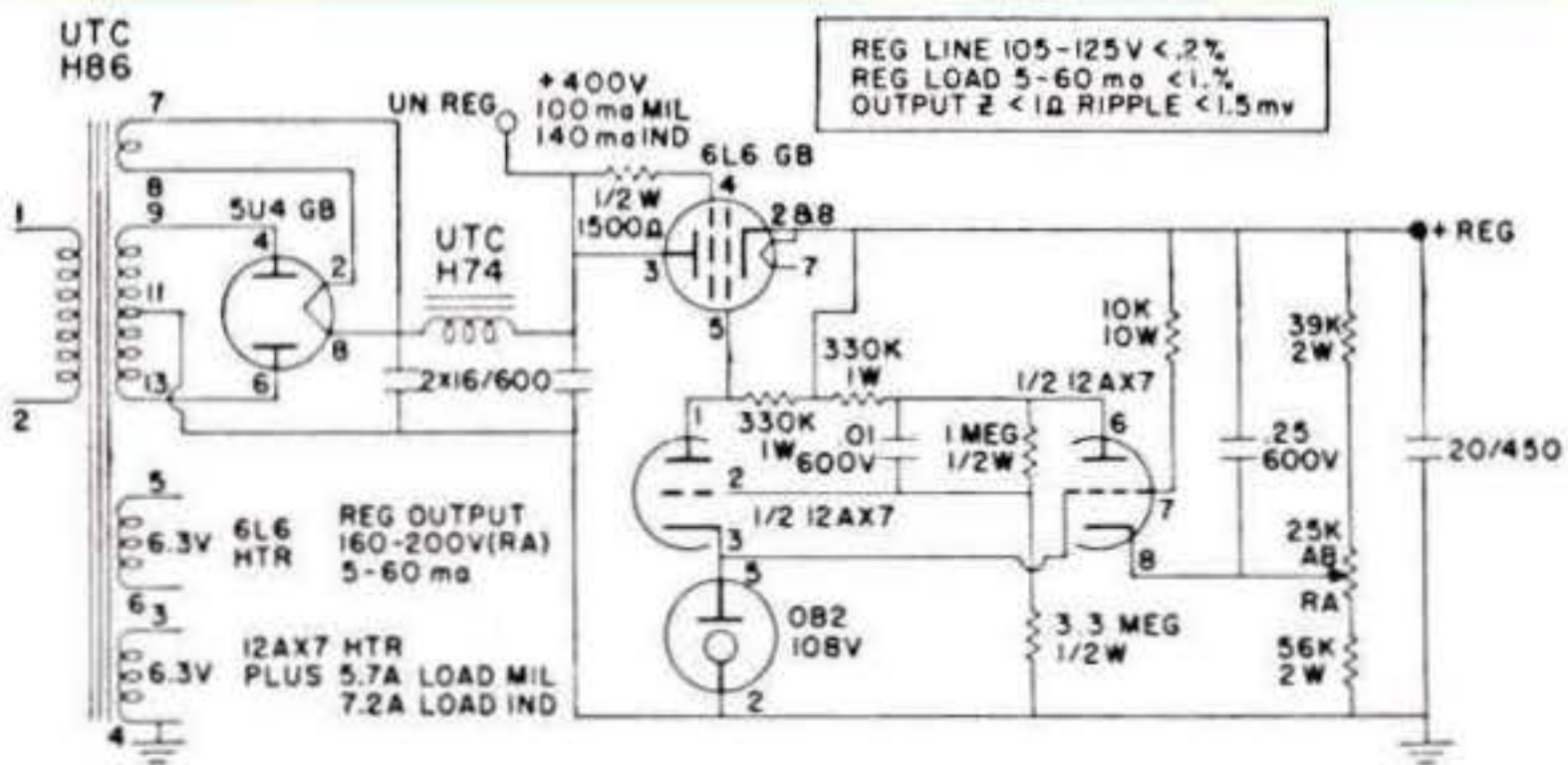

REG LINE 105-125V <.2%
 REG LOAD 5-60ma <.1%
 OUTPUT Z < 1A RIPPLE < 1.5mv

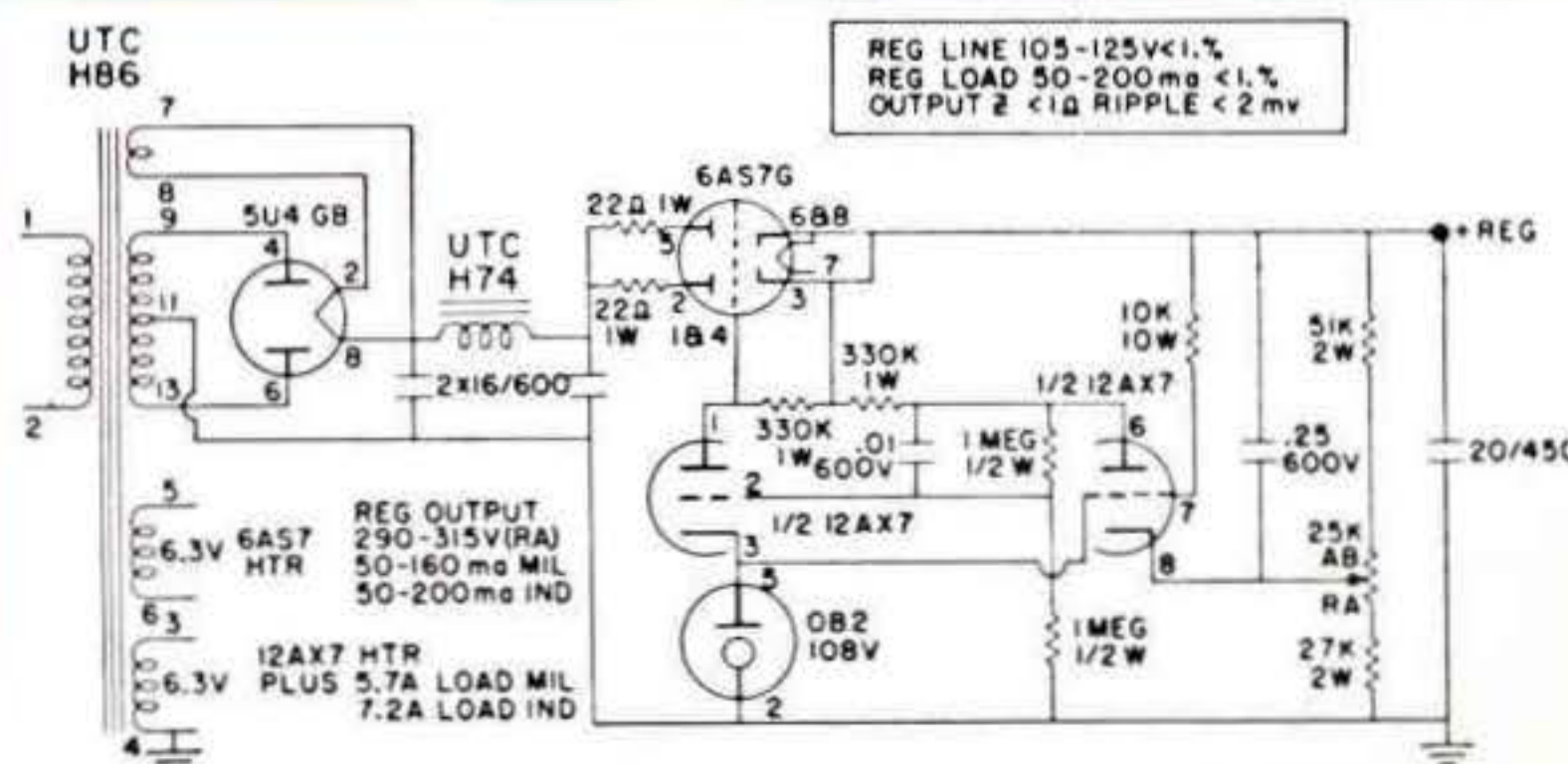

REG LINE 105-125V <.1%
 REG LOAD 50-200ma <.1%
 OUTPUT Z < 1A RIPPLE < 2mv



SPECIAL CUSTOM BUILT POWER TRANSFORMERS TO YOUR SPECIFICATIONS

In addition to the needs met by UTC stock power components, there are many unique applications which require special units. The units illustrated below are intended to show some of the thousands of special units produced by UTC and to help provide the equipment engineer with a concept of the possibilities in present special transformer design. Range covered is from milliwatts to 100 KVA.

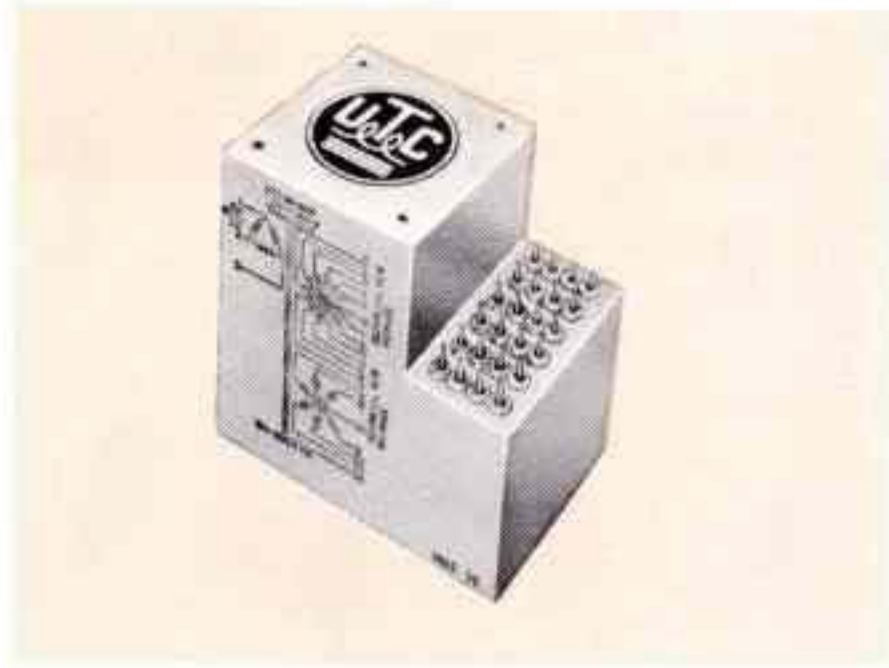

Power transformer; 3 phase input, one 12 phase and one 6 phase output. 25 VA total. MIL-T-27C, Class R. Size: 2 x 3 x 3".

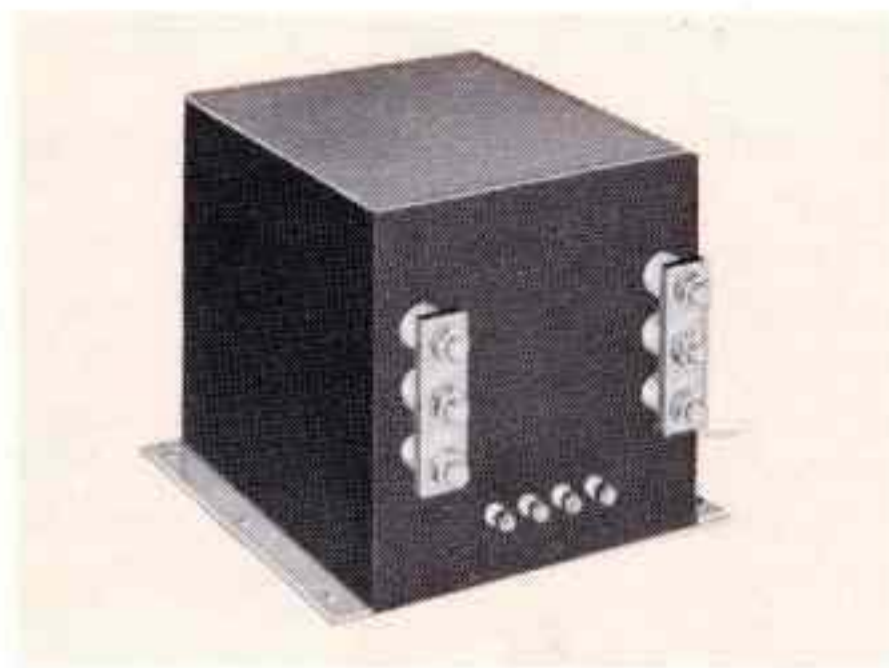

High current filament transformer. Primary 140/156 V., 47/63 Hz to 1.8 V.-1070 A. Current limiting through separate primary reactor, MIL-T-27C; 10 x 10 x 11½". 150 lbs.

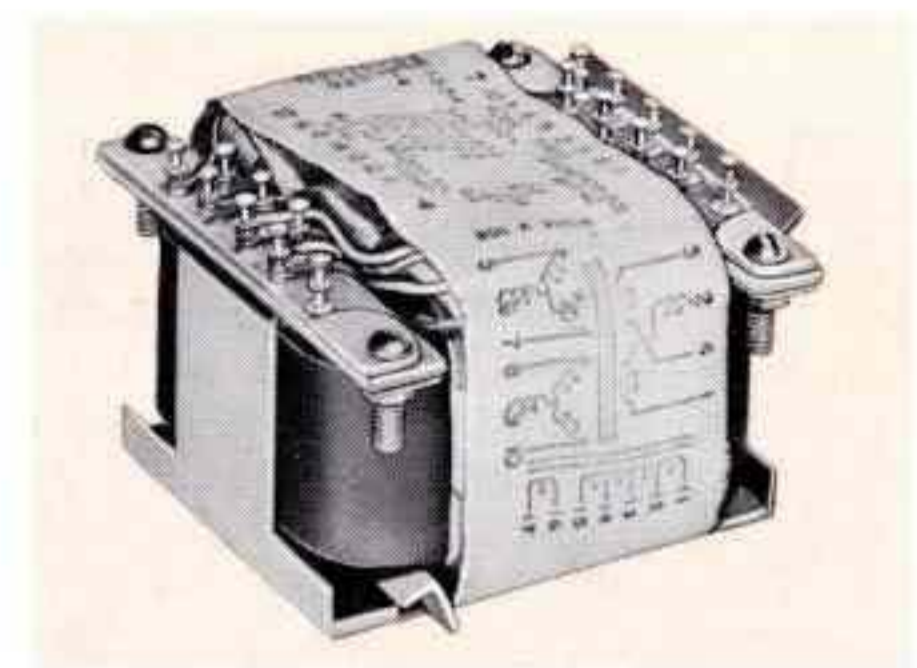

230° C. power transformer. Primary 115 V., 3 phase, 300/420 Hz to 200 V. and 20 V. secondaries, 525 V.A. 230° C. operating; 2¾ x 3 x 2", 1.8 lbs.

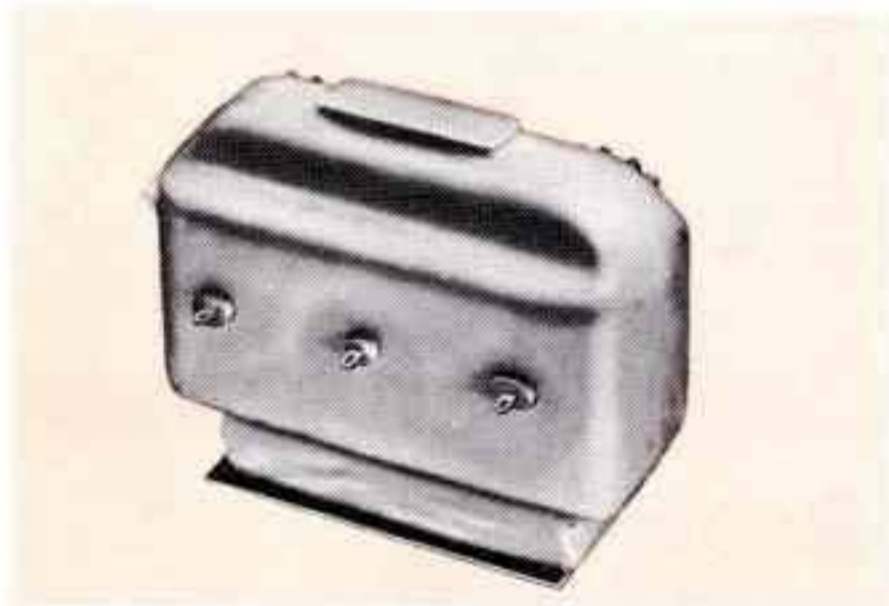

High temperature plate transformer. Primary 208 V., 3 phase 380/1000 Hz to 5100 V./leg, 1400 V. A. 200° C. MIL-T-27C; 6 x 3 x 4½", 6 lbs.

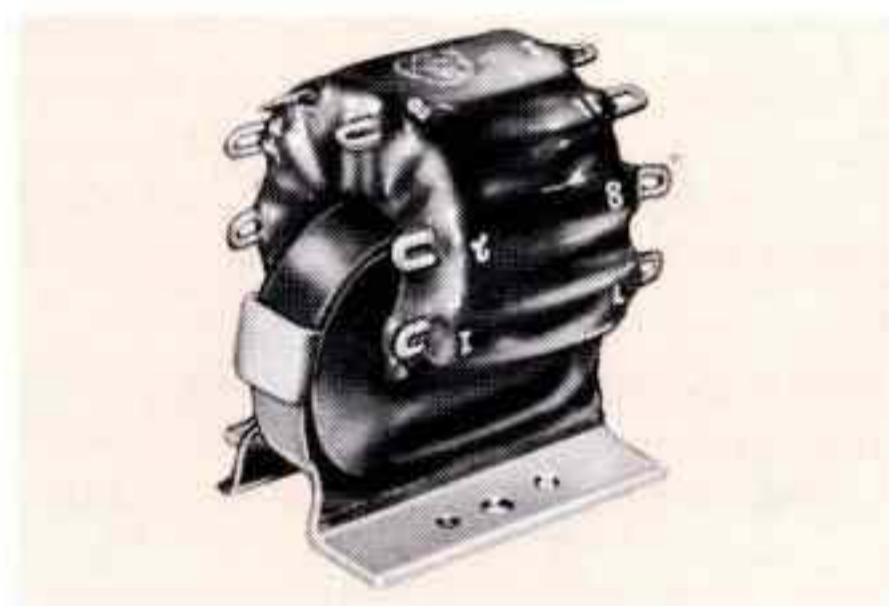

High temperature power transformer. Primary 115 V., 320/1000 Hz to four 6.3 V. and one 475 V. secondaries. 200° C. MIL-T-27C; 2¼ x 2 x 2", 9 ounce.



Low capacity current limiting filament transformer. Primary 118 V. 60 Hz to 6.3 V. at 3 A., 8 A. at short circuit. 25 MMFD capacity, 30 KV hipot and 200:1 capacity divider; 5 x 3¾ x 4½", 9 lbs.



High Current and High Voltage Transformer. Input 115 V 400 Hz to 7.5 V CT-51A, 22 KV hipot. MIL-T-27C, Grade 4; 6½ x 6¾ x 6¾", 30 lbs.

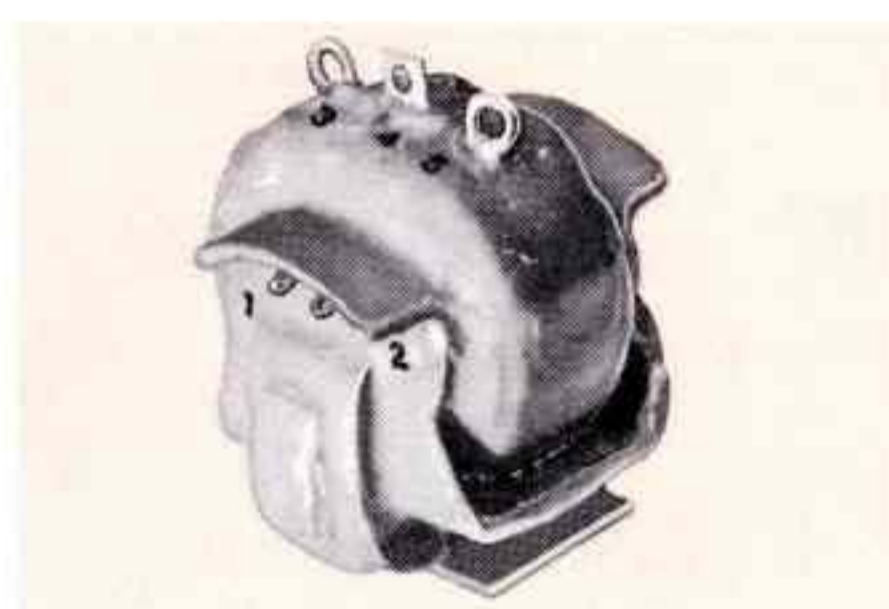

High voltage filament transformer. Primary 115 V., 380/1600 Hz to 5 VCT-10 A., 21 KV hipot. 160° C. MIL-T-27C Grade 5; 2¼ x 2½ x 2¼", 10 ounce.

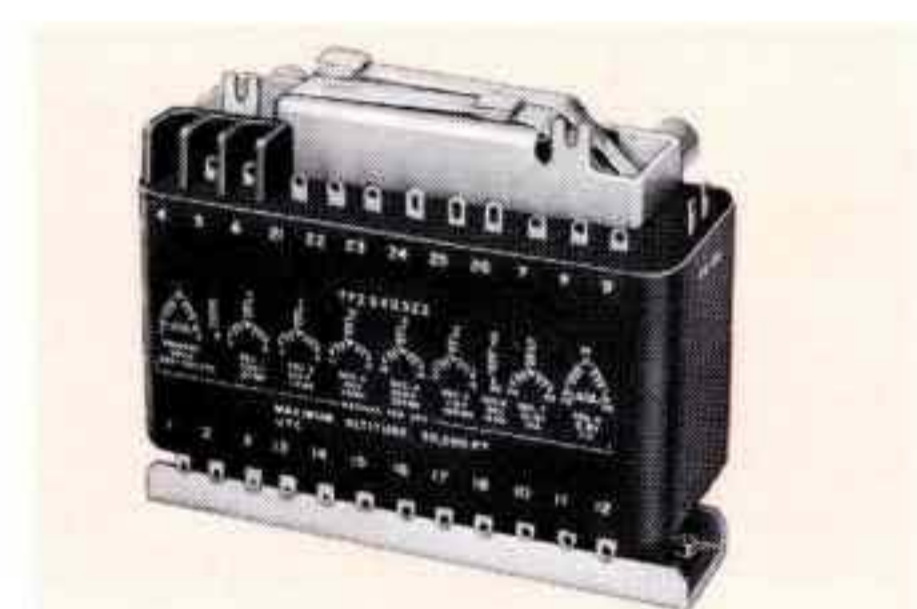

Molded Power Transformer 3 Phase. Input 200V, 380-420 Hz Electrostatic Shield, 8 output windings. 26 terminals. MIL-T-27C, Grade 2 Class S. Max. Alt. 50K Ft. Size 6 x 2½ x 5", 8 lbs.

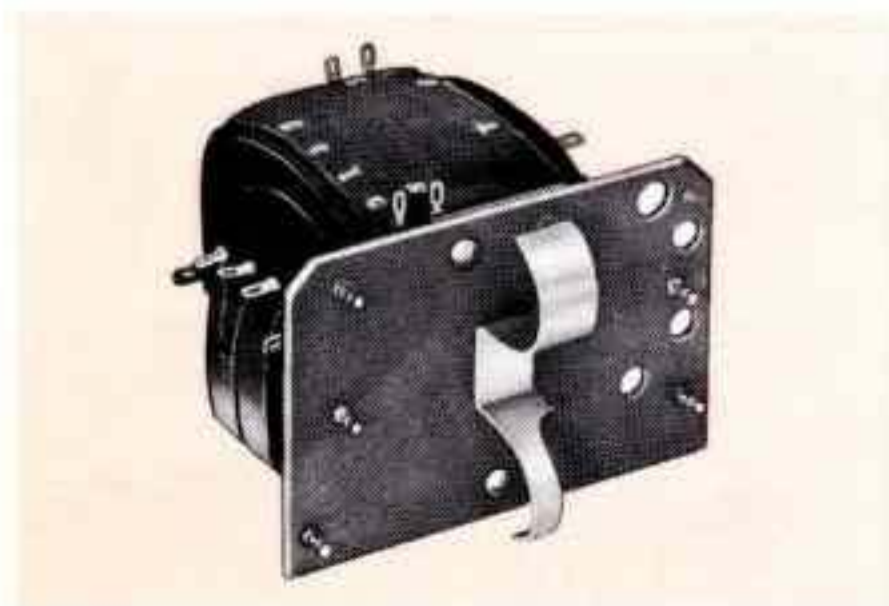

Scope power transformer with board for rectifiers. Primary 115 V., 400 Hz to two 14 KV filament windings, one 6.3 V. low capacity filament winding, 4.5 KV and 1.75 KV high voltage windings. 25 KV hipot when in oil; 2¾ x 3½ x 2½", 1¼ lbs.

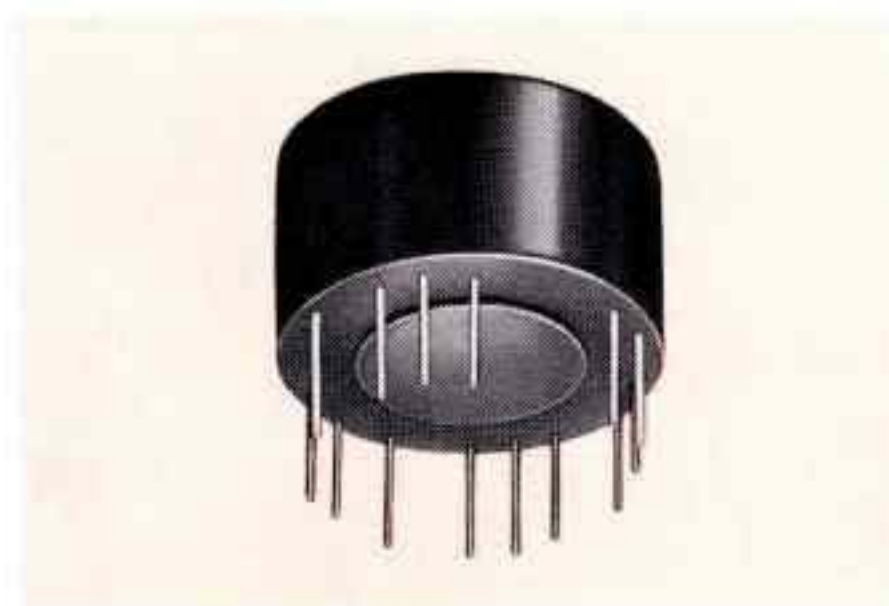

Self-saturating inverter transformer; 100 V DC input. Frequency of oscillation 20 kHz. MIL-T-27C, Class T. Size: 1.25 Dia x .60 H, PC mounting.

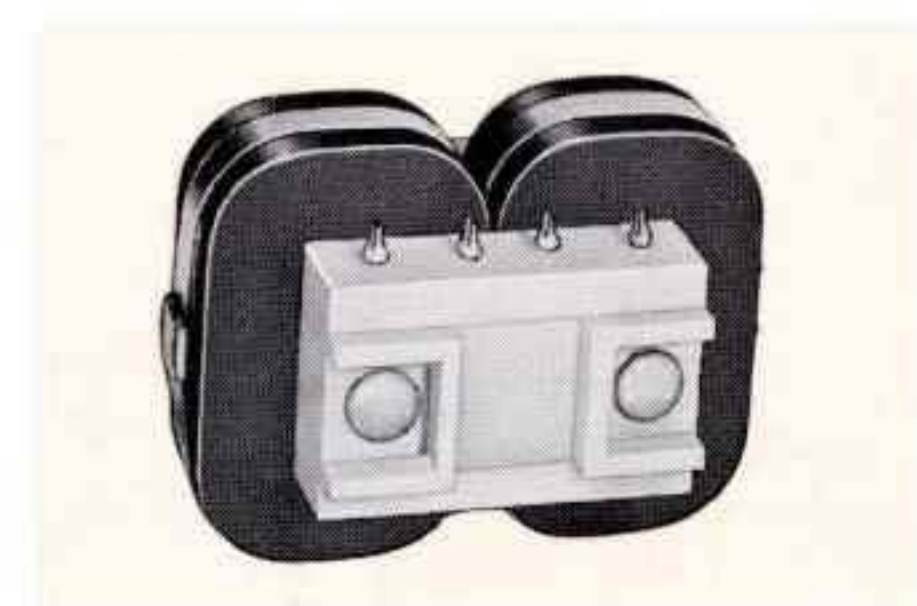

Molded High Temperature, High Voltage Transformer. Input 115 V 400 Hz, output 3400 V, 80 ma DC. Corona free molded terminals. MIL-T-27C Grade 5, Class T (170°C), 3¾ x 2¾ x 2½", 2 lbs. 10 oz.



MAGNETIC AMPLIFIERS FOR SERVO MOTOR APPLICATIONS

MAT™ SERIES

The MAT 1 through 4 and 7 through 10 magnetic amplifiers are exceptionally stable units designed for the control of 2 phase, 115V, 400 Hz servo motors. They are compact, hermetically sealed, magnetically shielded, and meet MIL-T-27C and MIL-E-5400 specifications. The output is sinusoidal, amplitude variable, and phase reversible. Control is provided by triode or transistor discriminator. The input signal can be polarity reversible DC or phase reversible 400 Hz with or without suppressed carrier modulation. The high input impedance provides minimum loading on sensing elements and high power gain. Ringing at low load level has been reduced to a minimum through high internal damping factors. The power output figures are conservative. Power gain of the magnetic structure is approximately 40. Response time approximately 7.5 milliseconds. The maximum null voltage is 3 Volts RMS. For single phase supply voltage the load capacitor should effect 90° phase shift for motor load, for 3 phase 30° phase shift.

MAT 1 THROUGH 4 are designed for tube input. For AC signal control the circuit of Figure 1 is employed. For DC signal control Figure 2 applies. Figure 3 shows the use of a power transformer (MAT-5) which provides higher plate voltage (230V supply data of chart) and eliminates the input transformer (MAT-6). The typical response curve of Figure 4 applies to all units.

MAT 7 THROUGH 10 are designed for transistor input. They have low impedance control windings required for transistor circuitry. Typical circuits are illustrated in Figures 5, 6 and 7. The input transformer may be chosen by impedance ratio rather than precise rated impedance. For example, the DO-T11 can be used as the input in Figure 5 (7500 ohms to 1500 ohms) and would have 2.3° phase shift; the H-14 used as the input (3750 ohms to 1500 ohms) would have phase shift of .6°.

MAT 60 is designed for 115V, 60 Hz servo motor in the 40 in.-oz. range. Figure 7 shows the use of power transformer MAT-65, with this unit, in a typical application. The input transformer should be chosen by impedance ratio requirements. Input impedance, looking into a 1:1 transformer, UTC H-25 is 350 ohms.

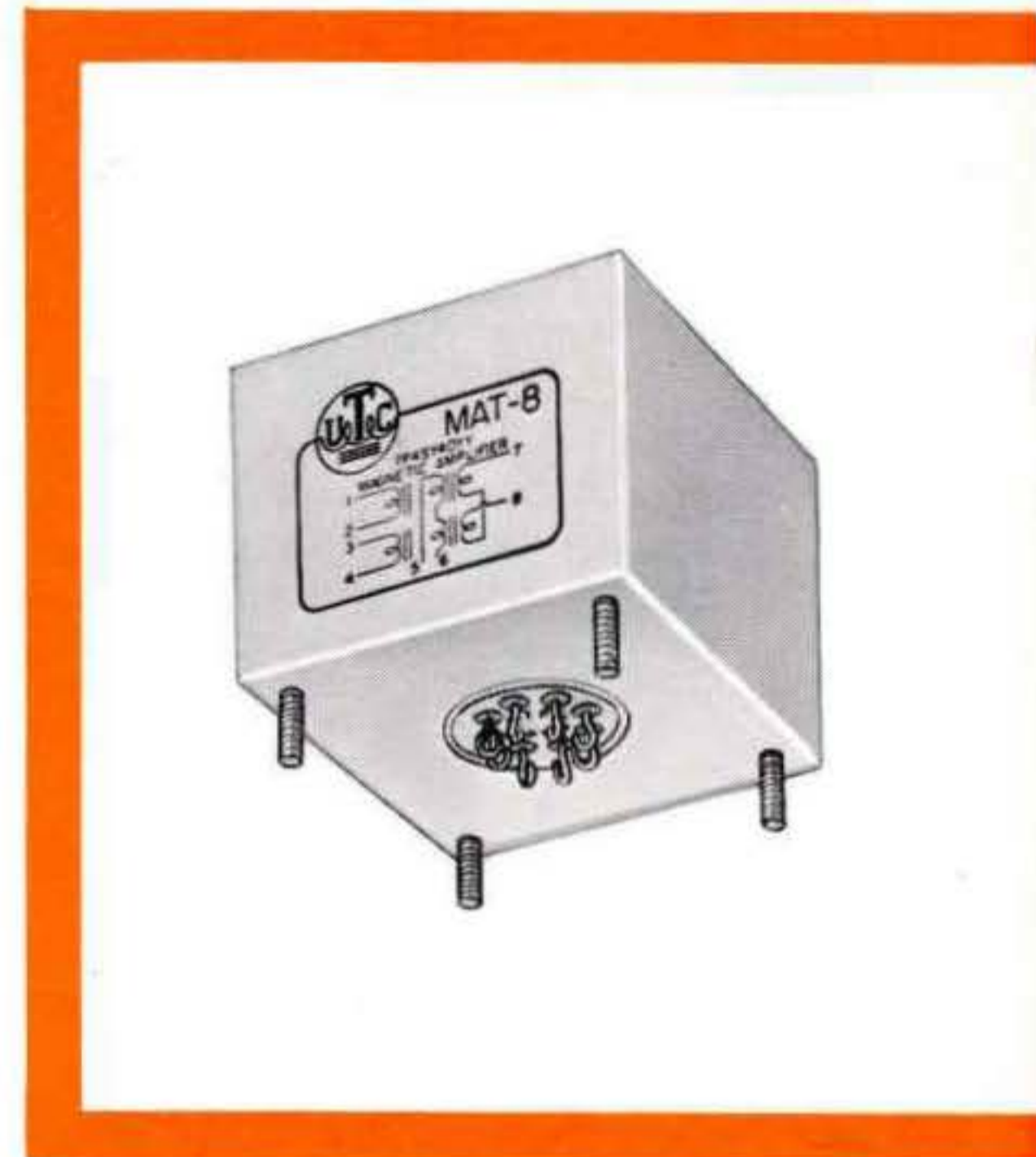

TRANSISTOR TYPES

400 Hz TYPES

Type No. →	MAT-7	MAT-8	MAT-9	MAT-10
Power output	4 W.	8 W.	11 W.	18 W.
R _L , ohms	3300	1600	1200	720
C _L , mfd, approx.	.2	.3	.5	.7
Cont. Wind. Res.	38 Ω	52 Ω	30 Ω	36 Ω
Case Length, in.	2 ⁵ / ₁₆	2 ¹ / ₂	2 ³ / ₄	2 ² / ₃₂
Width, in.	1 ¹ / ₁₆	2 ¹ / ₄	2 ¹ / ₂	2 ² / ₃₂
Height, in.	1 ¹ / ₃₂	1 ¹ / ₁₆	2	2 ¹ / ₄
Mtg. Dim., in.	1 ³ / ₈ x 1 ⁷ / ₈	1 ¹ / ₁₆ x 2	1 ¹ / ₁₆ x 2 ³ / ₁₆	2 ³ / ₈ x 2 ³ / ₈
Studs, stainless	4-40	6-32	8-32	8-32
Cutout, in.	1	1	1	1
Weights, lbs.	.65	1.1	1.7	2.75

MAT-11 115V.-400 Hz, to two 28 Volt .2 A. windings for 56 VCT-.2 A. or 28 V-.4 A. RC-37 case (Pg. 42). MIL type TF4SY02YY.

60 Hz TYPES

Type No. →	MAT-60
Power Output	50 W.
R _L , ohms	260 Ω
C _L , mfd, approx.	7 Mfd.
Cont. Wind. Res.	50 Ω
Case and Wt.	MB. (see pg. 51)

MAT-65 115V. 60 Hz to 8.5 VCT @ 500 ma and 63 VCT @ 300 ma. FA case (see pg. 51) Mil Type TF4SX02FA

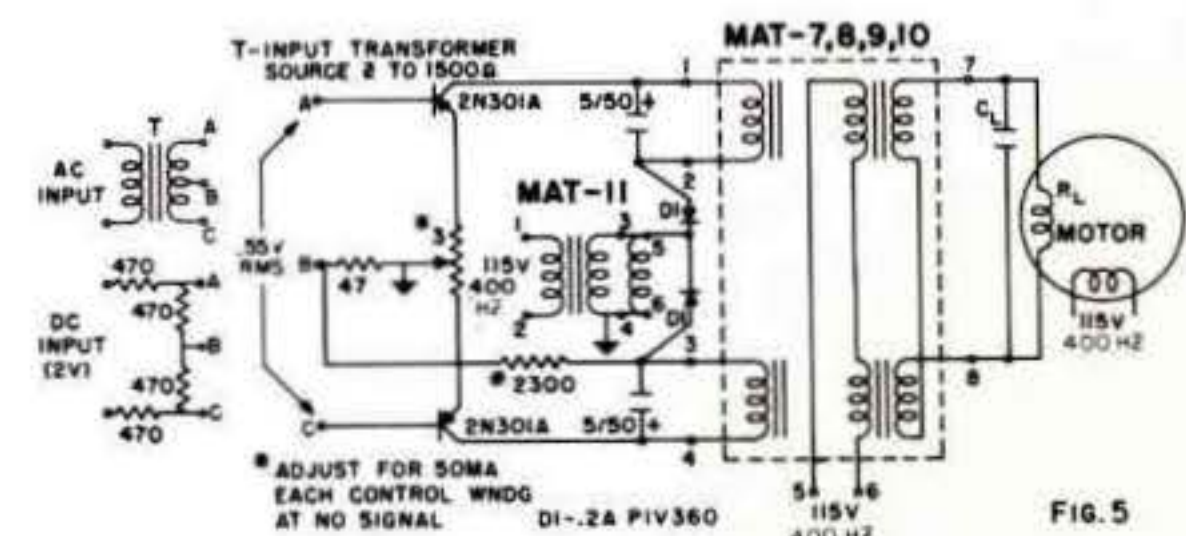
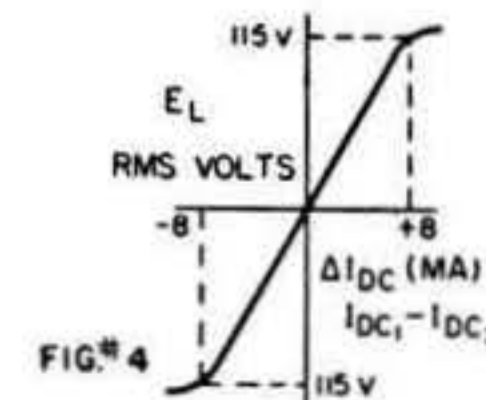
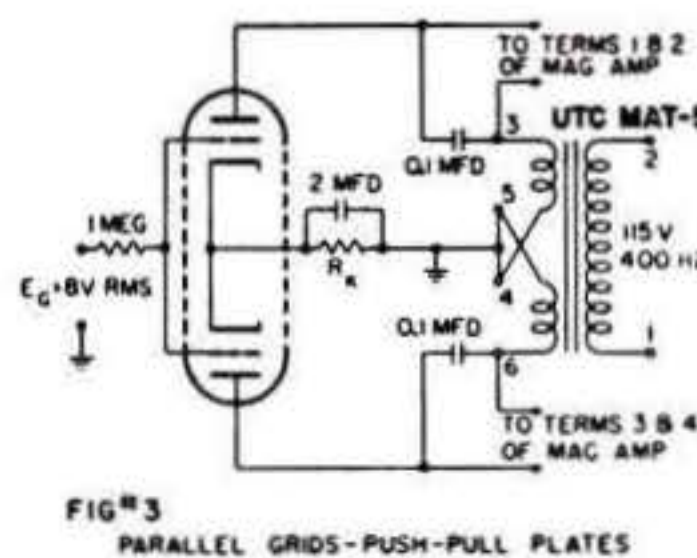
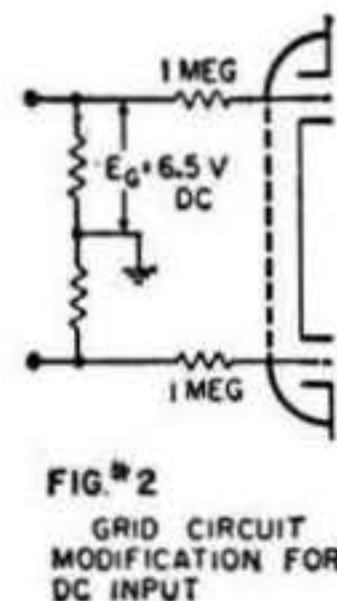
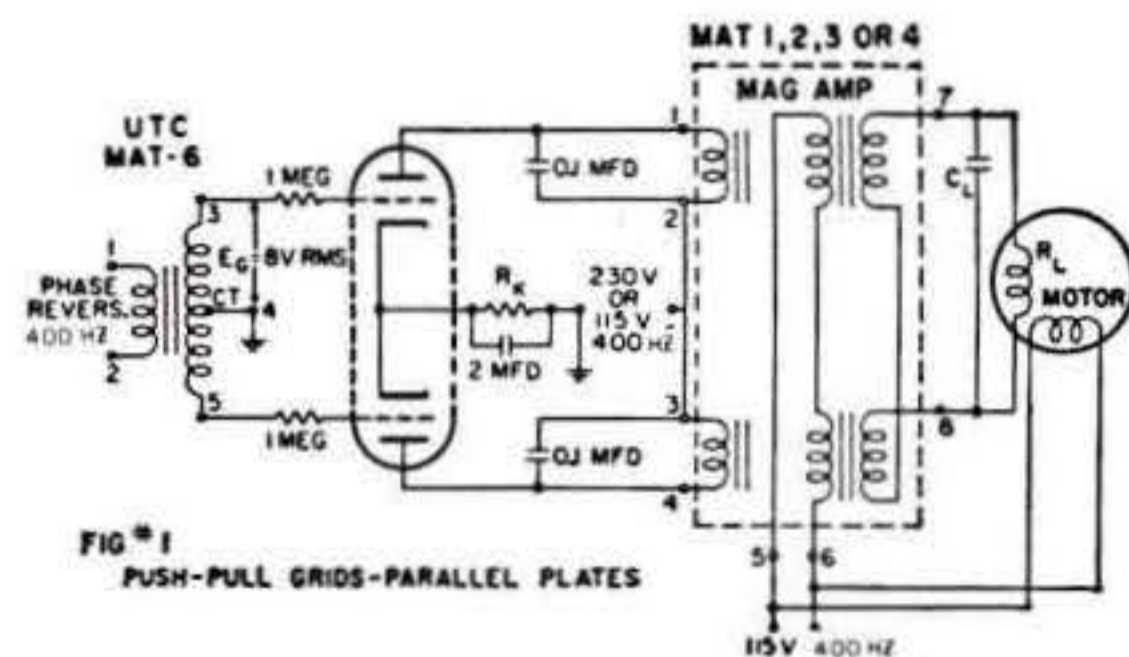

SOLID STATE PUSH PULL MAGNETIC AMPLIFIERS MAS™ SERIES

PACKAGING Hermetically sealed steel case with plug-in octal compressed glass terminals.

OPERATION Input of 115 V 400 Hz, output of ± 7.5 V DC, 1000 ohm load and have 2 isolated control inputs. These magnetic amplifiers afford a power gain of approximately 30,000. The power input and output are also completely and individually isolated.

NOTE Advantages over other active circuit elements such as tubes, transistors, etc.

- Long life and years of maintenance free operation due to magnetic characteristics and solid state elements.
- Ruggedness—can withstand high shock, vibration, radiation, and moisture.
- Reliability—can withstand 10 times overloads and operating into short circuit without damage.



3" x 1 1/2" Dia. Wt. 1/2 lbs.

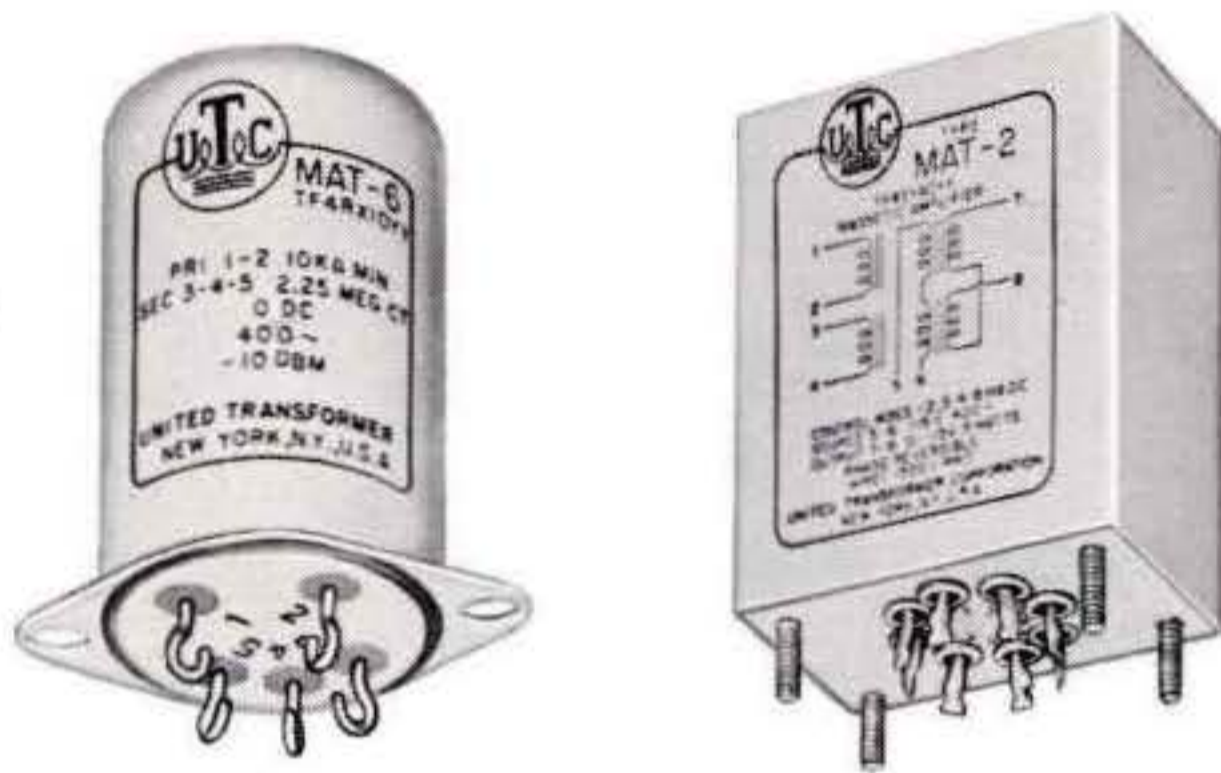

TUBE TYPES

Type No. →	MAT-1	MAT-2	MAT-3	MAT-4
230 Volt Supply				
Power output	4 W	8 W	11 W	18 W
RL, ohms	3300	1600	1200	720
CL, mfd., approx.	.2	.3	.5	.7
115 Volt Supply				
Power output	2 W	4 W	6 W	9 W
RL, ohms	6500	3300	2200	1450
CL, mfd.	.13	.2	.3	.45
Reson. Freq. (Hz)	40	35	35	20
Log-Decr.	.18	.23	.03	.65
Cont. Wdg. Res.	6200 ohms	8450 ohms	4750 ohms	5650 ohms
Case, Length, in.	1 1/4	1 1/2	1 3/4	2 1/8
Width, in.	1 1/16	2 1/8	2 1/2	3 1/8
Height, in.	2 3/16	2 3/4	2 1/16	3 3/8
Mtg. Dim., in.	1 3/16 x 1 1/2	1 x 1 5/8	1 1/8 x 1 7/8	1 1/2 x 2 1/2
Studs, stainless	4-40	6-32	8-32	8-32
Cutout, in.	1	1	1	1
Unit Weight, lbs.	.67	1.1	1.7	2.75

MAT-5 115V.-400 Hz to 460 VCT; provides 230V. 48 ma DC or 460V. 24 ma DC. RC-37 Case (pg. 42). MIL type TF4SY02YY.

MAT-6 Input . . . 10,000 ohms pri. . . 1:15 C.T. ratio . . . phase shift under 1° . . . RC-25 case (pg. 13). MIL type TF4SX10YY.

Type Number	Winding Number	Input Resistance Ohms	Trans-resistance Ohms	Nominal DC μ amps 5V DC Output 1000 Ω Load
MAS-400	1	45	2.5×10^4	200
	2	45	2.5×10^4	200
MAS-410	1	500	8.0×10^4	60
	2	500	8.0×10^4	60
MAS-420	1	1000	12.5×10^4	40
	2	100	4.0×10^4	125

POSSIBLE APPLICATIONS INCLUDE:

- Control Amplifier
- Photocell
- SCR Controls
- Strain Gauge Amplifier
- Meter Preamps
- Thermocouple
- Differential Amplifier
- Signal mixing, summing, integration
- Hydraulic Servo Valve Driver
- Servo Motor
- Linear Amplifications of Transducer Signals.

TYPICAL CHARACTERISTICS

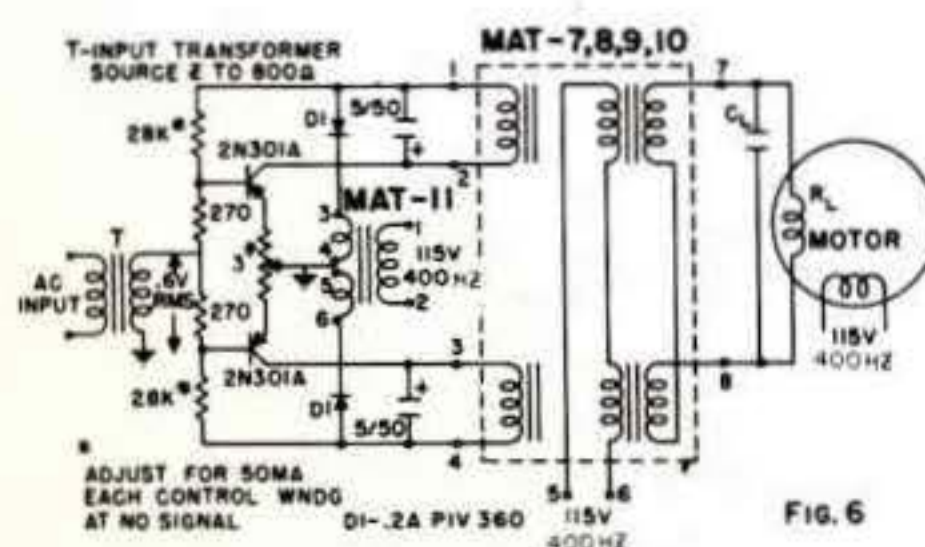
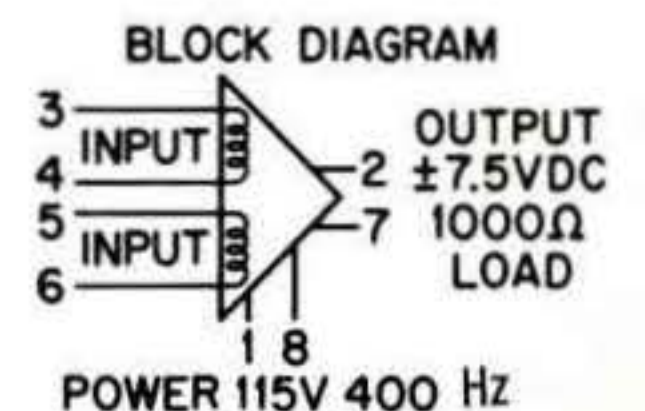
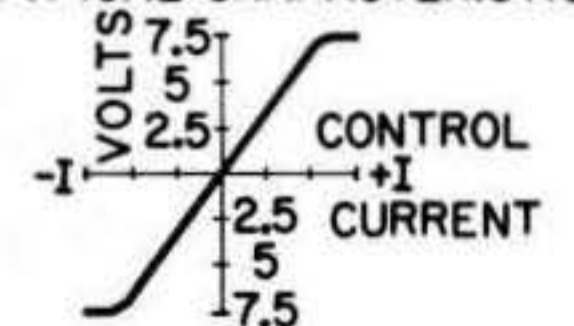

FIG. 6

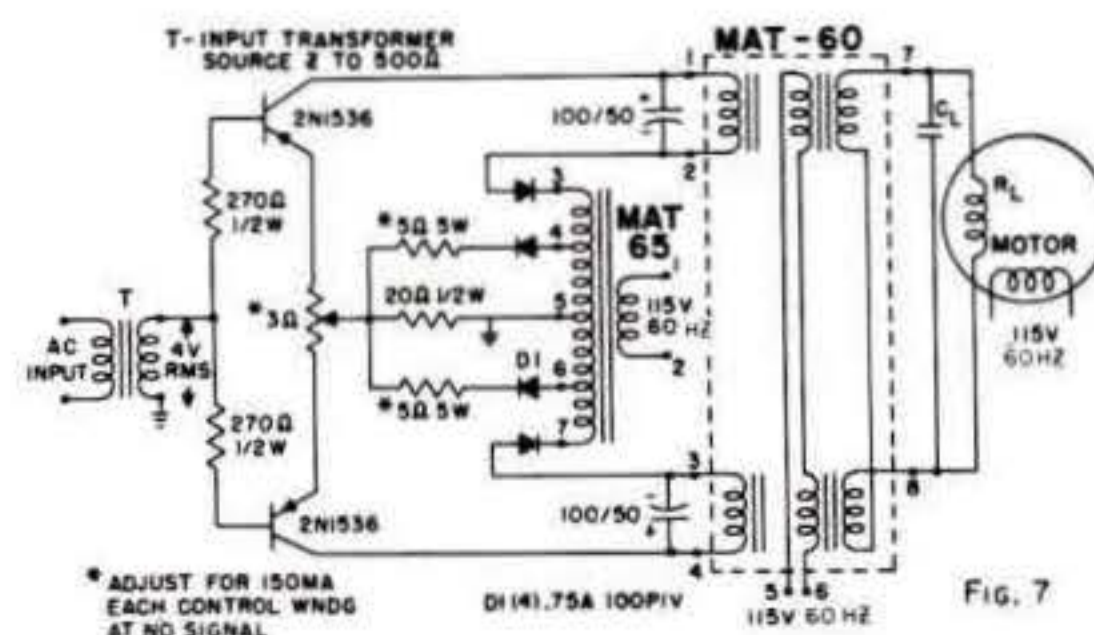
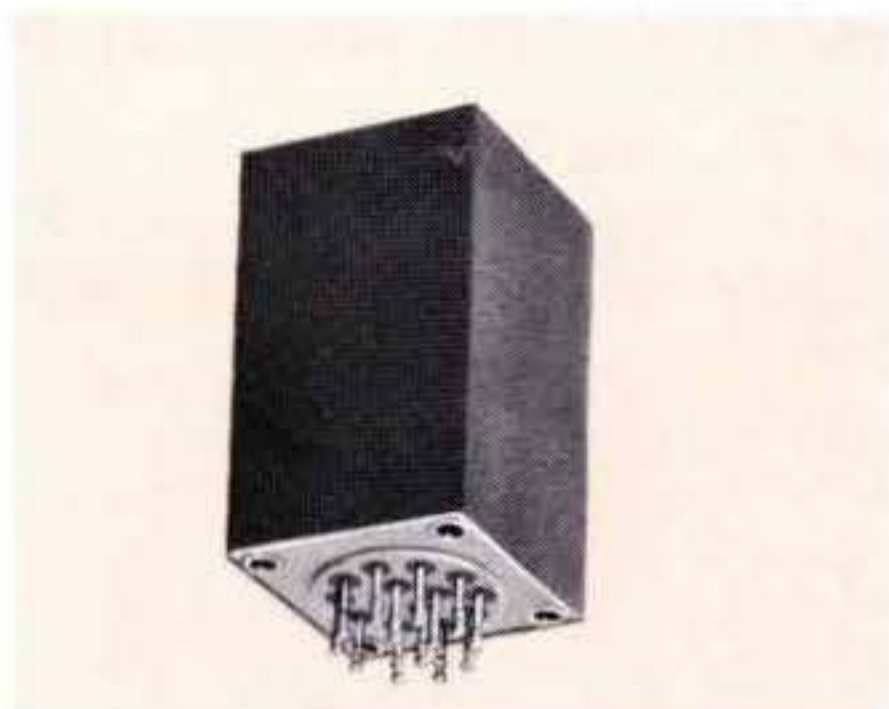

FIG. 7



**SPECIAL CUSTOM BUILT MAGAMPS, SATURABLE REACTORS
REFERENCE UNITS ... TO YOUR SPECIFICATIONS**

In addition to the many needs met by UTC stock components, there are a variety of unique applications which require special units. The illustrations below are intended to show some of the thousands of special units produced by UTC and to provide the equipment engineer with a concept of the possibilities in present special component design. Magamp range is from microwatts to 100 KVA.



Two self saturating magamps in one case. Output 250 V. into 750 ohms. Power gain 135,000. MIL-T-27C; 2 x 2 x 2½, 12 oz.

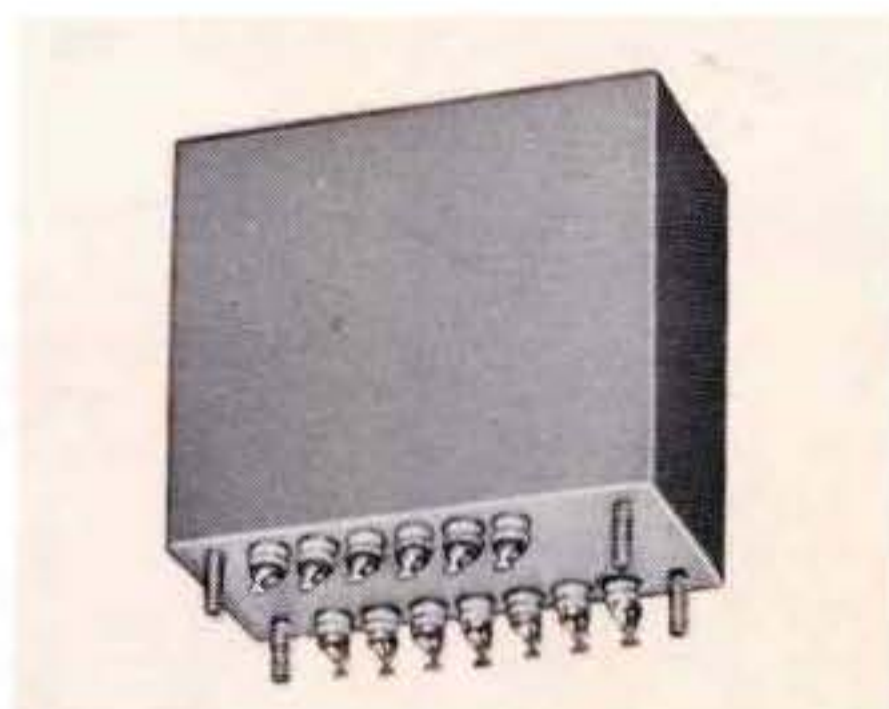

Servo reference transformer. Input 120 V., 380 to 420 Hz. Output ratios under load held to .005% tolerance. Phase shift .05° max. MIL-T-27C; 2¼ x 1¾ x 2, 12 oz.

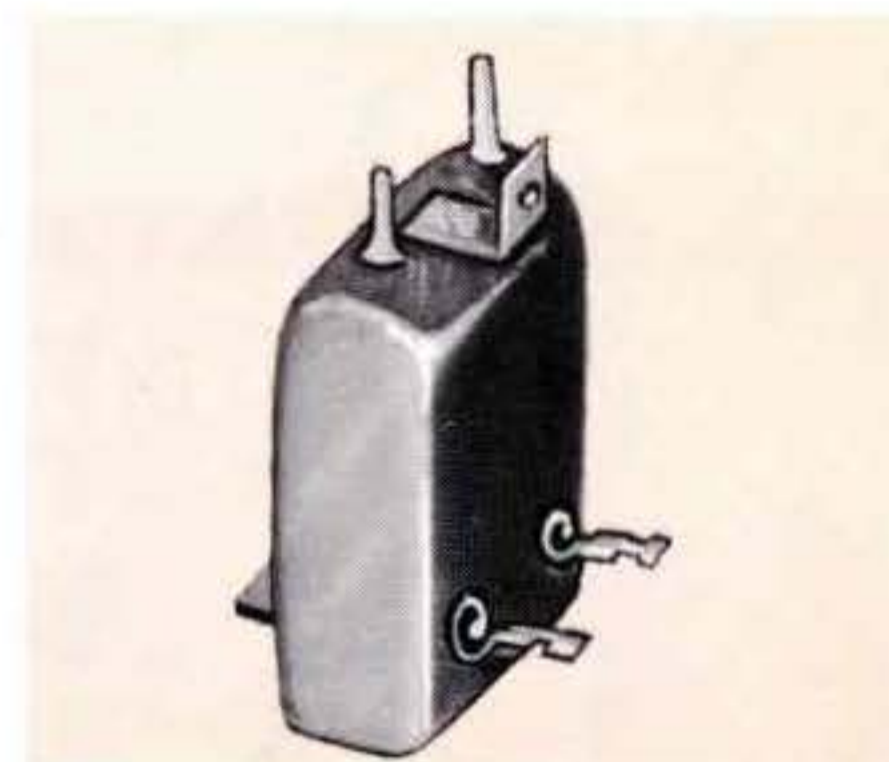

RF saturable inductor. 2 MA DC for sweep from 17 MHz to 21 MHz. MIL-T-27C; 2 oz.

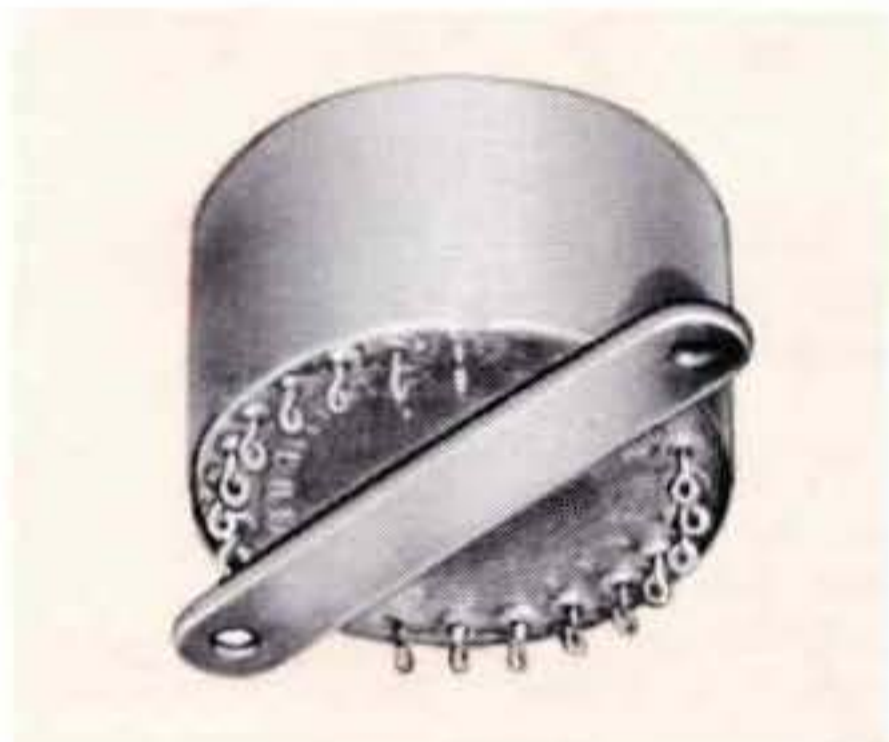

Multi Control Magamp. Power gain 400,000. Control Current. .00003A. Output 25 V. DC into 1K. Six power windings, bias, feedback, and two control windings. MIL-T-27C; 2¼ dia. x 1¼ high, 8 oz.

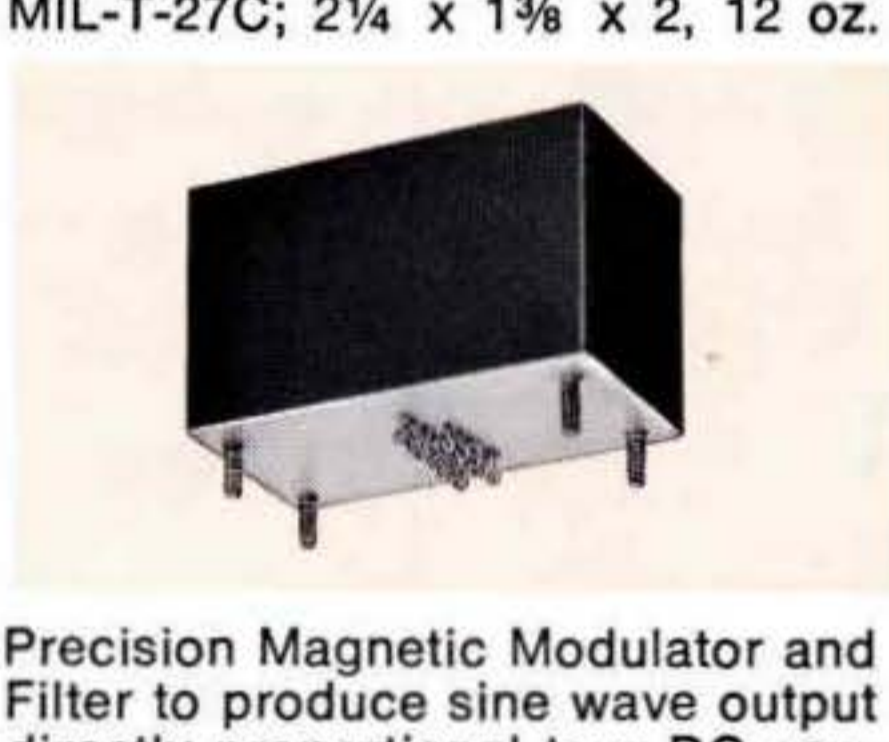

Precision Magnetic Modulator and Filter to produce sine wave output directly proportional to a DC control input. Temperature stabilized from -55°C to 85°C. Distortion and linearity less than 3% thru temperature and frequency range of 380-420 Hz. MIL-T-27C, 1½ x 1½ x 3½", 12 oz.



Magamp for 11 watt, 115 V., 400 Hz servomotor. Standard octal plug. MIL-T-27C; 1¾ x 2½ x 3, 1.7 lb.

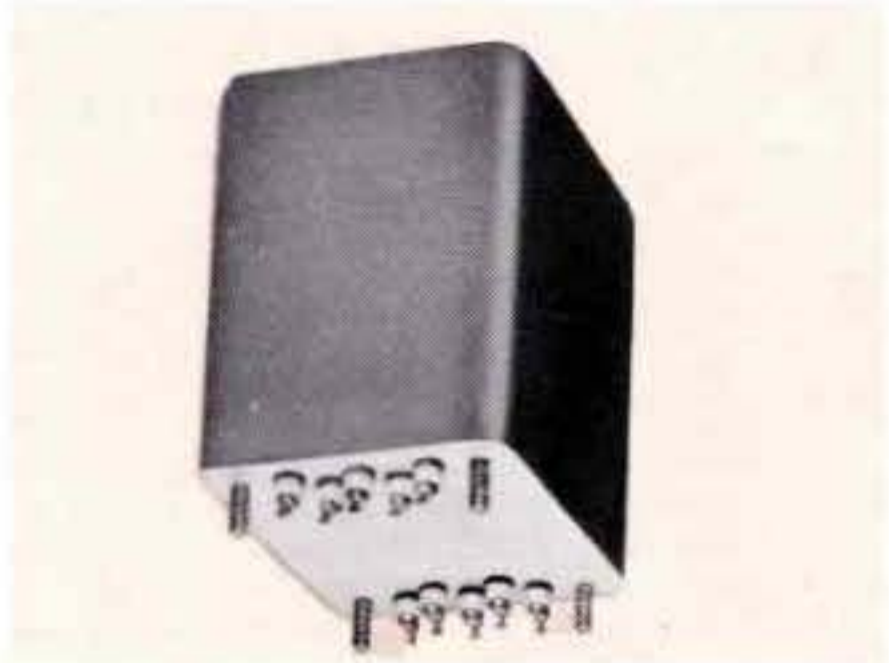

Magamp for 50 watt, 60 Hz servomotor. Two control windings. One feedback winding, one power winding, diode panel. Power gain 100. MIL-T-27C; 30 lbs.

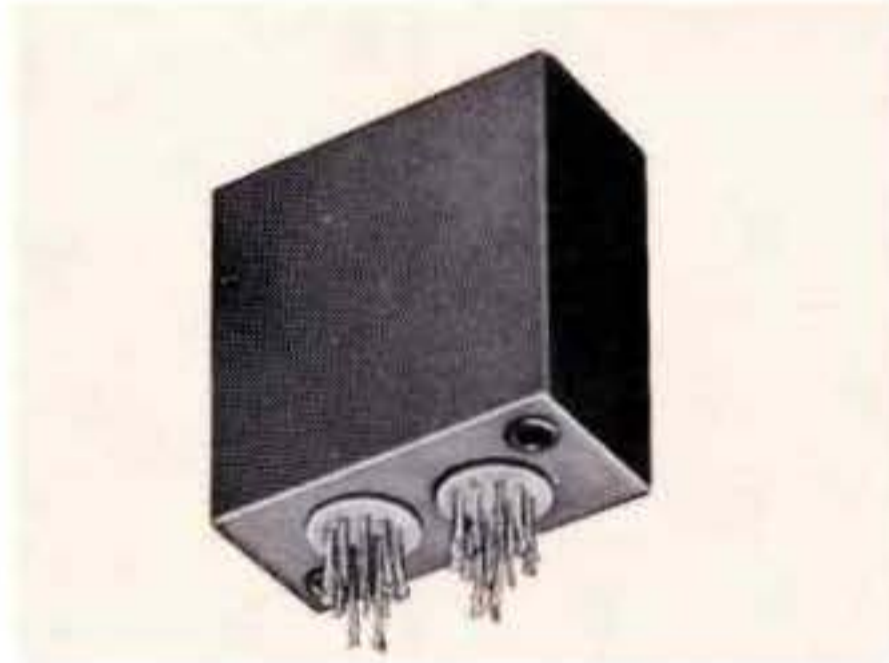

Precision reference transformer. Input 14 V., 400 Hz. Twelve secondaries held to low phase shift and .1% tolerance MIL-T-27C; 1¾ x 2 x 1¾, 4.5 oz.

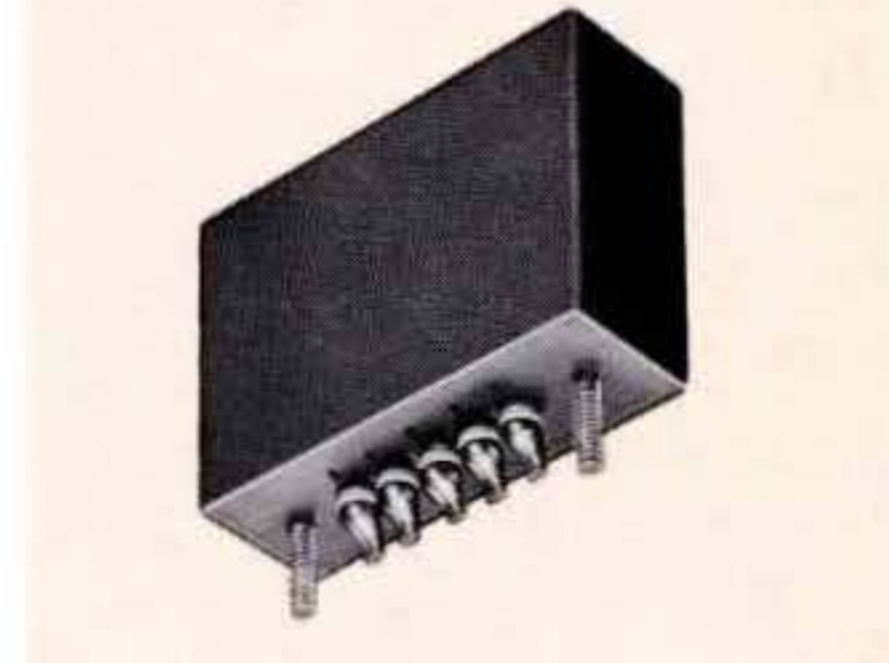

Saturable reactor. Input 50 V.-60 Hz. Output 10 V., 4 MA DC control current. MIL-T-27C; 7/8 x 2½ x 1½, 6 oz.



Toroidal Transistor inverter transformer. Input 24 V DC, outputs 4 windings 150 V to 1050 V DC. Hipot 3800 V. Hermetically sealed, MIL-T-27C, 2½ dia. x 1½", 15 oz.

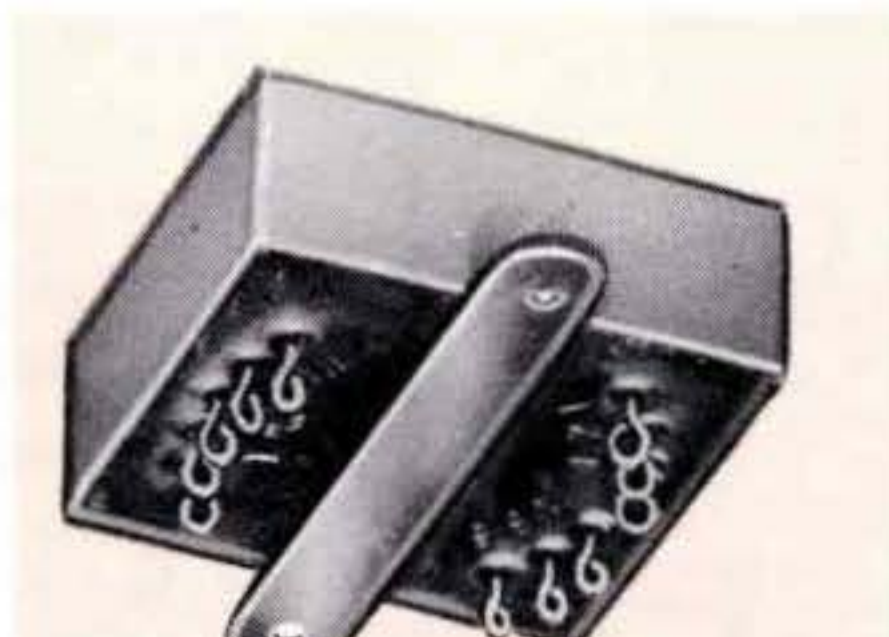

Instrument reference transformer. Input 50 V. 400 Hz. Three 5 V.-.025A. Outputs to .05% accuracy. Saturation characteristics and DCR balance to 3%. MIL-T-27C; 1½ x 1¾ x ¾, 2 oz.



Dual saturable reactor. Input 10 V. - 1 kHz. Output 3.5 V. 2 MA DC control current. 130° C. MIL-T-27C; 1¾ x 1¾ x 1¼, 5 oz.



HERMETIC POWER COMPONENT DIMENSIONS

CASE AND CUTOUT DIMENSIONS, INCHES

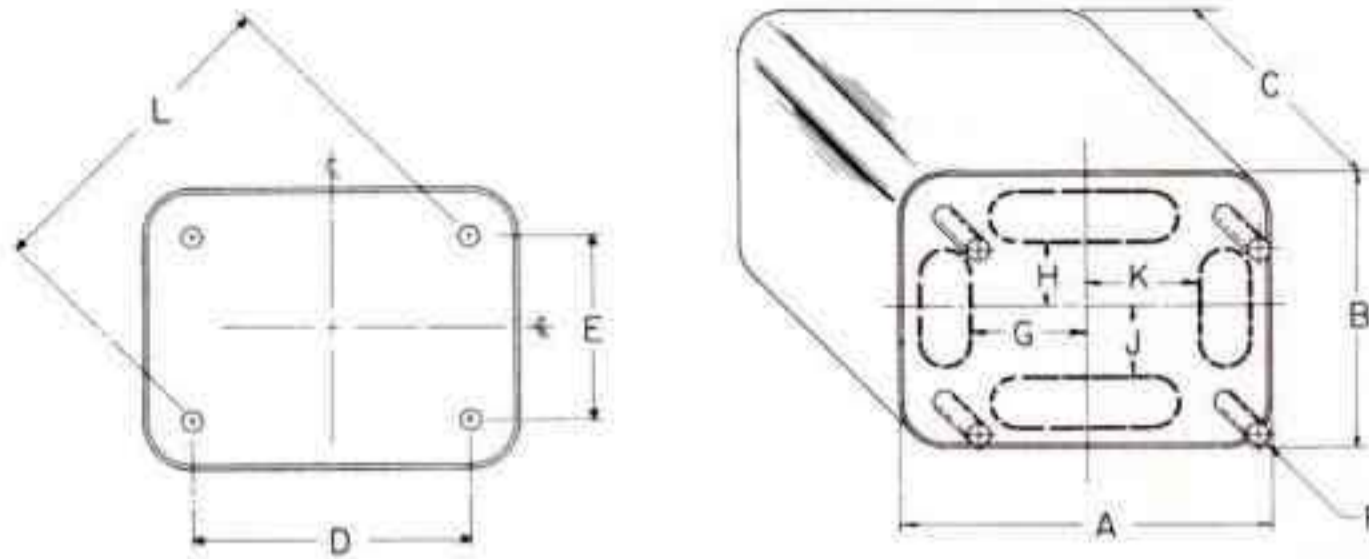

A, B & C dimensions are Max.

MIL CASE DIMENSIONS, INCHES

Mil Case	A	B	C	D	L	E	Mtg. Studs	Wt. Lbs.
AF	3/4	3/4	1 1/8		3/8		4-40x3/8	.1
AG	1	1	1 3/8		3/4		4-40x3/8	.15
AH	1 3/8	1 3/8	1 3/4		1 1/4		6-32x3/8	3/8
AJ	1 3/8	1 3/8	2 3/4	1 3/8		1 3/8	6-32x3/8	3/8
EA	1 1/8	1 1/8	2 3/4	1 3/8		1 1/4	6-32x3/8	1
EB	1 1/8	1 1/8	2 1/8	1 3/8		1 1/4	6-32x3/8	7/8
FA	2 3/8	2 3/8	3 3/8	1 1/8		1 3/8	6-32x3/8	1 3/4
FB	2 3/8	2 3/8	2 1/2	1 1/8		1 3/8	6-32x3/8	1 1/2
GA	2 3/4	2 3/8	3 1/8	2 3/8		1 3/4	6-32x3/8	3 1/2
GB	2 3/4	2 3/8	2 3/8	2 3/8		1 3/4	6-32x3/8	2 1/2
HA	3 3/8	2 5/8	4 1/4	2 1/8		1 5/8	8-32x3/8	4 1/2
HB	3 3/8	2 5/8	3 3/8	2 1/8		1 5/8	8-32x3/8	3 1/2
JA	3 3/8	3 3/8	4 3/8	2 5/8		2 3/8	8-32x3/8	6
JB	3 3/8	3 3/8	3 3/8	2 5/8		2 3/8	8-32x3/8	5
KA	3 3/8	3 3/8	5 1/4	3		2 3/8	10-32x1/2	8 1/2
KB	3 3/8	3 3/8	4 3/8	3		2 3/8	10-32x1/2	7
LA	4 3/8	3 1/8	5 1/8	3 3/8		2 1/8	10-32x1/2	11
LB	4 3/8	3 1/8	4 1/2	3 3/8		2 1/8	10-32x1/2	10
MA	4 1/8	4	6	3 1/8		3	1/4-20x5/8	15
MB	4 1/8	4	4 3/8	3 1/8		3	1/4-20x5/8	14
NA	5 3/8	4 3/8	6 3/8	4 3/8		3 3/8	1/4-20x5/8	18
NB	5 3/8	4 3/8	5 1/2	4 3/8		3 3/8	1/4-20x5/8	15
OA	5 1/2	4 1/2	6 3/4	3 3/4		3	1/4-20x5/8	21

UTC METAL YY CASED UNITS, INCHES

Type No.	A	B	C	D	E	Mtg. Studs	Wt. Lbs.
H-79 ‡	7	7	8	5 3/8	5 3/8	3/8-16(6)	60
H-113	6	5 3/8	6 3/4	5	4 3/8	1/4-20	27
H-114 ‡	6 3/4	6 1/2	8	5 3/8	5 3/8	3/8-16	50
H-115 ‡	6 3/4	6 1/2	8	5 3/8	5 3/8	3/8-16	50
H-117 ‡	11	11	14 3/4	8 3/8	8 3/8	5/8-11	160
H-128 ‡	6 1/2	5 1/2	7 3/4	5 3/8	4 3/8	3/8-16	34
H-129 ‡	6 1/2	5 1/2	7 3/4	5 3/8	4 3/8	3/8-16	28
Z-857	5 1/8	4 1/8	7 1/2	4 3/8	3 3/8	1/4-20 x 5/8	35

‡Terminals opposite mounting

UTC MOLDED ZZ UNITS, INCHES

Type No.	L	W	H	Mtg. Dim. and Studs	Wt. Lbs.
H-101	1 3/32	1 3/32	2	1 1/8 x 1 3/32 .157 Dia 4 holes	.3
H-102	1 3/4	2	2 1/4	1 1/8 x 1 3/32 .157 Dia 4 holes	.44
H-103	2 3/8	2 3/8	2 3/8	1 1/8 x 1 3/32 .157 Dia 4 holes	.8
H-104	2 3/8	2 1/2	3 1/2	2 3/8 x 1 3/32 .157 Dia 4 holes	1.5

TERMINAL AND CUTOUT LOCATION AND DIMS,

UTC No.	Case (Dim. left)	Cutout Location	Cutout Dim.	Cutout Location	Cutout Dim.
H-70	AH	H=3/8	3/8x3/8		
H-71	FB	H=1 1/32	1/2x1 1/4		
H-72	GB	H=1 1/32	1/2x3/8		
H-73	HB	H=5/8	5/8x1 1/8		
H-74	JB	H=3/4	5/8x1 1/8		
H-75	KB	G=1 3/16	5/8x1 3/16		
H-76	LB	G=1 1/2	1 1/8x1 3/16		
H-77	MB	G=1 1/2	1 1/8x1 1/4		
H-78	OA	H=1	1x2		
H-80	FA	Centered	1 1/2 Dia		
H-81	HA	Centered	2 1/2 Dia		
H-82	JB	Centered	2 1/4 Dia		
H-83	JA	Centered	2 5/8 Dia		
H-84	KA	Centered	2 3/16 Sq*		
H-85	LA	Centered	2 3/16 Sq*		
H-86	MB	G=2 3/32	1 1/4x2 3/8	K=2 3/32	1 1/4x2 3/8
H-87	NB	Centered	2 3/8 Dia		
H-89	OA	H=3/8	1 1/4x2 1/2	J=3/8	1 1/4x2 1/2
H-91	KA	Centered	2 3/16 Sq*		
H-92	MB	G=2 3/32	1 1/4x2 3/8	K=2 3/32	1 1/4x2 3/8
H-93	OA	H=3/8	1 1/4x2 1/2	J=3/8	1 1/4x2 1/2
H-94	HA	Centered	1 3/16 x 2*		
H-95	KA	H=3/4	3/4x2 1/8	J=3/16	1 1/8x2 3/4 †
H-96	OA	H=3/8	3/8x2 3/8	J=3/8	1 1/2x3 3/4
H-97	AH				
H-98	AJ	Centered	1 3/16 x 1 1/16*		
H-99	FA	Centered	1 3/16 Sq*		
H-100	GB	Centered	1 3/8 Sq		
H-110	MB	G=1 3/16	1 3/8x2 3/8	K=1 3/16	1 3/8x2 3/8
H-111	NA	H=1 3/16	7/8x3 1/4	J=1 3/16	5/8x3
H-112	NA	H=1 3/16	7/8x3 1/4	J=1 3/16	5/8x3
H-113		G=1 1/16	3/4x2 3/8	K=1 1/16	1 3/8x3 1/2
H-119	AH	Centered	1 Dia		
H-120	GB	H=3/8	3/4x1 1/8	J=3/8	5/8x1 1/8
H-121	JB	G=5/8	5/8x2	K=1/8	1 3/8x2 1/8
H-122	KB	G=1	3/4x2	K=3/8	1 3/8x2 1/8
H-123	NB	Centered	3 1/4 x 4 3/8*		
H-124	FB	H=3/8	3/8x1 1/4	J=3/8	1/2x1 1/8
H-125	KB	G=1	5/8x2	K=3/8	1 3/8x2 1/8
H-126	LA	H=3/8	1 3/8x2 3/8	J=3/8	1 3/8x2 3/8
H-130	AJ	Centered	1 1/4 Dia		
H-131	FB	H=3/8	3/8x1 1/4	J=3/8	3/8x1 1/4
H-132	JA	Centered	2 3/8 x 2 1/8*		
H-133	HB	H=5/8	5/8x1 1/8	J=5/8	5/8x2
H-134	HA	H=3/8	3/4x1 1/8	J=3/8	5/8x2
H-135	JB	G=1 3/16	3/4x1 3/4	K=1 3/16	3/4x1 3/4
H-136	LA	Centered	2 3/8 Dia		
H-137	EB		1 3/8 Dia		
H-138	GA		1 3/8 Dia		
H-141	EB		1 1/4 Dia		
H-142	EA		1 1/4 Dia		
H-143	HA		1 3/4 Dia		
H-144	LA		2 1/2 Dia		
H-145	RC-175 (see page 42)		2 1/2 Dia		
H-146	RC-175 (see page 42)		2 1/2 Dia		
H-147	KA		2 1/2 Dia		
H-164	AG	Diagonal	3/32x7/8*		
H-166	AH	Centered	1" Dia		
H-168	AJ	Centered	7/8 Dia		
H-170	GB		1 1/2 Dia		
H-171	JA		1 3/8 Dia		
H-172	HA	Centered	1 3/8 Sq		
H-173	KA	H=3/8	1 3/8x2	J=3/8	1 3/8x2
H-174	MB	G=1 1/16	5/8x1 7/8	K=1 1/16	5/8x1 7/8
H-194	HA	Centered	1 3/4 Dia		
H-195	JA	Centered	2 1/8 Dia		
H-196	KA	H=3/8	1 1/8x3 3/8	J=3/8	1 1/8x2 1/8
H-197	MB	G=1 1/4	1x2 1/2	K=1 1/4	3/4x2 3/8
H-198	HA		2 3/8 Dia		
H-915	AH	Centered	2 3/32 Dia		
H-925	AJ	Centered	1 3/8 Dia		
H-935	FA	Centered	1 1/2x1 5/8**		
H-965	HA	Centered	1 5/8x2 1/16		
MET-400	AH	Centered	2 3/32 Dia		
MET-405	EA	Centered	2 3/32 Dia		
MET-420	AH	Centered	2 3/32 Dia		
MET-430	FA	Centered	1 3/16**x1 3/16*		
MET-435	FA	Centered	1 3/16**x1 3/16*		
MET-440	GB	Centered	1 3/4**x2 1/16**		
MET-445	AH	Centered	2 3/32 Dia		
MET-455	AJ	Centered	1 3/8 Dia		
MET-465	FA	Centered	1 1/8 Dia		
MET-475	HA	Centered	1 3/16x2 1/16		
MET-495	AJ	Centered	1 3/8 Dia		

* Denotes 1/4 radius at corners of cutouts.

** Denotes 1/4 radius at corners of cutouts.

† Note: 45° corner for stud clearance.



GENERAL INFORMATION ON PULSE TRANSFORMERS

UTC manufactures a wide variety of pulse transformers and inductors for military, space, industrial and commercial application. For military applications, transformers are made to fully meet MIL-T-21038B or MIL-T-27C. The pulse stock line consists of the BIT-P, PIP, and H lines of precision miniature wide application pulse transformers made to MIL-T-21038B. Examples of the breadth of our pulse magnetic component design and production capabilities are shown on page 59.

Theory

A pulse, being a step function, consists of a wide band of sine wave frequency components. The high frequency components determine the rise and fall time of the pulse. The droop characteristic of the pulse is determined by the low frequency components of the pulse.

Ideally, a perfect pulse consists of a zero rise and fall time and zero percent droop. In order for a transformer to pass this ideal pulse, band pass from DC to infinity is required. Since a transformer is basically a limited band pass device, perfect fidelity cannot be obtained. The pulse transformer is designed to give a wide frequency pass band in order to minimize the deterioration on the rise time, fall time, and droop of the pulse. Consequently, pulse transformers make excellent wide band sine wave transformers.

Pulse Characteristics

- | | |
|----------------|--------------------|
| 1. Pulse width | 5. Overshoot |
| 2. Rise time | 6. Backswing |
| 3. Fall time | 7. Repetition rate |
| 4. Droop | |

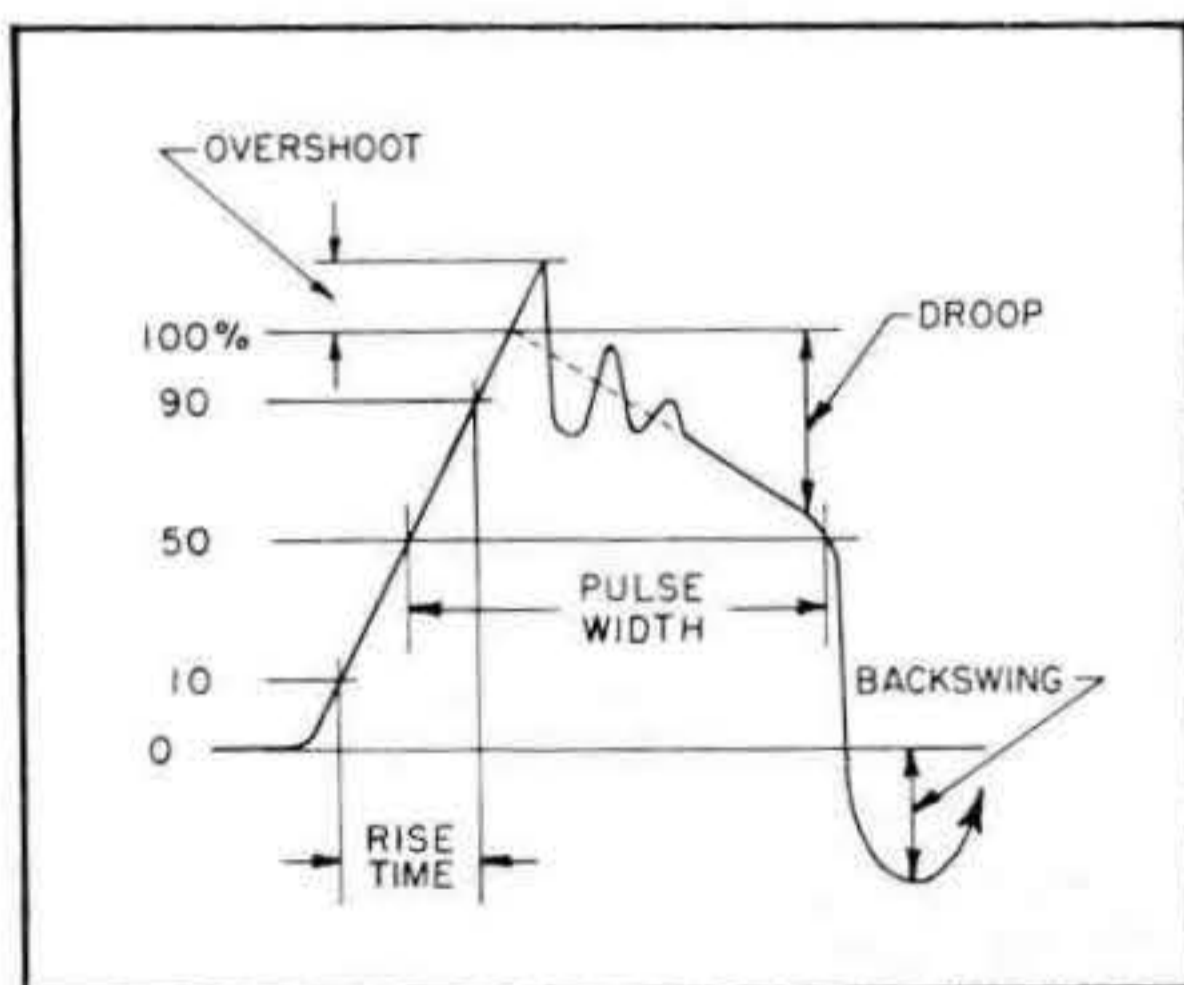

Pulse Transformer Equivalent Circuit

1. High Frequency Model

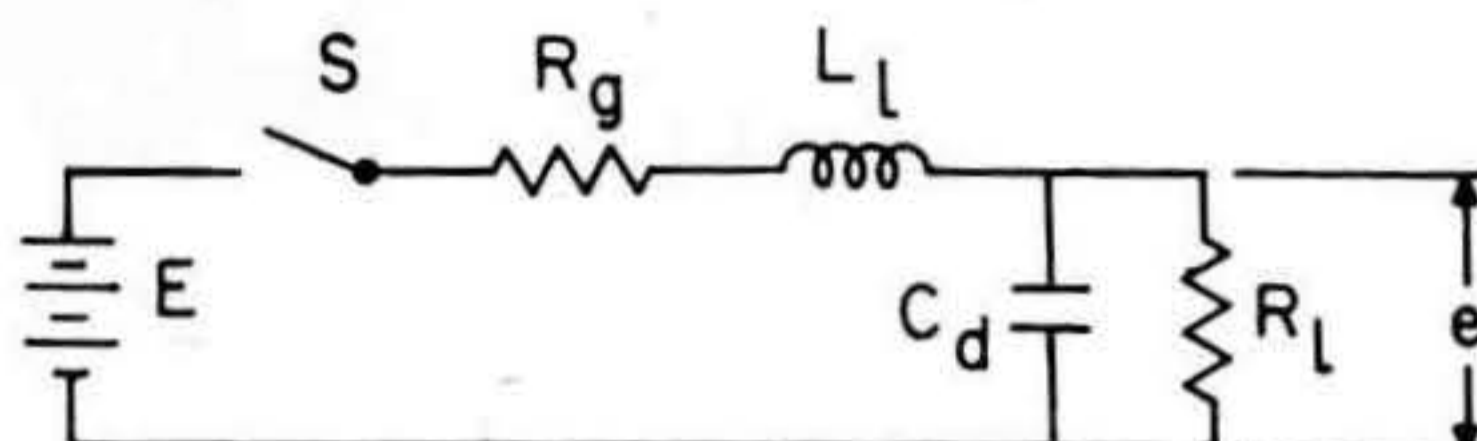

This circuit was obtained from the generalized transformer equivalent circuit by eliminating all components that are not effective at high frequency.

S is the switch which produces the step function.

R_g consists of all resistances in the generator and primary circuit, which also includes the resistance of the transformer.

L_l is the combined leakage inductance referred to the primary.

C_d is the combined distributed capacity referred to the primary.

R_l is the load resistance, referred to the primary.

Rise time is a function of L_l and C_d since $T = 2\pi\sqrt{LC}$.

The value of R_g and R_l determine the damping factor of the circuit and affect rise and fall time, overshoot and backswing.

2. Low Frequency Model – Affects Droop and Backswing

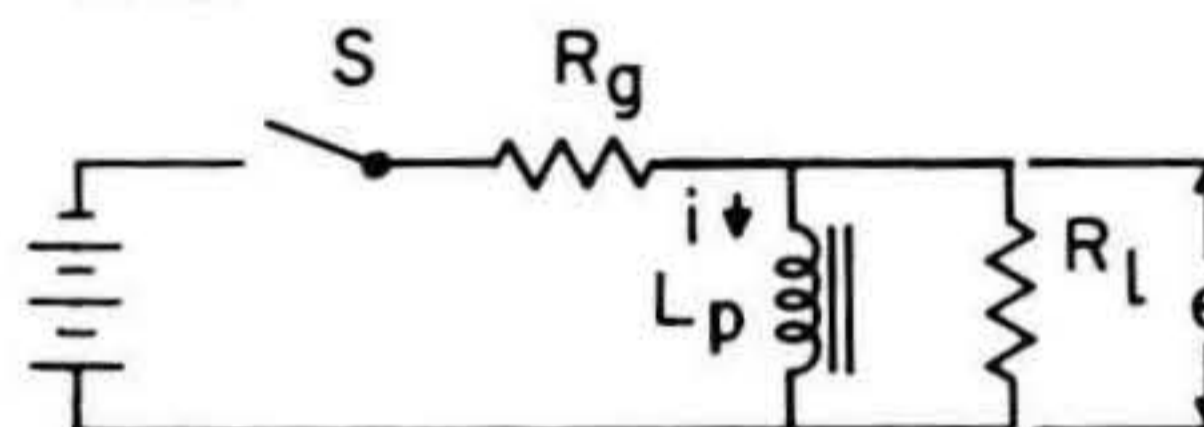

This circuit was obtained from the generalized circuit by eliminating all components that are not effective at low frequency.

L_p is the incremental pulse inductance of the primary of the transformer.

S , R_g and R_l are as above.

The ability to hold up the flat top of a step function in this circuit, is a function of L_p , R_g , and R_l .

$$e = L_p \frac{d(i L_p)}{dt}$$

$$\text{but } \frac{d(i L_p)}{dt} = \frac{K}{L_p} \text{Exp} - \left(\frac{R_g R_l}{R_g + R_l} \right) t$$

$$\text{Therefore } e = K \text{Exp} - \left(\frac{R_g R_l}{R_g + R_l} \right) t$$

Application

Pulse transformers can be classified into coupling or impedance matching or acting in a circuit to form a pulse (blocking oscillator with tube or transistor).

In the pulse generating application, the characteristics of the circuit elements other than the transformer are effective in determining the pulse characteristics. Consequently, the design engineer must know the circuit in which it will be used.

The best way of specifying a coupling application is to state the source and load impedance, the voltage levels, the repetition rate, and the nature of the desired output pulse in pulse parameters.

As can be seen below the given transformer will have the same rise time regardless of the pulse width impressed on it. The droop characteristic, in percent, will be a linear function of the pulse width. A given transformer, having a 10% droop at 1 microsecond, will have a 20% droop at 2 microseconds.

The repetition rate and the pulse width determine the duty cycle which the transformer will see. This is important in the design for temperature rise consideration. Core loss energy is lost on each pulse due to eddy currents and hysteresis. The repetition rate determines the power loss in the core as well as in the windings. The voltage level as well as the pulse width determines the flux density of the transformer. This is usually stated as the ET constant and expressed in volt-microseconds.

A transformer of a given ET Constant can be used for wider pulse widths and lower voltage levels or vice versa, within the insulation working voltage capability of the transformer.

Special Designs

Because of the greatly varied nature of pulse components application, UTC stock items cover only low power transistor and tube application requirements. Thousands of special units to customer specification are produced annually by UTC. Range covered is from micro-watts to 100 megawatts. A partial list of application, to provide the equipment engineer with a concept of our capability is itemized below:

1. Output Transformer for Magnetron.
2. Linear Charging Reactors.
3. Output Transformer for Klystron and TWT.
4. Sonar Output Transformer.
5. Ferrite Core Pulse Transformer.
6. Pulse Current Transformers.
7. Impulse Transformers.
8. Memory Core Transformers.
9. Differentiating Pulse Transformers, etc.

Our Engineering and Laboratory facilities are uniquely equipped to handle customer problems in tough design areas.

UTC facilities are available for full production testing of all components. Pulse transformers are tested in customer's circuits, assuring uniform electrical performance.

STANDARD PULSE TRANSFORMER SELECTION GUIDE

Type No.	Ratio	Pulse Width Micro-Seconds	Rise Time Micro-Seconds	Droop in %	Hi-Pot Voltage RMS	Size	Wt. Grams	MIL Designation	Service	Page
BIT-P	4:4:1	.05-100	.01-.40	0-30	200	¼ x ¼" Dia.	1.1	TP6RX4410CZ	Coupling and Blocking Oscillator	54, 55
PIP	4:4:1 & 5:3:1	.05-10	.018-.40	0-15	100	⅜ x ⅜" Dia.	1.5	TP6RX4410CZ	Coupling and Blocking Oscillator	56
H-60 to H-69 H-611 H-641 H-671	4:4:1 & 5:3:1	.05-10	.012-.40	0-25	100	⅜ x ⅜" Dia.	1	TP7SX4410AZ	Coupling and Blocking Oscillator	58
H-45 to H-58 H-461 H-501 H-531 H-561	1:1:1 & 5:3:1	.05-25	.01-2	0-30	1250	*	*	TP7SX1110(*)	Coupling and Blocking Oscillator Higher voltage, Tube, SCR, etc.	57

*(AZ): ⅜" x ⅜" Dia., 1 gram; (AC): ⅜" x ⅜" Dia., 4 grams; (AN): ⅜" x ⅜" Dia., 6 grams.
KITS AVAILABLE: PIP-100 (PIP-1 thru PIP-9); H-69 (H-60 thru H-68); H-58 (H-45 thru H-57).



NEW BIT-P™ LINE

ULTRAMINIATURE TRANSFORMERS

Smallest Metal Encased Transformers Available

NEW HIGH PERFORMANCE PULSE TRANSFORMERS

PACKAGING Size reduction without loss of performance is achieved by major reduction of air gaps in the magnetic circuit. Core permeability closely approaches the theoretical maximum for material and structure.

Materials, dimensions, and surface finish are identical with IC Flat Pack standards. Removable support protects terminal alignment prior to final assembly. This insulated support allows testing in conventional jigs.

RELIABILITY Cylindrical bobbin-winding techniques eliminate corner stress normally found in fine-wire windings of conventional rectangular structures.

Lead arrangements and terminations have been designed to maximize reliability under thermal shock and temperature cycling.

FLEXIBILITY Stock units are designed for the standard blocking oscillator circuit shown as well as for coupling application. By interconnecting windings, a variety of primary to secondary ratios may be obtained.

SPECIALS BIT-P's not found in stock line will be designed to customers' requirements.

- Special electrical parameters
- 10 or more leads
- Special termination arrangements, such as gold-plated straight pin leads, ribbon-style leads perpendicular to the terminal board for "dual in-line" packaging, etc.
- Operation to 130°C per MIL Class S.



- NOTES**
- **PULSE WIDTH** .05 μ sec-100 μ sec
 - **DIELECTRIC STRENGTH** tested @ 200 VRMS
 - **MIL SPECS** To complete MIL-T-21038B. Metal encased, ruggedized Grade 6, Class R, Life X. See pages 86, 87
 - **SHIELDED** All units electromagnetically self-shielded
 - **LEAD MATERIAL** Gold-plated ribbon-style Kovar, solderable and weldable MIL-STD 1276, Type K

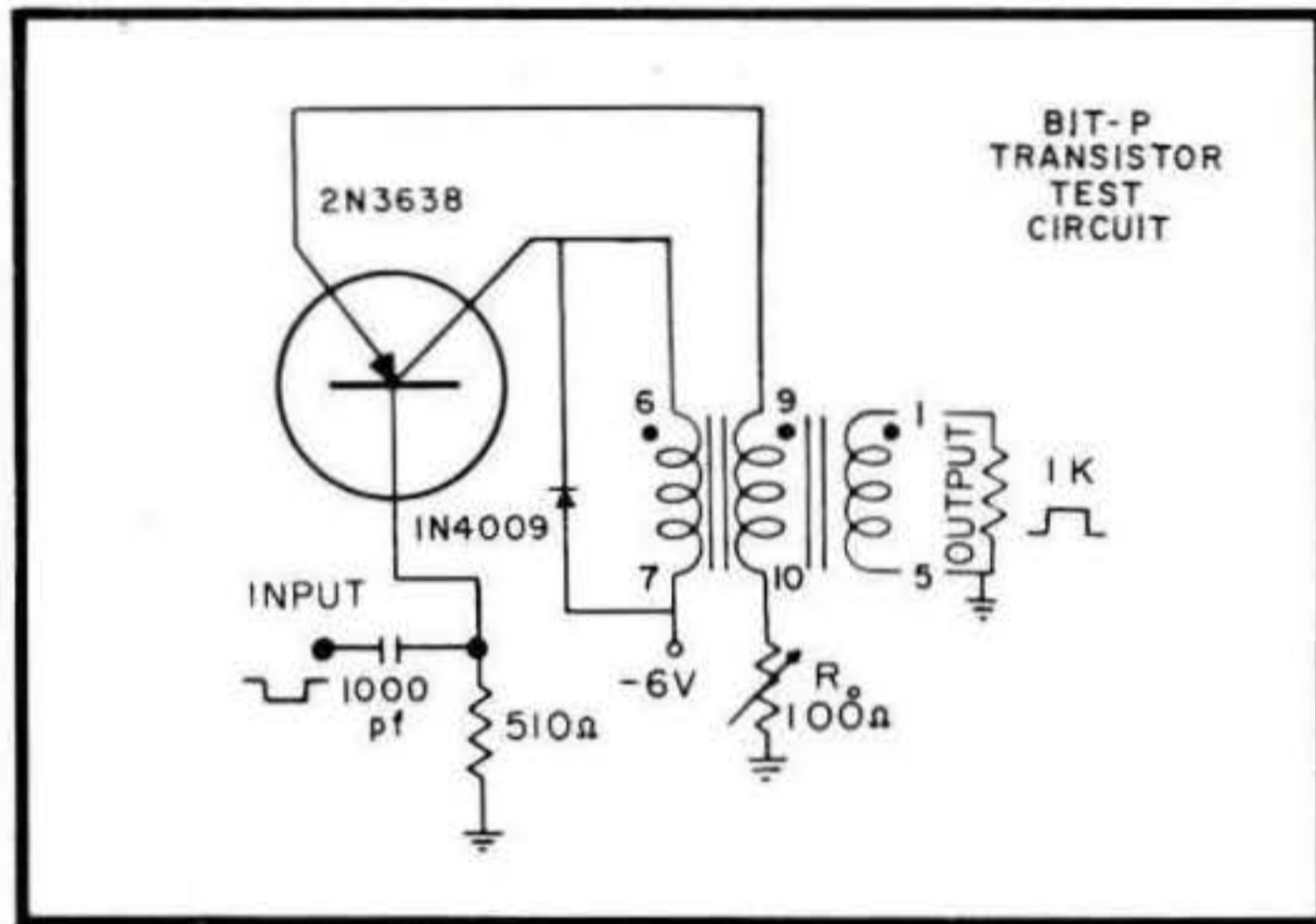

- BIT-P TERMINATION ADAPTABILITY
FOR PLUG - IN PC APPLICATIONS**
-
- BIT-P's stock units are manufactured with Flat Pack type terminations extending outward. Terminations may be bent for adaptation to plug-in applications. Unique termination configuration isolates strain and affords safety during bending process. Variations of bends are pictured above.
- Right-angle bend outside the confines of the unit.
 - Right-angle bend inside the confines of the unit.
 - Right-angle bend at the confines of the unit.
 - (As C, above) with three terminations eliminated.
- Bending may be done by customer or by UTC on special order.

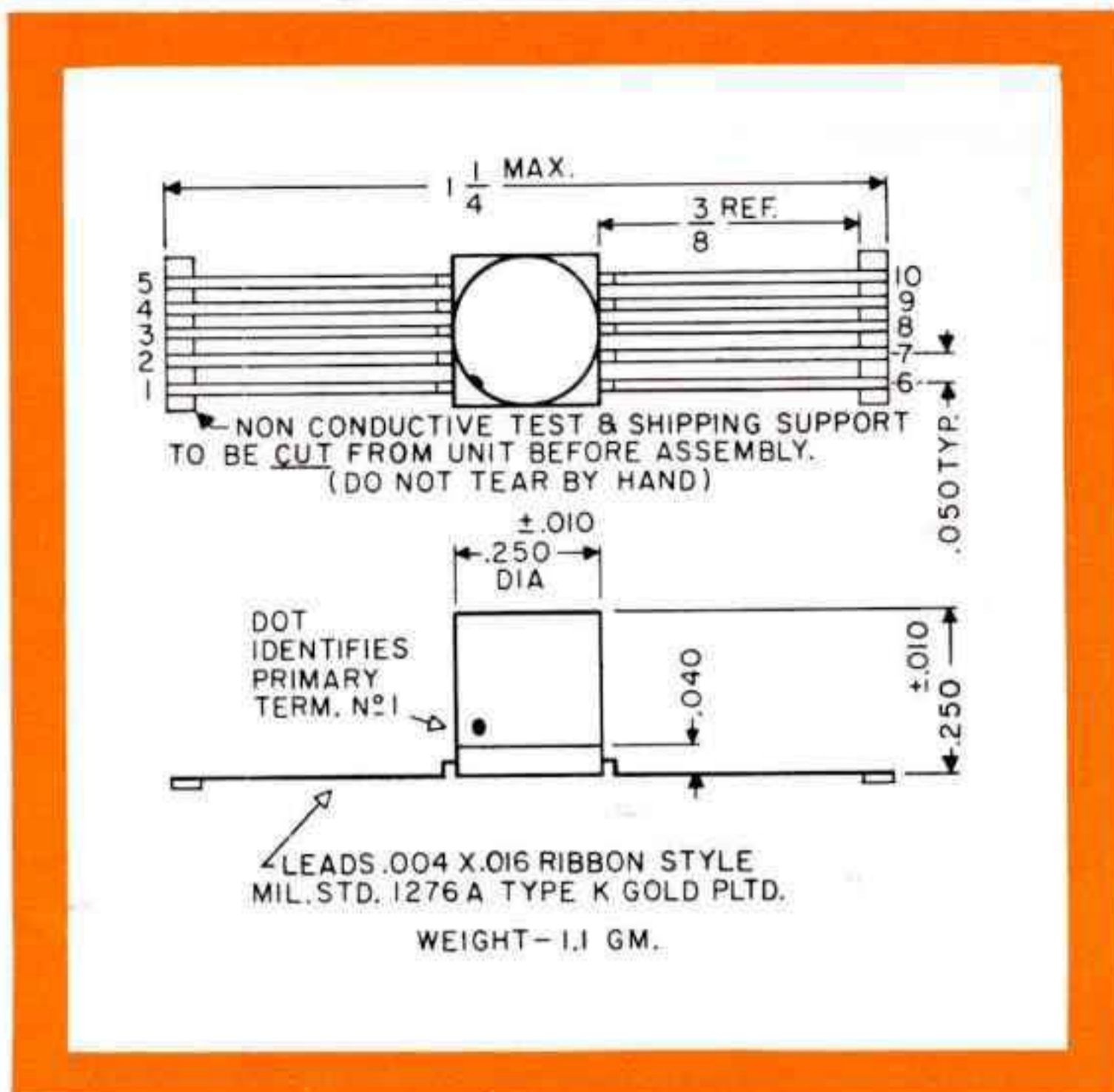

RATIO 4:4:1 MIL TYPE TP6RX4410CZ

Type No.	APPROX. DCR, OHMS			BLOCKING OSCILLATOR PULSE					COUPLING CIRCUIT CHARACTERISTICS						
	1 & 5	6 & 7	9 & 10	P Width μ Sec.	Rise Time	% Over Shoot	% Droop %	% Back Swing	P Width μ Sec.	Volt Out	Rise Time	% Over Shoot	% Droop %	% Back Swing	Imp.* in/out,
BIT-P21	.32	.29	.28	.05	.01	0	0	35	.05	0.2	.01	0	0	20	50
BIT-P22	.33	.32	.29	.1	.012	0	0	25	.1	.5	.015	0	0	20	50
BIT-P23	.38	.37	.3	.2	.02	0	0	15	.2	1.2	.02	0	0	20	100
BIT-P24	.5	.48	.32	.5	.023	0	5	15	.5	1.5	.022	0	5	25	100
BIT-P25	.62	.57	.35	1	.03	0	10	14	1	1.5	.025	0	20	28	100
BIT-P26	.7	.64	.4	2	.035	0	12	15	2	1.5	.028	0	15	23	100
BIT-P27	.85	.76	.48	3	.04	0	13	15	3	1.5	.032	0	18	28	100
BIT-P28	.96	.86	.52	5	.045	0	15	14	5	2	.035	0	20	20	200
BIT-P29	1.4	1.1	.57	10	.065	0	15	10	10	2	.05	0	25	25	200
BIT-P30	2.1	1.7	.8	15	.07	0	15	13	15	2	.06	0	27	18	200
BIT-P31	2.7	2.1	.97	25	.08	0	15	13	25	3	.1	0	30	30	500
BIT-P32	20	15	6	50	.2	0	10	5	50	3	.3	0	22	20	500
BIT-P33	42	32	12	100	.35	0	11	13	100	6	.4	0	15	18	500

* Input winding terminals 1 & 5; output winding terminals 6 & 7; terminals 9 & 10 open.



PRECISION MINIATURE WIDE APPLICATION PULSE TRANSFORMERS

PIP™ SERIES

PACKAGING Hermetically sealed. DO-T family construction, see page 6.

MIL SPECS To complete MIL-T-21038B. See pages 86, 87.

APPLICATION Transistor.

NOTE All individually adjusted to parameters shown and checked in test circuit to give required pulse width.

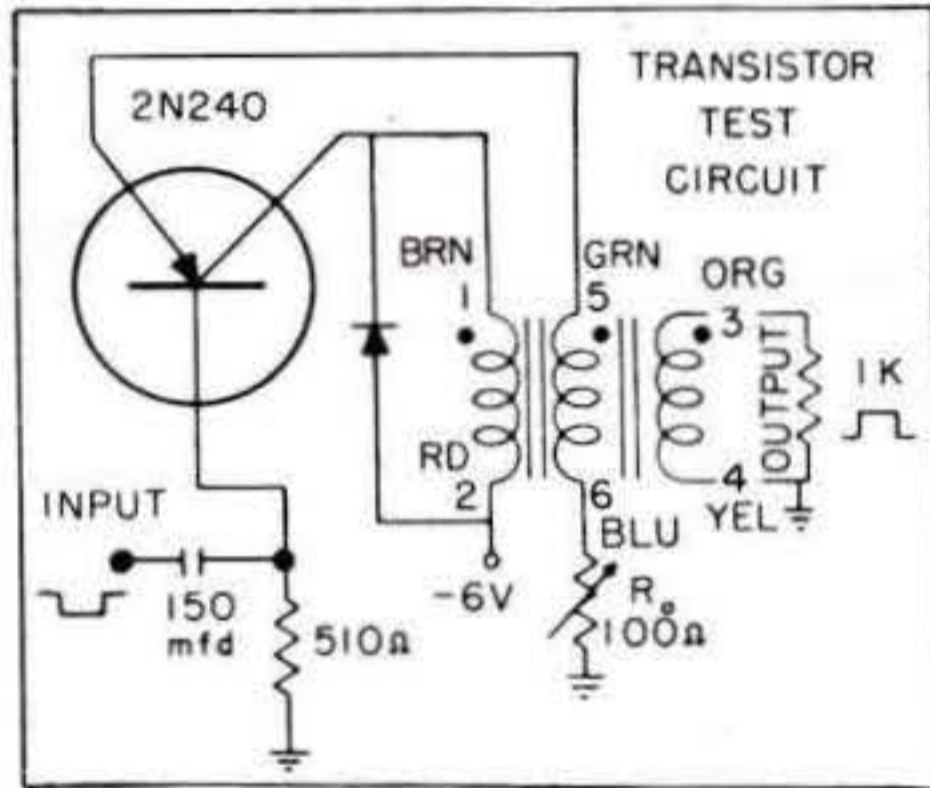

RATIO 4:4:1 MIL TYPE TP6RX4410CZ

Type No.	APPROX. DCR, OHMS			BLOCKING OSCILLATOR PULSE					COUPLING CIRCUIT CHARACTERISTICS							
	1-Brn 2-Rd	3-Org 4-Yel	5-Grn 6-Blu	P Width μ Sec.	Rise Time	% Over Shoot	% Droop	% Back Swing	P Width μ Sec.	Volt Out	Rise Time	% Over Shoot	% Droop	% Back Swing	Imp.* in/out,	Frequency response within 2 db**
PIP-1	.21	.23	.13	.05	.02	0	0	37	.05	9	.018	0	0	12	50	150kHz- 29 MHz
PIP-2	.47	.56	.17	.1	.025	0	0	25	.1	8	.02	0	0	5	50	100kHz- 17 MHz
PIP-3	1.01	1.25	.37	.2	.030	2	0	15	.2	7	.035	0	0	5	100	16kHz- 9.5MHz
PIP-4	1.5	1.85	.54	.5	.05	0	0	15	.5	7	.06	0	0	0	100	7kHz- 3.25MHz
PIP-5	2.45	3.1	.9	1	.08	0	0	14	1	6.8	.15	0	0	5	100	7.5kHz- 2.25MHz
PIP-6	3.0	3.7	1.1	2	.10	0	0	15	2	6.6	.18	0	2	10	100	2.2kHz- 1.32MHz
PIP-7	4.9	6.05	1.8	3	.20	0	0	14	3	6.8	.20	0	2	10	100	1.7kHz- 1.5 MHz
PIP-8	8.0	9.7	2.9	5	.30	0	0	3	5	7.9	.22	0	13	25	200	1.8kHz- 1.45MHz
PIP-9	13.1	15.9	4.7	10	.35	0	5	12	10	6.5	.4	0	15	20	200	1.5kHz- 1.14MHz
PIP-100	Transistor pulse transformer kit, consisting of PIP-1 thru PIP-9 in plastic case.															

RATIO 5:3:1 MIL TYPE TP6RX5310CZ

PIP-10	.55	.41	.15	.1	.01	0	0	20	.1	8	.01	0	0	5	140/50	170kHz- 32 MHz
PIP-11	2.9	2.2	8.2	1	.02	4	4	6	1	6.6	.05	0	6	12	280/100	12.5kHz- 3.25MHz
PIP-12	9.4	7.1	2.6	5	.05	0	12	12	5	8	.09	2	12	25	560/200	15kHz- 4 MHz
PIP-SH	Drawn Hipermalloy shield and cover for PIP's provides 20 to 30 db shielding 9/32 h x 23/64" dia, 1/8" hole in cover															

* Input winding leads Brn-Rd (1-2); output winding leads Org-Yel (3-4); leads Grn-Blu (5-6) open.
 ** Per coupling circuit Z in/out, 1 V input.



PRECISION MINIATURE WIDE APPLICATION PULSE TRANSFORMERS

PACKAGING Hermetically sealed. Vacuum molded to Mil Grade 5.

SERVICE -70°C to +130°C.

MIL SPECS To complete MIL-T-21038B. See pages 86, 87.

APPLICATION Tube, SCR and transistor Test Voltage 1250 V RMS.

NOTE All individually adjusted to parameters shown and checked in test circuit to given required pulse width.

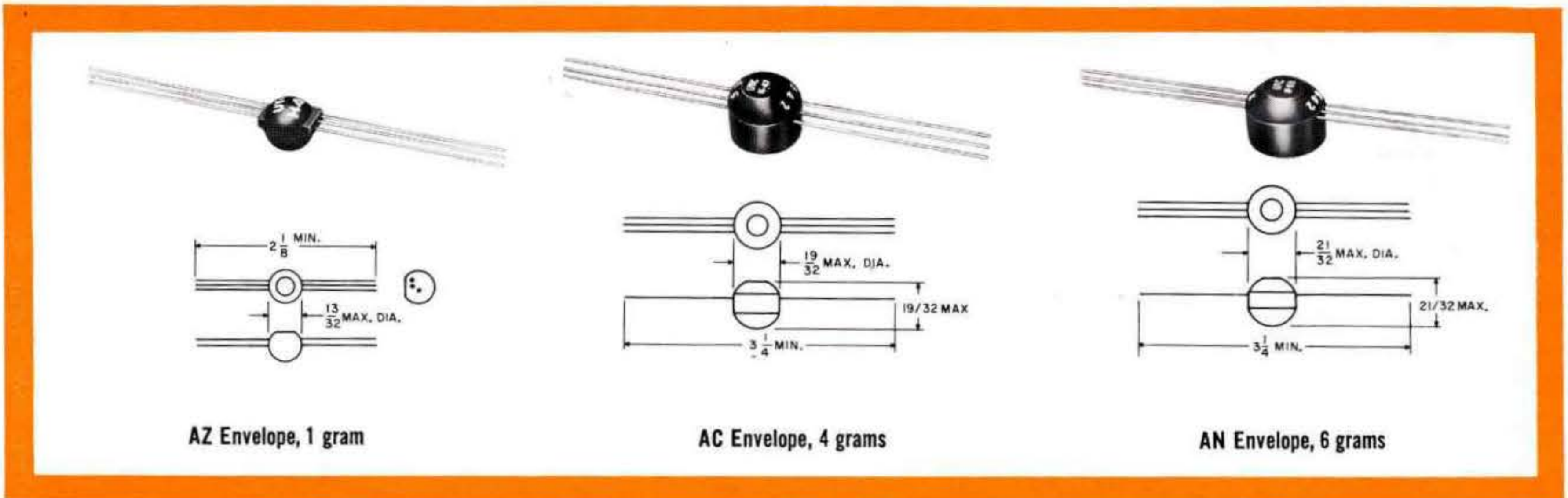
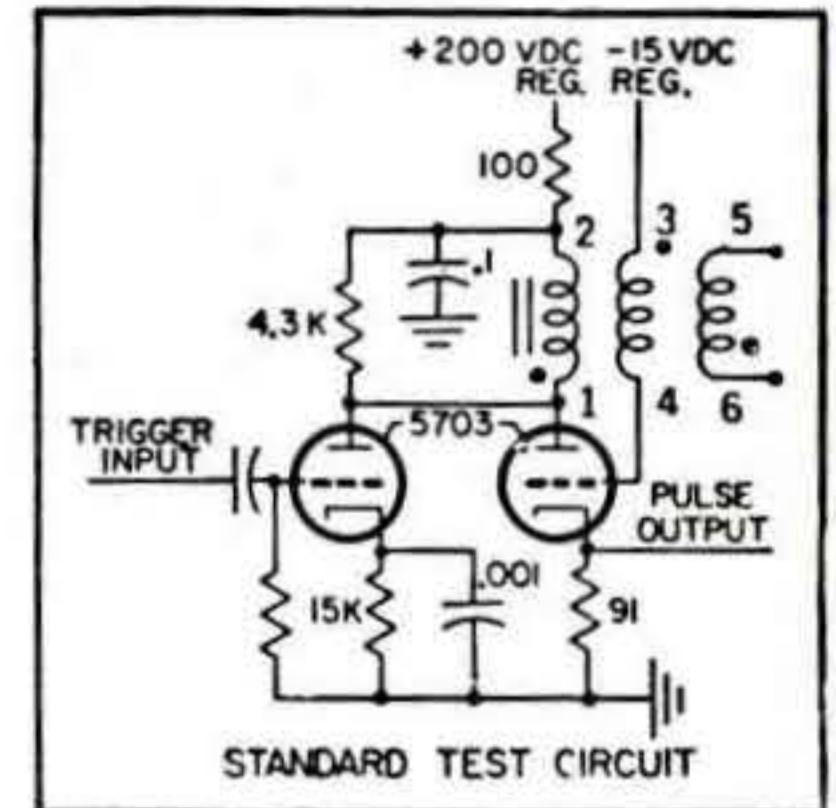

RATIO 1:1:1 MIL TYPE TP7SX1110(†)

Type No.	APPROX. DCR, OHMS			BLOCKING OSCILLATOR PULSE					COUPLING CIRCUIT CHARACTERISTICS							Frequency Response within 2 db**	† Style & Envelope
	1-2	3-4	5-6	P Width μ Sec.	Rise Time	% Over Shoot	Droop %	% Back Swing	P Width μ Sec.	Volts Out	Rise Time	% Over Shoot	Droop %	% Back Swing	Imp. in,* out, ohms		
H-45	3	3.5	4	.05	.022	0	20	10	.05	17	.01	20	0	35	250	260kHz-34MHz	AZ
H-46	5.5	6.5	7	.10	.024	0	25	10	.10	19	.01	30	10	50	250	220kHz-34MHz	AZ
H-47	3.7	4.0	4	.20	.026	0	25	8	.20	18	.01	30	15	65	500	260kHz-93MHz	AC
H-48	5.5	5.8	6	.50	.03	0	20	5	.50	20	.01	30	20	65	500	85kHz-73MHz	AC
H-49	8	8.5	9	1	.04	0	20	10	1	24	.02	15	15	65	500	50kHz-62.5MHz	AC
H-50	20	21	22	2	.05	0	20	10	2	27	.05	10	15	35	500	24.5kHz-49MHz	AC
H-51	28	31	33	3	.10	1	20	8	3	26	.07	10	10	35	500	12.6kHz-5.65MHz	AC
H-52	36	41	44	5	.13	1	25	8	5	23	.15	10	10	45	1000	13kHz-3.465MHz	AC
H-53	37	44	49	7	.28	0	25	8	7	24	.20	10	10	50	1000	9.5kHz-6.3MHz	AN
H-54	50	58	67	10	.30	0	20	8	10	24	.25	10	10	50	1000	7.1kHz-1.35MHz	AN
H-55	78	96	112	16	.75	0	20	10	16	23	.40	5	15	20	1000	1.65kHz-3.05MHz	AN
H-56	93	116	138	20	1.25	0	25	10	20	23	.6	5	10	10	1000	2.15kHz-285kHz	AN
H-57	104	135	165	25	2.0	0	30	10	25	24	1.5	5	10	10	1000	1.7kHz-315kHz	AN
H-58	Pulse transformer kit. Consists of one of each of the above units in partitioned plastic case.																

RATIO 5:3:1 MIL TYPE TP7SX5310(†)

H-461	9.6	6.4	2.5	.1	.025	0	0	8	.1	19	.02	3	5	20	$\frac{700}{250}$	4MHz-18MHz	AZ
H-501	30	20	7	2	.08	0	12	5	2	27	.06	12	15	35	$\frac{1400}{500}$	40kHz-6MHz	AC
H-531	66	47	17	7	.32	0	12	3	7	24	.23	12	10	40	$\frac{2800}{1000}$	25kHz-1.6MHz	AN
H-561	180	142	53	20	1.75	0	13	5	20	23	.7	5	10	10	$\frac{2800}{1000}$	5kHz-300kHz	AN

*Input winding terminals 1-2; output winding terminals 3-4; terminals 5-6 open.
**Per coupling circuit z in/out, 1 V input.



PRECISION MINIATURE WIDE APPLICATION PULSE TRANSFORMERS

PACKAGING Hermetically sealed. Vacuum molded.

SERVICE — 70° to + 130°C

MIL SPECS To complete MIL-T-21038B Specs. Grade 7, Class S, Life X. See pages 86, 87.

APPLICATIONS Transistor

NOTE All individually adjusted to parameters shown and checked in test circuit to give required pulse width.

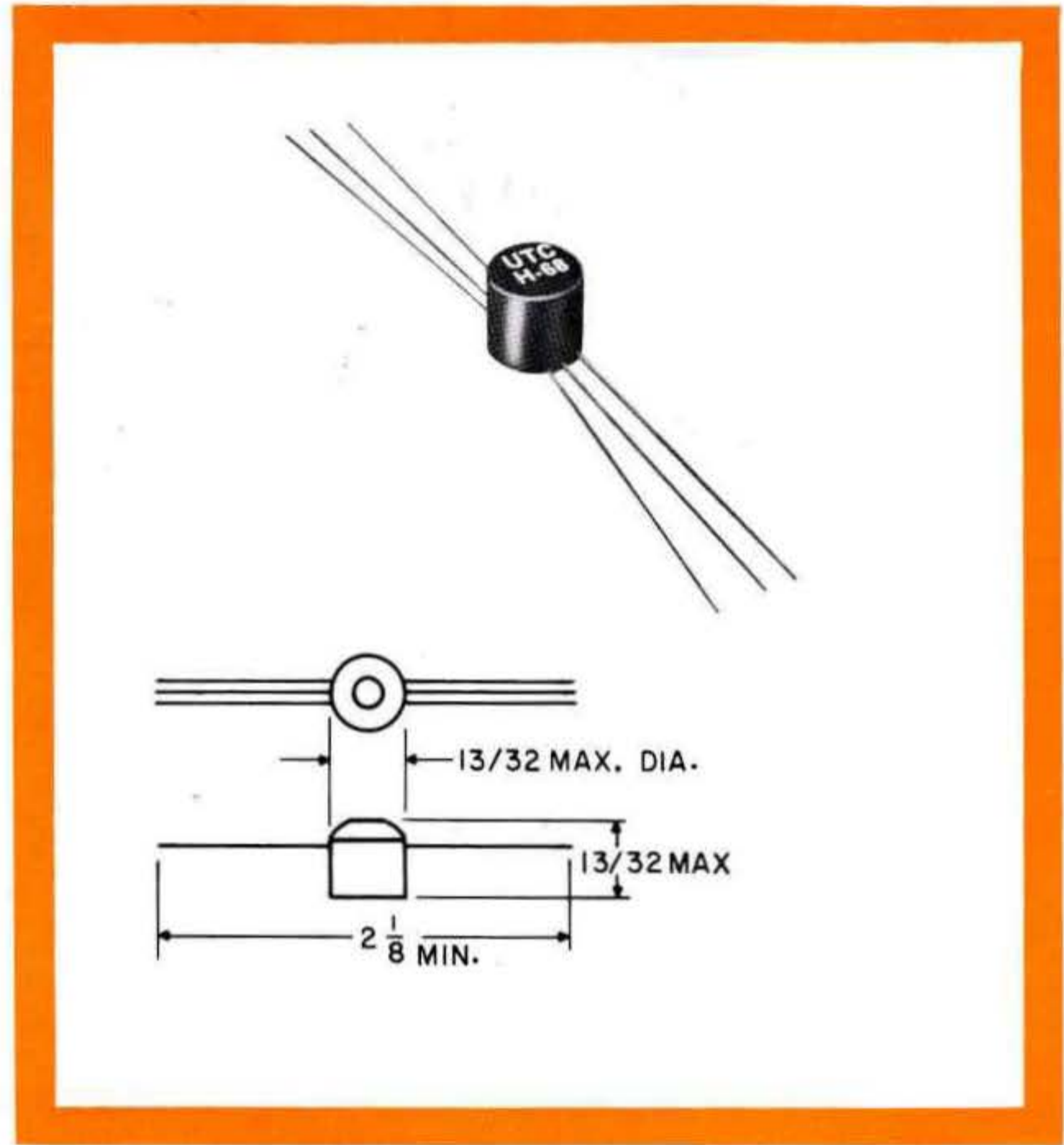
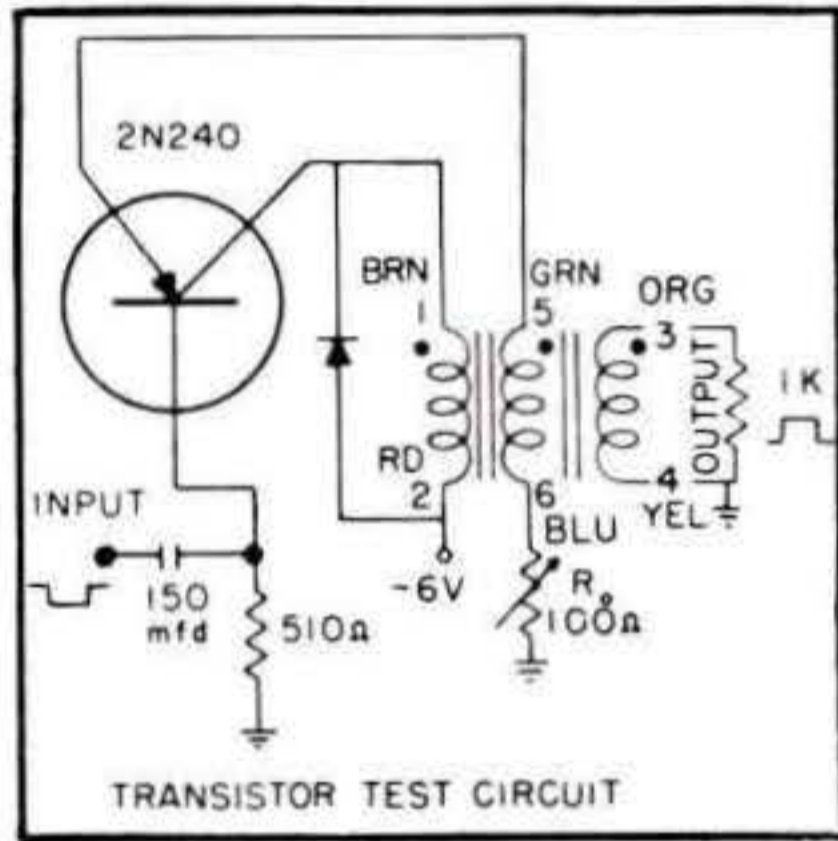

RATIO 4:4:1 MIL TYPE TP7SX4410AZ

Type No.	APPROX. DCR, OHMS			BLOCKING OSCILLATOR PULSE					COUPLING CIRCUIT CHARACTERISTICS							
	1-2	3-4	5-6	P Width μ Sec.	Rise Time	% Over Shoot	Droop %	% Back Swing	P Width μ Sec.	Volts Out	Rise Time	% Over Shoot	Droop %	% Back Swing	Imp. in/out,* ohms	Frequency Response within 2 db**
H-60	.124	.14	.05	.05	.016	0	0	30	.05	9.3	.012	0	0	20	50	550 kHz-43 MHz
H-61	.41	.48	.19	.1	.016	0	0	30	.1	8.2	.021	0	0	15	50	95 kHz-17 MHz
H-62	.78	.94	.33	.2	.022	0	0	18	.2	7.4	.034	0	5	12	100	60 kHz-14.5 MHz
H-63	1.86	2.26	.70	.5	.027	2	10	20	.5	7.5	.045	0	20	25	100	22 kHz-3.7 MHz
H-64	3.73	4.4	1.33	1	.033	0	12	25	1	7	.078	0	15	23	100	12 kHz-2.3 MHz
H-65	6.2	7.3	2.22	2	.066	0	15	25	2	6.6	.14	0	10	20	100	8.5 kHz-1.675 MHz
H-66	10.2	12	3.6	3	.087	0	18	30	3	6.8	.17	0	10	20	100	3.9 kHz-950 kHz
H-67	14.5	17.5	5.14	5	.097	0	23	28	5	7.9	.2	0	18	28	200	3.6 kHz-840 kHz
H-68	42.3	52.1	14.8	10	.14	0	15	28	10	6.5	.4	0	15	30	200	1.1 kHz-400 kHz
H-69	Transistor pulse transformer kit, consists of H-60 thru H-68 in plastic case.															

RATIO 5:3:1 MIL TYPE TP7SX5310AZ

H-611	.426	.32	.132	.1	.018	8	0	12	.1	8.2	.02	0	0	30	140/50	200 kHz-31.6 MHz
H-641	5	3.6	1.4	1	.04	0	10	10	1	7	.07	0	20	30	280/100	32 kHz-4.5 MHz
H-671	21	16	6	5	.08	0	14	12	5	8	.2	0	25	30	560/200	7.6 kHz-1.6 MHz

*Input winding terminals 1-2; output winding terminals 3-4; terminals 5-6 open.
**Per coupling circuit Z in/out, 1 V input.



SPECIAL CUSTOM BUILT PULSE COMPONENTS TO YOUR SPECIFICATIONS

Because of the greatly varied nature of pulse component application, UTC stock items cover only low power transistor and tube requirements. The units illustrated below are intended to show some of the thousands of special units produced by UTC and to provide the equipment engineer with a concept of the possibilities in present special pulse circuit units. Range covered is from microwatts to 10 megawatts.



Impulse Transformer, discharge 37.5 mfd. Capacitor @ 5 KV DC, Peak Current 167,000 amps. Pulse width 2 μ sec, Rise time .2 μ sec, Energy level 470 watt-sec. MIL-T-27C Grade 5, Size 10 x 12 x 9 1/2", 135 lbs.



Sonar Output Transformer. 36 KW pulses, 100 millisecc @ 5% duty cycle. Input 4K Ω CT, output 120-180 Ω , Hipot 29 KV. Hermetic, MIL-T-27C Grade 4, 6 1/2 x 9 x 8", 37 lbs.



Output to Klystron. 3.5 μ sec. pulses in group of pulse trains at high rep. rate. 1% droop over pulse train. 43 KV Hipot. MIL-T-27C; NA case; 4 1/4 x 5 x 6 3/4, 11 1/2 lb.

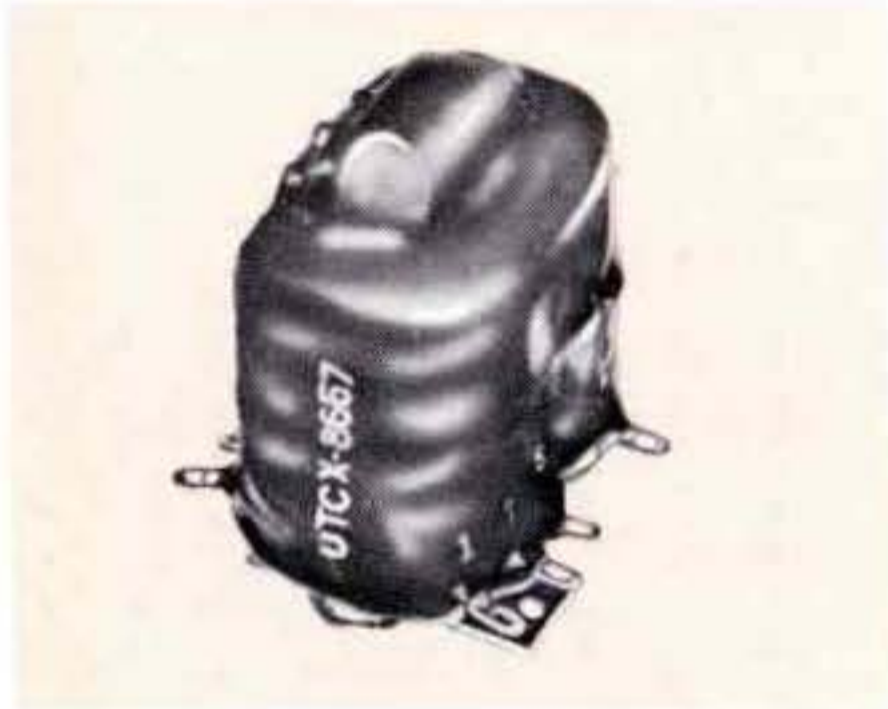

Output to 2J42 magnetron. Input 1300 V.-50 ohms. Output 6.5 KV to 1200 ohms and .6A. bifilar filament winding. .15 μ sec., 1000 PPS. Trigger winding. MIL-T-27C Grade 5; 1 1/2 x 2 1/2 x 2 3/4, 10 oz.

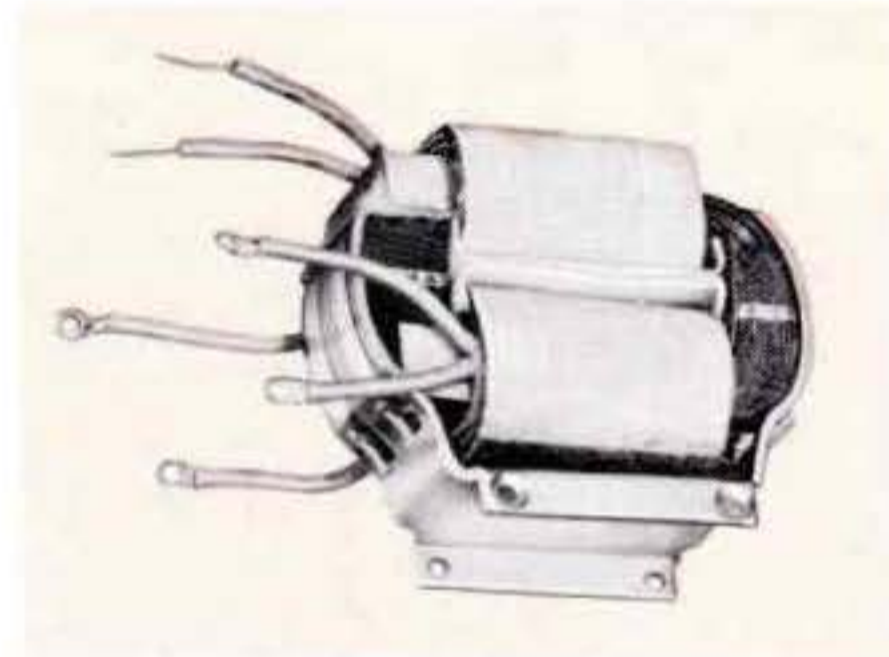

Output to magnetron. Input 6 KV peak 2.5 μ sec. or .5 μ sec. Output 28 KV-27 A. peak and 14.2A. bifilar magnetron filament winding. MIL-T-27C, 170° C.; 2 5/8 x 5 3/8 x 4 5/8, 7 1/2 lb.



Linear charging reactor for line type pulser. 20 Hys., .11A. DC, 5 KV, 1000 PPS, 11 KV hipot. MIL-T-27C, 200° C.; 3 1/4 x 4 x 3 3/4, 3 lb.



Pulse current transformer, Thyatron cathode to 50 ohms. Input 100A. Output 200 V. to 50 ohms. .5/2.4 μ sec. 2000 PPS. MIL-T-27C; 1 3/4 x 1 1/4 x 1 1/4, 2 oz.



Free running blocking oscillator transformer. 600 ohms, 1:1:1, 5 μ sec. \pm 1, 12000 \pm 10% PPS. Output 600 V. \pm 10%. Temperature stable -62° C. to 85° C. MIL-T-27C; 3/4 x 1 1/4 x 1 1/8; 1 1/2 oz.

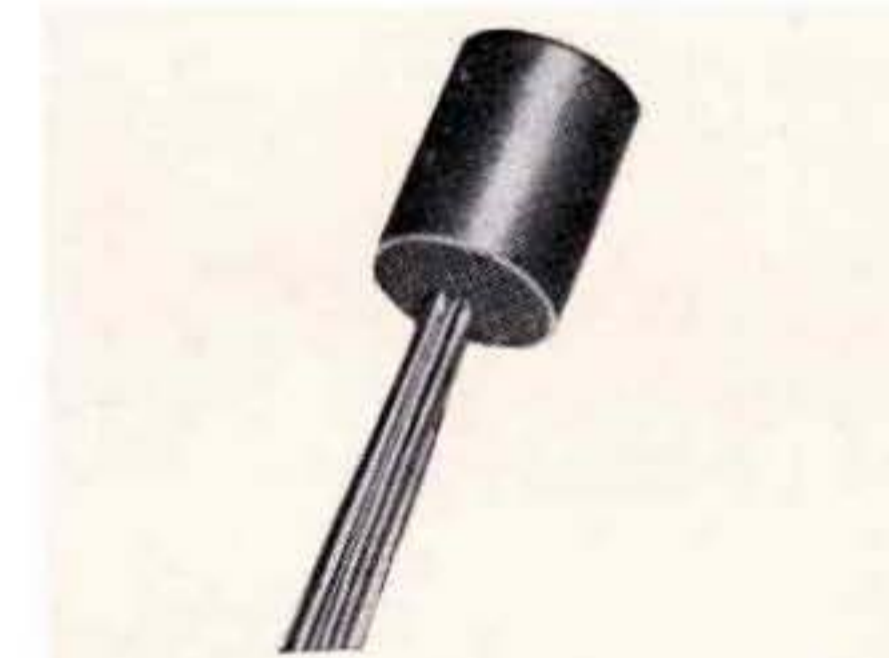

DO-T Pulse Transformer, width 150 μ sec., ratio 1:1:1. Transistor output to gating circuits. -65°C to 105°C. MIL-T-21038B. 5/16 Dia. x 13/32, 1/10 oz.

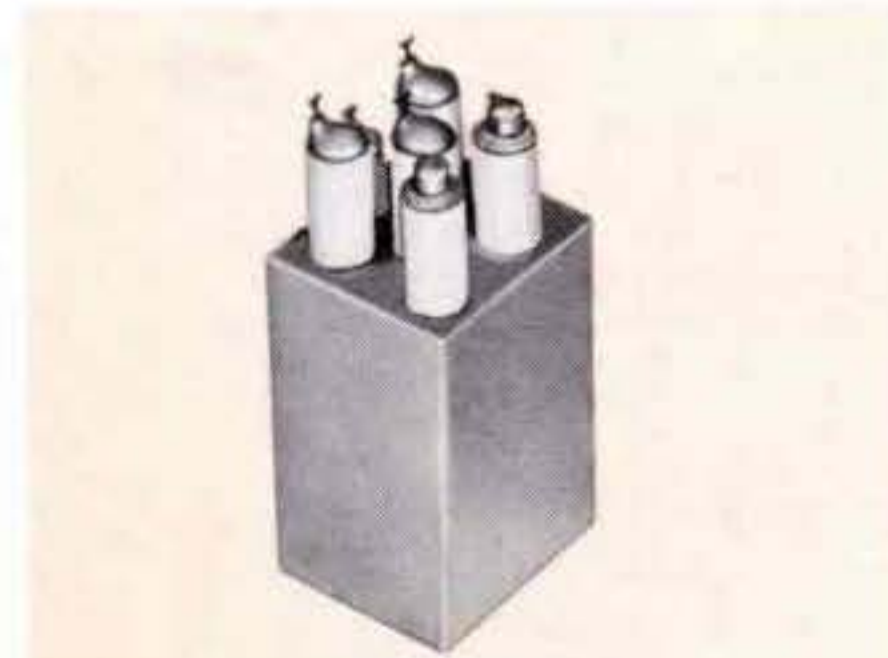

Gaussian wave shape pulse output. Input 2 KV, 3.5 μ sec. Output 2.5 KV-5A., 80 kHz rate. Corona free-35,000 feet. MIL-T-27C; 1 5/8 x 1 5/8 x 3 3/8, 1 lb.

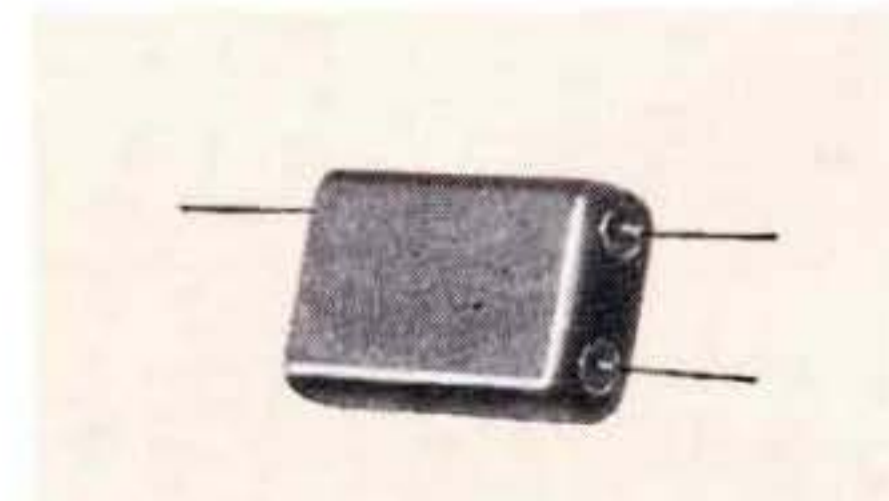

Differentiating pulse transformer. Input 150 V. 40 MA peak, 6 μ sec., 3000 PPS. Output 30 V. .5 μ sec. Ferrite core. Rise, droop, and pulse duration held to 5%. MIL-T-21038B, -55° C. to + 100° C.; 5/16 x 5/8 x 1; 7 grams.

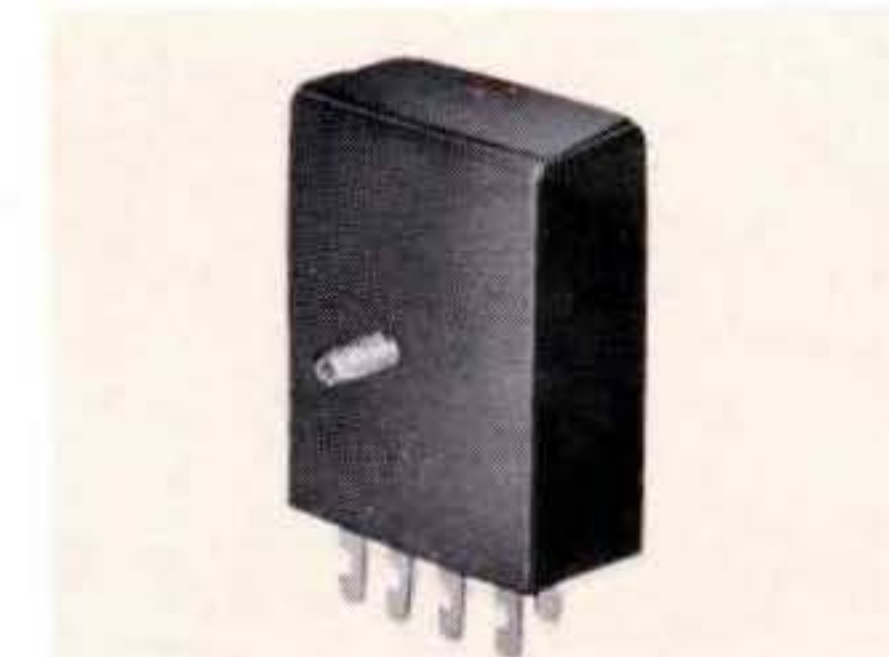

Ferrite core pulse transformer. 30 V. . . . three windings, 5-10 μ sec. Couples to magnetic tape head for high speed read in and out. Hiper-malloy shield. Commercial; 5/8 x 1 1/4 x 1 5/8, 2 oz.



GENERAL INFORMATION ON HIGH Q INDUCTORS

Almost 40 years of specialization in High Q Inductors are reflected in the superior Q and temperature stability of the molybdenum permalloy dust toroid, ferrites, and laminated structures produced by UTC today. Range of applications is from DC to 30 MHz.

While this catalog lists 24 different types of stock inductors, special custom designs produced to customers' specifications are available on special order. Characteristics such as taps, additional windings, special adjustments such as in a resonant circuit, higher voltage capability, inductance adjusted with DC, special mechanical configurations, even better temperature stability than our stock items, etc. are available to customers' requirements.

Technical

While the toroidal coil is superior for frequencies above 1 kHz, the laminated structure is superior for lower frequencies. The ML, MO, MQM, and MQL use a hum-reducing lamination structure and, in addition, the ML, MQM, and MQL are in hipermalloy shield cases.

The toroidal coils MS, MM, MH, MW, FE, FI, FO, MQA, MQB, MQE, MQD, HQA, HQB, HQC, HQE have extremely low hum pickup due to the symmetrical winding on the toroidal core.

All stock inductors are measured at 0 DC. The maximum DC listings are for approximately 5% drop in inductance, and negligible heat rise. The typical curves of inductance variation with AC or DC currents, illustrated on the following pages, best show the range of operation for a particular inductor. The excitation is plotted in milliamperes $\times \sqrt{\text{mHy}}$. For example, the 100 mHy MS toroid (MS-100) with 10 ma of DC flowing has an excitation factor of $10 \text{ ma} \times \sqrt{100 \text{ mHy}} = 100$, and the curve shows that approximately 90 mHy will be measured with 10 ma DC.

In the curves shown below, the solid line represents a stock series, the dotted line represents a few of the special capabilities of UTC in the specific stock size.

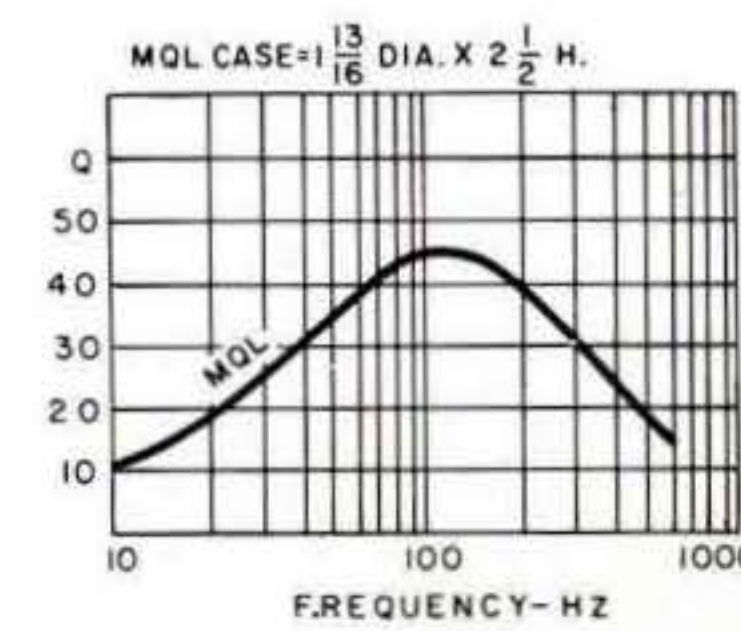
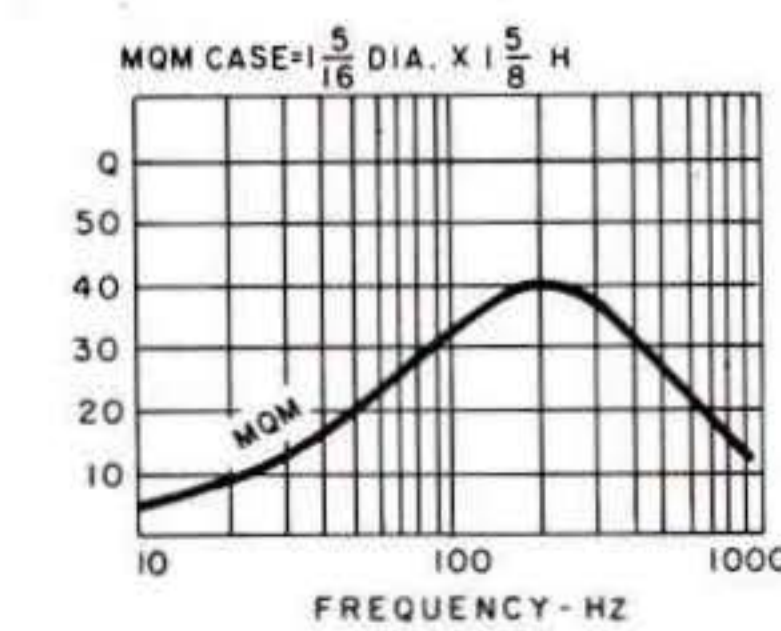
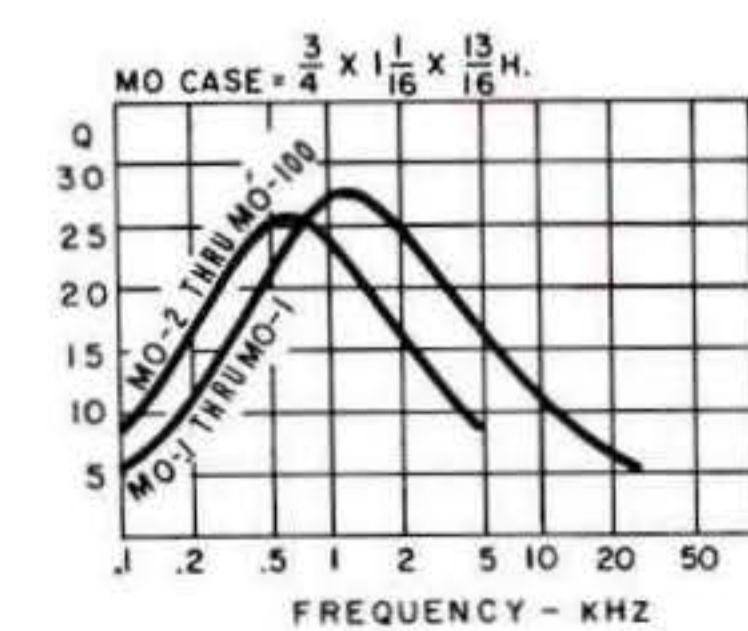
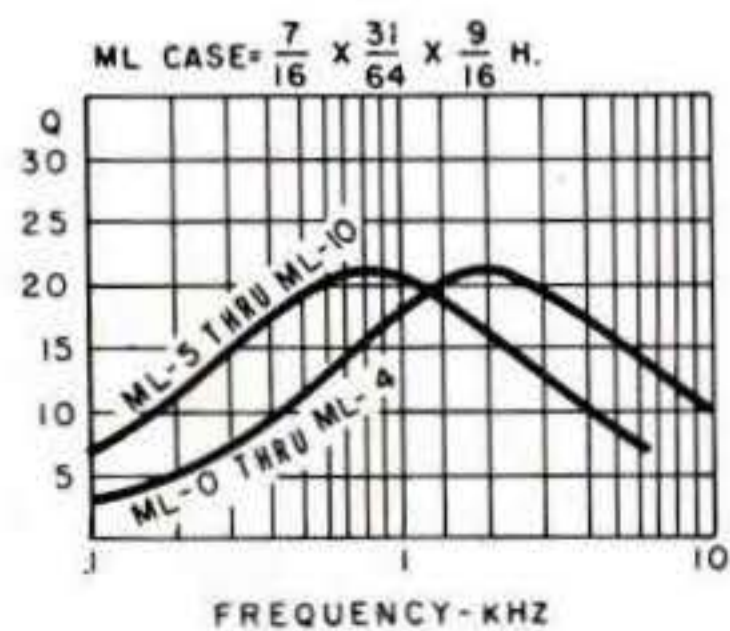
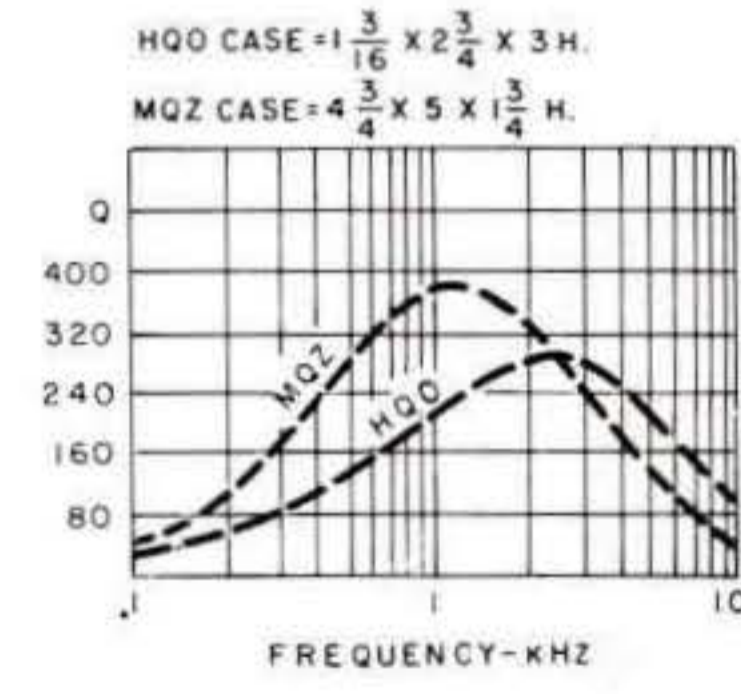
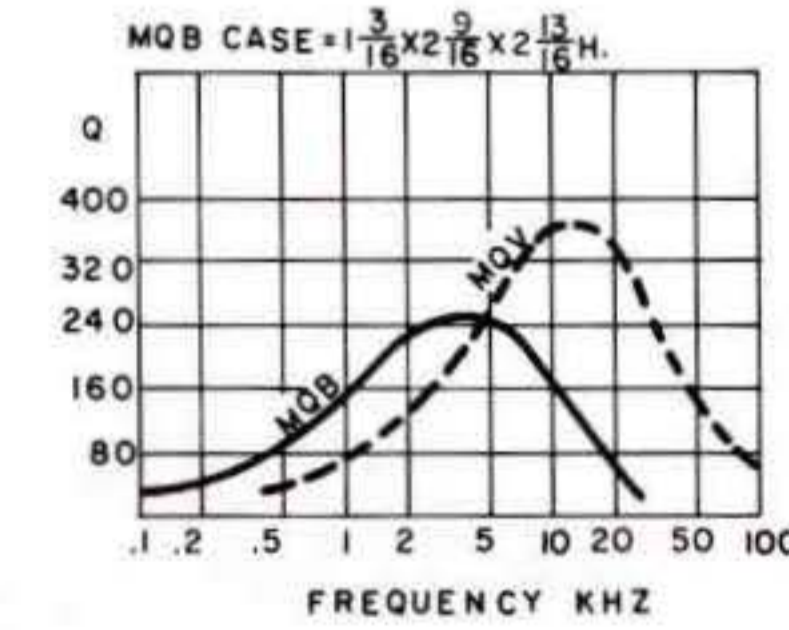
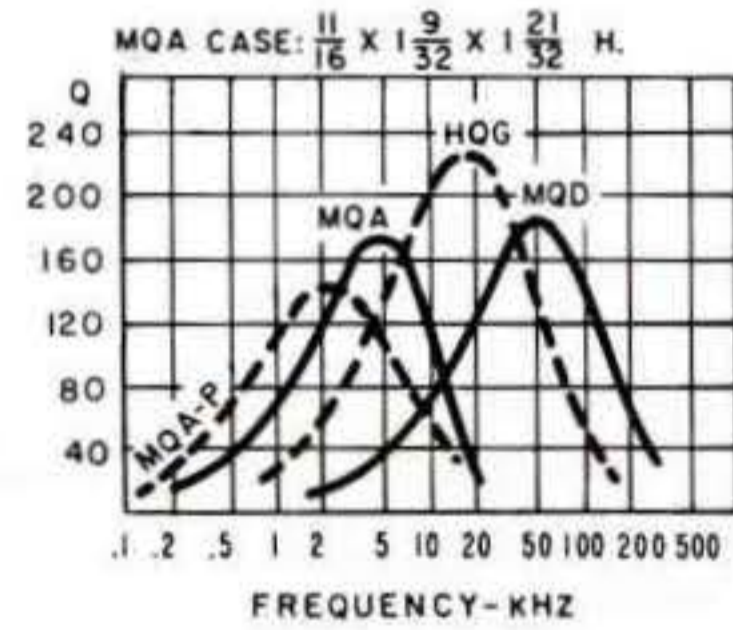
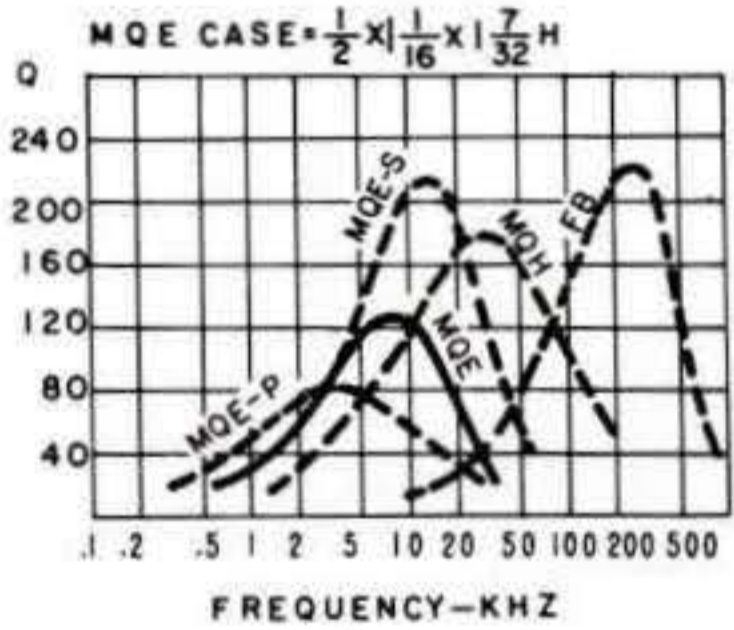
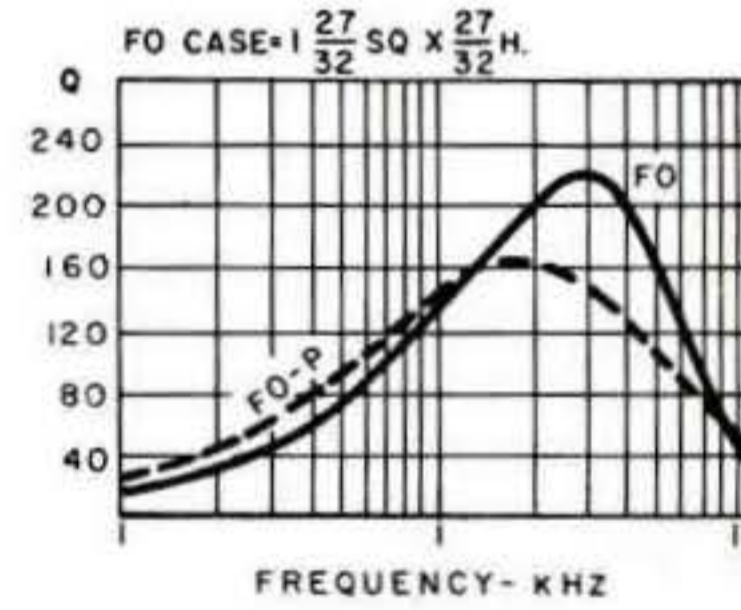
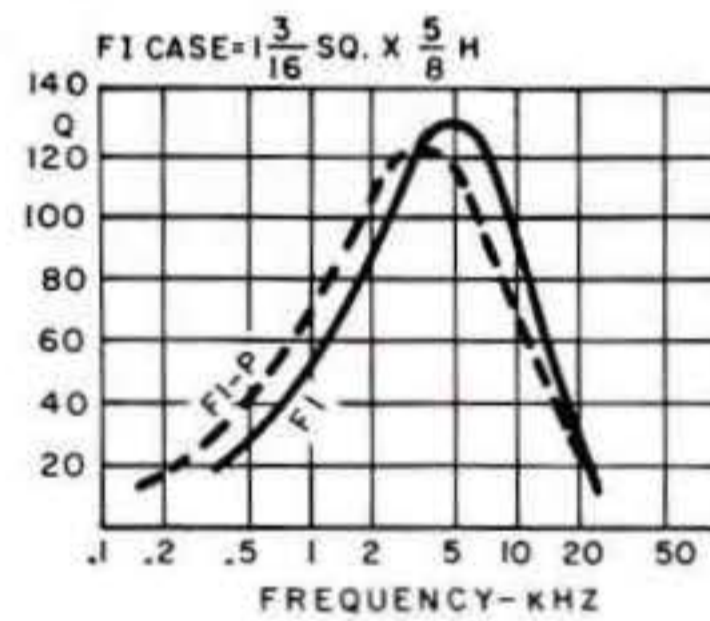
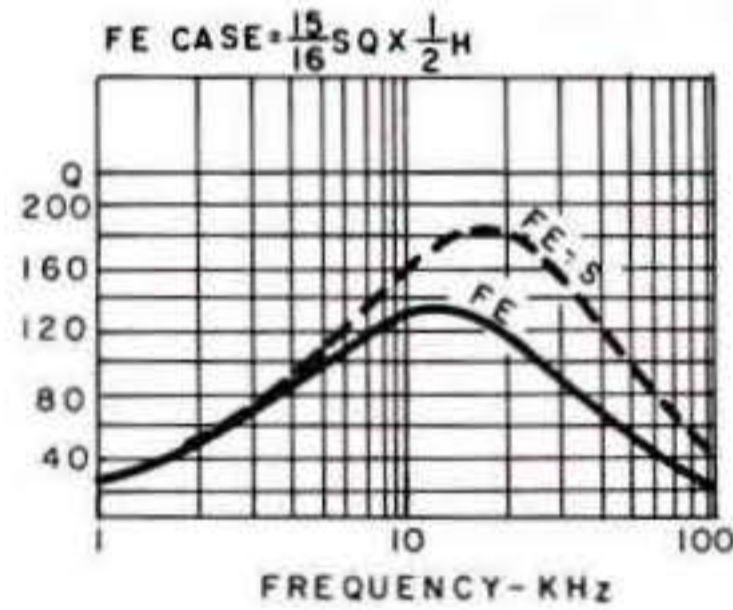
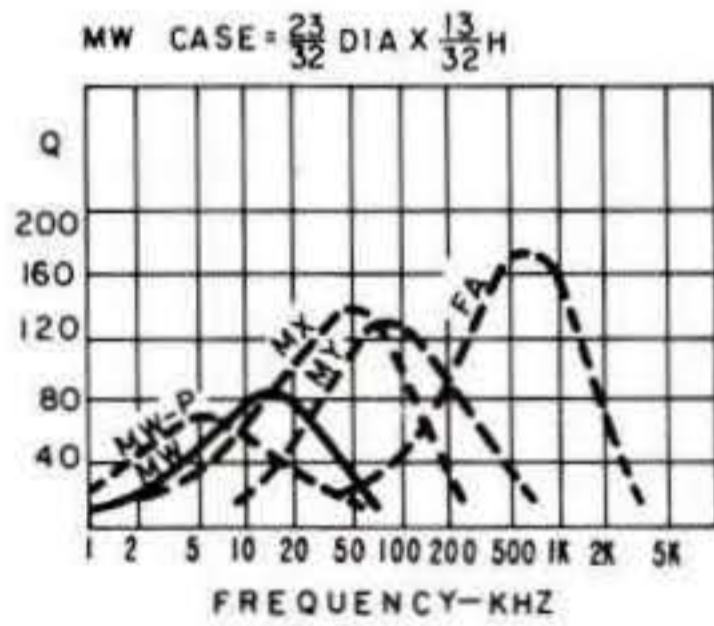
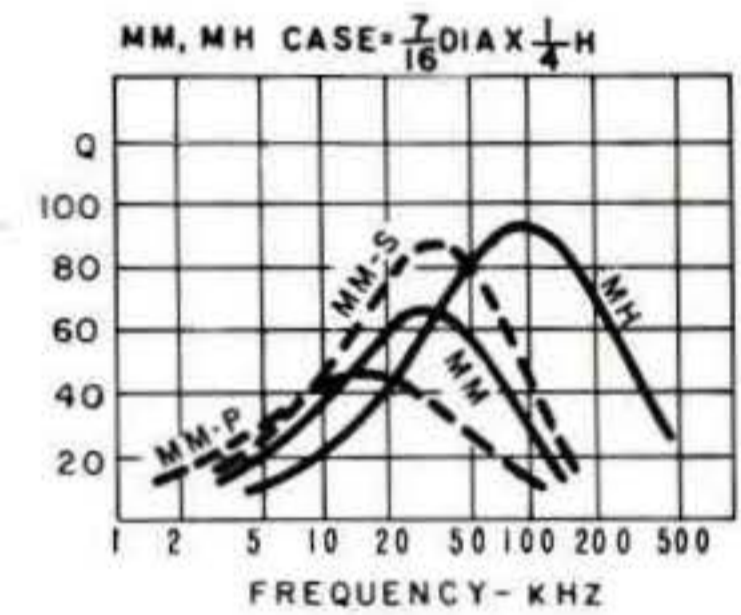
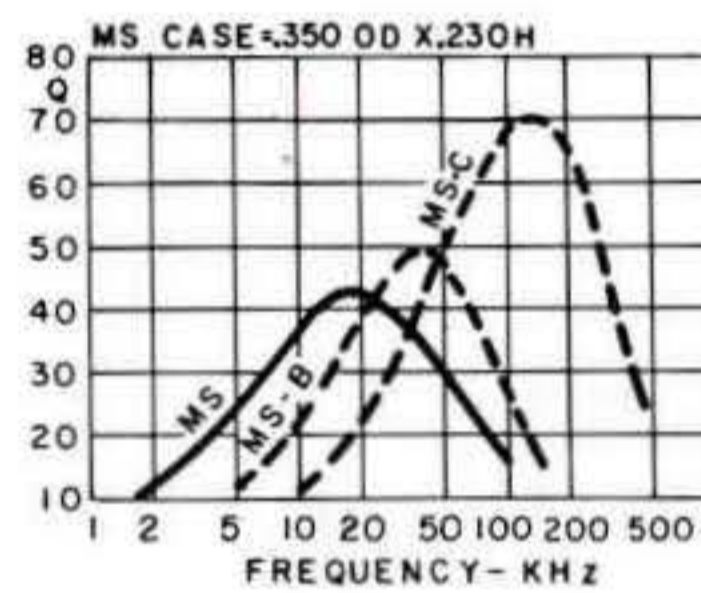

Since these high Q coils will saturate before any appreciable temperature rises occur, heating is usually not a problem. A general rule would be that 4 times the DC listings may be applied without any detrimental heating due to copper loss.

For variable inductors such as HVC, TVC, HVV and VIC, the DC values listed apply at the mean to minimum inductance settings only. The maximum inductance cannot be obtained with that amount of DC current flowing.

Temperature stability of all UTC inductors is excellent. Guaranteed limits and typical curves of inductance variation with temperature are shown for most types.

Engineering, laboratory, and production facilities are available for full engineering discussion, sampling, and large quantity production to meet special requirements.

Intermediate inductance values in an existing stock toroidal series are available, priced as the next higher inductance unit.

STANDARD HIGH Q INDUCTORS SELECTION GUIDE

HIGH Q INDUCTORS—FIXED

Type No.	Size	Wt.	MIL Gr.	Stock Line Inductance Range	Approx. DCR Ω /Hy	Approximate Peak Q	@ Freq.	Inductance Tolerance Adjustment	Temp. Stb'l	Temp. Range	Pg.
MS	.23" h x .35" dia	1.3 gm	5	1 MHy-100 MHy	1300	40	20 kHz	$\pm 2\%$ @ .1V, 1 kHz	$\pm 2\%$	-55°C to +105°C	63
MM	1/4 h x 1/16" dia	2 gm	5	3 MHy-120 MHy	1300	60	30 kHz	$\pm 2\%$ @ .1V, 1 kHz	$\pm 2\%$	-55°C to +105°C	63
MH	1/4 h x 1/16" dia	2 gm	5	.6 MHy-40 MHy	2700	80	100 kHz	$\pm 2\%$ @ .1V, 1 kHz	$\pm 1\%$	-55°C to +105°C	63
ML-0 thru ML-4	7/16 x 31/64 x 9/16" h	.2 oz	5	.15 Hy-1.4 Hy	150	22	1.5 kHz	$\pm 3\%$ @ 1V, 1 kHz	within 2%	-55°C to +105°C	62
ML-5 thru ML-10	7/16 x 31/64 x 9/16" h	.2 oz	5	2.5 Hy-60 Hy	85	22	800 Hz	$\pm 3\%$ @ 1V, 400 Hz	$\pm 2\%$	-55°C to +105°C	62
MW	13/32 h x 23/32" dia	.25 oz	5	.05 Hy-5 Hy	500	80	10 kHz	$\pm 1\%$ @ 1V, 1 kHz	$\pm 1\%$	-55°C to +105°C	63
MO-1 thru MO-1	3/4 x 1 1/16 x 1 3/16" h	1 oz	5	.1 Hy-1 Hy	130	27	1.5 kHz	$\pm 2\%$ @ 1V, 1 kHz	+1% -2%	-55°C to +105°C	62
MO-2 thru MO-100	3/4 x 1 1/16 x 1 3/16" h	1 oz	5	2 Hy-100 Hy	65	25	600 Hz	$\pm 2\%$ @ 1V, 400 Hz	+1% -3%	-55°C to +105°C	62
FE	15/16 x 15/16 x 1/2" h	.7 oz	5	.01 Hy-2 Hy	200	125	8 kHz	$\pm 1\%$ @ 1V, 1 kHz	$\pm 1.5\%$	-55°C to +105°C	64
FI	13/16 x 13/16 x 5/8" h	1.5 oz	5	.04 Hy-4 Hy	100	150	5 kHz	$\pm 1\%$ @ 1V, 1 kHz	$\pm 1.5\%$	-55°C to +105°C	64
FO	1 27/32 x 1 27/32 x 2 7/32" h	5 oz	5	.10 Hy-10 Hy	35	240	3 kHz	$\pm 1\%$ @ 1V, 400 Hz	$\pm 1.5\%$	-55°C to +105°C	64
MQA	1 1/16 x 1 9/32 x 1 21/32" h	4 oz	4	7 MHy-35 Hy	84	160	5 kHz	MQA 1-14: $\pm 1\%$ @ 1V, 1 kHz MQA 15-20: $\pm 1\%$ @ 1V, 500 Hz	< 1%	-55°C to +105°C	66
TQA	1 1/16 x 1 9/32 x 1 21/32" h	4 oz	4	7 MHy-35 Hy CT	106	160	6 kHz	TQA 1-14: $\pm 1\%$ @ 1V, 1 kHz TQA 15-20: $\pm 1\%$ @ 1V, 500 Hz	< 1%	-55°C to +105°C	66
MQB	1 3/16 x 2 9/16 x 2 1 3/16" h	14 oz	4	10 MHy-60 Hy	30	250	3 kHz	MQB 1-12: $\pm 1\%$ @ 1V, 500 Hz MQB 13, 14: $\pm 1\%$ @ 1V, 400 Hz	$\pm 1.5\%$	-55°C to +105°C	67
MQD	1 1/16 x 1 9/32 x 1 21/32" h	4 oz	4	1 MHy-30 MHy	570	180	50 kHz	$\pm 1\%$ @ 1V, 1 kHz	$\pm .5\%$	-55°C to +105°C	66
MQE	1/2 x 1 1/16 x 1 1/32" h	1.5 oz	4	4 MHy-4 Hy	170	140	8 kHz	$\pm 1\%$ @ 1V, 1 kHz	$\pm 1\%$	-55°C to +105°C	67
SQL	2 1/2 h x 1 13/16" dia	1 lb	4	.25 Hy-2500 Hy	5	45	100 Hz	$\pm 2\%$ series @ 1V, 60 Hz parll @ .5 V, 60 Hz	< 3%	-55°C to +105°C	65
MQM	1 5/8 h x 1 5/16" dia	5 oz	4	.5 Hy-600 Hy	10	40	200 Hz	$\pm 2\%$ series @ 1V, 60 Hz parll @ .5V, 60 Hz	$\pm 2\%$	-55°C to +130°C	65
HQA	1 3/16 h x 1 13/16" dia	5 oz	4	5 MHy-15 Hy	75	140	4 kHz	HQA 1-13: $\pm 1\%$ @ 1V, 1 kHz HQA 14-18: $\pm 1\%$ @ 1V, 500 Hz	$\pm 1.5\%$	-55°C to +105°C	70
HQB	1 5/8 x 2 5/8 x 2 5/8" h	14 oz	4	10 MHy-25 Hy	30	220	3 kHz	$\pm 1\%$ @ 1V, 500 Hz	$\pm 1.5\%$	-55°C to +105°C	70
HQC	1 3/16 h x 1 13/16" dia	5 oz	4	1 MHy-20 MHy	270	170	25 kHz	$\pm 1\%$ @ .1V, 1 kHz	$\pm 1\%$	-55°C to +105°C	70
HQE	1/2 x 1 1/16 x 1 1/32" h	1.5 oz	4	5 MHy-200 MHy	240	115	10 kHz	$\pm 1\%$ @ 1V, 1 kHz	$\pm 1.5\%$	-55°C to +105°C	70

HIGH Q INDUCTORS—VARIABLE

Type No.	Size	Wt.	MIL Gr.	Mean Inductance Range	Variable Inductance Range	At Mean Inductance	Pg.
HVC	25/32 x 1 1/8 x 1 9/32" h	2 oz	4	.006 Hy-150 Hy	+200% -70% (10 to 1)	$\pm 1.5\%$ -55°C to +105°C	68
TVC*	25/32 x 1 1/8 x 1 9/32" h	2 oz	4	.006 Hy-150 Hy	+200% -70% (10 to 1)	$\pm 1.5\%$ -55°C to +105°C	68
HVV	25/32 x 1 1/8 x 1 9/32" h	2 oz	4	.006 Hy-150 Hy	$\pm 10\%$	$\pm 1\%$ -55°C to +105°C	68
VIC	1 1/4 x 1 1 3/32 x 1 1/16" h	5 1/2 oz	com	.0085 Hy-130 Hy	+85% -45% (3 to 1)	$\pm 3\%$ -55°C to +105°C	69
DI	Precision decade inductors. Inductance range 10 x .01 Hy to 10 x 10 Hy; 4 1/2 x 4 3/8 x 2 3/8" h; wt. 2 lbs.						69

*Same as HVC but with taps @ 30%, +50%



ULTRAMINIATURE HIGH Q INDUCTORS

MINIDUCTOR™ SERIES

PACKAGING Hermetically sealed. MS, MM, MH, MW, epoxy molded symmetrical toroids. ML, hipermalloy shield cased, hum reducing laminated inductor. MO, epoxy molded hum reducing laminated inductor. All have straight pin terminals for printed circuit applications.

TERMINALS Per MIL-STD-1276.

MIL SPECS To complete MIL-T-27C Specs. Mil Type TF5RX20ZZ. See pages 86, 87.

Type No.	Inductance Tolerance at 25°C	Test Frequency	Test Level RMS V	Max L Variation -55° to +105°C
ML-0 Thru 4	±3%	1 kHz	1.0	Within 2%
ML-5 Thru 10	±3%	400 Hz	1.0	±2%
MO-1 Thru 1	±2%	1 kHz	1.0	+1% -2%
MO-2 Thru 100	±2%	400 Hz	1.0	+1% -3%
MS	±2%	1 kHz	0.1	±2%
MM	±2%	1 kHz	0.1	±2%
MH	±2%	1 kHz	0.1	±1%
MW	±1%	1 kHz	1.0	±1%

LAMINATED TYPES

ML SERIES

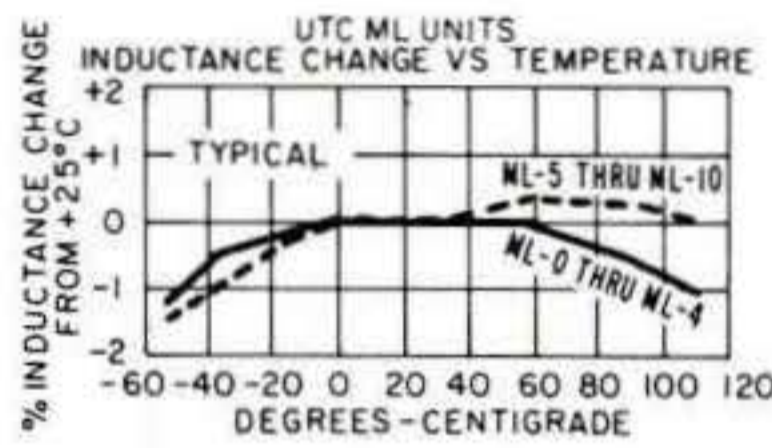

Type No.	Ind. Hy (0 DC)	ma DC Max.	DCRΩ ±20%
ML-0	.15	12	33
ML-1	.25	9	55
ML-2	.4	7	90
ML-3	.7	5	135
ML-4	1.4	3	210
ML-5	2.5	1	210
ML-6	4.0	.7	340
ML-7	6.0	.6	530
ML-8	10	.5	850
ML-9	25	.3	2300
ML-10	60	.2	5160

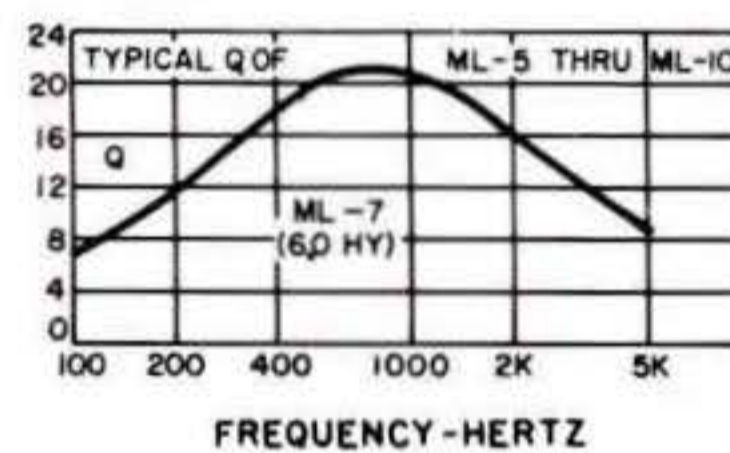
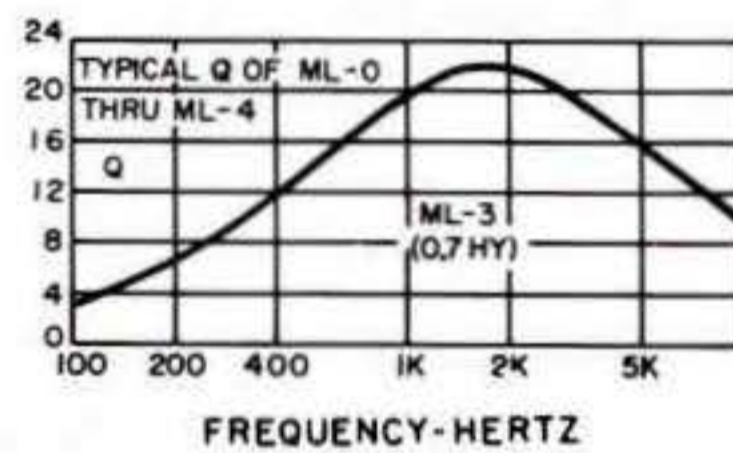
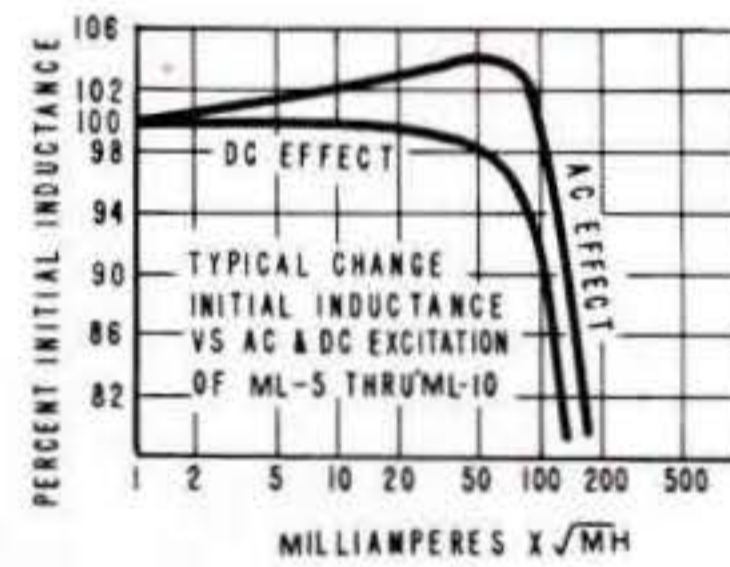
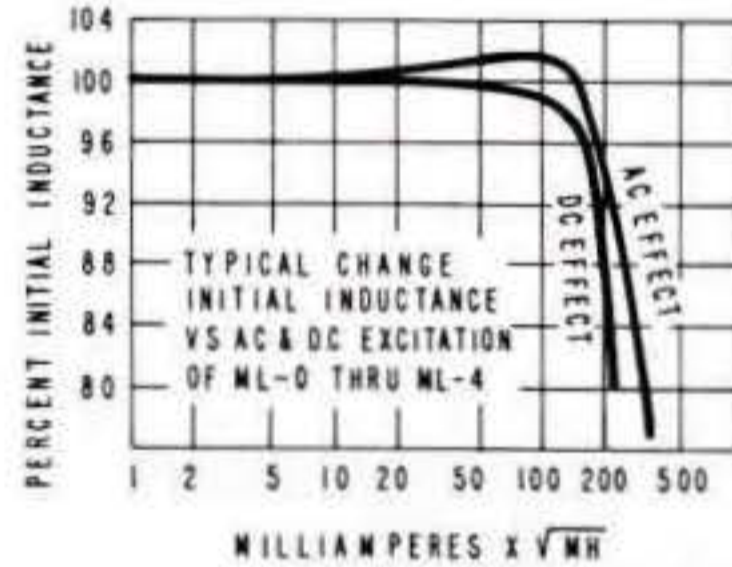

MO SERIES

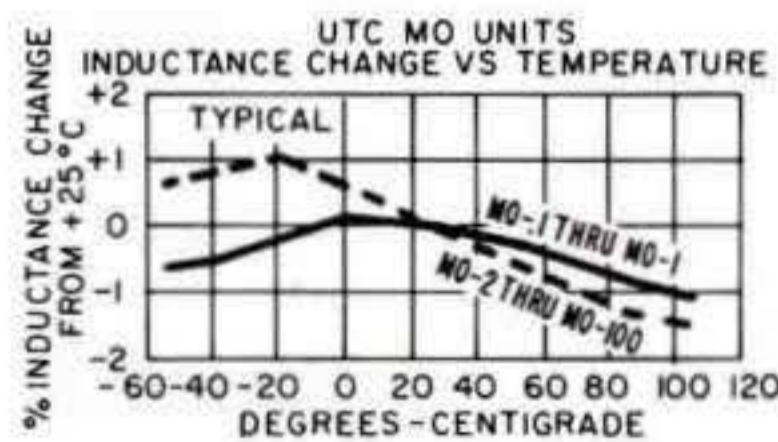

Type No.	Ind. Hy (0 DC)	ma DC Max.	DCRΩ ±20%
MO-1	.1	55	14
MO-15	.15	45	22
MO-3	.3	28	34
MO-5	.5	23	54
MO-1	1	16	130
MO-2	2	8	130
MO-5	5	5	340
MO-7.5	7.5	4.5	517
MO-20	20	2.7	1310
MO-50	50	1.4	3180
MO-100	100	1.1	8550

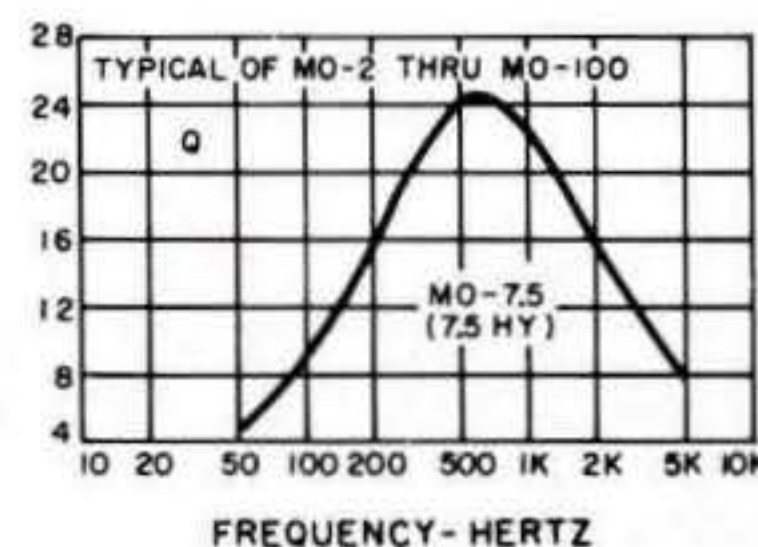
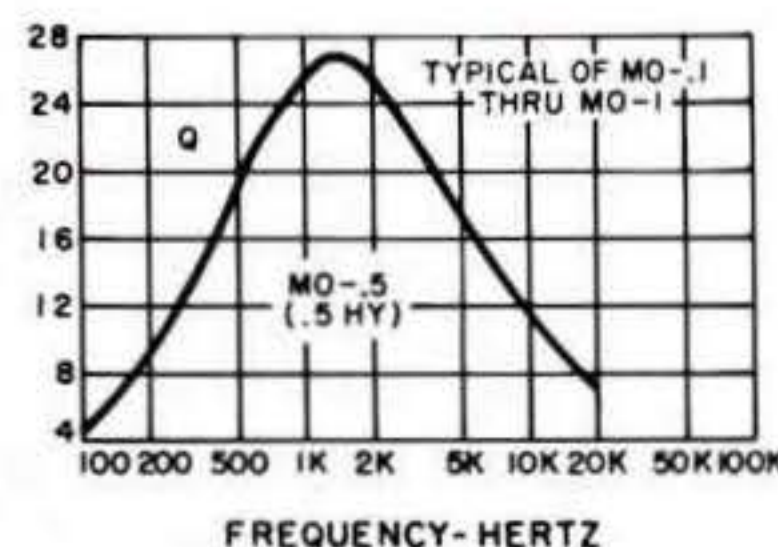
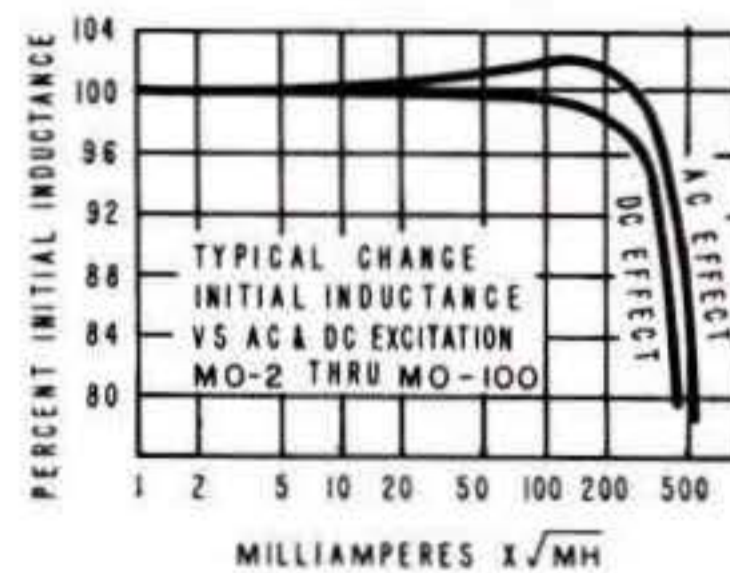
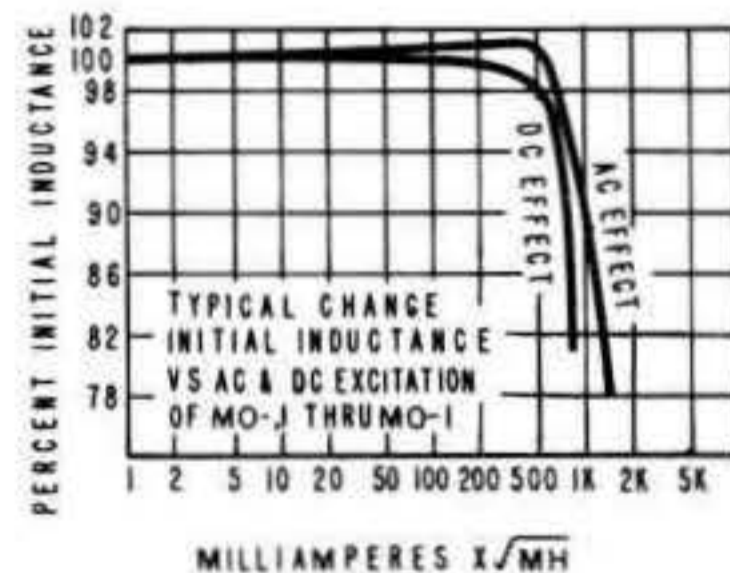

MINIDUCTOR™ SERIES

TOROIDAL TYPES

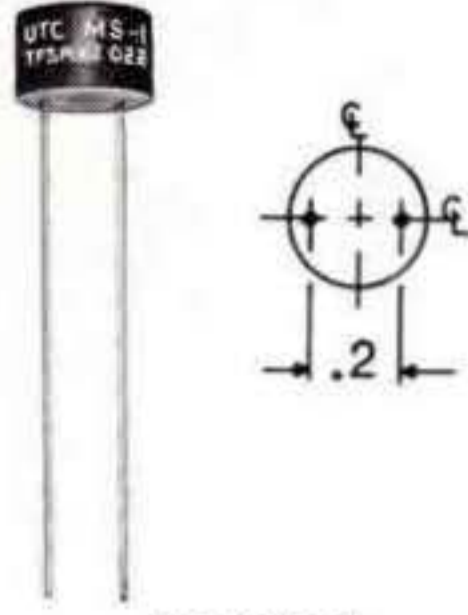

MS CASE
 .35" Dia. x .23 high
 Weight 1.3 Gm.
TERM. Type D
 gold-plated Dumet
 .025" Dia. x 1 1/4" long

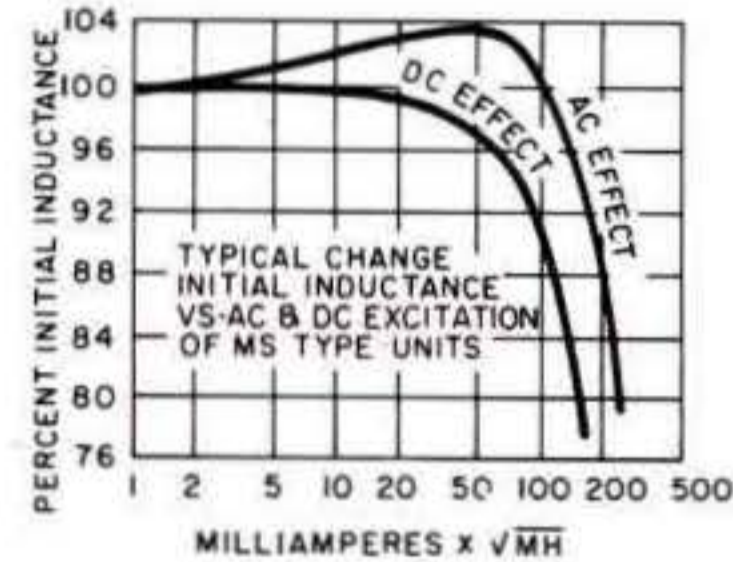
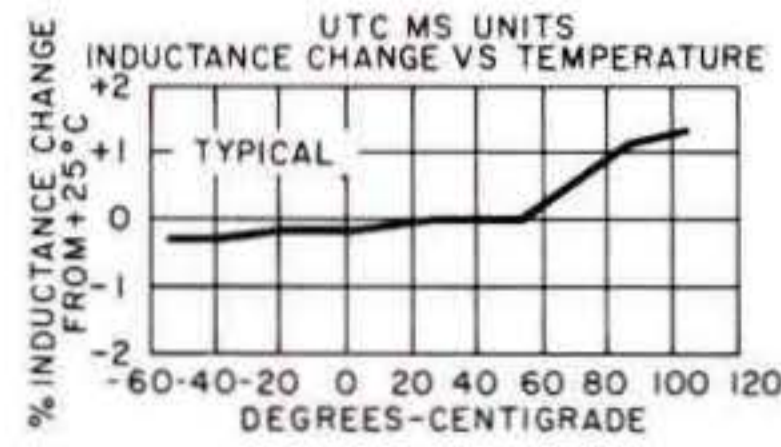
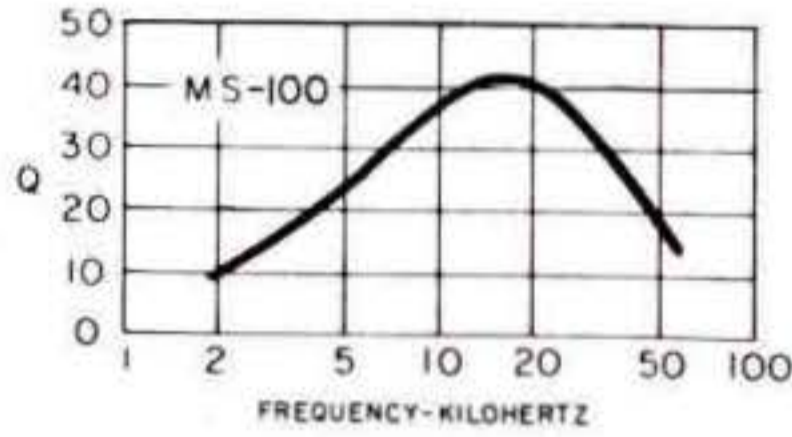
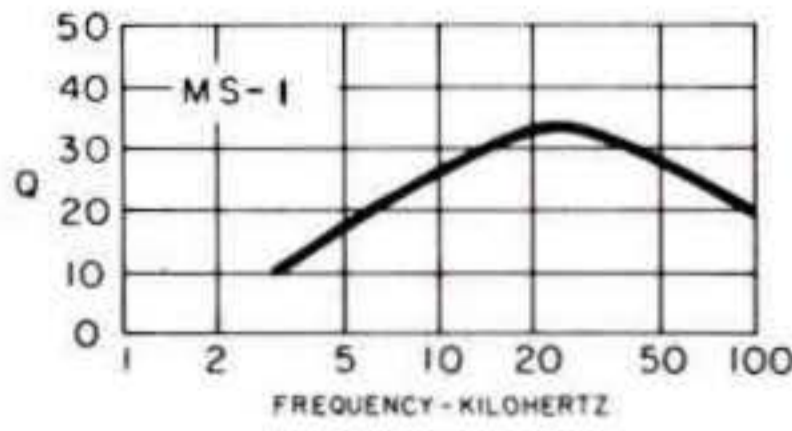

NEW MS SERIES

Type No.	Ind. Mhy (0 DC)	ma DC Max.	DCRΩ Max.
MS-1	1	60	1.4
MS-5	5	28	7
MS-10	10	20	11
MS-25	25	13	38
MS-50	50	9	75
MS-100	100	6	132

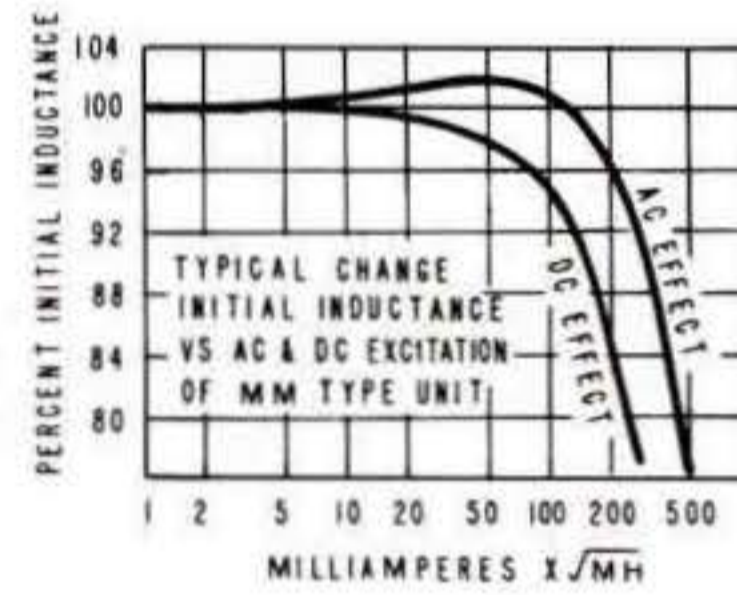
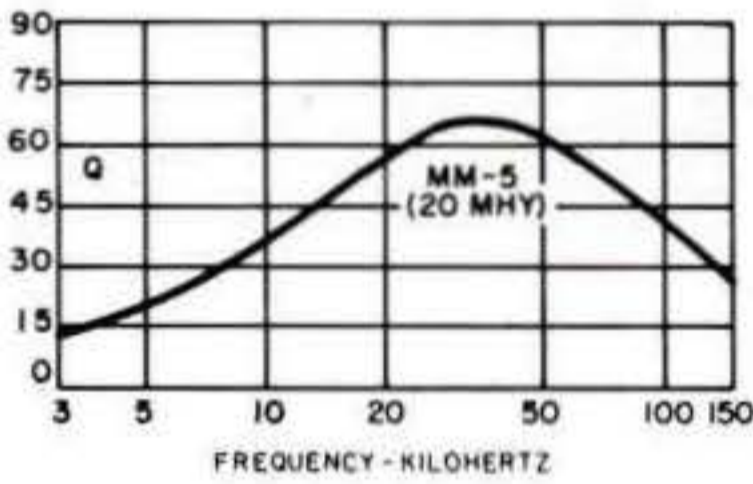
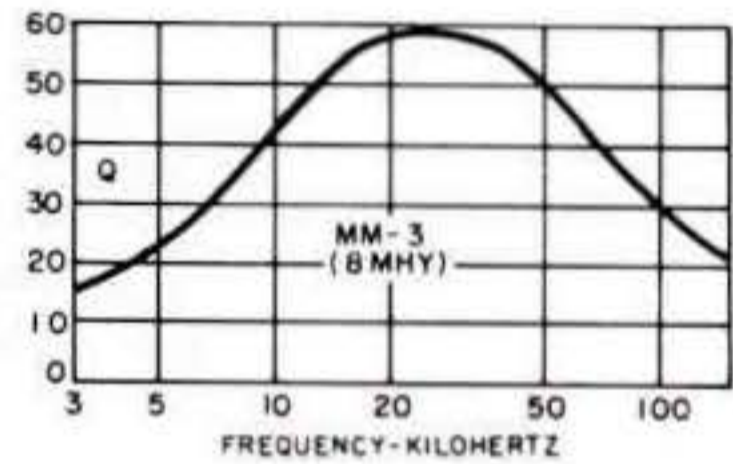
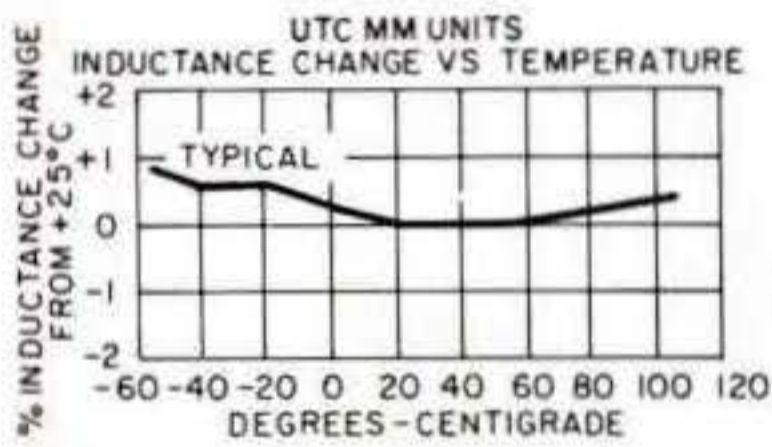

MM SERIES

Type No.	Ind Mhy (0 DC)	ma DC Max.	DCRΩ Max.
MM-1	3	50	4.8
MM-2	5	40	8.0
MM-3	8	30	13
MM-4	12.5	25	19
MM-5	20	20	31
MM-6	30	16	47
MM-7	60	11	94
MM-8	120	8	186

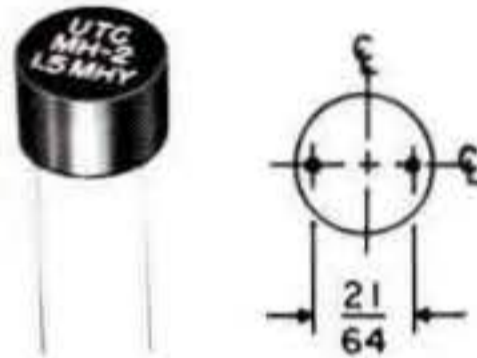

MM, MH CASE
 3/16" Dia. x 1/4" high
 Weight .07 oz.
TERM. Type D
 gold-plated Dumet
 .025" Dia. x 1 1/4" long

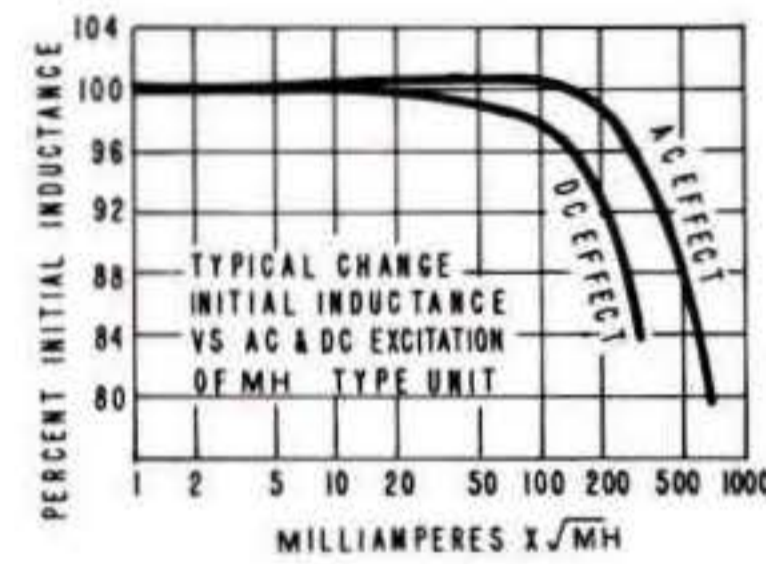
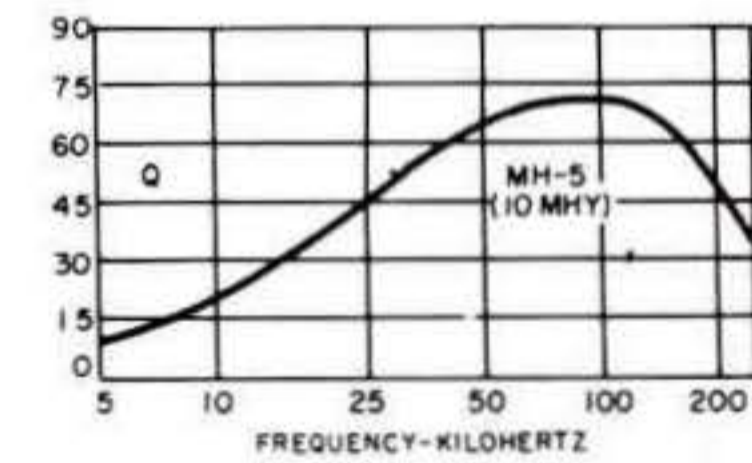
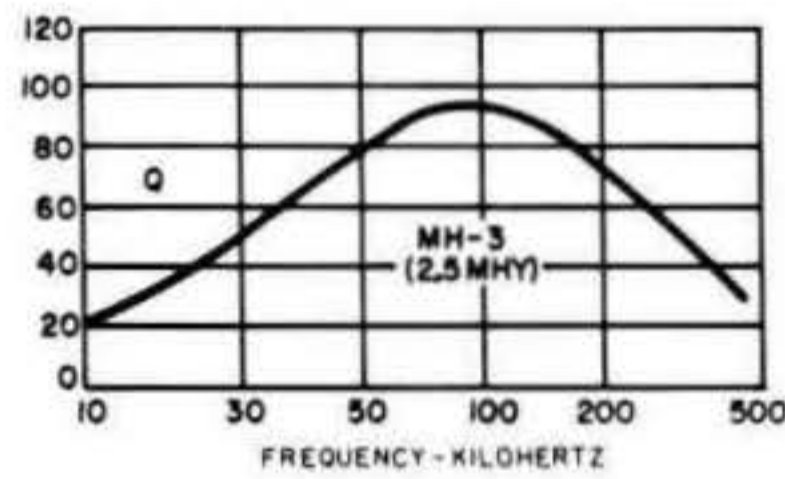

MH SERIES

Type No.	Ind Mhy (0 DC)	ma DC Max.	DCRΩ Max.
MH-1	.6	90	1.9
MH-2	1.5	57	4.9
MH-3	2.5	44	8.2
MH-4	6	28	19
MH-5	10	22	32
MH-6	15	18	49
MH-7	25	14	82
MH-8	40	11	130

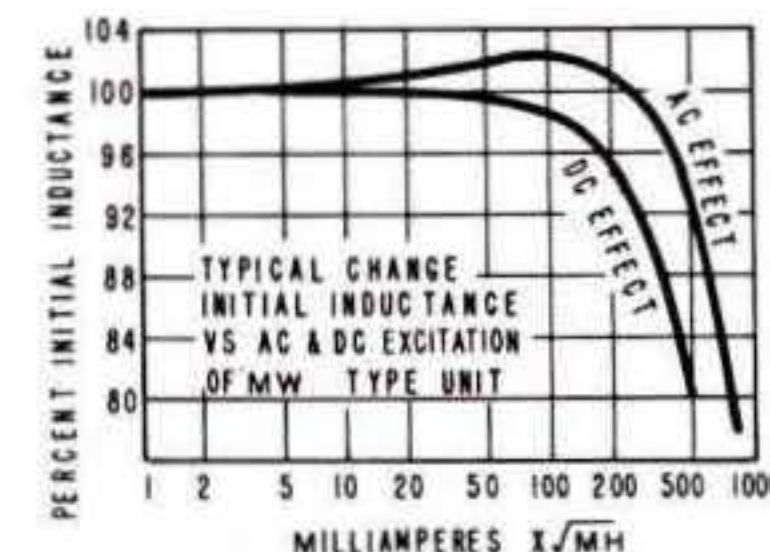
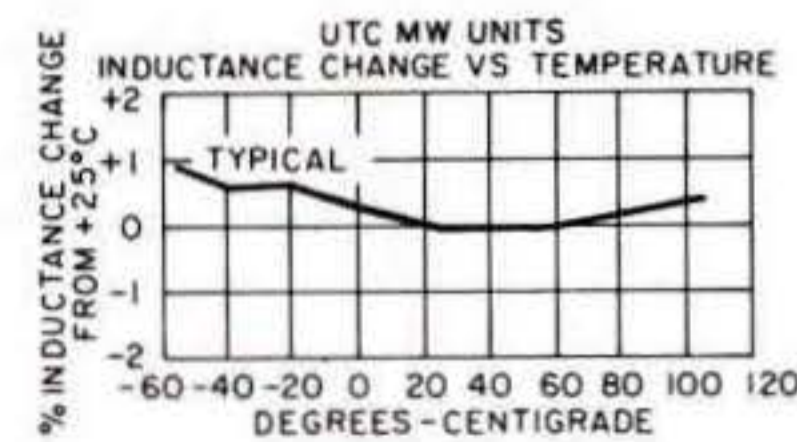
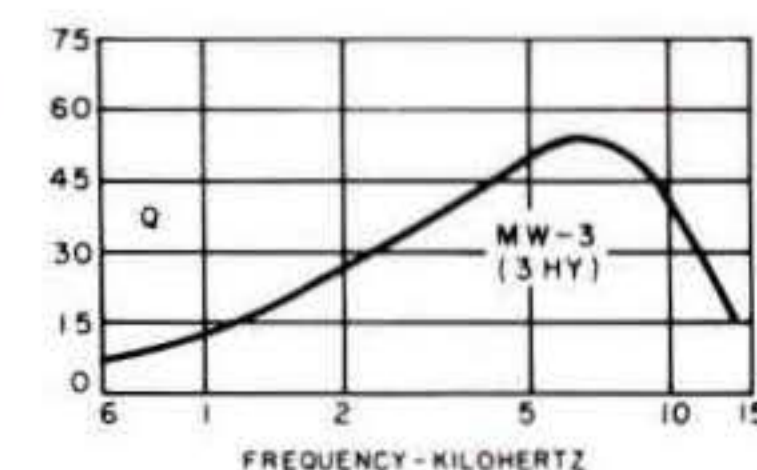
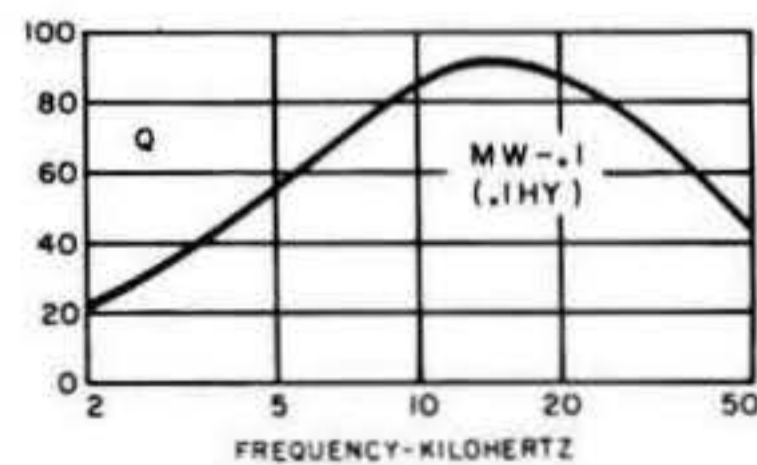
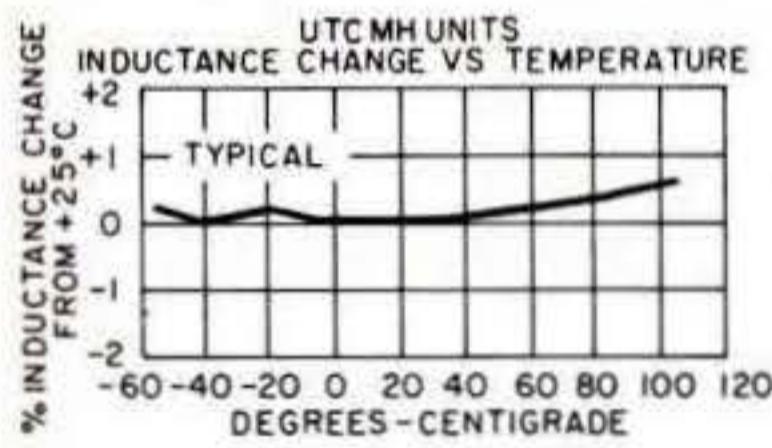

MW SERIES

Type No.	Ind. Hy (0 DC)	ma DC Max.	DCRΩ ±20%
MW-.05	.05	25	27
MW-.10	.10	18	51
MW-.25	.25	11	136
MW-.5	.5	8	243
MW-.75	.75	7	355
MW-1	1.0	6	500
MW-1.2	1.2	5	560
MW-2	2	4	870
MW-3	3	3.5	1340
MW-5	5	3	2500

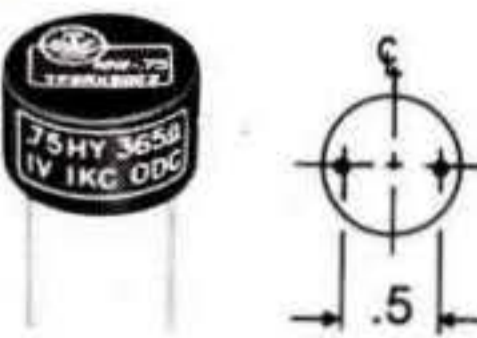

MW CASE
 3/32" Dia. x 13/32" high
 Weight .25 oz.
TERM. Type N-2
 gold-plated nickel
 .040" Dia. x 3/8" long



FE™ FL™ FO™ MINIATURE INDUCTORS

PACKAGING Hermetically sealed. Molded flat construction, symmetrical toroids.

TOLERANCE FE, FI, ±1% @ 1 V, 1 kHz. FO, ±1% @ 1 V, 400 Hz.

TERMINALS Per MIL-STD-1276, gold plated nickel, type N-2, .040 diameter x 3/8" long.

MIL SPECS To complete MIL-T-27C Specs. Mil Type TF5RX20ZZ. See pages 86, 87.

TEMPERATURE STABILITY -55° C to +105° C, ±1.5%.

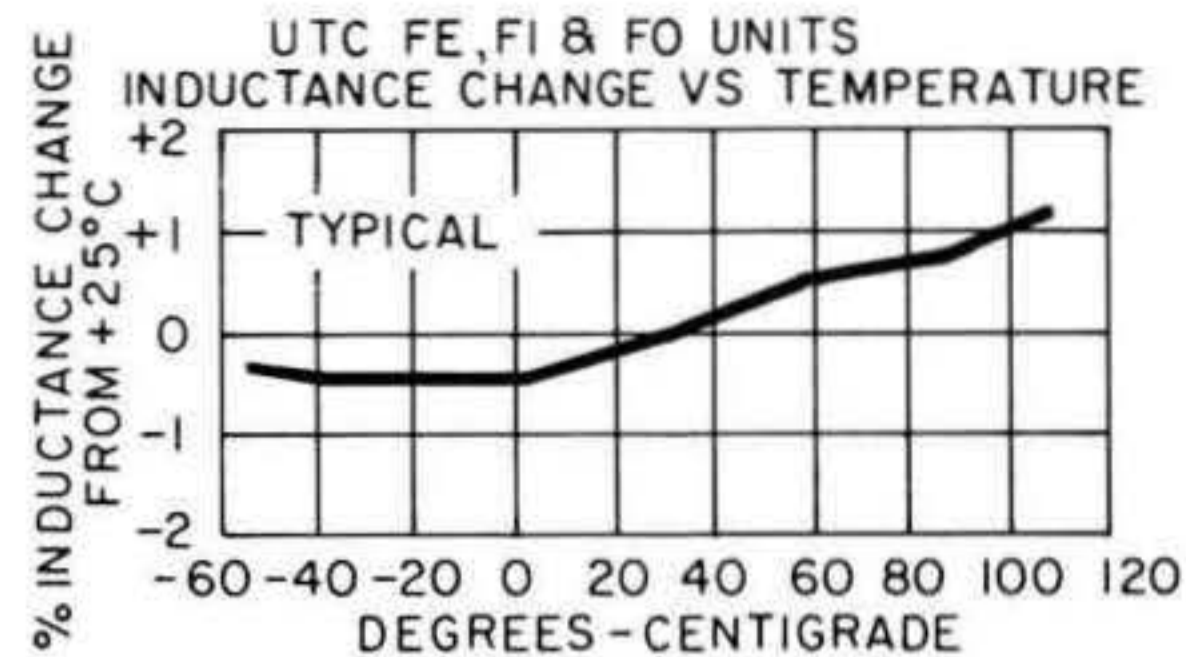

FE™

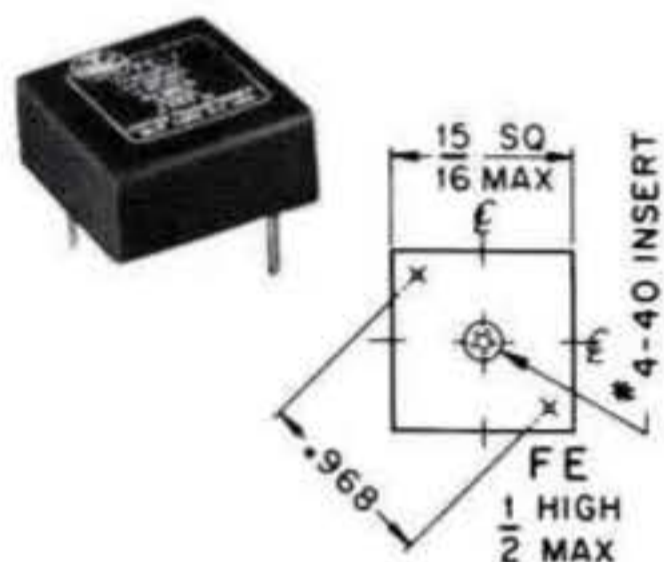

wt: 0.7 oz

FI™

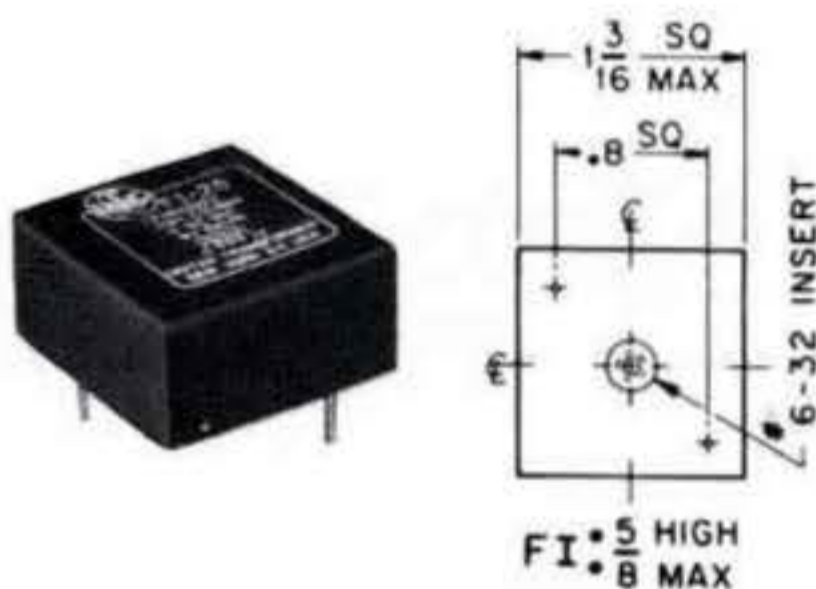

wt: 1.5 oz

FO™

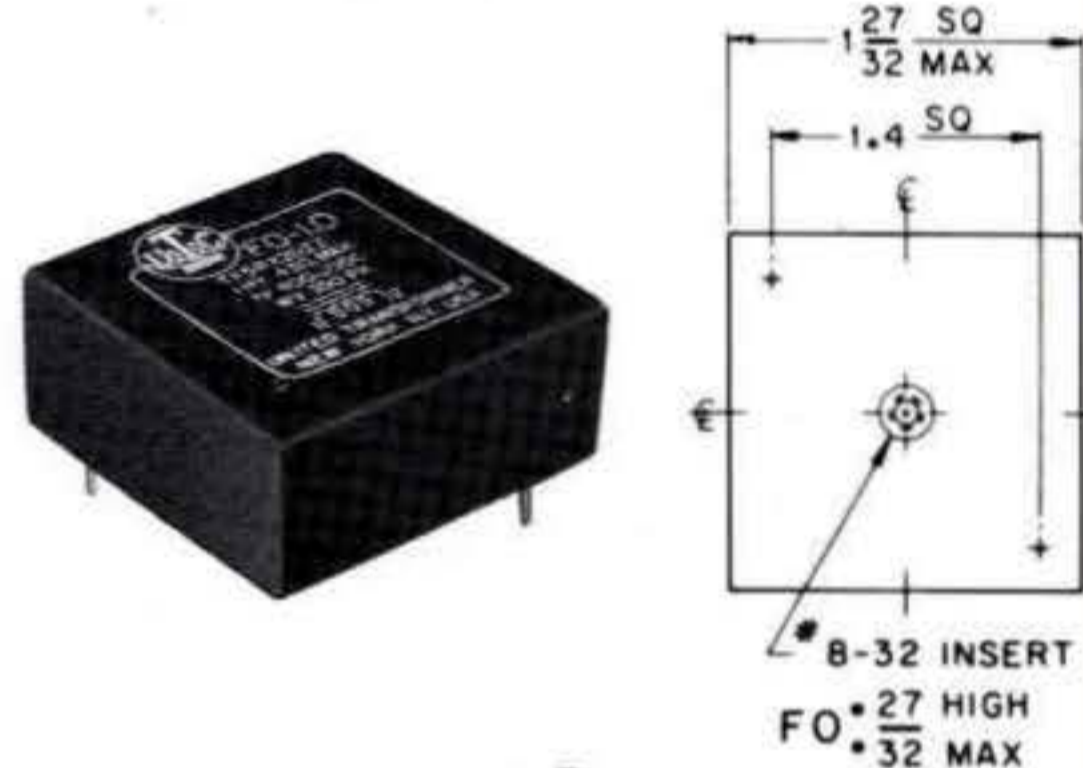

wt: 5 oz

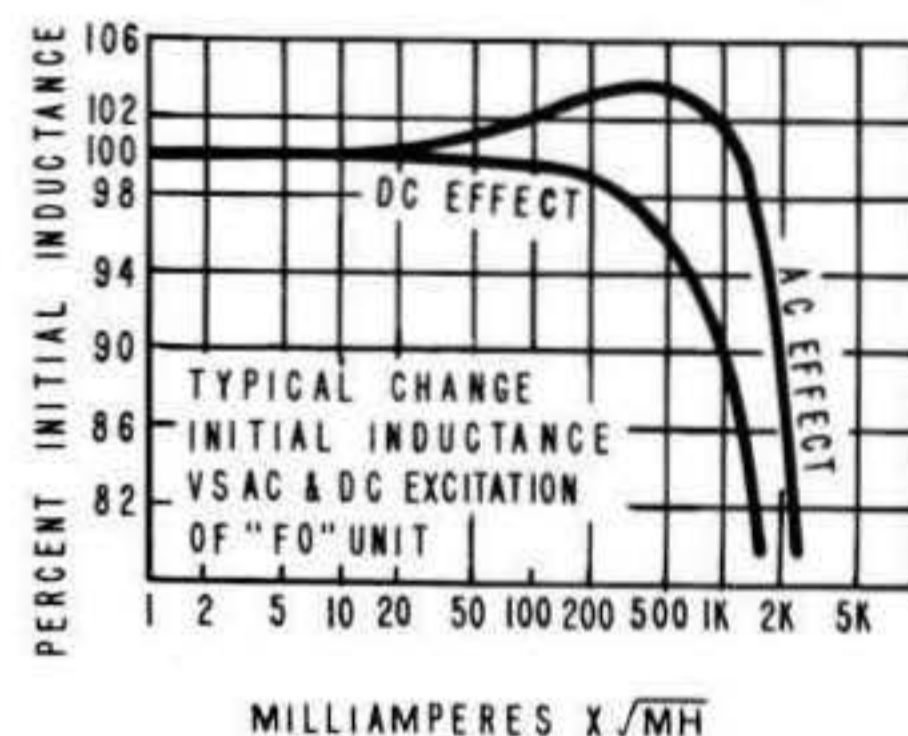
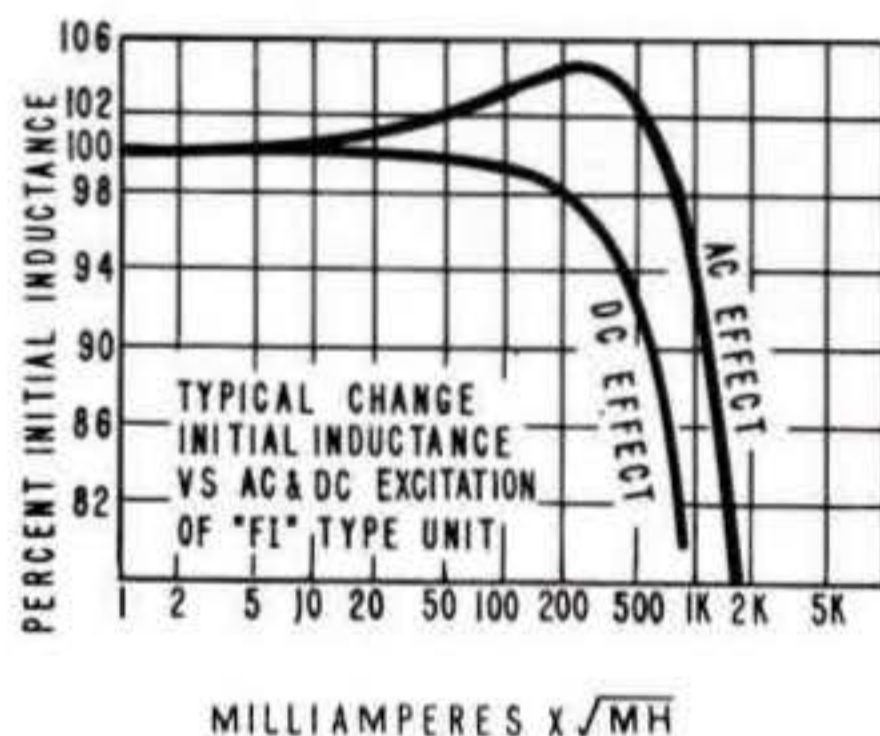
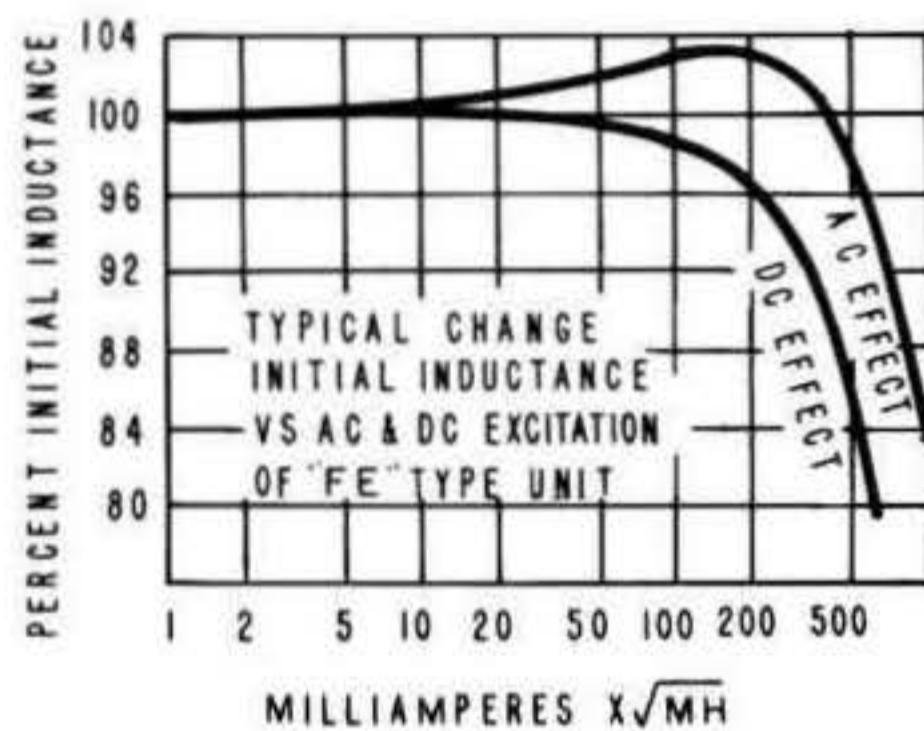
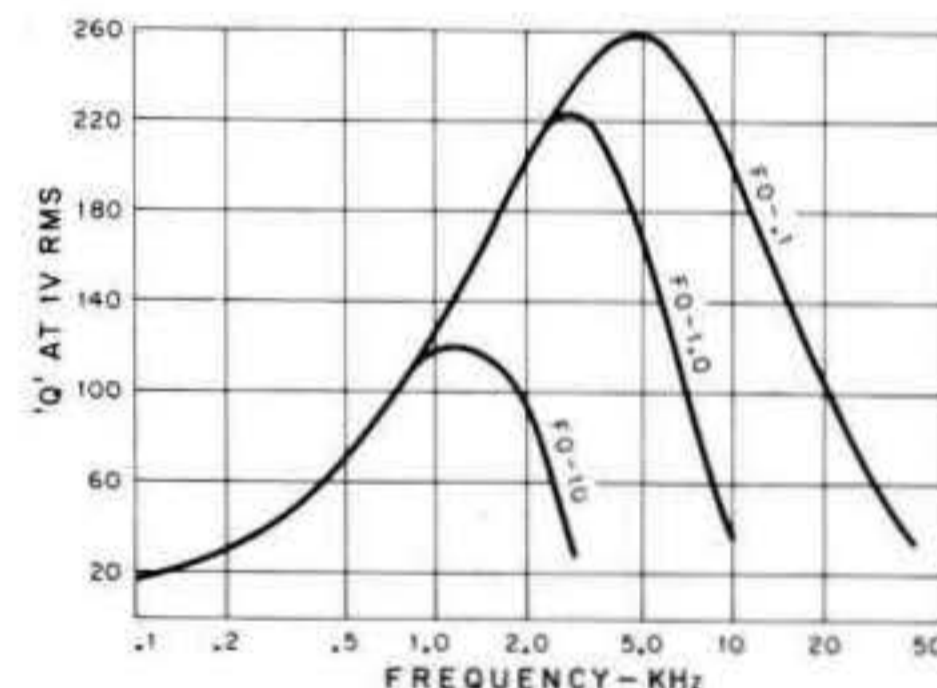
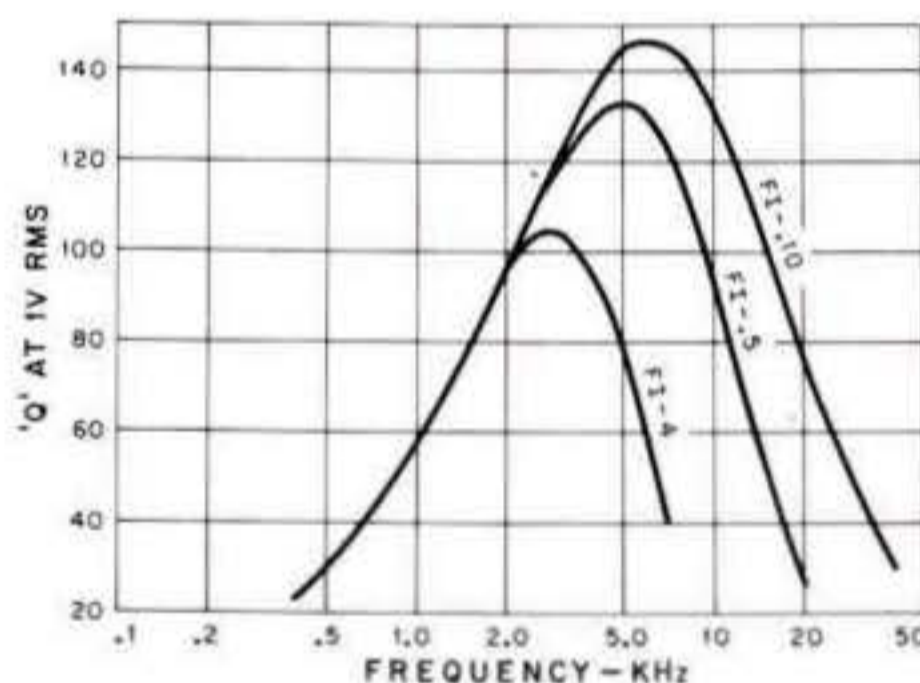
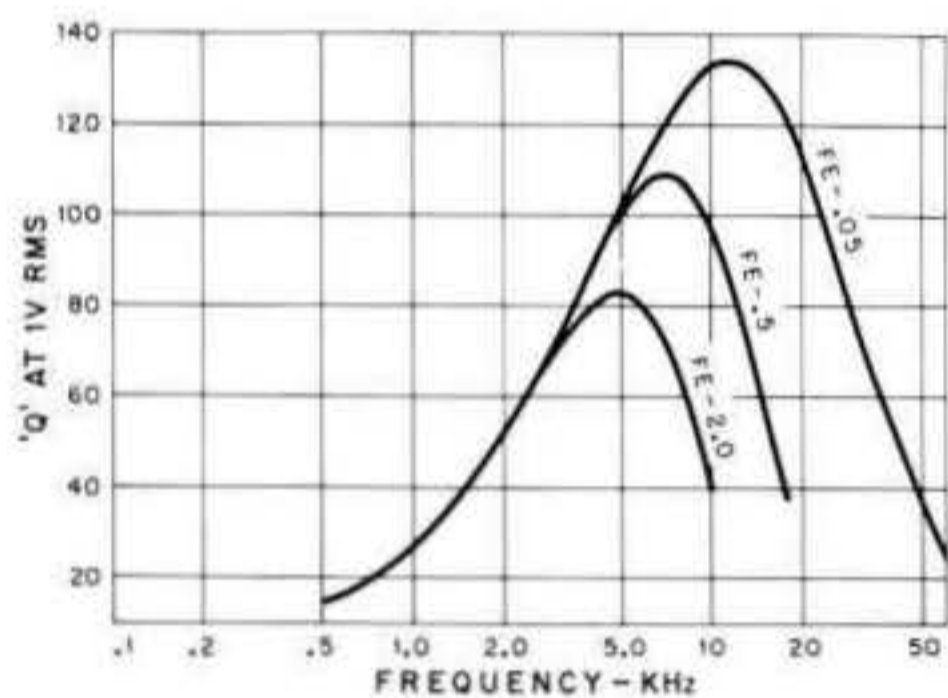

Type No.	Ind Hy (O DC)	ma DC Max	DCR Ω Max
FE-01	.0100	70	2.5
FE-02	.0200	50	5.1
FE-05	.0500	30	12
FE-.1	.100	22	22
FE-.5	.500	10	122
FE-1	1.00	7	250
FE-2	2.00	5	500

Type No.	Ind Hy (O DC)	ma DC Max	DCR Ω Max
FI-.04	.0400	50	4.3
FI-.1	.100	30	11
FI-.25	.250	20	27
FI-.5	.500	14	60
FI-1	1.00	10	110
FI-4	4.00	5	430

Type No.	Ind Hy (O DC)	ma DC Max	DCR Ω Max
FO-.1	.100	60	4.2
FO-.5	.500	25	23
FO-1	1.00	18	43
FO-2	2.00	12	92
FO-5	5.00	8	240
FO-10	10.0	6	440



LOW FREQUENCY HIGH Q COILS

PACKAGING Hermetically sealed. Laminated coils housed in hipermalloy shield case.

APPLICATION High Q at low frequencies.

CONNECTIONS Two identical windings brought out to four terminals permit series, parallel, center tapped, or transformer type connections.

TOLERANCE ±2% @ 60 Hz, IV series, 0.5V parallel.

MIL SPECS To complete MIL-T-27C Specs. MQM, Mil Type TF4SX20YY. MQL, Mil Type TF4RX20YY. See pages 86, 87.

TEMPERATURE STABILITY MQM, -55° to +130° C, ±2%. MQL, -55° to +105° C, less than 3%.

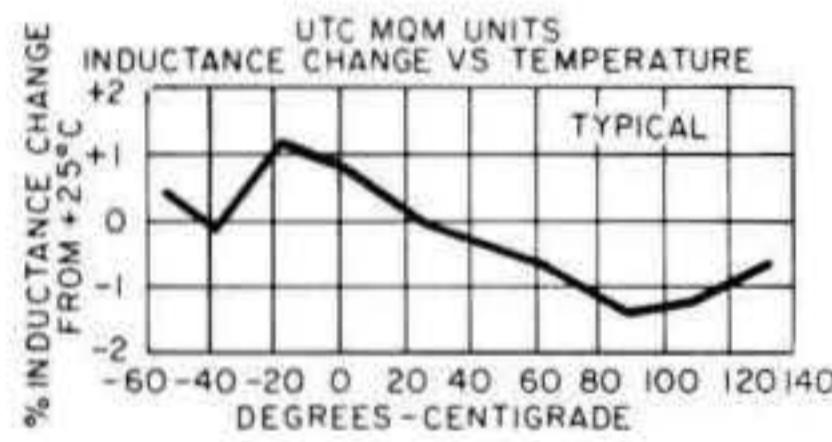
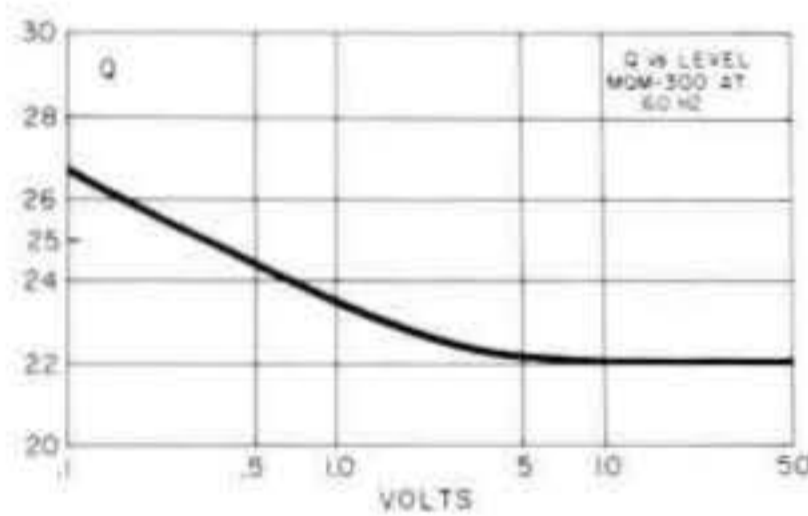
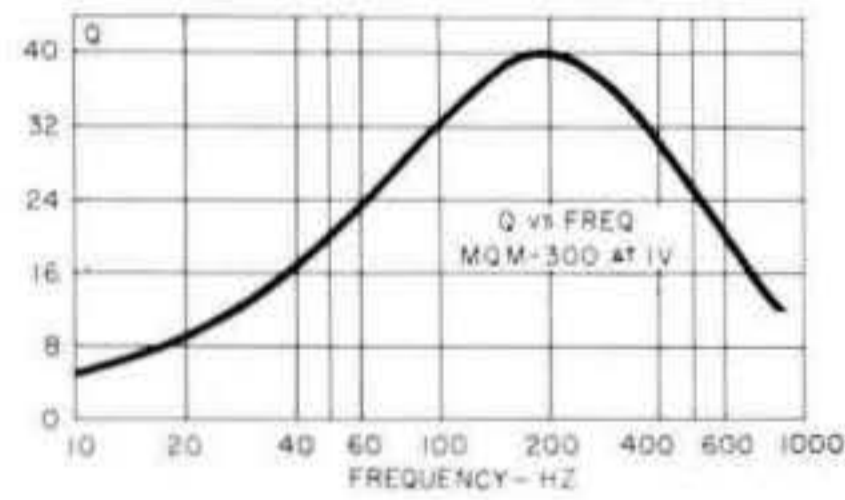

MINIATURIZED

MQM SERIES

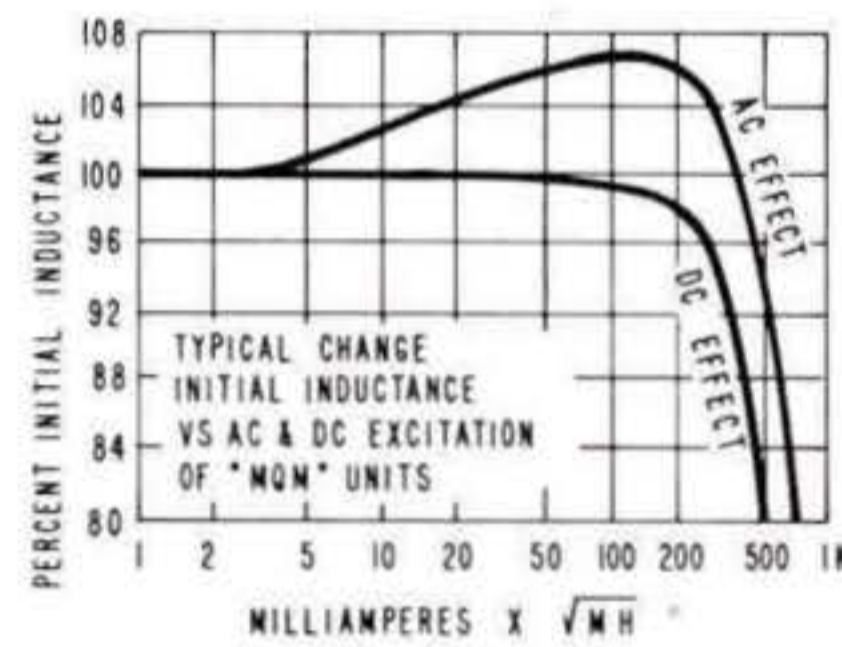

Type No.	Series Henries (0 DC)	Parallel Henries (0 DC)	Series DCR Ω ±20%
MQM-2	2	.5	21
MQM-16	16	4	143
MQM-40	40	10	368
MQM-300	300	75	3700
MQM-600	600	150	5720

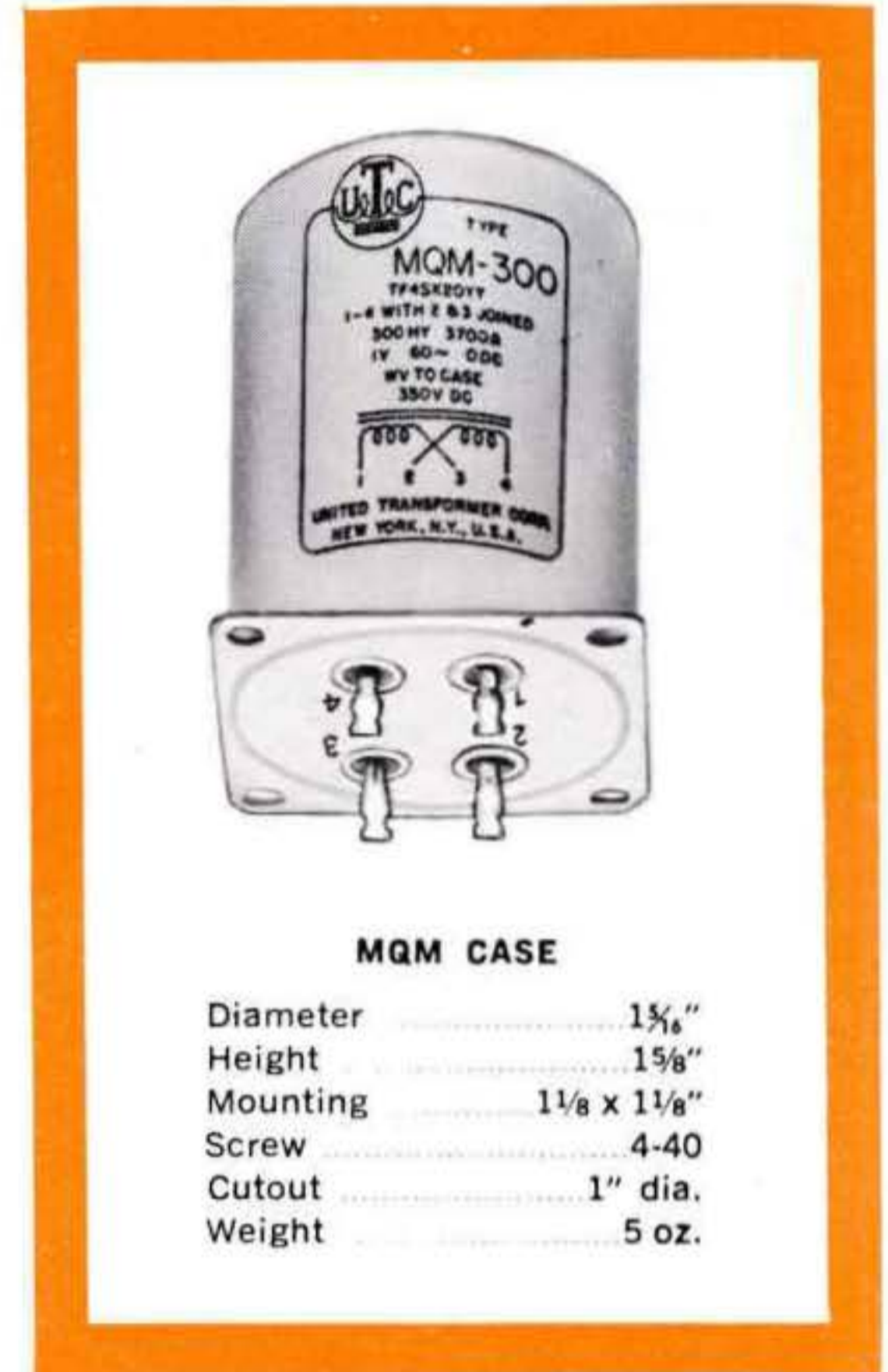

MQM CASE

- Diameter 1 $\frac{3}{8}$ "
- Height 1 $\frac{5}{8}$ "
- Mounting 1 $\frac{1}{8}$ x 1 $\frac{1}{8}$ "
- Screw 4-40
- Cutout 1" dia.
- Weight 5 oz.

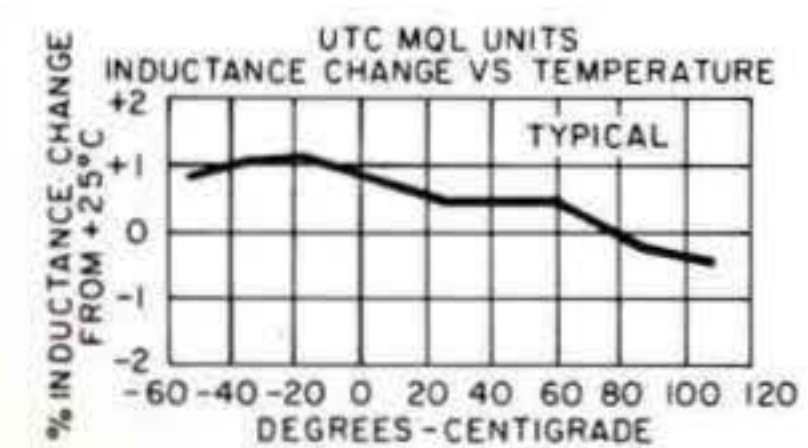
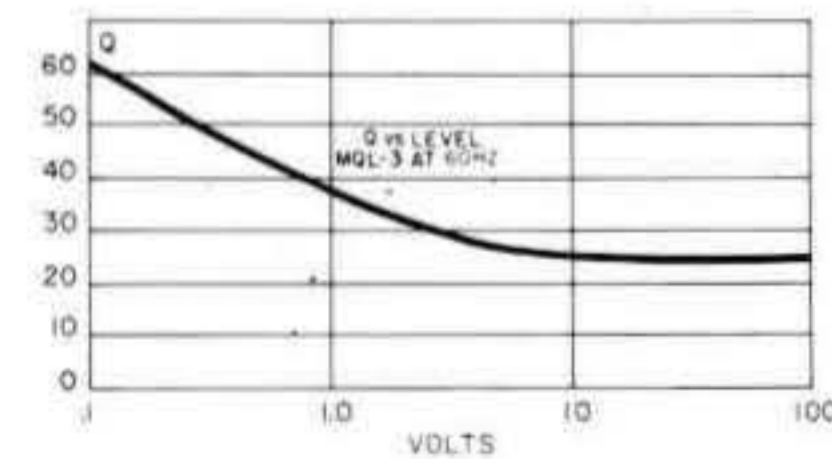
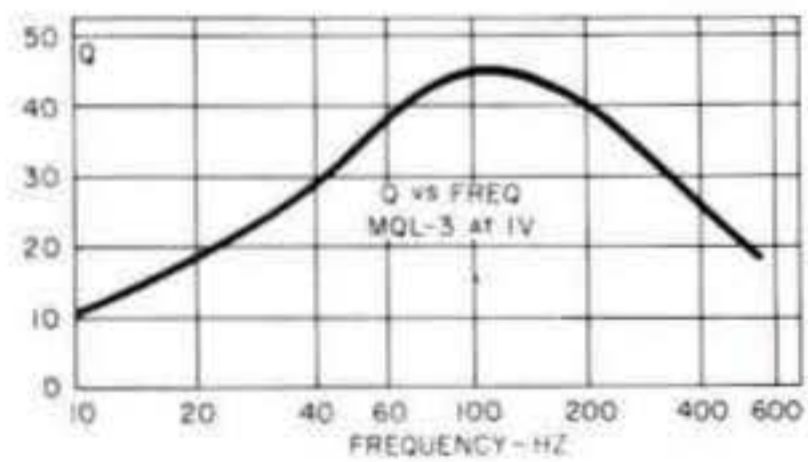

MQL SERIES

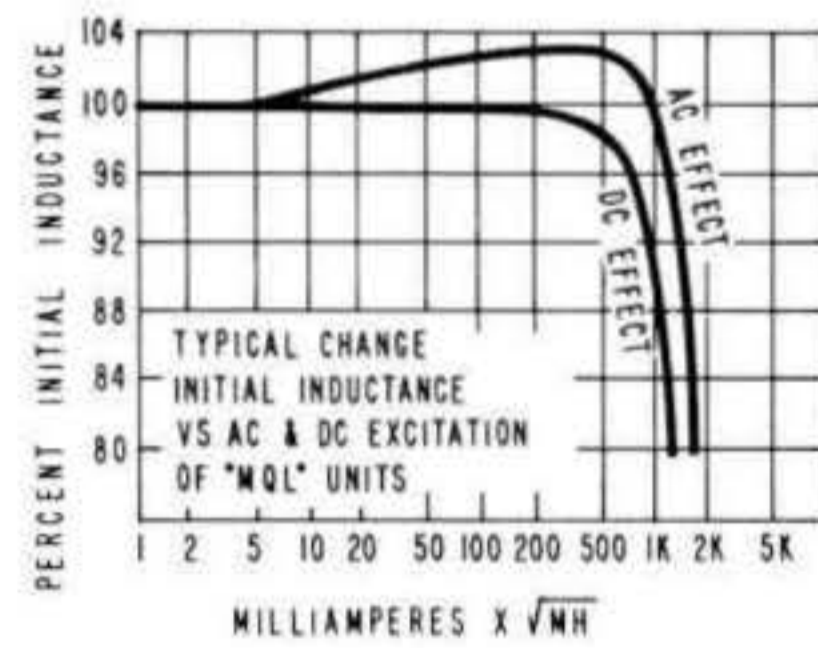

Type No.	Series Henries (0 DC)	Parallel Henries (0 DC)	Series DCR Ω ±20%
MQL-0	1	.25	5
MQL-1	10	2.5	50
MQL-2	20	5	82
MQL-3	200	50	820
MQL-4	400	100	2100
MQL-5	2500	625	13 K

(For 60 Hz and lower)

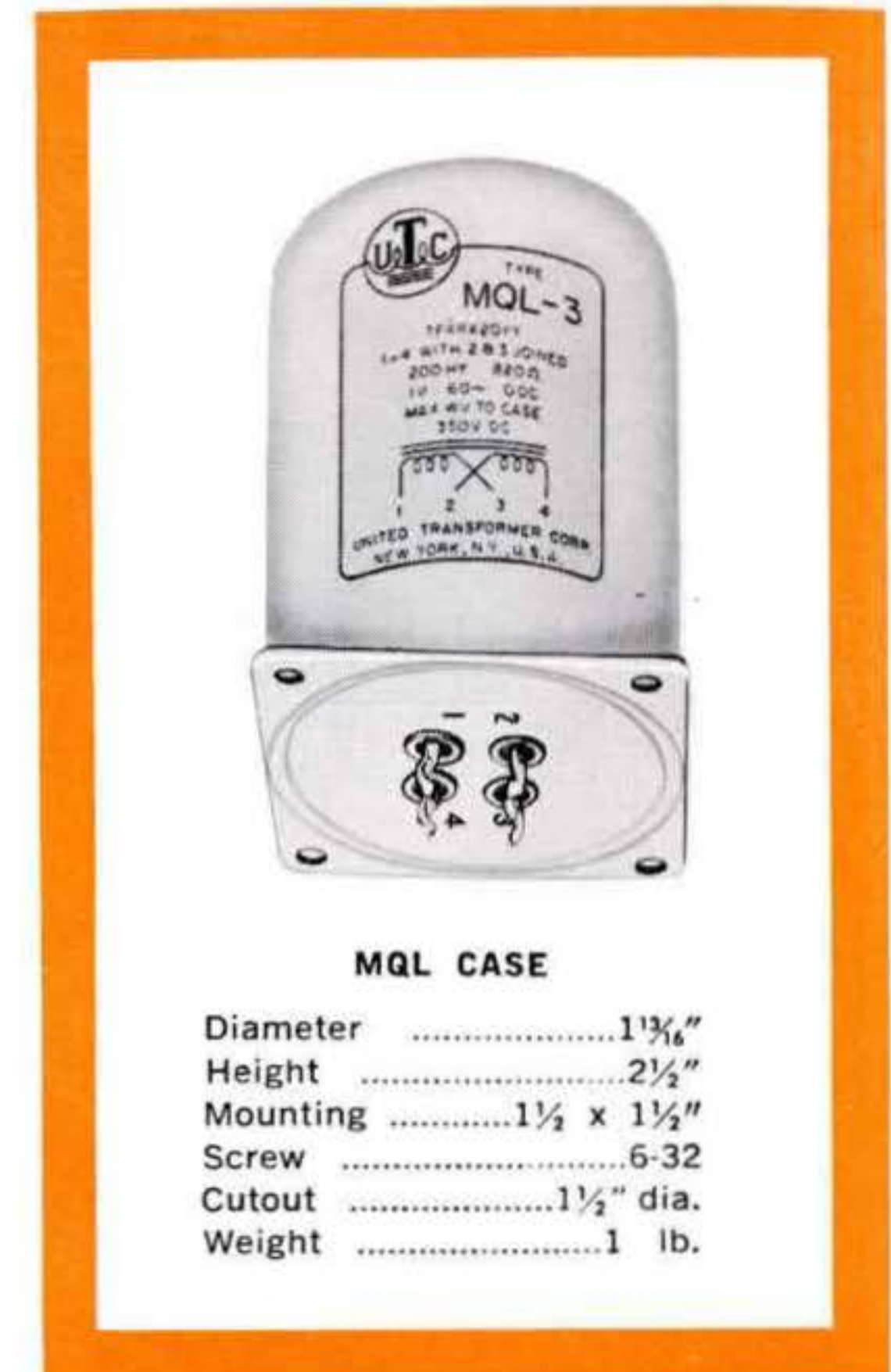

MQL CASE

- Diameter 1 $\frac{3}{8}$ "
- Height 2 $\frac{1}{2}$ "
- Mounting 1 $\frac{1}{2}$ x 1 $\frac{1}{2}$ "
- Screw 6-32
- Cutout 1 $\frac{1}{2}$ " dia.
- Weight 1 lb.



MINIATURE HIGH Q TOROIDAL INDUCTORS



MQD, MQA & TQA CASE
 Length 1 1/32"
 Width 1 1/16"
 Height 1 2 1/32"
 Mounting 7/8 x 9/32"
 Screws 4-40
 Cutout 5/16" x 1/2"
 (TQA, 5/16" x 3/4")
 Unit Weight 4 oz.



MQD TYPES

Type No.	Inductance (0 DC)	ma DC Max.	DCR Ω ±20%
MQD-0	1 mhy	820	.75
MQD-1	2 mhy	580	1.6
MQD-2	3 mhy	470	2.4
MQD-3	5 mhy	360	4.0
MQD-4	7 mhy	300	5.3
MQD-5	12 mhy	240	6.8
MQD-6	20 mhy	180	11
MQD-7	30 mhy	150	17

MQA Type No.	TQA Center Tapped Type No.	MQA & TQA Inductance (0 DC)	MQA & TQA ma DC Max.	MQA DCR Ω ±20%	TQA DCR Ω ±20%
MQA-1	TQA-1	7 mhy	250	.6	.8
MQA-2	TQA-2	12 mhy	200	1.1	1.3
MQA-3	TQA-3	20 mhy	150	1.6	2.1
MQA-4	TQA-4	30 mhy	125	2.5	3.1
MQA-5	TQA-5	50 mhy	100	3.9	4.9
MQA-6	TQA-6	70 mhy	80	5.7	7.2
MQA-7	TQA-7	120 mhy	60	9.1	12
MQA-8	TQA-8	.2 hy	50	16	20
MQA-9	TQA-9	.3 hy	40	25	32
MQA-10	TQA-10	.5 hy	30	39	49
MQA-11	TQA-11	.7 hy	25	58	73
MQA-12	TQA-12	1 hy	20	84	106
MQA-13	TQA-13	1.5 hy	17	130	165
MQA-14	TQA-14	2.5 hy	13	215	270
MQA-15	TQA-15	4 hy	10	335	425
MQA-16	TQA-16	6 hy	9	510	645
MQA-17	TQA-17	10 hy	7	840	1060
MQA-18	TQA-18	15 hy	5	1350	1700
MQA-19	TQA-19	22 hy	4	1960	2470
MQA-20	TQA-20	35 hy	3	3200	4030

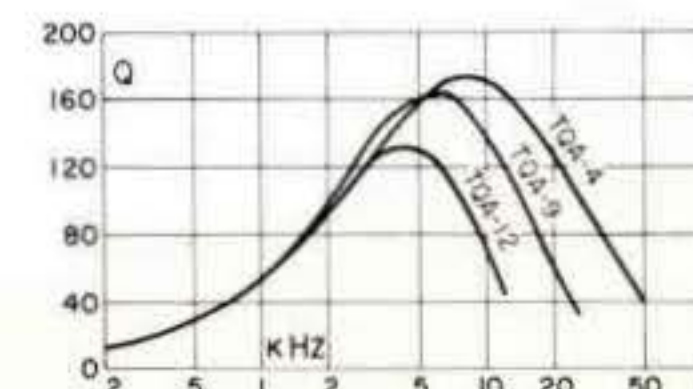
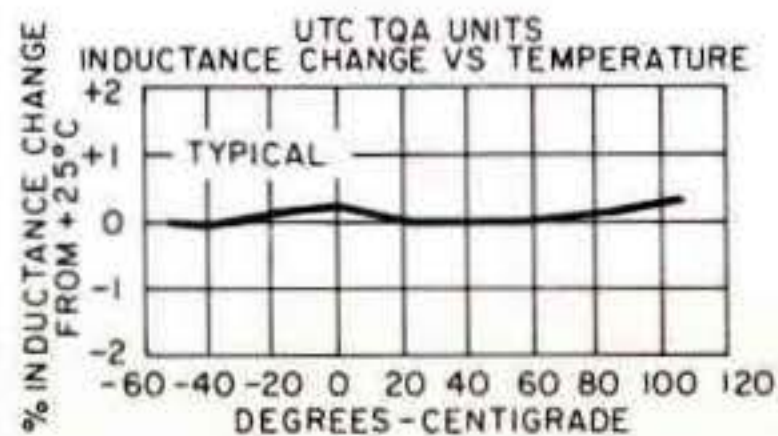
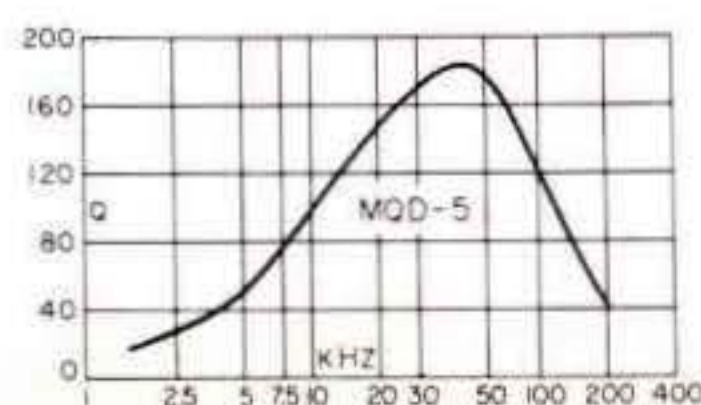
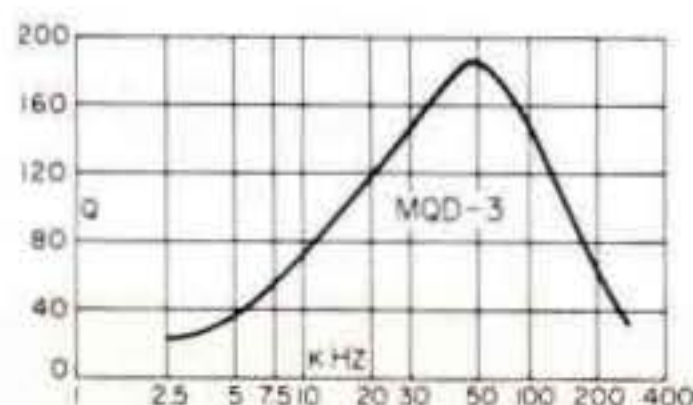
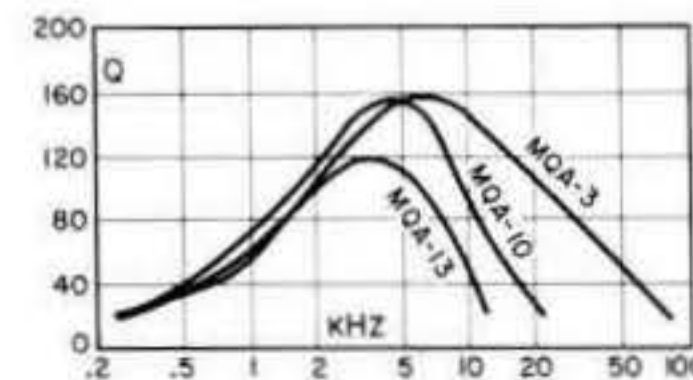
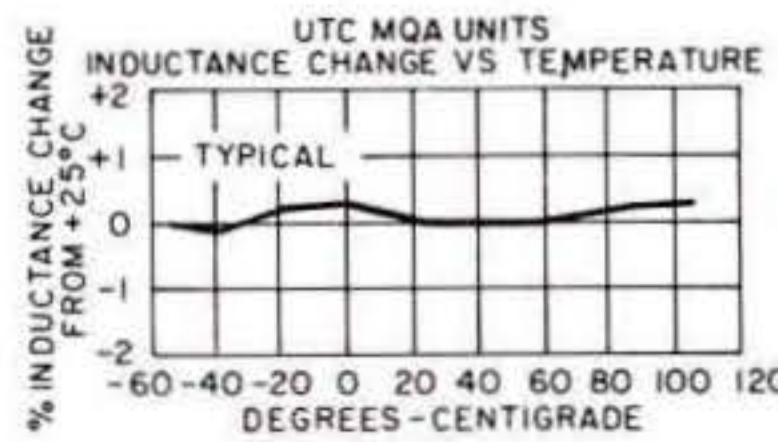
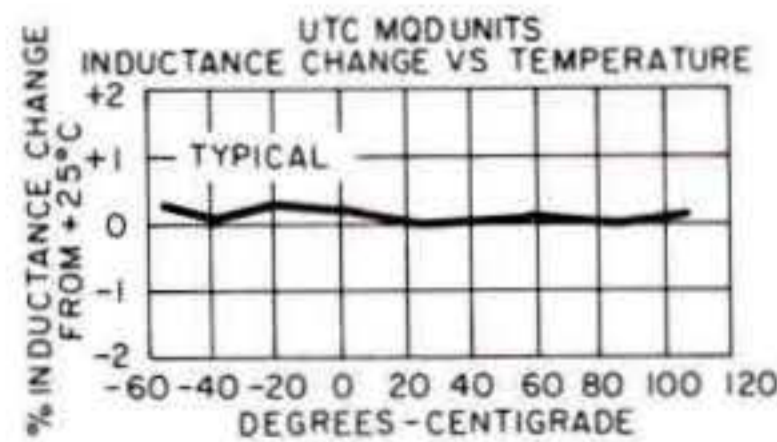
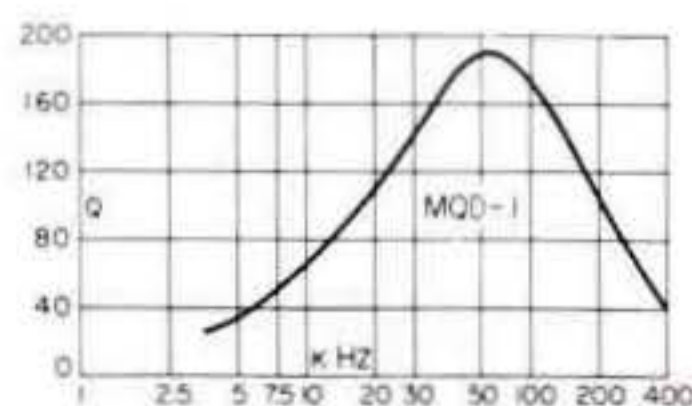
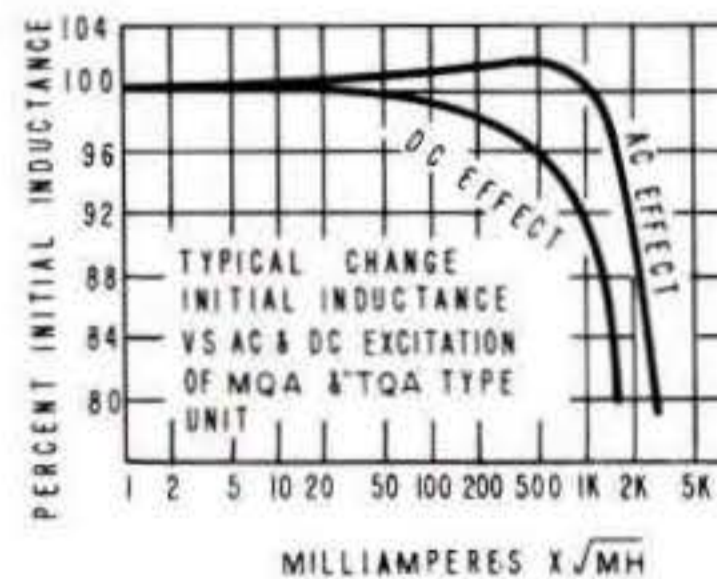
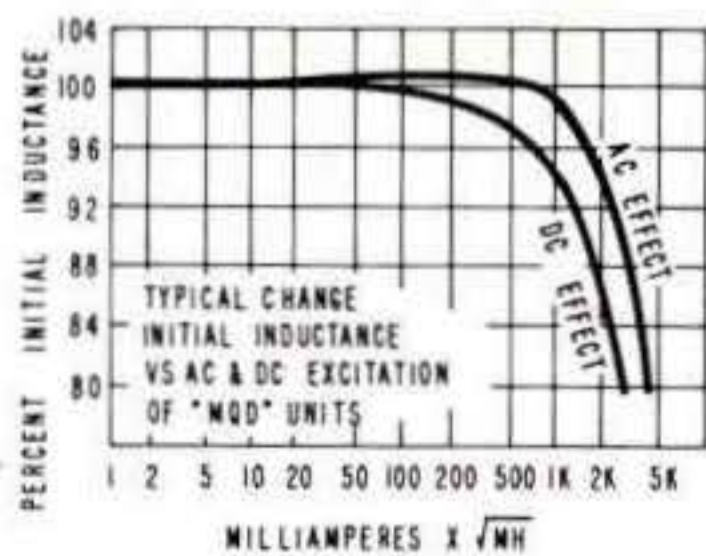

PACKAGING Hermetically sealed. Metal cased symmetrical toroids.

ADJUSTMENT MQA-1 thru 14, TQA-1 thru 14, MQD, MQE, $\pm 1\%$ @ 1 V, 1 kHz. MQA-15 thru 20, TQA-15 thru 20, MQB-1 thru 12, $\pm 1\%$ @ 1 V, 500 Hz. MQB-13 & 14, $\pm 1\%$ @ 1 V, 400 Hz.

MIL SPECS To complete MIL-T-27C Specs. Mil Type TF4RX20YY. See pages 86, 87.

APPLICATIONS TQA similar to MQA but centertapped for oscillator applications, impedance matching, etc. Maximum Q approximately 5 kHz. MQD maximum Q approximately 50 kHz. MQB maximum Q approximately 3 kHz. MQE maximum Q approximately 7 kHz.

TEMPERATURE STABILITY All from -55° to $+105^\circ$ C. MQA & TQA, less than 1%. MQB, $\pm 1.5\%$. MQD, $\pm 5\%$. MQE, $\pm 1\%$.

MQB CASE

Length $2\frac{7}{16}"$
 Width $1\frac{1}{16}"$
 Height $2\frac{1}{16}"$
 Mounting $2\frac{1}{16} \times 1\frac{1}{16}"$
 Screws 6-32
 Cutout $\frac{7}{8} \times \frac{1}{2}"$
 Unit Weight 14 oz.



MQE CASE

Length $1\frac{1}{16}"$
 Width $\frac{1}{2}"$
 Height $1\frac{1}{32}"$
 Mounting $\frac{3}{4}"$
 Screws 4-40
 Cutout $\frac{5}{16} \times \frac{1}{2}"$
 Unit Weight 1.5 oz.



MQB TYPES

Type No.	Inductance (0 DC)	ma DC Max.	DCR Ω $\pm 20\%$
MQB-1	10 mhy	400	.3
MQB-2	30 mhy	250	.9
MQB-3	70 mhy	170	2.2
MQB-4	120 mhy	120	3.6
MQB-5	.5 hy	60	16
MQB-6	1 hy	40	28
MQB-7	2 hy	30	64
MQB-8	3.5 hy	22	101
MQB-9	7.5 hy	16	230
MQB-10	12 hy	11	373
MQB-11	18 hy	9	463
MQB-12	25 hy	8	680
MQB-13	40 hy	6	1075
MQB-14	60 hy	4	1670

MQE TYPES

Type No.	Inductance (0 DC)	DC MA Max.	DCR Ω $\pm 20\%$
MQE-0	4 mhy	160	.7
MQE-1	7 mhy	135	1.2
MQE-2	12 mhy	100	2.0
MQE-3	20 mhy	80	3.1
MQE-4	30 mhy	65	4.8
MQE-5	50 mhy	50	8.0
MQE-6	70 mhy	40	12
MQE-7	100 mhy	35	17
MQE-8	150 mhy	30	27
MQE-9	.25 hy	22	43
MQE-10	.4 hy	17	69
MQE-11	.6 hy	14	102
MQE-12	.9 hy	12	160
MQE-13	1.5 hy	9	266
MQE-14	2 hy	8	385
MQE-15	2.8 hy	7.2	555
MQE-16	4 hy	5	850

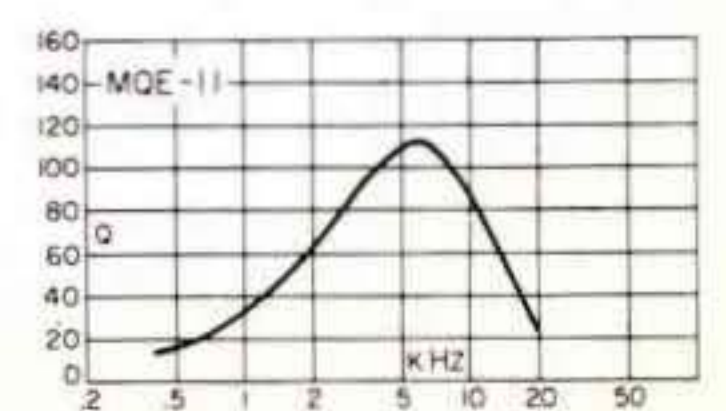
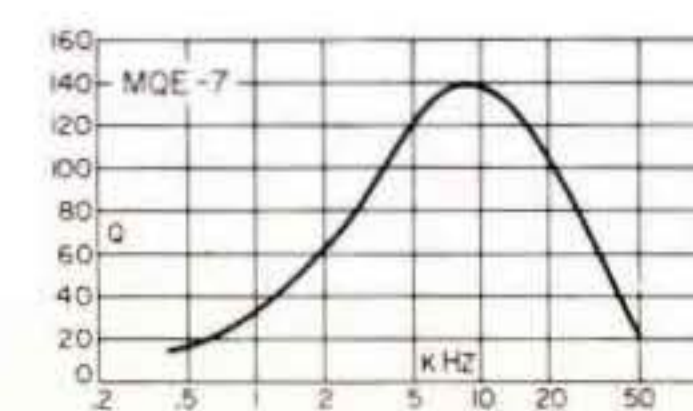
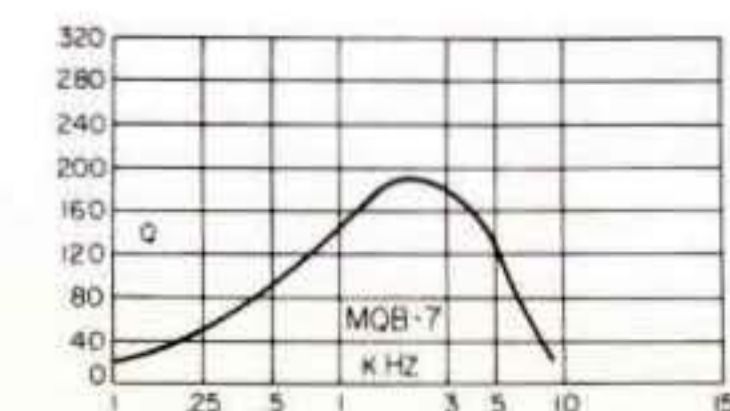
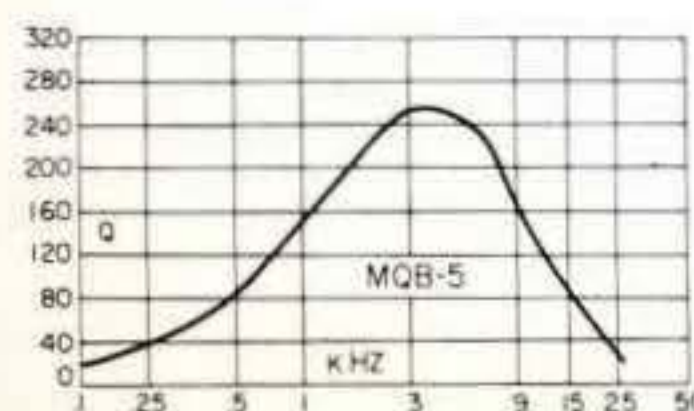
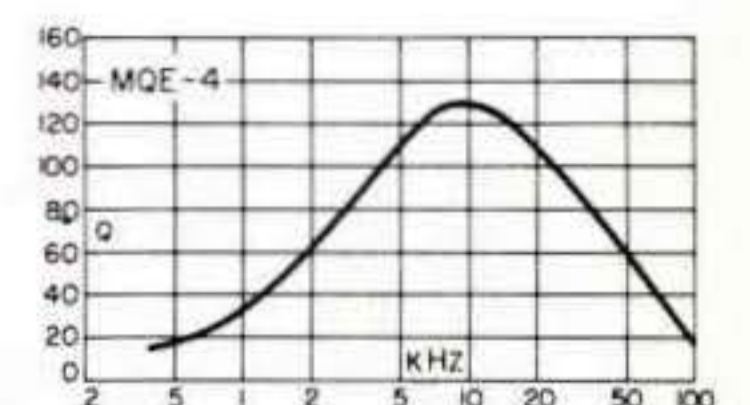
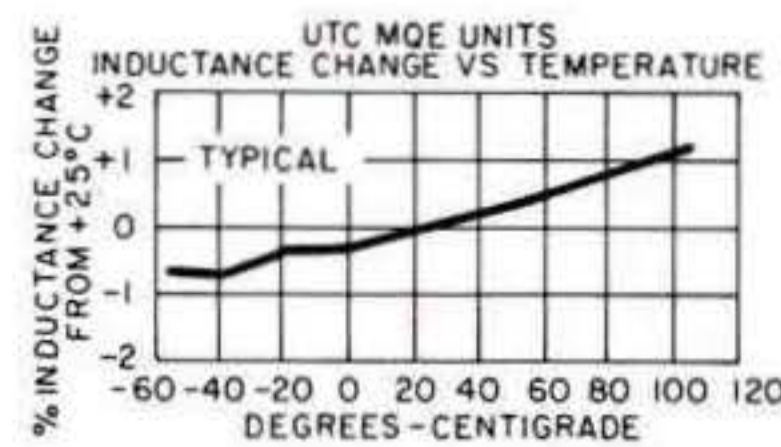
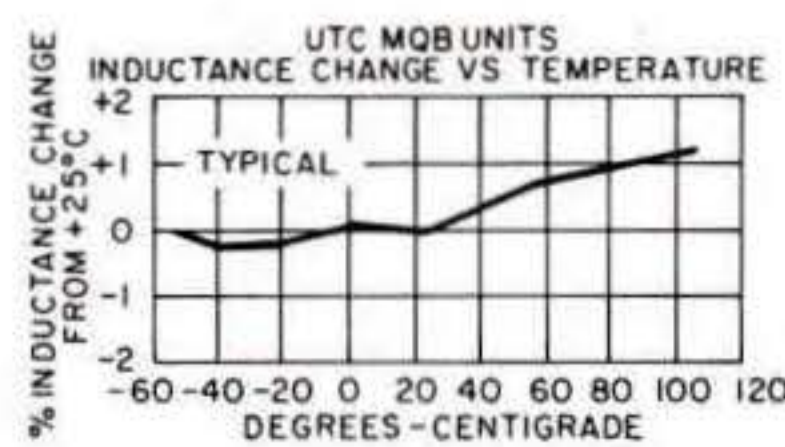
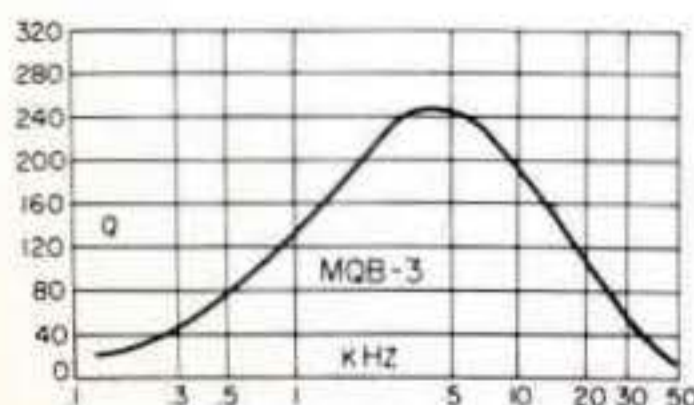
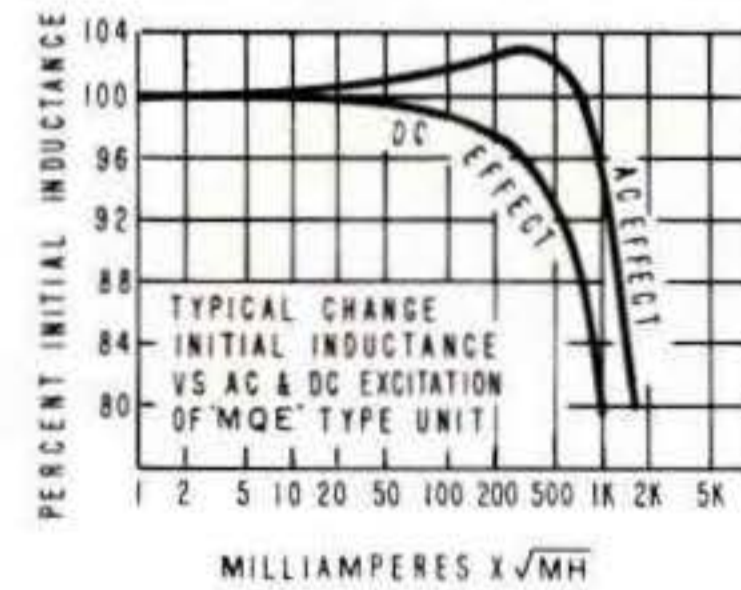
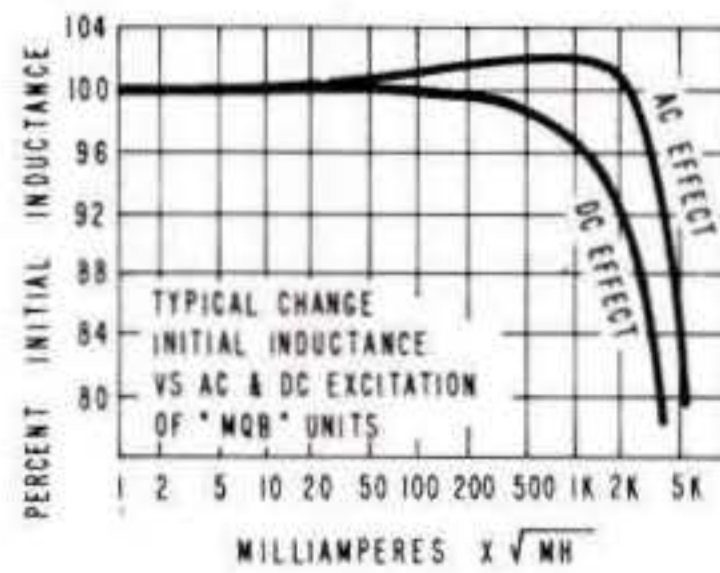



VARIABLE INDUCTORS

PACKAGING Hermetically sealed. Metal encased. Inductance variation controlled by adjustment screw on top of case. Range is covered in 900° rotation. Setting is positive. TVC is tapped version of HVC, with taps at 30% and 50% of total turns.

APPLICATION Oscillators, equalizers, filters, impedance matching, phase inversion, tuned circuits, etc.

RANGE HVC, TVC +200% -70% of nominal value. HVV vernier adjustment. Variation is ±10% of nominal value.

MIL SPECS To complete MIL-T-27C Specs. Mil type TF4RX20YY. See pages 86, 87.

TEMPERATURE STABILITY At mean inductance, from -55° C to +105° C. HVC & TVC: ±1.5%. HVV: ±1%.

HVC & TVC VARIDUCTOR™
-WIDE RANGE

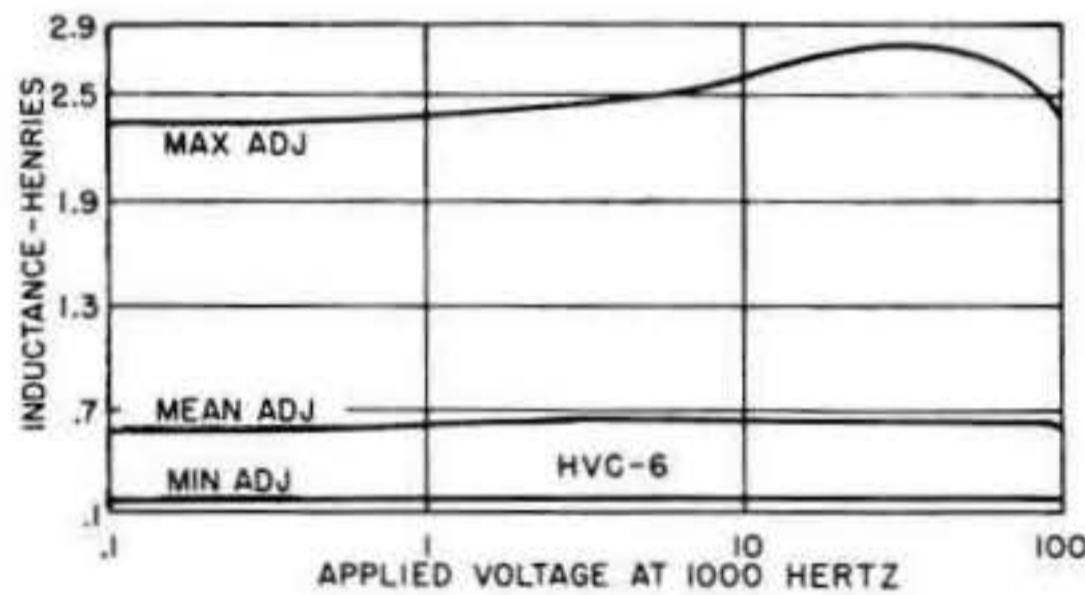
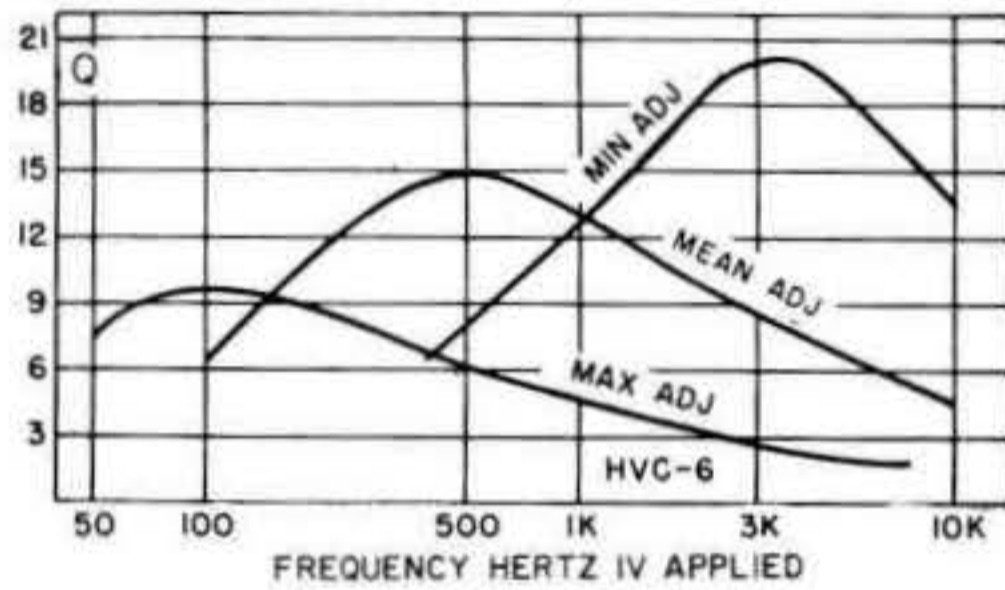
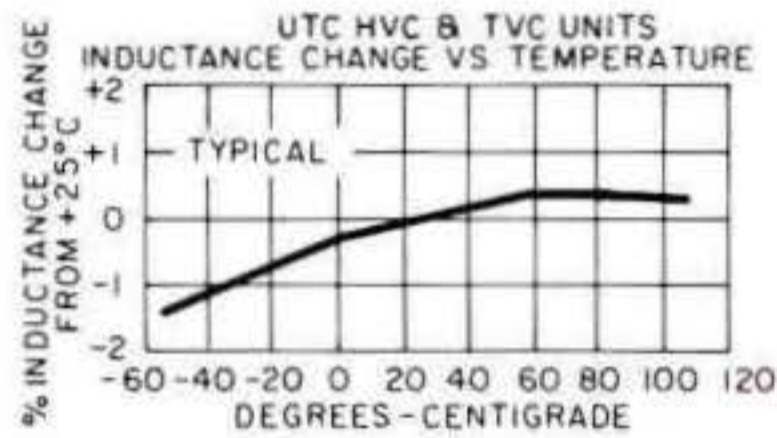

Type No.	Tapped Type No.	Min Hys	Mean Hys	Max Hys	ma DC	DCRΩ ±20%
HVC-1	TVC-1	.002	.006	.02	100	.5
HVC-2	TVC-2	.005	.015	.05	60	1.4
HVC-3	TVC-3	.011	.040	.11	40	3.6
HVC-4	TVC-4	.03	.1	.3	30	8.6
HVC-5	TVC-5	.07	.25	.7	20	22
HVC-6	TVC-6	.2	.6	2	15	55
HVC-7	TVC-7	.5	1.5	5	10	141
HVC-8	TVC-8	1.1	4	11	7	360
HVC-9	TVC-9	3	10	30	5	950
HVC-10	TVC-10	7	25	70	3.5	2220
HVC-11	TVC-11	20	60	200	2	5550
HVC-12	TVC-12	50	150	500	1.5	15.6K

Choosing Type No.: If frequency is above 100 Hz, use type providing required inductance between mean and min. values.

HVV VARIDUCTOR™
-NARROW RANGE

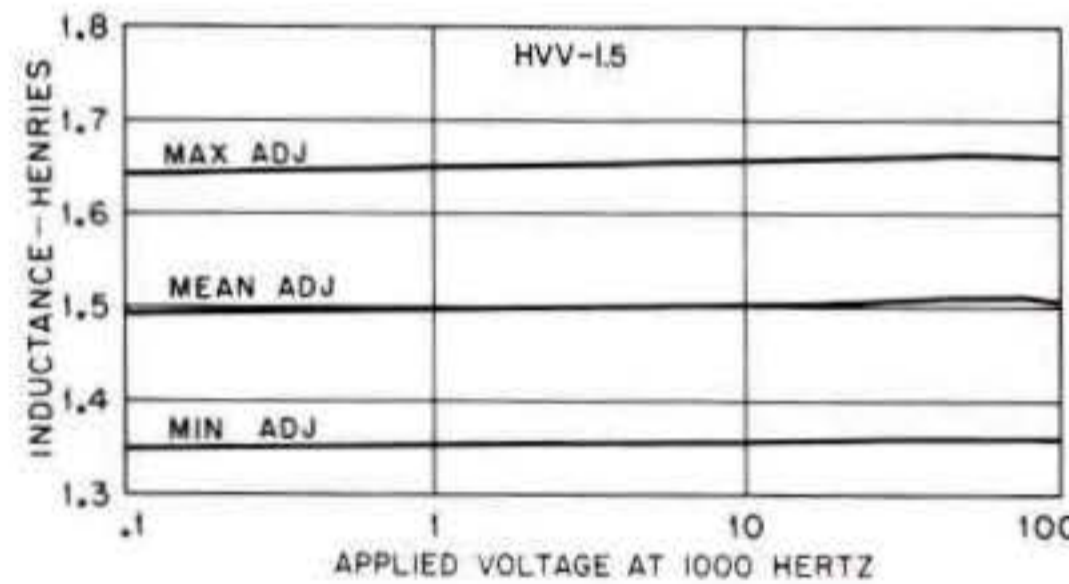
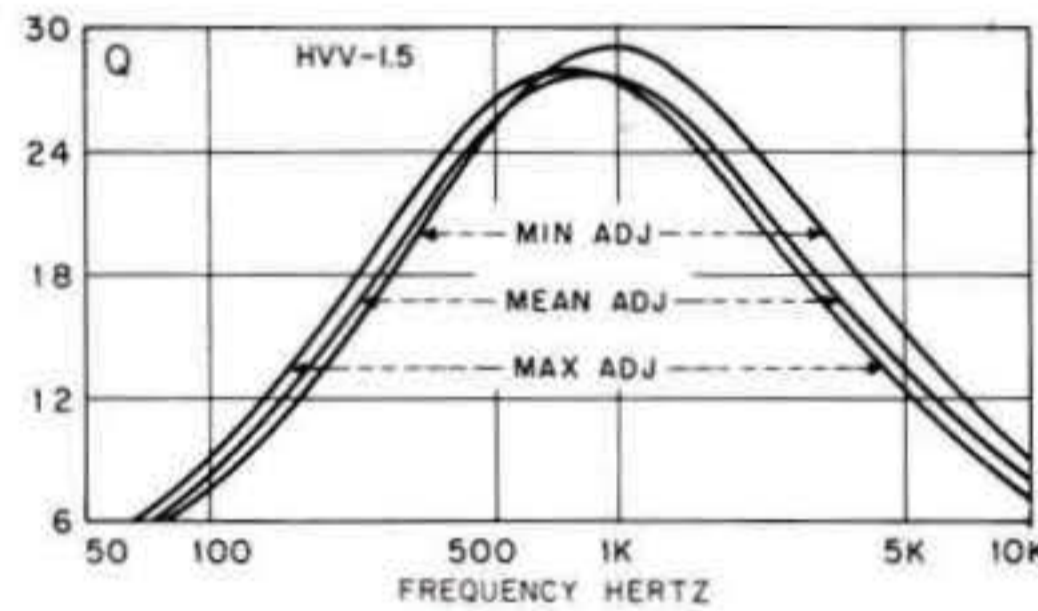
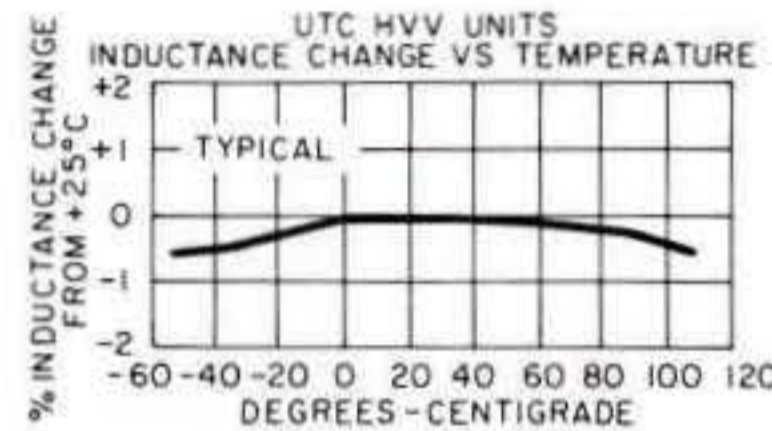

Type No.	Min Hys	Mean Hys	Max Hys	ma DC	DCRΩ ±20%
HVV-.006	.0054	.006	.0066	200	.44
HVV-.015	.0135	.015	.0165	120	1.05
HVV-.04	.036	.04	.044	80	2.75
HVV-.10	.09	.10	.11	50	6.80
HVV-.25	.225	.25	.275	30	17.2
HVV-.6	.54	.6	.66	20	43
HVV-1.5	1.35	1.5	1.65	13	105
HVV-4	3.6	4	4.4	6	275
HVV-10	9	10	11	4.5	725
HVV-25	22.5	25	27.5	3	1770
HVV-60	54	60	66	2	4300
HVV-150	135	150	165	1.3	11K

HVC & HVV

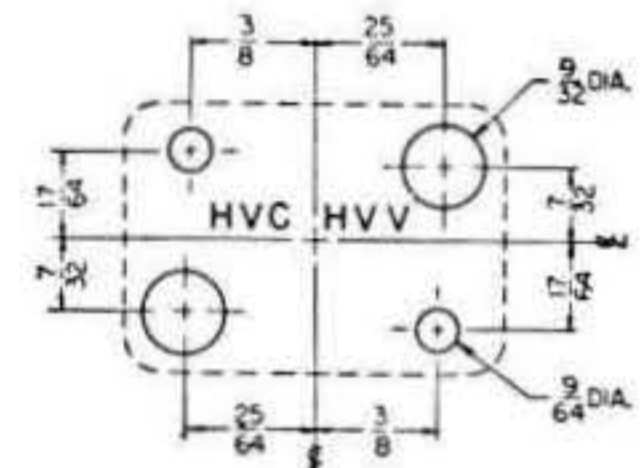

TVC

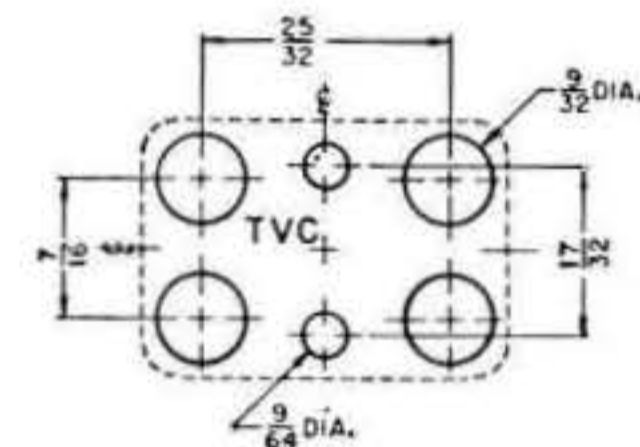

HVC, TVC, & HVV CASE

- Length 1 1/8"
- Width 25/32"
- Height* 1 1/2"
- Screws 4-40
- Weight 2 oz.

* Height includes adjustment screw

U. S. PAT. NO. 2,879,489 3,267,400

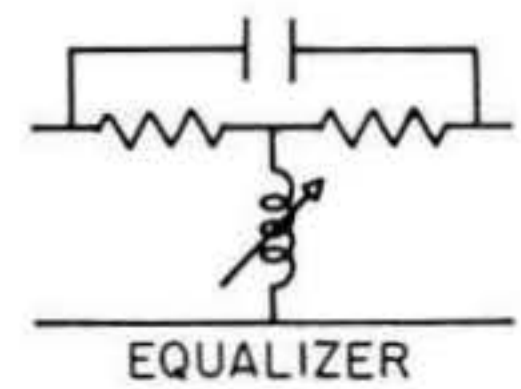
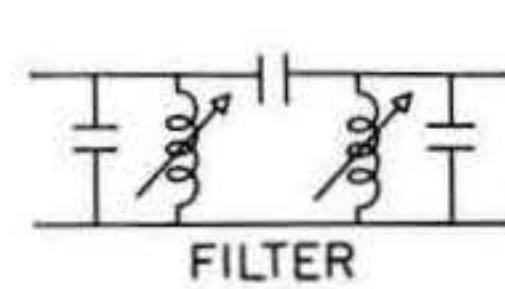
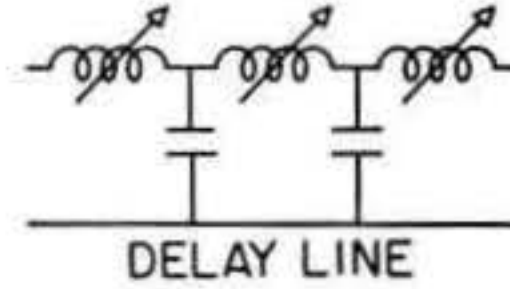
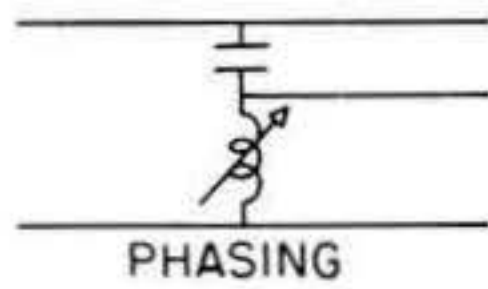
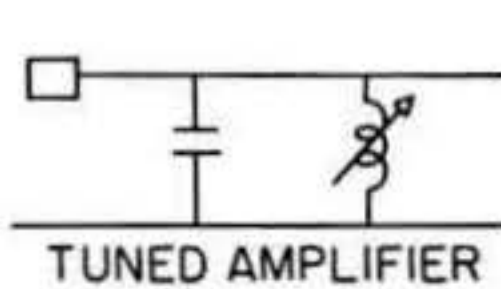
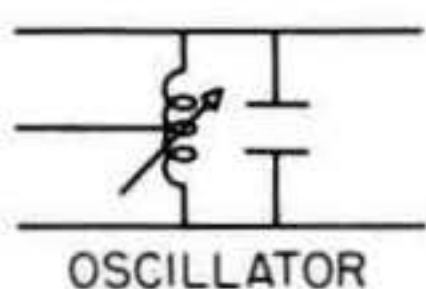



VARIABLE INDUCTORS - VIC VARIDUCTOR™ - WIDE RANGE

PACKAGING Rugged die cast case. Inductance variation controlled by set screw in side of case. Range is covered in 600° rotation. Setting is positive.

RANGE +85% to -45% of mean value.

TEMPERATURE STABILITY At mean inductance, from -55°C. to +105°C. ±3%.

VIC CASE

Length	1 1/2"
Width	1 1/4"
Height	1 7/16"
Mounting	1 3/16" x 2 1/2"
Screws	4-40
Cutout	1 x 1/2"
Weight	5 1/2 oz.

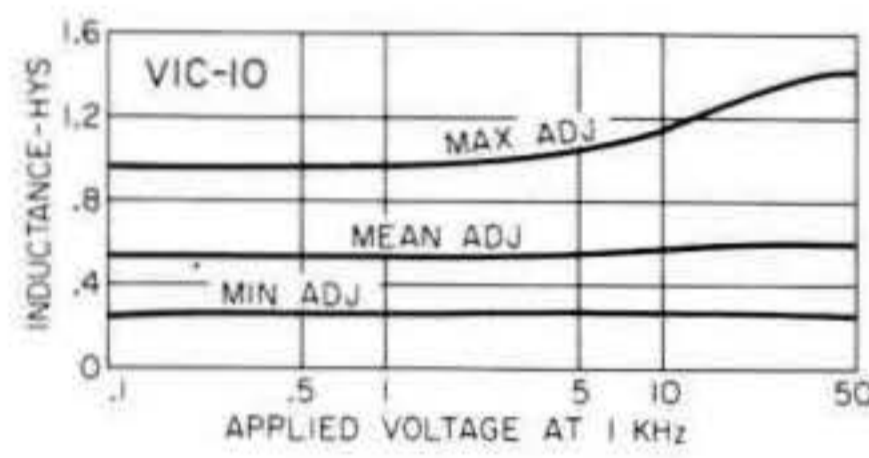
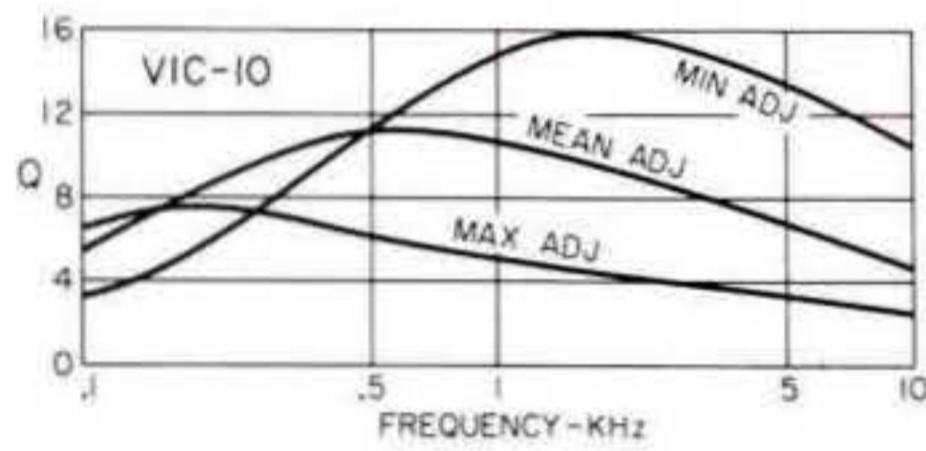

Type No.	Mean Hys.	DC Ma	DCRΩ ±20%	Type No.	Mean Hys.	DC Ma	DCRΩ ±20%
VIC-1	.0085	75	.9	VIC-12	1.3	10	145
VIC-2	.013	60	1.4	VIC-13	2.2	8	233
VIC-3	.021	50	2.3	VIC-14	3.4	7	370
VIC-4	.034	40	3.5	VIC-15	5.4	6	580
VIC-5	.053	35	5.9	VIC-16	8.5	5	950
VIC-6	.084	30	9.2	VIC-17	13	4	1530
VIC-7	.13	25	15	VIC-18	21	3.5	2350
VIC-8	.21	21	24	VIC-19	33	3	3570
VIC-9	.34	18	36	VIC-20	52	2	5820
VIC-10	.54	15	57	VIC-21	83	1.5	9350
VIC-11	.85	12	90	VIC-22	130	1	15.4 K



HIGH Q PRECISION INDUCTANCE DECADES

PACKAGING Compact, rugged, die-cast case with control on sloping panel. Low capacity, low contact resistance switch.

APPLICATION Design and experimental work with tuned circuits, wave filters, and equalizers.

CHARACTERISTICS Special winding techniques plus molybdenum permalloy cores provide high Q, excellent voltage, temperature stability, and high self-resonance frequency.

NOTE Inductance values are laboratory adjusted to better than 1% precision, with hand-written calibration recorded on base.

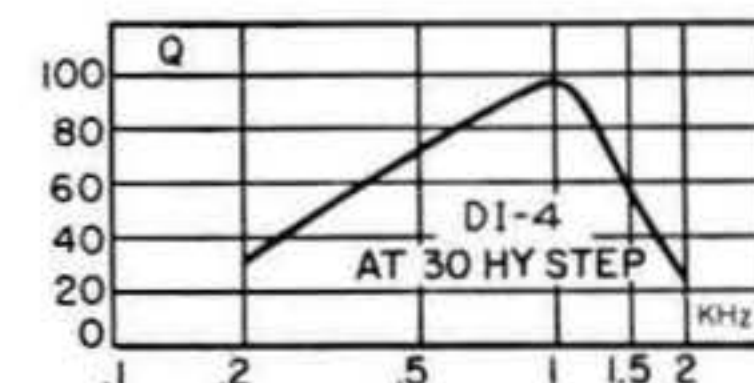
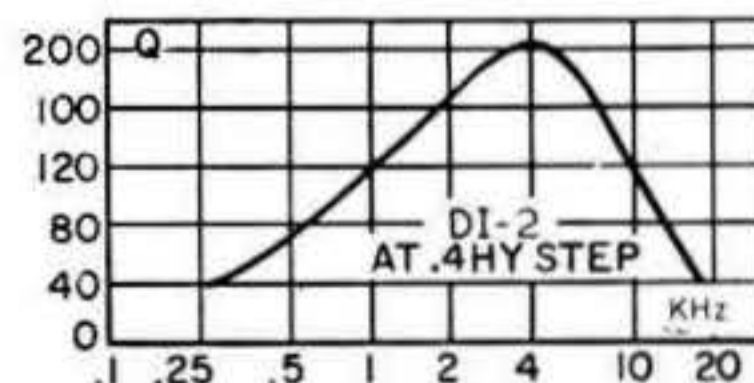
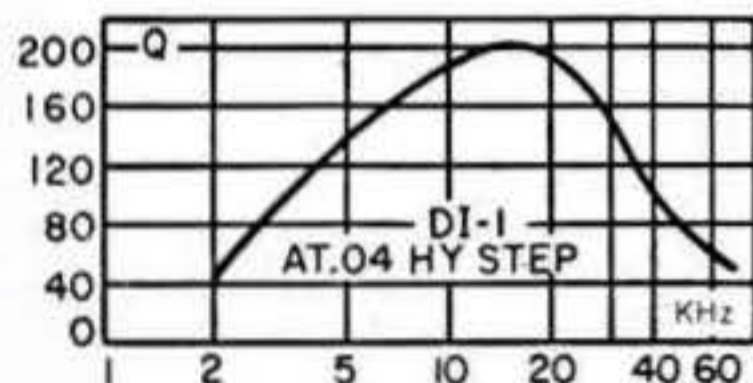

DI CASE

Length	4 1/2"
Width	4 3/8"
Height	2 3/8"
Weight	2 lbs.

Type No.	Induct. Henries	Optimum Range kHz	Max. Q	ACma Max.	Volts RMS Ins. Test
DI-1	10 x .01	2-60	200	500	500
DI-2	10 x .1	.25-20	200	150	500
DI-3	10 x 1	.25-10	200	50	500
DI-4	10 x 10	.2-1.5	100	15	500



HIGH Q TOROID INDUCTORS

PACKAGING Hermetically sealed. Metal cased, symmetrical toroids.

MIL SPECS To complete MIL-T-27C Specs. Grade 4, Class R, Life X. See pages 86, 87.

TOLERANCE HQA-1 thru 13, HQE: $\pm 1\%$ @ 1V, 1 kHz. HQA-14 thru 18, HQB: $\pm 1\%$ @ 1V, 500Hz. HQC: $\pm 1\%$ @ 0.1 V, 1 kHz.

TEMPERATURE STABILITY From -55°C to $+105^{\circ}\text{C}$. HQC: $\pm 1\%$. HQA, HQB, HQE: $\pm 1.5\%$.

HQA and HQC CASE		HQB CASE		HQE CASE	
Diameter $1\frac{1}{8}"$	Length $2\frac{5}{8}"$	Length $1\frac{1}{8}"$
Height $1\frac{3}{8}"$	Width $1\frac{5}{8}"$	Width $\frac{1}{2}"$
Mounting $1\frac{1}{8}"$	Height $2\frac{5}{8}"$	Height $1\frac{1}{32}"$
Screws6-32	Mounting $1\frac{1}{4} \times 2\frac{1}{4}"$	Mounting $\frac{3}{4}"$
Cutout $\frac{3}{8} \times 1\frac{3}{8}"$	Screws6-32	Screws4-40
Weight5 oz.	Cutout $\frac{3}{8} \times 1\frac{1}{8}"$	Cutout $\frac{3}{8} \times \frac{1}{2}"$
		Weight14 oz.	Weight1.5 oz.

TYPICAL Q CURVES

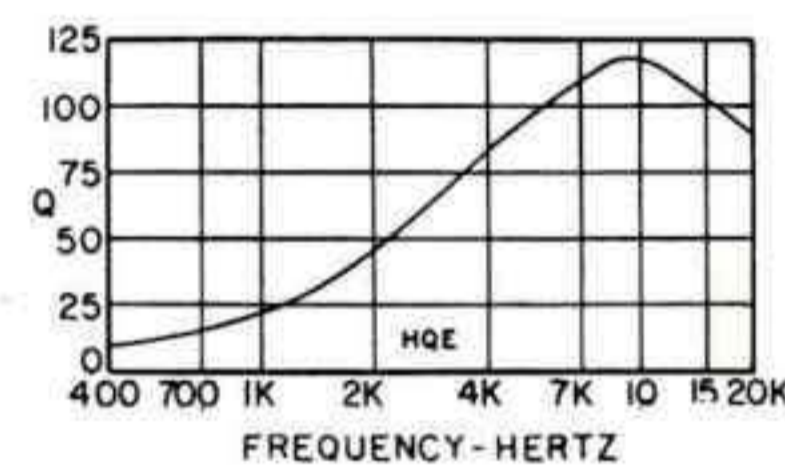
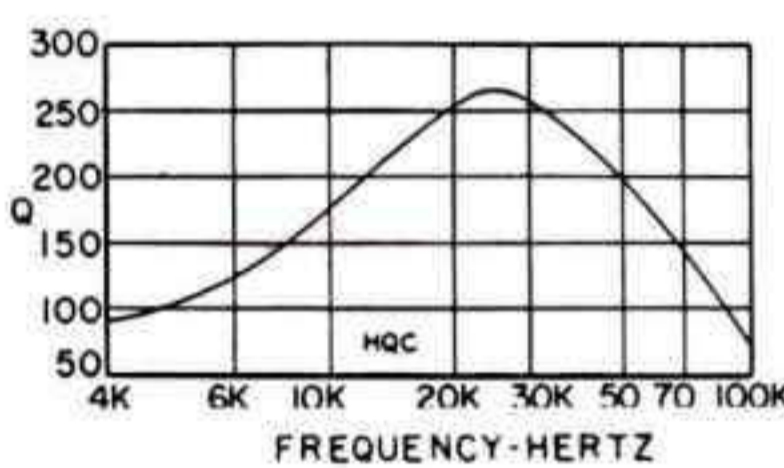
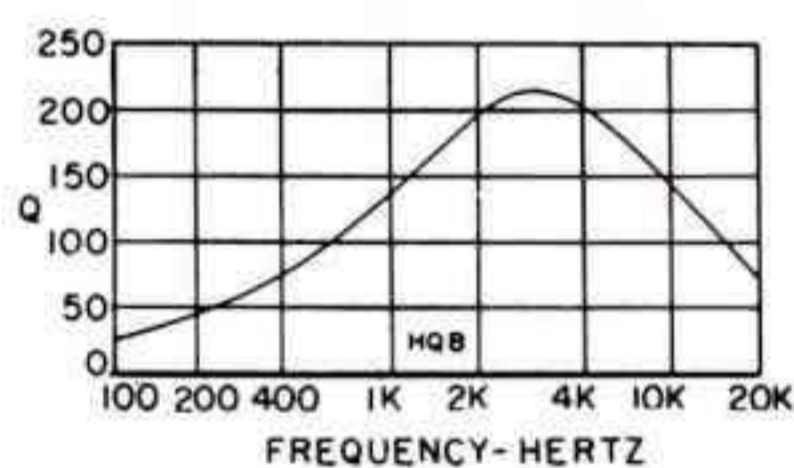
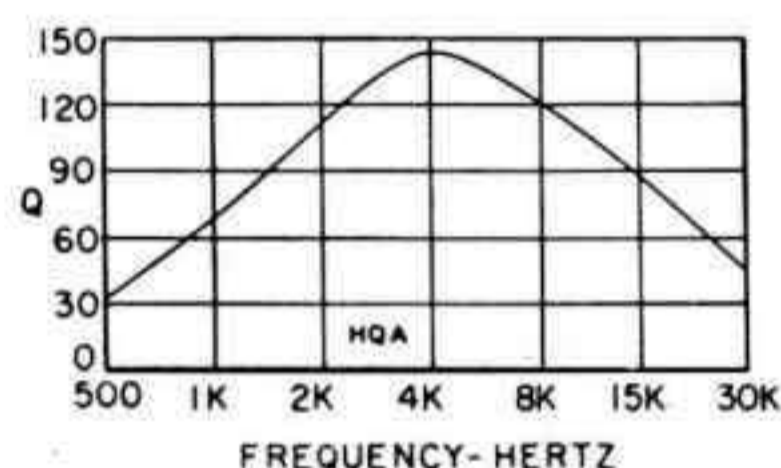

INDUCTANCE VS AC & DC EFFECTS

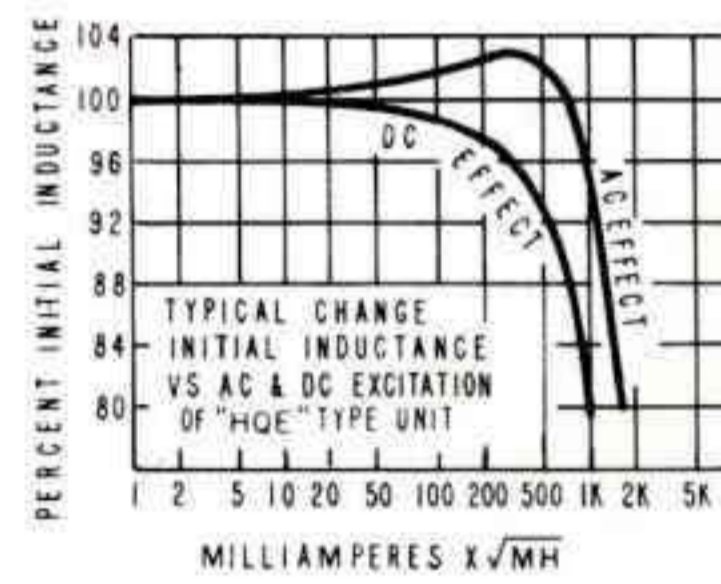
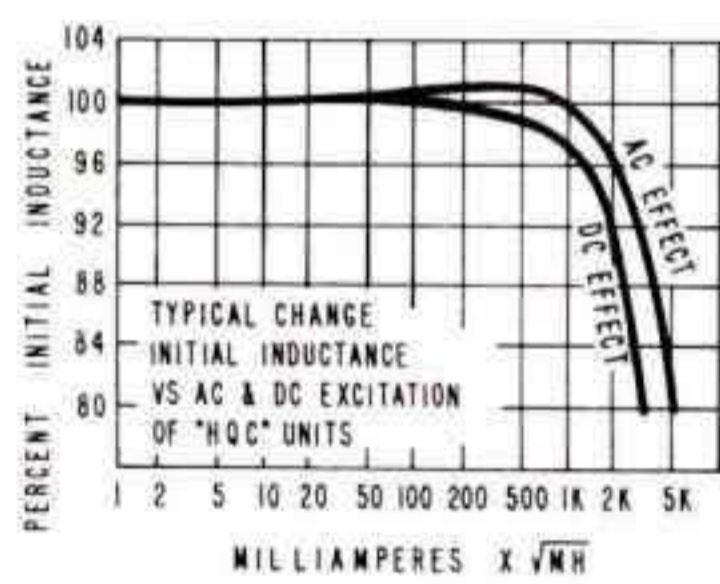
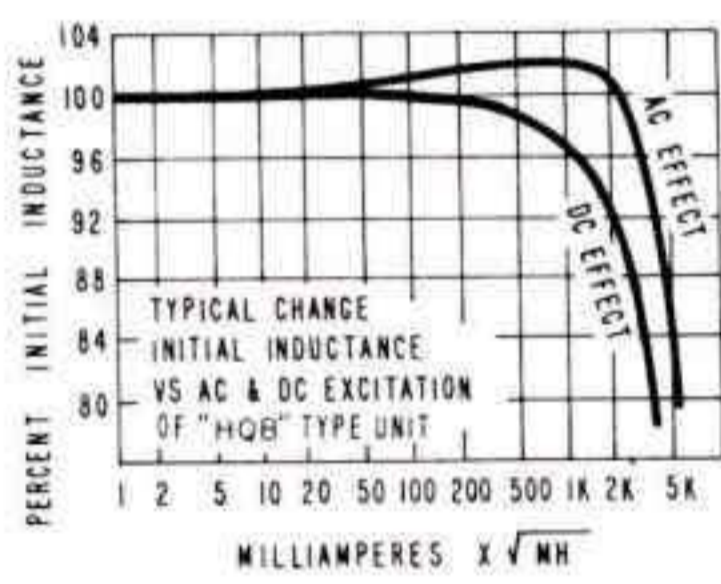
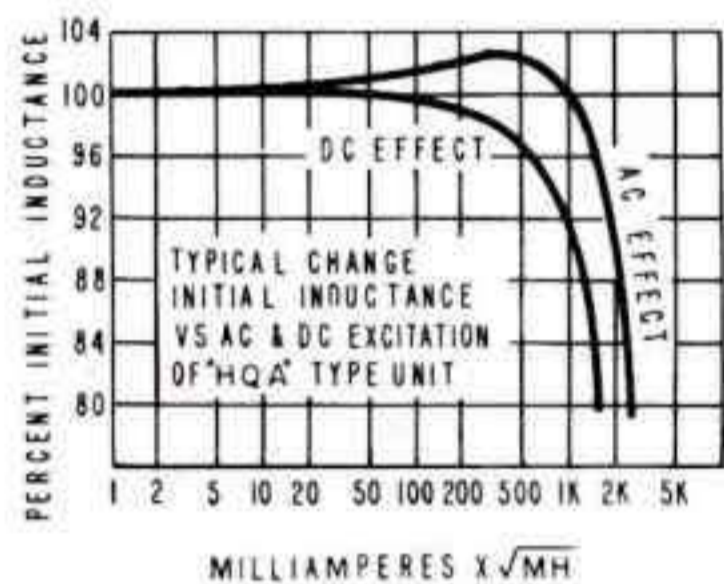

Type No.	Inductance (0 DC)	ma DC Max.	DCR Ω $\pm 20\%$
HQA-1	5 mhy	400	.5
HQA-2	12.5 mhy	260	1.0
HQA-3	20 mhy	200	1.8
HQA-4	30 mhy	160	2.3
HQA-5	50 mhy	130	3.6
HQA-6	80 mhy	100	5.8
HQA-7	125 mhy	85	9.1
HQA-8	200 mhy	65	15
HQA-9	300 mhy	50	25
HQA-10	.5 hy	40	38
HQA-11	.75 hy	35	56
HQA-12	1.25 hy	26	96
HQA-13	2 hy	20	154
HQA-14	3 hy	16	250
HQA-15	5 hy	13	410
HQA-16	7.5 hy	10	615
HQA-17	10 hy	9	740
HQA-18	15 hy	8	1115

Type No.	Inductance (0 DC)	ma DC Max.	DCR Ω $\pm 20\%$
HQB-1	10 mhy	410	.3
HQB-2	30 mhy	240	.9
HQB-3	70 mhy	170	2.2
HQB-4	120 mhy	120	3.5
HQB-5	.5 hy	60	15
HQB-6	1 hy	41	27
HQB-7	2 hy	30	60
HQB-8	3.5 hy	22	100
HQB-9	7.5 hy	16	220
HQB-10	12 hy	11	350
HQB-11	18 hy	9	475
HQB-12	25 hy	8	680

Type No.	Inductance (0 DC)	ma DC Max.	DCR Ω $\pm 20\%$
HQC-1	1 mhy	1350	.26
HQC-2	2.5 mhy	850	.5
HQC-3	5 mhy	600	1.3
HQC-4	10 mhy	420	3.0
HQC-5	20 mhy	300	4.7

Type No.	Inductance (0 DC)	ma DC Max.	DCR Ω $\pm 20\%$
HQE-1	5 mhy	155	1.4
HQE-2	10 mhy	110	2.5
HQE-3	50 mhy	50	14
HQE-4	100 mhy	35	24
HQE-5	200 mhy	25	53



**SPECIAL HIGH Q INDUCTORS
TO YOUR SPECIFICATIONS**

Almost forty years of specialization in high Q coils are reflected in the permalloy dust toroid, ferrite, and laminated structures produced by UTC today. Range is from DC to 400 MHz area. Special winding machines and stabilization methods have resulted in coils of superior performance and stability. While this catalog lists over 200 stock high Q coils, a large

portion of our production is on special coils to customers requirements. The units below illustrate the capabilities of a few structures among the many permalloy dust, ferrite and laminate types produced by UTC. These high Q coils are shown to indicate to the electronic design engineer some of the possibilities in present special components.

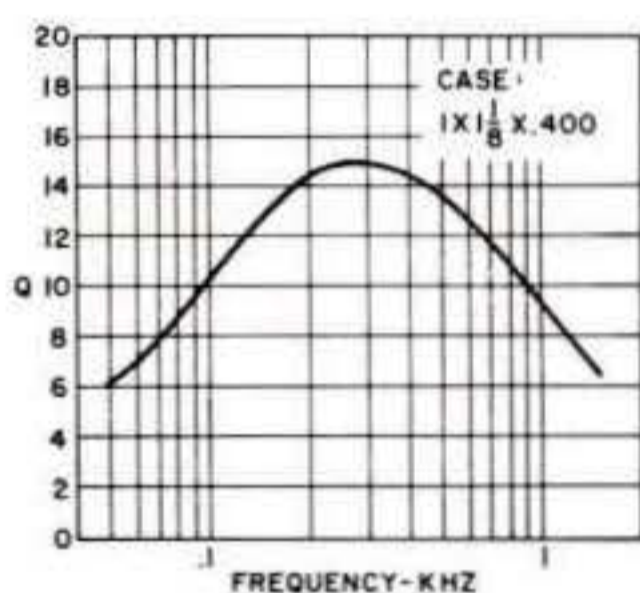
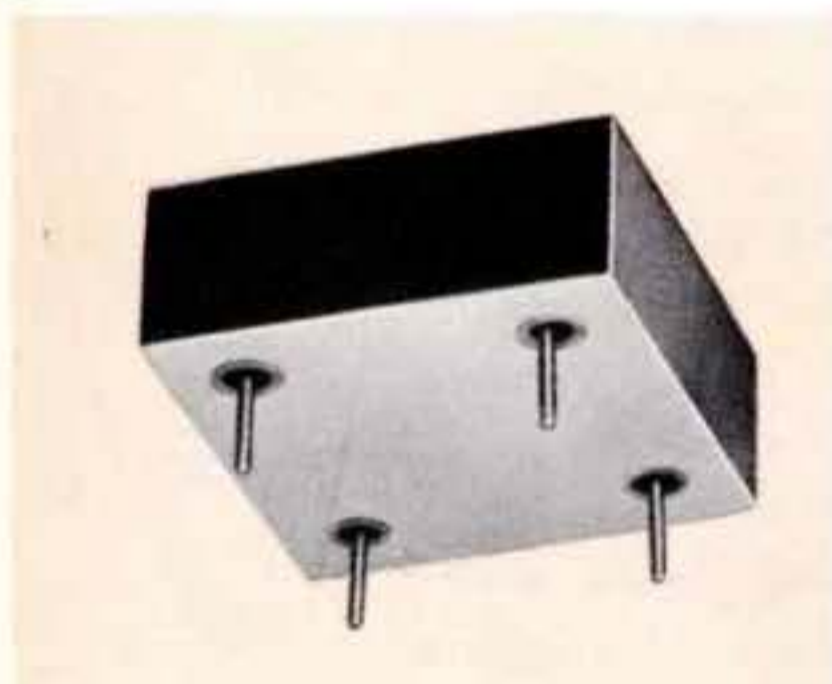

Flat low frequency 50 henries inductor only .400 high. Q of 10 at 100 Hz, DCR 2360 ohms. Grade 4, MIL-T-27C.

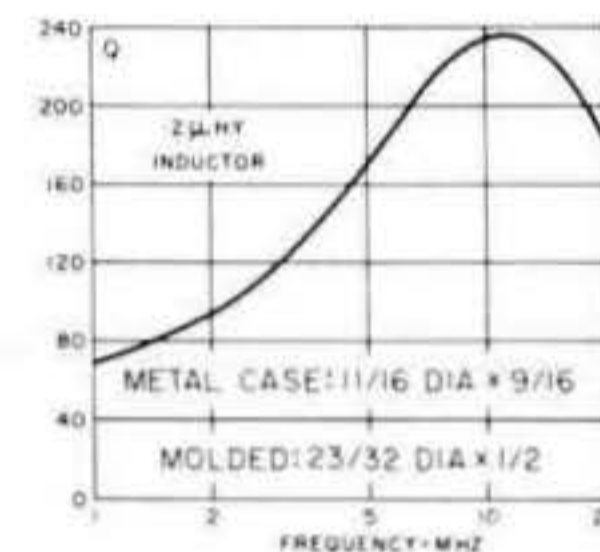
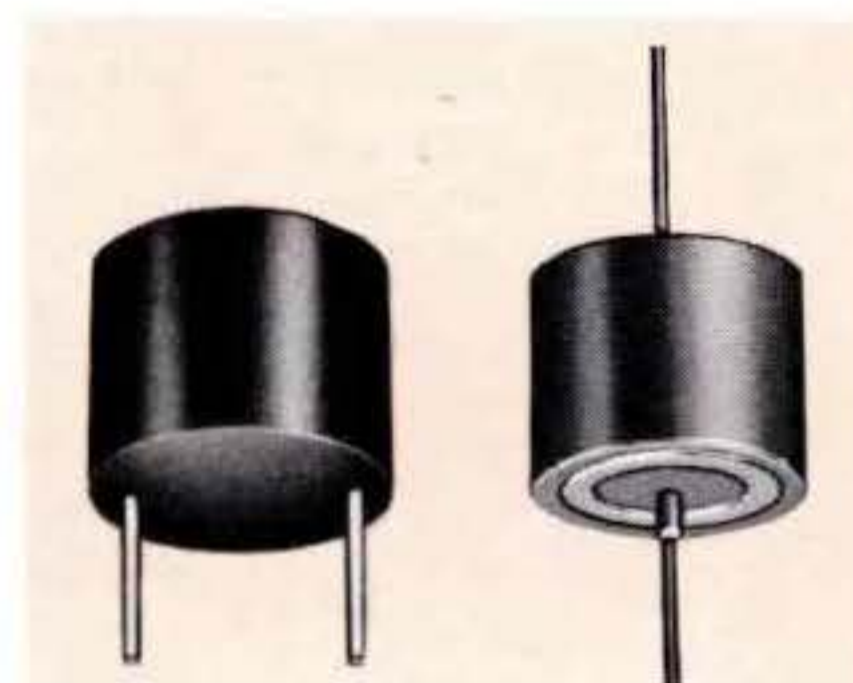

Type FD, 2 microhenry temperature stable miniature inductor. High Q in the 2 MHz to 20 MHz frequency range. Supplied in either epoxy case (23/32 dia x 1/2" high) Grade 5 or metal case (11/16 dia x 9/16" long) Grade 4. MIL-T-27C.

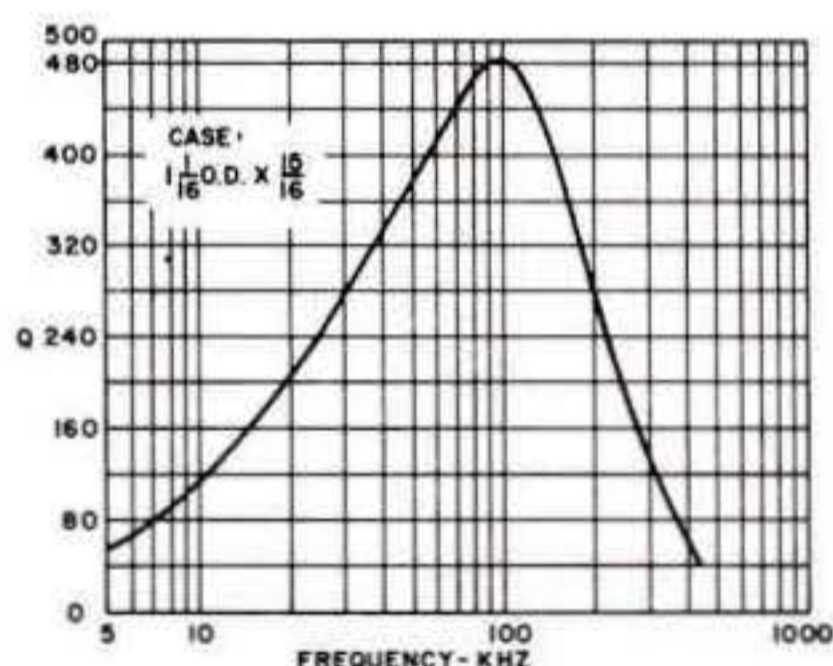

High Q, 5 millihenries inductor. High Q in the 10 kHz to 300 kHz frequency range. Grade 4, MIL-T-27C. Weight approximately 1.5 oz.

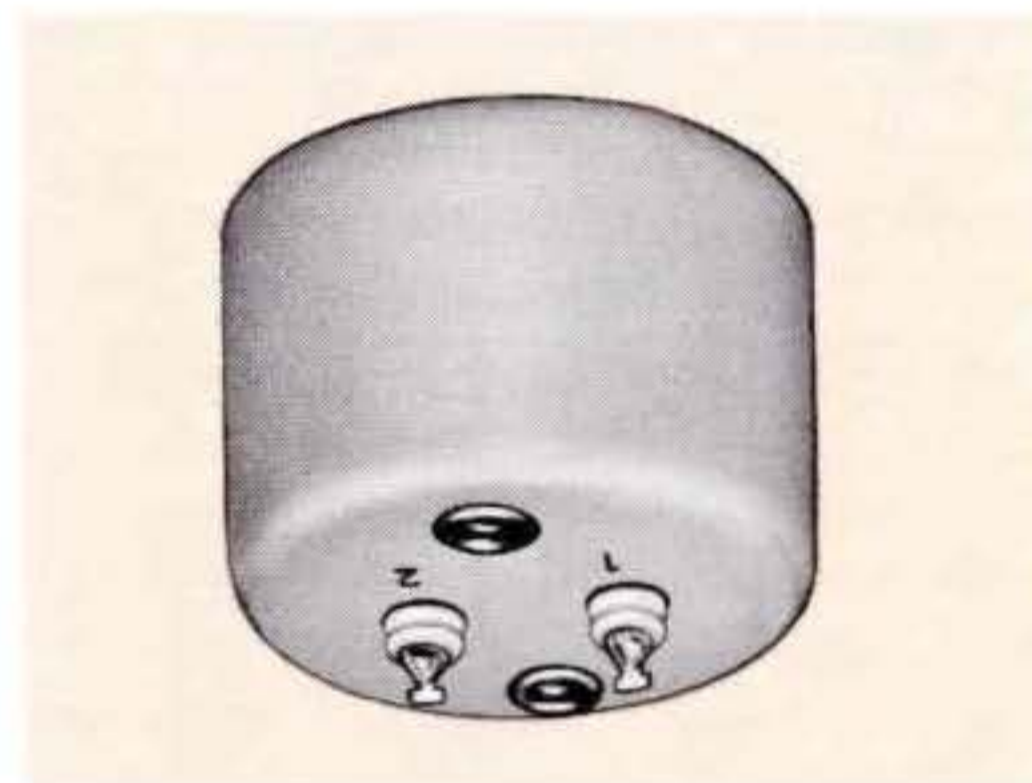

Constant 20 millihenries inductor. Inductance variation less than 2% from 0.1 to 500 V at 100 kHz. Q at 1 volt 100 kHz greater than 100. Case size: 1 7/8 O.D. x 1 3/16" high. MIL-T-27C.

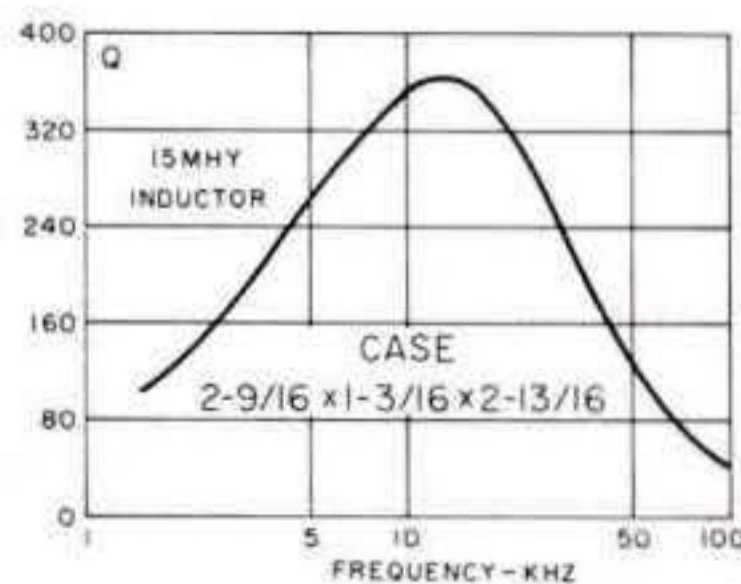

Type MQV, 15 millihenries temperature stable inductor. High Q in the 2 kHz to 50 kHz frequency range. MIL-T-27C. Wt. 14 oz.

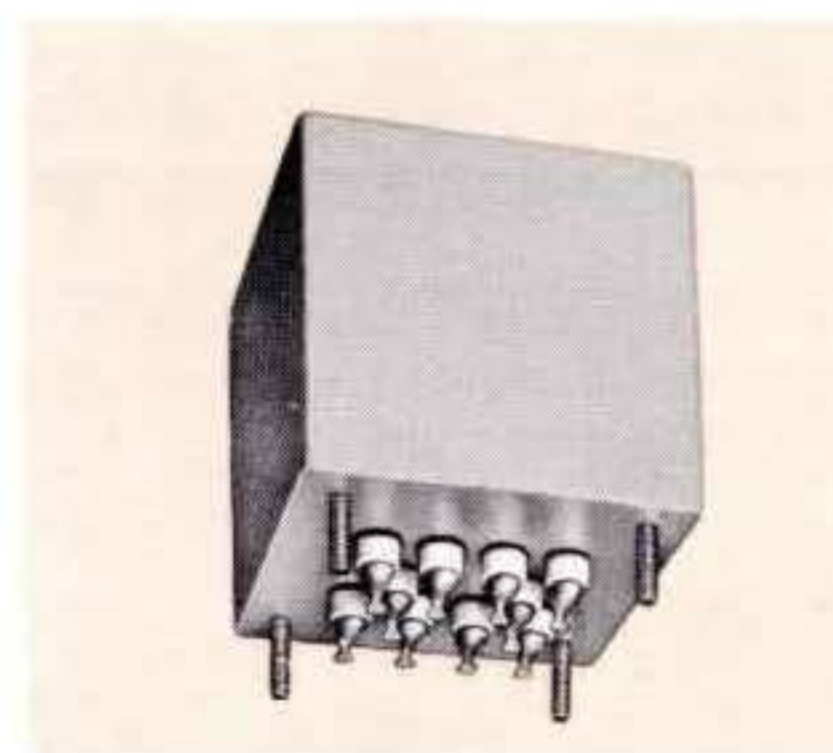

High voltage, constant inductance, tapped inductor. 16 millihenries, 8 kHz, inductance variation less than 1% from 1 volt to 1600 volts. Q greater than 40 at 1600 volts. Case size: 3 1/8 x 3 1/8 x 2 3/4" high. Grade 4, MIL-T-27C.



GENERAL INFORMATION ON ELECTRIC WAVE FILTERS

Almost 40 years of specialization in selective networks, from image parameter design to modern network synthesis are reflected in the superior performance, miniaturization, stability, and reliability of the electric wave filters produced by UTC today.

Because of the tremendous variation in requirements of frequency, band width, impedance, shape factor, size configuration, and other special characteristics such as envelope delay distortion, and return loss, UTC's catalog items are only a portion of the filters made. Special "custom" designs to customers' specifications range from DC to 30 MHz, from a volume of less than 0.1 cubic inches to more than 250 cubic inches. They cover applications such as telephone, telegraph, telemetering, multiplexing, carrier elimination and restoration, etc.

Technical

UTC follows the standard method of measurement of insertion loss and attenuation as defined in MIL-F-18327C, the military specification for filters.

Insertion Loss is defined as the ratio of power delivered to the load before insertion of the filter, to the power delivered to the load after insertion of the filter.

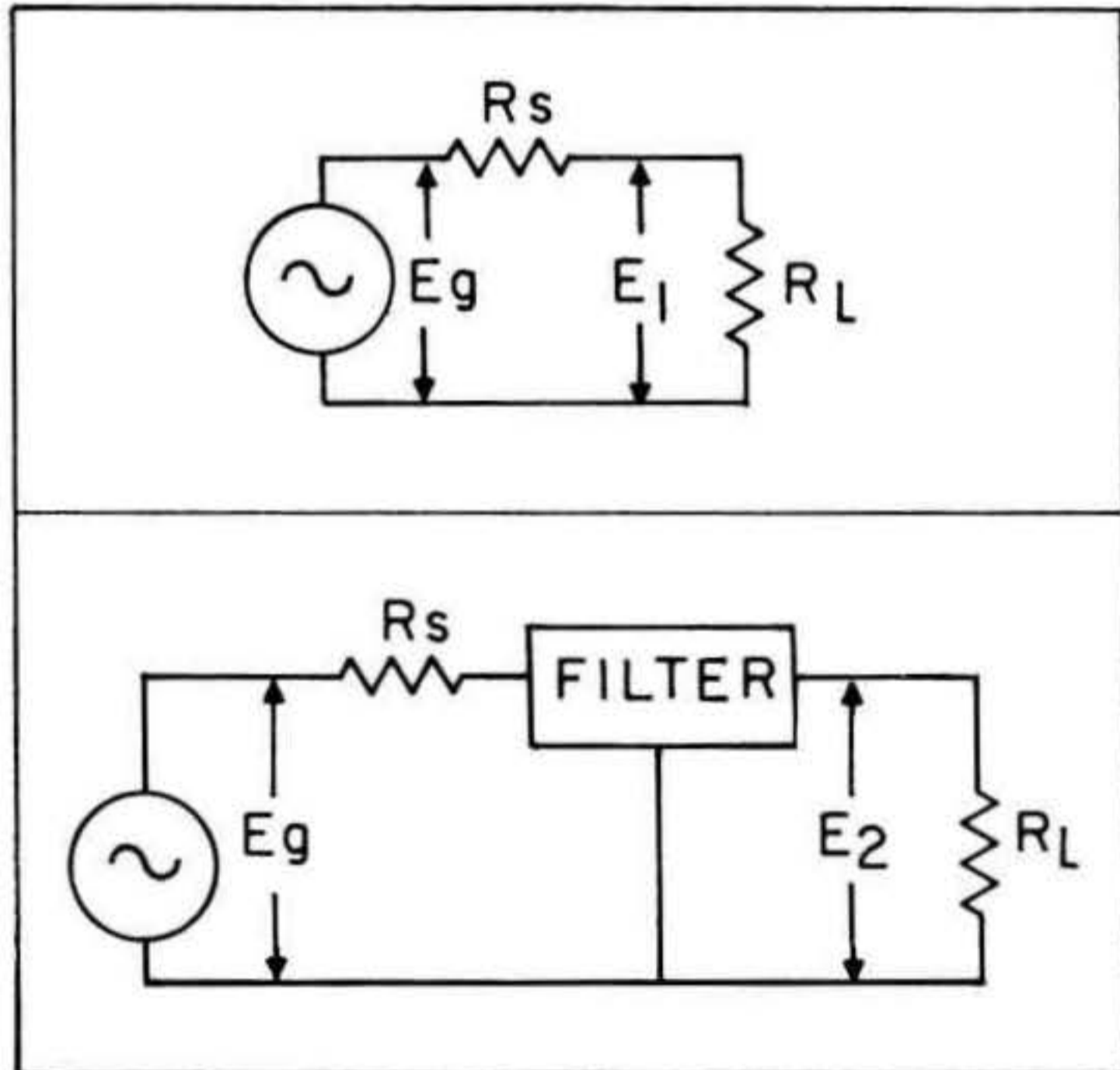

$$IL \text{ in db} = 20 \log_{10} \frac{E_1}{E_2}$$

where

R_s = Source resistor

R_L = Load resistor

E_g = Generator voltage—must be maintained constant for all measurements. The generator impedance should be less than 10% of the source impedance.

E_1 = The load voltage with the filter not in the circuit

E_2 = The load voltage with the filter in the circuit

Attenuation, the relative transmission loss, is measured as the ratio of output voltage (E_2) at the reference frequency to the output voltage (E_3) at the test frequency.

$$\text{Attenuation in db} = 20 \log_{10} \frac{E_2}{E_3}$$

Reference Frequency is that frequency at which the insertion loss is measured and to which all attenuation measurements are referred. In band pass filters, the reference frequency may be the center of the pass band or the frequency at which maximum output occurs. In low pass and high pass filters the reference is a frequency well within the flat portion of the pass band.

On stock, UTC uses the center frequency on band pass filters, 1/5 of the cutoff frequency on low pass filters, and 5 times the cutoff frequency on high pass filters.

Cutoff Frequency is that frequency marking the edge of the pass band. The attenuation at the cutoff frequency can be any number such as .1, 3, or 6 db depending upon the specification. The LPM's for example, are specified as 6 db maximum at cutoff frequency, while the FLH's are specified as 3 db \pm 1 db at cutoff.

Pass Band Ripple is the difference from peak to valley of the amplitude response in the pass band measured in db.

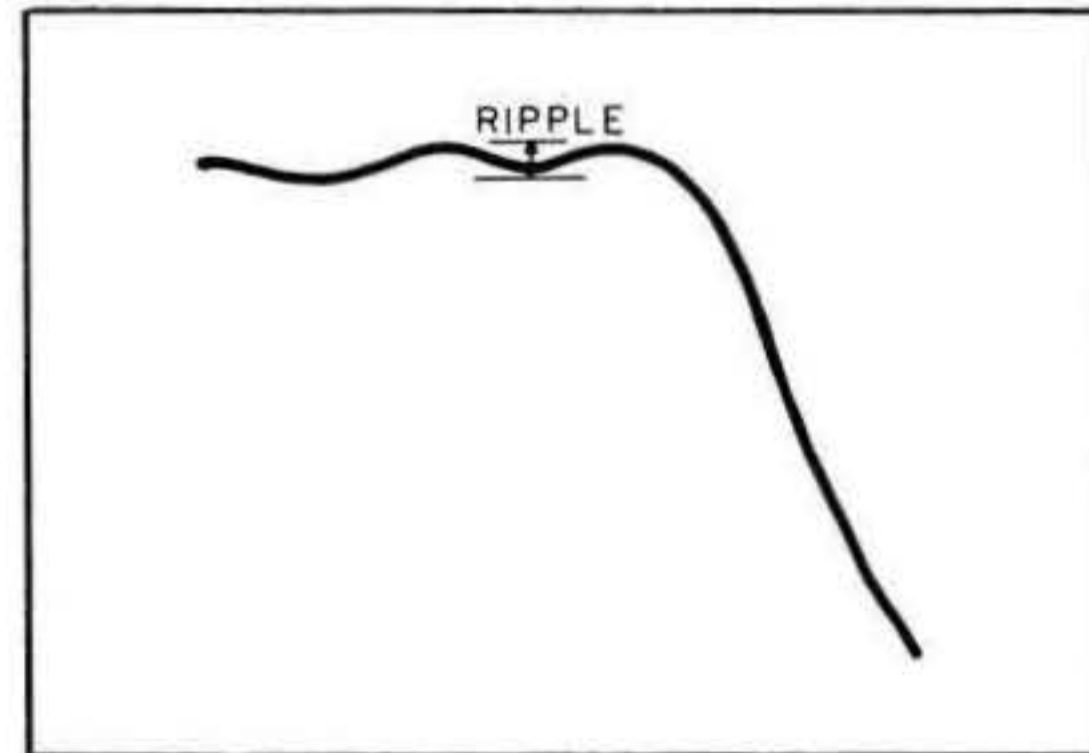

Stop Band is that band of frequencies that the filter discriminates against.

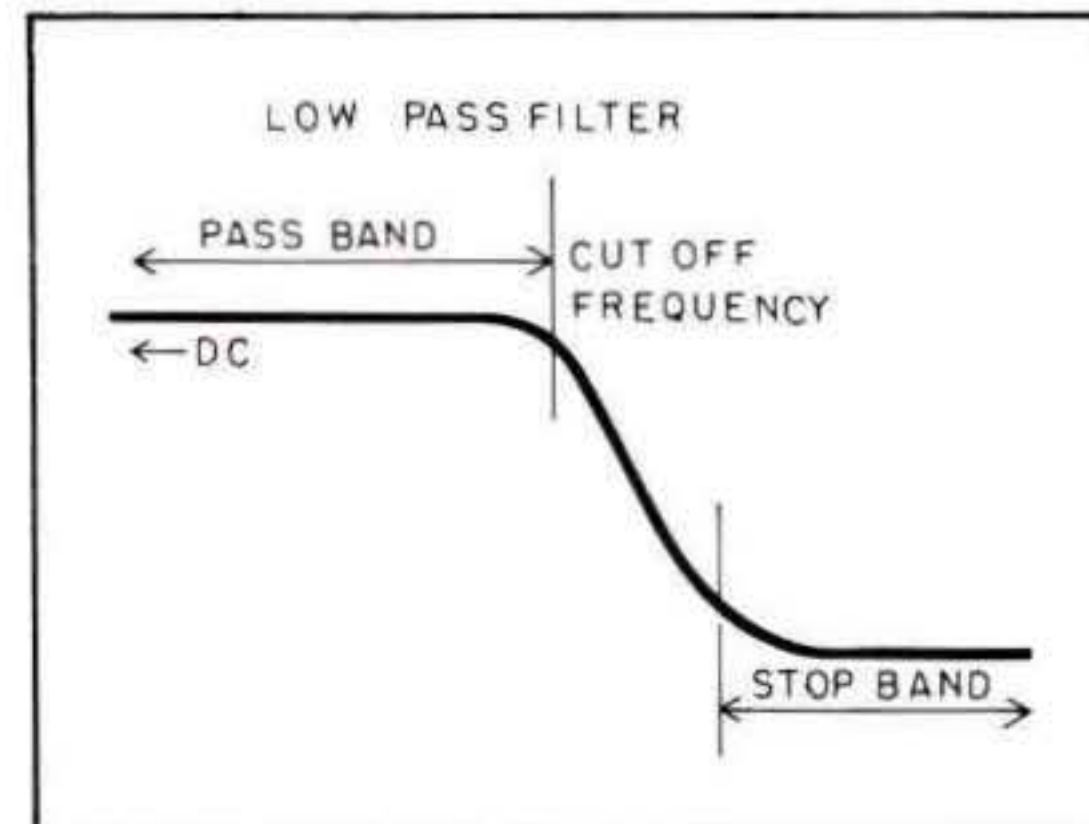

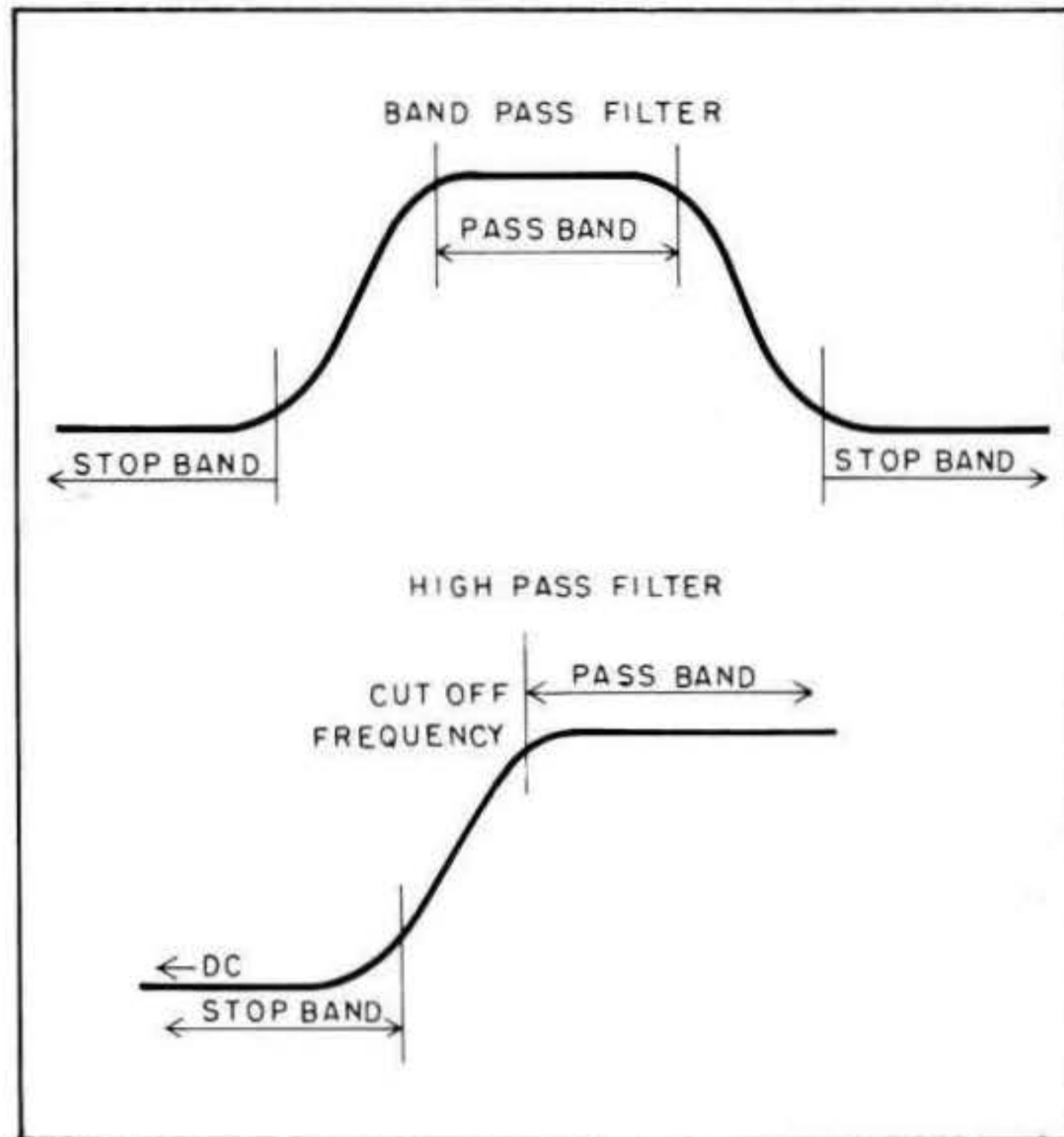

Input Impedance Z_{in} is the impedance looking into the filter's input terminals with the filter properly loaded at the output terminals.

Output Impedance Z_{out} is the impedance looking into the filter's output terminals with the proper resistor across the input terminals.

Neither of these impedances, not to be confused with source and load impedances, should be specified with tolerances unless absolutely necessary. Restricting the actual impedance looking into one end or the other of a filter may complicate the design, increasing size and cost. Adjacent filters that are going to be used in parallel at their inputs or outputs, should be so specified in order to obtain units whose stop band impedances are high and thus have minimal effect on each other. For instance, adjacent TGT's (telegraph transmitting filters) may be paralleled on their outputs and adjacent TGR's (telegraph receiving filters) may be paralleled on their inputs.

In general, to reduce size and cost of special filters, the user should be careful not to overspecify. The maximum amount of attenuation and ripple that can be tolerated in the pass band as well as the minimum stop band attenuation should be specified. The flatter the pass band and the sharper the skirt attenuation, the more complex the network and the larger and more expensive the unit becomes.

For special designs the following information must be known: source and load impedances, insertion loss, pass band, stop band, operating level, operating temperature range, and size restrictions, plus any other special requirements such as phase matching, insertion loss matching, or attenuation matching between units, envelope delay distortion, return loss limits, etc.

Since filters usually contain many precisely adjusted elements and are used in critical applications where continued reliable performance is a necessity, all UTC filters, both stock and specials, are manufactured and guaranteed to MIL-F-18327. See pages 86, 87.

Units with identical electrical and mechanical characteristics as stock items, except for center frequency on band pass filters, or cutoff frequency on low and high pass filters, are known as stock specials. For example, a band pass filter identical to the BPM series with a center frequency of 2700 Hz would be identified as BPM-2700, a 2700 Hz center frequency band pass filter identical to the MNF series would be identified as MNF-2.7, a low pass similar to LPM series with a 2700 Hz cutoff frequency would be identified as LPM-2700.

For Wide Band Pass applications (more than an octave wide) low pass and high pass filters may be connected in tandem. For instance, the FLH-5000 in tandem with the FHH-200 will result in an attenuation characteristic flat within 1 db from 300 to 4200 Hz, approximately 3 db at 200 and 5000 Hz, 40 db below 140 Hz, and 43 db above 6400 Hz.

For Band Reject applications, the BPM band pass minifilters may be used by connecting as shown on page 76, Figure A. The LBP-10, shown on page 83, may be also used for band reject application.

In measuring filters, precautions should be taken to be certain that the test equipment does not affect the measurement. For instance, when the lower stop band of a band pass filter or the stop band of a high pass filter is being measured, the apparent attenuation may be that of the harmonic output of the generator (which may lie in the filter pass band) rather than the actual filter attenuation at the test frequency. To eliminate this problem the use of a wave analyzer, if available, or another filter which passes the test frequency but rejects its harmonics is recommended.

Generally, on stock filters, variations of $\pm 20\%$ in the source and load impedances will have negligible effect on the attenuation response. FHH, FLH, FLL, FBH, BPM, BPH, BMI, & BTI filters may be used with a much lower source impedance and still give satisfactory results.

The nominal test level, E_g , is 2.0 Volts RMS for all stock filters except 0.5 Volt on the BPM and BML, 1.0 Volt on the LPM and HPM, 10 Volts on the LLP, and 115 Volts on the PLF and PLP filters.

Superior and consistent performance, stability, and reliability are achieved through meticulous control of all materials and processes during the entire manufacturing cycle from the first sample to each production filter.

Engineering, laboratory, and production facilities are available for full engineering discussion, sampling, and large quantity production to meet special requirements.

STANDARD ELECTRIC WAVE FILTER SELECTION GUIDE

BAND PASS

Type No.	Center Freq Range	Band Width	Source (Ohms)	Load (Ohms)	MIL Grade	Operating Temp Range	Size	Weight	Page
MNF	400 Hz to 5.4 kHz	± 7.5%	10K	10K	7	-55°C to +105°C	1 ³ / ₁₆ sq x 1/2" h	1 oz	78
MNF	7.35 kHz to 70 kHz	± 7.5%	10K	10K	7	-55°C to +105°C	2 ³ / ₃₂ sq x 1/2" h	1/3 oz	78
MWF	22 kHz to 70 kHz	± 15%	10K	10K	7	-55°C to +105°C	2 ³ / ₃₂ sq x 1/2" h	1/3 oz	78
TMN	400 Hz to 1.7 kHz	± 7.5%	100K	100K	4	-55°C to +105°C	1 ¹ / ₁₆ x 1 ⁹ / ₃₂ x 2" h	3.5 oz	78
TMN	2.3 kHz to 70 kHz	± 7.5%	100K	100K	4	-55°C to +105°C	2 ³ / ₃₂ sq x 1 ³ / ₈ " h	1.2 oz	78
TMW	22 kHz to 70 kHz	± 15%	100K	100K	4	-55°C to +105°C	2 ³ / ₃₂ sq x 1 ³ / ₈ " h	1.2 oz	78
BPM	400 Hz to 20 kHz	± 3%	10K	10K or Grid	6	-55°C to +105°C	3/4 sq x 1 ¹ / ₈ " h	1 oz	76
BPH	50 kHz to 100 kHz	± 5%	500	500	6	-55°C to +105°C	3/4 sq x 1 ¹ / ₈ " h	1 oz	76
FBH	1.5kHz	1 octave	10K	10K	6	-55°C to +105°C	1 ¹ / ₂ x 2 x 1/2" h	2.2 oz	75
FBH	15 kHz	1 octave	10K	10K	6	-55°C to +105°C	1 ¹ / ₄ sq x 3/8" h	1 oz	75
BMI	30 Hz to 50 Hz	± 3%	10K	Grid	6	-55°C to +105°C	1 ³ / ₁₆ x 1 ¹¹ / ₁₆ x 2 ¹ / ₂ " h	9 oz	80
BMI	60 Hz to 10 kHz	± 3%	10K	Grid	6	-55°C to +105°C	1 ³ / ₁₆ x 1 ¹¹ / ₁₆ x 1 ⁵ / ₈ " h	6 oz	80
BTI	60 Hz to 120 Hz	± 3%	10K	10K	6	-55°C to +105°C	1 ³ / ₁₆ x 1 ¹¹ / ₁₆ x 1 ⁵ / ₈ " h	6 oz	80
BML	400 Hz to 1 kHz	± 3%	500	Grid	6	-55°C to +105°C	1 ³ / ₁₆ x 1 ¹¹ / ₁₆ x 1 ⁵ / ₈ " h	6 oz	80
TGT	425 Hz to 3315 Hz	± 42.5 Hz	600	600	6	-55°C to +85°C	1 ¹ / ₂ sq x 2 ¹ / ₂ " h	8 oz	79
TGR	425 Hz to 3315 Hz	± 42.5 Hz	600	600	6	-55°C to +85°C	1 ¹ / ₂ sq x 4 ¹ / ₄ " h	15 oz	79
LBP	10 Hz	± 4%	10K	10K or 3.3 Meg	6	-55°C to +105°C	2 ¹ / ₁₆ x 2 ⁵ / ₁₆ x 2 ¹ / ₂ " h	1 ¹ / ₄ lbs	83
PLP	400 Hz	± 25 Hz	115 V line	1000	4	-55°C to +105°C	3 ¹ / ₁₆ x 4 ⁵ / ₁₆ x 4 ¹ / ₂ " h	6 ¹ / ₂ lbs	83

BAND REJECT

Type No.	Freq Range	Source (Ohms)	Load (Ohms)	MIL Grade	Operating Temp Range	Size	Weight	Page
BPM	400 Hz to 20 kHz	10K	10K	6	-55°C to +105°C	3/4 sq x 1 ¹ / ₈ " h	1 oz	76
LBP	10 Hz	10K	50K	6	-55°C to +105°C	2 ¹ / ₁₆ x 2 ⁵ / ₁₆ x 2 ¹ / ₂ " h	1 ¹ / ₄ lbs	83

LOW PASS

Type No.	Cutoff Freq Range	Source & Load (Ohms)	Grade	Operating Temp Range	Size	Weight	Page
LPM	6 kHz to 15 kHz	10K	6	-55°C to +105°C	3/4 sq x 1 ¹ / ₈ " h	1 oz	77
LPM	200 Hz to 5 kHz	10K	6	-55°C to +105°C	1 sq x 1 ³ / ₈ " h	2 ¹ / ₄ oz	77
FLH	600 Hz	10K	6	-55°C to +105°C	2 sq x 1/2" h	2 ¹ / ₂ oz	75
FLH	5 kHz	10K	6	-55°C to +105°C	1 ¹ / ₂ x 2 x 3/8" h	2 oz	75
FLL	3.5 kHz to 18 kHz	600	6	-55°C to +105°C	2 sq x 1/2" h	2 ¹ / ₂ oz	75
FLL	50 kHz	600	6	-55°C to +105°C	1 ¹ / ₂ x 2 x 3/8" h	2 oz	75
LMI	150 Hz to 10 kHz	10K	6	-55°C to +105°C	1 ³ / ₁₆ x 1 ¹¹ / ₁₆ x 1 ⁵ / ₈ " h	6 oz	81
LMI	50 Hz to 100 Hz	10K	6	-55°C to +105°C	1 ³ / ₁₆ x 1 ¹¹ / ₁₆ x 2 ¹ / ₂ " h	9 oz	81
LML	500 Hz to 12 kHz	600	6	-55°C to +105°C	1 ³ / ₁₆ x 1 ¹¹ / ₁₆ x 2 ¹ / ₂ " h	9 oz	81
LLP	10 Hz to 15 Hz	100K	6	-55°C to +105°C	2 ¹ / ₁₆ x 2 ⁵ / ₁₆ x 3 ¹ / ₈ " h	1 ¹ / ₂ lbs	83
PLF	425 Hz	115 V line 500Ω Load	4	-55°C to +105°C	4 ⁵ / ₁₆ x 5 ¹ / ₁₆ x 5 ¹ / ₂ " h	10 lbs	83

HIGH PASS

Type No.	Cutoff Freq Range	Source & Load (Ohms)	MIL Grade	Operating Temp Range	Size	Weight	Page
HPM	500 Hz to 4 kHz	10K	6	-55°C to +105°C	1 x 1 x 1 ³ / ₈ " h	2 ¹ / ₄ oz	77
FHH	200 Hz	10K	6	-55°C to +105°C	2 sq x 1/2" h	2 ¹ / ₂ oz	75
HMI	50 Hz to 3 kHz	10K	6	-55°C to +105°C	1 ³ / ₁₆ x 1 ¹¹ / ₁₆ x 2 ¹ / ₂ " h	9 oz	82
HML	40 Hz to 1 kHz	600	6	-55°C to +105°C	1 ³ / ₁₆ x 1 ¹¹ / ₁₆ x 2 ¹ / ₂ " h	9 oz	82



FLATS™ — LOW PASS, BAND PASS, HIGH PASS

PACKAGING Flat metal case. Shielded to reduce hum pick-up. Hermetically sealed. Straight pin terminals.

MIL SPECS To complete MIL-F-18327C Specs. Grade 6, Class R, Life X. See pages 86, 87.

NOTE Filters with other frequencies than shown can be supplied on special order.

LOW PASS

Mil Type FR6RX11YY1

Type No.	Source & Load Ω	Pass Band db (less than 1) (3 ± 1)	Stop Band	Case	
FLH-600	10K	DC to 450 Hz	600 Hz	40 db above 800 Hz	FP-A
FLL-3500	600	DC to 3 kHz	3.5 kHz	40 db above 4.5 kHz	FP-A
FLH-5000	10K	DC to 4.2 kHz	5 kHz	43 db above 6.4 kHz	FP-B
FLL-18000	600	DC to 15 kHz	18 kHz	43 db above 23 kHz	FP-A
FLL-50000	600	DC to 42 kHz	50 kHz	43 db above 64 kHz	FP-B

BROAD BAND PASS

Mil Type FR6RX22YY1

Type No.	Source & Load Ω	Pass Band (less than 3 db)	Stop Bands (more than 36 db)		Case
			Below	Above	
FBH-1	10K	1 kHz to 2 kHz	.5 kHz	4 kHz	FP-C
FBH-10	10K	10 kHz to 20 kHz	5 kHz	40 kHz	FP-D

HIGH PASS

Mil Type FR6RX33YY1

Type No.	Source & Load Ω	Pass Band db (less than 1) (3 ± 1)	Stop Band	Case	
FHH-200	10 K	300 Hz & above	200 Hz	40 db below 140 Hz	FP-A

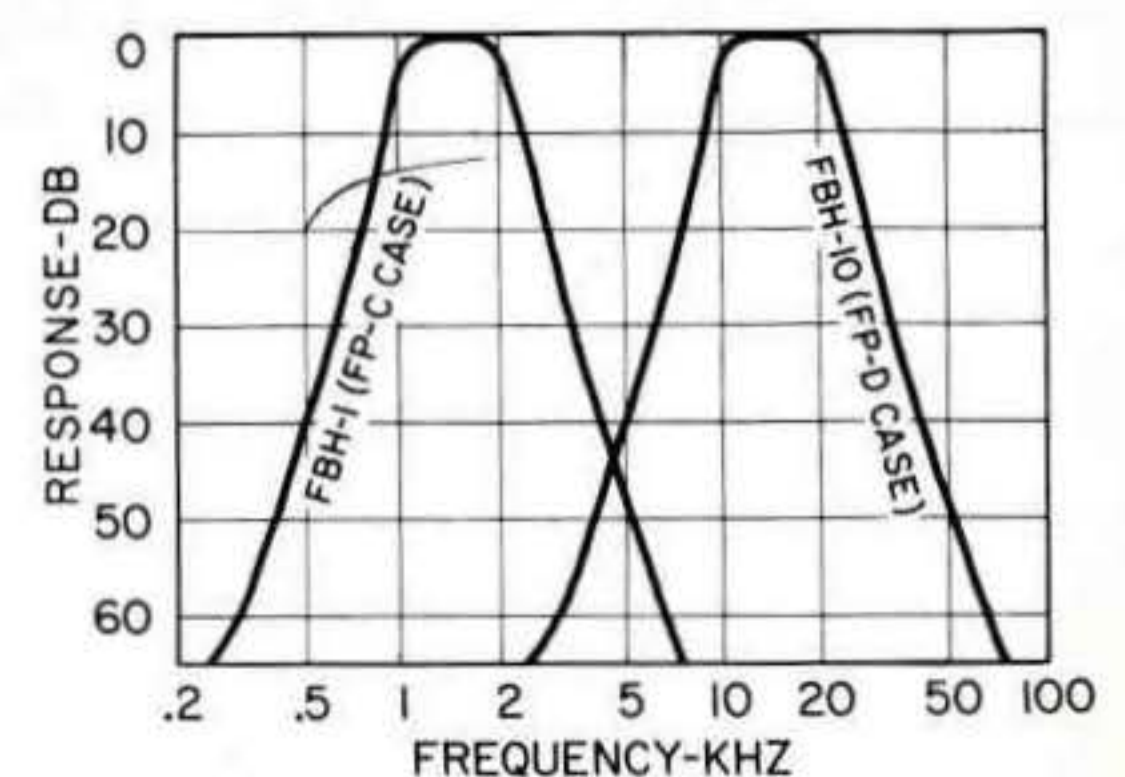
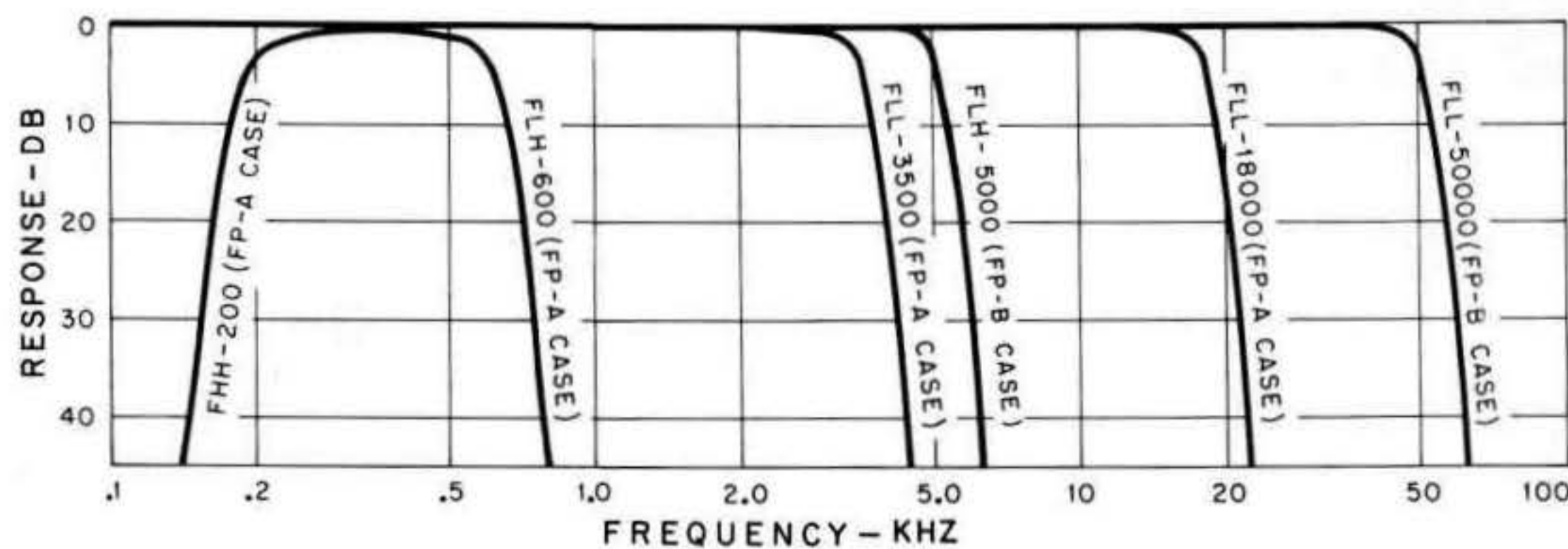
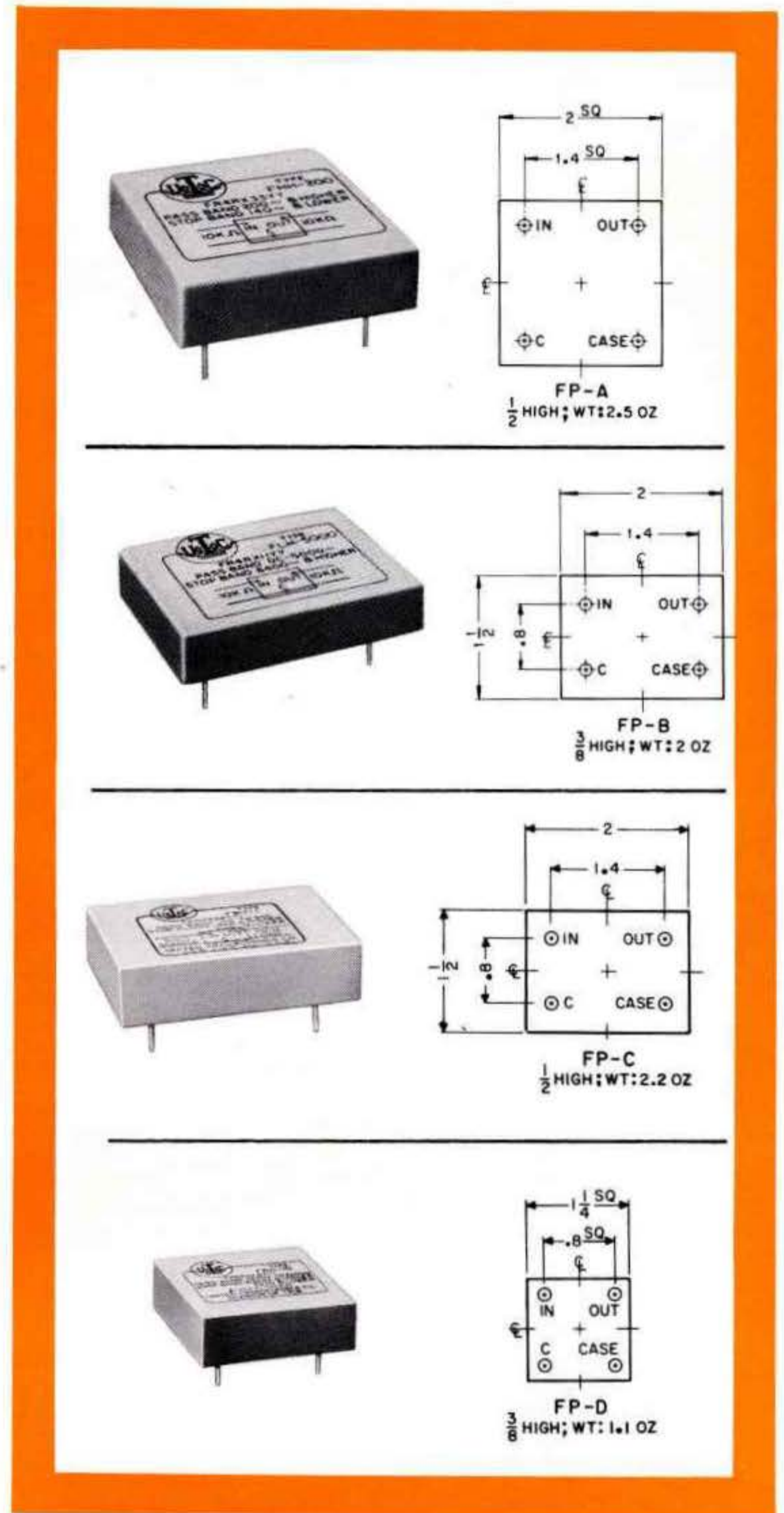



MINIATURE FILTERS—BAND PASS, HIGH PASS, LOW PASS

PACKAGING Hermetically sealed. Standard MIL metal cases. Straight pin terminals. Shielded to reduce hum pick-up.

MIL SPECS To complete MIL-F-18327C Specs. Grade 6, Class R, Life X. See pages 86, 87.

WIDE BAND PASS APPLICATIONS The HPM and LPM may be connected in tandem. For example, the HPM-500 in tandem with the LPM-5000 will be flat within 1 db from 625 Hz to 4000 Hz with an attenuation of 40 db at 300 Hz and 8250 Hz.

BAND PASS

MIL TYPE FR6RX22AF1

BPM's source 10K ohms ; load 10K ohms or grid.
Grid output gives 2:1 gain.

NOTE: Special BPM filters with center frequency of 30 kHz to 200kHz are available with 10,000 ohms load only, these have three terminals.

BPH's 500 ohms source and load

Type No.	Center Frequency (Hz)	Pass Band (less than 2 db) (Hz)	Stop Band (more than 35 db) Below (Hz)	Stop Band (more than 35 db) Above (Hz)
BPM-400	400	388-412	200	800
BPM-440	440	427-453	220	880
BPM-500	500	485-515	250	1000
BPM-600	600	582-618	300	1200
BPM-750	750	727-773	375	1500
BPM-800	800	776-824	400	1600
BPM-1000	1000	970-1030	500	2000
BPM-1200	1200	1164-1236	600	2400
BPM-1500	1500	1455-1545	750	3000
BPM-1600	1600	1552-1648	800	3200
BPM-1800	1800	1746-1854	900	3600
BPM-2000	2000	1940-2060	1000	4000
BPM-2500	2500	2425-2575	1250	5000
BPM-3000	3000	2910-3090	1500	6000
BPM-3200	3200	3104-3296	1600	6400
BPM-4000	4000	3880-4120	2000	8000
BPM-4800	4800	4656-4944	2400	9600
BPM-5000	5000	4850-5150	2500	10000
BPM-6000	6000	5820-6180	3000	12000
BPM-6400	6400	6208-6592	3200	12800
BPM-8000	8000	7760-8240	4000	16000
BPM-10000	10000	9700-10300	5000	20000
BPM-20000	20000	19400-20600	10000	40000
		(less than 3 db)	(more than 40 db)	
BPH-50000	50000	47500-52500	25000	100000
BPH-100000	100000	95000-105000	50000	200000

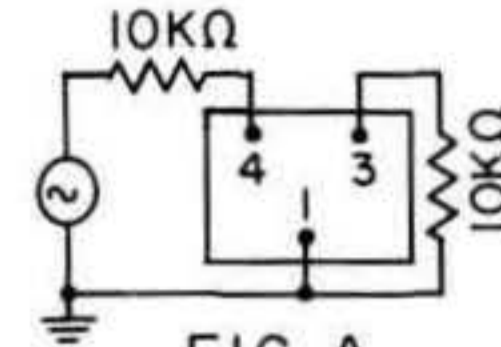
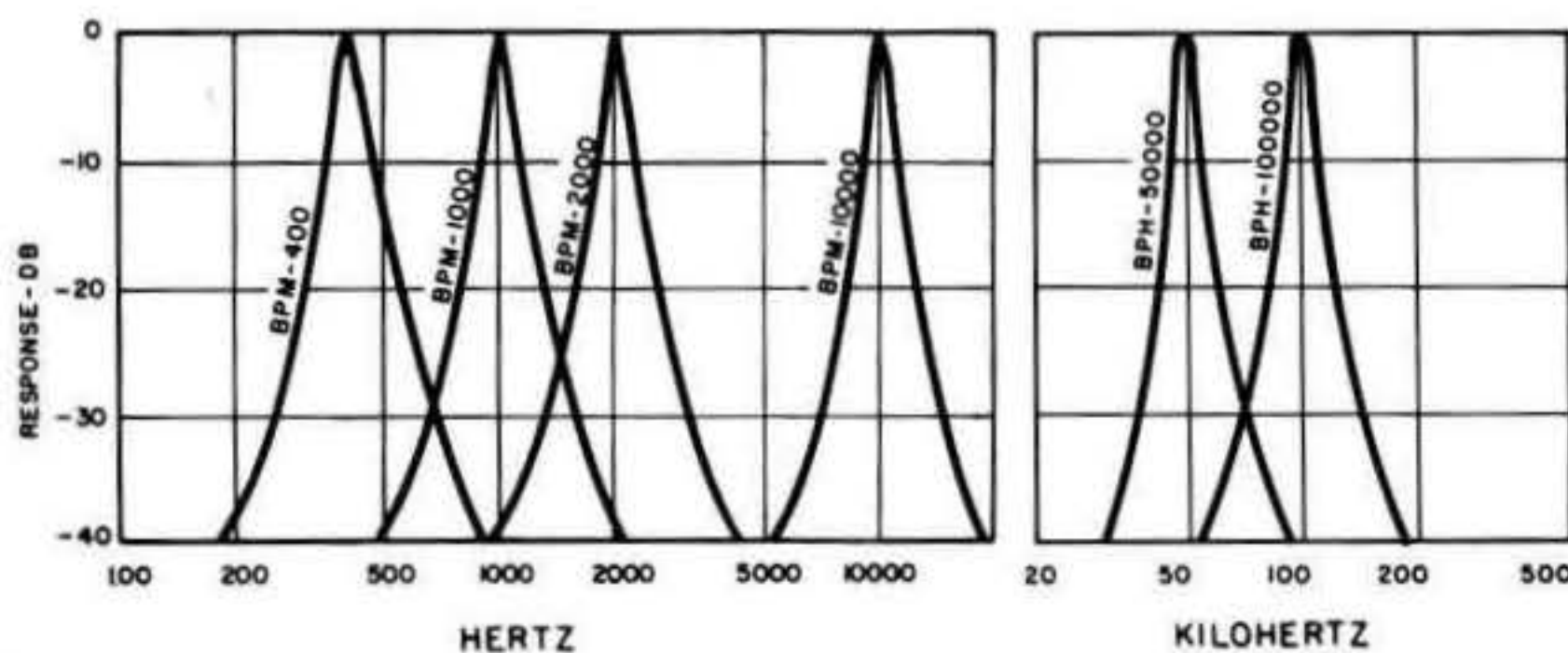
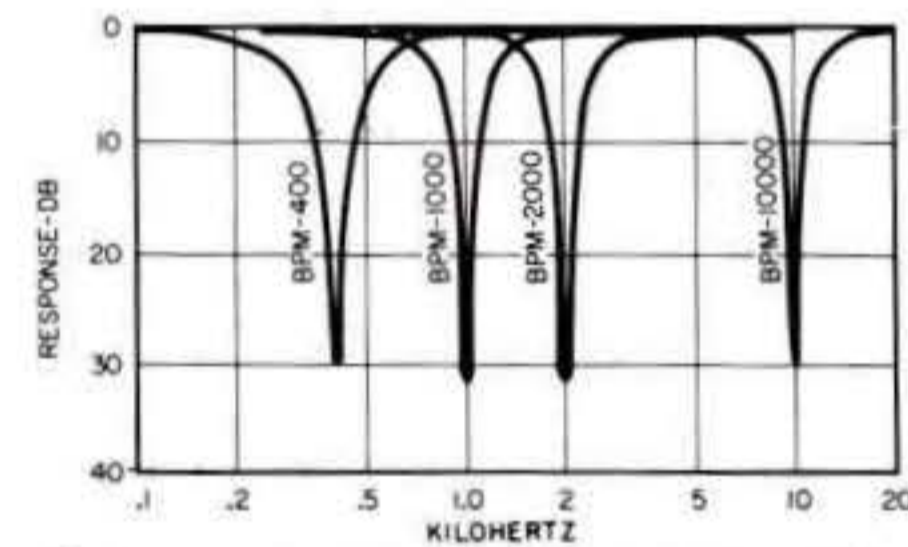

FIG. A

CONNECTIONS FOR BAND REJECT APPLICATIONS

BAND REJECT

BPM units are designed for both band pass and band reject applications. For band reject connect as in Fig A above.



TYPICAL BAND REJECT RESPONSES

BAND PASS

TYPICAL NORMALIZED BPM RESPONSE

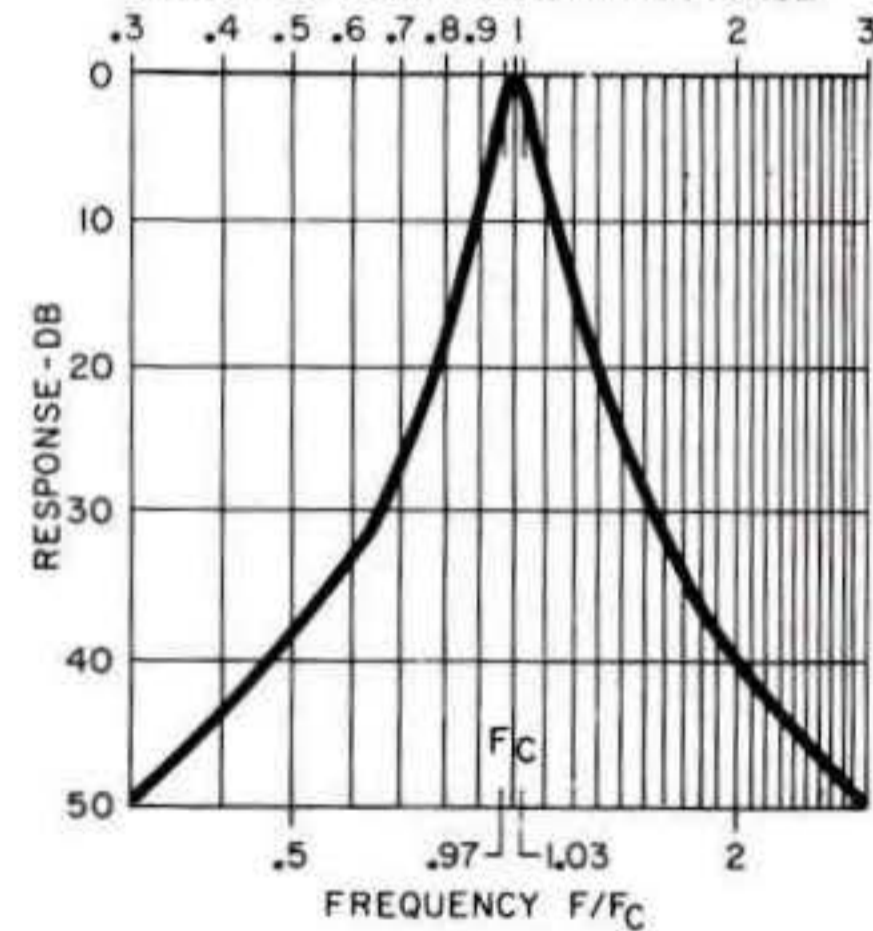

TYPICAL NORMALIZED BPH RESPONSE

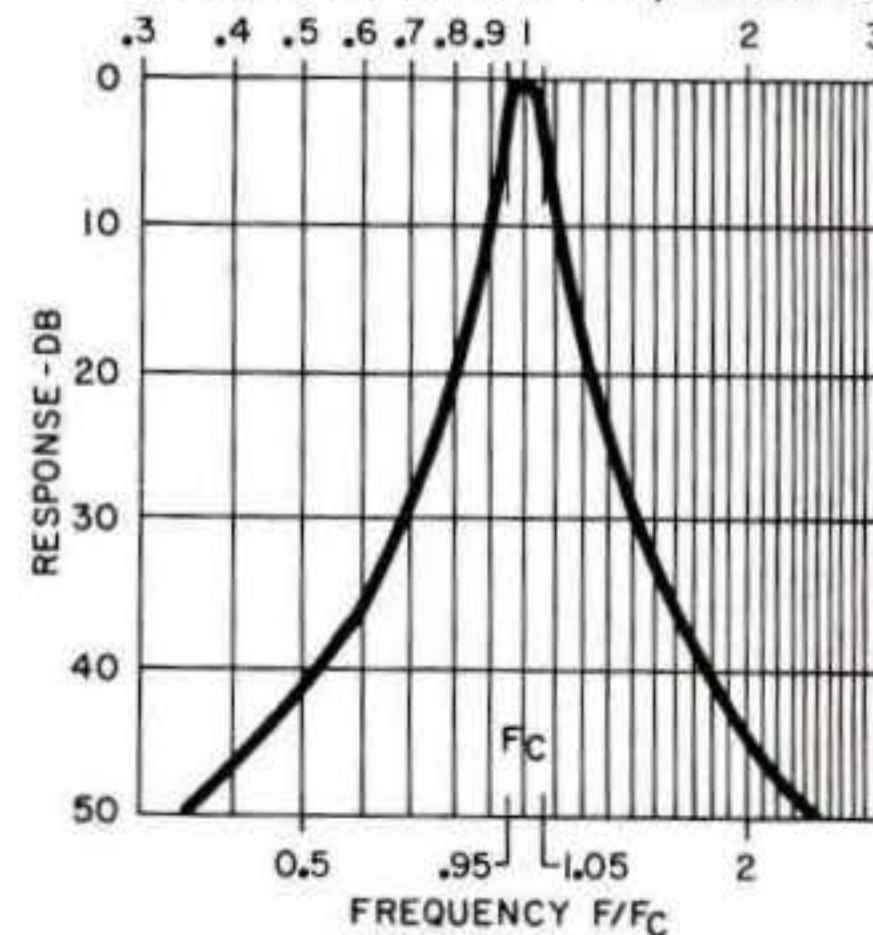

MINIFILTER™ SERIES

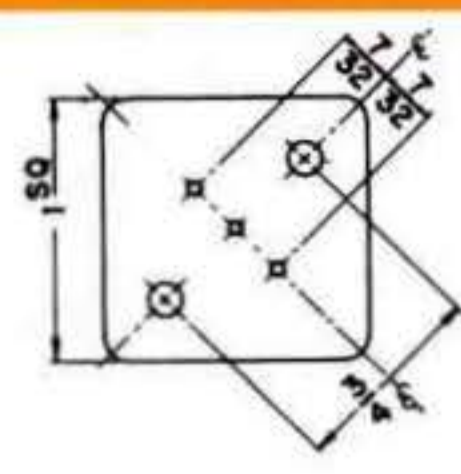

HPM and LPM case (MIL AG)
1 x 1 x 1 1/4"
Weight.....2 1/4 oz.

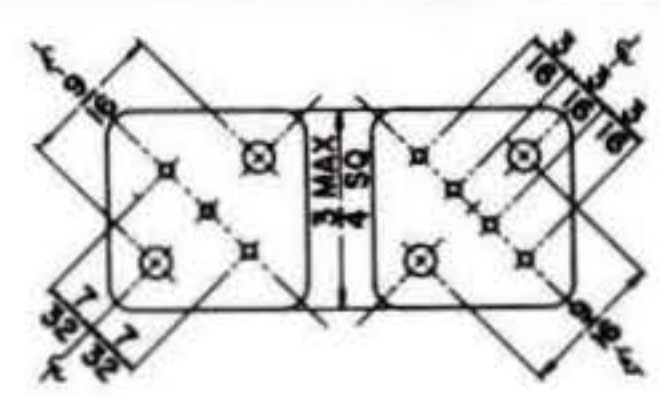

BPH and BPM case & LPM-6000 or higher (MIL AF)
3/4 x 3/4 x 1 1/4"
Weight.....1 oz.



LOW PASS

LPM's BELOW 6000 MIL TYPE FR6RX11AG1
LPM-6000 & ABOVE MIL TYPE FR6RX11AF1
All LPM's 10K ohms source and load

Type No.	Pass Band (less than 6 db) DC to: (Hz)	Stop Band min db @ (Hz)	Mil Case
LPM-200	200	30 @ 300 40 @ 400	AG
LPM-300	300	30 @ 450 40 @ 600	AG
LPM-500	500	30 @ 750 40 @ 1000	AG
LPM-1000	1000	30 @ 1500 40 @ 2000	AG
LPM-1500	1500	30 @ 2250 40 @ 3000	AG
LPM-2000	2000	30 @ 3000 40 @ 4000	AG
LPM-3000	3000	30 @ 4500 40 @ 6000	AG
LPM-5000	5000	30 @ 7500 40 @ 10000	AG
LPM-6000	6000	30 @ 9000 40 @ 12000	AF
LPM-8000	8000	30 @ 12000 40 @ 16000	AF
LPM-10000	10000	30 @ 15000 40 @ 20000	AF
LPM-15000	15000	30 @ 22500 40 @ 30000	AF

HIGH PASS

MIL TYPE FR6RX33AG1
HPM 10K ohms source and load

Type No.	Pass Band (less than 6 db) (Hz) & above	Stop Band min db @ (Hz)
HPM-500	500	30 @ 333 40 @ 250
HPM-1000	1000	30 @ 667 40 @ 500
HPM-1500	1500	30 @ 1005 40 @ 750
HPM-4000	4000	30 @ 2680 40 @ 2000

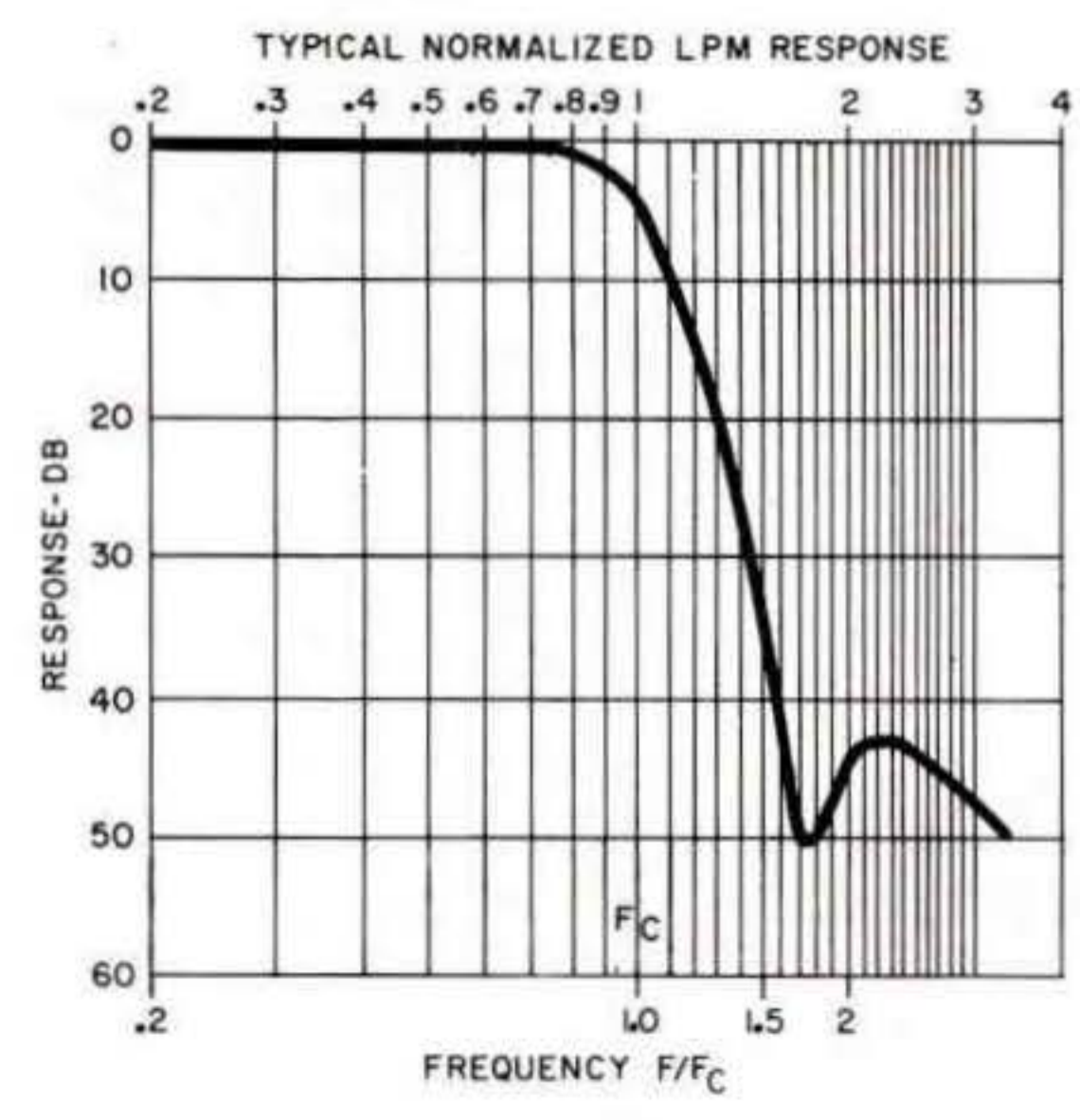
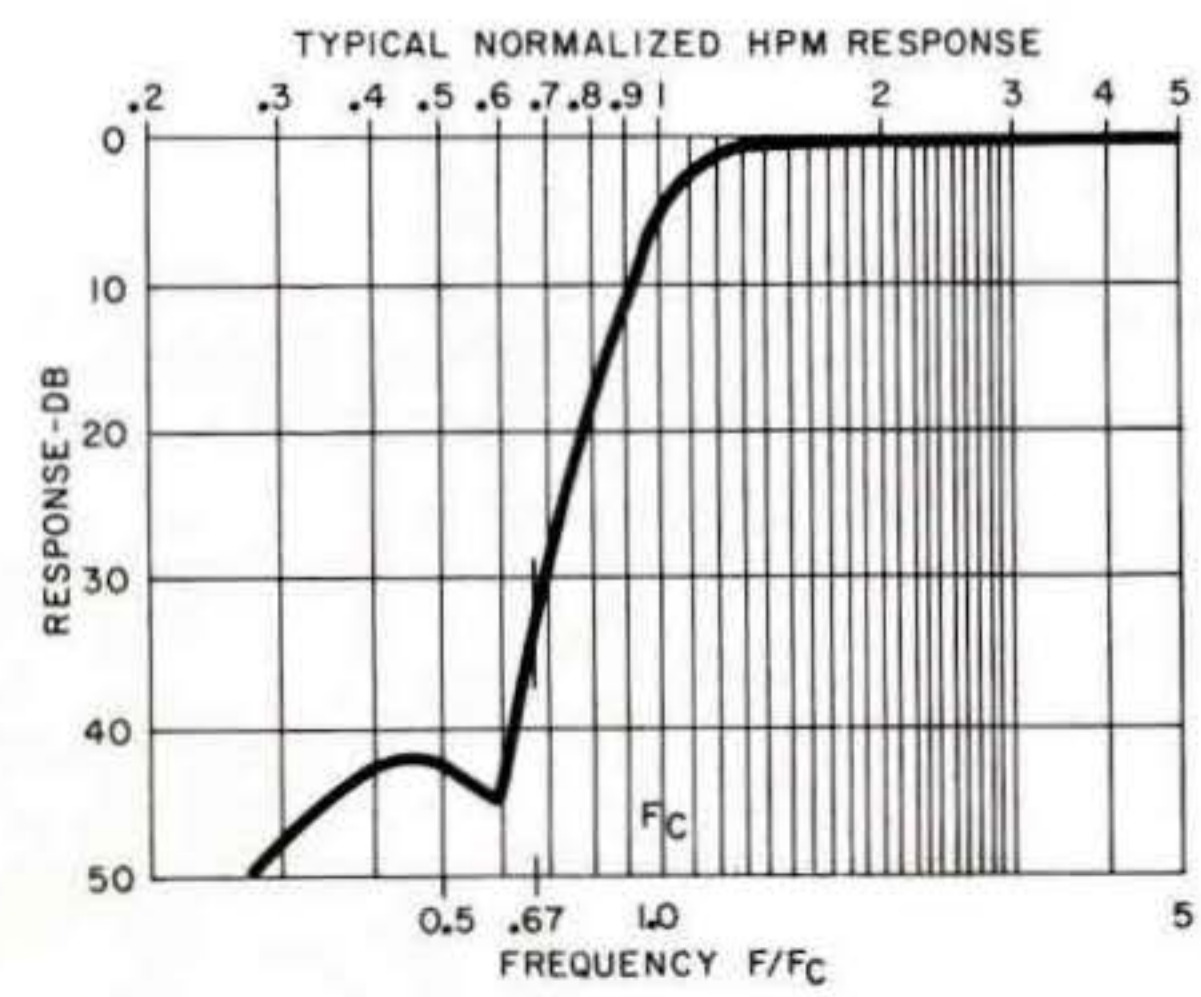



TELEMETERING BAND PASS FILTERS

PACKAGING All hermetically sealed. MNF and MWF units metal cased, epoxy terminal board with pin terminals. TMN and TMW units metal cased with plug-in 4 pin header for Winchester M4S-LS socket.

NOTES The low potential connections (2 & 3 on MNF & MWF, B & C on TMN & TMW) are brought out to individual terminals so that input and output may be used at different DC potentials if desired.

MIL SPECS All to complete MIL-F-18327C Specs. MNF and MWF: FR7RX22ZZ1. TMN and TMW FR4RX22YY1. See pages 86, 87.

IMPEDANCES MNF and MWF 10K ohms source and load. TMN and TMW 100K ohms source and load.

SPECIALS MNF and MWF filters can be obtained with special center frequencies from 400 Hz to 200 kHz.

TELE-MINIFILTER™



**MNF-7.35 thru
MWF-70**
2 3/32" Sq. x 1/2" high
Weight 1/3 oz.



**MNF-4 thru
MNF-5.4**
1 3/16" Sq. x 1/2" high
Weight 1 oz.

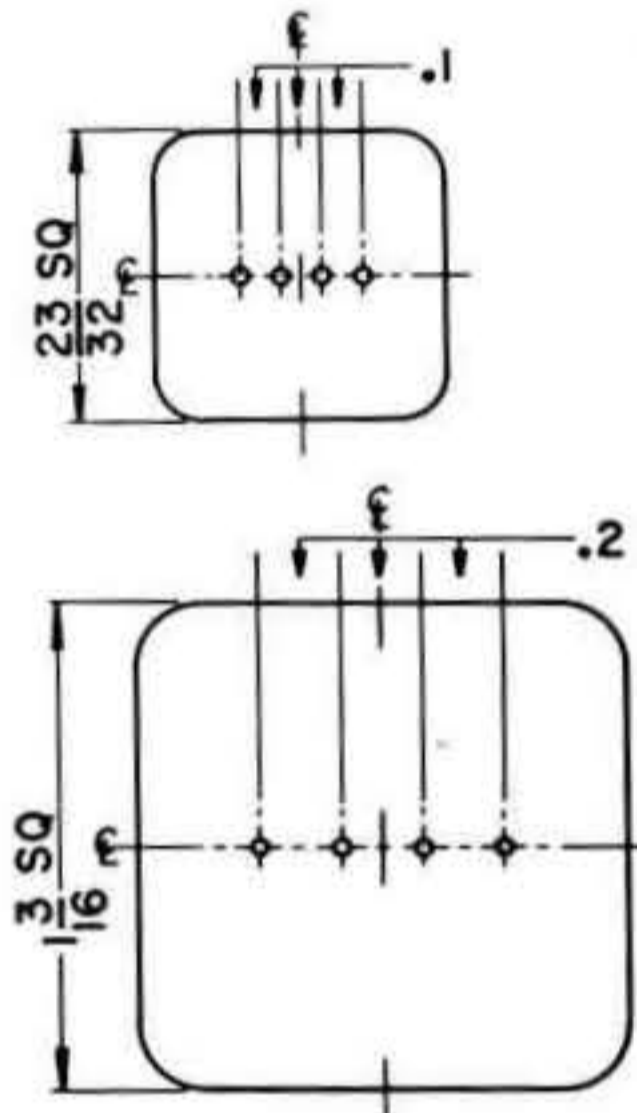

Leads: .025 Dia. x 1"; type N-2, Gold Plated Nickel, MIL-STD-1276

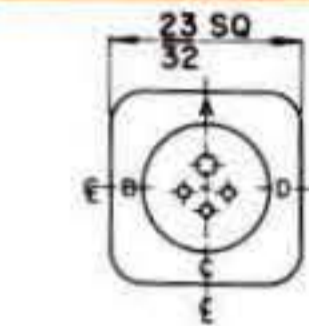

**TMN-2.3 thru
TMW-70**
2 3/32" X 2 3/32" X 1 3/8"
Weight 1.2 oz.

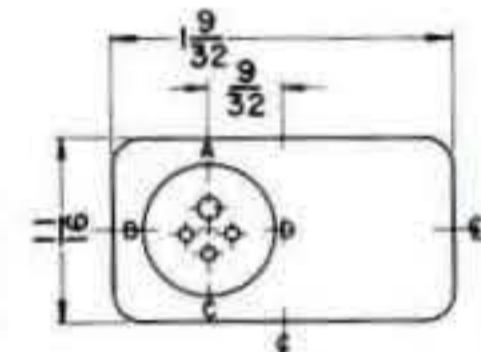

**TMN-4 thru
TMN-1.7**
1 1/8" X 1 1/2" X 2"
Weight 3.5 oz.

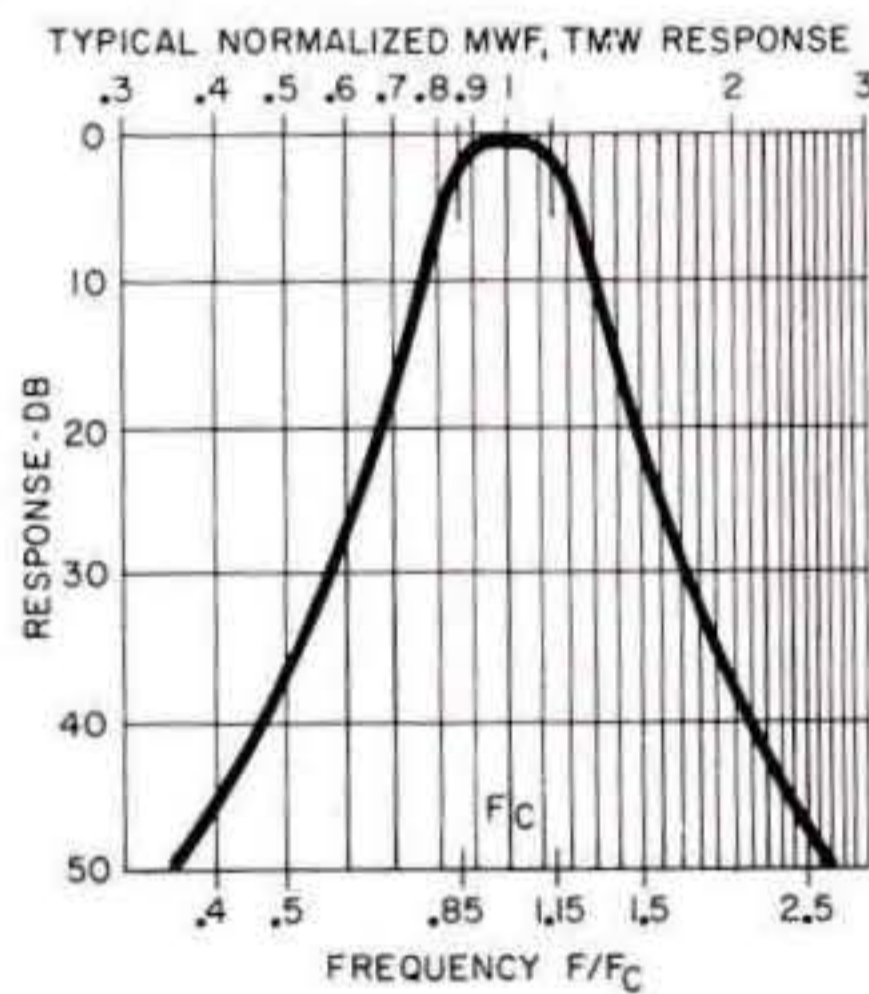
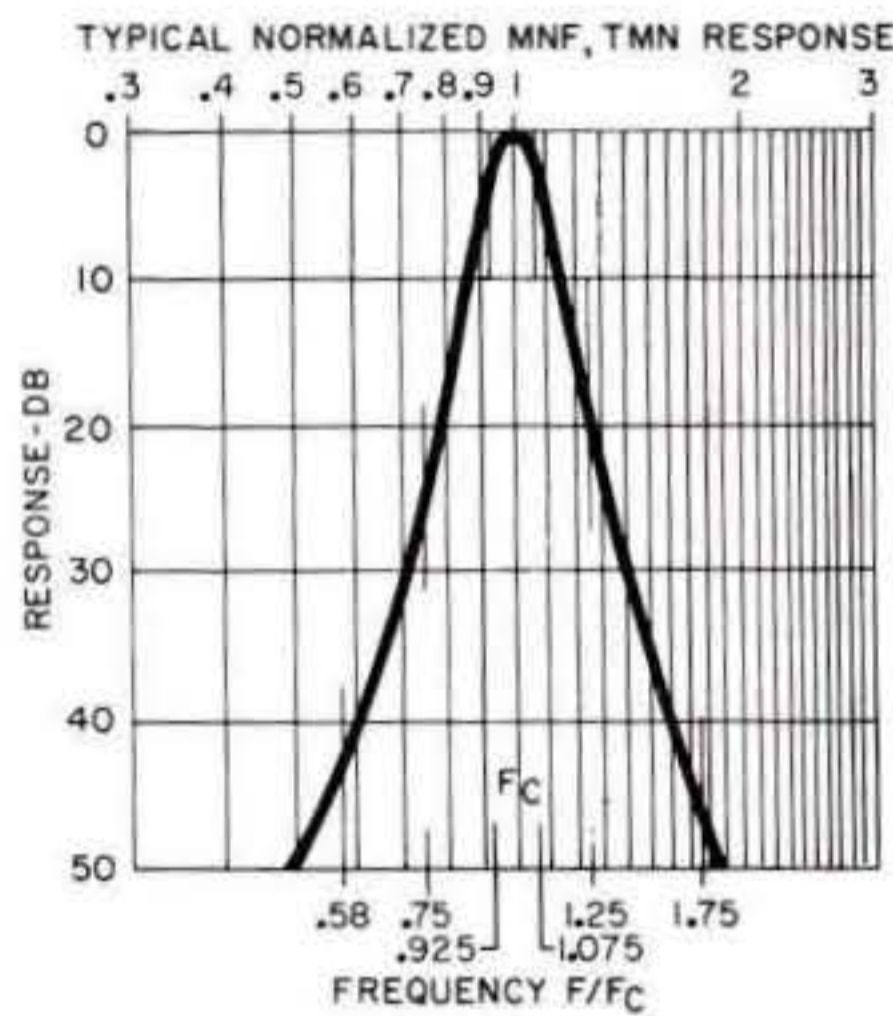

Type No.	Center Frequency (kHz)	Type No.	Center Frequency (kHz)
MNF-.4	.4	MNF-14.5	14.5
MNF-.56	.56	MNF-22	22
MNF-.73	.73	MNF-30	30
MNF-.96	.96	MNF-40	40
MNF-1.3	1.3	MNF-52.5	52.5
MNF-1.7	1.7	MNF-70	70
MNF-2.3	2.3	MWF-22	22
MNF-3.0	3.0	MWF-30	30
MNF-3.9	3.9	MWF-40	40
MNF-5.4	5.4	MWF-52.5	52.5
MNF-7.35	7.35	MWF-70	70
MNF-10.5	10.5		

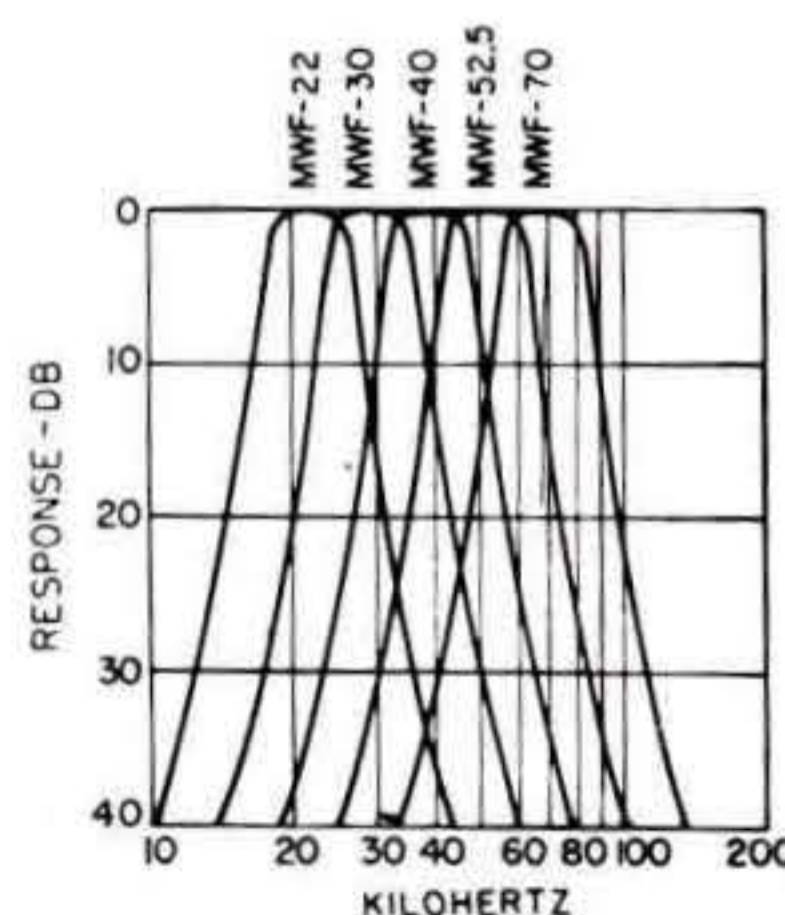
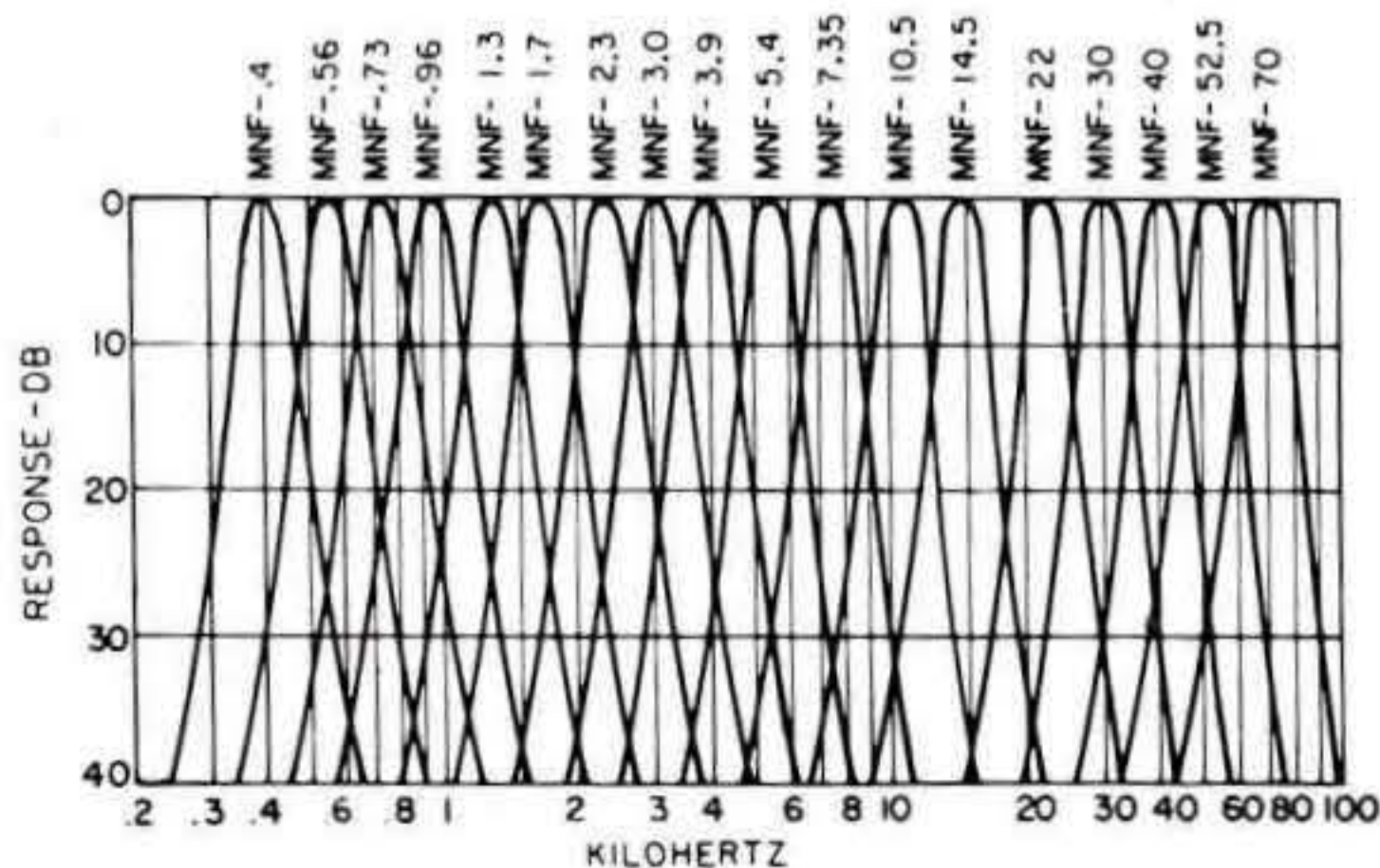

ATTENUATION CHART

Type No.	Pass Band Width (less than 3 db)	Stop Band
MNF	± 7 1/2%	15 db min @ ± 25% 40 db min @ 1.75 Fc .58 Fc
MWF	± 15%	15 db min @ ± 50% 40 db min @ 2.5 Fc .4 Fc
TMN	± 7 1/2%	same as MNF
TMW	± 15%	same as MWF

NOTE: TMN curves are equivalent to MNF's of similar frequency.
Likewise, TMW curves are equivalent to MWF's.



TELEGRAPH TONE CHANNEL FILTERS

PACKAGING Hermetically sealed. Metal cased. Pin terminals to fit subminiature 7-pin socket.

MIL SPECS To complete MIL-F-18327C Specs. Mil Type FR6QX22YY1. See pages 86, 87.

IMPEDANCE 600 ohms source and load.

Types	Pass Band Width (less than 3 db) (Hz)	Stop Band Width Min db @ (Hz) from Fc
Transmitting Types TGT	±42.5	16 @ ±170
Receiving Types TGR	±42.5	30 @ ±170



TGT CASE
1 1/2 x 1 1/2 x 2 1/2"
Mtg.....1 1/8 x 1 1/8"
Screws6-32
Weight.....8 oz.

TGR CASE
1 1/2 x 1 1/2 x 4 1/4"
Mtg.....1 1/8 x 1 1/8"
Screws6-32
Weight.....15 oz.

TRANSMITTING FILTERS

Type No.	Center Frequency (Hz)	Type No.	Center Frequency (Hz)
TGT-425	425	TGT-1955	1955
TGT-595	595	TGT-2125	2125
TGT-765	765	TGT-2295	2295
TGT-935	935	TGT-2465	2465
TGT-1105	1105	TGT-2635	2635
TGT-1275	1275	TGT-2805	2805
TGT-1445	1445	TGT-2975	2975
TGT-1615	1615	TGT-3145	3145
TGT-1785	1785	TGT-3315	3315

RECEIVING FILTERS

Type No.	Center Frequency (Hz)	Type No.	Center Frequency (Hz)
TGR-425	425	TGR-1955	1955
TGR-595	595	TGR-2125	2125
TGR-765	765	TGR-2295	2295
TGR-935	935	TGR-2465	2465
TGR-1105	1105	TGR-2635	2635
TGR-1275	1275	TGR-2805	2805
TGR-1445	1445	TGR-2975	2975
TGR-1615	1615	TGR-3145	3145
TGR-1785	1785	TGR-3315	3315

TYPICAL
RESPONSE
CURVES

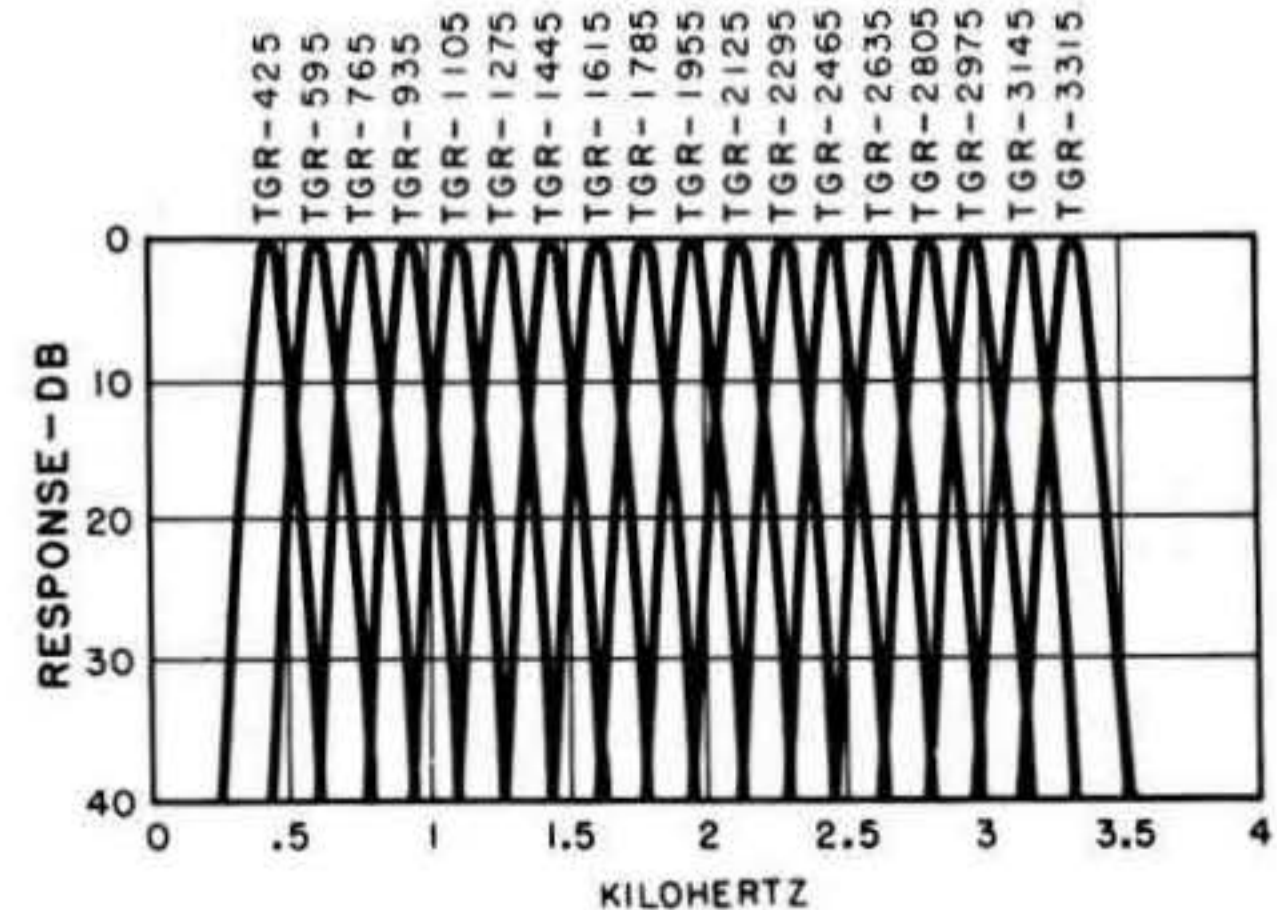
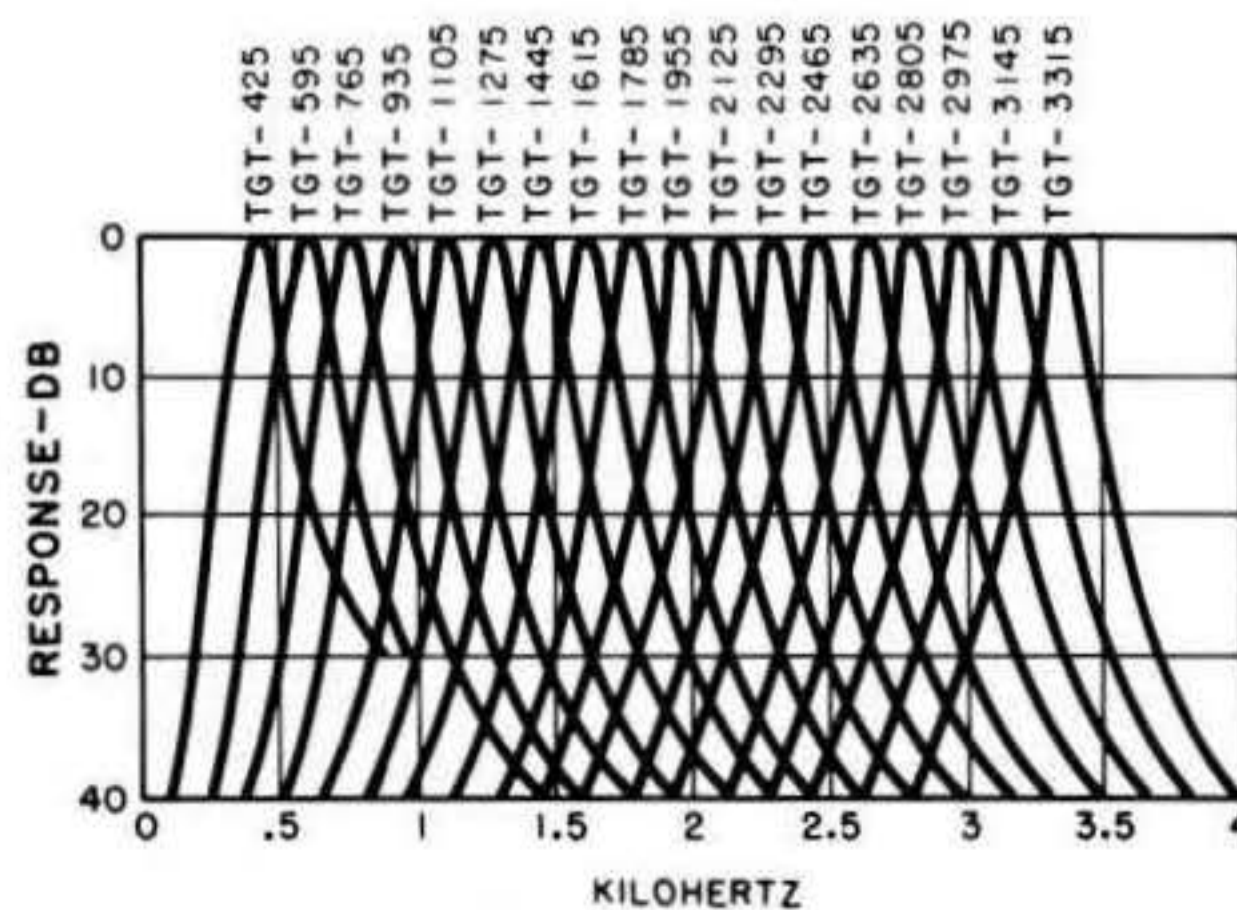



FILTERS—BAND PASS—STANDARD INTERSTAGE and LINE

PACKAGING Hermetically sealed. Metal case. Specially shielded to reduce hum pickup.

MIL SPECS To complete MIL-F-18327C Specs. Mil type FR6RX22YY1. See pages 86, 87.

SPECIALS BMI and BTI units available from 20 Hz to 50 kHz, above 400 Hz smaller size and weight can be obtained by selecting BPM units (see page 76). BML units available from 60 Hz to 50 kHz.

NOTES BMI, BML and BTI filters have a phase slope over the pass band that is essentially linear. For wide band pass filters, the HMI and LMI or HML and LML filters may be connected in tandem. For example, the HMI-200 in tandem with the LMI-4000 will result in a filter flat within 1 db from 250 Hz to 3200 Hz and with an attenuation of 35 db at 133 Hz and 6 kHz. See pages 81 and 82 for LMI, LML, HML and HMI units.

MIL TYPE FR6RX22YY1

Type No.	Source Ω	Load Ω	Gain
BMI	10K	Grid	2:1
BML	500/600	Grid	9:1
BTI	10K	10K	—

Type No.	Center Frequency (Hz)	Pass Band (less than 2 db) (Hz)	Stop Band	
			Below (Hz)	Above (Hz)
BMI-30	30	29.1-30.9	15	60
BMI-50	50	48.5-51.5	25	100
			(more than 35 db)	
BMI-60	60	58.2-61.8	30	120
BMI-90	90	87.0-93.0	45	180
BMI-100	100	97.0-103	50	200
BMI-120	120	116.4-123.6	60	240
BMI-150	150	145.5-154.5	75	300
BMI-200	200	194-206	100	400
BMI-240	240	233-247	120	480
BMI-300	300	291-309	150	600
BMI-400	400	388-412	200	800
BMI-500	500	485-515	250	1000
BMI-750	750	727.5-772.5	375	1500
BMI-800	800	776-824	400	1600
BMI-1000	1000	970-1030	500	2000
BMI-1500	1500	1455-1545	750	3000
BMI-2000	2000	1940-2060	1000	4000
BMI-3000	3000	2910-3090	1500	6000
BMI-4000	4000	3880-4120	2000	8000
BMI-5000	5000	4850-5150	2500	10000
BMI-10000	10000	9700-10300	5000	20000
BML-400	400	388-412	200	800
BML-1000	1000	970-1030	500	2000
			(more than 35 db)	
BTI-60	60	58.2-61.8	30	120
BTI-100	100	97.0-103	50	200
BTI-120	120	116.4-123.6	60	240

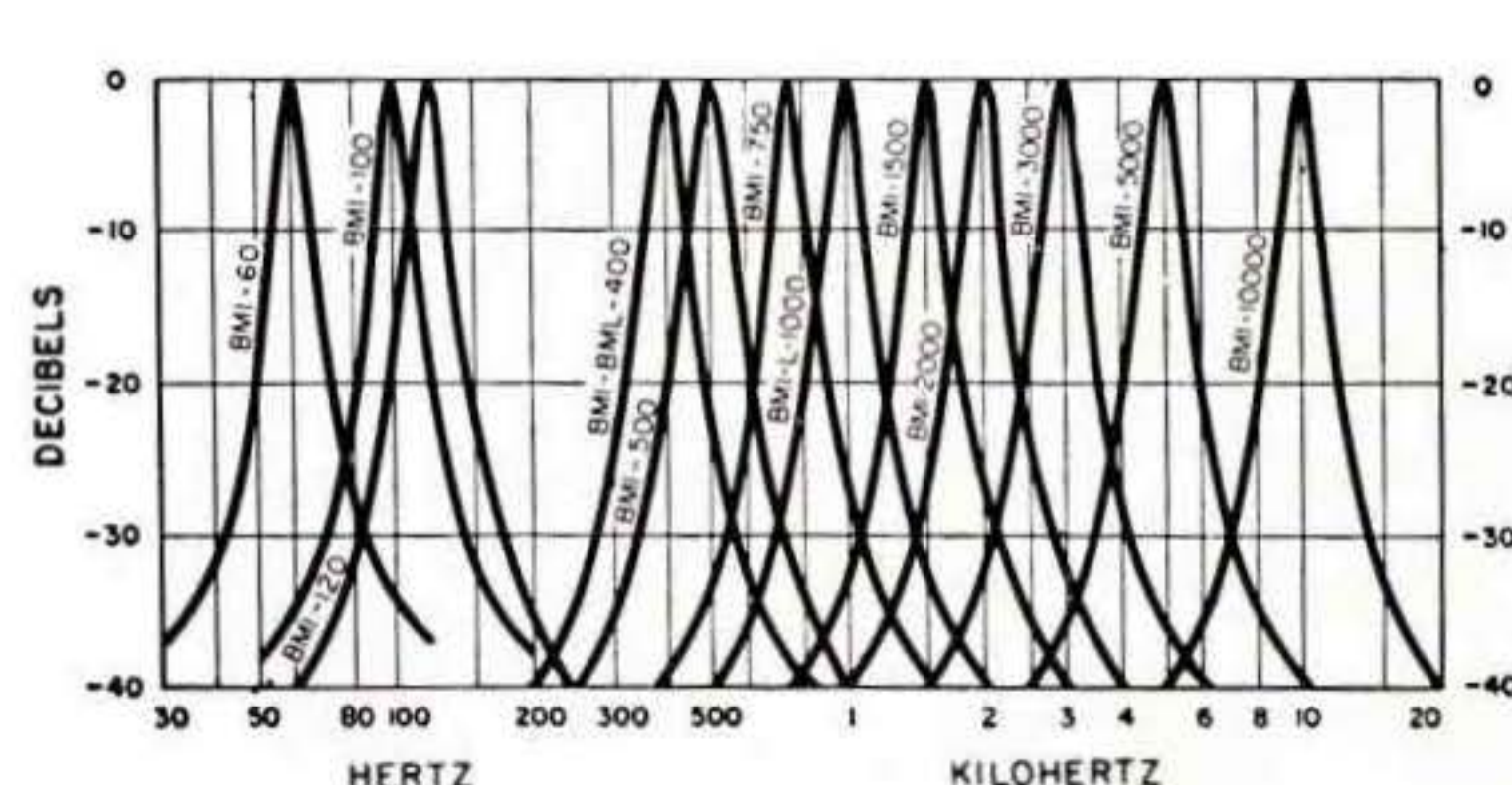
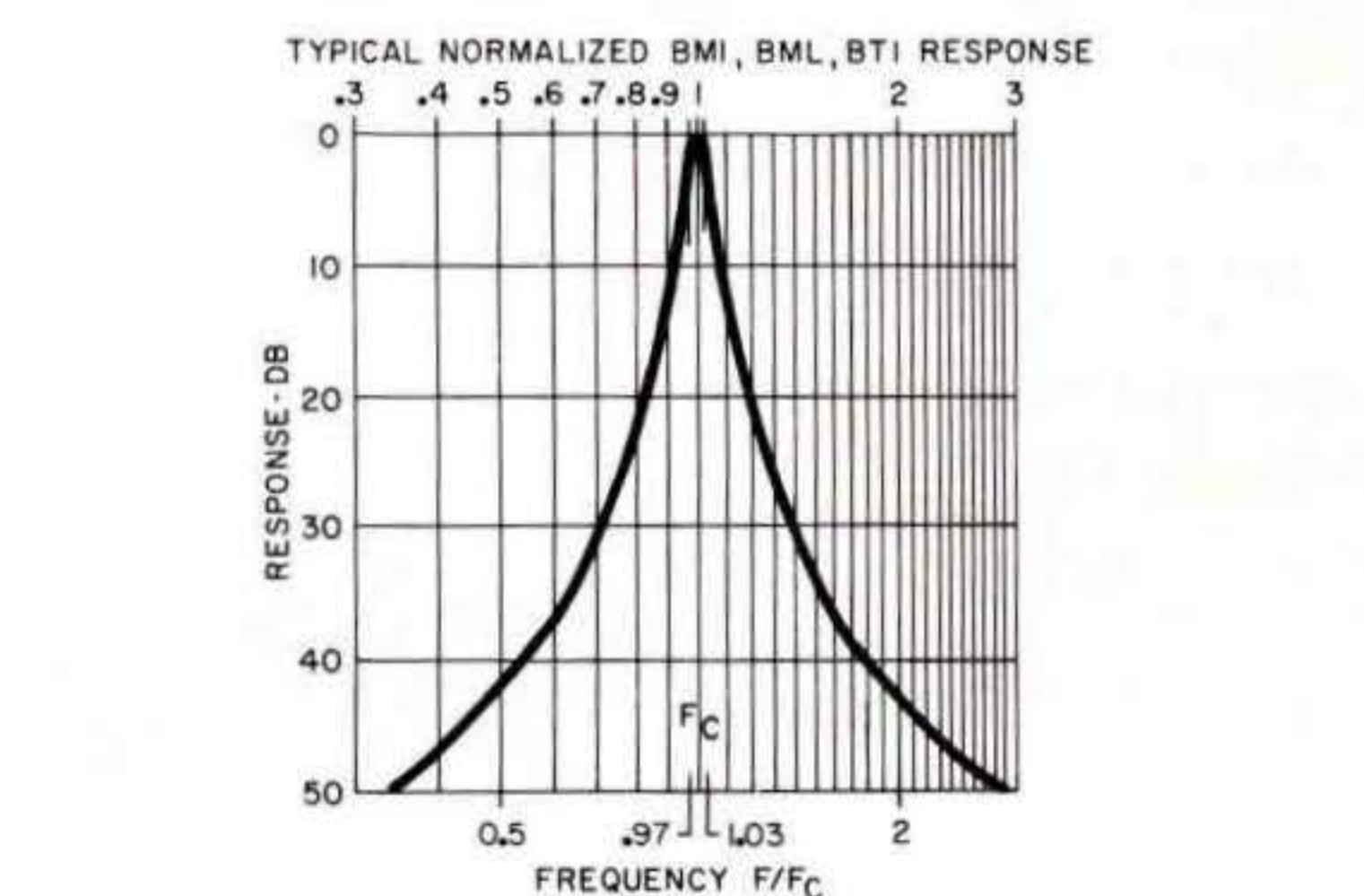
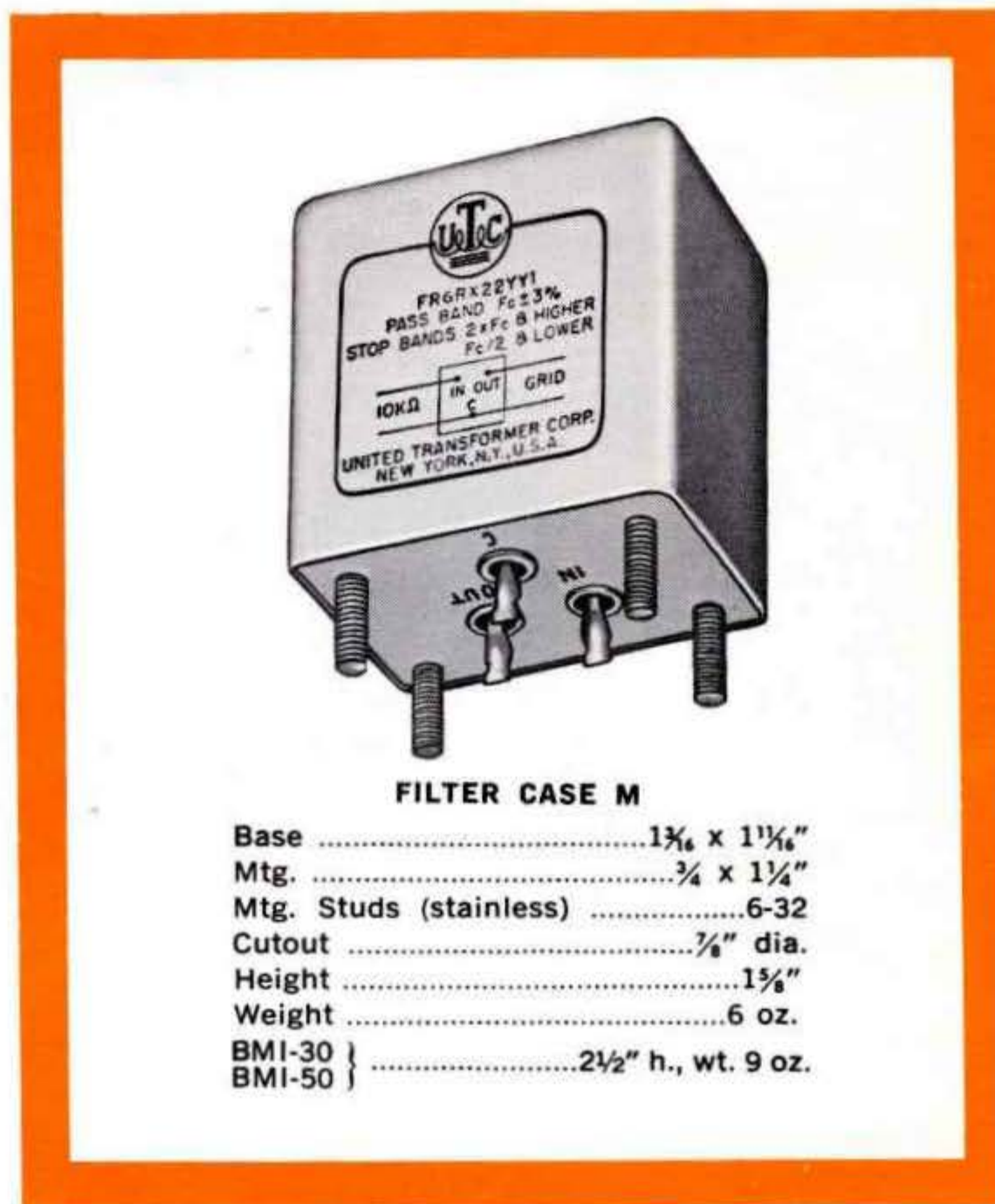



FILTERS—LOW PASS—STANDARD INTERSTAGE and LINE

PACKAGING Hermetically sealed. Metal encased. Specially shielded to reduce hum pickup.

MIL SPECS To complete MIL-F-18327C Specs. Mil type FR6RX11YY1. See pages 86, 87.

SPECIALS LMI units available from 50 Hz to 25 kHz, for frequencies above 200 Hz, smaller size and weight can be obtained by selecting LPM units (see page 77). LML units available from 500 Hz to 100 kHz.

NOTE LMI and LML filters have a phase slope that is essentially linear in the pass band up to .67 cutoff frequency.

Type No.	Pass Band (less than 6 db) DC to: (Hz)	Stop Band min. db @ (Hz)	
LMI-50	50	30	75
		40	100
LMI-100	100	30	150
		40	200
LMI-150	150	35	225
		40	300
LMI-200	200	35	300
		40	400
LMI-400	400	35	600
		40	800
LMI-500	500	35	750
		40	1000
LMI-800	800	35	1200
		40	1600
LMI-1000	1000	35	1500
		40	2000
LMI-1500	1500	35	2250
		40	3000
LMI-2000	2000	35	3000
		40	4000
LMI-2500	2500	35	3750
		40	5000
LMI-3000	3000	35	4500
		40	6000
LMI-4000	4000	35	6000
		40	8000
LMI-5000	5000	35	7500
		40	10000
LMI-10000	10000	35	15000
		40	20000
LML-500	500	35	750
		40	1000
LML-1000	1000	35	1500
		40	2000
LML-1500	1500	35	2250
		40	3000
LML-2000	2000	35	3000
		40	4000
LML-2500	2500	35	3750
		40	5000
LML-3000	3000	35	4500
		40	6000
LML-4000	4000	35	6000
		40	8000
LML-8000	8000	35	12000
		40	16000
LML-10000	10000	35	15000
		40	20000
LML-12000	12000	35	18000
		40	24000

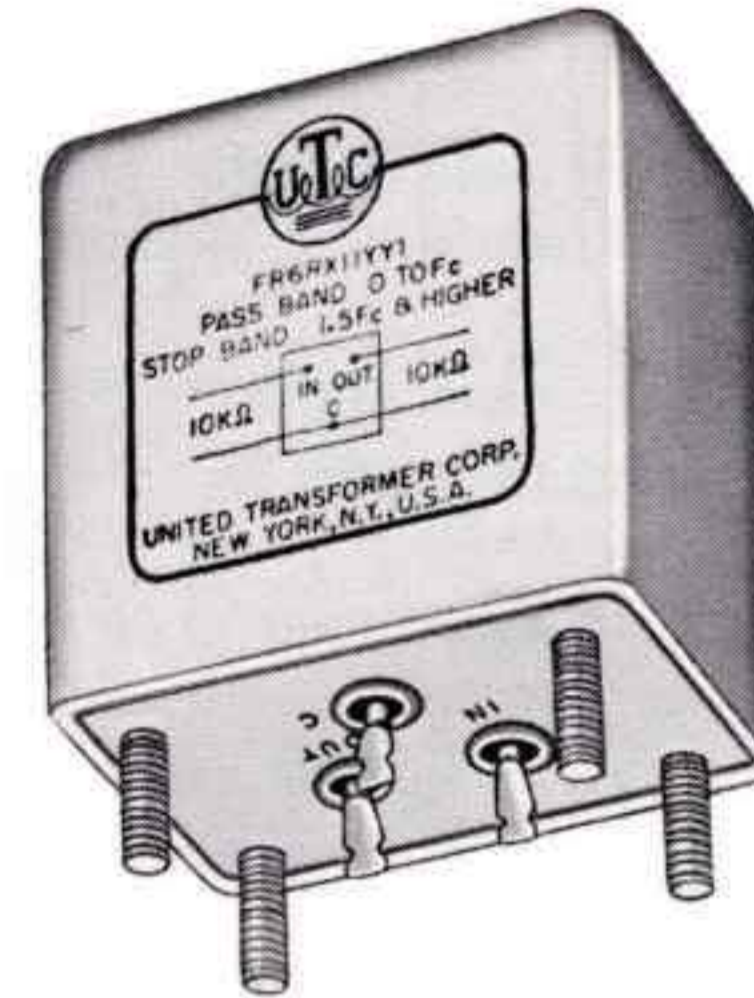

FILTER CASE M

Base1 1/8 x 1 1/8"
Mtg.3/4 x 1 1/4"
Mtg. Studs (stainless)6-32
Cutout7/8" dia.
Height, LMI1 1/4"
Height, LML2 1/2"
Weight6 oz. and 9 oz.
LMI 50 & 1002 1/2" h., wt. 9 oz.

MIL TYPE FR6RX11YY1

Type	Source Ω	Load Ω
LMI	10K	10K
LML	500/600	500/600

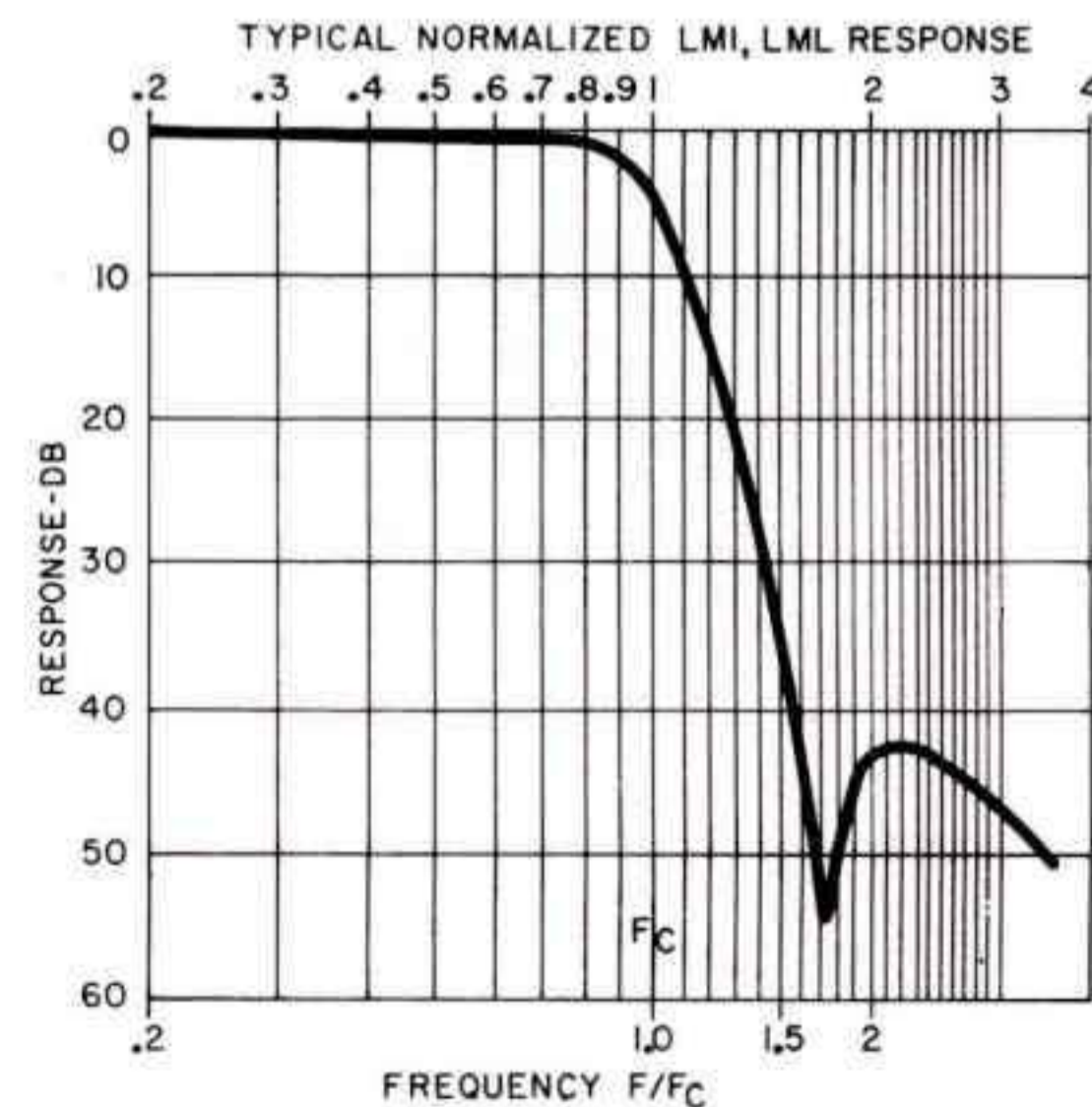



FILTERS—HIGH PASS—STANDARD INTERSTAGE and LINE

PACKAGING Hermetically sealed. Metal encased. Specially shielded to reduce hum pickup.

MIL SPECS To complete MIL-F-18327C Specs. Mil type FR6RX33YY1. See pages 86, 87.

SPECIALS HMI units available from 30 Hz to 25 kHz, for frequency above 500 Hz, smaller size and weight can be obtained by selecting HPM units (see page 77). HML units available from 30 Hz to 100 kHz.

Type No.	Pass Band (less than 6 db) (Hz) & Above	Stop Band min. db @ (Hz)	
HMI-50	50	30	33.4
		40	25.0
HMI-100	100	35	66.7
		40	50.0
HMI-200	200	35	133
		40	100
HMI-300	300	35	200
		40	150
HMI-400	400	35	267
		40	200
HMI-500	500	35	333
		40	250
HMI-800	800	35	533
		40	400
HMI-1000	1000	35	667
		40	500
HMI-2000	2000	35	1333
		40	1000
HMI-3000	3000	35	2000
		40	1500
HML-40	40	30	26.8
		40	20.0
HML-200	200	35	133
		40	100
HML-300	300	35	200
		40	150
HML-500	500	35	333
		40	250
HML-1000	1000	35	667
		40	500

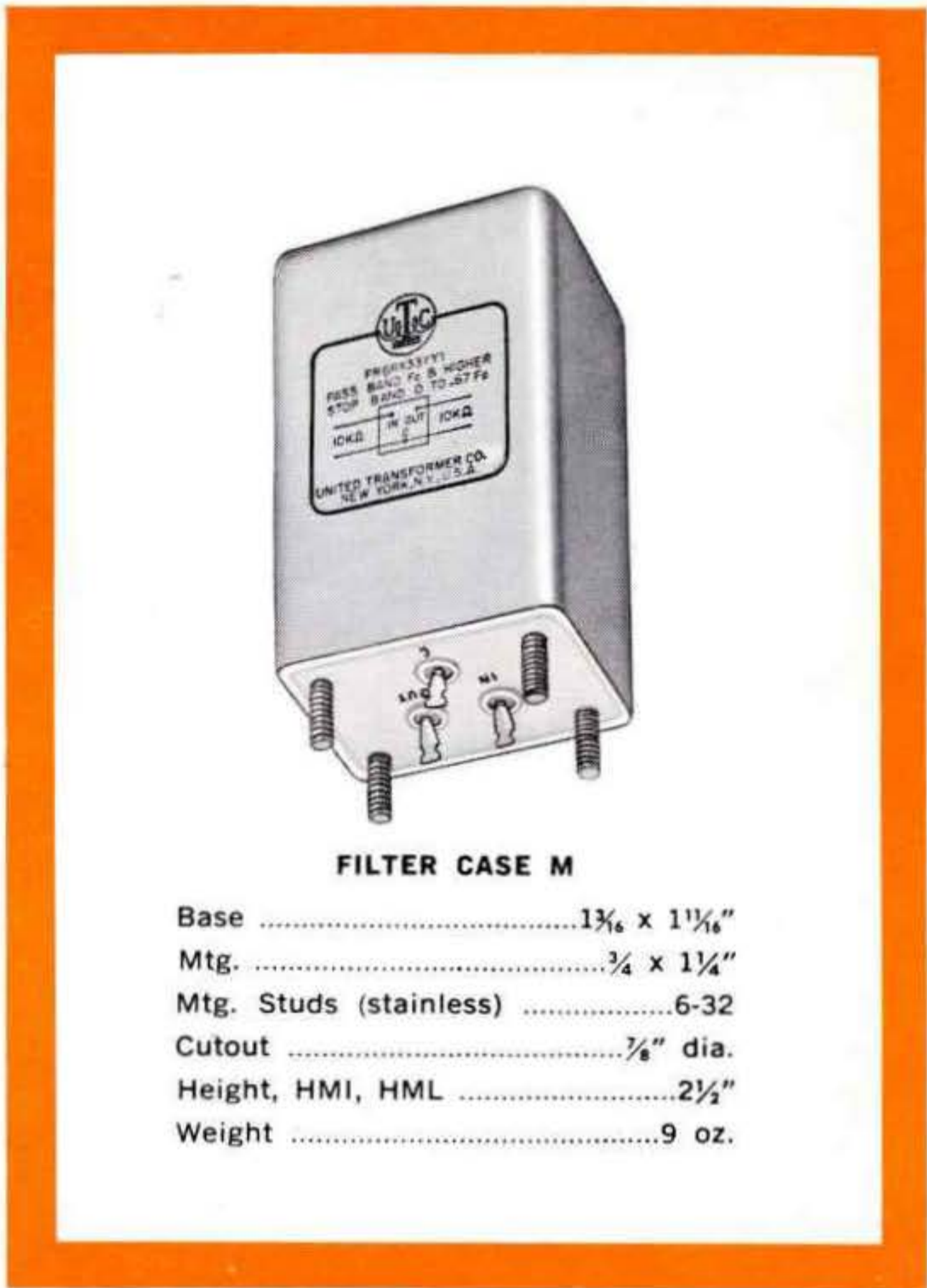

FILTER CASE M

- Base 1 1/8" x 1 1/8"
- Mtg. 3/4" x 1 1/4"
- Mtg. Studs (stainless) 6-32
- Cutout 7/8" dia.
- Height, HMI, HML 2 1/2"
- Weight 9 oz.

Type	Source	Load
HMI	10K Ω	10K Ω
HML	500/600 Ω	500/600 Ω

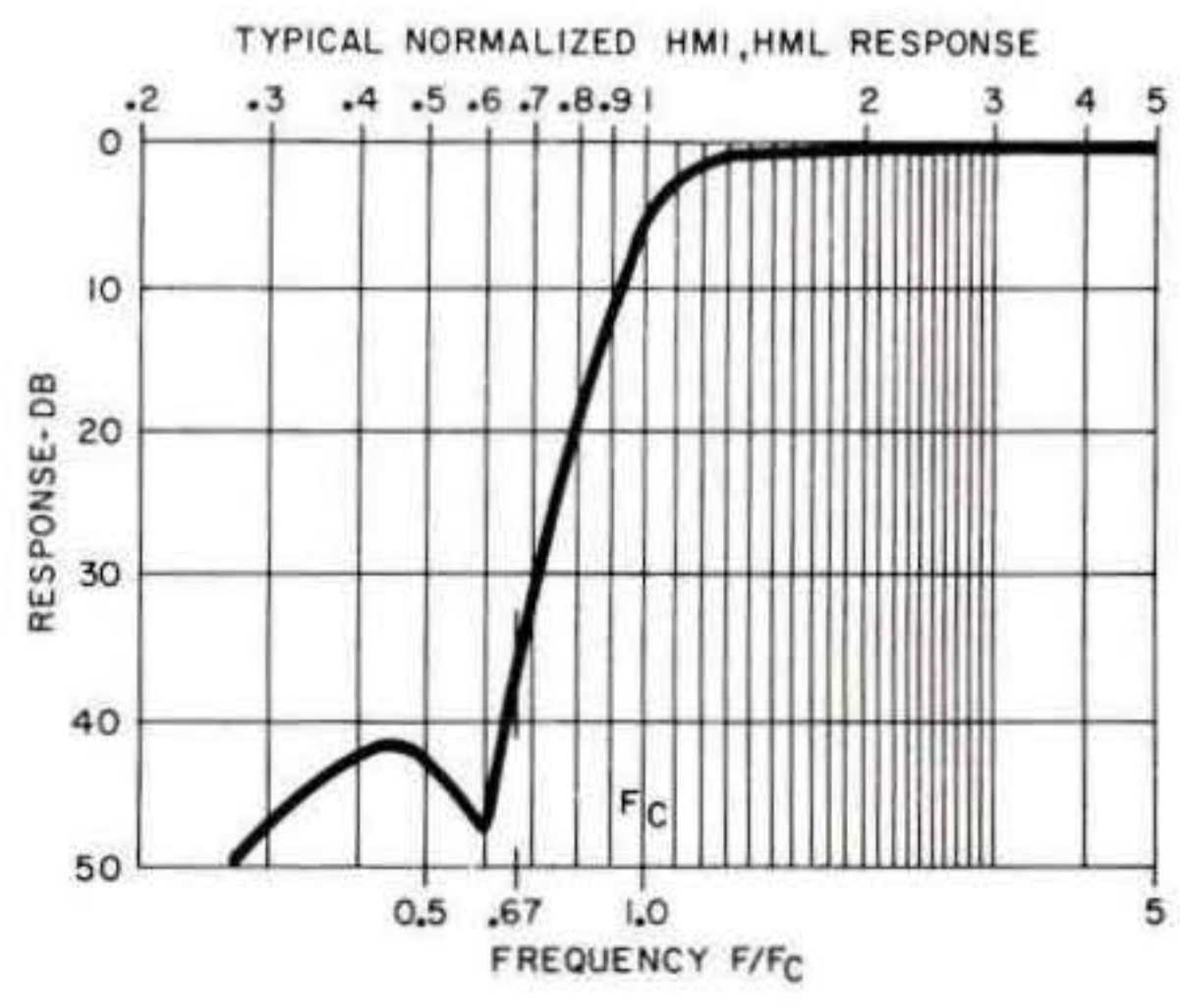



LOW FREQUENCY FILTERS

Hermetically sealed, metal encased, to complete MIL-F-18327C specs. See pages 86, 87.
NOTE: Other cutoff frequencies available on special order.

10 Hz BAND PASS or BAND REJECT FILTER

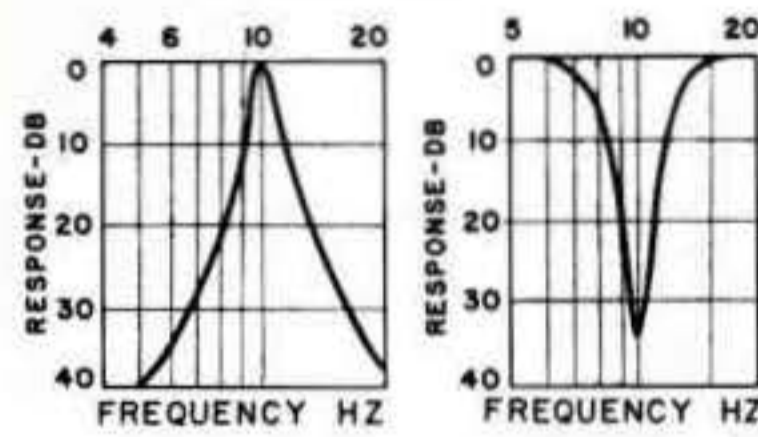

MIL FB CASE



Base $2\frac{1}{16} \times 2\frac{5}{16}$ "
Mtg. $1\frac{1}{8} \times 1\frac{11}{16}$ "
Mtg. Stud $6-32 \times \frac{3}{8}$
Height $2\frac{1}{2}$ "
Weight $1\frac{1}{4}$ lbs.

LOW PASS FILTERS

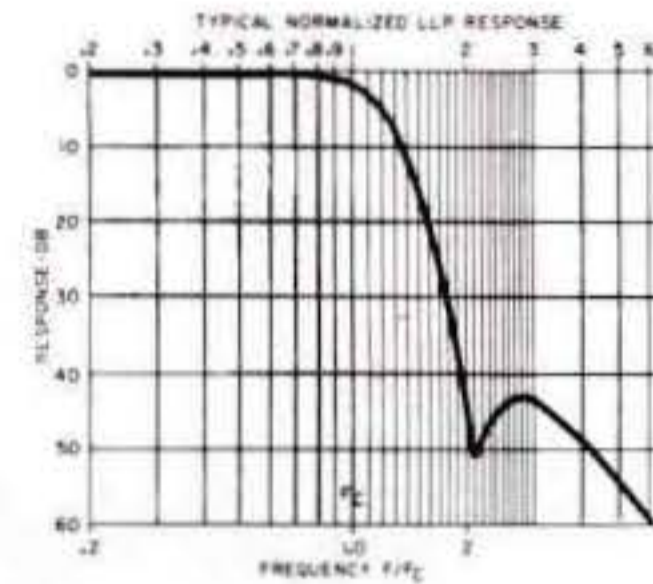

MIL FA CASE



Base $2\frac{1}{16} \times 2\frac{5}{16}$ " ; Height $3\frac{1}{8}$ " ; Weight $1\frac{1}{2}$ lbs.
Mtg. $1\frac{7}{16} \times 1\frac{11}{16}$ " ; Mtg. Studs 6-32 ; Cutout $\frac{3}{8} \times 1$ "

TYPE No. LBP-10 MIL TYPE FR6RX22FB1

At All Applications Listed Below:

SOURCE-10K Ω ; CENTER FREQUENCY-10 Hz

Appli- cation	Load Ω	In- put	Terminals Com.	Out- put	Pass Band (< 3 db) (Hz)	Stop Band Min. db @ (Hz)
Band Pass	10K	1	2	3	9.6-10.4	30 5 & 20
Band Pass	3.3 Meg	1	2	4	9.6-10.4	35 5 & 20
Band Reject	50K	4	1	3	DC-7 14-36K	30 10

MIL TYPE FR6RX11FA1

Type No.	Source and Load	Pass Band (less than 3db) DC to: (Hz)	Stop Band (more than 40db) (Hz)
LLP-10	100K Ω	10	20
LLP-15	100K Ω	15	30



400 Hz 115 V LINE FILTERS

PLF-25 25 Watt 115 V 400 Hz

Intended for use on 115 volt 400 Hz line to eliminate harmonic distortion. The PLF-25 operating from the 115 volt line into a 500 ohm load will give 115 volt output at 400 Hz, will be within ± 1 db from 375 to 425 Hz and will attenuate 800 Hz by 30 db, 1200 Hz and higher by at least 50 db. Hermetically sealed, metal encased, to complete MIL-F-18327C specs. MIL type FR4RX11NB1. See pages 86, 87.

PLP-13 13 Watt 115 V 400 Hz

Intended for use on 115 volt 400 Hz line to eliminate harmonic distortion, reject 60 and 120 Hz, and give zero phase shift at 400 Hz. The PLP-13 operating from the 115 volt line into a 1000 ohm load will give 115 volt output at 400 Hz, will be within ± 1 db from 375 to 425 Hz, will attenuate 800 Hz by 15 db, 1200 Hz by 45 db, frequencies above 1200 Hz by at least 35 db, 120 Hz by 20 db, and 60 Hz by 30 db. Hermetically sealed, metal encased, to complete MIL-F-18327C specs. MIL Type FR4RX22LB1. See pages 86, 87.

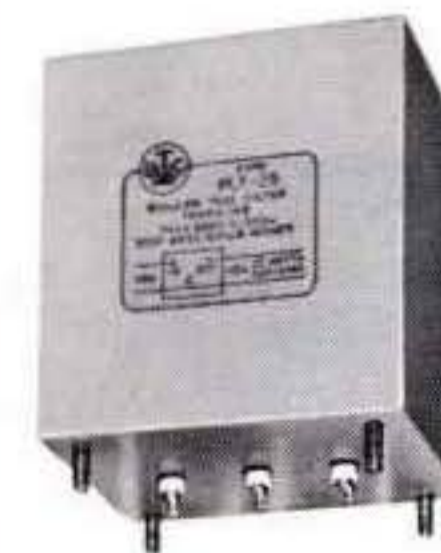

PLF-25

Base $4\frac{5}{16} \times 5\frac{1}{16}$ "
Mtg. $3\frac{5}{16} \times 4\frac{1}{16}$ "
Mtg. Studs $\frac{1}{4}-20 \times \frac{5}{8}$ "
Cutout $1\frac{1}{8} \times 3\frac{1}{8}$ "
Heights $5\frac{1}{2}$ "
Weight 10 lbs.



PLP-13

Base $3\frac{11}{16} \times 4\frac{3}{16}$ "
Mtg. $2\frac{11}{16} \times 3\frac{3}{16}$ "
Mtg. Studs $10-32 \times \frac{1}{2}$ "
Cutout $1\frac{1}{8} \times 2\frac{1}{8}$ "
Height $4\frac{1}{2}$ "
Weight $6\frac{1}{2}$ lbs.



**SPECIAL CUSTOM BUILT FILTERS
TO YOUR SPECIFICATIONS**

Almost forty years of experience in the design and production of special filters have resulted in UTC being a first source for difficult units. Present designs incorporate a wide variety of core structures, winding methods, and capacitors to provide maximum performance, stability, and reliability. Stock items are covered on the preceding pages. The units illustrated

below and on the facing page are intended to show some of the thousands of special units produced by UTC and to provide the equipment engineer with a concept of the possibilities in present special components. Range of frequencies on special units is from DC to 30 MHz.

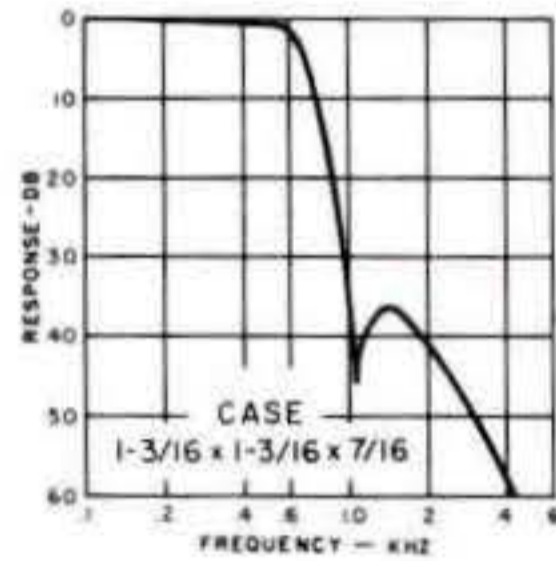
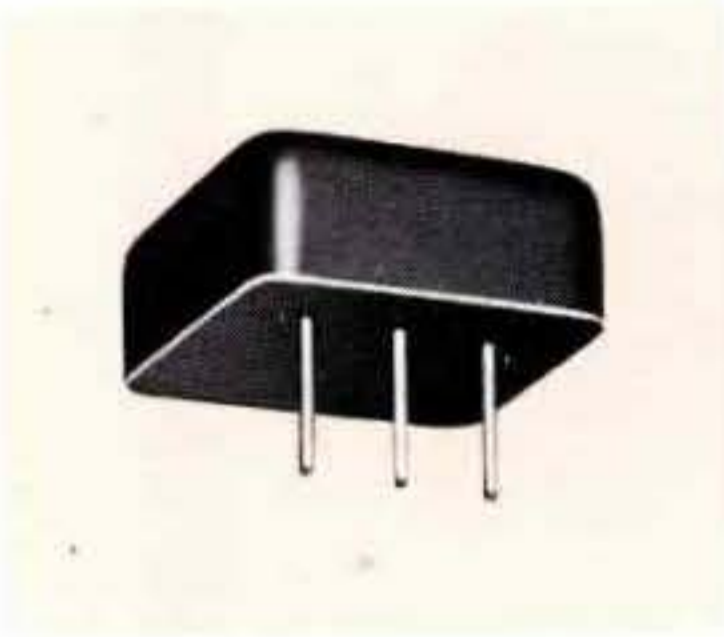

Telemetry low pass filter 560 Hz. Available from 400 Hz to 70 kHz. $\pm 7.5\%$ bandwidth flat to 1 db. Attenuation greater than 35 db beyond the 2nd harmonic of -7.5% frequency. Impedance 47K ohms. MIL-F-18327C. Wt. 0.8 oz.

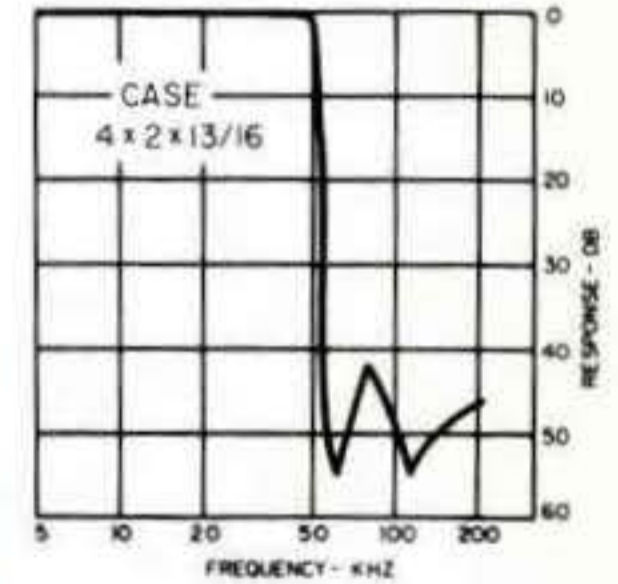
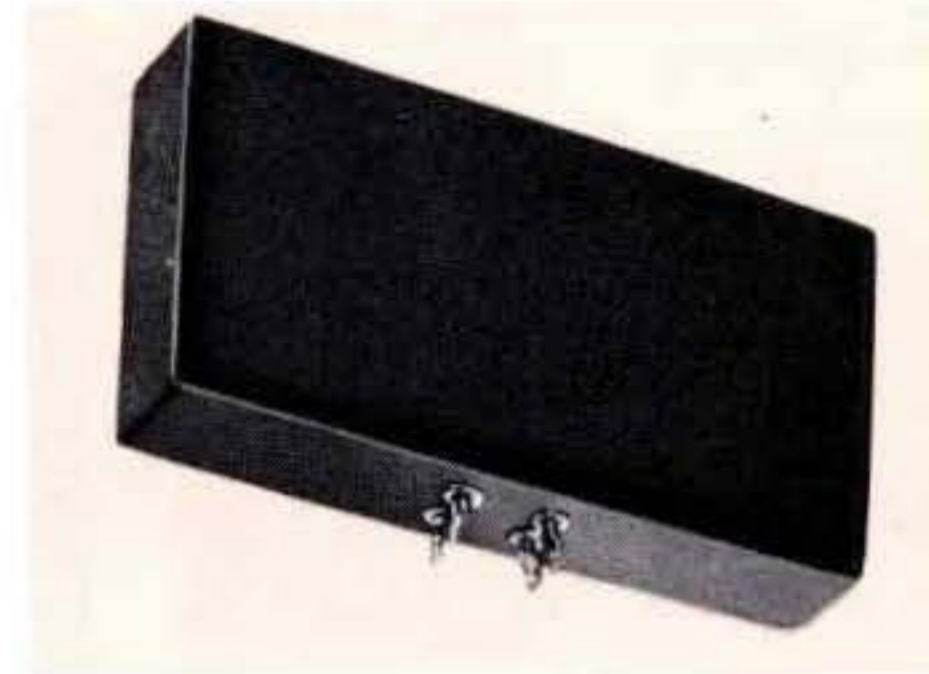

Sharp cutoff 49 kHz low pass filter. Stable to .1 db in pass band from 0°C. to 85°C. Within 1 db 5 kHz to 49 kHz, over 40 db at 56 kHz. MIL-F-18327C; .6 lbs.

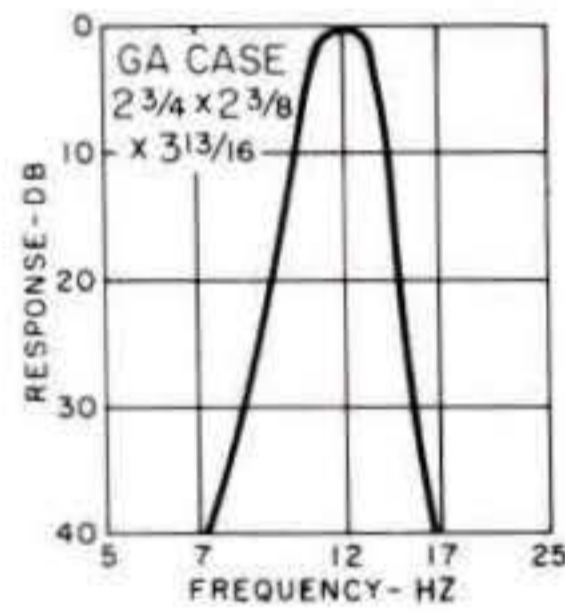
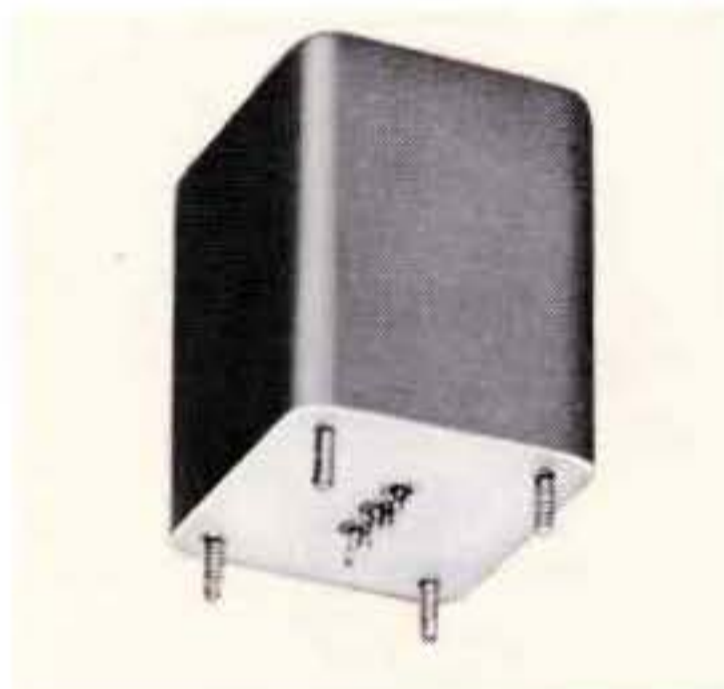

Twelve Hz band pass filter. From 11 thru 13 Hz attenuation less than 2 db. At 7 Hz and at 17 Hz, attenuation greater than 40 db. Source and load 50K ohms. MIL-F-18327C. Wt. 2.5 lbs.

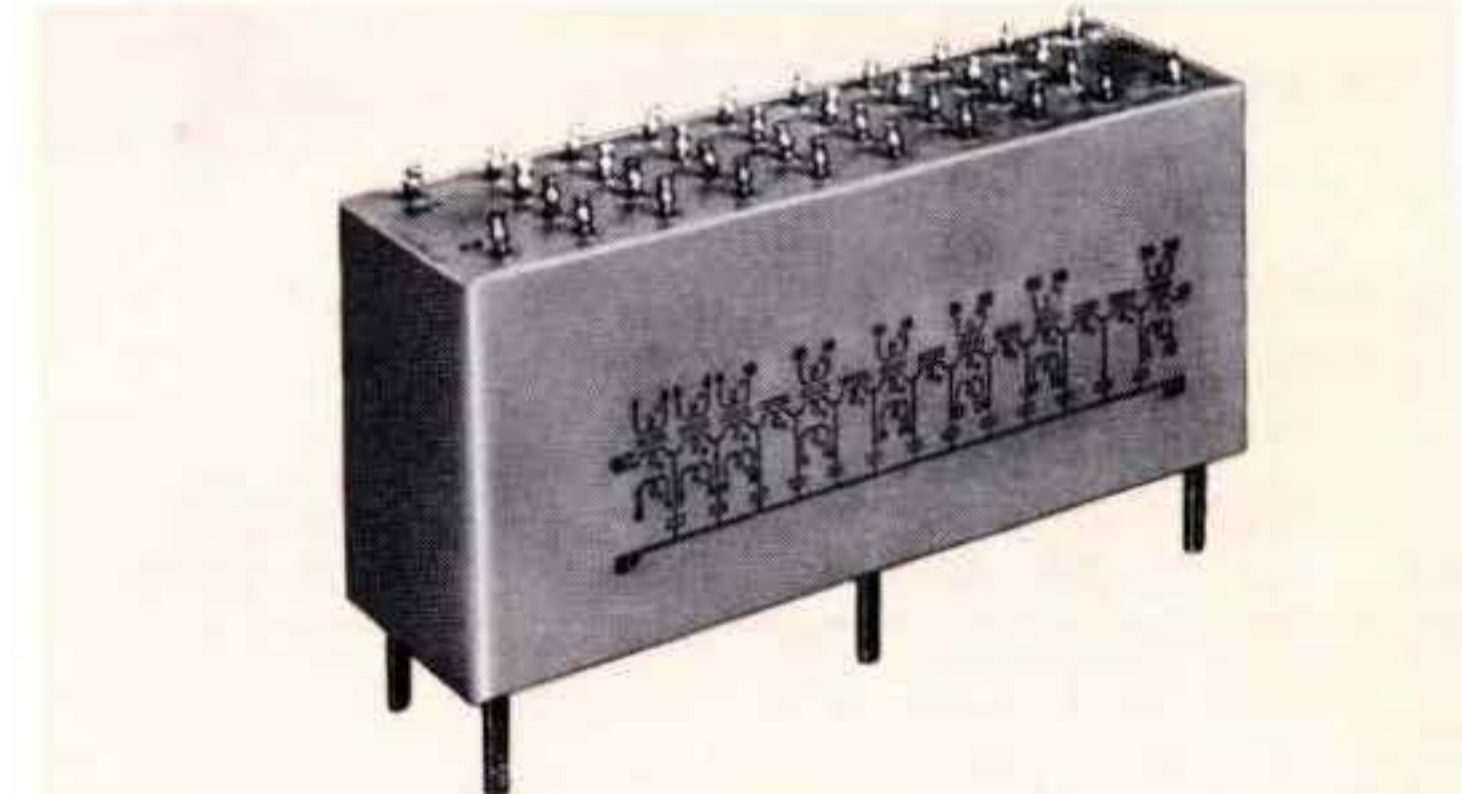

Lumped constant delay line. 15 kHz. Impedance 600 ohms. Balanced outputs tapped for delays from 27 microseconds to 118 microseconds. Delay tolerance $\pm 1\%$. MIL-F-18327C.

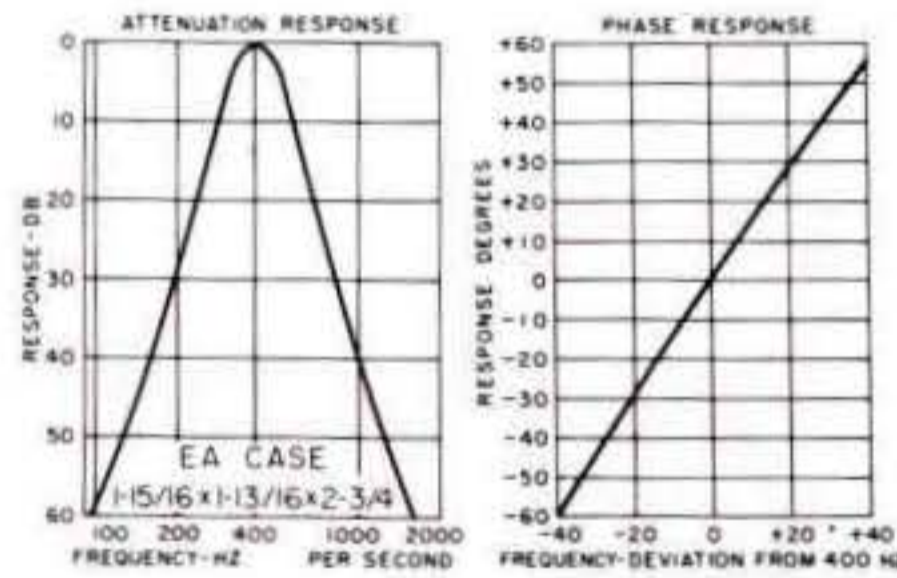
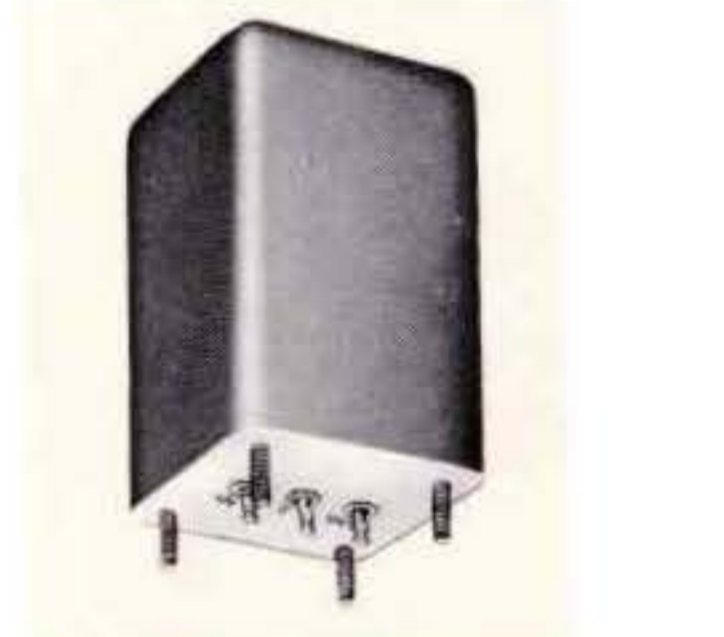

Band pass 400 Hz Gaussian filter. Linear phase response in pass band. Attenuation 380 Hz to 420 Hz within 0.5 db. 2nd harmonic down 25 db, 3rd harmonic down 45 db. Source and load 5K ohms. MIL-F-18327C. Wt., 0.9 lbs.

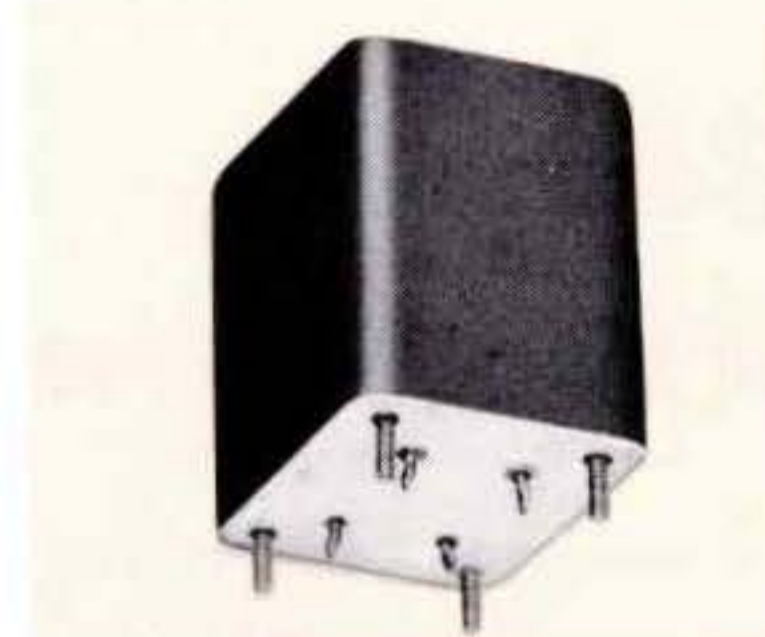

Constant phase shift band pass filter, 400 Hz. 380 Hz to 420 Hz within ± 0.2 degrees and within ± 0.5 db. At least 5 db at 800 Hz, 40 db at 1200 Hz and other harmonics of 400 Hz. Harmonic distortion less than 0.3%. Source 200 ohms, load 100 K ohms. MIL-F-18327C. FA CASE, $2\frac{1}{8} \times 2\frac{3}{8} \times 3\frac{1}{8}$ ". Wt. approx. 1 lb.

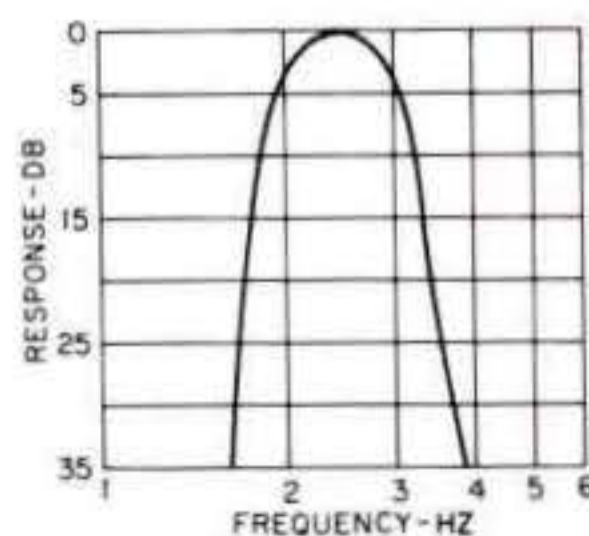
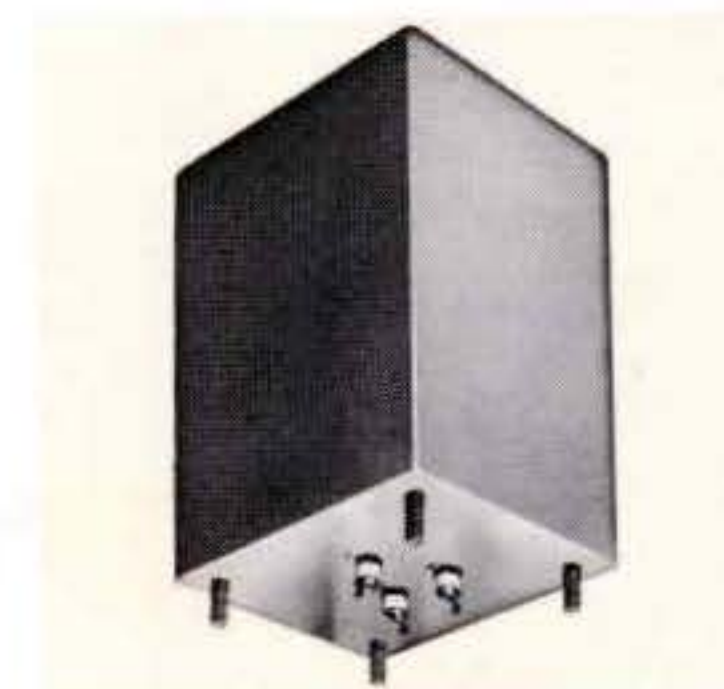

Low frequency band pass filter. From 2 to 3 Hz within 3 db. At 1.5 Hz and lower, and 4 Hz and higher, greater than 30 db. Source and load 10K ohms. MIL-F-18327C. Wt. $12\frac{3}{4}$ lbs. MA case, $4 \times 4\frac{1}{8} \times 6$ ".

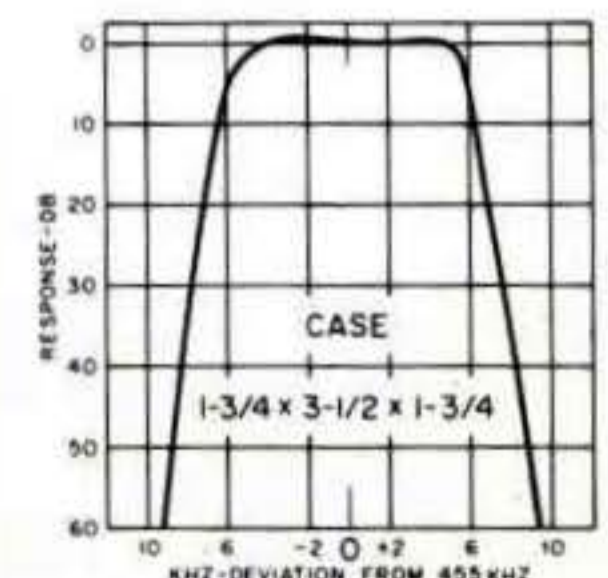
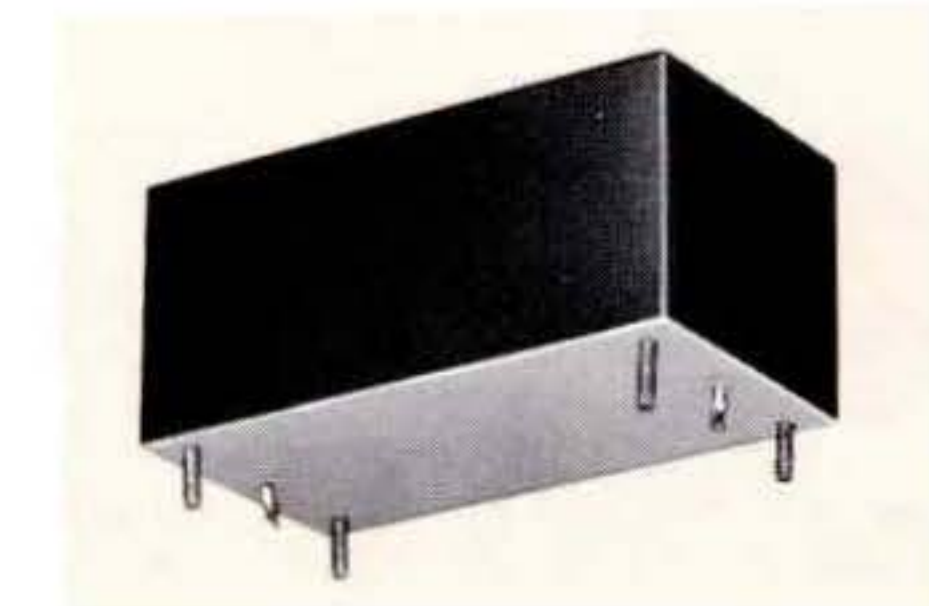

Crystal filter, 455 kHz. Source 70 ohms, load 5K ohms, 6 db bandwidth, 11 kHz minimum. Shape factor 60 db BW/6 db BW = 1.75/1. Max. ripple 1 db, Wt. 0.5 lbs.



**SPECIAL CUSTOM BUILT FILTERS
TO YOUR SPECIFICATIONS**



High frequency Mini-filters, .33 oz. MIL-F-18327C Grade 5.

Band Pass
3 db from
95 kHz to
145 kHz.
Down 40 db
below 60 kHz,
30 db above
375 kHz.
15K ohms.

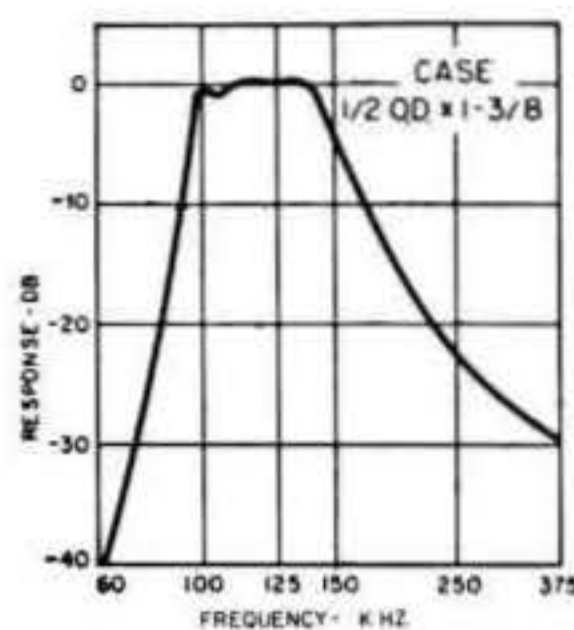

150 kHz
High Pass
3 db to
150 kHz,
down 45 db
below
85 kHz.
7500 ohms

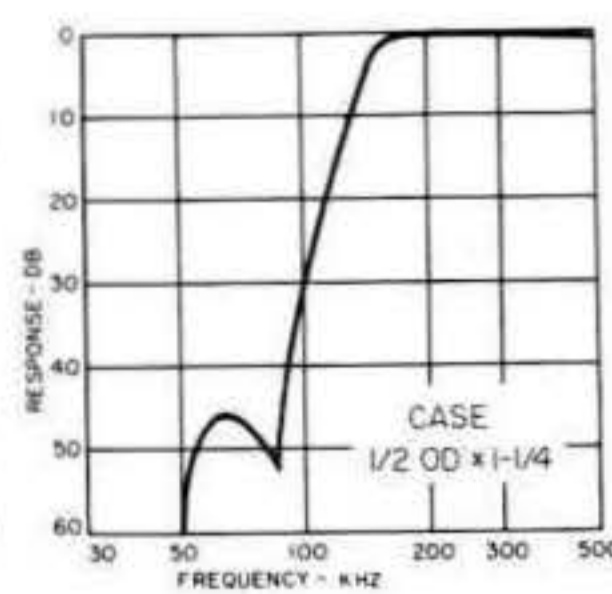

150 kHz
Low Pass
3 db to
150 kHz,
down
45 db
above
250 kHz.
1500 ohms.

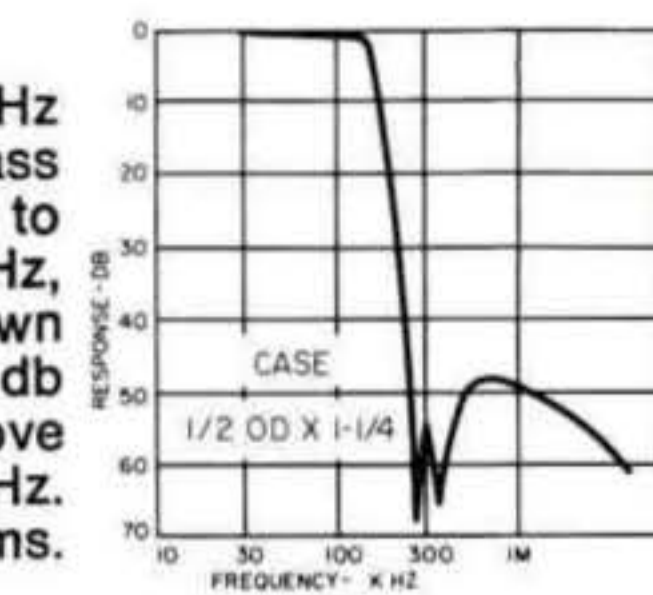

Ultra-miniature low pass filter only 1/4" high. DC to 40 kHz within ± 0.1 db, within 1 db to 60 kHz, 3 db to 70 kHz. Attenuation of at least 40 db above 81 kHz. Source and load 1K ohms. MIL-F-18327C. Wt. 1.2 ounces.

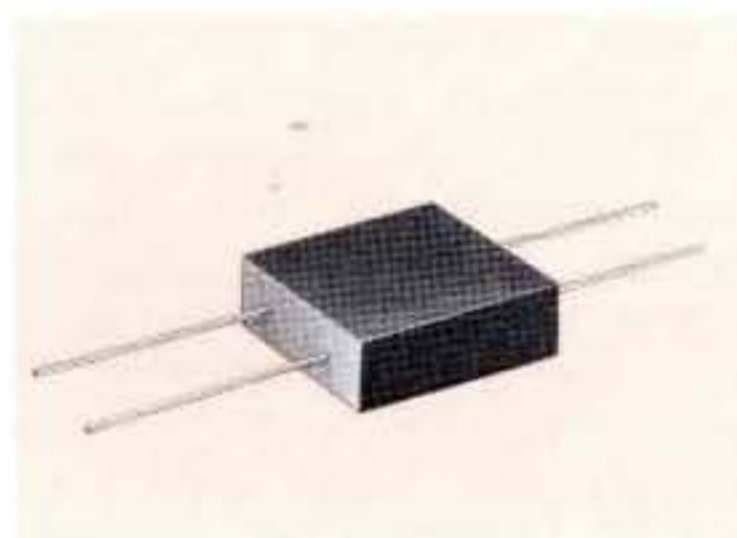
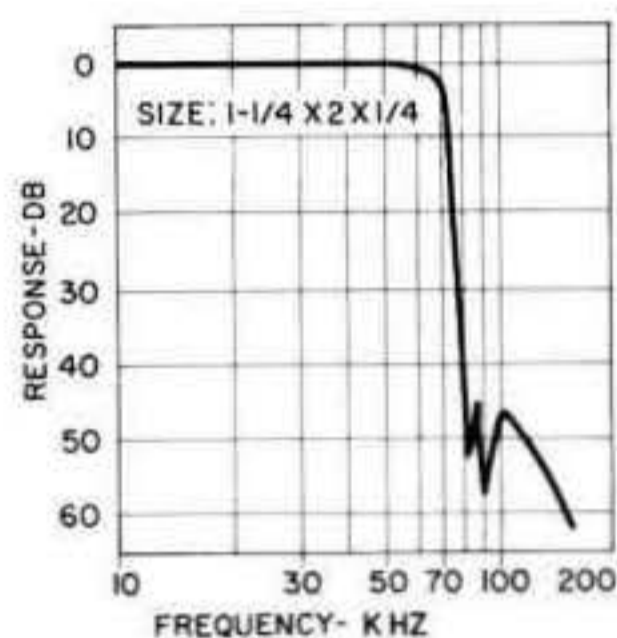

Ultra-miniature 100 kHz band pass filter only 1/4" high. Within 3 db 90 kHz to 110 kHz. Attenuation of at least 45 db at 50 kHz and at 200 kHz. Source and load 10K ohms.

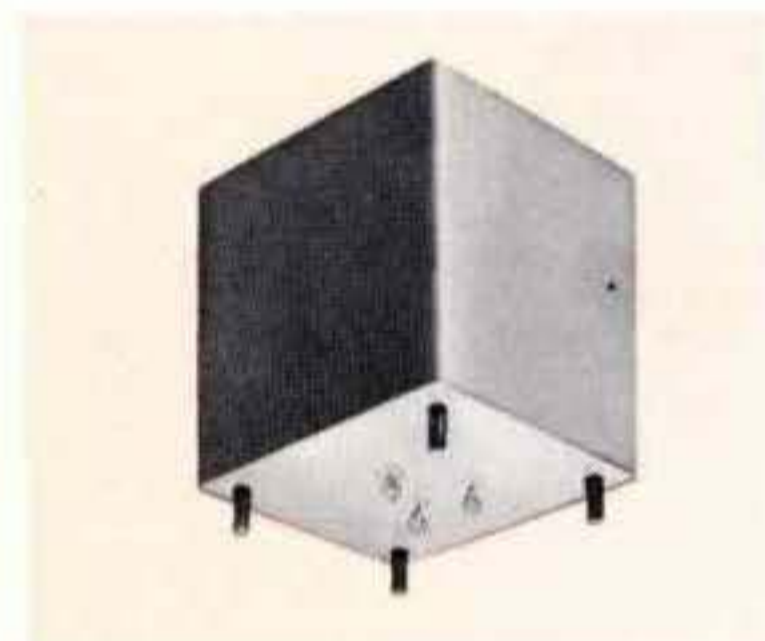
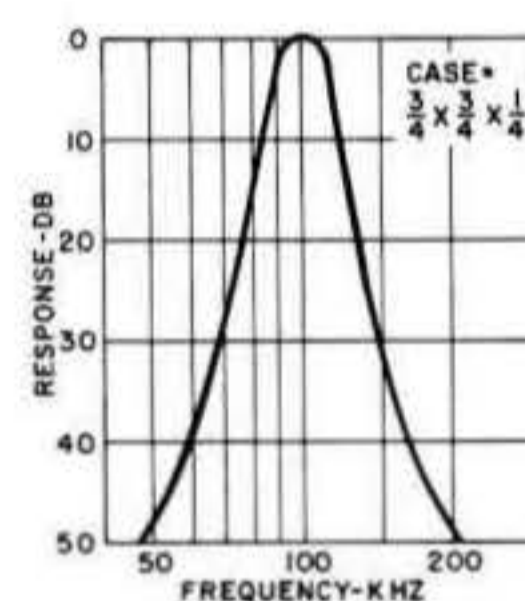

One Hz low pass filter. Flat to 1 db up to 0.75 Hz, within 2 db up to 1 Hz. Attenuation of at least 40 db for frequencies above 2 Hz. Source and load 10K ohms. MIL-F-18327C. Wt. 6 lbs.

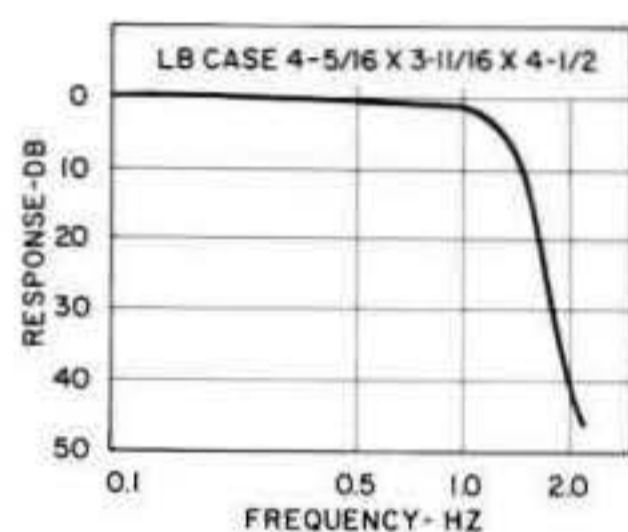

High pass filter, 30 Hz, used to eliminate from the output, 25 Hz sine wave pulses which control automatic programming on audio tracks of music tapes. Flat to 1 db from 50 Hz to 15 kHz, within 3 db to 30 Hz. Attenuation of at least 35 db from 25 Hz to 20 Hz. Source and load 600 ohms. Wt. approx. 6 lbs. MIL-F-18327C.

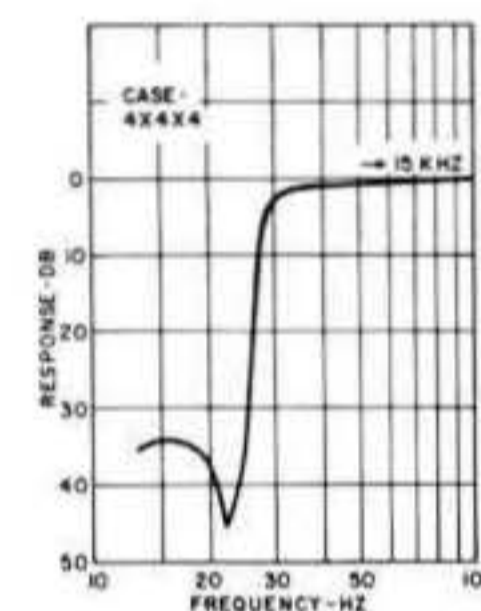

Band reject filters (two shown). The 1050 Hz filter has 50 db attenuation at center frequency and is only 3 db down at 950 and 1150 Hz. The 12.75 kHz filter has more than 100 db attenuation at center frequency and is only 3 db down at 10.8 kHz and 15 kHz. Source and load for each filter 600 ohms, both are MIL-F-18327C. Wt. 0.7 lbs.

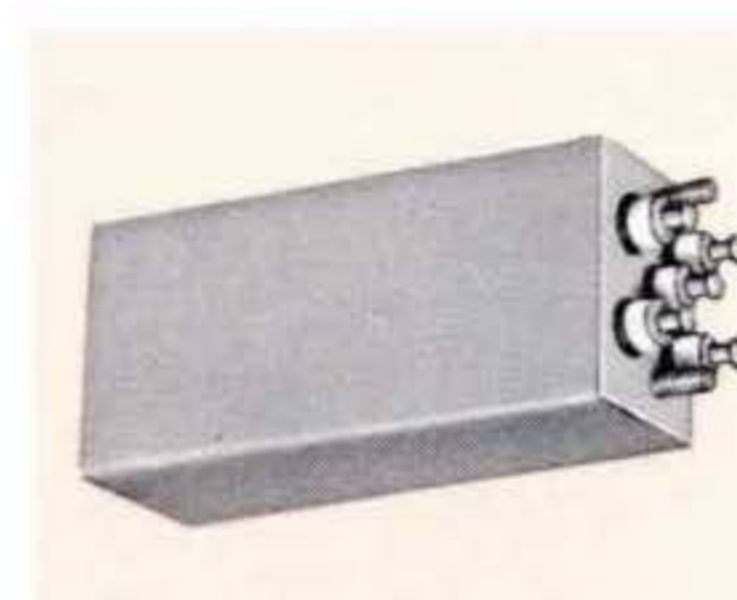
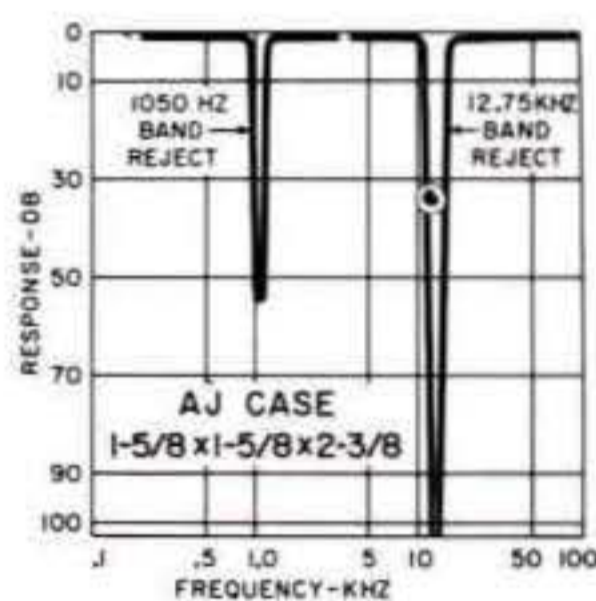

UTC high Q discriminators provide exceptional amplification and linearity. Values are volts. 1 1/16" x 1 3/8" x 3".

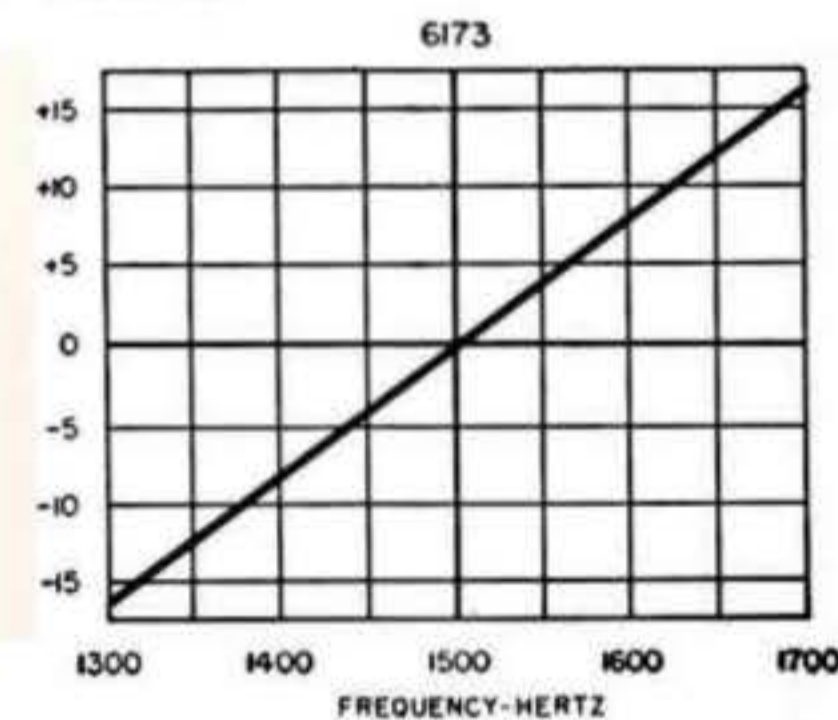

Low pass filter, 6 MHz. DC to 6 MHz within ± 0.1 db. Attenuation at least 40 db at 8.5 MHz and higher. Source and load 75 ohms. Wt. approx. 8 oz.

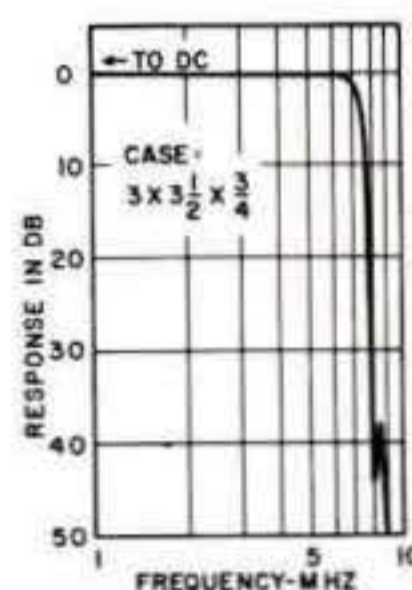

Miniaturized receiving filters, available from 425 Hz to 3315 Hz. Within 3 db at ± 42.5 Hz and attenuation of at least 36 db at ± 130 Hz. Source and load 600 ohms. Wt. approx. 3/4 lbs.

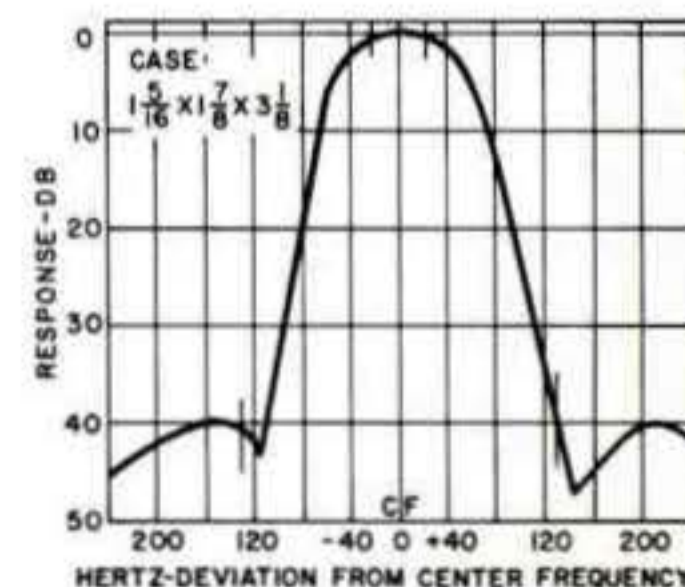

IMMEDIATE DELIVERY ON ALL ITEMS

INDEX AND NET PRICE LIST

QUANTITY PRICES AVAILABLE ON REQUEST

TYPE NO.	PG	TYPE NO.	PG	TYPE NO.	PG	TYPE NO.	PG	TYPE NO.	PG	TYPE NO.	PG	TYPE NO.	PG
A-10	20	BPM-1000	76	CG-710	26	DO-T28	6	H-7	13	H-113	39	HIT-15	40
A-11	20	BPM-1200	76	†CVA-1	42	DO-T29	7	H-8	13	H-114	39	HIT-450	40
A-12	20	BPM-1500	76	CVA-2	42	DO-T30	7	H-9	13	H-115	39	HMI-50	82
A-15	20	BPM-1600	76	CVA-3	42	DO-T31	7	†H-10	13	H-117	39	HMI-100	82
A-16	20	BPM-1800	76	†CVA-4	42	DO-T32	7	H-11	13	H-118	37	HMI-200	82
A-18	20	BPM-2000	76	CVA-5	42	DO-T33	7	H-12	13	H-119	40	HMI-300	82
A-19	20	BPM-2500	76	CVL-1	26	DO-T34	7	H-13	13	†H-120	40	HMI-400	82
A-20	20	BPM-3000	76	CVL-2	26	DO-T35	7	H-14	13	H-121	40	HMI-500	82
A-21	20	BPM-3200	76	CVL-3	26	DO-T36	7	H-15	13	†H-122	40	HMI-800	82
A-22	20	BPM-4000	76	CVM-0	26	DO-T37	7	H-16	13	H-123	40	HMI-1000	82
A-23	20	BPM-4800	76	CVM-1	26	DO-T38	7	H-17	13	H-124	40	HMI-2000	82
A-24	20	BPM-5000	76	CVM-2	26	DO-T39	7	H-18	13	H-125	40	HMI-3000	82
A-25	20	BPM-6000	76	CVM-3	26	DO-T40	7	H-19A	14	H-126	40	HMI-Spl.	82
A-26	20	BPM-6400	76	CVM-4	26	DO-T41	7	H-20	14	H-127	40	HML-40	82
A-27	20	BPM-8000	76	CVM-5	26	DO-T42	7	H-21	14	†H-128	40	HML-200	82
A-28	20	BPM-10000	76	CVP-1	26	DO-T43	7	H-22	14	H-129	40	HML-300	82
A-30	21	BPM-20000	76	CVP-2	26	DO-T44	7	H-23	14	H-130	40	HML-500	82
A-32	21	BPM-Spl.	76	CVP-3	26	DO-T45	7	†H-24	14	H-131	40	HML-1000	82
A-33	21	BTI-60	80	CVP-4	26	DO-T46	7	H-25	14	H-132	40	HML-Spl.	82
A-34	20	BTI-100	80	CVP-5	26	DO-T47	7	H-26	14	H-133	40	†HP-122	25
A-35	20	BTI-120	80	DI-1	69	DO-T48	7	H-27	14	H-134	40	HP-123	25
A-36	20	BTI-Spl.	80	DI-2	69	DO-T49	6	†H-30	12	H-135	40	HPM-500	77
A-37	20	CAT-15	26	DI-3	69	DO-T50	6	H-31	12	H-136	40	HPM-1000	77
A-38	20	CAT-20	26	DI-4	69	DO-T51	7	H-32	12	H-137	40	HPM-1500	77
A-39	20	CAT-25	26	DI-T1	10	DO-T52	7	†H-33	12	H-138	40	HPM-4000	77
A-40	21	CAT-30	26	DI-T2	10	DO-T53	7	H-35	12	H-141	40	HPM-Spl.	77
A-41	21	CAT-40	26	DI-T3	10	DO-T54	7	H-36	12	H-142	40	HQA-1	70
A-42	21	CG-1C	42	DI-T5	10	*DO-T255	8	H-37A	12	H-143	40	HQA-2	70
A-43	20	CG-1S	42	DI-T8	10	*DO-T275	8	H-38	12	H-144	40	HQA-3	70
A-44	20	†CG-2L6	26	DI-T9	10	*DO-T277	8	H-39	12	†H-145	40	HQA-4	70
A-45	21	CG-15	26	DI-T10	10	*DO-T278	8	H-40A	12	H-146	40	HQA-5	70
†A-46	21	†CG-16	26	DI-T11	10	*DO-T283	8	H-41A	12	H-147	40	HQA-6	70
A-47	21	†CG-19	26	DI-T19	10	*DO-T288	8	H-42A	12	H-148	37	HQA-7	70
A-48	21	†CG-20	26	DI-T20	10	*DO-T297	8	H-45	57	H-149	37	HQA-8	70
*BIT-250-03	5	†CG-21	26	DI-T21	10	*DO-T200SH	8	H-46	57	H-164	36	HQA-9	70
*BIT-250-05	5	CG-30	42	DI-T22	10	DO-T400	37	H-47	57	H-166	36	HQA-10	70
*BIT-250-06	5	†CG-31	42	DI-T23	10	DO-T410	37	H-48	57	H-168	36	HQA-11	70
*BIT-250-09	5	†CG-32	42	DI-T25	10	DO-T420	37	H-49	57	H-170	36	HQA-12	70
*BIT-250-14	5	CG-33	42	DI-T26	10	DO-TSH	7	H-50	57	H-171	36	HQA-13	70
*BIT-250-18	5	CG-34	42	DI-T27	10	FBH-1	75	H-51	57	H-172	36	HQA-14	70
*BIT-250-20	5	CG-35	42	DI-T28	10	FBH-10	75	H-52	57	H-173	36	HQA-15	70
*BIT-250-26	5	†CG-36	42	DI-T36	10	FBH-Spl.	75	H-53	57	H-174	36	HQA-16	70
*BIT-250-30	5	CG-40	42	DI-T37	10	FE-.01	64	H-54	57	H-194	39	HQA-17	70
*BIT-250-36	5	CG-44	42	DI-T38	10	FE-.02	64	H-55	57	H-195	39	HQA-18	70
*BIT-250-40	5	CG-45	42	DI-T41	10	FE-.05	64	H-56	57	H-196	39	HQB-1	70
*BIT-250-48	5	CG-48C	42	DI-T43	10	FE-.1	64	H-57	57	†H-197	39	HQB-2	70
*BIT-250-56	5	CG-51AX	26	DI-T44	10	FE-.5	64	H-58	57	H-198	39	HQB-3	70
*BIT-250-60	5	CG-53AX	26	DI-T51	10	FE-1	64	H-60	58	H-219	13	HQB-4	70
*BIT-250-64	5	†CG-59AX	26	DI-T52	10	FE-2	64	H-61	58	H-220	13	HQB-5	70
*BIT-250-70	5	CG-100	42	DI-T53	10	FHA-5	12	H-62	58	H-221	13	HQB-6	70
*BIT-250-90	5	†CG-101	42	DI-T204	11	FHA-10	12	H-63	58	†H-222	13	HQB-7	70
*BIT-P21	55	CG-102	42	DI-T208	11	FHA-15	12	H-64	58	H-224	13	HQB-8	70
*BIT-P22	55	†CG-103	42	DI-T212	11	FHA-25	12	H-65	58	H-225	13	HQB-9	70
*BIT-P23	55	CG-104	42	DI-T216	11	FHH-200	75	H-66	58	H-280	14	HQB-10	70
*BIT-P24	55	CG-105	42	DI-T225	11	FHH-Spl.	75	H-67	58	H-281	14	HQB-11	70
*BIT-P25	55	CG-108	42	DI-T230	11	FHI-3	12	H-68	58	H-282	14	HQB-12	70
*BIT-P26	55	CG-109	42	DI-T235	11	FHI-7	12	H-69	58	H-283	14	HQC-1	70
*BIT-P27	55	CG-111	42	DI-T240	11	FHI-11	12	H-70	36	H-284	14	HQC-2	70
*BIT-P28	55	CG-112	42	DI-T245	11	FI-.04	64	H-71	36	H-286	14	HQC-3	70
*BIT-P29	55	†CG-113	42	DI-T250	11	FI-.1	64	H-72	36	H-290	14	HQC-4	70
*BIT-P30	55	CG-120	42	DI-T255	11	FI-.25	64	H-73	36	H-291	14	HQC-5	70
*BIT-P31	55	CG-121	42	DI-T260	11	FI-.5	64	H-74	36	H-295	14	HQE-1	70
*BIT-P32	55	CG-122	42	DI-T265	11	FI-1	64	H-75	36	†H-300	36	HQE-2	70
*BIT-P33	55	CG-124	42	DI-T270	11	FI-4	64	H-76	36	H-461	57	HQE-3	70
BMI-30	80	†CG-125	42	DI-T273	11	FLH-600	75	H-77	36	H-501	57	HQE-4	70
BMI-50	80	CG-126	42	DI-T276	11	FLH-5000	75	†H-78	36	H-531	57	HQE-5	70
BMI-60	80	CG-131	26	DI-T278	11	FLH-Spl.	75	H-79	36	H-561	57	HVC-1	68
BMI-90	80	CG-132	26	DI-T283	11	FLL-3500	75	H-80	38	H-611	58	HVC-2	68
BMI-100	80	CG-133	26	DI-T288	11	FLL-18000	75	H-81	38	H-641	58	HVC-3	68
BMI-120	80	CG-134	26	DI-TSH	10	FLL-50000	75	H-82	38	H-671	58	HVC-4	68
BMI-150	80	CG-135	26	DI-T200SH	11	FLL-Spl.	75	H-83	38	H-915	32	HVC-5	68
BMI-200	80	CG-136	26	DO-T1	7	FO-.1	64	H-84	38	H-925	32	HVC-6	68
BMI-240	80	CG-137	26	DO-T2	7	FO-.5	64	†H-85	38	H-935	32	HVC-7	68
BMI-300	80	CG-141	26	DO-T3	7	FO-1	64	H-86	38	H-965	32	HVC-8	68
BMI-400	80	CG-141	26	DO-T4	7	FO-2	64	H-87	38	†HA-100	24	HVC-9	68
BMI-500	80	CG-233	26	DO-T5	7	FO-5	64	H-89	38	HA-100X	24	HVC-10	68
BMI-750	80	CG-235	26	DO-T6	7	FO-10	64	H-91	38	HA-101	24	HVC-11	68
BMI-800	80	CG-300W	42	DO-T7	7	FT-1	44	H-92	38	HA-101X	24	HVC-12	68
BMI-1000	80	CG-301W	42	DO-T8	6	FT-2	44	H-93	39	HA-103A	24	HVV-.006	68
BMI-1500	80	CG-302W	42	DO-T9	7	FT-3	44	H-94	32	†HA-104	24	HVV-.015	68
BMI-2000	80	CG-303W	42	DO-T10	7	FT-4	44	H-95	32	†HA-105	24	HVV-.10	68
BMI-3000	80	†CG-304W	42	DO-T11	7	FT-5	44	H-96	32	HA-106	24	HVV-.25	68
BMI-4000	80	CG-305W	42	DO-T12	7	FT-6	44	H-97	34	HA-107	24	HVV-.6	68
BMI-5000	80	†CG-306W	42	DO-T13	7	FT-7	44	H-98	34	HA-108	24	HVV-1.5	68
BMI-10000	80	CG-307	42	DO-T14	7	FT-8	44	H-99	34	HA-108X	24	HVV-4	68
BMI-Spl.	80	†CG-308	42	DO-T15	7	FT-10	44	H-100	34	HA-113	25	HVV-10	68
BML-400	80	CG-309	42	DO-T16	7	FT-11	44	H-101	37	HA-114	25	HVV-25	68
BML-1000	80	†CG-310	42	DO-T17	7	FT-12	44	H-102	37	†HA-130X	24	HVV-60	68
BML-Spl.	80	†CG-311W	42	DO-T18	7	FT-13	44	H-103	37	HA-133	25	HVV-150	68
BPH-50000	76	CG-312	42	DO-T19	7	FT-14	44	H-104	37	HA-134	25	†LAB-5	15
BPH-100000	76	CG-315	42	DO-T20	7	FT-15	44	H-105	36	HA-135	25	LAB-10	15
BPH-Spl.	76	CG-316	42	DO-T21	7	FT-16	44	H-106	36	HA-136	25	LAB-20	15
BPM-400	76	CG-333	26	DO-T22	7	H-1	13	H-107	36	†HA-137	24	LBP-10	83
BPM-440	76	CG-422	42	DO-T23	7	H-2	13	H-108	36	HIT-1	40	LLP-10	83
BPM-500	76	†CG-428	42	DO-T24	7	†H-3	13	H-109	36	HIT-2	40	LLP-15	83
BPM-600	76	CG-429	42	DO-T25	7	H-4	13	†H-110W	39	HIT-3	40	LMI-50	81
BPM-750	76	†CG-431	42	DO-T26	6	H-5	13	H-111W	39	HIT-4	40	LMI-100	81
BPM-800	76	CG-433	26	DO-T27	6	H-6	13	H-112W	39				

IMMEDIATE DELIVERY ON ALL ITEMS

INDEX AND NET PRICE LIST

QUANTITY PRICES AVAILABLE ON REQUEST

TYPE NO.	PG	TYPE NO.	PG	TYPE NO.	PG	TYPE NO.	PG	TYPE NO.	PG	TYPE NO.	PG	TYPE NO.	PG
LMI-150	81	MET-410	37	MQB-12	67	0-15	18	†R-105	44	*SO-18	17	TMN-2.3	78
LMI-200	81	MET-420	37	MQB-13	67	0-16	18	R-110	44	SO-2P	17	TMN-3.0	78
LMI-400	81	MET-430	37	MQB-14	67	0-17	18	R-111	44	SO-3P	17	TMN-3.9	78
LMI-500	81	MET-435	37	MQD-0	66	0-18	18	R-112	44	SO-5P	17	TMN-5.4	78
LMI-800	81	MET-440	37	MQD-1	66	0-19	18	R-113	44	SO-7P	17	TMN-7.35	78
LMI-1000	81	MET-445	32	MQD-2	66	0-20	18	R-220	44	SO-8P	17	TMN-10.5	78
LMI-1500	81	MET-455	32	MQD-3	66	0-21	18	†S-2	27	SO-9P	17	TMN-14.5	78
LMI-2000	81	MET-465	32	MQD-4	66	0-22	18	S-3	27	SO-14P	17	TMN-22	78
LMI-2500	81	MET-475	32	MQD-5	66	0-23	18	†S-5	27	SO-15P	17	TMN-30	78
LMI-3000	81	MET-495	32	MQD-6	66	0-24	18	S-6	27	SO-17P	17	TMN-40	78
LMI-4000	81	MH-1	63	MQD-7	66	0-25	18	†S-8	27	SO-18P	17	TMN-52.5	78
LMI-5000	81	MH-2	63	MQE-0	67	0-26	18	S-9	27	SO-CH	17	TMN-70	78
LMI-10000	81	MH-3	63	MQE-1	67	0-27	18	S-10	27	SRC-10	40	TMN-Spl.	78
LMI-Spl.	81	MH-4	63	MQE-2	67	0-28	18	S-11	27	SSO-1	16	TMW-22	78
LML-500	81	MH-5	63	MQE-3	67	0-29	18	S-12	27	SSO-2	16	TMW-30	78
LML-1000	81	MH-6	63	MQE-4	67	0-30	18	S-13	27	SSO-3	16	TMW-40	78
LML-1500	81	MH-7	63	MQE-5	67	0-31	18	S-14	27	SSO-4	16	TMW-52.5	78
LML-2000	81	MH-8	63	MQE-6	67	0-32	18	S-15	27	SSO-5	16	TMW-70	78
LML-2500	81	ML-0	62	MQE-7	67	0-33	18	S-16	27	SSO-6	16	TMW-Spl.	78
LML-3000	81	ML-1	62	MQE-8	67	0-34	18	S-17	27	SSO-7	16	TQA-1	66
LML-4000	81	ML-2	62	MQE-9	67	0-36	18	S-18	27	SSO-8	16	TQA-2	66
LML-8000	81	ML-3	62	MQE-10	67	0-37	18	S-19	27	SSO-9	16	TQA-3	66
LML-10000	81	ML-4	62	MQE-11	67	0-38	18	S-20	27	SSO-10	16	TQA-4	66
LML-12000	81	ML-5	62	MQE-12	67	0-BR	18	S-21	27	SSO-11	16	TQA-5	66
LML-Spl.	81	ML-6	62	MQE-13	67	P-1	19	S-22	27	SSO-12	16	TQA-6	66
LPM-200	77	ML-7	62	MQE-14	67	P-2	19	S-23	43	SSO-13	16	TQA-7	66
LPM-300	77	ML-8	62	MQE-15	67	P-6	19	S-24	43	SSO-14	16	TQA-8	66
LPM-500	77	ML-9	62	MQE-16	67	P-7	19	S-25	43	SSO-15	16	TQA-9	66
LPM-1000	77	ML-10	62	MQL-0	65	P-8	19	S-26	43	SSO-16	16	TQA-10	66
LPM-1500	77	MM-1	63	MQL-1	65	P-9	19	S-27	43	SSO-17	16	TQA-11	66
LPM-2000	77	MM-2	63	MQL-2	65	P-10	19	†S-28	43	SSO-18	16	TQA-12	66
LPM-3000	77	MM-3	63	MQL-3	65	†P-11	19	S-29	43	SSO-19	16	TQA-13	66
LPM-5000	77	MM-4	63	MQL-4	65	P-12	19	S-30	43	SSO-20	16	TQA-14	66
LPM-6000	77	MM-5	63	MQL-5	65	P-15	19	S-31	43	SSO-21	16	TQA-15	66
LPM-8000	77	MM-6	63	MQM-2	65	P-16	19	S-32	43	SSO-22	16	TQA-16	66
LPM-10000	77	MM-7	63	MQM-16	65	PF-1	45	S-33	43	SSO-23	16	TQA-17	66
LPM-15000	77	MM-8	63	MQM-40	65	PF-3	45	S-34	43	SSO-24	16	TQA-18	66
LPM-Spl.	77	MNF-.4	78	MQM-300	65	PF-5	45	S-35	43	SSO-25	16	TQA-19	66
LS-6L1	23	MNF-.56	78	MQM-600	65	PF-6	45	†S-36	43	SSO-26	16	TQA-20	66
LS-6L4	23	MNF-.73	78	*MS-1	63	PF-7	45	S-37	43	SSO-27	16	TVC-1	68
LS-10	22	MNF-.96	78	*MS-5	63	PIL-5	9	S-38	43	SSO-3P	16	TVC-2	68
LS-10X	22	MNF-1.3	78	*MS-10	63	PIL-8	9	S-39	43	SSO-5P	16	TVC-3	68
LS-12	22	MNF-1.7	78	*MS-25	63	PIL-12	9	S-40	43	SSO-8P	16	TVC-4	68
LS-12X	22	MNF-2.3	78	*MS-50	63	PIL-50	9	S-41	43	SSO-14P	16	TVC-5	68
LS-14X	22	MNF-3.0	78	*MS-100	63	PIL-70	9	S-42	43	SSO-15P	16	TVC-6	68
†LS-19	22	MNF-3.9	78	MW-.05	63	PIL-75	9	S-44	43	SSO-19P	16	TVC-7	68
LS-21	22	MNF-5.4	78	MW-.10	63	PIL-850	9	S-45	43	SSO-20P	16	TVC-8	68
LS-25	22	MNF-7.35	78	MW-.25	63	PIP-1	56	S-46	43	SSO-21P	16	TVC-9	68
LS-26	22	MNF-10.5	78	MW-.5	63	PIP-2	56	S-47	43	SSO-22P	16	TVC-10	68
†LS-27	23	MNF-14.5	78	MW-.75	63	PIP-3	56	S-48	43	SSO-23P	16	TVC-11	68
LS-30	22	MNF-22	78	MW-1	63	PIP-4	56	S-49	43	SSO-24P	16	TVC-12	68
LS-30X	22	MNF-30	78	MW-1.2	63	PIP-5	56	S-50	43	SSO-25P	16	TVC-1	68
LS-31	22	MNF-40	78	MW-2	63	PIP-6	56	S-51	43	SSO-27P	16	TVC-2	68
LS-32	22	MNF-52.5	78	MW-3	63	PIP-7	56	S-52	43	SSO-CH	16	TVC-3	68
LS-33	23	MNF-70	78	MW-5	63	PIP-8	56	S-53	43	TGR-425	79	TVC-4	68
LS-34	23	MNF-Spl.	78	MWF-22	78	PIP-9	56	S-54	43	TGR-595	79	TVC-5	68
LS-35	23	MO-.1	62	MWF-30	78	PIP-10	56	S-55	43	TGR-795	79	TVC-6	68
†LS-40	22	MO-.15	62	MWF-40	78	PIP-11	56	S-57	43	TGR-935	79	TVC-7	68
LS-47	22	MO-.3	62	MWF-52.5	78	PIP-12	56	S-58	43	TGR-1105	79	TVC-8	68
LS-48	22	MO-.5	62	MWF-70	78	PIP-100	56	S-59	43	TGR-1275	79	TVC-9	68
†LS-50	23	MO-1	62	MWF-Spl.	78	PIP-SH	56	S-60	43	TGR-1445	79	TVC-10	68
LS-51	23	MO-2	62	N-583A	41	PLF-25	83	S-61	43	TGR-1615	79	TVC-11	68
LS-52	23	MO-5	62	N-584A	41	PLP-13	83	S-62	43	TGR-1785	79	TVC-12	68
LS-54	23	MO-7.5	62	N-585A	41	R-14	44	S-63	43	TGR-1955	79	VIC-1	69
LS-55	23	MO-20	62	N-586A	41	R-15	44	†S-64	43	TGR-2125	79	VIC-2	69
LS-56	23	MO-50	62	N-587A	41	R-16	44	†S-67	43	TGR-2295	79	VIC-3	69
†LS-57	23	MO-100	62	N-588A	41	R-17	44	†S-68	43	TGR-2465	79	VIC-4	69
†LS-58	23	MQA-1	66	N-589A	41	R-18	44	S-70	43	TGR-2635	79	VIC-5	69
LS-61	23	MQA-2	66	N-590A	41	R-19	44	S-71	43	TGR-2805	79	VIC-6	69
†LS-63	23	MQA-3	66	N-591A	41	†R-20	44	S-72	43	TGR-2975	79	VIC-7	69
LS-65	23	MQA-4	66	†N-592A	41	†R-21	44	S-75	43	TGR-3145	79	VIC-8	69
LS-68	22	MQA-5	66	N-593A	41	R-41	45	S-76	43	TGR-3315	79	VIC-9	69
LS-140	22	MQA-6	66	N-594A	41	R-42	45	S-77	43	TGR-Spl.	79	VIC-10	69
LS-141	22	MQA-7	66	N-595A	41	R-43	45	S-78	43	TGT-425	79	VIC-11	69
LS-150	23	MQA-8	66	N-596A	41	R-44	45	S-79	43	TGT-595	79	VIC-12	69
LS-151	23	MQA-9	66	†N-597A	41	R-45	45	S-80	43	TGT-765	79	VIC-13	69
LS-666	23	MQA-10	66	N-598A	41	R-46	45	S-81	43	TGT-935	79	VIC-14	69
LS-667	23	MQA-11	66	N-599A	41	R-47A	45	SC-3	45	TGT-1105	79	VIC-15	69
†LS-691	23	MQA-12	66	†N-600A	41	R-48A	45	SC-4	45	TGT-1275	79	VIC-16	69
†LS-692	23	MQA-13	66	*NV-520	35	R-49A	45	SC-5	45	TGT-1445	79	VIC-17	69
MAS-400	49	MQA-14	66	*NV-530	35	R-55	44	SML-70	17	TGT-1615	79	VIC-18	69
†MAS-410	49	MQA-15	66	*NV-720	35	R-64	45	SO-1	17	TGT-1785	79	VIC-19	69
†MAS-420	49	MQA-16	66	*NV-730	35	R-72	45	SO-2	17	TGT-1955	79	VIC-20	69
†MAT-1	49	MQA-17	66	*NV-920	35	R-73	45	SO-3	17	TGT-2125	79	VIC-21	69
†MAT-2	49	MQA-18	66	0-1	18	R-74	45	SO-4	17	TGT-2295	79	VIC-22	69
MAT-3	49	MQA-19	66	0-2	18	R-75	45	SO-5	17	TGT-2465	79	W-783	15
†MAT-4	49	MQA-20	66	0-3	18	R-76	45	SO-6	17	TGT-2635	79	W-784	15
MAT-5	49	MQB-1	67	0-4	18	R-77	45	SO-7	17	TGT-2805	79	W-785	15
MAT-6	49	MQB-2	67	0-5	18	†R-78	44	SO-8	17	TGT-2975	79	W-786	15
†MAT-7	48	MQB-3	67	0-6	18	R-79	44	SO-9	17	TGT-3145	79	W-787	15
†MAT-8	48	MQB-4	67	0-7	18	R-80	44	SO-10	17	TGT-3315	79	W-788	15
†MAT-9	48	MQB-5	67	0-8	18	R-81	44	SO-11	17	TGT-Spl.	79	W-789	15
†MAT-10	48	MQB-6	67	0-9	18	†R-86	44	SO-12	17	TMN-.4	78	W-790	15
MAT-11	48	MQB-7	67	0-10	18	R-97	45	SO-13	17	TMN-.56	78	W-791	15
†MAT-60	48	MQB-8	67	0-11	18	R-101	44	SO-14	17	TMN-.73	78	Z-848	41
MAT-65	48	MQB-9	67	0-12	18	R-102	44	SO-15	17	TMN-.96	78	†Z-849	41
MET-400	37	MQB-10	67	0-13	18	R-103	44	SO-16	17	TMN-1.3	78	†Z-850	41
MET-405	37	MQB-11	67	0-14	18	†R-104	44	SO-17	17	TMN-1.7	78	†Z-851	41

* NEW PRODUCT

† MANUFACTURED WHEN ORDERED

UTC REPRESENTATIVES

ARIZONA

TRW Electronics
77 West 3rd Avenue
Suite 203
Scottsdale, Arizona 89251
(602) 947-5791

CALIFORNIA

Recht Associates
900 North San Antonio Road
Los Altos, California 94022
(415) 941-0336 TWX 910-370-7454

TRW Western Sales Office
5410 W. Imperial Highway
Los Angeles, California 90045
(213) 673-5262

Transdynamics, Inc.
P.O. Box 3476
San Diego, California 92103
(714) 298-8215

COLORADO

Straube Associates, Inc.
P.O. Box 1649
Boulder, Colorado 80302
(303) 443-8600

CONNECTICUT

Gerber Sales Co., Inc.
29 Whalley Avenue
New Haven, Connecticut 06511
(203) 777-6279

FLORIDA

Hawkins Hutto, Inc.
P.O. Box 1509
501 Park Avenue N.
Winter Park, Florida 32789
(305) 647-7407

GEORGIA

Millar Electronics, Inc.
P.O. Box 12137, Northside Station
3110 Maple Drive, NE, Rm. 110
Atlanta, Georgia 30305
(404) 261-6160

ILLINOIS

John G. Twist Co.
5222 West Diversey Avenue
Chicago, Illinois 60639
(312) 777-2250 TWX 910-221-1313

INDIANA

Robert O. Whitesell & Associates, Inc.
6691 E. Washington Street
Indianapolis, Indiana 46219
(317) 359-9283 TWX 810-341-3320

Robert O. Whitesell & Associates, Inc.
3426 Taylor Street
Fort Wayne, Indiana 46804
(219) 432-5591 TWX 810-332-1416

Robert O. Whitesell & Associates, Inc.
3827 South Lafountain Square
Kokomo, Indiana 46901
(317) 453-6868 TWX 810-269-1917

IOWA

Lorenz Sales, Inc.
Suite 302 Executive Plaza
4403 First Avenue S.E.
Cedar Rapids, Iowa 52402
(319) 366-0774

KENTUCKY

Robert O. Whitesell & Associates, Inc.
3620 Lexington Road
223 Lex-Manor Bldg.
Louisville, Kentucky 40207
(502) 893-7303

MARYLAND

L. D. Lowery, Inc.
6200 Annapolis Road
Hyattsville, Maryland 20784
(301) 773-4977

MASSACHUSETTS

Gerber Sales Co., Inc.
44 Baldwin Street
East Longmeadow, Massachusetts 01028
(413) 525-3059

Gerber Sales Co., Inc.
176 Second Avenue
Waltham, Massachusetts 02154
(617) 891-8040 TWX 710-324-1937

MICHIGAN

Robert O. Whitesell & Associates, Inc.
25100 Evergreen Road
Southfield, Michigan 48075
(313) 358-2020 TWX 810-224-4939

Robert O. Whitesell & Associates, Inc.
Room 214
Shepard & Benning Bldg.
St. Joseph, Michigan 49085
(616) 983-7373 TWX 810-270-3180

MINNESOTA

Northport Engineering, Inc.
2027 Grand Avenue
St. Paul, Minnesota 55105
(612) 698-3841 TWX 910-563-3674

MISSOURI

L. R. Harry & Associates, Inc.
13314 South 71 Highway
P. O. Box 288
Grandview, Missouri 64030
(816) 763-3634

L. R. Harry & Associates, Inc.
11722 Studt Avenue, Rm. 209
P.O. Box 12608
St. Louis, Missouri 63141
(314) 872-3183

NEW YORK

Bob Dean, Inc.
714 W. Clinton Street
Ithaca, New York 14850
(607) 272-2187 TWX 510-255-5876

Comtronic Associates
370 Old Country Road
Garden City, New York 11530
(516) 741-8966 TWX 510-222-7276

NORTH CAROLINA

Millar Electronics, Inc.
North Hills Office Mall—Rm. 134
P.O. Box 17173
Raleigh, North Carolina 27609
(919) 787-9564

OHIO

Robert O. Whitesell & Associates, Inc.
4133 S. Dixie Avenue
Dayton, Ohio 45439
(513) 298-9546 TWX 810-459-1827

Robert O. Whitesell & Associates, Inc.
1172 W. Galbraith
Cincinnati, Ohio 45231
(513) 521-2290 TWX 810-465-8330

Robert O. Whitesell & Associates, Inc.
21139 Lorain Avenue (Magek Bldg.)
Cleveland, Ohio 44126
(216) 333-2585 TWX 810-421-8521

OKLAHOMA

Vista Engineering, Inc.
7966 East 41st Street
Allstate Bldg.
Tulsa, Oklahoma 74145
(918) 622-1358

OREGON

N. R. Schultz Company
P.O. Box 156
Beaverton, Oregon 97005
(503) 646-1345

PENNSYLVANIA

Robert O. Whitesell & Associates, Inc.
201 Penn Center Blvd.
Pittsburgh, Pennsylvania 15235
(412) 242-0100

L. D. Lowery, Inc.
1501 Allison Street
Harrisburg, Pennsylvania 17104
(717) 233-0917

L. D. Lowery
2801 West Chester Pike
Broomall, Pennsylvania 19008
(215) 356-5300

TENNESSEE

Robert O. Whitesell & Associates, Inc.
Professional Bldg. of Bristol
340 Edgemont Avenue, Rm. 512
Bristol, Tennessee 37620
(615) 968-4195

TEXAS

Vista Engineering, Inc.
1614 South Post Oak Road
Houston, Texas 77027
(713) 622-5680

Vista Engineering, Inc.
777 South Central Expressway
Central Exchange Bldg., Suite 6B
Richardson, Texas 75080
(214) 235-4547 TWX 910-867-4703

UTAH

Straube Associates, Inc.
RFD #1 Highland
Box 316
Morgan, Utah 84050
(801) 829-6448

WASHINGTON

N. R. Schultz Company
305 112th Avenue N.E.
Bellevue, Washington 98004
(206) 454-5224

UNITED TRANSFORMER COMPANY

DIVISION OF **TRW** INC. • 150 VARICK ST., NEW YORK, N.Y. 10013

TELEPHONE: (212) 255-3500 • TWX: 710-581-2722 • CABLE: ARLAB