

COMPUTERS AND AUTOMATION

CYBERNETICS • ROBOTS • AUTOMATIC CONTROL

Vol. 6
No. 2

- Computation for an Earth Satellite . . . Neil D. Macdonald
- New Computer Developments Around the World . . . Everett S. Calhoun
- Industry and the Automated Future: Problems
Along the Way . . . John Diebold
- Electronic Digital Data-Handling . . . Howard T. Engstrom
- Electronic Computing Machines in the National
Economy of the Soviet Union . . . V. Pekelis
- The Nine Billion Names of God . . . Arthur C. Clarke
- The Solution of Boundary Value Problems on a
REAC Analog Computer . . . M. Yanowitch

Feb.
1957

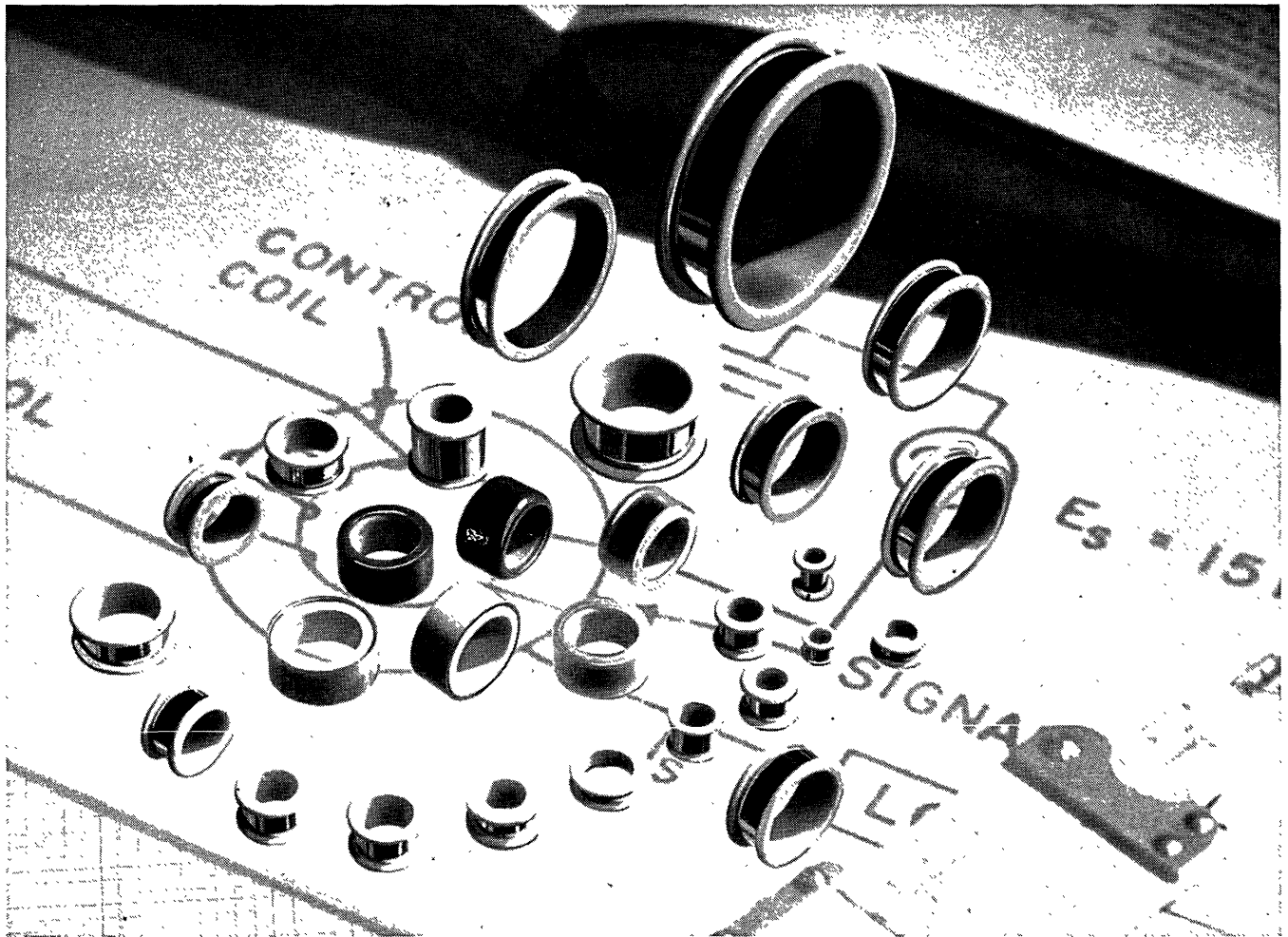

In BOBBIN CORES, you need PRECISION *and precision is the word for ARNOLD*

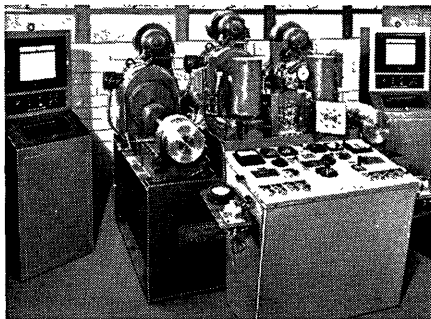

Ultra-thin tape for bobbin cores is rolled to high precision standards for thickness and finish on our own 20-high Sendzimir cold reducing mill, beta-ray controlled.

Write for BULLETIN TC-108
"TAPE-WOUND BOBBIN CORES
FOR COMPUTER APPLICATIONS"

Includes essential data on applications and properties, fabrication and testing of Arnold Bobbin Cores; lists standard sizes, etc.

ADDRESS DEPT. CA-72

For use in shift registers, coincident current matrix systems, pulse transformers, static magnetic memory elements, harmonic generators and similar equipment, Arnold Bobbin Cores meet the most exacting requirements.

Quality and uniformity? *You'll find them no problem*—because, as a fully integrated producer with highly modern facilities, we're able to maintain close control over every step.

Arnold Bobbin Cores are available in a wide range of sizes, tape thicknesses, widths and number of wraps depending on the ultimate use of the core. Magnetic materials usually em-

ployed are Deltamax, Permalloy and Supermalloy, in standard thicknesses of .001", .0005", and .00025". Core properties include quite rectangular hysteresis loops, relatively low coercive values and high saturation densities, plus the ability to shift in a few microseconds from negative remanence to positive saturation, and vice versa, under conditions of pulse excitation. • Let Arnold supply your requirements for Bobbin Cores—or other tape-wound cores, powder cores, permanent magnets, etc.—from the most complete line of magnetic materials in the industry.

WSW 6399

THE ARNOLD ENGINEERING COMPANY



Main Office & Plant: Marengo, Illinois

Repath Pacific Division Plant: 641 East 61st Street, Los Angeles, Calif.

District Sales Offices:

New York: 350 Fifth Ave. Los Angeles: 3450 Wilshire Blvd. Boston: 200 Berkeley St.

COMPUTERS AND AUTOMATION

CYBERNETICS • ROBOTS • AUTOMATIC CONTROL

Vol. 6, No. 2

February, 1957

ESTABLISHED SEPTEMBER, 1951

ARTICLES AND PAPERS

Computation for an Earth Satellite	.. Neil D. Macdonald	6
New Computer Developments Around the World	... Everett S. Calhoun	10
Industry and the Automated Future: Problems Along the Way	... John Diebold	14
Electronic Digital Data Handling	... Howard T. Engstrom	20
Electronic Computing Machines in the National Economy of the Soviet Union	... V. Pekelis	22
The Solution of Boundary Value Problems on a REAC Analog Computer	... M. Yanowitch	26
Simulation of a Liquid Level Control System With an Analog Computer — Part 1	... Charles W. Worley	30
REFERENCE INFORMATION: Books and Other Publications		34
New Patents		38
FICTION: The Nine Billion Names of God	... Arthur C. Clarke	24
FORUM: Information About Computers and Their Applications		4
Los Angeles Chapter, Association for Computing Machinery, Statler Hotel, Los Angeles, March 1, 1957		40
What Readers Say About "Computers and Automation"		44
Computer People: Master File		50
Variable Length Multiplication	... I. J. Good	54
NEWS RELEASES: Air Traffic Control System	... Bendix	32
Magnetic Recording Heads	... Ferroxcube	42
Electric Typewriter Input-Output for Computers	... Intern. Bus. Mach. Corp.	43
The Editor's Notes		4
Index of Notices		4
Advertising Index		58

Editor: Edmund C. Berkeley

Assistant Editors: Neil D. Macdonald, F.L. Walker

Contributing Editors: Andrew D. Booth, John M. Breen, John W. Carr, III, Alston S. Householder

Advisory Committee: Part 1 - Samuel B. Williams, Herbert F. Mitchell Jr.

Part 2 - Howard T. Engstrom, Alston S. Householder

Publisher: Berkeley Enterprises, Inc.

815 Washington Street, Newtonville 60, Mass. - Decatur 2-5453 or 2-3928

Advertising Representatives:

New York - Milton L. Kaye, 601 Madison Ave., New York 21, N.Y., Plaza 5-4680

San Francisco - W.A. Babcock, 605 Market St., San Francisco 5, Calif., Yukon 2-3954

Los Angeles - Wentworth F. Green, 439 So. Western Ave., Los Angeles 5, Calif., Dunkirk 7-8135

Elsewhere - the Publisher

COMPUTERS AND AUTOMATION is published monthly. Copyright, 1957, by Berkeley Enterprises, Inc.

Subscription rates: in the United States - one year \$5.50, two years \$10.50; in Canada - one year \$6.00, two years \$11.50;
elsewhere - one year \$6.50, two years \$12.50

Entered as second class matter at the Post Office, New York, N.Y.

FORUM & THE EDITOR'S NOTES

INFORMATION ABOUT COMPUTERS AND THEIR APPLICATIONS

I. From the Editor (reprinted from the November, 1956 issue of "Computers and Automation", in order to make clear the present discussion without the trouble of looking up the reference):

It is clear to even a casual observer that information about computers, data processors, cybernetics, robots, automatic control — in short, information about machines that handle information — is mushrooming into a tremendous and continuous explosion. The great quantity of information about computers overstrains the capacity of people in the computer field to find out about it, keep track of it, and get access to it.

For example, there was submitted to us for publication recently a bibliography on automatic programming. We estimated that there were 1400 cards in this bibliography, the first half an index by subjects, the second half an index by authors. We had to reply that we did not think there was room in "Computers and Automation" to publish it — and THIS IS ONLY A BIBLIOGRAPHY!

For another example, at the meeting of the Association for Computing Machinery in Los Angeles in August there were presented 61 papers and addresses. The association distributed at the meeting three and four page abstracts of 44 of the papers. The remaining 17 (which corresponded with invited papers) had no preprints or summaries. Furthermore, we have been told that the Association has no more copies of the set of preprints, having intended to give them out only to registrants. The Association doubtless has good reasons for these decisions conducing to the unavailability of desired information; but the main underlying reason certainly is that computer people are so busy with actual computers that they are unable to do a good job with information about computers.

We would like to help organize, with the assistance of leading organizations in the computer field, a "Master Library" and "Superintendent of Documents" for the computer field. We would gladly contribute all the books and other information we have; and we are sure there are some more people in the computer field who would eagerly contribute likewise, in return for easily getting copies of whatever they wanted. With suitable support from leading organizations, including support of salaries to librarians and operators of mul-

tiplex copying machines, it might be possible to set a fine example of a scientific field well-organized from the point of view of access to the information it produces.

II. From Eugene Garfield, Pres., Documation, Inc., Woodbury, N. J., to the Editor

"Your comments about the need for a 'Master Library' and 'Superintendent of Documents' in the field of automation will receive hearty approval from the members of this growing profession. We here at DOCUMATION thought they were particularly interesting since we are the first organization which is devoted primarily to the two problems of the 'documentation of automation', hence DOCUMATION, and the automation of documentation. The relationship between information problems and information handling is probably appreciated best by the people working in the field of automation.

You are already familiar with our publication Management's DOCUMATION Preview. I think you will agree that automation is of fundamental importance to all types of management today. This was the reason we emphasized automation in the title of this publication. At the same time all the other conventional management subjects such as personnel are of great importance to the people in top management and all those concerned with automation. Management's DOCUMATION Preview meets the requirements of an extremely interdisciplinary area — that of management. The same is true of automation.

(cont'd on page 49)

INDEX OF NOTICES

<u>For Information on:</u>	<u>See Page:</u>
Advertising Index	58
Advertising Rates and Specifications	56
Back Copies	52
Bulk Subscription Rates	50
Manuscripts	48
Reader's Inquiry Form	58
Special Issues	37

Address Changes: If your address changes, please send us both your new and your old address (torn off from the wrapper if possible), and allow three weeks for the change.

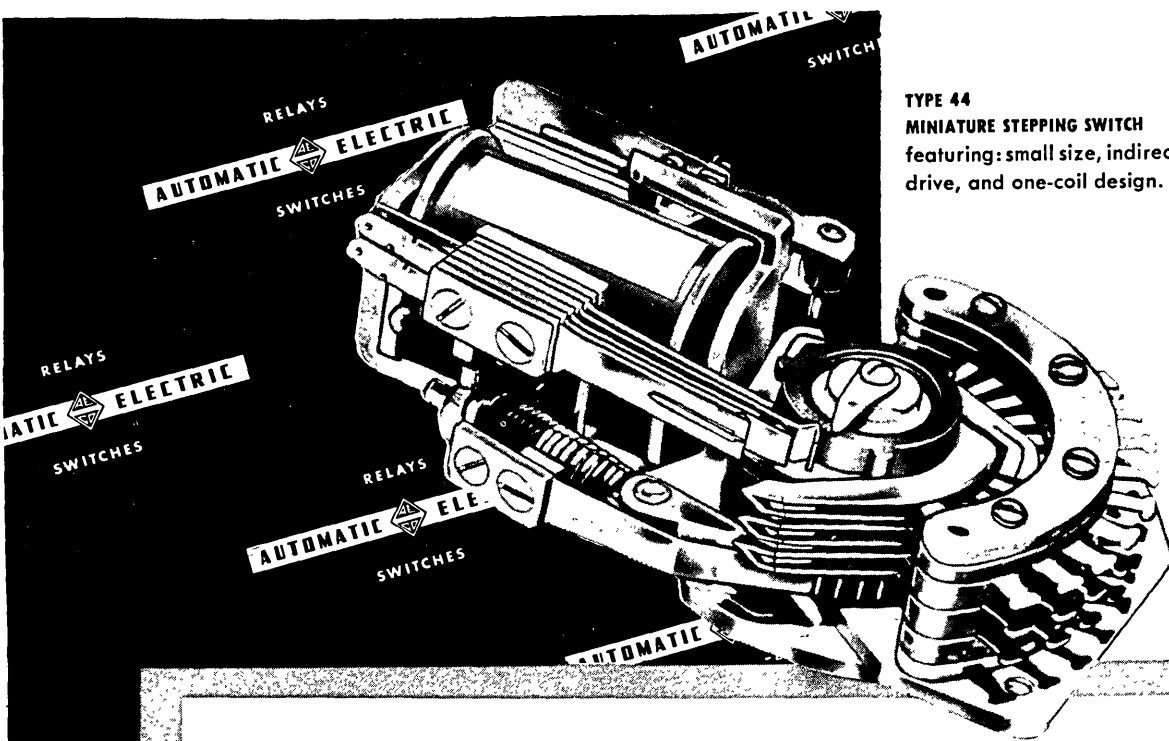

TYPE 44
MINIATURE STEPPING SWITCH
 featuring: small size, indirect drive, and one-coil design.

Well-Adjusted

for a long, active life

**200,000,000 operations,
 with little
 or no adjustment!**

This rugged little stepping switch is racking up an outstanding service record in countless operations. It's Automatic Electric's Type 44 Miniature Stepping Switch, now going into more products than ever before!

Its cost-reducing features are impressive. One-coil design eliminates a separate release coil. Indirect drive gives smooth, high-speed stepping. There's no wiper "double loading" or galloping. Here's the first compact, lightweight switch for 10-, 20- or 30-point operations. Use any dc voltage up to 110 (with rectifier, up to 115 volts, 60 cycles, ac).

To improve your products without raising costs, get the full details on Type 44 and Automatic Electric's *complete* line of stepping switches. Write to: Automatic Electric Sales Corporation, 1033 West Van Buren Street, Chicago 7, Illinois. In Canada: Automatic Electric Sales (Canada) Ltd., Toronto. Offices in principal cities.

AUTOMATIC  ELECTRIC

Originators of the dial telephone • Pioneers in automatic control



COMPUTATION FOR AN EARTH SATELLITE

NEIL D. MACDONALD
New York, N.Y.

The Navy Department and International Business Machines Corporation are providing a high-speed electronic computing facility to calculate and predict the orbit of the earth satellite to be launched for scientific purposes during the International Geophysical Year (IGY). "Project Vanguard" has the responsibility for the satellite.

During the IGY, which begins July 1, 1957 and continues through December 31, 1958, scientists will try to place the satellite in an orbit from 200 to 300 miles above the earth.

The Vanguard Computation Center will be located in Washington, D. C. and will use an IBM 704. Dr. Paul Herget, a consultant of the Naval Research Laboratory, will head its staff. Dr. Herget is Director of Cincinnati Observatory and Professor of Astronomy at the University of Cincinnati, and is noted for his work in keeping track of some 1600 minor planets or asteroids for the International Astronomical Union. He has rediscovered the orbits of several which have been lost from view for decades. Much of Dr. Herget's computational work has been done with electronic computers, and so Dr. Herget knows the problems of tracking fast-moving celestial objects. Using the IBM 701, the forerunner of the 704, Dr. Herget located the "lost" asteroid Athalia two years ago.

The Vanguard Computation Center will be connected by teletype and telephone with the Vanguard Communication Center, to be located also in Washington. A second standby Navy computing facility, however, will also be on call somewhere else, quite likely at the Naval Proving Ground, Dahlgren, Virginia.

After the launching of the satellite, the Vanguard Computation Center will operate around the clock, calculating the orbit. The Center will use data from a number of radio tracking stations and observation points all over the world.

According to present plans, each radio

tracking station will send three sets of data to the Vanguard Communication Center within 20 minutes after the satellite passes the meridian longitude of the station. After screening of the data, it will be given to the computer. Each set of data will consist of two angles defining the direction of the satellite and a time of observation. The Vanguard Communication Center will also receive information from unofficial tracking stations and from optical observation points throughout the world and turn this information over to the Computation Center for calculation.

The computer will use the information obtained from the tracking stations to calculate a set of factors to describe the satellite orbit. These orbital factors will be used by observers all over the world to predict the time of passage of the satellite over various observation points. The orbital factors will also be supplied to the radio tracking stations, official IGY optical observing stations, principal astronomical observatories of the world, and major cities of the world. The prediction data to be computed for IGY optical stations will include the time of meridian passage, the zenith angle, the angular velocity, and the location of a favorable acquisition direction before meridian passage. Information furnished for the major cities will tell when and where to look for the satellite.

The satellite can probably be observed optically under favorable weather conditions. But in any event the Naval Research Laboratory expects to track the satellite in almost any kind of weather, using a method called "Minitrack". This employs a miniature radio transmitter which will be placed in the satellite and will radiate a continuous signal to sensitive receiving equipment on the ground. This signal will be picked up by official radio tracking stations and other radio observers and relayed to the Vanguard Communication Center.

Present plans call for official U. S. tracking stations to be located at the following sites:

Blossom Point, Maryland (40 miles south of Washington, D. C.)

Earth Satellite

Fort Stewart, Georgia
Batista Field, Havana, Cuba
Coolidge Field, Antigua Island, British
West Indies
Mt. Cotopaxi, Quito, Ecuador
Ancon, Lima, Peru
Antofagasta, Chile
Peldehue Military Reservation, Santiago,
Chile
Navy Electronics Laboratory, San Diego,
California

Information obtained from the satellite is expected to help scientists learn much more about the size and shape of the earth and its atmosphere than they now know. According to Dr. John P. Hagen, who is Director of Project Vanguard at the Naval Research Laboratory, the satellite will allow scientists for the first time to make astronomical observations of certain electromagnetic radiations from the sun which do not penetrate the earth's atmosphere. The satellite, it is expected, will also give more knowledge about the atmosphere, incoming radiations, higher regions of the atmosphere such as the ozonosphere and the ionosphere, and certain phenomena in the atmosphere such as the aurora.

Work on Project Vanguard began during the summer of 1955, after President Eisenhower announced that the U. S. would launch an unmanned earth satellite as part of this country's participation in the International Geophysical Year.

Project Vanguard was undertaken by the Department of Defense at the request of the U. S. National Committee for the International Geophysical Year, established by the National Academy of Sciences, and of the National Science Foundation.

Department of Defense participation is on a three-service basis, with Navy management under the Chief of Naval Research. Project Vanguard has been established at the Naval Research Laboratory, which has received the responsibility for implementing the technical program. This includes the development of a three-stage rocket-launching vehicle, the launching, the initial radio tracking of the satellite, and the determination and prediction of its orbit. The Glenn L. Martin Co. of Baltimore is the prime contractor for the launching vehicle.

The satellite will be fired from Patrick Air Force Base, Florida, sometime between July 1, 1957 and December 31, 1958.

The Vanguard Computation Center will make preliminary tests and dry runs well in advance of the launching date. As the satellite, a 20-inch sphere, is carried into space by a three-stage rocket, the Vanguard computer will seek to predict its course. The problem compares with keeping track of a golf ball dropped from a supersonic jet plane 12 miles high. The internal operations of the IBM 704 takes place at a speed many times faster than the earth satellite which it will track. A typical electronic signal travels back and forth over the wires of the computer at 186,000 miles per second, reversing direction a million times a second. These impulses are harnessed by complex circuitry in the arithmetical and logical unit so as to perform additions and subtractions at a rate of 41,800 per second and multiplications and divisions of ten-digit numbers at 4,700 per second.

From a minimum of one position report per 90-minute revolution of the satellite around the earth, the 704 will calculate the satellite's expected time of passage overhead for the benefit of observers all around the world.

The task of keeping ahead of the fast-moving satellite is very complicated. The earth's surface will shift 1600 equatorial miles to the east, in the hour and a half required for the satellite to complete a full trip around the earth. Unlike an aircraft, the tiny sphere will be almost free of our atmosphere at heights from 200 miles and up. The man-made moon will rise in the west and set in the east approximately fifteen times a day over the longitude of the planet from which it is launched.

A further factor which must be taken into account is the inclination of the satellite's orbit, which is expected to lie between 30 and 45 degrees. If the inclination were 45 degrees for example, the satellite's orbit would pass over locations in a belt lying between 45 degrees north latitude and 45 degrees south latitude. Accordingly, the satellite would be visible at locations in and sufficiently near this region. The satellite will only be visible, however, at dawn or twilight, provided the sky is sufficiently free from clouds. It will be seen only when its bright, metallic outer skin is lighted by the rays of the sun against a darkened sky. If the orbit remains constant, the imaginary shadow cast by the satellite on the rotating earth below can be traced on a wall map as a series of curving lines crossing back and forth over the equator. The upper and lower limits of the lines depend on the angle of launching. The larger the angle, the greater the area of the earth over which the satellite will be visible at some time.

(cont'd on pages 8, 9, and 23)

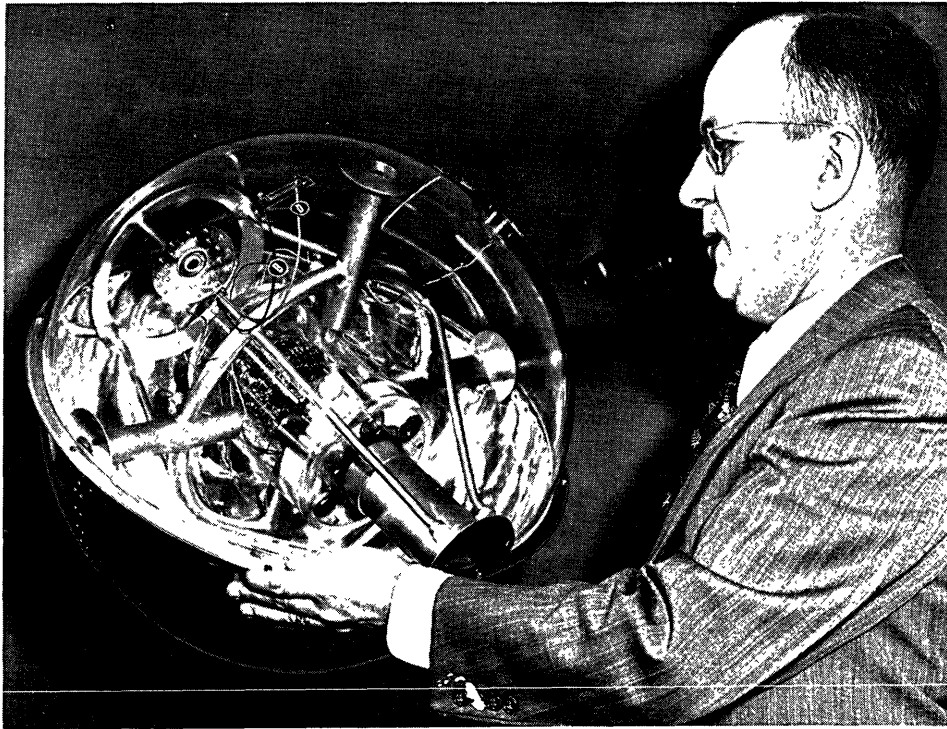

Dr. John P. Hagen, Director of Project Vanguard, is shown here with a full-scale cutaway model of the earth satellite designed by scientists working under his direction at the Naval Research Laboratory, Washington, D. C. The instrumentation shown inside includes telemetering equipment which will transmit a radio signal to earth after the satellite has been launched into space. This information, relayed to an IBM 704 electronic computer in Washington, D. C., will be used to predict and calculate the satellite's orbit.

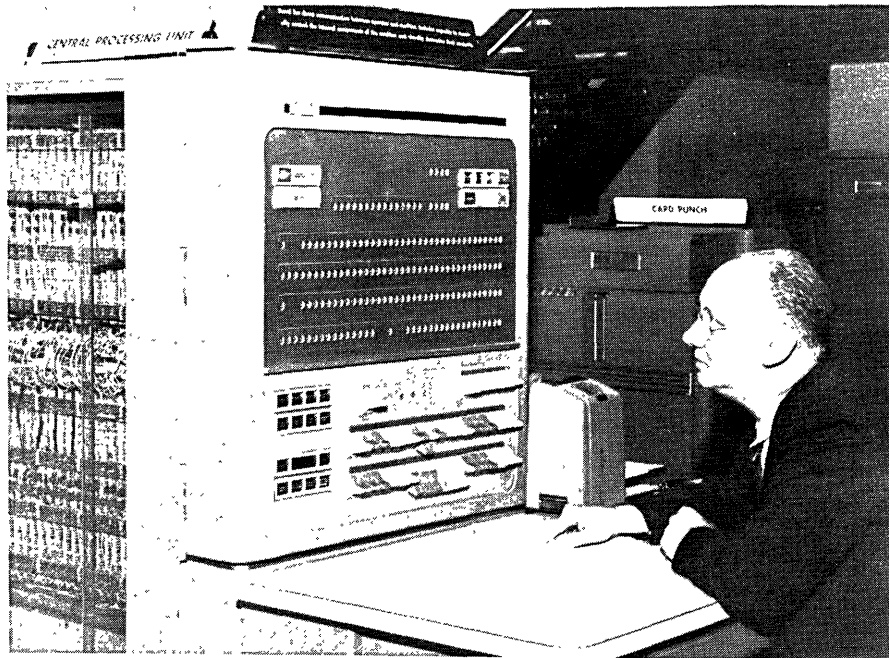

Dr. Paul Herget is shown at the console of the IBM 704 Electronic Data Processing Machine. He will head the Project Vanguard Computing Center, Washington, D. C., which will utilize a high-speed system of this type to predict and calculate the orbit of the man-made earth satellite to be launched during the International Geophysical Year.

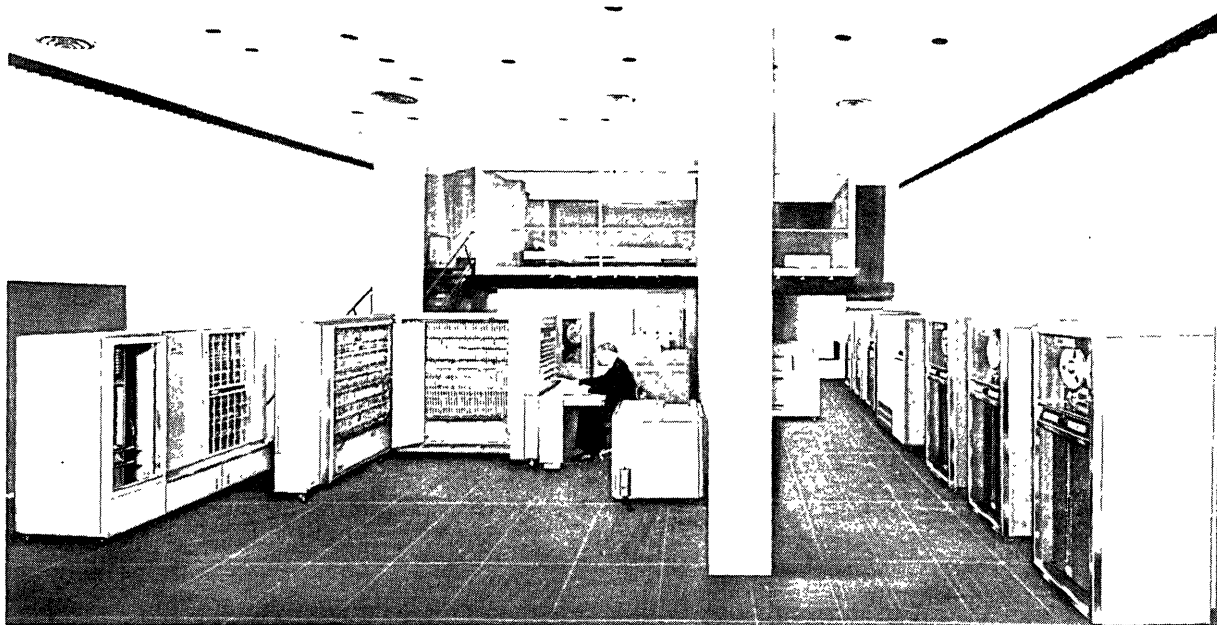

The IBM 704 Electronic Data Processing Machine, which will calculate and predict the course of the earth satellite at tremendous speeds. The 704 will be the heart of the Project Vanguard Computing Center, Washington, D. C. Radio signals emitted by the satellite will be relayed to the Center, where the giant machine will process information and compute the orbit of the tiny sphere for the benefit of radio tracking stations and optical observers.

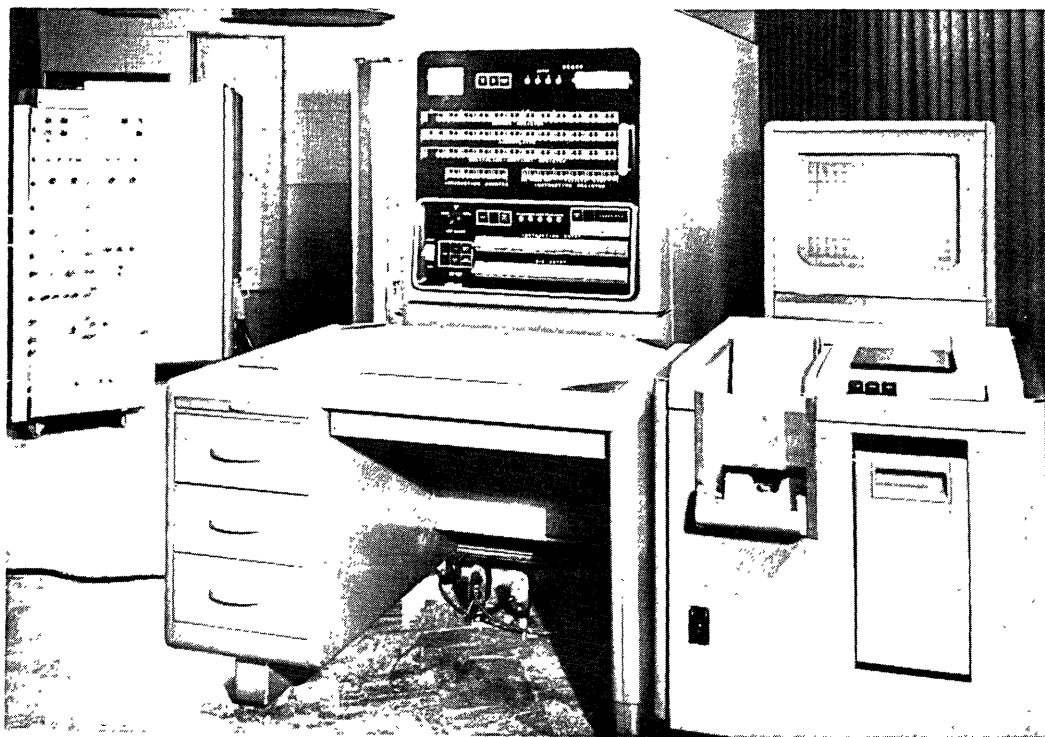

The IBM 740 Cathode Ray Tube Output Recorder (CRT), a visual display unit which pictures the output of the IBM 704 Electronic Data Processing Machine in the form of engineering symbols, words, numbers, or geometrical figures. The orbit of the earth satellite can be plotted on the screen of the CRT as this information is being computed by the machine. With the CRT, Project Vanguard scientists plan to trace the course of the satellite over the face of the earth directly below, photographing the pattern and superimposing it on maps of regions having favorable observing conditions. They can also use the cathode ray tube for any other phase of the satellite problem which they wish to demonstrate visually.

(text cont'd on page 23)

NEW COMPUTER DEVELOPMENTS AROUND THE WORLD

Everett S. Calhoun
Stanford Research Institute
Economics Division
Menlo Park, Calif.

(Presented at the Eastern Joint Computer Conference, New York, Dec., 1956)

It has indeed been an interesting assignment to travel during the past four months through twenty countries to observe the developments in electronic computers and office automation. Ninety-five visits have turned up over thirty-five different computers and a host of electromechanical devices for data recording.

Inasmuch as my primary interest was in automatic data-processing no special effort was made to visit analog computer laboratories or scientific computer installations. However, as in the United States, nearly all of the European computers were originally designed for military or scientific-mathematical purposes. In order to capture a share of the larger business data-processing market, most of these are now being altered to provide better input-output facilities.

The concepts of IDP (Integrated Data-Processing), EDP (Electronic Data-Processing), and Office Automation are already accepted by big business abroad. I found government bureaus, banks, insurance companies, manufacturers, department stores and mail order houses eagerly awaiting the day when automation will supply an answer to their rising office costs. Although salaries appear low compared to ours when converted to U.S. dollars, the percentage of clerical costs to total overhead is too high, and good clerks are scarce in Europe also. It is widely known that new business tools will soon be available which will not only do routine work automatically, but also provide management with better and quicker information.

Europe is undergoing a building boom that is unprecedented. Many parts of the world, particularly our former enemies, are approaching a prosperity similar to ours in the "Roaring Twenties". New factories, stores, offices and apartments are replacing the bomb shattered obsolence of the thirties, and the most modern equipment is being installed. Business men speak about

"Univac" and #650 and "Datatron" with the same familiarity as in this country.

In the Far East most of the electronic developments are coming from Tokyo. The Shibaura Electric Company built their first computer, the TAC (Tokyo Automatic Computer), for Tokyo University. This serial, digital, binary machine has both electrostatic tube and magnetic drum storage. A second model is nearly completed. In the Government Electrotechnical Laboratory a partly transistorized computer was demonstrated to me, called the "ETL Mark III". 120 Transistors are used along with 55 vacuum tubes and 1600 germanium diodes. 256 words are stored in glass supersonic delay lines, providing multiplication in less than one millisecond. Kyoto University is also using a computer in its mathematical department, and several other firms are designing new machines. When entering the air-conditioned room where a large relay computer was in use at the telephone company, I was asked to remove my shoes "to prevent the entry of dust". Removing shoes is of course a common occurrence in Japan, but perhaps some of our magnetic tape installations could adopt this plan as a cure for "dropped bits".

The Statistical Institute of India has ordered a "URAL" Computer from Russia. This decision followed a trip to the U.S.A. to investigate available equipment. Dr. Mahlinobis, the Director, was not sure of the characteristics or specifications, nor the type of input and output equipment which would be furnished, but it appears to be in the class with a Univac #120 or an IBM #607 or BULL "Gamma".

Discussions with several people who have visited Russian computer developments indicate they have completed a number of designs of modern computers at several laboratories, the principal one being the Institute of Exact Mechanics and Computing Techniques at the Academy of

New Developments

Sciences at Moscow. I heard a speech at the Instruments and Measurements Conference in Stockholm, by S. A. Lebedev of this organization. He described the installation of Williams Tubes in the BESM, replacing the Mercury Delay lines. He seemed rather disappointed that even Dr. Williams agrees that the CRT storage is obsolete, and that every other speaker was emphasizing the replacement of CRT tubes with Magnetic Core store. I have no doubt, however, that their reputed 30,000,000 document library in Lomonosoff University, translated from every language by the 10,000 technical foreign language staff, has access to every process and patent published anywhere. Mr. Lebedev also discussed the use of magnetic drums and tapes, and the existence of a rotary wheel printer and another output device projecting 200 digits per second to photographic film. The BESM computer is reported to have an average operating speed of 7,000 to 8,000 three-address operations per second including access time.

A visit to the Leipzig Fair in East Germany proved fruitless as far as electronic machines were concerned. Eastern Germany was the location of the office equipment industry before the war, and firms like Reinmettal, Astra, Mercedes and others are still in operation and doing considerable export business to all the world except the U. S. A. While the quality of these machines suffered as a result of poor quality steel after the war, most users now report very satisfactory quality in recent production. It was significant that not one word regarding Russia was included in the publicity, and not one display was marked "made in the USSR". In former years such products formed a prominent part of the huge trade fair.

An exciting documentary could be written about the reestablishment of the office equipment industry in Germany since 1945. Many plants were demolished in the war, and, particularly in Berlin, the Russians removed the remaining equipment and took it to their Zone. Branch factories of large U. S. firms were left with a shell of a building, without a tool or even a light bulb. These plants have all been restored with modern tooling and machines now, and there is no evidence that the Russians ever got the removed equipment into production.

I talked with a number of East German factory executives who fled with microfilms and worthless Marks across the line by bicycle. They reassembled, pooled their resources, acquired financing and personnel. Buildings were constructed for production of typewriters, adding machines and

bookkeeping machines to meet the needs of western Europe. The basic superiority and talent of German technicians in the mechanical arts has resulted in a surprising comeback, and have established Germany as the largest exporter of office equipment.

Computer developments in Germany have been sponsored by the Deutsche Forschungs-Gemeinschaft (DFG) organization, with members representing various industries and branches of government. With a budget of many millions of Marks for the advancement of science, they have allocated to several universities sufficient money to build electronic computers. Goettingen University was putting the finishing touches on "Mark III" when I was there, and they have been operating "G-I" since 1952. "G-1" and "G-2" were built out of U. S. radar surplus for the most part, and are relatively slow, but "G-3" is a Ferrite Core storage parallel machine of much more ambitious proportions. The "G-2" model includes a magnetic drum with 2096 words of storage, and is serial in operation.

When one wishes to find out about computers in Germany, he visits Prof. Dr. Alwin Walther at Darmstadt Technische Hochschule. His staff maintains the best library of computer information in Europe. Prof. Walther has been the inspiration to design and construct computers in several other schools in Germany, and his own group have nearly finished the "DERA" (Darmstadt Electronic Recorder Automatic) which they will use in the Mathematics Department. Another group has been working for four years at the Munich Technical Highschool (6,000 student enrollment, college level) on the "PERM", a computer with an exceptionally fast drum, 15,000 rpm. Completion is being delayed by the replacement of 100,000 faulty connectors, a not-too-uncommon complaint of current computers.

The only operation in Germany where a quantity of computers have been made and sold is in a barn in Neukirchen-Hünfeld where Dr. Konrad Zuse has built 12 relay analog machines. He is currently finishing the first digital electronic, magnetic drum model, and reports that he has a backlog of half a dozen sales orders. The price will be in the neighborhood of 100,000 Marks (\$25,000). This can be better understood when salaries of \$100 per month and plant rent of perhaps \$100 per month are taken into account.

The center of full-fledged production of electronic computers in Germany will probably be

Stuttgart, a beautiful, thriving, modern industrial city of 1,000,000 skilled people. IBM have established their first #650 production-line here. Standard Electric Co. (IT&T) have formed the "Informatik" division of their 10,000 man operation to build transistorized computers. They are closely linked with large operations in Pforzheim, and in Belgium, where two computers have been built, one for an American buyer. Standard in Britain is also mass-producing a computer designed in Holland, and with their communication facilities and teletypewriter subsidiary, Lorenz, A. G., the I. T. & T. operation are impressive.

The first installation of a large-scale electronic data-processing system in Europe is at the Battelle Institute in Frankfurt where Remington Rand have installed a UNIVAC system. A new modern building, complete with air-conditioning and 60-cycle power source was built for this facility; it is strictly first-class. The machine will be used by industry and government as a computing center. I talked to people as far away as Madrid who were attending programming classes in Frankfurt, and many firms are planning to train personnel in the use of this equipment. IBM will use a #650 at Stuttgart for computing service, and plans are being discussed for a #705 at some other location in the near future.

One of the finest programs of technical development and group research is in the wonderful Scandinavian countries. Here the various technical schools have cooperated and the result is an excellent high-speed computer called the "BESK". To avoid the requirements for maintenance, increase its speed, and enlarge its storage capacity, the Williams Tubes have recently been replaced by a 4,000 word ferrite core store. These new core matrix boards were assembled at the technical school in Stockholm at minimum cost from cores of General Ceramics manufacture, and they were very proud that it worked perfectly three days after installation. Duplicates of this machine have been built at several commercial and governmental installations in Sweden, and a copy is nearing completion in Copenhagen. The University of Lund saved money on their copy by installing a magnetic drum initially.

One cannot help admiring the fact that, in spite of limited capital and resources, each of the smaller countries in Europe has some activity toward building computers. Norway has a small drum machine in the Central Institute at Blindern University, and partly as a result, the government is to receive the first "MERCURY" Comput-

er from Ferranti. The Mathematics Center at Amsterdam built a small relay computer four years ago. Now they have a new electronic core model, and they built a duplicate for the Fokker Aircraft Company. Due to the interest created, the Shell Company bought a "PEGASSUS" computer, and the government Telephone & Telegraph laboratory built a series of computers, one of them for mass production. This machine incorporates a novel system of programming, each instruction word includes a "long" and a "short" address plus up to 12 functional operations, each designated by one character.

The inspiration for a number of computer and electronic developments in Europe is the operation known as PTT, Postal, Telegraph and Telephone, which operates the banking system of the various governments. This is the largest single data-processing operation in the world, unless our Social Security tops it. Every day, in each large center in Europe, hundreds of thousands of postal checks are issued, and a statement is mailed each day to every depositor whose account is active. The problem of sorting the paper is a major one, and there is great current interest in magnetic ink character recognition. The Holland group are trying to find a method of reading handwriting. The BULL Company in Paris is demonstrating a magnetic-ink coded check sorter. In Switzerland they have punched 40 holes, 1/4" diameter, in the checks so they can be sorted, but the result looks like Swiss cheese. Some solution is bound to come to the problem before long.

Switzerland and Italy have no commercial developments in computers as yet. The Technical Highschool at Zurich had the "ERMETH" built for them by Hasler A. G. in Bern. IBM have just dedicated their new research laboratory in Zurich; the director is Dr. Speiser who designed the Ermeth machine. In Italy, Spain and Portugal, the business machines industry is dominated by OLIVETTI, and it will probably not be too long before some announcements in the electronic field will be forthcoming. Research is under way at Pisa. A Ferranti is in use at the University of Rome, and many Italian banks are using machines such as the Univac #120, the IBM #604 and the BULL Gamma, all punched-card-programmed electronic calculators.

If punched-card-programmed calculators are included, then the largest producer of electronic computers in Europe is the Compagnie de Machines Bull in Paris. This firm has installed several hundred "GAMMA" machines, largely in banks, and is now starting to produce a new faster model in-

New Developments

corporating a magnetic drum with 8,000 words of storage. Magnetic tapes will probably be added also, although there has been little if any effort to develop magnetic tape devices anywhere in Europe. At the other commercial computer factory in France, the Society for Electronics and Automation, Mr. Francois Raymond is installing Potter Tape units on the "CAB #3000" which is nearing completion, at a price of about \$250,000. A still faster model operating at 200 kc will perform multiplication in 0.21 milliseconds according to the announcements. I was told that a printer, called the "Numerograph", consisting of a CRT projection on film, would be delivered on a business data processing application in March 1957 but the prototype had not been started. Such faith and confidence is reminiscent of our earlier-day predictions in the U. S. A. This organization has produced, however, about 50 analog machines, mostly for machine tool control. I visited an installation of the first "CAB #2000" digital computer in a defense plant in Paris and was told it had performed excellently for one year with only part-time maintenance.

There is little doubt that the principal commercial production of electronic computers, especially for export, will come from Great Britain. The Universities have produced an able group of electronic designers and the knowledge of computer circuitry and component design is on a level with that in the U. S. A. A number of well financed manufacturers have passed the prototype building stages, and now have a backlog of orders which would probably total over \$10,000,000. The government, through the N. R. D. C., is stimulating and supporting developments in this field as evidenced by the granting, through the University Grants Committee, of six Ferranti computers to as many colleges for use in mathematics and research. Export sales to very remote countries are being made, and others considered, with utter disregard for the maintenance facilities now non-existent, but we should not try to tell England how to handle export business. I talked with computer salesmen who had been to the Orient on sales trips. Ferranti have sold machines in Italy, Canada, Sweden, Switzerland and South Africa, and Elliott Bros. will deliver machines in 1957 as far away as Australia from service facilities. Therefore we can assume there would be no hesitation to accept orders from the U. S. A., where dollar credits are so very desirable at this time.

British electronics firms operating in their domestic market, are finding, however, that the lack of established sales and service facilities is

a serious handicap, especially in the new field of business data-processing. They are following the lead of the U. S. A. by joining with business machines distributors whose knowledge of system selling and installation is based on sound experience. The machines of Ferranti will be sold by Powers-Samas. Elliott Bros. have concluded a sales agreement with National Cash Register. British Tabulating Machine Co. has joined with Laboratory for Electronics in Boston. Standard Electric, EMI Electronics, English Electric and Decca are still independent, but none have faced the sales problem as yet.

No report of British computer progress would be complete without some mention of LEO, the Lyons Electronic Office. The Lyons Tea Co. is a large, diversified firm, with 250 bakeries and restaurants and 400 kinds of tea distributed house to house. Even so, it was quite a departure to start building an electronic data-processing machine in 1950. This 6,000 tube machine with mercury delay line store has been in operation on payrolls since early 1954, and now has enough time to turn out 6,000 pay checks for Ford in addition to the 30,000 for the bakeries. A separate subsidiary has been established to build the computers which other firms are ordering, and 70 people are employed. A large Coop chain will be the first customer for the first of the "LEO II" machines, which are four times faster due to a shortening of the mercury lines. Bull or Samas printers will be used for output.

A number of unique design features are included in British computers which we are not using in the U. S. One is Nickel Delay lines for fast storage, first used in the "Nicholas" computer built by Elliott Bros. and continued in their newer data-processing models, the #404 and #405. Nickel lines will be used in the new Ferranti Data-Processor and probably in the EMI transistorized computer. Bull of Paris have incorporated nickel lines in their newest drum "Gamma". For bulk storage, however, Elliott Bros. have provided either a 4,096 word drum or a 16,384 word aluminum disc, 1/2" thick and 19" diameter. This appears to be considerably more simple in construction than most of the magnetic drums which are in almost universal use. Elliott are also alone in using 35 mm. film instead of plastic or mylar for magnetic tape storage, the film movement of 30" per second being controlled by the sprocket perforations. Two high-speed wire-matrix data printers are under development which will be used by the various computer manufacturers who wish faster speeds of output than the punched card tabulators. One of these by Samas has been demonstrated here by Underwood-Elecom, which

(cont'd on page 54)

INDUSTRY AND THE AUTOMATED FUTURE:

Problems Along The Way

JOHN DIEBOLD
John Diebold and Associates
New York, N. Y.

(An address delivered January 9, 1957 at the
Conference on Automation, University of California, Fairmont Hotel, San Francisco)

Despite the millions of words that have been written about automation, from Congressional hearings to comic books, very little has been said about automation as a business problem. And yet automation presents a unique problem to business management. It is only through the successful solution of this problem and through the widespread application of automation to business and industry that we can realize the benefits it promises to our society — in taking the work out of work, and in freeing mankind for the human use of human beings, as one philosopher has expressed it.

To the businessman, automation presents something of a contradiction. He has heard much of its wonders and of its fantastic potential. Yet when he looks about him for specific cases, he sees more promise than payoff. It is about this, automation as a business problem, that I want to address you this evening.

I have been asked to anticipate the nature of industry in the automated future, but before adding to the all too frequent speculations about the future, I should like to concentrate on some of the mistakes that are being committed in thinking about automation, and in applying it. The future depends upon the successful solution of the problems that face us today in understanding and applying automation.

Talk vs. Achievement

To begin with, there is much less concrete achievement than talk. We in business have found the application of this new technology a much slower process than might be assumed from the many newspaper articles that have appeared in the past few years. In many cases individual machines or devices have been applied, but not automation systems. Consequently, only a fraction of the poten-

tial benefit has been realized. In the area of automatic data processing, for example, there are well over a thousand computers already in operation, but only a small fraction of them are functioning as more than punched card calculators. As a result very few have produced real savings, or even the singularly important advances in the level of management control which has been a rationalization used to justify the dollar savings that have not appeared. This is true not only of office automation — thus far the most advanced area — but also of industrial or factory type automation.

The Managerial Problem

I should like now to discuss the managerial problem responsible for this situation. If we are ever to achieve the benefits of increased production and greater leisure that automation holds out as a promise, we must concentrate on the practical problems of the ideas and techniques of automation just as we must be alert to the many social, economic, and human problems of a changed society.

There are many problems that have handicapped a full realization of the potentialities of automation, but on the managerial side I think that the problems reduce themselves to two.

The first mistake is made when the businessman concentrates his attention on the hardware or individual machines of automation rather than the system.

The second major error is that because the businessman has been impressed into thinking of automation as a scientific or engineering problem, the important decisions have often been delegated to technicians, rather than dealt with as essentially managerial problems.

Automated Future

A whole chain of subsequent problems results from these two initial errors.

The "Electronics Committee"

To begin with, there is the Electronics Committee. Countless times I have heard otherwise responsible executives state, when I questioned them about what they were doing with regard to automation: "We have formed an electronics committee." And they have stated it in a manner implying that this takes care of the problem! In practice this often means no more than that the committee spends a year — or in one case I know of, three years — wandering about the country attending manufacturers' schools and visiting computer installations. This experience is somehow supposed to be sufficient for making critical decisions about the highly detailed process of automating. In no other area of business activity, with the possible exception of advertising, would any manager have so confident a feeling that a problem would be solved by delegating such a crucial problem to a committee.

All too often the electronics committee has been a device, whether intentionally or not, for creating the impression of doing something about automation while at the same time avoiding any action that could possibly backfire. I know of one case in which the electronics committee of a major oil company actually presented the final equipment choice, after more than a year's study, to the president of the company and asked him to choose between machines of two different manufacturers!

The training received by the committees at manufacturers' schools usually gives the members a pseudo-scientific appreciation of the equipment, and a bias toward whatever specific equipment they have studied. They return filled with technical phrases and parrot the sales arguments of the equipment company.

Operational Problems

While the scope of the automation problem encompasses virtually all areas of the business organization, the nature of the analysis and the decisions that must be undertaken, in short, the detailed work, does not lend itself well to committee organization — they are operational problems and should be treated as such. As has often been said, an administrative board has the same characteristics as any other board — it is long,

narrow, and wooden. It can be useful for insuring company-wide understanding and cooperation; but the problem of automation should be specifically assigned as the responsibility of an operating executive, preferably not a management eunuch — one who knows exactly how something is done but can't do it himself.

The "Scientist to Handle Automation"

A second major area of management trouble arises from the assumption that you must have an engineer or a scientist to handle the automation program. This has created a mad quest for skilled scientific personnel. I think we should accept the fact that as yet there are very few competent people trained to handle automation in the office. At the same time, a large group of job-hoppers has come into existence. This group would be considered "floaters" in any other field, giving themselves impressive job titles — rarely true job descriptions — and going through several employers in a few years. These floaters are disruptive in any organization. Introduced into a company structure on the ground of a need for specialists over the cries of good personnel people, they mean trouble.

Competently Trained People

When you come right down to it, one cause of the trouble is that the hardware of automation is being shipped faster than competent people can be trained to operate it. IBM, for example, is shipping about two million and a half dollar machines a week and close to two medium scale computers, \$50,000 a year rental, a day. But the answer is not to go into the job market for specialists. Good ones are exceptionally hard to find and money is no longer an incentive for the already highly paid — \$18,000 to \$30,000 a year — experienced men. These men are looking for very specialized kinds of opportunities. You cannot count on the loyalty or the stability of the job hoppers, and you are bound to disturb your regular organization. The consequences are, of course, none other than you would expect to find after violating any other sound personnel policy.

The solution is to train personnel from your own organization. Business is beginning to realize this. I find that my own firm has been spending an increasingly large amount of time training client personnel. We have come to realize that the training of personnel in analytical procedures, machine operation, and programming is one of the most critical problems of a successful automation installation. Indeed, as I will discuss more fully

later, education is the basic problem of automation. This is but one example.

Thorough Understanding of the Business

A successful installation of automation equipment cannot be made in business unless a thorough understanding of the business itself, and the functions and needs of its operations, underlies the installation. While the businessman may regard the specialized knowledge of the engineer with something approaching awe, the engineer all too frequently regards the unfamiliar processes of business as something that can be mastered in a few months. Glenn White of the Chrysler Corporation has remarked out of the experience of his company that:

We are satisfied that the way to put together a team of people to work on electronics is to take somebody who has a good knowledge of how to run your business, a good systems and procedures man, if you please. They can be trained in electronics much easier than somebody who knows electronics can be trained in how to run your business.

The problems arising from the delegation of authority to make decisions about automation to a technical group unfamiliar with the total business environment are perhaps corollary to the basic mistake made when businessmen approach automation from the standpoint of technology or hardware. There has been an unfortunate preoccupation with the machines of automation and an unfortunate eclipse of the more significant techniques of automation. The senior partner of one of the leading public accounting firms, which has widely touted data processing as the solution to all sorts of chronic business ills, recently made the statement that the first step in applying automation to the office is selecting the machines. Nothing could be more erroneous.

Computers are actually being ordered with some homely phrases as, "If you are going to make a rabbit stew, you had better begin by getting yourself a rabbit." The very phrase, "feasibility study", so often used on connection with the study preceding installation of a computer, frequently serves to imply to those conducting the study that they are trying to find an application for a computer. Their objective should be to design the best possible information and communication system for meeting the needs of the organization, whether it relies upon a computer, a simple manual and machine system, or entirely upon humans.

"Step-by-Step Approach"

A phrase that is often heard in this field is: "We are taking a step-by-step approach to automation." This, as intended, conveys the impression of caution and proper business reserve. But the fact of the matter is that it often means that another uncoordinated misstep is being taken into automation. What is so misleading about the 'step by step' approach is that while caution is a desirable thing, the whole concept of systems analysis and design, which is basic to automation, requires a careful and detailed plan for the entire organization if the benefits realized are to be more than marginal.

Following a step-by-step approach has all too often resulted in throwing out the previous step and redoing a great amount of work in installing the procedures and equipment associated with the new steps. The result is a continuing state of potential saving — always just ahead, after the next step.

In much of the work that my firm has done in this field we have been confronted with situations in which prior to our arrival the application of automation to the office was simply thought of as adding a new IBM machine to the tab room. I know of several firms that are installing major machines on just this basis. In reality there is an enormous opportunity for viewing and analyzing the entire organization as an integrated system, and we always insist that this precede evaluation of equipment. You begin with the system, not the machinery. In viewing the entire organization, great improvements can sometimes be made without recourse to automatic machinery. It is very unlikely that the reverse is true.

Disappointments in Savings

One of the reasons dollar savings have been so disappointing in existing computer installations is that by treating the computer as just another tabulating machine and not integrating it into the business system, high costs of data preparation are encountered and often seriously negate the dollar savings of automatic processing. On virtually every project my firm has worked on, one of our principal sources of savings has been the automatic derivation of data from a process as a by-product and the elimination of extensive key punching or other data preparation costs encountered when the computer is treated as just a newer, faster, and more automatic addition to the tabulating room. It is through just this process of reaching out into production and other business processes for auto-

matic collection of data that the office and factory are gradually being drawn more closely together.

So many examples of poorly used computers exist at this time because initially machines were bought with the obvious intention of applying a simple machine. Too much has been left to the sales representatives of the equipment companies. These firms simply do not have the experienced people necessary to do the application work for the new, highly complex machine systems. The top managements of companies are the first to admit this. What happens is that the unstudied system has been embarrassed with the wrong machinery.

In a system study we ordinarily insist that we concentrate on an analysis of the separate parts and on joining these parts into an effective and functional whole. But before we can insist on this, we must be sure that there really exists equipment which can be ordered to fit the needs of the system for automation.

Thus far I have stressed the fact that management has concentrated on hardware rather than the systems concept of automation. I want to make clear that there is both too great an emphasis on the hardware, and too incomplete a knowledge of the hardware. To manage successfully the conversion to automation, it is necessary to be familiar with the hardware that is available. Nothing that I have said thus far should be interpreted as implying the contrary.

The Production Process as a Whole

Just as the first step in automating the office should be a systems study, so the basic step in industry is viewing the production process — from the introduction of raw material to the completion of the final product — as an integrated system. To me, this is the distinctive fact about automation. It is no longer a question of thinking in terms of individual machines, or even groups of machines. It is a new way of organizing and analyzing production, a concern with the production process as a system and a consideration of each element as part of that system. It is something of a conceptual breakthrough, as revolutionary in its way as Henry Ford's concept of the assembly line. Indeed, it may in the end have an even more widespread effect on business and industry, since it rests on an idea rather than on a method or particular kind of machine and is adaptable to many different kinds of operations, office work as well as factory work, small

concerns as well as large.

Integrating all the separate stages of the production process into a single smooth-running system — the first step in industrial automation — cannot be done by designing a machine to help a worker do his job more effectively. It can only be done by questioning each stage in the production process and finding out whether it really is necessary, whether it must be separate from other stages, and whether it can be performed without the help of a human operator. R. H. Sullivan, Vice President of the Ford Motor Company, has stated:

"I don't mean that our factories had no automatic machines. We found, for example, that it was fast becoming impossible to utilize the full capacity of up-to-date machine tools, because men couldn't load and unload them fast enough by hand. The trouble with our manufacturing methods was that, like Topsy, they 'just grew', and nobody had taken time out for a long view. What we needed was a complete rethinking of the problem — a whole new philosophy of manufacturing."

Automation: Transfer Machines

So much progress has been made in the application of automation systems to the automotive and related supply industries that an unfortunate stereotype has arisen to the effect that automation is limited to companies with large dollar resources and exceptionally long runs of product. This is not true, but the reason the impression has grown is easy to understand. The kind of industrial equipment used in the automotive industry, for example, is very specialized, made for the requirements of a particular product. It also costs a lot of money. But it is simply one manifestation in hardware of the technique of automation applied to a particular type of industry. The large transfer machine complete with loading and unloading device is well suited for the automobile industry, where literally millions of identical parts pass through a line before new equipment has to be considered.

Automation: Control Systems

It is not so well suited to the estimated 80 per cent of American industry that produces in lots of 25 or fewer identical pieces. Nor is it well suited for industries that frequently redesign their products, since any major change in design means costly re-adjustments at best and may even mean scrapping

these expensive machines. But the new technology of automation that deals with feedback and control systems is producing a new family of machines guided by magnetic or punched paper tape that makes it possible to obtain the benefits of automatic production yet retain the flexibility of operation essential for job shop production. These machines are only beginning to appear. Some forty different prototypes can today be found in the shops of machine tool manufacturers and during the next few years they will begin to have an enormous impact on the small lot producers of this country.

Automation: Highly Instrumented Industries

A second stereotype that I believe exists in the public mind with regard to automation is the impression that the ultimate in automation can be symbolized by an oil refinery or any other highly instrumented process industry. Nothing could be further from the truth. In fact, although automatic operation has been achieved in these refineries, they are only beginning to feel the full impact of a second, and more significant, stage of automation.

The intricate controls that run a refinery almost by themselves are far from being the ultimate in automation. Feedback, after all, only makes it possible to maintain a variable at a desired value without human intervention. The value itself must still be selected, and the control instrument adjusted accordingly. In many cases, it is not possible to determine the relationships among variables that will hold true throughout an entire process. This means that the operator cannot simply set his controls and go home. He must reset them every time a test of the product during processing shows that changes are needed. And making these adjustments is not as easy as inching up the dial of a thermostat, for example, and seeing what happens. Indicators and recorders have multiplied in such bewildering profusion that they have had to be greatly reduced in size to allow for ready comprehension of the entire process by a single operator in a single control room, or even a number of operators. Even so, the panels of miniaturized instruments schematically reproducing the operations of a process often cover all four walls of a large room.

The result is that even such a highly automated industry as refining works most of the time on a trial-and-error basis. A refinery may not be operating at optimum for more than a few minutes out of its entire twenty-four hour operating day. Genuinely effective control, it is estimated, could

increase yields by as much as thirty per cent. In the case of some of the newer petrochemicals the question of effective control becomes vital. Polyethylene, for example, the plastic that has become so common to us in the form of squeezable containers, turns to a useless wax unless an exquisite balance is maintained among a number of rapidly fluctuating variables.

Thus, in spite of the impressive and numerous dials on the control panels of a modern process plant, the actual control of the process is still in a primitive state. To achieve the kind of control that is required, all of the individual controls need to be integrated into a single, coordinated, self-regulating system. Just as a single machine designed on the feed-back principle notes and corrects variations in its output, so an integrated self-regulating system will note and correct variations in the end-product of an entire plant, making precise and almost instantaneous adjustment whenever the product itself shows any variation from optimum quality. Since the control of a number of variables to produce the desired end is essentially a calculating operation, the integrated operation of the process plant of the future will depend upon an electronic computer to analyze, correlate, and correct the operations of the individual control devices.

At present, however, we simply do not know enough to use a computer in this way and, although we are very close to achieving such a controlling computer, we do not yet possess a computer that is reliable enough to operate suitably in an 'on line' capacity for long periods of time. We do not yet have instruments that can measure reliably, accurately, swiftly, and continuously enough all the variables of refinery operation. We do not yet know how to measure, relate and reduce to equations that a computer can handle, all the process conditions that determine the quality of a given end-product. The most limiting problems hampering the development of automation in industry today are technical. In the office they are managerial. And so far as automation in the office is concerned, if all technological development were to stop today, it would take us many years before we would find that we had fruitfully applied and made proper use of the machines and techniques we already possess.

The Soviet Ministry of Automation

A British spokesman remarked recently that whoever wins the automation race will have won

Automated Future

the cold war. This may well be true. A fact that is not generally known in this country is that the Soviet government recently created a Ministry of Automation headed by a minister of cabinet rank, Mikhan A. Lesechko. A large part of the current five year plan is devoted specifically to automation.

This is not entirely surprising. Russian computer work, for example, has always been conducted under a high security classification. Several years ago all development work in this field was withdrawn from the satellite countries and confined to the heartland. Nevertheless, many Russian mathematical texts and journals reach us and it has been obvious for some time through the type of problems they are concerned with, and the methods of solution they propose, that there must be access to enormous computing capacity behind the iron curtain.

When you consider the fact that General Electric was recently awarded a jet engine contract because their company was four years ahead of the field in blade design, having used a computer to shorten the immense labor of simulating blade designs in pre-construction "drawing board flight tests", you can begin to appreciate that Russian concern with automation goes far beyond a desire for reduced production costs.

For example, the Russians are well aware that Douglas Aircraft was able to get the DC-7 into the air six months sooner because of a giant IBM 701 computer. They know, too, that our atomic energy program would not have been possible without high speed computing facilities. It would be folly to underestimate USSR ability in this field. The Russians have always been a highly capable people in the field of mathematics, and this discipline, after all, is the basis of success in the field of computers. No one interested in business, industry, or education is unaware of the fact that the Russian government has an effective and extensive program for turning out thousands of engineers and technicians each year.

I don't think that these facts are matters for hysteria or fear, but I do think that they are conditions on which our survival rests. I think that we must realize that automation will play a crucial role in determining whether we can maintain the high standard of living we now enjoy in the future. Our high standard of living, which is based on our magnificent productive achievements, is one of the sources of our freedom. In the past few years much attention has been given to the potential threat of automation. Perhaps some attention should now

be given to the fact that we are not automating fast enough.

A Study of the True Effects of Automation

In the autumn of 1955, when I presented the opening testimony at the first Congressional hearing on automation, I proposed that an unbiased and objective study be undertaken of the true economic and social effects of automation. At that time I stated that:

"The problem, in assessing the economic and social impact of automation is that we do not have the facts. If there is concern over the effects of automation, it seems to me highly desirable that we get these facts in the most expeditious way possible: through a thorough analysis of automation, based upon a complete, factual, industry-wide investigation. Such a study would provide, for the first time, a realistic basis for planning on both a national and a private scale. With the broader perspective such a study would provide, industry could plan automation policy with a finer regard for the consequences. National policy concerning education and training programs, retirement benefits, and unemployment compensation must be based upon such a factual and intimate understanding of the subject."

Since that time my firm has completed a pilot study for a committee of the National Planning Association. This study outlines a plan for an objective program of exploration of the social and economic consequences of automation, based in part upon a series of case studies in different industries. I believe that such a program would do much to clear the air as to the real effects of automation. The facts rather than conjectures should be the basis for planning action.

Education for Automation

I think that the most important question of all is: How shall we go about educating ourselves for an age of automation?

The question of education goes far beyond better training for work in specialized fields. Many of the new jobs that automation will create will require an increasing ability to think and to judge, increased understanding of logical methods, in short, increased education in the largest sense of the term. Management will need these abilities on a higher level. And all of us, if our increased

(cont'd on page 43)

ELECTRONIC DIGITAL DATA HANDLING

HOWARD T. ENGSTROM
National Security Agency
Washington, D.C.

(Based on Dr. Engstrom's Introduction and Keynote Address to the Eastern Joint Computer Conference, New York, December, 1956)

I am honored to be invited to furnish the keynote to this important conference. As a mathematician by training, I am perhaps misplaced in this role. But, by a curious sequence of circumstances, I have been in a position to observe the progress of electronic digital data-handling since the beginning of World War II.

Although the term "electronic computing" covers a wide range of equipment, I am using the term in the sense of large-scale internally programmed digital computers. They have made very many contributions to the scientific and business life of the country during the past five years.

Military Impetus to Science

The great impetus to this art came from the military during World War II. The impact of military needs on scientific progress is not a new thing. It probably began with Archimedes, who helped his cousin, the tyrant of Syracuse, to defend that city against the Romans in 212 B. C. I quote from Plutarch's "Life of Marcellus" in this regard.

"The king prayed him to make him some engines, both to assault and defend, in all manner of sieges and assaults. So Archimedes made him many engines, but King Hieron never used many of them, because he reigned the most part of his time in peace without any wars."

Skepticism and Belief

Electronic computing engines were constructed during World War II, and some of them made significant contributions to our victory. However, only at the end of World War II did general purpose electronic computing devices begin to be delivered.

Conviction in their practicality and faith in their future rested at that time principally among those people who had been working in the field for the military during the war. The Defense Department in general was convinced of the necessity of pursuing research and development in this area for the solution of military problems. But American industry in 1946 was not so convinced.

As a result, in the post-war period, many individuals with faith in the future of the field established small independent companies which were financed by the Defense Department. I do not need to name these companies since I am sure most of you are familiar with them.

Some universities also, such as Harvard, Princeton, and the University of Pennsylvania, carried on research and development in logical structure and component development. Again in these universities the program was stimulated essentially by individuals who had faith in the future of large-scale computing devices. University management was not convinced, and in some cases still remain unconvinced, that the field of logical structure and design of computing devices is one with proper academic stature.

Well-Balanced Computing Devices

About 1950 many of the problems with respect to memories, input-output devices, and peripheral equipment had been solved so well that well-balanced large-scale computing devices were put into operation. At this point big business became strongly interested in the field. Many small companies who had had a difficult financial struggle to keep going were merged with large companies; so in the early 1950's the electronic data processing industry achieved financial stability as well as technical maturity.

Data-Handling

Present Volume of the Industry

The phenomenal growth of the industry is difficult to estimate. It is certainly true that the present volume of business in electronic-data handling equipment is in excess of one billion dollars per year. Speculations as to its ultimate position are difficult; but certainly the industry will not reach a saturation point before expanding at least ten times.

The delivery of many of these equipments to industry and government has opened up tremendous activity in the field of applications. I believe the most important aspect of electronic computation in the last several years has been precisely in the area of a better understanding of the value of this equipment in our scientific and business problems.

Although the computer and data processing industry has achieved technical reliability and financial stability, serious problems still exist in many areas. I should like to point out some of these areas which come to mind and which I believe members of this Computer Conference can assist in resolving.

Over-Optimism

The enthusiasm with which electronic data handling and automation possibilities have been greeted is astonishing. I should not like to state categorically that the field has been much oversold, but I do think the over-optimism of engineers and scientists in connection with the field is a definite fact. This optimism causes serious complications. If a business or the Department of Defense is to rely upon estimates of delivery and performance which are made by engineers, they must have some degree of confidence in the technical and financial judgment of the estimators. Too many cases of long delays in the delivery of vital equipment have occurred. Many of these delays I believe could have been avoided had projects been technically less ambitious. It is better to have equipment on time even though it may operate at only half the technically feasible speed.

Engineering Manpower

Another aspect of the industry which I believe you should consider rather seriously is that of engineering manpower. The Defense Department is pursuing many projects in electronic computing. These projects result in many contracts with pri-

vate industry. The usual procedure following the award of one of these major contracts has been for the contracting firm to proselyte engineering personnel from its competitors. As a result there is an inflationary spiral of salaries for engineering and scientific personnel.

You may well say that a man is worthy of his hire. I do not subscribe completely to this point of view. The usurer who extracts excessive interest rates is not particularly admirable; nor is prostitution recognized as a reputable profession.

I believe that it is within the power of you technical people to assist in rectifying this situation. I believe you have lost a great deal of dignity in participating so actively in this mad scramble for personnel. You can be of tremendous assistance to the national defense in assessing proposed employment changes not only on the basis of salary but on the basis of the technical merit of the projects concerned and your potential achievement in a technical sense. It is certainly your responsibility to see that our industrial and defense program is on a sound basis.

Achievements

I hope you will not feel that these criticisms of over-optimism and personnel instability detract from your achievements over the past ten years in the creation of a tremendous industry, which is in fact one of the important elements of our national defense. The many papers which will be presented at this conference are a witness to the continued dynamic advance in the art as well as the industry. However the soundness of your position in American economic life is clearly dependent upon your personal integrity.

I believe we should all give more attention to the two points I have tried to make with respect to (1) dependability in the matter of prediction of achievements, and (2) money and engineering manpower.

Disparity of Computing Equipment and the Human Spirit

One of your previous speakers quoted the great German novelist, Thomas Mann, as follows:

"What perplexes the world is disparity between the swiftness of the spirit and the immense unwieldiness, sluggishness, in-

(cont'd on page 32)

ELECTRONIC COMPUTING MACHINES IN THE NATIONAL ECONOMY OF THE SOVIET UNION

V. PEKELIS

(Reprinted from Soviet News Bulletin, Dec. 18, 1956, published by
Press Office, USSR Embassy in Canada, Ottawa, Canada)

Man has built an immense variety of machines and instruments.

Today, we have machines to help man not only in his physical labor, but in his mental labor, too. There are machines which perform complex calculations; others analyze the structure of crystals, inventory books in libraries, pick out reference material, operate machine tools and even whole factories. These are high-speed automatic electronic computing devices operating at a really fabulous speed, and the results are precise to within .000000001.

Electronic computing machines developed and built in the USSR are the BESM, Strela, and M-2 universal machines, the Ural serial machine, and the Crystal, Pogoda and STsM specialized machines. These are the first representatives of a new branch of engineering and every new day sees them used more extensively in the national economy.

A BESM machine has recently computed tables showing the utmost limit of steepness of slopes of canals, beyond which they would crumble. It took less than three hours to obtain ten variants of the tables, whereas fifteen ordinary computing machines could not have obtained even one variant after several months' work.

Another machine — the M-2 — has solved a highly complicated problem to determine the stability of concrete dams of large hydro-electric stations. It took the machine some nine hours to compute each variant of the problem and, in all, the machine performed 50 million mathematical operations.

By going over hundreds of variants of calculations using high-speed computing machines, Soviet engineers find the best form for plane wings, for

the nozzle of a jet engine, or for the contour of a turbine blade. Already thousands of such problems have been solved by electronic machines.

Soviet scientists and engineers have now developed what are called specialized mathematical machines, which machine parts and manufacture articles on man's assignment. The machines control the movement of the tool, regulate the speed of the machine tool, and perform all operations in proper order. Two automatic milling machines of this kind can turn out as much production as a whole shop with ten ordinary milling machines. Self-operating machines will be installed in many factories of the Soviet Union during the current five-year period.

Machine-controllers and machines which control electric-arc steel-smelting furnaces are already undergoing tests. Electronic computing machines for controlling blast and open-hearth furnaces, on the basis of data obtained by them on pressure, temperature, and composition of gases, will determine in a fraction of a second what rectification has to be made in the melting process and give the necessary "orders" to the machines regulating the melt.

Controlling machines will be widely introduced in petroleum refineries and chemical plants, in the first instance in factories where work is unhealthy.

There is varied application of these computing machines in the power industry, in particular in the operation of a power system extending for thousands of kilometres and having a voltage of hundreds of thousands.

One of the Soviet Union's great power engineers, Academician G. M. Krzhizhanovsky, says that complete automation will be reached in this

(cont'd on next page)

field with the aid of computing devices connected with automatic "operators" at electric stations and substations. Like the legendary hero with incredibly long hands, these devices will themselves start and stop units in many stations, cut-in and cut-out transmission lines, regulate frequency, voltage, and currents of energy over the lines, and distribute power among the stations.

On railways, too, electronic machines are being introduced to make work easier. Undergoing tests at this time in a research institute is a computing device which can drive a train by itself. It "takes into account" the time-table, the condition of track, the weight of train and every change that may occur for any reason while the train runs. The automatic locomotive engineer can drive the train through rain and fog. At night, a special device radiates a beam of infra-red light, and its reflection is picked up by a television device. This instrument illumines the track, so to speak, so that the automatic driver "can see" many metres ahead.

Automatic interlocking switches are being installed on Soviet railways, and soon marshalling yards will be mechanized by means of computing machines. In hump yards having these machines, radio-locators will "see" all wagons on all tracks and will "report" this information to the computer-dispatcher, which will marshal trains itself.

These automata will make it possible to do away with the trades of switchman, brakeman and coupler, and send them to take special technical courses to enable the workers to operate the automata to do the heavy work which they were doing before.

Planes too now have computing devices. During the flight they constantly figure out the plane's course, take their bearings on radio-waves and use the indications from the instruments to guide the flight.

Several main airlines in the USSR are now operated by fast jet airliners, which have the latest equipment. If necessary, they can fly without a pilot and make a blind landing on an airport. They can fly in fog, cold and rain, at any hour of the day or night, and in any season of the year.

- END -

IGY observation points will be sent the time and elevation of passage, and angular velocity. The latter is especially important, since an optical station must know both the direction and speed beforehand in order to fix the satellite in the telescope sights as it appears, traverses the sky swiftly from west to east, and disappears below the horizon in a few minutes' time. The satellite will move across the sky, at the rate of about a degree per second; for example, it will appear to move a distance equivalent to the diameter of the moon in about half a second.

Mathematicians have begun to devise various programs for the 704, all aimed at predicting the satellite orbit as accurately as possible. Generally, each program is first punched into cards and then transferred onto magnetic tape in a card-to-tape converter. Thus, the machine memory can be quickly erased and tape-fed a new set of instructions at the rate of 2,500 words per second. Among the programs to be developed is one which will operate on observations made near the firing site, at the time the rocket reaches third-stage burnout and ejects the satellite in space. This early data will be computed to determine whether the satellite has attained a good orbit — one which will not bring it so close to the earth as to be destroyed by atmospheric friction. A second program, to which the 704 will then be switched immediately, will make calculations on reports received from the earliest Minitrack observations. There will also be a complete program to refine the orbit after sufficient observations have been made to predict the course of the satellite more accurately. In fact, this refining process is characteristic of the over-all computer function.

The lightweight radio transmitter batteries in the satellite will last only a relatively short time. When the radio signal stops, IGY scientists will have to rely on optical observations alone. For this reason, an exact satellite timetable becomes even more important as the artificial moon continues in its orbit. Without the computer's calculations, it is possible that the satellite would soon be lost from view.

- END -

THE NINE BILLION NAMES OF GOD

ARTHUR C. CLARKE

(Author of 'The Exploration of Space' and other books and stories)

"This is a slightly unusual request," said Dr. Wagner, with what he hoped was commendable restraint. "As far as I know, it's the first time anyone's been asked to supply a Tibetan monastery with an Automatic Sequence Computer. I don't wish to be inquisitive, but I should hardly have thought that your — ah — establishment had much use for such a machine. Could you explain just what you intend to do with it?"

"Gladly," replied the Lama, readjusting his silk robe and carefully putting away the slide rule he had been using for currency conversions. "Your Mark V Computer can carry out any routine mathematical operation involving up to ten digits. However, for our work we are interested in letters, not numbers. As we wish you to modify the output circuits, the machine will be printing words, not columns of figures."

"I don't quite understand . . ."

"This is a project on which we have been working for the last three centuries — since the lamasery was founded, in fact. It is somewhat alien to your way of thought, so I hope you will listen with an open mind while I explain it."

"Naturally."

"It is really quite simple. We have been compiling a list which shall contain all the possible names of God."

"I beg your pardon?"

"We have reason to believe," continued the Lama imperturbably, "that all such names can be written with not more than nine letters in an alphabet we have devised."

"And you have been doing this for three centuries?"

"Yes: we expected it would take us about fifteen thousand years to complete the task."

"Oh." Dr. Wagner looked a little dazed.

"Now I see why you wanted to hire one of our machines. But exactly what is the purpose of this project?"

The Lama hesitated for a fraction of a second and Wagner wondered if he had offended him. If so, there was no trace of annoyance in the reply.

"Call it ritual, if you like, but it's a fundamental part of our belief. All the many names of the Supreme Being — God, Jehovah, Allah, and

and so on — they are only man-made labels. There is a philosophical problem of some difficulty here, which I do not propose to discuss, but somewhere among all the possible combinations of letters which can occur are what one may call the real names of God. By systematic permutation of letters, we have been trying to list them all."

"I see. You've been starting at AAAAAAAAAA . . . and working up to ZZZZZZZZZZ . . ."

"Exactly — though we use a special alphabet of our own. Modifying the electromatic typewriters to deal with this is, of course, trivial. A rather more interesting problem is that of devising suitable circuits to eliminate ridiculous combinations. For example, no letter must occur more than three times in succession."

"Three? Surely you mean two."

"Three is correct: I am afraid it would take too long to explain why, even if you understood our language."

"I'm sure it would," said Wagner hastily.

"Go on."

"Luckily, it will be a simple matter to adapt your Automatic Sequence Computer for this work, since once it has been programmed properly it will permute each letter in turn and print the result. What would have taken us fifteen thousand years it will be able to do in a hundred days."

Dr. Wagner was scarcely conscious of the faint sounds from the Manhattan streets far below. He was in a different world, a world of natural, not man-made mountains. High up in their remote aeries these monks had been patiently at work, generation after generation, compiling their lists of meaningless words. Was there any limit to the follies of mankind? Still, he must give no hint of his inner thoughts. The customer was always right . . .

"There's no doubt," replied the doctor, "that we can modify the Mark V to print lists of this nature. I'm much more worried about the problem of installation and maintenance. Getting out to Tibet, in these days, is not going to be easy."

"We can arrange that. The components are small enough to travel by air — that is one reason

why we chose your machine. If you can get them to India, we will provide transport from there."

"And you want to hire two of our engineers?"

"Yes, for the three months which the project should occupy."

"I've no doubt that Personnel can manage that." Dr. Wagner scribbled a note on his desk pad. "There are just two other points —"

Before he could finish the sentence the Lama had produced a small slip of paper.

"This is my certified credit balance at the Asiatic Bank."

"Thank you. It appears to be — ah — adequate. The second matter is so trivial that I hesitate to mention it — but it's surprising how often the obvious gets overlooked. What source of electrical energy have you?"

"A diesel generator providing 50 kilowatts at 110 volts. It was installed about five years ago and is quite reliable. It's made life at the lamasery much more comfortable, but of course it was really installed to provide power for the motors driving the prayer wheels."

"Of course," echoed Dr. Wagner. "I should have thought of that."

The view from the parapet was vertiginous, but in time one gets used to anything. After three months, George Hanley was not impressed by the two-thousand-foot swoop into the abyss or the remote checkerboard of fields in the valley below. He was leaning against the wind-smoothed stones and staring morosely at the distant mountains whose names he had never bothered to discover.

This, thought George, was the craziest thing that had ever happened to him. "Project Shangri-La" some wit at the labs had christened it. For weeks now the Mark V had been churning out acres of sheets covered with gibberish. Patiently, inexorably, the computer had been rearranging letters in all their possible combinations, exhausting each class before going on to the next. As the sheets had emerged from the electromatic typewriters, the monks had carefully cut them up and pasted them into enormous books. In another week, heaven be praised, they would have finished. Just what obscure calculations had convinced the monks that they needn't bother to go on to words of ten, twenty or a hundred letters, George didn't know. One of his recurring nightmares was that there would be some change of plan, and that the High Lama (whom they'd naturally called Sam Jaffe, though he didn't look a bit like him) would suddenly announce that the project would be extended to approximately 2060 A.D.

They were quite capable of it.

George heard the heavy wooden door slam in the wind as Chuck came out on to the parapet beside him. As usual, Chuck was smoking one of the cigars that made him so popular with the monks — who, it seemed, were quite willing to embrace all the minor and most of the major pleasures of life. That was one thing in their favor: they might be crazy, but they weren't bluenoses. Those frequent trips they took down to the village, for instance ...

"Listen, George," said Chuck urgently. "I've learned something that means trouble."

"What's wrong? Isn't the machine behaving?" That was the worst contingency George could imagine. It might delay his return, than which nothing could be more horrible. The way he felt now, even the sight of a TV commercial would seem like manna from heaven. At least it would be some link with home.

"No — it's nothing like that." Chuck settled himself on the parapet, which was unusual because normally he was scared of the drop. "I've just found what all this about."

"What d'ya mean — I thought we knew."

"Sure — we know what the monks are trying to do. But we didn't know why. It's the craziest thing —"

"Tell me something new," growled George.

"— but old Sam's just come clean with me.

You know the way he drops in every afternoon to watch the sheets roll out. Well, this time he seemed rather excited, or at least as near as he'll ever get to it. When I told him that we were on the last cycle he asked me, in that cute English accent of his, if I'd ever wondered what they were trying to do. I said 'Sure' — and he told me."

"Go on: I'll buy it."

"Well, they believe that when they have listed all His names — and they reckon that there are about nine billion of them — God's purpose will be achieved. The human race will have finished what it was created to do, and there won't be any point in carrying on. Indeed, the very idea is something like blasphemy."

"Then what do they expect us to do? Commit suicide?"

"There's no need for that. When the list's completed, God steps in and simply winds things up ... bingo!"

"Oh, I get it. When we finish our job, it will be the end of the world."

Chuck gave a nervous little laugh.

"That's just what I said to Sam. And do you know what happened. He looked at me in a very queer way, like I'd been stupid in class, and said 'It's nothing as trivial as that.'"

(cont'd on page 41)

THE SOLUTION OF BOUNDARY VALUE PROBLEMS ON A REAC[®] ANALOG COMPUTER¹.

M. Yanowitch ²
Reeves Instrument Corp.
New York, N.Y.

SUMMARY

It is shown how an electronic analog computer can be utilized in the solution of boundary value problems for ordinary differential equations by the method of superposition. The procedure is illustrated by application to two beam problems. Some of the attendant advantages and disadvantages are discussed.

1. Introduction

Frequently, boundary value problems for ordinary differential equations can be solved with the aid of an electronic analog computer. Since the computer is a device which naturally solves initial value problems, the BV³ problem must first be reduced to a sequence of IV problems. The simplest procedure for doing this is one of trial and error. It consists of generating solutions which satisfy the prescribed conditions at one end point, and varying the remaining "initial" values and parameters, until the resulting solution also satisfies the prescribed conditions at the other end point. This scheme has been used to solve BV problems for DE's of second and of fourth order⁴. Unfortunately, it is not likely to be useful for DE's of higher order, since the manner in which the initial conditions are to be varied is not generally known beforehand. However, an important advantage of the method is that it can be used equally well with both linear and nonlinear problems.

Another means of obtaining a solution to a BV problem by solving IV problems is based on the principle of superposition. It is, of course, applicable only to linear problems, and consists of finding the correct linear combination of solutions to the DE which will satisfy all the prescribed boundary conditions. The method is ideal when a fundamental set of solutions to the DE can be written down explicitly, and in this form it has been in vogue at least since 1744, when Euler used it to compute frequencies of vibration and critical loads for beams. In general, however, the solutions are not known, and their computation may prove to be cumbersome⁵. The value of the analog computer in conjunction with the method of superposition lies in the facility with which it can be used to generate the required solutions.

In this paper, our experience with the use of this method will be described. In the next two sections the method will be illustrated by applying it to two problems in beam theory. The computer setup for these problems will be given in Section 4; the final section will be devoted to a discussion of some of the advantages and disadvantages of the method.

2. The Boundary Value Problem

A typical boundary value problem is one of finding the deflection of a cantilever beam of length L , under a transverse load of intensity $f(x)$. Suppose the beam also rests on an elastic support at the point $x = \bar{x}$. The DE and boundary conditions are

$$\begin{aligned} (EI_b u'')'' &= f & 1 \\ u &= u' = 0 & \text{at } x = 0 \\ u'' &= u''' = 0 & \text{at } x = L. \end{aligned} \quad 1a$$

There is further the condition

$$[(EI_b u'')]' + ku = 0 \quad \text{at } x = \bar{x}. \quad 1b$$

Here x is the distance along the beam, measured from the fixed end, $u(x)$ is the beam deflection, $EI_b(x)$ is the flexural rigidity, k is the support-spring constant, and $[g]$ signifies the jump in the value of g at $x = \bar{x}$.

The problem can be solved on the computer in the following way:

- a. A solution, v , of the non-homogeneous equation [1], satisfying [1b], is obtained. The initial condition can be assigned arbitrarily, but it is convenient to choose

$$v = v' = v'' = v''' = 0. \quad \text{at } x = 0.$$

The values of v' and v''' at $x = L$ are measured.

- b. Any two linearly independent solutions, u_1 and u_2 , of the homogeneous equation

$$(EI_b u'')'' = 0 \quad [2]$$

satisfying 1b and the BV's prescribed at $x = 0$, are generated. The other values at $x = 0$ can be set at

$$u_1'' = A_1, \quad u_1''' = 0 \quad [2a]$$

$$u_2'' = 0, \quad u_2''' = A_2 \quad [2b]$$

¹ This work was carried out at Project Cyclone, Reeves Instrument Corporation, under U.S. Navy, Bureau of Aeronautics Contract NOas-54-545-c; and was presented at the meeting of the Association for Computing Machinery, held in Philadelphia on 16 September 1955.

² Reeves Instrument Corporation, 215 East 91st St., New York, N.Y. (Copies of this report available on request.)

³ The following abbreviations will be used: IV - initial value, BV - boundary value, EV - eigenvalue, and DE - differential equation.

⁴ E.g. see (1), (2). It had been used earlier in conjunction with the differential analyzer, (3) (Numbers in the parentheses refer to the bibliography).

⁵ A.N. Krylov (4), and others have used this method, obtaining the solutions by numerical integration.

The values of u_1'' , u_1''' are now measured at $x = L$.

c. Now one can find two constants, c_1 and c_2 , such that the linear combination, $c_1 u_1 + c_2 u_2$, satisfies

$$\begin{aligned} c_1 u_1''(L) + c_2 u_2''(L) &= -v''(L) \\ c_1 u_1'''(L) + c_2 u_2'''(L) &= -v'''(L). \end{aligned} \quad [3]$$

Clearly,

$$u = v + c_1 u_1 + c_2 u_2$$

is the solution to the original problem, Equation [1], with conditions [1a] and [1b]. At $x = 0$,

$$u = u' = 0, \quad u'' = c_1 A_1, \quad u''' = c_2 A_2.$$

These values can now be set into the computer, and the solution u will be obtained.

The procedure just described can be used with any regular linear BV problem. For an equation of order $2n$, it requires the solution of no more than n linear algebraic equations for the constants c_i ⁵. Since systems of 4 or 5 linear equations can be quickly and easily solved using a desk computer, the method appears to be practical for DE's of order 8 or 10 at least.

3. The Eigenvalue Problem

The problem of finding the frequencies and modes of "coupled" bending and torsion vibrations of a cantilever beams leads to an eigenvalue problem for a system of 6th order:

$$\begin{aligned} (EI_b u'')'' &= \lambda (m u + S \theta) \\ -(GJ \theta')' &= \lambda (S u + I \theta) \end{aligned} \quad [5]$$

$$\begin{aligned} u = u' = \theta &= 0 \text{ at } x = 0, \\ u'' = u''' &= \theta' = 0 \text{ at } x = L, \end{aligned} \quad [5a]$$

where $EI_b(x)$ = flexural rigidity
 $GJ(x)$ = torsional rigidity
 $m(x)$ = mass per unit length of beam
 $s(x)$ = first moment per unit length, taken about the elastic axis
 $I(x)$ = moment of inertia per unit length, taken about the elastic axis
 $u(x)$ = amplitude of vibration in bending
 $\theta(x)$ = amplitude of vibration in torsion
 and λ = square of the circular frequency of vibration.

The eigenvalues and eigenfunctions of this problem can be found by successive approximations, in the following manner:

A value of λ is selected, and three linearly independent solutions to Equation [5], which satisfy the desired conditions at $x = 0$, are generated. For example, the solutions might be chosen to satisfy

$$\begin{aligned} u'' = A_1, \quad u''' = 0, \quad \theta' &= 0 \\ u'' = 0, \quad u''' = A_2, \quad \theta' &= 0 \text{ at } x = 0 \\ u'' = 0, \quad u''' = 0, \quad \theta' &= A_3, \end{aligned} \quad [6]$$

The values of u'' , u''' , and θ' at $x = L$ are measured, and the determinant

$$D = \begin{vmatrix} u_1'' & u_2'' & u_3'' \\ u_1''' & u_2''' & u_3''' \\ \theta_1' & \theta_2' & \theta_3' \end{vmatrix} \quad x = L$$

is then computed. This determinant is a continuous (in fact, analytic) function of λ , and it vanishes if and only if λ is an eigenvalue. Thus, if D is found to have opposite signs at two different values of λ , it is immediately known that there is an eigenvalue between them. The eigenvalue can now be estimated, and D computed again. The same process can be continued until the required accuracy is obtained.

After the eigenvalue is located, the condition, $D = 0$, will yield a set of initial values to produce an eigenfunction.

These are

$$\begin{aligned} u = u' = \theta &= 0 \\ u'' = c_1 A_1, \quad u''' = c_2 A_2, \quad \theta' &= c_3 A_3 \end{aligned} \quad [7]$$

at $x = 0$. Of course, one constant can be assigned arbitrarily. For example, if $c_3 = 1$, c_1 and c_2 can be calculated from

$$\begin{aligned} c_1 u_1''(L) + c_2 u_2''(L) &= -u_3''(L) \\ c_1 u_1'''(L) + c_2 u_2'''(L) &= -u_3'''(L) \end{aligned} \quad [8]$$

For a differential equation of order $2n$, with n conditions at each end point, the procedure outlined above requires the computation of several⁶ determinants of order n . Consequently it does not seem to be practical for DE's of order 8 or greater.

4. Computer Setup

Schematic diagrams of the computer setup for the problems described in sections 2 and 3 are shown in Figures 1 and 2⁷. It can be readily seen that the programming is straightforward. Several problems of this type, but with constant coefficients (i.e. for uniform beams), were solved at Project Cyclone. For these, the time period representing the length of the beam was usually chosen to be 5 or 10 seconds, and a relay was arranged to throw the computer into HOLD⁸ at the end of that time. The required voltages were then measured with a digital voltmeter sensitive to 0.01 volts, so that the quantities used in the computations were generally known to four significant figures.

For the problems solved on the computer the eigenvalues were found to be in error by less than 0.3%. The solutions obtained after calculating the correct initial values usually satisfied the prescribed BV to within .01 or .02 volts. Of course, less favorable results might be expected in the case of DE's with variable coefficients. Several sample solutions are shown in Figure 3. They represent the plotting board traces of the first four coupled modes, and their derivatives, for a uniform cantilever beam, specified by the DE's

$$\begin{aligned} u^{iv} &= \mu (u + \theta) \\ \theta'' &= \mu (u + 5\theta). \end{aligned}$$

⁶ Usually about 7 or 8. See section 4.

⁷ A table of computer symbols is attached in the appendix.

⁸ This stops the integration and preserves the voltages which have been attained.

⁵ The number can be less than n if more conditions are prescribed at one of the endpoints than at the other one.

For this and other 6th order EV problems, it was found that anywhere from 6 to 11 trial values of μ were required. The total time needed to obtain each of these eigenvalues was about an hour.

5. Concluding Remarks

Experience with the method indicates that it can be quite useful in many problems. Among its good features are:

1. It is relatively fast and accurate. The programming and the computer setup are both usually simple, and only a small amount of computing equipment is needed.
2. It yields not only the solution to a problem, but also its derivatives up to $(n-1)$ th order (for a DE of order n). For example, in the problem for the bending of a beam, one can obtain the deflection, slope, bending moment, and shear force, and all with approximately equal accuracy. This is frequently not the case in other methods. For example, in variational methods, like the Rayleigh-Ritz method, the accuracy of the higher derivatives may be very bad. In fact, the higher derivatives of the successive approximations may not converge altogether.
3. The method may be especially valuable for problems with DE's which contain several powers of λ , e.g. the DE for the buckling of a twisted shaft,

$$\alpha u^{iv} + \frac{M^2}{\alpha} u'' = -2\lambda u'' - \frac{\lambda^2}{\alpha} u.$$

The application of finite difference methods to such problems leads to matrices with elements which are polynomials in λ , and these are not as easy to solve as the usual matrix eigenvalue problems.

4. The method is applicable to DE's which are not self-adjoint (provided λ is real).

The most serious disadvantages in the application of the method are:

1. In some problems only the first few eigenvalues can be obtained. This is true, for example, in beam vibration problems. The reason for this is that the solution to the DE contain terms which grow exponentially, and these increase with λ^9 . Sometimes it is not too difficult to remedy this situation by using the transformation $u = e^{ax}v$, and solving for v . The constant a is adjusted so that v does not grow too rapidly. Of course, there are also many problems in applied mechanics where this difficulty does not occur, e.g. problems in the stability of circular arches and of beams on an elastic foundation.
2. Accurate function generation may be difficult sometimes. This probably represents the main source of error in problems for DE's with variable coefficients. Frequently, however, the magnitude of the error can be quickly ascertained. For example, upper and lower bounds for the frequencies of vibration of a beam can be easily obtained by approximating $EI_b(x)$ above and $m(x)$ below and vice versa.

9 See 5.

BIBLIOGRAPHY

1. "Application of the Electronic Differential Analyzer to Eigenvalue Problems", by G. Corcos, T. Howe, U. Rauch and J. Sellers, Project Cyclone Symposium II, part 2, 1952, pp. 17-24.
2. "Application of the Electronic Differential Analyzer to Oscillation of Beams, including Shear and Rotatory Inertia", by C. Howe and R. Howe, Journal of Applied Mechanics, v. 22, 1955, pp. 13-19.
3. "The Evaluation of Transient Temperature Distribution in a Dielectric in an Alternating Field", by C. Copple, D. R. Hartree, A. Porter and H. Tyson, Journal of the Institution of Electrical Engineers, v. 85, 1939, pp. 56-66.
4. Collected Works of A. N. Krylov (Russian), Akademyia Nauk USSR, Moscow-Leningrad, 1937, pp. 311 ff.
5. "Numerical Analysis", by D. R. Hartree, Oxford University Press, London, 1952, pp. 143-144.

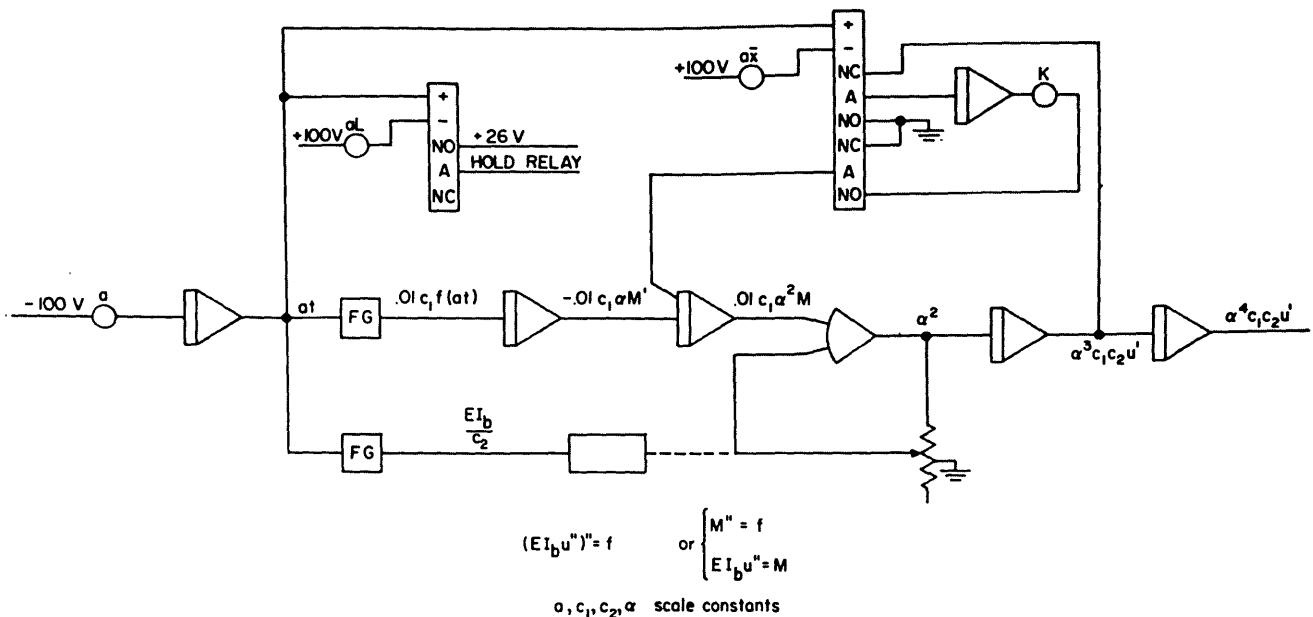

Figure 1. Schematic, beam bending problem

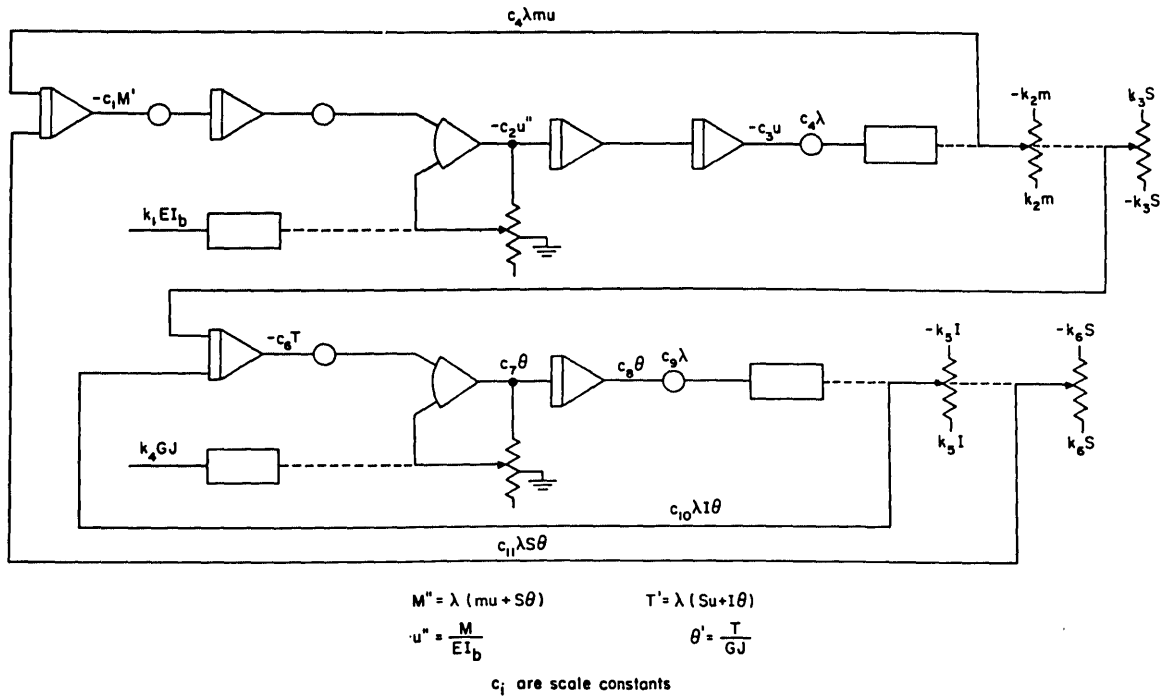

Figure 2. Schematic, coupled beam vibrations

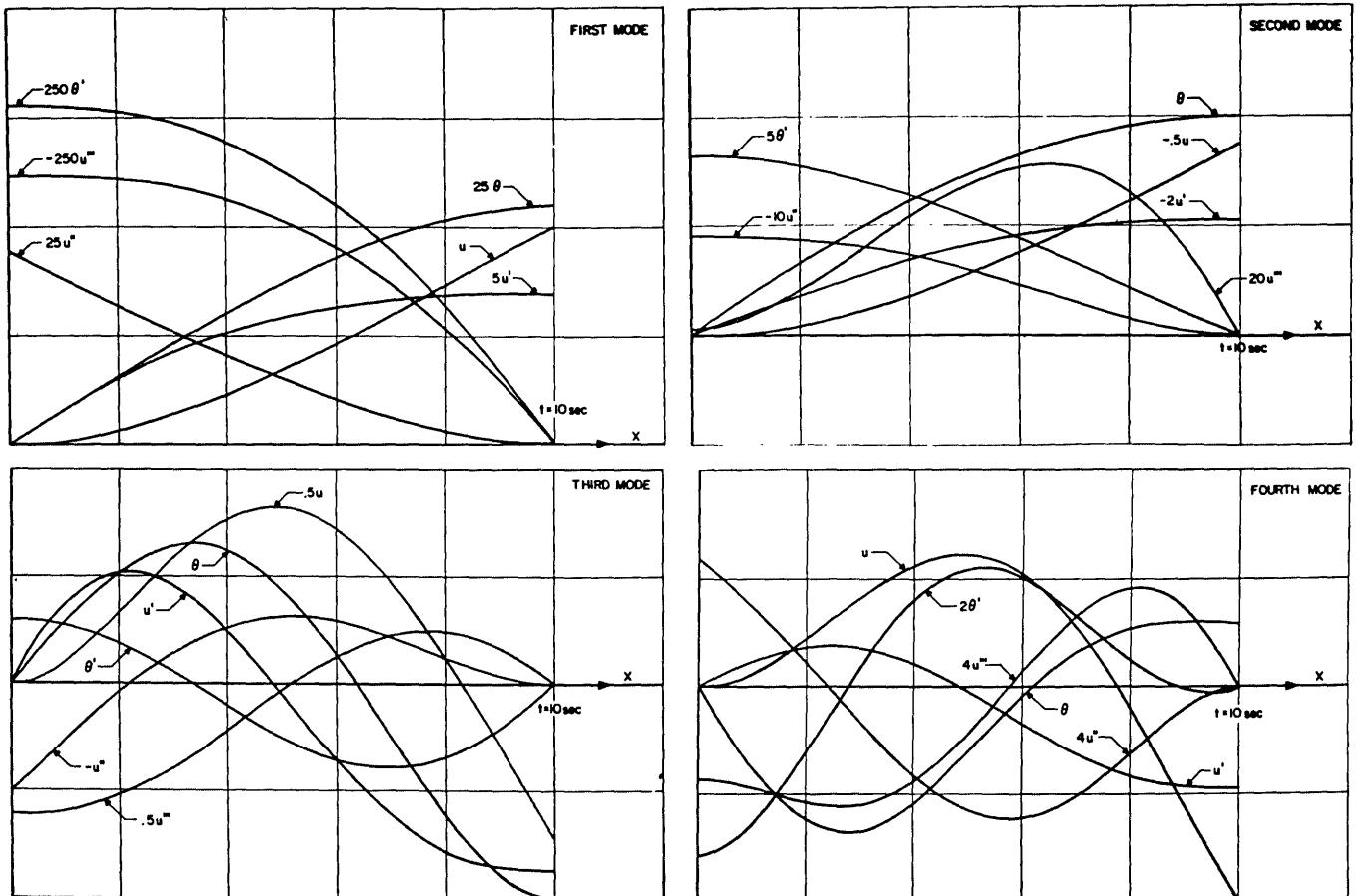

Figure 3. Coupled modes of vibration

(cont'd on page 39)

SIMULATION OF A LIQUID LEVEL CONTROL SYSTEM WITH AN ANALOG COMPUTER

Part 1

Charles W. Worley
Application Engineering
Electronic Associates, Inc.
Long Branch, N.J.

Analog computers can yield significant advantages in the designing of control systems. The advantages from using them can be illustrated by considering a control problem which is common in the field of process control. Suppose the system to be analyzed is a system for controlling liquid level, where the height of liquid in an open tank is to be controlled. This example, although simple, illustrates the basic techniques used in simulating process control systems on the analog computer.

A schematic diagram of the liquid level control system is shown in Figure 1. The process variable of interest is the level or head H of the liquid in the tank. This head is measured by a differential pressure measuring instrument with the low pressure chamber open to atmospheric pressure. The output of the measuring instrument is fed into a stack-type industrial controller whose output goes to a pneumatic control valve.

The pressure on the downstream side of the control valve is assumed to be atmospheric and

the flow into the tank is assumed constant for a given setting of the regulator hand valve. The tank is open to the atmosphere.

The functional block diagram of the process shown in Figure 2 may be arrived at by making a dimensional analysis. During any finite time interval, the flow rate F_1 in cubic feet per minute causes a given quantity of liquid to spill into the tank. The volume of liquid flowing into the tank during a time interval is obtained by integrating this flow. At any given instant of time, there will be a net quantity of fluid in the tank. This quantity will be the difference between the volume that has spilled into the tank and the volume that has left the tank, and will naturally depend upon the flow rates F_1 and F_2 . The amount of fluid remaining in the tank is the sum of the two signals feeding into the summing point. This quantity of fluid, expressed in terms of a volume, is then divided by the area of the tank to give the height of the fluid in the tank at any instant of time. The height or level H is the output of the block diagram, since it is the variable selected to indicate the state of the process.

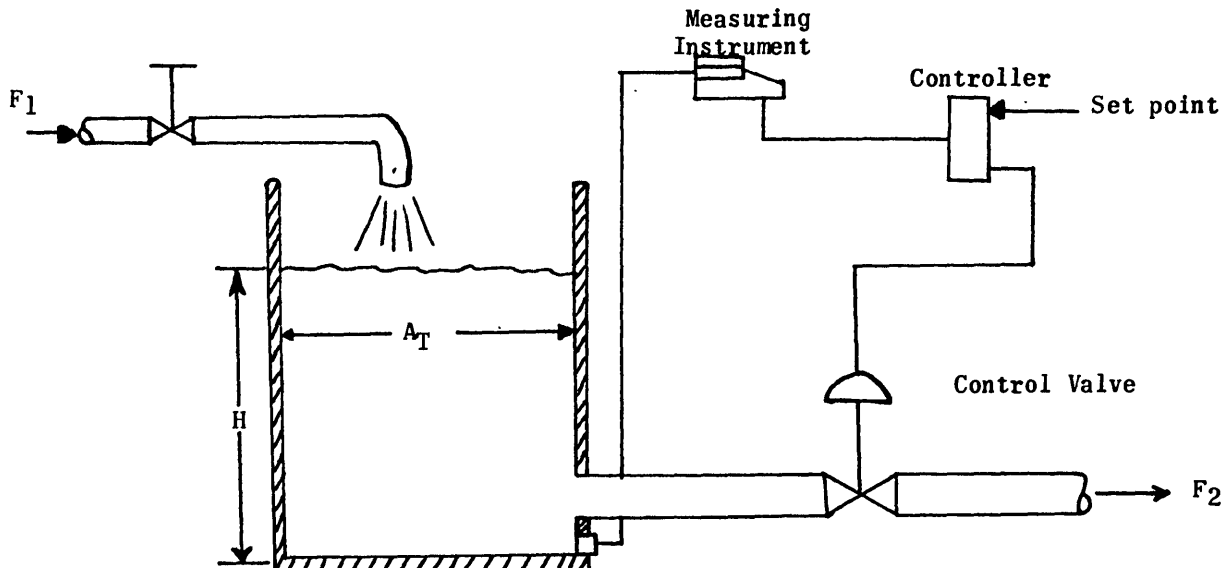

Figure 1: Schematic Diagram of Liquid Level Control System.

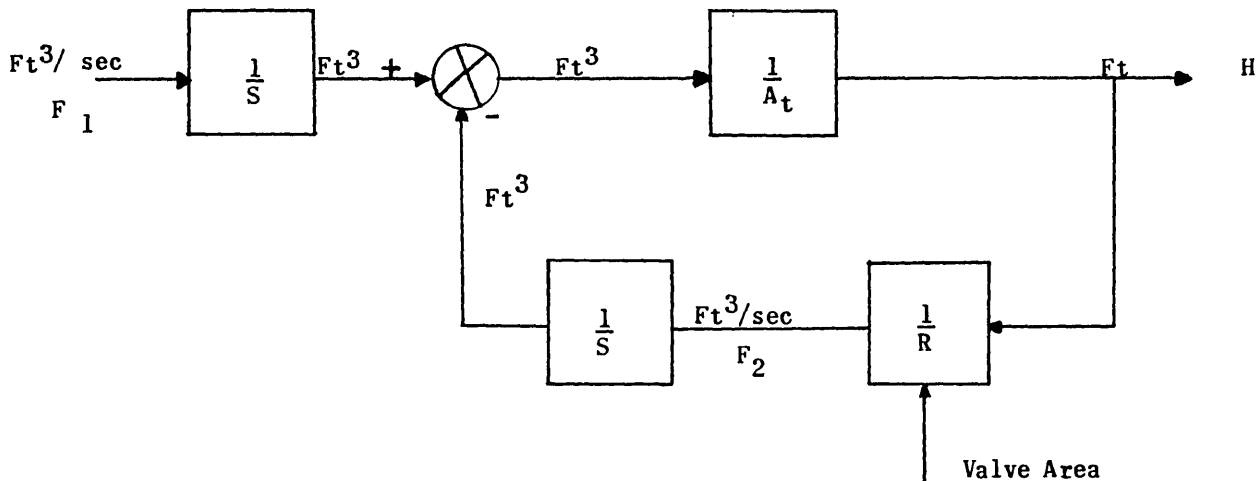

Figure 2. Functional Block Diagram of a Liquid Level Process.

(to be continued in next issue)

ADVERTISEMENT

GLOSSARY OF TERMS

in the field of

COMPUTERS AND AUTOMATION

- Over 480 terms defined
- Careful definitions; most of them expressed in plain words understandable to persons who have newly come into the computer field
- Many examples of meaning
- 4th cumulative edition, as of Sept. 19, 1956
- Reprinted from the October 1956 issue of "Computers and Automation"
- If not satisfactory, returnable within week for full refund (if in good condition)

\$1.00 postpaid; 10% discount on orders for 20 or more copies.

--Mail this coupon (or a copy of it)--

To: Berkeley Enterprises, Inc.
815 Washington St., R 191
Newtonville 60, Mass.

Please send me _____ copy(ies) of the GLOSSARY, 4th edition. I enclose

\$_____ in full payment.

Returnable if not satisfactory.

Name _____

Address _____

AIR TRAFFIC CONTROL SYSTEM

Bendix Pacific Division
North Hollywood, Calif.

A fully developed navigation system and a potential air traffic control system is now available to handle the rapidly growing use of today's airways, according to representatives of Pacific Division, Bendix Aviation Corporation, in North Hollywood, Calif. This system, known as the Bendix-Decca Navigator System (see Figures 1 and 2)*, was first developed in Great Britain by two Americans and was first used in the Normandy invasion. It is now in current use in most of the European area and covers over two million square miles of land and sea area.

The system is of the area coverage type and operates on low frequency radio waves in the range of 100 KC. The use of this low frequency transmission provides a system which is usable behind hills, in valleys, beyond line-of-sight and below the curvature of the earth. Good reception and high accuracy is provided from ground level to the highest altitudes, thus making the system ideal for helicopter as well as fixed-wing use.

The Bendix-Decca System operates by transmissions from a master station and three slave stations. The master controls the accurate emission of radio waves from the slave stations which results in a network pattern of hyperbolic waves which occupy precisely known and stable geographic positions. The location of the aircraft is, of course, basically determined by making a phase comparison of the signals from two of the transmitting stations. The system provides a position fix by deriving the arbitrary index numbers on an appropriate pair of ordinates which intersect at the point of position. With this information the position can be automatically and instantaneously displayed on a chart through the medium of a moving ink stylus.

Using the Bendix-Decca System, an air track for lateral separation can be assigned to each aircraft and the pilot will be able to change altitude while flying an assigned track without running the risk of interference with other aircraft. In the cockpit the pilot has a pictorial display which accurately plots the flight course at all times. The pilot thus has continuous, precise and graphic information as to his present location, direction of flight, and track.

This system will expedite landing procedures by having aircraft approach the airport on parallel tracks separated at minimum intervals. Approaches can be made more quickly and safely by using the Bendix-Decca System, according to Bendix-Pacific engineers. Knowing the exact time of arrival, traffic flow in the terminal area can be handled much more expeditiously which, in turn, will eliminate long periods of awaiting clearance for landing. These waiting periods are particularly hazardous for turboprop and turbojet powered aircraft because of the excessive consumption of fuel at low altitudes.

The Bendix-Decca System is extremely accurate and, in fact, has accuracies of better than 25 yards under normal conditions at distances of up to 50 miles from transmitting stations. The Bendix-Decca System is designed for short and medium range navigation, although a similar system, called Dectra, has also been developed for long range use. The pilot, with one set of receiving equipment aboard his aircraft, could use the Bendix-Decca System after take off and during approach to his terminal area, and Dectra while flying at his selected cruising altitude.

The Bendix-Decca Navigator System is a proved system which fully meets the requirements of the common system serving helicopters, ships, fixed-wing aircraft and ground vehicles with equal facility. It is a fully developed system which has been proved in operation over many years and its use is constantly expanding throughout the world. The accuracy, flexibility and wide coverage of the system, the use of the flight log to give the pilot continuous position information, flexibility of use, and safety in air traffic control systems are not approached at the present time by any other known system.

*see page 33 .

◆ ————— ◆ ————— ◆
DATA-HANDLING
(cont'd from page 21)

ertia, permanence of matter. "

As far as the arts with which we are concerned, I think this statement may well be reversed. We have developed computing equipment of tremendous speed and capacity. What perplexes the computing industry and the Department of Defense is the sluggishness of the human spirit in participating in their fundamental problems.

- END -

Air Traffic

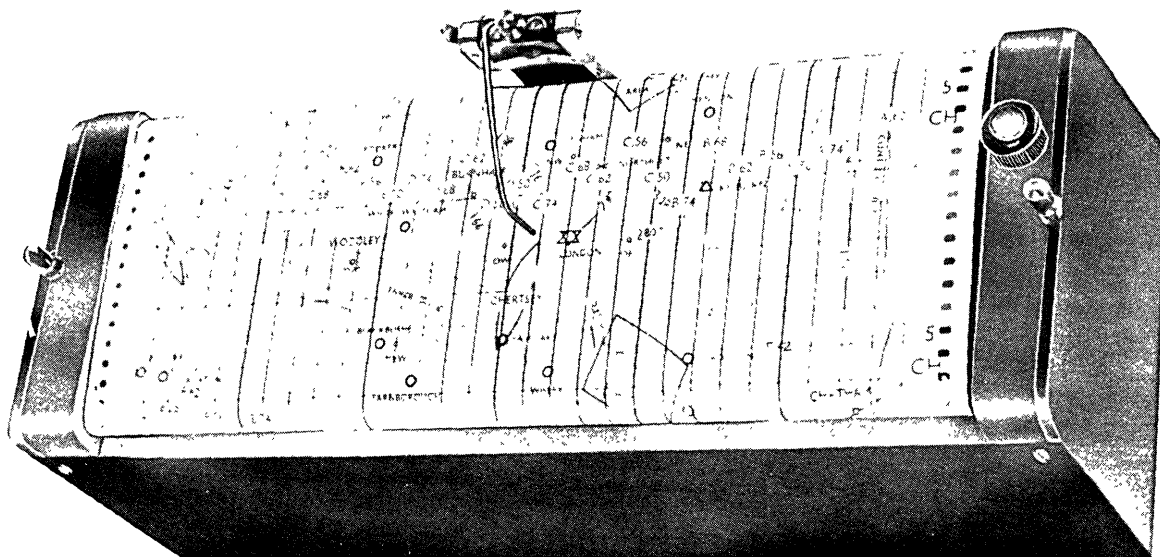

Figure 1 — The Bendix-Decca Navigator System: reporting board.

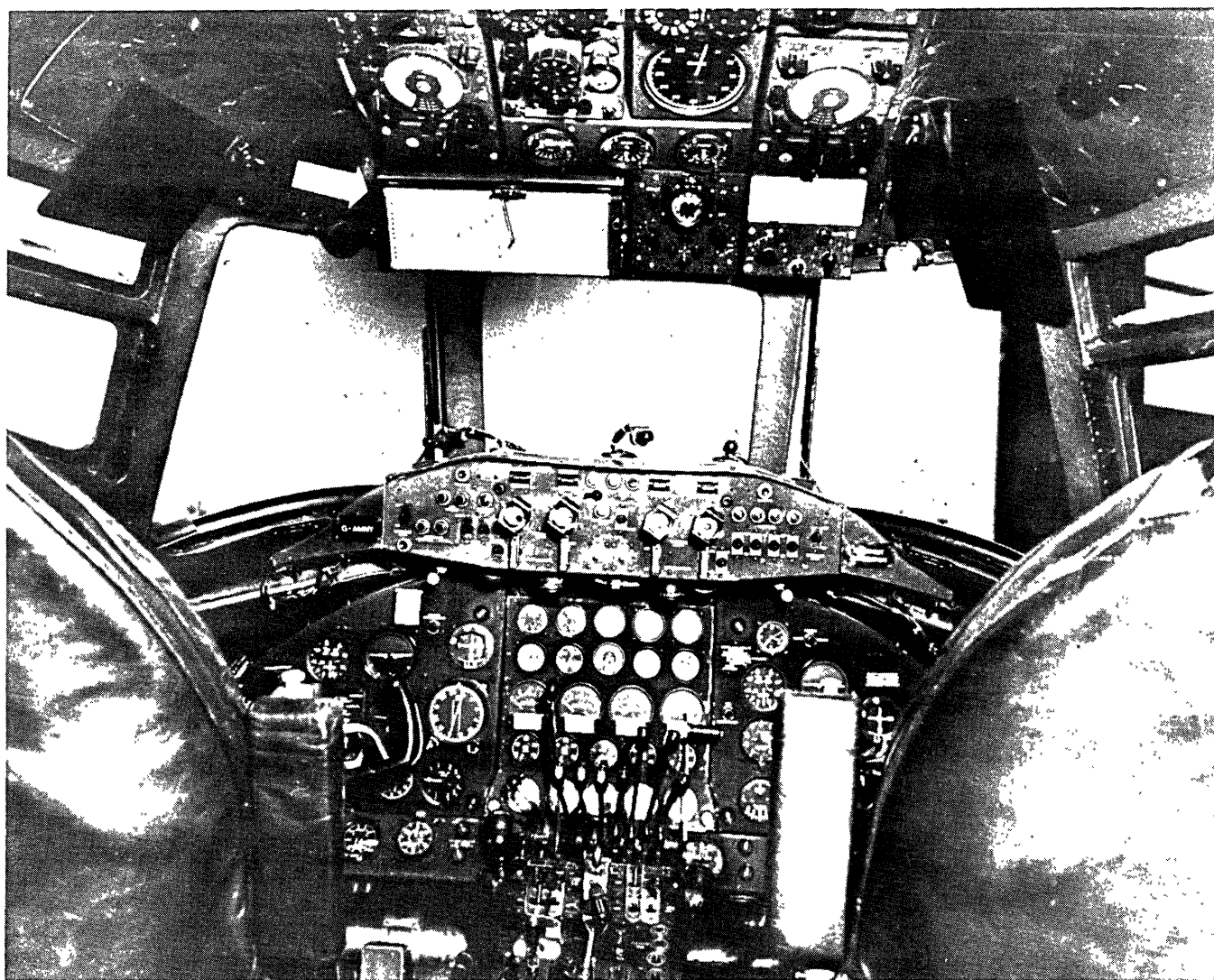

Figure 2 — The reporting board as it appears in an airplane cockpit.

BOOKS AND OTHER PUBLICATIONS

(List published in "Computers and Automation", Vol. 6, No. 2, February, 1957)

We publish here citations and brief reviews of books, articles, papers, and other publications which have a significant relation to computers and automation, and which have come to our attention. We shall be glad to report other information in future lists if a review copy is sent to us. The plan of each entry is: author or editor / title / publisher or issuer / date, publication process, number of pages, price or its equivalent / comments. If you write to a publisher or issuer, we would appreciate your mentioning "Computers and Automation".

NOTICE — CHANGE

We invite all our readers to send us citations and brief reviews, provided the style of citation of the reference shown here is exactly followed. We pay about 1/2 cent a word, upon request made after we publish the review, and upon sending of a bill to us by the reviewer. Even if the same book is reviewed more than once, the different comments of different reviewers may be of interest to readers of "Computers and Automation". In the case of a review with a byline, the opinions expressed are those of the reviewer and not necessarily the views of "Computers and Automation".

I. Reviews by Ned Chapin, Menlo Park, Calif.

Klein, Martin L., Frank C. Williams, Harry C. Morgan / "Analog-to-Digital Conversion", pp. 911-917 in "Instruments and Automation" May, 1956, vol. 29, no. 5 / Instruments Publishing Co., 845 Ridge Ave., Pittsburgh 12, Pa. / May, 1956, printed, \$4.00 a year.

The author points out the basic requirements of an analog-to-digital converter as (1) the discrete and time-regular rate of conversion of the continuous analog record; (2) the accuracy of the conversion; (3) the time available for the making of each discrete conversion in relation to the rate of conversion; and (4) the avoidance of ambiguity.

Three types of converters are available. One type is known as a time encoder in which the input signal is compared with a controlled signal that varies in a known manner. As the controlled signal passes a reference point, a counter (usually binary) is activated, and is fed pulses until the controlled signal equals the input signal. While the controlled signal is being returned to its initial state, the counter may be read out.

The second type of converter is known as a feedback encoder. In this type of device, the input signal is successively compared with a known signal which decreases in steps of powers of two. For the first such comparison, the known signal is greater than the input signal. For the first and all following comparisons, no pulse is emitted if the known signal exceeds the input signal. But if the known signal is less than the input signal, the known signal is subtracted from the input signal and a pulse is emitted. The third type of converter is known as a spatial encoder. In this type of device, the input signal activates a spatial geometric configuration, such as a code wheel or cathode ray tube, from which in turn a digital representation is obtained.

The authors discuss each of these three types of converters in terms of the four requirements they list at the start of their article. In addition, they discuss some of the physical features and the circuitry associated with each type of converter. They close their article with a brief discussion of advantages and disadvantages of various types of converters.

Carr, John W., III / "Solving Scientific Problems", pp. 63-70 in "Control Engineering", Jan., 1956, vol. 3, no. 1 / McGraw-Hill Publications, 330 W. 42 St., New York 36, N. Y. / Jan. 1956, printed, \$3.00 a year.

The major types of problems that can be solved are: linear, non-linear (such as differential equations), partial differential equations, simulation (as in Monte Carlo), and operations research or management science.

To solve such types of problems satisfactorily, computers need: fast arithmetic speed, adequate handling of round-off and truncation errors, moderate to large storage, good reliability, and ease of repetitive operation and of programming.

Gilbert, von H. / "Measurements on Ferrite Toroids Subjected to Magnetization from Nearly Rectangular Impulses", pp. 368-376 in "Rohde and Schwarz - Newsletter", May, 1955, no. 6 / W. Sachon KG, Mindelheim, Germany / 1955, printed, illustrated with diagrams, price and availability unknown.

The author discusses briefly experiments with transformer and storage magnetic cores having nearly rectangular hysteresis loops. The object of the experiments was to determine the relation-

Books and Other Publications

ships among switching time, field strength, useful voltage, and unwanted voltage. The experimental set-up and the observations are summarized in diagrams and photographs.

ing publicity, arm-chair engineering, ill-considered equipment selection, unrealized "opportunity" savings, and man-hour-based justifications.

Management Methods, editor / "The Care and Feeding of the Human Beings Who Control the 'Giant Brains' ", pp. 37-41 in "Management Methods", Aug. 1956, vol. 10, no. 5 / Management Methods, 141 E. 44 St., New York 17, N. Y. / Aug. 1956, printed, \$5.00 a year.

The editor neglected to mention much of anything about the care and feeding of the human beings who control the — as he puts it — "giant brains". The editor confines his remarks to describing office layouts used in Monsanto Chemical and Southern Railway offices for programmers. His most interesting comment was on the use of L-shaped desks.

The rather loose organization and somewhat rambling character of this article tends to leave the reader without an understanding of the relative magnitude or significance of the factors the author lists. In addition, in regard to some points, questions can be raised.

Warner, H. A. / "Electronics: Boon or Bane?", pp. 3-7 in "Systems and Procedures Quarterly", Feb., 1956, vol. 7, no. 1 / Systems and Procedures Association, 4463 Penobscot Bldg., Detroit 26, Mich. / Feb. 1956, printed, \$3.75 a year.

The author indicates that in his belief, high volume; high activity, high velocity, high rigidity, high training, and high dependence upon machines are apparently characteristic of automatic computer applications in business. But the author also indicates that high benefits can often be obtained simply by high quality study of whether or not to install a computer. This reviewer considers this article to be more bane than boon.

Levin, Howard S. / Office Work and Automation / John Wiley and Sons, Inc., New York, N. Y. / 1956, 203 pp., printed, \$4.50.

This small book (about 50,000 words in length) was written by a very capable mathematician and consultant of Ebasco Services. The book is divided into five chapters, headed: 1. New Tools for the Office, 2. A Common Language, 3. Electronics for the Office, 4. The Businessman and the Scientist, and 5. A Changing Office. The fourth chapter, on mathematical model building, is easily the strongest chapter in the book.

Alden, William, and Franklin Wyman, Jr. / "The Dangers of Waiting for Automation", pp. 12... of "The Office", Aug., 1956, vol. 44, no. 2 / Office Publications Co., 232 Madison Ave., New York 16, N. Y. / Aug. 1956, printed, \$3.00 a year.

The danger, according to these authors, is in a relative loss in personnel development, data processing and manufacturing costs, and management quality, with respect to firms that do not wait for "automation". Actually, the bulk of the article discusses in general terms how to avoid "waiting". In this discussion they draw upon their considerable experience with an organization that has helped other firms avoid waiting, the Alden Systems Co.

The general style of the book is agreeable and easy to take. The author has generally met his goal of discussing technical things in a non-technical manner. Unfortunately, except perhaps in chapter four, he has, in accomplishing this goal, apparently lost a good deal in depth of treatment. In chapter four, however, he has conveyed something of the flavor of the mathematical "tools" he discusses, although he has conveyed little of the conditions that need be met to use the "tools" appropriately.

The major value of the book is its broad scope and general coverage. It looks at nothing in detail but looks at some of the general outlines of many things. For this reason, the book will be of interest to the lay public, and to business personnel not directly concerned with data processing activities. Persons concerned with data processing in business will find profit in reading chapter four to strengthen their backgrounds. But for fuller treatment, they, like others, will probably want to turn to other sources.

Faulkner, Charles E. / "What to Consider When You Buy EDP", pp. 92-99 in "Control Engineering", Nov. 1956, vol 3, no. 1 / McGraw-Hill Publishing Co., 330 W. 42 St., New York 36, N. Y. / Nov., 1956, printed, \$3.00 a year.

The author suggests consideration of objectives, available computers, and of operations. The objectives should be considered in terms of input, output, and (sic) storage devices. The operations should be considered in terms of personnel, subsidiary equipment, physical facilities, operating supplies, process time, labor cost, forms and supply costs, and rentals. The author also lists some pitfalls: being steamrolled, overwhelm-

Seward, J.S. / Programming Manual for the NAREC (NRL Report 4652) / published by the Naval Research Laboratory but available from U. S. Dept. of Commerce, Office of Technical Services, Washington 25, D. C. / Nov. 17, 1955, 77 pp., offset, price unknown.

The manual discusses the use of the various NAREC order codes (the NAREC is the Naval Research Electronic Computer at the Naval Research Laboratory in Washington, D. C.) and a brief discussion of programming techniques. The first eight pages provide a brief introduction to and description of the NAREC. It is a single address, binary machine with electrostatic and magnetic drum storage. The next eleven pages

describe operations in the binary system. The following ten pages describe the major order codes. Then follows a 21 page discussion of routines and subroutines including: decimal to binary conversion, binary to decimal conversion, square root, fractional power, trigonometric, and interpretive routines. The remaining 22 pages provide reference information of value to persons programming for NAREC.

Jorgensen, W.E., I.G. Carlson, and C.G. Gros / NEL Reliability Bibliography / U.S. Naval Electronics Laboratory, San Diego 52, Calif. / May, 1956, 101 pp., offset, looseleaf, price and availability unknown. The work lists 404 articles, papers, reports, and other publications under the following headings: Circuit Design (24 references), Components (76 references), Electron Tubes (96 references), Failure Analysis (28 references), General (60 references), Human Engineering (20 references), Maintenance (16 references), Mechanical Design (20 references), Systems (28 references), and Testing (36 references).

This bibliography arose from the work of AGREE (Advisory Group on Reliability of Electronic Equipment). Only sources since 1950 were used in compiling the bibliography.

Reports published by government agencies, and conference proceedings appear to have received a relatively heavy emphasis in the selection of sources since the standard sources (such as the "Proceedings of the IRE") seem to bulk less than would be expected. The listings in this work are four to the single-side page so that they may be cut out and mounted on 3 x 5 cards.

II. Reviews by Edith Taunton, Weston, Mass.

Anthony, Robert N., editor, and 14 authors / Proceedings, Automatic Data Processing Conference / Division of Research, Graduate School of Business Administration, Harvard Univ., Soldiers Field Rd., Boston, Mass. / 1956, printed, 194 pp., \$3.50.

This conference was held at the Harvard Business School, September 8 and 9, 1955. The main purpose of the conference was (1) to give businessmen an opportunity to tell technical people their requirements for data, in order that applicable equipment might be designed to furnish the data, and (2) to give technical people an opportunity for acquainting businessmen with news of recent equipment, its capabilities, and limitations. The conference proceedings are in five parts: basic principles and techniques; centralized vs. decentralized organization for data processing; criteria for selection of equipment; case studies of certain applications; operations research and data processing. Much of the material presented here is good. The discussions of each topic make interesting reading.

Bevitt, William D. / Transistors Handbook / Prentice-Hall, Inc., 70 Fifth Ave., New York 11, N.Y. / 1956, printed, 410 pp., \$9.00.

This handbook is concerned with transistors and the practical applications of transistor circuits. It seeks to demonstrate effective utilization of transistors, rather than discuss their design. It describes how and where transistors have already been used, and discusses possible future applications of transistors and transistor circuits. Over 400 illustrations, a comprehensive subject index, and clear exposition lend to the handbook's practical value. Fundamental transistor concepts, various transistor types, characteristic measurements, noise and temperature effects, and circuitry applications are some of the topics covered.

Carroll, John M. / McGraw-Hill Book Co., Inc., 330 West 42 St., New York 36, N.Y. / 1956, printed, 343 pp., \$6.50.

The author, associate editor of "Electronics", here presents a great deal of information intended for (1) the mechanical engineer who needs to acquire specialized knowledge of problems peculiar to the design and manufacture of devices using electron tubes and transistors, and (2) the electronics engineer who needs to know more about the mechanics of packaging circuits. The book is based on a group of articles that appeared in "Electronics", but goes beyond them. The book contains numerous illustrations, a bibliography, and an index.

Chute, George M. / Electronics in Industry / McGraw-Hill Book Co., 330 West 42 St., New York 36, N.Y. / 1956, 2nd edition, printed, 431 pp., \$7.50.

The author presents a broad introduction to the use of electronic circuits and equipment in industry. He makes little use of mathematics beyond simple arithmetic in the examples cited in the text. In this revised second edition the material — including questions and assignments — has been rearranged and supplemented to make it suitable for use in technical survey courses. Recent designs of industrial controls have been included. The volume contains an interesting and useful bibliography of visual aid films which can be used as aids to the study of industrial electronics.

Hunter, Lloyd P., editor, and 13 authors / Handbook of Semiconductor Electronics — A Practical Manual Covering the Physics, Technology, and Circuit Applications of Transistors, Diodes, and Photocells / McGraw-Hill Book Co., Inc., 330 West 42 St., New York 36, N.Y. / 1956, printed, approx. 500 pp., \$12.00.

This is an excellent handbook, a thorough, efficiently arranged guide and reference work in which an attempt is made to present all the major principles of the field of semiconductor electronics. The editor is Senior Physicist, IBM,

Poughkeepsie, N. Y. Part I briefly describes transistor action, giving the background physics necessary to an understanding of such action. Part II surveys the technological processes utilized in transistor and diode fabrication. Part III gives the principles of transistor circuit design. Part IV, Reference Material, covers graphical analysis of non-linear circuits, matrix methods of circuit analysis, etc. A 68-page bibliography, and author index, and a subject index are included.

Hugh-Jones, E. M., editor, and 7 authors / The Push-Button World, or Automation Today / B. Blackwell, Oxford, England, and Univ. of Oklahoma Press, Norman, Okla. / 1956, printed, 149 pp., \$3.75.

An examination, by Earl of Halsbury, R. H. Macmillan, F. G. Woolard, H. R. Nicholas, W. R. Spencer, M. Argyle, and E. M. Hugh-Jones of: automation as a method in engineering production; automation's bases in science; its probable effects on labor; its possible administrative applications; its social implications. The book is an attempt to define automation, and to bring some of its implications clearly home to management and labor and to the public in general.

Korn, Granino A., and Theresa M. Korn / Electronic Analog Computers (D-c Analog Computers), 2nd edition / McGraw-Hill Book Co., Inc., 330 West 42 St., New York 36, N. Y. / 1956, printed, 452 pp., \$7.50.

This new edition of the book is again a textbook treatment of direct-current analog computers. It is intended to give research and development workers practical methods for using such computers. Much of the book has been rewritten to present up to date design information on computer components and systems. The book demonstrates how to set up problems for analog computation, and how to design these computers. It covers circuit theory, components and overall systems.

Nodelman, Henry M., and Frederick W. Smith / Mathematics for Electronics with Applications / McGraw-Hill Book Co., Inc., 330 West 42 St., New York 36, N. Y. / 1956, printed, 391 pp., \$7.00.

In this book the authors correlate electronic engineering practice with mathematical theory, yet have constantly retained an emphasis on applications, rather than on theory. Part I describes the use of mathematics in electronics and presents certain engineering problems using calculus for their solution; Part II introduces dimensional analysis as applied in electronics; Part III deals with the algebra of determinants; Part IV presents the fundamental properties of series approximations; Part V demonstrates solutions of differential equations; Part VI discusses elements of Boolean algebra and switching circuits. The book presupposes that the reader understand elementary calculus, physics, and elementary

electrical network theory.

Quastler, Henry, editor, and 12 authors / Information Theory in Biology / Univ. of Illinois Press, Urbana, Ill. / 1953, printed, paper bound, 273 pp., \$4.00.

This book is a collection of exploratory essays on the applications of information theory to the higher functions of living organisms, and on the use of information theory principles in analyzing functions such as metabolism, growth and differentiation. The essays themselves, in the words of the editor, "range from authoritative reviews of well-known facts to hesitant and tentative formulations of embryonic ideas". The papers are concerned specifically with: the concepts of information theory; definition and measurement of "information"; the structural analysis of fundamental biological units; the functional analysis of fundamental biological units; and the information content of bio-systems. Applicable and interesting illustrations accompany the various papers.

Tsien, H. S. / Engineering Cybernetics / McGraw-Hill Book Co., Inc., 330 W. 42 St., New York 36, N. Y. / 1954, printed, 289 pp., cost?

This is a theoretical study and analysis of that part of cybernetics which has "direct engineering application in designing controlled or guided systems". To understand this work, the reader needs some knowledge of advanced mathematics including variational calculus and differential equations, and he must be somewhat familiar with advanced mathematical and engineering terminology. Some topics discussed and analyzed are the method of Laplace transforms, the theory of various servomechanisms and linear systems, the theory of control designs, noise, and stability; also theoretical means for controlling error.

- END -

SPECIAL ISSUES OF "COMPUTERS AND AUTOMATION"

The June issue of "Computers and Automation" in each year commencing with 1955 is a special issue, "The Computer Directory", containing a cumulative "Roster of Organizations" and a cumulative "Roster of Products and Services in the Computer Field", and other reference information.

In early 1957, we shall publish Edition No. 2 of a cumulative "Who's Who in the Computer Field", as an extra number of "Computers and Automation". For more information, see page 51.

NEW PATENTS

RAYMOND R. SKOLNICK Reg. Patent Agent
Ford Inst. Co. Div. of Sperry Rand Corp.
Long Island City 1, New York

The following is a compilation of patents pertaining to computers and associated equipment from the Official Gazette of the United States Patent Office, dates of issue as indicated. Each entry consists of: Patent number / inventor(s) / assignee / invention.

October 23, 1956 (cont'd from Jan. issue):

- 2,767,913 / Robert D. Mitchell, So Orange, N. J. / - / Device for computing relative motion problems.
- 2,767,915 / Harold S. Hansen, Pacific Palisades, Calif. / - / A Logarithmic computer.
- 2,767,917 / Howard N. Faucett, Pleasantville, N. Y. / U. S. A. / A mechanical vector computer for a sound ranging azimuth detector.
- 2,767,919 / Franz J. A. Huber, Dayton, Ohio / True airspeed indicator.
- Oct. 30, 1956: 2,769,124 / John R. Erbe, Pittsburgh, Pa. / Westinghouse Electric Corp., East Pittsburgh, Pa. / A remote control system with automatic follow-up.
- Nov. 6, 1956: 2,769,591 / Paul Zamboni, Zurich, Switzerland / Landis & Gyr A. G., Zug, Switzerland / An integrating mechanism.
- 2,769,595 / Alan S. Bagley, Los Altos, Calif. / Hewlett-Packard Co., Palo Alto, Calif. / A frequency counter.
- 2,769,903 / Gordon Donald Paxson, El Cerrito, Calif. / U. S. A. / A pulse forming network.
- Nov. 13, 1956: 2,770,415 / John L. Lindesmith, Sierra Madre, Calif. / Clary Corp., Calif. / A readout and radix conversion apparatus for electronic computing apparatus.
- 2,770,724 / Henry N. Frihart, Brookfield, and George F. Baroch, Lombard, Ill. / Motorola, Inc., Chicago, Ill. / A converter.
- 2,770,725 / John J. Lentz, Chappaqua, N. Y. / International Business Machines Corp., New York, N. Y. / A binary-decade counter.
- 2,770,728 / Gerald B. Herzog, Princeton, N. J. / Radio Corp. of America, Del. / A semi-conductor frequency multiplier circuit.
- 2,770,734 / Robert J. Reek, Bellwood, Ill. / Teletype Corp., Chicago, Ill. / A transistor relay device.

- 2,770,743 / Bernard H. Wallach, New York, N. Y. / Kearfott Co., Inc., Little Falls, N. J. / A servo system and servo motor with built-in damping action.
- 2,770,797 / Francis E. Hamilton, Binghamton, and George V. Hawkins, Robert E. Lawhead, Jr., and Ernest S. Hughes, Jr., Vestal, N. Y. / International Business Machines Corp., New York, N. Y. / A data storage apparatus.
- Nov. 20, 1956: 2,771,244 / Francois Henry Raymond, Le Vesnet, France / Societe d'Electronique et d'Automatisme, Paris, France / A coded pulse circuit for multiplication
- 2,771,551 / Robert W. Hampton, Contra Costa County, Calif. / Marchant Calculators, Inc., Calif. / A counting circuit.
- 2,771,573 / Ake Hugo Petrus Blomqvist, Johannesov, and Per Ake Lindegren, Stockholm, Sweden, Aktiebolaget Bofors, Bofors, Sweden / A remote control follow-up system for positioning a controlled unit by a control unit.
- 2,771,595 / Arnold P. Henrickson, Minneapolis, and William R. Keye, St. Paul, Minn., and John H. Howard, Springfield, Pa. / Sperry Rand Corp., New York, N. Y. / A data storage system.
- November 27, 1956: 2,772,050 / Arthur Alexander Robinson, Scunthorpe, Frederic Calland Williams, Timperley, and Tom Kilburn, Manchester, Eng. / National Research Development Corp., London, Eng. / An electronic digital computing machine.
- 2,772,370 / George D. Bruce, Wappinger Falls, and Joseph C. Logue, Kingston, N. Y. / I. B. M. Corp., New York, N. Y. / A binary trigger and counter circuits employing magnetic memory devices.
- December 4, 1956: 2,773,250 / Pierre R. R. Aigrain and Georges B. A. Laindrat, Paris, France / International Standard Electric Corp., New York, N. Y. / A device for storing information.
- December 11, 1956: 2,773,444 / Gordon E. Whitney, Derby, Colo. / International Business Machines Corp., New York, N. Y. / A magnetic core storage for business machines.
- 2,773,641 / Richard V. Baum, Akron, Ohio / Goodyear Aircraft Corp., Akron, Ohio / An electronic multiplier.
- 2,773,648 / John B. Cannon, Jr., State College, Pa. / Research Corp., New York, N. Y. / A binary-decimal counter.
- 2,773,983 / Richard H. Baker, Los Angeles, and Donald E. Eckdahl, Manhattan Beach, Calif. / Northrop Aircraft Inc., Hawthorne, Calif. / An electronic counting device.
- 2,774,019 / Anthony J. Hornfeck, S. Euclid, Ohio / Bailey Meter Co., Del. / An electric servo system for measuring and control.

APPENDIX

TABLE OF COMPUTER SYMBOLS

POTENTIOMETER

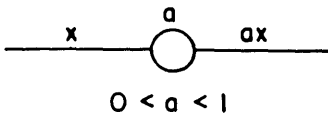

SUMMING AMPLIFIER

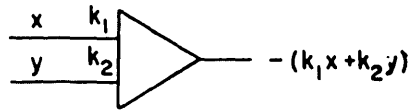

HIGH GAIN AMPLIFIER

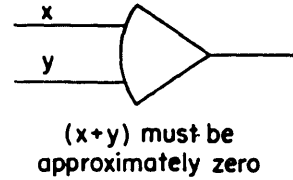

INTEGRATOR

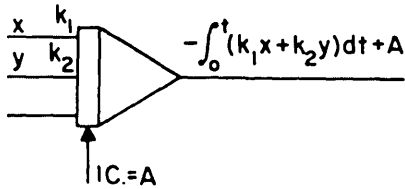

SERVO MULTIPLIER

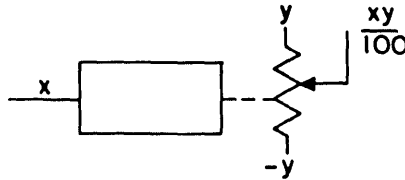

FUNCTION GENERATOR

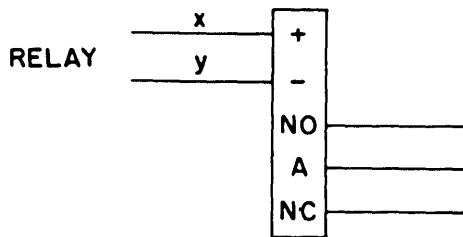

Relay closes when $x > y$, connecting A (arm) to NO (normally open); otherwise A is connected to NC (normally closed).

The Ramo-Wooldridge Corporation

Digital Computer PROGRAMMERS

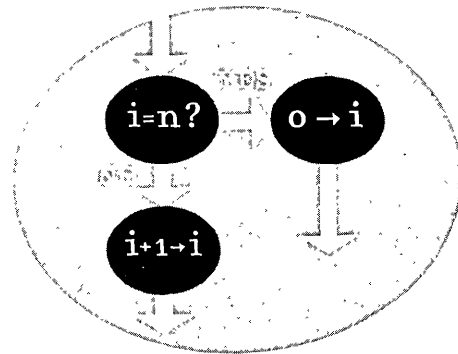

The Ramo-Wooldridge Corporation has several opportunities for those interested in programming the UNIVAC Scientific Model 1103 A, and other electronic digital computers. A college degree in mathematics, physics or engineering is required, and several years of programming experience is desirable.

Please direct inquiries for additional information to: Mr. R. Richerson

The Ramo-Wooldridge Corporation

5730 Arbor Vitae Street • Los Angeles 45, California • Telephone: ORchard 2-0171

Forum

LOS ANGELES CHAPTER, ASSOCIATION FOR COMPUTING MACHINERY,
STATLER HOTEL, LOS ANGELES, MARCH 1, 1957

Eugene H. Jacobs
Association for Computing Machinery
The Rand Corp.
1700 Main St.
Santa Monica, California

The Los Angeles Chapter of the Association for Computing Machinery is sponsoring, in conjunction with, and immediately following, the forthcoming Western Joint Computer Conference, a one day symposium on "New Computers — A Report from the Manufacturers". This meeting, which will be held on March 1, 1957, at the Statler Hotel in Los Angeles, will provide a forum for computer manufacturers to announce and explain new computer developments. The program has been restricted to papers on general purpose computer systems for commercial or scientific uses, involving high-volume, high-speed storage systems and high operating speeds. Only the newest, most advanced and most recently publicized equipment will be discussed. The material to be presented will stress the viewpoint of the user rather than that of the logical or circuit designer.

A copy of the program is attached. Also, we should like to point out that there will be no registration fee for this Symposium.

We believe that these "Reports from the Manufacturers" will be of interest to your many readers in the computing field, and your assistance in publicizing this meeting will be appreciated.

NEW COMPUTERS —
A REPORT FROM THE MANUFACTURERS

Golden State Room, Statler Hotel, Los Angeles

9:00 A.M., Friday, March 1, 1957

Opening Remarks

Walter F. Bauer, The Ramo-Wooldridge Corporation, Chairman, Los Angeles Chapter, Association for Computing Machinery

Session I

Chairman: Paul Armer, the RAND Corporation

Magnetic Tape File Processing with the NCR-304, a New Business Computer, J. S. Sumner, National Cash Register, Inc.

The Cardatron and the Datafile in the DATATRON System, F. G. Withington and Dean H. Shaw, ElectroData Corporation

Intermission

A New Large-Scale Data Handling System — DATAmatic 1000, W. C. Carter, DATAmatic Corp.

The RCA BIZMAC II — Characteristics and Applications, J. A. Brustman, H. M. Elliott, and A. S. Kranzley, Radio Corporation of America

Lunch

1:30 P.M., Friday, March 1, 1957

Session II

Chairman: Jack A. Strong, North American Aviation, Inc.

Advanced Techniques in Univac Scientific Computer Systems, A. A. Cohen, Remington Rand Univac

Recent IBM Developments in High Speed Computation and Design Objectives for the Super Speed Stretch Computer, J. L. Greenstadt and S. W. Dunwell, International Business Machines Corp.

(cont'd on page 48)

George thought this over for a moment.

"That's what I call taking the Wide View," he said presently. "But what d'ya suppose we should do about it? I don't see that it makes the slightest difference to us. After all, we already knew that they were crazy."

"Yes — but don't you see what may happen? When the list's complete and the Last Trump doesn't blow — or whatever it is they expect — we may get the blame. It's our machine they've been using. I don't like the situation one little bit."

"I see," said George slowly. "You've got a point there. But this sort of thing's happened before, you know. When I was a kid down in Louisiana we had a crackpot preacher who said the world was going to end next Sunday. Hundreds of people believed him — even sold their homes. Yet nothing happened, they didn't turn nasty as you'd expect. They just decided that he'd made a mistake in his calculations and went right on believing. I guess some of them still do."

"Well, this isn't Louisiana, in case you hadn't noticed. There are just two of us and hundreds of these monks. I like them, and I'll be sorry for old Sam when his lifework backfires on him. But all the same, I wish I was somewhere else."

"I've been wishing that for weeks. But there's nothing we can do until the contract's finished and the transport arrives to fly us out."

"Of course," said Chuck thoughtfully, "we could always try a bit of sabotage."

"Like hell we could! That would make things worse."

"Not the way I meant. Look at it like this. The machine will finish its run four days from now, on the present twenty-hours-a-day basis. The transport calls in a week. O. K. — then all we need do is to find something that wants replacing during one of the overhaul periods — something that will hold up the works for a couple of days. We'll fix it, of course, but not too quickly. If we time matters properly, we can be down at the airfield when the last name pops out of the register. They won't be able to catch us then."

"I don't like it," said George. "It will be the first time I ever walked out on a job. Besides, it would make them suspicious. No. I'll sit tight and take what comes."

"I still don't like it," he said, seven days later, as the tough little mountain ponies carried them down the winding road. "And don't you think I'm running away because I'm afraid. I'm just sorry for those poor old guys up there, and I don't want to be around when they find what suckers

they've been. Wonder how Sam will take it?"

"It's funny," replied Chuck, "but when I said good-bye I got the idea he knew we were walking out on him — and that he didn't care because he knew the machine was running smoothly and that the job would soon be finished. After that — well, of course, for him there just isn't any After That ..."

George turned in his saddle and stared back up the mountain road. This was the last place from which one could get a clear view of the lamasery. The squat, angular buildings were silhouetted against the afterglow of the sunset: here and there, lights gleamed like portholes in the sides of an ocean liner. Electric lights, of course, sharing the same circuit as the Mark V. How much longer would they share it, wondered George. Would the monks smash up the computer in their rage and disappointment? Or would they just sit down quietly and begin their calculations all over again?

He knew exactly what was happening up on the mountain at this very moment. The High Lama and his assistants would be sitting in their silk robes, inspecting the sheets as the junior monks carried them away from the typewriters and pasted them into the great volumes. No one would be saying anything. The only sound would be the incessant patter, the never-ending rainstorm, of the keys hitting the paper, for the Mark V itself was utterly silent as it flashed through its thousands of calculations a second. Three months of this, thought George, was enough to start anyone climbing up the wall.

"There she is!" called Chuck, pointing down into the valley. "Ain't she beautiful!"

She certainly was, thought George. The battered old DC 3 lay at the end of the runway like a tiny silver cross. In two hours she would be bearing them away to freedom and sanity. It was a thought worth savoring like a fine liqueur. George let it roll round his mind as the pony trudged patiently down the slope.

The swift night of the high Himalayas was now almost upon them. Fortunately the road was very good, as roads went in this region, and they were both carrying torches. There was not the slightest danger, only a certain discomfort from the bitter cold. The sky overhead was perfectly clear and ablaze with the familiar, friendly stars. At least there would be no risk, thought George, of the pilot being unable to take off because of weather conditions. That had been his only remaining worry.

MAGNETIC RECORDING HEADS

Ferroxcube Corp. of America
Saugerties, N. Y.

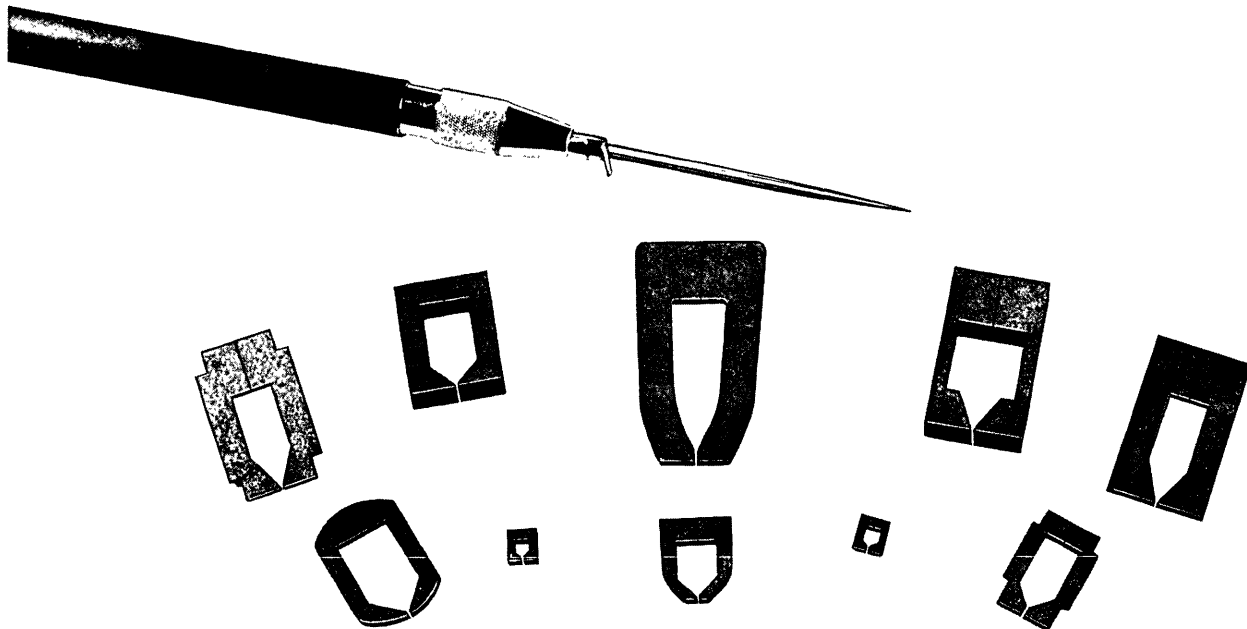

TYPICAL FERROXCUBE RECORDING HEADS

Here are some of the recording heads recently in production at the Saugerties, New York plant of the Ferroxcube Corporation of America for use in various types of electronic computers.

* _____ *

NINE BILLION NAMES
(cont'd from page 41)

He began to sing, but gave it up after a while. This vast arena of mountains, gleaming like whitely hooded ghosts on every side, did not encourage such ebullience. Presently George glanced at his watch.

"Should be there in an hour," he called back over his shoulder to Chuck. Then he added, in an afterthought: "Wonder if the computer's finished its run? It was due about now."

Chuck didn't reply, so George swung round in his saddle. He could just see Chuck's face, a white oval turned towards the sky.

"Look," whispered Chuck, and George lifted his eyes to heaven. (There is always a last time for everything.)

Overhead, without any fuss, the stars were going out.

- END -

* _____ *

ROBOT SHOW STOPPERS

From time to time you may need to help organize a display in a business show including some device that you hope will "STOP" every person attending the show and make him notice your display -- a device which may be called a "SHOW-STOPPER".

In addition to publishing the magazine "COMPUTERS AND AUTOMATION", we have for six years been developing and constructing "ROBOT SHOW-STOPPERS", small robot machines that respond to their environment and behave by themselves.

Write us for more information:
Berkeley Enterprises, Inc.,
815 Washington St., R 191
Newtonville 60, Mass.

leisure is to mean something more than just another day when we can sleep late, will need to develop some of these qualities. In view of these needs, one of the greatest mistakes we could make would be to concentrate all our attention on the specialized problems of educating scientists and technicians.

A hundred years ago, when it was necessary for most people to put in 60 or 70 hours a week in miserable factories, just in order to survive, the question of what to do with non-work — with leisure — never presented itself. Today, with our forty hours of work a week, we are already facing the two-day weekend with something of a self-conscious attitude. When leisure time spills over from the weekend to Monday and Friday, when a man leaves his desk or his station after six hours of work, still fresh and full of energy, then for the first time in history, we will really face the problem of what to do with leisure time.

Change

Like the pioneers of the Industrial Revolution in the 18th century, we face a world in which only one thing is sure: change, fundamental change.

Instead of fearing change; I think we might do well to think about the words that the great philosopher and teacher Alfred North Whitehead wrote more than twenty-five years ago:

"It is the business of the future to be dangerous; and it is among the merits of science that it equip the future for its duties. . . . In the immediate future there will be less security than in the immediate past, less stability. It must be admitted that there is a degree of instability which is inconsistent with civilization. But, on the whole, the great ages have been unstable ages."

An Age When the Buttons Push Themselves

Today we are leaving the pushbutton age and entering an age when the buttons push themselves. We should greatly benefit from it. Farsighted and aggressive managements see not only the possibility of decreasing operating costs, but also of entering the field with new products and new services. Entirely new markets are coming into existence, and alert businessmen are already seizing the opportunities they see before them. I think it is fair to say that automation offers as great a challenge and reward as any industry has ever known.

- END -

News Release

ELECTRIC TYPEWRITER INPUT-OUTPUT FOR COMPUTERS

International Business Machines Corp.
New York, N. Y.

The Electric Typewriter Division of International Business Machines Corporation has announced the development of a new model electric typewriter designed for use as an input and output device for the data processing field.

The new typewriter automatically types at a rate of 120 words a minute or approximately twice as fast as the average typist. It can be used associated with computers, as well as with measuring and recording instruments, scales, and meters, in such applications as engine testing, liquid flow through pipelines, production control, wind tunnel research and others, providing a visual record.

The input-output typewriter is operated by a series of electro-magnets and solenoids mounted beneath the keyboard. When used as an output device, the magnets and solenoids receive signals transmitted from the controlling device, or computer, and automatically actuate keyboard functions of the typewriter, including carriage return, spacing, tabulation, ribbon color control, and others. When used as an input device, electrical impulses are transmitted from the typewriter by merely depressing a key.

It is approximately the same size as a standard IBM electric typewriter and may be used for general office procedure. The new typewriter is available with carriage lengths up to 30 inches and is priced from \$740.

- END -

* ————— *

WHAT READERS SAY ABOUT "COMPUTERS AND AUTOMATION"

from 82 readers of "Computers and Automation"

The following are comments received from readers of our magazine "Computers and Automation". The sources of these comments are entry forms for "Who's Who in the Computer Field 1956-7" sent in to us; the comment is usually written in a space on the form entitled "Remarks and views?".

In order to give a complete and fair picture, here are all comments (1) relevant to the magazine, (2) unselected, both favorable and unfavorable, (3) arranged in sequence according to date received, October 18, 1956, up to about December 7, 1956. If the meaning or context of any comment is not clear, we shall be glad to try to explain it if we can.

To draw attention to some comments which are particularly important to us, we have enclosed them in boxes.

Aside from a few free subscriptions to advertisers, agencies, editors of other magazines, and similarly placed persons, every subscription to "Computers and Automation" is paid for.

William W. Allen, Product Development Analyst, Remington Rand-Univac Div., 315 Fourth Ave., New York 10, N. Y.

"Computers and Automation seems to be growing in popularity in my office. It does a good job in covering all aspects of the computing industry."

Lynn A. McCabe, Assistant to Comptroller, Campbell Soup Co., Camden, N. J.

"Very Good"

Edward S. Stein, Consultant to Electronic Systems, U.S. Bur. of Census, Washington 23, D. C.

"Not technical enough."

Willard G. Bouricius, Director of Computing Center, IBM Research Lab., Poughkeepsie, N. Y.

"Your publication is doing more than any other to get new people interested in and informed about computers."

Wm. G. Deutsch, Information Systems Applications Engineer, Panellit, Inc., 7401 N. Hamlin Ave., Skokie, Ill.

"Suggest an issue devoted to discussion of Automatic Logging of Physical data — An Input for Computers."

Lt. j.g., A. Robert Rafner, U. S. Navy Aviation Supply Office, Electronic Computer Branch, 700 Robbins Ave., Philadelphia 11, Pa.

"Excellent magazine. Look forward to each issue."

J. James Ingram, Sr., Engr., IBM Corp., Product Development Lab., Endicott, N. Y.

"Would seem desirable to list last or possibly all degrees."

Howard H. Metcalfe, Mathematician, The Rand Corporation, Lincoln Lab., Lexington, Mass.

"Excellent magazine — filling a great need in this field for such distribution of information."

Howard S. Levin, Consultant, Ebasco Services, Inc., 2 Rector St., New York 6, N. Y.

"Thanks for planning a complete directory of computer people."

C. Hugh Spencer, Marketing Services Manager, The Reuben H. Donnelly Corp., 401 North Broad St., Philadelphia, Pa.

"I appreciate your recent articles on programming and applications in industry."

Warner G. Cumber, Manager, Advanced Process Application, American Airlines, Inc., 100 Park Ave., New York 17, N. Y.

"Would like to see more articles on applications of computers to business which are outside the accounting and financial fields."

Mrs. Nora M. Taylor, Mathematician, David Taylor Model Basin, Washington 7, D. C.

"I dropped my subscription because I don't think the content justifies the present high price."

What Readers Say About Computers and Automation

John H. Kain, Sales Repr., Underwood Corp., 2424 W. Brand Blvd., Detroit 8, Mich.

"Practical application of small medium scale computers will depend largely upon experienced accounting machine salesmen."

E. J. Quinby, Product Mgr., Computers, Philco Corp., Govt. & Indus. Div., Philadelphia 44, Pa.

"We do subscribe, of course, because Computers and Automation is the pioneer and the most widely read in its field."

N. T. Grisamore, Asst. Prof., George Washington Univ., Washington, D. C.

"The idea of not including the Who's Who as part of the regular subscription is, at the least, irritating. My subscription will be dropped at the end of its period. This is no must publication to individuals since it can be obtained at any technical library."

George V. Maverick, Mathematician, IBM Corp., 3287 Wilshire Blvd., Los Angeles 5, Calif.

"Present method of financing Who's Who is an improvement. In C & A I regularly read the fiction first."

Otis N. Minot, Pres., Minot Informatic Devices, 22 Eliot Road, Lexington 73, Mass.

"I like your Computers and Automation."

L. Eugene Handloff, Design Engr., IBM Product Devt. Lab., 99 Notre Dame, San Jose, Calif.

"I enjoy your magazine very much. One of its best features is its brevity. I appreciate not having to wade through mountains of over-specialized articles and generality."

Herbert F. Lindsay, Logistics Data Processing Office, Sacramento Air Materiel Area, McClellan, Calif.

"I am interested in the planned, properly integrated use of electronic data processing machines as a balanced part of the total organization."

George H. L. Norman, Sales Manger, Sprague Electric, Pacific Division, 12870 Panama St., Los Angeles 66, Calif.

"Computers and Automation is much appreciated."

Mrs. David A. LaMarre, Jr. Mathematician, American Optical Co., Southbridge, Mass.

"Always seems quite interesting and informative."

Robert F. Meyers, Meteorologist, Air Force Cambridge Res. Cen., L. G. Hanscom Field, Bedford, Mass.

"Very good; would like a periodic review of automatic digital computers and similar pieces of equipment."

Zoel M. Radner, Head, Integrated Business Systems, Hughes Aircraft Co., Culver City, Calif.

"More business systems preparation steps required."

Jerome J. Dover, Chief, Data Reduction Branch, Air Force Flight Test Center, Edwards AFB, Calif.

"Keep up the good work."

Ashley J. Hollingsworth, Devt. Engr., Friden Calculating Machine Corp., San Leandro, Calif.

"Your magazine is improving or else my interest in subject is."

William H. Jenkins, Computing Devices of Canada, Ltd., Ottawa, Ontario, Canada

"Computers and Automation is improving steadily. Trust the editors are not completely satisfied. Technical level could be higher."

John L. Little, Electronic Scientist, National Bureau of Standards, Washington 25, D. C.

"Worthwhile reading."

D. K. Ritchie, Senior Elec. Engr., Ferranti Electric Ltd., Mount Dennis, Toronto, Canada

"The 'Science Fiction' stories are not only not very good: they also do nothing to improve the prestige of the publication."

Roderick Gould, Research Asst., Harvard Comp. Lab., Cambridge 38, Mass.

"Your magazine would be greatly improved by:
(1) getting rid of those awful Danach cartoons;
(2) eliminating or greatly improving your fiction."

William F. Atchison, Head, Programming and Coding Group, Rich Electronic Computer Center, Georgia Inst. of Tech., Atlanta 13, Ga.

"Very interesting."

Stanley H. Cohn, Computing Specialist, Avro Aircraft Ltd., Malton, Ontario, Canada

"Science fiction stories out of place. 'Truth is stranger than fiction.'"

Miss Frances C. Benthine, Ass't. Director Sales Support, Sperry Rand Corp., 315 Fourth Ave., New York, N. Y.

"Articles are very useful in keeping our staff informed of developments in the computer field."

Alfred Walker, Director of Public Relations, Logistics Research, Inc., 141 S. Pacific Ave., Redondo Beach, Calif.

"Very useful, very necessary. Fills need for publication devoted exclusively to Computers and Automation."

Theodore C. Austin, Elect. Eng., ARO, Inc., Tullahoma, Tenn.

"Very enlightening information."

Arthur R. Friedenheit, Sales Technical Specialist, 288 S. Marengo Ave., Pasadena, Calif.

"Read circulating copy; a fine magazine!"

Herbert O. Brayer, Management Consultant, Professor of Automation, Loyola Univ., Chicago, Ill.
"Excellent material — wish we could get more information on costs in relations to systems and operations rather than just machine costs. Also management experience, problems, etc., in automation from business and commercial view rather than manufacturing or engineering."

Gerald S. Briney, Section Head, Application Engrg. Div., Minneapolis-Honeywell, Wayne & Windrim Aves., Philadelphia 99, Pa.
"I enjoy your magazine and have read it since its inception. It is, in my estimation, a valuable contribution to this field."

Paul H. Hunter, Engr., Headquarters Staff, Western Electric Co., Inc., Lexington Rd., Winston-Salem, N. C.

"Interested in systems for reducing cost, manpower and time lag involved in reduction of statistical quality data in the electronic manufacturing area. As far as I know, a completely undeveloped field for automatic data processing."

Lowell S. Michels, Senior Engr., Bendix Computer Div., 5630 Arbor Vitae St., Los Angeles 45, Calif.
"Informative and enjoyable publication."

Richard C. Singleton, Research Engineer, Stanford Research Inst., Menlo Park, Calif.
"Enjoy your publication."

Matthew A. Alexander, Senior Staff Engr., Telemeter Magnetics, 2245 Pontius Ave., Los Angeles 64, Calif.
"The publication is in my experience widely read. Why not publish short essays on subjects which are part of our general field in place of the articles like 'Pure Word', etc."

Herbert J. Holzman, Mathematician, The Rand Corp., 1700 Main St., Santa Monica, Calif.
"Enhance the quality of your short stories."

H. Arthur Hatch, Data Processing Analyst, Argonaut Underwriters, Inc., 250 Middlefield Road, Menlo Park, Calif.
"Read it all every month — Very useful and interesting."

Howard Bromberg, Systems Analyst, Remington Rand-Univac, 19th and Allegheny Ave., Philadelphia, Pa.
"The only really comprehensive magazine for a field whose scope expands daily."

Theodore R. Meyer, Ass't. Actuary, Guaranty Union Life Ins. Co., Beverly Hills, Calif.
"Excellent coverage."

Robert E. Margolies, Project Engineer, Arnoux Corp., 11924 W. Washington Blvd., Los Angeles 66, Calif.
"A worth while magazine."

George T. Davis, Treasurer, Erdco, Inc., 511 Locust St., St. Louis, Missouri
"I enjoy your publication, Computers and Automation. This is the ONLY direct contact we have with the computer field outside of our own little group."

Buckley C. Pierstoree, Sr. Member, Tech. Staff, Simulation Lab., RCA Airborne Systems Lab., Waltham, Mass.
"Try for more analog computer material in C & A."

Harold J. Ehlers, Assoc. Engr., Boeing Airplane Co., Seattle, Wash.
"Would like more articles of a technical nature. Drop the fiction stories."

Cecil N. Batsel, Jr., Engr., Radio Corp. of America, 11819 W. Olympic Blvd., Los Angeles 69, Calif.
"Very informative."

William J. Stadler, Engr., Physical Research Staff, Boeing Airplane Co., Plant II, Seattle, Wash.
"Feel the need for abstracts of published material on Digital Computing: programming, applications, hardware, conference, etc."

Frank M. Delaney, Ass't. Director, Automatic Programming Devt., Remington Rand Univac Div., Sperry Rand Corp., 19th and Allegheny, Philadelphia, Pa.
"Very interesting — keep up the good work!"

Bruce N. Jenks, Systems Analyst, Continental Assurance Co., 310 S. Michigan Ave., Chicago, Ill.
"Improving magazine with every issue — Keep it up."

Ralph J. Preiss, Associate Engineer, IBM Product Devt. Laboratory, Poughkeepsie, N. Y.
"I am glad that you have decided that purchasers should pay the cost of preparing and publishing this 'Who's Who'."

Marcel A. Martin, Physicist, Data Processing Analysis, General Electric, Missiles and Ordnance Systems Dept., 3198 Chestnut St., Philadelphia, Pa.
"Congratulations for your free listings."

Ladimer J. Andrews, Project Engr., National Cash Register Co., Hawthorne, Calif.
"Format very good; fiction welcome break in routine."

James H. M. Williams, Senior Engineer, Ferranti Electric Inc., 30 Rockefeller Plaza, New York, N. Y.
"Very Informative and Interesting."

Eugene Garfield, President, Documation, Inc., Woodbury, N. J.
"Telephone numbers would be extremely valuable and time saving. Ours is Tilden 5-7876."

Vincent F. St. John, Accounting Supervisor, New York Telephone Co., 140 West St., New York, N. Y.

"We here in headquarters find the magazine loaded with up-to-date and valuable information."

Arthur A. Ernst, General Engr., National Bureau of Standards, Data Processing Systems Div., Washington 25, D. C.

"O. K. and useful — but it is really 'mechanization' rather than 'automation'."

Howard S. White, Physicist, University of California Radiation Lab., Berkeley 4, Calif.

"Good, well rounded selection of material."

Mrs. Nan H. Adams, Programmer, Lenkurt Electric Co., Inc., San Carlos, Calif.

"Very good. More glossaries of all related words and terms would be helpful."

D. G. O'Connor, Manager, Digital Computer Devt., Link Aviation, Binghamton, N. Y.

"I feel the 'Who's Who' performs a valuable service to the industry."

Mr. Marvin C. Green, Chief, Simulation & Computation Division, Holloman Air Development Center, Holloman AFB, N. M.

"Computers and Automation is very helpful in my work."

Robert E. Koning, Tabulating Equipment Supervisor, Stat. Services, MacDill AFB, Florida

"Would like to see articles or letters on Braw Analogue (Self Programming Machines)."

Richard Lindaman, Technical Writer, Remington Rand Univac, Univac Park, St. Paul, Minn.

"Except for some of the fiction, I have enjoyed nearly everything in Computers and Automation including ads."

Byron E. Wicks, Operations Research Assistant, Bank of America N. T. and S. A., 300 Montgomery St., San Francisco 20, Calif.

"I like it very much; very interesting and informative."

Charles B. Slack, Administrative Assistant, Baird Associates - Atomic Instrument Co., 33 University Rd., Cambridge, Mass.

"I would like to see more extensive treatment of data handling techniques — data conversion, multiplexing, high speed printers, etc."

Lawrence F. Hope, Consultant to General Motors Research Staff, Grosse Pointe Farms 36, Mich.

"How about more emphasis on 'fringe areas' which may contribute much to techniques, e. g., information theory, learning, adaptation?"

Joseph M. Zappia, Store Project Representative, Burdine's, Miami 30, Florida

"Excellent publication and organization."

Robert C. Ferber, Business Consultant, Peat, Marwich, Mitchell & Co., 70 Pine St., New York 5, N. Y.

"Excellent publication; copy should be in justified type style."

Stanley R. Klion, Consultant, Peat, Marwich, Mitchell & Co., 70 Pine St., New York 5, N. Y.

"Fine magazine but a little amateurish in format."

Joseph M. Bernard, Research Engineer, Boeing Airplane Co., c/o Lincoln Laboratory, Lincoln, Mass.

"Enjoy your publication and its informative presentations."

Lucille J. Albers, Mathematician, Air Force Armament Center, USAF, Elgin AFB, Florida

"Computers and Automation is keeping me up to date on programming techniques, computer installations, and people."

Burton W. Bostad, Sr. Syst. Design Engr., Convair Astronautics, 653 Minot Ave., Chula Vista, Calif.

"Enjoy your publication and hope to see it grow with the automation field."

David Gindoff, Partner, Gindoff & Swartz, CPA's, 5858 Wilshire Blvd., Los Angeles, Calif.

"There appear to be many more computer people than computers."

Benjamin F. Cheydleur, Dept. Manager, Remington Rand Univac, 1902 W. Minnehaha Ave., St. Paul, Minn.

"Continue the good work! Best wishes!"

Peter G. Neumann, Research Assistant, Harvard Computation Laboratory, Cambridge 38, Mass.

"Enjoyed the Examination of John Carr III. Excellent idea to reproduce such."

Maurits P. de Regt, Sales Technical Representative, Electrodata Division of Burroughs, 201 Boren North, Seattle, Wash.

"Many valuable contributions to the field of computers."

R. B. Curry, Comptroller, Southern Railway System, Washington 13, D. C.

"Excellent publication."

Joel Franklin, Senior Mathematician, Electrodata Division of Burroughs Corp., Pasadena, Calif.

"You have a very fine publication, and you deserve continued success."

Robert C. Brackett, Production Control Department, Zenith Radio Corp., Chicago 39, Ill.

"To me this (the computer field) is a most interesting field, and your 'Computers and Automation' has helped me tremendously."

MANUSCRIPTS

We are interested in articles, papers, reference information, science fiction, and discussion relating to computers and automation. To be considered for any particular issue, the manuscript should be in our hands by the fifth of the preceding month.

Articles. We desire to publish articles that are factual, useful, understandable, and interesting to many kinds of people engaged in one part or another of the field of computers and automation. In this audience are many people who have expert knowledge of some part of the field, but who are laymen in other parts of it. Consequently a writer should seek to explain his subject, and show its context and significance. He should define unfamiliar terms, or use them in a way that makes their meaning unmistakable. He should identify unfamiliar persons with a few words. He should use examples, details, comparisons, analogies, etc., whenever they may help readers to understand a difficult point. He should give data supporting his argument and evidence for his assertions. We look particularly for articles that explore ideas in the field of computers and automation, and their applications and implications. An article may certainly be controversial if the subject is discussed reasonably. Ordinarily, the length should be 1000 to 4000 words. A suggestion for an article should be submitted to us before too much work is done.

Technical Papers. Many of the foregoing requirements for articles do not necessarily apply to technical papers. Undefined technical terms, unfamiliar assumptions, mathematics, circuit diagrams, etc., may be entirely appropriate. Topics interesting probably to only a few people are acceptable.

Reference Information. We desire to print or reprint reference information: lists, rosters, abstracts, bibliographies, etc., of use to computer people. We are interested in making arrangements for systematic publication from time to time of such information, with other people besides our own staff. Anyone who would like to take the responsibility for a type of reference information should write us.

Fiction. We desire to print or reprint fiction which explores scientific ideas and possibilities about computing machinery, robots, cybernetics, automation, etc., and their implications, and which at the same time is a good story. Ordinarily, the length should be 1000 to 4000 words.

Discussion. We desire to print in "Forum" brief discussions, arguments, announcements, news, letters, descriptions of remarkable new developments, etc., anything likely to be of substantial interest to computer people.

Payments. In many cases, we make small token payments for articles, papers, and fiction, if the author wishes to be paid. The rate is ordinarily $\frac{1}{2}$ ¢ a word, the maximum is \$20, and both depend on length in words, whether printed before, whether article or paper, etc.

- END -

ACM
(cont'd from page 40)

The Philco S-2000 Transistorized Large-Scale Data Processing System, S. Y. Wong, Philco Corp.

The Logistics Research Model 800 Computer, Neil Block, Logistics Research, Inc.

Closing Remarks

John W. Carr III, University of Michigan,
President, Association for Computing
Machinery

SYMPOSIUM COMMITTEE

Walter F. Bauer, Chairman, The Ramo-Wooldridge Corp.

Paul Armer, The RAND Corporation
Eugene H. Jacobs, The RAND Corporation
Jack A. Strong, North American Aviation, Inc.

- END -

MAKE YOUR OWN BABY GENIUS COMPUTERS
WITH

GENIAC

Electric Brain

Construction Kit No. 1

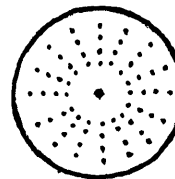

Diagram of the versatile multiple switch, which can be assembled to make any switch combination from 16 decks of 2 positions, to 2 decks of 16 positions.

This kit is an introduction to the design of arithmetical, logical, reasoning, computing, puzzle-solving, and game-playing circuits.

Write us for more information:
Berkeley Enterprises, Inc.,
815 Washington St., R 191,
Newtonville 60, Mass.

We have long been aware that the listing of contents pages of those journals of interest to management is not a sufficiently complete service. There must also be convenient access to the original articles and magazines. To this end we are now developing a service for our readers which will enable them to obtain photocopies, reprints, or single copies from a single source or as you phrase it a 'Master Library'.

DOCUMATION will be delighted to participate in any plan for facilitating the flow of information in the field of automation. We would be delighted to act as the central depository for the many articles mentioned in your editorial as well as any others of possible interest to automation personnel. We would carry this one step further and stipulate that we will be glad to regularly feature lists of such articles or unpublished papers in the pages of Management's DOCUMATION Preview. In this way many new users will be found for the information reported.

Please let me know whether your firm and any other readers of 'Computers and Automation' would be interested in such a plan, or a modification suitable to all concerned."

III. From the Editor

We welcome the comments of Mr. Garfield. We would like very much to hear from more readers of "Computers and Automation" on this subject and know what their ideas may be.

IV. From the Editor to Mr. John W. Carr, III, President of the Association for Computing Machinery, Univ. of Mich., Dept. of Math., Ann Arbor, Mich.

Would you please send me when convenient a statement representing the views of the Council of the Association for Computing Machinery about the availability and the publishing of preprints?

I would like to publish this in "Computers and Automation", so that many people who want preprints will know what they are up against, and why the ACM has its present policy about preprints.

V. From John W. Carr, III, to the Editor

The policy of the A. C. M. Council with respect to pre-prints to be passed out to persons attending the Annual Meetings has been based on very practical considerations generally not understood by those persons who have requested further copies after the meeting.

The custom of pre-prints was first instituted at the suggestion of C. W. Adams of the A. C. M. Council, and was a trial idea. However, the editors of certain professional journals consider the issuance of pre-prints as publication of the paper. Thus a paper presented at Los Angeles of which pre-prints were distributed, is not acceptable in several journals. Persons presenting papers complained bitterly about this, and indicated that they would not present papers at further A. C. M. meetings if the custom of pre-print distribution were continued.

Beyond this, the A. C. M. Local Arrangements Committee at Los Angeles found that the requests for pre-prints after the meeting would have been as much of a job to satisfy as certain portions of preparation for the meeting itself. They made the rule, therefore, that only persons registering for the meeting could receive pre-prints. I feel that their decision was justified because they knew the local situation, the amount of work involved, and the amount of resources in personnel and funds they had on hand.

The pre-print situation is now in the hands of the National Program Committee, of which Dr. James Robertson is Local Representative for the Houston, 1957 meeting. It is my understanding that a decision has been made against the publication of pre-prints for the Houston meeting, for the several reasons described above.

VI. From Edmund C. Berkeley, Editor, "Computers and Automation"

It seems to me that a short-sighted and non-altruistic policy on the part of some authors is being allowed to influence the policy of the Association for Computing Machinery with regard to all authors.

It would be very easy for the local arrangements committee or the program committee to question authors and divide preprints of papers into two classes: (1) those papers where the author is hoping to publish later in a professional journal which has the policy of a preprint disabling the author from later publication, and (2) all other papers — which will include the great majority of authors who have no objection at all to having their preprints widely distributed. It would be very easy to distribute only preprints of the latter papers.

As one of the original founders of the Association for Computing Machinery, and secretary of it for more than five years (1947-53), I believe that the decision of the Council of the Association as

reported above by the President is not in the best interests of the computer field or the members of the Association, and is contrary to the constitution of the Association (paragraph 2, "Purpose"), and should be promptly reversed.

In regard to the work of preparing and distributing the preprints, if there is no other outfit that wants to undertake the work, we shall gladly undertake the work, and charge a break-even cost for the preprints.

I should like to suggest that other members of the Association for Computing Machinery (besides myself) and other persons, who would like to have copies of the preprints, write to the Council of the Association, c/o the President, point out that this Council decision is contrary to their desires and interests, and quite possibly contrary to the constitutional purpose of the Association, and request reconsideration.

Forum

COMPUTER PEOPLE: MASTER FILE

Edmund C. Berkeley
Computers and Automation
Newtonville 60, Mass.

For more than two years "Computers and Automation" has been maintaining a master file of computer people. It may interest our readers to know the present status and availability of the file, especially as a result of discussions that we had in December with the Council of the Association for Computing Machinery and the National Joint Computer Committee, and decisions then made.

These two groups decided to withdraw from any direct participation in the master file. Accordingly, we shall maintain the file as our sole responsibility, and of course seek to maintain it in the best interests of all computer people and the advancement of the computer field.

As of the present time, the file contains the names and addresses of over 10,500 people believed to be interested in computers. Since the maintenance of the file on punch cards (see the May 1956 report) proved to be more expensive than was reasonable, the whole file has now been transferred to metal plates of the type known as Speedamat, from which envelopes can be readily addressed. The file is now referred to as the "master file of

computer people". It has been put together, and will continue to be enlarged, from lists of persons published or available, and believed to be interested in computers. For example, the recently published proceedings of the National Simulation Conference gave us a number of names and addresses to include in the master file. Registrations of persons attending computer meetings when available will also go into this list. And, of course, information from Who's Who entry forms sent in to us will go into the list.

According to our procedure established in December, this file may be used by anyone for addressing of reputable mailings at a cost of \$19.00 for addressing a thousand envelopes. In the case of any non-profit organization, the file may be used at a cost of \$14.00 a thousand. In the case of any organization, profit or non-profit, which sends us substantial contributions of names and addresses of computer people for inclusion in the file, the file may be used at \$9.00 a thousand.

We invite people and organizations to make use of this mailing list in appropriate ways to reach computer people. We also will welcome any comments or suggestions.

BULK SUBSCRIPTION RATES

These rates apply to prepaid subscriptions coming in together direct to the publisher. For example, if 7 subscriptions come in together, the saving on each one-year subscription will be 24 percent, and on each two-year subscription will be 31 percent. The bulk subscription rates, depending on the number of simultaneous subscriptions received, follow:

**Bulk Subscription Rates
(United States)**

Number of Simultaneous Subscriptions	Rate for Each Subscription, and Resulting Saving to Subscriber	
	One Year	Two Years
7 or more	\$ 4.20, 24%	\$ 7.25, 31%
4 to 6	4.60, 16	8.00, 24
3	5.00, 9	8.80, 16
2	5.25, 5	9.55, 9

For Canada, add 50 cents for each year; outside of the United States and Canada, add \$1.00 for each year.

WHO'S WHO in the COMPUTER FIELD, 1956-7

- Second cumulative edition
- Extra number of "Computers and Automation"
- Coming out early in 1957
- Containing **NAMES, ADDRESSES AND OTHER INFORMATION** for about 10,000 COMPUTER PEOPLE
- probably over 150 pages long
- every entry is free (see entry form in November issue)

The Who's Who extra issue of "Computers and Automation" will not be included in the subscription.

--- MAIL THIS ORDER FORM ---
(or a copy of it)

Date _____

To: Computers and Automation
Berkeley Enterprises, Inc.
815 Washington St., R 191
Newtonville 60, Mass.

Please send us _____ copy(ies)
of WHO'S WHO IN THE COMPUTER
FIELD, 1956 (extra number of "Com-
puters and Automation"), at \$17.50 a
copy.

We enclose \$_____. Please
mail copy, when published to:

Name: _____

Address: _____

MATHEMATICIANS
ELECTRONIC ENGINEERS

The Johns Hopkins University Applied Physics Laboratory

ANNOUNCES

... important openings on our guided missile research and development staff for men who wish to identify themselves with an organization whose prime purpose is scientific advancement.

Because the Applied Physics Laboratory (APL) exists to make rapid strides in science and technology, staff members require and receive freedom to inquire, to experiment, to pursue tangential paths of thought. Such freedoms are responsible for findings that frequently touch off a chain reaction of creativity throughout the organization.

As a staff member of APL you will be encouraged to determine your own goals and to set your own working schedule. You will associate with leaders in many fields, all bent on solving problems of exceptional scope and complexity. The resources of our 350,000 sq. ft. laboratory are complemented by those of the 18 universities and industrial organizations who are working under our technical direction on prime contracts.

Equidistant between Baltimore, Md., and Washington, D. C., our new laboratory allows staff members to enjoy suburban or urban living and the rich cultural, educational and research facilities offered by both cities.

Openings Exist In These Fields:

Programming for electronic analog computers; programming for Univac; dynamic analysis of closed-loop control systems; servo-mechanisms design; missile systems dynamics; transistor and magamp applications to control circuits; operations research.

SEND NOW FOR OUR NEW 30-PAGE PUBLICATION DESCRIBING IN DETAIL THE SCOPE OF THE LABORATORY'S PROGRAMS AND THE UNIQUE ENVIRONMENT IN WHICH STAFF MEMBERS WORK AND LIVE.

WRITE:

Professional Staff Appointments
The Johns Hopkins University
APPLIED PHYSICS LABORATORY
8641 Georgia Avenue • Silver Spring, Maryland

COMPUTERS AND AUTOMATION — Back Copies

REFERENCE INFORMATION

Sixteen kinds of reference information that computer people can hardly afford to be without (latest issues containing each are indicated):

Organizations:

- Roster of Organizations in the Computer Field (June, Aug. 1956)
- Roster of Computing Services (June 1956)
- Roster of Consulting Services (June 1956)

Computing Machinery and Automation:

- Types of Automatic Computing Machinery (Dec. 1955)
- Roster of Automatic Computers (June 1956)
- Outstanding Examples of Automation (July 1954)
- Commercial Automatic Computers (Dec. 1956)
- Types of Components of Automatic Computing Machinery (March 1955)

Products and Services in the Computer Field:

- Products and Services for Sale (June 1956)
- Classes of Products and Services (June 1956)

Words and Terms: Glossary of Terms and Expressions in the Computer Field (Oct. 1956)

Information and Publications:

- Books and Other Publications (many issues)
- New Patents (nearly every issue)
- Roster of Magazines (Dec. 1955)
- Titles and Abstracts of Papers Given at Meetings (many issues)

People: Who's Who in the Computer Field (various issues)

ARTICLES, PAPERS, ETC.

March: Organization of a Programming Library for a Digital Computer Center -- Werner L. Frank
Translating Spoken English into Written Words -- E.C. Berkeley

IBM Trust Suit Ended by Decree

April: Computing Machines and Automation -- A.V. Astin

Tape Identification and Rerun Procedures for Tape Data Processing Systems -- L. Eselson

May: The Position of the University in the Field of High Speed Computation and Data Handling -- A.S. Householder

Free Use of the Toronto Computer, and Remote Programming of It -- C.C. Gottlieb and others
The Mechanized Muse -- Elizabeth W. Thomas

June: THE COMPUTER DIRECTORY, 1956 (104 pages)

Part 1: Roster of Organizations in the Computer Field (cumulative)

Part 2: The Market Place -- The Computer Field: Products and Services for Rent or Sale (cumulative)

Part 3: Who's who in the Computer Field (supplement)

Part 4: Roster of Automatic Computers (cumulative)

July: Solving Problems with Digital Computers -- A.S. Householder

The Operation of a Computer Away from a Central Staff -- Howard Bromberg

August: Two Electronic Computers Share a Single Problem -- National Bureau of Standards
IBM Electronic Data Processing Operations in the Midwest -- Neil D. Macdonald

Complaint by Sperry Rand Corp. in Anti-Trust Suit Against Intern. Bus. Mach Corp., & Answer and Counterclaim by IBM

September: The IBM Computer AN/FSQ-7 and the Electronic Air Defense System SAGE -- H.T. Rowe

Glass and Metal Honeycomb Type of Electrostatic Storage Memory -- General Electric Research Laboratory

The Computer Age -- Staff of Business Week
An Ocean-Based Automatic Weather Station -- National Bureau of Standards

U.S. District Court, U.S.A., Plaintiff, vs. IBM Corp., Defendant Final Judgment

October: Glossary of Terms in the Field of Computers and Automation (cumulative)

Systems Engineering in Business Data Processing -- Ned Chapin

Magnetic Ink Character Recognition in Mechanization of Check Handling

November: Use of Automatic Programming -- Walter F. Bauer

Data Problems of a Grocery Chain -- Frank A. Calhoun

The Power of the Computer -- George J. Huebner, Jr.

An Automatic Micro-Image File -- National Bureau of Standards

December: Indexing for Rapid Random Access Memory Systems -- Arnold I. Dumey

Self-Repairing and Reproducing Automata -- Richard L. Meier

The Computer's Challenge to Education -- Clarence B. Hilberry

January, 1957 (vol. 6, no.1): Modern Large-Scale Computer System Design -- Walter F. Bauer

Logical and Combinatorial Problems in Computer Design -- Robert McNaughton

Transistorized Magnetic Core Memory -- Bell Telephone Laboratories

BACK COPY PRICE: If available, \$1.25 each, except June 1955, \$4.00, and June 1956, \$6.00 (the June issue is the Computer Directory issue)

----- Mail this coupon (or a copy of it)-----
To: Berkeley Enterprises, Inc.
815 Washington St., R191
Newtonville 60, Mass.
Please send me the following back copies:
I enclose \$_____ in full payment. If not satisfactory, returnable within week for full refund (if in good condition).
My name and address are attached.

COMPUTER

ENGINEERS
SCIENTISTS

GENERAL
ELECTRIC'S

NEW
COMPUTER DEPT.
MOVES

HEADQUARTERS TO

PHOENIX
ARIZONA

AT ITS NEW permanent Phoenix headquarters, General Electric plans to develop and manufacture a full line of digital and analog, special and general-purpose, computers and peripheral equipment. These computers will be utilized for INDUSTRIAL and COMMERCIAL applications on a broader scope than has previously been attempted by any single company. Computer engineers and scientists are already at work in leased space on the campus of Arizona State College in suburban Tempe.

Jobs—permanent; salaries—excellent; your rate of advancement limited only by your own ability. You'll be placed in a job you like right from the start and be associated with some of the finest computer engineers and scientists in the country—all working on new and vitally interesting projects. The personal and professional G-E benefits are comprehensive... including an Educational Assistance Program which, consistent with our promotion-from-within policy, pays for a substantial part of your study toward MS and PhD degrees.

Representatives of the G-E Computer Department will attend the Western Joint Computer Conference in Los Angeles February 26-28. Computer engineers and scientists are invited to visit the General Electric suite at the convention hotel.

Or, if it is more convenient, either phone collect or send your reply in strict confidence to:

Mr. James Torrey, Computer Department
General Electric Co. • 1026 Van Ness • Tempe, Arizona

Immediate openings exist at both our Phoenix, Arizona and Menlo Park, Calif. installations for men with experience in:

System Integration

Establish system element characteristics — and their interrelationship — to economically meet overall requirements.

Logical Design

Reduction of system functional requirements to computer and peripheral equipment logic through application of circuit elements.

Electronic Design

Analysis and synthesis of transistor and magnetic circuitry including component evaluation to establish tolerances.

Peripheral Equipment Development

Devise mechanical and electro-mechanical mechanisms.

Product Packaging

Mechanical design and equipment layout of electronic components and assemblies.

Components and Instrumentation

Standardization, evaluation, and approval of electrical components and test equipment.

Advanced Programming

Preparation of complex problems of a scientific, engineering or industrial nature for a general-purpose computer.

GENERAL  ELECTRIC
COMPUTERS

VARIABLE-LENGTH MULTIPLICATION

I. J. Good
Cheltenham, England

It is well recognized that the time for performing most calculations on an electronic computer is roughly proportional to the number of multiplications. Further that the time for performing one multiplication is proportional to the number of significant digits or to the square of the number, depending on whether the multiplication circuits are parallel or serial.

It therefore seems natural to suggest that machines should be designed with variable-length multiplication. For the sake of flexibility the length could be allowed to vary in the course of a single calculation, in accordance with internal instructions. One possible technique would be for each number to carry a label of say three binary digits specifying how many significant digits it contained. A reasonable set of "word" lengths would be 1, 4, 8, 12, 20, 28, 32 and 40. When two numbers were fed into the multiplication circuits the two labels would be interpreted in order to determine the accuracy of the multiplication. The number of digits in the product would probably be taken as the minimum of the two lengths of the factors.

Although this suggestion seems obvious, it has perhaps been generally overlooked, with the result that many calculations could be performed considerably faster than at present with only a slight increase in expense, and without any new electronic techniques.

- END -

NEW DEVELOPMENTS
(cont'd from page 13)

represents Samas in the U. S. A.

In conclusion I want to emphasize what I believe to be the most pressing problem in the computer industry, not only in all the countries I visited but here at home also. This is the lack of trained manpower to design, build, program, install and maintain these rather complicated new business tools. I was sorry to see that the col-

leges and universities are buying machines rather than designing and building their own. It was by the process of designing and building that all of our present progress was made, and from these design groups have come the electronics engineers who are now able to assist industry in the use of the systems. The atmosphere of a commercial laboratory is not as likely to produce revolutionary techniques as is a group in the environment of an educational institution. An illustration is the current effort by Dr. Kilbourn at Manchester to read scribbling electronically. He says if he thought it could be done he wouldn't be interested — but who knows — he may! The future of EDP depends on the development of new techniques which will increase capacity and lower costs.

I was disappointed to find business machines firms funnelling off the cream of all the university design groups into commercial product developments, lured by higher salaries of course. The entire group from BESK at Stockholm has recently moved to Atvidaberg, makers of Facit Calculators. The heads of the design groups at Darmstadt and Munich have gone to Standard, Telefunken, IBM and Siemens. There is not sufficient training taking place to replace these pioneers, and some unfinished computer projects are left with no experience to complete the work. The answer is to establish, at once, computer design and operation courses in our universities all over the world and to increase the training given by manufacturers.

The electronic automation business, like most other highly scientific fields, recognizes few national boundary limitations. We should give technical assistance to less prosperous countries instead of robbing them of their best talent. This does not refer to temporary transfers or exchanges which are most welcome. One of the most complimentary things I heard about the U. S. A. was that a college here granted the money to send a scientist over there to help them build an electron microscope. He stayed a year, made friends, taught a group the techniques he was expert in, and they like that much more than just money. And the whole world benefits any time knowledge is spread. Let's do it in the computer business. Let's have an international computer congress soon, and hold it over there, because the one thing they don't have is dollars. We have no monopoly on brains and much can be learned from discussions with the wonderful group of dedicated engineers it has been my privilege to meet during this interesting trip.

- END -

Top drawer developments

achieved through Convair's
ENGINEERING to the Nth POWER

1944-1945
1954-1955
1957-1958
1959-1960

1944-1945: Convair F-102 fighter
1954-1955: Convair F-105 fighter
1957-1958: Convair F-106 fighter
1959-1960: Convair F-107 fighter

Other aircraft shown: Convair F-101, Convair F-104, Convair F-108, Convair F-109, Convair F-110, Convair F-111, Convair F-112, Convair F-113, Convair F-114, Convair F-115, Convair F-116, Convair F-117, Convair F-118, Convair F-119, Convair F-120, Convair F-121, Convair F-122, Convair F-123, Convair F-124, Convair F-125, Convair F-126, Convair F-127, Convair F-128, Convair F-129, Convair F-130, Convair F-131, Convair F-132, Convair F-133, Convair F-134, Convair F-135, Convair F-136, Convair F-137, Convair F-138, Convair F-139, Convair F-140, Convair F-141, Convair F-142, Convair F-143, Convair F-144, Convair F-145, Convair F-146, Convair F-147, Convair F-148, Convair F-149, Convair F-150.

Around these top-drawer developments at Convair, the men who plan the defense of our nation are building entirely new concepts of military strategy. Only Convair has designed and produced all basic types of aircraft — fighter, interceptor, transport, bomber, and water-based. And now, Convair has attained leadership in producing guided missiles that meet the most exacting military requirements. For our national defense for your security, look to *Engineering to the Nth Power*

CONVAIR
A DIVISION OF
GENERAL DYNAMICS CORPORATION

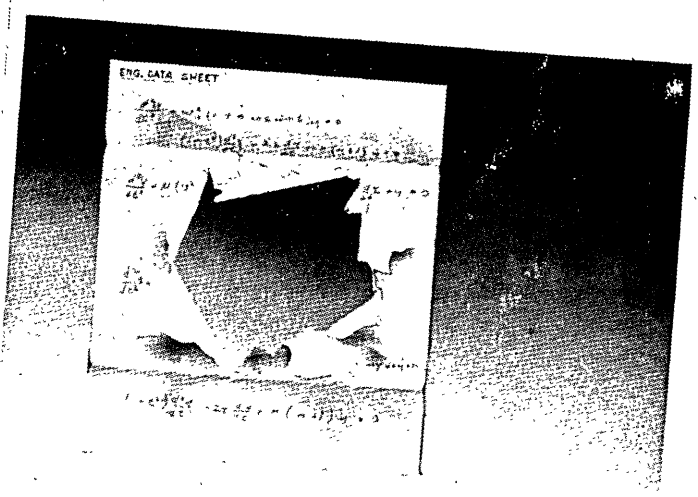

Break Through The PROBLEM Barrier

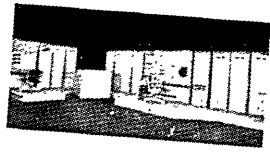

Making it possible for Engineers to break through the problem barrier is our most important project. Since our Convair's equipment is used in the human engineering factor here through all our products such as High Speed Servos, Automatic Extended Be about with push button control, Problem Checkers, Electronic Multiplicities, Servo Volt meters, Resolvers and Function Generators, etc. Our standard production is the further advance of a tail race of the field before being announced as new. Just one more reason why you can always look to PACE for Progress in Analog Computing Systems, for reliability, stability and overall economy. For details write Electronic Associates, Inc., Dept. EA-1, Long Branch, New Jersey.



E A I S E T S T H E P A C E
PRECISION ANALOG COMPUTING EQUIPMENT
LONG BRANCH, NEW JERSEY

To help them achieve "top drawer developments", Convair selected PACE Analog Computing Equipment. One more example of two leading companies joining together to break through the problem barrier. Setting the PACE® for progress throughout the world, Electronic Associates, Inc. continues to serve major industry — offering the rental of computing time in either the Los Angeles, Calif. Computation Center or the Princeton, N. J. Computation Center — and, through progressive engineering, supplying industry with the latest advances in analog computing equipment. For full details, address Dept. CA-2, Electronic Associates, Inc., Long Branch, New Jersey.



E A I S E T S T H E

P A C E
PRECISION ANALOG COMPUTING EQUIPMENT

LONG BRANCH • NEW JERSEY



ADVERTISING IN "COMPUTERS AND AUTOMATION"

Memorandum from Berkeley Enterprises, Inc.
Publisher of COMPUTERS AND AUTOMATION
815 Washington St., Newtonville 60, Mass.

1. What is "COMPUTERS AND AUTOMATION"?

It is a monthly magazine containing articles, papers, and reference information related to computing machinery, robots, automatic control, cybernetics, automation, etc. One important piece of reference information published is the "Roster of Organizations in the Field of Computers and Automation". The basic subscription rate is \$5.50 a year in the United States. Single copies are \$1.25, except the June issue, "The Computer Directory", (1956, \$6.00; 1955, \$4.00). For the titles of articles and papers in recent issues of the magazine, see the "Back Copies" page in this issue.

2. What is the circulation? The circulation includes 2500 subscribers (as of Nov. 10); over 300 purchasers of individual back copies, and an estimated 3000 nonsubscribing readers. The logical readers of COMPUTERS AND AUTOMATION are people concerned with the field of computers and automation. These include a great number of people who will make recommendations to their organizations about purchasing computing machinery, similar machinery, and components, and whose decisions may involve very substantial figures. The print order for the October issue was 3000 copies. The overrun is largely held for eventual sale as back copies, and in the case of several issues the overrun has been exhausted through such sale.

3. What type of advertising does COMPUTERS AND AUTOMATION take? The purpose of the magazine is to be factual and to the point. For this purpose the kind of advertising wanted is the kind that answers questions factually. We recommend for the audience that we reach, that advertising be factual, useful, interesting, understandable, and new from issue to issue. We reserve the right not to accept advertising that does not meet our standards.

4. What are the specifications and cost of advertising? COMPUTERS AND AUTOMATION is published on pages 8 1/2" x 11" (ad size, 7" x 10") and produced by photooffset, except that printed sheet advertising may be inserted and bound in with the magazine in most cases. The closing date for any issue is approximately the 10th of the month preceding. If possible, the company advertising should produce final copy. For photooffset, the copy

should be exactly as desired, actual size, and assembled, and may include typing, writing, line drawing, printing, screened half tones, and any other copy that may be put under the photooffset camera without further preparation. Unscreened photographic prints and any other copy requiring additional preparation for photooffset should be furnished separately; it will be prepared, finished, and charged to the advertiser at small additional costs. PLEASE DO NOT SEND US METAL PLATES OR ELECTROPS; please send reproduction proofs instead. In the case of printed inserts, a sufficient quantity for the issue should be shipped to our printer, address on request.

Display advertising is sold in units of a full page (ad size 7" x 10", basic rate, \$190) two-thirds page (basic rate, \$145), half page (basic rate, \$97), and quarter page (basic rate, \$55); back cover, \$370; inside front or back cover, \$230. Extra for color red (full pages only and only in certain positions), 35%. Two-page printed insert (one sheet), \$320; four-page printed insert (two sheets), \$590. Classified advertising is sold by the word (60 cents a word) with a minimum of 20 words.

5. Who are our advertisers? Our advertisers in recent issues have included the following companies, among others:

Aircraft-Marine Products, Inc.	Lockheed Aircraft Corp.
American Bosch Corp.	Lockheed Missile Systems
Ampex Corp.	The Glenn L. Martin Co.
Armour Research Found.	Monrobot Corp.
Arnold Engineering Co.	Norden-Ketay Corp.
Automatic Electric Co.	Northrop Aircraft Inc.
Bendix Aviation Corp.	George A. Philbrick Researches, Inc.
Bryant Chucking Grinder Co.	Potter Instrument Co.
Cambridge Thermionic Epsco, Inc.	Ramo-Wooldridge Corp.
Ferranti Electric Co.	R. C. A. Service Co.
Ferroxcube Corp.	Reeves Instrument Co.
General Electric Co.	Remington Rand, Inc.
Hughes Research and Development Lab.	Republic Aviation Corp.
International Business Machines Corp.	Sprague Electric Co.
	Sylvania Electric Products, Inc.

IMPORTANT ACHIEVEMENTS AT JPL



The Analytical Mind and Electronic Computers

The Jet Propulsion Laboratory is a stable research and development center located north of Pasadena in the foothills of the San Gabriel mountains. Covering an 80 acre area and employing 1600 people, it is close to attractive residential areas.

The Laboratory is staffed by the California Institute of Technology and develops its many projects in basic research under contract with the U.S. Government.

Opportunities open to qualified engineers of U.S. citizenship. Inquiries now invited.

The Jet Propulsion Laboratory supports its research and development programs with extensive modern digital and analog computing systems. To this end our computer-equipment staff has made important original contributions in the development of new analog computer components, encoding techniques, and digital data handling equipment including advanced systems for handling the high volume output of supersonic wind tunnels.

Though the computing machines have made dramatic contributions to the Laboratory program, the central figures in this

drama remain the applied mathematicians, engineers, and scientists focusing their analytical minds on the problems of their respective technologies and formulating them for computing machine solutions.

Every technology applying to missile propulsion and guidance is represented on the Laboratory: aerodynamics, guidance, instrumentation, electronics, chemistry of propellants, propulsion systems, design and metallurgy. It is in this setting that applied mathematicians and computer engineers find rich opportunities for growth and achievement in scientific computation.

JOB OPPORTUNITIES
IN THESE FIELDS NOW

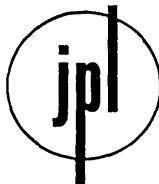

COMPUTERS • APPLIED MATHEMATICS • DATA HANDLING • INSTRUMENTATION
APPLIED PHYSICS • TELEMETERING • RADIO AND INERTIAL GUIDANCE
GUIDANCE ANALYSIS • SYSTEMS ANALYSIS • ELECTRO-MECHANICAL
MICROWAVES • PACKAGING • MECHANICAL ENGINEERING

JET PROPULSION LABORATORY

A DIVISION OF CALIFORNIA INSTITUTE OF TECHNOLOGY
PASADENA • CALIFORNIA

ADVERTISING INDEX

The purpose of COMPUTERS AND AUTOMATION is to be factual, useful, and understandable. For this purpose, the kind of advertising we desire to publish is the kind that answers questions such as: What are your products? What are your services? And for each product: What is it called? What does it do? How well does it work? What are its main specifications?

Following is the index and a summary of advertisements. Each item contains: Name and address of the advertiser / subject of the advertisement / page number where it appears / CA number in case of inquiry (see note below).

- Arnold Engineering Co., P. O. Box G, Marengo, Ill. / Bobbin Cores / Page 2 / CA No. 141
- Automatic Electric Co., 1033 W. Van Buren St., Chicago 7, Ill. / Relays / Page 5 / CA No. 142
- Computers and Automation, 815 Washington St., Newtonville 60, Mass. / Glossary, Who's Who, Back Copies, Advertising / Pages 31, 51, 52, 56 / CA No. 143
- Electronic Associates, Inc., Long Branch, N. J. / Analog Computation / Page 55 / CA No. 144
- General Electric Co., Computer Dept., 1026 Van Ness, Tempe (Phoenix), Arizona / Employment Opportunities / Page 53 / CA No. 145

- General Transistor Corp., 1030-11 90th Ave., Richmond Hill, N. Y. / Hi-Speed Switching Transistor / Page 60 / CA No. 146
- International Business Machines Corp., 590 Madison Ave., New York 22, N. Y. / Research / Page 59 / CA No. 147
- Jet Propulsion Laboratory, California Institute of Technology, Pasadena, Calif. / Employment Opportunities / Page 57 / CA No. 148
- Johns Hopkins University, Applied Physics Laboratory, 86-41 Georgia Ave., Silver Springs, Md. / Employment Opportunities / Page 51 / CA No. 149
- Ramo-Wouldridge Corp., 8820 Bellanca Blvd., Los Angeles 45, Calif. / Employment Opportunities / Page 39 / CA No. 150

READER'S INQUIRY

If you wish more information about any products or services mentioned in one or more of these advertisements, you may circle the appropriate CA Nos. on the Reader's Inquiry Form below and send that form to us (we pay postage; see the instructions). We shall then forward your inquiries, and you will hear from the advertisers direct. If you do not wish to tear the magazine, just drop us a line on a postcard.

Paste label on envelope: ↓

READER'S INQUIRY FORM

Enclose form in envelope: ↓

4¢ Postage Will Be Paid By

BERKELEY ENTERPRISES, INC.

38 East 1st Street
New York 3, N. Y.

BUSINESS REPLY LABEL

NO POSTAGE STAMP NECESSARY IF MAILED IN U.S.A.

FIRST CLASS

PERMIT NO 1680

Sec. 349, P. L. & R.

NEW YORK, N. Y.

READER'S INQUIRY FORM

Name (please print).....

Your Address?.....

Your Organization?.....

Its Address?.....

Your Title?.....

Please send me additional information on the following subjects for which I have circled the CA number:

1	2	3	4	5	26	27	28	29	30	51	52	53	54	55	76	77	78	79	80	101	102	103	104	105	126	127	128	129	130
6	7	8	9	10	31	32	33	34	35	56	57	58	59	60	81	82	83	84	85	106	107	108	109	110	131	132	133	134	135
11	12	13	14	15	36	37	38	39	40	61	62	63	64	65	86	87	88	89	90	111	112	113	114	115	136	137	138	139	140
16	17	18	19	20	41	42	43	44	45	66	67	68	69	70	91	92	93	94	95	116	117	118	119	120	141	142	143	144	145
21	22	23	24	25	46	47	48	49	50	71	72	73	74	75	96	97	98	99	100	121	122	123	124	125	146	147	148	149	150

REMARKS:

IBM

 announces a

Ground-Floor Opportunity

For Scientific and Engineering Men

in IBM's new

Special Engineering Products Division

.....

It's like joining a new company—the ground-floor opportunities you will find in this new IBM Division—plus all the advantages of the stability and security of IBM.

REALLY NEW

We want men with creative ingenuity to solve problems *never encountered before* . . . who will significantly influence the new Division by their enterprise. Projects are not routine . . . and small enough to permit individual contributions that will establish your stature as a professional engineer.

OUTSTANDING OPPORTUNITIES

Career opportunities exist not only for electronic and mechanical engineers but also physical and chemical scientists and metallurgists with experience in any of the following areas:

- analog or digital computers*
- telemetering
- servo systems
- process control
- electronic packaging
- design of intricate mechanisms
- data conversion, transmission, processing or display systems
- instrumentation
- advanced component design
- automation
- solid state devices

Graduating E.E.'s, M.E.'s, physicists and mathematicians will find responsible, stimulating assignments in this Division.

PURPOSE OF THE DIVISION

The new Special Engineering Products Division has been created to enable IBM to apply systems knowledge, engineering and production skills to organizations seeking assistance on specific problems connected with the processing of industrial, commercial and scientific data. Its engineers will design, fabricate and install tailor-made systems for such applications as engine test stands . . . wind tunnels . . . flight test . . . industrial process control . . . machine tool and material handling control . . . nuclear reactors . . . innumerable others.

EMPHASIS ON VERSATILITY

It should be emphasized that the new Division has the responsibility for developing and building equipment related to, *but outside of*, IBM's regular line of products. The variety and diversification of projects call for ultimate creativeness to *develop nonstandard* computing and data-handling components, machines and systems for tie-in with existing IBM equipment.

FOR COMPLETE DETAILS, write today to R. A. Whitehorne, International Business Machines Corporation, Dept. 7102, 590 Madison Avenue, New York 22, N. Y.

DATA PROCESSING
ELECTRIC TYPEWRITERS
TIME EQUIPMENT
MILITARY PRODUCTS
SPECIAL ENGINEERING PRODUCTS
SUPPLIES

IBM

**SPECIAL
ENGINEERING
PRODUCTS**

General NEW HI-SPEED SWITCHING TRANSISTORS Assures Computer Reliability

Computer engineers long seeking PNP transistors in applications requiring high current and fast switching will specify General Transistor's new 2N315, 2N316, and 2N317 for peak reliability.

2N317: As developed by General, a typical switching speed of .3 of a microsecond at 400 milliamps of collector current is possible with only 20 ma. of drive current.

The series resistance of these GT transistors, when conducting, is $\frac{1}{2}$ ohm; the nonconducting series resistance is as high as 10 megohms with a result that approaches optimum efficiency at high current levels.

Computer manufacturers know they can depend on General's engineering and development as well as their quality and service. That's why GT is the largest supplier of transistors for computers.

CHARACTERISTICS

Parameter	Conditions	Min	Typical	Max
Collector-Base Voltage (V_{cbo})	$I_c = -25 \mu a$ Emitter Open	-20V	-30V	
Collector Cut-off Current (I_{cbo})	$V_{cb} = -5V$ $I_c = -400 ma$	-1 μa	-2 μa	
D.C. Current Gain (h_{fe})	$V_{ce} = -0.2V$	20	30	50
Alpha Cut-off Frequency (f_{α})	$V_{cb} = -5V$ $I_c = -1 ma$		20mc	

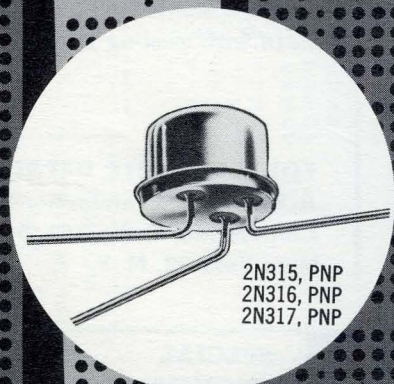
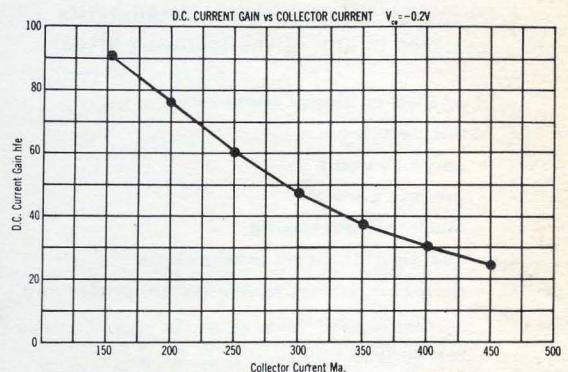
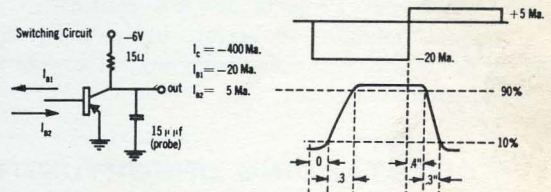

Write for GT's special Computer Transistors Specifications Bulletin.

GENERAL TRANSISTOR CORP.

Richmond Hill 18, N. Y.—Virginia 9-8900

Cable: Transistor New York