

SYSTEM DEVELOPMENT CORPORATION
DEC 20 1961



computers and automation



ANNUAL PICTORIAL ISSUE

December 1961

Vol. 10 — No. 12

LIBRARY
DEC 20 1961

Scientific programmers for Space Technology Leadership

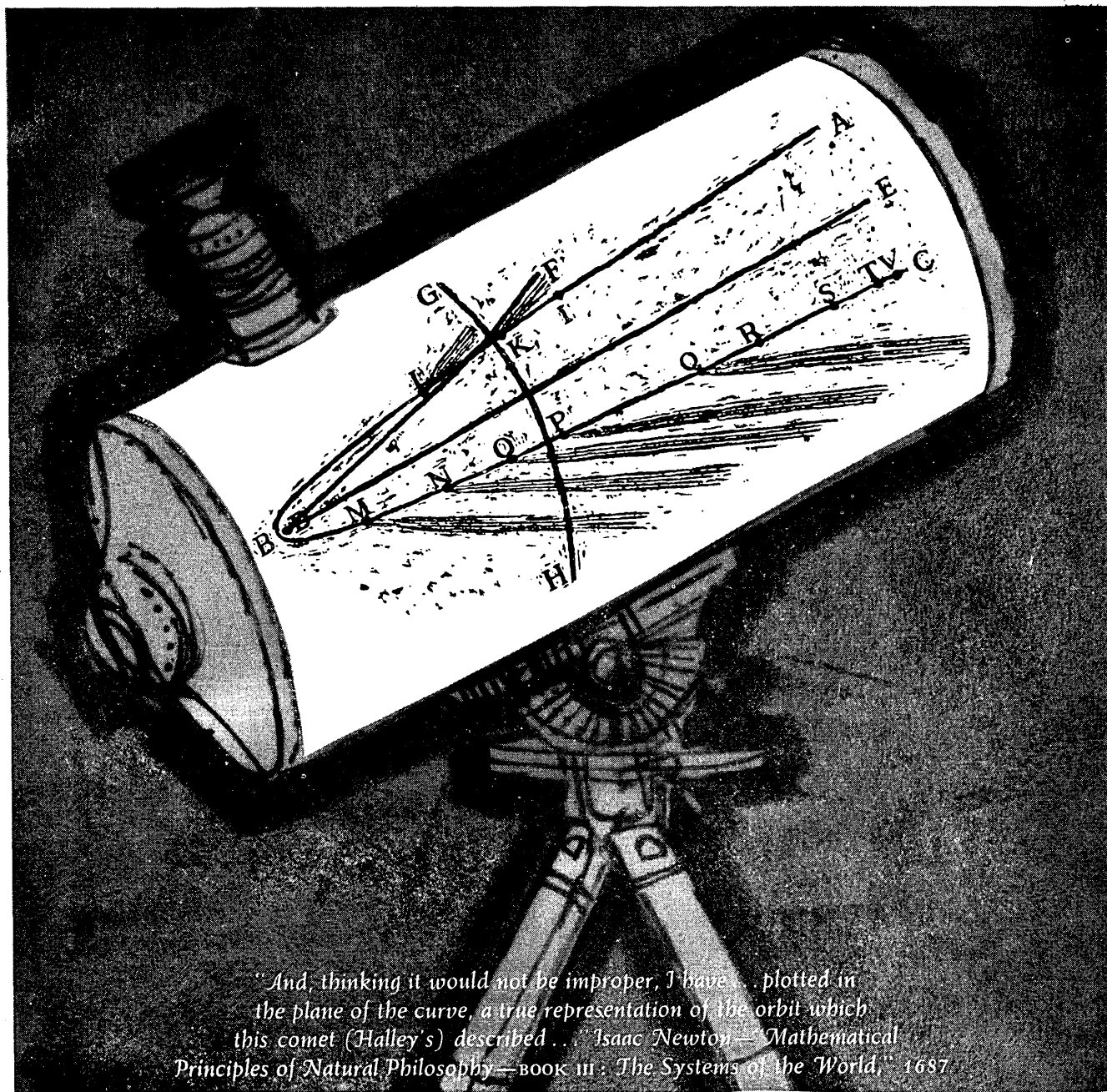

"And, thinking it would not be improper, I have plotted in the plane of the curve, a true representation of the orbit which this comet (Halley's) described..." Isaac Newton — *Mathematical Principles of Natural Philosophy* — book III: *The Systems of the World*, 1687

REPRINTS OF THE DRAWINGS CREATED FOR THIS SERIES, SUITABLE FOR FRAMING, ARE AVAILABLE ON REQUEST.

Thinking it not improper, we invite your attention to the challenging opportunities for scientific programmers at Space Technology Laboratories, Inc. In the tradition of Newton, you might well be interested in helping to develop a better understanding of such phenomena as the orbiting of bodies—celestial and man-made. At STL there is continuing interest in the solution of the broad spectrum of unsolved problems relating to space technology. It is indeed proper, therefore, that we invite you to participate with us in exploring new areas of Space Technology Leadership. Your inquiry will be welcomed and will receive our meticulous attention.

SPACE TECHNOLOGY LABORATORIES, INC. P.O. BOX 95005BB, LOS ANGELES 45, CALIFORNIA
a subsidiary of Thompson Ramo Wooldridge Inc.

Los Angeles • Santa Maria • Cape Canaveral • Washington, D. C.



Boston • Dayton • Huntsville • Edwards AFB • Canoga Park • Hawaii

EJCC Washington interviews, December 12-14. Please call STL's H. R. Stevens at the Sheraton-Park, 232-1271.

Your Computer is Wasting Time and Money!

[unless it's asynchronous]

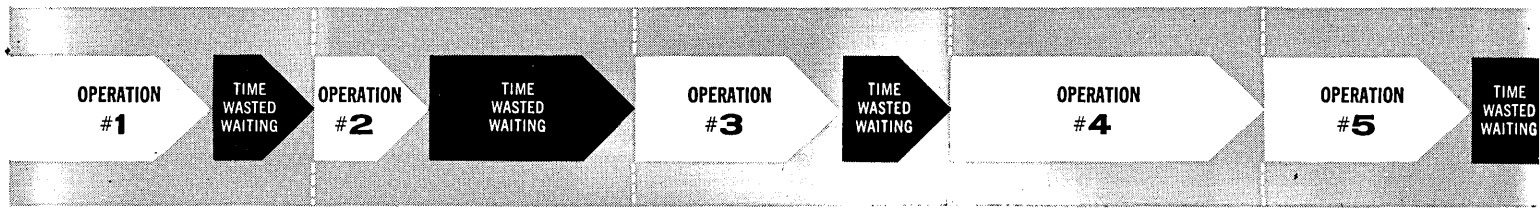

SYNCHRONOUS

Synchronous computers waste time waiting!

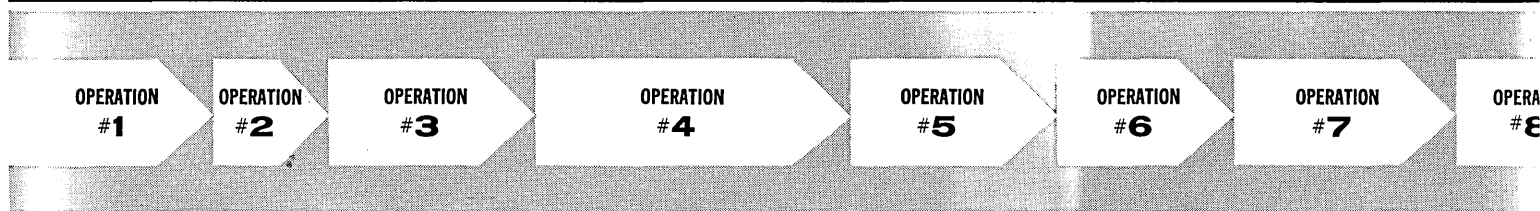

ASYNCHRONOUS

The Philco 2000 Series, the only asynchronous computers, work full time!

Save money with the Philco 2000 Series

In other computers the master clock breaks time into cycles tailored to the longest operation. Shorter operations are also completed within these same time limits. Time is wasted . . . *waiting*.

In the asynchronous Philco 2000 Series, there are no clocks. Each operation triggers the next. Time is spent *working* . . . not waiting. More operations accomplished in the same time.

Let us tell you more about asynchronous operation and the Philco 2000 Series, the only asynchronous computers. Write today.

HOW MUCH TIME DO THE PHILCO 2000 SERIES COMPUTERS SAVE? COMPARE:

Typical processing rate: 639,000 additions per second, including access time.

Access time: 0.5 microsecond.

Multiple processing capability: up to seven instructions simultaneously through four-way processing. Multiplies time saving by four. Typical problem: Invert a 100 x 100 matrix.

Computation load: 1 million multiplications and 1 million additions.

Time: only 50 seconds!



Challenging positions exist at Philco for Senior Computer Specialists.

PHILCO[®]



Famous for Quality the World Over

PHILCO CORPORATION • GOVERNMENT & INDUSTRIAL GROUP
COMPUTER DIVISION, 3900 WELSH ROAD, WILLOW GROVE, PA

why did **PACKARD BELL COMPUTER**
select **ELCO VARICONS** for its
new **PB250** model?

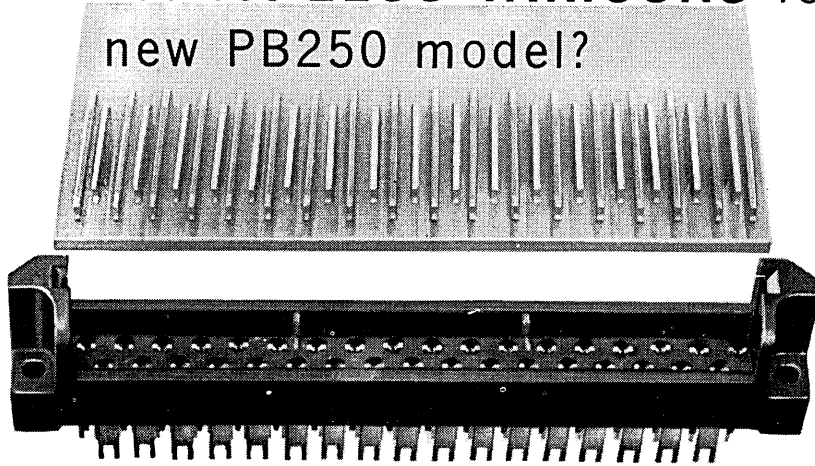

because

...the reliability which Packard Bell required for its amazingly small, medium-scale, low cost model (capable of competing with large-scale, high cost models) was "... further increased by the use of Varicon Connectors." This is another example of another world famous manufacturer relying upon the reliability of the Varicon contact, with its unique forklike design and 4 coined mating surfaces. Packard Bell specified our Series 7001, 35 contact subminiature printed circuit Varicons. They are also available to you along with countless others for a limitless variety of applications. In each, you will find the same unchallenged reliability; plus the versatility challenged only by your own imagination!

so

why not request your copy of Varicon Catalog V4 immediately!



IF IT'S NEW... IF IT'S NEWS... IT'S FROM



Booth No. 36
Eastern Joint Computer Conference
December 12-14, Washington, D. C.



"M" Street below Erie Avenue, Philadelphia 24, Pa., CU 9-5500
Elco Pacific: 2200 Centinela, W. Los Angeles 64, Cal., GR 8-0671

COMPUTERS and AUTOMATION

COMPUTERS AND DATA PROCESSORS, AND THEIR CONSTRUCTION,
APPLICATIONS, AND IMPLICATIONS, INCLUDING AUTOMATION

Volume 10
Number 12

DECEMBER, 1961

Established
September, 1951

EDMUND C. BERKELEY *Editor*
PATRICK J. MCGOVERN *Assistant Editor*
NEIL D. MACDONALD *Assistant Editor*
MOSES M. BERLIN *Assistant Editor*

CONTRIBUTING EDITORS

ANDREW D. BOOTH
JOHN W. CARR, III
PETER KUGEL
NED CHAPIN
ALSTON S. HOUSEHOLDER

ADVISORY COMMITTEE

MORTON M. ASTRAHAN
GEORGE E. FORSYTHE
ALSTON S. HOUSEHOLDER
HOWARD T. ENGSTROM
RICHARD W. HAMMING
HERBERT F. MITCHELL, JR.

SALES AND SERVICE DIRECTOR

PATRICK J. MCGOVERN
815 Washington St.
Newtonville 60, Mass.
DEcatur 2-5453

ADVERTISING REPRESENTATIVES

Los Angeles 5 WENTWORTH F. GREEN
439 So. Western Ave. DUnkirk 7-8135
San Francisco 5 A. S. BABCOCK
605 Market St. YUkon 2-3954
Elsewhere PATRICK J. MCGOVERN
815 Washington St. DEcatur 2-5453
Newtonville 60, Mass.

COMPUTERS and AUTOMATION is published monthly at 815 Washington St., Newtonville 60, Mass., by Berkeley Enterprises, Inc. Printed in U.S.A.

SUBSCRIPTION RATES: United States, \$15.00 for 1 year, \$29.00 for 2 years, including the June Directory issue; Canada, add 50c a year for postage; foreign, add \$1.50 a year for postage. Address all Editorial and Subscription Mail to Berkeley Enterprises, Inc., 815 Washington St., Newtonville 60, Mass.

ENTERED AS SECOND CLASS MATTER at the Post Office at Boston, Mass.

POSTMASTER: Please send all Forms 3579 to Berkeley Enterprises, Inc., 815 Washington St., Newtonville 60, Mass.

Copyright, 1961, by Berkeley Enterprises, Inc.

CHANGE OF ADDRESS: If your address changes, please send us both your new address and your old address (as it appears on the magazine address imprint), and allow three weeks for the change to be made.

1961 PICTORIAL REPORT ON THE COMPUTER FIELD	24
1. Digital Computers	24
2. Analog Computers	41
3. Computer Input/Output	65
4. Data Transmission and Conversion Equipment	72
5. Computer Components	83

ACROSS THE EDITOR'S DESK

News of Computers and Data Processors	90
---	----

FRONT COVER

New Computer Center of Honeywell at Minneapolis	1, 9
---	------

ARTICLES

Mathematical Programming for Better Selection of Advertising Media Schedules	12
Automated Information-Processing Assistance for Military Systems, Part 2, M. O. KAPPLER	38
Missile Program at Cape Canaveral Supported by Advanced Computer Supply Systems, D. H. ADDISCOTT	46

READERS' AND EDITOR'S FORUM

The Tenth Anniversary Year of "Computers and Automation"	6
Announcing a New Cumulative Edition of Computers and Automation's "Who's Who in the Computer Field"	7
The Future of Computers	9
Correction — Friden's Product Lines	9
Calendar of Coming Events	10
Computer Repair	59

REFERENCE INFORMATION

Roster of Organizations in the Computer Field (Supplement)	50
1961 Eastern Joint Computer Conference — Program	53
Books and Other Publications, M. M. BERLIN	81
Who's Who in the Computer Field (Supplement)	89
New Patents, RAYMOND R. SKOLNICK	99

INDEX OF NOTICES

Advertising Index	100
Computer Directory and Buyers' Guide	see Oct., page 31
Glossary of Computer Terms	see Nov., page 50
Manuscripts	see Oct., page 30
Reference and Survey Information	see Oct., page 31
Who's Who Entry Form	8

THE TENTH ANNIVERSARY YEAR OF COMPUTERS AND AUTOMATION

In September, 1951, the first issue of "Computers and Automation" (then called "Roster of Organizations in the Computing Machinery Field") was offered for sale — seven purple ditto pages listing some 75 organizations! That was all.

This year sees Volume 10 of the magazine, and to celebrate, we are making the December issue, Vol. 10, No. 12, far bigger and we hope much better than any December issue so far.

As you can see by our new cover, the celebrating reached into that too. We had a long argument with the designer — who wanted to get rid of the front cover picture — but finally after a knock-down struggle we won — we kept the front cover picture. For we believe the picture ought to be more interesting than any design, and besides that it tells some news about the computer field, and this relates to the job of "Computers and Automation":

— to publish information which is factual, useful, and understandable, about computers and data processors, and their construction, applications, and implications, including automation.

The computer field is growing vigorously. And as it grows, we hope "Computers and Automation" will continue to grow, to meet the demands of this new billion dollar industry. The forty pages

of pictorial section in this issue we hope present a vivid report of much of what has happened in the computer field this past year. We are proud of this progress, proud of the people who produced it, and glad of any part we may have played in helping to make it possible.

Other signs of progress in this issue are the following new divisions of "Across the Editor's Desk: News of Computers and Data Processors". They have been designed to present up-to-date news in the field of computers and data processors in a style more organized and more easily read:

- New Installations
- New Computing Centers
- New Contracts
- New Firms, Divisions and Mergers
- New Software
- New Computers
- Other New Products
- People of Note

Additional sections are planned for early issues.

We said in September 1961: The editors of this magazine are fortunate in having a reporter's view of the extraordinary developments flowing from machines which handle information in reasonable ways at speeds and reliabilities a million times the capacity of human beings.

During the years ahead, "Computers and Automation" intends to take continuing and increasing advantage of this position by publishing a magazine that provides concepts, facts, and figures of great interest and value to people in the expanding world of computers.

As always, we invite comments, suggestions, and criticisms from our readers.

A few of the comments we have received in the last few weeks appear below:

"I enjoyed your comments regarding the 10th anniversary of "Computers and Automation" in the September issue.

"In my opinion you have notably achieved your objective as published in September 1952, and we look forward to your continued successes as a discriminating publisher." —

Charles H. Koenig, Principal
A. T. Kearney and Co., Management Consultants
Chicago 3, Ill.

"Congratulations on completing ten years of publication and on the progress that you have made during that time. Many of your articles are far above my head, but I find several others in every issue that make very good sense.

"So, from a selfish standpoint, I hope you will continue for many years to come. More than that, your field is growing, and I know you'll grow with it, as you have these last ten years."—
Walter Axelsen, Director of Technical Information
Automatic Electric Co.
Northlake, Ill.

"This is just a note of appreciation for the October issue of "Computers and Automation". The three principal articles were excellent, especially those on the FX-1 computer and the Russian program for mechanization of accounting and statistics." —

Lowell H. Hattery, Director
Center for Technology and Administration
The American University, School of Government
and Public Administration
Washington, D. C.

ANNOUNCING A NEW CUMULATIVE EDITION OF

COMPUTERS AND AUTOMATION'S

"WHO'S WHO IN THE COMPUTER FIELD"

In the early spring, 1962, "Computers and Automation" will publish its

NEW CUMULATIVE EDITION OF
"WHO'S WHO IN THE COMPUTER FIELD"

The last cumulative edition was published in 1957, and contained over 12,000 entries. We expect that this edition may contain over 20,000 entries. It will have a good binding, enabling you to make easy use of this valued addition to your ready references.

Entries: Each full entry in the Who's Who will show:

Name, home address / Title, organization, its address / Interests / Year of birth, col-

lege or last school, year of entering the computer field, occupation / Publications, distinctions, etc. (See the typical entries on page 89.)

Who May be Included? Any person will be included (1) who is working in the computer field or has a substantial interest in computers and data processors, and (2) who completes and sends in to us a "Who's Who Entry Form" (see the form below), on or before the closing date, February 15, 1962. If you have sent us an entry form in November, 1961, or later, it is not necessary to send us another entry form for we will look up that one and use it.

However, we do not plan to include anyone for whom we do not have an adequate, up-to-date entry. The name and address only is not adequate.

When Will It Be Ready? We hope it will be printed and distributed about three months after closing date, late May, 1962.

Why Should I Own My Own Who's Who? In the rapidly growing computer field, often one can remember only the last name, or other fragments of information, about people whom one has once met, read about, or heard of. The "Who's Who in the Computer Field" puts full information on these people within your arm's reach. For example,

- It supplies you with backgrounds, home addresses, and professional activities of associates.
- It tells you where former associates are now working, and what they are doing.
- It gives you a valuable source of facts and

statistics about the people in the computer field; which people are working in what types of positions, and where they are located.

- It provides you with suggestions for talent to fill new positions.

The Who's Who in the Computer Field is an essential reference that you will use again and again with satisfaction and profit.

How Do I Get My Copy? You may reserve your copy of the Who's Who by sending us your order on or before February 15 with a prepayment of \$10.00 (45% discount from the price after publication). After February 15 and before publication, the price will be \$13.50. After publication the price will be \$18.50.

YOUR WHO'S WHO ENTRY FORM

(may be copied on any piece of paper)

1. Name? (please print) _____

Your Address? _____

Your Organization? _____

Its Address? _____

Your Title? _____

Your Main Computer Interests?

- () Applications () Logic
- () Business () Mathematics
- () Construction () Programming
- () Design () Sales
- () Electronics
- () Other (specify): _____

Year of birth? _____

College or last school? _____

Year entered the computer field? _____

Occupation? _____

Anything else? (publications, distinctions, etc.)

2. Associates who should be sent Who's Who Entry Forms?

<u>Name</u>	<u>Address</u>
_____	_____
_____	_____
_____	_____

3. Any Remarks? _____

When you have filled in this entry form please send it to: Who's Who Editor, COMPUTERS AND AUTOMATION, 815 Washington Street, Newtonville 60, Mass.

ORDER FORM

(may be copied on any piece of paper)

To: COMPUTERS AND AUTOMATION
 815 Washington St., Newtonville 60, Mass.

() Please reserve my copy of the 1962 Cumulative edition of "Who's Who in the Computer Field." I enclose \$10.00 to take advantage of the 45% discount before February 15, 1962.

Name _____

Address _____

Readers' and Editor's Forum

FRONT COVER: NEW COMPUTER CENTER OF HONEYWELL AT MINNEAPOLIS

The front cover shows a night view of the new computer center of Minneapolis-Honeywell Regulator Co. in Minneapolis, Minn. It is considered to be the first in the industry to perform scientific computation of an analog and digital nature while simultaneously handling business problems. It is located in the new \$5 million aerospace facility of Honeywell.

The center includes the most powerful Honeywell 800 electronic data processing system yet built and also an array of 16 REAC[®] analog computers, of Reeves Instrument Co., Garden City, N. Y.

A staff of 117 persons, including programmers, computer operators and tabulating machine operators, will be required to operate the center.

The computer center is to be used mainly to develop guidance and control devices for missiles and space vehicles, by unravelling the complex formulas used for their design.

The H-800 and the analog complex will be linked by an analog-to-digital converter and a real-time control unit permitting a transfer of problems directly from one computer to the other, so as to take automatic advantage of the extreme accuracy of the digital computer and the speed of the analog computer.

The computer will daily solve the problem of scheduling its own time to meet the needs of the many departments that will use its services. A program for this scheduling has been developed.

THE FUTURE OF COMPUTERS

Edmund C. Berkeley
Editor, Computers and Automation

Computer people have seen enough of the development of the computer field to be able to forecast several developments of considerable importance.

One is the development of microminiature computers produced by a process of chemical

growth. One of the pictures in this issue shows a computer with more than 5000 components per cubic foot of computer. And the existence of the human brain is further proof of possibilities in this direction.

A second development is the transfer to computers of many problems of optimizing arrangements which are totally beyond the powers of human beings to solve. Linear programming and similar techniques imply that there is hardly any limit to the fields where many objectives can be simultaneously fulfilled with due regard to limiting conditions. See for example the article in this issue on scheduling advertising media. Included in this area is putting computers to work on finding solutions to problems of moral welfare, applying computers to "the greatest good for the greatest number".

A third development is discussion between human beings and computers. Two articles published in "Computers and Automation" (in Oct., 1959, "Conversation with a Computer", and in Sept., 1960, "Computer Conversation Compared with Human Conversation") have reported results accomplished in this field. The English mathematician Turing's challenge — of conversing with X in another room and not being able to tell whether X is a human being or a computer — is coming close to being answered.

Fortunate indeed are those young people coming from school and college into the computer field now. They have 40 years or more ahead of them to see some of the most extraordinary developments which can be imagined — the ramifications of The Computer Revolution; — provided that the world we know is not smashed into radioactive dust from nuclear war — and we shall have more to say about that in the January issue, reporting on "War Safety Control."

CORRECTION — FRIDEN'S PRODUCT LINES

From Norman S. Jones
Friden, Inc., San Leandro, Calif.

In reference to your story on Page 2B of the September issue, I realize that it is a printing of a report by "Product Engineering", but we are not confined to calculators. We also produce automatic writing and data processing machines, and mail-room and graphic arts products.

CALENDAR OF COMING EVENTS

- Dec. 12-14, 1961: Eastern Joint Computer Conference, Sheraton Park Hotel, Washington, D. C.; contact Jack Moshman, C-E-I-R, Inc., 1200 Jefferson Davis Highway, Arlington 2, Va.
- Dec. 14-16, 1961: Forum on Legal Questions Raised by Computer Use in Business, Industry, and Government, sponsored by Joint Committee on Continuing Legal Education of the American Law Institute and American Bar Association, Statler-Hilton Hotel, Los Angeles, Calif.; contact John E. Mulder, Esq., Director, The Joint Committee, 133 So. 36 St., Philadelphia 4, Pa.
- Jan. 15-17, 1962: Symposium on Optical Character Recognition, Dept. of the Interior Auditorium, C St. between 18th & 19th St., N. W., Washington, D. C.; contact Miss Josephine Leno, Code 430A, Office of Naval Research, Washington 25, D. C.
- Feb. 6-7, 1962: Symposium on Redundancy Techniques for Computing Systems, Dept. of the Interior Auditorium, C St. between 18th & 19th St., N. W., Washington, D. C.; contact Miss Josephine Leno, Code 430A, Office of Naval Research, Washington 25, D. C.
- Feb. 7-9, 1962: 3rd Winter Convention on Military Electronics, Ambassador Hotel, Los Angeles, Calif.; contact IRE Los Angeles Office, 1435 So. La Cienega Blvd., Los Angeles, Calif.
- Feb. 12-16, 1962: 4th Institute on Information Storage and Retrieval, American University, Washington, D. C.; contact Dr. Lowell H. Hattery, Director, Center for Technology and Administration, The American University, 1901 F St., N. W., Washington 6, D. C.
- Feb. 14-16, 1962: International Solid State Circuits Conference, Sheraton Hotel & Univ. of Pa., Philadelphia, Pa.; contact Richard B. Adler, Rm. C-237, MIT Lincoln Lab., Lexington, Mass.
- Feb. 27, 28-Mar. 1, 1962: Symposium on the Application of Switching Theory in Space Technology, Lockheed Missiles and Space Co., 1123 No. Mathilda Ave., Sunnyvale, Calif.; contact Kenneth T. Larkin, Lockheed Missiles & Space Co., Sunnyvale, Calif.
- Mar. 13-15, 1962: Symposium on Application of Statistics and Computer to Fuels and Lubricants Research Programs (Unclassified), Granada Hotel, San Antonio, Tex.; contact Roy Quillian, Southwest Research Inst., Box 2296, San Antonio 6, Tex.
- Mar. 26-29, 1962: IRE International Convention, Coliseum & Waldorf-Astoria Hotel, New York, N. Y.; contact E. K. Gannett, IRE Headquarters, 1 E. 79 St., New York 21, N. Y.
- April 9-13, 1962: Business Equipment Exposition, McCormick Place, Chicago, Ill.; contact G. H. Gutekunst, Jr., Mgr., Press Information, Business Equipment Manufacturers Exhibits, Inc., 235 E. 42 St., New York 17, N. Y.
- April 11-13, 1962: SWIRECO (S. W. IRE Conference and Electronics Show), Rice Hotel, Houston, Tex.; contact Prof. Martin Graham, Rice Univ. Computer Project, Houston 1, Tex.
- April 16-18, 1962: Symposium in Applied Mathematics on "Interactions Between Mathematical Research and High-Speed Computing", at American Mathematical Society and Association for Computing Machinery Symposium, Atlantic City, N. J.; contact Mrs. Robert Drew-Bear, Head Special Projects Dept., American Mathematical Society, 190 Hope St., Providence 8, R. I.
- April 24-26, 1962: 12th Annual International Polytechnic Symposium, devoted to "The Mathematical Theory of Automata", United Engineering Center, 345 E. 47 St., New York, N. Y.; contact Symposium Committee, Polytechnic Inst. of Brooklyn, 55 Johnson St., Brooklyn 1, N. Y.
- May 1-3, 1962: Spring Joint Computer Conference, Fairmont Hotel, San Francisco, Calif.; contact Richard I. Tanaka, Lockheed Missile & Space Div., Dept. 58-51, Palo Alto, Calif.
- May 28-June 1, 1962: Colloquium on Modern Computation Techniques in Industrial Automatic Control, Paris, France; contact French Association of Automatic Control (AFRA), 19, Rue Blance, Paris 9, France
- June 27-29, 1962: Joint Automatic Control Conference, New York Univ., New York, N. Y.; contact Dr. H. J. Hornfeck, Bailey Meter Co., 1050 Ivanhoe Rd., Cleveland 10, Ohio
- July 18-19, 1962: Data Acquisition & Processing in Medicine & Biology, Whipple Auditorium, Strong Memorial Hospital, Rochester, N. Y.; contact Kurt Enslein, Brooks, Inc., 499 W. Comm. St., P. O. Box 271, E. Rochester, N. Y.
- Aug. 21-24, 1962: WESCON (Western Electronics Show and Conference), Los Angeles, Calif.; contact WESCON, 1435 La Cienega Blvd., Los Angeles, Calif.
- Aug. 27-Sept. 1, 1962: 2nd International Conference on Information Processing, Munich, Germany; contact Mr. Charles W. Adams, Charles W. Adams Associates, Inc., 142 the Great Road, Bedford, Mass.
- Sept. 3-7, 1962: International Symp. on Information Theory, Brussels, Belgium; contact Bruce B. Barrow, Postbus 174, Den Haag, Netherlands
- Sept. 3-8, 1962: First International Congress on Chemical Machinery, Chemical Engineering and Automation, Brno, Czechoslovakia; contact Organizing Committee for the First International Congress on Chemical Machinery, Engineering and Automation, Vystaviste 1, Brno, Czechoslovakia
- Oct., 1962: National Symposium on Space Elec. & Telemetry, Miami Beach, Fla.; contact Dr. Arthur Rudolph, Army Ballistic Missile Agency, R & D Op. Bldg. 4488, Redstone Arsenal, Ala.
- Oct. 8-10, 1962: National Electronics Conference, Exposition Hall, Chicago, Ill.; contact National Elec. Conf., 228 N. LaSalle, Chicago, Ill.
- Oct. 29-31, 1962: 15th Annual Conf. on Elec. Tech. in Medicine and Biology, Edgewater Beach Hotel, Chicago, Ill.; contact Dr. J. E. Jacobs, 624 Lincoln Ave., Evanston, Ill.

YOUR business will benefit with NCR Data Processing!

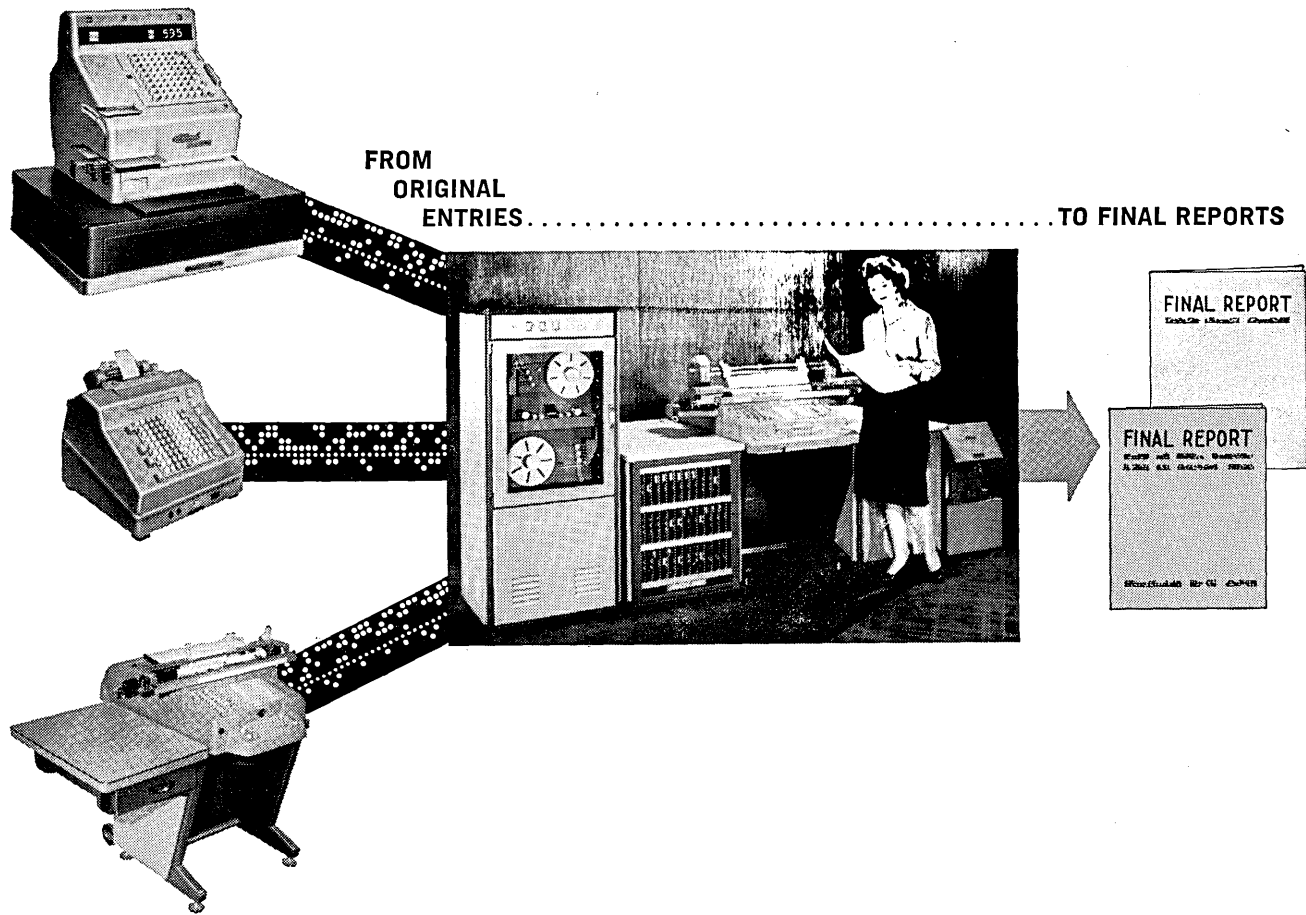

Regardless of the type or size of your business, you will benefit from the efficiencies of National Data Processing. From one or more of NCR's original entry products—accounting machines, cash registers, listing, window posting and receipting systems—you can get just the input media of your need and choice. This may be punched paper tape or punched cards.

This input media is processed quickly, accurately and economically by an NCR computer specifically designed to furnish complete record information tailored to your specific needs. NCR offers a full range of Data Processing Systems: small, medium, and large-scale computers, plus a network of processing centers.

For more complete information on

how NCR Data Processing can benefit your business, call your local National Branch Office or WRITE TO US TODAY!

NCR *National*
TRADEMARK—REG. U.S. PAT. OFF.

ELECTRONIC DATA PROCESSING
 ADDING MACHINES • CASH REGISTERS
 ACCOUNTING MACHINES
 NCR PAPER (NO CARBON REQUIRED)

NCR GOES ALL THE WAY FROM ORIGINAL ENTRIES TO FINAL REPORTS.
 THE NATIONAL CASH REGISTER COMPANY, Dayton 9, Ohio
 1039 OFFICES IN 121 COUNTRIES • 77 YEARS OF HELPING BUSINESS SAVE MONEY

Mathematical Programming For Better Selection Of Advertising Media

(Based on a report before the annual eastern conference of the American Association of Advertising Agencies, New York, November 16, 1961)

I.

BBDO UNVEILS MEDIA PROCESS

Leo J. Turner

Batten, Barton, Durstine, and Osborne, Inc.
New York 17, N. Y.

Before a packed session of the annual eastern conference of the American Association of Advertising Agencies on November 16, the advertising agency, Batten, Barton, Durstine & Osborn, Inc., revealed the details of a new mathematical-programming method for scientific selection of media schedules. President Charles H. Brower said of it, "It gives a media man a power shovel instead of a spade."

The purpose of the new method is to get the most advertising effectiveness for the budget dollar. However, it augments but does not replace human judgment.

The new method is being given to all advertising agencies. It was considered to be a great forward step in marketing research by academic participants in the conference.

Dr. Darrell B. Lucas, Professor of Marketing at New York University, long associated with the Advertising Research Foundation, said that scientific evaluation of media "is today our greatest opportunity for a major gain in advertising efficiency."

Some of the history of linear programming was given in a joint paper by two scientists responsible for much of the pioneering in this field, Professor William Cooper of Carnegie Institute of Technology, and Professor Abraham Charnes of Northwestern University.

Professors Cooper and Charnes stated that they had been present when similar breakthroughs were made in difficult management problems in many other industries, and that they had witnessed the subsequent widespread use of pioneer discoveries by many business firms. They said they believed a series of rapid developments was likely to follow the original research effort reported November 16.

Other speakers said that the accomplishment would accelerate marketing research in other fields so as to provide the information needed for efficient spending of the marketing dollar.

In brief, the new process combines research information, human judgment, monetary considerations, and client directions into mathematical problems solved by electronic computers.

II.

NEW TECHNIQUES IN THE ADVERTISING BUSINESS

Dr. Clark L. Wilson
Vice President in Charge of Research
Batten, Barton, Durstine, and Osborne, Inc.

The advertising industry has a spotty history when it comes to adopting new techniques. In the creative areas there tends to be a constant and vigorous fight to keep ahead of your competitors. In the fact-finding areas of research and marketing the competitive struggle has been, unfortunately, less vigorous.

To be sure, advertising and media people adopted good sampling methods almost as soon as

they were developed and proved in government research. On the other hand, many very efficient research and analysis techniques have been in the literature for twenty-five to forty years, and yet have hardly seen the light of day in advertising and marketing studies. The principles and techniques of learning theory and information theory, for example, have hardly been explored in the advertising context. The methods of psychometrics, of experimental psychology and sociology have been applied in a sporadic fashion. Good studies using sophisticated scaling techniques and factor analysis are few and far between. And so it goes, in general, — a lack of up-to-dateness in the important area of advertising research.

To be sure, some efforts have been made to bring the advertising industry up to date by exposing new analytical and research methods. But these attempts have frequently encountered a very serious communications obstacle. Knowledgeable people outside the industry, often from academic situations, have been given frequent opportunities to expose advertisers and agencies to these new methods. Too often such presentations have been highly abstract in nature. As you read them or listen to them, you have quite a task for yourself in attempting to interpret the presented information in terms of the advertising business. Most often you will see that the writer or speaker seriously lacked a familiarity with advertising or marketing.

An example of this is the spate of papers and speeches given on the adaptation of Operations Research to the advertising business. For every pound of real OR study that's actually been conducted, there has been a ton of speeches and papers by people outside the advertising industry asserting that it ought to use OR more effectively.

There have been all too few studies using data from the real world of advertising and marketing.

In our company for the past two years we have been trying to close the gap by trying out new techniques and methods. The report presented here represents one of those attempts. We are reporting the results of our initial studies on the use of mathematical methods for setting media schedules. More specifically, we are reporting on the use of Linear Programming methods for media selection.

In this context, Linear Programming is the practice of transforming the everyday operating processes and procedures of media selection from plain language into the language of mathematics, then into equations and groups of equations. We

speak of Mathematical Programming to cover the general practice. We speak of Linear Programming when the mathematical equations we write represent straight lines or flat planes. One can understand the techniques in use here quite fully if he has a working knowledge of high school algebra.

The general purpose of this mathematical programming approach is to allocate limited resources in such a way that a business can obtain maximum profit. The media purpose is to allocate a given budget for maximum advertising. In short, the purpose is to get the most advertising for the dollar.

III.

LINEAR PROGRAMMING IN BUDGETING AND PLANNING MEDIA SCHEDULES

A. Charnes

The Technological Institute
Northwestern University
Evanston, Ill.

W. W. Cooper

Graduate School of Industrial Administration
Carnegie Institute of Technology
Pittsburgh, Pa.

In their 1961 report, "Toward Better Media Comparisons," the Audience Concepts Committee of the Advertising Research Foundation has said:

"Whenever money is spent on advertising, a decision is made about the way it will be allocated among media. This decision is unavoidable, since operating within a fixed budget, the use of any medium to any degree implies the avoidance of some other medium to some extent. . . . Since different ways of allocating advertising between various types of media can show very different results, some allocations must be better than others, and quite possibly, one allocation might be the best of all."

This quotation provides an excellent starting point for discussion of linear (or mathematical) programming and its implementation by electronic computers. The rest of the cited report is also in accord with what we shall try to say. Thus, the Committee's report does not stop with this good start, but uses it rather as a springboard to examine the further connections between advertising, sales, and related variables, as well as to explore

the needs and qualities of various kinds of data, differing business and agency objectives, and so on. By merely exchanging technical words in advertising for technical words in mathematics, or computer usage, we could easily translate the Committee's report so that it would also appear as an excellent prescription for fruitful and prudent uses of linear programming in any of its numerous managerial applications.

It may be useful to provide a rough general characterization of the nature and origins of linear programming. Like the electronic computers — to which it is intimately related — both the general theory and the widespread applications of linear programming are of very recent origin. They had their inception, in modern form, under the aegis of the military forces in World War II. Their now widespread (and growing) applications to private business is largely a phenomenon of the last decade.

Mathematical Programming and computers have both been experiencing rapidly accelerating developments in response to two forces: (1) widening opportunities for new applications, and (2) intense research by scientists, and others, either in response to the needs revealed by these opportunities or in anticipation of the still further opportunities that might be opened by further research. The present report illustrates the connections and interactions between computer usage, linear programming, analytical research, and managerial applications.

Linear programming is one of the many techniques now available for managerial applications under the branches of knowledge "Operations Research" or "Management Science." It is distinguished by two features: first, its ability to handle very large numbers of interacting variables and conditions, both qualitative and quantitative; second, its use of analytical formulations by means of mathematical models with explicitly stated objectives — such as the objective of a best utilization of resources, as assessed by various benefits and penalties that might be incurred under different planned courses of action.

The example being reported on refers to an allocation of limited budget funds for media schedules in order to achieve the maximum total impact on a target audience. This is accomplished by reference to various indexes of benefits and penalties, and with due regard to limitations of the environment, client policies or customs, and budgeted funds available.

IV.

RATED ADVERTISING EFFECTIVENESS

David Learner
Assoc. Director of Research
Batten, Barton, Durstine, and Osborne, Inc.

The media problem is typical of all problems dealing with allocation of resources. We have a situation here where there are limited resources. This resource, of course, is our budget. We are attempting to allocate our resource among a variety of competing media, within fixed limits that reflect real-world restrictions on how and where we can spend this money. These restrictions depend upon marketing objectives, budget, commitments, data, etc.

We take everyday procedures for scheduling of advertising units in various media, and translate them into mathematical language. We thereby make available to ourselves a whole kit of tools, and specifically linear programming.

The determination of what advertising units to consider must be dependent upon the marketing strategy of the product for which the media schedule is being developed. The product marketing strategy must be stated in precise categories of the population group or sub-groups toward whom the advertising will be directed. Such categories include sex, age, education, county size, region, income, family size. With a marketing profile in hand, we translate it into the number of households, or better yet, the number of individuals, in each of the categories. In the example that will be developed here, the first step utilizes a market profile of those who are heavy users of a food product that has \$4,000,000 available to spend on advertising. For this product the market profile is defined in terms of homes by county size, family size, income, and age of head of household. The women who are heavy users in these groups become our marketing target: these are the people we want to reach with our advertising message.

In addition to defining the market, the profile also defines our desired audience. Each advertising unit must then be analyzed to determine the size of its audience, whether individuals or households in each of the profile categories. If audience duplication data are available, they may be utilized simply by combining the two or more advertising units into one additional composite unit that accounts for the overlap. Duplication

may also be handled by appropriate weighting of single unit audience. Generally we will be making an assumption when relating marketing profiles to audience profiles that the same people or households are present in both groups. That is, when we speak of a county audience, and a county readership, the assumption is made that the audience and users are the same people. In fact, this is open to serious question. But we will continue to make this assumption, as we have all done in the past, until the data that relate purchasing habits and media habits is generally available for a wide variety of products and media.

In our example the media department determined a list of 47 advertising units comprising print and broadcast media. The print media included national magazines and Sunday supplement insertions of four-color pages or four-color spreads. The broadcast media included spot radio, nighttime network TV scatter plans, and shows, and daytime TV network shows and TV spots in prime, fringe and day time. For each of the advertising units the audience was categorized by county size, family size, income, age of head of household, and number of women. In addition the dollar cost of a time or space unit was listed for each media activity.

Conventionally, a media schedule is evaluated in terms of reaching a target audience with media that will have the best qualitative impact on that audience. The same kind of criterion or objective applies for mathematically programmed media schedules. Three factors are combined into one criterion that the programmed schedule must make as big as possible (maximize). The criterion starts with total households or total audience divided into age, income, and other categories that coincide with the marketing and audience profiles. This total audience is then weighted by the marketing plan that defines the best prospects for the product. This combination is once more weighted by the qualitative value of each advertising unit, just as has been done by the schedule planner in the past. This Rated Exposure value is computed for each advertising unit separately and for each product or service separately.

These qualitative ratings were determined for the example product on the basis of the judgments of a dozen experts comprising media planners, account managers and the client. Each person was asked to evaluate each advertising unit on a ten-point scale of effectiveness. In making their judgments they were asked to rate each advertising unit independently and consider only the qualitative factors such as repeated exposure value, quality of printing or broadcast sig-

nal, the relative advantages of sight, movement and color and the general editorial climate of the media vehicle. They were not to consider the cost or the audience size. They were to rate only the subtle qualitative factors that the media vehicle adds to advertising effectiveness. These ratings were then summarized and scaled according to a mathematical scaling technique that provides values of the qualitative effectiveness of each advertising unit relative to all the others that were rated for that product. Interestingly enough, when the average ratings of the media planners and account managers were compared, there were virtually no differences between the ratings of each group.

These ratings provide us with the final basic information we need to serve as input to the mathematical programming of media schedules, deriving an effectiveness index for each advertising unit for this product. In the example the total audience of each media schedule was weighted by the households in the marketing target of heavy users. This figure was then weighted by the qualitative effectiveness or rating of the advertising unit. This Rated Exposure is the quantity we want to make as large as possible for the entire schedule; the linear programming method will choose that combination of media that maximizes the Rated Exposure within the restrictions that express real-life limitations on the way in which the budget may be allocated.

These restrictions are of two kinds, environmental restrictions and judgmental restrictions. Environmental restrictions reflect the way the world is. For example, we might have to buy at least 20 minutes of a weekly network TV show because it is a corporate buy and our product must share the load; or, on an annual basis we are clearly limited to 52 insertions in a weekly magazine. These, then, are restrictions that the environment imposes on the schedule. Judgment restrictions reflect preferences, customs or biases of the media planner, client, or account group, that also must be satisfied. For example, it may be stated that we must put one third of the budget into spot TV; buy at least 12 pages in a women's monthly; buy center spreads — because "it has always been done." These are restrictions that reflect judgments that must be adhered to in the schedule.

These two kinds of restrictions account for all the decisions that management builds into the problem. One difficulty that may arise relates to over-restricting the problem so that there are no possible schedules within the restriction. Since this is possible, it is good that the program can tell us which restrictions are the limiting ones and how they should be changed to allow feasible

media combinations to appear. The programmed solution of course can tell us many other things besides.

V.

COMPUTER PROCESSING AND
COMPUTER RESULTS

Milton Godfrey
Director of Operations Research
C-E-I-R, Inc.
Arlington 2, Va.

The inputs to the problem of finding the most effective advertising schedule result from the research and the judgment of experienced media men.

We start with a list of all media considered suitable for the product. For our purpose, specific alternatives are considered to be different advertising units: for instance, a full page, black and white in Magazine A is one advertising unit, while a full page, four-color, in the same magazine, is considered to be another advertising unit. In a separate statement we tell the computer that it can choose one or the other, but not both.

After providing the computer with a list of all relevant advertising units, the next list provided is the cost per insertion for each. (Provision can be made to handle discounts for multiple insertions.)

The amount of the total media budget is provided, plus the information that total expense must be less than, or equal to, the budget.

Restrictions based on the judgment of the media man or the policy of the advertisers can also be stated for the computer. The following are examples:

- Monthly medium B must be used at least six times and at most twelve
- Weekly Medium C must be used exactly twenty-six times
- 60-second, daytime TV spots on show X must be used at least three times per week for thirty-nine weeks: at most five times per week

Algebraic methods exist for stating all of the various types of restrictions on frequency of use. Additional restrictions are usually needed

to insure adequate coverage of various demographic divisions. For instance, we could specify that 30% of the total audience must be women; or that 30% of the TV audience must be women. If for "women" we substitute an income group, or an age group, we can visualize the variety of restrictions of this type that can be used.

An illustration may be the best means of providing an insight into the usefulness of linear programming in the selection of media. This illustration is not a "cooked-up" example; rather it is an actual media schedule, recently completed by computer for a food-product account. But identification has been altered, in order to protect the interests of the advertiser involved.

We start out with profiles of the market that the advertiser desires to reach. This market consists of present heavy users of this type of product, and comprises 13,300,000 families, distributed as follows:

<u>COUNTY SIZE:</u>	A	29.1%
	B	7.0
	C	35.9
	D	28.0
<u>FAMILY SIZE:</u>	1-2	23.0%
	3-4	60.0
	5 & over	17.0
<u>AGE:</u>	Under 35	25.0%
	35-45	34.1
	45 & over	40.9
<u>INCOME:</u>	Under \$5000	40.5%
	\$5-7000	30.4
	\$7000 +	29.1

Advertising is to be directed to the adult female audience in these categories.

To reach this market, the advertiser has an annual budget of \$4 million. He has specified restrictions on the way this money is to be spent.

- At least \$2,100,000 is to be spent among advertising units V, W and X.
- Of this sum at least \$900,000 must be spent on either advertising unit V or advertising unit W.
- At least \$500,000 of the \$2,100,000 must be spent on advertising unit X.
- In medium C3 a minimum of two, and a maximum of four units must be used.

Other limitations, provided by media specialists, are based on practical media purchases and

A
in th
nam
/ in
the
lette
Com
Log
Sale
last
ente
pati
distr
absen
by -
are
gues
book
E
com
com
orga
help
the
arra
orga
repr
F
Wh
Unit
De
Ingv
nic
'58
Shrac
nic
'58
Tayl
nic
W
Wen
Te
Un
U S
Fo
In
Gett
An
Ur
Gree
nic
by
ma
'56
Jacol
An
'57
CO

and scheduling. These are as follows:

Total number of units available which can be used at the rate of one unit of medium V3 or two units of medium V6: 117

Total number of units available which can be used at the rate of one unit of medium W3 or two units of medium W6: 78

Total number of units of media V and W must be at least: 39

Maximum number of units of medium X to be: 624

Maximum number of units of media S, T and U to be: 780

Maximum number of units of medium U to be: 624

Maximum number of units of medium R to be: 3900

The media considered suitable include:

13 magazines in any of which a single page in four-color or a double spread in four-color can be used: 26 choices

Also, a back cover must be used in one specified magazine: 1 choice

3 Sunday supplements in which a single page, four-color or double spread four-color, can be used: 6 choices

2 evening network TV shows in which 30 or 60-second spots can be used:

4 choices

Spot announcements on:

radio,
daytime TV,
fringe TV,
prime TV,

with two available lengths of spot in each case: 8 choices

Daytime network TV in which 30- or 60-second spots are available on a variety of shows. The choice here represents four selected shows considered as a group: 2 choices

TOTAL NUMBER OF CHOICES TO BE CONSIDERED: 47

The problem can now be restated:

COMPLY WITH ALL OF THE ABOVE RESTRICTIONS AND MAXIMIZE RATED ADVERTISING EFFECTIVENESS ON THE SPECIFIED AUDIENCE

From these inputs, by means of the computer and the program (our "black box"), we can now go directly to the output, to see what it can tell about a basic media schedule and possible alternative schedules.

The results of the computations are the selection of five media as follows:

2 UNITS (MED C3)
12 UNITS (MED G1)
624 UNITS (MED X6)
69 UNITS (MED W3)
1 UNIT (MED E1)

The computer supplied us with a total effectiveness value of the schedule which rounds off to 3731.45. Because of the underlying mathematics, we know that this is the maximum value possible from any allowable combination of media. It is computed by multiplying the number of insertions in each media by the effectiveness per insertion. For the schedule above this would be:

MEDIA	NUMBER OF INSERTIONS		ADVERTISING EFFECTIVENESS PER INSERTION		TOTAL EFFECTIVENESS
Med C3	2	x	15.95	=	31.90
Med G1	12	x	14.45	=	173.40
Med X6	624	x	4.85	=	3026.40
Med W3	69	x	6.93	=	478.17
Med E1	1	x	21.58	=	21.58
VALUE OF SCHEDULE				=	<u>3731.45</u>

This schedule, while mathematically correct, clearly illustrates the need for intelligence of the human kind, since one ad in MED E1 does not necessarily make a practical schedule. In the computation, this was the last selected and there was just enough budget money left for one insertion.

Several choices are now available to the media man in adjusting ads between the two. One is to eliminate MED E1 entirely; another is to divide the money more evenly between MED E1 and MED G1. For guidance in this, the linear programming solution has some information to offer:

CONSIDERING COST AND EFFECTIVENESS, AN INCREASE IN THE EFFECTIVENESS OF MED E1 OF APPROXIMATELY 5% (TO 22.79) WILL MAKE IT EQUIVALENT TO MED G1.

In other words, considering both cost per unit and advertising effectiveness, there is little to choose between these two media. The linear programming computation will make a decision based on very small differences, but at the same time, it tells just what it has done.

Additional information on this same choice is that:

BASED ON THE ORIGINAL ADVERTISING EFFECTIVENESS VALUES AND THE DIFFERENCE IN COST PER UNIT, THE ADS MAY BE SUBSTITUTED APPROXIMATELY ON A 2 FOR 3 RATIO:

THE REDUCTION IN OVERALL ADVERTISING EFFECTIVENESS IS ONLY 0.77 FOR EACH ADDITIONAL AD IN MED E1.

Further information is available about other choices that the program has made. MED C3 was required by management decision and the minimum specified number (2) has been chosen. From the data we know that each additional unit which the media man might arbitrarily select will reduce the effectiveness value of the schedule by 17.11. Presumably this would be at the expense of the advertising in MED E1 and MED G1. The program also tells us that if the advertising effectiveness of MED C3 had been 33.06 instead of 15.95, it would then have used the maximum allowable number rather than the minimum required number of units. Hence we have a measure of the sensitivity of the solution to variations in the estimates of the value of the media and to possible inaccuracies in the data about demographic make-up of audience. In this case, since the advertising effectiveness value would have to be more than doubled, it can safely be concluded that normal errors in estimates were not factors in holding the use of MED C3 to a minimum.

It is interesting to note that the schedule has used a maximum of 624 insertions in MED X6. It then selected the maximum allowed insertions in MED G1.

Then, after including the minimum required amounts of MED C3 and MED W3, it used the remaining funds for one insertion in MED E1.

The fundamental reason for this is the requirement that the advertising be directed to adult females. The complete disregard of the balance of the audience leads to selection of the

high quality media with the best ratios of female audience to cost.

The arbitrary use of media is a frequent occurrence. For instance, management might require an ad each month in Magazine Z for merchandising purposes. Valid reasons for this are usually based on factors that can't be expressed in equations but have great importance to management. Such items conceivably could be omitted from the computations, leaving only discretionary funds to be allocated. However, there is a sound reason for including the non-discretionary items:

The results of the computation give a measure of the resulting reduction in advertising effectiveness. This non-monetary price can be a valuable aid to decisions of this kind.

In the sample problem discussed here, there are several examples of management requirements. For instance, MED W3 results in a decrease in advertising effectiveness of slightly less than 0.5 per unit when compared to the same amount spent in MED E1 which the program states is the best of the still available media.

Another way of stating this is:

If the advertising effectiveness of MED W3 had been increased from 6.93 to 7.41, a 7% increase, this would have been used on its own merits. In addition, the funds spent on MED E1 would have been channelled to MED W3.

Since known possibilities of error in measuring the number of readers or viewers could alone account for a difference as large as 7%, facts made explicit by this linear programming approach to the problem indicate that the requirements related to Media V and W result in little or no loss in advertising effectiveness.

The preceding examples have illustrated the information available as the result of the computation. In general there are three types of data available in this output:

For every medium not in the computed schedule, substitution information is given in relation to each of the media in the schedule.

This is the ratio of the number of substitute ads inserted to the

number of original ads removed, and the change in the effectiveness of the schedule resulting from the substitutions.

For every medium in the schedule the solution states the range of advertising effectiveness values for which the solution remains unchanged.

It states, for the extremes of the range, the media which would then come into the solution. For instance, the effectiveness of MED E1 is given at 21.58. If this were reduced to 20.18 it would drop out of the solution and MED W3 would come in. If this were increased to 22.79 more ads in MED E1 would be used, replacing those in MED G1.

For every restriction used, the results of a change in the restriction are given.

For example, relaxation of the requirement of at least two units in MED C3 would increase the effectiveness value of the solution by 17.11 per unit if the funds were then used to purchase advertising in MED E1.

Thus, linear programming can provide a strong and useful tool for the media man. His ability to measure, to compare, and to evaluate new combinations will be enhanced.

While other theoretical approaches to the problem are possible, and are included in the literature, this report presents an immediately useful operational solution. The data, information, or estimates fed into the computer are the same as the data, information, or estimates, now available and being used in making media decisions by manual methods. However, the heretofore impossible task of examining thousands, or millions, of possible schedules from a set of acceptable media has prevented the media man from following his data and judgment to an ultimate conclusion.

With the advent of linear programming applied to media selection, it becomes possible to re-examine data, estimates, and judgments in the light of the logical conclusion to which they lead. It is possible to measure the sensitivity of these outputs to changes in the inputs and from this the real needs for accuracy of information can be determined. Extensive use of this technique may well result in new concepts of informational needs.

While this statement may seem unduly strong, our experience has indicated that these mathematical tools are at present limited in their usefulness only by the information available. For example, if data were available on the demographic profile of coverage of media for each month, or even for each quarter year, a time-scheduling ability could be added to the present program. If the same information were available for geographic areas, by months, or quarters, an ability to schedule regional media purchases could be added.

This is a small glimpse at a future which can be as close as available information allows it to be.

For the present, applying the results of the mathematical research of recent years to modern large-scale computers gives the media man a new and practical tool.

VI.

HOW THE PRACTICAL MEDIA MAN HANDLES THE OUTPUT

Herbert D. Maneloveg
Vice President in Charge of Media
Batten, Barton, Durstine, and Osborne, Inc.

Mathematical programming is a natural evolution of the media man's craft. Rather than offering a revolutionary concept, it essentially presents a mathematical translation of a buying process that, within certain circles, has been moving forward in sophistication and enlightenment during the past decade. With this new technique, the purchase of space and time now becomes totally related to the clients' aims, the products' market, and the brands' specific potential. Certainly clients and agencies have in the past been threading their way along this path of correctly matching media to markets. This new technique gives an added thrust in this direction for the knowledgeable, and offers a source of enlightenment, we hope, for the unbelieving.

Marketing knowledge has grown rapidly; an agency is only as successful as its ability to explore and interpret that knowledge. We now know or possess capabilities of knowing more and more about the customers of the products we advertise. We can ascertain where these buyers live, what is their makeup, how much they buy of the brand in terms of heavy users, light users, and medium users. We are learning to break out the repeat buyer from the infrequent buyer. We determine seasonality patterns and can plot advertising to

sales ratios by districts and regions. We have a firmer fix on the patterns of our competitors. Within a household or an industry itself, we are learning not only who makes the purchase but who initiates the purchase and, hopefully, why they buy. All this data is within our grasp. We must make sure that we always reach out for it. Not only for the large accounts but for the small ones as well.

Once the client and his agency (in concert) deliver this marketing direction, once they can numerically document the demographic and geographic patterns of their consumers, and can place a weighted value on these people, the job of the media man takes on new meanings. For not only is his assignment that of selecting a media plan at a given budget allocation, but in making sure that the plan delivers the maximum number of prospects for the product, prospects not only in total numbers of homes reached, but specifically prospects most likely to purchase.

Quantitative factors of input are only half the story, however: qualitative or judgmental factors are also needed. They are on equal part of the over-all linear programming scheme. There must be decisions on the impact value of all media, judgments on the effectiveness of space units and commercial lengths. Here the media man must work with copy people, account executives, promotional and research experts to arrive at a numerical impact value for the media alternatives before him. This he also does every day now; his only new venture is in quantifying those judgments. And above all, the media man must be a true realist. The qualitative value of a medium is different for every product, and this changing value index should be fed into each problem. The method of arriving at this value index is time-consuming and complex, but is an integral part of the operation. Our system of arriving at qualitative value indexes is exclusive to us at this time. Other agencies I am sure will differ in the method and spend months and perhaps years debating the feasibility of this idea.

Black and white pages might be adequate and acceptable from a judgmental basis for an industrial advertiser campaign, but it would fall far down the scale for a food product. Single columns have a place in the media spectrum for a kitchen utensil but a spread may only be the way to go to introduce a product that cleans that kitchen utensil.

If the product has a strong competitive story to tell, ID's or 20-second commercials might be illogical; however, if the product has a billboard quality and frequency is of prime importance, per-

haps the same ID can be as effective as a minute commercial. All these judgmental factors can and are placed into our machine. Added to this is the "political" buy, the corporate network allocation, competitive counter-maneuvers and many others. But here I strongly state that if this information cannot be mathematically-fed through input factors and quantitative indexes (and some of it cannot) we must be on hand to apply it once the answer comes out. For we must always remember that linear programming does not offer the complete solution, only a direction.

In the same light, restrictions are fed into the problem as well. A media man must determine within the framework of his total budget what portion of the total dollars logically should go into a magazine effort, a spot budget, a TV corporate pool. He must determine there should be no more than so many dollars and no less than so many. The media man may determine, through his restrictions, that three shows must be used in order to have representation on all company-owned properties and in order to deliver a desired reach factor. Or he may determine that no more than 50% of the magazine exposure should be directed to women or that only 20% of a spot announcement campaign should be directed towards men.

All these factors are restrictions that a media man must think of in building a problem, and he must see to it that these restrictions are properly placed into the machine, or if not, are studied after the output is delivered to him. As you can see this doesn't make our job more easy, it merely makes good media men more necessary.

VII.

PERSPECTIVE — SOME IMPLICATIONS, QUESTIONS, AND COMMENTS

Darrell B. Lucas
Professor of Marketing
New York University
New York, N. Y.

So far, four aspects of the mathematical approach to media planning have been discussed: the background of these new tools; aspects of media which are related to schedule selections; an actual mathematical solution computed for a real advertiser; and comments on how to use the results.

Now I have the task of putting this whole thing into perspective, and asking some questions.

First, for background, where did quantitative measurement of media come from? It started, of course, with the advent of certified audits of circulation — the ABC — in 1914. A later step was the gauging of radio by ratings started in the 1930's. Then LIFE began an avalanche of audience studies in 1938. Now Nielsen has combined the two media most exclusively national in his multiple measurement of magazines and network television. Each step in measurement has been a step away from media buying on hunch and intuition. All we now propose to add is a systematic and fast method of applying our facts to practical media buying.

How important is the quantitative evaluation of media? The answer to that is emphatic: it is, today, our greatest opportunity for a major gain in advertising efficiency. Creative people, by their very nature and because of the exposure of their art, have always sought new ways of improving copy in a constantly competitive world. Yet media planners have only recently felt the incentive to seek out the new. Those of us who worked on early audience studies can well remember the opposition to "nose counting" and the "numbers game." Now that media and research are teaming together, the opportunity includes not only a great increase in measured facts, but also mathematical methods and machines for speedy application.

But — another question — aren't there unmeasured qualitative factors in all media selections? How can these go into a formula? Subjective estimates do enter into mathematical programming. These are mighty elastic, but actually they have to be quantified in making any decision.

Recently two well dressed ladies were riding in the seat ahead of me in a commuter bus. One remarked to the other, "My son was planning to give Margie that emerald ring of his, but he had it appraised — he isn't going to give it to her. He found it is worth \$560, and he isn't that serious." Obviously, even romance has a dollar value! I only wish the lady had stated the cut-off point. Maybe Margie would have made it at \$500 even!

More to the point, recently a food advertising manager gave a speech in which he explained that he based the division of his publication budget between consumer magazines and supplements on the superior reproductive quality of magazines. As he sat down beside me, I asked how much more value he felt he gained through improved physical appearance. He said he didn't know. I asked, "Is it in the order of five per cent or ten or maybe twenty or more?" He pondered a while

and said, "I just don't know." But surely he did place some order of magnitude on this factor in making his budget division. All that our mathematical friends are asking us to do is to make our best estimates of these values in numbers; if we can't systematize our thinking in these subjective value areas, then we can't fully use the measured facts at hand in reaching more intelligent media decisions.

The picture is actually brighter than that. Bit by bit, our media research people have cut into hitherto unexplored areas. The POST, for example, has pioneered in quantifying exposure opportunities within magazines and, more recently, in quantifying the values of repeated reader impressions of the same advertisement through re-reading of the same issue. The point is that research will be used in a continuous attack on areas where once we had only subjective judgments as guides to values.

Since measurement may change our value estimates, won't this throw off the weights now used in the computer? The answer is that weights will change for this and for many other reasons, but this presents no problem to the solution method in the computer. It is merely a part of the problem formulation; new weights can quickly be converted into new solutions.

But, aren't there other weights we have been applying to media which were left out of this demonstration? The answer I would give is an emphatic "Yes!", but with one qualification. The qualification is the statement that we are always putting weights into the computer, even if they are not specified. Anything which does not have a designated weight is automatically given some common weight value, such as a value of one. If, for example, we ignore duplication of media reach within a market, we are simply giving each opportunity or exposure or impression a fixed, uniform value, regardless of whether each prospect is reached only once or fewer prospects are hit more times. This is not the real world, as any space salesman can tell you. We just wanted to point out that the weight is there in the formulation of the problem, whether you specify it or not.

So far the answers seem clear, but aren't we leaving out some good facts we already have? Yes, we are leaving out some findings on reading days and also data on time spent reading. Maybe these factors went into the making of our subjective estimates of unit values for each media vehicle. Maybe they aren't important to advertisers. I get the impression that the industry never reacted

eagerly to evidence on magazine reading time. There is one solid bit of data which is notably absent, and this bothers me a little. The problem solution presented here takes no direct account of ABC figures. You could insert ABC figures if you wish, but there are no breakdowns by age, sex and economic level. An alternative is to consider ABC in arriving at your subjective weights in the problem formulation. This would enable you to make some distinction between the values of primary and pass-along households. But, to be perfectly frank, our mathematical approach to media problems depends very slightly on audits of copies sold.

May I divert just a moment to mention one of the most attractive features of this mathematical approach? It not only provides a guide to what kinds of data we need or don't need; it also provides a precise guide to the required accuracy of the needed measures. Many of you have shared our experience of more than twenty years of effort to bring all media measurement to a useful level of accuracy. We have always assumed that, so long as the budget wasn't cut, we would make the measures as accurate as humanly possible. Now, in the mathematical programming approach we suddenly find ourselves confronted with the possibility that we have been spending too much money in pursuit of precision. Or, it is possible that we may suddenly find ourselves demanding better methods and bigger samples to obtain more precision.

Projectable measures of advertising audiences will help us, but aren't there still other factors in the media function which can be subjected to a degree of measurement? I am sure there are, and many of you have made major contributions to methodology for these purposes. The more we can measure, the less we need to guess. And there is no concealing the fact that our fine mathematical approach is infiltrated with a lot of guessing at this stage.

What, then, is the value of so magnificent a mathematical formulation if it still has so much in it that is subjective? It seems to me that there are two worthy answers to that question. In the first place, it forces us to systematize our thinking, and to quantify those vague values which have been both our weakness and our protection in the past. Secondly, the use of this procedure enables us to gain the utmost from such facts as we already have; and we do have some substantial facts.

So, if we go along with the proposals in this report, does this mean that the decisions coming out of the computer are the best to be had? Wait a minute — who said decisions were coming out of

the computer? There is no intention of making the computer output a final answer. Instead, it is a starting point or a platform on which to consider all of the desired choices not in the computer solution. And if you have another choice, appraisal, or assumption, try it on the computer! Maybe it would be better and maybe it wouldn't. It costs very little to find out. But the final decision should still be made by men and not by machines.

This development puts us on the threshold of a very new and promising era in media planning. The real significance, of course, is the effects of such procedures on media buying. Boiled down to a few sentences, the effects will be:

1. To force us all to put down in figures those judgments which we always have matched against figures — namely, media dollars.
2. To enable us — for the first time — to make real sense out of and maximum use of our media research facts.
3. To produce for us specific, optimized media schedules from the facts and judgments available when media decisions have to be made.
4. Then, finally — and most important — to provide us with a scaled framework on which we can superimpose our considered alternatives and intelligently remold the media plan — knowing what we pay for and what sacrifice we make, regarding each change in the schedule.

Despite all of the promise and the logic of this analysis, you may ask, "Aren't we getting a little premature? Wouldn't it be best to wait until we have more measured facts — more data for making those subjective estimates of weights?" I don't think so. Even with limitations of data, we gain the advantages of systematized thinking. Now, I'm getting too vague and academic: why not get right down to practical facts? Computer procedures for improving media planning are here. The mathematicians have done their job, and await our inputs. The equipment is also ready and waiting. A lot of the preliminary thinking has already taken place throughout our business. If a demonstrated application had not been announced here, it would have come soon from some other source. This application is the obvious next step enabling media men to keep pace with creative men in improving the efficiency of the advertising business.

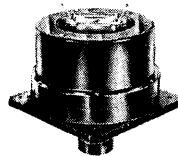
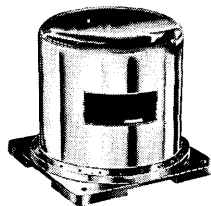
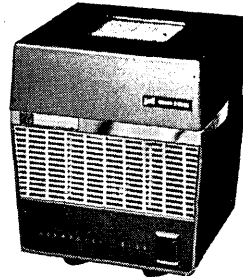
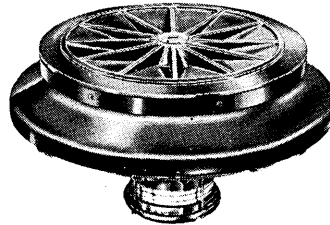
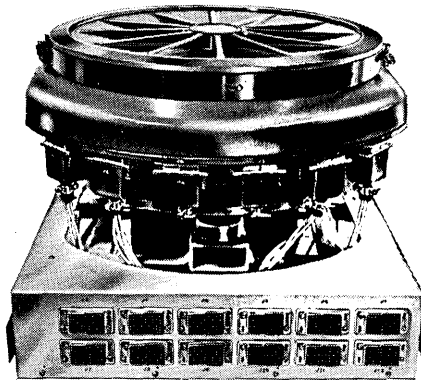

LFE's BERNOULLI DISK FAMILY IS GROWING

Now LFE offers FIVE series of Bernoulli Disk magnetic memory storage devices. 25,000 to 2,000,000 bits. Built-in modularity. Fast random access. All meet military specs. Fixed station. Mobile. General-purpose EDP systems. Three series meet airborne specs.

Simple, low cost, small size. Utilize Bernoulli's principles of gas motion to maintain positive separation between small Mylar Disk storage medium and read/write heads. Hence withstand severe shock, vibration, environment. *Complete storage systems* including electronic read/write modules available. Details in new, complete brochure of entire family. Write.

LFE
COMPUTER PRODUCTS
DIVISION

LABORATORY FOR ELECTRONICS, INC.

1079 COMMONWEALTH AVE. • BOSTON 15, MASSACHUSETTS

See us at Booths No. 109, 110 at the EJCC Show

Annual Pictorial Report

1. DIGITAL COMPUTERS

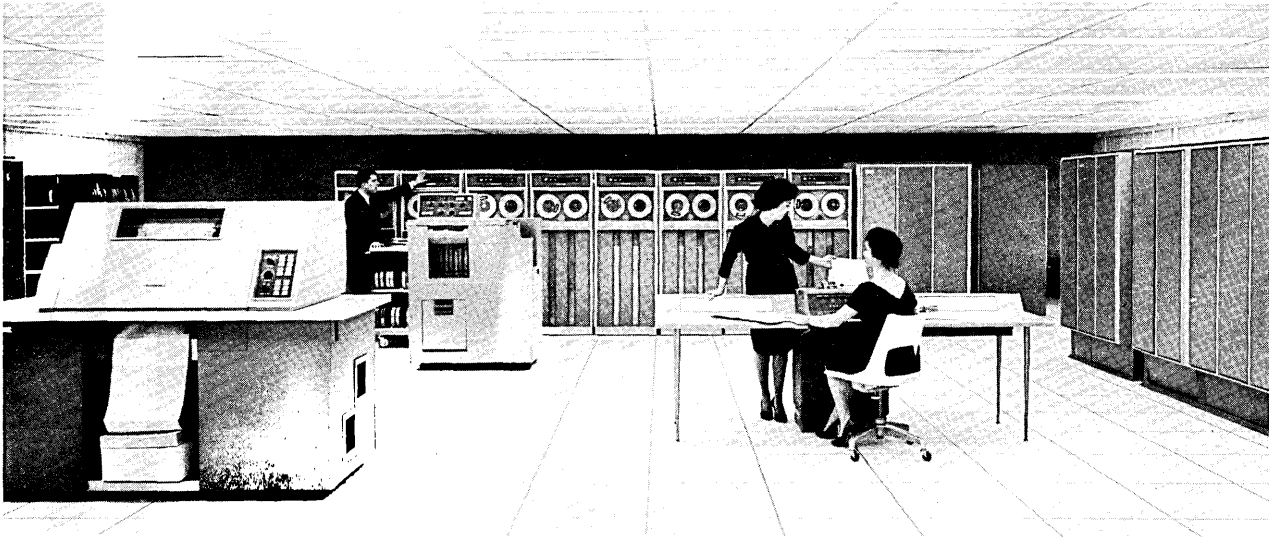

This is a view of the Honeywell 800, Service Bureau in the Minneapolis-Honeywell's Electronic Data Processing division, Wellesley, Mass. This general view from left to right shows high-speed printer, card reader, magnetic tape units and their controls, console, floating point unit and part of the central processor. Not seen in the picture is a high-speed card punch (behind printer) and other electronic control equipment. The service bureau, provides customers with pre-delivery check-out of their programs, personnel training facilities and data processing time for emergency use.

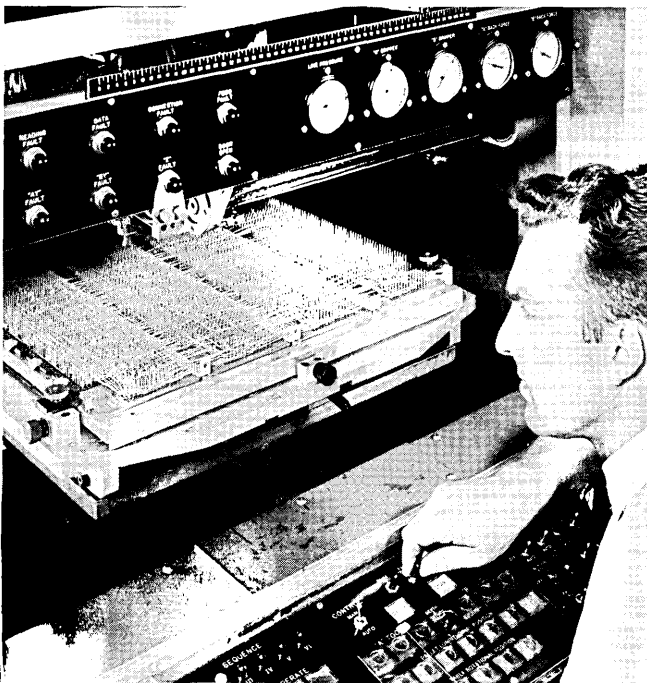

Shown here is one phase of the manufacture of the B200 Central Processing Unit, made by the Burroughs Corp., Pasadena, Calif. Some 5,000 wires are automatically routed and wrapped around terminal pins of back panels. Approximately 10,000 connections are made in this manner for each panel.

Y
br
pu
ca
pr
wh
We
fo
co
en
pu
ca
pr
If
su
me
ma

Ma
ce
In
p

un
gro
The
fr
In
es
Pu
of
Ac
Ma
ti
dis
tin
Flo

Raj
b
A
S

bo
po
st
an
th
Ma
He
en
co
tr
mo
ba
pa
Ma
of
pe

Big
D
F
vc
Sc
Sc

al
i.
Th
de
st
Ti
di
di
an



John Wickham, assistant to Dr. Donald McIntyre, chairman of Pomona College Geology Dept., Claremont, Calif., sets up a problem for the Clary DE-60 computer to solve. The computer is available to all geology students in the undergraduate college. This computer is a small general purpose digital computer, and was specifically designed for engineering and scientific applications by the Clary Corp., San Gabriel, Calif.

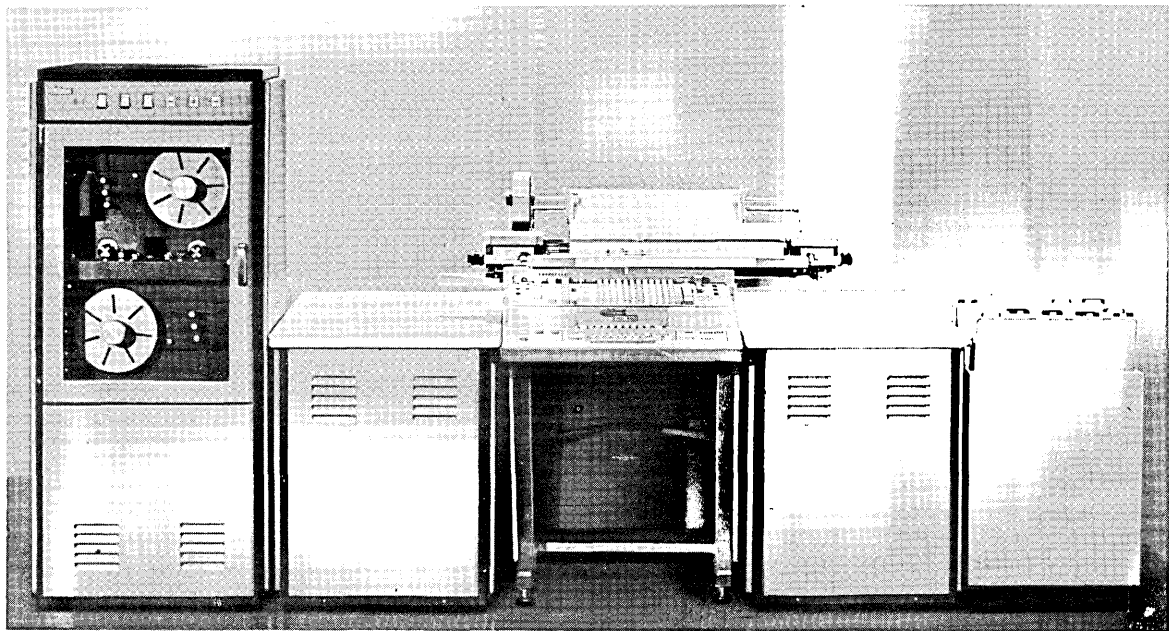

Electronic Data Processing System, Class 390 — National Cash Register Co., Dayton, Ohio. The 390 consists of a central processor, a console, units to read punched paper tapes or punched cards used as input media, and auxiliary equipment to create punched paper tape or punched cards and to control other peripheral equipment. The 390 is solid-state, magnetic-core, fully transistorized, and may be used to handle all basic accounting functions. It is fully compatible with other processing machines, and may be integrated into all existing data processing systems. An important feature of this model is the magnetic ledger card which stores data in magnetic tape strips on the back of the form, yet carries all necessary printed information for reference and auditing on the front of the form.

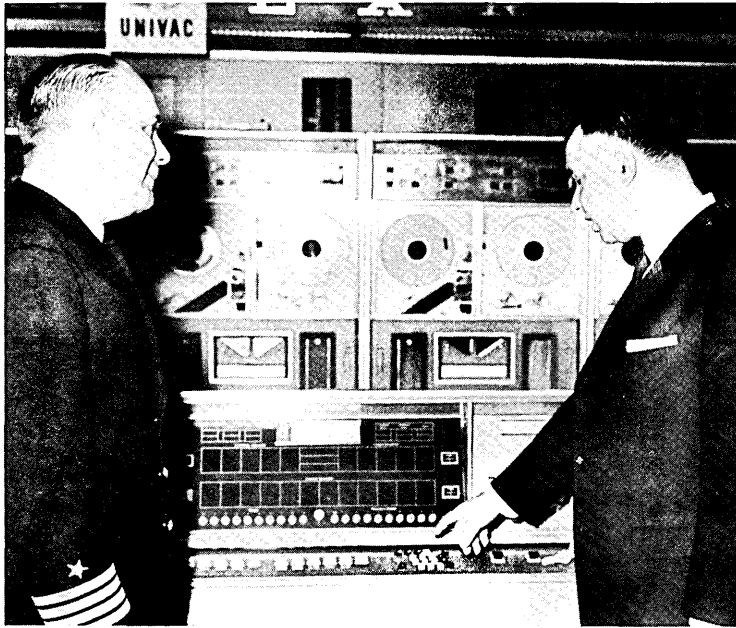

LARC (Large Automatic Research Calculator) system -- Remington Rand UNIVAC, Division of Sperry Rand Corp., New York, N.Y. Capt. J. A. Obermeyer, Commanding Officer, David Taylor Model Basin, Washington, D.C., discusses the operator's control panel of the UNIVAC LARC II computing system with Dr. Harry Polachek, Director of the Model Basin's Applied Mathematics Laboratory. The computer is one of the most powerful in operation; it is capable of performing 250,000 additions per second, of 12 decimal digit numbers. Another LARC is currently in operation at the Univ. of California's Lawrence Radiation Laboratory, Livermore, Calif. which is operated for the U.S. Atomic Energy Commission by the University. The system can be geared to handle a range of problems extending from basic scientific research to the preparation of a company's payroll.

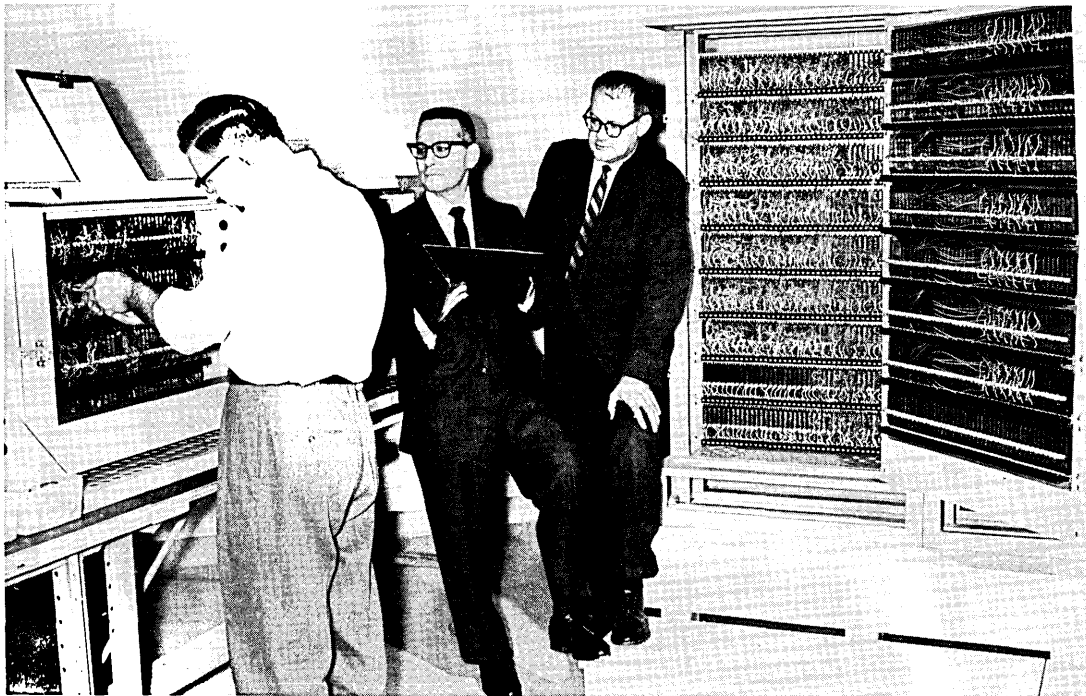

(Courtesy of Minneapolis Star)

BEGINNING A NEW FAMILY OF DIGITAL COMPUTERS -- Advanced Scientific Instruments, Inc., Minneapolis, Minn. This is one of the first pictures of a member of a new family of digital computers to be introduced starting in January, 1962. The assembly of the ASI-420 is watched by Pres. Francis Alterman, and V-P. Ralph Mueller (right) of the new company. The ASI-420 is stored-program, parallel, and solid-state. It uses 42-bit words and a memory expandable to 8192 words. Buffered input-output channels with total transfer rate of 125,000, 42-bit words per second are anticipated. Multiple indexing and indirect addressing are also available on this new computer. It is expected to be ready for display and demonstration by the end of Jan., 1962.

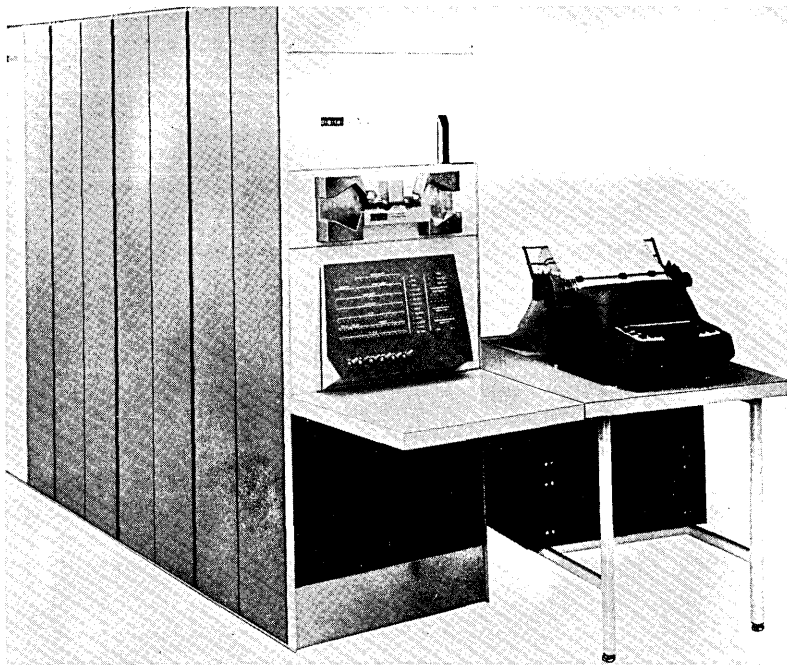

Programmed Data Processor PDP-1 -- Digital Equipment Corp., Maynard, Mass. This high speed digital computer was presented to Massachusetts Institute of Technology in Cambridge, Mass. where it will be used by the Dept. of Electrical Engineering to teach students the principles and operation of modern electronic data processing equipment.

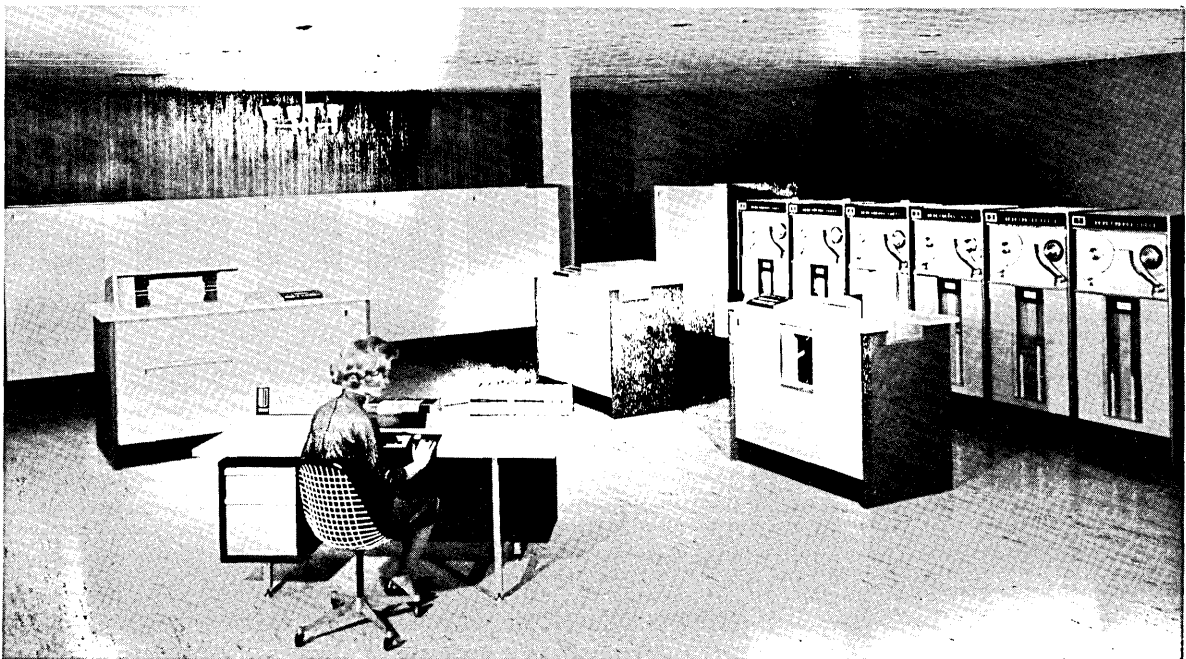

UNIVAC III -- Univac Div., Sperry Rand Corp., New York, N.Y. This general-purpose digital computer will be acquired by the Houston Lighting & Power Company, Houston, Texas, in early 1963. It will be used by the utility for information processing in accounting operations, relating to customers, payroll, store, dividends, and transportation. A new, character-packing, technique stores the same amount of information on a single reel of Univac III tape as formerly required as many as 20 reels. This data can then be read at the rate of 200,000 digits per second.

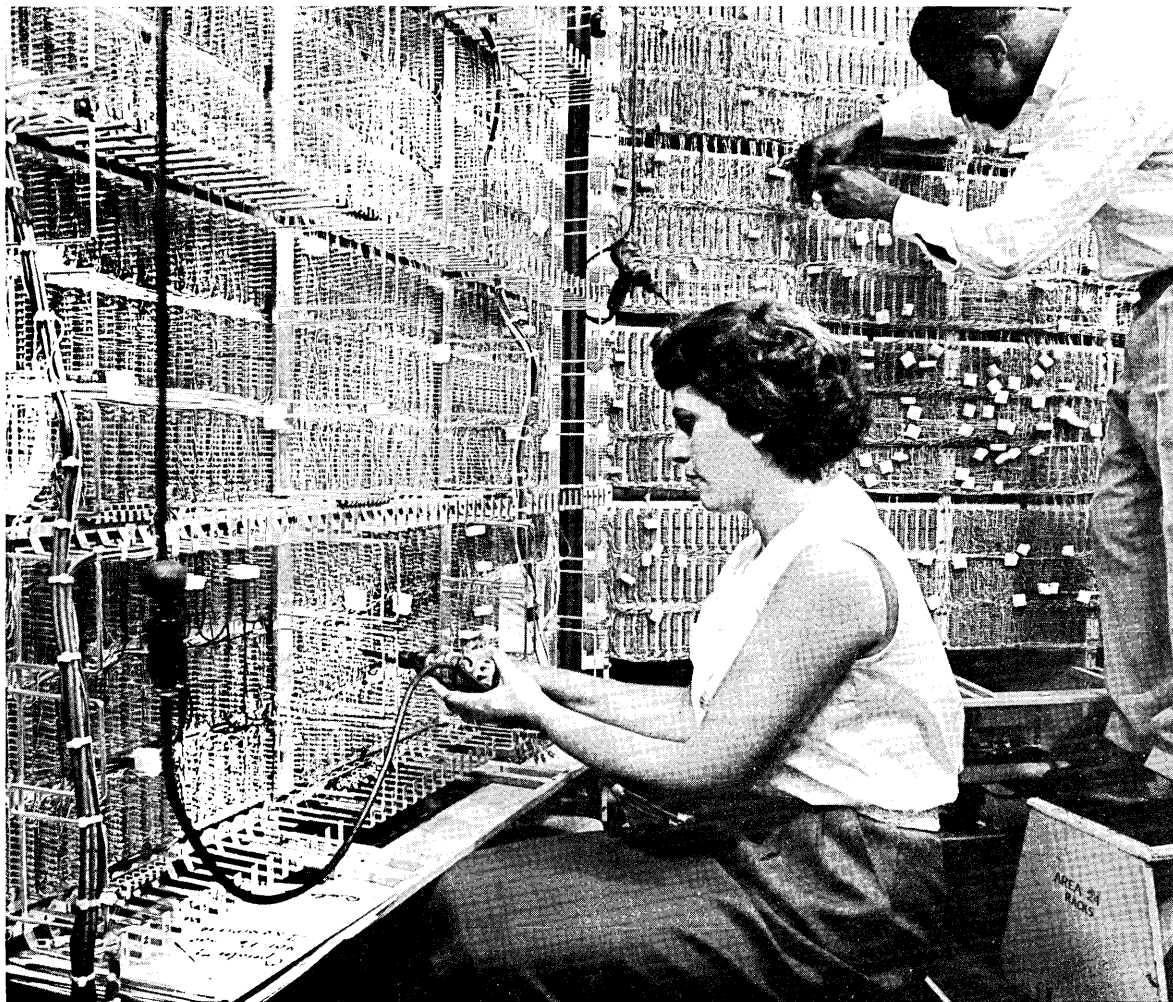

Honeywell 400 computer -- Minneapolis-Honeywell's Electronic Data Processing Division, Boston, Mass. Shown here are skilled workers wiring the central processor, or "brain", of the computer system. Volume production of this medium-scale computer started this year. This unit can average 10,000 additions or subtractions per second.



Telebank system -- Teleregister Corporation, Stamford, Conn. One of the first fully automatic on-line data processing systems for banks permits a transcontinental banking transaction to be completed in one second. This was demonstrated in October at the American Bankers Association Meeting in San Francisco.

T
t
P
m
m
e
D
t
d
l
t

Digital Data Processor -- Computer Control Co., Inc., Western Division, Los Angeles, Calif. This high-speed, stored program digital computer, the DDP-19, is compact, modular and medium-size. It is single-address, parallel, and binary. It is also adaptable to special applications requiring a variety of input-output equipment and/or very high operating speed. As installed at Convair, Fort Worth, Texas, this computer performs quick look, reformatting, plotting, and digital or analog output functions on B-58 analog flight test data from analog magnetic tape through a Beckman analog-to-digital converter.

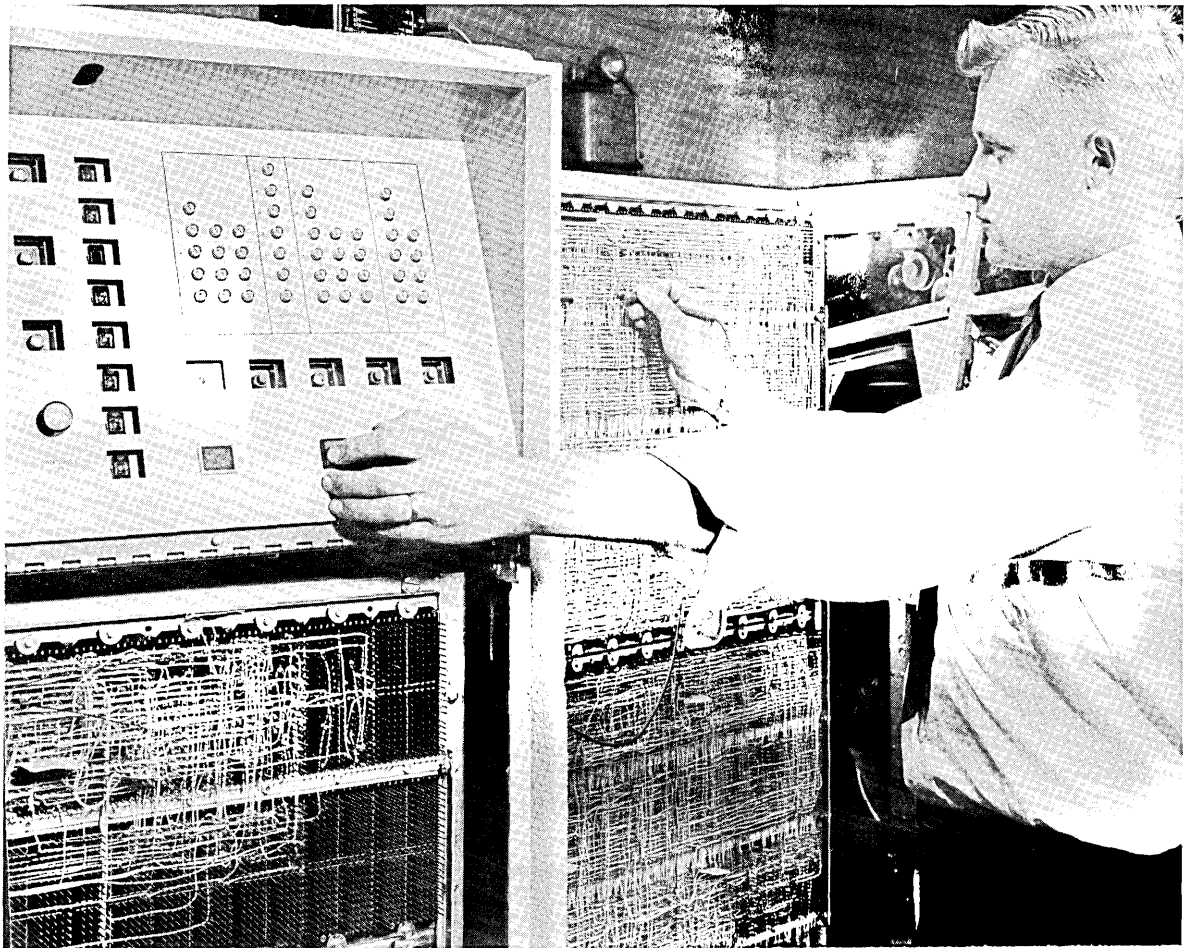
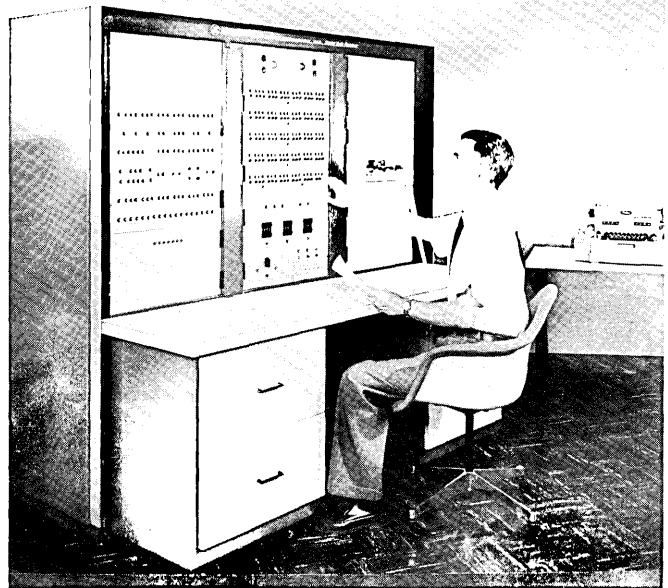

B 200 Series Systems -- Burroughs Corp., West Coast division, Pasadena, Calif. The completed central processing unit of a B200 series systems undergoes a comprehensive system check-out before release from the Pasadena manufacturing center. This division carried out research and electronics design of the B200 system.

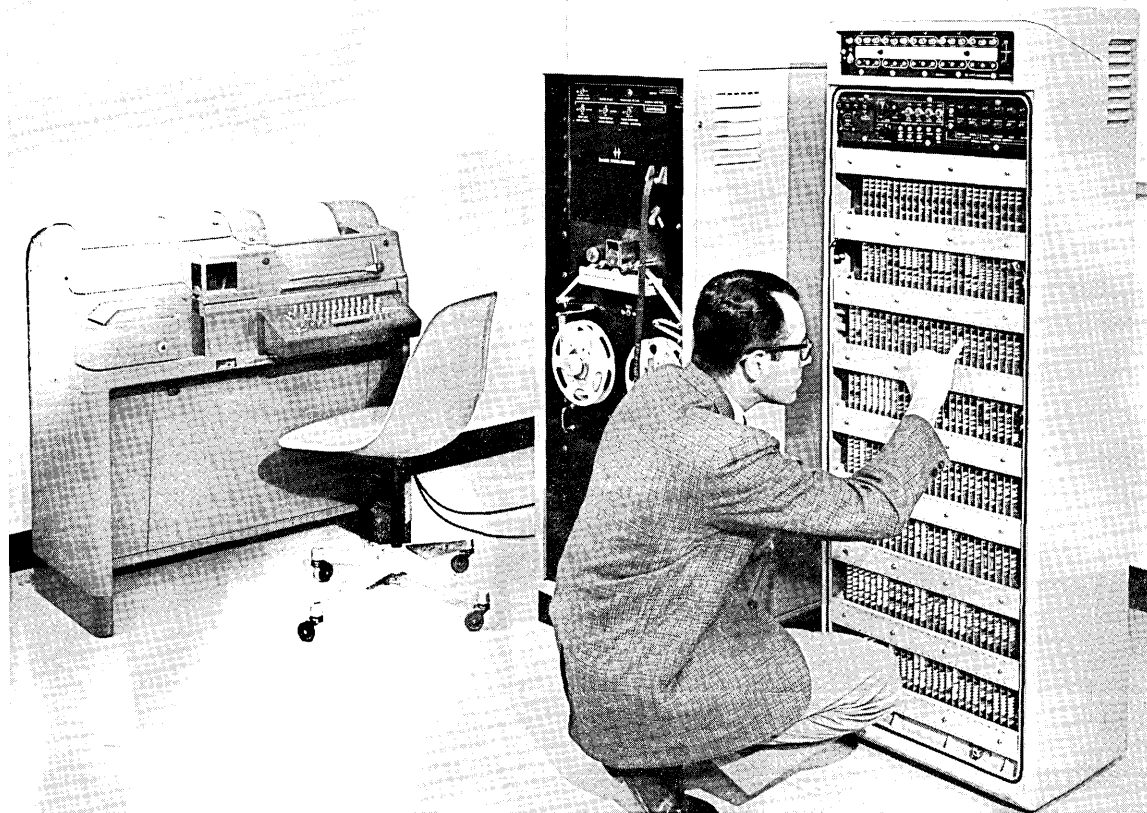

AN/UYK-1 digital computer -- Ramo-Wooldridge, division of Thompson-Ramo-Wooldridge Inc., Canoga Park, Calif. This multiple-purpose digital computer is claimed to have achieved a degree of versatility and user convenience not ordinarily possible in an inexpensive computer by using "stored logic" techniques. This permits the user to select a word length, order structure, and instruction repertoire especially suited to the problem at hand. These normally "wired in" characteristics are specified by data stored in the computer's memory and may be changed during the normal loading procedures without hardware modifications.

Mult
Paci
cent



Honeywell 400 EDP System -- Minneapolis-Honeywell Regulator Co., Boston and Lowell, Mass. Harold W. Sweatt (seated), chairman of the board of directors of this company, throws a switch to turn on the power of the first Honeywell 400 electronic computer. Paul B. Wishart, Honeywell president, looks on. This new medium-scale computer is said to be one of the most powerful available in its price class. It is capable of handling as many as 10,000 three-address operations per second. In addition to the central processor, the basic unit includes four magnetic tape units, an independent console with keyboard and printer, a high-speed printer and card reader. Major options include off-line printing, optical scanning, and random-access memory.

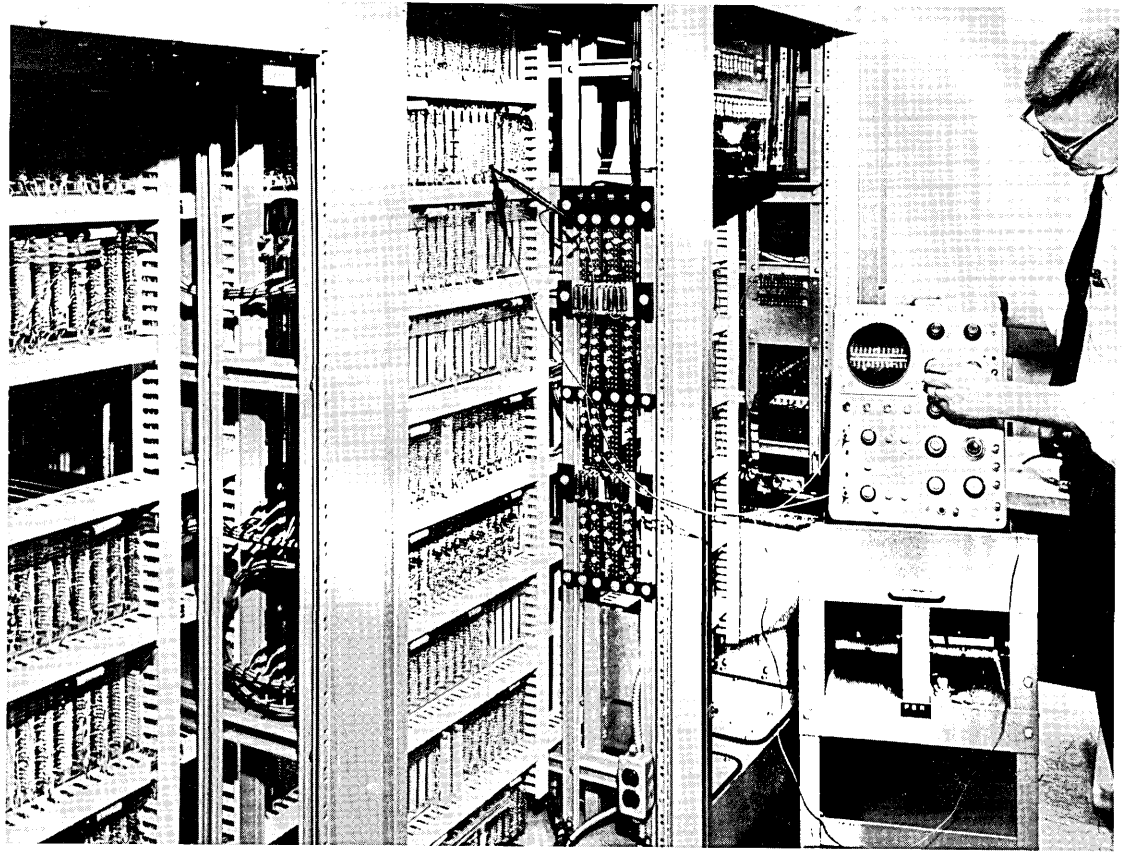

General Electric information searching system, GE 225 -- General Electric Co., Phoenix, Ariz. This system consists of a transistorized general purpose computer with an 8192-word magnetic core storage memory and special programming features for conducting literature searches. It is equipped with a dual magnetic tape handler and tape controller, a high-speed punched card input and an electric typewriter output. It is installed at the Center for Documentation and Communication Research at Western Reserve University, Cleveland, Ohio, and is the first of its type anywhere in the world for purposes of literature searching.

Minivac 601, digital computer -- Scientific Development Corp., Watertown, Mass. This miniature computer was developed to enable the curious to discover and understand the fascinating world of electronic brains. It is a table-size computer able to perform all of the functions of a large-scale computer but with miniature numbers. Minivacs may be used by businessmen, teenagers, hobbyists, educators, and industrial and military training schools. The machine comes with a set of six books, which explain experiments and programs.

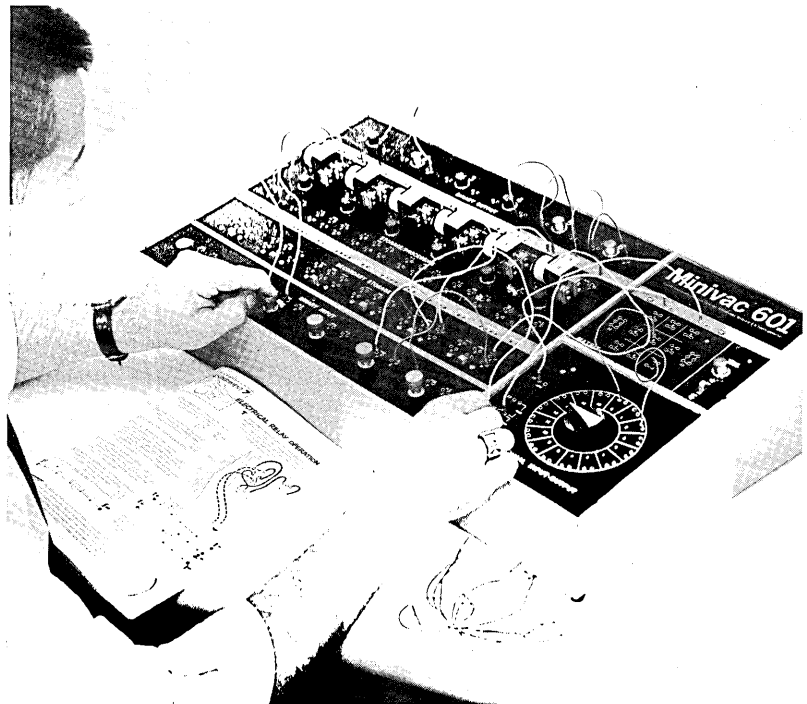

General Electric Information searching system GE 225 -- General Electric Co., Phoenix, Ariz. The control console includes register display lights, indicator lights, power switches, status lights, and 20 program control switches. The console typewriter types 10 characters per second maximum under control of central processor. The card reader (left) reads 400 cards per minute. The engineer is examining one of the 750 printed-circuit, logic-component pluggable cards in the cabinet of the GE 225. To the upper left of the console are the magnetic tape units. Each role of tape will store approximately 2500 documents.

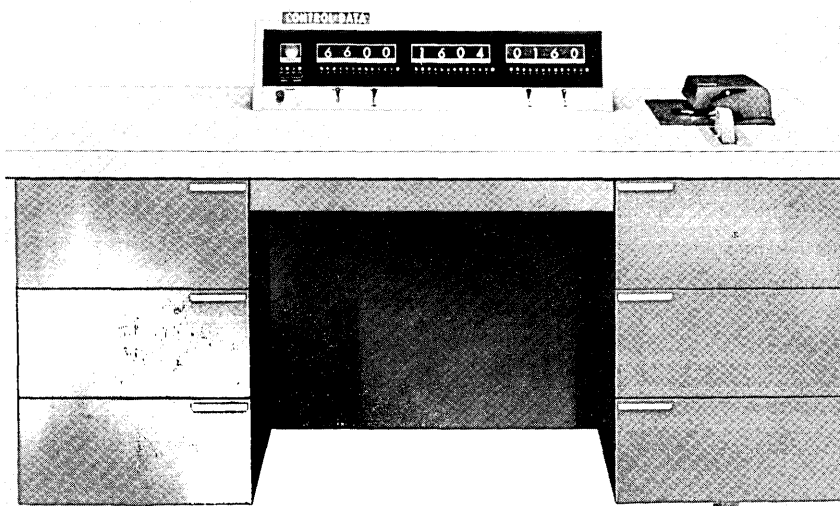
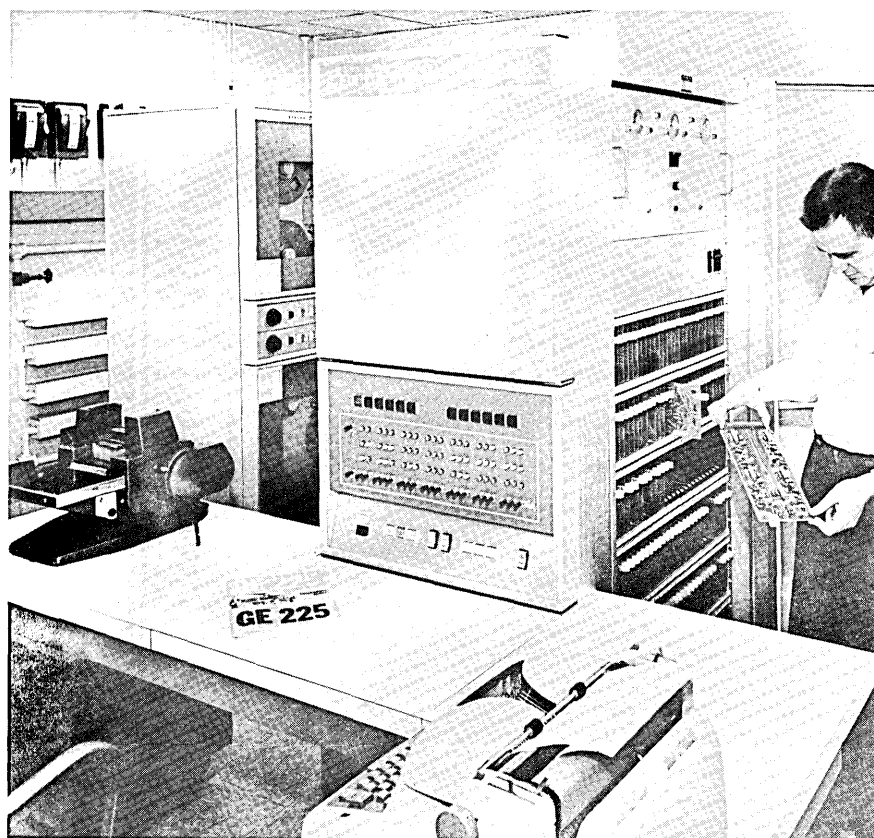

The CD 160 Digital Computer -- Control Data Corp., Minneapolis, Minn. The 160 Computer is a fully transistorized, general purpose digital computer. It is controlled by an internally stored program. Operating in a parallel mode, the 160 can execute 60,000 instructions in one second. It can handle data transmissions from input-output equipment at speeds up to 160,000 characters per second. The magnetic core memory has 4096 words with a cycle time of 6.4 microseconds. A list of 62 instructions, complete programming package including FORTRAN, and provisions for a complete system of peripheral equipment are provided with the CD 160. Standard equipment includes a 350 character per second photoelectric tape reader and a 110 character per second paper tape punch.

Bar
ci
he
tr
ca
up
ma
du
ti
mo
is
br
in
co
pr
It
ch
ty

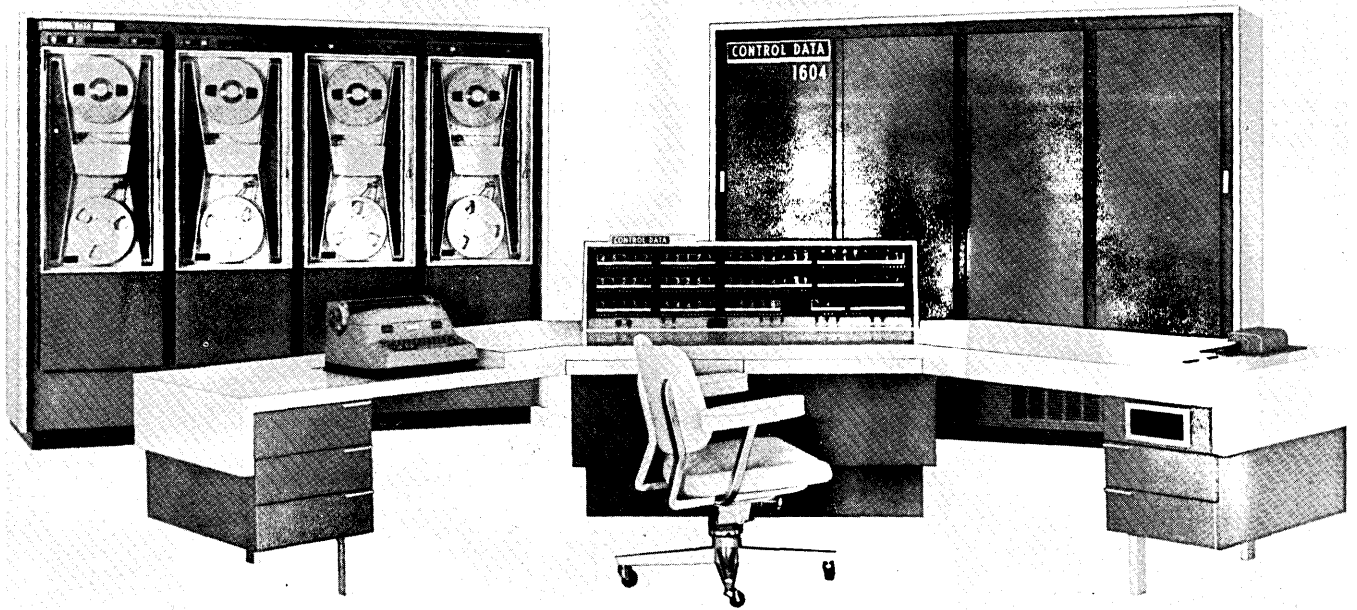

The CD 1604 Digital Computer -- Control Data Corp., Minneapolis, Minn. The Control Data 1604 Computer is a solid-state, general purpose digital computer. It operates in a parallel mode and has a core storage memory of 32,768 48-bit words. The 1604 has single-address logic, 2 instructions per word, and average cycle time is 6.4 microseconds. Its input-output facilities include: three 48-bit buffer input channels; three 48-bit output channels; one high-speed 48-bit input transfer channel (4.8 microseconds, 48-bit parallel word); and one high-speed 48-bit output transfer channel (4.8 microseconds, 48-bit parallel word). Other standard features include program interrupt, a flexible repertoire of 62 instructions, low power consumption, real-time clock, indirect addressing feature, and 6 index registers. Provisions are made for the 1604 to handle a complete system of peripheral equipment.

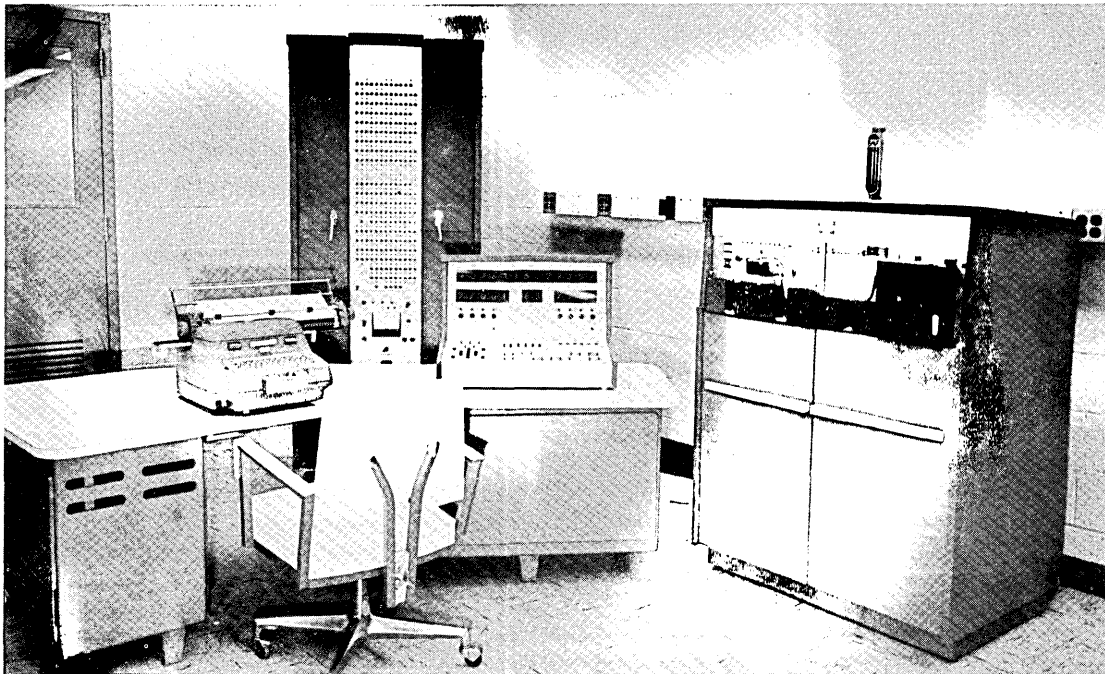

This is one of the five General Mills digital computer systems slated for use in the Orbiting Astronomical Observatory program of the National Aeronautics and Space Administration. This computer will be used by NASA for mathematical analysis of real time satellite control problems in addition to analysis of other data. The General Mills AD/ECS computer is a solid state, parallel, digital computer system. It utilizes plug-in printed circuit instruction cards for tying together various units of the computer system, such as the arithmetic unit, memory unit, control unit and input-output buffer. The Central Computer can be altered easily in storage capacity, operational registers, and even order structure.

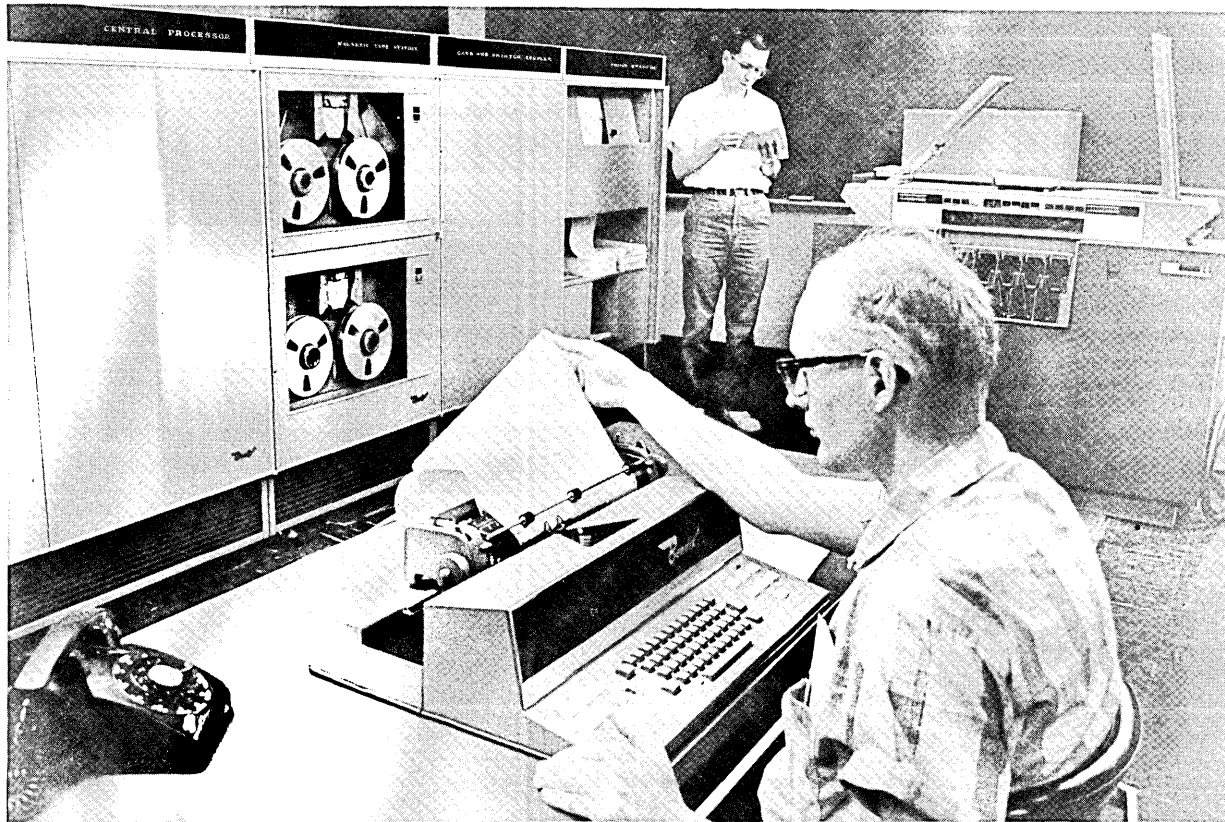

This is the first installation of the Bendix G-20 solid-state computer made earlier this year at Carnegie Institute of Technology. Shown from left to right are the Central Processor with 8192 words of core memory, Magnetic Tape Station, Card and Printer Coupler, Print Station, and standard card equipment. The control console is operated in the foreground.



TRW-330 Digital Control Computer -- TRW Computers Co., Canoga Park, Calif. This control computer has a design based on solid-state components, modular construction, plug-in circuit cards, and Mercury-wetted-contact relays. The basic systems accepts up to 1024 variable-voltage inputs from pressure, flow, temperature, or other process state measuring instruments. It samples, converts, and stores this data with an accuracy said to be 0.1%. The work length is 24 bits, including sign. The memory capacity goes to 100,000 words in units of 4000. Speed for an addition or subtraction is 260 microseconds.

- Bu
- Int
- Ex
- Co
- 11

- Up
- Inp
- Pu
- Lo
- Hig
- Pl
- An

TYP

REAL

The 25th Honeywell 800 -- Minneapolis-Honeywell Regulator Co., Electronic Data Processing Div., Boston, Mass. Computer technicians make a final check on the 25th Honeywell 800 EDP system. Shown here is part of the battery of high-speed magnetic tape drives included in the large scale system which has since been installed in the Philadelphia Electric Co., Philadelphia, Pa. There it is being used to automate the billing of the utility's 1.1 million customers, help solve intricate engineering problems related to a constant and economic supply of electric power, and for general accounting purposes. The first Honeywell 800 system was delivered early in January to Associated Hospital Services of New York.

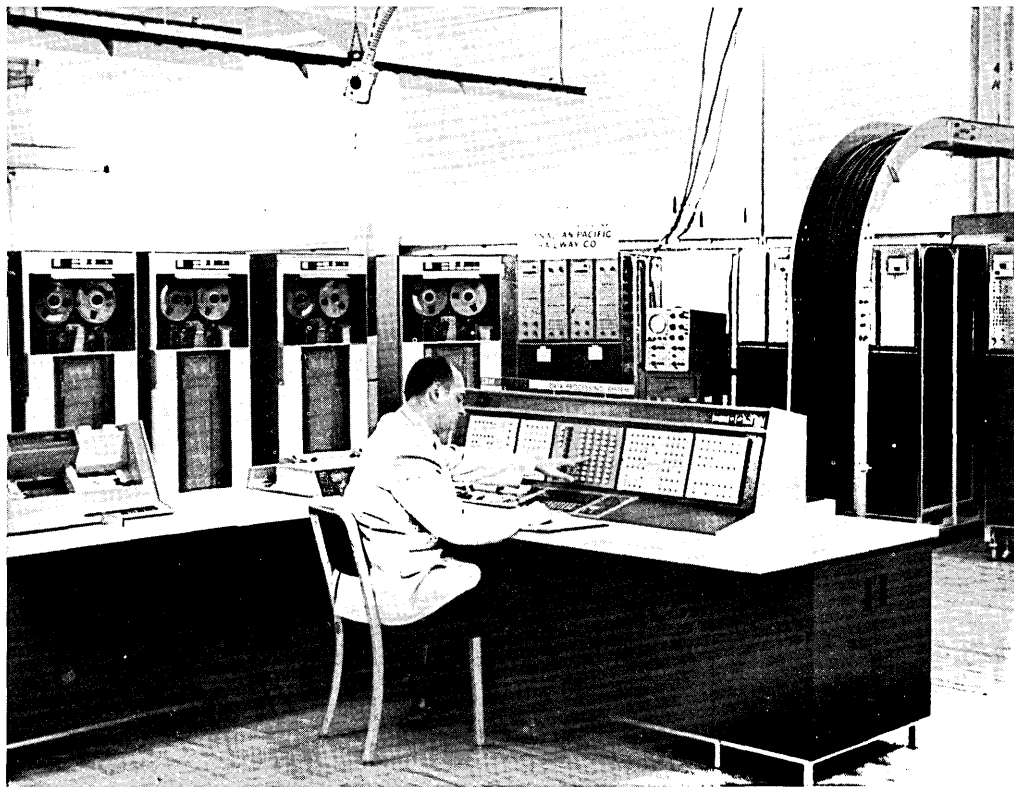
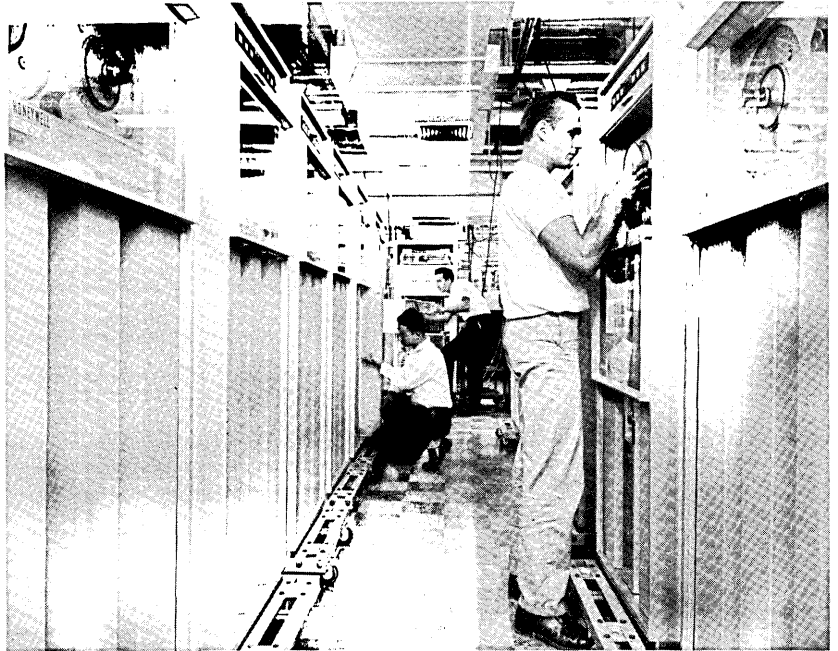

An International Business Machine Type 7080, one of the most powerful commercial computers in the world, has been installed at Canadian Pacific's headquarters in Montreal, Canada. The computer is fully transistorized, and can handle management reports, payrolls, and the great mass of data required in day-to-day railway operations. It is up to six times faster than the IBM 705 Model III used previously. The computer is shown here in the factory at Poughkeepsie, N.Y., just before shipment in September.

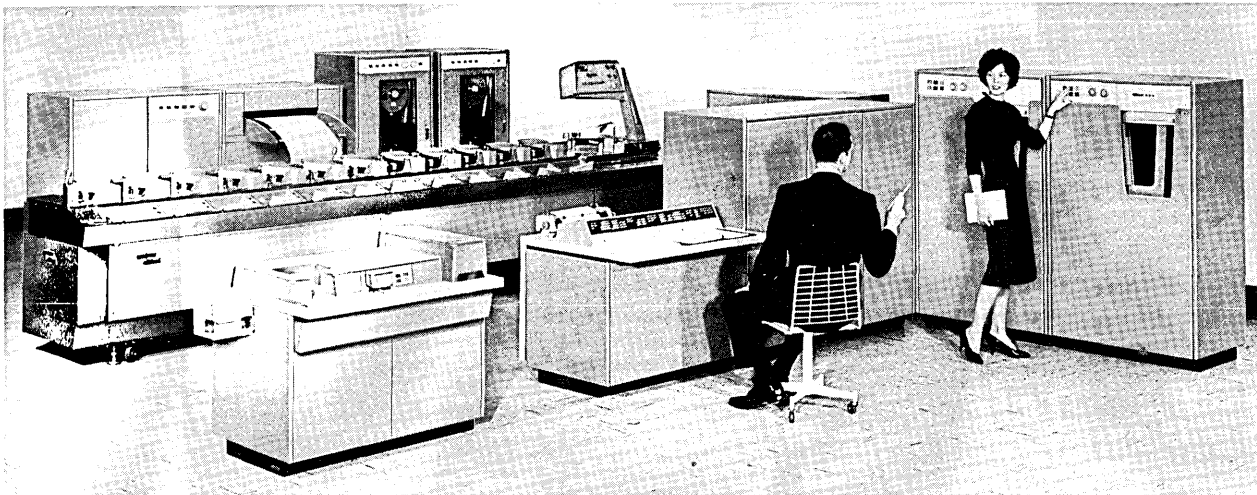

Electronic Data Processing System, Class 315 -- National Cash Register Co., Dayton, Ohio
 This solid-state computer accepts and delivers large volumes of information in all common business-machine media at high speeds. The main memory, the random-access file, the magnetic tape file, and the input and output systems are all variable in size or capabilities to fit closely the requirements of the user. Up to sixteen Card Random-Access Memory (CRAM) units may be incorporated in a 315 system. Using CRAM, the 315 system can process any number of special transactions in random order at any time.

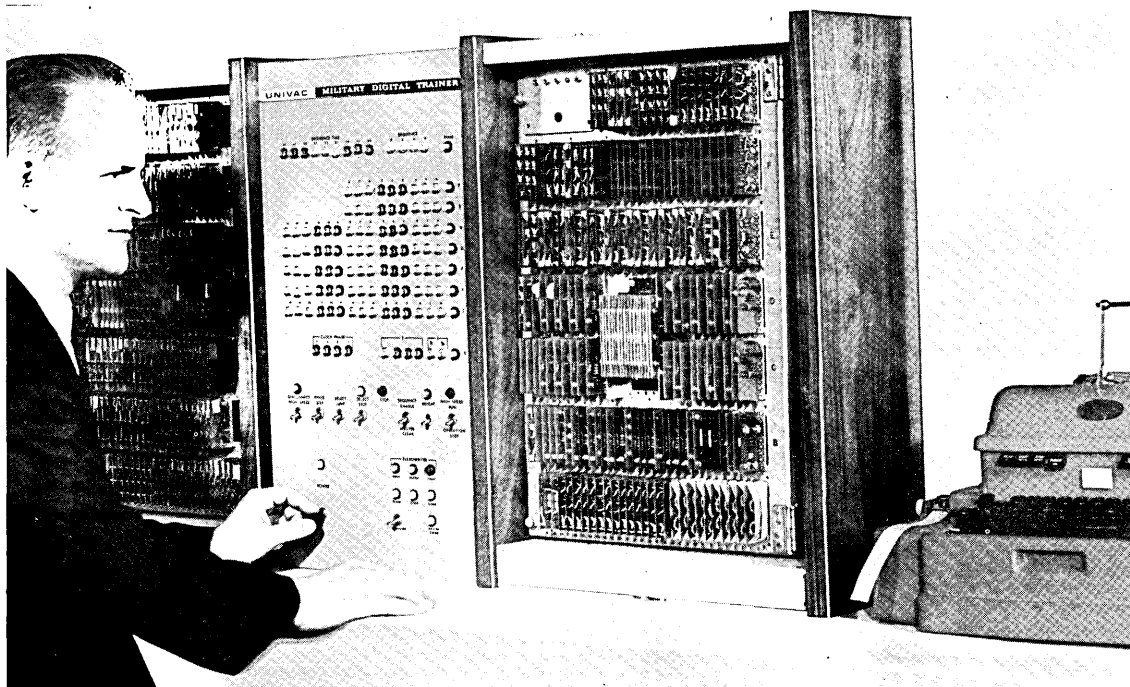

UNIVAC Military Digital Trainer -- UNIVAC, Div. of Sperry Rand Corp., Military Dept., St. Paul, Minn. This is a desk-size, 8-cubic-foot, binary computer with many large-scale computer characteristics. It has applications ranging from training in computer maintenance, design and programming to the solution of many data-processing problems. The Trainer includes: a high-speed magnetic core memory; single-address instruction repertoire; a complete console with all arithmetic and control registers, available on the panel for operator intervention and teaching procedures; a solid-state parallel-logic circuitry. The machine permits the instructor to demonstrate all elements of larger computers.

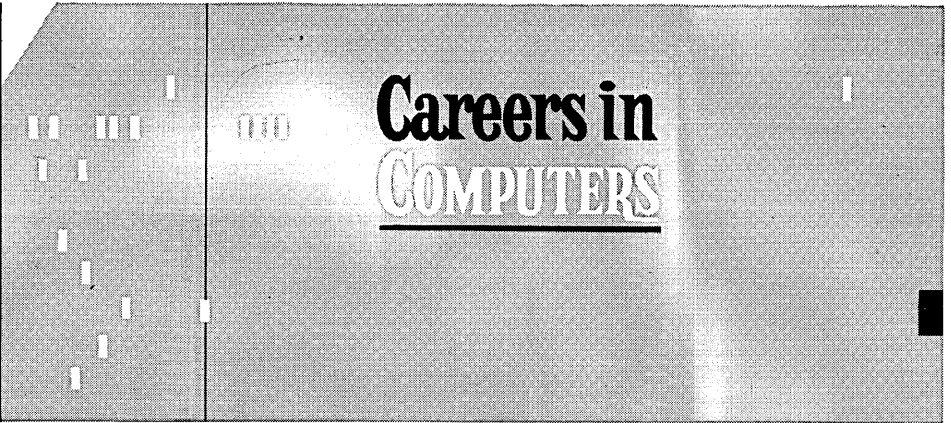
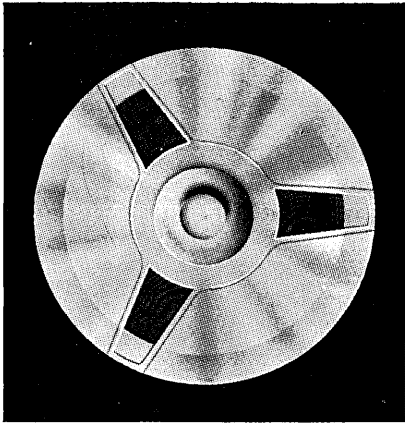

COMMUNICATIONS ENGINEERS

Experienced in Telegraph Systems, Data Transmission, Switching Systems, Transmission Systems, Communications Planning, to work on the development of new large-scale, communications based data processing systems for unique business and industrial applications.....\$17,000

SYSTEMS PLANNERS

Experienced in machine organization and design of multi-terminal business systems with particular emphasis in communications. Will specify optimum configurations of system components to solve actual and hypothetical problems. Degrees in Electrical Engineering, Mathematics or Physics.....to \$16,000

SYSTEMS-INDUSTRY ANALYSTS

Experienced men with particular "industry" background. Ability to determine the proper data processing system for a specific industry or determine if a unique system should be designed. Should have knowledge of at least one computer manufacturer's equipment and the capabilities of such equipment.....to \$15,000

PROGRAMMERS

Experience to include programming on large scale equipment with programs and applications of a Business, Scientific, or Engineering nature. 7090 experience preferred.....to \$13,000

Our client, a leader in the data processing field, is presently expanding a major division (East Coast location). Professionals whose interests and qualifications are in the above areas, please submit complete resume with salary requirements to:

DATAMAN*
ASSOCIATES
PERSONNEL CONSULTANTS

6 Beacon St., Boston, Mass. - Richmond 2-1932

*DATA MANAGEMENT...Recruiting Specialists for Data Processing and Computer Personnel Exclusively.

Contact A. J. Girdis
during EJCC at the
Sheraton-Park Hotel

Automated Information-Processing Assistance For Military Systems

PART 2

M. O. Kappler
President
System Development Corp.
Santa Monica, Calif.

Component Design

Once the operating-system description is available, the component producers can set component design requirements. The operating-system description allocates among the various components the task which the system must perform. It does not, however, specify in any detail the design of the component which will accomplish the task. The operating-system description states these requirements in functional terms. It may, for example, stipulate that the transmission equipment must be able to handle messages of X word length from Y sources at the rate of Z words per minute. Or it may say that the computer must have a storage capacity of X words, a buffering system with Y capacity, and so on. It is the component designer who must specify how his component will fulfill the requirements specified in the operating-system description.

It is important to note once more the interdisciplinary approach required in system design. Not only must the system designers be able to see interactions and interrelations implied by the system but they must thoroughly understand the capabilities and characteristics of each component. This enables them to allocate tasks effectively and to specify the requirements for each component in appropriate language and detail.

IMPLEMENTING THE SYSTEM DESIGN

In the preceding section, we saw how a system plan or blueprint is designed. The next step is implementing the design. Words must be transformed into buildings, equipment, communications facilities, computer programs, trained people, and myriad other parts and pieces and all these elements must be combined as an integrated, functioning entity—the system. Several of these key elements in the implementation are perhaps less well understood than the rest. They are computer programming, development of methods and procedures, system training and exercising, and the formulation of organizational requirements.

In the first part of this article printed in the November issue the author defines "automated information-processing assistance" as the use of high-speed digital computers together with their related equipment and computer programs as a tool in the performance of a job. His "military system" includes not only the set of equipment, but also the men who follow defined procedures to carry out a mission.

He gives examples of several automatic information-processing systems in use by the military. To illustrate how these systems are developed, he describes how a customer's statement of his problem is turned into a detailed list of performance requirements for the proposed system. He then outlines the steps in the system design procedure: (1) the close communication and study achieved by the system designers and the potential users, (2) the use of simulation in the development and validation of the system, and (3) the development of the operating-system description.

Below he describes the last step in system design (namely, the design of the components), and gives a thorough description of the implementation of the system design — from the computer-programming stage to system training and exercising.

Computer Programming

In an automated information-processing system, the computer program is a large and important element. A useful analogy in understanding the function of the computer program is the operations order which sends

a military aircraft on a mission. In this analogy, the aircraft is the computer and the operations order is the computer program. If the Commander is on a mission and discovers that the operations order is not satisfactory, he can change it. Similarly, if the information-processing assistance is not satisfactory, it can be changed, both before and after the operational date. An important case of this kind occurred in SAGE. At the very last minute, the need arose for early provision of automatic target assignment and battery evaluation (ATABE) for NIKE batteries. Other information-processing functions were compressed a little to make room in the computer, work priorities were adjusted, and ATABE soon became operational.

We achieve such flexibility in the information-processing aspects of these systems by using the iterative approach. Even after the system is operational, the functions supported by information processing can be revised by changes in the computer program. For the greatest flexibility to be achieved, however, the likelihood of such changes must be considered in the original design so that the facility for modification can be incorporated in the system. We must also consider the role of the computer program in terms of the hardware and in its relation to the human element and the imbedding organization.

Modern automated information-processing systems center around a general-purpose computer, "general purpose" because it can be used for many jobs. The general-purpose computer becomes a special-purpose machine when a special computer program is written for it. When we write a program for a special purpose, we give the machine that special purpose or capability. Later, if we write a new program, we give the machine a new purpose. In the case of a military system, our practice has been to write a set of perhaps twenty-five or thirty computer programs. Here, the general-purpose digital machine becomes twenty-five or thirty different special-purpose machines solving different problems or carrying out different data-processing functions. Sometimes the machine runs through a whole sequence of these in a few seconds. However, there is no necessity for it to go through this sequence in a fixed order. The order or timing may be varied according to the needs of the system. This is particularly important in SACCS where some jobs on the computer are for future planning and need not operate at any specific time while other jobs which involve real-time control of airplanes and missiles must operate on demand. We have solved the timing problem for SAC by developing an Executive Program which can interrupt whatever it is doing when a real-time control function is needed. Afterwards, it comes back to the original job. In addition, the Executive Program maintains a priority list of jobs to be done. It looks ahead and starts preparing for the next job before it has finished the one which is actually operating. An Executive Program has many applications in systems where computers would otherwise stand idle on the chance that a request for an emergency operation might be received.

This Executive Program is written in an advanced computer language called JOVIAL. JOVIAL is an SDC-designed language which makes it possible to write computer programs in English words and the

familiar notations of algebra and logic. This allows even inexperienced programmers to write and test programs in a fraction of the time previously required. Because of its wide applicability, JOVIAL is well suited for scientific problems involving numeric computation, for business problems involving large data files, and for logically complex problems involving symbolic data. JOVIAL made an early SACCS capability possible by allowing computer programs to be written for any computer (including the IBM 709, IBM 7090, the AN/FSQ-31, and the Philco S 2000).

No matter what the language, however, the detailed process of program formulation must be accomplished before the first program instruction can be written. Formulation is the process of translating operational concepts into mathematical functions that can be used by the machine. For example, in SAGE, certain hostile aircraft tracks are assigned according to defined assignment criteria. These criteria have to be translated into a mathematical model which permits the machine to compare the position of a hostile aircraft with the assignment model and make the assignment if the criteria are satisfied. Obviously, the program formulator must have a detailed understanding of operational procedures and equipment performance. (This is one of the reasons why we consider it important to include programmers on our design teams.)

After the problem has been formulated, we are ready to write a program. A computer program is no more than a set of step-by-step instructions which the computer will follow just as a man follows instructions in carrying out some assigned task. Suppose we want to make a display on a panel. If we call on a man to make the display, we tell him to write—for instance—ALERT on the blackboard and he does so. However, if we want the computer to make the display, the instructions have to be considerably more detailed. In the first place, we have to tell the computer that we want the first letter to be 10 inches from the left-hand side and 14 inches from the top. Then we have to say what the first letter is. Next, we must say that we want the second letter 14 inches from the top and 11 inches from the left-hand side. We have to describe each letter, a very laborious process. This is one of the difficulties with data-processing assistance in the present state of the art. Methods of communicating with the machine are not optimum from our viewpoint. We have to do much, much more than tell the computer to put ALERT on the panel. We have to write out a very detailed description (the computer program) of what we want done.

Unfortunately, our knowledge of all military operations is not as complete as our knowledge of how to write ALERT on the blackboard. Military operations are infinitely more complicated and a great deal of effort is required to deal with the information-processing problems they present. We have to formalize what we want to say and then say it with great precision, especially when we express it in computer language. In many cases, we are unable to write the program in a fashion that will enable the machine to assist us as completely as we should like—particularly when intuition and judgment are involved. When this happens, our usual procedure is to let the program operate up to a certain point. Then a man reads the

machine's display, takes some sophisticated action, reports this to the machine, and the program carries on. We use the man as a mechanism because no one knows at present how to design a program that is clever enough to do this particular job without using too much time or too many instructions to the computer.

There is no magic in writing a computer program. The specificity necessary in computer programming requires a great volume of instructions, but it is an orderly process. We would have no difficulty in writing a computer program telling the machine to display ALERT if we knew the details of the mechanism of getting the letter down 14 inches and over 10. However, there is a difficult problem associated with specifying precisely the military activity for which automated information-processing assistance is needed.

There is another way to approach this problem and that is to learn to communicate with the machine in some manner different from the detailed fashion we now use. The JOVIAL language has significantly simplified communication with the computer. Not nearly enough attention, however, is being given to this kind of activity. The problem of getting a word description into machine language needs much more investigation. In spite of the modest research which has thus far gone into computer programming, our know-how has advanced a great deal. The number of people involved in writing the SACCS computer program is only a tenth of that required to write the original SAGE program even though the actual program is much longer. With additional research we can expect still further improvement.

Methods and Procedures

The computer program tells the computer what to do. Something is also needed to tell the men in the system what to do. The methods and procedures documents fill this need. These documents are essentially handbooks which tell each man in detail what he is to do in various situations.

For example, the operating-system description might say, "This message is to be routed by hand to the Director of Operations, Director of Materiel, Director of Intelligence, and the Commander." The methods and procedures document might detail this requirement as follows:

- a. Copy the messages from the status board onto five-part Form 6X512.
- b. Remove Copy 4 and file in central file.
- c. If message is Top Secret, prepare the standard hand receipts.
- d. Hand Copies 1, 2, 3, and 5 to a messenger to be delivered in the following order:

Commander
D/OPS
D/INT
D/MAT

Methods and procedures documents are useful in defining procedures and serve as excellent source material for training.

System Training and Exercising

The capability for training and exercising is still another factor which should be considered in the de-

sign of any system. A system-training capability for military systems is especially critical. Most military systems are built to do a job that we hope they will never have to do, that is, fulfill their mission under emergency or wartime conditions. We can permit such systems to flex their muscles with large-scale live exercises but live exercises are extremely expensive and cannot fully duplicate the expected threat. How, for example, can we mount a live exercise which presents a ballistic-missile attack against the Continental United States?

The answer to the need for system training lies in simulation. Realistic simulated inputs of great variety and complexity can be introduced which will simultaneously exercise all elements of the system. Our experience with system training programs for the manual system and the SAGE System has demonstrated that training through simulation can materially assist in preparing a system to face a variety of emergency or wartime conditions.

Training requirements should be formulated early in the design phase so that they can be incorporated in the equipments and the computer programs. Fitting a training capability into an existing system is far more expensive and usually less satisfactory than including the capability in the original design.

Organizational Requirements

Several automated military systems are currently in the conceptual stage. Few, if any, of the operating elements of these systems currently exist. Each system will be completely new. On the other hand, other large operating systems are currently being modified to incorporate information-processing assistance. In either case, the development of an operating-system description, the production of computer programs, the specification of equipment requirements, the detailing of methods and procedures, and the formulation of system training and exercising requirements all provide quantitative and qualitative job information. When a new system is being built, this information may be invaluable for forecasting how many people will be required, how their jobs should be organized, and what the job interrelationships should be. The introduction of automated information-processing assistance to existing systems will have an impact on organization, new jobs will be created, and existing ones will be changed or eliminated. Thus the formulation of an organizational structure is a key step in the development of an automated information-processing system.

CONCLUSION

Automated information processing is a powerful tool in a large military system. The design of a system which incorporates such information-processing assistance is an orderly process requiring an interdisciplinary team approach. The resulting design document, the operating-system description, is the plan or blueprint for implementing the system. Of the many implementation jobs, several are unique to automated information-processing systems; they are computer programming, development of methods and procedures, system training and exercising, and formulation of organizational requirements.

2. ANALOG COMPUTERS

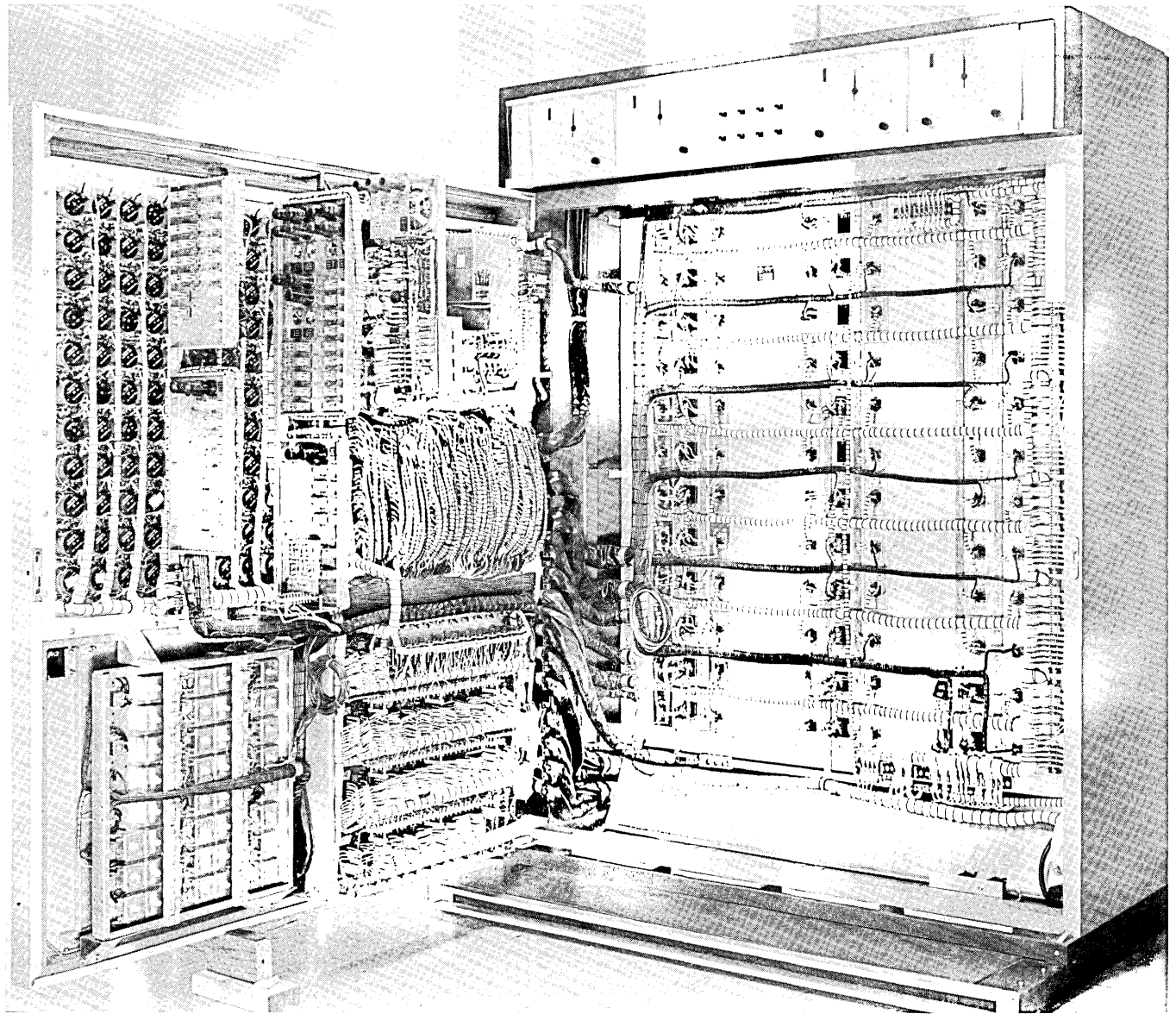

5800 DYSTAC[®] Iterative Analog Computer -- Computer Systems, Inc., Monmouth Junction, N.J. Because of its memory feature, the DYSTAC computer can follow iterative procedures by automatic transfer of stored results from one iteration to the next. Memory also permits time sharing of computer elements. There have been nine recent installations of this unit at such places as Daystrom, Systems Div., La Jolla, Calif.; Humble Oil & Refining Co., Baytown, Texas; and Case Institute, Cleveland, Ohio.

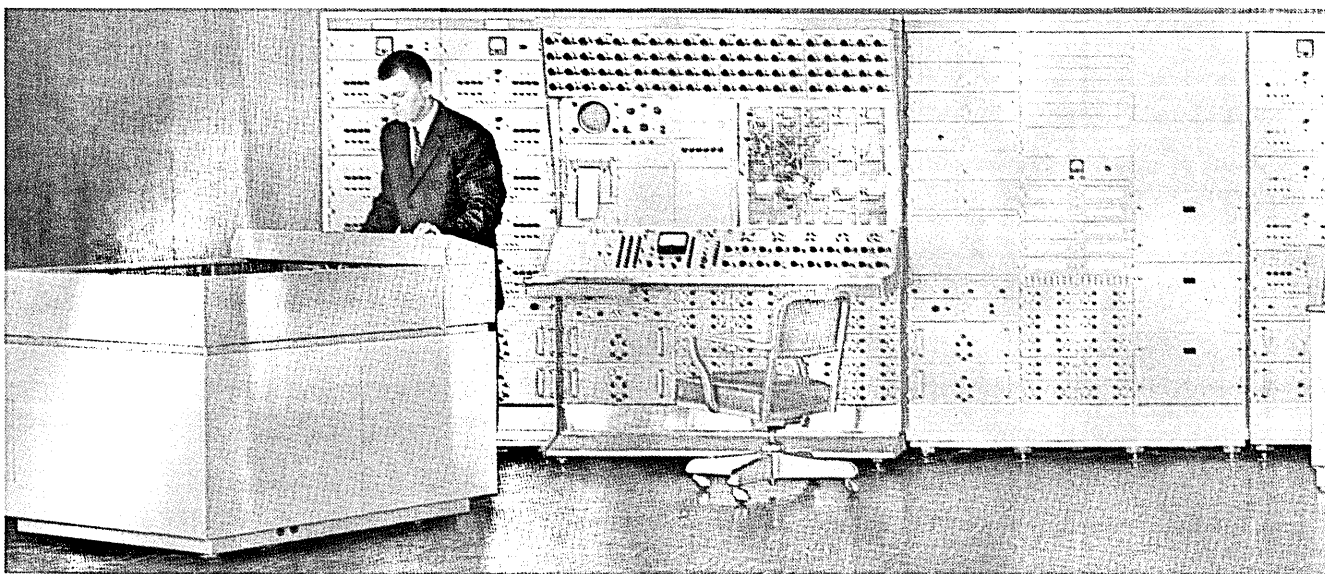

PACE 231R analog computer -- Electronic Associates, Inc., Long Branch, N.J. This general purpose analog computer may include 100 operational amplifiers (30 summer integrators, 45 summers, 25 inverters); 150 potentiometers; 10 multipliers; 20 diode-function generators; 5 resolvers; and 10 comparators. The unit comes with a flexible memory system for digital-type calculations. On the left a problem solution is being displayed on the Dataplotter® X-Y automatic plotter.

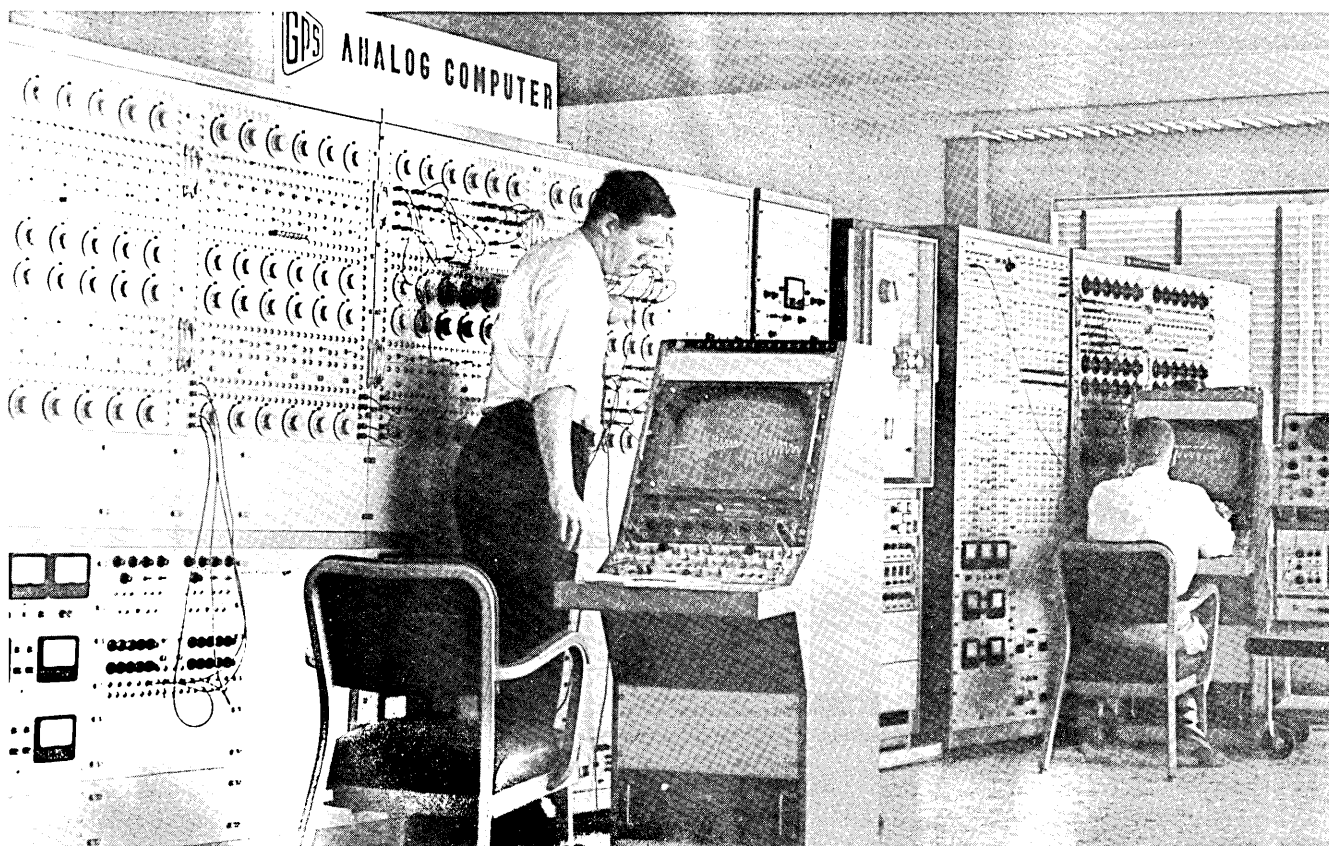

Statistical-Analog Computer -- GPS Instruments Co., Inc., Newton 64, Mass. In the foreground a vibration-damping problem connected with missile flight control is being solved. The basic GPS computer, assembled for repetitive mode calculations, can operate on a compressed time-scale of 3000 to 1. The computer is a general-purpose analog machine with some digital capabilities. It features a one megacycle bandwidth.

In
in
di
su

CO

ANALOG COMPUTING

TYPICAL PROBLEM: Calculate % Conversion in Reactor

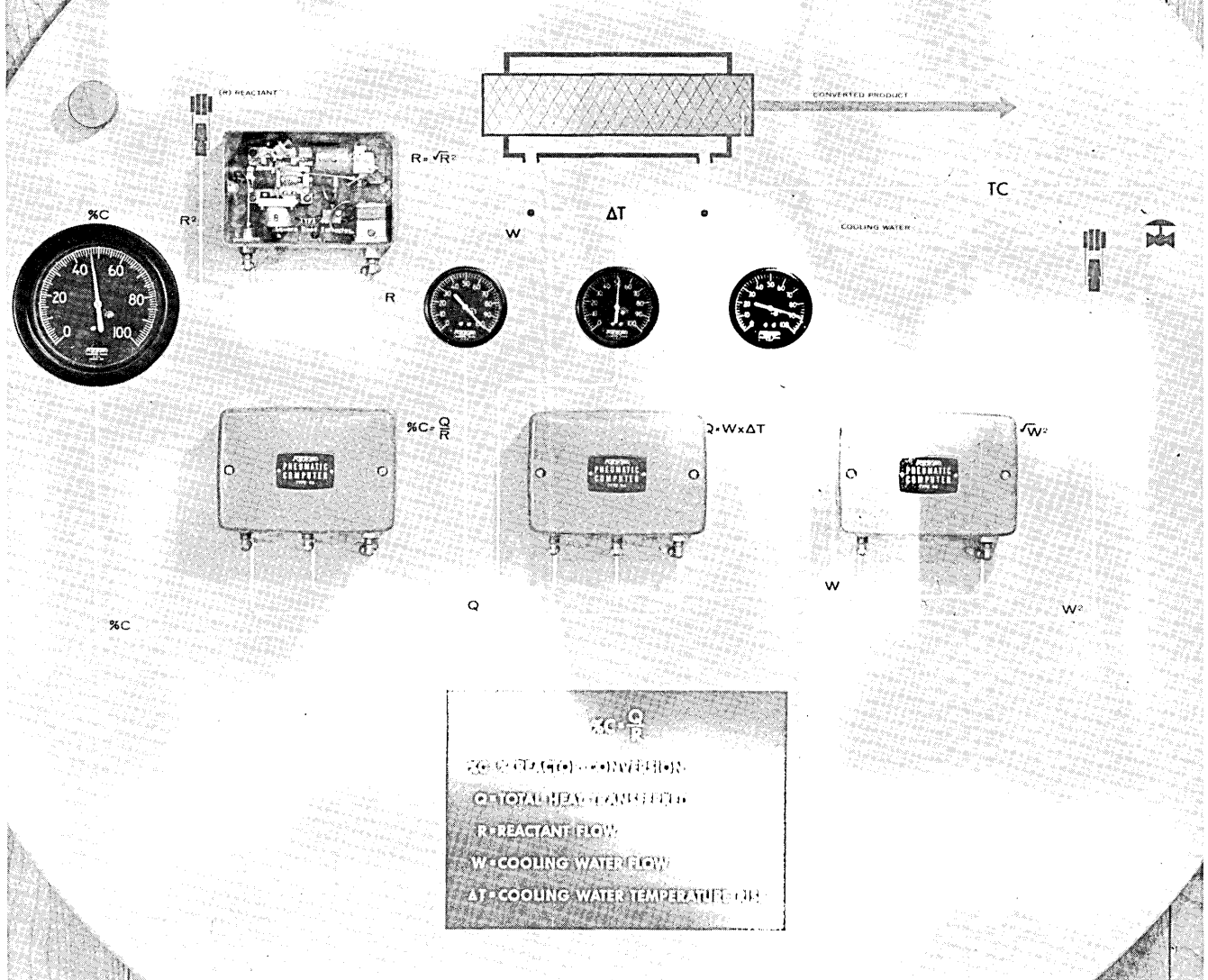

Here is an Analog Computing display shown by The Foxboro Company, Foxboro, Mass., at a Chemical Show in November. It presents a typical chemical processing calculation and a method of solving it with pneumatic analog computing units. Only simple read-out gauges and four Foxboro Type 46 pneumatic computing instruments are required. At the upper left and lower right are square root extractors which are used to extract the square root from the measurements of reactant and cooling water flows. The center instrument is a multiplier which multiplies cooling water flow by cooling water temperature rise, giving total heat transferred to the cooling water per unit of time. At the lower left is the divider that divides total heat transferred by reactant flow. System output, read on the gauge at the left, is in terms of percent reactor conversion. In actual practice, the gauge could be made to read in BTU per pound of reactant or other convenient units.

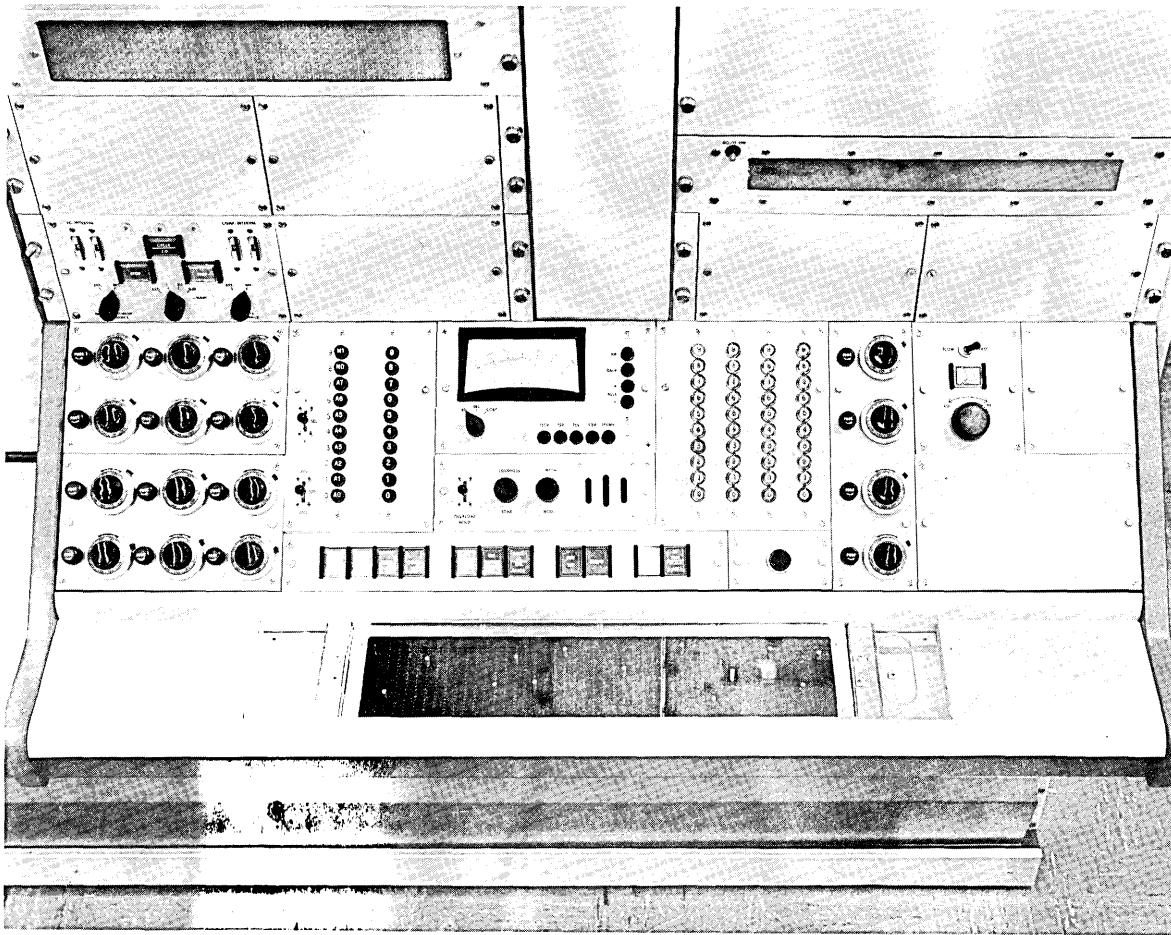

Control Console for EASE Analog Computer -- Beckman Instruments, Berkeley Division, Richmond, Calif. This new control panel allows push-button location and control of operational elements of the EASE Analog Computer. The unit is designed to complement the iterative differential analyzer function of the latest series of the analog computer. A removable pin board for ease of programming is shown in the foreground of the console.

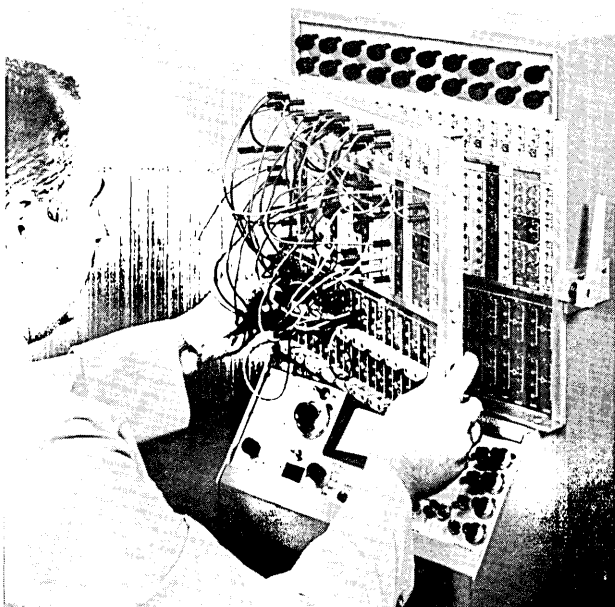

TR-10 Desk Top Analog Computer -- Electronic Associates, Inc., Long Branch, N.J. A computer operator installing a pre-programmed removable patch panel on the EAI TR-10 transistorized desk-top size general purpose analog computer. Each patch panel, programmed for a different problem, can be installed in less than one minute. This allows almost continuous operation for this unit, claimed to be "the engineers' new slide rule".

Cont
 -- A
 unit
 Seri
 the
 asso
 Incl
 cuit
 quer
 also
 prov
 syst
 char
 exp
 cia
 is 1

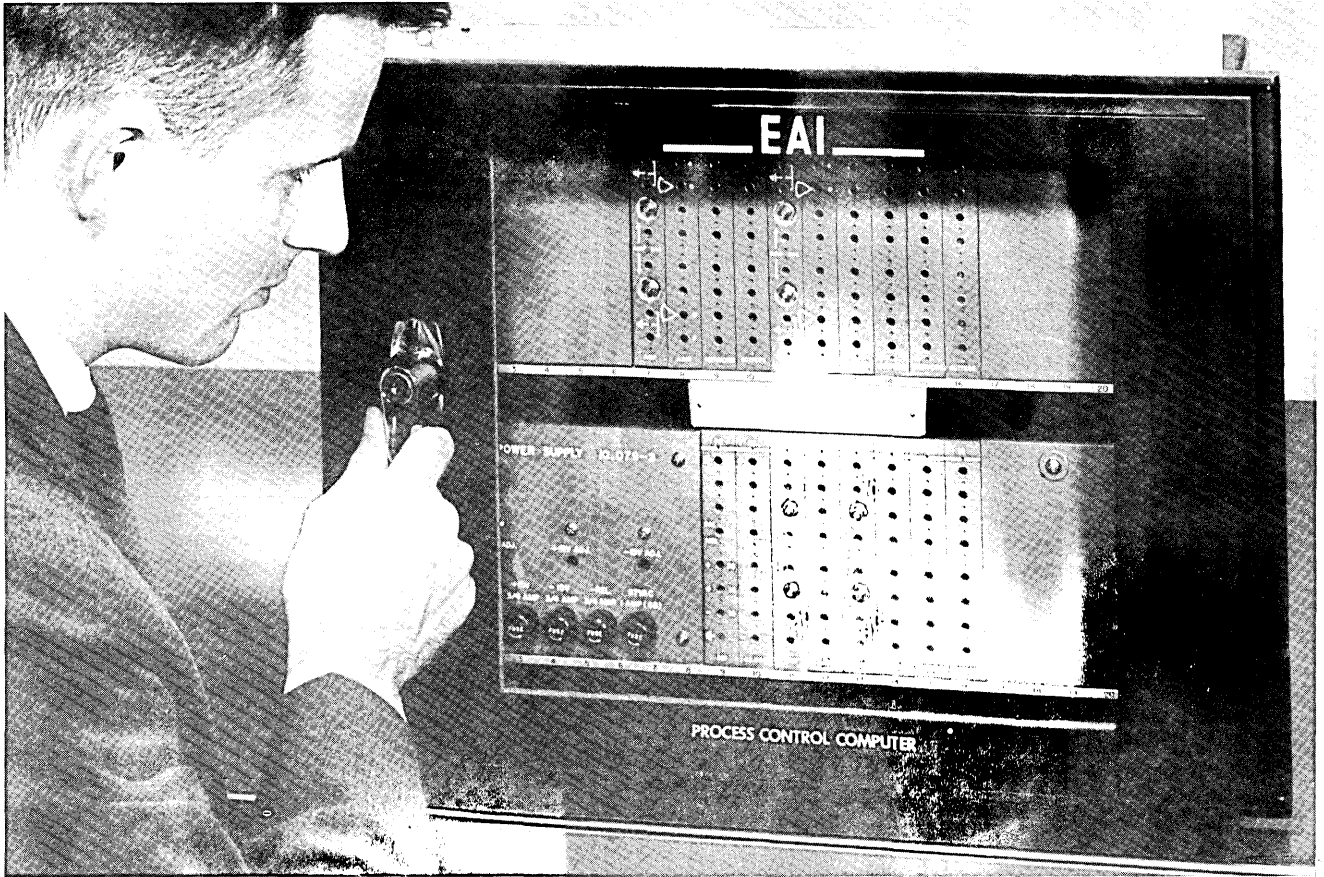

Analog Process Control Computer PC12 -- Electronic Associates, Inc., Long Branch, N.J. Computers of this type are assembled from stock: solid-state, modular-design components. The computers meet specific requirements of chemical, steel, and other industrial processes. During assembly components are permanently programmed to fit the specific application, ready for on-line installation.

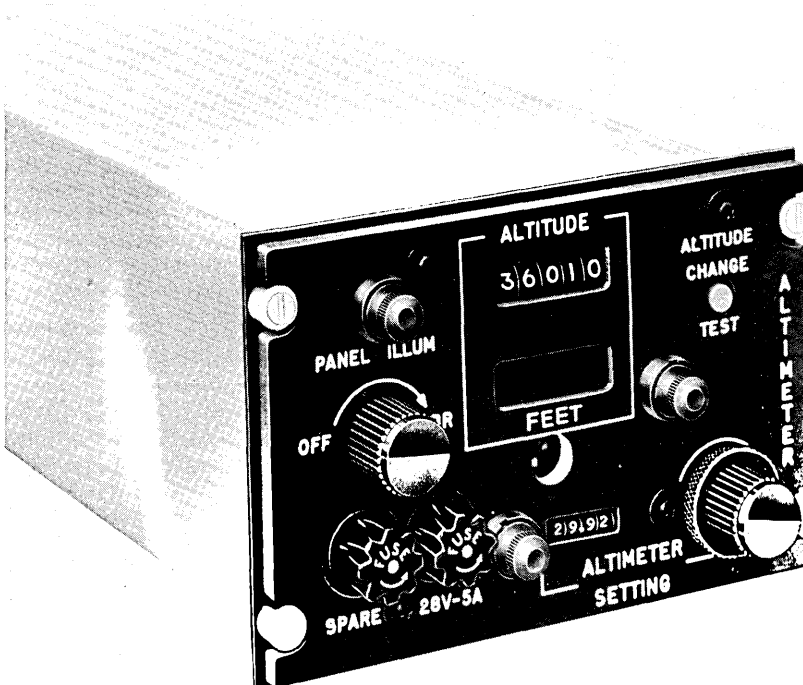

Precision altitude computer Guidance and Control Systems Div., Litton Systems, Inc., Beverly Hills, Calif.--This is an accurate and rugged altitude computer. It requires only 21 square inches of panel space. Its accuracy in an aircraft environment is within $\pm 0.05\%$ of full-scale pressure; thus at 30,000 feet, indicated altitude is within 20 feet of actual altitude.

Missile Program at Cape Canaveral Supported by Advanced Computer Supply System

D. H. Addiscott
Mgr., Electronic Data Processing
Pan American World Airways
Cape Canaveral, Fla.

For the big missiles to lift from their pads at Cape Canaveral and soar more than 5,000 miles down the Atlantic missile range, an army of men and machines must move into action.

Part of the story of this missile-age task force involves a computer system — one of the most comprehensive of its kind — set up by Pan American's Guided Missiles Range Division to control and schedule supply operations throughout the entire range. The computer system, in effect, maintains a full pipeline of vital supplies and equipment from Cape Canaveral down to Ascension Island — and beyond into the South Atlantic.

Pan Am's IBM computers, located at Patrick Air Force Base in Florida, have on their random access disks and magnetic tapes a wide variety of information about some 190,000 stocked and non-stocked items representing a \$12-1/2-million inventory. The system, however, is far from a straightforward inventory problem. It is a vital link in one of the most massive and important undertakings of the American space program.

Rarely have so many complex items, needed by so many people in such a short period of time, been entrusted to one electronic system. But despite the complexity of the problem, the system is a proved success.

History

To get an idea of just why the system is so complex, let's take a brief look at the Cape and its missile range:

As missile research progressed after World War II, it became apparent that a testing area would be required for long-range vehicles. After careful consideration, the Defense Department settled on Cape Canaveral, a barren wedge of land jutting out from Florida into the Atlantic.

In 1953, the Air Force Missile Test Center awarded a contract for operation of the range to Pan American World Airways. The same year, the Guided Missiles Range Division came into being, assuming responsibility as prime contractor to the United States Air Force for the management, operation and maintenance of the 5,000-mile missile test range.

Since that date, Pan Am's GMRD has undergone rapid growth. The full goal of the missile range became a reality in October, 1957, with the activation of posts on Antigua and Ascension Island. Today, this support activity takes in ten downrange bases, six specially fitted floating range instrumentation vessels, and 24 stock issue locations at the Cape and Patrick Air Force Base.

Variety

One of the amazing parts of this operation is the wide assortment of supplies and services Pan Am's GMRD must provide. Missile tests mean high-voltage and high-pressure lines to the pads, hangars and machine shops; storage areas and magazines for highly volatile fuels and pyrotechnics. It also means wells, water plans and power stations; garages, warehouses and medical facilities. A typical downrange station needs, besides

complex tracking and recording gear, bottle-gas storage plants, a laundry, maintenance shops, supply store, weather station, barracks, administration and control buildings. In short, all the facilities of a city-sized community engaged in ultra-technical activities.

Circumventing Delay

In addition to the supply of a tremendous assortment of items to widely separated points, there is one other critical element in Pan Am's operation: the system must make certain that no missile shoot is ever delayed or hampered by a supply problem. And here is where the IBM computers come into play.

Twenty reels of magnetic tape hold the key to the supply system. These master tape records contain pertinent information on some 190,000 different items. This tape data runs the gamut from source, current balance, and price to a detailed record of past usage — in effect, just about every factor needed by GMRD to keep close tabs on the item.

The information on these tapes — and on the random-access disks of an IBM computer — is in a constant state of flux. 24 hours a day, 7 days a week, data flows into the computer center at Patrick Air Force Base, by hand, courier, mail, and IBM Tele-processing equipment. About 2,500 requisitions a day are handled by the center, with some 8,000 to 10,000 other transactions processed by the system. Once requisition slips are punched into IBM card form, all the other documents in the system are produced automatically. Thus, the accuracy factor is maintained at an all time high simply because manual transcribing is at an all time low.

The principal equipment in Pan Am's GMRD supply system has been an IBM 650 computer with three RAMAC disk files and a tape data selector. IBM Tele-processing equipment and a teletype network link this installation to some of the range bases and to Army and Air Force supply depots.

The system, however, now is being augmented by newer, more powerful solid-state equipment. An IBM 1401 has replaced the tape data selector, simultaneously absorbing new accounting applications. Two 1401 card systems will replace much of the present peripheral equipment, speeding off-line operations. Finally, a powerful 1410 computer with 40,000 positions of core storage will take over the 650's duties. A new IBM RAMAC disk file, pro-

viding random access to twenty million digits of information then will be linked to the 1401 tape system. The GMRD will do essentially the same job with the newer equipment; but it will do it faster and more economically than before.

Automatic Processing of Supply Transactions

Present or future, the system is designed for automatic control and processing of virtually all supply transactions. When a requisition goes into the computer, the system finds out — in seconds — if enough stock is on hand to fill the order, where the stock is located (down to the very bin), and just how much is available in each warehouse and stockroom within the entire 5,000-mile range complex. The computer then prepares a material release to the appropriate stock room, where the order is filled and sent to the requisitioner.

The system constantly checks to make certain that stock levels are at an adequate point. If a requisition causes the level to fall below a previously determined minimum point, then the computer system will automatically generate a purchase order. As a result, the system provides a margin of safety for the entire missile program — and eliminates supply recordkeeping at each of the bases.

Purchase orders printed out by the system are forwarded to Procurement and then sent to the proper vendor for purchase. To expedite certain items, the GMRD computer center at Patrick Air Force Base in Florida (near Cape Canaveral) is linked to Robbins Air Force Base in Macon, Ga., by IBM Transceivers. This Tele-processing equipment automatically transmits computer output cards to the supply depot without manual transcribing.

Interrogation

While the requisition-to-order cycle is going on, the computer also is storing key data on its RAMAC disks. In the present system, one RAMAC unit contains data pertaining to customer requisitions. At any time — even in the midst of a processing operation — the computer can be interrogated for answers to queries concerning document number, status of requisition, amount wanted and similar data.

Another RAMAC file contains "due-in" information which shows the exact status of each purchase order. In less than 15 seconds, overdue and

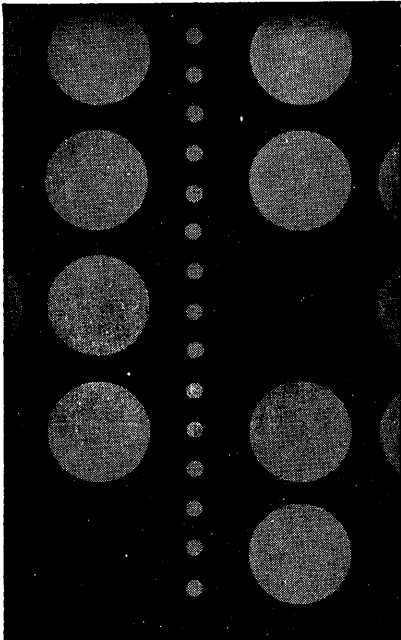

COMPUTER SYSTEMS ENGINEERS

SALARY: TO \$20,000

Several immediate openings exist at Hughes-Fullerton for Computer Systems Engineers qualified in the design and testing of large scale digital systems—and in the preparation of proposals for large scale digital computers.

These professional assignments involve such R & D areas as:

- Solid state digital circuitry involving millimicrosecond logic
- Microwave carrier digital circuits
- Sub-microsecond core memory
- Thin film storage techniques
- Functional circuit concepts
- Micro-miniaturization concepts
- Tunnel diodes ■ Microwave parametrons ■ Circuit organization for maximal-speed computing.

Located in Southern California's Orange County (the nation's fastest growing electronics center), Hughes-Fullerton offers you: a stimulating working environment; private or semi-private offices; long-term stability.

CALL COLLECT TODAY!

For complete information on these challenging assignments, call us collect today! Ask for:

**Mr. B. P. RAMSTACK at:
TRojan 1-4080, ext. 3741.**

Or, airmail resume to: HUGHES-FULLERTON R & D, P. O. Box 2097, Fullerton 1, California.

At Hughes, all qualified applicants will be considered for employment without regard to race, creed, color or national origin.

HUGHES

HUGHES AIRCRAFT COMPANY

outstanding orders can be ascertained, traced and follow-up procedures instituted.

This inquiry feature — made possible by the random access memory — has proved to be one of the most important attributes of the system. At present, upwards of 1,000 questions regarding supply are put to the computer each day — and answered in detail. In fact, there is hardly a facet of the supply system supporting the Cape Canaveral missile range that cannot be answered through the facilities of the IBM computer.

Other Jobs

The overall system, however, is programmed to do many other jobs as well: from the stored records of past usage, for example, the computer adjusts stock level points to conform with the activity of the item. Thus, GMRD is assured that a sudden demand for an item will be taken into consideration by the computer and, if necessary, supply levels will be increased to meet it.

Another result of computer processing is the transfer of supplies from one warehouse to another when the stock level is disproportionate.

The system also conducts automatic checks to make certain that an item number hasn't been supplanted by a new number. This means that the system meshes intimately with the government's own supply system. It also assures that only the latest model of an item will be shipped to the customer.

Although there are many factors which can delay a missile firing, supply is not one of them. Pan Am's Guided Missile Range Division, using advanced computing techniques, is providing efficient and effective support service to one of our nation's most important undertakings.

The in
proces
govern
facilit
system
cessin

The ba
sion o
plish
in da
the pr
data
sis w
stres
tempt
istin
will
of the

COM

A.

In th
tions
ated
tual
are p

The m
deter
tions
time
outlin

Some
descr
the p
commu

J.

The c
the S
the us
close

An exp
simul
for a
is ch
final
can b
check

A comp
SOL (S
the g
grams

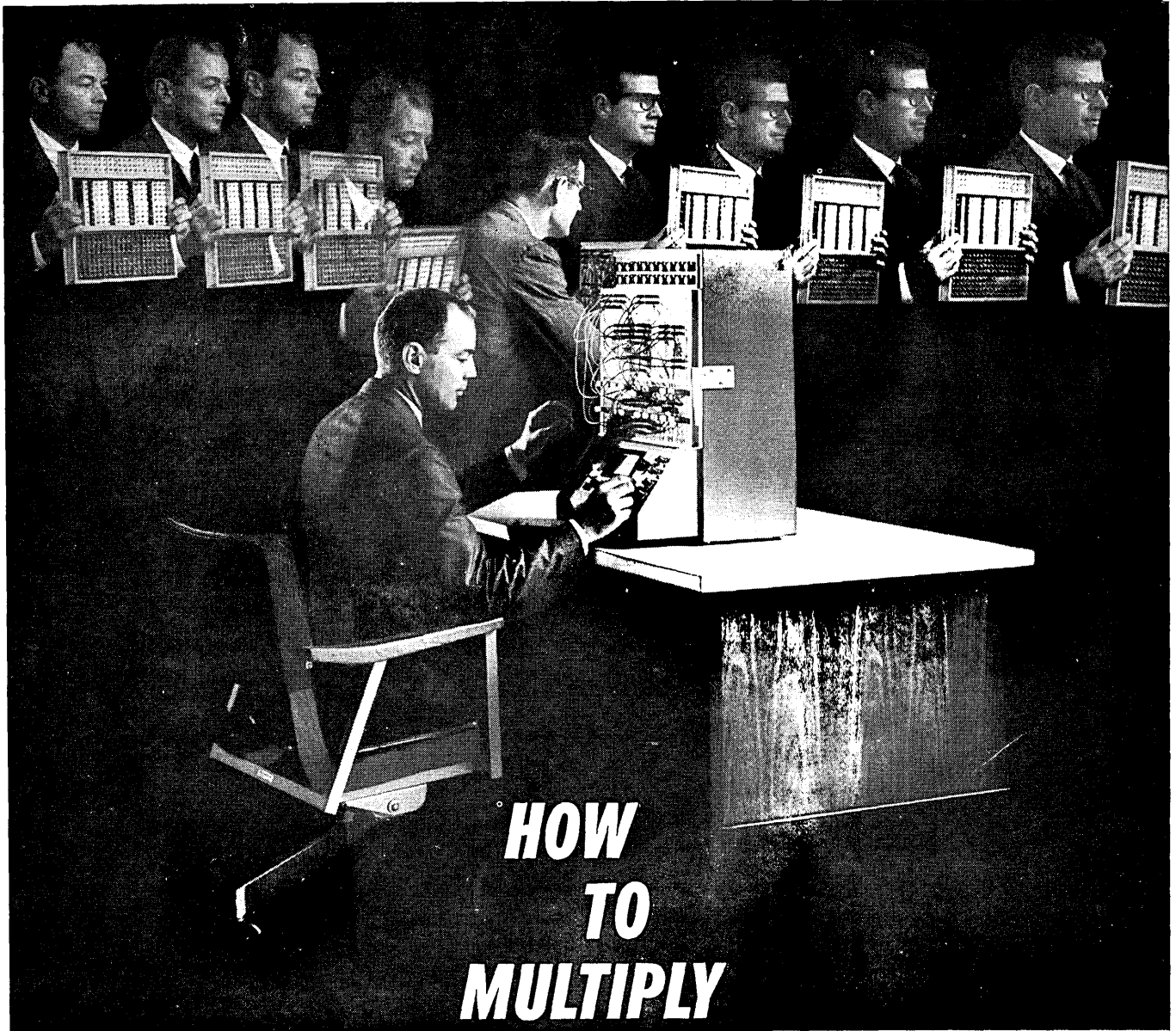

HOW TO MULTIPLY ENGINEERS

One engineer and an EAI PACE® TR-10 transistorized desktop analog computer can be the equal of several men limited to conventional design tools. The TR-10 multiplies the design capabilities of the most able engineer. One TR-10, equipped with a removable patch panel, will serve the needs of a roomful of engineers. This new patch panel permits pre-patching of programs away from the computer. It plugs into the computer instantly — valuable computation time is conserved. ■ Versatility of the TR-10 is unequalled. Unique simplicity makes it excellent for students or engineers unfamiliar with analog techniques. Accurate to a tenth of one percent, the TR-10 performs admirably for the experienced user in 95% of routine engineering problems. And with High-Speed Repetitive Operation added, or with several units slaved to operate as one, the TR-10 meets the demands of many advanced applications. ■ For technical data on this almost infinitely versatile computer, write for Bulletin No. AC 934.

Visit us at Booths 81, 82, 83 at Eastern Joint Computer Conference

Career Opportunity for Engineers — Graduate or advanced degrees in EE, Physics, Math — call or write Gordon Strout, Director-Personnel

EAI

ELECTRONIC ASSOCIATES, INC. Long Branch, New Jersey

Leader in Analogics Analog/Digital Computers Data Reduction Process Control Instruments Computation Service

ROSTER OF ORGANIZATIONS IN THE COMPUTER FIELD

(Supplement, information as of November 15, 1961)

The purpose of this Roster is to report organizations (all that are known to us) in the computer field: organizations making or developing computing machinery or data-processing machinery; organizations supplying services in the computer field; and organizations supplying components used in the computer field if related to the field (for example, magnetic drums would be such a component).

This listing is a supplement to the last cumulative roster published in the June, 1961 issue, "The Computer Directory and Buyers' Guide".

Entries. Each Roster entry if complete contains: Name of the organization, its address / Telephone number / Description of its main activities, main products in the field, any comments / Types of activities it engages in, size (expressed in number of employees), year established, nature of its interest in the computer field. In cases where we do not have complete information, we put down what we have.

Accuracy. We have tried to make each entry accurate to the extent of information in our possession. We shall be grateful for any more information or additions or corrections that anyone is kind enough to send us. Although we have tried to be accurate and complete, we assume no liability for any statements expressed or implied.

Abbreviations

The key to the abbreviations follows:

Activities

- Ma Manufacturing activity
- Sa Selling activity
- Ra Research and development
- Ca Consulting
- Ga Government activity
- Pa Problem-solving
- Ba Buying activity
(Used also in combinations as in RMSa "research, manufacturing and selling activity")

Size

- Ls Large size, over 500 employees
- Ms Medium size, 50 to 500 employees
- Ss Small size, under 50 employees
(no. in parentheses is approx. no. of employees)

When Established

- Le Long established organization (1930 or earlier)

- Me Organization established a "medium" time ago (1931 to 1950)
- Se Organization established a short time ago (1951 or later)
(no. in parentheses is year of establishment)

Interest in Computers and Automation

- Dc Digital computing machinery
- Ac Analog computing machinery
- Ic Incidental interests in computing machinery
- Sc Servomechanisms
- Cc Automatic control machinery
- Mc Automatic materials handling machinery

*C This organization has kindly furnished us with information expressly for the purpose of the Roster and therefore our report is likely to be more complete and accurate than otherwise might be the case. (C for Checking) / 61: information furnished in 1961 / 60: information furnished in 1960 / etc.

Organization Entry Form

The form to be completed for an entry in the Roster of Organizations follows:

1. Your organization's correct name? _____
2. Street address? _____
3. City, zone state? _____
Telephone number? _____
4. Types of computers, data processors, accessories, components, services, etc., that you produce or offer? _____

5. Types of activity that you engage in:
() Research
() Manufacturing
() Selling
() Consulting
() Other (please explain) _____
6. Approximate number of your employees? _____
7. Year organization was established? _____
8. Listings for two of your executives:
Name & Title _____
Name & Title _____
This data supplied by _____
Title _____ Date _____

Input
tences
ployed
tive s
by dem
gressi

THE

Moder
H.
C
D

Panel
C.
ing
Com

A.
l
A

R.
C
t

R.
D
C

Englis
has al
in pro
mercia
busine
chines
guage,
scient

ASA Su
ISO/TC
of gen
progr

The s
eral
autho
langu

Ses

Motor

This
for
and

COM

ROSTER

- Advanced Scientific Instruments, Inc., 5249 Hanson Court, Minneapolis 22, Minn. / KE 3-2051 / *C 61
Computers. Digital instrumentation. Scientific and engineering computations; on-line and off-line process control and data processing / RMSa Ms(50) Se(1961) DIc
- AiResearch Mfg. Co. of Arizona (a div. of the Garrett Corp.), 402 S. 36th St., Phoenix, Ariz. / BR 5-6311 / *C 61
Pneumatic analog computers / RMSa Ls(3600) Me(1950) Ac
- American Data Machines Inc., 7 Commercial St., Hicksville, L. I., N. Y. / WE 8-9800 / *C 61
Data integrators, card reading devices, card punch machines, attendance recorders; generally data collection equipment / MSa Ss(25) Se(1961) Ic
- Asbjorn Habberstad A/S, Konowsgt. 8, Oslo, Norway / Oslo 67.47.80 / *C 61
Management consultants specializing in management science and all problems of data processing with punch card machines or electronic computers / Ca Ms(70) Me(1940) DAc
- Astrometrics, Inc., 1108 Santa Barbara St., Santa Barbara, Calif. / WOODland 5-0931 & 965-0406 (all-number call) / *C 61
Electronic commutators, FM receivers (telemetry), Servosound high-fidelity audio systems, Articulator audio system (intelligence improving receiving equipment), no-moving parts recorder and playback system, low-level amplifiers, etc., automatic data processing systems, telemetry systems, amplitude probability-density analyzer system / RMSa Ss(9) Se(1957) DAic
- Auerbach Corporation, 1634 Arch St., Philadelphia 3, Pa. / LOCust 3-7377 / *C 61
Information sciences and technology. Systems engineering, equipment development, programmed teaching, product and market planning, operations research, business systems consultation, programming / RCa Ms(100) Se(1957) DAic
- Bull Corp. of America, 521 5th Ave., New York 17, N. Y. / YUKon 6-9966 / *C 61
Punched card equipment, data processing systems, electronic gamma computers / MA ?s Se(1960) Ic
- The Bureau of National Affairs, Inc., 1231 24th St., N. W., Washington 7, D. C. / FE 3-6800 / *C 61
Reports on electronic data processing / publishing Ms(300) Me(1933) Ic
- Cadre Industries Corp., 20 Valley St., Endwell, N. Y. / PI 8-3373 / *C 61
Cable harnesses / RMa Ls(1300) Me(1950) Ic
- Cognitronics Co., Treasure Hill, Pleasantville Rd., Briarcliff Manor, N. Y. / ROgers 2-0100 / *C 61
— / RMSa Ss(22) Se(1961)
- Commercial Computers Inc., 36 Pleasant St., Watertown 72, Mass. / WA 6-0335 / *C 61
Small desk top computers, digital modules / Ma Ss(6) Se(1961) DIc
- Compu-Center Corporation, 136 West 52nd St., New York 19, N. Y. / CI 5-8806 / *C 60
Consulting, analysis, training, programming, and programmers on a contractual basis, as well as assisting in, or assuming complete responsibility for a short or long-term computer effort / RCa Ss(5) Se(1960) Ic
- Computer Concepts, Inc., 1012 14 St., N. W., Washington, D. C. / 783-7215 / *C 61
Advanced programming systems, machine translation / Ca Ss(35) Se(1961) Ic
- Computer Equipment Corporation, 11612 W. Olympic Blvd., Los Angeles 64, Calif. / GR 9-4131 / *C 61
Digital data acquisition systems; range instrumentation; time sequencing systems. Time-to-digital converters. Computer-formatting systems / RMSa Ms(60) Se(1958) DIc
- Computer Usage Co., Inc., 18 East 41 St., New York 17, N. Y. / MU 9-7672 / 1825 Connecticut Ave., N. W., Washington 9, D. C., NO 7-7225 / 6266 Manchester Blvd. (at Sepulveda), Los Angeles 45, Calif., OR 0-7246 / *C 61
Digital computer systems; analytical and programming services; data processing; scientific programming; automatic programming; computer times sales on IBM 7090, 7070, 705, 1401, 704, in New York and Philadelphia areas / RSCa Ms(102) Se(1955) Dc
- Computron, Inc., 122 Calvary St., Waltham 54, Mass. / TW 9-0880 / *C 61
Manufacturers of magnetic data processing and instrumentation tape / RMa Ss(25) Se(1960) Ic
- Control Electronics Co., Inc., 10 Stepar Place, Huntington Station, L. I., N. Y. / HAMILton 7-7961 / *C 61
Delay lines (computer types), audio filters, transducers, microwave components, oscillators, etc. / RMa Ms(125) Se(1951) Ic
- Control Logic, Inc., 11 Mercer Rd., Natick, Mass. / OL 5-1170 / *C 61
Welded circuit modules, real-time and digital control systems / RMSCa Ss(20) Se(1961) DIc
- Cybetronics, Inc., 132 Calvary St., Waltham 54, Mass. / TW 9-0012 / *C 61
Digital pattern generators, magnetic tape certifiers and cleaners, consulting in the computer and instrumentation field / RMCa Ss(10) Se(1960) DIc
- Daniel, Mann, Johnson, & Mendenhall, 3325 Wilshire Blvd., Los Angeles 5, Calif. / DUNKirk 1-3663 / *C 61
System design for military, commercial and industrial needs. Consulting services in the system and automation field. Design, evaluate, implement, train, supervise conversion to automated systems / RC(educational)a Ms Me(1947) Ic
- Datanamics, Inc., 7810 Burnet Ave., Van Nuys, Calif. / TR 3-5370; Los Angeles sales office, DU 8-0431 / *C 61
Source data recorders (off-line) which punch IBM cards for EDP input as a by-product of source transactions / MSa Ms(50) Se(1958) Ic

ROSTER OF ORGANIZATIONS

- Datapulse Inc., 509 Hindry Ave., Inglewood, Calif. /
ORchard 1-7713, ORegon 8-3983 / *C 61
Data simulators, pulse generators / RMSa Ss(28)
Se(1961) Ic
- Delta Data Corp., 3134 Shane Dr., Richmond, Calif.
/ CA 3-7100 / *C 61
Consulting services, testing, scoring / Ca Ss(10)
Se(1959) Ic
- Dresser Products, Inc., and Dresser Engineering, Inc.,
114 Baker St., Providence 5, R.I., ST 1-4430 /
*C 61
Punched-tape handling equipment, filling sup-
plies / MCa Ss(8) Se(1955)
- Drexel Dynamics Corp., Maple Ave., Horsham, Pa.
/ WA 7-6200 / *C 61
High-speed printer/plotter, tape to tape trans-
lators, digital process control systems, digital
logic circuit cards / RMSa Ms(215) Se(1956)
DICc
- Duke University, Computing Laboratory, Durham,
N.C. / 681-0111, Ext. 3695 / *C 61
IBM 7070 used for research and instruction /
R(instruction)a Ss(16) Se(1958) Ic
- Dynamics Corp., 2525 E. Franklin Ave., Minneapo-
lis 6, Minn. / FE 5-8711 / *C 61
Digital transducers, encoders, satellite control
computers, digital control systems / RMSa Ms
(50) Se(1961) DICc
- Electric Boat, Div. of General Dynamics Corp., Gro-
ton, Conn. / HI 5-4321 / *C 61
Structural analysis and pipe stress analysis, both
static and dynamic. Computer services, 32K
IBM 704 with peripheral equipment, also IBM
1401 system; analog to digital conversion equip-
ment; GPS analog equipment; also programming
and analysis services available / RCGa ?s ?e
DAIc
- Electro International, P.O. Box 391, 2nd St. Extended,
Greenwood Acres, Annapolis, Md. / Colonial
3-2661 / *C 61
Program selection and processing consoles
(NASA) and installation / RMa Ms(156) Me
(1950) ICc
- Electroplex, Inc., 120 West 131 St., Los Angeles 61,
Calif. / FAculy 1-6212 / *C 61
Plug-in digital circuit modules (compatible
families); high efficiency power supplies, time
base generators / MSa Ss(30) Se(1961) Ic
- Ess Gec, Inc., 15 Havens St., Elmsford, N.Y. /
LYric 2-8620 / *C 61
Airborne data processing equipment and in-
strumentation. Ground data handling systems /
RMCa Ss(35) Se(1960) IMc
- Executive Computer Utilization, 1323 No. Water St.,
Milwaukee 2, Wisc. / BRoadway 6-2733 / *C 61
Feasibility analysis, equipment evaluation,
EDP organization planning, management semi-
nars on EDP problems, EDP personnel selec-
tion and training, operations research, business
systems design, computer programming, com-
puter operations technique, periodic reappraisal
/ CP(educational)a Ss(6) Se(1960) Ic
- Harman-Kardon, Inc., Ames Court, Plainview, N.Y.
/ OV 1-4000 / *C 61
Digital modules / MSa Ms(500) Me(1950) Ic
- G.L. Hollander Associates, 734 W. Maple Ave., Ful-
lerton, Calif. / TRojan 1-4918 / *C 61
Design and consulting in general and special pur-
pose computers and their application to business,
control, communications switching, and defense
/ RCa Ss(4) Se(1961) ICc
- Indiana General Corporation, General Ceramics Div.,
Crows Mill Road, Keasbey, N.J. / VALley 6-5100
/ *C 61
Ferramic memory cores, memory planes, ar-
rays, microstacks, memory systems, buffers,
large memory systems / RMSa Ls(550) Le
(1908) Ic
- Information Products Corp., 156 Sixth St., Cambridge,
Mass. / EL 4-1206 / *C 61
CRT display units, computer on-line interroga-
tors, hard copy printers / MSa Ss(15) Se(1961)
Ic
- Itek Electro-Products, Inc., Div. of Itek, Inc., 75
Cambridge Parkway, Cambridge 42, Mass. / UN
4-7200 / *C 61
Data translators, tape search units, digital
clocks for precision timing, crystal filters /
RMSa Ms(250) Se(1955) Ic
- Kalvar Corp., 909 So. Broad St., New Orleans, La.
/ 822-1600 / *C 61
Film for input services / RMSa Ss(45) Se(1956)
Ic
- Liskey Aluminum, Inc., Box 506, Glen Burnie, Mary-
land / CIRCLE 2-7300 / *C 61
Computer-room free-access flooring / MSCa
Ms(100) Se(1958) Ic
- Litton Systems, Inc., Guidance and Control Systems
Div., 5500 Canoga Ave., Woodland Hills, Calif. /
DI 6-4040 / *C 61
Military data processing systems, computer
components including: drum memories, input-
output devices, test equipment, computing center
for providing complete computing services /
RMSa Ls(5000) Se(1954) DAIc
- Memorex Corp., 1180 Shulman Ave., Santa Clara,
Calif. / CH 8-3344 / *C 61
Magnetic tape / RMSa Ss(20) Se(1961) Ic
- Moog Servocontrols, Inc., Industrial Div., East
Aurora, N.Y. / NL 2-2000 / *C 61
Servovalves and electrohydraulic servo systems
for missile and aircraft use. Hydra-Point nu-
merical control system for drilling and milling
machines / RMSa Ls(750) Se(1951) Ic
- Motorola, 4501 W. Augusta Blvd., Chicago 51, Ill. /
SP 2-6500 / *C 61
Data transmission in microwave radio relay sys-
tems / MSa ?s ?e Ic
- National Physical Laboratory, Mathematics Div.,
Teddington, Middlesex, England / TEDdington
Lock 3222 / *C 61
Computing service using DEUCE and ACE.
Digital and punched card / RCPEa Ms(60) Me
(1945) Dc
(To Be Continued in the January Issue)

1961 EASTERN JOINT

COMPUTER CONFERENCE — PROGRAM

Sheraton-Park Hotel, Washington, D. C. ,

December 12-14, 1961

PRELIMINARY TECHNICAL PROGRAM

Including Abstracts of Papers
of the

1961 EASTERN JOINT COMPUTER CONFERENCE

Tuesday, December 12, 1961

Morning Session

OPENING SESSION

Moderator: BRUCE G. OLDFIELD
IBM Federal Systems Division
Program Chairman, 1961 EJCC

Opening Remarks: JACK MOSHMAN
C-E-I-R, Inc.
Chairman, 1961 EJCC

WILLIS H. WARE
RAND Corp.
AFIPS Chairman

Keynote Address: DAUSE L. BIBBY
Executive Vice President
Remington Rand Division
Sperry Rand Corporation

Tuesday, December 12, 1961

Afternoon Session

TOTAL SYSTEMS IN REAL TIME

Session Chairman: JAMES H. BURROWS
Mitre Corp., Bedford, Mass.

MULTILEVEL PROGRAMMING
IN A REAL TIME SYSTEM

A. B. Shafritz and A. E. Miller
Auerbach Electronics Corporation
Philadelphia, Pennsylvania

Many complex, modern, real-time systems include, as an integral part, a sophisticated electronic digital data processor. There are usually several, quite diverse, timing requirements imposed on the operational program to meet the real-time deadlines of the system. To obtain efficient processing the program is divided into levels, each level satisfying a different type of system deadline. This paper uses the vehicle of a store-

and-forward communication system to demonstrate the power of multilevel programming. The establishment of these levels, their relationship, and criteria for assigning functions to a given level are discussed. The unusual approach for mechanizing the control of transfers between levels is highlighted.

PROJECT MERCURY REAL-TIME
COMPUTATIONAL AND DATA-FLOW SYSTEM

S. I. Gass, W. K. Green, J. E. Hamlin,
R. Hoffman, R. D. Peavey, A. Peckar and
M. B. Scott
IBM Federal Systems Division
Washington, D. C.

This paper will be presented in four sections:

The use of digital computers as an integral part of real-time decision making in Project Mercury. Duplexed IBM 7090 computers are used throughout a mission to process observations made in the launch, orbit and re-entry phases and to supply a continuous, real-time record of the known environmental status of the spacecraft. In addition, a computer oriented procedure - CADFISS - is used to determine the operational status of world-wide data flow systems prior to a mission.

The Mercury programming system. This system has been built on the modular concept whereby groups of processors which perform various tasks are combined by a monitor program to form a system to handle the demands of any particular phase of the Mercury mission. The techniques employed have required a negligible trade-off between speed and accuracy and have provided the flexibility needed in handling an enormous task with ever-changing specifications.

Simulation procedures. The first method allows the operational programs to run in a quasi-real-time environment under control of a simulation program. The second simulation method allows for the generation of a known set of data which is then processed in real-time by the operational programming system.

Data flow and equipment configurations of the Mercury Launch Monitor Subsystem. The configuration of equipments comprising this system is unique from the standpoint of processing high and low speed data transmissions of extreme distances involving computer to computer, computer to special displays and real-time data sources to computer.

Wednesday, December 13, 1961

Morning Session

SYSTEMS SIMULATION

Session Chairman: JACK SHERMAN
Lockheed Aircraft Corporation
Sunnyvale, California

and

PROGRAMMING LANGUAGE STANDARDIZATION --

A PANEL DISCUSSION

Moderator: HERBERT S. BRIGHT -- Data Processing
Group, BEMA, New York, N. Y.
Chairman ASA X3 Committee (Computers
and Data Processing)

A SIMULATION MODEL
FOR DATA SYSTEM ANALYSIS

Leon Gainen
The Rand Corporation, Dayton, Ohio

Designing a data system to support management objectives is, at present, no more than a highly specialized art. Data system designers can bring their profession closer to a predictive science by adapting for data system analysis purposes analytical tools which make possible prediction and qualification of data system behavior.

This paper discusses a generalized data system model and describes a technique of simulating dynamic system operation. Benefits possible through such simulation are explored. The major purpose presently proposed for this analytical technique is to test the feasibility of a data system design before acquisition of actual hardware.

A GENERAL PURPOSE SYSTEMS SIMULATION

Geoffrey Gordon
IBM Advanced Systems Development Division,
Yorktown Heights, New York

The paper discusses a general-purpose program that is being used to carry out simulation studies of systems on a digital computer. The principles upon which the program is based are discussed and a description of the program operation is given. To use the program, the system to be simulated is represented as a block diagram constructed from a set of simple block types. Given such a description, the program automatically prepares a model that simulates the system. The program has proved to be easy to use and has been applied to a wide variety of systems. Experience gained with the program is used to assess the value of general purpose programs in system study work.

USE OF A COMBINED ANALOG-DIGITAL SYSTEM
FOR RE-ENTRY VEHICLE FLIGHT SIMULATION

Dr. Allan Wilson
General Dynamics - Astronautics
San Diego, California

Simulation of space flight for cis-lunar-vehicle with re-entry capability is being done at General Dynamics Astronautics on its combined analog-digital system. An unusual feature is the insertion of a pilot and rudimentary cockpit display in the loop. Vehicle dynamics are simulated in real time on a large, general purpose analog computer. On-board digital guidance computer is simulated by a digital program on a high-speed digital computer. Closed loop operation is attained by interconnection through an analog-digital conversion system.

Problems of computer synchronization and control, operating procedures, and results of the simulation will be presented. The problem of error analysis, and the study of simple but definitive test cases for closed loop simulation will also be discussed.

COMBINED ANALOG-DIGITAL SIMULATION

Arthur J. Burns and Richard E. Kopp
Grumman Aircraft Engineering Corporation
Bethpage, New York

Combined analog-digital systems are rapidly becoming operational to overcome the respective limitations of analog and digital computers. One such system which has been successfully used to link an IBM 704 with an analog computer is described.

A missile intercept problem has been solved using analog-digital simulation. Dynamic equations are solved on the analog computer, while guidance and kinematic equations are solved simultaneously on an IBM 704.

Advantages of this type of simulation are illustrated by comparing the accuracy and computing time of the combined analog-digital solution with those of an all-digital and all-analog solution.

CONTRANS - (CONCEPTUAL THOUGHT
RANDOM-NET SIMULATION)

David Malin
Walter Johnson High School
Rockville, Maryland

CONTRANS is a computer simulation of a physiologically-oriented reasoning and problem solving model. It utilizes semi-random nets to recognize sensory patterns, attempts to create and manipulate meaningful assemblies of data and to modify its own potential for handling future data. Besides several layers of semi-random nets, the model employs a screen-like memory and representation medium, and several motor functions controlling scanning of the memory.

Input and output consist of modified English sentences. Two kinds of logical operations are employed. One explores the data rapidly for tentative strategies and solutions; the other proceeds by demonstrable intermediate steps, creating progressive intermediate goals.

THE CURRENT STATUS OF PROGRAMMING LANGUAGE STANDARDIZATION: A PANEL DISCUSSION

Moderator:

H. S. Bright - Data Processing Group, BEMA -
Chairman ASA X3 Committee (Computers and
Data Processing)

Panel Members:

C. A. Phillips - Department of Defense, Wash-
ington, D. C. - Chairman, CODASYL Executive
Committee

A. J. Perlis - Carnegie Institute of Techno-
logy, Pittsburgh, Pennsylvania - Chairman,
ACM Language Committee

R. E. Utman - Remington Rand UNIVAC, New York
City - Chairman Pro Tempore, ASA Subcommit-
tee X3.4 (Languages)

R. F. Clippinger - Minneapolis-Honeywell, EDP
Division, Wellesley Hills, Massachusetts -
Chairman, ISO/TC 97 Working Group (Languages)

English-based Common Business Oriented Language has already been implemented, or soon will be, in processors for most of the U. S. built commercially-available computers widely used for business data processing, and for several machines of foreign manufacture; ALGORITHMIC LANGUAGE, or dialects of it, for many engineering-scientific machines here and abroad.

ASA Subcommittee X3.4 is working in the U. S., ISO/TC 97, internationally, toward development of generally-acceptable standards in the area of programming languages.

The speakers hold responsible offices in the several organizations concerned and will provide an authoritative snapshot of computer programming language standardization as of December 1961.

Wednesday, December 13, 1961

Afternoon Session
ADVANCES IN EQUIPMENT

Session Chairman: DR. SAMUEL N. ALEXANDER
National Bureau of Standards
Washington, D. C.

DIGITAL TO VOICE CONVERSION

Evan Ragland
Motorola, Inc., Military Electronics Division
Chicago, Illinois

This paper presents a report of a new technique for conversion of digital words into vocal words and describes the laboratory experiments and

studies directed toward establishment of feasibility of the technique. The conversion method uses photographic memory for the storage of a vocabulary of one to several thousand words. The photographic word is projected onto an electrically charged photo sensitive plate for electrostatic readout. The vocabulary is optically scanned at a rate sufficiently high to provide access to any given word in a time imperceptible to the listener. The feasibility experiments performed to establish the operational capabilities of the technique are described in detail. In addition the program for further development and a report on possible applications are presented.

GRAM (CARD RANDOM ACCESS MEMORY): FUNCTIONS AND USE

Leon Bloom and Isador Pardo
National Cash Register Company
Electronics Division, Hawthorne, California

William Keating and Earl Mayne
National Cash Register Company
Data Processing Systems and Sales
Dayton, Ohio

The National Cash Register Company has developed a new memory configuration which exhibits characteristics heretofore seen only independently in tape systems or random access systems. This paper will discuss the specifications of the NCR 315 GRAM system, its application and the programming packages designed for its use.

GRAM's time-efficiency performance factors as well as its systems versatility are currently unique in the general data processing area. Its uses in file maintenance (random, serial selective and "father-son") as well as sorting will be outlined.

The packaged GRAM Executive (PACE) has been programmed to control all GRAM input and output functions, as well as to provide overall supervision of the entire system. The program retains all the features of earlier NCR Tape Executive Programs.

THE LOGIC DESIGN OF THE FC-4100 DATA PROCESSING SYSTEM

W. A. Helbig, A. Schwartz, C. S. Warren,
W. E. Woods, H. S. Zieper - Radio Cor-
poration of America, W. Coast Missile &
Surface Radar Division, Van Nuys, Calif.

A general purpose multiprogram computer has been designed by RCA to meet the need for a compact, reliable, and highly flexible system. This system is capable of handling up to 16 different programs on a sophisticated priority interrupt basis. Each instruction, in addition to performing a conventional operation, may be used to test results for control of short program loops without requiring additional program steps or execution time.

The use of logic on a time-shared basis leads to a considerable saving in hardware thus achieving high computing ability per dollar invested.

VERSATILE MAN-MACHINE COMMUNICATION CONSOLE

R. Green, P. Lazovick, J. Trost and A. W. Reickord - RCA Astro-Electronic Products Division, Princeton, New Jersey

This paper describes a unique man-computer communication and buffering device designed by the Astro-Electronics Division of RCA. The console allows individuals not trained in machine language to use a computer directly. Translation and machine-language editing are controlled by the console. The time differential between a man's actions and a computer's responses are automatically buffered. The console can be used in a wide variety of information-retrieval and data-processing applications.

DATAVIEW, A GENERAL PURPOSE DATA DISPLAY SYSTEM

R. L. Kuehn - Aeronutronic, Division of Ford Motor Company, Newport Beach, Calif.

In computer-centered complexes, one of the most pressing requirements in recent years has been the presentation of processed data in such a manner as to expedite human comprehension, assimilation and reaction. The latter is particularly true in command and control as well as other decision oriented systems. The DATA-VIEW system has been developed as a result of extremely stringent operational requirements of a mobile Army headquarters, the Army Tactical Operations Central (ARTOC). Digital signals originated by a central computer are translated with extreme precision and high resolution to multi-colored displays of either alphanumeric or graphical content. The methodology of accomplishing this transition to both console size and large screen displays is discussed, including the unique application of the photographic and optical sciences, mechanics and electronic concepts.

A COMPUTER FOR DIRECT EXECUTION OF ALGORITHMIC LANGUAGES

James P. Anderson - Burroughs Corporation, Paoli, Pennsylvania

A functional design is presented for a computer that directly executes programs written in a particular algorithmic language (ALGOL '60), with no prior translation.

Hardware recognition and interpretation of the various syntactic elements occurring in the string of symbols making up a program, is through the use of push-down lists for the various classes of elements; control, operators, and variables. An address table is employed that relates a variable name (identifier) to a value in a data memory, as well as permits the arbitrary re-use of variable names as specified by the

definition of the language. Considerations for other algorithmic languages are given as well as conclusions regarding the future trend of computer design.

EDDYCARD MEMORY - A SEMI-PERMANENT STORAGE

T. Ishidate, S. Yoshizawa, K. Nagamori - Nippon Electric Co. Limited, Kawasaki, Japan

The Eddycard memory is a semi-permanent memory device similar to the Unifluxor in principle. However, phenomena are observed from the other point of view, analyzing eddy current distributions in a conductor.

Besides the theoretical analysis, an experimental Eddycard memory with capacity of 1,024 words of 45 bits each is introduced in detail.

In the experimental memory, information "0" is represented by a square copper film with a punched slot, and "1" by a film without a slot.

The memory works at a cycle time of 100 m μ sec., but a 50 m μ sec. memory will be realized.

Thursday, December 14, 1961

Morning Session

COMMUNICATION SYSTEMS

Session Chairman: JACK STRONG
North American Aviation
Los Angeles, California

DIGITAL DATA TRANSMISSION: THE USER'S VIEW

Justin A. Perlman - Hughes Aircraft Company, Culver City, California

In July 1960 members of eight major firms in the aerospace industry met to establish an informal Data Transmission Study Group. Objectives of the group were established as exchange of knowledge, standardization of terminology, discussion of total systems requirements, development of reasonably uniform requirements for equipment and service, forecasting of long range needs, and acting as a coordinating group for these users with the common carriers and equipment manufacturers.

This paper will describe the group's results to date in developing composite requirements for intra-plant and interplant data collection and transmission systems. Both wireline and microwave systems are included. Projects scheduled for completion in the near future will also be discussed.

TELE-PROCESSING SYSTEMS

J. D. Shaver - IBM - Data Systems Division, White Plains, N. Y.

The impact of data transmissions on information processing and the ever increasing demand of government and industry to utilize transmission facilities in extending the use of computing systems is being reflected in today's data processing equipment development.

The background of development in data transmission devices will be discussed as well as accomplishments in this new area. New developments in data handling will be explored, indicating the problems encountered in providing a balanced data transmission and processing system. Emphasis will be in the data communications area, stressing the business machines suppliers' attempts to provide equipment compatible with existing and future transmission services and that will also satisfy the operational requirements of the user.

COMMUNICATIONS FOR COMPUTER APPLICATIONS

A. A. Alexander - American Telephone and Telegraph Company, New York, New York

In this paper some of the interesting applications of communication to computers in associated data processing systems are reviewed. Actual examples of operations and proposed systems are presented.

The major considerations that are involved in determining the type and extent of communications that may be used such as cost, speed, time value, availability and reliability are outlined and discussed.

Some of the newer communications facilities are described and some thoughts are presented as to the possible future systems applications of communication to computer.

THE SATURN CHECKOUT SYSTEM

J. Heskin - Packard Bell Computer Corporation, Los Angeles, California

The checkout procedure for the booster stage of the Saturn vehicle is being automated through the use of a computer-controlled, realtime, closed loop system.

An expandable multi-computer net allows for the simultaneous running of several test programs for a number of test stations when the vehicle is checked out from the component level to the final over-all system. More than one vehicle can be accommodated at different stages of checkout.

A compiler is provided with a source language, SOL (System Oriented Language) which simplifies the generation of realtime process control programs.

INFORMATION HANDLING IN THE DEFENSE COMMUNICATION CONTROL COMPLEX

T. J. Heckelman and R. H. Lazinski -
Communications Systems Division, Philco Corporation, Fort Washington, Pennsylvania

The Defense National Communications Control Center (DNCCC), recently installed in Washington, is the nerve center of the Defense Communications Control Complex. It provides a realtime on-line system for control and supervision of the world-wide Defense Communications System (DCS), made up of the major military long-haul communications facilities.

Messages concerning the status of communications facilities and traffic backlog in the DCS are inserted directly into a computer at the DNCCC, where they are processed and presented on large, wall-type displays.

The flow of information through the system is reviewed in detail, with special emphasis on digital data interchange between communications, computer, and displays.

AN AUTOMATIC DIGITAL DATA ACQUISITION SYSTEM FOR SPACE SURVEILLANCE

Marvin S. Maxwell - U. S. Naval Weapons Laboratory, Dahlgren, Virginia

An automatic space surveillance system is being developed to detect and determine the orbital elements of unannounced non-cooperative satellites as an extension of the present SPASUR system. To do this digital data from many remote stations is sent continuously at 2,500 bits per second to a central assembly system. Selected data is assembled into a form for entry via a tape channel into an IBM 7090 computer with a maximum delay of one second for on-line processing of the data.

FOUR ADVANCED COMPUTERS - KEY TO AIR FORCE DIGITAL DATA COMMUNICATIONS SYSTEM

R. J. Segal - RCA - Electronic Data Processing Division, Camden, New Jersey

Four Computers of advanced design play a central role in the world's largest and most advanced Digital Data Communications System, ComLogNet. The system will initially link 240 Air Commands and other installations.

Two Computers (Communication Data Processors) incorporating 1.5 microsecond memories, coordinate message flow and sequencing.

Two additional Computers (Accumulation and Distribution Units) sample incoming channels, perform code conversion, temporarily store information, provide automatic accuracy control, and control out-station and trunk transmissions.

The paper describes how the data communications function is automated. Photographs and a description of the hardware, stressing the unique role of the Computers are presented.

Thursday, December 14, 1961

Afternoon Session

PROGRAMMING AND APPLICATIONS

Session Chairman: CHARLES A. PHILLIPS
Department of Defense, Washington, D. C.

THE ATLAS SUPERVISOR

T. Kilburn and R. B. Payne - The University
of Manchester, Manchester, England

D. J. Howarth - Ferranti Limited, London,
England

All activities of the Atlas computer are controlled by the supervisor programs within the computer. Basic protection is provided by hardware but extra complete protection is provided by the routines themselves. Overall control of jobs is designed to maintain the highest possible activity of all parts of the computing system. The allocation and addressing of storage is done by the supervisor through which the operation of tapes and other peripheral equipment is organized.

A SYNTAX DIRECTED GENERATOR

S. Warshall - Computer Associates, Inc.,
Woborn, Massachusetts

A novel technique of compiler organization permits tabular description of not only the source language, but also the target machine. A short, universal algorithm - independent of both language and machine - uses instances of such tables to effect translation. Since a compiler for a new language and a new machine is simply a new set of tables, compiler construction cost may frequently be cut to a matter of man-weeks of effort. The unusual organization of the compiler makes it a useful tool in the translation of languages which are not completely formal, and also permits very inexpensive embedding of the compiler in an overall programming system.

AN AUTOMATED TECHNIQUE FOR CONDUCTING
A TOTAL SYSTEM STUDY

A. O. Ridgway - IBM - Federal Systems Division,
Bethesda, Maryland

In conjunction with a comprehensive analysis of the data processing at an Air Force Base, a system study technique was developed which utilized EAM equipment for recording and analyzing all primary data processing applications. The study effort also included the initial postulation of a total data processing system.

The automated study technique facilitated systems analysis by: automatically relating significant data, providing thorough analyses of existing systems, simplifying documentation correction, and automatically preparing flow charts.

The study technique is completely independent of the data processing complex being analyzed, the organization involved, the mission it supports, and hardware considerations.

DISPLAY SYSTEM DESIGN CONSIDERATIONS

R. T. Loewe and P. Horowitz - Aeronutronic,
Division of Ford Motor Company, Newport
Beach, California

Several significant system concepts and human engineering factors related to display systems are discussed. These include: amount of information displayed, group versus individual displays, response times, retinal resolution, display detail and size, audience configuration and viewing environment. Types of formats used for presenting information are summarized. Display system evaluation criteria and a checklist of primary display system requirements and characteristics are discussed.

ABSTRACT SHAPE RECOGNITION BY MACHINE

M. E. Stevens - National Bureau of Standards,
Washington, D. C.

Graphic pattern recognition in development of total systems for information selection and retrieval is considered. A machine model for abstract shape recognition is described. Examples are given of recognition of 15 to 20 categories of geometric shapes. Using a contour-projection principle, the model identifies various graphic patterns, regardless of size and locational transformations. It provides means for predicting whether large classes of patterns would be confused with any of the patterns that are recognizable. Possibilities for recognition of constrained handdrawn figures, such as chemical structure diagrams, are considered. Possible means of instrumentation are also discussed.

A CHARACTER RECOGNITION SYSTEM WHICH IS
INDEPENDENT OF CHARACTER TRANSLATION AND
ORIENTATION

D. N. Buell - Chrysler Corporation, Center-
line, Michigan

A character recognition system is described which incorporates a lens-and-retina input and a relatively simple computer. The system operates effectively with the image focused anywhere on the retina and may operate so as to be independent of image orientation.

The characters which may be unambiguously discriminated are those which have distinct transform functions T^* . A simple algorithm is given for obtaining T^* for both curvilinear and recti-

linear figures. Examples are given and possible means of resolving the ambiguities discussed.

THE DIGITAL COMPUTER AS AN AID IN THE
DIAGNOSIS OF HEART DISEASE

C. A. Steinberg and W. E. Tolles - Airborne
Instruments Laboratory, Deer Park, Long
Island, New York

A. H. Freiman, M. D. - Memorial Sloan -
Kettering Cancer Center, New York, New York

C. A. Caceres, M. D. and S. Abraham -
United States Public Health Service,
Washington, D. C.

The rapid computational capabilities and large storage capacity of the digital computer provides the physician with a powerful tool for analyzing physiological waveforms of the heart and their relationship to cardiovascular pathology. A pattern recognition program for automatically recognizing clinically useful parameters from physiological waveforms has been successfully developed. These parameters from the physiological waveforms were then combined into a multi-dimensional probability distribution. Different distributions were formulated and stored in the computer for the normal and pathological groups of patients. The compatibility of a patient's parameters with those stored in the computer was calculated and can be used as a diagnostic aid.

COMPUTER REPAIR

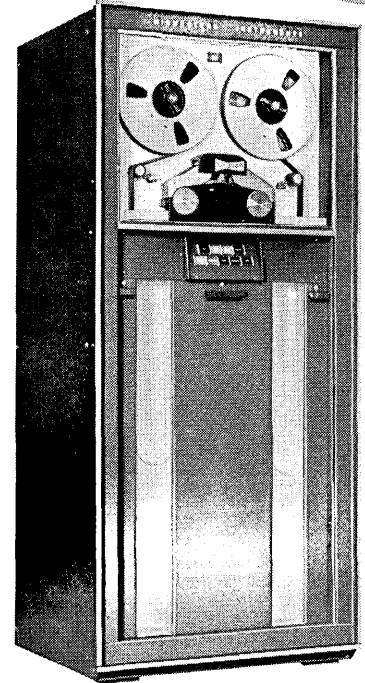

BECAUSE IT DELIVERS
WITH
CONTINUOUS RELIABILITY

THE
M-3000
DIGITAL TAPE
TRANSPORT
IS REPLACING
THE WEAKEST LINK
IN AUTOMATIC
DATA PROCESSING
SYSTEMS

M I D W E S T E R N
I N S T R U M E N T S
P. O. BOX 7509 • TULSA 35, OKLAHOMA

ON DISPLAY AT 1961 EJCC
BOOTH NO. B 6

3. INPUT / OUTPUT DEVICES

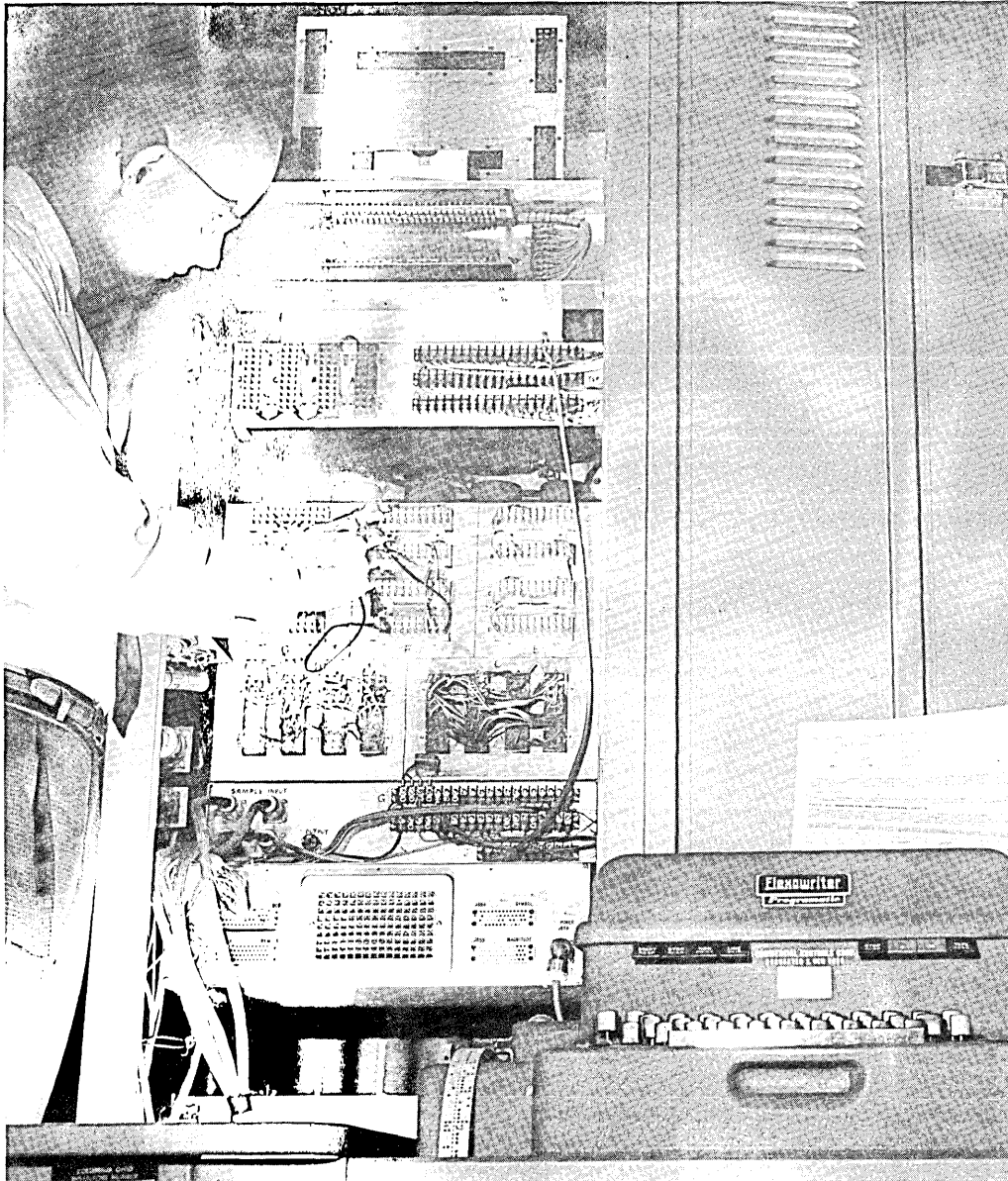

An automatic data recording system for use in research on the properties of semi-conductors and electronic components has been designed and built at Battelle Memorial Institute, Columbus, Ohio. The data taker can measure current, resistivity, temperature, magnetic field strength, or any property that can be translated into a d-c voltage between 1 microvolt and 100 volts. In a single programming, the machine can take and record up to 10,000 individual measurements and thereby makes possible faster, more efficient analyses of materials and components.

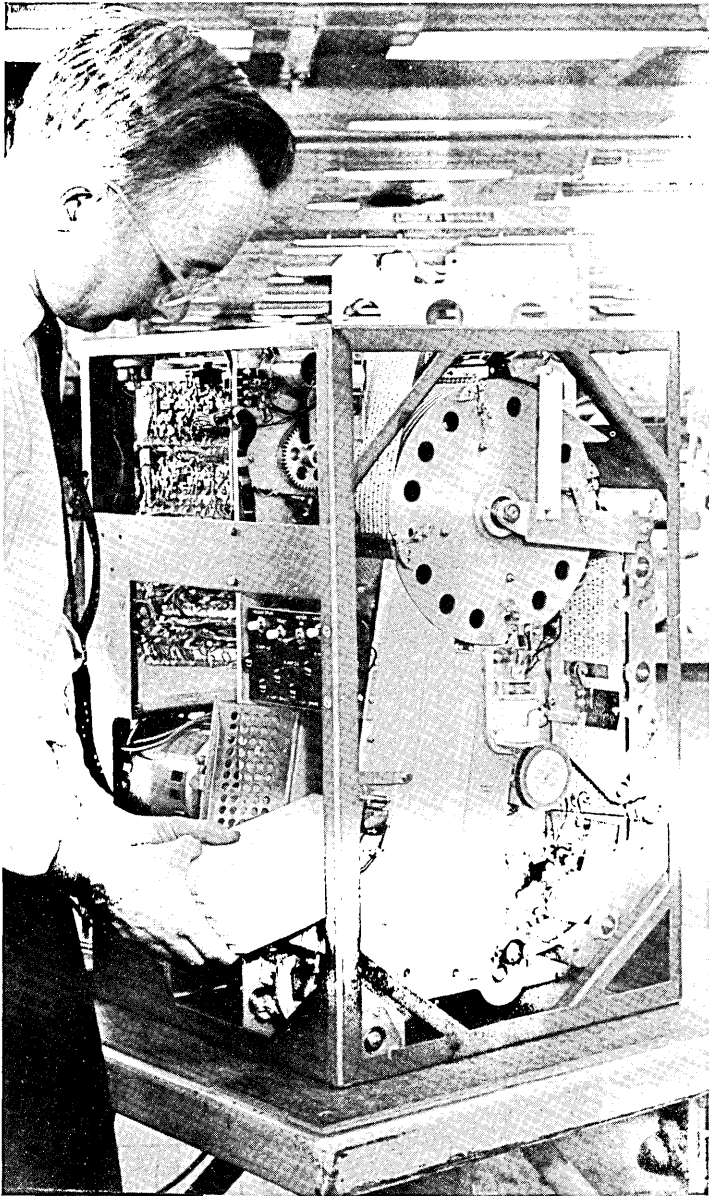

Automatic Recircling Card Programmer -- IBM's General Products Development Laboratory, Endicott, N.Y. The technician is demonstrating how a deck of cards is placed in the card programmer. Cards can be seen in the feed chute and attached to the drum. The reading head is located on top of the drum. The chief feature of the device is its ability to recirculate the entire deck or any three cards under the reading head without outside assistance. The device was designed expressly for controlling testing programs on the Army's Nike-Hercules air-defense systems. It may also become a practical controller for machine tools, electronic testing systems, and batch component equipment.

Control Pedestal for High Speed Printer -- Anelex Corp., Boston, Mass. This unit, which may serve as a base for the Series 4-1000 Printer, houses all of the electronic components ordinarily associated directly with the Printer. Including solid-state hammer-drive circuitry, power supplies and power-sequencing units, buffering and logic can also be added. Its modular construction provides builders of data processing systems with a choice of performance characteristics without the time and expense of designing and building special circuits. No special installation is required.

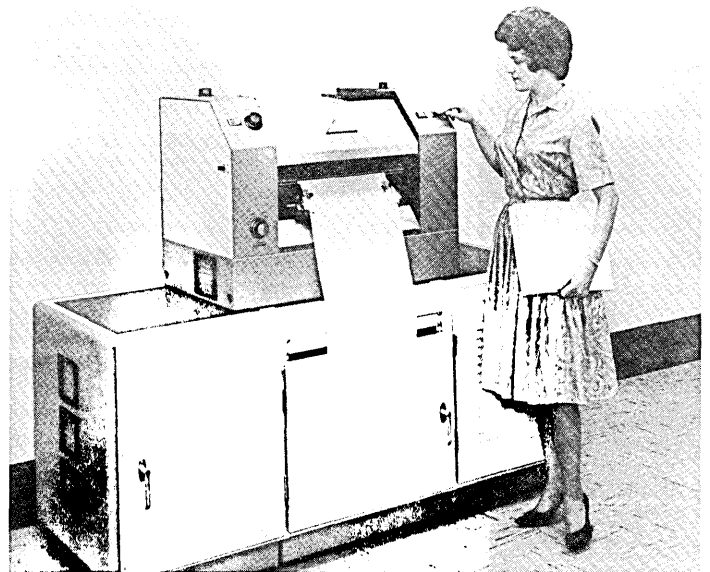

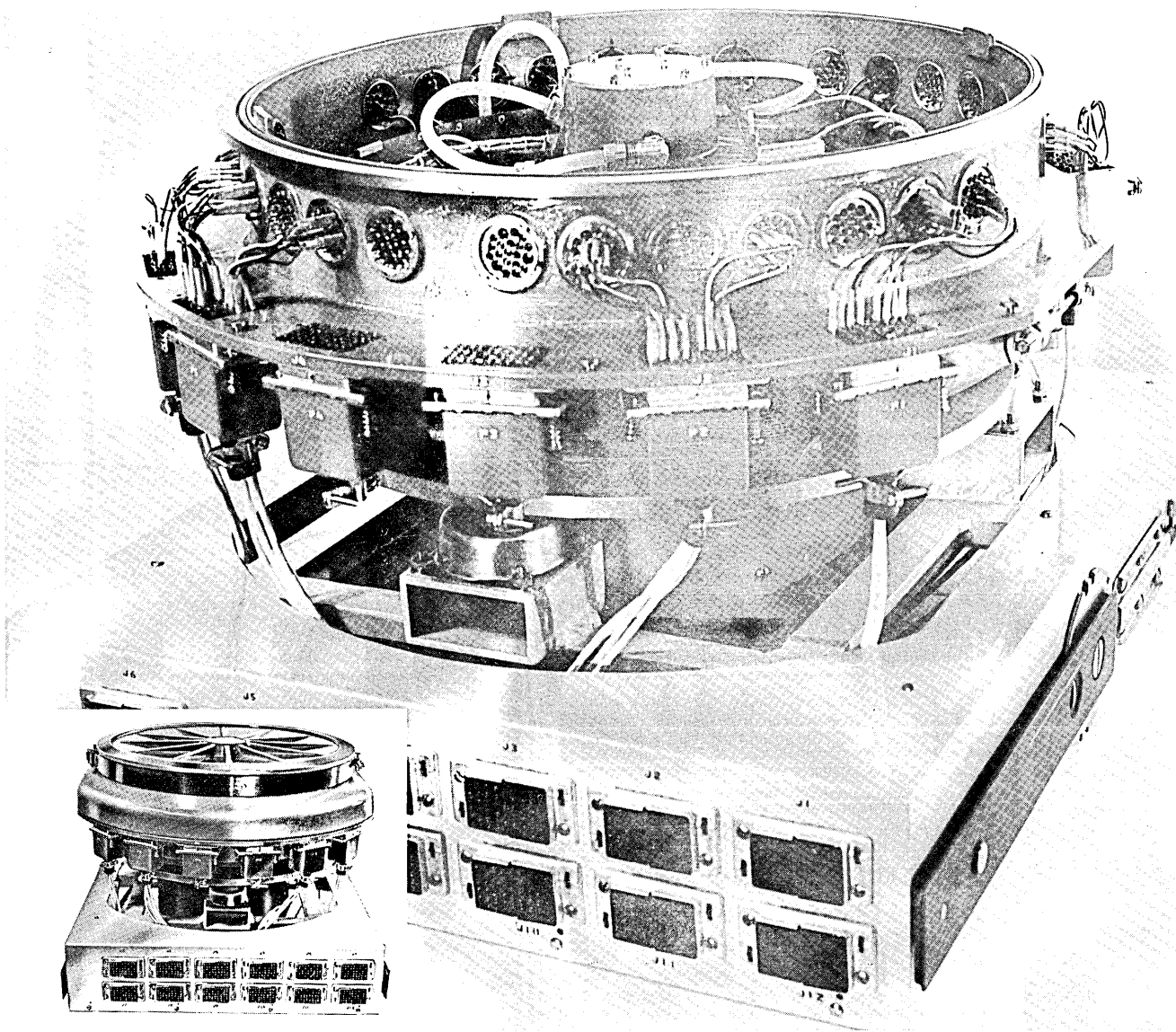

Bernoulli disk rotating storage device -- Laboratory for Electronics, Inc., Boston 15, Mass. This rotating storage device is used in general-purpose EDP systems and digital computers. The storage capacity ranges from 200,000 to 500,000 bits. The units maintain a controlled separation between the storage disk and the read/write head by using principles of gas motion. The technique claims high resistance to severe shock and vibration.

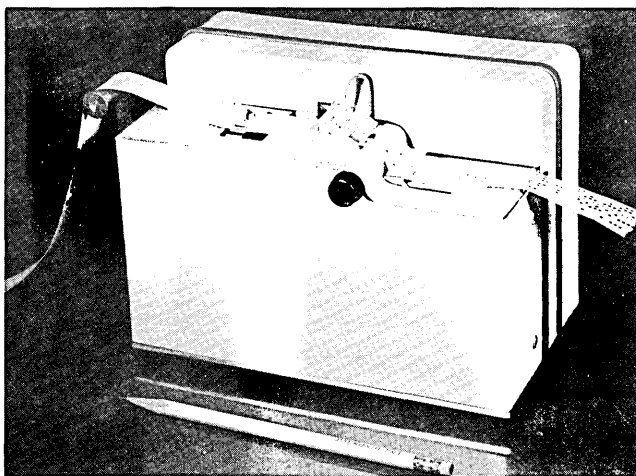

Motorless Paper Tape Punch, Model P-100 -- Invac Corp., Natick, Mass. This motorless, direct-drive paper-tape punch will perforate any 5, 6, 7 or 8 hole tape at rates up to 20 characters per second. Punches are actuated directly by solenoids; a restoring mechanism assures positive return. Typical applications for this punch include: business data processing, communications, process control, machine tool control, automatic testing and checkout, and telemetry data reduction.

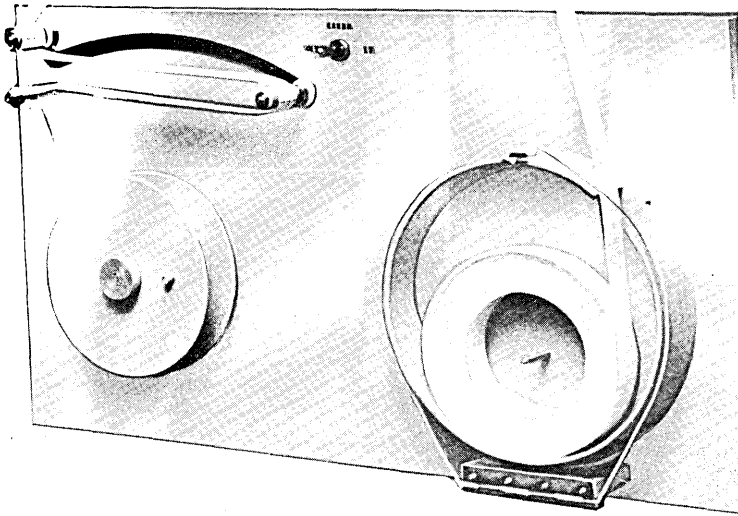

Dykor[®] high-speed uni-directional perforated tape handler, Model 4544 -- Digitronics Corp., Albertson, L.I., N.Y. For use with digital computers, machine tool controls, ground support equipment and other instrumentation, this model used with model 3500 readers handles 500 feet of 5 to 8 level tapes interchangeably at speeds up to 500 characters per second.

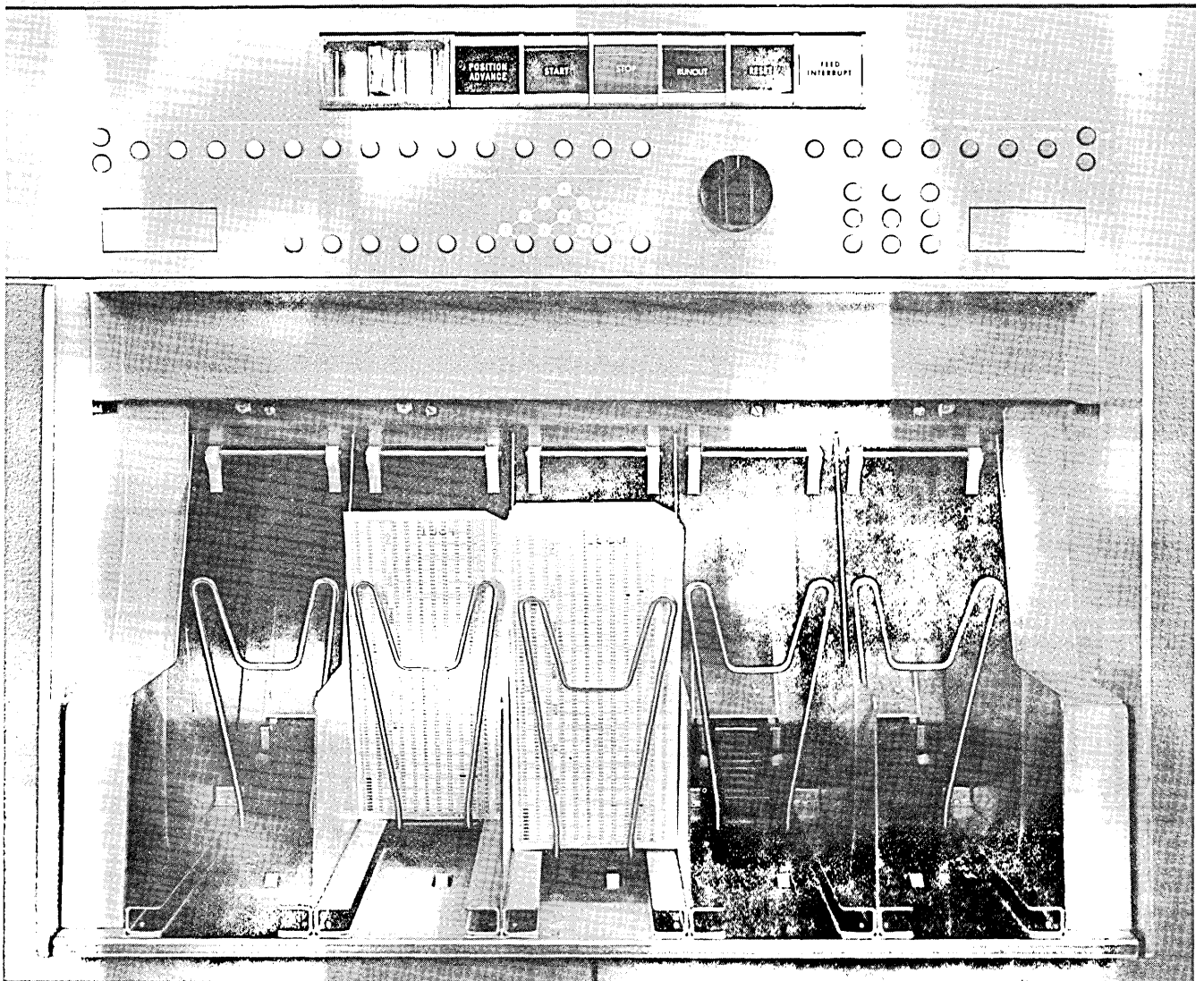

International Business Machines' Type 188 collator is fully-transistorized and has core storage in place of relays. It performs alphanumeric filing functions at 1300 cards per minute. Its display lights diagnose trouble, register any errors, and show contents of storage and the results of comparisons between cards.

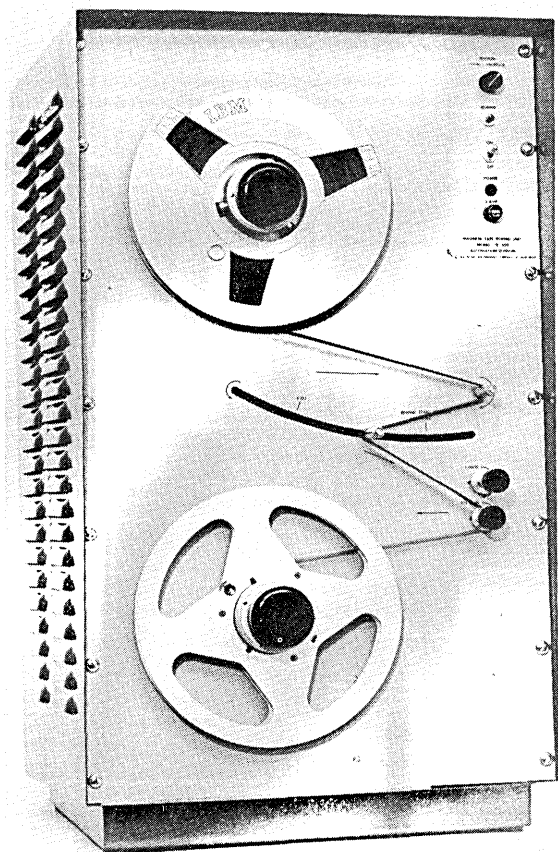

EECO TR-300 Magnetic Tape Rewind Unit (at left) -- Automation Division, Electronic Engineering Company of California. This magnetic tape rewind unit will spool a 10-1/2" reel in 90 seconds; thus it releases expensive tape transports from the simple operation of high-speed tape rewinding. Tape is rewound under constant tension controlled by a button which selects desired tension control. The average rewind speed is 500 inches per second.

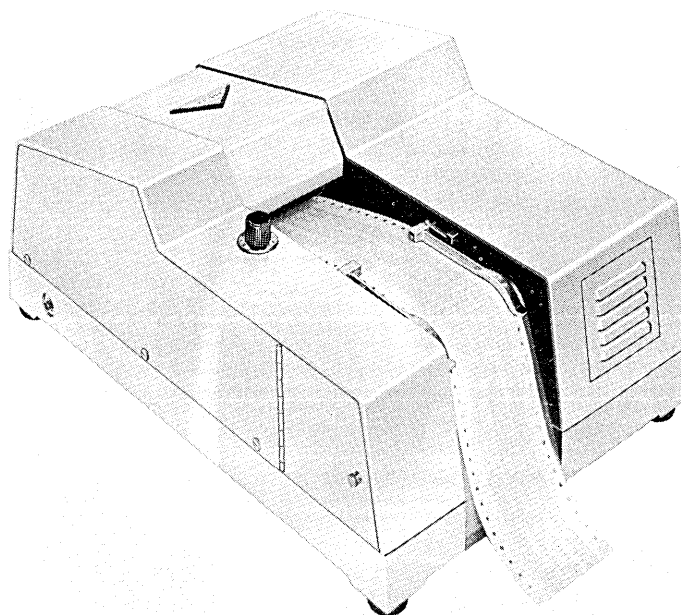

(Shown above) High-speed Lister -- ANalex Corp., Boston, Mass. This high-speed lister prints a line of 24 characters, at the rate of 1200 lines per minute for numeric data and 600 lines for alphanumeric. Other models print up to 72 columns in a line.

(Shown lower right) Unicall, computer-inquiry voice-reply device -- Remington Rand UNIVAC Div. of Sperry Rand Corp., Whitpain Township, Pa. An operator is composing an inquiry message for transmission via Unicall, a new computer input device; she is setting movable levers in positions which correspond to appropriate letters or numerals. The message display window in an illuminated panel enables the operator to corroborate each alpha-numeric selection; then the message is sent via telephone lines to a Univac Real-Time Computing System. Less than 5 seconds after a message is transmitted, a computer-generated voice reply is fed back from the computer to the Unicall set and its adjacent telephone receiver. This enables a computer to give verbal answers to inquiries, useful for reservations answers, credit reference information, etc. The computer may be located hundreds of miles distant.

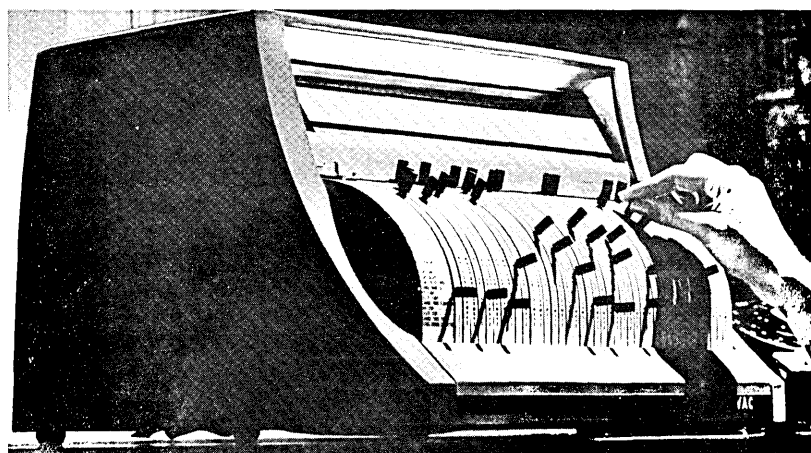



High-speed printer -- Minneapolis-Honeywell's Electronic Data Processing Div., Wellesley, Mass. The high-speed printer (foreground) prints the system's output at the rate of 900 lines a minute. In the background (l. to r.) are a multiple-purpose control unit (for printer, card punch and card reader), a magnetic tape storage rack, and a high-speed card punch.

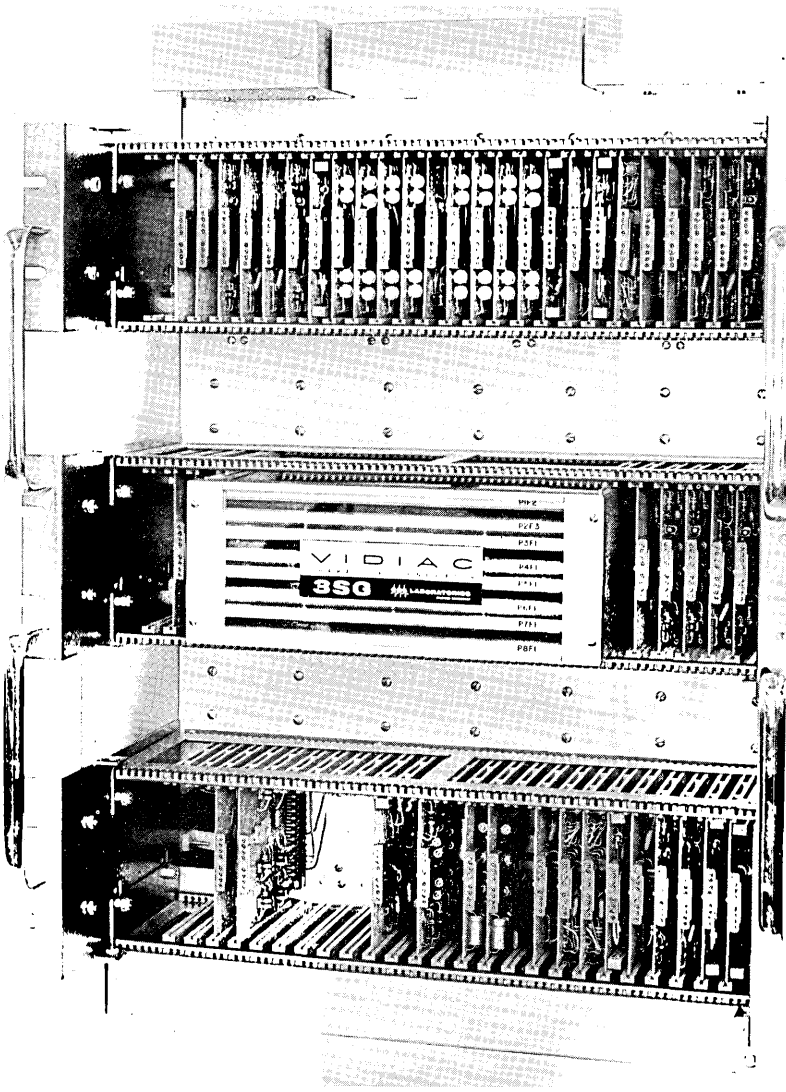

Model 3SG-10 VIDIAC solid-state character generator -- CBS Laboratories, a division of Columbia Broadcasting System, Inc., Stamford, Conn. A VIDIAC (Visual Information Display And Control) system takes information in digital form, from sources such as magnetic tape, and displays it in bright, sharply defined letters, numbers, and symbols on the screens of high-resolution cathode-ray tubes. Such machines are in use at Thompson Ramo-Wooldridge, Inc. and the Naval Air Development Center, Johnsville, Pa. This machine has a standard font of 64 alpha-numeric characters and symbols supplied in eight simple core matrices. It operates at the rate of 50,000 characters per second.

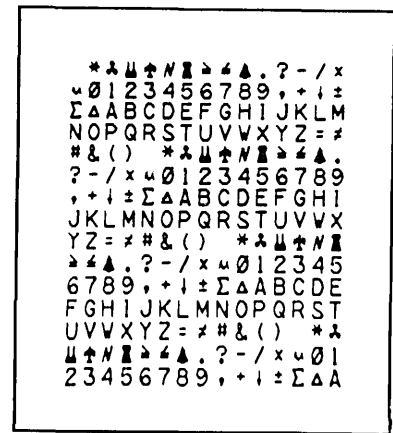

Unretouched photograph of display tube face showing readout of a low resolution character font (10 lines per character).

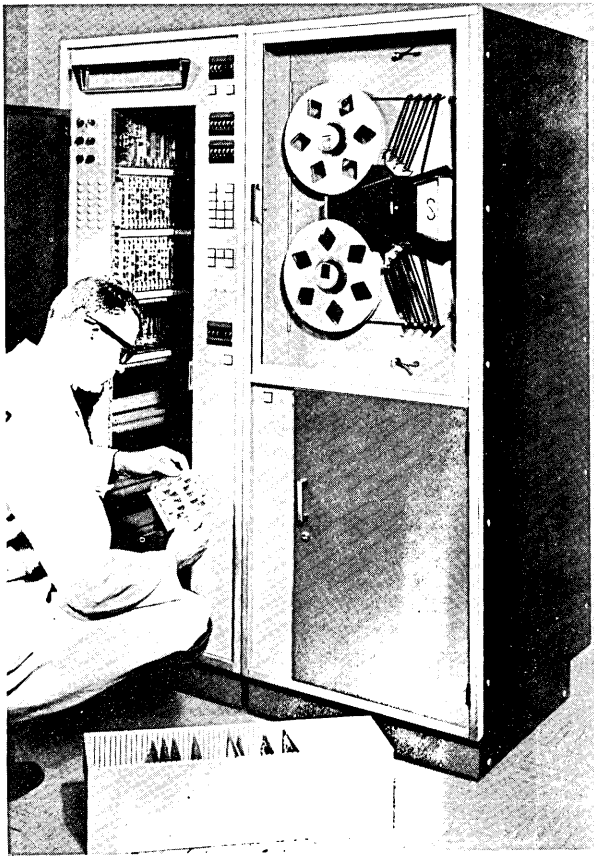

New MicroSADIC -- Consolidated Systems Corp., Pasadena, Calif. The second-generation MicroSADIC is a high-speed, solid-state, digital acquisition system, for gathering, converting, and recording data from nuclear reactors, wind tunnels, rocket-engine test stands, and other complex test facilities. It samples several hundred channels of analog data at up to 15,000 samples per second.

Coded paper tape, Omni-Data Recorder, Model ETR-7 -- Omnitronics, Inc., Philadelphia, Pa. Capsule-shaped spots instead of round punched holes permit greater packing density and make possible reading and writing speeds in excess of 1000 characters per second. The tape used is a high-resistivity, plastic-coated paper tape with a conductive backing. The coded paper tape may be visually interpreted or read by a reflective photoelectric technique with this company's tape readers.

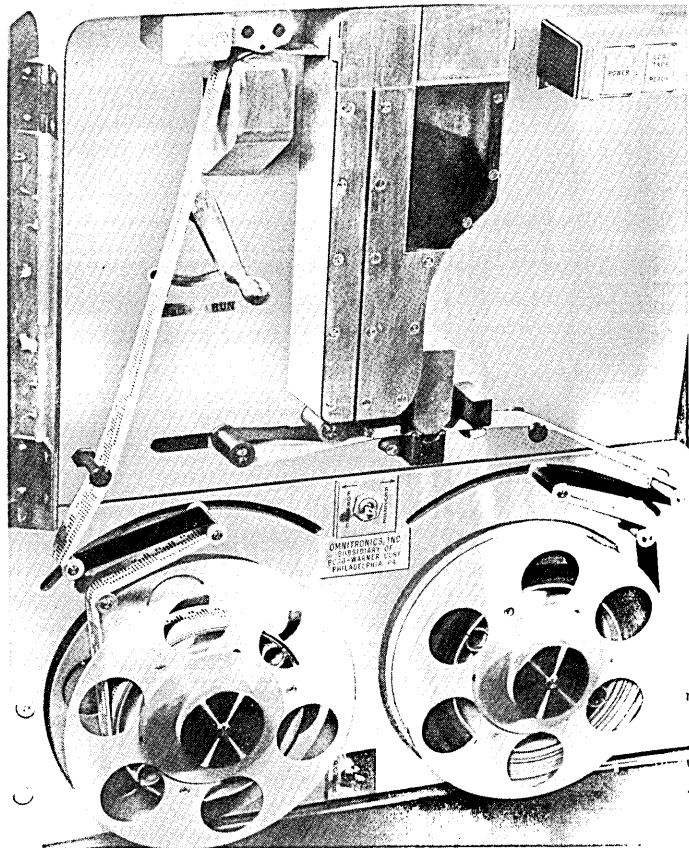

a m
aircr
the
miss
satis
mati
be c
date
At t
visio
eval
form
tle t
were
W
essin
app
lunc
be r
the
likel
origi
can
sider
the l
and
M
cent
purp
gene
mach
for i
we g
Late
a ne
prac
or th
pose
diffe
prob
func
who
ther
in a
acco
larly
com
ate a
real-
ate o
for S
can
cont
to th
mai
ahead
has
Exec
wher
char
migh
T
com
SDC
writ



Automatic Reading System -- General Electric Co., Computer Dept., Phoenix, Ariz. This reading system is the heart of the Magnetic Ink Character Reader system (MICR) now in use by major banks across the nation for electronic processing of checking accounts. It "reads" the E-13B type font shown in the background of the photograph on an enlarged version of a bank check. Dr. Kenneth R. Eldredge, staff scientist at Stanford Research Institute, Menlo Park, Calif., is shown with a production model. For the invention he received the 3,000,000th patent to be issued by the Patent Office, U. S. Department of Commerce, since its establishment by Congress in 1826.

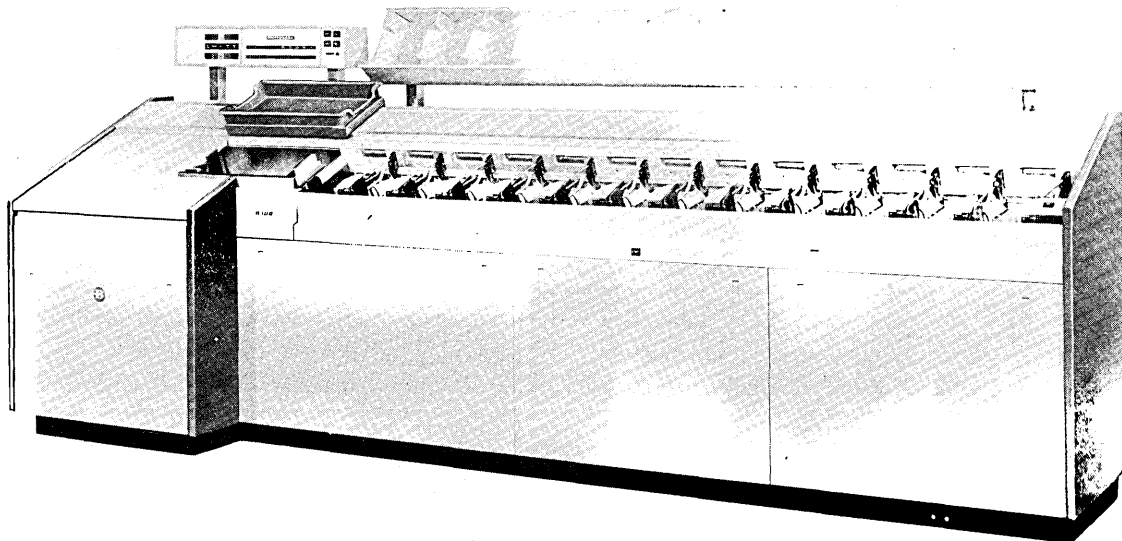

Series B-100 Sorter-Reader -- Burroughs Corp., Detroit, Mich. The off-line or on-line speed of this unit is 26 inches of document per second. It can read an amount, the associated account number, and then transfer number fields in 14.4 milliseconds. In 19.5 ms the unit reads a 9½ inch document (the maximum permitted size) directly into magnetic core storage. The hopper capacity is about 3,000 documents; each of the thirteen pockets can contain about 800.

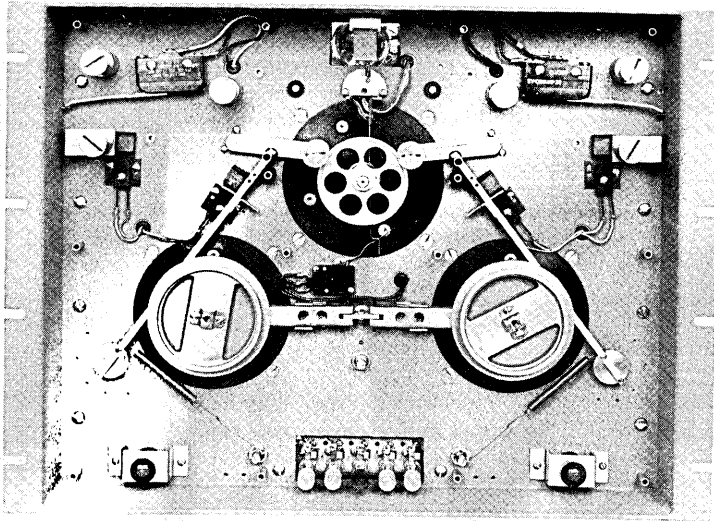

Photoelectric tape reader, high speed model 300R (seen with/without front panel) -- Photocircuits Corp., Glen Cove, N.Y. A PMI printed motor (patent pending) is used as the tape transport of the Model 300R. Tape advance is asynchronous; reading speed is 0 to 300 characters per second; the device stops on a character even at the rate of 300 characters per second; reading is bi-directional; and the machine is fully transistorized.

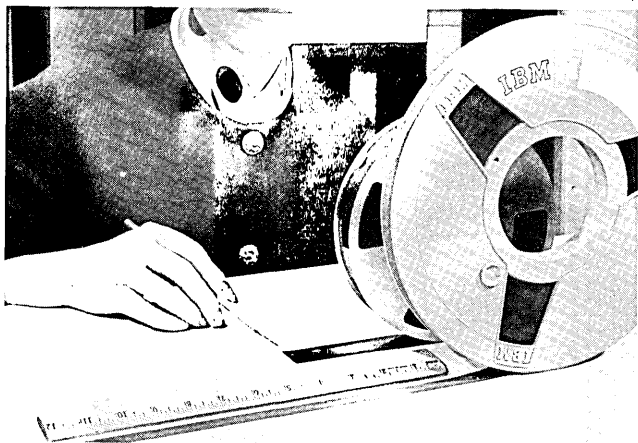
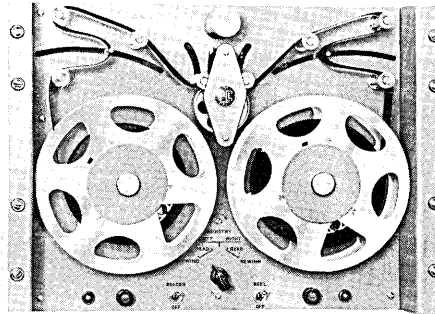

Hypertape -- International Business Machines Corp., White Plains, N.Y. A new cartridge-loading technique and more closely packed tape, provides computers with the ability to "read" and "write" information faster than before. More information can be recorded on four inches of this tape than on a foot of regular magnetic tape on a larger reel. The Hypertape cartridge contains a reel holding 1800 feet of tape -- on which approximately 25 million characters can be recorded -- and an empty take-up reel. When the cartridge may be placed inside the IBM 7340 Hypertape drive the unit automatically opens the cartridge, engages the tape and starts processing -- all within twenty seconds.

Random Access Storage and Display System (RD-900) -- Laboratory for Electronics, Inc., Boston, Mass. This storage and display unit may be used with a computer or separately. In the picture an operator is shown entering instructions via keyboard so as to superimpose additional information over the map display. Areas where this unit is applicable are: account servicing, air traffic control, ticket and reservation control, immediate stock information, military command control.

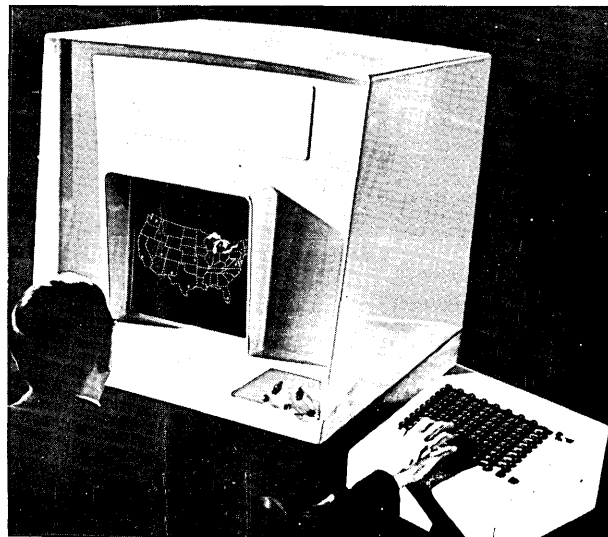

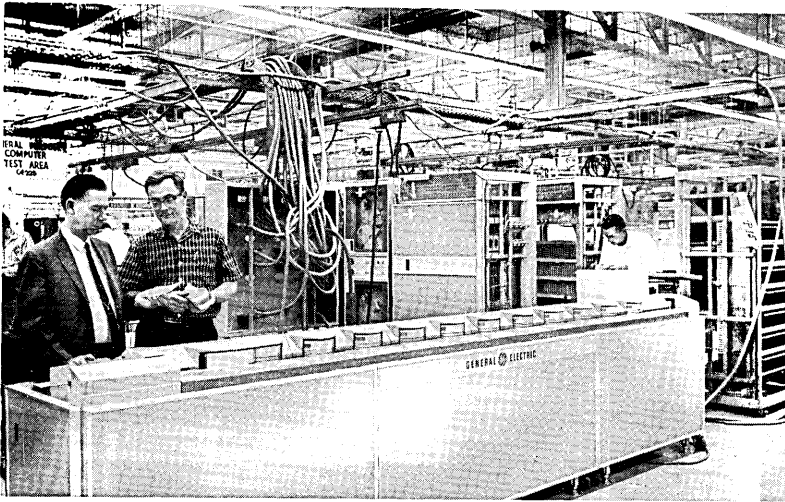

This is General Electric's document handler, which reads and sorts documents imprinted in magnetic ink at the rate of 1200 per minute. The inventor of the reading system, Dr. Kenneth R. Eldredge, staff scientist at Stanford Research Institute, Menlo Park, Calif., standing left foreground, was granted the 3,000,000th patent to be issued by the Patent Office, U. S. Dept. of Commerce in its 125-year history. The patent, for an automatic reading system, covers the magnetic ink character reader in the document handler.

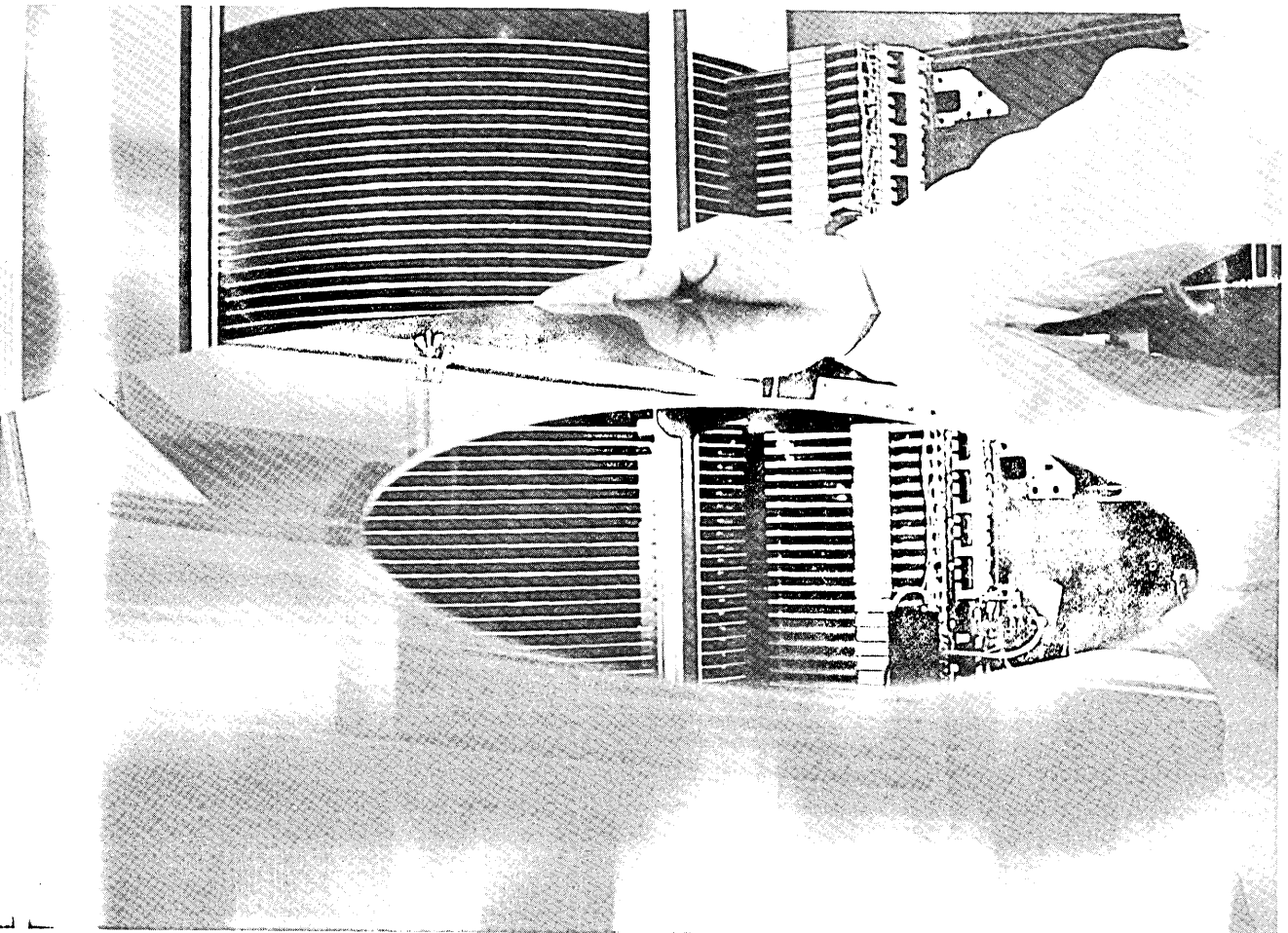

Magnetic Disk Storage Unit -- International Business Machines, White Plains, N.Y. A single disk (foreground) from IBM's new 1301 disk storage unit, (background) can pack up to 1,400,000 alphabetic or numeric characters of data on its magnetically coated sides, more information than can be recorded on 10,000, eight-column IBM cards. The 1301 unit used for auxiliary data storage can hold up to 56 million characters of information. Up to five 1301s, holding from 250 to 280 million characters, can be employed with either the 1410; 7070; 7074; 7080; or 7090 IBM computers.

o
on
g-
ies
ss

NEW CONTROL DATA

Technical Information Series #1
The 160-A Computer

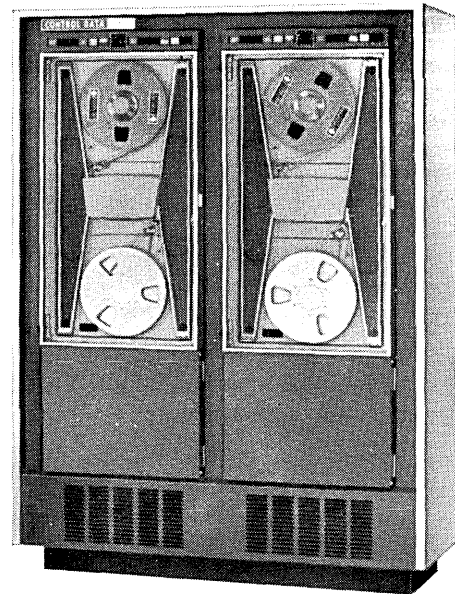
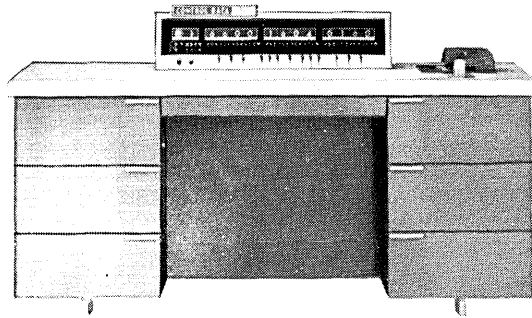
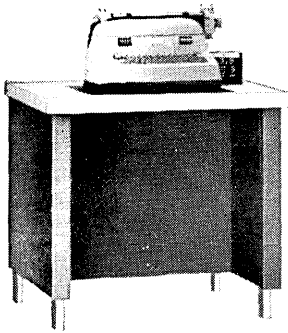

The
pol
Ele
Bos
cia
25th
Sho
of
inc
tem
in
Phi
ing
of
tom
gin
con
ele
acc
Hon
ere
iat
Yor

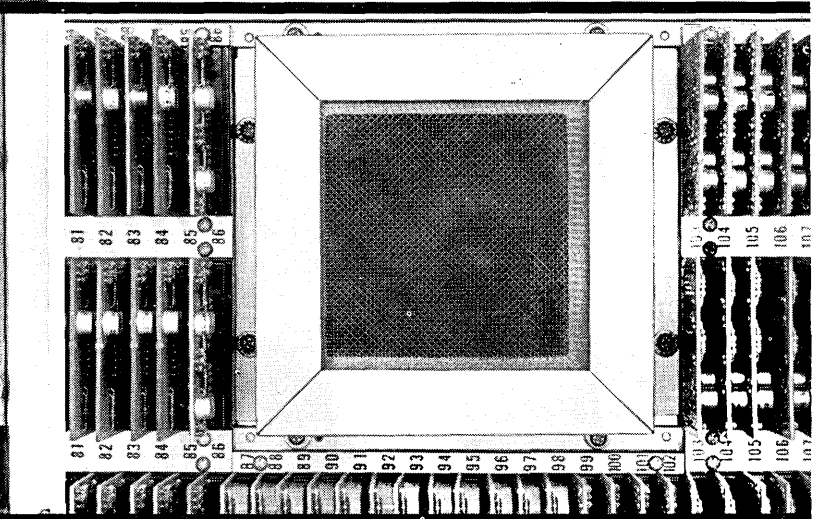
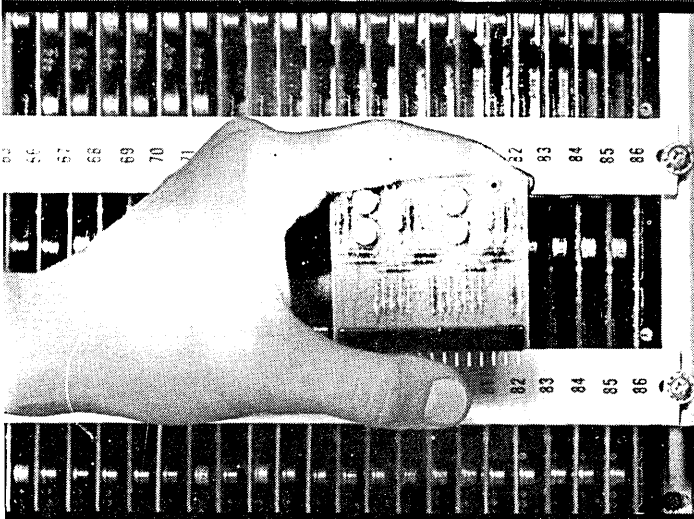
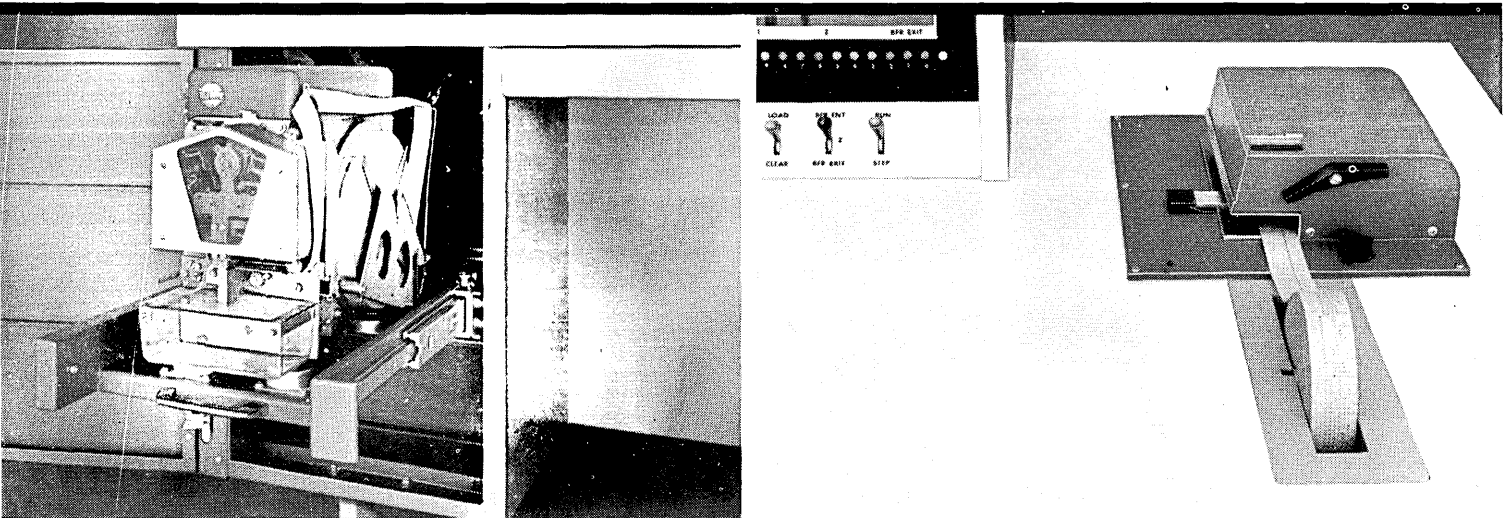

160-A COMPUTER

SMALL-SCALE COMPUTER WITH LARGE COMPUTER CAPABILITIES

The 160-A is a parallel, single address data processor. Basic memory consists of two banks of magnetic core storage, each with a capacity of 4096 words and a **storage cycle time of 6.4 microseconds**. This basic memory can be expanded in modules of 8192 words up to a maximum of 32,768 words. Instructions with 12-bit operands are executed in one to four storage cycles, with execution time varying between 6.4 and 25.6 microseconds. Average program execution time is approximately 15 microseconds per instruction.

Other features of the 160-A Computer include:

- **Buffered** input/output
- Internal and external **interrupt**
- External **multiply and divide unit**
- Control Data 350 Paper Tape Reader
- 110-character/second paper tape punch

The 160-A weighs 810 pounds and is 61 $\frac{5}{8}$ " long by 30" wide by 29" high . . . the size of an ordinary office desk. It requires 16 amps, 110 volt, 60 cycles.

A basic 160-A Computer System can be expanded to include the following external equipment:

- Up to 40 magnetic tape handlers
- Input/output typewriters
- Punched card readers and punches
- Low-speed line printers (150 lines/minute)
- High-speed line printers (1000 lines/minute)
- Plotting and digital display devices
- Analog-to-digital and digital-to-analog converters

TYPICAL APPLICATION AREAS FOR THE 160-A COMPUTER

The 160-A is a general purpose computer and can be used in an almost unlimited number of applications including:

REAL-TIME APPLICATIONS

The 160-A exchanges data with input-output devices at any rate up to 70,000 words per second. This transfer rate, an average instruction execution time of 15 microseconds, and the capability of buffering data while computing or while the operator manually enters data (whether the computer program is running or stopped) make the 160-A ideal for real-time applications.

OFF-LINE DATA CONVERSION

The 160-A is capable of controlling a variety of off-line peripheral equipment. Available service routines permit: 1) card-to-magnetic tape, 2) magnetic tape-to-card, 3) paper tape-to-magnetic tape, 4) magnetic tape-to-paper tape, 5) magnetic tape-to-printer, and 6) plotter output operations.

COMMERCIAL DATA PROCESSING

Along with the capability of buffering input-output devices, the 160-A Computer system includes accessories for reading 1300 cards per minute, printing 1000 lines per minute, or filing 30,000 characters per second.

DATA ACQUISITION AND REDUCTION

The input-output circuitry in the 160-A Computer permits direct communication with analog-to-digital conversion equipment. Following transmission, the data can be converted, reduced, or formatted by a stored program and written on magnetic tape for later analysis if desired.

ENGINEERING-SCIENTIFIC PROBLEM SOLVING

The high-speed, buffering, and interrupt features of the 160-A make it exceptionally useful in engineering-scientific applications.

COMMUNICATIONS AND TELEMETERING SYSTEMS

The 160-A Computer, used as a high-speed, parallel processor with decision-making powers, can be the principle element in communication and control networks. Proven reliability of the 160-A is a prerequisite for such application.

CONTROL DATA SATELLITE COMPUTER SYSTEM

The desk-size 160-A Computer is an integral part of the Control Data Satellite Computer System. Working with the large-scale 1604 Computer and the 1607 Magnetic Tape Sub-System, the 160-A presents a new dimension of computer power added to its own speed and versatility.

The Control Data 160-A is a small-scale computer with the speed, capability, and flexibility of many large-scale computers. For more detailed information, write for the **160-A Programming Manual**.

CONTROL DATA

CORPORATION

COMPUTER DIVISION

501 PARK AVENUE, MINNEAPOLIS 15, MINNESOTA

4. DATA TRANSMISSION AND CONVERSION EQUIPMENT

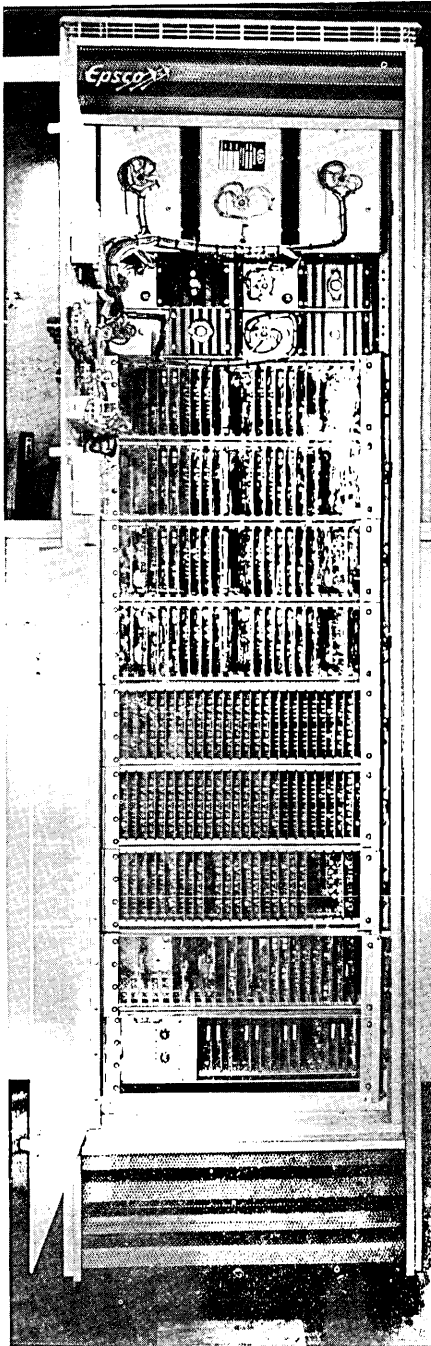

Addaverter computer -- Epsco Systems, division of Epsco, Inc., Cambridge, Mass. This unit links an Electronics Associates analog computer with a Bendix G-15 digital computer providing on-line, bi-directional communication between the two computers. The system samples the analog channels, converts to digital, and delivers this data to the digital computer memory; later it converts the results of digital computations to analog values and presents this data back to the analog computer. It is an 8x8 thirteen-bit binary computer with time-programming option. The first of the type is being used by the National Research Council of Canada.

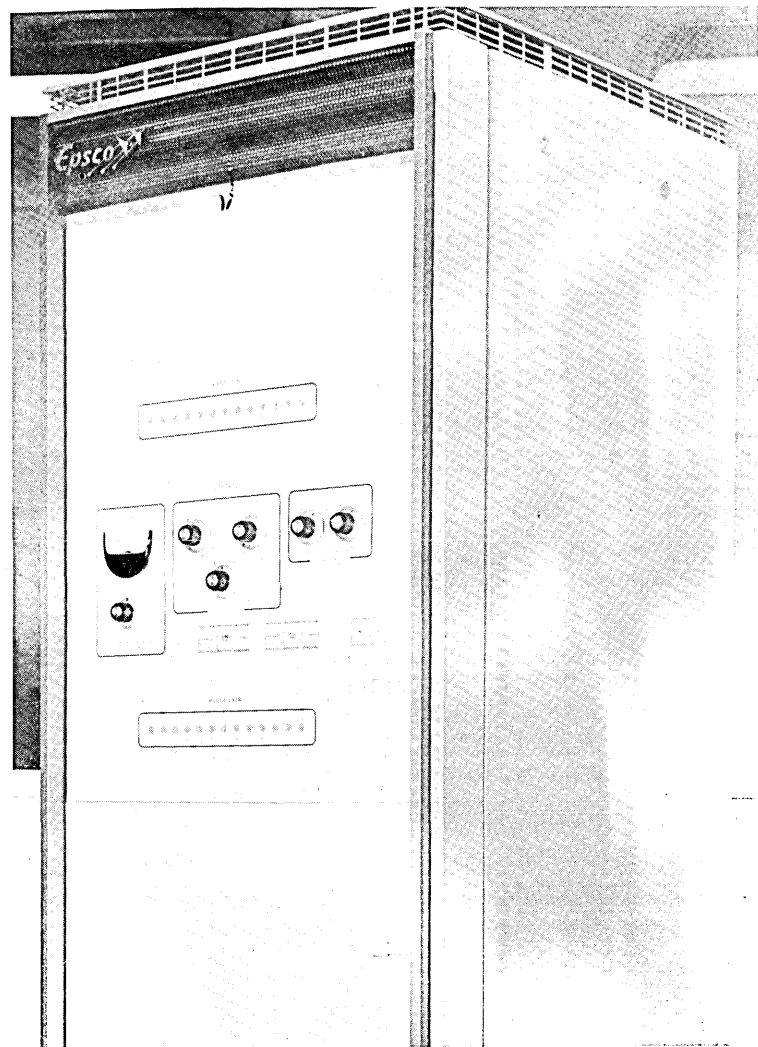

The
Com
has
tio
thr
tra
tra
gran
ind
a c

This
Ast
put
add
digi
er v
and
tion
COM

Bar Chart Recorder -- Electronic Associates, Inc., Long Branch, N.J. Shown here in remote operation, this electronic device can monitor and graphically record the efficiency of use of up to 40 production or data processing machines. It provides cost and production control information on a continuous chart, with minute-by-minute monitoring. In this way management is able to pinpoint lost time due to breakdowns, poor scheduling, tardiness in starting, absences, etc. The recorder can monitor almost any machine, process operation or series of events. It is connected to each of the machines being monitored by telephone-type wires.

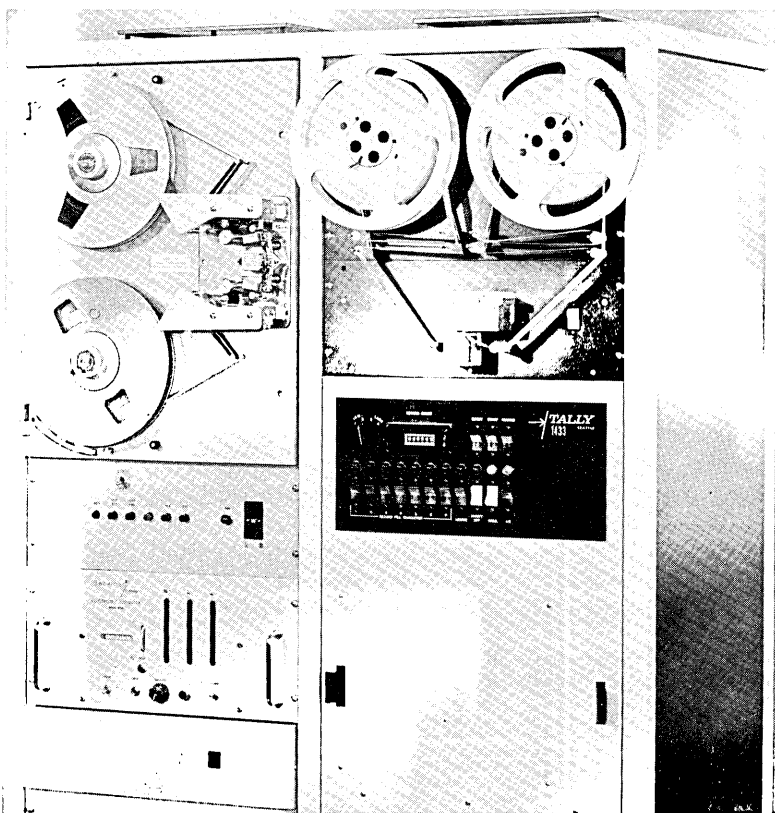
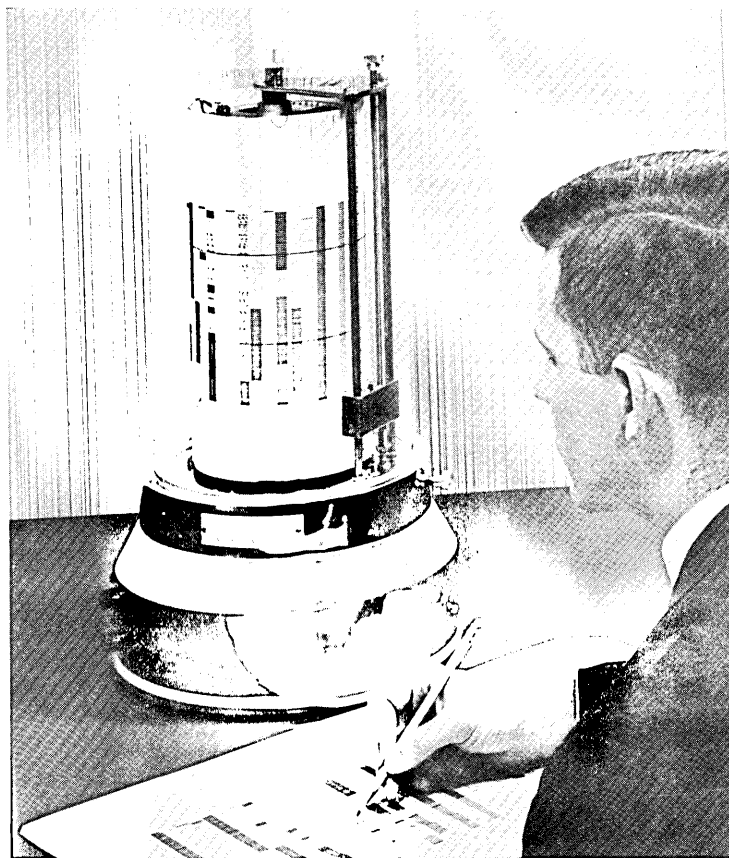

Paper tape to magnetic tape converter, Model 1433 -- Tally Register Corp., Seattle, Wash. Designed to solve media-conversion problems, this converter is complete in itself, having a 120 character-per-second paper-tape reader, a Potter magnetic-tape handler, and necessary electronics.

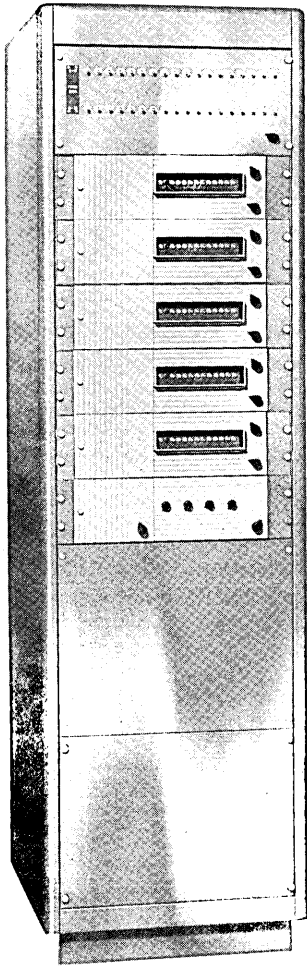

Analog-digital conversion system -- Adage, Inc., Cambridge, Mass. This system has been installed at The Grumman Aircraft Corporation, and is now a part of the automatic computing facility there, linking an IBM 704 digital computer with a Reeves REAC analog computer. By combining the accuracy and reliability of the digital computer with the speed and flexibility of the analog computer, the system is capable of solving problems that would be difficult, if not impossible, for an analog or digital computer to handle independently. Each converter contains an 11 bit binary digital-to-analog and analog-to-digital channel, with sign. Both the DAC output and ADC input are ± 100 volts full scale.



Automatic dial telephone -- Bell Telephone System, New York, N.Y. The card dialer has the automatic dialing unit in the set; it has unlimited capacity. Coded plastic cards, on which the user has previously punched out the specific telephone number, control the dialing equipment.

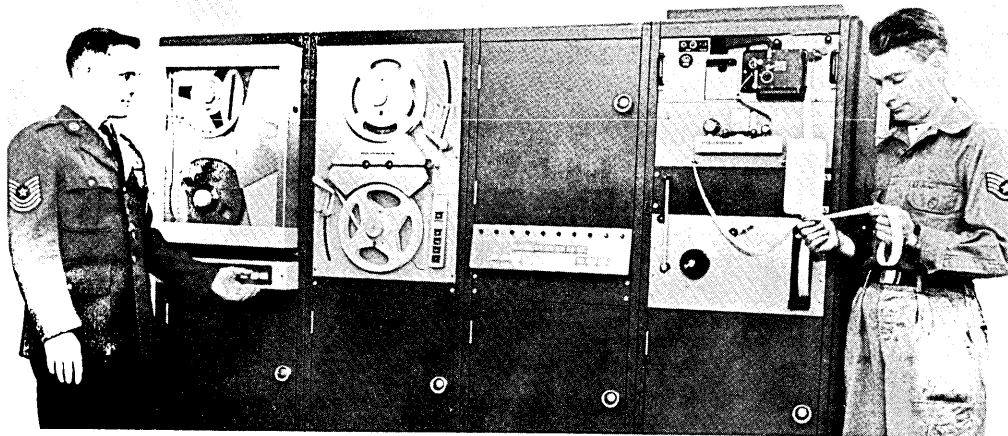

Electronic converter -- Digitronics Corp., Albertson, N.Y. This unit will prepare trajectory instructions for Minuteman, Atlas and Titan missiles at 50 words per second, approximately four times the speed of previous equipment. The Digitronics converter is solid-state, bi-directional, and converts magnetic tape to punched paper tape. Unusual accuracy is accomplished by a method of comparison. The converter has been installed for the Strategic Air Command at Offutt Air Force Base, Omaha, Nebraska.

Mi
er
Co
Th
de
io
st
of
a
to
ti
pu
nu
us
ag
an
tr
ch
si
ex

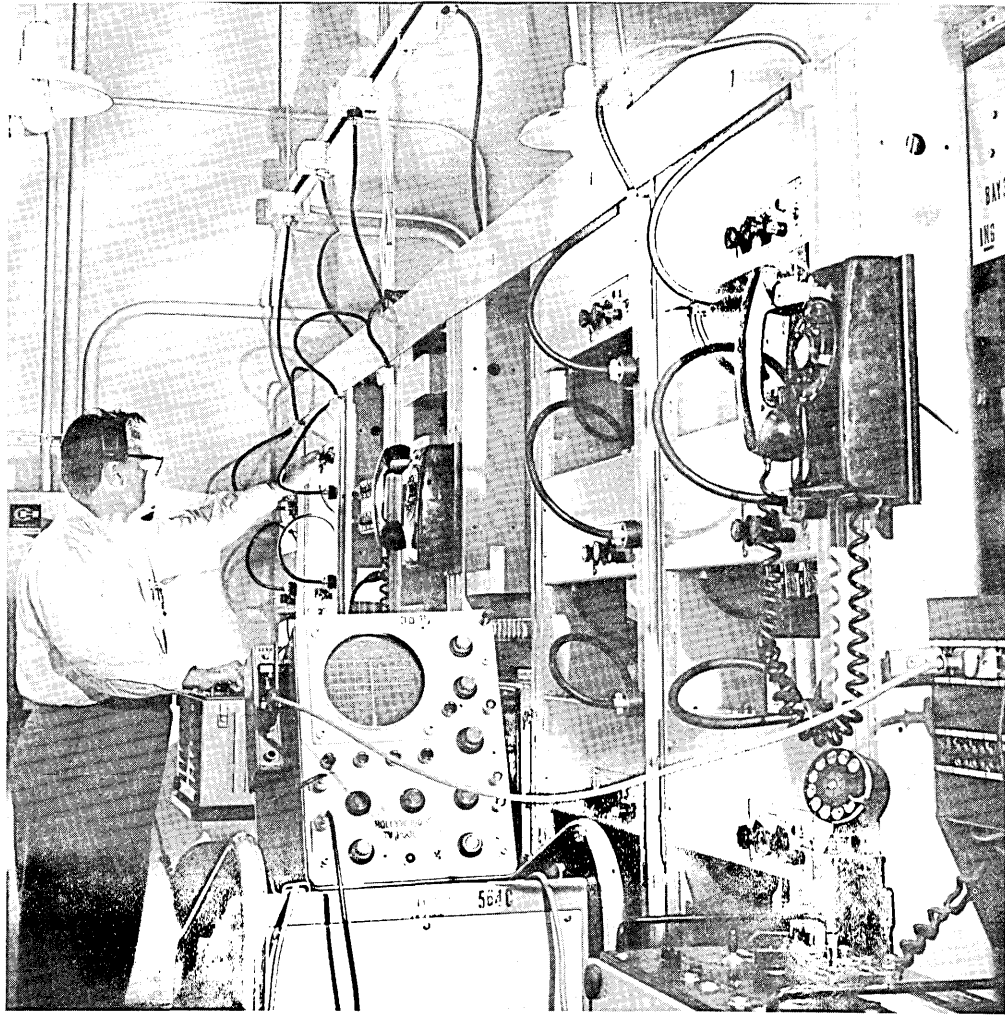

Multiplex equipment -- North American Aviation, Inc., Los Angeles 45, Calif. Shown here is the Pacific Telephone multiplex equipment which converts data beamed to and from divisional computer centers by way of the repeater station on Oat Mountain into form acceptable to IBM 1945s.

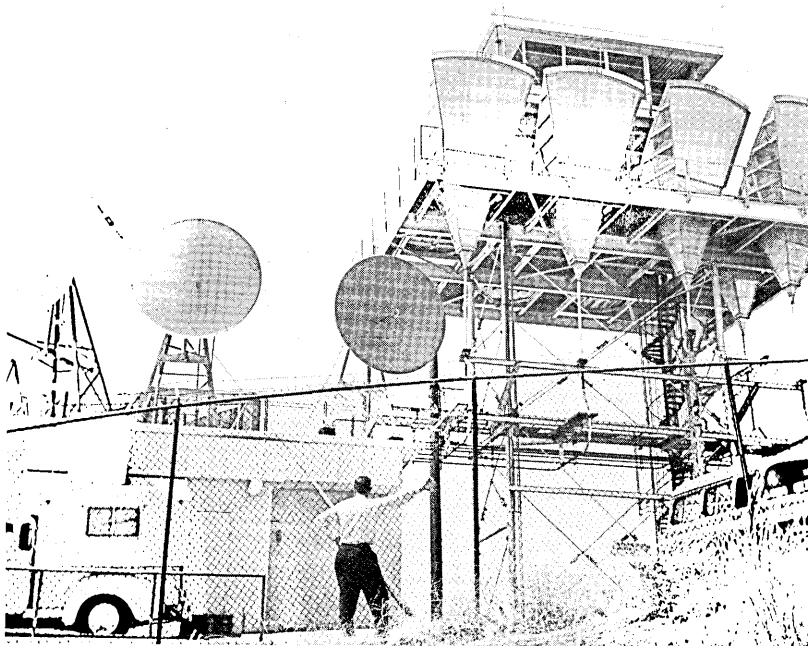

Micro-wave data transmission -- North American Aviation, Inc., Los Angeles, Calif. Three "dishes" (lower left) on Oat Mountain receive signals micro-waved from three divisions of this company and re-direct them to the desired computer center. "Horns" at the upper right handle network television signals. The building on top of the structure is a fire watcher's station.

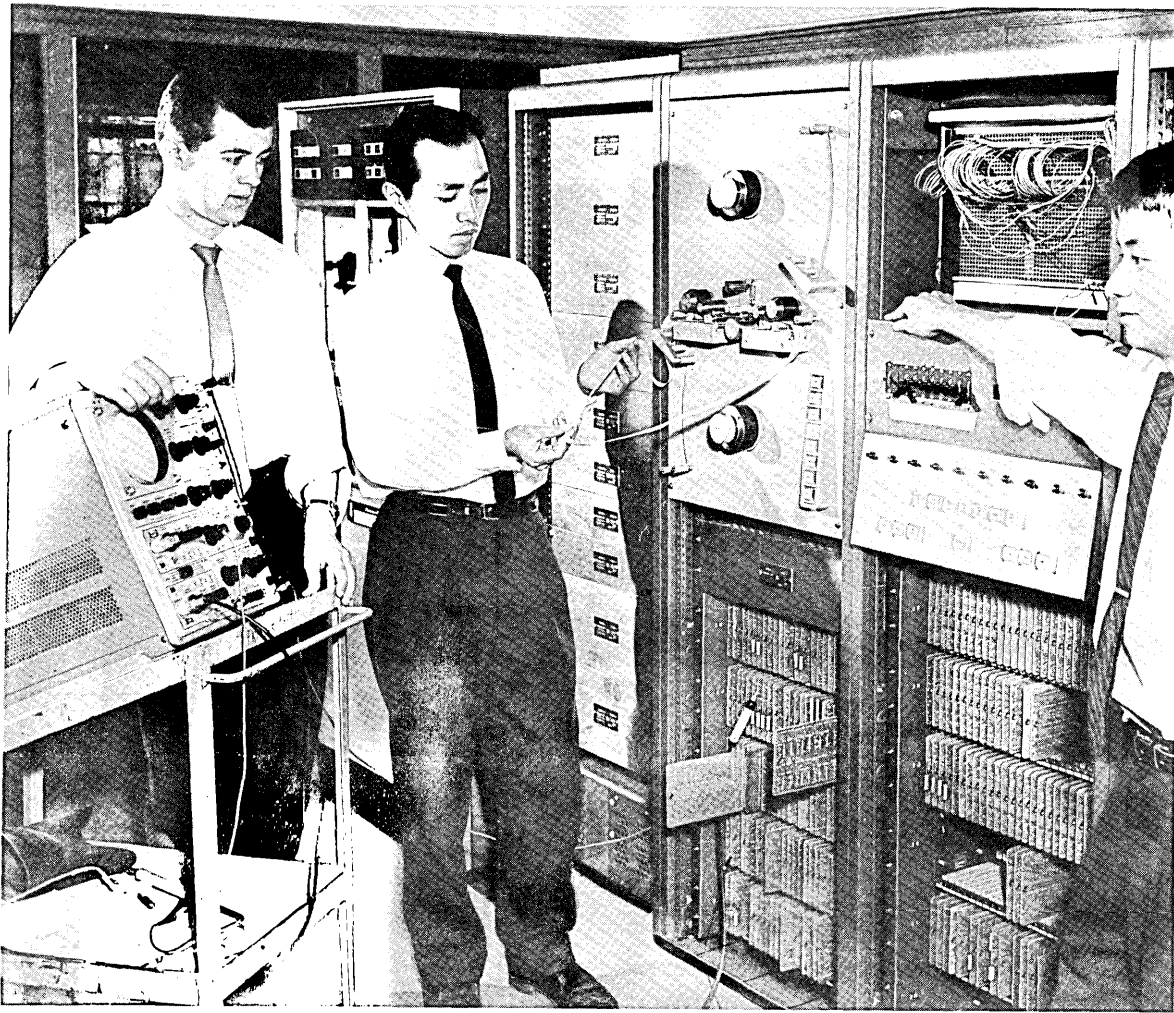

Electronic converters -- Digitronics Corp., Albertson, N.Y. Two specially designed converters which accommodate both English and Japanese languages are being used by the Tokyo Electric Power Co. in conjunction with their Remington Rand Univac installation. The converters are used to convert data from perforated paper tape (data transmitted over Japanese teletype lines in received as paper tape) to magnetic tape and from magnetic tape to perforated tape, at high-speed in both directions. Digitronics adapted their equipment to conform to Japanese standards.

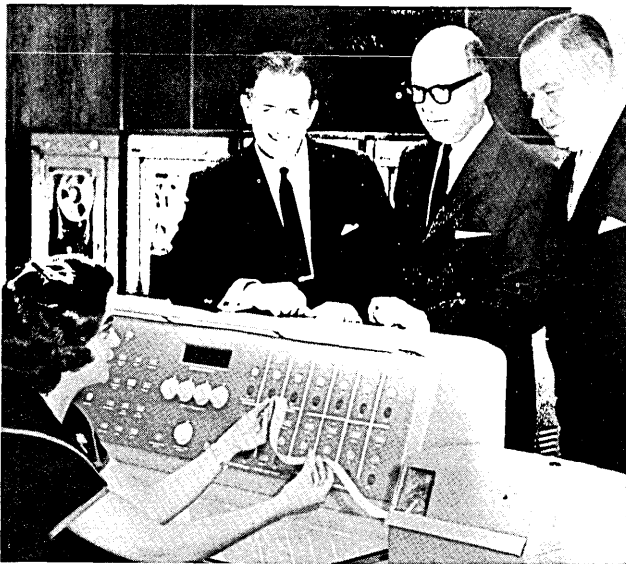

Branch Bank Data Handler -- National Cash Register Co., New York, N.Y. The operator shown here is receiving information over the Data-phone equipment installed in the New York Telephone Co. The device transmits data recorded on punched tape directly into a computer center, eliminating the conversion of tape to punched cards. In use by The Manhattan Savings Bank's Westchester County office in Mt. Kisco, their savings account data is fed directly into a National Cash Register Company computer center 40 miles away in midtown New York over a telephone connection. Observing the operation of a data-phone are (l. to r.) Willard K. Denton, bank president; Robert S. Oelman, NCR president, and J. D. Dodd, vice-president of the New York Telephone Co.

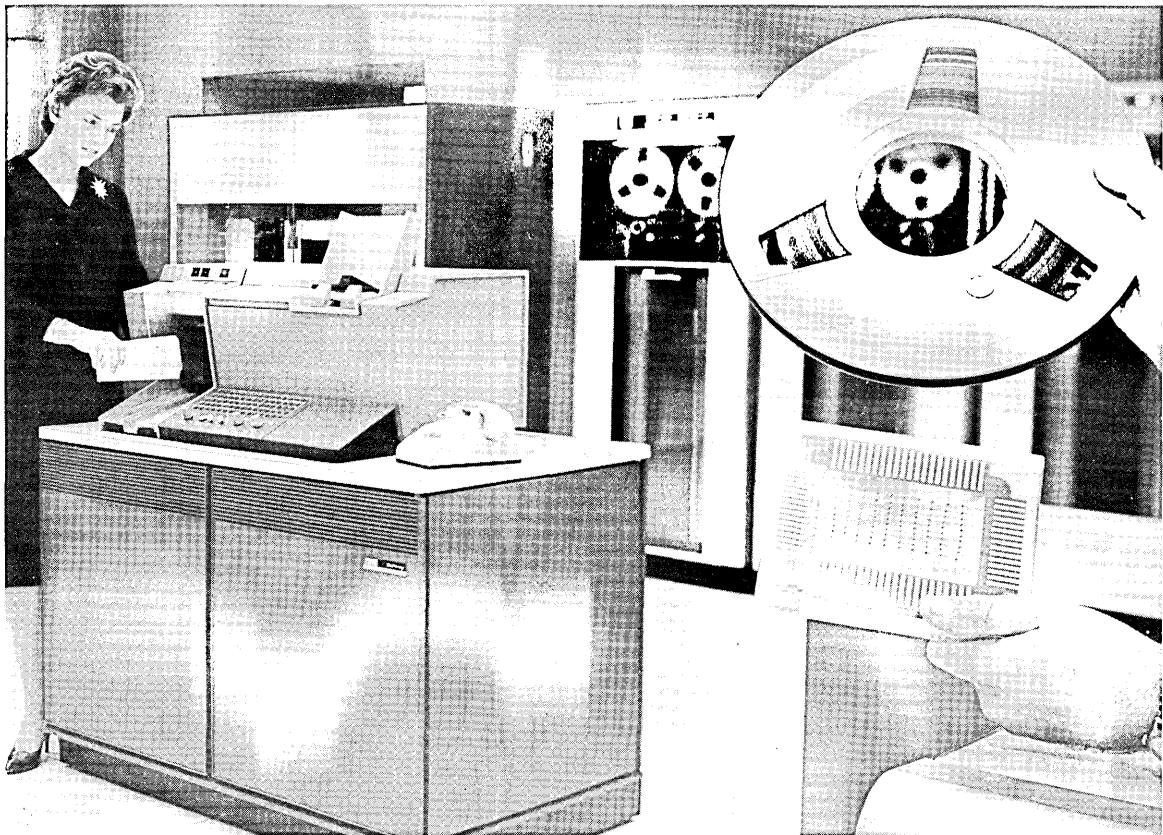

IBM 1013 card transmission terminal shown can communicate directly: (1) with the core memory of an IBM 1401 or 1410 computer (symbolized by core plane at right); or (2) with an IBM 7702 magnetic tape transmission terminal (symbolized by tape reel); or (3) with another 1013. -- International Business Machines Corp., White Plains, N.Y.

Type DAT bidirectional converter, magnetic tape/paper tape -- General Devices, Inc., Princeton, N.J. This machine will accommodate all of the wide variety of record media and machine codes presently encountered in electronic data processing systems. Data can be transmitted over great distances and prepared for insertion into any digital computer; the unit also will translate data from one type of computer format to another.

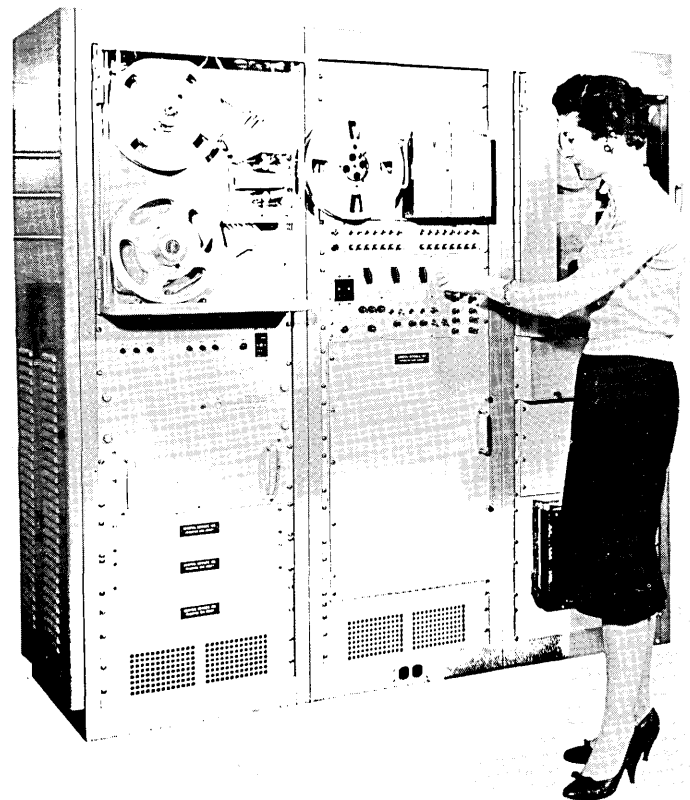

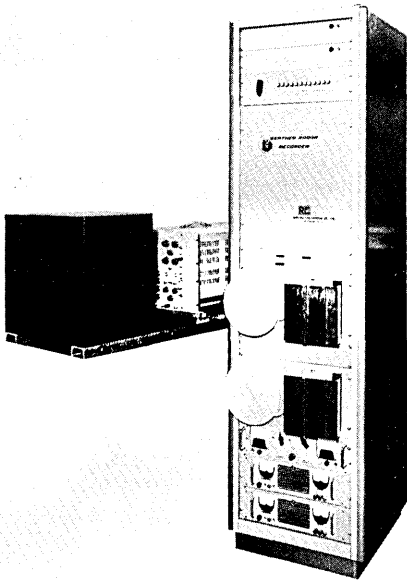

The Rabinow Pattern Converter -- Rabinow Engineering Co., Inc., Washington, D.C. The device is capable of converting any display such as oscilloscope, map or chart, to digital language; it may be modified to enable it to convert any analog display to other conventional digital media such as magnetic tape, drums or punched cards. The RPC was originally developed for the Federal Aviation Agency to convert weather radar echo patterns on a scanning scope to a digital record on punched tapes, which were then used in a weather-forecasting development project using digital-computer techniques.



Specially developed IBM data transmission terminals will be able to handle 60,000,000 words daily for the Air Force's Combat Logistics Network (COMLOGNET), being built by Western Union. Each compound terminal consists of four basic units: IBM terminal control (left), converts data to and from the FIELDATA code used for transmission over communication lines, and controls the flow of data in and out of the terminal; a Western Union teleprinter (center background) for sending and receiving information in five channel punched paper tape at speeds up to twenty characters a second, and for receiving in page copy form; two modified IBM printing card punches (right) which send or receive information in eighty column cards at the rate of eighteen characters a second. -- International Business Machines Corp., White Plains, N.Y.

WE REALIZE THAT THESE POSITIONS WILL BE AD- VERTISED AGAIN NEXT YEAR!!

BECAUSE MANY OF THE PEOPLE WE HIRE NOW WILL HAVE BEEN PROMOTED. Our H800 and H400 scientific and business computer systems have been gathering users like bees to honey. To keep the supply equal to the demand, Honeywell EDP has had to grow.

Hence, one year from now you'll probably see this ad again. Where will you be then? Still looking for a way out of your present job, or growing with Honeywell EDP?

PROGRAM SYSTEMS DIVISION

Opportunities exist for:

SENIOR ANALYSTS

Responsibilities in the Language Definition and Systems Determination Group. Analysis of the COBOL specification and the development of compiling systems for implementation. A degree in mathematics or physics is desirable, with 3-5 years' experience in Automatic Programming. Specific experience in constructing Assemblers with generators and library sub-routines is desirable.

STAFF ANALYSTS

Should have 2-4 years' experience. You will organize and direct the implementation of complex program systems such as Compilers and Assembly Routines.

PROGRAMMERS

College degree preferred. A minimum of one year's experience is required. You will write and check out portions of Automatic Programming Systems. These and other Programmer opportunities exist in the following areas: Program Monitoring Systems; Scientific Programming; Operational Programming; Service Routines.

These career assignments are available throughout the United States, particularly in the New England area. Honeywell EDP offers an excellent employee benefits program, the opportunity to continue your education and periodic salary reviews. Relocation expenses will be paid. The confidential nature of all inquiries shall be completely respected.

Honeywell



Electronic Data Processing

'An Equal Opportunity Employer'

MARKETING DIVISION

Opportunities exist for:

INSTRUCTORS

Courses are presented at our Branch Offices and at customer locations, therefore some foreign travel is possible. Must have at least one year's experience teaching EDP Programming and Systems. Willingness to travel and relocate is essential.

SALES REPRESENTATIVES

Qualified candidates should have at least one year's experience selling magnetic tape EDP systems.

SYSTEMS SERVICE REPRESENTATIVES

Requires prior experience in Programming and Systems Analysis work on tape computers.

If you are planning to attend the Eastern Joint Computer Conference in Washington, D. C., interviews may be arranged with Dr. Roger Bender, Program Systems Divisions or Mr. Donald Brosnan, Marketing Division, by contacting John L. Ritchie, Personnel Manager, at the address below.

Opportunities also exist for qualified personnel from design through programming and sales. For information, write to: John L. Ritchie, Personnel Manager, 60 Walnut Street, Dept. 14, Wellesley Hills 81, Massachusetts.

IF

- *you're weary of matching one assembler instruction per one machine language instruction*
- *you're spending half of your machine time translating compiler programs into machine language programs of questionable efficiency*
- *you're using up time and money with hunt-and-peck machine language debugging and reprogramming*
- *you're tired of seeking, teaching or even becoming a bilingual programmer—fluent in both problem and machine languages*
- *you're fed up with programming methods that are cumbersome, time-consuming and costly*

Then, you'll be interested in Burroughs B 5000, a new kind of information processing system which is the result of a total departure from traditional computer design concepts. A system in which software dictates equipment designs and specifications to bridge the communication gap between man and machine

As a problem oriented system, its software capa-

bilities accept ALGOL and COBOL statements directly because its logic matches the logic of problem-language programming. Instead of an instruction-address-instruction-address sequence, there's a continuous flow of instructions with table references when addresses are required. Addresses are independent of instructions.

The system language is designed to implement the problem language for extremely rapid translations allowing program translation each run. Object programs, as efficient as those written in machine language, can be created far faster than with the most advanced conventional computers.

The need for the programmer to know both problem and machine languages is eliminated. Now for the first time, the programmer is free to concentrate on the processing problem itself. Free of the gymnastics he used to employ to make his problem acceptable to the machine, he merely states the problem and the Burroughs B 5000 provides an efficient, rapid solution.

Burroughs—TM

Burroughs Corporation, Detroit 32, Michigan

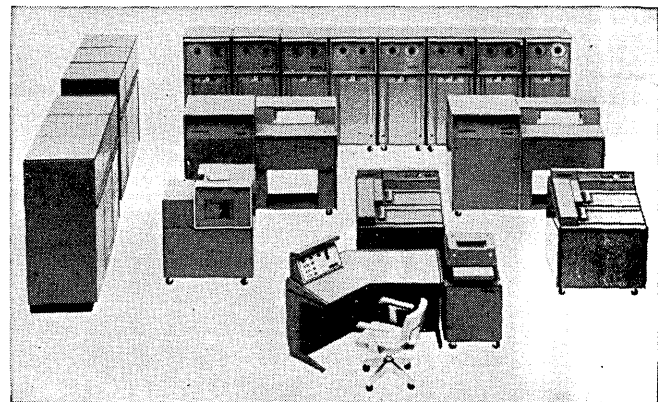

Burroughs Corporation



BOOKS AND OTHER PUBLICATIONS

Moses M. Berlin
Allston, Mass.

We publish here citations and brief reviews of books and other publications which have a significant relation to computers, data processing, and automation, and which have come to our attention. We shall be glad to report other information in future lists if a review copy is sent to us. The plan of each entry is: author or editor / title / publisher or issuer / date, publication process, number of pages, price or its equivalent / comments. If you write to a publisher or issuer, we would appreciate your mentioning **Computers and Automation**.

Martin, E. W., Jr. / *Electronic Data Processing -- An Introduction* / Richard D. Irwin, Inc., Homewood, Ill. / 1961, printed, 423 pp, \$10.60

This book is designed for the advanced undergraduate student and no prior background in data processing is necessary. The information is in the main presented from a business-application point of view. In seventeen chapters the author discusses: Fundamentals of Data Processing, Punched Card Data Processing, Development of a Computer Processing System, Random Access Files, Systems Analysis and Design, Management Responsibility Toward Information Technology, etc. Four appendices discuss: Operating the 650, Tracing Routines, Binary Notation and Arithmetic, and Floating Decimal Representation. Index.

Rapoport, Anatol / *Fights, Games, and Debates* / University of Michigan Press, Ann Arbor, Mich. / 1961, printed, 400 pp, \$6.95

This is an important and interesting book from a social as well as a technical point of view, "addressed to any serious student of human conflict." The author, an Assoc. Prof. of Mathematical Biology at the Univ. of Mich., and senior Research Mathematician at the University's Mental Health Research Institute, proposes scientifically founded methods by which human conflict can be understood and perhaps controlled. In an introduction the three modes of conflict -- fights, games and debates -- are briefly discussed. The three parts of the book, *The Blindness of the Mass*, *The Logic of Strategy*, and *The Ethics of Debate* discuss game theory, strategy, persuasion, etc. Index.

Bionic Machines -- A Step Toward Robots / Dr. Peter M. Kelly, Aeronautronic Div., Ford Motor Co. / Industrial Research, vol. 3, no. 1, Feb.-Mar., 1961, p 31 / Scientific Research Pub. Co., Inc., 200 South Michigan Ave., Chicago 4, Ill.

Electronic systems which are designed along the lines of biological systems, i.e., bionic systems, are discussed. Their application to certain processes is described, and the increasing need for such systems, or robots, is discussed. The "neuron that learns", bionic hybrids, machine ability to recognize and distinguish, and learning capabilities, are among the subjects which are covered.

*"A new perforated
tape reader?"*

"By Digitronics?"

"All photo-electric?"

*"At the cost of
mechanical readers?"*

*"Reads at 300
characters/second?"*

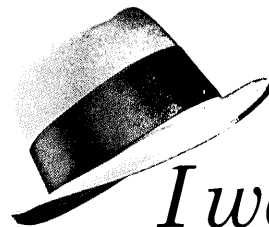

*I want to see
this for myself
at the EJCC"*
BOOTH 95

In case you won't make the Eastern Joint Computer Conference, we'll be happy to send you all the details—just write to: Digitronics Corporation, Albertson, New York

How To Get Things Done Better And Faster

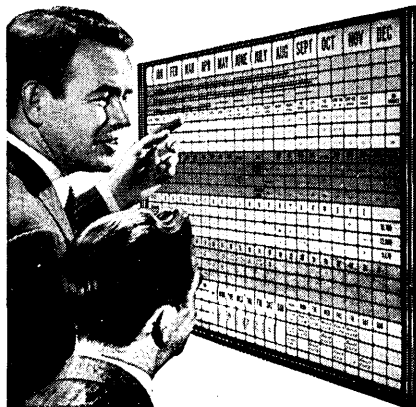

BOARDMASTER VISUAL CONTROL

- ☆ Gives Graphic Picture — Saves Time, Saves Money, Prevents Errors
- ☆ Simple to operate — Type or Write on Cards, Snap in Grooves
- ☆ Ideal for Production, Traffic, Inventory Scheduling, Sales, Etc.
- ☆ Made of Metal. Compact and Attractive. Over 500,000 in Use

Full price **\$4950** with cards

FREE 24-PAGE BOOKLET NO. DC-10
Without Obligation

Write for Your Copy Today

GRAPHIC SYSTEMS
YANCEYVILLE, NORTH CAROLINA

ADVANCED SYSTEMS DEVELOPMENT

Emerging now from three years' intensive effort at International Electric is a computer-based communication system that equals the state-of-the-art. Future progress will depend upon our ability to advance the state-of-the-art in our design and development of future systems.

Research Specialists are needed for original contributions in *Artificial Intelligence*, to result in advanced techniques in man/machine communications. They will perform studies in such fields as linguistics, philology, learning theory, automatic programming, information retrieval, simulation and compilers.

Programming Specialists are needed for advanced program analysis and development for large, real time digital systems. For consideration, send your resume to Manager of Technical Staffing, Dept. CA.

INTERNATIONAL ELECTRIC CORPORATION

An Associate of International Telephone and Telegraph Corporation
Rte. 17 & Garden State Pky.
Paramus, New Jersey
An equal opportunity employer.

Lazzaro, Victor, Editor / Systems and Procedures: A Handbook for Business and Industry / Prentice-Hall, Inc., Englewood Cliffs, N.J. / 1959, printed, 464 pp, \$10.60

Nineteen experienced users and designers of data processing systems and cost control systems for industrial application discuss current techniques and applications, pointing out the problems and some solutions which are inherent in the implementation of automation and control processes. In sixteen parts the authors discuss: Electronics in Business, Management Research, Selecting and Training Systems Men, Budgets and Cost Control, The Systems Study, etc. Index. Fourth Printing, September, 1960.

Letov, A.M. / Stability in Nonlinear Control Systems / Princeton University Press, Princeton, N.J. / 1961, offset, 316 pp, \$8.50.

The theory of the stability of motion as applied to automatic systems is here discussed. The author, a Nobel prize-winner, is chairman of the Russian National Committee for Automatic Control; for this English translation, he has added material not presented in the Russian version. Following an introduction which discusses the problem of stability, twelve chapters discuss: "Stability of Control Systems", "Formulation of Simplified Stability Criteria", "Inherently Unstable Control Systems", "Programmed Control", "Stability of Control Systems with Two Actuators", etc. Author and subject indices.

Druzhinin, G. V. / Time Delays / Pergamon Press, 122 East 55 St., New York 22, N.Y. / 1961, offset, 80 pp, \$2.50

This book, an English translation from Russian, describes the properties and discusses the principles of many types of time relays. Written for the engineer and student engineer, the four chapters discuss: Time Relays With: 1. Electrical Delay; 2. Mechanical Delay; 3. Electrothermic Delay; 4. Electrochemical Delay. Two appendices provide additional technical data. References.

Tentative Standard for the Protection of Electronic Computer Systems, NFPA no. 75-T / National Fire Protection Assn., 60 Battery March St., Boston 10, Mass. / 1961, printed, 29 pp, 50¢

This report discusses safety measures which are recommended to protect large machine systems from damage by fire or associated effects. The recommendations cover the computer room, utility requirements and certain special constructional needs. A section on protection and duplication of records is included.

Bank of America's Great Data Processing Center in San Francisco / Kenneth R. MacDonald / The Office, vol. 53, no. 5, May, 1961, p 122 / Office Publications, Inc., 232 Madison Ave., New York 16, N.Y.

This article describes "the largest building...especially built for completely automated clerical procedures" and the computer systems which are housed in the building. Presently, \$5 million of data processing equipment for bookkeeping, accounting, and collating are used to process checks, loans, etc. The text is supplemented by blueprints showing the building's structural design.



von Neumann, John / The Computer and the Brain / Yale University Press, New Haven, Conn. / 1958, printed, 86 pp, \$4.00

The analogies between the computing machine and the human brain are discussed by the eminent mathematician. The text was originally prepared for presentation as the annual Silliman Lectures at Yale, but not given on account of illness. The thesis is that the brain operates in part digitally, in part "analogically". The first part of the book discusses the computer's logical processes, describing analog and digital procedures, the characteristics of computer memory and of modern machines. The second part is devoted to the brain, with chapters on the nature of nerve impulses, the genetic mechanism of memory, the logical structure of the nervous system, and a discussion of the role of codes in the control of logical machines and systems. The final pages discuss the languages of the brain and of machines.

COMPUTER PROGRAMMING

... learn programming from Home Study Courses in use over 5 years.

IBM 1401 SYSTEM ... programming for the card, magnetic tape and MICR models.

PROGRAMMING THEORY ... principles, processing, practical practice programming.

Prepare yourself ... your staff ... for the day when you will need to consolidate your stake in computers.

Write for free catalogue describing our training courses.

Business Electronics Inc.
Training Section
420 Market Street
San Francisco 11, Calif.

Accredited Member National Home Study Council

5. COMPUTER COMPONENTS

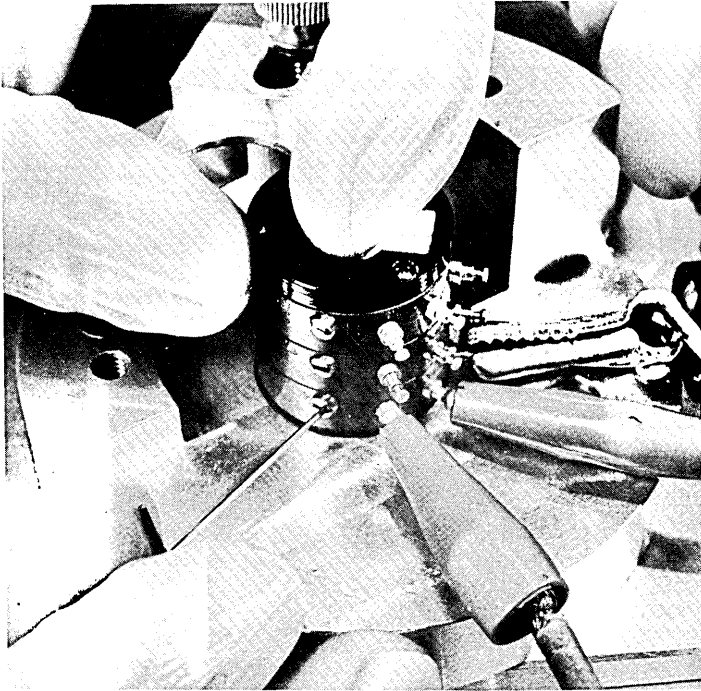

Phasable ganged potentiometer -- Daystrom Inc., Archbald, Pa. This potentiometer is being adjusted prior to shipment to meet exact performance specifications. The surgically-clean fingertips are one of a number of precautions taken to prevent body acids from possibly impairing accuracy and reliability of this circuit component. Any number of individual cups can be ganged on a single shaft -- as many as 24 pots in a space of only 6 inches. Individual cups can be phased through 360°, without affecting the adjustment of adjoining cups, simply by adjusting the wiper from outside the potentiometer by using a simple Allen wrench.

Model M10 One-Megacycle Flip-Flop -- Navigation Computer Corp., Morristown, Pa. This device has five identical flip-flops which will operate as a counter at rates up to 2 megacycles. Each flip-flop has a neon indicator. Together with another module, this one forms a parallel-entry adder which will complete a 5-bit addition in a maximum of 4 microseconds; and the sum in the adder can be shifted for serial-parallel multiplication.

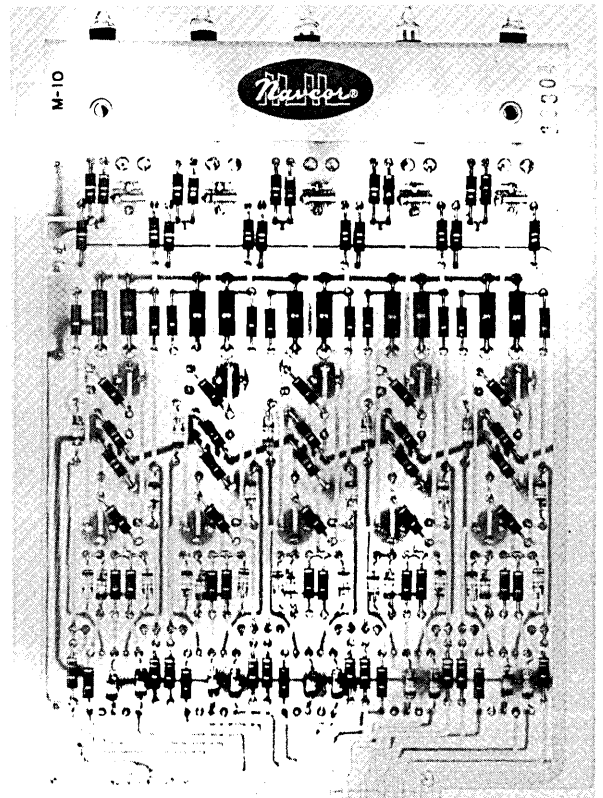

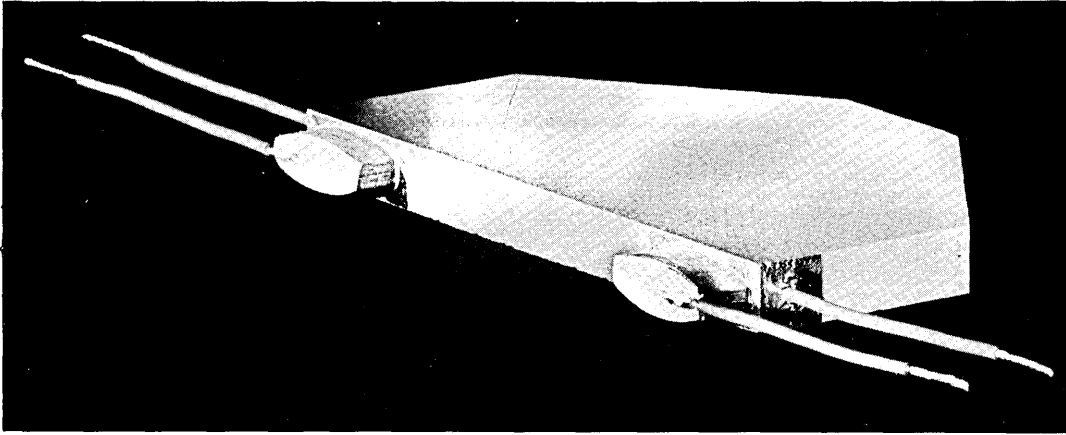

A temperature-independent glass ultrasonic delay line is used as the storage element in the SM-40 serial memory manufactured by the Computer Control Company, Inc. The delay line utilizes a delay medium of "zero TC" glass (TC stands for temperature coefficient), designated Code 8875 glass by Corning Glass Works, Corning, New York. The glass exhibits a nominal temperature coefficient of time delay equal to zero at 25° centigrade. Variation of this glass with temperature is less than one part in a million per 15° centigrade. Delay lines, using this glass, are manufactured by Corning Electronic Components, a Corning department at Bradford, Pa. The velocity of this glass is roughly two-thirds of that of fused quartz (the usual standard). Delay lines have been made of this glass that hold 2000 bits with a storage density of 25 million bits.

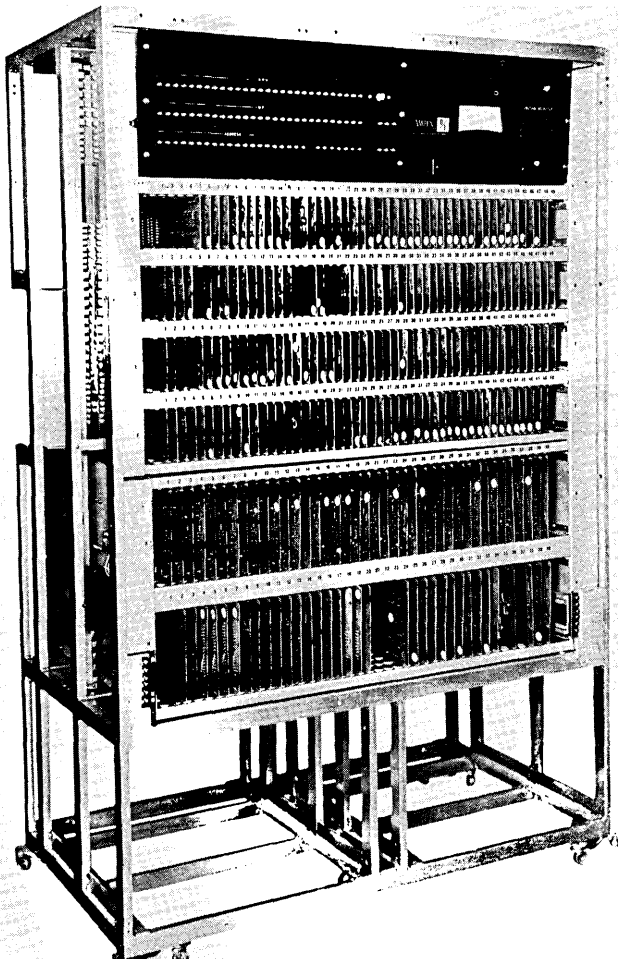

LQ Core Memory -- Ampex Computer Products Co., Culver City, Calif. This core memory has 1.5 microsecond cycle time. The storage elements are special ferrite cores with 30 mil outside diameters. The temperature rise during full-speed operation is negligible. The memory is compatible with current computer designs.

tive
of co
cula
the g
Then
in 19
mos
men
step
med
prop
appl

of m
today
in ac
their
their
prov
Yet
cent
work
ber
"num
are
only
math
appl

mea
tions
tive
ming
have

in th
rem
give
it ap
foun
Obvi
only
May

ing
that
betw
the
As l
mor
phys
ask
or r

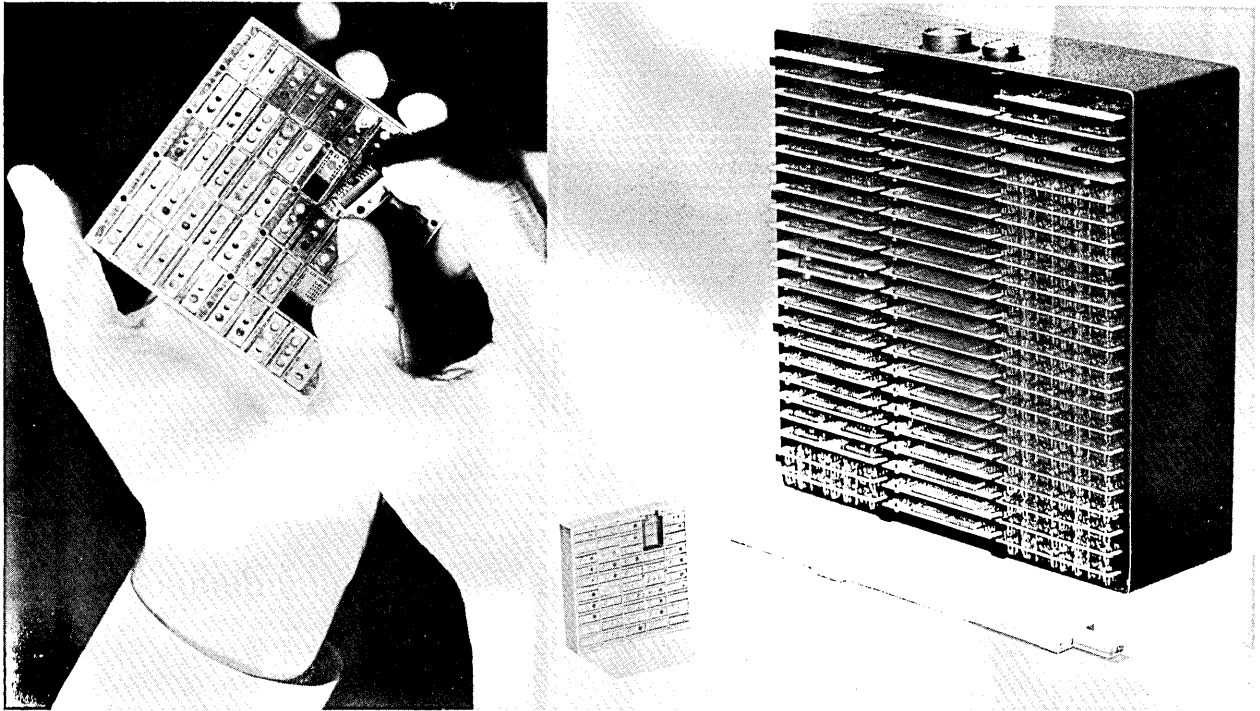

A molecular, electronic, Semiconductor Network Computer -- Texas Instruments, Inc., Dallas, Texas. This micro-miniature digital computer is 6.3 cubic inches in size and 10 oz. in weight. It was developed for the Aeronautical Systems Division of the U. S. Air Force in connection with ASD's Molecular Electronics Program. The micro-computer performs the same functions as the "conventional" computer shown but is 150 times smaller and 48 times lighter. Each of its 587 digital circuits is formed within a minute silicon bar. Three types of semiconductor networks are used: RS flip-flop, NOR gates, and logic drivers.

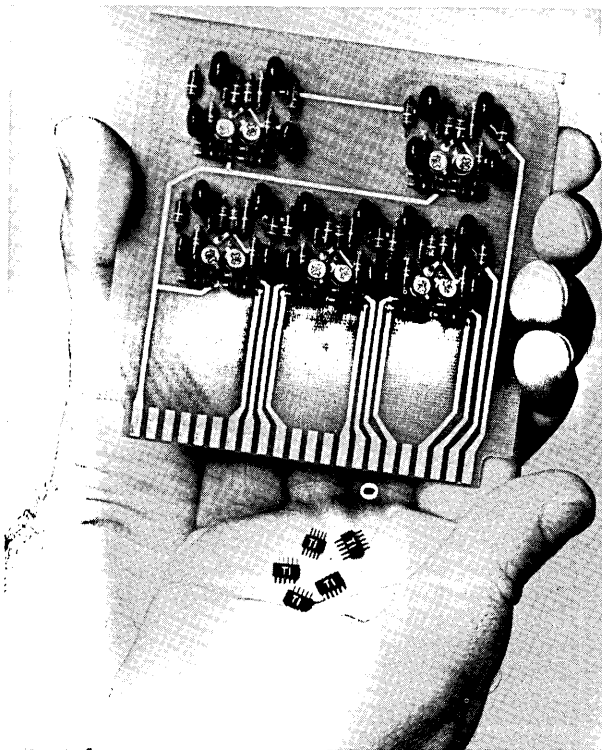

Solid Circuit[®] semiconductor networks, Series 51 -- Texas Instruments, Inc., Dallas, Texas. These miniature units provide six different digital circuits. They will handle 90% of the circuit functions of digital equipments. Each unit is in a hermetically sealed package measuring 1/4 by 1/8 by 1/32 of an inch; they use only 1/10 as much power as most conventional circuits. The five networks shown in the palm of the right hand are the functional equivalent of the entire large assembly.

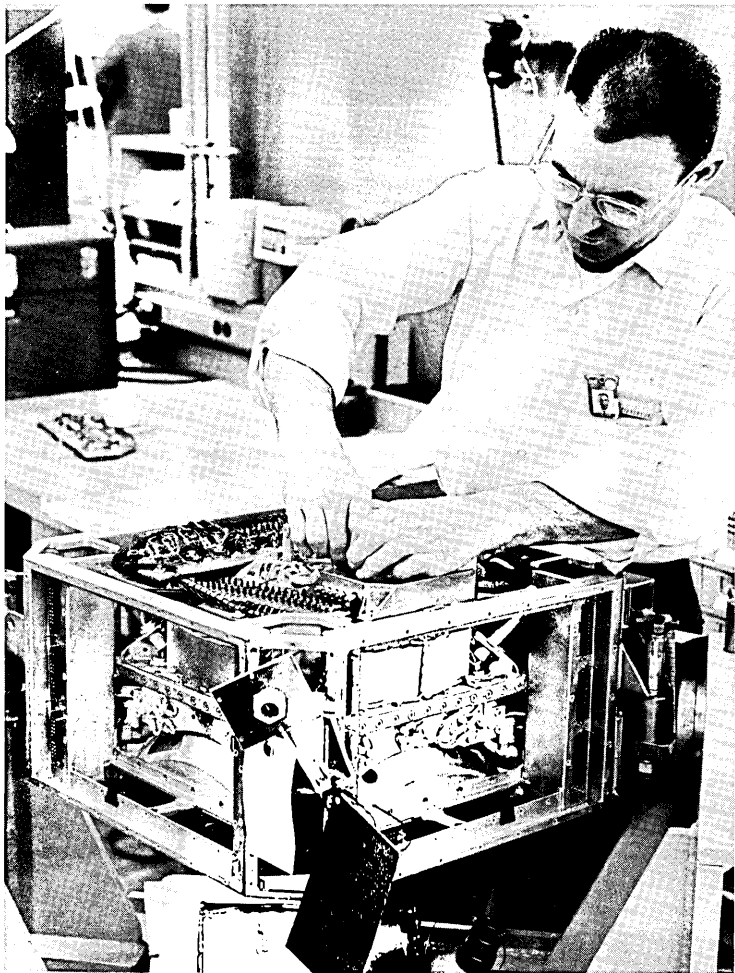

An employee at IBM Federal Systems Division Space Guidance Center, Owego, N.Y., fastens frame around the magnetic drum memory in a TITAN II guidance computer. The miniature magnetic memory drum represents an achievement in ruggedness and compactness. The thin shell memory drum operates at 6000 RPM's. Data is carried along 57 tracks on the magnetic skin of the drum, and 82 magnetic heads put the data in memory and retrieve it when needed. These magnetic heads float on an air cushion 1/10,000ths of an inch thick.

Dr. Walter O. Freitag, head of the Materials Development Group at the UNIVAC Engineering Center in Whitpain Township, Pa., catches his reflection in a circular plate of gold about to "go up in smoke" as part of an experiment in thin-film memories. After being inserted in the spindled stand, the gold plate will be vaporized in a bell chamber and then condensed to form a "thin film" on a glass plate. Investigations of the magnetic qualities of many metals for possible use in computer thin-film memories are being made. This type of memory permits information to be accessed from a computer more rapidly than is possible with standard computer core or drum memories.

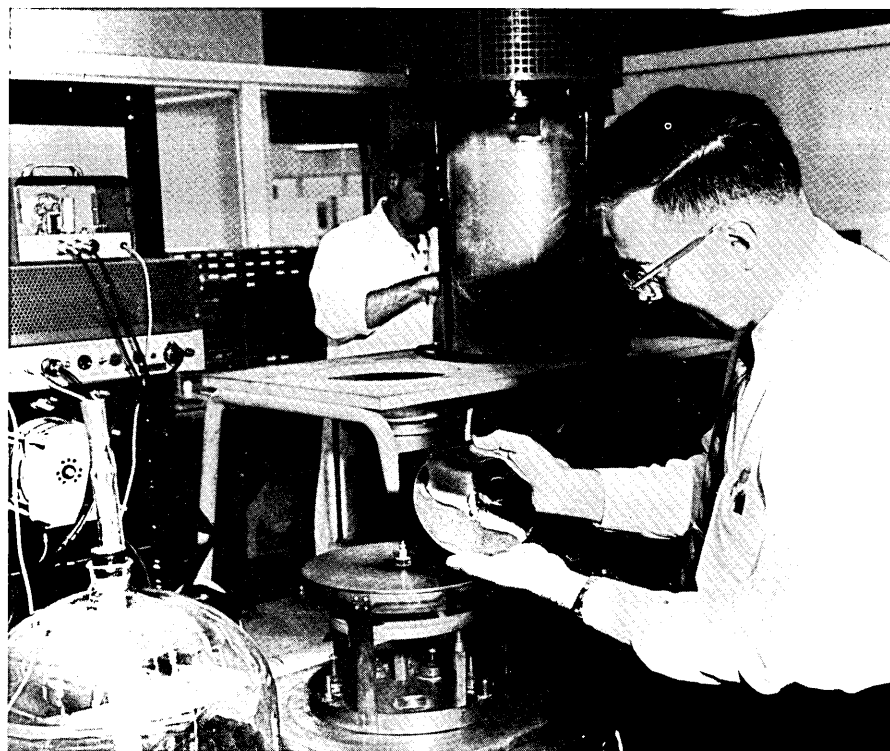

str
abi
nev

pro
era
ful
or
as
abl
ma
pos
of p
me
his

plic
re-
ligh
It i
out
rea
ter
wel

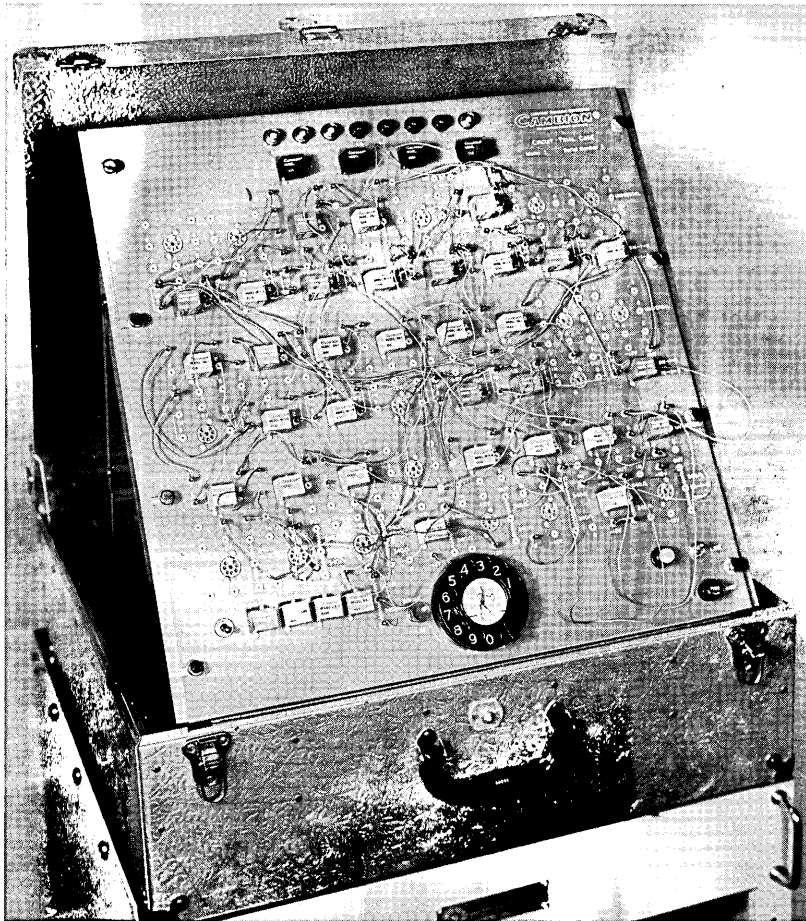

Circuit simulation board -- Cambridge Thermionic Corp., Cambridge, Mass. With this circuit simulation board, experimental circuits are made using Cambridge Thermionic modules as components.

HD Magnetic file drum -- Laboratory for Electronics, Inc., Boston 15, Mass. This high density magnetic file drum has wide application to data processing systems: it gives rapid access to an enormous volume of stored data. Though only 15 inches in diameter by 14 inches tall, yet they store 15 million bits.

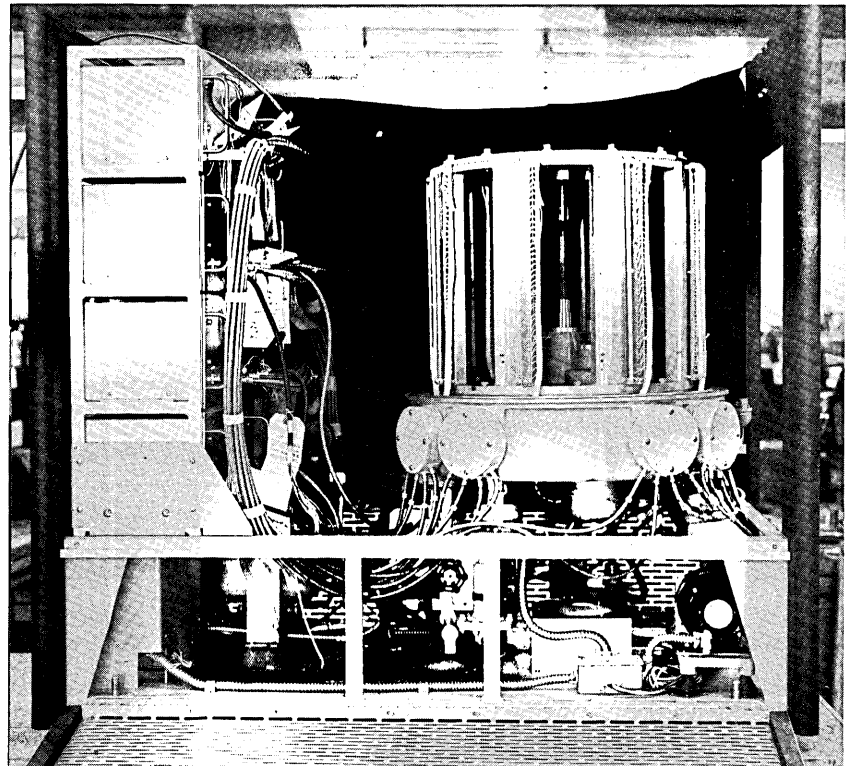

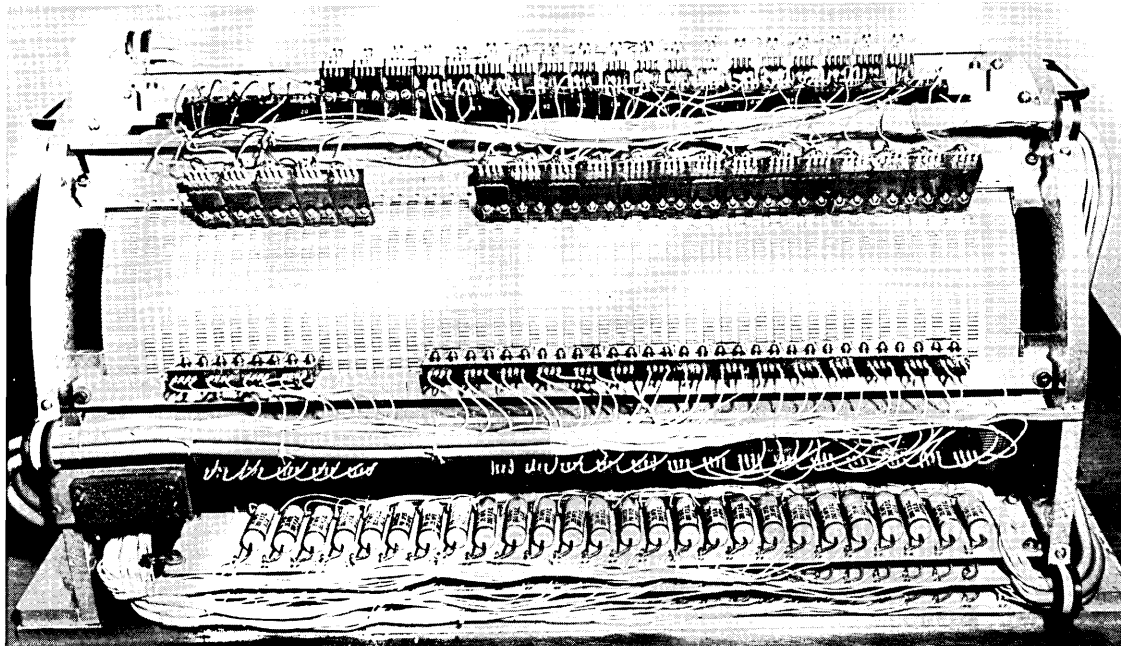

Dynastat magnetic memory drum -- Consolidated Controls Corp., Bethel, Conn. This drum presents stored information independent of speed of rotation: it can be read even while stationary. This drum therefore is as suitable for use with stepping operations as with continuous processes. It is particularly suited to sorting in connection with materials-handling conveyor systems.

Memory-Core System -- Computer Control Co., Inc., Framingham, Mass. This is a transistorized, high-speed, random-access, magnetic-core memory. It has a storage capacity ranging from 20,480 bits to 163,840 bits. It has an access time of 2.5-4.0 microseconds and a read-write cycle time of 5-10 microseconds.

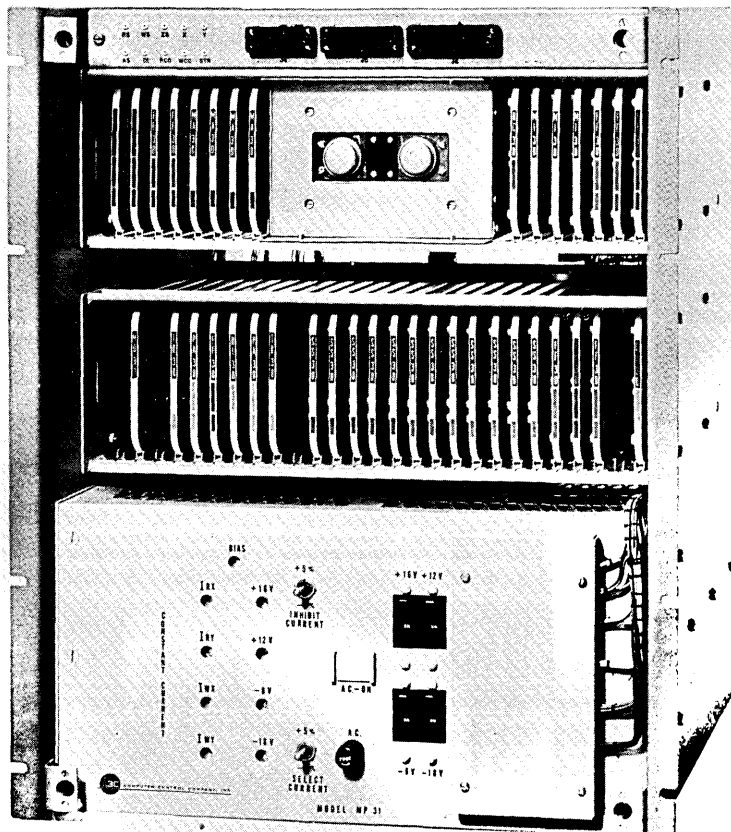

Who's Who in the Computer Field (Supplement)

A full entry in the "Who's Who in the Computer Field" consists of: name / title, organization, address / interests (the capital letters of the abbreviations are the initial letters of Applications, Business, Construction, Design, Electronics, Logic, Mathematics, Programming, Sales) / year of birth, college or last school (background), year of entering the computer field, occupation / other information such as distinctions, publications, etc. An absence of information is indicated by — (dash). Other abbreviations are used which may be easily guessed like those in the telephone book.

Every now and then a group of completed Who's Who entry forms come in to us together from a single organization. This is a considerable help to a compiler, and we thank the people who are kind enough to arrange this. In such cases, the organization and the address are represented by . . . (three dots).

Following are several sets of such Who's Who entries.

United Air Lines, DENRZ Stapleton Field, Denver 7, Colo

Ingve, Donald C / Data Processing Technician, . . . / P / '30, Univ of Ill, '58, —

Shrader, Peter J / Data Processing Technician, . . . / P / '31, DePaul Univ, '58, —

Taylor, Selwyn H / Data Processing Technician, . . . / P / '26, State Coll of Washington, '60, —

Wenger, Robert W / Data Processing Technician, . . . / P / '28, DePaul Univ, '58, —

U S Army, The Adjutant General's Board, Fort Benjamin Harrison, Indianapolis 16, Ind

Getty, Lt Col Charles W / Management Analyst, . . . / A / '12, Georgetown Univ, '56, management analyst

Greene, Raymond M / Deputy for Technical Operations, . . . / A, optional use by top management in the decision-making process / '08, Harvard Univ, '56, management analyst

Jacobs, Lt Col Stanley E / Management Analyst, . . . / A / '13, Univ of Minn, '57, army officer

Lawrence, Gerald M / Asst Res Analyst, . . . / A, address computation, index register functions and applcns, reports generators / '15, —, '56, soldier

McCord, Hayden F / Management Analyst, . . . / A, future dev of equipments & applcns / '22, —, '56, method and system analysis

Meredith, Glen P / Management Analyst, . . . / A / '18, Missouri Univ, '56, analyst

Quisenberry, Joe F / Proj Officer, . . . / A / '17, Ohio Univ, '56, army officer

Stringer, C Gordon / Management Analyst, . . . / A / '14, Indiana Univ, '57, management analyst

U S Army Signal Supply Agency, 225 S 18th St, Phila 3, Pa

Beisel, William L / Dig Comptr Systems Analyst Trainee, . . . / ABLMP / '18, Penn State Univ Ext Schl, '59, systems analyst

Beyer, Harold / Chief, Applcns Analysis Div, IDP Activity, . . . / ABMP / '21, CCNY, '54, supervisory comptr systems analyst / article, "Selecting the Right Equipment"

Bleakney, Howard F / Management Analyst, . . . / AB / '21, Drexel Inst of Tech, '56, system analyst

Brady, Robert E / Dig Comptr Systems Analyst Trainee, . . . / ABL / '27, Temple Univ, '60, dig comptr system analyst trainee

Chase, Milton / Dig Comptr Systems Analyst, . . . / ABLP / '28, Temple Univ, '56, —

Vought Electronics, a Div of Chance Vought Corp, P O Box 1500, Arlington, Tex

Bussey, Gene R / Chief of Comptr Systems, . . . / ABDP, self-organizing sys-

tems, heuristic prob solving, adaptive real time control, non-redundant coding, machine learning / '19, Oklahoma Univ, '51, electronics engr

Davis, Charles R / Desgn Engr, . . . / CDEL / '31, Stephen F Austin State Coll, '60, engr

Deering, C S / Engrg Specialist, . . . / DEL / '31, The Univ of Texas, '53, electrical engr / "A Wide Band Direct Coupled Operational Amplifier"

Guerra, Raymond / Desgn Engr, . . . / LM / '36, Texas Christian Univ, '59, desgn engr

Gunnip, Robert W / Systems Engr, . . . / E / '22, TCU, '60, electronics

Martin, W E / Engrg Specialist, . . . / DEL / '24, SMU, '53, engr

Shelman, C B / Engrg Specialist, . . . / CDELM / '22, Univ of Tex, SMU, '54, comptr engr / three patents

Zombolas, George P / Senr Electronics Desgn Engr, . . . / ACDE, input-output eqpmt / '23, Temple Univ, Arlington State Coll, '60, systems desgn

Westinghouse Elec Corp, Steam Turbine Div, Lester Branch P O, Phila 13, Pa

Burdette, Billy R / Manfacturg Engr, . . . / A, manufacturing systems analysis / '34, Auburn Univ, '59, manufacturing engr

Carson, Donald B / Manufacturing Engr, . . . / AB / '26, Univ of Penn, '59, mfg engr and mfg systems

Parks, Robert S / Mfg Engr, . . . / A, mfg systems analysis / '34, Georgia Inst of Tech, '59, mfg engr

Vaillancourt, Robert E / Comptr Planning Head, . . . / ABMP, systems analysis for both engrg and data prog applcns / '26, American Int'l Coll, '54, comptr planning and systems

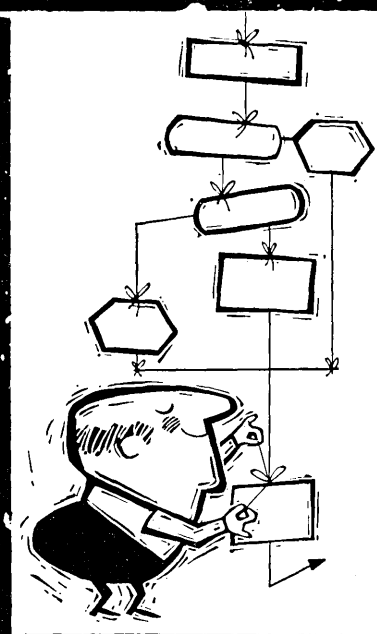

COMPUTER PROGRAMMER

We need mobile minds capable of ranging analytically over a wide range of program formulation and documentation requirements for digital computer-centered, command-control systems. Programmer-linguists fluent in machine language of this sort are invited to write to Harry Laur.

An equal opportunity employer



LITTON SYSTEMS, INC. Data Systems Division

Canoga Park, California

ACROSS THE EDITOR'S DESK

News of Computers and Data Processors

New Installations

400TH UNIVAC SOLID-STATE COMPUTER GOES TO FUEL & IRON COMPANY

The 400th UNIVAC Solid-State Computer to be built by Sperry Rand's Remington Rand UNIVAC Division has been installed at the Colorado Fuel & Iron Co., Pueblo, Colo.

The magnetic-tape computing system delivered to Colorado Fuel & Iron will be used for both a broad range of accounting functions, and for production, inventory control and production scheduling.

The new system supplements a UNIVAC Solid-State card system which was installed in May, 1960. It will employ 90-column punched cards for input and output. Peripheral units of the system include four Uniservo magnetic tape units, a processor, a synchronizer, a card reader, a card punch and a high-speed printer.

IBM 7070 OPERATES AT UNIV. OF ROCHESTER

The first IBM 7070 system in New York State to be installed at a university is in operation at the University of Rochester.

The unit will be one of only five such systems in the country to be installed in a university computing center and will be the first 7070 installation in the Rochester area. The National Science Foundation recently awarded the University a grant of \$200,000 to aid expansion of the Computing Center.

The new Computing Center installation will offer considerably greater memory capacity, speed and flexibility than the IBM 650 equipment which has been used at the Center since 1956. Although the University Computing Center has been used primarily in the area of numerical calculations, a whole new range of applications, such as the simulation of behavioral, social, and biological processes, will now be possible.

HONEYWELL SET TO EQUIP AUSTRALIA'S LARGEST EDP CENTER

Plans for installation of the largest electronic data processing center in Australia have been announced by the Commonwealth's Department of Defence and Minneapolis-Honeywell Regulator Company, Minneapolis, Minn.

The Department of Defence said it has contracted for the initial purchase of two large-scale Honeywell 800 electronic computers, valued at over \$2 million, for installation next summer at its EDP Proving and Training center.

Honeywell has reported it will open an EDP sales office in Australia "to assure the Department of Defence the best possible service in connection with its Honeywell 800 installations and to seek new business in the Commonwealth."

The Department of Defence's EDP plans include a permanent joint-services automatic communications network connecting the computer centers to the various units of the Australian Armed Services.

The EDP centers in peacetime will deal with the accounting and administration associated with an inventory of 500,000 stock items dispersed throughout Australia and overseas, which are affected by an estimated 60,000 individual reports a day.

BRITISH MARKET RESEARCH FIRM GETS FIRST OVERSEAS SHIPMENT OF IBM 1410

The first overseas shipment of a new type of intermediate data processing system - the IBM 1410 - was made this weekend to A. C. Nielsen Co., Ltd., British market research firm, in Oxford.

Nielsen will use the electronic data processing system to help compile retail indices for food, drugs, cigarettes, tobacco and candy. These are continuing audits which measure consumer sales of each important brand with its share of the total market. IBM United Kingdom, Ltd., will install the powerful new computer.

TEXTILE BANKING CO. INSTALLATION

Textile Banking Company, Inc., New York, N. Y., one of the nation's largest factoring firms, has placed in operation a new computer which processes automatically the \$750 million worth of accounts receivable purchased annually by the financial institution.

Developed by the National Cash Register Company, the desk-size NCR 390 system provides Textile's clients with faster and more accurate information about their accounts.

In two hours, the computer prepares detailed monthly statements for hundreds of clients -- 10 times faster than formerly. The machine figures debits and credits incurred by each client during the month, calculates its new balance, and prepares an itemized record showing all the transactions that took place during the period. The speed of the data processor is expected to enable Textile's clients to receive their financial statements much earlier.

The machine automatically handles all the paperwork connected with a client's account. It figures the discounts, commissions, interest and other charges on millions of invoices purchased annually by the institution.

ARTOC RECEIVES MOBIDIC B

The U. S. Army Tactical Operations Central (ARTOC) has taken delivery of a Mobile Digital Computer, Model B (designated Mobidic B). The unit is made by the Sylvania Division of General Telephone and Electronics Corporation under contract to the Signal Corps Research and Development Laboratory. Final acceptance tests of Mobidic B were carried out at the Aeronutronic Division of Ford Motor Company's Engineering and Research Center in Newport Beach, Calif. ARTOC is intended to put the speed and versatility of modern electronics to work for the Army field commander, helping him to make appropriate decisions in the more arduous tactical environment of the mid-1960's.

COMPUTER TO BE INSTALLED AT CELANESE CORP. PLANT

Celanese Corporation of America will install a digital computer system to control two of the four primary oxidation units of its chemical plant at Bishop, Texas. The system will be supplied by Thompson Ramo Wooldridge Inc., Canoga Park, Calif. Celanese anticipates that the computer control system will pay for itself within two years by increasing

productivity and efficiency at the Bishop plant.

The computer, known as the RW-300, will exercise closed-loop control over Bishop's non-catalytic vapor-phase process that converts liquefied petroleum gases (propanes and butanes) to formaldehyde, acetaldehyde, methanol, ethanol, acetic acid, acetone, and other chemicals. Bishop plant production is approximately 400,000 tons per year. Computer control is expected to result in increased product yield, through closer control of such factors as chemical reactor temperature and richness of feedstock.

OREGON BANK USES MARC I SYSTEM

An advanced data processing center housing a 1.7 million dollar electronic banking system, nicknamed MARC I, was activated in Portland recently.

The computer-based banking system will serve over 600,000 customers in a broad range of banking applications. The First National Bank of Oregon, Portland, Ore., and its 87 branches will use the MARC I system for maintaining loan liability ledgers, loan accruals, general ledgers, outstanding official checks, Christmas savings and other applications.

Component parts of MARC I are the IBM 7070 computer and the IBM 1401-1412 bank data processing combination.

BOSTON BANK WILL USE TWO H-800'S

One of the nation's largest computer banking systems under one roof will be installed early next year at The First National Bank of Boston, Mass. This computer system, through its ability to handle the Bank's large volume of daily transactions at high speeds, is expected to produce savings in operating costs.

The new electronic system will be basically composed of two Honeywell 800 large-scale computers, valued at approximately \$2 1/2 million, and will be leased by the bank under a purchase-option agreement.

In addition to the two computers, the Bank has also leased four General Electric Company reader-sorters which will read from the checks the magnetic ink characters -- the machine language adopted by the American Bankers Association.

New Computing Centers

BENDIX WILL OPEN COMPUTING CENTER NEAR DETROIT

The Bendix Corporation's Systems Division has announced plans to open a new computing center in the Greater Detroit Area.

The center, to be opened in the spring of 1962, will contain a high-speed Bendix G-20 digital computer system, designed and manufactured by the Bendix Computer Division, Los Angeles.

Features of the computing center will include security-cleared premises for military projects, and a location convenient to the growing complex of research and industrial organizations in the area.

The center will be augmented by a new COED Mark II display and control system, developed by the division. Analog computer facilities for dynamic simulation and a BOSCAR reader for display data reduction are also housed within the center.

GENERAL ELECTRIC'S TEMPO GETS COMPUTER CENTER

The General Electric Company has announced plans to establish a major Computer Center at TEMPO, GE's long-range planning and advanced engineering organization, at Santa Barbara, Calif.

The Computer Center will employ an IBM-704 system, with a 32,000-word magnetic-core memory, ten magnetic tape units, and a variety of peripheral equipment. The computer will be compatible with the nation-wide SHARE program. Installation of the computer itself is expected to be completed by January 15, 1962, with full-scale operation of the Computer Center scheduled for February 1.

Later in the year, a GE-225 system will be added to work both separately and with the IBM-704, to provide expanded capability and several additional operating features.

ITEK LABORATORIES HAS NEW COMPUTER CENTER

Itek Laboratories, Lexington, Mass., has put into operation a new computer center built around an IBM 1401 computer.

CEIR SAN FRANCISCO COMPUTER CENTER RECEIVES ADDED COMPUTER POWER

Addition of an IBM 7090/1401 computer system to the facilities of the San Francisco Computer Center of C-E-I-R, Inc., Washington, D. C. is announced.

Installation of the new computer system will be completed early in January 1962, providing what is believed to be the largest electronic data processing installation available commercially to business, industry, government and defense establishments of the San Francisco Bay area and the Pacific Northwest.

NEW EDP CENTER ANNOUNCED IN NEW YORK

The establishment of a computer controlled data processing center was announced by Computer Sciences, Inc., Westbury, New York.

The processing of both scientific and business problems is accomplished with an IBM 1620 Data Processing System after initial programming by a staff of highly trained mathematicians and engineers. In the business field the automatic preparation of payrolls and invoices as well as automatic inventory control has been started. Scientific programs currently in existence are associated with the nation's defense efforts.

COMPUTER TAPE CONVERSION CENTER ANNOUNCED

A service bureau for the conversion of computer tapes will be established at the Santa Ana plant of Electronic Engineering Company of California in April.

The Computer Tape Conversion Center hopes to save computer users both time and money in the conversion of data from one computer format into a form ready for direct insertion into another type of computer. The center expects to find use when branch plants which use a different computer from the one used at their headquarters office want to transmit information to the home office. Also companies which are changing over to larger computers with a different format can convert their records to a new format.

New Contracts

R. C. A. GETS \$3 MILLION FOR DESK-TOP COMPUTER

The U. S. Navy has awarded a \$3 million contract to the Radio Corporation of America, for final stage development of a high-speed computer approximately the size of a portable television set.

The contract is an extension of one under which RCA has been working to perfect a billion-cycle computer for the Navy's Bureau of Ships.

TELEMETRY SYSTEM FOR TELSTAR SATELLITE

Radiation Incorporated, Melbourne, Fla., has been awarded a contract to design and build PCM/FM telemetry systems for the Bell System Project Telstar communications satellite.

The contract, from Bell Telephone Laboratories, Murray Hill, N. J., calls for delivery of an electrical development model, a prototype qualification model and two flyable units by early 1962. The company is also providing two automatic-tracking antennas that will be used with the Bell System's experimental communications satellite.

INTERNATIONAL ELECTRIC CORP. GETS \$57 MILLION FOR DEFENSE COMMUNICATION SYSTEM

International Telephone and Telegraph Corporation announced today that its subsidiary, International Electric Corporation, has been awarded a contract currently funded in excess of \$57-million to proceed with the production phase of Program 465L, the new command and control system for the Strategic Air Command.

International Electric Corporation, Paramus, N. J., was designated in 1958 to manage the design, development, production and installation of the 465L System. The major portion of the development phase was recently completed by IEC, which has systems management responsibility for ITT's U. S. Defense Group.

Program 465L, the designation given to the automated command and control system, will link together all SAC bomber, missile and logistic support bases in a world-wide communications network. At each SAC headquarters, a switch will automatically route messages to their proper destinations. The system also uses a high-speed transistorized computer

which will process the information, comparing planned events with actual events. This computer's output will be displayed on large wall screens for the SAC Commander and his staff.

IBM GETS B-52 NAVIGATION CONTRACT

The International Business Machines Corp., White Plains, N. Y., has been awarded a contract for the production of B-52 navigation systems. The U. S. Air Force contract is said to amount to \$1,960,000.

MINUTEMAN ELECTRONIC TEST UNIT AWARDED TO BECKMAN

Two contracts totaling approximately \$1,500,000 have been awarded Beckman Instruments, Inc., for electronic units to be used in the automatic checkout system of the Air Force's Minuteman ballistic missile.

The contracts were awarded Beckman's Systems Division, Fullerton, Calif., by North American Aviation, Inc., whose Autometrics Division produces the Minuteman inertial guidance and flight control systems. The new transistorized equipment will perform diversified functions for the guidance and control system of the solid-propellant missile.

SDC TO DEVELOP INTEGRATED SATELLITE CONTROL PLAN

System Development Corporation of Santa Monica, Calif., has received a letter contract from the Air Force Space Systems Division for computer program integration of six satellite control programs.

The contract calls for the firm to integrate and systematize existing computer programs involving satellite guidance, stabilization, command control, telemetry, payload and data reduction. Among the satellite programs to be studied for the Air Force Satellite Control Facility are Midas, Discoverer, and Advent. The amount of the contract was not announced.

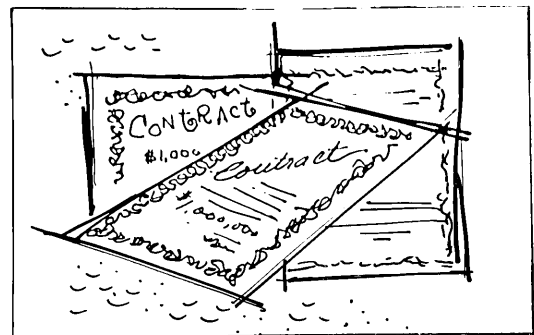

New Firms, Divisions, and Mergers

BURROUGHS SETS UP TEACHING MACHINE DIVISION

Burroughs Corporation has established an auto-instructional systems division to develop programs for using electronic techniques in automatic teaching.

Dr. Felix F. Kopstein, a psychologist who has directed numerous auto-instructional projects for the U. S. Air Force over the past 11 years, has been appointed director of the new division.

C-E-I-R TO HELP LAUNCH NEW ADVERTISING MEDIA SERVICE

C-E-I-R, Inc., world-wide industrial, economic and operations research firm is supplying technical assistance, electronic computing know-how, and capital to help launch Central Media Bureau, Inc.

C-E-I-R's investment approximates half of C M B's capitalization and the older corporation becomes the major shareowner of the new company.

Through the use of advanced electronic computers and programming methods, C M B will offer an advertising media service which includes centralized estimating, billing, and payment, for radio and television spot commercials, and high-speed communication of vital rate data to advertisers, agencies, radio-TV stations, and sales representatives.

DAYSTROM DIVISION RENAMED AMERICAN GYRO

American Gyro, a Division of Tamar Electronics, Inc., Gardena, Calif., will be the official name of the former Pacific Division of Daystrom, Inc., Los Angeles, Calif. The former Daystrom division was purchased by Tamar in late August. American Gyro was the name formerly used by the firm prior to purchase by Daystrom.

UNIVAC ENTERS COMMERCIAL BANKING EQUIPMENT FIELD WITH PURCHASE OF DALLAS OUTFIT

The Remington Rand Division of Sperry Rand Corporation has announced purchase of National Data Processing Corporation, Dallas, Texas.

National Data Processing since 1958 has engaged in the development, manufacture and marketing of Magnetic Ink Character Recognition (MICR) equipment for the automatic processing of checks and other bank documents. Included in the product line are check encoders, document processors and audit listers.

COMPUTER EQUIPMENT CORP. ACQUIRES NOVA-TECH

Computer Equipment Corp., Los Angeles, Calif., has acquired Nova-Tech, Inc., of Manhattan Beach, Calif.

Computer Equipment produces timing systems in the nanosecond range, data processing products, and missile cabling devices. Nova-Tech manufactures aircraft and marine navigational equipment, FM multiplex receiving systems, and home multiband aircraft-marine radio receivers.

LITTON INDUSTRIES ACQUIRES AERO SERVICE CORP.

Aero Service Corporation, Phila., Pa., an international aerial survey company, will be acquired by Litton Industries, Beverly Hills, Calif.

The transaction will involve exchange of an undisclosed amount of Litton stock.

Aero Service Corporation has annual revenues of \$10 million and has 700 employees.

Aero Services, with its photogrammetric engineering and geophysical survey capabilities, will work with Litton's Western Geophysical Company and other divisions of Litton in aerial survey and mapping projects.

It will become part of one of Litton's four groups of operating companies covering the fields of defense equipment and systems, business machines, electron tubes and components and industrial electronic equipment and services.

ACM NATIONAL COMMITTEE FOR BUSINESS DATA PROCESSING EXPANDS

The National Committee for Business Data Processing, ACM, is sponsoring the movement to form The Special Interest Group for Business Data Processing (SIGBDP), as a semi-independent membership group within the framework of the National ACM organization. Petitions for this status will be submitted to the ACM Council at either the EJCC or the Spring JCC.

New Software

NEW PROJECT PLANNING PROGRAM

C-E-I-R, Inc.
1200 Jefferson Davis Highway
Arlington 2, Va.

RAMPS, (Resource Allocation and Multi-Project Scheduling), an automated method of project planning and control, has been developed.

The new programming method is based on the critical-path scheduling concept of PERT (Program Evaluation and Review Technique). But it goes further by introducing competition among activities for a given resource, and taking into account many projects, resources, and costs.

A working program has been coded for the IBM 7090 computer, and several applications have been made in actual situations. In one application, the 7090 took three minutes to generate a schedule based on 3 projects, 113 activities, 11 different types of resources and 3 rates of resource utilization for 146 sample time periods.

GENERATOR FOR STATISTICAL TABULATION

Dick H. Brandon
Director of Programming Services
John Diebold & Associates, Inc.
430 Park Ave., New York 22, N. Y.

A program designated "DIGEST", (Diebold Generator for Statistical Tabulation) for the IBM 1401 data processing system has been developed.

The system of programs has been designed to:

- simulate the operation of the 101 statistical sorter
- generate object programs for statistical analysis
- provide complete flexibility in the use of the 1401 as a rapid, inexpensive statistical tool
- avoid expensive set-up charges

Generation of instructions is controlled by parameter cards, with up to 130 of these cards possible, expressed in the English language. These cards control the generation of specific features desired by the

user, thus reducing memory and time requirements of the object program. All information fed to the DIGEST generator is program-checked for validity and consistency to avoid erroneous calculation.

This program represents the first of a series of programs putting into effect the concept of "application generation" as used by this organization.

DEMONSTRATION OF FACT

Minneapolis-Honeywell Regulator Co.
Electronic Data Processing Division
80 Walnut St.
Wellesley Hills, Mass.

A new programming aid, known as FACT (Fully Automatic Programming Technique), was demonstrated for the first time in November at Honeywell's Boston area EDP facilities.

The basic FACT system, transcribed on magnetic tapes, has been distributed to Honeywell customers for field testing. These tapes will permit users to compile and operate many FACT programs that have already been written.

The miniaturized version is said to have wide uses in radar distance measuring systems, digital doppler applications and missile distance measuring equipment, in addition to its present application in radar altimeter equipment.

FACT is a very large compiler, comprising some 150,000 computer instructions covering the full range of business electronic data-processing operations. It is the EDP industry's most complete business compiler in that it provides an easy and uniform method of handling all aspects of data processing, including input editing, sorting, processing of variable length records and report writing.

Included with FACT is Honeywell's Executive Monitor, a programming aid that permits the automatic processing of a series of computer programs in parallel on the Honeywell 800 without human intervention. The Executive Monitor, among other things, makes possible parallel processing, a feature of the Honeywell 800.

New Computers

FIRST ASI COMPUTER ORDERED BY GOVERNMENT SPACE AGENCY

NEW SPACE-BORNE COMPUTER HAS THIN-FILM MEMORY

Univac, St. Paul 16, Minn., has developed a general-purpose space-borne computer utilizing thin-film memory and welded encapsulated circuit modules. The unit is expected to have exceptional reliability. This development has produced a computer with a maximum operation rate of over 80,000 operations per second. A thin-film memory and welded circuit computer compressed into little over a cubic foot makes the design adaptable to space and airborne applications. The advent of microtronic circuits may allow construction of these computational capacities in less than one-half cubic foot within the next two years. The marriage of thin-film and microtronics makes practicable reliability goals of 15,000-20,000 hours without component failure.

MINIATURIZED DIGITAL COMPUTER

A miniaturized computer -- the size of a loaf of bread yet capable of performing calculations at the speeds of a room size computer -- has been announced by Burroughs Corp., Detroit 32, Mich.

The operating model shows how a new method of construction allows the shrinkage of a commercial computer from room size to desk-size. Military electronic equipment may be thus "compressed" for use in aircraft, spacecraft or missiles.

Called MADDAM (the name is derived from Macro-Module and Digital Differential Analyzer Machine organization), the computer has 5,500 components housed in a space measuring 3 x 6 x 11 inches and a component density of 69,000 components per cubic foot. The computer weighs 12 pounds and can perform 33,000 mathematical calculations per second.

The Macro-Module method has a finned heat exchanger as a central element in a "log" or row of triangular chips. The chips, approximately three-eighths inch thick and the height of a half-dollar contain electronic circuitry and plug into a folding printed circuit board. Additional compactness is obtained by folding (or actually wrapping) the board holding the upright chips around the heat exchanger. The chips fit snugly between the fins of the heat exchanger. Two such rows of chips each three inches square and ten inches long, contain the circuitry, logic, memory and other working parts of the computer.

The first order for an Advanced Scientific Instruments, Inc., Minneapolis, Minn., computer has been received from the National Aeronautics and Space Administration (NASA).

The computer, an ASI-210, will be used by Goddard Space Flight Center, Greenbelt, Md. in the design of satellite attitude control systems and orbital calculations for such programs as Nimbus, OAO (Orbiting Astronomical Observatory) and OGO (Orbiting Geophysical Observatory). The ASI-210, a small but powerful computer, has a basic cost of \$130,000 and is priced in the \$130,000 to \$200,000 range depending on the peripheral equipment required.

ASI, although only seven months old, now has a 210 prototype in advanced stage of manufacture, a larger 420 nearing completion, and production has begun on the second 210 for the NASA order. The ASI computer for Goddard Space Flight Center is expected to be delivered and in operation by April, 1962.

The ASI 210 is said to include a program package simplified so that engineers with minimum specialized training can "talk" with the computer in plain English language and conventional mathematical symbols.

Other New Products

BAILEY 750 INFORMATION SYSTEM ORDERED BY CANADIAN FIRM

A contract for a new solid state Bailey 750 information system has been received by Bailey Meter Company Limited, Montreal, from the Aluminum Company of Canada Limited. The system will be installed at Arvida, Quebec.

The 750 system utilizes magnetic drum programming and an arithmetic unit for performing temperature rate-of-rise computations. It has an initial assigned capacity of 300 inputs. The system can be expanded through the use of standard components. Functions to be performed include: (1) periodic logging, (2) alarm monitoring and logging, (3) selectable point trend logging, and (4) selectable point analog trend recording. A simple single purpose calculating section is included to compute the rate-of-rise of 40 temperature inputs. The rate-of-rise is monitored by the alarm system.

NEW "MODU-CON MODULE"

Elco Corporation
M St. and Erie Avenue
Philadelphia 24, Pa.

A new micro-modular flip-flop for application in counter circuits, set-reset flip-flop circuits or for specially designed circuits has been introduced.

Called the Modu-Con module, the pluggable unit is being displayed at the Eastern Joint Conference in December. Features of the new unit include Varicon contacts, fully recessed and protected; all-welded construction; and easy replacement in event heat causes deterioration of semi-conductors. The flip-flop will be available in three ways: unassembled, including plastic header with Varicons staked to header, and potting shell; or completely assembled; or specially designed to meet specific applications.

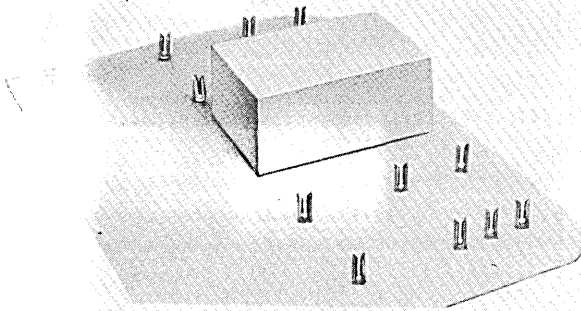
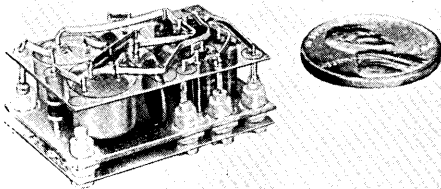

ECONOMY TAPE DRIVE

Minneapolis-Honeywell Regulator Co.
Electronic Data Processing Div.
Wellesley Hills, Mass.

"Economy" tape drives for optional use with the Honeywell 400 have been developed. The new drives will rent for half the price of standard Honeywell magnetic tape transports.

The new tape drives are capable of transferring data to and from magnetic tapes at a rate of 32,000 alpha-numeric characters or 40,000 decimal digits per second. The tapes written by the economy system and the standard system are compatible.

COMPACT MEMORY CORE

Radio Corporation of America
30 Rockefeller Plaza
New York 20, N. Y.

A new memory core that suggests compact computer memories capable of operating without air-conditioning or other temperature compensation devices has been developed.

The memory core computer is expected to allow memories to function without temperature control or current compensation over a range from -55° degrees to $+85^{\circ}$ degrees Centigrade -- a range up to four times larger than conventional memories.

Additional features of the new cores include: full driving current, 900 milliamperes; partial write current, 450 milliamperes; pulse rise time, 0.5 microseconds; pulse duration, 4.0 microseconds; core size, .050 x .030 x .015 inches; core variation less than 0.25 millivolts per degree Centigrade; and at a driving current of 900 milliamperes, 233MI has a switching speed of 1.1 microseconds, making it suitable for memories in the 5 microsecond operating-cycle range.

LOW-COST PHOTOELECTRONIC PAPER TAPE READER

Digitronics Corp.
Albertson, N. Y.

A new low-cost photoelectric paper tape reader is being introduced by this company at the Eastern Joint Computer Conference, December, 1961. The unit, designated Model 2500, is designed for applications in numerical control, ground support, instrumentation and digital computer input -- where reliability is required but speed need not exceed 300 characters per second.

The new unit has silicon photodiodes. The amplifiers are two-stage sprocket-gated. Output voltage steps from 0 volts to 10 volts (no hole or hole).

COMMUNICATIONS-CONTROL SYSTEM

International Electric Company
Paramus, N. J.

A new concept in "total-electronic-systems" has become a reality with introduction of the ITT 7300 Automatic Data Exchange (ADX) system. Developed by the new ITT Information Systems Division of this company, the ADX System is an extremely fast, versatile, and fully automatic message switching and control system.

MAGNETIC TAPE DATAPLOTTER

Electronic Associates
Long Branch Ave.
Long Branch, N.J.

A high-speed, high-accuracy magnetic tape X-Y Dataplotter that automatically and economically reduces digital data to graphic form for easy interpretation and study has been developed.

The Series 3440 magnetic tape Dataplotter can provide off-line plotting of digital information as ink plots on 30-x-30-inch or smaller graph sheets. Digital data may be read directly from magnetic tape, punched cards, or punched paper tape. Point plotting, line plotting and symbol printing may be done with equal facility.

The chief features of the 3440 are: completely solid-state for greater reliability; no temperature-controlled environment necessary; automatic set-up from commands written on magnetic tape; plotting speeds up to 75 line segments per second; all data selection performed by dials; automatic data selection and location; overall plotting accuracy very close to the width of the line drawn; plots up to four-decimal-digit numbers of either sign.

NEW DATA SETS SEND 50 WORDS PER SECOND

Bell Telephone System
195 Broadway
New York 7, N.Y.

New data sets with the capacity for transmitting information from business machines over telephone lines at speeds up to 2400 bits per second, the equivalent of 3000 words per minute, have been developed. This is twice the speed of data sets currently available.

Two models of the new voice band serial data sets are planned. The 201A is designed for Data-Phone service over the regular message telephone network at a fixed speed of 2000 bits per second, the equivalent of 2500 words per minute in eight-channel code. This data set may also be used on private line networks or alternately with Data-Phone and private line services.

Speed increase is made possible through use of a new phase modulation-demodulation technique which permits the transmission of a bit each second per cycle of bandwidth.



People of Note

PACKARD-BELL COMPUTER CORP. GETS NEW DIRECTOR

Kenneth R. Jackson has been named the new director of Packard-Bell Computer Corp. In his new post he will also serve as vice-president of the Packard-Bell Electronics Corp., the parent company.

Two vice-presidents of the computer subsidiary were also named. They are William Seiden and Theodore J. Smith.

MINNEAPOLIS-HONEYWELL OFFICERS IN NEW POSTS

Changes in the top corporate positions at the Minneapolis-Honeywell Regulator Co., Inc., Minneapolis, Minn. are announced.

Paul B. Wishart, president of the company since 1953, is the new chairman. He succeeds Harold W. Sweatt, chairman since 1953, who is named chairman of the finance committee. James H. Binger, former vice-president and director, is the new president of the company.

Stephen F. Keating, former director and vice-president, is occupying the newly created post of executive vice-president.



SYSTEM DEVELOPMENT CORP.

Stanley Rothman is appointed Manager of the new Satellite Control Department at System Development Corporation, Santa Monica, Calif.

NEW

from

DRESSER ELECTRONICS

the improved
**CM-3 ANALOG
COMPUTER
CONTROLLER**

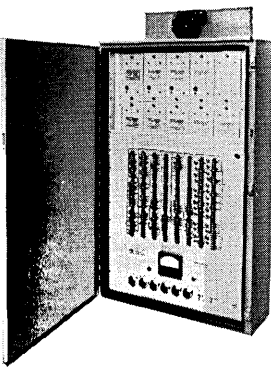

Apply the mathematical representation of your process to direct computer control with the new CM-3. This solid-state computer/controller operates in real time — continuously — in a fail-safe configuration. Used with feedback or feed-forward techniques, it provides constant process control optimization.

The CM-3 is convenient, accurate, ultra-reliable, economical, rugged — and now proven in commercial use.

Try this "computer program" yourself:

1. Calculate what improved process control could mean to you in dollars.
2. Divide this number by \$7000 — the average cost of a CM-3.
3. If the resulting ratio is of interest to you, write for details.

DRESSER ELECTRONICS
SIE DIVISION / ONE OF THE DRESSER INDUSTRIES

10201 Westheimer, Houston 42, Texas
Sunset 2-2000

NEW PATENTS

RAYMOND R. SKOLNICK

Reg. Patent Agent

Ford Inst. Co., Div. of Sperry Rand Corp., Long Island City 1, New York

The following is a compilation of patents pertaining to computer and associated equipment from the "Official Gazette of the U. S. Patent Office," dates of issue as indicated. Each entry consists of patent number / inventor(s) / assignee / invention. Printed copies of patents may be obtained from the U. S. Commissioner of Patents, Washington 25, D. C., at a cost of 25 cents each.

August 15, 1961

2,996,703 / Joseph Luongo, Cedar Grove, N. J., and Dorsey Davidoff, Berkeley, Calif. / International Tel. & Tel. Corp., Nutley, N. J. / A method of reversing count in digitizers.

August 22, 1961

2,997,154 / James J. Lahm, Brookfield, Ohio, and Dale W. Gardner, Athens, Ga. / Westinghouse Electric Corp., East Pittsburgh, Pa. / A data handling apparatus.

2,997,233 / Ernst S. Selmer, Oslo, Norway / Burroughs Corp., Detroit, Mich. / A combined shift register and counter circuit.

2,997,234 / William R. Hughes, Sylmar, Calif. / U.S.A. as rep. by the Sec. of the Army / A digital multiplier.

2,997,235 / Herman Schmid, Binghamton, N. Y. / General Precision, Inc., a corp. of Del. / An electronic function generator.

2,997,540 / Robert J. Ertman, Rochester, N. Y., Irving Sperling, Panorama City, Calif., and Watson F. Walker, Pittsford, N. Y. / General Dynamics Corp., Rochester, N. Y. / A binary information communication system.

2,997,606 / Theodore Hamburger, Baltimore, and Charles H. Wood, Jr., Arbutus, Md. / Westinghouse Electric Corp., East Pittsburgh, Pa. / A high speed switching circuit.

2,997,692 / Richard C. Lamy, Poughkeepsie, N. Y. / I.B.M. Corp., New York, N. Y. / A binary comparator.

2,997,693 / William J. Deehake, Alpine, and Byron L. Havens, Closter, N. J. / I.B.M. Corp., New York, N. Y. / An electrostatic storage system.

2,997,694 / Francis T. Thompson, Pittsburgh, Pa. / Westinghouse Electric Corp., East Pittsburgh, Pa. / A system for utilizing intelligence signals to perform control functions.

2,997,695 / Robert L. Conger, Riverside, and Alfred F. Kudela, Arlington, Calif. / U.S.A. as rep. by the Sec. of the Navy / A magnetic core storage device.

2,997,696 / Werner Buchholz and Munro K. Haynes, Poughkeepsie, N. Y., and Gordon E. Whitney, Princeton, N. J. / I.B.M. Corp., New York, N. Y. / A magnetic core device.

2,997,697 / Walter K. MacAdam, Valhalla, N. Y. / American Telephone & Telegraph Co., New York, N. Y. / A data transmission system.

**ENGINEERS—SCIENTISTS
NEXT**

CAREER CENTER

Washington, D. C.
December 12-14

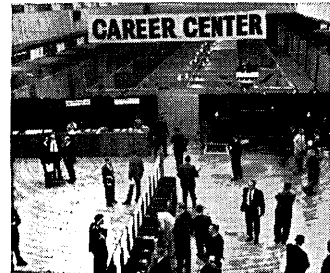

- Talk to employer representatives—from all over the country—in private interview rooms.
- Confidential registration—by closed circuit teletype process—takes less than 10 minutes.
- More than 60 employers see your qualifications. You reveal your identity only when interested.
- Ideal location! Just across the street from the Eastern Joint Computer Conference.
- Employer-sponsored. No fees or charges at any time.

LOCATION:
The Shoreham Hotel
DAYS:
December 12, 13, and 14
TIME:
10:00 a.m.-9:00 p.m. daily
PHONE:
CO 5-9882

If interviews are inconvenient at this time, you can still register for future interviews. Write for registration forms and copy of CAREER listing hundreds of current job openings with national employers. Write: Careers Incorporated, Dept. 12A, 770 Lexington Avenue, New York 21, N. Y.

CAREER CENTER

Career Centers are a service of
Careers Incorporated, 770 Lexington Ave., New York 21, N. Y.

Sponsors are Equal Opportunity Employers

outstanding individuals for permanent posts in

SYSTEMS ENGINEERING

sought by Battelle Memorial Institute



With skills in . . .

- ★ Simulation and operational gaming
- ★ Stochastic modeling of systems
- ★ Weapons systems analysis
- ★ Information theory
- ★ Optimization methods
- ★ Servo analysis
- ★ Logical design

to participate in . . .

- ★ Countermeasures systems
- ★ Transportation systems
- ★ Missile defense systems
- ★ Information storage and retrieval
- ★ Radio telescope systems
- ★ Digital computer systems

Satisfactions unlimited . . . to grow with the expanding division of a growing organization; to contribute to present programs (for government and industry) and develop fields of your special interest; to produce and publish; to associate with virtually all sciences and broaden your horizons; to earn a most attractive salary

plus comprehensive benefits . . . Advanced degree in mathematics or engineering, with three or more years in the field, desired. Write today for details.

Battelle is an institute engaging in both contract and basic research. Principal laboratories occupy a million square feet in a campus setting adjacent to Ohio State University.

A staff of 2300 is comprised of engineers and scientists in all fields, skilled technicians and supporting personnel. Facilities, among the finest, include a splendid data processing center, technical library and specialized information centers.

Our home city and its suburbs offer good living, recreational and study opportunities (three universities and many nearby colleges). Columbus is a metropolitan center of over a half million yet offers good neighborliness, gracious living within minutes of your job, and ready access to many recreation areas . . . Investigate your opportunity with us. Write for details to Les Hill,

Battelle Memorial Institute

505 King Avenue
Columbus 1, Ohio



DEDICATED TO THE ADVANCEMENT OF SCIENCE

ADVERTISING INDEX

Following is the index of advertisements. Each item contains: Name and address of the advertiser / page number where the advertisement appears / name of agency if any.

Automatic Electric Co., Northlake, Ill. / Page 103 / Kudner Agency, Inc.

Battelle Memorial Institute, 505 King Ave., Columbus 1, Ohio / Page 100 / Byer & Bowman

Bennett Associates, Commercial Trust Bldg., Philadelphia 2, Pa. / Page 104 / -

Burroughs Corp., Detroit 32, Mich. / Page 80 / Campbell-Ewald Co.

Business Electronics, 420 Market St., San Francisco 11, Calif. / Page 82 / Graham Kislimgbury

Careers, Inc., 770 Lexington Ave., New York 21, N.Y. / Page 99 / Fairfax, Inc.

Control Data Corp., 501 Park Ave., Minneapolis 15, Minn. / Pages 70, 71 / -

Dataman Associates, Inc., 6 Beacon St., Boston, Mass. / Page 37 / Larcom Randall Advertising, Inc.

Digitronics, Inc., Albertson, N.Y. / Page 81 / Hazard Advertising Co., Inc.

Dresser Electronics, SIE Div., 10201 Westheimer, Houston 42, Tex. / Page 99 / Weekley and Valenti Elco Corp., M St. below Erie Ave., Philadelphia 24, Pa. / Page 4 / Fien and Schwerin, Inc.

Electronic Associates, Long Branch, N.J. / Page 49 / Gaynor & Ducas, Inc.

Graphic Systems, Yanceyville, N.C. / Page 82 / Caswell Advertising Agency

Honeywell Electronic Data Processing Div., 60 Walnut St., Wellesley Hills 81, Mass. / Page 79 / Allied Advertising Agency, Inc.

Hughes Aircraft Co., Culver City, Calif. / Page 48 / Foote, Cone & Belding

International Business Machines Corp., 590 Madison Ave., New York 22, N.Y. / Page 102 / Benton & Bowles, Inc.

International Electric Corp., Rt. 17 & Garden State Parkway, Paramus, N.J. / Page 82 / Carpenter, Matthews & Stewart, Inc.

Laboratory for Electronics, Inc., 1079 Commonwealth Ave., Boston 15, Mass. / Page 23 / -

Litton Systems, Inc., Data Systems Div., Canoga Park, Calif. / Page 89 / Compton Advertising, Inc.

Midwestern Instruments, Inc., P.O. Box 7509, Tulsa 35, Okla. / Page 59 / Paul Locke Advertising, Inc.

National Cash Register Co., Main & K Sts., Dayton 9, Ohio / Pages 11 and 101 / McCann-Erickson, Inc.

Philco Corp., Government & Industrial Group, Computer Div., 3900 Welsh Rd., Willow Grove, Pa. / Page 3 / Maxwell Associates, Inc.

Space Technology Laboratories, Inc., P.O. Box 95005, Los Angeles, Calif. / Page 2 / Fuller & Smith & Ross, Inc.

NCR Research

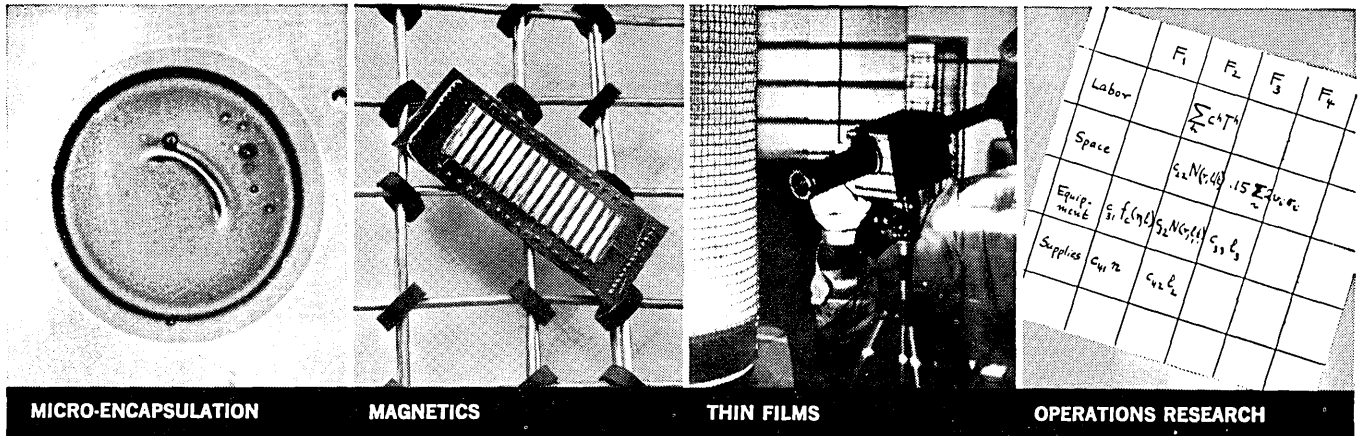

MICRO-ENCAPSULATION

MAGNETICS

THIN FILMS

OPERATIONS RESEARCH

and Development

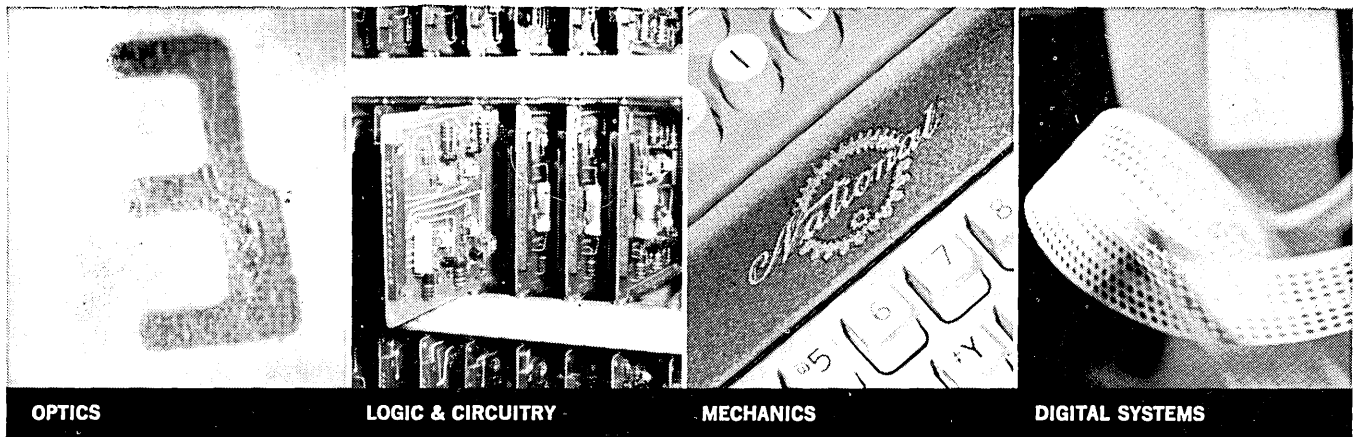

OPTICS

LOGIC & CIRCUITRY

MECHANICS

DIGITAL SYSTEMS

The National Cash Register Company presents above-average opportunity for the experienced scientist or engineer to apply his talents in a stable organization. Whether your interest lies in commercially oriented projects or advanced military electronic development, you will find lasting satisfaction and encouragement for professional advancement.

If your interests lie in one of the many fields of endeavor being carried on by The National Cash Register Company, you are invited to submit your resume to us for consideration for one of the fine opportunities now open in Dayton, Ohio at our modern Research and Development facility.

Positions open are at all levels of experience, including Project Manager. Prompt and personal attention will be given to your inquiry. All qualified applicants will be considered regardless of race, creed, color or national origin. Send resumé and letter of application to: T. F. Wade, Technical Placement, G-5 The National Cash Register Co., Main and K Streets, Dayton 9, Ohio.

SEMI CONDUCTOR RESEARCH
LOGIC AND CIRCUIT DESIGN
COMPONENT EVALUATION
TECHNICAL WRITING

ADVANCED ELECTRONIC SYSTEMS
SYSTEMS RELIABILITY
DIGITAL COMMUNICATIONS

NCR *National*

*Trademark—Reg. U.S. Pat. Off.

ELECTRONIC DATA PROCESSING
ADDING MACHINES • CASH REGISTERS
ACCOUNTING MACHINES
NCR PAPER (NO CARBON REQUIRED)

THE NATIONAL CASH REGISTER COMPANY, DAYTON 9, OHIO
ONE OF THE WORLD'S MOST SUCCESSFUL CORPORATIONS
77 YEARS OF HELPING BUSINESS SAVE MONEY



"In mathematics alone,
each generation
builds a new
story to the
old structure."

Hermann
Hankel

IBM mathematicians and programmers are doing work today that will still have meaning years from now.

They are, for example, teaching computers to work out proofs for theorems in Euclidean geometry. They are applying new techniques to problems in symbolic logic originally outlined by Russell and Whitehead. They are crossing into frontier territory in the fields of automatic storage allocation... design automation... multi-programming... lexical processing... and in almost every other area of applied and applications programming.

IBM regards programming and programming research as essential to its future growth. At IBM, mathematicians and

programmers have at their disposal the machine time they need for the full development of their ideas. And they have before them unusual opportunity for professional growth and personal advancement.

If you'd like to know more about the stimulating and rewarding work at IBM, we'd like to hear from you. All applicants for employment will be considered without regard to race, creed, color or national origin. Write to:

Manager of Technical Employment
IBM Corporation, Dept. 539M
590 Madison Avenue
New York 22, N. Y.

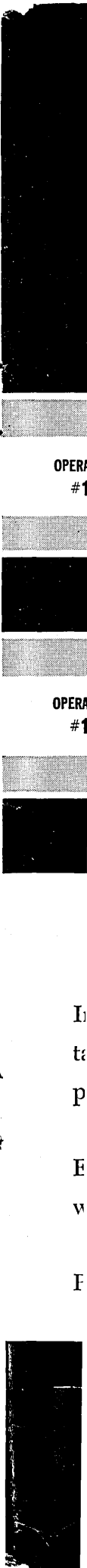

AE

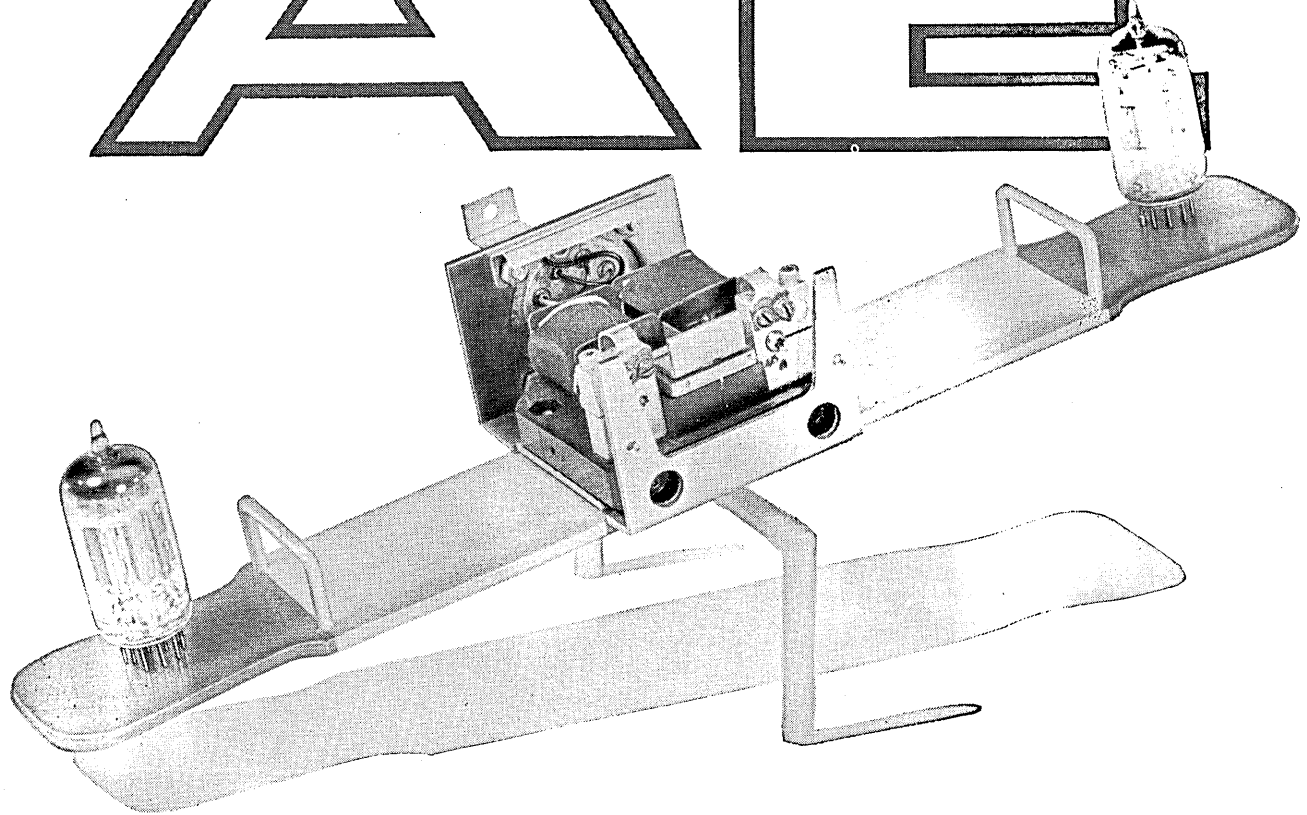

To the Engineer looking for a fast circuit seesaw

If you're in need of something better than a flip-flop that only *partially* transfers a circuit—something with a transit time of less than a millisecond—then you'll be delighted with AE's Series PTW Polar Relay. This magnetically biased relay will transfer a circuit with the beautiful regularity of an observatory clock, and trigger on only a few mils from your available energy source.

Substantially smaller than other polar relays, the PTW's unique design virtually guarantees the high-speed switching of a single circuit *billions of times without readjustment!* Its service records to date in telegraph and

teleprinter circuits and differential controls suggest that its life is practically limitless. Terminals to meet your specs.

Our circuit engineers will be happy to work with you in adapting the PTW to your designs. Or possibly you'd like to leave the switching to us—in which case we can take on the complete packaging and more than likely shave your costs.

For full information on the PTW, ask for Circular 1821-E — *and* for answers to your control problems, write the Director, Control Equipment Sales, Automatic Electric, Northlake, Illinois.

**AE
CAN
DO**

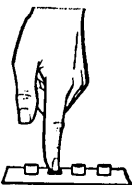

AUTOMATIC ELECTRIC

Subsidiary of

GENERAL TELEPHONE & ELECTRONICS





"OPPORTUNITY"

BENNETT ASSOCIATES

EXECUTIVE SEARCHES - INDUSTRIAL RELATIONS - PSYCHOLOGICAL TESTING

COMMERCIAL TRUST BLDG. • LOCUST 3-4830 • PHILADELPHIA 2, PENNSYLVANIA

May we take this opportunity to introduce ourselves to you.

We are a service organization devoted to meeting the requirements of the computer and allied fields for qualified engineering and management personnel.

Below are listed just a few of the specific requirements we have been called upon by industry to search for.

DIRECTOR DATA PROCESSING SYSTEMS To \$40,000

Ph.D./EE—emphasis on Math. Top Administrator experienced in military applications of digital computers. Analyze, evaluate programs and planning of military as related to digital computers. Act as consultant to V.P. Engineering and other high level management.

SPECIALISTS—CIRCUIT DESIGN AND THEORY To \$25,000

Ph.D./EE/Math—Thorough knowledge of circuit logic and familiar with analog type circuitry, communications information theory and basic network theory. One specialist with circuit logic on digital-type circuitry related to computer design.

E.D.P. CONSULTANT To \$25,000

Corporate level for multi-plant organization to analyze present systems and procedures and make recommendations to centralize.

SALES/MARKETING MANAGER To \$22,000 + Profit Sharing + Stock

To maintain existing business and develop new customers for company's services and skills in the areas of: Systems Engineering, Equipment Development, Programmed Teaching, and Product and Market Planning. This man will develop a marketing program and direct the efforts of the Sales Staff to achieve the goals established. He will guide the preparation of an advertising sales campaign. This is a top-flight spot. He will report to the President.

PROGRAM MANAGER To \$20,000 + +

Background should include at least a BS/EE and several years of broad systems experience. Should be thoroughly familiar with advanced analog and digital hardware as well as with large system integration and application. As a Program Manager, will assume major responsibility for developing, presenting, and co-ordinating engineering and development efforts in connection with multi-million dollar data systems programs.

SYSTEMS ENGINEER (Senior) (3) To \$20,000 + Profit Sharing + Stock

Synthesizes designs for large scale complex computer systems. Requires thorough understanding of computer operations at the block diagram level. Understanding of timing considerations necessary and logical design experience helpful. Knowledge of operation (functional) of input/output devices and use of computer in on-line situations desired. Should be able to define program and systems requirements and write specifications from broadly stated objectives and be able to break down complex problems into major, relatively independent sections which can be handled by less-senior personnel.

SYSTEMS ANALYSTS To \$20,000

EE/Math Deg. Min. 2-10 yrs. exp. Analysis of data to develop comprehensive systems and full responsibility for programming.

SECTION HEAD—Digital Computer Laboratory To \$19,000

Analysis and logic design. Supervise up to 30 scientists and engineers.

APPLICATIONS SPECIALIST/SENIOR PROGRAMMER To \$18,000

Math/Physics. Aero or E.E. Min. 10 yrs. professional exp. (a) programming of scientific and/or process control problems for small to medium binary computers, (b) Systems Analyses or design of launch control and check-out equipment for a large missile or space vehicle system, (c) operations analyses in the customer's facility. Ability to work well with other people and to assume role of technical leadership. NOT SALES JOB.

LOGIC DESIGN To \$18,000

Engineers capable of analyzing computer systems, skilled in mathematics and familiar with advanced State-of-the-Art digital components such as memories, delay lines, shift registers, etc.; of performing trade-off analysis among the various systems components and methods; of determining the required storage and computation characteristics; of specifying the characteristics, number and interconnection of each of the computer building blocks such as the flip-flops, memory elements, arithmetic registers, analog-to-digital and digital-to-analog devices, etc.

SECTION HEAD MAGNETIC MEMORY SECTION To \$16,000

Leadership and supervision. Design of high speed magnetic memory circuitry and design of transistors magnetic core circuitry.

MATHEMATICIANS \$15,000 UP

For operations research and computer applications. Programming on large scientific types of digital computers and systems designs. Need creative people who have designed compilers; translators, executives, etc.

SENIOR PROGRAMMER \$14,000 UP

Min. 3 yrs. exp. in data processing applications on medium scale binary computers. Highly creative approaches to program development for many types of new information systems. Programming decisions requiring optimum utilization of computers for command decisions.

SYSTEMS PROGRAMMERS \$9-\$14,000 UP

Application Programming; design and development of new systems.

TECHNICAL PROPOSAL WRITERS \$10,000 UP

Work with engineering and management in the preparation of technical proposals. Write and/or edit text that clearly and concisely explains techniques and systems concepts. Must be capable of writing engineering reports and handbooks. Prefer applicants with engineering degrees and previous experience in technical writing. Familiarity with methods of reproduction is desirable.

SENIOR STAFF SCIENTIST—SYSTEMS ENGINEERING DEPT. To \$19,000

Theoretical circuit studies, analog and digital applied research, electro magnetic wave, information and data handling and solid state materials investigation. Ph.D. in EE, Solid State Physics with advanced mathematics.

SECTION HEAD—AIRBORNE COMPUTER LAB To \$16,500

Supervise up to 30 engineers in the design of analog special purpose computers.

GROUP LEADER—DIGITAL COMPUTER LAB To \$16,500

Supervise group in logical design of digital computers.

UNIT HEAD—ELECTRONICS LAB To \$16,500

Direct group in thermo-electronic device application to special products. MS Physics, EE or ME (Heat Transfer).

SENIOR CIRCUIT ENGINEER—DIGITAL COMPUTER LAB To \$15,000

Design and development of transistorized-high speed digital memory or logic circuits. Ph.D. or MSEE.

P.S. Visit us at the Presidential Suite at the Sheraton Park Hotel, Washington, D. C., during the Eastern Joint Computer Conference, December 11-14, 1961. If you cannot see us, please do not hesitate to write to us enclosing your comprehensive resume.

A