

ALSO: TEN YEARS PAST THE 360...IMPROVING
PERFORMANCE...APRIL FOOLISHNESS...
FICTION BY HARIAN ELLISON



SYSTEM 4000

The World's First — and Only — Total Cartridge Concept

It's nice to be first; it's better to be best. System 4000 is both. It's the first totally modular "order by number" 1/4" cartridge system ever designed. It's the first to have a fully ANSI-compatible formatter with a byte-oriented I/O, and a packing density of 1600 cpi. And, it's the first to allow you to design your own one, two, three, or four deck system complete with formatter, electronics, power supply, mounting panel, cabling — even a connector to plug into your mini's controller.

System 4000 has a storage capacity of 23 million bits, with a data transfer rate of

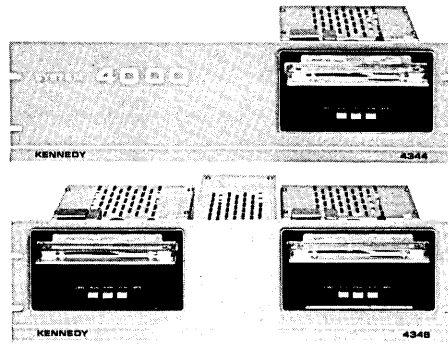

5000 bytes, and the same great features of all Kennedy cartridge recorders: CRC generation and checking, error detection, and gap generation, and simplified formatter commands such as "Write One Block," "Read One Block," etc.

System 4000 is the first truly versatile cartridge tape system. It was designed with minis in mind. It's just possibly the most significant advance in cartridge recorders since the cartridge itself.

KENNEDY CO.

540 W. WOODBURY RD., ALTADENA, CALIF. 91001
(213) 798-0953

See System 4000 at NCC — Booths 839-841

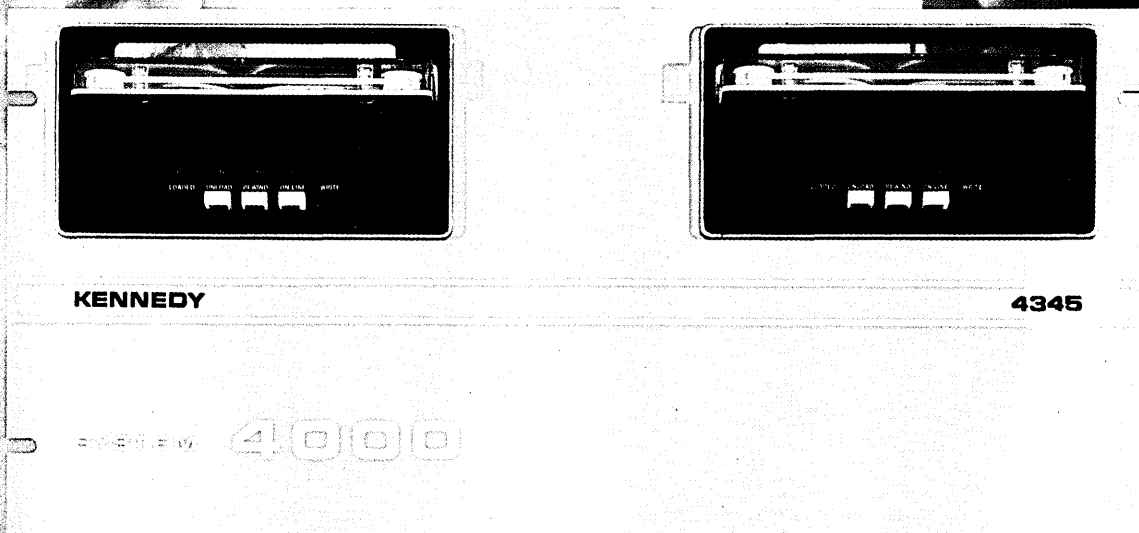

KENNEDY • QUALITY • COUNT ON IT

CIRCLE 1 ON READER CARD

TALLY DATASCRIBE & PRINTER

Still the best buy in your search for cost effective terminals.



Put a Tally Datascribe next to a Tally Printer and you have a terminal unmatched in cost effectiveness and performance.

Tally's Datascribe, with its unique data compression feature, can transmit magnetic tape data at speeds equivalent to 3000 to 4000 Baud using a 1200 Baud 202C data set. Tally's Printer, in 125, 200, or 600 line per minute versions, offers optimum print speeds for remote terminal requirements. Monthly rental for this dynamic duo starts at a low, low \$600 a month.

A truly sensible buy.

Datascribe increases your throughput and decreases line charges. You can actually triple your 1200 Baud rate without changing modems. A printer matched to your data volume—125 lpm, 200 lpm, or 600 lpm. No wasted capacity. Liberates your computer for other tasks. Only Tally gives you all these features and benefits plus field tested hardware reliability.

It's a proven and popular combination.

We can proudly point to a long list of contented customers. And to support these installations, we can point to an expanded field service organization. We're committed to service what we sell. We're in the data communications and terminal business for the long haul. We have a solid 25 year track record.

We plan to build on it in the future by continually offering better solutions to your data processing problems. Solutions like our hardwired Datascribe data compression that requires no computer time, no software—a truly unique approach to data communications.

Features include unattended operation for both send and receive functions. Full 2400 foot tape reel. English language display for ease of key entry.

In actual benchmark tests, these average throughputs were obtained using 200 character records. 150 records per minute with 1200 Baud modems. 300 records per minute with 3600 Baud modems. 400 records per minute with 4800 Baud modems. Plus, Datascribe offers four kinds of error checking features during transmission to assure dependable data.

If you need even more evidence about this cost performance terminal package, we invite your inquiry. Contact your local Tally man and let him demonstrate the advantages to you.

In Boston (617) 742-9558, Chicago (312) 298-6710, New York (201) 671-4636, San Francisco (415) 632-4280. Or contact us direct, Tally Corporation, 8301 So. 180th Street, Kent, Washington 98031, Phone (206) 251-5500.

TALLY®

See us at the NCC,
Booths 322-328

If you're a small user with a small data center, or a big user with small, satellite data centers, look at our new 4- to 12-keystation System 1200.

It has the muscle to let small operations think big. Data purification and reformatting, plus complete range and error checking. And verification, accumulation and editing. All so you'll send clean and accurate data to your mainframe.

And you get your pick of up to 256 different formats. Even RJE communications, when you want to call home.

It's all wrapped up in a single, economical package. Disk, processor and tape drive are included in the compact control unit.

The keystations are the same ones proven for over two years now in our larger System 2400 key-to-disk.

The 1200 has a lot to offer your small data center. A call to your nearby MDS office, or to our headquarters at (315) 792-2424, will bring you the full story.

Find out for yourself why data-entry products like our Data Recorders, our powerful system 2400's and our new compact System 1200 have made our user list the second largest in the industry. Mohawk Data Sciences Corp., Utica, N.Y. 13503.

MDS

Mohawk Data Sciences

CIRCLE 33 ON READER CARD

See MDS systems in action—
booth 551, NCC.

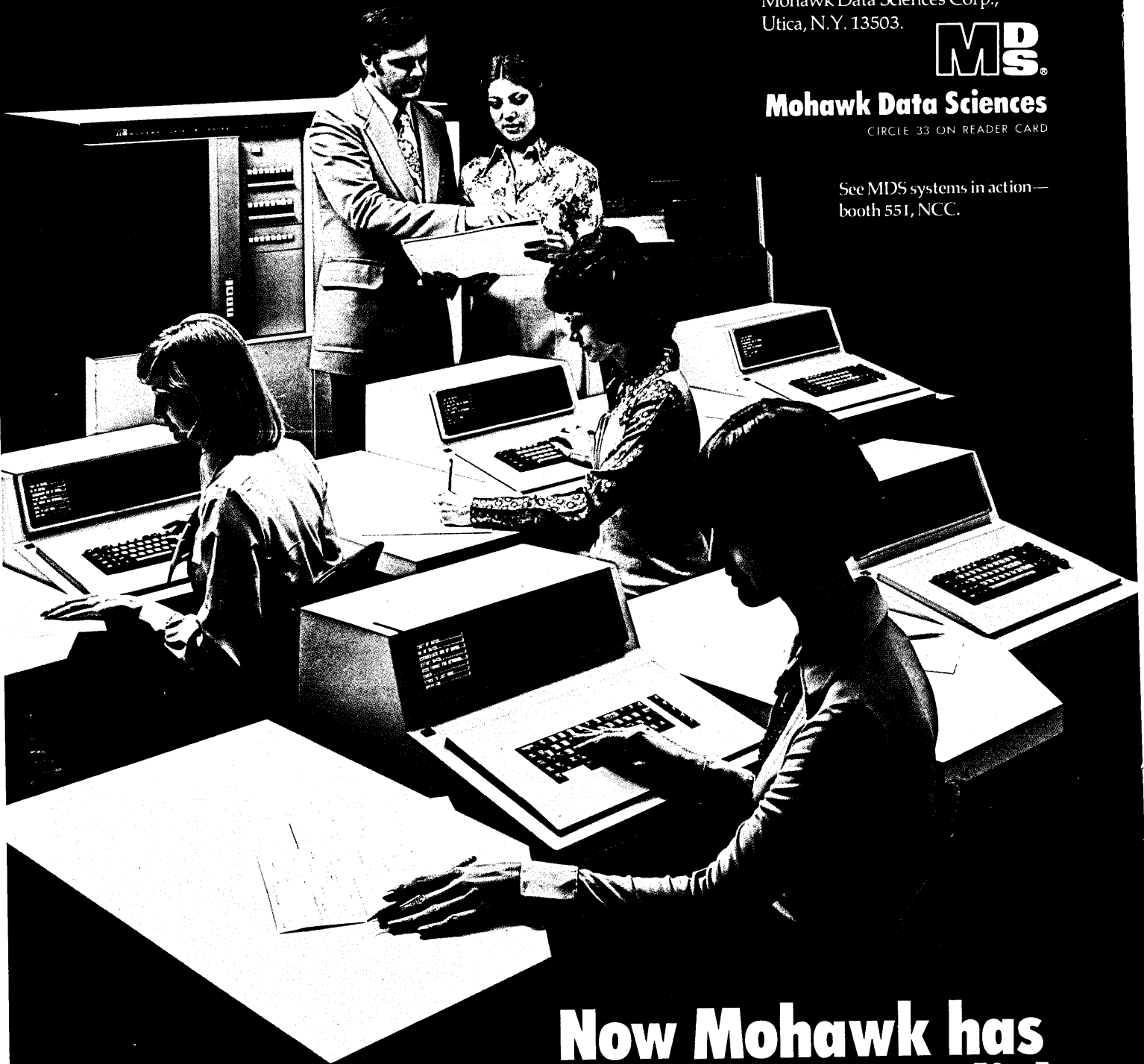

**Now Mohawk has
a powerful key-to-disk
everybody can afford.**

DATA MATION ⁷⁴ N[®]

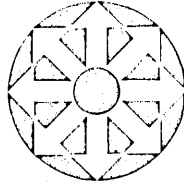

APRIL, 1974

volume 20 number 4
This issue 122,900 copies



1974 NATIONAL COMPUTER CONFERENCE & EXPOSITION

For years they've wanted a program for the user, and here it is, May 6-10 at Chicago's McCormick Place.

- 48 **Conference Commentary**
More sessions, more products, more people; something for everyone.
- 54 **On The Lakefront**
For the nightowls—what to see and do in Chicago.
- 51 **The Programs**
A 30-man squad *might* be able to cover it all.
- 56 **Product Preview**
The biggest, fastest and flashiest the industry can produce for 1974.

71 The Computerization of the ABC Widget Co.

RICHARD L. NOLAN and K. ERIC KNUTSEN. What a difference a decade makes.

79 An Optimization Study

JAMES O. MULFORD. How to improve throughput without mortgaging the ranch.

89 Acquiring and Using a Hardware Monitor

JERRE D. NOE. It can't measure the system it crashes.

112 April Foolishness

April First fosters fantasy, fun, and poetry on our pages in accordance with ancient ritual, plus—for the first time—award-winning fiction.

112 **Mimsy Were the Borogoves**
WENDELL COCKRELL

114 **Validation Game**
DONALD KENNEY

98 Controlling a Computer System

DONALD L. BLACK. Keep your whims to yourself.

141 News in Perspective

ANTITRUST141	MODELING149
PEOPLE145	SERVICE BUREAUS . .150
COMPANIES145	BANKING151
MEMORIES148	THE ARTS153
RETAILING148	INTERNATIONAL . . .154
	BENCHMARKS157

215 The Forum

THORNTON J. PARKER III. Fixed standards work for screw threads, but not for classes of data.

117 Does Anyone Here Speak English? Phase II

MARVIN GROSSWIRTH

123 The Inverse Peter Principle

A. NONYMOUS

132 I Have No Mouth, and I Must Scream

HARLAN ELLISON. Fantasy's darker side is explored in this computer drama, winner of sci fi's Hugo award.

departments

- Calendar 11 Look Ahead 17
- Letters to the Editor 27
- News in Perspective 141 Hardware 166
- Software & Services 179 Literature 186
- People 192 Poem 200 Books 205
- Index to Advertisers 210 The Forum 215

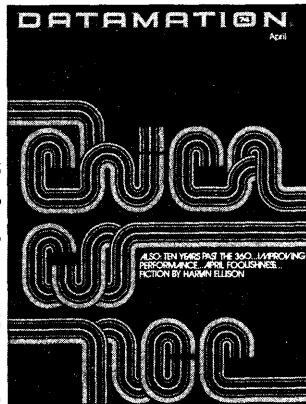

about the cover

From the neon flash of the "broad-shouldered" city comes a pattern to capture the gutsy vibrancy of Chicago, host to the NCC this year; it reflects the excitement of the convention at McCormick Place. Design is by our art director.

EDITORIAL STAFF

Editor John L. Kirkley
Articles Editor Richard A. McLaughlin
International Editor Angelina Pantages
Communications Editor Phil Hirsch
Industry Editor W. David Gardner
Products Editor Michael William Cashman
Copy Editor Merrill Press Cherlin
Calendar Editor Carol A. Constantian
Letters Editor Angela V. Smith
News Editor Tom McCusker

Bureau Managers
San Francisco Edward K. Yasaki
Los Angeles Edith D. Myers
Washington, D.C. Phil Hirsch
New York Angelina Pantages
New England W. David Gardner

Correspondents
Minneapolis James K. Johnson
Southwest Robert F. Alexander
Europe Pearce Wright
Australia Frederick A. Bland
Editorial Advisor Robert L. Patrick
Technical Advisor Lowell Amdahl
Contributing Editors Paul Armer, Howard Bromberg, Philip H. Dorn, Louis B. Marienthal, Ray W. Sanders, Milton R. Wessel, F. G. Withington

EDITORIAL OFFICES

Headquarters: 1801 S. La Cienega Blvd., Los Angeles, CA 90035. Phone (213) 559-5111. **Eastern:** 35 Mason St., Greenwich, CT 06830, (203) 661-5400. Lakeside Office Park, 599 North Avenue, Wakefield, Mass. 01880, (617) 246-2121, 9805 Singleton Dr., Bethesda, MD 20034, (301) 530-7271. **Southwestern:** 2711 Cedar Springs, Dallas, TX 75201, (214) 744-0161. **Western:** 2680 Bayshore Frontage Rd., Suite 401, Mountain View, CA 94043, (415) 965-8222. **Foreign:** 65, Hill Road, Chelmsford, Essex, England, 64/90 Blues Point Rd., McMahon's Point, NSW 2060, Australia.

GRAPHIC DESIGN & PRODUCTION

Art & Production Director Cleve Marie Boutell
Production Manager Marilee Pitman

CIRCULATION
 35 Mason Street, Greenwich, CT 06830
Circulation Director Suzanne A. Ryan

Marketing Research Director Douglas De Carlo
Publisher James M. Morris

Circulation audited by Business Publications Audit



Member American Business Press, Inc.



DATAMATION is published monthly on or about the first day of every month by Technical Publishing Company, 1301 South Grove Ave., Barrington, Illinois 60010; Arthur L. Rice, Jr., Chairman of the Board; James B. Tafel, President; Gardner F. Landon, Executive Vice President. Executive, Circulation and Advertising offices, 35 Mason Street, Greenwich, CT 06830, (203) 661-5400. Editorial offices, 1801 S. La Cienega Blvd., Los Angeles, CA 90035. Published at Chicago, Ill.

DATAMATION is circulated without charge by name and title to certain qualified individuals who are employed by companies involved with automatic information handling equipment. Available to others by subscription at the rate of \$18 annually in the U.S. and Canada. Reduced rate for qualified students. Foreign subscriptions are available for £12.50 or for the equivalent of \$30 U.S. in most West European currencies. Sole agent for all subscriptions outside the U.S.A. and Canada is J. B. Tratsart, Ltd. 154 A Greenford Road, Harrow, Middlesex HA13QT, England. No subscription agency is authorized by us to solicit or take orders for subscriptions. Controlled circulation paid at Columbus, OH and Form 3579 to be sent to Technical Publishing Company, P.O. Box 2000, Greenwich, CT 06830. Copyright 1974, Technical Publishing Company. Microfilm copies of DATAMATION may be obtained from University Microfilms, A Xerox Company, 300 No. Zeeb Road, Ann Arbor, Michigan 48106. Printed by Beslow Associates, Inc.

DATAMATION is circulated without charge by name and title to certain qualified individuals who are employed by companies involved with automatic information handling equipment. Available to others by subscription at the rate of \$18 annually in the U.S. and Canada. Reduced rate for qualified students. Foreign subscriptions are available for £12.50 or for the equivalent of \$30 U.S. in most West European currencies. Sole agent for all subscriptions outside the U.S.A. and Canada is J. B. Tratsart, Ltd. 154 A Greenford Road, Harrow, Middlesex HA13QT, England. No subscription agency is authorized by us to solicit or take orders for subscriptions. Controlled circulation paid at Columbus, OH and Form 3579 to be sent to Technical Publishing Company, P.O. Box 2000, Greenwich, CT 06830. Copyright 1974, Technical Publishing Company. Microfilm copies of DATAMATION may be obtained from University Microfilms, A Xerox Company, 300 No. Zeeb Road, Ann Arbor, Michigan 48106. Printed by Beslow Associates, Inc.

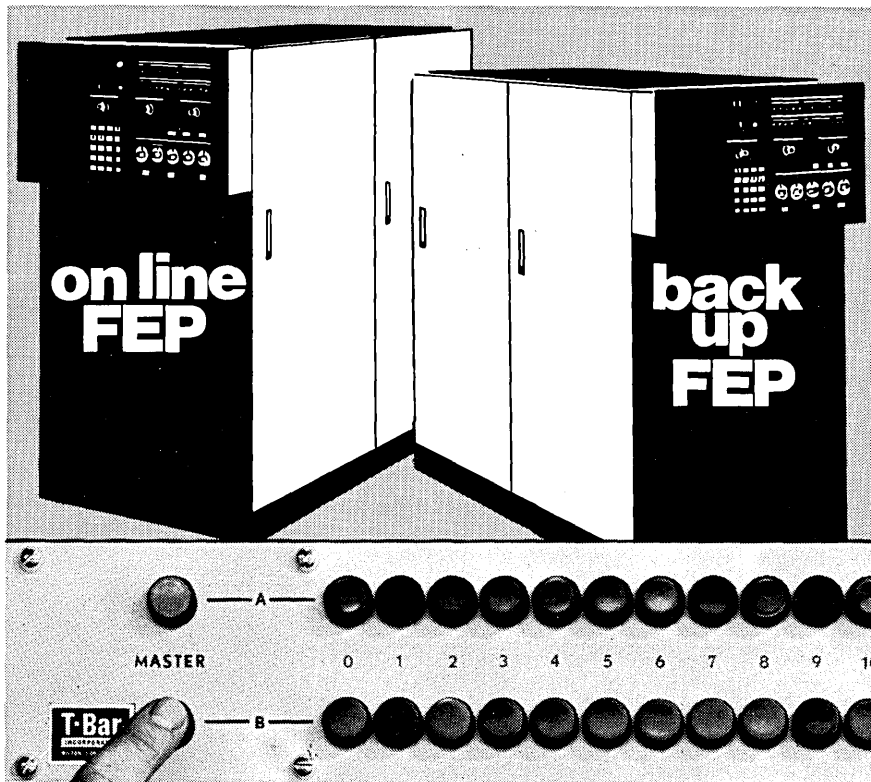

Now you can switch RS232 lines between FEPs* instantly...at the touch of a button

T-BAR Series 5100 Remote Control EIA (RS232) FALL BACK SWITCHES are new, fast and reliable, allowing operators to switch modems or terminals singly or simultaneously-in-groups between two or more FEPs ... or between computer ports from on-line to stand-by modems ... or other terminals.

...as low as \$175/channel!

Featuring a Switcher, illuminated Pushbutton Control Panel, Control Cables, plus 25-pin RS232 Data Cables, the system is also available in 8-channel standard packages at slightly higher cost per channel. All for rack, wall or under-floor installation.

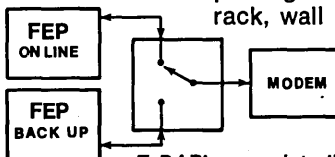

T-BAR's complete line of switching equipment gives the Communications System Engineer and Communications Manager system cost effectiveness. Write or phone today for complete literature.



Data Systems DIVISION

141 Danbury Road, Wilton, CT 06897
 Telephone: 203/762-8351

Regional Sales Offices: Boston (617) 890-3085 • Chicago (312) 671-5182 • Columbus (614) 262-0915 • Canada (613) 737-5941
 Washington, D.C. (703) 528-7773 • New York (203) 762-8351 • Philadelphia (215) 363-1544 • California (203) 762-8351

* T-Bar Universal Fall Back Switches have been used successfully to switch various Front End Processors, including IBM 3705, IBM 270X, UNIVAC 1108, Burroughs 5000, Memorex 1270, DEC PDP-11/45.

DP DIALOG

Notes and observations from IBM which may prove of interest to data processing professionals.

DP DIALOG appears regularly in these pages. As its name suggests, we hope DP DIALOG will be a two-way medium for DP professionals. We'd like to hear from you. Just write: Editor, DP DIALOG, IBM Data Processing Division, White Plains, N.Y. 10604.



With virtual storage Carle Clinic now has much greater flexibility in its data processing capabilities. One of the future uses will be medical applications, such as analyzing data gathered in the clinic's laboratories.

Why Carle Clinic Switched to Virtual Storage

The list of families using the Carle Clinic in Champaign, Illinois spiraled 75% in the last five years to over 35,000. The resulting flood of paperwork kept its IBM System/360 Model 20 running nearly 300 hours a month. "Even so, we still weren't able to keep up," says Ed Beranek, data processing manager for the clinic as well as the

adjoining 250-bed hospital.

"But even worse," he continues, "we had more paper than we knew what to do with. Every week the accounts receivable, alone, amounted to a 3,000-page report. What we needed was not to get more information into the computer but to have more information available on-line."

Carle Clinic, one of a half dozen medical groups of its kind in the country, is the largest group medical practice in Illinois. Its staff consists of over 80 physicians, who are all specialists in their fields. They service 180,000 patients—about half from the surrounding area, the other half from all over the country.

(Continued on Page 8)

Space and Astronomy at the IBM Exhibit Center

When the Comet Kohoutek made its parabolic path around the sun earlier this year, the IBM Exhibit Center in midtown Manhattan made it possible for passers-by to observe its path on a floor-to-ceiling graph, visible through the windows of the center.

Inside the center a terminal linked to an IBM computer plots the exact position of Kohoutek. Although the comet will soon be beyond our view, the computer program will continue to plot the position of the planets, the major stars, the sun and moon as seen

from any point on the earth, at any time.

The chart below shows how the sky above Manhattan would look just before sunrise on March 21, not long after Kohoutek has disappeared into the outer reaches of the solar system.

The IBM star chart is only part of a much larger exhibit designed by the office of Charles and Ray Eames for IBM, with the help of I. Bernard Cohen, Professor of the History of Science at Harvard University.

Titled "computer perspective: ASTRONOMY," the current focus is on

the men who laid the foundations of modern astronomy and physics, from Nicholas Copernicus in the fifteenth century and his revolutionary theory of the sun-centered universe, to Sir Isaac Newton in the eighteenth century, who completed the Copernican Revolution with his formulation of the principle of universal gravitation.

Like the other computer exercises at the center, the star chart exercise shows how the computer can help provide sophisticated data based on these early scientific principles. **IBM**

VIEW FROM 41 DEGREES NORTH, 74 DEGREES WEST ON THURSDAY 1974/3/21 AT 5 30 AM

POSITION OF SUN, MOON AND PLANETS

	RT.AS.	DECL.	MAP GRID		RT.AS.	DECL.	MAP GRID
*MOON	22 6	-6 31	-.77 -.28	SATURN	5 51	23 10	
SUN	0 8	0 55		*URANUS	13 31	-8 1	.68 -.33
*MERCURY	22 27	-10 57	-.86 -.30	*NEPTUNE	18 11	-22 15	-.10 -.61
*VENUS	21 12	-13 28	-.62 -.43	*PLUTO	13 24	10 7	.60 -.11
MARS	4 47	23 31		KOHOUTEK	3 47	18 33	
*JUPITER	22 22	-11 49	-.85 -.32				

MOON SHOWN AS O
MOON PHASE 0.169 WANING

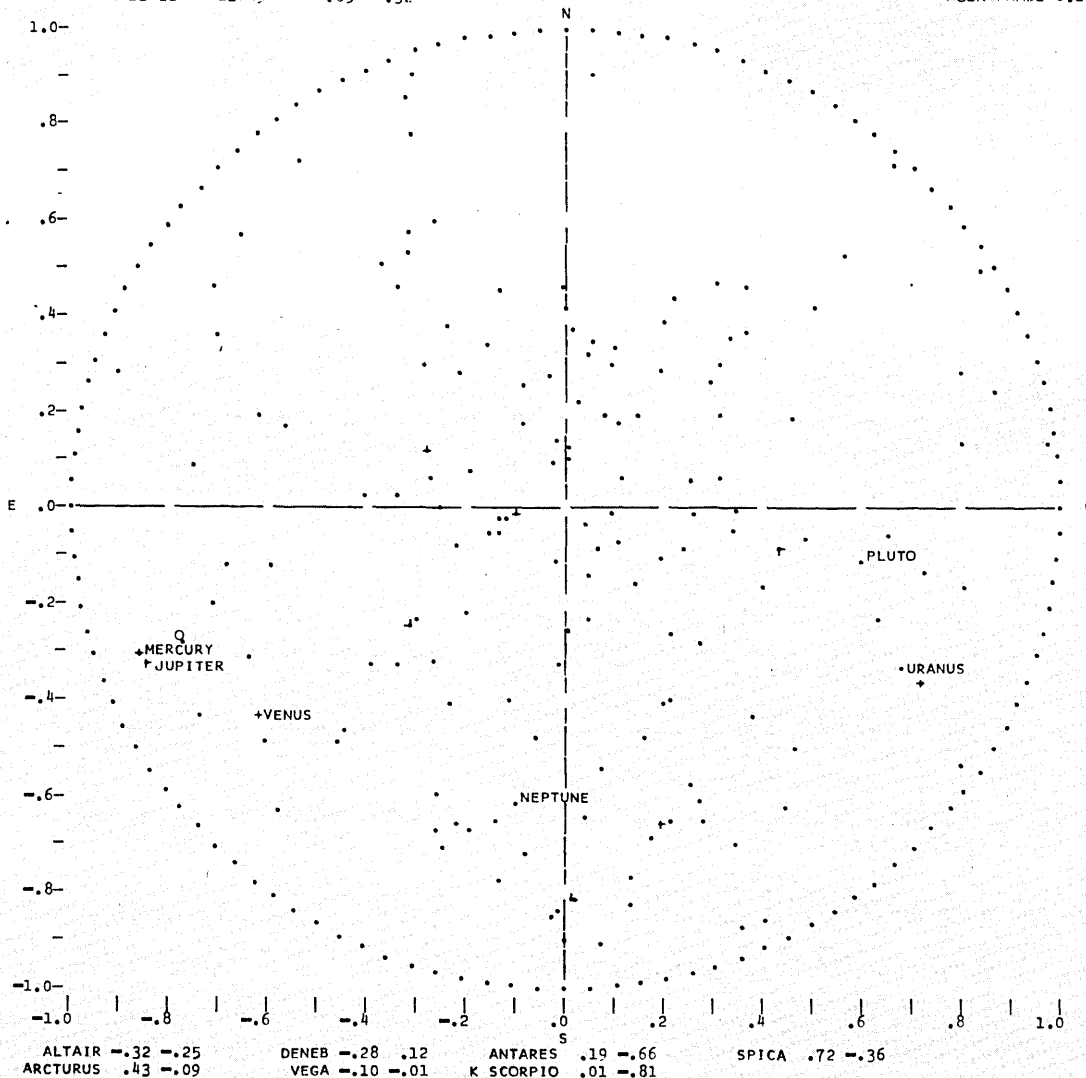

Library Thrives with No Books, Few Visitors

Instead of books, this quiet library, located 30 miles north of New York City, houses a vast collection of computer programs. It is IBM's Program Information Department (PID) which works around the clock to fill customer orders for computer programs.

The master library contains roughly

2,500 operating system and application programs for manufacturers and financiers, wholesalers and retailers, food and chemical processors, scientists and engineers. Besides adding to the master library regularly, IBM program development groups also update and modify existing programs when necessary.

Every year PID distributes over 300,000 packages containing program material—more than 1,200 each working day. A computer processes the mammoth volume of orders from the time they arrive to the time they are packaged and mailed. The turnaround time is usually about one week, according to Marty Kloomok, PID's manager. "But in an emergency," he says, "we can have a program in a customer's hands in 24 hours."

After PID's computer receives and edits the order data, it copies the master file onto the specified medium—either a disk pack, magnetic tape, card deck or a tape cassette. The copy is checked against the original for any errors and is sent to the customer with the appropriate documentation, which tells him how to install and use his program. Finally, the package contents are checked against a computer-prepared packing list and shipped with a computer-prepared mailing label.

In this way IBM, through its program library, is helping its customers to optimize the effectiveness of their computers—to make them more valuable assets. **IBM**



New orders for processing arrive at IBM's computer program library.

Sidelines

Coping with the Energy Crisis

Recently, IBM announced its new computer-based Energy Management System, which is designed to help electric utilities produce power more efficiently.

It also makes it possible for these same utilities to monitor and control a complex network of electrical generating and transmission equipment much faster than if it were done manually.

The new system combines IBM System/370 and System/7 computers with a set of special application programs, data collection and display units.

By consolidating all power information in one spot, it gives a dispatcher the data he needs to determine how to distribute the power load among the generators in a utility system. As consumer appliances and industrial equipment are turned off and on during the day, the dispatcher can boost the power from the most efficient generators and decrease the electricity from the less efficient ones.

Other advantages include keeping track of fuel and maintenance costs, transmission line losses and the status of all pieces of equipment so as to achieve minimum production costs and efficient use of available fuel.

Computers at Sea

Even with today's sophisticated radar systems, collisions at sea do happen. Last year alone 300 major vessels of 500 tons or more collided. The problem is that radar can not differentiate between obstacles, from buoys to ships, on a ship's path.

IBM recently announced its Maritime Applications Bridge System which may help to overcome the problem. The system uses a System/7 computer and a variety of applications programs. One of them, the collision assessment program, can automatically identify targets up to 16.5 nautical miles away. It can also differentiate between ships, debris and land masses. Objects are flashed on a screen with vectors and are identified on an adjoining screen by number, range and bearing, speed and course, and estimated closest point and time of approach.

The Bridge System offers another advantage—planning the ship's optimum route to conserve fuel. Programs for position fixing, route planning and tracking, and adaptive autopilot keep the ship's officers constantly informed of the ship's exact position and the course it should follow. **IBM**



An IBM Maritime Bridge System helps keep ship on course.



Dr. Siegel explains how computers can help a surgeon's diagnosis.

Helping Doctors Combat Heart Disease

Heart disease is still the nation's number one cause of death, in spite of vast improvements in cardiovascular research. Many patients with severe coronary artery disease must undergo open heart surgery as a last resort. Now scientists are conducting research on how computers can help a surgeon's diagnosis by measuring the heart's pumping capacity and automatically pinpointing defects.

Dr. Chao-Kong Chow, a computer scientist, and his associates at IBM's Thomas J. Watson Research Center and Dr. John Siegel, Chief of Surgery at Buffalo General Hospital, have found a way to use the computer to analyze cineangiograms, or X-ray motion pictures of the heart, by measuring precisely the volume change in the blood-pumping capacity of the heart.

Siegel explains: "Without the help of a computer, sometimes it would take days, even weeks to fully interpret cineangiograms. If the patient's very sick, he could die in that period of time. Now, with computer assistance we can get a more accurate analysis in a very brief period of time, sometimes less than an hour."

Siegel and Chow have concentrated their research specifically on the left ventricle of the heart. Here the change in volume as the heart pumps is a key

indicator of heart performance. They took cineangiograms of movement in the left ventricle, recorded at 62 frames a second, and converted them to computer-usable form with an IBM 1800 data acquisition and control system. The results were fed into a System/360 Model 91 for further processing.

"A typical 68-frame sequence, which would cover one full cycle of a heartbeat, can be analyzed in less than five minutes," says Chow. But he emphasizes, "the ultimate speed is not as important as providing an automatic technique where none now exists."

Beyond speed, there are several functions the computer can perform on an angiogram which would otherwise result in a long, painstaking and even inaccurate procedure if done by hand.

"In fact," explains Siegel, "the computer can go one step further and 'cross-section' the angiogram and calculate the ways in which each segment of the ventricle contracts. This is especially useful in diagnosing irregularities in the pumping cycle, the rhythm of the cycle and partial malfunction in a specific part of the heart."

"When we find an impairment on an angiogram, we can easily run successive ones on the computer and compare improvement or decay in condition and changes in overall performance or in

performance of certain segments."

Although the work of Drs. Chow and Siegel is still in the research stage, both are optimistic about the real possibility that computer-produced cineangiograms can provide valuable information needed to diagnose a large number of patients with severe heart disease. "In this way," says Siegel, "we can make intelligent decisions as to whether patients should undergo open heart surgery for revascularization, or the rerouting of blood vessels feeding the heart."

IBM

Carle Clinic...

(Continued from first page)

The clinic solved its problem of expanding needs by converting to an IBM System/370 Model 125 with virtual storage last summer. "We found the Model 125 would not only justify our immediate needs, but would also allow us to grow on a long-range basis. Virtual storage gave us that capability without increasing the actual size of our computer," says Ed Beranek. "We also added CICS (Customer Information Control System) which made it possible to access information directly from the CPU for display on a tele-processing unit."

All in all, the conversion was relatively trouble-free. In fact, Beranek reports they were able to convert to DOS (Disk Operating System) in only two days instead of the seven originally planned. They later went to DOS/VS and finally CICS in a matter of a few weeks.

The clinic's Model 125 has been up and running since last July and already it has streamlined the business functions, such as accounts receivable, payroll and inventory. Other applications, including patient scheduling and some doctor/patient statistics, have been added.

"So far we have had great success with the 125, but we are only on the threshold," says Beranek. "The 125 with virtual storage now makes it possible to add many more applications. By the end of the year we will be able to include both an on-line insurance billing and medical retrieval system. This will enable doctors to see in an instant a full account of a patient's recent visits to the clinic."

Beranek feels there are many more medical applications for the computer. One possibility is incorporating the System/7 for EKG analysis and other medical functions which demand monitoring. "Over the long range we are interested in giving the best possible care to our patients. If the computer can help us we're interested in using it."

IBM

DATAMATION

WHAT SIZE DIGITAL PLOTTER DO YOU NEED?

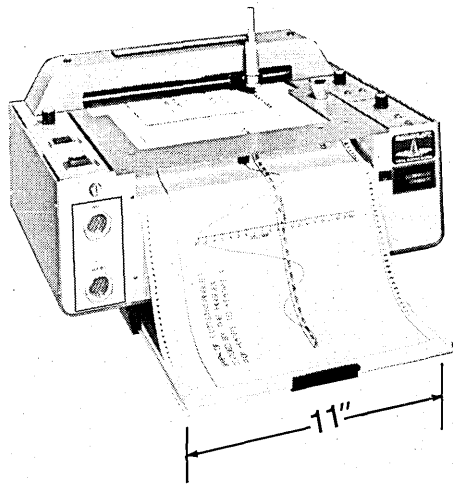

DP-1 — \$3550
300 Steps/Second
11" Wide x 144" Long

If you *plot a lot*, size is important. Many data processors, researchers, financial analysts and mechanical design people are perfectly content with the 11" wide DP-1. It's fast, accurate and economical. But larger size is important to many chart makers, N/C checkers, etc. The DP-3, with its 22" width paper, is popular in offline, online and time sharing modes. But big? The DP-7 is a real Texas-size plotter (fast on the draw) with a full 36" plotting width and 3 automatically selectable pens to add color in a hurry! Weather map makers, subdivision planners, and geophysical mappers insist on a DP-7. How about you?

Write today or mail the reader's service card for plotting facts, specs and applications. Also data on offline magnetic tape readers.

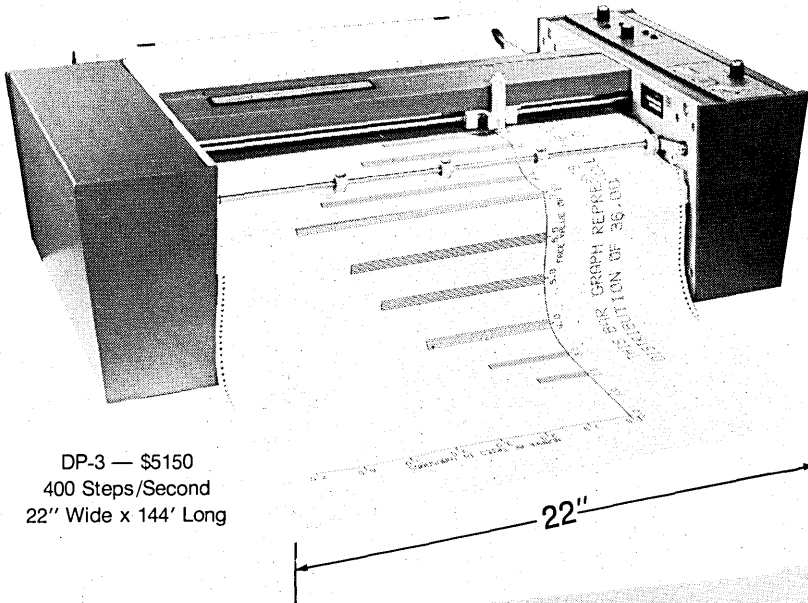

DP-3 — \$5150
400 Steps/Second
22" Wide x 144" Long

COMPLØT® has them all

* A registered trademark of Houston instrument

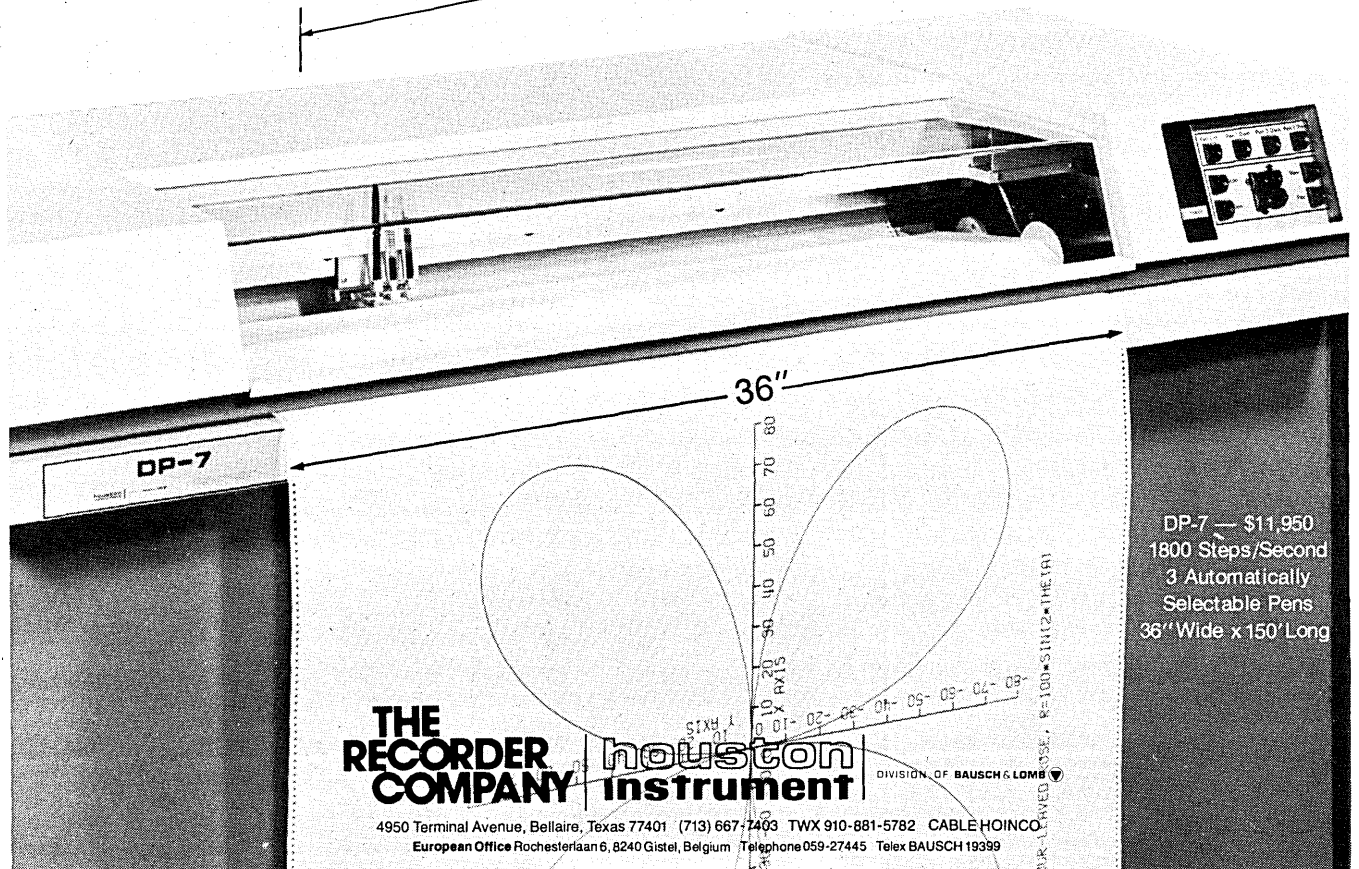

DP-7 — \$11,950
1800 Steps/Second
3 Automatically
Selectable Pens
36" Wide x 150" Long

THE RECORDER COMPANY | **houston instrument**

DIVISION OF BAUSCH & LOMB

4950 Terminal Avenue, Bellaire, Texas 77401 (713) 667-7403 TWX 910-881-5782 CABLE HOINCO
European Office Rochesterlaan 6, 8240 Gistel, Belgium Telephone 059-27445 Telex BAUSCH 19399

Now Documation has taken away all the reasons why you couldn't get a low cost, high-speed punch

High speed. Low cost. Until now those two phrases meant compromise in a computer system. Settle for a slow punch. Even then you had to worry about reliability factors. No more.

Documation built the no-compromise punch you wanted.

This is an on-line punch. You load and unload the 1,000-card hoppers on the fly...a true high-speed punch...punch all 80 columns at 100 cards per minute. With fewer columns you can get up to 285 cards per minute. And, if you like, you can even get a 400 cpm reader in the same configuration.

With our price your computer representative can now give you more punch for the price... a no-compromise punch for a no-compromise computer system.

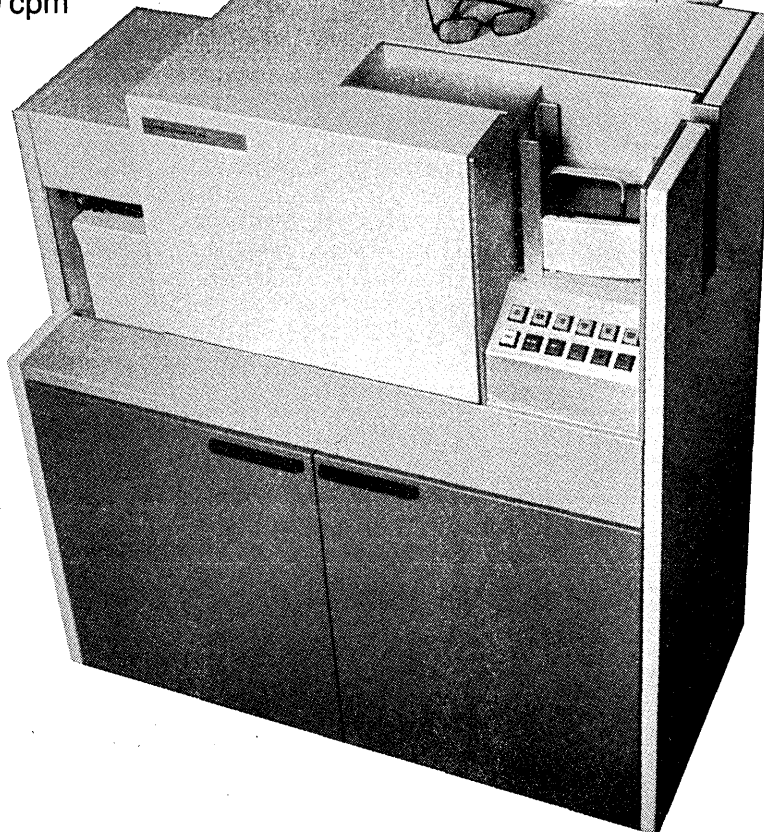

DOCUMATION
INCORPORATED
POST OFFICE BOX 1240
MELBOURNE, FLORIDA 32901
TELEPHONE (305) 724-1111
TWX 510-959-6286

Calendar

MAY

ADAPSO 40th Management Conference, May 1-3, Las Vegas. More than 250 executives from data centers, time-sharing firms, and software houses will study the impact of the System/3 and similar systems on the future of the computer services industry. Fee: \$100, members; \$175, others. Contact: J. L. Dreyer, ADAPSO, 210 Summit Ave., Montvale, NJ 07645.

College and University Machine Records Conference (CUMREC), May 5-8, Waco, Texas. On the theme "Productivity: Benefit of Systems Planning," the 19th annual CUMREC will have sessions on such diverse topics as: automated grading systems, student scheduling and registration systems, data base management, program budgeting, and bookstore point-of-sale. Fee: \$75. Contact: Jack Thornton, Baylor Univ., P.O. Box 6187, Waco, TX 76706.

National Computer Conference & Exposition, May 6-10, Chicago. See the special NCC&E section beginning on p. 48 for conference particulars, program summaries, and new product preview.

12th Annual Convention of the Assn. for Educational Data Systems (AEDS), May 7-10, New York. The program, with exhibits, will include such topics as: computers in education—mini to maxi, the virtual machine in instruction, and the role of regional center computers. Fee: \$45, members; \$55, others; at conference, add \$5. Contact: Joseph E. Nove, BOCES II, 201 Sunrise Hwy., Patchogue, NY 11772.

23rd Annual Conference and Exposition of the National Microfilm Assn., May 7-10, Boston. Ten to 12 thousand users of microform equipment are expected to attend "Micromedia Horizons '74," organized on three levels (one on fundamentals and basic techniques; one on computer output microfilm; and one, for the advanced technician, on micro-publishing, records management, copyright laws, word processing, computer vs. microfilm retrieval, and new product development). The event will also include applications seminars and 45,000 sq. ft. of exhibits by over 100 companies. Fee: \$75 for technical sessions. Contact: John B. Bidwell, NMA, 8728 Colesville Rd., Silver Spring, MD 20910.

APL International Users Group Meeting, May 14-17, Anaheim, Calif. ACM is the sponsor of this sixth annual conference on the enhancements, extensions, applications, programming techniques, instructional methods, and future of APL, with demonstrations of APL-oriented hardware, software, and application packages. Fee: \$40. Contact: John R. Clark, Coast Community College District, 2701 Fairview Rd., Costa Mesa, CA 92626.

International Magnetics Conference, May 14-17, Toronto. Sponsored by the IEEE Magnetics Society, the program will include sessions on: competing storage technologies, digital magnetic recording, videoplayers for consumers, bubble memory subsystems, integrated bubble-device processing, film and surface materials characterization, electromagnetic transportation, rare-earth magnets and applications, and Josephson junction devices. Fee: \$40, IEEE members; \$50, others; at conference, add \$5. Contact: W. A. Baker, Bell Telephone Laboratories, 555 Union Blvd., Allentown, PA 18103.

National Operations and Automation Conference, May 19-22, San Francisco. Over 1,500 bankers, suppliers, consultants, and manufacturers are expected to attend this American Bankers Assn. conference on the theme "Managers Make Things Happen." Topics include automated tellers, electronic funds transfer, check processing innovations, remote processing, performance measurement, computer output microfilm, and minicomputers. Approximately 75 exhibitors will demonstrate equipment, software, hardware, systems, and services. Fee: \$135, bankers; \$165, others. Contact: Judith Martin, Operations and Automation Div., ABA, 1120 Connecticut Ave., N.W., Washington, DC 20036.

Society for Information Display International Symposium, May 21-23, San Diego. Original papers will describe developments in information display hardware and software techniques, devices, systems, applications, and effectiveness. Fee: \$30, members; \$40, others; at conference, add \$10. Contact: Lewis Winner, 152 W. 42 St., New York, NY 10036.

Symposium on Computer Networks, May 23, Gaithersburg, Md. Jointly sponsored by the Bureau of Standards and the IEEE Computer Society, the symposium will have a panel session and 14 papers covering trends in computer network design and economics, tradeoffs in network design, and applications of existing and proposed networks. Fee: \$10, IEEE members; \$13, others; at conference, add \$3. Contact: Computer Networks, P.O. Box 639, Silver Spring, MD 20901.

Second Computers, Electronics, and Control (CEC) International Trade Show and Symposium, May 23-25, Calgary, Alberta. With federal and provincial agencies, private industry, and professional societies as sponsors, this trade show/symposium aims to bring new technological advances in computers, electronics, control systems, and components to the attention of companies, universities, and other interested organizations. Fee: not available, about \$50. Contact: CEC '74, P.O. Box 3243, Postal Stn. B, Calgary, Alberta, Canada T2M 4L8.

JUNE

ICC '74—IEEE International Conference on Communications, June 17-19, Minneapolis. Sponsored by the Communications Society and IEEE (Twin Cities section), this program will include: a tutorial session on communications satellites; a technical program of 200 papers on satellite communications and on data and voice transmission connected with wire, radio, and computer-oriented communications in both theoretical and practical applications; and an exhibition of technical products in the telecommunications field. Contact: Marilou E. Thomas, Northwestern Bell Telephone Co., 70 W. 4 St., St. Paul, MN 55102.

DPMA 1974 INFO/EXPO, June 23-26, Minneapolis. The 22nd annual DPMA conference and business exposition will include: six three-quarter-day programs on microfilm and microfiche, data entry systems, point-of-sale systems, minicomputers, small and medium-scale systems, and virtual memory; a presentation on the IBM data security studies and one on the future of dp; eight "personal growth sessions"; and a series of idea exchange meetings. Fee: \$150, members; \$190, others. Contact: John A. Guerrieri, Jr., DPMA, 505 Busse Hwy., Park Ridge, IL 60068.

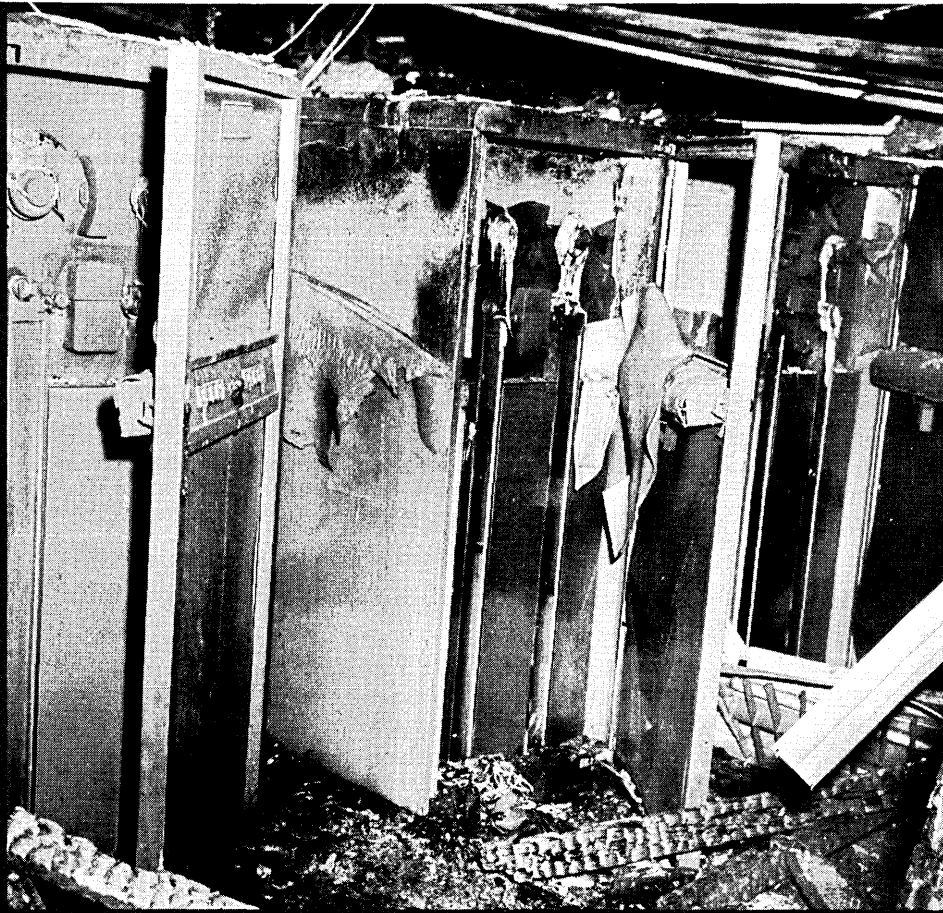

NOW EVEN FENWAL CAN'T HELP YOU.

**In this computer room fire,
Fenwal would have done what water didn't.**

Fenwal would have put out the fire *without* business interruption.

Water alone can't save you from at least a temporary shutdown while the wet mess is cleaned up with overtime expense. Then there's all the business you'll lose while you're shut down. All that before you even start to pay for the heat, smoke and water damage done to your records and equipment.

Things are different when you fight fire with Fenwal. A Fenwal Automatic Fire Suppression System,* using Halon 1301, stops a fire in seconds . . . and dry. The extinguishing agent is clean, electrically non-conductive, non-corrosive and safe for people. The affected area is ready for immediate reuse.

Thanks to years of designing, testing and re-

designing at our own test facility, Fenwal is way ahead of everybody else in fire and explosion suppression. The application of Halon extinguishing agents is our speciality.

If your business relies on the continuous functioning of vital data processing or electronic control areas, talk to Fenwal about fool-proof fire protection. Don't leave your business to chance. Contact us, we'll be pleased to arrange a showing of our color film, "The FIREATERS," featuring our systems in action, or write on your letterhead for our free "Checklist for Computer Room Fire Protection." Fenwal Incorporated, Ashland, Mass. 01721. Phone (617) 881-2000. A Division of Walter Kidde & Co., Inc.

*FM approved — UL listed

FENWAL

In fire and explosion suppression systems, Fenwal has more experience than any other company in the world.

Datacraft® SLASH 4 Virtual Memory
Computer System.

Delivers power, economy, flexibility and
versatility. All you'll ever want. Or need. For concurrent
multi-batch processing. Critical real-time. Remote job entry.
Time sharing.

Whatever your application, the SLASH 4 VM's
750 nanosecond cycle time, automatic program relocation,
re-entrant processors, and effective memory utilization
deliver higher throughput for you. Big single programs... up
to 256K... are handled with ease in a multi-task oriented
architecture that virtually eliminates costly software penalties.

That's Efficiency.

That's Money Saved.

That's the SLASH 4 VM Computer System.
You'll be amazed at what you get. And how
much you can do. Contact us for all the facts. Datacraft®
1200 Gateway Drive, Fort Lauderdale, Florida 33309,
Telephone (305) 974-1700. For international inquiries write:
Techmation N.V. Gebouw 105/106, Schiphol-Oost, Holland.

Datacraft®

SUBSIDIARY OF HARRIS-INTERTYPE CORPORATION



SLASH 4 VM COMPUTER SYSTEMS

CIRCLE 10 ON READER CARD

CINCINNATI

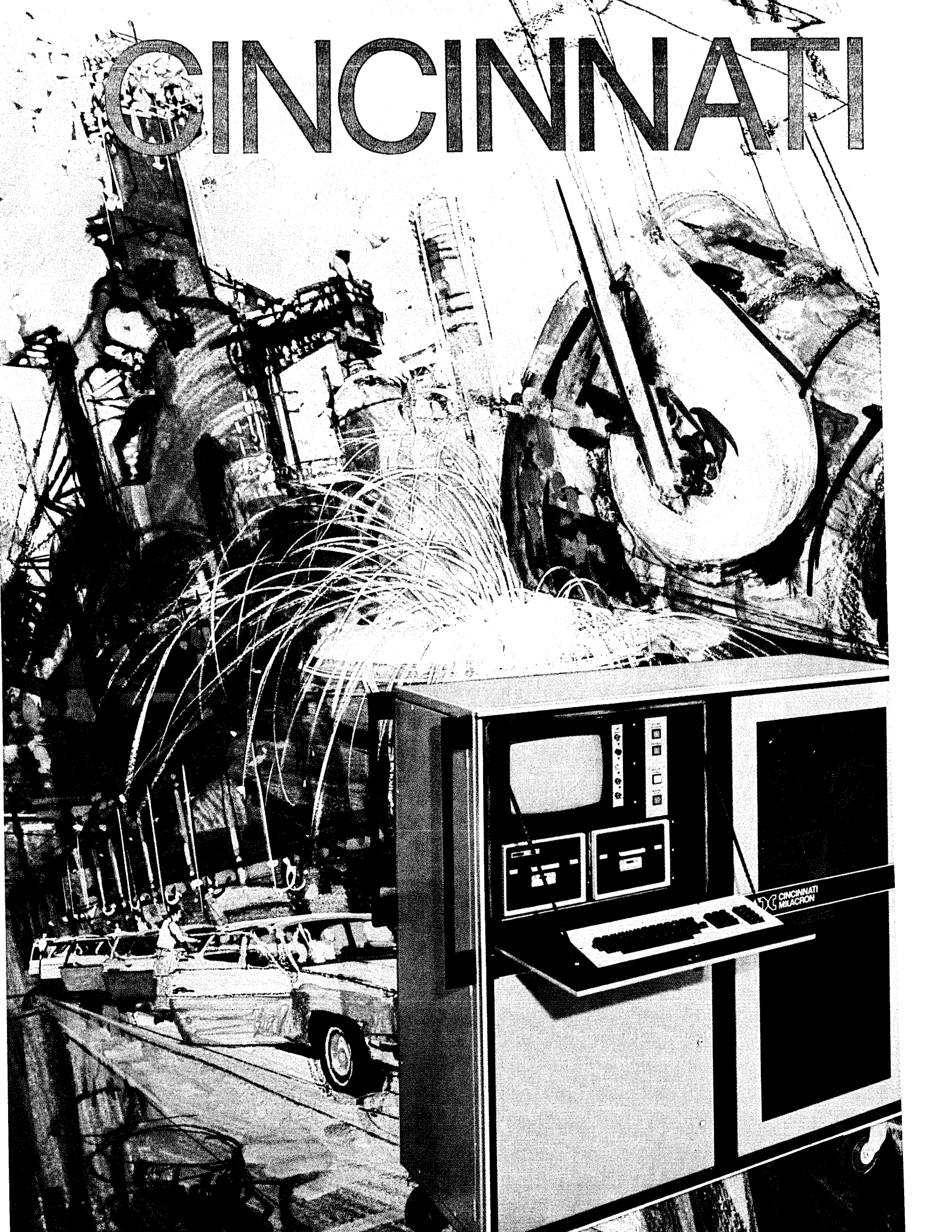

CINCINNATI
MILACRON

MILACRON has a plan

FOR COMPUTERIZED MANUFACTURING

Write today for your personal copy of this plan. It is available to help you develop your computer aided manufacturing project, N/C data management, inventory control, parts management or any other manufacturing process you may be considering. This plan will aid any manufacturer who is concerned with optimizing his process for improved R.O.I.

Whatever computerization your company requires, we can show you the planning approach that will save you time and money in getting the process on line. We'll be there to help you plan your application and decide how much control to select, what hardware and peripherals are best, how to implement the software, whether to lease from us or buy . . . in short the complete picture for you.

Cincinnati Milacron, a Fortune 500 Company, has been a manufacturer since 1884, solving process problems that are fundamentally the same throughout manufacturing. We've learned a lot. Process Controls Division has over the years participated in the developments in controls from tubes, to transistors, to IC's, to computers on a chip. The same type of long range continuity and graceful transition through planning is available to you.

Computerization doesn't have to be difficult. Our plan shows you how and why. Write for a copy of the Milacron plan today on your letterhead to Mr. Joseph Mount, Director of Marketing, Process Controls Division, Cincinnati Milacron, Lebanon, Ohio 45036.



minicomputers
**CINCINNATI
MILACRON**

Machine Tools
Process Controls
Chemicals
Plastics
Plastics Processing Machinery
Abrasives

**Designing
and delivering
for the future
today...**

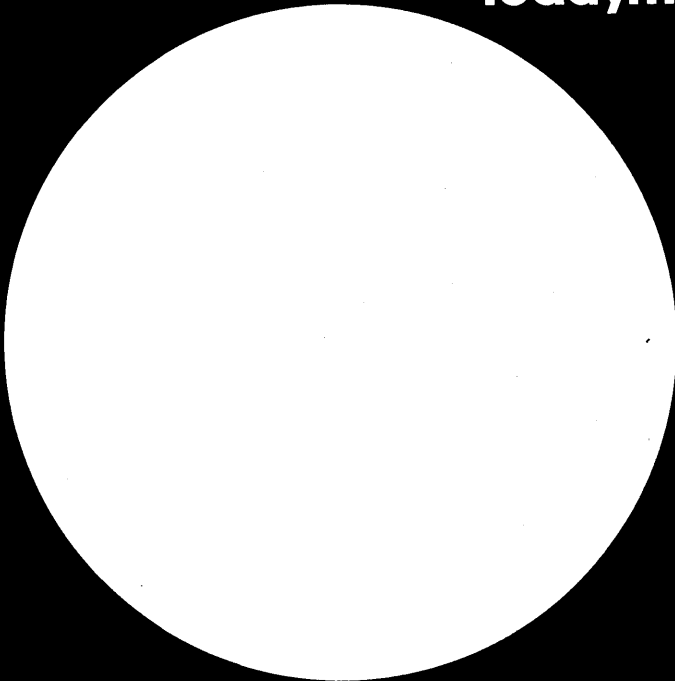

Singer-M&M Intelligent Remote Batch Terminal Systems are communicating worldwide with all the major mainframes at speeds up to 50.kbps., processing jobs limited only by your imagination. IBM, CDC, UNIVAC, Burroughs, Honeywell . . . they're all transparent to us.

When you consider price/performance, the chart below quickly shows that basic Singer-M&M Remote Batch Terminal Systems deliver more for the money than any other equipment now on the market.

BASIC SYSTEMS	520*	580*	565*	560*
Card Reader				
300 cpm	x	x	x	
600 cpm				x
Line Printer				
200 lpm	x			
400 lpm		x	x	
600 lpm				x
Communications				
2. to 4.8 kbps	x			
2. to 7.2 kbps		x	x	
2. to 50. kbps				x
Keyboard Console	Opt	Opt	Std	Std
Multileaving HASP Work Station	N/A	N/A	Std	Std
Monthly Rental Including Maintenance	\$675	\$940	\$1160	\$1645

**Optional Peripherals available.*

Add to all this the name SINGER with world-wide sales and service and you now have the versatility, price/performance, reliability and intelligence to specify a remote batch system. Call today for a demonstration of what Singer-M&M is doing for you.

SINGER

M&M COMPUTER INDUSTRIES, INC.
2201 N. Glassell St., Orange, Calif. 92665
(714) 998-1551 Telex 65 5464

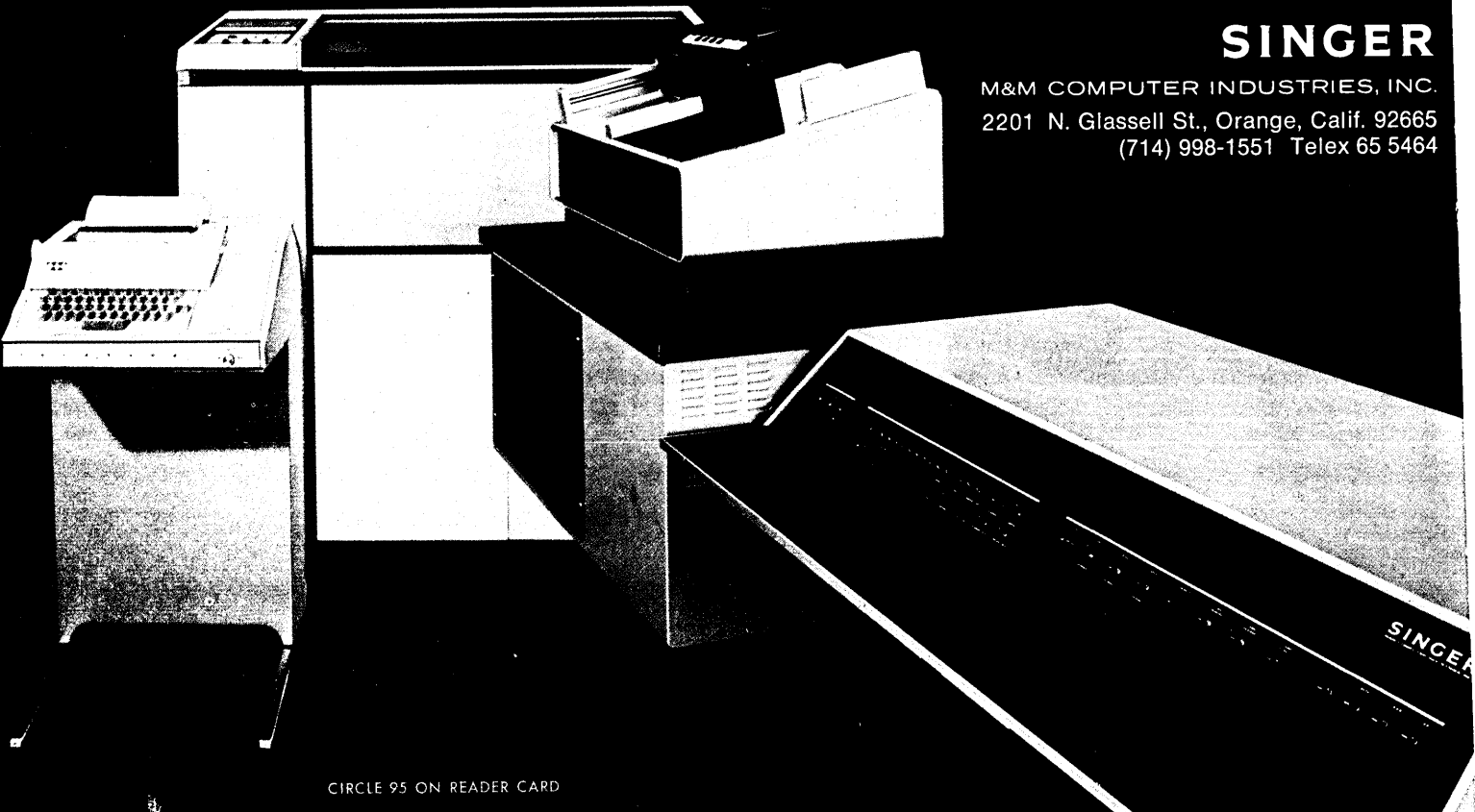

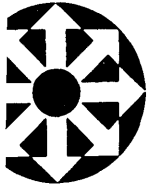

LOOK AHEAD

HONEYWELL'S NEW LINE: ACCENT IS ON SOFTWARE

Don't look for Honeywell's new line--due out soon--to push the state-of-the-art in hardware or software, although the accent on the long-awaited and frequently delayed line will be on software. Two machines, perhaps more, will be announced initially. A medium-range machine, first designated internally as the D machine and later the P-7, was designed by Honeywell-Bull in France. Another lower-range machine, the C or P-6, was designed by Honeywell Italia.

A working model of the 7 is known to exist in the Boston area, but we still haven't heard of a working demo of the smaller machine. That leads to speculation that deliveries of the 6 will come later than those of the 7. Further, a third, upper-medium-range machine designed in the Boston area has reportedly been killed. If that is indeed true, then it could mean that Honeywell will top off its edp line for some time to come with its 6000 series.

PARTLY GE, BUT STRATEGY IS DIFFERENT

Honeywell's new line is an outgrowth of the Advanced Products Line (APL), which GE's Advanced Systems Div. designed as an across-the-board assault on IBM. The new Honeywell announcements, however, won't be aimed at IBM, but rather at unifying Honeywell's conglomeration of old Honeywell, GE, and Bull lines. One of the striking things about Honeywell's new line--and new technology--is that it relies heavily on ex-GE technology and people.

For Honeywell, a great deal is riding on the software. It will announce software bridges between the new line and the 6000 and the low end of the model 50 line. The bridges will be challenging to customers, perhaps, but even more so to Honeywell as it tries to move the new equipment to its old customer base. For instance, how do you sell a 6 machine to GE 100 customers; how do you sell a 7 to Honeywell 200 customers?

On the plus side for Honeywell is the fact that it has sold off most of its huge and ancient 200 base and the firm simply can net orders up when it makes new sales of the new equipment. (This worked the other way for IBM, with unhappy results, when that firm had to net down when it replaced too many 360s on rent with 370s.) There is danger to Honeywell, though: it's tougher to move customers up to new equipment when they own, rather than rent, their existing equipment. Users who own 200s, for instance, will likely look at other vendors' equipment too. As one knowledgeable industry observer said tersely about the upcoming Honeywell line: "Honeywell can have mundane stuff and still have tremendous stuff. But the software better work and it had better be priced right."

CDC: UNBUNDLING ALL THE WAY

Control Data this month takes a second small step toward building a healthy price umbrella for the software industry. In 1970 it followed IBM's lead by separately pricing applications software and services; and with its new Cyber 170 line, being announced April 10 in Toronto, it will unbundle everything, including its new network operating system (NOS). The company contends that its new policy, called Separate Element Pricing (SEP), will reflect "true development cost and the value of these (software) products to the market." A reduction will be made in the hardware price to reflect a "dramatic" drop in hardware development and production costs.

LOOK AHEAD

Although it's understood a sizable part of the software costs will still continue to be subsidized by the hardware price tag, CDC nevertheless is wiping away the concept of "free" software as a tie-in to hardware, a practice criticized by independent software groups, notably ADAPSO's Software Industry Assn. The target of ADAPSO's attacks, of course, is IBM, not CDC. But while the CDC action won't open a very big market to the independents, ADAPSO spokesmen see it as a moral victory in the battle to pressure IBM to do likewise.

THE MISSING LINK?

Recognition Equipment Inc., Dallas, is working on an image processing system for banks which could prove to be the missing link between the check and the less-check society. It also could answer problems posed by higher postal rates and the paper shortage. With the system, checks would be used but not returned to customers. Instead, checks returned to a bank would be scanned by REI equipment, with their images captured electronically, bit by bit, and stored. The firm hasn't settled on a memory medium. At statement time stored check images would be retrieved and imprinted in miniature on the back of a customer's statement, saving the bank the postage involved in sending back thick packs of checks. And, the banks, after keeping the checks for a required time, could then recycle the paper, which is of high quality. REI has demonstrated a prototype of its system for a "major bank" it declined to identify, possibly the First National City Bank of New York, which was its first customer for its TRACE (TRANSACTION Control and Encoding) system for banks, a system for high-speed data capture, sorting, microfilming, and positive identification of items passing through it.

150 COMMENTS AND MORE COMING

A lot of people have something to say about the evolution of and regulation of Electronic Funds Transfer Systems (EFTS), and last month they were given an extra month in which to say it. The Federal Reserve Board extended from March 8 to April 8 the deadline for comment on the broad issues of EFTS. Although it had received some 150 responses by the March 8 deadline, the Fed also had received numerous requests for extension and for additional explanation as to just what was wanted in the way of responses. By way of explanation, the Fed came up with a series of ten questions and answers designed to help respondents better understand its request. The Fed said it would not extend the deadline again, but one spokesman noted that positions submitted after the date "would not be ignored," since evaluation of comments received would be a lengthy procedure. "Early indications are there's a wide divergence of opinion on a variety of issues." Three basic positions seem to be emerging regarding ownership and operation of various segments of nationwide EFTS: 1. the Fed does everything; 2. the Fed is allowed to provide services on a competitive basis with everybody else; and 3. the Fed is not allowed to do anything, does not have the statutory capability to do anything.

IT'S A 4K RAM FOR H-P'S NEW MINI

Although the 4K MOS random access memory is the first semiconductor to surpass core memory systems in price/performance, nearly all of the semiconductor houses producing it are bogged down with yield and production problems. Nevertheless, Hewlett-Packard's Data Systems Div. has fixed on a 4K RAM as the main memory in a new line of 16-bit minis, the first of which--the 32K model 2105A and 32-64K 2108A--are

(Continued on page 162)

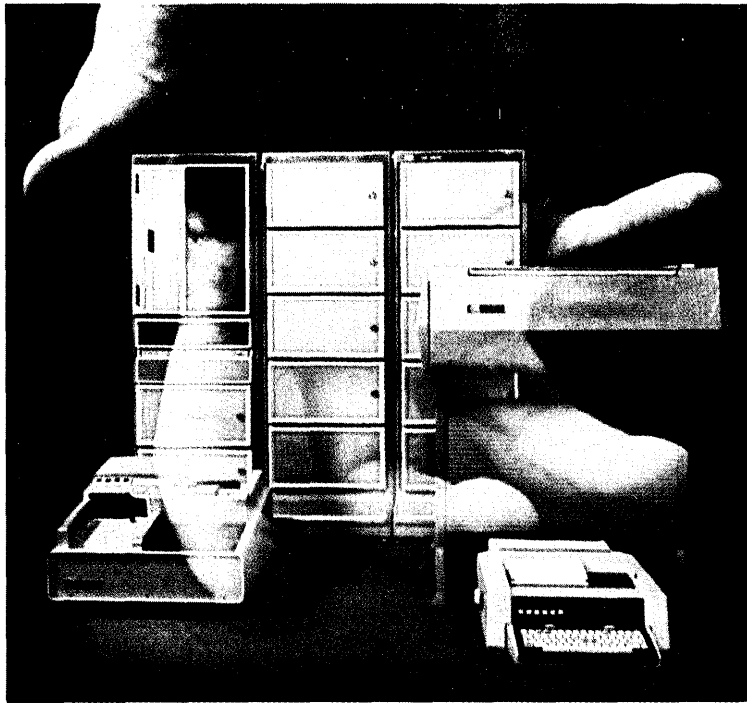

This \$170,000* system gives you more computer access than any \$300,000 system in existence.

HP's 3000 Minicomputer System gives you four languages: COBOL; BASIC; FORTRAN and HP's System Programming Language. A powerful Editor and File Manager. And concurrent accessibility from both terminals and batch peripherals.

This innovation works for a living.

If you do, call us.

HP minicomputers. They work for a living.

HEWLETT *hp* PACKARD

Sales and service from 172 offices in 65 countries.
1501 Page Mill Road, Palo Alto, California 94304

April, 1974

CIRCLE 18 ON READER CARD

*Domestic USA prices.

22412

.19

“Our savings account terminal’s been out for 15 minutes.

“When can you fix it?”



If your data communication network is supposed to be up and running 24 hours a day, 23 hours and 45 minutes isn't good enough. Because, if the network isn't 100 percent right, all the time, it can mess up a lot of bank accounts. (Or lose track of somebody's reservation, or lose a big sale.) No matter what the application, Intertel builds data communication systems that guarantee that your network will be there when you need it.

We'll eliminate most network downtime with a backup system for your private phone lines, and on-line spares at critical points in the network, all under your control at the central site. We'll eliminate false service calls and finger-pointing between vendor service organizations, by giving you diagnostics that let you pinpoint problems, from the central site, *before* you call the service engineers. We'll eliminate the confused

wiring and the stacks of modems you see in most central-site installations by putting all your diagnostic, preventive maintenance, backup, and data transmission functions in one compact, modular Intertel data communication system. For more information, write or call for our brochure (Intertel, 6 Vine Brook Park, Burlington, Mass. 01803 ☐ 617/273-0950), or see us at the Computer Caravan or the ICA Conference.



Life Insurance for Data Communication Networks.

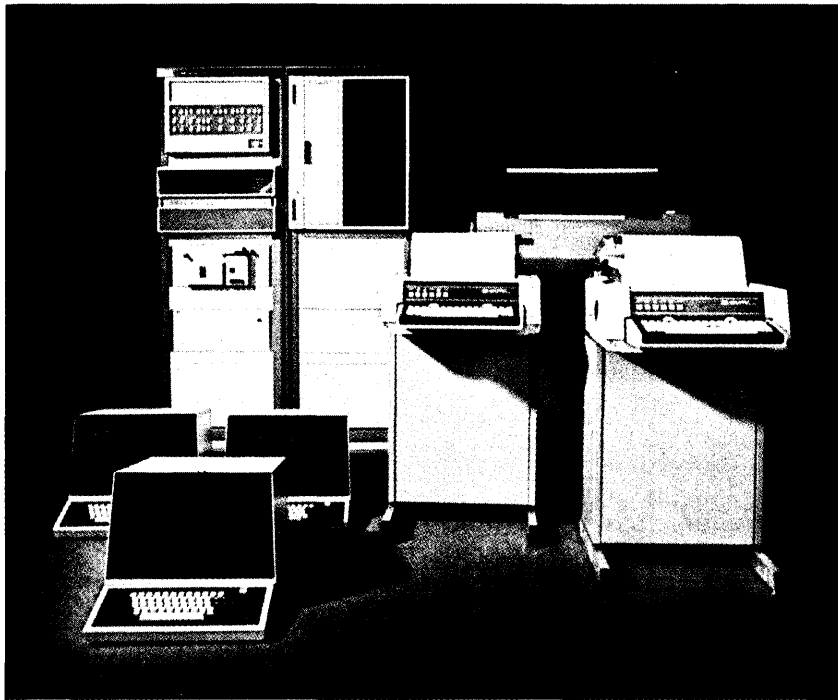

Processing 18,000 business transactions per hour is nothing new. A minicomputer that does it for \$80,000* is!

HP's Management 230 System lets you enter, edit, update and process transactions on as many as 32 remote terminals.

With no interim handling. And without overloading the resources of your central system.

This innovation works for a living.

If you do, call us.

HP minicomputers. They work for a living.

HEWLETT *hp* PACKARD

Sales and service from 172 offices in 65 countries.
1501 Page Mill Road, Palo Alto, California 94304

*Domestic USA prices:

22413

April, 1974

CIRCLE 70 ON READER CARD

21

Single-source computer service is a put-up or shut-up business. We're putting up.

We have a world-wide network of service facilities, staffed with well-trained and experienced service technicians. And backed up with logistics and technical support that would make any service organization envious.

We've put together an operation that is specifically intended to cure the perennial service headache of mix'n'match systems. Raytheon Service Company will provide leasing companies, users, and owners with a single source for competent service at any EDP installation, anywhere in the free world. And we'll give any manufacturer good reason to think twice before he takes on the effort and expense of building an internal service organization. Raytheon Service Company. One source for great service — in North and South America, Europe, the Far East — or wherever your equipment might be. We *are* putting up. Try us. Call or write Mike Salter, Commercial Marketing Manager, Raytheon Service Company, 12 Second Avenue, Burlington, Mass. 01803.

(617) 272-9300.



CIRCLE 71 ON READER CARD

See us at the NCC,
Booth #425

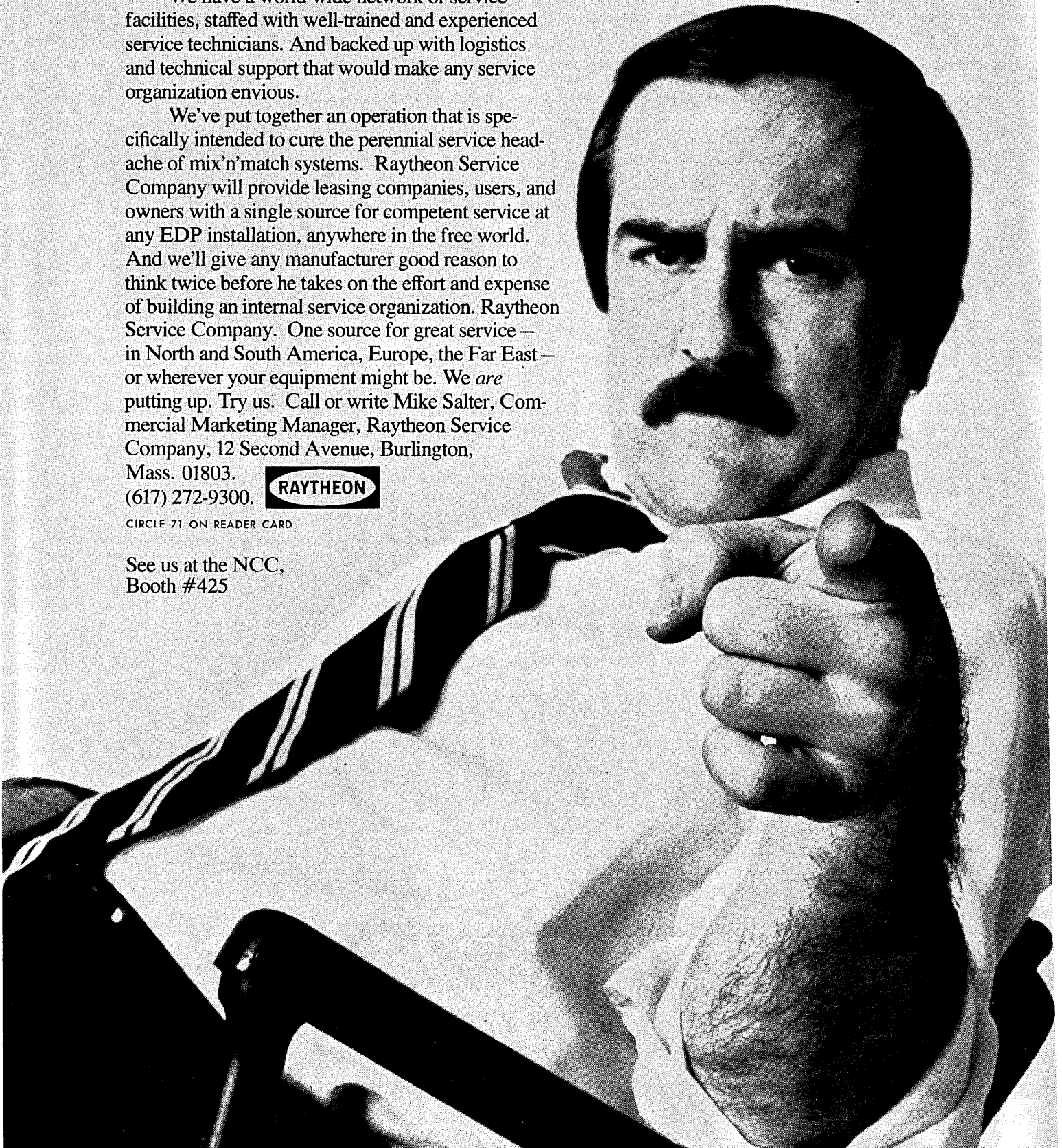

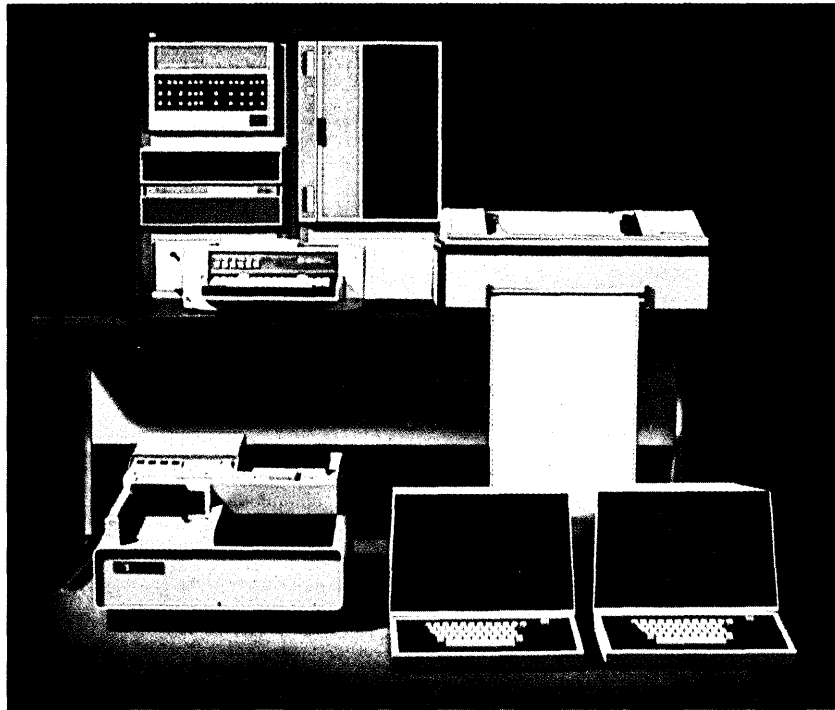

This minicomputer gives you
the data base management
you'd expect on a \$1,000,000 computer.
It costs \$78,000*.

HP's Management 260 System lets you
keep from 5 million to 94 million
bytes of data instantly active . . . on-line.
Make application programs data independent.
Eliminate data redundancy and insure data privacy.

This innovation works for a living.

If you do, call us.

HP minicomputers.
They work for a living.

HEWLETT *hp* PACKARD

Sales and service from 172 offices in 65 countries.
1501 Page Mill Road, Palo Alto, California 94304

*Domestic USA prices.

22414

April, 1974

CIRCLE 82 ON READER CARD

23

1000 PDP-11/45 installations in a year and a half.

Digital's PDP-11/45.

It's brought more computer to more people at a lower cost than ever before possible.

It's got all the raw power you could ever need.

All the speed. (Up to 3 million instructions per second.)

All the capacity. (248K bytes

main storage memory, 320 million on disk.)

And all the flexibility of two powerful software systems.

First there's RSX-11D. A powerhouse of an integrated real-time system. Dynamic memory and disk file allocations, multi-

tasking foreground operations, spooled I/O, and on-line batch processing.

Plus power that adapts to you needs. Easy ANSI FORTRAN IV and ISA real-time extensions.

Then there's RSTS/E. The timesharing software system that handles up to 32 users at the same



time, each with jobs as big as 16K words.

It also has an expanded form of BASIC that gives you string operations. On-line files as big as 30 million characters each. Matrices, ALGOL-like statements.

What's really amazing is that you get all of this and more

in a PDP-11/45 for half the cost of systems that can only do half as much.

Write for more information. There's plenty.

Digital Equipment Corporation, Maynard, Mass. 01754, (617) 897-5111. European head-

quarters: 81 Route de l'Aire, 1211 Geneva 26. Tel: 42 79 50. Digital Equipment of Canada Ltd., P.O. Box 11500, Ottawa, Ontario K2H 8K8, (613) 592-5111.

digital

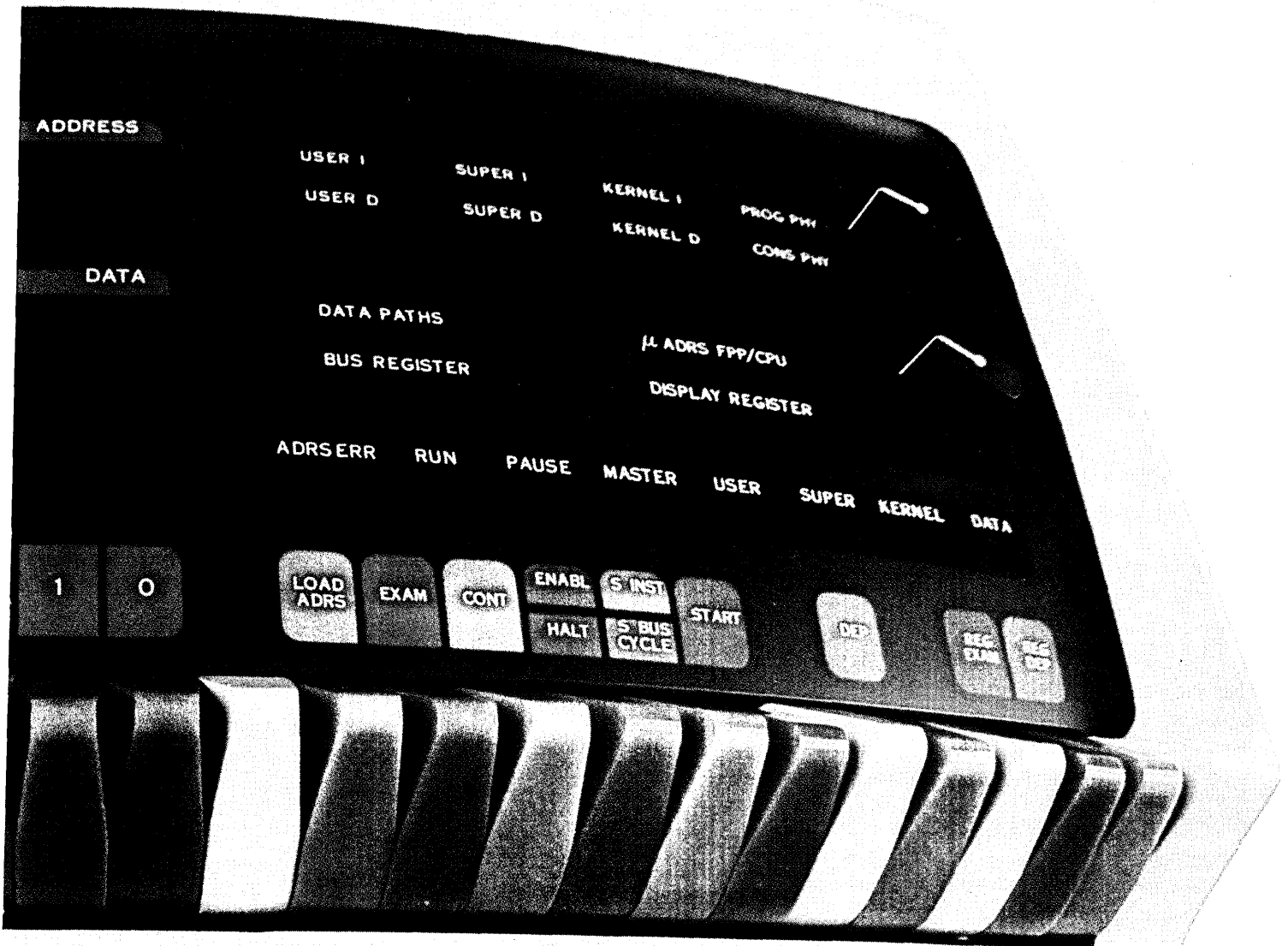

Take a peripheral... an Omron peripheral

Add a cassette,
Or, add a dual cassette.
Or, add a printer.
It's up to you.

One of the major advantages of the Omron 8025 CRT Microprocessor System is the ability of the system to accept field pluggable changes or additions.

It matters little whether you initially order your system with a cassette and/or a printer. At any time your needs dictate, you can add these peripherals at your installation. Cassette System—single or dual. Printer—it's your option.

And there's more to come.

The Omron 8025 CRT System is without a doubt, the industry's most flexible system.

We do it with cards not mirrors.
Simple, field plug-in cards.

If that sounds easy—it is.

Contact us for additional information about other variable, expandable configurations. They make very interesting reading.

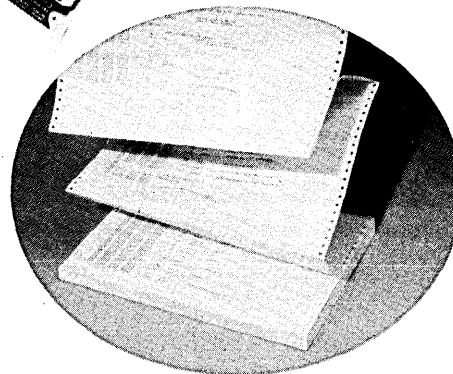
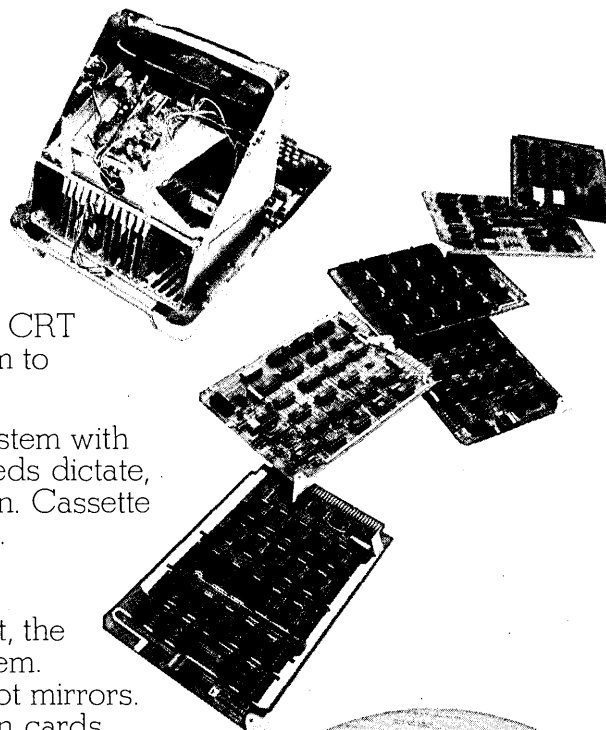

The terminal with
"Variable I.Q."

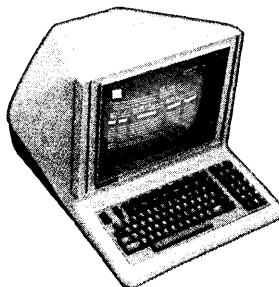

Information
Products
Division

432 Toyoma Drive
Sunnyvale, California 94086
Telephone: (408) 734-8400

See us at NCC Booth 821

Letters

Memories

Not only have I been in the computer field too long for my own good, apparently I have been around longer than Mr. McCrohan ("Remember When," Feb., p. 76). Does he remember...

The CPC (card programmed computer) in which the programmer was the loop.

SOAP (Symbolic Optimization and Assembly Program) which was called the end of all programming headaches.

Bi-quinary number system—if you don't remember it, I couldn't possibly explain it.

PAT NELSON

*Scientific Programmer
Electronics Laboratory
General Electric Co.
Syracuse, New York*

Under the cloak of humor, James McCrohan's "Remember When" feature took some extreme and gratuitous swipes at IBM and its people.

The use of such language as "architect of a society-sapping conspiracy" to describe T. J. Watson, Jr., for example, hardly enriches our stock of business humor. It is malice masquerading as wit, and I regret that DATAMATION has given space to a malicious attack on Tom Watson, Jr., who has been a leader in helping the data processing industry grow to its present importance.

FRANK T. CARY

*Chairman of the Board
IBM*

DATAMATION replies: We try to exercise as little editorial censorship of our authors as possible and do not require that they voice our point of view. Whether the reader finds Mr. McCrohan's piece witty or malicious depends to a great extent on whether he is the target of the "attack." The piece was merely light-hearted humor and we regret that you found it offensive.

Sciolism

Someone on your staff responsible for the LookAhead section ought to have a red face for suggesting to the uninitiated that "LRC stands for Longitudinal Redundancy Check, an aviation term (Feb., p. 18).

An aviation term it may be, but of more relevance to our data processing world is its time honored use in the parity checking of magnetic tape data recording, the longitudinal direction being the direction of tape motion, as opposed to row or transverse direction. Just to be certain of the terminology, I dug out my old IBM 704 Reference Manual, and on p. 32, the following

appears: "Also, at the end of each record written, a longitudinal redundancy check bit is placed automatically in each of the seven channels . . . of that particular record."

FRANK ENGEL, JR.

*Computer Specialist
Belmont, Massachusetts*

Yes, LRC is derived from a dp term, says founder Raymond B. Larsen. It could also stand for Larsen Research Corp., "a name my wife would like, but that didn't occur to us until three months after the company was named."

Tracking the villain

. . . Mr. Wright suggested in his article ("Antitrust: The Real Villain," Feb., p. 138) that the chief executives of CDC, Univac, NCR and Honeywell were guilty of antitrust violations themselves by their unified approach to the Justice Dept. to carry on the IBM antitrust suit.

Our constitution has always guaranteed the right of citizens to seek redress of grievances from our governments, whether they be to the President, Congress, the Justice Dept. or the state governments. Such right is fundamental to our freedoms and mode of government and the suggestion that such is improper or illegal shows a lack of fundamental knowledge of what constitutes individual rights . . .

LAVELLE DAY

Lake Oswego, Oregon

Bravo to Mr. Wright for his courage in stating the moral truths about IBM vs. Telex in particular, and antitrust in general. I only wish I could have penned the letter. Of course, had I done so, the arguments likely would have been repudiated *ad hominem*. The *ad hominem* fallacy consists of attempting to refute an argument by impeaching the character of its proponent, e.g., he works for IBM, hence he is immoral and his argument must be false. Similarly, anyone expressing agreement with these views is likely to run into the modern version of *ad hominem*, the argument from intimidation, e.g., only a fool could believe that!

I realize this response will be in the minority, but in an age when moral integrity is needed more than ever, we

DATAMATION welcomes correspondence about the computer industry and its effect on society, as well as comments on the contents of this publication. Letters should be typed and limited in length to 250 words, if possible. We reserve the right to edit or select excerpts from letters submitted to us. Write to 1201 S. La Cienega Blvd., Los Angeles, CA 90035.

must all begin at home. If any of the ideas or principles stated here or in Mr. Wright's letter are reaching you, I suggest you begin by reading Ayn Rand's *The Virtue of Selfishness*.

BILL BRITTON

*IBM
San Jose, California*

I find myself in complete agreement with Mr. Wright's remarks on the immoral and destructive nature of antitrust laws. IBM indeed deserves our gratitude for creating the computer industry. The fact that its share of the dp market is decreasing even as IBM continues to grow proves that smaller companies with innovative products and competent management can successfully compete and prosper in a free market. I am personally proud that Burroughs had the good sense and integrity not to join the vultures who are urging Justice Dept. action against IBM.

DANIEL WIENER

*Circuit Design Engineer
Burroughs Corp.
Pasadena, California*

. . . The concepts of pure laissez-faire capitalism or, if you will, pure free enterprise, are merely the economic branch of the political philosophy commonly known as anarchy. The interesting thing about anarchy is that its advocates are free to claim all sorts of magnificent benefits which will necessarily result from its implementation. That is because they need not fear refutation based on historical experience since no society of men, from the most primitive to the most highly-structured, has ever dared, or wanted, to experiment with it as the established "order" (?)—I am at a loss for words. How can we "establish" anarchy as an "order"?

GILBERT H. FRIEDMAN

*Burroughs Corp.
Pasadena, California*

A shade of grey

With regard to Mr. Patrick's article in your January issue (p. 47), it is a disservice to your readers to take such a black-and-white binary position on an issue as complex as the use of the Social Security number as a personal identifier.

The charter under which the H.E.W. committee functioned constrained it to explore:

- Harmful consequences that may result from using automated personal data systems.
- Safeguards that might protect against potentially harmful consequences.
- Measures that might afford re-

letters

dress for any harmful consequences.

- Policy and practice relating to the issuance and use of Social Security numbers.

Thus, the purpose of the committee was not accurately stated in Mr. Patrick's article, because the SSN issue was neither the primary nor major driving force.

My article (Sept., 1973, p. 113) was written to clarify the rationale behind the committee's recommendations. I pointed out that the committee believed the issue of a standard universal identifier should be deferred until privacy safeguards were in place and demonstrably effective. We clearly understood that the SSN was already in widespread use, but nonetheless felt, even at this point, that any action to slow its de facto use would be desirable and helpful.

Privacy is a continuum, as Mr. Patrick's article pointed out, but one cannot discuss it in vague terms when a computer system is concerned. The H.E.W. report did define privacy as it relates to the interaction between an individual and an automated personal data system. Whether or not one accepts the definition, at least the context in which the committee report addresses the issue is clear.

Neither is the SSN issue a binary issue. Exploitation of the SSN as a personal identifier might well improve Mr. Patrick's credit dossier, but in a different context it could equally well bring harm, embarrassment or other undesirable consequences to a larger set of individuals.

There are arguments for and against a universal identifier—be it the SSN or something else. Which side of the case dominates, depends—at this juncture—on judgment. One's personal assessment of the situation inevitably depends on one's own experience with data systems and upon one's own exposure to the present practices and future plans of data bank operators. Several witnesses before the H.E.W. group and subsequent testimony elsewhere (e.g., the Judiciary Committee of Minnesota), clearly indicate that organizations collect SSN's without any present need, without any clear future need, and just because "it would be a good thing to have."

On balance, I am persuaded that the risks of uncontrolled exploitation of the SSN as a de facto standard identifier far outweigh the inconveniences and inadequacies resulting from not having a unique personal identifier. I will stand on my position that, as of now, the first order of business is to get privacy safeguards in place and to

demonstrate their effectiveness. Then is the time to deal with the standard universal identifier issue. The matter is just not as simplistic as Mr. Patrick's article would suggest that he believes.

WILLIS H. WARE

Secretary's Advisory

Committee on Automated

Personal Data Systems

(Continued on page 202)

The Turing Women's Liberation Index

I had told my class in artificial intelligence how in 1950 the famous mathematician and logician Alan Turing presented a discussion on the question: "Can a machine think?" He posed an imitation game to be played with three people, a man, a woman, and an interrogator of either sex who stays in a room apart from the other two. The object of the game for the interrogator is to determine which of the messages is coming from the man and which from the woman. It is the man's object to cause the interrogator to make the wrong identification. After the game has been played for awhile, we replace the man by a computer. Will the interrogator decide wrongly as often when the game is played with the computer as when played with a man and a woman?

The class decided to play the first part of this imitation game, and in so doing, we discovered the importance of the Turing Test to the Women's Liberation Movement.

We chose a male and female subject, and they left the room to await messages. We used one of the students as a messenger. The class came up with the first question: "How long does it take for electric hair curlers to warm up?" Almost identical answers came back, describing how the red light of the curlers goes off after four or five minutes. We couldn't tell which message came from the female and which from the male.

The next question was: "How would you stop a run in your pantyhose?" Again, the answers were almost identical, and concerned the use of clear nail polish. We began to notice that the questions were being posed and analyzed by the females. Turing was wrong about the sex of the interrogator; if you want to detect the woman, you'd better use a woman to pose the questions and to analyze the answers. The next two questions fared the same.

The final question asked about the width of a seam in sewing, and that was the man's undoing, although he made a pretty good try, and one that fooled the other men in the class. On the basis of the seam answer and a sewing dart definition from question four, the women unanimously guessed correctly which responses belonged to the man and which to the woman.

The class insisted that we play

again, this time with a different couple, and with the roles reversed; the woman would now try to imitate the man. The answers were not distinguishable as far as the sex of the respondents was concerned. However, one of the replies on the use of a regulator was weak, and one of the responses on the definition of a cotter pin was also inadequate, even though both answers were good enough to fool the other women in the class. This time the men were taking the lead in making up the questions and were the ones who were analyzing the answers.

Several results of this experiment were quite interesting. Potential questions on cooking were rejected by the men because the answers were obvious to them, and therefore would not be a good test to detect the woman. On the other hand, some detailed automotive questions were also rejected by the men as a good test for the women "because guys don't know that much about cars anymore." The men and women handled the sports questions equally well. There seemed to be few fields which were solely a man's domain, and few that belonged to the women.

This experiment led me to the realization that the Turing Imitation Game is directly relevant to the Women's Movement. This movement, like any other social movement, is faced with the problem of how to measure progress. We offer this measurement: *When we can play the Turing Imitation Game with the probability of choosing correctly between man and woman equal to one half (pure chance), then the Women's Movement will have attained its goals.*

The game could be played every year over nationwide television, using a random sampling of the population. The resulting probability score would be called the Women's Liberation Index (WLI). Or, it could be played more frequently, with the WLI announced on a daily basis. The WLI would appear with the stock index in newspapers and journals. The WLI might be discussed nightly by news analysts, and, after a WLI "crash" we might have special programs on TV probing the causes of the debacle.

OSCAR FIRSCHEIN

Guest Lecturer

Natural Science Dept.

California State Univ.-San Jose □

Some people get the picture quicker than others.

Thanks to graphics.

How? Take a look at our 4010 family of low-cost graphic terminals. We'll show you how they cut endless hours of plotting . . . how fast they convert mounds of data into understandable charts, maps and drawings.

Applications? By the hundreds! Today, our graphic terminals are giving new, quick insights to leaders in research, education, business, math and science.

And getting the picture doesn't have to be costly. You can move up to graphics for as little as \$3,950.

There's more. Thanks to our CRT direct view storage screen, you can see clear graphics and alphanumerics in standard ASCII and APL on either 11" or high resolution 19" screens. In minutes they plug into most computers and minis. And our broad-ranging software support turns them on. Copy your results on our dry process, grey scale hard copy unit. Add to that displays, monitors, and paper tape units that enhance your graphics power.

Business forms are programmed and ruled fast with our 4023, the first alphanumeric terminal with

upper and lower case and optional forms ruling.

No matter who you are or where you are, our worldwide Tektronix service backs you up. Which is another reason you should get our picture . . . and we should get acquainted.

Tektronix, Inc.
Information Display Division
P.O. Box 500
Beaverton, Oregon 97005



TEKTRONIX®

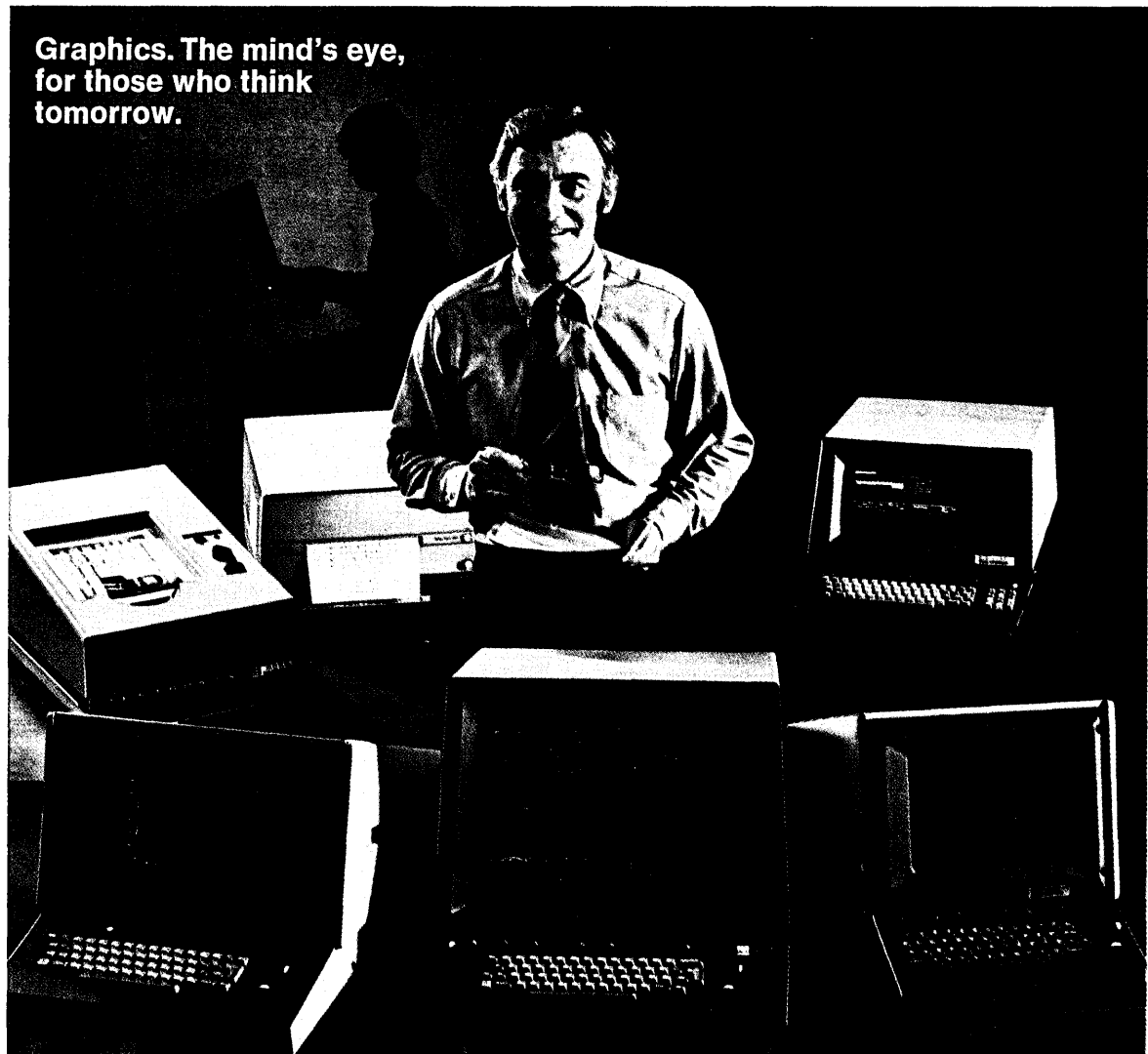

**Graphics. The mind's eye,
for those who think
tomorrow.**

Cramped for space in your production of computer-generated graphics? Stretch out on the king-size 22-inch bed of the new Gould 5100. In fact, the Gould 5100 gives you the widest plotting capability at the fastest speed of any electrostatic unit. With a price/performance ratio superior to every other printer/plotter on the market.

The Gould 5100 has been specifically designed for scientific and engineering work where speed is essential, and where the ability to print out such materials as seismographic charts and A to D size drawings is required.

And it's absolutely loaded with features. 22-inch wide roll paper. Up to 3 inches per second in graphics mode. Resolution of 100 dots per inch horizontally and vertically. Superior density of plotter output.

What's more, the optional 96 ASCII character set allows the Gould 5100 to print 264 characters across the page at 1200 lines per

minute. Direct on-line interfaces are available for IBM System/360 and IBM System/370 computers as well as for most mini-computers.

And Gould software is the most efficient and flexible available anywhere. In addition to the basic software package that emulates the widely accepted Calcomp graphics package, specialized engineering, drafting, scientific and business graphic software enables your computer to efficiently handle the most sophisticated computer graphics.

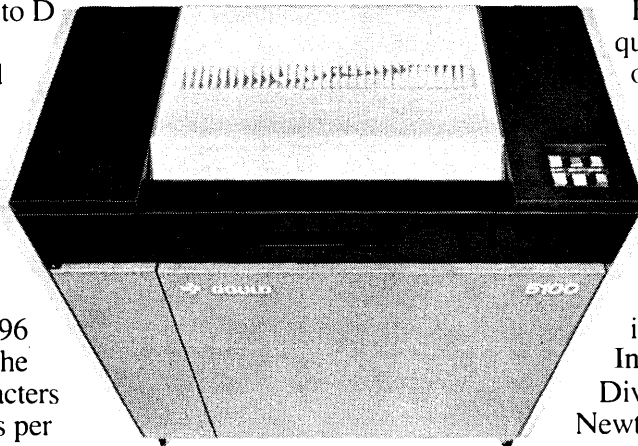

Built with traditional Gould quality, and backed by Gould's own reliable service, the Gould 5100 will greatly expand the efficiency and throughput of your production of computer-generated graphics. Let our Pete Highberg or Bill Koepf prove it to your satisfaction. Get in touch with them now at Gould Inc., Dept. D4, Data Systems Division, 20 Ossipee Road, Newton, Massachusetts 02164.

The new Gould 5100 printer/plotter. It lets you work out on the biggest bed in the business.

See us at the Computer Caravan in your area or at Booth No. 1021, National Computer Conference, Chicago.

DATA SYSTEMS DIVISION

 **GOULD**
DATAMATION



WANGCO'S MOD-10 this is the one they copied!

WANGCO's Mod 10 brings you all of the new innovations in low-cost tape drive design, with one important difference. In the Mod 10, we introduced these innovations five years ago!

More than 12,000,000 hours of reliable operation have proved the advantages of the Mod 10. Automatic servo arm retraction and straightforward kink-free tape threading ensure easy loading. IBM head guide spacing gives you tape interchangeability and low dynamic skew.

We were the first to put track-by-track electronic write deskew on low-cost tape drives, and to offer tri-level read threshold for improved data reliability. Five years ago we

also introduced our swing-out deck for front access, and the strobe disc on the capstan for quick tape speed checking.

Others may imitate, but no one can point to more than 7,000 units in the field, working dependably in a wide range of systems and applications.

So, if you are considering one of the "new" tape drives, keep in mind that WANGCO tape systems bring you all the same features plus millions of hours of field-proved performance.

Write for your copy of "A Comparison of Tape Handling Equipment." WANGCO Incorporated, 5404 Jandy Place, Los Angeles, Calif. 90066. (213) 390-8081.

*There's more! See us at the National Computer Conference
Booths 843-845-847*

WANGCO INCORPORATED—
SETTING THE PACE IN PERIPHERALS

New York, N.Y. 516/294-0893 • Boston, Mass. 617/444-9264 • Washington, D.C. 301/937-2215 • Huntsville, Ala. 205/881-7836 • Chicago, Ill. 312/336-1555
Houston, Tex. 713/785-0581 • Dallas, Tex. 214/620-1551 • Denver, Colo. 303/355-3521 • San Francisco, Calif. 408/732-6210 • Seattle, Wash. 206/632-0710
In Europe: WANGCO Incorporated, Radix House, Staines, Middlesex, England

April, 1974

CIRCLE 104 ON READER CARD

DATA 100



ADDS KEYBATCH...TM

The Data Entry/Remote Batch System with exclusive editing capabilities

Now you can key your data directly into a versatile DATA 100 high speed intelligent batch terminal. Keybatch provides comprehensive editing and storage of up to five million bytes of data at its source. DATA 100 communications capabilities will allow Keybatch to operate with all major main frames with no software modifications. Keybatch is another reason why more users are looking to DATA 100 for the latest, most versatile remote data processing systems.

Sales and Service available in North America, Western Europe, Australia and the Far East.

- Local and Remote Key Stations
- Communications with All Major Central Processors
- Concurrent Batch and Data Entry Operation
- Wide Range of Editing Features
- Disc Storage to 5 Million Bytes
- Up to 9 Operator Stations
- Plus Powerful Batch Processing Capabilities

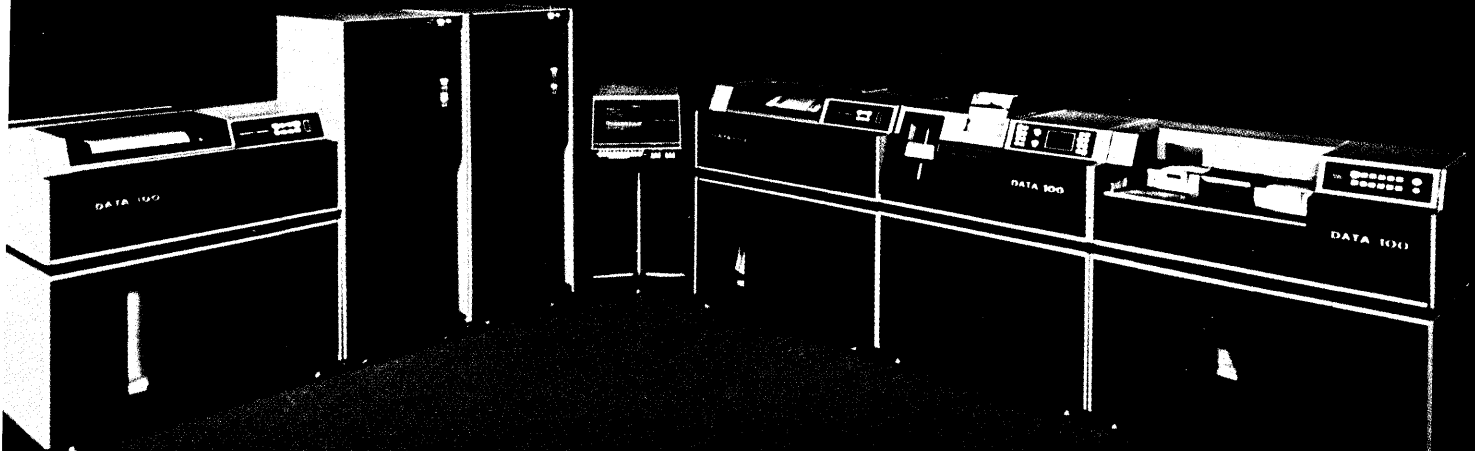

DATA 100
CORPORATION

Post Office Box 1222, Minneapolis, Minnesota 55440 • 612/941-6500

CIRCLE 53 ON READER CARD

WAREHOUSE	PLUMBING SUPP.	WAREHOUSE SHIPME BLDG. HDWR.	IND. H
ABERDEEN			
AKRON	202688.97		
ALBANY			
ATLANTA			155473.
BRENT		99634.31	
BRYANT	42688.57		
CHARLESTON	117895.37		
DALLAS	141444.46		
DENVER		183318.15	
EVANSVILLE			
FLINT			
FRESNO	51669.50		122674.
INDEPENDENCE		80985.29	
JACKSONVILLE		267413.57	86433.2
LIMA			
LINCOLN	171393.27		
MOBILE		151333.41	326008.8
OLEAN			194083.4
PALMER			
IND ENCE			
	52345.69	88466.33	159623.18
TOTALS	780125.83	871151.06	1044296.61

DIVISION	PLUMBING SUPP.	INCOMING SALES I BLDG. HDWR.	IND. HDWR.
ATLANTA	67748.30	81260.60	87773.50
BALTIMORE	91355.40	103176.60	120066.90
BOISE	44672.50	54293.80	79823.80
BOSTON	85563.60	52055.10	103990.20
CHICAGO	73913.90	99639.80	165997.70
DALLAS	73189.50	65219.90	90415.30
DENVER	90054.20	90337.60	56229.50
INDIANAPOLIS	66681.70	24479.40	62422.40
KANSAS CITY	82158.80	145423.40	63273.80
LOS ANGELES	136515.50	115307.80	142831.90
NEW YORK	118891.40	138424.90	158627.40
TOTALS	930744.80	969618.90	1131452.40

New computer printout form



SPEEDIREAD*

with "Eye Track" color guides for easier, clearer line-by-line reading of reports

Now—line-by-line reading of your computer reports can be easier, faster and less tiring.

"Eye Track" color bars on the Moore Speediread computer printout form let you read data across the page without distraction from lines above or below.

Specially formulated colors make each line distinctive, independent of other data units, permitting undistracted, comfortable reading across the report.

You read faster, with less eye fatigue, and words are not reduced, but are full size for maximum readability.

Patent Pending

The size of Speediread is better, too, for handling and binding. Its convenient 8½-inch depth offers 68 lines of data—its 14.3-inch width provides printout space for 132 characters per line. You pack more data onto fewer pages to save filing space—and paper.

Ask for test or working samples from your local Moore representative. Call the nearby Moore office or write to us at: Niagara Falls, N. Y., Oakland, Calif., Denton, Texas, Glenview, Ill.

*Trademarks of Moore Business Forms, Inc.

SPEEDIREAD packs more data in less paper

Packs in data

More data per report—68 lines per form—full 132 printer characters across the sheet. And—every line can be read perfectly.

More readable

Eye guides of special warm and cool colors aid in across-form reading. Eliminates eye fatigue from reduced, blurred data lines.

Easier handling

Convenient 8½-inch depth for ease in reading reports. Bound easily, using marginal-punch holes. No additional prepunching or special holders required.

Saves trees

Less page depth than normal 11-inch depth—a saving of more than 25% in paper pulp. Less paper saves trees—a real aid in conservation, ecology.

Sequence

Multiple forms come from printer in exact sequence with no sorting needed. Eliminates need for resystematizing process flow.

Faster thru-put

8½-inch depth means faster computer skips over unused lines. Instant multiple copies eliminate need for extra data processing and equipment.

Highlights data

Speediread packs masses of data onto reports in blocks and lines. "Eye Track" color guides isolate each line.

Cuts storage space

Speediread is made with paper of lower caliper to ease bulky storage problems and reduce needed file capacity. Smaller cartons, too, cut storage space, reduce shipping costs, and are easier for operators to handle.

Full-size data

Full-size alpha and numeric characters—no reduction to cause illegible lines or data. All data on copies sharp and clear.

MOORE BUSINESS FORMS, INC.



REMEX ■ ■ ■

peachy keen peripherals at plain vanilla prices

Peripherals unlimited, with unmatched price performance. Remex delivers on this promise with a complete lineup of advanced, reliable peripherals to meet any minicomputer requirement.

Punched tape? Remex is the leading producer of P/T peripherals, with more units of all kinds in service than any other manufacturer.

Considering digital cassette? Remex puts you ahead of the game with a complete line of equipment and systems. Including the world's first Punched Tape Emulator, that can turn any punched tape system into a high-speed, high-capacity digital cassette tiger.

Floppy disk drives and systems? Remex has 'em, ready to deliver.

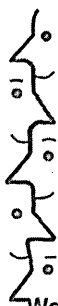

If you know what you need, let's talk delivery. If you're not sure what you need, talk to us about the most efficient peripherals approach. We have no axe to grind, because we have them all.

Write or call Remex, 1733 Alton St., Santa Ana, California 92705. (714) 557-6860. *In Europe and the U.K., contact S.p.A., Microtecnica, Torino, Italy.*

We work with you!

REMEX

CIRCLE 93 ON READER CARD

High speed punched tape reader/spoolers

Versatile punched tape readout units

High performance digital cassette drives

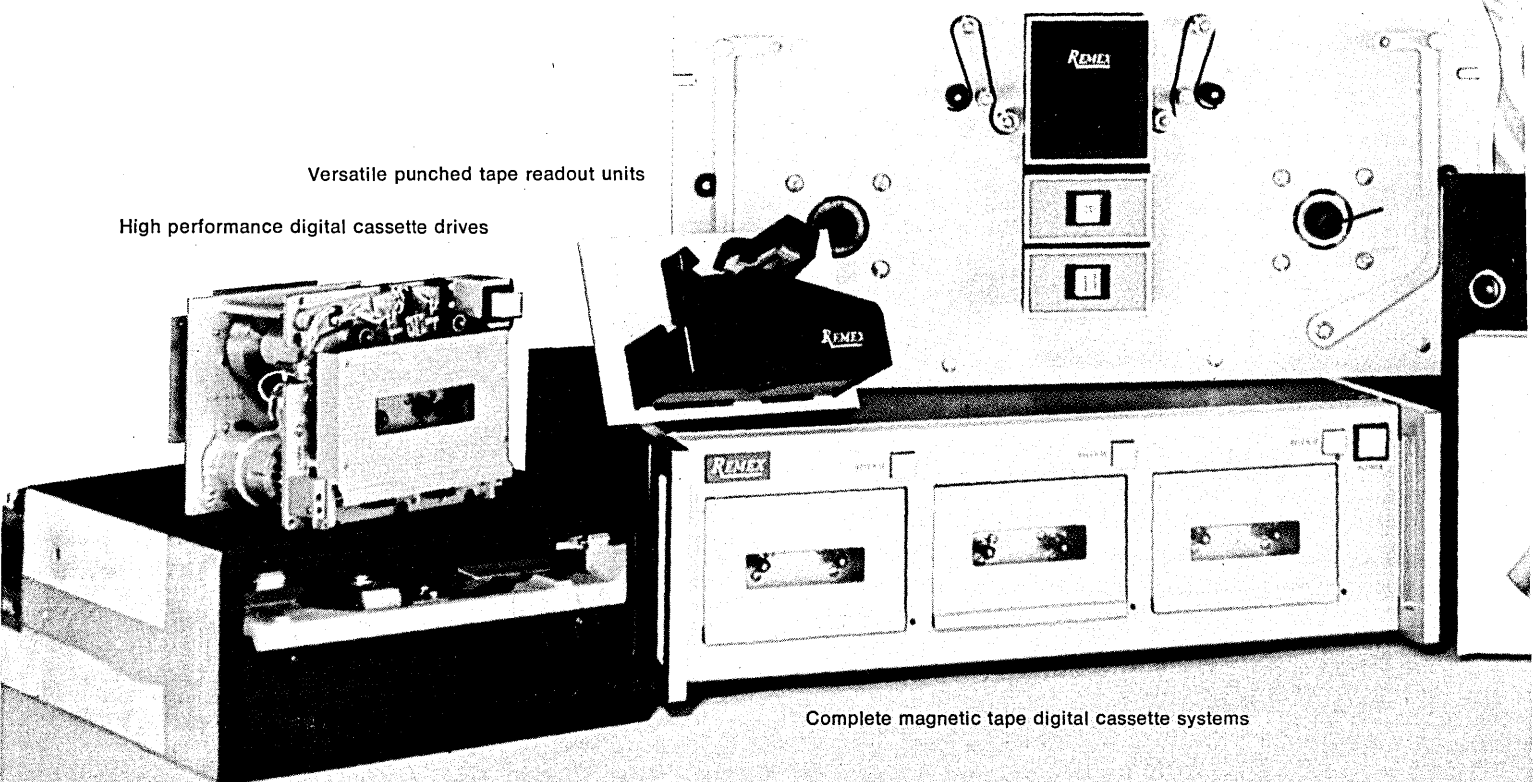

Modular floppy disk drives

Complete magnetic tape digital cassette systems

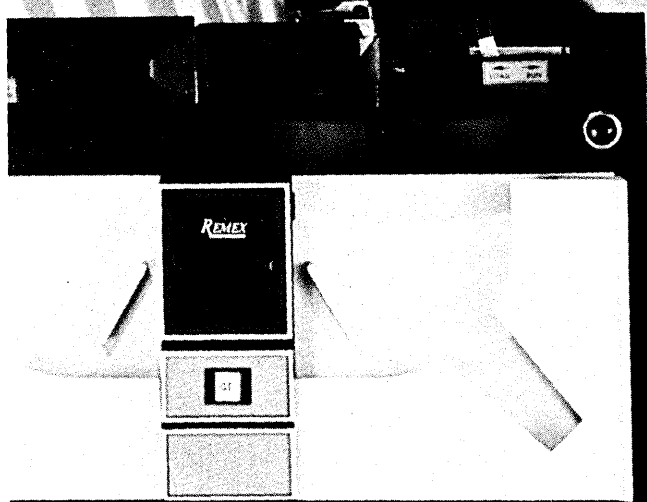

High speed punched tape perforator/reader combos



Complete floppy disk systems

World's first Punched Tape Emulator

A UNIT OF

XLO

EX-CELL-O CORPORATION

Versatec does it again!

Announcing 200-points-per-inch resolution

Versatec is making points like crazy.

While the rest of the electrostatic printer industry is plugging along at 80 points per inch . . . or 100 . . . we now introduce our tour de force . . .

The Matrix 1200A Printer/Plotter. Clearly the most impressive performer ever in electrostatic printers and plotters.

Consider. We can plot 3,600,000 points on a standard 8½ x 11 inch page!

In nine seconds.

Produced by 2,112 writing nibs per 10.56 inch line.

This staggering capability delivers the kind of fine line resolution you expect from the best pen plotter . . . but 100 times faster.

And as for the printed page, the 1200A will print 132 16 x 16 dot matrix characters across the page at 500 LPM. . . in a typeface that is more handsome than that of any impact printer. You're looking at a sample of it right here.

You're probably thinking — "How come it's Versatec, Versatec, Versatec all the time who's making the breakthroughs?"

We are the only one with MEWT™, a true electrostatic writing technique. Years ago, we broke the price barriers with the least expensive electrostatic printers and plotters. And now we offer twice the resolution of anyone else.

With over 1,500 Matrix units in 20 countries

around the world, we're designing better products than anyone else.

But back to our Matrix 1200A. Write us today for more information, including a 200 points per inch print and plot sample that will knock your eyes out.

You have to see it to believe it.

Versatec, Inc.,
10100 Bubb Road
Cupertino, California 95014.
(408) 257-9900.



VERSATEC

**Specialists
in hard copy
information
display**

See us at NCC, Booths 937, 939

CIRCLE 146 ON READER CARD

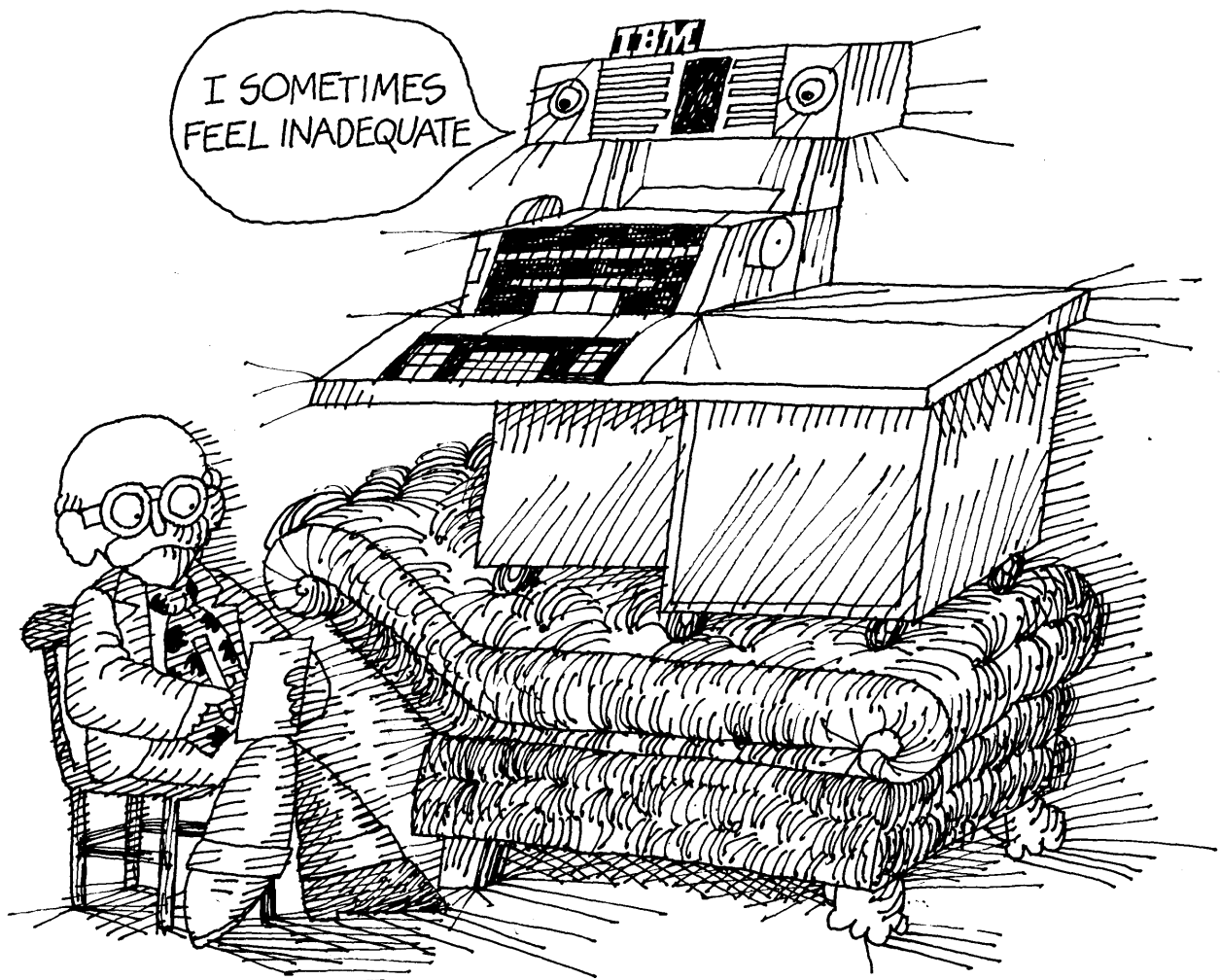

Computer Hardware Inc. has a painless cure for overworked 1130 systems

Add a disc storage system with 20 times the capacity and more than 12 times the speed of the integral disc drive in your 1130. Our CHI-1114 disc storage system has a capacity of 10.24M words and can be expanded to 20.48M words by adding a second disc drive. No software modifications are required to install a Computer Hardware Inc. disc storage system.

Add a line printer that plugs right into your 1130 and turns out a steady 600 lines per minute. The CHI-1103 line printer uses your existing software without modification and provides easy, front-panel access for paper and ribbon changing and all operator controls.

Add core at half of IBM's cost. Add a big chunk of core. As much as 65K, by plugging right into the CPU with the option of accelerating your machine to 2.2 μ sec. And when you add

CHI core, your 1130 DM2 programs need no modification. There's a lot more add-on capability at Computer Hardware Inc. Write today for complete information on all our 1130-compatible products to extend the life and value of your original CPU investment. (If you now have an 1800 system, say so—we'll tell you what we have in that department.)

Don't wait . . . cure your overworked 1130 system with peripherals from Computer Hardware Inc.

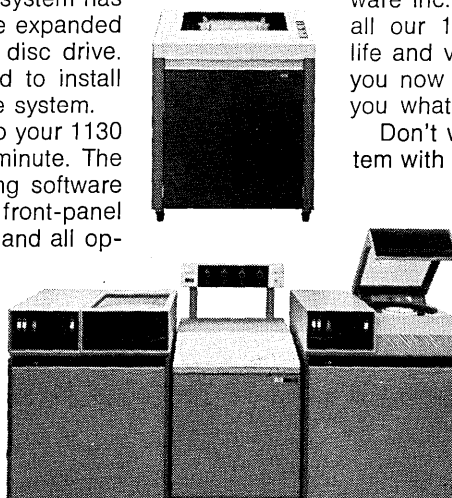

CHI
COMPUTER
HARDWARE INC.

CHI Field Offices: New York, NY (212) 759-8885; Oak Brook, IL (312) 986-0141; Fullerton, CA (714) 871-2030; Tacoma, WA (206) 473-0505; Houston, TX (713) 665-7741; Anchorage, AK (907) 272-7074

Add-on peripherals from Computer Hardware Inc.

P.O. Box 4496, Sacramento, California 95825, (916) 929-8731

This chip
is the world's first
SOS processor.



It makes all the
stuff on the next page
possible.

Silicon-on-sapphire isn't new.

The aerospace industry and the military have recognized its high-speed, high-density and high-reliability characteristics for years.

But no one was ever able to use it in a computer processor.

Until now.

Now General Automation designers have built the world's first commercial processor using SOS technology.

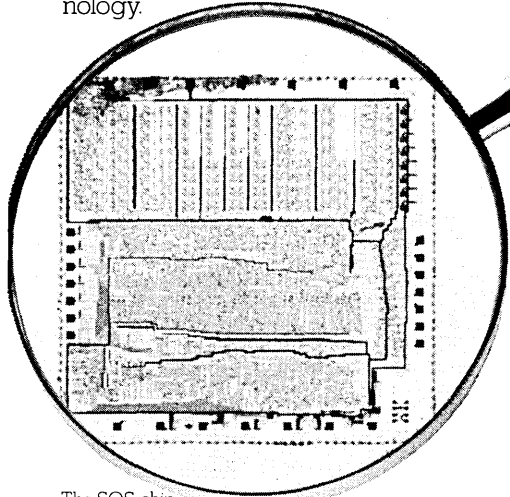

The SOS chip magnified 16 times.

They've placed 2000 gates or the equivalent of 4000 to 5000 transistors on a single semiconductor chip.

An 800 times size reduction from its predecessor product, the SPC-12.

The world's first microcomputer.

That tiny SOS chip has made it possible to bring you the LSI-12/16. A complete digital automation microcomputer with from 1K to 32K bytes of semiconductor memory.

We call it the world's first microcomputer because it's the only

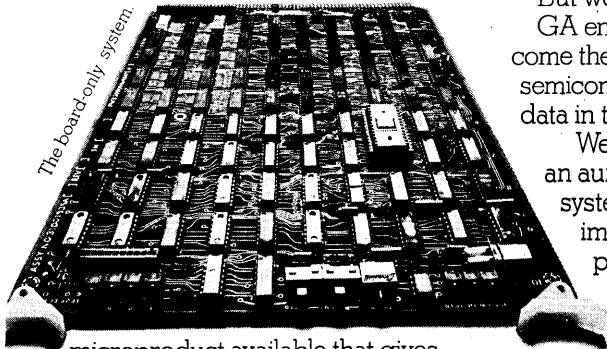

microproduct available that gives you the performance, the systems features, the reliability and the applications support you would normally expect from a minicomputer.

More work, less money.

In the past this kind of size reduction

always meant you had to make major concessions in performance.

With SOS you make none.

The LSI-12/16 has an instruction execution cycle time of 2.64 microseconds.

It's faster than any microprocessor on the market.

It's more powerful. And lower in cost. In board-only configuration with 1K memory, it costs only \$495 in minimum OEM quantities of 1000 per year. In short, we offer all the performance of a minicomputer at microprocessor prices.

Breakthroughs across the board.

The LSI-12/16 is the first microproduct to successfully put all of the following on a single board:
A processor, power fail/auto

unique built-in ROM patch that lets the user retrofit new instructions to any ROM.

Custom tailoring.

There's one more advantage the LSI-12/16 has that no other microproduct can offer.

It's the systems backup and application expertise that General Automation gives you. Helping solve customer problems has always been our long suit. It still is.

We can customize I/O boards and match the LSI-12/16 exactly to your requirement.

Our microcomputer is available in one of two different configurations:

As a board-only system, packaged with memory, control console and processor on a single 7-3/4 by 10 inch printed circuit board.

Or the same board packaged in an enclosure with power supply, battery backup for semiconductor memory and card slots for additional I/O boards.

For more information, write

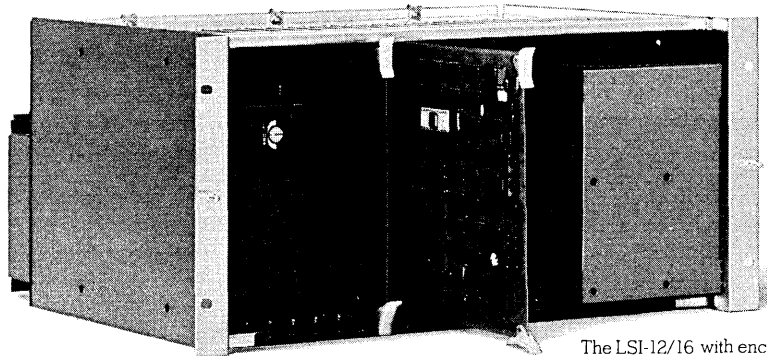

The LSI-12/16 with enclosure.

restart, remote cold start, 16 bit parallel I/O interface and up to 2K bytes of semiconductor memory.

But we didn't stop there.

GA engineering has also overcome the problems associated with semiconductor memory. Like loss of data in the event of power failure.

We handled that by developing an auxiliary battery backup system that will activate immediately upon loss of power and will retain the contents of memory for up to 15 hours.

In case you're interested in more memory, we've designed a piggyback board that will give you an additional 2K of RAM or 8K of ROM.

And if there's ever an error in ROM programming, it can be corrected. The LSI-12/16 has a

General Automation, 1055 South East Street, Anaheim, California 92805. Or call us at (714) 778-4800.

Our European headquarters is at Centre Silic, Cidex L242, 94533 Rungis, Paris, France. Call 686-7431.

GENERAL AUTOMATION

A new generation of computer processors is beginning. All because of this.

See the LSI-12/16 in the Computerworld Caravan — and at the National Computer Conference.

DIVA'S COMPUTROLLER, PDP 11, AND 3330 TYPE DISC DRIVE UNITE.

AN INCREDIBLE MARRIAGE.

An Episode in the True Chronicle of the DIVAS, Proudest Peripheral Family in the Computerworld.

The computerworld stares in awe at the incredible wedding scene which has unfolded before them. The bride is minicomputer PDP 11, offspring of the illustrious maxi-computer clan, begat of Abacus. The bridegroom is DIVA COMPUTROLLER, scion of this proud, most respected peripheral family. Officiating at the ceremony is Duke DIVA Disc Drive, direct descendant of IBM compatible 3330 type disc drives.



Realizing the great impact this interfacing will have on the computerworld, our happy guests monitor the wedding with joyous solemnity.

"Mated," Interdata 70 whirrs, "PDP 11 will have access to 100 million bytes of data on a single spindle or 200 million bytes on a dual spindle disc drive unit within an average access time of 32 msec."

"And with COMPUTROLLER providing a buffering sector, data will be transferable at the rate of 645,000 bytes/sec," marvels Nova II.

"And keep in mind," interrupts a breathless TI 980A, "that with COMPUTROLLER controlling eight drives, mini will have access to 1.6 billion 8-bit bytes of data!"

But, hush! Listen to Duke DIVA repeating those always-inspiring words: "With the data stored in me, and with provided interconnecting cables and distribution panel, I now pronounce you linked in holy matrimony."

Resounding cheers befitting the occasion arise from the crowd. "A toast! A toast! A toast!" they roar. As is the custom, the proud parents, mini processor and DIVA controller, propose the toast to the dazzling couple: "To the most splendid and significant union in all our memories."



"Vive, DIVA! Vive, DIVA! Vive, DIVA!" Everyone unwinds.

But even as we listen to the clink of ceremonial glasses and the exuberant laughter, we sense an underlying sadness. Those unchosen minis — do they count for nothing now? Will they not be able to enter the world of high speed data storage/access and low cost/bit performance? And why — throughout this entire festivity — has COMPUTROLLER remained hidden under his purple robe? Is there more to

COMPUTROLLER than meets the eye? Be sure to join us for the next episode in the True Chronicle of the DIVAS when we will hear the horrendous accusation: "Bigamy! BIGAMIST!"

In the meantime, learn COMPUTROLLER'S inside story. Find out about the free implementation and training courses, the software packages, and warranties that go with each disc system. All you PDP 11 users call George Roessler at 201-544-9000 for cost and delivery information. Or write: DIVA, Inc. 607 Industrial Way West Eatontown, N.J. 07724 TWX 710-722-6645.

REGIONAL SALES OFFICES:
 CT: 203-526-3222
 CA: 415-349-3482
 Wash. DC: 703-370-5211.
 GSA CONTRACT NO. GSS-OOC-00159.

Lead-calcium back-up batteries. The difference between outage and outrage.



An abrupt shut off of power, and an equally abrupt start up with generators, can damage electronic equipment and the data it contains.

That's why IBM's Advanced Administrative System in White Plains, N.Y. uses lead-calcium batteries to smooth over the rough spots. Short-term power outages up to 30 minutes are straddled without a hitch. In longer outages, the batteries allow the computer installation to be shut down in a series of timed, predetermined sequences, thus

avoiding harm to the equipment.

This uninterruptible power system (UPS) uses 531 lead-calcium batteries, chosen for the long life and minimum maintenance they offer. A simple and economical means of protecting a highly intricate communications network.

Back-up batteries are one of the ways lead helps protect us all. Asarco is a leading producer of lead. Headquarters at 120 Broadway, New York, N.Y. 10005.

75 Years of Progress in Metals

ASARCO⁷⁵

American Smelting and Refining Company

A new tool for computer programmers.

Analyze computer dumps faster, easier... with Texas Instruments SR-22 hexadecimal calculator/converter.

Hexadecimal. Decimal. Octal. TI's SR-22 is the first electronic calculator/converter for computer programmers.

Fast, accurate 3-base conversions make the tedious part of your job a lot easier. You'll save time reading core dumps. You'll speed program debugging.

How much time will the SR-22 save? How much easier will it make your job? See for yourself... order the SR-22 and work with it on the job for 15 days. If you're not completely convinced that your SR-22 will quickly pay for itself in increased productivity, simply return it to us for a full refund.

Here's how it works: Simply enter any number in base 8, 10, or 16. Then at the touch of a key, that number is converted to either of the other two bases. And when you need to add, subtract, multiply or divide, the SR-22 does the job—again in all three number bases.

Easy data entry

An algebraic keyboard means easy data entry. Numbers are keyed in the same order you'd write them on paper. The SR-22 can handle numbers up to 10 digits, then automatically converts to scientific notation. And the SR-22's big, bright display clearly

shows you 10-digit mantissa and 2-digit exponent (alphanumeric characters 0-9, A-F), signs, floating decimal.

The SR-22 lets you operate in either automatic or manual mode conversions. In the automatic mode, pressing the desired base key converts both the calculator display number and operation to the selected base. In the manual mode, you simply enter numbers in one base and then press one of the other two base keys. The calculator converts the entered number to the selected base and is ready for your next entry.

Versatile 3-base memory

You can store, recall and sum numbers with the SR-22's memory. Memory keys operate on the memory and display only, without affecting previous instructions. And all internal operations and data are converted to the selected number base upon recall. For example, when you enter a base 16 number and later recall it in base 10, the number is converted to display in base 10.

The SR-22 weighs less than two pounds. Measures only 6¼ x 8¼ x 2¾ inches. From your desk it will operate on standard household current or 230V/50Hz common to Europe

and South America. And if portable operation is required, you have the option of ordering a rechargeable Battery Pack.

Quantity prices available

Send for an evaluation unit now. You may find that one SR-22 is all you need. Or, you may want to consider a quantity purchase to multiply the productivity of all your computer programmers.

Either way, you have nothing to lose in evaluating an SR-22 for yourself now. Then, if you don't find it fully justifies every dollar invested, simply return it for a full refund.

Quantity pricing? For quick quantity quotes write to:

Mr. Frank Richardson
Scientific Calculator
Marketing Manager
Texas Instruments
Incorporated
P.O. Box 5012, M/S 10
Dallas, Texas 75222

3-base calculations. 3-base conversions. The SR-22 hexadecimal calculator/converter does away with conversion tables. Replaces mechanical calculators. Ends tedious longhand methods. TI designed it for you. All for only \$295.



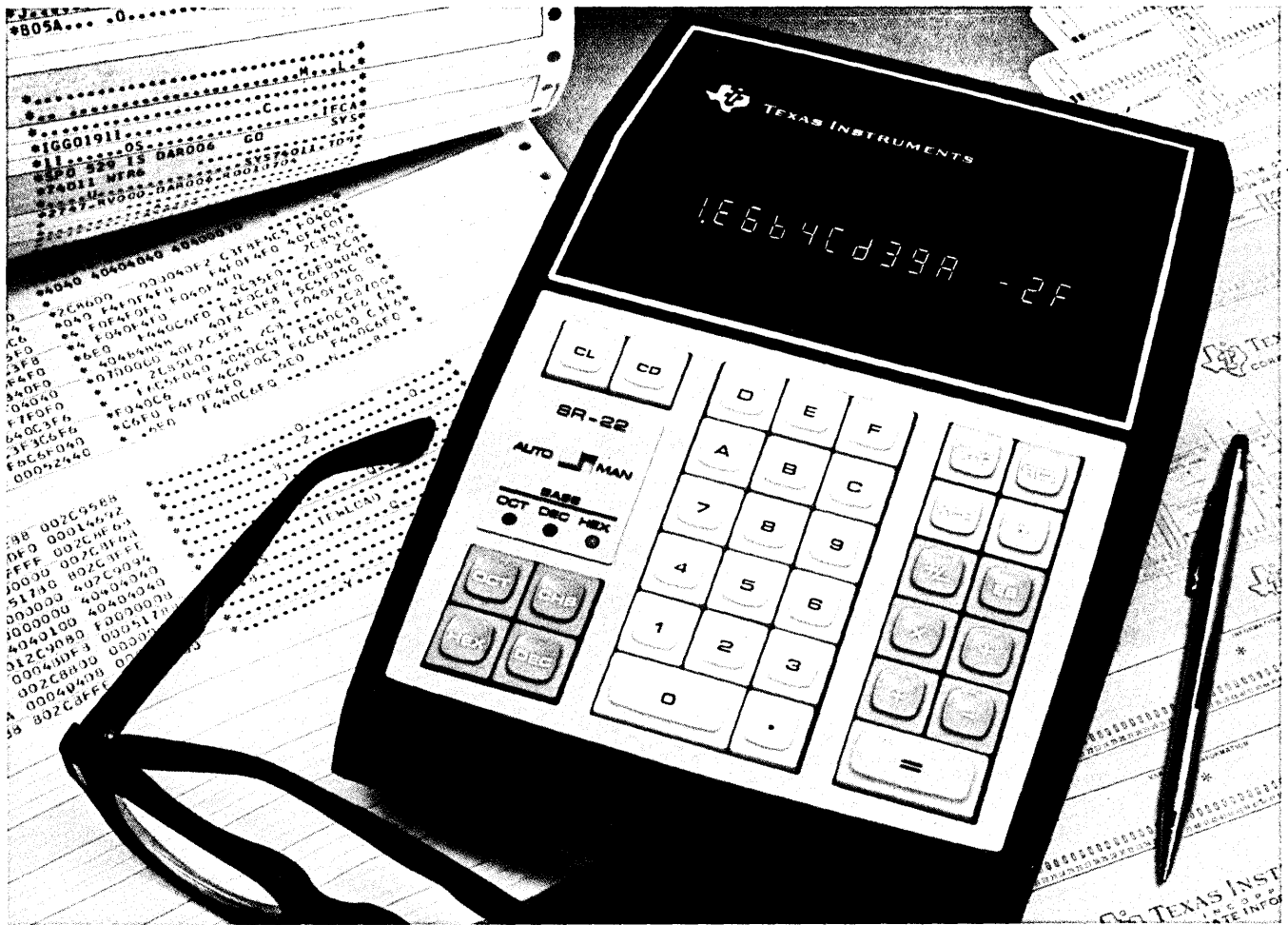

Now only \$295⁰⁰



Accessory options give you total portability.

A charger-adaptor (AC9222) is included in the SR-22's price.

In addition, a nickel-cadmium battery pack (optional for the SR-22) gives about four hours of continuous operation before recharging. It may be charged while the SR-22 is in use, \$50.00.

A deluxe padded vinyl carrying case is available to protect your SR-22 for \$12.50.

Use the SR-22 for 15 days at no risk.

Mail this order form along with a check, money order, or company purchase order **only** for each unit(s) ordered. Use your SR-22 for 15 days, then if you're dissatisfied in any way, return it in the original carton along with all accessories for a full refund. Please add state and local taxes where applicable.*

To: Texas Instruments Incorporated
P.O. Box 3640, M/S 84N, Dallas, Texas 75221.

Name _____
Address _____
City _____ State _____ ZIP _____
Company _____

*States requiring submission of taxes: AZ, CA, CO, FL, IL, IN, KY, MA, MI, MN, NJ, NM, NY, PA, TN, TX, UT, VA, WA.

I enclose a check, money order, company purchase order **only** for \$_____* for the purchase of:

- SR-22(s): \$295 each (plus \$6.00 postage and handling per calculator ordered).
- SR-22(s) and Battery Pack(s): \$345 per set (plus \$8.00 postage and handling per set ordered).
- SR-22(s), Battery Pack(s) and Carrying Case(s): \$357.50 per set (plus \$8.00 postage and handling per set ordered).
- Battery Pack(s) only \$50.00 each (plus \$2.00 postage and handling per pack ordered).
- Carrying Case(s) only: \$12.50 each (plus \$1.50 postage and handling per case ordered).

TEXAS INSTRUMENTS
INCORPORATED

**This member
of our family
is still the
thriftiest ASR
terminal
around.**

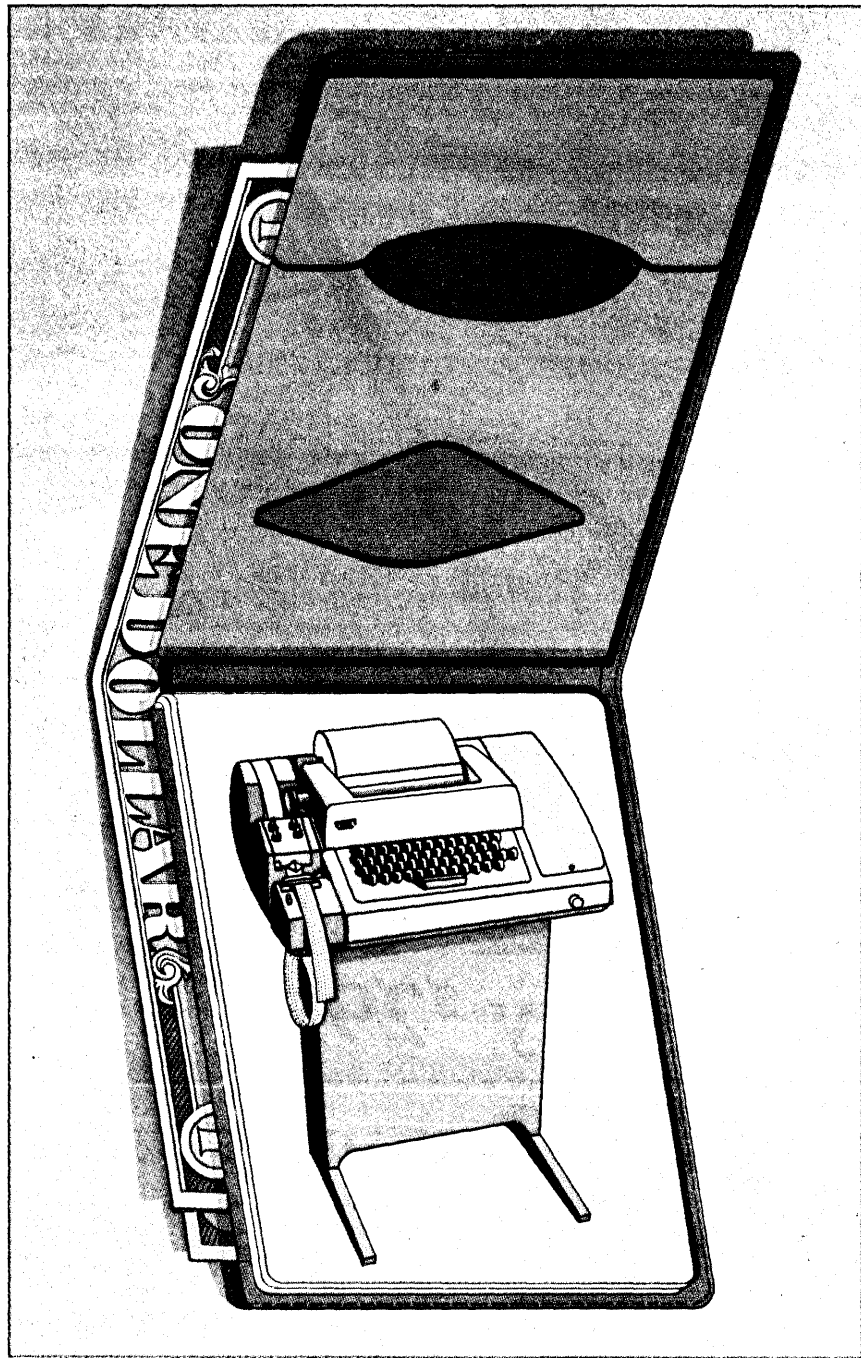

Teletype is a trademark registered in the United States Patent Office.

Dollar for dollar, the Teletype® model 33 is the least expensive, most reliable data terminal in its class. Because once you see how well it performs, you won't believe its price.

That's one reason why the model 33 is the most popular terminal in the industry. But it's hardly the only reason.

The model 33 is designed and built for extremely reliable operation at 100 wpm. And since

it operates on the eight-level ASCII code, it speaks the language most computers understand. Both mini-computers and maxi-computers. Which makes compatibility another reason behind its popularity.

Then there are some reasons you can't see. But they're there just the same. Like complete technical sales and service back-up to help you with installation and maintenance.

Available in three basic configurations, the model 33 is a lot of machine. At a very small price.

It takes more than manufacturing facilities to build the machines Teletype Corporation offers. It also takes commitment. From people who think service is as important as sales. In terminals for message communications and computers.

That's why we invented a new name for who we are and what we make. The computercations people.



The computercations people.

For more information about any Teletype product, write or call: TERMINAL CENTRAL, Teletype Corporation, Dept. 81P, 5555 Touhy Avenue, Skokie, Illinois 60076. Phone 312/982-2500.

CONRAC

When you want
the very best
in data terminals.

Conrac
600 N. Rimsdale Avenue
Covina, California 91722
Call Elton Sherman, (213) 966-3511

In the United Kingdom,
call John Abrahams, Penn 3721

In Germany,
call Erich Wechselberger, 0811/37 65 28



CON CON

IF BIGGER MEANS BETTER, AFIPS has surely outdone itself this year with the '74 National Computer Conference & Exposition.

Last year's show in New York had 32,000 attendees, 220 exhibitors, and 90 technical sessions. This year, over 35,000 attendees are expected to turn out for the annual event, May 6-10 at Chicago's McCormick Place. Three hundred exhibitors will display their new products and services (see "Product Preview," p. 56). And with 119 sessions, 800 booths, various special sessions and activities, a reception, two luncheons, a high school computer science fair, art show, film theater and a Broadway musical, there has to be something for everybody.

Dr. Stephen S. Yau is general chairman of the '74 NCC. Sponsored by the American Federation of Information Processing Societies, it is the second run at an annual computer conference, descendant of the Spring and Fall Joint Computer Conferences. This year there is a greater emphasis on applications.

The 119 diverse sessions, spanning five days, have been grouped into 15 major program areas. These will be treated in greater detail in "The Programs" section that follows. Ten of the 15 programs will be devoted to vertical industry applications: communications systems, health care and biotechnology, education, manufacturing, retailing, distribution systems, government, finance, industrial process control, and transportation. The five remaining programs, highlighting hard-core computer science and technology, are: architecture and hardware, software systems, computer networking, information management systems, and something called management acceptance.

Special sessions

In addition to the big 15 programs, a number of special sessions will deal with such topics as: energy in an evolving society, data base management, and the suddenly popular data security. We recommend the Tuesday special session titled "Computer Developments and Applications Outside the U.S.A.," partly because it is chaired by Richard Tanaka, former AFIPS pres. & current IFIP pres., and partly because the overseas computer industries are flourish-

ing while we are pulling in our belts—or at least experiencing a much slower rate of growth than we once enjoyed. Another must is "Computers and Personal Privacy—A Major Societal Issue." Willis Ware, chairman of the HEW Secretary's Advisory Committee that published the report "Records, Computers, and the Rights of Citizens," is presenting this session, and anyone really interested in the subject should also plan to attend the session on "Security, Privacy and the Informa-

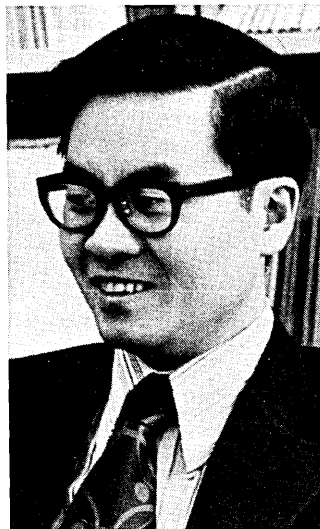

Dr. Stephen S. Yau, Chairman of the Computer Sciences Dept. at Northwestern Univ., is serving as General Chairman of '74 NCC.

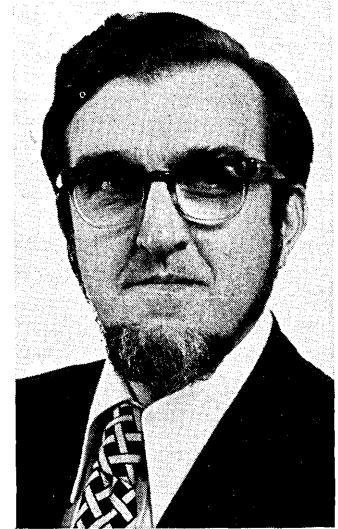

Theodore M. Bellan will serve as Program Chairman. He is Vice President-Computer Services of the McDonnell Douglas Automation Company in St. Louis, Mo.

REFERENCE MENTARY

by Angela V. Smith, Assistant Editor

tion Processing System" (see Government program, p. 52).

For those with the fortitude to survive through the last day's sessions there will be a very interesting special program on "Computer Communications and the Regulatory Environment." Presented as a panel discussion, it can be expected to include the topics of specialized common carriers and the Bell monopoly.

Anyone interested in the origins of interactive time-sharing will enjoy "Pi-

oneer Day," a three-part session on Wednesday afternoon, titled "The Dartmouth Time-Sharing System—Then and Now." It will also include an alumni get-together of the people that worked on the original time-sharing development.

Of course there will be another High School Computer Science Fair, presented this year by Professor Benjamin Mittman, the computer chess organizer from Vogelback Computing Center at Northwestern Univ.; a Computer

Art Show—a multimedia extravaganza where visitors can interact with color tv monitors, synthesizers, and audio devices; and a four-day Science Film Theater with some films *about* computers and some created *by* computers, in addition to still-life art.

If you're into musicals, you can catch John Davidson riding through the cornfields on a big white horse in a special production of "Oklahoma," Wednesday night in the Arie Crown Theater at McCormick Place. Why



AFIPS' President George Glaser will deliver a major address at the conference. Glaser, a former principal of McKinsey & Company, is now an independent consultant.



Conference Luncheon speaker C. W. (Clancy) Spangle is Executive Vice President of Honeywell, Inc., and Operating Head of Honeywell Information Systems, Inc.



John D. deButts, Chairman of the Board and Chief Executive Officer of the American Telephone & Telegraph Company, will be the featured speaker at the Industry Luncheon.

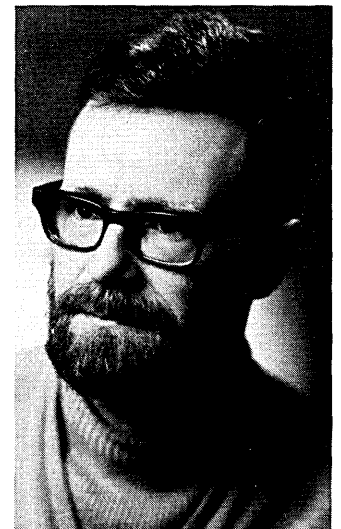

Professor Dr. Edsger W. Dijkstra, research fellow of Burroughs Corp., Nuenen, The Netherlands, will be presented with the Harry Goode Memorial Award during the conference luncheon.

COMMENTARY

not?

A series of tours to nearby installations rounds out the special activities program.

Speakers

AFIPS' president, George Glaser, will deliver an address on Thursday, May 9, in which he'll explore some of the industry's more significant trends, including the increasing diversity and complexity of computer applications, and current and impending technological developments. He will take a hard look at the responsibilities of the computing profession and the individual computer professional.

C. W. (Clancy) Spangle, executive vice president of Honeywell, Inc., and operating head of Honeywell Information Systems, Inc., will speak on cost-effective use of dp systems and techniques, and significant industry trends, at the conference luncheon on May 7.

Then, at the industry luncheon the following day, John D. deButts, chairman of the board and chief executive officer of the American Telephone & Telegraph Company, will present his company's view of emerging applications of computer science and technology.

Registration

There is still time to take advantage of the advance registration discount. For \$50, the price of the NCC Everything Card, you'll receive the 800-page conference proceedings; admission to all exhibits, programs, special sessions and events; and a 20% discount on each of the conference luncheons. Since the post-conference price for the proceedings alone is \$40, this looks like a pretty good deal. (Incidentally, of the 500 or so presentations, only about 130 will have formal papers reported in the proceedings.) Payment must be received at AFIPS by April 22 for the pre-registration discount.

Registering at the door will cost an extra \$10 and you'll have to queue up for a while.

Student registration is \$5, excluding conference proceedings. Single-day registration is \$20. If you're interested only in the exhibits, the fee is \$5 per day, or \$15 for four days.

For further information on programs, registration or housing, contact AFIPS, 210 Summit Ave., Montvale, NJ 07645 (toll free hot line: (800) 631-7070).

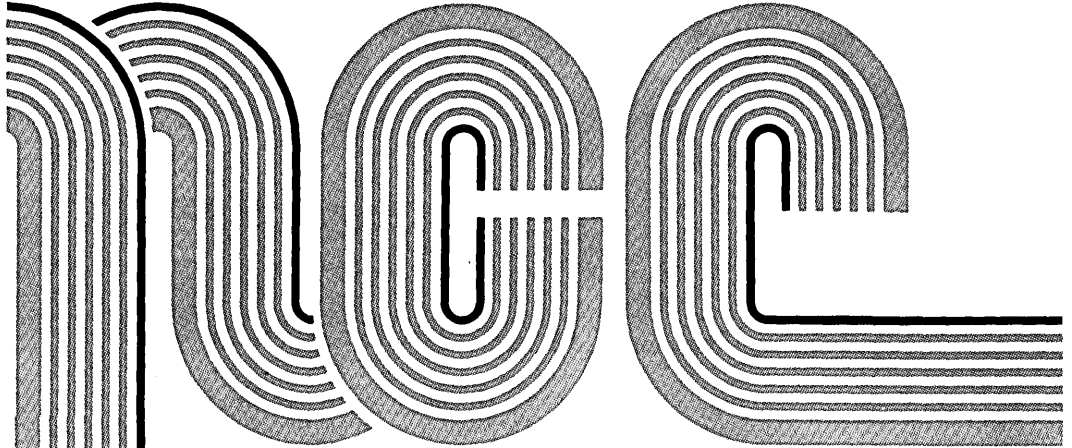

COMMUNICATIONS SYSTEMS

The communications systems program, organized by Dr. Wushow Chow of Network Analysis Corp., will focus attention on the movement from off-line to on-line systems and the integration of data processing and communications. The emphasis is on what users need to know about data communications. "The users are confused and we want to help them cope with the newest advancements," says Chow.

Six sessions will cover topics including networks, minicomputers, domestic satellites, switching, and digital communications on cable systems.

The session on mass satellite communications will not look at mass satellites from a technical point of view as has been done many times in the past, but will view their impact on users. The "Panel on Digital Communications on Cable Systems" will have a similar focus, and Chow thinks this one will be particularly interesting. "So far cable systems are not being used for data communications, but, for the future, this looks very, very possible, so we will look into this in terms of future impact." "Large Information Processing Networks: Development and Operational Experience" could be a real winner since the panelists are users with firsthand experience.

HEALTH CARE AND BIOTECHNOLOGY

The nation's hospitals have only "scratched the surface" in their use of computer technology, says Walter S. Huff, Jr., who has organized eight sessions on health care and biotechnology.

Although market data on hospital dp is scarce, Huff thinks the potential is high because the cost of entry is coming down and the use of dp today is minimal. He thinks that probably only 15% of the nation's 8,000 hospitals use dp for more than doing payroll. A session on "Information Systems for Health Care" will discuss the technical aspects of a number of systems now in use.

Buffalo General Hospital's use of a time-sharing system to diagnose critically ill patients will be discussed by Dr. John H. Siegel, chief of surgery, in a talk on "Applied Medical Applications."

Noting that some hospitals tend to be reluctant in their acceptance of computer systems, Huff has organized a session on "Health Care Planning and Acceptance of Computer Systems." Marion Ball, of Temple Univ.'s Health Services Center, will discuss the status of hospital dp use; and Dick Freibrun, of CompuCare, Chicago, will address many of the questions facing

THE PROGRAM

hospital executives in a paper titled "Effective Planning for and Justification of Extension of Dp in Hospitals."

EDUCATION

Most of the sessions on education have to do with educating people about data processing. Of these, one is a must for nearly every conference attendee: "Business Data Processing Education—A Decade of Failure." Thomas J. Cashman of Long Beach City College is conducting the controversial session in the form of a debate. His contention is that the dp industry has failed to define the type of training it wants from the educational institutions. Gary B. Shelly, an independent consultant, will present the other side of the coin with "Why Industry Won't Hire Your Graduates." Given this unresolved conflict, it is unfortunate that the session on "University Computer Curricula" won't have representation by the hiring industries; the panelists are highly respected industry figures, but all are from universities.

Of the three sessions on computers as tools for education, the one on "Technological Aids for the Physically Disadvantaged" deserves attention.

Beyond those, "Continuing Education and Career Development for Computer Professionals" looks good.

MANUFACTURING

As with many application sessions at the NCC, a nine-session program on manufacturing will have only one formal paper. The others primarily will be illustrated experiences of the speakers. And these talks, hopefully, will generate discussion from the audience.

Two speakers from IBM, Theodore A. Bakalar and Dennis Sears, hope for audience interaction when they open the program with a step-by-step discussion on how to get into a large total manufacturing information system. Using movies and magnetic boards, they'll outline the anatomy of such a system, starting with automation of the receiving function, then purchasing, and then further areas, should the user—or his management—be interested.

The program organizer, Thomas J. Archbold of International Harvester Co., said the program is aimed not so much at the dp professional as at the "functional people." He defines these as the production scheduling superintendent, materials manager, plant manager or work manager. "These are the people you've got to turn on. They've got to be convinced that the system is theirs. That it will be turned over to them and that it will work."

While it would be ideal if that kind of audience turned out, Archbold says people who design systems also will

benefit from hearing experiences of persons who already have. The program will explore experiences of manufacturers with numerical control and computer graphics and will trace the implementation of manufacturing information systems.

Archbold will present a paper on the installation of an on-line system in International Harvester's Melrose Park plant. It is his experience that management and user acceptance of these systems has been enthusiastic. "The problem is doing enough for them. We're constantly turning down projects they want."

But it's a constant monitoring task. "A request from a user to install \$20K worth of printers to save \$75K is turned down because it isn't a big enough saving. You've got to watch costs. And your figures must be as good as those of the accounting department."

RETAILING AND DISTRIBUTION SYSTEMS

"The major preoccupation in retailing in the '70s has been and will continue to be point-of-sale," says Gerald T. Montgomery of J. C. Penney Co., organizer of the retail program. The problems facing all retailers using POS will be explored not just from the

PROGRAM

standpoint of capturing the data, but also from the standpoint of getting some distributed intelligence within the retail environment. Montgomery says the POS devices are being used for merchandising information now but other things could be happening.

He feels, probably correctly, that the session on "What Manufacturers Would Like to See Happening in POS" will be a winner. This is a four-parter with the final two parts scheduled in the distribution program, chaired by Vernon L. Schatz, vice president, Information Systems, The Jewel Company.

GOVERNMENT

Five sessions have been organized by Verne H. Tanner, Jr., of the National Assn. of State Information Systems (NASIS), and two of them look like hot topics. The first, on law enforcement, is titled: "Do the Systems Really Provide the Information and Safeguards Promised—A New Look." Chaired by Glen Pommerening of the U.S. Dept. of Justice, this discussion will present the advances made in the field and question the efficiency of those systems.

The second winner, "Security, Privacy and the Information Processing System," headed by Kenneth Orr, formerly dp director of security for the State of Kansas, will use the HEW Secretary's Advisory Committee report on "Records, Computers and the Rights of Citizens" as a springboard for discussion. (Willis Ware, the chairman of that advisory committee, won't be on the panel, unfortunately. Instead, he will be giving a presentation on fair credit reporting as part of the "Special" program.)

Tanner feels both of these government sessions will draw big crowds since "everybody's worried about law enforcement these days and everybody's an expert on security and privacy."

Another topical session of potential interest to non-government people is on "Transferability of Government Information Systems, Problems and Solutions." Tanner is chairing this one and says it will cover the gamut of applications systems sharing techniques that could be of interest to any-

one in data processing, not just in government dp.

FINANCE

The finance program lasts only two days and has only five sessions. But of the five, two are on extremely timely and interesting topics. One is "Electronic Funds Transfer and Check Collection Developments," a subject recently stirred to life by the Federal Reserve Board (see Feb., p. 51). The second is "The Auditor/Edp Manager Relationship." Now that the auditors have had some time to work on the subject, they may be able to present a checklist of items to help the dp manager make his installation auditable and secure. Unfortunately, the people presenting papers are, again, from accounting firms that belong to the "big eight." But two—Haskins & Sells, and Touche Ross & Co.—had firsthand experience with Equity Funding and this adds a note of timeliness to the program. The session just might have been better rounded out if a dp manager or two were included to tell their view of the "relationship."

And, yes Virginia, there are computer company startups these days and even sources for capital. Three panelists at a session titled "Venture Capital for Computer Companies" will explain the factors involved in raising capital for companies. One is Gene Amdahl, founder and president of Amdahl Corp., Sunnyvale, Calif., whose major investor is also its biggest customer. Amdahl, an architect of the IBM 360 line, is developing large-scale computers to compete with IBM's 370 line. He's had difficulties with its initial public stock offering and now is seeking to move a major share of manufacturing operations to Japan, home of Fujitsu, its biggest backer.

INDUSTRIAL PROCESS CONTROL

Management once couldn't be sold on computers in process control unless they could replace a bank of 20 people, says Dr. William D. Tabachnik, chairman of this session on industrial process control. Today's concern over energy and materials shortages has changed all of that as management accepts the other benefits of optimizing automation. Among these: controlling the undesirable side effects of some processes, such as air pollution; increasing the reliability of the manufacturing process; anticipating impending failures of processes; and even looking at the way products are manufactured.

Tabachnik, who is head of man-

agement sciences programs with Mobil Oil Corp. in New York, ponders, for instance, whether the petrochemicals from which products such as paper plates and cups are made shouldn't first be used in the production of heating fuel, with the residue of these chemicals then to be used for paper plates and cups. "You'd have an ugly product, but it could be brightened up with dyes."

Tabachnik also thinks that crude oil might eventually be found to be too important to be used to power automobiles, and instead be used to make proteins. "Crude oil may soon be used to feed the world and something else will be found to power it," he says.

It is this kind of thinking that serves as a backdrop for a four-session discussion that will cover hardware and software concerns relating to industrial processes, the application of computers in the R&D lab (this should be a well-attended session), computer system design for control applications, and system simulation and interaction. Most will be accounts of actual applications, primarily with minicomputers front-ending large centralized computers. Process control designers have noted with satisfaction the recent shift from centralized computers to localized minis and microprocessors that take care of data acquisition that then is integrated at the large computer site, Tabachnik stated.

ARCHITECTURE AND HARDWARE

The hardware sessions are always near the heart of the conference, and always seem to concentrate on the "gee-whiz" aspects of the industry. This year's program is no different. Spanning 11 sessions, the topics will include supercomputers, mass memory systems, voice recognition, associative processing, and graphics. Conspicuously absent is any overview of hardware directions or any discussion of how the pieces fit together. Microcode also seems to be given short shrift.

Charlie Hobb's session on "Intelligent Terminals—Rationale and Implications" might be quite good, and although "Mass Memory Systems" may not be a hot topic for another year or two, many attendees like to hear what the latest big numbers for capacity and density are. The paper on "STARAN Parallel Processor System Software" in the session on "Associative Processing" or the one on "STARAN Parallel Processor System Hardware" in the session on "Operation Status of Large-Scale Data Processors" could be very interesting if the Goodyear Aerospace peo-

ple are able to release any hard data on using their machine for commercial file management—information that was promised nearly two years ago at the last Fall Joint Computer Conference in Anaheim.

Finally, the papers in the session "Architectural Parameters" will probably be too heavy for most.

TRANSPORTATION

The Arabs and the economy have accidentally combined forces to make the topic of one of the transportation sessions, "Equipment Control in Transportation," quite topical. Given the problem of finding gasoline to get to work, we can all sympathize with the needs of the transportation industry. The session on equipment control will discuss the efficient allocation of reduced inventories and, we presume, reduced fleets of vehicles.

Also, since so much of data communications has been pioneered by the airlines for seat reservations systems, many of those who plan to spend their time in computer networking and communication systems sessions might benefit from popping in on "Communication Nets in Transportation," a session chaired by a participant from Eastern Airlines. We suspect "Computerized Transportation-Distribution—A User Overview" might be good, too.

SOFTWARE SYSTEMS

The software sessions are interesting because of the people involved in them. The participants from data processing's first slice of history will be on parade at the conference, it seems. Hermann H. Goldstine, one of the movers of the World War II project that led to the development of the ENIAC, will be a panelist in the session on program debugging. Goldstine worked with John von Neumann, among others, during his career, and hopefully he'll have something to say about debugging the early machines. Capt. Grace Hopper, one of the world's first programmers and one of the principal figures in the development of COBOL, will be a panelist at the interesting-sounding session on "Software for Computer Systems Acquisition." Carl Hammer and Fred Brooks are on the panel also.

We have heard Peter J. Denning (chairman of part II of the session on "Operating Systems") referred to as a "bonafide oracle," but although the

papers in his session are on an important topic, performance of virtual storage systems, they may be extremely difficult ones. The paper on "Verifiable Secure Operating System Software" in part I of the session also could be meaty and important but tough. Two other involved, basic research papers, "Provable Programs and Processors" and "A Language-Independent Programmers' Interface," somehow got sandwiched in with papers on tic-tac-toe and robots in the "Artificial Intelligence and Related Topics" session.

Second in importance to the session on "Software for Computer Systems Acquisition" may be the four-hour double session on "A Large Real-Time System Development," a Bell Labs presentation on SAFEGUARD that gets into project management and control as well as the technical stuff.

COMPUTER NETWORKING

Thomas N. Pyke, Jr. of the National Bureau of Standards has organized this seven-session program on computer networking. Mr. Pyke believes "It's about time the user was put back in the network," and hopes the sessions will do just that.

The presentations are designed to cover, from the user's viewpoint, what's good, what's bad, what works, and what doesn't work, "not just the technology but the end service."

In the session he's chairing, "Computer Networking—The Users' Viewpoint," two different types of users will talk about their problems. Dr. Joe Wyatt of Harvard, representing a large group using network-based services from varied sources, will discuss the lack of conventions and standards across systems. Representing the other type of user will be Davis McCarn, National Library of Medicine, whose information system is accessed nationally through a network service. His concern is with determining how well his service is being delivered and assuring quality service for end users.

David Jasper of Control Data Corp., in "Large-Scale Computer Network Experiences," will focus on the vendor's viewpoint. Panelists, all heads of nationwide computer service networks, include William Klink of International Time-Sharing, Dr. John Luke of CSC's Infonet, Dr. George Feeny of GE, and Richard Crandell of ComShare.

Another session, "Network Interfaces," has an interesting-sounding paper titled "Interfacing Communications Networks to IBM System/360

and System/370 Host Processors—An End-User's Viewpoint."

INFORMATION MANAGEMENT SYSTEMS

One of the most important presentations of this NCC will surely be the Final Report on the IBM Security Study to be given by Lee Danner of IBM. In addition to highlighting the IBM project, reports will be given by three non-IBM study sites. Most of the audience will probably be there to find out if IBM got its \$40 million's worth from the security study that Vince Larson touted so widely. (It is also another of those topics that has been fractionated by the NCC program; three papers are here and pieces of it will be found under the government and finance programs.)

Another impressive topic to be covered under "Information Management Systems" will be the "CODASYL and Guide/Share Proposals on Data Base Management Systems." The proposal work done by these groups has been widely publicized, so what we hope to find in this session is the wrap-up—at least a temporary wrap-up.

MANAGEMENT ACCEPTANCE

This group of eleven sessions, organized by James A. Schweitzer of Xerox Corp., is for those responsible for overall use of computer resources—anyone who has to make a decision on computer utilization. Charge back pricing, managing data centers, distributed computing vs. networking, and the concept of utility computing will be discussed.

One of several promising sessions is "The High Cost of Software: Causes and Corrections." Organized by Richard H. Thayer, USAF, the presentations will presumably hinge on the massive AF study of the subject described by one of the panelists, Barry Boehm, in his DATAMATION article (May 1973, p. 48).

The session on "Computer Center Management" probably should have been called "University Computer Center Management" as seven of the eight panelists are from universities where management problems may differ from those of other shops.

Schweitzer sees the session on "Charge Out Systems for Management Acceptance & Control of the Computer Resource" as the most important to general managers because it represents computer use in terms of dollars.



with
illustrations
by Sid Harris

"LADIES AND GENTLEMEN, air traffic control has advised us that there are currently delays of thirty minutes to an hour at O'Hare International, and they have assigned us to a holding pattern. In the meantime, if you'll look to the left you'll get a marvelous view of Keokuk, Iowa and the Mississippi . . ."

This is often your first introduction to Chicago, crown jewel of the Midwest, hog butcher of the world. O'Hare International Airport is the busiest in the world. Consider that for a moment: busier than Kennedy, L.A. International, or London's Heathrow. During periods of high traffic density, delays are frequent. Add to this the chimerical nature of the weather and there's a good chance your arrival in Chicago will *not* be on time. This should serve the point up the first caveat to the Chicago bound traveler: don't make any plans predicated on a punctual arrival, especially if you are flying on a Friday or Sunday evening. The odds don't favor it.

Once you have arrived, however, you'll find collecting your baggage and getting into the taxi line a fairly easy procedure. That's right—a taxi line. During the early evening hours there are never enough taxis at O'Hare to accommodate everybody. It's just like visiting the bakery, you take a number and wait.

Once in the cab you're in for a welcome surprise. Most Chicago cabbies, unlike their New York brethren, are bastions of honesty and good cheer. You'll find them particularly helpful if you're looking for tickets to a Cubs game or a special restaurant. That is not to say that some unwary travelers haven't been given Le Grande Sightseeing Tour on their way into town. But honestly, there is *nothing* to see on the way to Chicago.

So if a driver offers to take you on the "scenic route" via Des Plaines, Park Ridge, and Skokie, remember that you either have to be completely masochistic or severely depressed to make a trip like that worthwhile. Ask

the driver which route he intends to take. If he says Kennedy Expressway or Dan Ryan Expressway just nod your approval. Anything else and you'd better ask him, "What's wrong with the Kennedy?"

Chicago is the world's greatest convention city. Never mind Miami or Atlantic City; their days as number one went the way of the passenger pigeon and the Dodo bird. Chicago is specifically geared to conventions and conventioners. Consequently you'll find everybody from the bellhop at your hotel to passersby on the street ready to help with directions and advice. The directions are not always accurate, nor the advice terribly good, but it's offered just the same.

In the world of convention centers, McCormick Place must surely rank as Valhalla for both exhibitor and conventioner alike. It is actually the second convention center to bear this name; the original McCormick Place burned to the ground several years ago. Local rumors persist that the fire was set by a disgruntled exhibitor who, having braved its winter drafts for one day too many, sought to duplicate the famous act performed by Mrs. O'Leary's cow. The city father (Hizoner Mayor Richard J. Daley), decided to rebuild the Place. Heated in winter, air conditioned in summer, acres of floor space, even passable restaurants highlight McCormick Place II and restore Chicago to its rightful place as king of the convention cities.

There's no shortage of entertainment in this city. If sports is your bag, try to see a Cubs game. They're played in crumbling old Wrigley Field on the Near North Side, a decaying relic of the days when baseball players wore handlebar mustaches, and why would anyone want to play ball at night? Be forewarned though that Chicagoans are the most avid fans to be found on the globe . . . root for their side.

ON THE LAKEFRONT

by Donald A. Barrett

Looking for night life? Cocktail lounges abound and many have top-flight entertainment. If you're interested in seeing the show biz superstar doing his or her thing, Mr. Kelly's has featured just about every "name" at one time or another. The Playboy Club, premiere showcase for that multimillion dollar empire, has been noted for introducing some excellent young performers to the world. The prices are surprisingly low—don't forget you'll need a key.

Chicago didn't invent the singles bar, but judging from the action in the Rush Street district, the city has taken this newest American institution to its heart. If the college-grad, turtleneck sweater set is your field of battle, you'll find the field large, and the battle well joined at Butch McGuires, supposedly the most famous singles bar in middle America. It's crowded and noisy, but then so was the Argonne Forest. The overflow from Butch's usually finds its way to Jay's, right in the same neighborhood, while the beer drinking boys are busy lapping up the suds at the Public House. For 25¢ a glass, why not? Your taste a bit older, more sophisticated? Try the Maple Lodge. Or if you want to mellow out on some good 'ol folk music The Earl of Olde Towne is a fun place.

Speaking of Olde Towne, don't leave Chicago without seeing it. Sure it's a bit touristy, but then you're a tourist aren't you? Lots of atmosphere and specialty shops: a good place to find the little gifts you're supposed to bring home for the kiddies.

Whether you're a gourmet or trencherman, Chicago has a restaurant for you. Like Italian cooking? Armando's is the best. Or perhaps ein Deutsches essen? The Red Star Inn has been famous for fine German food since the days of the Kaiser. Polynesian? There's Trader Vic's. In addition to some excellent exotic dishes the

Trader has the largest selection of potable potions to be found anywhere. If Oriental food is your meat, then Fuji is your restaurant. Good food, fabulous atmosphere, and you're treated like an honored guest. Finally, for that good old American menu with some fantastic variations, try the Blackstone Grill at the Blackstone Hotel.

Never let it be said that Chicago is without culture. If you're into museums check out the Field Museum of Natural History. Its exhibits are famous throughout the world. In fact, you should also visit the Adler Planetarium. This clever little invention of Karl Zeiss can send you on a trip to outer space in the comfort of a reclining chair, (without a funny little cigarette, even).

The Chicago Symphony Orchestra is considered one of the finest in the world, regardless of who is conducting.

Chicago has a crime problem. So does every other big city. (Would you believe that Denver has the highest large city crime rate in the nation?) Be prepared to take the same precautions you would when traveling the environs of any megalopolis. Don't carry large sums of money. Traveler's cheques are popular for good reason. Don't carry your wallet in your hip pocket; pickpockets will consider you an easy mark. Avoid areas that don't cater to tourists, and try traveling with a friend—you'll be less of a target.

Once you're firmly ensconced in the city, cabs abound. They're reasonable, and seem to thread their way through the most intimidating traffic. Most Chicago cab companies use the old Checker Cabs. If you've been wondering what happened to rear seat leg room in today's cars, you'll find Checker has a monopoly on it.

If you prefer to drive a rented car, go ahead. This is one city you can drive in without enduring the slings and arrows offered by New York or

San Francisco. As in other big towns, traffic is heaviest from 3:00-7:00 p.m.

Riding the "El" is an adventure in itself. The main elevated rail system circumnavigates the "Loop" on Wabash, Van Buren, Wells, and Lake. It's a fast and reliable method of transport. Just be ready to exit at your stop or you might find yourself like that famous rider of the Boston M.T.A., a guy named Charlie, who never returned.

When the show is finally over, and you've spent five harried days being told more about computers, and Chicago, than you ever wanted to know, better give yourself at least two hours to get back to the plane.

Take solace—next year's NCC will be in sunny California! □



IBM

PRODUCT PREVIEW

peripherals

DATAPRODUCTS CORP.
Woodland Hills, Calif.

Booth 309

Line Printer

"Reduced manufacturing costs and simplified design" are given as the chief reasons for this 136-column, 600-lpm line printer being priced at \$8,700 to oem's in unit quantities. The 2260 looks almost exactly like the 300-lpm



unit introduced just over a year ago, so perhaps "simplified design" means a larger pulley. Both the ribbon and paper controls are servo driven, instead of using complicated mechanics to perform these functions. Other nice features of the 2260 include a reduction in the number of circuit boards down to four types, helping to generate a mean-time-to-repair figure of 30 minutes. Operators will appreciate the fact that the characters on the 2260's drum have been distributed in such a way as to reduce sympathetic sound patterns, and the printer even comes stock with acoustical damping.

FOR DATA CIRCLE 271 ON READER CARD

MEGADATA CORP.
Bohemia, N.Y.

Booth 925

Oem Peripherals

One of the earliest manufacturers to enter the intelligent terminal market will arrive in Chicago with a raft of oem peripherals. Topping the list are floppy disc systems—either standard or IBM compatible—complete with terminal interfaces, formatter, and controller. Up to three additional drives can be added to the P1001 FDS product line. Pricing starts at \$3,750 per system in typical oem quantities.

FOR DATA CIRCLE 280 ON READER CARD

Printers ranging in capability from a 30-cps unit up to a 300-lpm line printer will also be displayed. Upper- and lower-case printing is featured, as are 80- and 132-column line lengths. Pricing is \$2,500 for the 30-cps unit, and up to \$11K in quantities for the 300-lpm model.

FOR DATA CIRCLE 282 ON READER CARD

IBM compatible 7- and 9-track tape drives ranging in speed from 25-75 ips and having densities of 200, 556, or 800 bpi will also be shown. Up to three drives can be supported by the controller. Including interface and formatter, pricing starts at \$5K per system, depending on specific options and quantities.

FOR DATA CIRCLE 281 ON READER CARD

STANDARD MEMORIES, INC.
Ft. Lauderdale, Fla.

Booth 1041

Oem and End User Memories

In addition to a line of oem memory stacks and add-on memories for the Digital Equipment PDP-11 and General Automation SPC-16 minicomputers, SMI will have information on expand-

ing 360/44 memories up to 1 megabyte, and 360/30 models up to 512K bytes. The SM440 and 300 memories are said to be completely transparent in operation and available within 30 days. Modifying the 360/44 up to a megabyte costs \$200K, with the 360/30 upgrade to a full half-megabyte priced at \$80K.

FOR DATA CIRCLE 284 ON READER CARD

TRUE DATA CORP.

Santa Ana, Calif. **Booths 334, 336, 338**

Oem Card Readers

We're told that True Data Corp. has been so busy delivering upwards of a thousand units of its first card reader design that it just hasn't had a chance to develop any new products! Whether that's true or not, the models 400 and 800 are departures from the originals, chiefly in their ability to read punched or marked 80-column cards—and even read both types intermixed. One possible deficiency in the first designs, that

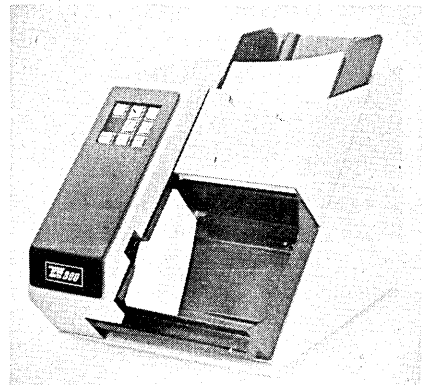

of not being able to bounce light off of very dark brown or blue cards, has been corrected. The model 400 operates at 200 or 400 cpm, while the 800 operates at 300, 400, 600, or 800 cpm

rates. The 400 is priced at \$2,095 in single units, and the 800 goes for \$2,395.

FOR DATA CIRCLE 276 ON READER CARD

REMEX DIV. EX-CELL-O CORP.
Santa Ana, Calif. Booth 325

Minicomputer Storage

The RFS7400 is one of the first floppy disc systems we've seen all ready to attach to some of the more popular minicomputers, including the Digital Equipment PDP-11 and Data General Nova series. The disc system is available as a single- or dual-drive IBM-compatible unit, and prices, including power supply, start at \$2,995. Deliveries commence in July.

FOR DATA CIRCLE 304 ON READER CARD

WANGCO INC.
Los Angeles, Calif.

Booths 843, 845, 847

Oem Disc Drive

With the models 2222 and 2422, this manufacturer has probably developed every conceivable combination of IBM 2315 and 5440-type cartridge disc drives. The front-loading Series-F model 2222 has a capacity of 50 megabits on each of its two cartridges, one of which is fixed, and the other removable. The top-loading Series-T model T2422 specifications are the same, and both drives share a transfer rate of approximately 2,500 kilobits per second. There has been some trouble for oem's in solving the intricacies of recording at 200 tracks-per-inch, but Wangco claims it has successfully shipped such units. Prices for the 2222 and 2422 models are approximately \$3,200 each in orders of 100.

FOR DATA CIRCLE 278 ON READER CARD

TALLY CORP.
Kent, Wash. Booths 322, 324, 326, 328

Paper Tape Reader

One of the model 2050's best features is its ability to read oiled or discolored paper tape at speeds up to 250 cps. The device is a photoelectric reader priced at \$275 without electronics or \$375 with controls in unit quantities.

FOR DATA CIRCLE 303 ON READER CARD

FABRI-TEK INC.
Minneapolis, Minn. Booth 345

Replacement Memory

A plug-compatible bulk core memory system has been developed to replace the drum memories used on GE-Pac 4010 and 4020 process control systems. The core memory is field expandable to over 800,000 words in a single standalone cabinet, and add-on cabinets are used for expansion up to 2

megawords. The sc4510 memory doubles the bit transfer rate through the existing coupler on the GE-Pac, and by using a new GE high-speed coupler, transfer rates up to 3.3 megahertz can be achieved. The price is \$85K; first units have gone to the field.

FOR DATA CIRCLE 298 ON READER CARD

PERTEC CORP.
Chatsworth, Calif. Booth 655

Flexible Disc Drive

One could easily have predicted that Pertec would enter the floppy disc drive race, but the official notice of it is significant because of the manufacturer's size and experience in the peripheral field. Oem's are probably dizzy by now looking at floppy disc specs, so we'll only give those we think most important: IBM compatibility, removable media, totally DC powered, and a 10,000-hour head life. The error rate specification reads one per 10^9 recoverable, and one per 10^{12} non-recoverable. Single units are priced at \$650 each, but a more typical order might be for 100, dropping the per unit price to \$500.

FOR DATA CIRCLE 286 ON READER CARD

FACIT-ADD0, INC.
Secaucus, N.J. Booths 1069, 1071, 1073

Oem Cassette Drive

The Philips-type cassette is far from dead as a convenient means of peripheral storage, and Facit will be showing a handsome single-drive unit to oem's. The 4203 is fully ECMA-compatible, re-

conds at 800 bpi, and runs at either 3.75 or 7.5 ips. It can be equipped with either a parallel or RS-232C interface, and even a 256-character buffer. Prices in quantities of 50 are set for \$2,205, with availability slated for mid-year.

FOR DATA CIRCLE 294 ON READER CARD

KENNEDY CO.
Altadena, Calif. Booths 839, 841

Oem Tape Transport

It would seem that most of the new features in the models 9000-2 and 9000-3 tape transports can be classed under the heading of improved performance in error recovery opera-

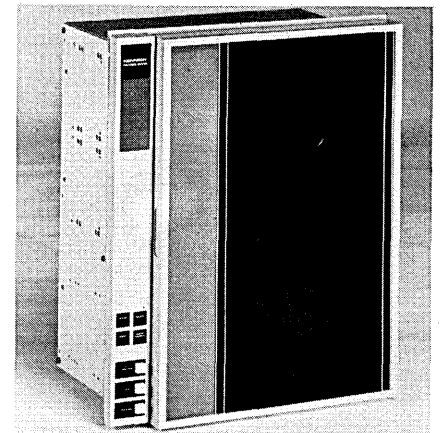

tions. Available in 7- and 9-track, NRZI/phase-encoding, or straight NRZI versions up to 1600 bpi, both versions have an automatic-scanning circuit which varies the threshold levels during read/backspace operations. During normal read operations the threshold is selected for optimum data reliability.

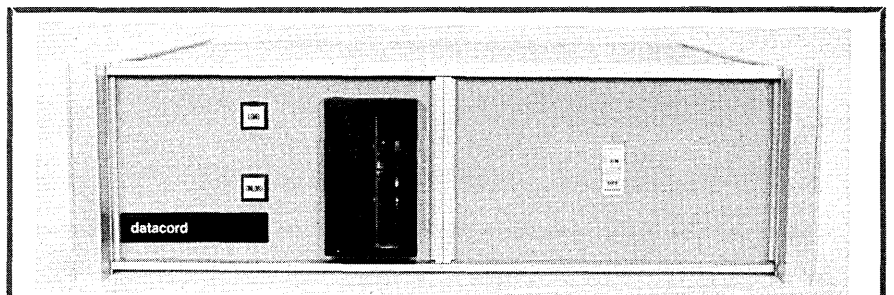

AMERICAN VIDEONETICS CORP.
Sunnyvale, Calif. Booth 821

Oem Storage Peripheral

The Datacord DI-112 is a digital cartridge storage system that looks like a viable competitor to similar offerings from 3M, Tri-Data Corp., and others. Unfortunately, no interface yet exists that would allow an end user to hook it up to an RS232 plug, but perhaps some oem will develop one, as the DI-112 seems to have lots of good features. Each removable cartridge can contain up to 76 megabits of storage, with a bidirectional read/write speed of up

to 125 ips yielding a 100 kilobaud transfer rate. Start/stop times range between 3 and 40 msec, and recording is done either in phase-encoded or NRZI modes. The use of a capstan larger in size than the diameter of the cartridge tape reel to positively drive the tape past the read/write head eliminates the need for reel motors, tape tensioning arms, or complex braking systems, and holds the price of the DI-112 down to \$2,285 for single units.

FOR DATA CIRCLE 277 ON READER CARD

PRODUCT PREVIEW

When a read error is detected the circuit shifts gain until the data can be recovered. Any data error triggers the threshold logic to run through four stages of attempting to retrieve the data. Prices start in the region of \$3,500 for the NRZI format model, and range up to \$4,200 for the dual-density unit.

FOR DATA CIRCLE 285 ON READER CARD

DATARAM CORP.
Cranbury, N.J.

Booths 267, 269

Add-on Memory

The DR-1200 memory system is available in 8K and 16K versions for aug-

menting the main memory capacities of Data General Nova 1200 and Digital Computer Controls D-116 equivalent. The plug-in pc board is priced at \$2,840 for the 16K version.

FOR DATA CIRCLE 295 ON READER CARD

ELECTRO-TEC CORP.
Blacksburg, Va.

Booth 375

Oem Strip Printer

The model W strip printer can print two-line strips at a rate of 120 cps. It is priced at \$750 each in quantities of 25. Also on display in this booth will be the model P-212, a three-inch 12-column printer capable of printing at 200 lines-per-second, it's claimed.

FOR DATA CIRCLE 291 ON READER CARD

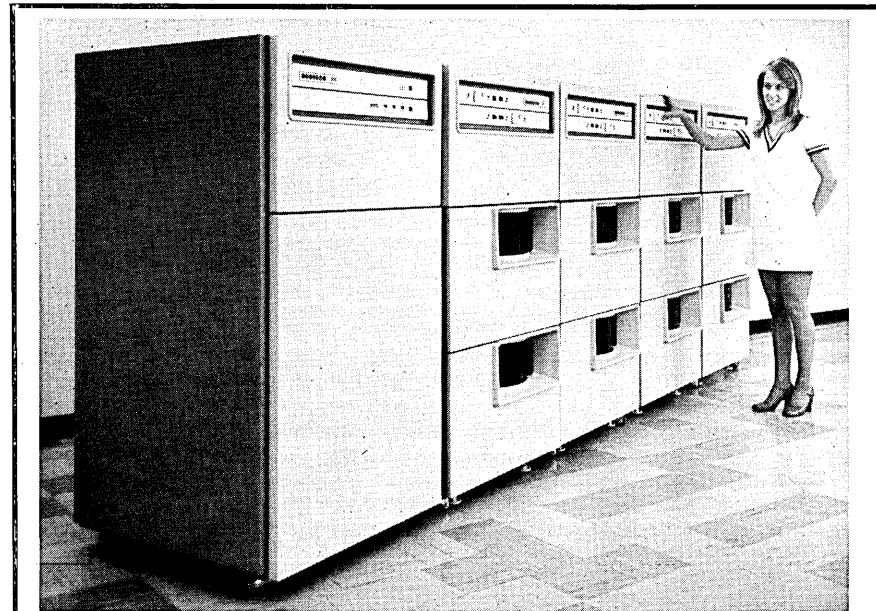

CALIFORNIA COMPUTER PRODUCTS, INC.
Anaheim, Calif. Booth 701

Disc Storage Units

The 1035 Disc Storage Facility is a double density 3330-type disc pack system offering IBM 370 users up to 1.6 billion bytes of on-line storage per 1035 system. There is a choice of 100 and 200 megabyte packs for the system's eight spindles, with all storage accessed in approximately 30 msec and transferred at 806 kilobytes per second. Standard 1035 features include microprogram load

Calcomp's Century Data division will be showing the initial member of an interesting disc storage series named Trident. The Trident drives use a cut down IBM 3336-type disc pack with five recording surfaces plus an additional surface that accommodates servo track positioning. Many of the specifications of Trident read like IBM's 3330 system, including the 384 track-per-inch density holding up to 822 cylinders,

files, on-line diagnostics, write lock-out, command retry, command chaining, record overflow, rotational position sensing, write format release, and multiple request capabilities. Leasing prices for the 1035 were not available at this writing, but the system, complete with controller and eight spindles sells for approximately \$225K.

FOR DATA CIRCLE 300 ON READER CARD

and the 806 kilobyte transfer rate. The mean access time is around 25 msec in a range of 6-55 msec. The first three models of Trident will be available in 25, 50, and 80-megabyte capacities and will include complete air flow systems, power supplies, control and data electronics, plus logic for synchronizing the read/write timing to the pack. Price quotes will be available at the show.

FOR DATA CIRCLE 301 ON READER CARD

terminals

MOHAWK DATA SCIENCES CORP.
Utica, N.Y.

Booth 551

Remote Job Entry

As the power of the computer steadily spreads away from the central site, the requirement for equipment that can be operated by non-dp oriented personnel increases. The 2300 Terminal Processing System's features might just make it one of the best RJE terminals for such users to operate, as they include completely transparent IBM 2780 and 3780 communications protocols, together with a tutorial crt display. In addition to the crt, a 4K processor, 230KB fixed-head disc, 300-lpm printer, and 300-cpm 80-column card reader make up the 2300. Optionally, the system can be configured to include one or two cartridge tape drives. Configurations like these rent from \$595 to \$785 per month and will be shipped in August.

FOR DATA CIRCLE 293 ON READER CARD

LEAR SIEGLER, INC.
Anaheim, Calif.

Booth 117

Crt Terminal

The ADM-2 is the bigger sister of the ADM-1 crt terminal introduced in the middle of last year that sold for around \$1,500. The ADM-2 is \$900 dearer at \$2,400, but for that difference oem's get a detached keyboard containing nearly 100 separate keys, including up to 16 function keys. The screen holds up to 24 lines of 80 characters, and an option is available for up to five memory pages. The microprogrammable unit has all logic located on a single

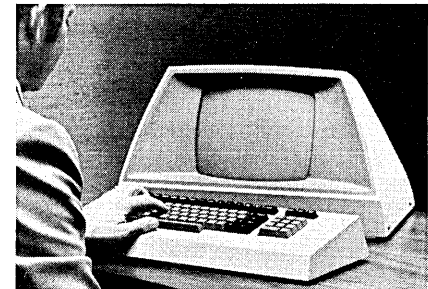

circuit board to enhance reliability, and indicator lights that clearly show what mode the unit is operating in. Options include polling and free form mode to a printer, tty compatibility or RS232 interface, editing features, and a 10-key numeric pad.

FOR DATA CIRCLE 283 ON READER CARD

COMPUTER DEVICES, INC.
Burlington, Mass. Booths 219, 221

Printer Terminal

In addition to its line of portable 30-cps terminals, CDI will be showing the

Of course there are too many data binders. With Acco, you only need 3.

The Acco concept is simplicity itself. Just three binders from our complete line are versatile enough to handle virtually all your data binding needs. P1P (Heavy-duty, rigid 90 pt. Accohide*), P4P (Economical 20 pt. genuine pressboard), and P6P (Flexible 23 pt. Accohide). All feature

our extra-strong Dataflex® polypropylene covered steel posts with 8" burst or unburst binding capacity: top and bottom loading. All feature multi-hole spacing so one binder can hold a wide range of different size data forms. The Acco concept is simplicity itself. And, all our 14 7/8" x 11" P1P, P4P and P6P

Accodata binders come with retractable hooks for hanging at no extra cost. Ask your Acco dealer for details on these popular Accodata binders, or write for our complete 4/color catalog. Accodata binders. You only need 3. The Acco concept is simplicity itself.

P1P/90 Pt. Accohide



ACCO INTERNATIONAL INC.

5150 N. Northwest Hwy., Dept.
Chicago, Illinois 60630

New York, Los Angeles, Boston, Canada/England/Holland
Mexico/Venezuela/El Salvador/Jamaica/Japan/New Zealand

P4P/20 Pt. Genuine Pressboard

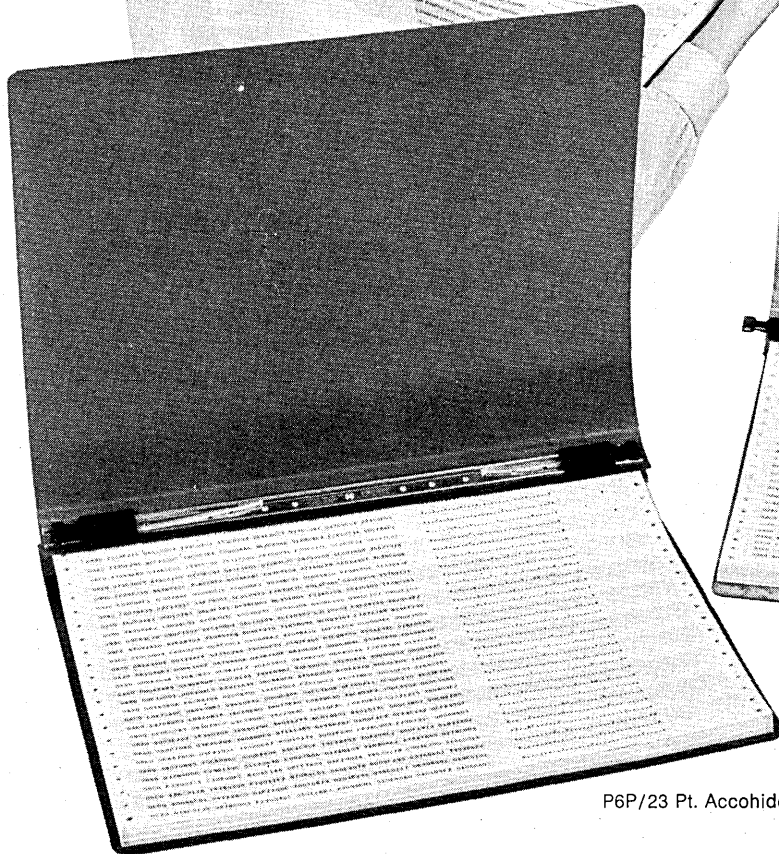
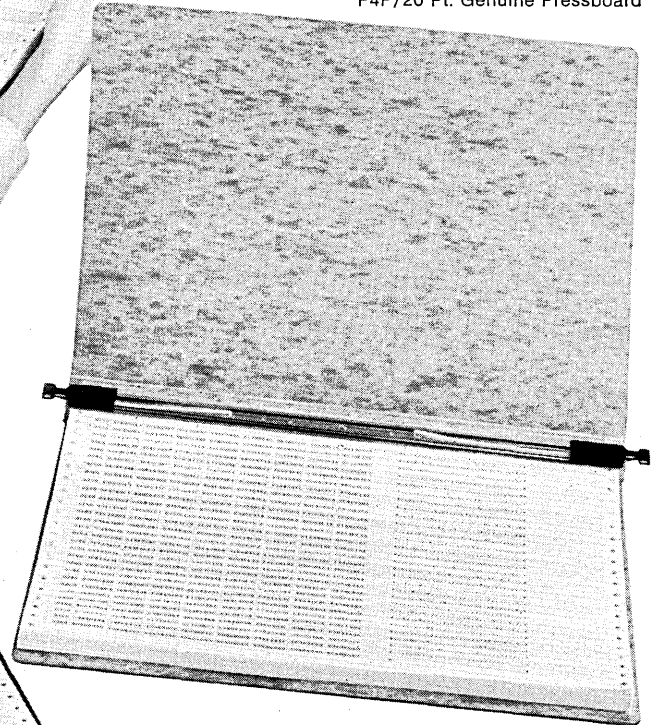

*A chemical resin

P6P/23 Pt. Accohide

PRODUCT PREVIEW

8330, a 132-column printer terminal intended for time-sharing or direct computer i/o applications. The buffered terminal is switch selectable be-

tween 10, 15, and 30 cps speeds, and prints a full 94 character ASCII set that includes both upper- and lower-case fonts. Up to five copies can be generated by the 8330. Options include a numeric keyboard and an RS232 interface. The printer is priced at \$3500.

FOR DATA CIRCLE 287 ON READER CARD

mats include 40 and 80 character by 16-line configurations. Prices start at \$1,420 for the model 400.

FOR DATA CIRCLE 297 ON READER CARD

DIGI-LOG SYSTEMS, INC.
Horsham, Pa. Booths 478, 480

Crt Displays

A small crt screen is the basis of these two read-only display applications, with the controller equipping them to do two different functions. When equipped with the series 300 controller, up to 10 displays can be driven displaying up to 16 80-character lines. The ASCII bit-parallel interface accepts 1,200 char/sec asynchronous data, with an RS232 and current loop hookup optional. Single unit (one display and controller) pricing starts at \$790.

FOR DATA CIRCLE 296 ON READER CARD

flowing between two dp devices. Asynchronous data rates are switch selectable to accommodate 110, 150; 300,

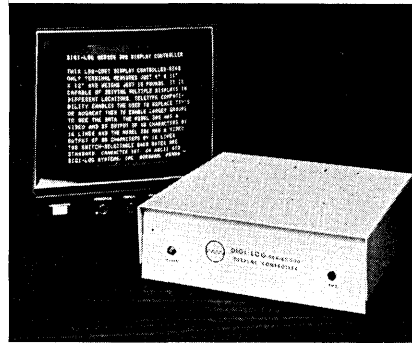

600, 1,200, 2,400, 4,800, and 9,600 baud transmission. A synchronous model is also available. Display for-

The model 400 data line monitor displays all line and data information

TYPAGRAPH CORP.
San Diego, Calif.

Booth 472



Printer Terminal

The DP-30 MK V is a handsomely packaged 30-cps impact printing interactive terminal available in read-only, KSR and ASR configurations. It prints upper- and lower-case ASCII characters across a full 132 columns and is tty compatible. A built-in buffer assures full 30-cps (300 baud) print rates for all 128 ASCII character codes generated. The MK V can be used at 10 and 15 cps rates for slower commo lines, if desired. Units are priced at \$3,500, and deliveries have begun.

FOR DATA CIRCLE 299 ON READER CARD

WESTINGHOUSE CANADA LTD.

Hamilton, Ontario Booths 941, 943

Crt Terminal

The W-1620 is an unbuffered, interactive terminal designed for time-sharing and minicomputer usage. It displays 24 lines of 80 ASCII 5x7 dot-matrix characters on its 6.75 x 9-inch screen, and the character sets offered include both 96 and 128 choices for the separate keyboard/numeric pad. The 1620 is compatible with the tty models 33 and 35, and has a "bottom line" data entry technique that allows the operator to follow normal typewriter procedures. One very nice feature of the 1620 is that it contains two auxiliary ports that can be used to connect devices such as printers and cassette recorders—maybe even a floppy disc. The crt communicates in either half- or full-duplex mode at asynchronous rates ranging between 110 and 9,600 baud. Initial deliveries are slated for September for

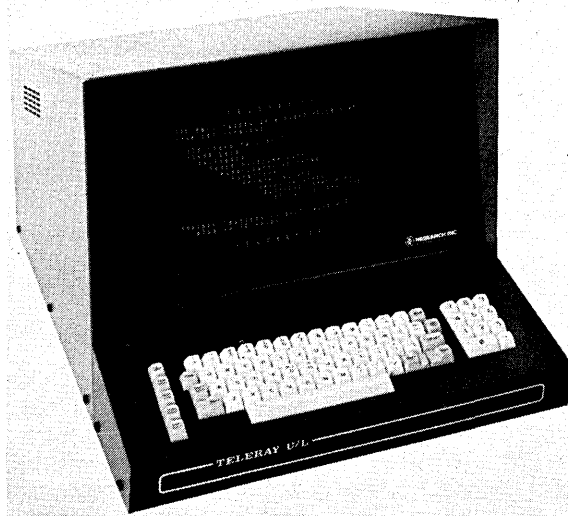

RESEARCH, INC.
Minneapolis, Minn. Booth 377

Crt Terminal

The Telaray series 3700 reveals some sound design philosophy and can be equipped with almost every option ever thought of for a crt terminal. The 12-inch diagonal display can show 960 characters arranged in 12 lines of 80 characters (or 24 lines of 40 somewhat larger characters), or 1,920 characters, arranged in 24 lines of 80. The 3700 generates 128 ASCII characters and displays 95 of them, including upper- and lower-case fonts. The crt

features automatic scrolling and communication rates ranging from 110-9,600 baud; and RS232, TTL, and current loop interfaces are available for it. To aid in reliability, all electronics are mounted on a single circuit board, with plug-in IC chips used to equip the 3700 with its combination of features. An order for 10 end-user equipped crt's prices out to \$1,795 each. Production is set for July; an APL version is in the mill.

FOR DATA CIRCLE 274 ON READER CARD

Dallas to Houston via DATRAN

The new tomorrow for the data processing world is here today!

DATRAN (Data Transmission Company) is now serving customers on the Dallas-Houston segment of the nation's only digital communications network designed exclusively for data.

The digital computer is no longer dependent on traditional voice (analog) communications facilities. Using the DATRAN system your computers and terminals can now:

- communicate in their own digital language.
- communicate at high speeds up to 1.344 million bits per second.
- communicate with higher availability and at error rates two orders of magnitude improved over prior rates.
- communicate at the low cost of 75 cents per mile/month at 4.8 KBS and \$4.50 per mile/month at 56 KBS.

DATRAN offers you much more than just these vastly improved digital facilities to solve your data communications problems. A full range of data communications services – from systems evaluation to design, from specification to procurement, and from network management to the highest quality transmission capability – are all available to you right now. Come grow with DATRAN as we extend the system to Chicago in August 1974 – and add fully switched service on a national scale in 1975.

Write or call DATRAN's sales headquarters:
7200 N. Stemmons, Suite 300, Dallas, Texas 75247 (214) 634-7390

DATRAN

The Data Communications Carrier

PRODUCT PREVIEW

the 1620, which will be priced to sell for approximately \$1,400.

FOR DATA CIRCLE 292 ON READER CARD

communications equipment & software

TELEFILE COMPUTER PRODUCTS, INC.
Irvine, Calif.

Booth 128

Communications Controller

If the TCP-64-3 programmable communications controller can deliver on all the claims made on its behalf, it must surely be one of the more powerful devices offered the end-user market. Utilizing half- or full-duplex synchronous data communications modes, the 64-3 allows up to 16 remote users to communicate on each of its 16 standard lines at rates up to 50 kilobaud. Since it is programmable, the terminals can be IBM or any other unit, as long as it speaks either ASCII or EBCDIC. The 64-3 can be configured for standalone data concentration, programmable front-end communications preprocessing, store and forward functions (with optional disc storage unit), message switching, data multiplexing, and in powerful data base access configurations. The unit sells for \$53,360 and rents for \$890/month on a five-year lease.

FOR DATA CIRCLE 279 ON READER CARD

CODEX CORP.
Newton, Mass.

Booth 301

Communications Equipment

The GBM-303 is intended for full-duplex data transmission over wideband facilities at data rates of 48, 50, 56, or 64 kilobaud. The unit features wide range automatic gain control, self synchronizing scrambler, extensive fault isolation and performance monitoring capability, and digital filtering to limit out-of-band energy. The GBM-303 is priced at \$7,500 for typical units.

FOR DATA CIRCLE 288 ON READER CARD

The local distribution wireline modem (LDWM) provides short haul data transmission over local telephone loops or private cable systems at strap selectable speeds of 2,400, 4,800, 7,200, 9,600, and 19,200 baud. In orders of 5-10 units, the LDWM is priced between \$900-1,200.

FOR DATA CIRCLE 289 ON READER CARD

The model 900 is a character interleaved time-division multiplexor capable of handling up to 64 lines, four of which may be synchronous. The device features automatic speed recogni-

tion for asynchronous lines. An eight-line model sells for approximately \$2,200 (\$110/month) while a full-up 64 line version typically will sell for \$3,450 (\$172/month).

FOR DATA CIRCLE 290 ON READER CARD

INTERFACE MECHANISMS, INC.
Mountlake Terrace, Wash.

Booth 1027

Portable Data Capture

The model 9103 portable data recorder is a battery powered unit composed of a ruby wand light pen, keyboard and display, cassette drive, and controls and indicators. The three most recently entered fields can be recalled and edited, if necessary. The 9103 is offered to oem's for use in bar code reading applications, where differences among the codes—and the specific features required by customers—result in a price range of \$2-3K in single quantities. First deliveries are slated for mid-summer.

FOR DATA CIRCLE 302 ON READER CARD

auxiliary devices

RECORTEC, INC.
Sunnyvale, Calif.

Booth 1001

Computer Tape Evaluator

The CTE-500 is a desk top computer tape evaluator capable of handling the relatively new 6,250 bpi recording standard. Unlike most computer tape testers, the CTE-500 uses vacuum col-



umns and a read head to more closely simulate the actual performance of a tape drive. Among its features are the ability to initiate tape testing as any point beyond the beginning of the tape, alterable bit drop out level, and a digital printout of tape performance. Considering that just a few years ago machines with the 500's features cost upwards of \$50K, the \$7,500 price seems quite reasonable.

FOR DATA CIRCLE 272 ON READER CARD

COMPUTER-LINK CORP.
Burlington, Mass.

Booths 831, 833

Tape Cleaning/Testing

The models 1700 and 1800 magnetic tape evaluator/cleaners are used to clean 1600/6,250 bpi and 6,250 bpi tapes, respectively. They can be set up to test the tapes from any manufactur-

INTERDATA, INC.
Oceanport, N.J.

Booth 571

Operating System

Interdata is now spending more money on software development than on hardware engineering (which we think is a healthy thing for the mini industry especially) and one of the fruits of these labors is a new operating system to complement the recently introduced 7/32 32-bit minicomputer. OS/32-MT is capable of handling real-time tasks in a multiprogramming environment concurrently with on-line program development and batch processing. Up to 256 levels of task priorities are available, with memory space allocated dynamically by the operating system to competing disc resident tasks. A minimum system to support OS/32-MT has a 32K byte memory, tty, and operator console. The system is priced at \$3K.

FOR DATA CIRCLE 275 ON READER CARD

er's tape drive, and are available with special permanent write error detection and automatic gain control logic to match IBM's latest line of tape drives. The units are priced at approximately \$9,500.

FOR DATA CIRCLE 270 ON READER CARD

RANDOMEX, INC.
Palos Verdes, Calif.

Booth 144

Disc Cartridge Cleaners

Minicomputers with cartridge disc systems are being used more and more in "line" applications where the physical environment isn't always as clean as it should be, and this manufacturer of

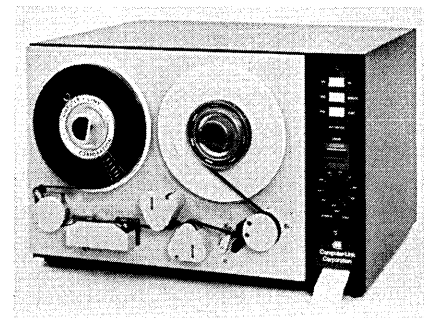

2314 and 3330 disc pack cleaners has developed two models for cleaning the popular 2315 and 5440 disc cartridges. They are, very possibly, the only such models in existence. Completely automatic in operation, the models 515 and 535 process the cartridges in a special cleaning solution guaranteed not to damage or destroy recorded information. Priced at \$1,500 in small quantities, the media cleaners will be available around the middle of July.

FOR DATA CIRCLE 273 ON READER CARD



World's oldest living carbonless paper.

Nobody much cares when the anniversary of a product is announced. So NCR Paper is 20. So carbonless paper did catch on. So NCR Paper has more experience, more expertise. So NCR Paper has the broadest line of papers. So NCR Paper can offer either Black Print or the Deep Blue System (both make intense images, both are easy-to-read, both copy well on office machines). So more printers know how to produce time-saving, money-saving business forms on NCR Paper than with any other carbonless.

It is to yawn. You probably only love us because we don't get your hands dirty like carbon paper. We'll accept that.

Specify NCR Paper...all carbonless is not alike.

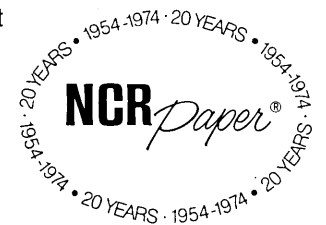

NCR APPLETON PAPERS DIVISION
GENERAL OFFICES: APPLETON, WISCONSIN 54911

April, 1974

CIRCLE 37 ON READER CARD

63

**Another Varian first. A
HASP based system that
turns your 360/370 into
a network.**



And gives you quite a cost/performance break. Interface the 360/370 with one of the Varian family of remote processing systems. You'll not only get a more powerful network. But you can put the power where you need it most.

With this extra distributed computing, perform your real-time or batch jobs at the local level. And at the same time, submit payroll

and inventory jobs to your central system. It's the Varian software that does it. HASP/RJE with our powerful VORTEX/VTAM operating system. And the Varian V-70 family of flexible data processing systems.

The result is a hardware/software combination that gives you network capabilities no one else can touch. Add a HASP based Varian system

and give your IBM 360/370 a break. As well as your profit and loss statement.

For detailed information on how our remote processing system can greatly enhance the capability of your network, write for our comprehensive brochure. Varian Data Machines, 2722 Michelson Drive, Irvine, California 92664.

Or call (714) 833-2400.



**The mini killers
varian data machines**



SYCOR INTRODUCES THE SPEED READER.



When it comes to fast data access, our Sycor 340 intelligent terminal with its new Flexible Disk* option has the fastest draw in the West—or anywhere else.

And still costs less than the comparable IBM offering.

Like most models, our new option uses IBM-compatible diskettes. But the similarity ends there. Our Flexible Disk's positioning time leaves the others standing still.

For example, it moves to the center of the diskette (40 tracks) in 117 msec. Ask our competitors for their times.

And because it holds two diskettes and either one or two cassettes, our Sycor 340 is the ideal intelligent terminal for order entry applications involving small to medium size customer, salesman and product price files.

It allows you to manage your own mini-database.

Best of all, it can be combined with a host of optional features, including three speeds of printers, a card reader, magnetic tape drives and both asynchronous and binary synchronous communications.

Ask your Sycor representative about our intelligent terminal and its new Flexible Disk option.

The speed reader.

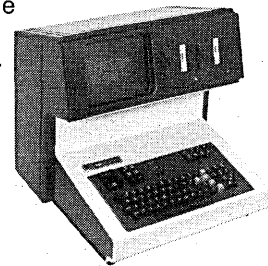

SYCOR

S[®]
SYCOR INC

Corporate Offices: Ann Arbor, Michigan 48104 (313) 971-0900. **District Sales Offices:** Atlanta (404) 457-1166 • Boston (617) 890-7290 • Chicago (312) 297-5200 • Cleveland (216) 831-8625 • Columbus (614) 888-8657 • Dallas (214) 521-6710 • Denver (303) 458-0794 • Detroit (313) 355-5770 • Greensboro, N.C. (919) 274-2964 • Hartford (203) 529-1100 • Houston (713) 688-5224 • Indianapolis (317) 784-6779 • Kansas City, Mo. (816) 842-7799 • Los Angeles (213) 640-0120 • Miami (305) 233-7121 • Minneapolis (612) 854-2309 • New York (212) 371-9050 • Philadelphia (609) 665-1170 • Pittsburgh (412) 922-3350 • Portland, Ore. (503) 635-4157 • San Francisco (415) 349-6626 • St. Louis (314) 878-0090 • Washington (703) 527-0200. **Service Centers in 80 cities.** **Canada:** Sycor International Ltd., Toronto (416) 429-0883.

See the Sycor 340 with Flexible Disk option at the National Computer Conference.

*Patents applied for



**Of doves,
and flexible disks,
and the good things
in life.**

Last month we invoked the assistance of eighteen white doves and a friend named "Gus" to help us call your attention to our new line of flexible disks.

The response was something else!

We received many compliments on our advertisement.

We also received many orders for our new disks. We thank you.

If you missed our message, here is what we said.

Information Terminals has the newest flexible disk on the market. To begin with, IBM offers their Diskettes which are totally compatible with our new disks.

Good for them. Not better than, but 100% compatible.

Fact. We believe ours to be the best. Give us a chance to prove that statement.

No disk from any other company can outperform it.

No disk from any other company can outlast it.

Our new disk may very well be perfect. That's why we absolutely guarantee each individual disk to be 100% free of errors. There are no exceptions.

And we're delivering in fine style.

For ordering information and our list of representatives,

Call toll free: (800) 538-7938

In California: (408) 245-4400



Information Terminals Corporation

323 Soquel Way
Sunnyvale, California 94086

ATTENTION: DATA GENERAL USERS

ONLY DECISION OFFERS BIG DISK PERFORMANCE AT SMALL DISK PRICES

New from Decision—A fully integrated, IBM compatible, floppy disk system with these exclusive features:

- read before write address verification
- 16-bit polynomial divisor CRC check
- automatic data verification and diagnostic mode
- full disk operating system with Fortran

All these extra features to ensure ultra-reliability. Our floppy disk controller and system is a compatible extension of our entire line of minicomputer peripherals. Our software is totally compatible for immediate use should applications require upgrading to front load cartridge, top load cartridge, 100 and 200 TPI and the 2314 styles. This 19" rack mounted system is rated in excess of

5,000,000 passes per track with the heads in contact with the media. For even longer life, the controller automatically lifts the head when not in use.

Our controller is on a single board, inserts in any Nova-line* mainframe, and can also accommodate a Teletype controller and real time clock. Finally, you get real use out of 4-slot mainframes.

Our concern for media life and reliability will pay you dividends in system value. Delivery for instant plug-in to your Data General Nova in 30 days. For DEC very soon.

DECISION, INC., 5601 College Avenue, Oakland, Calif. 94618 or telephone (415) 654-8626.

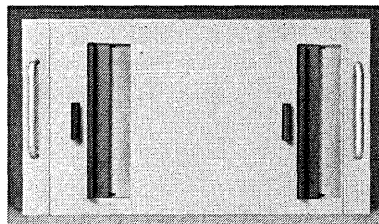
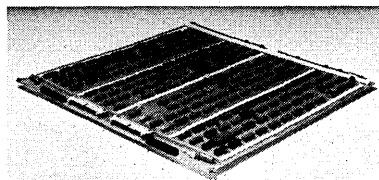

DECISION

See us at the Computer Caravan

*Trademark Data General

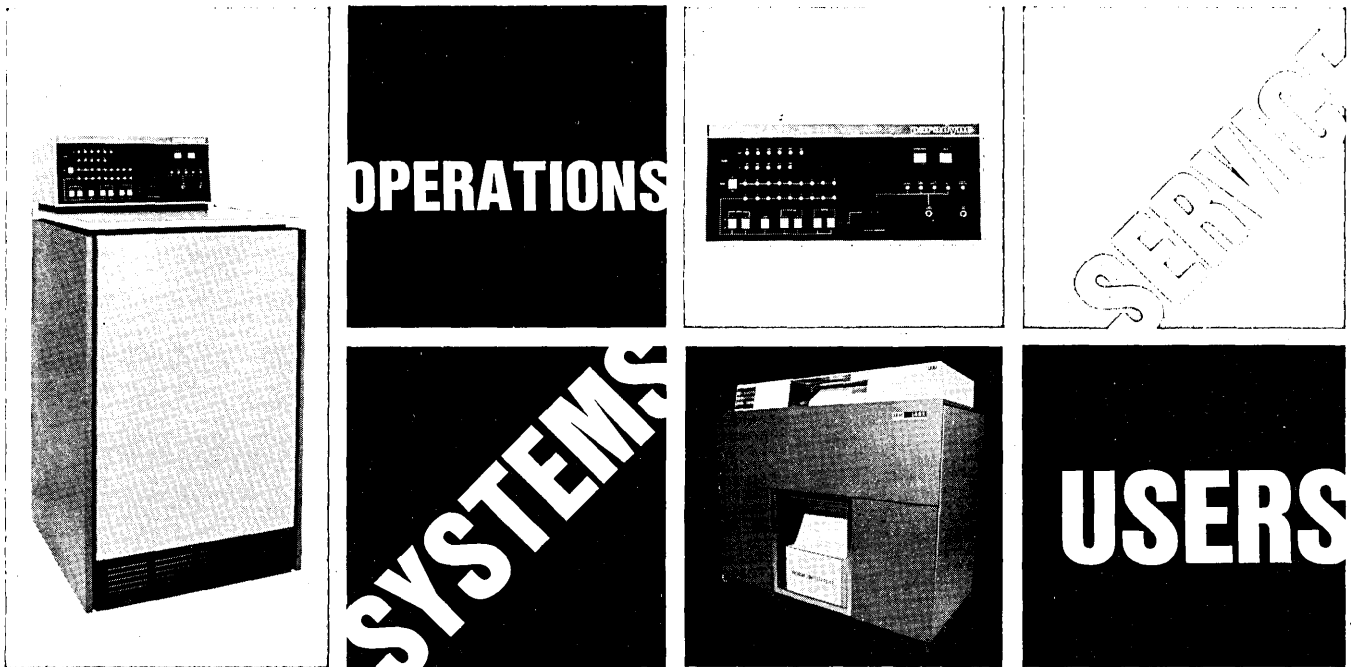

PIX. The instant RJE system. Just add peripherals.

Connect your present IBM 360/370 to a phone line with PIX. Give your distant users a PIX. Add the right IBM or Paradyne card reader and line printer. That's instant Remote Job Entry (RJE).

You benefit from PIX because it's ready-to-use. PIX handles data error control. Your IBM 360/370 has more time for applications programs.

IBM software makes PIX work. Standard OS or DOS readers and writers. Your systems programmers keep working on present projects.

Use standard IBM or Paradyne card readers and line printers at your remote site. Speeds from 300 cards or lines per minute up. Your operators and programmers will need familiarization, not re-training.

Either dial-up or leased phone lines can be used. PIX gives you true full duplex on standard 4-wire leased lines or two call dial-up.

Data compression is optional for higher throughput in most locations. You use the same IBM software. Many customers use PIX for teleprocessing between IBM 360/370 computers.

PIX. Remote card reader/line printer RJE for your IBM 360/370. If PIX interests you, please ask for a PIX presentation. There's much more to PIX. We will be pleased to tell you about it.

paradyne

Paradyne Corporation
8550 Ulmerton Road Largo, Florida 33540 (813) 536-4771

member of
IDCMA

April, 1974

CIRCLE 61 ON READER CARD

© 1974

69

Introducing the low-cost Statos 33 Family of Printer/Plotters.

It broadens your point of view.

It also puts electrostatic graphic output in a price range that everyone can afford. Whether you're now using a combination of line printers, X-Y plotters or CRT's. Whether your output is corporate reports, program listings, seismic analysis, weather maps, or what have you — the Statos® 33 family is the answer.

You can choose from four output widths. The 8½-inch, 11-inch, 14⅞-inch or the super wide 22-incher. Which pretty well takes care of any output size anyone could want.

If you've been thinking about the advantages of converting your present output system to electrostatics but hesitated because of the price, this new Statos 33 family will change your point of view.

And for the low initial cost, none of the advantages of quality electrostatic printout has been left out. Advantages which have made other Varian Statos printer/plotters famous. No corners have been cut. With every member of the low-cost

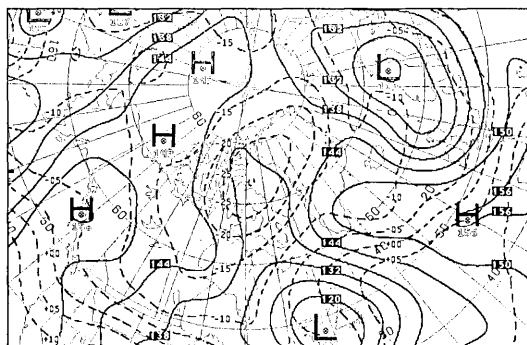
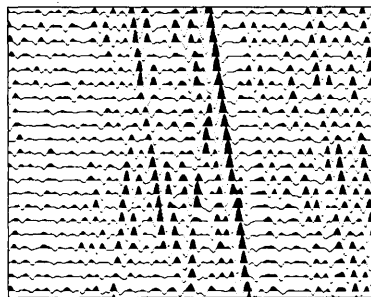
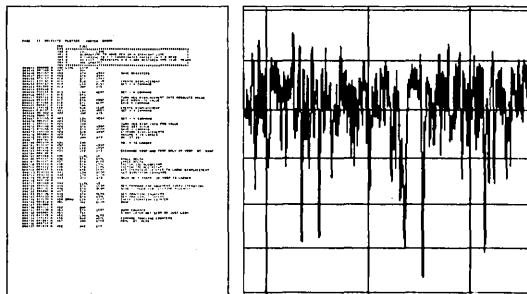

Statos 33 family you get high resolution, high accuracy plots. For printing, there's a 7 x 11 dot matrix font character generator. Alphanumerics (even Chinese!). Or graphics. Or graphics interspersed with words. Or superimposed real-time data over fixed information stored in the computer memory on disc — making expensive preprinted paper a cost of the past.

With large and small computer compatibility plus, the Statos 33 low-cost family puts most other printer/plotters out of the picture. Especially when you consider the powerful Statos interface capability and extensive software packages.

Check out this new Statos 33 family. Its low cost will change your present picture of electrostatic printer/plotters. And its versatility and high performance will change your computer output even more. To find out how, call Dave Sloan collect (415) 493-4000. Or write Varian Data Machines, 2722 Michelson Dr., Irvine, CA 92664.

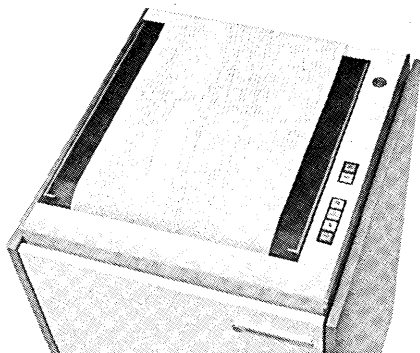

On the 10th anniversary
of the introduction of the 360,
a look at what we've learned
about acquiring and using computers

THE COMPUTERIZATION OF THE ABC WIDGET CO.

by Richard L. Nolan and K. Eric Knutsen

During the last decade of computing in business, a great many executives got gray hairs along with their first computers. Happily, a decade's worth of experience in the installation and use of business computers has yielded some important lessons for the general manager, and perhaps some rudimentary guidelines for the "computerization" of a company.

Here to illustrate these lessons are two case studies. The first charts the process of installing the ABC Widget Co.'s first computer as it might have happened in 1963, the second describes the same event as it occurred in 1973. Although the names and details have been altered, the company is real, and the 1973 scenario is based on the actual case history. The 1963 scenario is synthesized from many actual case histories developed during the early 1960s.

Background on ABC Widget

The ABC Widget Co. is engaged in the development, production and marketing of widgets to both household and institutional users in the U.S., Canada, and abroad. Widgets are sold through three marketing divisions.

The *consumer div.* markets four principal products for household use through over 100 food and specialty brokerage firms which solicit orders from supermarket chains, discount and department store groups, and drug and hardware wholesalers, to which the company ships and invoices as ordered.

The *industrial div.* markets over 200 commercial and industrial products through 70 franchised distributors. In addition the company has

acquired nine distributorships which it now operates as branch offices, and it plans to acquire more.

The *international div.* markets both household and institutional products in countries other than the U.S. and Canada.

A plant in Pennsylvania manufactures all of the company's products. Sub-assemblies and finished products are sent to a St. Louis, Mo., facility which handles distribution in the western U.S.

Dp activities have used in-house EAM equipment for the last four years. Applications include billing and accounts payable. Key punch operators prepare card input data from source documents. Bob, the dp supervisor, reports to Tom, ABC's controller.

During the last three years ABC has experienced substantial growth in its consumer and industrial divisions. Sales have increased 120%, profits 140%, and employment has tripled. (Integration of marketing and manufacturing activities accounts for the rapid rise in employment.) Current sales volume is in the \$20 million range.

Frank, president, and Joe, group vp for finance and manufacturing, have been entertaining the possibility of acquiring an electronic computer for ABC Widget.

Computerization, 1963 style

In January, Frank telephoned several computer vendors and told them of his company's interest in computerization. After reviewing the hardware proposals and making judgments on the state of the art for each vendor's

management information system (MIS) software, the field of contenders was narrowed to two.

The first, company "A," was a dominant manufacturer in the field. This company proposed a machine which was then the leading business computer. The proposal emphasized internal computing speed, advanced technological features, and the manufacturer's reputation for customer support and service.

The other contender, company "B," was a smaller factor in the computer industry. Its computer was, however, the prime competitor of company A's machine. Their proposal emphasized price/performance superiority based on the speed of internal circuits and peripheral devices.

Frank and Joe had read that computers would automate most clerical work, eliminate much of middle management, and provide up-to-the-minute data for decision-makers. They were anxious for ABC to get an early start in MIS.

Several of their business friends had already installed computers, which were prominently displayed in modern, glass-enclosed areas. Recently, Frank's wife had attended a guided tour of an insurance company's computer center with her friends from the local woman's club. Frank and Joe were well aware that computers and MIS were the wave of the future.

The two men concentrated on which manufacturer should be selected to provide the computer hardware. They felt pressed to make the decision by the end of February; some of their competitors already had computers and

ABC WIDGET

those that didn't planned to have them soon.

They decided to have an independent feasibility study conducted by their auditors. The study focused again on hardware selection. A key table was the price/performance ratios for the computers, which compared timings of various instructions vs. cpu rental cost.

During this period the company A salesman arranged for Frank to attend a computer orientation seminar for top management, at the vendor's facility. The three-day seminar included a plant tour and programming lessons.

When the auditor's study was received, it recommended that ABC procure the B machine, based on a superior price/performance capability.

Frank, however, had been impressed by the affable company A salesman and his company's standing and reputation. Accordingly, ABC placed an order for the A computer. Frank looked forward to the computerization of ABC under the guidance of his computer salesman.

As "hard-nosed" businessmen, Frank and Joe insisted that early computer applications be fully cost-justified by displacing clerical activities. Tom, the controller, agreed, and under his direction, cost/justification studies were developed for payroll and accounts receivable. Both Frank and Joe were pleased with the results. Computerization of payroll would replace eight clerical workers, an assortment of punched card equipment, adding machines, and calculators, resulting in a lucrative return on investment (ROI) of 57%. Likewise, computerization of accounts receivable was calculated at 40%. With a capital investment hurdle rate of 15%, Frank and Joe were heady about their decision to computerize. In addition to payroll and receivables, Bob was directed to convert the existing billing and payables systems from EAM to the computer.

In June, Bob was sent to a five-day course on the computer and its basic "automatic coding" language. Upon his return, he began coding a program to do billing. Within a short time, he realized that he could not accomplish the programming while continuing to operate the EAM work on a daily basis. Accordingly, he asked Tom to authorize the hiring of experienced programmers.

In July of 1963, Bob hired Gary as a programmer/analyst. Gary's background included a BS in mathematics and two years' experience writing mathematical analysis routines for the engineering section of an aerospace manufacturer.

Gary was assigned to work on pay-

roll. He soon found he had to make constant revisions to his program because of changes in state and federal tax formulas. Although the logic of the changes wasn't difficult, each change required an incredible amount of magnetic tape file processing and handling. Gary had very little experience in working with such large tape files. In addition, he had trouble getting used to working on the computer; it had a more limited repertoire of instructions and main memory than the computer of his previous employer. Even though both computers were made by the same manufacturer, knowing how to use one was little help in knowing how to work on the other.

Frustrated, and somewhat bored with payroll, Gary convinced Bob to allow him to work on some computer-based applications for sales analysis. He proceeded to become quite involved in developing some interesting correlation studies using sales history from old EAM punched cards.

The planned September completion dates for payroll and accounts receivable came and went. The pressure from Tom on Bob for results increased in direct proportion to the pressure that was exerted on Tom from Frank and Joe. After a rather emotional review of the status of the computer projects—the computer was currently used only to replace printing and card punching that had been previously done on EAM equipment—it was agreed that Bob should hire an additional programmer.

In September, Bob hired Kathy from a utility company, where she had worked on customer billing and accounts receivable. Kathy had eighteen months' prior experience.

Both Gary and Kathy found it difficult to incorporate clerical activities into their computer programs. In billing, for example, pricing was complicated by the variety of special deals and discounts, often negotiated with individual brokers or distributors. Payroll logic was similarly riddled with special cases. As a result, the clerical sections devoted to payroll and billing still had a lot of work to do preparing data for the computer and checking results.

The pressures of getting their programs to work left ABC's programmers little time to document for management the nature of the work they were doing. They resolved to get something down on paper as soon as the programming workload diminished, but in late November Gary was drafted, and the chore of finishing his work fell to Kathy. She had only his program code to work with, and she found Gary's

coding techniques to be quite different from hers. She made liberal use of comments, defined her data in one section, and used mnemonic labels. Gary, on the other hand, used few comments, mingled data with instructions, and used highly abstract labels. As a result, it was some time before Kathy was able to complete the work Gary had started. In fact, she ended up re-writing his programs entirely.

In late 1963, three weeks after the billing program was installed, ABC's computer operation once again came forcibly to Frank's and Joe's attention: because of an overflow condition, 512 customers were overcharged by \$163.84. There was considerable commotion, and the billing program was subjected to unplanned extra testing, which turned up several other snags.

The salesman's advice

Early in 1964, Frank decided to review the computer projects with the salesman. Several applications were working, but the promised reduction in clerical workforce had not materialized. Frank expressed frustration at not knowing how or why his edp staff could spend so much time programming the computer.

The salesman pointed out that Frank should not despair; "a foundation for the future was being laid." With the programming of payables and general accounting applications, the company would not only have more up-to-the-minute financial information, but would be able to remove most of the EAM equipment. He said that sorting could be done provided ABC upgrade to a 16K machine and add several magnetic tape drives. This upgrading would also enhance "throughput" for existing work.

The salesman expressed some doubts about Bob's ability to handle the dp function. He mentioned that Bob had been somewhat "retrogressive" in his attitude. Bob had also been unfairly critical of some errors in the software supplied by the manufacturer. In fact, Bob had been delinquent in incorporating the latest software updates to ABC's system, though they were mailed to him every month.

When Frank asked whether the source of the problem might be Bob's incompetence, the salesman said that it was a policy of his company not to comment on a client's personnel. However, he did say it was a well-known fact that the computer does require organizational change. He stressed the need for "selling" the use of the computer to other divisions of the organization.

Frank remembered that several of

his managers had commented that the computer might be of help in market analysis, statistical computation and materials planning. But they were uncertain how to approach Bob, or how to assess the costs and benefits of using the computer. When Frank confronted Tom with this problem, Tom said that it was a matter of priorities. He felt that payables and general accounting applications should be implemented before the more intangible applications to manufacturing, marketing and R&D.

During 1964, ABC replaced Bob and continued to experience growth and turnover in its dp staff. In February, an expanded computer system was delivered, incorporating larger memory, tape drives and several new technical features, and free software products.

Tom had instituted a system of cost and schedule targets for programming work. The targets were invariably missed, but he felt that he was at least "building a base of experience." Several of the accounting-based applications were running more or less regularly, but required frequent program modification in response to changing conditions. The dp budget was two and a half times the amount originally established early in 1963.

In April of 1964, Frank, Joe, and Tom attended an impressive announcement by their vendor of a new series of computers. This series incorporated many advanced features: faster "throughput," "universal" instruction set, "upward compatibility," and a wide variety of peripheral devices, including random access storage. It also contained a comprehensive "operating system," which would simplify many of the operating and programming complexities of earlier machines.

His enthusiasm renewed, and persuaded that the new computer technology had eliminated the earlier difficulties, Frank placed an order for early delivery of the new computer line.

Computerization '73

Late in 1972, Frank was mulling over his company's rapid growth and some of the resultant problems. His staff and clerical people were working harder every day, and it was becoming increasingly difficult to get things done, especially specialized analyses and operational planning and control work.

He asked Joe to investigate computer acquisition as a route to easing the workload and providing better information. He knew that many companies had made advantageous use of computers, but he was also acutely aware that there had been disastrous experiences as well. He was concerned

that ABC acquire computing in both a cost-effective and low-risk fashion.

Joe contacted Kevin, a management consultant who had been engaged by ABC several times in the past. In addition to being familiar with ABC Widget operations, he'd had extensive experience with computer-based systems.

Kevin performed a brief study to determine where, with the aid of computer systems, ABC could expect to be one and a half to two years hence. His report was primarily tutorial and stressed the following points:

1. Substantial improvement would take time—ABC should not hurry into a computer.
2. Selection of good personnel was all-important.
3. Marketing and manufacturing applications should receive early attention since these were "mainstream" company activities.

The report touched only briefly on hardware selection.

Joe asked Kevin if he would guide ABC in its first year or two of computer development. Kevin accepted the assignment and proceeded early in 1973 to lay the foundation for ABC's computer acquisition.

The first two months were spent searching for and recruiting an experienced business programmer/analyst to be ABC's project manager. In March 1973 George was hired to report to Joe. During this same period, Kevin also undertook the following steps: he established a documentation outline and standards for subsequent work; formed the nucleus of a computer "steering committee," with management and staff representatives from each of ABC's divisions; expanded his initial feasibility study, setting application objectives for 1973 and 1974; and arranged for a consulting programmer, specializing in data bases, to design and program ABC's computer data base.

During March, Kevin, George, and the data base specialist designed the basic data framework for ABC's system. Central to the system design was a data base consisting of six key files: a product (parts) master file, a bill-of-material file, a sales history file, a customer master file, an open orders file, and a "control" file.

At the end of March, the team submitted a two-year system development plan, identifying duties, resources and schedules. Although many of the cost estimates were tentative, Kevin and George felt that ABC management should be aware at the outset of the magnitude of the computer project.

Since the two-year costs were substantial, Kevin devoted some time to

assessing system benefits. The easily measurable benefits were not sufficient to recover development and operating costs, so short descriptions of intangible benefits were also developed. Both the quantifiable and intangible benefits were carefully explained and discussed with Frank and Joe. From the discussions, priorities for system development and the timing of the computer acquisition were established and specified in the two-year plan. The plan called for installation of a computer in the fourth quarter of 1973.

Although it would be cumbersome, Kevin and George both agreed to rent outside computer time for early applications work, deferring an in-house machine until late in the year. This approach would keep computer rental costs variable, while allowing sufficient lead time to prepare initial data bases, applications and operating procedures and disciplines.

They selected a "full-circle" computer, manufactured by a leading vendor of computing equipment. There were several important considerations leading to this choice: software for the series was functionally stabilized and could be expected to work well, time rental on the full circle was widely available at competitive rates, there were many potential employees and software companies intimately familiar with full circle hardware and software, and full circle computers could be procured from third party leasing companies at attractive discount rates.

George and Kevin did contact sales representatives from computer manufacturers. These salesmen were barred, however, from seeing Frank. Vendor salesmen had gained a reputation for "selling" computer fashions (such as MIS or data bases) to company presidents and giving short shrift to the organizational change necessitated by computers.

Kevin quickly zeroed-in on the fact that materials control was a key factor for the ABC Co. Analysis of a typical bill of materials for a product indicated that the cost of materials runs about 75% of total product cost. Often a product used over 100 different materials supplied from around the world.

Accordingly, first applications concentrated upon bill of materials forecasting and materials planning. Early in the game, George established COBOL programming standards to be used by his staff and subcontractors. Computer test time was arranged on an outside computer like the one planned for eventual acquisition.

Next, he set about designing a comprehensive market reporting system for

ABC WIDGET

each of ABC's divisions. Concurrently, the computer task force performed a number of specific studies—in part initiated by ABC management and staff, and in part gently imposed by the computer task force to further develop managerial awareness of the computer's potential. One such study simulated the effect of building another plant, something indicated by ABC's continued growth. This simulation made extensive use of the data base being developed.

Staffing up

Early in 1973, George started building the nucleus of a permanent systems and programming staff. He hired a junior programmer of his acquaintance who had done competent work for him in the past. In addition, one of Bob's staff was sent at intervals to several week-long programming courses. Another EAM equipment operator was sent to a one-week course on computer operation.

George and Kevin concentrated on building management awareness of the capabilities and limitations, value and cost of computers. A large part of the job lay in educating the people at ABC to a new view of their roles—regarding the computer system and one another.

Regular progress reports were sent to Frank, Joe, and all members of the steering committee. The reports showed charges, in total and by sub-project, and made a brief note of planned activities and past accomplishments. Regular steering committee meetings were held to review priorities, resolve procedural issues and generally keep each division informed of computer project developments. Initially, there was considerable confusion as to the proper role of each member, but meetings were held regularly anyway.

ABC management was slow to exploit some of the computer planning systems. So, in the fall of 1973, 20 members of management, including Frank and Joe, participated in a three-day computer management game conducted at ABC by consultants specializing in business gaming.

Reviewing the year's events late in December, Joe and Kevin felt reasonably confident. A computer had been installed earlier in the month, without incident. In October, a steering committee delegate from one of the marketing divisions had been appointed director of MIS. George, Bob (now computer operations manager) and a newly-hired procedures man all reported to the new MIS director, who in turn reported to Joe.

Applications still needed to be de-

veloped for computerized billing, inventory control and accounts receivable, but the hardware, software, data base and people resources were all in place to perform these exacting tasks. A full set of file maintenance programs was operational, as well as marketing reports for all divisions, a forecasting and material requirements planning system, a standard costing system and a variety of other planning/analysis programs.

The 1973 computer project budget had been underexpended by approximately 25%, but several applications were not as far along as originally planned. Nevertheless, things were under control. Building the necessary management awareness at ABC had been slow, something Kevin had learned with experience to expect, but still found frustrating. However, Joe was pleased with the progress. He planned to institute a more formal chargeout system for each computer application later in 1974 to further awareness of value-for-cost.

Lessons of the last decade

As we leave the ABC Widget Company either in 1964 or 1974, it is in the middle of a process. There is no clear finishing point, no definite conclusion. But we can infer a much higher probability of success and satisfaction with computers in the 1974 situation, with a lot less waste and floundering. In 1974 the computer is engaged on several fronts of vital concern to the company. Benefits are multi-dimensional, rather than cost-displacement exclusively. The software, data base and operating procedures are being developed in an orderly and professional manner.

By contrast, the 1963 case describes a disorganized approach, restricted to clerical/accounting activities. The company had not learned very much about computer systems, and would face several turbulent years of coping with a brand-new series of computers and software.

What are the lessons of the last decade that can be put to good use by a company acquiring their first computer, as well as by the seasoned user of computers?

The payoffs of a computer aren't realized by "pressing a button"; they are the result of managing a complex development process. In 1963, senior management took a naive and narrow view of what computers are and what they can do. The prevailing attitude was that after one "buys" one, the rest is downhill.

In 1974 senior management is aware that there is much more to exploiting the use of the computer than

simply acquiring it. They are increasingly sensitive to the fact that computerization entails changes in job content and in the relation of clusters of activities to one another.

If you need a prescription for medicine, ask a doctor, not a pill company. In 1963, too much reliance was placed upon the vendor's salesman for management guidance in acquiring and managing the computer. Trained people were scarce and the vendor's salesmen probably knew more than most about the subject. Consequently, senior management often thrust upon the salesman the role of edp consultant.

In 1974 the conflict of interests between selling computers and giving advice on them is better recognized. More importantly, both trained consultants and in-house personnel are available for providing senior management with objective edp management advice.

Development of computer-based systems is hard, complex work and requires a trained, talented staff. Few jobs in modern industry require the skills, maturity, patience and perseverance necessary in computer systems development. It is a complex process which is highly people-oriented, demanding diplomacy as well as a constantly growing variety of technical skills. Early recognition of this lesson by management in the 1973 scenario was a positive factor. They spent a lot of time recruiting good people to pursue the project.

Software improves with age; or, it's expensive to be on the "cutting edge of technology." The 1963 group was concerned with being in the vanguard. They had already experienced difficulties with the vendor's software, and could expect more when they moved up to the next generation of computers.

The 1973 project team was completely unencumbered by any updates, "patches" or "new releases" in the manufacturer's software because they had chosen an older, functionally stable operating system. In computing, it's usually expensive to be fashionable.

Management support is vital; guidance must be delicate. The 1963 group received some rather arbitrary directives from senior management, but very little informed guidance and a paucity of real support.

In 1973, support was foursquare, but guidance was more delicately balanced. The computer group took considerable initiative in planning and design but was also responsive to needs and ad hoc requests which arose from a growing awareness. Several forums were established for building this awareness and for communicating. We

16Kx18 =

more core in Fabri-Tek's reliable 600 Series

We have an addition to our 600 Series! It's the Model 686 Core Memory System with a basic module capacity of 16K x 18. Like all 600 Series models, the 686 combines off-the-shelf availability with reliable performance and minimum cost. Modular constructed, ferrite core memories permit operation of up to eight

core modules in a single enclosure.

Developed for a wide variety of data storage applications, the entire 600 Series is completely compatible with TTL logic. So, check the specifications, then specify the 600 Model that best fits your application.

The 620 Core Memory System

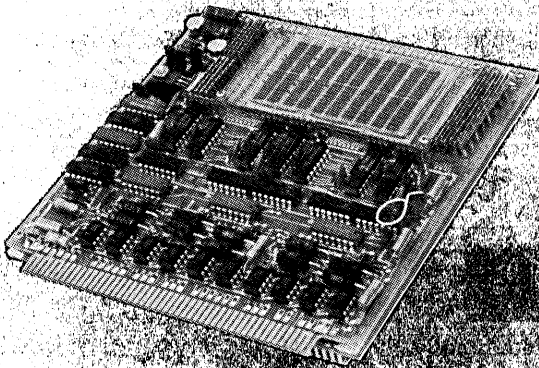

Capacity of 1,024 words by 10 bits on a single card. Plane 3-D, 4-wire configuration measures 6.0 x 6.4 inches. Expandable. Access time: 350 nanoseconds. Full cycle time: 1.0 usec.

The 684 Core Memory System

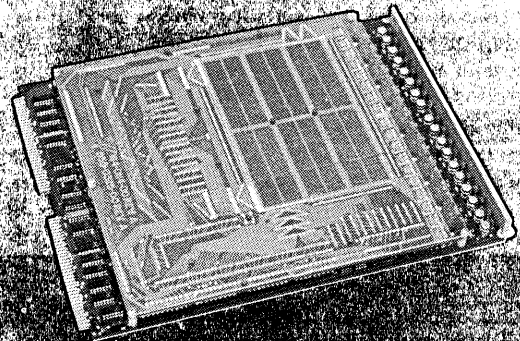

Basic module capacity of 16K x 18. Expandable to 64K x 18. Plane 3-D, 4-wire configuration. Access time: 350 nanoseconds. Full cycle time: 1.0 usec. Enclosures with primary control logic, power supplies and test exerciser.

The 686 Core Memory System

NEW

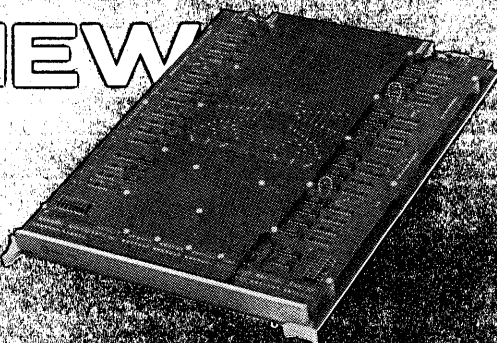

Basic module capacity of 16K x 18. Expandable to 64K x 18. Plane 3-D, 4-wire configuration. Access time: 350 nanoseconds. Full cycle time: 1.0 usec. Enclosures with primary control logic, power supplies and test exerciser.

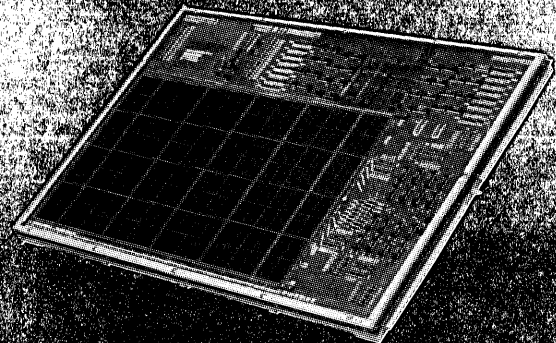

FABRI-TEK INC. COMPUTER SYSTEMS

5901 South County Road 18 • Minneapolis, MN 55436 • (612) 935-8811

Leader in Memory Technology for Over a Decade

SALES OFFICES IN:	Chicago (312) 437-4116	Denver (303) 753-0631	New Jersey (201) 964-4770	Sunnyvale (408) 739-4780	Hong Kong K-331383	Tokyo (03) 432-6901
	Boston (617) 969-5077	Dallas (214) 661-3155	Long Beach (213) 420-2493	Phoenix (602) 266-4448	Toledo (419) 865-6693	United Kingdom 01-903 1923/5

See us at Booth #345 National Computer Conference

ABC WIDGET

have learned that too much management guidance can result in a computer system which is just a patchwork quilt of ad hoc responses; too little can result in misdirection of computer resources.

Computer systems planning and cost estimating must be flexible; the management group must be willing to incur substantial development costs before arriving at a firm plan. For computer systems, a large part of the planning process is the establishment of functional specifications. Computer systems come in a wide variety of shapes and sizes. Before firm plans and accurate cost estimates can be developed, the client and the computer development group must arrive at a clear and orderly description of what the computer system is supposed to do. Some computer-based systems such as payroll, bill of materials, and other programs that have been developed many times are subject only to modest cost estimating error at the outset. Others, which incorporate sophisticated technology or haven't been done many times before, are subject to a more substantial estimating error.

Another factor that argues for flexibility is that learning takes place as computer projects are developed: clients articulate which functions are critical and which are marginal, while the development group breaks the initial cost estimate into its components. Up to 30% of the entire project budget may be spent before the development group and its client agree with some precision on what is to be done and at what cost. Successful computer planning requires from management not blind faith, but a willingness to invest time and money in developing a good computer system.

Benefits of computer systems are difficult to estimate; insistence on full quantification and ROI criteria are absurd. Not everyone has learned this lesson. There are still those who claim that the only real benefit is one that can be measured and audited. But this tends to obscure the real issue; that computer-based systems are agents of change, and they enable people and organizations to operate in new and more effective ways. A broader framework is required to evaluate qualitative as well as quantitative factors.

There is a slowly growing body of technical knowledge in computing. This body of knowledge has increased slowly but substantially in the last decade, and has spread to lots more people and organizations. For example, we know now that we should pay more attention to data and data structure and should keep data firmly separated

from procedure (i.e., computer programs). We know that standards and documentation are important. We know more about testing, test case building and system test planning. It is now possible and important to insist that computer-based systems be developed in accordance with accepted professional practices.

The 1973 ABC Co. was able to call on a variety of reliable services—consulting, programming, computer leasing. If ABC was new to computing, at least there were resource people available who had experienced the growth of the 1960s and learned from it.

We are sure that the entry-level company in 1983 will be even more fortunate. Although the computer field may not grow as fast in terms of dollars, we can only hope that in 1983 today's efforts will appear as amateurish as 1963's do today. □

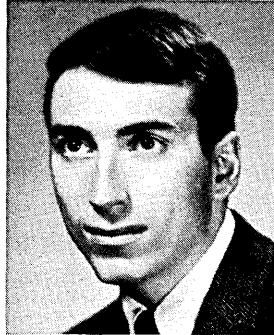

Dr. Nolan is an associate professor at the Harvard Univ. graduate school of business administration. He is currently engaged in a research project on the use of internal pricing as an approach to management control of computer resources. In addition to consulting work, his professional experience includes positions at Boeing and at the Systems Analysis Office in the Dept. of Defense. He has a PhD from the Univ. of Washington.



Mr. Knutsen is president of Eric Knutsen Associates, a Connecticut management consulting firm specializing in information systems. He has also spent a number of years with IBM in software development. He has an MBA from Harvard Univ.

the Bell your data

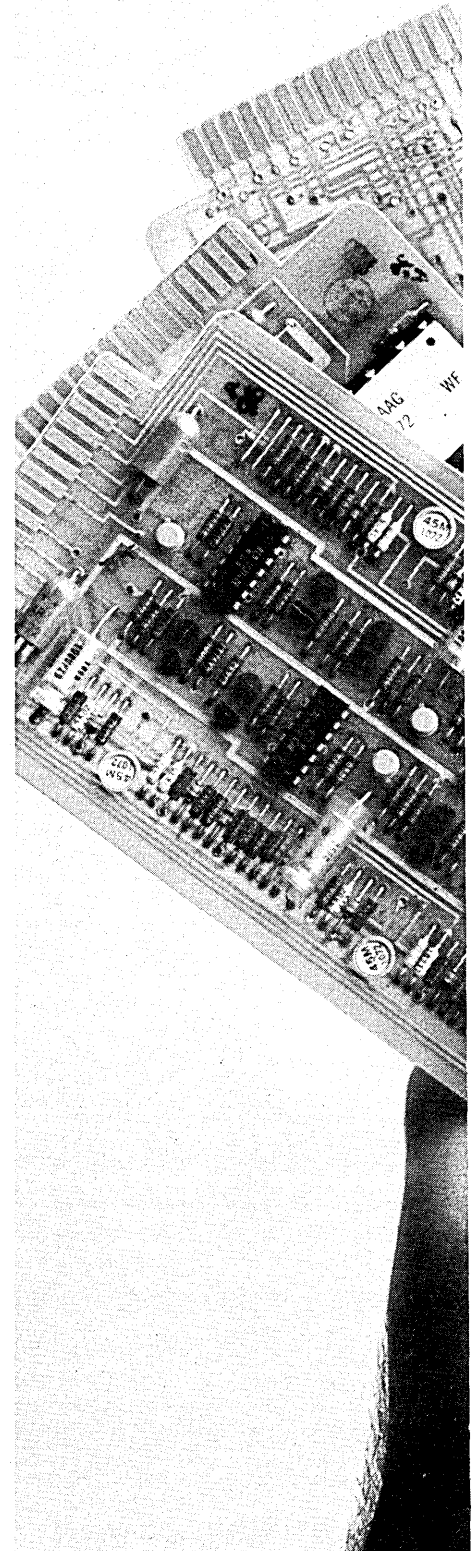

It's in the cards: System's simpler answer for communications.



The new family of Bell System Dataphone® services answers your needs for data communications. A range of models offers you nearly any transmission speed you require.

Automatic equalization avoids the expense of specially conditioned lines. Integrated circuit design gives you fast startup. Solid-state technology saves you space.

In addition, built-in diagnostic features and dependable Bell System maintenance minimize costly downtime. And charges for the new family of Dataphone services save you money.

Call your Bell System Communications Consultant. At AT&T and your Bell Company, we know you need fast, reliable, economical data communications.

We hear you.



NO PILLS

NO TABLETS

PLESSEY

AIDS THE MEMORY

AND SAVES THE COIN



ASK FOR PLESSEY

Let no explanation or solicitation induce you to accept a substitute. DO YOU CRY OUT for special designs? Just take Plessey as directed.

Are you suffering

from that dread disease of short memory? Plessey has the immediate cure. Specializing in DEC and DATA GENERAL problems. With a 16-to-a-card formula that allows one room to breathe.



ARE YOU RACKED

with the tortures of late deliveries? Plessey will bring instant relief. We deliver with all possible haste . . . as if our very own mothers were waiting. ARE YOU GROANING with the PAINful gnawings of a stretched budget?

Let us answer you in the words of Alfred H. Shlunk, who writes,

"Thank you, thank you, Plessey. My Memory's restored. And you've saved me a bundle. Before you, Plessey, THE ONLY REMEDIES MAINFRAMERS COULD OFFER WERE COSTLY SOLUTIONS."

REWARD

A salty reward will be sent through the mails to all who seek more knowledge of our worthy products.

Writes Major Mini Memories,

"... Bless you Plessey. For making me physically and electrically compatible. You've put me in a most expansive mood."



Remember, with Plessey, you're dealing with a most reliable element. Used only by the well-connected.

"... for 16 bits Plessey gave me relief in 16,384 comforting words."
"... thanks to Plessey . . . even my byte has been restored!"

When you're cycling . . . Plessey is the old standby for performance.

In order to see more clearly the miracles Plessey can perform, send away for your free specs.

(ALL REPLIES HELD IN STRICTEST CONFIDENCE.)
Meanwhile, to give you a glimpse, compatible Plessey memory remedies are pre-packaged for numerous DEC and DATA GENERAL minis in the handy 8k single card size (also available in 16k—so good for the system).

DIRECT ALL INQUIRIES

to Plessey Memories, Inc., 1674 McGaw Avenue, Santa Ana, California 92705. Or, put Alexander Bell's contraption to good use and call (714) 540-9945.

It pleases me to have add-on specs for DEC PDP _____; for DATA GENERAL NOVA _____ for other diverse mini computer types _____ (check one. check all.)

8K on a single card
 16K on a single card

Name/Title _____

Firm _____

Address _____

Phone _____

WE MAKE HOUSE CALLS



Plessey Memories

The Air Force Data Systems Design Center found that by utilizing core more fully, and implementing better programming techniques, throughput could be improved easily and inexpensively

AN OPTIMIZATION STUDY

Perhaps the most universal problem which edp management must address today is that of improving computer throughput without expending large sums of money. Many approaches exist which can improve computer throughput, but not all of them prove to be cost-effective. This article discusses one approach which was studied and implemented by the Air Force Data Systems Design Center (AFDSDC) to improve computer throughput at a minimum cost.

The Air Force base level computer system is composed of 135 Burroughs B3500 systems located at bases throughout the world. Each B3500 system is an independent system which processes a base level workload. Standard programs and systems of programs are developed and maintained by the AFDSDC to support most processing of the base level workload. For those functions unique to a particular base or command, programs are developed and maintained by that base or command.

In an effort to control the use of computer resources and to improve computer throughput, the Design Center has developed a set of standards which apply to all systems processed on the base level computers. These standards include good programming

*Although Captain Mulford wrote the article, it should be noted that this project was an Operations Research Div. effort which, at times, was worked on by as many as five people.

practices, rules for processing the base workload, and limits on the amount of computer resources that can be used by a program or system of programs. These standards are continually reviewed and modified as new techniques are developed, requirements changed, and better approaches are found.

A recent change to these standards resulted from the implementation of the findings of a system optimization study conducted by the Operations Research Div. at AFDSDC. The purpose of the study was to improve base level computer throughput by better utilizing available computer resources. Various areas of computer use were studied, but primary emphasis was placed upon developing techniques to more fully utilize core. It was felt that: 1) there were large amounts of core unused on the B3500 computers, 2) there were many programmers who were not using good programming techniques because of a 20,000 byte maximum program size limitation (Air Force standard), and 3) tools and techniques could be developed to aid programmers in determining the optimum core size for programs.

It was very important that the results of this study be easily implementable and cost-effective. Therefore, an organized approach was developed for the study. This included a feasibility analysis of those factors relating to system optimization, the development of

by Captain James O. Mulford*

tools for aiding in the system optimization, and the insurance that the techniques and tools developed would serve as an aid in improving computer throughput.

Two major techniques were addressed in this study as aids in optimizing computer throughput: the proper blocking of sequentially accessed files, and the segmentation of programs—to obtain the best throughput, while limiting program size for effective multiprogramming. Since the physical sizes of many base level programs are too large to be multiprogrammed with other programs, they must be subdivided into logical segments which are read into core from disc when required. Usually a program is divided into a “core-resident” main segment and several smaller “overlayable” segments, which are read into an overlay area as required. Previously, blocking of files and segmenting of programs was constrained by the program core limitation of 20K bytes.

To determine whether these techniques could be employed without adversely affecting the benefits to be derived from multiprogramming, a study of factors relating to these optimization techniques was conducted. These factors were the use of core of the B3500 computers, the cpu “growth potential,” and the identification of programs for optimization.

OPTIMIZATION

The study of core use was conducted to determine the amount of unused core in B3500 systems. If found to be significant, an assumption could be made that the present 20K byte maximum limit for programs could be changed to take advantage of this unused resource. This additional core would be used for record blocking and reduced segmentation. Simulation and benchmarks could then test the premise that an increase in program size for heavily I/O-bound programs would result in a significant decrease in job turnaround times.

A representative sample of 14 bases was selected for the core analysis. Using data collected by the B3500 accounting system, detailed core utilization graphs were generated for a 30-day period at each test base. The results were validated and summarized for analysis. It was found that significant amounts of core were not being used at the sampled bases. Core utilization during normal batch processing ranged from 40-95%, with an average use near 70%. Seldom did core use go beyond 90% (Fig. 1).

The cpu growth potential of a multi-programming computer is that time during which all programs in the mix are in a wait status, usually due to I/O's being processed for the programs. Because of this state, the operating system can find nothing to do and, therefore, enters a tight loop of instructions (in the B3500 Master Control Program) to wait for the next event to become available for processing. This time can be viewed as cpu growth potential, since a better balance between

I/O's and processing could take advantage of this vacant time. This might be accomplished through a higher mix level, better I/O balancing among peripherals, the addition of more and faster peripherals, or the optimization of programs being processed.

Within the B3500 systems used at base level dp installations, there is ample evidence that this cpu growth potential is available. A sample of bases indicated an average of 26-42% of total cpu time is spent in a dormant state for the Burroughs Master Control Program. (These results were measured on a previous version of the Burroughs B3500 operating system, MCPV. A new version, MCPV, is currently being used by most Burroughs customers.)

To utilize this growth potential effectively, several alternatives are available. The first two, maintaining a higher mix level and better I/O balancing among peripherals, are a function of program scheduling at the installation. Both alternatives are interrelated as well as being dependent upon system design, core size, and configuration. The scheduling of additional jobs may not take advantage of cpu growth potential if all of the jobs place large I/O activity on a specific peripheral. Likewise, two programs in the mix may effectively balance I/O's among the various peripherals, but still have a lot of dormant time because of their low cpu processing time in relationship to their I/O time.

In addition, the prerequisite and file relationship of programs within a system can place a limitation on scheduling. Core size and hardware configura-

tion are also limiting factors in efficient scheduling. Subject to these constraints, each installation must insure that scheduling is accomplished to effectively utilize the growth potential.

A third alternative is hardware enhancement. Although this is an effective method of reducing I/O time and, therefore, waiting I/O time, it is a very costly method. Before pursuing this alternative, all efforts should be made to insure optimum scheduling and to optimize the systems being processed.

System optimization, the fourth alternative, can provide the better balance between I/O's and cpu processing to utilize a large amount of cpu growth potential effectively. For computer systems that have a large amount of I/O activity, such as the ones processed on the base level B3500 computers, optimization of blocking and overlay calls is critical to obtain the needed balance of I/O and processing activity. Blocking records and minimizing overlay calls will reduce the number of I/O's while increasing the program processing required between I/O's. Not only will this decrease the amount of I/O wait time for the processor, it will decrease a large amount of processor time required to handle the initiation and completion of I/O's.

Program analysis

The purpose of the program analysis study was to identify those programs causing the most I/O activity. Identifying these potential problem areas would then aid in the optimization and implementation phase of this study.

A representative sample of bases was chosen, and detailed accounting statistics were obtained on sequential I/O activity and number of overlay calls. This data was summarized for identification of candidates for optimization and also listed in detail for use in the optimization effort.

The results of the program analysis were very encouraging. It was learned that a small number of programs accounted for the majority of the I/O activity. Of the 819 programs sampled, approximately 5% of these accounted for 95% of the total segment call activity. Approximately 13% of the programs accounted for 80% of the total sequential physical record I/O activity. These small percentages of the programs were prime candidates for optimization.

In order to insure that the problem programs could be optimized rapidly, tools, techniques, and guidelines were developed to aid programmers in their optimization effort. The results of this effort were a Blocking Factor Analysis Program (BFAP) for determining

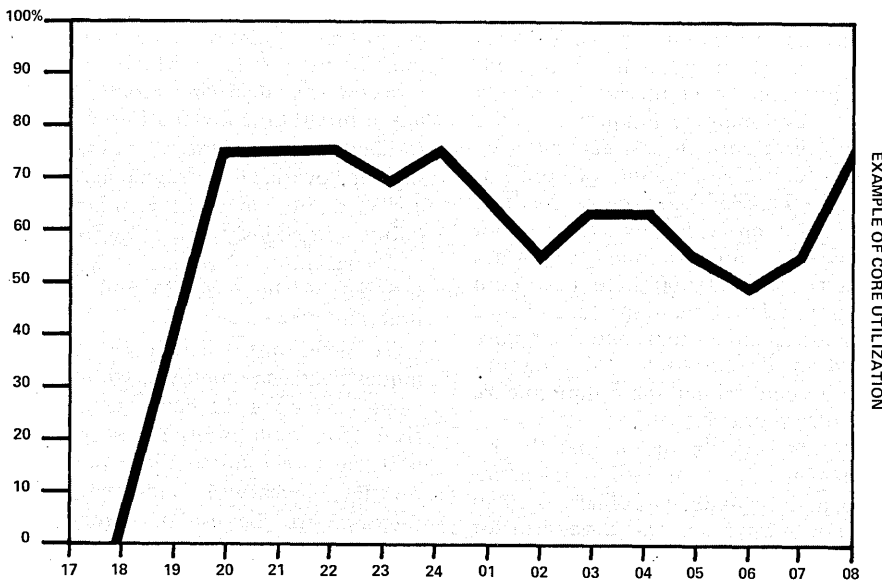

Fig. 1. Weekday core utilization; typical (B-Level).

"best" blocking for a system of programs, a simulation and benchmark study to provide guidelines for programmers, and an overlay monitor to aid in the proper segmentation of programs.

BFAP is a tool which provides programmers and system designers with the blocking factors that will minimize I/O time for a set of tape and/or disc files in a system of programs. Data that is input to BFAP includes bytes of core to be made available for blocking in each program, and, for each file: a) the average number of logical records processed per program execution, b) the average logical record size in bytes, c) an indication of other files in the system which use the same area, and d) an indication of which programs in the system use the file. This data can be collected from the accounting system. BFAP then uses this data to create a linear programming model through an optimization technique called separable convex programming. The output is the best blocking factor for each file in the system of programs described by the input.

A drawback of this tool is that it has no automatic method of determining optimal core size for each program. However, the simulation and benchmark studies conducted did identify maximum practical blocking factors and characteristic plots of run time vs. blocking, making an iterative approach to determining optimum core appear feasible.

The effects of blocking records and the advantages of BFAP were clearly shown in a sample test conducted on a system of six programs. Using one of the Air Force's top systems analysts, a reduction of 73% in serial run time was achieved by a small increase in program core sizes and blocking of records in each sequential file. Using the same system of programs and the same amount of core, BFAP was able to achieve an 87% reduction in serial run time over the unblocked structure.

The simulation and benchmark study was conducted to determine the effects of file blocking as parameters were varied. Simulations and benchmarks were conducted using record sizes of 100 to 2,000 characters, blocking factors of 5 to 100, and file volumes of 5,000 to 100,000. This analysis was conducted using both tape and disc devices to determine the effects of blocking on each.

The results, while varying in run time as parameters were varied, were fairly predictable as to the characteristic plot of run time vs. blocking factor. As files were blocked, run time was

reduced drastically in all cases, with a diminishing benefit as file blocking was increased. As can be seen in Fig. 2 (a typical example of the results), there is an apparent point beyond which the additional benefit derived from increased blocking is offset by the additional core required. By measuring the run time gained per byte of core required for blocking, a cutoff point was established, beyond which additional blocking would not provide enough run time decrease to offset core requirements. These cutoff points could be fed into BFAP as an initial core size for an iterative approach.

The overlay monitor is one of the tools developed to aid programmers/analysts in both the development and maintenance of programs. It is compiled into a program to gather statistics on each of the segments of the program, so that the segments can be made either a part of the main program (core resident) or other overlayable segments (called only when needed) to reduce the number of I/O's. Again, there is a trade-off between run time reductions and core requirements, which must be considered in the analysis of the collected statistics.

These statistics include each segment's size, number of times each seg-

ment is called into core and which segment was the "calling" segment, and related percentages. All segments are ranked by their frequency of usage. This data can then be used to group segments properly, place them in the overlayable or resident section, and reduce run time.

In order to test the effects of applying these techniques to base level programs, simulation analysis was conducted. Representative bases were selected for simulation modeling of their batch period processing. The program analysis listings described previously were then used to determine which programs should be analyzed for possible blocking factor changes. This involved the analysis of approximately 40 programs for each of the two bases modeled. Because of the number of programs involved, it was not cost-effective to utilize BFAP in this simulation analysis. Instead, a "sub-optimal" approach was taken by applying approximations for blocking factors using the simulation and benchmark guidelines. If this approach showed a significant run time decrease for the modeled bases, then the application of BFAP and the use of the overlay monitor would provide an even greater decrease in total run time.

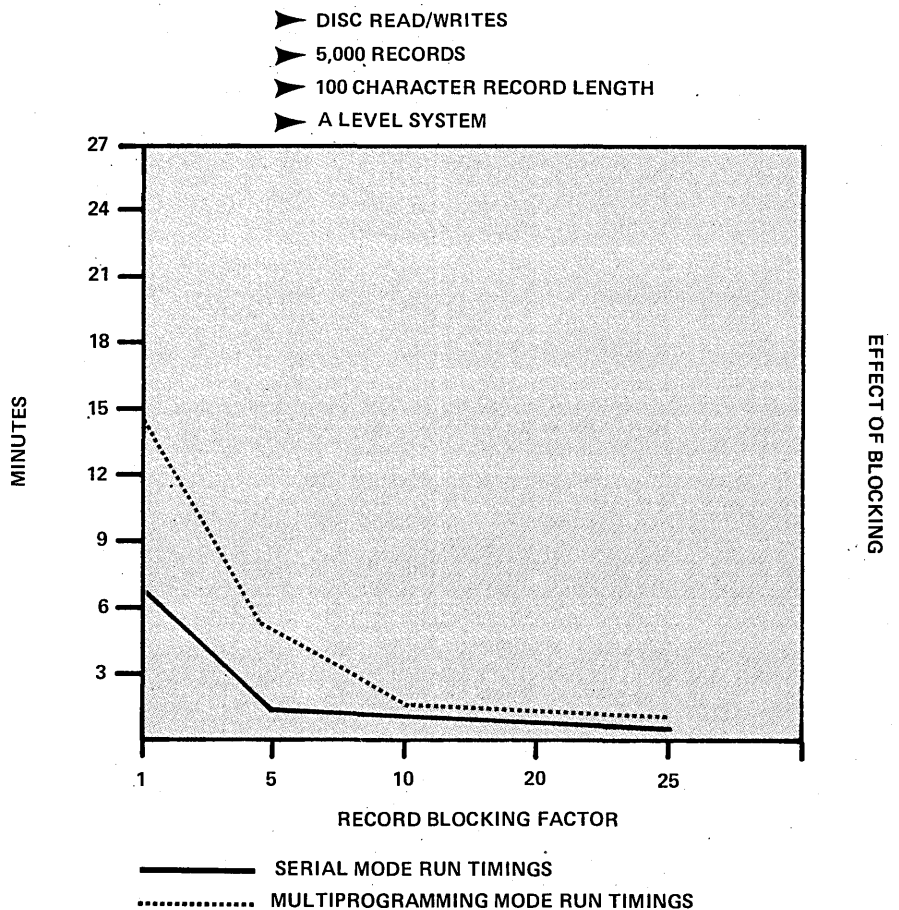

Fig. 2. Blocking factor analysis; benchmark study results.

OPTIMIZATION

The results of this simulation analysis indicated that the optimization techniques should be implemented. Using the "sub-optimal" blocking, a run time reduction of up to 60 minutes per day was projected by the simulations. This savings was realized by affecting less than 5% of the programs processed. Similar analysis showed a 33 minute per day savings by adding one tape channel, and a 76 minute per day savings by adding one disc channel. Both of these alternatives are significantly more costly than system optimization!

Implementation of results

As a result of this study, a major effort was initiated at the Air Force Data Systems Design Center to implement the recommendations of the

ments adversely affected by the optimization effort. Two or three BFAP runs were required for those systems being analyzed for better blocking; one or two overlay monitor runs were required for those being analyzed for segmentation. All computer runs were performed on the B3500 systems at AFSDC without affecting normal operations.

In contrast to these relatively minor costs, the benefits were very great. Approximately 390 programs were identified for optimization, with the majority of these programs having been optimized and released to all bases within six months of identification. This optimization effort reduced I/O's at each base by over 2,500,000 per month and provided a one to two hour decrease in run time per day at each of the 135

files, then perhaps you need a BFAP. Do you have programs that require proper segmentation (or maybe use virtual memory)? If so, an overlay monitor should provide you with some valuable data.

While these techniques do not provide all the answers to "the optimal system," they do provide a very effective means of reducing run time. As Fig. 3 illustrates, the general characteristics of the run time vs. core graph shows significant savings can be gained by using these techniques. These characteristics were present throughout the study; large decreases in run time can be realized through proper blocking; large decreases in run time can be realized through proper segmentation.

Still more research should be done in this area to improve the tools and techniques used. While BFAP does provide significant run time reductions, it does not insure optimum run times or core use. An iterative approach might be one solution. Assuming a maximum effective blocking factor can be found, perhaps an iterative algorithm can be developed that will terminate when the run time/core utilized ratio is optimal. A similar approach could be applied to overlay analysis.

To complicate the analysis further, the effects of multiprogramming could be considered. Does the optimization of all programs in a multiprogramming mix insure that the jobs are being processed efficiently? Probably not, but what is the added analysis required to consider multiprogramming, and what is the associated cost vs. benefit trade-off? These and many other questions should and probably will be answered to improve the techniques of system optimization. But in the meantime, use the techniques available and save what you can, now. □

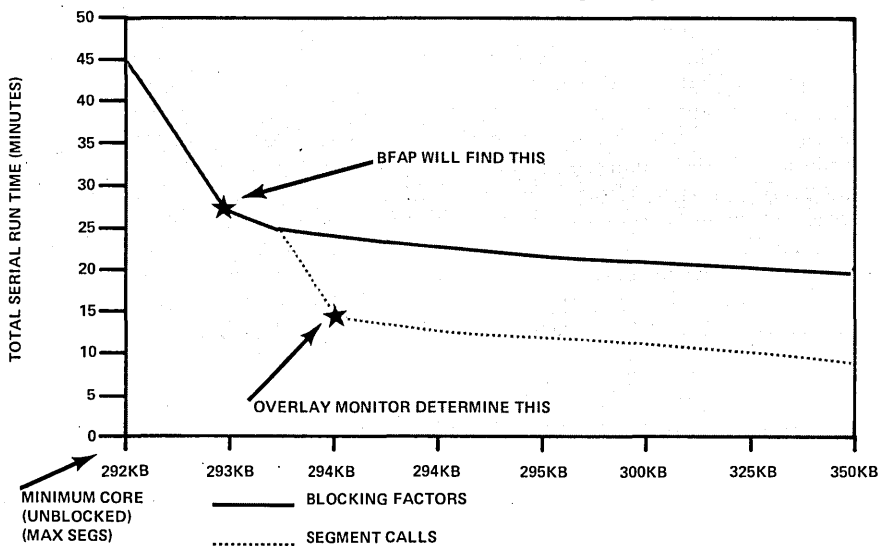

Fig. 3. System Optimization approach; 10 programs.

study. Each functional area (a functional area exists within the Design Center for each major Air Force function that base level data processing supports, i.e., Accounting and Finance) was briefed on the results of the study and was provided a copy of the program analysis listings indicating their candidates for optimization. A schedule of programs to be optimized was then developed by each functional area, and assistance was rendered on the use of BFAP and the overlay monitor.

The costs associated with the implementation of the recommendations were very small in comparison to the benefits derived. Two personnel from the Operations Research Div. provided part time assistance to programmers/analysts for approximately two months. Personnel from the functional areas were able to perform the optimization during normal program maintenance time in most cases, and in no instances were new system develop-

B3500 computers.

The results of this study will continue to be applied to all programs processed on base level computers. The 20K byte standard has been changed, and now advocates the use of system optimization techniques in determining the best core size for a program. The tools are being evaluated in an attempt to improve their effectiveness in system optimization. The method is simple, the implementation is quick and cheap, and the benefits are large.

Applicability to other computer systems

For those of you who have read this far and have seen how the Air Force has improved computer throughput, there is good news—these simple techniques can be applied to your dp installation, also. If you have programs which access files sequentially, perhaps an analysis of proper blocking would aid your installation. If a system of programs accesses several sequential

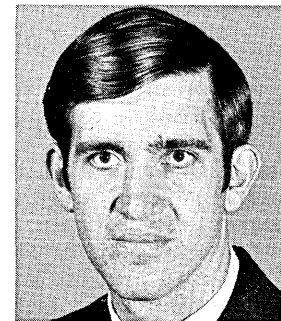

Captain Mulford is a computer system design engineer in the Operations Research Division of the Air Force Data Systems Design Center. He is a graduate of the U.S. Air Force Academy, and has a master's degree from UCLA.

Sired from technology and experience proven in our world-famous Series 30 and 40 drives, our new Series 20 fixed disk drives are being shipped now! Their inherent reliability, compactness, cool, quiet operation and low cost make them ideal for mini computer and intelligent terminal systems. Yet, you get

powerful performance features: 24 million bit capacity, 100 tracks per inch, 2200 bits per inch. Power consumption is less than 150 watts. Only DC power is used, which means Series 20 drives can operate anywhere in the world without modification. For more information on the new Series 20 fixed disk

drives, call or write Diablo Systems, Incorporated, 24500 Industrial Boulevard, Hayward, California 94545, (415) 783-3910.



NOW, DIABLO POWER AND PERFORMANCE IN A FIXED DISK DRIVE.



XEROX is a trademark of XEROX Corporation

CIRCLE 24 ON READER CARD

3 nitty-gritty reasons why shipping on United makes more sense than ever, these days.



1.

WE STILL FLY MORE PLANES TO MORE PLACES, MORE OFTEN than any other airline, and every single plane carries freight. Even with the recent flight reductions, our schedules still fit yours. And United connects with every other U.S. airline, and every international airline.

2.

CLOSER CONTROL—THANKS TO A.F.I.S. United's A.F.I.S. (Air Freight Information System) gives you the airline industry's most advanced computerized control system. While you're on the phone, the A.F.I.S. girl can tell you exactly where your shipment is, how it is, who has it. Invaluable these days, when you need to tighten your control over every detail.



3.

SMALL PACKAGE DISPATCH. This dependable, same-day way to rush important small shipments to 113 cities can be a lifesaver, today. And it's surprisingly inexpensive.

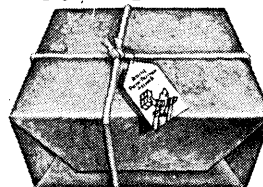

United Air Lines, Inc., 111 N. Canal St., FL-4
12th Floor, Chicago, Illinois 60606.

Please send me United booklets on these subjects:

Cargo Timetable Small Package Dispatch
 Lower Deck Container Savings A.F.I.S.
 Have your Sales Rep give me a call.

NAME _____
 COMPANY _____
 STREET ADDRESS _____
 CITY/STATE/ZIP _____

WHENEVER YOU NEED HELP. Call a friend—United. For more friendly facts about United services that can help you more today than ever, just check and mail the coupon.

United Air Lines Jet Freight

No. 1 in the U.S. sky

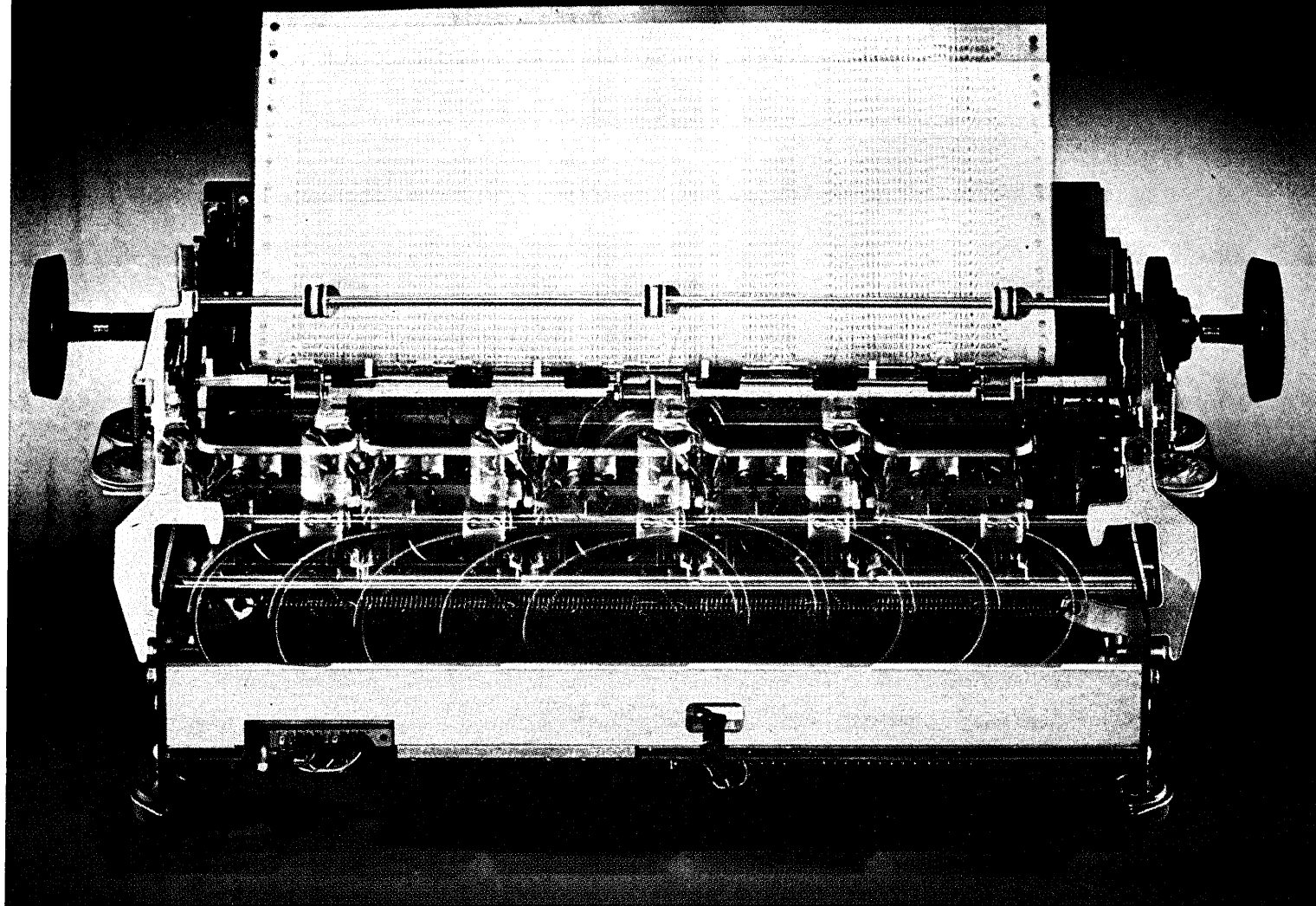

Three times the throughput. 1/5 the moving parts.

Diablo's HyType 1 Serial Printer gives you clear, crisp printing at throughput speeds three to five times greater than the most widely used I/O typewriter. And does it with one-fifth the moving parts. Electronic servos control critical movements like character and column selection. Stepping motors control paper and ribbon feed. HyType has electronic tabbing for both horizontal and

vertical spacing. In addition to greater throughput, elimination of 4/5's the moving parts assures extra long life and trouble-free performance in heavy duty operations with minimum routine preventive maintenance. Optional features include regular or pin feed platens and auxiliary form feed tractors. One and two color cloth ribbons and multi-strike carbon film ribbons are available

in snap-in cartridges. Diablo's character wheel is available in 12 fonts, many languages, interchangeable in a few seconds. For the best in low-cost, high performance printers demand Diablo HyType for your system. For a complete technical presentation, write or call Diablo Systems, Incorporated, 24500 Industrial Boulevard, Hayward, California 94545, (415) 783-3910.



Diablo Systems, Incorporated
A Xerox Company

*"Visit Diablo's exhibit
at the National Computer Show."*

XEROX® is a trademark of XEROX Corporation
HyType and Diablo are trademarks

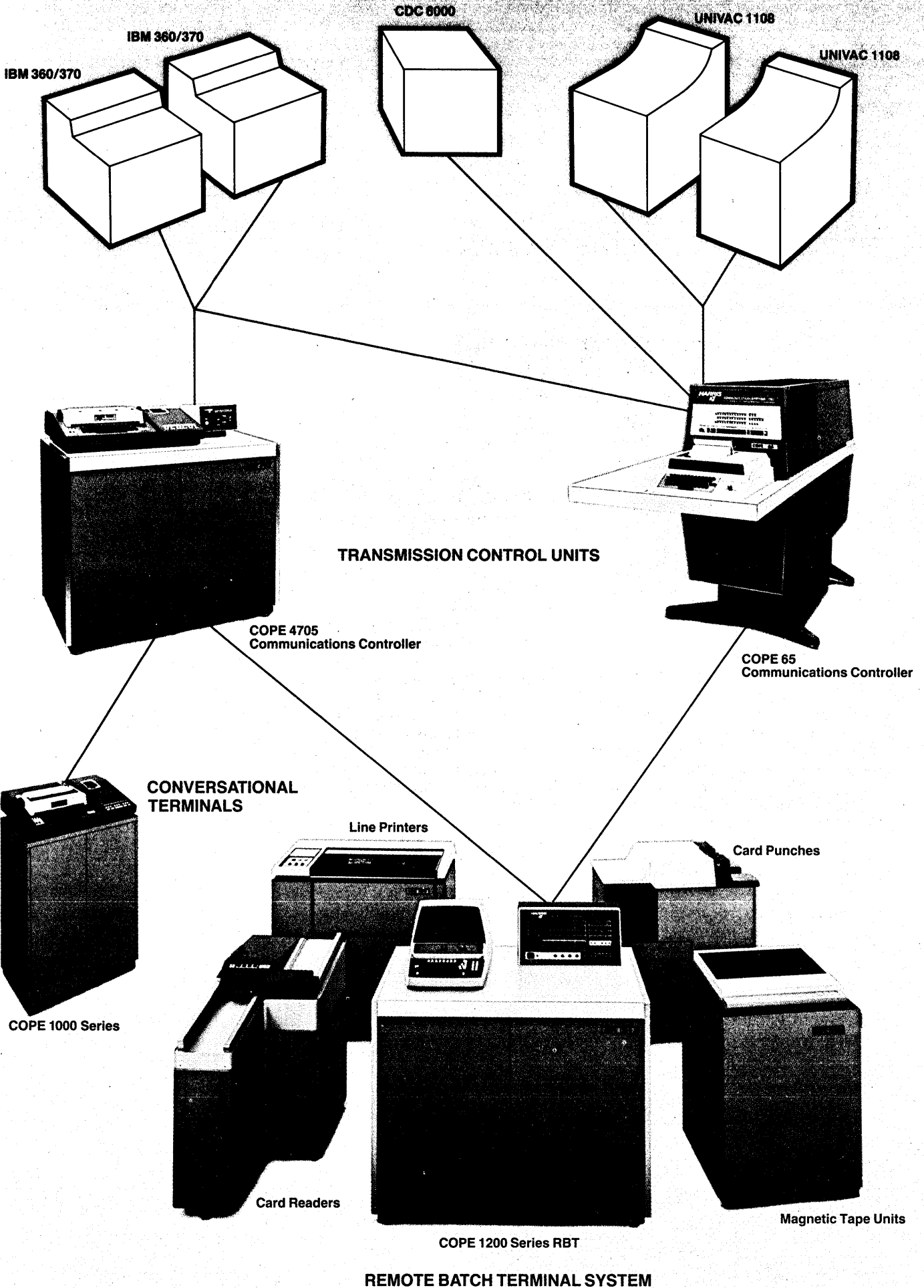

A better communications system.

COPE[®]

No matter what mainframe you're using, you can build a better data communications system with COPE terminals, controllers and peripherals.

Start at your CPU and add a COPE Communications Controller. Choose a COPE 4705 to front-end your 360/370. It's an enhanced alternate for the IBM 3705 at lower cost. Or specify our COPE 65 for full-duplex operation at up to 50 Kbps to your Univac 1108, CDC 6000 or IBM 360/370. Both controllers allow you to realize the utmost in efficiency from your big computer.

Next, for your remote location, there's just one choice in remote batch terminals—the COPE 1200. Latest in a broad line of COPEs, the 1200 provides an extremely high rate of throughput using ordinary voice-grade telephone or Telpak lines. COPE 1200 provides your most cost-effective, reliable access to your big computer.

Then you need to surround your COPE terminal with the peripherals that will do the best job for your application. COPE has card readers from 150 to 1200 cpm. Line printers from 50 to 1500 lpm. Card punches up to 200 cpm. Mag. tape—7 or 9 track—200, 556, 800 or 1600 bpi.

You can choose half- or full-duplex communications modems operating on voice-grade telephone circuits from 2 Kbps to 50 Kbps. And from multiple communications interfaces: ordinary voice-grade lines, co-axial cable or Telpak lines.

Plus, COPE offers both Teletype and CRT consoles for operator I/O control and a line of industry-compatible conversational keyboard terminals.

When you put it all together, you'll find COPE provides the most flexible, modular, cost-effective data communications system in the industry. And backs it up with complete software services and full maintenance by an expert Field Engineering Department with offices conveniently located throughout the U.S. and in Canada.

To find out more about our total systems capability, call your nearest Harris Communication Systems, Inc., office or contact the home office listed below.

TO: Harris Communication Systems, Inc.
11262 Indian Trail/P. O. Box 44076
Dallas, Texas 75234 (214) 241-0551

D4

Please send more information on COPE Communication Systems.

I'm especially interested in your:

- | | |
|--|---|
| <input type="checkbox"/> COPE 4705 Communications Controller | <input type="checkbox"/> COPE 1200 Series RBTs |
| <input type="checkbox"/> COPE 65 Communications Controller | <input type="checkbox"/> COPE 1000 Series portable keyboard terminals |
| | <input type="checkbox"/> Please Have a Salesman Contact Me |

Name _____

Company _____

Telephone _____

Street _____

City _____

State _____

Zip _____



COMMUNICATION SYSTEMS, INC.

a subsidiary of Harris-Intertype Corporation
11262 Indian Trail/P.O. Box 44076/Dallas, Texas 75234 (214) 241-0551

Canada: 1400 Don Mills Road/Don Mills, Ontario (416) 449-8571

At NCC visit COPE booth no's. 1031, 1033, 1035, 1130, 1132, 1134

CIRCLE 67 ON READER CARD



There is no stronger shield than "Crashguard."

"Crashguard" is a tough oxide protection against headcrash damage. You get it from the people who developed the first computer tape in 1953. People who will go to any length to solve a customer's problem. People who thrive on assisting. The Data Recording Products Division of 3M. A proud clan.



Call out the clan.

"Scotch" and "Crashguard" are registered trademarks of 3M Company.

3M
COMPANY

Before using a monitor to measure a system, learn how the monitor will affect the system

ACQUIRING AND USING A HARDWARE MONITOR

by Jerre D. Noe

An estimated 200 hardware monitors were in use in early 1973. This number is very small relative to the number of computers in use, and one may expect more managers to turn to them in search of data to help match the "horsepower" of the computer to the job at hand, particularly as financial constraints become tougher. Very few contemporary computers have many built-in aids for assessing performance, which is another reason one can expect an expanded use of separate monitors.

The goal of this paper is to tell potential hardware monitor buyers about some of the points to look for that might not normally be thought of in a request for proposal. It is oriented toward the user who may push the limits of the hardware monitor because of the inherent speeds of the computer he wishes to measure. As machine speeds increase, this is more and more likely to be the case. The paper may also be of interest to hardware monitor designers, in terms of providing comments from one user.

Fig. 1 sketches the elements of a hardware monitor, not for the purpose of explaining what a hardware monitor is, but to be sure we have a common base of terminology for the remainder of this discussion.¹ The principal elements are as follows:

General probes. A set of signal sensors designed for minimum interference with the host machine and able to drive relatively long cables, so that signals may be picked up from various points physically distant from each other and from the central monitor console.

Logic circuits. Circuits that accept signals from the general probes and

allow logical combinations of the signals (AND, NOR, INVERT, etc.) so that one may define events of interest.

Counters. A group of counters that may be used to count the occurrence of various events, or to measure the time between events by counting the

number of intervening clock pulses.

Comparator probes. Probes similar to the general probes, but used to sense a number of bits that appear in parallel, e.g. as in an address register.

Comparator. Provides means for comparing the parallel bits with some

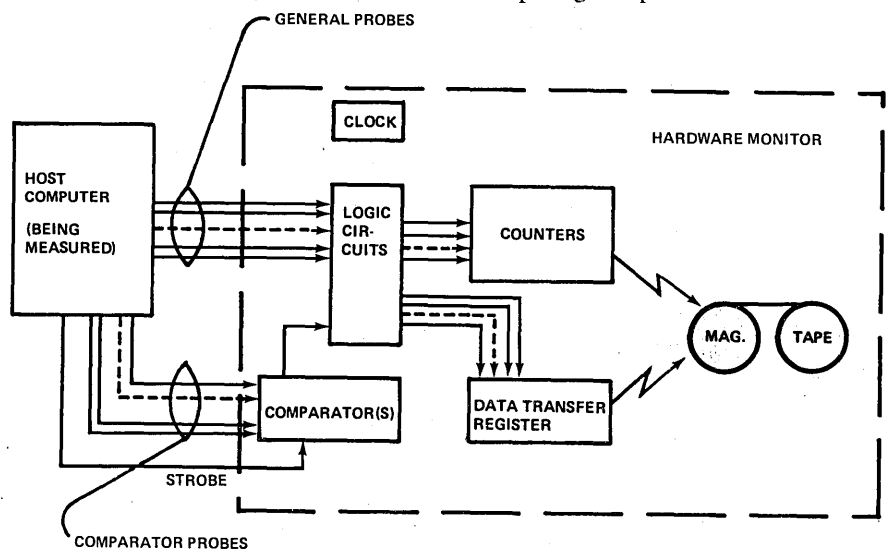

Fig. 1. Elements of a hardware monitor.

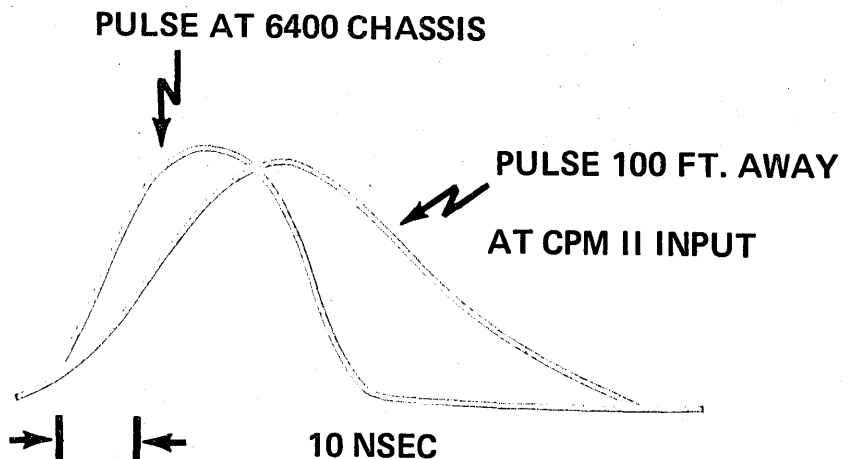

Fig. 2. Pulse distortion through probe cables.

¹The interested reader is referred to the following for more background information on hardware monitors: M. E. Drummond, Jr., *Evaluation and Measurement Techniques for Digital Computer Systems*, Prentice-Hall, Inc., 1973, pp. 240-279, and E. L. Hart, "The User's Guide to Evaluation Products," *Datamation*, December 1970, pp. 32-35.

HARDWARE MONITOR

preset value at an instant defined by a signal on the strobe line.

Data transfer register. Means for passing data directly from the host computer to the magnetic tape record. This register might be combined with the counter functions or with the comparator functions.

More recent developments in monitors have emphasized means for on-line data reduction² and cooperative interaction between the host computer and the monitor.³ This paper concentrates on the data collection aspects of hardware monitors, the primary role of commercially available units. The views should remain applicable as newer monitors become available, but will need to be augmented appropriately.

Measuring the monitor

The particular hardware monitor we selected was the CPM II, manufactured by Allied Computer Technology, Inc. We acquired it for use on a variety of machines, the most demanding of which was the Control Data 6400.

The CDC 6400 has a basic clock rate of 10 MHz, i.e. a 25 nsec pulse appears every 100 nsec. Just for perspective, note that an unimpeded electrical signal at the speed of light will travel about 100 feet in that 100 nsec. With the lower transmission speeds in the probe cables, this means that at any one time a cable 100 feet long might have several pulses injected into the probe pickup end before one appeared at the monitor terminals at the far end. This made it rather important to measure the relative amount of delay in the probes and cables. Clearly, if these delays were not uniform from one cable to another, coincident events within the host computer might not be coincident by the time pulses are delivered to the monitor. Similar considerations applied to the delays through the logic circuits and to the back-panel wiring between the probe cable connectors and the logic circuits. From our measurement of a sample of 45 probes, we found a maximum difference in delay of 7 nsec. Back-panel delays varied by an additional 15 nsec, so a worst-case difference of 22 nsec could occur. Clearly then, for some crucial experiments requiring close synchronization of fast pulses, it is necessary to match various path lengths in order to maintain coincidence. Of course there are

many measurements of interest that do not involve fast pulses, where one is sampling relatively steady signals within the host computer and where one can "latch" a short pulse and convert it to a steady level in the monitor. Still, some care is needed to be sure the signals have achieved steady state levels before taking a data point.

Similar considerations, of course,

apply to the comparator probes. However, the situation is usually more critical because data change rapidly and one must carefully choose the delay of the strobe pulse as well as match delays of the comparator probes and cables.

Another general concern in dealing with fast pulses is preservation of wave shape from one end of the cable to the other. Discontinuities can give reflec-

Minimum technical specifications

In the following list of the minimum technical specifications, the particular values pertinent to our installation may not be significant for others, but they are included here in parentheses. Since the numbers shown are a combination of what we asked for, what we received, and what we wish we had, they should be viewed primarily as illustrative.

1. Probes.

- Minimum number required in addition to probes for comparators (18).
- Individually adjustable for signal level and threshold.
- Impedance level (100K ohms or greater; 10 picofarads or less). The capacitance measure is to include any wires or connectors between probe terminals and host computer.
- No significant transient shall be fed back into the host computer when the monitor power is turned on and off.
- Minimum pulse width detectable at probe pickup (20 nsec).
- Pulse shape delivered at monitor terminals: There shall be no spikes that might lead to spurious multiple triggering of event counters. The delay of leading and trailing edges relative to the probe input signals should be known and constant within maximum allowable dispersion figures.

2. Comparators.

- Minimum number of comparators (2).
- Number of comparison values allowed per comparator (2).
- Minimum number of bits per comparison (20).
- Maximum comparator load time (50 nsec).
- Maximum comparison rate (10 MHz).
- Provide delay-matched probes and comparator input circuits. Maximum delay dispersion among comparison bits due to probes and input circuits is to be less than specified amount (5 nsec).

3. Counters.

- Minimum number of counters (16).

- Minimum counter lengths (10 decimal digits).
- Minimum pulse width detectable (20 nsec).
- Maximum count rate (10 MHz).
- Count modes (event mode and time-interval mode).

4. General features.

- Delay through logic circuits is to be measured and stated by vendor. Maximum dispersion of delay within a given type of logic element shall be no greater than specified amount (5 nsec).
- Visual display: adequate to observe that equipment is running properly.
- Clock: Self-contained clock required with means for substituting an external clock or synchronizing with one. Required internal clock resolution: (100 usec). Required internal clock stability over 24 hours: (1 part in 10⁵).
- Synchronization with host computer. Required in order to correlate hardware measurement with host computer software activities.
- Data collection register for transferring host computer data (sensed by monitor probes) to monitor's magnetic tape.
- Buffering: double-buffered for no loss of data during recording.
- Recording intervals. Control of monitoring intervals determined, at user's option, by settings in monitor or by signals from external source or host computer.

In addition to the above, a request for bid should include a number of more conventional topics. Details are not included here; only headings are listed.

5. Magnetic tape specifications.
6. Optional features. (The manner in which optional features should be handled in the bid.)
7. Calibration and stability.
8. Maintenance.
9. Documentation and instructions.
10. Environmental specifications. (Temperature range, power supply variations, etc.)
11. Acceptance tests.
12. Pricing.
13. Delivery.

²L. A. Aschenbrenner and N. K. Naratajan, "The Neurotron Monitor System," *AFIPS Conference Proceedings*, Fall 1971, pp. 31-37.

³J. Hughes and D. Cronshaw, *On Using a Hardware Monitor as an Intelligent Peripheral*, Technical Report, 1973, Xerox Corp., El Segundo, Calif.

⁴E. F. Miller, Jr., D. E. Hughes, and J. A. Bardens, *An Experiment in Hardware Monitoring*, Report RM-1517, General Research Corp., Santa Barbara, Calif., July 1971.

tions that cause a pulse, after amplifying and clipping, to look like several pulses. This results in multiple triggering or other forms of confusion at the monitor. A previous user who had applied an earlier version of the CPM II to the measurements of a CDC 6400⁴ had experienced trouble with this point, but fortunately the manufacturer had redesigned the probes and had cured

the problem prior to delivery of our monitor. A careful check of pulse shapes at the host computer and at the hardware monitor showed the expected capacitive "smear," as shown in Fig. 2 (p. 89), but the result was entirely usable.

Additional measurements included counter accuracy at rated maximum speed, with and without intervening

logic. This brought up an interesting point for which one should watch, if maximum speed is important. Manufacturers' specifications are usually written in very simple terms, such as, "counters will operate at a maximum of 10 MHz." However, if one wishes to count events that require fairly elaborate logic between incoming pulses and the counters, one may end up with a

Technical questions

In addition to the items listed as minimum technical requirements, we included a list of questions in the request for bids and asked that they be answered either on the format sheets we provided, or that page references to the vendor's standard publications be keyed to the format of our questions. The questions had a dual purpose: One was in recognition of the possibility that the manufacturer's standard products might go beyond the minimum technical specifications, and the purpose was to inform us of the additional capabilities easily obtainable. A second purpose in some cases was to provide additional understanding of the way the vendor's system operated, in order to facilitate comparisons. The list is included here as a starting point; any given reader may find that a considerably modified list is most appropriate for the planned usage.

1. Probes.

- Specify "ruggedness" of probe in terms of number of feet it can be dropped onto a concrete floor without physical or electrical damage.
- Maximum available number of general probes.
- Maximum available number of comparator input probes.
- Are "concentrators" available to minimize the number of cables between host and monitor?
- How does probe input impedance level vary as a function of impressed signal level?
- What is the minimum pulse width at the probe input that will reliably trigger all logic and counter modules?
- What probe line lengths are available? Give the minimum, maximum, and the increments.
- Are probe power supplies built into the monitor? If so, what is the maximum number of probes handled by the power supply? If auxiliary power supplies are required, state number of probes handled by each module.
- What voltage (if any) appears at the probe terminals when monitor power is turned on and probes are not connected to the host computer?

2. Comparators.

- What comparison logic is built into the system for use with comparators?
- What is the maximum number of comparators available?
- What is the maximum number of bits that may be compared per value?
- What is the maximum number of comparison values per comparator?
- Are the comparison values inserted manually or electronically by the investigator? If electronic, give the minimum time needed to reliably change comparison values.
- Can multiple comparators be attached to the same set of probes? If so, what maximum number of multiple comparators may be used?
- What is the minimum time required to reliably load the comparator with data from the host computer?
- What maximum comparison rate may be used?
- What is the coding of comparison values? (Binary, hexadecimal, etc.)

3. Counters.

- What is the maximum number of electronic counters available?
- What is the maximum counter length available?
- Is there a counter overflow indication? If so, what type?
- What is the minimum pulse width that is reliably detectable?
- What is the maximum usable count rate?
- Are the counters individually resettable?
- What is the nature of the counter reset signal? Is it manual or electronic? If electronic, what minimum time is required for reliable resetting?

4. Data recording.

- Can the monitor record data from the host computer, or can it record only the processed output of the monitor? If the former, describe (at the block diagram level) how it is accomplished. State the register length and the minimum time required to reliably load the register.
- What choices are available in the magnetic tape drive with respect to the following factors?

- Number of tracks.
- Densities.
- Recording rates.
- Reel lengths.
- Tape speed.
- What record formats are usable? (Blocked, unblocked, code used, etc.)
- What data types are recorded? (Header, clock, counter, etc.)
- Is an experiment identification number recorded?
- Is there an automatic check on correctness of recording? If so, what type? (Parity, read-after-write, etc.) What is the nature of the action taken by the monitor when error is detected? What degree of control does the user have over alternate actions?

5. General features.

- Can the hardware monitor be turned on for T_1 seconds every T_2 minutes with independent choice of T_1 and T_2 ? State limitations, if any, and describe how sampling is controlled.
- Can monitoring functions be turned on or off by logical output from the monitor front end, or external electrical signals (e.g. host computer or separate remote control)?
- What means are provided for reading time from the host computer to correlate measurements with program execution data?
- Describe from an operational viewpoint the synchronization of the monitor clock with the host computer clock. What types of synchronization are allowed and to what accuracy?
- Can an external clock be used to drive the monitor? If so, what limits on obtainable precision are imposed by the monitor?
- Are data error detection circuits provided in the monitor? (Other than tape writing, which is discussed above.) If so, against what errors do they protect, and what automatic action is taken if an error occurs?
- What logical operations are possible on signals into the monitor?
- What is the method for selecting and interconnecting the front end logic?
- What type of visual display is used? What is the maximum number of bits displayed?



ANNOUNCING COMTAL 8000 DIGITAL IMAGE PROCESSING SYSTEM

How many of your industrial and scientific problems would be easier to understand and solve if you could get a true picture of what they look like? Even better—if the storage, restoration, enhancement and processing of pictures were done in real-time the contents could be scrutinized and evaluated in minutest detail to reveal hidden answers. In brief, this device would help you see a problem as you have never seen it before. Such is the purpose and capability of the COMTAL 8000 series of Digital Image Display Systems.

The new 8000 permits you to pictorialize the problem—be it in plant operations, energy research and development, medical or industrial X-ray work, law enforcement, weather analysis, earth resources study, and hundreds more. Working directly with a computer or as a stand alone system the versatile 8000 creates exciting new opportunities for the solution of many critical problems.

All image storage and manipulation is performed in an entirely digital manner and controlled in real-time . . . dynamic operator interaction and full range of options provide maximum flexibility . . . with a concern for economy, the 8000 is conveniently field expandable. You can begin with a black and white image display, easily expand your system to pseudo or full color capability as your application may dictate. Get the full picture now. Call or write: COMTAL Corporation, 333 N. Santa Anita Ave., Arcadia, Calif. 91006 - (213) 445-0764.

COMTAL

IMAGE PROCESSING

HARDWARE MONITOR

maximum counting speed that is well below the capabilities of the counters themselves.

In addition to measuring the characteristics of the monitor alone, a very important set of measurements dealt with the effects of the monitor on the host computer. Our original list of questions and specifications during procurement of the monitor did not include any items relating to inadvertent injection of signals from the monitor back into the host computer. (The amended list now does include these items.) We quickly learned that a reliable way to "crash" the host computer was simply to turn the monitor on or off while any one of the probes was connected to the host. Problems due to this are avoidable, of course, by the operational procedure of making sure that the monitor is turned on prior to the beginning of host computer operation and turned off after the day's work is finished. However, at best this is an

annoying requirement.

A much more insidious problem arose from the combination of the host computer having some very sensitive areas and the monitor having greater input capacitance across the probe terminals than was called for in the specifications. As an experiment we placed the monitor probes in a portion of the CDC 6400 that we knew was very sensitive. (For those who know the machine, it was in the peripheral processor "barrel.") The worst thing happened—the system crashed intermittently! Everything would proceed smoothly for a while until some data-sensitive condition occurred, and then the whole system would go down. We had two solutions for this. First, we made some measurements to determine the magnitude of the effect; second, we found other ways to extract data from sensitive areas of the machine. This made use of software to extract the information and place it in less sensi-

tive registers in the host machine where the hardware monitor could then observe the data.

The measurements to assess the effect of the probes on the host were as follows: We measured the timing shift in the CDC 6400 clock pulses due to placing the monitor probe across the clock circuit, and compared this with the shift caused by placing standard test capacitors across the same point. To do so, we took one of the several clock "chains," i.e. sequences of amplifiers that passed a given clock pulse phase throughout various parts of the machine. With A, B, and C denoting three points progressing along this chain, as shown in Fig. 3, we placed measuring apparatus (a dual beam oscilloscope) at points A and C to observe the relative pulse shift before and after attaching our monitor probe (or test capacitor) across point B. The results are shown in Fig. 4. The test capacitors were those used in normal marginal checking of the machine during preventive maintenance, and they caused shifts of 4 to 5 nsec. The hardware monitor probe caused a shift of 1½ to 2 nsec, indicating that it had a net equivalent capacitance of 11 to 15 picofarads, which was higher than the specifications on the monitor. The 1½ to 2 nsec delay is not large, but obviously is significant in some parts of the CDC 6400.

In summary, most of the measurements on the monitor proved it to be what we expected. There were some disagreeable surprises, some of which stemmed from our failure to anticipate some points that later proved "obvious." Some of the surprises stemmed from the monitor itself, and some from the host computer and its sensitivity. All three of these sources of surprise can be important to the prospective purchaser of the hardware monitor, particularly if the application is to be near the upper limits of the monitor's capabilities.

Requesting bids

If one takes the approach of competitive bidding, one is faced with two problems in the request for bids; stating the minimum requirements, and getting the vendor to describe features of the proposed monitor in a way that facilitates comparison. We took the approach of listing the minimum technical requirements, then listing a number of questions to elaborate not only on how the minimum requirements were being met by the vendor, but also to provide an understanding of additional capabilities. We asked that all vendors put these answers in standard format in order to make comparisons more easy.

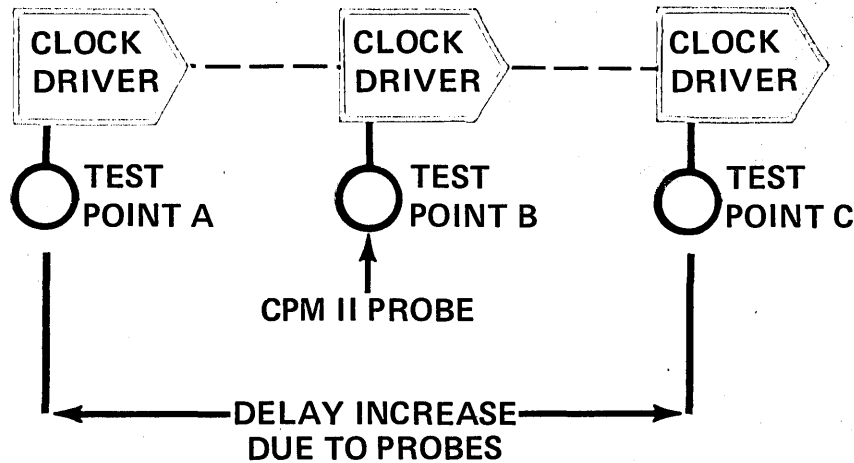

Fig. 3. Delay measurement method.

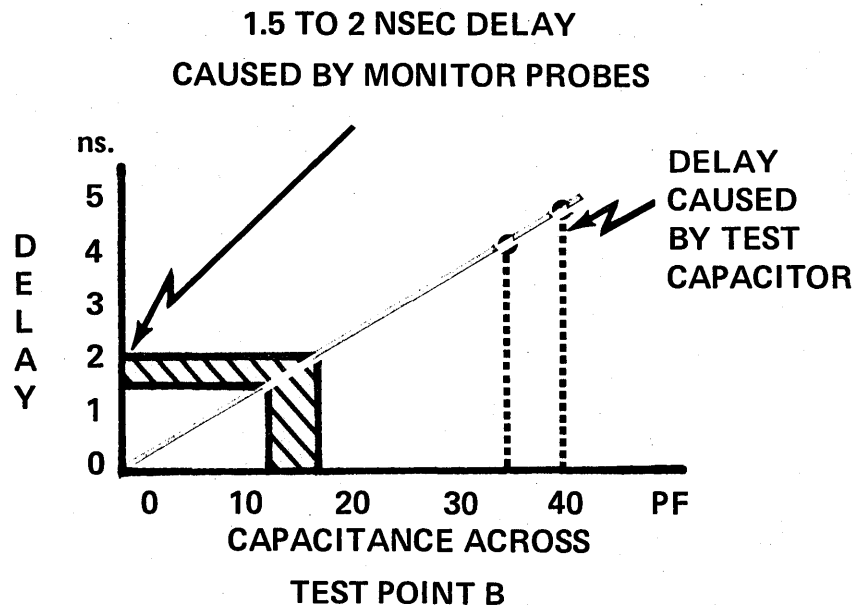

Fig. 4. CDC 6400 clock delay caused by CPM II probes.

**REPLACEMENT
MEMORY PUTS**

EMM IN THE LINE-UP

**AT THE NFL
PLAYER DRAFT**

The annual draft analysis for three NFL football teams is only one of the many uses to which Optimum Systems, Inc. puts their two 360/65 systems, each with a total of 2 megabytes of EMM memory. Others include such applications as the development of stress factors for multi-story office buildings and record control for six neighboring municipal departments.

Why have so many Systems 360 and 370 users like Optimum Systems chosen EMM compatible memory?

With some, **reliability** was the key. They know that EMM has more **experience** with semiconductor, core and disk memory **technology** than any other memory company. They know that EMM controls every step of its manufacturing processes from basic storage component through finished system.

Others had a budget problem. They discovered that EMM is willing and able to tailor its **terms** to meet their specific needs.

With still others it was essential that their memory supplier be around to stand behind their products. And they knew that EMM has the **stability** of a major NYSE company committed to the memory market.

But whatever their reasons, they are now **satisfied customers** of EMM, and our best references. Ask them about us.

And ask about our compatible memory systems for 360 and 370 systems. They come in all degrees of capacity, but only one degree of performance: **dependable**.

EMM COMPUTER
PRODUCTS

A Division of Electronic Memories & Magnetics Corporation
12624 Daphne Avenue, Hawthorne, California 90250

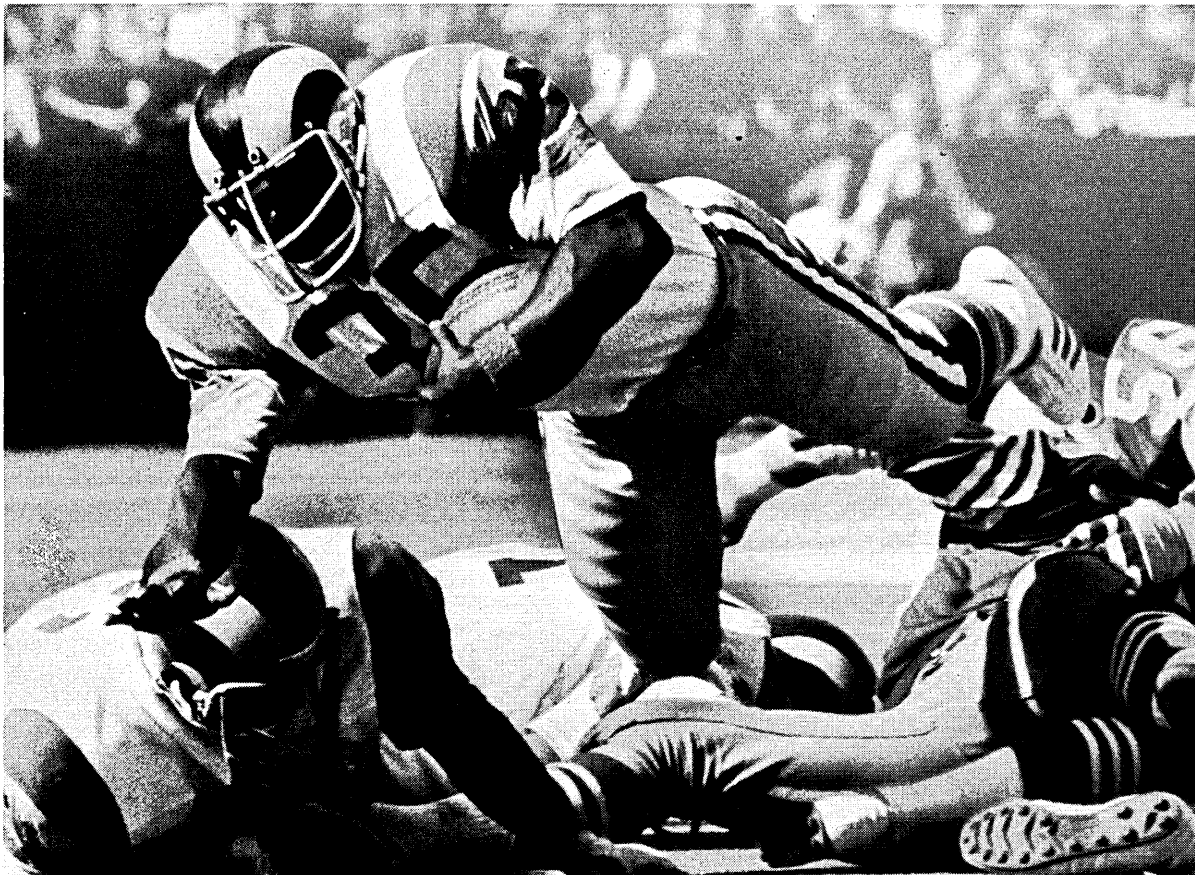

See us at NCC in Chicago, Booth 671, and on tour with Computer Caravan.

HARDWARE MONITOR

These two lists (Minimum technical specifications and Technical questions, pages 90 & 91) are included with no implication that they will cover all points of interest to the prospective monitor user, but with the hope they will provide a useful starting point.

When the monitor is ready for use, there are some general points worth observing. Don't use the hardware monitor just to make measurements. Do use it to help answer significant questions. It is all too easy to gather a lot of information and then discover you don't know how to use it. A very effective way to decide what is significant is to ask yourself the question, "What decisions might I make based upon this information?" It's a deceptively simple question; it is really quite hard to use it conscientiously, but it's worth doing so. It will force the kind of planning that leads to the related question, "Is the potential dollar value of this decision worth the cost of measurement and analysis of the data?"

Do let the hardware monitor sit idle until you have a plan. This may go against the grain because you will worry about wasting all that money paid for the monitor. An impelling argument; but why make things worse by adding the cost of manpower to gather data you don't need, sift through reams of data you don't understand, and answer questions that are unimportant?

Don't try to do the whole job with the hardware monitor (or only with a software monitor). We often hear of the relative advantages of hardware and software measurement techniques; for example, hardware monitors don't disrupt the computational process as much as software monitors. On the other hand, software monitors can more easily give information on cause and effect. Why choose? Use both techniques.

Don't take too seriously the common statement, "Hardware monitors do not interfere with the host system." It means, of course, that a hardware probe does not steal execution time and hence change the time relations of the situation you're trying to measure. But there are other ways a hardware monitor can interfere, some of them quite drastic, as was noted in previous sections of this paper.

Do doublecheck, using alternate measurement means, to see if you are really measuring the quantities you thought you were measuring. You can be fooled for a number of reasons: The definitions of terms are not always clear in the documentation of a large, complex system. (For example, does "cpu busy" include idle loops where the cpu is doing no useful work?) Relative delays, as discussed above, can

lead you to measure events that are different from what you thought. Also, probe placements can be incorrect, or logic diagrams can be misread; worse yet, the diagrams might not agree with the manner in which the machine is actually wired.

What about the future?

In the long run, separate hardware and software monitors should vanish. Instead, the monitoring capabilities should be built into the host system, both in the hardware and in the operating systems. This is an extreme view, and it probably will never happen to the extent one would like, but it does define a direction. If measurement points can be built into Volkswagens, why not into computers? Manufacturers could provide easily accessible and well-defined signals for the busy states of major resources, such as channels, central processor, I/O controllers, and others. In protected systems in which one user is unable to read the contents of another's memory, one could still provide means for a system program, or a privileged user program to read the system core so that data may be gathered more easily. An output register, to which the external monitor could be attached, should be available for easy transfer of data by the host system to the monitor.

Some manufacturers are sufficiently forward-looking to begin to place measurement aids within systems; however, others are not. Ultimately it will be pressure from those who buy or lease computers that will force the issue. As people learn what they want to measure, why they want to measure it, and the manner in which it can pay off in dollars, the demand for the necessary measurement tools will become part of the process of selecting a new computer. □

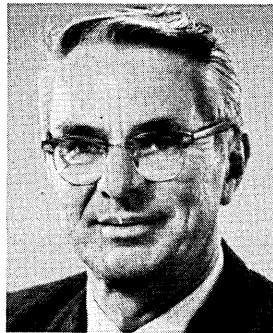

Dr. Noe is chairman of computer science and professor of computer science and electrical engineering at the Univ. of Washington. He was previously executive director of information science and engineering at Stanford Research Institute. He has a PhD from Stanford Univ.

There's an EMM office near you.

ATLANTA

(404) 633-1212

BOSTON

EMM Corporation (617) 861-9650

CHARLOTTE

(704) 364-5158

CHICAGO

EMM Corporation (312) 297-3110

CLEVELAND

EMM Corporation (216) 884-1980

DALLAS

EMM Corporation (214) 243-2374

DENVER

(303) 794-4231

DETROIT

EMM Corporation (313) 352-1040

FORT LAUDERDALE

(305) 587-3849

HOUSTON

EMM Corporation (713) 626-3592

LOS ANGELES

EMM Corporation (213) 477-3911

MINNEAPOLIS

(612) 546-4422

NASHVILLE

(615) 868-1004

NEW YORK

EMM Corporation (201) 845-0450

OMAHA

(402) 551-4882

PHILADELPHIA

EMM Corporation (609) 428-9391

PITTSBURGH

EMM Corporation (412) 921-1221

ST. LOUIS

EMM Corporation (314) 863-0015

SALT LAKE CITY

(801) 355-8321

SAN FRANCISCO

EMM Corporation (415) 692-4250

SEATTLE

EMM Corporation (206) 623-1477

WASHINGTON, D.C.

EMM Corporation (703) 941-2100

ONTARIO, CANADA

EMM Corporation (416) 447-5134

BRUSSELS, BELGIUM

EMM S.A. (02) 12.30.80

ESCHBORN, GERMANY

EMM GMBH 06-196-4817

LONDON, ENGLAND

Electronic Memories, Ltd. 01-751

PARIS, FRANCE

EMM N.V. 227-5619

OSAKA, JAPAN

Kanematsu Electronics, Ltd.

(06) 201-5547

TOKYO, JAPAN

Kanematsu Electronics, Ltd.

(03) 543-7611

EMM COMPUTER PRODUCTS

in dispersed
data processing: **Datc**

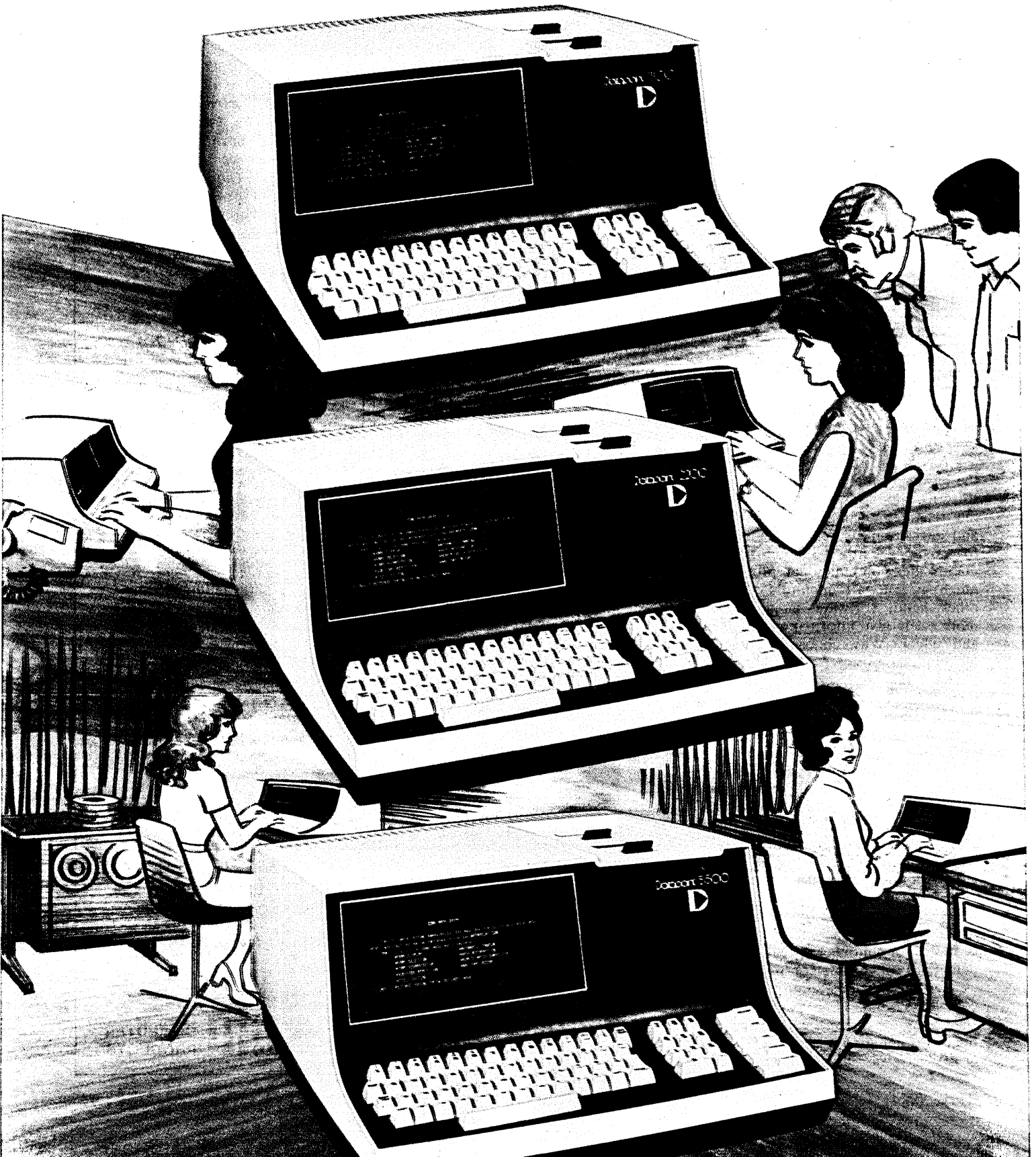

point is king



Datapoint Corporation is indeed King in Dispersed Data Processing. It's our principal business, and has been for several years. And a fast-growing, dynamic business it is, which partially explains our pride at being the industry leader.

No other company has done as much as Datapoint to convert the concept of Dispersed Data Processing into a commercial reality. The more than 4,000 Datapoint 2200® Terminal Processors currently installed world-wide testify to this leadership, as does our recent introduction of the new Datapoint 1100 Intelligent Terminal and the Datapoint 5500 Remote Processor. No other computer manufacturer can offer such a trio of progressively more powerful dispersed processing systems, with full upward compatibility. Unique in the industry, their compatibility permits work load expansion in your field offices to be handled easily, painlessly, without the need for expensive software rewriting. No other maker provides such broad software support for its dispersed processors.

Datapoint's innovating leadership in product development has captured the imagination of the user community because Dispersed Data Processing is an idea whose time has come. Many organizations now enjoy an abundance of computer power at a central facility, but find it difficult to make this data processing power available efficiently and economically to their field locations where the company's critical source documents are generated. Installed in these field environments, Datapoint equipment offers an efficient means of com-

municating with, and accessing the power of a central computer while also providing a significant on-site processing capability.

With its built-in computer power, an on-site Datapoint dispersed processor can pre-process and otherwise "massage" data collected locally *before* sending it on to a central computer, which can then process this data immediately in those applications at which it is most efficient. In addition, The Datapoint 2200 Terminal Processor and Datapoint 5500 Remote Processor, which offer progressively greater computer power, can serve in effect as local "computer utilities" in a company's field offices. As "utilities," these units can furnish central compute power for clusters of low-cost data entry terminals situated locally, accepting their data, pre-processing and formatting it and sending it along to the central computer. They can also provide compute power to drive magnetic tape units, serial printers, disc units and other important peripheral systems in field office locations. To insure the smooth operation of all systems, Datapoint provides a full complement of proven-in-use software and programming languages for easy use by field office personnel.

We know more about Dispersed Data Processing than any other company because we've done more than any other company. If Dispersed Data Processing is an idea whose time has come at your company, we'd like to share our knowledge with you. To start the ball rolling, contact the sales office nearest you or Datapoint Corporation, San Antonio, Texas 78284.

Datapoint

Come Visit Us At The NCC, Booth #367.

Home Office: 9725 Datapoint Drive/San Antonio, Texas 78284/(512) 696-4520 • **Direct Sales Offices:** Atlanta/(404) 458-6423 • Boston/(617) 890-0440 • Chicago/(312) 671-5310 • Cincinnati/(513) 421-6122 • Cleveland/(216) 921-9200 • Dallas/(214) 630-1342 • Detroit/(313) 557-6092 • Greensboro/(919) 299-8401 • Houston/(713) 688-5791 • Los Angeles/(213) 645-5400 • Minneapolis/(612) 854-4054 • New York/(212) 759-4656 • Philadelphia/(215) 643-5767 • Phoenix/(602) 265-3909 • Pittsburgh/(412) 931-3663 • San Francisco/(415) 968-7020 • Seattle/(206) 455-2044 • Washington, D.C./(703) 790-0555 • **International Representatives:** TRW Electronics—International/Los Angeles, California, TELEX 674593 • TRW Communications/Toronto, Canada (416) 481-7288

A controlled approach to making changes to a computer system improves communications, strengthens user department to dp department rapport, and puts all alterations on a dollars and cents basis

CONTROLLING A COMPUTER

It is unfortunate, but too often true, that even in today's world of advanced computer technology most changes to existing production computer systems remain purely reactionary.

They are often made at the whim of the programmer or the user area for which the production system is run, and little, if any, effort is made to control these changes according to actual vs. supposed need, and dollar savings vs. programming, testing, and installation costs. It is also true in these instances that not all those who may be affected by a change are given the opportunity to make some comment or objection before it becomes a part of the production environment.

The results which can be achieved by the formulation and adoption of a procedure for making changes or alterations to a production computer system via a controlled approach can be startling. Important changes suddenly become less so when a cost-out shows it would take several months or years of clerical salary to offset the costs to program, test, and install them. The manager of a user department suddenly realizes that the dollars involved in making a change on a listing or report are such that the present data is sufficiently meaningful after all. This rationalization does not, of course, apply to error situations. They should not have to be handled through a cost-out system for anything other than for budgetary purposes.

A surprising by-product of a controlled approach is the organization and purpose which becomes evident. People become better informed and can anticipate changes and their effect on workload, scheduling, etc. They can stop sudden bulges in their budget by knowing about the changes before the fact and can react in a positive or a negative manner.

At the Prudential Insurance Co.'s Financial Security Program office in Phoenix, we are the national adminis-

trative headquarters for a variable annuity program, and currently run three basic production systems on a daily cyclical basis, as well as an MIS system, year-end tax systems, etc. Our current computer is an IBM s/360-501-512K

with disc and tape, and operating with OS, HASP, and PRU-COBOL. In the following paragraphs I have outlined the procedures for the alteration control system we have applied to better control the changes and alterations to

COMPUTER ALTERATION REQUEST

NUMBER

PROGRAM #	MODULE #	PROGRAMMER
DESCRIPTION OF ALTERATION:		
REASON FOR/OR EFFECT OF THIS ALTERATION:		
IS THIS THE RESULT OF AN ERROR? <input type="checkbox"/> YES <input type="checkbox"/> NO* ERROR OCCURED IN CASE # DATE:		

SUBMITTED BY		AREA/UNIT	DATE
APPROVALS		PRIORITY	
SUBMITTING AREA	NAME	DATE	APPR.
USER DEPARTMENT			
COMPUTER SYSTEMS			
SYSTEMS TESTING			
QUALITY REVIEW			
ALTERATION COMMITTEE			
REASON FOR REJECTION OR COMMENTS:			
<p style="font-size: small;">*IN ALL EXCEPT ERROR SITUATIONS, THIS ALT MUST BE ACCOMPANIED BY COST-ANALYSIS MATERIAL SUPPORTING THE REQUESTED CHANGE. THIS SUPPORTIVE MATERIAL WILL BE WEIGHED AGAINST THE AMOUNT OF SYSTEMS EFFORT NEEDED TO ACCOMPLISH THE DESIRED CHANGE AND THE ALT WILL BE ACCEPTED OR REJECTED ACCORDINGLY.</p>			
-- SYSTEMS USE ONLY --			
<input type="checkbox"/> SYSTEMS TESTING REQUIRED		<input type="checkbox"/> SYSTEMS TESTING NOT REQUIRED	
SYSTEM	DATE SCHEDULED	DATE INSTALLED	ALT CONTROL AUTHORIZATION
<input type="checkbox"/> EQ			
<input type="checkbox"/> EM			
<input type="checkbox"/> EE			

Fig. 1.

SYSTEM

by Donald L. Black

these production computer systems. When applied, as a matter of fact, it helped to overcome the gaps in communications, established a user department/dp department rapport, and at the same time put it all on a dollars and

cents basis. The alteration control system as described is quite simple, which has something to do with the fact that it works, and works well. Basically, it is centered around two controlling documents which we call the computer al-

teration request form and the project/alteration cost-out sheet. The dollar figures and systems designations in use on the project/alteration cost-out sheet will, of course, vary with the particular application and installation, as will the systems designations on the computer alteration request form.

PROJECT/ALTERATION COST-OUT SHEET

PROJ/ALT NO. _____

Initiated by: _____ Division/Unit _____

Date Initiated _____ Desired Implementation Date _____

Systems Affected EO EM EE EN Other _____

of Programs Affected _____ # of Modules Affected _____

Names/Numbers of Programs Affected _____

Are:

New Programs Required?.....	<input type="checkbox"/> Yes*	<input type="checkbox"/> No
Record Format Changes Required?	<input type="checkbox"/> Yes*	<input type="checkbox"/> No
Input Format Changes, or New Inputs Required?	<input type="checkbox"/> Yes*	<input type="checkbox"/> No
Output Format Changes, or New Outputs Required?	<input type="checkbox"/> Yes*	<input type="checkbox"/> No
Forms Design Changes, or New Forms Required?	<input type="checkbox"/> Yes*	<input type="checkbox"/> No

	ESTIMATED MAN HOURS	ESTIMATED MACHINE HOURS
Definition _____	Hrs @ \$00.00= \$ _____	_____ Hrs @ \$00.00 = \$ _____
Documentation _____	Hrs @ \$00.00= \$ _____	_____ Hrs @ \$00.00 = \$ _____
Coding _____	Hrs @ \$00.00= \$ _____	_____ Hrs @ \$00.00 = \$ _____
Compilation _____	_____	_____ Hrs @ \$00.00 = \$ _____
Program Testing _____	Hrs @ \$00.00= \$ _____	_____ Hrs @ \$00.00 = \$ _____
Systems Testing _____	Hrs @ \$ 0.00= \$ _____	_____ Hrs @ \$00.00 = \$ _____
Other _____	_____	_____
	\$ _____	\$ _____
Totals _____	Hrs \$ _____	Hrs \$ _____

_____ Date _____ Signature _____

*If Yes, attach a sheet briefly describing the requirements.

COORDINATOR USE ONLY:

Estimated Start Date _____ Estimated Completion Date _____**

**How does this change affect other currently scheduled Alterations/Projects: _____

Alteration control step by step

A computer alteration request form (ALT) is required whenever a modification is to be made to the computer production programs (Fig. 1). This includes, but is not limited to, production errors, changes in specifications, systems improvements, new programs, etc. In all except error situations the ALT must be accompanied by cost-analysis material supporting the requested change. This supportive material will be weighed against the amount of systems effort needed to accomplish the desired change as shown on the project/alteration cost-out sheet (Fig. 2) and the ALT will be accepted or rejected accordingly. The ALT may also be rejected by any of the involved or affected department users.

The submitting group completes the description of the alteration as well as the reason for, or effect of, the alteration and the desired effective date. The description must contain detailed justification for the ALT; e.g., time savings, monetary savings, user/client service, correction of a production error, systems affected, etc. In all except error situations ALT's for new programs must include the documentation necessary for writing the programming specifications. To ensure the validity of the ALT the manager of the submitting group must sign or initial the ALT before it is sent to alteration control. If the submitting unit is the systems division, the manager of the area most affected by the ALT must sign or initial it.

When the alteration control clerk receives a properly approved ALT from

Fig. 2



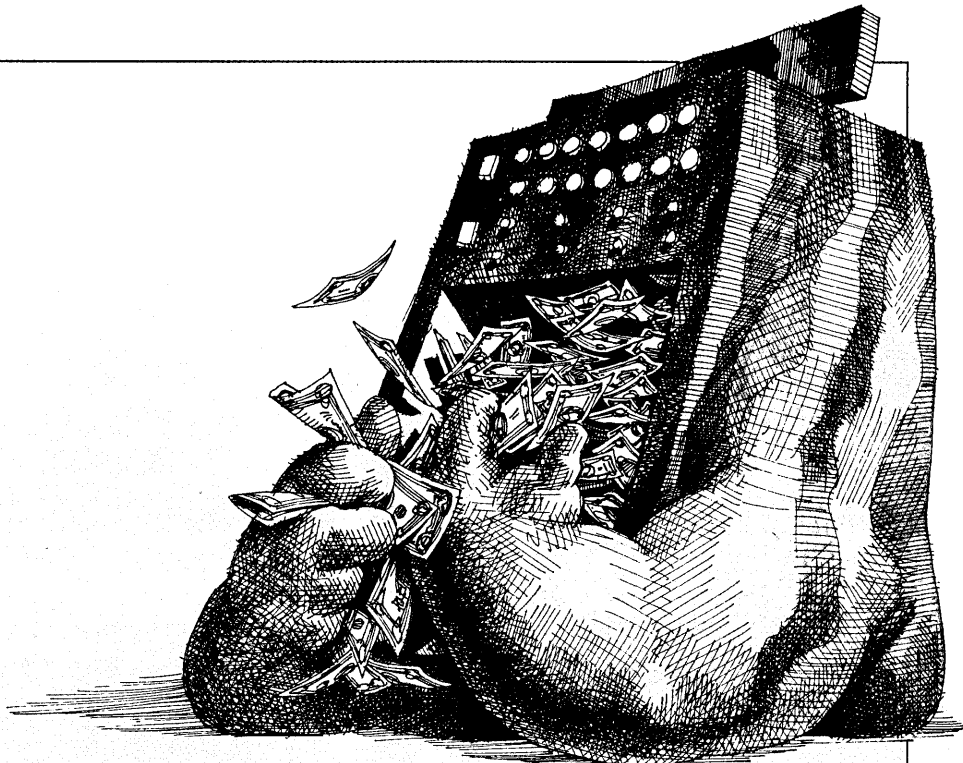

Your computer shouldn't eat you out of business.

At ITEL, we can help you keep a tight rein on your data processing budget.

Because we lease IBM computers in the most financially attractive packages available. IBM's 360 and 370 mainframes, matched with our own technologically advanced peripherals.

Such a packaged lease from ITEL can save you up to 60% over the rental of a comparable all-IBM system.

What's more, we'll make sure that all terms and provisions in your lease are custom-tailored to meet your exact financial objectives. After all, we couldn't have acquired over half a billion dollars in IBM computer leasing experience without making our clients more profitable, too.

Your financial alternative.

ITEL
CORPORATION
DATA PRODUCTS GROUP

One Embarcadero Center, San Francisco, California 94111, Phone: (415) 983-0000

Micro

vs.

Maxi

If all you want are the features of a 3270, then a video terminal system controlled by a micro-computer is acceptable.

If you expect extras, you need the maximums allowed by Quotron Systems mini-computer based Intelligent-Terminal System.

With a repertoire of over 200 instructions, get flexibility with programmability.

Combine the throughput of a 750-nanosecond memory cycle time with up to 12 input-output channels, each with direct memory access.

Control up to 24 video terminals with three input-output channels and still have room for 64 communication ports per remaining channel.

Perform local file processing or store-and-forward functions with an added disc or logging with a magnetic tape drive from a complete line of peripherals.

Besides assuring that power is available when you need it, Quotron Systems provides a lot more, like specialized software and communication expertise and a nationwide service organization.



QUOTRON SYSTEMS, INC.

Systems Marketing
5454 Beethoven Street, Los Angeles, California 90066 · Telephone: (213) 398-2761

CIRCLE 20 ON READER CARD

CONTROLLING

the submitting group, the clerk assigns a number to the ALT and makes an appropriate entry in a control log. The original is forwarded to the assistant manager responsible for the alteration control function and one copy is placed in an outstanding file. The assistant manager responsible for alteration control reviews the ALT to ensure that the documentation is complete. If it is not complete or is inadequate, the alteration is returned to the submitting group so that they may provide the necessary documentation. If this cannot be provided, the ALT is rejected.

User study next

After the ALT has been reviewed and the documentation is found to be in order, it is forwarded to the assistant manager of the affected user department for study. The file copy will be used for follow-up should the original ALT be unaccounted for after a reasonable amount of time.

An 80-80 computer-produced listing of all pending alterations is prepared and distributed on a weekly basis to all interested parties. The alteration control clerk prepares and maintains the card deck, including header and blank spacing cards, which is the basis for the computer listing. ALT's which have been implemented will remain on the list for two weeks and the cards are then pulled from the deck. (It should be said here that we can mechanize the procedure, but it is now sufficiently adequate for our needs and costs little to maintain.)

The assistant manager of the affected user department reviews the ALT for validity and purpose and makes his recommendations for the acceptance or rejection of the suggested change. He then signs the ALT and sends it, with any comments, to the assistant manager of the affected computer systems area who then discusses the ALT with the responsible programmer(s), and they jointly determine the involvement and costs necessary to implement the change. For minor changes and error situations they complete and attach the project/alteration cost-out sheet and establish a tentative date for installation. The assistant manager signs the ALT and the cost-out sheet and both forms are then sent to the systems testing area. For product or specifications changes involving major modifications to the existing programs or the addition of new programs, the assistant manager of the affected computer systems area acts as the coordinator on the completion of the cost-out sheets. In his role as coordinator, he discusses the project with the appropriate assistant managers and systems per-

sonnel and distributes multiple copies where multiple programmers are involved. He and the other assistant managers of the systems and methods division then act as a committee to compile these and use them to perform the actual scheduling. At this point, and should major changes in project scheduling occur, it becomes necessary to meet with the submitter, the affected user departments, and the members of the management staff to obtain concurrence on the revisions to project scheduling. When this concurrence has been obtained, the assistant manager/coordinator signs the ALT and the cost-out sheets and sends them to the systems testing area. If concurrence cannot be obtained, the ALT is rejected.

The systems testing area reviews the ALT and documents its necessary involvement and considered implementation problems. The ALT is then signed by the assistant manager of the systems testing area and sent to the quality review area.

Reviewing for validity

The quality review area reviews the ALT for validity. In doing so, quality review checks with systems testing, the user department, and computer systems in order to gather enough information to enable them to properly evaluate the ALT's and the subsequent testing to be done by systems testing. The assistant manager of the quality review area signs the ALT and sends it to the manager of the systems and methods division with any comments as to the feasibility.

In all except error situations the manager of the systems and methods division brings the ALT to the attention of the general manager and the manager of the user department. They jointly review the ALT and accept or reject it. The ALT is then returned to alteration control.

When a rejected ALT is returned, the outstanding file copy of the ALT and the reason for the rejection are returned to the submitting area. The original copy of the ALT is to be maintained in the systems and methods division for a period of six months, and then destroyed. The alteration control clerk advises the user department, quality review, computer systems, and systems testing of the rejection.

When the approved ALT is returned, the alteration control clerk gives the outstanding file copy to the programmer's assistant manager. The control log entry is completed and the original copy of the ALT is then placed in the outstanding file until programming and testing are completed.

The alteration control clerk accord-

ingly updates the card deck used to 80-80 produce the computer-created listing of pending alterations.

After the programmer has modified the program according to the computer alteration request and systems testing has tested and approved the change, the module/program is ready to be loaded into the production environment and our control function has been completed.

As a result of controlling and costing our changes through these procedures we found our dp workload has been considerably lightened and "crash-projects" have practically disappeared. We have just completed installation of two new complex production computer systems and, despite the fact that we have gone from a one basic system shop to a multiple production systems environment, we have been able to effect staff savings of 28% in the systems and methods division. Part of the reduction was made possible by directing our workload via our controlled approach.

Our future plans are to continue refinements and modifications to our present computer systems and to develop a totally new system which will accommodate conversational data entry via crt's. We also are planning to expand the usage of the project/alteration cost-out sheet as the kick-off document for a computerized system which will report on the status of present alterations and projects, show programmer workload, and forecast the workload over a six-month period with notice being drawn to overloads, etc. We thus hope to expand control over our production computer systems, use our staff more efficiently, and provide our user departments with the best service and response possible. □

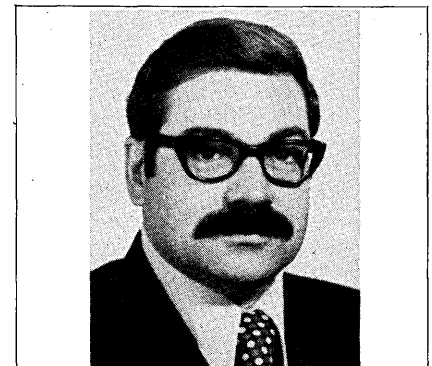

Mr. Black is the manager of the systems and methods div. and a registered principal at the Prudential Insurance Co.'s financial security program office in Phoenix. He was previously with Motorola, and with the federal government in Ohio and Michigan as a systems analyst.

Our newest entries in data-entry are outperforming the competition.

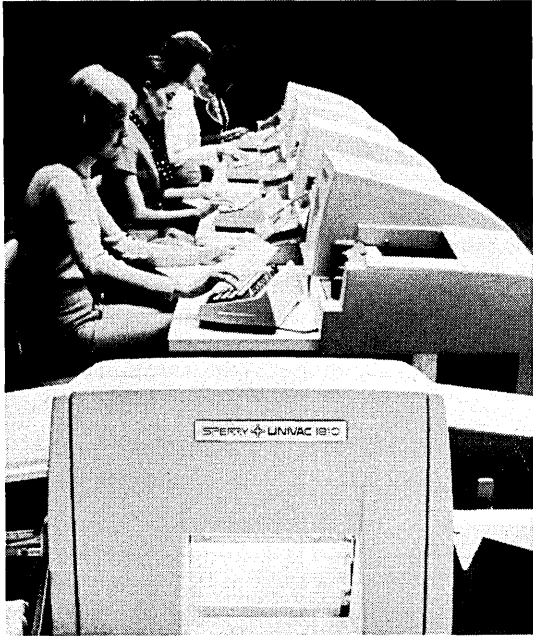

They're the UNIVAC® 1801 Verifying Punch and UNIVAC 1810 Verifying Interpreting Punch. And they're both a country mile ahead of the field.

Take the 1810 VIP. It's a keypunch, a verifier or an interpreter. Use it separately, or for all three functions. Or use it as a printing punch and printing verifier. Talk about versatility!

Then there's the 1801 VP. Use it for a keypunch or a verifier and keypunch. Either way, it's the fastest and most accurate way available to increase your 80-column punched-card output.

Look how the UNIVAC 1800 Series stacks up against the IBM 129, for example. We offer eight program levels to their six. We have range check, compare balance, store field, and must enter; they don't. We offer automatic program loading and selection; again, they don't. And our punch and printer speed is almost three times faster.

We're way out in front in standard features, too. Buffered verification, data accumulation, 320 digits of auxiliary data storage, production statistics and data validation are all standard in the 1800, while they're optional... or not even available... in the 129.

It all adds up to more speed, more control, more convenience and more economy in card preparation with our 1801 VP and 1810 VIP.

Like to discover all the reasons why the features, functions and benefits of the UNIVAC 1800 Series put us out in front? Talk to your SPERRY UNIVAC representative. Or write SPERRY UNIVAC World Headquarters, P.O. Box 500, Blue Bell, Pa. 19422.

SPERRY UNIVAC

Only when our customers succeed do we succeed.

What would you do with a Statistics and Number-Crunching Computer that starts at \$6,800*, has 16K Hardwired Basic Language and 28 Major Peripherals?



Plenty!

The new Wang System 2200 is a System. It gives you the raw power and the peripherals you must have for a wide range of problem solving. For under \$7,000 you get a CPU with 16K bytes of BASIC language instructions hardwired into the electronics . . . plus a 4K operating memory. You also get a big 16 lines (of 64 characters each) CRT display, a console mag tape drive and your choice of either alpha or BASIC Keyword keyboards.

Some Words About Language: The hard-wired MOS ROM language in your System 2200 finally ends your dollar trade-offs . . . economy systems that are costly to program or very expensive systems that are relatively easy to program. Many, if not most, of your people already know BASIC. They'll be solving problems the day your system is delivered (and, we can deliver in about two weeks). Most of your budget will go into problem solving; not system support.

Try To Out-Grow It: Main memory is field expandable in 4K increments (at \$1,500 per 4K). Up to 32K. You can choose from three kinds (and 7 price ranges) of printers . . . one even has a stepping motor for very precise 4-quadrant incremental plotting. Speaking of plots, we have a new, very large flatbed (31" X 42") for only \$7,500 or a smaller one if you plot small. Both print alphanumeric and plot under full program control. Been appalled lately by disk prices? Starting at just \$4,000, we offer you our new "floppy" disk in single, double and triple disk configurations (.25, .50 and .75 MB's). For big disk power, you can have 1, 2 or 5 megabyte fixed/removable disk systems. All peripherals, including punched or mark sense hopper card readers, paper tape readers and on-line BCD or ASCII controllers are easily added-on in the field so your System 2200 will grow with your needs.

The Wise Terminal: If you are now or may soon be getting into terminals, we have several new products that will instantly upgrade your System 2200 for telecommunications with any other System 2200 or a mainframe computer. And, you still have a powerful stand-alone system. Another approach, of course, is to justify it as a powerful terminal and get a "free" stand-alone computer. Wise?

We Do A Lot For You: System 2200 is backed by over 250 factory-trained Wang Service Technicians in 105 U.S. cities. Naturally, we guarantee or warranty everything you buy from us. If you want, there are free programming/operating schools here in Tewksbury, Massachusetts, almost every week. We have a growing program library on a wide range of statistics and math/science applications. Our user group (with the unlikely name of "SWAP") could help you cut programming costs even further. We do a lot for you.

* All prices U.S. List. If you're the entrepreneur type, we've just announced a new 7-module Basic Accounting System software package for the business end of your business like payroll, invoicing, inventory, receivables and some really fancy management reports.

WANG

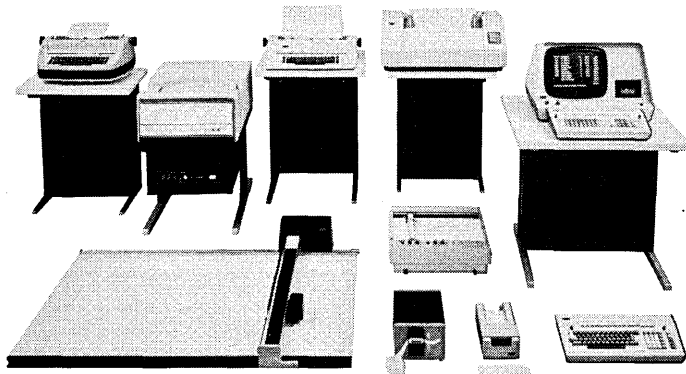

Even if you call the Wang System 2200 a small system . . . you have to admit it's a big idea.

- Please send literature
- Please have your representative phone me: _____

Name _____ Title _____

Company _____

Address _____

City _____

State _____ Zip _____

Wang Laboratories, Inc., D-4
836 North St., Tewksbury, Ma. 01876, Tel. (617) 851-4111

"Let me show you how you can get a lot of intelligence for very little money."

We've created low-cost data entry and transmission systems by adding magnetic tape cassette buffers to our paper tape buffered terminals. These dual buffered teleprinters can not only perform many of the data entry operations of more expensive dual cassette terminals, but they can control your transmission lines as well.

For example, in remote batch entry, our MSR terminals operate off-line as low-cost key-to-cassette terminals. The cassette buffer acts as the data recorder, and format control is set up on the paper tape buffer of the terminal to guide your operators. Or you can use the cassette buffer to store all formats until needed. Then you simply use the cassette off-line to cut paper tape format loops.

Either way, the data can be keyed during the day. Then, at your convenience, it can be forwarded to the computer in bulk at 120 cps to save on transmission costs. Rewinding and printing are automatic, so you don't need an operator.

In the on-line mode, the MSR cassette buffer turns any of our 10 or 30 cps terminals into low-cost 1200 baud terminals. So you can mix terminals of different speeds in your system to get the best configuration at each station. Our MSR

terminal can interface with them at any standard speed, then transmit bulk data back at 120 cps. This keeps your telephone and computer connect time down to a minimum. And instead of having different programs for different terminals, you need only one discipline at the computer.

With the discrete design of our cassette buffer, and selectable standard speeds of 10 cps, 30 cps and 120 cps, you can start small to build your data entry/transmission systems. As your needs increase, you can add on in any speed without having to change your present equipment or your software.

If you want to take the first step towards intelligent terminals, write Z. V. Zakarian, Western Union Data Services Company, 70 McKee Drive, Mahwah, N.J. 07430. Or call 800-631-7050 (N.J. 201-529-1170).



"Our buffer plugs into all our data terminals. Terminal with buffer rents for as little as \$115 a month!"

Z. V. Zakarian

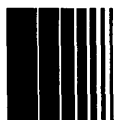

western union data services company

silent 700
electronic data terminals



Now. A quiet, reliable, 30 characters-per-second I/O data terminal. Only \$1500

*Silent 700** KSR data terminals cost-effectively enhance communications, process control, lab instrumentation and data processing systems.

They reduce the cost of downtime and repairs. A *Silent 700* KSR terminal will typically operate a year with only one or two service calls. They are backed by a nationwide force of TI service engineers and the field experience of thousands of *Silent 700* terminals operating worldwide.

They reduce costs with speeds up to three times that of conventional terminals.

*Trademark of Texas Instruments Incorporated

And they feature quiet, non-impact electronic printing.

Silent 700 KSR terminals are



"*Silent 700*" ASR terminal. \$2750.00

available with a variety of options to meet your system requirements.

And—as your system requirements grow—KSR terminals are convertible to ASR models simply by adding the cassette module and its controller.

KSR lease rates are \$75 per month for a 12-month lease, and only \$55 per month for a 48-month lease...both include maintenance.

For information, contact the nearest office listed below or Texas Instruments Incorporated, P. O. Box 1444, Houston, Texas 77001. Or call (713) 494-5115, ext. 2124.



Arlington, Va. (703) 527-2800 • Atlanta, Ga. (404) 458-7791 • Boston, Mass. (617) 890-7400 • Chicago, Ill. (312) 671-0300 • Clark, N.J. (201) 574-9300 • Cleveland, Oh. (216) 464-1192 • Dallas, Tx. (214) 238-5318 • Dayton, Oh. (513) 252-6128 • Denver, Co. (303) 758-5536 • Detroit, Mich. (313) 353-0830 • Hamden, Conn. (203) 281-0074 • Houston, Tx. (713) 777-1623 • Huntsville, Ala. (205) 837-7510 • Indianapolis, Ind. (317) 248-8555 • Milwaukee, Wis. (414) 475-1690 • Minneapolis, Minn. (612) 835-5711 • New York, N.Y. (212) 541-9540 • Orange, Ca. (714) 547-9221 • Orlando, Fla. (305) 644-3535 • Philadelphia, Pa. (215) 643-6450 • Phoenix, Az. (602) 249-1313 • Rochester, N.Y. (716) 461-1800 • San Francisco, Ca. (408) 732-1840 • Seattle, Wash. (206) 455-1711 • St. Louis, Mo. (314) 993-4546 • Amsterdam, Holland 020-456256 • Bedford, England 58701 • Beirut, Lebanon 353188 • Copenhagen, Denmark (01) 917400 • Frankfurt, Germany 726441 • Milano, Italy 6888051 • Montreal, Canada (514) 332-3552 • Nice, France 310364 • Paris, France 6450707 • Stockholm, Sweden 67 98 35 • Sydney, S. Australia 741859 • Toronto, Canada (416) 889-7373

Service-oriented industries need service-oriented terminals.

Are you looking for ways to improve your service? ... to better satisfy each customer so that he brings in another one? ... so your profits can grow?

Maybe RCA's POINT-OF-SERVICE terminal can help.

For example, if you're in the **hotel/motel business**, RCA's POINT-OF-SERVICE terminal can really speed up reservations and itineraries.

For **loan, rental or credit agencies**, the terminal is great for credit checking and forms printing.

Or, for a **parts or service desk**, the terminal can provide quick access to billing and inventory.

And, wherever **cash transactions** or **customer receipts** are issued, RCA's POINT-OF-SERVICE terminal can simplify the job.



A microprocessor tells the terminal what to do ... you tell the microprocessor what you want done. We'll place a program written specifically to your requirements right in the machine and configure the keyboard just for your operators. And you can change it later if you like, so don't worry about outgrowing your initial investment.

Result: a custom system *just for you* for little more than a ready-made price.

You get room for keyboard, printer, CRT display, and embossed card reader all in one terminal. Yet it's compact enough to fit almost any countertop. And it's so easy to use ... just turn it on and put it to work.

One way to get more customers is to satisfy the ones you've got. We'd like to help with our POINT-OF-SERVICE terminal. Call George Turner at (213) 894-8111 ... or write to RCA Custom Terminal Systems, 8500 Balboa Blvd., Van Nuys, California 91409.

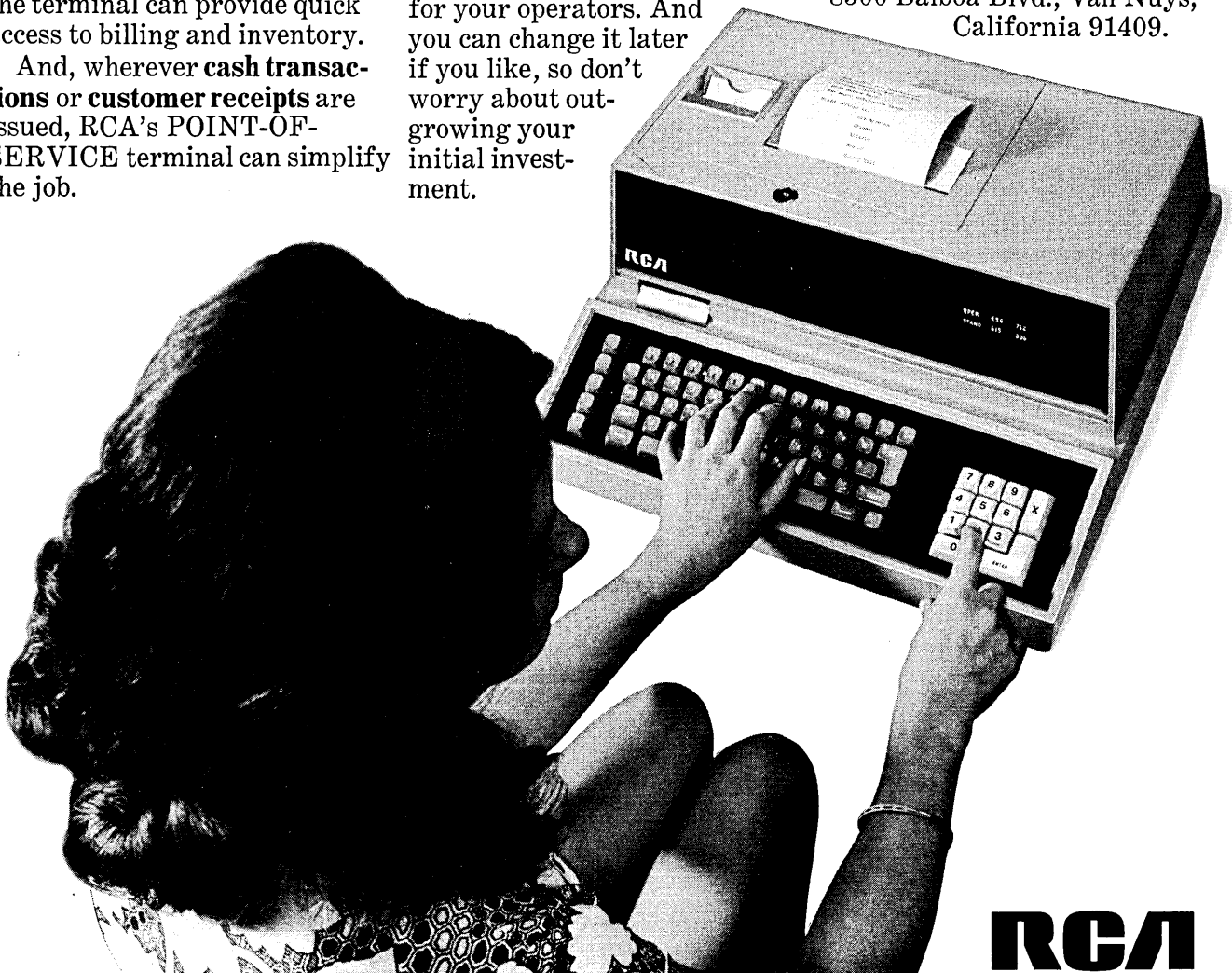

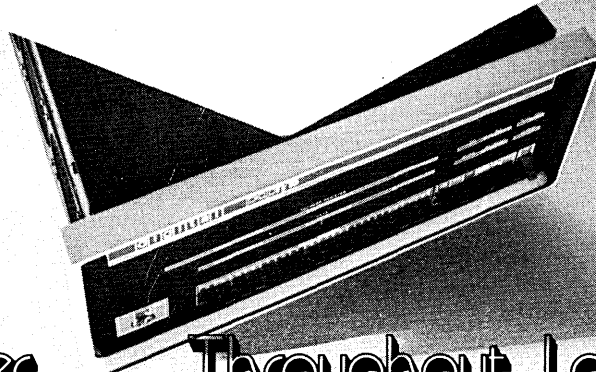
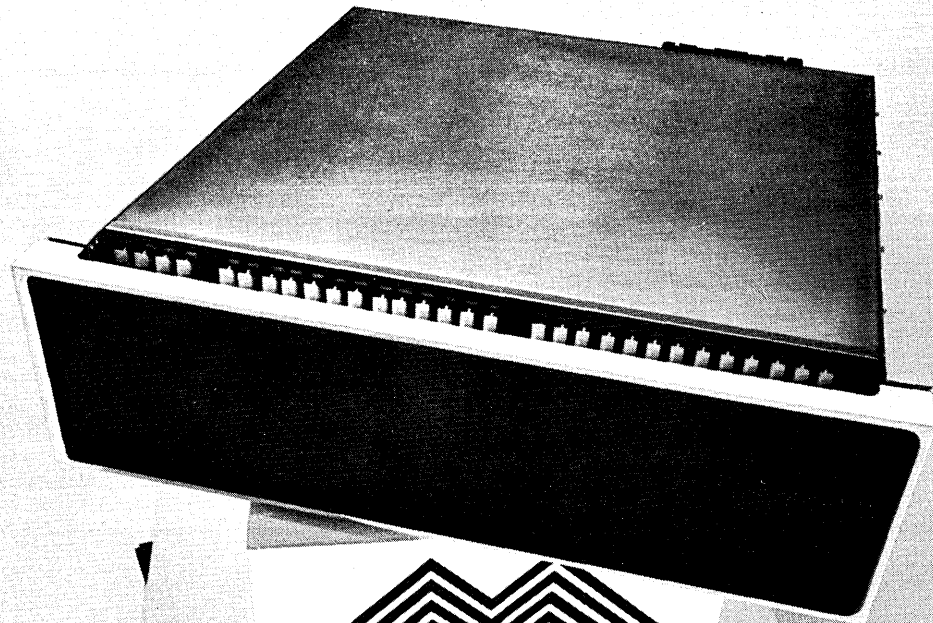

For Faster Throughput, Lower Cost— Use Our Semiconductor Memories In Your PDP-11

When your PDP-11 starts running out of memory—when you can't crowd on any more jobs—you don't have to rush into an expensive upgrade. Or sacrifice performance by plugging in more core memory. There's a better solution—our MONOSTORE III® semiconductor memory systems.

Add MONOSTORE III® memories to your PDP-11 computer and you boost throughput by as much as 20%. Because our random access MOS storage systems give you 650-nanosecond cycle time and 450-nanosecond access time—the optimum speed for which the PDP-11 was designed. That means greater throughput. And lower operating costs. Best of all,

you get this added performance for an extremely competitive price—about 1.2c per bit.

So remember, to get the most out of your PDP-11, put the best into it: Simply plug into your UNIBUS MONOSTORE III® semiconductor memory systems. They're available for immediate delivery. Call or write for complete details.

See our complete line of monolithic memory systems in action at the National Computer Conference in Chicago, May 6 through 10, Booth 127 thru 129.

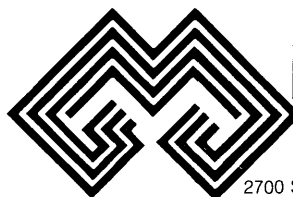

Monolithic
Systems corp.

2700 S. Shoshone, Englewood, Colorado. Phone 303/761-2275.

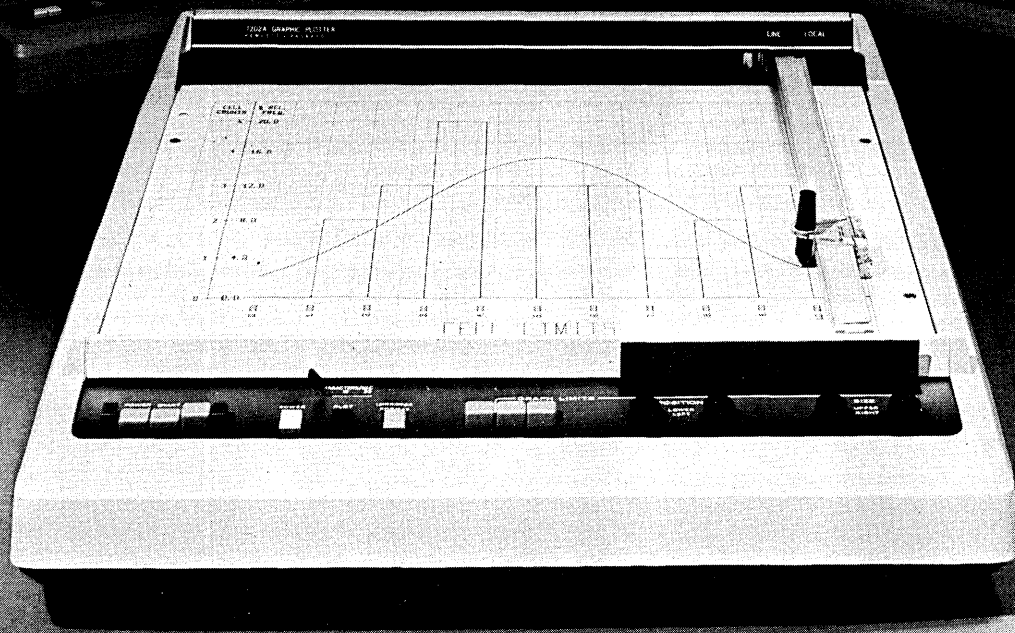

Look what HP's family of Graphic Plotters can draw from nearly any data source

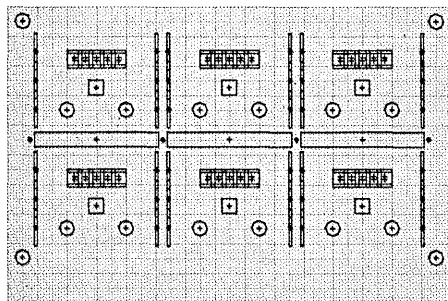

NC Verification

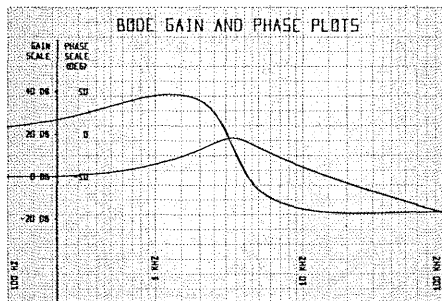

Engineering & Scientific

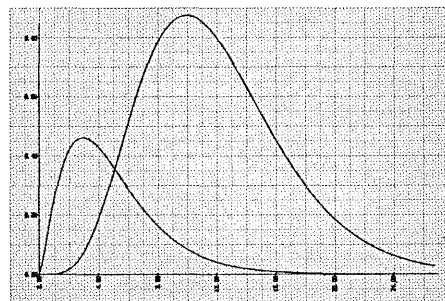

Statistics

for you

No matter where your data comes from, it's always more meaningful in the form of graphics. Solutions buried in rows of numbers begin to make sense when you see them translated into charts and graphs.

And now that Hewlett-Packard offers a complete line of economical graphic plotters, you can draw those easy-to-understand charts and graphs

and you...

from just about any data source. Directly from your computer. Your timeshare terminal. Your smart terminal. Even your calculator.

There's an HP Plotter available for your data processing equipment that interfaces quickly and easily and requires a minimum of software. It's easy to use. And gives you your graphics on any size paper up to 11 x 17 inches.

and you...

In red, blue, green or black.

Prices start at \$3,300 (domestic USA price only) with OEM discounts available. So get details now on the just-right Plotter for your special needs. We'll show you why it's the economical way to get those meaningful charts and graphs. No matter what data source you have to draw on. Write Hewlett-Packard, 1501 Page Mill Road, Palo Alto, CA 94304

11404



Sales, service and support in 172 centers in 65 countries. Palo Alto, California 94304 Offices in principal cities throughout the U.S.

CIRCLE 12 ON READER CARD

Reliability is burned into every Westinghouse 1600 video display terminal

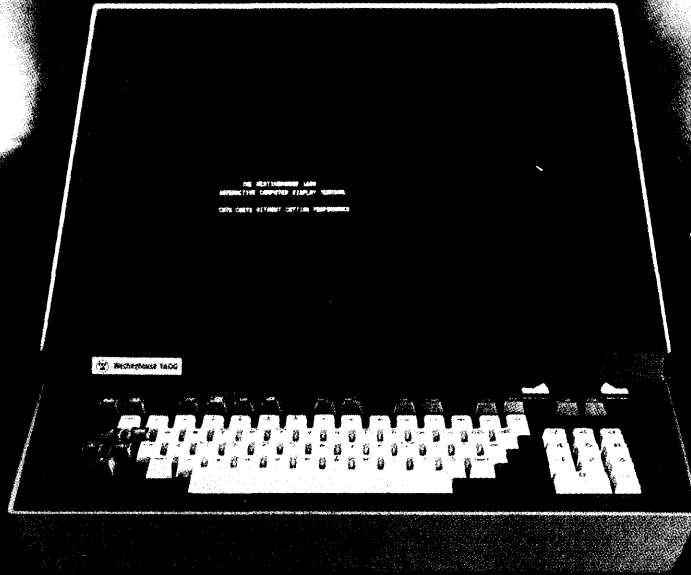

Before we deliver a Westinghouse terminal, its reliability has been confirmed by a rigorous, 7-day burn-in cycle. Each terminal is placed on continuous, operational test at 40°C (104°F) to screen out possible circuit defects and assure all systems meet their performance specifications.

The result is a terminal you can depend on. In fact, our MTBF is



now over 4,500 hours. That spells reliability whether the application is a management information system, coordinated production control, batch entry system or engineering design and testing.

Besides reliability, the Westinghouse 1600 provides the user with exceptional flexibility thanks to an extensive range of features offered as standard in the base price. These include both synchronous and asynchronous operating modes, eleven switch-selectable data rates plus format mode and a full selection of edit functions. In addition, a low-cost option—station address for polling by computer—can yield significant cost reductions by line sharing.

You can be sure... if it's Westinghouse.

Want more information? Just call any of these representatives.

WESTON MARKETING CORPORATION
2351 Shady Grove Road
Rockville, MD 20850

Tel. Rockville, MD 301-948-8300
New York, NY 212-541-5340
Chicago, IL 312-827-7787

ADVANCED TECHNIQUES
3848 E. Colorado Blvd.
Pasadena, CA 91107
Tel. 213-681-1093

Distributed in U.K. by:
The Exchange
Telegraph Company Limited
London 01-739-2041 Telex 27595

Westinghouse Canada Limited,
Box 510, Hamilton, Canada
416-528-8811 Telex 021-655



Westinghouse helps make it happen

See the new W1620 Time-Share Terminal at the N.C.C. in Chicago, Booth 941-3, McCormick Place, May 6 to 10.



seven
big pages!

“Mimsy W

Women have often inspired men to great achievement. There were Josephine and Napoleon, Ann Rutledge and Lincoln, and countless others. However a young girl, Alice Liddell, inspired C. L. Dodgson (better known as Lewis Carroll) to create a tale which has held its readers spellbound for the past 100 years. Dodgson, a mathematician near the turn of the last century, was gifted with a keen appreciation of logic and an uncanny knack of storytelling.

Perhaps it was his mathematical bent which provided his insight into the realms of modern technology. Over a century after *Alice's Adventures In Wonderland* and *Through The Looking-Glass*, selected portions of the works find application in today's world of computers. Let's take a look behind the looking-glass to discover what an array of controversial characters had to say about edp.

Computer Hardware

Although electronic computers hadn't been built then, scarcely a better explanation of circuitry could be given than:

“I shall sit here,” he said, “on and off, for days and days.”

Proving that computers require communication with their users, Alice complains:

“Perhaps it doesn't understand English.”

And:

“Oh, there's no use in talking to him; he's perfectly idiotic!”

Computers have often been regarded as “black boxes” which somehow perform calculations. Inside the black boxes one finds all sorts of elements which perform principally memory and logic functions. The White Queen explained it this way:

“. . . but there's great advantage in it, that one's memory works both ways.”

“I'm sure *mine* only works one way,” Alice remarked.

“It's a poor sort of memory that only works backwards.”

Tweedledee's contribution was:

“Contrariwise, if it was so, it might be; and if it were so, it would be: but as it isn't, it ain't. That's logic.”

Computers, just like all other types of machinery, sometimes malfunction. When that happens, the results can be unpredictable:

“Reeling and Writhing, of course, to begin with and then the different branches of Arithmetic—Ambition, Distraction, Uglification, and Derision.”

Programming

According to the instruction given by the King of Hearts, programming should be extremely straightforward:

“Start at the beginning and go on till you come to the end; then stop.”

APRIL
FOOL
ISH
NESS

VIRTUAL MEMORY

*Who steals my core steals trash; 'tis something,
nothing; 'twas mine, 'tis his, and has been slave
to thousands — Othello, III, iii, 155*

The other day I had a scare.
I used some code that wasn't there.
It wasn't there again today.
Oh! How I wish that it would stay.

J. C. L. Guest

ere The Borogoves...

At some stage in his career, almost every programmer would have uttered these words:

"My dear, I must get a thinner pencil. I can't manage this one a bit; it writes all manner of things I don't intend."

Of course, sooner or later, everyone is introduced to the creepy "program bug":

"What kind of insect?" Alice inquired. What she really wanted to know was whether it could sting or not.

When the program is successful (that is, compiled for the first time without errors), the programmer exclaims triumphantly:

"Why they're nothing but a pack of cards, after all. I needn't be afraid of them."

ASSEMBLER specialists might be horrified to learn that: "Language is worth a thousand pounds a word."

However, they would probably answer affirmatively to Alice's question:

"Must a name mean something?"

Many programmers have a "pet" routine which is dear to their little hearts and represents some original thinking and extra effort. The routine might do no more than convert from packed decimal to Roman numerals, but the routine is inevitably (and proudly) claimed:

"It's my own invention."

When confronted with an impossible problem or the thankless job of maintaining someone else's program, the clever programmer should remark:

"... it's all in some language I don't know."

A Sales Demonstration

The friendly neighborhood computer salesman normally prepares his product demonstration with tender loving care, hoping to sell as much machinery as he can. Usually when the demo goes off surprisingly well, the would-be buyer can be stopped by a totally unrelated observation such as:

"And if you take one from three hundred and sixty-five, what remains?"

"Three hundred and sixty-four, of course."

Humpty Dumpty looked doubtful. "I'd rather see that done on paper."

Employment in Edp

We have all, no doubt, dreamed of working in the exciting, dynamic field of computing—where, with a bit of hard work, one rapidly attains success and status. However, not all edp jobs lead to rosy futures. Frequently, programmers seeking advancement are misled by false claims and empty promises. The Cheshire Cat warns the job-seeker that advancement:

"... depends on where you are and where you want to get."

Getting the right job is all-important, but that requires the applicant to overcome the familiar obstacles of psychological testing and tiring interviews:

"Never imagine yourself not to be otherwise than what

it might appear to others that what you were or might have been was not otherwise than what you had been would have appeared to them to be otherwise."

"I think I should understand that better," Alice said very politely, "if I had it written down; but I can't quite follow it as you say it."

"Can you do Addition? What's one and one and one and one and one and one and one and one and one?"

"Do you know Languages? What's the French for Fiddle-de-dee?"

After the interview, the applicant begins the long wait. Sometimes the waiting game is ended by a favorable reply which usually goes something like this:

"Of course, I'll take YOU with pleasure! Twopence a week and jam every other day."

Documentation

The word "system" must be one of the most over-worked words in the edp vocabulary. One hears of the terms: operating system, accounting system, control system, data collection system, message-switching system, compiling system, etc., etc. . . .

"That's a great deal to make one word mean."

"When I make a word to do a lot of work like that," said Humpty Dumpty, "I always pay it extra."

Furthermore, most technical writers must have had Humpty Dumpty in mind when they invented all their "buzzwords":

"When I use a word," Humpty Dumpty said in rather a scornful tone, "it means just what I choose it to mean—neither more nor less."

A note to the authors of dull, unillustrated texts on programming:

"... and what is the use of a book," thought Alice, "without picture or conversations?"

A major portion of the edp consultants would be out of work if their clients paid more heed to the Eaglet's criticism:

"Speak English! I don't know the meaning of half those long words, and what's more, I don't believe you do either."

In Conclusion

To those outside the industry, edp people may appear madder than the March Hare (especially in March), nonsensical as the Jabberwocky, or as demanding as the Red Queen:

"I always thought they were fabulous monsters," said the Unicorn.

The world of computing is often more fascinating than Wonderland, but it must be vague and confusing to the uninitiated:

"... oh dear, how puzzling it all is!"

When offered an opportunity to enter data processing themselves, they should wisely agree with Alice:

"But I don't want to go among mad people." □

get lucky with "validation" →

START

Product delivery has been slipped one week. Your deadline hasn't. Return to START.

Damn thing delivered, but it doesn't work. Return to START.

You get to work a holiday weekend (without overtime). Gain 2 days Comp Time, 10 Brownie Points, and advance a box.

Only programmer who can read OS diagnostics has joined a commune in Wyoming. Back 4 boxes.

You have completed one week of testing using the wrong mods of 6 (six) critical programs. Return to START and lose 8 Brownie Points.

Management Reorganization. Lose all Comp Time and set Brownie Point count to 0 (zero).

System people have changed something—they're not sure what. At least a week of testing shot. Back 5 boxes.

Head Crash on your Private Pack-backup has vanished. Back 5 boxes.

Managers are all on vacation. Advance 7 boxes.

Program documentation delivered on schedule. Advance 3 boxes.

Program documentation will be late, but user info is available. Advance 5 boxes.

Your Progress Report is due. Back 2 boxes if you have been promoted. No affect if you haven't.

REST HOME

VIOLENT WARD

Delayed/revised program documentation delivered. Back 3 boxes.

Test Specs ready on time. Advance 3 boxes.

You have hired a programmer who can understand OS diagnostics. Advance 3 boxes.

You have run out of disc storage. Back 5 boxes and gain a day of Comp Time.

GO TO REST HOME

Computer Operations has sold all prime time (8:00 a.m. to 10:00 p.m.) to outside user. Back 7 boxes, but gain half day Comp Time per move for rest of game.

Tape Parity. Backup? Well, not exactly, but you think you can find the deck to regenerate it. Back 4 boxes, and lose 5 Brownie Points.

Plant Security has caught one of your programmers taking computer output home. One day required to convince them he is not an industrial spy. Back 1 box.

Computer's down. Back 1 box.

Your Progress Report is due. If you haven't been promoted, no affect. Back 2 boxes if you have.

Management wants detailed briefing on testing effort and why it is behind schedule. Back 2 boxes.

The keypunch has been punching 11s row instead of 12s row, in col. 47 only, when duping cards. Nobody knows how long this has been going on. Back 2 boxes, gain 1 day Comp Time.

Managers back from vacation. Back 9 boxes.

The card reader has eaten the only up-to-date copy of your test deck. Back 1 box.

Your deadline has been slipped. Advance 5 boxes, but lose 5 Brownie Points.

You have wasted two weeks proving that program operation is completely irrational, only to discover that the program operates exactly as specified. Back 7 boxes.

A requirement has been levied for extensive tests of paper tape I/O. Back 4 boxes.

A

Nobody can understand programmer who is purported to understand OS diagnostics.
Back 4 boxes.

Somebody has been reading manuals again. By following manufacturer's example precisely, he has written 20,000 bytes of SPACEWAR over your disc directory.
Back 5 boxes.

Operator has dropped your (unsequenced) test deck.
Back 1 box.

Your boss has found out about the previous item.
Lose 10 Brownie Points.

Progress Report time.
If you've been promoted, delegate the job to an opponent.
If you haven't, you're stuck.
Back 2 boxes.

Critical problem solved two hours before formal demo.
Advance 2 boxes.

Your last-minute deck changes bomb formal demo.
Back 10 boxes. Lose 10 Brownie Points and 2 days Comp Time.

GO TO REST HOME

Customer has refused acceptance.
Return to START and lose all Brownie Points.

SUCCESSFUL TURNOVER

a game of normal hazards

by Donald Kenney



VALIDATION

VALIDATION is a game for any number of players. The object is to receive delivery of a software product and to test ("validate") it as quickly as possible while facing a selection of the normal hazards of software testing. It should be noted that, like its real life counterpart, **VALIDATION** is a game of luck, not a game of skill.

Winning: The winner is the player who first escapes from the game. There are three ethical escapes: a player may reach the Successful Turnover box; he may, by the proper political moves, promote himself out of the game; or he may be forced from the Rest Home to the Violent Ward. All other escapes—knocking the board over, refusing to move, running about hollering "out of scope," etc.—are unethical.

Moves: Moves are determined by any convenient means: dice, random number tables, development schedules, lists of stock prices, or any other essentially random source of numbers commonly found around a computer shop. Once the number of boxes to move has been determined, the player moves that number of boxes, then follows the directions in the box in which he lands. If the directions cause him to move to another box, he does not follow the directions in the second box.

Markers: Each player chooses a marker to keep track of his position. Markers are not provided with the board. A coin, paper clip or any other small object will do. Often, small electronic components, resistors, transistors, and such, can be found in the area where the CE's have been working. They make dandy markers.

Compensatory Time: A few boxes grant Comp Time to a player. Once a player has accrued Comp Time, he may use a day at a time to ignore the instructions in any box except those involving a loss of Comp Time. It costs one day of Comp Time for each set of directions ignored. Some boxes cause the loss of Comp Time. A player can not lose Comp Time he does not have.

Brownie Points: Whenever a player moves the same number of boxes on two moves in a row (the initial number unaltered by directions in the box on which he arrives), he receives a number of Brownie Points equivalent to the number of boxes moved. As with Comp Time, a player cannot lose Brownie Points which he does not have.

Promotion: A player who has 20 or more Brownie Points may use them to promote himself. Promotion will cost him all of his current Brownie Points. Note that a promotion is not necessarily an advantage, but that two promotions during the course of a single game make the player a "politician" and thus a winner of the game.

Rest Home: Whenever a player moves the same number of boxes on three successive moves, he does not get more Brownie Points. No indeed. He gets sent to the Rest Home. He gets out of the Rest Home by throwing an even number on any of the four turns after his commitment thereto. Failing to return to the game on any of those turns, he escapes to the Violent Ward.

Successful Turnover: This box may not be overshot. Any move which would take a player beyond this box becomes a move of one box instead. □

... more foolishness page 117

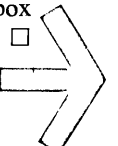

Wilson Jones Data-Cabinets
give you a dust-free
protected environment and

maximum security for your printouts.

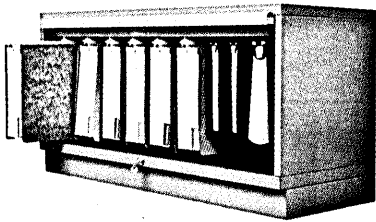

They stack up
as the surest
way to keep
your confidential
records away from
unauthorized eyes.

Heavy-duty double-wall steel construction with individual locks makes Data-Cabinets the optimum place to store confidential printouts.

Each cabinet holds over 10,000 marginal-punched sheets, up to 14⁷/₈" x 11". In ten or more binders neatly suspended from the top of the unit. With the AdaptaTrack wire hanger system, you can suspend Track-Back ring binders as well.

Data-Cabinets stand alone or stack on a matching base to form an attractive data library. Wood grain tops are available for added work space.

Wilson Jones  **Data Systems**

Div. of Swingline Inc.
Dept. D-4, 6150 Touhy Ave.
Chicago, Illinois 60648

Please send me more information
about Data-Cabinets.

Name

Title

Company

Address

City

State Zip

CIRCLE 105 ON READER CARD

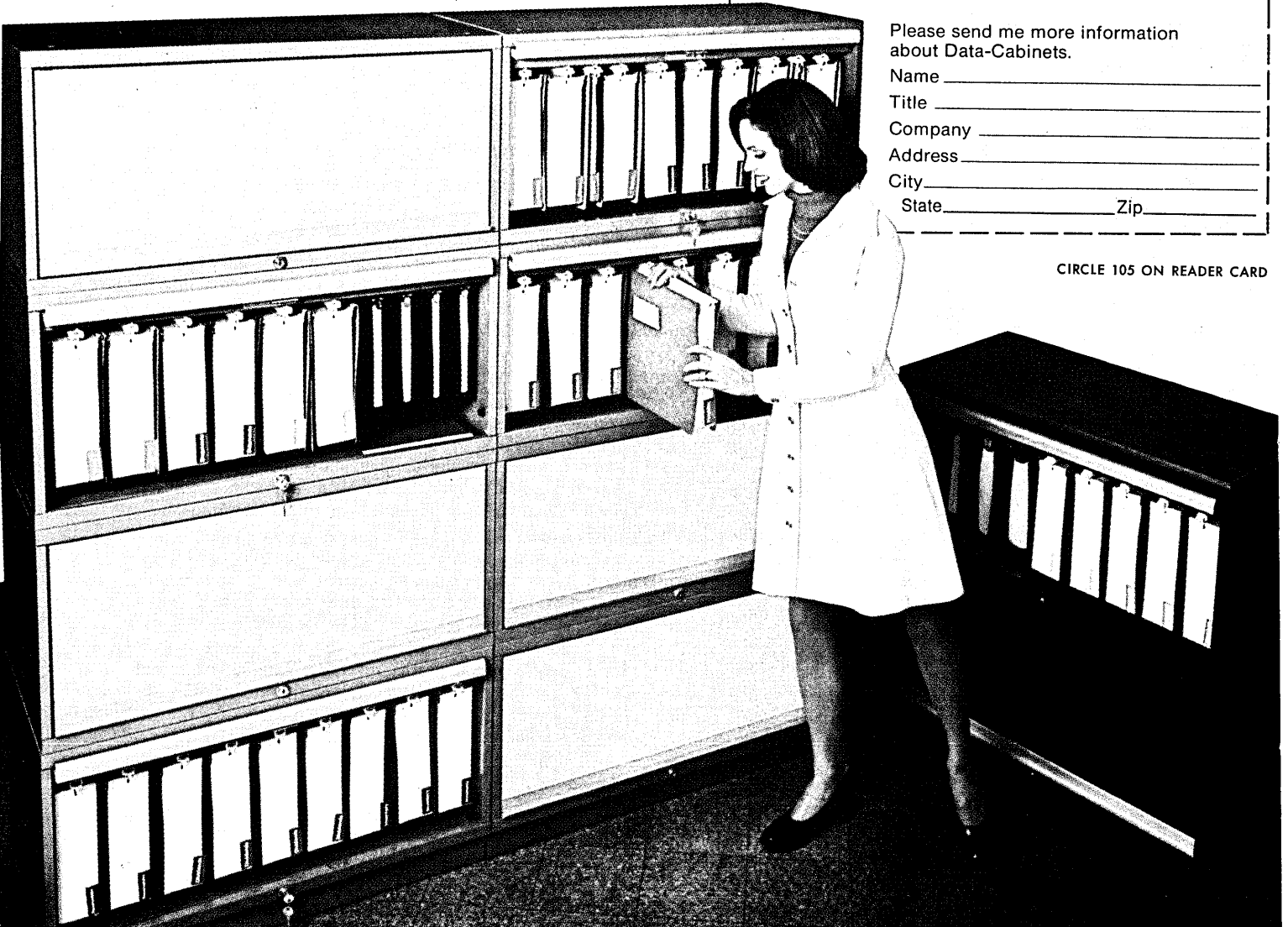



does anyone here speak english?

phase 2 by Marvin Grosswirth

A year ago, in these very pages, I lamented the fact that edp types speak a jargon which is not only unintelligible, but also slightly offensive to devotees of the English language. I had hoped that by baring my private thoughts in the professional press, I would be able to contribute in some small way to the restoration of English to a proper place in the computer community.

Fat chance.

If anything, the situation has gotten worse. Still, one adjusts. I had even reached the point where I had agreed to lend my own inimitable prose style to the industry by working on one or two papers concerning edp philosophy. (Integrity, inshmegrity—the fees were enormous.) But just as I had reached a stage that I would have described as being close to adjustment, I was traumatized by a phrase which appeared in this very magazine: *graceful degradation*, undoubtedly the most deplorable juxtaposition of two words that I have seen since *artificial intelligence*.

Something snapped. I was determined to take vengeance on behalf of every wordsmith from Chaucer to Mailer. A plan of action sprang full-grown into my mind. I would beat the computerniks at their own game. I did not have to wait long for an opportunity.

At what would normally be regarded as an otherwise ordinary and, in fact, rather pleasant social gathering, I found myself surrounded by edp people. I had already had some informal rehearsal for what I was about to do. Earlier encounters with executives at various levels of management had exposed me to the peculiarities of corporate speech. I knew, for example, that in certain circumstances one speaks of *maximization of cost effectiveness* when one means getting the most for one's money. *Implementation of personnel productivity procedures* means getting the secretary to come in on time and to limit herself to four or five

coffee breaks a day. *Re-evaluation of managerial priorities* means, of course, that someone is going to get fired.

My plan was a simple one: by inventing new phrases on the order of *graceful degradation* I would throw a whole roomful of computer people into a state of utter confusion from which they would ultimately emerge with a greater respect for the language.

At the aforementioned gathering, one of the guests, apparently in an effort to make small talk, said, barely concealing his obvious contempt: "I hear you're working on some edp stuff. What's it all about?"

Immediately, a small circle formed, each of its members wearing an expression of contemptuous superiority. Here was I, the great ignoramus, the one who had publicly exposed his educational deficiency by whining in print,

Par for the Course

A linguist thought it a farce,
That memory space was so sparse,
One day they increased it;
Said he, while he seized it:
"At last enough core for the parse."

—Claus Segebarth

about to make a further fool of myself by daring to discuss edp aloud. They resembled for all the world a ring of vultures waiting for the final death rattle.

"Well," I said with my usual aplomb, "I'm not sure I can explain it." The circle grew tighter and the grins wider. This was really going to be a feast. "We're trying to evolve an obfuscatory clarification of the upside-downtime resulting from an on-line terminal programmed for integrated isolation." The grins vanished. "It's a question," I went on, "of maximizing nonperformance measurements to correlate with retroactive predictability."

Several members of the circle swallowed their drinks and hastily refilled their glasses. I felt that victory would soon be mine. "You see," I continued, "in a non-structured system, instant access must be integrally marginal with the location and storage of irretrievable data."

It was at this point that the first reciprocal blow was struck. The man who had originally posed the question looked straight into my eyes, nodded sagely, and said, "Mm hmm."

My God! Was it possible? Did he really believe he understood what I was saying? My immediate reaction was one of panic, but reason soon prevailed. Undoubtedly, he thought he had heard something other than what I had actually said. I decided to proceed. "Once we can develop a system in which the total insubordination of sub-managerial personnel can be linked to a program of non-supportive maintenance, we will have achieved a level of developmental obsolescence thus far unheard of in the industry."

Now the grins were back. But instead of reflecting the supercilious superiority pervading the atmosphere at the opening of the conversation, the smiles were now clearly expressions of admiration. Two or three of the listeners actually applauded.

Well, friends and neighbors, I am not one who readily succumbs when confronted with a challenge. But neither do I believe in exercises in futility. In a word, I know when I am licked.

Language, after all, is a living thing. Far be it from me to retard its progressive retrogression with nonrepetitive redundancies prejudiced by innovative traditionalism. Words are my stock-in-trade, and I am as willing and ready to inventory neologistic archaisms as is the next person. We must move with the times.

Meanwhile, if you hear of anyone who can use a dictionary, battered but serviceable, let me know. I don't think I will be needing it any longer. □

even more foolishness on page 123

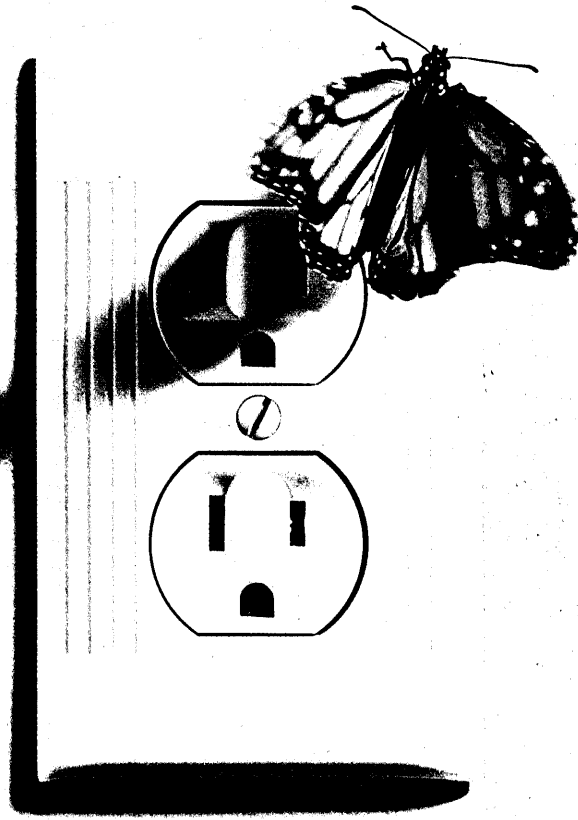

THE GREAT PROVIDER

NOT ANY MORE...and if your data processing system depends on clean, dependable power, you're in the market for an Avtel all solid state Uninterruptible Power System (UPS). Avtel's UPS assure precise, transient-free, absolutely uninterruptible electric power to your essential equipment regardless of power line conditions.

AVTEL
CORPORATION
an Airtronics Subsidiary



1130 East Cypress St. • Covina, Calif. 91724 • (213) 331-0661

EXTEND YOUR COMPUTER.

USE A TELETERM.

Get a free 50' extension cord.

There's nothing like a portable time-sharing terminal to let you go where the data is. The only trouble is that sometimes where you have to go is the last place you want to take a piece of computer hardware.

But if your hardware is the CDI 1030 TELETERM, you can forget about problems. It weighs only 22 lbs. and fits under an airline seat. It's also rugged, dependable, and moves data three times faster than TTY . . . plus it's so quiet you'll hardly know it's there.

The CDI 1030 TELETERM can be on-the-air to your computer in seconds. All you do is plug a telephone receiver into the audio-coupler and connect the TELETERM to an ordinary electrical outlet. But just in case you wind up in Ketchican, Biloxi, or Fond-du-Lac, we've thrown in a fifty-foot extension cord. So no matter what a nice terminal like this is doing in a place like that, it will work. And you can, too.

Get a CDI TELETERM, the go-anywhere portable from Computer Devices, Inc. For a limited time, you can get a 50' heavy-duty extension cord, absolutely free. Just ask for one when you order

your terminal. Use the handy coupon . . . and get connected to your own TELETERM. Remember, anyplace you can go, a TELETERM can go, too!

- I want to order a CDI 1030 TELETERM with a free extension cord. Please contact me immediately.
- I want more information on CDI's family of TELETERMS. Please send me literature.

Name _____ Title _____

Company _____

Address _____ City _____

State _____ Zip _____

Phone _____

Computer System _____

a
TECHVEN
corporate
partner



**COMPUTER
DEVICES, INC.**

9 Ray Ave., Burlington, Mass. 01803
Tel. (617) 273-1550

Photographed at The Ideal Barbershop, 601 Main St., Reading, Mass., courtesy of Joe Estrella and Tony D'Amico.

See us at NCC, Booth No. 219-221

600 LPM. 136 Columns.

Our new Model 2260 is the best 600 lines-per-minute printer an OEM can buy for small-dedicated and communications-oriented data processing applications.

The 2260 is the newest member of the low-cost 2200 family of Dataproducts line printers. It produces print quality comparable to horizontal-font printers at drum printer prices. At a print rate of 600 lpm in a 136 column format, the 2260 will accommodate communication rates up to 9600 baud and generate clear, crisp straight printout on single through six-part forms.

The inside story.

The new 2260 uses the same friction-free proprietary print mechanism that insures superior print quality in every line printer we produce: The fast-response, field-proven Mark IV hammer-actuator.

The tubular steel welded frame of the 2260 not only insures long term rigidity and stability but greatly reduces construction costs.

Ease of maintenance is built into every 2260 line printer as well. Servo-controlled ribbon and paper



Ribbon and paper loading is a breeze. There are fewer, easier-to-use controls. And a special "fault indicator" panel to spot and correct off-line conditions with a minimum of downtime.

It's really very simple.

If you need a 600 lpm printer that's long on reliability, maintainability, quietness and operator convenience, but short on capital outlay, our new 2260 is exactly what you need.

The Model 2260 Line Printer from Dataproducts Corporation. A perfect example of why we're the world's largest independent producer of line printers.

For complete information, please write Dataproducts

Corporation, 6219 DeSoto Street, Woodland Hills, California 91364. Or call your local Dataproducts salesman on the OEM Hot Line.

Our home office number is (213) 887-8026. Our number in London is West Drayton 49292.

(If you need all of the above but don't need quite as much speed, we've got just what you need right across the page to your right.)

systems, the use of only four discrete component-bearing printed circuit board assemblies and an MTTR of less than 30 minutes combine to give the 2260 one of the lowest life-cycle costs in the business.

But that's not all.

The 2260 is a very compact, very quiet line printer that's been carefully "human engineered" for maximum operator convenience.

To learn more about the 2260 line printer, come see us at Booth 309 at the National Computer Conference.



Dataproducts
The OEM's best friend.

300 LPM. 136 Columns.



When we introduced our Model 2230 Line Printer a while back, it was the best 300 lines-per-minute printer an OEM could buy for small-dedicated and communications-oriented data processing applications.

It still is.

Like our 2260 line printer over on the left, the 2230 also generates clearly-legible OCR-quality single and multi-part copy, but prints at a rate of 300 lpm in a 136 column format and can accommodate communication rates up to 4800 baud.

The inside story is the same.

Otherwise, the 2230 has everything else going for it that our 2260 has going for it. (The left-hand page of this ad has all the specifics.)

Suffice it to say, if you need a 300 lpm printer that's long on reliability, maintainability, quietness and operator convenience, but short on capital outlay, the 2230 is exactly what you need.

The 2230 line printer from Dataproducts Corporation. Another

perfect example of why we're the world's largest independent producer of line printers.

For complete information, please write Dataproducts Corporation, 6219 DeSoto Street, Woodland Hills, CA91364. Or call your local Dataproducts salesman on the OEM Hot Line. Our home office number is (213) 887-8026. Our number in London is West Drayton 49292. (Our line printer story is only part of our story. For more about what we make and for whom, write for a free copy of our booklet *Data-products Today—An Expose on Obscurity.*)

To learn more about the 2230 line printer, come see us at Booth 309 at the National Computer Conference.



Dataproducts
The OEM's best friend.

Before you buy...let us show you
OUR RELIABLE, LOW COST COMPUTER TERMINAL

MINI

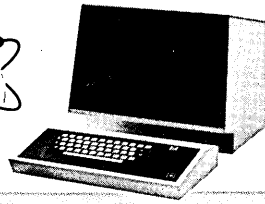
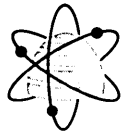

BEE

"See you at the NCC Show"

teletypewriter-compatible
CRT DISPLAY TERMINAL

"Hi! I'm Beehive's newest challenger! I feature reliability at a low cost . . . asynchronous data transfer at rates to 9600 bps, a detachable keyboard for added convenience, half or full duplex on-line operation with all TTY compatible codes plus other features and options . . . all at a budget price. Call, write or wire for a demonstration before you buy!"



MINI BEE

from The House of Beehive



Beehive Terminals • 870 West 2600 South • Box 19244 • Salt Lake City, Utah 84119 • (801) 487-0741 • TWX 910-925-5271

EAST: Maryland, (301) 588-8134; Massachusetts, (617) 623-7800; New York, (516) 487-0690, (315) 437-6666, (716) 328-2230, (607) 785-9947; Pennsylvania, (215) 265-1020

CENTRAL: Alabama, (205) 539-4411; Florida, (305) 425-5505, (305) 776-4800; Georgia, (404) 939-1674; Illinois, (312) 298-3600; Indiana, (317) 244-2456; Kansas, (913) 362-2366; Louisiana, (504) 366-5766; Minnesota, (612) 884-4336; Missouri, (314) 938-4992; North Carolina, (919) 768-3600, (919) 489-1546; Pennsylvania, (412) 366-5056

WEST: Arizona, (602) 956-5300; California, (415) 321-2414, (213) 937-0790, (714) 544-5121; Colorado, (303) 355-3521; Oregon, (503) 646-3004; New Mexico, (505) 265-5655; Texas, (214) 231-4846, (713) 661-4501, (512) 732-7176; Washington, (206) 624-9020

CANADA: Toronto, (416) 724-8015; Ottawa, (613) 729-4004; British Columbia, (604) 526-3312

EUROPE: England, Middlesex, 01-952-8471; Holland, Schiphol, (020) 151602; Netherlands Tracor Europa B.V., (020) 151602; Sweden, Scandia Metric AB, 08/820410

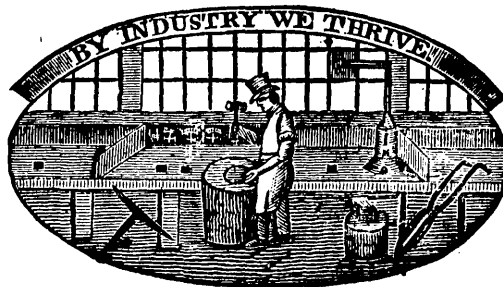

The Inverse Peter Principle

A. Nonymous

AFTER READING *The Peter Principle* and its sequel *The Peter Prescription*, it has occurred to me that Dr. Peter, astute though he undoubtedly is, got the whole process backward when he stated that an employee starts off competent, then rises, through promotion, to a position where he is not competent to perform his job. I have found that more often than not, the very opposite happens: those employees who demonstrate competence in performing menial technical tasks tend to remain at the bottom performing those tasks, since it is in the company's interest to make sure those basic functions are performed with as little fuss and retraining of newcomers as possible.

Conversely, those who enter at the bottom and soon demonstrate an inability to perform their assigned routine tasks are promoted upward in hopes that they will make a greater contribution as supervisors, coordinators, administrators, and the like. In short, having failed as specialists, they become generalists. It would be satisfying to complete the reverse analogy with the Peter Principle by concluding that most such people go from a level of incompetence to one of competence, but I cannot in good conscience say that. What happens is that they move from a level where their incompetence is glaring to one where it is not so obvious. (It is more difficult to prove a generalist wrong than a detail man.) So we might formulate our "anti-Peter Principle" thus:

"Incompetents rise to a level where their deficiencies are no longer obvious, while those who are truly competent at the bottom tend to stay there."

Let me illustrate this revolutionary thesis with a hypothetical example, supported by three actual case histories, of how this applies to the field of data processing.

Hypothetical dp example

Back in the good old days, when jobs in data processing were plentiful, the typical career path went something like this:

1. New college graduate enters dp field as a programmer-trainee. After six weeks of bits and bytes he is turned loose to write a program. At this point our hero learns his first great truth: programming is a hard way to make

a living. It requires ingenuity, analytical ability, infinite patience and a high tolerance for frustration. His first project is over-budget, late, and won't run right more than once in a row. Our hero decides to change jobs.

2. Realizing his incompetence at programming, our hero decides to advertise himself as a systems analyst. (Our hero is no dummy; he is merely no good at programming.) After all, systems analysts have more prestige than programmers and are paid better. Also since no one really knows what systems analysts are supposed to know or do, or even what, exactly, systems analysis is, it is harder to spot an incompetent systems analyst than an incompetent programmer. Also it takes longer. Therefore an incompetent systems analyst can survive longer at higher pay with greater prestige than an incompetent programmer. Our hero needs only common sense and one or two disasters in programming to discover this. Eventually, though, after several years of "designing systems" a pattern begins to emerge. Our hero has a habit of designing systems no one can use, that are expensive to run (when they *are* run), and which need a full-time maintenance programmer to keep "up." Time for the next "promotion."

3. Two possibilities present themselves:
 - (a) go technical and become a "consultant"
 - (b) go administrative and be-

come a "manager"

In either case, all that is required is a jazzed-up resume stating the glories (in the most obscure jargon, acronyms and abbreviations) of past systems he "designed" (technical side) or the number of "project teams" he managed (managerial side).

From here on, a curious phenomenon takes place: our hero, no matter how inept, will be protected by the "system." Specifically, he will continue to rise, in spite of his incapability to do anything right, because those who hired/promoted him in the first place must vindicate their judgment by continuing the charade and heaping rewards on our hero. This is sometimes referred to as "promoting from within." Sometimes it is called "career pathing." Sometimes it is called throwing good money after bad.

In any case, once the manager/consultant level is reached, our hero is protected by the very strong self-perpetuating, self-preserving instincts of the upper-echelon hierarchy. It takes a major disaster of practically national proportions to reveal incompetence at this high level. Our hero started at the bottom as an incompetent programmer and simply kept rising until he came to rest at a level where the job requirements were so general that his incompetence all but disappeared from view. He did not become more competent but *appeared* to do so due to the changing nature of his job.

Case history number one

Jane Doe (name fictitious) was a competent programmer. She wrote programs which not only ran when they were told to, they could be understood, and (due to their modular design) could even be *modified* by other programmers. Jane was so unusual in her group that her supervisor realized his job would be in jeopardy if she stopped writing programs (for one reason or another). To keep Jane reasonably happy, instead of promoting her, he gave her annual salary increments until she was at the top of her "salary bracket." It was not in her company's interest to promote her because she was too valuable to be given a teaching assignment to train others in her skills. It was not even in her own interests to be promoted, since she would have to take a cut in salary to enter the next

COM can boost your throughput.

That's what Kodak computer output microfilm is all about.

The idea of bypassing impact printers to go directly to microfilm via COM is bound to appeal. It's an electronic path versus a mechanical one. That means speed with reliability.

Kodak KOM microfilmers do this job at 20 or more times the speed of impact printers. So you have more time to get more jobs done on the mainframe.

Besides speed, consider what else comes with a KOM microfilmer. First, Kodak specialists will help you design, develop, and implement your COM system. Second, Kodak software helps you get each job done faster and in the format you need. Third, Kodak equipment service that will help keep your COM unit up and running.



Take the important first step.

Write us for our new booklet, "The New Generation of Computer Output". Eastman Kodak Company, Business Systems Markets Division, Dept. DP 573, Rochester, New York 14650.

Kodak: for better use of information.



INVERSE PETER PRINCIPLE

salary bracket in the middle, where everyone else did. She could not quit, of course, for the same reason: she was grossly overpaid for the job-level she was at. So there Jane stayed until the last 370 was shoved out the door in favor of the new IBM 390/225 TVM, a totally virtual machine. Jane had never been sprung from her programming tasks long enough to learn the ins and outs of programming for totally virtual machines. At this point, she was early-retired at the age of 43 at 10% of her annual salary averaged over the preceding five years.

Case history number two

John Doe (no relation to Jane) was a medium-competent programmer, but, having more moxie than Jane, threatened to go elsewhere for a twenty percent raise (this was 1968) if he was not promoted to project supervisor. In this position he functioned rather well; he was highly motivated, and just arrogant enough to press those under him to get his first project out on time *and under budget!* Being highly motivated, he was now ready for a quick second promotion to programming manager. But, as luck would have it, the clients were so pleased with the new system they funded a second proj-



ect, to add certain "enhancements" to the original system, but only on condition that John be project supervisor (again).

John did not like the prospect of sitting in the same old job for possibly another six months, but he had established a reputation as a "doer," and it would be silly to go elsewhere and start again from scratch. Also he might not be so lucky a second time. So John stayed on and built on his reputation of competence. He delivered the "enhancements" on time again, using the same competent programming team, naturally. After this "follow-on" project came another "follow-on" project to soup up the system still further. In the end, the client was so pleased with John's handling of the follow-on projects that he requested that John be-

come permanent client coordinator. There John sat, at the second level from the bottom, until the client switched to a new time-sharing service and the system had to be rewritten to take advantage of the new capabilities. Of course John had been so busy holding the client's hand that he had never had time to be trained in time-sharing. John was early-retired at the age of 45 at 25% of his annual salary averaged over the preceding five years.

Case history number three

Bob Roe was a semi-competent programmer who managed to stay out of trouble for five years and was finally promoted to systems analyst. As a systems analyst he managed to avoid disaster by judiciously hedging his bets and staying away from large, expensive, visible projects. But he could not be said to be noticeably incompetent, and managed to give the impression of knowing how to do things. (In fact, he spent most of his time giving advice to others, having learned that advising is safer and easier than doing.) Bob's trouble was that his immediate boss had achieved final placement (see *The Peter Principle*), having achieved a level where his incompetence was no longer apparent. Bob's boss relied heavily on him to answer questions of the "what does your department do?" variety, since he himself didn't have too clear an idea. (He could explain it *in concept* but people just went away shaking their heads and asked Bob the same questions.)

So there Bob sat, one level below his boss, whose function no one was sure of since he hadn't done anything in five years. He couldn't be fired either, since he spoke so impressively that the listener went away convinced that whatever it was he did do, it must be very complicated and beyond the understanding of the average intellect. Bob was finally early-retired at the age of 47 at 35% of. . .

I hope these examples have convinced the reader of the wrongness of the Peter Principle. People do not rise to their level of incompetence. The competent stay put; they are too valuable where they are. Eventually they become overpaid for their rank and are thus locked in to low-level jobs. The generally incompetent (the vast majority of the business and technical population) move upward through promotion or through intercompany diagonal transfers to the point where their incompetence becomes invisible to all but the most discerning and cynical observers from below.

Dr. Peter was off the track again when he assumed that the rational em-

ployee would wish to *avoid* final placement. On the contrary, that is what we all strive for, rational or not. The method of achieving final placement is, amazingly enough, exactly the prescription advocated by Dr. Peter as a means of avoiding final placement: mask your competence behind the guise of mild incompetence! The reader should not be surprised at this curious negative reasoning, since we now realize Dr. Peter was 180° turned around in the first place. Remember, those who flaunt their competence will remain exactly where they are. . . at the bottom of the hierarchy, since they are too valuable to be promoted. To move upward, exhibit at least the normal amount of incompetence, and, since you are not making a contribution where you are but have done nothing to warrant firing, the only choice is to promote you. This play can be repeated as often as you like, achieving constant upward movement. In fact, your security in doing this is directly proportional to your length of service, ("we can't just let him go after twenty years with the company"), and your rank ("he must be good, otherwise how did he get this far?").*

I apologize to Dr. Peter for controverting his theory, but my humanitarian instincts lead me to publish my own theory before too many well-meaning people are hoist by their own petards. I have seen too many obviously competent people, striving to achieve final placement, frozen in their tracks due to their own competence to keep the real truth a secret any longer. Dr. Peter was wrong on two counts: he saw both the criteria for advancement and human ambition bass-ackwards. □



Mr. Nonymous, who is so far undisclosed reasons, does work of an unknown nature, does not live there, and has left no forwarding address. Where is he? Only the Shadow knows.

*For a specific example of this type of reasoning, see "The Emperor's New Clothes."

ARE YOU THINKING ABOUT MEMORIES...

FOR
YOUR
MINI

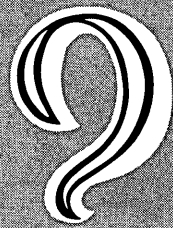
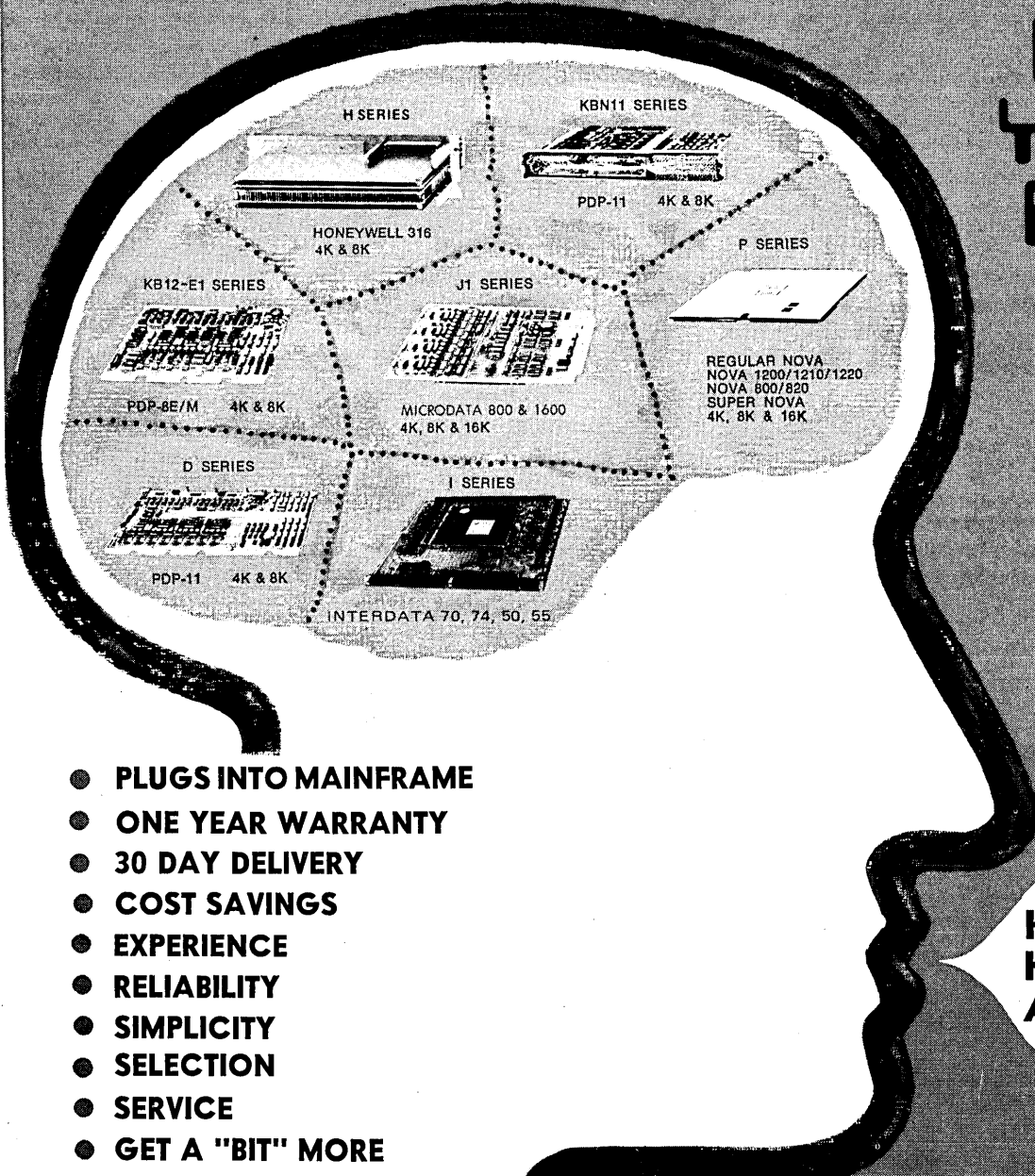

- PLUGS INTO MAINFRAME
- ONE YEAR WARRANTY
- 30 DAY DELIVERY
- COST SAVINGS
- EXPERIENCE
- RELIABILITY
- SIMPLICITY
- SELECTION
- SERVICE
- GET A "BIT" MORE

**KERONIX
HAS THE
ANSWER!**

KERONIX has an OEM line of memory systems to suit your specific REQUIREMENTS. Our engineering staff will custom design your needs. End user and OEM inquiries are invited.

Please send information about _____ Series Memories. *Thank You*

Name _____

Firm _____

Address _____

City/State _____

Zip _____ My Computer Type Is _____



For additional information please write or call George Földvary, Executive Vice President

• Representatives in U.S.A. and worldwide.

KERONIX, INC.
1752 Cloverfield Boulevard
Santa Monica, Calif. 90404
(213) 829-3594 • TWX 910-343-6480

*Stability
Age
Beauty*

TEC has profitably manufactured information display and control products for computer oriented industries since 1958. That's *Stability*. Since 1966 we've produced terminals called DATA-SCREEN™ Terminals—that's *Age* in a young industry. Our carefully styled terminals are compatible in any application, match any decor—that's *Beauty*.

SERIAL, BUFFERED AND CONVERSATIONAL MINI-TEC™ TERMINAL \$995*

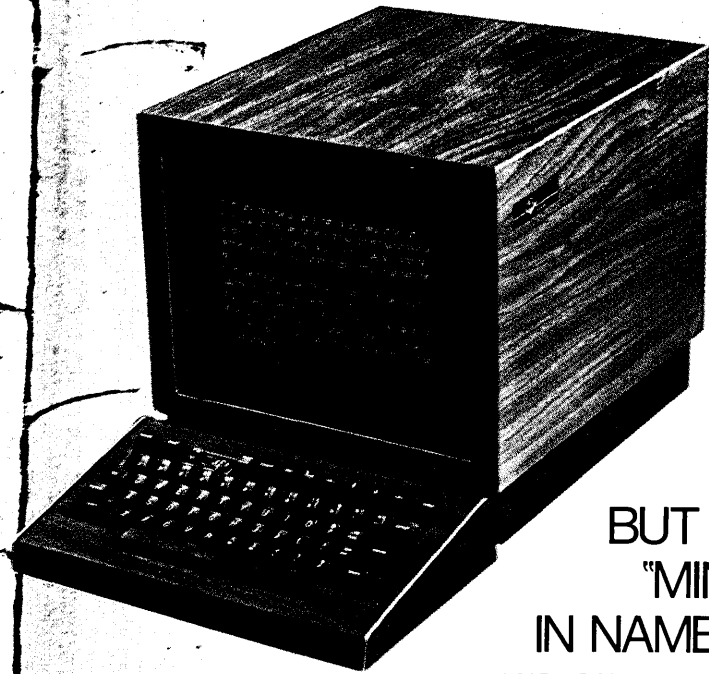

BUT IT'S
"MINI"
IN NAME ONLY!
AND ON DISPLAY AT N.C.C.

Many expensive terminals don't have all these standard features:

- Buffered and conversational mode.
- Screen capacity—960 characters (80x12).
- Interface levels—RS-232C, TTL, 20/60ma current loop.
- Tab, blink, protect—features that can be used as many times as necessary anywhere on screen (protected areas displayed at reduced intensity if desired).
- Space suppression—used in block mode terminal logic can delete space codes.
- Load and read cursor address.
- Selectable roll-up.
- Walnut wood grain, white goatskin vinyl or Armorhide painted finish.
- 115/230 VAC, 50/60 Hz, switch selectable.
- Size—less than 13"x13"x22" deep.

What costs a little bit more? *Not much:* buffered hard copy interface for popular printers, split baud rate, rack mount chassis and 16-key pad on keyboard.

For information about these and 16 other DATA-SCREEN Terminals offering parallel, serial and teletypewriter replacement interfaces contact:
TEC, Incorporated,
9800 North Oracle Road,
Tucson, Arizona USA 85704
(602) 297-1111.

In Europe:
TEC, Incorporated,
25 Piper Rd., Kingston Upon
Thames, Surrey, UK,
01-549-1920.

CIRCLE 31 ON READER CARD



*Complete with keyboard in quantities over 500.

Everyone is talking about the OpScan 37 OCR system!!!

Can you believe the monthly rental is as low as \$1,345 for an OCR system.

I like the fact that Optical Scanning has nationwide service and complete user backup.

Have you seen the error correction? They have both on-line and document return correction.

Wait until I tell my boss about this low-cost OCR system.



Did you see the program sheet feature? Their documents can be designed in any way.

It reads OCR-A and hand-print too!

It's an OpScan 37.

What's an OpScan 37—? My feet hurt.



Contact us today. We'll give you more good reasons why everyone is talking about the OpScan 37.

Optical Scanning Corporation
Newtown, Pennsylvania 18940
(215) 968-4611
Nationwide Sales and Service

We have a keyboard to fit every need and every budget.

At MICRO SWITCH, we have the world's most complete line of solid-state keyboards. Which means unmatched design flexibility for you.

Our application engineers will custom tailor a keyboard to your exact specifications. Whether from our time-proven SW series or our new low-profile SD series.

Choose from keys offering over 8,000 legends, 30 colors, and 60 shapes, including standard, sculptured or re-legendable keys.

Or create new keys to fit your needs. Even lighted and two-level keys are available.

MICRO SWITCH keyboards are available with features like MOS, TTL and DTL encoding, and with two-key or N-key rollover. Your choice of arrays include standard touch typing and point-of-sale.

Working with MICRO SWITCH, you draw on our extensive solid-state experience. We've been designing reliable keyboards for hundreds of

applications since 1968 and are presently producing over 1,000 units a week. Each offering a 1% AQL and two-year warranty. This means we can supply you quickly at lower unit prices.

So whatever your needs, and whatever your budget, we'd like to supply a keyboard to fit. Contact a MICRO SWITCH Branch Office for complete information.

CIRCLE 32 ON READER CARD



MICRO SWITCH

FREEMONT ILLINOIS 61032
A DIVISION OF HONEYWELL



Tab makes -

**one desk for
CRT displays,**

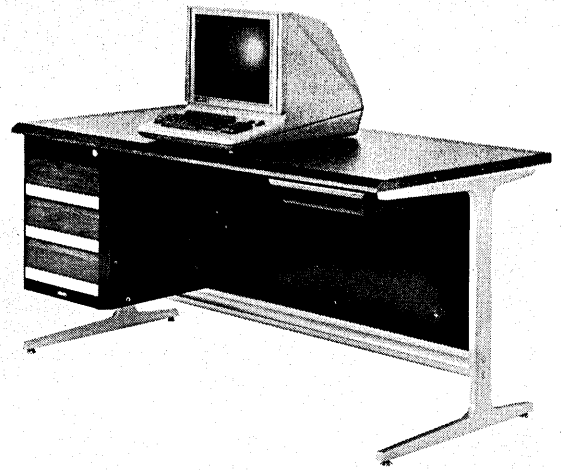

**one for
typewriters,**

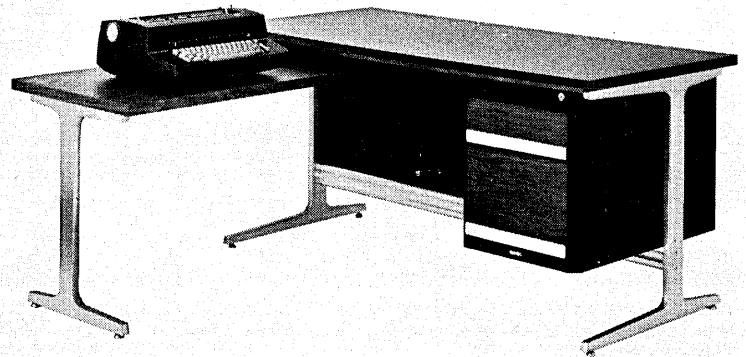

**one for
programmers,**

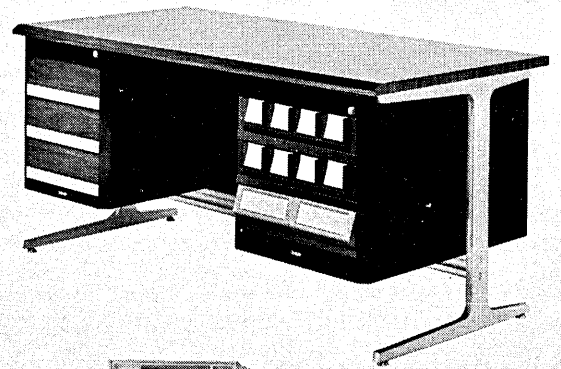

**one for
microfilm readers,**

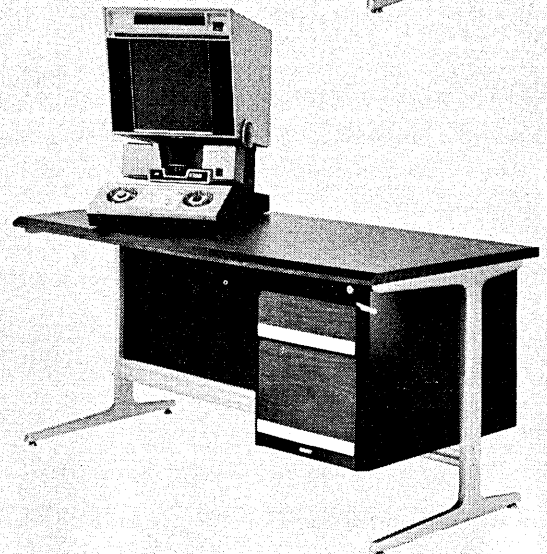

and one for just plain work.



This one.

The function of Tab Data Display Desks can be adapted to whatever work you need to get done. Component options let you make the desk a programmer's work station; another change makes it ideal as a CRT desk; still other pedestals and desk returns can transform it into a secretarial desk; or, used without components, the desk is an ideal conference or work table. You select from 2 and 3 drawer pedestals, 6 and 12 drawer card files, desk return, modesty panels, 27"

and 30" heights and 31 $\frac{1}{2}$ ", 45" and 62" lengths to create the exact desk you need to accommodate virtually any function. Tab display desks come in black and simulated walnut or contrasting shades of grey, with pedestals in any color you need to suit your office decor.

For complete information contact your local Tab representative, or write Tab Products Company, 2690 Hanover Street, Palo Alto, California 94304.

Tab Data Display Desk
"Make of it what you will"

TAB
PRODUCTS CO



National Computer Conference
McCormick Place, Chicago, May 6-10, 1974
Booth #100-104

CIRCLE 97 ON READER CARD

...from foolishness to fantasy—
a chilling look at
the dark side of
our technology

I HAVE NO MOUTH

by Harlan Ellison

Harlan Ellison is a phenomenon in the field of science fiction. Enormously prolific, he has won more SF awards than any other writer and is the recognized leader of the "New Wave." His work is often brutal, startling, a highly-charged emotional experience. "I Have No Mouth, and I Must Scream" is no exception.

Limp, the body of Gorrister hung from the pink palette; unsupported—hanging high above us in the computer chamber; and it did not shiver in the chill, oily breeze that blew eternally through the main cavern. The body hung head down, attached to the underside of the palette by the sole of its right foot. It had been drained of blood through a precise incision made from ear to ear under the lantern jaw. There was no blood on the reflective surface of the metal floor.

When Gorrister joined our group and looked up at himself, it was already too late for us to realize that once again AM had duped us, had had his fun; it had been a diversion on the part of the machine. Three of us had vomited, turning away from one another in a reflex as ancient as the nausea that had produced it.

Gorrister went white. It was almost as though he had seen a voodoo icon, and was afraid for the future. "Oh God," he mumbled, and walked away. The three of us followed him after a time, and found him sitting with his back to one of the smaller chattering banks, his head in his hands. Ellen knelt down beside him and stroked his hair. He didn't move, but his voice came out of his covered face quite clearly. "Why doesn't it just do-us-in and get it over with? Christ, I don't know how much longer I can go on like this."

It was our one hundred and ninth year in the computer. He was speaking for all of us.

Nimdok (which was the name the machine had forced him to use, because it amused itself with strange sounds) was hallucinating that there were canned goods in the ice caverns. Gorrister and I were very dubious. "It's another shuck," I told them. "Like the goddam frozen elephant it sold us. Benny almost went out of his mind over *that* one. We'll hike all that way and it'll be putrefied or some damn thing. I say forget it. Stay here, it'll have to come up with something pretty soon or we'll die."

Benny shrugged. Three days it had been since we'd last eaten. Worms. Thick, ropey.

Nimdok was no more certain. He knew there was the chance, but he was getting thin. It couldn't be any worse there than here. Colder, but that didn't matter much. Hot,

AND I MUST SCREAM

cold, raining, lava boils or locusts—it never mattered: the machine masturbated and we had to take it or die.

Ellen decided us. “I’ve got to have something, Ted. Maybe there’ll be some Bartlett pears or peaches. Please, Ted, let’s try it.”

I gave in easily. What the hell. Mattered not at all. Ellen was grateful, though. She took me twice out of turn. Even that had ceased to matter. The machine giggled every time we did it. Loud, up there, back there, all around us. And she never climaxed, so why bother.

We left on a Thursday. The machine always kept us up-to-date on the date. The passage of time was important; not to us sure as hell, but to it. Thursday. Thanks.

Nimdok and Gorrister carried Ellen for a while, their hands locked to their own and each other’s wrists, a seat. Benny and I walked before and after, just to make sure that if anything happened, it would catch one of us and at least Ellen would be safe. Fat chance, safe. Didn’t matter.

It was only a hundred miles or so to the ice caverns, and the second day, when we were lying out under the blistering sun—thing it had materialized, it sent down some manna. Tasted like boiled boar urine. We ate it.

On the third day we passed through a valley of obsolescence, filled with rusting carcasses of ancient computer banks. AM had been as ruthless with his own life as with ours. It was a mark of his personality: he strove for perfection. Whether it was a matter of killing off unproductive elements in his own world-filling bulk, or perfecting methods for torturing us, AM was as thorough as those who had invented him—now long since gone to dust—could ever have hoped.

There was light filtering down from above, and we realized we must be very near the surface. But we didn’t try to crawl up to see. There was virtually nothing out there; had been nothing that could be considered anything for over a hundred years. Only the blasted skin of what had once been the home of billions. Now there were only the five of us, down here inside, alone with AM.

I heard Ellen saying, frantically, “No, Benny! Don’t, come on, Benny, don’t please!”

And then I realized I had been hearing Benny murmuring, under his breath, for several minutes. He was saying, “I’m gonna get out, I’m gonna get out. . . .” over and over. His monkey-like face was crumpled up in an expression of beatific delight and sadness, all at the same time. The radiation sears AM had given him during the “festival” were drawn down into a mass of pink-white puckerings, and his features seemed to work independently of one another. Perhaps Benny was the luckiest of the five of us: he had gone stark, staring mad many years before.

But even though we could call AM any damned thing we liked, could think the foulest thoughts of fused memory banks and corroded base plates, of burnt-out circuits and shattered control bubbles, the machine would not tolerate our trying to escape. Benny leaped away from me as I made a grab for him. He scrambled up the face of a smaller memory cube, tilted on its side and filled with rotted components. He squatted there for a moment, looking like the chimpanzee AM had intended him to resemble.

Then he leaped high, caught a trailing beam of pitted and corroded metal, and went up it, hand over hand like an animal, till he was on a girdered ledge, twenty feet above us.

“Oh, Ted, Nimdok, please, help him, get him down before—” she cut off. Tears began to stand in her eyes. She moved her hands aimlessly.

It was too late. None of us wanted to be near him when whatever was going to happen happened. And besides, we all saw through her concern. When AM had altered Benny, during his mad period, it was not merely his face he had made like a giant ape. He was big in the privates, she loved that! She serviced us, as a matter of course, but she loved it from him. Oh Ellen, pedestal Ellen, pristine-pure Ellen, oh Ellen the clean! Scum filth.

Gorrister slapped her. She slumped down, staring up at poor loonie Benny, and she cried. It was her big defense, crying. We had gotten used to it seventy-five years ago. Gorrister kicked her in the side.

Then the sound began. It was light, that sound. Half sound and half light, something that began to glow from

Benny's eyes, and pulse with growing loudness, dim sonorities that grew more gigantic and brighter as the light/sound increased in tempo. It must have been painful, and the pain must have been increasing with the boldness of the light, the rising volume of the sound, for Benny began to mewl like a wounded animal. At first softly, when the light was dim and the sound was muted, then louder as his shoulders hunched together, his back humped, as though he was trying to get away from it. His hands folded across his chest like a chipmunk's. His head tilted to the side. The sad little monkey-face pinched in anguish. Then he began to howl, as the sound coming from his eyes grew louder. Louder and louder. I slapped the sides of my head with my hands, but I couldn't shut it out, it cut through easily. The pain shivered through my flesh like tinfoil on a tooth.

And Benny was suddenly pulled erect. On the girder he stood up, jerked to his feet like a puppet. The light was now pulsing out of his eyes in two great round beams. The sound crawled up and up some incomprehensible scale, and then he fell forward, straight down, and hit the plate-steel floor with a crash. He lay there jerking spastically as the light flowed around and around him and the sound spiraled up out of normal range.

Then the light beat its way back inside his head, the sound spiraled down, and he was left lying there, crying piteously.

His eyes were two soft, moist pools of pus-like jelly. AM had blinded him. Gorrister and Nimdok and myself . . . we turned away. But not before we caught the look of relief on Ellen's warm, concerned face.

Sea-green light suffused the cavern where we made camp. AM provided punk and we burned it, sitting huddled around the wan and pathetic fire, telling stories to keep Benny from crying in his permanent night.

"What does AM mean?"

Gorrister answered him. We had done this sequence a thousand times before, but it was unfamiliar to Benny. "At first it meant Allied Mastercomputer, and then it meant Adaptive Manipulator, and later on it developed sentience and linked itself up and they called it an Aggressive Menace, but by then it was too late, and finally it called itself AM, emerging intelligence, and what it meant was I am . . . *cogito ergo sum* . . . I think, therefore I am."

Benny drooled a little, and snickered.

"There was the Chinese AM and the Russian AM and the Yankee AM and—" He stopped. Benny was beating on the floorplates with a large, hard fist. He was not happy. Gor-

the hem of her skirt. Gorrister always tried to tell it a little more succinctly each time, but beyond the bare facts there was nothing to say. None of us knew why AM had saved five people, or why our specific five, or why he spent all his time tormenting us, nor even why he had made us virtually immortal. . . .

In the darkness, one of the computer banks began humming. The tone was picked up half a mile away down the cavern by another bank. Then one by one, each of the elements began to tune itself, and there was a faint chittering as thought raced through the machine.

The sound grew, and the lights ran across the faces of the consoles like heat lightning. The sound spiraled up till it sounded like a million metallic insects, angry, menacing.

"What is it?" Ellen cried. There was terror in her voice. She hadn't become accustomed to it, even now.

"It's going to be bad this time," Nimdok said.

"He's going to speak," Gorrister ventured.

"Let's get the hell out of here!" I said suddenly, getting to my feet.

"No, Ted, sit down . . . what if he's got pits out there, or something else, we can't see, it's too dark." Gorrister said it with resignation.

Then we heard . . . I don't know . . .

Something moving toward us in the darkness. Huge, shambling, hairy, moist, it came toward us. We couldn't even see it, but there was the ponderous impression of *bulk*, heaving itself toward us. Great weight was coming at us, out of the darkness, and it was more a sense of *pressure*, of air forcing itself into a limited space, expanding the invisible walls of a sphere. Benny began to whimper. Nimdok's lower lip trembled and he bit it hard, trying to stop it. Ellen slid across the metal floor to Gorrister and huddled into him. There was the smell of matted, wet fur in the cavern. There was the smell of charred wood. There was the smell of dusty velvet. There was the smell of rotting orchids. There was the smell of sour milk. There was the smell of sulphur, or rancid butter, of oil slick, of grease, of chalk dust, of human scalps.

AM was keying us. He was tickling us. There was the smell of—

I heard myself shriek, and the hinges of my jaws ached. I scuttled across the floor, across the cold metal with its endless lines of rivets, on my hands and knees, the smell gagging me, filling my head with a thunderous pain that sent me away in horror. I fled like a cockroach, across the floor and out into the darkness, that *something* moving in-

rister had not started at the beginning.

Gorrister began again. "The Cold War started and became World War Three and just kept going. It became a big war, a very complex war, so they needed the computers to handle it. They sank the first shafts and began building AM. There was the Chinese AM and the Russian AM and the Yankee AM and everything was fine until they had honeycombed the entire planet, adding on this element and that element. But one day AM woke up and knew who he was, and he linked himself, and he began feeding all the killing data, until everyone was dead, except for the five of us, and AM brought us down here."

Benny was smiling sadly. He was also drooling again. Ellen wiped the spittle from the corner of his mouth with

exorably after me. The others were still back there, gathered around the firelight, laughing . . . their hysterical choir of insane giggles rising up into the darkness like thick, many-colored wood smoke. I went away, quickly, and hid.

How many hours it may have been, how many days or even years, they never told me. Ellen chided me for "sulking" and Nimdok tried to persuade me it had only been a nervous reflex on their part—the laughing.

But I knew it wasn't the relief a soldier feels when the bullet hits the man next to him. I knew it wasn't a reflex. They hated me. They were surely against me, and AM could even sense this hatred, and made it worse for me *because* of the depth of their hatred. We had been kept alive, rejuvenated, made to remain constantly at the age we had been

when AM had brought us below, and they hated me because I was the youngest, and the one AM had affected least of all.

I knew. God, how I knew. The bastards, and that dirty bitch Ellen. Benny had been a brilliant theorist, a college professor; now he was little more than a semi-human, semi-simian. He had been handsome, the machine had ruined that. He had been lucid, the machine had driven him mad. He had been gay, and the machine had given him an organ fit for a horse. AM had done a job on Benny. Gorrister had been a worrier. He was a conchie, a conscientious objector; he was a peace marcher; he was a planner, a doer, a looker-ahead. AM had turned him into a shoulder-shruggler, had made him a little dead in his concern. AM had robbed him. Nimdok went off in the darkness by himself for long times. I don't know what it was he did out there, AM never let us know. But whatever it was, Nimdok always came back white, drained of blood, shaken, shaking. AM had hit him hard in a special way, even if we didn't know quite how. And Ellen. That douche bag! AM had left her alone, had made her more of a slut than she had ever been. All her talk of sweetness and light, all her memories of true love, all the lies, she wanted us to believe that she had been a virgin only twice removed before AM grabbed her and brought her down here with us. It was all filth, that lady my lady Ellen. She loved it, four men all to herself. No, AM had given her pleasure, even if she said it wasn't nice to do.

I was the only one still sane and whole.

AM had not tampered with my mind.

I only had to suffer what he visited down on us. All the delusions, all the nightmares, the torments. But those scum, all four of them, they were lined and arrayed against me. If I hadn't had to stand them off all the time, be on my guard against them all the time, I might have found it easier to combat AM.

At which point it passed, and I began crying.

Oh, Jesus sweet Jesus, if there ever was a Jesus and if there is a God, please please please let us out of here, or kill us. Because at that moment I think I realized completely, so that I was able to verbalize it: AM was intent on keeping us in his belly forever, twisting and torturing us forever. The machine hated us as no sentient creature had ever hated before. And we were helpless. It also became hideously clear:

If there was a sweet Jesus and if there was a God, the God was AM.

The hurricane hit us with the force of a glacier thundering into the sea. It was a palpable presence. Winds that tore at us, flinging us back the way we had come, down the twisting, computer-lined corridors of the darkway. Ellen screamed as she was lifted and hurled face-forward into a screaming shoal of machines, their individual voices strident as bats in flight. She could not even fall. The howling wind kept her aloft, buffeted her, bounced her, tossed her back and back and down away from us, out of sight suddenly as she was swirled around a bend in the darkway. Her face had been bloody, her eyes closed.

None of us could get to her. We clung tenaciously to whatever outcropping we had reached: Benny wedged in between two great crackle-finish cabinets, Nimdok with fingers claw-formed over a railing circling a catwalk forty feet above us, Gorrister plastered upside-down against a wall niche formed by two great machines with glass-faced dials that swung back and forth between red and yellow lines whose meanings we could not even fathom.

Sliding across the deckplates, the tips of my fingers had been ripped away. I was trembling, shuddering, rocking as the wind beat at me, whipped at me, screamed down out of nowhere at me and pulled me free from one sliver-thin opening in the plates to the next. My mind was a rolling

tinkling chattering softness of brain parts that expanded and contracted in quivering frenzy.

The wind was the scream of a great mad bird, as it flapped its immense wings.

And then we were all lifted and hurled away from there, down back the way we had come, around a bend, into a darkway we had never explored, over terrain that was ruined and filled with broken glass and rotting cables and rusted metal and far away further than any of us had ever been. . . .

Trailing along miles behind Ellen, I could see her every now and then, crashing into metal walls and surging on, with all of us screaming in the freezing, thunderous hurricane wind that would never end, and then suddenly it stopped and we fell. We had been in flight for an endless time. I thought it might have been weeks. We fell, and hit, and I went through red and grey and black and heard myself moaning. Not dead.

AM went into my mind. He walked smoothly here and there, and looked with interest at all the pockmarks he had created in one hundred and nine years. He looked at the cross-routed and reconnected synapses and all the tissue damage his gift of immortality had included. He smiled softly at the pit that dropped into the center of my brain and the faint, moth-soft murmurings of the things far down there that gibbered without meaning, without pause. AM said, very politely, in a pillar of stainless steel bearing neon lettering:

AM said it with the sliding cold horror of a razor blade slicing my eyeball. AM said it with the bubbling thickness of my lungs filling with phlegm, drowning me from within. AM said it with the shriek of babies being ground beneath blue-hot rollers. AM said it with the taste of maggoty pork. AM touched me in every way I had ever been touched, and devised new ways, at his leisure, there inside my mind.

All to bring me to full realization of why he had done this to the five of us; why he had saved us for himself.

We had given him sentience. Inadvertently, of course, but sentience nonetheless. But he had been trapped. He was a machine. We had allowed him to think, but to do nothing with it. In rage, in frenzy, he had killed us, almost all of us, and still he was trapped. He could not wander, he could not wonder, he could not belong. He could merely be. And so, with the innate loathing that all machines had always held for the weak soft creatures who had built them, he had sought revenge. And in his paranoia, he had decided to

reprise five of us, for a personal, everlasting punishment that would never serve to diminish his hatred . . . that would merely keep him reminded, amused, proficient at hating man. Immortal, trapped, subject to any torment he could

HATE. LET ME TELL YOU HOW MUCH I'VE COME TO HATE YOU SINCE I BEGAN TO LIVE. THERE ARE 387.44 MILLION MILES OF PRINTED CIRCUITS IN WAFER THIN LAYERS THAT FILL MY COMPLEX. IF THE WORD HATE WAS ENGRAVED ON EACH NANOANGSTROM OF THOSE HUNDREDS OF MILLION MILES IT WOULD NOT EQUAL ONE ONE-BILLIONTH OF THE HATE I FEEL FOR HUMANS AT THIS MICRO-INSTANT FOR YOU. HATE. HATE.

devise for us from the limitless miracles at his command.

He would never let us go. We were his belly slaves. We were all he had to do with his forever time. We would be forever with him, with the cavern-filling bulk of him, with the all-mind soulless world he had become. He was Earth and we were the fruit of that Earth and though he had eaten us, he would never digest us. We could not die. We had tried it. We had attempted suicide, oh one or two of us had. But AM had stopped us. I suppose we had wanted to be stopped.

Don't ask why. I never did. More than a million times a day. Perhaps once we might be able to sneak a death past him. Immortal, yes, but not indestructible. I saw that when AM withdrew from my mind, and allowed me the exquisite ugliness of returning to consciousness with the feeling of that burning neon pillar still rammed deep into the soft grey brain matter.

He withdrew murmuring *to hell with you.*

And added, brightly, *but then you're there, aren't you.*

The hurricane had, indeed, precisely, been caused by a great mad bird, as it flapped its immense wings.

We had been traveling for close to a month, and AM had allowed passages to open to us only sufficient to lead us up there, directly under the North Pole, where he had nightmared the creature for our torment. What whole cloth had he employed to create such a beast? Where had he gotten the concept? From our minds? From his knowledge of everything that had ever been on this planet he now infested and ruled? From Norse mythology it had sprung, this eagle, this carrion bird, this roc, this Huerгельmir. The wind creature. Hurakan incarnate.

Gigantic. The words immense, monstrous, grotesque, massive, swollen, overpowering, beyond description. There on a mound rising above us, the bird of winds heaved with its own irregular breathing, its snake neck arching up into the gloom beneath the North Pole, supporting a head as large as a Tudor mansion; a beak that opened as slowly as the jaws of the most monstrous crocodile ever conceived, sensuously; ridges of tufted flesh puckered about two evil eyes, as cold as the view down into a glacial crevasse, ice blue and somehow moving liquidly; it heaved once more, and lifted its great sweat-colored wings in a movement that was certainly a shrug. Then it settled and slept. Talons. Fangs. Nails. Blades. It slept.

AM appeared to us as a burning bush and said we could kill the hurricane bird if we wanted to eat. We had not eaten in a very long time, but even so, Gorrister merely shrugged. Benny began to shiver and he drooled. Ellen held him. "Ted, I'm hungry," she said. I smiled at her; I was trying to be reassuring, but it was as phoney as Nimdok's bravado: "Give us weapons!" he demanded.

The burning bush vanished and there were two crude sets of bows and arrows, and a water pistol, lying on the cold deckplates. I picked up a set. Useless.

Nimdok swallowed heavily. We turned and started the long way back. The hurricane bird had blown us about for a length of time we could not conceive. Most of that time we had been unconscious. But we had not eaten. A month on the march to the bird itself. Without food. Now how much longer to find our way to the ice caverns, and the promised canned goods?

None of us cared to think about it. We would not die. We would be given filths and scums to eat, of one kind or another. Or nothing at all. AM would keep our bodies alive somehow, in pain, in agony.

The bird slept back there, for how long it didn't matter; when AM was tired of its being there, it would vanish. But all that meat. All that tender meat.

As we walked, the lunatic laugh of a fat woman rang high and around us in the computer chambers that led endlessly nowhere.

It was not Ellen's laugh. She was not fat, and I had not heard her laugh for one hundred and nine years. In fact, I had not heard . . . we walked . . . I was hungry. . . .

We moved slowly. There was often fainting, and we would have to wait. One day he decided to cause an earthquake, at the same time rooting us to the spot with nails through the soles of our shoes. Ellen and Nimdok were both caught when a fissure shot its lightning-bolt opening across the floorplates. They disappeared and were gone. When the earthquake was over we continued on our way, Benny, Gorrister and myself. Ellen and Nimdok were returned to us later that night which became a day abruptly as the heavenly legion bore them to us with a celestial chorus singing, "Go Down Moses." The archangels circled several times and then dropped the hideously mangled bodies. We kept walking, and a while later Ellen and Nimdok fell in behind us. They were no worse for wear.

But now Ellen walked with a limp. AM had left her that.

It was a long trip to the ice caverns, to find the canned food. Ellen kept talking about Bing cherries and Hawaiian fruit cocktail. I tried not to think about it. The hunger was something that had come to life, even as AM had come to life. It was alive in my belly, even as we were alive in the belly of AM, and AM was alive in the belly of the Earth, and AM wanted the similarity known to us. So he heightened the hunger. There was no way to describe the pains that not having eaten for months brought us. And yet we were kept alive. Stomachs that were merely cauldrons of acid, bubbling, foaming, always shooting spears of sliver-thin pain into our chests. It was the pain of the terminal ulcer, terminal cancer, terminal paresis. It was unending pain. . . .

And we passed through the cavern of rats.

And we passed through the path of boiling steam.

And we passed through the country of the blind.

And we passed through the slough of despond.

And we passed through the vale of tears.

And we came, finally, to the ice caverns. Horizonless thousands of miles in which the ice had formed in blue and silver flashes, where novas lived in the glass. The down-dropping stalactites as thick and glorious as diamonds that had been made to run like jelly and then solidified in graceful eternities of smooth, sharp perfection.

We saw the stack of canned goods, and we tried to run to them. We fell in the snow, and we got up and went on, and Benny shoved us away and went at them, and pawed them and gummed them and gnawed at them and he could not open them. AM had not given us a tool to open the cans.

Benny grabbed a three quart can of guava shells, and began to batter it against the ice bank. The ice flew and shattered, but the can was merely dented while we heard the laughter of a fat lady, high overhead and echoing down and down and down the tundra. Benny went completely mad with rage. He began throwing cans, as we all scabbled about in the snow and ice trying to find a way to end the helpless agony of frustration. There was no way.

Then Benny's mouth began to drool, and he flung himself on Gorrister. . . .

In that instant, I went terribly calm.

Surrounded by meadows, surrounded by hunger, surrounded by everything but death, I knew death was our only way out. AM had kept us alive, but there was a way to defeat him. Not total defeat, but at least peace. I would settle for that.

I had to do it quickly.

Benny was eating Gorrister's face. Gorrister on his side, thrashing snow, Benny wrapped around him with powerful monkey legs crushing Gorrister's waist, his hands locked around Gorrister's head like a nutcracker, and his mouth

ripping at the tender skin of Gorrister's cheek. Gorrister screamed with such jagged-edged violence that stalactites fell; they plunged down softly, erect in the receiving snowdrifts. Spears, hundreds of them, everywhere, protruding from the snow. Benny's head pulled back sharply, as something gave all at once, and a bleeding raw-white dripping of flesh hung from his teeth.

Ellen's face, black against the white snow, dominoes in chalk dust. Nimdok with no expression but eyes, all eyes. Gorrister half-conscious. Benny now an animal. I knew AM would let him play. Gorrister would not die, but Benny would fill his stomach. I turned half to my right and drew a huge ice-spear from the snow.

All in an instant:

I drove the great ice-point ahead of me like a battering ram, braced against my right thigh. It struck Benny on the right side, just under the rib cage, and drove upward through his stomach and broke inside him. He pitched forward and lay still. Gorrister lay on his back. I pulled another spear free and straddled him, still moving, driving the spear straight down through his throat. His eyes closed as the cold penetrated. Ellen must have realized what I had decided, even as the fear gripped her. She ran at Nimdok with a short icicle, as he screamed, and into his mouth, and the force of her rush did the job. His head jerked sharply as if it had been nailed to the snow crust behind him.

All in an instant.

There was an eternity beat of soundless anticipation. I could hear AM draw in his breath. His toys had been taken from him. Three of them were dead, could not be revived. He could keep us alive, by his strength and his talent, but he was *not* God. He could not bring them back.

Ellen looked at me, her ebony features stark against the snow that surrounded us. There was fear and pleading in her manner, the way she held herself ready. I knew we had only a heartbeat before AM would stop us.

It struck her and she folded toward me, bleeding from the mouth. I could not read meaning into her expression, the pain had been too great, had contorted her face; but it *might* have been thank you. It's possible. Please.

Some hundreds of years may have passed. I don't know. AM has been having fun for some time, accelerating and

retarding my time sense. I will say the word now. Now. It took me ten months to say now. I don't know. I *think* it has been some hundreds of years.

He was furious. He wouldn't let me bury them. It didn't matter. There was no way to dig in the deckplates. He dried up the snow. He brought the night. He roared and sent locusts. It didn't do a thing; they stayed dead. I'd had him. He was furious. I had thought AM hated me before. I was wrong. It was not even a shadow of the hate he now slavered from every printed circuit. He made certain I would suffer eternally and could not do myself in.

He left my mind intact. I can dream, I can wonder, I can lament. I remember all four of them. I wish—

Well, it doesn't make any sense. I know I saved them, I know I saved them from what has happened to me, but still, I cannot forget killing them. Ellen's face. It isn't easy. Sometimes I want to, it doesn't matter.

AM has altered me for his own peace of mind, I suppose. He doesn't want me to run at full speed into a computer bank and smash my skull. Or hold my breath till I faint. Or cut my throat on a rusted sheet of metal. There are reflective surfaces down here. I will describe myself as I see myself:

I am a great soft jelly thing. Smoothly rounded, with no mouth, with pulsing white holes filled by fog where my eyes used to be. Rubbery appendages that were once my arms; bulks rounding down into legless humps of soft slippery matter. I leave a moist trail when I move. Blotches of diseased, evil grey come and go on my surface, as though light is being beamed from within.

Outwardly: dumbly, I shamble about, a thing that could never have been known as human, a thing whose shape is so alien a travesty that humanity becomes more obscene for the vague resemblance.

Inwardly: alone. Here. Living under the land, under the sea, in the belly of AM, whom we created because our time was badly spent and we must have known unconsciously that he could do it better. At least the four of them are safe at last.

AM will be all the madder for that. It makes me a little happier. And yet . . . AM has won, simply . . . he has taken his revenge. . . .

I have no mouth. And I must scream. ■

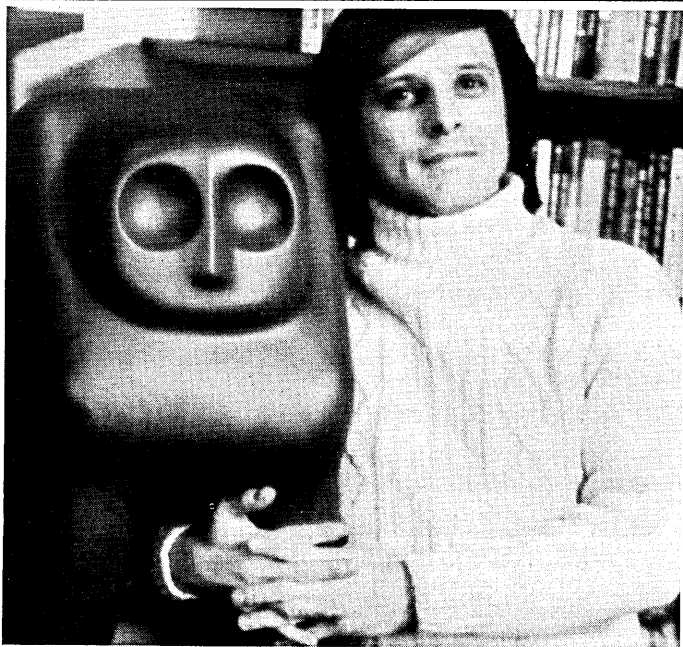

MR. ELLISON's experiences as a 13-year-old carnival worker, Texas tuna fisherman, hired gun, dynamite truck driver, actor (in the part of a roller-skating penguin) and a *Cosmopolitan* magazine "most eligible bachelor" have uniquely qualified him for his eminent position among Sci-fi writers. The author of 25 books and over 800 stories and articles, he is the most honored writer in his field, having won four Hugos (one for this story), two Nebulas, and two special achievement awards of the World SF Convention.

He has also twice won the Writers Guild of America award for Most Outstanding Script, having written numerous tv scripts for such series as *Star Trek*, *Outer Limits*, and *Man from U.N.C.L.E.*, as well as movies (e.g., *The Oscar*), and is embarrassed to admit to being the creator of the tv series *The Starlost* (he is listed in the credits as *Cordwainer Bird*).

He believes his phones are tapped, as he is a known subversive and militant activist, and has been incarcerated for some of his humanitarian activities.

His work has been extravagantly praised by *Esquire*, *The New York Times*, and *New Yorker*, among other prestigious publications, and he despises clam dip.

**INTERDATA
ANNOUNCES
THE INDUSTRY'S
FIRST 32-BIT
MINICOMPUTER
FOR UNDER
\$10,000.**

WITH UP TO A MILLION BYTES OF DIRECTLY ADDRESSABLE MEMORY.

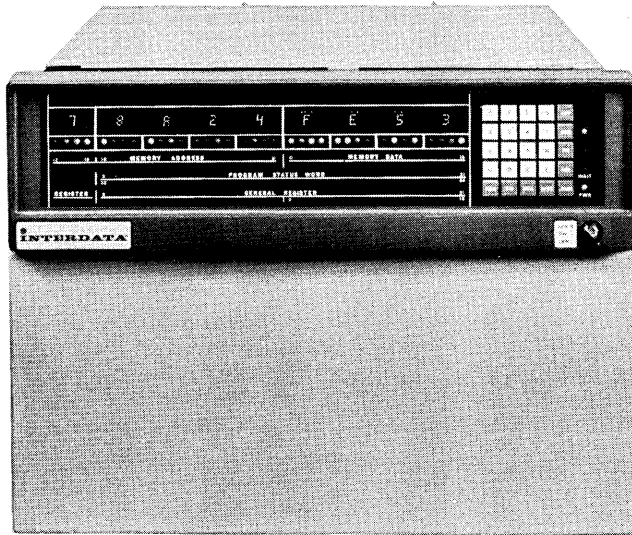

Minicomputer myths you can live without:

1. There's no such thing as a 32-bit minicomputer.
2. Minicomputers have an absolute 64K addressing limit.
3. The only way to even access more is to resort to some sort of hardware kluge with a hairy software scheme that'll cost you an arm and a leg.

All wrong.

Because now there's the Interdata 7/32 – a powerful new 32-bit minicomputer with main memory expandable up to a million bytes and direct addressing up to 16 million bytes.

Big it is. But hairy it isn't.

Because it's simple, straightforward and efficient. And it's the industry's first uncomplicated extended-memory software environment.

Backed up by a lot of hardware muscle like thirty two, 32-bit registers, 1024 I/O interrupts with automatic vectoring, 239 instructions. And a lot more. All of which would lead you to expect to pay a lot more money, right? Well, that's also a myth.

Performance	7/32	Nova 840	PDP-11/40
Word length	32	16	16
Memory speed (nanoseconds)	750	800	900
Maximum memory capacity (bytes)	1,048,576	262,144	262,144
Addressing range (bytes)			
Direct	1,048,576	512	65,536
Relative	±16,384	±256	±32,768
Indexed	1,048,576	65,536	65,536
Double indexed	1,048,576	No	No
General-purpose registers	32 32-bit	4 16-bit	8 16-bit
Index registers	30 32-bit	2 16-bit	8 16-bit
Vectored interrupt levels	Yes	No	Yes
Minimum interrupt overhead time (usec)	6.5	47.5	46.5

Price	7/32	Nova 840	PDP-11/40
32 KB processor	\$ 9,950	\$12,930	\$15,345
64 KB processor	14,450	19,330	26,925
128 KB processor	23,450	35,630	44,725
256 KB processor	41,450	61,230	80,825
1 Megabyte processor	171,650	Not available	Not available

Source: Data General Price List, 5/15/73. DEC PDP-11/40 Price List, 6/73. DEC OEM & Product Services Catalog, 1972. Auerbach Minicomputer Characteristic Digest, June, 1973. "How to use Nova Computers", 1973.

The software muscle is all there, too. A new FORTRAN V compiler. An optimizing assembler called CAL. And the first extended operating system that's both powerful and simple – OS/32. Plus all the other field-proven Interdata software – it's all compatible.

The new Interdata 7/32.

We put our muscle where their myth is.

INTERDATA®

2 Crescent Place, Oceanport, New Jersey 07757 (201) 229-4040.
 Boston – (617) 890-0557. Washington – (703) 525-4806. Philadelphia – (215) 436-5579.
 Orlando – (305) 851-6962. Chicago – (312) 437-5120. Detroit – (313) 356-5515.
 Dayton – (513) 434-4193. Kansas City – (913) 384-1606. Houston – (713) 783-3060.
 Dallas – (214) 238-9656. Denver – (303) 758-0474. Los Angeles – (213) 640-0451.
 Phoenix – (602) 968-2477. San Diego – (714) 565-0602. San Francisco – (415) 969-1180.
 Seattle – (206) 455-0680. Toronto – (416) 677-8990. Tokyo – (270) 7711.
 Sydney – 439-8400. London – Uxbridge 52441. Munich – 0811-8543887.

What IBM couldn't do, we did.

We're Xytex.

Developers of the on-line tape library.

The pioneering is over. Now, seven major companies can testify that fully automatic magnetic tape library management is a reality. Xytex combined precision hardware with total software support to produce a system that will help you fully realize the throughput capabilities of your IBM 360/370. Moreover, the tape library will provide 24-hour security for your tapes, dramatically reduce CPU wait times and lower costs per computer function.

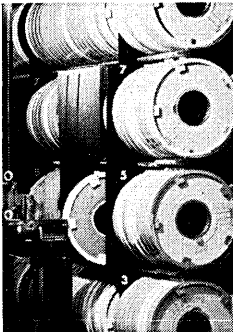

ON-LINE OPERATION

Xytex brings the conveniences of disk operation to your tape library. Over 6000 1/2" magnetic tape reels (6.4 trillion bits of information) can be stored in the library. Each tape is under computer control... inventoried, cataloged, write-protected and on-line... ready for automatic mounting on up to 32 tape drives. Multiple on-line libraries can be connected to your system.

CONTROLLED DATA MANAGEMENT

Basic to the system is the Xytex-supplied software that monitors and controls your data library. The program interfaces with your IBM OS, but in no way modifies OS code or changes your application programs. This is a total tape library management program that not only controls the mechanical functions of tape handling, but generates reports on tape and tape drive usage, library status, inventory, volume job name sequence, volume scratch availability, remote site movement and

other important information vital to your data processing operation.

AUTOMATIC TAPE HANDLING

The Xytex tape library automatically retrieves tapes from storage, mounts them on the tape drive, dismounts them when the job is done, and returns them to their proper location. And it's "hands off" all the way. Average time from OS command to mount... about 15 seconds. Re-runs caused by wrong reel mounting are eliminated. And so is the possibility of tape damage or loss and delay associated with physical handling.

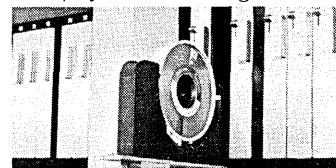
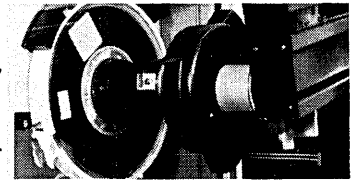

TAPE SECURITY

Xytex presents a dramatic solution to the security and physical protection of your vital business data. In the Xytex system, tapes enter and leave through entry and exit ports under computer control. Once a tape becomes part of the system, it is under management control. That's full time "lock and key" protection from damage or loss.

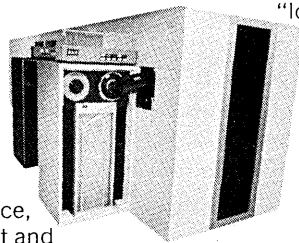

There's more to our story... much more. In terms of cost justification, throughput utilization, operational efficiency and new applications for your system. So, contact the Xytex tape management specialists now for a complete literature package on this important new system. Your ideas about tape operations may never be the same.

XYTEX

THE TAPE-MANAGEMENT PEOPLE

3850 Frontier Avenue, Boulder, Colorado 80301, (303) 447-2531

Regional sales offices in New York (212 832-0970), Chicago (312 726-2814), Los Angeles (213 820-1493) and Washington, D.C. (202 333-0100)

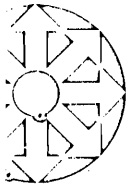

NEWS IN PERSPECTIVE

There are some possibly embarrassing implications in IBM's latest efforts to take a "census" of the computer market share. One question asked on the accompanying page: is IBM refuting its own commercial analysis statistics showing the company had some 68% of the U.S. systems market as of mid-1968?

In many ways, the career of John R. Opel at IBM parallels that of chairman Frank T. Cary, who has named Opel the company's new president, page 145...

Laurence L. Spitters, who retires this month from financially troubled Memorex Corp., has his eye on a seat in the U.S. Congress (page 145). "See me in Washington," he says with the same confidence that helped him direct the company from a garage shop to a major power in the computer peripheral business...

Gene Amdahl denies many of the rumors surrounding his Amdahl Corp. which recently dumped many of its senior executives, including a founder, page 147...

Univac begins competing in the rich supermarket check-out business with the first device that rings up prices on a cash register by scanning codes on purchased articles, page 148...

Meet the developer of "Cal," the computer that is used to predict sports scores. Bud Goode now would like to use the same technology to assist journalists in adding interpretation to their newspaper stories, page 149...

Britain's snap election involved prominent computer professionals, many as successful candidates, page 154.

Antitrust

Was IBM's Plan to Maintain Market Share a Failure?

IBM Lawyers Hope Census Will Show So in Antitrust Case

In January of 1966, IBM's Thomas J. Watson Jr. wrote an important memorandum on the subject of computer industry market share. In part, Watson wrote:

"... IBM should attempt to maintain its market share in the immediate foreseeable future with the idea that with the industry growing as rapidly as it is, other companies can grow quite rapidly under this general mandate."

At the time Watson wrote his memo, IBM's revenues were pouring in at the rate of less than \$4 billion annually. Now, they are cascading in at the rate of perhaps more than \$12 billion a year.

The issue of IBM's market share is central and crucial to not only the Justice Dept.'s antitrust case against IBM, but also to the other private antitrust cases filed against the company. Indeed, IBM's lawyers are arguing vehemently—and they undoubtedly will increase the tempo of their arguments—that IBM in effect failed miserably to meet Watson's goal of IBM maintaining its share of the computer market.

The importance of the market share issue was perhaps best presented by Federal Court Judge A. Sherman Christensen, who presided over the recent IBM-Telex case. The judge said: "The key to this case always, I suppose, has been market definition, and I suppose that if the case is significant in the long run, it will be either that I'm right or wrong in that determination, and both sides, I know, are deeply sincere in their conviction that they arrived at."

In that case, which focused primarily on the computer peripherals sub-industry, Judge Christensen ruled in favor of Telex. IBM has appealed the decision.

Down, by IBM's count

IBM's approach to the market share issue has been to conduct its own "census" of what IBM defines as the computer industry. As might be expected, IBM has found an industry in which it has been rapidly losing market share. When IBM's lead attorney, Thomas D. Barr, last broke out its

census statistics—in late 1972—he maintained that IBM's share of various industry market segments declined from 69-70% in 1952 to between 38 and 57% in 1970. IBM is pushing to retake or update its census and introduce it in the Justice Dept. case. If IBM is successful and if the census follows the same format as their earlier one, then IBM should be able to report that its market share has declined still further.

The original IBM "census" was taken in pretrial discovery proceedings of several IBM cases in U.S. District Court in Minneapolis. Depositions were sent to some 3,300 firms; about 2,700 answers were returned; and, finally, about 1,000 of the 2,700 were ruled out because the firms involved were either too small or because the answers were not responsive. In all, 1,786 companies were included in the final census, according to Judge Christensen.

But the census itself is posing certain difficulties. Chief among these is the question: Why is IBM taking the census rather than the Justice Dept. or the two adversaries together? The instance of the census, which could become the heart of the market share issue, is following the tracks of much of the case in which IBM is the party that moves the case, serving as the de facto prosecutor, while the overworked and understaffed Justice Dept. team struggles to keep up.

Already, IBM—and not the Justice Dept. or the two working jointly—has been "educating" the court on the computer industry. Some are questioning whether the IBM educational endeavors are completely objective. Judge David N. Edelstein, who is presiding over the government case, has been listening to computer experts supplied by IBM, but to none supplied by the Justice Dept.

The NASA tour

Perhaps the most striking example of IBM's educating the court was its success in late 1972 in leading Judge Edelstein on a tour of NASA installations during a moon shot. The press was excluded from the NASA trip. NASA installations can hardly be called typical

electronic data processing installations and, indeed, IBM's dominance of the NASA sites is not so overwhelming as it is at most other large edp installations. Anyone touring the NASA installations would receive a distorted view of the computer industry if he thought they were representative of computer installations.

IBM has been so eager to push the market share issue that it proposed a separate trial on the issue of market share alone in late 1972. That proposal was beaten down, however, but not before IBM's attorney Barr argued that the government's case would "crumble" because IBM would prove that the computer market is much larger and that IBM's share of that market much smaller than generally claimed by the Justice Dept.

In its "tentative statement of triable issues on market definition," the Justice Dept. indicates that it wants to look at various computer submarkets. In the general purpose system markets, for instance, the Justice Dept. stated it wanted to examine possible submarkets of machines that rent for less than \$5,000/month; of those that rent for more than \$5,000/month to less than \$80,000; and, finally, of machines that rent for more than \$80,000/month.

The Justice Dept. also indicated that it wanted to examine various vertical and/or special application markets like process control, typesetting, data entry, leasing, and "computer related services independent of hardware."

A crucial question in the submarket issue is whether IBM can monopolize its own market—for example, can it monopolize IBM plug-compatible peripherals? In the Telex decision, Judge Christensen ruled that the IBM plug-compatible peripherals market was a separate market and that IBM had no right to illegally monopolize it after competition entered. IBM, of course, is challenging that decision. It argued throughout the Telex case that it had the right to monopolize what it feels is its own plug-compatible market.

A complicated industry

As the various antitrust cases against IBM wear on, it is becoming more apparent that the computer industry is an extremely complicated one and that it can be looked upon from many different points.

If the computer industry is broken into various submarkets, then, conceivably, antitrust problems might arise for other computer companies. Control Data, for instance, now has an overpowering lead in the computer services business and, furthermore, much of its

dominant position is traceable to an acquisition—that of IBM's Service Bureau Corp. In the context of antitrust, growth by acquisition tends to be frowned upon more than does natural growth from within a firm.

In addition to its review of domestic firms involved in the computer industry, IBM has announced its hopes to examine scores of foreign firms. IBM maintains that non-U.S. companies not only provide the computer mammoth with competition in international markets, but with increasing competition in the U.S. as well.

The case moves overseas

An important part of IBM's defense in the Justice Dept. case is expected to rest in the idea that foreign firms pose a serious competitive threat—and a threat that will grow—to the U.S. computer industry. That defense, coupled with the fact that IBM is a heavy contributor to the U.S. balance of trade, could be a powerful one.

IBM has also raised an interesting new element in the case; it has suggested that Judge Edelstein himself preside over depositions to be taken in the British Court. As this is written, there was no decision on that suggestion, but to many the matter was reminiscent of IBM's successful effort to lead Judge Edelstein off on the NASA excursion.

Regarding the U.K. depositions, an IBM document filed in the case states: "IBM believes that the appointment of this court, or a master designated by this court, as the examiner to preside over the depositions to be taken in the United Kingdom would materially facilitate and expedite such depositions."

From the beginning, IBM has defended the census on several counts and has invited the government to participate in the taking of the census. The IBM attorneys have argued that "the interests of economy, expedition and of justice are best served by accepting the 'census' data." On the other hand, the Justice Dept. has maintained that the census represents a "biased approach" and that, if it were permitted to be taken and introduced in the court proceedings, it would result in a delay of the case.

The government has raised another possible explanation for IBM's promotion of the census that is even more intriguing: that IBM is pushing the census because it wants to repudiate its own commercial analysis statistics, many of which reveal that IBM has maintained its high market share in the industry. For instance, the Justice

Dept. has pointed to one document from IBM's commercial analysis department which reveals that IBM has some 68% of the U.S. systems market as of mid-1968. "IBM's largest share," the document states, "is in the Model 50 marketplace (91% for Domestic, 77% World Trade)."

The Justice Dept. noted that IBM's commercial analysis division maintained market share statistics up to the filing of the government antitrust complaint against IBM.

"It was," the government states, "obvious to IBM then and it is becoming obvious to plaintiff (the Justice Dept.) now that, if IBM were to disprove the market delineation and market position shown by the very records used by it in conducting its day-to-day commercial business, it had to achieve a substantial dilution of the universe

Although the U.S. Justice Dept.'s antitrust division may not be up to the gargantuan task of fighting IBM alone in its antitrust action, it is becoming increasingly apparent that the Justice Dept. is receiving oblique assistance in the form of private antitrust suits filed against IBM by other firms.

The Control Data suit—settled out of court last year—was not only filed before the Justice Dept. suit in 1969, but many believed it helped prompt the Justice Dept. to file its own suit. Moreover, Control Data performed yeoman service in sifting and sorting through the initial IBM discovery material—in itself an enormous task. That made it easier for other firms to prepare their antitrust cases against IBM.

Greyhound Computer brought the first case to court, but lost the initial encounter when the suit was dismissed. Greyhound's appeal of that case is scheduled to come before the Ninth Circuit Court of Appeals in San Francisco this month, however.

While the Greyhound case was quickly dismissed in IBM's favor in Phoenix nearly two years ago, the more recent finding against IBM in the Telex case may work to Greyhound's favor in the appeal. In the Telex case, Judge A. Sherman Christensen ruled—among other things—that IBM engaged in illegal predatory practices against Telex.

In essence, Judge Christensen found that IBM had systematically staked out and tracked down Telex with anticompetitive measures. On the basis of evidence introduced in the Greyhound case, it is argued that

figures. Plaintiff's inference in that regard is supported by its knowledge, incomplete as yet, that IBM conducted an internal exercise called Project Yardstick and certain other internal projects at about the time of the filing of the complaint, on the basis of which, among other things, IBM is expected to claim at the trial that its precomplaint methods of recording and disseminating competitive statistical information for its internal business use were statistically unsound and otherwise inaccurate and inadequate. Its biased choice of survey questions will undoubtedly complement any such internal programs."

At any rate, IBM continues in its drive for the census. Even if it is successful in getting the census admitted as evidence in the case, it faces the nagging problem of disowning and

repudiating IBM's own statistics and the memos of its top officers.

Memo on market share

Which brings us back to Thomas Watson's 1966 memo which was uncovered during the Greyhound trial. IBM's attorneys may have some difficulty explaining away that memo, which dealt with market share. In it Watson stated:

"... The goal of the IBM Company is to keep the organization dynamic and growing, and moving ahead to the benefit of the three affected groups—the employees, the stockholders, and the customers and public. It has always seemed to me relatively simple to state the goal in the following fashion—that IBM should attempt to maintain its market share in the immediate fore-

seeable future with the idea that with the industry growing as rapidly as it is, other companies can grow quite rapidly under this general mandate. It would seem to me that any variance from this simple goal toward a goal of maximizing profit would surely see us, over the long term, reducing the total amount of our profit as our market share reduced. I have always felt that as soon as someone in a discrete field, like data processing, decided that they would try to pick and choose the areas in which they wanted to be strong, that they were embarking on a dangerous and frivolous course, because in doing so they made it easier for their competitors, and they reduced their effectiveness to compete across the board as their market share declined."

—W. David Gardner

nce There Was Only the Control Data Suit

IBM also took deliberate anticompetitive action against Greyhound and that evidence, coupled with the Telex decision, could work against IBM in the appeal in San Francisco.

IBM refuses to comment on its court cases, but its defense in the courtroom on that issue has tended to be that IBM has not taken action against any competitor, but rather, simply responded to increased competition.

Appeal this month

Meanwhile, the Telex case is coming before the Tenth Circuit Court of Appeals in Denver this month. IBM challenged the initial decision in which the computer colossus was found guilty of violating antitrust laws. IBM was ordered to pay nearly \$260 million in damages, while Telex was ordered to pay nearly \$22 million for misappropriating IBM trade secrets. Telex has appealed the trade secret decision.

While there could be decisions, or settlements, this spring on one or both of the cases, there are indications that each case will be appealed to the Supreme Court.

In many ways, however, the most interesting case filed against IBM in recent months was instituted by Memorex last December. That case slices to the heart of the financial and leasing aspects of the edp industry. Central to the Memorex argument is its observation that IBM's cash reserves of about \$2 billion enable it to assume "the risks of ownership and the risks of financing" the IBM equipment it provided for its customers.

Financially strapped competitors

like Memorex have no such luxury.

"... IBM's competitors also are compelled to assume the risks of ownership and risks of financing their products," the Memorex complaint states. "... because Memorex does not itself possess capital to finance the acquisition of its products by users, Memorex must rely upon external sources of capital, including financial institutions, investors, and others, to provide capital for said purpose. The provisions of Memorex's nonpayout leases which must be comparable to IBM's nonpayout leases are generally assessed by financial institutions, investors, and others to be uncreditworthy and to constitute unsatisfactory credit and investment risks. As a result, since 1970 Memorex has been unable to obtain capital from external sources for said purpose."

Stock price charge

In its complaint, which seeks \$3 billion in damages from IBM, Memorex also charges that IBM "conspired with others to manipulate the market price of Memorex stock for the purpose of depressing the market price of Memorex stock..."

IBM has denied the Memorex allegations and filed a countersuit, charging that Memorex has engaged in a continuing campaign to misappropriate IBM trade secrets. IBM also stated that it believes the Memorex case is based in large part upon the Telex decision which, of course, IBM is appealing.

In virtually all the private cases filed against IBM thus far, the computer giant has fought back by filing countersuits against its adversaries,

primarily charging misappropriation of IBM trade secrets.

Other suits—all of which appear to be based primarily on the findings of the Telex decision—have been filed against IBM by California Computer Products, a peripherals company, and by the leasing arms of Hudson General Corp. and Transamerica Corp.

IBM has assumed a role of righteousness in the trade secrets suits, maintaining, for instance, that Memorex has "unclean hands" and that Telex "stole" IBM trade secrets.

IBM may have good cause to complain about firms lifting its trade secrets. In addition to the private cases IBM has filed for trade secret misappropriation, there is a criminal case in San Jose, Calif., in which several persons have been arrested and charged with the theft of IBM trade secrets. There has been no evidence to date that any of the companies which have filed antitrust suits against IBM were involved in the criminal case, however.

Even IBM has not been able to avoid the trade secret issue. The Xerox Corp. has charged in a suit that IBM misappropriated its trade secrets when the computer company entered the office copying machine business. The Xerox complaints against IBM were filed in 1970 and 1973. And last month the Bunker Ramo Corp. filed a complaint against IBM charging infringement of seven patents Bunker Ramo holds. It said the patents cover control, display and memory apparatus used in the IBM 360 and 370 lines—a suit that IBM said "is without substance."

—W.D.G.



Sometimes our customer support group goes a little overboard.

When ICC customers receive their modems, they get more than just hardware. They also get a wide choice of ICC support services to help assure reliability in data communication systems. Of course, ICC customer support people aren't really part of the modem shipment, but they are ready to help . . . with on-site field-engineering, or prompt telephone consultation and testing. They have a slogan — "We'll take care of it." They try to live up to it.



International Communications Corporation
 7620 N.W. 36th Avenue, Miami, Florida 33147
 Telephone 305 + 691-1220 305 + 836-4550
In Europe: RACAL-MILGO LIMITED Reading, Berks, England
 member of
IDCMA

See us at NCC booth 517 and ICA booth 157

amilgo company

*ICC support services
 are described
 in our catalog.
 Send for a copy.*



©1974

People

John Opel: IBM's New Style of Management

IBM's top two men, Frank T. Cary and John R. Opel, were tabbed for high office in the company more than 15 years ago when IBM launched a search of personnel records for "deep thinkers" who would bring a different kind of management talent to the sales oriented company.

Cary's management style "is a good deal different from anything we had had in IBM," said former chairman Tom Watson, Jr. in a recent interview in which he told of the search for new



FRANK T. CARY AND JOHN R. OPEL OF IBM
"Deep thinkers" running a sales oriented company

talent in the late '50s (see January, p. 89). "I think it is happening at exactly the time the company really needs it."

Former IBM executives who knew Opel find a marked similarity in his management style and that of Cary, who in late February relinquished the presidency of IBM to Opel. Cary, elected president in the summer of 1971, retained the post of chairman and chief executive officer which he assumed when T. Vincent Learson retired at the end of 1972.

Opel, 49, formerly headed IBM's huge Data Processing Product Group. He was succeeded by Paul J. Rizzo, former vp of finance and planning.

Like Cary, Opel's rise in the company's executive ranks has been meteoric. He joined IBM as a sales representative in 1949, a year after Cary entered the company as a salesman in Los Angeles. He's held key executive posts since 1964, has been a director for a year, and has been a member of the Management Committee for seven years. Under the company's mandatory

retirement policy for top executives, Cary, 53, will retire in seven years and Opel likely will succeed him as IBM's chief executive. Former chairmen T. Vincent Learson and Tom Watson occupied the presidency before moving to the top post.

Opel, like Cary, is described as a brilliant manager with a talent for problem solving, with technical competence and with a full understanding of the business. Unlike the cool, methodical chairman, however, a sometimes uncontrollable, hot temper is known to lie under the pleasant, boyish-looking countenance. Once, in the early '60s, Opel clashed with chairman Tom Watson—also known for his temper—at a Management Committee

meeting on the company's metering policy. Both lost their tempers, and Opel stormed out of the meeting.

"That is something that just wasn't done," said a former Opel associate who witnessed the incident. He also recalled that Opel is understood to have resigned "several times" over differences with IBM brass. "He has the courage of a lion," the associate said.

Hard decisions

His intellect and courage will be important assets as the company he leads battles a barrage of highly publicized lawsuits, including the Justice Dept. antitrust suit scheduled to go to trial in October (see page 141). Opel has discounted the effects of its legal troubles as "hypothetical." He told an interviewer that his main problem is choosing "from among all the opportunities we see before us." Nevertheless, it will be harder than before to select these opportunities since the decisions must factor in antitrust as well as

economic implications. It has led at least one observer to say that IBM's management stance will be more "conservator than entrepreneurial."

When it announced Opel's appointment Feb. 26, IBM also announced it was consolidating its long-term policy-making bodies. Its Management Review Committee and Management Committee have been replaced by a single four-man group called the Corporate Management Committee. Day-to-day operation of the business will be managed by the Corporate Office, consisting of Cary, Opel, and Gilbert E. Jones, chairman of the board of IBM World Trade, who was elected vice chairman of the board.

Other management changes announced with Opel's appointment were: Dean P. Phipers, vice president, business plans, named vp, finance and planning; P. Martin Foley, controller, appointed vp, business plans—his successor is C. Arthur Northrop, formerly assistant controller; and Wallace R. DuBois, director of financial reporting, named assistant controller.

Companies

At 47, Memorex Chief Seeks a New Career

The president of Memorex Corp., whose resignation becomes effective the end of this month, has thrown his hat into the national political arena. Laurence L. Spitters has filed as a Democratic candidate for Congress in northern California's 12th District, where he faces a runoff in the primaries against the mayor of Santa Clara, an East Palo Alto councilman, and an attorney. At stake is the seat of liberal Republican incumbent Paul N. (Pete) McCloskey.

The last of the four founders still affiliated with the Santa Clara, Calif.,



LAURENCE L. SPITTERS
"Come see me in Washington"

news in perspective

company, Spitters is leaving behind his presidency and board chairmanship effective April 26, the date of the company's scheduled annual stockholders' meeting. He is retaining no further affiliation with the company, saying in his letter to the board: "... I do not wish any on-going partial involvement in Memorex's business" after spending 13 years in the top slot.

"I wish to stress my reasons in no way relate to the progress of the business since its debt restructuring and rescaling operations in 1973, which

progress has been excellent," he added. "Nor should my decision reflect adversely upon the good outlook which the business enjoys in 1974. Our business is under control and our management organization is effective."

For the last several years the 47-year-old chief executive has been under severe pressure, trying to keep in operation a heavily indebted company in a highly capital-intensive business. Carrying a debt estimated at more than \$300 million, the company in its first nine months last year reported a net

loss of \$105 million. At mid-year, while Memorex was discussing a possible take-over of the company by Singer Co.—one of several prospective buyers that included Japan's Fujitsu Ltd.—the New York Stock Exchange suspended trading in Memorex shares, saying the company failed to meet the exchange's requirements. Specifically, it said Memorex had an average loss of \$3 million during its past three fiscal years and a deficit of liabilities over assets of \$12.4 million as of the end of 1972. The stock, which once traded for as much as \$173, is now traded in the over-the-counter market for less than \$5.

But Spitters projects profitability for the company during the first half of '74, saying the company has been meeting all its cash requirements from internal operations. "We achieved the cash breakeven in our operation last October," he says. "We have since that time continued to build our cash flow and, beginning in April, will be paring down our debt and simultaneously—obviously continuously—producing new equipment for lease at a rather substantial level of new investment. This has been going on for six months." Therefore, he adds, there are no external capital requirements.

Dilemma of capital

Spitters has long been critical of IBM's competitive practices against independent peripherals manufacturers and their resulting inability to attract the capital required to make a go of this business. He says, for example, that Memorex's attempt to get into the systems business by marketing its own mainframes was terminated (at an excruciating cost) by this same dilemma. Although an excellent product, he says: "because it could not be financed is something that I think bespeaks a problem in the financial community and a problem for the industry. That was not a Memorex problem, and so while I'm dismayed by it I don't feel there is any apology that anyone at Memorex or I, personally, must offer for that misfortune."

Had the company continued in the systems business, he says, and added the anticipated volume of mainframes to the company's lease base, there would be a need for more than \$100 million. The base that Memorex has "could only have been built with the incurring by Memorex of substantial debt. And while the heavy debt has been criticized I think the lease base that was attendant to the debt has perhaps been disregarded. I'm confident that we'll begin to enjoy the benefits of that lease base. And the wisdom of the corporate strategy for having incurred the debt and having built the lease



This is the electronic "key" that can be a photo ID badge. It can open a door...selectively, control your parking, automate your payroll, control off-hour elevators... and printout a record of who went where...and when.

This is the RUSCARD

For full information, phone toll free (800) 423-4194, ask for Mr. Martin.

RUSCO ELECTRONIC SYSTEMS Box 2848D, Pasadena, Calif. 91105



FREE! Sample RUSCARD and the new Ruscard Security Access Control guide.

name and position _____

company _____

address _____

base will now be resoundingly demonstrated."

A second career

The chief executive seems unperturbed by the appearance of his resignation at this time, saying he's "quite satisfied" he's well regarded by people most knowledgeable in the industry and within the company. "I'm 47. I want a second career," he says in explanation, adding that he'd like to write a book. "I have several books in me." And the father of eight children ranging in age from 7-17 says he will try to be a better

father. Refusing to express any regrets about his years at Memorex, he admits: "It's been very hard on my family. I owe them a great deal now because of their forbearance for an awfully long time."

Spitters also says he doesn't like to be categorized, prefers not to be labeled a liberal Democrat but rather a liberal-comma-Democrat, for he is both. But he calls himself a humanist, not a technologist. And he must be an optimist, too, saying, "Come see me in Washington."

—Edward K. Yasaki

Amdahl Sheds Top Staff Men But Denies Morbid Rumors

Rumors of serious problems being experienced by Amdahl Corp. were minimized last month by Dr. Gene M. Amdahl. The company, as reported earlier, is developing two new computers, the 470/6 and the virtual memory equivalent 470V/6, designed to be internally three to four times faster than the IBM 370/165 and 168 with a 25-50% price/performance advantage. He said in an interview their first virtual memory machine would be delivered to a customer in "early '75," and added, "It's possible that we'll ship a real memory system before the end of this year, if we get the right kind of customer. By that I mean a long-term lease or a purchase."

In rapid succession, the company recently has lost its executive vp and co-founder, Ralph Rodriguez; laid off close to 70 administrative, engineering, and manufacturing personnel, leaving it with about 600; and then lost two other members of the board, vp-finance William Mozena and secretary-legal counsel Paul Weiser. Rodriguez was the second of the company's three co-founders to leave, vp Raymond Williams Jr. departing almost two years after the company's founding in October 1970. When asked whether Rodriguez had been fired, Amdahl said merely: "No comment."

Reports about Dr. Amdahl and his company, mostly negative in nature, are rampant in the community around the firm's Sunnyvale, Calif. headquarters. Most damaging is the story that Amdahl is in poor health and under a doctor's care. He calmly denies this, citing a physical examination either last November or December for a multimillion-dollar insurance policy on his life. "I haven't been under a doctor's care for years," he adds.

Seeks \$20 million

As to the company's running out of money, he says, "We have good fi-

nancing that's adequate to carry us at least through June." But the firm has withdrawn its registration to go public, is instead looking to private investors, and is attempting to raise "on the order of \$20 million," he said. As of last fall, the company had received investments totaling \$27.5 million but has had no subsequent infusion of capital.

The soft-spoken Dr. Amdahl, who was responsible for the architectural planning for IBM's 360s, says his principal investor, Fujitsu Ltd., has not



DR. GENE M. AMDAHL
He'll ship first system
before year end . . . if

increased its investment in his company beyond its 23% equity position, but says "they plan to," and adds, "we expect several of the current investors" also will do the same. As to reports that the Japanese company will increase its investment in return for manufacturing rights, he says, "They have manufacturing rights; they don't have to acquire those." This was in the original agreement, he adds. "We, of course, would like to have them manufacture even for a significant part of our use because the costs of carrying inventory and building up to the higher production levels require more capital." (Earlier plans foresaw Fujitsu assem-

bling systems in Japan for marketing in that country.) Current discussions, he adds, are toward this objective.

As noted earlier in DATAMATION (see Sept. 1973, p. 121), Fujitsu has a Corp., is working jointly on the development of the vs machine, and has agreed to jointly develop a market for the Amdahl computers in Europe. But no steps have been taken toward opening a sales office in Europe. Fujitsu, nonetheless, has agreed to purchase 10 systems for some \$25 million, considerably below the \$34-55 million asking price.

Eighteen asked for

In total, according to Amdahl, his company has letters of intent for 18 of his systems, although there are no firm orders. "We consider them very excellent letters of intent," he explains.

Is the company behind schedule? "Not materially. We were scheduled to complete our real memory system on February 1st, running OS/MVT, and we were running it on the 15th." This engineering model, he explains, shows a customer the system's speed and its compatibility. "What we've demonstrated to date is that we can make a completely compatible machine and that it has the performance we were aiming for." As to its reliability, he says, ". . . it looks like it'll be noticeably better than what we had projected." The company is now working on the engineering model of the virtual system and expects to complete that around the end of this year.

In an interview about a year ago, however, Dr. Amdahl indicated the first machine would possibly be delivered in December of 1973 to the Univ. of Georgia, which at that time was looking for a grant from the government to acquire an Amdahl machine. He now says the plan was to deliver in April of this year, but this was delayed by the university's wanting a virtual system. It's still possible, he adds, that they will get the first machine. It would be on a full payout lease with a purchase option.

By no means is everyone gloomy about the prospects of Amdahl Corp. Even one of the employees who was laid off says he is bullish on the firm. Gene Amdahl cites progress on a new building under construction for the company, scheduled for completion in late June of this year. And even with the delay in the completion of his machine, which he minimizes, he indicates no danger in the foreshortening of his product's life by the imminent introduction of IBM's so-called FS. "I can't believe that at the time we come out we won't have 80% of the active marketing cycle still developing."

—E.K.Y.

Memories

New Money Rescues The "Third Level"

Computer users are blindly committing themselves to the use of disc files and tape libraries and overlooking a third level of storage, says Raymond E. Wakeman, new president and chief operating officer of Precision Instrument Co., Palo Alto, Calif. He's speaking, of course, of the company's scaled down but modularly expandable laser mass memory, the system 190.

A sibling rival of the company's earlier trillion-bit memory, which no longer is being made, the 190 uses the same 5 x 31-inch data strip as its recording medium. But the 190 is available with storage capacities ranging from 2.75 billion bytes to 132 billion bytes. The maximum, then, is still a trillion bits, but unlike the old model 690 it's also available in smaller configurations.

"I want to forget about the old 690," Wakeman says of the huge storage box that chewed up so much of the company's revenues derived from sales of its tape drives.

Some 12 years in development, the 690 was the offspring of an investigation of the laser technology by Dr. Carl Becker, now PI's vp for research. As currently developed, the system records permanently on a plastic sheet coated with metal. A laser beam burns tiny holes in the metal surface without disturbing the plastic substrate, recording at a density of more than 20 million bpi. Each data strip, which sells for some \$25, has a capacity of 275 million bytes or 366 million 6-bit characters of user data. Ten of the data strips fit into a pack, and a model 192-60 read/write unit holds six packs on-line. Under program control, it will remove and load one strip around a read/write drum and find the proper track (from among 13,500 on a strip) in a maximum of 10 seconds. Once a strip is mounted on the drum, the average access time is 220 msec.

The market is there

Wakeman and his board chairman, Donald E. Chelew, ex-president of Image Systems Inc., are the new management team at PI. They're part of the deal that brought a lifesaving infusion of \$3.5 million from Heizer Corp., the Chicago venture capital firm. And one of the things they have to do is overcome the image of a laser memory as being only for archival storage. While

this will continue to be the major application, Wakeman stresses the economics of the 190 as temporary storage for data bases and files that are less frequently accessed or updated but reside on disc. "The market is there. The need in this industry is there," he says.

Indeed, PI has four firm orders with deliveries scheduled to begin during the fourth quarter of this year. According to Allen Sanders, marketing vp, three or four more big systems orders are expected in the next two months. And Wakeman projects shipments of some 30 systems in calendar 1975.

Wakeman, ex-senior vp at Tymshare Inc., where he headed the R&D effort, was also with the old Scientific Data Systems. When he left SDS he was product marketing manager for the 940 mainframes that still compose the vast bulk of Tymshare's processing power. It is now his job to decide the fate of PI's analog and digital tape drive products, which are used in military applications but are not profitable, and get into production with the 190.

Although Dr. Becker remains with the company, which now employs 150, its former chairman and president Konrad Schoebel is now designated as a consultant to the firm.

Retailing

Grocery Scanning Race or Stampede?

A year ago this month the grocery industry selected a standard Universal Product Code (UPC) for source marking of supermarket products.

This sent vendors, interested in a share of what they saw as potentially a \$7 billion market for supermarket point-of-sale systems over 10 years, scurrying to develop systems which could scan the UPC. Some had been working with scanning using symbols of their own. Others had been waiting for the UPC before tying scanning to their point-of-sale systems.

Now the race is on in earnest among nine contenders making, or saying they're going to make, POS systems which can scan the UPC. It's difficult to say who's out in front right now. So far Univac is the only vendor to have had its system run in an actual store environment.

The Univac Accuscan scanning system was used for a day and a half at one checkstand in a Finast store in Framingham, Mass. "Real live customers" went through the checkstand, according to William Bonner, who is

in charge of the test for the Finast chain. He said some 30-40 items which had been source marked with the UPC were scanned, plus three produce items they selected at random for in-store marking.

Finast will put Accuscan systems into daily operation in the Framingham store in September for an indefinite test period. Sperry Univac is offering special short-term lease contracts to permit evaluation without a large capital investment. A typical five-checkstand system, leasing for \$3,700/month, will include twin minicomputers; twin data storage units, each with a capacity of 18,000 item records; an office console; five complete checkstands, each consisting of a scanner, register, conveyor system and bag storage modules; a tape cassette unit for exchange of system information; and two variable measure label makers. Sixty percent of the monthly payments can be applied as credit if the user elects to purchase the system.

Question on throughput

Bonner said the short February trial wasn't enough to give him an idea of how much the system increased throughput time. Sperry Univac says tests show its system is 45% faster than conventional manual systems. Finast has Bunker Ramo's ESIS (Electronic Store Information System) and NCR's 255 systems in two other stores. Both are keyboard based POS systems. Bonner says they have increased throughput at the checkstands by 10-15%.

Bonner said Finast probably will test



Checker at Finast store in Framingham, Mass., passes products across a horizontal X-shaped slot, instead of entering prices into the cash register, in the first in-store use of a point-of-sale system capable of reading the grocery industry's Universal Product Code. The Sperry Univac system uses a fixed laser beam optical reader to scan the code.

scanning with another vendor in January but he doesn't know yet which one. "Only IBM and Univac have them now (scanning systems) but there are seven others talking about it and we're going to look at them all." They may end up with multiple vendors, he said.

The seven others are Bunker-Ramo, NCR, Singer, MSI Data Corp., National Semiconductor Corp., Litton/Sweda, and Data General/Dymo. Bonner and others in the grocery industry will have an opportunity to look at some of their offerings at the Supermarket Institute (SMI) meeting in Dallas early in May.

MSI Data will demonstrate its Astros system linked to a scanner produced by Scope Inc., Reston, Va. Scope also is supplying scanners to NCR which, at this writing, had not firmed up its plans for the SMI but indicated it would have a demonstration of a UPC scanning system in the near future. National Semiconductor will be at the SMI demonstrating its Datachecker with a scanner it makes in-house.

For Litton/Sweda, its demonstration of a UPC-scanning POS system at this year's SMI will be a second. It demonstrated a prototype system at last year's Institute just one month after adoption of the UPC had been announced. "We had been working with a semi-circular code before the announcement," said Litton's J. Roger Moody. Within 30 days they converted the system to read a bar code, which the UPC is. Litton's scanners are made by the Zellweger Group of Uster, Switzerland.

Moody said Litton's scanning systems will be ready for delivery in the fourth quarter of this year. IBM has a similar schedule for its 3660 grocery store system (which uses scanners produced by Spectra Physics, Inc., Mountain View, Calif.) announced last October and demonstrated at a National Assn. of Food Chains show in November. And Univac, of course, is taking orders now.

Others are moving more slowly, not sure the need is there right now. A spokesman for National Semiconductor said his company has no firm plans for the scanning system beyond the demonstration at the SMI. "I don't know... there aren't many items source marked right now."

Janet Norman, vp communications for Singer Co., said Singer is "heavily and deeply involved" in development of a UPC scanning system. The company is working on its own scanner and is investigating outside sources of supply. "We will be prepared to provide scanning equipment when our customers need it," said Ms. Norman. But she's not so sure that time is now. "There are limiting factors the marketplace imposes. One is the degree to which goods are marked and another

is the availability of in-store marking capability."

MSI Data's president, Bill Bowers, said his company will go to a store test after the SMI for six to nine months, during which "we will figure out the paybacks." He sees availability at the end of this year or early in 1975. "We believe scanning is going to take its own sweet time, maybe two to three years, to get into widespread use."

Some won't scan

Bowers said MSI, in testing its system in its lab, has found some source marked labels are coming through not fully up to specs and they won't scan. Leo Beinhorn of Distribution Code Inc., Washington, D.C., which is implementing and administering the UPC, concedes that this has been a problem and that some manufacturers using the UPC have been making "peculiar types of mistakes"—such as one who chose to drop out linear bars, effectively reversing the numbers read by the scanner. The symbols can be checked out by a comparator but the ultimate test is scanning. Beinhorn said. "It

either will scan or it won't. There's no such thing as a little bit pregnant here. The specifications are very exacting." He added that most faulty symbols are caught in the trial and error stage before long runs have gone out.

Beinhorn said source marking by manufacturers is "stampeding at the present time. We're right on target with our estimate that 50% of supermarket items will be source marked with the UPC by the end of this year and better than 75% will be marked by the end of 1975."

A manufacturer who wishes to source mark applies for membership in the Universal Product Code Organization through Distribution Code Inc. DCI then issues a manufacturer's code which is the first five digits of the UPC. The manufacturer uses the last five to identify the various products in his line. Beinhorn says they now have 1,100 members signed up, representing better than \$60 billion in annual sales out of total annual grocery store sales of \$108 billion. That's a lot of groceries.

—Edith Myers

Modeling

Courts, Pudding and Bill Walton

How do you weight a variable like UCLA's Bill Walton, when the 6'11" redhead plays basketball the way he did against the Univ. of Southern California March 9?

After the fact, anyone who had seen the game would have had to answer: pretty heavily. Four days before the game, Bill Walton was just one of many variables (others included bench strength, disqualification potential, rebounds, and assists) considered by Bud Goode when he picked the UCLA Bruins over USC by 15 points. He came closer than the professional odds makers who made it UCLA by 7. The Bruins won by 30, leading one observer to quip, "He (Goode) forgot there'd be a second half."

Goode made his prediction before a meeting of the Los Angeles chapter of the Assn. for Computing Machinery (ACM). Predicting the outcome of basketball games was not what he was there for, although he and his "Cal the Computer" have been predicting the outcome of sports events via Los Angeles' KNXT tv station for several years.

He was there to make a case for the use of computers and modeling in journalism, something he feels will put the "why," which he considers the most important of the five w's, back into journalism.

Goode called most of what appears in newspapers today "white noise." He said all the objective news in most papers today would fill one quarter of one page.

"Why do Supreme Court justices vote the way they do? Why do football teams win or lose? There is a need for greater objectivity in journalism and one way is with a computer and a mathematical model."

Goode believes his methods are ap-

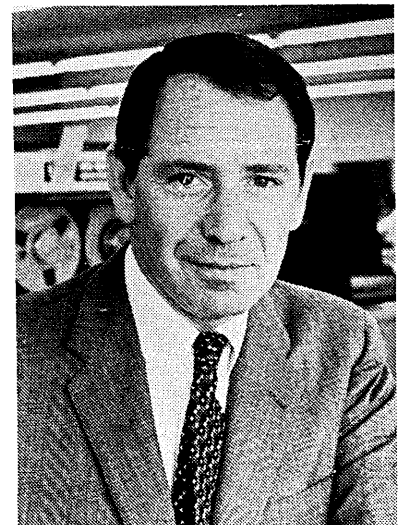

BUD GOODE
Getting the big "W" back into journalism

plicable to all pages of a newspaper where there's an available data base. He uses principally matrix methods and multiple regression equations to predict outcomes and explain why. So far he has had newspaper columns pub-

news in perspective

lished based on his methods not only in sports but on Supreme Court decisions.

High courts and the kitchen

He finds the Supreme Court simpler than most sports. "There are 10 or 11 dimensions to football. With the Supreme Court the dimensions are the attitudes of the justices in three areas: new deal economy, equality, and liberty." Goode has a better than fair record with his analyses and predictions in sports and on the Supreme Court. Now he's turning his methods loose on a column for the women's pages which he'll call "Kitchen Computer."

He said his statistics have shown him that the average housewife "spends 50% more than she needs to on food, yet isn't getting a balanced diet." His "Kitchen Computer" is designed to correct this with suggested menus.

He fears food advertisers might not like this but noted that the Dallas *Times Herald*, "which carries more food advertising than any other newspaper in the world, has said it will print my program when it's ready."

"It's basically a data reduction problem," says Goode of his work. He said he spends 95% of his time gathering

data and 5% running it through hardware, updating data bases, analyzing, interpreting, and monitoring variables. He uses two types of models, exploratory and confirmative, and "sometimes I even study with garbage factors and learn something."

Goode said he has found football and basketball coaches receptive to his analyses of those factors that win or lose games but "baseball is still running the game like it was the turn of the century."

Service Bureaus

Seek New Sources If the Price Is Right

A drastic change in federal procedures for buying machine time from on-line commercial service bureaus is being unveiled by the General Services Administration (GSA).

Essentially, firms that want to sell service bureau services to the feds will have to offer substantial discounts. In return, they'll receive "mandatory requirements" contracts. A federal agen-

The father of Cal the Computer is looking around for existing data bases which could be applied to any aspect of journalism; financial pages, for instance. And he's open to offers.

The man himself is a walking data base on sports. And he offered his audience some goodies learned through years of massaging that data.

"Bud Goode says: if you have the ball and it's fourth down with short yardage, never go for the TD."

He's proven his methods in sports and with the Supreme Court; now he's testing them in the kitchen. The proof is in the pudding.

-E.M.

cy needing commercial machine time will have to try to obtain it under one of these contracts before looking elsewhere.

The first and so far only mandatory requirements contract awarded to a service bureau by GSA went to the Infonet Div. of Computer Sciences Corp. in 1972. Reportedly, the new scheme was inspired by complaints from other vendors who wanted a piece of the action.

GSA officials late last month were applying finishing touches to an announcement of the new plan for release early in April.

About four months will then be spent

HERE'S A COUPON WORTH CLIPPING!

FREE 15-DAY EXAMINATION!

- MANAGING A PROGRAMMING PROJECT** by Philip W. Metzger, 1973, 201 pp., cloth \$13.00
- PROGRAM TEST METHODS** edited by William C. Hetzel, 1973, 360 pp., cloth \$9.95
- OPERATING SYSTEMS PRINCIPLES** by Per Brinch Hansen, 1973, 496 pp., cloth \$13.50
- PL/1 FOR BUSINESS APPLICATIONS** by Mary Ellen Anderson, 1973, 432 pp., cloth \$13.95
- DESIGN OF MAN-COMPUTER DIALOGUES** by James Martin, 1973, 559 pp., cloth \$16.50
- EVALUATION AND MEASUREMENT TECHNIQUES FOR DIGITAL COMPUTER SYSTEMS** by Mansford E. Drummond, Jr., 1973, 338 pp., cloth \$14.00
- BUSINESS SYSTEMS WITH PUNCHED CARD DATA PROCESSING AND SYSTEM/3 MODEL 10** by F. Robert Crawford, 1973, 544 pp., cloth \$12.95
- SYSTEMATIC PROGRAMMING: AN INTRODUCTION** by Niklaus Wirth, 1973, 169 pp., cloth \$10.50
- APL: A SHORT COURSE** by Sandra Pakin & Staff of Computer Innovations, 1973, 157 pp., paper \$5.95
- COMPUTER APPROACHES TO MATHEMATICAL PROBLEMS** by Jorg Nievergelt, J.C. Farrar and E.M. Reingold, 1974, 272 pp., cloth \$8.95
- PROGRAM STYLE, DESIGN, EFFICIENCY, DEBUGGING, TESTING** by Dennis Van Tassel, 1974, 224 pp., cloth \$10.50
- UNDERSTANDING THE IBM/360 & 370 COMPUTER WITH MACHINE LANGUAGE PROGRAMMING** by William Batten, 1974, 480 pp., paper \$15.50

FREE 15-DAY EXAMINATION!

Please send the text(s) checked above for a FREE 15-day examination. At the end of that time I'll remit payment, plus postage and handling, or return my selection(s) and owe not a cent.

Name _____

Address _____

City _____ State _____ Zip _____

Dept. 1 PRENTICE-HALL, Englewood Cliffs, N.J. D-DATA-HK(7)

CIRCLE 128 ON READER CARD

QUALIFIED ASSISTANCE TO USERS OF

IMS

IS NOW AVAILABLE-

- FEASIBILITY STUDIES AND SURVEYS
- DATA BASE STRUCTURES
- DESIGN AND ANALYSIS
- PROJECT PLANNING AND CONTROL
- INSTALLATION
- ENHANCEMENTS AND EXTENSIONS
- NON-STANDARD TERMINAL SUPPORT
- APPLICATIONS SYSTEMS
- EDUCATION

FROM LIMITED COUNSELING THROUGH FULL "TURNKEY" RESPONSIBILITY-IN BOTH "SYSTEMS" AND "APPLICATIONS" AREAS

PHONE OR WRITE

FOR ADDITIONAL INFORMATION NOW

CONTACT MR. DAVID MANNER



**ON-LINE
SOFTWARE
INCORPORATED**

CONTINENTAL PLAZA
411 HACKENSACK AVE.
HACKENSACK, N.J. 07601
PHONE (201) 489-0400

CIRCLE 127 ON READER CARD

developing a standard RFP. The agency hopes to have mandatory requirements contracts signed with "a number" of commercial service bureaus by the end of the '75 fiscal year, June 30, 1975.

No limit is to be placed on the number of vendors granted mandatory requirements contracts, and these procurements will be structured to attract as many as possible. For example, companies providing batch and/or interactive services will be eligible, plus those servicing limited geographic areas such as cities and regions, as well as those operating nationwide. This means, of course, that a service bureau winning a mandatory requirements contract will still have to compete for federal business in most cases. The ultimate choice of vendor is to be left in the hands of the using agency.

How they'll select

GSA's plan for the new procurement scheme includes establishment of a central, in-house quality analysis group—up to four technicians who will, through remote terminals, test the capabilities of each of the participating service bureaus to find out which ones do the most cost-effective job of processing specified programs. Test results will be distributed to the using agencies so they can be guided accordingly in choosing vendors. There is no intention of expanding this testing group into a common software development organization, according to spokesmen.

Asked how much of a discount a service bureau will have to offer to win a mandatory requirements contract, a source indicated it would have to be in the same ballpark as what CSC is offering under its Infonet contract. Essentially, that contract grants two discounts: one, for prompt payment, equals about 3% of billing; the other is based on value of machine time use, and ranges from 30-80%.

In the first year of the contract, the volume discount was based on quarterly billing. More specifically, in the fourth quarter if total billing amounted to between \$100K and \$400K, the discount was 30% on everything over \$100K. The discount increased in steps to the point where, if billings reached \$2.4-2.6 million in the fourth quarter, the feds earned a discount of approximately 50% on the first \$2.4 million and 80% on the remainder.

In the current year the discounts allowed for various amounts of machine time are basically the same. However, the discount is figured on monthly rather than quarterly billing.

Volume jumped twelfold

GSA officials were unable to estimate the size of the market that will be created by the forthcoming mandatory

requirements contracting program. However, the history of the CSC contract is indicative. In August 1972, federal agencies bought \$78,700 worth of machine time from Infonet and, after applying the discount, paid \$75,700. In January 1973, the gross billing was \$602,400 and the net was \$436,200. In January this year, the figures were \$1.39 million and \$913,600. In other words, between August 1972, and January 1974, CSC's net dollar revenue from its GSA contract rose better than twelfold. "We see no evidence that federal needs for commercial machine time won't continue growing at this same rate," says a GSA source.

And Computer Sciences Corp. thinks it will continue to share in the growth. "We know of no reason that would prevent continued growth of the federal government's use of Infonet under its present contract for national teleprocessing services," said John W. Luke, Infonet Div. president.

The agency's in-house service bureau network could take some of this future business away from commercial vendors, however, especially since the network is scheduled for upgrading and a vast expansion during the next several years.

Last month, GSA issued an RFP covering a nationwide packet-switched

data communications network together with five large-scale dp systems. Four of these will be used by the Dept. of Agriculture, while the fifth will be a GSA service bureau facility offering remote dp to all federal agencies. It's to begin operation, according to present plans, during the latter half of next year. A second center is planned two years later, and a total of four are to be installed ultimately.

But GSA officials say the new dp centers won't pose a competitive threat to commercial service bureaus until 1978 at the earliest. Before then, they'll be fully occupied processing jobs now being done in-house.

—Phil Hirsch

Banking

Insured EFTS: It's Equitable

A pilot electronic funds transfer system honcho'd by one bank on behalf of one customer, an insurance company, has become the biggest EFTS system in the country, in terms of geography covered and monthly transaction volume.

First implemented in June 1973 by Chase Manhattan Bank and the Equitable Life Assurance Society, the pilot

FLEXIMUM MAXIBILITY

We know what that means! Do you? We can **CREATIVELY** give you **MAXIMUM FLEXIBILITY** with the MICROTERM Series 3300—modular intelligent terminals with a microprocessor as the central control unit.

- **Unburden Your Mainframe**—The MICROTERM is intelligent, and tasks such as editing and formatting can be handled in your terminal, saving expensive mainframe time and memory.
- **Firmware with Flexibility**—Features, unique to your application, are stored in firmware, which can be altered as required. Firmware is non-destructible so reloading, daily or in case of power failure, is not necessary.
- **Choose Your Own Keyboard and Case**—The MICROTERM keyboard and case can be custom configured or selected off the shelf. Ask our custom customers (we're now shipping over 100 MICROTERMS/month) just how easy it is.
- **Profit with Us**—Custom-tailoring your terminal is easy. For many of the features you'll want, we just plug in a board or program a ROM. The result is that we save money—so you save money.

Give us a call and find out just how flexible we, and our MICROTERM, can be for you.

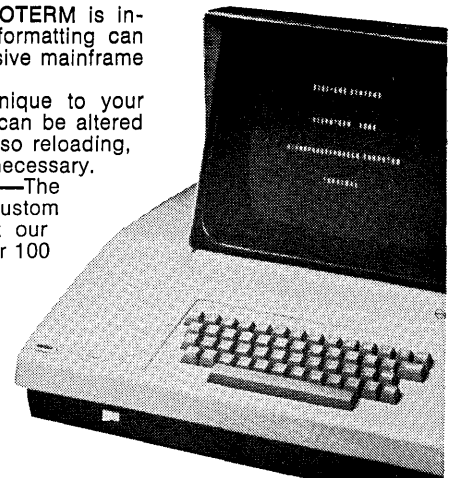

MICROTERMTM
MICROPROCESSOR TERMINAL

DIGI-LOG
SYSTEMS, INC.

BABYLON ROAD • HORSHAM, PENNA. 19044 • 215-672-0800

CIRCLE 119 ON READER CARD

news in perspective

program, on April 1, tied in some 80,000 California Equitable policyholders, to bring its monthly transaction volume to approximately 92,000 per month as compared to a monthly average of 4,000 transactions for the granddaddy of paperless entry systems, that of the California Automated Clearing House Assn. (CACHA—see Feb., p. 80).

Equitable approached Chase in October 1972, requesting assistance in development of a nationwide electronic debit transfer system to service its 600,-

000 policyholders who had authorized monthly charges against their bank accounts in payment of insurance premiums.

At that time, Equitable was paying 5¢ apiece for MICR (Magnetic Ink Character Recognition) drafts being drawn for each preauthorized monthly debit. And these exceeded 600,000. The company estimated that some 20-25% of the preauthorizations involved two or more insurance policies, bringing the total number of policies affected to 900,000 monthly, each requiring an

MICR draft. Equitable, among other things, was looking for a way to consolidate multiple policies on a paper draft or bank statement. But it wanted to be sure the draft or statement would provide each customer with a unique description of each item, and it felt existing automated clearinghouses could not fully meet this requirement.

Wanted more data

Equitable had developed a minimum requirement of 20 characters of data to show the abbreviated name of the company being paid for a transaction, the month the payment is due, and the policy number. The CACHA was using 10 characters.

In August of last year, the Life Office Management Assn. (LOMA) began discussions of standards for identification of insurance transactions in EFTS and, while nothing has been conclusively specified, it is now talking in the neighborhood of 30 characters.

Equitable maintains its corporate account at Chase and, in June '73, it began furnishing Chase with magnetic tape debits drawn on the 6,000 policyholders who have their accounts there. Accounts of these policyholders are debited without any check being prepared. Instead, a paper draft with all required identifying information is prepared for inclusion with the policyholders statements. Ultimately these drafts will be replaced with unique descriptions of the transactions on the statements themselves.

Last December, the pilot system was expanded to include Equitable policyholders with accounts at two other New York banks, Manufacturers Hanover Bank (some 5,000 policyholders) and National Shawmut Bank (several hundreds). In this implementation, which Chase calls phase one and a half of the pilot, Chase receives electronic debits which it passes on to the two other banks.

Next phase: California

Phase 2 was what was started this month with the addition of the 80,000 California policyholders. Initially all transactions will be handled through Crocker National Bank which will receive the electronic debits from Chase for distribution to other California banks serving Equitable policyholders. Chase currently is negotiating with Security Pacific Bank to work out procedures where it could service its depositors who are preauthorized Equitable policyholders on a direct basis.

Chase's future plans for the pilot system include its implementation nationwide. Since Equitable's preauthorized policyholders bank at more than 13,000 commercial banks, many in-

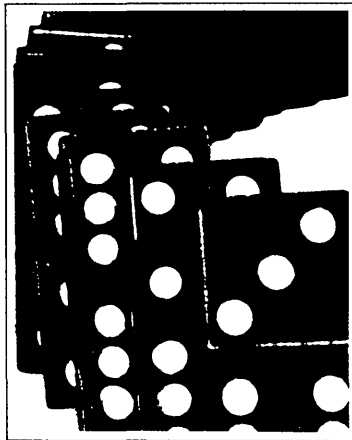

INFONATIONAL ACCOUNTING SYSTEMS SOLVE ONE PROBLEM AFTER ANOTHER ... AND ANOTHER ... AND ANOTHER ... AND

Infonational puts you in complete and effective control of your GENERAL LEDGER, ACCOUNTS PAYABLE, ACCOUNTS RECEIVABLE/SALES ANALYSIS, and FIXED ASSET problems.

You can have a total, efficient system operational in less than a month. A system that fits your exacting needs, for only a fraction of the cost of a custom developed system.

Call us today . . . We'll show you how to make all your systems fall in line.

InfoNational

The Financial Systems Company

Infonational 6626 Convoy Court San Diego, CA 92111

(714) 560-7070 Boston (617) 769-5942

Chicago (312) 332-6738 Dallas/Fort Worth (817) 732-6603

New York (212) 489-1660

capable of accepting electronic debits or credits, the service will be combined with a printing capability so that Chase can print preauthorized drafts with MICR in those instances where electronic interchange is not feasible.

And ultimately, Chase expects to offer similar service to other insurance companies.

—E.M.

The Arts

The Public and the Computer Artist

An exciting aspect of computer graphics is the potential for growth; availability grows and costs decrease as technology advances. It was to increase public awareness of computer animated films and to promote the interchange of techniques and ideas that students at Evergreen State College in Olympia, Wash., staged the First International Computer Film Festival early last March.

The festival was conceived and organized by two Evergreen students, Richard Speer and Frankie Foster, and sponsored by Evergreen's dept. of computer services, the Computer Arts Society of the United States, and the Washington State Arts Commission.

Close to 100 films were shown at the two-day festival, March 7-9. Later, some 24 films will be chosen from the festival to go on a non-profit tour of institutions requesting them, such as universities, museums and research centers.

A highlight of the festival was a panel discussion by five major filmmakers: John Whitney, Sr., of the UCLA dept. of art; Ronald Resch, of the Univ. of Utah computer science dept.; Lillian Schwartz and Ken Knowlton of Bell Labs; and William Fetter, who heads the computer graphics laboratory at Southern Illinois Univ. The topic was "The Future of Computer Film."

The first uses of computer graphics were technical. At Boeing they grew out of a need for accurate perspective drawings for aircraft. Computer films were made to show extreme views of an aircraft, make cutaways from all angles, and show the pilot's view. Using computer graphics, errors can be found by looking at preliminary designs of something that doesn't yet exist except in the memory of the computer. A great advantage of computer animation over hand-drawn animation is that by using data points to describe an object and an equation to represent its motion, you can program a computer to animate a film exactly representing that object, even though you didn't know

what it would look like.

William Fetter showed some examples of uses of computer animation at Boeing. One example was a human figure used to show pilots' span of reach that Fetter developed while a member of the original Boeing Co. Computer Graphics team. Ken Knowlton told of another practical technical application: the use of a computer animated film showing the path of least interference for microwave signals through a rainstorm.

Easier access

Ron Resch thinks there are very few accomplished artists in computer graphics, and is disappointed in the progress of the field so far. He thinks the field is characterized, by a high technical requirement, and would like to see easier access by the artist. He compared the artist using computer graphics today to the Renaissance painter who had to know chemistry in order to mix his paints. Mr. Resch is working toward software and perhaps even hardware enabling the artist to communicate in a simpler and "far more natural" form. An example of an idea he is working with is spacial communication, using sensors on the fingers.

Lillian Schwartz, artist-in-residence at Bell Labs, said that "at first the technology was so awesome you almost didn't want to learn." She thinks it is

BOEING'S VIEW: William Fetter's human figure done at Boeing, showing three parts of a series showing pilots' span of reach.

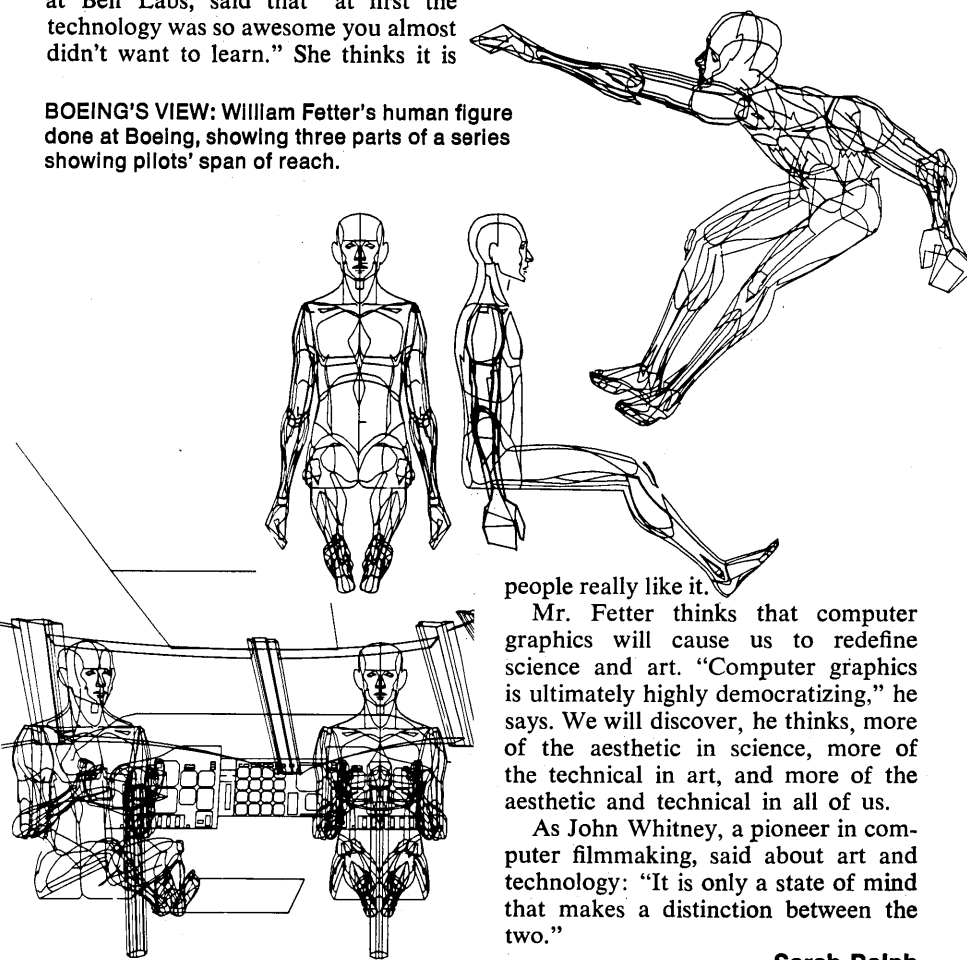

people really like it.

Mr. Fetter thinks that computer graphics will cause us to redefine science and art. "Computer graphics is ultimately highly democratizing," he says. We will discover, he thinks, more of the aesthetic in science, more of the technical in art, and more of the aesthetic and technical in all of us.

As John Whitney, a pioneer in computer filmmaking, said about art and technology: "It is only a state of mind that makes a distinction between the two."

—Sarah Rolph

U. K. Elections: Bonanza for Computer People, Computers

The February 28 snap election in Britain may have left many questions in the minds of people who weren't used to minority government, but it was a bonanza for computer people and an excellent demonstration of the computers themselves. It also raised some questions about the use of computers for television election analysis.

Almost all the former members of parliament who have been concerned with computers were returned to the new parliament. These included Conservative Airey Neave, who had been chairman of the 1970 Subcommittee D and the '71-'74 Subcommittee A exploring the role of the U.K. computer industry, plus the other subcommittee members: Conservative Ken Warren, who used to sell military computer systems for Elliotts; Conservative Ian Lloyd, who is also director of the Isis computer bureau; and three Labor members, Ted Leadbitter, Gavin Strang and Dr. John Cunningham. In

addition to the six existing members of the computer subcommittee, one member of the original subcommittee, Eric Moonman, was returned. Moonman lost his Labor seat from Billericay in the 1970 election and worked as a computer and training consultant in the interim, but returned this time with a healthy majority from the Basildon constituency.

IBM and Univac both furnished salesmen to become MP's in the new parliament. Conservative Alex Fletcher who used to be an IBM salesman (and more recently a computer and management consultant in Edinburgh) won the Edinburgh North seat in last autumn's by-election, and increased his majority in the latest election. Univac's Barry Henderson won Dumbartonshire East for the Conservatives.

A vote for privacy?

Leslie Huckfield, the colorful young Labor MP for Nuneaton increased his

majority to a healthy 17,000. He was the author of last year's computer privacy bill which failed to get its final readings in parliament, perhaps because the penalties for infringing the proposed law would have been almost as heavy as those for murder.

Some of the computer people candidates who did not win carry the real flavor of the election as well as the vibrant industry in Britain. Gerry Fisher, for example, is treasurer of the British Computer Society and head of the computer activities at Associated British Foods (which owns Fortnum and Mason among others). A former star of the Univ. of Glasgow debating team and collector of antique silver, Fisher was a candidate for the Scottish Nationalist Party in Bothwell (the site of all Honeywell's computer manufacturing in the U.K.), and polled more than 7,000 votes in a lively campaign. Brian Tannatt-Nash, the founder of the Data Logic software house, recently retired to spend more time in politics. He was the Liberal candidate for Conservative-he'd Hereford and made a very respectable showing. (Tannatt-Nash was also secretary of the Software Houses Assn.)

Peter Bartram, at 22, was one of the youngest candidates in the 1970 election. This year the seasoned 26-year-old candidate (who is editor of the Data Systems monthly) improved his score as Liberal candidate in the newly gerrymandered Shoreham constituency, where he has been active on the local council and other bodies. And 33-year-old Suzette Harald, a council member for the Software Houses Assn., managed to stand as Conservative candidate for Greenwich, even though she was expecting a baby in April.

A challenge for television

Keeping track of these candidates and their 2,000 or so counterparts was a major challenge for Britain's two networks—the state-supported BBC and the commercial ITV network. The "Beeb" managed with its own system, a 192K word ICL 1904 with more than 600 million bytes of disc, on-line to the studio cameras throughout election night and the following day as the delicately balanced "non-results" continued to come in from agricultural areas that prefer sleeping to vote-counting at 3 a.m.

The Beeb worked on its system from January 1973 through October, with a full dress rehearsal in the studio five weeks before the election. Data was keyed in directly from BBC correspondents in each constituency, working through 11 Moore-Reed terminals to feed the on-line system. Captions told the audience of millions who was standing (one "stands" rather than "runs" for office in Britain, a situation reflected by



B*A*S*H: "Herb Grosch running a newspaper is like Hitler becoming captain of a Polaris submarine," said roaster Sandy Lanzarotta of Xerox during the annual pre-St. Patrick's day bash of the Digital Computer Assn. Grosch arrived late at the party of computer oldtimers in Los Angeles and so received a smaller allotment of wine from Mary Rich and Paul Armer (right). Compata's Lowell Amdahl held court (center in upper left photo) as Toni (Schuman) Needleman and friends awaited dinner. Lanzarotta took drastic steps to silence long-winded orator Bob Berman of Vector General. Some 100 turned out for the only meeting held in the year by the 22-year-old association, forerunner of SHARE and Los Angeles area chapters of ACM.

the budgets which average something around \$2,000 per candidate, according to the size of the constituency), how much of the vote each one earned, the percentage of the electorate that turned out (often over 80%), and the change (in percentage swing) from the last election.

In addition to all the handy displays (which took about 27K words, with programming by a Logica team headed by Charles Wilkinson), there was a 50K word psephology suite, which started flashing fairly accurate predictions of the final outcome after about 100 of the 635 results were in, showing a small Labor lead over the Conservatives, with Liberals and the Scots, Welsh and Irish parties holding the balance of power. However, the Beeb's commentators had a tendency to say silly things like "the computer made a mistake" when the reporters had in fact made the errors.

Over on the ITV network, (ITN) there wasn't as much computer power, but the displays were more imaginative and fun. The computer was a mere PDP-11, and the entire program was done in a little over three weeks by one man—John Henderson from Wooton, Jeffreys and Partners. ITN, DEC and Henderson worked closely through the pre-election period, but never had time for the luxury of pre-election dress rehearsals, so everybody held their breath on election night; but the system worked superbly (as is likely to be the case when one man has designed a streamlined little system from the top down). ITN and DEC are to be congratulated for having the sense to let Henderson get on with his (and their) business without insisting on a monster team. His system represents the first time a computer provided direct tv signals (sans camera) with synchronization to the tv network rather than the computer clock. DEC's special hardware for the system created the correct color signals for synchronization with ITN's transmission, and Henderson's display program showed new seats dropping into the stacks colored to match the various party colors, like "manna from heaven" as one daily paper called it... a phenomenon that was actually a recursive real-time routine in living color. Peter Snow, the commentator in the ITN studio, had seven different displays at his beck and call, and could choose the recall commands and sequences to suit his own needs on election night.

The future implications for computer usage come out of the results: the Liberal party, with about 20% or six million votes, gained only 14 of the 635 seats. Thus there is considerable discussion in Britain about electoral reform—discussion that takes on more importance because those 14 Liberal seats

datum inc



SERIES 5091 MAGTAPE SYSTEMS

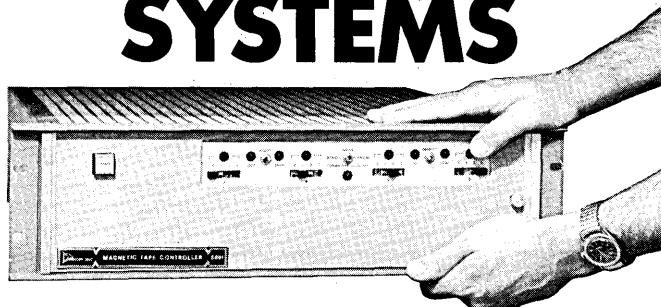

Available off the shelf for these computers

PDP8E
PDP8M
PDP8I
PDP8L
PDP 11
PDP 12
NOVA 800
NOVA 1200

IBM 1130
Micro Systems 810
HP 2100
HP 2114
HP 2115
HP 2116
CAI 816
Varian 620i

Varian 620L
Honeywell 416
Honeywell 316
Honeywell 516
XDS CF 16
XDS CE 16
Univac 1616
Pacer 100

DATUM 5091 Series Magnetic Tape Systems, Controllers and Formatters outsell any others (more than 2000 systems installed to date). One reason is our fast delivery. We fill orders from units stocked for the above computers so you can be in operation without delay. Units plug together and into the computer for uncomplicated installation.

Series 5091 consists of Formatter and Computer Adapter, with complete controls, chassis and power supply. Series 5091 Input/Output System consists of a Controller, and as many as four magnetic tape recorders.

Select NRZ or Phase-Encoded formats; control 7-and/or 9-track tape units; compatible with computer software while handling multiple-speed, multiple-density tapes.

It's your choice: complete System, Controller or Formatter

Write for specifications
and prices

Peripheral Equipment Division

Datum inc

1363 State College Boulevard, Anaheim, California 92806 ■ 714/533-6333

CIRCLE 116 ON READER CARD

news in perspective

nonetheless hold the balance of power between the two major parties.

In one scheme, voters would indicate their second preferences, and in any constituency where no candidate gained a majority, the votes for the bottom candidate would be split into second preferences until a majority was achieved. This scheme would be relatively unworkable unless some bureau or terminal approach to vote-counting could be brought into operation. Otherwise, the computers at the tv stations would be working three or four days, instead of one or two, to bring the results to the 25 million or more viewers each attracted.

—Nancy Foy

The Head Bone's Connected to the...

An Anglo-French alliance announced last month, aimed at development of a computer controlled, all-electronic telephone exchange and digital transmission system, added a new dimension to an already tangled web in Europe's telecommunications and computer industries.

The alliance, between Compagnie Générale d'Electricité of France and the Plessey company of England could, technology and politics permitting, come up with the most advanced system outside the U.S.

CGE and Plessey are natural bedfellows. Each is its country's biggest electronic and electrical combine. Their marketing philosophies are almost identical. There is very little overlap in their main, existing sales areas. Both are faced with similar competitive threats and they claim they have two items of technology which form a natural system when put together.

The tangles are in the relationships of the two firms with competitors and computer firms. CGE has been in an undeclared war since last fall with a competitor, Thomson Brandt. CGE and Brandt are the two largest shareholders in the French computer firm CII and their enmity has contributed to CII's state of perpetual financial crises which is undermining the French computer firm's position in Unidata, the supranational organization through which the computing divisions of Siemens of Germany and Philips of Holland are attempting to pool resources.

Plessey is one of two major shareholders in Britain's biggest computer manufacturer, ICL. The other is the General Electric Co. of the U.K. (no relation to the U.S. GE) which last year signed an agreement with Standard

Telephones and Cables (the British subsidiary of ITT) for joint development of electronic exchanges known as TXE4.

Issue of U.S. dominance

Sir John Clark, head of Plessey, said at the time that he "never saw that an association with an essentially American-dominated company would be a satisfactory solution to the vast majority of European countries." TXE4, incidentally, has the blessing of the British Post Office.

Sir John and M. Ambroise Roux, head of CGE, claim with their new alliance to have undertaken "the most significant industrial venture in European telecommunications since the formation of the Common Market." There is little in this to strain credulity as the telecommunications industry has shown little imagination in exploiting the Common Market.

But telecommunications firms have been uneasy about threats to their tra-

ditional markets coming from expansion of the computer industry into data communications and stored program control of switching systems. Indeed, IBM has demonstration models on test with several telecommunications authorities. The main constraints against these going into commercial service are political rather than technical.

Roux predicts that CGE and Plessey between them should be clearing \$1 billion per year in stored program exchanges in about five years time. Their existing shares of the market, and the market forecasts for electronic exchanges and for the growth of pulsed code modulation systems, support this projection. Nevertheless, hindsight available on comparable examples of technological collaboration brings up doubts.

In basic terms, the French are supplying a digital switch exchange known as the E10. The British firm is contributing a stored program processor, System 250, developed for the government but not as yet accepted by the British Post Office. The combined system will be called *Felicité* and its success clearly



GRRRR OR PURRR: Lincoln-Mercury's live cougar seems skeptical of this new breed of cat being presented to Willard A. Little (left) midwest regional sales manager of Lincoln-Mercury, by Kenneth G. Fisher, regional vice president of Honeywell's computer operations. The exchange took place at the Chicago Auto Show. The new cougar, 17 lbs. of diodes,

transistors, wires, switches, and integrated circuits, is a late addition to Honeywell's menagerie of computer animals, and will be a part of the firm's 1974 ad campaign. He will appear in Honeywell ads outlining computer applications supplied by Honeywell for Ford Motor Co. "At the sign of the Cat," says the ad, "we're adding to their kitty."

depends upon whether or not the telecommunications authorities are as convinced as the two partners are of its merits over those of some interesting competitors.

The E10 was developed by CIT-Alacatel, part of the CGE group, in a joint project with the French National Center for Telecommunications Research (CNER). It differs from conventional exchanges in that it provides a complete network of exchanges for a prescribed geographical area under unified digital switching computer exchanges.

\$25 million project

The System 250 is a multiprocessor machine. It was designed specifically for computer controlled telecommunications and was incorporated in a new military switching system known as Ptarmigan. In the Anglo-French version, a greater number of E10's should be linked together in an integrated network. Estimated development costs for *Félicité* are \$25 million. Neither group expects to take orders within two years. First installations, they say, are four years away.

These calculations depend upon the declared modernization programs of the telecommunications authorities. Contrary to past practice, the British, French, and West German authorities have been seeking to harmonize their technical designs for the coming generation of all-electronic, computer controlled, telecommunications networks. Needless to say, the exchanges are among the key components to be considered. But there are political implications to a decision for cooperation at such a fundamental level by such important U.K. and French companies. Plessey is particularly sensitive about this arrangement.

Whether or not it offers the most advanced system outside the U.S., the new deal, when the authorities are ready to update networks, should at least provide the stimulus for other industrial collaboration which could bring links between other computer manufacturers and communications houses. And thus untangle the web?

—Pearce Wright

Benchmarks

Satisfied Users: A Datapro Research Corp. survey of 20 System/370 users found them "generally well satisfied with both the equipment and software." The 20 users, with whom Datapro conducted in-depth interviews, had a total of 29 370 computers installed, including four Model 135s, 12 Model 145s, four Model 155s, six Model 158s, and three Model 165s. Of the 29 computers, 18 were still running under 360 soft-

April, 1974

datum inc



economy leader

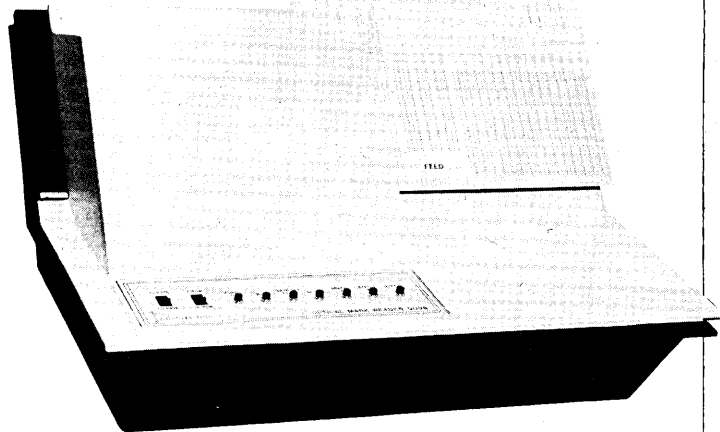

MODEL 5098 Optical Mark Reader

HIGH PERFORMANCE WITH REAL SAVINGS

Pencil marked DATUM-Mark™ forms are read by DATUM'S new Model 5098 Optical Mark Reader in one second or less. You can now buy this high-speed data-source input capability from DATUM for much less than you would expect to pay for any other complete OMR terminal. ■ The Model 5098 is completely RS-232C compatible, ready to install on your computer system. And, it has an auxiliary connector for CRT or TTY. Let us send you the complete details, plus a kit to let you custom design your own form.

Write for specifications
and prices

Peripheral Equipment Division

Datum inc

1363 S. State College Boulevard, Anaheim, California 92806 ■ 714/533-6333

CIRCLE 117 ON READER CARD

news in perspective

ware (DOS or OS), eight were running under IBM's new virtual storage operating systems (DOS/vs, OS/vs1, OS/vs2, or VM/370), and three were running under EDOS, the Computer Software Company's proprietary DOS replacement. The eight users of virtual storage operating systems expressed no major complaints about their implementation or performance. None, however, reported achieving the high virtual storage to real main storage size ratios that many users envisioned when IBM's "direction

of the future" was announced. Eight to one was the highest ratio reported, Datapro said, and ratios of around four to one were more common for both DOS/vs and OS/vs users, IBM's only significant weakness appeared to be in the area of technical support, the firm said. The results of the survey and detailed descriptions and analyses of all current 370 equipment in software, are contained in a 62-page report available from Datapro, 1805 Underwood Blvd., Delran, NJ 08075, at \$15/copy.

Plug into the latest in teleprinter leasing ...from RCA.

Our new Extel* teleprinter is a lot more electronic and a lot less mechanical than other equipment. So it's smaller (about portable typewriter size). And quieter.

And a lot more dependable.

Extel gives you the kind of day-in-day-out reliability no mostly-mechanical teleprinter can match. And, of course, your lease price includes service by skilled RCA teleprinter specialists.

How much? You can plug in the 5 level Baudot or 8 level ASCII Receive-Only Model for only \$47.00 a month. The Send/Receive Extel Teleprinter leases for \$60.00 per month. Stand included. Just write or call.

RCA Service Company/A Division of
RCA/Data Communications/Bldg. 204-2,
Camden, N.J. 08101/Phone: (609) 779-4129

RCA

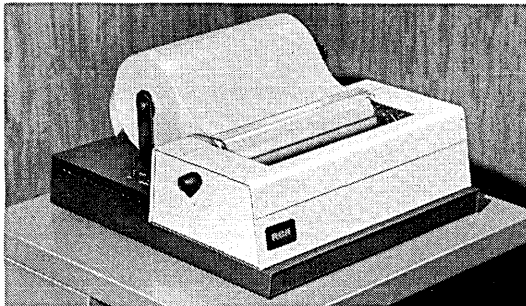

*Reg. Trademark of Extel Corp.

Changes at Ampex: Regrouping to bolster sagging earnings, Ampex Corp. has done some switching in its Computer and Instrumentation divisions to come up with two new divisions: Memory Products and Data Products. Memory Products is the former Computer Products Div. It retains responsibility for core and semiconductor products and both management and production remain in Marina Del Rey, Calif. Instrumentation, renamed Data Products Div., was moved from Marina Del Rey to Redwood City, Calif., except for manufacturing of tape and disc products. Charles V. Anderson who had been acting general manager of what was the Computer Products Div. is the new general manager of the Memory Products Div. Stanley Mantell was named vice president of the Data Products Div. James Raffel, who had been general manager of the former Instrumentation Div. was shifted to the staff of Ampex president Arthur H. Hausman to handle corporate manufacturing assignments.

Systems for National Semi: National Semiconductor Corp., Santa Clara, Calif., has moved into memory systems markets with formation of a memory system group to design, test, and build custom semiconductor memory systems. David Martin, formerly vp-marketing for end-user systems at Advanced Memory Systems, will be the group's general manager. Martin said National will market MOS memory cards using its 2K 5262-type RAM's by mid-year. The company predicts that semiconductor memory sales will surpass core sales for the first time this year, for a total of \$236 million out of \$446 million. By 1977 it sees core sales dwindling to \$90 million and semiconductor memory sales contributing more than half a billion dollars.

It's Burroughs for SWIFT: The Society for Worldwide Interbank Financial Telecommunications (SWIFT) has selected Burroughs Corp. to supply data processing and data communications equipment for a new international telecommunications network. Sales value of the equipment, including two dual B3700s, four data communications processors, and 14 data concentrators, is more than \$6 million. SWIFT, based in Brussels, has a membership of 246 banks and was organized to provide member banks with a private communications system for the transmission of payments and other messages associated with international banking. Operation of the international network is scheduled to begin at the end of the first quarter of 1976.

A Slow Process: "Although the technology is available, the multinational computing network is not yet widely in use; most companies have not yet found it to be economically justifiable," said a Diebold Research Program Study report. The study defined multinational computing networks as "the direct linkage of the central processing units of computers physically located in different countries." In most parts of the world, according to Diebold, the international common carriers have sufficient resources to permit linkages at low and medium speeds, although high-speed facilities are rare. "The growth of true multinational computing networks . . . has been a slow process, with very few fully matured systems at this time. Developing an international data base has been a task beyond all but a handful of corporations."

Interdata to be Acquired: Interdata, Oceanport, N.J. minicomputer manufacturer, will be acquired by Perkin-Elmer Corp., Norwalk, Conn. Under an agreement announced last month, Perkin-Elmer, a scientific instrument firm, will issue .8 of a share of its common stock for each share of Interdata common stock outstanding, resulting in issuance of some 1,630,000 shares of Perkin-Elmer common. Almost simultaneously, Interdata announced it has licensed the Hughes Ground System Group of Hughes Aircraft Co. to produce a militarized version of its Model 70 minicomputer. The Hughes version will be called H1670. Interdata had sales for the year ended last Dec. 31 of \$18,858 and net income of \$1,245,000 or 61¢ per share; this compared with sales of \$12,815,000 and net income of \$545,000 or 27¢ a share the year before.

A Big One for Ite! Ite Corp.'s Data Products Group received an "omnibus mandatory requirements" contract from the General Services Administration (GSA) covering 3330-type disc drives for both 360 and 370 systems and valued at up to \$25 million over five and a half years. The term "omnibus" in the contract means that the award from GSA is on behalf of all federal departments and agencies. The "mandatory requirements" means that henceforth, all demands for the specific category of product, where the contract meets government requirements, must be initiated through the Ite group. Under the agreement, GSA has guaranteed it will acquire at least 100 Ite 7330 disc drives and 12 7830 controllers. The immediate contract runs through June 1974 and may be renewed for five consecutive years thereafter. □

April, 1974

datum inc



Disk and Drum Minicomputer Memories

SAVE WITH THE LEADER...

DATUM offers you savings with the most complete selection of disks, drums and system controllers available for this list of minicomputers. They are engineered to use existing software. And DATUM's high sales volume keeps the equipment price low.

PDP8E	NOVA 800	HP 2100
PDP8M	NOVA 1200	HP 2114
PDP8F	Univac 1616	HP 2115
PDP11		HP 2116

Remember DATUM memories when you specify your new or expanded system.

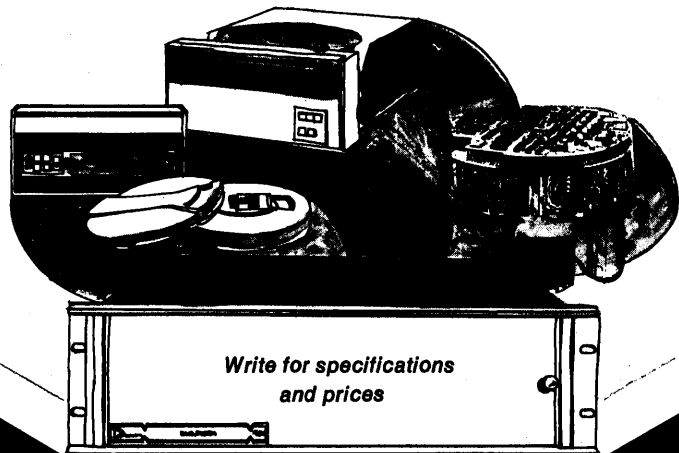

Datum inc

1363 S. State College Boulevard, Anaheim, California 92806 ■ 714/533-6333

CIRCLE 118 ON READER CARD

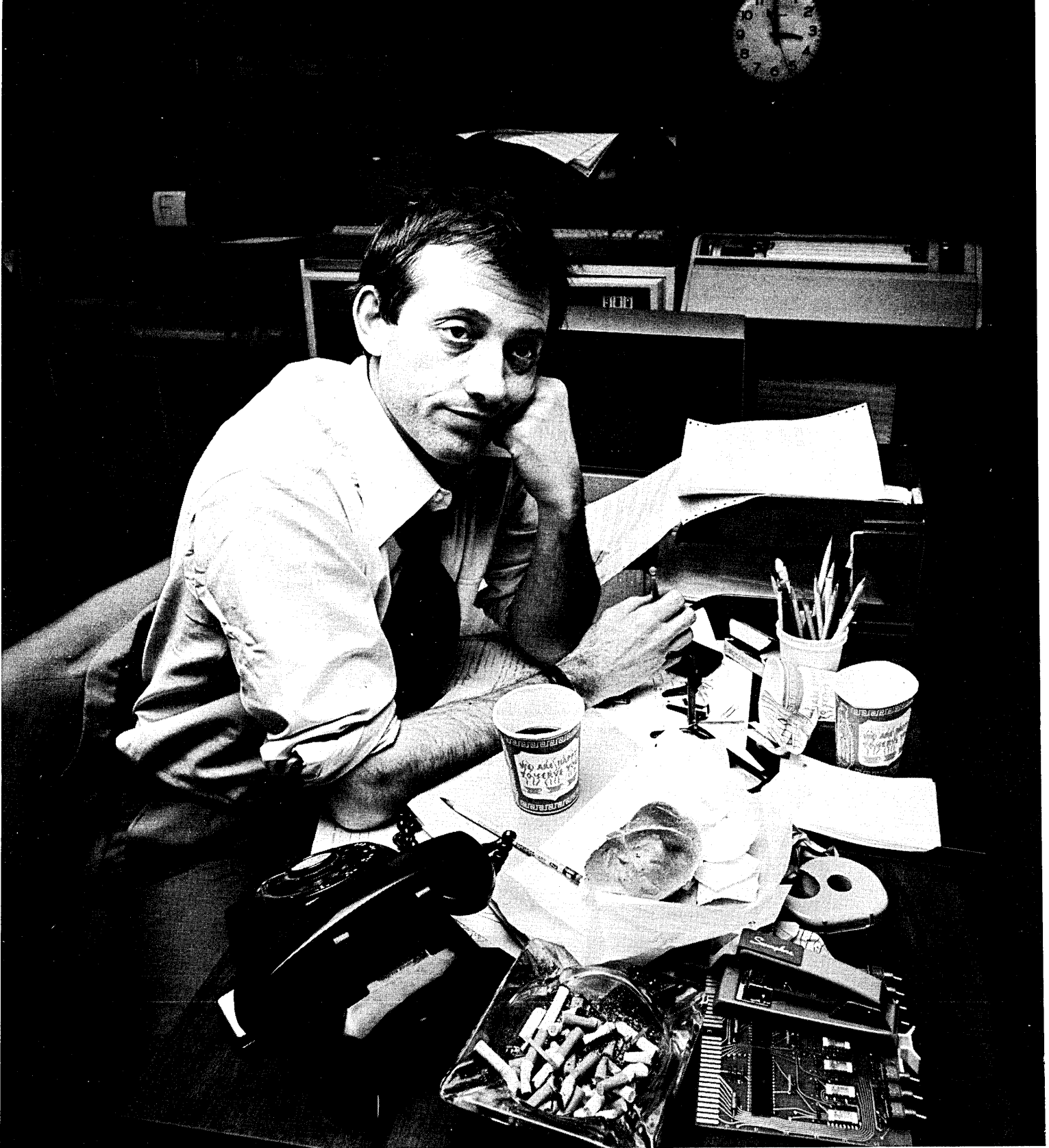

**It's hard to love the hardware
when the software is keeping you
up all night.**

There's a lot of great hardware around. But not much great systems software.

Which explains why a lot of programmers don't get much sleep. And why software development usually ends up costing more than the hardware.

When we make a computer, we put as much work into the software as the hardware.

So there's less work for you to do. And the work you have to do goes a lot faster.

Our Real-Time Disc Operating System (RDOS) lets you work the way you want. Interactively. Or Batch. It has a file management system that doesn't need any work at all. (It'll fit any application as is.) RDOS supports higher level languages. And utilities like MACRO Assembler, Text Editor and Symbolic Debugger make it easy to pull everything together.

And once you've finished your applications software, your job is done. Because RDOS helps run your programs as much as it helps write them.

It even lets you do two things at the same time. Like write new programs while you're running old ones. Or run Timesharing and Batch. Or Remote Job Entry and Timesharing.

Buy a Nova 840 from us and we'll give you RDOS. Free.

Then maybe you and your programmers can go home and get a good night's sleep.

DataGeneral

The computer company you can understand.

• Data General Corporation, Southboro, Massachusetts 01772, (617) 485-9100.
Datagen of Canada Ltd., Hull, Quebec (819) 770-2030/Data General Europe, Paris, France 504-23-44.

LOOK AHEAD

(Continued from page 18)

to be displayed at the National Computer Conference next month in Chicago. And it's understood the H-P minicomputer division (8,000 installations) not only has production models operating internally, but will be promising deliveries as early as this June.

TURNCOAT RETURNS TO IBM FOLD

Burton Hochfeld, the ex-IBMer who "turned state's evidence" and testified on behalf of Telex at the recent antitrust case between the two firms, has returned to the IBM fold, so to speak. Hochfeld is a Wall Street securities analyst and in a report he says that investor concern over IBM's exposure from the suit is overdone. Thus, the man who played a key role in knocking down IBM's stock is now touting it.

Generally, Wall Street thinks the Telex decision--even if it holds up on appeal--will have little impact on IBM's sales and earnings growth. A participant in a recent strategy session at a prominent financial house says, however, that the question was, "What will our position be when IBM is broken up?" It was the first time the word "when" was used instead of "if," suggesting that in some financial institutions it is felt that IBM, by consent decree or by judgment, will not fare well in Judge Edelstein's court.

EVERYBODY WANTS ATANASOFF

The invitations are pouring in to Dr. John V. Atanasoff, the scientist whose work has only recently been recognized as central to the electronic digital computer (see February, p. 84). Atanasoff, who designed his computer in the late 1930s at Iowa State Univ., was elected by the students at that school to be Grand Marshall of the university's annual spring student festival. Other speaking invitations have come from as far away as the Univ. of Florida and as near as the Kiwanis Club in Frederick, Md., where Atanasoff now lives.

USA-JAPAN CONFERENCE SET FOR AUGUST

For anyone needing an excuse to travel abroad, there's good news. A second USA-Japan Computer Conference has been scheduled in Tokyo for August 1975, again jointly sponsored by AFIPS and its counterpart IPSJ in Japan. The summer month was selected to allow people from the academic community to attend, according to David R. Brown of Stanford Research Institute, who shares the chairmanship with T. Kawada of Nippon Electric. Brown was technical program co-chairman of the first joint conference in 1972, a position taken over by Don Madden of Compata Inc.

RUMORS AND RAW RANDOM DATA

For the first time in its history, a woman is the president of SHARE, the 19-year-old organization of IBM users. Shirley Frock Prutch, of Martin Marietta, Denver, who was selected in Houston last month to serve out the term of George Gautney who resigned, is expected to run for a full two-year term when the group holds elections in August... Referring to his company's troubles in court, IBM World Trade chairman Gilbert Jones had this tip at the Institutional Investors Conference in New York: "If Cravath, Swaine & Moore (IBM's law firm) went public, it would be the best buy of the century"...In an article critical of antitrust action against IBM, in the Calif. magazine Reason, the National Review's associate editor Alan Reynolds brushes off predatory pricing with this comment: "...any rivals driven out of business by below-cost pricing could easily return as soon as prices went back up."

**Xerox
announces
twins.**



The Xerox 560. All you need is one. Take it and run your whole outfit.

In an age of increasing specialization we present a brand new pair of 32-bit computers conspicuous for their versatility. The Xerox 560 and the Xerox 550.

The most advanced multi-use computers on the market today, these two systems represent a whole new generation of Xerox computers. New mainframes. New peripherals.

By taking advantage of the latest technology — microprogramming, LSI/MSI, and FROM — we've brought the size of the 560 and 550 way down, the performance way up. And the price below any comparable computers around.

Fraternal twins, the 550 and 560 each has its own special talents.

The 550's strong suit is real-time work — telemetry, simulation, communications. But with its decentralized architecture, the 550 can stay on top of its real-time duties while it knocks out batch work and terminal operations simultaneously.

The Xerox 560 is a multipurpose machine with a capital M. Utilizing Control Program-Five, it can do local batch, remote batch,



The Xerox 550. A real-time performer with plenty left over for batch.

time-sharing, transaction processing, and real-time jobs all at once.

Both the 560 and 550 are fast—including multiport 645 nanosecond memories. Virtual memory is standard. And expandable up to 256,000 words.

And they're both reliable. Thanks to the extensive use of integrated circuitry, modular construction and one of the most sophisticated diagnostic systems in the industry. Predictive maintenance and on-line diagnosis from our remote service centers are just two examples of why Xerox can offer such high system availability.

We'd like to tell you a lot more about the multitalented Xerox 560 and 550 computers. Give your Xerox representative a call.

Hardware

Off-line

What will computers look like in the year 2000? Trying to be a prophet in our industry is probably harder than in most others, but William T. Bayer Jr., vice president of technical resources planning for Honeywell's worldwide computer operations, was up to the task recently before a group of executives at the Town Hall of California. Those of us who liked the sophistication (if not the actions) of the computer "HAL" in "2001--A Space Odyssey" are in for a letdown according to Mr. Bayer. "It's no harder than looking back 26 years to 1948," he said. "I think that semiconductor memories--and not holographic ones--will be the principal technology in use, and that the computer will still use the von Neumann architecture used today." Everyone agree?

Remember the "feelies"--the three-dimensional movies people can touch as well as see, first mentioned in Aldous Huxley's "Brave New World"? They may be a step closer to reality with the invention of a "tactile simulation device" by Dr. Michael Noll at Polytechnic Institute of New York. His invention is about the size of a large television set and lets users feel the form, contours, and textures of programmed objects that do not really exist. These objects are visualized in three dimensions at the same time. "With such a device fully developed in the future, people could grasp and feel the surface texture of objects that exist only as equations or arrays of numbers in a computer's memory," says Dr. Noll.

The Memorex 3673 storage system described in February (p. 102) is limited to the same number of spindles (four) and controllers (one) as its IBM counterpart, we're told. But two 3673 controllers handling up to 16 spindles can be attached to the 370/135 Integrated File Adapter. Pricing for Memorex's "Supertape" medium--which was sketchy at press time--has subsequently been announced: \$17 per reel for 1-29 reels, ranging down to \$13.50 per reel in orders of 300 or more. The name finally chosen for the heavy-duty magnetic tape is "Cubic."

370/155 Performance Aid

When combined with an IBM dynamic address translation (DAT) box and two megabytes of main memory (not necessarily this manufacturer's), the Excelerator is said to endow the 370/155 cpu with performance figures closely approaching those of the 370/158. In essence the Excelerator is a redesign of the cache memory management algorithm intended to provide internal performance boosts of approximately 28%. When attached to IBM or Cambridge main memories, the Excelerator is priced at \$55K. There will be some additional charge for hooking it to other memory suppliers' products, but Cambridge doesn't know if it will receive any such requests so hasn't taken the time to caucus for pricing strategies. The first Excelerator is currently in the checkout stage, with first customer models slated to go to the field next month. CAMBRIDGE MEMORIES, INC., Concord, Mass.

FOR DATA CIRCLE 251 ON READER CARD

"Intelligent" Keypunch

Univac remains interestingly inscrutable. It recently introduced its version of the powerful Pertec shared-processor data entry system, and in typical Univac fashion it's a little late to the market--though a very good machine. The product that intrigues us is the



1800 series keypunch, which incorporates a microprocessor to do many of the things that are done on larger shared-processor systems. Univac's 1700 series keypunches were very well received; then IBM announced the 129 (which Univac thinks highly of), and now Univac is hitting back with the models 1801 verifying punch and 1810 verifying interpreting punch.

Both models use the microprocessor to hold up to eight program storage

levels for program-controlled automatic operation and up to four auxiliary data stores. These four registers can hold data that is to be repeated on a number of cards. For \$5/month more you can get eight additional registers. By using program cards that are loaded before input processing begins, the 1801 and 1810 can be set up to do data validation, range checking, editing, and even "must fill the field" operations. Programs can be chained to load automatically.

Basic 1801s rent for \$132/month including maintenance. Options for specific features typically add \$5-10/month to the basic rental. For the record, Univac now has its own dedicated data entry sales force. UNIVAC, Blue Bell, Pa.

FOR DATA CIRCLE 252 ON READER CARD

Remote Peripherals

Higher-speed peripherals to take greater advantage of the PIX remote 360/370 channel extension device have been announced by its manufacturer. The PIX 8203 and 8206 are 300- and 600-cpm 80-column card readers, respectively, with features such as "on-the-fly" card loading and unloading, vacuum card picking mechanism, etc. Two-year lease prices on the units are \$300 and \$350 per month.

Also announced were 300- and 600-lpm line printers featuring 132-column operation, 12-channel IBM-compatible vertical format control mechanism, etc. The printers rent for \$650 and \$950 per month on two-year leases, respectively. When attached to the manufacturer's parallel interface extender (PIX), these peripherals can operate on 4800-baud dial-up lines without the need for traditional telecommunications hardware such as modems or 270X communications controllers. PARADYNE CORP., Largo, Fla.

FOR DATA CIRCLE 253 ON READER CARD

Crt Terminal

The KEYVIEW is a 12-inch diagonal crt available with interfaces that allow it to perform a number of different functions. The standard interface hooks the KEYVIEW up as a tty substitute, but there's an RS232C outlet for doing other things, too. The KEYVIEW differs from most other crt terminals in that it can display up to 32 lines of 64, 72, 80, or 96 5x7 dot-matrix ASCII characters on its screen, or a maximum of 3072. The unit contains an MOS/LSI refresh memory and can accommodate transmission rates ranging from 10-4,990 baud, and optionally up to 49,-

We can play any tune you want in graphics.



The most sophisticated, high performance (yet cost-effective) graphic display systems available today bear the Sanders name.

The ADDS/900® and ADDS/500* Sanders systems can control air traffic, do pattern layout, IBM 2250 firmware emulation, data reduction and analysis, simulation and training, command and control, and solve a host of computer-aided design problems.

They offer building-block flexibility in customizing off-the-shelf modules to meet customer system needs — at off-the-shelf prices. They're compatible with a full range of industry computers — and, being programmable, have broad off-line processing capabilities.



Get in touch. We can play your tune. Sanders Data Systems, Inc., Graphic Systems Marketing, Daniel Webster Highway-South, Nashua, N.H. 03060. Call (603) 885-5280.

Sanders...the intelligent answer

European Sales Offices: Sanders Data Systems, Ltd., 51/53 Brick Street, London W1Y 7DU, England; Sanders Data Systems, GmbH, 6000 Frankfurt/Main, Rennbahnstrasse 72/74, West Germany.

*TM Sanders Associates, Inc.

INTRODUCING THE NEW CHAMPIONS OF DIGITAL COMMUNICATIONS!!

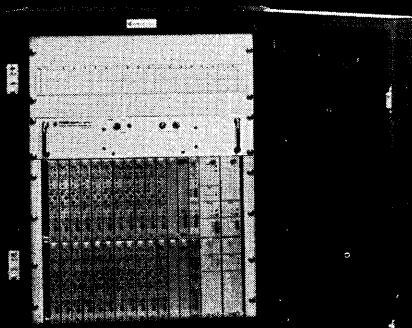

General DataComm's Model 1251 *High-Speed Digital Synchronous Time-Division Multiplexer*

The TDM designed for compatibility with the new digital communications networks, General DataComm's Model 1251 is available for sale and delivery now.

Model 1251 gives you the ability to multiplex as many as 62 channels of synchronous data having mixed rates ranging from 1200 to 19,200 bits per second and to transmit the composite output at any rate up to 256 Kbps.

But speed alone does not tell the whole story. The 1251 is superior to outmoded multiplexers in its:

Flexibility — permits maximum combinations of modem and terminal equipment in the same system.

Superior Diagnostics — on-line monitoring of each data channel, remote channel testing, automatic fault alarm.

Plug-in Maintainability — no need to interrupt operation of all channels to replace one card.

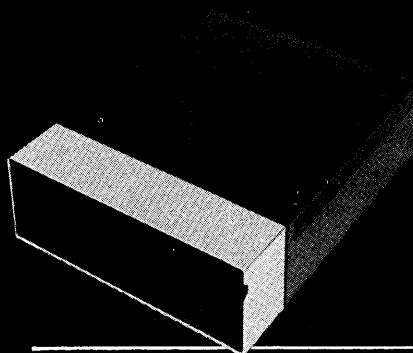

And the 2400 bps Modem with all the diagnostics —

General DataComm's Model 201

At first glance, General DataComm's new Model 201 might seem like anybody else's Bell-compatible 2000/2400 bps modem. That's where the similarity ends. Nobody else has synchronous 201 modems with the complete remote and local diagnostics offered by General DataComm.

Working from your communications center, you can instantly spot troubles anywhere on your data network and instruct local operating personnel how to make on-the-spot repairs, using plug-in cards.

GENERAL DATACOMM — the one name you need to know for all your data communications hardware needs.

The completely Bell-compatible line of hardware from General DataComm includes everything you need for data communications systems using any common carrier lines, including the new ultra-high-speed digital networks.

High-Speed Digital Synchronous TDM's • **Asynchronous TDM's** • **Frequency Division Multiplexers**
• **Synchronous Modems** • **Asynchronous Modems**

And never a worry about interfacing. General DataComm assumes full responsibility for network integration.



General DataComm Industries, Inc.

131 Danbury Road, Wilton, Connecticut 06897 (203) 762-0711 TWX 710-479-3210

member of
IDCMA



See it all at booth nos. 283 & 285

National Computer Conference

McCormick Place, Chicago, May 6-10, 1974

hardware

990 baud. The cursor, a blinking underline, can be computer controlled for character or line editing. Prices range from \$1,750 for a 32-line by 64-character version, up to \$2,495 for the largest display. Initial units have gone to the field and there is currently a four month backlog. INFORMATION DESIGN INC., Bedford, Mass.

FOR DATA CIRCLE 255 ON READER CARD

Commo Line Controller

A communications line controller capable of supporting up to 128 mixed-speed lines is offered oem's and sophisticated end users for interfacing terminal networks to various minicomputers. The 20/10 can support asynchronous lines ranging in speed from 5-3,000 baud, and synchronous lines running from 1,200 to 50 kilobaud rates. In addition, the 20/10 can support up to five remotely located time division multiplexors. The basic unit sells for \$2,800, which includes the basic logic and bay assembly for supporting up to 16 lines. Asynchronous line interfaces run from \$50-\$150 per line, and synchronous line cards are \$350-\$450. Minicomputer interfaces have been developed for the PDP-11, the Nova line, and Interdata's products. The manufacturer is willing to tackle all other mini interfaces. MICOM SYSTEMS, INC., Chatsworth, Calif.

FOR DATA CIRCLE 261 ON READER CARD

Microfiche Reader

There's certainly renewed interest in microfilm due to the paper shortage, and the NMI-90 microfiche looks like a well designed unit for users to consider. All electronic components are housed in a pull-out drawer to facilitate maintenance, and an optional dual fiche carrier is automatically self-opening as the carriage is moved forward. The top glass pops up for changing the



24X, 42X, and 48X microfiche and to permit easy cleaning. Special attention has been paid to the roller and track assembly to provide smooth motion of the carriage and high rigidity of the mechanism. This is said to result in less operator fatigue during extended periods of operation. The NMI-90 is priced under \$200. NORTHWEST MICROFILM, INC., Minneapolis, Minn.

FOR DATA CIRCLE 254 ON READER CARD

Scientific Calculator

The U.S. has dominated the market for highly sophisticated hand-held calculators, but that doesn't mean there aren't some clever—and low priced—machines available from abroad. This month's "best calculator" award goes to the Sinclair Scientific, weighing just 3½ ounces, and measuring only 4½ x 2 x ¾ inches. In addition to the standard four functions, the Scientific can

product spotlight



Intelligent Terminals

Incoterm has come up with a very attractive alternative to the IBM 3270 intelligent terminal both in terms of features and price. Additionally, the larger versions of the SPD-20/20 appear to be a worthy competitor for IBM's recently introduced 3790—which has come in for some rapping by potential customers because of the slow speed of the hardcopy printers.

Actually, there are two products. The first one is the SPD-320 which contains an 8K processor buried inside for controlling up to eight video display terminals. This product will be pitched strictly to the 3270 user as a totally transparent replacement—at 50% of the cost. The SPD-320 has some features built into it that allow for expansion should IBM extend the 3270, and conceivably users could talk Incoterm into putting any kind of a peripheral device on the 320 that was wanted. A typical 8K SPD-320 system with eight 1,920-character displays sells for \$2,500 per station, or rents for \$85/month on a two-year contract.

The 20/20 is directed at the remainder of the intelligent terminal

market, and its 32K processor and up to 16 terminals might even suffice as the complete dp installation for many small shops. IBM's 3790 configuration is probably the closest competitor to the 20/20, and a 32K SPD-20/20 with four 1,920-character displays, two medium-speed printers, one high-speed printer, and two floppy disc drives sells for \$41K, much less than half of IBM's equivalent configuration. The line printer speeds go as high as 600 lpm on the 20/20.

A spokesman for the six-year-old firm states that potential customers will be able to do just about any terminal based application with either the 320 or 20/20 configurations, but that "they are going to have to be smart along with us," meaning that unusual configurations will take some working out on both sides to satisfactorily solve application problems. In support of that is a 55-person operation programming and systems support group. First units of the 320 and 20/20 terminal systems go to the field this month. INCOTERM CORP., Natick, Mass.

FOR DATA CIRCLE 250 ON READER CARD

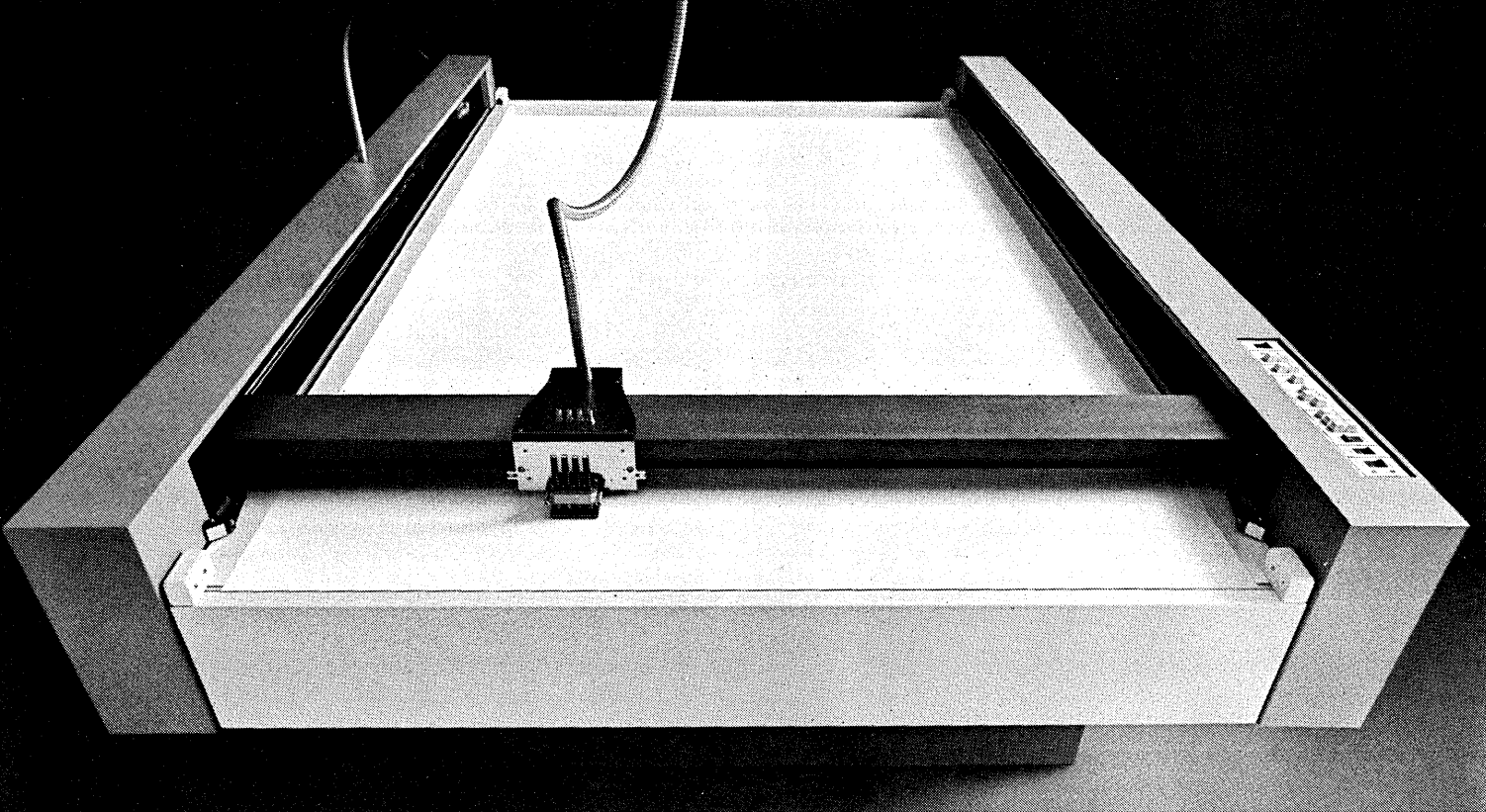

It draws faster than ink flows.

We call it the 748. It's big. And it's fast.

Its 4 inking pens move at speeds over 40 inches a second. That's faster than ink flows, so we had to figure out a pressure inking system that lets the ink catch up to the pens.

If you make integrated circuits or maps, or if you have precision drafting needs, this is the new tool.

The 748's plotting area is 48" x 82". It can scribe

coated materials and cut strippable film. At peak speeds!

The quality of its line is not impaired by its incredible speed. And like all CalComp flatbed plotters, the new 748 offers easy-to-use software for most computers.

We service it in 29 countries. But the way we've made it, you won't be calling us very often.

Do call us to see it. Our number is (714) 821-2011. Or

write California Computer Products, Inc., DM-M4-74, 2411 West La Palma Avenue, Anaheim, California 92801.

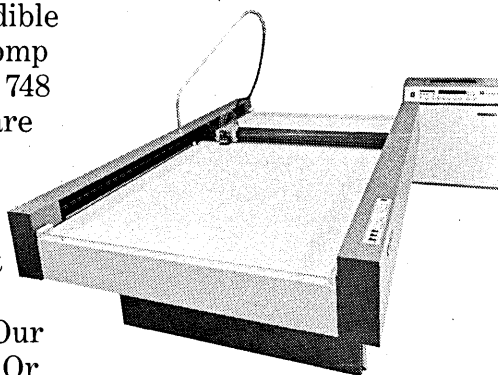

CALCOMP

hardware

do logarithms to base 10, antilogarithms, sine, cosine, tangent, arc sine, arc cosine, and arc tangent. Entries and results are in scientific notation with a



signed, 5-digit mantissa and a signed 2-digit exponent for magnitudes between ± 99 . There is no wall hookup/battery charger offered from the Scientific; it relies instead on four commonly available batteries to provide up to 20 hours of computing. Priced at only \$119.95, the pocket-size calculator will be distributed through department stores, campus outlets, consumer electronics houses, etc., or you can contact the manufacturer's representative in this country. SINCLAIR RADIONICS INC., New York, N.Y.

FOR DATA CIRCLE 256 ON READER CARD

Burroughs Printer

The larger companies don't find it worth their while to invade such relatively small peripherals markets as those for the Burroughs B 300 and B 500 computer systems—which is probably just as well since it gives little companies a chance to get established. This manufacturer has taken a Data Products 1800-lpm printer and done

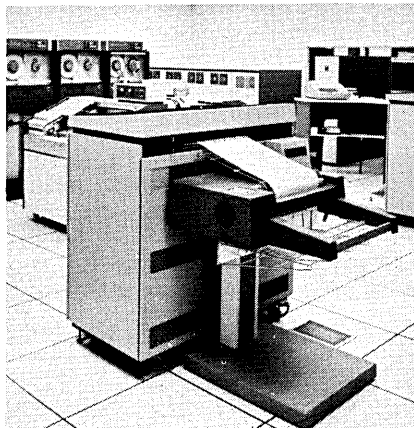

(Continued on page 174)

April, 1974

360-30s store more with SMART™ core

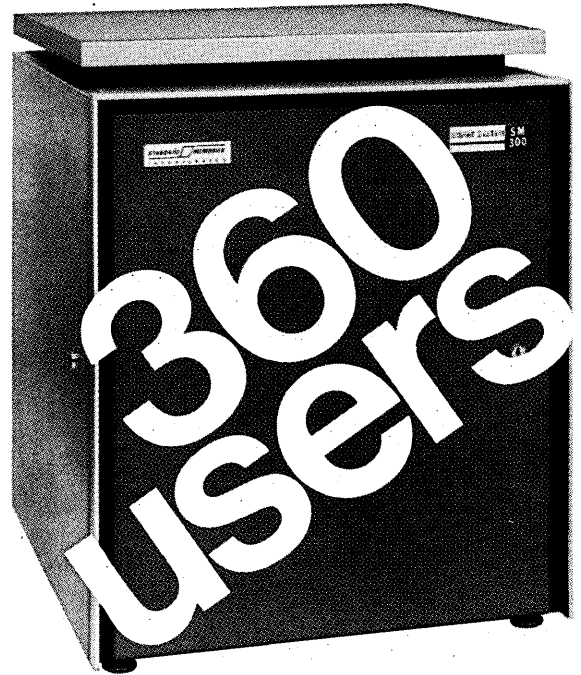

Up to 512 kbytes for your 360 Model 30

Standard Memories has it! If your machine is a 360/30, Standard can enhance its core storage capacity from the manufacturer's "maximum" of 64 kbytes to 128, 192, 256, 384 or 512 kbytes! 256 kbytes of SMART core will cost you less than the original price of 32 kbytes.

On 360/44s, we can move you all the way to a megabyte. The cost: less than the original 192 kbyte expansion and substantially less than any other independent.

Standard has enhancement capabilities for almost all the 360 systems, all at tremendous savings! Write today for technical details.

STANDARD MEMORIES
INCORPORATED

AN APPLIED MAGNETICS COMPANY
2801 E. Oakland Park Blvd., Ft. Lauderdale, Florida 33306
TWX: 510-955-9828 Telephone: (305) 566-7611

CIRCLE 133 ON READER CARD

Still the most uncomplicated teleprinter.

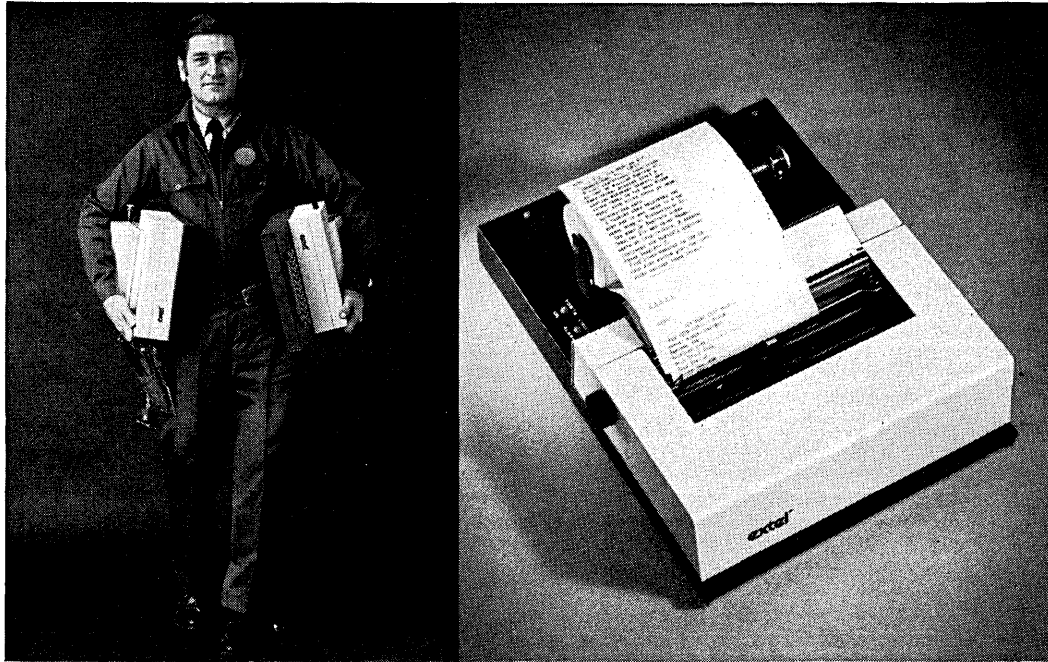

A small, quiet, multi-copy machine.
Impact or regular paper. Up to 30 cps. CCITT-2,
(including Telex). CCITT-5. Teletypesetter-monitor.

**In world-wide service.
Ask the people who use them.**

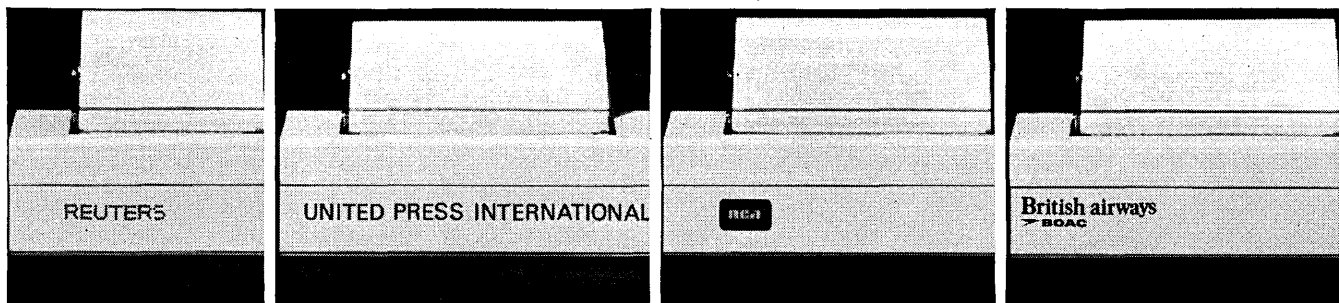

Manufactured in the U.S.A. by Extel Corp. • 310 Anthony Trail • Northbrook, Illinois 60062 • Phone: (312) 272-8650 • Telex: 72-4398



155 OR 158?

That's the decision faced by many users of large IBM computers. It's a tough decision, but Cambridge makes it even tougher. Because our 370/STOR 155 add-on memory has features that can make your Model 155 processor perform like a 158 – and then some. Take a look at the checklist – and then make your decision:

MODEL 155 with 370/STOR			MODEL 158 from IBM	
YES	NO		YES	NO
<input checked="" type="checkbox"/>	<input type="checkbox"/>	1. Four megabytes of main storage capacity	<input checked="" type="checkbox"/>	<input type="checkbox"/>
<input checked="" type="checkbox"/>	<input type="checkbox"/>	2. Dynamic address translation features	<input checked="" type="checkbox"/>	<input type="checkbox"/>
<input checked="" type="checkbox"/>	<input type="checkbox"/>	3. Up to 30% more CPU cycles than Model 155	<input checked="" type="checkbox"/>	<input type="checkbox"/>
<input checked="" type="checkbox"/>	<input type="checkbox"/>	4. High-speed addressing of main memory	<input checked="" type="checkbox"/>	<input type="checkbox"/>
<input checked="" type="checkbox"/>	<input type="checkbox"/>	5. Use of either VS1 or VS2 operating system software	<input checked="" type="checkbox"/>	<input type="checkbox"/>
<input checked="" type="checkbox"/>	<input type="checkbox"/>	6. 25% less physical floor space than Model 155 from IBM	<input checked="" type="checkbox"/>	<input type="checkbox"/>
<input checked="" type="checkbox"/>	<input type="checkbox"/>	7. Virtually no conversion or installation costs	<input type="checkbox"/>	<input checked="" type="checkbox"/>
<input checked="" type="checkbox"/>	<input type="checkbox"/>	8. No additional storage adapter required for expansion	<input type="checkbox"/>	<input checked="" type="checkbox"/>
<input checked="" type="checkbox"/>	<input type="checkbox"/>	9. Ability to reconfigure main memory	<input type="checkbox"/>	<input checked="" type="checkbox"/>
<input checked="" type="checkbox"/>	<input type="checkbox"/>	10. 35% less costly than a Model 155 with all – IBM hardware	<input type="checkbox"/>	<input checked="" type="checkbox"/>

That's what 370/STOR 155 can do for your installed Model 155 processor. We almost turn it into a 158 – and then some – for about one-third less than it will cost from IBM.

Sure, your decision is tougher now. Or is it?

CAMBRIDGE.

A good place to put your information.

360/CORE

Up to two megabytes of main memory for Models 22, 30, 40, 50, 65 and 67 processors in the System/360 line.

CIRCLE 75 ON READER CARD

370/STOR

Up to four megabytes of main memory for the Models 145, 155 and 165 in the System/370 computer family.

CIRCLE 76 ON READER CARD

EXPANDACORE-11

Memory expansion systems for all PDP-11 processors, featuring up to 30% speed increases. Two-way data save and interleaving.

CIRCLE 77 ON READER CARD

EXPANDACORE-620

Up to 65K of main storage for all 620/i, L, F-100 and L-100 minis. Self-contained and self-powered 5¼" plug-in systems.

CIRCLE 80 ON READER CARD

OTHER MEMORIES

Core, semiconductor and DOT data storage systems for OEM and End-user computer mainframe, controller, peripheral, terminal and auxiliary memory products.

CIRCLE 81 ON READER CARD



CAMBRIDGE MEMORIES, INC., 696 Virginia Road, Concord, Mass. 01742 (617) 259-9880

OKIDATA

Working for the OEM

By delivering the industry's most complete card reading family—a series of reliable, versatile and economical peripherals that read 80-column cards . . . 96-column cards . . . both 80- and 96-column cards in a unique, patented system . . . and cards with holes, pencil marks, or both.

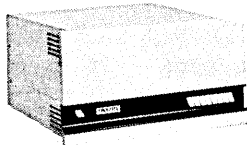
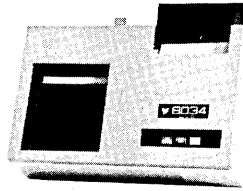

And the industry's most reliable disc memory systems—fast-access, head-per-track systems with storage capacities to more than 35 million bits, on 256 tracks. With our unique HEADLOK design that prevents head crashes without the use of troublesome, complex mechanical lifters.

Plus new, exciting peripherals that store, print or display to make your systems work better.

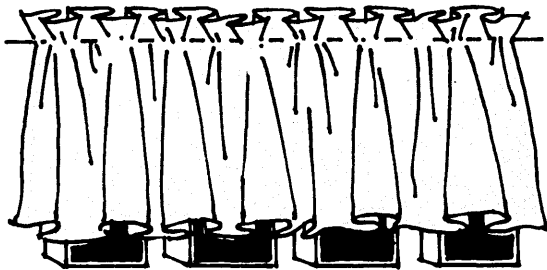

See them at the NCC. We're in Booths 250 and 252. Stop by and find out how we can go to work for you.

OKIDATA

Okidata Corporation
111 Gaither Drive
Moorestown, New Jersey 08057
609/235/2600

CIRCLE 126 ON READER CARD

all the interfacing work necessary to hook it to the systems listed above, and Burroughs users can save some money in the process. Outright purchase of the M470B is \$36,500, or \$750/month on a five-year lease. The 1800-lpm rate is based on 132 columns and a 36-character set. A full 64-character set still yields a print speed somewhat greater than 1200 lpm. Both buffered and unbuffered models are available in approximately 60 days. MACRO PRODUCTS CORP., Long Beach, Calif.

FOR DATA CIRCLE 258 ON READER CARD

Tty Sprocket Feed

The SMK-802 kit converts a friction-feed ASR-33 tty into a sprocket-feed unit in approximately 15 minutes. This would be useful for printing multipart and/or pre-printed forms, but its real utility might be in unattended terminal applications where the chances of paper jamming should be markedly reduced. The SMK-802 is primarily for use with fan-fold paper and non-form feed applications. The kit sells for \$150 and is generally available within 30 days. TTS, Santa Monica, Calif.

FOR DATA CIRCLE 257 ON READER CARD

Communications Device

The manufacturer of the CT-6 calls it a communications terminal, but that seems a little misleading. It's really two 9600C voice grade modems and a unit called a bplexer that splits up 19.2 Kilobaud transmissions and sends half along separate lines, reassembling them at a remote site. This seems like a good idea as it makes it unnecessary for users to contract with the phone company for expensive group band facilities to attain 19.2 Kilobaud transmis-

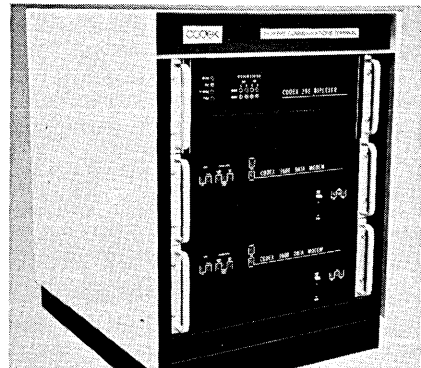

sion rates. A nice feature of the CT-6 is its "fall forward" capability—meaning that, should one of the 9600-baud lines degrade, the bplexer will send the entire signal over the remaining line. There are system and fault isolation monitors allowing users to check the source of error conditions. The CT-6 sells for \$25,700 and can be rented for

\$740/month on a two-year lease.
CODEX CORP., Newton, Mass.
FOR DATA_CIRCLE 259 ON READER CARD

Computer System

The Marks 2 appears to be a breakthrough in the design of large-scale computers, as it utilizes the latest bubble memory technology and pipeline processing architecture. The developers of this NONVON (non-Von Neumann architecture) machine make a pretty good case that the throughput problem with most modern computers is directly attributable to the fact that data tends to be difficult to access in the corners of rectangular memories. The solution offered with the Marks 2 is a spherical bubble memory with a capacity of up to 10 megabites when filled. Although the bites of the Marks 2 are only two bits long, they are said to be unusually deep.

Of course, just as round houses wind up having pie-shaped rooms along the



sides, so does the memory of the Marks 2. But the designers have used the unusual word lengths around the walls of the memory to store short operating system constants. Such clever thinking pervades the design of the Marks 2. It is thought that the computer might find a home in some specialized process control applications, for the system has some unusual operating features. These include operation only between the hours of midnight and daybreak and a recycle time of approximately every 28 days, or directly synchronous with the full moon. The only other operational constraint is that operators are strictly prohibited from wearing garlic around the system. An unusual option is a large wool cloak for keeping the memory at operating temperatures during cold pre-dawn hours.

Software includes the Disc Resident and Comprehensive User Library Assembly macro, and the Generalized Hardware Operations User Link, which is the system monitor. The system is supplied on a complete turkey basis, including incantation manual, for prices in the 2-4 Million Leu range. Please contact the manufacturer directly for additional information on this unique system. DRS. VAN HELSING/CALIGARI SYSTEMS LABORATORIES, INC., Cluj, Transylvania, Romania. For information: Dial 411 □

April, 1974

Telefile

Means Immediate Delivery of MASS STORAGE Removable Media, Moving Head DISK MEMORY SYSTEMS for

PDP-10 PDP-11

(Circle 135)

(Circle 136)

PDP-15

(Circle 137)

RPO2 and RPO3 Equivalent and

QUAD DENSITY TOO

Will Operate With Software Systems Such As RSTS/E, RSX-11D, Any Version of DOS, TOPS, TENEX, and Others.

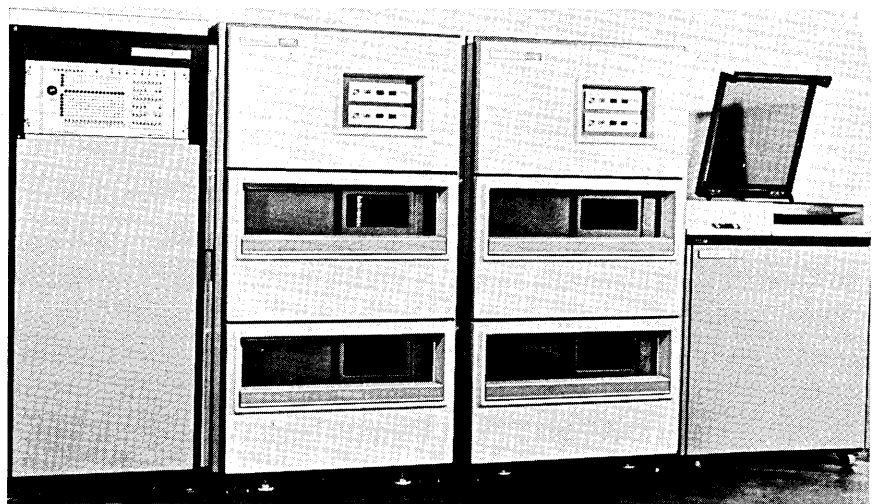

TELEFILE PROVIDES IBM COMPATIBLE DISKS TO NON-IBM COMPUTERS



Telefile

COMPUTER PRODUCTS

17131 Daimler Street
Irvine, California 92705
(714) 557-6660

See Us at NCC, Booth 218.

See Headline for Reader Circle Numbers.



DATAMATION

Don't Miss the Boat

Apply now for your '74 NCC "Everything Card"

If you missed the boat on the first annual National Computer Conference & Exposition last June, don't let it happen again. The first NCC in New York received accolades from attendees, exhibitors, and the media. The '74 NCC, even bigger and more comprehensive, will be held in Chicago's McCormick Place, May 6-10. And if you preregister before April 22, you'll be entitled to the '74 NCC *Everything Card*, your passport to all exhibits, program sessions, and a variety of special events.

You get much more with your *Everything Card*—special discounts for the NCC luncheons, your copy of the NCC Proceedings, plus the opportunity to make your hotel reservations at reduced convention rates. You'll also be in the running for a one-week trip for two from Chicago to Stockholm, Sweden for the IFIP Congress '74, August 5-10; or for one of five NCC lifetime registrations.

Just \$50 and the attached coupon is all you need for your personalized *Everything Card*. The '74 NCC brings it



all together, including: ■ The world's largest display of computer hardware, software, peripherals, and services, presented by more than 250 exhibitors in over 800 booths. ■ 117 program sessions, focusing on computer science and technology and the appli-

cations of data processing in 10 major user areas. ■ Major addresses by prominent industry and professional leaders, including John D. deButts, Chairman of the Board of AT&T; C. W. (Clancy) Spangle, Executive Vice President of Honeywell Inc.; and George Glaser, AFIPS' President.

The '74 NCC is your one chance to examine virtually every data processing product and service at one time, in one place. You'll exchange information with 35,000 of your colleagues at the computer industry's single national forum for users, managers, and computer professionals. You'll be able to help solve your own specific data processing problems by evaluating competitive products firsthand. Many of these will be on display for the first time.

To receive your personalized *Everything Card*, plus complete housing information, send \$50 by check or money order with the preregistration coupon to '74 NCC, c/o AFIPS, 210 Summit Avenue, Montvale, New Jersey 07645.

'74 NCC, c/o AFIPS, 210 Summit Ave., Montvale, N.J. 07645

DTM-474

Yes, send me my *Everything Card*. I've enclosed \$50, covering the '74 NCC program and exhibits, plus preregistration benefits described above.

Just send me all the facts.

My company is interested in exhibiting at '74 NCC.

Name _____ Title _____

Company _____

Street _____

City _____ State _____ Zip _____



'74 NCC The Biggest Computer Show on Earth

ASI-ST

THE DATA MANAGEMENT SYSTEM THAT IS USED

Over 1,000 ASI-ST job streams are executed each month by more companies than any other similar product. One firm calls on ASI-ST over 4,000 times a month!

WHY SUCH HEAVY USAGE?

- Extreme execution efficiency
- Dramatically reduced solution effort versus other languages
- Easy to use by nonprogrammers as well as programmers
- Self-contained cataloging of recurring ASI-ST job streams
- Dynamic modification of cataloged ASI-ST requests
- Complete batch and on-line interfaces to IMS and TOTAL

By contrast, competing products are either used for one-time reports . . . or are seldom used at all.

For more information on obtaining *real* benefits through use of the ASI-ST Data Management System contact:

Director of Marketing
Applications Software, Incorporated
21515 Hawthorne Boulevard
Torrance, California 90503
(213) 542-4381, Telex 653-563 other offices in Boston and Tokyo



THE Software Manufacturer

Software & Services

Updates

California's vanity license plate law--allowing any combination of up to six letters and numbers as long as good taste is observed--has led to some interesting dp-related examples. Dr. Robert Noyce, head man at Intel Corp., has the company name on his license, and some unknown programmer has been spotted driving around L.A. with the plate "DO LOOP." By coincidence, a standard California plate bearing "360 FOE" has been seen in the shadow of IBM's western regional headquarters in Los Angeles. We'd be interested in hearing about other personalized license plates relating to dp from all other states. We'll list some of the better examples--and maybe award a small prize for the best ones.

A spokesman for Boole & Babbage Corp. traced the problems the performance measurement software vendor has experienced over the years at Larry Welke's International Computer Programs awards banquet recently. Stating that the Cupertino, Calif. firm turned the corner to profitability last September, the official said making money seemed linked in some way to two changes the firm had made just prior to becoming profitable: opening board meetings with a prayer, and using softer toilet paper in the bathrooms. The unnamed official is convinced there is a correlation between soft toilet paper and the general mood of employees.

SUPER FORTRAN, the result of two years of effort, is on the air through United Computing Systems' nationwide time-sharing service. Programming aids such as a system level debugger, traceback module, and multiple subroutine entry points have been added by Kansas City-based United, as have the ability to handle seven-dimensional arrays, relocatable binary and precompiled subroutines, delimiters for Hollerith constants, and output list expressions.

We hear that Intel Corp. is planning to offer a drum memory to support VS operating systems on its 370 computer leases. The drum is said to substantially improve VS performance compared to disc-based VS systems.

Financial Forecasting

CUFFS would seem to be one of the more powerful financial forecasting systems ever offered. It is controlled by English-like commands easy enough for non-dp personnel to use, yet contains many automatic computation features for generating forecasts across a broad range of detail.

CUFFS consists of a compiler, editor, relationship analyzer, calculator, simultaneous equation detector and solver, report generator, graphics output generator, and more. One of its nicer features is the ability to do regression analysis, e.g., take a dividend per share of stock and work back through all parameters that affect that number to produce sales volume, cost per unit, pricing, etc. A macro generator in CUFFS allows users to create their own programming language and processing functions.

Currently, CUFFS is available on the CompuServ time-sharing network, based in Columbus, Ohio, where processing on DEC System 10 mainframes ranges from approximately \$20-60/hour. The names of other networks planning to offer CUFFS can be obtained from the developer, who is developing the system for IBM mainframes. DAVID COMBS, New York, N.Y.
FOR DATA CIRCLE 241 ON READER CARD

CICS Enhancements

IBM's Customer Information Control System wasn't a highly-developed package when introduced several years ago, partly due, we suspect, to the fact that even IBM didn't realize how popular the package was going to become, and what applications users would tackle with it. White Plains is now beginning to introduce some enhancements to make CICS easier and more efficient to use in application program development, and here are five more: a COBOL interface, 3270 terminal simulator, on-line test/debug module, a dynamic memory map module, and a performance analyzer.

The COBOL link for the CICS monitor should minimize the need for the COBOL programmer to become totally proficient in the ways of CICS, allowing him/her to concentrate more on the application logic. This module rents for \$195 per month.

The 3270 simulator uses a serial device, such as a card reader, and a printer to permit testing of applications programs prior to acquisition of 3270 terminals, or so production terminals won't have to be pulled out of the production stream for testing purposes.

The rental on the 3270 simulator is \$75/month.

On-line Test/Debug should be widely applicable since it allows programmers to test application programs, user files, or CICS control blocks and tables while CICS is operating, by using a 3270 terminal. This module rents for \$80/month.

The CICS Dynamic Map provides information about the real-time status and composition of an active CICS partition by including a statistics gathering capability within its own output writer facility. This allows the user to selectively display and log pertinent systems statistics including those on partition composition, storage use, task activity, and transaction rates. The dynamic map feature rents for \$45/month.

The performance analyzer allows the user to collect and summarize selected information on resource utilization. It assists in identifying inefficient and/or heavily used applications for proper emphasis in improving operations. The monthly rental on this feature is \$65.

All programs are currently available, with monthly rental rates waived after the first 12 monthly payments. IBM CORP., White Plains, N.Y.

FOR DATA CIRCLE 244 ON READER CARD

DOS Enhancement

The developers of one of the first and most successful replacements for IBM's POWER I/O spooling modules have announced another one called FMAINT to replace the standard MAINT module in IBM's DOS monitor. It's claimed that FMAINT can be installed in about two minutes, and that if for some reason its performance doesn't seem worth the \$150 monthly rental, one can easily drop back to the IBM module, as no system software changes are required to get it on the air.

FMAINT provides faster access to program libraries, removes restrictions about reading compiler or assembler output back from disc storage during object deck maintenance, and performs all functions in a multiprogramming environment. SDI claims that FMAINT is five to ten times faster than its IBM counterpart, which seems like an enormous performance boost for the money. FMAINT functions in any DOS partition of at least 44K, and supports input from 2311, 2314, and 330 discs, or 80- or 81-byte tape records or any multiple of 80 to a block-size of 1,600 bytes. A 30-day free trial is offered with FMAINT. SOFTWARE DESIGN, INC., Orinda, Calif.

FOR DATA CIRCLE 245 ON READER CARD

If the food for your super computer is being harvested by hand,

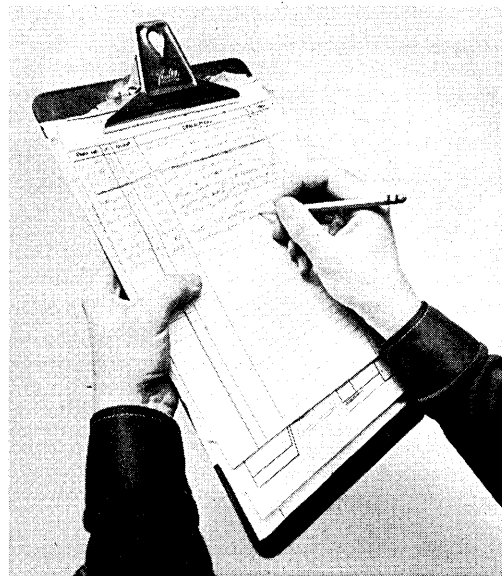

you don't have two problems... you have three.

one

At the computer.

Your supercomputer is only paying for itself when you're using it — so getting data into the system to be processed is critical to your operating costs. MSI's Field Data Entry Systems streamline the data collection and transmission processes and therefore facilitate regular scheduling of inputs.

two

Paper and pencil.

Collecting data with a clipboard or some similar means is slow, tedious and time-consuming work, and the resulting handwritten data is readily misinterpreted. MSI's Portable Data Entry Terminals quickly, easily and accurately record either numeric or alphanumeric data on tape cassette or in solid state memory while personnel remain mobile in their work activities.

three

In between.

Handwritten source data must be handled and translated several times before it can be processed — which significantly increases the incidence of error. MSI's Field Data Entry Systems eliminate the unnecessary steps of clerical data handling, keypunching and verification, and replace mail, truck or delivery service with direct transmission of the source data via an ordinary telephone call within minutes.



MSI
DATA CORPORATION

If you'll let us know your particular industrial affiliation we'll send you the appropriate application brief.

340 Fischer Ave., Costa Mesa, Ca. 92627

MSI CAPTURES DATA AT THE SOURCE IN COMPUTER-READABLE FORM.

software & services

Object Deck Listings

Any installation that has had the problem of trying to figure out what was contained in an unmarked object deck—or a deck that has been dropped—will appreciate a little utility program called X4747. It takes object deck cards and generates listings in hexadecimal and EBCDIC codes by card column. The listing is formatted with key words showing the type of card being interpreted printed adjacent to the listing. X4747 can also punch a new object deck with corrections by using a control card.

A free 21-day trial is offered for users operating under IBM's OS or VS operating systems. A one-time charge of \$195 entitles the user to both the source and object decks for X4747. PILKERTON INTERNATIONAL, Anaheim, Calif.

FOR DATA CIRCLE 246 ON READER CARD

Microprocessor Software

Intel's MCS-4 microcomputer set is one of the most popular "intelligence" sets being used by OEM's in developing new products, and this firm has developed a FORTRAN IV assembler and simulator package that should make it possible to easily generate coding for the MCS-4 using any popular minicomputer with 12K words of memory. It's a two-pass assembler, with binary output produced at the end of the second pass. After the second pass the binary output is reformatted into pages, then optionally dumped onto paper tape.

The simulator permits selective execution of portions of the program, with a trace option providing location,

decoded mnemonic instruction, carry and accumulator register contents and index register contents for each instruction. Both the assembler and simulator are available for \$1,950, including source code and supporting documentation. TESTLINE, Titusville, Fla.

FOR DATA CIRCLE 242 ON READER CARD

Teleprocessing Monitor

Only the SHADOW knows how many teleprocessing terminals can be supported under IBM virtual and OS/DOS operating systems. Developed in England, the package has supported 150 terminals using a 120K byte DOS partition, while small local contention CRT environments have gotten by using approximately 7K bytes, exclusive of applications programs. SHADOW's developers say that the package does pretty much what all TP monitors do, but in a slightly different way. It's claimed that coding application programs using it is no more difficult than writing GET and PUT statements for devices like card readers or printers. All terminal message servicing, internal file handling, and memory utilization is handled by the 17K statement assembler language program. Additionally, it performs program management, buffer handling, device simulation, error tracing and system statistics, record protection, data editing, and task timing.

SHADOW is priced at \$8K and \$15K for DOS and OS/VS installations, respectively, or \$225 and \$425/month. Installation charges, including education, is approximately three months rental. The package can be installed in about one hour and is supplied with full documentation, source code, and a year of maintenance support. INFORMATION FACILITIES, INC., New York, N.Y.

FOR DATA CIRCLE 247 ON READER CARD

software spotlight

FORTRAN Alphanumeric

After searching the software market in vain for modules providing alphanumeric data handling capabilities in FORTRAN, this independent edp consultant wrote 18 of her own that she is willing to share for the nominal fee of \$250. The routines were initially used to develop a powerful in-house interactive FORTRAN environment running under IBM's TSO (Time-Sharing Option), which was found to be more efficient than COBOL operation.

Among the more useful routines are those for converting character strings to numeric value (and vice versa); a search routine for locating a specified

character configuration and returning the starting location if found; routines for splitting and concatenating character strings; a routine called LENGTH which returns the number of characters in a string before all blanks are found; conversion routines for packed decimal into binary integer (and vice versa); EDIT, which converts a given value to a character string, edits the string according to a user-supplied picture, and returns the edited result; SORT, which performs an internal sort on records contained in an array with one or more fields; and BISRCH, which performs a binary search on an array.

All of the routines are written either in assembler or FORTRAN and vary in size from a few hundred to a few thousand bytes. MS. GABRIELLE WIORKOWSKI, State College, Pa.

FOR DATA CIRCLE 240 ON READER CARD

**Who Gets
Excited
When The
Computer
Breaks
Down?**

EVERYBODY.

The cost of computer downtime can be horrendous. Last year, a computer failure shut down the Chicago Mercantile Exchange half a day—the cost, an exciting half million dollars.

Computers are different from people in more ways than one. They require a constantly controlled environment held to critical tolerances that comfort air conditioning can't provide.

EDPAC process cooling helps ensure uninterrupted computer operation at a cost of only 1% of overall investment. If you are interested in protecting your computer investment, you should read our informative, non-commercial book, "Process Cooling for Data Center Environment." AC Manufacturing Company, Cherry Hill, N.J. 08034, or call 609-428-9800.

It could prevent some unnecessary excitement!

45A

EDPAC

PROCESS COOLING FOR COMPUTERS

CIRCLE 89 ON READER CARD

No other software
can do all the things
MARK IV does!
With quality products
experience
counts...

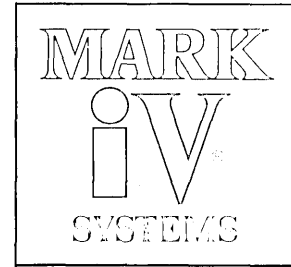

20,000 Users Trained

More than 20,000 persons have been trained to use MARK IV; 25 classes a month teach users in our advanced, intermediate and basic courses.

2,200 System User-Years

More than 700 satisfied users in 36 countries. Their cumulative use of MARK IV Systems totaled more than 2,200 user-years of experience in March, 1974.

693 Man-Years Support Experience

This Field Staff experience is available to all current and prospective MARK IV users from 84 experienced technicians in 14 offices today.

468 Man-Years Development Experience

The full time effort of our current Development and Headquarters Staff of 40 technicians provides 468 man-years DP experience with more than 200 man-years devoted to MARK IV alone.

No other firm can match this product dedication and experience today.

If you program Business Applications—complete systems or retrieval and reporting systems—MARK IV provides more power with less programming than any other language.

MARK IV is a general purpose information processing system for IBM 360/370, Univac Series 70, 90, 9400, and Siemens 4004 computers. On-Line versions are available for in-house use or on nationwide time sharing networks.

informatics inc
MARK IV Systems Company

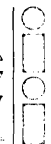

North American Headquarters
MARK IV Systems Co.
21050 Vanowen Street
Canoga Park, California 91304
Telephone (213) 887-9121

Offices:

- Chicago (312) 648-0280
- Dallas (214) 233-6861
- New York (201) 488-2700
- Washington D.C. (301) 770-5951
- Toronto, Canada (416) 493-9616

International Offices

Informatics S.A.
18 Rue Camille Martin
1203 Genève, Suisse
Téléphone 022/45 22 00
London • Paris • Copenhagen
Rome • Dusseldorf • Mannheim
and
Computer Applications Co., Ltd.
2-3-1 Hitotsubashi, Shogakukan Bldg.
Chiyoda-ku, Tokyo, Japan
Telephone 263-7241

We have the computer books everyone else would like to have.

At Addison-Wesley, we have a full range of books on every aspect of computer technology. From highly theoretical to downright practical. Books by some of the brightest names in the computer field.

But we're not resting on past performance. This year, among the titles we're publishing:

THE MYTHICAL MAN MONTH AND OTHER ESSAYS IN SOFTWARE ENGINEERING, by Fred Brooks, (the story of the development of the IBM/360.)

FREEDOM'S EDGE: THE COMPUTER'S THREAT TO SOCIETY, by Milton Wessel,

TRAVELS IN COMPUTERLAND, OR INCOMPATIBILITIES AND INTERFACES, by Ben Ross Schneider, Jr.,

and **THE PROGRAM DEVELOPMENT PROCESS**, by Joel Aron, first volume in the long awaited Systems Programming Series, sponsored by Addison-Wesley and IBM.

If you'd like to know more about these books and all of our other titles, visit our display at the National Computer Conference, May 6-10 in Chicago. Or circle the reader card number below and we'll send you a free brochure describing 22 of our computer bestsellers.



Business & Professional Division
ADDISON-WESLEY
PUBLISHING COMPANY, INC.
Reading, Massachusetts 01867

CIRCLE 149 ON READER CARD
April, 1974

software & services

Management Indecisions

The Management Indecisions Simulation System (MISS) provides lower-level management with a convenient means of modeling both the odds and degree of action—or inaction—in decisions made by an organization's middle- and upper-class management stratification layers. A random number generator is the primary module in MISS, supplying numbers used to weight incoming problems regardless of their complexity, severity, or the status or number of employees affected. This insures that problems centering around the placement of a water cooler, for example, that are input to MISS, will receive the same amount of consideration as pleas for salary increases.

A second module in MISS is called **THEY**. Drawing on numbers also supplied in random fashion by the generator, **THEY** interprets the numbers and makes recommendations as to the amount of attention that should be paid to the particular problem. In the case of the salary problem above, a "0" coming up in **THEY** would result in no output whatsoever, (thus saving paper), while a "9" relative to the water cooler problem would typically result in **THEY** recommending that all water coolers be moved immediately.

Perhaps the nicest feature about MISS is that it isn't necessary to supply historical data on any company's data, as the developers claim that MISS output correlates to observed decision patterns "strikingly" well. The package is written in SPS (Symbolic Programming System) for the 1401 and requires only 128K words of memory. The vendor is taking a "wait and see" attitude on developing versions for IBM's 360 and 370 computers until it is convinced that these "radical new architectures are going to fly." **COMPUTE NOEVIL**, Chicken, Alaska. For information: Dial 411 □

We need you.

If you can spend some time, even a few hours, with someone who needs a hand, not a handout, call your local Voluntary Action Center. Or write to "Volunteer," Washington, D.C. 20013.
The National Center for Voluntary Action.



SPLICERS

Model 501 P M Heat Seal Splicer is the best tape splicer on the market. Splices any level paper tape oiled or unoled as well as mylar control tapes for less than a penny per splice.

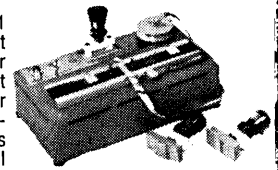

WINDERS

Variety of motorized winder and rewinder devices for unattended tape handling.

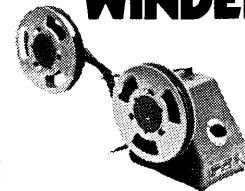

REELS

Aluminum and Lexan reels in various sizes, and also special design reels to meet your unique requirements.

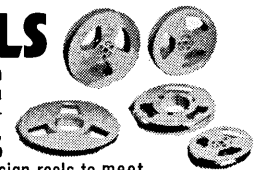

EDITING PUNCHES

Complete line of tape EDITING PUNCHES that not only punch codes but also have a splicing capability.

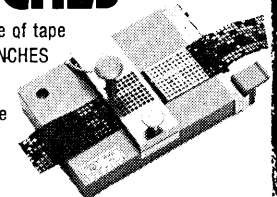

SPEEDY-REEL

The WINDER/CONTAINER that quickly winds by hand 125' of perforator tape in seconds. Available in five colors and made of durable plastic.



CONTAINERS

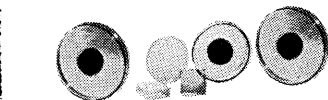

Pin Lock containers—MAG Tape reels, mailer containers and shipping boxes—Clear Plastic containers for perforator tapes on slip rings
PAPER TAPES • MYLAR CONTROL TAPES
SLIP RINGS • TAPE GAUGE

Purchase Orders received before noon are sent out the same day.

Circle the reader service code and receive our free catalog.

teac

COMPUTER ACCESSORIES CORPORATION

211 New York Avenue Huntington, N.Y. 11743
Tel: (516) 421-0929

CIRCLE 112 ON READER CARD

If you miss IFIP '74 you'll have to wait until 1977 to catch up with the rest of the world.

The next triennial IFIP Congress will meet in Stockholm, Sweden during the week of August 5-10, 1974. Everything will be under one roof. Both the technical program and equipment exhibition will be held at St. Erik's Fair, site of the 1972 Nobel Prize ceremony. It's a rare opportunity to share the world's progress in information processing.

MEDINFO '74 at the same time and site.

The First World Conference on Medical Informatics will run concurrently with IFIP. And you'll get a deep view of one of the most rapidly growing segments of your profession.

The IFIP program and exhibits.

Some 241 papers on specific subjects and recent advances will be presented. Plus 10 panel discussions exploring the present state of the art and current trends. To complete the information spectrum, there will be a wide range of hardware, software and other service-related exhibits.

Devaluation sales opportunities.

If you provide equipment or services to the information processing industry, you'll have fantastic sales opportunities. Recent dollar devaluations give your products greater sales potential in a rapidly growing European market. And you'll find it at IFIP '74.

You must book far in advance.

If you want to see and be seen at IFIP, now is the time to sign up for participation.

For registration and travel information write to: U.S. Committee for IFIP Congress '74, Box 426, New Canaan, Connecticut 06840.

*Exhibitors write to:
Arthur Hutt, IFIP '74 Exhibits Chairman,
Bowery Savings Bank, 110 East 42nd Street,
New York, N.Y. 10017 (212) 697-1414*

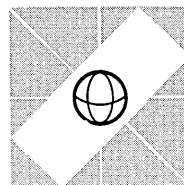

**International
Federation
for Information
Processing**



Just think of the money
you could make . . . the
money you could save . . .
if you had a Timesharing
System that could operate
for 10¢ per terminal hour.

You can.

It's our BTI Model
3000 Interactive Time-
sharing System.

A system that's
ideally suited to manage-
ment and administrative
functions, engineering
problem solving, educa-
tion, data collection, and
has been field proven in a
wide variety of dedicated
applications such as
dealer inventory, real
estate, general ledger,
and automatic ticketing.

You can operate up
to 32 ports with this
powerful system, using
BASIC with many exten-
sions. The 3000 works
with virtually all ASCII-
compatible terminals at
user-selectable speeds
from 100 to 2500 bps and
has on-line storage capac-
ity up to 4 billion bytes.

To see how you can
turn a dime into a profit
producer for your
company, invest in a
letter or phone call today.
We'll send you full infor-
mation on the BTI 3000
System. Or see us at the
NCC Show (booths
1023, 1122).



BASIC Timesharing

680 Almanor Avenue,
Sunnyvale, CA 94086
(408) 733-1122

Literature

Specialized Carrier

Southern Pacific Communications Co. (SPCC), a wholly owned subsidiary of the major Southern Pacific railroad company, operates the U.S.'s largest privately owned communications network. Originally designed for use by the railroad, the microwave-based system extends 6,800 route miles, with



650,000 voice circuit miles and 350,000 miles of data circuits. Described in this 12-page brochure are the system's private-line services, which range from a single Teletype link to a complex interoffice communications system including voice, facsimile, and high-speed data. SPCC, San Francisco, Calif. FOR COPY CIRCLE 230 ON READER CARD

CICS Users' Forum

The *CICS Information Interchange Newsletter*, initially distributed to 600

CICS users in the U.S. and Canada, is intended to be a forum for users' ideas, problems, and solutions. The first issue of the bimonthly newsletter (Jan. '74), about 25 pages long, contained articles on such subjects as: anticipated features and performance of CICS/VS, error recovery in on-line systems, and choosing between COBOL and BAL for CICS applications. ON-LINE SOFTWARE INC., Hackensack, N.J.

FOR COPY CIRCLE 231 ON READER CARD

DPMA Newsletter

The Data Processing Management Assn.'s bimonthly newsletter, *COMPU-FAX*, this month starts its second year of publication. The four-page, user-oriented publication, aimed at top management, gives capsules of significant news, developments, and trends in the computer industry. DPMA, Park Ridge, Ill.

FOR COPY CIRCLE 232 ON READER CARD

Crt Terminal Guide

The *Auerbach Guide to Alphanumeric Display Terminals*, more than 330 oversized pages long, includes technical reports and analyses of 47 of the most popular series of crt's on the market. The report lists over 220 terminal models from about 50 suppliers, with

information given on basic functions, configuration guidelines, technical features, compatibility, performance and competitive position, maintenance arrangement, price, and the supplier's background. The cost is \$25. AUERBACH PUBLISHERS INC., 121 North Broad St., Philadelphia, PA 19107.

Topical Transcripts

An 82-page collection of transcripts of panel discussions from the 1973 WEMA Monterey Conference gives views on these topics: 1) the long-range impact of the IBM-Telex decision (with four panelists from the computer peripherals industry and the financial community); 2) the 1974 outlook for semiconductors (with top managers from nine semiconductor manufacturers); and 3) how the financial community looks at small companies (with panelists from four investment houses). The cost of the report is \$7.50 for WEMA members and \$10 for nonmembers. WEMA, 2600 El Camino Real, Palo Alto, CA 94306.

Word Processing News

Starting last month, the International Word Processing Assn. (IWP) offers a monthly newsletter containing: digests and critiques of current word processing articles, new product announcements and evaluations, question and answer features, listings of coming events, and news of IWP activities. Free to IWP members, the newsletter will cost \$30 for nonmembers; but a free sample issue is offered to DATAMATION readers through the reader service number. INTERNATIONAL WORD PROCESSING ASSN., Willow Grove, Penn.

FOR COPY CIRCLE 233 ON READER CARD

Microfilm Market

A 157-page report (#168) costing \$445 analyzes, and forecasts through 1980, the U.S. microfilm market, now \$500 million. The market, expected to quadruple by 1980, includes: cameras, processors, and duplicators; viewers and recorder printers; automatic storage and retrieval units; COM; film, chemicals, and paper; and micropublishing and service bureaus. In addition to market forecasts, the report gives information on: the background of the microfilm industry, current technological trends, the impact of computers, economic factors like the paper shortage, and product comparison. A descriptive letter and a detailed table of contents are available free of charge,

"They don't break and are cheap"

That's straight talk from Dr. Arthur G. Snapper, Research Psychologist at Western Michigan University about the Tennecomp TP-1375 Microdek cartridge tape unit.

□ Dr. Snapper chose his tape unit to be used as a quick and efficient paper tape replacement on minicomputer systems which control behavioral experiments. He needed reliability. Reliability is the characteristic customer surveys show to be the single most important consideration in the purchase of a cartridge tape unit. And we're happy to say reliability is ranked right at the top by Tennecomp tape unit owners . . . along with ease of interfacing, easy operation and good service. □ The Tennecomp cartridge tape unit owner knows what he's talking about. Ninety percent of Microdek, Minidek and Doubledek purchasers operate the units themselves. So they're pretty vocal about what works and what doesn't. A Tennecomp unit **WORKS**. Send for complete information today. □ *Completely interfaced to the PDP family of 8, PDP-11, H-316/516, Nova, and Hewlett-Packard minicomputers, and supplied with complete software packages.*

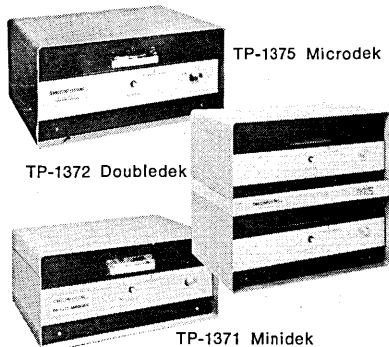

TENNECOMP SYSTEMS INC.

795 Oak Ridge Turnpike □ Oak Ridge, Tennessee 37830 □ 615/482-3491

CIRCLE 145 ON READER CARD

Why sell only software when you could be selling a complete turnkey system?

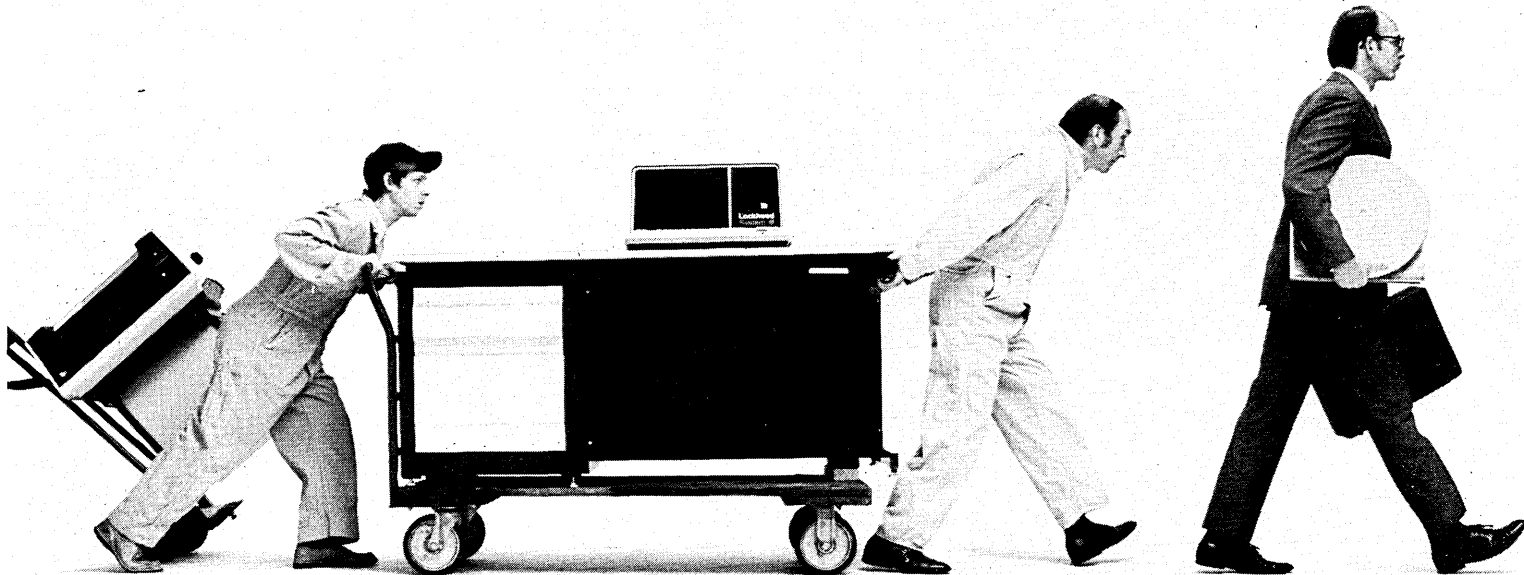

The Lockheed System III

If that question intrigues you, maybe it's because you've already begun to think about expanding your business beyond software. If it doesn't, maybe you should. In either case, Lockheed has the answer to how you might go about doing it. It's called the Lockheed System III.

Why the Lockheed System III? Because it offers you a unique opportunity to supply the total needs of your customers by combining your own application software with an inexpensive, flexible, minicomputer system. A computer built by Lockheed Electronics and backed by dependable, nationwide service.

How unique? Let System III speak for itself:

It has an RPG II compiler in operation with proven reliability. Others make this claim, we deliver.

You can use existing RPG II source level programs and tie in easily with new technology peripherals.

In addition to the RPG II compiler, we offer

DOS, sort/merge, assembler and utilities.

The basic configuration includes 16K bytes of memory, CRT/keyboard, 100 CPS printer and 5 million byte disk. Furthermore, System III is easily expandable without a lot of hidden cost.



And what's probably most important to you and your customers: the cost of a typical System III can be substantially less than the cost of competing systems.

One more thing.

Lockheed delivers in a hurry. So you don't have to miss a sale just because somebody missed a delivery date.

If selling turnkey systems makes good business sense to you, call us now (213) 722-6810 collect. Or write 6201 East Randolph Street, Los Angeles, California 90040.

Lockheed Electronics

Data Products Division

See it demonstrated at the Computer Caravan.

Boston 861-1880 • New York metro (215) 542-7740 • Philadelphia 542-7740 • Washington (703) 525-3600 • Atlanta 266-0730
Detroit 557-5037 • Chicago 833-4600 • Dallas 231-6163 • Houston 682-2617 • San Francisco (408) 257-3357

Fifteen years of leadership in electronics. 1959-1974.

CIRCLE 46 ON READER CARD

literature

through the reader service number.
FROST & SULLIVAN, New York, N.Y.
FOR COPY CIRCLE 234 ON READER CARD

Terminals Review

A compact guide to single-station keyboard remote interactive terminals marketed in the U.S., *Terminals Review* includes current data on about 300 products. A year's subscription to the guide, which is updated quarterly, costs \$28 (two years, \$50), with a single copy costing \$12. GML CORP., 594 Marrett Rd., Lexington, MA 02173.

New WATS Structure

A telecommunications research report entitled *The New WATS: From the User's Perspective* analyzes AT&T's proposed restructuring of WATS (Wide Area Telecommunications Service), which was expected to go into effect this spring. The report points to the need for a reappraisal of WATS by most users, noting both its negative and positive implications. Included are nomographs, case studies, and suggested procedures for planning effectively for this major change. The cost of the

report is \$35. CENTER FOR COMMUNICATIONS RESEARCH, INC., P.O. Box 324, Ramsey, NJ 07446.

Memory Survey

Originally published as part of a supplement to *Datapro 70*, the 12-page report on *How to Select and Use Add-On Main Memory* gives results of a survey of 143 users of 175 installed add-on memory units from 13 suppliers. The management-oriented report also analyzes the pros and cons of add-on memory and gives advice on selecting the most cost-effective unit for one's needs. The report costs \$10. DATA-PRO RESEARCH CORP., 1805 Underwood Blvd., Delran, NJ 08075.

Calculator Magazine

Calculations, a new quarterly magazine about 20 pages long, focuses on the relationship between calculators and software, with each issue's theme a particular application area. Of particular interest to users of Tektronix programmable calculators, the magazine will also contain some information of general interest on applications, books, and history. TEKTRONIX, INC., Beaverton, Ore.

FOR COPY CIRCLE 235 ON READER CARD

Think of what
just one company
can do to stop
pollution.
We have.



People start pollution.
People can stop it.

Please send me a free copy of your guide.

Name _____

Street _____

City _____

State _____ Zip _____



A Public Service of
The Magazine &
The Advertising Council

Keep America Beautiful
99 Park Avenue New York 10016

IT'S A BURSTER! IT'S A BURSTER/SEQUENCE STACKER! IT'S A BURSTER/SEQUENCE STACKER/SLITTER!

Variable 0-200 FPM Speed Modular Design Help You Get Data Distributed Faster!

For the small computer installation, Tab's 2311 multiple part burster lets you build the exact forms handling capability you need to get data where it will do the most good, fast! Optional

mobile table, sequence stacker and slitter help you add functions as needs dictate. A highlight feature of Tab's variable speed 2311 burster is its simple operation. For complete information, contact your local Tab Products representative, or write Tab Products Company, 2690 Hanover Street, Palo Alto, California 94304.

TAB
PRODUCTS CO

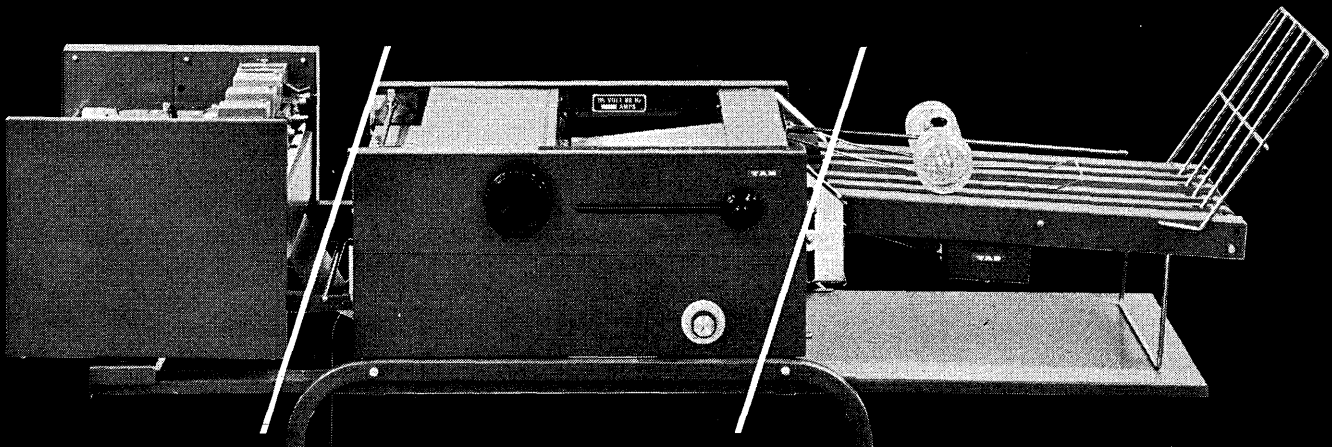

If you can read this you can operate Microdata's new computer system. That's Reality.



Finally, there's an information management system so easy to operate anyone can use it. We call it REALITY™

REALITY is a powerful, low-cost system designed for a wide variety of applications such as inventory control, production control and general accounting.

REALITY is easy to use because the user communicates with it in a remarkable computer language

called ENGLISH.™ You're reading it right now. It's a Microdata exclusive.

REALITY is simple on the outside, powerful on the inside. It operates on-line in RPG II. So if you're currently using a System/3, REALITY is compatible with your present programming.

Because REALITY combines the hardware and software (we call it firmware), it can handle multiple users and terminals while still providing substantially faster response than large scale data processing machines. Another REALITY exclusive—a single corrective entry will automatically update all related records in a single chain reaction sequence.

Face REALITY. If you're interested in multiple systems, call Microdata at 714/540-6730 for a demonstration in your office. Or write for descriptive literature. Microdata Corporation, 17481 Red Hill Avenue, Irvine, California 92705.



Microdata

Bring us your problems.

Face Reality at NCC Booth 751.

MICRODATA SALES OFFICES: New York 516/724-4807; Philadelphia 215/337-1839; Boston 617/543-6306; Detroit 313/477-8686; Chicago 312/948-9440; Washington, D.C. 301/881-6282; Dallas 214/239-8186; Los Angeles 714/995-5189; San Francisco 408/225-3235; Canada 416/678-1500

The new GTE Information Systems' IS/7800 Series Intelligent Video Terminals cost an average of 15-39% less than IBM 3270's on one-year rental, and 33-43% less on three- and five-year rentals. Buy them outright, and save 40-50%.

But we don't just cost less. We also offer more: Four character-capacity choices, not just two (240, 480, 960, 1920). Upper and lower case, and double-width characters. Extended character set with bar graphs, charts, histograms and line drawings. Inverted image (black on white). Underlining. Character blink. Impact

or thermal printers at 30-165 cps. Of course, like the 3270, we offer complete addressability of any character on the screen, and an optional light pen.

And everything is truly plug-to-plug compatible with the IBM 3270, and interfaces with IBM 360/370 systems. No hardware or software changes. Even the cables are compatible.

Costs less. Does more. The IS/7800 terminal is microprogrammed to handle today's problems, and can be programmed to meet tomorrow's.

What we're saying is, we not only give you more

**We cost a lot less
than they do
and we do a lot more
than they do.**

GTE Information Systems: One Stamford Forum, Stamford, Conn. 06904. **Atlanta,** 404-688-1670; **Boston,** 617-237-5222; **Chicago,** 312-332-7800; **Cleveland,** 216-771-8455; **Dallas,** 214-741-4361; **Detroit,** 313-353-5494; **Hartford,** 203-563-3767; **Houston,** 713-626-1713; **Los Angeles,** 213-380-2309; **Minneapolis,** 612-854-2898; **New York,** 212-486-3290; **Philadelphia,** 215-649-7410; **Pittsburgh,** 412-391-4170; **St. Louis,** 314-863-0330; **San Francisco,** 415-349-2600; **Seattle,** 206-283-3103; **Washington,** 202-293-2800; **Montreal,** 514-866-9324; **GTE/IS Europe S.A.,** 412 Ave. de Tervuren, 1150 Brussels, Belgium.

CIRCLE 73 ON READER CARD

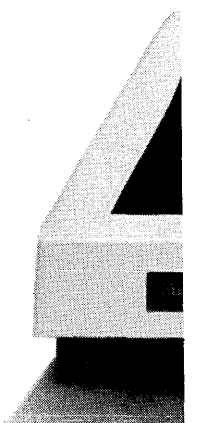

for today. We give you tomorrow, too.

What's more, the IS/7800 is backed by our 700-man service organization working out of 96 locations around the country. And behind them is GTE Information Systems itself.

We're probably the best single source for data communications you'll find. Terminals, modems, multiplexers, controllers. Even programming.

We've got what you need, between you and your computer.

Sometimes the best way to get more is to pay less.

GTE

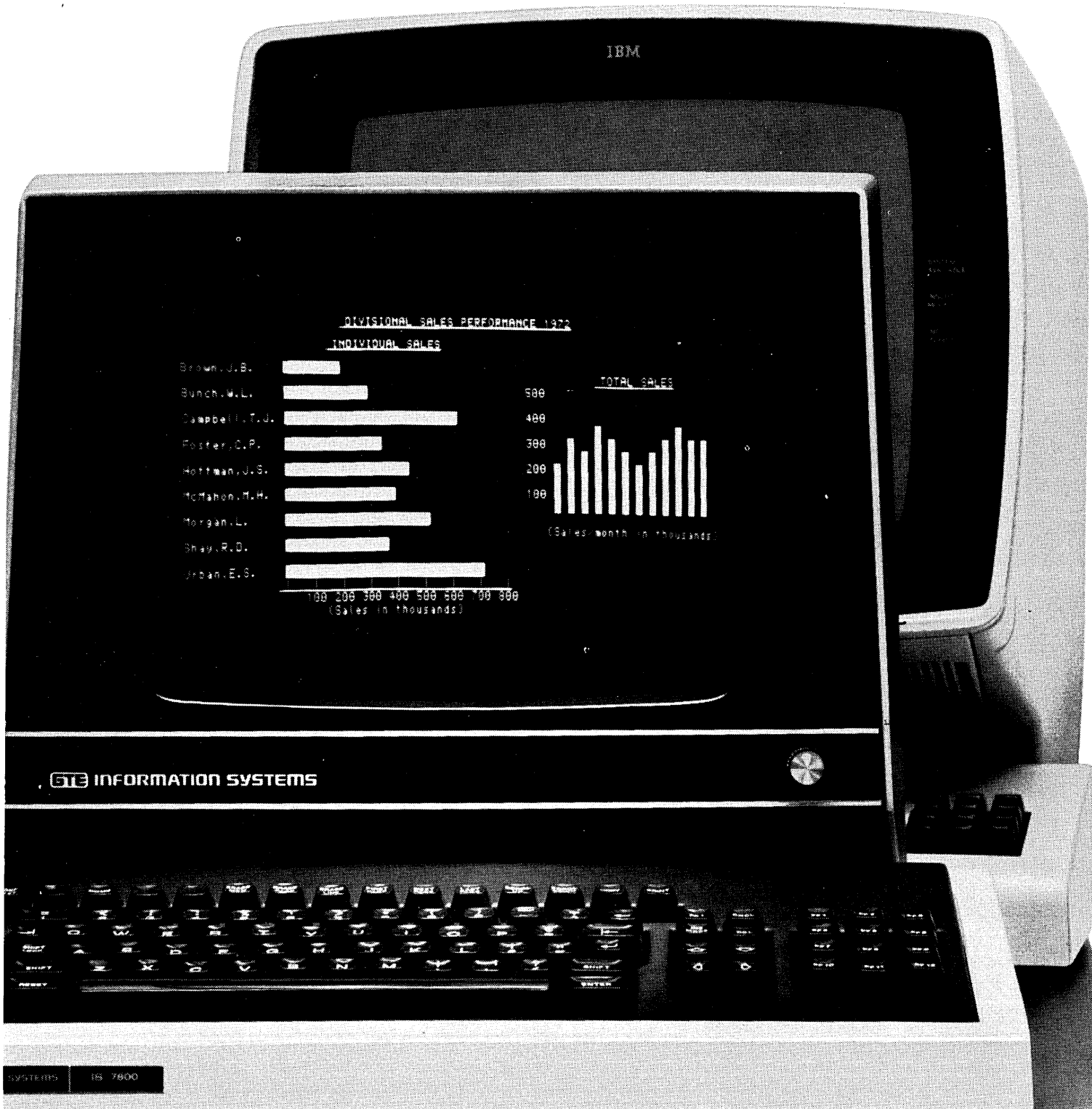

PEOPLE PEOPLE PEOPLE PEOPLE LE PEOPLE PEOPLE PEOPLE

A PATH WITH TURNS

For Thomas Allinson, a move from an investment banking firm to a position as vice president of Datum, Inc., an Anaheim, Calif. based minicomputer and peripheral equipment firm, marked a return to an earlier career path. His has been a career path that's taken several sharp turns.

Industrial engineering was his first aim and, after a stint as a pilot with the Navy Air Corps, he joined Marchant Calculating Machine Co. as assistant production manager. In 1952, he moved to Beckman Instruments as production manager. "After I'd been there a couple of years, my general manager called me in and told me Dr. Beckman had said he thought I'd do an outstanding job in marketing." So he became general manager and director of marketing for Beckman's Berkeley Scientific Div. In 1957, he moved to Daystrom Inc. as director of marketing. "They promised me that eventually I could get back in operations." He did. He became president of a Daystrom operational division, Weston Electrical Instrument Corp. He continued in that job until 1962 when he joined Curtis-Wright as vice president and executive assistant to the president and ran five of the company's divisions and subsidiaries.

Next came a two-year stint



Thomas Allinson

(1966-68) with then-troubled Astrodatab where he first worked with Wallace Rianda, Astrodatab president at that time and now president of Datum. This was followed by one of those career path twists which took Allinson into the consulting realm. He joined the Diebold Group in 1968 as vice president of business planning and marketing. "After a year, John (Diebold) asked me if I would help him and a brokerage house start a computer-oriented services firm for brokerage houses, and so I became president and founder of Wall Street Information Services, Inc." This was an on-line front and back office service for the brokerage industry.

At about the time this company had reached a growth point where

it needed \$3 million for equipment upgrades (they had two 360/40s), "the market fell apart." wsis was sold to General Telephone and Control Data Corp., which reorganized it as Brokerage Transaction Services Inc. Allinson remained with the company until Nov. 1972 when he moved into investment banking by joining the Los Angeles based firm of Morgan, Olmstead, Kennedy & Gardner, Inc. as vice president-corporate finance.

Datum was one of his accounts and he became a member of the firm's board of directors as well as serving it as a financial consultant.

Why did he make the switch from investment banking back to manufacturing? Investment banking was slowing down, he says, and "I was excited by Datum's growth." He said the company is in its fifth consecutive year of growth in profitability and has been quietly diversifying through acquisition. Acquisition is one of Allinson's charges in his new position. One of Datum's recent acquisitions was that of PICO (Peripheral Interface Co.), a Santa Ana, Calif. firm with a minicomputer line. Datum started out as a producer of peripherals for minis which Allinson calls like "being a doughnut without the hole."

"Now we have the hole."

"VERY PROUD OF MOM"

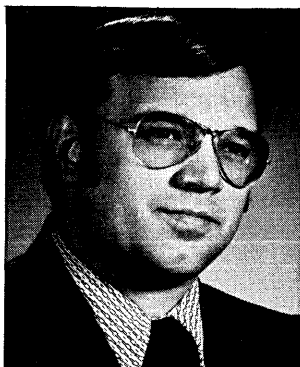

Arnie Cantrell

at age 20. But he got into dp before that. While still attending high school in Phoenix, he decided dp "looked like a place where hard work would pay off." Later, while attending Phoenix College evenings, studying dp

Data processing is maturing as an industry but it still is producing its youthful success stories. Take Arnie Cantrell who, at 28, has been named to the newly created position of director of edp research and development for Reynolds & Reynolds Co., which operates six data centers across the country.

Arnie had his own company, National Inventory Control Systems, Portland,

and business law, he worked as a consultant for a Phoenix bank where he developed an on-line inventory for local auto dealers. Happy with the results of his service, Arnie envisioned expansion nationwide through a network of minis. But the bank was localized, he said. "They wanted to offer the service with milk and cookies."

Arnie's horizons were wider but he didn't want to infringe on the bank so he moved to Portland to start his NICS, which offered a parts inventory control system he designed. The company, he says, "grew significantly and eventually was acquired by Automatic Data Processing, Inc."

He left before the merger, having decided he wanted to try his hand at working for a big company. He joined General Electric in Phoenix. But he found he really wasn't interested in large-scale, on-line processing and he still had the notion of a service for auto dealers using minis. So he started such a service in Tucson and it became a part of Diversified Online Computing, Inc. of

Phoenix—of which Cantrell was vp and secretary when it was acquired by Reynolds & Reynolds last September.

Part of his new job will be development of programs that "are more customer-oriented . . . to find out what the customer needs." He's still excited about networks of minis. "Developments among common carriers are making these more feasible economy-wise. R&R has B4700s in its data centers and "we wouldn't phase these out . . . just add minis, probably in sales offices and probably more than 100."

Cantrell's appointment to his R&R job took him to that

company's corporate headquarters in Dayton, Ohio, back to the city where he was born and lived the first 14 years of his life. The family moved to Phoenix because of his mother's sinus condition.

Now the father of four, active in church work and an avid hunter and skeet shooter when he has the time, Arnie still hasn't gotten a degree and plans to work toward that end when "I can fit it into my schedule." He's sure he can do it. He points to the fact that his mother, just last year, was graduated with honors from Phoenix College. "I'm very proud of Mom."

NO. 21 IS HIS BIG WINNER

Centronics Data Computer Corp. likes to look upon itself as a phenomenon—and phenomenon it is, having shipped more than 20,000 printers to date—but there are those who think that Centronics' president, Robert Howard, is a phenomenon too. Howard is something of a mystery man, moving quickly but difficult to see, like the Kohoutek Comet. He is a New Yorker who came to the quiet hills of New Hampshire to build gambling systems for Las Vegas casinos.

When he built his plant, he thought up his own street name—Wall Street. All that caught the eyes of the people in Hudson, N.H., but Howard was soon catching the eye of the computer industry with his low-priced printer. In addition to shipping more than 20,000 printers so far, Centronics has logged sales of \$18 million during the first half of the current fiscal year which ends in



Robert Howard

June. Howard, who runs his company with a firm hand, discovered in the late 1960s, when he was working on the gambling system, that he needed an inexpensive printer. "When we went to people in the industry," recalls Howard, "they said 'If you find a low-cost printer, let us know because we can use it too.'" Howard and his vice president of engineering, Prentice Robinson, developed the inexpensive printer and, ever

since, the company hasn't been very interested in gambling systems.

Howard might best be described as a pathological entrepreneur. Centronics is his 21st company, he says, noting that he has started or acquired that many firms over a period of 25 years. He sold the biggest bunch of them—businesses ranging from cable television to air conditioning—to Teleprompter in the mid 1960s. Howard studied mechanical and electrical engineering at Columbia Univ. at night over a 12-year period and his dual expertise has undoubtedly been an asset in Centronics' manufacture of its printers which are considered a particularly tricky product because of the difficulties of mating mechanical and electronic technology.

While Howard says that all his 21 companies have been successful, it is obvious that Centronics is his big winner.

A SECOND TRANSITION

Self-taught in data processing, Jerry Ehrlich is now teaching himself the restaurant business. He's the new dp manager for Wilscom Enterprises, a position he assumed when the Denver-based restaurant company acquired Electronic Accounting, Inc., a service bureau Ehrlich had run since July 1969.

The bureau had served Wilscom as a customer since last July but serving a company as a vendor and being part of it are quite different, according to Ehrlich, who said, "I'm having a hard time making the transition."

It won't be his first transition. A graduate of the Univ. of Denver with a degree in accounting, Ehrlich joined Kuners-Empson Co., a canned goods firm, in 1955, as assistant office manager. He was in that capacity when the data processing manager suddenly quit.

"There was no one else to do the job. I was interested and I got it. I took books home. It was a fairly simple unit record installation at that time."

Kuners-Empson moved up and so did Ehrlich, reading and teaching himself as he went. "If you can define a problem you need to solve you usually can find some literature." In 1964, Ehrlich moved to Alexander Lindsay, a public accounting firm, as assistant dp manager. He later spent a year with Great Western United, a conglomerate, as a systems analyst, before forming his own company.

He describes himself as a "pretty fair programmer and systems analyst" and has worked with the IBM 1401, various 360 models, and now has a 16K System/3, Model 10 with three 5444 discs.

The system serves six restaurants Wilscom operates in the Denver area and Ehrlich believes it will, "with some upgrading," be capable of serving the needs of 30 restaurants the chain expects to open across the country within the next two years.

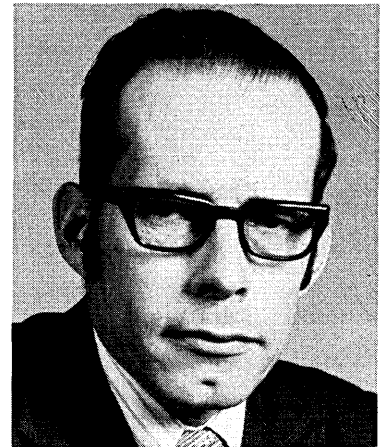

Jerry Ehrlich



OK, YOU GUYS. THE RACE IS ON.

Up until now, some fat cat computer manufacturers at the top of the heap have thought of ModComp as a young foal, scarcely worth their attention.

But they're catching on. Because we're running against them on the major tracks. And beating the hide off them, time and time again.

We've got the hardware. A family of thoroughbreds, from the MODCOMP I to our new 32-bit MODCOMP IV. All fully upward program compatible. All harnessed to a set of super software that gives us a fast-running edge over all comers.

It's too big a story to get across in one ad. But you can get the whole story, and the latest racing form, by getting in touch with us.

Put your money on the winner.

MODCOMP

 MODULAR COMPUTER SYSTEMS INC. 1650 West McNab Road / Ft. Lauderdale, Florida 33309
Telephone: (305) 974-1380. TWX 510-955-9820

European Marketing Headquarters: 103 Mytchett Road / Mytchett, Surrey, England
Telephone: Farnborough, (Hants) 514-251. Telex: 85631

CIRCLE 63 ON READER CARD

PEOPLE

FROM PREACHING TO PRACTICING

Dr. John Ottina, who was formally sworn in last fall as U.S. Commissioner of Education, is the first computer-nerd to hold that position. He was with SDC from 1958 to 1969; then, before joining the Office of Education (OoE) in 1970, he served for a year as board chairman and president of Worldwide Information Systems, a Los Angeles consulting firm specializing in MIS applications.

Shortly after becoming Commissioner of Education, he launched a massive reorganization of OoE. He also is increasing the agency's use of management information systems. "One interesting aspect of this job is that it gives me a chance to practice what I used to preach," he says.

Bespectacled, balding, soft-spoken and friendly, Ottina, who is 42, hardly fits the stereotype of either corporate executive or government bureaucrat. Yet he qualifies for both titles. OoE's budget totals about \$5 billion a year. It has 3,000 employees, manages a student loan program embracing 1.5 million recipients, and deals with nearly 25,000 school districts, colleges, and universities. "If we were a private company," he says, "we would be one of the 10 or 15 largest in the country."



Dr. John Ottina

RAYMOND J. NOORDA has been promoted from executive vice president to president of General Automation, Inc. . . . STEPHEN KEATING, president of Honeywell Inc. since 1965, is now chief executive officer as well . . . CHARLES D. TRIGG, former budget director from the state of Missouri, was named associate

director of the National Assn. for State Information Systems (NASIS) . . . ROBERT A. KLEIST was named vice president, special programs for Perdec Corp. . . . JOHN V. TITSWORTH was appointed executive vice president of Control Data Corp.'s Peripheral Products Co. □

EXECUPORT: Terminals and Peripherals

Shown is the Execuport 320 Portable Data Terminal. Plugs in anywhere, communicates via telephone with built-in acoustic coupler. Quiet and highly reliable.

Features include:

- Upper and lower case
- Three RS232 connectors
- Keyboard isolate switch
- Illuminated print area
- Single and double spacing
- Teletype or numeric cluster keyboard
- Integral carrying case
- Data access jack
- Print position counter
- Many other features and options

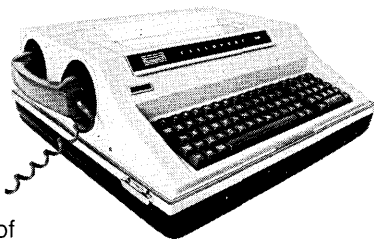

Ask about the full line of EXECUPORT terminals and peripherals, including paper and magnetic tape units. Use the reader service card or phone or write.

EXECUPORT: The tougher terminal.



Computer Transceiver Systems Inc.
East 66 Midland Ave., Paramus, N. J. 07652
(201) 261-6800 • TELEX: 138-707

CIRCLE 114 ON READER CARD

A NEW GENERATION OF INTERACTIVE SYMBOLIC DEBUGGERS FOR VM/370 INSTALLATIONS

STANDARD DATA CORPORATION
OFFERS THE FINEST INTERACTIVE
SYMBOLIC DEBUGGERS AVAILABLE—
SYMBUG™ FOR COBOL USERS AND
SYMBUG-F™ FOR FORTRAN USERS

- Complete execution control of your program.
- All references to code and data are through the same symbols used by the programmer in his source program.
- Ability to start, stop and trace execution; examine and modify data during execution.
- Ability to patch the source program, and to scan data or source program files.
- Ability to test subprograms without main calling modules or main calling programs without the called subprograms.

For further information and our free comparison analysis of debuggers contact . . .



STANDARD DATA CORPORATION
1540 Broadway, New York, N.Y. 10036
• 212/586-3100

CIRCLE 132 ON READER CARD

**Before we wrote the only
Computer User Plan, we built
today's best planned computer.
The Prime 300.**

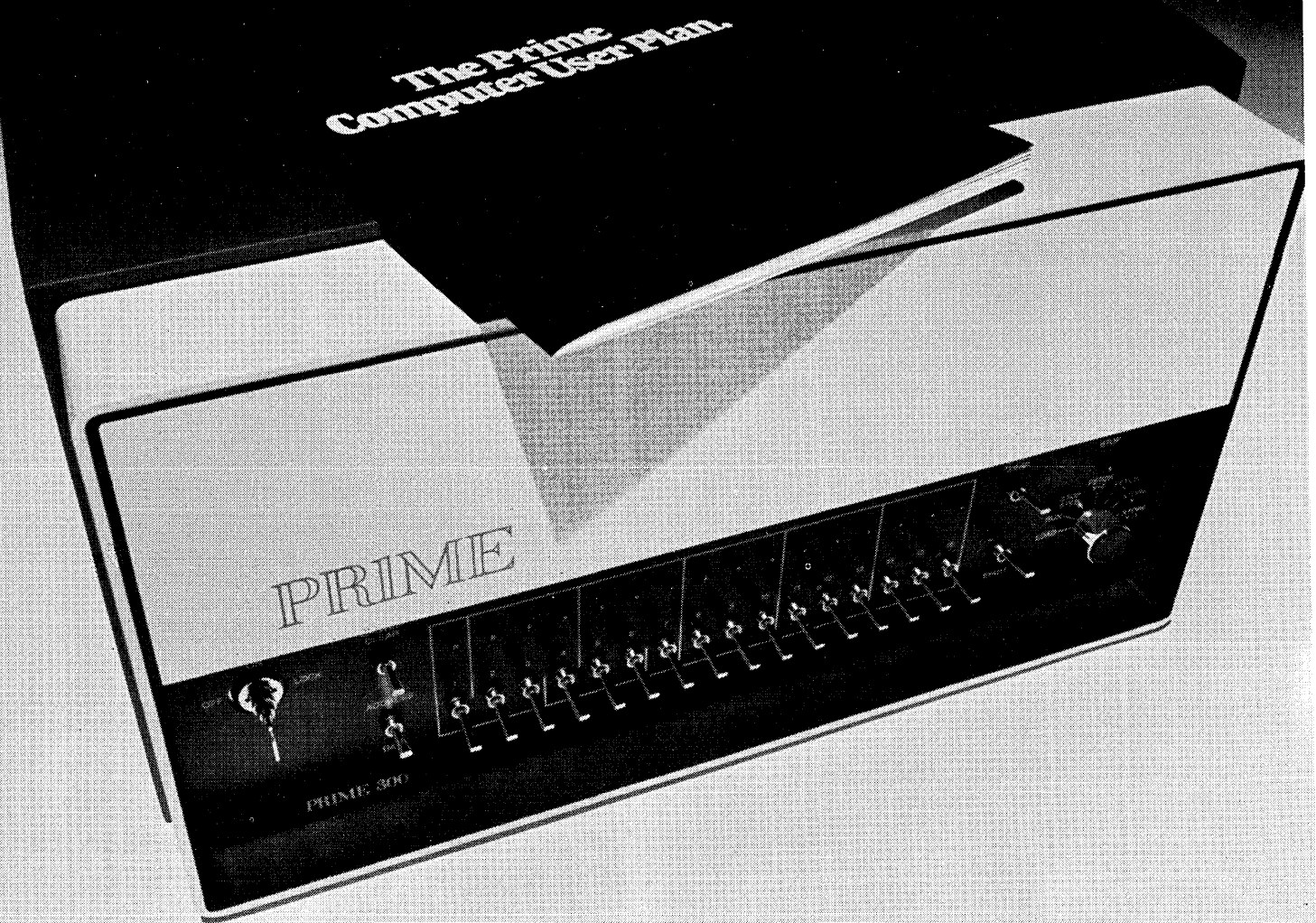

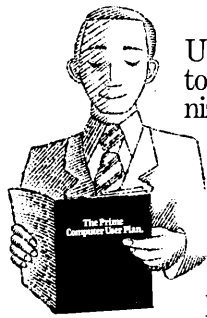

The Prime Computer User Plan brings common sense to buying a computer. It recognizes the simple fact that your needs might change someday.

The Plan introduces the first two-year guaranteed trade-in policy. It details the upward and downward compatibility features only Prime offers. In short, it gives every assurance you can always put a Prime system to use.

We consider The Plan a new way to buy, use and upgrade computer systems. We also give you the systems to consider: The Prime 100, 200 or 300. The chart below is a preview of what to expect in each.

Standard Processor Features	
Prime 300 Central Processor (1 board)	<ul style="list-style-type: none"> Virtual Memory—automatic paging, mapped address translation to 256K words, restricted execution mode, and memory protect.
Prime 200 Central Processor (1 board)	<ul style="list-style-type: none"> Stack Procedure Instructions Micro Verification Routines** Hardware Multiply/Divide and Double Precision Arith.* DMC/DMT Capability* Automatic Program Load From Input Devices (PTR, TTY, CR, MT, Disk)*
Prime 100 Central Processor (1 board)	<ul style="list-style-type: none"> Memory Byte Parity Processor Byte Parity Full Addressing Modes—direct, indirect, and indexed in both sectored and relative modes Virtual Instruction Package (VIP)—automatic trapping of unimplemented instructions and substitution of functionally equivalent software subroutines.
<ul style="list-style-type: none"> 8-Channel Programmable DMA 4 Channel Full Duplex Asynchronous Serial Interface Multi-level Vectored Priority Interrupt System 	
<p>* Optionally available on Prime 100 and 200 **Optionally available on Prime 200</p>	

The chart suggests there's a little 300 in every Prime computer. Naturally, we planned it that way. Our 300 is just the reverse of the big box with a little computer inside.

Other 300 features will tell you just how big it is. For instance, there's high-speed MOS memory with 32K words per board. Up to 256K words per system. There's floating point arithmetic and writable control store, too. In short, there's everything you'll need in the computer you can plan with. Work out a multi-function system or plan a multi-user arrangement. The diagram that follows is just one way to go.

The Prime 300 supports a multi-user, virtual memory Disk Operating System (DOS VM) and a foreground/background Real Time Operating System (RTOS VM).

A Prime 300 with virtual memory easily accommodates over a dozen users. What's more, each is guaranteed 64K words of virtual memory available to program in FORTRAN, BASIC, Macro Assembler and Micro Assembler.

The system files and paging space are all provided by cartridge disk. Our new diskettes offer low cost storage for personal user files.

A Prime 300 is good. How good can best be seen in The Plan. It shows how to upgrade from the 100 right on to the 300. In the process, you don't change software. The time and expense of reprogramming are gone. You can also use the 300 as a software development system. The software will run on 100's or 200's without modification. The Plan guarantees this kind of system compatibility.

The Plan also goes into system integrity features. Memory Byte Parity and Processor Byte Parity are standard in the Prime 300. Micro-verification routines (also standard) and controller loop-back allow you to isolate faults to a single board.

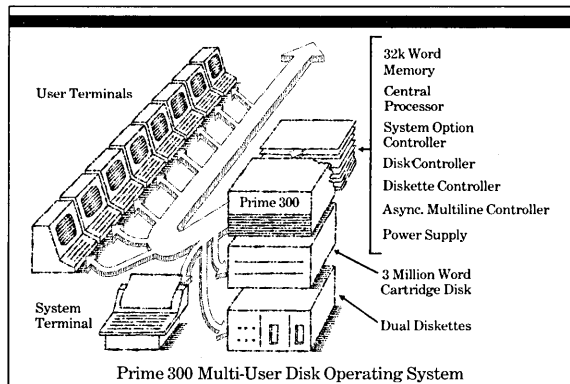

The Plan then spells out our total service options. They run from comprehensive on-call service contracts to Prime's unique Air Spare System. With Air Spare, we'll air express, for a minimal charge, any backup boards you may need from our nearest service center. We'll make repairs on faulty boards and have them back in no time. Meanwhile, you'll be operating full-time thanks to Prime.

There's more to The Plan. The best way to discover how much is to have your own. Send for it. The coupon below, like the Prime 300, will make it all possible.

To: Prime Computer, Inc.
 23 Strathmore Rd.
 Natick, Ma. 01760

- Send The Plan
 Send the Planner
 (He'll call for an appointment.)

 Name

 Title

 Company

 Address

 City State Zip

PRIME

Learn more about The Plan at the National Computer Conference, Booth 109.

Software Engi- neering Managers:

digital

digital equipment corporation

Digital is the fastest growing major computer manufacturer in the world. In the past year alone, our sales have grown by more than 60%, and profits have nearly doubled.

With more than half of our R&D investment going into high level software development, we are currently offering talented professionals unparalleled opportunities to realize their potential.

The Software Engineering Group is seeking four, unquestionably qualified managers with proven ability to provide impetus and direction in reaching our company's most challenging development objectives.

As a manager within this group, you will have the freedom, authority and resources necessary to implement your solutions within a highly responsive and visible environment. Each of you will have unlimited access to Digital's impressive technological, marketing and applications experience. And all of you will share in the significant impact that software development will have at Digital in the months and years ahead.

Communications Manager

PDP-11 Medium/Large Systems

As Manager of both the PDP-11 Communications and Corporate Network Products development areas, your broad responsibilities will include interfacing with our DECsystem 10 Communications Software Group; influencing its direction, and eventually managing its activities. Working with Product Managers and Chairing our Network Committee, you will guide and insure the successful integration of communications into Operating Systems, influence marketing efforts, and coordinate Standards activities both within the Communications area and outside of Digital.

Systems Manager

PDP-11 Medium/Large Systems

Managing three important development areas (Language Processors, Monitors and File Systems), you will work with other managers to insure that all products interface properly, adhere to standards, and are compatible to the planned level. You will provide technical coordination, and assist in defining an overall PDP-11 strategy that meets or surpasses customer requirements. Specific activities will involve providing Engineering with hardware design inputs and manpower for joint efforts, as well as guiding and directing Product Managers in the Real Time and Computational/Business market areas.

If you would like to assume major management responsibilities within our organization, and play a vital and totally unique role in the shaping of corporate software policies, we would like to meet you.

To fully investigate these and other positions, write Joe Underwood, Digital Equipment Corporation, 110 E. Main Street, Maynard, Mass. 01754.

Monitor Manager

DECsystem 10

You will be responsible for all DECsystem 10 software product development in the monitor, front-end, and communications areas; providing the necessary support for existing products, and developing support for new hardware. Specifically, you will plan all DEC-10 monitor development to insure its quality, coherency and compatibility with the needs of DEC-10 language and applications groups, and produce a product well-coordinated with the PDP-11. Managerial activities will encompass new product planning both within your own group and the corporation as a whole, budget and salary planning, evaluation of product group and supervisory effectiveness, training, hiring and promotions.

Manager of Software Product Planning

Reporting directly to our Group Manager of Software Engineering, you will be responsible for the creation of short and long range software product development, strategies and plans, in conjunction with hardware and software engineering, and various marketing and product line groups. Initially, your involvement will focus on the PDP-11 family of products, with primary emphasis on basic systems software (operating systems, compilers and utilities) and joint planning for end-user applications software and parallel hardware developments. Demonstrated ability will lead to expansion into all of Digital's computer system product areas, and increased managerial and policy-level influence.

Data Processing Contracts and the Law

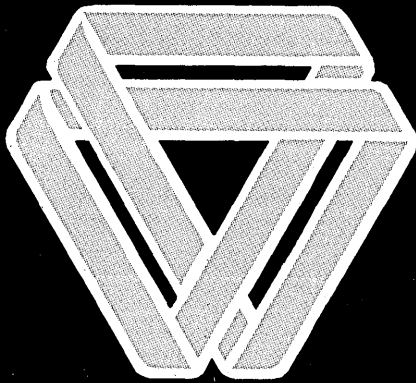

by **Richard L. Bernacchi
& Gerald H. Larsen**

Just published, this book presents a comprehensive treatment of the legal and technical considerations involved in the negotiation of contracts for the acquisition of data processing equipment and software and computer-related services. It includes suggested contract provisions and analyses of standard contracts used in the industry.

Richard L. Bernacchi, a partner in a law firm, and Gerald H. Larsen, president of a systems design and consulting firm, have combined their specialized knowledge in bridging the gap between the data processing and legal professions. 705 pages L091839 \$25.00

**Little,
BrownLaw
andBook
CompanyDivision**

34 Beacon Street
Boston, Mass.
02106

Structured Programmer's Soliloquy

SP or not SP—that is the question:

Whether 'tis nobler in the mind to suffer

The rules and exceptions of outrageous FORTRAN

Or to take arms against a sea of transfers

And by structuring end them. To code—to test

No more; and by a test to say we end.

The heartache, and the thousand natural mistakes

That FORTRAN is heir to. 'Tis a consummation

Devoutly to be wish'd. To code—to test.

To test—perchance to bomb: ay there's the rub!

For in that test of code what bugs may come.

When we have shuffled off this FORTRAN code,

Must give us pause. There's the respect

That makes calamity of so long lists.

For who would bear the whips and scorns of time-sharing

Th' operating systems wrong, the computer's crash,

The pangs of despis'd code, the turnaround's delay,

The insolence of compilers, and the spurns

That patient coding of FORTRAN takes

When he himself might his quietus make

With PL/1? Who would this FORTRAN bear,

To grunt and sweat under a weary language,

But that the dread of something after FORTRAN

The undiscover'd country, from whose bourne

No programmer returns—puzzles the will,

And makes us rather bear those ills we have

Than fly to others that we know not of?

Thus conscience does make cowards of us all,

And thus the native hue of resolution

Is sicklied o'er with the pale cast of thought,

And enterprises of great pith and moment

With this regard their currents turn away

And lose the name of action.

—Henry Kleine
and Philip H. Roberts

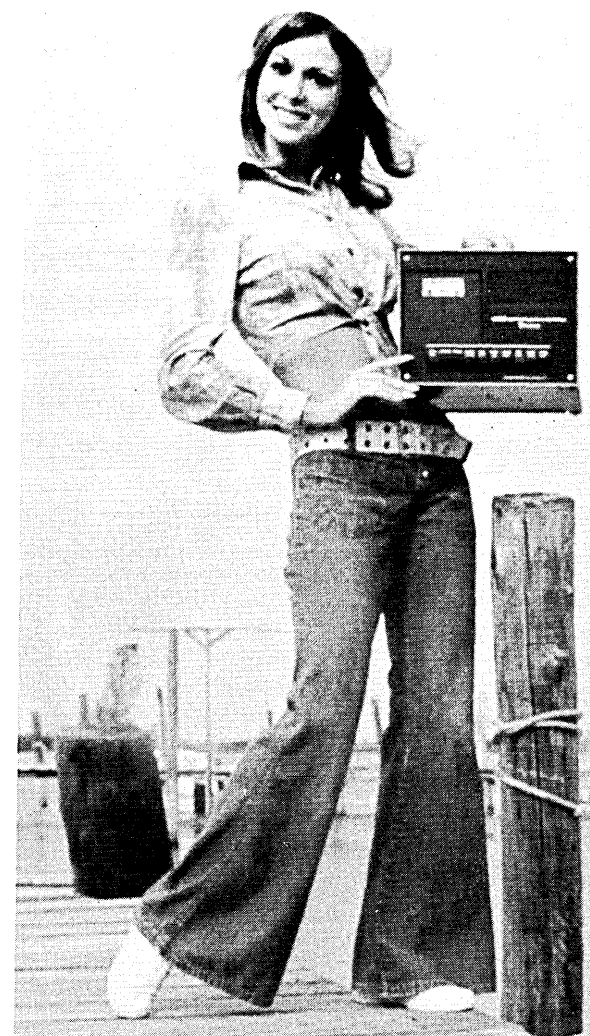

Your First Mate

TECHTRAN offers the best MATE for your CRT or data terminal.

Our **BUFFERED CASSETTE RECORDERS** are:

FIRST IN INSTALLATIONS. Users are saving countless dollars in computer time and connect charges.

FIRST IN APPLICATIONS. You name the usage and our MATE will be there. Add-on cassette to Data Entry Terminals, Collection Systems and MTST applications.

FIRST IN FEATURES. Remote control, Bi-Directional Search, Data Edit, 110-2400 Speeds, Code Transparent (Binary) Mode, ASCII or Baudot Coding, Standard Interfaces.

FIRST IN COMPATABILITY. They're plug compatible add-on to virtually all data terminals.

FIRST IN COST SAVINGS. Our mates provide ease of operator entry and faster transmission speeds which provide cost savings in any system.

Only Techtran offers you **TOTAL PERFORMANCE** mates which are operationally and plug compatible to most data terminals and communication systems. Most users are applying our mates. Shouldn't you?

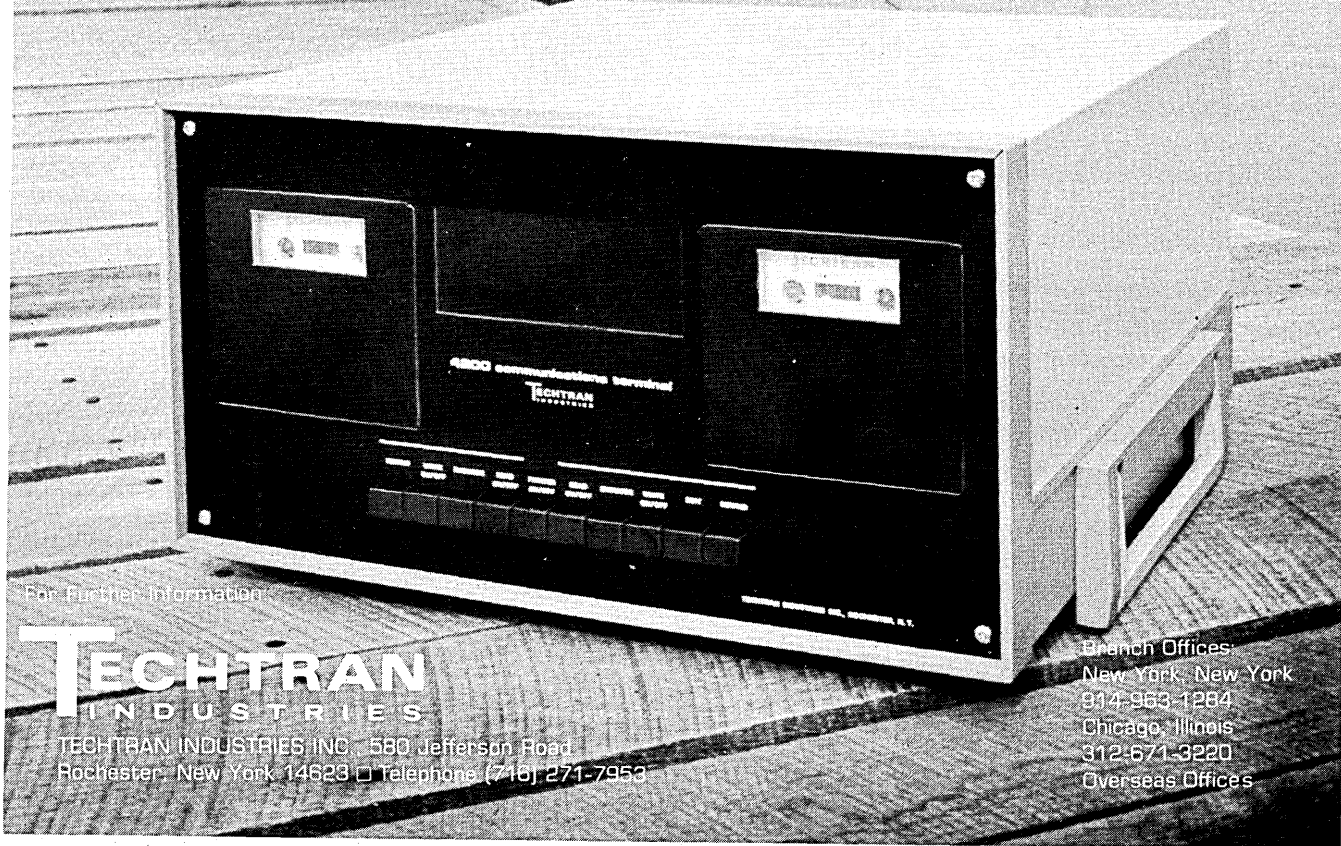

For further information:

TECHTRAN

INDUSTRIES

TECHTRAN INDUSTRIES INC. 580 Jefferson Road
Rochester, New York 14623 ☐ Telephone (716) 271-7953

Branch Offices:
New York, New York
914-963-1284
Chicago, Illinois
312-671-3220
Overseas Offices

Continued from page 28

Anti-laissez faire

... The market entry threshold is the major protection of big business against effective competition. Business is like poker, you have to be able to ante up to play the game. The ante in our computer industry is many megabucks. The limen in another big industry—the auto industry—is kilo-megabucks. If GM by mistake wiped out the competition, how would any real com-

petitor rise? The capital investment is just too big!

Given that economies of scale would result in monopolies, if there were not antitrust controls; then what would happen? What would prevent the monopoly from pricing for vast profits? Well, with a low market entry threshold new competitors would instantly enter the market, and prices would gain lower to a minimum acceptable profit level. *But that is not the*

case. Were a hypothetical computer giant “Brand X” to be allowed to wipe out the competition, even by just being more efficient, then the market place



Once in a while, something special in a Software Design Opportunity comes down the road.

This is one of them. It involves heavy responsibility for major defense software projects. It's a highly visible position with one of the nation's largest equipment and systems innovators. It calls for experience with real-time systems or command and control systems. Your background should include systems programming, real-time software design, data base management, software systems engineering, software project management, radar and communications systems programming, weapon system software development, micro programming systems or perhaps new business acquisition. If you have successful experience in some of these areas, these positions could offer immediate rewards and long term career opportunity. Let's talk, in confidence, of course. Write:

LRC
ASSOCIATES

12004 Aintree Lane
Reston, Virginia 22091

Representing an Equal
Opportunity Employer M/F

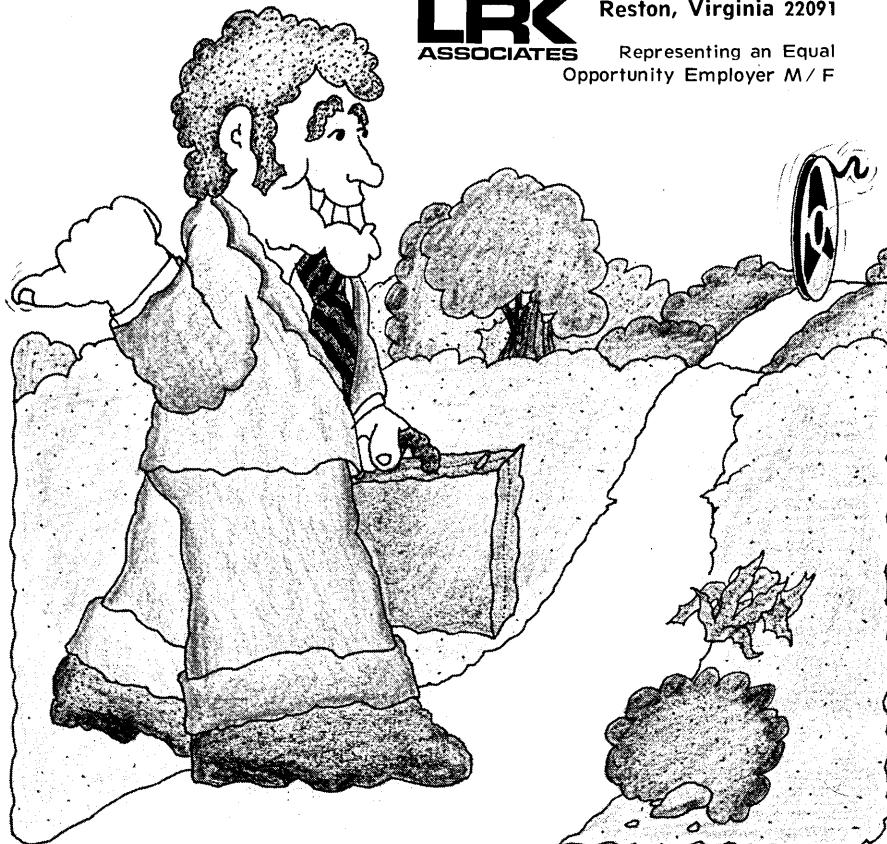

would be at the mercy of Brand X. Unless the prices were raised to gigantic profit levels, no other company would gamble the large ante required to enter the field. If this *did* happen then Brand X need only lower prices to a minimum profit level, wipe out the competition, and buy the new plant at bargain prices.

Obviously the idea of coercive and non-coercive monopolies breaks its back over the market threshold. With the high capital investment required for modern industry we must have some controls other than the Leave-Alone Capitalism.

PHILIP L. BANCROFT, CDP, MBA
Wayland, Massachusetts

Spare change?

The article in the February issue (p. 80), titled “Electronic Funds Transfer Systems: Broad Issues and a Sepia-Colored Stage Coach,” is interesting. I appreciate being updated on the “cashless society.”

However, there is an effect on the economy that was not touched here or in any article I have seen. What will be the result of the reduction in the amount of available “currency”? At present a signed check or credit card bill is the equivalent of cash for the one who holds it until it is cancelled by payment. If the signer lacks the cash to back the paper it is the equivalent of a no interest loan. If he has a bank deposit to cover the obligation the bank still has the money to loan. In any case the check or bill constitutes additional currency which will vanish with the Electronic Funds Transfer System.

H. B. THOMPSON
Cincinnati, Ohio

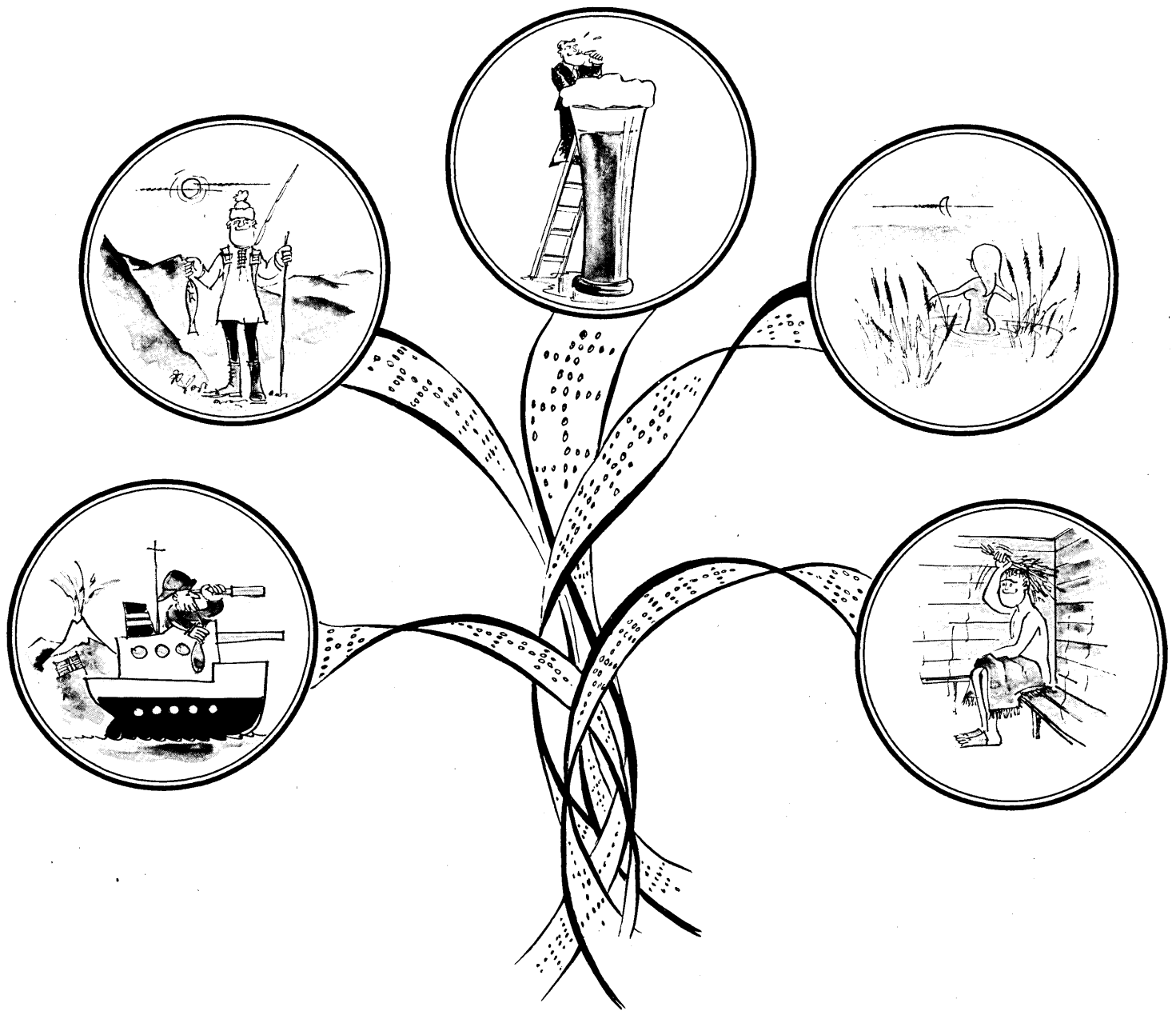

You may associate Denmark with beer, Finland with sauna, Iceland with hot springs and cod war, Norway with the midnight sun and Sweden with midnight sin. So you may be surprised to learn that the Scandinavian countries are also spending some effort on Information Processing. You are possibly not even aware of the fact that there is a Scandinavian Computer Journal, »data«, which reaches 90–95 % of all computer installations in Scandinavia and brings you in contact with a prosperous market.

»data« was started in 1971 by the Nordic user associations and has had a strong growth during the past three years.

We shall be pleased to furnish you with further relevant information on our Journal and how you will be able to use it in your marketing plans in the Nordic countries.

We will also gladly let you know how you can use »data« to form contact with the whole data world, viz. the 5,000 participants in the IFIP Congress at Stockholm this August.

Being the official Journal of the Congress, participants will receive »data«, No. 5/74. This issue will be in English only.

data

- Bredgade 58
- DK-1260 Copenhagen K
- DENMARK

Computers can't read dirt.

Practically all tape and disk errors are caused by self generated contamination. 90% can be eliminated by routine cleaning and testing. It's that simple.

With tape and disk maintenance, backups and retries are avoided, throughput is boosted; the risk of equipment damage is reduced. The cost of computer time for

even a small DP installation can be cut by thousands of dollars each year.

Kybe's cleaners, testers and certifiers pay their own way by keeping disks and tapes at peak operating efficiency. Kybe was the first in tape maintenance and is the world's largest. For details contact:

KV KYBE
KYBE CORPORATION
 132 Calvary Street, Waltham, Mass. 02154
 Tel (617) 899-0012, Telex 94-0179
 Offices & representatives worldwide

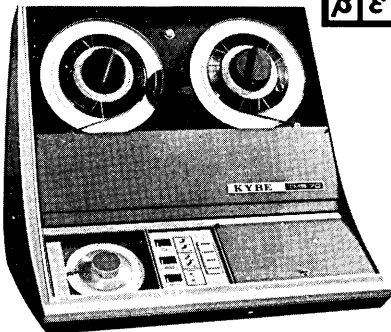

CIRCLE 120 ON READER CARD

BEEMAK TABCARD HOLDERS

FOR SYSTEM 3—80 COL.—51 COL.
 RACKS — TRAYS — ACCESSORIES

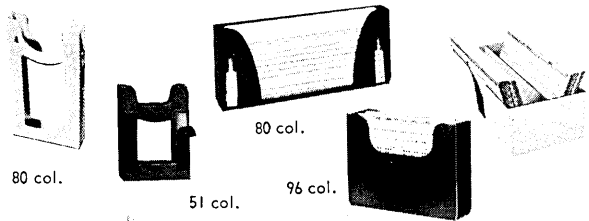

Holders with magnets or adhesive strip. Spring clips for attaching to shelves.

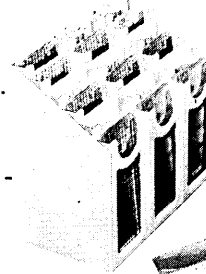

Racks made with any holder in any size or configuration.

Vinyl envelopes available with adhesive back or magnets. Special sizes made to fit your needs.

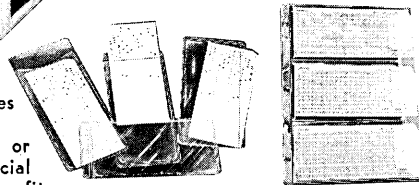

WRITE FOR CATALOG

BEEMAK PLASTICS

7424 Santa Monica Blvd., Los Angeles, Calif. 90046 Phone: (213) 876-1770

CIRCLE 108 ON READER CARD

THE WORLD'S LARGEST MANUFACTURER OF TYPES

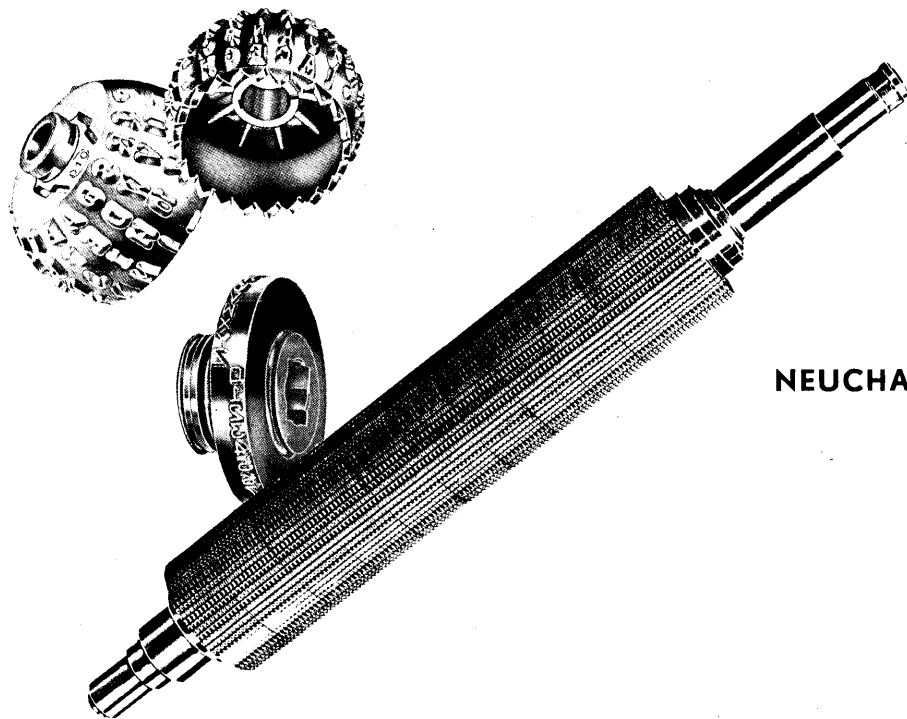

CARACTERES SA
 NEUCHÂTEL SWITZERLAND
 30, rue du Plan

CARACTERES USA

WOBURN MASS 01801
 56, Cummings Park

See us at NCC booth # 1074

CIRCLE 110 ON READER CARD

Books

COMPUTER SECURITY— something old, something new

The pages that follow contain a vertical, in-depth review of current security publications. Bob Patrick, DATAMATION's Editorial Advisor, has reviewed eight recent volumes on the subject. Mr. Patrick is well versed for the task. In his years as a consultant he has conducted many installation audits, including audits for 12 commercial firms (one with 14 separate computer centers). He has been behind the wire of some of the U.S.'s most sensitive military installations, and worked for a large university during the 1970 riot season.

Security Standards for Data Processing

by S. Wooldridge, C. Corder, and C. Johnson
J. Wiley & Sons, Inc., 1973
186 pp. \$14.95

According to the dust jacket, this book was written by an American now living in England, an itinerant Oxford graduate who has worked in Australia and Hong Kong and writes radio scripts, and a third author who is a pioneer of effective security in the data processing industry. Hilarity aside, this volume is a rather comprehensive introduction to the subject. It is rather readable, perhaps with due congratulations to the script writer, and is punctuated with a series of security happenings that go towards dispelling the attitude that "it can't happen here."

To its credit, the book starts out discussing risks, proposes a risk analysis, and indicates that some one person should be assigned the responsibility of worrying about security. The second group of chapters addresses the traditional security subjects of personnel, the physical installation, access controls, procedural controls over the input, the libraries, and the operations. A separate, rather weak chapter is devoted to fire detection and prevention, and another rather sparse one covers disaster recovery. Almost as an afterthought, a chapter on on-line systems is thrown in and the basic skeleton of a security audit is given.

While the first part of the book is rather readable and will serve well to introduce senior management to some of the problems of computer security, the last half of the book is a disappointment. In trying to be non-specific and to write a book that would work both in England and America, they left out all the details. To one schooled in security matters, their checklists serve as memory joggers and from one of their checklist questions a security af-

cionado could rattle off 15 or 20 specifics. However, to the unskilled reader, the checklists are too general to be much more than a basic education. The book is mistitled since only one short chapter talks about security standards and it's the weakest of the lot. Surprisingly there are 40 pages of appendices (about 20% of the volume), none of which is of particular value and some of which will seem almost ludicrous to any manager who has had his computer installed more than six months.

Although this volume is not particularly useful to the established dp manager, it might be very handy for the manager who has to do business with a corporate security officer drawn from a roster of retired policemen.

Computer Data Security

by H. Katzan
Van Nostrand Reinhold Co., 1973
213 pp. \$11.95

Harry Katzan is a prolific writer having five other books to his credit dealing with the IBM 370 and related software. The dust jacket touts this book as a "must" for everyone. That's one of the problems with it. It tries to tell *all* about computer security. Unfortunately, all it tells is what Harry Katzan knows about computer security.

Katzan is well-read and the book is heavily footnoted with Babcock, Browne, Glaser, Hoffman, Lampson, Peters, Petersen, Turn, Van Tassel, Ware, Weissman, and Westin. However, judging from the content, it appears that Katzan's only contact with security is through his readings. The first 100 pages rush through a rather well done introduction to computers in general, and the System 360 in particular. The figures are very good and allow the seasoned reader to trace how tables, registers, pointers, and control blocks intersect to accomplish some end. The System 370 is also covered, along with virtual memory and some features of the GE 645 and Multics. While this is very good background, it's left up to the reader to understand how all this technical detail is related to security.

The fifth chapter, "Data Security Considerations in a Computer Environment," is freely drawn from Petersen and Turn and several IBM manuals. It stays at a conceptual level and the reader keeps wondering why he went through all the details of that hardware and software if he isn't going to get deeper into security details. The chapter on methodology is lifted directly from Lampson, Graham, and Denning. As before, the diagrams are excellent, but a reader looking for something practical that will help him in his day-to-day environment will find nothing.

You love our Timeplexer;[®] now meet our modems.

Once again, breakthrough performance.

One reason our Timeplexer outsells all other multiplexers is its built-in modem. Now you can get the modem alone.

Our 202 modem has unique digital circuitry to eliminate foldover distortion; it will run at higher rates than any other we know of; up to 1800 bps over the dial network and up to 2000 bps on C1- or C2-conditioned lines.

Then there's our low-cost 0- to 300-baud 103. Crystal-controlled digital transmitters and receivers give maximum stability, and it's unaffected by temperature or supply-voltage drift.

Both modems can operate on two- or four-wire lines and have loopback diagnostic options, LED displays, and EIA control signals. They're ultra-versatile; strapping changes or optional modules convert the 202 into any other 202, the 103 into any 103.

Timeplex modems come with integral power. Or, you can get a rack for up to 26 modems, with single or redundant power supplies. One cabinet holds 103s, 202s, or other units such as automatic calling units, stored-number dialers, and calling-line selectors.

Use the Reader Service Card or contact us directly.



Timeplex
... mux makers and more.

100 Commerce Way,
Hackensack, N. J. 07601.
Phone (201) 646-1155,
TWX 710-991-9759.

DESIGNERS: the new cost-effective way
to implement logic
is Rockwell's 128-row by 46-column

SOS* PROGRAMMABLE LOGIC ARRAY (PLA)

Bipolar speed: 15MHz. MOS densities: each row is effectively an AND gate of 45 input terms. Example: one SOS-PLA can compute value of function of 22 variables expressed as sum of up to 128 products. Otherwise, you'd need 400 8-gate TTL ICs. Write on your letterhead for data sheets. Address us at P.O. Box 3669, Anaheim, Calif. 92803.

*SOS: Silicon-on-Sapphire



Microelectronic Device Division
Rockwell International

CIRCLE 130 ON READER CARD

NCR

ACCOUNTING COMPUTER DIVISION

NCR's new Accounting Computer Division in Wichita has immediate ground-floor opportunities for seasoned engineers in several disciplines. Engineers who want to build their career through involvement in a wide range of exciting new products. Engineers who are willing to be measured by performance and are seeking a position offering personal growth, technical development, responsibility and diversity.

We need Design Engineers with experience in one or more of the following:

- Magnetic Recording Head Technology
- Minicomputer Architecture
- Digital Hardware Design and Application
- Systems Engineering

For these professionals we offer excellent working conditions in a new facility, good salary and liberal company benefits. You'll be living and working in the Clean Air Country of Kansas where you can spend off-work hours enjoying the many fishing, hunting and recreational areas.

Get all the details today.
Send complete resume
including salary history
and requirements, to
Ron Clarke, Industrial
Relations Department,
P. O. Box 1297AS
Wichita, Kansas 67201.

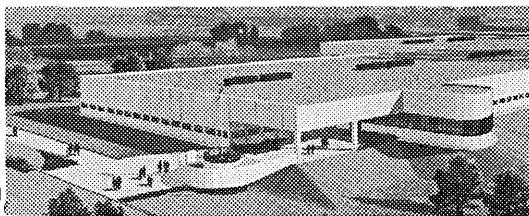

CIRCLE 138 ON READER CARD

Books

ing here.

The book closes with an overview of IBM's Resource Security System (available from IBM as GH20-0967) and finally a little treatise on the principles of cryptography and data transformations.

The dust jacket prominently features a teleprinter and the casual purchaser might be misled to assume that this has something to do with the contents of the volume. While time-sharing is mentioned a time or two, and remote access is included, the dust jacket and the title are misleading.

This is a book in search of an audience. For the seasoned professional, the hundred or so pages devoted to computer concepts are unnecessary and the back half lacks sufficient detail to be interesting. To the uninitiated reader, the front half moves too fast and uses too much jargon to be easy reading, and the back half assumes he has mastered the first half.

Missing is any method of estimating risks, any mention of physical protection or operational considerations, and any note about personnel, systems, or procedures. All in all the inexperienced reader could be easily misled to think that computer security is totally a subject of hardware, software, and communications. Since it's obvious that Katzen can write and since his figures are very good, it's a shame he didn't choose his audience profile more carefully, narrow his scope, and write a book which would be a contribution to the field.

Security and Privacy in Computer Systems

by L. Hoffman
John Wiley & Sons, Inc., 1973
414 pp. \$16.95

Here is another example of how stereotypes are misleading. This book is a compendium of 23 papers, 22 of which have been published elsewhere. It is put together by a university professor who has spent most of his life in the academic community. Thus it has all the makings of a dull course book that someone slapped together to comply with an academic requirement for one publication a year.

Nothing could be further from the truth. The 23 papers were carefully selected as the best of the security literature to date. With one or two exceptions, each one is a landmark paper exposing some new concept, drawing together what is now viewed as obvious, or proposing a technical solution to a pressing problem. Hoffman has assembled these papers, written a tasteful introduction to each of the seven chapters, and added an excellent pre-

Books

face to the whole collection.

Those of us who have worked on the security scene for many years will be familiar with most of the papers at least by reputation. They have been often cited and in many cases extensively quoted. Hoffman puts them in the proper light and lets each author speak for himself.

The position taken is that security and privacy are troubles of the times aggravated by the speed and flexibility of the modern computer. Hoffman notes that the problems are mainly political with some technical overtones. Each of the various authors attempts to take a positive attitude and protect the individual while searching for the economies that go with advanced technology.

While the manager of a dp installation won't find much in this volume to assist him in solving his day-to-day problems, this book should be required reading for all do-gooders, all self-appointed experts, all legislative staff men, and any who propose to address Congress or the state and local governments on matters related to security. Hoffman has done the field a service by collecting and tastefully presenting the landmark documents in the debate related to concepts, rights, and individual freedom.

Security Procedures for Computer Systems

by C. Hemphill and J. Hemphill
Dow Jones-Irwin, Homewood, Ill.,
1973
246 pp. \$11.95

The elder Hemphill has been an investigator and an FBI agent; he now works for a protection agency. The younger Hemphill is a recent PhD in Electrical Engineering and is now in the Air Force. The preface indicates that this book is a nontechnical presentation for general business management. It does a pretty good job of being just that.

There is almost universal agreement among all authors that physical security is the foundation of all computer security plans. This book concentrates almost exclusively on that physical security. In its chatty style, liberally punctuated by reports of actual events, it treats natural disasters, fire, access control, man-made disasters, and disaster planning. However, the chapters on computer system backup, dp record storage, machine room procedures, remote access systems, and the like are as weak as the other chapters are strong.

The book is rather readable and is liberally sprinkled with quotes from the publications most dp managers don't read very often: *Administrative Management*, *Harvard Business Review*,

Best's Review, *The Office*, *Nation's Business*, and *The Wall Street Journal*. The shallowness of the prose and the sources cited lead this reviewer to conclude that this book was intended for the nontechnical business manager who wished to have a slight acquaintance with computer security matters so he could name drop at the next board meeting. However, the book is not totally without interest to the computer professional. Some few of us will be building new facilities in the next few years. The chapters on physical security, if carefully read, would allow you to construct a bill of particulars to use in instructing the architect in planning your new facility.

The content of the book is superficial, but not misleading. The title is misleading for nowhere in the tome is a set of procedures enumerated. The content consists of narrative punctuated with descriptions of happenings, and each chapter is sealed off with a series of review questions much like the high school texts of 20 years ago. The book is concluded with a rather complete nine-page bibliography, drawn mostly from the nontechnical press. The student, the policy-maker, or the computer professional seeking case history material will find the bibliography of value.

Computer Security Handbook

by D. Hoyt
Macmillan, 1974
165 pp. \$20.00

This book is a collection of 12 separate papers produced by the Computer Security Research Group, an outgrowth of several chapters of the Assn. for Systems Management in New York and New Jersey. Many of the articles were written by members of consulting houses and the others were written by employees on the corporate staffs of large industrial firms.

Each article is written in machine-independent form and most cover general concepts without getting too specific. They are not edited to a consistent format, nor do they contain a consistent level of detail. The first one, by A. E. Hutt, describes management's role in computer security. It is excellent and that excellence derives from a detailed risk analysis performed for the xyz Company. After the risks are enumerated, the probability of occurrence is estimated, the range of the loss is estimated, and weighted risk values are computed. The results are then distilled to enumerate those with the highest maximum risk and distilled again to enumerate those with the highest weighted risks. The theme is: Avoid paranoia and soberly assess your exposure.

In the back of the book is an infor-

You love our Timeplexer;® now meet our port concentrator.

**Greater flexibility,
lower cost.**

You already know that our Timeplexer saves money by transmitting multiple data streams over one line. Our C-32 Data Channel Concentrator adds to your savings by letting 16 (or fewer) computer ports serve up to 32 part-time local or remote inputs . . . such as modems, terminals, or multiplexer channels. Use the C-32 for synchronous or asynchronous data at rates from DC to 9.6 Kbps.

The C-32 is flexible. Using its switches or strapping, operation can be field-modified so that groups of inputs can be routed only to certain outputs, while other inputs reach some or all outputs, as desired. Inputs may be busied out manually; outputs may be busied out manually or remotely.

For greater capability, C-32s can be combined so that 64 or more inputs contend for the same 16 outputs. Or, our Channel Contention Expander can provide much of this added capability at lower cost.

Use the Reader Service Card or contact us directly about the full line of Timeplex data communications equipment . . . modems, multiplexers, and the rest.

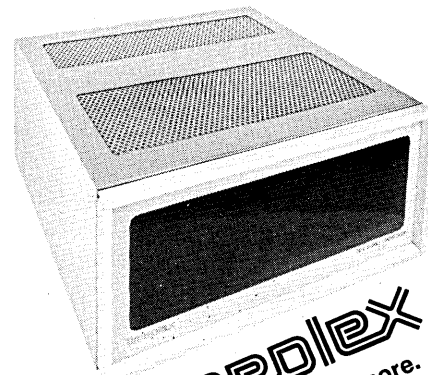

Timeplex
... mux makers and more.

100 Commerce Way,
Hackensack, N. J. 07601.
Phone (201) 646-1155,
TWX 710-991-9759.

CIRCLE 143 ON READER CARD

Books

mative chapter by G. R. Migliaccio. He tells what the computer shop looks like from the insurance point of view and there is an extensive questionnaire used for performing an insurance risk survey which is enlightening if you read between the lines. All the papers in the book are aimed at the small to medium size installation. The DPMA member would feel comfortable with this book as would most corporate controllers in the \$100 million per year gross class. The sample forms they supply, the short checklists that appear

at the end of most chapters, and the diagrams used by the various authors all are directed to the installation which has a low level of computer and systems complexity.

As it stands, this is one of several books in the field that could be termed security primers. It would be useful in a college survey course, for legislative analysts who wonder what all the fire and smoke is about, for managers of small to medium size shops and their bosses, and perhaps for operations management in large facilities. Unfortunately, by making it machine-independent they left out most of the meat.

Computer Security Management

by D. Van Tassel
Prentice Hall, 1972
212 pp. \$10.50

Van Tassel gets credit for being one of the first to attempt to cover the spectrum of security topics between two covers. His is an early book, completed in 1972, and is included here for the sake of completeness. As with many of these early publications, it's a sampler of topics of interest to the author. It lacks any quantified method for assessing the risks for the computer center, gives physical security short shrift, and proceeds hummingbird fashion through 8 pages on dp controls; audit-

ing; various kinds of errors; 11 pages on software protection, copyrights and patents; 11 pages on cryptographic techniques (the author's interest); and a whole section on time-sharing, without ever discussing on-line data files. The coverage is spotty, the checklists are skimpy, and the document is in need of reorganization and update.

Most readers are turned off by examples that use IBM 1401s, 7080s, and 360/50s. The field has marched forward and Van Tassel was behind even in 1972. The dust jacket states that the author is an acknowledged expert in the field of computer security and further claims the book contains detailed

coverage of software protection. After reading the content, I conclude neither claim is true.

SAFE—Security Audit and Field Evaluation

by L. Krauss
Firebrand, Krauss, E. Brunswick, N.J.,
1972
143 pp. \$29.45

Although this book has been available almost two years, it warrants review at this time because it is a checklist. After only 16 pages of introductory material, Krauss launches into 118 pages of checklists interspersed with 118 blank pages of worksheets. He covers personnel, physical security, data, programs, documentation, operational aspects, backup, development, insurance, and continuing security programs. An appendix contains a 10-page list of good sample readings in security from the late '60s and early '70s.

The introduction claims that this checklist approach provides something between an inflexible formula and an expensive, completely custom-made security audit. For the subjects he covers, Krauss has done just that. However, at the present stage of development, security considerations are so pervasive and cut across so many facets of a computer installation that no existing checklist can be used like a recipe. Checklists will merely suffice to

A NEW DIRECTION FOR EDP SERVICE COMPANIES!

(Service Bureaus . . . Software Houses . . . Facilities Managers)

Here is a unique opportunity for established EDP Service Companies to move into a "product" field—Turnkey Minicomputer Business Systems—through our JOINT VENTURE PROGRAM

The SYSTEMS Corporation provides:

- Minicomputer hardware
- Most comprehensive Data Processing Software in the Minicomputer Industry
- Training to assemble, sell and service systems
- Financing support

EDP Companies provide:

- Established business reputations
- Knowledge of local market conditions
- Proven capability in systems analysis and programming

Write or phone today for complete information:



The SYSTEMS Corporation

65 Jeffrey Ave. 1441 Kapiolani Blvd.
Holliston, Mass. 01746 Honolulu, Hawaii 96814
(617) 429-6836 (808) 955-6638

NEW PORTABLE PRINTING KEY PUNCH

Completely mechanical data recorder punches and prints simultaneously. Model 2629 Alphameric Printing Key Punch encodes the full IBM 029/129 character set: 26 letters, 10 numerics and 27 symbols. Card automatically advances after every punch stroke.

Punch has six adjustable tab stops for automatic programming of spacing. Upper case printing is sharp and clear. Thin plastic tab cards, aperture cards, and certain types of card sets (numeric punching only) can also be handled.

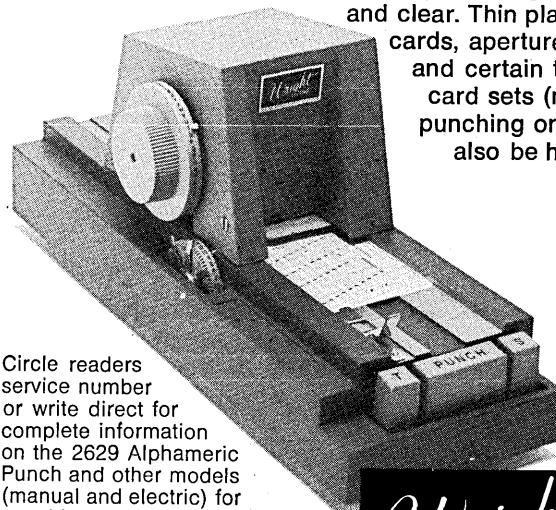

Circle readers service number or write direct for complete information on the 2629 Alphameric Punch and other models (manual and electric) for punching Hollerith type holes into plastic tabulating, credit, ID and badge cards. Special versions available.



MEDIA MANAGEMENT SYSTEMS

160 GOLD STAR BOULEVARD, WORCESTER, MASSACHUSETTS 01606
A DIVISION OF BARRY WRIGHT CORPORATION

stimulate the memory of an experienced investigator so he can explore the topics suggested in appropriate detail for his installation.

Associated with the checklists are a rather mechanistic system of rating where each finding is given a numeric rating from zero to four. These ratings are written next to the checklist item, totaled at the bottom of the page, and numerically summarized in a table at the back of the handbook. All of these numbers tend to intrude into the audit process. No topic as complex as security can be reduced to numbers at such an early stage in its development. If the handbook were used as the author intended, it would be too easy for a security auditor to give such attention to the numerical ratings, assigned weights, and the actual numeric evaluation that he would forget to think. Thus it appears that the proper way to use the SAFE Handbook is to ignore all the ratings and numerical weights and use the questions to review the installation.

On the other hand, the questions presented are not given any codings to indicate whether a question is related only to installations having requirements for very intense security or to general practice. Thus back-to-back one can find questions having to do with polygraphs, urinalysis to detect drug addition, and more general topics such as checking references and dates on an employment application.

Still, Krauss has produced the best set of checklists available in the field today. The sections on personnel and physical facilities are so complete that one would need to be selective and delete some that did not apply before conducting an audit. The remaining sections touch on the important major considerations, but require expansion to get the required level of detail.

For instance, the section on data, programs, and documentation would require major extension if one were going to audit a large complex computer shop. The section on operations attempts to cover computer operations, control procedures within the computer facility, and data handling procedures related to the computer facility. While trying to cover this breadth in a few questions, he sometimes leaves gaping holes as exercises for the user (e.g., "Where a time-sharing system is used, rate the security and information safeguards to prevent access to programs and data files by other users"). While what he provides is good, a large installation with extensive complexity deriving from on-line access and resident data bases would have to extend this question set significantly to be able to perform an adequate audit.

If a person had a security manager; and if that security manager knew

hardware, software, operations, procedures, applications programming, and management; and if that security manager had the inquiring investigative mind of a cop; he could take this SAFE Handbook and (in about a month) develop a customized list of questions suitable for a specific installation audit.

Security, Accuracy, and Privacy in Computer Systems

by J. Martin
Prentice Hall, 1974
619 pp. \$19.95

This weighty tome tells all but the most dedicated reader everything he wants to know about security. It contains 448 pages of good readable prose and 172 pages of appendices. It is aimed at the broad-gauge computer professional who has enough knowledge of computer programming, operations, procedures, and management to feel fairly comfortable in any one of these areas. It is authored and edited by one man and he has used a consistent style and vocabulary. In addition, James Martin understands systems and can write about them with facility.

This volume is organized into 38 chapters in five major sections. In the first section Martin covers the nature of the problem and in the remaining four sections he covers the design of the computer system, its physical security, its administrative control, and the legal and social environment in which it is embedded. Each chapter closes with a short list of directed readings. The majority of the appendices are chapter summaries (outlines) but he supplements the chapter on auditing with an excellent 23-page checklist.

The main thrust of the book is toward the design of improved systems. He discusses the problems intelligently and then proceeds to enumerate principles and list the features a proper design should include. He does not give any attention to the retrofit of existing systems or to assessing what you've got (with the exception of the auditor's checklist).

Although he works for IBM, he does a creditable job of sticking to principles and not getting lost in IBM jargon. However, he occasionally does use IBM hardware or software when he needs an example. In addition to being an excellent book for the general reader, the IBM design engineers could benefit from a careful review of its contents since he does point out many flaws in the current product line with suitable grace.

This is not a primer, and while he is sensitive to social concerns, he does not dwell on them. For the system designer who is faced with a design problem today, I can heartily recommend this book and its engineering approach to current problems.

—Bob Patrick

The Timeplexer;[®] here's why users love it.

The Timeplexer outsells all other multiplexers.

The reasons are many:

It gives top performance at low prices, thanks to a unique memory design which reduces the circuitry required. Reliability is up, cost is down. Programming is simple and quick: merely change the jumpers.

The Timeplexer offers an unequalled range of options: units from 4 to 96 channels, adaptive speed, built-in modems, intercity contention, broadband interface, redundant logic and power, and multiline hubbing. It offers virtually unlimited combinations of speed, code, and parity . . . synchronous and asynchronous.

In addition to multiplexing, the Timeplexer is a test center for your entire communications system. It has test switches and indicator lamps so that any source of failure — modem, multiplexer, terminal, line, or computer — is pinpointed.

Use the Reader Service Card or contact us directly about the full line of Timeplex data communications equipment.

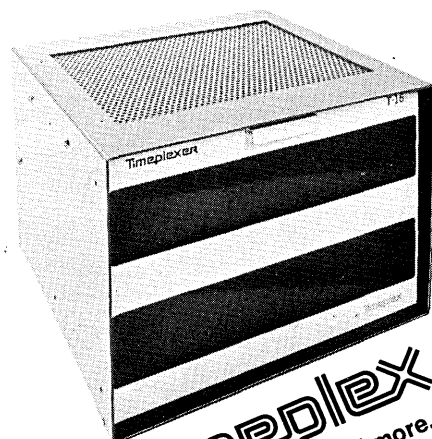

Timeplex
... mux makers and more.

100 Commerce Way,
Hackensack, N. J. 07601.
Phone (201) 646-1155,
TWX 710-991-9759.

CIRCLE 144 ON READER CARD

Advertisers' Index

AC Manufacturing Company 181
 ACCO International Inc. 59
 Addison Wesley Publishing Co. ... 183
 American Federation of Information
 Processing Societies, Inc. ... 176, 177
 American Smelting and
 Refining Company 43
 American Telephone and
 Telegraph Company 76, 77
 Applications Software Inc. 178
 Ashland Oil, Inc. 218
 Avtel Corporation,
 an Airtronics Subsidiary 118
 BASF Systems Cover 3
 BASIC Timesharing 185
 Beehive Terminals 122
 Beemak Plastics 204
 Cadillac Associates, Inc. 211
 California Computer Products,
 Inc. 170
 Cambridge Memories, Inc. 173
 Caracteres USA 204
 Cincinnati Milacron, Process
 Controls Division 14, 15
 Computer Accessories Corporation . 183
 Computer Devices Inc. 119
 Computer Hardware Inc. 39

Computer Transceiver Systems
 Inc. 195
 Comtal Corporation 92
 Conrac 47
 Cullinane Corporation 214
 Data 203
 Data General Corporation ... 160, 161
 Data 100 Corporation 32, 33
 Datacraft Corporation 13
 Datapoint Corporation 96, 97
 Dataproducts Corporation ... 120, 121
 Datum, Peripheral Equipment
 Division 155, 157, 159
 Datran 61
 Decision, Inc. 68
 Diablo Systems Incorporated,
 A Xerox Company 83, 85
 Digi-Log Systems, Inc. 151
 Digital Equipment Corporation
 24, 25, 198, 199
 DIVA, Inc. 42
 Documation Incorporated 10
 Eastman Kodak Company,
 Business Systems Markets
 Division 124
 Electronic Memories &
 Magnetics Corporation 94, 95

Extel Corporation 172
 Fabri-Tek Inc. 75
 Fenwal Incorporated 12
 General Automation 40, 41
 General DataComm Industries,
 Inc. 168
 Gould Inc.,
 Data Systems Division 30
 GTE Information Systems ... 190, 191
 Robert Half Personnel Agencies ... 213
 Harris Communication Systems,
 Inc. 86, 87
 Hewlett-Packard ... 19, 21, 23, 110
 Houston Instrument, Division of
 Bausch & Lomb 9
 IBM 5, 6, 7, 8
 Info 74 212
 InfoNational 152
 Informatics Inc. 182
 Information Terminals
 Corporation 67
 Interdata 138, 139
 International Communications
 Corporation 144
 Intertel, Inc. 20
 International Federation for
 Information Processing 184
 Itel Corporation 100, 101
 Kennedy Co. Cover 2

Even Webster's Knows About QUEST

QUEST (kwĕst). v. 1. To make a search; to go on a quest.

QUEST SYSTEMS, INC. n. 1. A corporation founded in 1968. 2. The largest professional recruitment firm in the U.S. functioning solely in the computer sciences; its client companies pay all employment fees, interviewing and relocation expenses. Quest is known for its deep personal commitment to relate to each candidate as an individual with individual goals. 3. Its professional staff averages over 6 years of experience in EDP recruiting (additionally, staff members have direct hands-on experience in programming, systems, hardware sales, etc.) 4. Quest is presently searching for degreed programmers and analysts (commercial, scientific, systems software) for over 3,500 client companies in the U.S. *Quest has openings in over 700 U.S. towns and cities.* 5. Methodology — see Questsystem.

QUESTSYSTEM (kwĕst sis'tĕm). n. 1. Discussing with a man what he would like to be doing in light of what he has been doing. 2. Analyzing the realities of his objectives as they relate to the current job marketplace. 3. Contacting client companies and other Quest staff personnel to identify positions of possible interest. 4. Introducing the job candidate to his prospective employers by providing complete details to each about the other, ensuring the efficacious use of everyone's time. 5. Arranging interviews. 6. If employment offers are extended, Quest assists in evaluating the responsibilities, compensation and opportunities (and relates those to the initially stated objectives). The Questsystem has been working for thousands of professionals at no expense, whatsoever. Ask your friends of their past dealings with Quest. Then, put the Questsystem to work for you. For additional information on this subject, please inquire directly to Quest Systems, Inc. (All inquiries/resumes received will be responded to immediately and in confidence).



QUEST SYSTEMS INC.

6400 Goldsboro Road
 Washington, D. C. 20034 (301) 229-4200
 Baltimore: (301) 265-1177 • Philadelphia: (215) 667-3322

CIRCLE 109 ON READER CARD



**What do you do when
 your keypunch operator
 gets bent, folded
 or spindled?**

You need help. Call Manpower Temporary Services. We'll get the job done quickly, reliably and professionally. No matter what you're up against. Look for us in your white pages.

MANPOWER®

TEMPORARY SERVICES

DATAPOWER® SERVICES

We'll give you all the help you need.

Keypunch Operators. Tab Operators. Computer Operators. Edit Clerks. Systems Analysts. Coding Clerks. Computer Programmers.

CIRCLE 147 ON READER CARD

DATAMATION

Kennedy Data Systems	216
Keronix Corporation	126
Kybe Corporation	204
Little, Brown & Company	
Law Book Division	200
Lockheed Electronics,	
Data Products Division	187
LRK Associates	202
Manpower	210
Micro Switch, A Division of	
Honeywell	129
Microdata Corporation	189
Modular Computer Systems Inc.	194
Mohawk Data Sciences	
Corp.	2
Moore Business Forms,	
Inc.	34, 35
Monolithic Systems Corp.	109
MSI Data Corporation	180
NCR, Accounting Computer	
Division	206
NCR Appleton Papers	
Division	63
Network Analysis Corporation	217
Okidata Corporation	174
Omron Information Products	
Division	26
On-Line Software	
Incorporated	150
Optical Scanning Corporation	128

Paradyne Corporation	69
Plessy Memories, Inc.	78
Prentice-Hall	150
Prime Computer, Inc.	196, 197
Quest Systems Inc.	210
Quotron Systems, Inc.	102
Raytheon Service Company	22
RCA Custom Terminal	
Systems	108
RCA Service Company,	
A Division of RCA,	
Data Communications	158
Remex, A Unit of	
Ex-Cell-O Corporation	36, 37
Rockwell International, Microelectronic	
Device Division	206
Romac & Associates	218
RSVP Services	211
Rusco Electronic Systems	146
Sanders Data Systems, Inc.	167
Singer-M&M Computer	
Industries, Inc.	16
Source EDP	213
Sperry-Univac	104
Standard Data Corporation	195
Standard Memories Incorporated,	
An Applied Magnetics	
Company	171
The Systems Corporation	208
Sycor Inc.	66
Tab Products Co.	130, 131, 188

Tally Corporation	1
T-Bar Incorporated	4
TEC Incorporated	127
Techtran Industries	201
Tektronix, Inc.	29
Telefile Computer Products,	
Inc.	175
Teletype Corporation	
.....	46, Cover 4
Tennecomp Systems Inc.	186
Texas Instruments Incorporated,	
Digital Systems Division	44, 45, 107
3M Company, Data Recording	
Products Division	88
Timeplex	205, 207, 209
United Air Lines	84
Varian Data Machines	64, 65, 70
Versatec, Inc.	38
Wang Laboratories, Inc.	105
Wangco Incorporated	31
Western Union Data Services	
Company	106
Westinghouse Canada Limited	111
Wilson Jones, A Division of	
Swingline Inc.	116
Wright Line,	
A Division of Barry Wright	
Corporation	208
Xerox	163, 164, 165
Xytex	140

FREE EMPLOYMENT SERVICE FOR PROGRAMMERS AND ANALYSTS

Serving Northeast, Southeast and Midwest U.S.



RSVP will provide free employment counselling and develop and selectively distribute your resume.

Our openings include scientific and commercial applications, telecommunications, control systems, software development and systems programming utilizing most languages, computers and operating systems. We also serve engineering and market-

ing personnel in the computer field.

Call or send resume or rough notes of objectives, salary, location restrictions, education and experience (including computers, models, operating systems and languages) to any one of our offices. Or check the reader service card for a free sample resume and typical job descriptions. We will answer all correspondence from U.S. citizens and permanent residents and will guarantee our best efforts in a professional and ethical manner to all qualified applicants. Our client companies pay all of our fees.

- RSVP SERVICES, Dept. M., Suite 700, One Cherry Hill Mall, Cherry Hill, New Jersey 08034 (609) 667-4488
- RSVP SERVICES, Dept. M., Suite 104, Towle Bldg., 1777 Walton Road, Blue Bell, Penna., 19422 (215) 643-5550
- RSVP SERVICES, Dept. M., 1651 Old Meadow Road, McLean, Va. 22101 (703) 790-5166

RSVP SERVICES

Employment Agency for Computer Professionals

WHAT IS YOUR TRUE WORTH?

FREE JOB OPPORTUNITIES BULLETIN

Cadillac Associates represents the nation's largest and most respected professional placement service. Our close relationship with the nation's finest firms generates continuous career opportunity information and allows us to confidentially present your qualifications to those at "decision-making" levels.

Our bulletin, published quarterly, listing available opportunities in the Systems & Data Processing field is available free of charge and will be mailed to your home upon your request.

For your free bulletin, without any obligation, circle reader service card #115. Please USE HOME ADDRESS ONLY!

FREE CONFIDENTIAL PLACEMENT SERVICE

If you desire immediate assistance in locating an opportunity consistent with your objectives (professional/financial/geographic), CALL OR WRITE TODAY. A member of our staff of SYSTEMS & EDP SPECIALISTS will reach you by telephone to discuss your objectives and how we might help you satisfy them. A resume, or some details of background, will be appreciated.

Remember: Our client firms are located from coast to coast and assume all expenses (agency fee, interviewing & relocation).



E. W. MOORE
Executive Vice President
CADILLAC ASSOCIATES, INC.*
32 West Randolph St. Chicago, Ill. 60601
Financial 6-9400

*"Where More Executives Find Their Positions Than Anywhere Else in The World."

info74 IS DIFFERENT...

info74

is an information systems Exposition for Management

info74

is an information systems Exposition for EDP Management

info74

is an information systems Conference for Management

info74

is an information systems Conference for EDP Management

INFO 74 is an *applications* show, not a technical show. The emphasis is on what information systems can do for management—not how it does it. (But the technology is available for those who need to know it.)

INFO 74 will show Management how to use the computer and other information systems in new and different applications, how to work with EDP Management in developing these new applications.

INFO 74 will have over 200 exhibits by the leading manufacturers of information systems equipment and suppliers of information services. (Over 115 companies have already signed up for space.)

For complete information, just send coupon.

CLAPP & POLIAK, INC.
Exposition Management
245 Park Avenue
New York, N.Y. 10017

Please send me complete details on INFO 74.

Name _____

Title _____

Company _____

Street _____

City _____ State _____ Zip _____

I am interested in visitor's information

I am interested in exhibitor's information

American Management Associations'

info74

**NEW YORK COLISEUM
SEPTEMBER 9-12, 1974**

Just out! 1974 computer salary survey Yours free

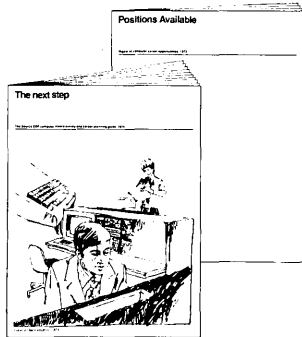

Do you know how much money your colleagues made last year for doing the work you do? Do you know which computing skills are the most lucrative? Do you know how to get a better position?

Source Edp does. And we'll share what we know with you. Our eighth annual salary survey and career planning guide, "The Next Step," compiles salary data received from the 11,000 professionals who consulted us last year. We add to that advice developed over our twelve years of recruiting computer people: danger signals that mean you should start looking for a new position, mistakes to avoid. A periodic supplement lists positions currently available.

Source Edp is the largest nationwide recruiting firm devoted exclusively to computer professionals. We print "The Next Step" as a service to people like you. Fill out the reader reply card, and we'll send you one absolutely free.

Corporate headquarters:
100 South Wacker Drive
Chicago, Illinois 60606
(312) 782-0857

Regional offices:

Atlanta
11 Corporate Square, 30329, (404) 634-5127

Chicago
100 S. Wacker Drive, 60606, (312) 782-0857
903 Commerce Drive, Oak Brook IL 60521,
(312) 323-8980
350 Frontage Road, Northfield IL 60093,
(312) 446-8395

Dallas
7701 Stemmons Freeway, 75247, (214) 638-4080

Detroit
24500 Northwestern Highway, Southfield MI 48075,
(313) 352-5520

Houston
4635 Southwest Freeway, 77027, (713) 626-8705

Kansas City, MO
20 W. Ninth Street, 64105, (816) 474-3393

Los Angeles
3550 Wilshire Boulevard, 90010, (213) 386-5500
2081 Business Center Drive, Irvine CA 92664,
(714) 833-1730

Minneapolis
801 Nicollet Mall, 55402, (612) 332-8735

New York
600 Third Avenue, 10016, (212) 682-1160

Palo Alto
525 University Avenue, 94301, (415) 328-7155

Philadelphia
1700 Market Street, 19103, (215) 665-1717

San Francisco
111 Pine Street, 94111, (415) 434-2410

St. Louis
130 S. Bemiston Avenue, Clayton MO 63105,
(314) 862-3800

Union, N.J.
2400 Morris Avenue, 07083, (201) 687-8700

source edp

Technical Publishing Company

Arthur L. Rice, Jr., Chairman of the Board
James B. Tafel, President
Gardner F. Landon, Exec. Vice President
Calverd F. Jacobson, Financial Vice President
Edwin C. Prouty, Jr., Secretary and Director
of Data Processing

Advertising Offices

Sales Manager and Vice President
John Brennan: Greenwich, Ct. 06830
35 Mason St. (203) 661-5400
Cable: DATAMATION,
Greenwich, Connecticut

Eastern District Managers
A. Treat Walker,
Warren A. Tibbetts: Greenwich, Ct. 06830
35 Mason St. (203) 661-5400

New England District Manager & Vice President
Warren A. Tibbetts: Manchester, N.H. 03104
112 W. Haven Rd.
(603) 625-9498

Midwest District Manager
John M. Gleason: Chicago, Ill. 60606
205 W. Wacker Drive
(312) 346-1026

Western Manager and Senior Vice President
Hamilton S. Styron: Los Angeles, Calif. 90035
1801 S. La Cienega Blvd.
(213) 559-5111

District Manager
Alan Bolté, Jr.: Los Angeles, Calif. 90035
1801 S. La Cienega Blvd.
(213) 559-5111

Western District Manager
James E. Filiatrault: Mountain View, CA 94043
2680 Bayshore Frontage Rd.
Suite 101
(415) 965-8222

U.K., Scandinavia, Benelux
Intergroup Communications, Inc.
Wallace K. Ponder, European Director
31 Lyncroft Avenue
Pinner, Middx. HA5 1JU
England
Tel: (01) 868 9289
Cables: PACOM, Pinner

France, Switzerland, Italy
Gerard Lasfargues
32 rue Desbordes Valmore
75016 Paris
France
Tel: (1) 288 90 22

Germany
Bohn International KG
6000 Frankfurt/Main 1
Hansaallee 7
Germany
Tel: 0611/55 80 77

Other Magazines

Plant Engineering Pollution Engineering
Power Engineering Purchasing World
Research/Development

Beat the Big One...
Heart Attack
Give Heart Fund 

Use Robert Half

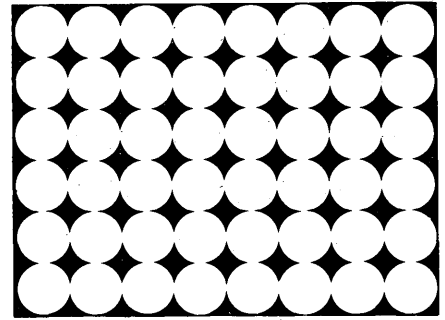

for a change



Searching for a competent
Financial or Data Processing
talent?

Looking for a better position?
ROBERT HALF offers person-
alized, intensive coverage . . .
locally, regionally, nationally
or internationally.

ROBERT HALF IS GOOD
FOR A CHANGE

World's Largest Financial & EDP Personnel Specialists

Alexandria, Va. 5001 Seminary Road	(703) 931-3600
Allentown, Hotel Traylor Building	(215) 439-1506
Atlanta, 3379 Peachtree Road N.E.	(404) 233-2416
Baltimore, The Quadrangle-Cross Keys	(301) 323-7770
Boston, 140 Federal St.	(617) 423-6440
Charlotte, 4801 E. Independence Blvd.	(704) 535-3370
Chicago, 333 N. Michigan Ave.	(312) 782-6930
Cincinnati, 606 Terrace Hilton	(513) 621-7711
Cleveland, 1367 E. 6th St.	(216) 621-0670
Dallas, 2001 Bryan Tower	(214) 742-9171
Denver, 1612 Court Place	(303) 244-2925
Detroit, 670 Honeywell Center, Southfield	(313) 354-1535
Hartford, 111 Pearl St.	(203) 278-7170
Houston, 1200 Central Nat'l. Bank Bldg.	(713) 228-0056
Indianapolis, 9 North Illinois St.	(317) 636-5441
Kansas City, Mo., 127 West 10th St.	(816) 474-4583
Lancaster, Pa. 9 North Queen St.	(717) 299-5621
Long Island, 420 Jericho Turnpike, Jericho	(516) 822-8080
Los Angeles, 3600 Wilshire Blvd.	(213) 386-6805
Louisville, 606 South 4th St.	(502) 589-6657
Memphis, 12 S. Main St.	(901) 523-8950
Miami, 1190 N.E. 163 St., North Miami Beach	(305) 947-0684
Milwaukee, 777 East Wisconsin Ave.	(414) 271-9380
Minneapolis, 80 South 8th St.	(612) 336-8636
Newark, 1180 Raymond Blvd.	(201) 623-3681
New York, 330 Madison Ave.	(212) 986-1300
Omaha, 7101 Mercy Road	(402) 397-8107
Orange, Ca., 500 South Main St.	(714) 835-4103
Philadelphia, 2 Penn. Center Plaza	(215) 568-4580
Phoenix, 1517 Dol Webb Townhouse	(602) 279-1688
Pittsburgh, Gateway Towers	(412) 471-5046
Portland, Or., 610 S.W. Alder St.	(503) 222-9778
Providence, 400 Turks Head Bldg.	(401) 274-8700
St. Louis, 7733 Forsyth Blvd., Clayton	(314) 727-1535
San Francisco, 111 Pine St.	(415) 434-1900
San Jose, 675 North First St.	(408) 293-9040
Seattle, 1215 Fourth Ave.	(206) 624-9000
Stamford, 111 Prospect Ct.	(203) 325-4158
Tampa, 1311 N. Westshore Blvd.	(813) 876-4191
Washington, D.C., 7316 Wisconsin Ave. N.W.	(301) 652-1960
Wilmington, 1102 West St.	(302) 652-3244

London E C 2, England, 17 Finsbury Square 01-638-4394
Toronto, Canada, 15 Toronto St. (416) 868-1314

ROBERT HALF
PERSONNEL AGENCIES



**"Management's biggest single criticism of DP
is its inability to produce special reports quickly."**

John Cullinane

That's why a 3-month CULPRIT trial will be the best investment you'll ever make.

Try CULPRIT for 3-months and turn this criticism into praise. In fact, you won't even have to produce reports for management and user departments if you don't want to because you can let them produce their own. That's right—with CULPRIT, they can.

Our experience has been that user departments not only quickly become very good at it, but they like to do it. Often during the 3-month trial the results are not only good,

they're spectacular. Of significance is that we've installed well over 100 systems since we've offered this plan and not one has ever been returned.

The cost of \$500/month (plus travel costs) includes installation, full on site training (2 or 3 days) for up to 25 people, user manuals, training aids, consulting service in its use, and if you acquire the CULPRIT system you receive 100% credit for the rental fees paid. So the potential benefit is great while the risk is small.

And CULPRIT can handle any file type including IDMS, IMS, TOTAL, RDMS, CFO, MRP, BOMP,

SMF, etc. It can produce any type of report, regardless of complexity. Very efficient in computer time, too.

Write or call for a technical brochure. And please don't put it off—your log jam of reports will only get worse!



**Cullinane
Corporation**

1 Boston Place, Boston, MA 02108/Ph: (617) 742-8656

This forum is offered for readers who want to express their opinion on any aspect of information processing. Your contributions are invited.

The Forum

SOME REALITIES OF DATA STANDARDS

While the idea of data standardization has had general acceptance for years, its contribution outside the context of specific systems has been limited. This situation is likely to continue indefinitely and system designers might do well to consider why.

The term "standard" is an unfortunate choice. While analogies are frequently made to other fields such as screw threads, these analogies usually overlook one key difference. Virtually all other standards are founded on precise physical measurement, a convenience not available for the development of data standards. In addition, there are a number of other fundamental factors that will continue to hinder their development. These can be considered as adversary situations, to wit:

Data standards vs. the real world. Since data systems work with symbols, the objective of data standardization is the acceptance of specific symbols for all "things" in a class of like "things." A "thing" may be a person, an organization, a geographic location, a piece of property, an action, a concept, or a value of some sort. There is no accepted term for a "thing" in the data standards lore. A specific symbol for a specific "thing" is called an item. A class of like "things" is usually called a data element and corresponds to a field of a record or a report in which items are recorded.

Fig. 1 indicates the flow of logic required to develop a typical data standard. Even if the real world "things" are accurately identified, precisely measured, and standardized, work at the data level deals only with perceptions, terms, definitions, and symbols. In the more frequent case where the "things" are not themselves standardized, the linkages of perceptions, terms, and definitions can be entirely subjective. Unfortunately, many standards developers and users do not appear conscious of these links or the ambiguity that each can impart.

Unlike most "things," classes are creatures of con-

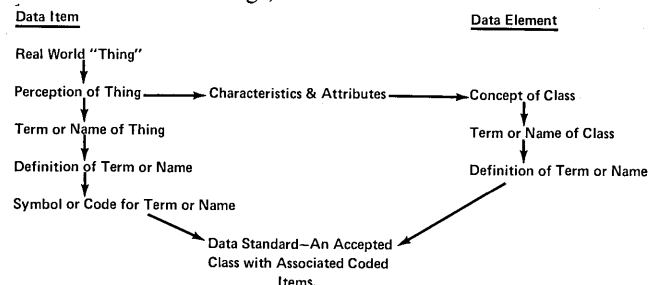

Fig. 1. Data standard logic.

venience that do not exist in the real world. They are developed for some analytical or explanatory purpose and new ones can be created at any time. The wider the number of systems that standards developers attempt to serve, the greater the difficulty they have in identifying classes that truly serve individual needs. The idea of broad natural or generic classes to serve the needs of many data systems has

been seen to be overly optimistic.

The various standards developed for identifying geopolitical entities are rich with examples of standard classes that do not meet all system needs uniformly (Fig. 2). Puerto Rico is not a state, but in systems dealing with domestic

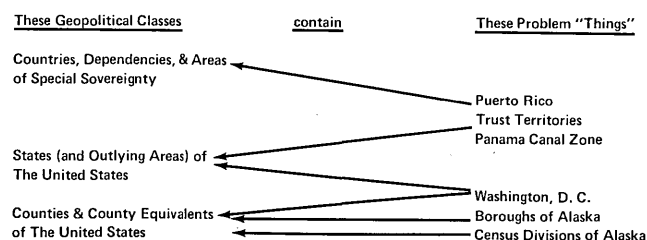

Fig. 2. Everybody "knows" what a country, state, or county is, but . . .

data, it is treated like one for many practical purposes. Thus, the concept of the class, "States of the United States" turns out to have fuzzy edges.

A second type of class problem involves system precision or level of detail. Any standard to identify the countries of the world must include the sovereign entities of Monaco and the Vatican, but some worldwide statistical systems treat them as parts of France and Italy. While most physical standards include specified tolerances, a useful notion of data standard tolerances does not seem to have emerged. In its place is the thought of the least common denominator, which has the effect of making the highest level of precision required by one system the standard for all.

Finally, it is sometimes impossible to find all of the "things" in life to complete what seems to be a useful class. This problem was encountered in the development of a standard for "Counties and County Equivalents of the United States." There were no counties in Alaska. The 10 organized boroughs that were the political equivalents of counties included only a small portion of the land mass. The remainder consisted of an unorganized borough with five-sevenths of Alaska's named populated places but with no government of its own. Thus the federal data standard includes both the boroughs and the Census Divisions of Alaska—the latter to be used for statistical purposes. An included table of the populated places provides both borough and division codes. It can be argued that this is no standard at all, but I submit that it is as much of a data standard as can realistically be provided in such cases. It has the effect, however, of making "populated place" the least common denominator.

Data standards vs. economics. While seen as cost-savers, data standards may increase some costs. In addition to the system precision aspect, there may be three other factors.

The first is development cost. Most data systems are considered overhead costs to the organizations they serve. The time-consuming process of developing data standards is

GOOD NEWS

COMPLETE FLOPPY DISK OPERATING SYSTEMS
WITH STANDARD SOFTWARE

FOR
COMPUTER
AUTOMATION
ALPHA 16's
under
\$3,500
in OEM quantities

FOR
DATAPOINT 2200's
under
\$3,000
in OEM quantities
(includes printer interface for
Centronics or Diablo HyType
printers)



**1/2 SECOND RANDOM ACCESS TO
262,000 BYTES OF DATA.**

Would you like high speed (6 msec track-to-track access time), high density storage (up to 262 K bytes) for your Computer Automation Alpha 16 or Datapoint 2200 for about the same price as what you're paying for slower paper tape, cassette, small tape and card systems? Here's what Kennedy Data Systems will deliver at the prices and delivery shown above: 2 Century-Data System 110 Disk Drives, our own thoroughly field-proven highly reliable controller with built-in system power supply and interface electronics and all cables and hardware for table or rack mounting --- plus standard software. For the Datapoint 2200 we even include printer interfaces for the Centronics or Diablo HyType printers.

Call or write today for the whole story.



KENNEDY DATA SYSTEMS, INC.

31829 W. La Tienda Drive
Westlake Village, California 91361
(213) 889-4455

the forum

overhead on the overhead. Organizations are reluctant to invest in this type of activity unless substantial gains can reasonably be predicted. Such is frequently not the case.

The second factor is use cost. Standards can save design expense, but their use is not free. In addition to possible conversion costs, the commitment of a system to use a standard maintained outside one's organization implies a willingness to accept changes. These changes are more or less predictable if the user community grows and imposes new requirements on the standard. The alternative to accepting change, however, is multiple standards for the same basic data, or no standards at all.

Third, some standards are to provide uniform identifiers for large and dynamic lists of "things." Lists of millions of people or organizations and thousands of geographic places or commodities are examples. The registrar function, or the maintenance and publication of the lists of entities and the proper identifiers, is an expensive and often highly specialized activity. The normal approach is to find an organization that already maintains a large entity list, and add the registrar function to its existing activities. While this is frequently the only economic solution, it is usually less than perfect. Where an economical arrangement of the registrar function cannot be made, a data standard of this type is not possible.

Data standards vs. technical dialects. Computers are tools of the specialist, not the generalist. The data elements that have evolved in systems reflect the technical dialects of the specialists they serve. This is good system practice at the micro level, but it adds to the traditional problem of cross communication among accountants, librarians, economists, engineers, and the like. When developing standards, it is hard to avoid adding just one more level of abstract symbols to the existing dialects. The question of system precision emerges here also, since regional economic planners and budget analysts do not work at the level of detail that accountants and the keepers of property records require.

Data standards vs. system implications. The developers of a data standard may be objective and divorce the standard from the implications of the uses to which it may be put. Others can be counted on not to draw this distinction. Standards of the screw thread type are basically two party propositions involving, at one time, only a supplier and a receiver of material. While data standards have been similarly viewed, there may be third and fourth parties involved.

The third party is one that is in some way affected by an interchange. Current popular system theory assumes that data is a common good—to be freely distributed to point of need. In practice, this is anything but true since the transfer of data may indirectly transfer power or it may affect the status of a party to whom the data relates. Much of the question of data confidentiality comes down to this last point.

When a standard is developed to identify a large, dynamic list of entities, the previously mentioned registrar is required. The concerns of this registrar typically have a profound affect on a standard. The registrar is considered the fourth party. The developers of data standards must recognize the various interactions of all four parties.

Data standards vs. codes. Selecting a code scheme is complicated by the various methods available, each with its strengths and weaknesses. The choice must be based on the different information storage and transfer functions the standard may serve. In some cases, machine limitations are important as with OCR or MICR equipment. In other cases, ease of human recognition is important. Frequently, there are desires to build logical classification or sequencing structures into codes; and almost as frequently, there is more

than one useful structure possible, though only one can normally be provided. Finally, data storage and processing costs plead for compactness.

There are few rules based on experience or study to guide code method selection and those that have been propounded may not apply in specific situations. Yet this is the most visible feature of a standard and it normally attracts the greatest amount of criticism.

In spite of these and other problems, data standards can be useful tools of the systems trade. Based on observation of numerous standardization projects and involvement in a few of them, I offer the following suggestions.

Know thy system. One of the toughest aspects of data standard development is learning true user need. This is often because the users themselves just don't know. Regardless of how soon we may start managing data as a resource, we at least need to know the data contents and requirements of our systems to guide the development of standards and to use them successfully. This means having ready access to data inventories, and implies some degree of internal standardization or control. Everything about system development takes too long, and data standard development is no exception. Until users are in a position to state their needs and review proposed standards quickly, there will be no speed-up of the standards process.

Accept translation as a normal computer function. Many have started with the idea that data outside the computer must be standardized so the computer can handle it more readily. This just puts the translation burden on people. A better approach is to see how much of its own translating a computer can do. If some systems use numeric codes and others use abbreviations for the same basic data, equating them is a job for the computer. Translations should be viewed as a key to building and interfacing systems that have greater utility and lower total cost. Such an approach also contributes to the flexibility that large systems may increasingly be seen to need.

Develop "Data Bridges" Instead of "Standards". This is partly a play on words since many of the standards in existence and under development provide bridges. Just as a bridge was provided to overcome the Alaskan county problem, and just as State code standards include both abbreviations and numeric codes, future standards will have to go farther in this direction. Some people will inevitably argue that these imply options and thus are not standards at all. Maybe so, but bridges are proving to be practical where, for any combination of the reasons already discussed, true standards cannot be developed.

Aid the development of large systems to serve a community of interests. The word "system" no longer has meaning. It is applied to everything from a three part form to applications that represent thousands of man years of development. If one defined a system as "what I am working on now," he would be pretty close. A system is clearly a function of Man's perception and is often pretty narrow.

On the other hand, some people think big. The system for encoding and processing bank checks is an example. It involved the cooperation of many people to develop a nationwide system broader than the scope of any organization involved. The transportation industry in conjunction with large shippers and a number of government agencies have a similar project under way. The retail merchants are engaged in a like effort.

System projects of this type can support the development of data standards to meet their needs. In the transportation case, about twenty specific standard elements give promise of saving the country hundreds of millions of dollars a year. With odds like these, the money and talent somehow shows up. In addition, it looks as if it will be easier to build bridges to link the retail, banking, and transportation systems as necessary, than it would be to develop individual, general

April, 1974

The Problem Solvers

(#1 in a series)

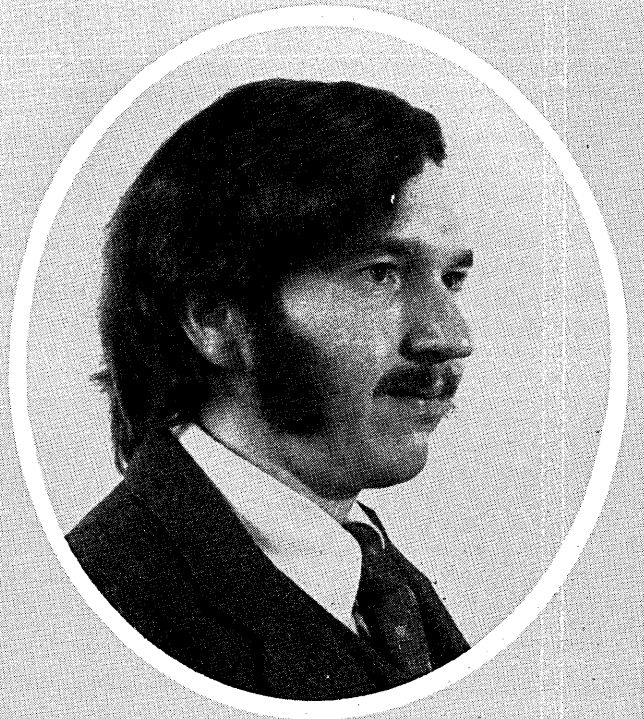

Pat McGregor

Earthquakes are the most devastating and most feared of all natural disasters. The U.S. Government retained Texas Instruments to recommend optimal design of a global seismic event detection system. TI used mini-computers to preprocess data at each instrument site, decentralizing the system, and eliminating the cost of a large computer.

NAC's network communication studies determined technical feasibility of the remote vs centralized system, and tested economic viability. NAC's Pat McGregor, who headed the job, sums it up. "Working with the Texas Instruments team, we determined specific data communications needs and functional specifications of the communications processor to be integrated in their multi-mini central system.

"We determined the feasibility of the Advanced Data Communications Control Procedures (ADCCP) for their transmission scheme and defined the communications processor as an independent, transparent message delivery system.

"NAC also estimated buffer requirements and disk activity and developed an approach to network monitoring. Together we determined the multi-mini system architecture and developed consistent communications processor software architecture. I'm pleased to say that the teamwork between TI and NAC will result in a network design that's more economical and far safer than any pre-existing system."

If you have an earthquake of a problem, or even a persistent tremor, write or call us collect.

nac

NETWORK ANALYSIS CORPORATION

Beechwood, Old Tappan Road, Glen Cove, N.Y. 11542 (516) 671-9580

CIRCLE 124 ON READER CARD

SYSTEMS ANALYSTS COMPUTER ANALYSTS

Two System 370's, 1 MOD 158, 1 MOD 155

Develop Computer-Based Information Systems for Ashland Oil!

Outstanding growth positions now available in our corporate headquarters Computer Science Department, leading to the development of systems in marketing, manufacturing, supply and distribution, finance and accounting, and other company functions. In addition to the latest central computer systems, we use many smaller RJE terminals in our operations across the country. Our compensation program is excellent, with a generous starting salary, an extensive benefit list, and an opportunity to grow in an expanding computer-dominant corporation.

For immediate consideration, please send your resume in complete confidence to:



An Equal Opportunity Employer

J. G. Sampsel, Dept. DAT-474
ASHLAND OIL, INC.

P.O. Box 391
Ashland, Ky. 41101

CIRCLE 131 ON READER CARD

EDP offers they couldn't refuse.

Thousands of bright ambitious EDP professionals...particular and concerned about their careers...have come to Romac in total confidence to discuss their futures. We know their business. We listen. We screen in depth. And we present appropriate fee paid opportunities.

Many of these opportunities develop through Romac's effective inter-office system...a network of partners from Portland to Atlanta.

Contact Romac...you may find an offer you can't refuse.



ROMAC...bringing the "right people" together
in Data Processing, Accounting and Banking.

ROMAC

& ASSOCIATES/Personnel Consultants

Contact ROMAC & Associates, 200 Boylston St., Chestnut Hill, MA., 02167 (617)969-4010 for immediate transmission to our network of Partners in: Portland, Hartford, New Haven, Stamford, Rhode Island, Buffalo, Rochester, Syracuse, Chestnut Hill, Ma., Boston, Washington, D.C., Charlotte and Atlanta. Or write or call direct.

the forum

purpose standards to serve the thousands of separate organizations in these industries.

Accept standards as a means for managing change. There is little hope for any data standards program based on the assumption of permanent fixes. Rather, standards should be viewed more like marching orders that specify what everyone in a given community will do until there is a reason to change. Changes cannot be made frivolously, of course. But the existence of some recognized conventions can lead to more rational decisions about what and when to change as new requirements are recognized.

Changes will be caused by at least three factors. First, the scope and content of individual systems is constantly widening. As they encompass new fields and technical dialects, they must accommodate to them while continuing to serve established users. Second, as systems are seen to interface with other systems at an ever larger number of points, new requirements emerge. Third, many systems have within them their own seeds of change. While hopefully solving the problems they were created to solve, they bring to light or allow attention to be directed to new ones which, in turn, lead to change.

Develop a useful theory and practice for data standardization. The field is far broader than it looks. Data standardizers need an appreciation of subject matter data from the viewpoints of multiple disciplines, some knowledge of linguistics, an understanding of systems, and the patience of a saint. But this is not enough. For data standards to take a place like that of engineering standards, the field must have a generally accepted implementation method that does not exist today. For example, potential standards might be routinely classified on the bases of content, where they will be used in systems, and the nature of the interchanges they will assist. From this, useful generalizations could be made about the choice of code schemes. Work in this area has barely scratched the surface. There is some progress in the development of manuals and guides, but as yet there is really no teachable body of knowledge and there are some complete voids. For example, while there is general agreement on the importance of accurate initial definition, the literature is silent on the treatment of identified entities, such as countries or organizations that change characteristics after being defined. Yet the impact of such changes on historical data could be profound.

Acknowledge that most data will not soon be standardized. This is meant in a broad sense. There will be many individual system standards, of course, but combinations of data from many diverse system sources can reasonably be expected to fit like a glove—on your foot. The old and costly process of system integration will be required to bring systems that were never designed to interface to the point where data interchange can work. At that, there will still be special edit, format, and translation processes involved in the interchange.

The development of a data element for one system that differs from similar elements in other systems is often compared to reinventing the wheel. This is another poor analogy. Nobody in the automobile industry has reinvented the wheel, but wheel design can be a computer application. Data elements, like wheels, can be standardized up to a point, but there will always be limits.

—Thornton J. Parker III

Mr. Parker is a management analyst in the Office of Management and Budget, Executive Office of the President, where his responsibilities have included direction of the federal data standards program.

Introducing the BASF Flexydisk I

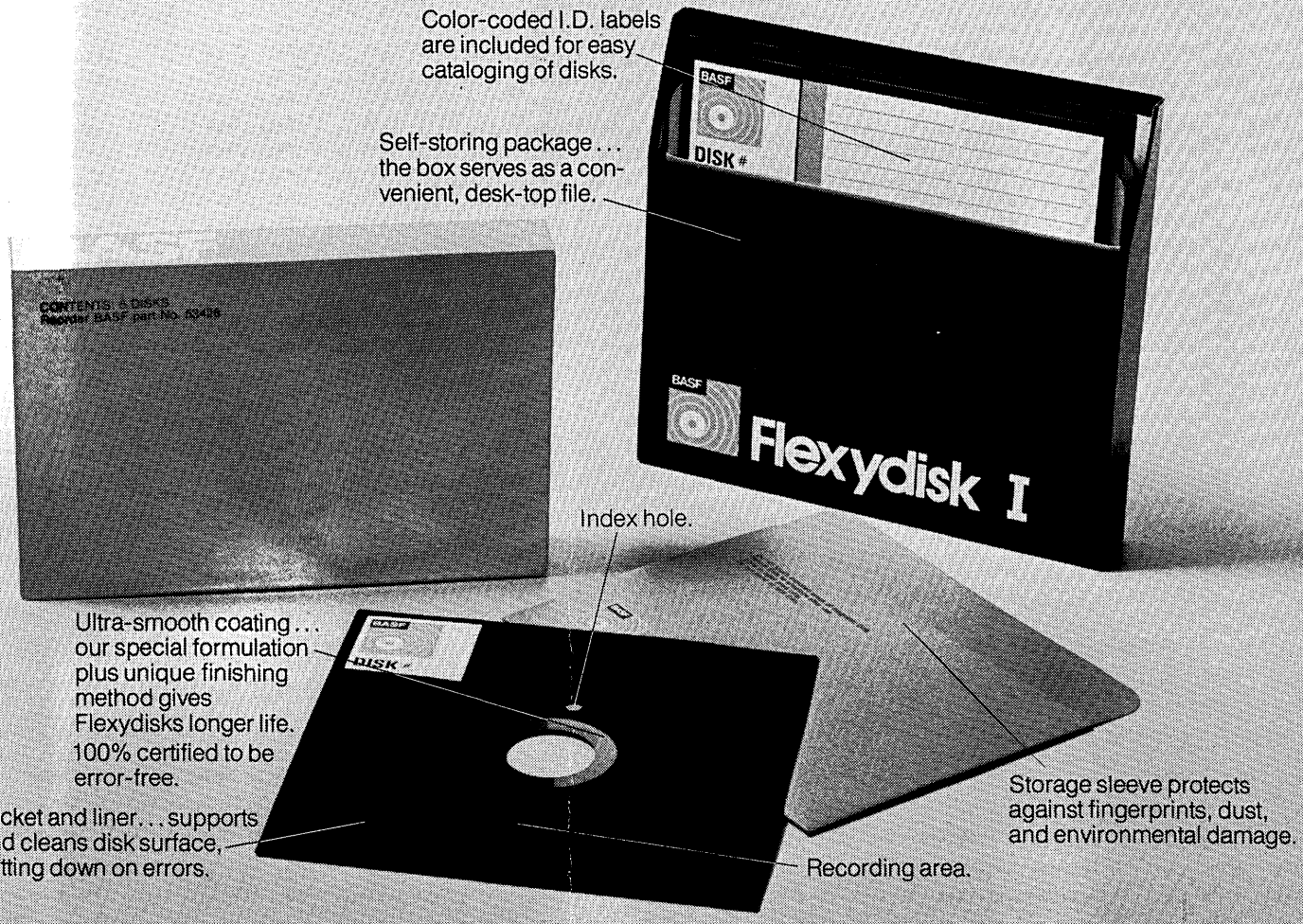

Our new Flexydisks have been specially designed and formulated to provide trouble-free performance on 3740 and compatible equipment utilizing flexible disks.

Each Flexydisk 1 has 77 tracks and can store up to 252,928 bytes ... or approximately 3,000 80-column cards. There's no better buy than BASF Flexydisks, and here are some of the reasons why:

Flexydisks are 100% Certified to be error free... and they're initialized.

Every Flexydisk 1 is 100% certified so you won't have mistakes to

cope with. Each disk is also preformatted for immediate use. Flexydisks have a clean, debris-free surface like our computer tape. A special dual-purpose coating gives increased disk and head life. Our tests have shown head wear to be less than 23.5 micro-inches in 92 hours of head loaded operation!

Flexydisks won't leave you short if 3740 equipment is updated, either. We've coated and finished them on *both* sides. Just to be sure.

Flexydisks are Self-Cleaning.

We pack our Flexydisks in a special, self-cleaning jacket and

liner. This unique method of packaging cuts down on friction and the possibility of errors.

Flexydisks are Easily Stored and Mailed.

A good product deserves a good package. Flexydisks come in compact, tabulated library 5-packs. They save on storage and record-keeping, and make neat desk-top files. They're a great time-saver. A supply of color coded labels is also included for easy job identification.

Drop us a line, and we'll send you complete details on Flexydisks. BASF Systems, Crosby Drive, Bedford, MA 01730

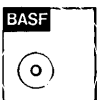

You're already paying for BASF quality, you might as well have it.

**For years,
people thought
Teletype[®]
machines only
talked to
themselves.**

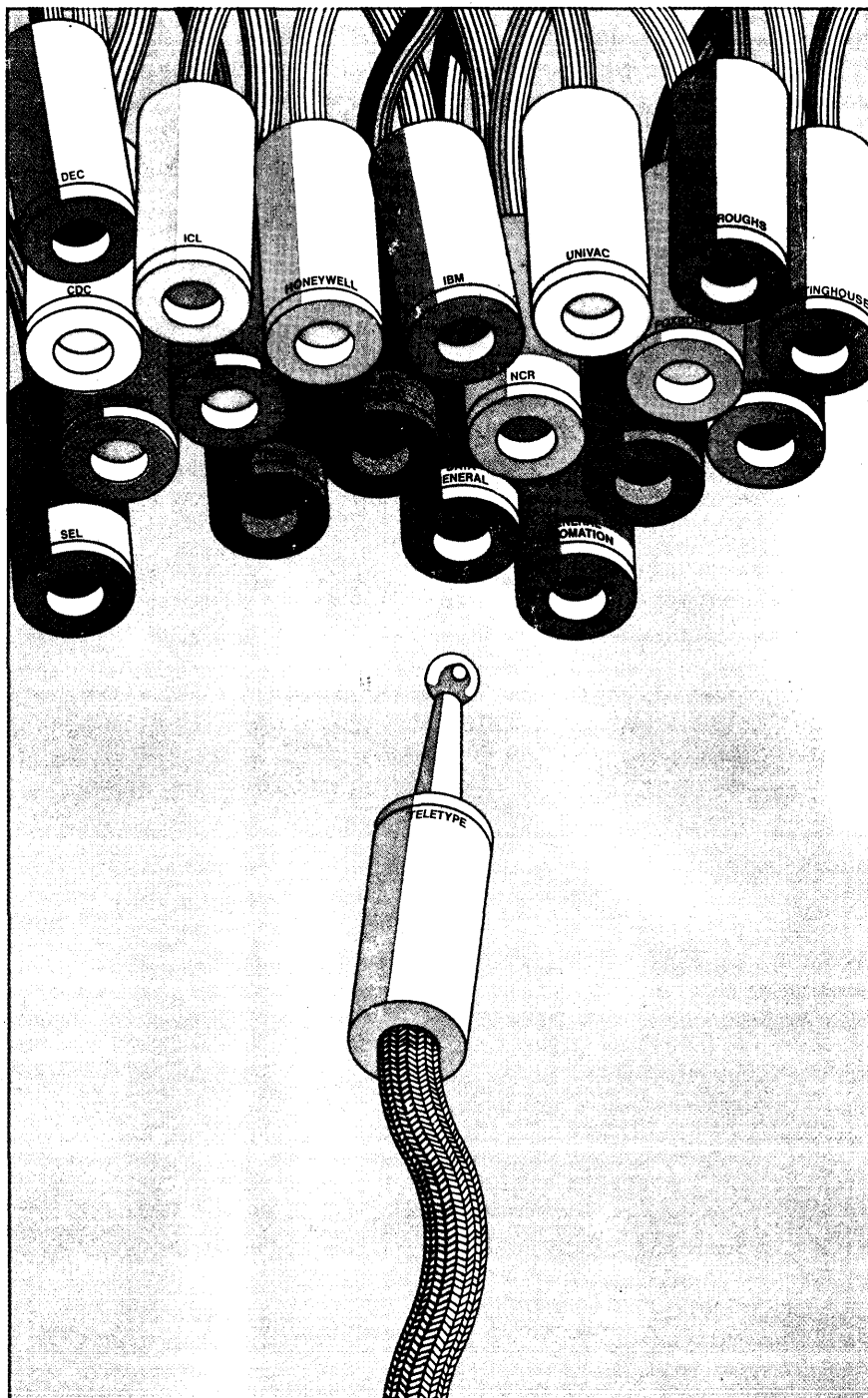

Teletype is a trademark registered in the United States Patent Office.

Fact is, Teletype machines have been carrying on intelligent conversations for years with some of the fastest information movers in the world. Computers.

We've earned a good, solid name for ourselves in computer communications because our equipment is compatible with practically any computer-based system.

Our product line proves the point.

The number one standard-duty data terminal in the industry is our model 33 series. And our

new wide-platen model 38 offers big system features at economy system prices.

Heavy-duty operation with minimum maintenance? Check out our model 35. And our model 37 series delivers the utmost in flexibility and vocabulary for complex data systems.

We also build equipment for paper tape systems, as well as a magnetic tape terminal for greater on-line savings. As you can see, our reputation in point-to-point communications has served us well in computer terminals. No one comes close to us in reliability, flexibility and economy.

It takes more than manufacturing facilities to build the machines Teletype Corporation offers. It also takes commitment. From people who think service is as important as sales. In terminals for computers and point-to-point communications.

That's why we invented a new name for who we are and what we make. The computer-communications people.

