

EDN[®]

ELECTRONIC TECHNOLOGY FOR ENGINEERS AND ENGINEERING MANAGERS WORLDWIDE

A CAHNERS PUBLICATION

September 17, 1992

SPECIAL REPORT

Choosing complex PLDs and FPGAs

pg 74

EDN DIRECTORY

EDN's DSP-Chip Directory

pg 90

Extensive details about 22 DSP chips begin on pg 100

TECHNOLOGY UPDATE

CAE tools for wireless systems

pg 39

News Breaks

pg 19

Product Updates

pg 57

Processor Updates

pg 65

Design Ideas

pg 143

Special Report

**Complex PLDs and FPGAs:
How to make an informed choice**

pg 74

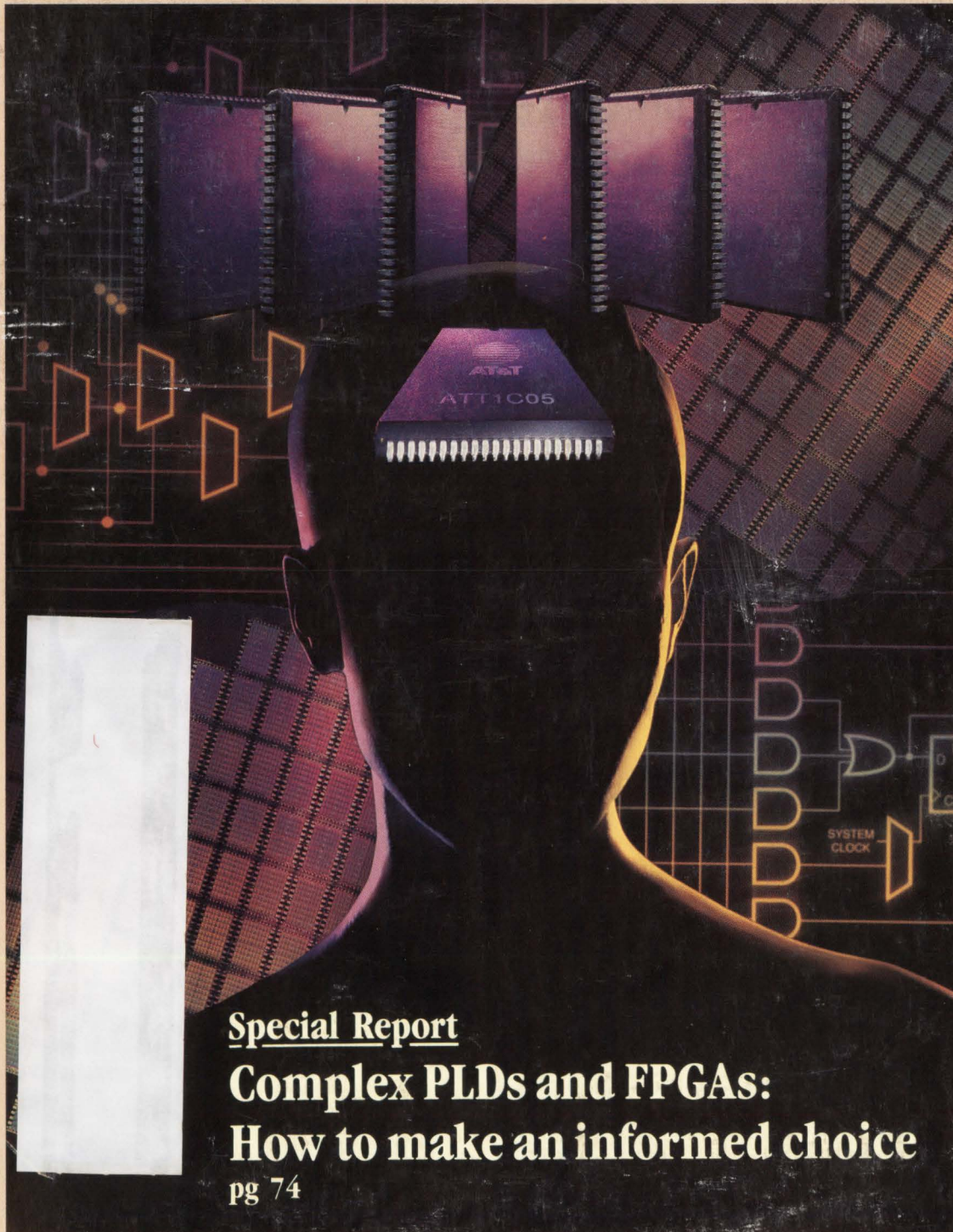

Designing automotive subsystems? Here's how to achieve global presence.

More and more, improving – or even maintaining – your position in the automotive market calls for some deft maneuvering on an around-the-world basis. And that's precisely where Murata Erie can be a valuable ally.

You see, with us as your passive component source, you can count on complete and easily accessed support no matter where your manufacturing and marketing roads lead. Whether you're making trip/navigation computers in Nürnberg, sensors in Seoul or emission controls in Canada.

And, more than worldwide manufacturing resources, we mean technical support as well. So whether you're designing – or re-designing – an engine control system, CD player or cellular telephone, we'll be there. And we'll put nearly a half-century of technological expertise and leadership to work for you, plus all the advantages of Murata Erie's 1.0 QRS (100% quality, reliability, service) program.

A final, important point. Because our component line is a massive one, from chip caps to piezoelectric gyroscope systems, it offers real opportunities to gain measurable economic ground while achieving vendor reduction goals.

Call or write for details: Murata Erie North America, Marketing Communications, 2200 Lake Park Drive, Smyrna, GA 30080; 1-800-831-9172. Because, when it comes to global presence, it's best to travel with people who have it.

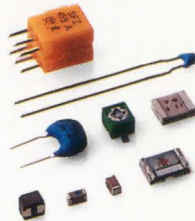

MURATA ERIE NORTH AMERICA

Delivering Technology WorldwideSM

CIRCLE NO. 3

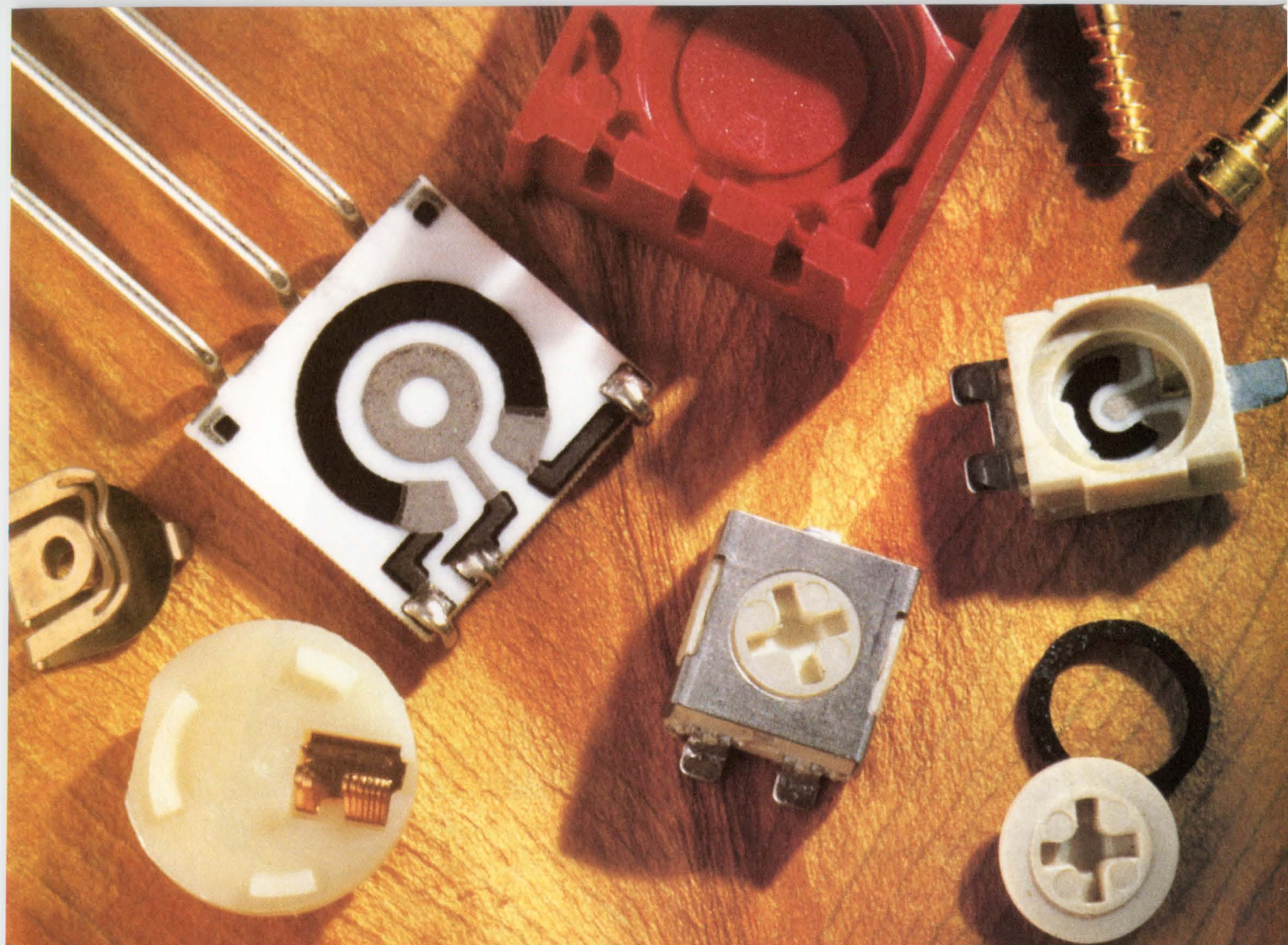

Wipers, collectors and screws
can't help you trim
circuit adjustment costs.

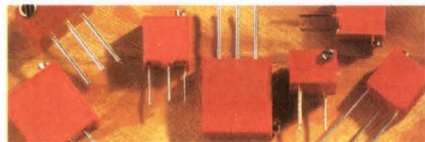

MILITARY TRIMMERS from the Techno Division include broad MIL qualification to RT24, 26, 27; RTR24; RJ24, 26 and RJR24, 26. Techno RJ24 and RJR24 trimmers offer you 25 turns for precision adjusting, while the RJ26 and RJR26 offer 22 turns. They have zero backlash and offer a monolithic clutch.

In addition, Techno offers 1/4" and 3/8" multiturn trimmers with a TCR of ± 50 PPM/ $^{\circ}$ C for precision applications. All Established Reliability trimmers meet the requirements of MIL-STD-202, Method 208.

Contact: **Techno Division**, Dale Electronics, Inc., 7803 Lemona Avenue, Van Nuys, California 91405-1139 **Phone (818) 781-1642.**

Dale® Can.

Add trimmers to the list of ways Dale® can help keep your project under budget and on-time. We offer immediate interchangeability with models you're using now. Cermet, wirewound. Military, industrial, commercial. Square, round, rectangular. Surface mount and through-hole. Discover how Dale trimmers can end your search for multiple suppliers. More than ever we're your 1-stop source for resistive components — always ready to match your delivery schedule from factory or distributor stock. Call today.

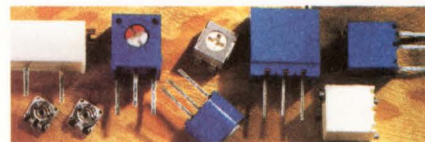

COMMERCIAL TRIMMERS include Surface mount: Thick film chips (.2W) plus .197" (.2W) and 1/4" (.25W) square cermet styles. Through-hole cermet styles include: .276" (.5W) round, 1/4" (.25W), 9/32" (.5W), and 3/8" (.5W) square cermet. Rectangular: 3/4" (.75W) wirewound.

For more information contact: **Dale Electronics, Inc.**, 1155 West 23rd Street, Tempe, Arizona 85282-1883. **Phone (602) 967-7874.**



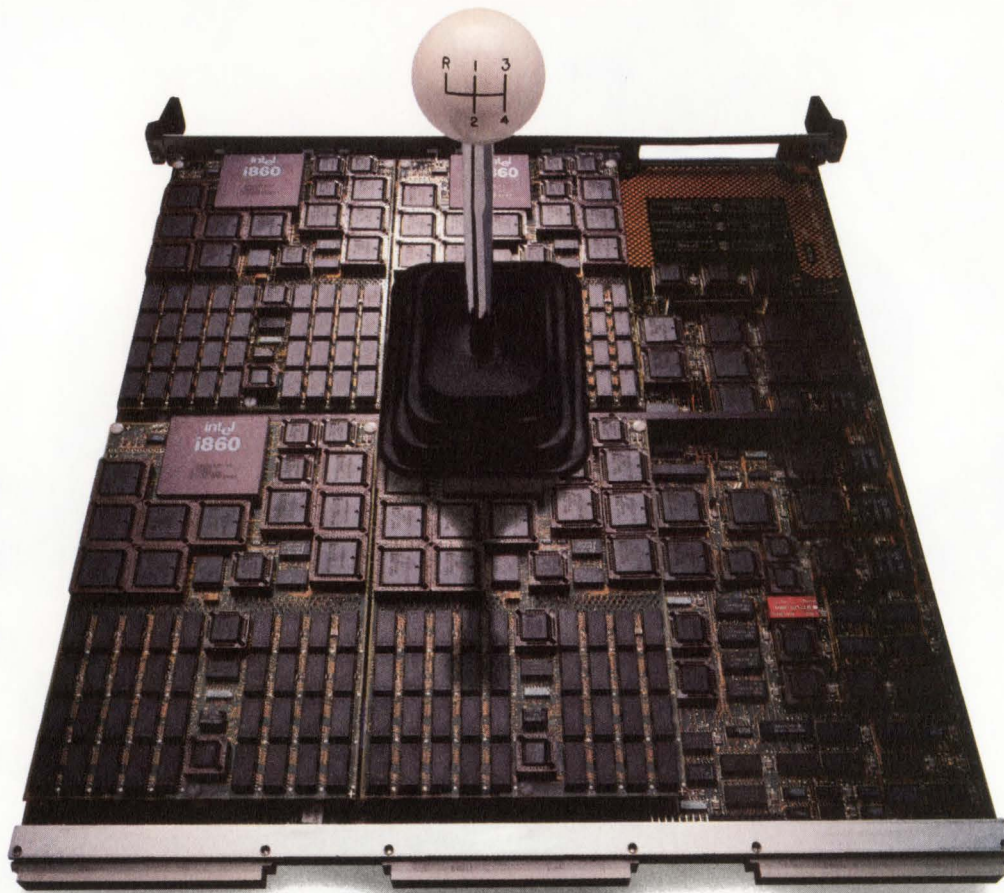

THE ONLY ATTACHED PROCESSOR WITH FOUR ON THE BOARD AND 2.5 GIGAFLOP PERFORMANCE.

Mercury's MC860VS. The only attached processor that offers up to 32 Intel i860s in no more than 8 VME slots. So you get 80 Mflops to 2.5 Gflops of horsepower to handle demanding applications in defense signal processing and medical imaging. And all Mercury products can be configured in workstations and chassis systems to deliver scalable performance at a scalable price.

So if you're building or buying a high performance computing solution, take full advantage of Mercury's unparalleled investment in standards, innovative hardware, and software development environment. And get the most complete, flexible, high performance computing solutions available. If it's time you moved into the fast lane, it's time to call or write Mercury today for more information.

- Please send me more information on the MC860VS right away.
- I want to learn more. Send me your white paper "Multiprocessing for the 1990s" and enroll me in your Education Series program today.

Name _____
 Title _____
 Company _____
 Address _____
 City/State/Zip _____
 Phone _____

Please send to
 600 Suffolk Street,
 Dept. K,
 Lowell, MA 01854
 Fax (508) 458-9580
 (508) 458-3100

Computer Systems, Inc.
MERCURY

The Ultimate Performance Machine.

SURFACE MOUNT MIXERS

...with a difference



actual size

up to 1900MHz from **\$6²⁵**

Now available, a large variety of tiny, ultra-rel high performance mixers to handle your applications from extra wideband, high isolation, low two-tone third-order IM, to very low +3dBm LO power.

Mini-Circuits' new LRMS-series Ultra-Rel™ mixers are offered with a difference... unprecedented reliability. Units are manufactured with Ultra-Rel diodes, all-welded construction, metal stubs to all connections, and to 4.5 sigma performance repeatability. Each Ultra-Rel™ LRMS mixer can withstand strenuous shock and vibration, will perform over a -55° to +100°C range, and is guaranteed for five years.

Aim for 4.5 sigma repeatability in your product designs by specifying Mini-Circuits' Ultra-Rel™ LRMS mixers, available for immediate delivery in tape-and-reel format (500 units, 16mm width) at prices from \$6.25.

**ULTRA-REL™
MIXERS**
5-YR. GUARANTEE *

with extra long life due to unique HP monolithic diode construction, 300°C high temp. storage, 1000 cycles thermal shock, vibration, acceleration, and mechanical shock exceeding MIL requirements.

SPECIFICATIONS: all spec limits are 4.5 σ from mean

Model	Freq. Range LO. RF	(MHz) IF	LO Level (dBm)	Conv. Loss Mean (X̄) mid-band (dB)	L-R Isol. Mean (X̄) mid-band (dB)	Price \$ (1-9)
LRMS-2L	800-1000	DC-200	+3	6.6	24	6.95
LRMS-1	0.5-500	DC-500	+7	6.4	45	6.25
LRMS-1W	2.0-750	DC-750	+7	5.8	45	6.75
LRMS-2	5-1000	DC-1000	+7	6.8	38	6.95
LRMS-2D	5-1000	DC-1000	+7	6.8	40	7.25
LRMS-2U	10-1000	10-1000	+7	6.5	46	11.45
LRMS-5	5-1500	DC-1000	+7	6.0	41	13.95
LRMS-11A	1400-1900	40-500	+7	7.0	25	16.95
LRMS-1LH	2.0-500	DC-500	+10	5.8	47	7.95
LRMS-2LH	5-1000	DC-1000	+10	6.6	40	8.95
LRMS-5LH	10-1500	DC-900	+10	5.4	38	14.95
LRMS-1MH	2.0-500	DC-500	+13	5.7	44	8.95
LRMS-2MH	5-1000	DC-1000	+13	6.6	44	9.95
LRMS-5MH	10-1500	DC-900	+13	5.8	46	15.95
LRMS-1H	2.0-500	DC-500	+17	6.3	44	10.95
LRMS-2H	5-1000	DC-900	+17	7.2	36	11.95
LRMS-2UH	10-1000	10-750	+17	7.1	38	14.45
LRMS-5H	10-1500	DC-900	+17	7.2	45	17.95

finding new ways...
setting higher standards

CIRCLE NO. 9

Mini-Circuits

WE ACCEPT AMERICAN EXPRESS AND VISA

P.O. Box 350166, Brooklyn, New York 11235-0003 (718) 934-4500 Fax (718) 332-4661 Telexes: 6852844 or 620156

C146 REV.ORIG.

incredible!

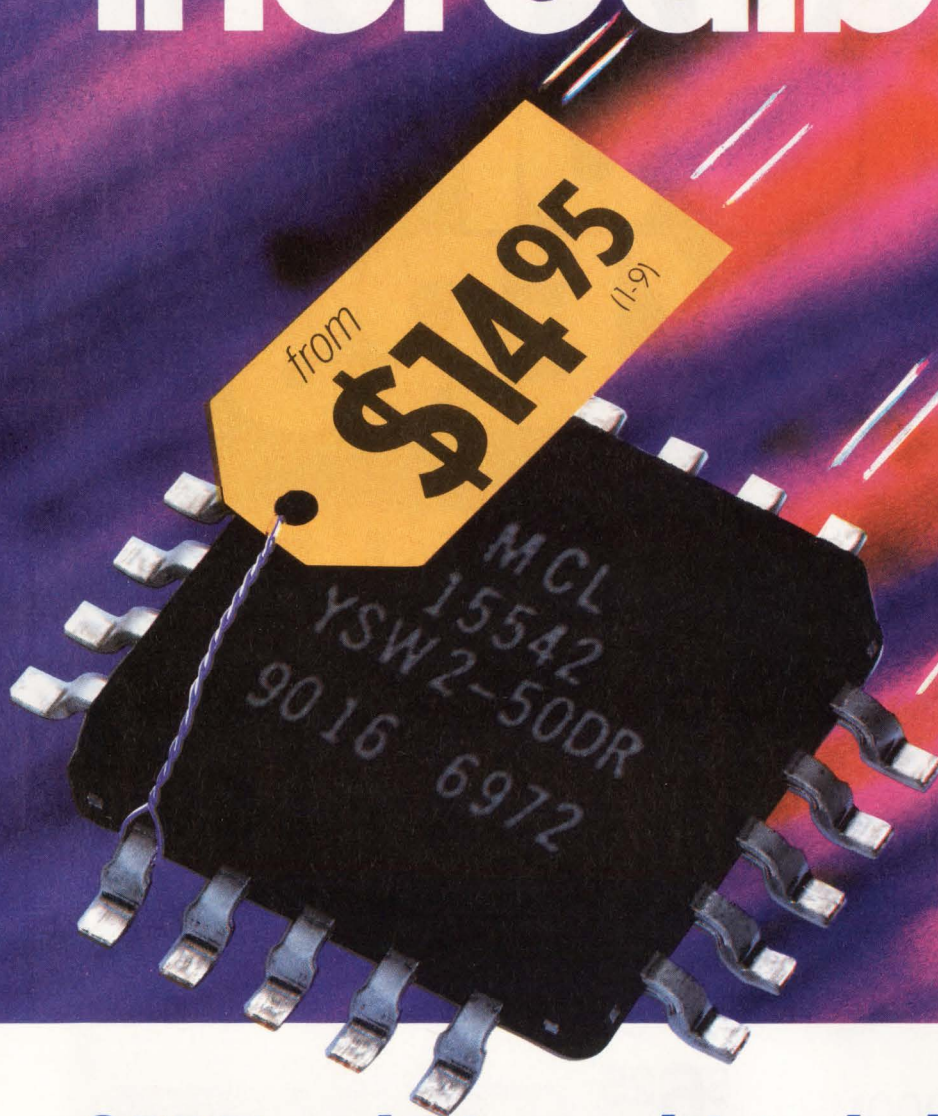

SPDT switches with built-in driver **ABSORPTIVE or REFLECTIVE dc to 5GHz**

Truly incredible...superfast 3nsec GaAs SPDT reflective or absorptive switches with built-in driver, available in pc plug-in or SMA connector models, from only \$14.95. So why bother designing and building a driver interface to further complicate your subsystem and take added space when you can specify Mini-Circuits' latest innovative integrated components?

Check the outstanding performance of these units...high isolation, excellent return loss (even in the "off" state for absorptive models) and 3-sigma guaranteed unit-to-unit repeatability for insertion loss. These rugged devices operate over a -55° to +100°C span. Plug-in models are housed in a tiny plastic case and are available in tape-and-reel format (1500 units max, 24mm). All models are available for immediate delivery with a one-year guarantee.

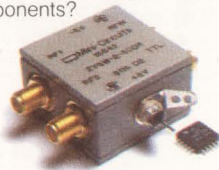

finding new ways ...
 setting higher standards

SPECIFICATIONS (typ)	Absorptive SPDT			Reflective SPDT		
	YSWA-2-50DR	ZYSWA-2-50DR		YSW-2-50DR	ZYSW-2-50DR	
Frequency (MHz)	dc- 500- 2000- 500 2000 5000			dc- 500- 2000- 500 2000 5000		
Ins. Loss (dB)	1.1 1.4 1.9			0.9 1.3 1.4		
Isolation (dB)	42 31 20			50 40 28		
1dB Comp. (dBm)	18 20 22.5			20 20 24		
RF Input (max dBm)	— 20 —			22 22 26		
VSWR "on"	1.25 1.35 1.5			1.4 1.4 1.4		
Video Bkthru (mV,p/p)	30 30 30			30 30 30		
Sw. Spd. (nsec)	3 3 3			3 3 3		
Price, \$	YSWA-2-50DR (pin) 23.95			YSW-2-50DR (pin) \$14.95		
(1-9 qty)	ZYSWA-2-50DR (SMA) 69.95			ZYSW-2-50DR (SMA) 59.95		

Mini-Circuits™

P.O. Box 350166, Brooklyn, New York 11235-0003 (718) 934-4500 Fax (718) 332-4661
WE ACCEPT AMERICAN EXPRESS AND VISA

Distribution Centers NORTH AMERICA 800-654-7949 • 417-335-5935 Fax 417-335-5945 EUROPE 44-252-835094 Fax 44-252-837010

For detailed specs on all Mini-Circuits products refer to • THOMAS REGISTER Vol. 23 • MICROWAVES PRODUCT DIRECTORY • EEM • MINI-CIRCUITS' 740-pg HANDBOOK

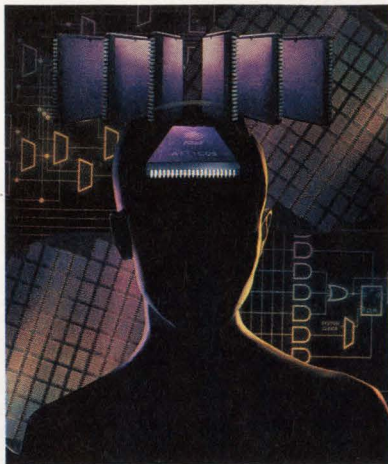

On the cover: Making informed choices about the many types of complex PLDs and FPGAs means sifting carefully through your design criteria. Among the things to consider is your choice of hardware architecture and what design methodologies you will use. (Photo courtesy of AT&T; photography by Clayton J Price; concept by Bessen Tully & Lee) **PAGE 74**

Foldout Contents

Turn to the last information-retrieval service card in the back of this magazine and you'll find a foldout table of contents. Now, instead of flipping back and forth from this table of contents to the articles you want to read, you can have the convenient foldout open at all times while you're reading EDN. Use the foldout contents to mark off articles you'd like your colleagues to read or to remind yourself to copy stories for your files.



ELECTRONIC TECHNOLOGY FOR ENGINEERS AND ENGINEERING MANAGERS WORLDWIDE

SPECIAL REPORT

Choosing complex PLDs and FPGAs

Design methodology, performance, and software tools should all influence you as you seek the right high-density PLD. But first you have to know the foundations of complex PLD and FPGA architectures.

—Anne Watson Swager, *Technical Editor*

74

EDN's DSP-chip directory

EDN DIRECTORY

DSP chips have touched almost all areas of electronics. Now the DSP industry is making it easier for you to use these powerful devices. Complete systems in chip-set form are now available, as are good tools to develop DSP applications.—David Shear, *Technical Editor*

90

TECHNOLOGY UPDATE

CAE tools for wireless systems: System simulators meet wireless challenges

Designers of wireless RF and microwave systems can turn to specialized software tools to help them simulate complex systems efficiently.—Doug Conner,

Technical Editor

39

Continued on page 7

EDN® (ISSN 0012-7515, GST Reg. #123397457) is published 48 times a year (twice monthly with 2 additional issues a month, except for March and October, which have 3 additional issues and July and December which have 1 additional issue) by Cahners Publishing Company, A Division of Reed Publishing USA, 275 Washington Street, Newton, MA 02158-1630. Terrence M McDermott, President/Chief Operating Officer; Frank Sibley, Executive Vice President; Jerry D Neth, Senior Vice President/Publishing Operations; J J Walsh, Senior Vice President/Finance; Thomas J Dellamaria, Senior Vice President/Production and Manufacturing; Ralph Knupp, Vice President/Human Resources. EDN® is a registered trademark of Reed Properties Inc., used under license. Circulation records are maintained at Cahners Publishing Company, 44 Cook Street, Denver, CO 80206-5800. Telephone: (303) 388-4511. Second-class postage paid at Denver, CO 80206-5800 and additional mailing offices. **POSTMASTER: Send address changes to EDN®, PO Box 173377, Denver, CO 80217-3377.** EDN® copyright 1992 by Reed Publishing USA; Robert L Krakoff, President and Chief Executive Officer. Rates for nonqualified subscriptions: EDN Magazine and EDN News combined (48 issues) U.S. \$154.95/year; EDN Magazine only (26 issues) U.S. \$119.95 year; EDN News only (22 issues) U.S. \$74.95/year. Subscription rates higher outside U.S. Please inquire at Denver office for rates. Telephone (303) 388-4511. Except for special issues where price changes are indicated, single copies are available for \$20 U.S. and \$25 foreign. Please address all subscription mail to Ellen Porter, 44 Cook Street, Denver, CO 80206-5800.

FAST FLASH 22V10

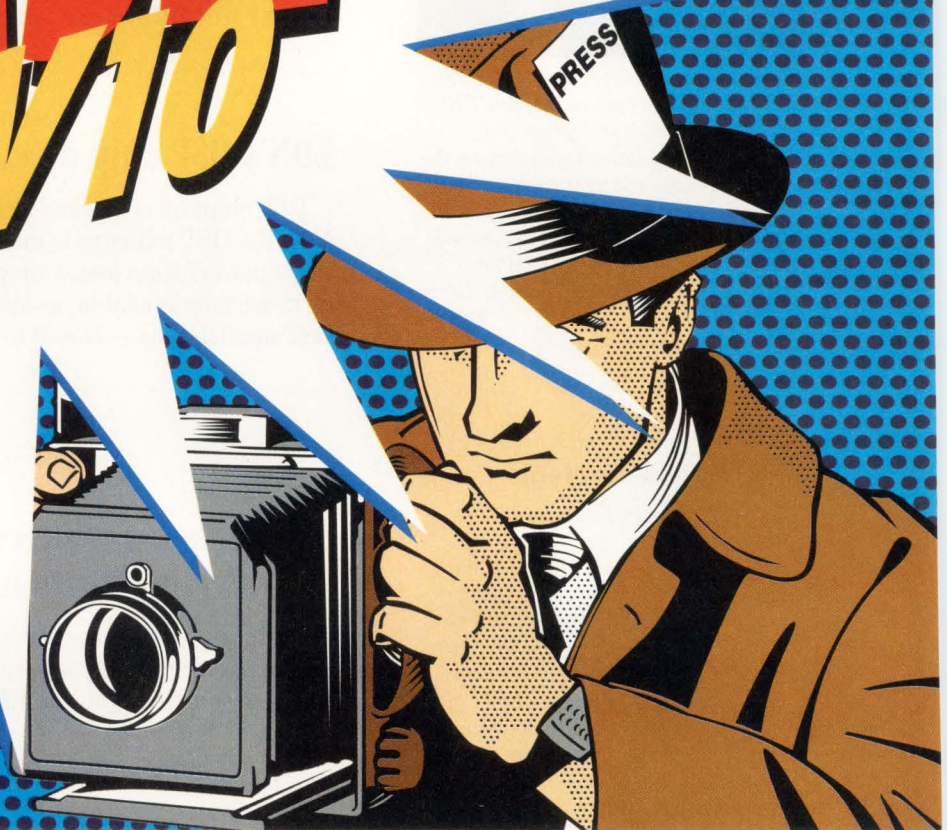

EXTRA! CYPRESS STUNS WORLD WITH FIRST FLASH PLD.

Stop the presses! Once again, Cypress has the lead story in PLD technology for high-performance systems. Cypress is first on the world scene with 10 ns, Flash 22V10 devices. Electrically alterable 22V10s are your fastest route to risk-free inventory and ease of design. Cypress scoops the competition again!

Also newsworthy: This 22V10 is CMOS, needing just 90 mA max (commercial) and 100 mA (military applications), so it stays cool for reliable operation. Choose from DIP, PLCC and LCC packaging options.

Cypress's Flash 22V10 is the latest member in a complete family of landmark PLD products with the widest variety of speeds, densities and architectures to suit your application. Read all about it—call the Cypress hotline for your free Flash sample certificate and data sheet today.

FREE FLASH SAMPLE HOTLINE: 1-800-858-1810*

Ask for dept C47.

*In Europe, fax your request to the above dept. at (32) 2-652-1504 or call (32) 2-652-0270. In Asia, fax to the above dept. at 1 (415) 961-4201.
© 1992 Cypress Semiconductor, 3901 North First Street, San Jose, CA 95134. Phone 1 (408) 943-2600, Telex: 821032 CYPRESS SNJ UD, TWX: 910-997-0753.



Home Office

275 Washington St, Newton, MA 02158
 EDN Bulletin Board: (617) 558-4241
 MCI: EDNBOS
 (617) 558-extension

VP/Publishing Director

Peter D Coley -4673

VP/Publisher

Roy Forsberg -4367

VP/Editor/Editorial Director

Jonathan Titus -4573

Executive Editor

Steven H Leibson -4214

Managing Editor

Joan Morrow Lynch -4215

Assistant Managing Editor

Anne Gallagher -4653

Gary Legg, *Senior Technical Editor* -4404
 Tom Ormond, *Senior Technical Editor* -4414
 Charles Small, *Senior Technical Editor* -4556
 MCI: EDNSMALL; Compuserve: 70324, 3270
 Dan Strassberg, *Senior Technical Editor* -4205
 John A Gallant, *Technical Editor* -4666
 John C Napier, *Technical Editor* -4690
 Julie Schofield, *Senior Associate Editor* -4619
 Carl Quesnel, *Associate Editor* -4484
 Susan Rose, *Associate Editor* -4738
 Helen McElwee, *Senior Copy Editor* -4311
 James P Leonard, *Copy Editor* -4324
 Gillian A Caulfield, *Production Editor* -4263
 Erin Heffernan, *Production Editor* -4333
 Chuck Harper, *BPEF Intern*

Editorial Field Offices

Doug Conner, *Technical Editor*
 Atascadero, CA: (805) 461-9669
 MCI: EDNDCONN

J D Mosley, *Technical Editor*
 Arlington, TX: (817) 465-4961
 MCI: EDNMOSLEY

Richard A Quinnell, *Technical Editor*
 Aptos, CA: (408) 685-8028
 MCI: EDNQINNELL

David Shear, *Technical Editor*
 Corvallis, OR: (503) 754-9350
 MCI: EDNSHEAR

Anne Watson Swager, *Technical Editor*
 Wynnewood, PA: (215) 645-0544
 MCI: EDNSWAGER

Ray Weiss, *Technical Editor*
 Woodland Hills, CA: (818) 704-9454
 MCI: EDNWEISS

Brian Kerridge, *Technical Editor*
 22 Mill Rd, Loddon
 Norwich, NR14 6DR, UK
 (508) 28435
 MCI: EDNKERRIDGE

Contributing Technical Editors

Robert Pease, Don Powers, Dave Pryce,
 Bill Travis, Maury Wright

Editorial Coordinator

Kathy Leonard -4405

Editorial Services

Helen Benedict -4681

Art Staff

Robert L Fernandez, *Art Department Director*
 Ken Racicot, *Senior Art Director* -4708
 Chinsoo Chung, *Associate Art Director* -4446
 Cathy Madigan, *Associate Art Director* -4599

Marketing & Business Director

Deborah Virtue -4779

Marketing Communications

Kathy Calderini, *Manager* -4526
 Pam Winch, *Promotion Specialist* -4660

PRODUCT UPDATES

Systems for EMI detection	57
Modular dc/dc converters	61
Uninterruptible power supplies	62

PROCESSOR UPDATES

16-MHz RISC μ P	65
8-bit μ C for closed-caption TV	65

DESIGN IDEAS

CMOS switches develop negative voltage	143
Hartley transform beats FFT for DSP μ Ps	143
VHDL "wait" statement inserts registers	144

NEW PRODUCTS

Integrated Circuits	151
Computers & Peripherals	160
Components & Power Supplies	169
Test & Measurement Instruments	173
CAE & Software Development Tools	176

DEPARTMENTS

Inside EDN	9
News Breaks	19
Editorial	29
Career Opportunities	186
EDN's International Advertisers Index	192

WANTED EXPERIENCED EDA ASSISTANT

Must be friendly, intelligent and easy to work with. Capable of handling complex board design from start to finish. Require ability to work with both novice and expert users. Please respond today.

HIRE INTELLIGENCE.

CADSTAR™

EDA SOFTWARE

238 Littleton Road
Westford, MA 01886
Phone: 800-356-8352
Fax: 508-692-4725

- Objective:** Provide intelligent PCB design assistance on a PC platform.
- Education:** Easy to learn, OSF/Motif™ style graphical user interface integrated across schematic capture, layout, autorouting. Toll free hotline support provided.
- Personal Skills:** Proactive interface anticipates designer's next move and intelligently defaults to the logical command, saving thousands of keystrokes per design. User defined hot keys and macros multiply this power.
- Experience:** Proven ability to design double-sided, multilayer, SMD technology boards. Comfortable with analog, digital, or mixed signals. Capacity for 3,000+ parts and 15,000+ connections.
- Description:** Integrated schematic capture, layout, autorouting, manufacturing outputs. 5,000+ part library. Analog design functions include curved tracks, teardrop pads, copper hatching, copper pouring and more. Forward and back annotation. Automatic routines for placement, gate and pin swap, component rename, routing and more.
- Associations:** CADSTAR Advanced Router. DOS-based, 100% completion router has gridless, rip-up and retry, shove aside technology. May be bundled with CADSTAR for unparalleled performance at a great price. CADSTAR is fully compatible with MAXI/PC and upwardly compatible with Racal-Redac's sophisticated, workstation-based EDA Expert Series.
- References:** 10,000+ satisfied design engineers worldwide.
- Availability:** Available immediately.

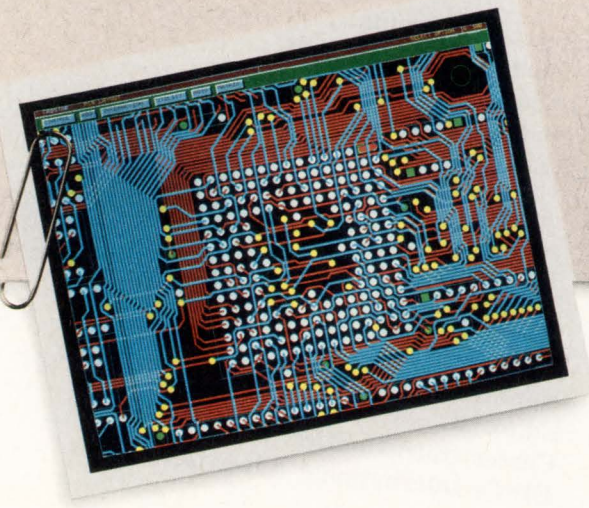

Call for more details and your free
CADSTAR demo disk.

1-800-356-8352

CADSTAR™

EDA SOFTWARE

RACAL-REDAC

RACAL

Racal-Redac, Inc.
238 Littleton Road
Westford, MA 01886 USA
Fax: 508-692-4725

If you're designing wireless communications systems, you not only have to be an expert, you need help too. Communications is a hot area, and we're seeing an increasing demand for engineers with experience designing wireless products. Today, those products go beyond cellular phones, from mundane garage-door openers to wireless office networks. Doug Conner takes a look at **CAE tools that let designers simulate wireless systems** from the beginning to the end of the sys-



Anne Swager takes a close look at the differences between designing with FPGAs and complex PLDs.

tem. Unfortunately, vendors differ on how they define beginning and end. Some tools help you design modulators and demodulators, and others easily handle the RF front ends of communications systems.

Specifically, Doug's report looks at how you can use simulation tools to observe the effects of small changes in wireless systems. These are often tough problems to discover and solve. Doug says that engineers facing the challenge of designing sensitive wireless communications systems often don't know what tools are available.

Engineers can use assistance, too, when trying to decide which type of complex programmable logic device (PLD) or field-programmable gate array (FPGA) to

use. Anne Swager's Special Report gives you a brief tutorial about what's available and **how to approach complex-PLD and FPGA design problems**. Anne says that most designers are used to working with simple PLDs. However, the complex PLDs and FPGAs present new problems and require new ways of thinking. FPGAs are blocks of logic functions, but PLDs remain structured sets of sum-of-product blocks. It's not as easy as it might seem to go from one to the other.



Doug Conner's Technology Update covers CAE tools for wireless systems.

Anne's report tells you how to compare and select products. She also tells you about the design methods you can choose.

David Shear completes this issue's line-up with our annual **Digital Signal Processor Chip Directory**. David has dug deeply through mounds of DSP-chip information to bring you the latest compilation of chip specs, facts, and figures.

Jon Titus
Editorial Director

LCD Proto Kit

Everything you need to start your LCD application create complex screens in just a few hours!

240 x 64 pixel Supertwist LCD mounts directly onto CYB003 prototyping board.

Kit provides serial interface to IBM PC for quick prototyping. Board also supports displays up to 240 x 128 pixels.

Interface to 6 soft keys or 4 x 4 key matrix.

Dial 0-25k ohms for LCD contrast.

* The CY325 LCD Windows Controller provides parallel or serial high-level control of Instrument-size LCDs. Up to 256 built-in windows support window-relative text, bargraphs, waveforms, and plots. Text and graphics are maintained in separate planes, facilitating special effects. Complete User Manual included.

Wirewrap area for custom circuitry or backlight.

RJ 11 serial jack for Rx/D, Tx/D, CTS, and GND, plus 2 spares.

5 Pin Power DIN.

Alternate Power Connector.

Add your own 8051 CPU for stand alone operation.

Kit also includes:

Power supply provides +5v and Gnd for board, -12v for LCD, and +12v spare.

Sample routines in 8051 Assembler and QuickBasic.

LCD Paint™ for creating your own graphics images.

4-wire RJ11 style cable with DB25F connector for your IBM PC.

LCD demo

Demo routines preprogrammed into 8751 for immediate gratification.

\$495 - Kit
Popular LCD Starter Kit.



(\$595 pre-assembled & tested)

*The CY325 CMOS 40-pin DIP and 44-pin PLCC LCD Controller IC are available from stock @ \$75/singles, \$20/1000s .

CyberneticMicroSystems

Box 3000 • San Gregorio CA 94074
Tel: 415-726-3000 • Fax: 415-726-3003

CIRCLE NO. 20

Soon, Eight Ho Computing Will



(actual size)

AMD Introduces The World's First 386 Microprocessor With 3-Volt Technology.

Two standard dry-cell batteries. There's really nothing special about them. Aside from the fact that they can run a powerful, portable 386 computer for a full eight hours. Provided, of course, that portable is built around a low-voltage Am386™ microprocessor.



The 25MHz DXLV and the 25MHz SXLV are available in POPF packaging.

Thanks to the low-voltage Am386 microprocessors, laptop, palmtop and notebook computer designs will become smaller, lighter, and more powerful than ever before.

With battery life of up to eight hours or more. That's a full day's worth of 386 performance—the per-

Users Of Portable Look Like This.

formance you need to run sophisticated applications like Windows™ 3.0.

And rest assured, the low-voltage Am386 microprocessors are proven compatible and comply fully with JEDEC standards for low-power, 3-volt computing. We can even supply you with the 3-volt EPROMs your systems will need. Other 3-volt system logic is also readily available.

For more information on the low-voltage

Am386 microprocessors call AMD today at **1-800-222-9323**. You'll never look at dry-cell batteries the same way again.



Advanced Micro Devices
"We're Not Your Competition."™

Put These G And Take So

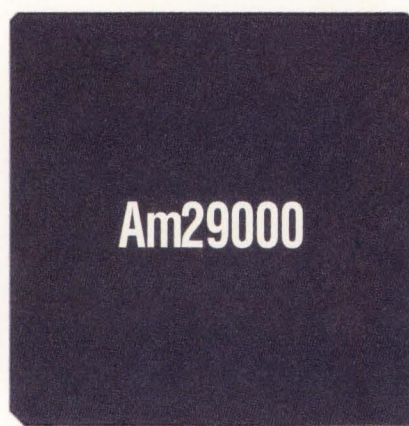

Whatever you're working on, please stop. You deserve to take some time off. And with any member of the AMD 29K™ Family of embedded RISC processors, you can take several months off your design cycle.

That's because 29K processors' simple, highly integrated designs will knock time-consuming steps off your schedule. Take the inexpensive, new Am29200™ microcontroller. With many features like I/O controls and serial ports included on-chip, it's the easiest to

use embedded processor available. Adding memory requires no interface circuitry. It's as simple as playing "Connect the dots."

Memory interface throughout the rest of the family is fast and easy too. Each processor in the 29K Family integrates easily with low-cost PLDs or simple glue logic to minimize your circuitry needs.

You'll also save valuable time when you're expanding your product line. The entire 29K family is binary compatible. So you just deter-

Ways To Work me Time Off.

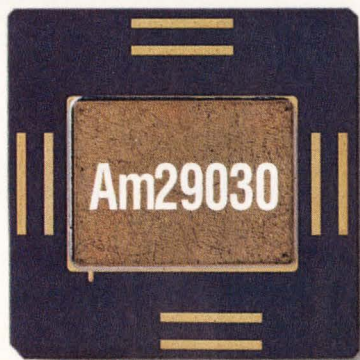

mine the performance you need and select the appropriate chip—from the Am29200 to the high-end Am29050™ processor. There's no need to recompile your applications' software as you scale up or down the performance ladder.

And thanks to the 29K's RISC architecture, you can use inexpensive memory devices to lower your system costs and still deliver the high performance your customers demand.

For more information on the 29K embedded

RISC family call today at **1-800-292-9263 Ext. 3**. Then kick back and watch the AMD guys go to work.



Advanced Micro Devices

901 Thompson Place, P.O. Box 3453, Sunnyvale, CA 94088. © 1992 Advanced Micro Devices, Inc. 29K, Am29200, and Am29050 are trademarks of Advanced Micro Devices. All other brand or product names are trademarks or registered trademarks of their respective holders.

CIRCLE NO. 22

Compare Us To The F And You'll Have Second

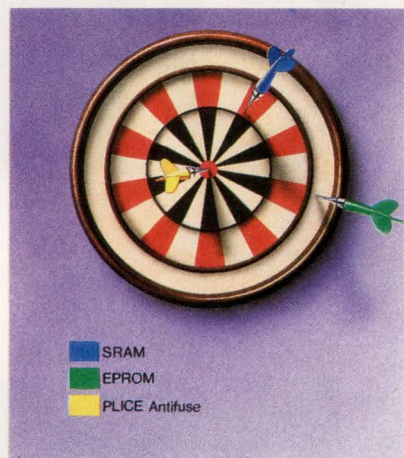

Optimal Programming Element.

PLICE® antifuse elements combine small size and high reliability, giving you FPGAs with higher speed, lower cost, greater ease-of-design, and more capacity than any other.



Superior Performance.

The antifuse-based ACT 2, the most predictable FPGA available, incurs short delays in interconnecting logic functions, which means higher speeds to keep pace with your latest microprocessor.

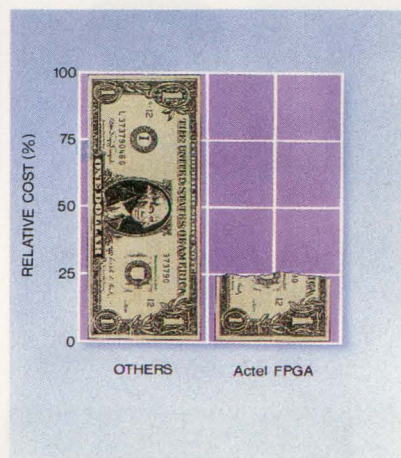

Lower Cost.

PLICE antifuse technology results in smaller die sizes, saving you as much as 75% off the cost of the alternative solution.

Once You Witness The Performance Of Our ACT™ 2 FPGAs, You'll Know The Real Leader Is Actel.

If you plan to move to the superior capacity, flexibility and cost of FPGAs, you should know the facts. Compare us against the industry "leader." You'll find our ACT 2 FPGAs turn in some very impressive numbers indeed.

#1 in architecture. The ACT 2 family's innovative PLICE antifuse technology provides the ideal programming and intercon-

nect elements for high-density FPGAs. Our FPGAs offer superior reliability and design flexibility, and give you the most predictable FPGA performance available. And with more than 1 million FPGAs shipped, Actel has more experience manufacturing antifuse-based FPGAs than anyone. That's experience you can count on.

#1 in speed. The fastest ACT 2 family member—the A1225—offers 2,500 gates of pure speed. With a 4 ns logic delay and system-level speeds up to 66MHz, ACT 2 helps you make the most of your design.

#1 in ease-of-use. With ACT 2, designs are easily captured with standard PLD tools like ABEL™ and PLDesigner-XL™, as well as with your favorite sche-

matic capture program from Mentor Graphics, OrCAD, Valid Logic Systems and Viewlogic. And Actel's Action Logic® System rapidly converts captured designs into programmed Actel devices. For years, our 100% automatic placement and routing has simplified the design process. And it's still faster and easier than any other solution.

#1 in affordability. Our FPGAs also provide the best price/performance available. Actel offers

© 1992 Actel Corporation, 955 E. Arques Ave., Sunnyvale, CA 94086. ACT, PLICE and Action Logic are trademarks or registered trademarks of Actel Corporation. All other products or brand names mentioned are trademarks or registered trademarks of their respective holders.

PGA Market Leader, Thoughts About Who's #1.

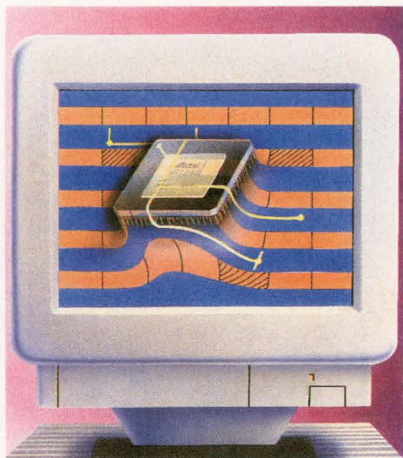

Designing Made Simple.

Actel devices' plentiful routing resources give you 85% gate utilization using 100% automatic placement and routing, letting you place and route a 4,000-gate design in our A1240 chip in only 30 minutes.



Greater Capacity.

With 8,000 gate-array equivalent gates, the A1280 has led the industry in capacity for over 2 years. And it's still the only high-density, high-performance FPGA available in volume production.



Catch Our Next Act.

We're building on this FPGA technology to set new performance levels with our upcoming ACT 3 FPGAs. Whichever ACT you catch, you'll get a long-term partner and the best performance in town.

much quicker time-to-market and complete control of the design process, as well as competitive FPGA



The FPGA Design Guide

And #1 in service and support. Customers can call our technical hotline and talk to a real person—not voicemail. Or customers can use our automatic Action FACTS system to fax themselves quick

answers to their application questions.

We're building on our experience to bring you the most advanced products for any application, and we're committed to establishing a quality, long-term partnership with you for your future success.

Call 1-800-228-3532 for more information on our powerful family of FPGAs. And discover how far the real industry leader can take you.

Broad Family With High Capacity

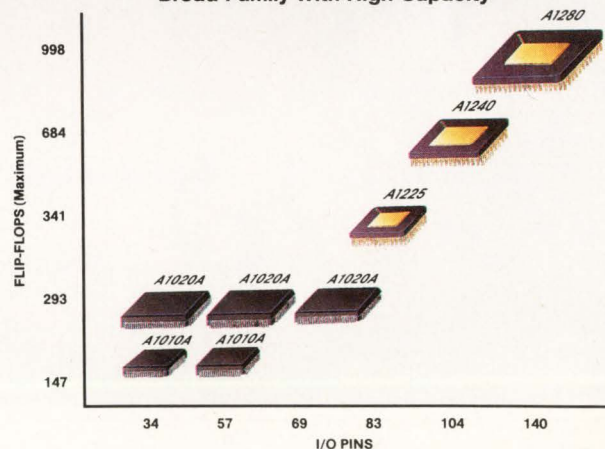

Actel
Risk-Free Logic Integration

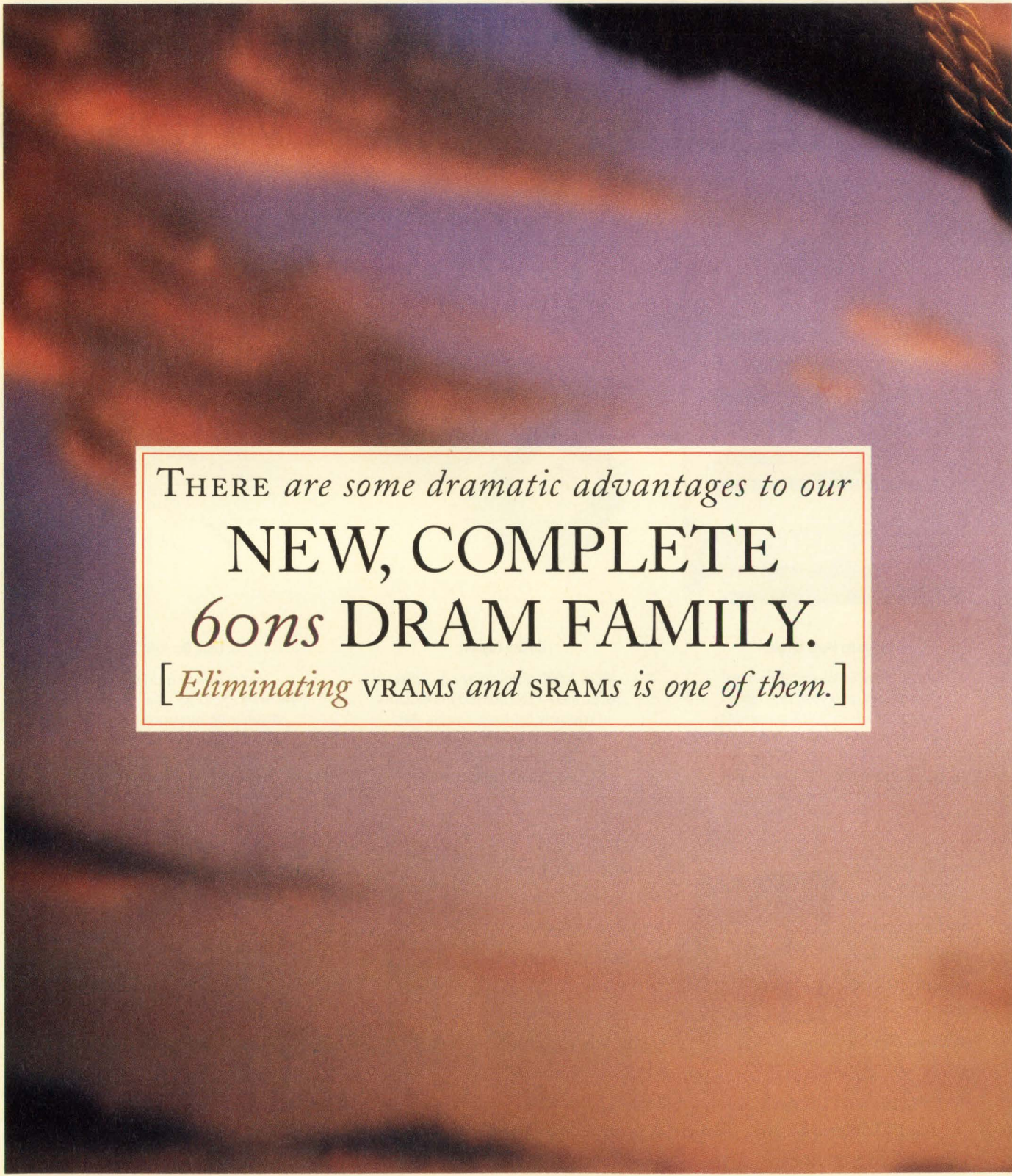

There are some dramatic advantages to our

**NEW, COMPLETE
60ns DRAM FAMILY.**

[*Eliminating VRAMS and SRAMS is one of them.*]

At Samsung, we're not content to have brought the world its first 16-meg DRAM.

We're extending the gains we've made in this important segment of technology, by introducing a com-

plete family of DRAMS at the highest speeds in use—60 nanoseconds.

These are speeds that will let designers of many 386 systems eliminate SRAM cache altogether. And for many high-end graphics

OEMs, it will be possible to eliminate VRAMS.

Of course, one result of those things will be that you'll be able to lower the axe, so to speak, on unwanted costs.

The Samsung Fast DRAMs

PART	ORG.	FEATURES	SPEED
KM41C16000	16MX1	Fast page, 4k ref	60 ns
KM41C16100	16MX1	Fast page, 2k ref	60 ns
KM44C4000	4MX4	Fast page, 4k ref	60 ns
KM44C4100	4MX4	Fast page, 2k ref	60 ns
KM41C4000	4MX1	Fast page	60 ns
KM41C4002	4MX1	Static column	60 ns
KM44C1000	1MX4	Fast page	60 ns
KM44C1002	1MX4	Static column	60 ns
KM41C1000	1MX1	Fast page	60 ns
KM41C1002	1MX1	Static column	60 ns
KM44C256	256KX4	Fast page	60 ns
KM44C258	256KX4	Static column	60 ns



But the advantages don't end there. Reduced parts count will mean greater reliability, lower power consumption, and reduced assembly costs.

We offer the fast DRAM in 1Mb,

4Mb, and even 16Mb densities. Which not only puts us on the cutting edge. But will do the same for you.

For more information, please call 1-800-446-2760 or 1-408-954-7229

today. Or write to DRAM Marketing, Samsung Semiconductor Inc., 3655 No. First St., San Jose, CA 95135.



A Generation AHEAD.

Prepare yourself for HP's brightest LED yet.



HP's new AllInGaP lamps put all your applications in a whole new light.

Presenting Hewlett-Packard's most brilliant lighting innovation to date! These AllInGaP lamps are a full 5 to 10 times more luminous than any other GaP LED available—bright enough to be

AllInGaP intensity ranges from 1,000 mcd to 10,000 mcd, typical. Products shown are not at actual size.

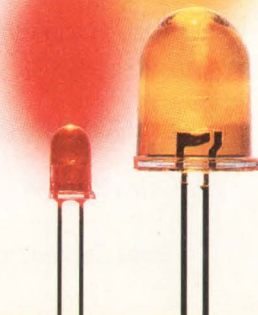

easily visible during any kind of daylight. Yet they don't require a single mA of extra power. In fact, AllInGaP lamps deliver their high-efficiency, high-quality output over a range of drive currents. Making them ideal for all applications—from battery powered to automotive lighting and exterior message boards.

With a device lifetime of more than 100,000 hours, these new LEDs offer reliability that's equally dazzling. And you'll appreciate the flexibility of having these lamps in your choice of amber or reddish-orange.

Other LEDs pale by comparison.

AllInGaP lamps are the world's best and the brightest LEDs available

anywhere—just what you'd expect from HP, long established as a pacesetter in innovative LED technology, reliability, and premier worldwide service.

For a free sample of our AllInGaP lamps, just call **1(800) 752-0900, ext. 3340** in the U.S.* And get the details on the HP LEDs that far outshine the rest.

There is a better way.



*In Canada, call 1(800) 387-3867, ext. 3340.

Analog ASIC gives choice of design basis

Designers of digital ASICs have long had a choice between gate-array, standard-cell, and full-custom designs, each offering a different tradeoff between circuit density and ease-of-design. Raytheon's Semiconductor Division is now giving analog designers a similar choice by adding a standard-cell library to its RPA160 BiCMOS analog tile-array family. Because the tile array and standard cells share the same process, designers can take advantage of the quick turnaround for the array, then migrate their design to standard cells as production levels warrant.

The npn and pnp transistors of the base process have a toggle frequency (f_t) of 4 and 1.5 GHz and a breakdown voltage of 13V. The resulting cells are also fast and include a 500-MHz buffer, a 70-MHz 8-bit DAC, and a 30-MHz ADC. The standard-cell library also includes digital cells, offering both CMOS and ECL logic. The company has CAD software for both PC and workstation platforms for the array and standard-cell library or will handle your design as a turnkey operation. NRE charges for standard-cell designs begin at \$40,000, with prototype delivery in eight weeks. Raytheon Co, Mountain View, CA, (415) 968-9211, FAX (415) 969-8556.

Scalable processor board suits STD 32 Bus

Designs requiring high processing power for industrial applications can take advantage of Ziatech's ZT8911 Scalable Processor Board. The processor board accommodates performance options ranging from a 25-MHz 486SX to a 66-MHz 486DX2. In addition, the replaceable CPU module will also accommodate Intel's next-generation CPU when it becomes available. The board uses the 32-bit capability of the STD 32 Bus with data-transfer rates up to 32 Mbytes/sec.

The scalable processor board can function as the permanent master in multi-processor systems, providing the bus-arbitration function for as many as six temporary masters in an STD 32 Star system. The board provides two interrupt controllers, two DMA controllers, two serial ports, a printer port, a real-time clock, an optional 64-kbyte second-level cache, and as much as 16 Mbytes of RAM. The processor board also has features for industrial applications such as watchdog timers, ac power-fail detect circuitry, timer/counters, and 24 lines of general-purpose digital I/O. The board occupies two

card slots on the backplane. Single-unit price is \$3500. Ziatech, San Luis Obispo, CA, (805) 541-0488, FAX (805) 541-5088.

120-MHz frequency generator costs \$495

Four independent phase-locked-loop frequency sources on the GT310 let you generate frequencies from 360 kHz to 120 MHz. In addition, one of the four channels includes synthesis down to 0.0024 Hz, generating counted bursts, and precision pulse widths. All channels drive a 50Ω load with TTL-compatible levels. Frequency step size is less than 0.8% of output frequency. The PC/AT plug-in board comes with software for a virtual front panel, drivers, and library functions for Micro-soft C or QuickBasic. Guide Technology, San Jose, CA, (408) 246-9905.

Add a solder mask to multilayer pc-board prototypes

When you need a prototype pc board fast, you can use a variety of pc-board prototyping systems to put one in your hands in less than one day. Unfortunately, you often have to give up im-

portant features you take for granted in a production pc board, such as multilayer designs with solder masks. Direct Imaging has now added dry-film solder-mask capability to their multilayer prototyping system, letting you create pc boards with solder masks that are as big as 11 × 14 in. and have 12 layers. The solder mask reduces bridging and electrical shorts when the pc board is soldered and provides an environmental barrier. The System Two Soldermask Station is \$2995. Complete multilayer prototyping systems including the solder-mask station are less than \$50,000. Direct Imaging, West Lebanon, NH, (603) 298-8383, FAX (603) 298-5257.

Software tests embedded systems

Texas Instruments' Scan Engine is a testability software package currently under development. The package will provide scan-based testing in embedded systems, eliminating external field-service test equipment. The software eliminates the test equipment because it can test anything that initiates and executes with boundary scan, such as built-in self-test, interconnect, functional, device, or logic cluster testing.

The software lets you embed GO/NO GO tests and

Text continued on pg 20

Text continued from pg 19

logging capabilities for batch test programs. The package is portable ANSI C source code that reads serial scan vectors from memory and applies those vectors to the unit under test with the end-user application. Designers receive the source code for the software so they can compile it on their target μP or μC . The source code is used for test application and response retrieval, response logging options, and portability to the embedded environment. User-definable parameters, such as the memory location of the test data, let you customize the test application to the target system. The licensed list price for the software package is \$12,000. The company will charge a nominal royalty fee per unit shipped. Texas Instruments, Semiconductor Group, Dallas, TX, (214) 995-6611, ext 3990.

Data converter adds serial link for remote sensing

Many remote-sensing applications use an A/D converter at the sensor end and report data back to the host over a serial link. Now a single IC can handle all of those tasks. The ML2223 combines an A/D converter, S/H circuit, voltage reference, RS-232C UART, and baud-rate generator into one 16-pin plastic DIP. The device's base A/D converter uses a self-calibrat-

ing algorithmic successive-approximation technique to provide 12 data bits with one sign bit for an input-voltage range of -5 to $+5V$. The device can provide data on command with a conversion time of $45.6 \mu\text{sec}$, or send a continuous stream of data over the serial link. The UART will handle RS-232C data rates as great as 19.2 kbps and RS-422 data at rates of 200 kbps. Samples are available for \$14.50 (1000), with full production scheduled for September. Contact Micro Linear, San Jose, CA, (408) 433-5200.

Port graphics applications to Sun platforms

If you want to port Silicon Graphics (SGI) applications to a Sun SPARCstation, you can use a \$900 software package called Nth Portable GL to accomplish the task within a few days, instead of the months the job might otherwise require. The program provides such high porting speeds because it supports almost all of the 478 SIG Iris GL V4.0 calls and provides a font manager and mixed-windowing functions. The program uses Sun's native XGL graphics protocol, so the ported application will work with every Sun graphics board. Nth Graphics, Austin, TX, (512) 832-1944, FAX (512) 832-5954.

Engineers work for education

The steady decline in mathematics and science achievement of elementary and secondary students has made it increasingly difficult for American corporations to compete in the world marketplace. To change this trend, engineering professionals are taking to the schools. Engineers for Education is a nonprofit association of 45 engineering professional societies with the objective of recruiting 100,000 engineers as volunteers to improve math and science education in elementary and secondary schools throughout the US. Volunteers will serve as an additional resource for schools' math and science teachers—enhancing the caliber of education for our students. The group is establishing local coalitions that will work closely with individual schools and school boards to ensure that the programs respond effectively to the schools' needs.

The group offers many of programs through which engineers can volunteer. Activities depend on the interests and abilities of the volunteer and the needs and desires of the principal and teachers in each local school. Specific assignments are mutually agreed to by all parties. Typical activities include conducting classroom demonstrations and presentations, participating in career days, sponsoring or leading science and technology clubs, arranging field trips, providing mentorship, tutoring individual students, and more.

Volunteers can choose from a variety of programs that cater to specific age groups. For fourth through sixth graders, the group sponsors three programs: "A World in Motion" is a partnership of professional engineers assisting elementary school teachers in motivating students and bringing excitement and relevance to physical science and mathematics. "MAS" is a collaborative program designed to increase interest and achievement in math and science. It was originally used in communities along the Texas-Mexico border but is being expanded nationally. "SKILL" is an after-school and summer program designed to stimulate interest and encourage children. SKILL volunteers work closely with members of the National Action Council for Minorities in Engineering Inc.

Patterned after after-school sports, "Mathcounts" is designed for seventh- and eighth-grade students. "Mathcounts" combines a "coaching" component at the school level with a series of competitions at local, state, and national levels. For high-school students (grades 9 to 12), volunteers can work for "TEAMS." TEAMS gives students a chance to apply what they learn in math and science classes to real work situations in a national competition. Finally, "Science by Mail" teams up volunteer scientists with children as pen pals.

For more information about these programs or Engineers for Education, call the EFE hotline at (800) 489-0348. For more information on "Science by Mail," call (617) 589-0437. Engineers for Education, 39 Old Ridgebury Rd, Danbury, CT 06817.

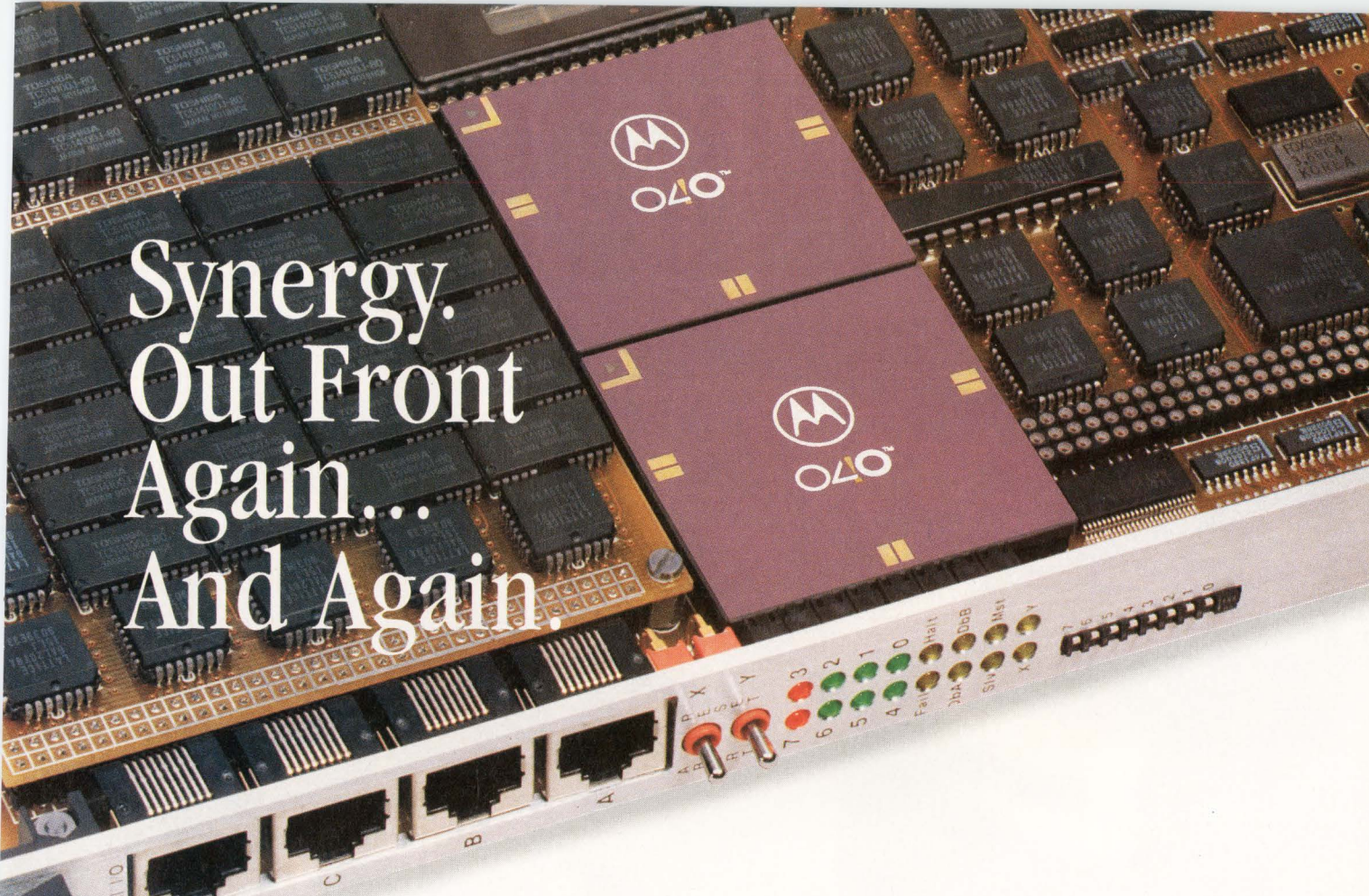

Synergy. Out Front Again... And Again.

The New Dual '040 VME SBC: Faster, More Efficient and Lower Cost Than Any Multi-board Solution

Get on-board multiprocessing and an astounding **40 MIPS** throughput, when you power your system with Synergy's new SV420 single-slot SBC. The SV420's dual-CPU design means you'll need fewer boards in your VME chassis, with no VMEbus bandwidth bottlenecks between the '040s, and system-wide cost saving of more than 40%.

And even if you don't need multiprocessing right now, the SV420 still puts you out front. Use the second '040 as a super-smart DMA controller. When combined with the SV420's **66 MByte/sec VME64[®]** circuitry, nothing communicates faster over the VMEbus.

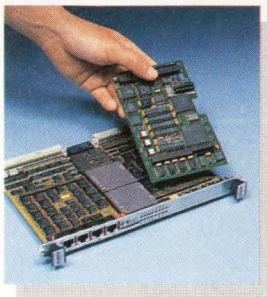

Over a dozen smart, powerful I/O modules fit Synergy's '020, '030, '040 and Dual '040 SBC's.

Add even more on-board power by selecting from Synergy's big list of

high-performance, intelligent plug-on I/O modules – such as our latest Super-VSB module offering 40+ MB/sec over the VSB bus. Or choose another module, from a T1/E1 controller to a super-fast graphics engine, that plugs onto any Synergy SBC.

Better yet, just tell us what you need. We're the company you can talk to about your VME system design problems. You'll find that we listen *and deliver* (every Synergy I/O module on our list started as a customer request). We mean business when we say customer support is our most important mission.

So if you want to be out front in system performance, just be up front with Synergy. Call us today.

CIRCLE NO. 26



SYNERGY
microsystems

Synergy Microsystems, Inc.
179 Calle Magdalena, Encinitas, CA 92024
(619) 753-2191 FAX: 619-753-0903

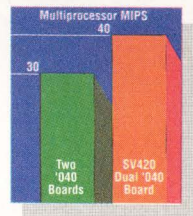

RF TRANS

Over 80 off-the-shelf models...



Having difficulty locating RF or pulse transformers with low droop, fast risetime or a particular impedance ratio over a specified frequency range?...Mini-Circuits offers a solution.

Choose impedance ratios from 1:1 to 36:1, in connector, TO-, flatpack, surface-mount, or pin versions (plastic or metal case built to meet MIL-T-21038 and MIL-T-55831 requirements*). Coaxial connector models are offered with 50 and 75 ohm impedance; BNC standard, other types on request.

Ultra-wideband response achieves low droop and fast risetime for pulse applications. Ratings up to 1000M ohms insulation resistance and up to 1000V dielectric voltage. For wide dynamic range applications involving up to 100mA primary current, use the T-H series. Fully detailed data appear in our 740-pg RF/IF Designer's Handbook.

Need units in a hurry?...all models are covered by our exclusive one-week shipment guarantee. Only from Mini-Circuits.

*units are not QPL listed.

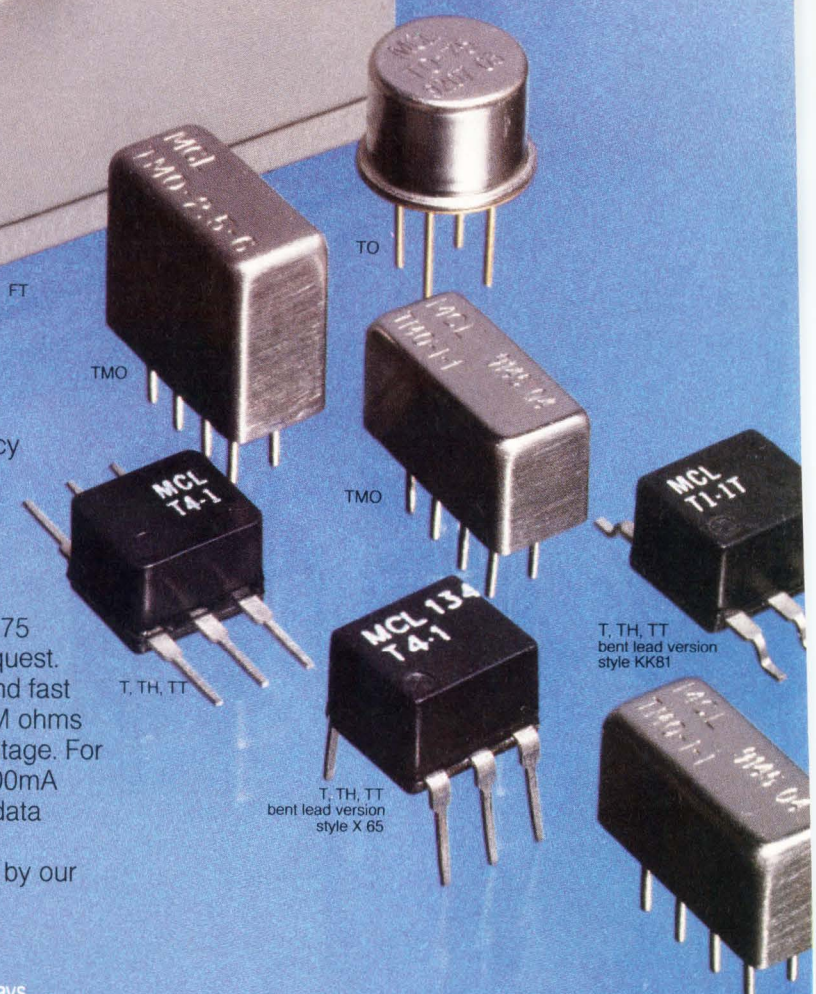

finding new ways ...
setting higher standards

 **Mini-Circuits™**

WE ACCEPT AMERICAN EXPRESS AND VISA

P.O. Box 350166, Brooklyn, New York 11235-0003 (718) 934-4500 Fax (718) 332-4661

Distribution Centers / NORTH AMERICA 800-654-7949 • 417-335-5935 Fax 417-335-5945 EUROPE 44-252-835094 Fax 44-252-837010



For detailed specs on all Mini-Circuits products refer to • THOMAS REGISTER Vol. 23 • MICROWAVES PRODUCT DIRECTORY • EEM • MINI-CIRCUITS' 740-pg HANDBOOK

22 • EDN September 17, 1992

F 72 REV. D

FORMERS

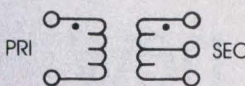
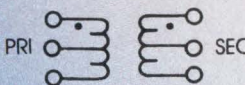
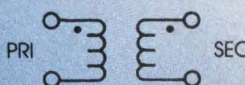
3KHz-1500MHz from \$195

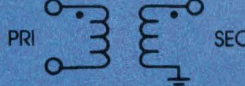
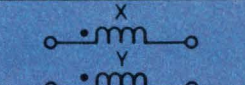
	MODEL NO.	Ω RATIO	FREQUENCY MHz	INSERTION LOSS			PRICE \$ Qty. (1-9)			
				3dB MHz	2dB MHz	1dB MHz				
A* 	T	T1-1T	1	.05-200	.05-200	08-150	2-80	4.45		
		T1-6T	1	.015-300	.015-300	021-150	03-50	6.95		
		T2-1T	2	.07-200	.07-200	1-100	5-50	4.95		
		T25-6T	2.5	.01-100	.01-100	02-50	50-20	4.95		
		T3-1T	3	.05-250	.05-200	1-200	5-70	4.95		
		T4-1	4	2-350	2-350	35-300	2-100	3.25		
		T4-6T	4	.02-250	.02-250	05-150	01-100	4.45		
		T5-1T	5	3-300	3-300	6-200	5-100	4.95		
		T8-1T	8	0.3-140	0.3-140	0.7-90	1-60	7.95		
		T13-1T	13	3-120	3-120	7-80	5-20	4.95		
		T16-6T	16	.03-75	.03-75	.06-30	1-20	5.65		
		T4-1H	4	10-350	10-350	15-300	25-200	5.95		
		TH	TMO1-1T	1	.05-200	.05-200	08-150	2-80	7.95	
			TMO2-1T	2	.07-200	.07-200	1-100	5-50	8.45	
			†TMO2.5-6T	2.5	.01-100	.01-100	02-50	05-20	8.45	
			†TMO3-1T	3	.05-250	.05-250	1-200	5-70	7.95	
TMO4-1	4		2-350	2-350	35-300	2-100	6.25			
TMO	TMO5-1T	5	3-300	3-300	6-200	5-100	8.45			
	TMO13-1T	13	3-120	3-120	7-80	5-20	8.45			
B* 	TT	TT1-6	1	.004-500	.004-500	02-200	1-50	6.95		
		TT15-1	1.5	.075-500	.075-500	2-100	1-50	5.95		
		TT25-6	2.5	.01-50	.01-50	025-25	05-10	6.45		
		TT4-1	3	.05-200	.05-200	2-50	1-30	5.95		
		TT4-1A	4	0.1-300	0.1-300	0.2-250	0.3-180	6.95		
		TT25-1	25	.02-30	.02-30	05-20	1-10	9.95		
		TTMO	TTMO25-1	25	.02-30	.02-30	05-20	1-10	11.95	
			TTMO1-1	1	.005-100	.005-100	01-75	05-40	11.45	
			TTMO4-1A	4	0.1-300	0.1-300	0.2-250	0.3-180	13.95	
		C 	T	T1-1	1	.15-400	.15-400	35-200	2-50	3.25
				T1.18-3	1.18	0.01-250	0.01-250	0.02-200	0.03-50	5.65
T1-6	1			.01-150	.01-150	.02-100	.05-50	5.65		
T15-1	1.5			1-300	1-300	2-150	5-80	4.45		
T15-6	1.5			.02-100	.02-100	05-50	01-25	5.65		
T25-6	2.5			.01-100	.01-100	02-50	05-20	4.45		
T4-6	4			.02-200	.02-200	05-150	1-100	4.45		
T9-1	9			.15-200	.15-200	3-150	2-40	3.95		
T16-1	16			3-120	3-120	7-80	5-20	4.45		
T36-1	36			0.3-20	0.3-20	05-10	1-5	6.95		
TO	TQ-75			1	10-500	—	10-500	40-250	6.95	
	T1-1H			1	8-300	8-300	10-200	25-100	5.95	
	T9-1H			9	2-90	2-90	3-75	6-50	6.45	
TH	T16-1H			16	7-85	7-85	10-65	15-40	6.45	
TMO	TMO1-02			1	1-800	1-800	2-500	—	9.45	
	TMO1-1			1	.15-400	.15-400	35-200	2-50	6.25	
	TMO15-1			1.5	1-300	1-300	2-150	5-8	8.45	
	†TMO2.5-6			2.5	.01-100	.01-100	02-50	05-20	7.95	
	†TMO4-6			4	.02-200	.02-200	05-150	1-100	7.95	
	TMO6-1			6	3-200	3-200	5-150	5-50	7.95	
	TMO9-1			9	.15-200	.15-200	3-150	2-40	7.95	
	TMO16-1	16	3-120	3-120	7-80	5-20	7.95			
D 	T	T2-1	2	.050-600	.050-600	1-400	5-200	3.95		
		T3-1	3	5-800	5-800	2-400	—	4.45		
		T4-2	4	2-600	2-600	5-500	2-250	3.95		
		T8-1	8	15-250	15-250	25-200	2-100	3.95		
		T14-1	14	2-150	2-150	5-100	2-50	4.95		
		TMO	TMO2-1	2	.050-600	.050-600	1-400	5-200	7.95	
			TMO3-1	3	5-800	5-800	2-400	—	8.45	
			TMO4-2	4	2-600	2-600	5-500	2-250	7.95	
			TMO8-1	8	.15-250	.15-250	25-200	2-100	7.95	
			TMO14-1	14	2-150	2-150	5-100	2-50	8.45	
FT	FT122-1	1.22	.005-100	.005-100	01-50	05-25	35.95			
	FT15-1	1.5	1-400	1-400	5-200	1-100	35.95			
E 	FTB	FTB-1	1	2-500	2-500	5-300	1-100	36.95		
		FTB1-6	1	01-125	01-125	05-50	1-25	36.95		
		■FTB-1-75	1	5-500	5-500	5-300	10-100	36.95		
F 	T	T-622	1	0.1-200	0.1-200	0.5-100	5-80	3.25		
		T626	1	0.01-10	0.01-10	0.2-5	.04-2	3.95		
		T2-613.1								

■ Denotes 75 ohm models

* FOR A AND B CONFIGURATIONS
 Typical Amplitude Unbalance
 0.1 dB over 1 dB frequency range
 0.5 dB over entire frequency range
 Typical Phase Unbalance
 1.0° over 1 dB frequency range
 5.0° over entire frequency range

case styles

T, TH, case W 38. X 65 bent lead version. KK81 bent lead version
 TMO, case A 11, + case B 13. FT, FTB, case H 16
 NEW TC SURFACE MOUNT MODELS from 1 MHz to 1500 MHz

CIRCLE NO. 27

We've just tested the performance of our new i960 CF processor.

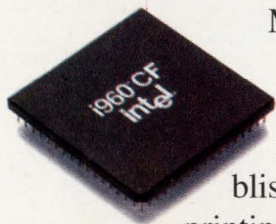

Make no mistake. This is no middle-of-the-road processor. It's our new superscalar i960™ CF chip. And it delivers blistering speed to your high-end printing, imaging, communications and networking applications. Simply put, it outruns every 32-bit embedded processor on

the market—and we have over 25 benchmarks to prove it.

You see, only our i960 RISC architecture brings superscalar processing with multiple operations per clock to embedded applications. Our new i960 CF processor is highly integrated with optimized data and instruction caches for throughput up to

© 1992 Intel Corporation. i960 is a trademark of Intel Corporation.



twice that of our i960 CA chip. Which makes it the most advanced technology available for embedded applications.

If you're already using our i960 CA processor, you can quickly shift up to higher performance with full code and pin compatibility. And, of course, we offer a comprehensive array of Solutions960 development tools to

further speed up your design process.

So step on it. Call 800-548-4725 and ask for literature packet A9A51 for complete benchmarks. And learn what your applications can do with a faster engine.

intel®

An Object Less For Absolutely Pr

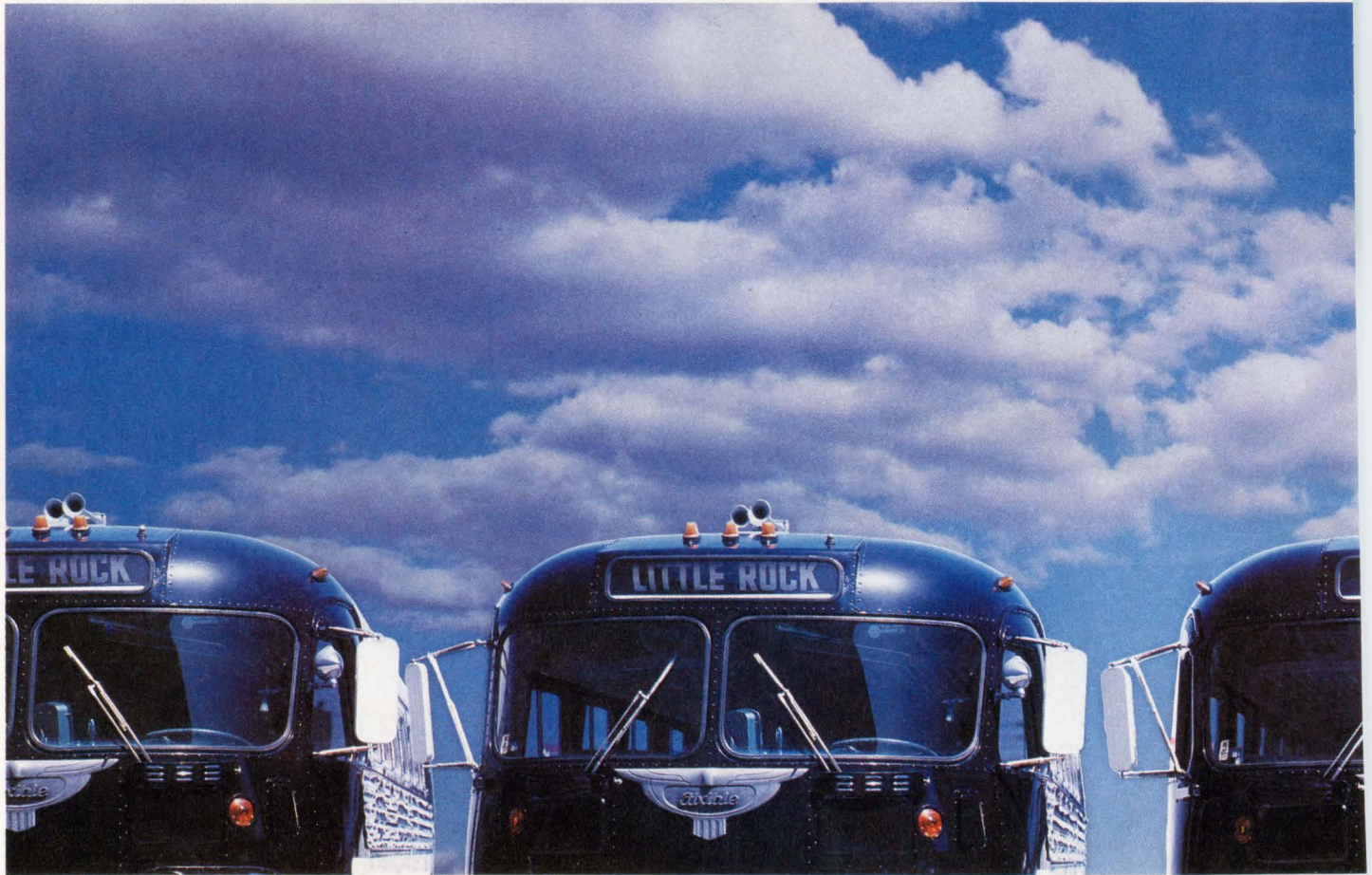

The MACH™ Family From AMD: The Fastest, Most Predictable High Density PLDs Available Today.

Oops! You're a couple of nanoseconds shy this time, and it's going to hurt. Perhaps next time you'll choose a more predictable vehicle. And the most predictable high speed, high-density PLDs available are the MACH family from AMD.

Only the MACH Family offers you worst case delays of 15ns* or

less. Because MACH parts are essentially PAL® devices, just like the kind you already know. Not some hybrid

PLD/FPGA, where you don't know how it performs — until it's too late. So you don't have to guess your delays or clock speeds, you just read them right off our datasheet.

But they're not just ordinary

Model Number	Equiv. Gates	Macro Cells	Max. Delay	System Speed	I/O Pins	Hard-Wired Option
MACH 110	900	32	12ns	66.7 MHz	44	MASC 110
MACH 210	1800	64	12ns	66.7 MHz	44	MASC 210
MACH 120	1200	48	15ns	50 MHz	68	MASC 120
MACH 220	2400	96	15ns	50 MHz	68	MASC 220
MACH 130	1800	64	15ns	50 MHz	84	MASC 130
MACH 230	3600	128	15ns	50 MHz	84	MASC 230

*In applications with a full 16 product terms. Every MACH part is specified using real-life conditions with all outputs switching.

on In The Need edictable Speed.



PAL devices. They're bigger and better, with densities ranging from 900 to 3600 gates, all in our submicron CMOS technology.

Nor will you face unpredictable delays when you order. Because the entire MACH family is now shipping in volume.

Working with them is equally predictable. You don't have to learn any new techniques, just use the software and test equipment you already know. Like ABEL, CUPL, OrCad, and others. Not to mention the software and support from over 20 FusionPLD vendors — all prepared to bring your products to market on time.

And each MACH part can migrate easily to a pin-

compatible, hard-wired MASC™ counterpart for high volume. So you can get the volume you need, without redesign, NRE, or unforeseen delays.

So call AMD today at **1-800-222-9323**. And let the MACH family make your design cycle a whole heck of a lot safer.



Advanced Micro Devices

© 1992 Advanced Micro Devices, Inc. 901 Thompson Place, P.O. Box 3453, Sunnyvale, CA 94088. PAL is a registered trademark, and MACH and MASC are trademarks of Advanced Micro Devices, Inc. All brand or product names mentioned are trademarks or registered trademarks of their respective holders.

CIRCLE NO. 29

OrCAD Turns Another Page

OrCAD's Schematic Design Tools is the most popular electronic design automation product in the world. Designed by engineers for engineers, its "intelligent" interface and power features are a favorite for electronic designers in huge manufacturing companies and small job shops alike.

Schematic Design tools offers incredible value in a single package: **30+ industry netlist formats** (or write your own); support for hundreds of displays, printers and plotters; the innovative ESP framework, which allows the user to seamlessly transfer information between OrCAD products and many third party products.

In the 60+ libraries are IEEE, TTL, ECL, CMOS symbols and much more. In fact, Schematic Design Tools has over **20,000 unique library parts**. Parts may be rotated, mirrored, converted to DeMorgan equivalent with the press of a single key.

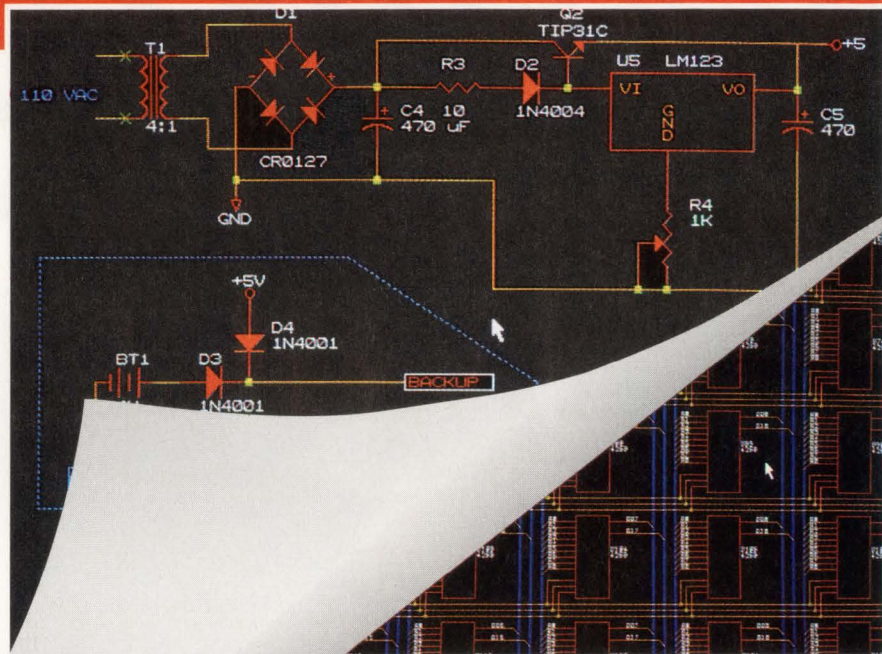

Introducing Schematic Design Tools 386+

*Designed specifically for 386/486 based PCs.
A true protected-mode product using 32 bit
addressing and data structures for maximum
performance on today's faster PCs.*

Features and enhancements:

- Virtually unlimited design size
- Virtually unlimited netlisting capacity
- Faster netlisting due to improved memory management and 386/486 optimization
- Compatible with all OrCAD products including OrCAD PCB II, Programmable Logic Design Tools 386+, and Digital Simulation Tools
- Virtually unlimited graphic part size
- All existing SDT designs and libraries may be easily translated into Schematic Design Tools 386+ format.
- Schematic Design Tools 386+ is compatible with nearly every known printed circuit board, programmable logic and FPGA layout system.

**Call today
for information
including a FREE
demonstration disk.
(503) 690-9881**

OrCAD®

The Better Solution

3175 N.W. Alcock Drive • Hillsboro, OR 97124 USA
(503) 690-9881 • Fax (503) 690-9891

We listen

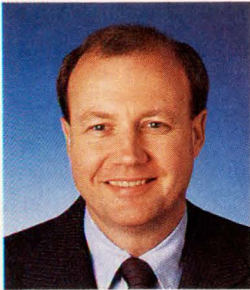

We're pleased to listen to what readers tell us. Even when we may not like what you have to say, we listen to your comments, criticisms, and ideas. We appreciate your writing, phoning, and keeping in touch. Even if you simply print a quick note on a bingo card, we read it.

As part of our continuing program to improve EDN, we've been listening closely to what you have been telling us about your needs for information. You've said many times that products and technology are important, followed by information about career planning, education, and professional issues. So, starting in October, you'll see more of an emphasis on those topics in our companion tabloid edition. Also, to dispel any confusion, both our magazine and our tabloid will simply carry the EDN logo, but you'll see the subheading, "Products & Careers" on the tabloid. What you'll see and read isn't a radical shift for us or for you—we've been covering products, technology, and careers since we started tabloid editions several years ago.

You'll also see a new emphasis on direct communications between you and our editors. We'll routinely ask your opinions on pressing technical and professional issues. We'll also ask you to tell us which products you like and which ones you don't. And we'll want to know which companies you would like to work for and which ones you wouldn't. You'll see your responses in articles that feature poll results and comments from many readers. Numer-

ous articles will ask for reader feedback. In addition to your opinions, EDN Products & Careers will bring you the faces and the stories of your colleagues in engineering and management.

Besides our regular and new career information we'll also run product-preference polls that let you tell us what you think about products. We'll publish the results with no holds barred. If you and your colleagues pan a product, we'll let you know. All too often, publications become cheering sections for advertisers. Not in EDN. To help you find the products you need, we've aligned the product classifications we use in EDN Magazine and in our sister Products & Careers tabloid.

Reading any publication should be interesting and enjoyable. We're adding several new columnists, and you'll get their biased and unbiased opinions on everything from the latest products and technologies, to the best engineering bookstores, to the neatest high-tech hangouts, museums, and other places you want to know about. Columns will cover technical topics from analog circuit design to power-supply design, too. Also, if you've got a puzzle that will stump your colleagues, send it in.

We're pleased that you've been telling us what you think of EDN. I'm sure you'll be pleased with the Products & Careers tabloid edition of EDN you'll receive in October. After you read a few issues of EDN Products & Careers, let us know what you think. We'll be listening.



Jesse H. Neal
Editorial Achievement Awards
 1990 Certificate, Best Editorial
 1990 Certificate, Best Series
 1987, 1981 (2), 1978 (2),
 1977, 1976, 1975

American Society of
Business Press Editors Award
 1991, 1990, 1988, 1983, 1981

Jon Titus
 Editor

Send me your comments via fax at (617) 558-4470, or on the EDN Bulletin Board System at (617) 558-4241 300/1200/2400, 8,N,1; on 9600-bps modems, try (617) 558-4580, 4582, or 4398.

NATIONAL KNOWS NETWORKING

In fact, National is the only silicon supplier to offer solutions across all three major networking standards: Ethernet, Token Ring, and FDDI. We know the market demands improved connectivity, performance, quality, **INTEROPERABILITY** and network management. And at National Semiconductor, we're providing market-driven mixed analog + digital silicon solutions to make all this a reality. Our first **ETHERNET** silicon helped foster the

THE NATIONAL

worldwide acceptance of LANs. In fact, well over 13 million Ethernet adapter cards have been designed using National's silicon — more than all other suppliers combined. National's ST-NIC™ was the first single-chip **10BASE-T** controller to put 10Mbps Ethernet on standard unshielded twisted pair wire. And our newest 16- and 32-bit solutions are making the first "Network Ready" PCs, MACs and peripherals a reality. National is also developing solutions to simplify the role of **NETWORK MANAGEMENT.** Our Product of the Year Award-winning RIC™ + SONIC™ chipset is the first to fully support the IEEE 802.3 mandatory and optional repeater management requirements. We're

also creating silicon solutions to ensure full interoperability of **MIXED MEDIA** and multiple protocol environments and to deliver new desktop services and applications. We've joined efforts with IBM, the leader in Token-Ring technology, to make it easier for your customers to seamlessly connect Ethernet and **TOKEN-RING** protocols. And we recently introduced TROPIC™, the industry's first fully-integrated single-chip Token-Ring controller. That's just the first step in a joint IBM-National relationship that will deliver new levels of flexibility to the world of networking.

STANDARD.

National is also providing new levels of performance with breakthroughs like **100BASE-T™** technology and our upcoming 2-chip FDDI solution. 100BASE-T is the first silicon solution proposed for **FDDI** across twisted pair copper wire. These solutions will drive affordable FDDI performance to the desktop. We're supplying proven "National Standard Silicon" today. And together we're **SETTING THE STANDARDS** that will take you where networks are going in the future. For more information, give National a call at **1-800-NAT-SEMI (Ext 191)**. We'll show you why no one knows networking like National Semiconductor.

©1992 National Semiconductor Corporation.



Memories of Tomorrow. Available Today.



H I G H S P E E D

For fast answers, call us at:

USA Tel:1-800-632-3531. Fax:1-800-729-9288. Germany Tel:0211-650302. Fax:0211-6503490. The Netherlands Tel:040-445-845. Fax:040-444-580. Sweden Tel:08-753-6020. Fax:08-755-3506.
France Tel:1-3067-5800. Fax:1-3946-3663. Spain Tel:1-504-2787. Fax:1-504-2860. Italy Tel:02-6709108. Fax:02-66981329. UK Tel:0908-691133. Fax:0908-670290. Ireland Tel:01-6794200.
Fax:01-6794081. Hong Kong Tel:755-9008. Fax:796-2404. Taiwan Tel:02-719-2377. Fax:02-719-5951. Korea Tel:02-551-0450. Fax:02-551-0451. Singapore Tel:253-8311. Fax:250-3583.
Australia Tel:03-8878012. Fax:03-8878014. Japan Tel:03-3454-1111. Fax:03-3798-6059.

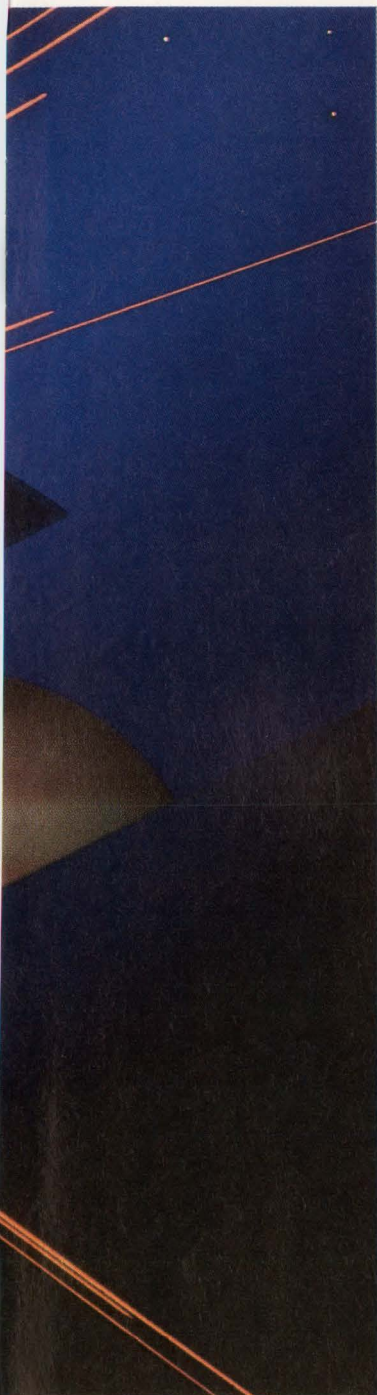

NEC offers the industry's broadest line of high-speed memories.

Memory access is as critical as processing speed in the design of a successful system. For memories fast enough to run with your leading-edge processor, come to NEC. We'll help you select the optimum match for your processor and system parameters from the industry's broadest line of high-speed memories.

NEC memories combine fast-access with high-density.

□ Fast SRAM	1M	15ns	x8, x9, x16, x18
		20ns	x1, x4
	4M	20ns	x1, x4, x8
□ DRAM	4M	60ns	x1, x4
		70ns	x8, x9, x16, x18
	16M	60ns	x1, x4
□ VRAM	2M	70ns	x8
□ SRAM	256K	55ns	x8
	1M	70ns	x8

NEC is the front-runner in memory design because we give you more speed and more choice, including low-voltage and thin-package options. For memories fast enough to keep pace with the future, call NEC today.

From the leader in memory technology

FACE IT. WITH TODAY'S FASTER SYSTEMS, YOU'VE GOT A

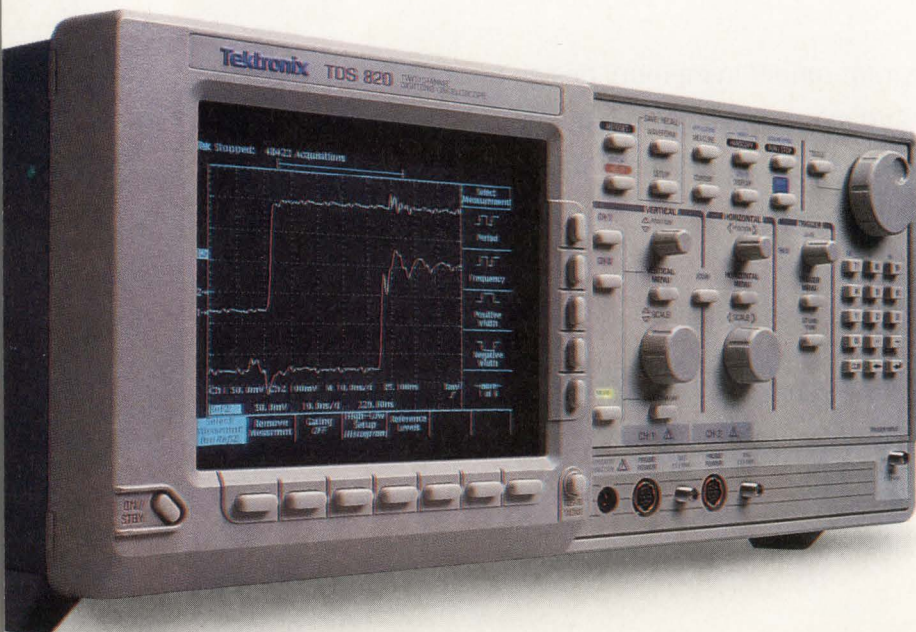



NOT LESS

MARGIN

FOR ERROR. And that's exactly why we built the TDS

820. The digital oscilloscope that's accurate to within **2 ps**

and provides time resolution in femtoseconds. In fact, at 0.40ps

with a **6 GHz** bandwidth, now even the narrowest timing

margin is nothing to be afraid of. Combine that with the intuitive

TDS user interface, and applications like device characterization

require nothing more than the push of a button. Better still, there

is another aspect of the **TDS 820** that, upon compari-

son with any so-called competitive scope, will ease your toughest

margin of all: The price tag. **TALK TO TEK/1-800-426-2200 EXT. TDS8**

Tektronix

Test and Measurement

CIRCLE NO. 33

SIEMENS



With Four Times The Performance Of The Competition, Nobody Else In The Field Is Even In The Running.

Our innovative controllers keep you on the fast track of communications.

With our advanced 8-channel Enhanced Serial Communication Controller—the ESCC8 (SAB82538)—Siemens demonstrates once again why we lead the pack in communication IC technology.

The World's First 8-Channel Multi-Protocol Data IC.

The ESCC8 is the latest in a long line of advanced communications controllers which have made us the industry leaders. Like the HSCX (SAB82525) for telecommunications and the ESCC2 (SAB82532), the first 2-Mbit asynchronous multi-protocol communications controller.

The ESCC8 offers a superior price/performance solution for your communications applications. Compared to the standard 2-channel devices, the ESCC8 provides four times the data throughput,

and the fastest speeds in the industry—up to 10 Mbit/sec synchronous and 2 Mbit/sec asynchronous. Which lets you replace four 2-channel devices with one ESCC8, for substantial savings in time, boardspace, and development costs.

The ESCC8 also supports a wide range of protocol options—including X.25 LAPB, ISDN, LAPD, HDLC, SDLC, and both ASYNC and BISYNC—plus easy adaptability to either Intel® or Motorola® microprocessors through the use of a 16-bit data bus interface. For fast, reliable and accurate multi-protocolling.

A New Breed Of Performance ICs.

With 16- or 32-bit CRC handling and 28 programmable universal I/Os, the ESCC8 gives you superior performance in a communications controller. And only the ESCC8 offers a collision detect resolution scheme which provides multiple masters on one bus to prioritize data instructions,

plus 64-byte FIFOs per channel for increased storage capabilities.



2- and 8-Channel Controllers

And Siemens continues to hold a leadership position throughout the rest of the industry, with innovations like the DSP-based

ARCOFI-SP, the world's most advanced speakerphone IC for digital terminals. As well as advancements in CMOS echo cancellation technology which have made us the front-runner in single-chip ISDN U-interface transceivers.

For an ESCC8/ESCC2 evaluation kit, or more information on our full line of innovative communications ICs, call **800-456-9229**. And put yourself on the fast track of communications.

Ask for literature package M12A014.

Siemens
World Wise, Market Smart.

CAE TOOLS FOR WIRELESS SYSTEMS

System simulators meet wireless challenges

DOUG CONNER, Technical Editor



Designers of wireless RF and microwave systems can turn to specialized software tools to help them simulate complex systems efficiently.

Simulating wireless systems requires tools that have the flexibility to simulate systems at a rough block-diagram level, yet can also integrate the results of circuit-level simulations. Furthermore, to be useful, a system simulation must run quickly.

Wireless systems are often complex. The complexity stems not just from the demands of high-frequency analog design of transmitters and receivers. Their complexity is due in part to the fact that wireless systems operate within the RF-to-microwave frequency range where there is great pressure from industry and the government to make efficient use of scarce spectrum. The need to preserve spectrum encourages the use of ever more complex communication techniques to squeeze as many channels as possible into a given bandwidth.

Wireless-system designers also face challenges common to other electronic products. Many wireless systems require portability. The lighter, smaller, and less power consuming, the better. Long battery life is important, but even if great strides are made in the energy density of batteries, most portable systems must remain low-power to minimize the exposure of humans to RF and microwave energy. Efficiency is key. Even if you have a wireless LAN that can plug into the wall for power, you

want an efficient system to minimize the RF energy in your office.

The unknown environment between transmitter and receiver adds additional difficulties to wireless systems. You don't need someone actively trying to jam your transmissions, a consideration in military applications, to have trans-

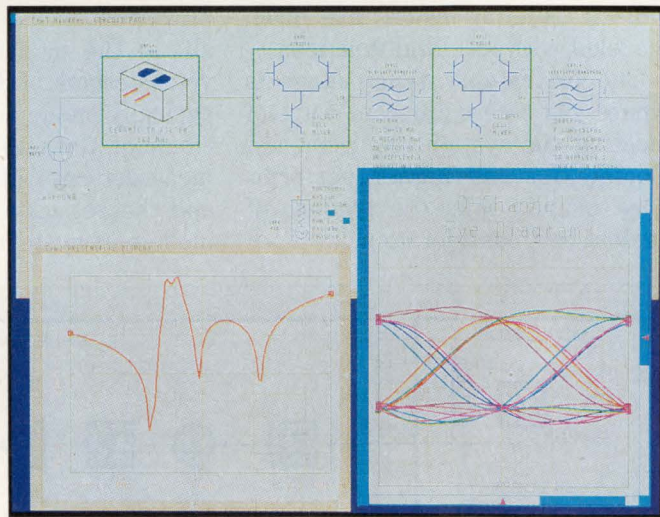

A 900-MHz CT1 digital cordless telephone simulated with the Hewlett-Packard RF Design System shows the receiver's frequency response from 100 to 2200 MHz and an eye diagram of the demodulated performance.

mission problems. Multipath signals caused by reflections from terrain or buildings can impair the signal and degrade system performance. You can evaluate the effects of these transmission problems using simulation with appropriate models for the signal impairments.

To design a wireless system that meets a specification, you need to look at all the function blocks working together to really know if you've designed a suitable system. You can't just throw

CAE TOOLS FOR WIRELESS SYSTEMS

together a simple prototype for RF and microwave work as you might with low-speed analog or digital designs. Simulation or an expensive prototype are your two choices.

If you choose to enlist the aid of simulation during the design process, then you need to focus on the three fundamentals of simulation—models, stimulus, and measurements.

The right model for the job

When you first start a design and are working at the proposal or preliminary-design stage, you may not have specific hardware and detailed models available. You'll often be designing and simulating with generic building blocks for amplifiers, mixers, filters, and whatever function blocks your system requires. These generic building blocks are often modeled with idealized functions.

The preliminary-design stage is where you assess different ways of meeting the system requirements. Complexity and higher performance usually must be traded off against cost considerations.

As the system design begins to stabilize, you want more detailed information out of the simulation, which means you need to start using more refined models. At this point in the design you may still be using functional blocks, but you are modeling the nonideal aspects of those blocks more accurately. Eventually, you may start simulating the system with specific components at the circuit level. If the simulator you are using provides a way to mix high-level functional blocks with circuit-level simulation, you'll be able to make the transition smoothly.

Simulation results are very dependent on how well the models represent the real circuit. With any simulator you'll hope to obtain a library that includes most, or ideally all, of the models you'll need for your designs. Library models are typically made up from combinations of data-sheet information, measurements of actual products, and theoretically derived data. For models of system blocks or circuit

elements that aren't available in a library, you'll have to create the models or obtain them from a company that provides that service.

You can often create components models from data-sheet information, as long as the simulator can use models based on S-parameter data or other readily available data. Another way to create models is to characterize the circuit element with a network analyzer or other test instruments to obtain the necessary data.

Special function blocks that let you easily simulate some of the more complex modulation and demodulation techniques can save you considerable time. For example, function blocks that perform the $\pi/4$ DQPSK (differential quadrature phase shift keying) modulation and demodulation will make it easier to create a simulation of a system using that communication technique than having to create your own function blocks. The trend toward ever more complex communication standards will make the

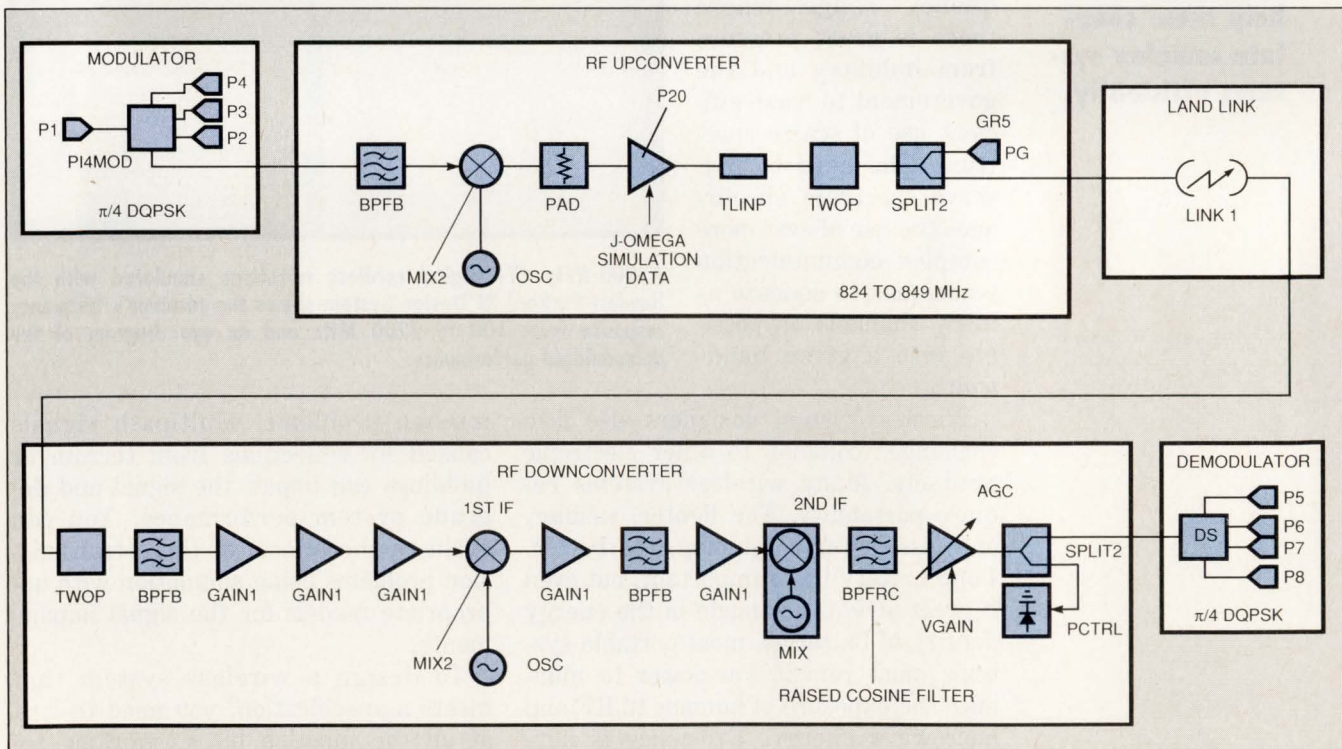

Fig 1—The block diagram shows the IS-54 digital cellular communication system simulated using EEsos's Omnisys simulator.

availability of these specialized modulation and demodulation function blocks even more of an asset.

As your simulation models become more detailed, especially if you start simulating part or all of a design at the circuit-level, simulation times will increase. Different types of simulators not only provide different results, they also vary in the time required to simulate a given circuit.

Linear simulators typically run the fastest. Linear simulation is useful for some parts of systems, but it isn't adequate for general-purpose system simulation. The major drawbacks to linear simulation are the inability to simulate systems through frequency translation devices such as mixers, and the obvious lack of nonlinear results.

Time-domain simulation methods, such as Spice, can provide nonlinear analysis and can also simulate system transients. Some versions of Spice have extensions to better suit them to RF and microwave applications, especially for circuit-level simulations. Simulating a 1-GHz

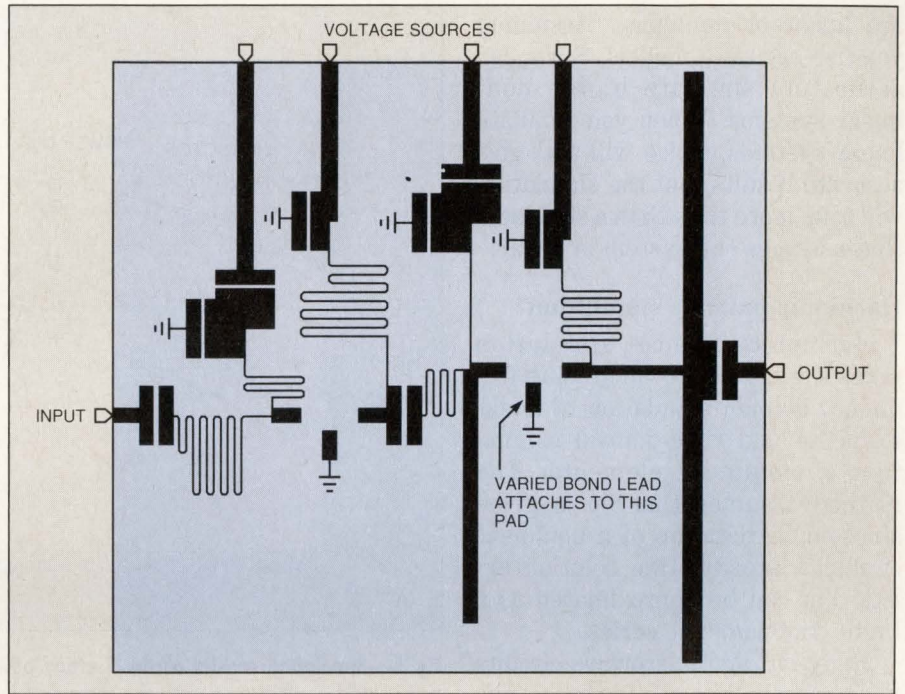

Fig 3—The figure shows the layout of the substrate for the 2-stage power amplifier. Ground symbols are shown for those elements that have vias to the ground plane.

signal requires extremely small (subnanosecond) time increments in the simulation, yet the modulating signal may be in the tens of kilohertz. To simulate the signal for

several milliseconds will take many thousands of time increments, making simulation relatively slow.

Spice analyzes all circuit elements in the time domain, whether they

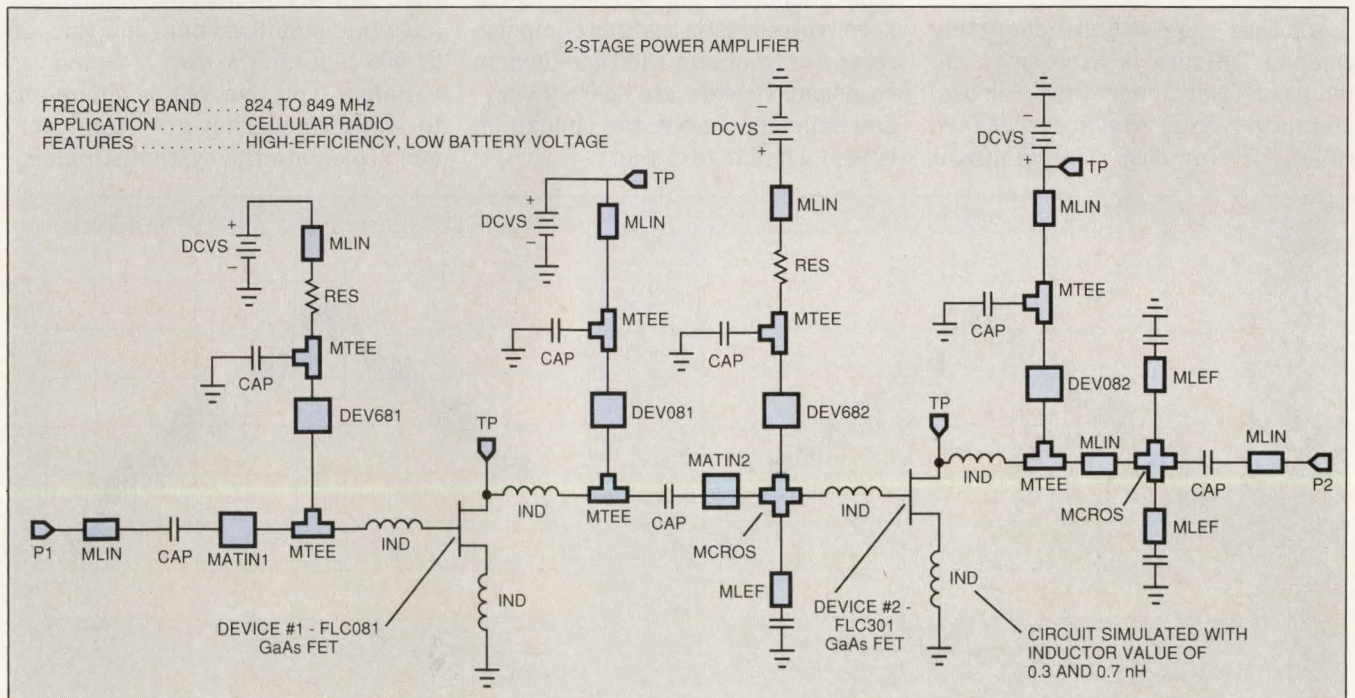

Fig 2—The schematic shows the 2-stage power amplifier module used in the RF upconverter. The inductor indicated is varied in the simulation to determine the effect of changing the bond lead length.

CAE TOOLS FOR WIRELESS SYSTEMS

are linear or nonlinear. Assuming you use accurate models, Spice can accurately simulate highly nonlinear systems. When you simulate linear systems, Spice will also give accurate results, but the simulation will take more time than a simulator that assumes the system is linear.

Harmonic-balance simulation

Harmonic-balance simulation takes the middle ground, using frequency-domain simulation of linear elements and time-domain simulation of nonlinear elements. The method assumes that for a given sinusoidal excitation of a nonlinear circuit, a steady-state solution exists that can be approximated as a finite trigonometric series.

Many RF and microwave circuits have mostly linear elements, primarily passive components, and only a few nonlinear components such as diodes and transistors. If the steady-state response to a sinusoidal input is what you need, then these mildly nonlinear systems can be simulated accurately and much faster than Spice using harmonic balance.

Another approach to simulating complex circuits is a recently announced (December 1992 release) simulator from Hewlett-Packard called HP Impulse. The simulator

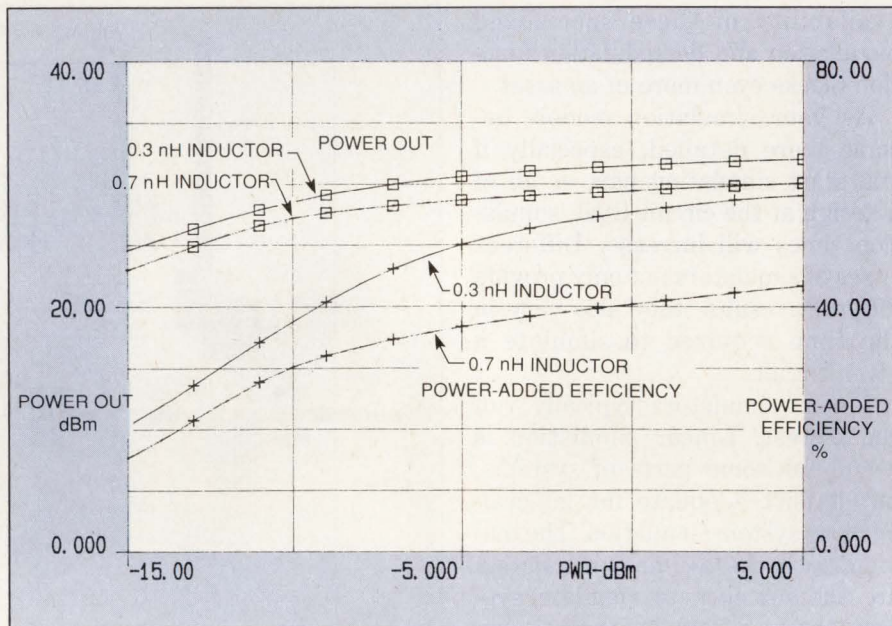

Fig 4—Simulation results of the 2-stage power amplifier show the reduction in gain and power added efficiency with the increased inductance.

incorporates frequency-domain components into a time-domain simulator using a technique that the company calls dynamic convolution. Dynamic convolution converts the frequency response of each frequency-domain component into a finite-impulse response. The incoming signal is convolved with the finite-impulse response to obtain the time-domain response. If there are no frequency-domain components, the simulation is very similar to Spice.

System simulators such as Omnisys from EEsof and Success from Compact operate in the frequency domain. Such simulators cannot simulate system transients, although they can simulate nonlinear elements. Also important is the fact that they are multitone simulators, allowing simultaneous analysis of 64,000 tones in the case of Omnisys.

Before you can put a simulator to work simulating a system, you need to create the system stimulus.

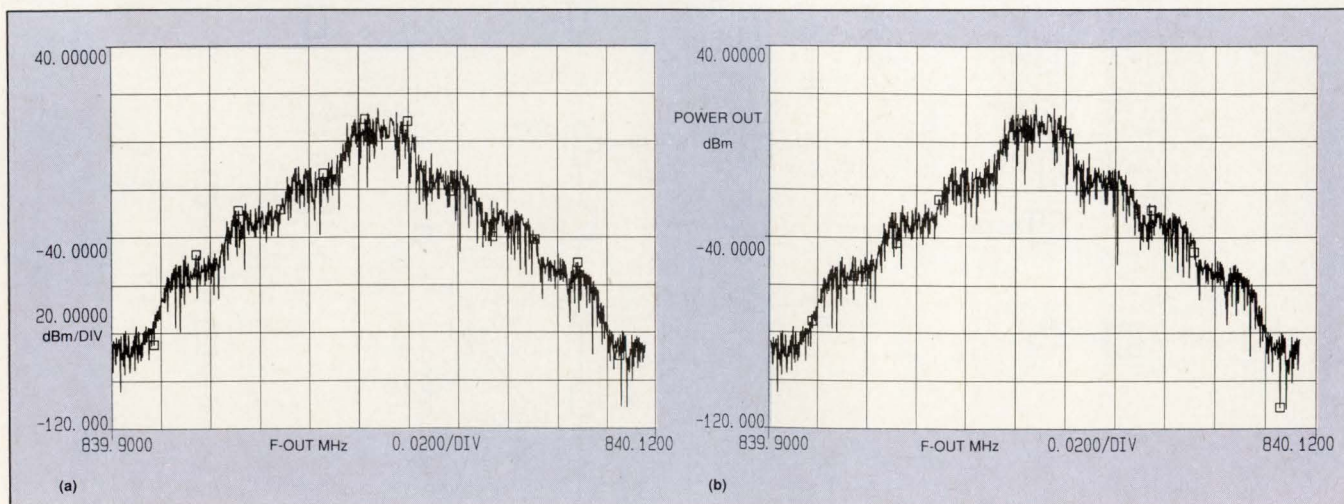

Fig 5—(a) shows the upconverted and amplified spectrum for the circuit with 0.3 nH of inductance and (b) shows the same plot for the circuit with 0.7 nH of inductance.

SIGNAL PROCESSING. GRIZZLY?

Designing a signal processing system can be a bear of a problem—immense, mean, and unforgiving. Engineers grappling with conventional analog or digital technologies face risk and unpredictability at every turn, with no guarantee of success. Designers invest months of development time in a brutal design process that's as lengthy as it is frustrating. Productivity and time to market are devoured in the struggle!

SPROC Technology Tames The Task

At the core of STAR Semiconductor's unique signal processing solution is the SPROC™ chip, the first-ever programmable signal processor using the "Sketch and Realize™" design approach. With a single SPROC chip and a SPROClab development system, signal processing becomes a tame task.

Why wrestle with circuit breadboards crawling with sensitive analog components? Or agonize over line after line of assembly code? One SPROC chip integrates the functionality of hundreds of analog and passive components to cut system costs. And SPROClab employs system-level graphical programming so you can capture designs as signal flow block diagrams. You gain all the benefits of a digital solution—

without writing software!

Stop laboring with trial-and-error debug methods, cumbersome logic analyzers, or software simulators to debug a design! Engineers using SPROC technology download designs **directly** onto actual silicon and interactively debug systems as they execute in **real time!** Using the SPROC chip's unique built-in probe feature, you can easily modify design specifications to tune system performance during execution.



With SPROC technology, engineers focus on designing to create better products in less time.

If you can't bear to see your productivity mauled by the problems of signal processing design, call STAR Semiconductor at **908/647-9400**. We'll send you a brochure and demo disk telling how to tame your next signal processing project.

STAR Semiconductor Corporation
25 Independence Boulevard, Warren, NJ 07059
Telephone: (908) 647-9400 FAX: (908) 647-4755

SPROC Users Slash Development Time

APPLICATION	PREVIOUS TECHNOLOGY	PREVIOUS DEV. CYCLE	SPROC DEV. CYCLE	\$ SAVINGS (1st YEAR)
Secure FSK modem	analog	6 months	3 weeks	\$50,000†
Adaptive noise canceler	DSP	6 months	1 week	\$57,500*
Power supply controller	analog	6 months	1 day	\$60,000*
Closed-loop vibration controller	analog	3 months	2 weeks	\$240,000†

†Total system savings including project overhead, engineering resource, and system hardware costs.
*Estimated savings in engineering resource based on cost of \$10,000 per man month.



The Signal Processing Company

CIRCLE NO. 36



**50MHz SPROC
Now Available!**

CAE TOOLS FOR WIRELESS SYSTEMS

Depending on the type of system you are simulating and where you choose to make the system boundaries, you may be using analog or digital inputs. For digital data transmission, you'll often use pseudorandom bit sequences.

The objective of any simulation is to see how the system performs. You can evaluate system performance easiest if you can get output data in a format that is most useful

for you. Standard plots such as power vs frequency, voltage vs time, or frequency vs time are commonly available. Eye and constellation diagrams are information that you may have available from test equipment and may also be valuable during simulation too.

For digital transmissions, the bit-error rate may be the most informative overall measure of a system's performance. If the bit-error rate

is poor, you'll need other information to diagnose where the problem lies in the system. Budget analysis methods that look at the contribution of each component or system block and compare them to the total are helpful.

DSP methods are having a large impact on wireless communication systems too. Methods that attempt to extract data from a noisy background may be treated as a post processing function on some simulators without DSP function blocks. For these simulators, it's up to you to develop the DSP software algorithm. A more direct approach is to use a simulator that is capable of simulating wireless systems and has DSP function blocks in the simulator.

For example, the Signal Processing Worksystem from Comdisco provides more than 500 system blocks, including many for DSP functions that let you simulate wireless systems. Although the software is capable of simulating complete wireless systems with extensive DSP ability, it concentrates on the baseband signal, the lower frequency signal before modulation, and the lower frequency signal after the demodulation. If you want to simulate the analog details of an RF system between the modulator and demodulator, you'll typically need additional simulation tools, perhaps a circuit-level simulator.

Optimizing for manufacturing

After you've created a satisfactory system design, you can get more utility out of a system simulator that helps you look at manufacturing optimization and yield. By simulating typical component variations, often using Monte Carlo simulation runs, you can see how component variations will affect your design.

Manufacturing optimization methods, such as design centering, help you make sure to choose the

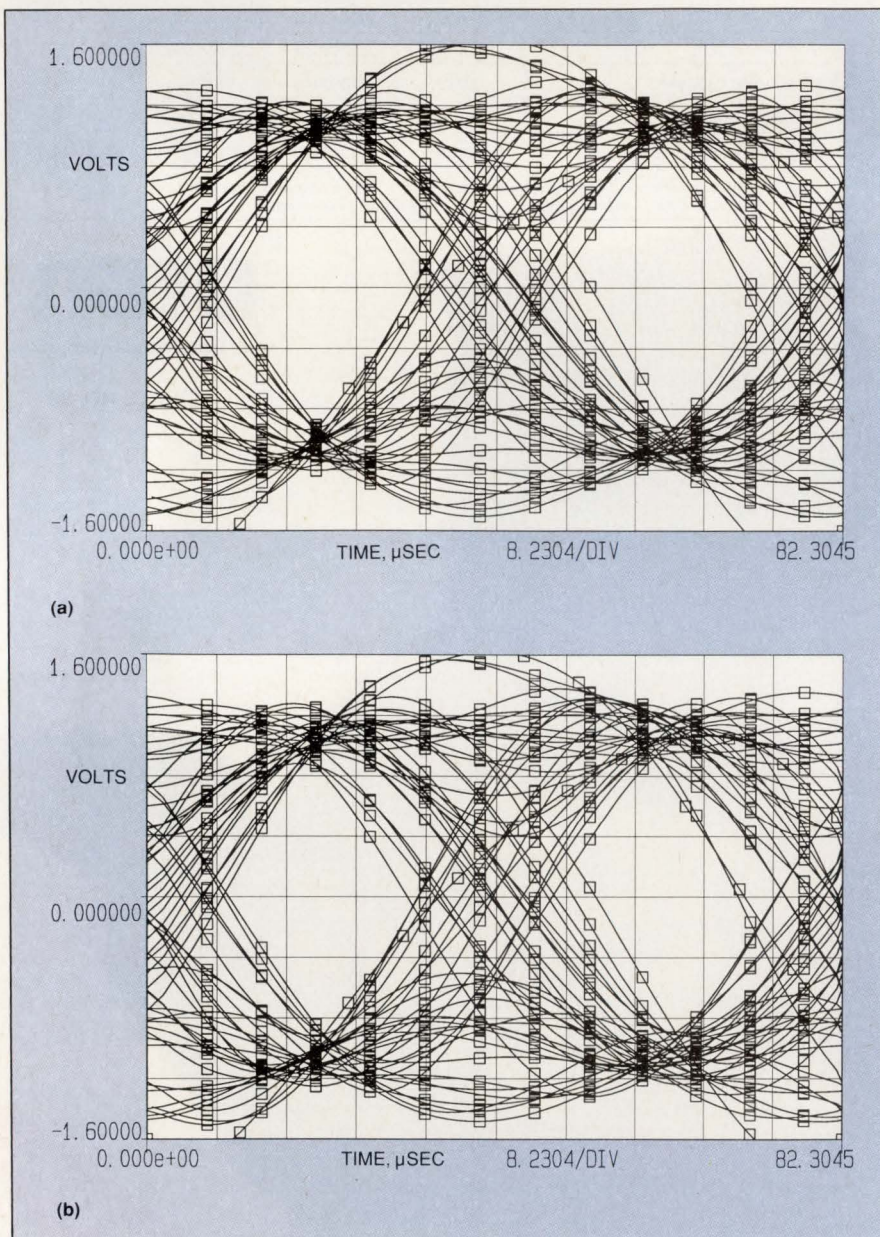

Fig 6—(a) shows the eye diagram of the demodulated signal for the circuit with 0.3 nH of inductance. (b) shows the same plot for the circuit with 0.7 nH of inductance.

MILITARY PRODUCTS OPERATION



Five Star DSP

DSPs don't come any better than Motorola's high-performance Military 96002. It's our premier 96-bit floating point digital signal processor, ideally suited for processor intensive applications such as radar and communications.

Available NOW is this single-chip, dual-port, low-power HCMOS general purpose IEEE DSP, screened in accordance with MIL-STD-883. The SMD version is slated for introduction in fourth quarter 1992.

Ada Supported

Motorola understands the unique demands placed upon Military systems and works closely with software vendors to ensure that its products are fully supported.

Available NOW in the "Pin Grid Array" (PGA) and "Ceramic Leaded Chip Carrier" (CLCC) is the Military 56001 HCMOS, low power, general purpose DSP in full MIL-883 and SMD versions. For price and delivery information and Brochure #BR912/D, contact your local sales office.

For more information on the 96002, order our DSP Brochure #BR1402/D by calling toll-free 1-800-441-2447. Or complete and return the coupon below to Motorola, P.O. Box 20912, Phoenix, AZ 85036.



MOTOROLA

To: Motorola Semiconductor Products, Inc., P.O. Box 20912, Phoenix, AZ 85036

Please send me Motorola's DSP Brochure #BR1402/D.

567EDN091792

Name _____

Title _____

Company _____

Address _____

City _____

State _____

Zip _____

Call Me () _____

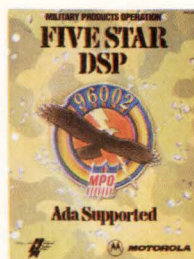

CAE TOOLS FOR WIRELESS SYSTEMS

correct nominal component value to achieve the best system performance with component variation. When trying to minimize the cost of a system while achieving some minimum performance level for all systems, manufacturing optimization methods help you know which components to spend money on for tighter tolerances and when you can save money on loose tolerance components.

Simulating designs

An example best demonstrates the value of a system simulation tool for a wireless system. The example shown here is a cellular radio using the IS-54 digital cellular communication standard for North America. The system uses the $\pi/4$ DQPSK modulation technique to transmit data at 48.6 kbps. Radio systems designed to this standard are just now starting to appear.

The simulation uses EEsof's Omnisys system simulator for everything except the power amplifier in the upconverter section is modeled using the company's \$29,000 J-Omega RF circuit-level simulator. Fig 1 shows the block diagram of the system. The system simulator is used in this example as a way to examine how a circuit-level design

Table 1—System-level simulators for wireless systems

Manufacturer	Product	Compatible computer systems	Price	Notes
Comdisco Systems	SPW (Software Processing Worksystem)	HP, DEC, Sun workstations	\$25,000	Optional software generates DSP code or VHDL netlist for synthesis of DSP functions. Optional network and protocol simulator.
Compact Software	Success	PCs under Windows or OS-2	\$8000 to \$10,500	The company also offers circuit-level simulators.
EEsof Inc	Omnisys	Unix-based workstations from HP, DEC, Sun, IBM. PCs under OS-2.	\$25,000 (US typical system price)	Unix-based X-Window interface. The company also offers circuit-level simulators.
Hewlett-Packard	Microwave Design System	Workstations from HP, DEC, Sun, IBM. 386/486 PCs.	\$31,000	A circuit-level simulator that uses system-level function blocks for system simulation.
	RF Design System	Workstations from HP, DEC, Sun, IBM. 386/486 PCs.	\$28,093	A circuit-level simulator that uses system level function blocks for system simulation. Available in December 1992.
Tesoft Inc	TESLA	PCs	\$695	

Note: VHDL = VHSIC Hardware Description Language.

change in a power amplifier module affects the whole system.

The 2-stage power-amplifier schematic is shown in Fig 2 and layout of the power-amplifier module is shown in Fig 3. The layout shows

schematic ground symbols for those elements that have vias to the ground plane. Two simulation runs look at the effect of changing the bond-lead inductance on the source leg of the output-stage GaAs FET.

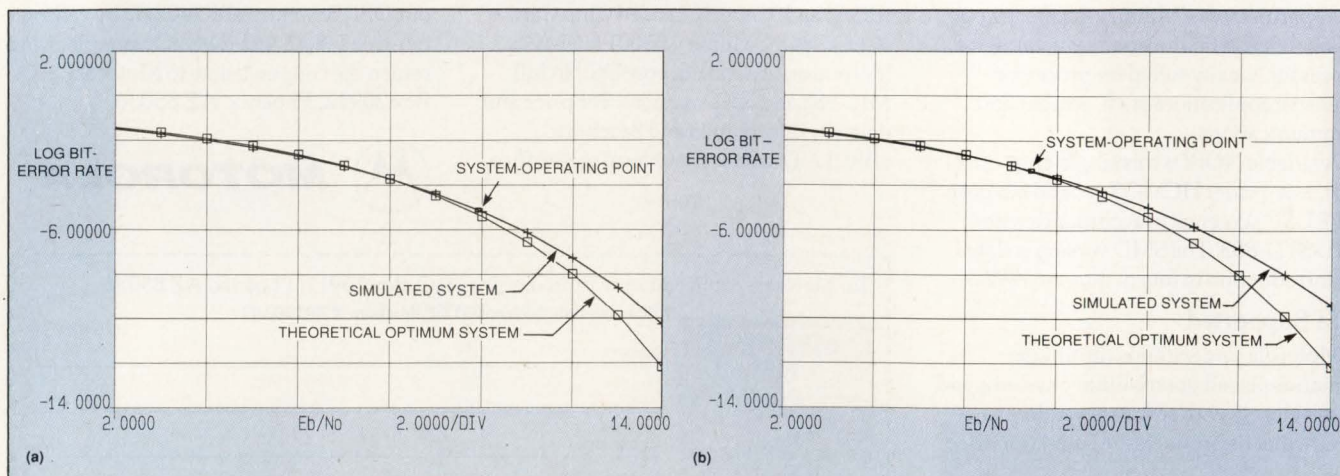
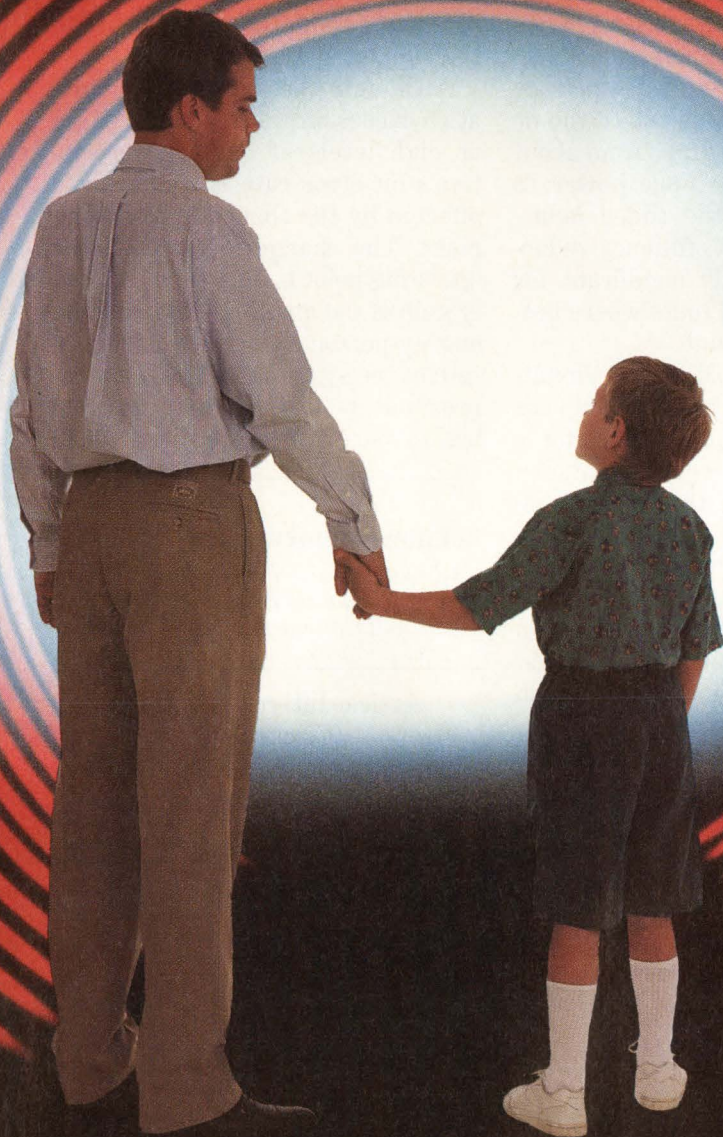

Fig 7—(a) shows the change in bit error rate as a function of the energy per bit per noise output density for the circuit with 0.3 nH of inductance. (b) shows the same plot for the circuit with 0.7-nH of inductance. Note how the system operating point has moved between the two plots, indicating a much higher bit error rate for the 0.7-nH inductance case.

A Truly New Compiler Comes Along Only Once In A Generation.

Introducing **Ultra C**™. It lets you explore the boundaries of performance for hard real time.



When performance counts, you need a C compiler that will produce the fastest, tightest code possible—especially in demanding hard real-time applications. Yet most C compilers commonly used today were originally written ten or more years ago. Since then, computer scientists have learned a lot about how to make better compilers.

That's why Microware undertook the epic task of creating an all-new C compiler based on the latest academic research—a compiler able to eke out every drop of performance from modern 16-, 32- and 64-bit CISC and RISC microprocessors. Microware's **Ultra C** uses a modular architecture that creates a virtual playing field for vigorous action by dozens of optimizers to analyze, arrange, accelerate and compress code into fast, compact executables. Heuristic analysis of register and variable usage *far surpasses the capabilities of what most human programmers could do themselves.*

State-of-the-art, plus...

Of course **Ultra C** has all features expected in a state-of-the-art compiler, such as full ANSI C compliance, C source code symbolic debugging, and a comprehensive set of standard libraries including support for the extensive real-time capabilities of the OS-9® and OS-9000® Real-Time Operating Systems. Options allow selection of either ANSI or K&R compatibility. You can even turn the optimization knobs yourself to best match your application's requirements.

Built-in quality and reliability

You can count on **Ultra C** right now, because it's probably the most thoroughly tested new compiler in history. Before the first copy went into beta test, it successfully passed the massive Plum Hall ANSI C Validation Suite—eight major sections, in all over 500,000 lines of C compiler torture track. Compilers are not a sideline at Microware—we've been developing them in-house since 1978.

CISC now, RISC soon

Ultra C is available now for all 680X0 family and 386/486 family CPUs running Microware's OS-9 and OS-9000 Real-Time Operating Systems. RISC versions are coming soon.

Call Microware Today!

1-800-475-9000

In California, call (408) 980-0201

microware

MICROWARE SYSTEMS CORPORATION

1900 N.W. 114th Street • Des Moines, Iowa 50325-7077

England / Benelux / Scandinavia: (44) 703 601990 • Germany: (49) 6221-862091
France / Spain / Italy: (33) 42.58.63.00 • Switzerland: (41) 56-83-3377

MORE CHOICES • MORE OPTIONS • TOTAL SUPPORT

CIRCLE NO. 37

CAE TOOLS FOR WIRELESS SYSTEMS

Simulating the system with a bond-wire inductance from 0.3 to 0.7 nH is equivalent to a bond-wire length of 12 to 28 mils. A circuit-level simulation of just the 2-stage power amplifier provides the data in Fig 4.

You can see by comparing the two curves that the output power of the amplifier for a -5-dBm input changes from approximately 31 to 28 dBm with the increased inductance. The power-added efficiency (a ratio of the power out to the dc and RF power in) drops from about 50% at -5-dBm input power to about 37% with the added inductance. The power efficiency reduction is particularly significant for portable handheld units where battery life is important.

The data from the above circuit-level simulation is imported into the system-level simulation using a power-dependent S parameter file. Now you can use the full system-level simulation to evaluate how the power-amplifier change affects the performance of the full system.

The power vs frequency plots in Figs 5a and 5b show a small change. The eye diagrams in Figs 6a and 6b show only a small closing of the eye. The qualitative measurements shown in Figs 5 and 6 might lead you to believe that the system per-

formance has not been significantly altered by the increased inductance.

The bit-error rate tells a different story. Figs 7a and 7b show the change in bit-error rate as a function of the energy per bit per noise output density. The curves marked with the small squares show the theoretical system performance, and the curves marked with the plus signs show the performance of the simulated system.

Although the inductance variation causes only a small divergence at high levels of Eb/No, the system's bit-error rate is significantly affected by the change in operating point. The change in the system's operating point is caused by the lower gain of the amplifier reducing the energy-per-bit value. The bit-error rate of the system changes from approximately one error in 100,000 bits to one error in 3000 bits. **EDN**

Acknowledgment

I'd like to thank Tim Hopple of EEsof for providing the simulation of the IS-54 digital cellular system.

Article Interest Quotient
(Circle One)

High 479 Medium 480 Low 481

For more information . . .

For more information on the CAE products discussed in this article, circle the appropriate numbers on the Information Retrieval Service card or use EDN's Express Request service. When you contact any of the following manufacturers directly, please let them know you read about their products in EDN.

Comdisco Systems Inc

919 E Hillside Blvd
Foster City, CA 94404
(415) 574-5800
FAX (415) 358-3601
Circle No. 664

Compact Software

483 McLean Blvd
Paterson, NJ 07504
(201) 881-1200
FAX (201) 881-8361
Circle No. 665

EEsof Inc

5601 Lindero Canyon Rd
Westlake Village, CA 91362
(818) 991-7530
FAX (818) 991-7109
Circle No. 666

Hewlett-Packard Co

19310 Pruneridge Ave
Cupertino, CA 95014
(800) 752-0900
Circle No. 667

Tesoft Inc

205 Crossing Creek Ct
Roswell, GA 30076
(404) 751-9785
FAX (404) 664-5817
Circle No. 668

You Need the World's Fastest* FPGAs!

- To support high speed-RISC and CISC CPUs
- To integrate fast PAL, TTL and FCT logic
- To operate in the data path at 33 to 66 MHz

*QuickLogic FPGAs are two to three times faster than Actel and Xilinx in most applications...offer fast, fully automatic place and route on designs using 100% of the logic cells....and will be second sourced by Cypress Semiconductor.

QuickLogic Corporation, 2933 Bunker Hill Lane, Santa Clara, CA 95054

FOR QUICK RESPONSE

Fax: 408-987-2012
Phone: 408-987-2000

- Please send the Very High-Speed FPGA Data Book

Name

Company

Address

City

State Zip

Phone Fax



the new abbot SM200.

- Highest density in a military power supply
- 50 Watts per cubic inch
- Size: 2.4" W x 4.6" L x .5" H
- Power limit: up to 280 Watts
- Fixed frequency; no derating
- Temperature range of operation: -55°C to +100°C
- Extended input voltage range: 11-40Vdc
- Output: 5, 12, 15, 24, 28Vdc; sync pin, trim pin
- OVP, TTL included
- Remote Error Sensing
- Qualifications: Mil-Stds 704D, 810E, 901C
- Board-mountable
- Readily available, off-the-shelf military
- Price: *very competitive*

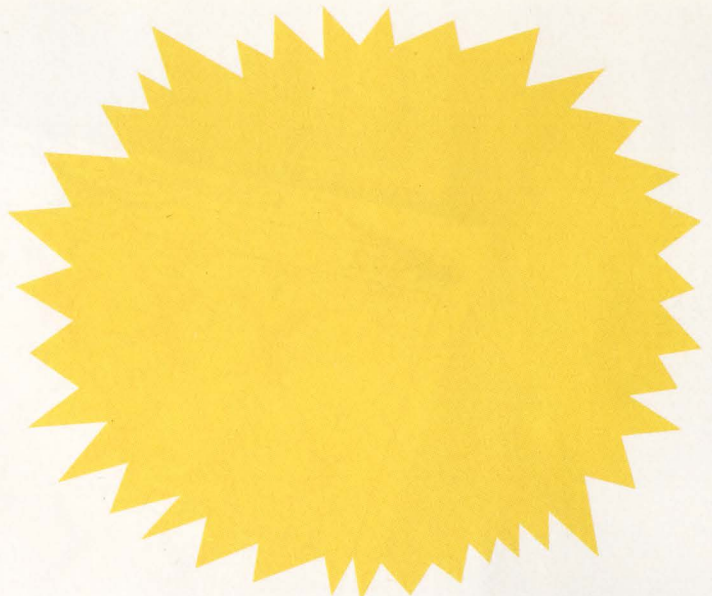

the sun.

- Highest density in the solar system
- 500,000,000,000,000 Watts per cubic inch
- Size: diameter = 864,000 miles
- Power limit: undetermined
- Variable frequency; derating nonverifiable
- Temperature range of operation: +5500°C to +15,000,000°C
- Extended input voltage range: 1-10⁴³Vdc
- Output: unchanneled; scattered dispersion
- Output protections: shade, sunscreen
- No system of error sensing/detection
- Mil-Std qualifications: none
- Board-mountable: *not*
- Readily available; not deliverable in unit form
- Price: *very expensive*

COMPARE OUR VERY-HIGH-DENSITY POWER SUPPLY WITH ITS CLOSEST COMPETITOR.

While the competition is admittedly tough, a closer look at the specs should serve to convince even the most skeptical reader of the many practical benefits of our new SM200 very-high-density power supply, which, despite its shorter track record, in reliability is second to — only one.

abbott
when reliability is imperative®

Abbott Electronics, Inc., 2727 S. La Cienega Blvd., Los Angeles, CA 90034-2643 • Telephone 310/ 202-8820 • Fax 310/ 836-1027



When you go with Xilinx, what do you get?

Software so automated it can shrink a development cycle to less than a starting employee's vacation.

The fastest, densest, most cost-efficient devices.

Support from the league-leader in programmable logic.

And a head start on everybody else who didn't go with us.

TOMORROW WILL BE HERE ANY MINUTE.

These days, you just don't have a moment to lose.

You blink twice and there are four competitors with a product just like yours. Only cheaper.

Even being first to market isn't

enough anymore.

You also have to be the first to follow up with new, feature-rich models.

And in that kind of market environment, Xilinx FPGAs and EPLDs become more valuable than ever.

For starters, our software is virtually automatic.

So we look for all the world like the prototypical prototyping tool.

But why stop there? Our FPGAs can get you into production instantly.

When you need to come back and build new models, it's as easy as reprogramming — something our FPGAs let you do right in the system.

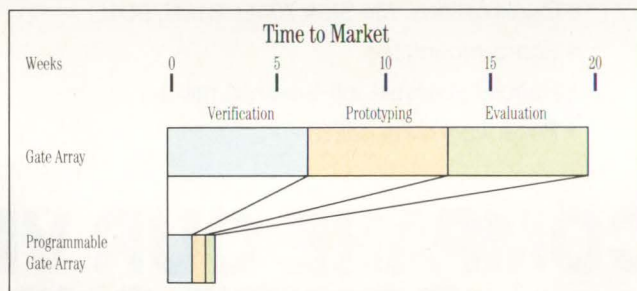

You can't buy time, but you can certainly do the next best thing. You can buy Xilinx and save time. Almost four months, compared to using a conventional gate array.

And when you're ready for high volumes, our pin-for-pin compatible HardWire™ Gate Array is ready to go.

THE MOST EXPERIENCED PROGRAMMABLE LOGIC.

In all modesty, we know more about FPGAs than anybody.

After all, we invented them.

Thirteen million devices, and 12,000 development systems later,

YOU'RE NOT JUST BUYING A LOGIC DEVICE. YOU'RE BUYING A HEAD START.

we now offer more than 250 options for the widest range of applications.

Our staff of FAEs has more experience designing with complex PLDs than any other single group in the industry. And when you go with us, they're with you.

And no one has more experience working with the third party people you rely on for CAE. You can work with whatever and whomever you're



The most valuable thing in a horse race? A good lead. As the leader in programmable logic, we can help you get one. And keep it.

working with now. You don't have to reinvent a thing.

Which means your investment in equipment and training, as well as the future of your future product line, are protected.

THE LOGIC OF OUR APPROACH IS INESCAPABLE.

We're not burdened by expensive fabs, so we can invest where it really counts: in device improvements.

We have the largest software team in programmable logic — half of our total R&D staff.

Our goal is to automate even the toughest designs, till the process becomes just as quick and painless as it possibly can be. We'll also continue to push the industry in device

speed and density, something we've done from the very beginning. After all, we're in the best position to do that — our R&D budget is bigger than most of our competitor's revenues.

So find out how we can help.

Call our 24-hour literature hotline at **800-231-3386** for the latest product information

and the name of the Xilinx representative nearest you. We'll take it from there. But do it soon.

Because these days, getting ahead is the only way to go.



The Programmable Logic Company.™

©1992 Xilinx, Inc., 2100 Logic Drive, San Jose, CA 95124. Europe, 44 (932) 349401; Japan, 81 (3) 297-9191; Asia, 852 (3) 721-0900. Xilinx and the XC designation are trademarks, and The Programmable Logic Company is a service mark of Xilinx, Inc. All other trademarks or registered trademarks are the property of their respective holders.

Making your 24 bits better.



PC display

That's AT&T "Customerizing."

"Customerizing" means being ready today with a total 24-bit graphics solution—a complete package to enhance your multimedia PC applications.

It's an industry first from AT&T Microelectronics. A true-color graphics chip set with complete driver support, including 24-bit window drivers. Today!

Developed to give you one-stop, hassle-free, true-color shopping. And priced to take a surprisingly small bite out of a PC design budget.

16 million colors

Offering quick and easy implementation, our chip set includes a True-Color VGA Controller and highly-integrated RAMDACs.

This high-performance system, capable of generating over 16 million colors, makes possible a virtually unlimited range of shading possibilities.

The system also delivers photographic-quality graphics

display, provided by an AT&T True-Color VGA Graphics Controller that supports resolutions as high as 1024 by 768.

Integrated Solution

AT&T's chip set is designed for a 5-chip motherboard that consumes only 30 square centimeters, and incorporates two memory devices.

Flexibility? AT&T's chip set offers three RAMDAC options—24, 16/18 and 8/6 bit—so you can differentiate your application with various price/performance points.

Development time? Our complete manufacturing kit helps you sharply reduce design-in time and cost.

For more on how you can give your product a 24-bit edge at the lowest possible system cost, just give AT&T Microelectronics a call at 1 800 372-2447, ext. 903. FAX: 215 778-4106.

(In Canada:
1 800 553-2448, ext. 903)



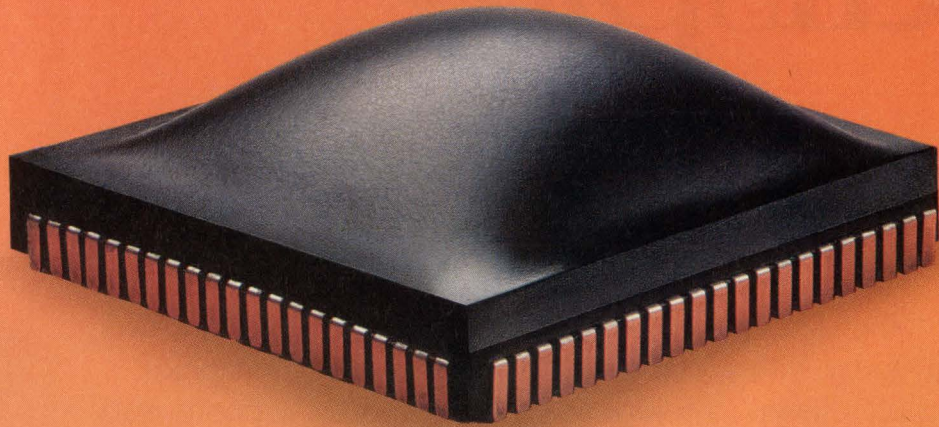

Pack more logic into every FPGA.

NEW ABEL-FPGA helps you get the most out of the latest FPGAs. If you want to take advantage of the sophisticated capabilities of today's FPGAs, only Data I/O's new ABEL-FPGA™ Design Software has the power to pack in maximum logic. It combines the industry-standard ABEL Hardware Description Language (ABEL-HDL™) with our new intelligent FPGA Device Fitter™

technology. So, you can create more complex designs with less effort—ABEL-FPGA does the hard work for you!

ABEL-FPGA's powerful Device Fitters automatically optimize your circuits for minimum area or maximum speed. Fitters are available for all the leading architectures, including Actel, Altera, AMD, Atmel, Cypress, ICT, National, Plus Logic, Texas Instruments, and Xilinx. And with built-in knowledge of its target architecture, each fitter masters the

complex features of its device automatically, intelligently.

Practical, detailed documentation, complete with FPGA design examples, also helps to ensure that you get the most from each architecture. And for added design power and flexibility, ABEL-FPGA lets you specify place-and-route constraints directly in your circuit description, so you can easily migrate the same design between multiple FPGA vendors.

Pack more logic into your next FPGA design, with the single solution to all your FPGA behavioral entry needs: ABEL-FPGA.

Call us today to find out more about NEW ABEL-FPGA.



1-800-3-DataIO
(1-800-332-8246)

DATA I/O

CIRCLE NO. 42

ABEL-FPGA

Design Software

NEW
ABEL-FPGA
with FPGA
Device Fitters!

Data I/O Corporation 10525 Willows Road N.E., P.O. Box 97046, Redmond, WA 98073-9746, U.S.A. (206) 881-8444
1-800-3-DataIO (1-800-332-8246)
Data I/O Canada 6725 Airport Road, Suite 302, Mississauga, Ontario L4V 1V2 (416) 678-0761
Data I/O Europe 660 Eskdale Road, Winnersh, Wokingham, Berkshire, United Kingdom RG11 5TS, 0734 448899
Data I/O GmbH Lochhamer Schlag 5A, 8032 Graefelfing, Germany, +49 (0)89-858580
Data I/O Japan Sumitomoseimei Higashishinbashi Bldg., 8F, 2-1-7, Higashi-Shinbashi, Minato-Ku, Tokyo 105, Japan
011-81-3-3432-8991
©1992 Data I/O Corporation



Testers let you pinpoint the causes of EMI failures

An irony of electronics is that, despite binary signals' high noise immunity, common types of electromagnetic interference (EMI) are more likely to cause malfunctions in modern digital products than in older analog gear. A group of threats—electrostatic discharge (ESD), electrical fast transients (EFTs), surges, and power-line disturbances—can create problems for which neither the true causes nor the remedies are obvious. Keytek's ECAT systems (for expert computer-aided test) not only simulate these threats but include optically coupled data-acquisition modules to accurately monitor signals within equipment *while* you apply the threats. Combining simulation and monitoring facilitates finding the causes of failures and fixing them.

If you think that manufacturers of products such as process-control, communications, and military equipment are the only ones concerned with EMI susceptibility, you're wrong. Concern is growing even among manufacturers of consumer products. The International Electrotechnical Commission (IEC) has promulgated a series of test standards (IEC 801-2, -4, and -5), and the European Community (EC) is getting ready to require that several types of products sold in Europe comply with them. In the US, at least one large retail chain requires manufacturers of products sold under its name to cer-

tify that the products meet the US equivalents of these standards.

One reason for the great emphasis on EMI immunity is the growing pervasiveness of digital technology; microprocessors have found their way even into such commonplace items as vacuum cleaners. Most digital systems contain circuits that respond to fast edges, which are among the most prevalent of EMI threats; analog equipment rarely had enough bandwidth to respond—some of these edges are as short as a few tens or hundreds of psec. Although some EMI-induced failures are relatively benign (you can correct them by turning the equipment off and then on again), some necessitate costly repairs, and others are life threatening.

Many of the threats are truly

massive—kilovolt-level transients, for example. Because the ECAT systems' μ P-based Fibersense data-acquisition modules let you monitor both digital and analog signals (including low-level signals) within your product in the presence of disturbances produced by the systems' simulation modules, you can learn exactly what circuits or subsystems malfunction and quickly devise remedies. Heretofore, the only alternatives were tedious series of experiments, which, with luck, would lead you to deduce the problem.

The systems' simulation modules fall into four categories: the E200 series for ESD, the E400 series for EFT, the E500 series for surges, and the EP series for power-line disturbances (the vendor uses the trademark PQF, for power-quality

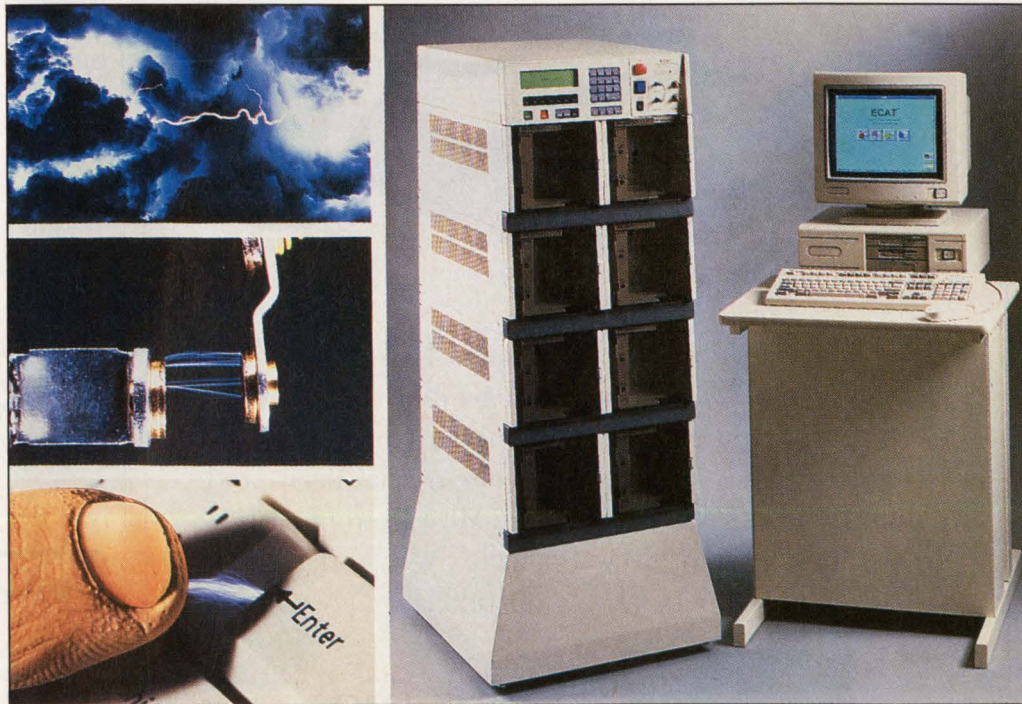

Electromagnetic interference from sparks, as from a finger to a keyboard (top left), from the opening and arcing of an ac-line contactor (center left), or from lightning—even when it jumps between two clouds and doesn't strike the earth (bottom left)—can play havoc with your equipment. The ECAT system (right) simulates all of these threats and enables you to find out exactly why your product fails.

We developed
some of the first
clock oscillators.

But some of
the most
significant things
we've developed
have been
relationships.



When you design in VCXO or ECL clock oscillators from MF Electronics, you get more than reliable parts. You get the company that pioneered the technology, ready to help with your special needs and unique problems. So write or call: MF Electronics Corp. 10 Commerce Drive, New Rochelle, New York 10801. (914) 576-6570. Fax:(914) 576-6204.

MF Electronics

COMPONENTS THAT SET THE PACE



CIRCLE NO. 43

faults). Of these, ESD, usually from sparks to the chassis of the equipment under test, is best understood. EFT refers to very fast or very-high-frequency transients, normally of relatively low energy, coupled onto signal or power lines from power switching. Surges, which originate in lightning or power switching, are somewhat slower but have much higher energy (currents can be as high as several kA). They most often appear on power lines but can sometimes couple into signal lines. PQFs are dropouts, dips, and other anomalies on the ac line, usually lasting for several cycles.

ECAT systems consist of a controller and one or more simulator modules either in a free-standing arrangement or, in larger configurations, in a 19-in. equipment rack. You can upgrade a system's capabilities at any time by adding modules. Adding modules requires no change to the existing ones. The μ P-based controller's keypad and 8-line \times 40-character LCD let you completely control the system without a host computer. However, MS-Windows-based software allows remote control of all system functions from a host PC. Pricing begins at \$22,630. A system with EFT, surge, and PQF simulators costs \$67,170. Shipments have already begun.—**Dan Strassberg**

Keytek Instrument Corp, 260 Fordham Rd, Wilmington, MA 01887. Phone (508) 658-0880. FAX (508) 657-4803. TLX 951389.

Circle No. 700

What's Coming Up In EDN

Beginning in the October 1 issue, EDN Magazine will show you how to "Design It Right." In this four-part series, we'll relate the do's and don't's that are essential to good product design. Many of these techniques may work for you!

All the benefits of a laser printer on a much larger scale.

A-size (8.5" x 11")



B-size (11" x 17")

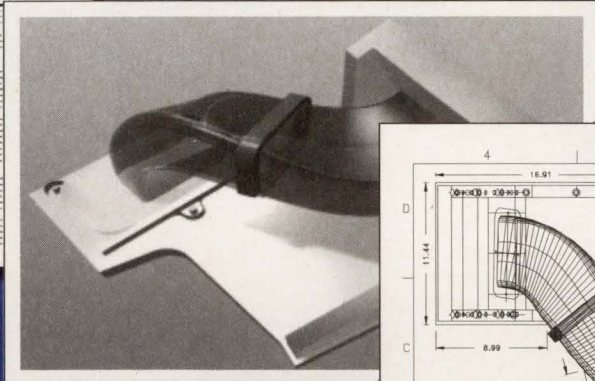

C-size (17" x 22")

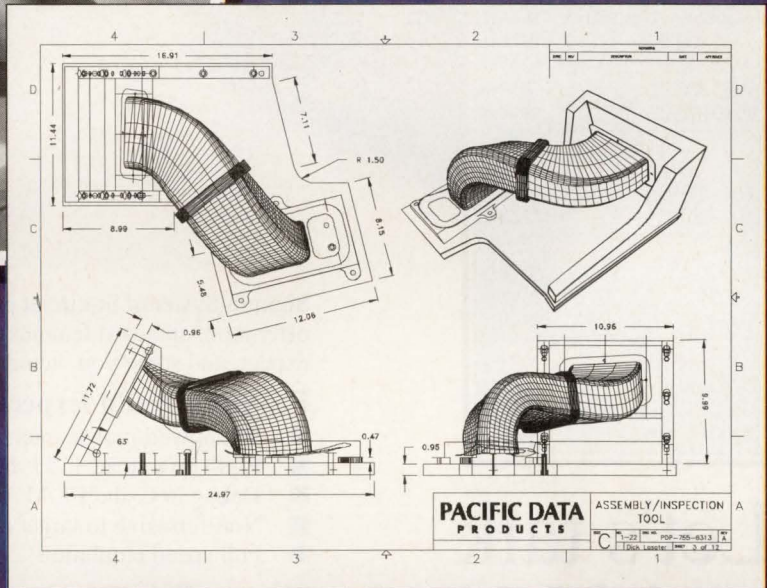

At last. A personal output device that combines the best features of a desktop laser printer with the ability to produce large format drawings. It's called ProTracer™ — a 360 dpi desktop printer/plotter that produces A, B, as well as C-size output.

FEATURES INCLUDE:

- High performance inkjet engine from Canon®
- Fast, Intel i960™ processor—drawings that take over one half hour on pen plotters take as little as five minutes on ProTracer!
- Optional HP-GL® and PostScript® language emulations, memory expansion boards, and sheet feeders
- Unsurpassed customer service—60 day money back guarantee of satisfaction, one year warranty, and free lifetime technical support

PROTRACER BASE UNIT	PROTRACER WITH HP-GL	PROTRACER FULLY CONFIGURED
<ul style="list-style-type: none"> ■ Customized ADI and PADI drivers for AutoCAD users ■ Epson and ProPrinter emulations <p style="text-align: center; font-weight: bold; color: #003366;">\$1499</p>	<ul style="list-style-type: none"> ■ ProTracer base unit ■ HP-GL emulation card ■ 5 MB memory <p style="text-align: center; font-weight: bold; color: #008080;">\$2249</p>	<ul style="list-style-type: none"> ■ ProTracer base unit ■ HP-GL emulation card ■ PostScript language emulation card ■ 5 MB memory* ■ Sheet feeder (100 sheet) <p style="text-align: center; font-weight: bold; color: #990066;">\$2897</p>

If you'd like to expand your printing and plotting capabilities, call Pacific Data Products at (619) 597-3200 ext. 2270, Fax (619) 552-0889.

PACIFIC DATA PRODUCTS

* If outputting C-size PostScript documents, an 8 MB memory board must be used. Pacific Data Products, Inc., 9125 Rehco Road, San Diego, CA 92121. ProTracer is a trademark of Pacific Data Products, Inc. HP-GL is a registered trademark of Hewlett-Packard Co. i960 is a trademark of Intel Corporation. PostScript is a registered trademark of Adobe Systems, Inc. Canon is a registered trademark of Canon, Inc. All other trade names referenced are the trademarks or registered trademarks of the respective manufacturer. Images courtesy of AutoDesk Inc. ProTracer uses the latest in high technology innovation including PeerlessPage™, the advanced Imaging Operating System from Peerless. PhoenixPage is a registered trademark of Phoenix Technologies Ltd. © 1987, 1988. EUROPEAN OFFICES: England Tel 0800 51 5511, Fax (44) 442 236540; France Tel 05 90 65 09, Fax (33) 1 39 63 31 20; Germany Tel 0130 81 3685; Ireland Tel (353) 61 475609; Fax (353) 61 475608; Switzerland Tel (41) 22 341 26 50, Fax (41) 22 341 06 82; Belgium Tel 078 111292; Netherlands Tel 06 0222065. © 1992 Pacific Data Products, Inc.

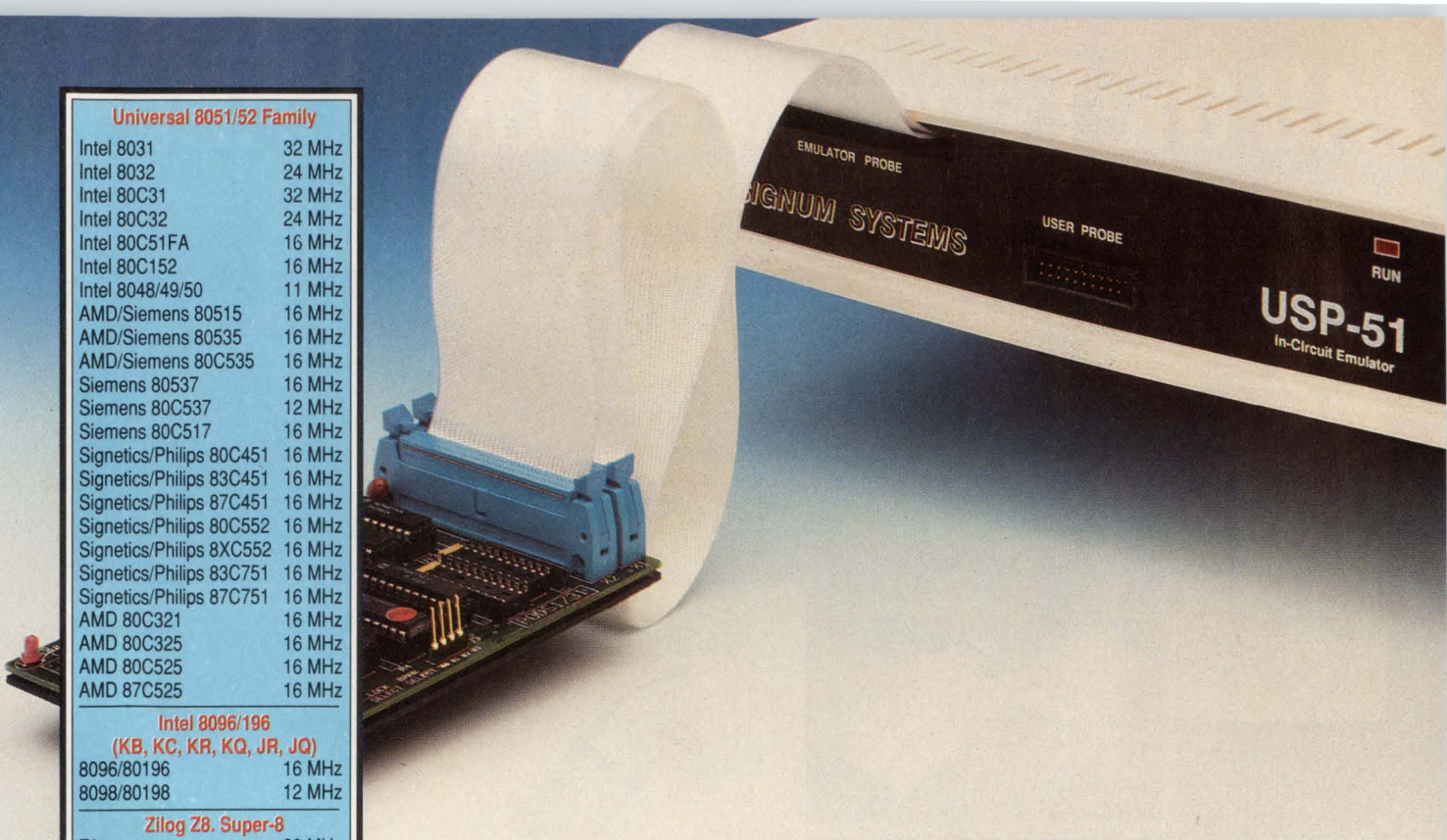

Universal 8051/52 Family	
Intel 8031	32 MHz
Intel 8032	24 MHz
Intel 80C31	32 MHz
Intel 80C32	24 MHz
Intel 80C51FA	16 MHz
Intel 80C152	16 MHz
Intel 8048/49/50	11 MHz
AMD/Siemens 80515	16 MHz
AMD/Siemens 80535	16 MHz
AMD/Siemens 80C535	16 MHz
Siemens 80537	16 MHz
Siemens 80C537	12 MHz
Siemens 80C517	16 MHz
Signetics/Philips 80C451	16 MHz
Signetics/Philips 83C451	16 MHz
Signetics/Philips 87C451	16 MHz
Signetics/Philips 80C552	16 MHz
Signetics/Philips 8XC552	16 MHz
Signetics/Philips 83C751	16 MHz
Signetics/Philips 87C751	16 MHz
AMD 80C321	16 MHz
AMD 80C325	16 MHz
AMD 80C525	16 MHz
AMD 87C525	16 MHz
Intel 8096/196 (KB, KC, KR, KQ, JR, JQ)	
8096/80196	16 MHz
8098/80198	12 MHz
Zilog Z8. Super-8	
Z8	20 MHz
86C94	30 MHz
Super-8	20 MHz
Texas Instruments DSP's	
320C10/15	33 MHz
320C16	35 MHz
320C17	20 MHz

Let's talk
real 8051
8096/196
in-circuit
emulation.
... and
DSP's too!

Signum Systems' in-circuit emulators offer more standard features than you'd expect, and some you wouldn't.

Features You'd Expect

- Windowed/mouse interface
- Flash download 115 k-baud
- Debug in C and PL/M
- Non-intrusive to target or PC
- Full speed emulation

Signum Extras

- C-51 and C-96 HLL debugger with locals support
- Full bank switching support
- Up to 256K emulation program RAM
- Graphic trigger window
- 32K x 80 real-time trace
- Access on-the-fly to:
 - All emulation RAM contents
 - 3 complex trace triggers
 - 8 level sequencer
 - Trace and execution displays
 - 256K address breakpoints
 - 2 16-bit event counters
- Performance analysis
- Unlimited user support

Performance . . .

Ultimately Depends on You

See what **Graphic Triggering** can do for you. For the first time you can have intuitive, precise control of the full debugging power of your emulator. You'll avoid errors and get more done.

Debugging in a High Level Language means that eventually you will have to track something right down to a member of a local complex structure. Signum lets you zoom in on any structure— **with just the click of a mouse.**

Opportunity . . .

The Signum Advantage

The right tools do make a difference, and there's no equality among emulators. You have to actually use them to appreciate what they can do for you. Better features that are easier to use mean you're finished sooner. That's performance, and that is exactly what we are about at Signum Systems.

Prove it to yourself, check out a Signum emulator today! Write or call to evaluate the Signum advantage.

10 DAY FREE TRIAL

SIGNUM SYSTEMS

... for the most discerning

171 East Thousand Oaks Blvd.
Thousand Oaks, CA 91360
Tel: 805-371-4608
Fax: 805-371-4610

England	(0254) 682-092
France	(33) (74) 43 80 45
Italy	(39) (2) 688-00548
Switzerland	(41) (91) 568-721
Poland & Eastern Europe	(48) (71) 484-221

Modular dc/dc converters develop 3.3 to 48V outputs

SMQ Series high-density dc/dc converters reflect the industry's most popular mounting, dimensional, pin-out, and cooling specifications. More than 100 models are available with inputs ranging from 12 to 300V and outputs covering a 3.3 to 48V range. Special versions with 1.2V outputs are available for applications such as backplane termination. Output power capability ranges from 75 to 230W—equivalent to a power density of 40W/in.³

The SMQ converters operate at a fixed frequency between 250 and 300 kHz—a range where low equivalent-series resistance, high-temperature electrolytic capacitors provide low ripple and six times more capacitance than typically found in many competitive units. As a result, SMQ converters have a guaranteed transient response—a characteristic always expected of high-performance, higher-power computer or telecommunications supplies.

Responding to market trends toward fault-tolerant (redundant mode) applications, SMQ converters have single-wire paralleling. To help in fault isolation, they also have a de-good signal as a standard feature. This feature is almost always found in more expensive, higher-power, off-line power supplies.

The units in the SMQ line rely on a time-proven PWM forward converter with current-mode control. Using a 2-transistor forward converter lessens MOSFET capacitance losses and helps make the power section bullet-proof in terms of susceptibility to overvoltage damage. Limiting the operating frequency to 300 kHz sharply reduces capacitance-related losses, which inherently occur at 750 kHz or higher.

One area of performance often



Housed in an industry-standard package, SMQ dc/dc converters feature a 230W output capability. They are available with outputs of 3.3 to 48V and incorporate single-wire paralleling and protection against overvoltage, overcurrent, and overtemperature conditions.

cited by users relates to the differential and common-mode noise that often appears at the output as spike noise. This noise is caused by the power semiconductor switching transitions. In the SMQ converters, a proprietary noise filtering technique significantly reduces this noise.

All SMQ converters incorporate overvoltage, overtemperature, and overcurrent protection along with remote shutdown, option synchronization, and a standard on-status signal to indicate proper drive-chip operation. A preset turn-on delay lets the converters drive incandescent or highly capacitive loads without going into an overcurrent mode—a definite problem with fast turn-on converter designs.

SMQ converters are housed in a 2.4 x 4.6 x 0.5-in. encapsulated package, which is compatible with either surface-mount or through-hole assembly operations. The units use planar magnetics and can deliver a 230W output at an 85°C baseplate temperature. \$125 to \$250. Delivery, six to eight weeks ARO.

—Tom Ormond

*Electronic Measurements Inc.,
405 Essex Rd, Neptune, NJ 07753.
Phone (908) 922-9300. FAX (908)
922-9334.*

Circle No. 733

Sprague-Goodman



Surfcoil® SMT Inductors

- Inductance from 10 nH to 1 mH
- 8 model series in 3 sizes:
2.5 x 2.0 x 1.6 mm (0.098" x 0.079" x 0.063")
3.2 x 2.5 x 2.2 mm (0.126" x 0.098" x 0.087")
4.5 x 3.2 x 3.2 mm (0.177" x 0.126" x 0.126")
- Shielded, unshielded, ferrite core and nonmagnetic models
- Operating temp: -20° to +85°C
- Carrier and reel standard
- Fully encapsulated

Phone, fax or write today for
Engineering Bulletin SG-800B.



134 Fulton Ave., Garden City Park, NY 11040
Phone: 516-746-1385 • Fax: 516-746-1396

CIRCLE NO. 45

Sprague-Goodman

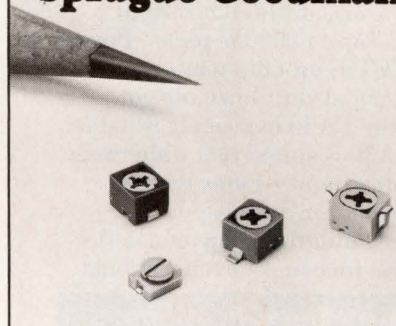

Surftrim® Surface Mount Trimmer Capacitors

- 2 sizes:
3.2 x 4.5 x 1.6 mm
4.0 x 4.5 x 2.7 mm (sealed)
- 4 mounting configurations
- Carrier and reel, or bulk pack
- 1.7 to 50 pF in 7 cap ranges
- Operates to 85°C

Phone, fax or write today for
Engineering Bulletin SG-305B.



134 Fulton Ave., Garden City Park, NY 11040
Phone: 516-746-1385 • Fax: 516-746-1396

CIRCLE NO. 46

61



2.68 HORSEPOWER or 2000W RMS

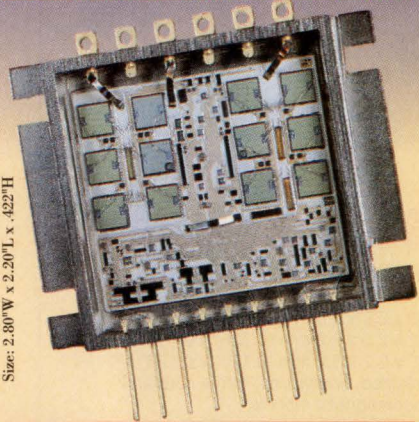

Size: 2.80"W x 2.20"L x .422"H

HYBRID HORSE POWER

The PA30 from Apex is the first hybrid IC amplifier capable of 2000W rms continuous output power—up to 8000W pulse. Power MOSFETS, on-chip temp sensors and thermal shutdown output make the PA30 extremely reliable. The PA30 is suited to a wide range of applications—sonar transducers, motor drives, power source simulation magnetic deflection and focusing—even welding!

Key Specifications:

- 2000W rms output power
- 100A output current pulse
- 30V to 200V supply
- 1000W power dissipation
- 45V/ μ s slew rate
- Programmable current limit



APEX MICROTECHNOLOGY CORPORATION
5980 N. Shannon Road, Tucson, AZ 85741

For Product Information or
Applications Assistance Call
1-800-862-1029 or FAX (602) 888-3329

BELGIUM/LUX (03) 458 3033
CANADA (416) 821-7800
DENMARK 42 24 48 88
DEUTSCHLAND (6152) 61081
ESPAÑA (1) 530 4121
FRANCE (1) 69 07 08 24
HUNGARY/CZECH 1-176-2783
ISRAEL (3) 934517
ITALIA (2) 99041977

INDIA (212) 339836
NEDERLAND (10) 451 9533
NORGE (2) 50 06 50
ÖSTERREICH (222) 505 15 220
SCHWEIZ (56) 26 54 86
SUOMI (0) 8041-041
SVERIGE (8) 795 9650
TURKEY (1) 337 2245
U.K. (844) 278781

In U.S. Circle No. 7 In Europe Circle No. 8

Intelligent supplies have power-out warning

Targeted at local-area-network (LAN) applications, Languard uninterruptible power supplies (UPSs) are available in 400-, 600-, 900-, and 1250-VA models. The smart units feature power-outage warning, advance battery-condition monitoring, and orderly network shutdown. The units also incorporate batteries that the user can replace in 60 sec.

Languard systems meet the UL1778 rating as a UPS and UL1449 as a transient-voltage surge-suppression device. Suppression circuitry tracks the ac sine wave and provides an effective clamping barrier of less than 50V. The units operate as a line-interactive UPS with a response time that provides 15 minutes of sine-wave output power when connected to a 386 workstation. A boost feature eliminates battery discharge during brownouts.

During a power outage, the Languard UPS uses the company's Nettrax software interface to automatically notify the LAN administrator of the outage. If no one shuts

the network down, the UPS automatically saves files and shuts down any connected equipment. Languard network power-management software is compatible with windows and supports all major LAN operating systems.

Power-monitoring features include a surge counter and power-disturbance snapshot, which captures power disturbances. Also included is the Mousetrax remote system—a peripheral for control and monitoring of ac power and UPS functions. This system continuously monitors all critical functions—UPS load and temperature, battery condition, charge and uptime, outlet ground and polarity, and surge monitoring. These features can often eliminate the need for expensive power monitoring equipment.

Communication between the Languard UPS and the workstation happens over the network media or by daisy-chaining the units through the serial port, which effectively creates a local UPS network. This serial network lets the network administrator monitor LAN components, such as file servers and workstations, and equipment that is off the LAN, such as a PBX.

While Languard is primarily designed for LAN applications, it can also back up single computers. The removable remote front panel lets you place the UPS out of the way while still keeping the monitoring display and control switches within easy reach. \$499.95 for the 400-VA version.—Tom Ormond

EFI Electronics Corp, 2415 S 2300 W, Salt Lake City, UT 84119. Phone (800) 877-1174. FAX (801) 977-0200.

Circle No. 734

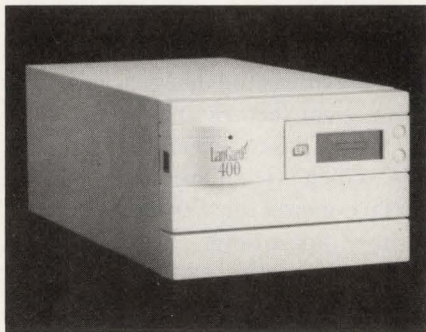

Targeted at LAN applications, the Languard UPS line features power-outage warning, advance battery-condition monitoring, and orderly network shutdown. Removable front panels let you locate the units out of the way while keeping the monitoring display and control functions within easy reach.

NEWS

1553 DATA BUS
 SYNCHRO CONVERSION
 A/D & D/A CONVERSION
 MOTOR DRIVES
 SOLID-STATE POWER CONTROLLERS

DDC
ILC DATA DEVICE CORPORATION®

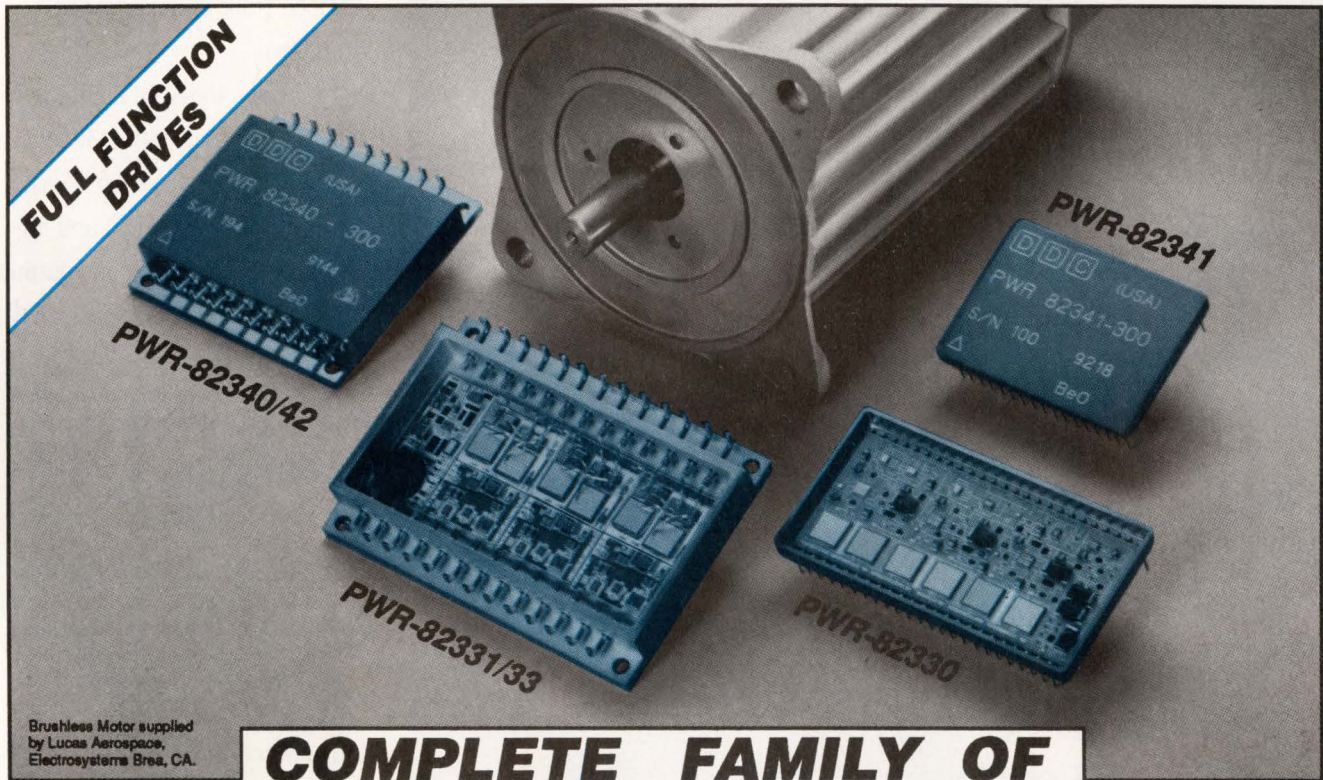

Brushless Motor supplied by Lucas Aerospace, ElectroSystems Brea, CA.

COMPLETE FAMILY OF MOTOR DRIVE SOLUTIONS

Now your motor control designs have just become simpler with DDC's complete family of Smart Power motor drive solutions. We offer an array of full mil, 3-phase and 2-phase motor drives designed to deliver from 5 to 30A of current to the motor with bus voltages from 15 to 270Vdc.

Our 3-phase drives begin with the 250W PWR-82330, which is designed to operate from a 28V MIL-STD-704 power bus and can deliver 5 amps to the load. This high-efficiency MOSFET drive has a self-contained charge pump, complete gate drive including cross-conduction lock out, and operates

from either 5 to 15V input logic signals. Housed in a 50-pin PCB mount package, requiring 3.6 square inches of board space, the PWR-82330 measures only 1.4"W x 2.6"L x 0.25"H.

Now you need to upgrade your design for high current, so choose our 4.2kW PWR-82331 drive. Designed to operate up to 140V (after derating), the PWR-82331 delivers 30 amps to the load and requires only 6.3 square inches of space. The PWR-82331 has an internal dc-dc converter for continuous gate drive, a high-efficiency MOSFET drive stage with separate flyback diodes and the same front-end logic as the PWR-82330.

Then you need to further upgrade your system to 270V. No problem, use the 10.5kW PWR-82333, 270V drive with an IGBT output stage. This drive is a pin-for-pin, form fit function, high voltage replacement of our PWR-82331. Both drives are available in a 2.1"W x 3.0"L x 0.39"H package and operate from -55°C to +125°C case temperature.

Additionally we offer complementary 2-phase drives with both high and low voltage capability.

Give Bob Fryer a call at 516-567-5600, ext. 7390 (toll free outside N.Y. 1-800-DDC-1772 ext. 7390) to receive more information and become a member of the family. □

DDC
ILC DATA DEVICE CORPORATION®

HEADQUARTERS AND MAIN PLANT: ILC Data Device Corporation, 105 Wilbur Place, Bohemia, NY 11716, (516) 567-5600, TLX: 310-685-2203, FAX: (516) 567-7358, (516) 563-5208, Toll Free Outside N.Y.: 1-800-DDC-1772
WEST COAST (CA): GARDEN GROVE, (714) 895-9777, FAX: (714) 895-4988;
 WOODLAND HILLS, (818) 992-1772, FAX: (818) 887-1372
WASHINGTON, D.C. AREA: (703) 450-7900, FAX: (703) 450-6610
NORTHERN NEW JERSEY: (201) 785-1734, FAX: (201) 785-4132
UNITED KINGDOM: 44 (635) 40158, FAX: 44 (635) 32264; **IRELAND:** 353 (21) 341065, FAX: 353 (21) 341568
FRANCE: 33 (1) 4333-5888, FAX: 33 (1) 4334-9762; **GERMANY:** 49 (8191) 3105, FAX: 49 (8191) 47433
SWEDEN: 46 (8) 920635, FAX: 46 (8) 353181; **JAPAN:** 81 (33) 814-7688, FAX: 81 (33) 814-7689

“Excellent low harmonic distortion performance pulls at the heart strings...a must-see spec.”

— Jim Smith, PictureTel

“The best differential gain and phase that I’ve seen in years...don’t miss it.”

— Bill Love, PictureTel

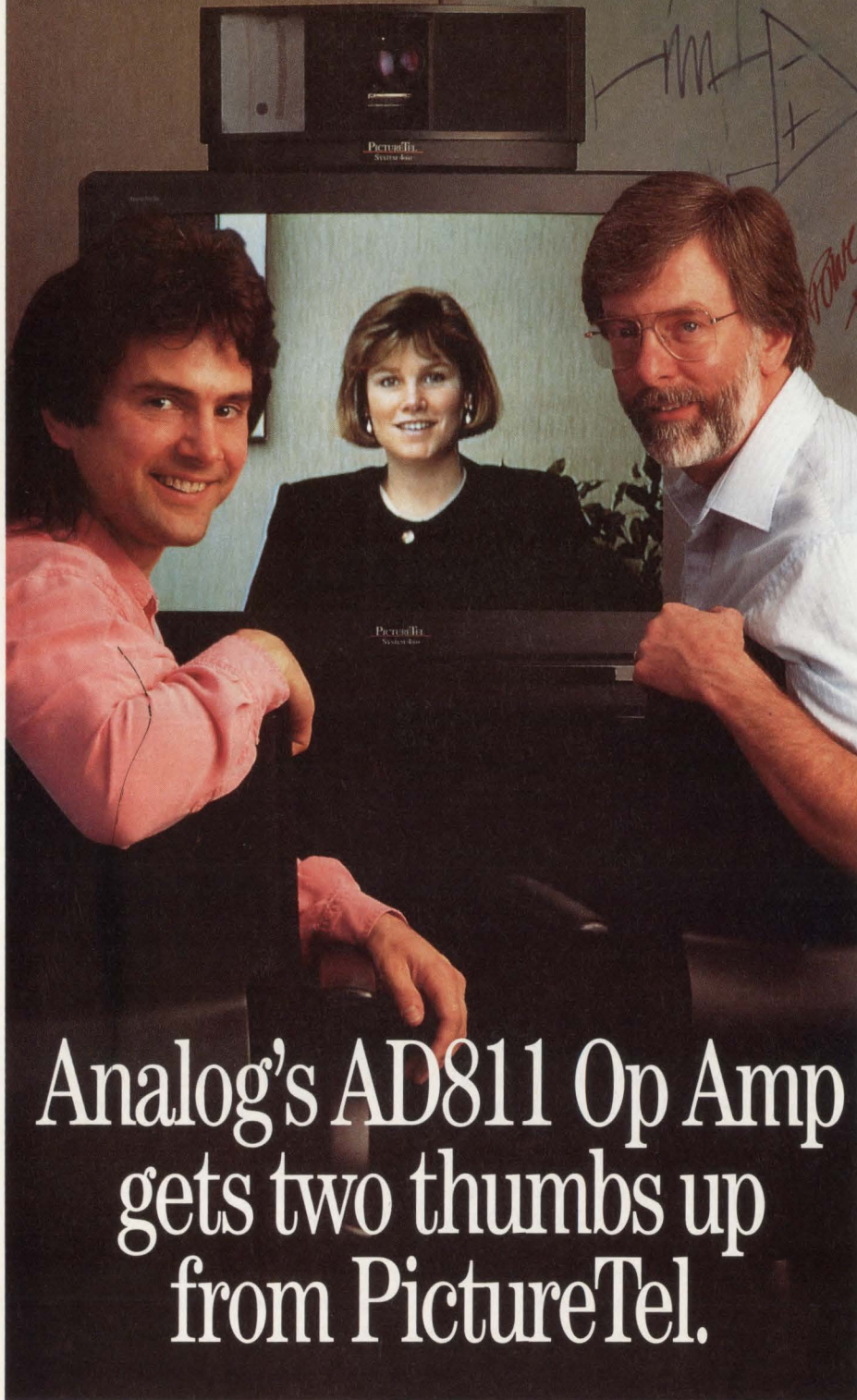

Introducing the premier high speed video op amp – the AD811 from Analog Devices.

What makes the AD811 such a star is that it delivers maximum performance in all the critical specs for video, while costing just \$2.85 (in 1000s).

In fact, the AD811 offers excellent specs in bandwidth (140 MHz, $G=+1$), slew rate (>2500 V/ μ s), differential gain (0.01%) and differential phase (0.01°), and output drive (>100 mA) – and this high per-

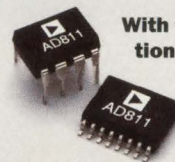

With the specs mentioned above, as well as excellent flatness (0.1 dB to 35 MHz), settling time (50 ns to 0.1% and 65 ns to 0.01%), low noise (1.9 nV/ $\sqrt{\text{Hz}}$) and low distortion (-74 dB @ 10 MHz), the AD811 will make your video design look great. Also available in an 8-pin SOIC.

formance is achieved whether driving one or two back-terminated 75 Ω cables. All of which makes the AD811 not only HDTV compatible, but ideal for professional and consumer video cameras, routers, special effects generators, multi-media and general purpose high speed data acquisition.

The AD811 is one more example of how Analog Devices is the one company you can look to for affordable performance. For our free High Speed Op Amp Selection Guide, SPICE model diskette and an AD811 sample, call 1-800-262-5643. Or write to us at the address below.



Analog Devices, One Technology Way, P.O. Box 9106, Norwood, MA 02062-9106. Distribution, offices and application support available worldwide.

Authorized North American Distributors: Alliance Electronics 505-292-3360 • Allied Electronics 800-433-5700 • Bell Industries 310-826-2355 • Future Electronics 514-694-7710 • Hall-Mark Electronics 214-343-5000 • Newark Electronics 312-784-5100 • Pioneer-Standard Electronics 800-874-6633 • Pioneer Technologies Group 800-227-1693 • WYLE Laboratories 800-866-9953 • Zentronics 416-564-9600

16-MHz RISC μ P strips down for action

RISC μ Ps are making it big in the embedded-systems world, especially in printers, X-terminals, and communications gear. In these arenas the push is on for cheaper, minimal RISCs (reduced-instruction-set computers). AMD's newest member of the 29K family, the 29205, aims to please. A stripped-down 29200, the 29205 delivers four native MIPS sustained, on a 16-bit data bus.

The 29200 was designed specifically for printer-type applications. It interfaces to video RAM, produces printer-control signals, and provides a range of peripheral interfaces. The 29205 trims away the overhead for low-cost, down-in-the-dirt applications. The external memory bus is trimmed from 24-bit address and 32-bit data lines, to 22-bit address and 16-bit data lines. Video-RAM support is dropped, as

well as burst-mode ROM accesses. ROM chip selects have been trimmed back, and the chip can use only 8- and 16-bit peripherals. These reductions decrease pin count from 168 to 100 pins.

The 29205 has one programmable 8-bit I/O port; you can program the 8 bits to act as external interrupts for control applications. The chip also handles DMA transfers between on-chip (1 channel) or off-chip peripherals (1 channel) and dynamic RAM (DRAM) memory. DMA offloads prevent the CPU from obtaining and moving data to memory.

The 29K family members were originally desktop RISC processors, but missed their market window. The chips were initially structured for Unix, so they have a supervisor and user mode, which is useful for real-time applications and interrupt handling. In addition, the CPUs contain 192 registers, many of which are available for application tasks. The large number of registers helps keep the top of the user stack on chip and provides fast, local storage for processing data.

The original chip also had a branch-target cache, which cached the target addresses of branches to speed up the next iteration of loops. To cut costs, this cache was left out of the 29200 and 29205 μ Ps. Later 29K family chips added a 4-kbyte on-chip cache.

One of the most respected features of the 29K family is its simple memory interface, which lets the CPU run with standard, fast DRAM, rather than requiring an on-chip or supplemental cache memory. The 29200, and now the 29205, have simplified the 29K memory interface further with an on-chip memory controller that eliminates memory glue logic. The 29205 uses as much as four banks of DRAM, and the ROM controller uses as much as four banks of ROM or static

memory with programmable-access characteristics. You can stretch memory-access times by asserting the chip's wait* pin.

The 29205 is code compatible with the 29K family and has a range of development software and tools for the 29K RISC CPU. For evaluating the 29205, AMD supplies the SA29205 demonstration board. The 29205 includes a 16.7-MHz 29205, 512 kbytes of 16-bit-wide DRAM, 1 Mbyte of one-time-programmable logic, 16-bit-wide EPROM, an RS-232C serial interface, and an expansion connector. The board links to a PC host and can be controlled via a ROM monitor, MiniMon29K, in EPROM.—**Ray Weiss**

AMD, 5204 E Ben White Blvd,
Austin, TX 78741. Phone (512) 385-
8542. **Circle No. 688**

AMD 29205 RISC embedded processor

- 16-MHz, 32-bit CPU
- 192 registers
- 117 instructions with mainly 2-cycle execution (two 16-bit accesses for instruction words)
- No full MPY/DIV instructions done in software
- 4M native MIPS sustained 50% of 29200
- 4-stage, pipelined RISC
- Load/store multiple register instructions for speed
- External memory bus, Harvard architecture with separate 22-bit address and 8-/16-bit data lines
- ROM (8-bit), DRAM (16-bit) controller with DRAM page-mode support
- 2-channel DMA controller
- 8-bit I/O port
- 2 external interrupts, also I/O pins programmable as external interrupts
- UART, bidirectional parallel-port video interface for imaging applications
- Interrupt controller, timer
- 2-port peripheral interface adapter
- In 100-pin PQFP, \$38.25 (1000)

8-bit μ C drives closed-caption TV

The clock is counting down: By mid-1993, all new TVs (13 in. or larger) must handle closed captions. Motorola's 8-bit 68HC05CC1 will supply a complete TV microcontroller (μ C) for TV control, on-screen display (OSD), and closed-caption applications. It makes today's expensive decoder boxes obsolete.

The 68HC05CC1 is pin and function compatible with the 68HC05T2, which many engineers now use for TV and display control. Using the 68HC05CC1, engineers can upgrade to closed-caption processing with a minimum of hardware design. The chip replaces the older chip with only a few wiring modifications. It handles closed-caption processing with up to 34 characters/line and can fill the full screen or present a smaller number of lines that are scrolled or popped up.

Providing closed-caption TV

services requires a controller to monitor the video output to the display. The controller detects line 21 of the TV display, which carries the TV-programmer's closed-caption instructions. These instructions are pulled off the transmitted line and used to direct the closed-caption controller in building and transmitting the captions. The 68HC05CC1 Data Slicer peripheral monitors the signal and pulls off the closed-caption directives, which are then stored in RAM for processing. The slicer (and OSD) trigger off of the horizontal and vertical sync signals: All timing is related to the signals.

A Data Slicer interrupt signals the CPU when it receives a new set of caption directives. Software then sets up the Output Screen Device to put characters at a given scan line. The chip compares the current screen line to the event line. When a match occurs, the

Motorola 68HC05CC1 closed-caption μ C

- 8-MHz clock, 4-MHz bus cycle
- Accumulator-based architecture with accumulator, index register, and stack pointer
- 16-bit program counter
- 16-kbyte ROM
- 544-byte RAM
- 32-kbyte memory address space for RAM, ROM, vectors, I/O
- 1664 \times 9-bit character ROM
- 8-bit pulse accumulator
- Watchdog-timer option
- 8-channel, 6-bit PWM (DAC)
- 1-channel restive ladder A/D converter
- Serial I/O port with I²C master capability
- Video display outputs (RGB and a signal for blanking video) closed-caption video generator
- Clocks video data in to 28 MHz generated by an internal PLL
- 15 I/O pins
- 45-pin shrink DIP, 40-pin DIP
- Less than \$7 (50,000)

characters are scanned and output to the RGB signals. A blanking signal, FBKG, blanks the incoming video, eliminating interference with the character pixel stream.

The closed-caption display characters are defined by the OSD character ROM. Users can program it for special character sets. The ROM defines 128 display characters. Each character is 9 bits wide and up to 13 pixels high.

The chip is built on a simple accumulator-based architecture with a single index register, the 68HC05, which serves as a base for more than 130 variations, many of them application-specific CPUs. The 68HC05 is also popular as a low-end 8-bit μ C for replacing control logic and tackling simple control problems.—**Ray Weiss**

*Motorola Inc, 6501 William Cannon Dr W, Austin, TX 78735.
Phone (512) 891-2000. Circle No. 689*

HEAT SINKS for INTEL 80486 and i860XR MICROPROCESSORS

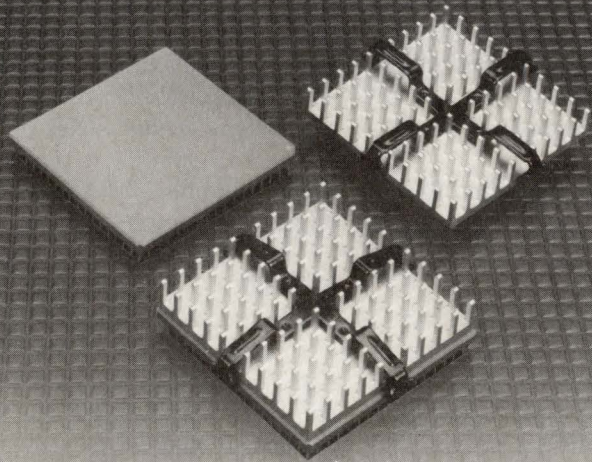

EG&G WAKEFIELD ENGINEERING
60 AUDUBON ROAD, WAKEFIELD, MA 01880
TEL: (617) 245-5900 • FAX: (617) 246-0874

Designed for use with the Intel 80486DX and 80486SX microprocessors and the Intel i860XR RISC processor, packaged in 168-pin ceramic PGAs, the EG&G Wakefield 669 Series Heat Sink/Clip Assembly offers a cost-effective heat dissipation solution for today's high-speed microprocessors. This assembly provides the highest clamping force available with a nylon-coated stainless steel clip, for the most efficient interface heat transfer and to meet system shock and drop test requirements. Our omnidirectional heat sink offers optimized heat dissipation and ease of application; the symmetrical clip is suitable for high volume installation with the EG&G Wakefield 162-IT installation tool.

Heat dissipation with the 669 Series Heat Sink/Clip Assembly is optimized for PC, workstation, and server applications with low airflows (e.g., 50-200LFM). Pressure drop is minimized in multiple-processor applications.

Intel, 80486, i860XR, and 80386 are trademarks of Intel Corporation.

Call our Application Engineering Department today at (617) 245-5900 for information about the EG&G Wakefield Engineering 669 Series (patent pending) and other heat sinks for the Intel 80386 and 80486 microprocessor family. Also ask for information about the EG&G Wakefield DELTEM™ family of heat sinks for cooling high-speed cache RAM used with 50 MHz microprocessors.

CIRCLE NO. 48



***HOW DO YOU
BECOME
THE POWER
BEHIND
A WORLD
SUPERPOWER?***



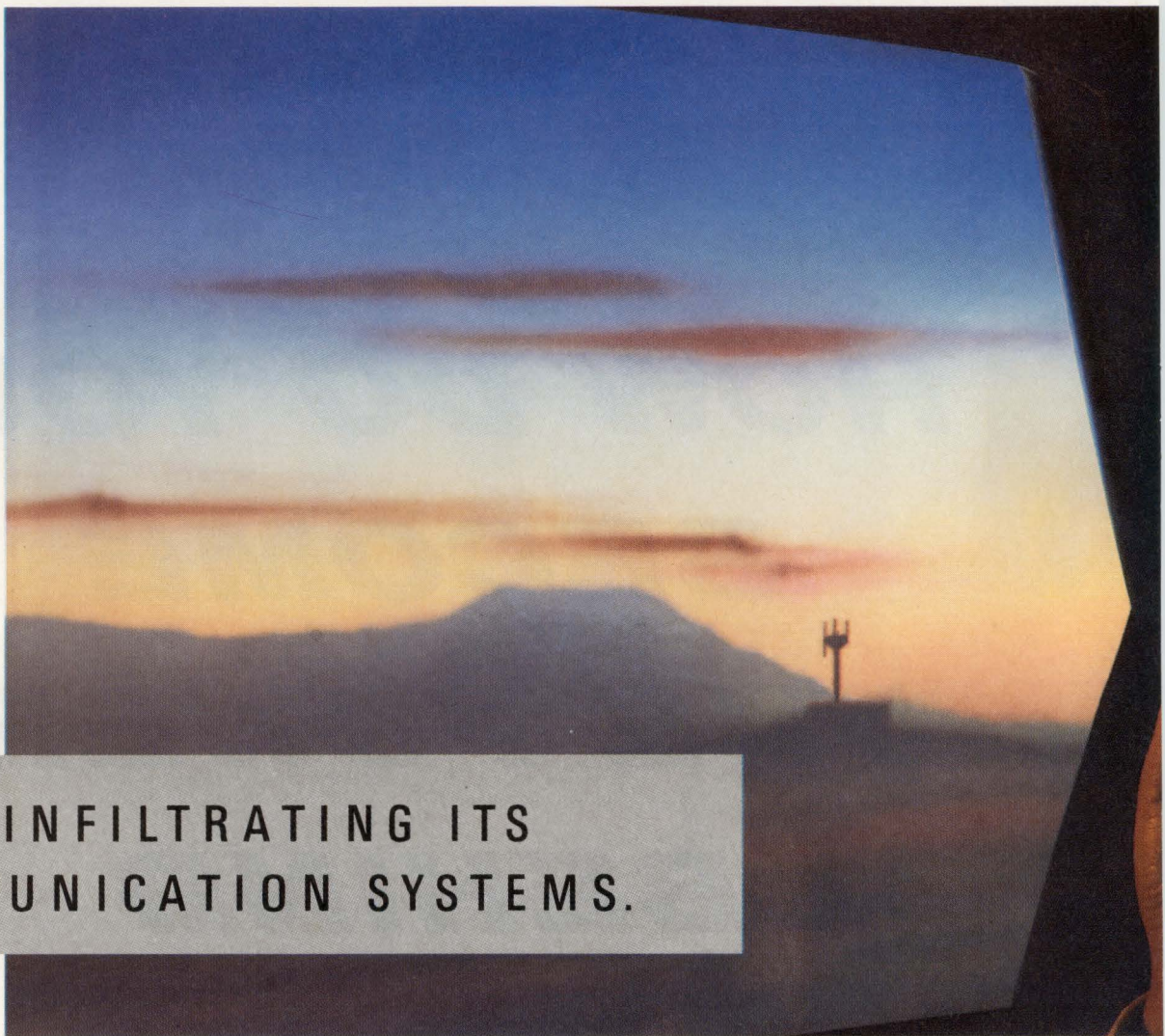

BY INFILTRATING ITS COMMUNICATION SYSTEMS.

The superpower in cellular radio is the United States.
The world leader in RF transistors is Philips.
Together they're creating a revolution in cellular communications.

AT&T, as one of the key players in the industry, relies on Philips' RF power transmitting transistors

for its rapidly growing network of base stations. At the other end of the scale, Philips' RF wideband transistors are working undercover in the top-rated cellular phone handsets.

Philips' ability to meet precise specifications, guarantee quality and deliver on time, was key to

Philips Components Discrete Products Division, 2001 W Blue Heron Blvd, Riviera Beach, FL 33404 USA. Tel: 1-800 447 3762.

Philips Semiconductors



this success. But that's not the end of the story.

Our latest RF wideband transistors feature 5 and 4 micron technology, ready for the next generation of equipment.

And our user-friendly Data Disks are further proof of Philips' commitment to communication. They give

information on every one of our 4,200 discrete semiconductors – including many that are ideal for phone systems.

So if you want to make the most of the growing telecoms revolution, your course of action is clear.

Get in touch with Philips.



PHILIPS



Telecom relays from the winning team in telecommunications. Because you know the score.

Scoring points is never a coincidence. Neither in sports nor in telecommunications.

We took a three-way approach to make our MT relay family the industry's top contender. After all, we've played the game long enough to know what counts.

First, in the development phase, we made sure that our products thoroughly address current and future requirements. Granted, we have an edge on the competition: we happen to be the largest user of telecom relays.

Second, our specifications in terms of materials and fabrication are probably unmatched. They're so strict that we had to design and build our own production facilities. Your advantage: greater precision.

And third, our MT4 relay is remarkably compact. It takes up less space without sacrificing reliability

or function. That means greater packaging densities and lower cost!

The bottom line: MT2 relays and MT4 relays score top points. Mail the coupon below to join the winners.

We're interested in scoring big points. Please send us detailed literature on the MT relay family.

Name _____

Job title _____

Company _____

Address _____

Telephone _____ Telefax _____

Alcatel STR AG, CH-8055 Zurich, Friesenbergstr. 75
Telephone +41-1-465 21 52, Telefax +41-1-465 21 60

How do you get 1600 x 1280 resolution in an X-terminal design right away?



Use TI's TLC34074 Video Interface.

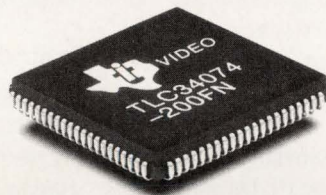

It's the first 200-MHz video interface optimized for X terminals, enabling 1600 x 1280 resolution at a 72-Hz refresh rate. And it's in distributor stocks now.

The TLC34074 from Texas Instruments integrates a complete grey-scale graphics system back-end onto a single chip, eliminating up to 30 components.

Best yet, it is pin compatible with TI's full-featured TLC34076 palette that supports monochrome to 16- and 24-bit-per-pixel true color. Which allows you to make system cost/performance trade-offs while maintaining a common architecture.

More advantages

- Both devices are compatible with

TLC34074				TLC34076			
Designed specifically for B&W/grey-scale applications				True color for X terminals, high-end PCs and workstations			
Resolution	Refresh Rate	Price (1,000s)	Speed	Resolution	Refresh Rate	Price (1,000s)	Speed
1600 x 1280	@ 72 Hz	\$34	200 MHz	1280 x 1024	@ 72 Hz	\$45	135 MHz
1600 x 1280	@ 60 Hz	22	170 MHz	1280 x 1024	@ 60 Hz	30	110 MHz
1280 x 1024	@ 72 Hz	12	135 MHz	1024 x 768	@ 72 Hz	18	85 MHz

virtually any video controller architecture: CISC and RISC microcontrollers, including TI's TMS340 graphics coprocessors,

as well as hard-wired controllers.

- Handles Big- or Little-Endian formats with no hardware modifications.
- Direct interface to VRAM and controller.

For more information

About TI's '34074/76 mail the return card. For faster response call (214) 995-6611, ext. 3429, your local sales office or an authorized TI distributor.



CHOOSING COMPLEX

Design methodology, performance, and software tools should all influence you as you seek the right high-density PLD. But first you have to know the foundations of complex PLD and FPGA architectures.

Anne Watson Swager, Technical Editor

Complex PLDs and FPGAs are proliferating, and so are the software tools necessary to work with them. In fact, the task of choosing from such a vast array of high-density programmable logic devices (PLDs) is enough to overwhelm unsuspecting newcomers. However, an overview of the hardware architectures, design methodologies, and other important criteria can help you on your way to choosing the right device for your design.

Not only is there currently a wide assortment of architectures to choose from—both complex PLDs and field-programmable gate arrays (FPGAs)—but the list of such architectures keeps growing. Within the last year, at least three start-ups—Concurrent Logic, Crosspoint Solutions, and Quicklogic—started shipping their FPGAs. AT&T Microelectronics, which currently second-sources a number of FPGA market leader Xilinx's devices, announced a proprietary architecture that will be in full production by the beginning of 1993. Cypress Semiconductor recently announced an agreement with Quicklogic that will potentially lead to wider availability and expanded capability of the latter company's architecture. Motorola (Phoenix, AZ) has announced its intention to enter the FPGA market and, at the time of this article's writing, is close to making its specific plans public. And even Harris Semiconductor (Melbourne, FL) is getting into the FPGA act through an agreement with Xilinx to produce a radiation-hardened version of one of their FPGAs.

Just as there are multiple architectures, so there are myriad software tools, from both IC vendors and third-party vendors, that embody various design-entry approaches, from schematic capture, to Boolean entry, to waveform entry, to hardware-description languages.

CAE vendors have been extremely busy introducing all manner of software tools such as retargeters, which take a design intended for one architecture and transform it for another, and device fitters, which take compiled designs and map them to a specific part.

Taking it all in

Absorbing all of the product and tool information necessary to make an informed choice (Fig 1) could possibly require more time than an entire design project. Becoming familiar with these devices' architectures is a critical first step. When you start learning about these devices, it is simplest to divide high-density programmable logic into two main camps: com-

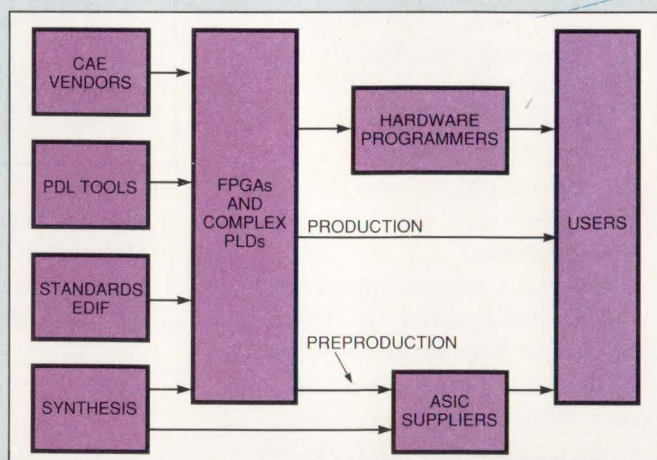

Fig 1—FPGAs and complex PLDs don't exist in a vacuum. Learning about the devices themselves is an important first step, but so is becoming familiar with their dependence on design software, programming hardware, and in some cases, ASIC conversion processes. (Diagram courtesy Actel Corp)

PLDs and FPGAs



The capabilities of computer PLDs and FPGAs do intersect, but different structures mean one or the other may perform a function faster or more predictably. (Photo courtesy Quicklogic Corp)

Choosing complex PLDs and FPGAs

plex PLDs and FPGAs. Both complex PLDs and FPGAs help you achieve the same goal, that is, to absorb large amounts of standard logic into one device. Using one or the other—or both—for your design requires understanding the strengths of each.

Complex PLDs are essentially large collections of PAL-like structures on one chip. In other words, a complex PLD is a large collection of sum-of-products arrays (Fig 2a). The connections between logic and I/O cells are typically fixed, and the devices feature a centralized programmable interconnect. This setup is sometimes referred to as a segmented-array architecture. These devices' relatively constrained routing provides them with one of their main advantages: predictable timing. With some exceptions in terms of architectural features, all complex PLDs share the same basic logic structure.

This last statement absolutely doesn't apply to FPGAs. Grouping diverse devices under the term *field-programmable gate array* makes FPGAs sound as if they all exhibit gate-array-like characteristics. In fact, they are distinguishable from complex PLDs simply because they comprise arrays of logic blocks connected by rows and columns of distributed interconnect lines (Fig 2b), which is sometimes referred to as a channeled-array architecture. Any more specific resemblance to each other ends there. Only one FPGA manufacturer's architecture closely resembles a gate array.

Each FPGA vendor's logic blocks and each product

family from one vendor contains a different collection of logic and different levels of logic functionality. FPGAs have no predetermined coupling between logic and I/O blocks, although some devices do have a few dedicated inputs such as clock-drive inputs. These devices' unrestricted routing structure provides them with one main advantage: flexibility.

Reprogrammable vs one-time-programmable parts

Complex PLDs and FPGAs use different fabrication and interconnect technology. Most complex PLDs are CMOS-EPROM based or EEPROM based, and the PROM memory bit switches a transistor that controls the configuration pattern of the logic. Thus, no hard-wired physical link exists, and most off-the-shelf complex PLDs are reprogrammable. EPROM versions require UV erasure prior to reprogramming, but EEPROM devices do not, although both have to be removed from the circuit for programming. Lattice Semiconductor's in-circuit programmable device requires neither UV erasure nor removal from the circuit. On-chip charge pumps produce the required programming voltage from the 5V supply. This feature is particularly useful for hard-to-remove surface-mount packages.

Although complex PLDs start out reprogrammable in some form, once a design is established, many companies offer conversions to one-time-programmable versions. Altera offers a third step called MPLD, or

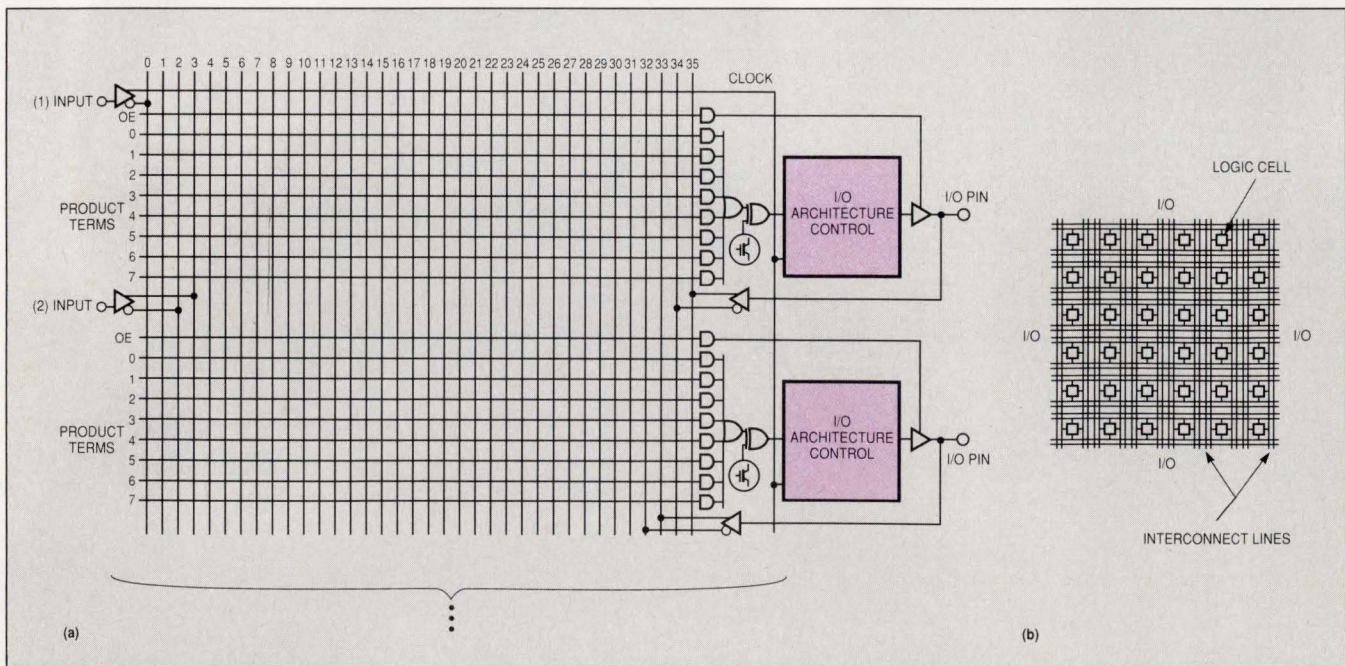

Fig 2—Complex PLDs (a) are large collections of sum-of-products arrays, whereas FPGAs (b) feature an array of identical logic cells connected by rows and columns of interconnect. Not all FPGAs are symmetrical like the array in (b), and internal logic cells and routing structures vary from device to device.

“mask-programmable logic device.” These one-time-and mask-programmable versions offer significant price savings.

FPGAs are available in both reprogrammable and one-time-programmable technologies, static RAM and antifuse, respectively. SRAM-based FPGAs, pioneered by Xilinx, and now manufactured by Algotronix, AT&T Microelectronics, and Concurrent Logic, use a memory bit to program connections open or closed on power up. Thus, SRAM-based FPGAs are reprogrammable and volatile. Like some complex PLD vendors, Xilinx also offers a conversion to a one-time programmable device, which the company calls “hard-wire.” In antifuse FPGAs, pioneered by Actel, and now manufactured by Crosspoint Solutions, Quicklogic, and Texas Instruments (second source to Actel), the high programming voltage establishes a hard-wired physical link. Thus, antifuse FPGAs are one-time programmable.

Basic architectural and technology differences are just two aspects that distinguish complex PLDs from FPGAs. One of the biggest differences between com-

plex PLDs and FPGAs is the design methodology necessary to implement logic functions in each device. Depending on your design perspective, you may have to make some adjustments. If you have experience designing with 7400 series devices, the jump to FPGAs won't be difficult. In fact, Doug Conner, in his hands-on projects (Refs 1 and 2), found it to be quite easy. And if you're currently a PAL designer, designing with complex PLDs won't take much of a change in your way of designing and implementing standard logic functions.

However, the jump from PLD design to FPGA design will require some adjustments. FPGAs are very flexible devices, and designing with them involves making tradeoffs. Whereas a complex PLD data sheet can closely predict the final speed of the design, the timing of an FPGA is not at all deterministic. How much of the FPGA a logic design utilizes influences the final speed of that logic. For example, a recent EDN Design Idea (Ref 3) shows how you can trade off modules for speed when using FPGAs. This Design Idea shows that using the fewest modules requires the

Benchmarking group grapples with performance comparisons

All vendors of complex PLDs and FPGAs have until now used their own unique ways of quoting system performance for particular designs implemented in their devices. Each of these performance predictions is a type of one-company benchmark—each company uses a different logic implementation to arrive at their performance numbers.

This situation is changing. The Prep Corp (San Jose, CA, (408) 356-2169)—PREP stands for programmable electronics performance—consists of a consortium of IC and software vendors trying to establish a viable benchmarking method. This method should help users make apples-to-apples comparisons of the speed and logical capacities of larger programmable logic devices, namely complex PLDs and FPGAs.

Prep has two essential goals: to help introduce the architecture of different PLDs to users so that they may better understand the factors

involved in selecting among them, and to allow experienced users to more quickly evaluate different architectures with respect to a specific design.

The suite of benchmarks includes a set of circuits implemented according to a prescribed methodology for measuring and reporting the capacity and timing measurements. Vendors will measure device capacity by using a “repeat and fill” scheme, whereby they will repeat the particular benchmark circuit as many times as possible, then fill the leftover logic space with filler circuits. Vendors will measure the maximum operating speed of a benchmark circuit by reporting the worst case delay of the circuit's slowest path.

The repeat-and-fill methodology is one of many that the group could have chosen for the benchmarking process. Although the vendors will be at least using the same implementation and measuring procedures

to compare the devices, keep in mind that few real designs contain repeated units of the same logic circuits. Thus, it's not wise to use these benchmarks to predict the overall speed of a design that contains a variety of circuits. Clearly, the ultimate benchmark is your circuit implemented in each architecture.

The first suite of benchmarks will include the following circuits: data path, timer/counter, state machine, large state machine, arithmetic circuit, 16-bit accumulator, 16-bit counter, and memory mapper. The small filler circuit is a combination of commonly found logic elements such as 4-bit counters, 4:1 multiplexers, 4:2 encoders, and 4-bit accumulators.

By the time of this article's printing, vendors should be very close to—if not done with—final verification of the benchmarks. Then, final Prep-approved data for each vendor's circuits should be published by the end of the year.

Choosing complex PLDs and FPGAs

largest number of logic levels, thus incurring the worst-case delay. The idea presents alternative designs that use fewer logic levels and decrease propagation delays at the expense of the module count.

Also, the speed of an FPGA depends on the interconnections between logic blocks and, thus, on the layout of the device. Each design, even each iteration of the same design, can use very different routing paths, the length and resulting impedance of which will heavily impact the speed of a final design. A smaller design can have a more efficient layout leading to more efficient routing and faster performance. A denser design places more constraints on layout and routing, leading to possibly slower performance.

The worst-case scenario that can occur with either complex PLDs or FPGAs is when so much logic space in the IC is occupied that there aren't enough routing resources to allow the necessary interconnections. This problem arises most often when I/O pins are fixed early in the design process.

You can use an FPGA's density-vs-speed flexibility to your advantage, but don't expect to predict how fast or slow an FPGA design will run at the outset. Also, routing efficiency—and therefore the IC's final performance—depends not only on how much of the FPGA a design utilizes, but also on the quality of the place-and-route software. Determining that final performance requires post-layout simulation. Having to use and rely so heavily on these software tools is quite different from working with complex PLDs.

Because there isn't one standard FPGA architecture, studying and understanding each architecture is important for designing optimum circuits with that architecture. In some cases, you'll need to learn more efficient ways of implementing certain logic functions such as state machines. Because few internal connections exist

within an FPGA, implementing a design takes two steps: partitioning the logic within the logic-cell structure of the FPGA and connecting the various blocks together using the device's routing resources.

Predictable vs unpredictable performance

Vendors of complex PLDs and FPGAs claim their devices can run at high speeds. However, their numbers are very difficult to judge and compare. One thing that you can bank on however, is that complex PLDs are usually a better choice for designs that have very tight speed requirements, simply because of their deterministic timing. This is not to say that the complex PLD will be the fastest implementation of a design, but simply that the final speed will be fairly predictable at the beginning of the design cycle. Creative FPGA design can result in very fast logic, but it can also require time-consuming attention to placement and routing details of internal logic blocks.

When it comes to implementing circuit applications, complex PLDs and FPGAs each have their strong points. However, each new architecture that debuts modifies those points somewhat. The parts themselves are changing to address some of the deficiencies of previous architectures (as the gray area in Fig 3 indicates). For example, Xilinx has improved the FPGA decoding situation in its XC4000 family by providing dedicated wide-decoding logic, which is directly coupled to input pins. Also, Quicklogic claims that its architecture is particularly suited to high-speed state machines. Complex-PLD vendors are adding more registers and I/O to their larger devices.

Still, for some applications, the choice between a complex PLD and an FPGA is fairly clear cut (as on the axes in Fig 3). Generally, complex PLDs excel at implementing large amounts of combinatorial logic, and

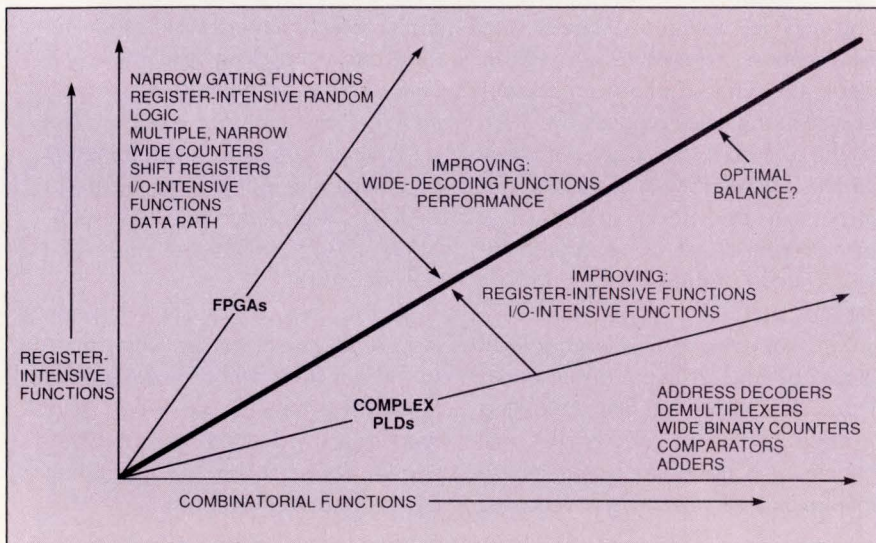

Fig 3—Complex PLDs excel at combinatorial functions. FPGAs excel at register-intensive functions. However, there is some gray area between the two. The parts themselves are improving, and techniques exist to implement logic functions in both device types. (Courtesy Advanced Micro Devices)

FPGAs excel at designs that require large numbers of registers. For example, implementing a large state machine or an extremely wide input decoder in an FPGA wouldn't make much sense because complex PLDs have a wide sum-of-products structure and are perfectly suited to that purpose. Likewise, implementing a design that requires many flip-flops, a register file or common-access memory for example, in a complex PLD wouldn't make much sense because FPGAs contain many more flip-flops than complex PLDs do.

These tradeoffs may be clear cut for a single logic circuit. However, if a design involves a variety of logic structures—if the state machine is only one quarter of the design, for example—the choice between complex PLDs and FPGAs isn't black and white. During the initial design-partitioning phase, you may discover that part of the design works well in a complex PLD and part in an FPGA.

If you must fit a variety of logic types into one device, you can implement the same logic function in both devices as long as you use the right structure for each. Techniques do exist to efficiently implement traditional register-intensive and combinatorial-intensive functions in both complex PLDs and FPGAs.

Techniques fit designs into FPGAs

State machines (Fig 4a) and binary counters are two examples that require different implementations to get optimum performance from the complex PLDs and FPGAs. Because of their wide decoding ability, complex PLDs are well suited for maximally encoded state machines, that is, state machines in which a minimal set of variables defines each state (Fig 4b). A 4-bit counter is one example of such a state machine—4 bits define a total of 16 states.

However, implementing a maximally encoded state machine in an FPGA is not a good use of the FPGA's narrow decoding, register-rich architecture. A better approach is to use the state-per-bit or one-hot method (Fig 4c), first proposed by FPGA consulting firm Highgate Design (Saratoga, CA). In this method, the state of a single, or "hot," register determines the current state. A state machine with 16 states thus requires 16 flip-flops. The input and a small amount of decode logic determine the next state. This approach usually requires fewer logic levels between clock edges than binary encoding and ultimately produces faster FPGA operation. One penalty of this approach is apparent if two registers become active at one time. The design may need extra logic to decode and then prevent such illegal states.

Likewise, implementing a classic binary counter in a complex PLD makes sense. Conventional binary counters use wide fan-in logic to generate high-end

carry signals. An FPGA's limited fan-in makes this particular implementation cumbersome. A much simpler structure, the linear-feedback-shift-register (LFSR) counter (Fig 5), sacrifices the binary count sequence but achieves high speed with very simple logic using an FPGA. The counting sequence is the

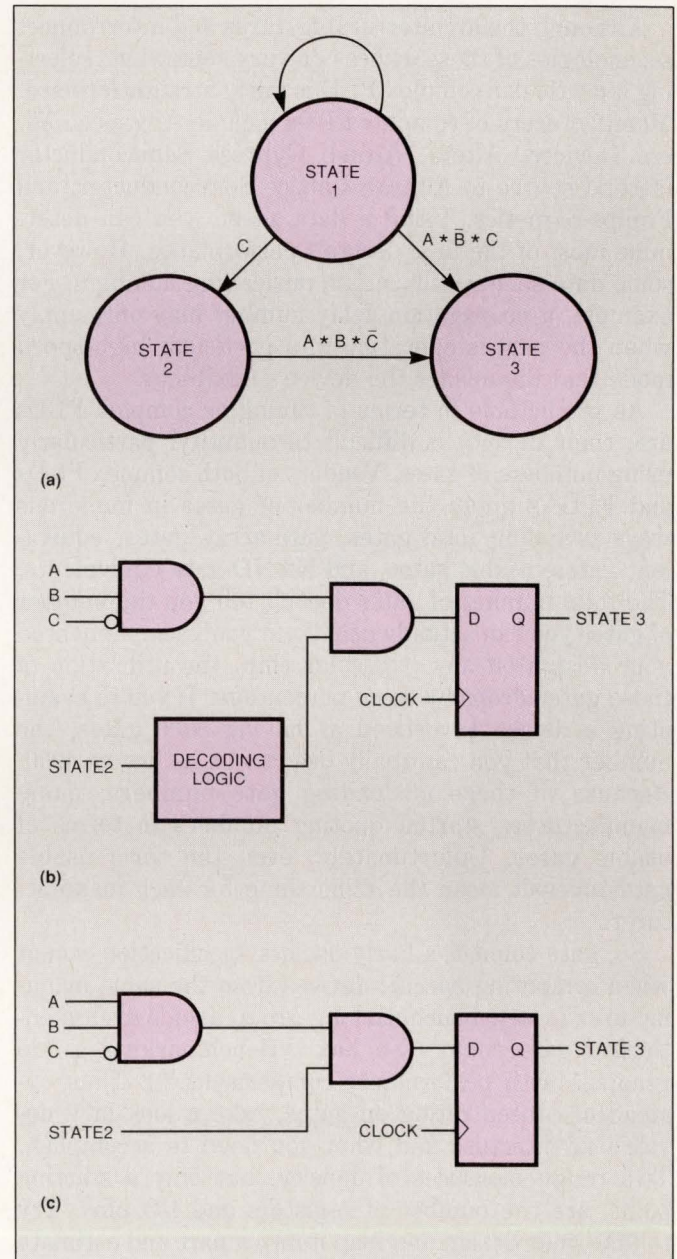

Fig 4—This very simple state machine (a) reveals the problem of implementing a maximally encoded state machine (b) in an FPGA. The decoding logic required is a waste of the FPGA's architecture. As the state machine grows in complexity, many such decoding blocks would be necessary. However, using the one-hot method (c) in which one and only one register's output (the "hot" one) determines the current state, does away with the decoding blocks entirely.

Choosing complex PLDs and FPGAs

major difference between a binary counter and an LFSR counter. The counting sequence of an LFSR counter is not binary and is essentially pseudorandom. Whereas a binary counter can count to 2^N states, an LFSR counter can count to $2^N - 1$ states.

Getting down to the specifications

Although the architectural features and interconnect technologies of these devices do vary somewhat, selecting a particular complex PLD is fairly straightforward. Manufacturers of complex PLDs include Advanced Micro Devices, Altera, Atmel, Cypress Semiconductor (second source to Altera), Lattice Semiconductor, and Philips-Signetics. Using a data sheet, you can determine most of the final design's performance. However, some data sheets still contain misleading numbers. For example, a propagation-delay number may only apply when the part is operating in a particular high-speed mode that diminishes the device's flexibility.

As predictable in terms of timing as complex PLDs are, their density is difficult to quantify, particularly using numbers of gates. Vendors of both complex PLDs and FPGAs quote the number of gates in numerous ways including total gates, gate-array gates, equivalent gates, usable gates, and NAND-gate equivalents. The total number of gates doesn't tell you the number of gates you can actually use. Once you've implemented your design on any particular chip, the utilization of those gates drops by some percentage. If you're evaluating a device advertised as having 8000 gates, the number that you can really use can be as low as 4000. Because of these misleading gate numbers, many manufacturers started quoting numbers in terms of usable gates. Unfortunately, even the term usable gates doesn't mean the same thing for each manufacturer.

So, gate count is a fairly useless specification except when comparing specific devices from the same manufacturer (a new benchmarking group avoids even mentioning gate count (see **box**, "Benchmarking group grapples with performance comparisons.")). Thus, instead of concentrating on gates, take a look at a device's architecture and what you need to accomplish. Two rough measures of density, but only a starting point, are the number of registers and I/O pins. Try to take your design and map it into a part and estimate how well the design will fit.

One approach is to estimate what your design would take in standard logic. Then, look those devices up in the vendor's library and note the logic-block count for implementing that function. Adding up all the logic blocks necessary will give you a rough estimate that will allow you to decide between a 2000-gate device and a 4000-gate device.

The first thing to recognize when choosing an FPGA is that each vendor's devices exhibit fundamental architectural differences. These differences manifest themselves in both the individual logic blocks and the routing structure of the devices. Designers of the first FPGAs focused most of their attention on the structure of the logic blocks themselves, only to discover that the lack or abundance of routing channels can make or break the final design. Thus, the latest FPGA designs, from market leaders and recent start-ups, pay close attention to both.

The structure of FPGA logic cells ranges from extremely fine granularity to coarse granularity (**Fig 6**). Granularity is the amount of logic contained in one logic block. A fine-grained architecture, such as **Fig 6a**, is one that has very simple, basic blocks, even down to the transistor level. A coarsely grained architecture, such as (**Fig 6b**), has logic blocks of high complexity containing a number of digital logic functions.

Other than having to sort through architectural details, the most frustrating part of choosing one FPGA

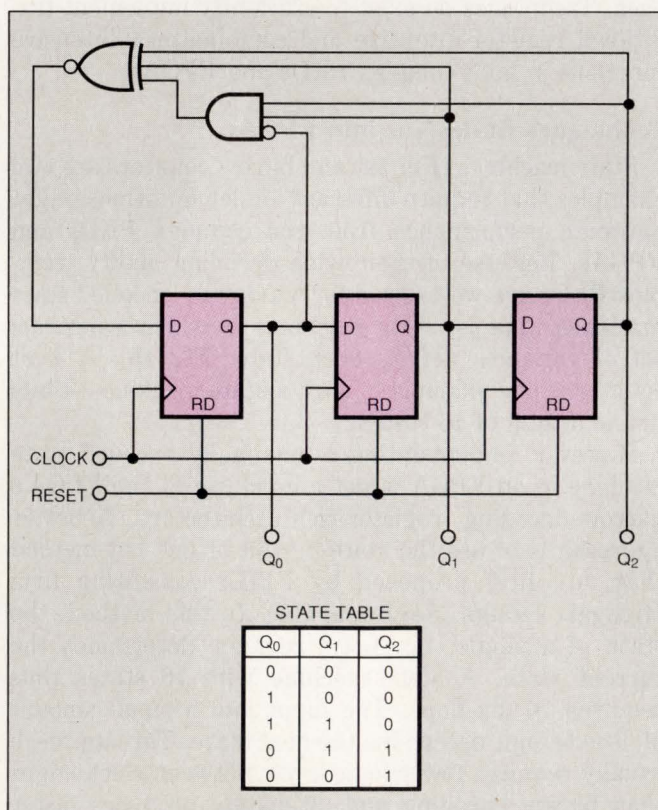

Fig 5—Implementing conventional binary counters in FPGAs isn't optimum because these counters use wide fan-in logic to generate high-end carry signals. A linear-feedback-shift-register counter, such as this 3-bit, modulo-five counter, is a more efficient implementation for an FPGA. Note from the state table that the counter skips some states and the counting sequence is a nonbinary, pseudorandom pattern. (Courtesy Xilinx application notes)

over another is that so very little data about the final density and speed is predictable from the outset. Whereas propagation delays of complex PLDs give you a good idea of your final design's performance, delays of the individual blocks within an FPGA are meaningless. The overall speed of an FPGA is determined both by the details of the internal blocks and the interconnect delays of the final utilized chip.

Every FPGA manufacturer's data sheets state things a little differently and with different underlying assumptions. Although the toggle rates of individual flip-flops inside each logic block tell you the speed possible from that block, there is no way to extrapolate system performance from that number due to the influence of the final routing paths.

Fortunately, more companies are now quoting attainable system-clock rates, but these numbers can also

be highly misleading. Because of the speed/density tradeoff inherent to FPGAs, the speed the company was able to achieve for its example depends on the placement, routing, and implementation of the logic. You may see an advertisement for an 80-MHz 16-bit counter, but it's very possible that to achieve that performance, the FPGA requires expert hand routing and contains no logic other than that lonely 16-bit counter. That same counter combined with other logic may run at only 25 MHz.

Propagation delay is another potentially misleading specification. Because of the structure of a complex PLD, propagation delay is a quite meaningful measure of ultimate system speed. However, because of the structure of an FPGA, you can't use one logic cell's propagation delay to predict the timing of the overall design.

Fortunately, help may be on the way in the form of

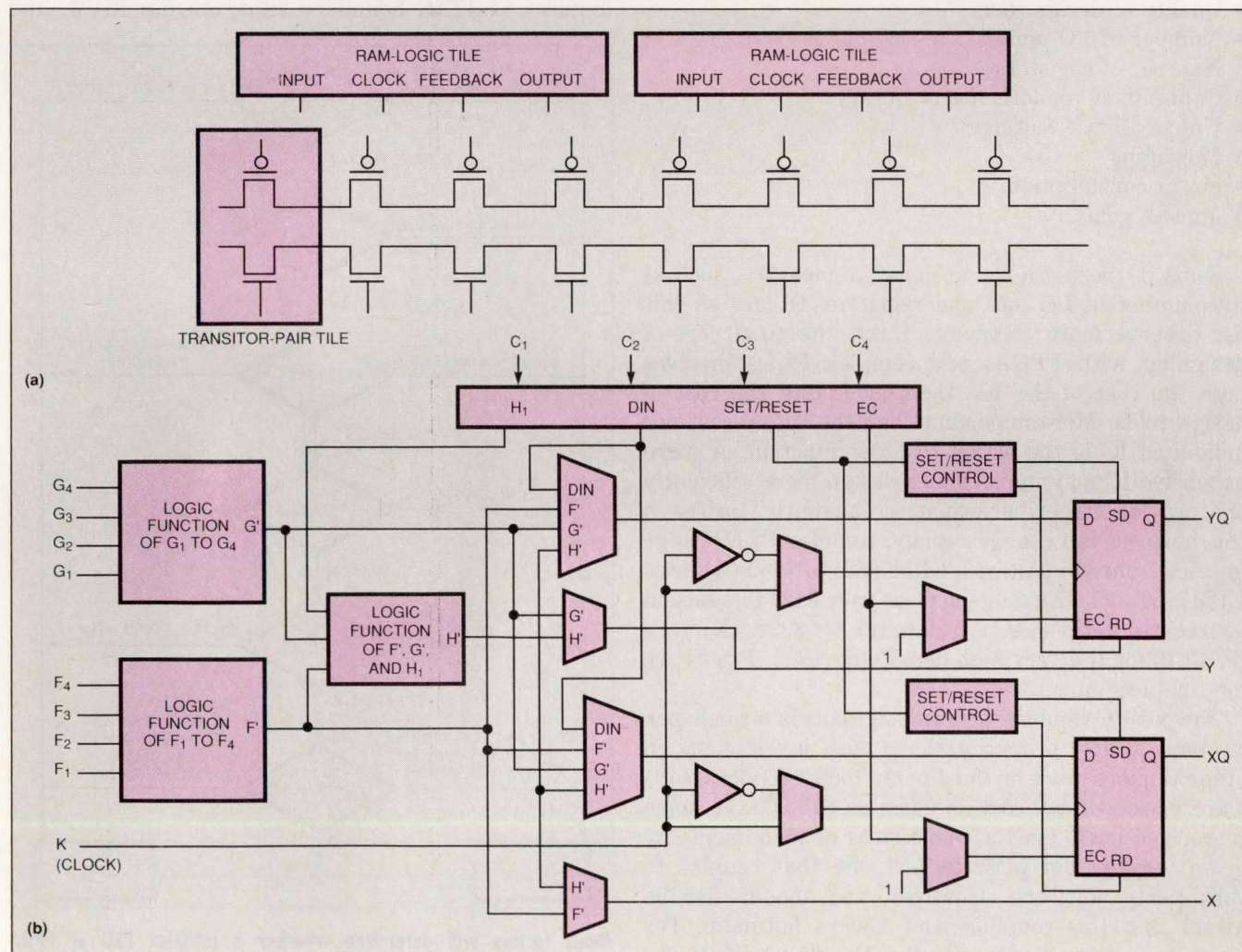

Fig 6—An FPGA's granularity can range from fine to coarse, respectively referring to the simplicity or complexity of the internal logic cell's structure. Crosspoint Solutions' devices and Xilinx's 4000 series represent the two ends of the granularity spectrum. Of all the available FPGAs, Crosspoint's devices, which connect transistor-pair and RAM-logic tiles to form macrocells, most closely resemble gate arrays.

Choosing complex PLDs and FPGAs

benchmarks that have a common methodology and implementation. Both complex-PLD and FPGA vendors are cooperating to produce useful benchmarks that showcase the performance of each architecture under similar implementation conditions (see **box**, "Benchmarking group grapples with performance comparisons").

Consider all criteria

Architectural differences, interconnect technologies, and design methodologies inherent in complex PLDs and FPGAs are important factors governing the choice of these devices. Many other criteria will ultimately determine the wisdom of the final choice. These criteria include (but aren't limited to) the following:

- Cost of devices *and* design tools
- Quality of design tools
- Number of I/O pins
- Number of registers
- Contents of vendor's macro library
- Unique device features
- Packaging
- Power consumption
- Market goals.

Some of these criteria are easy to measure, such as the number of I/O pins and registers. Others on this list deserve more comment. First, the total cost of designing with FPGAs and complex PLDs involves both the cost of the ICs themselves *and* the cost of design tools. More important than the actual cost per individual IC is the actual cost per function. A more expensive IC may implement a design more efficiently and provide higher performance. Currently, (prices in this business can change rapidly) complex PLDs range in price from \$15 (Altera's EPM7032) to \$400 (Altera's EPM7256). FPGAs range in price from \$12 (TI's second source to Actel's ACT 1 family) to \$922 (Xilinx's XC4010) for the very high density devices. (Prices are for 100-piece quantities.)

The cost of vendors' proprietary tools is a roadblock to many users, primarily those with investments in other vendors' tools or third-party tools. Vendors' software packages can cost as much as \$10,000. In some cases, you don't need a whole suite of tools from any given vendor, but perhaps just one that couples to third-party software. However, you should also be aware that this coupling isn't always optimum. For example, a design captured using third-party software may not run successfully on the vendor's compiler. You may get only a cryptic error message that says something's not right. So, though buying proprietary tools may seem excessive, you may run into some time lags

when using coupled software. On the flip side, third-party software can sometimes be better than proprietary tools at performing certain tasks.

Ultimately, judging the efficiency of the software tools isn't easy. One question that may help you judge is to ask vendors if hand routing will be necessary to produce an optimal design.

The completeness of a vendor's macro library—a library of expert-crafted logic functions—can also be a selling point for a particular complex PLD or FPGA. Every vendor supports some type of library. However, not all libraries contain exact equivalents to 7400 series standard logic but, instead, contain vendor-specific functions. Such a library makes retargeting and converting to a gate-array difficult.

Special features of FPGAs may influence your choice of devices. Some of the newest FPGAs include such features as JTAG boundary scan, on-chip RAM, and

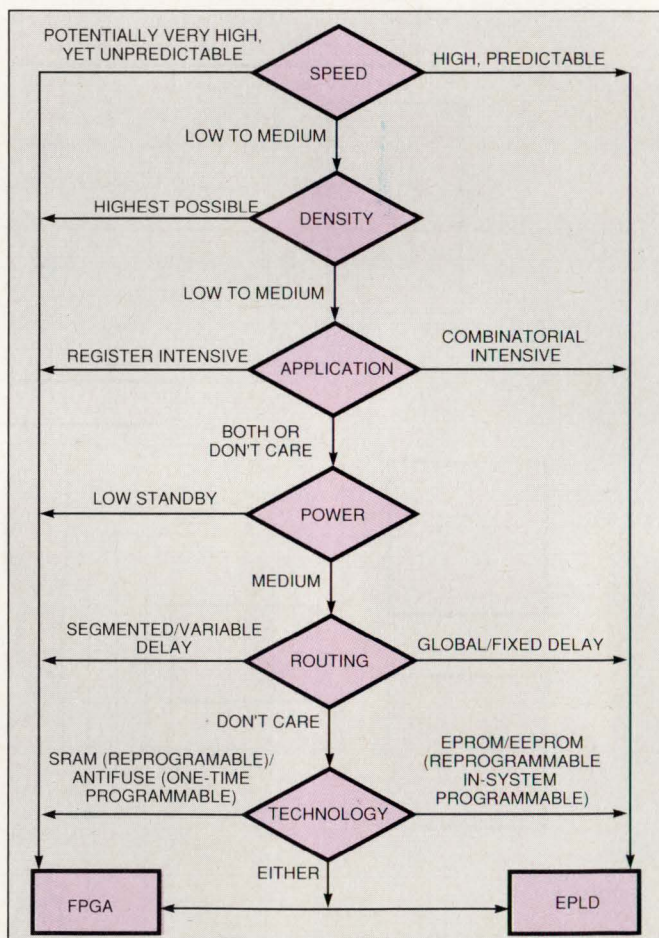

Many factors will determine whether a complex PLD or FPGA better suits a particular design. This decision tree includes some basic criteria to consider when choosing between the two types. This tree makes the decision look straightforward, but most complex designs will involve compromises between the two devices' strong points.



Situation Under Control.

The Military 68332 is the first member of the Motorola Military 68300 Family of modular embedded controllers featuring fully static, high-speed complementary metal-oxide semiconductor (CMOS) technology. This monolithic 32-bit integrated microcontroller combines high-performance data manipulation capabilities with powerful peripheral subsystems.

In short, it's fast, flexible, efficient and powerful.

Ada Supported

Motorola understands the unique demands placed upon Military systems and works closely with software vendors to ensure that its products are fully supported.

The Military 68332 is screened in accordance with MIL-STD-883. Electrical samples are available NOW! The 883 version will be available in September '92.

Introducing Additional Configurations

With the introduction of additional configurations powered by the CPU32, the Motorola Military Modular MCU family allows you to leverage your development

resources further. The 68340 integrates the CPU32 with a 2-Channel DMA, 2-Channel Serial I/O, and two Multiple-Mode 16-Bit Timers. The 68F333 integrates the same CPU and Timer as the 68332 with a massive array of 64 bytes of Flash EEPROM and an 8-Channel 10-Bit Analog to Digital Converter! Samples are planned for availability in third quarter '92.

For more information on the 68332, order Brochure #BR1406/D by calling toll-free 1-800-441-2447. Or complete and return the coupon below to Motorola, P.O. Box 20912, Phoenix, AZ 85036.



MOTOROLA

Motorola and  are registered trademarks of Motorola Inc.

To: Motorola Semiconductor Products, Inc., P.O. Box 20912, Phoenix, AZ 85036

Please send me Motorola's Military 68332 Brochure #BR1406/D

Name 559EDN091792

Title

Company

Address

City State Zip

Call Me ()

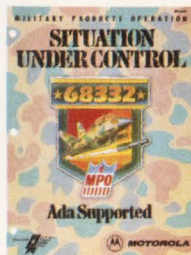

Choosing complex PLDs and FPGAs

fast carry logic. If package style is important, be aware that, for example, not all complex PLDs and FPGAs come in surface-mount packages.

Delving into small details too quickly can obscure some other information that you'll have to digest to choose the right complex PLD or FPGA. Backing away from the design details and considering overall market goals will also help narrow down the decision.

Most users may start out thinking that their product will sell millions and they'll end up converting to a gate array (Ref 4). However, according to the vendors and users interviewed for this article, it seems that many FPGAs or complex PLDs find permanent homes in the end product. Still, your estimated production volume will have great bearing on the device you choose, whether it's because of the specific device cost of the FPGA or because you're looking for an architecture amenable to gate-array conversion.

Another product development issue to consider is prototyping time. If it's necessary to turn out prototypes quickly, the design-compiling time and device-programming time may be huge factors in your product's success. And even though the programming time may not seem critical during development, it may turn out to be crucial to the manufacturing department. Depending on the design platform, PLDs can take minutes to compile, whereas very dense FPGAs can take hours.

Considering all facets of complex PLDs and FPGAs—from the design methodology to market goals—is indeed daunting to the new user, but these

devices are too useful to ignore. Although you won't find any easy answers when it comes to choosing high-density programmable logic, the rewards of density, flexibility, and user configurability are worth the effort. **EDN**

References

1. Conner, Doug, "Hands-on FPGA Project—taking the first steps," *EDN*, April 9, 1992, pg 98.
2. Conner, Doug, "Hands-on FPGA Project—Migrating to FPGAs: any designer can do it," *EDN*, April 23, 1992, pg 120.
3. Miller, Warren, "FPGAs trade off modules for speed," *EDN*, June 18, 1992, pg 136.
4. Small, Charles H, "FPGA conversion," *EDN*, June 4, 1992, pg 107.
5. Conner, Doug, "High-density PLDs," *EDN*, January 2, 1992, pg 76.



You can reach Technical Editor Anne Watson Swager at (215) 645-0544.

Article Interest Quotient (Circle One)
High 470 Medium 471 Low 472

Manufacturers of complex PLDs and FPGAs

For more information on complex PLDs and FPGAs such as those described in this article, circle the appropriate numbers on the Information Retrieval Service card or use EDN's Express Request service. When you contact any of the following manufacturers directly, please let them know you saw their products in EDN.

Actel Corp

955 E Arques Ave
Sunnyvale, CA 94086
(800) 228-3532
FAX (408) 739-1540
Circle No. 650

Advanced Micro Devices

Box 3453
Sunnyvale, CA 94088
(408) 987-3119
FAX (408) 987-3102
Om Agrawal
Circle No. 651

Algotronix Ltd

King's Buildings-TTC
Mayfield Rd
Edinburgh EH9 3JL
Scotland
(31) 668-1550
FAX (31) 662-4678
Circle No. 652

Altera Corp

2610 Orchard Pkwy
San Jose, CA 95134
(800) 800-7256
FAX (408) 435-1394
Circle No. 653

Atmel Corp

2125 O'Neil Dr
San Jose, CA 95131
(408) 441-0311
FAX (408) 436-4200
Circle No. 654

AT&T Microelectronics

555 Union Blvd
Allentown, PA 18103
(215) 439-5237
FAX (215) 778-4085
Tom Hickey
Circle No. 655

Concurrent Logic Inc

1290 Oakmead pkwy
Sunnyvale, CA 94086
(408) 522-8703
FAX (408) 732-2765
Circle No. 656

Crosspoint Solutions Inc

5000 Old Ironsides Dr
Santa Clara, CA 95054
(408) 988-1584
FAX (408) 980-9594
Circle No. 657

Cypress Semiconductor

3901 N First St
San Jose, CA 95134
(408) 943-2600
Circle No. 658

Lattice Semiconductor Corp

5555 NE Moore Ct
Hillsboro, OR 97124
(800) 327-8425
FAX (503) 681-3037
Circle No. 659

Philips-Signetics

Box 3409
Sunnyvale, CA 94088
(408) 991-2339
Kathryn Douglas
Circle No. 660

Quicklogic Corp

2933 Bunker Hill Lane
Santa Clara, CA 95054
(408) 987-2000
FAX (408) 987-2012
Circle No. 661

Texas Instruments

Semiconductor Group (SC-91084)
Box 809066
Dallas, TX 75380
US and Canada,
(800) 336-5236, ext 700;
outside US, (214) 995-6611,
ext 700

Circle No. 662

Xilinx Inc

2100 Logic Dr
San Jose, CA 95124
(408) 559-7778
FAX (408) 559-7114
Circle No. 663

Terminate Your SCSI Problems

Unitrode's new BUS BOSS™ - the UC5601 active terminator - is the one chip solution you've been waiting for. Let the UC5601 handle your toughest SCSI challenges. It's not just a regulator.

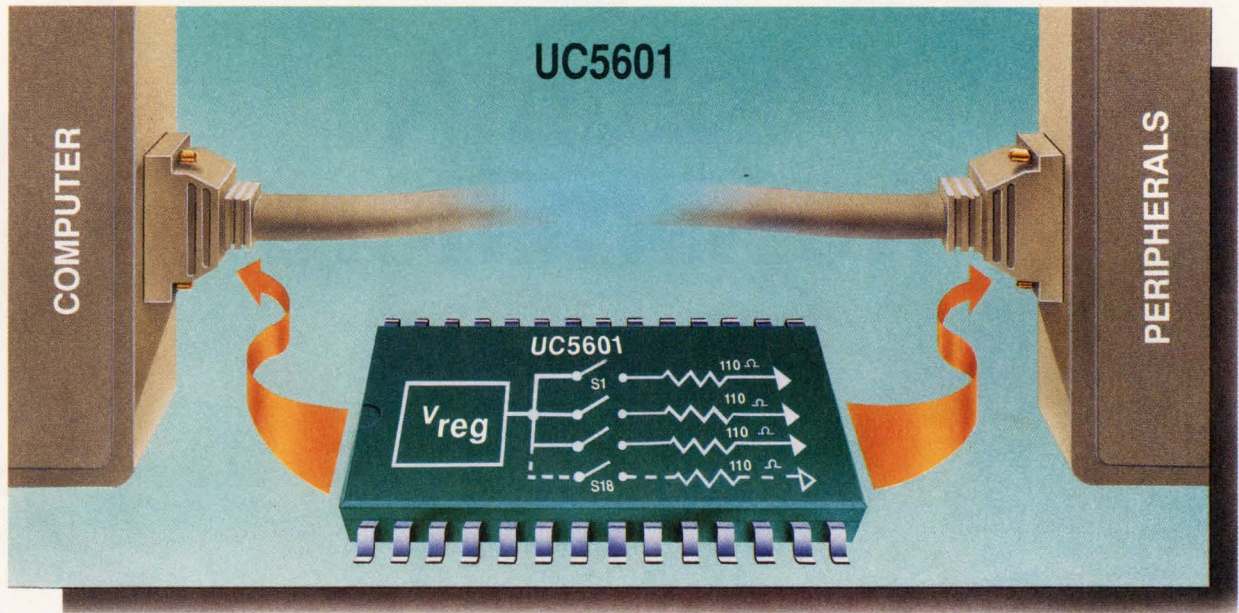

Unitrode's UC5601 assures a clean transmission

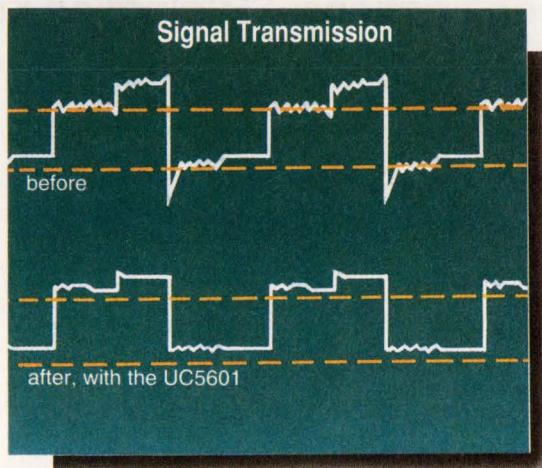

For more information on the UC5601 and your nearest Unitrode Representative, call, FAX or write us today: Unitrode Integrated Circuits, 7 Continental Blvd., Merrimack, NH 03054, FAX (603) 424-3460.

(603) 424-2410

Connectivity Solution

The UC5601. No other active terminator in the industry offers this level of capability, with these on-board features:

- ◆ 18 Thin film termination resistors
- ◆ Factory trimmed voltage regulator
- ◆ Low level clamping
- ◆ Logic command to disconnect all terminating resistors
- ◆ Low supply current in disconnect mode
- ◆ 28-Pin SOIC / PLCC
- ◆ Meets SCSI standards

 **INTEGRATED
CIRCUITS**
UNITRODE

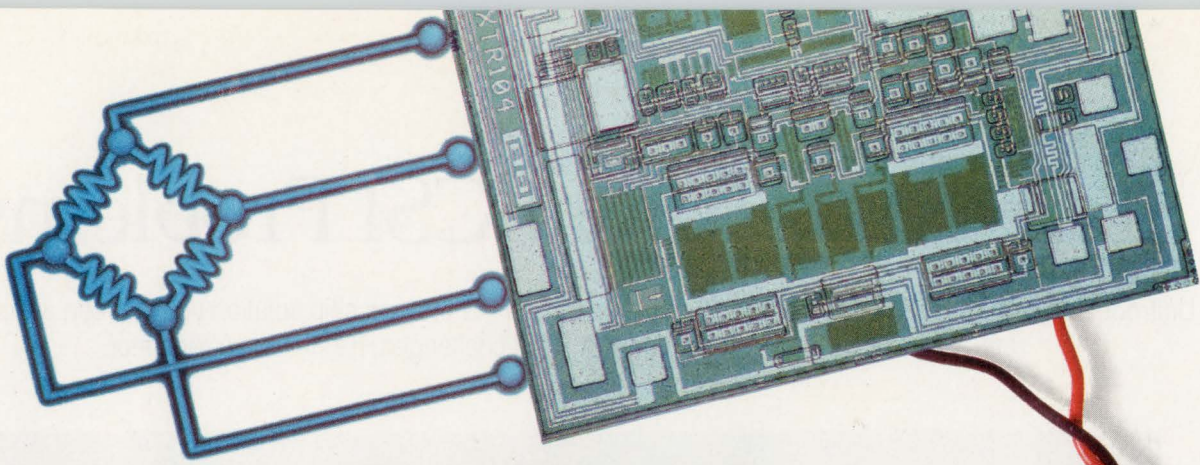

4-20mA Transmitters for RTDs & Bridges

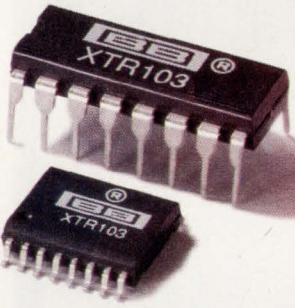

One Chip Solution

XTR103 and XTR104 are monolithic, two-wire transmitters providing, low cost signal conditioning solutions in 4-20mA current loops. **XTR103**—for RTDs— includes a precision instrumentation amplifier, excitation current sources, and current output circuitry. Compensation circuitry corrects the inherent nonlinearity of RTD temperature sensors. **XTR104**—for bridge sensors— adds 5V voltage for strain gages and other sensors. It's versatile linearization circuitry can actually correct sensor nonlinearity. They're your best choice for precision 4-20mA transmitter applications.

9V Operation

XTR103 and XTR104 perform with loop voltages down to 9V—ideal for personal computer-based systems. Compared to discrete designs they reduce complexity, improve performance and lower costs. And, they're specified over the extended -40/+85°C industrial temperature range. Available in 16-pin plastic DIP, 16-lead SOIC, and dice.

Key Specifications:

- 9V to 40V supply range
- $\leq 1\%$ total error (-40/+85°C)
- 110dB PSRR (min)
- Excitation outputs:
0.8mA (two)XTR103
5VXTR104
- From \$6.45
(U.S. OEM prices, in 1000s.)

Burr-Brown Corp.
P.O. Box 11400
Tucson, Az 85734

FREE Evaluation Kit

For your evaluation kit including samples, applications bulletins, data sheets, and instrumentation amplifier guide, just call **1-800-548-6132**. Or contact your local sales representative for more information.



FLUKE®



PHILIPS

A True 4-Channel Analog Scope:



\$875/Channel.

The Fluke PM 3094 is the only 200 MHz analog oscilloscope offering full 4-channel performance for under \$3,500. Only Fluke's PM 3094 gives you true 4-channel input, allowing four individual amplitude settings, with a full range from 2 mV to 5V on each channel. Plus dual trace differential measurements. And verniers are always calibrated. All for about *half* the price of other 4-channel scopes.

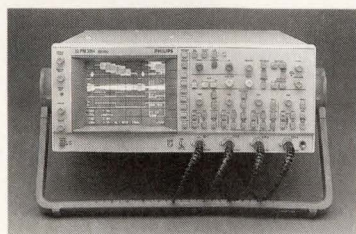

And about the same as "2 + 2" scopes that don't offer nearly the performance or flexibility. Dedicated switches for all major functions make the PM 3094 easier and more intuitive to use. Unlike other scopes with fewer buttons that force you to search through multiple layers of menus. All operations and settings are micro-controlled. And the Autoset function instantly displays any input signal, without manual

set-ups. Get the one scope that's at the *four-front* of price, reliability and accuracy: The PM 3094 from Fluke.

For a Scope Selection Guide, literature, or a demonstration, call **1-800-44-FLUKE**.

John Fluke Mfg. Co., Inc., P.O. Box 9090, M/S 250C, Everett, WA 98206-9090. U.S. (206) 356-5400. Canada (416) 890-7600. Other countries: (206) 356-5500. ©1992. All rights reserved. Ad No. 00209.

BELIEVING IS SEEING

FLUKE®

Desktop CAE and the Design Center!™

Your Path to

- ✓ Effective Engineering
- ✓ High Productivity
- ✓ Good Business

Desktop CAE means every engineer has his or her own design station, providing a comprehensive workspace for conceiving and designing the product to fulfill an engineering task. All of the engineer's design needs are at his or her fingertips.

The Design Center provides just this! As a universal circuit design environment, analog and digital circuits can be created using a schematic editor, then directly simulated and graphically analyzed for correct behavior. Whether you're operating on a Sun workstation running OpenWindows, or on an IBM-PC running Microsoft Windows, all of this is achieved from a single system designed for user friendliness. This is Desktop CAE.

The **Design Center** is a self-sufficient system, easily maintained and used by the engineer to whom it belongs. Easy installation, intuitive user interface, and comprehensive documentation are characteristic of the **Design Center**. Everything you need to get the job done is on your desktop. This is Desktop CAE.

MicroSim Corporation is proud to provide you with the **Design Center** for Desktop CAE. We believe the **Design Center** stands on its own. But if you ever need assistance, our development and application engineers are always available through our free technical support program.

The **Design Center** is synonymous with Desktop CAE. Consider the **Design Center** for your engineering business, and make it the most effective and productive business that it can be. For more information on the **Design Center**, please call us toll free at (800) 245-3022 or FAX at (714) 455-0554.

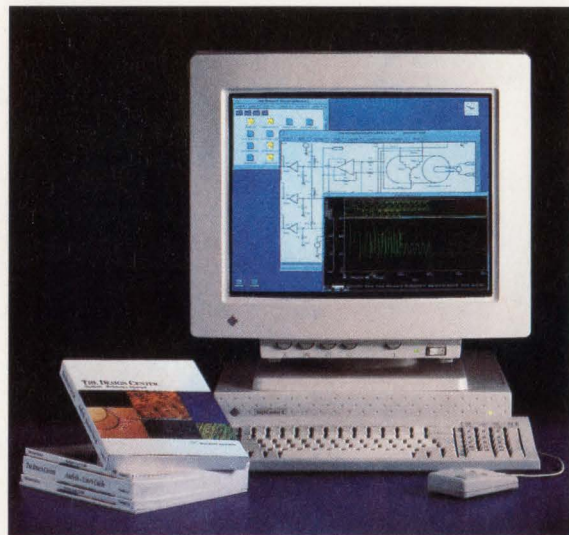

The Design Center under Sun OpenWindows



The Design Center under Microsoft Windows



MicroSim Corporation

The Standard for Circuit Design

20 Fairbanks • Irvine, CA 92718

THE MAKERS OF PSpICE

PSpice is a registered trademark of MicroSim Corporation

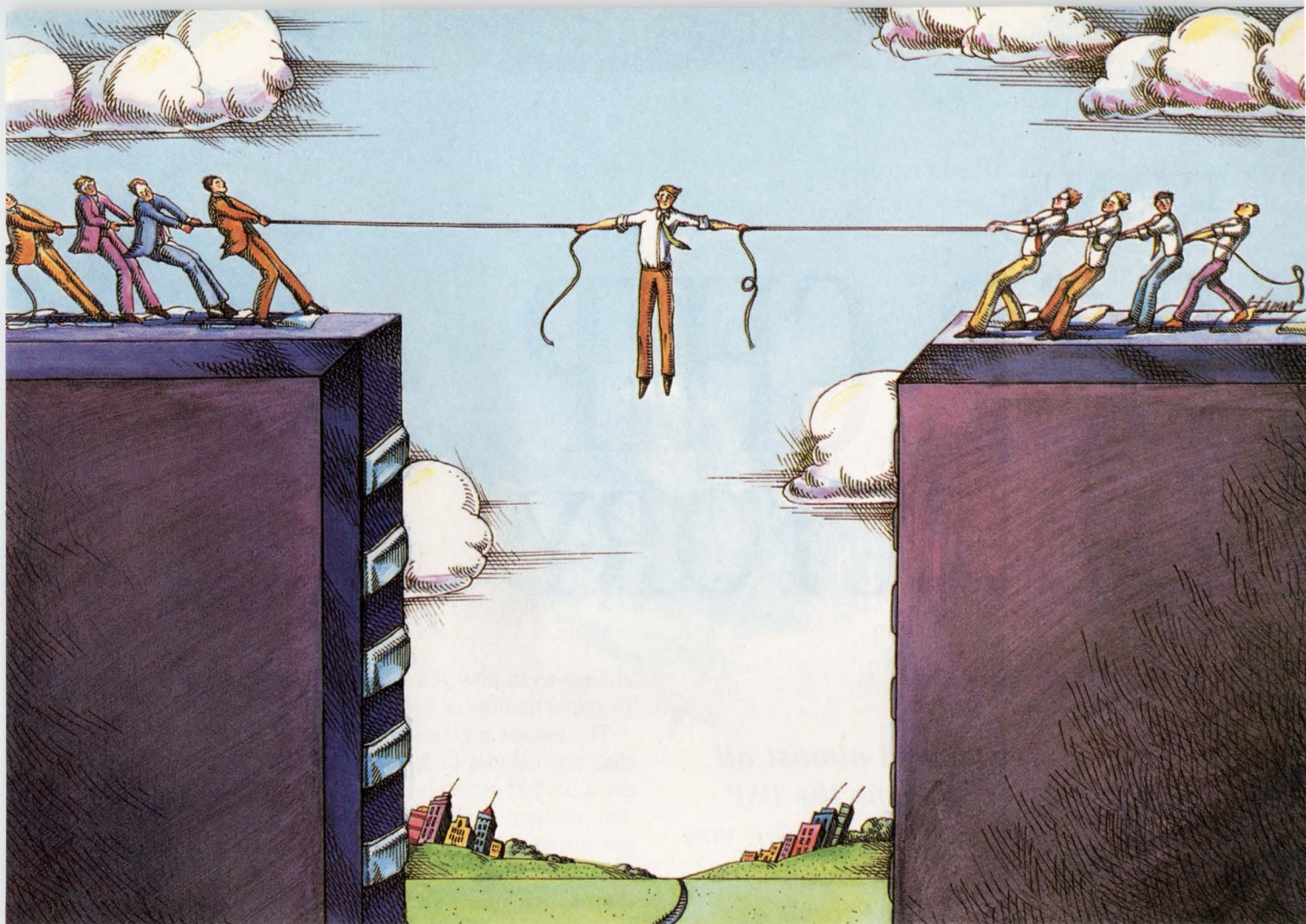

TI's 7.5-ns '22V10. For those times you're torn between profit and performance.

Trying to get the best performance on a tight budget can create a few hang-ups. Texas Instruments has a simple solution. Introducing the TIBPAL22V10-7. TI's newest high-performance programmable logic device that's designed to fit the bottom line as easily as it meets your design specs.

High performance, low price

While competitive pricing is one of our '22V10's most outstanding features (less than \$17 when you purchase 5,000 or more), you'll be even more impressed by its performance.

At an incredibly fast 7.5 ns, our '22V10 supports system speeds up to 50 MHz with a variable term distribution that gives you more design freedom with complex functions. It's an excellent choice for high-end systems

using the latest microprocessors. And since all this is achieved using our proven bipolar process, the '22V10 provides a universal architecture that's easy to work with using familiar design tools.

Accurate, dependable and available today

Speed and ease of use mean nothing if difficult programming keeps your product from getting to market on time. That's why our '22V10 is designed for quick, dependable programming with your present tools. In fact, we're running at a 99.4% first-time programming success rate.

Best of all, our 7.5-ns '22V10 is available in volume *today* with just-in-time and ship-to-stock delivery programs tailored to meet your needs. You'll also have the backing of our

global support network to help keep things running smoothly.



Hang in there —

a free sample is on the way
Simply return the attached reply card or call 214-995-6611, ext. 3717, for one free TIBPAL22V10-7.

 **TEXAS
INSTRUMENTS**

EDN September 17, 1992 • 89

EDN's DSP-CHIP DIRECTORY

David Shear, Technical Editor

DSP chips have touched almost all areas of electronics. Now the DSP industry is making it easier for you to use these powerful devices. Complete systems in chip-set form are now available, as are good tools to develop DSP applications.

The DSP industry is expanding into an ever increasing number of applications. DSP chips have invaded disk drives, cellular telephones, modems, radios, medical instruments, appliances, automobiles, and a number of other products. DSP is well beyond a strange new technology looking for applications. It is a maturing industry with chip sales alone exceeding a billion dollars in 1991. The expected growth is more than 30% per year for the next few years. The chances that one of your projects will benefit from using these devices is better than ever.

The biggest obstacle to many engineers is the perceived difficulty of using DSP. It would be very difficult if you just grabbed a DSP chip and a data book and tried to use it. That is what you would have had to do a few years ago. But the DSP industry has not been just sitting around. Many vendors are working hard to make DSP easier to use. You have many

choices as to how you will use DSP. It is not necessary to spend months or even years becoming a DSP expert.

The easiest method of using DSP is to buy a chip set that was created to fit a market niche. Modem chip sets are a perfect example. You can create a high-speed modem without really concerning yourself with the DSP portion of the system. For example, AT&T has a chip set for 9600-baud and above modems. In this application, a DSP16A works as a data pump in conjunction with an analog front end and a digital interface chip.

Motorola is working with many vendors to be able to license niche-application code directly. The company wants to be a one stop shop for DSP. You will be able to buy the DSP chip and the software from the same vendor. But if you wish, you can negotiate directly with the algorithm developer.

The DSP chip manufacturers aren't the only ones providing chip sets with software and hardware support. DSP Group Inc (San Jose, CA) is an example of a company that is providing niche market chip sets. They use custom versions of TI's fixed-point DSP chips to implement a variety of functions. For example, they provide a chip set for digital answering machines. You don't have to be aware that there is a DSP chip in the chip set. You just tell it what you want done and the chip set does it.

Analog Devices is attempting to create an open standard for DSP called Signal Computing. This unites a general-purpose DSP with third-party software so that you can gather the DSP functions you need. Independent Algorithm Vendors (IAVs) create the code that runs on the DSP, which you can license. With the

open nature of Signal Computing, each IAV can make its algorithms work on a variety of DSP chips. In many cases you will be able to select the hardware you need and get the DSP portion off the shelf.

It is too early to tell if Signal Computing will become the standard Analog Devices hopes it will. It will certainly make your job considerably easier if it does. With such a standard, as new DSP chips emerge, you will be able to transfer much of your design to the latest DSP. Since many products are expected to double in performance every 18 months, it would be nice to know that you didn't have to reinvent the wheel each time you had to design a new product.

Even without a standard, there are a number of vendors who sell algorithms. They will sell you a complete program for your needs or a partial program that contains all of the DSP code. Before you take on code development, check with the DSP chip manufacturer and see if they have or know of existing code. Each of the major DSP vendors has a very complete list of third-party vendors that can help you out.

TI has had a long tradition of offering tremendous support. They have an incredible amount of free DSP code on their bulletin board and in application manuals (call vendors for BBS numbers). Since the TI chips are the most popular DSP chips, more code has been writ-

The future looks bright for the DSP market

According to Will Strauss, President of Forward Concepts Co (Tempe, AZ), the total DSP-chip market was worth more than a billion dollars in 1991. This is divided into general-purpose, function- and algorithm-specific, building-block, and μ P/ μ C DSP chips. The general-purpose DSP chips make up 36%, or \$395 million, of the total market (**Fig A**).

Strauss expects the total DSP market to grow 29% next year, with the general-purpose DSP-chip market growing 39% in 1992. This growth is expected to continue for many years. There are so many applications and so much growth that there is room in the market place for many different products.

TI is still way out in front with 57%

of the market (**Fig B**). Many large-volume applications are beginning to hit production. The largest market is modems, followed by disk drives and then by speech and audio applications. Digital cellular phones are coming on strong and will be one of the top applications soon.

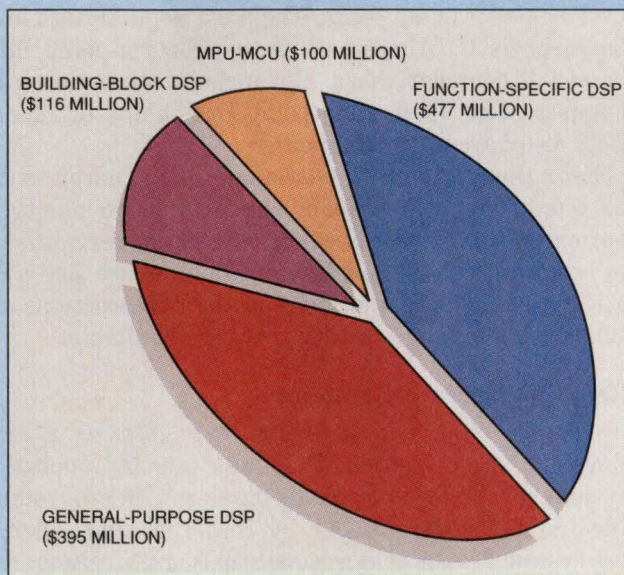

Fig A—This chart shows the total DSP market for 1991. (source Forward Concepts)

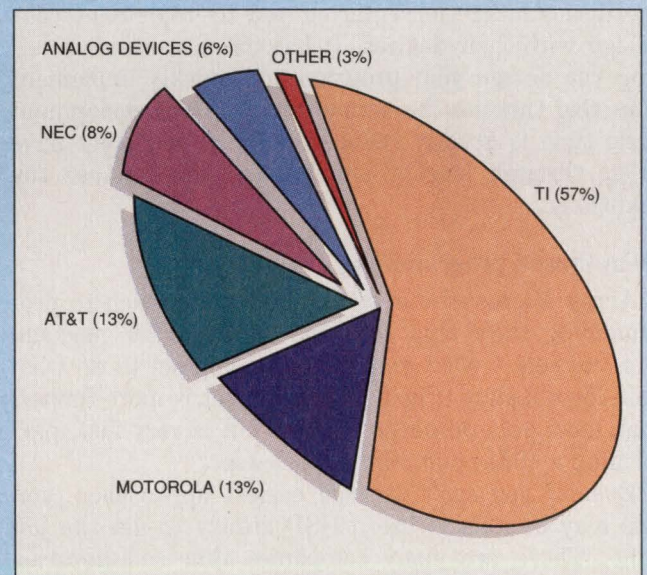

Fig B—This chart shows the general-purpose DSP market for 1991. (source Forward Concepts)

ten for them than any others. Many of the DSP text books you can use to get up to speed in using DSP have examples written for the TI chips.

Block-level programming

If you have to create your own algorithms, you may consider using a block-diagram type of programming system. Comdisco, Mentor, and Star Semiconductor have systems that let you create your program with block diagrams and then let the system implement it. Comdisco and Mentor have the ability to simulate the design and then implement it in a variety of ways.

Each of these systems has a library of blocks you can choose from. You use a graphical method to draw a signal-flow diagram to implement your algorithm. You can also create your own blocks to expand on the existing blocks.

Once the design is completed, you can simulate it and modify it to tune it to your application. After proving your concept, the system can automatically generate code for general-purpose DSP chips. You can implement your DSP system on an FPGA or other ASIC, or you can synthesize a custom IC.

Star Semiconductor uses a different approach. You enter the design in a similar manner but skip the simulation step because you can run the code directly on the SPROC-1000. The company's block-diagram programming tools work only with their chips. This has the disadvantage of requiring you to implement your design with their devices. It has the advantage of letting you design your program and quickly implement it in real time on the actual device. The development cycle time is greatly reduced because you don't have to go through lengthy simulations; you can use the real thing.

Menu-based programming

Array Microsystems has a similar approach to programming their chip set. The ArraysoFFT package lets you select what you want the chip set to do from pull-down menus (Fig 1). This chip set is more limited than most general-purpose DSPs but is very fast, performing a 1024-point FFT in 131 μ sec.

Even if you can't use the easiest approaches, you still may be able to use a DSP library to get the job done. There are many companies that sell libraries that have standard algorithms in either source code or object code. Sonitech International Inc (Wellesley, MA) is an example of a company that sells DSP libraries as well as board-level DSP products and also

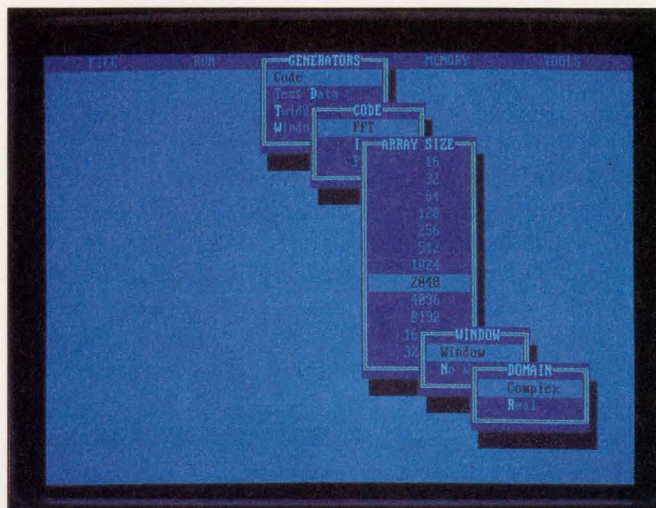

Fig 1—You can select what you want the a66 chip set from Array Microsystems to do by using pull-down menus. The ArraysoFFT package will then create the code.

licenses code for many of the popular algorithms.

There is more to most DSP projects than just the creation of code to run algorithms. You will often have to write a large portion of the code to take care of system functions such as controlling indicators, communicating, interfacing with an operator, or controlling a few lines here and there. High-level languages and operating systems have been available for DSP chips for many years. The most popular high-level language is C. Almost all of the floating-point chips have a C compiler. Most also include source-level debuggers. The TI floating-point DSP chips (C3X and C40) also have an Ada compiler.

Even though the DSP portion of code generation can be tough, you will probably have to write plenty of normal μ P-type code. The first DSP chips were difficult to program, but the more recent devices are fine μ Ps. Their architectures and many of their instructions are similar to a μ P, and quality tools are available.

Real-time operating systems

Another major aid to using DSP chips is a real-time operating system. The most popular operating system for DSPs is Spox by Spectron Microsystems Inc (Santa Barbara, CA). It is a real-time operating system that provides a real-time multitasking kernel and modules for memory management, stream I/O, DSP math functions, and a C library. The company has just added a debug feature and multiprocessing support. Spox runs on Analog Devices'

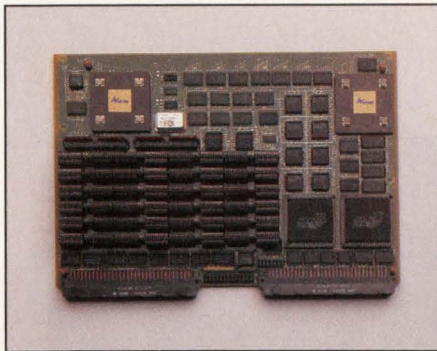

400 MOPS FOR 6U VMEbus SYSTEMS

This 6U VMEbus board performs 400 million operations per second and is optimized for frequency domain processing such as FFTs and finite impulse response (FIR) filters using fast convolution. The FDaP features a private 32-bit, 20 MHz high-speed data I/O bus and extensive double buffering for continuous processing of real-time data. An additional 32-bit complex output provides phase/magnitude data. The a66540 is available in 25 MHz and 40 MHz versions. A single 40 MHz version can execute a 1K point FFT in 132.7 μ s and a 64K point FFT in 13.1 ms. These times are nearly halved for real input. Multiple FDaPs can be cascaded to achieve almost linear improvement in FFT performance. Plug 400 MOPS into your system by calling **array** Microsystems' Hotline: 719-540-7999.

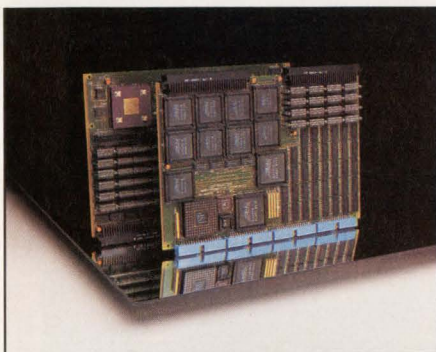

CORNERTURN PROVIDES QUANTUM LEAP IN 2D IMAGE PROCESSING PERFORMANCE

The a66545 Cornerturn™ board, used in conjunction with the a66540 FDaP board for real-time two-dimensional image processing, is the first capable of processing an entire 256 x 256 pixel frame of image data in 15.2 milliseconds. This equates to a continuous, real time rate of 65 frames per second. For 512 x 512 images, the board set transforms images in 71 milliseconds, or 14 frames per second. Designed for medical imaging, radar, sonar, machine vision, and other real-time 2D image processing applications, the board set features performance of 400 MOPS at a clock rate of up to 40 MHz. The Cornerturn accepts 32-bit complex I/O data through 10 MHz double-buffered external I/O connectors or through the VMEbus and stores it in one of four on-board frame store memory buffers. For technical assistance, call **array** Microsystems' Hotline: 719-540-7999.

OUTSIDE THE USA, CALL YOUR NEAREST INTERNATIONAL DISTRIBUTOR

AUSTRIA, GERMANY and SWITZERLAND - Alfatron GmbH, Tel: +49-89-45110-04, FAX: +49-89-45110-254 • **BELGIUM and the NETHERLANDS** - Maxtronix, Tel: +31-73-210400, FAX: +31-73-281190 • **FRANCE** - Microel, Tel: +33-1-69070824, FAX: +33-1-69071723 • **ISRAEL** - Tritech, Ltd., Tel: +972-3-544-7293-4-5, FAX: +972-3-497816 • **ITALY** - MicroElit S.P.A., Tel: +39-2-4817900, FAX: +39-2-4813594 • **JAPAN** - Nippon Imex Corporation, Tel: +81-03-3321-8000, FAX: +81-03-3325-0021 • **SPAIN** - Selco, Tel: +34-1-3264213, FAX: +34-1-3592284 • **SWEDEN** - Setron Sweden AB, Tel: +46-8-753-0055, FAX: +46-8-755-5594 • **UNITED KINGDOM** - METL Ltd., Tel: +44-844-278781, FAX: +44-844-278746



THE DaSP/PaC CHIPSET:

The heart of the world's fastest DSP product family

The Digital array Signal Processor (DaSP) executes 16 high-level instructions, including FFT butterflies, windowing, complex multiplies, and general-purpose functions. The Programmable array Controller (PaC) manages the entire system, including address generation for the DaSP and memory, and I/O up to 80 MHz. Using a single chipset, for example, a 1024 point FFT requires only 12 instructions and can execute in only 131 μ sec; a complex FIR filter, using 28 instructions, processes at a 2.3 MHz rate. For even higher performance, you can cascade the chipset. Both utilize a 144-pin PGA format and are available in 30 and 40 MHz versions. To receive complete technical information, call **array** Microsystems' Hotline: 719-540-7999.

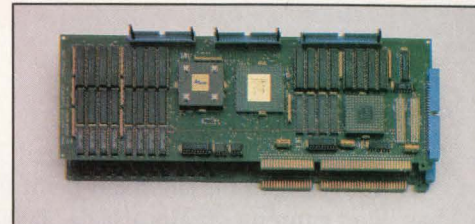

PC-FDaP PERFORMS 250 MOPS!

The a66550 Frequency Domain array Processor (FDaP) brings high performance FFT processing to any PC-AT compatible computer. The two board set will fit into two full size PC-AT slots, operate on the 16 bit PC-AT (ISA) bus, and allow real or complex input from either the high speed connectors on the back panel or from the PC-AT bus. The FDaP accommodates an optional complex I-and-Q to magnitude-and-phase converter for post-FFT processing. Available in two memory configurations, the a66550 handles complex FFTs up to 32K points and real FFTs up to 64K points. The a66550 can compute a 1024 point complex FFT in just 210 μ s. For complete technical information, call **array** Microsystems' Hotline: 719-540-7999.

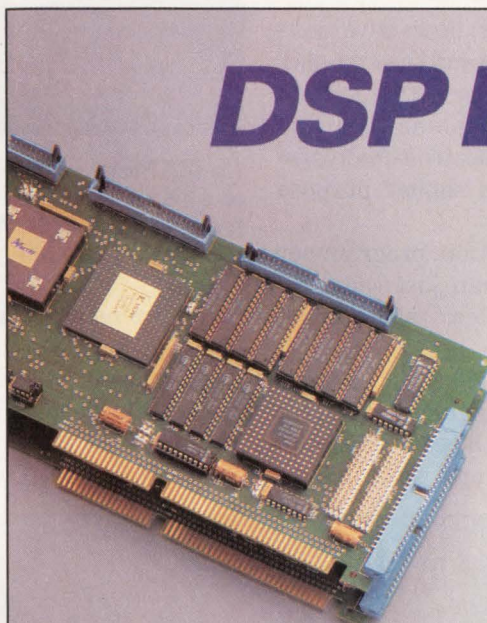

DSP Built For Speed

**PC-AT DSP
1K FFT/126 μ s**

DSP engine for the 16-bit PC-AT Industry Standard Architecture (ISA) bus

Performance Benchmarks

FFT size	a66550/32K @25MHz
64 Real	7.2 μ s
64 Complex	10.9 μ s
1024 Real	125.9 μ s
1024 Complex	209.9 μ s
32K Real	5.90 ms
32K Complex	10.49 ms
64K Real	15.73 ms
64K Complex	N/A

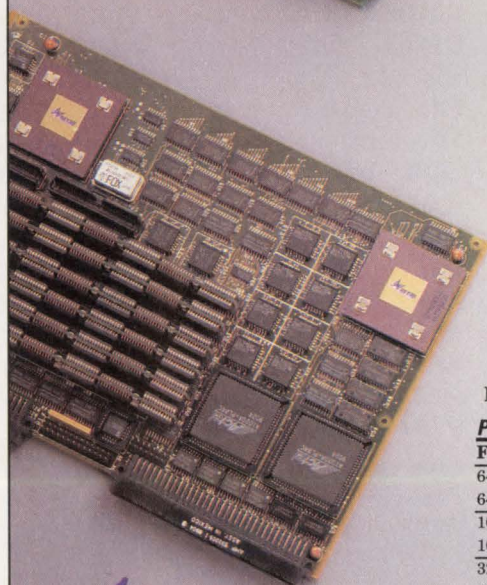

**VME DSP
1K FFT/79.6 μ s**

DSP engine for industry-standard VMEbus

Performance Benchmarks

FFT size	a66540A @40MHz	a66540A Cascade Sys.
64 Real	5.1 μ s	2.9 μ s
64 Complex	5.0 μ s	3.7 μ s
1024 Real	79.6 μ s	29.6 μ s
1024 Complex	132.7 μ s	59.1 μ s
32K Real	3.69 ms	0.91 ms
32K Complex	6.56 ms	1.82 ms
64K Real	7.37 ms	1.82 ms
64K Complex	13.11 ms	3.64 ms



Call the DSP Hotline: 1-719-540-7999

1420 Quail Lake Loop, Colorado Springs, CO 80906
Telephone 719-540-7900, FAX 719-540-7950
Email support@array.com

21000 family, Motorola's 96002, and TI's C3X and C40.

A new version for the fixed-point family, MicroSpox, has been running on Motorola's 56000 and is now available for Analog Device's ADSP2100 family and TI's TMS320C2X and TMS320C5X family. MicroSpox contains only the multitasking kernel, I/O, and memory management.

Motorola's 56000 also runs VRTX from Ready Systems, a real-time operating system that runs on virtually all major μ Ps. National Semiconductor is planning to have a real-time operating system for the 32SF640 available by the end of the year.

AT&T and Spectron Microsystems both have software interfaces between the DSP chip and the end-user application. VCOS from AT&T is an operating system that implements the DSP3210 on the mother board of a PC or workstation. OSPA from Spectron Microsystems works with Spox and serves a similar purpose with other DSP chips.

Both products isolate the application programmer from the algorithm developer. You can just call DSP functions and let the operating system take care of everything else.

In almost all projects you will have to write some portions of the code in assembly language. In some projects you may have to write all of the code in assembly language. Often the DSP portion must be optimized

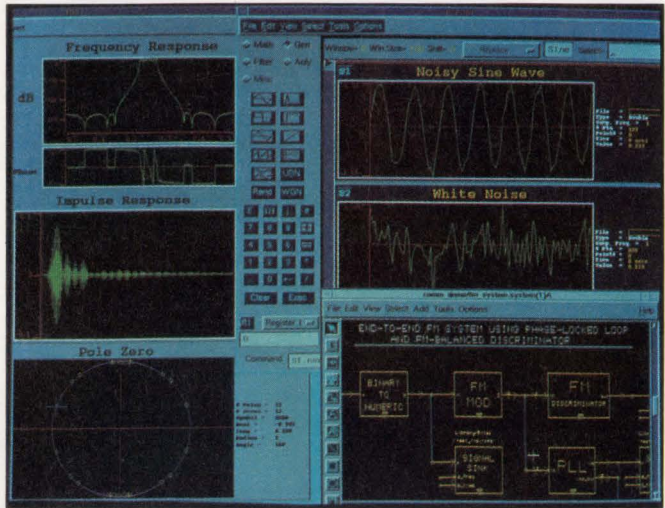

The DSP Framework provides an environment to enter your design as a block diagram, analyze its performance, and then implement the design on an FPGA, ASIC, custom chip, or general-purpose DSP chip.

by programming in assembly language. Writing assembly code for DSP chips is often like writing code for your favorite μ P. Many DSP chips are capable μ Ps. It is difficult to generate assembly code that takes advantage of all of the parallel features of the DSP chips. Unfortunately, this is usually the code that

Key to abbreviations used in block diagrams

AB—combined program-and-data address bus
ACC—accumulator
ADC/DAC—analog to digital and digital to analog converter
ADDR GEN—address generator
ALU—arithmetic logic unit
BIT MANIP—bit manipulation
BS—barrel shifter
CDB—control data bus
CM—cache memory
CPUB—CPU bus
DAB—data address bus
DB—combined program-and-data data bus
DDB—data data bus
DM—memory for data only
DMAAB—DMA address bus

DMADB—DMA data bus
DMAC—direct memory access controller
FX—fixed-point
FP—floating-point
GDB—global data bus
HOST INTER—host interface
IDB—instruction data bus
INT—external interrupt
MAC—multiplier accumulator
MULT—multiplier
PAB—program address bus
PDB—program data bus
P/DM—program and data memory
PIO—parallel I/O
PM—memory for program only
PPCP—parallel processor communication port

PRAB—peripheral address bus
PRDB—peripheral data bus
REG—register
REGB—register bus
SIO—serial I/O
TIM—timer
XAB—external address bus
XDB—external data bus
XDAB—external data address bus
XDDB—external data data bus
XIOAB—external I/O address bus
XIODB—external I/O data bus
***XPAB**—external program address bus
XPDB—external program data bus

Drive your DSP design all the way home.

Why complicate your travel plans? Zip along the entire DSP design route with SPW™ — the Signal Processing WorkSystem® from Comdisco.

SPW is the only DSP and communications design software tool that's complete and integrated. The only one that can take you all the way from idea to implementation. No matter where you're headed. No matter which road you take. And it's fast. It has all the horsepower you need to cut design time by as much as 90 percent.

First, SPW helps you choose your destination. You can quickly draw from its extensive libraries of reusable function blocks. And you can take advantage of SPW's open architecture to incorporate your own models.

After this, SPW automatically transforms your design into an



error-free simulation program. One that lets you perform accurate design, prototyping and analysis. One that confirms that you're headed in the right direction.

And, to assure that your way is free from bumps, potholes, and those awful "dead end" signs, SPW comes with the industry's widest range of implementation options. Options that generate code for floating- and fixed-point DSP chips as well as DSP systems with multiple processors. Options for bit-true fixed-point simulation that automatically generate VHDL and provide seamless links to the leading logic synthesis tools. Options that pave the way to fast FPGA and ASIC production.

So, how about a test drive? Call us at 415-574-5800. And learn how SPW can put you in the fast lane to market.

COMDISCO[®]
SYSTEMS, INC

U.S.: Telephone 1-415-574-5800, Fax 1-415-358-3601 Europe: Telephone 44-454-614256, Fax 44-454-614700

CIRCLE NO. 58

EDN September 17, 1992 • 95

has to be optimized for speed.

But vendors do not leave you on your own to create assembly-language programs. There is a considerable amount of free DSP code. You can find it on computer bulletin boards operated by the DSP vendors. Or, you can get it out of some of the excellent application manuals that are available. By looking at this code, you can quickly get up to speed on using assembly language. You may even be able to modify some existing code to get what you want.

Almost all of the DSP manufacturers have developed evaluation packages that include an evaluation board and enough software tools to give you a feel for what the chip can offer, what their support is like, and how well their tools work (**Ref 1**). Spending a couple of bucks and a few days can give you the confidence to make informed choices about which part to use.

Another trend that will make your job easier is custom DSP chips. You can take a DSP core and surround it by the memory and peripherals you need. So far, this approach is only viable for very-high-volume applications. All DSP chip makers are migrating their chips into a core that lets you surround the basic chip with the peripherals you need. At present TI sells between 10 and 20% of their products as custom devices based on their fixed-point core. Within a few years, custom devices are expected to grow to 50% of production. As the volume grows, it will become cheaper to get the DSP chip you need, and lower-volume applications will be able to take advantage of it.

You should also keep an eye on μ Ps and microcontrollers (μ Cs) because many are gaining some DSP capability. You will continue to see multipliers and other DSP elements sprout on these chips. But just sticking a multiplier on a chip doesn't mean that it can perform DSP functions. Many of the devices that have limited DSP capability are designed for a particular application. Your algorithm may or may not be enhanced by the added circuitry.

An example of DSP growth on a μ C is Motorola's 68HC16. It is a 16-bit device that can perform a multiply and accumulate in 720 nsec. In terms of traditional

Index to DSP μ Ps included in this directory

Supplier	Device	Type	Page
Analog Devices	ADSP-2100 family	16-bit fixed-point	100
Analog Devices	ADSP-21020	32-bit floating-point	121
Array Microsystems	a66 chip set	16-bit fixed-point	136
AT&T	DSP16 family	16-bit fixed-point	101
AT&T	DSP32C/3210	32-bit floating-point	122
Motorola	DSP56156	16-bit fixed-point	102
Motorola	DSP56001/2	24-bit fixed-point	103
Motorola	DSP96002	32-bit floating-point	125
National	NS32SF640	32-bit fixed-point	104
NEC	77C25	16-bit fixed-point	105
NEC	77016	16-bit fixed-point	106
NEC	77220	24-bit fixed-point	109
NEC	77240	32-bit floating-point	132
SGS-Thomson	ST18 family	16-bit fixed-point	110
Sharp Electronics	LH9124/9320 chip set	24-bit fixed-point	141
Star Semiconductor	SROC-1000	24-bit fixed-point	113
Texas Instruments	320C1X	16-bit fixed-point	114
Texas Instruments	320C2X/5X	16-bit fixed-point	117
Texas Instruments	320C3X	32-bit floating-point	135
Texas Instruments	320C40	32-bit floating-point	126
Zilog	Z89C00	16-bit fixed-point	118
Zoran	34325	32-bit floating-point	129

DSP, this is not very fast. But for the applications it was designed for, it works very well. This chip was designed for disk-drive applications but is useful elsewhere.

Motorola admits that the device is not fast but points out that many applications can't afford, and don't need, full general-purpose DSP capability. When reviewing requirements with potential customers, Motorola blocks out a combined μ C and DSP including memory for both devices. Everyone gets excited until the cost is discussed. All of that silicon costs a lot of money.

By adding incremental DSP capability, an incremental cost is incurred. By knowing your algorithm and knowing how to get by with only the capabilities you really need, you can reduce the cost of the μ C chip.

National is approaching the problem in a similar manner to Motorola. Almost all of their μ P products have some DSP capability on the chip. Each version is intended for a niche market, from digital answering machines, to modems, to faxes, to printers, to combined office equipment that does all of these functions. Each chip has a different amount of DSP based on the needs of the algorithm in the application.

Zilog has looked at the problem and decided to create its own DSP chip (Z89C00) and integrate it onto a Z8 μ C. The μ C and the DSP chip each have their own

Ariel V-C40 Hydra Breaks the BOPS Barrier

1.1 billion operations per second sets the record for 6U VMEbus coprocessor cards

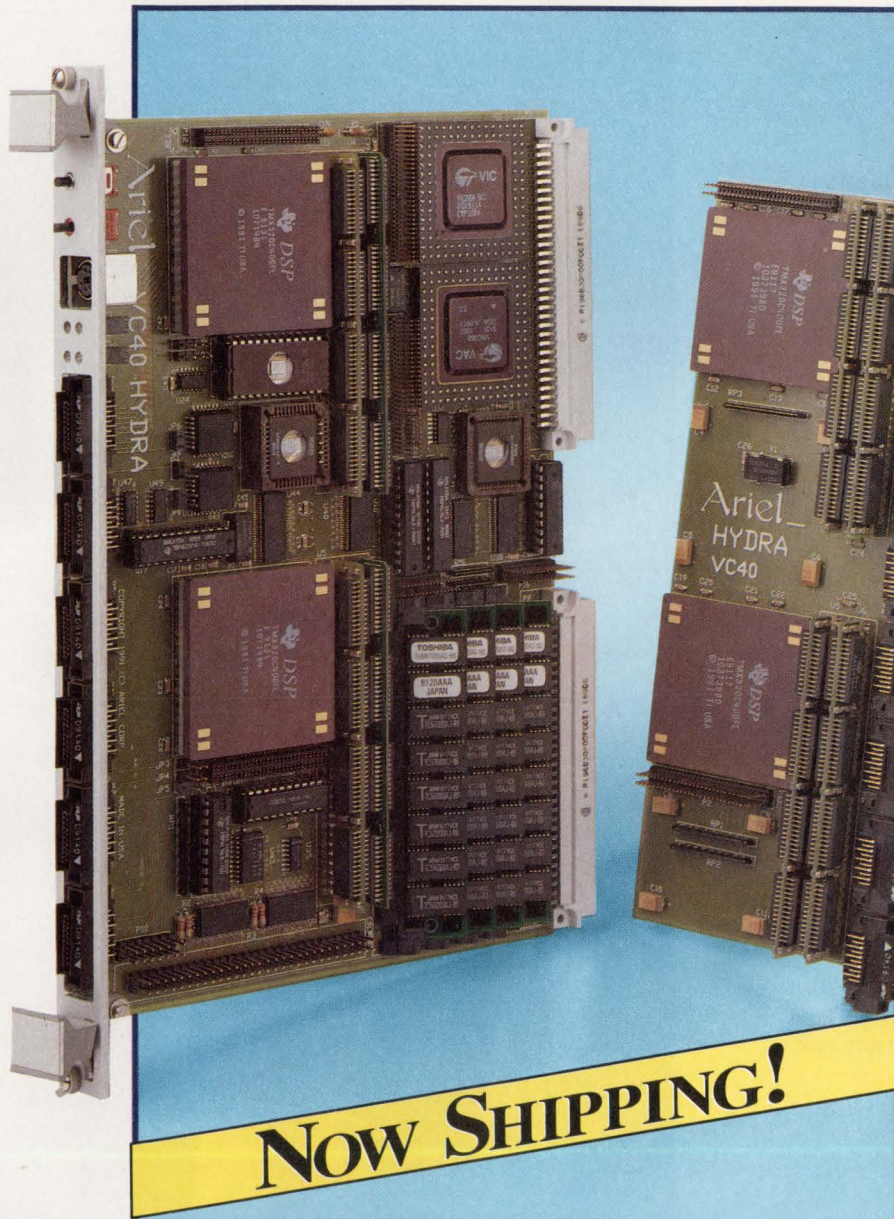

Only Ariel's Hydra combines four TI TMS320C40 DSPs to deliver twice the processing speed and four times the I/O bandwidth of any 6U VMEbus coprocessor card. It's the only choice for the most compute-intensive multiprocessor applications.

The V-C40 packs up to 64 Mbytes of DRAM as well as up to 5 Mbytes of SRAM in eight banks—two per processor. Each DSP has direct access to memory via dual 32-bit memory buses, as well as six parallel I/O ports and a high-speed six-channel programmable DMA controller. All six channels can transfer data simultaneously without interrupting program execution.

Hydra also includes a 24-bit parallel ADBus that lets you access a wide range of high-speed data acquisition cards. Development support includes an ANSI C compiler and the first PC-based XDS510 in-circuit emulator to support parallel processing. And of course, with Ariel's legendary technical support, you'll never work alone.

To learn more about the V-C40 Hydra, or any of Ariel's DSP products for ISA/EISA, VMEbus, SBus, Hewlett-Packard, NeXT, or Macintosh computers, send us a fax, leave us a message on the BBS or E-mail, or just give us a call.

Ariel

The DSP Authority

433 River Road Highland Park, NJ 08904
(908) 249-2900 FAX:(908) 249-2123
DSP BBS:(908) 249-2124
Email: ariel@ariel.com

Distributed in: **France**, REA Informatique, tel: 1 49 65 25 50, fax: 1 49 65 25 69; **Israel**, Militram Futuristic Technology Ltd., tel: 52-545685, fax: 52-574383; **Italy**, International Trading Device SRL, tel: 02-749 0749, fax: 02-761 0407; **Japan**, Marubun Corp., tel: 033-639 9816, fax: 033-661 7433; **South Korea**, Seoil Enterprise, 3030, 21-Dong, Sunin Electronics Bldg., 16-1, 2-Ku, Hankang-Ro, Yeoungsan-Ku, Seoul, tel: 2-704 1392, fax: 2-703 8090; **United Kingdom**, Data Beta, Unit 7, Chiltern Enterprise Centre, Theale, Berks RG7 4AA, tel: 44-0734 303631, fax: 44-734 323617.

ANNOUNCING YET ANOTHER FIRST IN THE ENDLESS QUEST FOR DISK DRIVE INNOVATION.

Fast lane, flat out. Only open road ahead. And no looking back. Just another day in the life of a disk drive designer.

Well, strap yourself in a little tighter—the race is picking up.

VTC proudly submits its latest addition to your high-tech disk drive toolbox for the '90s: the world's first 3-volt read/write preamp. Now ready for you to put through the paces.

It's another in a long line of industry firsts from VTC, your trusted partner in read/write electronics for almost three decades. The company that's been there through it all—and intends to stay right there in it with you.

The VM3200 is a high-performance, very low power read/write preamp for two-terminal thin-film/MIG recording heads. It operates on a single 3.3V power supply, making it ideal for battery-powered 2.5 and 1.8-in drives in laptops, notebooks, and palmtop PCs.

The innovative circuit design of the VM3200 maintains 5V performance at 3.3 volts. Not only does it meet your needs in today's mixed 5V/3V environment, it makes your transition to the complete 3V system much easier.

Key features include fast current rise time, low input noise level, and a sleep mode that reduces power dissipation to 1.8mW. It's available for two or four channels, in a variety of packages.

The VM3200: another first for VTC. Because we put you first.

So what's the first thing you do? Call us, of course, and — may we suggest speed dialing? VTC Inc., 2800 East Old Shakopee Road, Bloomington, MN 55425 USA. 612/853-5100. Fax 612/853-3355.

Call 1-800-VTC-DISC



VTC Inc.
Value The Customer™
CIRCLE NO. 60



**NEW
3.3V PreAmp
Shipping Now!**

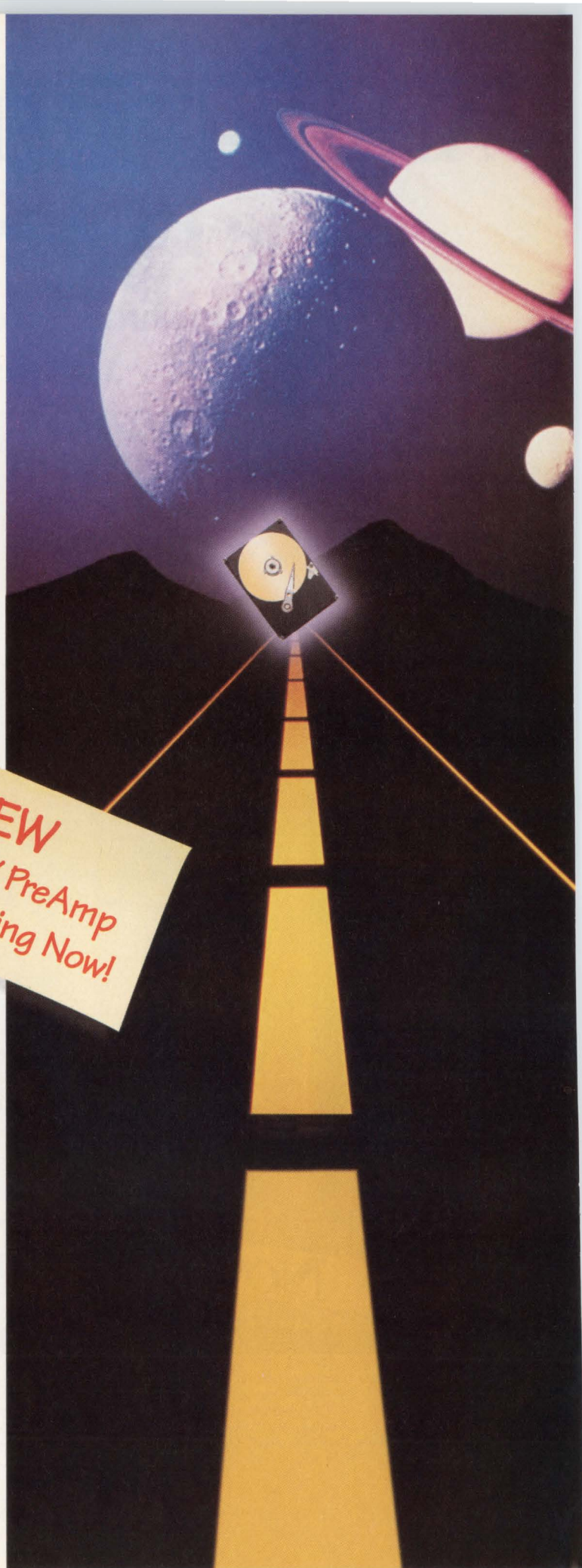

memory and communicate to each other via a set of common registers. The combined chip is intended for modem and fax applications. In these applications, the requirements of the DSP portion of the code are compute intensive enough to warrant more capable DSP hardware on the same chip. But even this chip is limited in order to keep the cost down. It doesn't have a barrel shifter or zero overhead looping, it only has a 24-bit accumulator, and it lacks a few more features of other DSP chips. But you don't always need all of the functions of a general-purpose DSP chip. By leaving some things off the chip, it costs a lot less.

It is also possible to let the DSP chip absorb the μ C functions. In many applications a μ C will run much less than 1 MIPS. When a DSP chip is runs at 20 MIPS, it usually has plenty of power to spend some time on the functions normally taken care of by a μ C.

Some DSP applications need as much power as possible. In these cases, like video compression, the DSP chip will usually be doing just DSP functions. But many other applications leave the DSP chip idle some of the time. With the increasingly capable tools, you should be able to bring the control functions into the DSP chip.

All of these methods have varying degrees of difficulty and flexibility. It is sometimes dangerous to adopt a new technology and expensive to acquire the expertise. There are many companies that are doing their best to reduce the danger and cost. But the most dangerous approach is to ignore DSP all together. You can be assured that your competition isn't ignoring it. It has been proven that DSP can bring immense performance and functionality gains to a product. **EDN**

Reference

1. Leibson, Steve, "Learn to use DSP chips with a minimum of pain," *EDN*, June 4, 1992, pg 45.

Author's biography

David Shear is one of EDN's technical editors. He can be reached at (503) 754-9310.

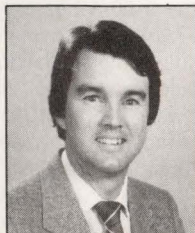

Article Interest Quotient (Circle One)
High 473 Medium 474 Low 475

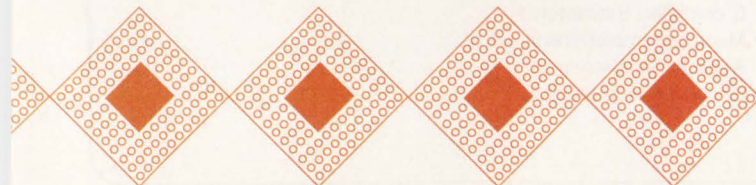

**AMETEK
DC Motors add
speed control
and reliability
to pumps**

These 12-24 VDC brushless motors give you controllability for smart pumping applications. Either 2.0" or 3.2" diameters, with stall torque to 84 oz.-in., puts high power in a compact package. And, no brushes to wear means more reliable operation. AMETEK, Technical Motor Division, 627 Lake Street, Kent, OH 44240. Tel: 216-673-3452. Fax: 216-678-8227. In Europe, Friedrichstrasse 24, D6200 Wiesbaden, Germany. Tel: 0611-370031. Fax: 0611-370033.

AMETEK
TECHNICAL MOTOR DIVISION

CIRCLE NO. 61

AUDIO PRO II

AUDIO PRO II Model SX-15 AUDIO PRO Model SX-10

Introducing...second generation CD quality, stereo hi-fidelity digital audio record/playback for PC-AT 386/486 or compatible. Now with DVI/CDI/CD-ROM XA audio compression up to 44.1 kHz.

Featuring...real time direct-to-disk data transfer... 18 bit resolution... 64x oversampling... 22kHz audio response... 0.005% THD... 6.25 to 50 kHz programable sample rate... 92dB dynamic range... 90db s/n ... plus 4:1 ADPCM compression.

For broadcast quality recording, editing and transmission in high-end entertainment systems, A/V presentations and interactive CDI/DVI applications. Phone 1 (800) 338-4231 for details on the 2nd generation AUDIO PRO Model SX-15.

ANTEX ELECTRONICS

16100 S. Figueroa St • Gardena, CA 90248 (USA) • Tel (310) 532-3092 • FAX (310) 532-8509

CIRCLE NO. 62

ADSP-2100 FAMILY

16-BIT FIXED-POINT CMOS DSP μ P

AVAILABILITY: All units are in production now.

COST: ADSP-2100 \$45 (1000); -2101, \$36 (1000); -2102, \$34 (min 5000); -2105, \$9.90 (1); -2106, 11.39 (min 25,000); -2111, \$48 (1000); -2112, \$46 (min 5000); -21msp50, \$57 (1000); -21msp51, \$40 (min 25000).

SECOND SOURCE: None.

Analog Devices Inc
Box 9106
Norwood, MA 02062
(617) 461-3881
Circle No. 669

DESCRIPTION: The ADSP2100 family offers a variety of options, ranging from the 2100, without any on-chip memory and a Harvard architecture brought off-chip, to the 21msp51, with program and data ROM and data RAM and peripheral

als, including an ADC, DAC, and host-interface port, on chip. The data memory has a 16-bit width, but the program memory has a 24-bit-word width to control the parallel operations. Low voltage versions are now sampling.

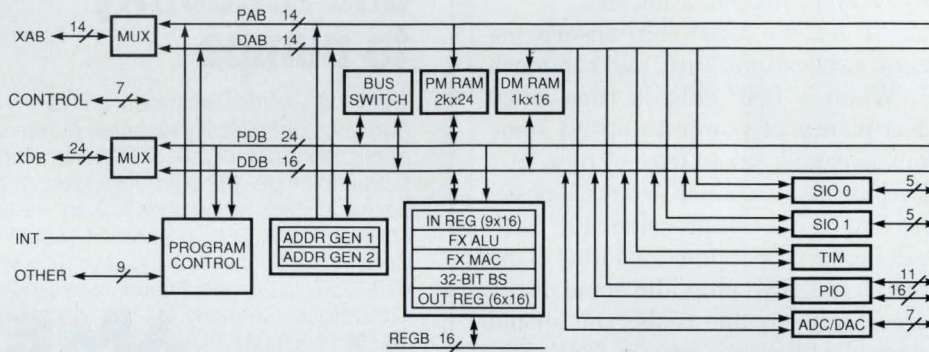

FEATURES: 60-, 77-, 80-, 100-, 125-, and 167-nsec cycle-time versions.

Separate on-chip program and data buses.

On-chip memory: The 2100/A has no on-chip memory. The 2101 has a $2k \times 24$ -bit program RAM and a $1k \times 16$ -bit data RAM. The 2102 has a $2k \times 24$ -bit program ROM or RAM and a $1k \times 16$ -bit data RAM. The 2105 has a $1k \times 24$ -bit program RAM and a 512×16 -bit data RAM. The 2106 has a $1k \times 24$ -bit program ROM or RAM and a 512×16 -bit data RAM. The 2111 and 21msp50 have a $2k \times 24$ -bit program RAM and a $1k \times 16$ -bit data RAM. The 2112 has a $2k \times 24$ -bit program ROM or RAM and a $1k \times 16$ -bit data RAM. The 21msp51 has a $2k \times 24$ -bit program RAM, $2k \times 24$ -bit program ROM, and a $1k \times 16$ -bit data RAM.

Separate program and data buses brought off the chip only on the 2100/A.

All other parts combine program and data buses off the chip.

Off-chip memory capacity: The 2100/A has $32k \times 24$ -bit program and $16k \times 16$ -bit data memory capacities. All the others have $16k \times 24$ -bit program and $16k \times 16$ -bit data memory capacities.

Boot memory controller loads program from external byte-wide EPROM (except 2100/A).

On-chip peripherals: The 2100/A has no on-chip peripherals.

The 2101 and 2102 have two serial I/O ports and a timer; the 2105 has one serial I/O port and a timer. The 2111/2 have two serial I/O ports, a timer, and a host interface port. The 21msp50 has two serial I/O ports, a parallel I/O port, a timer, and a 16-bit ADC/DAC (linear codec).

Multiplier/accumulator accepts 16-bit fixed-point input and creates 32-bit fixed-point results within a 40-bit accumulator. 16-bit ALU. 32-bit bidirectional barrel shifter. 40-bit accumulator.

Multiplier/accumulator, ALU, and shifter are separate blocks connected by the 16-bit R-bus and the data bus.

Zero-overhead looping.

Only the 2100/A has a 16×24 -bit on-chip cache.

Direct, indirect, immediate, circular, and bit-reversal addressing modes.

Two address generators.

No on-chip DMA. Serial port and codecs have auto buffer, which transparently transfers data to and from memory.

16-level hardware stack. Status stack limits interrupts to four levels of nesting on the 2100/A, seven levels on the others.

Four external interrupts on the 2100/A; three external interrupts on others.

The 2100/A has only hardware wait states. Others have only software-programmable wait states.

No on-chip emulation port.

Only the 21msp50 has power-down mode to CMOS standby levels. The 2101, 2105, 2106, 2111, and 2112 have an idle mode, which lowers power until an interrupt is detected.

Packaging: 2100/A, 100-pin PQFP and 100-pin PGA. 2101/2, 68-pin PGA and 68-pin PLCC. 2105/6, 68-pin PLCC. 2111, 100-pin PQFP and 100-pin PGA. 21msp50/1, 100- and 132-pin PQFPs, 144-pin PGA.

HARDWARE

Full featured in-circuit emulator.
Low-cost in-circuit emulator board.
Demo board.
Evaluation packages.
Third-party support: Contact Analog Devices for a list of third-party vendors.

SUPPORT

C compiler. Simulator.
Macroassembler/linker.
Application libraries.
Upcoming Numerical C.

SOFTWARE

16-BIT FIXED-POINT CMOS DSP μ P

AVAILABILITY: The DSP16A, DSP16C, DSP1610, and DSP1616 are in production.

COST: DSP16A, \$22.60; DSP1610, \$91; DSP1616, \$35.70 (1000).

SECOND SOURCE: None.

AT&T Microelectronics

Dept 52AL040420

555 Union Blvd

Allentown, PA 18103

(800) 372-2447, ext. 796;

in Canada, (800) 553-2448, ext. 796

Circle No. 670

DESCRIPTION: The members of the DSP16 family have long been the fastest fixed-point DSP chips. The DSP16A has a 25-nsec cycle time. The DSP16A and DSP16C also have the largest on-chip program memory at $12k \times 16$ bits. Many applications that would require external ROMs with other DSP chips can fit within the DSP16 family's on-chip memory. The DSP16C

has an ADC and a DAC on chip. The DSP16C also has a 4-pin JTAG interface, which assists in testing tightly packed boards. A 3.3V version of the DSP16A is available. The DSP1610/1616 are enhanced versions intended for digital cellular telephone use.

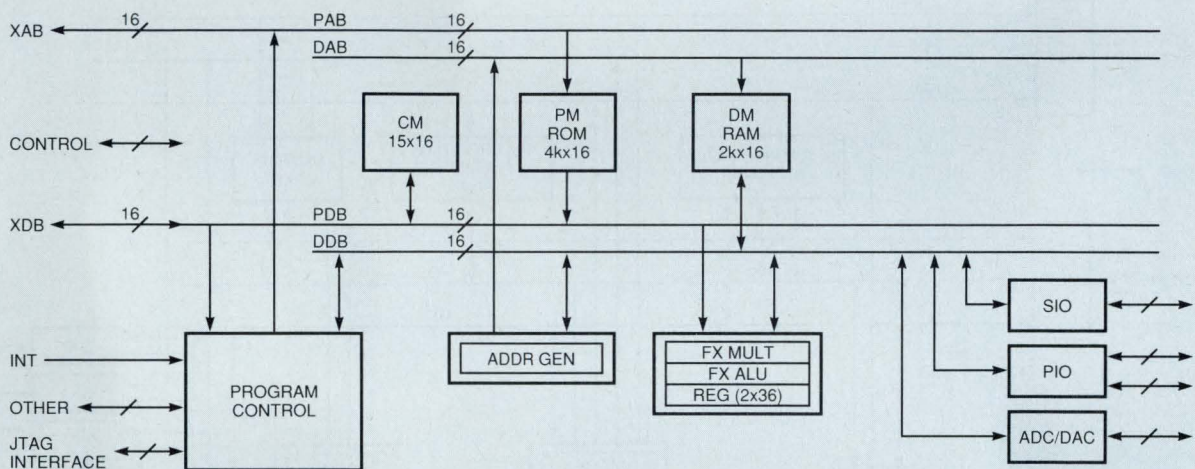

FEATURES: 25-, 33-, and 55-nsec cycle-time versions. The DSP16C has 25-, 28-, 33-, and 38-nsec cycle-time versions. Separate on-chip program and data buses.

On-chip memory: The DSP16A and -16C have a $12k \times 16$ -bit program ROM and a $2k \times 16$ -bit data RAM. The DSP1610 has a 512×16 -bit boot ROM and an $8k \times 16$ -bit dual-port RAM. The DSP1616 has a $12k \times 16$ -bit ROM and a $2k \times 16$ -bit dual-port RAM.

The program ROM on the DSP16A and -16C can be replaced or augmented with as much as 64k words of external memory.

The DSP1610/1616 can access two external 64k address spaces

Parallel and serial I/O port.

The DSP16C has an on-chip codec.

The DSP1610/1616 each have an on-chip timer.

The multiplier accepts 16-bit fixed-point data and creates 32-bit fixed-point results within a 36-bit accumulator.

32-bit ALU.

Only the DSP1610/1616 have a 36-bit barrel shifter and bit-manipulation instructions.

Two 36-bit accumulators.

Zero-overhead cache looping as many as 127 times.

15-word instruction cache.

Immediate, register-indirect, and circular addressing modes.

No on-chip DMA.

Single-level hardware stack is software expandable into main memory.

One external interrupt.

DSP1610 has hardware and software wait states. DSP1616 has software wait states.

DSP1610/1616 have on-chip emulation port.

The DSP16A, -16C, 1610, and 1616 have power-down mode.

The DSP1616 will run from 3.3 to 5V.

Packaging: DSP16A, 84-pin PLCC or 84-pin PQFP. DSP16C, 100-pin PQFP. DSP1610, 132-pin PQFP. DSP1616, 100-pin PQFP or SQFP.

HARDWARE

Development system with in-circuit emulation.
Evaluation board that plugs into a PC.

SUPPORT

Assembler/linker.

Simulator.

Application library.

Third-party support includes filter-design packages. Contact AT&T for a list of third-party vendors.

SOFTWARE

DSP56156

16-BIT FIXED-POINT CMOS DSP μ P

AVAILABILITY: Now.

COST: DSP56156—40 MHz, \$72 (1), \$50 (1000); 60 MHz, \$108 (1), \$75 (1000).

SECOND SOURCE: None.

Motorola Inc
Microprocessor Products Group
6501 William Cannon Dr
Austin, TX 78735
(512) 891-2030
FAX (512) 891-3874
Circle No. 671

DESCRIPTION: The 56156 is a 16-bit subset version of the 56001. It is intended for cellular telephone and other communication applications. It has a built-in codec and phased-locked loop. Development tools are similar to the 56001 and the 96002.

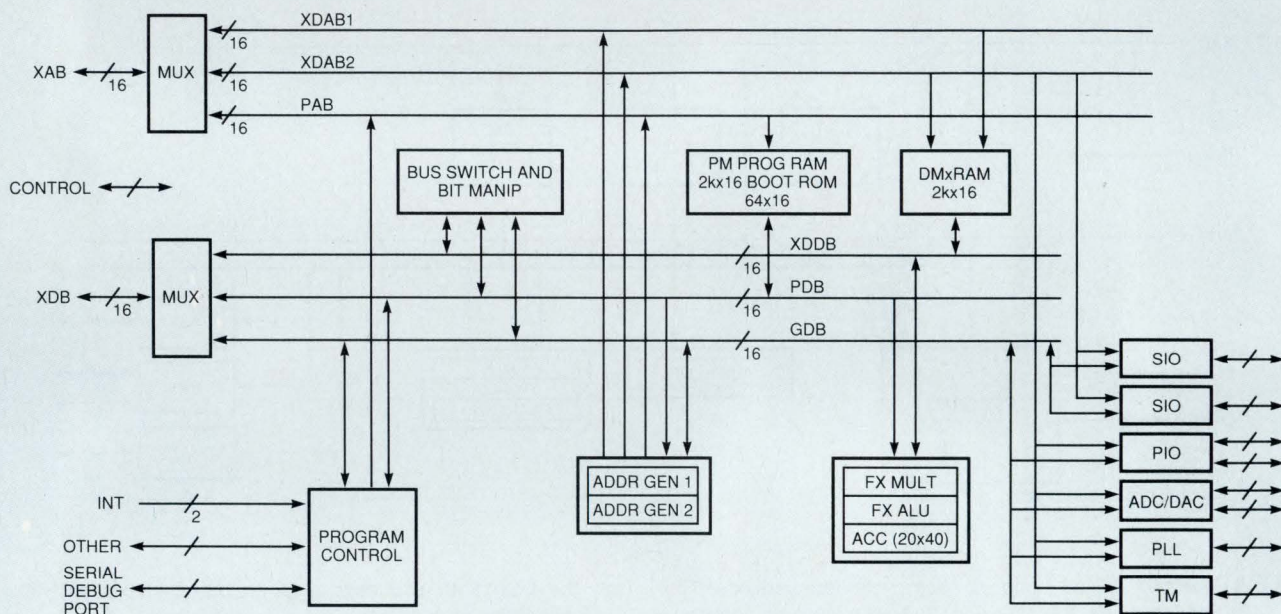

FEATURES:

- 33- and 50-nsec cycle-time versions.
- Three address buses and three data buses.
- On-chip memory includes a 2k x 16-bit program RAM and a 2k x 16-bit data RAM.
- ROM-based version (DSP56156ROM) contains a 12k x 16-bit program ROM.
- Separate external program and data memory spaces. Each can address 64k x 16-bit locations.
- Can load program from external EPROM.
- Asynchronous and synchronous serial I/O ports.
- Parallel port can interface with a host μ P.
- Has on-chip phase-locked loop (PLL).
- On-chip sigma-delta voice band codec.
- Multiplier accepts 16-bit data and returns 40-bit results to 40-bit accumulator.

- ALU performs arithmetic operations on 40-bit data and logical operations on 16-bit data.
- No barrel shifter.
- Two 40-bit accumulators.
- Zero-overhead looping.
- Immediate, direct, indirect, circular, and bit-reversed addressing modes.
- No DMA support.
- Two external vectored interrupts.
- Has on-chip emulation.
- Low-power mode.
- Packaged in a 112-pin ceramic quad flatpack.

HARDWARE

Application development system includes in-circuit emulator.
Contact Motorola for a list of third-party vendors.

SUPPORT

Macro cross assembler.
Linker.
Application development board.

SOFTWARE

24-BIT FIXED-POINT CMOS DSP μ P

AVAILABILITY: Now.

COST: DSP56001: 27 MHz, \$33 (1), \$27 (1000); 33 MHz, \$40 (1), \$33 (1000). DSP56002: 40 MHz, \$55 (1), \$43 (1000).

SECOND SOURCE: None.

Motorola Inc
 Microprocessor Products Group
 6501 William Cannon Dr
 Austin, TX 78735
 (512) 891-2030
 FAX (512) 891-3874
 Circle No. 672

DESCRIPTION: The 56001 provides one 24-bit data word and two 56-bit accumulators. This extended precision lets the chip process 16-bit data more easily than the 16-bit machines can. A 24-bit-word width eases scaling, and the 56-bit accu-

mulators prevent overflow. The 24-bit data width suits digital audio applications. The 56002 is a high-speed, low-power, low-voltage version of the 56001 that is 100% software compatible, and includes a PLL and on-chip emulation.

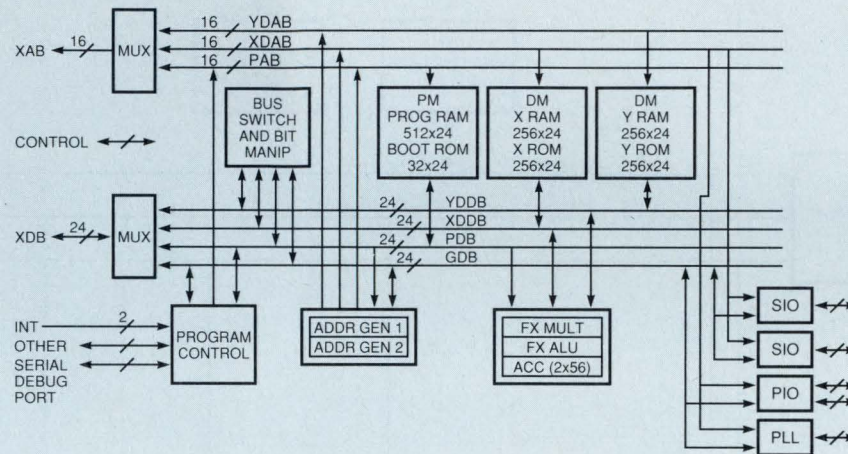

FEATURES: DSP56001 60- and 74-nsec cycle-time versions. DSP56002 50-nsec cycle-time.

Three address buses and four data buses.

Separate address buses for program ROM and the two data RAMs.

Separate data buses for program ROM, the two data RAMs, and global data.

On-chip memory includes a 512 \times 24-bit program RAM, a 32 \times 24-bit boot ROM, dual 256 \times 24-bit data RAMs, and dual 256 \times 24-bit data ROMs.

ROM-based version (56000) available.

Three separate memory spaces (X, Y, and P). Each can address 64k \times 24-bit locations.

Can load program from external EPROM.

Asynchronous 8-bit serial I/O port.

Synchronous 8- to 24-bit serial interface.

Parallel port can interface with a host μ P.

56002 has on-chip PLL.

Multiplier accepts 24-bit data and returns 48-bit results to 56-bit accumulator.

ALU performs arithmetic operations on 56-bit data and logical operations on 24-bit data.

No barrel shifter.

Two 56-bit accumulators.

Zero-overhead looping.

Immediate, direct, indirect, circular, and bit-reversed addressing modes.

Two address generators.

No DMA support.

System stack is 15 levels deep but can be read by program to extend stack into main memory.

Two external vectored interrupts on 56001, three on 56002.

Hardware and software-programmable wait states.

Only the 56002 has on-chip emulation.

Low-power mode.

Low-voltage version of 56002 by fourth quarter 1992.

56001 is packaged in a 132-pin ceramic quad flatpack or 88-pin PGA. 56002 is packaged in a 132-pin PGA or PQFP.

HARDWARE

Application development system includes in-circuit emulator.
 Contact Motorola for a list of third-party vendors.

SUPPORT

C compiler.
 GNU C compiler and source-level debugger.
 Macro cross assembler.
 Linker/librarian.
 Simulator.
 Code translator from TMS320C10 to 56001.
 Third-party support includes filter-design software, and VRTX32/DSP56001 and Spox real-time operating systems.

NS32SF640

32-BIT FIXED-POINT CMOS DSP μ P

AVAILABILITY: Available now.

COST: NS32SF640-25/50, \$195 (10,000).

SECOND SOURCE: None.

National Semiconductor Inc
2900 Semiconductor Dr
M/S 16-320
Santa Clara, CA 95052
(408) 721-2636

DESCRIPTION: Called Swordfish by National, the 32SF640 has a 64-bit data bus but operates on 32-bit data. The 32SF641 is identical except that it includes a floating-point unit. A highly

pipelined architecture lets the device perform more than one operation per cycle. It is more of a RISC μ P than a DSP, but the 20-nsec multiplier lets it perform many DSP functions.

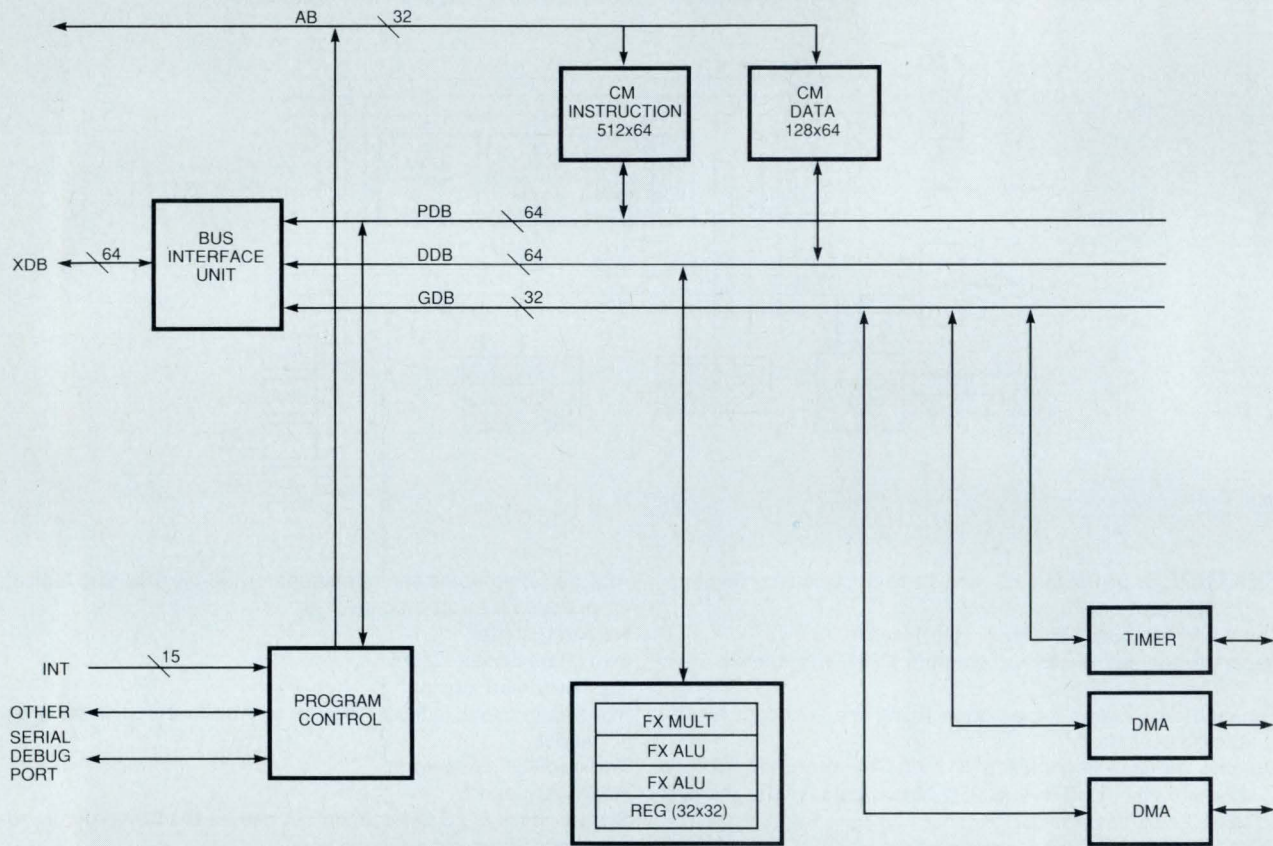

FEATURES: 20-, 25-, and 31-nsec cycle-time versions.
One 32-bit address bus, two 64-bit data buses, and one 32-bit I/O data bus on chip.
Separate data buses for program and data.
No on-chip memory.
4G words of external address space.
Two 32-bit ALUs.
IEEE-754 32-bit and 64-bit floating-point unit on the 32SF641.
Multiplier accepts 16- or 32-bit fixed-point data and returns 32-bit results.

512 \times 64-bit instruction cache.
128 \times 64-bit data cache.
No barrel shifter.
Thirty-two 32-bit register-based accumulators.
DMA is supported via two DMA controllers.
The stack is maintained in main memory.
15 external vectored interrupts.
Hardware wait states.
Serial debug port for in-circuit debugging.
Packaged in a 223-pin PGA.

HARDWARE

Hardware evaluation system includes development board.
In-circuit emulator by the end of 1992.

SUPPORT

GNX tool set includes C compiler, Assembler, Source-level debugger, Profiler.
PXROS real-time operating system due by the end of 1992.

SOFTWARE

16-BIT FIXED-POINT DSP μP

AVAILABILITY: The 77C25 is available now.

COST: The 77C25 costs \$9 (5000); the 77P25 costs \$45 (1000).

SECOND SOURCE: Oki Semiconductor (Sunnyvale, CA) also makes the 7720.

NEC Electronics
401 Ellis St
Mountain View, CA 94039
(800) 632-3531; (415) 965-6158
FAX (800) 729-9288; (415) 965-6130
Circle No. 673

DESCRIPTION: The 77C25 is an upgrade of the 7720, which was one of the first successful DSP chips. The basic architecture is out of date, and its memory can't be expanded off chip. The

manufacturer says there is still interest in new 77C25 designs because of the chip's low cost. The 77P25 is an EPROM version of the 77C25.

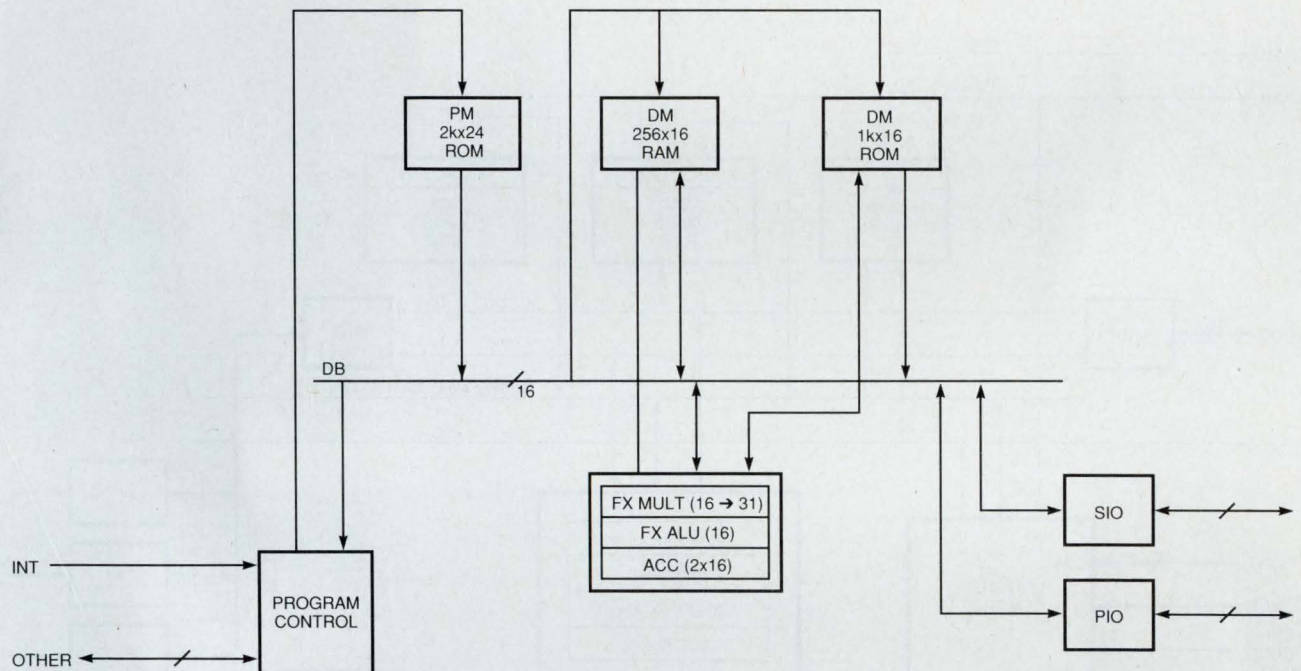

FEATURES: 100- and 122-nsec cycle time.
 Single address bus only for program memory.
 Pointers address data memory.
 Single data bus for both program and data.
 On-chip memory: The 77C25 has a 2k×24-bit program ROM, a 256×16-bit data RAM, and a 1k×16-bit data ROM. The 77P25 has the same memory as the 77C25 but replaces ROM with EPROM.
 No external memory expansion.
 One 8-bit serial I/O port.
 Parallel I/O port.
 Multiplier accepts 16-bit fixed-point data and produces 31-bit fixed-point results within two 16-bit accumulators.

16-bit ALU.
 No barrel shifter.
 Two 16-bit accumulators.
 No zero-overhead looping.
 No address generators.
 No on-chip DMA controller.
 4-level stack stores the program counter during subroutines and interrupts and is not expandable.
 Single external interrupt.
 No wait states.
 No on-chip emulation port.
 No low-power mode.
 Packaged in 28-pin DIP, 28-pin PLCC, 44-pin PLCC, and 32-pin SOP.

HARDWARE

Evaluation kit for application development also functions as an in-circuit emulator.

SUPPORT

Assembler/linker.
Third-party simulator available.

SOFTWARE

μPD77016

16-BIT FIXED-POINT CMOS DSP μP

AVAILABILITY: Engineering samples, fourth quarter 1992.
In production first half of 1993.

COST: 77016, 33 MHz, \$55 (1000).

SECOND SOURCE: None.

NEC Electronics
401 Ellis St
Mountain View, CA 94039
(415) 965-6620
FAX (800) 729-9288
Circle No. 674

DESCRIPTION: This DSP is optimized for digital cellular phones and high-speed data/FAX modem applications. It has a Harvard architecture that is maintained off chip and a large

amount of on-chip memory. The serial debug port allows for low-cost in-circuit emulation.

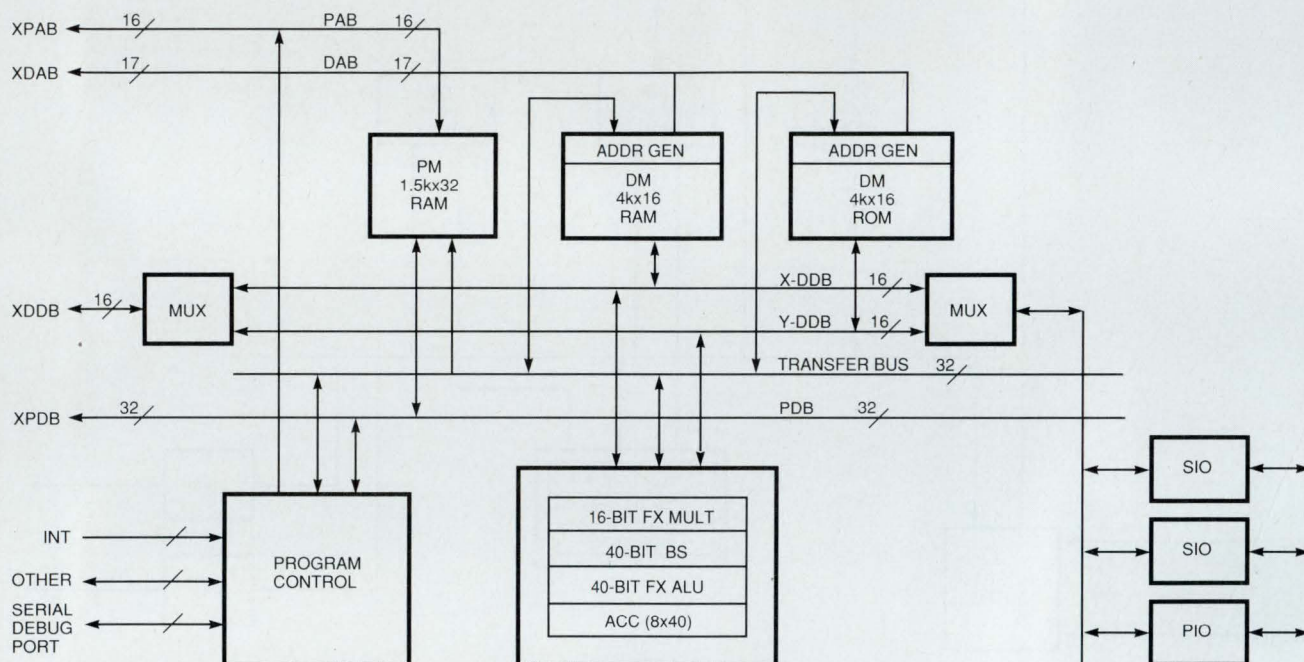

FEATURES: 30- and 50-nsec cycle-time versions.

Separate program and data buses maintained off chip.

Three internal data buses.

On-chip memory includes a 1.5k × 32-bit program RAM, a 4k × 16-bit data RAM, and a 4k × 16-bit data ROM.

Off-chip memory can be expanded to 64k × 32-bit program memory and 128k × 16-bit data memory.

Two serial I/O ports.

Parallel I/O port can be used as host μP interface.

Four general-purpose parallel I/O ports.

Multiplier accepts 16-bit fixed-point data and creates 40-bit fixed-point results within a 40-bit accumulator.

40-bit ALU.

40-bit barrel shifter.

Eight 40-bit accumulators.

Two address ALUs with circular buffering and bit-reversal addressing support.

On-chip DMA.

Zero-overhead looping.

12 interrupts (4 external/8 internal)

Wait-state control on both external buses.

On-chip emulation port.

Low-power mode.

Packaged in a 160-pin PQFP.

HARDWARE

Hardware emulator works with on-chip emulation port and runs on IBM PC.

SUPPORT

Assembler/linker.
Simulator.
C compiler planned.

SOFTWARE

GOOD IDEA. SAME IDEA.

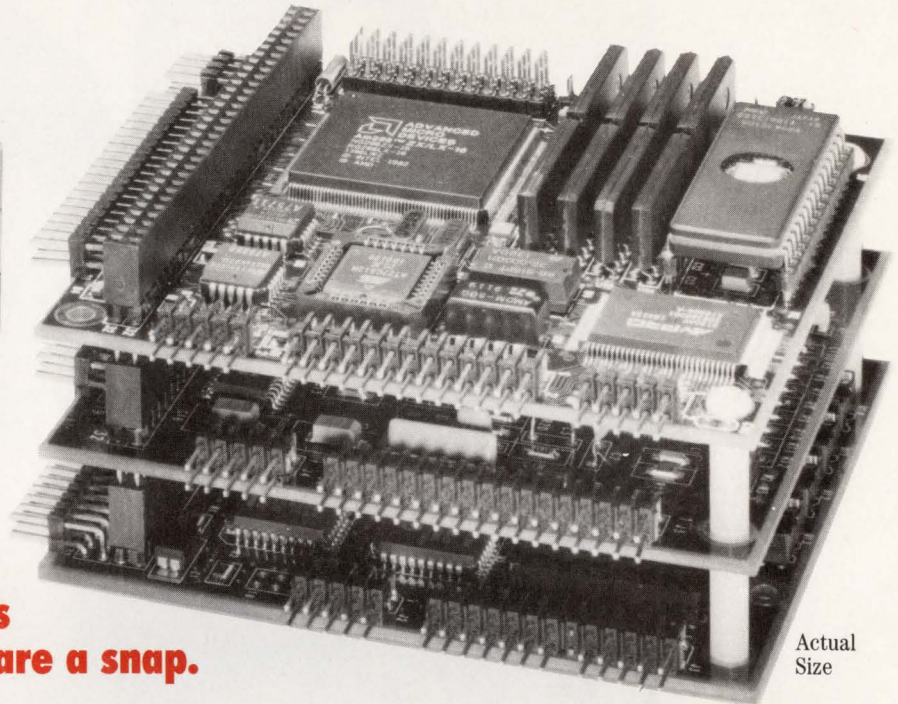
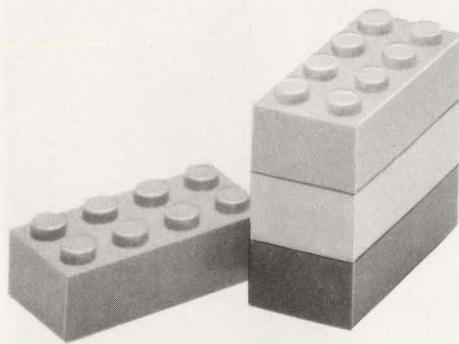

When time-to-market is critical, embedded PCs are a snap.

Ampro offers you fast, flexible answers to embedded PC development. Little Board™ single board systems on the left below, CoreModule™ CPUs on the right. Plus Mini-Modules™ that snap onto either. That means you can snap together a system customized to your specific application. Now.

Above, shown actual size: a complete AT-compatible system. 80286 processor, 4Mbytes of DRAM, floppy and IDE I/O, 2 serial and one parallel port, SVGA display driver . . . and more. It was snapped together in less than two minutes using Ampro's CoreModule/286 and two MiniModules. It fits in a space just 3.6"×3.8"×1.8." And it draws under 5W. Embedded PCs don't get easier

than that. CoreModules are now available in XT, 286 or 386SX. Your choice.

Single Board Solutions. Little Boards offer single board solutions to embedded systems. Little Boards accept all MiniModules. That means you can build custom systems as simply as stacking Legos.™ PC/AT-compatible Little Board capabilities include: a choice of PC, 286, 386SX, 386, and 486 CPU. Up to 16Mbytes of on-board DRAM. Dual serial and one parallel controller. Floppy, IDE and SCSI controllers. Bootable solid state disk . . . and more. Plus, compatibility with all PC/AT operating systems and software. All, in the form factor of a 5.25" disk drive.

The PC/104 standard. Ampro started it. But today you can buy PC/104 StackThru modules from 15 state-of-the-art manufacturers on three continents. The result? Snap-together systems specific to your embedded application.

Flexible answers. When it comes to embedded PC/AT computer systems, you can't buy faster, smaller, or more flexible answers. CoreModule or Little Board-based systems. Mini-

Modules. Development systems. And complete technical support. Flexible answers. Fast.

Hitting the window. When time-to-market and development costs are critical considerations in your embedded applications, Ampro products can help you significantly decrease both.

Write or call today. If you're developing products with embedded controllers, Ampro offers fast, cost-effective alternatives to in-house development. Call, write or fax. We'll send you Ampro's 80-page, full line catalog. Proven, cost-effective answers to high development costs and product introduction delays. Embeddable systems. In a snap.

Fast Answers. Toll Free
1-800-966-5200

AMPRO®
Proven Solutions for Embedded Control

Ampro Computers, Inc.
990 Almanor Ave., Sunnyvale, CA 94086
Phone: (408) 522-2100 Fax: (408) 720-1305

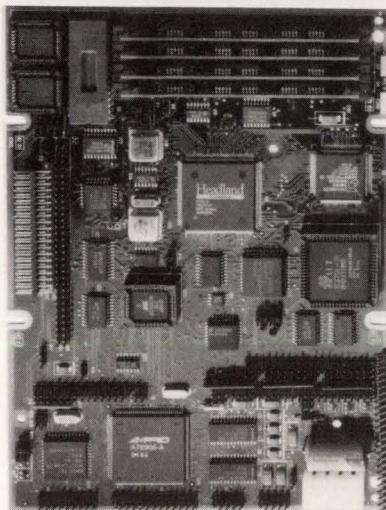

Little Board
PC, 286, 386SX, 386 and 486

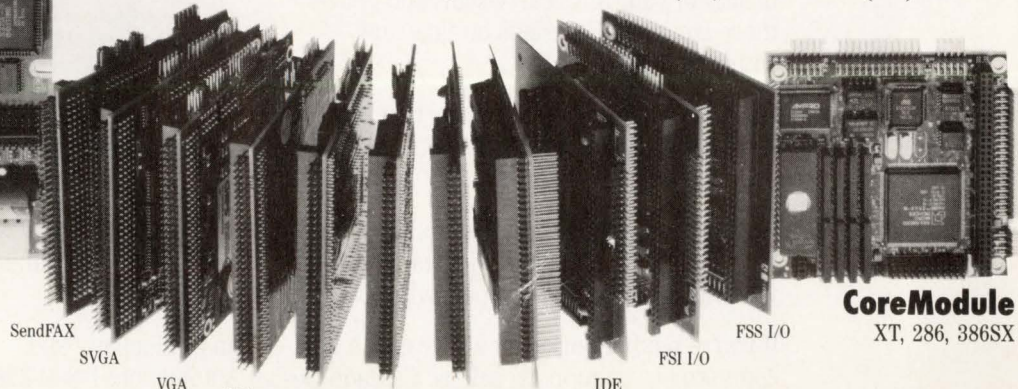

CoreModule
XT, 286, 386SX

"THIS ONE'S MY FAVORITE. WE LAID IT OUT IN THREE DIFFERENT PROCESSES AND STILL BROUGHT IT IN ON TIME AND UNDER BUDGET THANKS TO NEW EPOCH."



INTRODUCING EPOCH.

We named our new set of IC design tools Epoch because it truly is a new way of looking at IC design.

Whether it's Mentor, Cadence, ViewLogic, VHDL, Verilog or EDIF, with Epoch, you can continue to work in your familiar CAE environment. At the same time, you'll have quick access to Epoch's powerful set of tools. Tools that can help you improve the quality of your physical designs and deliver those complex IC designs on time and within budget.

Epoch is a new version of a tool that engineers throughout the world have used for years to design ICs for all kinds of applications, from engine controllers to consumer electronics and from medical imaging to DSP.

Epoch was developed, tested and proven by a team of engineers with widespread experience in IC design, IC software and a wide variety of foundry processes. This same team is available to provide you with full technical support whenever you need it.

If you're ready to discover a new epoch in IC design productivity and commitment to support, call us. Cascade Design Automation: 1-800-258-8574.

FEATURES AND BENEFITS

Open architecture for seamless interfacing with a wide range of CAE platforms.

Process-independent design methodology and a robust, parameterized library for true process migration and design reusability. Instead of simply re-scaling the entire design, Epoch automatically manipulates design rules independently to take full advantage of target processes.

Performance-driven layout to help create chips with the optimum balance of speed, density and power consumption.

Automated place and route with optional interactive optimization that enables the designer to fine-tune the design at critical junctures.

24-BIT FIXED-POINT CMOS DSP μP

AVAILABILITY: 100- and 122-nsec versions available now.
COST: \$30 (5000).
SECOND SOURCE: None.

NEC Electronics
401 Ellis St
Mountain View, CA 94039
(800) 632-3531; (415) 965-6158
FAX (800) 729-9288; (415) 965-6130
Circle No. 675

DESCRIPTION: The 77220 is a scaled-down version of the 32-bit floating-point 77230. The chip size and pin count are reduced by using 24-bit data and removing the floating-point exponent hardware. The 24-bit-word width suits the digital audio market. The instruction set is a subset of the 77230 and is

source-code compatible with the floating-point device. The vendor says the 77220's architecture is optimized for adaptive filter applications. The 77P220R EPROM version and the 77P220L one-time-programmable version are for prototyping and low-volume applications.

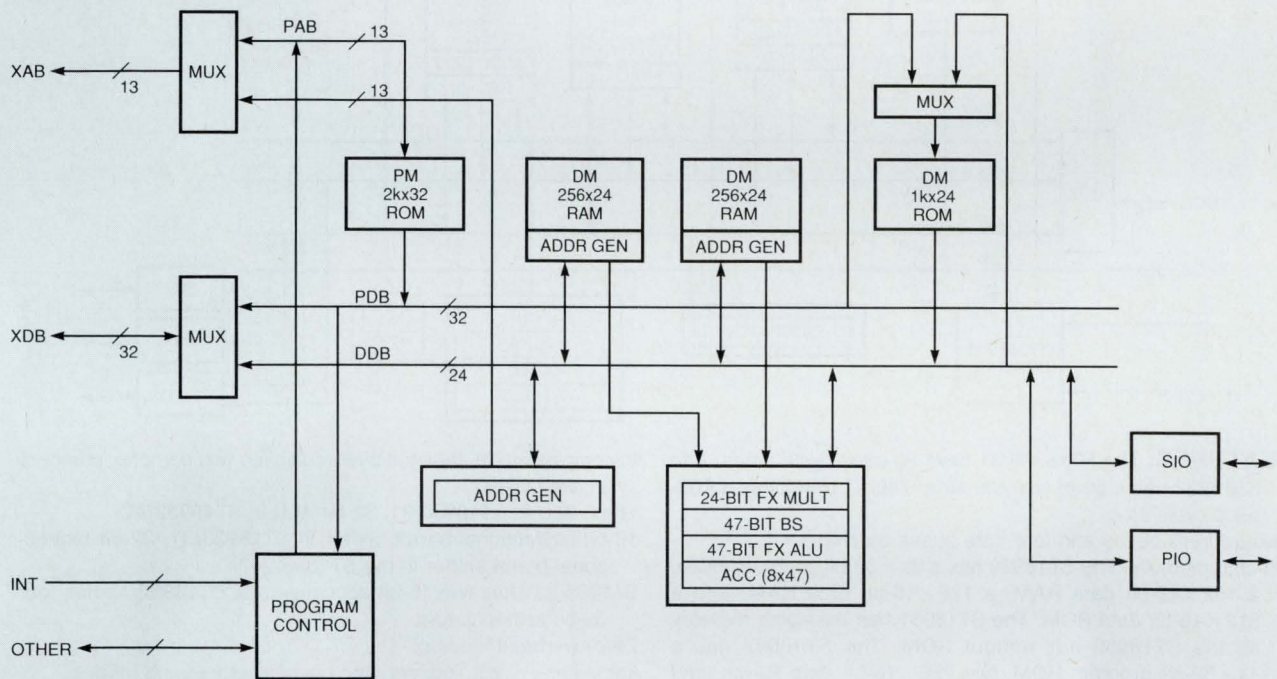

FEATURES: 100- and 122-nsec cycle-time versions.
 Separate on-chip program and data buses.
 On-chip memory includes a 2k × 32-bit program ROM, dual 256 × 24-bit data RAMs, and a 1k × 24-bit data ROM.
 Off-chip memory can be expanded to 8k × 32-bit program memory and 8k × 24-bit data memory.
 One serial I/O port.
 Parallel I/O port can be used as host μP interface.
 Multiplier accepts 24-bit fixed-point data and creates 47-bit fixed-point results within a 47-bit accumulator.
 47-bit ALU.
 47-bit bidirectional barrel shifter.

Eight 47-bit accumulators.
 Direct, indirect, immediate, circular, and bit-reversal addressing modes.
 Three address generators.
 No on-chip DMA.
 Hardware stack is eight levels deep and is not expandable.
 Two external interrupts.
 No supported wait states.
 No on-chip emulation port.
 No low-power mode.
 Packaged in a 68-pin PGA or 68-pin PLCC.

HARDWARE

Evaluation kit and IBM PC-based evaluation board.

SUPPORT

Assembler/linker.
Simulator.
C compiler.

SOFTWARE

ST18930/31/32/42

16-BIT FIXED-POINT CMOS DSP μ P

AVAILABILITY: Now.

COST: ST18930, \$15 (10,000); ST18931, \$75 (100); ST18942, \$35 (10,000); ST18R942, \$80 (100). The ST18932 is only available for ASIC designs.

SECOND SOURCE: None.

SGS-Thomson Microelectronics
1000 E Bell Rd
Phoenix, AZ 85022
(602) 867-6340
Circle No. 676

DESCRIPTION: The ST18 family consists of four devices. The ST18930 and -31 are CMOS versions of the NMOS original with a few enhancements and twice the speed. The ST18932 is a core for use in custom DSP μ Ps. The CMOS ST18942 offers

further enhancements in its arithmetic capabilities, addressing modes, and I/O functions. All family members can operate on complex and double-precision data. The ST18932/42 have a 32-bit ALU and 16-bit data buses.

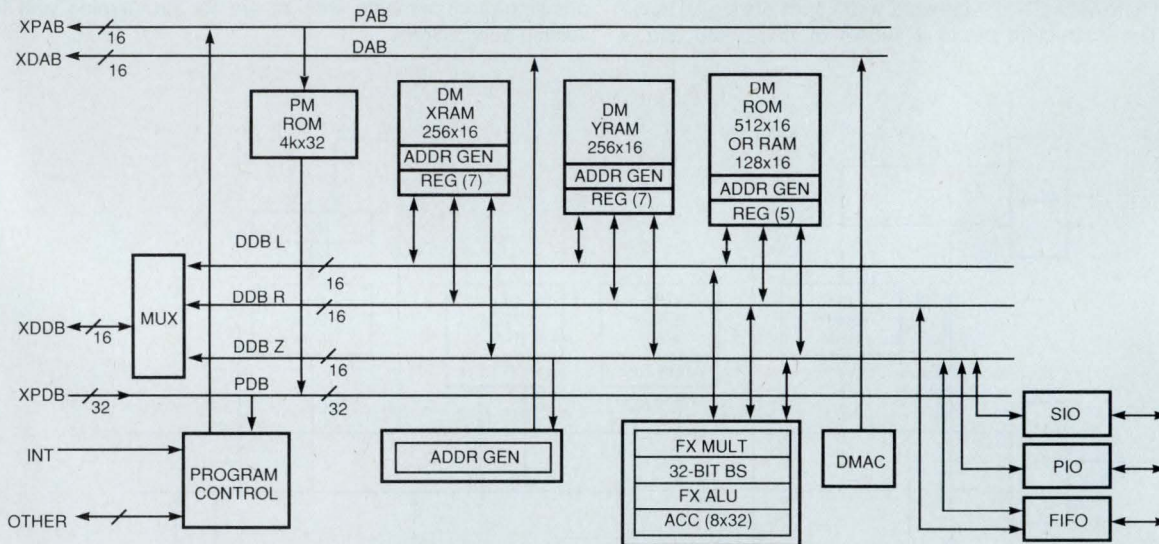

FEATURES: The ST18930/31 have 80-nsec cycle times. The ST18932 has a 50-nsec cycle time. The ST18942 has a 100-nsec cycle time.

Two address buses and four data buses on chip.

On-chip memory: The ST18930 has a 3k x 32-bit program ROM, a 192 x 16-bit data RAM, a 128 x 16-bit data RAM, and a 512 x 16-bit data ROM. The ST18931 has the same memory as the ST18930 but without ROM. The ST18942 has a 4k x 32-bit program ROM, two 256 x 16-bit data RAMs, and a 512 x 16-bit data ROM. The ST18R942 is a ROMless version of the ST18942 and has two 256 x 16-bit and one 128 x 16-bit data RAMs.

64k x 32-bit external program memory (except ST18930).

ST18930/31 4k x 16-bit external data memory space. ST18932

8k x 16-bit external data memory. ST18942 and ST18R942

64k x 16-bit external memory.

Only the ST18942 has both a serial I/O port and a parallel I/O port.

ST18932/42 multiplier accepts 16-bit fixed-point data and returns 32-bit fixed-point results to a 32-bit accumulator. The ST18930/31 returns 16-bit results.

In complex mode, the multiplier multiplies two complex numbers in two cycles.

16-bit ALU in ST18930/31. 32-bit ALU in ST18932/42.

16-bit bidirectional barrel shifter in ST18930/31. 32-bit bidirectional barrel shifter in the ST18932/42.

ST18930/31 has two 16-bit accumulators. ST18932/42 has four 32-bit accumulators.

Zero-overhead looping.

Immediate, direct, indirect, and circular addressing modes.

The ST18942 has on-chip DMA.

ST18930/31 has 1-, ST18932 has 2-, and ST18942 has 8-level hardware stack for interrupts and subroutines. All can be expanded into main memory with software.

Three external interrupts on the ST18930/31 and eight on the ST18932/42.

Hardware and software-programmable wait states.

Only the ST18932 has an on-chip emulation port.

Low-power mode.

Packaging: ST18930, 48-pin DIP, and 52-pin PLCC. ST18931, 124-pin PGA. ST18942, 160-pin PQFP. ST18R942, 160-pin PQFP and 144-pin PGA.

HARDWARE

SUPPORT

SOFTWARE

Hardware development system provides in-circuit emulation of as many as three DSP chips in real time.

Stand-alone emulator board connects to an IBM PC.

EPROM module. A ROMless version with EPROMs on a small board that plugs into a ROM-version socket.

Macroassembler/linker.
Simulator.

VALLEY Announces **a way for its high-speed DSP users** **to save thousands of dollars** **on DSP Code Development.**

"THE BUGBUSTER" **for VE32C Boards**



\$499.00

Available June '92

FEATURES:

- Menu-driven, screen oriented. Command lines aren't needed!
- Real time execution of application programs right on our DSP32C boards.
- Allows DSP32C serial I/O to occur between breakpoints.
- User can debug program code in final hardware.
- 4 debug sessions maintained simultaneously - concurrently debug programs residing in up to 4 DSP.
- Save entire debug session on disk and resume later at stop point.
- Compatible with SUN 3/4 and SPARC w/SBus-VME. Also SUN OS and Vx WORKS.

Also ask about our . . .

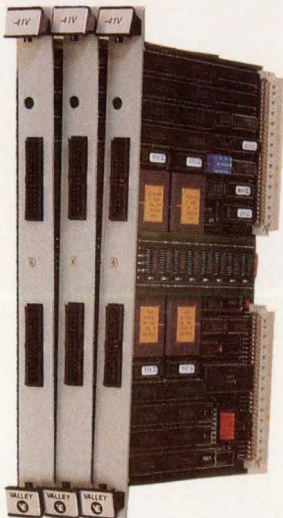

- High speed serial port upgrades.
- Family of DSP32C boards.
- Enhanced memory to 8 MB per/DSP
- 40 MHZ instrument grade compatible analog module.
- A/D, D/A ICS interfaces.



For further information, call:

VALLEY ENTERPRISES, INC.

RD#4, ROUTE 309 • TAMAQUA, PA 18252 USA
PHONE: (717)668-3737 • FAX: (717)668-6360

See us at Booth No 324 at DSPx For details on 3 hot new DSP products.

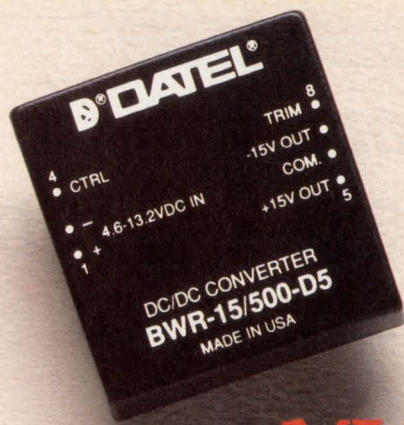

XWR Series DC/DC Converters

20Watt

DC/DC Converters
Single/Dual/Triple
34 New Models

- Inputs: 4.6-13.2V, 9-18V, 9-36V, 18-72V
- Typical Efficiencies to 84%+
- World's *ONLY* Wide Range 5V_{IN}
- Extended Operating Temperature
- V_{OUT} Adjustment Capability (TRIM)
- Insulated Case (will not short PC etch)
- TTL-compatible ON/OFF control
- Metal Case Shielding
- Single V_{OUT}: 2.1, 3.3, 5, 12, 15V
- Dual V_{OUT}: ±5, ±9, ±12, ±15V
- Triple V_{OUT}: 5, ±12V and 5, ±15V

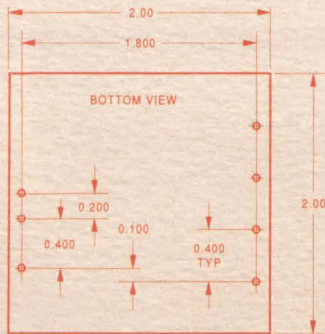

10Watt

DC/DC Converters
Single/Dual/Triple
25 New Models

- Inputs: 4.7-7V, 9-18V, 18-72V
- World's Smallest Commercial 10 W
- Lowest Profile: 0.37" tall
- Typical Efficiencies of 84%+
- Insulated Case (will not short PC etch)
- Metal Case Shielding
- World's *ONLY* Wide Range 5V_{IN}
- Extended Operating Temperature
- Single V_{OUT}: 3.3, 5, 12, 15V
- Dual V_{OUT}: ±5, ±12, ±15V
- Triple V_{OUT}: 5, ±12V and 5, ±15V

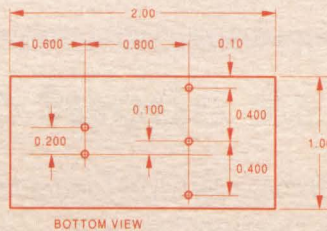

3 Watt

DC/DC Converters
Single/Dual Output
15 New Models

- Inputs: 4.5-9V, 9-18V, 18-72V
- Switching Frequency 200 KHz (typ)
- Black Plastic Case
- Pi-type Filter (L-type all -D48)
- Typical Efficiencies to 82%+
- Ideal for Telecomm/PCB applications
- Low Profile: 0.435" tall
- Excellent Line/Load Regulation
- 1000 Vdc Isolation (min)
- V_{OUT}: 5, 12, 15, ±12, ±15

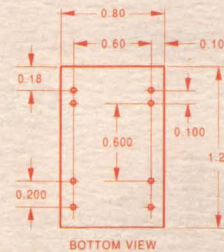

General Specifications

- State-of-the-Art Thermal Management
- Continuous Short Circuit Protection
- Internal Input/Output filtering
- Overvoltage Protection
- 100% Burn-in @ Full Load
- Industry Standard Pinout & Packaging
- Very High Reliability
- Fully Encapsulated
- Delivery From Stock!

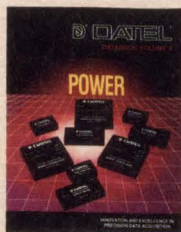

For complete data call or write today for a free new Power Supply catalog. DATEL, Inc., 11 Cabot Boulevard, Mansfield, MA 02048. Tel: (508)339-3000, FAX: (508)339-6356. For immediate assistance: all USA, EST business hours 1-800-233-2765.

DATEL
INNOVATION and EXCELLENCE

CIRCLE NO. 68

24-BIT FIXED-POINT CMOS DSP μ P

AVAILABILITY: Now.

COST: 50-MHz SPROC-1400 (four processors on chip), \$70 (1000). By mid 1993, the SPROC-1000 (one processor) will cost \$15 and the SPROC-1400 will cost \$50.

SECOND SOURCE: None.

Star Semiconductor Corp
25 Independence Blvd
Warren, NJ 07059
(908) 647-9400
FAX (908) 647-4755
Circle No. 677

DESCRIPTION: The SPROC family has one, two, or four general-purpose processors on the chip. Programs are generated with signal flow diagrams, which are converted into code for the processors. Automatic partitioning of the code isolates you from

the complexities of multiprocessing. You can very quickly create a system and see the results in real time. A probe port lets you see what the signal looks like anywhere in the block diagram.

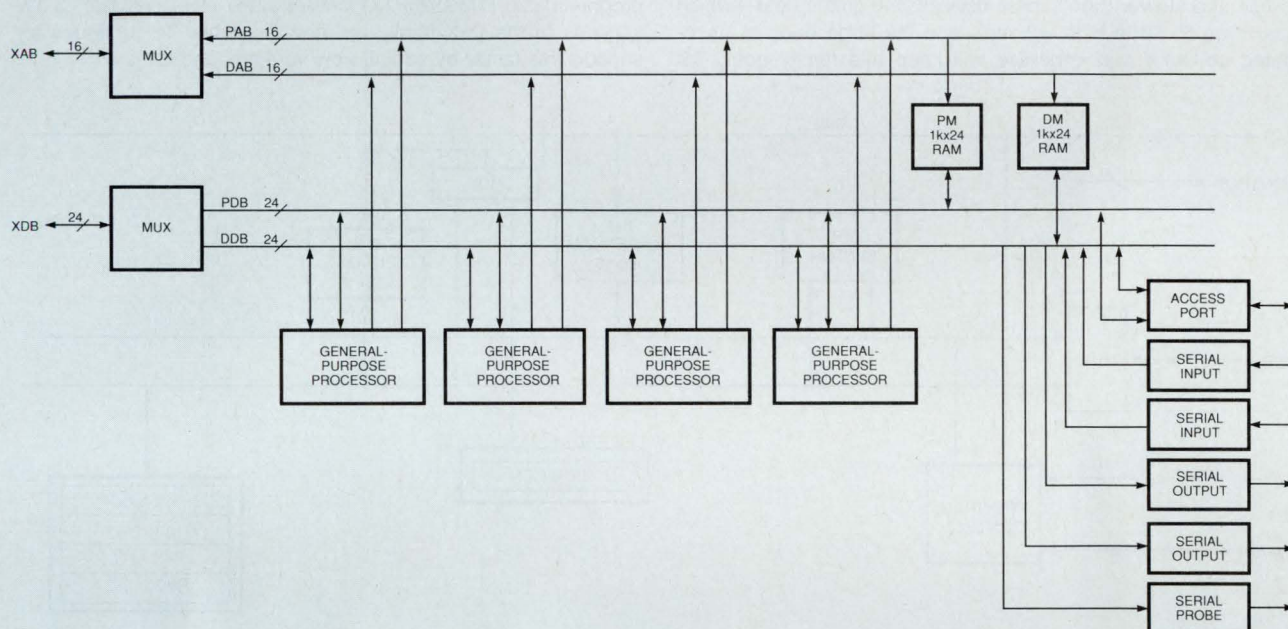

FEATURES: 20-, 40-, and 50-MHz versions.

One to four general-purpose processors share common program and data memory.

Multiported data memory lets each processor access memory each cycle.

Separate instruction and data bus on chip.

Can access external memory via parallel port.

Serial data flow into and out of chip is controlled by Data Flow Managers with no impact on performance.

24-bit multiply with 56-bit accumulation.

Two serial input ports and two serial output ports.

Serial ports configurable for 8-, 12-, 16-, or 24-bit data.

Initialized by μ P or external 8-bit EPROM.

Access port for development and debugging.

Probe port allows view of data at any point in the program.

Output to DAC board allows real-time view on oscilloscope, Parallel port transfers data to an external controller, peripheral, or memory.

Parallel port has hardware and software wait states.

Packaged in a 132-pin PGA.

HARDWARE

An interface box and an evaluation board are included with the SPROClab.

SUPPORT

SPROClab graphical development system. Includes signal flow editor, function block library, filter design tool, compiler, loading, and debugging tools.

SOFTWARE

TMS320C1X

16-BIT FIXED-POINT CMOS DSP μ P

AVAILABILITY: The C10, C15, C16, C17, E14, E15, E17, P15, P17, P14, LC15 (3.3V), LC16 (3.3V), and LC17 (3.3V) are available now. The C14 will be available in the third quarter of 1992.

COST: C10 (20 MHz), \$4.90; C14, \$10; E14, \$45; P14, \$22; C15 (20 MHz), \$7; E15 (20 MHz), \$36; P15, \$17; C16, \$8.40; E17, \$39; P17, \$19 (C10, quantity 1; all others, quantity 1000).

SECOND SOURCE: Microchip Technology (Chandler, AZ) second-sources the C10, C14, and E14. No second source for other parts.

DESCRIPTION: This first generation of the vendor's DSP family was introduced in 1982. Although this family is difficult to use and slower than similar devices, the chip's cost—which has fallen to \$3 in high volume—and the large body of associated software and expertise will keep this family going for

Texas Instruments Inc
Semiconductor Group
Box 809066
Dallas, TX 75380
(214) 995-6611, ext 3990
Circle No. 678

some time. Newer family members have additional memory and peripheral options. EPROM (TMS320E1X) and one-time-programmable (TMS320P1X) versions are also available. 3.3V versions of the C1X family are now available. TI continues to support this family by adding new versions and tools.

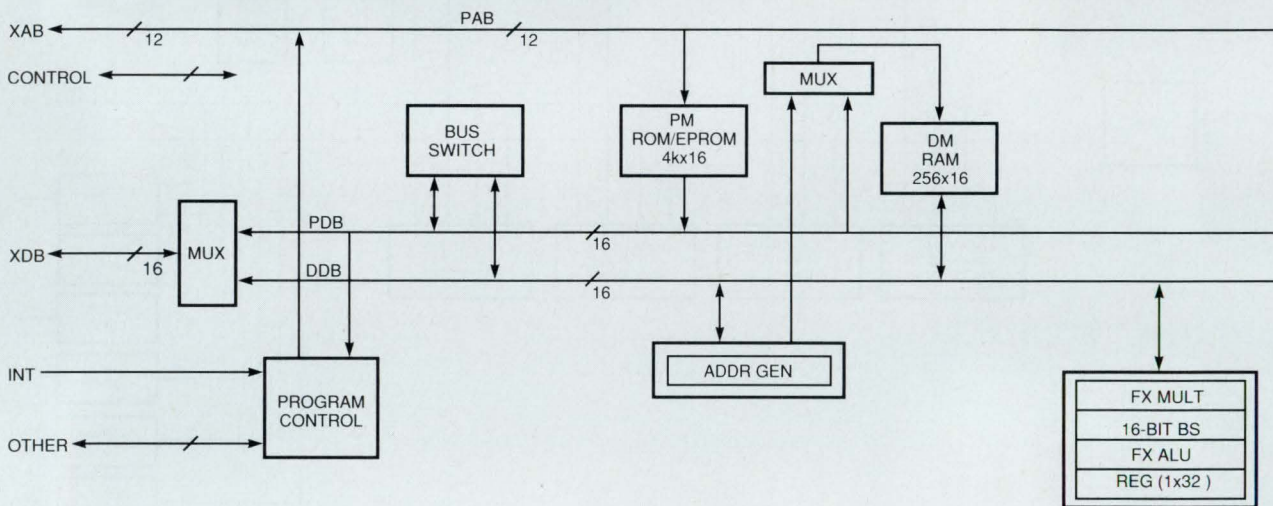

FEATURES: 114-, 160-, 200-, and 280-nsec cycle-time versions. Separate on-chip program and data buses.

On-chip memory: The C10 has a $1.5k \times 16$ -bit program ROM and a 144×16 -bit data RAM. The C14, C15, and C17 have a $4k \times 16$ -bit program ROM and a 256×16 -bit data RAM. The E14, E15, and E17 have a $4k \times 16$ -bit program EPROM and a 256×16 -bit data RAM. The C16 has an $8k \times 16$ -bit program ROM and a 256×16 -bit data RAM. P1X versions are one-time programmable.

Program and data buses are combined off chip.

$4k \times 16$ -bit total external memory except the C16, which has $64k \times 16$ -bit external memory, and the C17, which has no external memory.

On-chip peripherals: The C10, C15, and C16 have parallel I/O. The C14 has serial and parallel I/O. The C17 has two serial I/O ports, parallel I/O, and a compander.

Multiplier accepts 16-bit fixed-point data and creates 32-bit fixed-point results within a 32-bit accumulator.

32-bit ALU.

16-bit left barrel shifter.

Single 32-bit accumulator.

No zero-overhead looping.

No DMA.

4-level hardware stack except the C16, which has an 8-level hardware stack.

Single external interrupt.

No wait states.

No on-chip emulation.

LC1X devices operate at 3.3V.

Packaging: C10, 40-pin DIP or 44-pin PLCC. C14, 68-pin PLCC. C15, 40-pin DIP or 44-pin PLCC. C16, 64-pin QFP. C17, 40-pin DIP or 44-pin PLCC.

HARDWARE

In-circuit emulator.
Evaluation module.
Software development system.
Many third-party support tools. Contact manufacturer for a list of third-party vendors.

SUPPORT

Assembler/linker.
Simulator.
Application library.
Many third-party support tools.

SOFTWARE

WE'VE LOWERED
THE COST
OF HIGH
PERFORMANCE
FOR FRAMEMAKER.

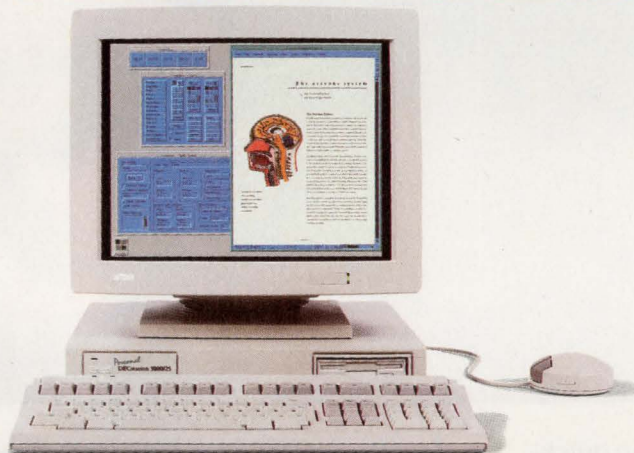

THE PERSONAL
DECSTATION
STARTS AT \$3995.

Today's applications like FrameMaker® demand the balanced performance of a complete workstation and only the Personal DECstation™ gives it to you at such an affordable price.

Many of the features other low-priced workstations offer, such as an open bus, 8-plane graphics and color, are add-ons. With the Personal DECstation, they're standard. And it's built for the future with new CPU and graphics cards, multimedia

DIGITAL'S SPEED AND FLEXIBILITY ARE PERFECT FOR FRAMEMAKER.

FrameMaker and Digital combine to provide a complete document publishing system for creating business and technical documents. FrameMaker incorporates full-featured WYSIWYG word processing, graphics, page layout, tables, conditional text, equations editing, and structured document tools into a single, easy-to-use application.

FrameMaker supports the Motif® windowing environment and takes advantage of the innovative tools available with Digital, such as Display PostScript®. In addition, FrameMaker supports Digital's multimedia capabilities and allows you to seamlessly incorporate audio and video into your FrameMaker document. FrameMaker on the Digital platform is the complete solution for your document publishing needs.

For a trial version of FrameMaker, please call 1-800-U4-FRAME, EXT. 146.

technology, network interconnects and upgrades.

The Personal DECstation from Digital. The power of a workstation. The productivity of a workstation. The price of a PC.

digital™

© Digital Equipment Corporation 1991. The DIGITAL logo, DECsystem, DECstation, DECwindows and ULTRIX are trademarks of Digital Equipment Corporation. UNIX is a registered trademark of UNIX Systems Laboratories, Inc. in the USA and other countries. FRAME is a trademark and FrameMaker is a registered trademark of Frame Technology Corporation. Motif is a registered trademark of Open Software Foundation, Inc. PostScript is a registered trademark of Adobe Systems, Inc.

DIGITAL. THE OPEN ADVANTAGE.

End the connector compromise...

1. SIMPLE PUSH BUTTON RELEASE

2. OPTIONS FOR 3, 7, 9 AND 12 POSITIONS

3. NO SHOCK PLASTIC HOUSING

...in patient
monitoring
equipment



Only Hypertronics ends the compromise in quick-disconnect plugs and receptacles...by combining patient-proof design, economical plastic housings and the reliability of military approved contacts in a line of electrical connectors.

Our injection-molded polycarbonate and polysulfone housings completely shroud current-carrying elements to avoid both reliability and repair problems, as well as user hazards. Yet a simple push-button release allows quick disconnects by untrained personnel.

The economically priced D Series connectors are available in 3, 7, 9 and 12 position modules. Each incorporates the Hypertac® low insertion force contact for unique operational and cost efficiency.

Now you can have it all...in long-life, user-

friendly circular connectors for medical, personal computer and other equipment. End the connector compromise by calling 1-800-225-9228, toll free.

HYPERTAC®:
Inserting pin into hyperboloid sleeve.

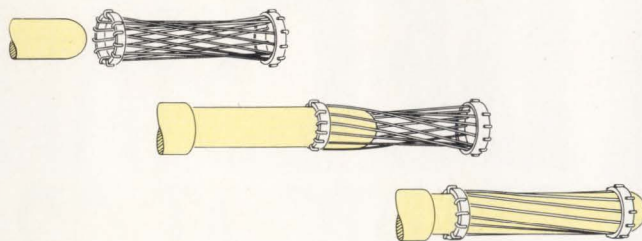

HYPERTRONICS CORPORATION

"New Horizons in Connectors"

16 Brent Drive, Hudson, MA 01749 (508) 568-0451 FAX (508) 568-0680
CIRCLE NO. 69

16-BIT FIXED-POINT CMOS DSP μ P

AVAILABILITY: The C25, C26, E25, C50, and C51 are available now. The C28 is sampling now and will be in production in the first quarter of 1993. The C53 is sampling now and will be in production in the fourth quarter of 1992.

COST: C25 (33 MHz), \$13; C25 (40 MHz), \$13.50; E25, \$67; C26, \$15; C50, \$106; C51, \$33; C53, \$50 (C25 quantity 1, all others, quantity 1000).

SECOND SOURCE: None.

DESCRIPTION: These chips make up the second and third generation of the vendor's fixed-point DSP family. They offer higher performance than the first-generation chips and are easier to use. For many applications, the C25's price has fallen to a point where the chip is replacing the C1X. The C5X parts are enhancements to the C25. They use the same basic core archi-

Texas Instruments Inc
Semiconductor Group
Box 809066
Dallas, TX 75380
(214) 995-6611, ext 3990
Circle No. 679

ecture as the C25 but have double the performance level, additional on-chip peripherals, and expanded memory. New family members include the C28 (which expands memory and adds a power down mode to the C25) and the C53 (which expands memory to the C5X).

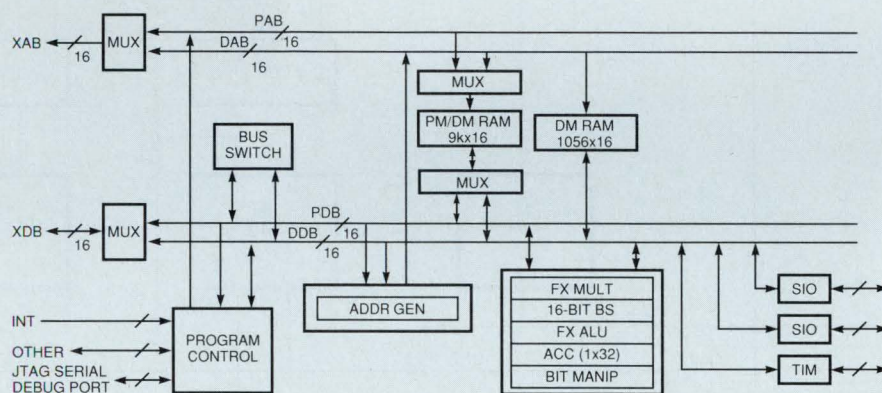

FEATURES: The C2X chips come in 78-, 98-, and 125-nsec cycle-time versions. The C5X chips come in 35- and 50-nsec cycle-time versions.

On-chip memory: The C25 has a 4k x 16-bit program ROM and a 544 x 16-bit data RAM. The C26 has a 1.5k x 16-bit program ROM with boot ROM to load programs from external memory and a 544 x 16-bit data RAM. The C28 has an 8k x 16-bit program ROM and 544 x 16-bit data RAM. The C50 has a 9k x 16-bit program/data RAM and a 1056 x 16-bit dual-access RAM. The C51 has an 8k x 16-bit program ROM, a 1k x 16-bit program/data RAM, and a 1056 x 16-bit dual-access RAM. The C53 has an 16k x 16-bit program ROM, a 3k x 16-bit program/data RAM, and a 1k x 16-bit dual access RAM.

Program and data memory are combined off chip.

The C2X and C5X can address 64k x 16-bit program and 64k x 16-bit data memory.

The C25 and C26 have one serial port each. The C5X has two serial ports.

Multiplier accepts 16-bit fixed-point data and creates 32-bit fixed-point results within a 32-bit accumulator.

32-bit ALU.

The C5X has a separate 16-bit parallel logic unit for manipulating bits without affecting the contents of the accumulator. 16-bit left barrel shifter.

Single 32-bit accumulator.

Next-instruction-repeat looping. Only the C5X has zero-overhead block looping.

Immediate, direct, indirect, and bit-reversal addressing modes. C5X also has circular addressing.

No DMA.

8-level expandable hardware stack.

C5X has a 1-level-deep shadow RAM, which stores some registers.

C2X has three external interrupts; C5X has five.

Hardware wait states. C5X also has software-programmable wait states.

The C5X has an on-chip emulation port.

The C2X is source-code compatible with the C5X.

The C5X has a JTAG interface.

The C25 and C26 have an idle mode. The C28 and the C5X have a power-down mode.

Packaging: C25 and C26, 68-pin PGA or PLCC. C28, 80-pin QFP. C50, C51, and C53, 132-pin QFP.

HARDWARE

Both the C2X and C5X have an in-circuit emulator, a software-development board for the IBM PC, evaluation boards.

Many third-party support tools. Contact manufacturer for a list of third-party vendors.

SUPPORT

C compiler.

Source-level debugger.

Assembler/linker.

Simulator.

Application library.

Many third-party support tools.

SOFTWARE

Z89C00

16-BIT FIXED-POINT CMOS DSP μ P

AVAILABILITY: Now

COST: Z89C00, \$15 (100), \$5 (25,000).

SECOND SOURCE: None.

Zilog Inc
210 E Hacienda Ave
Campbell, CA 95008
(408) 370-8000
FAX (408) 370-8056
Circle No. 680

DESCRIPTION: Zilog created the Z89C00 to let them provide system-level μ Cs with on-chip DSP capability. They consider the Z89C00 to be a competitive DSP chip and are supporting it

as a stand-alone device. In 1993 they will introduce an enhanced version that will be code compatible with the Z89C00. The device is made with a process that can be made to operate at 3V.

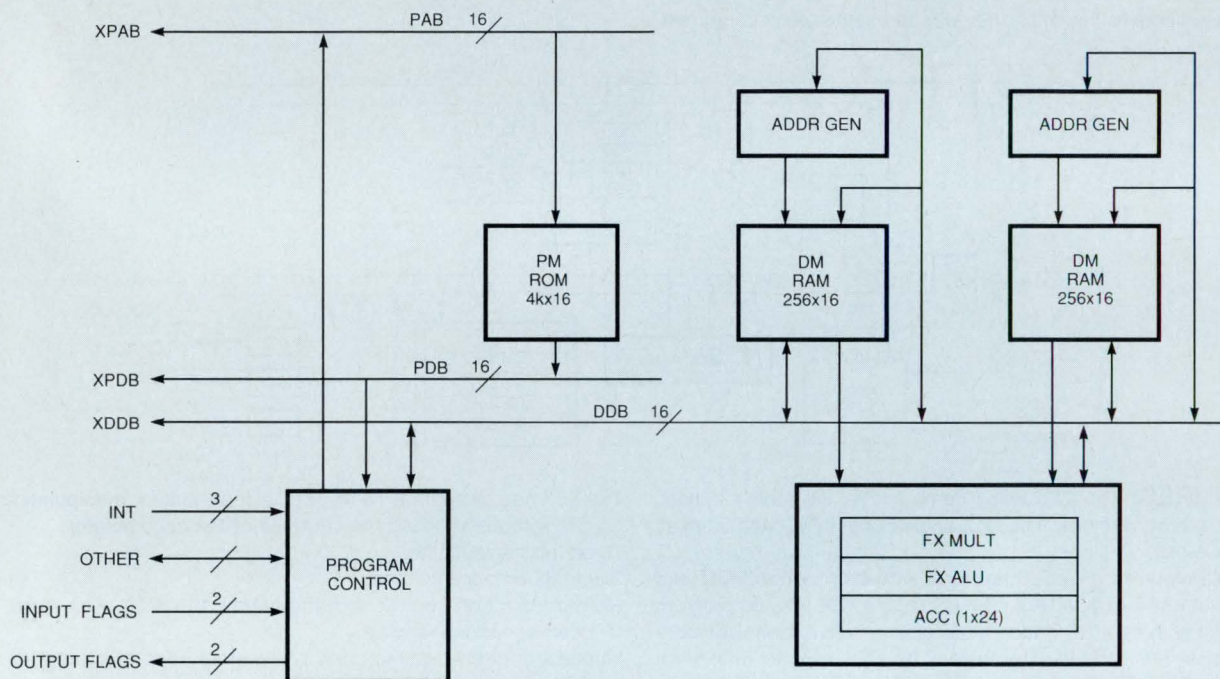

FEATURES: 100-nsec cycle time.

On-chip memory: 4k \times 16-bit program ROM and dual 256 \times 16-bit data RAM.

64k \times 16-bit off-chip program ROM.

Can access external memory via eight 16-bit memory locations.

Intended to interface to FIFO, DMA controller, or μ C.

16-bit parallel I/O, two output flags, and two input flags.

Multiplier accepts 16-bit fixed-point data and creates 32-bit fixed-point result, but only the top 24-bits are usable.

24-bit ALU.

No barrel shifter.

Single 24-bit accumulator.

No zero-overhead looping.

8 address registers. Circular buffering supported.

No on-chip cache.

No DMA.

6-level hardware stack.

3 external interrupts.

Hardware wait states.

Power down via external pin.

No on-chip emulation.

Packaging: 68-pin PLCC.

HARDWARE

In-circuit emulator.
Evaluation board.

SUPPORT

Assembler/linker.
Simulator.
C compiler.
Source-level debugger.
Application library.
TMS320 to Z89C00 assembly code translator.

SOFTWARE

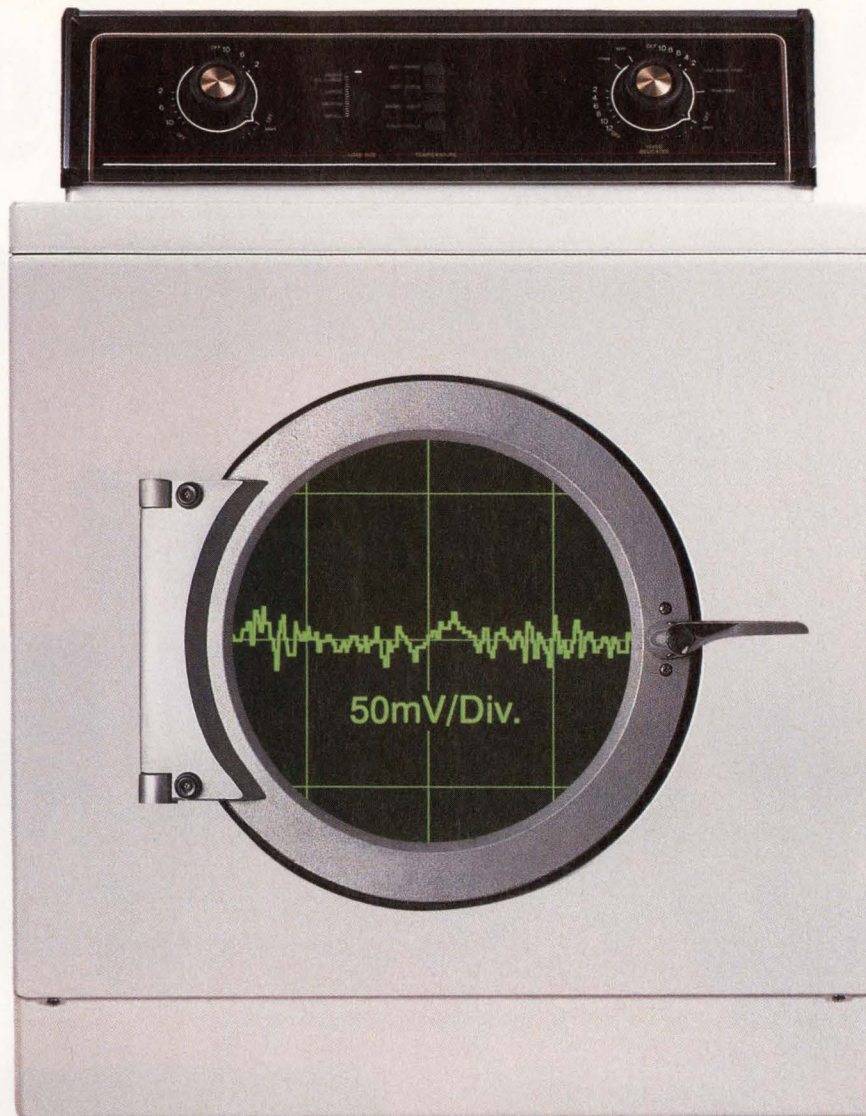

EMS II High Power Switchers. You've never seen power this clean.

The new EMS II Series Switch Mode DC Power Supplies give you clean power, every time...with no glitches, spikes or headaches. In fact, they handle the highest load of power per cubic inch in the industry. Here are some more features to make your decision easier:

- 50mV P-P PARD, 35mV typical
- 0-3 VDC @ 600A to 600 VDC @ 16A

- Models available from 600 Watts to 15,000 Watts, 1Ø and 3Ø



- No derating required
- Overload and short circuit protection
- IEEE-488 programmability and RS-232.

The EMS II DC Switchers. They can wash away your high power problems... once and for all. For more information or literature, contact:



ELECTRONIC MEASUREMENTS, INC.

405 Essex Road, Neptune, NJ 07753 • Telephone: 908-922-9300 • FAX: 908-922-9334

CIRCLE NO. 70

EDN September 17, 1992 • 119

POWER To Configure

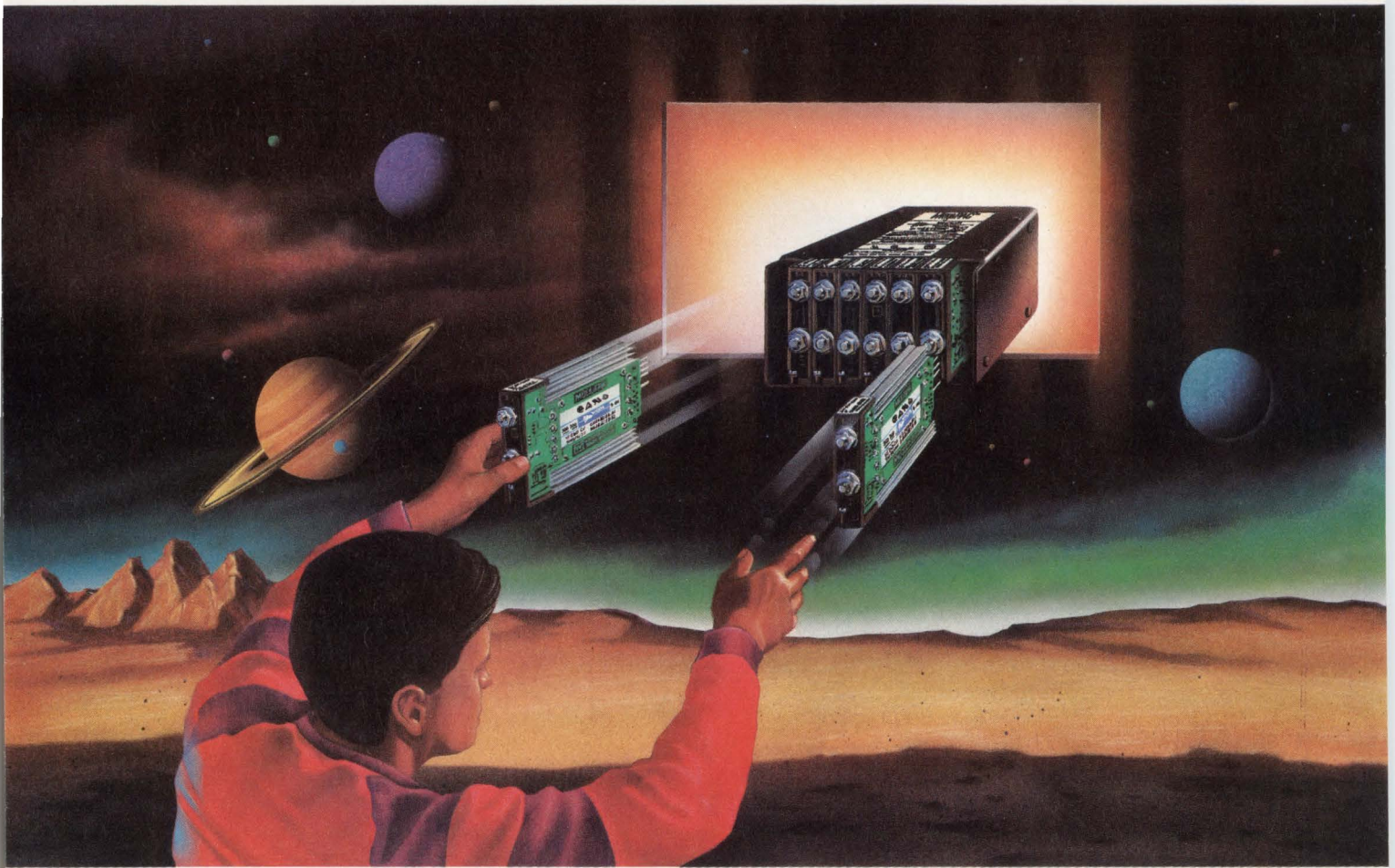

MegaPAC™

Power: Up to 1200 Watts
Input: 110/220 VAC, strappable; 300 VDC
Outputs: 1 to 8 isolated and fully regulated, 2 to 95 VDC
Size: 11.8"L x 6.0"W x 3.4"H



Plug into instant power supply configurability with the new MegaPAC switcher from our Westcor division. MegaPAC outputs can be configured in virtually an infinite number of voltage and power combinations using up to 8 slide-in

ModuPAC™ assemblies. Want to change a voltage or power level at your factory or at a customer site? No problem. . . shut down input power, slide out the ModuPAC you want to replace and slide in the new one. It's that simple.

MegaPAC's instant configurability takes Westcor's popular StakPAC to the next level of customization and flexibility. And its improved manufacturability means a substantial price reduction too! At the heart of each plug-in ModuPAC is a standard Vicor VI-26X series DC-DC converter module. . . over 1 million are operating reliably in systems world-wide. With potential applications around the globe, MegaPAC is designed to meet stringent UL, CSA, and IEC safety standards (approvals in process).

So take the risk out of specifying your system power supply. Contact us today and request ordering information. . . then sit back and relax. . . your custom-tailored MegaPAC will be delivered within four weeks.

Call VICOR EXPRESS (800) 735-6200 for information and be sure to ask for a MegaPAC data sheet. Or call WESTCOR (division of Vicor) at (408) 395-7050. Fax us at (508) 475-6715 or (408) 395-1518.



VICOR Corporation
23 Frontage Road, Andover, MA 01810

Component Solutions For Your Power System

32/40-BIT FLOATING-POINT CMOS DSP μ P

AVAILABILITY: The ADSP-21020 and ADSP-21010 are now in production.

COST: ADSP-21020, 33-MHz, \$220 (1000); ADSP-21020, 20-MHz, \$176 (1000); ADSP-21010, 12.5-MHz, \$49.90 (100).

SECOND SOURCE: None.

Analog Devices Inc
Box 9106
Norwood, MA 02062
(617) 461-3881
Circle No. 681

DESCRIPTION: This family has an off-chip Harvard architecture and is similar to the fixed-point 2100 family. On-chip emulation is supported via a JTAG port. The device conforms to the IEEE-754 floating-point standard. It has an algebraic-like assem-

bly language along with high-level-language support. The ADSP-21010 is a new lower-cost addition to the family. It lacks only the 40-bit floating-point support.

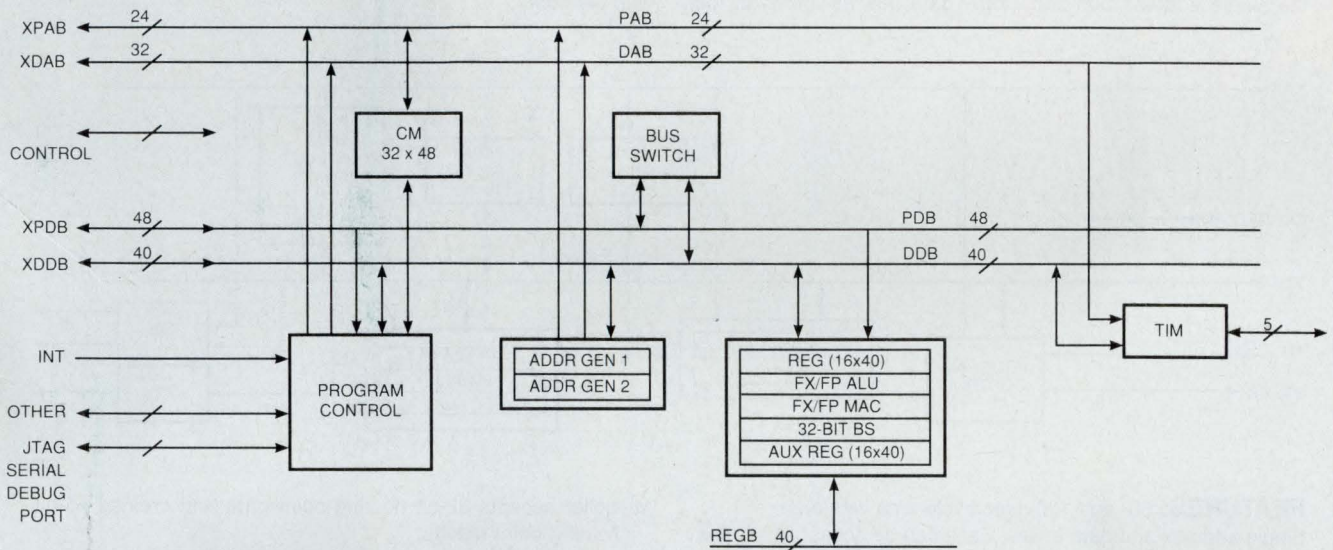

FEATURES: 21020 has 30-, 40-, and 50-nsec cycle-time versions. 21010 has 80-nsec cycle time.

One 32-bit and one 24-bit address bus.

One 40-bit and one 48-bit data bus.

Seven 40-bit additional buses in the CPU.

Separate program, and data buses (off-chip Harvard Architecture).

4G x 40-bit external data memory and 16M x 48-bit external program memory.

One 32-bit timer.

IEEE-754 32-bit and 40-bit floating point format. 21010 supports only 32-bit format.

Multiplier accepts 32 and 40-bit floating-point data and returns 32 or 40-bit results. 32-bit fixed-point operands produce 64-bit fixed-point products. The multiplier also incorporates dual 80-bit fixed-point accumulators.

ALU accepts 32 and 40-bit floating-point data and returns 32 or 40-bit results. 32-bit fixed-point operands produce 32-bit results.

Parallel multiplier and ALU operate in single cycle.

32-bit bidirectional barrel shifter (64-bit result).

32 40-bit register-based accumulators.

Zero overhead looping.

32 x 48-bit instruction cache.

Cache optimizes performance by selecting only 3-bus-operation instructions for storage in cache. Cache can be frozen to keep often-used instructions in cache.

Register, direct, indirect, immediate, relative, circular-buffer, and bit-reversed addressing modes. Two independent address generators.

The hardware stack is 20 deep and can be expanded into main memory.

Four external vectored interrupts.

Four bidirectional I/O flags.

Hardware- and software-programmable wait states.

JTAG support of in-circuit emulation.

IDLE state for low-power mode.

Packaging: 223-pin ceramic PGA and 304-pin PQFP.

HARDWARE

Full-speed in-circuit emulator.

Demo board for IBM PC.

Evaluation package.

Third-party support: Contact Analog Devices for a list of third-party vendors.

SUPPORT

Optimizing ANSI C and Numerical C compilers.

Source-level debugger for ANSI C/Numerical C.

Simulator, Assembler, Linker, PROM Splitter.

Application libraries.

Third-party support includes real-time multitasking operating system (SPOX), filter design packages with code generation, block-level algorithm development package.

SOFTWARE

DSP32C/3210

32-BIT FLOATING-POINT CMOS DSP μ P

AVAILABILITY: The DSP32C and DSP3210 are available now.

COST: DSP32C, \$70 (1000); DSP3210, \$50 (100,000).

SECOND SOURCE: None.

AT&T Microelectronics
Dept 52AL300240
555 Union Blvd
Allentown, PA 18103
(800) 372-2447, ext 796;
in Canada, (800) 553-2448, ext 796
Circle No. 682

DESCRIPTION: The DSP32C has one of the simplest architectures of the 32-bit floating-point DSP chips. It uses a single 4M-word linear memory space instead of the separate program and data memory common in other DSP chips. You can access the single address bus and single data bus as many as four

times per cycle. You can access each internal memory as many as two times per cycle. The DSP3210, along with the VCOS operating system, is intended for use on the mother board of personal computers and workstations where it shares memory with the host.

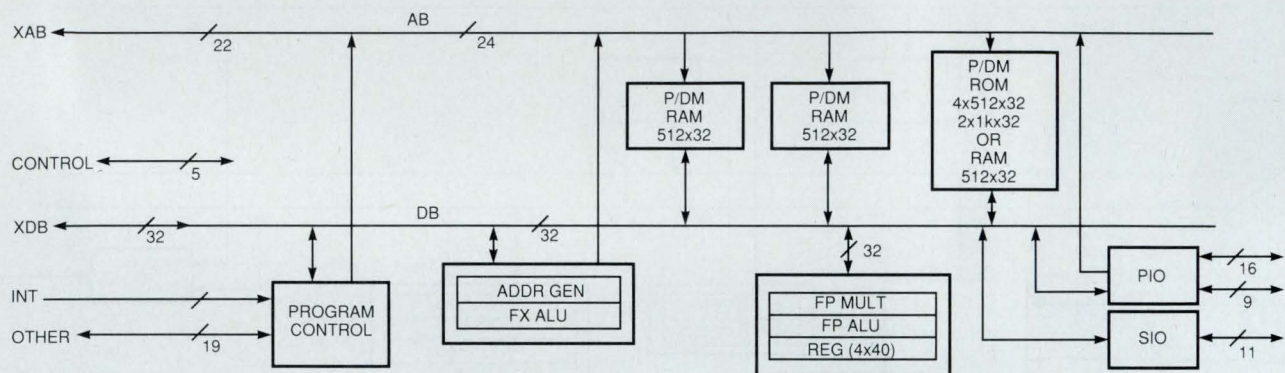

FEATURES: 80- and 100-nsec cycle-time versions.

Single address and data buses. Each can be accessed as many as four times per cycle to imitate separate buses.

DSP32C has three on-chip 512 \times 32-bit RAMs. Optional ROM-based DSP32C replaces one RAM with a 4k \times 32-bit ROM.

DSP3210 has two 1k \times 32-bit RAMs and a 256 \times 32-bit boot ROM.

The DSP32C can address as much as 4M \times 32-bits of external memory. The DSP3210 can address 4G bytes of external memory.

All memory is a general resource; both program and data can exist anywhere.

Data addressable as 8-, 16-, or 32-bit words.

DSP3210 can load program from external EPROM.

The DSP32C has on-chip serial and parallel I/O. The DSP3210 has serial I/O, timer, DMA controller, and a 32-bit bus interface that is compatible with Motorola and Intel μ Ps.

The serial I/O is a double-buffered port that allows concurrent input and output of 8-, 16-, 24-, or 32-bit data widths.

The DSP32C has an 8- or 16-bit parallel I/O port that an external μ P can control.

Proprietary 32-bit floating-point format.

Single-cycle conversion to/from nonstandard DSP32 floating-point format from/to IEEE-754 floating-point format.

Multiplier accepts 32-bit floating-point data and creates 45-bit floating-point results.

Separate floating-point adder accepts 40-bit floating-point data and creates 40-bit floating-point results.

Fixed-point ALU accepts 16- or 24-bit data.

Does not have a barrel shifter.

Four 40-bit accumulators.

Zero-overhead looping. As many as 2048 repeats of a block with a maximum size of 32 words.

Immediate, memory-direct, register-direct, register-indirect, and bit-reversal addressing modes.

You can use the DMA with both the serial I/O and the parallel I/O. No hardware stack.

1-level-deep shadow RAM of some registers.

Two external interrupts.

Hardware wait states. DSP3210 has software-programmable wait states.

No on-chip emulation port.

Only the DSP3210 has a low-power mode.

DSP32C packaged in a 164-pin PQFP, 133-pin PGA, or 68-pin PLCC (μ C version, no external memory).

HARDWARE

In-circuit emulator.

IBM PC-based development board.

VME bus-based development board.

Many third-party support tools, including the HP64773 in-circuit emulator from Hewlett-Packard. Contact AT&T for a list of third-party vendors.

SUPPORT

Optimizing C compiler.

Assembler/linker.

Simulator.

VCOS operating system and multimedia modules.

SOFTWARE

Twice the Logic in Half the Space



DOUBLE-DENSITY™ FROM IDT

46% BOARD SAVINGS

IDT's new 16-, 18-, and 20-bit Double-Density FCT-T Logic family offers the performance of two octal logic devices in one flow-through 48- or 56-pin high-density, JEDEC-standard, shrink small outline package (SSOP) or Cerpack, for twice the functionality in half the board space.

A WIDEBUS™ UPGRADE

IDT's Double-Density logic family is more than twice as fast as ACT, uses 35% less power than ABT, and it's form-, fit-, and function-compatible with both

of TI's Widebus families. The Double-Density family also offers typical pin-to-pin skew of 250ps and quiescent supply current at 0.05mA (typ.).

3 APPLICATION CHOICES

5V High Output Drive

Ideal for low-impedance bus and backplane applications.

5V Balanced Drive (Low Noise)

Contains on-chip, source-terminating resistors to minimize signal noise. These devices are ideal for driving point-to-point transmission lines and highly capacitive loads, such as a bank of DRAMs or SRAMs.

3.3V Low-Power Logic

Designed for regulated or unregulated 3.3V power supplies, these devices use less power than 5V parts, without sacrificing high speed. 5V-to-3.3V unidirectional and bidirectional translators are also available.

FREE SAMPLES

Call today for free samples and a copy of the new **High-Performance Logic Data Book** and start your Double-Density logic design today!



DOUBLE-DENSITY CONFIGURATION*	I _{OH}	I _{OL}	t _{PD} (Max.)	I _{CCQ} (Typ.)	PIN-TO-PIN SKEW (Typ.)	GND BOUNCE (Typ.)
High Drive	-32 mA	+64 mA	4.1 ns	0.05 mA	250 ps	< 1.0 V
Balanced Drive	-24 mA	+24 mA	4.1 ns	0.05 mA	250 ps	< 0.6 V
3.3V	-8 mA	+24 mA	4.8 ns	0.05 mA	250 ps	< 0.3 V

*Specs are for '244 device

Double-Density is a trademark of IDT. All others are trademarks of their respective manufacturer.

(800) 345-7015 • FAX: 408-492-8674
ASK FOR KIT CODE 3071



Integrated
Device Technology, Inc.

What do designers of notebook computers
and other battery-powered systems
get with Siliconix' new power conversion chip set?

MORE BANG FOR YOUR BUCK.

That means higher power conversion efficiency, smaller system size, both 3.3-V and 5-V compatibility and longer battery life. DC/DC conversion at 94% measured efficiency.

This high-efficiency produced by our new power conversion chip set, the Si9150DY Synchronous Buck Converter and the Si9942DY LITTLE FOOT™ MOSFET allows your DC/DC converter to run cooler and adds about 10% to battery life during normal operation. And in sleep mode it only consumes 100 μ A, to extend battery life by 1000%.

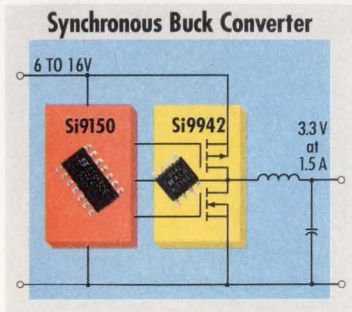

The smallest and simplest high-efficiency solution available.

The controller, in a tiny SO-14 package, is highly integrated and requires few external parts. Team it with our LITTLE

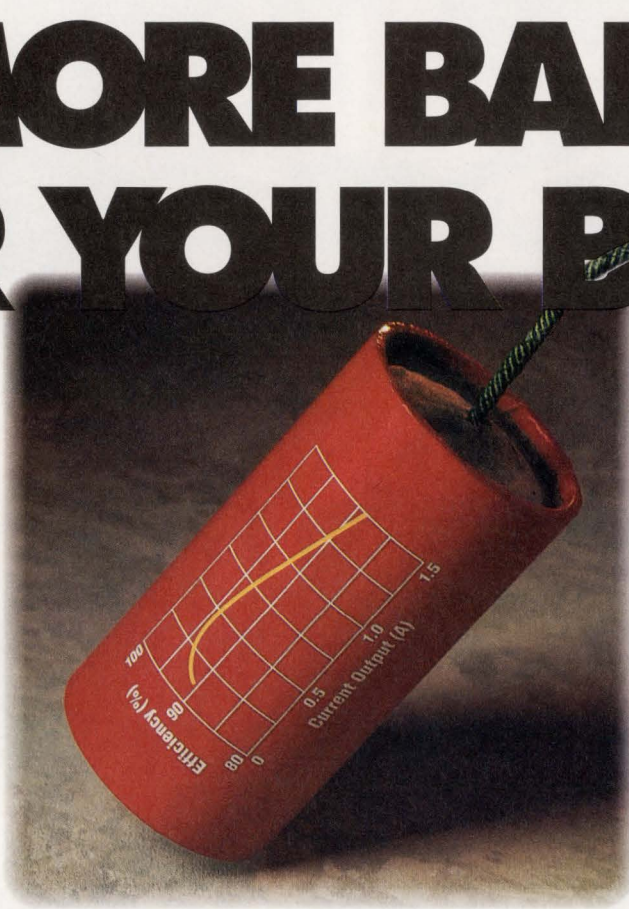

FOOT SO-8 to achieve the most compact converter design possible. Our Si9150 design manual includes complete instructions for building your DC/DC converter. The bottom line result ... your product gets to market faster!

Operating voltage options.

Many "next-generation" designs are employing lower, and sometimes multiple operating voltages. That's why our Si9150DY/Si9942DY buck converter takes unregulated battery voltage and converts it into 5.0 V or 3.3 V.

Get more bang for your buck converter!

For OEM quantities, prices of this 94% efficient power conversion chip set can be yours for less than \$3.00.

More power efficiency, more compact design, and more voltage options are as close as your local Siliconix sales office. Or call toll-free hot line now! (0635) 30905, ext. 970. Ask for the "More Bang for your Buck" Design Manual.

Siliconix

Weir House, Overbridge Square, Hambridge Lane, Newbury, Berks RG14 5UX

32-BIT FLOATING-POINT CMOS DSP μ P

AVAILABILITY: Available now.

COST: 96002 (33 MHz) costs \$368; 96002 (40 MHz) costs \$441.

SECOND SOURCE: None.

Motorola Inc
Microprocessor Products Group
6501 William Cannon Dr
Austin, TX 78735
(512) 891-2030
FAX (512) 891-0400
Circle No. 693

DESCRIPTION: The 96002 is an architectural superset of the fixed-point 56001. The 96002 continues Motorola's emphasis on precision. The 96-bit accumulators will support future double-precision parts. The 32-bit floating-point device con-

forms to the IEEE-754 floating-point standard. The dual 32-bit external buses support glueless multi-96002 systems. The external buses can access external memory and peripherals or communicate with a host μ P.

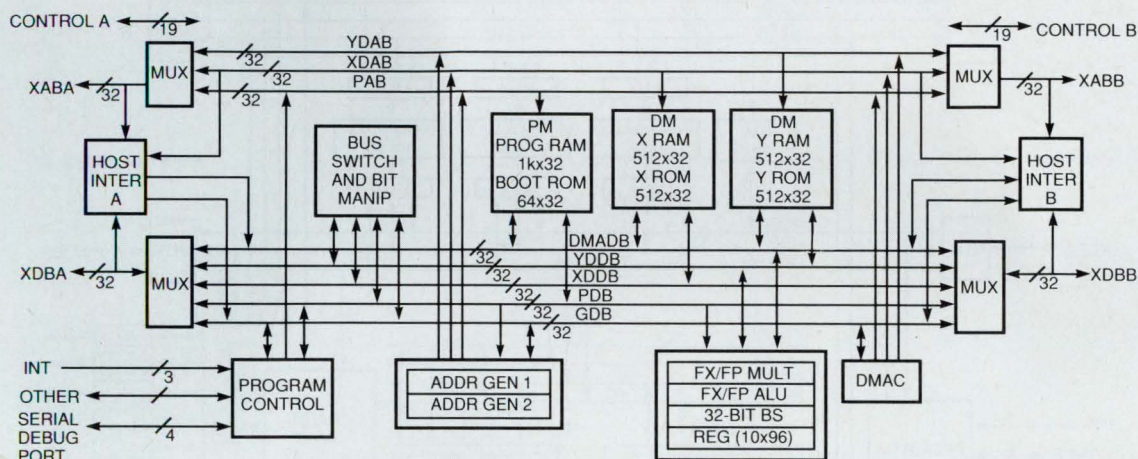

FEATURES: 50-, 60-, and 74-nsec cycle-time versions.

Three 32-bit address buses and five 32-bit data buses on chip. Separate address buses for program and the two on-chip RAMs. Separate data buses for program, the two on-chip RAMs, global data, and DMA.

On-chip memory includes a 1k \times 32-bit program RAM, a 64 \times 32-bit boot ROM, dual 512 \times 32-bit data RAMs, and dual 512 \times 32-bit data ROMs.

On-chip boot ROM loads program from external byte-wide EPROM.

Revised version will let the internal 1k \times 32-bit program RAM function like an instruction cache.

Two complete 32-bit external expansion ports for memory and I/O.

Three separate memory spaces (X, Y, and P). Each can address 4G words.

Each memory space is divided into eight 0.5G-word areas. Each can be programmed to either the A or B expansion ports.

Two host interfaces allow interface to μ P or other 96002s. No other on-chip peripherals.

IEEE-754 32-bit floating-point format.

Multiplier accepts 32-bit floating-point data and returns 44-bit results. Multiplier accepts 32-bit integer data and returns 64-bit results.

32-bit bidirectional barrel shifter.

Ten 96-bit or thirty 32-bit register-based accumulators.

Zero-overhead looping.

Immediate, direct, indirect, circular, and bit-reversal addressing modes.

Two address ALUs.

Supports DMA. Uses its own internal bus and doesn't cycle-steal. Can use all of the addressing modes, including bit-reversal, with the DMA controller.

The stack is 15 levels deep, expandable into main memory.

Three external vectored interrupts.

Hardware and software-programmable wait states.

Serial debug port for in-circuit debugging.

Low-power mode.

Packaged in a 223-pin PGA.

HARDWARE

Hardware evaluation system includes in-circuit emulator. Some third-party hardware products are available. Contact Motorola for a list of third-party vendors.

SUPPORT

Optimizing C compiler.
Assembler/linker.
Simulator.
Application library.
GNU C compiler and source-level debugger.
Third-party support includes optimizing C compiler, block-level diagramming language, filter-design software, and real-time operating system (SPOX).

TMS320C40

32-BIT FLOATING-POINT CMOS PARALLEL DSP μ P

AVAILABILITY: Preproduction available now. Production quantities in fourth quarter of 1992.

COST: Pre-production \$390 (100). Production \$250 (5000).

SECOND SOURCE: None.

Texas Instruments Inc
Semiconductor Group, SC-9026
Box 809066
Dallas, TX 75380
(800) 336-5236, ext 700
Circle No. 685

DESCRIPTION: This device was designed for applications that require the performance of parallel processing. It is upward compatible with the C30 but adds six 32-bit FIFO dual-buffered communication ports, two complete 32-bit external buses, an analysis module that supports multiprocessor debugging via a

JTAG interface, and a 4G-word address space. The chip also features single-cycle conversion to/from the IEEE floating-point standard and a cycle time of 40 nsec. Each communication port can transfer data to/from another C40 at 20 Mbytes/sec without any external logic.

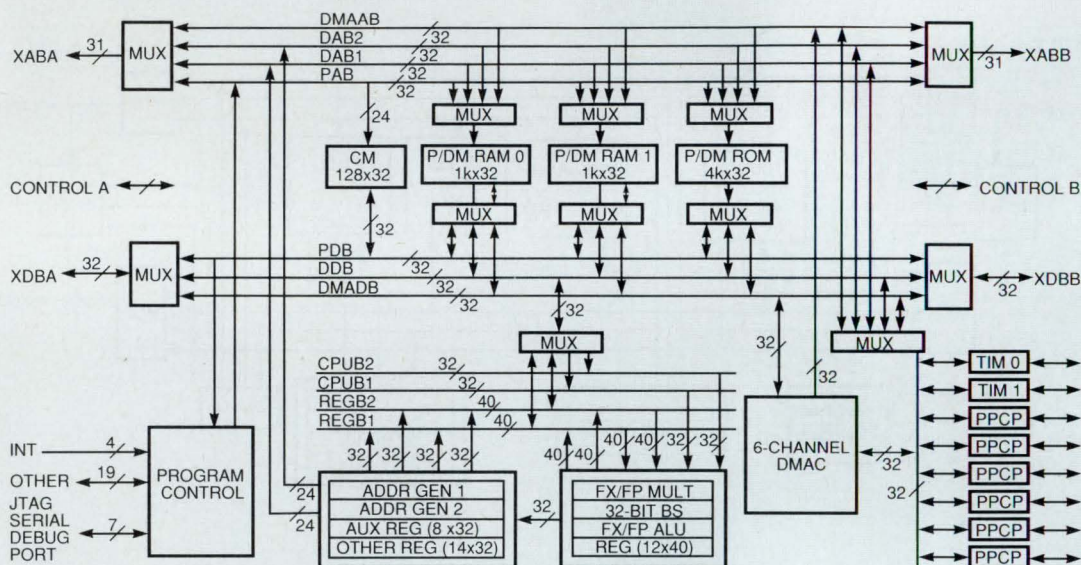

FEATURES: 40- and 50-nsec cycle time.

- Four 32-bit address buses and three 32-bit data buses.
- Two 32-bit and two 40-bit additional buses in the CPU.
- Separate program, data, and DMA buses.
- Each internal RAM and ROM allows two accesses per cycle.
- Any of the separate memories can be used for program or data.
- Two on-chip 1k x 32-bit RAMs and a 4k x 32-bit ROM.
- Dual 32-bit external buses. Each has a 31-bit address, so the 4G-word memory is equally divided between the two buses.
- Six independent 32-bit communication ports for glueless communications between C40s. Separate 8 x 32-bit FIFOs for input and output buffering.
- No on-chip serial ports. Two 32-bit timers.
- Proprietary 2's complement 32-bit floating-point format.
- Single-cycle conversion to/from the IEEE-754 32-bit format.
- Multiplier accepts 32-bit floating-point data and returns 40-bit floating-point data. 24-bit integers result in 32-bit fixed-point results.
- ALU operates on 40-bit floating-point and 32-bit fixed-point data.

- Parallel multiplier and ALU operations in a single cycle.
- 32-bit bidirectional barrel shifter.
- Twelve 40-bit register-based accumulators.
- Single-instruction and zero-overhead block looping.
- 128 x 32-bit instruction cache.
- You can disable cache when it's not needed and freeze it to keep an often-used portion of code available in the cache.
- Register, direct, indirect, immediate, relative, circular, and bit-reversed addressing modes. Two address ALUs.
- 6-channel DMA controller for concurrent I/O and CPU operation. Transmitting DMA can control the operation of the receiving DMA, so setup for DMA transfer will not affect CPU.
- Hardware pointer to software stack.
- Four external vectored interrupts.
- Hardware- and software-programmable wait states.
- JTAG-based debug port controls the analysis module, which functions as an in-circuit emulator. Multiple C40s can be debugged via JTAG interface.
- Packaged in a 325-pin ceramic PGA.

HARDWARE

- Development system includes in-circuit emulation via JTAG interface.
- 4-processor host-independent evaluation board.
- Third-party support. Contact TI for a list of vendors.

SUPPORT

- Optimizing ANSI C compiler with parallel-processing runtime support.
- Source-level debugger. Assembler/linker. Simulator.
- Application library.
- Third-party support includes SPOX, Helios, 3L, parallel C and Ada operating systems and languages.

SOFTWARE



SONY

SONY MAKES THE CHIP. SUN MAKES THE HISTORY.

Sun Microsystems' new SPARCstation™ 10 is fast making history running at speeds to 400 MIPS and beyond. Inside is SuperCache™, a Sony-designed, 20 ns, one-meg, self-timed static RAM that's optimized for SPARC³ processors. The CXK77910J-20.

This synchronous "STRAM" gives Sun's power users three times more fast cache than any other workstation. You, too, can make history with Sony SRAMs and other breakthrough ICs. Call 800-288-SONY. Or FAX your current requirements

to 714-229-4333 in U.S.A., 416-499-8290 in Canada.

Sony is a trademark of Sony. Sun, Sun Microsystems, and SuperCache are trademarks or registered trademarks of Sun Microsystems, Inc. All SPARC trademarks are trademarks or registered trademarks of SPARC International, Inc. SPARCstation is licensed exclusively to Sun Microsystems, Inc.

CIRCLE NO. 73

Custom shielding in record time.



For custom shielding, nobody helps you beat the clock—and the costs—like Instrument Specialties.

Using the most modern CAD capabilities plus a half-century of EMC experience, our experts can quickly determine the best shielding for your design... often before you've built it.

With maximum flexibility and minimum tooling, our prototyping capabilities are both fast and economical. We've even dedicated an entire fabricating operation just for short runs. Our in-house design, plating, photoetching and heat treating also keep your costs down. Or we could modify our standard

shielding products to fit your application... helping you save even more time and money.

When you do decide to start full production, you'll have the complete in-house capabilities of a leading worldwide shielding supplier behind you... including wire EDM toolmaking, sophisticated fabrication techniques,

and comprehensive EMC testing—all assuring just-in-time deliveries.

So call Instrument Specialties for your next custom shielding project. Because whether you need 5 parts or 5 million, we'll be on time... and on budget.



Instrument Specialties

Headquarters: Delaware Water Gap, PA 18327-0136
TEL: 717-424-8510 FAX: 717-424-6213

Western Division: 505 Porter Way, Placentia, CA 92670
TEL: 714-579-7100 FAX: 714-579-7105

European Division: 3 Avenue du Progres, B4432 Alleur, Belgium
TEL: +32-41-63-3021 FAX: +32-41-46-4862

32-BIT FLOATING-POINT CMOS DSP μ P

AVAILABILITY: Now.

COST: The 34325 (25 MHz) costs \$137; the 34325 (20 MHz) costs \$124 (10,000).

SECOND SOURCE: None.

Zoran Corp
1705 Wyatt Dr
Santa Clara, CA 95054
(408) 986-1314
FAX (408) 986-1240
Circle No. 688

DESCRIPTION: The ZR34325 is a vector-signal processor, which is a DSP chip that operates on complex data and large blocks of data with single high-level instructions. The instruction set includes a single instruction to calculate an FFT, FIR filter, IIR filter, and other complex functions. The highly specialized

architecture is optimized to perform these functions quickly. The architecture also eases programming because the programmer doesn't have to write code for complex DSP functions. The 32-bit floating-point data conforms to the IEEE-754 standard.

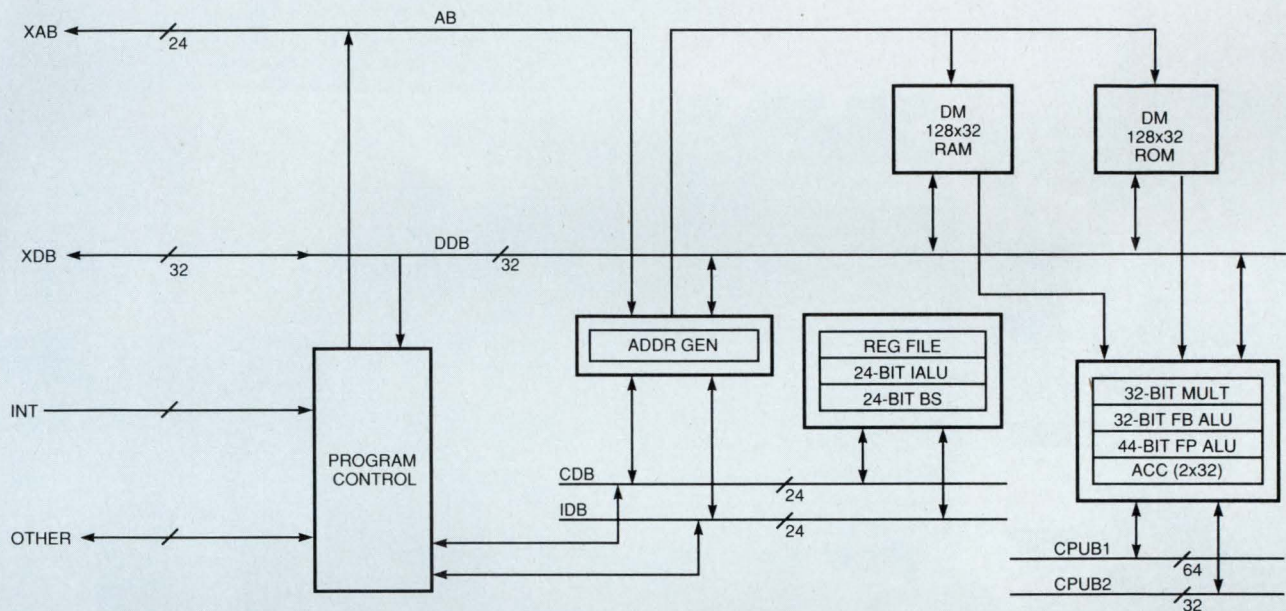

FEATURES: 80- and 100-nsec cycle-time versions.

Single address and data bus.

Vector instructions generally take longer to execute than to fetch, so little speed penalty is incurred with this simple bus architecture.

High-level instructions, such as those to calculate FFTs and FIR and IIR filters, simplify programming.

256 \times 32-bit coefficient dual-port ROM and 128 \times 32-bit dual-port RAM on chip.

No on-chip program memory.

Internal memory can be directly accessed by external device.

16M \times 32-bit memory space.

No on-chip peripherals.

IEEE-754 32-bit floating-point format.

Multiplier accepts 32-bit floating-point data and creates 44-bit results.

Three ALUs: two floating point and one integer. 32-bit floating-point data can be added to 32 bits with one ALU and to 44 bits with the other.

24-bit bidirectional barrel shifter.

Two 32-bit accumulators.

No zero-overhead looping.

Direct, indirect, register, immediate, circular, and bit-reversed addressing modes.

Address generators for internal RAM and ROM.

On-chip DMA.

Slave mode opens chip to external access.

Hardware stack maintained in main memory.

Single external interrupt.

Hardware wait states.

No on-chip emulation port.

No low-power mode.

Packaged in an 84-pin PGA or 84-pin MQFP.

HARDWARE

Hardware-development-system board.
VME bus-based product for development.
Third-party hardware available.

SUPPORT

Assembler/linker/simulator (MS-DOS and VAX/VMS).
Application library (MS-DOS and VAX/VMS).
PSS ADA Compiler for VAX/VMS.

SOFTWARE

When systems demand extra
can shape a TMS320 to your

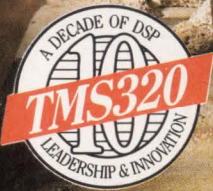

special DSPs, we needs.

Choosing the right DSP for your application is vital to your marketplace success. Only TI has the customizable capability and broad TMS320 family to help you get what you need.

What you want is what you get

With our unique customizable digital signal processing (cDSP) capability, you can achieve the integration and product



differentiation you want. You can choose system peripheral functions (A/D, D/A, serial ports, timers, phase comparators and oscillators),

add interface logic and then integrate them all directly on proven TMS320 DSP chips. You can even change the mix of on-chip memory and peripherals. Yet device development cycles are shorter and costs are lower than with full-custom gate-level approaches.

Over the past five years, this innovative TI technology has created winning solutions for hundreds of high-volume market leaders.

Broad TMS320 family

Our more than 30 standard DSP solutions can meet the majority of your price/performance needs.

You can choose from our 16-bit fixed-point DSPs that start at \$3 or from our 32-bit floating-point devices beginning

at \$25.

There are family members delivering 50-MFLOPS performance, EPROM and OTP DSPs and those optimized for specific applications, plus military versions.

When you want super-processing power, our parallel-processing TMS320C40 DSP allows direct processor-to-processor communications to achieve the MOPS, MBPS, MIPS and MFLOPS your design requires.

World-class support

To speed you to market faster, you can talk with TMS320 specialists, attend hands-on workshops, read over 2,000 pages of applications notes and contact more than 100 third parties and consultants.

The development environment you will use is the same as that for general-purpose microprocessors whether you are working with a standard TMS320 or a cDSP. It includes high-level-language optimizing compilers, multi-tasking operating systems and realtime emulation.

To make your DSP match, call 1-800-336-5236, ext. 3538

You will receive information on our cDSP capability, the complete TMS320 family of devices and our world-class support.

What's more, we'll send you "Designing with DSPs is Easy" – an interactive disk that gives you a personal look at TMS320 support and the TMS320 Programmer's Interface.



 **TEXAS
INSTRUMENTS**

EDN September 17, 1992 • 131

μPD77240

32-BIT FLOATING-POINT CMOS DSP μP

AVAILABILITY: The 132-pin PGA is available now. The PQFP will be available in 1992.

COST: \$75 (1000).

SECOND SOURCE: None.

NEC Electronics

401 Ellis St

Mountain View, CA 94039

(800) 632-3531; (415) 965-6158

(800) 729-9288; (415) 965-6130

Circle No. 683

DESCRIPTION: The 77240 is a 32-bit CMOS floating-point DSP chip. The internal instruction and data ROM are preprogrammed with math matrix routines. It has two external buses:

one for data addressing up to $16M \times 32$ bits, and the other for instruction addressing up to $64k \times 32$ bits. The vendor says the architecture suits adaptive filter applications.

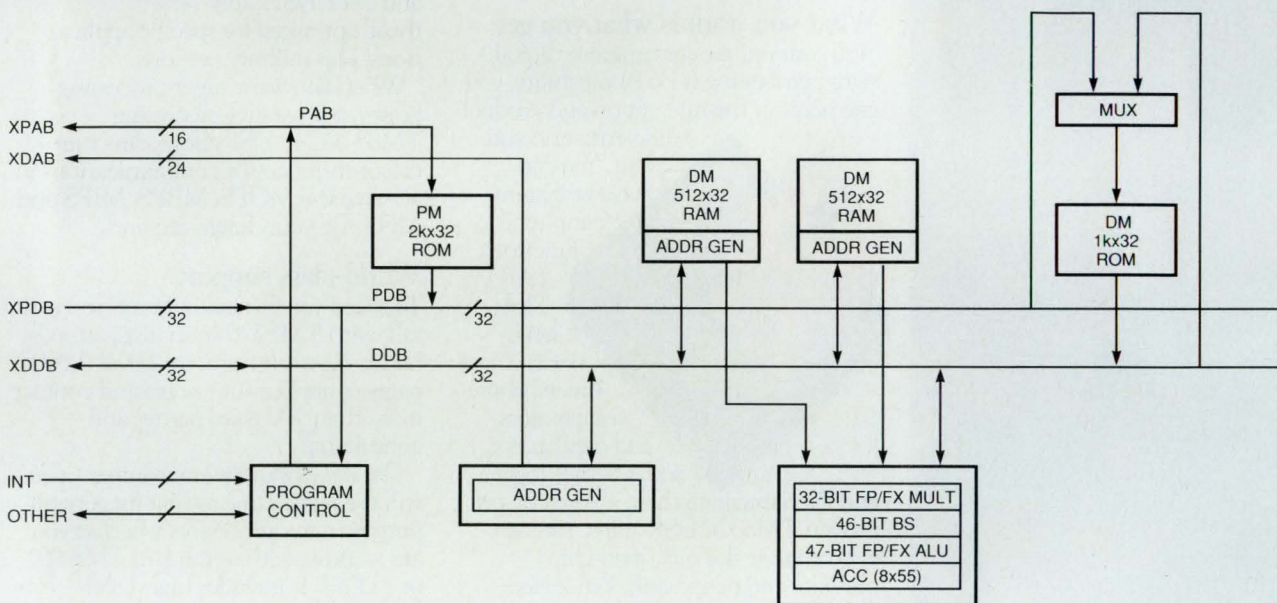

FEATURES: 90-nsec cycle time.

Separate on-chip program and data buses.

On-chip memory: $2k \times 32$ -bit program ROM (preprogrammed), dual 512×32 -bit data RAMs, and a $1k \times 32$ -bit data ROM (preprogrammed).

External memory expansion: $64k \times 32$ -bit program memory and $16M \times 32$ -bit data memory.

Separate external program and data buses.

The 77240 has no on-chip peripherals.

Proprietary 32-bit floating-point format.

Multiplier accepts 32-bit floating-point data and creates 55-bit floating-point results.

Multiplier accepts 24-bit fixed-point data and creates 47-bit fixed-point results.

47-bit ALU.

47-bit bidirectional barrel shifter.

Eight 55-bit register-based accumulators.

Direct, indirect, immediate, circular, and bit-reversal addressing modes.

Three address ALUs.

No on-chip DMA.

The stack is eight levels deep and is not expandable.

Two external interrupts.

No wait states.

No on-chip emulation port.

No low-power mode.

Packaging: 132-pin PGA.

HARDWARE

Evaluation kit, which includes an in-circuit emulator.

SUPPORT

Assembler/linker and simulator.

C compiler.

SOFTWARE



Targets Your Costs Without Compromising Your Standards.

Defense dollars have been significantly reduced but the performance demands of your system have not. IEE has **NDI** (non-development-item), **MODIFIED NDI** and **OFF-THE-SHELF** keyboard and display solutions to your man-machine interface requirements.

Flat Panel Displays

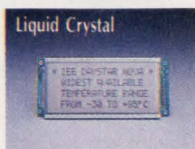
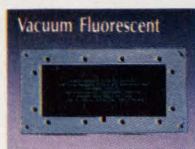

IEE designs and manufactures ruggedized and full-military VF, LCD and ACTFEL displays. VF displays are available with hermetically sealed and/or QPL components as well as shock mounting. Our standard LCD displays operate over a wide temperature range and can be illuminated. Our standard 3x5 and 4x8 ACTFEL displays are available in rugged and full-military configurations which can be EMI/RFI shielded.

IEE interactive displays combine VF, DC plasma, and ACTFEL displays with optical and mechanical touch switches to provide an integrated man/machine interface device. Information from a host system can be readily displayed, understood and controlled from a single assembly. Our V.I.P.[™], PEP[™] and EL interactive displays provide very sophisticated operator interface in a minimum amount of space.

Interactive Displays



Keypads and Keyboards



IEE Thinswitch, Panelswitch, Telswitch and Sealedswitch keypads are available in various standard configurations. These keypads incorporate such features as proprietary gold-plated switch domes, environmental sealing, integral illumination and EMI/RFI shielding.

Our FTMK (Full-Travel Modular Keyboard) is available with "full-travel data entry" or "snap-function" modular key-switches. The FTMK has proven itself in the most demanding operational environments and has unequalled survivability.

Our Standard Full-Military Handheld and Portable CDUs function as complete stand-alone man/machine interface devices. The Handheld CDU incorporates a dot matrix LCD with NVIS illumination, the Portable CDU an ACTFEL display. Both CDUs have sealed, backlit keypads. These environmentally rugged assemblies have been fully qualified and field proven.

Control Display Units



Industrial Electronic Engineers, Inc.
7740 Lemona Avenue Van Nuys California 91409 Tel 818-787-0311 Fax 818-781-9795
Circle No. 76 Immediate Circle No. 77 Reference

IEE is a sustaining member of **SOD**

More Choices. On Target.

ZILOG'S MICROCONTROLLER FAMILY BY APPLICATION/MARKET

APPLICATION	NO. DEVICES CMOS	I/O	ROM (KBYTE)	RAM (KBYTE)	LOW ENH (NUMBER)	OTP/EPROM (NUMBER)	FEATURES
CONSUMER	8	5	14-52	0-16	128, 256	5	LIGHT COUNTERTIMERS, INT. SP. COMPARATORS, LOW VOLTAGE
TELEVISION	3		14-32	0-8	256	2	CLASSIFIED BY PIN CLASSIFICATION, 5V VOLTAGE
AUTOMOTIVE	5		14-32	0-8	128, 256	3	SP. INT. LOW VOLTAGE FOR CLASSIFIED AUTOMOTIVE TEST
MASS STORAGE	6	3	14-32	24	0-16	256, 512	NO. I/O. PIN. LOW SP. ZONE. LOW POWER SW. LEVEL
COMPUTER PERIPHERAL	3	2	14-32	24	128, 256	4	MOUSE. 1.65V. SW. LEVEL. OPEN DRAIN PARTS, INT.

Zilog's Z8® family offers an impressive range of microcontrollers: Every one of them aimed at optimum cost/performance in your system, in your market.

The Z8 family is one of the broadest MCU lines in the industry. Choose from 1K to 16K ROM, and from 18 to 100 pins configured in the latest packages. It's a family of cost-effective, high-performance 8- to 16-bit microcontrollers . . . precisely targeted for particular applications in specific markets, such as mass storage, auto, computer peripherals, speech processing, and general purpose embedded control.

Zilog's Superintegration™ technology means more performance with fewer components. The Z8's familiar, elegant architecture guarantees ease of programming and use. Whether you need a highly sophisticated microcontroller, like the Z86C95™ with DSP or something much simpler, you'll find what you're looking for in the Z8 family – on target.

ASSPs are the best choice for a fast growing number of today's designs. At Zilog, we've been producing ASSPs and refining the technology in more innovative ways longer and better than anyone. We offer one of the industry's largest library of familiar cores and cells in the industry and a simple code-compatible migration path. Our own fabrication facilities provide the high standards of quality and reliability for which Zilog has always been known.

To find out more about the Z8 Microcontroller family, or any of Zilog's rapidly growing Superintegration product families, contact your local Zilog sales office or your authorized distributor today. Zilog, Inc., 210 East Hacienda Ave., Campbell, CA 95008-6600, (408) 370-8000.

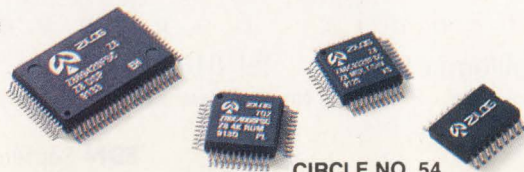

32-BIT FLOATING-POINT CMOS DSP μ P

AVAILABILITY: The C30 (27, 33, and 40 MHz) and the C31 (27, 33, and 40 MHz) are available now.

COST: C30, \$158; C30-27, \$137; C30-40, \$200; C31, \$56; C31-27, \$55; C31-40, \$67 (1000).

SECOND SOURCE: None.

Texas Instruments Inc
Semiconductor Group
Box 809066
Dallas, TX 75380
(214) 995-6611, ext 3990
Circle No. 684

DESCRIPTION: This device was the first floating-point member of the vendor's TMS320 family. It is not code compatible with the fixed-point chips. The C30 is available in a slower, lower-cost version called the C30-27. The C31 is object-code

compatible with the C30 and C30-27 but has only one serial port, one parallel port, and one timer. This feature reduction reduces the chip size and pin count, which lets TI offer a floating-point DSP for \$35 in high volume.

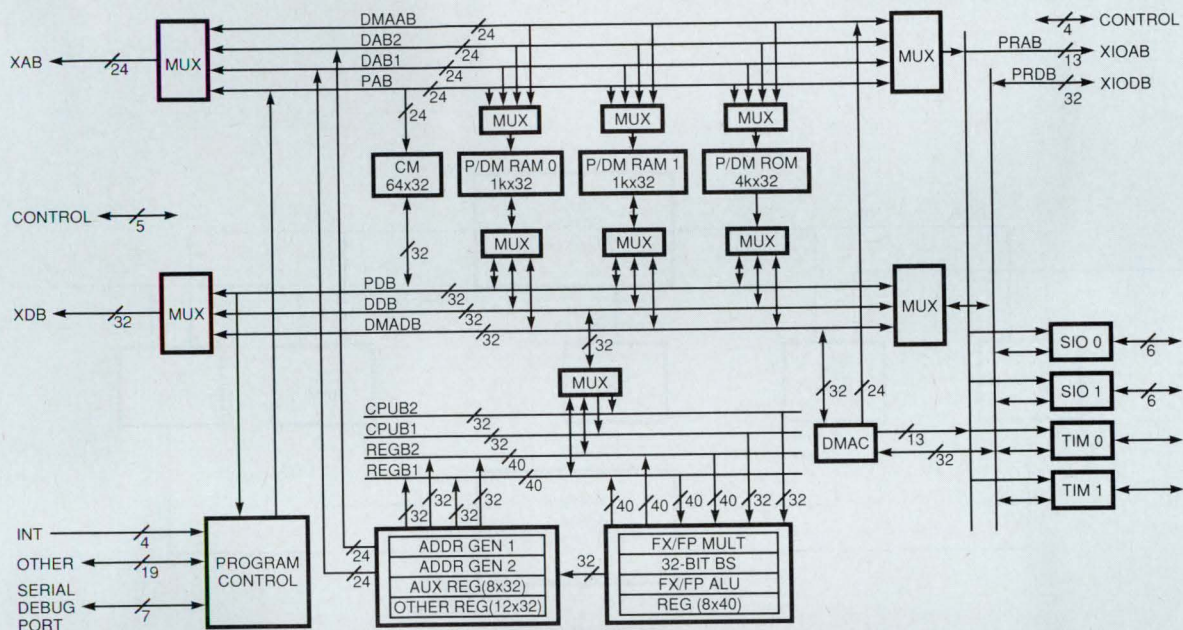

FEATURES: 50-, 60-, and 74-nsec cycle-time versions.
Four 24-bit address buses and three 32-bit data buses.
Two 32-bit and two 40-bit additional buses in the CPU.
Separate program, data, and DMA buses.
Each internal RAM and ROM allows two accesses per cycle.
Any of the separate memories can be used for program or data.
Two on-chip 1k x 32-bit RAMs and an on-chip 4k x 32-bit ROM.
24-bit external memory-address bus provides 16M x 32-bit total address space.
13-bit external-I/O address bus provides 8k x 32-bit I/O ports, which are mapped into the 16-Mbyte address space.
Two 8-, 16-, 24-, and 32-bit serial I/O ports. Two 32-bit timers.
Proprietary 2's complement 32-bit floating-point format.
Multiplier accepts 32-bit floating-point data and returns 40-bit floating-point result. 24-bit integers result in 32-bit fixed-point results.
ALU operates on 40-bit floating-point and 32-bit fixed-point data.

Parallel multiplier and ALU operations in a single cycle.
32-bit bidirectional barrel shifter.
Eight 40-bit register-based accumulators.
Single-instruction and zero-overhead block looping.
64 x 32-bit instruction cache.
Cache can be disabled when not needed and frozen to keep an often used portion of code available in the cache.
Register, direct, indirect, immediate, relative, circular, and bit-reversed addressing modes. Two address ALUs.
DMA controller allows concurrent I/O and CPU operation.
Hardware pointer to software stack.
Four external vectored interrupts.
Hardware- and software-programmable wait states.
Serial debug port can provide in-circuit emulation.
Packaging: C30, 180-pin PGA. C30-27, 180-pin PGA. C31, 132-pin QFP.

HARDWARE

Full-speed in-circuit emulator for IBM PC and Sun workstations. Evaluation module plugs into an IBM PC.
Significant third-party support. Contact manufacturer for a list of third-party vendors. Hewlett-Packard has a version of the HP64700 in-circuit emulator for the C30.

SUPPORT

Optimizing ANSI C compiler. Source-level debugger and code profiler. (PC or Sun).
Assembler/linker. Simulator. (PC or Sun).
Application library.
Third-party support includes real-time multitasking operating system (SPOX), Ada compiler, filter-design packages, and block-level diagramming language.

SOFTWARE

a66 FAMILY

16-bit FIXED-POINT DSP CHIP SET

AVAILABILITY: Now.

COST: a66111, 40-MHz, \$700; a66211, 40-MHz, \$680; a66311, 40-MHz, \$520 (1).

SECOND SOURCE: None.

Array Microsystems Inc
1420 Quail Lake Loop
Colorado Springs, CO 80906
(719) 540-7999
FAX (719) 540-7950
Circle No. 686

DESCRIPTION: The a661XX combines arrays of adders, multipliers, and ALUs for high-performance DSP applications. The a662XX provides system control and five address generators for FFT applications. The a663XX is a reconfigurable

memory array that can be used with the family to reduce chip count. A 1024-point complex FFT can be calculated in 131 μ sec. DSP operations are controlled by high-level DSP instructions.

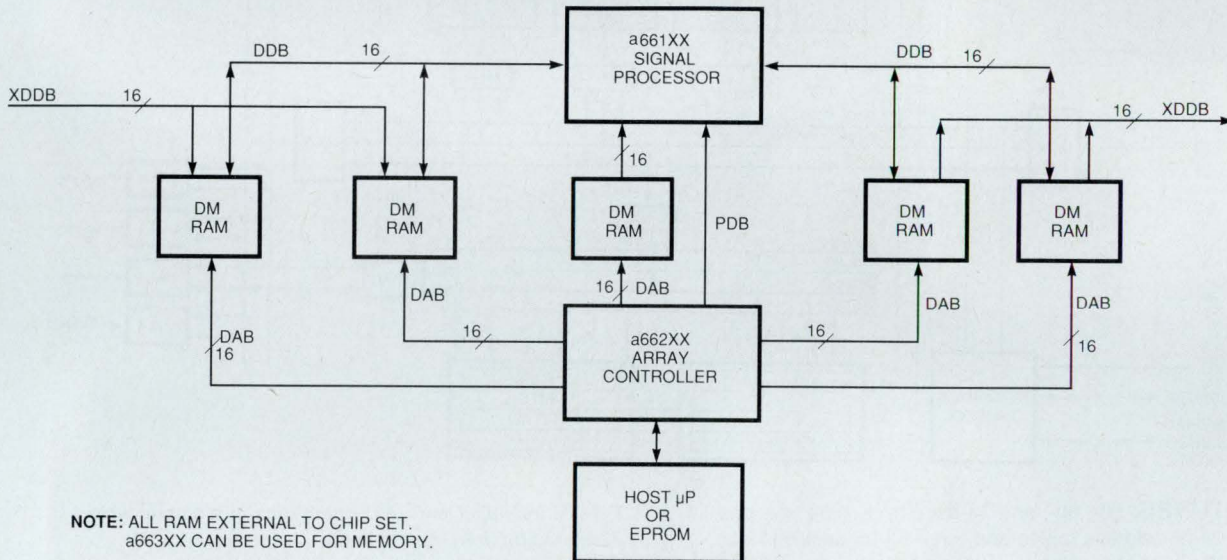

NOTE: ALL RAM EXTERNAL TO CHIP SET.
a663XX CAN BE USED FOR MEMORY.

FEATURES: 30- and 40-MHz versions.

Internal block floating-point maintained by a661XX.

16 high-level instructions execute FFT and general-purpose operations.

a662XX has 32-word instruction store for DSP programs.

Unlimited program size via external memory.

Directly supports up to 64k-point complex or 128k-point real data frames.

Simultaneously generates up to five 16-bit addresses to control memory array.

Program can be initialized by host μ P or automatically booted from ROM.

a663XX contains 64k-bit of configurable static RAM.

One a66111, one a66211, and three a66311 chips create a complete 1024-point double-buffered FFT engine.

Multichip-module version being developed.

MIL-883 versions available.

Packaging: 144-pin PGA.

HARDWARE

VME and pc boards available.

SUPPORT

Software development environment includes code generator, assembler, and graphical interface.

SOFTWARE

Our free information kit will change the way you pinpoint problems in your digital design.



If you only rely on an oscilloscope to locate flaws in your digital design, you're playing a game of trial-and-error.

Want some free advice?

Then order HP's information kit on the tool that can increase your test capabilities: the logic analyzer. You'll learn how a logic analyzer lets you view multiple channels at once, and see them the same way your hardware does — information your scope alone just can't analyze.

Your kit includes the invaluable book *Feeling Comfortable with Logic Analyzers*. Plus handy

information that reveals when to use your scope and when to use a logic analyzer.

Order your free digital debugging info kit today. And see how easy it is to hit the bull's-eye.

Call 1-800-452-4844 and ask for Ext. 3315 to get your free debugging info kit.

In Canada call 1-800-387-3867, Dept. 456.



There is a better way.



© 1992 Hewlett-Packard Co.

The Future in Autorouting... Here Today

Tango

For complete specs
and FREE evaluation
package, call
800 488-0680



New **Tango-Route PRO** is the fastest, high-completion PCB autorouter for PC workstations. Its speed, ease of operation and professional results set Tango-Route PRO apart from all other autorouters. Whether you're a novice or an experienced designer, you'll find Tango-Route PRO packed with features to help you be more productive, design better boards and get your products to market faster.

Unrivalled Performance and Features.

Tango-Route PRO has a unique "reconstruct" algorithm which iterates to 100% completion up to five times faster than comparable PC-based "rip-up and retry" or "push and shove" PC-based autorouters. Its automated options work like an "expert system" selecting the optimum routing configuration right out of the box for best results in the shortest time. Intelligent algorithms produce boards with fewer vias and shorter trace length to ensure high yields, lower fab cost and enhance board aesthetics. Uniform-, non-uniform- and off-grid routing offer performance equal to or better than "gridless routers." The program fully supports the 32-bit power of 386/486 computers, virtual memory and all current PCB technologies including advanced SMD. And you'll drive Tango-Route PRO with the easy-to-use, Windows™-like Tango interface.

Benchmark Tango-Route PRO.

Tango-Route PRO, together with our design editor, Tango-PCB PLUS, can greatly enhance your productivity. But don't take our word for it... call toll-free for complete specs and a free evaluation package to see the future in auto-routing for yourself.



Tango®

Helping good ideas become great products.

ACCEL Technologies, Inc.
6825 Flanders Drive • San Diego, CA 92121 USA
Service & Support 619/554-1000 Fax 619/554-1019

CIRCLE NO. 81

24-bit FIXED-POINT DSP CHIP SET

AVAILABILITY: Now.

COST: LH9124, \$1200; LH9320, \$260 (100).

SECOND SOURCE: None.

Sharp Electronics Corp
 5700 NW Pacific Rim Blvd, Suite 20
 Camas, WA 98607
 (206) 834-2500
 FAX (206) 834-8903
 Circle No. 687

DESCRIPTION: The LH9124 is optimized for block-oriented algorithms and array processing. It is microcoded to perform standard DSP functions in time domain or frequency domain. The LH9320 is an address generator with many patterns

to support DSP algorithms. High-level DSP commands simplify software generation. A 1024-point complex FFT can be performed in 81 μ sec.

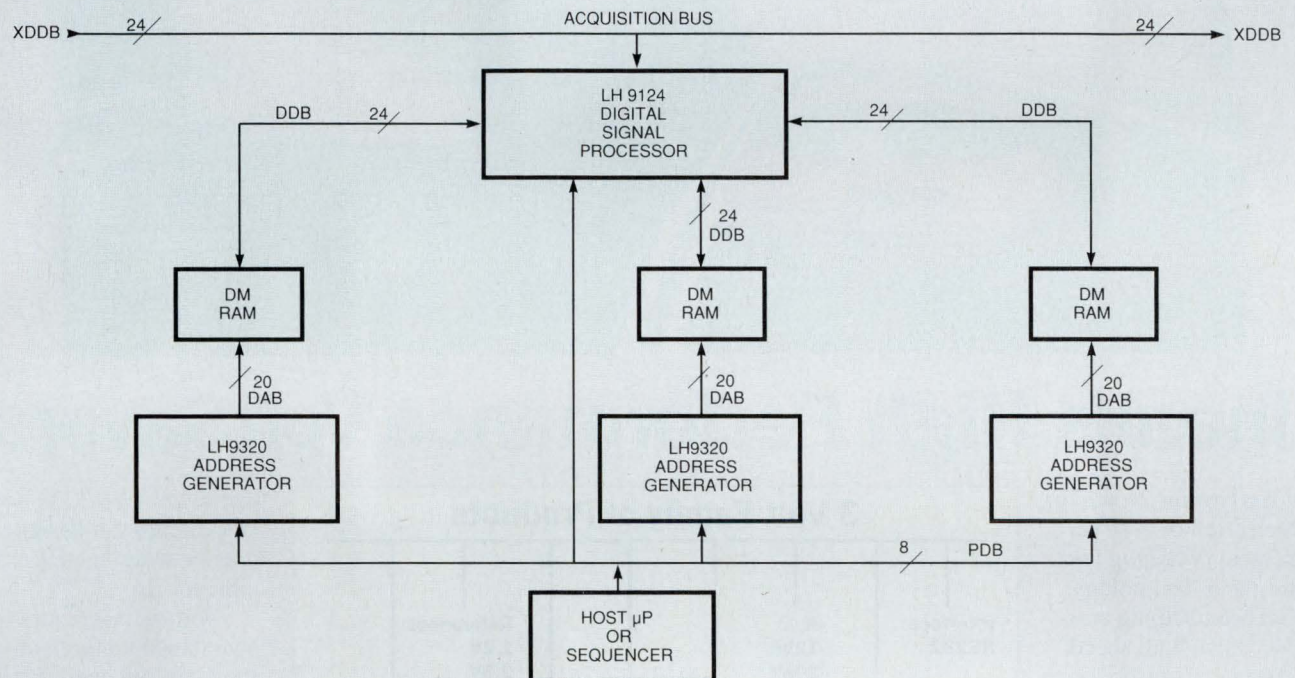

FEATURES: 33- and 40-MHz versions.
 LH9124 maintains internal block floating-point.
 26 high-level instructions execute FFT and general-purpose operations.
 Multiple units can be paralleled or cascaded for higher performance.

Data width can be 8- to 24-bit real or complex.
 No on-chip memory.
 Packaging: LH9124, 262-pin PGA; LH9320, 68-pin PLCC.

HARDWARE

System-validation card for each chip.
 Evaluation module.

SUPPORT

PC-based real-time simulator.
 Object-oriented high-level-language development system.

SOFTWARE

Don't let 3V stop your Design.



Linear's High Performance VoltSavers.™

Nobody offers you a bigger selection of high performance 3V analog parts than Linear Technology. We've been helping customers solve high speed, precision low power design problems with 3V analog solutions for years.

Our family of VoltSaver products covers a wide spectrum of 3V linear functions. Guaranteed performance at 3V levels allows you to work with confidence at this new power supply voltage. Power supply circuits are available to operate down to 2V and below or regulate 5V down to 3V. Micropower low dropout and micropower switching regulators reliably give 3.3V or 5V in portable systems, and 3V high-side switches provide power management. Op amps and instrumentation amplifiers have guaranteed performance at 3V and

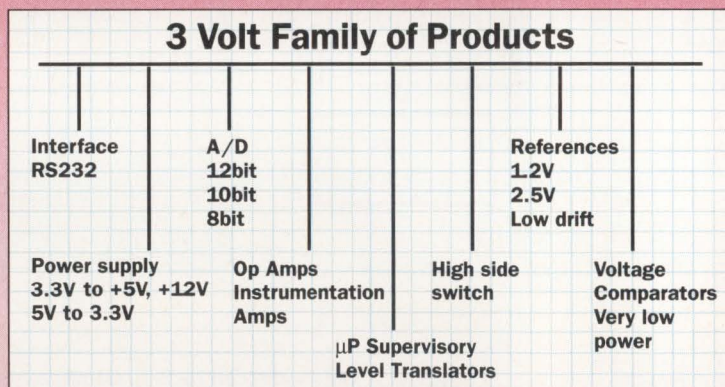

below. Also, RS232 interface circuits are designed to operate with the new 3.3V logic levels.

Voltage references with guaranteed temperature performance are available at 1.2V and 2.5V—ideal for 3V systems. Micropower comparators that operate on 3V, down to as low as 1.1V, can provide system resets as well as battery detection. A full line of 8-bit, 10-bit and

12-bit analog to digital converters are available with guaranteed specifications for 3V operation. Also, microprocessor supervisory circuits for 3.3V applications are available.

Call today for our Design Note 56 "3.3V Operation of Op Amps" and our 3V Selection Guide. For details, contact Linear Technology Corporation, 1630 McCarthy Blvd., Milpitas, CA 95035/408-432-1900. For literature only call 800-637-5545.



TOUGH PRODUCTS
FOR TOUGH APPLICATIONS.

CMOS switches develop negative voltage

Ľubomír Gálffy, Ústav Automatizácie a Komunikácie, Severná, Československo

The simple negative-voltage converter in **Fig 1** works over an input range of 3 to 9V with an internal resistance ranging from 2000 to 400 Ω (depending on input voltage and output loading). The converter's negative output is nearly equal in magnitude to the input voltage.

Resistor R_1 , capacitor C_1 , and switches IC_{1A} and IC_{1B} , functioning as inverters, form an RC oscillator. Switches IC_{1B} and IC_{1C} alternately charge C_2 from V_{IN} and discharge C_2 into C_3 .

If you use a 74HC4053 instead of a CD4053, the circuit will have a lower internal resistance, but function only over a V_{IN} range of 2 to 5V. If the negative output is greater in magnitude than the input, the circuit can feed energy back from output to input.

EDN BBS /DL-SIG #1184

EDN

To Vote For This Design, Circle No. 748

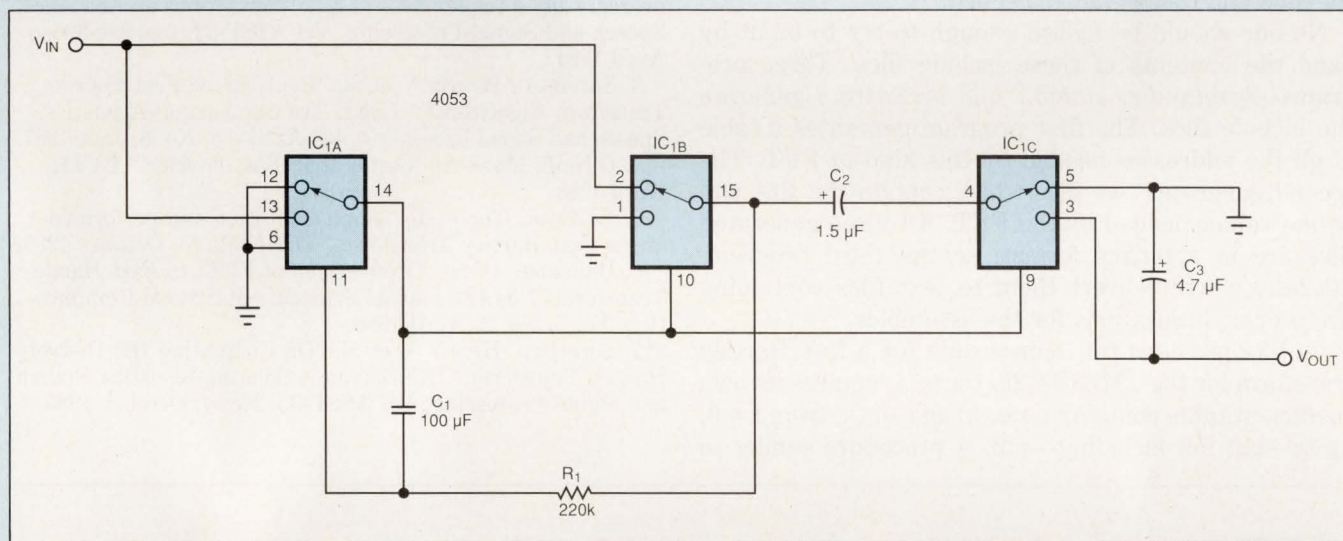

Fig 1—Cleverly using analog switches as inverters in an RC oscillator, this circuit will produce a negative output nearly equal in magnitude to its supply voltage.

Hartley transform beats FFT for DSP μ Ps

Vladimir Bochev, Université De Nancy, Nancy, France



Bergland's well-known algorithm for the FFT (**Ref 1**) has drawbacks in light of modern DSP μ Ps. His algorithm decreases the memory requirements and the number of operations of a bit-reverse FFT by a half. But Bergland's FFT has a much more complicated addressing scheme compared with the simple bit-reverse for the complex FFT.

The Hartley transform is a real transform for a real signal. Furthermore, the inverse-transform algorithm is exactly the same as the forward transform. The

overspeculated fast Hartley transform (**Refs 4 and 5**) better suits DSP μ Ps such as the TMS320C25. The fast Hartley transform is not faster than real valued FFTs and requires the same storage. It requires even a few more operations (**Refs 6 and 7**) to obtain a meaningful frequency spectrum. But the fast Hartley transform *is* faster than complex FFTs and requires less storage.

Its real-valued nature and the low memory requirements along with easy address generation makes the

fast Hartley transform the algorithm of choice for frequency analysis of real-time signals on DSP microprocessors.

The listings are much too long to be printed here. But you can find source code and examples that you can run of both the Bergland FFT and Hartley transforms, along with some handy utilities, posted on the EDN BBS. After obtaining the files, you can call the program *fft_real*, written in 80x86 assembly language, directly from a C program running on your PC. *fft_real* is very easy to understand—especially the section on the butterfly computations. To simplify generating addresses for the data and coefficient array, all addresses are precomputed and stored in an include file, as are the sine and cosine values needed.

No one should be foolish enough to try to input by hand the contents of these include files. Three programs—*bergland.c*, *sintab.c* and *hex2asca.c* generate the include files. The first program generates a table of all the addresses needed by this kind of FFT. The second generates two files which contain the sine and cosine values needed by the FFT. All three generated files are in a binary format, so the third program, *hex2asca.c* will convert them to text files containing the proper declarations for the assembler.

fmt.tms provides the source code for a fast Hartley transform for the TMS320C25. *fmt.tms* requires its own coefficient table containing $\tan(x)$ and $\sin(x)$ from $x=0$, up to—but not including— $\pi/2$. A procedure similar to

sintab for the Bergland FFT will generate the table in for the fast Hartley transform. To make an include file you'll need to slightly modify *hex2asca.c* to emit, for example, DATA statements instead of "dw", and also the proper "hex" header and not suffix "h".

EDN BBS /DL_SIG #1183

EDN

To Vote For This Design, Circle No. 749

References

1. Bergland, Glen D, "A Fast Fourier Transform Algorithm for Real Valued Series," Communications of the ACM, Vol 11, No. 10, Oct 1968.
2. Martens, J B, "Discrete Fourier Transform Algorithms for real valued sequences," IEEE Transactions on Acoustics, Speech and Signal Processing, Vol ASSP-32, pgs 390-396, April 1984.
3. Sorensen, Henrik V et al, "Real-Valued Fast Fourier Transform Algorithms," IEEE Transactions on Acoustics, Speech and Signal Processing, Vol ASSP-35, No. 6, June 1987.
4. O'Neill, Mark A, "Faster than Fast Fourier," BYTE, April 1988.
5. Le Ngoc, Tho et al, "Implementation and performance of the Fast Hartley Transform," IEEE Micro, October 1989.
6. Buneman, Oscar, "Conversion of FFTs to Fast Hartley Transforms," SIAM Journal Scientific Statistical Computation, Vol 7, No. 2, April 1986.
7. Sorensen, Henrik V et al, "On Computing the Discrete Hartley Transform," IEEE Transactions on Acoustics, Speech and Signal Processing, Vol ASSP-33, No. 4, October 1985.

VHDL "wait" statement inserts registers

Steve Carlson, Synopsys Inc, Mountain View, CA

The circuit in Fig 1 illustrates how a logic synthesizer interprets the VHDL (VHSIC hardware-description-language) *wait* statement (Listing 1). In the Listing, the *wait* keyword tells the logic synthesizer to store

certain logic values. The synthesizer then inserts registers where required. EDN BBS /DL_SIG #1181

EDN

To Vote For This Design, Circle No. 750

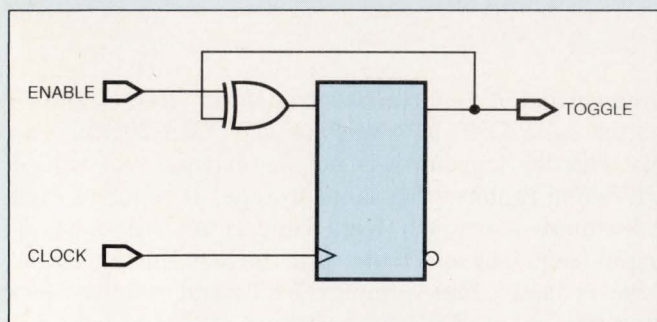

Fig 1—A logic synthesizer will generate a register like this one in response to a VHDL wait statement in the listing.

Listing 1—VHDL wait example

```
entity VHDL is
  port(
    ENABLE : in BIT;
    CLOCK  : in BIT;
    TOGGLE : buffer BIT
  );
end VHDL;

architecture VHDL_1 of VHDL is
begin
  process begin
    wait until not CLOCK'stable and CLOCK = '1';
    if (ENABLE = '1') then
      TOGGLE <= not TOGGLE;
    end if;
  end process;
end VHDL_1;
```

INDUCTORS

Call Nytron
for fast access
to MIL-C-39010.

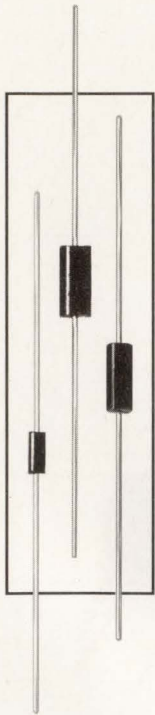

Save time. Call Nytron and get broad, one-stop coverage of MIL and commercial inductors, especially:

- "E-REL" Inductors, MIL-C-39010. Coverage includes M39010/01 through M39010/10 at "R" and "P" levels, plus
- MIL-C-15305 in a wide range of standard sizes, and
- High Current Chokes featuring many special designs.

Call today.

NYTRON INDUCTORS, INC., (VSD, Inc.)
Offered by DALE ELECTRONICS, INC.
East Hwy 50 • P.O. Box 180 • Yankton, SD 57078-0180
Phone (605) 665-9301 • Fax (605) 665-1627



CIRCLE NO. 84

POWER SUPPLY DESIGN TIPS

STRIFE TESTING INCREASES RELIABILITY

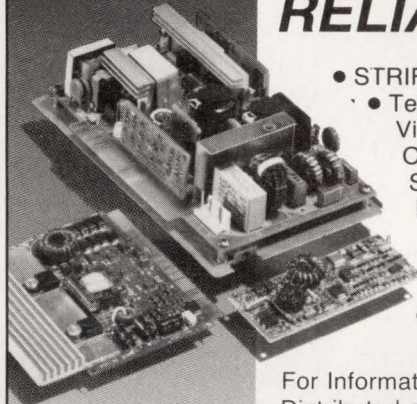

- STRIFE = Stress + Life
- Temperature / Vibration / Electrical Overload Beyond Specification Limits
- Make Your Design More Robust
- Reduce Failure Rate 2 to 3 Times

For Information on Standard Distributed and Custom Switching Power Supplies

CALL

1-407-831-2000



MicroENERGY INC

745 W. State Road 434 • Longwood, FL 32750-4909

PHONE: (407) 831-2000 • FAX (407) 831-1100

CIRCLE NO. 85

PROBE QUAD FLATPACKS

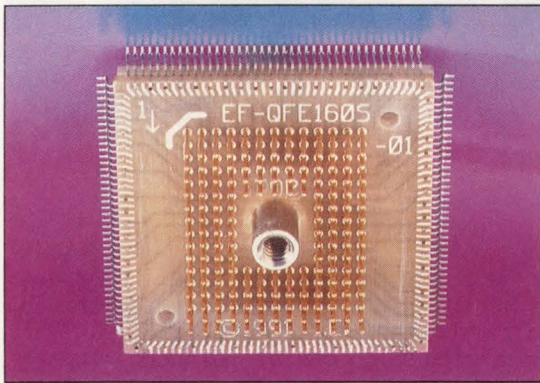

SURFACE MOUNT OR IN SOCKET

With the QFP Emulator Foot

- Solder in place or put into socket.
- Then plug a Socket/Test Probe assembly onto the foot. The Socket/Test probe assembly available in ZIF or production sockets with probing header for each pin with annotated overlay.
- Excellent lead coplanarity for reliable solder connection.
- Custom overlays and configurations available on request.
- Available in many sizes.

IRONWOOD ELECTRONICS
P.O. BOX 21151, ST. PAUL, MN 55121
(612) 431-7025; FAX (612) 432-8616

CIRCLE NO. 86



Starlights: A new fuseholder generation

Yet another innovative result of Wickmann technology. Fuseholders for 5 x 20 mm and 6,3 x 32 mm fuses feature extra solid contact pins, compatibility with existing shock-safe fuseholders, and sealed terminals. Now everyone can afford superior circuit protection.

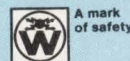

Wickmann-Werke GmbH

Postbox 2520 · D-5810 Witten 6 · Tel. 02302/6620 · Fax 02302/6622 19

CIRCLE NO. 87

When space is at a premium, stacking makes a lot of sense.



Micro/Q[®] 3500SM noise decoupling capacitors save valuable board space by surface mounting below PLCC packages.

In today's high-density designs, you need to maximize every square inch of PC board space. The low profile of the Micro/Q 3500SM makes it easy to mount under the PLCC, saving space and improving noise suppression at the same time.

Surface mounting under the PLCC increases board density by eliminating the need for traditional decoupling

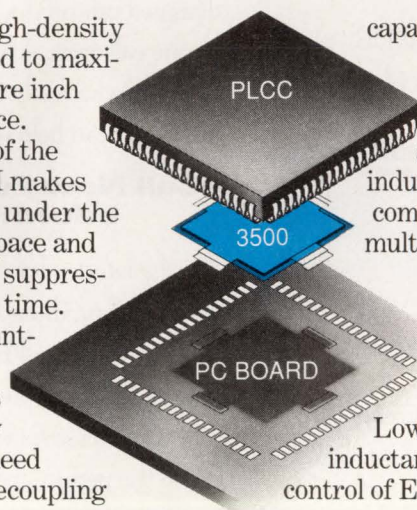

capacitors around the perimeter of the IC package. This "stacking" technique also helps to lower inductance and impedance compared to conventional multi-layer capacitors.

Very thin (0.020" MAX) metallic-parallel plate construction results in less than 1nH of inductance.

Low decoupling loop inductance value improves control of EMI/RFI. Besides

providing superior noise reduction, the Micro/Q 3500SM also absorbs CTE mismatch and prevents electrical failure caused by cracks typical of MLC chips.

The device is ideal for wide frequency bandwidth applications such as 16/32 bit MPUs, DSPs, FPPs, gate arrays, standard cells and custom ASICs. Now available in two sizes: 0.520" to fit below 44 and 52 pin PLCCs, and 0.820" for placement under 68, 84 and higher pin-count PLCCs. Choose either X7R or Z5V dielectric, in tape and reel or bulk formats.



Circuit Components Inc.

Formerly a Division of Rogers Corporation
2400 South Roosevelt Street, Tempe, AZ 85282
602 967-0624, FAX 602 967-9385

To see how all the advantages stack up, call a Circuit Components, Inc. Product Specialist today at (602) 967-0624. Ask for your free Micro/Q 3500SM specifier's kit. Also available through Mektron Europe, Ghent, Belgium, Nagoya, Japan. Micro/Q is a registered trademark of Circuit Components, Inc.

CIRCLE NO. 88

EDN September 17, 1992 • 147

TO MOTOROLA, THIS BOX REPRESENTS A VERY VISIBLE MEANS OF SUPPORT.

The Sensible Choice

When Motorola went looking for a software partner committed to the entire 68000 family, they decided on Intermetrics.

With superior product performance, a full range of software tools, and a reputation for high-quality technical service, Intermetrics was the perfect choice to support Motorola's line of premier embedded processors.

Hot Compilers For Hot Chips

Intermetrics InterTools C Compilers produce highly optimized code for all 68000 family processors, including the new EC series chips. This means that you can evaluate, prototype and build top-performing, Motorola-based systems in record time.

68000	68EC000
68020	68EC020
68030	68EC030
68040	68EC040
68302	68340

68330	68HC11
68331	68HC16
68332	96002

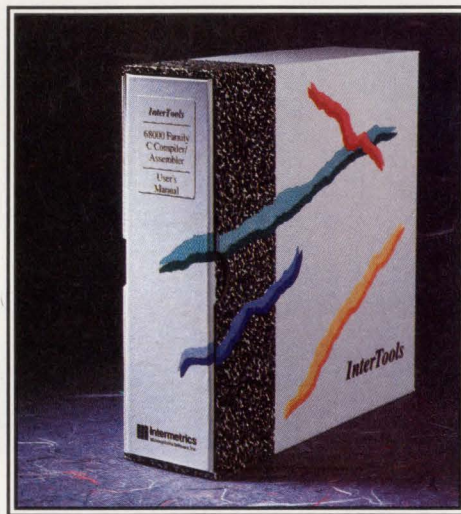

Expert Debuggers For Every Problem

Intermetrics also makes XDB Source Level Debuggers which are available

in many configurations— from low-cost ROM

Monitor-based systems to sophisticated emulator-based environments. XDB can help you debug fully optimized code, and is compatible with



many popular embedded real-time operating systems.

Real Support, Real Time

At Intermetrics, the engineers who designed our products are only a phone call away. After all, they're the ones who really understand your needs and can help you.

Call Now For Product Information

For the latest information on our full line of products that support the 68000 family, call Intermetrics or your Motorola representative today, and you'll discover why Motorola made the perfect choice when they needed a dependable software partner.

Make Every Bit Count

800-356-3594

MA: 617-661-0072
CA: 714-891-4631
FAX: 617-868-2843

 **Intermetrics**
Microsystems Software, Inc.

733 Concord Ave., Cambridge, MA 02138

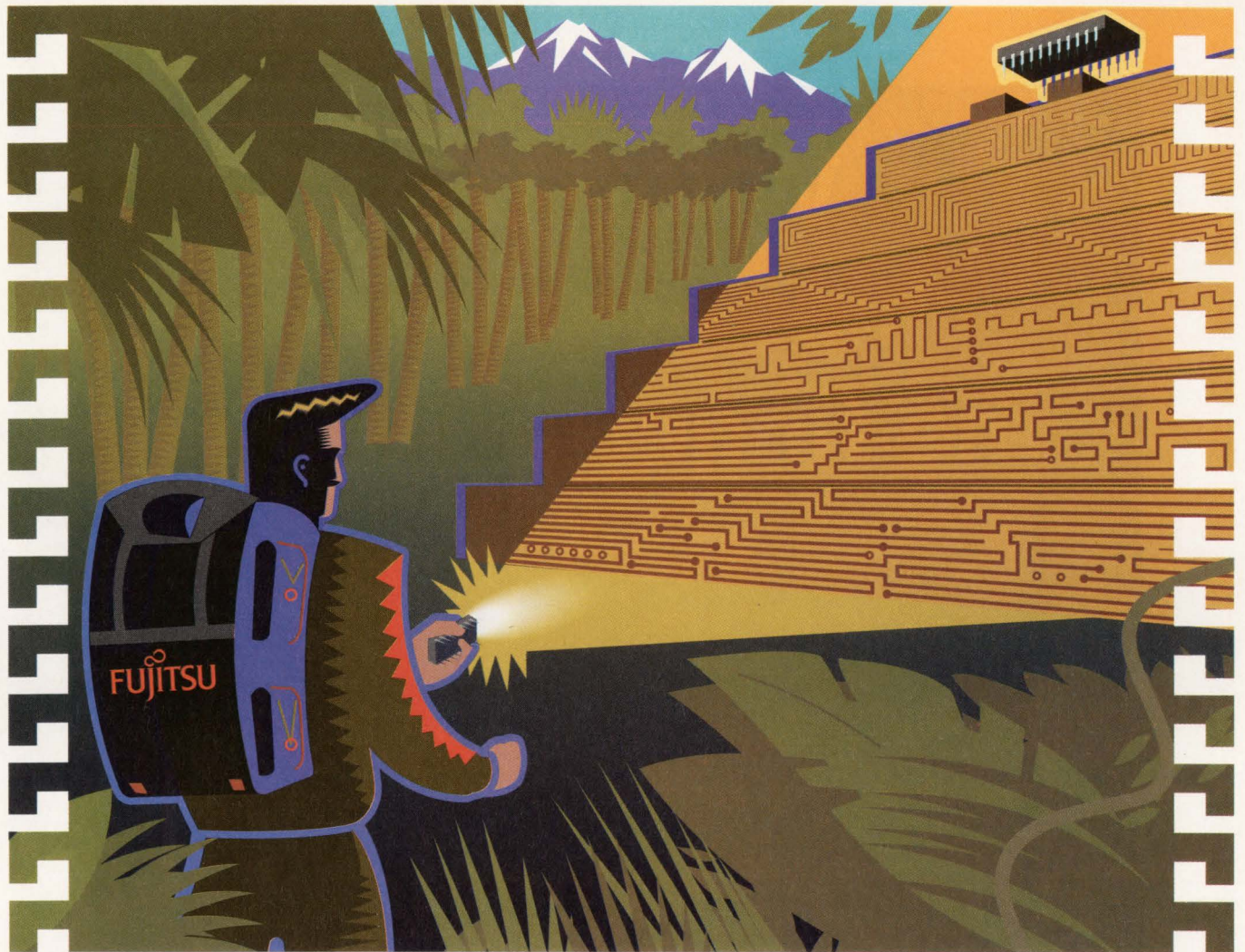

Looking for monumental embedded solutions? Let our SPARC[®]lite family lead the way.

Chip by chip, we've built a highly advanced family of processors which enables designers of embedded systems to scale greater heights than ever before.

The SPARC[®]lite™ family of RISC processors from Fujitsu Microelectronics gives you a wide range of bright solutions. From an inexpensive entry point into the world of SPARC[®] embedded computing, all the way up to clock speeds of 40 MHz. Providing 40 MIPs peak and 37 MIPs sustained performance. And soon, even higher speeds will be available.

Our SPARC[®]lite family of solutions can easily be designed into your embedded applications. Giving your designs much greater performance at very competitive prices. And to get you to market more

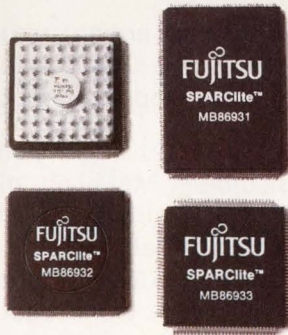

FUJITSU

Delivering the Creative Advantage.

quickly, they're complemented by a full range of multi-platform support tools. Like real-time operating systems, compilers, in-circuit emulators and evaluation boards. From the leading names in development systems.

What's more, as your computing needs grow, so does our SPARC[®]lite family. In fact, by the end of this year, two new SPARC[®]lite products will be added, bringing the family to four. Each and every one software compatible with the industry standard SPARC high-performance RISC architecture.

So call us at 1-800-642-7616. And discover our family of SPARC[®]lite processors. Built to lead the way—now and for the future.

FUJITSU MICROELECTRONICS, INC. 3545 N. First Street, San Jose, CA 95134-1804. Ph: 408-456-1161 Fax: 408-943-9293.
 FUJITSU MICROELECTRONICS ASIA PTE LTD. (Head Office, Singapore) Ph: 65-336-1600 Fax: 65-336-1609. HONG KONG SALES OFC Ph: 852-723-0393 Fax: 852-721-6555.
 TAIPEI SALES OFC Ph: 886-2-757-6548 Fax: 886-2-757-6571. JAPAN SALES OFC Ph: 81-3-3216-3211 Fax: 81-3-3216-9771. KML CORP. (Rep. Korea) Ph: 82-2-588-2011 Fax: 82-2-588-2017.
 PACIFIC MICROELECTRONICS, PTY. LTD. (Rep. Australia) Ph: 61-2-481-0065 Fax: 61-2-484-4460.
 FUJITSU MIKROELEKTRONIK GmbH (Dreieich-Buschlag, Germany) Ph: 06103-6900 Fax: 06103-690122.

SPARC[®]lite is a trademark of SPARC International, Inc., licensed exclusively to Fujitsu Microelectronics, Inc. SPARC is a registered trademark of SPARC International, Inc. © 1992 Fujitsu Microelectronics, Inc.

CIRCLE NO. 90

EDN September 17, 1992 • 149

When the chips are down, the finger pointing starts.

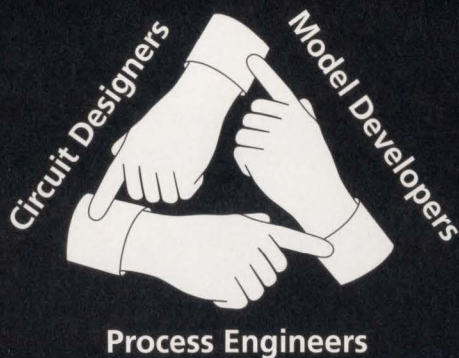

Every company experiences finger pointing when a design doesn't work.

Your circuit designers claim the models are not accurate. The model developers claim the process shifted since the time they began work on the models. The process engineers claim the model developers aren't tracking the process.

Meta eliminates finger pointing and helps you get it *right first time*[™]. Meta-Labs modeling services, combined with the HSPICE circuit simulator, provide the crucial link between your fab and circuit designers. The Meta-Software methodology helps your design, process and modeling groups work together as one team.

Get back in the chips with Meta-Software. For a *right first time* information package, call toll free (800) 442-3200, ext. A2.

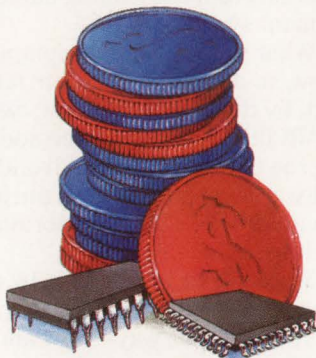

META-SOFTWARE

right first time[™]

Integrated Circuits

SPARC peripheral chip set. The SPARCset 7-chip chip set lets you build Mbus modules ranging from a single processor, 33-MHz CYM6001 SPARCset module to a dual-processor 66.7-MHz CYM6226 hyperSPARC module. The CY7C617 is a graphics controller that interfaces directly to the Mbus. The CY7C616 and CY7C618 provide an Mbus to SBus interface. The CY7C613 is a memory controller, and the CY7C604/5 is a cache controller/memory-management unit. The CY7C614 and CY7C615 are I/O controllers. Chip set, \$250 (100). **Cypress Semiconductor**, 3901 N First St, San Jose, CA 95134. Phone (408) 943-2600.

Circle No. 365

QPSK modulator. The HPMX-2002 is a monolithic quadrature-phase-shift-keyed (QPSK) modulator and dual-conversion unit. It modulates signals in the 40- to 300-MHz frequency range and transmits RF data at frequencies as high as 2 GHz. The I and Q bandwidths are greater than 10 MHz, and the output power is -11 dBm. The 20-pin plastic chip consumes 60 mW when operat-

ing from 5V and 50 μ W in standby mode. \$8.75. **Hewlett-Packard Co.**, Box 58059, Santa Clara, CA 95052. Phone (800) 752-0900.

Circle No. 366

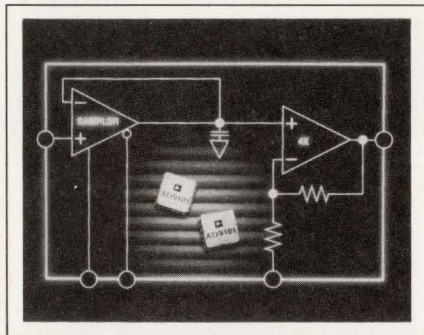

Sampling amplifier. The AD901 Sampling amplifier consists of a track and hold amplifier driving a positive gain op amp with a gain of 4 in a 20-pin SOIC or ceramic LCC package. Acquisition time to 0.4% of amplitude is 5 nsec, and 0.01% of amplitude is 11 nsec. The rms noise when the amplifier is tracking the input is 3.3 nV/ $\sqrt{\text{Hz}}$. The harmonic distortion during hold mode is -75 dB below full scale for a 50M-sample/sec sampling

rate and a 23-MHz input sine wave. \$33 (100). **Analog Devices Inc.**, Computer Labs Div, 7910 Triad Center Dr, Greensboro, NC 27409. Phone (919) 668-9511. FAX (617) 821-4273. Circle No. 367

Windows accelerator. The HT216-32 Windows Express is a local-bus VGA controller. It accelerates Windows applications for 486 and 386 μ Ps. The controller is register compatible with the IBM VGA standard and operates at CPU clock speeds from 16 to 40 MHz. Hardware in the controller assists the CPU in controlling Windows operations. \$25 (1000). **Headland Technology**, 46221 Landing Pkwy, Fremont, CA 94538. Phone (510) 623-7857.

Circle No. 368

FIFO memories. The QS7201 and QS7202 asynchronous FIFO memories have 12-nsec access times and 512k \times 9-bit and 1k \times 9-bit densities, respectively. The asynchronous QS7203 and QS7204 FIFO memories have 10-nsec access times and 2k \times 9-bit and 4k \times 9-bit densities, respectively. The syn-

We Make 41% Of The World's Memory Cards.

With a 41% market share,* Mitsubishi is the world's leading supplier of memory cards.

The largest share of today's memory card users depend on Mitsubishi for two good reasons: meticulous service and the best selection.

We manufacture cards in all five memory types — DRAM, SRAM, EEPROM, flash EEPROM, OTPROM and MROM — in the highest densities (up to 16Mbytes) and in the current versions of PCMCIA, JEIDA and

JEDEC standards. Plus, we offer custom cards and custom panel artwork. We can mix memory types, consolidate logic into ASIC, even add MCUs on board.

Whatever it takes, we'll work with our customers to achieve their memory card needs. With engineering and marketing support, well-stocked inventories and automated shipping services all onshore, Mitsubishi is the world's leading memory card source.

Call (408) 730-5900, ext. 2214.



MITSUBISHI
ELECTRONIC DEVICE GROUP

*Based on independent market research. Information available upon request.

EDN-NEW PRODUCTS

Integrated Circuits

chronous QS7223 and QS7224 FIFO memories operate with 66-MHz clocks and have $2k \times 9$ -bit and $4k \times 9$ -bit densities, respectively. \$30.15 to \$98.50. **Quality Semiconductor**, 851 Martin Ave, Santa Clara, CA 95050. Phone (408) 450-8000. FAX (408) 496-0591.

Circle No. 369

Board-history recorder. The Scope Diary TMS29F816 JTAG-compatible chip maintains the operational history of a PC board. It stores serial and model numbers, calibration constants, engineering revisions, elapsed operation time, repair history, and power-down status log. In addition, the chip has one-time write protection, 16 kbits of memory, and nonvolatile storage. \$15 (1000). **Texas Instruments Inc**, Semiconductor Group, Box 809066, Dallas, TX 75380. Phone (214) 995-6611, ext 3990.

Circle No. 370

GaAs products. This family of prescalers and gain-block amplifiers are the company's first commercial GaAs products. The divide-by-4, -8, and -32 pre-

scalers operate from a -5.2 to $-6V$ supply and from dc to 14 GHz. The gain-block amplifiers provide 10 or 20 dB of gain from dc to 10 GHz. The amplifiers operate from a 4 to 7V supply and consume 200 mW. Divide-by-8 prescaler in die form, \$14.95; 10-GHz gain block in die form, \$9.95. **Rockwell/MTC**, 2427 W Hillcrest Dr, Newbury Park, CA 91320. Phone (805) 375-1237. FAX (805) 375-1268.

Circle No. 371

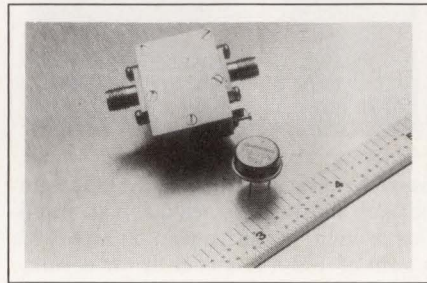

10- to 1500-MHz amplifier. The UTO-1576 RF amplifier provides 10.5 dB of gain from 10 to 1500 MHz. It comes in a T0-8 package and exhibits 50 dB of reverse isolation. Other features include 0.5-dB gain flatness, 5-dB

noise figure, and a 1-dB gain compression point of 9 dBm. The amplifier operates from -55 to $+85^\circ\text{C}$. \$120. **Hewlett-Packard Co**, Box 58059, Santa Clara, CA 95052. Phone (800) 752-0900.

Circle No. 372

4M-bit video RAM. This video RAM includes reading and writing of bits to split registers, $4 \times 4 \times 4$ block writes for fast area-fills, and CAS-before-RAS refresh. The chip integrates a $256k \times 16$ -bit dynamic RAM with a 256-bit serial-access memory. One version has a 70-nsec row-enable access time and a 20-nsec serial-data access time. Another version has an 80-nsec row-enable access time and a 25-nsec serial-data access time. From \$70. **Texas Instruments Inc**, Semiconductor Group, Box 809066, Dallas, TX 75380. Phone in US and Canada, (800) 336-5236, ext 3990; (214) 995-6611, ext 3990.

Circle No. 373

3V 22V10 PLDs. The AT22LV10 and AT22LV10L are 3V versions of the industry-standard 22V10 PLD. Both chips operate from 3 to 5.5V. Propaga-

PURE PERFORMANCE

	HSP45116	HSP45106	HSP45102
Phase accumulator size	32 bits	32 bits	32 bits
Phase control	16 bits	16 bits	2 bits
Frequency control	32 bits	32 bits	32 bits
Tuning resolution at maximum speed	0.008 Hz	0.008 Hz	0.009 Hz
Interface	Standard μP	Standard μP	Serial
Speed	33 MHz	33 MHz	40 MHz
Output	16 parallel	16 parallel or serial	12 parallel

DIGITAL MODULATION MADE EASY

QAM Implement nearly infinite levels of Quadrature Amplitude Modulation

PSK Implement all forms of Phase Shift Keying from DPSK to 8PSK

FM/FSK/FHOP Real time frequency control; change frequency in a single clock cycle

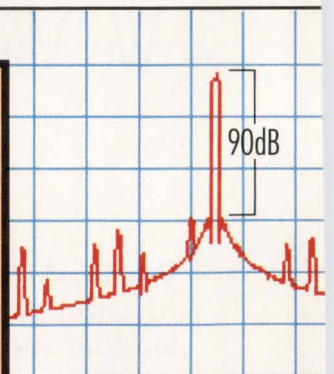

HSP45102
Shown Actual Size

For pure performance in frequency synthesis, catch the new wave in DSP. The new wave is Harris.

Our Numerically Controlled Oscillators (NCOs) offer spectral purity of better than 90 dB. Tuning resolution of 0.008 Hertz. 32-bit-wide

EDN-NEW PRODUCTS

Integrated Circuits

tion delay for both devices is 20 nsec. The AT22V10 draws 40 mA of standby current, and the AT22V10L draws 4 mA from a 3.6V supply. Packaged in plastic DIPs, AT22LV10, \$8.40; AT22LV10L, \$6.60 (100). **Atmel Corp.**, 2125 O'Neil Dr, San Jose, CA 95131. Phone (408) 441-0311. **Circle No. 374**

386DX ISA bus controller. The VL82C380 is an ISA bus controller chip with on-chip cache. Its cache controller employs a look-aside, write-back architecture. The chip controls 1- or 2-bank cache RAMs and maintains coherency during DMA and master-mode cycles to eliminate flushing and invalidating operations. The memory controller can access as much as 64 Mbytes of main memory. Approximately \$20 (OEM qty). **VLSI Technology Inc.**, SC386, 200 Parkside Dr, San Fernando, CA 91340. Phone (602) 752-6212. FAX (602) 752-6000. **Circle No. 375**

Quad video buffers. The Si584 monolithic quad video buffers have a 200-MHz bandwidth and an output drive-

current capacity of ± 20 mA. The unity-gain buffers don't require any external components, and the differential gain and phase errors are 0.8% and 0.1°, respectively. The chip comes in a 14-pin DIP or SO-14 package. \$10.15 (1000). **Siliconix Inc.**, 2201 Laurelwood Rd, Santa Clara, CA 95054. Phone (800) 554-4454, ext 1900; (408) 988-8000. **Circle No. 376**

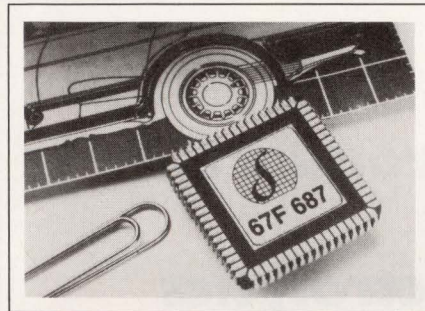

Combustion-engine peripheral. The 67F687 controls the spark and fuel control systems in 4-, 6-, or 8-cylinder engines. Because the chip generates fewer interrupts than other engine peripheral ICs, you can use simple, inexpensive

μ Ps. On-chip features include sensor conditioning and output predrivers. A digital phase-locked-loop circuit tracks engine position using two sensor inputs. \$3.50 to \$15. **Silicon Systems**, 14351 Myford Rd, Tustin, CA 92680. Phone (714) 573-6200. FAX (714) 573-6914. **Circle No. 377**

Audio chip sets. The Aria family consists of three chip sets for synthesizing music on a computer. The ST8000 emulates Creative Lab's Sound Blaster board and has a joystick port, a MIDI port, a Rowland MPU-401 port, and digital recording and playback. The ST8001 and ST8002 offer the same features and have a 512-kbyte and 1-Mbyte sound library, respectively. \$30 to \$60 (10,000). **Sierra Semiconductor**, 2075 N Capitol Ave, San Jose, CA 95132. Phone (408) 263-9300. FAX (408) 263-3337. TLX 384467. **Circle No. 378**

Power op amps. The single OMA541 and dual OMA2541 power operational amplifiers operate from ± 40 V power supplies and deliver 5A of continuous

SPECTRAL PURITY OF THE HARRIS NCO FAMILY

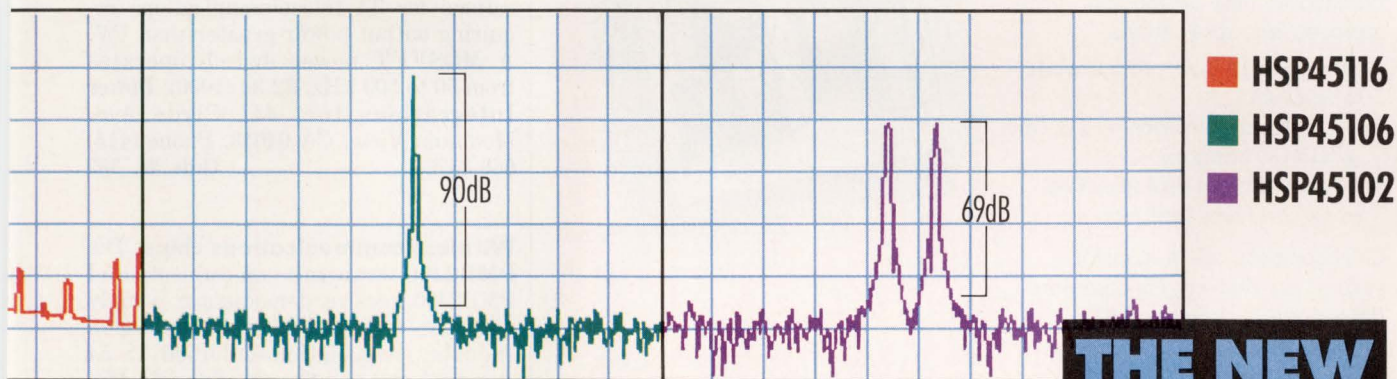

Typical spectral purity as measured by 2048 point FFT with Blackman window. The Harris family of NCOs will always have a spurious-free dynamic range better than shown.

phase accumulation. No one else offers NCOs that generate signals so pure with so much precision.

No one else offers NCOs with so many features, either. Our HSP45116 also implements Direct Digital Down Conversion on the same chip. And

our HSP45102 12-bit NCO has a footprint of just 0.28 square inches.

So get in tune with Harris. With our broad line of DSP products — including NCOs, digital filters and image processing — we're the new wave in DSP. Catch it. Call 1-800-4-HARRIS, ext. 1171.

**THE NEW
WAVE
IN DSP**

HARRIS
SEMICONDUCTOR

output current. The OMA501 delivers $\pm 10A$ and is stable in a unity-gain configuration. OMA501AK, \$76.90; OMA2541SK, \$106.70 (100). **Omnirel Corp**, 205 Crawford St, Leominster, MA 01453. Phone (508) 534-5776. FAX (508) 537-4246. **Circle No. 379**

Single-supply communications transceivers. The AD7306 combines two RS-232C and an RS-422 driver with

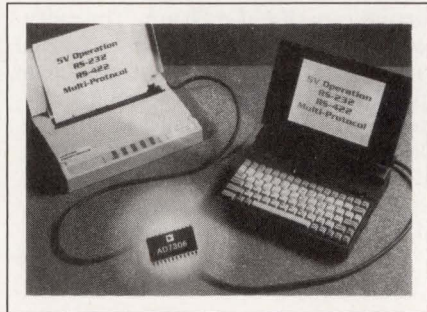

an RS-232C and configurable RS-232C or RS-422 receiver in a 24-pin SOIC package. The chip operates from a single 5V supply and internally generates $\pm 10V$ for the transceivers. A charge-pump voltage converter operates with an external nonpolarized 0.1- μF capacitor. **Analog Devices Inc**, 181 Ballardvale St, Wilmington, MA 01887. Phone (617) 937-1428. FAX (617) 821-4273.

Circle No. 380

SHRINK Size and STRETCH Product Life with New CKS Aluminum Electrolytics

New **CKS** radial-lead aluminum electrolytic capacitors are right for the times. Their subminiature size conserves space and their extended life design improves product reliability. These high-performance +85°C capacitors are excellent for coupling, blocking and filtering needs. Its smaller size makes it practical for new design and replacement applications.

- 33 mfd to 15,000 mfd 6.3 wvdc to 50 wvdc
- Capacitance tolerance $\pm 20\%$ (m); $\pm 10\%$ (k) optional.
- Solvent tolerant seal standard; epoxy end seal optional.

CKS capacitors are in stock for immediate delivery. For complete details contact your local IC distributor or IC.

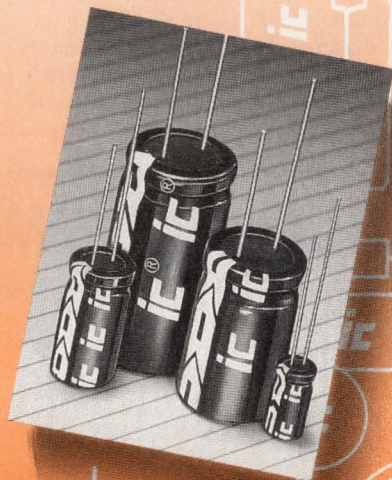

Ask for our **FREE** Capacitor Engineering Guide.



ic®
ILLINOIS CAPACITOR, INC.

3757 West Touhy Avenue, Lincolnwood, IL 60645
708 675-1760 • FAX: 708 673-2850

CIRCLE NO. 94

Real-time clock. The DS1587 serialized real-time clock is a timekeeper that can switch on a DOS-compatible computer to perform a scheduled task. It has a permanent 64-bit serial number to identify the computer. Besides the standard real-time clock registers and 50 bytes of user nonvolatile static RAM, the chip provides an additional 60 bytes of nonvolatile static RAM. \$15.50 **Dallas Semiconductor**, 4401 S Beltwood Pkwy, Dallas, TX 75244. Phone (214) 450-0448. FAX (214) 450-0470.

Circle No. 381

ISDN buck regulator. The PWR-SMP402 dc/dc converter for nonisolated ISDN (Integrated Services Digital Network) power-supply applications. The device accepts 20 to 72V dc inputs and generates a 5V supply line using a buck regulator. The IC meets ISDN specifications for T1 telecommunications requiring output power greater than 1W. A MOSFET power switch operates from 50 to 500 kHz. \$2.30 (1000). **Power Integrations Inc**, 411 Clyde Ave, Mountain View, CA 94043. Phone (415) 960-3572. **Circle No. 382**

Wireless communications chips. The PMB2200 transmit modulator and PMB2400 receive demodulator comply with the Cellular Telecommunication Industry Association-endorsed IS-54 standard and the Groupe Speciale Mobile standard for digital wireless communications systems. The PMB2200 converts baseband signals to RF carrier frequencies between 700 MHz and 1 GHz. The PMB2400 converts the RF carrier to baseband signals, using dual-stage heterodyne receivers. \$7.85 each (1000). **Siemens Components Inc**, Integrated Circuit Div, 2192 Laurelwood Rd, Santa Clara, CA 95054. Phone (408) 980-4500. **Circle No. 383**

Announcing the Economic Recovery Plan from Hewlett-Packard. Trade up to the new test equipment you need. And recover 20%.

Although technology is growing by leaps and bounds, chances are your budget isn't.

So, how can you get the new test equipment it takes to keep up, without breaking the bank?

With the Economic Recovery Plan from Hewlett-Packard — that's how. It's the best way to get the new-generation HP test equipment you need. At a substantial savings.

Just trade in your present high-performance oscilloscope, portable logic analyzer, or spectrum analyzer*, any time before January 31, 1993. And we'll give you a 20% credit toward an upgrade to one of HP's new state-of-the-art instruments.

If you'd like more information about our new test products — or if you're ready to trade up — call **1-800-452-4844 Ext. 7046** or your local field engineer.

But don't wait. If you miss this opportunity to save 20% on HP test equipment, you might never recover.

There is a better way.



*Certain restrictions apply.

CIRCLE NO. 95

Trade in your old equipment and save 20% on the latest models from HP.

HP 54700 family of high-performance, modular oscilloscopes lets you capture your most elusive problems.

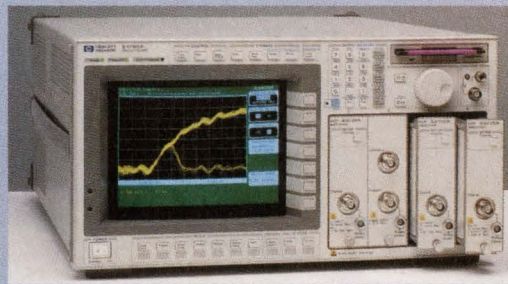

- 1 GHz single shot bandwidth (4 GSa/s)
- Accurate waveform reproduction with non-intrusive probing
- Modular system adapts to your changing needs

HP 1660 family of portable logic analyzers gives you the confidence to solve your toughest digital problems.



- 100 MHz state and 500 MHz timing
- 34, 68, 102, and 136-channel models
- Intuitive mouse, keypad, and keyboard interface

HP 8560 and 8590 E-Series of portable spectrum analyzers offer the highest performance for the price.

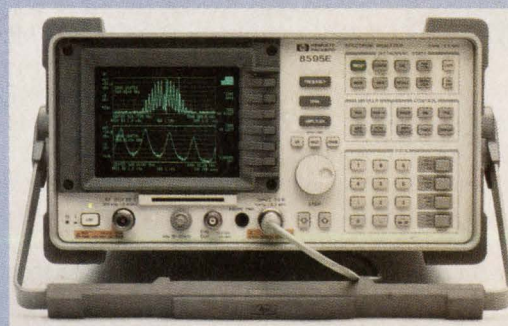

- Improved phase noise and narrower resolution bandwidth
- Many application-specific, one-button measurement functions
- User-friendly interface

© 1992 Hewlett-Packard Co. ADTMCOL252

Think Low Power.

2.4 μ W/MHz/gate

Think Mitsubishi Gate Arrays.

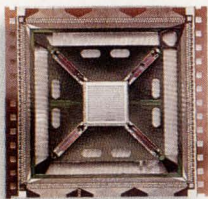

Whether you're designing your next gate array, or your first, you've got to think about system power requirements. Your very next thought should be: **Mitsubishi Gate Arrays.**

Our 0.8 μ m arrays give you four speed/power options to control total chip power consumption. Four transistor sizes within each macro allow optimization for either high speed or low power. The result is power dissipation as low as 2.4 μ W/MHz/gate, at 5V. And, with Mitsubishi's 3V library, you can achieve even lower power dissipation. You can switch more nodes in

the array, control the power and still use lower-cost, plastic packaging.

Add to all of this 400,000 gates, 512 I/Os, and Mitsubishi's exclusive μ Pitch TAB™ packaging with pin counts as high as 576.

We also offer design kits for industry's most popular workstations, from logic synthesis, to simulation, to automatic test pattern generation (ATPG). So you can design on your own workstation or ours.

With both local design support and the global resources of a stable, well-capitalized company, Mitsubishi is one of the world's top 10 semiconductor suppliers. We've been in the ASIC business for over 15 years and we're continuing to invest in technologies for the next decade.

When you think gate arrays, think low power. Then think Mitsubishi. You'll be glad you did. Phone (408) 730-5900, ext. 2106.

VISION®
ACTION
REALITY

 **MITSUBISHI**
ELECTRONIC DEVICE GROUP
CIRCLE NO. 96

EPSON The CrystalMaster

Awards its customers with the latest in CRYSTAL technology

CRYSTALS

THRU-HOLE



C-2

- LOW FREQUENCY TUNING FORK TYPE
- 32.768 KHz
- 20 KHz - 100 KHz

CA-301

- HIGH FREQUENCY AT - STRIP TYPE
- 4.0 MHz - 67.0 MHz

SMD

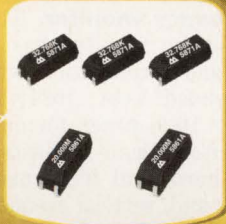

MC-405/6

- HEAT RESISTIVE C-2H INSIDE
- L10.4xW4.06xH3.56mm
- 20 KHz - 100 KHz

MA-505/6

- HEAT RESISTIVE CA-303 INSIDE
- L13.46xW5.08xH4.57mm
- 4.0 MHz - 67.0 MHz

MINIATURE SMD

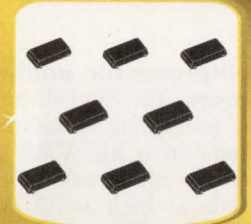

MC-306

- NEW TUNING FORK CRYSTAL TECHNOLOGY
- L7.9xW3.8xH2.5mm
- 32.768 KHz

MA-306

- NEW AT - STRIP CRYSTAL TECHNOLOGY
- L7.9xW3.8xH2.5mm
- 17.7 MHz - 40.0 MHz

OSCILLATORS

THRU-HOLE

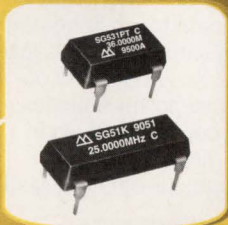

SG-51/531

- COST EFFECTIVE AUTO INSERTABLE FULL SIZE (SG-51) AND HALF SIZE (SG-531) DIP'S
- CA-301 CRYSTAL INSIDE
- 1.025 MHz - 67.0 MHz

SMD



SG-615

- SURFACE MOUNTABLE
- HEAT RESISTIVE CA-303 INSIDE
- L14.0xW9.8xH4.7mm
- 1.025 MHz - 67.0 MHz

MINIATURE SMD

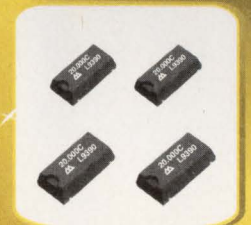

SG-636

- MINIATURE SURFACE MOUNT
- NEW AT - STRIP CRYSTAL TECHNOLOGY
- L10.3xW5.8xH2.8mm
- 2.20 MHz - 40.0 MHz

EDN-NEW PRODUCTS

Computers & Peripherals

IDE module. The Portfolio is a 13-port multifunction IDE (integrated-drive-electronics) interface module for serial, parallel, floppy, and game-port functions. Using this unit you can connect a laser printer, a dot-matrix printer, as many as four 1.2- or 1.44-Mbyte floppy-disk drives, two IDE drives, a tape-back-up unit, a serial mouse, a modem, and a joystick. \$79. **Quadtrek Corp.**, 6034 W Courtyard Dr, Suite 305-74, Austin, TX 78730. Phone (512) 338-2125. FAX (512) 338-2127. **Circle No. 384**

Multiprocessor application accelerators. The Skybolt-mp Shamrock offers processing speeds as high as 1.28 Gflops in a 9U VME slot, and the Skybolt Shamrock offers processing speeds as high as 320 Mflops in a 6U VME slot. The accelerators feature a modular design with an Intel i960 processor controlling several Intel i860 processors. The 6U Skybolt Shamrock, from \$27,450; 9U Skybolt-mp Shamrock, from \$32,350. **Sky Computers Inc.**, 27 Industrial Ave, Chelmsford, MA 01824. Phone (508) 250-1920. FAX (508) 250-0036. **Circle No. 385**

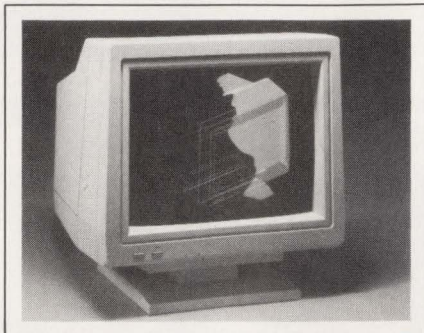

Multifrequency monitor. The Spectrum Autosync monitor has a 20-in. dark tube and is compatible with PGA, VGA, extended VGA, 1024×768-pixel and 1280×1024-pixel formats. The monitor automatically adjusts picture size from horizontal frequencies of 29 to 66 kHz and vertical frequencies of 40 to 120 Hz. \$3195. **Aydin Controls**, 414 Commerce Dr, Fort Washington, PA 19034. Phone (215) 542-7800. **Circle No. 386**

Super-VGA board. The VGAwonder XL24 displays 16.7 million colors in 640×480-pixel resolution or more than

32,000 colors in 800×600-pixel resolution. The board is available in 512 kbytes or 1 Mbyte and comes with drivers for Microstation, CADKey, OS/2 2.0, and Windows 3.X. \$179. **ATI Technologies Inc.**, 3761 Victoria Park Ave, Scarborough, ON M1W 3S2, Canada. Phone (416) 756-0718. FAX (416) 756-0720. TLX 06966640. **Circle No. 387**

Super-VGA graphics card. The SVGA Multiview/Micro Channel graphics card provides a 115-Hz refresh rate on the Micro Channel bus. The card and its software utilize Windows in 1024×768-pixel and 800×600-pixel resolutions and more than 16.7 million colors. \$549. **Radius Inc.**, 1710 Fortune Dr, San Jose, CA 95131. Phone (408) 434-1010. FAX (408) 434-0770. **Circle No. 388**

Solid-state power controllers. The SSP-21120 series solid-state power controllers operate as high as 80A at 28V dc. The controllers include a thermal memory that shortens trip times when repeated attempts are made to turn on



Power tool

KEPCO ANALOG/DIGITAL PROGRAMMABLE POWER...

HIGH SPEED/UNIPOLAR/BIPOLAR

The power golfer relies on his putter as much as the driver. The putter is his money club. A delicate touch is needed to wield this tool. The same sort of delicacy and precision you'll find in our analog-controlled operational power supplies. 120 dB of gain at your disposal, wide bandwidth. Single quadrant and four-quadrant voltage and current stabilization.

5-YEAR WARRANTY

Available from Stock. Call: 718-461-7000.

Ask for Tom Fischer.

He can arrange a demo in your place.



Instrumentation and Bench

Switching a-c to d-c and d-c to d-c



146-1785



146-1760

Call/fax/write to Dept. MUH-12 for any of our catalogs.

the device into an overload condition. Using several devices in parallel yields higher current ratings. From \$1295. Delivery, 60 to 90 days. **ILC Data Device Corp**, 105 Wilbur Pl, Bohemia, NY 11716. Phone (516) 567-5600, ext 7381. FAX (516) 567-7358. **Circle No. 389**

Minicartridge tape products. The three drives in the Tape250 series are QIC-80 tape drives that are able to read Irwin-formatted tapes and are based on the floppy-disk interface. The drives come with Central Point Backup software for DOS and Windows and data-compression software that allows the drives to store as much as 250 Mbytes. Insider, \$299; Insider Half-Height, \$349. Both drives fit into a standard 3½-in. bay. PC Powered drive, an external device, \$499. **IOmega**, 1821 W 4000 S, Roy, UT 84067. Phone (800) 456-5522. FAX (801) 778-3450. **Circle No. 390**

32-I/O line interface board. The Digital 488/32/OEM 4×4-in. 32-I/O line interface board enables data transfers between the IEEE-488 bus and devices



equipped with 8-, 16-, or 32-bit-wide digital ports. The 32 TTL-level lines are programmable in 8-bit groups as either inputs or outputs. \$495. **IOtech**, 25971 Cannon Rd, Cleveland, OH 44146. Phone (216) 439-4091. FAX (216) 439-4093. **Circle No. 391**

Memory cards. For pen-based and palmtop systems, the SmartRAM memory-card family combines flash and static-RAM (SRAM) memory and includes a built-in controller and battery backup circuitry. The PCMCIA-standard cards have average read-access

and write-cycle times of 150 nsec each. The cards, which weigh 35g, allow data-write cycles at 5V and incorporate 256 kbytes of SRAM and 768 kbytes of flash memory for a total of 1 Mbyte. \$160 (100). **Smart Modular Technologies**, 45531 Northport Loop W, Bldg 3B, Fremont, CA 94538. Phone (510) 623-1231. FAX (510) 623-1434. **Circle No. 392**

Ruggedized VMEbus module. The CPUC32 is a cost-reduced version of a militarized single-board computer for the VMEbus. The board is based on the 68030 processor and has as much as 4 Mbytes of battery-backed static RAM. Operating systems include OS-9 and VxWorks. \$5000. **Alphi Technology Corp**, 6202 S Maple Ave #128, Tempe, AZ 85283. Phone (602) 838-2428. FAX (602) 838-4477. **Circle No. 393**

Memory-card drives. These open-frame memory-card drives are compatible with JEIDA 4.0 and PCMCIA memory cards. The drives accept 512-kbyte to yet-to-be-released 64-Mbyte memory cards. Both drives are the

Power tools



**d-c single quadrant power
50-1000 Watts
voltage/current stabilization**

- Conventional/fast-programmable, selectable
- Analog & digitally programmable
- Precision stabilization: 0.001% source, 0.002% load
- Optional digital displays

Kepeco Group ATE Power Supplies

Power tools



**d-c four quadrant power
100-400 Watts
voltage/current stabilization**

- Analog programmable, bandwidth to 20KHz
- Digitally programmable, built in GPIB or serial controller
- Precision stabilization: 0.001% source, 0.002% load

Kepeco Group BOP Power Supplies

Power tools

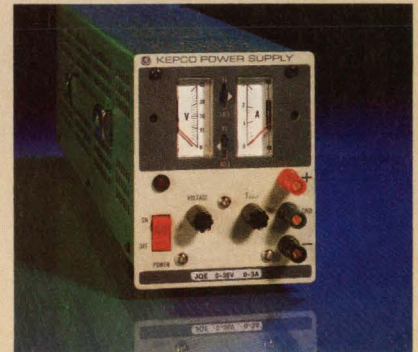

**d-c single quadrant power
100-1000 Watts
voltage stabilization**

- Analog programmable
- Precision stabilization: 0.0005% source, 0.005% load

Kepeco Group JQE Power Supplies



SEE OUR PAGES IN VOLUME D **eem**

Kepeco, Inc., 131-38 Sanford Avenue, Flushing, NY 11352 USA • Tel: (718) 461-7000 • Fax: (718) 767-1102 • Easylink (TWX): 710-582-2631
Eastern Region: 131-38 Sanford Avenue, Flushing, NY 11352 USA • Tel: (718) 461-7000 • Fax: (718) 767-1102 • Easylink (TWX): 710-582-2631
Western Region: 800 West Airport Freeway, Suite 320 LB 6018, Irving, TX 75062 USA • Tel: (214) 579-7746 • Fax: (214) 579-4608



CIRCLE NO. 98



The Key Building Block in High-Frequency EDA Applications

From cellular and satellite communications to radar and electronic defense, EEsof's electronic design automation (EDA) software suite is the key building block in today's rapidly growing RF and microwave applications. In fact, EEsof is the world leader in EDA software tools for high-frequency analog circuit and system design.

Top electronic engineering firms use EEsof's powerful design-for-manufacturing software to increase design efficiency, reliability and yields while reducing time-to-market.

Our easy-to-use tools provide engineers with a complete hierarchical suite to support

advanced circuit design... from top-down design of high-frequency systems, to bottom-up development of detailed electrical models. EEsof provides the most complete line of high-frequency simulators, along with libraries of circuit and system models. We support industry manufacturing standards like Gerber,TM GDSII,TM and IGES,TM and interfaces to Cadence, Mentor Graphics

and other top EDA vendors.

Make EEsof the key building block in your applications. Call, FAX or write EEsof for more information on the complete

suite of integrated high-frequency analog simulation software.

5601 Lindero Canyon Road
Westlake Village, CA 91362 USA
Phone: 1-800-34-EESOF
FAX: 1-818-879-6467.

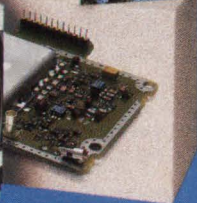
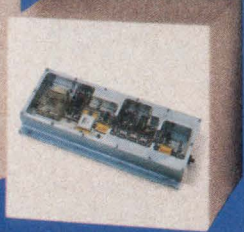
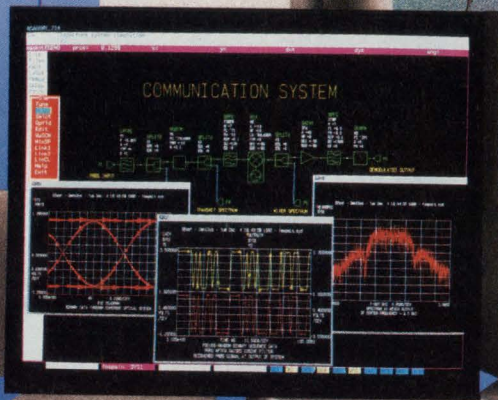
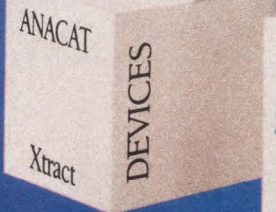
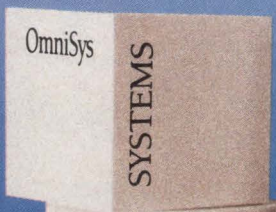
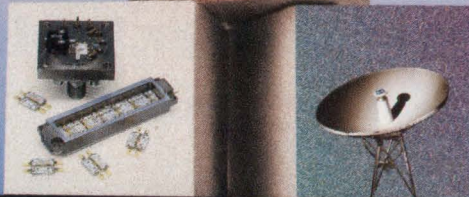
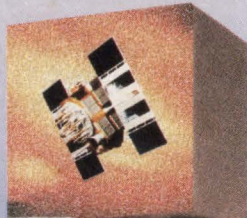

©1992, EEsof Incorporated

EDN-NEW PRODUCTS

Computers & Peripherals

same size as a standard 3.5-in. floppy-disk drive. The MCRW-B has an RS-232C port; the SCSI version is the MCdisk-1. \$495. **Gespac Inc.**, 50 W Hoover Ave, Mesa, AZ 85210. Phone (602) 962-5559. FAX (602) 962-5750.

Circle No. 394

HC11 CPU module. The 68HC11 includes a 68HC811E2FN 8-bit microcontroller, 2-Mbyte flash EPROM, 32-kbyte nonvolatile RAM, 2-kbyte EEPROM, 8-channel 8-bit A/D converter, a real-time clock/calendar, RS-232C and RS-485 ports, 16-bit timer, open-architecture 64/96 DIN expansion bus, and C and assembler routines. The module comes with 24-hour BBS support. \$287. **Ackerman Computer Sciences**, 4276 Lago Way, Sarasota, FL 34241. Phone (813) 377-5775.

Circle No. 395

I/O-module interface cards. The PSR00 and MSR01 Power I/O Module interface cards are compatible with Opto22, Gordos, Burr-Brown, and Potter and Brumfield. The PSR00 is for ISA- or EISA-style computers, and the MSR01 is for Wintek 6800- and 6809-based computer systems. As many as 24 I/O channels may be used as inputs or outputs in any combination. PSR00, \$159; MSR01, \$125. **Wintek Corp.**, 1801 South St, Lafayette, IN 47904. Phone (800) 742-6809; (317) 448-1903. FAX (317) 448-4823.

Circle No. 396

Networked microcontroller. Based on the Motorola MC68HC11F1 chip, the GCB11 is an 8-bit, networked microcontroller hardware-and-software package for distributed-control applications. The 3×4-in. board includes 32 kbytes of static RAM and 32 kbytes of ROM. The package comes with a set of development tools and network and application libraries. \$179. **Coactive Aesthetics**, Box 425967, San Francisco, CA 94142. Phone (415) 626-5152.

Circle No. 397

High-speed development platform. The DPS-1 Rev C is an SBus development platform for prototyping hardware and software. The development platform allows the designer to adapt new hardware or convert existing systems to the SBus. The kit uses LSI-Logic's L64853A DMA Plus controller. \$1095. **Dawn VME Products**, 47073 Warm Springs Blvd, Fremont, CA 94539. Phone (800) 258-3296; (510) 657-4444. FAX (510) 657-3274.

Circle No. 398

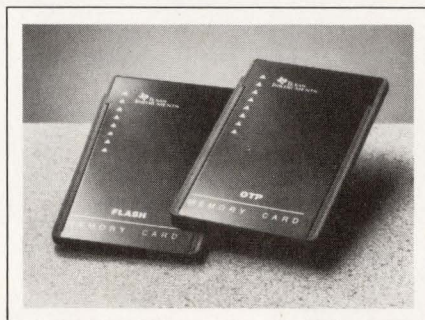

OTP and flash memory cards. The company's one-time-programmable (OTP) and flash memory cards follow PCMCIA standards and come with 256 kbytes to 1 Mbyte. Flash cards are available in 2-Mbyte density. OTP cards, \$72 to \$180; flash cards, \$117 to \$521. **Texas Instruments Inc.**, Semiconductor Group SC-92044, Box 809066, Dallas, TX 75380. Phone in US and Canada, (800) 336-5236, ext 3990; elsewhere, (213) 995-6611, ext 3990.

Circle No. 399

THE ENGINEER'S ULTIMATE PROGRAMMER

PROGRAMMABLE
EEPROMS
EPROMS
MICROS
FPGAs
PLDs



The 3900 supports more devices.

Starting at just \$2995,* the 3900 family of programmers gives you more for the money. The 3900 offers the broadest device support including leading-edge FPGAs, PLDs, memory devices, and microcontrollers up to 100 pins. This support comes in device libraries, so you pay for only what you need. And, the 3900 uses semiconductor manufacturer-certified algorithms, exclusively, to ensure the most

*U.S. list price only.

reliable programming.

To hear more reasons why the 3900 is the engineer's ultimate programmer, call today. We'll send you a FREE copy of our popular Wall Chart of Programmable Devices.

1-800-3-DataIO
(1-800-332-8246)

DATA I/O

CIRCLE NO. 100

EDN September 17, 1992 • 163



The Maxtor 7213. It drives a hard bargain.

Go ahead, search all you want. But we don't think you'll find a lower cost or higher quality 200 MB class disk drive than our new 7213.

The reason is simple. We made it with very few parts. Far fewer than any other drive in its class. So it's not only easier to manufacture, it assures exceptional reliability.

And that's critical. Because it's

that level of reliability that keeps your customers sold.

Now you might be thinking, "How could Maxtor possibly produce a quality 200 MB drive at such a low cost?" Well, after producing more than 3 million 7000 series drives, you get real good at it.

The 7213 is just one more example of the New Drive at Maxtor. A very serious commitment to customer satisfaction.

Unmatched service and support. And visionary product design.

For more information, please call 1-800-4-MAXTOR. Quite frankly, you won't find a better bargain than this.

Maxtor[®]

There's a new drive at Maxtor.

Maxtor Corporation, 211 River Oaks Parkway, San Jose, CA 95134

EDN-NEW PRODUCTS

Computers & Peripherals

Magneto-optical drive. A 3.5-in. rewritable optical disk drive, the RF-3000 provides as much as 128 Mbytes of storage and is compatible with ISO/ANSI-standard 3½-in. magneto-optical disks. The drive has an average seek time of 38 µsec and transfer rates of 640 kbytes/sec. The drive is controlled through a SCSI bus, and two drives can be daisy-chained together. \$2195; internal model, \$1995. **Plasmon Data Systems Inc.**, 1654 Centre Pointe Dr, Milpitas, CA 95035. Phone (800) 445-9400; (408) 956-9400. FAX (408) 956-9444. **Circle No. 400**

Keyboard network station. The 386SX-25-IDE Keyboard Network Station includes an IDE hard-disk drive in either 40, 80, 100, or 200 Mbytes. The pc within a keyboard has a standard 101/102 keyboard, 1 Mbyte of RAM (expandable to 16 Mbytes), a Super-VGA adapter, a 3½-in. floppy-disk drive, one parallel and two serial ports, and a 16-bit expansion slot. \$1095. **Advanced Interlink Corp.**, 15181 Springdale St, Huntington Beach, CA 92649. Phone (714) 894-1675. FAX (714) 893-1546. **Circle No. 401**

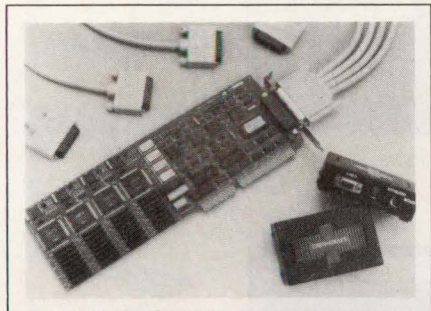

Multiple-VGA adapter kit. The Theo+Grafx Multi VGA Adapter Kit allows you to connect as many as four VGA monitors to one 386 or 486 host PC running DOS. The kit comprises the TG/4 multiuser video graphics adapter, software drivers, controller boxes, and cables. Kit for four users, \$1895. **Theos Software Corp.**, 1777 Botelho Dr, Suite 360, Walnut Creek, CA 94596. Phone (510) 935-1118. FAX (510) 935-1177. **Circle No. 402**

Multipurpose video boards. The Tango and Mambo boards for MS-DOS computers integrate multiple sources required for networked digital multimedia. Each board includes video display drivers, Ethernet drivers and interfaces, digital audio and video interfaces, and audio recording and playback capa-

bilities. Tango, for standard monitors, \$1895; Mambo, for portable computers with LCD screens, \$1495. **Mediashare Corp.**, 2035 Corte Del Nogal, Carlsbad, CA 92009. Phone (619) 931-7171. FAX (619) 431-5752. **Circle No. 403**

SBus board with SCSI interface. The TMS320C30 SBus board is based on the TI 33-MHz floating-point digital signal processor. The board has as much as

512k words of static RAM, dual-port RAM, analog-to-digital options, high-speed digital I/O from a disk at 2 Mbytes/sec, and a SCSI interface. \$4795; with TI's Sun-4-based assembler/linker/C compiler, SMON30 debug monitor, C interface library, and SunOS device drivers, \$9795. **Spectrum Signal Processing Inc.**, 8525 Baxter Pl, 100 Production Ct, Burnaby, BC V5A 4V7, Canada. Phone (604) 421-5422. FAX (604) 421-1764. **Circle No. 404**

THE ENGINEER'S ULTIMATE PROGRAMMER



The 3900 supports more packages.

Starting at just \$2995,* the 3900 family of programmers gives you more for the money. The 3900 offers the broadest package support including TSOPs, QFPs over 100 pins, PCMCIA cards, PLCCs, LCCs, JLCCs, SOICs, and PGAs. Its flexible universal socketing technology easily accommodates all of these packages, today and in the future. And, the 3900's 88 universal pin drivers provide full functional test

*U.S. list price only.

for the highest reliability.

To hear more reasons why the 3900 is the engineer's ultimate programmer, call today. We'll send you a FREE copy of our popular Wall Chart of Programmable Devices.

1-800-3-DataIO
(1-800-332-8246)

DATA I/O

The Software is the Instrument ... You Choose the Computer

LabWindows for DOS

NEW LabVIEW for Windows
NEW LabVIEW for Sun
LabVIEW for Macintosh

ACQUISITION

```

PROGRAM: C:\Programs\National Instruments\LabView\Examples\
double wave1[1024], wave2[1024];
double freq1[1024], freq2[1024];
double delta_t1, delta_t2;
double trig_pos1, trig_pos2;

main () {
  ~ Initialize and configure scope ~
  tek2400_init (1);
  tek2400_set_vertical_mode (2);
  tek2400_set_vertical (1, 50.00, 1, 0, 0);
  tek2400_set_horizontal (0, 20.0e-9, 20.0e-9, 20.0e-9, 512);
  tek2400_set_a_trigger (0.0, 1, 15, 0, 0, 0);
  ~ Acquire waveforms ~
  tek2400_read_waveform (1, wave1, delta_t1, &trig_pos1);
  tek2400_read_waveform (2, wave2, delta_t2, &trig_pos2);
}
    
```

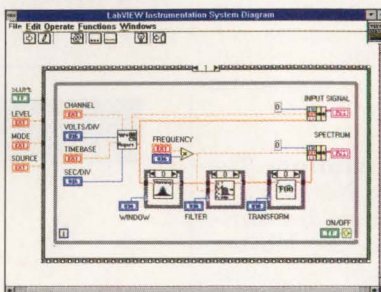

GPIB • Data Acquisition • VXI • RS-232 • Instrument Drivers

ANALYSIS

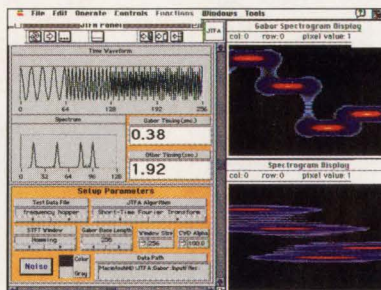
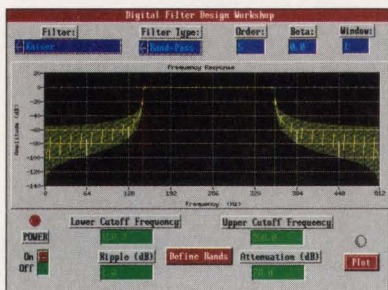

DSP • Statistics • Linear Algebra • Filters • Windows

PRESENTATION

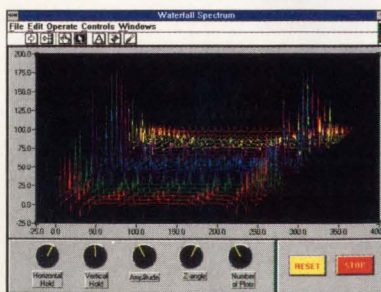
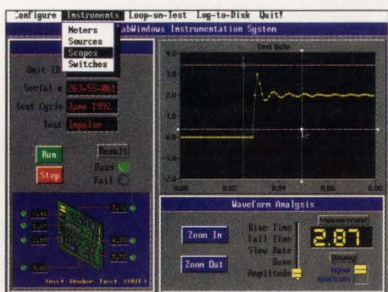

Graphical User Interface • Hard Copy • File I/O

C and BASIC Programming

Graphical Programming



Call for **FREE** demo disks
(800) 433-3488 (U.S. and Canada)

Branch Offices: Australia 03 879 9422 • Belgium 02 757 00 20 • Canada 519 622 9310
Denmark 45 76 73 22 • Finland 90 524566 • France 1 48 65 33 70 • Germany 089 714 50 93
Italy 02 48301892 • Japan 03 3788 1921 • Netherlands 01720 45761 • Norway 03846866
Spain 91 896 0675 • Sweden 08 984970 • Switzerland 056 27 00 20 • U.K. 0635 523545
© Copyright 1992 National Instruments Corporation. All rights reserved. Product and company names listed are trademarks or trade names of their respective companies.



6504 Bridge Point Parkway
Austin, TX 78730-5039
Tel: (512) 794-0100
Fax: (512) 794-8411

LabWindows®

LabVIEW®

DESIGNING YOUR OWN SWITCHING CIRCUITS? WHY RE-INVENT THE WHEEL?

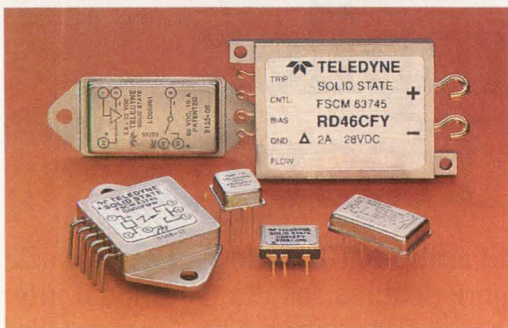

TELEDYNE SOLID STATE HAS IT!

If your system requires I/O or power switching and you're considering a discrete or hybrid circuit approach we should talk! And here's why —

- We now offer an extensive "menu" of military/aerospace solid state relays for DC, bi-directional, and AC loads from low level to 25 Amps.
- Our latest designs feature "smart" options

such as: output status for built-in test, short circuit protection and CMOS logic compatibility.

- All of our relays are designed and tested to MIL-R-28750 and applicable portions of MIL-STD-883, and most are qualified to existing MIL slash sheets or DESC drawings.

- We've already selected, derated, sourced, and qualified the required chip components, i.e., opto-couplers, drivers, FETs, SCRs, etc.

And if what you need is not in our catalog, call 1-800-284-7007, or FAX 1-213-779-9161. Chances are we're already working on it.

Home Office, 12525 Daphne Avenue, Hawthorne, CA 90250 • Telephone: 213-777-0077 • FAX: 213-779-9161

U.S. REGIONAL SALES OFFICES: EASTERN: (908) 272-0020, SOUTHEAST: (407) 682-9044, NORTH CENTRAL: (708) 529-1060, CENTRAL: (214) 348-0898, WESTERN: (408) 978-8899.
OVERSEAS: GERMANY, 0611-7636-0, ENGLAND: (081) 571-9596, FRANCE: 47-61-08-08, BELGIUM: (02) 673-99-88, JAPAN: (3) 3797-6956.

TELEDYNE SOLID STATE
A Division of Teledyne Relays

S T A N D I N G S

	W O N	L O S T	TOY PROGRAM		REAL PROGRAM					
			DHRYSTONES PER SEC.	% BEHIND	EXECUTION TIME SEC.	% BEHIND	CODE SIZE IN BYTES	% BEHIND	COMPILATION TIME MIN.	% BEHIND
SIERRA SYSTEMS	12	0	31604	—	5.73	—	284708	—	5.07	—
GNU	9	3	24390	30%	6.11	7%	298616	5%	17.12	238%
MICROTEC RESEARCH	7	5	23854	32%	6.49	13%	295466	4%	19.50	285%
OASYS/GREEN HILLS	6	6	28571	11%	7.80	36%	334632	18%	36.18	614%
INTERMETRICS	4	8	23234	36%	7.50	31%	314924	11%	17.11	238%
INTROL	4	8	19098	65%	7.03	23%	301524	6%	16.48	225%
SOFTWARE DEV. SYS.	0	12	16415	93%	9.47	65%	313360	10%	16.93	234%

68000 Compiler Benchmark Results.

Sierra Systems undefeated on the 68040.

Two benchmarks were selected, Dhrystone 2.1 (the Toy program) and the Sierra Systems production C compiler (the Real program). The compiler was selected because both its size and complexity are representative of real-world applications.

The Sierra C™ compiler delivers unchallenged compilation times with industry leading run-time performance on all applications. Add our equally fast QuickFix™ source-level debugger, and you have a package with all the quality, speed, and ease-of-use demanded by today's design teams.

68332 and 68010 standings also available.

For more detailed results, additional information, and a competitive edge for your products, call **800-776-4888**.

Won/Lost Record: For each benchmark, the compilers' run-time performances were compared to each other with wins and losses tallied in round-robin fashion. (See Dhrystones and Execution Time columns on scoreboard.)

Compilers: GNU 2.0, Intermetrics 8.0, Intral 3.06, Microtec Research 4.2d, Oasys/Green Hills 1.8.5Rc, Sierra Systems 3.0, Software Development Systems 5.1.

Hosts: 33 MHz 386 Zeos PC and Sun SPARCstation IPC. All compilers were run on the PC, except for GNU and Oasys/Green Hills, which were run on the Sun. Running the Sierra Systems compiler on both host systems allowed the Sun times to be scaled to PC time for the scoreboard.

Target: Motorola VME167, 25 MHz 68040 with caches enabled.

Sierra Systems

6728 Evergreen Avenue, Oakland, California 94611
Tel (510) 339-8200 Fax (510) 339-3844

Surface-mount socket. This 100-position development socket is a surface-mountable component with essentially the same pc-board footprint as the quad flatpack (QFP) device. In this way, you can prototype a pc board using the socket and then transfer to production using bare QFPs, without board layout changes. \$35. **Altera Corp.**, 2610 Orchard Pkwy, San Jose, CA 95134. Phone (408) 984-2800. **Circle No. 413**

Interface converter. Model 285 RS-232C to RS-422/RS-485 interface converter can be configured in five user-selectable modes. This flexibility allows support of any master-slave configuration found in industrial applications. Other features include a DTE/DCE switch, TD and RD LEDs, and a programmable terminating resistor. \$148. **Telebyte Technology Inc.**, 270 E Pulaski Rd, Greenlawn, NY 11740. Phone (800) 835-3298; (516) 423-3232. FAX (516) 385-8184. **Circle No. 414**

Optical modules. The Astrotec 1238 transmitter operates at rates of 1200 Mbps. The 1318 receiver provides conversion for data rates of 20 to 1500 Mbps. The receiver's dynamic range measures 26 dBm. Both units are housed in 20-pin DIPs compatible with SONET standard packages. Model 1238, \$1295; 1318, \$1000. Delivery, 12 weeks ARO. **AT&T Microelectronics**, 555 Union Blvd, Dept 520404200, Allentown, PA 18103. Phone (800) 372-2447, ext 843; in Canada, (800) 553-2448, ext 843; (908) 771-2826. **Circle No. 415**

Sensing resistors. PMA-Cu and PMB-Cu 4-terminal resistors are rated for 1 and 2.5W, respectively. Designed for Kelvin measurements, the units are available with values as low as 0.001Ω. Construction features Manganin alloy foil banded to copper substrates for good thermal performance and accuracy to 0.5%. From \$1.50 (10,000). Delivery, stock to eight weeks ARO. **Isotek Corp.**, 566 Wilbur Ave, Swansea, MA 02777. Phone (508) 673-2900. FAX (508) 676-0885. **Circle No. 416**

Power supplies. PU110 Series supplies are available in single- (5V/22A, 12V/9A, 15V/7.5A, and 24V/4.5A) and multiple-output (combinations of 5V/10A, 12V/5A, 24V/1A, -5V/1A, and -12V/1A) models. Features include EMI filter, power-fail signal, overvolt-

age protection, and short-circuit protection. Efficiency equals 65%. \$115; less than \$60 (OEM qty). **International Power Sources Inc.**, 200 Butterfield Dr, Ashland, MA 01721. Phone (508) 881-7434. FAX (508) 879-8669. TWX 510-100-3630. **Circle No. 417**

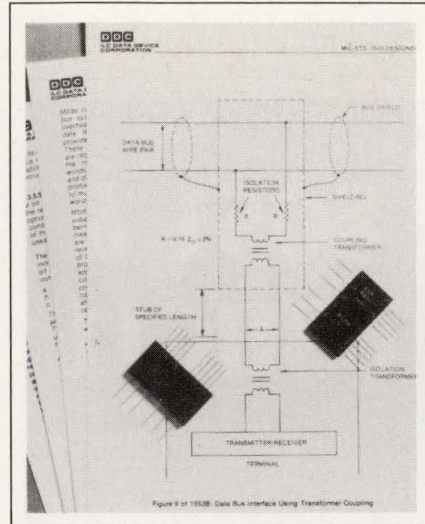

Low-profile transformers. DLP Series transformers have a 0.13-in.-high profile and are designed for MIL-STD-1553A or B serial-data-bus systems. The line includes 14 models that feature frequently used turns ratios. They are available with either straight tin-plated flatpack leads or tin-plated gull-wing leads for surface-mount packages. All units have center-tapped primaries and multitapped secondaries. \$125. Delivery, 12 weeks ARO. **Beta Transformer Technology Corp.**, 40 Orville Dr, Bohemia, NY 11716. Phone (516) 244-7393. FAX (516) 244-8893. **Circle No. 418**

LEDs. These multichip lamps have a warm white output. The units are available in T-1-3/4 and T-3-1/4 models with voltage ratings ranging from 5 to 120V ac and dc. Available bases range from midget flanged to miniature screw and include wedge, bi-pin, bayonet, and all telephone-style slide bases. Life ratings equal 100,000 hours. From \$4.99. Delivery, stock to 75 days ARO. **Lamp Technology**, 1645 Sycamore Ave, Bohemia, NY 11716. Phone (516) 567-1800. FAX (516) 567-1806. **Circle No. 419**

Connector. The DLM6 360 ZIF connector has 360 contacts and features an aluminum housing that provides EMI/RFI shielding. Lifetime equals 10,000 mating/unmating cycles. The gold over

beryllium copper contacts, rated for 5A/1200V ac, are available in either a crimp snap-in version or 0.025-in. square posts for pc-board and wire-wrapping applications. Less than \$150 (OEM qty) for a plug-receptacle pair. Delivery, 12 weeks ARO. **ITT Cannon**, 1851 Deere Ave, Santa Ana, CA 92705. Phone (714) 757-8257. **Circle No. 420**

Trimmer capacitors. Series 47000 trimmers are designed for RF and microwave applications. The units are supplied with either a removable cap or a poke-seal. The poke-seal replaces the traditional O-ring design. Voltage rating equals 500V and Qs measure 2500 min at 250 MHz. Operating range spans -65 to +125°C. \$6 (1000). Delivery, six to eight weeks ARO. **Johanson Manufacturing Corp.**, Rockaway Valley Rd, Boonton, NJ 07005. Phone (201) 334-2676. TWX 710-987-8367. **Circle No. 421**

Power supplies. The modular construction of the SPR5 Series 2000W power supply allows for as many as 15 outputs with an ac input and 9 outputs with a 48V dc input. The units are certified to UL1950 and IEC950 and feature fan cooling. Available options include battery backup, output paralleling with current sharing, and VME/VXI-compatible signals. \$1150 (100) for a 3-output model. **Power One**, 740 Calle Plano, Camarillo, CA 93010. Phone outside CA, (800) 235-5943; in CA, (800) 421-3439; (805) 987-8741. TWX 910-336-1297. **Circle No. 422**

Relays. Designed for switching capacitive loads, this line of relays includes 15 models capable of isolating as much as 65,000V dc and switching currents as high as 1500A at speeds of 500 nsec. The relays are sealed so there's no contact oxidation. In addition, the sealed units are compatible with applications involving explosive atmospheres. From \$105 (100). **Kilovac Corp.**, Box 4422, Santa Barbara, CA 93140. Phone (800) 253-4560; (805) 684-4560. FAX (805) 684-9679. **Circle No. 423**

Connector. The NE-1 is a metal-on-elastomer connector, which features more than 200 conductors per inch. With a 0.6-mm electrode, the unit can carry 100 mA/mm². With 0.25-mm-wide gold-plated electrodes, contact resistance measures less than 50 mΩ. The connectors are available in lengths

EDN-NEW PRODUCTS

Components & Power Supplies

ranging to 250 mm. \$1 per linear in. (1000). **Shin-Etsu Polymer America Inc.**, 34135 Seventh St, Union City, CA 94587. Phone (510) 475-9000. FAX (510) 475-0613. **Circle No. 424**

Edge connectors. Designed specifically for AT- and XT-compatible computers, Lyte Series connectors feature a double row of solder tails on 0.2-in. centers. Contact positions are 18/

36 + 31/62, 31/62, and 18/36. The units meet the performance criteria of MIL-C-21097 and operate over a -55 to +105°C range. \$0.24 to \$1. **Cinch Connectors**, 1500 Morse Ave, Elk Grove Village, IL 60007. Phone (708) 981-6000, ext 6043. **Circle No. 425**

Inductors. Series 2512 molded surface-mount power inductors cover a range of 1 to 100 μ H. Standard tolerance

equals 10%. Maximum current ratings range from 260 to 1640 mA. The solder-coated copper terminations are compatible with all soldering operations. \$0.599 (1000). Delivery, four to six weeks ARO. **American Precision Industries**, 270 Quaker Rd, East Aurora, NY 14052. Phone (716) 652-3600. FAX (716) 652-4814. **Circle No. 426**

LED lamps. SLR Series LEDs have a 10,000-hour operating life. Model SLR-56 is a T-1- $\frac{3}{4}$ lamp with an illumination of 6.3 to 10 mcd. Models SLR-37 and SLR-34 are T-1 devices with luminous intensities of 10 to 16 mcd. All units are available in red, red-orange, yellow, yellow-green, and green. From \$0.07 (1000). Delivery, eight weeks ARO. **ROHM Corp.**, 3034 Owen Dr, Antioch, TN 37013. Phone (615) 641-2020, ext 131. FAX (615) 641-2022. **Circle No. 427**

Headers. TMT Series surface-mount units are available with either single or double rows of contacts on 0.05-in. centers. Lead coplanarity measures 0.006 in., and the plastic housings can withstand infrared and vapor-phase soldering processes where temperatures do not exceed 230°C for 60 sec and 260°C for 10 sec. From \$0.038 per pin. **Samtec Inc.**, Box 1147, New Albany, IN 47151. Phone (800) 726-8329; (812) 944-6733. FAX (812) 948-5047. TLX 333918. **Circle No. 428**

Pin monitors. The PLcMO-84-ZL/A takes the place of 84-pin plastic leaded chip carriers (PLCCs) in a target socket. The hinged ZIF lid accepts PLCCs as well as J-bend and ceramic LCCs. The lid is rated for 10,000 insertions min. It accepts 50-mil pitch devices. The unit terminates in a male PLCC plug. \$221. **EDI Corp.**, Box 366, Patterson, CA 95363. Phone (209) 892-3270. **Circle No. 429**

Inductors. RL-3745 and RL-3750 devices are low-power inductors available in values ranging from 150 to 1000 μ H. Current ratings range from 0.5 to 1.7A. The devices are available in packages for vertical mounting with a pc-board footprint of 0.5 x 0.7 in. or in low-profile packages with a mounted height of 0.45 in. \$0.99 (1000). Delivery, stock to eight weeks ARO. **Renco Electronics Inc.**, 60 Jefryn Blvd E, Deer Park, NY 11729. Phone (516) 586-5566. **Circle No. 430**

8051 & 68HC11

PC-Based In-Circuit Emulators

Nohau Covers All Your Development Needs for the 8051 and 68HC11 Families!

Free Demo

You can start your debugging with this **FREE** demo simulator. You can load up to 512 bytes of code, assembler, C, or PL/M and do full debugging/simulation in assembly and source level. A great way to get started for **FREE**. Fantastic for schools! Just call and we'll send it!

Full Simulator

The full-blown simulator is an extension of the DEMO. You can load up to 64K of code and use 64K of XDATA space. You can program an "external environment" to interact with your code to simulate your target system. The emulator is the hardware extension of the simulator!

In-Circuit Emulation

The 30MHz real-time emulator has been the industry standard for years. With its complex breakpoint logic and advanced trace, nobody can beat it for performance. Plug-in or RS-232 configuration. All 8051 derivatives are supported!

NOHAU
CORPORATION

51 E. Campbell Avenue, Campbell, CA 95008
(408) 866-1820 • FAX (408) 378-7869

Call Nohau's 24-hour information center to receive info on your FAX 408-378-2912

Identical User Interface for All Three Products - You Can't Go Wrong!

Australia (02) 654 1873, Austria (0222) 38 76 38, Benelux +31 1858-16133, Canada (514) 689-5889, Czechoslovakia 0202-2683, Denmark (42) 65 81 11, Finland 90-452 1255, France (01)-69 41 28 01, Germany 08131-25083, Great Britain 0962-73 31 40, Greece 01-862-9901, Hungary (1) 117 6576, Israel (03) 48 48 32, Italy (011) 771 00 10, Korea (02) 784 784 1, New Zealand (09) 392-464, Portugal 01-80 9518, Norway 02-649050, Singapore (065) 284-6077, Spain (93) 217 2340, Sweden 040-9224 25, Switzerland (01) 740 41 05, Taiwan (02) 7640215, Thailand (02) 281-9596, Yugoslavia 061 621066.

Supporting Motorola's 68HC11, 68HC16 and many others ... Call for the complete list!

PENTICA SYSTEMS INC

IN-CIRCUIT EMULATORS

We love to solve puzzles!

Tom Baccei
President

Pentica Systems, Inc.
19A Crosby Drive
Bedford, MA 01730
Tel: (617) 275-4419
Fax: (617) 275-6514

#1. We stand by you.

"Plan for success! The right tools do the job right--
With Pentica emulators, solving puzzles can be FUN again!"

--Tom Baccei
President

CIRCLE NO. 123

MetaLink
Corporation

Melts the Price of 8051 ICE

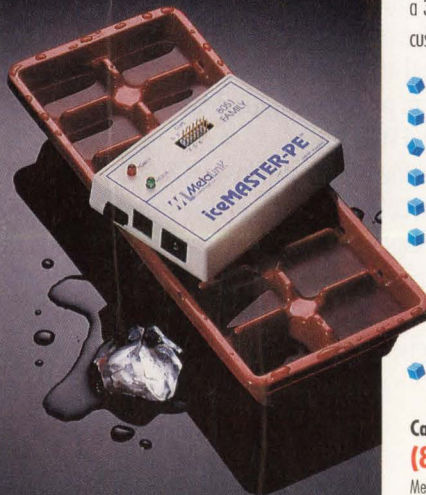

Only \$851 for iceMASTER-PE

The world's most innovative 8051 emulator is incredibly affordable. MetaLink's unique Advanced Emulation Technology (AET, patent pending) delivers the best possible emulator value for engineers, consultants and students.

AET is a revolutionary design architecture that provides more features with 75% fewer components, smaller board space and lower cost. Emulator and probe electronics are integrated in a single package only 3" by 4".

MetaLink also delivers leading-edge customer service, including a 30 day money back guarantee, 10 day trial for qualified customers, rental plans and free technical support.

- Up to 40 MHz Operation
- 64K Emulation Code Memory
- 64K External Data Memory
- 128K Hardware Breakpoints
- 16K Trace Memory
- Transparent Trace (View Trace While Executing)
- Real Time & Nonintrusive
- Symbolic & Source-Level Debug
- Built-In Self-Test
- Windowed User Interface
- Serial Link to Any PC
- Performance Analyzer
- Macro Cross Assembler
- Supports 8031 / 8032's
- Supports 8XC751 / 8XC752's



Call today for FREE DEMO DISK!

(800) METAICE (800) 638-2423

MetaLink Corporation P.O. Box 1329 Chandler, Az 85244-1329
Phone: (602) 926-0797 FAX: (602) 926-1198



CIRCLE NO. 124

HTBasic

DATA ACQUISITION

TransEra's 400 Series plug-in data acquisition boards transform your PC into a high-speed, high-precision system for a wide range of scientific test, measurement and monitoring applications.



The 400 Series combines all of the essential data acquisition system, including: DMA sample transfers from 50 to 200 KHz, up to 14 bit analog input and output, digital I/O, and counter-timers—all on half-sized cards for ISA 8 and 16 bit busses.

When you add HTBasic development software, you have the most powerful data acquisition system available for PC operation. HTBasic runs HP BASIC programs and offers advanced features like instrument control, data analysis, and graphic presentation capabilities.

So, put a powerful data acquisition system into your PC with TransEra's 400 Series plug-in boards and HTBasic. Find out more today.



TransEra

Engineering Excellence for 15 Years™

3707 N. Canyon Road • Provo, UT 84604
(801) 224-6550 • Fax (801) 224-0355

CIRCLE NO. 125

EDN September 17, 1992 • 171

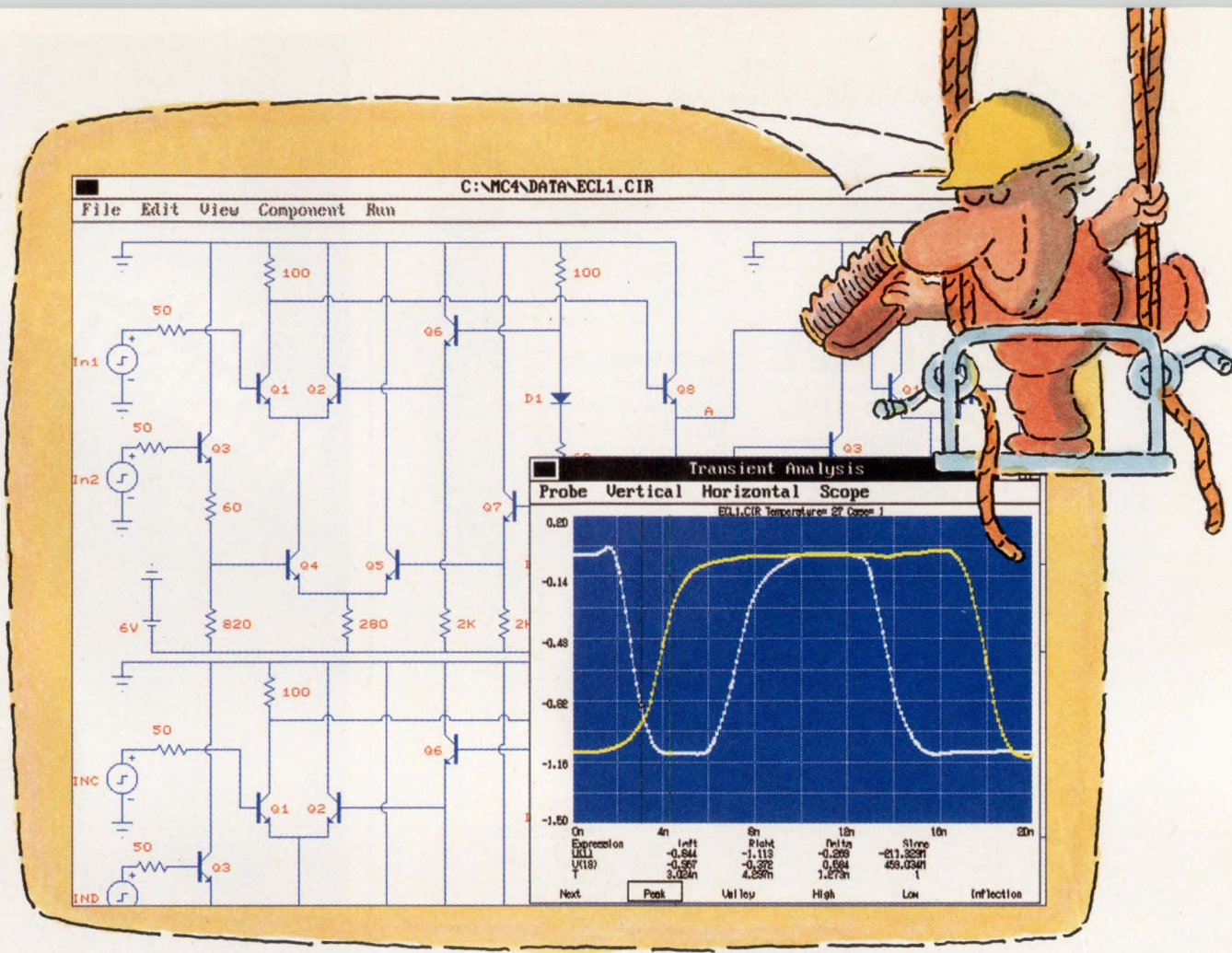

INTRODUCING MICRO-CAP IV.™ MORE SPICE. MORE SPEED. MORE CIRCUIT.

PC-based circuit analysis just became faster. More powerful. And a lot easier. Because MICRO-CAP IV is here. And it continues a 12-year tradition of setting CAE price/performance standards.

Put our 386/486 MICRO-CAP IV to work, and you'll quickly streamline circuit creation, simulation and edit-simulate cycles — on circuits as large as 10,000 nodes. In fact, even our 286 version delivers a quantum leap upward in speed. Because, for one thing, MICRO-CAP IV ends SPICE-file-related slowdowns; it reads, writes and analyzes SPICE text files and MC4 schematic files. It also features fully integrated schematic and text editors. Plus an interactive graphical interface — windows, pull-down menus, mouse support, on-line HELP and documentation — that boosts speed even higher.

Now sample MICRO-CAP IV power. It comes, for example,

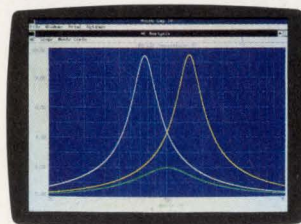

AC Analysis

from SPICE 2G.6 models plus extensions. Comprehensive analog behavioral modeling capabilities. A massive model library. Instant feedback plotting from real-time waveform displays. Direct schematic waveform probing. Support for both Super and Extended VGA.

And the best is still less. At \$2495, MICRO-CAP outperforms comparable PC-based analog simulators — even those \$5000+ packages — with power to spare. Further, it's available for Macintosh as well as for IBM PCs. Write or call for a brochure and demo disk. And experience firsthand added SPICE and higher speed — on larger circuits.

spectrum

1021 S. Wolfe Road
Sunnyvale, CA 94086
(408) 738-4387 FAX (408) 738-4702

EDN-NEW PRODUCTS

Test & Measurement Instruments

Low-cost, modular 200-MHz logic analyzers. You can configure the PM 3585/30 and PM 3585/31 with 32, 64, or 96 channels. Any channel can simultaneously capture data for state and timing analysis. The analyzers have support packages for more than 110 μ Ps, and the manufacturer is continually developing more. The /31 version works with IEEE-488.2 and SCPI (standard commands for programmable instruments), \$5450; \$5890 with IEEE-488.2 and SCPI support; upgrade to 64 channels, \$4975; upgrade to 96 channels, \$6995. **John Fluke Mfg Co Inc**, Box 9090, Everett, WA 98206. Phone (800) 443-5853; (206) 347-6100. FAX (206) 356-5116. TLX 185102. **Circle No. 405**

Philips Test and Measurement, Building TQIII-4, 5600 MD Eindhoven, The Netherlands. Phone local office. **Circle No. 406**

8-channel, 250k-sample/sec, simultaneous S/H ADC board for ISA bus. The DT2833 has eight differential inputs. It can simultaneously sample all of its input signals and then convert them with 12-bit resolution at 250k sam-

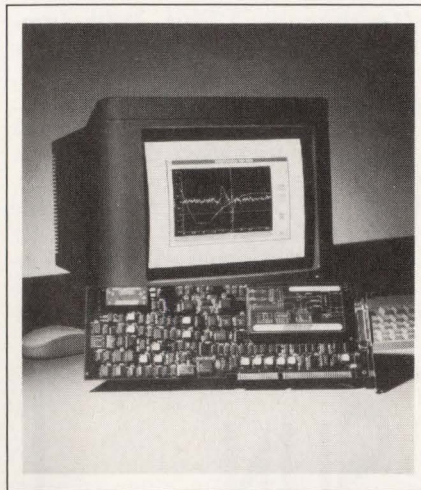

ples/sec. The board includes patented circuits that correct for offset on any channel. It also includes a pair of 12-bit D/A converters, eight lines of digital I/O, and two counter timers. The vendor supplies an MS-Windows data-acquisition library for its Global Lab software at no cost with the board. The library costs \$95 if purchased separately. You save \$1000 if, when you buy the board, you also buy Global Lab, its

signal-processing library, and printing module. \$2595. **Data Translation Inc**, 100 Locke Dr, Marlborough, MA 01752. Phone (508) 481-3700. FAX (508) 481-8620. TLX 951646. **Circle No. 407**

WAN protocol analyzer. The 4959A is intended for installation and maintenance testing of wide-area networks (WANs). It has an expansion slot that you can use to adapt it to testing of high-speed networks, such as 2-Mbps SMDS (switched-multimegabit data service) and frame-relay networks. The unit also runs MS-DOS application software on an 80386SX μ P with as much as 8 Mbytes of RAM. \$10,995; remote troubleshooting software, \$990. **Hewlett-Packard Co**, Box 58059, MS 51L-SJ, Santa Clara, CA 95051. Phone (800) 452-4844. **Circle No. 408**

Transformer tester. The AT3500 mounts on a bench top; it measures transformer turns ratios, mutual inductance, leakage inductance, magnetizing current, winding resistance, open-circuit voltage, and interwinding ca-

THREE THINGS To THINK ABOUT

*When You Select I/O
Cards For Your
PC-Based Data
Acquisition System...*

COST: Don't just **THINK** purchase price. **CONSIDER** the time and effort it takes to get your system up and running.

PERFORMANCE: **PONDER** hardware performance, but don't forget software, too!

AVAILABILITY: **THINK** off-the-shelf and then call **ACCES**. We've got a whole catalog full of PC-based I/O Boards.

Don't just sit there! Call us today!

ACCES
I/O Products, Inc.

TOLL FREE (800) 326-1649

9400 Activity Rd.
San Diego, CA 92126
(619) 693-9005
Fax: 619-578-9711

CIRCLE NO. 109

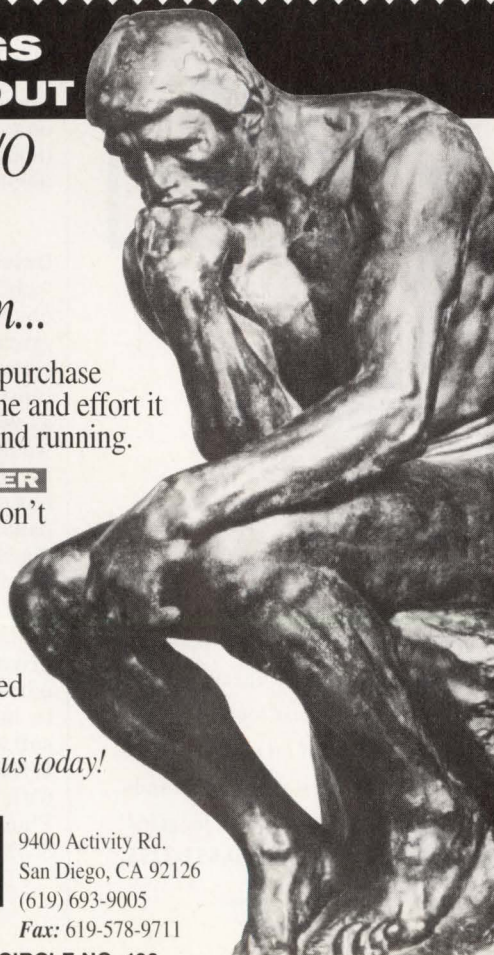

When
customers
demand
the best,
give 'em EL.

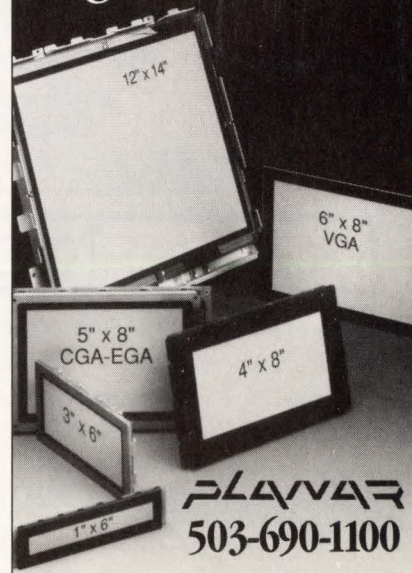

CIRCLE NO. 110 173

EDN-NEW PRODUCTS

Test & Measurement Instruments

capitance. It also measures line-frequency breakdown voltage between windings and from the windings to the core. You can vary the ramp and dwell times in breakdown tests. The unit can make most measurements at frequencies from 10 Hz to 1 MHz. It measures magnetizing current to 2.5 kHz. The tester operates in stand-alone mode or coupled to a PC. \$49,000. **Voltech Inc.**, 200 Butterfield Dr, Ashland, MA 01721. Phone (508) 881-7329. **Circle No. 409**

8/16-channel, 12-bit, 100k-sample/sec ADC boards for ISA bus. The DAS-1400 series includes two units, each with four programmable gains (1, 2, 4, and 8 or 1, 10, 100, and 500). A 3-channel programmable timer and several counters in the boards' ASIC provide flexible triggering. A burst mode mimics simultaneous S/H operation for slowly changing signals. The boards include eight digital-I/O channels. The vendor supplies drivers for several ver-

sions of Basic and a terminate-and-stay-resident application that lets you pop a control panel onto the screen. A \$99 software option includes drivers callable from programs in additional languages and file I/O drivers for all languages. \$699. **Keithley Metrabyte**, 440 Myles Standish Blvd, Taunton, MA 02780. Phone (508) 880-3000. FAX (508) 880-0179. **Circle No. 410**

PUT A SUNTM WORKSTATION ON YOUR DESK FOR ABOUT A GRAND.



TOMORROW.

It's called the Leasametric Workstation Rental Program. And it means that as an Authorized Sun Rental Company, we can get you the latest Sun workstations as soon as you need them. Perform any maintenance and



repair while you've got them. And you can send them back as soon as you are done with them. All on a payment program that can save you thousands.

Leasametric

Isn't renting grand?
1-800-553-2255.

Sun, Sun Microsystems and the Sun logo are trademarks or registered trademarks of Sun Microsystems, Inc.

CIRCLE NO. 112

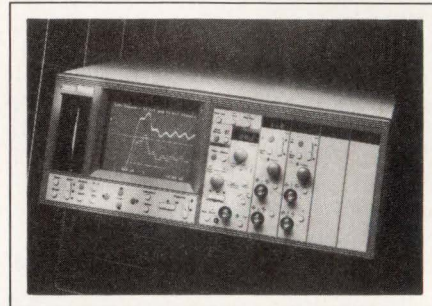

Deep-memory DSOs. The Pro 32 (2 channels, 12 bits, 20M samples/sec), Pro 42 (4 channels, 12 bits, 20M samples/sec), Pro 34 (2 channels, 14 bits, 5M samples/sec), and Pro 44 (4 channels, 14 bits, 5M samples/sec) are modular units that can have memory, which can store 4M samples. The Pro 92 includes both the 12-bit digitizer of the Pro 32 and 42 units and an 8-bit, 200M-sample/sec ADC. \$11,490 to \$29,990. **Nicolet Measurement Instruments**, 5225 Verona Rd, Madison, WI 53711. Phone (800) 356-8088; (608) 271-3333. FAX (608) 273-5061. **Circle No. 411**

Universal IC programmer. By using "job disks," production personnel can quickly set up the Allpro-88XR to program specific devices for specific applications. The job disk (a floppy disk) contains data and programming algorithms as well as command sequences that you would normally enter from the keypad or a host PC. The 88-pin programmer has a DAC-per-pin architecture and handles devices packaged in DIPs and plastic leaded chip carriers. It operates in stand-alone and PC-hosted modes and includes a floppy-disk drive, an LCD, and a keypad. A 40-Mbyte hard drive is optional. You can use either a parallel or a serial (57.6-kbps) interface to link the programmer to a PC. The software runs under MS Windows. \$9995. **Logical Devices Inc.**, 1201 NW 65th Pl, Fort Lauderdale, FL 33309. Phone (305) 974-0967. FAX (305) 974-8531. **Circle No. 412**

Minimum Daily Requirement

Compact TOKIN Surface Mount Devices get you through the day with flying colors.



When you need something extra to get you through your next project, try a dose of TOKIN Surface Mount Devices (SMDs). Designed to provide maximum working room in tight spaces, TOKIN SMDs offer the ideal remedy for downsizing computers and other electronic or communications equipment and systems. What's more,

TOKIN SMDs come in a wide range of sizes to ensure you of the right formulation for your own special needs. EMC components—such as EMC Chip Filters and ultra-small Solid Chip Inductors

and SN Coils—counter noise emissions from compact, high-frequency power supplies, data terminals, personal

computers, and so on. SMD Transformers make for easy high-density mounting on a wide range of communications equipment. And High-capacitance Multilayer Ceramic Capacitors enable automatic mounting on PC boards. If you're not getting the SMDs you need to get you through the day, be sure to call TOKIN.

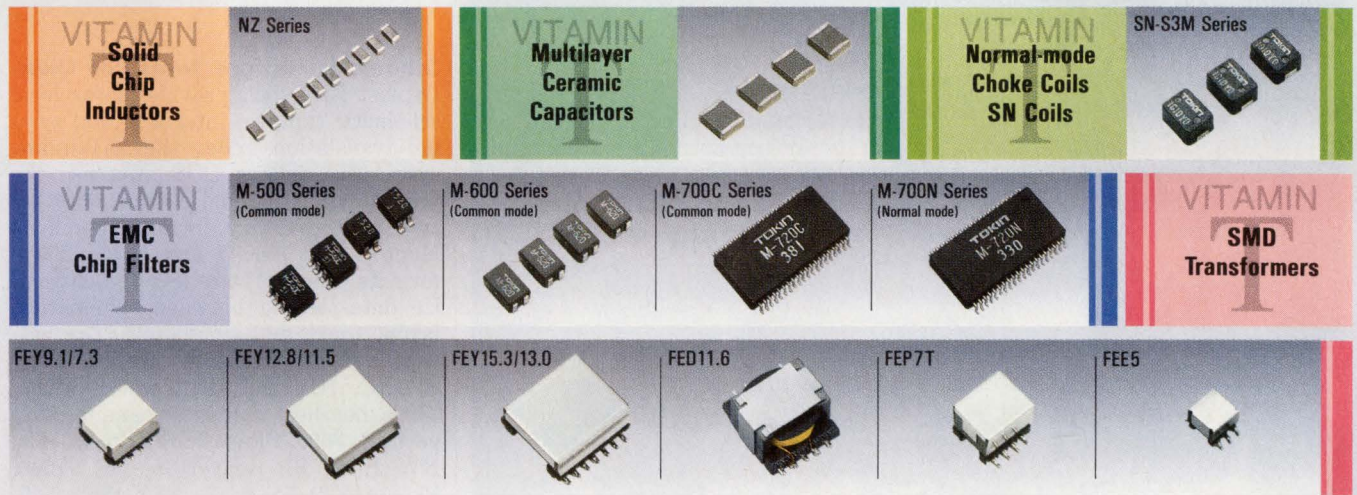

TOKIN

Tokin Corporation

Hazama Bldg., 5-8, Kita-Aoyama 2-chome, Minato-ku, Tokyo 107, Japan
 Phone: 03-3402-6166 Fax: 03-3497-9756
Korea Representative Office
 #602, Champs-Elysees Bldg., 889-5,
 Daechi-Dong, Kangnam-gu, Seoul, Korea
 Phone: (2) 569-2582-5 Fax: (2) 544-7087

Tokin America Inc.

155 Nicholson Lane, San Jose, California 95134, U.S.A.
 Phone: 408-432-8020 Fax: 408-434-0375
Chicago Branch
 9935 Capitol Drive, Wheeling, Illinois 60090, U.S.A.
 Phone: 708-215-8802 Fax: 708-215-8804
Boston Branch
 945 Concord Street, Framingham, Massachusetts 01701, U.S.A.
 Phone: 508-875-0389 Fax: 508-875-1479

Tokin Electronics (HK) Ltd.

Room 806 Austin Tower, 22-26A Austin Avenue,
 Tsimshatsui, Kowloon, Hong Kong
 Phone: 367-9157 Fax: 739-5950
Taiwan Liaison Office
 3F-4, No. 57 Fu Shing N. Road, Taipei, Taiwan
 Phone: (02) 7728852 Fax: (02) 7114260
Singapore Branch
 140 Cecil Street, No. 13-01 P1L Bldg., Singapore
 Phone: 2237076 Fax: 2236093, 2278772

Tokin Europe GmbH

Knorrstr. 142, 8000 München 45, Germany
 Phone: 089-311 10 66 Fax: 089-311 35 84

EDN-NEW PRODUCTS

CAE & Software Development Tools

Development tools. A set of integrated development tools for the Motorola CPU32 family of microcontrollers includes the Validate/XEL debugger interface and language tools, instruction-set simulator, Codetap, emulator, and support services. The tools run on PCs, Sun SPARCstations, and DECstations. Each tool priced separately, \$2000 to \$15,000. **Applied Microsystems Inc.**, Box 97002, Redmond, WA 98073. Phone (206) 882-2000. **Circle No. 351**



VHDL source-code libraries. The VHDL Source Model Libraries consist of a Small Scale Integration (SSI) Library with more than 600 standard logic parts and a Memory Library with more than 1200 commonly used memory devices including static RAMs, dynamic RAMs, and EPROMs. Both libraries comply with VHDL (VHSIC Hardware Description Language) IEEE-1076 and run in Mentor System 1076, Cadence VHDL-XL, Viewlogic Viewsim, Synopsys VHDL System Simulator, and Vantage Spreadsheet. Site licenses for Memory Library, from \$18,000; for SSI Library, from \$12,000. **Logic Modeling Corp.**, 1520 McCandless Dr, Milpitas, CA 95035. Phone (408) 957-5200. FAX (408) 945-9181. **Circle No. 352**

High Voltage 20¢/Volt

The PS300 programmable power supply series provides up to 5kV at 25 Watts for laboratory and ATE applications. These supplies offer a wide range of features including programmable current and voltage limits, selectable overload response, and short circuit protection.

Dual LED displays monitor both output current and voltage, while a third display allows error-free front panel entry. A full GPIB interface is available for ATE systems.

The combination of features, price, and performance make the PS300 series the perfect choice for laboratory or systems use.

\$1150

PS350	0 to 5kV
PS325	0 to 2.5kV
PS310	0 to 1.25kV

25 Watts output power
0.001% regulation
0.1% accuracy
Low output ripple
Dual polarity
Voltage and current readouts

GPIB Interface **\$495**



Stanford Research Systems

1290 D Reamwood Avenue, Sunnyvale, CA 94089
TEL (408) 744-9040 FAX 4087449049 TLX 706891 SRS UD

CIRCLE NO. 113

Nonlinear curve-fitting software. Peakfit 3 is an update to the company's chromatography/spectroscopy-analysis software package for PCs. The analysis techniques use nonlinear curve fitting to reduce noise and separate and characterize unresolved peaks in overlapping peak data. You can observe and control the nonlinear fitting process graphically on screen. \$595. **Jandel Scientific**, 2591 Kerner Blvd, San Rafael, CA 94901. Phone (800) 874-1888; (415) 453-6700. FAX (415) 453-7769. **Circle No. 353**

Schematic-capture tools for Unix. Capfast EDA tools provide hierarchical schematic capture, interface, and symbol translation under the X-Window system as well as DOS. You use the tools to translate and extract data between proprietary formats, such as Mentor, and ASCII and EDIF 2 0 0 formats. The software lets you customize data-passing between schematics, layout tools, and simulators. The network version runs under Unix on Sun/SPARC, HP, and DEC workstations. \$4995 per host computer; annual support fee, \$600. **Phase Three Logic**, 1600 NW 167th Pl, Beaverton, OR 97006. Phone (503) 645-0313. FAX (503) 645-0207. **Circle No. 354**

Internal and boundary-scan test translation. With software called TSSI version 5.0 you do scan test using existing testers and without dedicated scan-test hardware. The Waveform Database portion of the software stores, edits, manages, and augments test data produced by CAE tools such as those from Cadence, Synopsys, and Texas In-

struments. The software combines scan and primary input and output values with timing information, tester protocols data on shift chain order and produces programs that are tester ready. From \$10,000. **TSSI**, 8205 SW Creekside Pl, Beaverton, OR 97005. Phone (503) 643-9281. FAX (503) 646-4954.

Circle No. 355

Synthesis tools. The suite of synthesis tools called Dazix Synergy Synthesis assists with the design of ASICs. The software provides Archsyn for behavioral synthesis of VHDL, Verilog, and C HDLs (hardware-description languages), \$15,000; Macrosyn for datapath synthesis, \$10,000; Logsyn for timing-driven logic synthesis and optimization, \$30,000; Testsyn for test synthesis and automatic test-pattern generation, \$25,000; and Libsyn for building synthesis models, \$10,000. **Dazix**, 1 Madison Industrial Park, Huntsville, AL 35894. Phone (205) 730-2000. FAX (205) 730-8344.

Circle No. 356

DSP source-code interface. Using any one of more than 35 plug-in DSP boards, Hypersignal-Macro lets you create and add DSP algorithm and product code. The DSP Source Code Interface available for a variety of popular DSP chips, contains a library of math and DSP routines. The interface allows transfer of data, such as data recording, instrumentation, measurement, and simulation acceleration, between the DSP chip and the software. Hypersignal-Macro software, \$989; DSP Source Code Interface, \$795. **Signalogic**, 9704 Skillman, #111, Dallas, TX 75243. Phone (214) 343-0069. FAX (214) 343-0163.

Circle No. 357

Numeric compiler. Adding to the High Tech Basic product line, the HTBasic DOS 386/486 Numeric Compiler focuses on the subroutines, which often require the greatest amount of time to execute. The compiler lets you produce numeric-intensive subprograms without requiring additional programming skills. The company claims that much of the PC-based Rocky Mountain Basic code will run at speeds comparable to the fastest HP Basic workstations. \$1325. Upgrade for current HTBasic users, \$450. **Transera Corp**, 3707 North Canyon Rd, Provo, UT 84604. Phone (801) 224-6550. FAX (801) 224-0355. TLX 296438.

Circle No. 358

Behavioral model synthesis. Analog Model Synthesis for the company's Saber simulator eliminates the use of equations or modeling code to create behavioral models. Instead, it uses graphical data from previous simulations or laboratory instrument readings and automatically transforms them into behavioral models. \$2000. **Analogy Inc**, 9205 SW Gemini Dr, Beaverton, OR 97075. Phone (503) 626-9700. FAX (503) 643-3361.

Circle No. 359

Multidescription design-capture tools. Design Expressions, a suite of multidescription design-capture tools, lets you define functionality at any level of abstraction by a variety of familiar graphical and textual methods. It includes gate-level designs with schematic capture, register transfer level with state machines, graphical state diagrams, truth tables, and Boolean equations; behavior, structural and data-flow designs with VHDL syntax-

DESIGNED TO MEET YOUR SMALLEST EXPECTATIONS

Toyocom's surface mount clock oscillator for computer applications is the ideal SMD - small and compact, yet designed to deliver exceptionally high frequency stability.

Whether your automated assembly application involves IR reflow or vapor phase mounting, you can rely on our SMD to meet your toughest performance specs.

Let us develop a surface mount oscillator to meet your unique requirements. Contact TOYOCOM, 617 E. Golf Road, Arlington Heights, IL 60005.

Phone Toll-Free today **1-800-TOYOCOM**.

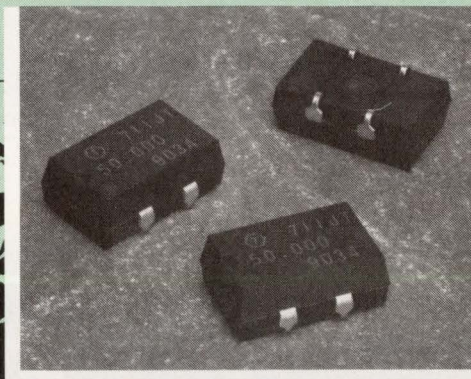

TOYOCOM

TIMING IS EVERYTHING

CIRCLE NO. 114

EDN September 17, 1992 • 177

EDN-NEW PRODUCTS

CAE & Software Development Tools

directed editor; and analog behavioral-level designs. \$15,000. **Dazix**, 1 Madison Industrial Park, Huntsville, AL 35894. Phone (205) 730-2000. FAX (205) 730-8344. **Circle No. 360**

ROM development kit. C-thru-ROM version 2.00 is a development kit to build stand-alone programs that run from ROM on Intel's 80x86 or NEC's



V-Series CPUs. It works with Microsoft C7 or C++, Borland C++, and the manufacturer's ROMview debugger. The ROMview debugging tool lets you start remote debugging on a stand-alone target system without tying up target-system serial ports or RAM. ROMview works with Borland's Turbo Debugger or the company's RDEB debugger. C-thru-ROM, \$495; ROMview, \$395. **Datalight**, 307 N Olympic Ave, Suite 201, Arlington, WA 98223. Phone (800) 221-6630; (206) 435-8086. FAX (206) 435-0253. **Circle No. 361**

Where you make the right contact.

Further information can be obtained from:
Münchener Messe- und
Ausstellungsgesellschaft mbH
Postfach 12 10 09
D-8000 München 12
Tel. + 49 89 / 51 07 0
Fax + 49 89 / 51 07-312

Electronica is the world's largest trade fair for electronic components and assemblies. Here state-of-the-art technology is on display, and developments, trends, methods and solutions are showcased in a comprehensive, precise, clear and up-to-the-minute style.

Accompanying events at a glance
Congresses and lectures on the following subjects will take place during electronica 92:

- 6th International conference on power semiconductors and their applications
- Smart sensors – markets and state of the art
- Quality management within the scope of international standards
- Technical experience with the GSM mobile radio network

Engineering-change-order software. Sherpa/View lets you view and comment on documents electronically, eliminating serial, paper-based approval processes. The product is integrated in Sherpa/PIMS, the company's information-management system, which eliminates the need for CAD seats for simply viewing documents; you can view data and make annotations from a 386-based PC on the network. Single copy, \$745 to \$1445. **Sherpa Corp**, 611 River Oaks Pkwy, San Jose, CA 95134. Phone (408) 433-0455. FAX (408) 943-9507. **Circle No. 362**

Real-time operating system. OS-9000 version 1.3 allows real-time data-acquisition and control tasks to be combined with DOS supervisory or postprocessing programs. The package includes VPC (Virtual PC), a DOS emulation program that runs DOS and Windows programs under OS-9000. The module emulates the DOS BIOS from OS-9000 RAM and transfers data between the two operating systems. \$995. **Micro-ware Systems Corp**, 1900 NW 114th St, Des Moines, IA 50325. Phone (800) 475-9000; (515) 224-1929. FAX (515) 224-1352. TWX 910-520-2535. **Circle No. 363**

Test system for ICs. The Analytical Probestation is an integrated system for CAD-driven probing and testing of complex integrated circuits. The system combines accurate probing and automated layout integration for verification, characterization, and failure analysis. The integrated system eliminates the need to assemble lab components from various sources. XL/ATS configuration, \$400,000. **Integrated Measurement Systems Inc**, 9525 SW Gemini Dr, Beaverton, OR 97005. Phone (503) 626-7117. FAX (503) 644-6969. **Circle No. 364**

MESSÉ MUNICHEN INTERNATIONAL

10 – 14 November

Munich

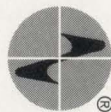

electronica 92

CIRCLE NO. 115

EDN

PRODUCT MART

This advertising is for new and current products.

Please circle Reader Service number for additional information from manufacturers.

EXPRESS

PROTO

Best Value in the World

for
5

DAY TURN

PRINTED CIRCUIT PROTOTYPES

2 PIECE PRICES

LAYERS	1	2	3&4	5&6	7&8
15	\$212	\$265	\$581	\$715	\$850
30	240	300	658	815	983
60	283	354	775	954	1034
90	325	407	891	1097	1304
120	350	442	949	1092	1417

- 5 PIECES x 1.34
- 10 PIECES x 1.67

EXTRAS

- Photo Plotting
- Testing
- Gold Contacts - \$50
- 25% - Below 8 Mil

DISCOUNTS

10%  **5%**

- COD
- NET 10
- CREDIT CARD SALES

FOR MORE INFORMATION CALL OR FAX

Ken Bahl
Sierra Circuits, Inc.
Phone (408) 735-7137 FAX (408) 735-1408 Modem (408) 735-9842

CIRCLE NO. 325

Looking for a Quality Programmer?

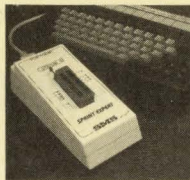

SPRINT Universal Programmers

Call now and find out why Sprint is the fastest growing 84 pin programmer in North America.

Tel 800/722-4122 FAX 206/883-8601 for a free demo disk

SMS
North America Inc.

CIRCLE NO. 326

INDUSTRIAL PC SINGLE BOARD COMPUTER & BACKPLANE B'D

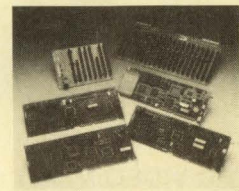

- Full surface mount technology.
- Single board is compatible with IBM and PC bus system. And all kind of industrial PC I/O board.
- 286C-12, 386SX-16/20, 386DX-33 CPU board.
- 6, 8, 12, 14, 18, 20 slot backplane board.
- Split backplane board is available.
- 19" rackmount PC enclosure is available.
- Centralized LAN station system (security)

COMY TECHNOLOGY

62 Bonaventura Dr.
San Jose, CA 95134

Tel #: California: 408-456-0333
Nationwide: 800-875-0333
Fax #: 408-456-0366

CIRCLE NO. 327

NEW! Little PLC™ \$195

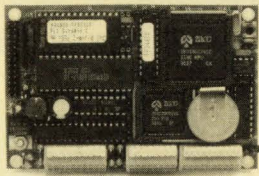

Program It In C

Our new Little PLC™ measures only 4.33 x 2.85 inches and can mount on standard DIN rail. This miniature controller costs only \$195, including 8 optically isolated inputs and 8 relay driver outputs. Low cost expansion cards allow you to add more inputs and outputs: digital and analog. It has dual RS-485 serial I/O, battery backed memory and time/date clock, programmable timers and a watchdog. Our easy to use and affordable Dynamic C™ integrated development system also costs \$195. You can write simple programs in an hour, or you can develop major applications with 20,000 lines of C language.

Z-World Engineering

1724 Picasso Ave., Davis, CA 95616
(916) 757-3737 Fax: (916) 753-5141
24 hr. Automatic Fax: (916) 753-0618
(Call from your fax, request catalog #18)

CIRCLE NO. 328

ROM-IT™ EPROM EMULATION SYSTEM

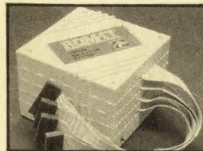

The Most Flexible EPROM Emulator You Can Get Today!

- Emulates up to 8 4-Megabit EPROMS through one standard serial port.
- Downloads 2-Megabit programs in less than 23 seconds.
- Allows you to examine and modify individual bytes or blocks.
- Accepts Intel Hex, Motorola S-Record and Binary files.
- Software available for IBM PC and compatibles.
- Base 27256 EPROM System \$395.00. Other configurations available.

ORDER TODAY--IT'S EASY
CALL OR FAX FOR MORE INFORMATION



Incredible Technologies, Inc.
(708) 437-2433
(708) 437-2473 Fax
Visa and MasterCard accepted.

CIRCLE NO. 329

UNIVERSAL PROGRAMMER, EMULATOR & TESTER

TUP-400 \$745.00 NEW
TUP-300 \$575.00 NEW



- New improved hardware and software.
- The most complete PC-based Universal Programmer. Programs PLD (PAL, GAL, FPL, EPLD, PEEL, MAX, MACH...), EPE PROM (up to 16 Mbit), Flash EPROM, B-PROM, Special PROM, MPU (87XX, 68XX, Z8, PSD301, PIC16XX, PIC16XX, TMS320EXX, UPD75PXX, HD637XXX...).
- Covers DIP, PLCC, QFP, SDP, and PGA with 8 to 84 pins. Gang Programming adapters available also.
- EPROM EMULATION capability.
- Tests digital ICs and DRAMs (SIMM/SIP adapter available).
- Free software updates and new devices added upon request.
- IC Manufacturers' approval.
- 1 year warranty, 30 day money back guarantee.

Supports Motorola and PIC MICROS, WSI PSD 3XXX, MAX and MACH.

CALL TODAY FOR MORE INFORMATION. Distributors are welcome!



Tribal Microsystems Inc.
44388 S. GRIMMER BLVD. FREMONT, CA 94538
TEL: (510) 623-8859
FAX: (510) 623-9925

CIRCLE NO. 330

DEVELOPER'S TOOLS

To advertise in Product Mart, call Joanne Dorian, 212/463-6415

Control Cross-C

Full ANSI Cross-C Compilers & Assemblers

- ◆ HD64180, HD647180X, Z80, Z180/1/2, Z280, 8085.
 - ◆ DOS based cross-compilers for ANSI and K&R C code.
 - ◆ C & assembler demos available on 24 hour BBS.
 - ◆ **Completely automatic MMU support (no programming effort) for UP TO 1 MEG Z180 programs.**
 - ◆ Includes HD64180/Z180 support library with source.
 - ◆ Comes with high-speed assembler, linker, and librarian.
 - ◆ Includes macros to interface C and assembly.
 - ◆ All ANSI .H files and libraries provided. Source available.
 - ◆ Generates inline port I/O. Char types are not promoted to int.
 - ◆ Allows in-line assembly with access to C variables.
 - ◆ All code is reentrant and ROMable.
 - ◆ Fast ANSI/IEEE 754/INTEL floating point support.
 - ◆ Supports C ISR's. Can compile to user defined segments.
 - ◆ 32 functions of real-time exec. (RTX) accessible from C.
 - ◆ RTX - 256 tasks, queues, & boxes w/ full interrupt support.
- ANSI C Compiler, Assembler, Linker - \$699**
Assembler and Linker Only - \$279
32 Fn. Real-Time Executive incl. Source - \$399



SOFTTOOLS, INC.
 8770 Manahan Drive
 Ellicott City, MD 21043
 (410) 750-3733
 FAX/BBS (410) 750-2008

CIRCLE NO. 331

TURBO 320 Realtime DSP Development System

User application daughter board

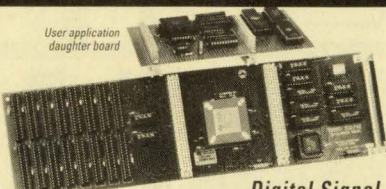

Digital Signal Processor development environment using TI's TMS320C30 40 MHz floating point DSP and the TI Compiler, Assembler, Linker and Debug software.

FEATURES
 Optional daughter board interface • 8 Mb RAM
 40 MHz speed • TI Software compatible



WINTRISS ENGINEERING CORPORATION
 PO Box 230035, Encinitas, CA 92023
800-733-8089

CIRCLE NO. 332

SCANTEAM® COMPONENT PRODUCTS

FIXED MOUNT MOVING BEAM BAR CODE SCANNER

Welch Allyn's SCANTEAM® 5600

is a high performance, laser diode based bar code scanner. Its rugged housing and mechanical design, together with all solid state electronics, combine to produce a highly reliable product which features:

- **Compact Design** (2.3" x 2.3" x 2.7")
Ideal for applications where mounting space is limited
- **Non-Contact Scanning**
Scans on curved and irregular surfaces in hard to reach locations
- **Scan Range** (From 2.0" to 6.0")
Adaptable to meet system requirements

Welch Allyn WA®

Jordan Road, Box 187
 Skaneateles Falls, New York 13153-0187
 For more information call 1-315-685-8945

CIRCLE NO. 333

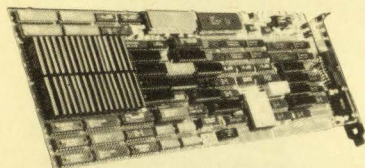

4MEG VIDEO Model 10 Flexible Image Processor and Application Accelerator For The PC/AT

- 8 to 8000 Pixels per Line
- 2 to 19 MHz sampling/display rate
- 10 MIPs Programmable Accelerator
- 4 Megabytes of Reconfigurable Image Memory
- RS-170, RS-330, and CCIR input/output
- Variable timing for nonstandard formats
- Genlock to external timing sources
- Analog or digital inputs
- Software programmable timing/resolution

EPIX®

3005 MacArthur Blvd., Northbrook IL 60062
708-498-4002 FAX: 708-498-4321

CIRCLE NO. 334

DSP & DATA ACQUISITION

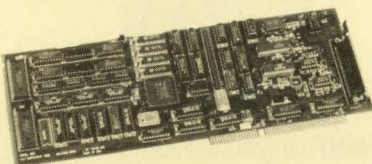

- TMS320 DSP's
- Multi-channel 250 KHz Analog I/O
- Development, FFT, Data Acquisition & Signal Display Software
- Other DSP Products Available

DALANCO SPRY

89 Westland Avenue, Rochester, NY 14618
(716) 473-3610
 Fax (716) 271-8380

CIRCLE NO. 335

Communicate Weekly

to the electronics
**OEM through
 EDN's Magazine
 and News Editions
 Product Mart**

CIRCLE NO. 336

Imagine if
YOUR
 product
 could
 talk!

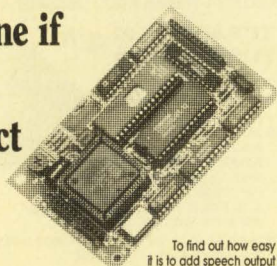

To find out how easy it is to add speech output to your own products, call for your free V8600 data book today!

- Converts plain ASCII text into high quality speech
- Unlimited vocabulary—no custom recording necessary
- Requires only a single 5V supply and speaker
- Built in µP, serial and printer interfaces
- Less than \$100 in OEM quantities
- Customization services available

RC SYSTEMS
 121 W Winesap Rd - Bothell, WA 98012

USA/Canada Phone/Fax: (206) 672-6909
 UK/Europe 81 539 0285 Fax: 81 558 8110

CIRCLE NO. 337

48 Channel 50MHz Logic Analyzer

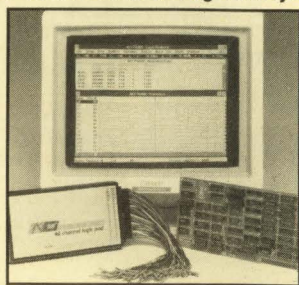

Complete System \$1895.00
New Windows 3.0 Compatible Software

- 48 Chnlns @ 50 MHz x 4K words deep
- 16 Trigger Words/16Level Trigger Sequence
- Storage and recall of traces/setup to disk
- Disassemblers available for: 68000, 8088, 8086, 6801, 6811, Z80, 8085, 6502, 6809, 6303, 8031

NCI □ 6438 UNIVERSITY DRIVE,
 HUNTSVILLE, AL 35806
 (205) 837-6667 FAX (205) 837-5221

CIRCLE NO. 338

MP-51



EPPL, MICROCONTROLLER AND EPROM PROGRAMMER

Supported Devices: DIP, PLCC and QFP Microcontrollers (8751H/BH, 87C51/2, 87C51FA/FB/FC/GB, 87C751/2, 87C652/4, 87C528, 87C550, 87C552, 87C562, 87C451, 87C592 and more), EPROMs (2716 to 27040 NMOS and CMOS) and EPLDs (Signetics/Atmel 22V10, ATV750, ATV2500 and ATV5000).
 Serially linked to a PC. Lock Bits, Encryption Tables and Security bits are supported.

AVAILABLE IN GERMANY FROM CEIBO-DARMSTADT
 TEL 06151/9932-0 FAX 06151/993299

CEIBO 1 BALLARD TERRACE LEXINGTON MA 02173
 TEL: 617-863-9927 FAX: 617-863-9649

CIRCLE NO. 339

To advertise in Product Mart, call Joanne Dorian, 212/463-6415
180 • EDN September 17, 1992

Advin

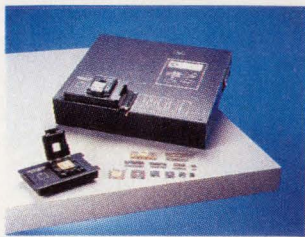

ADVIN versus DATA I/O

- **Data I/O and Model 2900:** reputable company, dependable equipment, supports 40-pins. Software updates: fair amount.
- **Advin and PILOT-U40:** reputable company, dependable equipment, supports 40-pins. Software updates: free via electronic BBS.

ADVIN SYSTEMS INC.

Smaller Company, Better Service.
800-627-2456, 408-243-7000, Fax 408-736-2503

CIRCLE NO. 340

TESLA

PC Block Diagram Simulator

Simulate Complete Analog/Digital ASICs and boards fast!

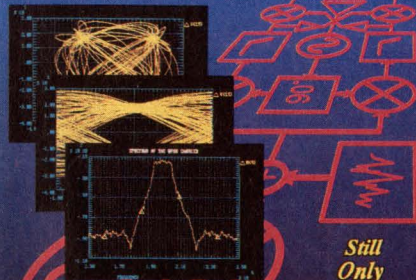

Still Only \$695!

Modems, HDTV, GPS, controls, synthesizers, DSP - any system!

Build up to 800-block systems. Hi-res graphics: time plots, spectrum analysis, XY plots. Do diagrams with OrCAD. Add new blocks with MODGEN option. Call for demo disk 404-751-9785 fax404-6645817 TESOF Inc, PO Box 305, Roswell, GA 30077

CIRCLE NO. 341

Tiny Embedded 386SX

-40° to +85° C

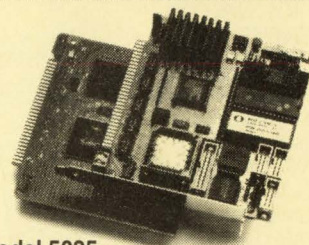

Model 5025

- ▶ 386SX, 25 MHz
- ▶ 4.5" x 4.9"
- ▶ 3 solid-state disks
- ▶ Low power CMOS
- ▶ Rugged, industrial quality
- ▶ Stand-alone or bus operation
- ▶ Flash memory programmer
- ▶ Coprocessor socket
- ▶ COM1, COM2, LPT1 ports
- ▶ 4 MB DRAM
- ▶ "Instant DOS" 3.31 in ROM
- ▶ Autoturn operation
- ▶ 5V only operation
- ▶ Keyboard/speaker port
- ▶ Watchdog timer
- ▶ Calendar/clock

THE MICROCOMP COMPANY

OCTAGON SYSTEMS
Tel: 303-430-1500, Fax: 303-426-8126

Call or Fax for full-line catalog

CIRCLE NO. 342

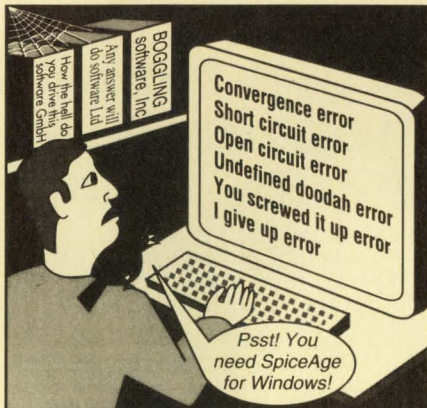

To hear more from the little bird about painless simulation phone Fred on 313 663 8810 (USA) or Charles on +44 (0)81 906 0155 (Europe)

TATUM LABS, INC Fax 313 663 3640
THOSE ENGINEERS LTD Fax +44 (0)81 906 0969

The Simulation People

CIRCLE NO. 343

LINK-56001



New emulator for Motorola's DSP56001

- True In Circuit Emulator (ICE)
- C and assembly language debugging
- Hardware breakpoint on program or data
- User-customized screen interface
- Slow motion and automatic screen update
- Graphical display of data
- Supports DSP56001 and DSP56002
- Emulates from 0 to 40 MHz
- PC based with mouse interface



1621 Scottsdale Dr.
Plano, TX 75023
(214) 985-7593
Fax: (214) 985-8579

CIRCLE NO. 344

THE EASY CHOICE

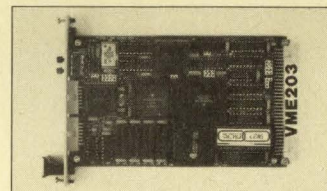

Micro-Link's VME203 SBC makes your design choice easy. Available in several configurations, VME203 prices start at less than \$1,025 in 100 piece quantities. Options include 68EC030 or 68030, FPU, 1 or 4 MB of DRAM with transparent refresh, burst mode Cache, up to 1 MB of EPROM, two RS-232 serial ports, and clock speeds of 16, 32 and 40 MHz. VME203 software support includes Microware OS-9, CrossCode, C FreeForm and Microbug II.

Micro-Link

Call For Your Free Configuration Guide:
1-800-428-6155 US & Canada
1-317-846-1721 International

CIRCLE NO. 345

REMOVE HARDWARE LOCKS

PROTECT YOUR INVESTMENT!
MAINTAIN PRODUCTIVITY!
Software utility that allows for the removal of hardware locks.

Available for most major CAD/CAM and PCB software programs

Easy - Simple - Guaranteed
Programs start at \$99.00 U.S.
Visa and Mastercard Welcome
Call or Fax for more Information

SafeSoft Systems Inc.
202-1100 Concordia Ave. Phone (204) 669-4639
Winnipeg, Mb. R2K 4B8 FAX (204) 668-3566
Canada

CIRCLE NO. 346

LaserPlotter

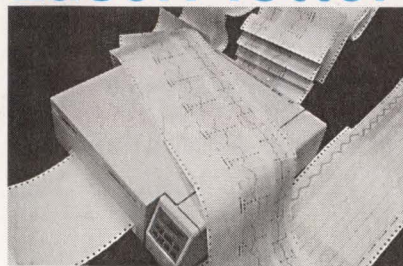

- Infinite Length Plots on Plain Fanfold Paper
- 300 DPI Resolution Laser Electrophotography
- 2.9 Inches Per Second Plot Speed
- Centronics Compatible Interface Capable of Continuously Plotting 274K Bytes Per Second
- Use as a Raster Transfer Plotter or as a High Speed (16 PPM) PCL4 Compatible Printer
- Form Overlay and Vector Graphics Commands
- Ideal for Telemetry and Medical Strip Charts
- Low Operating Cost Per Page
- Perfect Replacement for Electrostatic Plotters

Egis Engineering, Inc.

8133 Leesburg Pike, Suite 780 (703) 847-2013
Vienna, VA 22182 Fax: (703) 760-0840

CIRCLE NO. 347

LOW COST INTERFACE CARDS FOR PC/XT/AT



RS-485/422 Card [PC485A] \$95/125

- Serial Async. Communication up to 4,000ft, 2 or 4 wires, NS16450 UART
- Can be configured as COM1-COM4; Maximum Baud Rate 56KB
- Flexible configuration options: RTS or DTR control of transmission direction
- FullHalf duplex operation; Supports hardware handshaking (RTS/CTS)
- Dual drivers/receivers; Handles 64 devices; Compatible with most comm. SW
- High speed version (PC485AF) supports baud rates up to 256KB - \$165

Dual-Port RS-485/422 [PC485B] \$145

- Two independent channels/UARTs; 2 or 4 wire operation; max. Baud 56KB
- Dipswitch configurable as COM1-4 (IRQ2-7); On board terminator resistor
- Optional version protected with TRANSORBs (transient voltage suppressors) and Poly Switches (auto reset electronic fuse)

IEEE-488 Card [PC488A/C] \$145/295

- Includes DOS Device Driver and sample Communication program in BASIC
- Additional sample programs (source included) in C, Pascal & Assembly - \$50
- Selectable IRQ (1-4); DMA channel 1 or 2; Up to four boards per computer
- Compatible with most IEEE-488 Software packages for IBM-PC
- I/O Addresses and Control registers compatible with NI's GPIB-PC/IA
- PC488C card version with Built-in Bus Analyzer hardware and software (Allows Real Time 488 Bus Data Capture in background operation mode.)

12 Bit A/D/A Digit I/O [PCL711s] \$295

- 8 Single-ended Anlg IN, 1 Anlg OUT; AD574, conversion time 25.5
- Pascal & C Language Drivers, Calibration, Demo, Example Programs included
- 12 Bit A/D and D/A Resolution

MC / VISA / AMEX All prices are U.S. list only.

D&C MICROSYSTEMS INC.
750 N. PASTORIA AVE, SUNNYVALE, CA 94086 USA
Tel: (408) 730-5511 Fax: (408) 730-5521

CIRCLE NO. 348

To advertise in Product Mart, call Joanne Dorian, 212/463-6415

INTRODUCING PROTERM

FIRST IN A FAMILY OF
LARGER DISPLAY
OPERATOR INTERFACES

- 8 lines by 24 characters or 16 lines by 32 characters (selectable)
- VT-100 compatible (ANSI 3.64)
- User programmable keypad
- 30, or 45 key keypad
- Readily customized to suit your application
- RS-232 or RS-422 interface
- Two year warranty

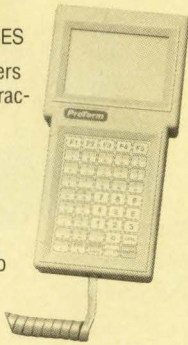

TWO TECHNOLOGIES, INC.
419 SARGON WAY
HORSHAM, PA 19044
(215) 441-5305 Fax (215) 441-0423

CIRCLE NO. 349

320C25 DSP ASAP \$1,995

Drive your embedded 320C25 design to market as fast as possible with our 320C25 in-circuit emulator. The MACROCHIP 'C25 emulator features real time emulation to 50 MHz with no wait states, 64K words of program overlay memory, simple software breakpoint, single step trace, disassembler, and RS-232 communications for fast downloading of programs from your PC COM port.

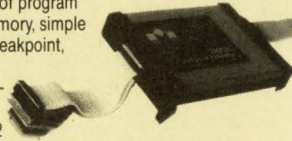

Call, write or fax for literature:



1301 N. Denton Drive
Carrollton, TX 75006
Tel 1-800-783-9546
Fax 214-245-1005

CIRCLE NO. 350

FREE DATA ACQUISITION & COMMUNICATION HANDBOOK

1991-1992 handbook features
86 pages of the latest information on our complete line of communication, data acquisition and waveform synthesizers.

1-800-553-1170

QUATECH

662 Wolf Ledges Parkway
Akron, Ohio 44311
(216) 434-3154

CIRCLE NO. 751

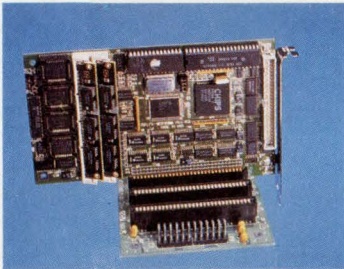

TURBO XT WITH SOLID STATE DISK

- PC Bus, 4.2" x 6.7", MS/DOS 2.0 - 5.0
 - 2 Serial Ports, 1 Parallel Port
 - Up to 2 FLASH SSDs, Bootable
 - 1 Meg total FLASH storage, 2 Meg DRAM
 - 10MHz Operation, WatchDog Timer
 - Software Included / SSD, EMS Handling
 - 6 Layer, CMOS, Wide Temp. Range
 - Made in the U.S.A. / 1 Year Warranty
 - \$295.00 qty. 1, Quantity **VMAX**®
- Pricing Available **TEMPUSTECH, INC.**
TEL: (800) 634-0701 295 Airport Road
FAX: (813) 643-4981 Naples, FL 33942

CIRCLE NO. 752

DR. "CHIP" MUNK SAYS



6805/68HC05/68HC11
DEVELOPMENT TOOLS
QUALITY AND SERVICE
AFFORDABILITY
TECI

"Chip" experts agree with Dr. Munk. TECI'S PC based microcontroller development tools are the most cost effective for veterans or beginners.

- 6805 PRIMER FOR BEGINNERS...\$195.00
- 6805/68HC05/68HC11 CROSS ASSEMBLERS...\$99.00
- 6805/68HC05 SIMULATOR / DEBUGGERS...\$99.00
- 68705 P3,P5,U3,U5,R3,R5 PROGRAMMERS FROM \$349.00
- 68HC705/68HC805 PROGRAMMERS FROM \$395.00
- COMPLETE PC BASED DEV. SYSTEMS FROM \$449.00
- 68HC05/68HC11 REAL TIME EMULATORS FROM \$895.00



TEL: (802) 525-3458
FAX: (802) 525-3451

The Engineers Collaborative, Inc.
RR# 3 Box 8C Barton, VT. 05822 USA
CALL TOLL FREE 1-800-336-8321

CIRCLE NO. 753

**4 Color Product
Mart Ads Are Now
Available In EDN's
Magazine and
News Editions!**

**Call Joanne Dorian for
more information**

(212) 463-6415

CIRCLE NO. 754

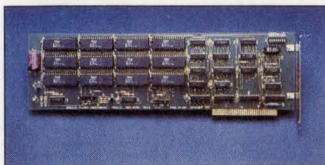

SOLID STATE DISK

- * BOOTABLE
- * VERSATILE
- * SIMPLE
- * COMPATIBLE
- * DURABLE
- * FAST
- * RELIABLE
- * ANOTHER SEALEVEL/
ANNABOOKS INNOVATION



SEALEVEL SYSTEMS
PO BOX 830
LIBERTY, SC 29657
803-843-4343

CIRCLE NO. 755

State Machine Design

For Complex & High Density PLDs



The most powerful PLD/FPGA CAE
design software from \$495.00

CUPL™ 4.2

**1-800-331-7766 LOGICAL
DEVICES, INC.**

CIRCLE NO. 756

Device Programming

Certified by the Semiconductor Industry

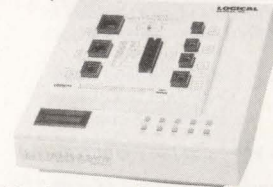

World's largest selection of PC based
and stand-alone programmers from
\$395.00 to \$10,000.

ALLPRO™ 88

**1-800-331-7766 LOGICAL
DEVICES, INC.**

CIRCLE NO. 757

To advertise in Product Mart, call Joanne Dorian, 212/463-6415

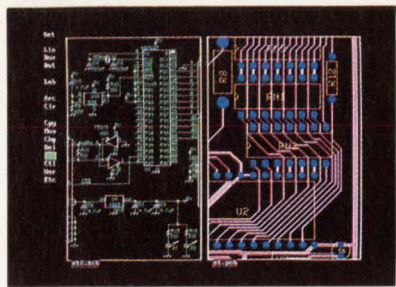

New Schematic and PCB Software

With support for extended and expanded memory, HiWIRE II can handle your most demanding schematic and PCB designs quickly and easily. The unique HiWIRE editor allows you to display and edit schematics and PCBs simultaneously, using the same commands for each. HiWIRE II is \$995, and is guaranteed.

Wintek Corporation

1801 South St., Lafayette, IN 47904
(800) 742-6809 or (317) 448-1903

CIRCLE NO. 758

16 MHz CPU
DRAM to 512K
20 MHz DSP
SRAM to 96K
DAPL™ Operating System
100+ standard commands
Custom commands in C

The Intelligent Solution For Data Acquisition

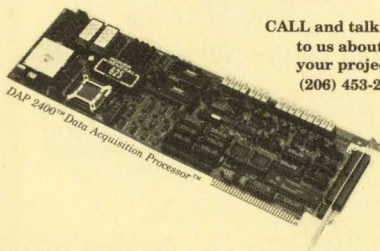

CALL and talk to us about your project.
(206) 453-2345

ANALOG I/O
DIGITAL I/O

Inputs to 235K samples per second
Outputs to 250K samples per second

Or call for FREE demo diskette.

MICROSTAR
LABORATORIES
2285 116th Avenue NE
Bellevue, WA 98004
FAX (206) 453-3199

CIRCLE NO. 759

INTELLIGENT DATA ACQUISITION



Now you can run high speed data acquisition under Windows™. A Data Acquisition Processor™ with on-board intelligence handles the critical part of an application: the tasks that run in real time. The DAP can be controlled from any Windows language or application that can make DLL calls. The one shown here is written in Visual Basic™ and uses only seven DLL functions.

Phone 206/453-2346, or fax 206/453-3199.

MICROSTAR
LABORATORIES

CIRCLE NO. 760

Now Networkable!

Facts about 750,000 ICs and Semiconductors at Your Fingertips

Cahners CAPS is the industry standard component search and selection tool for electronic design engineers.

- PC-driven, CD-ROM-based
- Includes unabridged manufacturers' technical documentation
- Represents more than 600 manufacturers worldwide

Call toll-free: 1-800-245-6696

CAHNER'S
CAPS
Computer Aided
Product Selection

275 Washington Street
Newton, MA 02158-1630
Telephone: 508-692-4148
Facsimile: 508-392-0603

CIRCLE NO. 761

8051 68HC11 COP8 68HC05



ice/MASTER Improved User Interface Features

- Easy to learn & use
- Windowed interface -- user configurable
- FAST! Download -- < 3 sec. typ. at 115KB
- Source level debug

- A 4K frame trace buffer with advanced searching capabilities.
- ice/MASTER connects easily to your PC, requires no disassembly or expansion slots. Works on any PC (DOS or OS/2), MicroChannel or EISA. Even laptops!
- Broad support of derivative devices.
- Rental and 10-day trials available.
- Now virtual memory and mouse support.
- Call today for free demo disk and ask about a free 8051 Macro Assembler! (800) 638-2423

MetaLink Corporation

MetaLink Corporation P.O. Box 1329 Chandler, AZ 85244-1329
Phone: (602) 926-0797 FAX: (602) 926-1198 TELEX: 499850MONTUM

NEW 68HC05!

CIRCLE NO. 762

CMOS 186

Single Board Computer

Runs C or QuickBASIC™ Programs

Powerful 16-bit computer directly executes EPROM's containing any C or BASIC .EXE file. NO LOCATORS! Software includes multi-tasking, multi-drop comm, PID control, OPTOMUX™

- 10, 12, 16 MHz 80C186
- CMOS design
- 512K RAM
- 384K EPROM
- STD BUS Expansion
- COM1 RS232/485
- COM2, LPT1
- RTC Avail
- 80C187 Avail
- OEM discounts

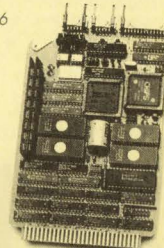

MICRO/SYS

3447 Ocean View Blvd., Glendale, CA 91208
(818) 244-4600 FAX (818) 244-4246

CIRCLE NO. 763



Avionics databus boards and software for IBM-PC and VMEbus.

Call toll-free: 1-800-829-1553

Ballard Technology

1216 NW 75th St.
Seattle, WA 98117
(206) 782-8704
FAX: (206) 782-8174

CIRCLE NO. 764

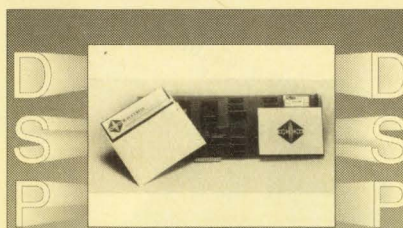

- 100-kHz Spectrum Analysis
- 50-kHz Arbitrary Signal Generation
- Versatile Signal Filtering
- DSP Code Development Platform
- Graphical Interface Software
- C Command Library Available

Based on Analog Devices' 2100 Family and
• Single-channel, 3µS, 12-bit, ADC & DAC
• Dual-channel, 50-kHz, 16-bit, ADC & DAC
• Eight-channel, 3µS, 12-bit, ADC & DAC

Prices start at: \$ 495



WAVETRON microsystems
1197 Oddstad Drive • Redwood City, CA. 94063
FAX: (415) 366-5375 • (415) 366-5371

CIRCLE NO. 765

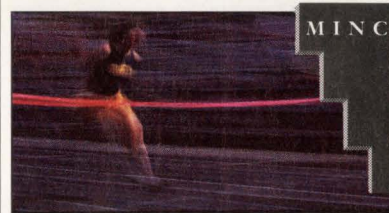

Break through your FPGA/PLD design puzzle!

MINC introduces PLDesigner-XL, the next generation in technology for PLD, CPLD and FPGA design synthesis. A breakthrough with an enhanced top-down environment including VHDL, state-of-the-art optimization and advanced cross-technology partitioning/fitting. Now all other software is generations behind. Call MINC toll-free at 800-755-FPGA.

CIRCLE NO. 766

Just \$495!*

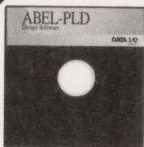

ABEL-PLD: Logic design for less.

- 150 PLD architectures supported (more than 4000 devices)
- Uses ABEL™ Hardware Description Language (ABEL-HDL™)
- Intelligent synthesis and optimization
- Upgradable to full-featured ABEL Design Software

1-800-3-DataIO
(1-800-332-8246)

*U.S. list price only.

Call Data I/O®
Direct today
to order
ABEL-PLD.

DATA I/O

CIRCLE NO. 767

Now \$1495!*



Save \$1000 on our entry-level logic system.

- Includes the 212 Multi Programmer with logic module, ABEL-PLD™ and PROMlink™ Ltd. PC Interface Software
- Supports 20- and 24-pin CMOS logic devices
- Full-hex keypad for extensive editing
- Optional EPROM and microcontroller modules

1-800-3-DataIO
(1-800-332-8246)

*U.S. list price only.

Call Data I/O®
Direct today to
order the 212
Logic System.

DATA I/O

CIRCLE NO. 768

FREE DEMO DISKS



See why over 20,000 engineers rely on SCHEMA for their design needs.

- ✓ Schematic Capture
- ✓ PCB layout & routing
- ✓ Simulation
- ✓ PLD design

Call 800-553-9119



801 Presidential • Richardson, TX 75081
(214) 231-5167 • FAX (214) 783-9072

CIRCLE NO. 769

FINALLY

One tool to satisfy all your
firmware development needs

PROMICE is a universal system.

- Develops code for any microprocessor
- Complete, real time, source level debugging
- Host software for DOS, Unix, Mac, VMS
- Non intrusive on your target system
- Simply plugs into any ROM socket

PROMICE also supports Turbo Debugger,
C_thru_ROM, FreeForm, GDB, and more.

PROMICE

...the affordable solution.



TEL: (614) 899-7878
West: (415) 750-0219
FAX: (614) 899-7888

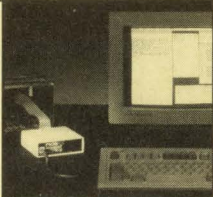

CIRCLE NO. 770

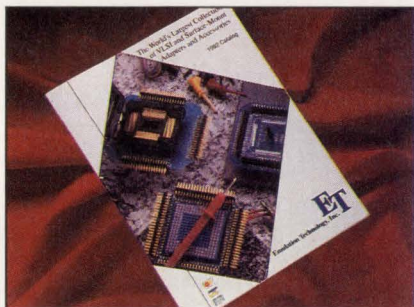

Free Catalog

The World's Largest Collection of Adapters &
Accessories for VLSI/Surface Mount Devices

- Emulator Pods & Adapters
- Debug Tools
- Programming Adapters
- Socket Converters
- Debugging Accessories
- Prototyping Adapters
- Custom Engineering

Emulation Technology, Inc.
2344 Walsh Ave. Santa Clara, CA 95051
Phone: 408-982-0660 FAX: 408-982-0664



CIRCLE NO. 771

Consistency is key

to the power of EDN Product Mart

CIRCLE NO. 772

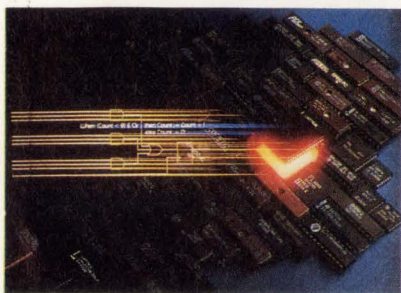

MacABEL

PLD Design on the Apple Macintosh!

Data I/O's industry-standard ABEL PLD design package is now available on the Macintosh, exclusively from Capilano Computing!
• Use Boolean and integer equations, state machines and truth tables to describe your design • Communicates directly with any serial PLD programmer • Best device support in the industry, including ALTERA, AMD, ATMEL, CYPRESS, GOULD, HARRIS, ICT, INTEL, LATTICE, NATIONAL, RICOH, SAMSUNG, SGS, SIGNETICS, SSS, TI, VTI and others • Interactive "in-circuit" schematic entry and simulation when used with DesignWorks

Call (800) 444-9064 Today for your free Demonstration Kit!
Capilano Computing
FAX: (604) 522-3972
(604) 522-6200

CIRCLE NO. 773

THE BEST PROGRAMMER VALUE AVAILABLE TODAY... and we'll prove it!
For starters, let us send you a DEMODISK



NEW SOCKET TECHNOLOGY SUPPORTS ALL PLCC SIZES!

- Universal PLCC & DIP ZIF Sockets
- Can support over 3,000 PLDs, E/EEPROMs, MICROS
- Up to 104 Programmable Pin Drivers
- Field Upgradable and Gang Module Options
- 24-Pin Entry Level Models start at \$995

BAC MICROSYSTEMS INC.
750 North Pastoria Avenue, Sunnyvale, CA 94086 USA
Tel: (408) 730-5511 Fax: (408) 730-5521

CIRCLE NO. 774

NEW POWER SUPPLIES

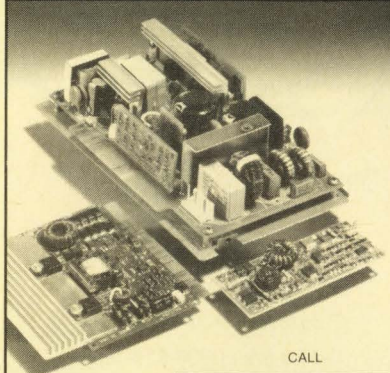

CALL

1-407-831-2000

MicroENERGY INC
745 W. State Road 434 • Longwood, FL 32750-4909
PHONE: (407) 831-2000 • FAX (407) 831-1100

CIRCLE NO. 775

To advertise in Product Mart, call Joanne Dorian, 212/463-6415

UNIVERSAL PROGRAMMER

PAL EPROM FLASH
GAL EEPROM MICRO

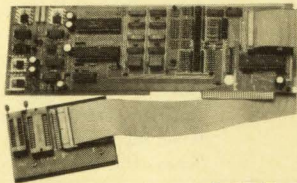

\$475.00

5ns PALs
4 MEG EPROM (8 & 16 bit)
22V10 & 26CV12 GALs
Parts added at your request

Free software updates on BBS
Powerful menu driven software

400 MHz LOGIC ANALYZER

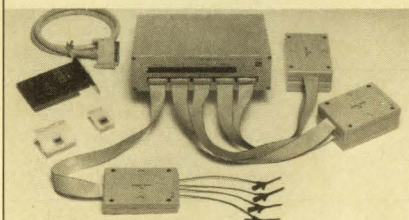

up to 128 channels Variable threshold
up to 400 MHz 8 External clocks
16K samples/channel 16 level triggering

Call for information on
100 MSa/s Pattern Generator (option)
\$799 - LA12100 (100 MHz, 24 Ch) Price is Complete
\$1299 - LA32200 (200 MHz, 32 Ch) Pads and Software
\$1899 - LA32400 (400 MHz, 32 Ch) included

Call (201) 808-8990
Link Computer Graphics, Inc.
369 Passaic Ave, Suite 100, Fairfield, NJ 07004 fax: 808-8786

CIRCLE NO. 779

Digital Voice Module

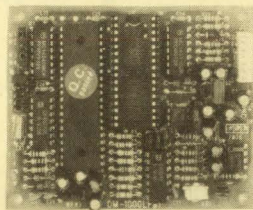

DM1000LP-1 (\$25, EPROM chip extra)
* Plays natural-sounding pre-digitized voice
* Playback triggered by contact closures
* Up to 256 seconds of message (8M-bit EPROM) digitized by using our VP880 digitization board
* Totally self-contained, single-voltage requirement
* 1 uA standby current, great for battery operation
* Built-in 3W power amplifier
* Many other models available, call for brochure

ELETECH ELECTRONICS, INC.
1262 East Katella Avenue, Anaheim, CA 92805
Tel: 714-385-1707 Fax: 714-385-1708

CIRCLE NO. 777

Small 2.3" x 6.25"
Swift 16 Mhz from 32KHz xtal

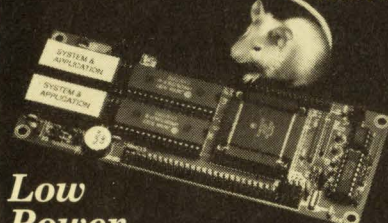

Low Power

BCC Compatible

\$249
Qty. 25

SBC332
MC68322 • Forth • C

vesta technology, inc.
(303) 422-8088
FAX: (303) 422-9800 • BBS: (303) 278-0364

CIRCLE NO. 780

OMNIPRO-10 UNIVERSAL PROGRAMMER from \$299.00

Now supporting entire MACH family!

- EPROMs to 4 meg/EEPROM & Flash
- GALs & EPLDs
- High Density PLDs/FPGAs/Mach 21X
- Micros, Intel, Signetics, Zilog
- Gang and Set Programming option

VAIL SILICON TOOLS
305 570 5580

CIRCLE NO. 778

PLD-1128 LOGIC DEVICE PROGRAMMER \$995.00



Program over 1100 different PLDs including the latest architectures from AMD, Cypress, NS

Qualified by AMD, Lattice, National Semiconductor, Signetics and others

Supports all MACH and MAPL devices, all versions of 22V10, including the /4 from AMD, -5 & -7 PLDs from NS, and Altera 900 & 1800 series EPLDs

Only uses the **manufacturer approved** programming algorithms to ensure accuracy
LIFETIME FREE SOFTWARE UPDATES VIA BBS and US MAIL

Risk free 30-day money-back guarantee
MADE IN THE USA

BP MICROSYSTEMS
1-800-225-2102

Houston, Texas 77043-3239 • (713) 461-9430 • (713) 461-7413

CIRCLE NO. 781

ISA & EISA THEORY & OPERATION

Here are the timing specifications for the ISA, EISA, and E-ISA busses explained in text, diagrams, and tables. Ed Solari, author of our famous "AT Bus Design", covers every type of cycle: memory access, DMA transfer, refresh, and bus master arbitration. He explains in detail how sources and destinations of different data widths (8, 16, and 32 bits) can operate with each other in any combination.

"ISA & EISA Theory & Operation" defines each bus signal line, and how it functions for different types and lengths of cycles. You will learn how to use wait states and data byte swapping to accommodate resources of various types. And you will see the effect that bus terminations, pull-up values, and signal distribution methods have on the bus timing.

Order now! This hard-bound book, containing over 500 pages and hundreds of diagrams and tables, is only \$89.95. It is without a doubt the most important ISA and EISA bus design reference.

ANNABOOKS

15010 Avenue of Science, Suite 101
San Diego, California 92128

1-800-462-1042 619-673-0870 619-673-1432 FAX

CIRCLE NO. 782

5 Volt Flash ?

- 64k x 8
- 5 Volt Only
- Byte Write
- No Erase Cycle Required
- Totally Self Timed
- PLCC, LCC, DIP, TSOP Packages Available

Samples of the X28C512 are available at your local Xicor Sales Office.

Xicor

Xicor, Inc., 1511 Buckeye Drive,
Milpitas, CA 95035
(408) 432-8888 - FAX (408) 432-0640

CIRCLE NO. 783

Telecom Solutions from Teltone

Loop Current Detectors

M-949 Line Sense Relays prevent failures caused by transients and current surges

RUGGEDIZED PACKAGE in the phone line. Superior

reliability means your products will last longer.

- Better survivability than optoisolators
- Improved RFI shielding
- For on-hook/off-hook monitoring, switchhook flash detection, and rotary dial pulse counting
- Available in UL-approved versions

1-800-426-3926

Or: 206-487-1515 Fax: 206-487-2288

TEL TONE

INNOVATING SOLUTIONS

In Telecom Interface Components

Teltone Corporation, 22121-20th Avenue SE, Bothell, WA 98021

CIRCLE NO. 784

To advertise in Product Mart, call Joanne Dorian, 212/463-6415

EDN September 17, 1992 • 185

ATLANTA

Loral Information Display Systems, a division of Loral Corporation (NYSE), designer of digital electronic information systems and graphic displays for military applications, has the following immediate opportunities:

DIGITAL DESIGN ENGINEER - BSEE with 8-10 years experience in high speed microprocessor based computer graphics design. Experience in military displays and display processor design preferred. Knowledge of CAE simulation technologies helpful.

MECHANICAL ENGINEER - BSME with 5-10 years experience in military electronic packaging design, analysis and quality testing. Strong background in chassis design, PWBs, CCAs, harness and thermal analysis. Prefer finite element experience with ANSYS.

PROJECT ENGINEER - BSEE with 5 years experience in project engineering or project management in a military electronics development engineering environment. Must have extensive scheduling, budgeting, and customer interface experience. Systems engineering background helpful.

RELIABILITY ENGINEER - BSEE with 5-10 years experience in reliability analysis and predictions, creating reliability test plans and performing stress analysis. Knowledge of Mil Std 217, 781, 785, and 1629 necessary. Background in failure analysis and maintainability a plus.

INTEGRATION ENGINEER - BSEE with 8-10 years experience in hardware/software design experience plus proven experience in Engineering Lab Integration and Testing.

MARKETING ENGINEER - BSEE with minimum 7-10 years experience in technical marketing of military electronic or avionics systems to prime contractors, Air Force and Navy. Prefer specific background in airborne and ground display systems. Responsibilities include generating new business opportunities with prime DOD contractors and Air Force and Navy customers.

Loral Information Display Systems is a progressive company offering unusual growth opportunities in our own office park in NE Atlanta. We provide top industry pay and benefits. If interested, please send or fax resume with salary history to: **Robert C. Hall, Loral Information Display Systems, Dept. EDN917, 6765 Peachtree Industrial Blvd., Atlanta, GA 30360. FAX (404) 448-9163.** EOE, M/F/H/V. U.S. Citizenship required.



**"A DIVISION OF
LORAL CORPORATION"**
LORAL
Information Display Systems

1992 Recruitment Editorial Calendar

Issue	Issue Date	Ad Deadline	Editorial Emphasis
News Edition	Oct. 8	Sept. 24	CAE • PC/Workstation Design • Engineering Management Special Series
Magazine Edition	Oct. 15	Sept. 24	Disk Drives • Portable-Computer Design • Switching Power Supplies • Design it Right Series—Part II
News Edition	Oct. 22	Oct. 8	Data Storage Technology Communications Technology Regional Profile: Michigan, Illinois, Missouri
Magazine Edition	Oct. 29	Oct. 8	ELECTRONICA SHOW ISSUE • Object-oriented Programming • Chipsets for PCs Design it Right Series—Part III Wescon Preview Issue
News Edition	Nov. 5	Oct. 22	COMDEX/WESCON SPECIAL ISSUE • Special Supplement: Design for Portability • Microprocessors • Wescon/Comdex Hot Products • CAE Software • Diversity Special Series
Magazine Edition	Nov. 12	Oct. 22	COMDEX/WESCON SPECIAL ISSUE • Integrated Circuits • Test & Measurement • Design it Right Series—Part IV
WESCON '92 SHOWGUIDE & PRODUCT SPOTLIGHT		Oct. 9	A free page available to all advertisers running a full page in 2 out of 3 Wescon issues.
News Edition	Nov. 19	Nov. 5	CAE Software • EDN's "Innovation Crusade"—Winners Coverage • Communications Technology • Regional Profile: So. California, Nevada
Magazine Edition	Nov. 26	Nov. 5	19th Annual Microprocessor Directory • ASICs • Sensors • EDN's "Innovation Crusade"—Winners Coverage
News Edition	Dec. 3	Nov. 19	ICs & Portable Computers • Power Sources • Laptops/Portables • Low-power Design • Regional Profile: Massachusetts, New Hampshire
Magazine Edition	Dec. 10	Nov. 19	INTERNATIONAL PRODUCT SHOWCASE—Vol. 1 • Power Sources • ICs & Semiconductors • Software • Hardware & Interconnect
Magazine Edition	Dec. 24	Dec. 3	INTERNATIONAL PRODUCT SHOWCASE—Vol. II • Computers & Peripherals • Components • Test & Measurement • CAE

Call today for information on Recruitment

East Coast: Janet O. Penn (201) 228-8610

National: Roberta Renard (201) 228-8602

THE FUTURE IS WIRELESS.

THE TECHNOLOGY IS

symbol

TECHNOLOGIES, INC.

While everyone has been talking about wireless computer networks, we have been designing, manufacturing and selling them. Symbol Technologies, Inc. has already installed over 3,000 Spectrum One wireless cellular networks. Symbol's Spectrum One Network gives our wireless hand held computers direct access to the user's host computer for applications in retail, manufacturing, military, healthcare and warehousing industries.

At Symbol Technologies, Inc.'s Costa Mesa (Southern California) and San Jose (Northern California) facilities, you will join an innovative team of Engineers involved in RF circuit design, digital communications research, RF and LAN protocol and software development. Your ideas will become reality in our next generation of wireless networks.

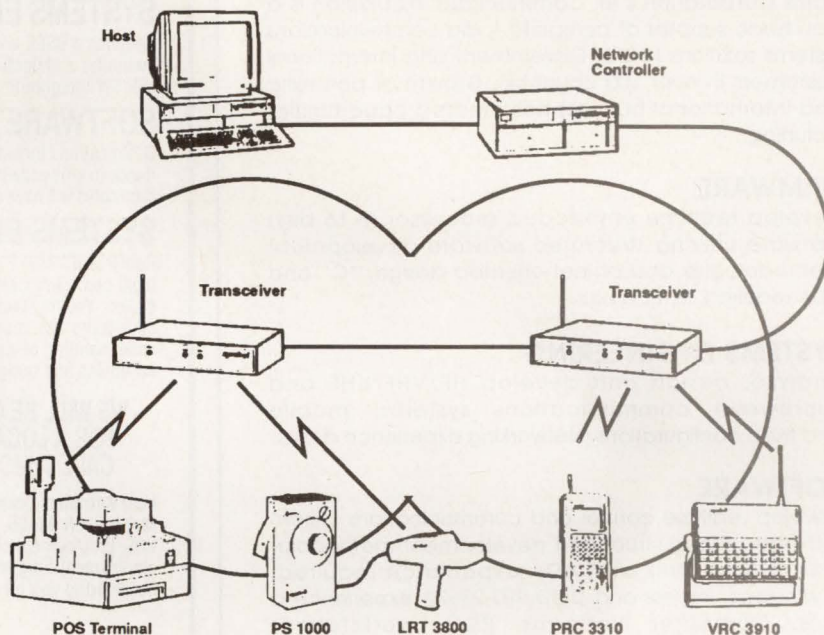

**RF COMMUNICATION
TECHNOLOGIST**

**DIAGNOSTIC
SOFTWARE TEST
ENGINEERS**

**SENIOR ASIC DESIGN
ENGINEERS**

**SENIOR NETWORK
ARCHITECT**

PRODUCT ENGINEERS

**QUALITY ASSURANCE
SOFTWARE TEST
ENGINEERS**

**SENIOR DIGITAL
DESIGN ENGINEERS**

**SOFTWARE
DEVELOPMENT
ENGINEERS**

**MARKETING PRODUCT
MANAGER (DATA
COMMUNICATIONS)**

Back your career with the strength and resources of an industry leader. Please mail your resume with salary history (indicating position and location of interest) to: **Symbol Technologies, Inc., Attn: Dick Stanion, Human Resources, Dept. EDN/917, 340 Fischer Avenue, Costa Mesa, CA 92626.** Equal Opportunity Employer M/F/D/V. Principals Only.

Engineering Opportunities

Harris Corporation's RF Communications Division is a worldwide supplier of complete radio communications systems solutions to U.S. Government and international customers in over 100 countries. Growth of domestic and international business has created opportunities including:

FIRMWARE

Develop realtime embedded processor (8,16 bits) firmware utilizing structured software development methodologies and object-oriented design. "C" and ADA required; INTEL a plus.

SYSTEMS ENGINEERING

Analyze, design and develop HF/VHF/UHF and microwave communications systems; mobile and fixed configurations. Networking experience a plus.

SOFTWARE

Develop realtime control and communications system software utilizing structured development methodologies (CASE). Unix and ADA experience required. X Windows, Ingress and DOD-STD-2167A experience a plus. Computer Platforms: PC's, workstations and minicomputers.

Positions require a BSEE or equivalent and 3+ years' relevant experience; an MS is desirable. Some positions require ability to obtain U.S. Security Clearance. Multilingual skills are desirable.

For prompt consideration, please send resume in confidence to: HARRIS CORPORATION, RF Communications Group, HR Dept. EDN, 1680 University Avenue, Rochester, NY 14610.

An Equal Opportunity Employer M/F/D/V.



WE'RE KNOWN BY THE CONTRACTS WE KEEP.

Lear Astronics Corp., a leading supplier of Avionics, Radar and Advanced Electronic Systems, has opportunities for:

SYSTEMS ENGINEERS

Requires a BSEE and design experience including digital computer architecture definition, redundancy management, HW/SW integration and system integration.

SOFTWARE ENGINEERS

Qualifications include a BSEE/BSCS degree and 5 years experience in embedded SW development and integration. Ideal candidates will have experience with 80960 or 1750A and Ada.

SYSTEMS ENGINEERING MANAGER

Requires BS/MSEE and 15 years experience in automatic flight control system proposal generation, design and integration. You must have at least 5 years management experience developing and implementing new designs, plus a solid understanding of aircraft systems/SW. Will be responsible for schedules and budgets.

**WE WILL BE COMING TO YOUR AREA SOON.
FOR A LOCAL INTERVIEW APPOINTMENT,
CALL CHUCK DOYLE AT: 1-800-LEAR-JOB**

Lear Astronics Corp., Dept. M25, 3400 Airport Ave., Santa Monica, CA 90406. (310) 915-6745. FAX (310) 915-8387. EOE. Employment offers are contingent on satisfactory pre-employment drug tests. You will be contacted only if we are considering you for the positions advertised.



32BIT

777 ACE

B2

F117

IDF

F22

RAH 66

QF4

F111

Your Future Starts Here

EDN Magazine Edition
News Edition

If you're looking for work, just look here.

EDN Magazine Edition
News Edition

Senior Principal Engineer — manage team of microcode engineers on ESCON part development for a complex disk drive subsystem for IBM mainframe application. Responsible for all aspects of project including management, research, definition, implementation and testing of subsystem. Requirements include Master of Science degree in Computer Science or related field, with at least four years managerial experience in design and modeling of software for reactive (real-time embedded) systems in a mixed hardware/software environment; strong background in definition of software development procedures and standards for software life-cycle, including budget, methods and tools, partition; and configuration control; thorough knowledge of CASE tools; software paradigms (requirement analysis and design); software architecture, quality evaluation, metrics, reverse engineering methods, communication protocols and integration of high-level languages with assembly language. Salary \$80,000/year. 40 hours/wk. Respond with two copies of resume to Job Order #21075, P.O. Box 8968, Boston, MA 02114

ENGR, Design: Logic design, circuit design, simulation, layout, testing & verification of new high performance digital integrated circuits. Min. MS or equiv. EE. Applicants must have project/research background in IC design (including mfg. & testing, logic & circuit design, logic & circuit simulation, layout & verification); advanced coursework in digital & analog circuit design; knowledge of h/w & s/w tools required for IC design (workstations, operating systems, schematic capture, circuit simulation, logic simulation, layout and verification). \$3615/month. Applicants clip ad and send w/resume to: Miss. State Employment Service, 100 Felix Long Drive, Starkville, MS 39759-9983, Job Order Number MS2619052.

Join the Leader in Wireless Digital Access Telephone Systems!!

The IMM Corporation designs, patents, manufactures and markets the telephone industry's most sophisticated and effective technology and products for the worldwide Wireless Digital Access market. IMM's breakthrough technology, Time Division Multiple Access (TDMA), has been selected by the Cellular Telecommunications Industry Association (CTIA) as the IS-54 United States digital cellular standard. With hundreds of systems currently up and running in six different countries; dramatic sales and revenue increases in the last two years; imminent cutover to operation of the first all wireless telephone service city in the United States; and its first royalty bearing technology license in place, IMM is about to embark on a major development effort which will truly extend the state of the art and result in a product line destined to maintain IMM's leadership position through the year 2000.

Qualified applicants will have a BSEE, BSME or BSCS and a minimum of 5 years experience in the telecommunications environment. An advanced degree and knowledge of Bellcore and/or CCITT standards will decidedly enhance an applicant's competitiveness. Specific opportunities are available for:

- SENIOR TELECOMMUNICATIONS SYSTEMS ENGINEERS
- SENIOR TELECOMMUNICATIONS HARDWARE ENGINEERS
- SENIOR MECHANICAL ENGINEERS
- SENIOR RADIO FREQUENCY ENGINEERS
- SWITCHING SYSTEMS MANAGER

If you have the experience we seek and want to share this exciting opportunity with some of the most creative telecommunications engineers in the business, send your resume and salary history to: IMM Corporation, Human Resources, Department ED-8, 2200 Renaissance Boulevard, Suite 105, King of Prussia, PA 19406-2755. Equal Opportunity Employer.



IMM Corporation

Knock, Knock.

In EDN's
Magazine
and News
Editions,
opportunity
knocks all
the time.

EDN

 Magazine
Edition
News
Edition

A Partnership in Power and Prestige Worldwide

EDN Databank

Professional Profile

Announcing a new placement service for professional engineers!

To help you advance your career, Placement Services, Ltd. has formed the EDN Databank. What is the Databank? It is a computerized system of matching qualified candidates with positions that meet the applicant's professional needs and desires. What are the advantages of this new service?

- It's absolutely free. There are no fees or charges.

- The computer never forgets. When your type of job comes up, it remembers you're qualified.
- Service is nationwide. You'll be considered for openings across the U.S. by PSL and its affiliated offices.
- Your identity is protected. Your resume is carefully screened to be sure it will not be sent to your company or parent organization.

- Your background and career objectives will periodically be reviewed with you by a PSL professional placement person.

We hope you're happy in your current position. At the same time, chances are there is an ideal job you'd prefer if you knew about it. That's why it makes sense for you to register with the EDN Databank. To do so, just mail the completed form below, along with a copy of your resume, to: Placement Services, Ltd., Inc.

IDENTITY

PRESENT OR MOST RECENT EMPLOYER

Name _____ Parent Company _____
 Home Address: _____ Your division or subsidiary: _____
 City _____ State: _____ Zip: _____ Location (City, State) _____
 Home Phone (include area code): _____ Business Phone if O.K. to use: _____

EDUCATION

Degrees (List)	Major Field	GPA	Year Degree Earned	College or University

POSITION DESIRED

EXPERIENCE

Present or Most Recent Position _____ From: _____ To: _____ Title: _____

Duties and Accomplishments: _____ Industry of Current Employer: _____

Reason for Change: _____

PREVIOUS POSITION:

Job Title: _____
 Employer: _____ From: _____ To: _____ City: _____ State: _____
 Division: _____ Type of Industry: _____ Salary: _____
 Duties and Accomplishments: _____

COMPENSATION/PERSONAL INFORMATION

Years Experience	Base Salary	Commission	Bonus	Total Compensation	Asking Compensation	Min. Compensation
Date Available	I Will Travel			I own my home. How long? _____		I rent my home/apt. <input type="checkbox"/>
<input type="checkbox"/> Employed <input type="checkbox"/> Self-Employed <input type="checkbox"/> Unemployed	<input type="checkbox"/> Light <input type="checkbox"/> Moderate <input type="checkbox"/> Heavy	<input type="checkbox"/> Married <input type="checkbox"/> Single		Height _____ Weight _____		
Level of Security Clearance	<input type="checkbox"/> U.S. Citizen <input type="checkbox"/> Non-U.S. Citizen	My identity may be released to: <input type="checkbox"/> Any employer <input type="checkbox"/> All but present employer				
<input type="checkbox"/> WILL RELOCATE <input type="checkbox"/> WILL NOT RELOCATE <input type="checkbox"/> OTHER _____						

EDN Databank

A DIVISION OF PLACEMENT SERVICES LTD., INC.

265 S. Main Street, Akron, OH 44308 216/762-0279

Fully QPL'd!

Trompeter's 70 Series...

Twinax/Triax Concentric Connectors

MIL-C-49142/3	MIL-C-49142/8
MIL-C-49142/4	MIL-C-49142/9
MIL-C-49142/5	MIL-C-49142/10
MIL-C-49142/6	MIL-C-49142/11

Send for 70 Series Mil Spec Sheet

For pricing and availability contact your Local Trompeter Rep or call our New 800# for Sales/Service/Technical Support.

(800) 982-COAX Inside California Call... (800) 655-2028

Quality doesn't cost...
It pays.



31186 La Baya Drive • Westlake Village, CA 91362

(818) 707-2020 Fax (818) 706-1040

CIRCLE NO. 116



You can control any IEEE-488 (HP-IB, GP-IB, 488.2) device with our cards, cables and software for the PC/AT/386, EISA, Micro Channel and Macintosh II. You get fast hardware and software support for all the popular languages, plus a software library of time saving utilities. Instrument control has never been easier.

FREE

Informative Catalog 800-234-4CEC
Applications help 617-273-1818

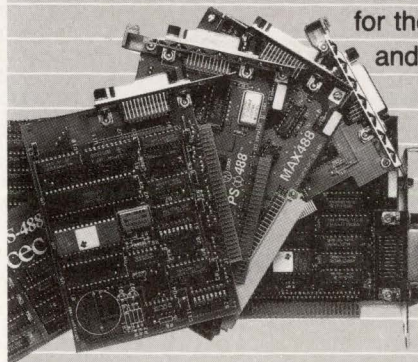

Capital Equipment Corp.
Burlington, MA. 01803

Micro Channel is a trademark of IBM

CIRCLE NO. 117

Now up to
100V DC Output

PICO DC-DC Converters

Wide Input Range
5 to 72V DC

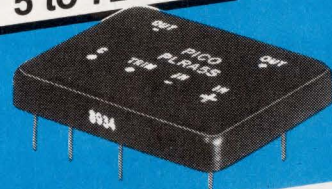

Regulated 5 to 30 Watts

- 365 Standard Models
- Single, Dual & Triple Output
- Remote Disable Pin Standard
- Up to 100V DC Output now Standard
- 500V DC Isolated Input to Output
- All Units Shielded

MIL-STD-883 UPGRADES AVAILABLE

- Expanded operating temp. (-55°C to +85°C)
- No Heat Sink Required
- Stabilization Bake (125°C ambient)
- Temperature Cycle (-55°C to +125°C)
- Hi temp., full power burn in (100% power, 125°C case temp.)

PICO also manufactures over 850 standard DC-DC converters and over 2500 ultra-miniature transformers, inductors and new AC-DC power supplies.

Delivery—
stock to
one week

See EEM or
FAX 914-699-5565
or send direct for
FREE PICO Catalog

PICO Electronics, Inc.

453 N. MacQuesten Pkwy. Mt. Vernon, N.Y. 10552

Call Toll Free 800-431-1064

IN NEW YORK CALL 914-699-5514

CIRCLE NO. 118

EDN September 17, 1992 • 191

ULTRA-MINIATURE SURFACE MOUNT

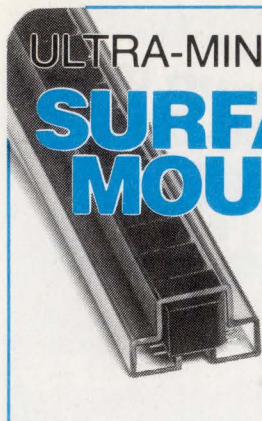

Actual Size

DC-DC Converter Transformers and Power Inductors

All PICO surface mount units utilize materials and methods to withstand extreme temperature (220°C) of vapor phase, IR, and other reflow procedures without degradation of electrical or mechanical characteristics.

These units have gull wing construction and are packaged in shipping tubes, which is compatible with tube fed automatic placement equipment or pick and place manufacturing techniques. Transformers can be used for self-saturating or linear switching applications. The Inductors are ideal for noise, spike and power filtering applications in Power Supplies, DC-DC Converters and Switching Regulators.

- Transformers have input voltages of 5V, 12V, 24V and 48V. Output voltages to 300V.
- Transformers can be used for self-saturating or linear switching applications
- Schematics and parts list provided with transformers
- Inductors to 20mH with DC currents to 23 amps
- Inductors have split windings

Delivery—
stock to one week

See EEM
or send direct for
FREE PICO Catalog

PICO Electronics, Inc.

453 N. MacQuesten Pkwy. Mt. Vernon, N.Y. 10552

Call Toll Free **800-431-1064**

IN NEW YORK CALL **914-699-5514**

FAX **914-699-5565**

CIRCLE NO. 118

EDN-INTERNATIONAL ADVERTISERS INDEX

Abbott Electronics	49	Motorola Inc	45
ACCEL Technologies Inc	140	Motorola Semiconductor Products Inc	83
Acces	173	Munchner Messgesellschaft	178
Actel	14-15	Murata Erie North America Inc	C2
Advanced Micro Devices	10-11, 12-13, 26-27	National Instruments	166
Advin Systems Inc	181	National Semiconductor Corp	30-31
Aegis Engineering Inc	181	NEC Corp	32-33
Alcatel	70	NCI	180
Ametek	99	Nohau Corp	170
Ampro Computers Inc	107	Octagon Systems	181
Analog Devices Inc	64	Omaton Inc	184
Annabooks	185	OrCAD Systems Corp	28
Antex Electronics	99	Pacific Data	59
Apex Microtechnology Corp	62	Pentica Systems	171
Ariel	97	Philips*	86-87
array Microsystems Inc	93	Philips Semiconductor	65-67
AT&T	52-54	Pico	191, 192
Ballard Technology	183	Planar Systems	173
B&C Microsystems	181, 184	Precimation AG*	*108
BP Microsystems	185	Quatech	182
Burr-Brown Corp	86	Quick Logic	48
Capital Equipment Corp	191	Racal-Redac	8
Capilano Computer Systems Inc	184	RC Systems	180
Cascade Design Automation	108	Safe Soft Systems	181
Ceibo Ltd	180	Samsung Semiconductor	16-17
Circuit Components Inc	147	SeaLevel Systems	182
Comdisco	95	Siemens AG*	88C-F
Comytch	179	Siemens Components Inc	38
Cybernetic Micro Systems	9	Sierra Circuits	179
Cypress Semiconductor	6	Sierra Systems	168
Dalance Spry	180	Signal Transformer Co Inc	C4
Dale Electronics Inc	1	Signum Systems	60
Dale Electronics Inc/Vishay Nyrtron	146	Siliconix Inc	124
Data I/O Corp	38*, 56, 163, 165, 184	SMS North American	179
Datel	112, 196E	Softools	180
Digital Equipment Corp	115	Sony	127
Domain Technology	181	Spectrum Software	172
DSP Development	89	Sprague Goodman	61
EESof	162	Stanford Research Systems Inc	176
EG&G Wakefield Engineering Inc	66	Star Semiconductor Corp	43
Electronic Measurements Inc	119	Synergy Microsystems	21
Eletech	185	Tatum Labs	181
Emulation Technology Inc	184	TECI	182
Enea Data AB*	C4	Tektronix	34-37
EPIX Inc	180	Teledyne Solid State	179
Epson America Inc	159	Teltone Corp	185
Fujitsu Microelectronics Inc	149	Tempustech Inc	182
Grammar Engine Inc	184	Tesoff	181
Harris Semiconductor	152-153	Texas Instruments Inc	71-73, 88A-B, 89, 130-131
Hewlett-Packard Co	18, 137-139, 155-157, C3	Tokin Corp	175
Hypertronics Corp	116	Toyocom	177
IDT	123	Transera	171
IEE	133	Tribal Microsystems	179
ILC Data Device Corp	65	Trompeter Electronics Inc	191
Illinois Capacitor	134	Two Technologies	182
Incredible Tech	179	Unitrode Integrated Circuits	85
Instrument Specialties Co Inc	128	Valley Enterprises	111
Intel	24-25	Vesta Technology Inc	185
Intelligent Systems Inc	183*	VST	185
Intermetrics Inc	148	VTC Inc	98
Ironwood	146	Wavetron	183
John Fluke Manufacturing Co Inc	87	Welch-Allyn	180
Kepeco Inc	160-161*	Westcor	120
Leap Electronic Co Ltd	180	Wickmann Werke	146
Leasametric Inc	174	Wintek Corp	183
Linear Technology Corp	142	Wintress Engineering	180
Link Computer Graphics Inc	185	Xicor Inc	185
Logical Devices Inc	182	Xilinx	50-51
Macrochip	182	Zilog Inc	134
Maxtor	164	Z-World	179
Mercury Computer Systems	2		
MetaLink Corp	171, 183		
Meta Software Inc	150		
MF Electronics	58		
MicroENERGY Inc	146, 184		
Micro Link	181		
Microstar Laboratories	183		
MicroSys	183		
Microtime Computer Inc	184*		
MicroSim Corp	88		
Minc Inc	183		
Mini-Circuits Laboratories	3, 4, 22-23, 145		
Mitsubishi Electronics America Inc	151, 158		

Recruitment Advertising 186-190

This index is provided as an additional service. The publisher does not assume any liability for errors or omissions.

HP's new 4 GSa/s scope helps you capture high-speed glitches.

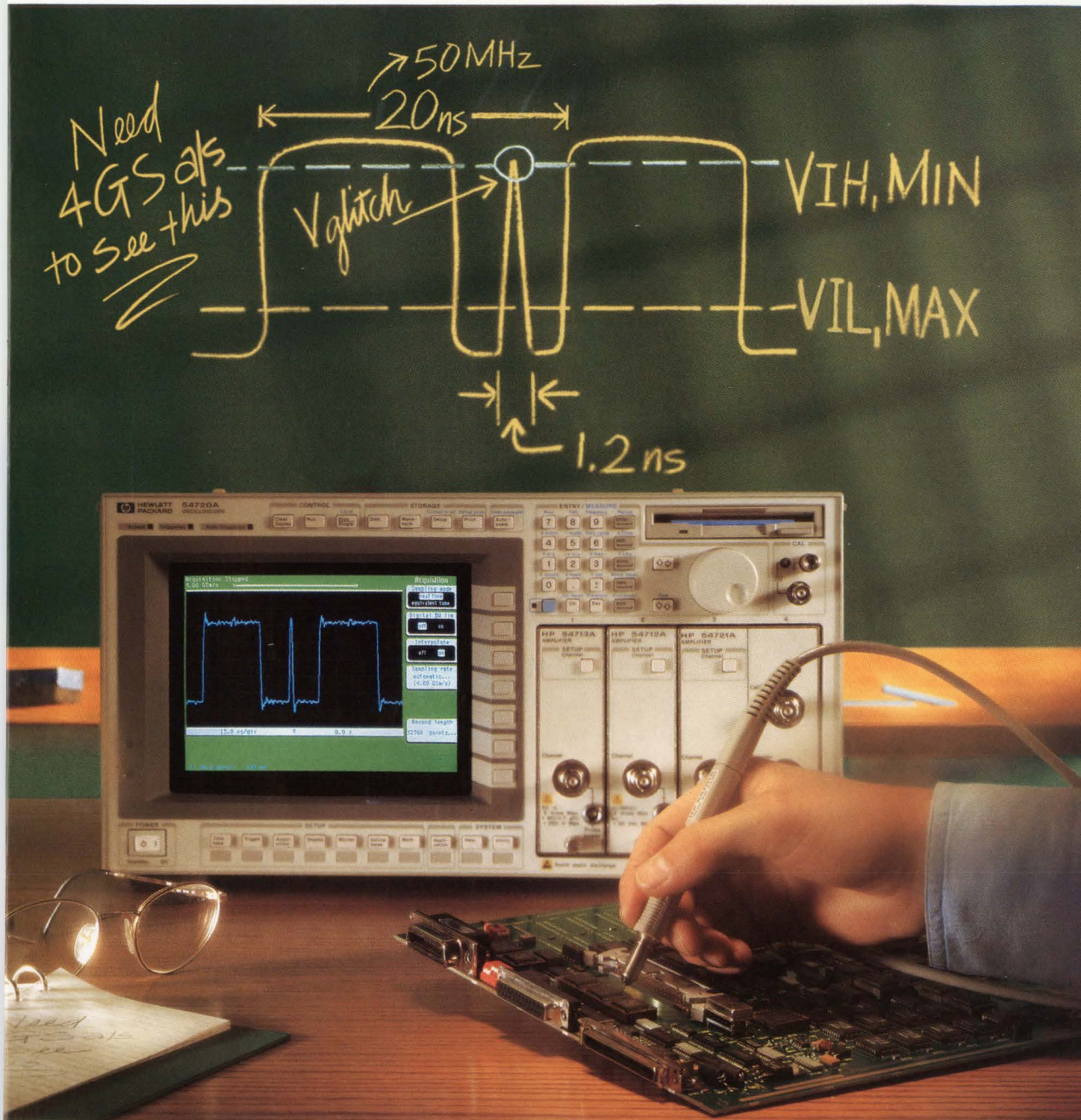

© 1992 Hewlett-Packard Co. TMCOL126/EDN

The new HP 54720A has the speed you need to solve intermittent problems.

When digital designs reach clock speeds above 33 MHz, you run into a new class of problems. That's when critical timing and noise margin analysis are crucial. And that's where the HP 54720A helps the most.

The HP 54720A has the highest sample rate available on multiple channels with exceptional real-time bandwidth—as well as low noise and jitter. So you get repeatable, high-fidelity waveform capture. And a clearer picture of the input signal.

To make sure the captured signal is reliable and distortion free, the HP 54720A has high vertical and horizontal accuracy. It teams up perfectly with the new non-intrusive HP 54701A active probe. And it's ideal for use with HP logic analyzers when you need maximum insight into digital system problems.

Plus, to make sure you have the information you need, HP offers educational programs, application notes, and seminars on solving high-speed digital design problems.

So, if intermittent problems are plaguing you, call 1-800-452-4844.*

Ask for Ext. 3079, and we'll send you a brochure and an application note that explain how the HP 54720A helps you get a clearer understanding of your high-speed digital designs.

There is a better way.



HEWLETT
PACKARD

* In Canada call 1-800-387-3867, Dept. 453.

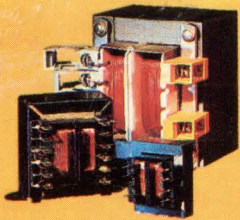

**WORLD CLASS
TRANSFORMERS
FOR WORLD CLASS
CUSTOMERS**

Signal International Series Transformers are VDE and CSA certified, UL recognized and comply with applicable IEC specifications. In an era of global marketing, and the inception of the European Economic Community in 1992, using Signal Transformers can open up new trade routes for you.

We'll even give you a competitive edge by customizing a JIT program

for you that will reduce your inventories and provide you with only as many Signal Transformers as you need, only as you need them. While our Pronto™ 24 hour service will ship standard catalog transformers in just one business day.

Naturally, with timing this critical you've no time for reject replacements. No problem. Our Total Quality Control Program utilizes the industry's most modern, automated test equipment to verify that every single unit meets with your specifications. And, because we use cellular assembly lines dedicated to one project at a time, nobody beats our quality in

producing quantities under tight deadlines.

If you want to profit from a global economy while saving money by buying direct, call for more information or a free catalog: Signal Transformer, 500 Bayview Avenue, Inwood, NY 11696.

FAX (516) 239-7208

BUY DIRECT (516) 239-5777.



You can send a Signal anywhere.

