

Electronic Design

THE MAGAZINE OF ESSENTIAL NEWS, PRODUCTS AND TECHNOLOGY

VOL. 14, NO.

2

JAN. 18, 1966

Computer on a chip? MOS arrays may lead the way. Already hundreds of tiny, simple devices have been put on a single chip. Some say they're a step beyond

diffused microcircuits. Others disagree. One thing's sure: The MOS is stirring up the industry. For latest developments plus a trade-off analysis, see pp 22, 42.

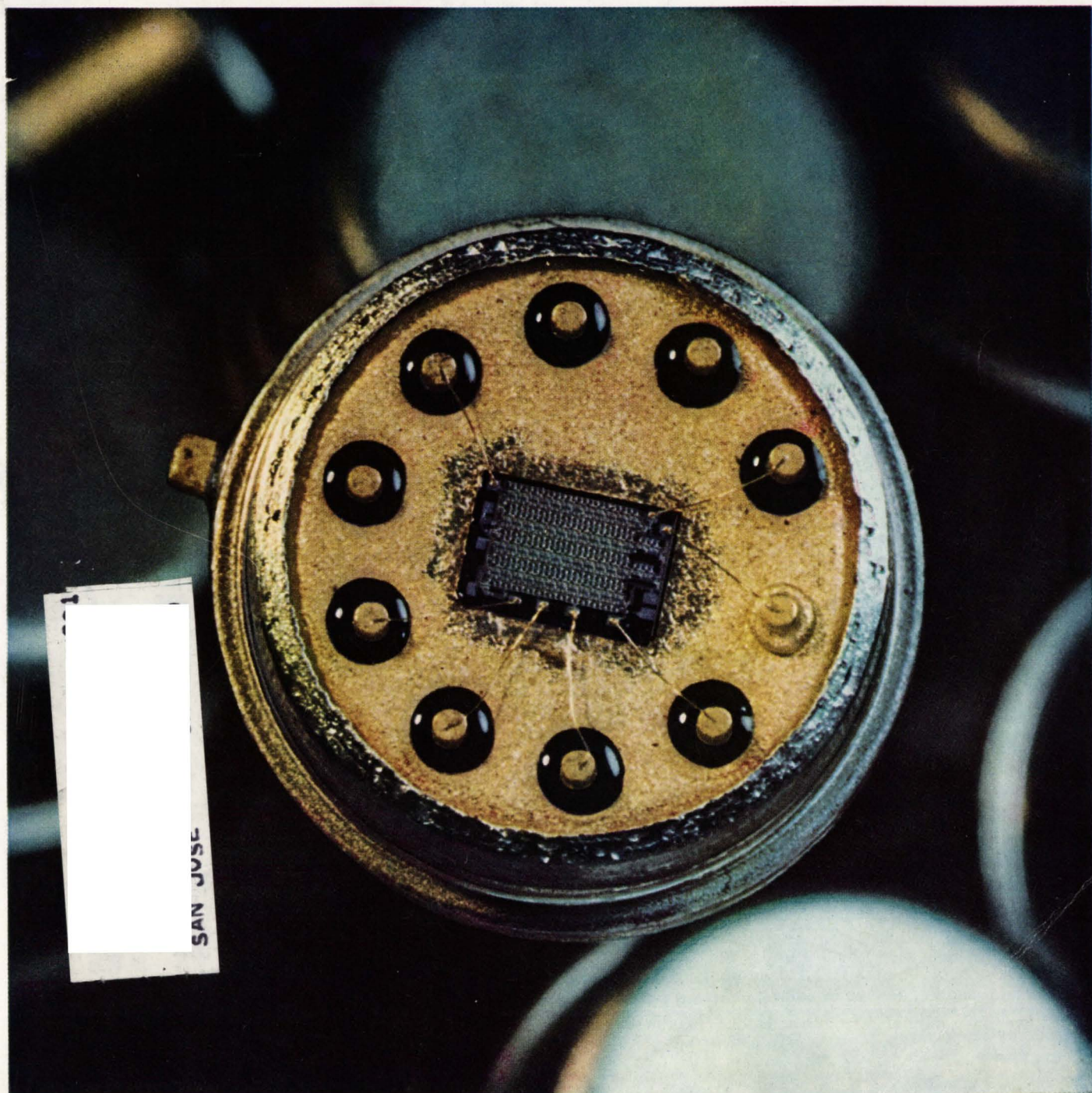

The Remarkable New Line of Clifton MOTORS and TACHOMETERS is important to YOU!

SERVO MOTORS

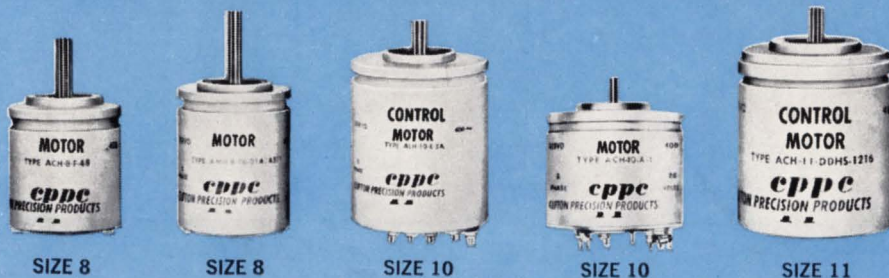

SIZE 8

SIZE 8

SIZE 10

SIZE 10

SIZE 11

TEMPERATURE COMPENSATED MOTOR TACH

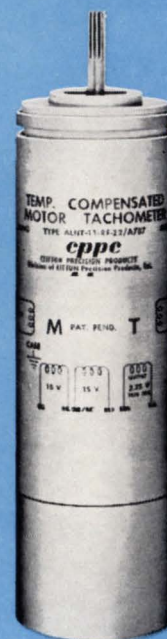

SIZE 11

MOTOR TACHOMETERS

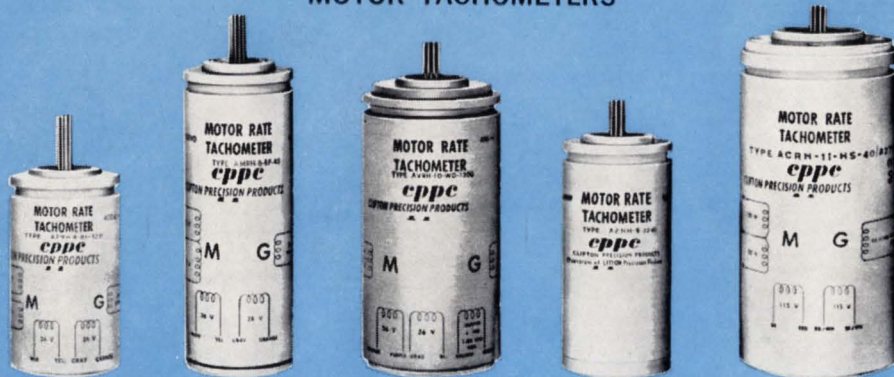

SIZE 8

SIZE 8

SIZE 10

SIZE 8

SIZE 11

In this new line of motors and tachometers, Clifton has overcome to a significant degree, many limitations inherent in current servo motor designs.

For instance, the incompatibility of efficiency and a linear speed torque curve plagues servo motor users. We have designed a motor which will minimize this conflict. Efficiency has been improved by factors as large as 40% at no expense to speed torque linearity. Thus Clifton motors can give you: more torque for the same power input or same torque with less power consumption; better theoretical acceleration; a cooler more reliable motor with high capacity for being "over-driven" if necessary. These improvements have been achieved without degeneration of air gap or single phasing considerations.

Response time is another important area of improvement in our motors. Certain of our units are specially designed to reduce inertia and increase torque, thereby offering: decreased dead zone, increased slew rate, reduced velocity error.

A further refinement in our servo motors is: lower and more uniform starting voltages with levels as low as 1% of control phase voltage. This, of course, increases the dynamic range of a servo system.

In addition, our servo motors and tachometers are using less heat vulnerable materials such as: improved high temperature resistant magnetic wire; improved lubricant;

improved slot insulation; welded leads; flanged and shielded bearings; glass to metal seals, and high temperature resistant impregnation. As a result our motors can withstand temperatures considerably above the standard 125°C.

Motor Rate Tachometers

Because of the improved torque to inertia designs mentioned previously, no generator is necessary in situations where inherent self damping is sufficient. Smaller generators with less output, less length and less power consumption can now be used when needed. Synchro length *full drag cup* motor tachometers are now possible—a great saving in size and weight over the present long, heavy units.

In addition to a wide variety of off-the-shelf units, we custom design servo motors and tachometers with special requirements of torque, inertia, and temperature resistance. We are eager to serve your standard or custom needs. Clifton Precision Products, Division of Litton Industries, Clifton Heights, Pa., and Colorado Springs, Colo.

cppe

CLIFTON
PRECISION PRODUCTS
DIVISION OF LITTON INDUSTRIES



Speed Inquiry to Advertiser via Collect Night Letter
ON READER-SERVICE CARD CIRCLE 242

Automatic Frequency-Response Recording System



For fast response studies of filters, networks, amplifiers, transducers, and other devices operating in the audio range

Type 1350-A
Generator-Recorder Assembly,
complete, \$2155 in U.S.A.

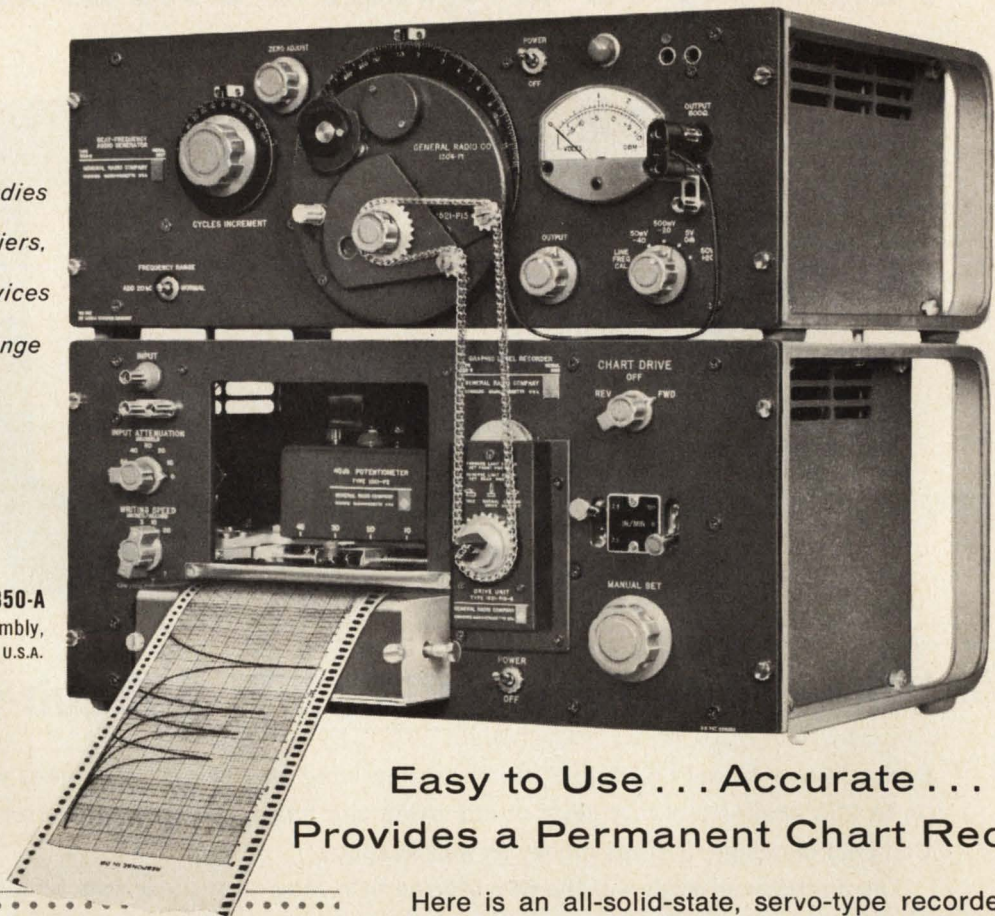

Easy to Use . . . Accurate . . . Provides a Permanent Chart Record

Here is an all-solid-state, servo-type recorder that plots the rms value of ac voltage logarithmically on a linear dB scale. It is coupled mechanically to a beat-frequency audio generator whose frequency characteristic over the audio range is flat within ± 0.25 dB. To use this automatic recording system, connect the output of the generator to the device you are testing and apply the device's output to the recorder . . . Flick a switch and set the system into motion; the recorder and generator operating in synchronism provide you with a response curve of the device under test in a few seconds.

Call us for a trial demonstration and see for yourself what this recording system can do for you.

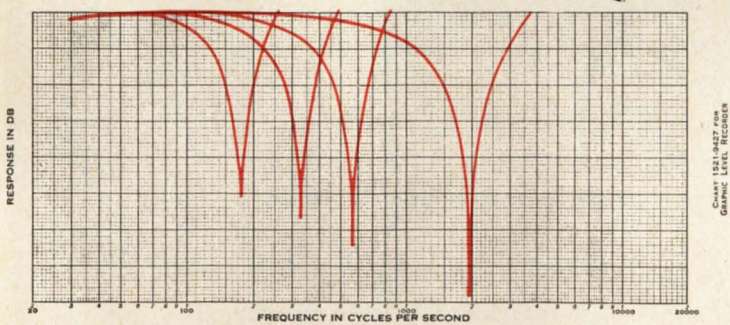

Recording of transmission characteristics of an adjustable notch filter for four different frequency settings. This plot is a permanent ink recording on 4-inch-wide chart paper. Dynamic recording range is 40 dB (20- and 80-dB dynamic ranges also available) Recorder chart speed and pen writing speed can be set over ranges of 2.5 to 75 in/min and 1 to 20 in/s, respectively

GENERAL RADIO WEST CONCORD, MASSACHUSETTS

Boston • New York • Chicago • Philadelphia • Washington, D.C. • Syracuse • Dallas • San Francisco • Los Angeles • Orlando • Cleveland • Toronto • Montreal
General Radio Company (Overseas), Zurich, Switzerland General Radio Company (U.K.) Ltd., Bourne End, England

ON READER-SERVICE CARD CIRCLE 212

Forget the Multiplexers and Analog to Digital Converters

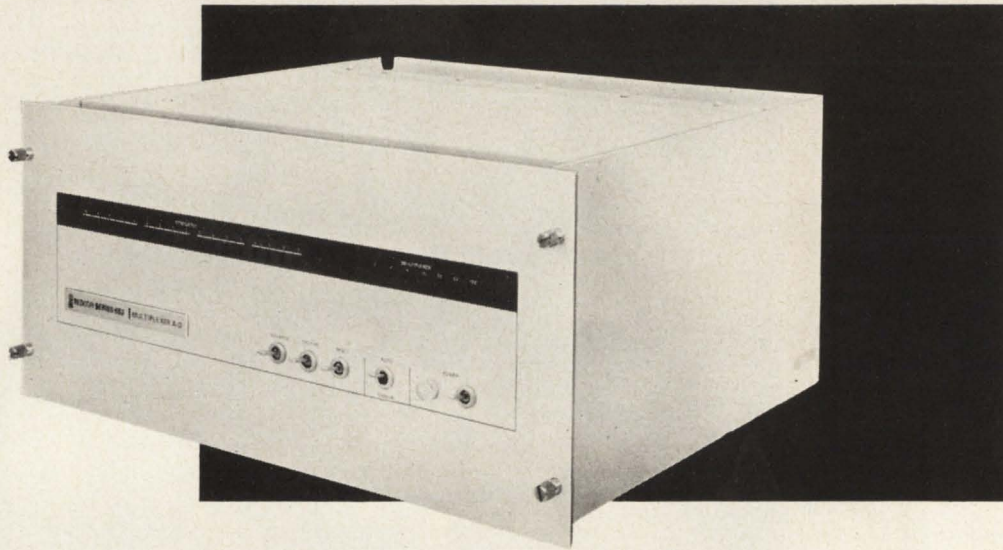

When you remember REDCOR'S 663 sub-system

Redcor's new Model 663 Sub-System utilizing integrated circuit techniques which include up to 256 channels of high level multiplexing and analog-to-digital converter capabilities. Compact in design, it saves money as well as space.

The multiplexer portion of the 663 utilizes field effect transistor switching for increased speed and reliability. It has an input impedance of 100 megohms. The 663's analog-to-digital converter provides up to 15 bits of binary data (17 bits BCD) at 1.5 μ sec per bit. Eight different output signal levels are available.

What's the best way to use Redcor's new 663 Sub-System? The choice is yours. It may be used as a system component that converts input voltages to digital form for subsequent recording or processing. Or, connected with companion Redcor components, it forms a complete data acquisition system.

Versatility such as this is built right into every reliable Redcor Data Acquisition System. For complete information on the 663 Analog-to-Digital Sub-System, and companion Redcor components, please request Special Bulletin 663 and write: Dept. ED 166.

Engineers: If your field is analog/digital data systems or component design, a career opportunity awaits you at Redcor. Write to Personnel Director.

 **REDCOR**

complete systems compatibility

7800 DEERING AVE., P.O. BOX 1031, CANOGA PARK, CALIFORNIA 91304

Phone: (213) 348-5892 • TWX 213-348-2573

An Equal Opportunity Employer

Speed Inquiry to Advertiser via Collect Night Letter
ON READER-SERVICE CARD CIRCLE 2

NEWS

- 13 News Report
- 17 **Pace of Gunn effect research quickens**
Radar and telemetry systems are expected to benefit from the high-power GaAs devices due within one to two years.
- 22 **MOS arrays diffuse into commercial market**
Metal-oxide-silicon FETs should boom in 1966, led by complex arrays which are solving basic application problems.
- 21 Diamond dies are cut by ruby laser
New coating blend ups cathode power
- 26 Dial a computer for design information at NAA
- 27 Blind may use speech compressor for 'speed hearing'
- 31 Washington Report
- 32 Letters
- 39 **Editorial:** The year to do yourself a favor

TECHNOLOGY

- 42 **Planning to use MOS arrays?** Learn which factors influence equipment size, weight and power, as well as systems cost.
- 48 **Treat the flip-flop logically.** When you do, it becomes a simple matter to compare the different types and select the one that best fits your needs.
- 56 **Shunt-motor speed control** takes a turn for the better when an SCR is used to regulate armature power. Cost, space savings and simplicity result.
- 66 **Heat detector uses fiber optics** in semiconductor bonding operation. This arrangement solves the problem of an obstructed target in an RF field.
- 68 **How does your company rate?** Is it a good place to work in? Here is a checklist to help you compare your company with others or with your ideal.
- 73 ELECTRONIC DESIGN annual index of articles
- 82 Ideas for Design:

PRODUCTS

- 96 **Microwaves:** Millimeter-wave switch operates in 2.5 ms
- 106 **Systems:** Analog desk-top computer designed for economy
- 114 **Semiconductors:** Photodiode and transistor read cards and tape
- 110 Test Equipment
- 116 Components

Departments

- 150 Advertisers Index
- 146 Application Notes
- 152 Designer's Datebook
- 140 New Literature

NEW LITTON TWT DELIVERS UP TO 500 WATTS PER POUND AT X-BAND





Litton's new L-5041 traveling wave tube. Features PPM focusing with low cost alnico magnets, conduction cooling and extreme compactness. Weighs just 3.6 pounds. Conservatively rated at 1,000 watts minimum power output between 8 to 12 Gc. Yet, typically produces 2,000 watts at mid-band and 1,000 watts or more above 12 Gc and below 6 Gc. Offers 30 to 40 db gain and duty factor of 0.01 or higher on

request. The rugged metal and ceramic Litton L-5041 performs reliably under the environmental extremes of MIL-E-5400, making it ideal for airborne and other similarly demanding applications.

Write for additional information on the L-5041 and other Litton TWT's or on our complete line of microwave tubes and display devices.

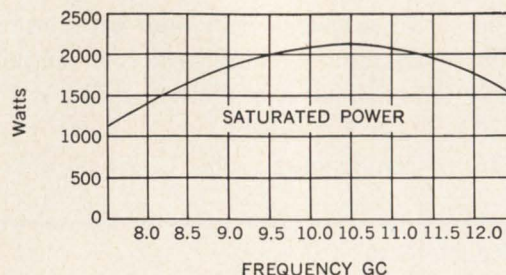
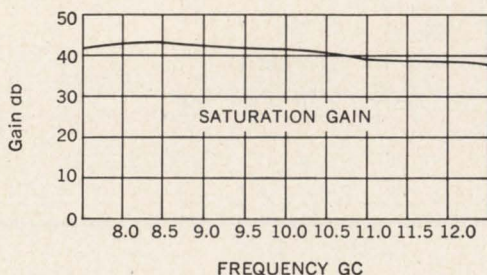
TYPICAL RF PERFORMANCE



LITTON INDUSTRIES  **ELECTRON TUBE DIVISION**

San Carlos, California / Williamsport, Pennsylvania / Canada: 25 Cityview Drive, Rexdale, Ontario / Europe: Box 110, Zurich 50, Switzerland

Speed Inquiry to Advertiser via Collect Night Letter

ON READER-SERVICE CARD CIRCLE 3

quick reference guide to RCA memory cores

Whatever your ferrite memory requirements, RCA has the right cores...conventional, wide-temperature-range or special-purpose types

Two new cores, RCA types 1100M5 and 1101M5, are specially designed and characterized for the new "2½D" and "3D" schemes for memory system operation. Check the table below for the basic characteristics of these new cores which also feature extra-square hysteresis loops.

RCA WIDE-TEMPERATURE-RANGE CORES
Operate over any 100° C range between the limits of -55° C and +125° C without temperature compensation, air conditioning, or special cooling.

CORES FOR SPECIAL APPLICATIONS
For custom-formulated cores designed to meet your special or unusual requirements, ask for a quotation.

FOR MORE INFORMATION and extra copies of our Quick Reference Guide, write, wire or phone your local RCA Sales Office, or: RCA Electronic Components and Devices, Memory Products Operation, 64 "A" Street, Needham Heights, Mass. Telephone: (617) 444-7200.

YOUR SYSTEM CYCLE-TIME	RECOMMENDED RCA CORE TYPE		RECOMMENDED COINCIDENT-CURRENT DRIVE CONDITIONS				TYPICAL OUTPUT CHARACTERISTICS @ 25° C				CORE SIZE OD/ID
	(Coincident-Current)	Conventional	Wide-Temp Range	I _m in Ma	I _{pw} in Ma	t _r in μsec	t _d in μsec	dV ₁ in mv	dV ₂ in mv	t _p in μsec	
< 1 μsec	NEW! 1100M5	0181M5	875	437.5	0.05	0.2	35	5	0.10	0.18	20/12
			875	437.5	0.05	0.2	40	5	0.10	0.18	23/15
1 to 2 μsec	0183M5 0172M5 0175M5	270M1 0187M5 NEW! 1101M5	550	275	0.1	0.5	55	7	0.21	0.41	30/18
			700	350	0.1	0.4	60	5	0.18	0.36	30/18
			700	350	0.05	0.3	40	5	0.13	0.25	23/15
			800	400	0.1	0.5	65	6	0.21	0.41	30/18
			820	410	0.05	0.25	35	5	0.11	0.22	20/12
2 to 4 μsec	0173M5	0167M5	450	225	0.2	0.8	50*	4	0.36	0.60	30/18
			625	312.5	0.2	0.8	50	4	0.36	0.58	30/18
4 to 6 μsec	232M1	264M1	480	240	0.2	1.5	80*	10	0.45	0.95	50/30
			630	315	0.2	1.5	80*	12	0.45	0.90	50/30
6 to 8 μsec	226M1	269M1	400	200	0.5	1.5	80*	7	0.70	1.25	50/30
			480	240	0.5	1.75	55	7	0.80	1.50	50/30
over 8 μsec	225M1 222M2	269M1	250	125	0.5	3.0	35*	3	1.15	2.40	50/30
			400	200	0.5	3.0	75*	10	1.15	2.30	80/50
			480	240	0.5	1.75	55	7	0.80	1.50	50/30

RCA ELECTRONIC COMPONENTS AND DEVICES

* μV₁



The Most Trusted Name in Electronics

ON READER-SERVICE CARD CIRCLE 213

ONLY 3C OFFERS

TOTAL INTEGRATED CIRCUIT CAPABILITY: μ -PACS, MEMORIES, AND COMPUTERS

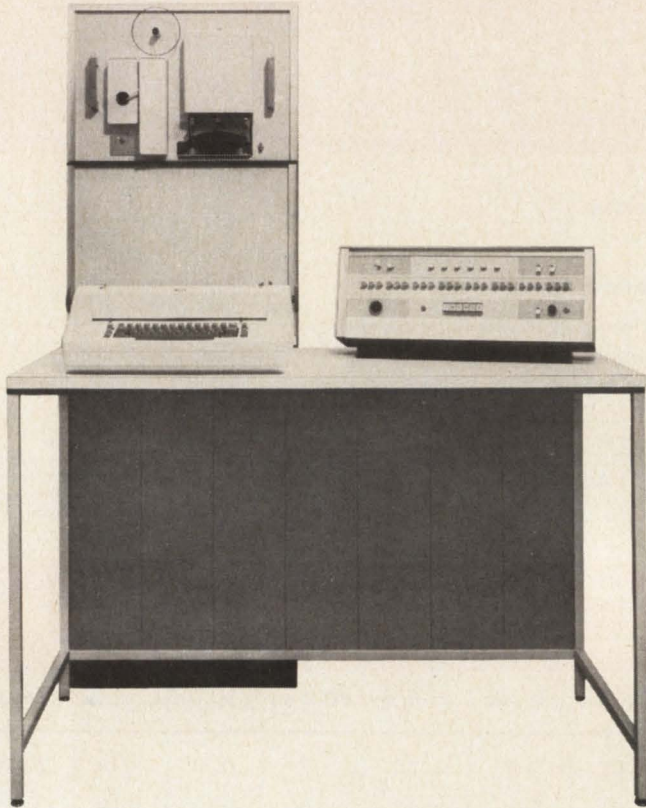

MICROCIRCUIT DDP-124

24-bit word DDP-124 features monolithic integrated circuit μ -PACtm construction; fast, reliable, and flexible logic configuration — binary, parallel, sign/magnitude, single address with indexing, powerful command structure. Over 285,000 computations per second. MEMORY: 8192 words (expandable to 32,768) directly addressable; cycle time 1.75 μ secs. INPUT-OUTPUT: Typewriter, paper tape reader and punch. (Strong optional I/O capability and broad range of peripheral equipment.) SOFTWARE: FORTRAN II and IV, assembler, executive, utility and service routines. Fully program compatible with DDP-24 and DDP-224 general purpose computers.

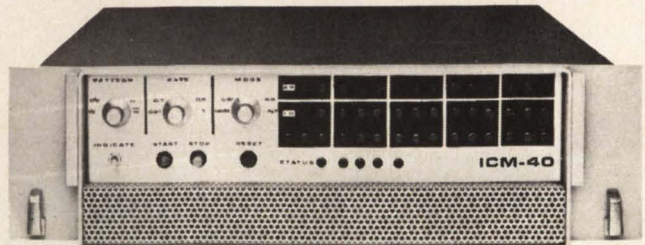

INTEGRATED CIRCUIT 1 μ SEC CORE MEMORY

New ICM-40 microcircuit, coincident current, random access core memories feature full cycle operation in 1 μ .SEC (less than 500 nsec access time). ICM-40's feature price, size and reliability advantages of integrated circuit μ -PACtm logic. Word capacities to 16,384 in a 5 $\frac{1}{4}$ " high unit for mounting in a standard relay rack. Design permits pull out front rack access. Operating temperatures from 0°C to +50°C, with broad margins. Clear/Write, Read/Restore and Read/Modify/Write are standard modes of operation. ICM-40 interfaces comfortably with both discrete component and integrated circuit systems. Low power dissipation.

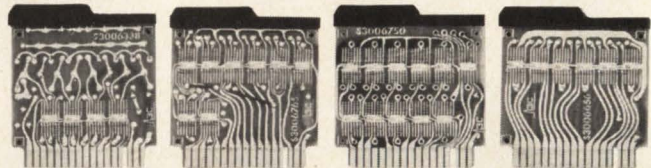

μ -PAC LOGIC MODULES

3C is the world's largest supplier of digital logic modules. With several years of in-house funded research and design, 3C has developed a broad line of standard, fully integrated, monolithic, 5mc circuit modules with the flexibility of 3C's long established discrete package lines. This has been achieved while retaining advantages inherent in the integrated circuit — price, size, reliability.

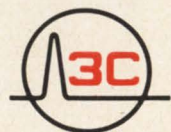

3C SALES OFFICES: NEEDHAM, MASS.; FOREST HILLS, N.Y.; LEVITTOWN, PA.; SYRACUSE, N.Y.; SILVER SPRING, MD.; HOUSTON, TEXAS; HUNTSVILLE, ALA.; COCOA BEACH, FLA.; DES PLAINES, ILL.; DETROIT, MICH.; WEST CARROLLTON, OHIO; LOS ANGELES, CALIF.; KENT, WASH.; ALBUQUERQUE, N.M.

COMPUTER CONTROL COMPANY, INC.
OLD CONNECTICUT PATH, FRAMINGHAM, MASSACHUSETTS 01702

Speed Inquiry to Advertiser via Collect Night Letter

ON READER-SERVICE CARD CIRCLE 4

NOTE

TO MANUFACTURERS OF:

small kitchen appliances
hair dryers
power drills
floor polishers
office copying machines
commercial temperature controls
light dimmers
space heaters
computers (tape drive control)
sewing machines
motion picture projectors

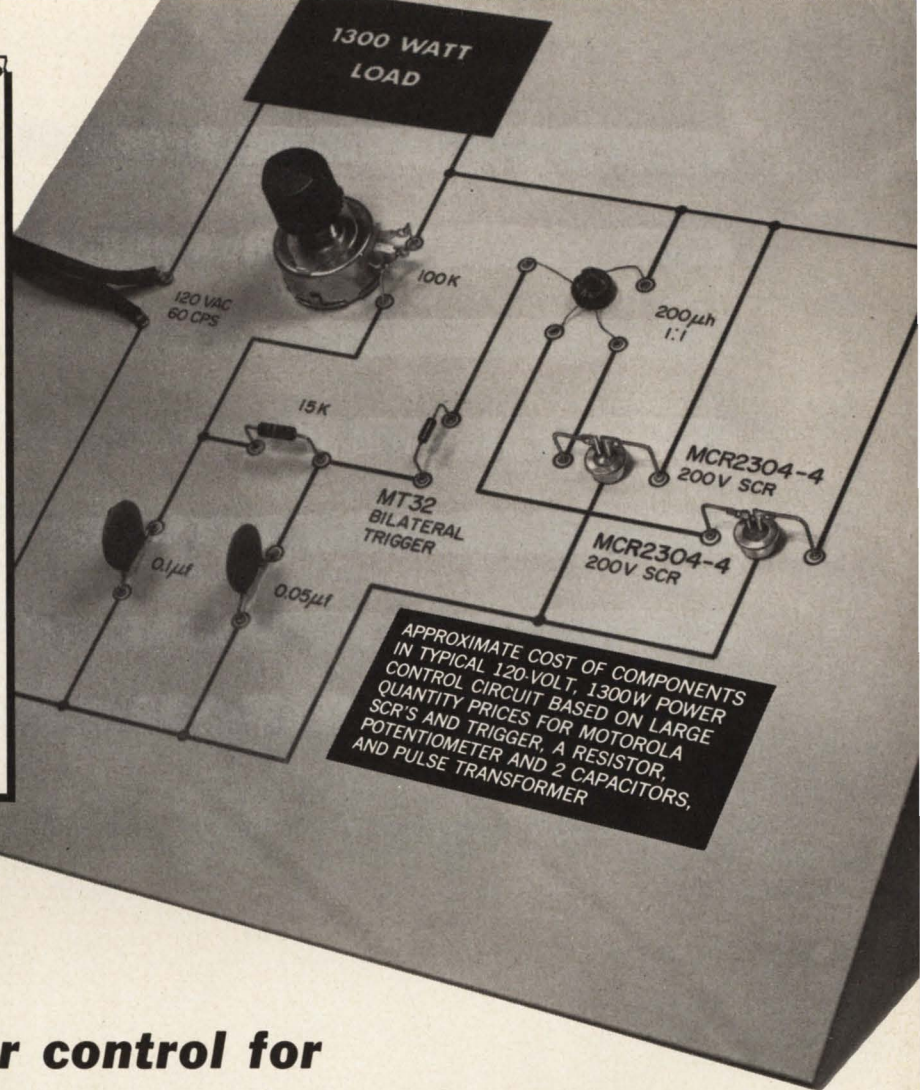

**You can add
solid state reliability
plus continuous power control for
less than \$2.50 in total component cost...**

Continuing development of the Elf® thyristor – Motorola's popular low-cost 8-ampere SCR – has opened up unlimited areas for stepless control of 120- and 240-volt operated electrical equipment. Now the Elf truly satisfies the current and power requirements of virtually every product using continuous control of motor speed, heat or light... retains all the safety features essential to reliable SCR circuit operation in these products... yet costs little more than non-hermetically-sealed devices having only a fraction of its current-handling capability.

Without waste, wear and repair...

common to expensive electro-mechanical switches and controls, the midget-sized "Elf" SCR's give you these design advantages:

- high power handling capability at elevated temperatures – 5 amperes (AV) at 75°C, case
- minimum power loss – low 1.3-volt forward voltage drop (max.) @ 5A @ $T_J = 25^\circ\text{C}$

- mounting versatility – 12 different hermetic cases (plus reverse polarity)
- immunity from false triggering due to noise – a realistic 10mA (typ.) gate firing level
- current surge protection – 100 amperes for 1 cycle, 60 cps, minimizes chances for damage from transients

Get symmetrical firing characteristics...

with the MT32, bilateral trigger – a versatile companion in value that replaces neon lamps, unijunction transistors, and other thyristor triggering devices requiring complex circuitry.

Investigate these products NOW...

Call your Motorola distributor for off-the-shelf engineering units... And for ideas that can help accelerate your thinking about electrical control designs, write for our set of "applications unlimited" thyristor circuits and device data sheets.

MOTOROLA



Semiconductor Products Inc.

P.O. BOX 955, PHOENIX, ARIZONA 85001

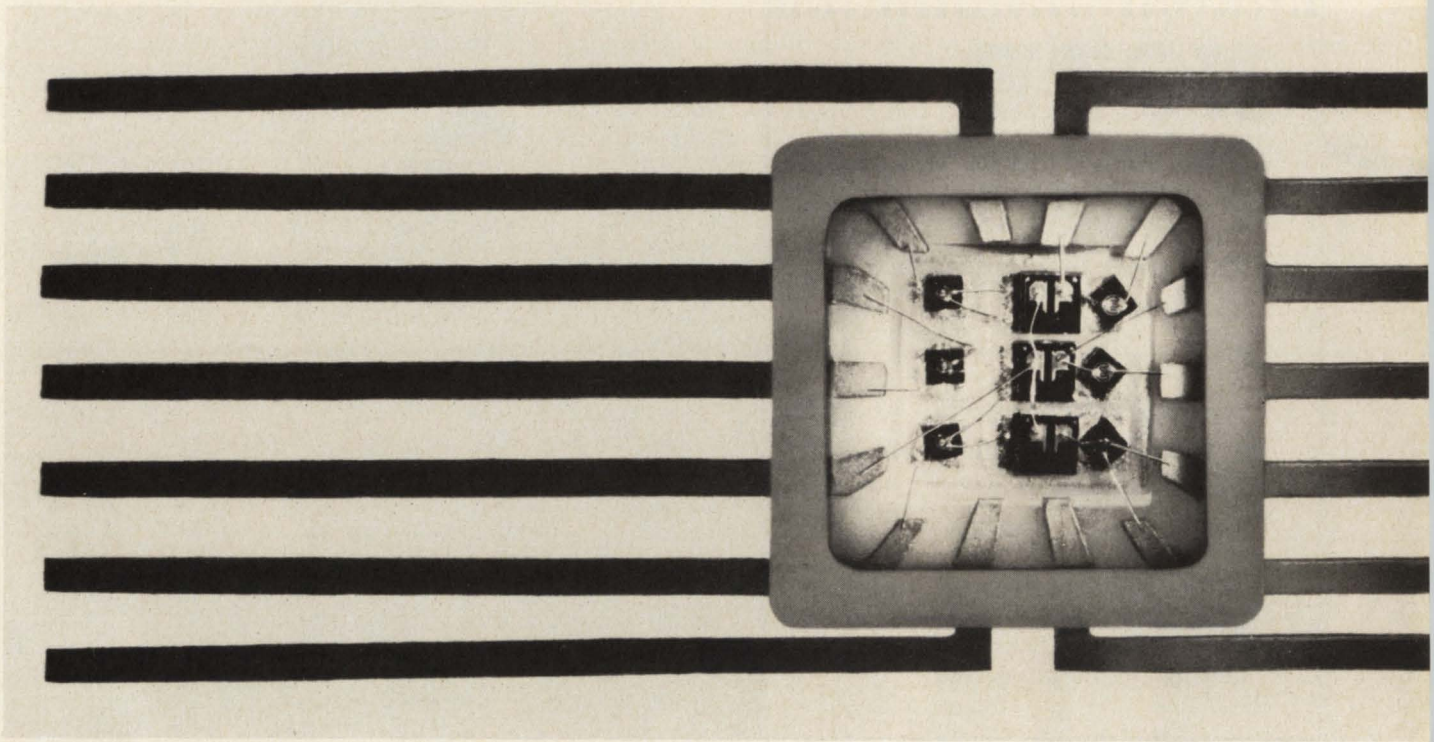

Reasons for buying Fairchild Hybrids, magnified 100 times.

What we have to offer:

Pick from the widest line of transistors, diodes, and integrated circuits in the industry.

Integrated circuits: A complete line of logic functions in μL^* standard resistor-transistor integrated circuits, $\text{F}\mu\text{L}^*$ industrial integrated circuits, $\text{MW}\mu\text{L}^*$ milliwatt integrated circuits, and $\text{DT}\mu\text{L}^*$ diode-transistor logic circuits.

Transistors and diodes: Our complete catalog of high-performance transistors and diodes. Anything our factory makes we will put in a hybrid circuit for you.

Resistors: We use nichrome thin-film resistors in all RETMA values from 20Ω to $500\text{K}\Omega$. Tolerances from 10% to 2%.

Capacitors: MOS capacitors from 20pf to 1000pf.

Packaging: TO-5 (8, 10 or 12 leads) or FlatPak (12 or 14 leads).

We're geared for action:

We have a complete staff devoted to hybrid work. This means you get immediate answers, quotes and delivery on your custom orders. Fast. We also offer assistance in converting your schematic to a hybrid design. Write for details on our Technicon (specifications delineation), our Hybrid Design Handbook, and our Design Kit. Or, if you're not in the market for a custom design, write for data sheets on our standard hybrid circuits.



* μL , $\text{F}\mu\text{L}$, $\text{MW}\mu\text{L}$ and $\text{DT}\mu\text{L}$ are Fairchild trademarks.

Did You Know Sprague Makes 51 Types of Foil and Wet Tantalum Capacitors?

FOIL-TYPE RECTANGULAR TANTALEX® CAPACITORS



Type 300D polarized plain-foil
Type 301D non-polarized plain-foil
Type 302D polarized etched-foil
Type 303D non-polarized etched-foil

ASK FOR BULLETIN 3650

ON READER-SERVICE CIRCLE 162

FOIL-TYPE TANTALUM CAPACITORS TO MIL-C-3965C

CL20, CL21 tubular 125 C polarized etched-foil
CL22, CL23 tubular 125 C non-polar etched-foil
CL24, CL25 tubular 85 C polarized etched-foil
CL26, CL27 tubular 85 C non-polar etched-foil
CL30, CL31 tubular 125 C polarized plain-foil
CL32, CL33 tubular 125 C non-polar plain-foil
CL34, CL35 tubular 85 C polarized plain-foil
CL36, CL37 tubular 85 C non-polar plain-foil
CL51 rectangular 85 C polarized plain-foil
CL52 rectangular 85 C non-polar plain-foil
CL53 rectangular 85 C polarized etched-foil
CL54 rectangular 85 C non-polar etched-foil

ON READER-SERVICE CIRCLE 163

125 C FOIL-TYPE TUBULAR TANTALEX® CAPACITORS



Type 120D polarized plain-foil
Type 121D non-polarized plain-foil
Type 122D polarized etched-foil
Type 123D non-polarized etched-foil

ASK FOR BULLETIN 3602C

ON READER-SERVICE CIRCLE 161

85 C FOIL-TYPE TUBULAR TANTALEX® CAPACITORS

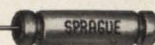

Type 110D polarized plain-foil
Type 111D non-polarized plain-foil
Type 112D polarized etched-foil
Type 113D non-polarized etched-foil

ASK FOR BULLETIN 3601C

ON READER-SERVICE CIRCLE 164

SINTERED-ANODE TUBULAR TANTALEX® CAPACITORS



Type 109D elastomer seal 85 C
Type 130D elastomer seal 125 C
Type 137D hermetic seal 125 C

ASK FOR BULLETINS 3700F, 3701B, 3703

ON READER-SERVICE CIRCLE 165

SINTERED-ANODE CUP STYLE TANTALEX® CAPACITORS



Type 131D 85 C industrial-type
Type 132D 85 C vibration-proof
Type 133D 125 C vibration-proof

ASK FOR BULLETINS 3710B, 3711

ON READER-SERVICE CIRCLE 166

SINTERED-ANODE CYLINDRICAL TANTALEX® CAPACITORS



Type 140D
up to 175 C operation,
3/8" diam.
Type 141D
up to 175 C operation,
1 1/8" diam.

ASK FOR BULLETIN 3800

ON READER-SERVICE CIRCLE 167

SINTERED-ANODE RECTANGULAR TANTALEX® CAPACITORS



Type 200D negative terminal grounded
Type 202D both terminals insulated

ASK FOR BULLETIN 3705A

ON READER-SERVICE CIRCLE 168

SINTERED-ANODE TANTALUM CAPACITORS TO MIL-C-3965C

CL14 cylindrical, 3/8" diam.
CL16 cylindrical, 3/8" diam., threaded neck
CL17 cylindrical, 1 1/8" diam.
CL18 cylindrical, 1 1/8" diam., threaded neck
CL44 cup style, uninsulated
CL45 cup style, insulated
CL55 rectangular, both terminals insulated
CL64 tubular, uninsulated
CL65 tubular, insulated

ON READER-SERVICE CIRCLE 169

For comprehensive engineering bulletins on the capacitor types in which you are interested, write to:

Technical Literature Service
Sprague Electric Company
347 Marshall Street
North Adams, Mass. 01248

45C-5158

SPRAGUE
THE MARK OF RELIABILITY

Sprague and "S" are registered trademarks of the Sprague Electric Co.

ED News

Pace of Gunn effect research quickens PAGE 17

Diamond dies are cut by ruby laser PAGE 21

MOS arrays diffuse into commercial market PAGE 22

Dial a computer for design information PAGE 26

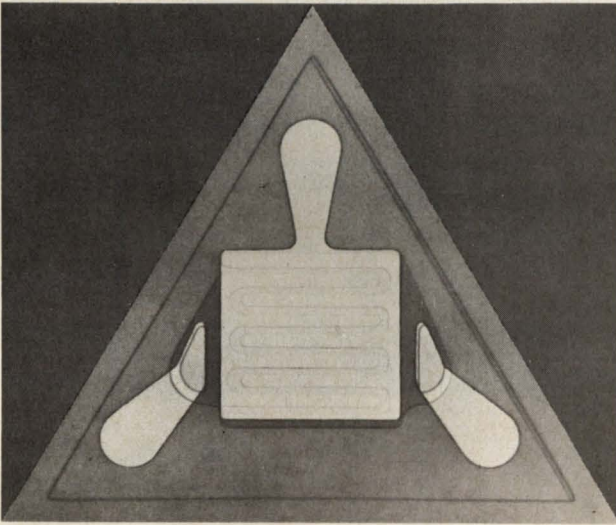

MOS-FETs broaden scope . . .22

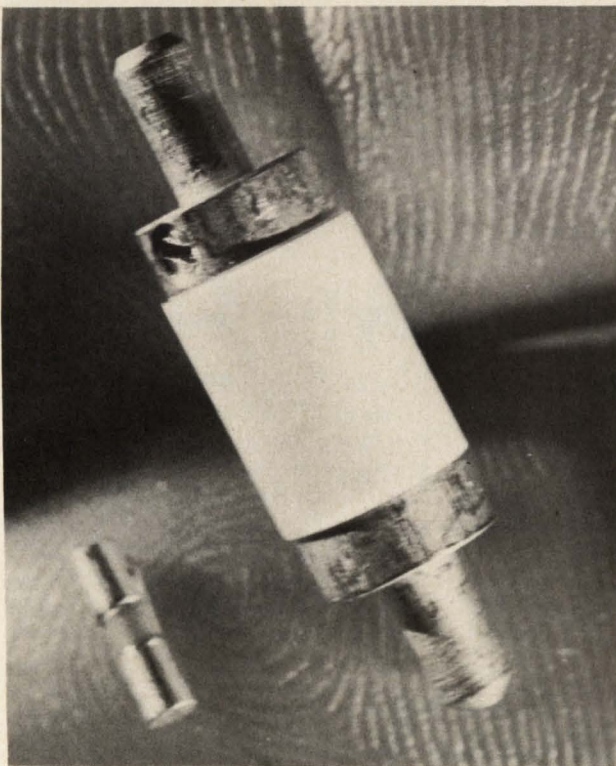

Gunn-effect devices coming . . .17



Diamonds cut by laser . . .21

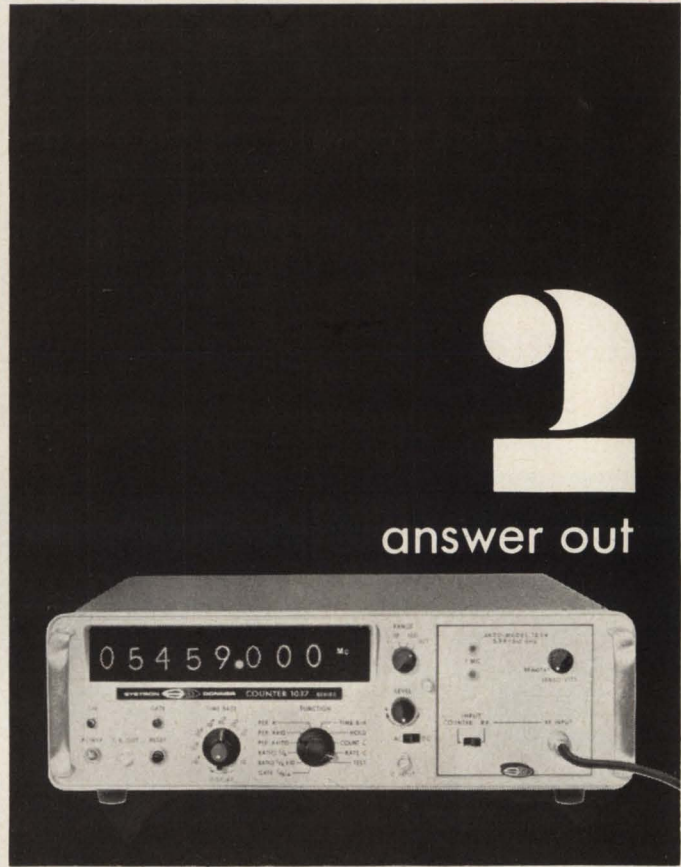

yes, it's that simple to measure microwave frequencies directly

(and with counter accuracy!)

Just connect the input signal and read the answer! Systron-Donner's new frequency measuring system is completely automatic. No calculations, no manipulations of any kind. This great new tool for the lab and production testing will prove to be as necessary as a digital voltmeter.

S-D can deliver this automatic system now for measurements between 3.95

and 8.2 GHz. Soon we'll offer coverage over the rest of the microwave spectrum. The system shown here illustrates the basic concept—a combination of the S-D 50 Mc Model 1037 Counter and the S-D Model 1254 Automatic Computing Transfer Oscillator. Other plug-ins will cover L, S and X bands.

FOR MAXIMUM STABILITY—Systron-Donner exclusively offers a high stabil-

ity oscillator with an aging rate of 1 part in 10^9 per 24 hours. That's a three-fold increase in stability over the best previous oscillators!

Prices: Model 1037 Counter, \$2,550. Model 1254 ACTO Plug-in, \$1,950. To learn more about automatic GHz counting, please write to us in Concord or contact your nearest S-D sales engineer (listed in EEM).

SYSTRON  DONNER
CORPORATION

888 Galindo Street • Concord, California
Speed Inquiry to Advertiser via Collect Night Letter
ON READER-SERVICE CARD CIRCLE 6

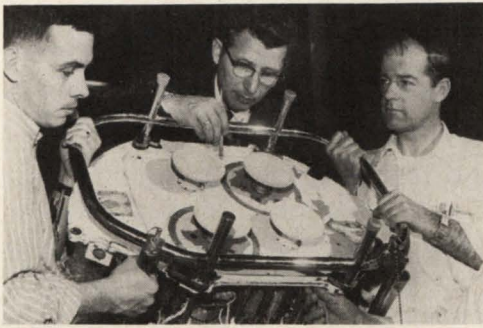

NASA scrambling to fill budget gaps

Once again, NASA's Voyager mission to land capsules on Mars has been deferred—from 1971 to 1973. Hoping to fill the gap, the agency has added three new Mariner voyages past Venus and Mars.

The first postponement of Voyager last year was due to limitations of the fiscal 1965 budget. And it now looks pretty certain that rather than the \$5.6 billion that NASA is seeking, the President will suggest the same amount that is in the current budget: \$5.17 billion.

The three newly scheduled Mariner missions will be one Venus photographic fly-by in mid-1967, using a modified version of the Mariner IV Atlas-Agena craft; and two Mars fly-bys in early 1969, using "somewhat heavier" Atlas-Centaur vehicles.

NASA's biggest job in the budget squeeze is to keep alive the vast resources built up for the Apollo lunar landing program. Twelve Saturn 1Bs and 15 Saturn 5 spacecraft have been ordered for that program.

In the Gemini program, as engineers at Westinghouse were checking out their rendezvous radar unit that performed so well in the spectacular Gemini 6/7 mission (see photo above) GE engineers announced modifications to the troublesome fuel cell system. The modified system will reportedly be ready for Gemini 8, now scheduled for March or April.

The fuel cell itself was not the problem. Engineers suspected that the water removal occasionally got clogged up from freezing, foreign matter or a stuck valve. Thus, they are eliminating some of the drainage pipes and valves and providing better insulation. But the most important change involves addition of sensing devices. Previously, only a warning light told of pressure changes in the water removal system. Now the light will alert the astronauts to "a problem," and they will be able to check conditions at a number of key points in the fuel supply line, water removal line and at all

News Report

important valves and regulators. These readings will be connected to the craft's telemetry system, for relaying to the ground.

MNS technique improves IC insulation

Researchers have developed a method called MNS (for metal-nitride-semiconductor) for depositing, rather than oxidizing, integrated circuit insulating layers through the use of silicon nitride.

Instead of oxidizing the surface of the doped silicon chip to provide gate insulation and masks for diffusion, scientists at Sperry Rand Research Center in Sudbury, Mass., deposit a layer of silicon nitride and get better results, according to Dr. Richard Wegener. An insulation thickness comparable to that of the present silicon dioxide—about 0.1 micron—results, he said, in a gate insulation with a breakdown voltage twice as high as gates made with SiO₂.

Other problems, such as ion drift and doping blur, caused by the high temperatures required for oxidation of the silicon surface, are eliminated by the low-temperature deposition.

In addition the nitride produces an insulation of unusually high electrical stability, which can be deposited ten times as fast as the silicon can be oxidized, Dr. Wegener reported. The nitride can be deposited in any thickness from a fraction of a micron to several mils. The SiO₂ layer cannot be grown any thicker than a few microns, according to Dr. Wegener. He also noted a reduction in threshold voltage for insulated-gate transistors made with the new technique.

U.S. forms Institute of Oceanography

An Institute for Oceanography, equipped with research ships, computers and the prospect of sea watching satellites, has been established by the Federal Government. The move will integrate oceanographic research, formerly spread through several agencies, into a single body.

Headed by Dr. Harris G. Stewart Jr.,

former chief oceanographer for the Coast and Geodetic Survey, the new institute will be a part of the equally new Environmental Science Services Administration, which reports to J. Herbert Holloman, Assistant Secretary of the Dept. of Commerce for Science and Technology. The administration was formed last summer to include the Weather Bureau, the Radio Propagation Laboratory and the Coast & Geodetic Survey.

The institute is looking forward to delivery this year of two research ships—the “Oceographer” and the “Discoverer”. Also planned is the use of satellites to measure ocean phenomena over wide areas.

As far as the institute’s immediate plans are concerned, Dr. Stewart reported that until budgets become larger, emphasis will be on integration of activities rather than on expansion. The upsurge in oceanographic studies means that “unless we start moving faster and better, we will be left in the dust,” he remarked.

The institute will make use of field installations the survey already has at Norfolk, Seattle and Honolulu.

Cimron Corp. acquired by Lear Siegler

Lear Siegler, Inc., with a \$200-million aerospace instrumentation business, has moved toward expansion in laboratory and industrial instrumentation by acquiring the Cimron Corp. of San Diego, Calif.

Cimron’s sales last year amounted to \$2.8 million, with a jump to \$4 million projected for fiscal 1966. The transaction involved an undisclosed amount of Lear Siegler’s preferred and common stock. The operations of the acquired company will continue under Cimron’s president, Wayne J. Wilkinson, according to John G. Brooks, president and board chairman of Lear Siegler.

Industry engineering salaries up 3.2%

Salaries of engineers in industry followed President Johnson’s recommended 3.2% annual increase in the 12 months ended March, 1965, a report just released by the Bureau of Labor Statistics shows. But for comparable federal engineering positions, a lag of 8 to 20% existed.

The average federal salary for a GS-12 engineer (the average job level) was \$11,723, compared with \$13,140 for

the engineer in industry—a difference of 12%. The report, BLS Bulletin 1469, is available for 45¢ from the Superintendent of Documents, Washington, D.C.

‘Control tower from fresh vegetables . . .’

It’s conceivable that in the not-too-distant future supermarket radios may carry messages like this: “Tower from fresh vegetables . . . we need corn, eggplant and spinach.”

Such messages would be received in an electronic control center, operating somewhat like an aviation control tower, in place of the cubicle that store managers now commonly occupy. A variety of store-management functions—from stock and pricing reports to customer contacts and even parking-lot traffic control—would be handled in the proposed control center.

Four companies—Pepsi-Cola; the Super Market Institute; Honeywell and Motorola—have joined in a cooperative effort to develop such a system. Honeywell’s EDP division is supplying the data-processing and display equipment and Motorola, closed-circuit TV and radio communications.

The system is scheduled for display at a supermarket convention in Chicago in April.

The 1 x 10⁻²¹ watt voice of Mariner IV has been picked up by an 85-foot antenna in California. The Mars spacecraft was at its farthest point from earth—216 million miles—at the time and is now heading back.

Four major Japanese component manufacturers (unidentified) have reportedly formed a joint research lab to push development of ICs for consumer products, possibly to include linear types.

An estimated 90 mergers took place in the electronics industry in 1965, up from 71 in 1964, according to a survey of W. T. Grimm & Co., financial consultants.

A radio-television pioneer, Frank A. D. Andrea, chairman of the board and president of Andrea Radio Corp., is dead at 77. Mr. Andrea was an early producer of ham radio kits. His company has lately been concentrating on the television market.

Mark 46 torpedoes for Navy BuWeps will be produced by Honeywell (guidance & control) and TRW (propulsion system) under a \$42.5 million contract just awarded. Work will be carried out at Honeywell’s Hopkins, Minn. Plant and TRW’s Cleveland center.

INSTRUMENTATION SPECS in 250 KC tape recording

... now start at under \$9966

(7 CHANNELS, 6 SPEEDS, DIRECT MODE)

The design approach that made possible Sanborn true IRIG instrumentation performance at lower cost in low bandwidth tape recording is now available in intermediate band systems. Sanborn Models 3917B and 3924B 7- and 14-channel systems record and reproduce data up to 250 kc in direct mode, to 20 kc in FM mode. Pulse mode enables digital information as short as 2 μ sec wide to be recorded and reproduced. A complete 6-speed system ready for direct recording/reproducing costs \$9966 for 7 channels, \$15,977 for 14 channels. (Same systems may be ordered with fewer tape speed plug-ins, at correspondingly lower costs.)

These new systems have the same improvements in performance, reliability and operating ease as the low bandwidth models, for instrumentation tape recording with complete IRIG compatibility. The tape transport, key to superior system performance, is of a rugged and simple Hewlett-Packard design which reduces costs without sacrificing uniform tape motion; six electrical speeds are pushbutton-selected (1 7/8 to 60 ips) without idler or capstan change. Other standard features include provision for edge track for voice commentary, adjustable input/out levels, built-in 4-digit footage counter accurate to 99.95%, and easy snap-on reel loading. The transport needs no maintenance except occasional cleaning of the tape path.

Check the system specifications here and call the H-P Field Engineer in your locality for complete technical data and application engineering assistance. Offices in 48 U.S. and Canadian cities, and major areas overseas. Sanborn Division, Hewlett-Packard Company, Waltham, Massachusetts 02154. Europe: Hewlett-Packard S.A., 54 Route des Acacias, Geneva, Switzerland.

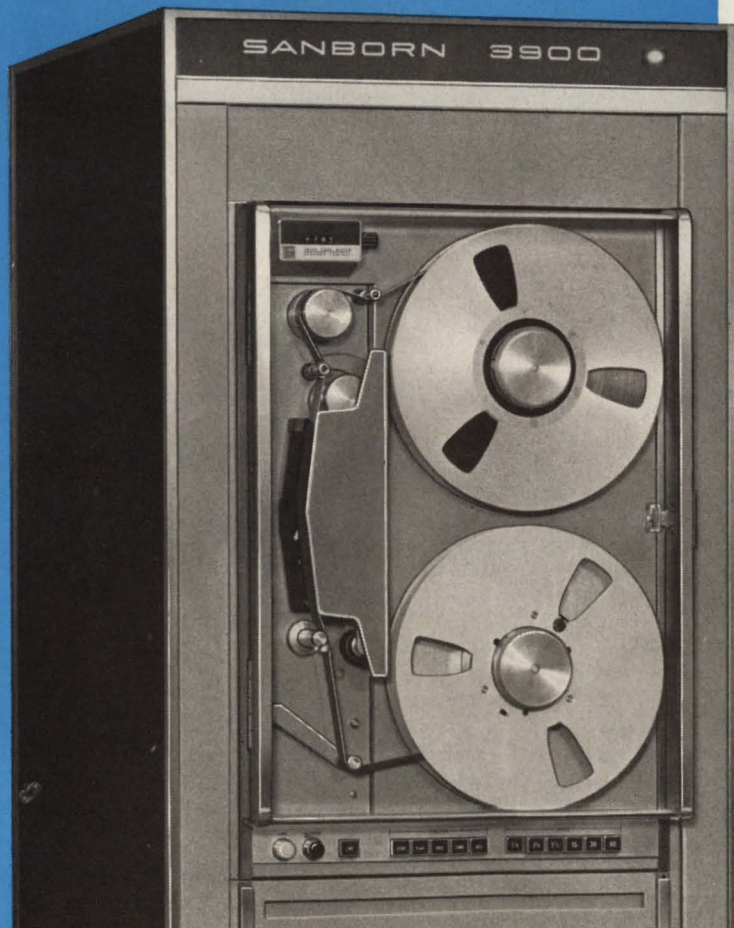

representative specifications

DIRECT MODE

Tape Speed	Bandwidth	Frequency Response	S/N Ratio Filtered	Minimum RMS Unfiltered
60 ips	300-250 KC	± 3 db	35 db	29 db
15 ips	100-62.5 KC 300-44 KC	± 3 db	32 db 38 db	27 db
1 7/8 ips	50-7 KC 300-5 KC	± 3 db	30 db 39 db	26 db

*Measured with bandpass filter at output with an 18 db/octave rolloff

FM MODE

Tape Speed	Bandwidth	Frequency Response	FM Center Carrier Frequency (Nominal)	S/N Ratio* Without Flutter Comp.	Total Harmonic Distortion
60 ips	0-20 KC	+0, -1db	108 KC	45 db	1.5%
15 ips	0-5 KC	+0, -1db	27.0 KC	45 db	1.5%
1 7/8 ips	0-625 cps	+0, -1db	3.38 KC	40 db	1.8%

*Noise measured over full bandwidth, min. rms at zero freq. dev., with lowpass filter placed at output. Filter has 18 db/octave rolloffs.

TAPE TRANSPORT

Maximum Interchannel Time Displacement Error: ± 1 microsecond at 60 IPS, between two adjacent tracks on same head.

Tape Speeds: 60, 30, 15, 7 1/2, 3 3/4, 1 7/8 ips standard; 0.3 to 120 ips optionally available.

Tape: 3600 feet, 1.0 mil, 1/2" (7 channel), 1" (14 channel).

Controls: Line (Power), Stop, Play, Reverse, Forward (fast) and Record are pushbutton relays. A receptacle at the rear of the transport is provided for remote control operation.

Drive Speed Accuracy: $\pm .25\%$.

FLUTTER

Speed	Bandwidth	Flutter (p-p)
60 ips	0-200 cps	0.2 %
	0-10 KC	0.6 %
30 ips	0-200 cps	0.2 %
	0-5 KC	0.8 %
15 ips	0-200 cps	0.25 %
	0-2.5 KC	0.6 %
7 1/2 ips	0-200 cps	0.5 %
	0-1.25 KC	0.65 %
3 3/4 ips	0-200 cps	0.5 %
	0-625 cps	0.8 %
1 7/8 ips	0-200 cps	0.8 %
	0-312 cps	1.2 %

HEWLETT
PACKARD  SANBORN
DIVISION

here are the resistors
you've been looking for
to use in your miniaturized circuits

ALLEN-BRADLEY Type BB 1/8-watt and
Type CB 1/4-watt hot molded resistors
shown approximately 4 times actual size

Here are two resistors that are ideally suited for your miniaturized circuits—the Allen-Bradley Type BB 1/8-watt and the Type CB 1/4-watt units. While extremely small, both have integrally molded insulated bodies and are full-fledged members of the Allen-Bradley hot molded resistor family.

This is made possible by employing the same exclusive hot molding process as used for the higher ratings of A-B resistors. The use of special automatic machines removes the element of human error, assuring complete uniformity of physical and electrical properties from one resistor to the next—from one billion to the next. And catastrophic failures are absolutely unheard of with Allen-Bradley hot molded resistors.

Be sure you have full specifications on both of these A-B hot molded resistors on hand. Please send for Technical Bulletin 5050 on the Type CB and Technical

Bulletin B5005 on the Type BB: Allen-Bradley Co., 222 West Greenfield Ave., Milwaukee, Wis. 53204. Export Office: 630 Third Avenue, New York, New York, U.S.A. 10017.

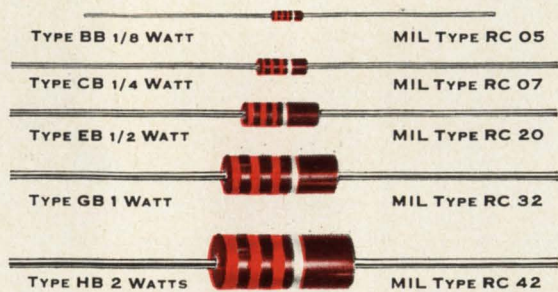

HOT MOLDED FIXED RESISTORS are available in all standard EIA and MIL-R-11 resistance values and tolerances, plus values above and below standard limits. Shown actual size.



ALLEN-BRADLEY
QUALITY ELECTRONIC COMPONENTS

ON READER-SERVICE CARD CIRCLE 7

1065-11AB

Pace of Gunn-effect research quickens

Labs are at work on thermal and impedance problems, with a product perhaps 1-2 years away. Radar, telemetry should gain from high-power GaAs devices.

Ralph Dobriner
West Coast Editor

Though the first commercial Gunn-effect devices may be on the market within a year or two, few are predicting that they will soon thereafter replace the whole gamut of microwave tubes. Nevertheless, these solid-state devices are now expected to have considerable impact in the whole area of microwave generation.

The amount of work going on in several laboratories, such as Varian, Raytheon, Watkins-Johnson, IBM and Bell Laboratories, indicates extreme interest in the rapid development of a Gunn-effect product. Problems, principally thermal, remain to be solved, however.

According to Dr. A. Uhler, vice president, Microwaves Associates, Burlington, Mass. (See E/D, Jan. 4,

1966, p 67), "The Gunn effect is unprecedented in both vacuum and semiconductor electronics—there are no close analogies. For this reason, it has the best chance for really new and different results. It is ahead of all the other microwave semiconductors in terms of power and efficiency."

During the past year, considerable progress has been made in understanding and developing both the Gunn effect and the high-field oscillations. Basically, the effect involves the generation of microwave oscillations in gallium-arsenide by the application of a constant-voltage dc source. A more complete description of the effect may be found later in this article.

Commercial units a year off?

Ian Gunn told ELECTRONIC DESIGN

recently that the first units should be marketed within one to two years. However, he observed that a number of major problems still need to be solved, including:

- The development of a GaAs crystal that is reliable and predictable. (The yield of good quality material is quite low), and

- The discovery of a workable method for depositing metal-alloy contacts on the crystal's surface.

Since the device is the only semiconductor with high-pulsed-power capability in the microwave range, Dr. Dan Dow, head of Varian Associates' tube division in Palo Alto, Calif., expects their widespread application in such areas as:

- Navigation beacons, both air and seaborne.

- Man-pack radars.

- Radar altimeters and light radars, especially for small aircraft.

- Pulse-code telemetry systems.

As a continuous-wave power generator, however, Dr. Dow said that the devices will have to compete with existing transistor, varactor and klystron devices and with the more recently discovered avalanche oscillations in junction devices (Read-effect diodes). He feels that Gunn-effect devices will predominate in many of the instrumentation, communication and industrial systems that now use klystrons.

Many firms are engaged in basic and applied research on Gunn-effect materials. However, few are willing to forecast how soon usable production-line devices will be available.

Varian hopes to sell lab prototypes within a year and commercial production units within two years. Raytheon Corp., Waltham, Mass., has built a lab unit that operates at K_u band (15 GHz) at peak powers of the order of 10 mW. Raytheon's subsidiary, Micro State Electronics Corp., Murray Hill, N. J., has a GaAs epitaxial-materials program going, and, they report, reliable material will be available during 1966 and workable units for many applications about six months later. Watkins-Johnson Co., Palo Alto,

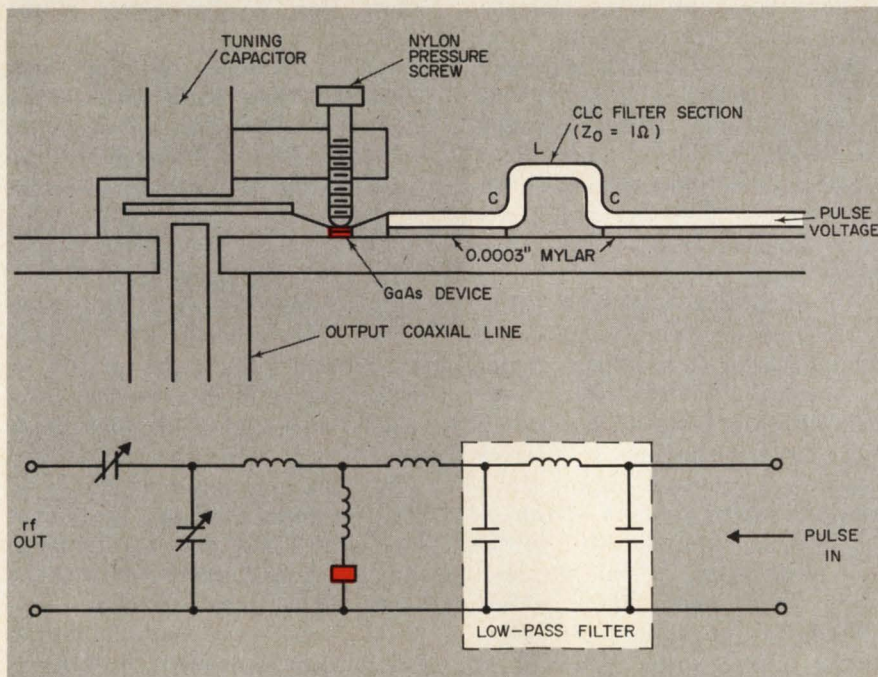

1. Gunn-effect device pulsed powers as high as 200 watts at 1.54 GHz were achieved by Varian Associates using the above configuration with two gallium arsenide devices in parallel. The low-pass filter is used as an RF bypass, and the inductive element of the resonant circuit is a short piece of stripline.

Gunn-effect . . .

Calif., under a NASA contract, is investigating bulk effects in solids for generating millimeter and submillimeter-wave power. IBM, which has stopped selling an 800-MHz experimental device introduced last year, is continuing active research under Gunn at the company's T. J. Watson Research Center in Yorktown Heights, N. Y.

10 kW at L-band predicted

Continuous-wave operation in gallium arsenide has now been observed at frequencies from 1 to 15 GHz and at power levels typically between 1 and 10 mW. Efficiencies of up to 14% have been reported. Continuous-wave operation at room temperature in the 2-3 GHz range with peak power exceeding 60 mW and efficiencies of between 5 and 6% have been reported by B. W. Hakki and S. Knight at Bell Labs.

Varian has achieved the highest peak-pulsed power reported so far—205 W at 1.54 GHz, using two GaAs devices in parallel operation at a rated efficiency of 6.5%.

These figures are the latest available, and with so much R&D activity in this area, they are being updated, literally, from week to week.

Varian's Dr. Dow predicted that, over the next couple of years, the maximum peak-pulsed power that can be achieved in these oscillators will approach 10 kW at L-band, dropping to about 100 W at X-band. These figures are based on a 1-ohm peak RF impedance. He emphasized that these predictions are speculative and depend to a considerable extent on the transverse-propagation properties of the devices and higher order modes in RF circuitry.

Gunn agreed that Dr. Dow's figures seemed reasonable. There should be no difficulty in obtaining higher and higher power, he declared, because, unlike most active devices, it is possible to go on increasing the power by simply increasing the cross-sectional area. The only penalty is lower input impedances with the larger devices.

He does not believe that the efficiencies of the devices will go much beyond the current 14-15% peak. "Basic semiconductor physics prevents reaching the 40 to 70%

efficiencies that are obtained in vacuum tubes.

Thermal, impedance problems

The limitations to high-power continuous-wave operation are principally thermal, Dr. Dow said. For example, the heat developed in a continuous-wave GaAs oscillator must exceed 500 W/cm² and is more typically several thousand W/cm². Power densities of this kind are difficult to dissipate on a large-area basis, therefore the cooling must be by radial flow of heat from a very small active area.

IBM solved this problem by using a mounting scheme for the GaAs crystal which efficiently drew heat away from the material. Instead of making soldered connections to the crystal, IBM used pressure contacts. The crystal was inserted between the ends of two copper rods whose surfaces had been plated with indium to insure good contact.

Pulsed devices have different power-limitation problems, including transient thermal effects and operating impedance levels.

The transient thermal problem comes about because of the relatively low heat conductivity of gallium arsenide. This heat conductivity is such that during a typical one- or two- μ s pulse, all of the energy delivered to the gallium arsenide is either converted to RF or to heat within the semiconductor material.

To achieve high-pulsed powers using these oscillators, said Dr. Dow, it is necessary to design first a low-impedance, parallel-resonant microwave circuit and, second, a bypass system that transmits the power-supply pulse to the device while assuring that the RF power is not lost.

A configuration used successfully at Varian is shown in the illustration on p 17. The low-pass filter is used as an RF bypass, and the inductive element of the resonant circuit is a short piece of stripline. It is terminated by a tuning capacitor and a coupling capacitor, both shown on the drawing and indicated in the equivalent circuit. Using a circuit of this type and gallium wafers 0.004 inches thick and 0.040 inches square, a peak power of 105 W at 800 MHz with a 14% efficiency has been generated. The same circuit with two devices in parallel achieved 205 W at 1.54 GHz.

It's not a narrow-band device

Dr. Dow pointed out some common fallacies about the Gunn effect. The most notable of these are concerned with tuning and frequency. The Gunn effect is not itself a narrow-band phenomenon, he stated. Devices have often tuned over one and a half frequency ranges and occasionally much wider.

It is clear, he noted, that the frequency is governed by the circuit, and, in this sense, the devices may be considered similar to klystrons, magnetrons or other resonant-cavity active devices. The active element does have a natural frequency. If it is imbedded in a completely resistive load, it will oscillate at this natural frequency. However, a tuned circuit with a Q as low as 5 is adequate to change the frequency a great deal and provide essentially a widely tunable oscillator. A further increase in the Q then improves frequency stability, of course, as it will with any circuit-dominated tuned device.

What is the Gunn effect?

Though Gunn and other researchers are still expending considerable effort to obtain better agreement between theory and observations of this new phenomenon, they now generally concur on the physical mechanisms involved in the Gunn effect. Here is a summary of the phenomenon:

When a constant field of about 2000-3000 V/cm is applied to n -type gallium arsenide or indium phosphide, the current through the material begins to fluctuate wildly at an extremely rapid rate. (This effect cannot be produced in p -type versions of the same material.)

In a short specimen of these compound semiconductors (roughly 0.005 inch or less), the current no longer fluctuates in a random fashion, but rises and falls in a cyclic way.

This phenomenon is explained by Gunn in terms of shock "waves" of high electric field, which build up at the cathode and travel across to the anode. Under constant-voltage conditions, these waves build up until a critical field of about 2000 V/cm is reached. At this point, the value of the field at the cathode rises above the threshold field to a peak value of greater than 20,000 V/cm, whereas

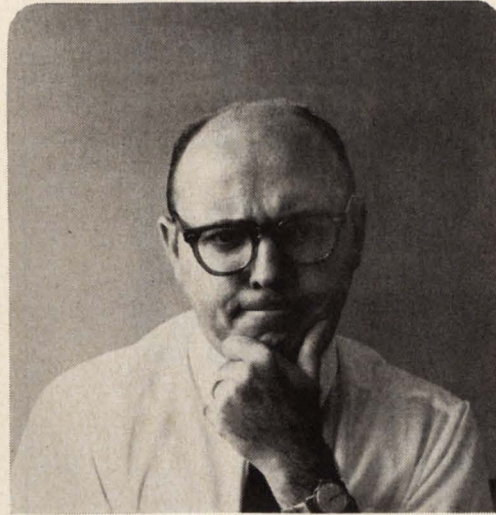

When Pete Balthasar concentrates on Bendix silicon power transistors...

Scott hears music!

Whenever you listen to an H. H. Scott stereo amplifier, you'll realize how Pete's concentration has paid off. The difference is the new Bendix silicon power transistors in the audio output.

Just take a look at what Pete, our Applications Engineering Manager, has to work with: I_C to 15 A, V_{CB} to 200 V, P_C to 175 W. Excellent beta stability over the entire operating range of -65°C to $+200^\circ\text{C}$. High voltage capabilities and diffused construction for fast switching. Outstanding thermal resistance characteristics, too.

Some of the more popular 2N performers? 2N3055, 2N3232 and 2N3235. Also the 2N1487-2N1490 that meet military specification MIL-S-19500/208 (EL).

Pete's defined SOAR (Safe Operating Area) for these types, too, with still more on the way. (That's a "first" for silicon power.) With SOAR, secondary breakdown is virtually impossible. There are also additional new commercial grades and lower cost types. (Our 2N3055 often proves more economical than germanium, for example.)

Now you can begin to see how you might put these powerful silicon mesas to work: for hi-fi and audio, of course. Voltage and current regulators, choppers, inverters, relay and solenoid actuating circuits and high power switching, too.

Like more information? Just write or phone our nearest sales office. Then sit back and enjoy the sound of Bendix.

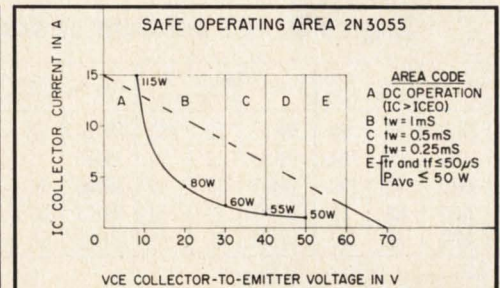
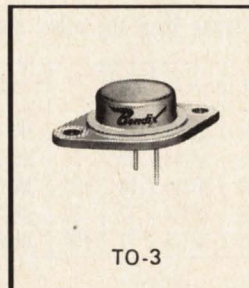

Bendix Semiconductor Division
HOLMDEL, NEW JERSEY



Baltimore, Md.—(301) 828-6877; Chicago—(312) 637-6929; Dallas—(214) 357-1972; Detroit—(313) JO 6-1420; Holmdel, N. J.—(201) 747-5400; Los Angeles—(213) 776-4100; Miami—(305) 887-5521; Minneapolis—(612) 926-4633; Redwood City, Calif.—James S. Heaton Co., (415) 369-4671; Seattle—Ray Johnston Co., Inc., (206) LA 4-5170; Syracuse, N. Y.—(315) 474-7531; Waltham, Mass.—(617) 899-0770; Export—(212) 973-2121. Cable: "Bendixint," 605 Third Ave., N. Y.; Ottawa, Ont.—Computing Devices of Canada, P.O. Box 508—(613) TA 8-2711.

ON READER-SERVICE CARD CIRCLE 8

New from Sprague!



LOW COST DUET[★] 3N123 DUAL-EMITTER CHOPPER TRANSISTORS

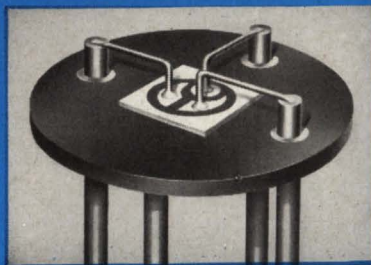

CHECK THESE FEATURES!

$$BV_{EEO} > 25 \text{ VOLTS}$$

$$|V_O| < 250 \mu\text{V}$$

$$|\Delta V_O / T_A| < 2.3 \mu\text{V per } ^\circ\text{C}$$

$$f_T > 6 \text{ mc}$$

HIGH VOLTAGE! RELIABLE PLANAR CONSTRUCTION!

Sprague offers more dual-emitter transistor types than any other source!

TYPE No.	BV _{EEO} (volts)	V _O (μV)	TYPE No.	BV _{EEO} (volts)	V _O (μV)	TYPE No.	BV _{EEO} (volts)	V _O (μV)	TYPE No.	BV _{EEO} (volts)	V _O (μV)	TYPE No.	BV _{EEO} (volts)	V _O (μV)
3N90	30	50	3N95	50	200	3N104	20	50	3N109	50	150	3N116	12	200
3N91	30	100	3N100	10	50	3N105	15	250	3N110	30	30	3N117	20	50
3N92	30	200	3N101	30	50	3N106	30	250	3N111	30	150	3N118	20	100
3N93	50	50	3N102	40	50	3N107	50	250	3N114	12	50	3N119	20	200
3N94	50	100	3N103	50	50	3N108	50	30	3N115	12	100	3N123	25	250

*Trademark

For complete information, write to Technical Literature Service,
Sprague Electric Co., 347 Marshall St., North Adams, Mass. 01248

SPRAGUE COMPONENTS

TRANSISTORS
CAPACITORS
RESISTORS
THIN-FILM MICROCIRCUITS
INTEGRATED CIRCUITS
INTERFERENCE FILTERS

PACKAGED COMPONENT ASSEMBLIES
FUNCTIONAL DIGITAL CIRCUITS
MAGNETIC COMPONENTS
PULSE TRANSFORMERS
CERAMIC-BASE PRINTED NETWORKS
PULSE-FORMING NETWORKS



*Sprague and ® are registered trademarks of the Sprague Electric Co.

ON READER-SERVICE CARD CIRCLE 9

NEWS

Gunn-effect . . .

the field in all other regions of the sample decreases below the threshold field.

As the wave travels towards the anode, the field on either side remains below the threshold. (See Fig. 2, top.) When it disappears at the anode, the level of the field in the specimen again rises to the threshold level and a new spike is generated at the cathode. Thus, under constant-voltage conditions, only one shock wave can exist at any one time, since the field on both sides of it is below threshold.

In this case, the current through the device drops as soon as a shock wave appears at the cathode. (Fig. 2, top, right.) This is because the field surrounding the wave is reduced below threshold; thus, these areas cannot carry as much current. When the wave disappears at the anode, the level of the field in the device increases, permitting the passage of more current. (Fig. 2, bottom, right.) The field, and thus the current, drops again when a new wave is formed at the cathode. The current spikes are produced in a periodic way, the time interval between current spikes being equal to the transit time of the shock wave.

Electrons lose mobility

Today the physics of the wave has been explained on the basis of a type of hot electron effect.

When the semiconductor is operated under constant-current conditions, where the voltage across the slab is not fixed, only random oscillations are produced. Since the voltage varies, the field on either side of the wave can be above the threshold, and thus new waves can be generated at random.

If the field in a semiconductor is continuously increased, the energy of the electron does not increase in a smooth transition. Electrons in some semiconductors can exist in two discrete energy bands. When an electron has been energized sufficiently, it will make the transition from the low-energy conduction band to the high-energy band.

The transfer mechanism—changing the mobility of an electron with

a high field—leads to the shock wave and ultimately to the generation of microwave oscillations.

Figure 3 shows a shock wave mid-way between the electrodes. The wave travels more slowly than conduction electrons in the low-energy conduction band (solid-black arrows). When electrons reach the high-field region of the shock wave, they jump to the high-energy band, their effective mass increases and their mobility decreases. Because they now become sluggish, they fall behind the wave (solid-color). But they soon give up their excess energy in scattering, return to the low-energy band and again catch up with the wave (color outline). The large number of sluggish electrons that bunch up at the wave account for the high-field region. The high-field region, in turn, forces the low-energy electrons into the higher energy low-mobility state.

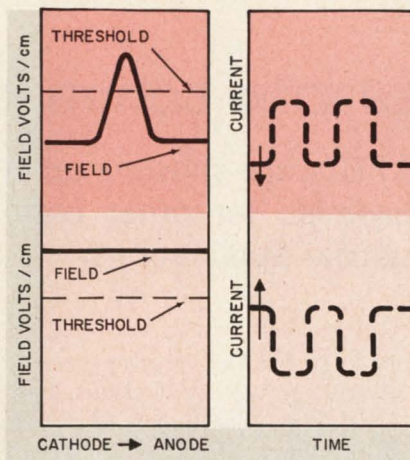

2. Gunn-effect current (right) varies as the field that surrounds the "shock wave" (left) in GaAs: It increases in the absence of the wave (bottom).

The energy-band theory also explains why the high-field region of the wave can carry the same current as the surrounding low-field region. Although electrons within

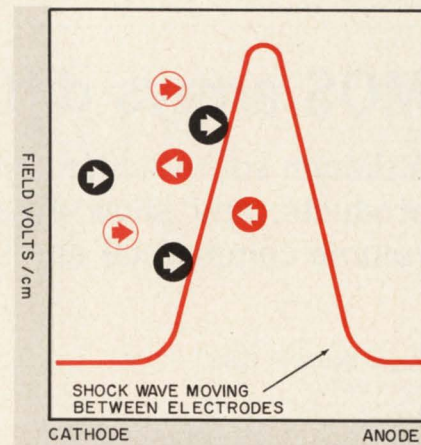

3. Mobility of electrons in the GaAs is changed by shock wave as they "chase" the wave from the cathode to the anode in the device (see text).

the region of the wave are under the influence of a high field, their net speed is the same as electrons in other regions because their mobility is reduced. ■ ■

New coating blend ups cathode power

A long-life cathode that handles much higher power than conventional oxide cathodes has been developed.

The same ingredients, barium and strontium oxide and nickel, are combined in a new way. The new cathode has a power-handling ability comparable with the convention-

al matrix cathode (between 0.5 and 1.0 A/cm²), yet it is less expensive in large sizes, operates at lower temperature (810°C) and has a predictable life expectancy of 20,000 to 30,000 hours, according to the developers.

The inventors, Drs. Dean Maurer and Charles Pleass of Bell Laboratories, accomplished the power-handling boost by vapor-coating the oxide particles with nickel before bonding them to a nickel base with

a nitro-cellulose binder. The binder improves the adherence of the nickel-coated particles to the nickel base.

Conventional low-power cathodes are made by spraying a carbonate compound onto the base material and processing the coating into an oxide. These handle up to 0.3 A/cm².

Conventional high-power cathodes are made by pressing nickel granules into an oxide mortar. ■ ■

Diamond dies cut by ruby laser

Lasers are a girl's best friend—at least for girl diamond cutters.

The complicated job of cutting diamond dies for electrical-wire drawing machines had required two to three days using diamond dust suspended in olive oil and tapered steel pins.

Western Electric Engineering Research Center at Princeton, N.J., came up with a simple ruby-laser device that does the job for the company's Buffalo, N. Y., wire-production facility in about two minutes. The job is monitored by closed-circuit television.

The researchers settled on a low-power (10-watt) pulsed ruby laser,

after finding that continuous-wave or higher power beams broke the diamond. The pulse rate of the 10-joule-or-less beam is generally one per second.

In the process, copper rod is drawn through progressively smaller dies that require diamond cutters in the smaller sizes. As many as 28 separate dies are required for sizes down to 42 AWG.

To produce some 160 billion feet of wire each year, the Buffalo facility requires 4000 diamond dies that must be resized at the rate of 30,000 a year. (Even diamonds wear down under constant abrasion from copper wire.)

The company has called this the first use of a laser in a production facility. The device was built by Raytheon Co. ■ ■

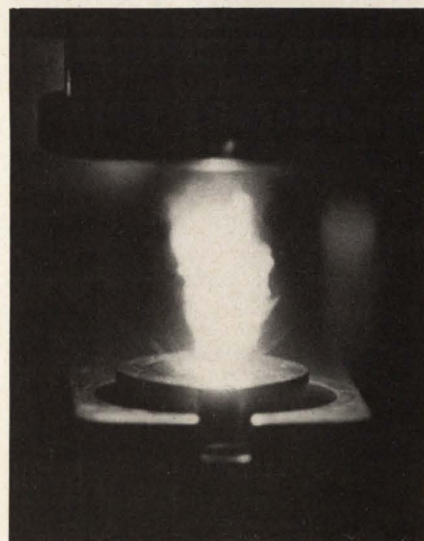

Ruby laser cutting a diamond die for wiredrawing operation at Western Electric Co. substitutes a two-minute job for a two-day task.

MOS arrays diffuse into commercial market

Although speed-limited, MOS FETs are showing up in products, and show great promise for other high-volume commercial and industrial applications.

Roger Kenneth Field
News Editor

Sales of MOS FETs—metal-oxide-silicon field-effect transistors—and MOS arrays have more than tripled during the first nine months of 1965, according to the Electronic Industries Association (see graph).

Presently only two companies market a commercial line of MOS arrays, compared to at least six engaged in MOS FET manufacture. Yet integrated circuitry will be a dominant force in the electronics industry, according to best estimates. The big question here is: How many integrated circuits will be MOS arrays?

Compared even to double-diffused integrated circuitry, MOS technology promises reduction in size, weight, susceptibility to noise, power dissipation and cost of electronic equipment as well as improved reliability. Cost reduction will be the main goal for most commercial application, according to the best estimates of industry observers. Already one company has marketed a desk calculator using MOS arrays, and a second firm is in the process of developing one for market.

So far these promises remain

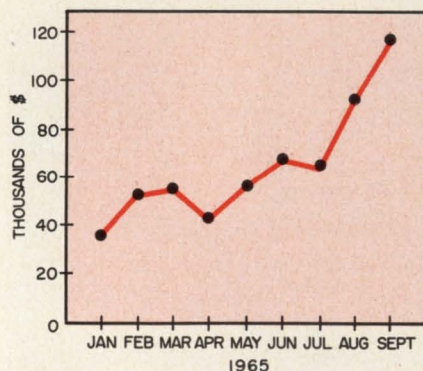

Sales figures are climbing, and predictions indicate an even steeper slope upward for the coming year, due in part to new application areas.

largely unfulfilled in computer and radio-frequency applications. Daniel von Recklinghausen, chief design engineer of H. H. Scott, explains why he used junction FETs rather than MOS Fets in the front end of the new Scott FM tuner: "Junction FETs are simply better for RF work than MOS FETs. MOS FETs and particularly MOS arrays are just beautiful for digital work, audio frequency applications, chopping and multiplexing. But they just aren't fast enough for radio frequency use. They have a poorer signal-to-noise ratio than competing devices, such as the junction FET.

"MOS FETs bring production headaches: Ordinary static charges transmitted in handling can break down the gate insulation causing permanent damage to a MOS FET. Also the square-law behavior of the transfer characteristics are better in depletion units (junction FETs) than in enhancement units (most MOS FETs)."

MOS devices and arrays presently offer a number of advantages over vacuum tubes, bipolar transistors, junction FETs and double-diffused integrated circuits.

Advantages include:

- **Low power consumption** in

switching circuits, especially when complementary switching pairs (like the recently announced Motorola MM2102, 3) are employed.

- **Extremely high input impedance** ($\cong 10^{16}$ ohms)

- **Good square-law behavior** minimizes intermodulation distortion when MOS is used as a pentode-like voltage amplifier.

- **Good dynamic input range.** A MOS amplifier can perform well with either a positively or negatively charged gate element.

- **Component variety in MOS array.** MOSs can serve as R, C or cross-over elements in an integrated array. Thus complex circuits can be made using only MOS devices (see illustration, p 24).

- **Outstanding device density.** A MOS transistor generally occupies one square mil compared to 24 square mils for a typical double-diffused IC transistor.

- **No isolation area.** Unlike its double-diffused counterpart, no space is needed between elements.

- **Low input capacitance.** This is usually in the fractional picofarad range for arrays, to a few picofarads for MOS FETs.

- **Operation in enhancement or depletion mode.**

- **Ease of fabrication** of integrated arrays. One diffusion is required for MOS, compared to at least four for double-diffused ICs. Similarly, MOS arrays are executed in 38 process steps compared to 130 for conventional arrays.

Disadvantages include:

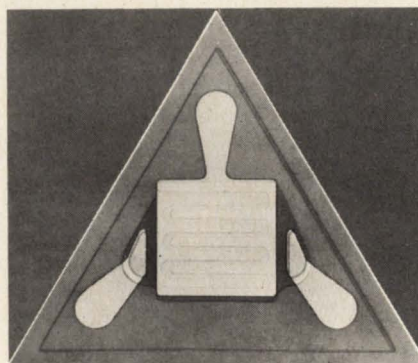

Complementary MOS switching pair device, introduced by Motorola Semiconductor recently. It consumes power only when executing a switch.



First commercial application of MOS arrays was the recently-announced completely electronic desk calculator, from Victor Comptometer.

■ **Delicate gate insulation.** Electrostatic charges accumulated by walking in crepe or rubber soles on a dry day are sufficient to permanently rupture the SiO₂ layer between the gate metal and the silicon chip. This happens if this accumulated electrostatic voltage exceeds the breakdown voltage ($\approx 130V$) of the gate. This poses a serious production handling problem.

■ **Limited compatibility with non-MOS elements.** High output impedances can cause either speed or power loss in cases of extreme mismatch.

■ **Limited application range** of complex chips. Great savings made possible by extremely complex MOS arrays are offset somewhat by a resulting narrowing of the range of application of these arrays. These complex arrays would have to be tailor-made for a specific purpose rather than be available off-the-shelf for a variety of purposes.

■ **Yield problems in complex arrays.** As the number of elements on a chip is increased, the yield falls off rapidly since it is described by an inverse exponential probability function. The cost of each array is roughly proportional to the fall-off.

MOS devices and arrays are already starting to move in quantity, and semiconductor manufacturers—especially those heavily committed to MOS technology—are anxiously watching for openings in the commercial market.

Reportedly, Autonetics Div. of North American Aviation has reached the breadboard stage with a commercial design for an electronic desk calculator that uses MOS arrays, each containing 1000 components on a chip. According to a company spokesman, the firm still considers this project a feasibility study. He indicated that Autonetics will announce their plans for the desk calculator this summer. This is significant in that this would be Autonetics' first venture out of the military/space industry.

A desk calculator using MOS arrays has already been marketed. MOS arrays, each containing 250 components, comprise the heart of a "typewriter-sized" completely electronic calculator introduced in October by the Victor Comptomet-



basic measuring tools from

**HEWLETT
PACKARD**

Field-proven hp 428B Clip-on DC Milliammeters

Totally unique concept for current measurement
Measure current, 1 ma to 10 a full scale, without breaking a lead
No circuit interruption
No circuit loading
Measure dc in the presence of ac

Use it for:

Fast computer circuit testing
Combined measurements for sum of or difference between currents
Transistor circuit analysis without loading
Low-frequency ac current measurements with external metering or recording of front-panel proportional output, dc to 400 Hz

A unique concept, involving a clip-on probe, lets you measure dc currents without breaking a lead, without loading or interrupting the circuit being measured. No direct connection to the measured circuit, no effect from ac, such as common mode. Probe insulated from voltages as high as 300 v. The probe merely clips around the lead, gives a reading based on the magnetic field caused by the dc current flow. Loop several turns of the lead through the probe to increase meter sensitivity. Accuracy $\pm 3\%$, ± 0.1 ma of full scale, 0-55°C. 428B, 0.1 ma to 10 a, \$600*, offers output proportional to full-scale deflection.

Accessories include 3528A Current Probe, for measurement in conductors up to 2½", with degausser, \$450, and 3529A Magnetometer Probe 0.1 milligauss to 10 gauss, \$75.

Request a demonstration from your Hewlett-Packard field engineer or write for complete specifications to Hewlett-Packard, Palo Alto, California 94304, Tel. (415) 326-7000; Europe: 54 Route des Acacias, Geneva.

*\$5 additional for rack-mount model.
Data subject to change without notice.
Prices f.o.b. factory.

HEWLETT  **PACKARD**
An extra measure of quality

909



428B

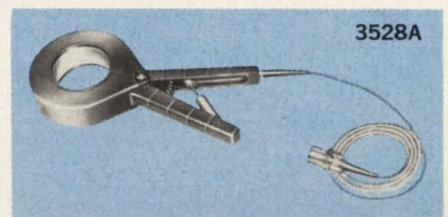

3528A

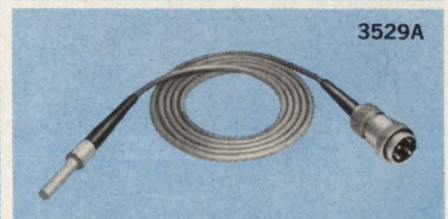

3529A

ON READER-SERVICE CARD CIRCLE 10

NEWS

(MOS FETs, continued)

er Corp. The thirty chips it contains are made for Victor by General Microelectronics of Santa Clara, Calif. The calculator sells for \$1825.

Where do we go from here?

Is it possible that MOS techniques are jack-of-all-trades but really good for nothing in the digital area but small desk calculators? Presently MOS FETs are much too slow for high speed computer design. Where will they go from here?

The future of MOS lies in applications that are, by today's fractional nanosecond standards, low speed and low performance, but require exceptionally low cost per circuit function—according to Dr. R. L. Petritz, director of semi-

conductor research and development at Texas Instruments Inc. Petritz notes that the speed of MOS devices are two to three orders of magnitude below their theoretical limit.

Bipolars are very close to their limit, however, and Petritz anticipates spectacular speed increases in MOS devices over the next couple of years. These, he feels, will be achieved through multiple clocking and elimination of parasitic capacitance. The big companies like Westinghouse and Texas Instruments are developing MOS capabilities and watching for possible off-the-shelf markets.

The key to big MOS array sales lies in raising the complexity/yield ratio and thus effecting a drop in cost-per-function, according to Dr. J. L. Seely, associate director of research of the General Instrument Corp., Hicksville, N. Y.

One possible method of improving yield is to slightly alter the last step of the production method, he observes. Devices should be connected in small chains rather than all together. These chains should be duplicated or even triplicated on the chip. A computer could then test each chain and (with proper selection of an appropriate finishing mask) connect only chains that work. "Using this redundancy technique, small chips with more than 20,000 working discrete devices could be made with high yields and sold at low prices," he ventured.

Within the last few weeks there has been a good deal of activity among the component manufacturers, with new MOS products coming to the market nearly every week.

Recently, General Microelectronics, announced its new MOS 100-bit shift register containing 612 devices on a single chip (see front cover). It is for sale at \$52 in quantity.

General Instrument Corp. has just announced a new series of 15 off-the-shelf MOS arrays which include a series-shunt chopper and a 90-bit shift register. The shift register contains 540 discrete devices on a chip and sells for \$46.80 in quantity.

Motorola recently made the industry's first complementary switching pair available off-the-shelf (see illustration). This is important because it is the first MOS switch which dissipates no power in both "on" and "off" positions. The only power used accomplishes switching itself and sustains a negligible gate/source-drain leakage.

Some big companies, only lightly committed to MOS development and with nothing in the way of new products to announce, are reportedly queuing up for announcements to be made in 1966.

Fairchild will shortly announce a chopper with a 50-ohm source-to-drain resistance in the "on" position, according to its marketing manager, Ben Anixter. Fairchild has not plunged into the MOS array tumble yet, but its IC marketing manager, Floyd Kvamme, says it will definitely come out with a line of MOS arrays during the second quarter of 1966.

Present off-the-shelf parameter limits

Current from source to drain: 0.5 A in enhancement mode devices, 20 mA in depletion mode devices

Gate breakdown voltages: $\cong 100$ V

Minimum output impedance, switch function: 50Ω
amplifier function: $5K\Omega$

Upper frequency limits, switch function: 1-2 MHz
amplifier function: 400 MHz

Audio range noise figure: 3-30 dB.

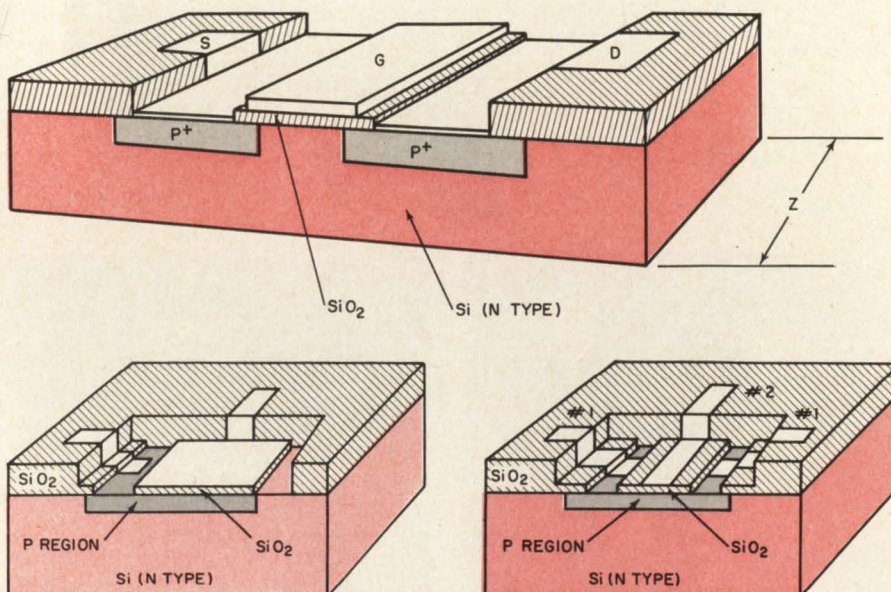

Cross-section detail of metal-oxide-silicon devices shows how MOS technique makes pentode (top), capacitor (bottom, left), and even crossovers (bottom, right) with equal ease, and with no extra steps in the process.

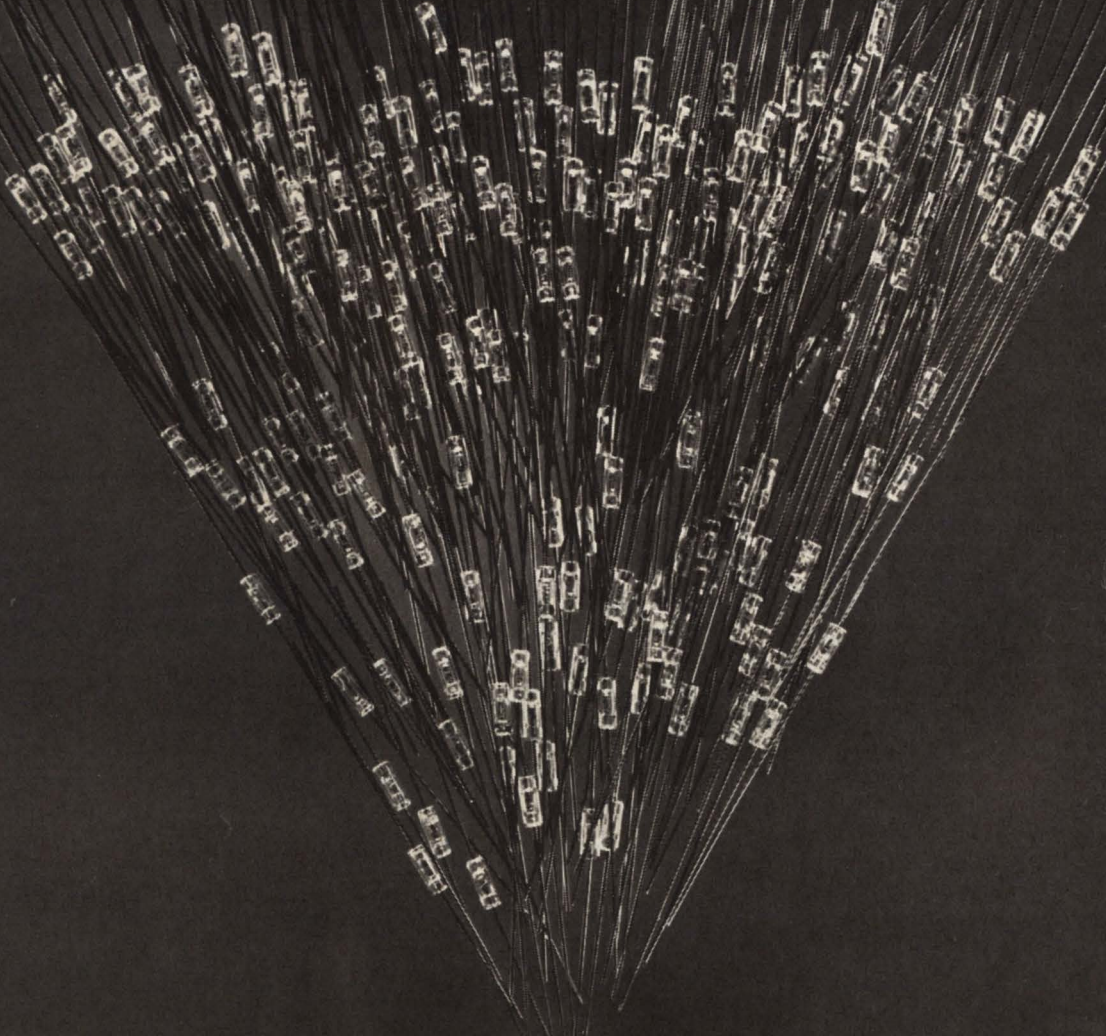

15  15

Monolithic Diode Matrix

Now available in any configuration from 5x5 to 15x15. Another microelectronics breakthrough from Radiation Incorporated. New matrix, pictured actual size, is equivalent to 225 general-purpose planar diodes.



For data sheets, price and delivery information, write: Radiation Incorporated, Physical Electronics Division, Dept. ED-01, Melbourne, Florida 32902. Phone: (305) 723-1511.
Sales offices: 650 North Sepulveda Blvd., Suite 622, El Segundo, Cal., (213) 322-5432 • 600 Old Country Road, Suite 438, Garden City, N.Y., (516) 747-3730
Speed Inquiry to Advertiser via Collect Night Letter
ON READER-SERVICE CARD CIRCLE 11

(MOS FETs, continued)

Paul Sullivan, product manager of Raytheon, Mountainview, Calif., said, "Anyone thinking seriously of FET manufacture must consider the MOS arrays." When asked flatly whether Raytheon had specific plans to market MOS arrays, he responded: "Yes, we do."

Prices beginning to drop

Already, prices are dropping on discrete MOS FETs.

KMC Semiconductors of Long Valley, N. J., has a MOS FET for audio applications to sell for \$3 in large quantity. General reductions in MOS FET price levels will account for a doubling to tripling of discrete unit sales, according to several MOS FET manufacturers.

Arrays solve some problems

But it is the large arrays that are generally considered to dominate the future MOS picture. The arrays solve, or nearly solve, some inherent problems.

Impedance mismatch is frequently unavoidable between MOS and non-MOS elements. Arrays of MOS elements limit the problem to matching only the first and last elements in a long chain.

Similarly, only the very first input gate requires protection from stray electrostatic voltage "punch through."

Effort and money are being poured into MOS technology. The results are just starting to find commercial applications. And their manufacturers hope that a rolling MOS will gather speed. ■ ■

Dial a number to get design information

By simply dialing a telephone at North American Aviation's Space Division at Downey, Calif., engineers will soon be able to obtain up-to-the-second computer-generated verbal reports on the design status of NASA's Apollo and Saturn II components.

Reports will be available by dialing an IBM 1460 computer system which will contain 35,000 Saturn II and 40,000 Apollo drawings and specifications. Information will come from the computer in the form of spoken words.

To use the new approach, called

Engineering Document Information Collection Technique (EDICT), an engineer dials a special code number and is connected with a trunk circuit leading to the computer. He dials the appropriate drawing number and the computer checks for current information in its disk storage units. The 1460 then generates and sends back a verbal reply through an IBM 7770 audio response unit which is linked to the computer.

The latter includes a magnetic drum which contains the numbers, words and sounds necessary to send a vocal response to the inquiry. These were first tape recorded by a linguist at Columbia University in New York and trans-

ferred to the magnetic drum by a computer. When the 1460 is queried for information it selects elements from the vocabulary to form the proper response message and directs the reply to the correct telephone.

Information is continually fed into EDICT from engineering groups in the Space Division's facilities at Downey and Compton, Calif., and Tulsa, Okla. EDICT can handle eight telephone calls simultaneously while still processing incoming data. An engineer who dials EDICT just as new information on the drawing is being added to the computer's memory will receive that data before his call is completed. ■ ■

Army unveils TASS, avionics simulator



TASS, a \$2 million facility at Ft. Monmouth, N. J., which simulates the in-flight performance of electronic systems used in Army tactical aircraft was recently unveiled by the Army Electronics Command.

At the heart of the large-scale system is a hybrid analog-digital computer, an expanded Hydac 2400 built by Electronics Associates, Inc. Two additional analog consoles were added.

The Link division of General Precision designed the visual and control loading systems, while Melpar provided the motion system. The cockpit simulators were designed and built at the Avionics Laboratory of the Army Electronics Command at Ft. Monmouth.

According to its developers, TASS will be used to evaluate proposed avionics systems for both new and existing aircraft. ■ ■

Speech compressor adapted to 'speed-hearing' for blind

A harmonic compressor developed to reduce speech bandwidth may be used for "speed hearing" recordings for the blind.

Developed several years ago by engineers at Bell Telephone Laboratories, the compressor would permit recorded speech to be heard at 300-400 words per minute, about the rate of speed reading. Bell Labs gave the design to the American Foundation for the Blind, and the foundation's engineers expect to develop the necessary hardware.

The harmonic compressor halves the frequency components of speech while preserving the original time duration. Playing the recording at double speed results in a normal-pitch, double-speed recording. No loss of comprehension is evident, although poetry or dramatic works might lose some of their interpretative or artistic content, the engineers stated.

Computer tests the idea

Computer simulation was used at Bell Labs to determine the value of the technique for the speed-hearing application. An analog-to-digital converter changed the actual speech to digital form. This data was fed to a computer programmed to carry out the operations of the harmonic compressor. The output was then re-converted back into analog form, which was determined to be intelligible enough for this potentially important application.

Meanwhile, engineers at Bell are continuing to investigate the techniques of frequency compression for the original purpose of conservation of telephone and other communications channels. The VOBANC (Voice Band Compressor) experimental system designed to halve transmission channel bandwidths, developed a few years ago by B. P. Bogert of Bell, used these same techniques.

Drs. M. R. Schroeder and R. M. Golden adapted the compressor to the needs of the Foundation for the Blind. Leo Levens, chief engineer at the foundation, will head the hardware development. ■ ■

January 18, 1966

*Will you be upset
if we now give you
an improved model
of our good old Type A time-delay relay*

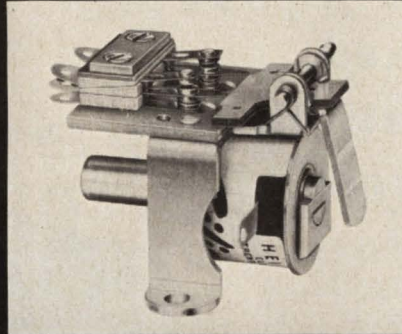

for the same good old price?

For years the Heinemann Type A time-delay relay has been a great buy for the money.

The second-generation model is an even better buy. It has a more efficient magnetic circuit. Heavier contact blades. Fine-silver contacts with gold-diffused contacting surfaces. Plus a few other refinements you can't hardly see unless you look very closely.

We haven't changed the hydraulic-magnetic actuating element one whit. (What kind of a nut would monkey around with a device that's been proved-out to the point of tedium?) And we haven't changed the package, either. The relay is still remarkably compact and light in weight.

The Type A and our other time-delay relay models are available in sixteen standard timings, from $\frac{1}{4}$ to 120 seconds, with SPDT or DPDT switching and generous contact capacities (up to 5 amps at 125 or 250 VAC, in one model). All can be supplied with any of 20 AC or DC coil voltage ratings. And all have significantly lower power consumption and better temperature stability than thermal-type time-delay relays. Our Bulletin 5005 will give you full technical data. A copy is yours for the asking.

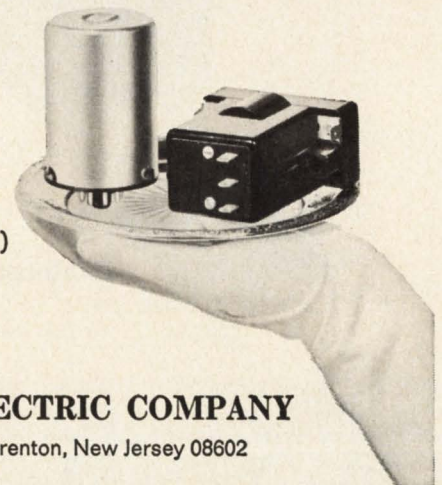

(We've improved these models, too.)



HEINEMANN ELECTRIC COMPANY

2616 Brunswick Pike, Trenton, New Jersey 08602

SA3927

Speed Inquiry to Advertiser via Collect Night Letter
ON READER-SERVICE CARD CIRCLE 12

A design advance

Broadest line of standard silicon modular power supplies for fixed voltage applications

UP TO 60 VDC • UP TO 90 AMPS

Features and Data

Meet Mil. Environment Specs.

RFI—MIL-I-16910

Vibration: MIL-T-4807A

Shock: MIL-E-4970A • Proc 1 & 2

Humidity: MIL-STD-810 • Meth. 507

Temp. Shock: MIL-E-5272C • (ASG) Proc. 1

Altitude: MIL-E-4970A • (ASG) Proc. 1

Marking: MIL-STD-130

Quality: MIL-Q-9858

Convection cooled—no heat sinking or forced air required

Wide input voltage and frequency range—105-132 VAC, 45-440 cps

Regulation (line) 0.05% plus 4mV
(load) 0.03% plus 3mV

Ripple and Noise—1mV rms, 3mV p to p

Package G

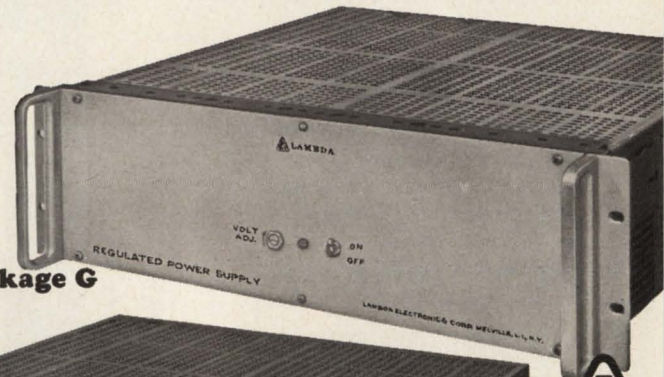

Package F



Package E



Package D

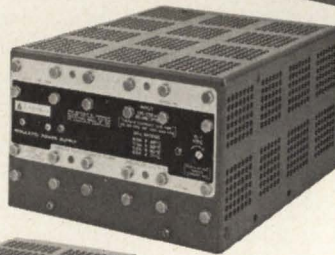

Package C

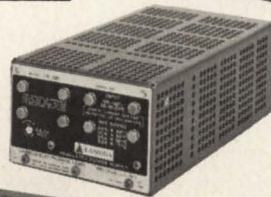

Package B



Package A

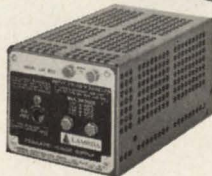

RACK ADAPTERS



LRA-5—3½" height by 27/16" depth.
Mounts up to 4 A package sizes;
3 B or C package sizes; or 2 A and 1 B or
C package sizes. Price \$35.00

LRA-4—3½" height by 14" depth.
(For use with chassis slides)
Mounts up to 4 A package sizes; 3 B or C
package sizes; or 2 A and 1 B or C
package sizes. Price \$55.00

LRA-3—5¼" height by 27/16" depth.
Mounts up to 4 A, B or C package sizes;
2 D or 2 E packages sizes; or 2 A, B or C
and 1 D or 1 E package sizes. Price \$35.00

LRA-6—5¼" height by 14" depth.
(For use with chassis slides)
Mounts up to 4 A, B or C package sizes;
2 D or 2 E packages sizes; or 2 A, B or C
and 1 D or 1 E package sizes. Price \$60.00

PATENTS PENDING

ON READER-SERVICE CARD CIRCLE NO. 216



LAMBDA ELECTRONICS CORP.
515 BROAD HOLLOW ROAD • MELVILLE, L. I., NEW YORK • 516 MYRTLE 4-4200

from Lambda

Ordering Information

METERS—3½" Metered panel MP-3 is used with rack adapters LRA-4, LRA-5 and packages A, B and C.

5¼" Metered panel MP-5 is used with rack adapters LRA-6, LRA-3 and packages A, B, C, D and E.

To order these accessory metered panels, specify panel number which MUST BE FOLLOWED BY the MODEL NUMBER of the power supply with which it will be used.

Examples For Lambda Panel Model No.
Metered Panels Model and Price
MP-3 LM-B2 MP-3-LM-B2 \$40
MP-5 LM-B2 MP-5-LM-B2 \$40

Note—F and G LM Packages are full rack power supplies available metered or non-metered. For metered



OVERVOLTAGE PROTECTION—Externally mounted adjustable crowbar type overvoltage protection accessory for use with A, B, C and D packages—\$25.

E, F and G packages available with built-in overvoltage protection. To order crowbar type overvoltage protection for E, F and G packages, add suffix OV to the model no. and \$60 to the E package price and \$90 to the F and G package price.

FIXED VOLTAGES—In addition to the fixed voltages listed, any fixed voltage is available up to 65 VDC at moderate surcharge.

models, add suffix M to the Model No. and \$30 to the non-metered price.



Package A 3½" x 3¼" x 6½"

Accessory Metered Panels: \$40.00

Model	ADJ. VOLT. RANGE VDC	I MAX. AMPS ¹				Price
		40° C	50° C	60° C	71° C	
LM-201	0-7	0.85	0.75	0.70	0.55	\$ 79
LM-202	0-7	1.7	1.5	1.4	1.1	99
LM-203	0-14	0.45	0.40	0.38	0.28	79
LM-204	0-14	0.90	0.80	0.75	0.55	99
LM-205	0-32	0.25	0.23	0.20	0.15	79
LM-206	0-32	0.50	0.45	0.40	0.30	99
LM-207	0-60	0.13	0.12	0.11	0.08	89
LM-208	0-60	0.25	0.23	0.21	0.16	109

Package B 3½" x 4¼" x 6½"

Accessory Metered Panels: \$40.00

Model	ADJ. VOLT. RANGE VDC	I MAX. AMPS ¹				Price
		40° C	50° C	60° C	71° C	
LM-217	8.5-14	2.1	1.9	1.7	1.3	\$119
LM-218	13-23	1.5	1.3	1.2	1.0	119
LM-219	22-32	1.2	1.1	1.0	0.80	119
LM-220	30-60	0.70	0.65	0.60	0.45	129
LM-B2	2 ±5%	3.4	3.0	2.3	1.4	119
LM-B3	3 ±5%	3.4	3.0	2.3	1.4	119
LM-B4	4 ±5%	3.4	3.0	2.3	1.4	119
LM-B4P5	4.5±5%	3.3	2.9	2.2	1.4	119
LM-B5	5 ±5%	3.3	2.9	2.2	1.4	119
LM-B6	6 ±5%	3.2	2.8	2.2	1.3	119
LM-B8	8 ±5%	3.0	2.7	2.2	1.3	119
LM-B9	9 ±5%	2.7	2.5	2.1	1.3	119
LM-B10	10 ±5%	2.6	2.4	2.1	1.3	119
LM-B12	12 ±5%	2.4	2.3	2.1	1.3	119
LM-B15	15 ±5%	2.1	1.9	1.7	1.2	119
LM-B18	18 ±5%	1.8	1.6	1.5	1.2	119
LM-B20	20 ±5%	1.6	1.4	1.3	1.1	119
LM-B24	24 ±5%	1.3	1.2	1.1	1.0	119
LM-B28	28 ±5%	1.2	1.1	1.0	0.90	119
LM-B36	36 ±5%	1.1	1.0	0.90	0.85	129
LM-B48	48 ±5%	0.90	0.85	0.80	0.75	129

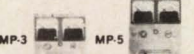

Package C 3½" x 4¼" x 9½"

Accessory Metered Panels: \$40.00

Model	ADJ. VOLT. RANGE VDC	I MAX. AMPS ¹				Price
		40° C	50° C	60° C	71° C	
LM-225	0-7	4.0	3.6	3.0	2.4	\$139
LM-226	8.5-14	3.3	3.0	2.5	2.0	139
LM-227	13-23	2.3	2.1	1.7	1.4	139
LM-228	22-32	2.0	1.8	1.5	1.2	139
LM-229	30-60	1.1	1.0	0.80	0.60	149
LM-C2	2 ±5%	4.9	4.2	3.5	2.4	139
LM-C3	3 ±5%	4.9	4.2	3.5	2.4	139
LM-C4	4 ±5%	4.9	4.2	3.5	2.4	139
LM-C4P5	4.5±5%	4.9	4.2	3.4	2.4	139
LM-C5	5 ±5%	4.8	4.1	3.3	2.4	139
LM-C6	6 ±5%	4.6	4.0	3.1	2.4	139
LM-C8	8 ±5%	4.4	3.8	3.0	2.0	139
LM-C9	9 ±5%	4.2	3.6	3.0	2.0	139
LM-C10	10 ±5%	4.0	3.5	2.9	2.0	139
LM-C12	12 ±5%	3.8	3.3	2.8	2.0	139
LM-C15	15 ±5%	3.4	3.2	2.7	1.8	139
LM-C18	18 ±5%	3.0	2.8	2.5	1.7	139
LM-C20	20 ±5%	2.9	2.7	2.4	1.7	139
LM-C24	24 ±5%	2.5	2.4	2.2	1.5	139
LM-C28	28 ±5%	2.3	2.1	2.0	1.4	139
LM-C36	36 ±5%	2.0	1.8	1.7	1.3	149
LM-C48	48 ±5%	1.6	1.4	1.3	1.0	149



Package D 4¼" x 7¼" x 9½"

Accessory Metered Panels: \$40.00

Model	ADJ. VOLT. RANGE VDC	I MAX. AMPS ¹				Price
		40° C	50° C	60° C	71° C	
LM-234	0-7	8.3	7.3	6.5	5.5	\$199
LM-235	8.5-14	7.7	6.8	6.0	4.8	199
LM-236	13-23	5.8	5.1	4.5	3.6	209
LM-237	22-32	5.0	4.4	3.9	3.1	219
LM-238	30-60	2.6	2.3	2.0	1.6	239
LM-D2	2 ±5%	13.1	11.3	9.2	6.2	199
LM-D3	3 ±5%	13.1	11.3	9.2	6.2	199
LM-D4	4 ±5%	13.1	11.3	9.2	6.2	199
LM-D4P5	4.5±5%	13.1	11.3	9.2	6.2	199
LM-D5	5 ±5%	12.6	10.8	9.2	6.1	199
LM-D6	6 ±5%	12.4	10.6	8.9	6.0	199
LM-D8	8 ±5%	12.2	10.3	8.8	5.9	199
LM-D9	9 ±5%	11.3	10.0	8.6	5.7	199
LM-D10	10 ±5%	10.8	9.7	8.5	5.7	199
LM-D12	12 ±5%	10.0	9.2	8.3	5.7	199
LM-D15	15 ±5%	9.0	8.4	7.9	5.3	209
LM-D18	18 ±5%	7.9	7.4	6.9	5.0	209
LM-D20	20 ±5%	7.4	6.9	6.5	4.9	209
LM-D24	24 ±5%	6.7	6.3	5.8	4.8	219
LM-D28	28 ±5%	6.0	5.6	5.2	4.7	219
LM-D36	36 ±5%	5.4	5.0	4.7	4.3	239
LM-D48	48 ±5%	4.1	3.9	3.6	3.1	239



Package E 4¼" x 7¼" x 11½"

Accessory Metered Panels: \$40.00

Model	ADJ. VOLT. RANGE VDC	I MAX. AMPS ¹				Price
		40° C	50° C	60° C	71° C	
LM-E2	2 ±5%	18.0	16.0	15.0	10.0	\$269
LM-E3	3 ±5%	18.0	16.0	15.0	10.0	269
LM-E4	4 ±5%	17.0	16.0	15.0	10.0	269
LM-E4P5	4.5±5%	16.0	15.0	14.0	10.0	269
LM-E5	5 ±5%	16.0	15.0	13.0	10.0	269
LM-E6	6 ±5%	15.0	14.0	12.0	10.0	269
LM-E8	8 ±5%	14.0	13.0	12.0	9.5	269
LM-E9	9 ±5%	13.5	12.5	11.0	9.5	269
LM-E10	10 ±5%	13.0	12.0	10.0	9.2	269
LM-E12	12 ±5%	12.0	11.0	9.5	9.0	269
LM-E15	15 ±5%	11.0	10.0	9.0	8.5	269
LM-E18	18 ±5%	10.5	9.5	8.5	8.1	269
LM-E20	20 ±5%	10.0	9.0	8.3	7.7	269
LM-E24	24 ±5%	9.0	8.5	7.7	7.0	269
LM-E28	28 ±5%	8.5	8.0	7.3	6.6	269
LM-E36	36 ±5%	6.8	6.3	5.9	5.2	279
LM-E48	48 ±5%	5.0	4.6	4.3	3.9	299



Package F 3½" x 19" x 16½"

For metered models, add suffix (M) to model number and \$30.00 to the price below.

Model	ADJ. VOLT. RANGE VDC	I MAX. AMPS ¹				Price
		40° C	50° C	60° C	71° C	
LM-F2	2 ±5%	44.0	39.0	32.0	24.0	\$425
LM-F3	3 ±5%	44.0	39.0	32.0	24.0	425
LM-F4	4 ±5%	44.0	39.0	32.0	24.0	425
LM-F4P5	4.5±5%	44.0	39.0	32.0	24.0	425
LM-F5	5 ±5%	44.0	38.0	31.0	24.0	425
LM-F6	6 ±5%	43.0	37.0	30.0	23.0	425
LM-F8	8 ±5%	40.0	34.0	28.0	22.0	425
LM-F9	9 ±5%	38.0	32.0	26.0	21.0	425
LM-F10	10 ±5%	36.0	31.0	25.0	20.0	425
LM-F12	12 ±5%	30.0	26.0	21.0	16.0	425
LM-F15	15 ±5%	25.0	22.0	18.0	15.0	425
LM-F18	18 ±5%	23.0	20.0	17.0	13.0	395
LM-F20	20 ±5%	21.0	19.0	16.0	12.0	395
LM-F24	24 ±5%	18.0	16.0	13.0	10.0	380
LM-F28	28 ±5%	17.0	15.0	13.0	9.5	380
LM-F36	36 ±5%	13.0	11.0	10.0	7.5	395
LM-F48	48 ±5%	10.0	9.0	7.5	6.0	425

Package G 5¼" x 19" x 16½"





For metered models, add suffix (M) to model number and \$30.00 to the price below.

Model	ADJ. VOLT. RANGE VDC	I MAX. AMPS ¹				Price
		40° C	50° C	60° C	71° C	
LM-G2	2 ±5%	90.0	83.0	62.0	43.0	\$575
LM-G3	3 ±5%	85.0	80.0	62.0	43.0	575
LM-G4	4 ±5%	77.0	71.0	61.0	43.0	575
LM-G4P5	4.5±5%	72.0	68.0	60.0	43.0	575
LM-G5	5 ±5%	68.0	64.0	59.0	43.0	575
LM-G6	6 ±5%	60.0	55.0	52.0	43.0	525
LM-G8	8 ±5%	59.0	54.0	48.0	39.0	525
LM-G9	9 ±5%	58.0	53.0	47.0	37.0	525
LM-G10	10 ±5%	56.0	52.0	44.0	35.0	525
LM-G12	12 ±5%	48.0	44.0	37.0	29.0	525
LM-G15	15 ±5%	39.0	37.0	31.0	24.0	525
LM-G18	18 ±5%	32.0	30.0	27.0	21.0	525
LM-G20	20 ±5%	30.0	28.0	25.0	20.0	525
LM-G24	24 ±5%	27.0	25.0	20.0	16.0	480
LM-G28	28 ±5%	25.0	23.0	19.0	15.0	480
LM-G36	36 ±5%	22.0	20.0	16.0	13.0	525
LM-G48	48 ±5%	17.0	14.0	12.0	9.0	575

¹ Current rating is from zero to I max.
Current rating applies over entire output voltage range.

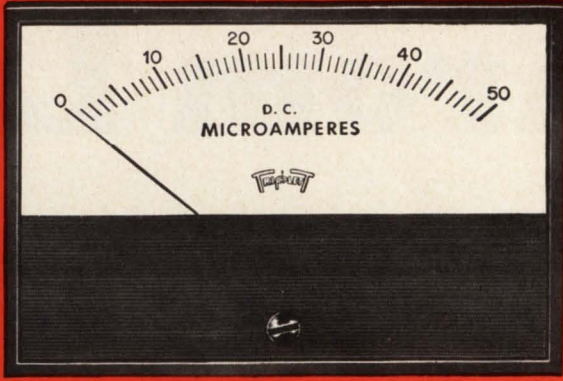
Current rating applies for input voltage 105-132 VAC 55-65 cps.
For operation at 45-55 cps and 360-440 cps derate current rating 10%.



R-Series
2-sizes: 3-1/2", 4-1/2"

TRIPLET

"CLEAN SWEEP" PANEL INSTRUMENTS

A fresh approach to ultra-modern instrument design provides a "clean sweep" of the pointer over the full scale.

- 1** You get instant readability easier and at greater distances—plus more attractive designs to integrate into your equipment.
- 2** Self-shielded, accurate, reliable D.C. instruments have the exclusive Triplet **BAR-RING** movements.
- 3** Whatever your panel instrument requirement, look to Triplet for the right size and style, the right capability at the right price.

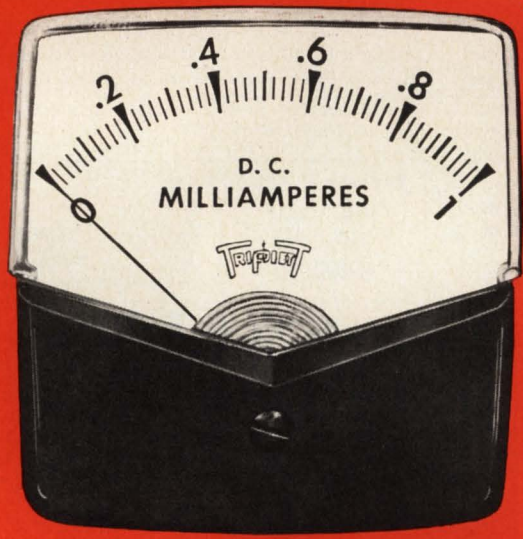

M-Series
5 sizes: 1-1/2", 2-1/2", 3-1/2", 4-1/2", 8"

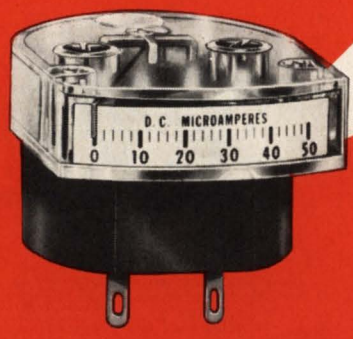

MODEL 120 Edgewise Panel Meters

SHIELDED BAR-RING MOVEMENTS

ALNICO MAGNET IS MOUNTED INSIDE SOFT IRON RING; FULLY SELF-SHIELDED

Not affected by magnetic panels or substantially by stray magnetic fields for D.C.

- More Torque
- Lower Terminal Resistance
- Faster Response
- Exceedingly Rugged and Accurate

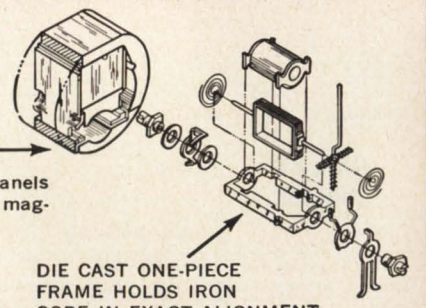

DIE CAST ONE-PIECE FRAME HOLDS IRON CORE IN EXACT ALIGNMENT

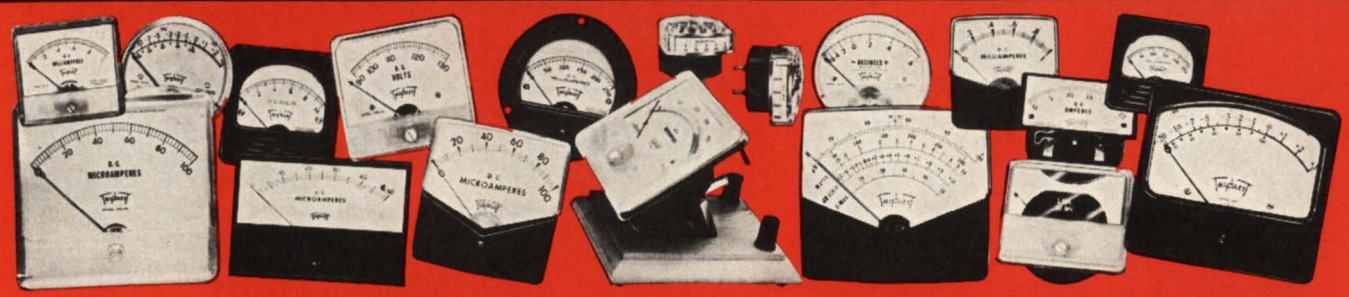

TRIPLET ELECTRICAL INSTRUMENT COMPANY, BLUFFTON, OHIO



NASA cuts hit electronics center hard

The National Aeronautics and Space Administration's new Electronics Research Center in Cambridge may be the space agency facility hardest hit by the Budget Bureau's slash into NASA's fiscal 1967 budget. At the very least, the growth of the center will be slowed if the agency is not able to get funds restored. It is the only installation that would have hired substantial numbers of new employees and carried out major construction. Progress at the Electronics Research Center would have been on schedule only by careful penny-pinching even before the budget cut.

NASA already has announced the cancellation of its advanced OSO satellite project and a two-year delay in the Voyager program. Other budget-forced cuts are expected. Criticism by Representative Reuss of off-shore R&D programs could severely affect NASA's international programs.

MOL also to suffer. The Air Force can hardly gloat over NASA's plight. There is little chance that the Air Force will be able to use the NASA budget squeeze to zoom ahead of the civilian agency is space leadership: Air Force's Manned Orbiting Laboratory (MOL) program may be pinched even harder. The current \$150 million fiscal 1966 budget was to have grown to over \$250 million in fiscal 1967. Instead, some Air Force officials are now prepared to receive little, if any, increase. In view of the Administration's desire to hold military spending to as little as possible—commensurate with the war in Vietnam—some Washington observers believe that the fiscal 1967 request for MOL may be as little as \$140 million.

If the pessimists are right, the pendulum of favored thinking may swing back to the use of Apollo as the vehicle for carrying out the studies proposed for MOL. A cut right now of little more than \$100 million from the Air Force request could so delay the program that MOL could not be ready until long after Apollo is available. The cut could end the MOL program before it really gets started.

Will R&D probe shrink?

The skeptical Congressional inquiry into domestic Federal R&D programs, slated for early this

Washington Report

S. DAVID PURSGLOVE,
WASHINGTON EDITOR

year, may have been toned down. That's the interpretation observers are placing on recent blasts by Rep. Henry S. Reuss (D-Wis.) against American-sponsored research programs abroad. An inquiry along these lines may delay or even supplant the earlier-promised broader investigation of Federally sponsored R&D in general. That probe, under the direction of Reuss, chairman of a House Government Operations subcommittee, had been billed as a latter day continuation of the searching work done under former Rep. Carl Elliott (D-Ala.).

The planned Reuss probe would seek to determine whether an inordinate amount of the Federal R&D budget goes into space and defense. Reuss believes it does. But he now also believes that an excessive amount, in view of the balance of payments deficit, is spent overseas in support of foreign research programs. An inquiry into these programs may delay, detract from or replace the more general investigation.

The Reuss view that less should be spent on space and military R&D and more on civilian programs was supported by the preliminary report of the National Commission on Technology, Automation and Economic Progress. The President-appointed group contended that space and arms R&D are crowding out needed R&D in health, air and water pollution, transportation and housing.

U.S. arms spending due to soar

The rising cost of the war in Vietnam is expected to send the national defense budget for fiscal 1966-67 to dizzy heights—perhaps to around \$60 billion. That's \$6 billion to \$7 billion more than defense spending estimates for the current fiscal year. The higher outlay would be part of a total Federal budget that is expected to reach \$115 billion.

Air Force plans new missile

The story of military R&D in the near future is not entirely one of cut-and-stretch. Several new programs are expected. Among those of interest to the electronics industry—a proposed Air Force air-to-ground tactical missile—seems likely to generate challenges for electronic designers. It would be a TV-guided missile. The price tag that planners place on development and initial procurement is \$100 million.

Letters

When is a spec not a spec? when it's a connector spec

Sir:

An article in the November 22 issue by the Washington Editor, Mr. Pursglove, pertaining to connector specifications struck a responsive chord [Washington Report, p 21].

First, let me say that I think MIL-C-39012 is a good specification—as far as it goes, but it doesn't go far enough. It doesn't provide adequate protection to the user or customer.

I would like to discuss this problem by commenting on design and construction, RF leakage, mechanical [dimensions] and implementation of the specification.

Design, construction and cable interface cannot be checked by the user without first assembling the connector.

Will the connector manufacturer agree to pay for all expenses should his product fail to meet specification requirements? If an equipment shipping date is missed because of this failure, will the manufacturer write a letter to the ultimate user and assume responsibility? The answer is no.

Even though the initial design may be excellent, what is to prevent changes being made to accommodate [the manufacturer's] production schedules? The easiest way to meet a schedule is to relax tolerances. Since no one can reject a connector because dimensions in the cable interface area are not defined—why not? Again the user is caught. Or will the change or defect show up when a mission has to be aborted?

RF-leakage information is available, but the equipment to perform the test is not, so connector manufacturers are not yet complying with this segment of the spec.

Mechanical dimensions for the cable interface are not given. It is an acknowledged fact that the connector industry wants to leave this area wide open. They don't want to disclose proprietary information. They want the freedom to make

changes at any time. We all know that a dimensional check of a connector usually shows non-compliance to the spec. If these are not held to, what is to guarantee the user that the cable interface parts are even the correct parts?

The [American Standards Assn. Subcommittee C83.2] report urging DOD to enforce the specification will create a hardship for users, unless the specification is made definitive.

Each time a part is bought from a new source, the user would have to prepare assembly instructions applicable to that specific part and manufacturer. Even then, the manufacturer could nullify these instructions by making changes.

All this illustrates that the standardization alluded to by the subcommittee is not really standardization.

James E. Boyd

Westinghouse Electric Corp.
Baltimore, Md.

A tip of the hat for supplying relay info

Sir:

Your article, "Curing interference in relay systems," in the November 29 issue of ELECTRONIC DESIGN [p 37] was of great interest. We would appreciate calling to the attention of your readers that Figs. 2, 4 and 7 and the cut labeled "Run interference into the ground" were taken from copyrighted articles describing work performed at Fairchild Space and Defense Systems. Permission for the use of these illustrations was granted to Mr. Burruano [author]; however, the bibliography did not clearly state the source of this material.

The series RC network shown in the cut on page 42 is also an FSDS design, and, to our knowledge, is not commercially available. However, similar results can be obtained using discrete components at some increase in volume. Do not attempt,

however, to rely on the filter for transistor bias, as stated in the article, since this is a misapplication, which will reduce the optimum suppression and endanger the transistor.

A. L. Albin

Manager, EMI Compatibility
Fairchild Space
and Defense Systems
Syosset, N. Y.

We aim to please— price data aids everyone

Sir:

I have noticed a trend in your magazine which I hope will continue. In both ads and product announcements, item costs are appearing. This is very important to those of us who must make spot decisions on procurement and do not have the time to inquire about cost. Often a decision will be made in favor of a product simply because its cost is advertised. People like General Radio and Hewlett-Packard have stated cost for years. This may explain why—in addition to having a good product—they are leaders.

Albert Segen

Federal Aviation Agency
Atlantic City, N. J.

• *We firmly agree with Mr. Segen. In our regular editorial coverage of products, we publish prices whenever they are made available to us, and we require price data on products that are selected for feature coverage. We also feel that an advertised price helps the vendor by improving the quality of the inquiries. The trend is certainly welcome in this quarter.*

EDITORS

Shades of yesteryear— battery car sought

Sir:

We wish to commend ELECTRONIC DESIGN for the article, "End pollution with battery-powered cars?," which appeared in the October 25 Washington Report column. The item called to the attention of industry leaders a challenge from Joseph C. Swidler, chairman of the Federal Power Commission.

Mr. Swidler, testifying before the House Interstate Commerce Committee, urged "converting of multitudes of motor vehicles used

DATA COMMUNICATIONS

equipment for on-line,
real-time processing

the shift-less keyboard that isn't!

Shifting between letters and numbers is no longer necessary as a result of the new 4-row keyboard on Teletype Models 33 and 35 page printers and automatic send-receive sets. However, when used in real-time data communications, these machines are anything but shiftless on the job.

"COMPUTER" SPOKEN HERE
Operating on the same permutation code approved by the American Standards Association for information interchange, this Teletype equipment can communicate with most business machines and computers. It is being used as input/output terminal gear in such applications as communications between branch offices and a centralized computer, making a data processing center available to all company offices.

b ₇	0	0	0	0	1	1	1	1
b ₆	0	0	1	1	0	0	1	1
b ₅	0	1	0	1	0	1	0	1
b ₄								
b ₃								
b ₂								
b ₁								
	0	0	0	0	b	0	@	P
	0	0	1	SOM	DC ₁	!	1	A Q
	0	1	0	EOA	DC ₂	*	2	B R
	0	1	1	EOM	DC ₃	#	3	C S
	0	1	0	EOT	DC ₄ (STOP)	\$	4	D T
	0	1	0	WRU	ERR	%	5	E U
	0	1	1	RU	SYNC	&	6	F V
	0	1	1	BELL	LEM	^	7	G W
	1	0	0	FE ₀	S ₀	(8	H X
	1	0	1	FF _{SK}	S ₁)	9	I Y
	1	0	1	LF	S ₂	*	:	J Z
	1	0	1	V _{TAB}	S ₃	+	:	K I
	1	1	0	FF	S ₄	^	<	L \
	1	1	0	CR	S ₅	-	=	M J
	1	1	1	SO	S ₆	.	>	N ↑
	1	1	1	SI	S ₇	/	?	O ←

The American Standard Code is composed of eight columns of 16 characters each. Control characters, found in the first two columns, include those required for the control of terminal devices, input and output devices, format, or transmission and switching operations. Common punctuation symbols are found in the third column, numbers in the fourth, and the alphabet in the fifth and sixth columns. The final columns are reserved for future standardizations. Teletype Models 33 and 35 sets generate an even parity in the eighth level.

PRINTS ON BUSINESS FORMS
Any business form, such as invoices, payroll checks, sales orders, freight records, and reservations, can be typed on these Teletype sets and transmitted directly to various departments. This minimizes recopying errors. The 4-row keyboard further reduces the possibility of errors, be-

cause it isn't necessary to shift when typing numbers. Notice the similarity to a regular typewriter keyboard, which is why any typist can easily learn to use these new machines.

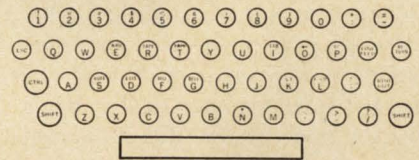

VERSATILITY PLUS

Added to the versatility of the 4-row keyboard is the complete reliability and economy of Teletype equipment. It's built to last, with pneumatic shock absorbers, nylon pulleys and gears, and all-steel clutches that keep maintenance down to a bare minimum. And, these sets are surprisingly low in cost.

That's why Teletype Models 33 and 35 page printers and automatic send-receive sets are made for the Bell System and others who insist on the most reliable communications equipment at the lowest possible cost. For more details on the capabilities of the Teletype 4-row keyboard in real-time data communications, write to: Teletype Corporation, Dept. 89A, 5555 Touhy Avenue, Skokie, Illinois 60078.

machines that make data move



ON READER-SERVICE CARD CIRCLE 13

LETTERS

(Battery car, continued)

for short-haul, start-and-stop activities in urban areas to battery-powered operation."

The FPC chairman's proposal, the article related, was supported, in effect, by Vernon K. MacKenzie, chief of the Public Health Service's Division of Air Pollution.

We wish to point out there are more than 40,000 battery electric cars and trucks on the road today in England, and battery-powered commuter trains are running at speeds of 60 miles an hour in Germany and Scotland. Fourteen different companies, including several dairies that make door-to-door deliveries, are street-testing electric trucks in the U.S.

Batteries capable of supplying the required power and performance for electric street vehicles are already available, and The Electric Storage Battery Co. offers a meter plan that provides an economical and convenient recharging system for industry and the general public.

We propose that the electrical manufacturing companies lead the way by starting now to develop a cheaper and better direct-current motor. Then let Detroit engineers design a new car from the ground up.

The Federal Government could well play an important role in this field. The Postal Department is the largest truck operator in the country. Fleets of electric mail trucks, particularly the compact models being used for house-to-house deliveries in many areas, would be ideal for test programs.

M. G. Smith
The Electric Storage Battery Co.
Philadelphia, Pa.

Look again: a slough is a slough is a slough

Sir:

I am now looking at "the Shark River Slough, Everglades National Park, Fla.," a picture on page 27 of [E/D, October 11, "Electronics expands vision of sky spies"].

Could this picture possibly contain lizards and scorpions instead of 'gators and mocassins?

This picture appears to me to be oriented to the northeast, exposed on a fall day and overflowed at about

5000 feet. The surface is probably of Wingate sandstone overlying a softer, clay-like material. The farm of about 20 acres lies in the bend of an incised meander carrying a small flow of water. The income of the farm was probably less than \$100 last season, but would be more if the farmer had made use of the irrigation ditch running along the lower edge of the farm.

The picture might be very closely placed as to location by a geologist, but since I have no training in that field, I can only guess that it was taken within 50 miles of the Arizona-New Mexico border. If so, the farmer makes his real living in a uranium mine to which the road in the upper right corner might lead.

I'll wager my guessing is closer than your guessing, or did you misprint this just to find out if people really read your fine publication?

William L. Briscoe
Los Alamos, N. M.

• *No guesswork here, but it does seem a good test of readership. Joseph Watson of Watson Electronics has assured us that the questionable photograph is indeed of the Shark River Slough. The special film used caused some color variation, leading to the impression of Mr. Briscoe (and others).*

EDITORS

N. H. averted blackout when its relays cut out

Sir:

Your news article ["Blackout sheds light on system faults," December 6, p 6] indicates that New Hampshire lost power with the rest of CANUS. This is not true. I believe that only one city (Claremont) had an extended outage, and they are tied to Vermont.

As for the "unexplained" cutoff by Maine, this also occurred in New Hampshire.

Charles Turner
Amherst, N. H.

• *A spokesman for the Public Service Co. of New Hampshire verified that his state, as well as Maine, were divorced from the rest of the blackout area, except for a smaller corner of the state, which was out for about four minutes. The official stated that the undervoltage was sensed by relays, which operated as*

designed. However, the distance of the state from the bulk of the demand lessened the problem for them.

EDITORS

When to split the hair: TEM coax is waveguide

Ref: "Graph speeds calculation of skin effect" by L. D. Jambor, ELECTRONIC DESIGN, November 8, 1965 [p 51].

Since TEM coaxial lines are also defined as waveguides, this nomograph could be misleading to TEM coaxial-line designers and, in fact, to waveguide designers in general. The implication is that $\mu\sigma$ is the important quantity for reducing the skin depth, which will then reduce loss, characteristic impedance error, etc., due to the skin effect. This is not the case.

In a TEM coaxial line, the loss expression is:

$$\alpha = \sqrt{\frac{\omega\epsilon}{2\mu_0}} \cdot \frac{\mu}{\sigma} \left(\frac{1}{a} + \frac{1}{b} \right) \frac{1}{\ln b/a}$$

also:

$$Z_o' = Z_c$$

$$\left[1 + \frac{1}{\pi Z_c} \sqrt{\frac{1}{2\omega\epsilon\mu_0}} \cdot \frac{\mu}{\sigma} \left(\frac{1}{a} + \frac{1}{b} \right) \right]^{1/2} (1 - j)$$

The critical term involving the choice of conductor material, therefore, is:

$$\sqrt{\frac{\mu}{\sigma}}$$

Optimum conditions are achieved when μ is minimum; i.e., $\mu = \mu_0$ (permeability of free space) and σ is maximum, not when μ is large, as implied.

This also applies to most hollow-tube waveguides.

Isn't the usual symbol for magnetic flux density B?

John Zorzy

Section Leader
General Radio Co.
Bolton, Mass.

• *Even though a coaxial cable may be considered as a special type of waveguide, in engineering practice, there is very little change of confusing the two. The ability of coaxial*

DATA COMMUNICATIONS

equipment for on-line,
real-time processing

stunt box*..your communication's girl friday

An important component of all Teletype Model 35 page printers and automatic send-receive sets is the stunt box. This is an automatic switching device which performs remote control functions usually expected only of larger, costlier, and more complex equipment.

The stunt box handles anything that can be electrically controlled—ranging from performing such non-typing functions as automatic carriage return and horizontal tabulation . . . to activating remote apparatus, including tape punches and readers, business machines, and computers.

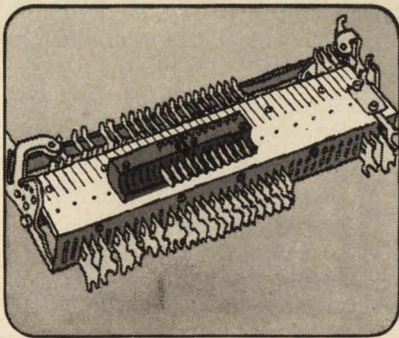

Basically, the stunt box does three things—mechanically initiates internal functions, electrically controls internal functions, and electrically controls external equipment.

STATION CALLER

Remote stations can be selectively called through the stunt box. Thus, one station can call others simultaneously, individually, or in predetermined groups. In this way, specific information can be selectively directed only to the stations specifically concerned with the information being transmitted. For example: an operator types out a sales order on a Teletype Model 35 page printer. Such information as the order number is received by all departments, while cost information is directed by the stunt box only to accounting, billing, and management departments.

AUTOMATIC BACK TALK

Teletype Model 35 sets can be equipped with an answer-back drum, which stores up to 20 characters. In on-line uses, the stunt box at a remote unattended station can trigger the answer-back mechanism so that the station automatically returns its identification call letters to the sending station.

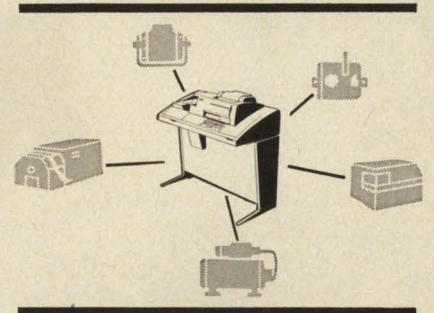

The stunt box can activate the mechanism that automatically feeds the information needed to program a computer so that it can accept the input data which follows.

The versatility that the stunt box gives to Teletype Model 35 page printers and automatic send-receive sets is another reason why they are made for the Bell System and others who require the most reliable communications equipment at the lowest possible cost. For more detailed information on the real-time uses of Teletype equipment, write to: Teletype Corporation, Dept. 89A, 5555 Touhy Avenue, Skokie, Illinois 60078.

*This device is used in Teletype machines to perform non-printing functions such as carriage return, line feed, etc.

machines that make data move



ON READER-SERVICE CARD CIRCLE 14

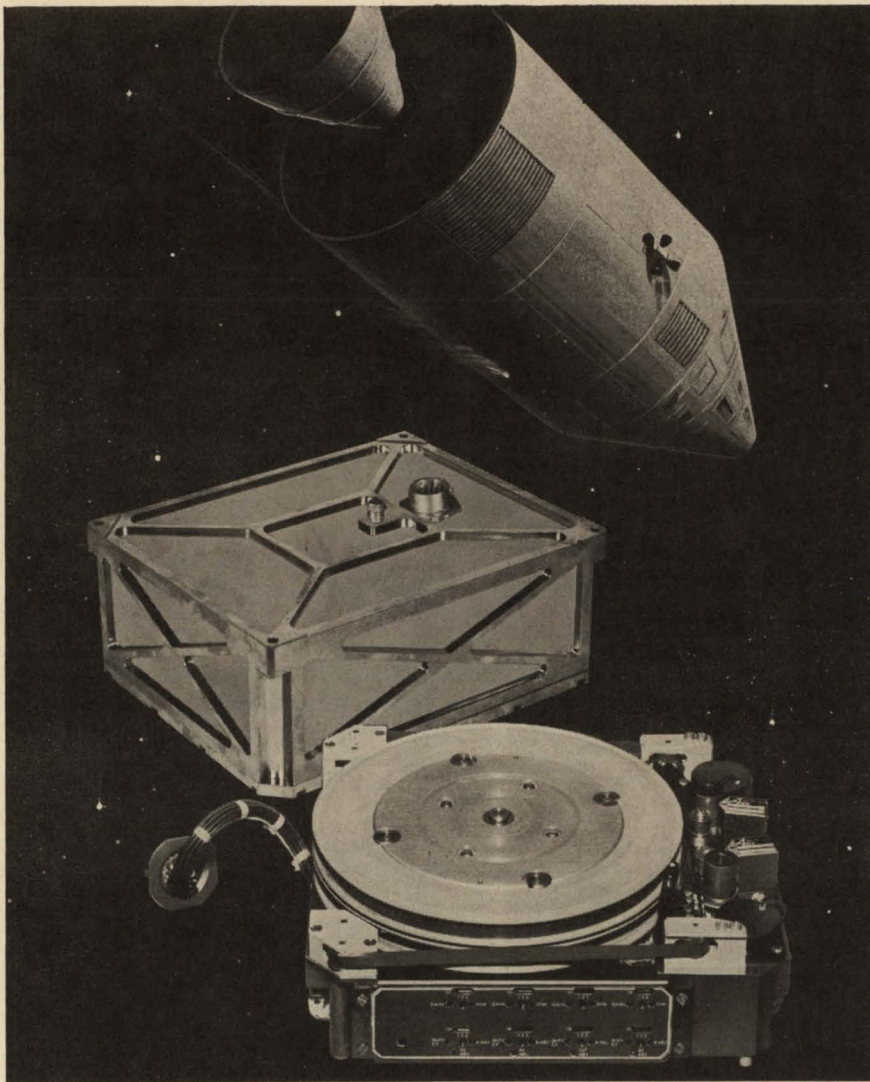

*In outer space...
maximum reliability
at every turn*

PARSONS Type SIR SPACEBORNE RECORDERS

Typical is the SIR-940 recorder-reproducer having a 16:1 reproduce/record ratio and equipped with four tracks of wideband FM electronics, exhibiting an operating MTBF in excess of 8,000 hours. The unit is internally pressurized to ensure operation under vacuum conditions.

To achieve reliability and long life, hysteresis-synchronous capstan motors are used and total power consumption has been maintained *below 5 watts recording and below 10 watts reproducing*. SIR-940 measures 7 $\frac{3}{8}$ " x 9" x 3 $\frac{1}{2}$ " and weighs 7 lbs. 8 oz., complete with electronics.

Other SIR-940 Recorders are available as PCM or analog (direct) recorder-reproducers in a variety of record and reproduce speeds. Write for complete details.



**THE RALPH M. PARSONS
ELECTRONICS COMPANY**

151 S. DE LACEY AVE., PASADENA, CALIF.
A subsidiary of The Ralph M. Parsons Company

LOS ANGELES
NEW YORK
WASHINGTON

OFFICES IN OTHER
PRINCIPAL CITIES
THROUGHOUT
THE WORLD

ON READER-SERVICE CARD CIRCLE 15

LETTERS

(TEM coax, continued)

lines to support the TEM mode resulted in a well-understood distinction between coaxial lines and hollow waveguides.

EDITORS

Borrowed 'Ideas' irksome to reader, E/D

Sir:

Ref: Oct. 11, 1965, issue, page 70, "Ideas for Design," No. 114.

The first time I saw this design was in *Electronics*, Jan. 31, 1958, page 43. Then I found this circuit in *Selected Semiconductor Circuits Handbook*, edited by Seymour Schwartz, pages 5-31. This handbook was also put out by the Navy in the form of a manual and can be obtained from the Superintendent of Documents.

I think I had better start sending in some circuits I have used and consider common.

I realize you would have a difficult job checking these ideas, but perhaps you should implore contributing engineers to be sure they've got something new.

Salvatore A. Romano
Brooklyn, N. Y.

• Considerable checking for originality is done for each "Idea for Design" received. Occasionally, a "bogus" item slips through. To a large extent we rely on the integrity of the submitter as to the novelty of the design idea. Unfortunately, the system is not 100% fool-proof. Please note that we are anxious to review all novel circuit ideas, so send them this way.

Accuracy is our policy

The author of "Semiconductor sources—What are the main design features?" from the special report on microwave solid-state sources, September 27 issue, points out a mistake in Fig. 6 on page 38.

The orientation of the diodes should be as shown in the illustration below.

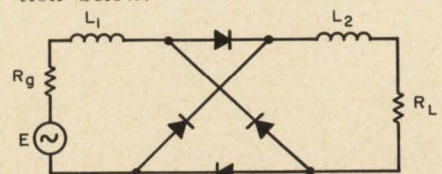

ELECTRONIC DESIGN

DATA COMMUNICATIONS

equipment for on-line,
real-time processing

picking paper tape punches and readers

The integration of paper tape punches and readers within data processing systems has been widespread. Paper tape has become an important communications link, and

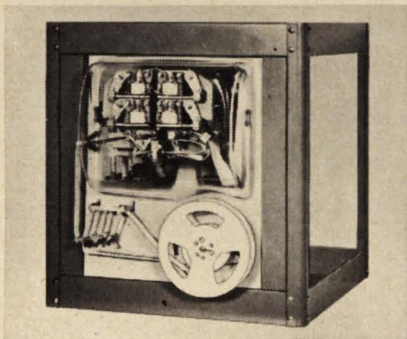

DRPE PAPER TAPE PUNCH

is still the most inexpensive and reliable continuous recording medium available.

OFFERS FLEXIBILITY IN COMMUNICATIONS

Teletype paper tape punches offer a variety of data communications uses. They can be used on the receiving end of high-speed tape-to-tape systems. They can combine data from various sources on one master tape. Some units include a printing mechanism for simultaneous punch and print information.

There are punches available to operate at 6 to 240 characters per second (60 to 2,400 words per minute), and for punching fully perforated or chadless tape.

Most Teletype paper tape units are available in 5, 6, 7, or 8-level, and either as self-contained units or as components in other Teletype equipment, such as automatic send-receive sets.

Teletype LARP Tape Punch—A multi-magnet punch designed to serve as a "slave" unit for a variety of data

processing systems. Operates on a parallel-wire basis at 20 cps (200 wpm) or less.

Teletype LPR Tape Punches—Actuated by incoming serial line signals, these self-contained units operate at 10 cps (100 wpm). They also have a printing mechanism to print out information that is simultaneously punched in the tape.

Teletype BRPE Tape Punch—This high-speed parallel-wire punch operates at 105 cps (1,050 wpm). It can record output of computers and other business machines, as well as produce master tapes by combining information from various sources.

Teletype DRPE Tape Punch—In this unit, instead of a motor, an electro-mechanical punch supplies the energy to perforate data into paper tape. Operates at speeds up to 200 cps (2,000 wpm). The unit is asynchronous and needs no adjustments or modifications when changing speeds.

FAST, ACCURATE DATA TRANSMISSION

Teletype tape readers are available to operate at speeds of 6 to 240 cps (60 to 2,400 wpm). They are designed for fast, accurate, and dependable data transmission, whether your needs involve simple station-to-station relay or the more complex transmission requirements of data processing. Most Teletype tape readers will handle fully perforated or chadless tape.

Teletype LX Tape Readers—These units convert data from punched paper tape into parallel-wire impulses. Speed may be varied from 6 to 20 cps (60 to 200 wpm) by substituting different drive gears.

Teletype LXD Tape Readers—Transmit a serial signal at 10 cps (100 wpm). Provide dependable, economical transmission of messages and data.

Teletype CX Tape Reader—Data collected from slower machines can be transmitted over this unit at 105 cps (1,050 wpm). It transmits parallel-wire signals, and can be used as an input device for computer and business machines, feeding synchronized data instantly into these systems.

Teletype DX Tape Reader—Transmits parallel-wire binary signals at speeds up to 240 cps (2,400 wpm). The DX is equipped with step-by-step feeding that enables it to start and stop on a single discrete character with no coasting.

The variety and reliability of Teletype paper tape punches and readers is another reason why they're made for the Bell System and others who require dependable communications at the lowest possible cost. For further information write to: Teletype Corporation, Dept. 89A, 5555 Touhy Avenue, Skokie, Illinois 60078.

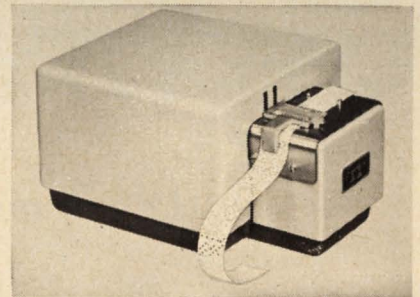

DX PAPER TAPE READER

machines that make data move



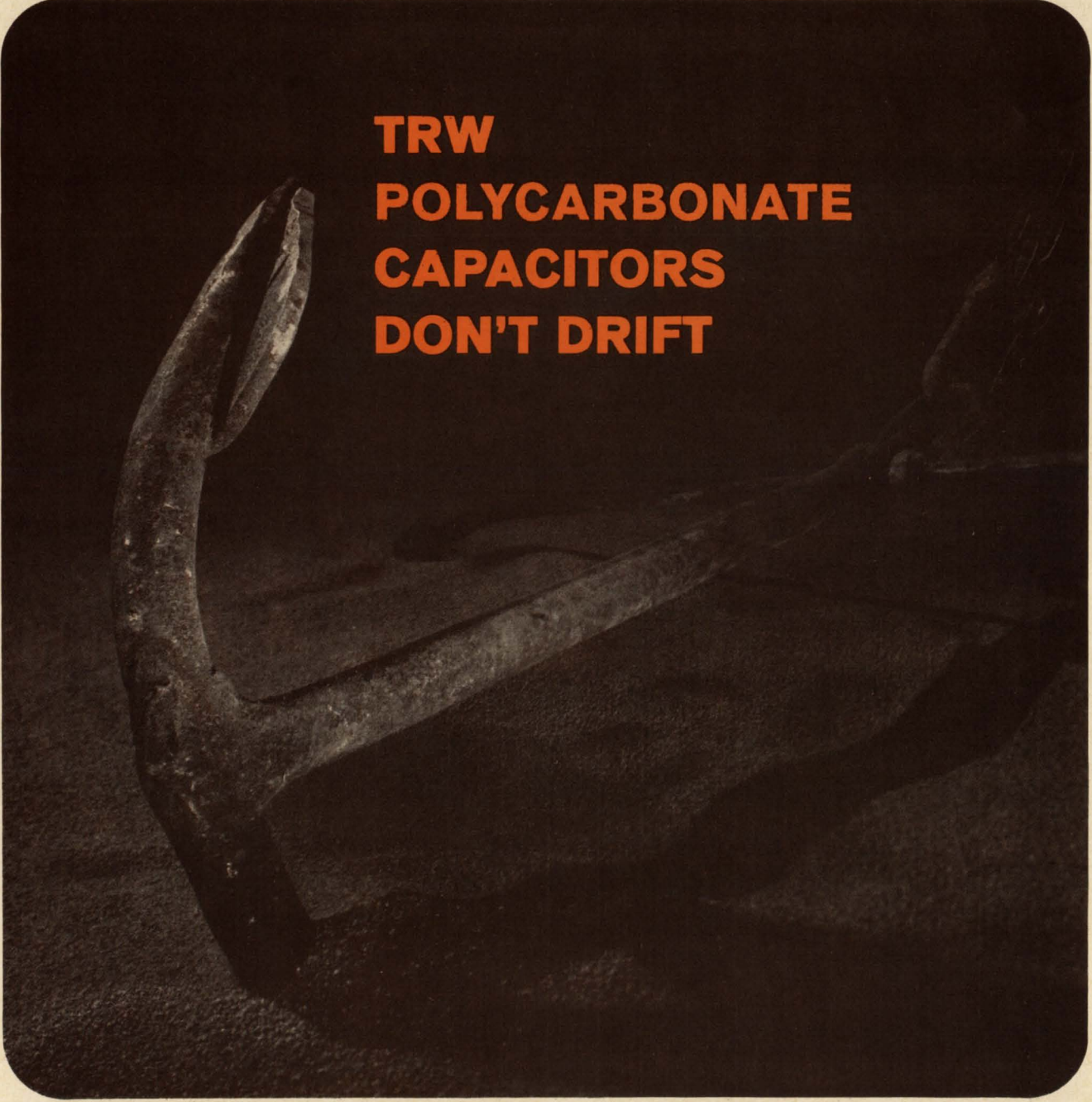

TRW POLYCARBONATE CAPACITORS DON'T DRIFT

Less than .01% T.C. from 0°C to + 125°C

TRW—acknowledged leader in film capacitors—continues its leadership with advanced polycarbonate types providing *mica-like stability* through 125°C.

This is a complete new line of low-TC devices designed for no-drift performance at elevated temperatures.

TRW polycarbonates are offered in a variety of styles to meet all design needs for operation from -55°C to 125°C.

- **WIDE-RANGE TEMPERATURE STABILITY**—< 1% capacitance change from 0°C to 125°C (positive or negative TC available).
- **LONG STABLE LIFE**—less than .1% drift after 10,000 hours.
- **CLOSE TOLERANCE**—available in capacity tolerances to $\pm 5\%$.
- **SMALL SIZE**—up to 90% less volume than paper dielectrics.
- **QUICK DELIVERY**—widely used styles available from stock.
- **MIL-C-19978 and MIL-C-27287** performance and ruggedness.

For full information phone, wire or write: 112 West First Street, Ogallala, Nebraska. Phone: 308-284-3611. TWX: 308-526-7816.

TRW CAPACITORS

ON READER-SERVICE CARD CIRCLE 17

Co-Publishers

James S. Mulholland, Jr.
Robert E. Ahrensdoerf

Editorial Director

Edward E. Grazda

Editor

Howard Bierman

Managing Editor

Robert C. Haavind

Technical Editors

Maria Dekany
Frank Egan
Mark B. Leeds
Rene Colen

News Editors

Roger K. Field
Richard Harnar
Alfred Rosenblatt

West Coast Editors

Ralph Dobriner
Peer Fossen

Copy Editor

Leonard Samuels

New Products Editors

Ronald A. McGee
Patrick Cook

Washington Editor

S. David Pursglove

Editorial Production

Dollie S. Viebig
Anne T. Lombardi

Art Director

Clifford M. Gardiner

Technical Illustrators

William Kelly
Lewis D. Hill
Cheh Nam Low

Production Manager

Thomas V. Sedita

Asst. Production Manager

Helen De Polo

Production Assistants

Bernard Wolinsky
Carl Merkin

Circulation Manager

Nancy L. Merritt

Reader Service

Diane Pellechi

E|D EDITORIAL

The year to do yourself a favor

As a new year gets off the ground, we'd like to make a proposal to you . . . to each of you individually.

Pick a subject that you'd like to learn something about. Then firmly resolve to find out as much as you can about it by the end of this year.

We'd like to put some limits on what you choose. The main restriction is that it should be something beyond what you ordinarily would have learned in the coming year in the normal course of your work.

Another requirement: Choose something that you, personally, would *like* to know about. If you pick something you feel obligated to learn, but have little liking for, you'll only struggle and flounder.

You may be interested in something in electronics that you now know little about. Computer programing, the math behind reliability, or cybernetics, for example. Or maybe you're curious about other things . . . management techniques, American history, theories of the universe, or how to play some musical instrument.

Whatever it is, don't plunge right in over your head. Start with a basic book or maybe some magazine articles. Stop at the library or a book shop to find what you need. Be prepared to spend a good deal of time mastering the fundamentals, perhaps glancing through some more advanced material as you go along, but not at the expense of covering basic material. Learning comes bit by bit, a little at a time, so you'll need patience.

Where will you get the time? If you pick a really appropriate subject you may find yourself spending every spare minute on it. But to start, set aside some regular time each week to spend at it, maybe one evening or a Saturday afternoon.

Many of you have already mastered the techniques of self-teaching (the more successful designers, we suspect). To others there may be a revealing experience in store. No grades. No credits. No raise. Just the satisfaction of learning something completely on your own.

We're curious about what you choose. How about sending us the Editorgram card from this issue with your subject written on it? (Putting your idea in writing will greatly strengthen your resolve.)

The post card is free. But your new knowledge on Jan. 1, 1967, may be worth a great deal.

ROBERT HAAVIND

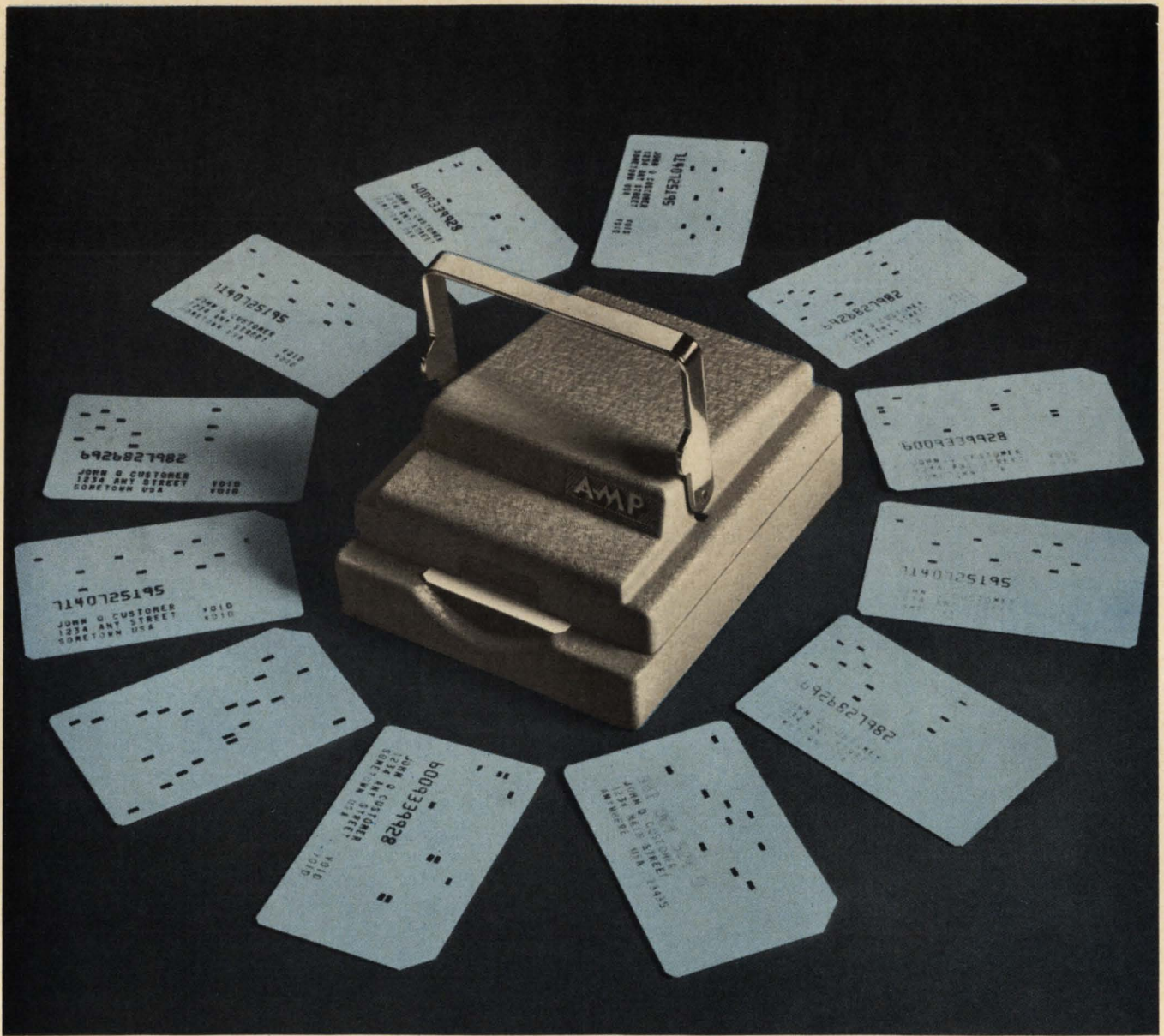

Credit's good here . . . over 1,000,000 times

This new, attractive card reader can register over a 1,000,000 insertions of various credit-type cards and translate the card information to electrical output circuits.

It's fast . . . it's reliable . . . it's foolproof!

Compact and rugged, the A-MP★ Credit Card Reader can be used as an input device for credit handling systems, validating systems, security systems or other data collection and control applications. Available in either desk top or rack mount models, this versatile reader is supplied with either manual or automatic operation. Long, trouble-free operation is assured by the quality features built in this rugged unit. Electrical and mechanical interlocks provide foolproof operation. Redundant contacts with exclusive double wiping action insure a clean electrical surface for reliable sensing.

Here's a sample of other quality features which are engineered into this new product.

- Semi-automatic or automatic card ejection
- Reads plastic credit-type cards 2½" x 3⅜"
- 250 ma, 500 V operation
- Pre-wired or wired to customer's specifications
- Redundant contacts with double wiping action for reliable sensing
- Long life—over 1,000,000 cycles
- Compact size—5" x 6" x 2¾"

Check the applications this item might find in your system, then write for complete information.

★Trademark of AMP INCORPORATED



A-MP★ products and engineering assistance available through subsidiary companies in: Australia • Canada • England • France • Holland • Italy • Japan • Mexico • Spain • West Germany

Speed Inquiry to Advertiser via Collect Night Letter
ON READER-SERVICE CARD CIRCLE 18

ED Technology

Tips on effective use of MOS arrays PAGE 42

Treat the flip-flop logically, and choice is easy PAGE 48

The way to better shunt-motor speed control PAGE 56

Heat detector uses fiber optics to solve RF problem PAGE 66

How does your company rate as a place to work? PAGE 68

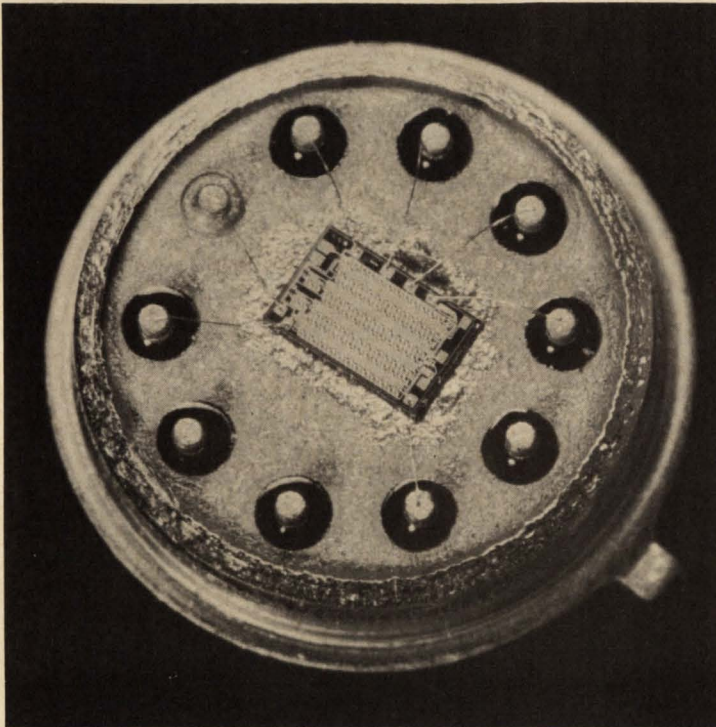

The MOS arrives . . . 42

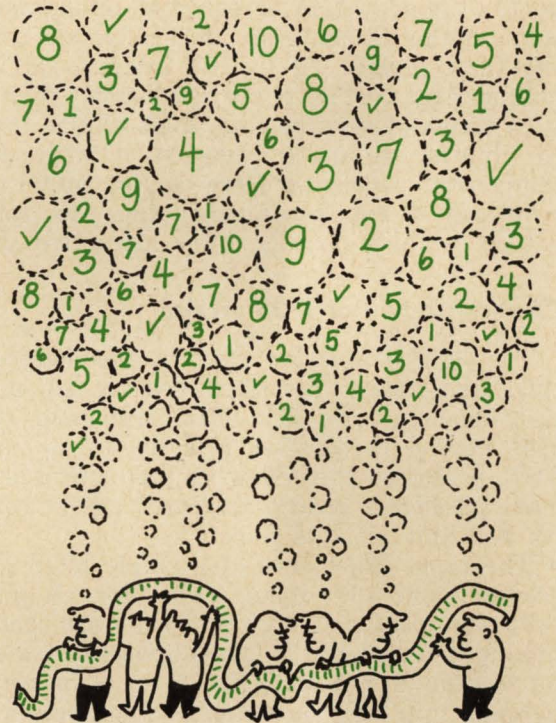

Score your company . . . 68

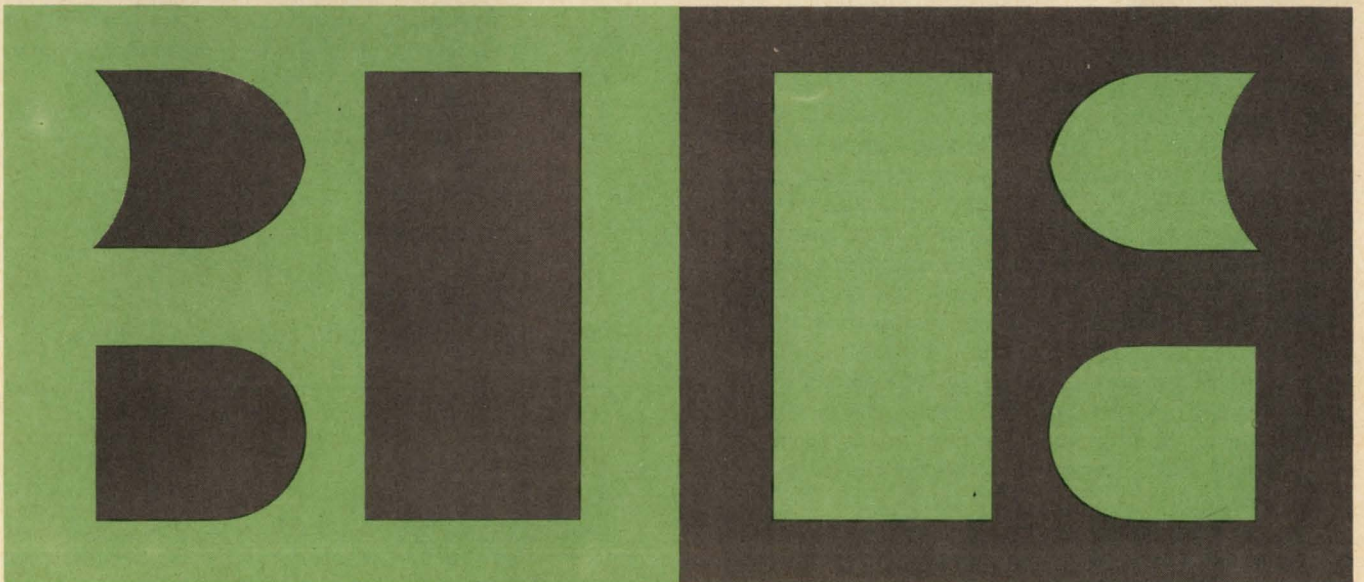

Select your next flip-flop, don't settle for it . . . 48

Planning to use MOS arrays? Learn

which factors influence equipment size, weight and power as well as systems cost.

Conventional double-diffused integrated circuits offer a substantial improvement in reliability over soldered or welded modules with discrete components; the reduction of external interconnections is the major factor. Now MOS chips are available that can replace 20 to 100 integrated circuits, making even further gains in reliability feasible.

In terms of relative cost, high-volume integrated circuits are quite competitive with discrete component packages. Here again, MOS arrays, requiring fewer processing steps to fabricate rather complex circuits, offer attractive savings.

Characterization of MOS arrays

The MOS transistor used in the complex circuits and arrays described here is an enhancement-mode, *p*-type, field-effect transistor (FET). This device, hereinafter referred to as an MOS FET, possesses the following characteristics that make possible a greatly increased circuit complexity per unit area of silicon.

- The input impedance of a single MOS FET is greater than 10^{16} ohms. Thus, for all practical purposes, insofar as digital circuits are concerned, the input impedance is the equivalent of a capacitor to ground. For MOS FET devices internal to a complex chip, this capacitance is typically a maximum of a few tenths of a picofarad. This capacitor can be charged or discharged through a high resistance with rise and fall times in the nano-second ranges.

- The resistors used to charge or discharge these gate capacitances are properly biased MOS FETs. A small MOS FET can have a resistance of several hundred-thousand ohms, while occupying only a few square mils of silicon. Hence, the MOS FET is used both as an active device and as a load resistor, and area-consuming silicon resistors are not required.

- The MOS FET fabrication techniques require no area-consuming isolation diffusions, as do conventional double-diffused integrated circuits. By allowing closer spacing between devices, a much higher device density can be achieved.

- In fact, since integrated MOS FETs require

only one diffusion, a single diffused area can be a part (either source or drain) of many transistors. Individual MOS FETs are recognizable only in that each transistor has an insulated gate. This, too, becomes an important area-saving factor.

A typical integrated MOS FET occupies approximately 1 mil² as compared with 24 mils² for a typical double-diffused transistor. Only an MOS FET that drives an output pad approaches conventional size. Hence, it can easily be seen that one of the objectives of complex MOS FET chip design would be to minimize area-consuming outputs. This is mainly dependent upon the skill of the systems designer.

Computer programs have been developed to help the design engineer partition a system into suitable chip functions and to physically order the nodes on each chip. The optimized arrangement of nodes on a particular chip tends to minimize chip area and signal-path crossovers. This, in turn, leads to a lower cost per chip as well as to an increase in speed attainable within a given chip size for a particular logic function.

Economics of MOS arrays

The typical replacement of 20 to 100 conventional integrated circuits by one MOS complex array leads to a notable reduction in system interconnections and wiring crossovers, obviating the need for expensive multi-layer printed-circuit boards. Thus, the level of system interconnections has been transferred to the complex MOS chip.

An example of this is the Victor Comptometer Corp.'s new Model 3900 desktop electronic calculator that uses MOS arrays. There are a total of 6000 interconnections present, including all of the interconnections within the complex chips. The total number of interconnections required for the

Table 1. Comparison of MOS and double-diffusion processing steps

	MOS	Double diffused
No. of diffusions	1	4 + Epitaxial
No. of process steps	38	130
High-temperature process steps	2	10

George E. Avery and Laurance E. Banghart
General Micro-electronics Inc.
Santa Clara, Calif.

double-diffused integrated-circuit implementation of the same function would be greater than 72,000. This is a 12-to-1 saving in interconnections. There is also a 60-to-1 reduction in the number of integrated circuits used for the MOS implementation. Since system reliability is a function of the number of system interconnections, the drastic reduction in the number of these interconnections directly enhances the reliability of the MOS system.

Another important facet concerning cost considerations of complex MOS circuits is the increase in yield for a given area of silicon. In comparison with the double-diffused fabrication process, the MOS fabrication process is much simpler (see Table 1).

The additional diffusions in the double-diffused process result in much lower yields due to pinholes in the oxide, pitting of the oxide and surface damage caused by the various diffusions and diffusants. The greater number of process steps (130) required by double-diffused devices than for the MOS circuits (38) leads to higher yields for the MOS integrated circuits, since yield is inversely proportional to the number of process steps necessary to manufacture a given device.

In particular the number of high temperature steps should be noted since these have a great effect on yield. Whereas 10 such steps are involved in double-diffused integrated circuits, only two are required for MOS integrated circuits. Much greater yields would be expected with such a 5-to-1 reduction in the number of high-temperature processing steps. In practice, the yield results of complex MOS circuits have been even better than expected and it appears that even more complex circuits can be made without significant decrease in yield.

Examples of MOS economies

The many-stage shift register on one chip represents a configuration with which great economy can be obtained. This is due to the very simple interconnection pattern, test simplicity and the small number of leads required. Forty-stage MOS shift registers have been fabricated within the same silicon area as a one-stage, double-diffused shift register. In production, a cost saving of at least forty times is assured. One-hundred stage shift registers on one chip are now an off-the-shelf item.

Nine- and eleven-stage binary count-down chains that have obtained roughly a 10-to-1 advantage in cost for this sort of circuitry also have been fabricated.

Assorted computer logic, as used in a serial, general-purpose computer, is being fabricated with approximately a 20-to-1 cost advantage. A typical unit of this computer logic, which can best be described as a time-shared control circuit, is shown in Fig. 1. A DTL design of this particular circuit required 23 cans; this complex MOS chip uses approximately 200 MOS FET devices to perform the same function.

The increased complexity of individual chips

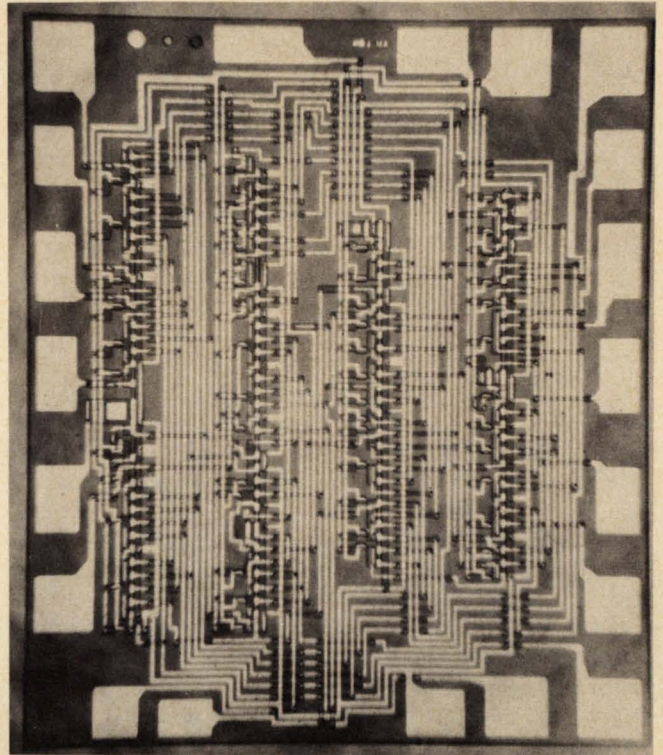

1. Time-shared control circuit consisting of approximately 200 MOS FET devices on one chip. An equivalent DTL design would require 23 packages.

calls for a greater number of connections to be made to the outside world. An example of this is a simple decode circuit manufactured by General Micro-electronic Inc. which consists of about 100 MOS FET devices and requires over 40 connecting leads. It will not be unusual to see this many leads or even more on a single chip in the future. The system requirements will dictate package configurations.

All of the examples mentioned are on conventional-size silicon chips. Due to the greatly increased yield of the MOS process, it is reasonable to assume these economies will become even greater when manufacturers develop the tooling to handle larger silicon areas.

Other economic factors

Certainly, there will be an area limitation in MOS technology, but this limitation is not known at this time. Due to reduced yield, double-diffused devices tend to become less economical when the silicon chip gets larger than 0.06 by 0.06 inches (a rough approximation). With MOS technology, it is estimated that four-to-ten times this area can be used for even greater cost savings.

Another economic consideration is the development cost particularly in relation to low volume production quantities. The development cost for an MOS unit equivalent to 300 discrete parts varies from \$15,000 to \$30,000.

The number of leads per package is a cost consideration; where more leads are required so is more testing, more tooling and more handling. The semiconductor industry is currently handling

14-lead packages at low cost. Twenty-, forty-, and fifty-lead packages are on the way. The connections involved should be as reliable and as inexpensive as conventional component welding or soldering. Nevertheless, equipment design should always minimize leads, since they must be individually handled. As previously discussed, the nature of complex MOS integrated circuits will reduce the total number of system interconnections.

Realizing ultimate economy

System requirements, system design and logic design all affect the economies that can be realized with MOS circuit fabrication. Serial logic requires fewer leads. Dynamic logic provides substantial power savings at low speed, thus permitting greater packaging density. Large volume production helps amortize development costs. Repetitive circuitry keeps development costs down by reducing the number of different units.

Obviously, not all of these factors can be optimized in every system. Described below are two examples of commercial-quality computer systems for which the estimated cost advantage is related to production quantity. These examples represent designs proposed for specific applications. Neither example has gone beyond the proposal stage at this time.

The first example is the arithmetic, logic and control portions of a general-purpose (GP) serial, digital computer with a 2- μ s clock. This assembly would require 600 conventional integrated circuits at an assumed cost of \$6000. The equivalent in present MOS technology is 30 different packages—each with a \$15,000 development cost and each with a maximum of 22 leads. The production cost of the MOS assembly is \$300. Fig. 2 shows the total cost of this GP computer as a function of the

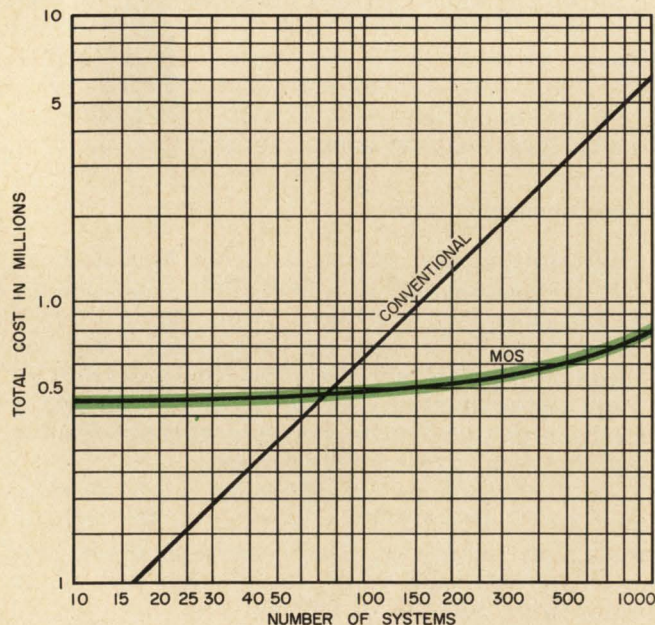

2. Total costs of a general purpose computer is a function of the quantity to be manufactured. At least 80 systems would have to be manufactured before cross-over to MOS technology would be advantageous.

number of systems. Note that a minimum quantity of 80 has to be assured before the MOS version becomes less expensive than the conventional integrated-circuit system.

For the second example, consider a digital differential analyzer (DDA) computer with 100 integrators and a total maximum rate of 10^7 iterations per second. Assume that the machine is serial by bit with 20-bit words and that it has a distributed semiconductor memory. This computer would require 6000 conventional integrated circuits and would cost \$60,000. The MOS equivalent consists of 100 units of four different types. The development cost is $4 \times \$20,000$ or \$80,000, and the production cost is \$1000 per assembly. Fig. 3 compares the total cost as a function of the number of systems. A comparison of the MOS economy of the two examples is shown in Table 2.

The difference in costs between these two examples demonstrates a key principle. The DDA can be assembled from single-chip integrators. Four varieties of these single-chip integrators are adequate. This means that only four complex units have to be developed. A GP computer, on the other hand, has no repetitive units on such a large scale. Essentially every unit is different and development costs soar.

Another advantage of the DDA is that the integrator has considerable complexity with few leads, while the GP units tend to be collections of independent circuits with many leads. Thus the DDA unit allows for greater complexity per unit cost in the integrator.

The DDA computer example represents the ultimate economy advantage that can be realized with current technology. On the other hand, there have been very few DDA computers built with such an iteration rate or with a distributed semiconductor memory, because of the obvious high

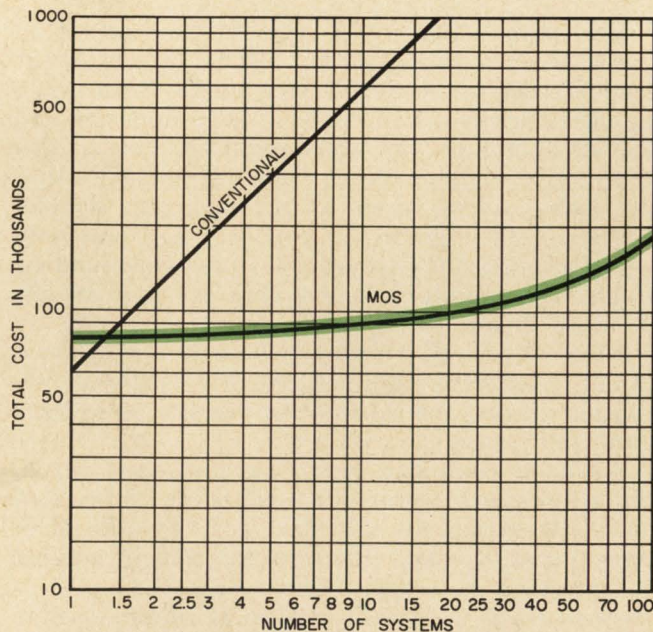

3. Total costs of a digital differential analyzer computer as a function of the quantity to be manufactured. The construction of two systems would give MOS technology the economic lead.

Table 2. MOS costs for a general-purpose vs a digital differential analyzer computer.

	MOS production cost	MOS development cost	Break-even quantity
GP Computer	1/20 of conventional integrated-circuit system	\$450,000	80
DDA Computer	1/60 of conventional integrated-circuit system	\$ 80,000	1.35

cost. However, it is anticipated that a computer with such obvious performance advantages will be of great importance now that the MOS technique is available.

Both of these examples represent equipment that would not otherwise be economically feasible without resorting to MOS technology.

Cost-of-ownership factor

The total cost picture of a piece of equipment or a system is incomplete if the cost of ownership is not considered. Cost of ownership is defined as the cost of maintaining the equipment: the problem of how many spares to stock, the level of competence required of maintenance personnel, the reliability of the equipment or system and other related considerations. Cost of ownership is an area that is too often ignored or slighted when considering the over all system cost.

Reliability is directly related to the total number of components in a system and the total number of system interconnections. The reduction of the number of components and system interconnections through the use of complex MOS integrated circuits has already been described. Thus, it is reasonable to assume that the reliability of an MOS system will be greater than the same system implemented using double-diffused integrated circuits.

The cost of maintaining a piece of equipment is directly related to the reliability of the equipment. By increasing the reliability for a given piece of equipment by using MOS arrays, the cost of maintenance is reduced over the lifetime of the equipment.

The very nature of the complexity allowed by MOS circuits allows redundancy and fault-isolation features to be incorporated with very little increase in functional complexity. This fault-isolation feature, in turn, allows maintenance to be performed by personnel who do not require extensive training.

By the use of repetitive circuitry, such as in the DDA computer example, the spares problem has been greatly reduced. The number of different types of spares, as well as the total number of spares required is greatly reduced. This reduction in total-spares inventory represents a considerable cost savings over the life of the equipment. ■ ■



**IF THIS
MINIATURE METAL
FILM RESISTOR
DOESN'T CHANGE YOUR
*design ideas***

...try one of these

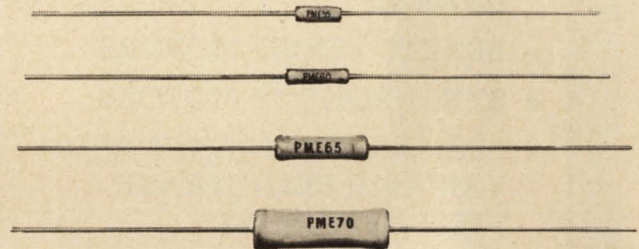

Part No.	Power	Ohms	Tol.	Temp. Coef.
PME 50	1/20 W	10Ω to 500K	±1% to .1%	T-0, T-2, T-9
PME 55	1/10 W	10Ω to 2M	±1% to .1%	T-0, T-2, T-9
PME 60	1/8 W	49Ω to 3.5M	±1% to .1%	T-0, T-2, T-9
PME 65	1/4 W	49Ω to 8M	±1% to .1%	T-0, T-2, T-9
PME 70	1/2 W	24Ω to 15M	±1% to .1%	T-0, T-2, T-9
PME 75	1 W	49Ω to 25M	±1% to .1%	T-0, T-2, T-9

The stability and accuracy of Pyrofilm's PME metal film resistors makes their use ideal in applications where before only wire wound resistors could be used. These resistors are virtually unaffected by environmental conditions and withstand constant exposure to high moisture conditions without change in specifications. PME resistors meet or surpass all requirements of MIL-R-10509F.

Send for fact-filled literature sheet!

PYROFILM RESISTOR COMPANY, INC.

3 SADDLE ROAD • CEDAR KNOLLS, NEW JERSEY • 201-539-7110



**PART OF AN EPICUREAN COLLECTION
FROM KEARFOTT CONSISTING OF**

- STANDARD HIGH TORQUE-TO-INERTIA SERVO MOTORS
- VISCOUS DAMPED SERVO MOTORS
- INERTIAL DAMPED SERVO MOTORS
- BRAKED SERVO MOTORS
- SYNCHRONOUS MOTORS
- PERMANENT MAGNET AND VARIABLE RELUCTANCE STEPPER MOTORS.

**IF YOU'RE RELUCTANT TO TEAR
OUT THESE PAGES, WE'LL SEND
YOU A HANDSOME, MULTI-
COLORED WALL CHART SHOWING
ALL THE DETAILS.**

Write Kearfott, Dept. 1451,
Little Falls, New Jersey 07424.
Or Phone 201 256-4000.
Or TWX 201 256-5926.

SIZE	PART NUMBER	VOLTAGE (VOLTS)			STALL TORQUE (IN. OZ.)	NO LOAD SPEED (RPM)
		PHASE 1	PHASE 2 SERIES	STARTING		
5	J126-02A**	26	26	.6	.10	9500
	J126-06A**	26	36	.9	.10	9500
	CJO 0126 650**	26	36	.9	.10	9500
8	CMO 0127 350	26	26	.7	.18 min.	6900 min.
	CMO 0128 450	26	33	.9	.26 min.	6900 min.
	CMO 0129 350	26	26	.7	.205 min.	10,000 min.
	CMO 0130 450	26	33	.9	.307 min.	10,000 min.
	CMO 0131 350	26	26	.7	.205 min.	6500 min.
	CMO 0132 450	26	33	.9	.316 min.	6600 min.
	CMO 0133 450	26	33	.9	.15 min.	6000 min.
	CMO 0134 450	26	33	.9	.18 min.	9000 min.
10	R118-1B**	26	26	.9	.30 min.	6500 min.
	R118-2B**	26	26	1.5	.34 min.	3500 min.
	R124-1**	26	26	.9	.30 min.	6500 min.
	R124-4**	26	80	2.7	.28 min.	3500 min.
	P124-06**	26	36	1.4	.30 min.	6800 min.
	P121-02**	115	115	2.5	.28 min.	10,000 min.
	CL9 0121 002	115	40	1	.28 min.	10,000 min.
11	R119-2	115	115	3	.60 min.	6200 min.
	R119-36	115	36	.95	.60 min.	6200 min.
	CRO 0132 670	115	36	.5	.70 min.	6300 min.
	MK 14 MOD 0	115	115	3	.60 min.	6200 min.
	CRO 0164 670†	115	36	3	.80 min.	3000 min.
	CR4 0164 001†	115	115	3	.80 min.	3000 min.
15	R110-2, -22	115	115	3	1.53	5300
	T110-36	115	36	1.1	1.53	5300
	MK 7 MOD 0	115	115	3	1.53	5300
	MK 7 MOD 1	115	115	3	1.53	5300
	CT9 0160 001†	115	36	1.1	1.5 min.	3000 min.
18	R111-2	115	115	3	2.35	5250
	V111-36	115	36	.95	2.35	5250
	MK 8 MOD 0	115	115	3	2.35	5250
	MK 8 MOD 1	115	115	3	2.35	5250
	R112-2	115	115	1.5	2.8	9800
	CV5 0112 650	115	36	.5	2.8	9800
	CV9 0112 005	115	115	1.5	5	9800
	CV5 0113 650	115	36	.94	.6	20,000
	R160-2†	115	115	3	3.88	3400
	R160-5†	115	40	1.1	3.8	3400
CV9 0160 007†	115	115	3	8	3200	
23	CY4 0127 001	115	115	3	6.5	10,000
	CY4 0127 003	115	115	3	9	10,000
	CY4 0127 007	115	115	3	9	10,000
	CY0 0128 650	115	36	.94	4	20,000

CHARACTERISTICS FOR KEARFOTT 60 AND 400 CYCLE SERVO MOTORS

*POWER		*CURRENT (MA)		*R (OHMS)		*X (OHMS)		*Z (OHMS)		*EFFECTIVE R (OHMS)		DC RESISTANCE (OHMS)		ROTOR MOMENT OF INERTIA (GM CM ²)	THEORETICAL ACCELERATION (RAD/SEC ²)*	TIME CONSTANT (SEC)	*PARALLEL TUNING CAPACITANCE FOR UNITY POWER FACTOR (μF10)		WEIGHT (OZ.)		
POWER INPUT/PHASE (WATTS)	POWER FACTOR	PHASE 1	PHASE 2 SERIES	PHASE 1	PHASE 2 SERIES	PHASE 1	PHASE 2 SERIES	PHASE 1	PHASE 2 SERIES	PHASE 1	PHASE 2 SERIES	PHASE 1	PHASE 2 SERIES				PHASE 1	PHASE 2 SERIES		PHASE 1	PHASE 2 SERIES
1.7	.85	75	75	285	285	180	180	335	335	400	400	142	142	.175	40,500	.020	.64	.64	.68		
1.7	.85	75	56	285	543	180	343	335	643	400	760	142	245	.175	40,500	.020	.64	.83	.68		
1.7	.85	75	56	285	543	180	343	335	643	400	760	142	245	.175	40,500	.020	.64	.83	.68		
2.1	.73	95	95	200	200	186	186	273	273	370	370	111	111	.46	29,300	.04	.995	.995	.95		
3.3	.73	158	121	121	200	107	187	164	274	223	375	67	112	.46	43,000	.018	1.53	.95	.95		
2.1	.616	117	117	137	137	175	175	222	222	360	360	48	48	.18	86,000	.013	1.10	1.10	1.5		
3.3	.61	185	141	86	143	111	186	140	234	229	381	29	49	.18	150,300	.009	1.75	1.08	1.5		
2.3	.565	141	141	105	105	151	151	185	185	322	322	57	57	.18	86,100	.008	1.22	1.22	1.5		
3.6	.565/.645	233	162	66	133	95	155	116	203	203	316	35	73	.18	133,800	.005	1.97	1.22	1.5		
2.1	.62	114 ref	85 ref	142	240	179	304	228	389	366	600	81	162	.10	105,900	.006	1.37	.85	.95		
2.1	.61	120	95	133	212	172	276	217	348	354	570	53	83	.10	126,000	.0074	1.45	.95	.95		
3.1	.63	191	191	98.5	98.5	123	123	157	157	250	250	53	53	.46	49,000	.0148	2	2	1.45		
3.75	.75	180	180	116	116	94	94	148	148	190	190	53	53	.46	52,000	.0087	1.7	1.7	1.45		
3.1	.63	191	191	98.5	98.5	123	123	157	157	250	250	53	53	.46	46,000	.0148	2	2	1.45		
3.75	.75	180	52	116	1160	94	1015	148	1540	190	2000	53	584	.46	44,000	.0116	1.8	.16	1.5		
3.1	.63	191	131	98.5	207	123	236	157	314	250	480	53	91	.46	46,000	.0148	2	.95	1.45		
2.5	.72	33	33	2520	2520	2430	2430	3500	3500	5280	5280	740	740	.46	44,000	.024	.09	.09	1.7		
2.8	.65	36	105	2080	248	2430	290	3200	381	4920	559	740	41	.46	43,000	.024	.08	.37	1.7		
3.5	.575	53	53	1250	1250	1780	1780	2175	2175	3800	3800	438	438	1.07	39,450	.0168	.16	.16	4.5		
3.5	.575	53	169	1250	123	1780	174	2175	213	3800	372	438	42	1.07	39,450	.0168	.16	1.5	4.5		
3.5	.514	60	185	995	99.4	1647	166.2	1933	194	3770	376.2	255	26.5	.76	69,700	.0113	.175	1.75	3		
3.5	.575	53	53	1250	1250	1780	1780	2175	2175	3800	3800	438	438	1.07	39,450	.0168	.16	.16	4.5		
3.5	.83	37	117	2580	255	1733	172	3108	308	3745	371	1450	144	.76	74,300	.0042	.072	.714	3		
3.5	.83	37	37	2580	2580	1733	1733	3108	3108	3745	3745	1450	1450	.76	74,300	.0042	.476	4.81	3		
6.1	.49	110	110	490	490	890	890	1030	1030	2200	2200	160	160	3.3	32,600	.0169	.32	.32	7.3		
6.1	.49	110	346	490	48	890	87	1030	101	2200	216	160	16.2	3.3	32,600	.0169	.32	3.14	7.3		
6.1	.49	110	110	490	490	890	890	1030	1030	2200	2200	160	160	3.3	32,600	.0169	.32	.32	7.3		
6.1	.49	110	110	490	490	890	890	1030	1030	2200	2200	160	160	3.3	32,600	.0169	.32	.32	7.3		
6.1	.90	59	188	1755	173	850	84	1950	192	2168	213	1050	104	3.3	37,500	.0098	.594	6.05	7.1		
9.2	.43	180	180	280	280	575	575	640	640	1460	1460	81	81	4	39,700	.0119	.55	.55	12.2		
9.2	.43	180	575	280	27	575	56	640	63	1460	144	81	8.4	4	39,700	.0119	.55	5.62	12.2		
9.2	.43	180	180	280	280	575	575	640	640	1460	1460	81	81	4	39,700	.0119	.55	.55	12.2		
9.2	.43	180	180	280	280	575	575	640	640	1460	1460	81	81	4	39,700	.0119	.55	.55	12.2		
15.8	.61	226	226	315	315	403	403	510	510	830	830	42	42	4	47,800	.0207	.6	.6	12.2		
15.8	.61	226	720	315	30.5	403	39.5	510	50	830	82	42	4.5	4	47,800	.0207	.6	6.3	12.2		
30	.58	460	460	182	182	171	171	250	250	434	434	18	18	6	58,800	.0174	1.08	1.08	20		
8.3	.76	95	305	920	90	787	77	1210	118	1591	156	69	5.85	4	10,600	.0158	.214	2.2	14		
8.3	.71	102	102	803	803	790	790	1130	1130	1590	1590	276	276	4	61,500	.00584	1.65	1.65	12.2		
8.3	.71	102	292	803	97	790	95	1130	137	1590	192	276	36.4	4	61,500	.00584	1.65	13.4	12.2		
28	.77	240	240	368	368	306	306	479	479	621	621	104	104	6	94,140	.00356	3.52	3.52	20		
40	.75	420	420	206	206	187	187	275	275	387	387	12.7	12.7	12	36,000	.0283	.985	.985	29		
45	.77	505	505	177	177	144	144	228	228	294	294	11.4	11.4	12	53,000	.0198	1.1	1.1	29		
50	.58	700	700	95	95	134	134	164	164	283	283	6	6	15.6	40,700	.0257	1.98	1.98	29		
45	.68	575	1840	115	11.3	164	16.1	200	19.6	348	34.1	14.5	.9	12	23,500	.0889	1.64	16.7	29		

*At stall.
 **Single-winding control phase; (J 126-06A, CJO 0126 650, R 124-4, and P 124-06 have center tape on control phase).
 †60 cycle units. All others are 400 cycle.
 All motors operate continuously at stall.



Treat the flip-flop logically.

When you do, it becomes a simple matter to compare the different types and select the one that best fits your needs.

Your choice of a flip-flop depends on the function it is to perform and its compatibility with other logic elements in your system. So why not consider the flip-flop as a logic gating element for initial design purposes.

When considered as a logic-gating element, the flip-flop can be treated as a combination of two components—namely, a basic flip-flop and a steering circuit. The basic flip-flop is the memory element by virtue of its two stable states, while the steering circuit provides the input to the basic flip-flop, thus controlling its state.

Both the basic flip-flop and the steering circuit can be represented as a combination of two or

more logic gates. On this basis, an analysis of the various types of flip-flops commonly used (R-S, J-K, etc.) can be made strictly from the standpoint of differences in their steering circuits.

The basic flip-flop

The basic flip-flop can be obtained by cross-connecting two transistorized gates so that each forms a feedback loop for the other. Four different configurations are possible, since AND, OR, NAND or NOR gates can be used. Although all four configurations are equally useful as logic representations of the basic flip-flop, there is usually one that is most appropriate for a specific application.

The NOR-gate (Fig. 1a) is the most suitable to use in a positive-logic system, because the "no-change" condition of the flip-flop occurs for the low (logic "0") state of both inputs (Fig. 1b). The following analysis of flip-flop types is arbitrarily limited to positive-logic systems, so the NOR-gate version of the basic flip-flop will be used exclusively.

The RTL circuit implementation of the NOR-gate flip-flop is shown in Fig. 1c. Each input terminal is placed in line with the output terminal it controls. Thus, Output Q will become high (logic "1") when Input "1" is high, etc.

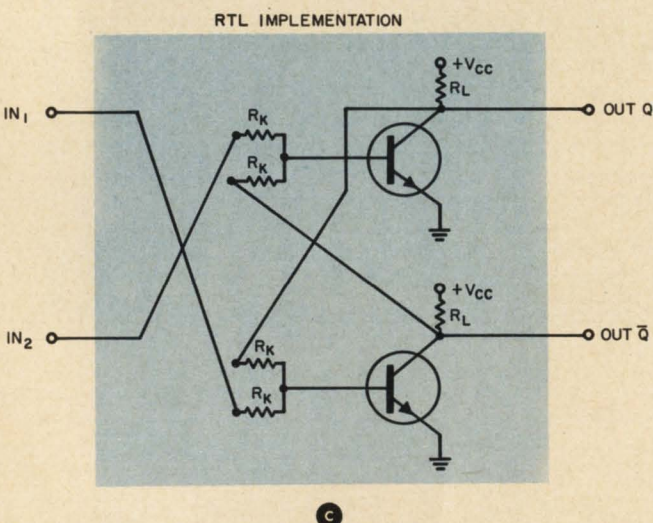
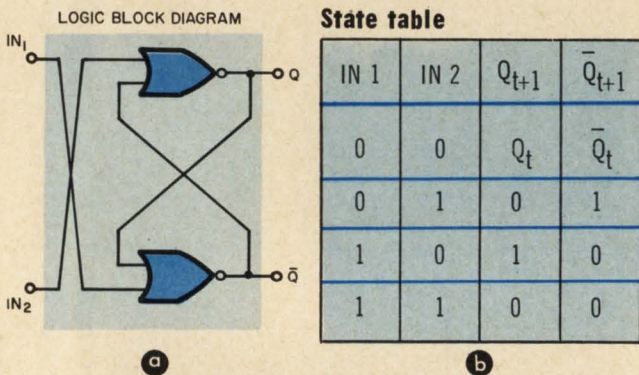

1. NOR-gate version of the basic flip-flop is the most useful representation for positive-logic-system applications.

The R-S flip-flop

The steering circuit for the R-S flip-flop (Fig. 2) is simply two OR gates. They are used to "set" and "clear" (reset) the flip-flop in applications where there is no possibility of both inputs being high (or "1") at the same time. If only one "set" input and one "clear" input to the gates are used, the R-S flip-flop becomes identical with the basic flip-flop.

The logic state table of the R-S flip-flop shows the logic states of the two outputs (called Q_{t+1} and \bar{Q}_{t+1}) at some period $t+1$. These outputs are due to the logic states of the two inputs S_{t+1} and C_{t+1} at the same period $t+1$.

In this flip-flop, a knowledge of the logic states of the two inputs during the previous period "t" is not necessary. Only the input states at $t+1$ are needed to determine Q_{t+1} and \bar{Q}_{t+1} . For example, when both inputs are "0" at $t+1$, the two outputs at $t+1$ will remain the same as they were at t (Fig. 2b). Similarly, for $S_{t+1} = 0$ and $C_{t+1} = 1$,

the outputs will become $Q_{t+1} = 0$, and $\bar{Q}_{t+1} = 1$ independently of the states Q_t and \bar{Q}_t in the previous period t .

The gated flip-flop

If there is the possibility that both the "set" and "clear" inputs to a flip-flop can be high at the same time, suitable gating must be used in the steering circuit to prevent both outputs from becoming "0." Such a circuit, consisting of two AND gates, is shown in Fig. 3.

In this scheme, only the gate connected to the high output of the flip-flop is enabled. The other gate is simultaneously inhibited by the low output. Only one of the two incoming signals can reach the

flip-flop at any one time, so both outputs cannot assume the same state. However, if both input lines are made high simultaneously, another problem arises: The circuit will oscillate, since the two AND gates will be alternately enabled by the flip-flop outputs. The frequency of this oscillation depends on the propagation-delay times of the gates and the basic flip-flop in series.

To prevent oscillation, the input signals should be removed from the gates before the flip-flop outputs complete the change-over. In other words, the input signals should be shorter than the combined propagation delay time of the circuit. Such short pulses will switch the flip-flop to its complement state without causing oscillation.

These short pulses, or spikes, are called ac

LOGIC BLOCK DIAGRAM

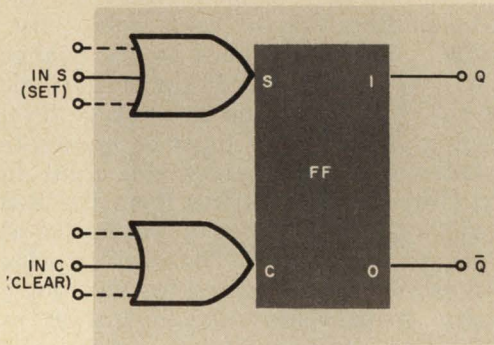

a

State table

States of inputs at t+1		Resulting states of outputs at t+1		
S_{t+1}	C_{t+1}	Q_{t+1}	\bar{Q}_{t+1}	Comments
0	0	Q_t	\bar{Q}_t	No change from previous state
0	1	0	1	Independent of previous state
1	0	1	0	Independent of previous state
1	1	0	0	Not permitted

b

2. R-S flip-flop has the simplest form of a steering circuit: just two OR gates.

LOGIC BLOCK DIAGRAM

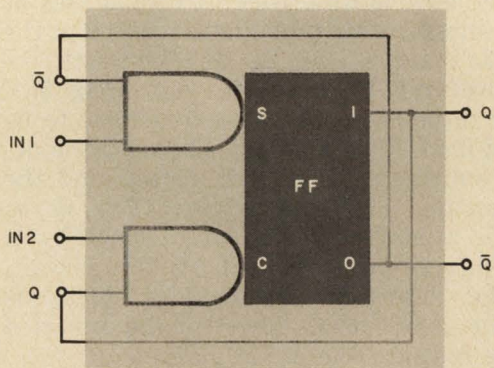

a

State table for dc inputs

States of inputs at t+1		Resulting states of outputs at t+1		
$(IN 1)_{t+1}$	$(IN 2)_{t+1}$	Q_{t+1}	\bar{Q}_{t+1}	Comments
0	0	Q_t	\bar{Q}_t	No change from previous state
0	1	0	1	Independent of previous state
1	0	1	0	Independent of previous state
1	1	~	~	Oscillating

b

State table for ac inputs

States of inputs at t+1		Resulting states of outputs at t+1		
$(IN 1)_{t+1}$	$(IN 2)_{t+1}$	Q_{t+1}	\bar{Q}_{t+1}	Comments
0	0	Q_t	\bar{Q}_t	No change from previous state
0	1	0	1	Independent of previous state
1	0	1	0	Independent of previous state
1	1	\bar{Q}_t	Q_t	Change to complement state

c

3. Gated flip-flop has a steering circuit that prevents both flip-flop outputs from becoming "0" at the same time. Ac input pulses must be used to prevent the flip-flop from oscillating. This situation can arise if both input lines are made high simultaneously.

pulses and can be located anywhere within the bit period of the input signal. Usually, they are located either at the very beginning or at the very end of the period (Fig. 4).

The J-K flip-flop

The input pulses to a gated flip-flop must be narrow enough to prevent oscillation, and they must at the same time have enough energy to cause reliable triggering of the flip-flop. This would indicate the need for a special input device that is

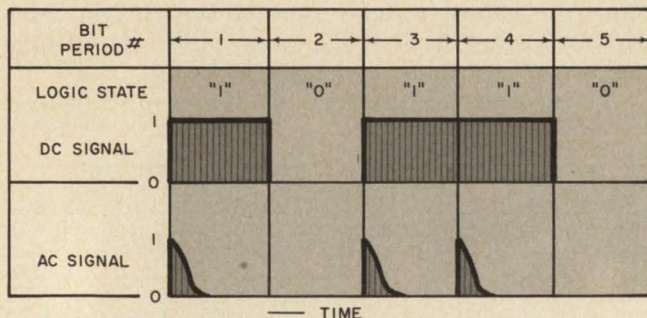

4. Ac input pulses usually coincide with either the beginning or the end of the bit period.

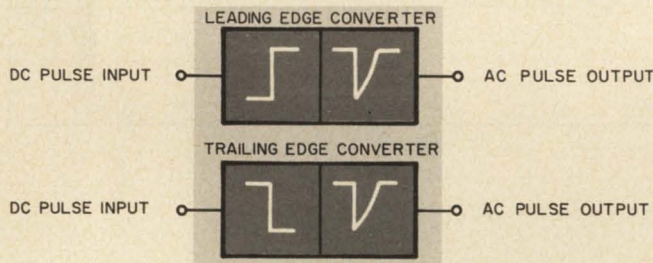

State table

dc IN _t	dc IN _{t+1}	ac OUT _{t+1}	
		Leading edge converter	Trailing edge converter
0	0	0	0
0	1	1	0
1	0	0	1
1	1	0	0

a

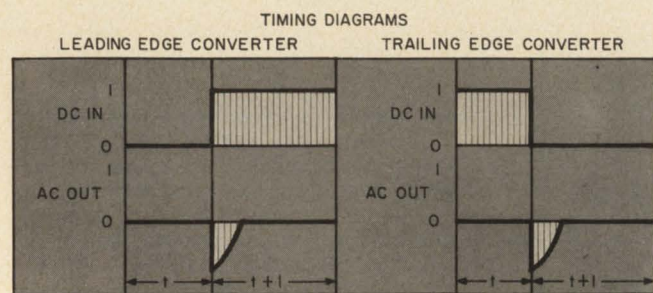

b

5. Dc-to-ac pulse conversion can be either the leading-edge or trailing-edge type. The state tables relating the logical states of the input and output pulses are different for each type.

matched to the requirements of the particular flip-flop. Such a device forms a part of the steering circuit and allows the flip-flop to be operated from dc signals of various widths without causing oscillations. The resulting circuit is called a J-K flip-flop.

The input device is, in effect, a dc-to-ac pulse converter. The conversion may be obtained by passing the incoming pulse through a delay element in parallel with the gate and using the delayed pulse to inhibit the gate. A short pulse will thus appear at the output of the gate, its width equal to the delay time of the delay element.

A more straightforward method is to pass the dc signal through a differentiating circuit, and use the output spike as the ac pulse. This type of device will be considered here.

With the differentiating-type converter, the output ac pulse can be obtained either at the leading edge or trailing edge of the dc input pulse. Since the output pulse is produced by the change in the voltage levels, both the voltage level (logic state) in the initial period t and the voltage level in the succeeding period $t + 1$ must be known to determine whether an output pulse will occur in period $t + 1$ (Fig. 5). This differs from the R-S flip-flop, in which only the states of the inputs at period $t + 1$ are significant. The trailing-edge triggering is usually preferred in positive-logic systems because it prevents false operation in multi-input flip-flop applications.

Fig. 6 shows the complete J-K flip-flop that can be operated by dc input pulses. The signal-flow diagram (Fig. 6a) illustrates the principle of pulse conversion, from dc to ac and back to dc, employed in this flip-flop. Fig. 6c shows the complete table of logic states, assuming dc pulses at the J and K inputs. This table is derived from the table of logic states shown in Fig. 3c, with the addition, however, of the converter logic (Fig. 5a).

There are three logic functions that have to be implemented in the J-K flip-flop. They are the dc-to-ac pulse conversion, the AND gating and the memory function (basic flip-flop). The dc/ac conversion is achieved most conveniently by a simple RC differentiating circuit. In this circuit, however, the desirable trailing-edge pulse is negative. The pulse must therefore be inverted before being fed into the AND gate.

A more economical approach is to use a complementary AND gate that will process the original negative pulse without the necessity for inversion. Now, however, the enabling dc signals from the outputs of the flip-flop must be inverted. This can easily be done by switching the connections of the complementary outputs, which by definition are the inverse of each other. The modified logic-block diagram is shown in Fig. 7a.

Fig. 7b shows the RTL circuit implementation of the J-K flip-flop. The dc/ac pulse converter is equipped with a diode, CR , which transmits the negative trailing-edge pulse and blocks the positive leading-edge pulse. The complementary AND gate is of the resistive Kirchhoff type, which will pass the negative pulse to the transistor base when enabled by a low signal from one of the flip-

flop outputs. The connections from the gates to the transistors are reversed because of the negative pulse, which must de-saturate the ON transistor, instead of saturating the OFF transistor, as in positive-pulse applications.

Fig. 7c shows the familiar re-organized schematic of the J-K flip-flop. Resistors R_c' and R_c'' are combined into one resistor, R_c , because point a of R_c' should logically be at the same level as the output Q of the flip-flop, and diode CR is relocated toward the base. Thus, R_c' and R_c'' are in parallel and can be replaced with one resistor. The same situation holds for resistors R_k' and R_k'' . As a re-

sult, these two can also be replaced with a single resistor—namely, R_k .

The T flip-flop

It can be seen from the state table in Fig. 6c that when both the dc inputs to a J-K flip-flop change simultaneously from "1" to "0," the flip-flop changes states for any initial conditions of the outputs. This property is utilized in the so-called T (for toggle or trigger) flip-flop, where the two input lines are connected together into only one input (Fig. 8a).

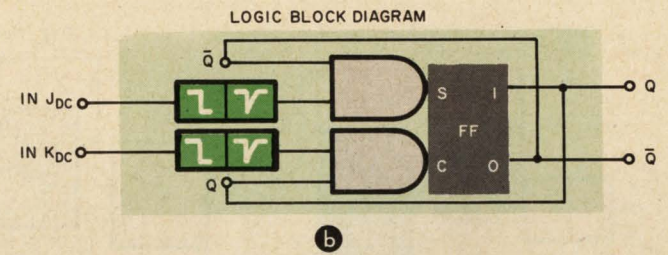
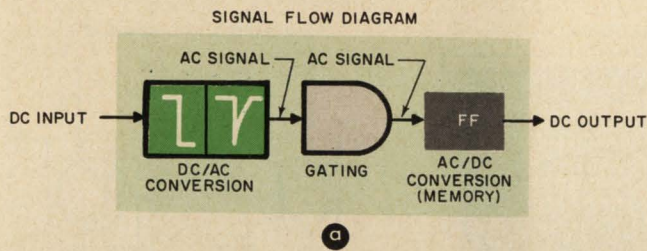

State table

States of inputs at t		States of inputs at t+1		Resulting states of outputs at t+1		Comments
J_t	K_t	J_{t+1}	K_{t+1}	Q_{t+1}	\bar{Q}_{t+1}	
0	0	0	0	Q_t	\bar{Q}_t	No change from previous state
0	0	0	1	Q_t	\bar{Q}_t	
0	0	1	0	Q_t	\bar{Q}_t	
0	0	1	1	Q_t	\bar{Q}_t	
0	1	0	0	0	1	Independent of previous state
0	1	0	1	Q_t	\bar{Q}_t	No change from previous state
0	1	1	0	0	1	Independent of previous state
0	1	1	1	Q_t	\bar{Q}_t	No change from previous state
1	0	0	0	1	0	Independent of previous state
1	0	0	1	1	0	
1	0	1	0	Q_t	\bar{Q}_t	No change from previous state
1	0	1	1	Q_t	\bar{Q}_t	
1	1	0	0	\bar{Q}_t	Q_t	Change to complement state
1	1	0	1	1	0	Independent of previous state
1	1	1	0	0	1	
1	1	1	1	Q_t	\bar{Q}_t	No change from previous state

c

6. J-K flip-flop is a gated flip-flop than can be operated by dc input pulses.

In this type of flip-flop, sometimes also referred to as a "binary," the outputs change state each time the input-signal voltage falls from "1" to "0," and remain unchanged when the input-signal voltage rises from "0" to "1." Thus, there is one change in output state for every two changes in input signal. This means that the frequency of the output is half the frequency of the input. A variety of frequency dividers and counters can be built utilizing this property.

The toggle flip-flop can be implemented by exactly the same circuit as the J-K flip-flop. The two input terminals, *J* and *K*, are simply connect-

ed together to form the *T* terminal (Fig. 8b).

The delay flip-flop

In the *T* flip-flop (Fig. 8a), one of the inputs to each AND gate either enables or inhibits the gate. For reliable operation of the flip-flop, these *Q* and \bar{Q} steering signals should reach the gate a certain time before the triggering signal, *T*, to ensure that the gates are fully enabled.

The enabling terminals of the flip-flop can be connected to some other points in the system, instead of to the *Q* and \bar{Q} outputs used in the *T* (continued on pg 55)

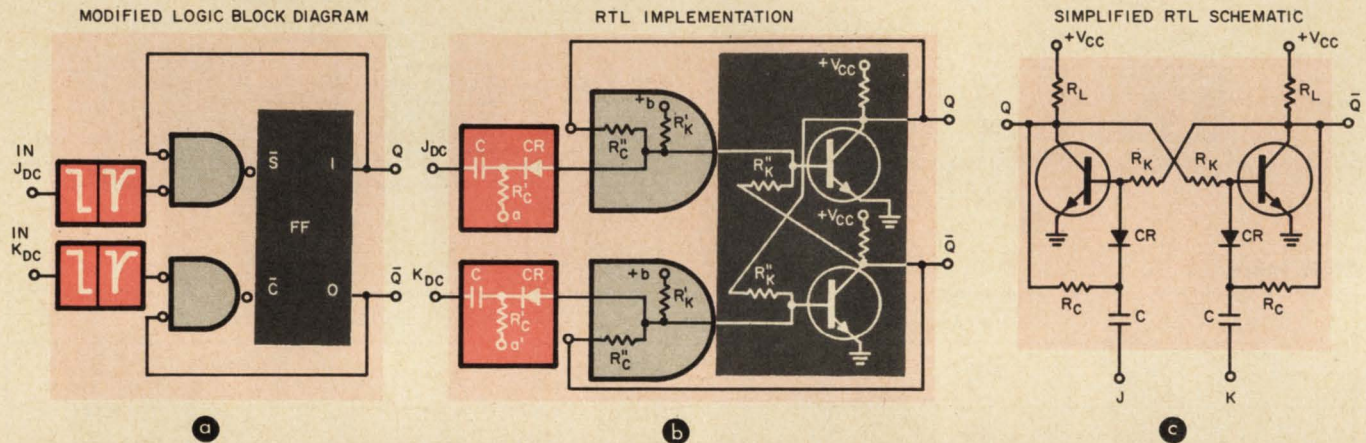

7. Practical J-K flip-flop accomplishes ac/dc conversion by RC differentiation. Complementary AND gates are used

at the inputs, and the input connections to these gates from the flip-flop outputs are reversed.

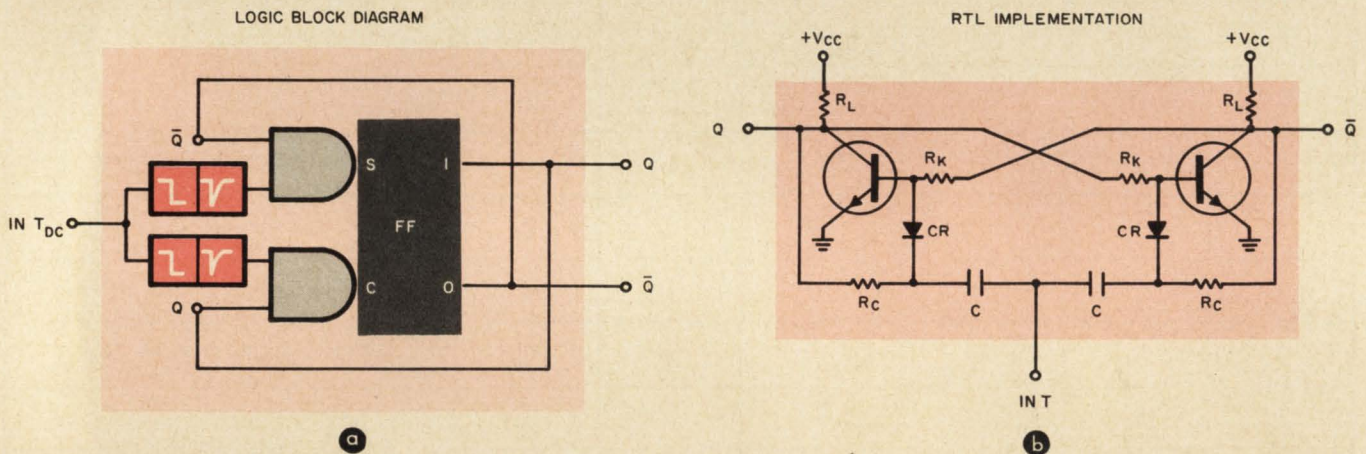

State table (trailing-edge converter)

State of input at <i>t</i>	State of input at <i>t</i> +1	Resulting states of outputs at <i>t</i> +1		
T_t	T_{t+1}	Q_{t+1}	\bar{Q}_{t+1}	Comments
0	0	Q_t	\bar{Q}_t	No change from previous state
0	1	Q_t	\bar{Q}_t	No change from previous state
1	0	\bar{Q}_t	Q_t	Change to complement state
1	1	Q_t	\bar{Q}_t	No change from previous state

8. T flip-flop is the same as the J-K flip-flop, except that it has a single input formed by connecting *J* and *K*.

LOGIC BLOCK DIAGRAM

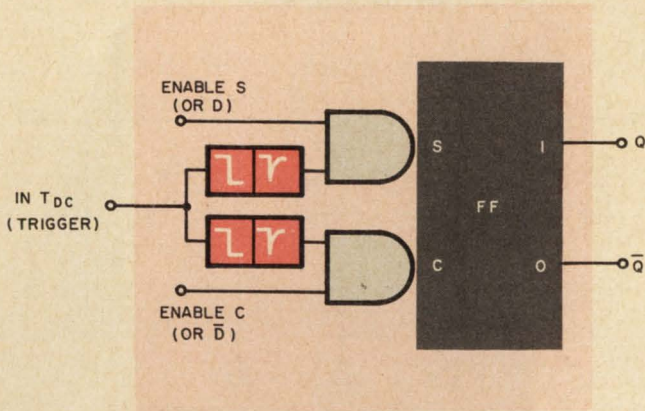

a

RTL IMPLEMENTATION

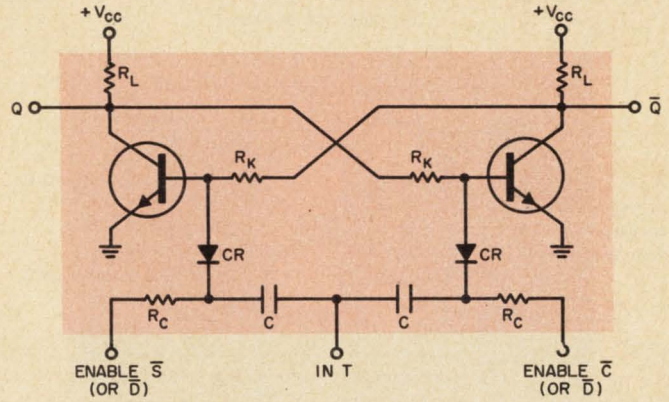

b

State table

State of inputs at t			State of input at t+1	Resulting states of outputs at t+1		Comments
S _t or D _t	C _t or D̄ _t	T _t	T _{t+1}	Q _{t+1}	Q̄ _{t+1}	
0	0	0	0	Q _t	Q̄ _t	No change from previous state
0	0	0	1	Q _t	Q̄ _t	
0	0	1	0	Q _t	Q̄ _t	
0	0	1	1	Q _t	Q̄ _t	
0	1	0	0	Q _t	Q̄ _t	Q _{t+1} = S _t ; Q̄ _{t+1} = C _t
0	1	0	1	Q _t	Q̄ _t	
0	1	1	0	0	1	No change from previous state
0	1	1	1	Q _t	Q̄ _t	
1	0	0	0	Q _t	Q̄ _t	Q _{t+1} = S _t ; Q̄ _{t+1} = C _t
1	0	0	1	Q _t	Q̄ _t	
1	0	1	0	1	0	No change from previous state
1	0	1	1	Q _t	Q̄ _t	
1	1	0	0	Q _t	Q̄ _t	Indeterminate
1	1	0	1	Q _t	Q̄ _t	
1	1	1	0	?	?	No change from previous state
1	1	1	1	Q _t	Q̄ _t	

c

9. Delay flip-flop has its enabling signals applied from some point external to the basic flip-flop. Its state table (c)

can be reduced to that portion shown in white if the inputs are complementary.

LOGIC BLOCK DIAGRAM

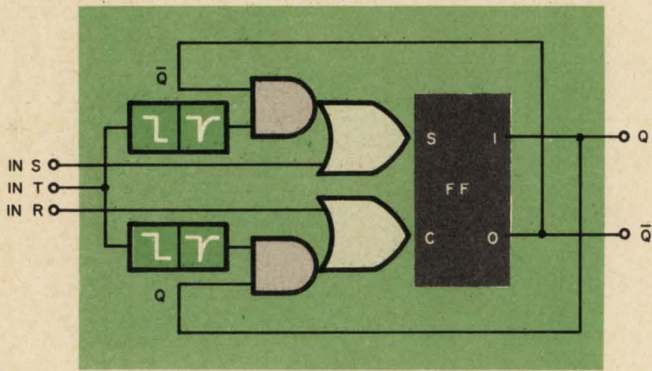

a

RTL IMPLEMENTATION

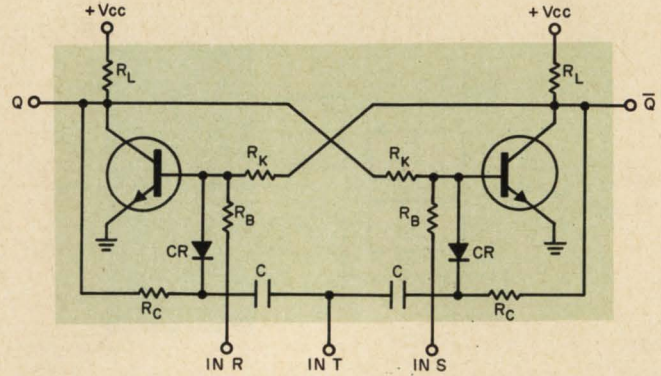

b

State table (trailing-edge converter)

State of inputs at t			State of inputs at t+1	Resulting states of outputs at t+1		
S _t	R _t	T _t	T _{t+1}	Q _{t+1}	\bar{Q}_{t+1}	Comments
0	0	0	0	Q _t	\bar{Q}_t	No change from previous state
0	0	0	1	Q _t	\bar{Q}_t	
0	0	1	0	\bar{Q}_t	Q _t	Change to complement state
0	0	1	1	Q _t	\bar{Q}_t	No change from previous state
0	1	0	0	0	1	Independent of previous state
0	1	0	1	0	1	
0	1	1	0	?	?	Indeterminate
0	1	1	1	0	1	Independent of previous state
1	0	0	0	1	0	
1	0	0	1	1	0	Indeterminate
1	0	1	0	?	?	
1	0	1	1	1	0	Independent of previous state
1	1	0	0	0	0	Not permitted
1	1	0	1	0	0	
1	1	1	0	0	0	
1	1	1	1	0	0	

c

10. R-S-T flip-flop incorporates the steering circuits of both the R-S and T flip-flops.

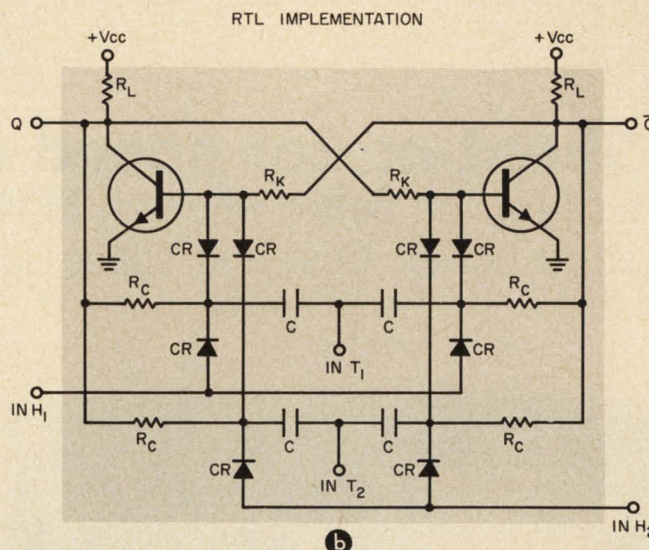
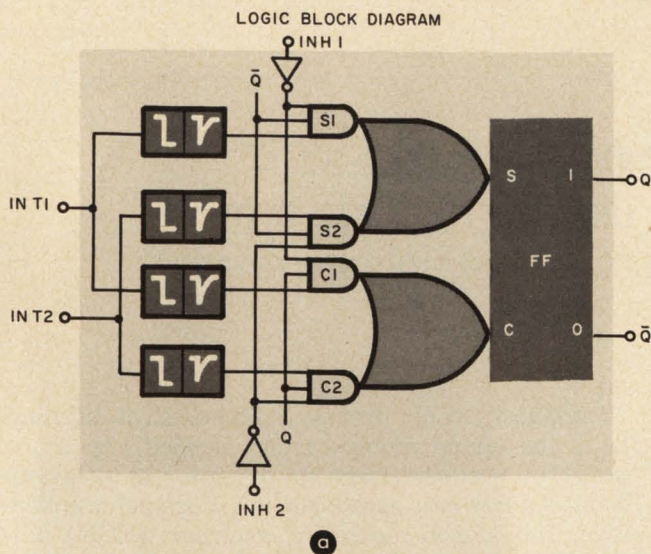

11. Up-down flip-flop has both "toggle" inputs and "inhibit" inputs.

flip-flop. This type of steering circuit characterizes the so-called "delay" flip-flop, (Fig. 9a).

Here the triggering signal, T , is coupled through the dc/ac converters, and the two enabling signals S and C are dc-coupled to the flip-flop. For correct operation, signals S and C should be established in period t , before the arrival of the ac-pulse T in period $t + 1$. Therefore, signals S and C are assumed to be the same in both t and $t + 1$ periods. Only the dc input T may change its state from T_t to T_{t+1} , causing, under appropriate conditions, the appearance of the ac pulse T_{ac} at $t + 1$.

The ac pulse T_{ac} acts as a searching, or sampling, signal, in that it detects the states of the S and C inputs and transfers them to the outputs of the flip-flop. In this way, the outputs of the flip-flop in period $t + 1$ will become the same as the inputs S and C were in the previous t period. Hence, the name "delay" flip-flop. The state table of the delay flip-flop is shown on Fig. 9c.

The two input signals S and C are usually complementary. When this is the case, the designations of the input terminals are D and \bar{D} , and the state table of the delay flip-flop can be simplified to that shown on the white portion of Fig. 9c.

The RTL implementation of the delay flip-flop (Fig. 9b) is again the same as the T flip-flop, except that the enabling inputs to the two AND gates are disconnected from the flip-flop outputs and are available for external connections.

The R-S-T flip-flop

Another very useful type of steering circuit is used in the so-called R-S-T flip-flop, shown with its state table in Fig. 10. It is an ORed combination of the R-S and the T steering circuits and can serve as any one of them, as required. It is used mostly as a "presettable" and "clearable" toggle flip-flop in binary counters.

The implementation of the R-S-T flip-flop (Fig. 10b) is basically the same as that of the T flip-flop. The only difference is the addition of the two

resistors, R_B , for dc coupling inputs R and S to the circuit.

The up-down flip-flop

All the input terminals of a steering circuit that serve to enable the flip-flop when a positive dc signal is applied to them (in positive-logic systems) are called the "enabling inputs," or simply "inputs" ($IN.S$, $IN.C$, etc.) Similarly, the terminals that serve to prevent (inhibit) the switching of the flip-flop on a positive signal are called "inhibiting inputs" ($INH.S$, $INH.C$, etc.).

A toggle flip-flop equipped with two sets of T inputs and two sets of inhibiting inputs is shown in Fig. 11. This is the "up-down flip-flop" used in reversible counters and similar devices. When $INH.1$ is high, gates S_1 and C_1 are inhibited, and only signals applied to $IN.T_2$ will operate the flip-flop. Changing $INH.1$ to low and $INH.2$ to high will activate the signal applied to $IN.T_1$ instead. The state table of this flip-flop is similar to the combination of two state tables of a T flip-flop, one for the $INH.1$ input when high, and the other for the $INH.2$ input when high. ■ ■

Bibliography:

- Bartee, Thomas C. *Digital Computer Fundamentals*. New York: McGraw-Hill Book Co., 1960.
- Humphrey, Jr., W. S. *Switching Circuits with Computer Applications*. New York: McGraw-Hill Book Co., 1958.
- Hunter, L. P. *Handbook of Semiconductor Electronics*. New York: McGraw-Hill Book Co., 1962.
- Hurley, Richard B. *Transistor Logic Circuits*. New York: John Wiley and Sons, 1961.
- Intellux, Inc. "Flip-Flop Microcircuit Logic Modules," Bulletin No. 6401, 1964.
- *ibid.*, Bulletin No. 6405, 1965.
- Maley and Earle. *The Logic Design of Transistor Digital Computers*. Englewood Cliffs, N. J.: Prentice-Hall, 1963.
- MIL-STD-806B "Graphic Symbols for Logic Diagrams," Feb. 26, 1962.
- Pressman, A. I. *Design of Transistorized Circuitry for Digital Computers*. New York: John F. Rider Publisher, Inc., 1959.
- Weber, S. *Modern Digital Circuits*. New York: McGraw-Hill Book Co., 1964.

Shunt-motor speed control takes a turn for the better when an SCR is used to regulate armature power. Cost and space savings and simplicity result.

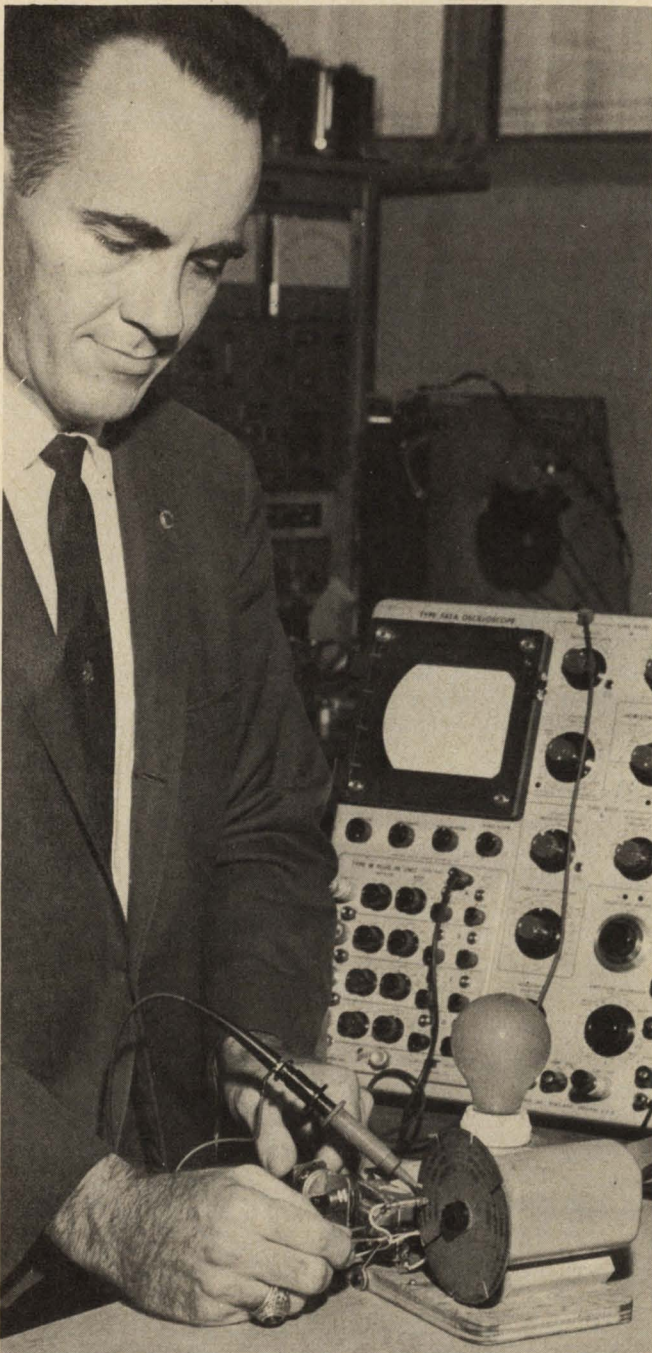

Shunt motor sees the light. Author Howell prepares a dc shunt motor for an SCR-based speed control system, where the light bulb demonstrates the amount of power supplied. By using the SCR to regulate armature power, a smooth, precise and inexpensive speed-torque relationship is developed.

High-cost, very precise speed-control systems for shunt-wound motors aren't needed any more. Industrial and consumer shunt-motor applications demand a low-cost speed control. For such applications, the silicon-controlled rectifier (SCR) fills the bill without a great sacrifice in the precision requirement.

Unlike the conventional adjustable-autotransformer method for speed control, the SCR approach offers better speed regulation and small size and design simplicity. And even though it is not as precise as complex tachometer-feedback systems, SCR speed control does more than an adequate job in most cases for much less cost.

With the SCR, speed control is easily achieved by regulating the voltage applied to the motor's armature.* A feedback path to the SCR is also provided so that the armature power source will resist variations in speed attributable to changes in torque. Although the number and arrangement of the semiconductor components are peculiar to each type of motor involved, the SCR-based speed control is so flexible, it accommodates a variety of motors with a minimum of design change.

Design basics given a whirl

Common to all line-operated shunt motors is the need for a rectifying stage. This will be either half-wave or full-wave, depending on the motor involved. Generally, the half-wave circuit is suitable for motors of less than 1/2-hp rating and with armature current levels under 10 amps. Moreover, with the half-wave rectifier, the motor itself must be able to operate with lower average voltages and higher peak currents.

The full-wave circuit is preferable for motors with characteristics in excess of those mentioned. Note also that the full-wave circuit provides better regulation and a faster response than the half-wave type.

When the motor involved is not a fractional-horsepower type, other factors, independent of the

*In the photograph, this regulating action is demonstrated by the lamp. The brightness of the bulb is a measure of the power being furnished to the motor.

E. Keith Howell, Manager of Transcription Products Engineering, General Electric Co., Utica, N. Y.

type of rectification, must be considered. For one, starting current is a serious problem, unless provision is made for "soft-starting." This action is achieved by permitting sufficient time for the build-up of field current and then gradually increasing armature power.

Another design aspect involves component ratings. In each of the speed-control circuits, the SCR must be selected to handle the average, full-load armature current. In parallel with the armature is a free wheeling rectifier whose rating must also tolerate this current value. In the half-wave circuit, the field rectifier only carries the field current. But the bridge rectifier in the full wave circuit must handle both field and armature current.

Moreover, the voltage rating on all semiconductor elements employed, excepting the diac, should be greater than the peak ac line voltage. The diac is a triggering element which exhibits a breakover voltage characteristic. The use of transient-voltage suppressors across the ac line is a recommended precaution for both full-wave and half-wave circuits.

SCR controls armature power

A simple and low-cost solid-state speed control for shunt-wound dc motors appears in Fig. 1a. The associated speed-torque curves of a typical motor operated by this control are given in Fig. 1b. The curves are for various motor speeds and control settings. The circuit uses a bridge rectifier to provide full-wave rectification of the ac supply. The field winding is permanently connected across the dc output of the bridge.

Armature voltage is supplied through the SCR at various points in each half cycle. The SCR is always turned off at the end of each half cycle. Rectifier D_3 provides a circulating current path for the energy stored in the armature inductance at the time the SCR turns off. Without D_3 , the armature current would circulate through the SCR and the bridge rectifier, thus preventing the SCR from turning off.

The operation of the circuit is best understood by referring to the voltage-phase relationships (Fig. 1c). At the beginning of each half cycle, the SCR is in the OFF state, and capacitor C_1 starts to charge through the armature, rectifier D_2 and adjustable resistor R_2 . When the voltage across C_1 reaches the breakover voltage of the diac trigger diode, a pulse is applied to the SCR gate, turning on the SCR and applying power to the armature for the remainder of that half cycle. At the end of each half cycle, C_1 is discharged through rectifier D_1 , resistor R_1 and the field winding.

Diac phases SCR turn-on

The time required for C_1 to reach the diac's breakover voltage governs the phase angle at which the SCR is turned on. This is established by the magnitude of resistor R_2 and the voltage across the SCR. Since this voltage is the output of

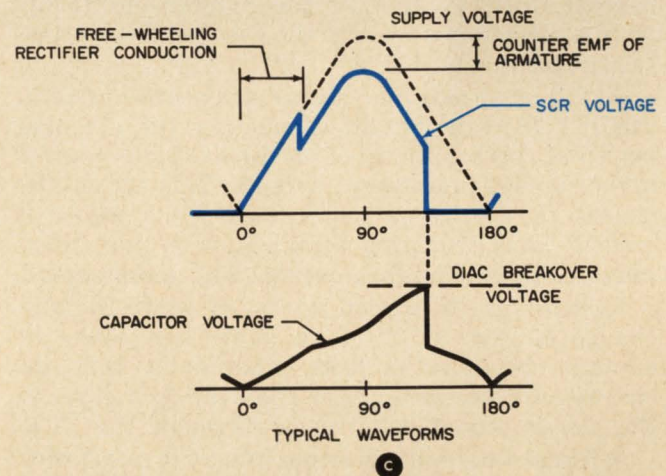
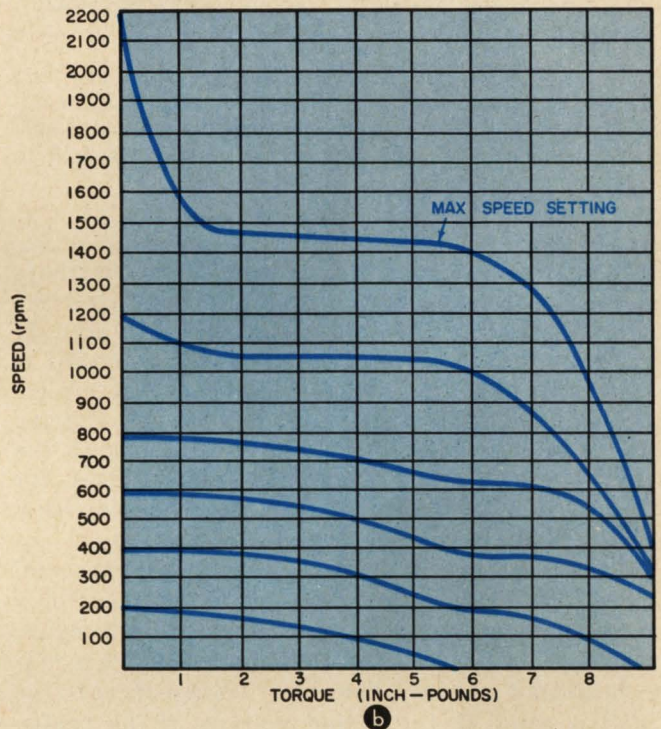
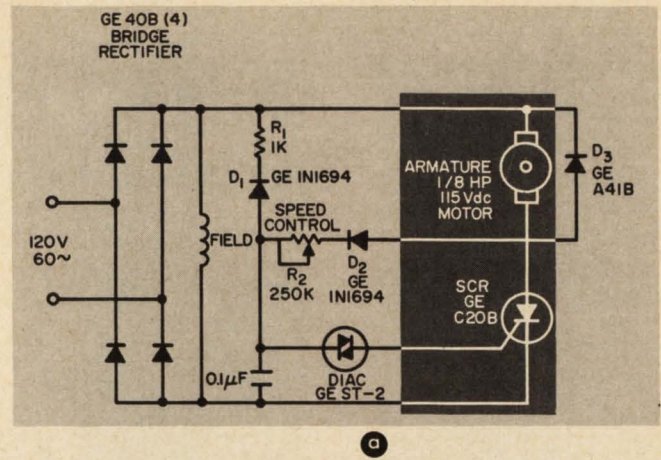

1. When an SCR is used to regulate the power applied to the armature (a), the result is a low-cost, small-sized, effective means of controlling the speed of a shunt motor. The ensuing speed-torque relationship (b) demonstrates the wide range of control. Key operating waveforms (c) show the phase relationships of commutation.

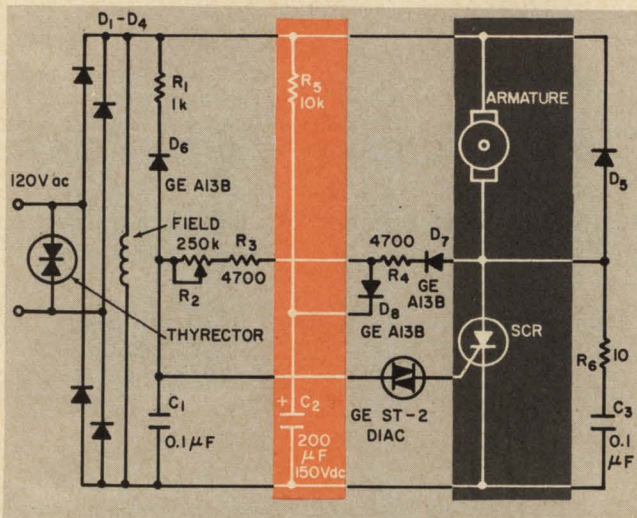

2. A soft-start characteristic is needed when the field winding's inductance is large. Armature power must be delayed until the field current reaches its nominal value. The C_2 charging network delays the firing of the SCR to achieve slow-starting.

the bridge rectifier minus the counter-emf across the armature, the charging of C_1 is partially dependent upon this counter-emf. The speed of the motor determines the magnitude of this emf. If the motor runs at a slow speed, the counter-emf is low and the voltage applied to the charging circuit is high. This decreases the time required to trigger the SCR and increases the power supplied to the armature. This action thereby compensates for the loading on the motor. If the speed increases, the exact opposite occurs.

Energy stored in the armature inductance will result in a current flow through rectifier D_3 for a short time at the beginning of each half cycle. During this interval, the counter-emf of the armature cannot appear. Thus, the voltage across the SCR is equal to the output voltage of the bridge rectifier. The length of time required for this current to decay and for the counter-emf to appear is determined by both the speed and the armature current.

At lower speeds and higher armature currents, rectifier D_3 will remain conducting for a longer period at the beginning of each half cycle than for higher speeds and lower currents. This action also causes D_1 to charge faster (when the motor is loaded), thus providing a compensation that is sensitive to both armature current and motor speed.

Resistor R_1 is chosen so as to limit the discharge current of C_1 to a value less than the current through the field winding. If this discharge current were larger than the field current, the excess would be diverted through the SCR.

Without the limiting action, the SCR may fail to turn off at the end of each half cycle. On the other hand, if R_1 is made too large, the voltage on capacitor C_1 may not be properly reset (obtained) at the end of each half cycle. Then, irregular operation would be apparent at the low-speed settings of the control.

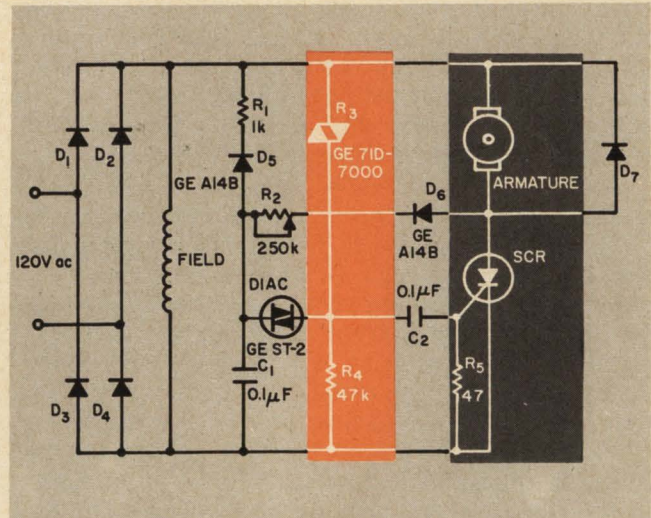

3. Line-voltage fluctuations affect the field winding and SCR firing network. If uncompensated for, they will alter the regularity of the speed control. Compensation is achieved by varistor R_3 , which modifies the triggering angle according to the line variations.

Soft-start overcomes inductance

The inductance of the field winding of a shunt motor is, in general, rather large. Because of it, a significant length of time is required for the field current to build up to its normal value after the motor is energized. It is desirable to prevent the application of power to the armature until just after the field current has reached its normal value. This avoids excessive armature current flow.

A shunt-motor speed-control circuit that provides this soft-start action appears in Fig. 2. The delay is caused by the charging of the large capacitor, C_2 , when the circuit is initially energized. The charging current for C_2 passes through D_7 , D_8 and resistor R_4 and causes the voltage applied to the C_1 charging circuit to increase slowly. As a result, the SCR-triggering phase angle initially starts at about 170° after a brief delay. It then advances to its normal setting after a period of several cycles has elapsed.

Resistor R_5 completes the charging circuit of C_2 . The capacitor voltage levels off at the average value of the bridge rectifier output to prevent any further interference with the action of the control circuit after the initial starting period. R_5 also discharges capacitor C_2 when the circuit is de-energized.

This speed-control contains two additional refinements that are of importance in certain applications. The Thyrector* connected across the input power lines is used to suppress high-voltage transients that could damage the circuit semiconductors. In addition, resistor R_6 and capacitor C_3 are connected in parallel with the SCR to limit the rate at which voltage appears across the SCR after the SCR has turned off. If this voltage appears and rises too rapidly, the SCR may not have

*selenium transient-voltage suppressor

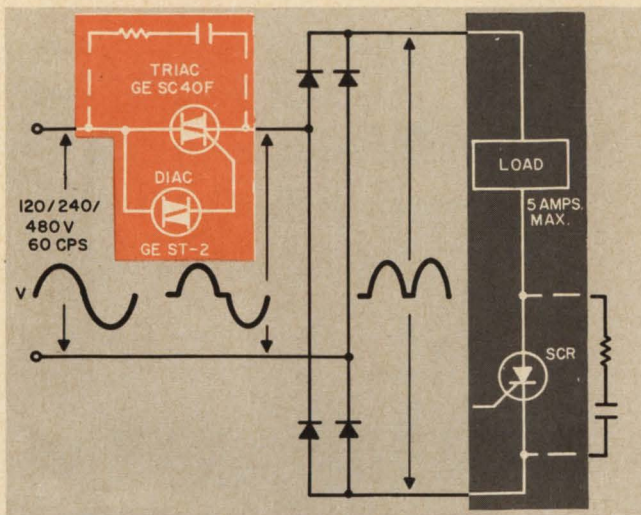

4. Turn-off time can be stretched to provide longer periods for SCR commutation. The use of the triac-diode network to delay the build-up of rectifier output accomplishes this. Note how the waveshapes at the key nodes illustrate the commutation.

sufficient time to completely turn off and may fail to commutate.

At high motor speeds, the counter-emf of the motor, subtracted from the rectifier output voltage, increases the time available for the SCR to turn off. Therefore, if R_6 and C_3 are not used (or are inadequate for the particular motor), a low-speed setting may cause rather violent speed fluctuations. This is caused by the failure to commutate at the low speeds and the ensuing driving of the motor to high speed and then commutation.

Supply changes demand compensation

Changes in the supply voltage have two major effects on shunt-motor speed controls. The first is a variation in field current which alters the relationship between counter-emf and speed. The second relates to the charging circuit for C_1 . Here the bridge-rectifier output voltage minus the counter-emf of the armature is sensed. Since changes in the line affect the bridge output, the charging relationships are modified.

Before taking up means to overcome these problems, it should be emphasized that setting the control for maximum speed applies full power to the armature, and precludes any compensation for changes in supply voltage (at that setting).

At reduced speeds, however, line-voltage compensation can be provided by the circuit shown in Fig. 3. In the previous system, triggering of the SCR occurred when the voltage across capacitor C_1 reached the breakover voltage of the diac trigger diode. In this circuit, the voltage on C_1 must reach the breakover voltage plus the instantaneous voltage appearing across resistor R_4 and capacitor C_2 . This latter voltage is developed by current flowing through thyrite varistor R_3 .

Since this current is an exponential function of the applied voltage, any change in the applied line voltage will result in an even greater relative

change in voltage developed across C_2 and R_4 . This action provides a compensating effect by shifting the voltage required across C_1 to produce SCR triggering.

If the line voltage increases, capacitor C_1 will charge at a faster rate, but it will be required to reach a much higher voltage before triggering can occur. Thus, C_1 will not produce a trigger pulse until some time later than normal. This reduces the power applied to the armature to compensate for the increase in supply voltage. The converse of this action occurs when line voltage decreases.

When higher supply voltages are required for the motor circuit, the fundamental problems associated with the use of an SCR operating from a bridge rectifier are encountered. The ability of the SCR to turn off at the end of each half cycle is contingent upon having its load current drop below the holding-current level for a sufficient period of time. This can only occur during the time interval that the ac supply voltage is instantaneously less than the forward voltage drop of the SCR and two of the bridge rectifiers (typically 1.5 volts).

Triac time-stretcher helps

The normal sinusoidal supply voltage crosses the zero axis at a rate of $377 E_p$ volts per second (where E_p is the peak line voltage). Therefore, the length of time that this is below the 1.5-volt level is very short and is dependent upon the magnitude of the supply voltage. Inductance in the ac supply or in the dc circuit of the bridge rectifier can greatly reduce the time available for SCR commutation. Figure 4 shows a way in which the available turn-off time can be stretched by the use of a triac in series with the ac supply line.

Assuming that the triac itself turns off at the end of each half cycle, it will not turn on at the beginning of the next half cycle until the supply voltage reaches the breakover voltage of the diac trigger diode, which is about 32 volts. At this voltage, the diac will conduct current into the gate of the triac and thereby connect the supply to the bridge rectifier. This provides a time period reaching $400 \mu s$ at 120 volts and $100 \mu s$ at 480 volts, during which the output of the bridge rectifier is zero.

This action provides ample time for the SCR to commutate between half cycles. Inductance in the ac supply line may also require the use of an RC network in parallel with the triac to reduce the rate of change of voltage across it and permit its commutation.

It may also be necessary to use an RC network in parallel with the SCR to limit the rate of change of voltage that can occur when the triac does turn on. This network should be chosen with care since an excessive discharge time constant can cause current to flow through the SCR during the time the supply voltage is zero. A large limiting network may prevent proper commutation from taking place.

If you ever want your power sources to get off the ground, read on:

When it comes to power sources and frequency multipliers we are tempted to say: We offer more of what you go to solid state for—excellent stability, high reliability and high efficiency in remarkably small, lightweight packages.

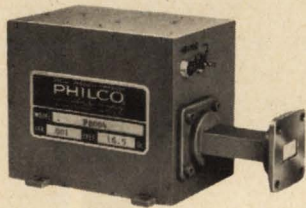

Take our P8004 Ku-band power source. This gives you a 16.5 Gc output frequency with 6mw output power in just 25 cubic inches, weighing 22 oz. Stability is crystal-controlled as part of the high reliability and long-life design. Input power requirements are unusually low.

For telemetry systems, the P8003 S-band power source gives you 20mw output power at a 2.2Gc output frequency, in 12 cubic inches weighing 8.5 oz.

As an example of broad bandwidth and high efficiency, consider the P8405 VHF multiplier: x3 multiplication factor, 360 to 420 mc output frequency, for a 15% bandwidth and greater than 42% efficiency. 12 watts output power.

Our unrelenting effort to achieve maximum reliability in our power sources gets an assist from this fact: we utilize our own demonstrably reliable varactors.



We pride ourselves, in addition, on a quick reaction to your custom-design requirements. Give us a try. For detailed information and prompt technical help, call, write or wire Russ Wright, or at least send in the Reader Service Card. (Phone: 215-855-4681.)

SOLID-STATE PRODUCTS OPERATION

PHILCO

A SUBSIDIARY OF *Ford Motor Company*
 LANSDALE DIVISION • LANSDALE, PA.
 In Canada, Don Mills Road, Don Mills, Ontario, Canada

Speed Inquiry to Advertiser via Collect Night Letter

ON READER-SERVICE CARD CIRCLE 21

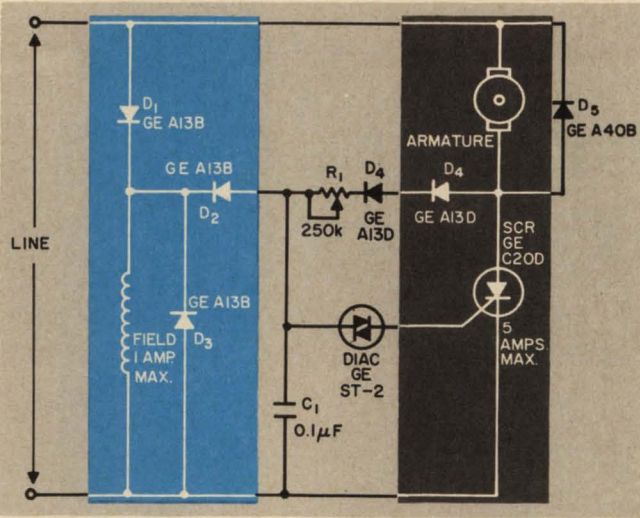

5. Half-wave-regulated speed control is suitable for shunt motors of up to 1/2-hp ratings. It costs less than full-wave control and offers design simplicity. Moreover, it accommodates up to 10 amp armature currents. However, regulation and speed of response are not as sharp.

Half-wave control is simpler

Many low-power shunt motors are more suitable for operation with half-wave rectification of the 120-volt supply rather than with the full-wave rectification shown in the previous circuits. A circuit designed for half-wave control of these shunt-wound motors appears in Fig. 5.

Field current is supplied by rectifier D_1 . Free-wheeling rectifier D_3 provides a circulating current path for the smoothing of the field-current waveform. The armature is supplied by current through the SCR and it also has a free-wheeling rectifier, D_5 .

Voltage for the control circuit is derived from the voltage across the SCR, as in previous circuits. At the end of each positive half cycle, the voltage across the field drops to zero and control capacitor C_1 is discharged through diode D_2 . This action ensures that the voltage on capacitor C_1 is always zero at the beginning of each positive half cycle, independent of the setting of speed-control resistor R_1 .

The operation of this circuit is essentially the same as with full-wave circuits. Note that free-wheeling rectifier D_5 across the armature may be eliminated, but only at the expense of greatly reduced available torque, particularly at low speeds.

It should be realized that the voltage rating required of the SCR is twice the normal rating that would be used with a resistive load. This is because the counter-emf of the armature at high speeds adds to the voltage of the power supply during the negative half cycle, thus nearly doubling the reverse-voltage level. This voltage also appears across diode D_4 , requiring that it also be rated for 400 volts.

All of the speed control systems mentioned are suitable for applications which require reasonable precision and low cost. The great majority of these are in the industrial/consumer market. ■ ■

the most advanced
5MC MICRO LOGIC CARDS

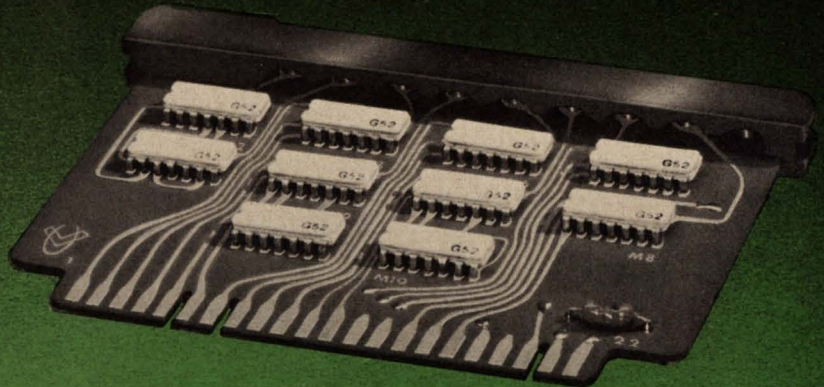

SERIES C — A COMPLETE FAMILY OF DC TO 5MC MICRO LOGIC CARDS

FEATURING • 1 V noise rejection • 300 pf capacity drive • TTL in-line IC modules

OVER 25 CARDS include input/output level shifters, lamp and relay drivers, signal shapers, line drivers, and analog converters.

BROAD LOGIC SELECTION of 2, 4, and 8 input NAND gates, JK flip-flops with 8 and 12 bit counters and registers, plus types for delay and clock generation.

RELIABLE TTL PERFORMANCE provides — 3 V signal levels, 1 V noise rejection, fanout of 6 to 24, and 5MC operation under 300 pf load.

SYSTEM DESIGNED with test terminals for checkout, buffered clock and reset inputs, and "functional cards" for multiplexing, comparison, encoding, and parity.

IN LINE IC MODULES give rugged low-cost construction with conventional solder assembly and easy replacement.

COMPLETE ACCESSORIES for rack, drawer, or instrument assemblies, 2A to 20A power supply, electrical test, and special card assemblies.

Plus "MIL option" for -55°C to $+125^{\circ}\text{C}$, and a forthcoming 20 MC companion family.

for further information on Series C — write to:

 **CONTROL LOGIC, INC.**
SUBSIDIARY OF SCHAEVITZ ENGINEERING

3 STRATHMORE ROAD, NATICK, MASSACHUSETTS. 617-655-1170 OR 235-1865.

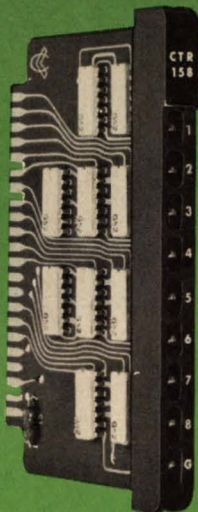



LOOK TO THE LEADER

FOR KLIXON® PRECISION CONTROLS

YOU CAN RELY ON

New from TI

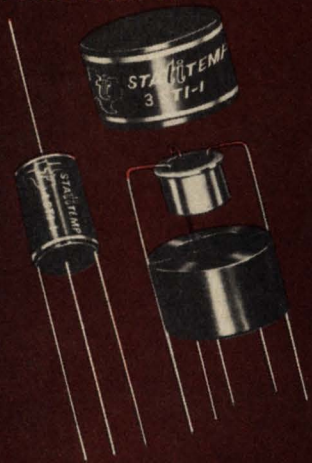

3 & 4ST Self-regulating Component Ovens

A breakthrough in semiconductor technology, its temperature-stabilizes components packaged in DO-7 and TO-5 envelopes at low cost. Made of polycrystalline semiconductor material, the ovens give accurate temperature control without the use of conventional heaters, thermostats or controllers. Operating temperature, $115^{\circ} \pm 5^{\circ}\text{C}$. Temperature gain of 30. Power requirements — 24 v-dc, 3.4 watts max (3ST), 6.5 watts max (4ST). Non-voltage sensitive. Unaffected by component current. Radio noise-free. Low power drain.

Solid State Temperature Stabilization

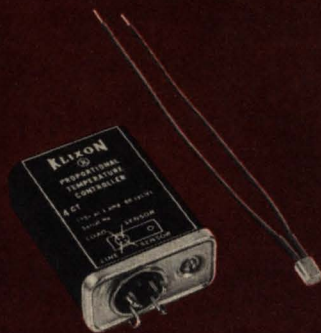

4CT Solid State Proportional Controller

This combination of thermistor sensor (surface element or immersion probe), magnetic amplifier and silicon controlled rectifier stabilizes temperature at $\pm 0.1^{\circ}\text{F}$. Reliability is high... no moving parts. Rated up to 3 amp, 60 or 400 cycle, 115 v-ac. Response within one cycle. Calibration range, -65° to 600°F .

Proportional Control to $\pm 0.1^{\circ}\text{F}$

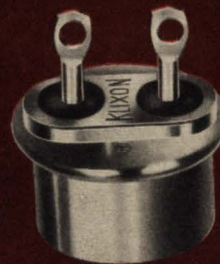

M1 High Capacity Thermal Switch

This highly reliable, hermetically-sealed, snap-action thermal switch is designed for applications with electrical loads up to 7 amp, 30 v-ac/dc. Qualified under MIL-E-5272C and MIL-T-5574A. Ambient temperature range, -320° to 500°F . Minimum differential, 9°F .

EHR Extra High Reliability



3 & 4BT Tiny-Stat Thermal Switches

The smallest, lightest, fastest snap-action thermal switches ever made. 3BT-2 weighs 0.4 g, 4BT-2 only 0.2 g and $3/32$ " thick. Responds up to five times faster than nearest equivalent. Unequaled resistance to shock and vibration. Ideal replacement for thermistors and their electronic switching circuitry. Rated at 1 amp, 115 v-ac/30 v-dc, 10,000 cycles. Temperature setting range, 0° to 350°F .

Small, Lightweight, Fast Response

TI

FOR TEMPERATURE CONTROL

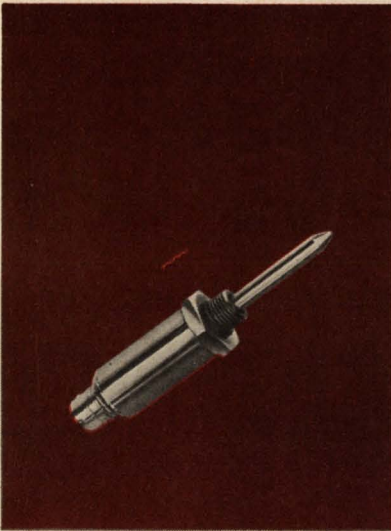

2PT Probe-Type Thermal Switch

Rod-and-tube mechanism provides temperature anticipation under conditions of rapid change. Temperature differential within 1°F. Rated at 2 amp, 125 v-ac/30 v-dc. Operating temperature 150° to 525°F. Slow make-and-break action. Ask about our complete probe-type series.

Anticipation

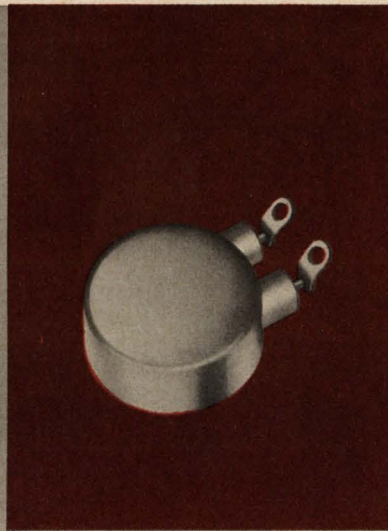

M2 Narrow Differential Thermal Switch

This hermetically sealed, snap-action thermal switch has a differential range of 2° to 5°F at 0° to 250°F. Ambient temperature range, -65° to 450°F. Electrical rating, 2 amp, 30 v-dc/120 v-ac 250,000 cycles, 3 amp, 30 v-dc 50,000 cycles.

Precise ON-OFF Temperature Control

NO OTHER LINE OF THERMAL SWITCHES OFFERS SUCH DIVERSIFIED CAPABILITIES!

Check these characteristics! Control within tenths of a degree. Narrow differential. Extremely fast response. Large electrical capacity. Subminiature size. Open or close on temperature rise or fall. Single or double throw switching. Automatic or manual reset. All-welded hermetic sealing. Immersion probe sensing. Tamperproof calibration. EHR (extra high reliability) series.

TI Precision Thermal Switches... identified by the trusted KLIXON® trademark... meet various combinations of the above requirements with eleven precision types... six are described at the left. Freedom from design limitations as well as savings in engineering and procurement time are yours when you evaluate these thermal switches first.

Wide-range application! KLIXON Precision Thermal Switches are now performing control or warning functions in rate gyros, accelerometers, crystal ovens, electronic tube ovens, computers, transistor circuitry, heater blankets, missile batteries, servo-mechanisms, aerial cameras, radar equipment, missiles and aircraft.

For complete information, write for your FREE copy of the TI-KLIXON Thermal Switch Fact File. We'll also send you the "Tunnel of Horrors" booklet which describes our testing program.



METALS & CONTROLS INC.
5101 FOREST ST., ATTLEBORO, MASS.
A CORPORATE DIVISION OF
TEXAS INSTRUMENTS
INCORPORATED

Here's a New Way to

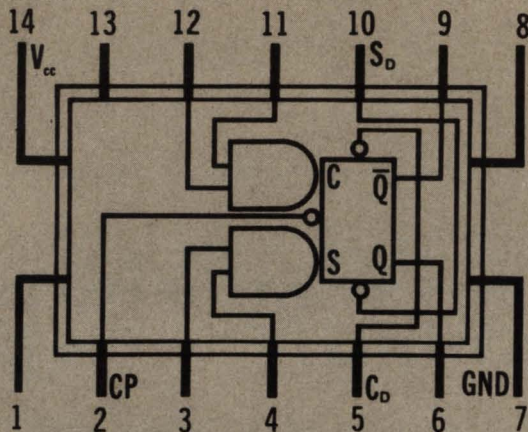

NEW

SN54 948
T²L Flip-flop
... replaces 931, 945 and 948 DTL

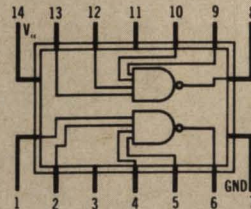

SN54 930
Dual 4-input Gate
... replaces 930 DTL

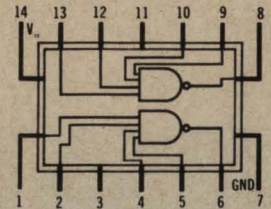

SN54 932
Dual 4-input Buffer
... replaces 932 DTL

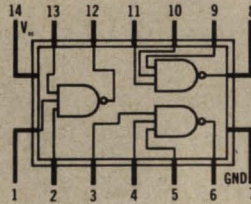

SN54 962
Triple 3-input Gate
... replaces 962 DTL

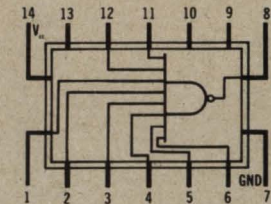

SN54 965
8-input Gate
No DTL circuit yet

T²L integrated circuits from TI replace 930-series DTL...

Upgrade 930-series DTL performance in your present systems *without* costly and time-consuming redesign. How? Simply replace the DTL circuits with new Series 54 930 T²L integrated circuits from Texas Instruments — now including a new flip-flop. No change in circuit boards or power supplies is necessary. Series 54 T²L offers 48% higher speed, 25% higher fan-out and 15% higher noise margin than DTL — *at competitive or lower prices!*

New Series 54 930 T²L circuits are now available with pin configurations that make them *direct electrical and mechanical replacements* for their older

DTL equivalents in most applications. These circuits are logically compatible with 930-series DTL, and can replace all or part of DTL-designed systems.

The new Series 54 930 circuits with DTL-type pin configurations are an expansion of TI's regular Series 54 line. They are identical in every respect with standard Series 54 circuits, except for pin configurations.

Series 54 Transistor-Transistor Logic (T²L) fully exploits the inherent capabilities of integrated semiconductor structures. The multiple-emitter transistor input provides a faster turn-off time than other logic forms, thereby minimizing

propagation delay. Because of unique circuit characteristics and exacting process control, propagation delays are almost independent of temperature and loading.

The output stage of the Series 54 circuit provides low line-termination impedance in both logical "0" (12 ohms) and logical "1" (100 ohms) states. This contributes to low propagation delays and preserves undistorted waveforms even when driving large-capacitance loads. The low line-termination impedance also accounts for low susceptibility to capacitively coupled noise.

Typical noise margin for Series 54 integrated circuits is one volt. Guarant

Upgrade Your DTL System

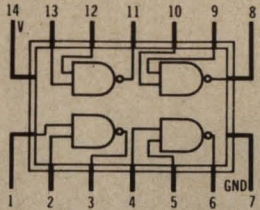

SN54 946
Quad 2-input Gate
 ... replaces 946 DTL

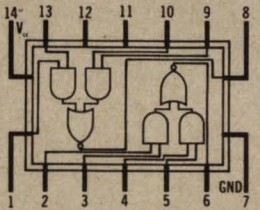

SN54 966
Dual EXCLUSIVE-OR
 No DTL circuit yet

Logic	Propagation Delay (Typical)	Fan-Out	D-c Noise Margin (Guaranteed)
Series 54 930 T ² L	13 nsec	10	400 mV
930-series DTL	25 nsec	8	350 mV

Series 54 930 T²L offers higher speed, higher fan-out and higher noise margin than 930-series DTL gates.

Oscilloscope traces compare speed degradation of 930-series DTL and Series 54 930 T²L as capacitance load is increased. Turn-off times for 50-pf and 100-pf loading conditions are shown at the 1.5-volt point.

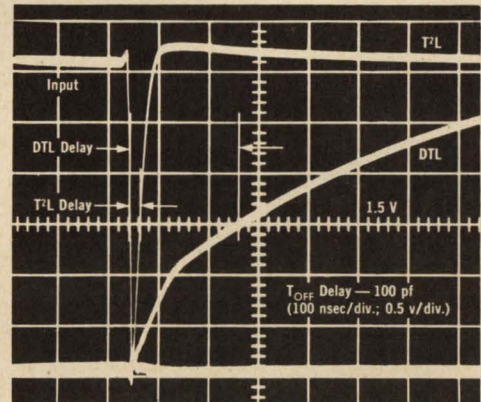
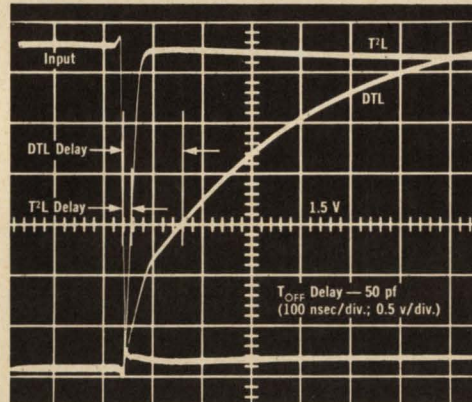

give you higher speed, higher fan-out, higher noise margin

teed worst-case noise margin is 400 millivolts for both logical "1" and logical "0" conditions.

TI's standard 1/4" by 1/8" flat package (TO-84) is used for all Series 54 circuits. This package — proved by more than 35,000,000 hours of controlled tests and four years of field use — features all-welded construction with hermetic glass-to-metal seals.

Why not try replacing DTL circuits with Series 54 T²L in your present system? See for yourself the improvement in performance. For evaluation quantities from stock, contact your local TI Sales Engineer or Distributor.



TEXAS INSTRUMENTS
INCORPORATED
 13500 N. CENTRAL EXPRESSWAY
 P. O. BOX 5012 • DALLAS 22, TEXAS

SEMICONDUCTOR PLANTS IN BEDFORD, ENGLAND • NICE, FRANCE • DALLAS, TEXAS

Heat detector uses fiber optics in semiconductor bonding operation. This arrangement solves the problem of an obstructed target in an RF field.

An infrared detector and a fiber-optic light pipe were used to measure the transistor header temperature during die-bonding operations.

The infrared detector was necessary as the sensing element because of the radiation from the RF heating coil. Thermocouples and resistance thermometers could not be used since they are affected by RF pickup. Optical pyrometers were unsatisfactory because of their lower useful limit of about 650°C and their inherent slowness.

The infrared detector used, on the other hand, had a lower limit slightly above room temperature, was not effected by RF fields and had a fast response time. In addition, it was non-contacting and could be used for near or distant objects.

Light pipe "sees" object

Although the infrared detector met the sensing requirements, its view of the header was obstructed

Benjamin Myers, IBM, Systems Manufacturing Div., Hopewell Junction, N. Y.

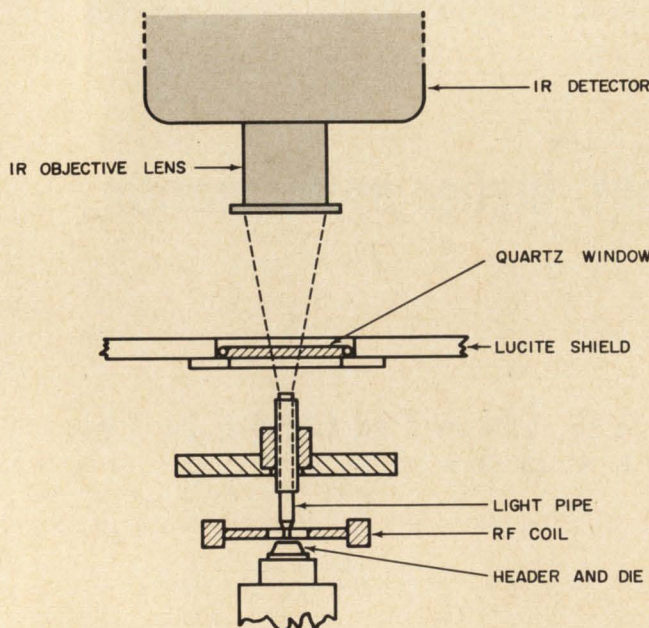

1. IR detector and light pipe combination proved very successful in overcoming the problems of RF radiation and an obstructed target.

ed by the die hold-down probe and the RF coil. The hold-down probe was therefore replaced by a 0.050-inch diameter sapphire rod, having a 0.025-inch diameter at the die end. The 0.025-inch diameter was chosen for mechanical considerations. The sapphire rod thus acted as both a hold-down probe and a light pipe, with its reduction of diameter apparently having no effect on its operation as a light pipe (Fig. 1).

This application involved gold-plated TO-18 headers. The germanium die was approximately 0.016 x 0.016 x 0.004 inch. The sapphire rod was placed in contact with the die, with the field of view taking in the entire germanium surface and part of the header in about a 1:1 ratio.

Thermocouple used for calibration

The infrared detector and sapphire light-pipe combination was calibrated against an iron-constantan thermocouple. Each of the thermocouple wires was placed in contact with the header close to the germanium die (Fig. 2), so that the thermo-

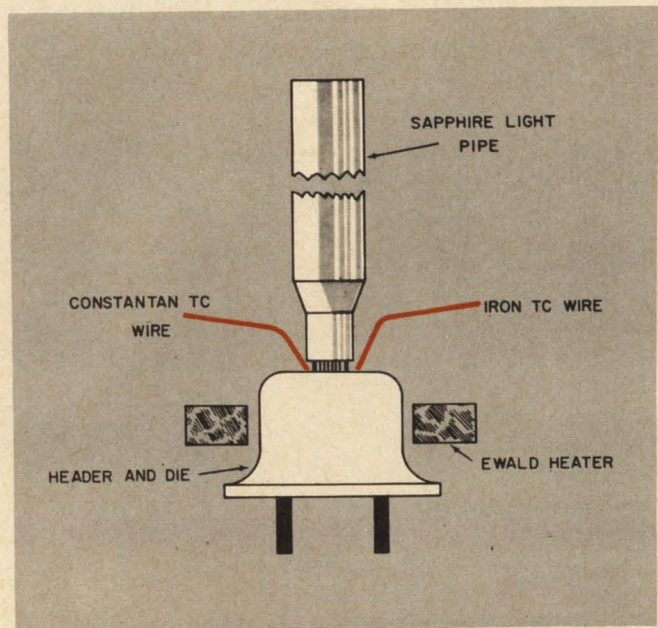

2. Iron-constantan thermocouple was used to calibrate the infrared detector and light-pipe combination. Open ends of the thermocouple were used for the measurements.

couple temperature was the average of the two temperatures at the contact points. This method of measuring surface temperature with an open thermocouple was found to be more effective than spot welding the junction to the header.

The header was resistance heated with an Ewald heater that could control both the temperature and heating rate. Two recorders were used for simultaneous recording of the thermocouple and detector outputs, and a calibration curve (Fig. 3) was made of the detector signal versus header temperature.

The effective emissivity of the light pipe and gold-plated header with a germanium die was also plotted against temperature. The effective emissivity was determined to be 0.10 at 425°C and decreased 0.2%/°C. The transmission factor of the light pipe need not be measured unless the target is to be viewed both with and without the light pipe.

Quartz window required

In the die-bonding operation, a Lucite shield was used to keep an inert atmosphere around the headers. Since Lucite has high infrared absorption, a quartz window was used between the detector and the light pipe. The calibration curve was corrected for a 3°C temperature drop through the quartz window.

In setting up a light pipe and detector, it is essential to know the light pipe's field of view. This can be found by using a small flashlight beam directed into the detector eyepiece to illuminate the light pipe. The light emerging from the entrance face onto the target will indicate the area seen by the light pipe. The light spot is well defined on the target surface. It may be necessary, however, to raise the pipe slightly for better observation. ■ ■

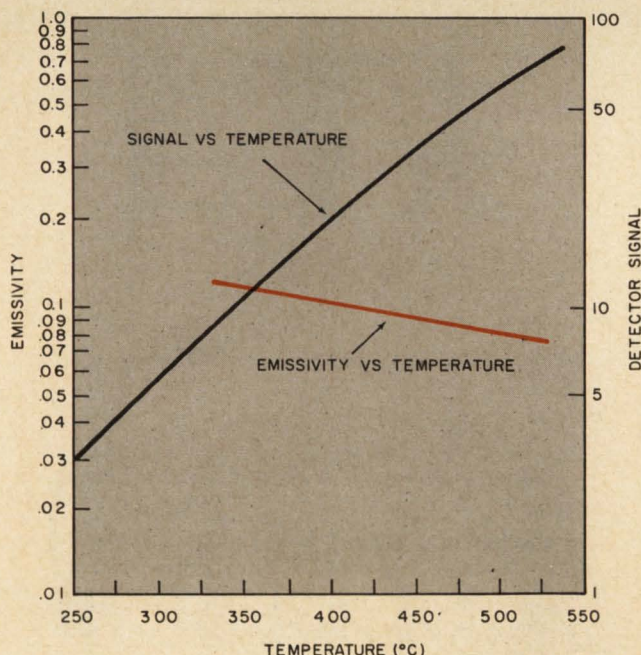

3. Calibration curves of both the detector signal and the emissivity of the light pipe, header and die were made using the iron-constantan thermocouple as a reference.



High Torque Synchronous Motors

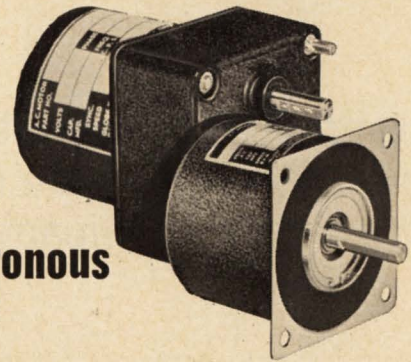

Globe Type UC hysteresis synchronous motors are for commercial products where high torque at exact speed, compactness and unfailing dependability count most. Only 2 5/16" diameter, three standard stack lengths produce outputs of 1, 3 and 6 oz. in. @ 1200, 1800 or 3600 rpm. sync speed. 115 and 230 v.a.c., 60 cycles, single or three-phase. For their size and price they outperform all competition. Dust and moisture can't touch encapsulated stator. Life-lubed ball bearings in stainless steel bearing seat; precision-ground stainless steel shaft. Mounting flange has four .187" holes located .950" from center. Thirteen spur gear-trains available with ratios from 6:1 to 1800:1. Induction versions also available. Request Bulletin UC.



Globe Industries, Inc., 2275 Stanley Ave.
Dayton, Ohio 45404, U.S.A., Tel.: 513 222-3741

Speed Inquiry to Advertiser via Collect Night Letter
ON READER-SERVICE CARD CIRCLE 25

MASKS

for integrated circuitry
thin film devices
semiconductors

PHOTOMASKS

NEW Perma-Chrome (metal film on glass).

High resolution photo emulsion.

EVAPORATION MASKS

Electroformed nickel.

Etched molybdenum and stainless steel.

Bimetal (electroformed nickel and copper).

Prompt quotations and deliveries.



TOWNE LABORATORIES, INC.

Somerville, N. J. • Tel. 201 - 722-9500

ON READER-SERVICE CARD CIRCLE 26

How does your company rate? Is it a good place to work in? Here is a checklist of factors to help compare your company with others or your ideal.

How can you tell if you are working for the right company? Is it possible to devise a rating system that will indicate to an engineer how good the company he works for is? These are questions that become especially important when an engineer is thinking of changing jobs or when he wants to take a good, hard look at his present situation.

It would be nice to have a checklist of some sort to get a meaningful rating for your company—one which would take all important factors into account, not just those which happen to be your own pet gripes. This article is an attempt at such a rating system.

Rating systems are difficult to devise because they must be applicable to many types and sizes of companies and because they produce subjective results—i.e., different people will come up with different ratings, depending upon where they work in a company, whom they work for and whom they work with. The rating system proposed here attempts to overcome these difficulties by aiming at an over-all characterization instead of exact scores. It is a guide and check list of factors you can use to compare the company you work for with those you have previously worked for or with a company you expect to work for. It can also be used to compare what your company is with what you would think it should be.

One thing to remember is that although you can arrive at some reasonably accurate rating for your past companies and the one you are now working for, it's quite another matter to obtain a meaningful rating for a prospective employer. You can get information on certain things—fringe benefits, professional turnover and company unions, for example. But, on most of the important factors, the best you can do is to get someone else's opinions. If you do, keep in mind that his opinions are bound to be colored by his own prejudices, just as yours are by your prejudices.

Another point is that companies are made up of people, people are not perfect, and therefore companies are not perfect. It's easy to see many specific things that are wrong with a company. It is important, however, that both good and bad aspects be considered objectively to get a fair and

more nearly correct picture of the company.

First read through the checkpoints listed and discussed below. Each is explained and one or more examples are given to illustrate it. A comment is also added that explains my own valuation.

The checkpoints fall into three categories:

- Management attitudes & practice.
- Opportunities for individual fulfillment.
- Company environment and remuneration.

Management attitudes and practices

The general attitude of management and the manner in which management techniques are practiced have an important bearing on how you feel about a company. A company may be highly successful in its field and show a healthy balance sheet, but it may be the wrong company for you to work for. The following management practices seem to be pertinent.

Cooperation versus competition

Does your company motivate its people by having them compete against one another, or does it entice motivation through cooperative effort? Does management try to direct engineering opera-

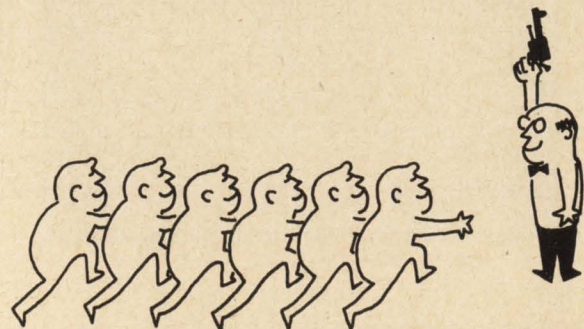

(continued on p 70)

Company rating sheet

Rate your company on each of the following factors. For each, select the condition that exists in your company and write the number associated with it (the figure in parentheses next to the condition) in the blank space at the right of the factor.

Management attitudes and policies

Competitive atmosphere

- (8) Cooperation natural; competition exists.
- (4) Cooperation exists, but is forced.
- (0) Competition is a way of life.

Communication upward

- (6) Management receptive to ideas.
- (4) Some degree of filtering exists.
- (0) Only noise gets through the filter.

Communication downward

- (4) Management keeps employees well informed.
- (2) Management tells you only enough to direct you.
- (0) The front office may exist, but you're not sure.

Responsiveness

- (6) General responsiveness at all levels.
- (3) People are responsive when it suits them.
- (0) People won't move without a fire started under them.

Opportunity for individual fulfillment

Technical development

- (8) Company urges participation and makes opportunities available.
- (3) Company is passively for technical development.
- (0) Forget about it! If we need a technique, we'll pirate an expert.

Are your talents used?

- (8) Company tries to provide a challenge when possible.
- (4) Once in a while a good job comes in, but generally it's "dog work."
- (0) It's all "dog work." (Maybe you're a dog?)

Opportunity for advancement

- (10) Promotion from within based upon performance when possible.
- (6) Promotion from within when possible, but seniority plays a large part.
- (3) New openings generally filled from outside.
- (0) New openings always filled from outside.

Review policy

- (6) Periodic review with both your boss and personnel department.
- (4) Periodic review with your boss.
- (0) No review policy.

Are there stimulating people around?

- (6) Many, the atmosphere is stimulating.
- (3) Some, there are few people to go to.
- (0) It's an isolated, dreary life.

Company environment & remuneration

Salary policy

- (4) Company tries to rectify problem.
- (0) Company ignores problem.

Salary level

- (4) Above average.
- (2) Average.
- (0) Below average.

Fringe benefits

- (4) Above average.
- (2) Adequate.
- (0) Lacking.

Professional turnover

- (4) Little, company dynamic.
- (3) Moderate.
- (1) Little, stagnation evident.
- (0) High.

Do you punch a time clock?

- (4) No.
- (1) We make time clocks, so everybody uses them.
- (0) Professional personnel all use the time clock, or time-clock atmosphere exists.

Is there a professional union?

- (4) No professional union.
- (2) Professional union exists.
- (0) No union, but ripe for one.

Are there adequate facilities?

- (6) Adequate.
- (4) Lack of facilities does not interfere with work.
- (0) Poor.

Geographical location

- (8) Desirable.
- (6) Adequate.
- (0) Undesirable.

Total

tions through commands and orders requiring compliance, or does it consult the people responsible for executing an order as to its workability, etc., prior to issuing the order? At the engineering level, do good ideas go down the drain because they were "not invented here," or do engineers get together to examine the alternatives to obtain the most effective solution? Here you must consider not only your boss, but the general approach and atmosphere within the company.

It is generally accepted that people work better in a cooperative atmosphere than in a competitive one. On the other hand, there are individualists who thrive on competition. My personal feeling is that a cooperative atmosphere is far better for most of us.

Communication upward

Generally, upper management is divorced from the technical aspect of engineering work because administrative and business matters claim most of its time and attention. The new technical ideas in the company must come from the lower echelon technical people, those who are actively working in their fields. Management must provide adequate review to filter the good ideas from poor ones. Is the management in your company receptive to these ideas, making decisions as to their worth and then acting upon them . . . or do they wither on the vine?

It is important that management realizes its own technical shortcomings and provide upward communication channels with adequate filtering.

Communication downward

Are management policies transmitted throughout the company so that company objectives are known clearly to all? It helps to have the whole organization working towards the same goals. Does management trust you to keep company secrets and strategies safe from the competition? (If they do, how do you react to their trust?)

People are more easily motivated when they are made party to company plans. I feel that knowing why you are doing something is nearly as important as knowing what you are doing. I give this a low rating, however, since some communication always exists.

Responsiveness

Are people you work with or those who work for you responsive to orders and requests? If given an assignment or a request, do they "pick up the ball" and supply the initiative to get the job done, or do they "punt" and try to shift the responsibility away from themselves? When people are responsive, it's because they are concerned with doing a job in which they consider themselves to be making an important contribution. A responsive attitude is enhanced if each knows what the other is doing.

I rate the willingness to respond at a middle

level, since it implies an atmosphere created by management which is the sum of many factors, including the checkpoints above. This responsiveness is as much an indicator as a cause.

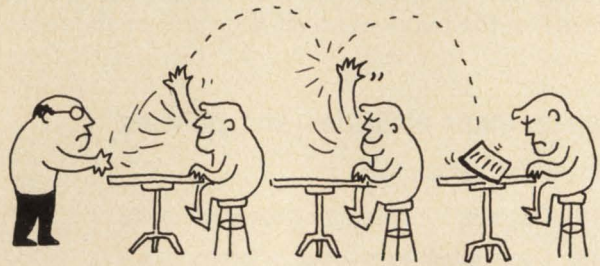

Opportunity for individual fulfillment

Management knows that good people will remain with a company only as long as an opportunity for individual growth is present. However, knowledge does not always imply the recognition and fulfillment of these needs.

Opportunity for advancement

Is there opportunity for promotion to higher positions from within, or are new people always brought in from the outside to staff these positions? When from within, is advancement based upon the ability to perform or on seniority, on an equitable basis or on company politics? In short, is merit rewarded?

The best policy is a judicious use of both internal and external staffing. This means that the company always looks inside for potential people, will take the trouble to groom them, but still take enough people from the outside to assure some degree of competitive spirit and an infusion of "new blood." Since this approach, hopefully, will motivate you to continually improve your capability through training and study, I rate it high.

Technical development

Does your company offer you an opportunity for technical development? Do they encourage participation in training and educational programs where you can continually add to and update your technical competence? A company is only as good technically as its qualified technical people.

This is fairly important to an engineer who does not want to become obsolete. I rate it rather highly.

Are your talents used?

Does your company extend you, over-extend you or under-extend you? Are you always given a little more responsibility and depth of work that you can handle, thereby being challenged, or are you loaded to the extent that you can do nothing well? Are you doing jobs way beneath the limits of your capabilities? One cannot always do just the job

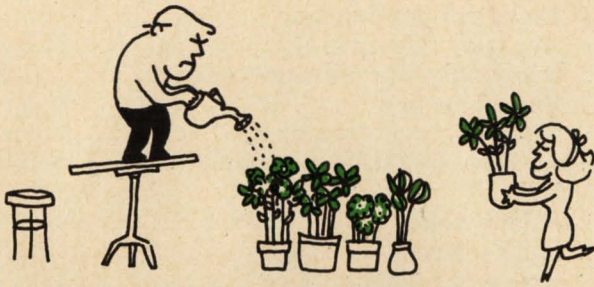

one likes; there are times when we must do the burdensome tasks along with the ones we enjoy. However, are you challenged in general or most of the time by the job given you?

Any person who involves himself in his work likes to receive a challenge and the satisfaction of meeting it successfully. Since it also provides an opportunity to increase one's capabilities, it is an important consideration.

Review policy

Is there a policy for periodic review of your job with your boss? Are you thus able to review your job objectives and determine what they are and how well you are meeting them? Are you and your boss able to interpret the objectives, the responsibilities and the authority that goes with them on your job in the same manner, or have you differences of opinion, known or unknown, to each other?

This is an obviously important policy. It's hard to imagine a well-run organization without some provision for job review.

Are there stimulating people around?

Are there people in the company with whom you frequently come in contact who stimulate you as an individual? Can you try out your ideas on them and get good feedback?

It is important to have outside stimulus. Working in an isolated atmosphere without colleagues can result in the atrophy of your own creative drive, as well as in a failure to keep abreast of developments within the company and the field.

Environment and remuneration

Items such as salary, fringe benefits and facilities are the more obvious things considered by most people in evaluating their company. It is often difficult to separate company policy on these items from our personal situation. However, to be objective in rating these points, the general policy of the company must be emphasized.

Salary policy

Are you paid fairly, commensurate with your experience and level of responsibility? The demand for engineers sometimes reaches the point where people are hired to do a job at a rate higher or not in proportion with the other people already in the organization. As you spend time in a compa-

ny, you tend to take on initiative and you find your responsibility automatically increases. Does the company recognize this and reward you accordingly?

A company should have some process of examining the work of its people to assure that a qualified man with years of experience is not penalized for his loyalty.

Direct remuneration is probably the most significant factor to be considered, yet it must be evaluated in proportion to other points. For example, a company with a high-salary-level policy may be paying the extra premium because it does not provide many of the things that other companies do. Thus, salary level is rated the highest of all checkpoints, but it may include salary level, salary policy and fringe benefits.

Fringe benefits

Fringe benefits could possibly be considered a part of salary policy. To note their importance, they are separated here. All companies have some fringe benefits.

I consider contributory hospitalization and major medical plans, insurance, retirement plans and a credit union as average for a company. If any of these, excepting credit unions, are paid totally by the company then it is above average. Stock purchase plan, bonuses and incentive rewards all tend to be above average.

Professional turnover

Is the professional turnover right? Are people marking time at your company waiting for other opportunities outside, or are they truly invested with the company's spirit? Does the company provide opportunities for advancement and other benefits for these people?

High turnover is an indicator of general dissatisfaction or of a company that hires for a contract and releases its personnel at the end of the contract. Low turnover by itself can also indicate a condition of stagnation.

Do you punch a time clock?

In a sense, a company that asks its professional employees to punch a time clock indicates a lack of

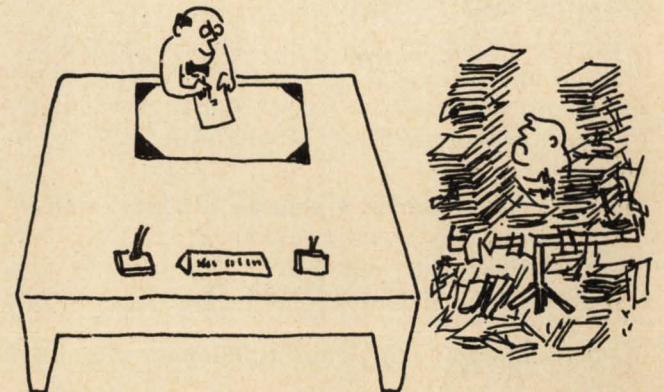

confidence in the general professional employee.

The keeping and posting of direct labor hours spent on different projects is a rather simple task for professional people. A time clock is not needed for this purpose.

Is there a professional union?

If there is a professional union in your company, management must have been deficient in its personnel relationships at some time. The strength of a professional union is needed only when management abuses the welfare of the professional employee.

Even though the company may have corrected itself since the union was organized, its continued existence may still be considered a detriment to the highly qualified engineer. However, the rating system places less weight on this area than most of the others. Those who consider a professional union important don't have much confidence in their company in the first place.

Are there adequate facilities?

Does the company provide adequate facilities for accomplishing your assigned tasks? Facilities include such things as adequate office space and office equipment, adequate parking facilities, adequate secretarial help and phone services. Are there adequate laboratory, test and technical facilities? Do engineers live in a "bull pen" office and atmosphere, or do they have some partitioning of office space?

We all have gripes of some sort, but if a lack of facilities does not generally interfere with getting your job done, they are adequate. A satisfactory set of facilities is above average.

Geographical location

Although it may not be of major importance to many people, the geographical location of your employer may be worth considering. Is it a rural or city area? Is there good transportation? Are good houses and schools available? Is the climate and way of life of the community suitable to you and your temperament?

Your own temperament must rate this.

Checkpoint weighting

On the accompanying test, I have weighted the relative importance of each of the checkpoints by the maximum possible score under each item. These total up to 100%. The weighting selected is as follows:

Management attitudes & policies (24 total points)

- Cooperation vs competition 8
- Communication upward 6
- Communication downward 4
- Responsiveness 6

Opportunity for individual fulfillment (38 total points)

- Technical development 8
- Are your talents used? 8
- Opportunity for advancement 10
- Review policy 6
- Stimulating people around? 6
- Company environment & remuneration (38 total points)**
- Salary policy 4
- Salary level 4
- Fringe benefits 4
- Professional turnover 4
- Punch a time clock? 4
- Professional union? 4
- Adequate facilities? 6
- Geographical location 8

Take your own test

Now take the accompanying test. For each of the 16 checkpoints, determine which of the alternatives you feel applies to your company and enter the number associated with it into the blank space. If you feel you can make a finer breakdown for various items, interpolate as seems best to you.

We can now consider the results in two lights:

■ A measure of how good your company is as compared with others you have rated or have had other people rate.

■ A measure of your company against what you think it ought to be.

To consider the score of your first trial as a means of telling you how good your company is as compared with others, score the other companies in the same manner that you did your own. If you have insufficient information to do the latter, sufficient gross guidelines for an absolute rating might be as follows:

- Poor Below 50%
- Average 50-75%
- Good 75-95%
- Perfect (Hard to believe) Above 95%

To evaluate the usefulness of this rating system, I have had several people from my company, who work in a variety of areas, make an evaluation. Their scores came within 15 points of one another. This small sample indicates that the rating system is at least indicative on a gross basis.

The second method is perhaps more revealing to your own situation. To do this, go through the rating chart again and evaluate those items that you feel it is important for your company to provide. Total this up and divide this new total into the first total to get a percentage score. This percentage score indicates how far your company is from meeting your ideal requirements. Anything above 80% should be considered very good.

The objective of this test has been to provide a relative rating system that covers all points, not just the obvious ones. It will become a personal test if you replace my weighting system with your own. This will result in a valuable device for yourself, but provides no standard for comparison with others. ■ ■

**Now — from Computer Control Company
A Comprehensive Catalog
of Integrated Circuit Logic Modules**

5 megacycle

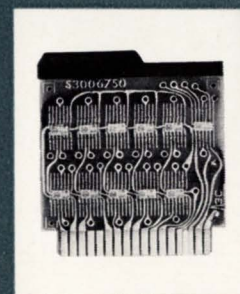

μ -PAC

integrated
circuit
digital logic
modules



COMPUTER CONTROL COMPANY, INC.

μ -PAC CATALOG CONTENTS

Introduction	1
Capabilities	2-3
Reliability	4
μ -PAC Logic	5
Specifications	6
Waveform Characteristics	7
Mechanical Features	8
Electrical Features	9
μ -PAC Symbology	10
PACS	11-34
Mounting Hardware	35
Power Supplies	36
Accessories	37-38
Instruction Manuals	39

FLIP-FLOP PACS

BC-335	Counter PAC	6 flip-flop for binary counting	11
BC-336	Binary Counter PAC	8 to 20 flip-flops prewired for binary counting	12
BC-337	Fast Carry Counter PAC	8 flip-flops for binary or BCD counting	13
BR-335	Buffer Register PAC	6 flip-flops prewired with common clock and common reset input	14
FA-335	Gated Flip-Flop PAC	4 flip-flops with DC, clock and control inputs	15
UF-335	Universal Flip-Flop PAC	3 flip-flops with AC and DC input gating	16
FF-335	Basic Flip-Flop PAC	8 flip-flops with DC input gating	17

GATE PACS

DC-335	Multi-Input NAND PAC	2 six-input NAND gates with nodes 4 three-input diode clusters	18
DI-335	NAND PAC	8 two-input NAND gates 2 two-input NAND gates with separate load circuits	19
DL-335	NAND Type 2 PAC	4 four-input NAND gates 2 four-input NAND gates with separate load circuits	20
DN-335	Expandable NAND PAC	4 three-input NAND gates with nodes 2 three-input NAND gates with nodes and separate load circuits	21

AMPLIFIER PACS

PA-335	Power Amplifier PAC	6 three-input inverting power amplifiers	22
--------	---------------------	--	----

DELAY PACS

DM-335	Delay Multivibrator PAC	2 monostable multivibrators, step adjustable pulse width	23
--------	-------------------------	--	----

CLOCK PACS

MC-335	Master Clock PAC	1 crystal-controlled clock	24
MV-335	Multivibrator Clock PAC	1 free-running multivibrator clock	25

SPECIAL-PURPOSE PACS

DG-335	Selection Gate Type 1 PAC	4 selection gate structures	26
DG-336	Selection Gate Type 2 PAC	2 selection gate structures	27
EO-335	Exclusive OR PAC	5 exclusive OR gate structures with 1 one-input NAND gate	28
OD-335	Octal/Decimal Decoder PAC	1 prewired binary-to-octal decoder 1 six-input NAND gate 1 three-input NAND gate	29
TG-335	Transfer Gate PAC	4 transfer gate structures	30

SYSTEM INPUT/OUTPUT PACS

SD-330	Solenoid Driver PAC	3 solenoid driver circuits with additional gate	31
ST-335	Schmitt Trigger PAC	2 schmitt trigger circuits	32
XD-335	Transmission Line Driver PAC	6 two-input transmission line drivers	33
LD-330	Lamp Driver PAC	12 indicator lamp driver circuits	34

FEATURES

- High packaging density
- Low cost per logic function
- Noise protection in excess of one volt
- Low power consumption
- Universally accepted NAND logic
- DC coupled circuitry throughout
- DTL monolithic semiconductor integrated circuits

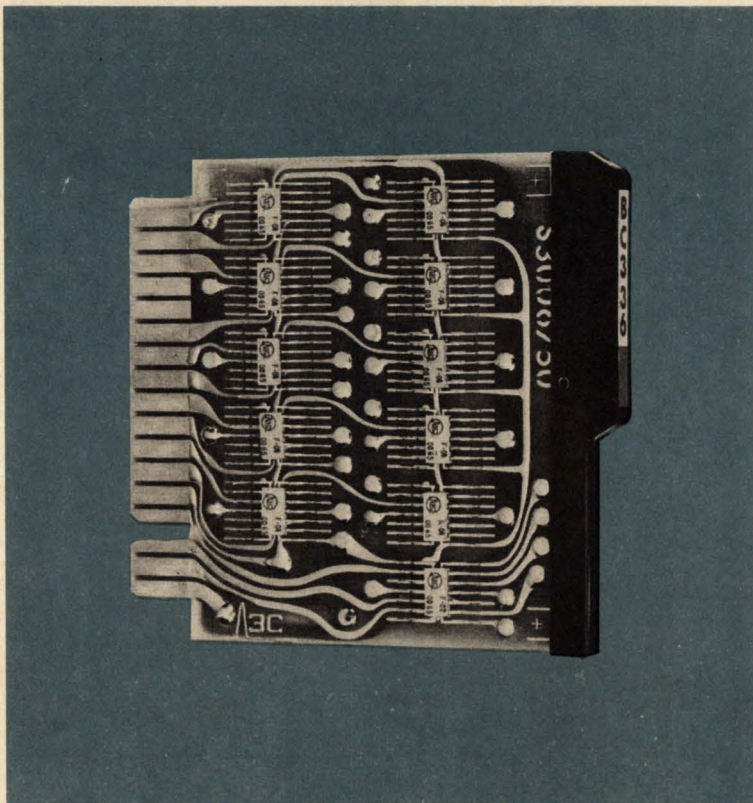

INTRODUCTION

μ -PACS combine low price, size, and reliability advantages of silicon monolithic integrated circuits with the straightforward logic design and implementation of 3C's discrete modular building block lines.

A static asynchronous digital logic series, μ -PACS utilize diode transistor logic for noise rejection and speed capabilities. In addition, μ -PAC circuits achieve input gate expansion, output cascading, high fan-out, high noise thresholds, and low propagation delays.

Individual integrated circuit assemblies in 14-lead flat packs are resistance soldered on copper etched glass-impregnated epoxy cards. With all circuit inputs and outputs available at connector pins, μ -PACS make possible traditional systems construction, permit modification and simplified procedures for check-out and maintenance.

More than twenty months of in-house funded research went into development of the standard μ -PAC line. As a direct result of this project, 3C has established a capability for producing special μ -PACS to meet customer requirements and for expansion of the standard product line.

CAPABILITY

Since introduction ten years ago of the first 3C PAC®, Computer Control Company, Inc., has designed, manufactured and delivered over one million discrete digital logic modules. These have met both general and special purpose needs of the military, government and industry for modular building block logic circuits. From early vacuum tube circuits, to the first transistorized circuits and the innovation of NAND operation, to uniquely designed and packaged circuits for the JPL/NASA Mariner Mars vehicle, 3C has made a total commitment to the design and manufacture of an extensive range of electrically, mechanically and logically complete circuit module lines. The success of these applied circuit design and packaging capabilities is due to the user orientation of all development efforts. This sensitive awareness to user needs for flexibility and reliability has in large measure grown out of 3C experience with its own general and special purpose systems business.

The company's first module line was the 1 mc vacuum tube V-PAC developed in 1955. The following year 3C introduced 100 kc M-PACS, the first commercially available fully transistorized digital circuit module. In 1957 1 mc T-PAC was announced, featuring synchronous dynamic logic and packaging economies. To this day, T-PAC sales still represent a significant contribution to the company and the industry. Three years later H-PAC became the first commercially available clocked 20 mc digital module line. This same line included unique serial memory glass delay line modules which have become one of the most popular features of this active module line. Shortly after the H-PAC introduction, 3C released S-PAC, a 1 mc, 5 mc, and 200 kc family of modules with over 150 standard models, extensive hardware options, design aids, and specials. If there is an industry standard today, S-PAC, which has achieved the largest single share of the module market, best represents that standard.

Late in 1960, parallel to these commercially-oriented developments, 3C embarked on a development program to produce low power, high density digital circuits and, ultimately, pellet components for JPL/NASA scientific Mariner Venus, Mariner Mars, and Ranger space probes. Unique packaging techniques developed for these programs led to the design of forerunners to 3C's new μ -PAC integrated circuit module line.

Almost two years ago during early developments in microcircuit technology — the fabrication of smaller, cheaper, and more reliable digital logic modules — 3C instituted a company-funded, analytical study to evaluate all implications of this relatively new technology and determine its present and future effect on the general electronics industry. Broad areas of investigation included circuit design, logic design evaluation, packaging, fabrication techniques, and other appropriate areas of study.

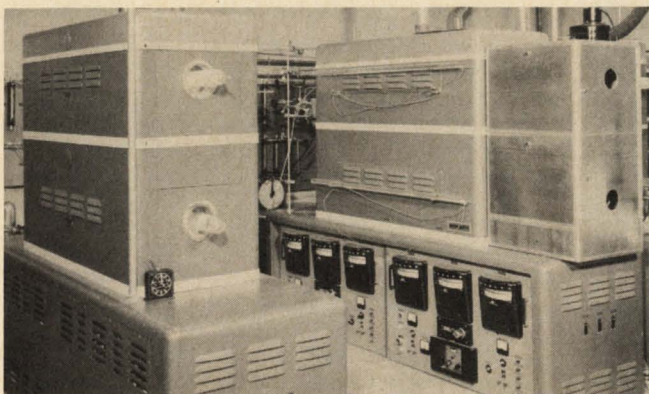

COMPUTER CONTROL COMPANY, INC.
OLD CONNECTICUT PATH, FRAMINGHAM, MASS.

In further support of these studies, 3C established a fully equipped and staffed microelectronic techniques laboratory. During the course of study, 3C laboratory scientists investigated all forms of microelectronic circuitry to evaluate every possible technique and their respective required trade-offs.

The laboratory staff evaluated thick films, thin films, monolithic integrated circuits, and hybrid circuits (the combination of one or more of the previous techniques or the combination of one or more of those techniques with various types of discrete components).

Simultaneously, 3C circuit design engineers analyzed and evaluated specific integrated circuits commercially available to industry. They tested characteristics, flexibility, and usability of each of these integrated circuits. 3C circuit design engineers also investigated various trade-off options in the design of digital circuits. They developed a capability for responding to various limitations in types of components, values, and tolerances. As the program matured, design breadboards of discrete components for various prototypes were built in conformance with the trade-offs determined by the techniques laboratory group.

Mechanical engineers drew upon extensive past product experience in the recommendation of appropriate size, shape, and configuration of related integrated circuit module equipment. They investigated the overall question of packaging to determine whether to combine cordwood capability with microelectronics, or go for still greater packaging economies. Interconnection schemes (including backboard wiring build-up in various logic configurations) and the capabilities of wire-wrap, solder, push-on and taper pin type connections were investigated. In addition, various types of materials for boards and cordwoods were examined, as well as multi-layer and double-sided printed circuit techniques, and the interconnection and mounting methods for the microcircuits.

3C computer and systems engineers determined logical capabilities of microcircuits used in different digital systems. They also examined historical logic configurations in order to assist in specifying necessary parameters for the proposed 3C product line.

By mid-1964, the techniques laboratory group had largely completed their evaluation of various microelectronic alternatives. They had developed the equipment and capability for producing not only components, but complete digital circuits. By achieving this capability, they were able to present to the circuit design group detailed restrictions and trade-off parameters for each type of microelectronic circuit. Similarly, circuit designers were capable of determining the 3C capability for design of specific general purpose product circuits within the trade-off specifications outlined by the techniques laboratory.

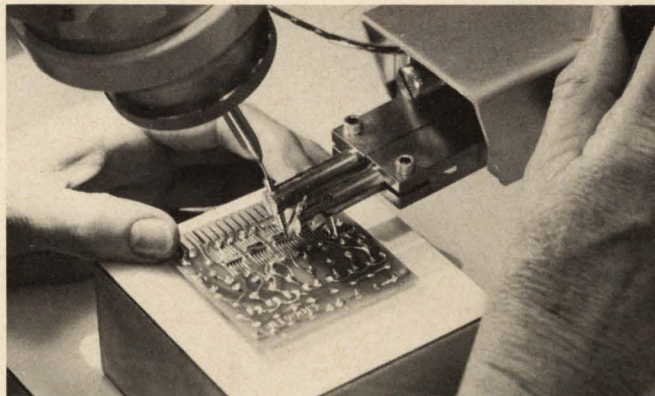

RELIABILITY

10 years of 3C circuit design experience have been drawn on to develop μ -PACS with optimum reliability characteristics. Extensive consideration has been given to circuit design approaches, component values, component tolerances, margins, heat transfer and performance specifications. In addition, 3C circuit designers have capitalized on unique inherent features of the integrated circuit to achieve reductions in the number of thermal compression bonds required on a typical circuit, reduction in component interconnections, reduction on sealed packages required per circuit, minimization of variability between individual circuits, as well as simplified production assembly, and testing programs leading to easier tracing of defective circuits. (Hybrid circuits used in the μ -PAC line employ high quality, high stability discrete components. All semiconductor components are silicon.)

From design of proprietary circuitry and logic functions through every step in the production of integrated circuits, 3C research and development efforts have been guided by reliability engineers toward the formulation of standards and procedures to be utilized in vendor procurement for volume μ -PAC manufacture.

Individual integrated circuits fabricated in the 3C Techniques Laboratory during research and development are on life test in a continuous running, self-checking series system. As of May 1, 1965, this system has operated 5,088 hours, or 485,280 circuit hours, without a component failure. (Life test program details are available on request).

Integrated circuit devices used in the μ -PAC line are custom fabricated for 3C by leading IC manufacturers who can call upon millions of hours of life test data to substantiate specified circuit performance.

Manufacturing procedures — both at 3C and at its high volume production facility Electropac, Incorporated — are governed by thoroughly documented controls.

Rigid inspection, testing and over-all quality assurance programs are an integral part of the μ -PAC manufacturing process. μ -PAC life test consists of NAND gates, flip-flops and power supplies operating in a system. A train of pulses is passed through a pattern generator into parallel counter-register systems. A comparison gate senses the signals being received from the identical counter-register systems. Any difference in pulse pattern is recorded in the comparator which activates the sense amplifier and automatically records a malfunction via attached indicator lamps. This life test unit utilizes a number of typical system applications and enables the rapid accumulation of reliability data.



μ -PAC LOGIC

μ -PAC circuits operate from DC to 5 mc and utilize the NAND function for positive logic. They can be used to directly implement the NOR function for negative logic or AND-OR logic.

3C chose the universally accepted NAND operator for positive logic for its μ -PAC family of digital modules because of simplicity and usage symmetry made possible by the basic NAND gate circuit.

All modules are DC coupled and hence are directly compatible with no intermodule coupling required.

J-K FLIP-FLOP LOGIC

The μ -PAC J K Flip-Flop utilizes double rank circuitry whereby two flip-flops are used to perform the necessary AC operations. The basic double rank circuit has DC Set and Reset inputs, Set and Reset Control inputs and a Clock input. The AC input portion of the Flip-Flop is composed of the Clock input and the Set and Reset Control inputs. (See Figure 1.)

Control inputs are activated by logical ONEs (not logical ZEROs as in S-PAC). A ZERO-ONE-ZERO pulse on the Clock will cause the Flip-Flop to assume the state determined by the condition of the Control inputs, there being no ambiguous state with J-K circuitry.

Control input information is entered into the first of the double rank flip-flops on the ZERO-to-ONE transition of the Clock input and is shifted to the second flip-flop on the Clock's ONE-to-ZERO transition.

In addition to steering Clock pulse, control inputs can be used as direct inputs or, when tied together, as a clock input. The DC Set and Reset inputs override any activity in the AC portion of the Flip-Flop.

The Clock inputs provide intrinsic pulse dodging by means of trailing edge triggering. This feature permits strobing of the Flip-Flop output with input signals. See " μ -PAC Waveform Characteristics" for input timing requirements.

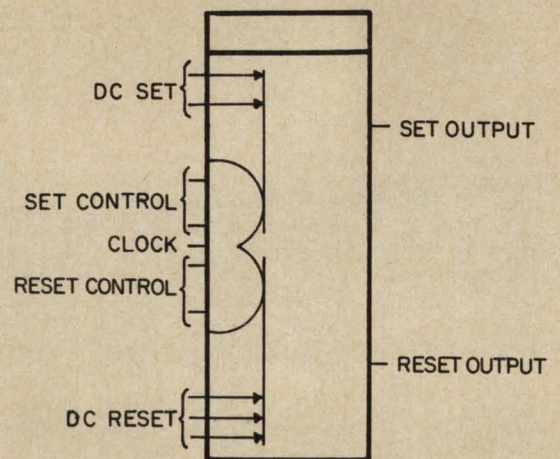
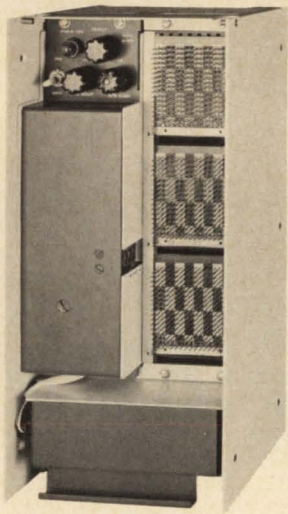

FIGURE 1. J-K FLIP-FLOP LOGIC DIAGRAM

MECHANICAL FEATURES



μ -PAC modules are monolithic integrated circuit assemblies supplemented by some discrete hybrid combinations mounted on 2.9 x 2.7 x .24 inch glass-impregnated epoxy cards.

All PACS feature gold-plated, etched fingers to guarantee reliable electrical contact with a 34-pin polarized connector.

Individual integrated circuits are assembled in 14-lead, .250 x .125 x .065 inch flat packs soldered to the etched wiring.

Up to 22 flat packs can be mounted on a single μ -PAC card for counting or shift register operations. Resistance soldering methods enable simple replacement of components.

μ -PAC modules plug into precious metal wire-wrap or taper pin connectors assembled in standard μ -BLOCS which permit flexible, low-cost backwiring techniques.

Wire-wrap terminals can be employed for other contact methods, including push on, stackable contact, soldering, and percussion welding.

Power and ground pins are factory prewired in all μ -BLOCS with laminated copper and epoxy glass distribution lines. The copper and glass planar arrangement permits maximum decoupling of spurious signals from power and ground lines.

Connector plane and power bus assembly can be easily removed from the μ -BLOC to permit convenient bench wiring of system logic.

Built-in cooling units are contained in each BLOC and are designed such that temperature rise within an integrated circuit is well within specified limits when outside ambient temperature of the BLOC is within the rated 55°C. When two BLOCS are used together in a cabinet, it is possible to arrange the units for push-pull fan action.

Plug-in power supplies are designed for easy BLOC insertion and removal. Rack-mount power supplies are available for driving a series of BLOCS.

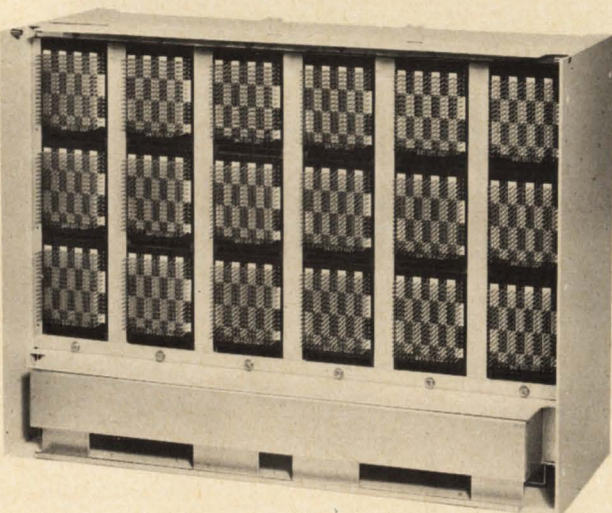

COMPUTER CONTROL COMPANY, INC.
OLD CONNECTICUT PATH, FRAMINGHAM, MASS.

ELECTRICAL FEATURES

μ -PAC is a static asynchronous digital logic line similar to S-PAC. Diode transistor logic (DTL) is employed for its noise rejection, speed and expandable input capabilities. Circuit designs meet the specification needs of a 5 megacycle product line featuring input gate expansion, output cascading, high fan-out, high noise thresholds, and low propagation delays.

Performance specifications are conservative — all applicable circuitry has been laboratory tested to operate at 8 megacycles under full load over the entire temperature range.

The basic logic unit, the NAND gate, performs a NAND function for positive logic and a NOR function for negative logic. Inputs are generally expandable by addition of diode clusters available on selected gate modules.

Most μ -PAC flip-flop modules utilize a single, versatile flip-flop circuit. This basic circuit is a double rank J-K flip-flop. In addition, a flip-flop consisting of two cross-coupled NAND circuits is used to provide an RS type flip-flop module.

The Power Amplifier PAC adds high drive capability gating to the line with the added feature of short delay time. Built-in short circuit protection (patent applied for) limits the output current when the output is short circuited.

Other electrical features:

1. All logic circuits operate from a single voltage source of +6 volts. Power supplies provide current at +6 volts and also supply current at -6 volts for auxiliary circuits such as the Multivibrator Clock, Master Clock or the Schmitt Trigger.
2. Input noise rejection is 1.35 volts typical.
3. All μ -PAC circuits are DC coupled.
4. Excessive stray capacitance loading will slow down circuit operation but will not cause failure.
5. Signal levels are nominally 0 volts for logical ZERO and +6 volts for logical ONE.
6. All inputs are diode coupled/isolated.
7. Loading numbers are expressed in easy-to-use unit numbers, and include wide safety margins at maximum operating frequency. In addition to indicated fan-out, ample margin is included for the specified stray capacitance to permit greater freedom in PAC-to-PAC wiring. Nominal μ -PAC unit load is 1.6 milliamperes.
8. Listed performance specifications are based on "worst case" stack-up of tolerances. Performance will usually exceed these specifications considerably.
9. All modules have standard power input connections.

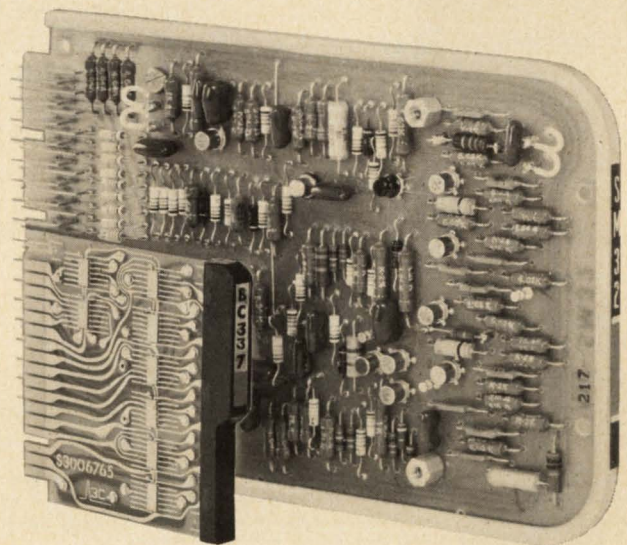

GENERAL μ -PAC SPECIFICATIONS

Frequency	DC to 5 mc*
Logic Levels:	
Logic ONE	+3.0 volts to +6.3 volts (or an open circuit at the input)
Logic ZERO	0 volt to +1.1 volts, maximum
Noise Rejection	1.35 volts, typical 1.05 volts, minimum
Ambient Operating Temp. Range	0°C to +55°C
Storage Temp. Range	-65°C to +150°C
Power Supply Voltage	+5.1 volts to +6.3 volts (-6 volts also available for some auxiliary non-logic circuits)

NAND GATE SPECIFICATIONS

Input Loading	1 unit load
Fan In	12
Fan Out	8
Stray Capacitance**	40 picofarads
Circuit Delay (measured at +1.5 volts, averaged over 2 stages)	24 nanoseconds, typical 30 nanoseconds, maximum

J-K FLIP-FLOP SPECIFICATIONS

Inputs:	Loading:
DC Set Input	$\frac{2}{3}$ unit load
DC Reset Input	$\frac{2}{3}$ unit load
Clock	1 unit load
Control	1 unit load
Fan Out	8
Stray Capacitance**	40 picofarads
Circuit Delay (measured at 1.5 volts):	
Clock input (ONE to ZERO transition) to flip-flop output	45 nanoseconds, typical 60 nanoseconds, maximum
DC Set input to Set output	45 nanoseconds, typical 80 nanoseconds, maximum
DC Set input to Reset output	45 nanoseconds, typical 60 nanoseconds, maximum
Set Control input to Set output	45 nanoseconds, typical 60 nanoseconds, maximum
Set Control input to Reset output	45 nanoseconds, typical 60 nanoseconds, maximum

POWER AMPLIFIER SPECIFICATIONS

Input Loading	1 unit load
Fan In	12
Output Drive Capability	25 loads
Stray Capacitance**	250 picofarads
Circuit Delay (measured at +1.5 volts, averaged over 2 stages)	24 nanoseconds, typical 30 nanoseconds, maximum

*At a 5 mc clock rate there is enough usable logic time in one clock cycle to preset and propagate through the clocked flip-flop, and pass through 3 series NAND gates.

**Specified at maximum circuit delay times. Additional stray capacitance affects only circuit delay times. See μ -PAC manual for additional details.



COMPUTER CONTROL COMPANY, INC.
OLD CONNECTICUT PATH, FRAMINGHAM, MASS.

μ-PAC WAVEFORM DEFINITIONS AND CHARACTERISTICS

Negative Time: Signal duration below +1.5 volts.

Positive Time: Signal duration above +1.5 volts.

Set and Reset outputs denote voltage levels and appear at the output of gates and flip-flops.

Assertion and Negation outputs denote pulses and appear at the output of clocks and delay multivibrators.

Timing is measured and specifications set at the +1.5 volt circuit switching point. Since all μ-PAC circuitry is DC coupled, rise and fall time specifications are less important.

ACTIVATION OF CLOCK INPUT

Negative time (T_1) = 60 nanoseconds, minimum

Positive time (T_2) = 40 nanoseconds, minimum

Voltage (V) = +3.0 volts, minimum

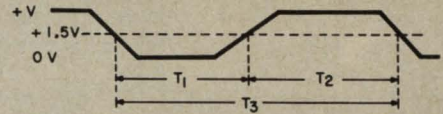

TIMING OF CONTROL UNITS (When used to steer clock pulse*)

Negative time of control input before clock pulse goes positive (T_1) = 0 nanoseconds, minimum

Positive time of clock pulse (T_2) = 40 nanoseconds, minimum

Positive time of control input before clock pulse goes negative (T_3) = 40 nanoseconds, minimum

Time from negative clock transition to set output (T_4) = 60 nanoseconds, maximum

Voltage (V) = +3.0 volts, minimum

No control input should go from +V to 0 volts while clock is at +V

*When control inputs are used as a clock input, refer to "activation of clock input" waveform.

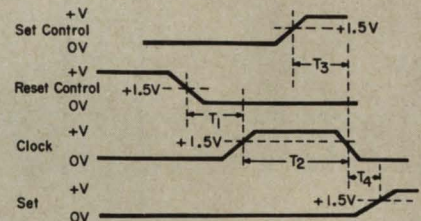

ACTIVATION OF DC SET AND RESET INPUTS

Negative time (T) (clock in ZERO state) = 80 nanoseconds, minimum

Negative time (T) (clock in ONE state) = 60 nanoseconds, minimum

Voltage (V) = +3.0 volts, minimum

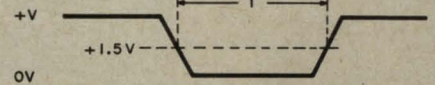

OUTPUT PULSE CHARACTERISTICS

Pulse duration (T) = 50 nanoseconds, nominal

Voltage (V) = +3.5 volts, minimum

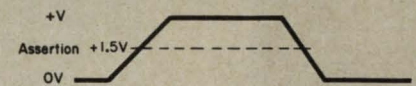
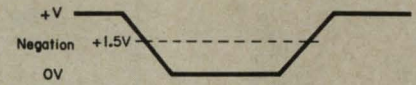

GATE PAIR DELAY

TWO 5 MC GATES IN SERIES

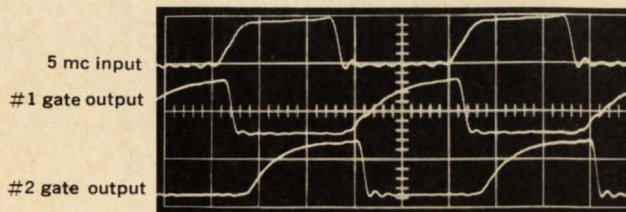

Voltage: 5 volts/cm Time Base: 0.04 μsec/cm



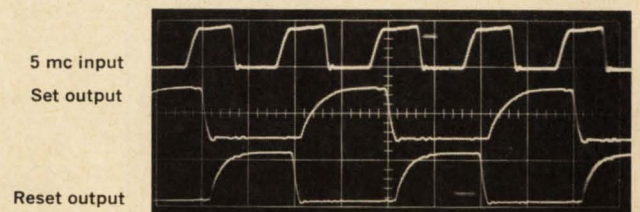

BINARY COUNTER (÷ 2) OPERATION

5 MC FLIP-FLOP

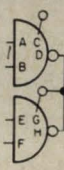
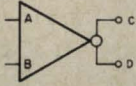

Voltage: 5 volts/cm Time Base: 0.1 μsec/cm

μ-PAC SYMBOLOGY

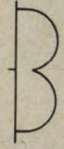
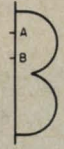
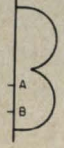
Symbol	Explanation	Boolean Expression (For Positive Logic)
	NAND Gate	$C = \overline{AB}$
	Diode cluster for expanding PAC inputs. Output node n is actually only one connector pin.	$n = AB$
	NAND gate with expandable input capability. Input node n, when used with diode clusters, provides input expandability. Node n is actually only one connector pin.	$C = \overline{AB}n$
	NAND gate with separate load circuit for paralleling gate outputs without decreasing drive capability. The paralleled gate outputs perform an AND operation for ONES and OR operation for ZEROS.	$D = H = \overline{AB+EF} = \overline{AB} \cdot \overline{EF}$
	Power Amplifier	$C = D = \overline{AB}$
	Basic flip-flop	$C = \overline{A} + ABC'$ $D = \overline{B} + ABD'$ where ' indicates previous state, and for $AB = 1$, $C' = D'$
J-K Flip-Flop Input Descriptions		
Symbol	Type Input	Explanation
	DC set or reset inputs	OR gate for ZEROS ($\overline{A+B}$) or NAND gate for ONES (\overline{AB})
	Clock input	
	Set control inputs	AND gate for ONES (AB)
	Reset control inputs	AND gate for ONES (AB)

counter
 μ -PAC
 BC-335

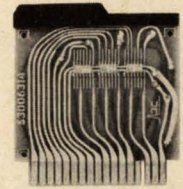

Counter PAC, BC-335, contains six independent flip-flops with appropriate inputs for operation as binary counters.

Individual DC set and reset inputs allow presetting in all modes. A common DC reset input is shared by all circuits.

When used in conjunction with external gating, the BC-335 also may be used for frequency division, BCD counting, up-down counting, and instantaneous carry counting.

Each stage has a complementing input which is activated by a ONE-ZERO-ONE transition sequence count signal pulse.

A counter output can be gated with the count signal pulse without the need for delay circuits or two-phase clocks.

SPECIFICATIONS

Frequency Range	DC — 5 mc
Input Loading:	
DC Set and Reset Inputs	$\frac{2}{3}$ unit load each
Common Reset Input	4 unit loads
Complement Inputs	1 unit load each
Output Drive Capability	8 unit loads each
Circuit Delay:	
Complement Input to Flip-Flop Output	60 nanoseconds, maximum
DC Set Input to Set Output	80 nanoseconds, maximum
DC Set Input to Reset Output	60 nanoseconds, maximum
Current Requirements per PAC:	
+6 volts	100 milliamperes, maximum
Power Dissipation	0.600 watt, maximum
Handle Color Code	blue

6 FLIP-FLOPS FOR BINARY COUNTING

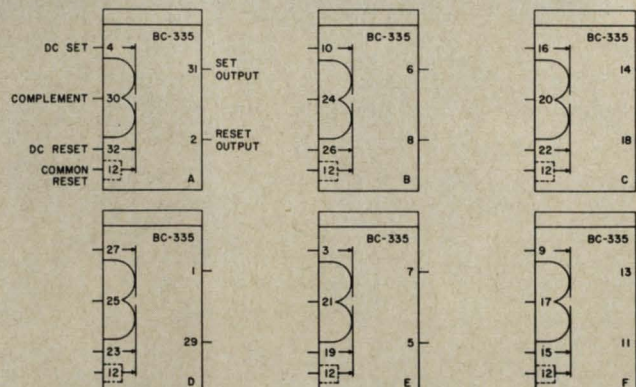

**binary
counter
 μ -PAC
BC-336**

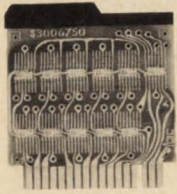

Binary Counter PAC, BC-336, contains between 8 and 20 prewired binary counter stages. The standard stocked BC-336 contains 8 stages and is custom assembled to 20 stages as specified by the user. The PAC also contains one independent two input NAND gate.

This high density module employs ripple carry counting and can be used as a binary counter.

Two reset inputs are provided to reset individually half of the counter stages. A common two input gated reset will allow resetting of all counter stages. Reset inputs and gated reset inputs are interdependent.

Set output of each counter stage is accessible at PAC terminals.

SPECIFICATIONS	BC-336
Frequency Range	DC — 5 mc
Input Loading:	
Count Input	1 unit load
Reset Inputs	1 unit load each
Gated Reset Inputs	1 unit load each
NAND Gate	1 unit load each
Reset Timing Requirements:	
Reset	80 nanoseconds, minimum at logic ONE
Gated Reset	100 nanoseconds, minimum at logic ZERO
Output Drive Capability:	
Counter	7 unit loads each
NAND Gate	8 unit loads
Circuit Delay:	
Counter Propagation Delay per Stage	60 nanoseconds, maximum
Clearing Counter from Reset Inputs	100 nanoseconds, maximum
Clearing Counter from Gated Reset Inputs	120 nanoseconds, maximum
NAND Gate Delay (measured at +1.5 volts, averaged over 2 stages)	30 nanoseconds, maximum
Current Requirements per PAC: (20 counter stages) + 6 volts	379 milliamperes, maximum
Power Dissipation (20 counter stages)	2.280 watts, maximum
Handle Color Code	blue

8 TO 20 FLIP-FLOPS PREWIRED FOR BINARY COUNTING

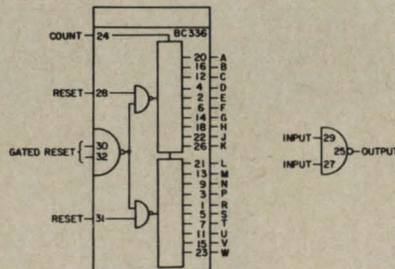

COMPUTER CONTROL COMPANY, INC.
OLD CONNECTICUT PATH, FRAMINGHAM, MASS.

**fast carry
counter
μ-PAC
BC-337**

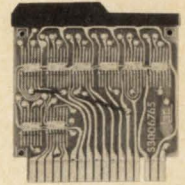

Fast Carry Counter PAC, BC-337, contains a prewired eight-stage counter. By utilizing a few jumper connections at the PAC terminals, the counter can be operated in either a binary or an 8421 BCD mode.

A common reset input is available for clearing all stages simultaneously.

Each stage has a DC set input which allows presetting any desired number in the counter.

Carries are anticipated on gating structures to reduce counter propagation delays to one half that of a ripple carry counter structure.

SPECIFICATIONS	BC-337
Frequency Range	DC — 5 mc
Input Loading:	
DC Set Inputs	2/3 unit load each
Common Reset Input	5 unit loads
Complement Input	2 unit loads
Output Drive Capability	5-8 unit loads
Circuit Delay:	
Counter Propagation Delay per Group of 4 Stages	100 nanoseconds, maximum
Counter Propagation Delay for 8 Stages	200 nanoseconds, maximum
DC Set Input to Set Output	80 nanoseconds, maximum
DC Set Input to Reset Output	60 nanoseconds, maximum
Current Requirements per PAC:	
+6 volts	133 milliamperes, maximum
Power Dissipation	0.800 watt, maximum
Handle color code	blue

8 FLIP-FLOPS FOR BINARY OR BCD COUNTING

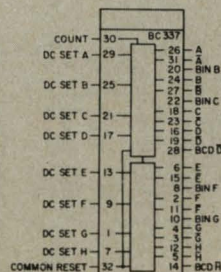

**buffer
register**
μ-PAC
BR-335

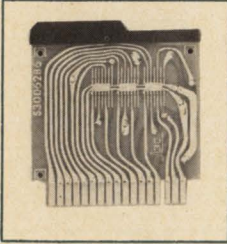

Buffer Register PAC, BR-335, contains six independent flip-flops for use in serial and parallel transfer applications.

Independent DC set inputs are available at each flip-flop for pre-setting operations.

A common clock input, associated with individual set and reset control inputs, provides simultaneous serial or parallel transfer operations in a variety of applications including shifting and accumulating.

A common DC reset input is shared by all circuits.

SPECIFICATIONS

Frequency Range

BR-335

DC — 5 mc

Input Loading:

DC Set Inputs

$\frac{2}{3}$ unit load each

Control Inputs

1 unit load each

Common Reset Input

4 unit loads

Common Clock Input

6 unit loads

Output Drive Capability

8 unit loads each

Circuit Delay:

Clock Input to Flip-Flop Output

60 nanoseconds, maximum

DC Set Input to Set Output

80 nanoseconds, maximum

DC Set Input to Reset Output

60 nanoseconds, maximum

Current Requirements per PAC:

+6 volts

100 milliamperes, maximum

Power Dissipation

0.600 watt, maximum

Handle Color Code

blue

6 FLIP-FLOPS PREWIRED WITH COMMON CLOCK AND COMMON RESET INPUT

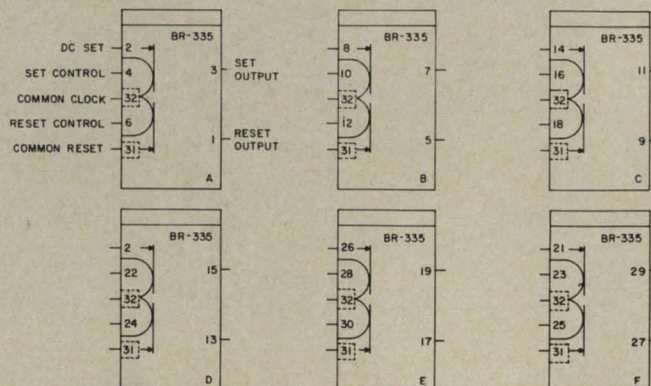

COMPUTER CONTROL COMPANY, INC.
OLD CONNECTICUT PATH, FRAMINGHAM, MASS.

gated
flip-flop
 μ -PAC
FA-335

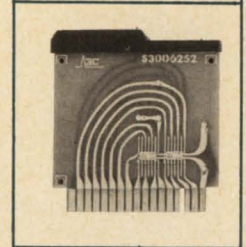

Gated Flip-Flop PAC, FA-335, contains four independent general purpose flip-flops, each with clocked and DC inputs and a common reset.

Each flip-flop has individual DC set and DC reset inputs for RS type applications.

Set and reset control inputs combine with the clock input for clocked operation of each flip-flop. Two of the four stages have dual set control inputs. A common DC reset is provided.

The versatile input structure allows for control of the flip-flop from a variety of level and pulse inputs. Typical uses of the Gated Flip-Flop PAC include storage, counting, shifting, and parallel transfer.

SPECIFICATIONS

Frequency Range	FA-335 DC — 5 mc
Input Loading:	
DC Inputs	$\frac{2}{3}$ unit load each
Control Inputs	1 unit load each
Common Reset Input	3 unit loads
Clock Inputs	1 unit load each
Common Reset Timing Requirements	60 nanoseconds, minimum, at logic ZERO
Output Drive Capability	8 unit loads each
Circuit Delay:	
Clock Input to Flip-Flop Output	60 nanoseconds, maximum
DC Set Input to Set Output	80 nanoseconds, maximum
DC Set Input to Reset Output	60 nanoseconds, maximum
Current Requirements per PAC:	
+6 volts	66 milliamperes, maximum
Power Dissipation	0.400 watt, maximum
Handle Color Code	blue

4 FLIP-FLOPS WITH DC, CLOCK AND CONTROL INPUTS

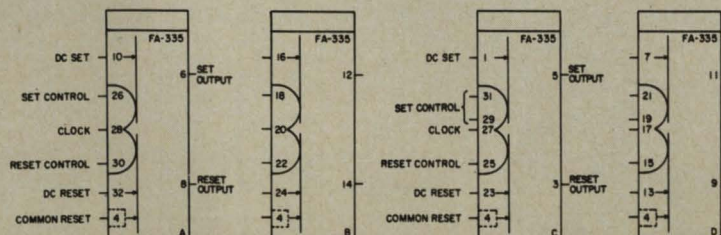

**universal
flip-flop
μ-PAC
UF-335**

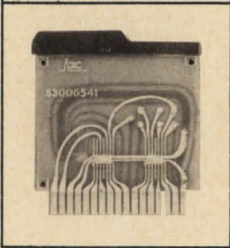

Universal Flip-Flop PAC, UF-335, contains three independent general purpose flip-flops, each with independent clocked and DC input gating and a common DC reset.

Each flip-flop contains two DC set and two DC reset inputs. Each flip-flop also contains individual clock, dual reset control and dual set control inputs.

With this range of inputs, these flip-flops can perform all the functions of any other μ-PAC flip-flop module. In addition, the Universal Flip-Flop PAC can be used in shifting, up/down counting, control, accumulating, parallel transfer, and complementing applications.

SPECIFICATIONS

Frequency Range

Input Loading:

DC Inputs

Control Inputs

Clock Inputs

Common Reset Input

Output Drive Capability

Circuit Delay:

Clock Input to Flip-Flop Output

DC Set Input to Set Output

DC Set Input to Reset Output

Current Requirements per PAC:

±6 volts

Power Dissipation

Handle Color Code

UF-335

DC — 5 mc

$\frac{2}{3}$ unit load each

1 unit load each

1 unit load each

2 unit loads

8 unit loads each

60 nanoseconds, maximum

80 nanoseconds, maximum

60 nanoseconds, maximum

50 milliamperes, maximum

0.300 watt, maximum

blue

3 FLIP-FLOPS WITH CLOCK AND DC INPUT GATING

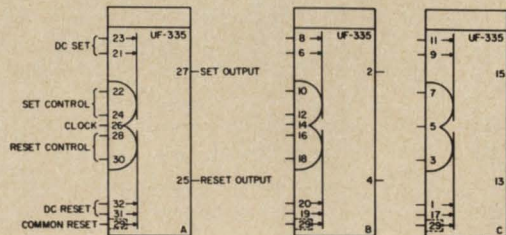

COMPUTER CONTROL COMPANY, INC.
OLD CONNECTICUT PATH, FRAMINGHAM, MASS.

**basic
flip-flop
 μ -PAC
FF-335**

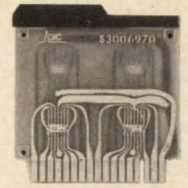

Basic Flip-Flop PAC, FF-335, contains eight independent, low-cost DC operated flip-flops. Individual DC set and DC reset inputs are provided.

These flip-flops are used for economical implementation of logic functions which do not require additional flip-flop inputs. Examples are control operations, input-output registers, storage and buffer applications.

SPECIFICATIONS

Frequency Range
Input Loading:
DC Inputs
Output Drive Capability
Circuit Delay
Current Requirements per PAC:
+6 volts
Power Dissipation
Handle Color Code

FF-335

DC — 5 mc
1 unit load each
7 unit loads each
60 nanoseconds, maximum
140 milliamperes, maximum
0.800 watt, maximum
blue

8 FLIP-FLOPS WITH DC INPUT GATING

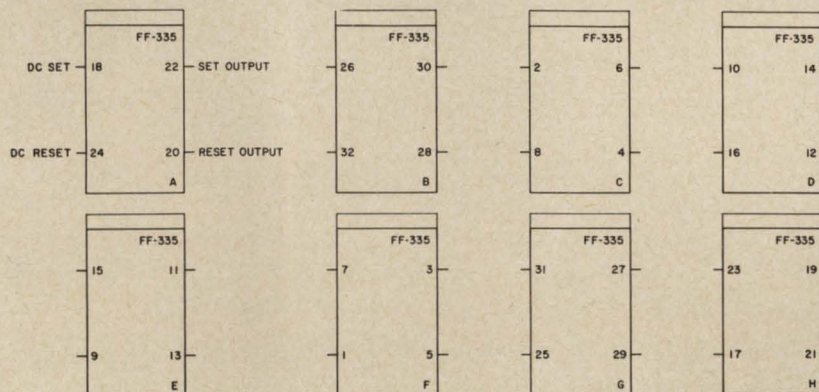

multi-
input
NAND
 μ -PAC
DC-335

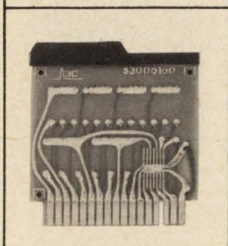

Multi-input NAND PAC, DC-335, contains 2 six-input NAND gates with nodes and 4 three-diode clusters. The diode clusters can be tied to the gate nodes of this or other μ -PACS to expand the number of gate inputs.

The basic logic element of the μ -PAC logic line, the NAND gate, is a diode gating structure followed by an inverting transistor amplifier. The NAND gate performs the AND-NOT logic function with positive voltage logic and the OR-NOT logic function with negative voltage logic.

SPECIFICATIONS

Frequency Range
Input Loading
Fan In
Output Drive Capability
Maximum Circuit Delay (measured at
+1.5 volts, averaged over 2 stages)
Current Requirements per PAC:
+6 volts
Maximum Power Dissipation
Handle Color Code

DC-335

DC — 5 mc
1 unit load each
12
8 unit loads each
30 nanoseconds, maximum
24 milliamperes, maximum
0.140 watt, maximum
red

4 THREE-INPUT DIODE CLUSTERS

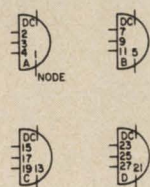

2 SIX-INPUT NAND GATES WITH NODES

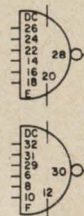

**NAND
type 1
 μ -PAC
DI-335**

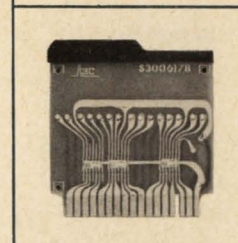

NAND Type I PAC, DI-335, contains 10 two-input NAND gates. Two of the gates have disconnected collector loads which are brought out on separate terminals.

By tying the gate collector outputs to a single load circuit, a number of these gates can be connected in parallel without reducing output drive capability.

When outputs of gates are connected in parallel, the AND-OR-INVERT function is formed. That is, if all the inputs to a single gate are at logical ONE, the output of the structure goes to ground.

The logic function of the independent DI-335 gates is identical to gates in the DC-335 PACS.

SPECIFICATIONS

Frequency Range	DC — 5 mc
Input Loading	1 unit load each
Fan In	12
Output Drive Capability	8 unit loads each
Circuit Delay* (measured at +1.5 volts, averaged over 2 stages)	30 nanoseconds, maximum
Current Requirements per PAC: +6 volts	117 milliamperes
Power Dissipation	0.700 watt, maximum
Handle Color Code	red

*Circuit delay increases 3 nanoseconds with each unloaded gate output added in parallel.

8 TWO-INPUT NAND GATES

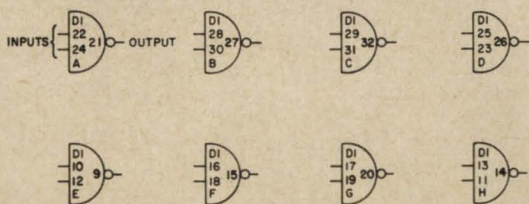

2 TWO-INPUT NAND GATES WITH SEPARATE LOAD CIRCUITS

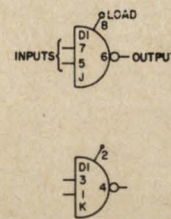

**NAND
type 2
 μ -PAC
DL-335**

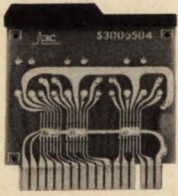

NAND Type 2 PAC, DL-335, contains 6 four-input NAND gates. Two of the gates have disconnected collector load resistors which are brought out on separate terminals.

By tying the gate outputs to a single load circuit, a number of these gates can be connected in parallel without reducing output drive capability.

When outputs of gates are connected in parallel, the AND-OR-INVERT function is formed. That is, if all of the inputs to a single gate are at logical ONE, the output of the structure goes to ground.

The logic function of the independent DL-335 gates is identical to gates in DC-335 PACS.

SPECIFICATIONS

Frequency Range	DL-335 DC — 5 mc
Input Loading	1 unit load each
Fan In	12
Output Drive Capability	8 unit loads each
Circuit Delay [°] (measured at +1.5 volts, averaged over 2 stages)	30 nanoseconds, maximum
Current Requirements per PAC: +6 volts	70 milliamperes, maximum
Power Dissipation	0.420 watt, maximum
Handle Color Code	red
[°] Circuit delay increases 3 nanoseconds with each unloaded gate output added in parallel.	

FOUR-INPUT NAND GATES

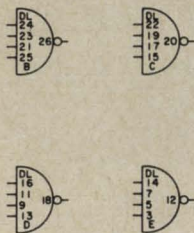

2 FOUR-INPUT NAND GATES WITH SEPARATE LOAD CIRCUITS

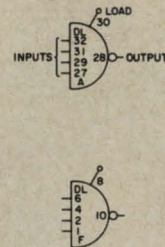

COMPUTER CONTROL COMPANY, INC.
OLD CONNECTICUT PATH, FRAMINGHAM, MASS.

expandable
NAND
 μ -PAC
DN-335

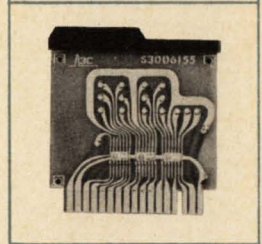

Expandable NAND PAC, DN-335, contains 6 three-input NAND gates with nodes. Two of the gates have disconnected collector loads which are brought out on separate terminals.

By tying the gate outputs to a single load circuit, a number of gates can be connected in parallel without reducing output drive capability.

When outputs of gates are connected in parallel, the AND-OR-INVERT function is formed. That is, if all the inputs to a single gate are at logical ONE, the output of the structure goes to ground. The gate node input allows for expansion of the number of gate inputs by attachment of diode clusters. The logic function of the independent DN-335 gates is identical to gates of the DC-335 PACS.

SPECIFICATIONS

Frequency Range	DC — 5 mc
Input Loading	1 unit load each
Fan In	12
Output Drive Capability	8 unit loads
Circuit Delay* (measured at +1.5 volts, averaged over 2 stages)	30 nanoseconds, maximum
Current Requirements per PAC:	
+6 volts	70 milliamperes, maximum
Power Dissipation	0.420 watt, maximum
Handle Color Code	red
*Circuit delay increases 3 nanoseconds with each unloaded gate output added in parallel.	

DN-335

2 THREE-INPUT NAND GATES WITH NODES AND SEPARATE LOAD CIRCUITS

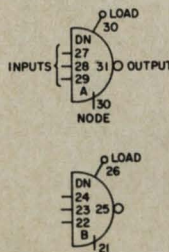

4 THREE-INPUT NAND GATES WITH NODES

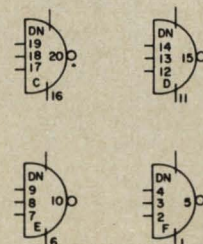

power
amplifier
 μ -PAC
PA-335

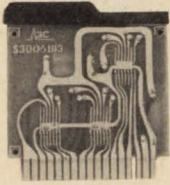

Power Amplifier PAC, PA-335, contains 6 three-input high drive NAND gates, each capable of driving 25 unit loads and 250 picofarads stray capacitance.

Each circuit has two electrically common output leads to reduce load distribution over any single wire. Built-in short circuit protection limits output current when the output is accidentally grounded.

Logically, the Power Amplifiers act as μ -PAC NAND gates, performing either AND gating for conventional positive μ -PAC logic or OR gating for negative logic, followed by logic inversion.

The Power Amplifier is useful for heavy load applications such as driving shift lines, common reset lines or long information leads. Also, two circuits can be wired back-to-back to form a DC set-reset power flip-flop.

SPECIFICATIONS

Frequency of Operation
Input Loading
Output Drive Capability
Circuit Delay (measured at +1.5 volts, averaged over 2 stages)
Current Requirements per PAC:
+6 volts
Power Dissipation
Handle Color Code

PA-335

DC — 5 mc
2 unit loads each
25 unit loads each
30 nanoseconds, maximum
41 milliamperes, maximum
0.360 watt, maximum
green

6 THREE-INPUT INVERTING POWER AMPLIFIERS

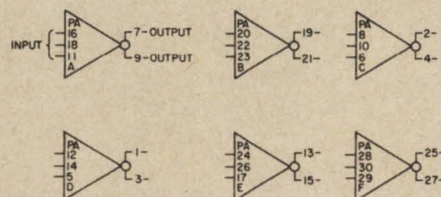

COMPUTER CONTROL COMPANY, INC.
OLD CONNECTICUT PATH, FRAMINGHAM, MASS.

delay
multi-
vibrator/
pulse
shaper
 μ -PAC
DM-335

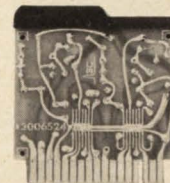

Delay Multivibrator PAC, DM-335, contains two independent monostable (one-shot) multivibrators capable of generating assertion and negation pulses in a variety of widths. Each circuit has two NAND inputs, an enable, a range control and three discrete variable delay taps.

With no external pin connections made, the output pulse width will be 100 nanoseconds. Pulse widths between 50 nanoseconds and 100 microseconds can be obtained by using the proper jumper connections. External capacitors may be used to obtain pulse widths up to several seconds.

A positive signal at the input will result in a positive pulse at the assertion output. If either input is at ZERO, triggering is inhibited at the other input.

The enable input controls circuit operation. If the enable input is at ONE or disconnected, the circuit will operate. If this input is set at ZERO, no output pulses will result. If ZERO is applied while an output pulse is being generated, the output pulse will end.

The range control input can be used to increase the existing pulse width by a factor of 5:1.

SPECIFICATIONS	DM-335
Frequency Range	DC — 5 mc or $\frac{0.75}{\text{Pulse Width}}$ whichever is lower
Pulse Width:	
Internal Connections	0.05, 0.1, 0.5, 1.0, 5.0, 10, 50, and 100 microseconds up to several seconds
External Capacitors	1 unit load each
Input Loading	50 nanoseconds at logic ONE
Input Signal Requirement	
Output Drive Capability:	
Assertion	8 unit loads
Negation	7 unit loads
Circuit Delay:	
Assertion	60 nanoseconds, typical
Negation	30 nanoseconds, typical
Recovery Time (for 5% reduction in pulse width)	100 nanoseconds or 100% of pulse width whichever is greater
Current Requirements per PAC:	
+6 volts	94 milliamperes, maximum
Power Dissipation	0.560 watt, maximum
Handle Color Code	yellow

2 MONOSTABLE MULTIVIBRATORS, STEP ADJUSTABLE PULSE WIDTH

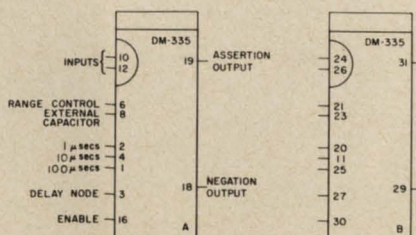

**master
clock
 μ -PAC
MC-335**

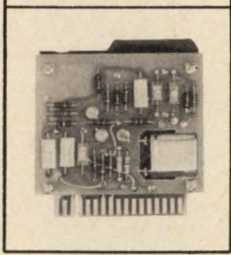

Master Clock PAC, MC-335, contains a crystal controlled oscillator, a pulse shaper and a power amplifier. The Negation pulse is available at the output of the power amplifier section. The additional power amplifier circuit is available to provide the Assertion output when tied in series with the Negation output.

The crystal oscillator section operates between 200 kc and 5 mc. When the crystal is removed, the oscillator can be driven by external signals in the form of sine waves or pulses.

The pulse shaper section controls the pulse width of the output signal by means of a built-in potentiometer-capacitor network. The potentiometer provides continuous pulse width adjustment. The standard range for Assertion pulse widths is from 45 to 200 nano-seconds. Increased pulse widths may be obtained by replacing the stud-mounted capacitor with a larger capacitor. Maximum pulse width is 50% of the oscillator's time period.

Two gated inputs are brought in at the power amplifier section and allow signal transfer to the Negation output. A ZERO at either gated input will block the signal to the output.

Using a clocked flip-flop, output pulse splitting can be prevented by synchronous start/stop control of the MC-335.

SPECIFICATIONS

Frequency Range
Input Loading:
Gated Input
Frequency Accuracy
Frequency Stability
Output Drive Capability:
Negation
Sync
Current Requirements per PAC:
+6 volts
-6 volts
Power Requirements per PAC:
Power Amplifier Circuit
Handle Color Code

MC-335

200 kc — 5 mc
2 unit loads each
.01%
.005%
25 unit loads
2 unit loads
70 milliamperes, maximum
40 milliamperes, maximum
0.680 watt, maximum
(see PA-335 specifications)
yellow

1 CRYSTAL-CONTROLLED CLOCK

FUNCTIONAL DIAGRAM

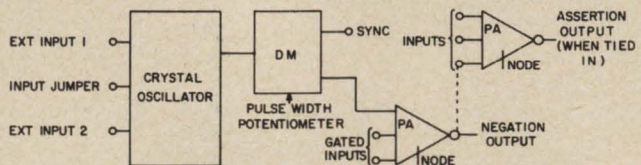
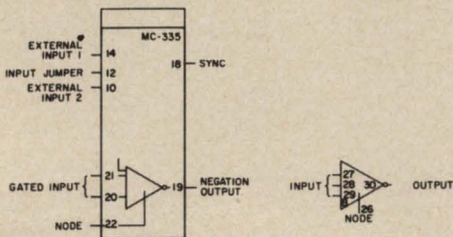

COMPUTER CONTROL COMPANY, INC.
OLD CONNECTICUT PATH, FRAMINGHAM, MASS.

**multi-
vibrator
clock
 μ -PAC
MV-335**

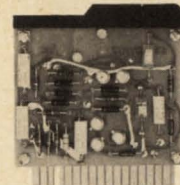

Multivibrator Clock PAC, MV-335, contains a self-starting, free running, variable frequency multivibrator, a pulse shaper section, and a power amplifier section. The Negation pulse is available at the output of the power amplifier section. The additional power amplifier circuit is available for providing an Assertion output when tied in series with the Negation output.

The multivibrator section functions as a variable frequency clock. Frequency of operation is from 200 kc to 5 mc in two overlapping ranges. The lower of the two frequency ranges is obtained by jumpering the frequency control terminals. Potentiometer adjustments provide continuous frequency changes in the respective range.

Frequencies lower than 200 kc can be obtained by mounting a capacitor on the stud-mounts provided.

The pulse shaper section controls the pulse width of the output signal by means of a built-in potentiometer-capacitor network. Standard Assertion pulse width range is from 45 to 200 nanoseconds. The pulse width range can be increased by use of stud-mounted capacitors.

Using the oscillator inhibit input, the MV-335 is wired to provide start/stop capability from external asynchronous signals.

A gated input is brought in at the power amplifier section and serves to control the signal transfer to the Negation output. A ZERO at the gated input blocks any signal to the output.

SPECIFICATIONS	MV-335
Multivibrator Circuit	
Frequency Range:	
Without Capacitor Changes	200 kc — 5 mc
With Capacitor Changes	Less than 5 cps to 200 kc
Input Loading:	
OSC Inhibit	2 unit loads
Gated Input	2 unit loads
Output Drive Capability	25 unit loads
Pulse Width:	
Without Capacitor Changes	45 to 200 nanoseconds
With Capacitor Changes	150 nanoseconds to 70 microseconds
Power Amplifier Circuit	
Current Requirements per PAC:	
+6 volts	95 milliamperes, maximum
-6 volts	50 milliamperes, maximum
Power Dissipation	0.870 watt, maximum
Handle Color Code	yellow

1 FREE-RUNNING MULTIVIBRATOR CLOCK

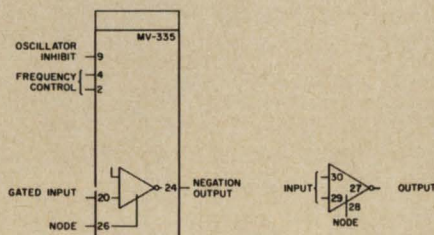

FUNCTIONAL DIAGRAM

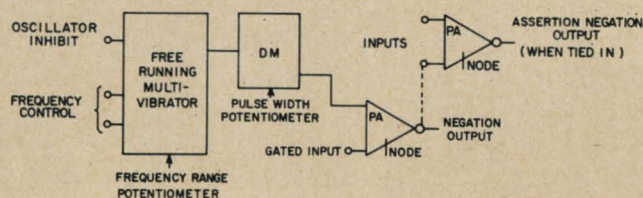

selection
gate
type 1
 μ -PAC
DG-335

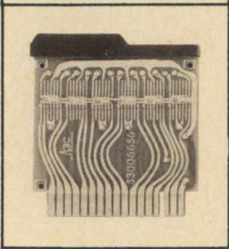

Selection Gate Type 1 PAC, DG-335, contains four independent functional gate structures. Each gate structure has 3 two-input NAND gates with separate load circuits and performs the AND-OR-INVERT function.

By using one gate input as a control and the other as a signal input, each structure can be used for transfer control of three data signals. By tying the various gate structures to a common load, gating arrangements for the transfer control of the desired number of signals can be performed.

SPECIFICATIONS

Frequency Range
Input Loading
Output Drive Capability
Circuit Delay* per Gate (measured at +1.5 volts, averaged over 2 stages)
Current Requirements per PAC:

+6 volts
Power Dissipation
Handle Color Code

*Add 3 nanoseconds delay for each gate with disconnected load whose output is connected in parallel.

DG-335

DC — 5 mc
1 unit load each
8 unit loads each
30 nanoseconds, maximum
141 milliamperes, maximum
0.840 watt, maximum
red

4 SELECTION GATE STRUCTURES

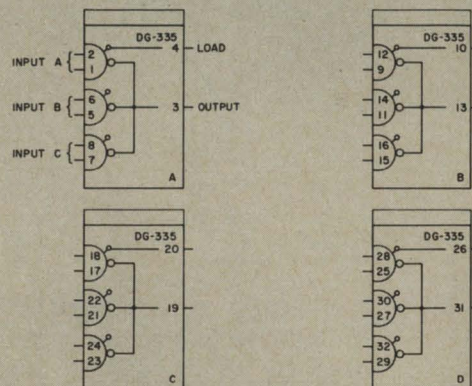

COMPUTER CONTROL COMPANY, INC.
OLD CONNECTICUT PATH, FRAMINGHAM, MASS.

selection
gate
type 2
 μ -PAC
DG-336

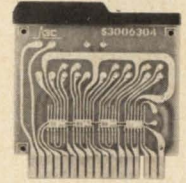

Selection Gate Type 2 PAC, DG-336, contains two independent functional gate structures. Each gate structure has 4 three-input NAND gates with separate load circuits and performs the AND-OR-INVERT function.

By using one gate input as a control and the other inputs as data inputs, each structure can be used for transfer control of four sets of data signals. Both gate structures can be tied to a common load and thereby allow transfer control of the desired number of data signals.

SPECIFICATIONS

Frequency Range	DC — 5 mc
Input Loading	1 unit load each
Output Drive Capability	8 unit loads each
Circuit Delay* per Gate	30 nanoseconds, maximum
Current Requirements per PAC:	
+6 volts	94 milliamperes, maximum
Power Dissipation	0.560 watt, maximum
Handle Color Code	red
*Add 3 nanoseconds delay for each unloaded gate output connected in parallel.	

DG-336

2 SELECTION GATE STRUCTURES

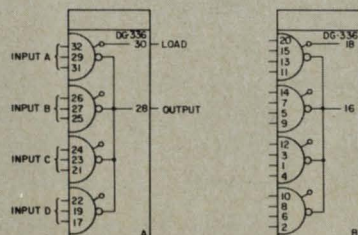

**exclusive
OR
 μ -PAC
EO-335**

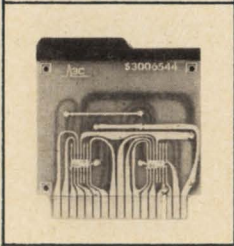

Exclusive OR PAC, EO-335, contains five independent functional gate structures and one independent single input NAND gate. Each gate structure contains 3 two-input NAND gates and performs AND-OR and AND-OR-INVERT functions.

Each gate structure can be used for sensing the Exclusive OR and for sensing equality of two inputs.

SPECIFICATIONS

Frequency Range

Input Loading

Output Drive Capability:

Output 1

Output 2

NAND Gate Output

Circuit Delay (measured at +1.5 volts, averaged over 2 stages):

Output 1

Output 2

NAND Gate Output

Current Requirements per PAC:

+6 volts

Power Dissipation

Handle Color Code

EO-335

DC — 5 mc

1 unit load each

8 unit loads each

4 unit loads each

8 unit loads

60 nanoseconds, maximum

30 nanoseconds, maximum

30 nanoseconds, maximum

187 milliamperes, maximum

1.120 watts, maximum

purple

5 EXCLUSIVE OR GATE STRUCTURES WITH 1 ONE-INPUT NAND GATE

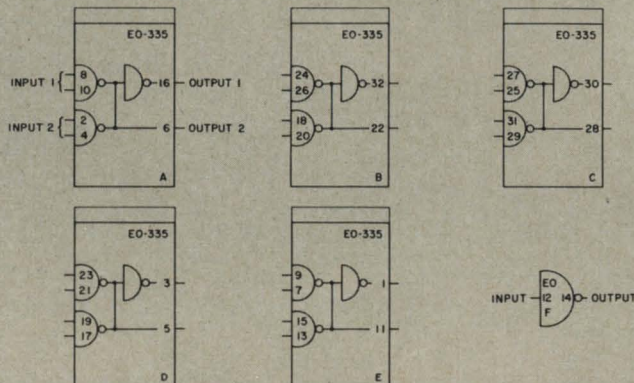

COMPUTER CONTROL COMPANY, INC.
OLD CONNECTICUT PATH, FRAMINGHAM, MASS.

octal/
decimal
decoder
 μ -PAC
OD-335

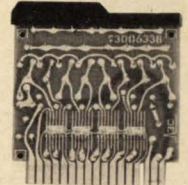

Octal/Decimal Decoder PAC, OD-335, contains a prewired binary-to-octal decoder and two additional independent NAND gates to expand the matrix for BCD-to-decimal decoding.

Three additional inputs, in addition to the six binary inputs, are provided to permit the matrix to be expanded to 16, 32, or 64 outputs by connecting additional decoders.

In the BCD-to-decimal mode, the octal matrix is used for the "zero" through "seven" output lines and two additional independent gates included on the PAC are used for output lines "eight" and "nine."

The two independent gates are standard NAND gates and may be used as such if BCD-to-decimal decoding is not required. One of these gates has six inputs, the other has five. Both gates have nodes for increasing the number of inputs.

SPECIFICATIONS

Frequency Range

Input Loading

Binary-to-octal and multi-octal matrices

- 8 Output Decoder (3 bits)
- 16 Output Decoder (4 bits)
- 32 Output Decoder (5 bits)
- 64 Output Decoder (6 bits)

BCD-to-Decimal Decoder:

- 2^0 and 2^1
- 2^1 , 2^1 , 2^2 and 2^2
- 2^3
- 2^3

Output Drive Capability

NAND Gate Specifications

Current Requirements per PAC:

+6 volts

Power Dissipation

Handle Color Code

OD-335

DC — 5 mc

- 3 unit loads each
- 4 unit loads each
- 7 unit loads each
- 14 unit loads each

- 4 unit loads each
- 3 unit loads each
- 2 unit loads each
- 5 unit loads each
- 8 unit loads

(See DI-335 specifications)

117 milliamperes, maximum

0.70 watt, maximum

purple

1 PREWIRED BINARY-TO-OCTAL DECODER

1 SIX-INPUT NAND GATE

1 FIVE-INPUT NAND GATE

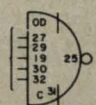
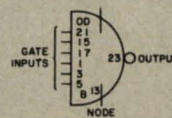
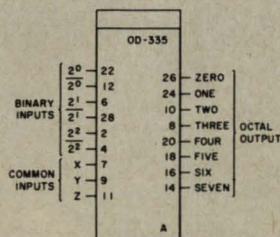

transfer
gate
 μ -PAC
TG-335

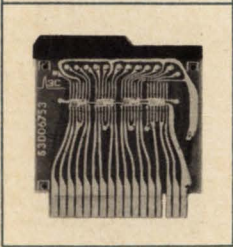

Transfer Gate PAC, TG-335, contains four independent functional gate structures. Two of the structures have 4 two-input NAND gates, one input on each gate being common to the other four gates.

The remaining two structures have 3 two-input NAND gates, one input being common to the three gates. Each gate structure can be used for the common transfer control of three or four data signals, respectively. Common inputs can be connected to transfer 14 data signals simultaneously on one module.

SPECIFICATIONS

Frequency Range

Input Loading:

Input

Common Input

Output Drive Capability

Circuit Delay (measured at +1.5 volts, averaged over 2 stages)

Current Requirements per PAC:

+6 volts

Power Dissipation

Handle Color Code

TG-335

DC — 5 mc

1 unit load each

1 unit load for each gate in the structure

8 unit loads

30 nanoseconds, maximum

164 milliamperes, maximum

0.980 watt, maximum

red

4 TRANSFER GATE STRUCTURES

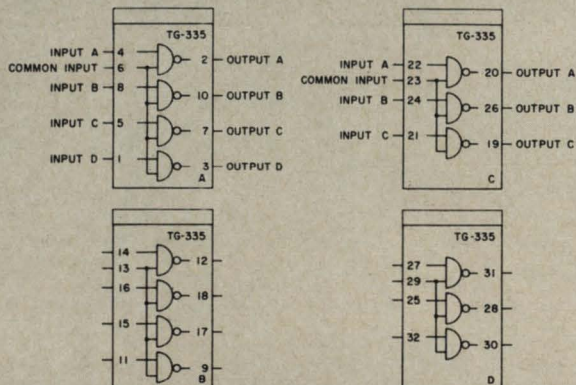

COMPUTER CONTROL COMPANY, INC.
OLD CONNECTICUT PATH, FRAMINGHAM, MASS.

**solenoid
driver
 μ -PAC
SD-330**

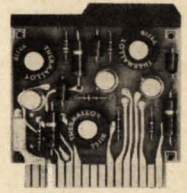

Solenoid Driver PAC, SD-330, contains three independent circuits for driving heavy resistive, capacitive or inductive loads in such applications as solenoid or relay driving. The PAC also contains an independent two-input NAND gate.

Each solenoid driver has a two-input NAND gate which drives a transistor amplifier inverter and is capable of switching up to one ampere of current at 500 cycles per second from a positive supply of up to 28 volts.

When both inputs are at logic ONE, the output is high and the solenoid is de-energized. When either input is at logic ZERO, the output is low and the solenoid is energized.

SPECIFICATIONS	SD-330
Solenoid Driver Circuits:	
Frequency Range	DC — 500 cps
Input Loading	1 unit load each
Output Drive Capability	1 ampere at 28 volts, supplied externally
Circuit Delay (switching 1.0 ampere):	
Turn on	400 nanoseconds, typical
Turn off	150 nanoseconds, typical
NAND Gate	(See DI-335 specifications)
Current Requirements per PAC:	
+6 volts	47 milliamperes, maximum
Power Dissipation	0.280 watt, maximum
Handle Color Code	orange

3 SOLENOID DRIVER CIRCUITS WITH ADDITIONAL GATE

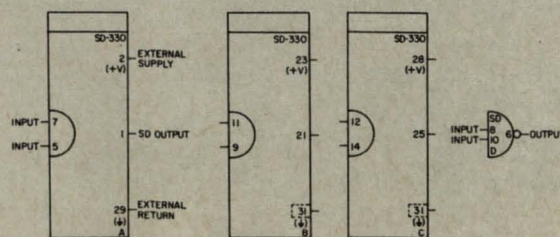

**schmitt
trigger
 μ -PAC
ST-335**

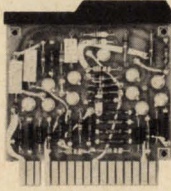

Schmitt Trigger PAC, ST-335, contains two independent trigger circuits, each capable of converting arbitrarily shaped inputs into μ -PAC compatible outputs.

Switching level can be varied from +2.5 volts to -2.5 volts by making use of appropriate pin connections, by mounting resistors on available stud-mounts and/or by employing an external voltage source.

Standard sensitivity (hysteresis) is typically one volt but can be reduced by using stud-mounted resistors.

When the input signal is greater than +6 volts on the positive side or greater than -20 volts on the negative side, an attenuating network will be needed. This consists of mounting a resistor pair on the available stud-mounts.

Differentiation and integration of input signals can be performed by use of stud-mounted RC networks.

SPECIFICATIONS

Frequency Range

Circuit Delay

Output Drive Capability

Current Requirements per PAC:

+6 volts

-6 volts

Power Dissipation

Handle Color Code

ST-335

DC — 5 mc

20 nanoseconds, typical

8 unit loads

90 milliamperes, maximum

60 milliamperes, maximum

0.900 watt, maximum

orange

2 SCHMITT TRIGGER CIRCUITS

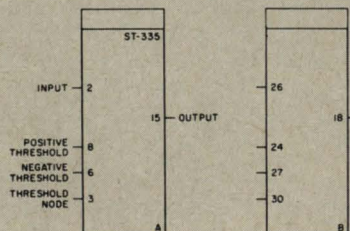

transmission
line driver
 μ -PAC
XD-335

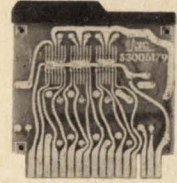

Transmission Line Driver PAC, XD-335, contains 6 two-input driver circuits. Each circuit is capable of driving standard 50 ohm, 75 ohm and 93 ohm coaxial cables or twisted pair cables at up to 5 mc repetition rates.

When transmission line termination other than the provided 62 ohms is required, the proper resistor can be mounted on available studs.

The transmission line should be terminated in a high impedance such as a standard μ -PAC gate or the DC input of a μ -PAC flip-flop.

Logically, the Transmission Line Driver circuit is identical to a μ -PAC two-input gate, performing NAND gating logic for conventional positive μ -PAC logic.

SPECIFICATIONS

Frequency Range

Input Loading

Output Drive Capability:

50, 75 or 93 Ω cable

Twisted pair cable

Circuit Delay

Current Requirements per PAC:

+6 volts

Power Dissipation

Handle Color Code

XD-335

DC — 5 mc

2 unit loads each

10 feet*

10 feet*

30 nanoseconds, maximum

41 milliamperes, maximum

0.250 watt, maximum

green

*Considerably longer drive length can be obtained by careful application of terminating resistors. See μ -PAC Instruction Manual for details.

6 TWO-INPUT TRANSMISSION LINE DRIVERS

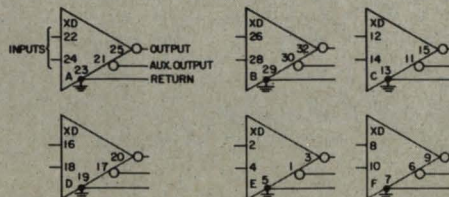

**lamp
driver
μ-PAC
LD-330**

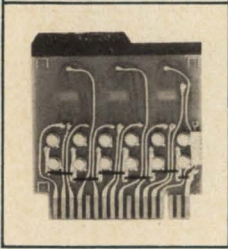

Lamp Driver PAC, LD-330, contains twelve identical independent lamp driver circuits. Each circuit is capable of switching up to 70 milliamperes of current from any positive voltage up to 20 volts at a maximum frequency of 100 kc.

If logic ONE (+6 volts) is applied to the input, the output voltage will be high (positive supply voltage). If ZERO is applied at the input, the output will be ZERO (ground).

The circuit can handle an initial in-rush current of 150 milliamperes, maximum.

SPECIFICATIONS

Frequency Range
Input Loading
Output Drive Capability:
 Quiescent
Current Requirements per PAC:
 +6 volts
Power Dissipation
Handle Color Code

LD-330

DC — 100 kc
1 unit load
70 milliamperes at up to 20 volts
140 milliamperes, maximum
0.840 watt, maximum
orange

12 INDICATOR LAMP DRIVER CIRCUITS

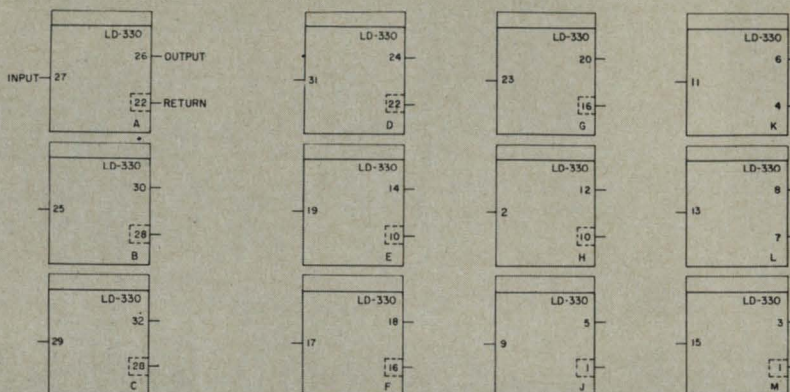

COMPUTER CONTROL COMPANY, INC.
OLD CONNECTICUT PATH, FRAMINGHAM, MASS.

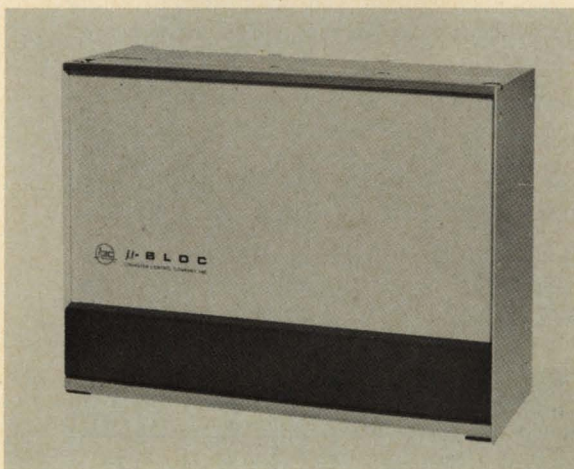
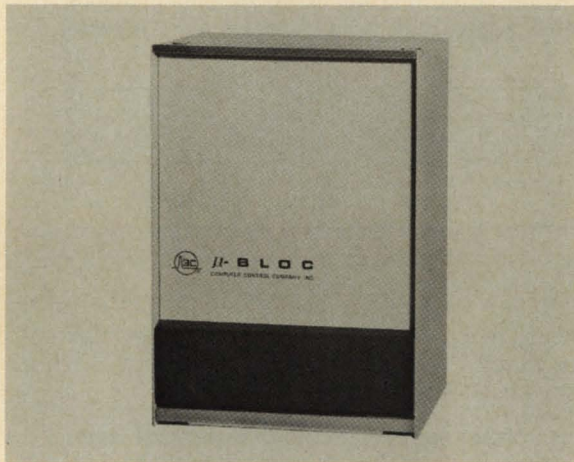
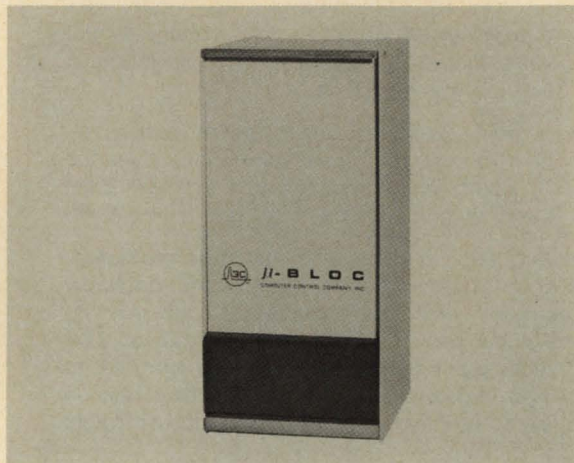

Seven different μ -BLOC units are available for housing μ -PACS. All BLOCS use the same basic structure but differ in width dimension, provisions for plug-in power supply and types and number of connectors (see table).

These BLOCS offer a choice of either wire-wrap or taper pin connectors. Each connector slot contains 34 contacts and is polarized. PAC capacity between 24 and 144 is provided in the combination of μ -BLOCS. Fan cooling units equipped with washable filters are located at the base of each assembly.

Mounting ears are detachable and allow front or back mounting of the connector plane. Laminated copper strips insulated by mylar are used for power distribution. PAC connectors are prewired for +6 volts and ground. Height and depth dimensions are standard for all BLOCS at 12 $\frac{1}{4}$ " by 5 $\frac{1}{4}$ " respectively.

BM Series

The BM Series μ -BLOCS include models BM-330, BM-335 and BM-337. The BM-330 is 6 inches wide, contains wire wrap connectors, and can house 24 μ -PACS. In addition, it has provision for mounting PB-330 plug-in power supply which can drive all of the contained modules.

The BM-335 is 8 $\frac{1}{2}$ inches wide and has 24 taper pin connector slots. As with the BM-330, it also has provision for housing the PB-330 plug-in power supply. When used in conjunction with a standard mounting panel, the BM-335 can be mounted in a 19-inch rack. The mounting panel can also be used as a control panel if desired. The BM-335 can also be coupled for side-by-side mounting in a 19-inch rack.

The BM-337 is identical to the BM-335 except that it has 36 taper pin connector slots and has no provision for the plug-in power supply.

BL Series

The BL Series μ -BLOC consists of the BL-330, BL-331, BL-332 and BL-333. Each BLOC is directly mountable in a 19-inch rack. The BL-330 and BL-331 have provisions for housing a PB-331 plug-in power supply which can drive up to 96 modules. The accompanying table details the difference in connector type, PAC capacity, etc. One μ -PAC Extractor Tool will be supplied with each BLOC.

SPECIFICATIONS

Model	PAC Capacity	Connector Type	Mech. Dimensions			Housing for Power Supply
			Height	Depth	Width	
BM-330	24	wire wrap	12 $\frac{7}{32}$	5 $\frac{1}{8}$	5 $\frac{11}{16}$	PB-330
BM-335	24	taper pin	12 $\frac{7}{32}$	5 $\frac{1}{8}$	8 $\frac{7}{16}$	PB-330
BM-337	36	taper pin	"	"	"	(none)
BL-330	96	wire wrap	12 $\frac{7}{32}$	5 $\frac{1}{8}$	16 $\frac{11}{16}$	PB-331
BL-331	48	taper pin	"	"	"	PB-331
BL-332	144	wire wrap	"	"	"	(none)
BL-333	72	taper pin	"	"	"	(none)



plug-in power supplies

Plug-in Power Supplies, PB-330 and PB-331, are integrally packaged units that can be mounted directly into μ -BLOCS. The PB-330 mounts directly in model BM-BLOCS and the PB-331 mounts into model BL-BLOCS. They supply current at both μ -PAC voltage levels, +6 and -6 volts, and are designed to drive all modules contained in their respective BLOCS.

Overall voltage level variations due to worst-case combinations of line voltage, DC load regulation, dynamic load regulation, ripple and long-term drift are less than $\pm 2\%$. This is well within μ -PAC voltage level tolerances.

The +6 and -6 volt circuits are Zener diode regulated. Each consists of a full wave rectifier, error detector, differential amplifier and pass transistors. Internal interconnections allow for an input voltage range of 100 volts to 240 volts. Input frequency can range from 48 to 400 cps. Voltage adjustments of $\pm 2\%$ can be made on both voltage levels. Ambient operating temperature range is 0°C to $+55^{\circ}\text{C}$.

Front panel features include an on-off switch, power-on indicator, three fuses, and voltage adjustment potentiometers.

Power Supply	+6 Volts DC	-6 Volts DC	Line Current Full Load	Overall Dimensions	Weight
PB-330	2.5 A	.25 A	0.3 A @ 100 VAC	$8\frac{3}{4} \times 2\frac{3}{4} \times 4\frac{1}{2}$	8 lbs.
PB-331	10 A	1.0 A	5.0 A @ 100 VAC	$8\frac{3}{4} \times 5\frac{1}{2} \times 4\frac{1}{2}$	17 lbs.

RP-330 power supply

The RP-330 rack-mounting power supply is a regulated power source capable of supplying current at both +6 volts and -6 volts μ -PAC voltage levels.

Overall supply voltage variations due to worst-case combinations of input line voltage, DC load regulation, dynamic load regulation, ripple and long-term drift are less than $\pm 2\%$. This is well within μ -PAC voltage level tolerances.

Input frequencies of either 50 ± 2 cps or 60 ± 2 cps can be used. At 50 cps, input voltage taps of 100 to 240 volts $\pm 10\%$ are available. At 60 cps, input voltages of 100, 115, and 120 volts $\pm 10\%$ can be used. Ambient operating temperature range is -20°C to $+55^{\circ}\text{C}$.

Power supply front panel includes an AC power-on indicator, two fast-acting circuit breakers with associated indicator lights, voltage adjustment potentiometers and an AC line input fuse.

Power Supply	+6 Volts DC	-6 Volts DC	Line Current Full Load	Overall Dimensions	Weight
RP-330	25 A	2.5 A	5.0 A @ 100 VAC	$5\frac{1}{4} \times 15 \times 19$	60 lbs.

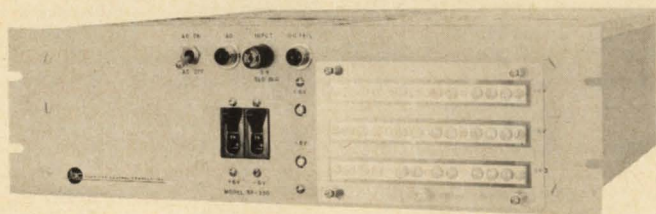
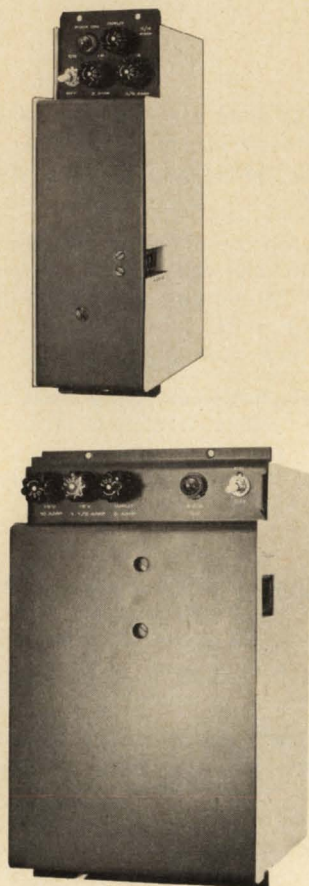

COMPUTER CONTROL COMPANY, INC.
OLD CONNECTICUT PATH, FRAMINGHAM, MASS.

auxiliary wire wrap kit WK-330

The Auxiliary Wire Wrap Kit WK-330 is designed to provide all associated equipment and material necessary to facilitate the easy implementation of μ -BLOC interwiring. WK-330 is intended for use with either the battery operated wire wrap gun or the manually operated wire wrap tool. Contents of the kit include:

- wire stripper
- wire wrap aid
- unwrap tool
- tweezers
- dressing fingers
- dummy wire wrap connector
- 30 gauge wire (25 feet)
- wire wrap manual

The wire stripper provides a simple method of stripping wire to the correct length. Both a connector and 25 feet of 30 gauge wire are provided for practice wire wrap operations. Detailed instructions are contained in the wire wrap manual.

wire wrapping tools

BATTERY OPERATED WIRE WRAP GUN

The Battery Operated Wire Wrap Gun provides a simple method for interwiring μ -BLOC wire wrap connectors with the prescribed 30 gauge wire.

The nickel-cadmium battery provides sufficient power to make up to 4,000 connections without recharging. For recharging the battery can be removed easily and plugged into a standard 110 volt wall socket. The entire unit including battery bit and sleeve weighs 16 ounces.

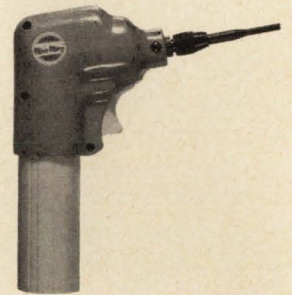

MANUALLY OPERATED WIRE WRAP TOOL

The Manually Operated Wire Wrap Tool provides a simple inexpensive method of wire wrapping 30 gauge wire to μ -BLOCK wire wrap connectors. It is useful for small one-shot wiring tasks, for prototype checkouts, demo units, etc.



taper pin insertion tool

The Taper Pin Insertion Tool is used to insert taper pin jumper leads into taper pin connectors. The tool's spring loaded action and ease of use greatly facilitates the taper pin wiring operation.



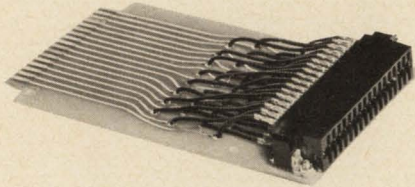

XP-330 extender PAC

The Extender PAC, XP-330, provides unobstructed access to any μ -PAC while the PAC is still electrically connected to its μ -BLOC connector slot.

The connector terminals on the front end of the XP-330 will mount into any μ -BLOC connector and the connector on the rear of the XP-330 will accept the μ -PAC which it is displacing. Front and rear terminals are directly tied together electrically.

jumper lead set JT-330

The JT-330 Jumper Lead Set contains 420 assorted lengths of taper pin jumper leads. The leads are made of plastic insulated #24 stranded wire with gold-plated AMP taper pins at each end. Lead lengths designate tip-to-tip taper pin distances.

Wire Color	2"	QUANTITIES			Per Color Quantity	Recommended PAC Type
		Lead Length 3 1/2"	5"	6 1/2"		
Blue	35	35	30	15	115	flip-flops
Red	35	35	30	15	115	gates
Yellow	25	25	20	10	80	amplifier/ I/O circuits
Orange	10	10	5	5	30	clocks, DMS
White	10	10	5	5	30	miscellaneous
Black	30	20	—	—	50	ground
TOTAL	145	135	90	50	420	

Jumper leads in the above lengths and colors are also available separately on special order in lots of 100 leads.



COMPUTER CONTROL COMPANY, INC.
OLD CONNECTICUT PATH, FRAMINGHAM, MASS.

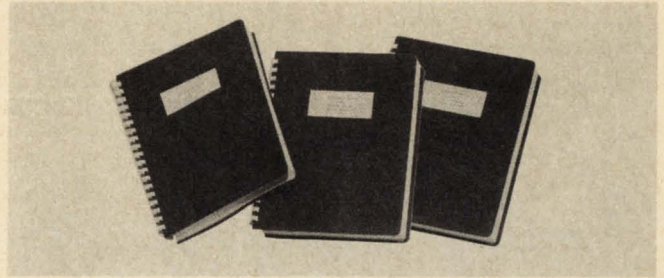

μ-PAC instruction manual

The μ-PAC Instruction Manual contains detailed information on the complete μ-PAC line. Included are product descriptions, performance specifications, design equations, timing diagrams, logic symbols, schematics, basic applications, parts lists, component call-outs and identifications, and other pertinent electrical and mechanical information.

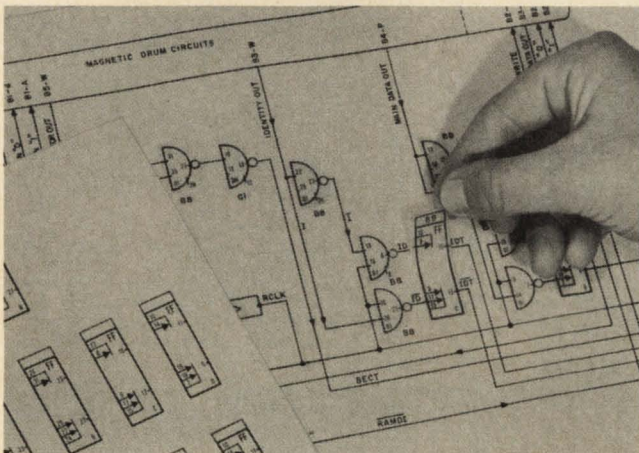

logic symbol sheets

Logic Symbol Sheets are available for each applicable product type in the μ-PAC line. Use of the logic symbol sheets greatly simplifies system logic design and wiring, and effectively minimizes drafting requirements for the production of final engineering drawings.

Printed on each sticker are logic symbol, pin connections and circuit identifiers. Space is provided for designating physical location in the respective μ-BLOC.

The symbols are printed on 8½" x 11" sheets and are pre-cut in block form for easy removal from the basic symbol sheet. A dull surface coating permits pencil or ink lettering on the symbol stickers.

3C SALES OFFICES

New England

570 Hillside Avenue, Rm. 28
Needham, Massachusetts 02194
(617) 449-1860
449-1861

Long Island and New York City

104-70 Queens Boulevard
Forest Hills, New York 11375
(212) 275-6200

Upper New York State

3001 James Street
Syracuse, New York 13206
(315) 463-4534
463-4535

New Jersey, Delaware and Eastern Pennsylvania

8367 Bristol Pike
Levittown, Pennsylvania 10954
(215) 943-2210

Southern Ohio, Kentucky and Western West Virginia

401 Astor Avenue
West Carrollton, Ohio 45449
(513) 299-8771

North Dakota, South Dakota, Minnesota, Wisconsin, Iowa, Nebraska, Illinois, Missouri Kansas and Western Pennsylvania

3158 Des Plaines Avenue
Des Plaines, Illinois 60018
(312) 824-5186
824-5187

Michigan, Indiana, and Northern Ohio

20441 James Couzens Highway
Detroit, Michigan 48235
(313) 836-7170

Maryland, Washington, D.C., Virginia, and Eastern West Virginia

World Building
8121 Georgia Avenue
Silver Spring, Maryland 20910
(301) 587-1712

Florida

Holiday Office Center
1325 North Atlantic Avenue
Cocoa Beach, Florida 32931
(305) 784-0606

Texas, Oklahoma, Arkansas, and Louisiana

3322 Richmond Ave.
Houston, Texas 77006
(713) 529-3163

Alabama, Mississippi, Georgia, North Carolina, South Carolina, and Tennessee

Holiday Office Center
3322 South Memorial Parkway
Huntsville, Alabama 35801
(205) 881-5640
533-2255

California

2217 Purdue Avenue
Los Angeles, California 90064
(213) 478-0481
272-9135

New Mexico, Colorado, Utah, Nevada, Wyoming, Montana, Arizona, Idaho, and Western Texas

1030 San Pedro, N.E.
Albuquerque, New Mexico 87110
(505) 268-6714

Washington and Oregon

24602 B Military Road
Kent, Washington 98031
(206) 878-2520

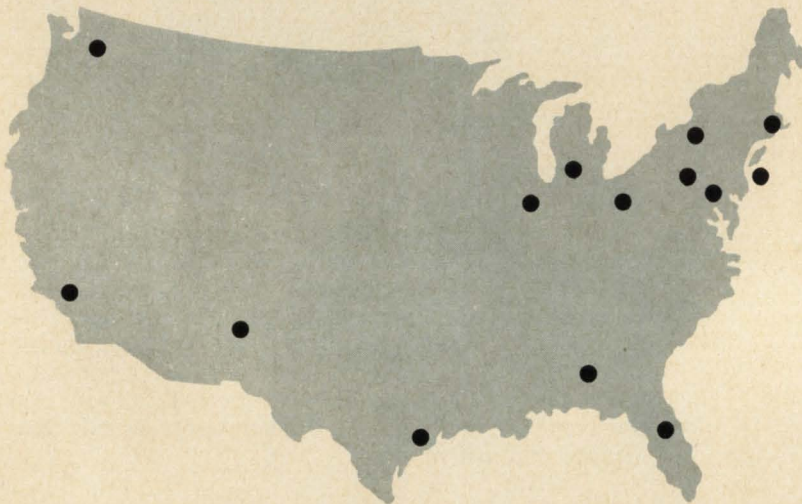

3C plants are located in Framingham, Mass., Peterborough, N.H., and Los Angeles, Cal. Sales offices are located in all strategic areas.

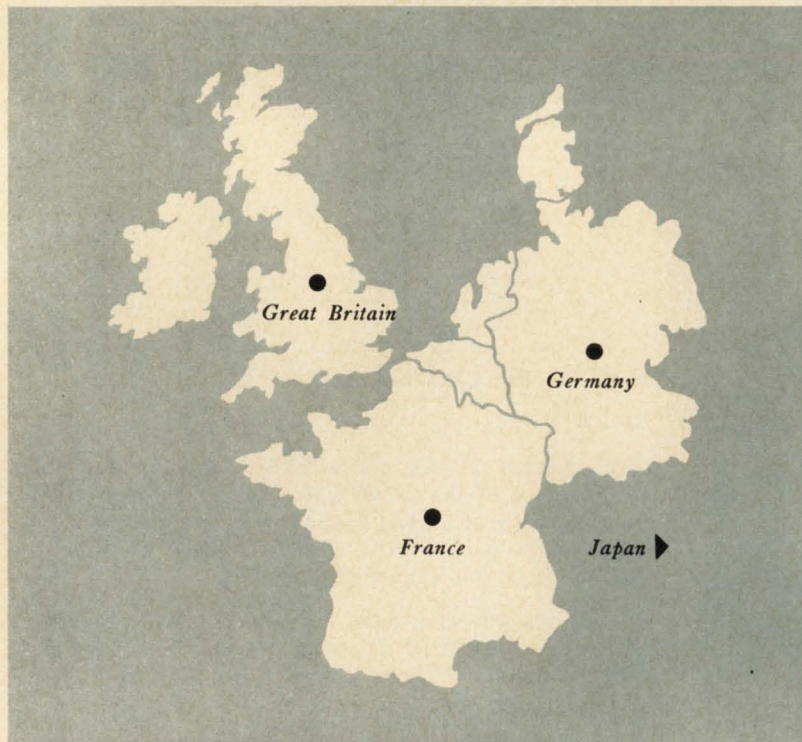

3C will soon have offices located in France, Great Britain and Germany. A distributor sales organization in Japan is already a reality.



COMPUTER CONTROL COMPANY, INC.
OLD CONNECTICUT PATH, FRAMINGHAM, MASS.

3C PRODUCTS



S-PAC Logic Modules
200 kc,
1 mc, 5 mc
and 1 mc
Silicon
1

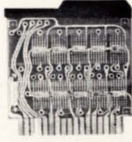

μ-PAC Logic Modules
5 mc
2



H-PAC Logic Modules
20 mc
3



Integrated Circuit Core Memories
1 μsec full cycle
(<500 nsec access time)
4



Pulse Current Generators
5

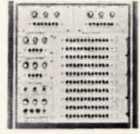

Digital Program Generators
5 mc and 20 mc
6

3C GENERAL PURPOSE COMPUTERS



DDP-124

24-bit word DDP-124 features monolithic integrated circuit construction; binary, parallel, sign/magnitude, single address with indexing, powerful command structure. Over 285,000 computations per second. 4096 words (expandable to 32,768) directly addressable; cycle time 1.75 μsec. (Strong optional I/O capability and broad range of peripheral equipment.) FORTRAN IV, assembler, executive, utility and service routines. Fully program-compatible with DDP-24 and DDP-224.
7



DDP-116

DDP-116 features a 16-bit-word, 1.7 μsec cycle, 4K memory, keyboard and comprehensive instruction repertoire, powerful I/O bus structure, multi-level indirect addressing, indexing, priority interrupt, extensive software package, diagnostic routines. Add time is 3.4 μsec. Options include high-speed arithmetic option, memory expansion to direct memory interrupt, real-time clock, and a full line of peripherals.
8

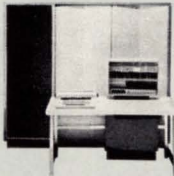

DDP-224

24-bit word DDP-224 features: 1.9 μsecs (0.8 access) memory cycle, and powerful command structure, 260,000 computations per second. Transfer rates up to 325,000 words per second. 3.8 μsecs add. 6.46 μsecs multiply. 17 μsecs divide. 4096-word memory expandable to 65,536 Typical add time with optional floating point hardware 7.6 μsecs (24-bit mantissa, 9-bit characteristic). Fully program compatible with DDP-24.
9

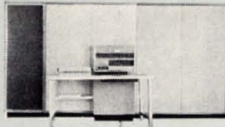

DDP-224 MULTI-PROCESSOR

Fully buffered control unit, access distribution unit and time multiplex unit make it possible to combine several DDP-224's into integrated large scale computer systems with functionally common and/or private memory, control arithmetic, system input/output facilities and peripherals.
10

Please send the information indicated*

1 2 3 4 5 6 7 8 9 10

μ-PAC prices

Have sales engineer call

NAME _____

TITLE _____

FIRM _____

STREET _____

CITY _____ ZONE _____ STATE _____

*If requesting four or more items, please reply on letterhead. Thank you.

For further information on μ-PACS or any of the 3C products listed on this page-- fill out and mail the attached postage paid return card.

Now — from Computer Control Company A Comprehensive Catalog of Integrated Circuit Logic Modules



COMPUTER CONTROL COMPANY, INC.
OLD CONNECTICUT PATH, FRAMINGHAM, MASS., U.S.A.



BUSINESS REPLY MAIL
First Class Permit No. 113, Framingham, Mass.

Postage will be paid by . . .

COMPUTER CONTROL COMPANY, INC.
OLD CONNECTICUT PATH
FRAMINGHAM, MASSACHUSETTS 01702



**DETACH AND MAIL
FOR ADDITIONAL
LITERATURE REQUESTS**

ELECTRONIC DESIGN

annual index of articles

Careers & Management

- About those crowded campusesEDIT p19 Jul 19
- Compare your salary with the averagesC&M p179 Mar 15
- Confusion raised to the Nth powerEDIT p19 Aug 2
- Design Engineers should think internationalC&M p47 May 24
- Engineering integrityEDIT p20 Mar 1
- Engineering jobs ..C&M p80 Sept 13
- Engineering obsolescence: its diagnosis and cureART p70 Feb 15

Subject listing

- Careers & Management
- Circuits, Mathematical Analysis
- Communications, Navigation, Guidance & Interference
- Components (See Microwaves, Semiconductors)
- Computers, Data Processing and Auxiliary Devices
- Consumer Electronics
- Controls, Automatic
- Human Factors
- Materials
- Measurements, Instruments and Test Equipment
- Microelectronics
- Microwaves
- Missiles and Space
- Packaging
- Power Sources
- Production, Processes and Cooling
- Reliability
- Research and Development
- Semiconductors, Solid-State Devices

- First aid for ailing speakersC&M p62 Oct 11
- If you can't beat 'em, join 'emEDIT p19 Sept 27
- It's your turn at the rostrum—can you deliver a technical paper?C&M p54 Mar 15
- More doors open for post-grad updatingC&M p186 Mar 15
- NSPE: the engineer's AMA?EDIT p31 Sept 13
- Professional groups and personal libertiesEDIT p19 Jul 5
- Profiles of successful engineersC&M p182 Mar 15
- Shortening the engineering-to-market time spanC&M p46 Apr 12
- The advent of the 'political' scientistC&M p188 Mar 15
- The articulate engineerC&M p38 Aug 2
- 'The trouble with you is... 'C&M p76 Sept 13
- To err is human ... or is it?EDIT p19 Aug 30
- What it takes to be a supervisor ..C&M p112 Jan 18

Circuits, Mathematical Analysis

- A blanket approach to a linear thermistor networkART (Part I) p20 Mar 29
- A blanket approach to a linear thermistor networkART (Part II) p36 Apr 12
- A Darlington improves monostable multi performance IFD p36 June 21
- A logical approach to comparator designART p50 Nov 11
- A new tool for easier network synthesisART p20 Feb 1
- Adder differentiator measures thyristor response time IFD p160 Aug 16
- All-pass filters accurately split the phaseART p38 Jan 18
- Analog circuit impedance follows signalIFD p31 Mar 1
- Analog long-time integrator employs transistor reset ...IFD p56 May 24
- Astable blocking oscillators—they can be practical-Part I ART p21 Mar 1
- Astable blocking oscillators—they can be practical-Part II ART p42 Mar 15
- Balanced modulator transformer increase carrier suppression

-IFD p46 Jan 18
- Beam deflection tube oscillates at two frequenciesIFD p48 Jul 5
- Bootstrapping boosts pre-amp input impedanceART p22 May 10
- Boxcar circuit provides pulse amplifier ageIFD p83 Sept 13
- Capacitor replaces transformer in low voltage power supplyIFD p57 Apr 12
- Cascaded UJT oscillators form stable frequency divider ..IFD p52 Nov 8
- Complementary diode feedback produces nonlinear gain IFD p42 June 7
- Complementary dual follower increases input impedance p58 Nov 8
- Complementary transistors replace meter relayIFD p53 Apr 12
- Conformal Invariants PT p79 Jan 4
- Constant-current regulator range determined by reference transistorIFD p44 Apr 26
- Curing interference in relay systems: Look at the source then suppressART p37 Nov 29
- Cylindrical Fields ...PT p31 June 21
- Dc feedback symmetry control creates wideband doubler IFD p154 Aug 16
- Dc load-voltage method simplifies gain calculationIFD p156 Aug 16
- Delay-line sync separator improves video resolution ...IFD p60 Nov 22
- Design of dc-coupled bistable circuitsART p26 Aug 2
- Differential amplifier offers efficient dual outputsIFD p37 Jul 19
- Differential amplifier provides improved common-mode rejectionIFD p44 May 10
- Differential comparator extends accuracyART p50 Oct 25
- Differentiator-divider network analyzes power-line transientsIFD p52 Dec 6
- Diode divider circuit provides ac gain controlIFD p46 Apr 26
- Double-coil relay simplifies AND circuitIFD p72 Nov 29
- Dual emitter transistor clears integrator circuitIFD p41 June 7
- Emitter-follower circuit protects against overloads ..IFD p61 Mar 15
- Error-rate feedback generation in servometer handled by toroidIFD p50 Apr 12

AN	Application Note
ART	Article
C & M	Careers and Management
DD	Design Decision
EDIT	Editorial
ENG DATA	Engineering Data
IFD	Ideas for Design
MAT	Materials
ME	Microelectronics
PF	Product Feature
PT	Practical Theorist
SR	Special Report

Feedback circuit converts pulse trains to staircaseIFD p69 Oct 11
 FET can be used to multiply two signalsIFD p34 Mar 29
 FET enhances parallel-T notch filter performanceIFD p36 Jul 19
 FET limits and resets operational amplifiersIFD p54 Nov 8
 Filter amplifier maintains gain over wide bankART p58 Oct 11
 Filter out 60-cycle pickup in dc amplifiersART p34 Dec 20
 Find comb-filter frequencies fastART p44 Dec 6
 Flip-flop operation enhanced by resistor-diode input ...IFD p35 June 21
 Flow graphs pinpoint frequency responseART p36 Nov 22
 Four components make dc regulatorART p64 Feb 15
 Four layer diode produces fast, high voltage pulses ...IFD p55 May 24
 Four layer diode provides time delay with instant reset IFD p33 Mar 29
 Gain-control circuit avoids dc shiftIFD p28 Feb. 1
 Gain-phase slide rule aids amplifier designART p64 Sept 13
 Graphical design for non-saturating Schmitt triggers ART p58 Feb 15
 Graphics yield fast, low-cost printed circuit breadboardp.56 Nov 8
 Graph speeds calculation of skin effectART p51 Nov 8
 Harmonic Generators: Is the step-recovery diode best? ART p28 Jan 18
 High ratio pulse counter utilizes UJT switchIFD p58 Mar 13
 Holding-coil switches form matrix monitorIFD p48 Dec 20
 Hysteresis of bistable circuit is displayed on CRT ...IFD p50 Jan 18
 If limiter—diode circuit is stable with temperatureIFD p158 Aug 16
 Improved squaring circuit is less temperature sensitive ..IFD p40 Jul 19
 Inexpensive oscillator is temperature stableIFD p70 Oct 11
 Inexpensive regulator uses transistors as breakdown diodeIFD p33 June 21
 Inexpensive relay drive from low-level signalsIFD p44 Jul 5

Infinite Z out source for long linear sweepsART p28 Jul 19
 Locking monostable circuit immune to false triggeringIFD p54 Dec 6
 Low cost multilayer boards with feed-through jumpers IFD p155 Aug 16
 Low cost 2 stage circuit forms versatile AM oscillator IFD p42 May 10
 Low frequency FET amplifier has narrow bandpassIFD p72 Jan 4
 Magnetic amplifier overcomes push-pull unbalanceIFD p68 Oct 25
 Mapping into a circle PT p33 Feb 1
 Matched transistors passe for FET squarersART p36 Nov 8
 Microelectronics at \$18 operational amp gives long time delayIFD p48 May 10
 Microvolt dc relay makes inexpensive thermocouple trip ..IFD p81 Nov 29
 Modified astable multivibrator produces very long time delayIFD p48 May 10
 Modified multi forms phantastron oscillatorIFD p46 Jul 5
 Modified multi forms voltage-controlled oscillator ...IFD p68 Oct 11
 Modified multivibrator has elongated pulse outputIFD p59 Mar 15
 Monitor circuits measure transient phenomena and soundsIFD p38 Jul 19
 More on Schwarz-ChristoffelPT p35 Mar 29
 MOS transistor provides sharp differential relay switchingIFD p32 Mar 29
 Multiple-reed relay acts as 2-frequency decoderIFD p71 Nov 29
 Multiply phasors the easy wayART p34 Aug 2
 Nand gates and UJT form stable hybrid monostable multiIFD p45 Apr 26
 Neon-tube circuit forms one-shot pulse generatorIFD p38 June 7
 New circuitry withstands deep-sea pressuresNEWS p6 Feb 1
 Nixie driver flip-flop also stores informationIFD p82 Sept 13
 No standby power needed for one-shot circuitIFD p30 Feb 1
 Nomograph: Rapid solution to bistable circuit designENG DATA p38 Apr 26
 NOR circuits easily convert to multipliersIFD p76 Feb 15
 Operational amplifier has flat bandwidth to 12 Mc ...IFD p47 Aug 30
 Operational amplifier theory can give answersART p20 Apr 26
 Out of lock detector for automatic phase controlIFD p53 Nov 8
 Out-of-lock detector performs digital frequency discriminationIFD p55 Dec 6
 Phase lock harmonically unrelated signalsART p146 Aug 16
 Plotting produces total astable designART p60 Sept 13
 "Pseudo" first stage makes self-clearing ring counter ...IFD p40 Aug 2
 Pseudo-Schmitt approach to trigger logicART p30 Nov 22
 Pulse compression via active devices

.....ART p134 Aug 16
 Pulse generator delivers a constant currentIFD p63 Mar 15
 Pulse height detector operates independently of dc input levelIFD p32 Mar 29
 Pulsed relay generates low-level step functionsIFD p81 Nov 29
 Pulse-sorter network detects, amplifies bi-polar signals ...IFD p48 Aug 30
 Pulse-width discriminator uses mismatched delay line IFD p60 Mar 15
 Raysistors find application in voltage multiplying, dividingIFD p58 Mar 15
 Reference amplifier is versatile and temperature stable IFD p44 Aug 30
 Relay provides simple reversal of dc motorIFD p78 Nov 29
 Remote switching technique reduces systemIFD p78 Feb 15
 Reset circuit independent of amplitude, polarityIFD p70 Oct 25
 Resistor stabilizes frequency of transistorized oscillator IFD p53 May 24
 Resonant reed controls timed latching relayIFD p80 Nov 29
 Resonant reed-relay produces pulsed toneIFD p74 Nov 29
 Resonant reed stabilizes audio oscillator frequency ...IFD p76 Nov 29
 Ripple suppression circuit solves space-limit problem IFD p35 Mar 1
 Rule of thumb simplifies maximum power calculations IFD p74 Feb 15
 Saturable core detects small current differenceIFD p44 July 5
 SCR and UJT form time-delay switchIFD p82 Sept 13
 Self-starting voltage regulator is short-circuit regulatedIFD p79 Feb 15
 Sensitive static relay detects resistance limitsIFD p75 Nov 29
 Series-parallel connection produces high-level pulses ...IFD p52 Dec 6
 Shaft-position generator provides zero referencesIFD p64 Mar 15
 Simple circuit improves stepping switch performance IFD p47 Jan 18
 Simple circuit measures tube transconductanceIFD p62 Mar 15
 Simple circuit starts tubes automaticallyIFD p44 Jan 18
 Simple techniques to measure high-power pulsesART p46 Oct 11
 Signal rejection accomplished by optical isolatorNEWS p18 Jul 19
 Solid-state current-limiter functions as circuit breaker IFD p59 Mar 15
 Start-up circuit insures initial state of flip-flopIFD p31 Feb 1
 Static switching circuit transfers power automatically ...IFD p74 Feb 15
 Strain gage output amplifier produces modulated pulse signalIFD p52 May 24
 Streamlined capacitor charge circuitsART p40 Mar 15
 Sub-audio sinusoids by integrator feedback loopIFD p38 June 7
 Symmetry amplifier compensated by FET current-sources IFD p70 Oct 25
 Tabular technique solves harmonic problemsART p36 Aug 2

Tabular technique solves harmonic problemsART p150 Aug 16

Telephone dial controls rotary stepping switchIFD p75 Nov 29

Temperature varies bandwidth to improve trigger sensitivityIFD p77 Jan 4

The Backward Monostable: A time delay switchART p58 Jan 4

Thermal relay forms simple stepped voltage regulator ..IFD p80 Nov 29

The Schwarz-Christoffel mappingPT p33 Mar 1

Three relays form low-speed, inexpensive power divider IFD p42 June 7

Time-delay relay protects against in-rush currentsIFD p80 Nov 29

Time-delay words with bi-polar voltageIFD p30 Feb 1

Time-delay relays sequentially switch motor starting systemIFD p71 Nov 29

Transformer delivers 5 Kw pulses for 10 nsecDD p48 Mar 15

Transistor, diode form bidirectional synchronous clamp IFD p84 Sept 13

Transistorized switch provides AC signal gateIFD p49 Jan 18

Triac time-delay circuit switches 1.2 kw of ac powerIFD p44 Jul 5

Funnel diode circuit offers non-distorted delayed pulse IFD p46 May 10

Funnel diode and UJT produce ultrafast trigger output ..IFD p40 Jan 7

Tunnel diode level detector is ultrasensitiveIFD p73 Jan 4

Two-dimensional mappingPT p45 May 24

Two phase-locked oscillators improve linearityDD p24 June 21

Two R-L network limits surge to low-starting loaded SCRIFD p52 Apr 12

Two relays form bistable trigger circuitIFD p71 Nov 29

Two-stage circuit improves hf signal generator's output IFD p71 Oct 11

Two-stage transistor replaces precision operational inverterIFD p54 Apr 12

UJT oscillator makes simple FM modulatorIFD p47 May 10

UJT oscillator provides negative voltage pulsesIFD p55 May 24

Ultrasensitive relay forms precise temperature controllerIFD p76 Nov 29

VCO frequency control via balanced-bridge mixerART p48 Nov 22

Voltage detector uses solidstate relaysIFD p30 Mar 1

Voltage regulator circuits permit decentralized operation PF p94 Jan 4

Why not an avalanche diode as an RF noise source?ART p32 Apr 12

Widerange multivibrator varies frequency from 8Kc to 3McIFD p50 Apr 12

Zener diode aids chopper in demodulator applicationIFD p56 Apr 12

Zener diodes provide high-level limitingIFD p77 Feb 15

Zig-Zag nomograph to equivalent resistance ..ENG DATA p30 Aug 30

Communications, Navigation

Balanced modulator transformer increases carrier suppressionIFD p46 Jan 18

Direction finder for re-entry works in S-bandNEWS p17 June 7

Frequency control techniques seen meeting ssb need NEWS p10 May 24

Mobile air control permits tactical emergency landingsNEWS p10 Oct 11

Navy communications looks toward the '70'sNEWS p12 Jul 5

Simple techniques to measure high-power pulsesART p42 Nov 8

Spawning salmon counted by sonarNEWS p19 Oct 11

Tradeoffs in choosing radar frequencyART p54 Oct 25

Components

AC or dc excitation: which is best for transducers?ART p26 June 7

An outside look at inside coil temperatureART p54 Oct 11

Avoiding shorted—coil failuresSR ART p54 Feb 15

Batch fabrication: new roads to system designNEWS p6 Apr 12

Bounceless switch unit acts as relay/chopperPF p88 Sept 13

Ceramic capacitors maintain $\pm 2\%$ temperature stabilityPF p74 Apr 12

Ceramic capacitors nearing glass-dielectric stability ...PF p72 Dec 20

Coax ribbon transmits highspeed dataPF p62 Jul 5

Commutated relay spearheads new switching technique ART p18 Nov 29

Comparing the three most popular temperature sensorsART p62 Jan 4

Conductor specification dataSR ART p36 Feb 15

CRT data display to aid liquor industryNEWS p24 Oct 11

Curing interference in relay systems: Look to the source, then suppressART p37 Nov 29

Designing with relays is more subtle than you think ...ART p30 Nov 29

Determining effect of loading on a potentiometer's linearityART p68 Feb 15

Don't dismiss the relay for data processing systems ART p24 Nov 29

Double-coil relay simplified AND circuitIFD p72 Nov 29

Electromechanical relays spar with solid stateNEWS p6 June 7

Five Gc coaxial cable drops 10 db per 100 ftPF p100 Feb 15

Four factors influence cable harness designSR ART p42 Feb 15

Functional specification speeds coaxial-cable selectionART p48 Feb 15

Guidelines for invading foreign marketsEDIT p31 May 24

Have semiconductors relegated relays to a second-class status?ART p14 Nov 29

How much delay from a delay line?ART p48 Sept 27

Inexpensive relay drive from low-level signalsIFD p44 Jul 5

Integrated circuit protected by reed relay-diode combinationIFD p78 Nov 29

International Exhibition of Electronic

Components ...NEWS p22 May 24

Is db passe for component noise?ART p32 Apr 26

Make sure switch you order is switch you want ...SR ART p44 Sept 13

Methodical approach leads to right coax switch ..SR ART p38 Sept 13

Microvolt dc relay makes inexpensive thermocouple trip IFD p81 Nov 29

Mil-spec coax crimp connectors assemble in half a minuteME PF p72 May 24

Modular power supplies are narrow, efficientPF p42 Mar 1

Modular switch saves wiring time by disassemblingPF p60 Nov 8

Modular VCO design "Customizes" from stockPF p76 Oct 25

Multi-Pin connector approaches cable diameterPF p102 Feb 15

Multiple-reed relay acts as 2-frequency decoderIFD p71 Nov 29

OR circuits simplified with double-coil relaysIFD p77 Nov 29

Passive miniature circulator operates at vhfPF p52 Aug 30

Pin coaxial-cable specs to your needsART p56 Sept 27

Pinpoint your relay needs by writing complete specificationsART p52 Nov 29

Pulsed relay generates low-level step functionsIFD p81 Nov 29

Relay provides simple reversal of dc motorIFD p78 Nov 29

Resonant reed controls timed latching relayIFD p80 Nov 29

Resonant reed-relay produces pulsed toneIFD p74 Nov 29

Resonant reed stabilizes audio oscillator frequency ...IFD p76 Nov 29

Ribbon cables show their versatilitySR ART p32 Feb 15

Save \$ in specifying TC wirewoundsART p36 Aug 30

Selecting and specifying trimming potentiometersART p34 Jan 18

Selecting the right insulation for hook-up wireSR ART p46 Feb 15

Self-coiling metal tape permits compact designART p56 Oct 11

Self-regulating ovens cap TO-5 and DO-7 cansPF p48 Aug 2

Sensitive static relay detects resistance limitsIFD p75 Nov 29

Shunt diodes protect polarized capacitorsIFD p64 Nov 22

Simple circuit improves stepping switch performance IFD p47 Jan 18

Six points to simplify rotary wafer selectionSR ART p48 Sept 13

Sliding disks simplify switchingDD p66 Jan 4

Special Report on Switchesp33 Sept 13

Standardized relay terminology simplifies selection and aids usageART p45 Nov 29

Stepping relay establishes matrix selector controlIFD p70 Nov 29

Switching needs dictate contact material, geometrySR p34 Sept 13

Table speeds RC network design for relay contact protectionIFD p77 Nov 29

Tantalum capacitor "price war" levels offNEWS p12 Mar 29

ANNUAL INDEX

Telephone dial controls rotary stepping switchIFD p75 Nov 29
Thermal relay forms simple stepped voltage regulator ..IFD p80 Nov 29
Thin-film thermistor fits on silicon chipPF p96 Mar 15
Three relays form low-speed, inexpensive power divider IFD p42 June 7
Time delay relay protects against inrush currentsIFD p80 Nov 29
Time delay relays sequentially switch motor starting systemIFD p71 Nov 29
Transformer core selection—quick as a winkART p46 Dec 20
Transformer delivers 5Kw pulses for 10nsecDD p48 Mar 15
Transistor switching regulates power suppliesPF p42 Mar 1
Two relays form bistable trigger circuitIFD p71 Nov 29
Ultrasensitive relay forms precise temperature controllerIFD p76 Nov 29
Voltage detector uses solid state relaysIFD p30 Mar 1
Which relay is right for you? Here's help in deciding ..ART p57 Nov 29
Wire and CableSR p31 Feb 15

Computers, Data Processing and Auxiliary Devices

AF wind tunnel has computer that handles Mw inputs NEWS p10 Aug 2
A logical approach to comparator designART p50 Oct 11
Analog circuit impedance follows input signalIFD p31 Mar 1
Batch-fabricated memory reported at NAECON meet ..NEWS p8 June 7
Case history: diode design boosts DTL speedME ART p36 Feb 1
Computer design of microelectronic circuitsART p26 Jan 4
Computer-driven real-time display projects 4 colors NEWS p18 Oct 25
Computer picks semiconductorsNEWS p17 May 10
Computer produces realistic musical instrument sound NEWS p18 Nov 22
Computer service offered for design and circuit analysisNEWS p25 Oct 11
Computer speeds design reviewsNEWS p12 Feb 15
Computer system to position Mohole ocean-drilling platformNEWS p16 Feb 15
Control Data to add two super computersNEWS p16 Jan 18
Design at Wescon Part 3 p20 Aug 30
Differential amplifier provides improved common-mode rejectionIFD p44 May 10
Don't dismiss the relay for data-processing systems ART p24 Nov 29
Eight-Mc IC computer serves as learning toolNEWS p6 Aug 2
Electronic gearing drives tapeDD p28 Mar 1

Electronics invades the accounting departmentNEWS p12 Dec 20
Good rocket computers come in tough packagesDD p68 Jan 4
Flip-flop operation enhanced by resistor-diode input ...IFD p35 June 21
FJCC: Faster cores vie with TF memoriesNEWS p6 Dec 20
Hybrid-IC memory can be produced for 7-14¢ per bit ..NEWS p11 Aug 30
Industrial control by digital computersART p54 Jan 4
Low-cost time-share computer debutsNEWS p23 Oct 11
Magnetics advanced by computer needsNEWS p6 May 24
Moderately priced amplifier gives 100-volt swingPF p58 June 21
Modular design adds flexibility to IC computer ...ME NEWS p40 Feb 1
Module line offered to do-it-yourselfersNEWS p11 May 24
NAND gates and UJT form stable hybrid monostable multiIFD p45 Apr 2
New data terminal for top computersNEWS p18 Jul 5
NOR gates generate non-clocked output pulseIFD p50 Dec 20
Operational amplifier response—shape countsART p36 Jul 5
Operational amplifier response—stage by stageART p24 Jul 19
Operational amplifier theory can give answersART p20 Apr 26
OR circuits simplified with double-coil relaysIFD p77 Nov 29
Out-of-lock detector performs digital frequency discriminationIFD p55 Dec 6
Passive computer systems increase efficiencyIFD p74 Jan 4
Pen and tablet input to computer made for sale ...NEWS p22 Jan 18
Pick off multiphase signals from a diskART p20 Jul 19
Remote terminal works off computer 6000 miles away ..NEWS p22 Jan 4
Sample-and-hold circuit for A/D converterIFD p44 Aug 2
Self-correcting memoryART p28 Aug 30
Seamless belt stabilizes tape motion in transportNEWS p10 Nov 8
Sonar computers ..NEWS p10 Aug 16
Tables speed design of sampled-data systems ..Part I ART p28 May 10
Tables speed design of sampled-dataPart II ART p40 May 24
Table speeds RC network design for relay contact protectionIFD p77 Nov 29
Temperature programmers follow analog functionsPF p86 Nov 22
Three easy ways to evaluate digital circuitsME NEWS p50 Jul 5
Threshold logic provides complete complementary outputIFD p50 May 24
Tunnel diodes simplify shift-register constructionIFD p29 Feb 1
Univac 1230 unit named for real-time Apollo data analysisNEWS p21 Aug 16
Western Union greatly expands data facilitiesNEWS p18 Jan 4

Consumer Electronics

Audio engineers spotlight innovationsNEWS p12 May 24
Silicon and germanium battle at hi-fi showNEWS p6 Oct 25
TV, stereo sound systems find new airline market ..NEWS p12 Feb 1

Human Factors

Can you put your ideas across?....C&M p46 Dec 6
Eighteen ways to save timeC&M p48 Nov 8
Gremlin-proofing: answers to nature's tricksART p42 Nov 22

Industrial Electronics

A special report on Industrial DesignSR p21 Nov 8
Ac or dc excitation: which is best for transducers?ART p26 June 7
Analog fields simplify designDD p29 June 21
Automated traffic systems picking up speedNEWS p6 Jan 18
Auto safety programs turn to electronicsNEWS p6 Jul 7
Blackout sheds light on system faultsNEWS p6 Dec 6
Chemical instruments seek more electronicsNEWS p6 July 7
Complexity limits adaptive systems' usesNEWS p12 Oct 25
Electromechanical relays spar with solid stateNEWS p6 June 7
Electronic gearing drives tapeDD p28 Mar 1
Error-rate feedback generation in servometer handled by toroidIFD p50 Apr 12
FETs, power types join economy trendNEWS p12 Aug 30
Industrial control by digital computersART p54 Jan 4
Industrial conversion: new hope, new wrinklesNEWS p6 Feb 15
Industrial Design Awards ... Wescon USApW124 Aug 16
Industrial users switch relays for solid stateNEWS p6 Aug 16
Magnetics advanced by computer needsNEWS p6 May 24
ME linear circuit modules meet many servo and control needsPF p46 Mar 29
Operational amplifier response—shape countsART p36 Jul 5
Operational amplifier response—stage-by-stageART p24 Jul 19
Out-of-lock detector for automatic phase controlIFD p53 Nov 8
Pentagon speeds shift to uhf telemetryNEWS p6 Jul 19
Photo-emitter-sensor controls feedback systemART p32 Aug 30
Servo unit converts metric to digital readoutPF p62 Apr 26
Solid-state integrator combines low duty cycle with low rippleDD p42 Apr 12
Switch-selector arrangement controls motor's revolutions IFD p40 Aug 2
Tables speed design of sampled-data systems Part I ..ART p28 May 10
Tables speed design of sampled-data systems Part II ..ART p40 May 24

Triac optimizes static control of ac powerART p32 May 24
Viscous effect simulated by servo damping systemIFD p43 Aug 2

Materials

AdhesivesMAT pM14 Jul 19
Composite design materials-basic conceptsMAT p64 Jan 18
Design advantages of gas dielectricsMAT p152 Aug 16
Epoxy bond can be severed without cuttingIFD p78 Jan 4
High strength conductor alloysMAT ART p210 Mar 15
Improve reliability via physics of failureMAT p70 Sept 13
InsulationMAT pM40 Jul 19
Laser materials ..MAT pM29 Jul 19
Magnetic materials MAT pM48 Jul 19
Material for power sourcesMAT pM4 Jul 19
Materials problems in contact designMAT p60 May 10
New techniques in radiation studiesMAT p52 June 7
PlasticsMAT pM22 Jul 19
Special purpose wire and cableMAT pM52 Jul 19
Solvent dissolves epoxy encapsulationNEWS p11 Nov 8
Wear—basic materials problemMAT p66 Apr 12

Measurements, Instruments and Test Equipment

A guide to the selection of multimetersART p6 May 3
Analog fields simplify designDD p29 June 21
Chemical instruments seek more electronicsNEWS p6 Jul 5
Complementary transistors replace meter relayIFD p53 Apr 12
Design at Wescon Part 3ART p20 Aug 30
Differential comparator extends accuracyART p50 Oct 25
Diode improves voltmeter's linearity and stabilityIFD p65 Nov 22
DVM accuracy—the factors that influence itART p40 May 3
DVM merges dual modes; maintains accuracy and speed ..PF p100 Mar 15
Efficient wave analyzer gets around IFART p22 Feb 1
Electroluminescent meters operationalNEWS p24 Nov 22
Electronic counter accuracy—three factors that influence itART p106 May 3
Europe challenges U.S. instrument designersNEWS p6 Oct 11
FET used for unity gain, high impedance scope probe ..IFD p46 Aug 30
Field strength meter can double in brassART p136 May 3
Inductance measurement of low-frequency coilsART p26 Feb 1
Inexpensive pattern generator simulates teletype code IFD p66 Oct 11
Infinite Z_{out} source for long linear sweepsART p28 Jul 19
IR scanner displays thermal "map" in just 2.5 seconds NEWS p24 Apr 12
Miniature timing devices indicate up to 10,000 hours ME PF p72 May 24

Monitor circuits measure transient phenomena and soundsIFD p38 Jul 19
N-decade count-rate meterART p34 Mar 15
Nothing replaces the slotted lineART p144 May 3
Oscilloscope Progress—A tool with many facesART p20 May 3
Oscilloscope sweep displays microcircuit transfer curve IFD p36 Jul 19
Phase lock harmonically unrelated signalsART p146 Aug 16
Plug-in and go: instant counting to 8Gc plusPF p58 Dec 20
Polarity selector follows pulsed or dc commandsIFD p34 June 21
Precise frequency tripler uses 400 cps standard source ..IFD p61 Nov 22
Programmable generators speed complex operationsPF p60 June 7
Pulse compression via active devicesART p134 Aug 16
Pulse generator is controlled by pinboardsPF p100 Jan 4
Purpose dictates choice of phase meterART p128 May 3
RF "stethoscope" locates latent circuit faultsNEWS p23 Oct 25
Scope method measures broad RF phase shiftsIFD p42 Aug 2
Separate frequencies with a spectrum analyzerART p64 May 3
Servo unit converts metric to digital readoutPF p62 Apr 26
Shaft-position generator provides zero referenceIFD p64 Mar 15
Simple CRO set-up finds FET's zero temperature coefficientIFD p48 Apr 26
Simple route to multi-purpose pattern generatorART p32 June 7
Simple techniques to measure high-power pulsesART p43 Oct 11
Six digit DVM offers absolute accuracyPF p46 Feb 1
Strip-chart recorder uses single servo systemPF p70 Jan 18
Test pattern checks step-and-repeat accuracyART p54 Sept 27
The modern VSWR amplifierART p152 May 3
The three main types of VTM's: How they differART p74 May 3
Thermoelectric probe performs in-circuit components test PF p98 Mar 15
Tunnel-diode curve tracing lowers oscillation tendency ..IFD p31 Mar 1
Unbalanced bridge simplifies phase measurementsDD p52 Mar 15
Universal bridge measures from one femtofaradPF p78 Nov 8
VLF to VHF noise generator delivers 0.05 db stabilityPF p46 Feb 1
Volt-ohmmeter achieves one Meg/v sensitivityPF p98 Mar 15
Voltmeter spans 1 Kc to 1 Gc using random samplingPF p58 Dec 6
Wavemeters—The high frequency toolsART p88 May 3

Microelectronics

Adapt your curve tracer for MOS displayART ME p50 May 10
Aging/breadboarding aided by test socketsART ME p52 June 21
Answering some "unanswered questions"ART ME p62 May 24
Bright future predicted for TTL logic

circuitsNEWS p86 Feb 15
Build a differential amplifier from logic gatesART ME p50 Apr 26
Can logic arrays be kept flexible?ART ME p58 May 24
Carriers help microcircuit handlingNEWS ME p90 Jan 4
Case history: diode design boosts DTL speedART ME p36 Feb 1
Complementary logic boasts 5-nsec speedPF p38 Mar 1
Computer design of microelectronic circuitsART p26 Jan 4
Computer picks semiconductorsNEWS p17 May 10
Costs spur renewed interest in screened-film techniquesNEWS ME p48 June 7
Design at Wescon-Part 3ART p20 Aug 30
Design with integrated circuits at 60 McME Part 1 p32 Jul 19
Design with integrated circuits at 60 McME Part 2 p30 Aug 2
3 easy ways to evaluate digital circuitsNEWS ME p50 Jul 5
Eighteen dollar operational amp gives 70 db gain to 100 kc ..PF p70 Nov 8
Embedded packages can be repairableSR ART p30 Jul 5
8 flat packs get EIA nod.....NEWS ME p50 June 21
Functional packaging for tomorrow's NavySR ART p44 June 7
Graph speeds film-resistor layoutART ME p44 June 7
Hybrid IC memory can be produced for 7-14¢ per bit ..NEWS p11 Aug 30
Integrated amplifiers are flexible at high frequencies ...PF p64 Apr 12
Integrated circuit protected by reed relay-diode combinationIFD p78 Nov 29
Integrated circuits spawn problems for systems suppliersNEWS ME p56 Apr 26
Integrated devices—What will be in your black box?ART p34 Oct 25
IR testing of microelectronics surgesNEWS p6 Apr 26
Low-power efficiency with tunnel-diode limiters NEWS ME p46 June 21
Machine-tool makers eye integrated circuitsNEWS p12 Jul 19
ME designers explore GaAs, new insulatorsNEWS p12 June 21
ME linear circuit modules meet many servo and control needsPF p46 Mar 29
Microcircuit offers inexpensive crystal-controlled oscillator IFD p30 Mar 1
Microcircuits used in driver/decoder modulesPF p92 Mar 15
Microelectronics '65 ..ART p82 Jan 4
Microelectronics at WesconNEWS ME pW48 Aug 16
Microelectronics comes down to earthSR p33 Oct 25
Modular design adds flexibility to IC computer ...NEWS ME p40 Feb 1
Molecular circuits used in lightweight radar transponderNEWS p16 May 10
Monolithic chips—should you roll your own?ART p48 Oct 25
Monolithic vs. hybrids: battle or wedding?NEWS p44 Mar 29
MOS complements pierce microwave micropower logic NEWS p10 Apr 26

Free reprints of E/D index

A single copy of this index of articles can be obtained by circling number 399 on the Reader-Service card.

- One dozen ways to cut cost in film circuitsART ME p36 Mar 1
 One wafer—one logic arrayART ME p66 Mar 15
 Optical scanner draws integrated circuit mask ...NEWS ME p56 Jul 5
 Oscilloscope sweep displays microcircuit transfer curve IFD p36 Jul 19
 Packaging—how do you juggle the tradeoffs?ART p44 Oct 25
 Prototyping—how closely can you approach reality? ...ART p40 Oct 25
 Semiconductor directorySPECIAL INSERT May 10
 Simple technique speeds J-K counter designART p52 Sept 13
 Skirting thin film design problems ..ART p38 Aug 30
 Tantalum films, new phase found ...NEWS p11 Aug 16
 Test pattern checks step-and-repeat accuracyART p54 Sept 27
 The integrated operational amplifier: six usesART p40 June 21
 Thermal plots check circuitsNEWS ME p58 Jan 18
 Thick films—how and when to use themART ME p58 Apr 12
 Thin-film kit is desk-top labPF ME p60 Jan 18
 Thin-films may boost integrated's performance ..NEWS ME p70 Mar 15
 Thin-film monolithic circuits—how and when to use them? Part 2ART ME p52 Jan 18
 Time-savers for breadboarding integrated circuits ART ME p38 Mar 29
 Unanswered questions on integrated circuitsART p82 Feb 15
 Using feedback pairs in integrated circuitsART p36 Dec 20
 Variable threshold integrated logic immune to noise NEWS p10 Mar 29
 Voltage regulator circuits permit decentralized operation PF p94 Jan 4

Microwaves

- Airborne laser to give better tracking dataNEWS p14 Jan 4
 A quick way to find radar rangeART p41 Jul 5
 Argon cw laser yields 10-second hologram exposure NEWS p16 Sept 13
 C-scan landings sought by carriersNEWS p20 May 10
 Dual frequency maser emission achieved at IBM NEWS p9 Sept. 27
 Electron beam focusingNEWS p24 Aug 16

Special Reports 1965

- Focus '65p25, Jan 4
 Computer design of microelectronic circuitsp26
 Optoelectronics—key to isolationp30
 Transistors invade microwave designp36
 New horizons in applied superconductivityp42
 Semiconductors: ready for 1 Kw at 1 Gcp48
 Industrial control by digital computersp54
 Wire and Cablep31, Feb 15
 Ribbon cables show their versatilityp32
 Conductor specification datap36
 Four factors influence cable-harness designp42
 Selecting the right insulation for hook-up wirep46
 Functional specifications speed coaxial-cable selectionp48
 Avoiding shorted-coil failuresp54
 Semiconductor Directory—Special insert, May 10
 Packagingp20, July 5
 Functional packaging for tomorrow's Navyp22
 Low-cost mock-ups make good sensep26
 Embedded packages can be repairablep30
 Give your modules that 'finished' lookp34
 Materialsinsert, July 19
 Materials for power sourcespM4
 AdhesivespM14
 PlasticspM22
 Laser materialspM29
 InsulationpM40
 Magnetic materialspM48
 Special purpose wire and cablepM52
 Switchesp33, Sept 13
 Switching needs dictate contact material, geometryp34
 Methodical approach leads to right coax switchp38
 Make sure switch you order is switch you wantp44
 Six points to simplify rotary-wafer selectionp48
 Solid-state sources—Their place in the microwave spectrum p21, Sept 27
 From many varieties—Which microwave source is for you? ...p22
 Reflex klystron or solid-state—When to use which source? ...p28
 Semiconductor sources—What are the main design features? ..p36
 Solid-state sources—How should you approach their design? ...p42
 Electronics expands vision of sky spiesp26, Oct 11
 Microelectronics comes down to earthp33, Oct 25
 Integrated devices—What will be in your black box?p34
 Prototyping—How closely can you approach reality?p40
 Packaging—How do you juggle the tradeoffs?p44
 Monolithic chips—Should you roll your own?p48
 Industrial designp21, Nov 8
 Industrial design ... for the home or industryp22
 Industrial design ... for the lab technician/engineerp28
 Industrial design ... for a broad market/low productionp32

- Five Gc coaxial cable drops 10 db per 100 ftPF p100 Feb 15
 High-power laser produces long, spikeless pulses ..NEWS p16 Mar 1
 High-power radar works on two bandsART p20 June 21
 High-power subharmonic varactor frequency dividerIFD p64 Sept 27
 Ionized argon laser produces 18 wattsNEWS p17 June 7
 Laser materialsMAT pM29 Jul 19
 Laser polarimeter to detect twists in ship's hullNEWS p18 Aug 2
 Laser sensor needs no opticsNEWS p25 Feb 15
 Laser transmission made practical by light detectorNEWS p15 Nov 8

- Lasers converted to single-line modeNEWS p15 May 24
 Metal-plasma laser will yield 100 wattsNEWS p24 Oct 11
 Microwave oven cheaper, simplerNEWS p17 Sept 13
 MOS complements pierce microwave micropower logic NEWS p10 Apr 26
 Optoelectronics—key to isolationART p30 Jan 4
 Passive miniature circulator operates at vhfPF p52 Aug 30
 PIN-type diode modulates gigacycle carrier by injectionNEWS p22 Oct 25
 Plasma arc pump increases output of common lasers ..NEWS p10 Oct 25

Plug-in and go: instant counting to 8Gc plusPF p58 Dec 20

S-band, L-band transmitters fill 12 cubic inchesNEWS p10 Sept 13

Simple techniques to measure high-power pulsesART p42 Nov 8

Sizing up antennas ART p58 Nov 22

Slotted antenna arrays can be smallerART p34 May 10

Solid-state devices challenge microwave tubesNEWS p12 Nov 22

Solid-state laser operates at cw with external cavity NEWS p18 Aug 30

Solid-state microwave design surges aheadNEWS p6 Mar 15

Solid-state source reaches 2 mw at 60 GcPF p72 Sept 27

Solid-state sourcesSR p21 Sept 27

Solid-state—the designers probe the problemsNEWS p12 Mar 15

Super cooled tin 'sandwich' emits 9 Gc microwaves ...NEWS p18 Sept 27

Tiny antennas have built-in systemsART p30 Dec 20

Transistors invade microwave designART p36 Jan 4

Waveguide performs well as dispersive deviceIFD p42 Apr 26

X-band delay amp promises low-cost, simple systems..NEWS p14 Jul 19

YIG resonators yielding practical low-noise devices ...NEWS p16 Dec 20

Missiles and Space

Apollo: system 'go' countdown continuingNEWS p12 Oct 11

Electronics expands vision of sky spiesSR p26 Oct 11

First Surveyor launch slips into early 1966NEWS p6 Nov 8

Military electronics step-up evident at WesconNEWS p6 Sept 13

Latest flight of Stratoscope II fails to deckNEWS p12 Aug 16

NASA designing radio-astronomy satelliteNEWS p12 Sept 27

NASA library file stores documents on magnetic tape NEWS p16 Apr 12

Phased-orbit system vies for Comsat jobNEWS p6 Mar 1

Space needs stimulate environmental testingNEWS p16 May 24

Suitcase receiver seeks satellitesNEWS p18 Oct 11

Packaging

Aging/breadboarding aided by test socketsNEWS ME p52 June 21

8 flat packs get EIA nodNEWS ME p50 June 21

Give your modules that 'finished' lookSR ART p34 Jul 5

Functional packaging for tomorrow's NavySR ART p22 Jul 5

Low-cost mock-ups make good senseSR ART p26 Jul 5

Low-power efficiency with tunnel diode limitersART ME p46 June 21

Power Sources

Capacitor replaces transformer in low voltage power supply IFD p57 Apr 12

Dc to dc converter does not use tapped transformerIFD p43 June 7

Fuel-cell power advances to 5-kw levelNEWS p6 June 21

High temperatures restore solar cells after radiation ..NEWS p22 Nov 22

Material for power sourcesMAT pM4 Jul 19

NiCd battery filters, regulates suppliesNEWS p14 May 24

R & D grows in rechargeable batteriesNEWS p12 Sept 13

Success of fuel cells speeds non-space usesNEWS p6 Sept 27

Tunnel diode detects battery voltage levelsIFD p44 Aug 30

Production, Processes and Cooling

Aging/breadboarding aided by test socketsART ME p52 June 21

Answering some "unanswered questions"ART ME p62 May 24

Avoiding shorted-coil failuresSR ART p54 Feb 15

Carriers help microcircuit handling ..NEWS ME p90 Jan 4

Circuit cards speed system prototypingART p52 Sept 27

Conductor specification dataSR ART p36 Feb 15

8 flat packs get EIA nodNEWS ME p58 June 21

Four factors influence cable harness designSR ART p42 Feb 15

Functional specifications speed coaxial-cable selectionSR ART p48 Feb 15

Good rocket computers come in tough packagesDD p68 Jan 4

Graph speeds film-resistor layout ...ART ME p44 June 7

Industrial control by digital computersART p54 Jan 4

Low-power efficiency with tunnel-diode limiters NEWS ME p46 June 21

Machine-tool makers eye integrated circuitsNEWS p12 Jul 19

Monolithic vs hybrids: battle or wedding?NEWS p44 Mar 29

Ribbon cables show their versatilitySR ART p32 Feb 15

Selecting the right insulation for hook-up wire ..SR ART p46 Feb 15

Sliding disks simplify switchingDD p66 Jan 4

Time-savers for breadboarding integrated circuits ART ME p38 Mar 29

Wire and cableSR ART p31 Feb 15

Reliability

di/dt failures in SCR circuitsART p140 Aug 16

Improved reliability via physics of failureMAT p70 Sept 13

Reliability specifications essential for power supplies ...IFD p65 Sept 27

Research and Development

Biomedical Institute: a little closer ..EDIT p31 Aug 16

Deep sea technology gains sharply in Thresher's wake NEWS p12 Jan 18

Eight-kw cryo supply uses armature at room temperature NEWS p14 May 10

First 'natural' neutrinos detected in 2-mile-deep mine ..NEWS p17 Oct 11

Flying standards set world's clocks

.....NEWS p12 Apr 26

Fun under the seaEDIT p19 June 7

Ionosphere study aided by 'phase interaction' radio NEWS p18 Sept 13

New circuitry withstands deep-sea pressuresNEWS p6 Feb 1

New horizons in applied superconductivityART p42 Jan 4

New tools to gather data from the oceansNEWS p6 May 10

Pavlov experiments now go electronic, and with cats, too NEWS p22 Oct 11

Shockley calls for more respect for basic science ...NEWS p23 Mar 15

VLF upsurge boosted by new military needsNEWS p6 Mar 29

Semiconductors, Solid-State Devices

Semiconductors, Solid-State Devices

A blanket approach to a linear thermistor network ...ART p20 Mar 29

Achieve optimum noise performance for FETsART p40 Oct 11

Acoustic amplifier uses CdS wafer at room temperature NEWS p16 Oct 11

Aging/breadboarding aided by test sockets ...NEWS ME p52 June 21

Bootstrapping boosts pre-amp input impedanceART p22 May 10

Box car circuit provides pulse amplifier ageIFD p83 Sept 13

Cascaded UJT oscillators form stable frequency divider ..IFD p52 Nov 8

Charge-depletion technique yields low-frequency carriers ..IFD p49 Dec 20

Complementary dual follower increases input impedanceIFD p58 Nov 8

Design of dc-coupled bistable circuitsART p26 Aug 2

di/dt failures in SCR circuitsART p140 Aug 18

Economy SCRs are plastic encapsulatedPF p44 Jul 19

8 flat packs get EIA nodNEWS ME p50 June 21

Full-time calculations of clamped transistor switchesENG DATA p38 May 24

FET as voltage-variable resistorART p66 Sept 13

FET can be used to multiply two signalsIFD p34 Mar 29

FET gives linear, uniform gain, zero or 180 deg phase shift IFD p31 Mar 3

FET limits and resets operational amplifiersIFD p54 Nov 8

FET used for unity gain high impedance scope probe ..IFD p46 Aug 30

FETs improve line on voltage amplifiersART p24 Dec 20

FETs, power types gain economy trendNEWS p12 Aug 30

Field-effect devices enjoy wider markets, new uses NEWS p16 Aug 16

Field-effect diodes provide current referencePF p68 May 10

Four components make dc regulatorART p64 Feb 15

Four layer diode ground switch controls core memory IFD p67 Sept 27

Four-layer diode produces fast, high-voltage pulses ...IFD p55 May 24

Four-layer diode provides time delay with instant reset ...IFD p33 Mar 29

From many varieties-which microwave source is for you

The performance of PRINTED MOTORS begins where ordinary motors leave off!

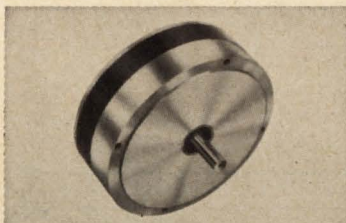

Precision Printed Motors—high performance printed armature servo motors in 10 standard sizes.



New Low Cost "U" Series — 4 models of printed armature motors at greatly reduced prices.

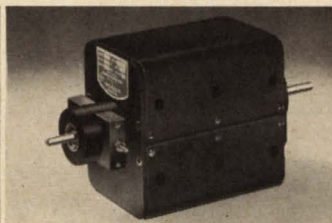

The Incredyne—cylindrical armature motor with the fastest possible speed of response.

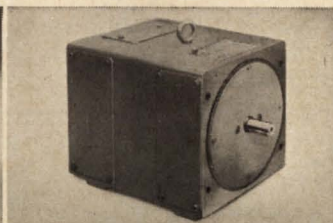

Minertia Motors—low inertia, slotless armature dc motors in sizes up to 200 h.p.

Are you designing tomorrow's electromechanical systems with horse and buggy motors?

Maybe you're not aware of the recent revolution in the design of high performance actuators that has made the problems and limitations of traditional motors obsolete and unnecessary. Unique advantages offered by PMI's complete line of precision and industrial servo motors include:

- Low inertia/high torque capability armatures give exceptionally fast speed of response.
- Wide speed ranges, typically 0 to 3000 rpm.
- Smooth, cogging-free torque, even at very low speeds; allows direct coupling of the motor to the load.

- Linear speed/torque characteristics, from no load to stall.
- Low mechanical and electrical time constants; armature inductance less than 100 microhenries.
- Low voltage/high current operation; allows simple, solid state control.

For information on any or all of PMI's high performance actuators, call or write: Printed Motors, Inc., Glen Cove, New York, (516) OR 6-8000.



PRINTED MOTORS, INC.

GLEN COVE, NEW YORK

Engineering, Manufacturing and Sales by:

Photocircuits CORPORATION

ON READER-SERVICE CARD CIRCLE 27

Cascade circuit arrangement generates sequential pulses

A simple RC-diode configuration repeated in a number of cascaded transistor stages will produce a sequence of parallel pulses. As opposed to other circuits that accomplish this (such as series multi-vibrators), it is less costly, easier to design and uses fewer components.

The circuit (see Fig. 1a), which functions as a series-to-parallel converter, was developed for use with AND gates. Normally, all stages except Q_A are saturated. Q_A is held cut off in the quiescent

condition. When a positive synch pulse is applied to the base of Q_A , it will saturate. This applies a negative step of V_{cc} volts to Q_1 , cutting it off. Q_1 remains cutoff until C_1 discharges through R_L from $-V_{cc}$ to zero volts. This is accompanied by the appearance of a positive gate at the collector of Q_1 . When Q_1 turns on and reaches saturation again, Q_2 is cut off, and the cycle is repeated until all of the stages have been sequentially switched (from saturation to cutoff to subsequent return to saturation). This operation is depicted in Fig. 1b.

For the component values shown, each pulse has a width of 1.74 ms, a rise time of 200 μ s and a fall time of 8 μ s. The rise time, which is particularly slow, is rounded because of the presence of the

IDEAS FOR DESIGN: Submit your Idea for Design describing a new or important circuit or design technique, the clever use of a new component, or a cost-saving design tip to our Ideas for Design editor. If your idea is published, you will receive \$20 and become eligible for an additional \$30 (awarded for the Best of Issue Idea) and the grand prize of \$1000 for the Idea of the Year.

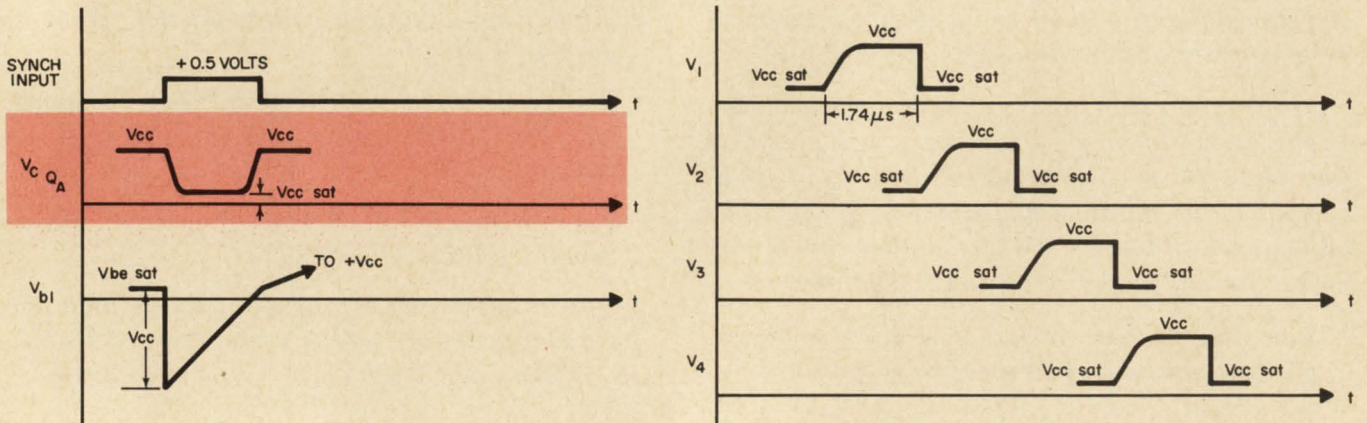
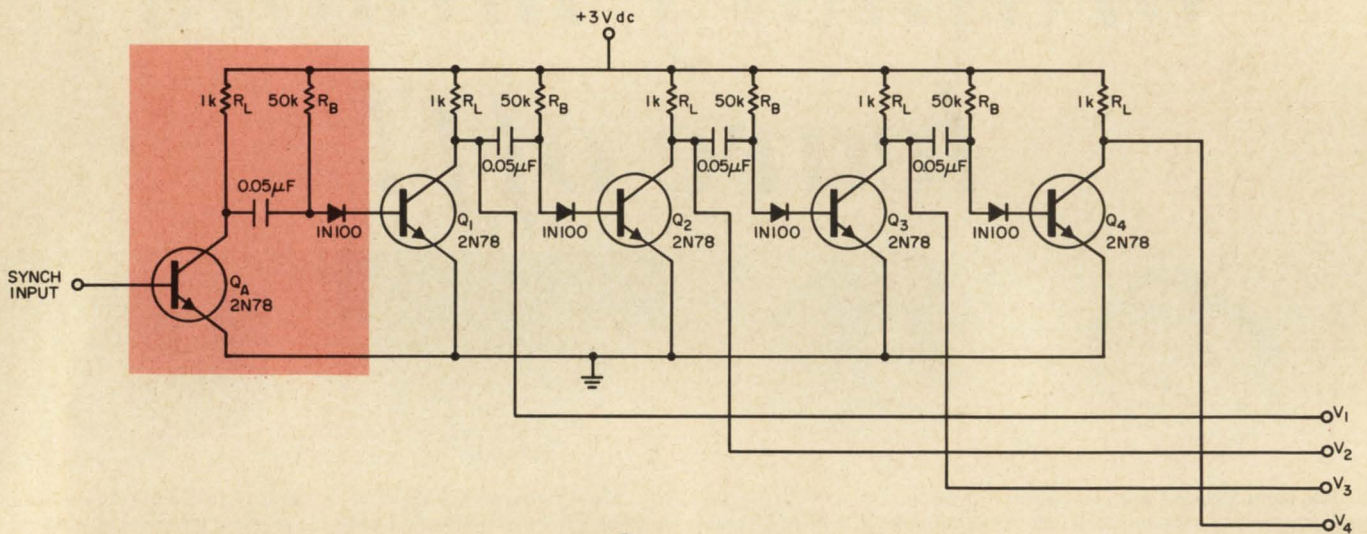

Train of sequential pulses is generated by cascaded series-to-parallel converter (a). Each leg is switched in turn from saturation to cutoff and back when an input synch pulse is applied. Output waveforms (b) depict order of switch.

SELECTED FOR THE MINUTEMAN PROJECT

More than 6 million El-Menco Dipped Mica Capacitors have been used in the Minuteman ground support and control equipment.

After 64,000,000 ACTUAL TEST unit-hours at 85°C with 225% of the rated DC voltage applied, no failures of any type occurred.

The accumulated 64×10^6 test unit-hours without any failures can be used to calculate many different failure rates depending upon the confidence level desired. However, we shall explore the meaning of the results at a 90% confidence level.

Assuming no acceleration factor for either temperature or voltage, we have verified a failure rate of less than 0.004% per 1000 hours. (Actually, there is a temperature effect and it has been found that, with the DC voltage stress remaining constant, the life decreases approximately 50% for every 10°C rise in temperature. There is also a voltage effect such that, with the temperature stress remaining constant, the life is inversely proportional to the 8th power of the applied DC voltage.)

Assuming no temperature acceleration factor and assuming the voltage acceleration exponent is such as to yield an acceleration factor as low as 100, we have nevertheless verified a failure rate of less than 0.00004% per 1000 hours.

Assuming no temperature acceleration factor and assuming the voltage acceleration factor is on the order of 250 (test results are available to confirm this) we have accumulated sufficient unit-hours to verify a failure rate of less than 0.000015% per 1000 hours!

All above failure rates are calculated at a 90% confidence level!

Write for a complete reliability study on your company letterhead.

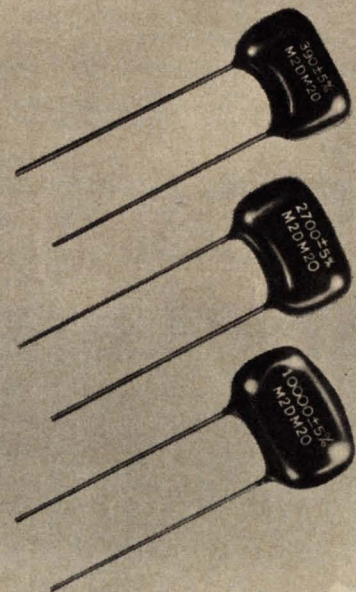

**DIPPED MICA
CAPACITORS
TYPE M2DM**

THE ELECTRO MOTIVE MFG. CO., INC.

MANUFACTURERS OF

El-Menco
Capacitors

WILLIMANTIC, CONNECTICUT

*Dipped Mica • Molded Mica • Silvered Mica Films • Mica Trimmers & Padders
Mylar-Paper Dipped • Paper Dipped • Mylar Dipped • Tubular Paper*

ARCO ELECTRONICS, INC., Community Drive,
Great Neck, L. I., New York
*Exclusive Supplier to Jobbers and Distributors
in the U. S. and Canada*

West Coast Manufacturers Contact:
COLLINS & HYDE CO., 1020 Corporation Way
Palo Alto, California
5380 Whittier Boulevard, Los Angeles, California

If you use Fractional hp MOTORS & CONTROLS

send for this

FREE GUIDE



Shows thousands of items for
"OFF-THE-SHELF" DELIVERY
at Factory Prices

MOTORS

1/2000 to 2 hp—7 to 10,000 rpm. Stock and Custom.
Also Printed DC Motors.

SPEED CONTROLLERS

Solid State, Thyatron, Tach. Generator Feedback,
Mechanical.

GEAR MOTORS

Multi-ratio, Dial-operated.

Also — Clutches, Brakes, Tachometer Speed Indication Sys-
tems, Rectifiers, Transformers, Chokes, Power Supplies.
Dept. 18

BB MOTOR & CONTROL CORP.
96 Spring Street, New York, N. Y. 10012

ON READER-SERVICE CARD CIRCLE 29

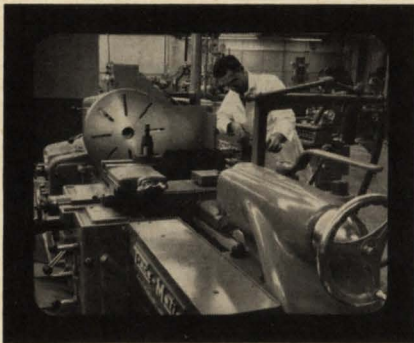

To electronic engineers with a sense of timing:

BENDIX IS ON THE MOVE!

(KANSAS CITY DIV.)

This is a highly opportune moment to send us your résumé. Bendix, prime contractor for the AEC, has enjoyed an enviable, orderly expansion for 16 years, but right now we are entering a unique developmental phase which opens new fields of activity in microminiaturization, microwave and logic circuitry. This situation adds up to a ground-floor opportunity in an already well-established engineering corporation. Let us hear from you promptly so we may spell out more clearly the many professional advantages we can offer you.

Please mail résumé to:

MR. E. C. MCGURREN
Tech. Personnel Rep.
BENDIX CORPORATION
Box 303-CF
Kansas City, Mo. 64141



An Equal Opportunity Employer

ON READER-SERVICE CARD CIRCLE 889

IDEAS FOR DESIGN

charging capacitor coupled to the collector. The 0.5-volt input synch pulse produces output pulse magnitudes of V_{cc} (less the saturation voltage).

Summer B. Marshall, Test Equipment Engineer,
North Adams, Mass. VOTE FOR 110

Tristable multivibrator forms 3-phase generator

A free-running, tristable multivibrator may be designed as an offshoot of the basic bistable multi. It is then used as a 3-phase wave generator.

The circuit (Fig. 1a), as well as extensions of the same idea, exhibits some unusual characteristics and offers many novel variations. The base and collector waveforms of the circuit are similar to that of a conventional free-running bistable multivibrator. However, there is one exception: there is a 120° phase relationship between adjacent collectors, instead of 180° (Fig. 1b).

Note that this circuit and all of the variations tried are extremely oscillatory. At lower collector supply voltages, they may oscillate at a second, much higher frequency with a smaller amplitude mode. The high-frequency mode can be damped out by shunting the collector-to-emitter junction of any one transistor with a small capacitor. The additional shunting capacitance does not appear to affect the oscillation frequency, but it tends to decrease the collector voltage's risetime.

The one cycle period is approximately:

$$T = 0.7 R_i C, \quad (1)$$

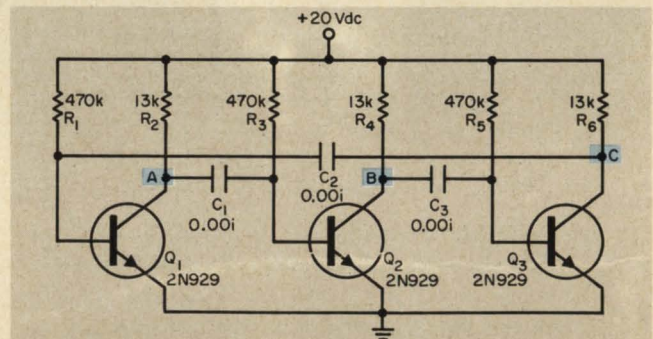

a

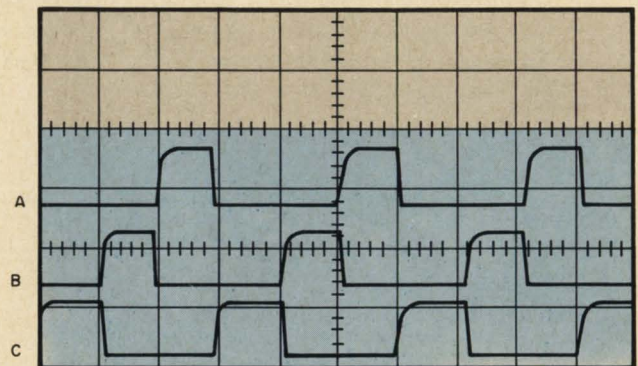

b

Tristable multivibrator exhibits 120° phasing relationships, thus making it a 3-phase wave generator (a). The outputs (b) may be filtered to produce sine waves.

Helipot's side-adjust
Helitrim® cermet
trimmer—world's
smallest—costs as little
as \$1.50 in quantity.



Helipot's side-adjust
Helitrim® cermet
trimmer—world's
smallest—costs as little
as \$1.50 in quantity.



Helipot's side-adjust
Helitrim® cermet
trimmer—world's
smallest—costs as little
as \$1.50 in quantity.

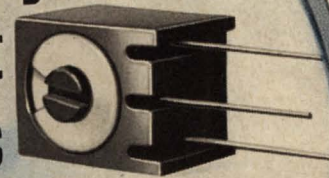

Helipot's side-adjust
Helitrim® cermet
trimmer—world's
smallest—costs as little
as \$1.50 in quantity.



The Model 62PA side-adjust is a new easy-access cermet trimmer with these quality features: virtually infinite resolution; excellent high frequency characteristics; and standard resistance from 10 ohms to 1 megohm. Its rugged cermet resistance element gives you long, trouble-free life and freedom from sudden failure. Inside its plastic case is a sealed metal housing identical to the popular 1/4" top-adjust Model 62P.

Focus in on delivery advantages, too . . . immediate stock availability. Call your Helipot sales rep for full specs.

Beckman®

INSTRUMENTS, INC.
HELIPOT DIVISION
FULLERTON, CALIFORNIA • 92634

INTERNATIONAL SUBSIDIARIES: GENEVA; MUNICH; GLENROTHES, SCOTLAND; TOKYO; PARIS; CAPETOWN; LONDON

Speed Inquiry to Advertiser via Collect Night Letter
ON READER-SERVICE CARD CIRCLE 30

Telrex

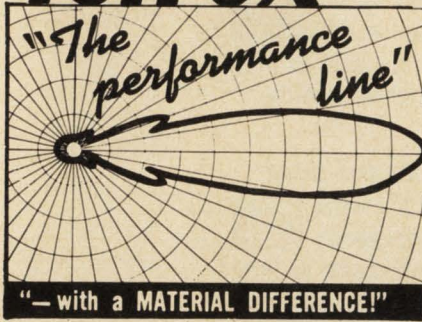

The Choice of the Discriminating Communication Engineer . . . the Man who Never Settles for Anything Less than THE-VERY-BEST!

telrex "BEAMED-POWER" ANTENNAS and ANTENNA SYSTEMS

Provide optimum performance and reliability per element, per dollar. Antennas from 500 Kc to 1500 Mc. Free PL88 condensed data and pricing catalog, describes military and commercial antennas, systems, accessories, Towers, Masts, Rotators, "Baluns" and transmission line data.



Asbury Park 41, New Jersey, U.S.A.
ON READER-SERVICE CARD CIRCLE 31

NOW AVAILABLE OFF THE SHELF
MODEL 118A

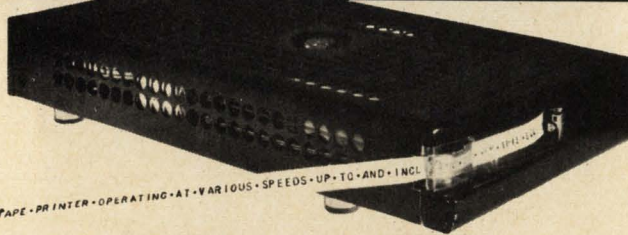

TAPE-PRINTER-OPERATING-AT-VARIOUS-SPEEDS-UP-TO-AND-INCL

MICRO-MINIATURIZED FULL 64-CHARACTER TAPE PRINTER

Thoroughly proved in commercial, telephone and military applications, Model 118A offers advanced capabilities for air-borne and ground communications, and as a "read-out" device for computers. Weight: under 4 lbs. 5" wide by 10" long by 2" high. Speed infinitely variable up to 12½ characters per second. Self-contained 3 inch roll of 5/16" impact-sensitive paper tape. Any 64-character alphabet can be furnished. For details on low cost, write —

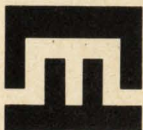

MITE Corporation
DEPT. ED 446 BLAKE STREET, NEW HAVEN, CONNECTICUT

ON READER-SERVICE CARD CIRCLE 32

IDEAS FOR DESIGN

where R_b is the resistance in the base circuit.

One variation of this circuit has the base resistors and the capacitor connected to the same collector. In the high-frequency oscillation mode, the collector waveforms are almost sinusoidal with a 120° phasing. Either by filtering or further circuit refinements, the circuit can be used as an inherent three-phase sine-wave generator. In an identical fashion, free-running quadrastable and quintastable multivibrators can be constructed. The quadrastable circuit has a 90° phase relationship between collector waveforms; the quintastable circuit has 72° phasing between collectors.

These two circuits have a greater tendency to oscillate in the high-frequency mode and are more difficult to work with. Oscilloscope probe capacitance tends to upset the mode stability.

Charles Alvine, Project Engineer, University of California at Los Angeles, Los Angeles, Calif.

VOTE FOR 111

Alarm circuit replaces large non-polar tantalum capacitor

A small, inexpensive electrolytic capacitor combined with a transistor can effectively replace

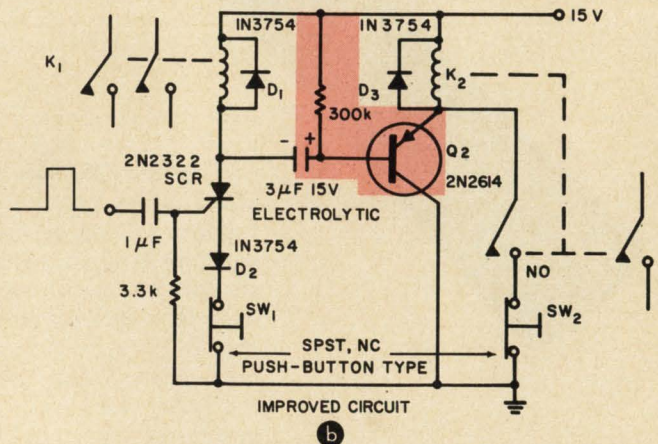
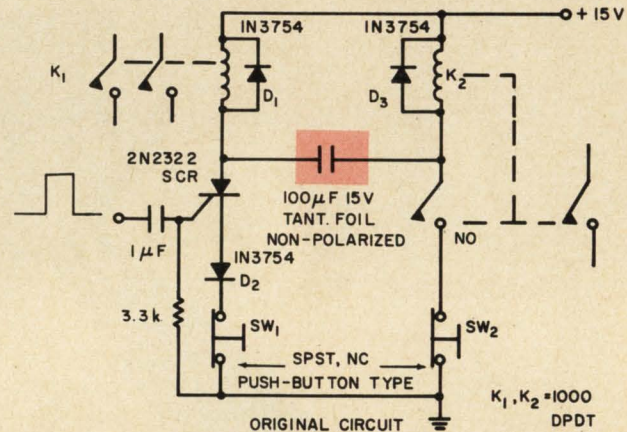

Alarm circuit uses non-polarized tantalum capacitor to discharge either of two relays separately (a). Small electrolytic-capacitor-transistor combination serves as a smaller, inexpensive substitute for the non-polarized type (b).

IRC

PRECISION POTENTIOMETERS

Choose from 375 models . . . for every application or price

INFINITE RESOLUTION METAL GLAZE TRIMMERS



Sealed, shockproof rectangular type 450. $\frac{1}{2}$ watt @ 70°C, 100 ohms to 1 meg. 10 and 20% tolerances. 2 pin arrangements, or leads.



$\frac{1}{2}$ " square type 251 has anti-backlash drive. $\frac{3}{4}$ watt @ 70°C, 100 ohms to 1 meg. 5, 10 and 20% tolerances. Available in 144 models.

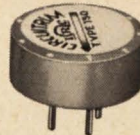

Economical $\frac{1}{2}$ " round unit offers speedy adjustment. $\frac{3}{4}$ watt @ 70°C, 100 ohms to 1 meg. 5, 10 and 20% tolerances. Type 150 in 24 different models.



$\frac{5}{16}$ " cube trimmer saves space. .30 watt @ 70°C, 50 ohms to 0.5 meg. 10 and 20% tolerances. Top and side adjustment or panel mount. Type 350.

WIREWOUND PRECISION TRIMMERS



$\frac{1}{2}$ " square type in MIL-R-27208 or commercial styles. Shock-resistant. 1 watt @ 60°C, 10 ohms to 50K, 5% tolerance. Type 201 in 144 models.

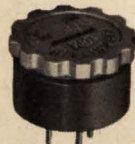

Popular $\frac{1}{2}$ " round trimmer with positive stops for fast response. 1 watt @ 50°C, 10 ohms to 50K, 5% tolerance. Type 100 in 24 termination and adjustment variations.



Microminiature $\frac{5}{16}$ " cube trimmer, TO-5 size, is ideal for miniaturization. .60 watt @ 60°C, 50 ohms to 20K. Top and side adjustment or panel mount. Type 300.



Precision rotary trimmers in $\frac{1}{2}$ ", $\frac{3}{4}$ " and $1\frac{1}{2}$ " dia., 2 to $3\frac{1}{2}$ watts @ 40°C. 10 ohms to 100K, $\pm 5\%$ tolerance. Meets environmental requirements of MIL-R-27208A.

PRECISION MULTI-TURN POTENTIOMETERS

HERMETICALLY SEALED TYPE



$\frac{3}{4}$ " dia., 5 and 10 turns. Dry nitrogen filled. 2 and 3 watts @ 40°C, 25 ohms to 250K. 5% tolerance, 0.5% linearity. Series HS-750.

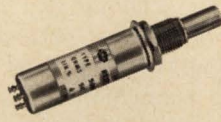

$\frac{1}{2}$ " dia., 5 and 10 turns. Shock and moisture-resistant. 1 and 1.5 watts @ 40°C, 15 ohms to 150K. 0.1% stability. Series 5000.



$\frac{3}{4}$ " dia., 5 and 10 turn models. 2 and 3 watts @ 40°C, 25 ohms to 250K. 5% tolerance, 0.5% linearity. Series 7500.

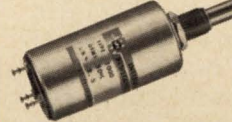

1" dia., 5 and 10 turns. From 1.5 to 4 watts @ 40°C, 50 ohms to 500K. 5% tolerance, 0.5% linearity. Series 1000.



1" dia., 15 and 20 turns. 4 and 5 watts @ 40°C, 750 ohms to 600K. 5% tolerance, 0.2% linearity. Series 1220.

METAL CASE TYPES

MOISTURE SEALED TYPES



$\frac{3}{4}$ " and 1" dia., 5 and 10 turns. 2 to 4 watts @ 40°C, 25 ohms to 500K. 5% tolerance, 0.5% linearity. Also with O-ring panel seal. Series H-750MS.

PLASTIC CASE TYPES

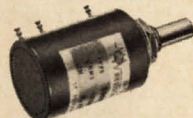

Popular $\frac{7}{8}$ " dia., 10-turn unit is ruggedly built. 3 watts @ 40°C, 25 ohms to 250K. 3% tolerance, 0.2% linearity. $\frac{1}{4}$ " or $\frac{1}{8}$ " dia., shaft. Series 8000.

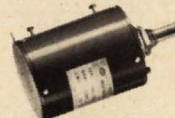

$1\frac{1}{2}$ " dia., 3, 5 and 10 turns. Designed for heavy-duty industrial use. 500 ohms to 600K. 3% tolerance, 0.25% or 0.1% linearity. Series HD-150.

LOW COST COMMERCIAL TYPE



$\frac{3}{4}$ " dia., 10-turn unit also saves space. Rated at 2 watts @ 40°C, 100 ohms to 100K, 5% tolerance. Screwdriver slotted shaft. Series 7300.

All IRC precision potentiometers are application-proved in the field over years of rugged use. They are continually tested for compliance to specifications. Current

documented test data is available on request. For complete technical specifications, prices and samples, write: IRC, Inc., 401 North Broad St., Phila., Pa. 19108.



Speed Inquiry to Advertiser via Collect Night Letter
ON READER-SERVICE CARD CIRCLE 33

IDEAS FOR DESIGN

a costly and large non-polarized tantalum capacitor in an alarm system, wherein the charging of the capacitor is bidirectional.

In the original circuit (Fig. 1a), two relays were simultaneously energized by a single positive input pulse. A further requirement stipulated that either relay could be separately discharged. Since either relay could be deenergized first, a non-polarized capacitor was needed.

The size of the capacitor was dictated by the need to transfer a sufficient amount of energy to the second relay to close it and keep it closed by its

own contacts. Note that the tantalum type is superior to large electrolytics because the former has a lower equivalent series resistance. This permits it to deliver maximum energy for the driving of K_2 .

The improved circuit (Fig. 1b) uses a pnp transistor and a small, common electrolytic to achieve the same functioning. Diode D_2 is used to create a back-bias on the gate of the SCR, thus providing a high input impedance.

Don Aufderheide, Engineer, RMC Instrument Division, Indianapolis, Ind.

VOTE FOR 112

Fast, free-running pulses generated by tunnel diode

A tunnel-diode switching network, keyed by a latch-drive integrator, forms a fast-start, free-running pulse generator. Output pulses appear 20 nsec after receipt of the start command and is 60 μ s. The system may be used as a clock or gate featured an adjustable spread between pulses of 3-for logic and timing operations.

In specific instances, it is desirable, or even necessary, to generate a number of pulses having a fixed and concise period. The use of some form of free-running clock (such as a multivibrator or blocking oscillator) or gating the desired number of pulses at precisely the proper time results in a charge build-up for complex logic and timing.

A relatively simple circuit to accomplish the above is shown in the illustration. The maximum delay recorded from the start command until the first pulse is produced is 20 ns and is chiefly limited by the turn-on delay of Q_5 . The latch can be almost any configuration that will supply maximum voltage to Q_1 in 100 ns or less.

Upon command, the latch supplies power to the integrator, Q_1 . At the same time, the command pulse is differentiated and coupled to tunnel diode D_1 , thus switching the diode to its high-voltage

state. D_1 supplies the required voltage gain to switch Q_4 on. When Q_4 turns on, it supplies the base drive to Q_5 . The drive is:

$$I_{b_5} = \alpha I_p - I_v, \quad (1)$$

where α is the common-base current gain of Q_4 and I_p and I_v are the peak and valley currents, respectively, of D_1 . At this time, Q_5 goes into saturation, and a negative pulse is produced at its collector. With base current available to Q_5 , Q_2 saturates and discharges C_2 to $-V_{EE}$. With the charge at point A equal to $-V_{EE}$, C_2 charges toward $+V_{b_1}$ when Q_2 turns off. As the potential at A rises toward $+V_{b_1}$, Q_3 conducts until βI_{b_3} reaches I_p . At this time, D_1 tunnels to its high-voltage state and the process is repeated.

For the component values shown, the typical pulse-output width is 100 nsec and the pulse spacing is 3-60 μ s. By operating D_1 as a monopulsor, the error between pulses is reduced. A more positive action as well as reduced power-handling requirements for Q_2 and Q_1 also remain.

C. A. Budde, member of technical staff, Electronic Specialties, Inc., Los Angeles, Calif.

VOTE FOR 113

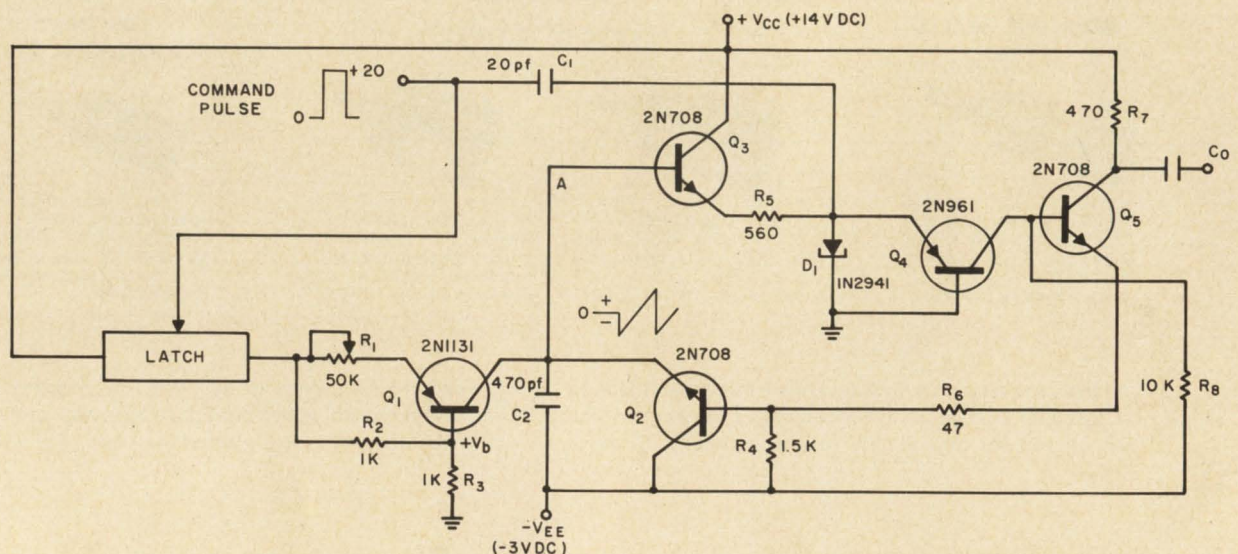

Tunnel diode switching network and latch-driven integrator generate a fast, free-running pulse train.

ANOTHER FIRST FROM U.S. COMPONENTS!

NEW REMOVABLE CRIMP-CONTACT

REPC* CONNECTORS THAT MEET

TRI-SERVICE SPECS MIL-C-23353/9

AND MIL-C-23353/10—AVAILABLE NOW!

REPC* A NEW ESTABLISHED RELIABILITY CONCEPT FROM U.S.C.

*REMOVABLE RE-ENTRANCY PRINTED CIRCUIT

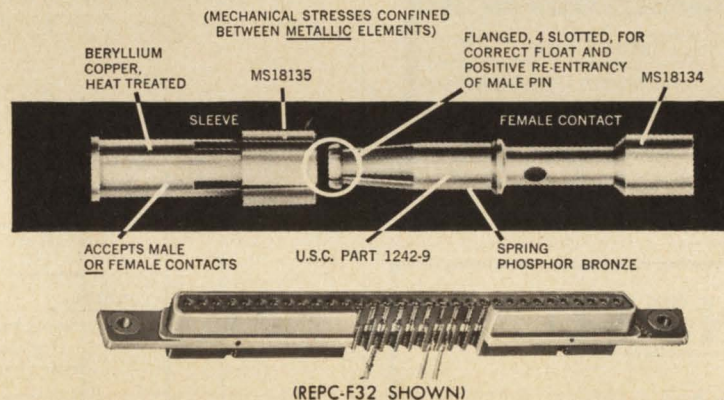

The new U. S. C. REPC concept utilizes the unique REMI design that confines mechanical stresses between metallic elements only. Five years of use in millions of REMI connectors is *proof* of its established reliability! This outstanding U. S. C. patented ** contact sleeve design, is now specified as MS18135 (per MIL-C-23216) along with U. S. C. Part No. 1242-9 (female crimp-barrel socket contact MS18134 per MIL-C-23216), on both new military specification sheets.

Why settle for less than the best removable crimp-contact connector for *your* equipment? Write for the new REPC brochure or phone today for prompt assistance regarding your standard or special connector needs.

**U. S. Pat. 2,979,689 & FIVE INTERNATIONAL PATENTS.

REPC-F () SERIES MEETS MIL-C-23353/9

CONTACT CENTER-TO-CENTER .156 INCH.

CONTACTS: Part 1242-9 meet MS18134 per latest MIL-C-23216 and are ordered separately. Type is crimp, removable, closed-entry.

NO. OF CONTACTS: 7, 11, 15, 19, 23 (in Military Spec.) and 32 Contact.

TEST VOLTAGE: 1800 V.R.M.S. at Sea Level.

CURRENT RATING: 7.5 Amps.

MATING CONNECTORS: Any numerical counterpart in UPCC-M () A, B, or C Series.

CONNECTORS WITH 7 THRU 23 CONTACTS MEET APPLICABLE PROVISIONS OF NAS713 AND NAS714. VARIOUS POLARIZATIONS OPTIONAL.

FULL LINE OF CRIMPING TOOLS AVAILABLE — MIL-T-22520A CLASS I, MS3191 (ALL) and CLASS II TOOLS. REMOVAL TOOL RT1256 MEETS MS18137 PER LATEST MIL-C-23216.

© U. S. COMPONENTS, Inc. 1965.

REPC-SGF () SERIES MEETS MIL-C-23353/10

CONTACT CENTER-TO-CENTER .100 INCH.

CONTACTS: Part 1242-9 meets MS18134 per latest MIL-C-23216 and are ordered separately. Type is crimp, removable, closed-entry.

NO. OF CONTACTS: 11, 17, 23, 29, 35.

TEST VOLTAGE: 1800 V.R.M.S. at Sea Level.

CURRENT RATING: 7.5 Amps.

MATING CONNECTORS: Any numerical counterpart in UPCC-SGM () A, B, or C Series.

THESE CONNECTORS MEET ALL APPLICABLE PROVISIONS OF NAS713. VARIOUS POLARIZATIONS OPTIONAL.



U. S. COMPONENTS, INC.

1320 ZEREGA AVENUE, BRONX, N. Y. 10462

TEL. 212 TA 4-1600

Cable Address: COMPONENTS NYK.

TELEX: 01-2411TWX—212-824-6990

NEW LOW COST RECTANGULAR SWITCH-LITES OFFER 5 OPTIONS, 14 LENS COLORS



SPST normally open switch and indicator; two normally open switches, DPST without indicator; or indicator only are available in this .870" x 1" x 1 1/16" deep module. Choice of front or rear replaceable lamps and variety of lens colors complete the options. Lenses may be hot stamped. TEC-LITE RSL Series can be mounted individually or abutting in vertical or horizontal rows. Lamps are incandescent or neon and the 500,000 operation switch is rated at 100 ma at 120 VAC, non-inductive. Push button force is 8 ounces, travel .090". Pin terminal diameter is .041" to accept collect connectors.

Price: \$1.00 each without lamp in 100-499 quantities.

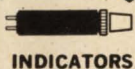

INDICATORS



DATA-PANEL

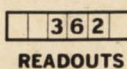

READOUTS

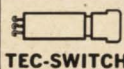

TEC-SWITCH

Transistor Electronics Corporation

Box 6191 Minneapolis, Minnesota 55424 Phone (612) 941-1100

ON READER-SERVICE CARD CIRCLE 35

WANTED

By major Aerospace
Company in Los Angeles area

CREATIVE ELECTRONIC CIRCUIT DESIGNERS

Our absolutely unique microelectronic circuit capability has entered the applications and production stage for both military/aerospace and commercial consumption.

Circuit designers with solid-state and/or integrated circuit experience are needed in the build-up required to meet our demands. Backgrounds in commercial design, in RF and video, in communications and telemetry are especially sought.

u.s. citizenship required

Investigate today by circling
Reader-service #895

an equal opportunity employer

ON READER-SERVICE CARD CIRCLE 895

IDEAS FOR DESIGN

Coin operates SCR-type electronic dispenser

Here is a handy, electronic coin-operated dispensing system that should be of interest to gadgeteers. Although it uses a nickel to initiate the dispensing action, the techniques involved lend themselves to operation with other coins.

The system is inexpensively constructed from ordinary lab components. It is attached to a coffee pot and permits one coffee cup to be filled when a nickel is deposited.

The circuit (see illustration) operates as follows. A nickel, when deposited in the slot, causes a momentary connection to be made between two contacts. Other coins are either too large to fit the slot or too small to bridge the gap between the contacts.

The coin switch momentarily closes and allows current to flow through R_1 into the SCR gate. SCR_1 turns ON and current then passes through C_2 into the gate of SCR_2 and R_2 . This establishes

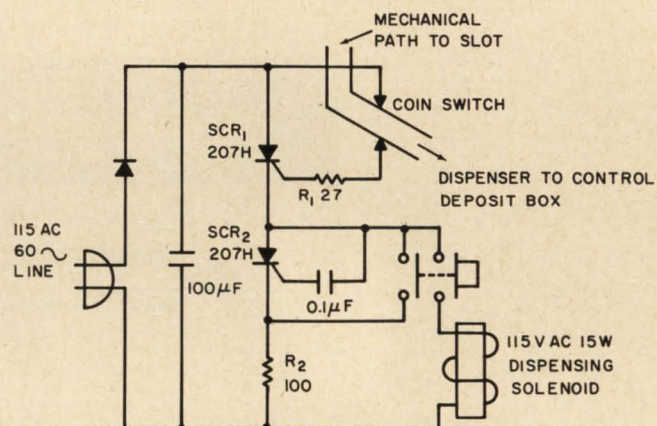

Coin-operated dispensing system is easily and inexpensively constructed with lab components.

a continuous current flow which keeps the SCR on. When the dispense button or switch is pressed, current flows into the dispensing solenoid which operates the coffee pot's valve. This action also shorts SCR_2 , thus returning it to the OFF state. When the dispense button is released, current ceases to flow and SCR_1 is returned to its OFF state. To repeat the cycle, another coin must be used.

Edwin R. DeLoach, Space Systems Engineer, Chrysler Corp., New Orleans, La.

VOTE FOR 114

IFD Winner for Oct. 11, 1965

Allan F. Pacela, Senior Project Engineer, Beckman Instruments, Inc., Fullerton, Calif.

His idea "Inexpensive oscillator is temperature stable" has been voted the \$50.00 Most Valuable of Issue Award.

Cast Your Vote for the Best Idea in this Issue.

REGULATED DC

POWER SUPPLIES



**VOLTAGE
PROBLEM
SOLVERS**

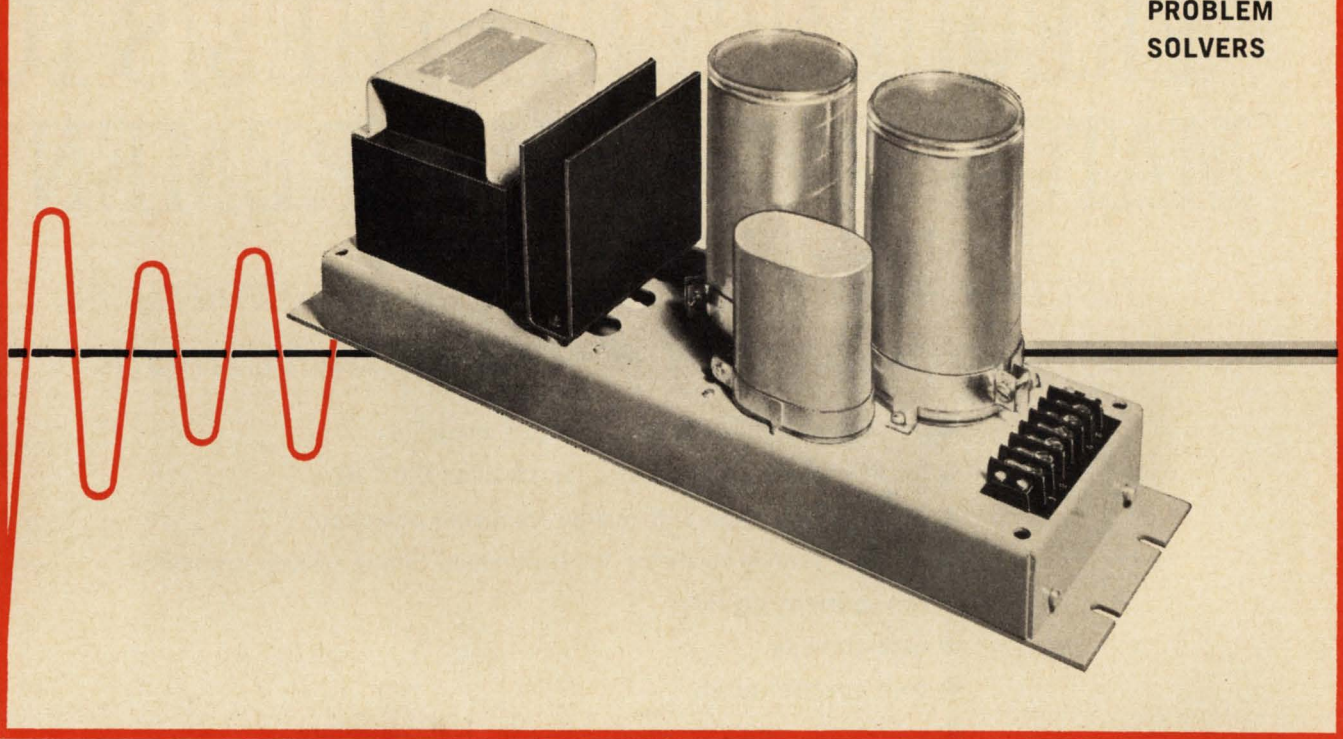

Regulate output voltage to within $\pm 1\%$

D-c output voltage will remain accurate despite line fluctuations when you install General Electric d-c power supplies in your electronic equipment.

For example, within an a-c input range of 97 to 130 volts, the d-c output varies no more than ± 1 percent when all other variables remain constant. The table shows the close tolerance maintained by G-E power supplies.

Variable	Excursion	DC Output Voltage Change
Line Voltage	97-130 volts	2%
Load	0-100% rated load	3%
Ambient Temp	40C temp change	1%

Regulation—2.5% at full to half load

Whatever your application—computers, process control, or electronic measuring devices—chances are there's a General Electric regulated d-c power supply designed to meet your requirements. Units are available for either 50- or 60-cycle power sources. Many models are available for immediate shipment from factory stock.

Give your equipment the benefits of using a power supply backed by experience and technological research—General Electric d-c power supplies. For complete descriptive and application data, write to General Electric Co., Section 413-28, Schenectady, N. Y. 12305.

Specify General Electric for all your voltage regulation and control needs

volt-pac[®] VARIABLE TRANSFORMERS

Get continuously adjustable voltage levels with these variable transformers. Three types of Volt-Pac transformers are available—manual, motor operated, and automatic. Write for publication GEA-8110.

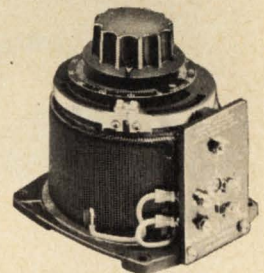

Stabiltron[®] AC VOLTAGE STABILIZERS

Maintain precise voltage output despite wide fluctuations of line voltage, frequency, load, load power factor and ambient temperature. Stabiltron is available in 0.5, 1, 2, 5, and 10 KVA ratings. Write for publication GEA-7358.

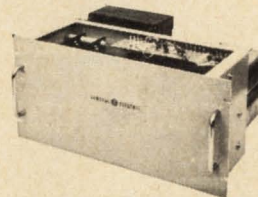

Progress Is Our Most Important Product

GENERAL  ELECTRIC

ON READER-SERVICE CARD CIRCLE 36

FAST-SWITCHING FREQUENCY SYNTHESIS TO MATCH YOUR REQUIREMENT:

*JUST CHOOSE FROM THREE HEWLETT-PACKARD SYNTHESIZERS,
DC TO 50 MHz, WITH THESE PERFORMANCE CHARACTERISTICS:*

- 20 μ sec switching time, the fastest available
- small frequency increments, as small as 0.01 Hz
- digital pushbutton and remote frequency selection
- internal search oscillator for continuous tuning, sweep capability
- low spurious signals
- high stability
- high spectral purity
- solid-state, modular construction for high reliability

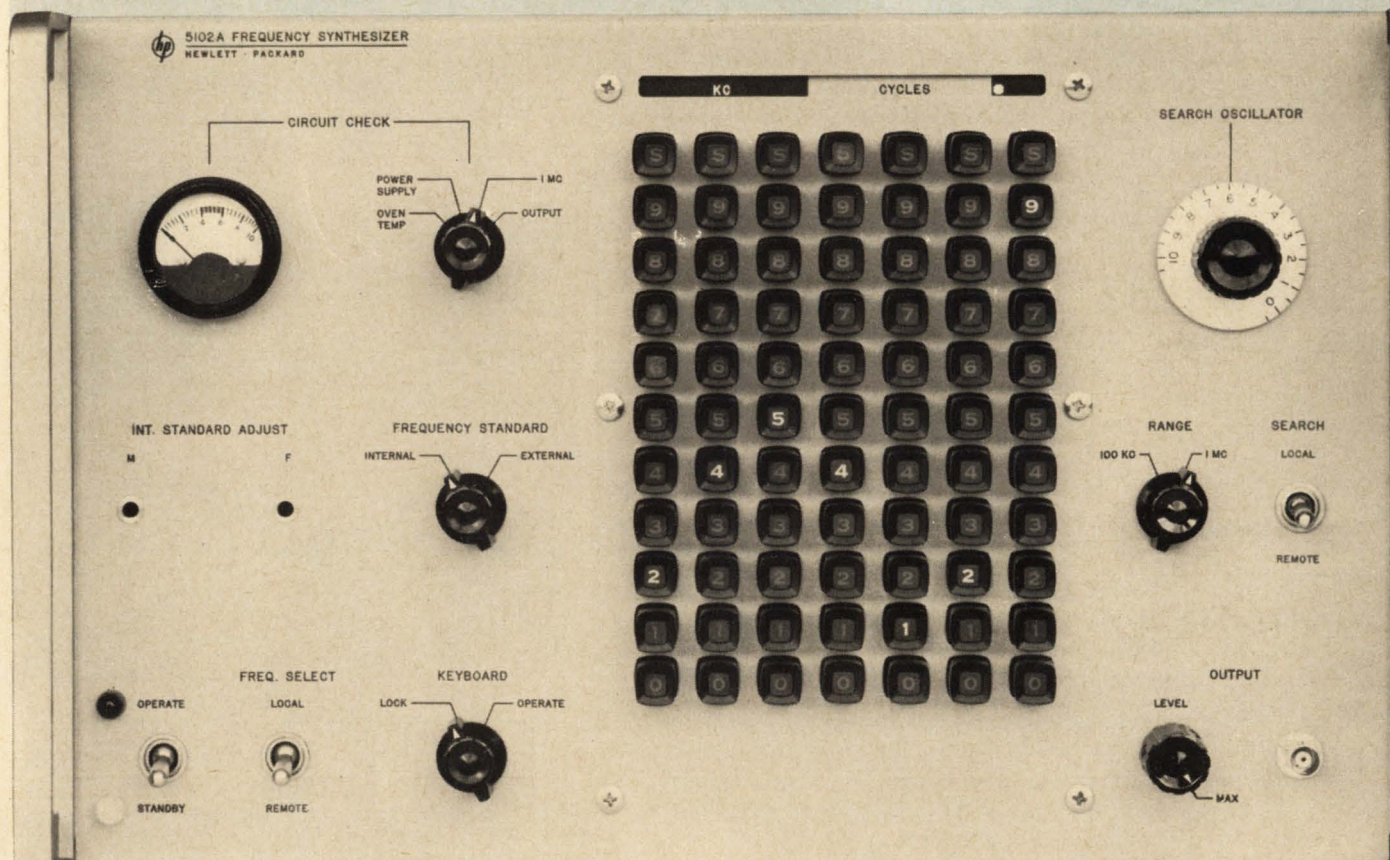

Your selection from three Hewlett-Packard frequency synthesizers gives you the broadest source of spectrally pure, stable test signals especially useful for their fast switching capability, digital pushbutton and remote programmability with random access, as well as superior signal-to-noise performance.

Signals are derived from a stable (3×10^{-9} / 24 hrs.) internal frequency standard, or you can use an external 1 MHz or 5 MHz standard. Each instrument employs a direct synthesizing technique, using arithmetic operations instead of phase-locked techniques. The stability of the source standard is preserved, and unknown variations caused by loss of phase lock are eliminated. Any significant column may be continuously "searched" over a discrete range.

Relate the brief specifications of the three hp synthesizers to your specific application, then call your hp field engineer for a demonstration or write for complete specs to Hewlett-Packard, Palo Alto, California 94304, Tel. (415) 326-7000; Europe: 54 Route des Acacias, Geneva.



Data subject to change without notice. Prices f.o.b. factory.

5100A/5110A Synthesizer—DC to 50 MHz (mc) selectable in steps as small as 0.01 Hz. The 511CA Driver generates 22 spectrally pure signals from the standard; these signals are fed to the 5100A Synthesizer, with arithmetic operations used to synthesize the variable output. Spurious signals 90 db down. Output 1 v rms ± 1 db, 100 kHz to 50 MHz; 1 v rms +2 db, -4 db, 50 Hz to 100 kHz. Price: 5100A, \$10,250; 5110A, \$5000.

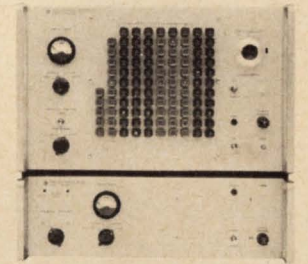

5102A Synthesizer—Dual-range, dc to 100 kHz (kc) with increments as small as 0.01 Hz (cps) and dc to 1 MHz (increments as small as 0.1 Hz). Spurious signals 90 db down (70 db down in 1 MHz range). Output 300 mv to 1 v rms; rear-panel auxiliary outputs include a dc to 1 MHz + 30 MHz signal. Price \$6500.

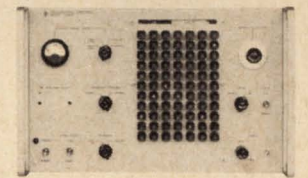

5103A Synthesizer—Dual-range, dc to 1 MHz (mc) increments as small as 0.1 Hz (cps) and dc to 10 MHz (increments as small as 1 Hz). Spurious signals 70 db down (50 db down in 10 MHz range). Output 300 mv to 1 v rms; rear-panel auxiliary outputs include a dc to 1 MHz + 30 MHz signal. Price \$7100.

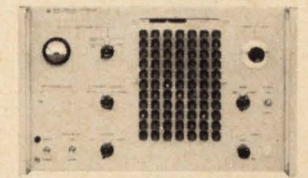

The outstanding performance of hp synthesizers has opened the door for solutions to many unusual problems. A special team of engineers assigned to synthesizer applications is at your service. Also available: The 10514A Double-Balanced Mixer, which extracts the sum or difference of two input frequencies with high efficiency, low intermodulation, input 200 kHz (kc) to 500 MHz (mc), output dc to 500 MHz; price \$250. The 10515A Frequency Doubler, which extends the usable frequency range of the synthesizers, input 500 kHz to 500 MHz, output 1 MHz to 1 GHz; price \$120.

ON READER-SERVICE CARD CIRCLE 37

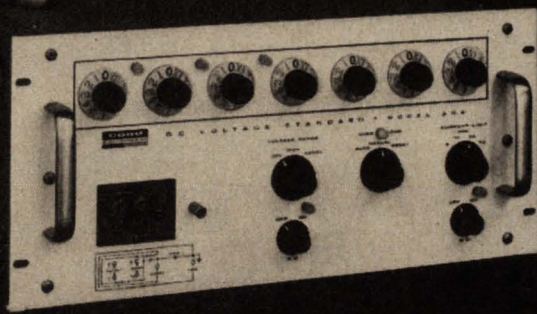

Meet the DC voltage standard with:

STABILITY WITHIN 15 PPM

... for 7 days, 25 ppm for 6 months.

Recorded stability history available representing
1344 hours of data logger time.

0.003% ACCURACY

... ensured by temperature-controlled precision
Zener reference.

IMMEDIATE DELIVERY

... the COHU Model 304 is off-the-shelf ... hundreds of units
already in use ... like the entire family of
COHU DC voltage standards.

... and voltages from 0 to 1222.2221 in 3 ranges;
steps as small as 1 μ v.

COHU
ELECTRONICS, INC.
SAN DIEGO, CALIFORNIA

Box 623
San Diego, Calif. 92112
Phone 714-277-6700

ON READER-SERVICE CARD CIRCLE 38

ED Products

Millimeter-wave switch operates in 2.5 ms PAGE 96

Analog desk-top computer designed for economy PAGE 106

Photodiode and transistor read cards and tape PAGE 114

New Literature PAGE 140

Application Notes PAGE 146

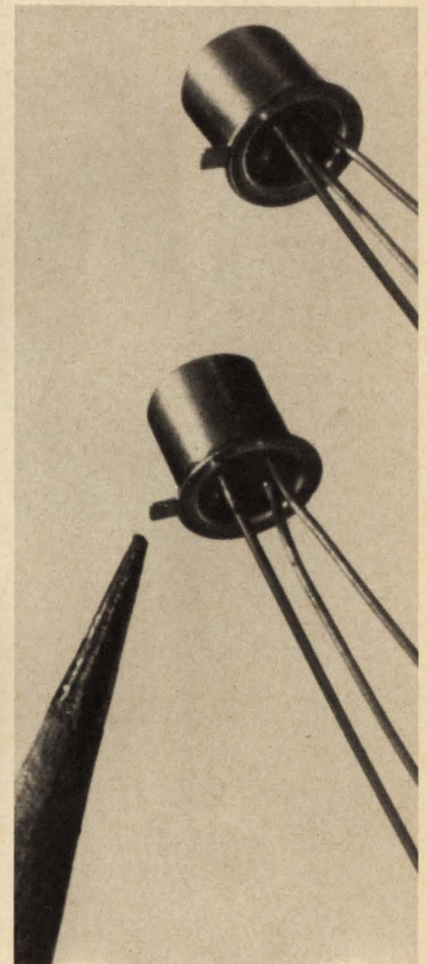
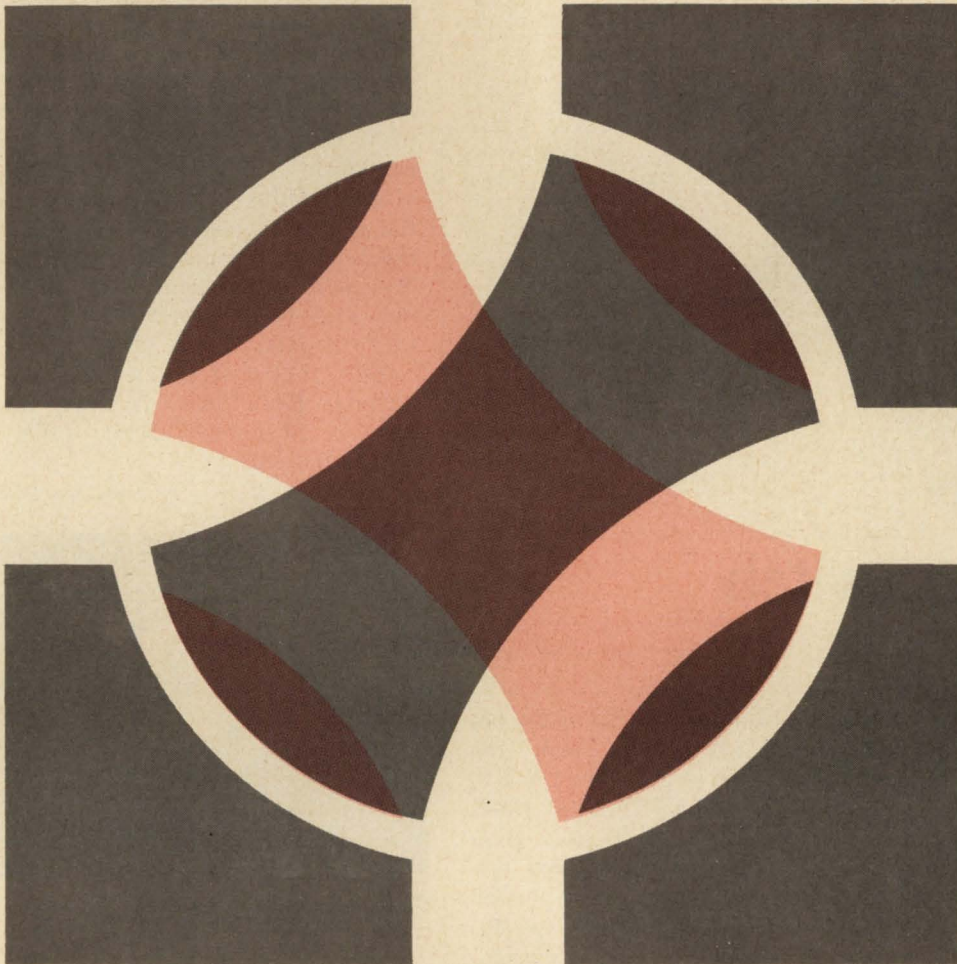

"Jumping Bean" switches millimeter waves in 2.5 ms . . . 96

4-layer diode now integrated . . . 114

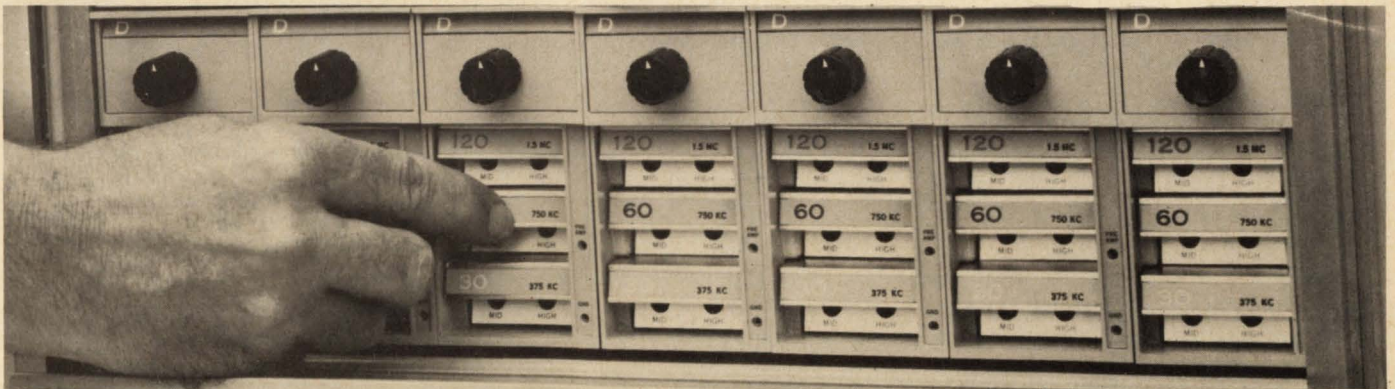

Instrumentation recorder offers plug-in flexibility . . . 106

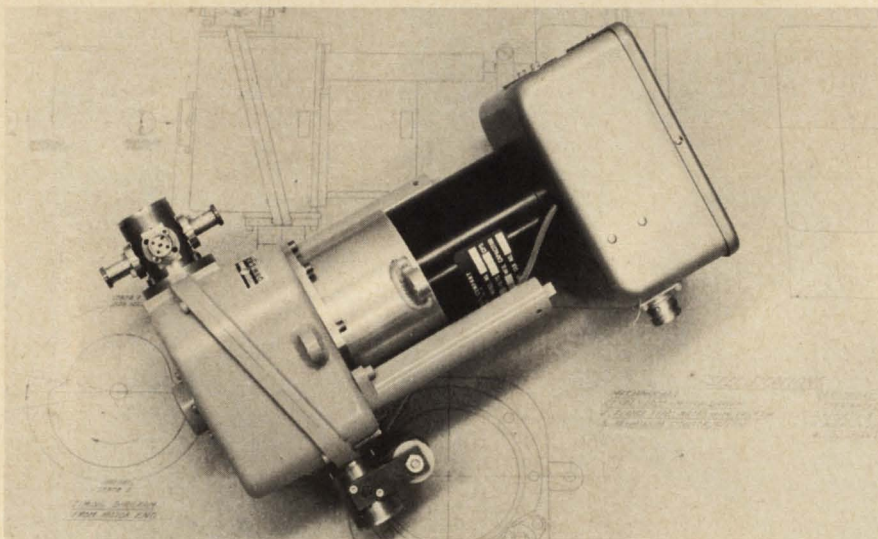
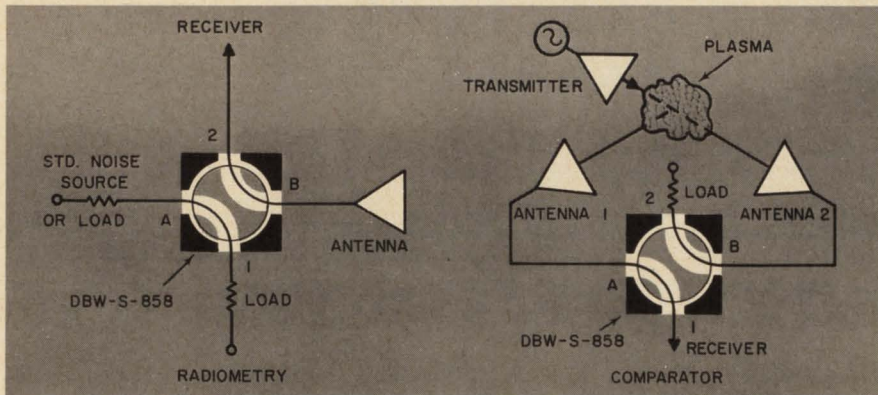

Millimeter wave switch operates in 2.5 ms

Called a "jumping bean" switch due to its continuous action, the DBW-S-858 is particularly applicable to radiometry for alternate receiver signal and source calibration. It is said to reduce signal errors that are caused by drift in receiver calibration. Other applications include use in interferometer circuits to compare samples from alternate sources or in boresight applications where a high degree of accuracy can be achieved. Two typical systems are diagramed in the sketch above.

The switch, for 90.0 to 140.0 GHz applications, switches continuously from one position to another in less than 2.5 ms and it remains in each position above 25 ms.

Designed for WRO8 waveguide, the unit employs a sliding, rather than a rotating, cylinder into which two waveguide paths are machined in each of two positions. A comple-

mentary cam is employed as the positioning mechanism and the switching time in positions 1 or 2 is controlled by the rise and fall times designed into the cams as well as the relative speed of the drive meters. One cam positions the switch cylinder, the other positions the magnetic pickup, and, being complementary, vibration is reduced to a minimum. A centrifugal clutch which engages just prior to top speed takes maximum advantage of meter running torque.

Additional specifications: Isolation greater than 35 dB; vswr less than 1.25:1 and insertion loss less than 1.0 dB.

P&A: \$6500; 60 days. Datapulse Inc., DeMornay-Bonardi Div., 780 South Arroyo Pkwy., Pasadena, Calif. Phone: (213) 681-7416. TWX: (910) 588-3282.

Circle No. 251

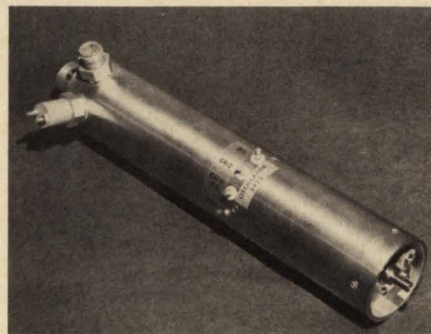

Tunable oscillator

The Model 2423 triode oscillator provides a high power signal-source that is continuously tunable over the 2 to 4.0 GHz frequency range. It uses a triode mounted in a multi-axial cavity. Average power out is 1.5 watts and minimum is 1.0. Tuning resolution is 40 kHz or better with overall residual FM less than 10 kHz. Varactor element incremental frequency control is provided over the entire octave band with a tuning range of ± 0.4 MHz at 2.0 GHz to ± 0.8 MHz at 4.0 GHz.

P&A: \$1750; 4 weeks. Scientific-Atlanta, Box 13654, Atlanta, Ga. Phone: (404) 938-2930. TWX: (801) 766-4912.

Circle No. 252

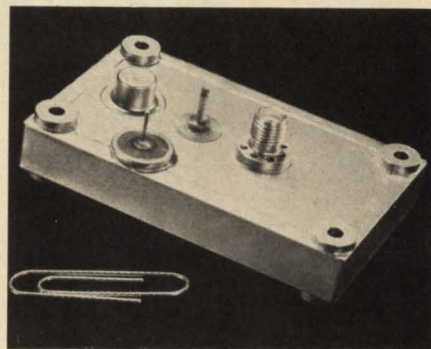

Triode oscillator

The model GSJ-1001 stripline triode oscillator is a novel concept in oscillator design that offers the conventional triode oscillator electrical characteristics in a simple package that is both rugged and light weight. Grid pulsed power is over 0.8 kW at a frequency of 2.25 GHz. The volume of the oscillator package is 1.5 cubic inches excluding projections, and unit weight is 3 ounces.

Terra Corp., 505 Wyoming Blvd. N.E., Albuquerque, N.M. Phone: (505) 255-0157.

Circle No. 253

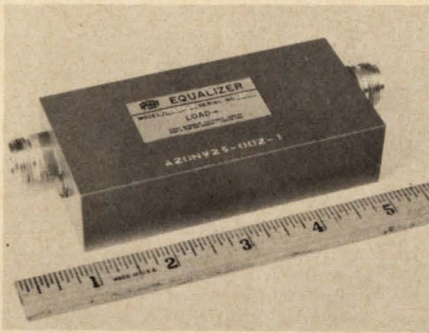

Wideband equalizer

Equalizer D14S2-2 is a passive power leveler for wideband use. Giving a constant power output with frequency, the unit eliminates the need for an APC loop or other similar active component.

Frequency range is 2.5-4 GHz, and equalization value is ± 1 dB.

Sperry Microwave Electronics, P.O. Box 1828, Clearwater, Fla. Phone: (813) 855-3311. TWX: (813) 855-4505.

Circle No. 254

Coax hybrid coupler

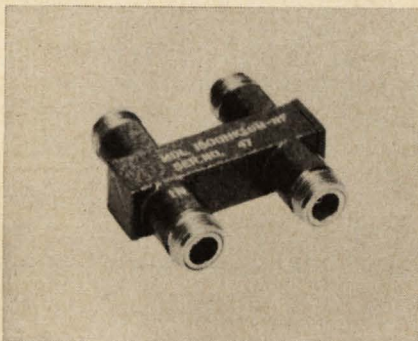

A coaxial hybrid coupler weighing less than four ounces, and operating over the frequency range 1000-2000 MHz has been designated model 1500HK?6M-NF.

This three dB unit features a typical vswr of 1.15 max, and insertion loss of 0.10. Directivity is 25 dB minimum. Both outputs are side-by-side, and all ports are in the same plane, making these units useful in sub-systems, such as mixers, duplexers, phase shifters, and power dividers.

Eight other models cover the frequency range 60-4000 MHz.

Microwave Development Laboratories, Inc., 87 Crescent Rd., Needham Hts., Mass. Phone: (617) 449-0700.

Circle No. 255

Standard **Optima** Racks, the "custom" enclosure for your instruments

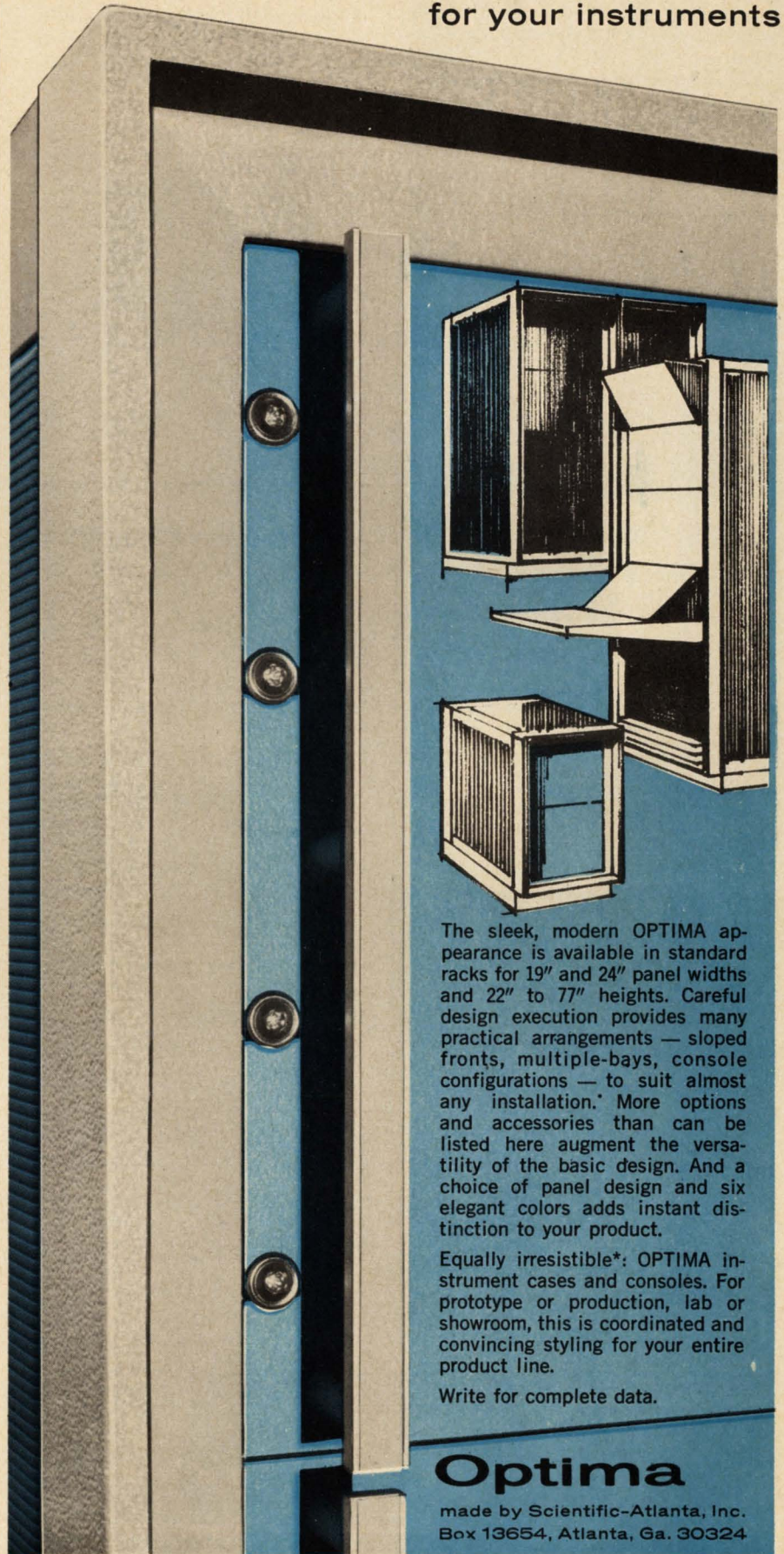

The sleek, modern OPTIMA appearance is available in standard racks for 19" and 24" panel widths and 22" to 77" heights. Careful design execution provides many practical arrangements — sloped fronts, multiple-bays, console configurations — to suit almost any installation.* More options and accessories than can be listed here augment the versatility of the basic design. And a choice of panel design and six elegant colors adds instant distinction to your product.

Equally irresistible*: OPTIMA instrument cases and consoles. For prototype or production, lab or showroom, this is coordinated and convincing styling for your entire product line.

Write for complete data.

Optima

made by Scientific-Atlanta, Inc.
Box 13654, Atlanta, Ga. 30324

* First prize, Advanced Packaging / Production Techniques, NEP / CON '65.

ON READER-SERVICE CARD CIRCLE 39

AMPERITE

Thermostatic DELAY RELAYS

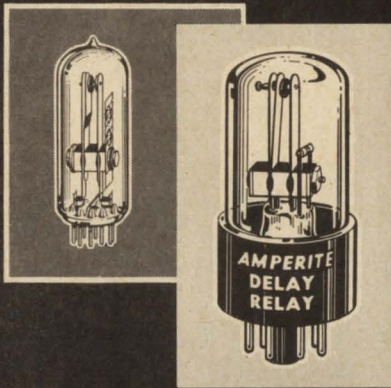

Only a glass seal
offers true hermetic sealing
... assuring maximum stability and life!

Delays: 2 to 180 seconds . . . Actuated by a heater, they operate on A.C., D.C., or Pulsating Current . . . Being hermetically sealed, they are not affected by altitude, moisture, or climate changes . . . SPST only—normally open or normally closed . . . Compensated for ambient temperature changes from -55° to $+80^{\circ}$ C. . . Heaters consume approximately 2 W. and may be operated continuously . . . The units are rugged, explosion-proof, long-lived, and—inexpensive!

TYPES: Standard Radio Octal, and 9-Pin Miniature.
List Price, \$4.00

PROBLEM? Send for Bulletin No. TR-81

AMPERITE

BALLAST REGULATORS

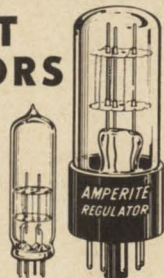
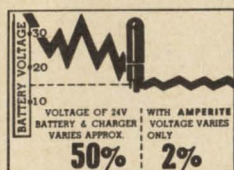

Hermetically sealed, they are not affected by changes in altitude, ambient temperature (-50° to $+70^{\circ}$ C.), or humidity . . . Rugged, light, compact, most inexpensive . . . List Price, \$3.00.

Write for 4-page Technical Bulletin No. AB-51

AMPERITE

600 PALISADE AVE., UNION CITY, N.J.
Telephone: 201 Union 4-9503
In Canada: Atlas Radio Corp., Ltd.,
50 Wingold Ave., Toronto 10

MICROWAVES

MW multipliers

A broadband microwave multiplier and a high output, single-diode microwave multiplier feature small size.

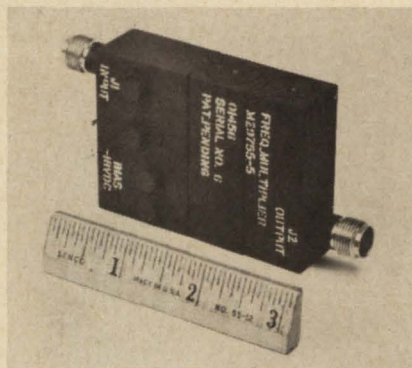

Model M-22-10-5-5 has an output frequency of 2100-2320 MHz, with five MW minimum power output, weighs 4 ozs., and measures 2.75 x 2.10 x 0.75 in. without connectors.

The high-output multiplier, M-2-1-32-8, achieves 1.5 watts output from one diode. Input power is 6 watts, minimum, and frequency range is 1.5-2.3 GHz. It weighs 6 ozs., and measures 2 x 2 x 1.10 in., less connectors.

Microwave Development Laboratories, Inc., 87 Crescent Rd., Needham Hts., Mass. Phone: (617) 449-0700.

Circle No. 256

CW microwave amplifier

A 20-watt traveling-wave tube amplifier is available in five bands: 1-2 GHz, 2-4 GHz, 4-8 GHz, 6-11 GHz, and 8-12.4 GHz.

Traveling-wave tubes are interchangeable, with minor adjust-

ments, making one amplifier cover all bands. Small signal gain of 35 or 50 dB can be specified. Power input is 105-125 or 210-230 Vac, 50-60 Hz. The 5-1/4 x 19 x 21 in. unit can be rack-mounted. Bench-mount adapters, 400 Hz operation, and modulation inputs are options.

P&A: 35 dB unit-\$4435, 50 dB unit-\$4710. 45-60 days. Alto Scientific Co., 4803 Transport, Palo Alto, Calif. Phone: (415) 321-3434. TWX: (415) 492-9273.

Circle No. 257

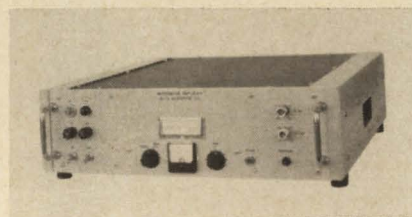

Quad hybrids

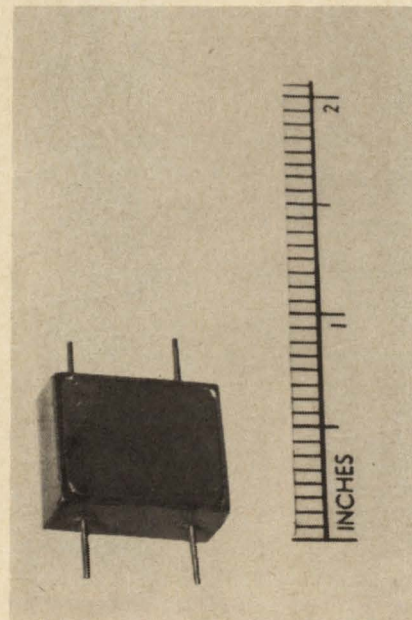

A series of microminiature quadrature hybrid couplers, for use with high-density electronic equipment, uses lumped element devices.

These units split input signals between the two output ports with amplitudes equal within 0.3 dB, and phase difference within 2° of quadrature. This feature is useful in image-reject mixers and single-sideband modulators.

Models are designed with bandwidths from 10% to an octave, and with center frequencies from arbitrarily low to better than 300 MHz. Impedance is 50 ohms, with other impedances available.

Delivery is 30-45 days. Merrimac Research and Development, Inc., 517 Lyons Ave., Irvington, N. J. Phone: (201) 371-1616.

Circle No. 258

Cut... clamp... install... save... with new Airflex* flexible waveguide



**CUT TO LENGTH ANY TIME,
ANY PLACE, TO MEET ANY
INSTALLATION PROBLEM.**

AIRFLEX flexible waveguide is a totally new concept that will revolutionize waveguide application. Available as finished assemblies or in field fabrication kits, Airflex waveguide actually costs less. It offers improved performance, lower VSWR, and meets or exceeds all MIL Spec requirements.

For advance technical data sheet or demonstration kit . . . call, write, or TWX.

**Litton trade mark. Patent Pending.*

AIRTRON



DIVISION OF LITTON INDUSTRIES

200 East Hanover Avenue, Morris Plains, N.J.

Telephone: 201 JEFFerson 9-5500 · TWX 201 538-6744

FROM TRANSISTORS TO TRIGGERS...

NEW MOTOROLA TYPES TO FIT YOUR TOUGHEST DESIGN JOBS

all new... all oriented to your needs!
in this handy "applications
brochure... yours for the

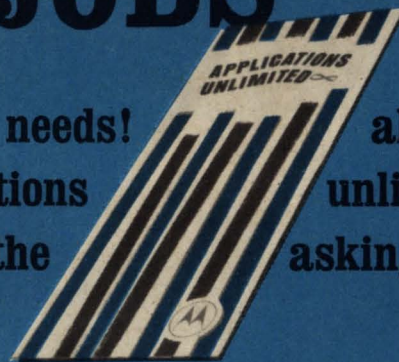

all described
"unlimited"
asking!

SILICON BILATERAL TRIGGER...MT-32 (32V±4V)

... For an economical, highly reliable device for use in Thyristor and other triggering circuits

- Symmetrical V-I characteristics
- High pulse-current — 2 Amps
- Packaged in miniature DO-7 "glass" hermetic encapsulation — $P_D = 150$ mW

VOLT/AMP. CHARACTERISTICS

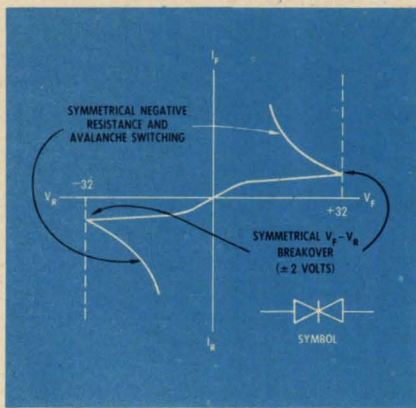

LOW-VOLTAGE, FAST SWITCHING, EPITAXIAL 4-LAYER DIODES

Series M4L3052, 53, 54

- Low breakover voltages: 8-12 volts
- Low junction capacitance: typically 35 pf @ 8-12 V_F
- Fast switching speeds: typically $t_{ON} = 50$ nsec, $t_{OFF} = 100$ nsec
- Packaged in DO-7 "glass" case ($P_D = 150$ mW)

All this at new low prices!

TYPICAL CHARACTERISTICS

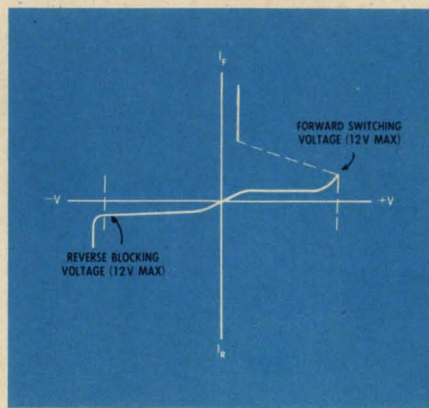

"NO COMPROMISE" LOW-COST PLASTIC SILICON TRANSISTORS

... with UNIBLOC* Performance and Reliability Features!

- NPN/PNP for complementary circuit design
- Complete "h" parameters specified
- Gain specified from 100 μ A to 100 mA
- High voltage — 40 volts (min)

*Trademark of Motorola Inc.

PNP — 2N3905-6

NPN — 2N3903-4



CHOOSE FROM 3 NEW RTL INTEGRATED CIRCUIT LOGIC COMPLEMENT LINES

... to best fit your particular performance/cost requirements!

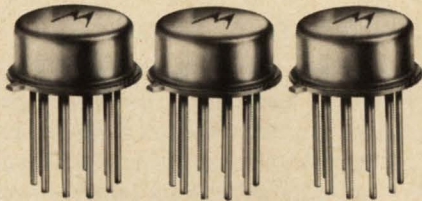

- Fan-out capability up to 5
- 12 nsec — typical propagation delay
- 15 mW/NODE Dissipation
- MC900G series — designed for MILITARY extreme environmental applications. Operating Temp. Range: -55°C to $+125^{\circ}\text{C}$
- MC800G series — for reliable operation in INDUSTRIAL logic applications. Operating Temp. Range: 0 to $+100^{\circ}\text{C}$
- MC700G series — value priced for broad INDUSTRIAL/COMMERCIAL applications. Operating Temp. Range: $+15^{\circ}\text{C}$ to $+55^{\circ}\text{C}$ — choice of 19 circuit functions.

✓ (New, comprehensive technical brochures are available describing the complete MC900G, MC800G, and MC700G series ... check coupon below for your copies.)

... for saturated switching

OPTIMIZED "FOUR-H" GEOMETRY — FOR MEMORY DRIVER DESIGNS TO 1½ AMPS!

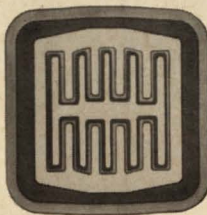

Optimized "Four-H"
Geometry

PNP 2N3762 Series

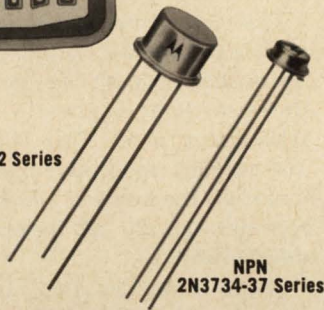

NPN
2N3734-37 Series

Featuring:

- High speeds — $f_T = 330$ mc (NPN), 220 mc (PNP)
- High current — to 1.5 A
- $C_{ob} = 7$ pf (NPN), 12 pf (PNP)
- h_{FE} — specified from 10 mA to 1.5 A
- Low $V_{CE(sat)} = 0.7$ V @ 1.0 A

... for non-saturated switching

1800 MC CURRENT-MODE SWITCHES NPN-2N3959 & 2N3960

CURRENT-GAIN — BANDWIDTH PRODUCT

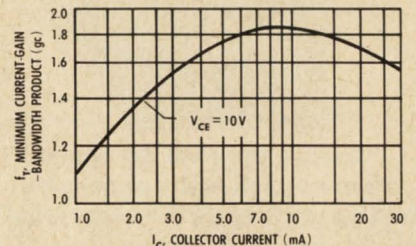

TYPICAL PERFORMANCE FOR THE 2N3960

Featuring:

- 1800 mc — frequency response
- Specified 12 volt (min) BV_{CEO}
- Low C_{ob} — 2.5 pf (max)
- Low $r'_b C_c$ — 20 psec (typ) TO-18 Pkg.

12-AMP SILICON RECTIFIERS (50-1000V) MR1120-MR1130

... filling your needs for high-performance, medium-current rectification at an economical price!

- 12 amps @ 150°C
- High surge-current @ elevated temperatures — 300 amps @ 150°C
- Low forward voltage drop — 0.55 V (average)
- Available in standard or reverse polarity

CURRENT VS. TEMPERATURE DERATING CURVE

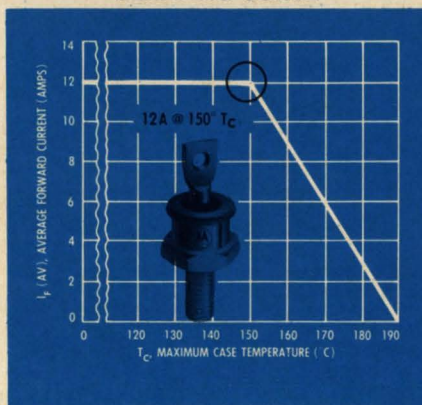

To receive your copy of APPLICATIONS UNLIMITED and the following design aids, just fill out coupon below and drop it in the mail to us.



MOTOROLA
Semiconductor
Products Inc.

5005 EAST McDOWELL ROAD, PHOENIX, ARIZONA 85008

Please print

NAME _____ TITLE _____

JOB FUNCTION _____

COMPANY _____ DEPT. NO. _____

ADDRESS HOME _____
WORK _____ PHONE _____

CITY _____ STATE _____ ZIP _____

Send to:

MOTOROLA SEMICONDUCTOR PRODUCTS, INC.
BOX 955, PHOENIX, ARIZONA 85001

- RTL Integrated Circuit Brochures Zener Selection Guide Silicon Rectifier Selection Guide Silicon Annular Transistor Selection Guide
- Germanium Power Transistor Selection Guide

Speed Inquiry to Advertiser via Collect Night Letter
ON READER-SERVICE CARD CIRCLE 42

Life before the PVB



"Before the PVB, we would have needed many expensive instruments to do the same jobs!"

Sam Yoshikawa wanted a resistance bridge for the Instrumentation and Calibration Lab he supervises for Signetics Corporation of Sunnyvale, California. We asked him why he chose our Model 300 PVB (Portametric Voltmeter Bridge). His answer: "The PVB gives us a lot more measuring capability than we bargained for. We use it principally as a high-accuracy resistance bridge, to calibrate decade boxes in the lab, and for other resistance measurements.

"But it also packs eight other measurement functions into one compact, portable case. So the boys in the Electronic Maintenance Department often take it over there to calibrate their test equipment. And the instrumentation group use it as a design tool in the development of our automatic test equipment.

"In fact, the PVB is so versatile we can hardly keep it in the lab. We sure got a lot of test and calibration equipment in this one \$750 instrument."

ESI, 13900 NW Science Park Drive, Portland, Oregon (97229)

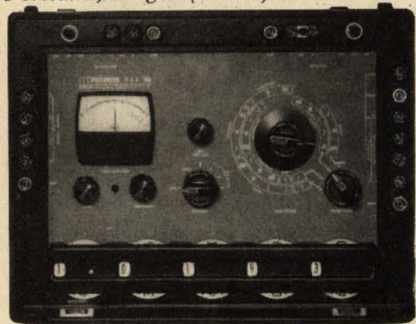

In a single battery-operated unit, the PVB combines the functions of a potentiometric voltmeter, voltage source, ammeter, guarded Kelvin double bridge, resistance comparison bridge, ratiometer and electronic null detector. Accuracy: $\pm 0.02\%$ of reading or 1 switch step on virtually all ranges.

esi

Electro Scientific Industries

ON READER-SERVICE CARD CIRCLE 43

MICROWAVES

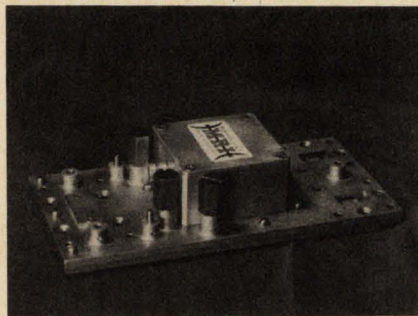

Ku-band SSB modulator

The Air-Strip single side-band modulator has an output power dividing network for Ku-band. It operates with a bandwidth of ± 250 MHz using a 60 MHz 90° hybrid. The carrier, upper side band and all spurious modulated signals are a minimum of 20 dB below desired side band.

Micro-Radionics Inc., 14844 Oxnard St., Van Nuys, Calif. Phone: (213) 873-1100.

Circle No. 273

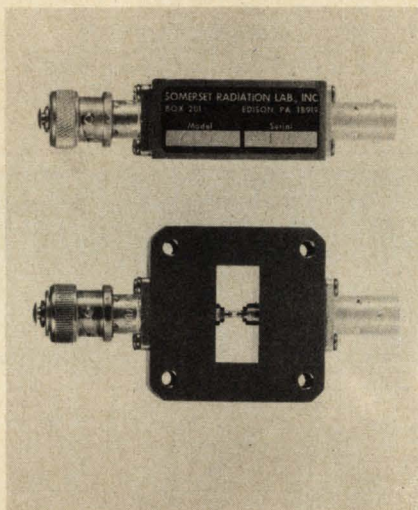

Step-recovery diode

The model X805 step-recovery diode multiplier features and X-band output of 3 mW. Input power is in the 100 MHz to 2 GHz range with output in the 8.2 to 12.4 GHz band.

The unit consists of a step-recovery diode mounted in a thin section of aluminum waveguide. Input is fed through a low-pass filter to the diode where the harmonic is generated for the waveguide.

P&A: \$125; stock. Somerset Radiation Laboratory, Inc., P. O. Box 201, Edison, Pa. Phone: (215) 348-8883.

Circle No. 274

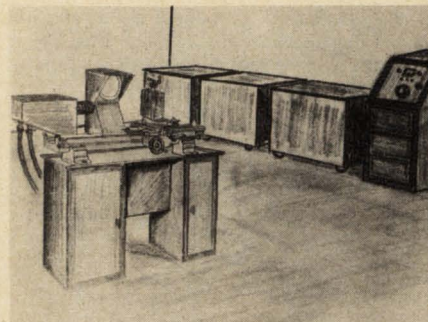

Laser metal working

A new laser metal-working system for production operations provides outputs ranging from a fraction of a joule to 1000 joules. Target area is mounted on a lathe bed and is available with X, Y, and Z positioning.

P&A: \$5,000-\$35,000, 30-60 days. Maser Optics Inc., 89 Brighton Ave., Boston, Mass. Phone: (617) 254-7880.

Circle No. 275

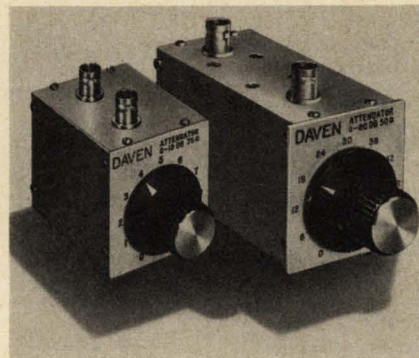

RF attenuators

Developed for use in signal generators and transmitters as well as for calibration of audio and RF equipment, a new line of rotary coax attenuators use 1% deposited-carbon resistors throughout. They meet vibration and shock conditions of MIL-STD-202C and basic switches meet MIL-S-3786B. Two models are available for either 50 or 75 ohms impedance.

McGraw-Edison Co., Daven Div., Grenier Field, Manchester, N. H. Phone: (603) 669-0940.

Circle No. 276

Accuracy is our policy

The headings for the two tables on pages 53 and 54 in November 29 Special Reference Issue on Relay Applications were inadvertently interchanged.

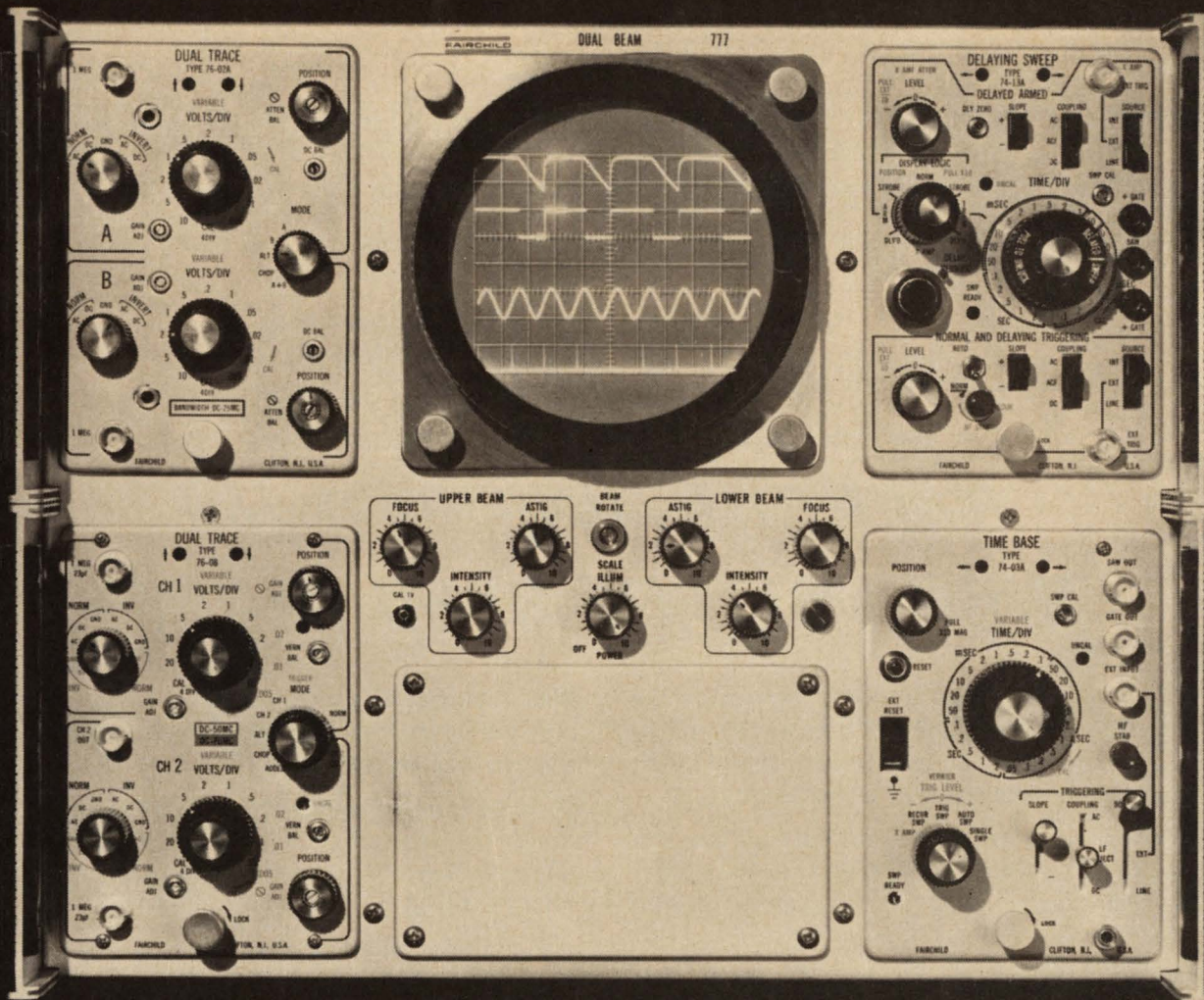

HOW MANY SCOPES CAN THIS ONE REPLACE?

A sizable number, depending upon the range of applications. For this is the Fairchild 777—the most versatile of all industrial scopes. The 777 is a dual beam, dual trace scope in which any four of 22 plug-ins are completely interchangeable in both X and Y cavities. These same plug-ins fit all Fairchild 765H Series scopes. They include DC-100 mc bandwidth, spectrum analyzer and raster display capabilities, sensitivity to 500 $\mu\text{v}/\text{cm}$, risetime to 3.5 ns.

Other features of the 777 include 6 x 10 cm display area for each beam with 5 cm overlap between beams for optimum resolution... unique 13 kv CRT with four independent deflection structures... solid state circuitry (with all deflection circuitry in the plug-ins)... light weight (44 lbs.)... environmentalized for rugged applications. Price (main frame): \$1,600 f.o.b. Clifton, N.J.



The 777 illustrates the Fairchild concept of value through versatility. One scope doing many tasks is only part of it. Future state-of-the-art capability is equally important because it helps you curb the high cost of Technological

Obsolescence. And finally, service. Fairchild has more service centers than any other scope manufacturer.

Ask your Fairchild Field Engineer for details on this and other new generation Fairchild scopes. Or write to Fairchild Instrumentation, 750 Bloomfield Ave., Clifton, N.J.

FAIRCHILD

INSTRUMENTATION

A DIVISION OF FAIRCHILD CAMERA AND INSTRUMENT CORPORATION

*Technological Obsolescence

ON READER-SERVICE CARD CIRCLE 44

For industrial and military control, instrumentation and communications switching you now get more contact capability...more versatility...with

NEW CLAREED[®]

MERCURY-WETTED and HIGH VOLTAGE REED RELAYS

Clare's newest innovations in Clareed contacts provide more design flexibility...more application versatility than ever before possible with any reed-contact relay. For instance:

New Power Output Capability—You can handle up to 50 va power output loads . . . and be assured of good low level performance, too, with the mercury-wetted Clareed.

New Voltage Stand-off Capability—You can perform hi-pot functions at 1500 v stand-off with the new high voltage Clareed relay... up to 5000 v peak with special assemblies.

New Bounce-Free Contacts—You are assured of faster response time. No waiting with bounce-free mercury-wetted Clareed contacts.

New Low and Consistent Contact Resistance—You can depend on mercury-wetted Clareed relays to hold original contact resistance to within ± 2 milliohms throughout life.

New Longer Life Ratings—You can specify mercury-wetted Clareed contacts and be sure of millions of operations at rated load over the life of your system . . . *billions* of operations at low level.

CLAREED Relay Versatility Meets Every Packaging Requirement

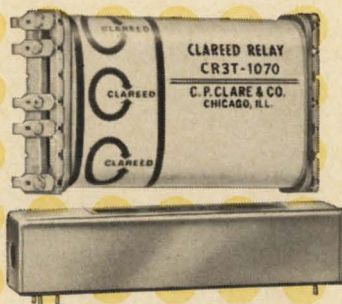

... for printed circuit boards
Types CRT, CRTN, CHT, CHTN, CRM, CHM

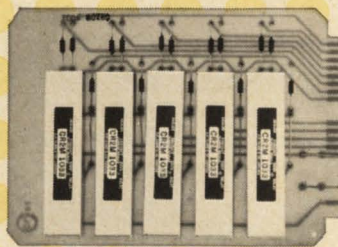

... as functional pcb assemblies
combining Clareed relays and other components



... for wired assemblies
Types CRA, CHA, CRB, CHB

CLAREED RELAY CHARACTERISTICS	For WIRED ASSEMBLIES		For PRINTED CIRCUIT BOARDS	
	Type CRA, CHA, CRB, CHB		Type CRT, CHT	Type CRM, CHM
Contact Arrangements (Maximum)	12 Form A 6 Form B 2 Form C 6 Form A and 6 Form B		12 Form A 6 Form B 4 Form C	3 Form A 2 Form B 1 Form C
Operating Voltages	.5 vdc to 340 vdc		1 vdc to 550 vdc	1 vdc to 145 vdc
Coil Resistances	2 ohms to 27,500 ohms		7.3 ohms to 35,500 ohms	10 ohms to 12,700 ohms
Operate Times* (Nom. coil power)	.6 to 9 ms		.6 to 3.4 ms	.6 to 2.8 ms
Must Operate Sensitivities*	80 mw to 2.3 watts		110 mw to 1.8 watts	110 mw to 750 mw
*Depending upon number of contacts.				
CONTACT CHARACTERISTICS (All Contacts Are Available In Any Assembly Shown Above.)				
	GENERAL PURPOSE		HIGH VOLTAGE	MERCURY-WETTED
Contact Rating Switched Load	15 va max, non-inductive 1 amp max, 250 v max		15 va max, non-inductive 1 amp max, 250 v max	50 watts DC resistive 25 watts AC resistive
Carry Load	5 amps max, not switched		5 amps max, not switched	3 amps max, 500 v max 5 amps max, not switched
Life Expectancy Full Rated Load Low Level	20 x 10 ⁶ operations 100 x 10 ⁶ operations		20 x 10 ⁶ operations 100 x 10 ⁶ operations	100 x 10 ⁶ operations 1 x 10 ⁹ operations
Stand-Off Voltage	500 v rms		1500 v rms, standard 5000 v peak, special	1000 v rms, standard 3000 v peak, special

Clareed relays help to assure that your system will operate dependably . . . to its design characteristics . . . over its planned life. Here's how:

Inherent Reliability—You can optimize your system design and depend on it to perform. Fully defined Clareed initial and life ratings allow you to design optimum performance into your system. Maintenance-free switches are sealed in glass and are not subject to environmental contamination or mis-adjustment.

Ample Speed for Most Applications—You'll realize ample switching speeds for most industrial control functions—particularly for applications having electromechanical input and output devices where solid state microsecond switching speeds are impractical . . . and expensive. Clareed relay switching speeds in the high microsecond and low millisecond range are entirely compatible with your system requirements.

Immunity to Transient Noise—Your Clareed relay system is not subject to inadvertent switching by ambient or line transients. No need to buffer or use special logic levels. And, by the way, you need only one power source . . . 24 vdc \pm 5% does the job.

Special Design Capability—You're not confined to standard relay ratings and packages. If your system demands special requirements, turn your problem over to the switching experts—Clare's Application Engineers. They have more experience than anyone else in providing effective time and money saving solutions for special switching problems.

Added Bonus! Clareed switches and relays are built by Clare from start to finish to one high quality standard. Careful production control procedures pay off in longer life, consistent performance and greater reliability for you.

Combine these new contact developments with the basic Clareed capabilities. Add the variety of packages available. You'll discover a relay line that meets the switching needs for practically any control function.

For complete information contact your nearest CLARE Sales Engineer

CALL—NEEDHAM (Mass.): (617) 444-4200 • **GREAT NECK, L. I. (N.Y.):** (516) 466-2100 • **SYRACUSE:** (315) 422-0347 • **PHILADELPHIA:** (215) 386-3385 • **BALTIMORE:** (202) 393-1337 • **ORLANDO:** (305) 424-9508 • **CHICAGO:** (312) 262-7700 • **MINNEAPOLIS:** (612) 920-3125 • **CLEVELAND:** (216) 221-9030 • **XENIA (Ohio):** (513) 426-5485 • **CINCINNATI:** (513) 891-3827 • **COLUMBUS (Ohio):** (614) 486-4046 • **MISSION (Kansas):** (913) 722-2441 • **DALLAS:** (214) 741-4411 • **HOUSTON:** (713) 528-3811 • **SEATTLE:** (206) 725-9700 • **SAN FRANCISCO:** (415) 982-7932 • **VAN NUYS (Calif.):** (213) 787-2510 • **TORONTO, CANADA:** C. P. Clare Canada Ltd. • **TOKYO, JAPAN:** Westrex Co., Orient • **IN EUROPE:** C. P. Clare International N. V., **TONGEREN, BELGIUM** • Clare-Elliott, Ltd., **LONDON, ENGLAND**

Write Group 01A9 **C. P. CLARE & CO.**
3101 Pratt Boulevard Chicago, Illinois 60645



relays and related control components,

Speed Inquiry to Advertiser via Collect Night Letter
ON READER-SERVICE CARD CIRCLE 45

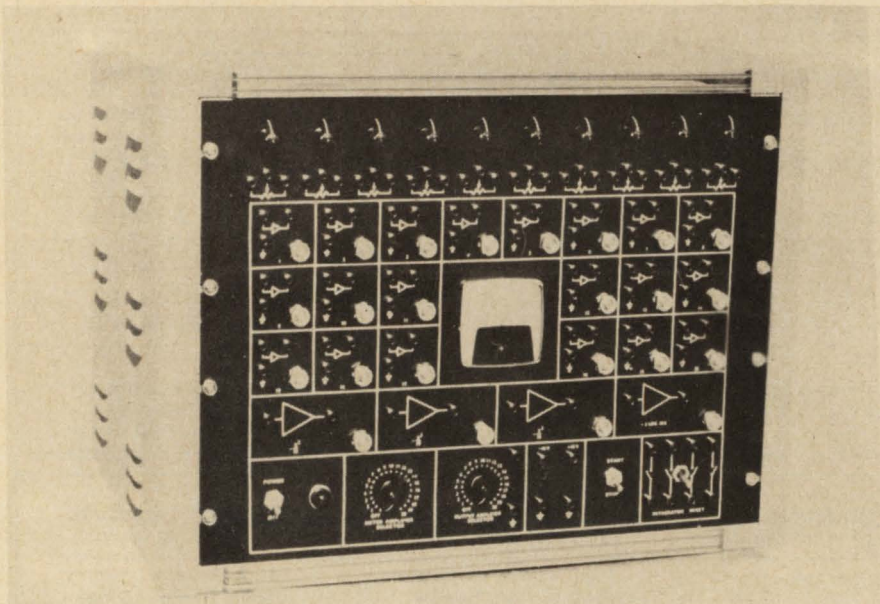

A-log desk-top computer designed for economy

The MK-1 desk-top analog computer is handy, inexpensive, and has good specs, but even its designer admits it's not very pretty.

Billed as a "Volkswagen" in the desk-top computer field, this \$3500 system is said to give performance comparable to that of \$10,000 computers in more attractive packages. Specifications include: ± 10 volt output from 20 operational amplifiers, three $X^2/10$ function generators, 10 potentiometers, a dc to 1 kHz response and $\pm 5\%$ accuracy.

The basic frame consists of a chassis with 10 patch cords, 10 input-output resistive feedback jumpers and two input-output capacitive jumpers. Accessories included in the

purchase price are chopper stabilized amplifiers, a strip-chart recorder and a dual-speed integrator reset oscillator.

The basic 20 operational amplifiers can be programmed to perform multiplication by constant, algebraic summations, integration with respect to time, generation of known functions of a variable, multiplication of two variables or any combination of the operations. The front panel access to all active components permits easy interconnection of amplifier blocks.

Control and Computing Devices Co., Box 925, Garland, Texas. Phone: (214) 741-5441.

Circle No. 259

Low-cost recorder

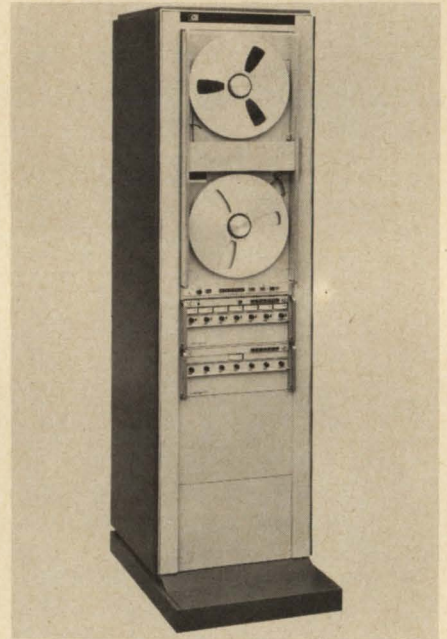
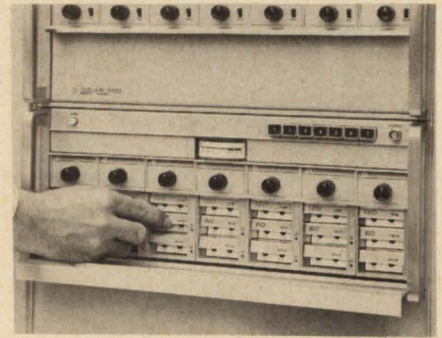

Series 3950 instrumentation recorders use simplified circuitry with mechanical damping of all flutter is coupled with easy threading.

Flutter measures 0.2%, dc to 1.5 kHz. Constant tape tension, fail-safe braking, and six-speed operation are featured. All functions are push-button controlled, and the unit can be set up, adjusted, and checked out from the front panel. All amplifiers are plug-in solid-state, with plug-in equalizers.

Front-panel meters read out both signal-level and bias of each channel. Signal to noise ratio exceeds 26 dB from 400 Hz to 1.5 MHz.

Both 7- and 14-channel systems are available, with optional cabinetry.

P&A: \$15,000-7 ch; \$20,000-14 ch. Hewlett-Packard, 1501 Page Mill Rd., Palo Alto, Calif. Phone: (415) 326-7000. TWX: (910) 373-1267.

Circle No. 261

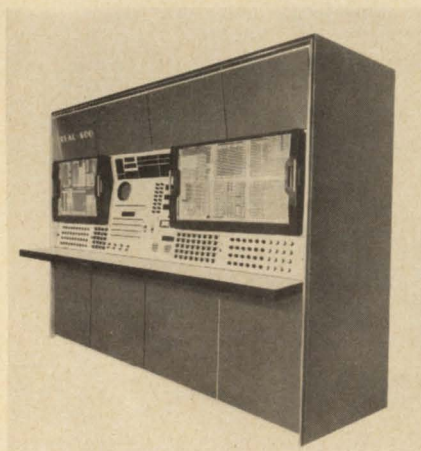

Hybrid computer

The REAC 600 is equipped with a main frame having two patchboards for a total of 8000 usable holes. The fully expanded system (prewired for up to 300 operational amplifiers) is engineered to reduce programing. Amplifier output is a max ± 120 volts with max current of 50 mA at ± 100 volts. All amplifiers are interchangeable.

Dynamics Corp. of America, Reeves Instrument Div., Garden City, N. Y. Phone: (516) 746-8100.

Circle No. 260



Digital synthesizers

A series of synthesizers in the 40 mHz to 400 mHz range provides frequency generation from a single crystal-reference source, eliminating mixers and multipliers to provide a purer signal.

Current applications include a 3500 channel transceiver for the Navy. Developments have included digital logic circuits which operate at UHF rates, a programmable digital divider that operates as rapidly as its discrete logic elements, a digital time discriminator, and a sampled phase detector. Remote programming by tape or other means is feasible, allowing for automated frequency-response plotters and other high accuracy automatic devices.

Electronic Communications, Inc.,
Box 12248, St. Petersburg, Fla.
Phone: (813) 347-1121. TWX (813)
347-7760.

Circle No. 262

1-2 Gc extender

A compact 1-2 Gc frequency extender incorporates a tunable four-selection YIG preselector and features a spring steel tape tuning dial. The FE-1-2A's YIG preselector is tracked electronically throughout its range. The preselector assures low oscillator radiation and image rejection of 70 db minimum. Noise figures are typically 16 db, with 18 db maximum.

P&A: \$4,000; 45 days. Communication Electronics Inc., 6006 Executive Blvd., Rockville, Md. Phone: (301) 933-2800.

Circle No. 263

high-voltage workhorse VICTOREEN DIODES

Regulator
Pulse Coupler
High-Impedance
Voltage Divider
High-Voltage
Reference



Victoreen GV1A Corotron diode actual size; other types available.

You probably think of Victoreen Corotron diodes as high-performance thoroughbreds for exotic uses. And they are. But this is only part of the Corotron pedigree. They're also real workhorse diodes for everyday uses. As regulators and H-V references... H-V pulse couplers... high-impedance voltage dividers. And still we haven't run out of Corotron applications. So put your imagination to work. Savings in cost, complexity and weight can put you on velvet. Right away, write away for latest dope on Corotron diodes — high-voltage workhorse. Address Applications Engineering Department.

Write for free copy of illustrated 40-page catalog of Victoreen diodes.

THE VICTOREEN INSTRUMENT COMPANY
10101 WOODLAND AVENUE • CLEVELAND, OHIO 44104
EUROPEAN SALES OFFICE: GROVE HOUSE, LONDON RD., ISLEWORTH, MIDDLESEX, ENGLAND



5471-A

Speed Inquiry to Advertiser via Collect Night Letter
ON READER-SERVICE CARD CIRCLE 46

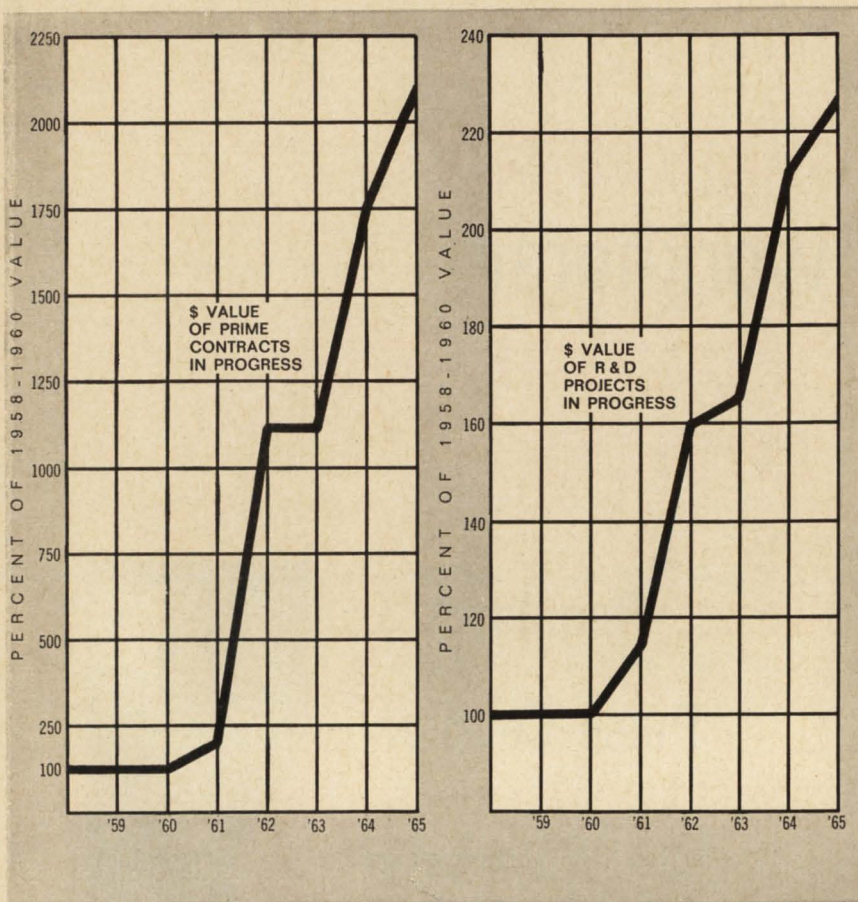

2 REASONS WHY THERE'S MORE ENGINEERING OPPORTUNITY AT ECI

Where there's engineering excitement there's engineering opportunity. Two key indicators — prime contracts in progress and R&D work in progress — prove that exciting things are happening at Electronic Communications, Inc. ECI has generated these remarkable activity increases by building a solid, successful reputation in airborne systems, multiplexing, space instrumentation and other areas of military and aerospace communication. You can get aboard this upward trend immediately if you are qualified in:

RF ENGINEERING — aggressive new programs are now under way in the design and development of microminiature transmitters and receivers. Positions require at least a BS degree, with a minimum of three years experience, and sound knowledge of transmitter and/or receiver design theory.

SPACE INSTRUMENTATION PROJECT ENGINEERING — you'll need in-depth technical ability, plus six years experience in data handling, control, or analog instrumentation.

THIN-FILM CIRCUIT DESIGN — involving theory and application of thermodynamics, mechanics of materials and electronic component design in the development of microelectronic circuitry. BS or MS in EE or physics required.

SYSTEMS INTEGRATION — you must be thoroughly grounded in aircraft electrical systems and be familiar with interface problems involved in installation of airborne communications equipment. Prior systems integration or field installation experience is most desirable.

If you are qualified, send your resume, in confidence, to Duane Meyer, ECI, Box 12248D, St. Petersburg, Fla., or call him collect at (813) 347-1121. (An equal opportunity employer.)

ELECTRONIC COMMUNICATIONS, INC.

ST. PETERSBURG, FLORIDA



ON READER-SERVICE CARD CIRCLE 47

SYSTEMS

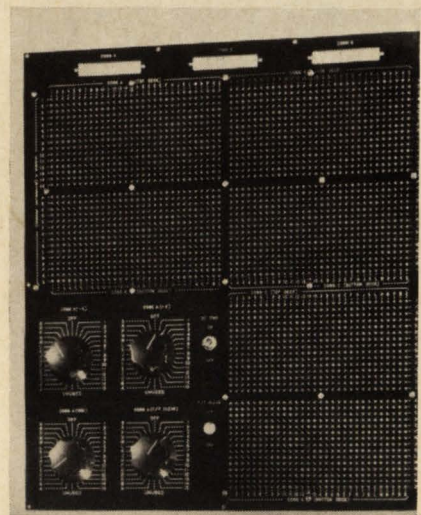

Program matrices

Selectoboard cordless program matrices are available with front-mounted selector switches. Fully interwired with the terminations of the X-Y matrix, they provide manual step-by-step readout of the program. Each line selected by the switches has distinctly different programs, obtained by inserting diode pins into the program board.

Selectro Corp., Mamaroneck, N. Y. Phone: (914) 698-5600. TWX: (710) 566-1110.

Circle No. 264

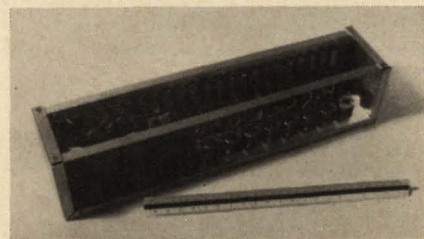

Ear analog

An analog of the human ear utilizes a passive 24-section wave-propagating electrical device. Response voltages represent vibrational velocities at the axis of the inner ear. When excited, these responses provide a spatial pattern of the sound.

The space-time patterns presented are not derivable from power spectra, therefore they aid interpretation of auditory behavior.

P&A: \$1865, FOB; 6 weeks. Santa Rita Technology, Inc., Commercial Div., 1040 O'Brien Dr., Menlo Park, Calif. Phone: (415) 324-4701.

Circle No. 265

ECONOMY!

**Versatile,
Value-priced
x-y recorder
...just \$795!**

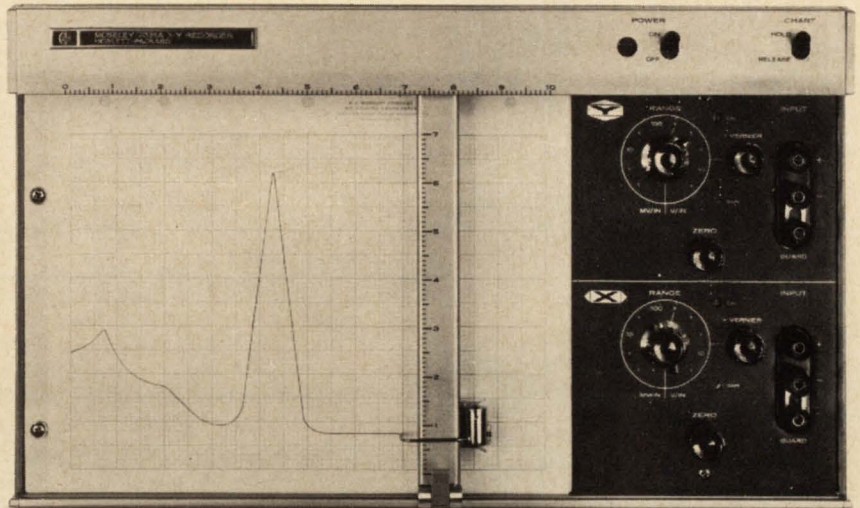

THE MOSELEY 7035A

This is a high-performance, low-cost solid-state recorder for every-day applications not requiring high dynamic performance. Five fixed calibrated ranges 1 mv/inch to 10 v/inch. High input impedance, floating guarded input, 0.2% accuracy at full scale. Adjustable zero set.

Each axis has an independent servo system with no interaction between channels. Maintenance-free AUTOGRIP* electric paper holddown, new writing system with inexpensive disposable unit. Options available include electric pen lift, locks for zero and variable range controls, rear input, re-transmitting potentiometers.

For general-purpose applications, you can't beat the Moseley Division 7035A. Ask your Hewlett-Packard field engineer for a demonstration. Or write for complete specifications to Hewlett-Packard, Palo Alto, California 94304, Tel. (415) 326-7000; Europe: 54 Route des Acacias, Geneva.

*Data subject to change without notice.
Price f.o.b. factory.*

**HEWLETT
PACKARD**  **MOSELEY
DIVISION**
An extra measure of quality

*Trade Mark Pat. pend.

Conductivity bridge



A portable bridge, Model #4959, when used with appropriate conductivity cells, is suited to measuring electrolytic conductivity or resistivity of grounded or ungrounded solutions. A dual range permits operation from 0.5 to 105,000 microhms or 9.5 to 2,000,000 ohms, based on the use of a 1.0 cm⁻¹ cell. An adjustable dial permits compensation for a wide range of cell constants and solution temperatures.

Leeds & Northrup Co., 4901 Sten-ton Ave., Philadelphia, Pa. Phone: (215) 329-4900. TWX: (215) 725-7360.

Circle No. 266

RF current probe

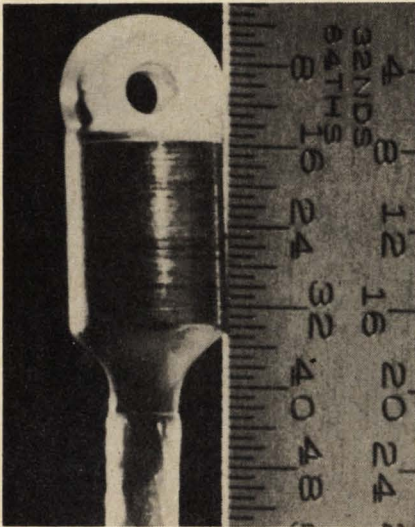

A new miniature RF current probe measures radio frequency and transient currents over a wide frequency range. Designated Model 6676.02 the probe measures 1/4-in. diameter and 1/2-in. length, allowing for easy installation in high-density circuitry and components.

It has a sensitivity of one micro-volt per microamp, a frequency response of 3 dB band width, 20 kHz—200 MHz and is supplied with a 50 ohm miniature coax.

P&A: \$155.00; 2-4 weeks. Atlantic Research Corp., Alexandria, Va. Phone: (703) 354-3400.

Circle No. 267

Spectrum analyzer

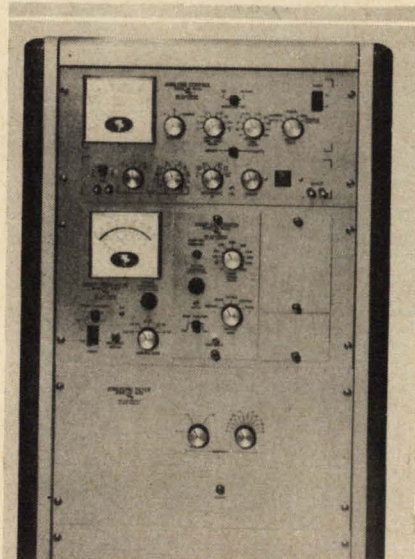

The T1000 swept spectrum analyzer covers the 0 to 40,000 Hz range.

The modular-constructed unit accepts data inputs of rmsV, rms-V/Hz, rmsV², rmsV²/Hz, average V, or average V/Hz. Input modes include calibration, data input, and filtered data input. Output detectors are linear, square law, or true rms; and 19 filters give a wide choice of output integration time, bandwidths, and time constants. Oscillator sweep modes are manual, ramp, sector, stepped, and track.

MB Electronics Div., Textron Inc., New Haven, Conn. Phone: (203) 389-1511.

Circle No. 268

Delco Radio Semiconductors available at these distributors

EAST

BINGHAMTON, N. Y.—Federal Electronics

P. O. Box 1208/PI 8-8211

PHILADELPHIA 23, PENN.

Almo Industrial Electronics, Inc.

412 North 6th Street/WA 2-5918

PITTSBURGH 6, PENN.—Radio Parts Company, Inc.

6401 Penn Ave./361-4600

NEWTON 58, MASS.—Greene-Shaw Company

341 Watertown Street/WO 9-8900

CLIFTON, N. J.—Eastern Radio Corporation

312 Clifton Avenue/471-6600

NEW YORK 36, N. Y.—Harvey Radio Company, Inc.

103 West 43rd Street/JU 2-1500

BALTIMORE 1, MD.—Radio Electric Service Company

5 North Howard Street/LE 9-3835

SOUTH

BIRMINGHAM 5, ALA.

Forbes Distributing Company, Inc.

2610 Third Avenue, South/AL 1-4104

WEST PALM BEACH, FLA.—Goddard, Inc.

1309 North Dixie/TE 3-5701

RICHMOND 20, VA.—Meridian Electronics, Inc.

1001 West Broad Street/353-6648

MIDWEST

BATTLE CREEK, MICH.—Electronic Supply Corporation

94 Hamblin Ave./P. O. Box 430/965-1241

INDIANAPOLIS 25, IND.

Graham Electronics Supply, Inc.

122 South Senate Avenue/ME 4-8486

CLEVELAND 1, OHIO—The W. M. Pattison Supply Co.

Industrial Electronics Division

777 Rockwell Avenue/621-7320

CHICAGO 30, ILL.—Merquip Electronics, Inc.

4939 North Elston Avenue/AV 2-5400

CINCINNATI 10, OHIO—United Radio, Inc.

7713 Reinhold Drive/241-6530

KANSAS CITY 11, MO.—Walters Radio Supply, Inc.

3635 Main Street/JE 1-7015

ST. LOUIS 17, MO.

Electronic Components for Industry Co.

2605 South Hanley Road/MI 7-5505

TULSA, OKLAHOMA 74119—Radio, Inc.

1000 South Main Street/(918)-587-9124

MINNEAPOLIS, MINNESOTA 55413

Northwest Electronics Corporation

336 Hoover St., N. E./612-331-6350

WEST

DALLAS 1, TEXAS—Adleta Company

1907 McKinney Ave./RI 2-8257

HOUSTON 1, TEXAS—Harrison Equipment Company, Inc.

1422 San Jacinto Street/CA 4-9131

SAN DIEGO 1, CAL.

Electronic Components of San Diego

2060 India Street, Box 2710/232-8951

LOS ANGELES 15, CAL.—Radio Products Sales, Inc.

1501 South Hill Street/RI 8-1271

LOS ANGELES, CAL. 90022—Kierulff Electronics

2585 Commerce Way/OV 5-5511

MOUNTAIN VIEW, CAL.—Kierulff Electronics

2484 Middlefield Road/968-6292

DENVER, COLO.—L. B. Walker Radio Company

300 Bryant Street/WE 5-2401

SEATTLE 1, WASH.—C & G Electronics Company

2600 2nd Ave./Main 4-4354

PHOENIX, ARIZ.—Midland Specialty Co., Inc.

1930 North 22nd Ave./258-4531

ALBUQUERQUE, N.M.—Midland Specialty Co., Inc.

1712 Lomas Blvd., N.E./247-2486

TUCSON, ARIZ.—Midland Specialty Co., Inc.

951 South Park Ave./MA 4-2315

Ask for a complete catalog

DELCO RADIO

DIVISION OF GENERAL MOTORS • KOKOMO, INDIANA

Get ready to change your thinking about high energy circuits.

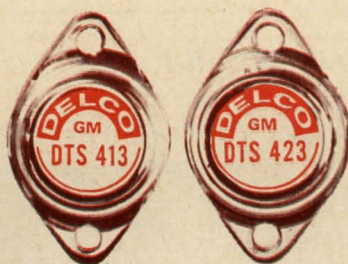

Now you can operate directly from rectified line voltage, reduce current, use fewer components, improve efficiency. All with Delco Radio's new 400V silicon power transistors—DTS 413 and DTS 423. And they're priced low—less than 3¢ a volt even in sample quantities.

A wealth of applications are possible. Vertical and horizontal TV outputs, for instance. High voltage high effi-

RATINGS	DTS 413	DTS 423
VOLTAGE		
V _{CEO}	400 V	400 V
V _{CEO} (Sus)	325 V (Min)	325 V (Min)
V _{CE} (Sat)	0.8 (Max)	0.8 (Max)
	0.3 (Typ)	0.3 (Typ)
CURRENT		
I _C (Cont)	2.0A (Max)	3.5A (Max)
I _C (Peak)	5.0A (Max)	10.0A (Max)
I _B (Cont)	1.0A (Max)	2.0A (Max)
POWER	75 W (Max)	100 W (Max)
FREQUENCY RESPONSE		
f _t	6 MC (Typ)	5 MC (Typ)

See applications for these and other Delco semiconductors at WESCON booths 1313-1314

ciency regulators and converters, single stage audio outputs, to name a few more.

And our standard TO-3 package dissipates more heat (junction to heat sink 1.0°C per watt).

Your Delco Radio Semiconductor distributor has these two new 400V silicon power transistors on his shelf. Call him today for data sheets, prices and delivery.

FIELD SALES OFFICES
UNION, NEW JERSEY*
Box 1018 Chestnut Station
(201) 637-3770
SYRACUSE, NEW YORK
1054 James Street
(315) 472-2668

DETROIT, MICHIGAN
57 Harper Avenue
(313) 873-6560
CHICAGO, ILLINOIS*
5151 N. Harlem Avenue
(312) 775-5411

SANTA MONICA, CALIFORNIA*
726 Santa Monica Blvd.
(213) 870-8807
General Sales Office:
700 E. Firmin, Kokomo, Ind.
(317) 452-8211—Ext. 500

*Office includes field lab and resident engineer for applications assistance.

DELCO RADIO

Division of General Motors
Kokomo, Indiana

WANT FACTS



ON THE WARLOCK TECHNIQUE FOR DESIGNING AND BUILDING EXTREMELY COMPACT MODULES?

Especially advantageous when high operating levels or precision preclude the use of conventional micro-circuit assemblies.

In addition to our standard product line, we specialize in micro-packaging of digital and analog interface circuitry to your requirements.

Write for our latest brochure on Compact Modules...



WARLOCK SYSTEMS, INC.
81 NEWTOWN ROAD, DANBURY, CONNECTICUT



TEST EQUIPMENT

Multi-axis counter

A multi-axis bi-directional counter is available in a single case com-

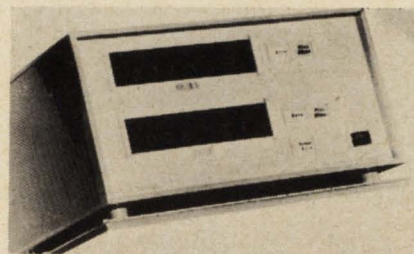

plete with power supply. Each of the two or three axes features rates in excess of 50,000 counts per second, in-line numerical display, zero reset and all-silicon plug-in circuitry.

Data Technology Inc., 127 Coolidge Hill Rd., Watertown, Mass. Phone: (617) 924-1773. TWX: (617) 924-4998.

Circle No. 269

Amplifier socket

Designed to meet MIL-M-14 and MIL-T-10727, the new 9005 socket

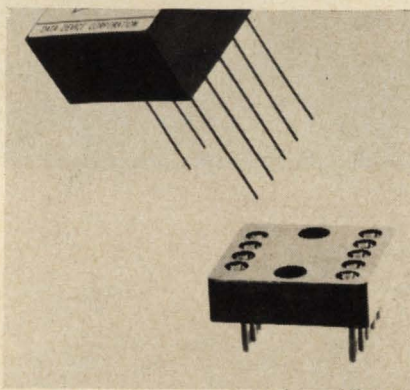

holds most standard encapsulated operational amplifiers of the 1-1/8 x 1-1/8-inch size with 7 or 9 leads on 0.2-inch grid spacing. It will accommodate 0.028-inch to 0.042-inch lead diameters.

The socket, made of black phenolic with beryllium-copper, electro tin plated contacts, measures 1-1/8 in. x 1-1/8 in. x 0.320 in. high.

P&A: 1-9, \$3.75 each; 10-24, \$3.50 each; stock. Data Device Corporation, 240 Old Country Road, Hicksville, New York 11801. Phone: (516) 433-5330.

Circle No. 270

Hour counter

The Type 550 Horacont is an hour counter with a zero reset, ena-

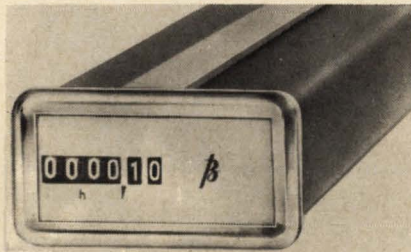

bling measurement of elapsed time, time since servicing, and other running time measurements.

Panel mounting is 1 x 2-in. The standard unit is 110 or 220 V, 50 Hz, with other units available from 12 to 380 V, 42 to 60 Hz.

Julius Bauser-Kontrolluhrenfabrik, 7241 Empfinden bei Horb, West Germany.

Circle No. 271

Spectrum analyzer

The new Model T495 manual test instrument, designed for use with electrodynamic vibration exciters, functions as a spectrum equalizer as

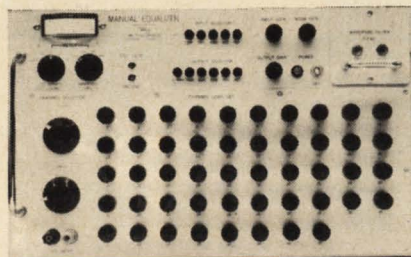

well as a spectrum analyzer.

In the equalizer mode the unit provides compensation of the frequency spectrum through the use of 48 narrow bandpass crystal filters in parallel.

Spectrum analysis is accomplished by using a noise input from an integral noise generator.

P&A: \$9850.00; 60-90 days. MB Electronics, 781 Whalley Ave., New Haven, Conn. 06508. Phone: (203)

Circle No. 272

**1/2 to 1/3 the size and
less than 1/2 the weight
of conventional units . . .**

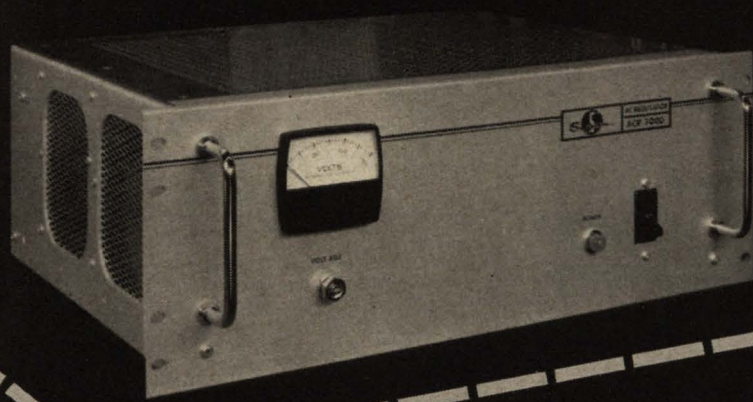

Sorensen ACR Voltage Regulators give up to 95% efficiency, too!

In these new Sorensen silicon controlled rectifier AC regulators, you get the best combination of power, performance, and packaging you've ever seen. The unit is reduced to the size of the transformer and control circuitry. Ideal for motor starting, lamp loads, tube filaments, X-ray applications, etc., ACR Series regulators are designed to control the RMS voltage to a variety of loads requiring precise regulation, fast response time, and low distortion.

- | | | |
|--|---|--|
| 1. 8 MODELS AVAILABLE (500, 1000, 2000, 3000, 5000, 7500, 10000, 15000 VA) | 4. UP TO 95% efficiency | 7. LOW DISTORTION (3% max.) |
| 2. LOW PRICES (starting at \$290) | 5. INPUT VOLTAGE RANGE 95-130 VAC; OUTPUT RANGE 110-120 VAC | 8. STABILITY (.05% / 8 hours, after a 30-minute warm-up) |
| 3. SMALL SIZE AND WEIGHT | 6. FAST RESPONSE to line or load changes (30 ms) | 9. REGULATION $\pm 0.1\%$ RMS |
| | | 10. PROGRAMMABLE |
| | | 11. REMOTE SENSING |
| | | 12. CONVECTION COOLED |
| | | 13. EASY MAINTENANCE (removable "plug-in" printed circuit) |

For complete data on the ACR Series and other Sorensen products, send for the "Controlled Power Catalog and Handbook." Write: Sorensen, A Unit of Raytheon Co., Richards Ave., South Norwalk, Conn. 06856. Or use reader service card number 200.

ACR ELECTRICAL AND MECHANICAL SPECIFICATIONS

MODEL NUMBER	OUTPUT VA RANGE	REGULATION ACCURACY		EFFICIENCY (FULL VA)	TYPICAL POWER FACTOR	TEMPERATURE COEFFICIENT		DIMENSIONS (INCHES)			PRICE**	
		LINE	LOAD			AMBIENT (°C)	COEFFICIENT (°C)	WIDTH	HEIGHT	DEPTH		RACK HEIGHT
ACR 500	0-500	$\pm 0.1\%$	$\pm 0.1\%$	88%	75%	0-50	.03%	15*	5	9	5 1/4	\$ 290
ACR 1000	0-1000	$\pm 0.1\%$	$\pm 0.1\%$	90%	75%	0-50	.03%	19	5 1/4	11	5 1/4	340
ACR 2000	0-2000	$\pm 0.1\%$	$\pm 0.1\%$	92%	75%	0-50	.03%	19	5 1/4	15	5 1/4	435
ACR 3000	0-3000	$\pm 0.1\%$	$\pm 0.1\%$	95%	75%	0-50	.03%	19	7	15	7	555
ACR 5000	0-5000	$\pm 0.15\%$	$\pm 0.15\%$	95%	75%	0-50	.03%	19	7	20	7	715
ACR 7500	0-7500	$\pm 0.15\%$	$\pm 0.15\%$	95%	75%	0-50	.03%	19	12 1/2	20	12 1/2	850
ACR 10000	0-10000	$\pm 0.15\%$	$\pm 0.15\%$	95%	75%	0-50	.03%	19	12 1/2	20	12 1/2	1,200
ACR 15000	0-15000	$\pm 0.15\%$	$\pm 0.15\%$	95%	75%	0-50	.03%	19	17 1/2	20	17 1/2	1,500

*A 19 inch adapter (rack) panel is available.

**Optional Meter \$22.



A UNIT OF RAYTHEON COMPANY

ON READER-SERVICE CARD CIRCLE 815

**TOO SMALL
TO BE A
LIFESAVER?***



**NOT
IF YOU'RE DESIGNING
ELECTRICAL CIRCUITS**

In the race toward smaller circuits and higher density packaging, some electrical design engineers are sinking in a sea of overlarge components. Those in the know are being buoyed up by Magnetics' miniature powder core line—moly-permalloy cores as small as 0.110" I.D.

Designers involved with highly critical inductor stability factors are welcoming another Magnetics innovation—guaranteed temperature stabilization in miniature powder cores. The "D" type limits the change in inductance to $\pm 0.1\%$ from 0 to +55 degrees C. The "W" type limits the change from $\pm 0.25\%$ from -55 to

+85 degrees C. Our new "M" type limits the change to $\pm 0.25\%$ from -65 to +125 degrees C. A wide selection of core sizes and permeabilities broadens the engineer's design scope even more. And all of these sizes are designed so they can be wound on present miniature toroidal winding equipment.

If you are faced with a problem of compacting a circuit design, it will pay you to investigate the condensing potential of Magnetics' miniature powder cores line. For the complete story, write Dept. ED-30, Magnetics Inc., Butler, Pa.

**Actual size of Magnetics' 0.110" I.D. powder core*

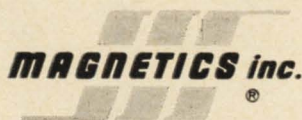

Speed Inquiry to Advertiser via Collect Night Letter
ON READER-SERVICE CARD CIRCLE 816



RELIABILITY

TOTAL CAPABILITY IN
PRECISION RESISTANCE



Dale Standard Wirewound
Power Resistors Prove
99.994% RELIABLE
in 32,000,000
Unit Hours of Testing!

RS Type Precision Wirewound Resistors are a part of the DALE High-Rel Development Program.

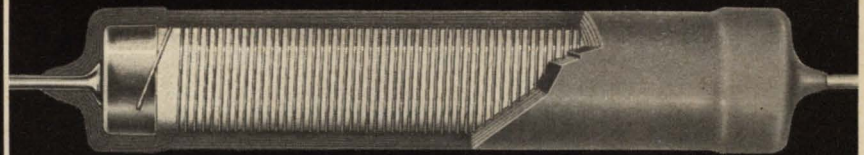

You simply can't match the reliability and versatility which Dale makes available in its RS Precision Power Wirewounds. *RS reliability*—yours at no extra cost—is solidly documented in continuing tests patterned after Dale's famous Minuteman High Reliability Development Program. Write for test report. *RS versatility* is so broad that more than 400 special variations have been made from our basic silicone-coated, all-welded construction. Standard or special—you simply can't buy more confidence at competitive prices.

WRITE FOR ■ RS Reliability Study
■ Catalog A

LATEST RS RELIABILITY REPORT

Unit Test Hours: 32,000,000 • **Reliability:** 99.994%

Stability: Units will not shift more than initial tolerance after 1,000 hours load life.

Test Conditions: 60% confidence level, 100% rated power, 25°C ambient 1% Δ R failure point.

RS SPECIFICATIONS

- **Applicable Mil. Spec:** MIL-R-26C & MIL-R-23379
(a new Spec. designed especially for precision power resistors)
- **Wattage Sizes:** ¼, ½, 1, 2, 2.5, 3, 5, 7, 10
- **Tolerances:** 0.05%, 0.1%, 0.25%, 1%, 3%
- **Operating Temperature Range:** -55°C to 350°C
- **Resistance Range:** .1 ohm to 273K ohms
- **Load Life Stability:** 1% max. Δ R after 1000 hours at full rated power
- **Moisture Resistance:** .5% max. Δ R after MIL-R-26C moisture test
- **Dielectric Strength:** 500 volts, RS-¼ through RS-1B;
1000 volts RS-2 through RS-10
- **Thermal Shock:** .5% max. Δ R after MIL-R-26C thermal shock test
- **Insulation Resistance:** 100 megohms minimum
- **Temperature Coefficient:** 20 ppm (high values); 30 ppm (intermediate values); 50 ppm (low values). Specific T.C. chart available on request.



DALE ELECTRONICS, INC.

1328 28th Avenue, Columbus, Nebraska

Also Sold by Dale Electronics Canada, Ltd., Toronto, Ontario, Canada



Speed Inquiry to Advertiser via Collect Night Letter

ON READER-SERVICE CARD CIRCLE 817

Uniring® grounds a shielded cable in less time than it takes to heat a soldering iron.

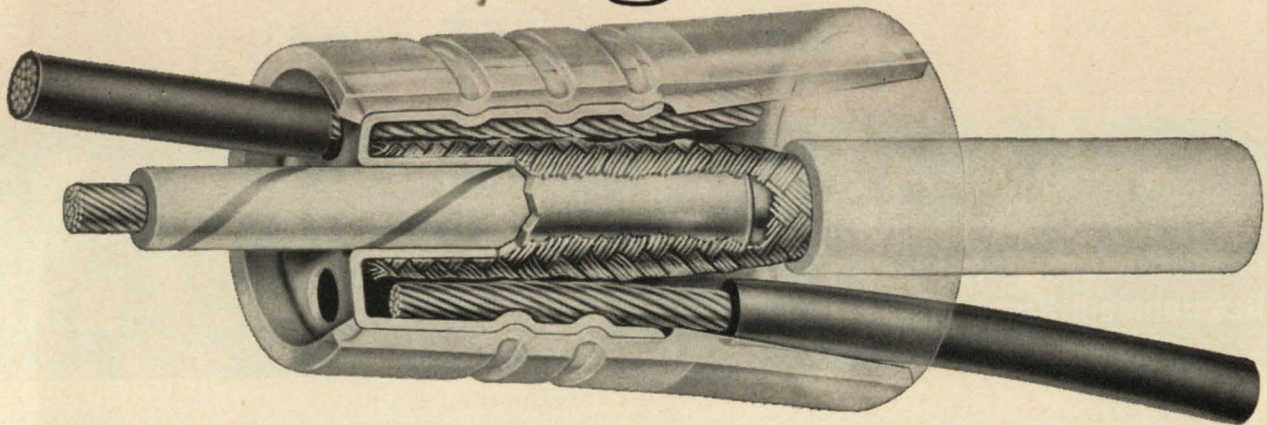

Uniring combines inner and outer ferrules in unitized construction. Simply insert a stripped conductor and tap wire, then crimp. One crimp does it. No heat. No burnt cables. Result: A vibration-resistant, noise-free connection that is mechanically and electrically stable. A uniform connection that takes virtually no time to make.

Uniring terminations are color coded for fool-proof size selection. And the insulated Uniring employs a nylon sleeve that's flared for fast, easy insertion of the shielding braid and tap. (These connectors are also available uninsulated.) No other type of connector is as fast, as reliable, or as low in cost to use. Time and labor savings offered

by the compression method of grounding and terminating shielded cable are recognized by the military and referred to in MIL-E-16400 and MIL-I-983. Burndy Uniring terminations conform in all details to MIL-F-21608 (dated 1/5/59). Send today for a free sample and catalog.

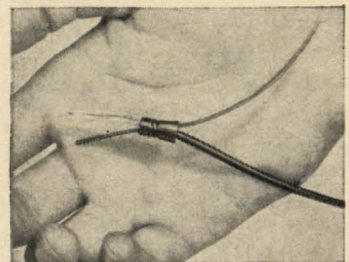

BURNDY

Norwalk  Connecticut

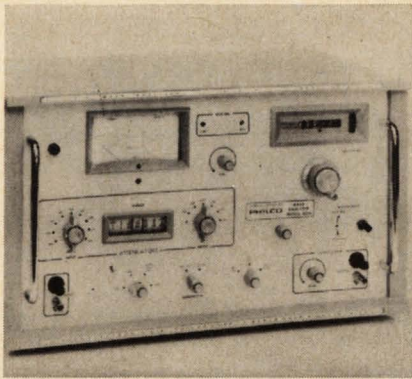

Digital wave analyzer

Fundamental frequencies, harmonics and other components of any signal between 20 Hz and 100 kHz can be examined through the 301A analyzer. Frequency resolution is specified as $\pm(1\% + 10 \text{ Hz})$ between 20 Hz and 10 kHz, and $\pm 100 \text{ Hz}$ from 10 kHz to 100 kHz. The five-digit readout reads frequency in 10-Hz increments with 2-Hz interpolation marks.

Price: \$1995. Philco Sierra Div., 3885 Bahannon Drive, Menlo Park, Calif. 94025. Phone: (415) 322-7222.

Circle No. 277

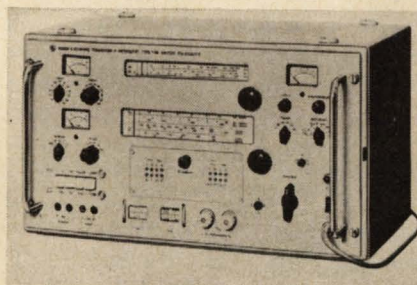

Transistor Y-meter

A transistor Y-meter measures both dynamic and static parameters of *pnp/npn* transistors and semiconductor diodes. The instrument, designated type TYM, operates at any of eight switch-selected test frequencies between 20 kHz to 37 MHz. It can also be used for impedance measurements on other circuit components.

Instrument range is 0 to 100, and 0.1 to 100 mA. Static parameters are measured with $\pm 3\%$ accuracy; limit of error in dynamic measurement is 10%.

P&A: \$4,900; 60 days. Rohde & Schwarz, 111 Lexington Ave., Passaic, N. J. Phone: (201) 773-8010.

Circle No. 278

AUGAT

FAST, EASY NETWORK TESTING AND BREADBOARDING

... eliminates trimming of i. c. from carrier

INTEGRATED CIRCUIT TEST AND BREADBOARD UNITS

for use with T. I. Mech Pack Carrier

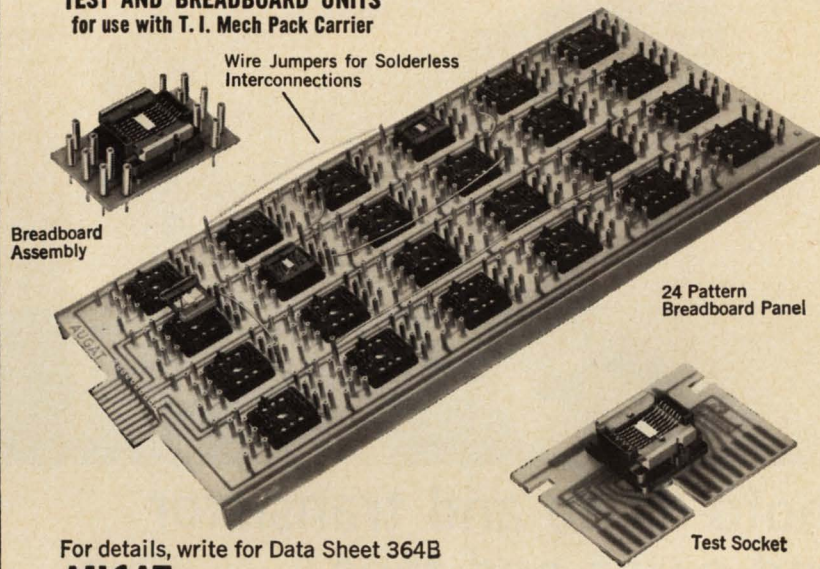

For details, write for Data Sheet 364B

AUGAT INC.

31 PERRY AVENUE, ATTLEBORO, MASS.

ON READER-SERVICE CARD CIRCLE 51

DIGITAL LOGIC DESIGN

ELECTRICAL DESIGN ENGINEER — SENIOR Design experience including schematic diagram presentation, electrical/electronic components, design installation and related circuit design and analysis for automatic checkout equipment.

ELECTRICAL DESIGN ENGINEER Design experience including preparation of schematics and wiring diagrams. Able to work from checkout parameter criteria and evolve checkout equipment circuitry utilizing current state-of-the-art components for electrical checkout equipment design.

ELECTRICAL DESIGN ENGINEER — JUNIOR Prefer recent college graduates with industrial design experience involving solid state circuitry and/or logistic presentation to assist in the design of automatic electrical checkout equipment.

BS in E.E. or Physics required for all of the above positions.

Write: K. R. Kiddoo, Professional Placement Manager, Lockheed Missiles & Space Company, P.O. Box 504, Sunnyvale, California. An Equal Opportunity Employer.

LOCKHEED
MISSILES & SPACE COMPANY
A GROUP DIVISION OF LOCKHEED AIRCRAFT CORPORATION

ON READER-SERVICE CARD CIRCLE 890

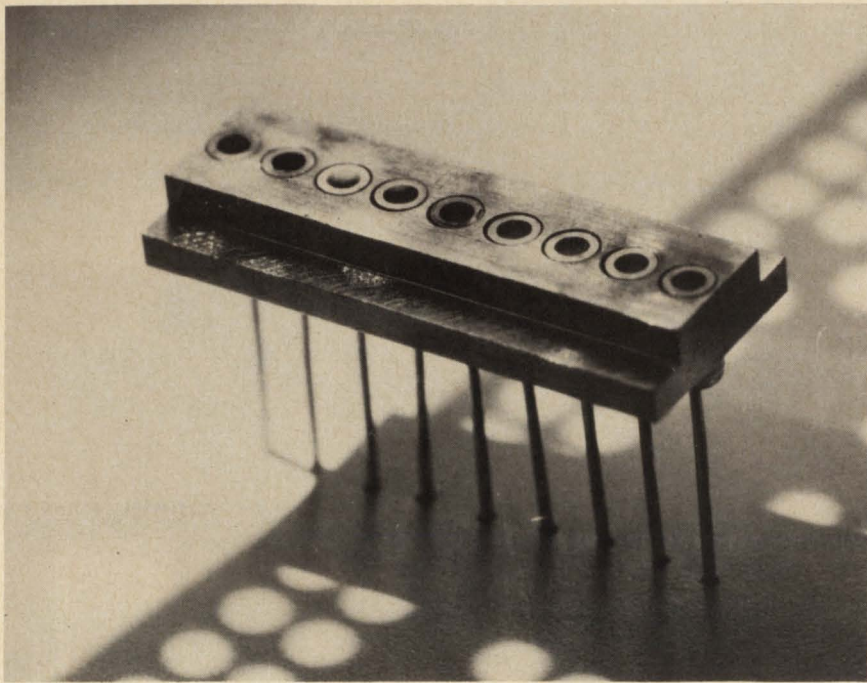

Photo-diode and transistor read cards and tape

Two miniature photosensors have been developed for use in tape and card readers, optically-coupled circuits, encoder-decoders, character recognition devices and process control applications. Both units are silicon and feature planar passivation for long term device stability.

The FPM-100 phototransistor has a special response extending from 0.4 to 1.1 microns and features a maximum power dissipation of 75 mW at 25°C. Collector current rises from a maximum dark value of 0.1 microamp to typical values in the range 1.5 to 2.5 milliamps upon illumination. Typical rise time is 3 microseconds.

The companion photodiode, FPM-200, is packaged in the same cylindrical welded case, and is rated for maximum -100 volts V_R . The dark current maximum is 25 nanoamps and the light current minimum is 13 microamps when illuminated with a source of radiation equivalent to 15 mW/cm² at a color temperature of 2870°K. Rise time for the FPM-200 is 3 microseconds.

Price: \$5.50-\$8.50 (FPM-100), \$5.25-\$8.00 (FPM-200) depending on quantity. Fairchild Semiconductor, 313 Fairchild Dr., Mountain View, Calif. Phone: (415) 962-2530.

Circle No. 279

HV power transistors

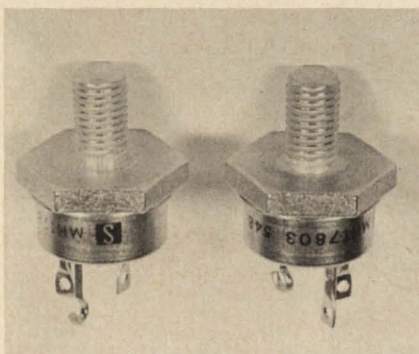

A line of high-voltage power transistors, MHT 7801 through MHT 7805, features sustaining voltages from 200V to 325V. These 10-amp planar *n*p*n* transistors have a frequency response of 50 MHz, and a common-base output capacity of 150 picofarads. They are packaged in an 11/16-in. hex stud.

Price: \$52.00 to \$100.00 in 100 quantity. Solitron Devices, Inc., 1177 Blue Heron Rd., Riviera Beach, Fla. Phone: (305) 848-4311.

Circle No. 280

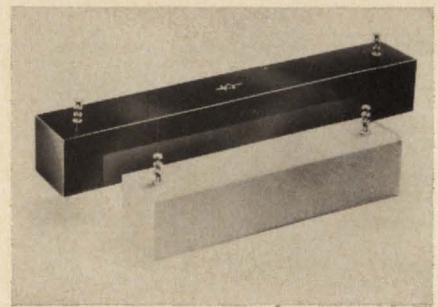

Silicon rectifier

A new KHP series of high voltage 3 amp silicon rectifiers offer a 300 amp surge current in a small rugged package. They are particularly suited for radio transmitters, radar systems, induction and dielectric heating equipment, high power precipitators, as well as other power supply and modulator applications.

Electronic Devices Inc., 21 Gray Oaks Ave., Yonkers, N. Y. Phone: (914) 965-4400.

Circle No. 281

Power rectifiers.

A series of 35-A silicon-controlled rectifiers for power-control and power-switching is available in both press-fit and stud-mounted styles.

Low-voltage, line-operated, and high-voltage, 8 kW SCR's have 200A/ μ s rate of forward current change, can withstand surge currents of 350 A, and have an operating range of -40 to $+100^\circ\text{C}$.

Price: about \$7.50. Commercial Engineering, RCA Electronic Components and Devices, Harrison, N. J. Phone: (201) 485-3900. TWX: (201) 621-7846.

Circle No. 282

Solid state chopper

The Model 26 high frequency solid state silicon chipper (or modulator) is a solidly encapsulated unit designed to alternately connect and disconnect a load from a signal source. It may also be used as a synchronous demodulator to convert an ac signal to dc. It is capable of linearly switching or chopping voltages over a wide dynamic range which extends down to a fraction of a millivolt and up to 5 volts.

Solid State Electronics Corp., 15321 Rayen St., Sepulveda, Calif. Phone: (213) 894-2271.

Circle No. 283

IC four-layer diodes meet broader demands

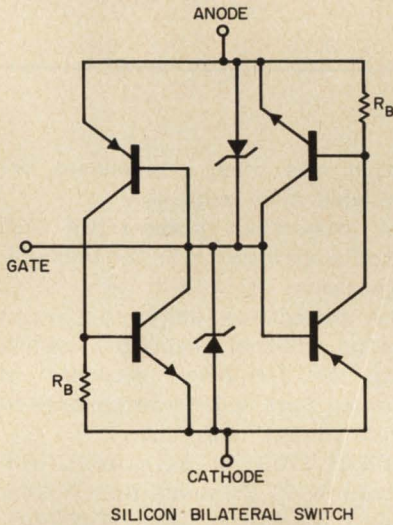
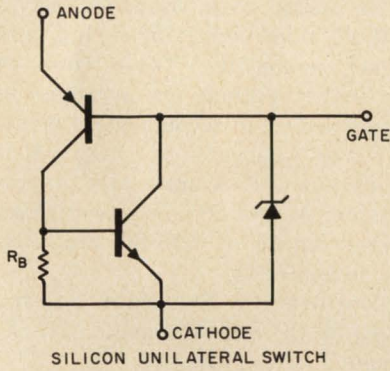

New solid-state switching applications in a broad range of military, industrial, and consumer products are possible for two integrated circuit, four-layer diodes, D13E1 and D13D1. The *pnpn* semiconductors, silicon bilateral switch SBS and silicon unilateral switch SUS, are suitable for monostable multivibrators, pulse generation, and pulse sharpening.

The SBS, for example, incorporates two *npn* and two *pnp* transistors, a voltage reference diode, and two resistors, in one transistor package.

Characteristics of both include a nominal switching value of eight volts with a temperature coefficient of less than 0.01% from -65 to +100°C. Switching voltage is independent of frequency from 60 Hz to five kHz. Turn-on time is 0.5 μ s, turn-off, 2 μ s.

Price: 100 to 999: SUS (D13D1), \$1 each; SBS (D13E1), \$1.10 ea. General Electric Components Div., Schenectady, N. Y. (518) 374-2211.

Circle No. 284

ON READER-SERVICE CARD CIRCLE 220 >



Series 2201 for airborne applications. 1" diameter. Less than 3" long. Weighs less than 3.50 ounces. Hysteresis error less than 0.05% FSO. End point non-linearity less than 0.1% FSO. Wide operating temperature range from -100°F to +300°F.

Series 2102 for general purpose differential pressure measurement. Extremely rugged, high proof pressure, field serviceable, completely "dry" construction (not fluid filled), zero shift with base pressure less than 1.0% FSO.

Series 2101 for ground support and test stand applications. Wide operating temperature range from -100°F to +300°F. Hysteresis error less than 0.05% FSO. End point non-linearity as low as 0.10% FSO. 1000 g's shock. Natural frequency over 20KC.

NEWEST Teledyne® Pressure Transducers feature greater accuracy, lower cost, smaller size, ruggedness

Incorporating unique new sensing elements, these three new Taber TELEDYNE® pressure transducers offer the features that today's instrumentation engineers are seeking — greater accuracy, lower cost and smaller size, with ruggedness and reliability.

All three of these new instruments utilize four strain gages bonded in optimum orientation to the controlled-stress zones of a semi-floating beam element, resulting in minimum error.

While these are Taber's newest pressure measurement products, even now Taber's scientists and engineers are engaged in an aggressive, continuing research and development program aimed at providing even finer equipment at lower cost without sacrificing the premium quality for which Taber is famous.

For descriptive literature, write Aerospace Electronics Div., Taber Instrument Corp., Section 161, 107 Goundry St., N. Tonawanda, N. Y.

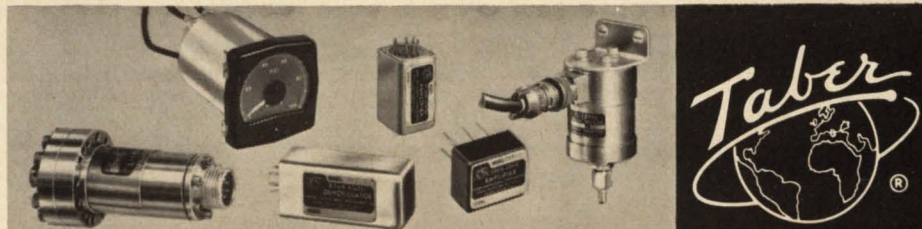

NEW MAGNETIC RELAY plugs into your PC board!

NO Springs, NO Wiring,
NO Sockets, NO Soldering,
NO Mechanical Linkage

Printact®

Standard Series G
Latching Series LS/LD

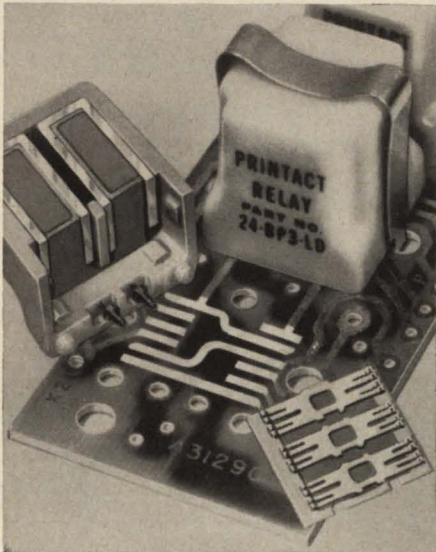

(actual size)

Plated Conductors on Your PC Board are the Fixed Contacts

Save SPACE, MONEY and MANHOURS with these new small, lightweight, highly reliable Standard and Latching PRINTACT Relays.

Available with Bifurcated Palladium or Gold Alloy contacts for more than 10 million cycle 2 or 3 pole switching. Handles up to 3 amp. res. loads. Coils for 6, 12, 24 and 48 vdc at 500 mw. Operating temperature -30°C to $+95^{\circ}\text{C}$. Operate time 7 ms. The little gem is an 0.8 oz. $\frac{7}{8}$ " cube.

Quality features include: double-break contacts; balanced armature, enclosed housing, plug-in application; encapsulated coil; self-wiping contacts and inherent snap-action—and the cost is lower than you think!

Executone

MAIL COUPON TODAY

PRINTACT RELAY DIVISION
47-37 Austell Place
Long Island City, N.Y. 11101

- Send Printact data and prices.
 Have your local rep. call.

Name _____ Title _____

Firm _____ Tel. # _____

Address _____

City _____

ON READER-SERVICE CARD CIRCLE 52

COMPONENTS

Micromin connectors

A microminiature series-connector is designed for multilayer packaging in flat pack computer applications. Designated series 1800, these

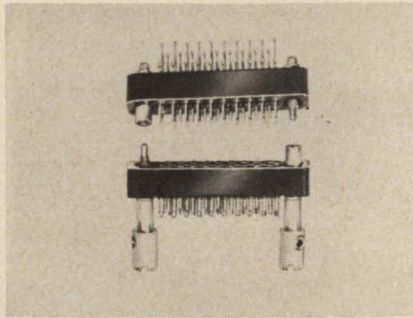

units mate with standard series MM-22 micro-miniature plug and socket connectors. Three rows of dip solder contacts are arranged in a step design to accommodate printed circuit tape cable in a high density package. Two sizes are in production, 26 and 29 contacts with an overall length of 1.25-in. and 1.34-in. respectively.

Continental Connector Corp.,
34-63 56th St., Woodside, N. Y.
Phone: (212) 899-4422.

Circle No. 285

Crystal oscillator

The model FFO-160 crystal oscillator provides a stability better than 5 parts in 10^{10} per day and 1 part in 10^8 per month in a 4-1/2-in. x 2-1/4-in. x 2-1.4-in. package. The standard unit provides a 1 MHz

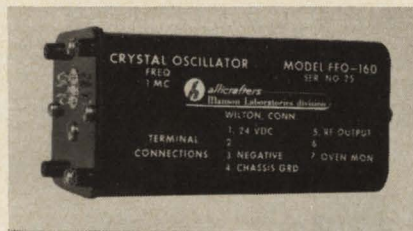

output and other frequencies are available upon request.

A proportionally controlled oven permits operation over the temperature range of -40°C to $+60^{\circ}\text{C}$. Low impedance buffer amplifiers and an internal regulation system hold the frequency accuracy to within 1 part in 10^9 over changes in input voltage and load.

P&A: \$750; 30 days ARO. Hallicrafters, 77 Danbury Rd., Wilton, Conn. Phone: (203) 762-8301. TWX: (203) 762-5779.

Circle No. 286

Lamp adaptor T-1 3/4

An adaptor permits the use of commercial and Mil-type T-1 3/4 lamps in low cost T-3 1/4 bayonet

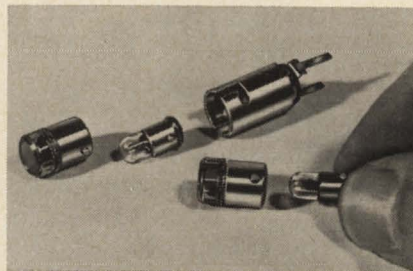

type sockets for panel indicators, back-lighted panels, and similar applications. The "adaptor-lens" incorporates a bayonet sleeve, with inserts to retain the T-1 3/4 lamp, and a plastic lens. The lamp is inserted at the rear of the assembly, and is retained under spring tension.

Display Devices Inc., 2117 Sepulveda Blvd., Los Angeles, Calif. Phone: (213) 477-1709.

Circle No. 287

Poly-film capacitors

Type 275P capacitors are wound of polystyrene film, and thin gage foil, with a conformal epoxy coating.

High Q, low dielectric absorption, high insulation resistance, and

linear negative temperature coefficient are features, as well as stability and good retrace.

Sprague Electric Company, 347 Marshall St., North Adams, Mass.

Circle No. 288



Belden has it...

Every electronic and electrical wire you need—from the finest drawn magnet wire to the most complex multi-conductor cables.

There is a Belden wire or cable in every insulation and shielding to meet your application and design needs. Here is just part of this complete line. Available from stock. Ask your Belden electronics distributor for complete line information or write for catalog. Request also a copy of A Buyers' Guide to Specifying Electrical Wire and Cable.













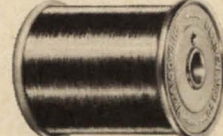



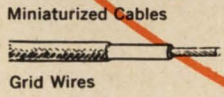
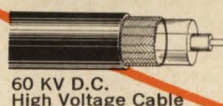



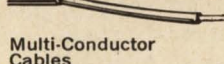
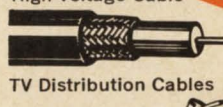
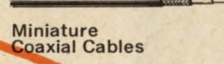
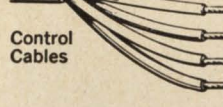



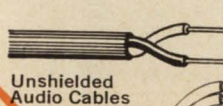





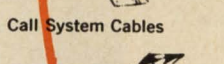

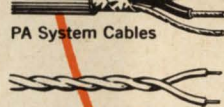

3 REASONS WHY Belden is the most specified line

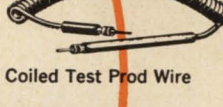
- 1. Basic Manufacturer**—Belden draws its own wire—compounds its own insulations for complete quality control.
- 2. Research and Testing**—All Belden wire and cable are laboratory tested to guarantee insulation and conductor efficiency. Lab test data available.
- 3. Design and Engineering Service**—Belden has a completely staffed design and engineering department to help customers meet unusual wire application or design requirements.

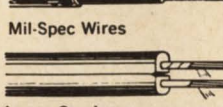
Better Built... Better Buy...

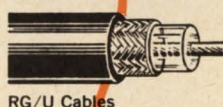
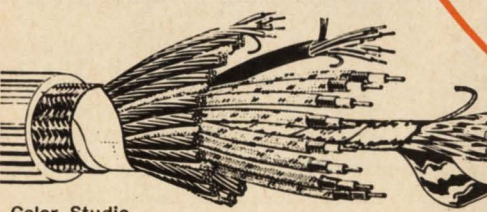

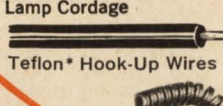
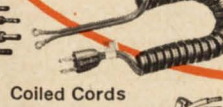
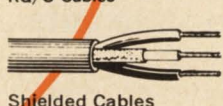
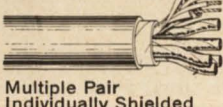
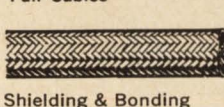
BELDEN MANUFACTURING COMPANY • P.O. Box 5070-A • Chicago, Illinois 60680

 Cathode Ray Tube Lead	 Miniaturized Cables	 Magnet Wire	 Automation Cable	 Miniature Microphone Cables
 Shielded Power Supply Cables—Rubber or Vinyl	 Grid Wires	 60 KV D.C. High Voltage Cable	 Language Lab Cables	 Control Cables
 Plastic Microphone Cables	 Multi-Conductor Cables	 TV Distribution Cables	 Miniature Coaxial Cables	 Unshielded Audio Cables
 Shielded Interconnecting Cables	 Low Impedance Lines	 Multiple Pair Individually Shielded RF Cables	 RG/U Transmission Line Cables	 Shielded Control Cables
 Strain Gauge Cables	 Call System Cables	 Test Prod Wires	 3-Conductor Power Cords	 Coiled Test Prod Wire
 Broadcast Audio Cables	 PA System Cables	 2 & 3 Conductor Extension Cords	 Rubber Microphone Cables	 Hook-Up Wires
 Closed Circuit Camera Cable	 Sound & Alarm System Cables	 Mil-Spec Wires	 Duplex Wires	 RG/U Cables
 75-Ohm Video Cable	 Power Supply Cordage	 Lamp Cordage	 Multiple Pair Cables	 Shielded Cables
 Color, Studio, Camera Cables	 Industrial Audio & Sound Wires	 Teflon* Hook-Up Wires	 Coiled Cords	 Miniature Audio Cables
		 Multiple Pair Individually Shielded Audio and Data Cables	 Shielding & Bonding Cable	 Special Sound Cables

*DuPont Trademark

8-1-4

Power film resistors

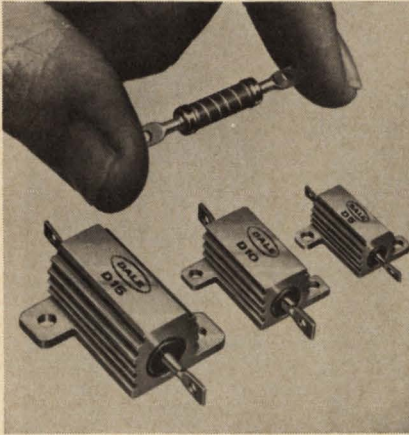

Housed power film resistors are now available in three models rated from 4 to 12 watts. Known as the D series, they have resistance range from 50 ohms to 5 Meg. Two standard temperature coefficients, ± 25 ppm/ $^{\circ}\text{C}$ and ± 50 ppm/ $^{\circ}\text{C}$, are available in an operating range of from -55°C to $+175^{\circ}\text{C}$. Standard tolerances are: 0.1%, 0.25%, 0.5%, 1% and 2%.

P&A: \$1.25; 2-3 weeks. Dale Electronics Inc., P. O. Box 488, Columbus, Nebr. Phone: (402) 564-3131.

Circle No. 289

Readout photocell

A nine element, punched-tape readout, silicon photocell NSL-701-

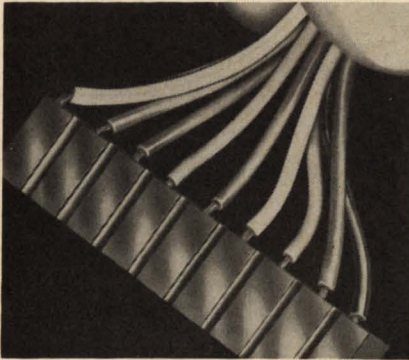

9A is especially designed to operate under dc bias conditions required by silicon transistors. Typical single segment reverse current at -1.0 v at 55°C is $1 \mu\text{a}$. This is said to represent an improvement of a factor of ten over previous units. The output of each segment in the array is matched within 10%.

P&A: From \$19; 4-6 weeks, samples from stock. National Semiconductors Ltd., 2150 Ward St., Montreal, Canada. Phone: (514) 744-5507.

Circle No. 290

FET amplifiers

Two all-silicon, epoxy-encapsulated operational amplifiers exhibit ultra high input impedance. The Models 1553 and 1953 use field-effect input transistors, feature 10^{12} ohms input impedance and 100 kHz band-

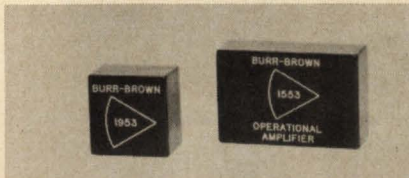

width at the rated output of ± 10 volts at 20 mA. Other specifications include a gain of 106 dB and a small signal bandwidth of 1.5 MHz.

Price: \$165 and \$185. Burr-Brown Research Corp., International Airport, Industrial Park, 6730 S. Tucson Blvd., Tucson, Ariz. Phone: (602) 294-1431. TWX: (910) 952-1111.

Circle No. 291

Solid-state gate

The SSG-51-C, gate switch designed for computers and airborne and ground telemetry systems is available either in the new potted

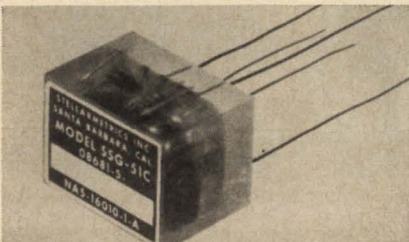

version or in a compact metal case.

The SSG-51-C is designed so that a dc signal can be applied continuously to the drive circuit, which is isolated from switching circuits, and thus may be used for continuous duty. It has a 0 to 40 kHz operating rate and low dc offset.

Stellarmetrics Inc., 210 E. Ortega St., Santa Barbara, Calif. Phone: (805) 963-3566.

Circle No. 292

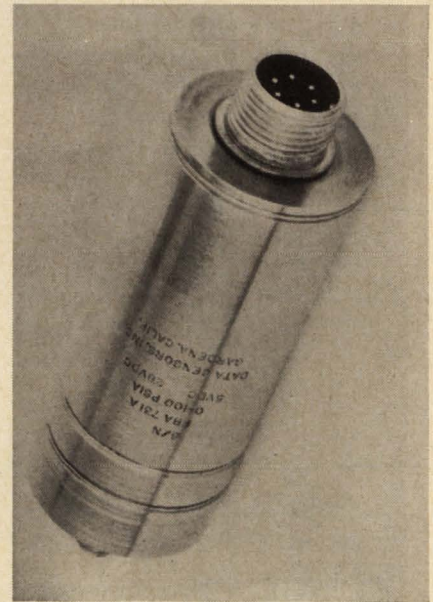

Pressure transducer

A high output pressure transducer provides a 0-5 Vdc output for 15-1000 psia or psig pressure ranges. The unit requires 28 Vdc input power. The unit, Model PBA 731 is just 3-in. long by 1-1/4-in. in diameter, and weighs only 7 ounces. It consists of a bonded strain gage sensor and a stable dc amplifier in a single stainless steel package.

Data Sensors, 13112 Crenshaw Blvd., Gardena, Calif. Phone: (213) 321-5501.

Circle No. 293

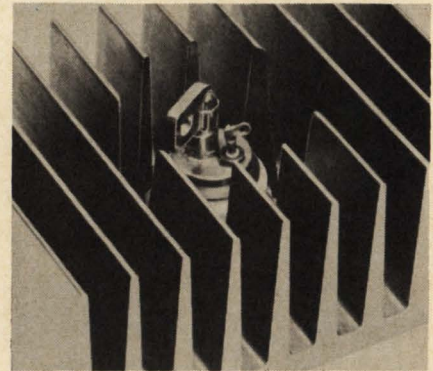

Heat sink

The HS8045-3-0-3 is suitable for thermo-electric devices and TO-3 or TO-36 semiconductors. All aluminum, with black anodized or special 1000 Vrms hardcoat anodization, it has dissipation characteristics of $0.3^{\circ}\text{C}/\text{watt}$.

Vemaline Products Co., 511 Commerce, Franklin Lakes, N. J. Phone: (201) 337-6200. TWX: (201) 337-4500.

Circle No. 294

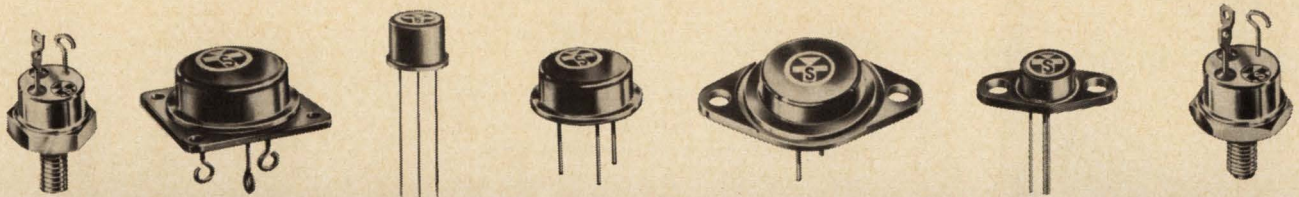

INTERROGATOR

PNP SILICON TRANSISTORS—76 TYPES IN 9 PACKAGES

Question: Why not PNP in your design plans?

Greater efficiency, greater reliability, overall savings.

A broad line of PNP SILICON POWER TRANSISTORS is available, from 8.75 watts to 85 watts of power capability, in a wide variety of package types. V_{CE0} ratings range from 40 volts to 120 volts, with saturation resistances as low as 0.3 ohms @ $I_C = 1$ Amp., and minimum h_{FE} of 10 @ $I_C = 3$ Amps., and 20 @ $I_C = 1$ Amp. These PNP types can be used as complements to Silicon Transistor Corporation's existing NPN silicon power transistors, and are supplied in the 2N3163 through 2N3208 series, and also in other series custom-designed to meet specific requirements. To satisfy virtually any power circuit design, these characteristics are available in the following packages: T0-5, 7/16" D.E.S., T0-8, T0-37, T0-53, 11/16" D.E.S., T0-3, and the isolated collector versions of the T0-53 and 11/16" D.E.S. For more information, be the interrogator yourself—and question.



SILICON TRANSISTOR CORPORATION

EAST GATE BLVD., GARDEN CITY, NEW YORK 11532, 516 Pioneer 2-4100. TWX 510-222-8258

REGIONAL OFFICES:

CHICAGO, ILL. 60625, 5555 NORTH LINCOLN AVE., 312-271-0366-7, TWX 910-221-1304
 LOS ALTOS, CALIF. 94022, 1 FIRST ST., 415-941-2842.

Questions and Answers. PNP.

Collector Voltage V_{CE0} -Volts	Use Current* I_C -Amps	Max. Current I_C -Amps	TYPE		
			T0-61	T0-53	T0-3
40	1.0	3.0	2N3163	2N3167	2N3171
	2.0	5.0	2N3175	2N3179	2N3183
	3.0	5.0	2N3187	2N3191	2N3195
60	1.0	3.0	2N3164	2N3168	2N3172
	2.0	5.0	2N3176	2N3180	2N3184
	3.0	5.0	2N3188	2N3192	2N3196
80	1.0	3.0	2N3165	2N3169	2N3173
	2.0	5.0	2N3177	2N3181	2N3185
	3.0	5.0	2N3189	2N3193	2N3197
100	1.0	3.0	2N3166	2N3170	2N3174
	2.0	5.0	2N3178	2N3182	2N3186
	3.0	5.0	2N3190	2N3194	2N3198

*Use Current: That collector current level at which the gain and saturation voltages are specified

ON READER-SERVICE CARD CIRCLE 54

Snap-action time delay

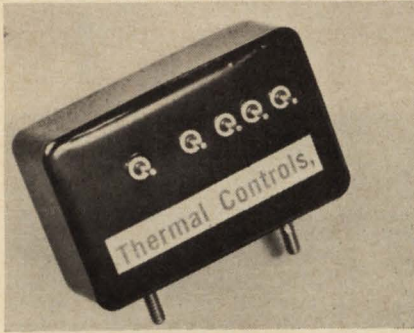

The Snap-Line time delay relay provides snap-action contact make and break characteristics in a thermal time-delay relay. Contacts are rated at 10 amps and time delay range is 2-180 seconds, factory pre-set.

Price: \$1.50 to \$6.00. Thermal Controls Inc., 75 Rutgers St., Belleville, N. J. Phone: (201) 759-7474. TWX: (201) 795-0769.

Circle No. 295

Test socket/carrier

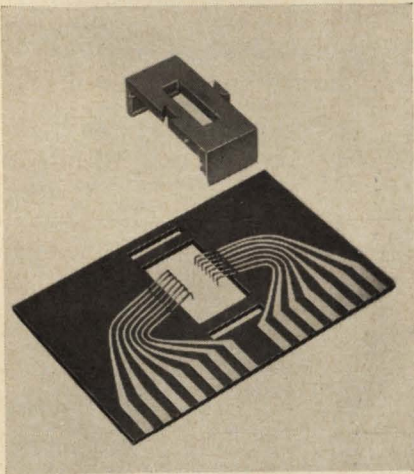

A test socket and shipping carrier for integrated circuit, flat packs up to 14 leads on 0.050-in. centers. The socket is a 2-1/2-in. x 1-3/4-in. glass epoxy, 2 oz. copper printed circuit board. Spring contacts provide wiping action. Contacts and circuitry are gold plated over nickel flash. Socket will plug into standard P/C board connectors.

Azimuth Electronics, Rte. 10, P. O. Box 463, Denville, N. J. Phone: (201) 361-0085.

Circle No. 296

Megohm film resistors

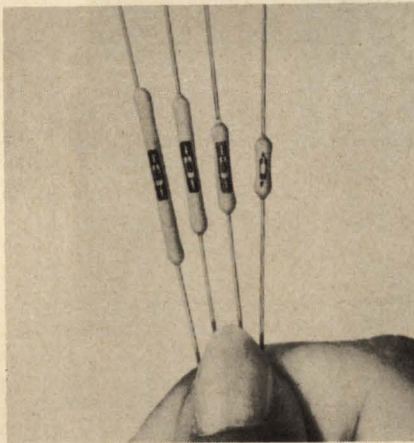

A series of film resistors, miniaturized to one-fifth the size of conventional types, cover the 1 Meg range. The line includes power ratings up to 1 w, voltage ratings up to 2 kV, with a temperature coefficient of 80 ppm/°C from -15°C to +105°C. All items are offered in the standard resistance tolerance of ±1%, with tolerances as close as 0.2% supplied on special order.

P&A: \$1.90; 2 weeks. Caddock Electronics, 6151 Columbus, Riverside, Calif. Phone: (714) 688-8650.

Circle No. 297

Thermoelectric module

Thermoelectric module, Model 3954-1, is suited to such applications as spot cooling of small elec-

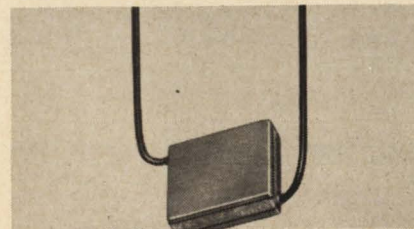

tronic components, oscillator crystal holders and infrared detectors. Package size is 2 cm x 2 cm x 0.5 cm. Optimum current is 7 amps dc, at 2.3 Vdc ($T_s = +27^\circ\text{C}$). The optimum heat pumping capacity for this unit is 9 watts (30.6 Btu's/hr).

Cambridge Thermionic Corp., 445 Concord Ave., Cambridge, Mass. Phone: (617) 876-2800.

Circle No. 298

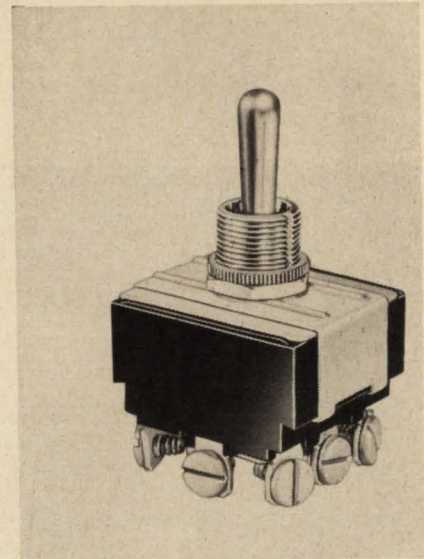

3-pole toggle switches

Not a modified 4-pole switch, the H-Series is a true three-pole switch in a compact package (typically 1-5/16 x 1-3/32 x 2-5/16-in. high). Ratings are 3 through 17 A, 125-250 Vac and up to 2 hp at 600 Vac 3-phase.

Carling Electric, Inc., 505 New Park Ave., West Hartford, Conn. Phone: (203) 233-5551. TWX: (710) 425-0034.

Circle No. 299

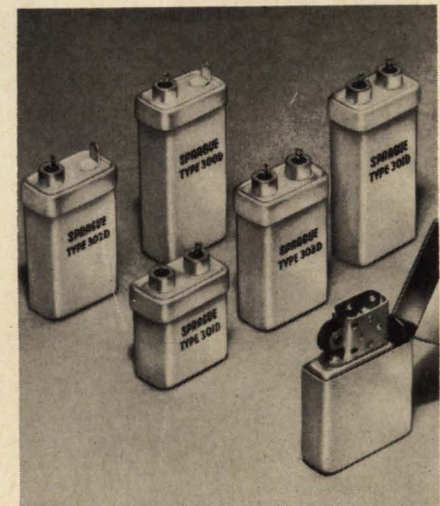

Tantalum capacitors

A new family of rectangular-case foil tantalum capacitors offer capacitance values almost twice those specified for style CL50 in military specification MIL-C-3965C. The new family, types 300D through 303D, include values from 25 to 8700 μF .

Sprague Electric Co., 347 Marshall St., North Adams, Mass.

Circle No. 351

An oscilloscope picture in 10 seconds: any longer is a waste of time.

Polaroid Land films don't make you wait to see if your trace zigged when it should have zagged.

They let you know in ten seconds.

They give you an oscilloscope picture you can study, attach to a report, send as a test record with a product shipment, or file for future reference.

You have a choice of 5 films for oscilloscope recording.

The standard film has an A.S.A.

equivalent rating of 3000. It comes in both roll film [Type 47] and pack film [Type 107]. They both give you 8 pictures $3\frac{1}{4} \times 4\frac{1}{4}$ inches. This emulsion is also available in 4 x 5 sheets [Type 57].

For extremely high-speed recording, there's Polaroid PolaScope Land film [a roll film, Type 410]. It has an A.S.A. equivalent rating of 10,000.

It can take pictures of traces too fleeting for the human eye: such as a scintillation pulse with a rise time of less than 3 nanoseconds.

One thing all these films have in common is a sharp, high-contrast image that's easy to read. Because the films are so sensitive, you can use small camera apertures and low-intensity settings.

To put these films to work on your scope, you need a camera that will take a Polaroid Land Camera Back.

Most oscilloscope camera manufacturers have one. For instance: Analab, Beattie-Coleman, BNK Associates, Fairchild, EG&G, General Atronics, Hewlett-Packard, and Tektronix.

You can get complete information by writing to Polaroid Corporation, Technical Sales Department, Cambridge, Massachusetts 02139, or by writing to one of the manufacturers mentioned above.

It will probably take a little longer than 10 seconds, but we promise the information won't be a waste of time.

"Polaroid" and "PolaScope"®

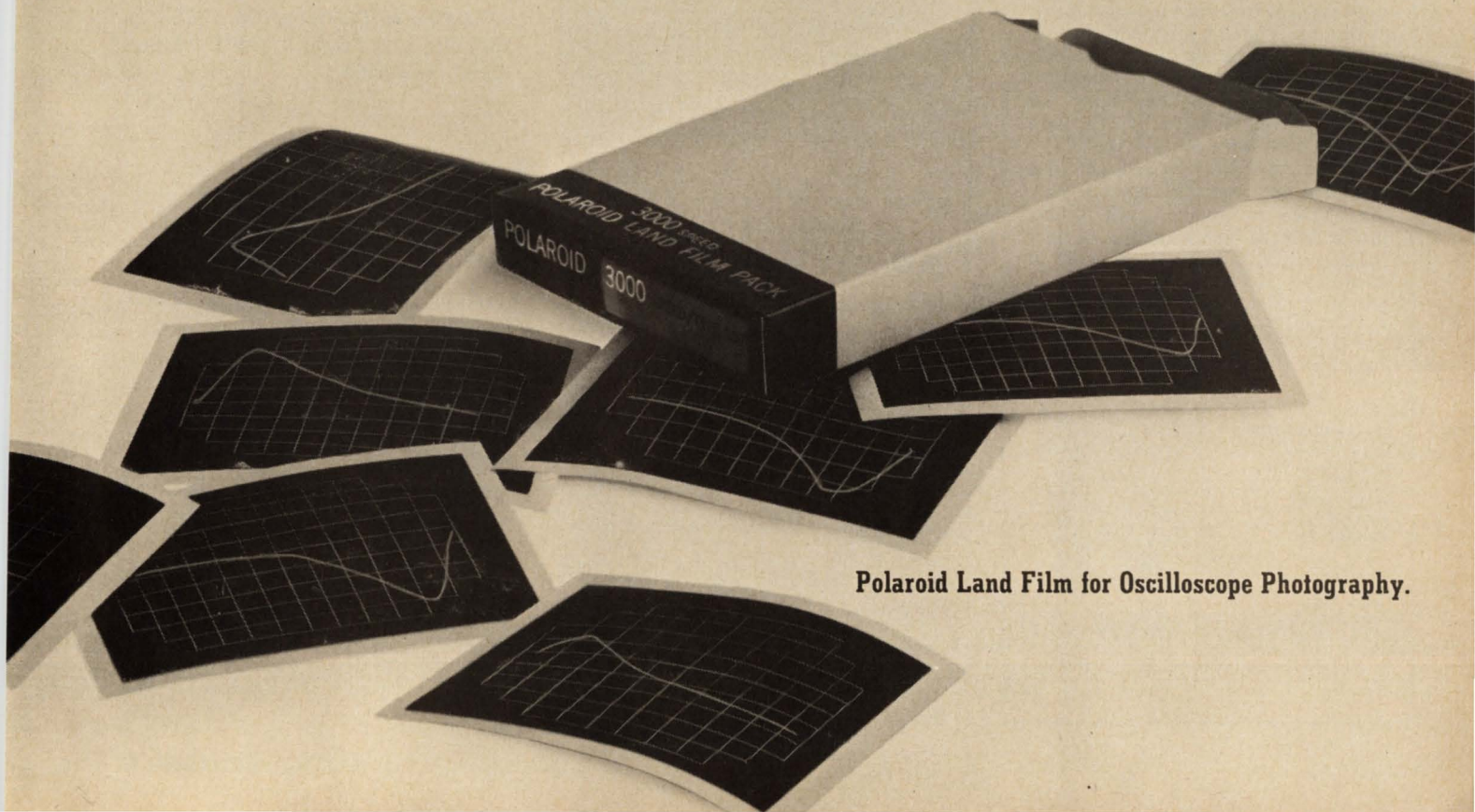

Polaroid Land Film for Oscilloscope Photography.

Tube cutting headache?

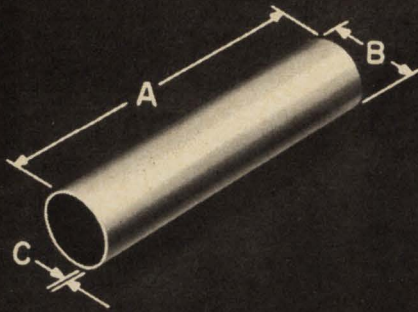

	A	B	C
Max. Dim.	7"	.500"	
Min. Dim.	.125"	.090"	.014"

Forget it!

Let Art Wire do it.

Tubing cut to precise spec is another of those maddening jobs that are best farmed out and forgotten. Art Wire can probably do the job a lot faster than you can. Our Automatic machines are already set up. At less cost, too, considering down-time and overhead.

Nice thing about it is that Art Wire takes over the problems, as well. Delivery, quality control and high-volume production are our worry, not yours.

Any non-ferrous metal tubing cut to dimensions shown above. Send us a part or a print. Phone 201-621-7272 if you're in a hurry.

We do wire forming and small part stamping, too. Bulletin 501 shows what we can do. Ask for it.



ART WIRE & STAMPING CO.

17 Boyden Place, Newark, N. J. 07102

COMPONENTS

Grid-space relay

The type 3SBK relay combines the proven magnetic motor design

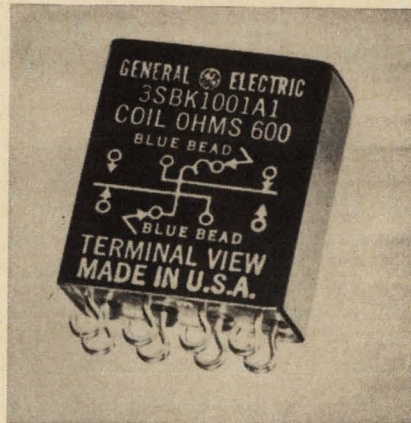

features of earlier relays with new heavy-duty contacts and terminal leads. This combination provides 5-amp switching capability in a grid-space package.

Specifications for the new relay, include a contact arrangement of 2PDT, contact rating from low level to 5 amp at 28 volts dc. Ambient temperature is -65°C to $+125^{\circ}\text{C}$. Operate and release time is five milliseconds maximum and life is 100,000 operations at rated loads.

General Electric, Schenectady, N. Y. Phone: (518) 374-2211.

Circle No. 352

Film capacitors

A line of miniaturized polystyrene and polyester film capacitors, feature capacitance stability and

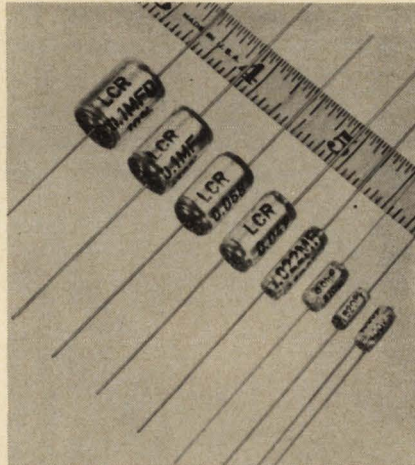

low temperature coefficient. The line includes: a 30- to 500-volt polystyrene series, a high voltage polystyrene series with working voltages of 2500 and 4000 volts, a 400-volt polyester series approximately 35% smaller than conventional units, and a 500-volt combined polystyrene-polyester model with an extremely low temperature coefficient.

All series are available in capacitances up to 100,000 pf, and tolerances as close as $\pm 1/2\%$, or $\pm 1/2$ pf.

Nucleonic Products Co., 3133 E. 12th St., Los Angeles, Calif. Phone: (213) 268-3464.

Circle No. 353

Polycarbonate capacitors

Two new "wrap and fill" metallized polycarbonate capacitors, des-

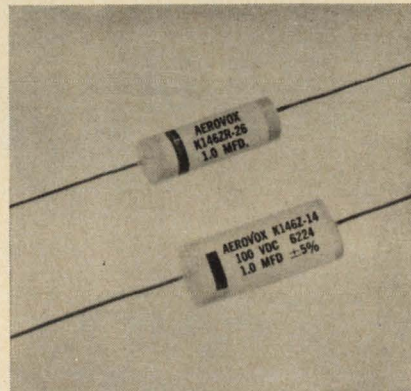

ignated types K146Z and K146ZR, offer characteristics suited to military as well as industrial and consumer applications. Basically the same, one unit has a cylindrical configuration and the other is flattened. Voltage ratings are 100, 200, 300, 400 and 600 volts. Capacity values range from .01 to 5.0 μF . Operating temperature range is -65°C to $+125^{\circ}\text{C}$.

Aerovox Corp., 740 Belleville, New Bedford, Mass. Phone: (617) 994-9661. TWX: (617) 922-2604.

Circle No. 354

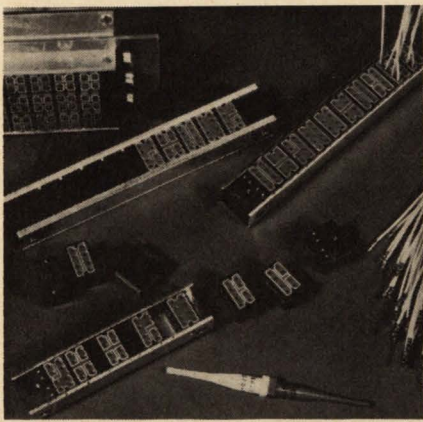

Terminal junctions

The new Deutsch TJ series of terminal junctions use crimp-type pin contacts in sizes 20, 16, 12, and 8, designed to geometry similar to NAS 1600. The contacts are inserted and removed from the rear by the use of a single insertion/removal tool; they are crimped by the use of a standard MS 3191 tool. The socket assembly is an integral part of the bus bar, and features a chamfer lead-in to accept the pin contact.

Deutsch Co., Municipal Airport, Banning, Calif. Phone: (714) 849-6701.

Circle No. 355

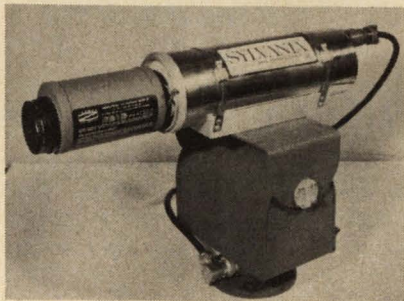

Time delay relay

The Model TDR-340 time delay relay incorporates a hermetically sealed relay and associated solid-state circuitry to produce a switch closure after a delay of 0.01 to 90 seconds adjustable over a 10:1 span. The dpdt contacts are rated for 2 amp continuous. Repeatability exceeds 1%. The unit is protected against line transients and reverse polarity.

P&A: \$59; stock-2 weeks. Temperature Systems, Inc., 1871 South Orange Drive, Los Angeles, Calif. Phone: (213) 931-3716.

Circle No. 356

SMART CIRCUITS know the difference!

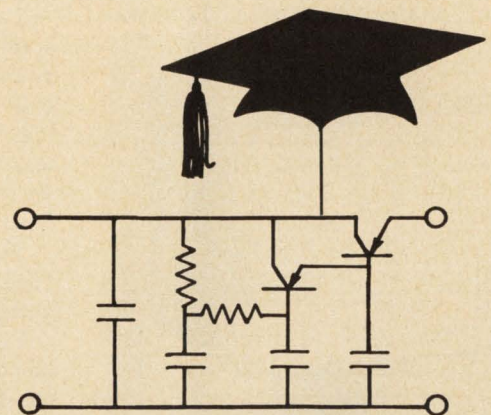

That's why Hopkins Capacitors come in such a wide selection of parameters.

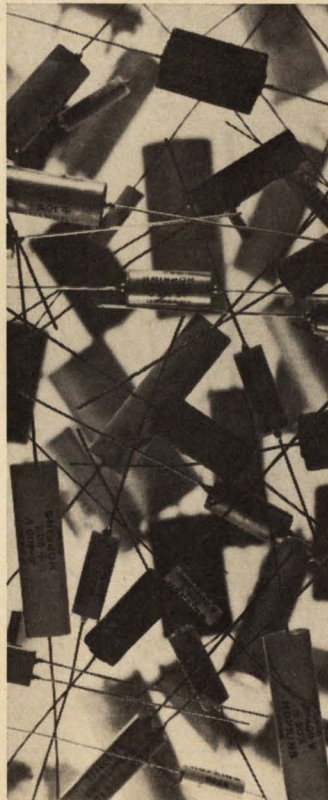

Some capacitors may be rejected by circuits as being incompatible with other components although they may seem to fit at first glance. As the circuit requirements become increasingly more stringent, smart designers often take a second look for capacitors with compatible characteristics to specify. To make your job easier, Hopkins makes a wide family of metallized dielectric capacitors—METALLIZED PAPER, METALLIZED MYLAR, HERMETICS, DUREZ COATED and WRAP & FILL—in hundreds of values, styles and sizes.

Whether you specify capacitors by capacitance, voltage, space, case style, price, polarity, temperature, tolerance, stability, resistance, or dissipation factor, check your HOPKINS catalog first—your circuit knows the difference.

Write for catalog.

HOPKINS
Engineering Company

Telephone: (213) 361-8691 • TWX 213-7645998 • Cable: HOP
12900 Foothill Blvd., P. O. Box 191, San Fernando, Calif. 91341

A Subsidiary of Maxson Electronics Corporation

Servo/differential relay

Model 14 servo/differential is an ac operated servo relay, differential relay, and phase detector. Tempera-

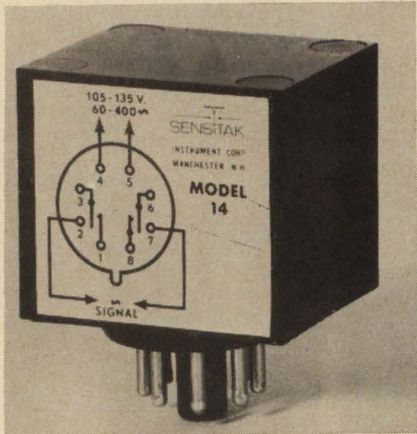

ture indication and control applications are possible.

This epoxy encased, silicon solid-state relay employs two reed switches in a four-arm bridge. Unbalance in either direction closes one reed. Switch-closure power is less than ten μ watts. Primary power requirements are one watt, 120 volts $\pm 15\%$, 60-400 Hz.

This unit can be specified for higher or lower primary power voltages, or special frequencies.

Price: \$21.75. Sensitak Instrument Corp., 531 Front St., Manchester, N. H. Phone: (603) 627-1432.

Circle No. 357

Linear position transmitter

Accuracy is 0.5% with resolution as low as one part in three thousand for the Model 31590 linear position transmitter. Designed for industrial on-line applications, the

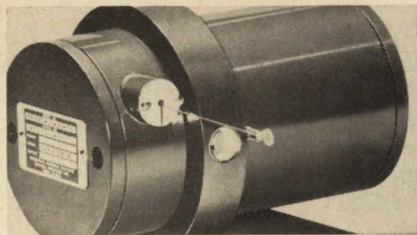

transmitter is essentially a rotary potentiometer built to withstand rugged environments. Resistance output of the new transmitter is standard, but it can be supplied with a separate power supply in a JIC housing to provide current or voltage outputs as well.

General Precision Inc., 6511 Oakton St., Morton Grove, Ill. Phone: (312) 966-4000. TWX: (312) 967-5670.

Circle No. 358

Heat dissipator

A forced air heat dissipator for semiconductor cooling dissipates 80

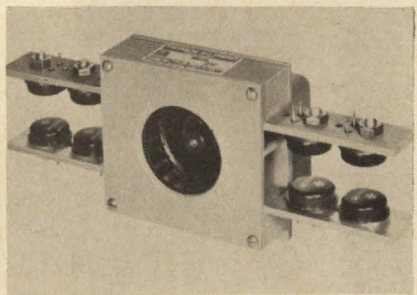

watts, has 0.25°C/watt thermal resistance, and mounts 12 semiconductors—or more when stacked. All aluminum, 6-1/2 x 4-3/4 x 4-in., units may be modified for specific needs.

P&A: about \$75, 2-4 wks. Vemaline Products Co., 511 Commerce, Franklin Lakes, N. J. Phone: (201) 337-6200. TWX: (201) 337-4500.

Circle No. 359

Operational amplifier

The Model 353A operational amplifier features a standard voltage drift of less than 1 microvolt per °C average over temperature range of -25°C to +85°C, without chopper intermodulation. Differential input current tracking vs temperature is

0.02 microamps per °C max. and open loop differential input impedance is typically 1.5 M.

P&A: \$58.00; stock. Monroe Electronics Inc., 5 Vernon St., Middleport, N. Y. Phone: (716) 735-3721.

Circle No. 360

Photoconductive cells

A new series of four T-2 photoconductive cells with a great variety of industrial and commercial applications employs cadmium sulfide in a hermetically sealed glass envelope as the light sensitive material. The cells measure only 0.260 inches in maximum diameter and are available in the range of 2000 to 128,000 ohms light resistance. Dark resistance is at least 100 times the light resistance value.

All four types—8318A, 8475A, 8477A, and 8582A—have a cell dissipation rating of 75 mW at 25 C, and are designed to withstand 300 G's impact shock and 2.5 G's vibration over extended periods.

Sylvania Electric Products, Inc., Seneca Falls, New York 13148. Phone: (315) 568-5881.

Circle No. 361

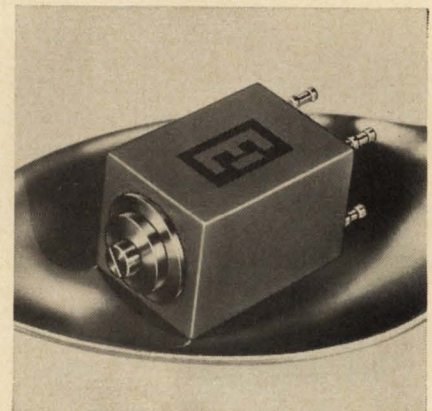

Multi-turn potentiometer

Resistance ranges from 20 ohms to 100k are available with infinite resolution and tolerance of 1% in a new line of multi-turn potentiometers. Linearity is 0.01% and TC is 10 ppm/°C to 125°C.

Elliott Industries, 23987 Craftsman Rd., Calabasas, Calif. Phone: (213) 346-2062.

Circle No. 362

Accuracy is our policy

The time standard shown on page 102 of the November 22 issue was mistakenly attributed to Datameetrics, Inc., of Waltham, Mass. The device is manufactured by Datameetrics Corp., of 6217 Lankershim Blvd., North Hollywood, Calif. The two companies are in no way related to each other.

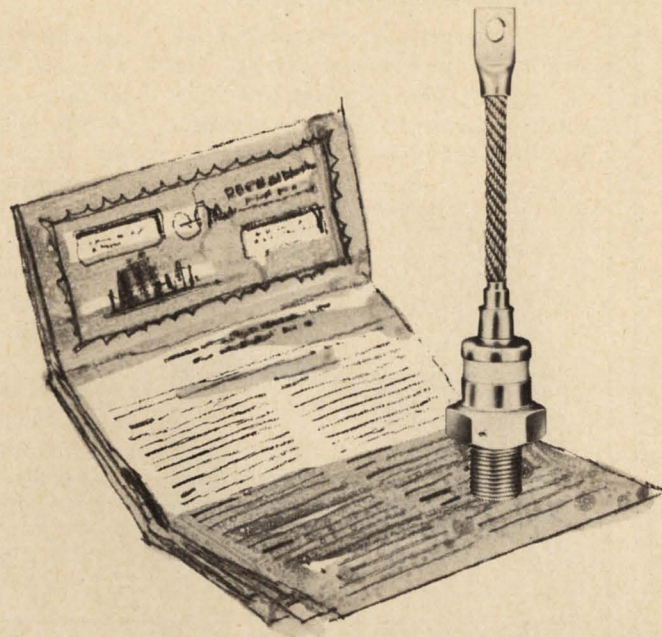

like taking out insurance!

trouble-free dependability and efficiency!

Syntron Avalanche Silicon Rectifiers provide protection against voltage transients. The Avalanche Silicon Controlled Rectifier gives you the same protection plus! They have the dependability and efficiency to help you meet the highest standards of reliability.

There is a Syntron Avalanche Silicon or Avalanche Silicon Controlled Rectifier for your every requirement.

Write For Literature

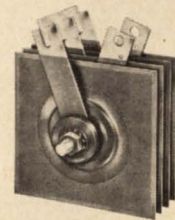
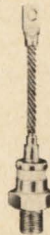

SYNTRON

SYNTRON COMPANY

283 LEXINGTON AVENUE • HOMER CITY, PA.

66R2

IN ELECTRONICS BIG THINGS ARE HAPPENING AT LOCKHEED-GEORGIA

Openings at all technical levels in these areas of

ELECTRONIC SYSTEMS ENGINEERING

Systems Analysis, Design, and Integration . . .

Command and Control . . .

Radar Theory . . .

Surveillance Systems . . .

Data Processing . . .

Displays . . .

Simulation . . .

Communications . . .

Navigation Electromagnetic Compatibility . . .

Antennas . . .

Circuit Design . . .

Aircraft Instruments . . .

Electrical Power Systems . . .

You and your family will like living and working in the growing metropolitan Atlanta area with its pleasant climate and many cultural and recreational advantages.

Send resume to: Charles E. Storm, Professional Employment Manager, Lockheed-Georgia Company, 834 West Peachtree Street, Atlanta, Georgia 30308, C-133.

LOCKHEED-GEORGIA CO.

A DIVISION OF LOCKHEED
AIRCRAFT CORPORATION

An equal opportunity employer

COMPONENTS

Operational amplifier

A new series of ac-powered operational amplifiers are called the "C series". The new amplifiers include a miniature dual power supply for 115V, 58-420 cps operation,

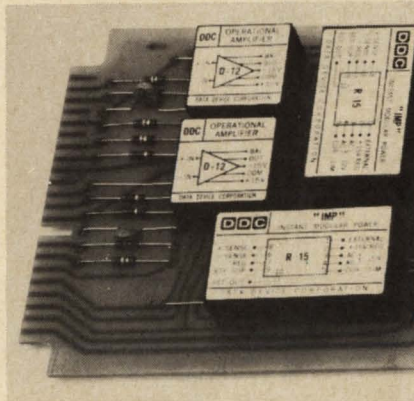

and offer the choice of any one or two of several encapsulated DDC amplifiers. The entire unit is only 5/8-in. high, on a 4-1/2-in. x 6-1/2-in. P C card, for insertion in a standard card rack or direct mounting in systems.

Typical amplifiers have open-loop gain in excess of 86 db, temperature coefficients from 10 $\mu\text{V}/^\circ\text{C}$, and output currents of 2 or 20 ma, at dc-10 Kc.

P&A: \$188-\$320; stock-10 days. Data Device Corp., 240 Old Country Rd., Hicksville, N. Y. Phone: (516) 433-5330.

Circle No. 363

Flat-conductor ribbons

High-performance insulations are now available with a line of



flat-conductor ribbon cables. Included, in addition to the common polyester laminate insulation, is homogeneous TFE Teflon, homogeneous FEP Teflon and a Teflon-Kapton (polyimide) laminate.

Standard constructions are available in 1-, 2- and 3-in. widths with conductor sizes ranging from 0.002 to 0.150-in. centers.

Prices range from \$0.25 per foot to \$6.00 per foot. W. L. Gore & Assocs., 555 Paper Mill Rd., Newark, Del. Phone: (302) 368-9183. TWX: (302) 737-1060.

Circle No. 364

PC receptacles

New PC board receptacles, "Reli-acon", series FD-RAL-814S-SF, feature dual terminations and are available for wire wrap or solder

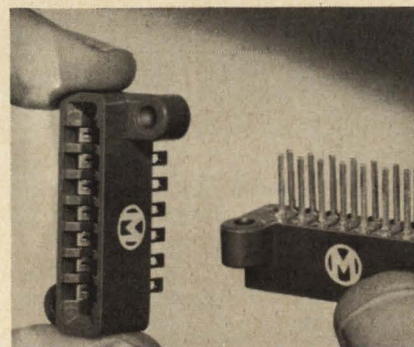

connections. The receptacles are standard "Reli-acon" types with lateral mounting pads.

They employ split-face, gold plated beryllium contacts, and each contact is provided with two individual surfaces for resistance to vibration and shock. Standard 0.150-in. contact spacing, center-to-center, is employed.

P&A: \$0.75-\$2.00; 3 weeks. Methode Electronics Inc., 7447 West Wilson Ave., Chicago, Ill. Phone: (312) 867-9600. TWX: (312) 265-1417.

Circle No. 365

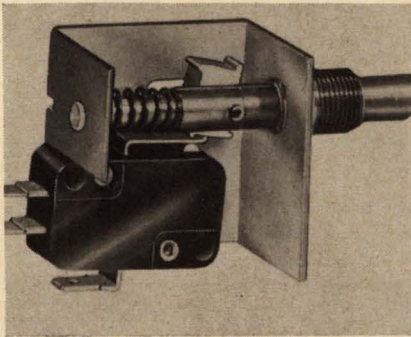

Alternate action switch

A cam and pawl arrangement provides a plunger action switch with push-on, push-again-off feature.

Switch E 34-OOG is rated 15 amps, 1/2 H. P., 125/250 Vac, while switch E 33-OOG has similar ratings at 10 amps. A threaded ferrule for a 3/8-32 nut provides for panel mounting. The plunger requires a maximum of 24 oz. operating force, and has a 3/8-in. flattened section for a knob or button.

Price: \$1.95, \$30.897 in 2000 lots. Cherry Electrical Products Corp., 1650 Old Deerfield Rd., Highland Park, Ill. Phone: (312) 432-8182. TWX: (910) 688-3782.

Circle No. 366

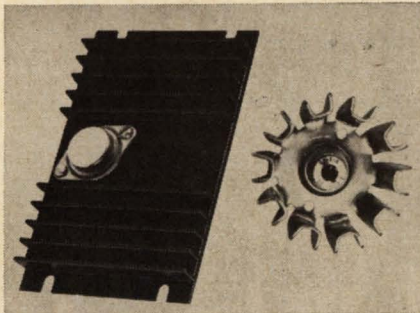

Low-profile heat sinks

Two new series of low profile heat sinks, designated Model 19 and Model 600, will both accommodate all transistor case styles and can be used with both natural and forced air cooling.

Model 19 is rectangular in design and has serrated fins, presenting a profile of only .460-in. Three sizes, 1-1/2-, 3- and 4-3/5-in., all 4-13/16-wide, are available. Model 600 is circular and is surrounded by a ring of 10 punch-formed fins. Diameter is 2-5/16-in. and fin height is 3/4-in.

P&A: \$0.33 (model 19) and \$0.23 (model 600); 2 weeks. George Risk Industries, 672 15th Ave., Columbus, Neb. Phone: (402) 564-2777.

Circle No. 367

Logic pulse generators

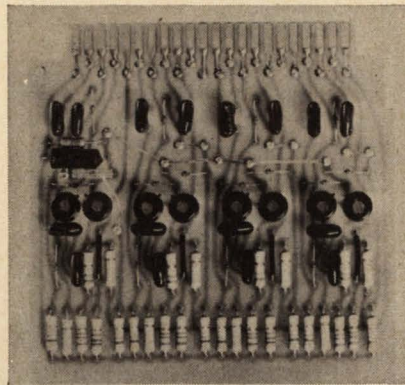

A pulse generator is available for timing systems requiring a nominal delay of 5 μ s. The Model AC2-M generator provides four one-shot circuits, each with two inputs. A positive going pulse in either input gives an output. As an ac-coupled OR gate, output level at "one" is $-10 \text{ V} \pm 2 \text{ V}$. At "zero" output is $-0.1 \text{ V} \pm 0.1 \text{ V}$.

Wyle Labs., Products Div., 133 Center St., El Segundo, Calif. Phone: (213) 322-1763. TWX: (213) 348-6283.

Circle No. 368

Miniature High Q Air Capacitors

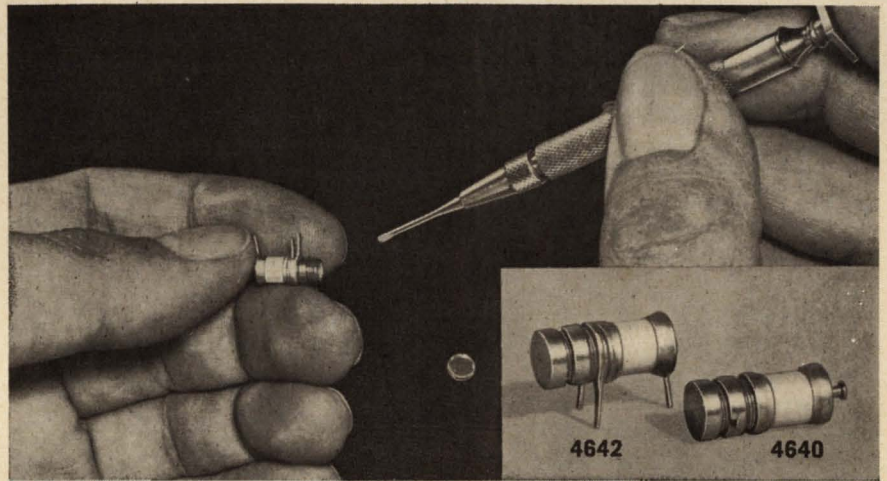

Small Size • High Q • Rugged High Selectivity • High Sensitivity

- Size: .220" dia. 15/32" length
- Q @ 100 mc: > 5000
- Capacitance Range: 0.4 — 6 pf
- Non-Magnetic

New miniature series features high quality materials and workmanship typical of all Johanson Variable Air Capacitors.

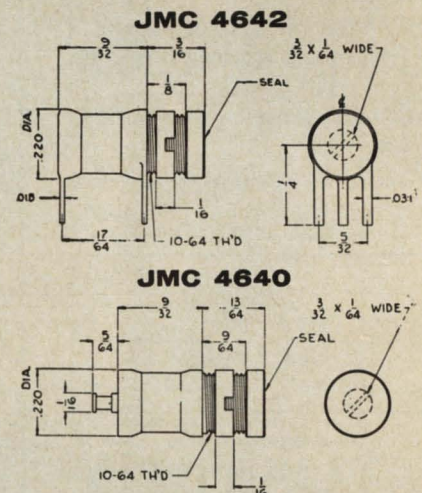

Write or Phone for Details, Prices

Johanson

MANUFACTURING CORPORATION

400 Rockaway Valley Road, Boonton, N. J. 07005 • Phone (201) DEerfield 4-2676

snapping bimetallic disc...



snappy way to control temperature

If your problem is maintaining temperature in liquids, gases or metals, here's the answer:

Our hermetically-sealed thermal switches (standard or custom), which use a reliable, snap-acting bimetallic disc to open and close contacts, are engineered for military ordnance, spacecraft, aircraft, and industry. The standard 500-series, available on immediate order, gives you:

- Fast response.
- Operating life exceeding 100,000 cycles.
- A compact 5-gram capsule.
- Temperature ambients from -80°F . to $+300^{\circ}\text{F}$.*
- Vibration exceeding 50 g to 2,000 cps.
- Shock and acceleration to 100 g.

*Higher temperature performance available on special order.

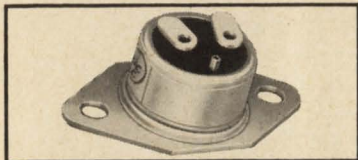

For detailed specs, call or write us:

U.C. **UNITED CONTROL CORPORATION**

Overlake Industrial Park, Redmond, Wash. 98052
Phone 206-885-3711 or TWX 206-999-1874

ON READER-SERVICE CARD CIRCLE 128

COMPONENTS

Dc amplifier

The new Model A414-12 is a combination of a differential dc am-

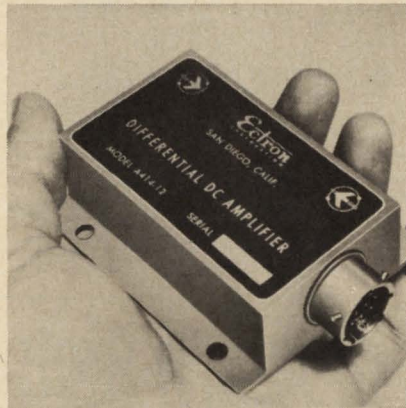

plifier and a precision transducer power supply in a single module. The instrument is designed for airborne and other severe environment applications.

Stability is better than $0.5 \mu\text{V}/^{\circ}\text{C}$ and common-mode rejection is 120 dB at 60 Hz. It will operate at temperatures from -65°F to $+210^{\circ}\text{F}$ and is immune to 100 G shock, 100 G acceleration and 20 G vibration.

Ectron Corp., 8070 Engineer Rd., San Diego, Calif. Phone: (714) 278-0800.

Circle No. 369

Square trimmers



A new line of miniature square trimming potentiometers offer resistances as high in 100 K in the standard package. Designated the series 07, the new trimmer features a cog wheel drive mechanism which replaces six parts or functions that are common to most other square trimming potentiometers. Standard resistances range from 50 to 100 K, operating to $+185^{\circ}\text{C}$, and rating is at 1 watt at 85°C .

Conelco Components, 465 West Fifth St., San Bernardino, Calif. Phone: (714) 885-6847.

Circle No. 370

Photomultiplier tubes



The XP1000 family is a group of 10-stage, 2-in. photomultipliers with standard 14-pin bases that are designed for uniform quality.

The tubes are available in production quantities and are direct replacements for many popular types. They are the XP1000 (S-11), XP-1002 (S-20), XP1004 (S-13) and the XP1005 (S-1).

Amperex Electronic Corp., Hicksville, Long Island, N. Y. Phone: (516) 931-6200. TWX: (516) 433-9045.

Circle No. 371



half the picture

When you look at electronic components are you seeing only half the picture?

We're the last people to argue with component purchasers who put performance, price and delivery first — meeting these three basic requirements is what keeps us in business. But most engineers are also on the lookout for something more, and many of them find it at Mullard.

Take research and development for instance. Out of Mullard R&D have come outstanding devices such as the travelling wave tubes for the New York—San Francisco and Montreal—Vancouver microwave links. Production resources? Mullard

plants are among the most efficient anywhere, with a reputation for the production of tight-tolerance devices to proved standards of reliability. As for circuit know-how, Mullard has the best equipped applications laboratories in Britain. And when it comes to technical services, you will find that Mullard provides the kind of comprehensive performance specs, survey documents and application reports that are just that much more useful. If you want to get the *whole* picture, why not ask us to help you with some of your component problems?

DIODES · TRANSISTORS · PHOTO-DEVICES AND RADIATION DETECTORS ·
RECTIFIER DIODES AND STACKS · THYRISTORS AND STACKS · INTEGRATED
CIRCUITS · CATHODE RAY TUBES · RECEIVING TUBES · ELECTRON OPTICAL
DEVICES · PHOTSENSITIVE DEVICES · COLD CATHODE DEVICES · POWER
DEVICES · TRANSMITTING TUBES · MICROWAVE DEVICES · CAPACITORS ·
FERRITE MATERIALS AND ASSEMBLIES · COMPUTER COMPONENTS AND
ASSEMBLIES · MAGNETIC MATERIALS · SPECIAL PURPOSE MAGNETS · VACUUM
DEVICES · WOUND COMPONENTS.

Mullard

where the product is only part of the deal
MULLARD LIMITED · TORRINGTON PLACE · LONDON WC1 · ENGLAND

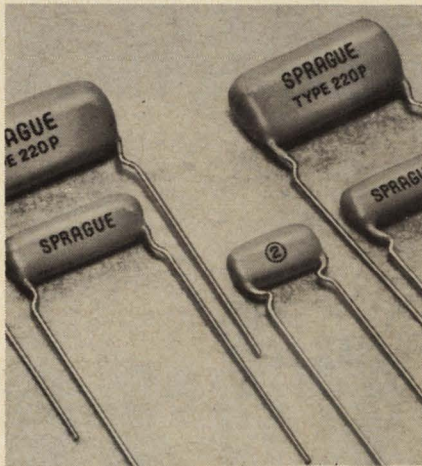

PC capacitors

Small-size capacitors for use on printed wiring boards are now available in 1000 volt ratings ranging from 0.001 to 0.1 μ F. The difilm orange drop capacitors, type 220P, are designed for service at temperatures up to 125°C with appropriate derating.

Sprague Electric Co., 347 Marshall St., North Adams, Mass.

Circle No. 372

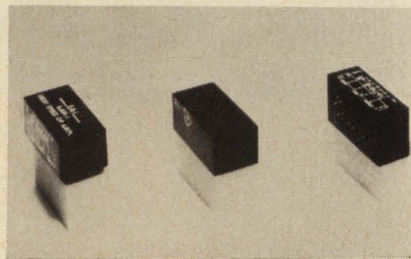

Control amplifiers

Series 6, 10-volt amplifiers for process control systems, instrumentation, test equipment and signal conditioning applications are available in several versions. Featured are output power and driving capability, conservatively rated at 25 mA without "booster" amplification.

Each amplifier is provided with short-circuit protection at input and output terminals. Offset voltage is adjustable and can be set to precisely zero.

P&A: \$65-\$95; stock. Electronic Associates, Inc., West Long Branch, N. J. Phone: (201) 229-1100.

Circle No. 373

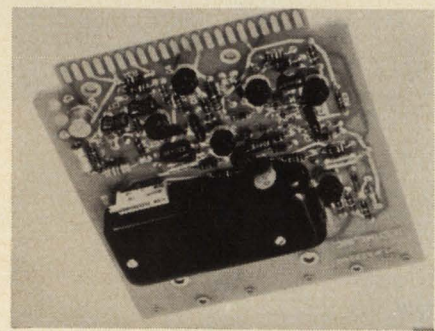

Digital circuit module

The RZ-1 is a digital write-read amplifier for magnetostrictive delay line applications packaged with the delay line. This results in a complete input-output module for long time delays up to 10,000 microseconds at 1 MHz PRF. The write amplifier drives the delay line, the read amplifier amplifies the delay line output and restores the input pulse waveform.

Sealectro Corp., 225 Hoyt St., Mamaroneck, N. Y. Phone: (914) 698-5600. TWX: (710) 566-1110.

Circle No. 374

EASTMAN 910® Adhesive Offers Quick Setting With Epoxy Adhesives

For quick fastening with epoxy resin adhesives, Eastman engineers have developed an EASTMAN 910 Adhesive and epoxy combination bond.

A drop of EASTMAN 910 Adhesive on one surface is laid between two stripes of conventional two-component epoxy adhesive. Stripes of epoxy are applied at right angles on the other surface. The surfaces are then

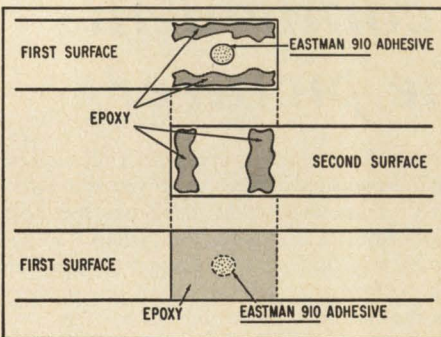

closely mated, forming a box of epoxy adhesive around the EASTMAN 910 Adhesive (see diagram). Clamps and jigs are not required since the EASTMAN 910 Adhesive sets within two minutes or less upon contact pressure, securing the bond until full strength of the epoxy develops. This combination bonding technique works well for most metal as well as non-metal applications.

EASTMAN 910 Adhesive will form bonds with almost any kind of material without heat, solvent evaporation, catalysts, or more than contact pressure. Try it on your toughest bonding jobs.

For technical data and additional information, write to Chemicals Division, Eastman Chemical Products, Inc., subsidiary of Eastman Kodak Company, Kingsport, Tennessee. EASTMAN 910 Adhesive is distributed by Armstrong Cork Company, Industry Products Division, Lancaster, Pa., and Loctite Corp., 705 N. Mountain Road, Newington, Conn.

Here are some of the bonds that can be made with EASTMAN 910 Adhesive

Among the stronger: steel, aluminum, brass, copper; vinyls, phenolics, cellulose, polyesters, polyurethanes, nylon; butyl, nitrile, SBR, natural rubber, most types of neoprene; most woods. Among the weaker: polystyrene, polyethylene, (shear strengths up to 150 lb./sq. in.).



There is no adhesive like EASTMAN 910® Adhesive

- SETS FAST**—Makes firm bonds in seconds to minutes.
 - VERSATILE**—Joins virtually any combination of materials.
 - HIGH STRENGTH**—Up to 5,000 lb./in.² depending on the materials being bonded.
 - READY TO USE**—No catalyst or mixing necessary.
 - CURES AT ROOM TEMPERATURE**—No heat required to initiate or accelerate setting.
 - CONTACT PRESSURE SUFFICIENT.**
 - LOW SHRINKAGE**—Virtually no shrinkage on setting as neither solvent nor heat is used.
 - GOES FAR**—One-pound package contains about 30,000 one-drop applications. (Or in more specific terms, approximately 20 fast setting one-drop applications for a nickel.)
- The use of EASTMAN 910 Adhesive is not suggested at temperatures above 175°F., or in the presence of extreme moisture for prolonged periods.

See Sweet's 1966 Product Design File 8a/Ea.

Now available! EASTMAN 910 Surface Activator. When certain surface conditions inhibit rapid bond formation, use of EASTMAN 910 Surface Activator is recommended to insure the rapid polymerization of EASTMAN 910 Adhesive.

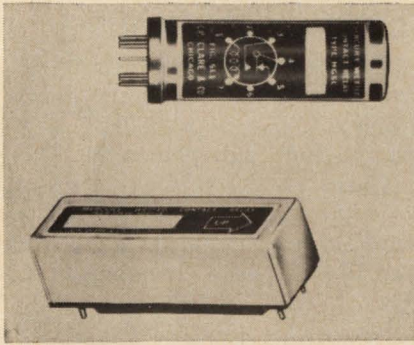

Sensitive relays

Two new miniature mercury-wetted-contact relays, type HGSL for wired assemblies, and type HGSM for printed circuit board applications, have sensitivity ratings of 40 mW single-side stable and 20 mW bi-stable. Either Form D (bridging) or Form C (non-bridging) contacts are available. The contacts can handle power switching requirements up to 100 VA ac or dc, over billions of operations. Low level contact ratings are 0-300 millivolts, 0-100 mA.

The HGSL has a contact circuit resistance of 35 milliohms max; the HGSM, 20 milliohms max. Both types have a nominal operate time of 1.0 ms at maximum coil power.

C. P. Clare & Co., 3101 Pratt Blvd., Chicago, Ill. Phone: (312) 262-7700.

Circle No. 375

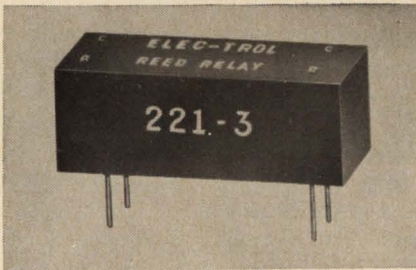

Magnetic reed relays

High reliability is insured by a complete test and retest of each batch of the Hi-Rel series 220 magnetic reed relays. All reeds are operated for 1,000,000 operations. Contact resistance is monitored during burn-in and after assembly, and each batch is miss-tested for 5,000,000 operations. Life ratings range to 200 million operations at signal currents and loads from dry circuit to 1/2 amp.

Elec-Trol Inc., 18828 Bryant St., Northridge, Calif. Phone: (213) 349-0622.

Circle No. 376

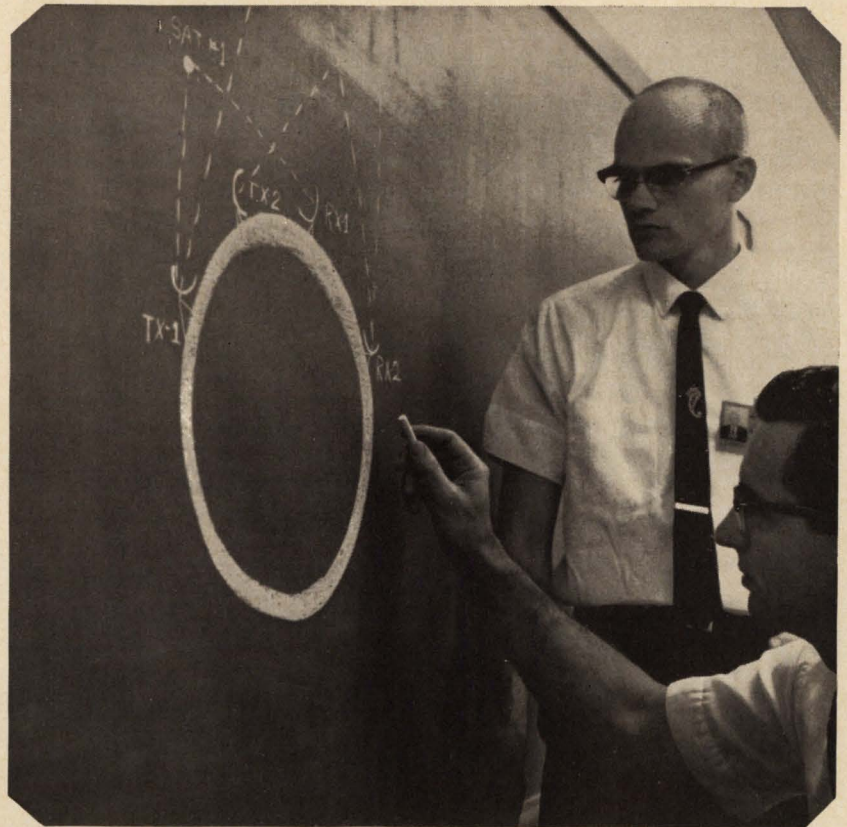

Is engineering a job... or an adventure?

The answer depends largely on where you work . . . and what you do. At Motorola we view engineering with a rare excitement, for much of the time and effort of Motorola's engineers is devoted to pushing back the horizons of knowledge in electronics. Innovating. Experimenting. Problem Solving. Creating. Pushing back frontiers. It's exciting work, rich in accomplishment and satisfaction.

And the entire climate at Motorola encourages the creative mind to grow. Your stature as an engineer is improved by the caliber of the people who surround you. Here you work with some of the most respected scientists and engineers in the entire electronics field.

They are quick to recognize and advance skill and creativity—and this is why career opportunities for good engineers are exceptional at Motorola. You can set your sights to the top—and make it.

Challenging positions now await ambitious electronic engineers in many diversified fields—2-way communications, space communications, radar, color TV, digital communications and others. Would you like to talk to us?

SYSTEMS ENGINEERS advanced R & D in radio communications systems related to Two-way, portable, mobile and radio-telephone equipment.

EQUIPMENT DESIGN high performance solid state receivers, transmitters, and data processing equipment for radar, communications, command and control, tracking and telemetry.

FAMILIARITY WITH STATE-OF-THE-ART statistical communications theory, advanced signal processing techniques, solid state r.f. techniques, ultra-reliability, antenna systems, advanced structural and thermal designs.

SECTION MANAGER direct engineers and support personnel in state-of-the-art communications, including r.f. systems and input-output devices.

CHIEF ENGINEER technical management of R & D group in advanced technology related to solid state r.f. communications.

CIRCUIT DESIGN ENGINEERS advanced R & D in receivers, transmitters, RF, digital, Color TV and automotive electronics.

DEVELOPMENT ENGINEERS advanced communications products in consumer, industrial and military electronics.

Excellent opportunities also available in Phoenix, Ariz.

Mr. W. H. HAUSMANN, Engineering Personnel Mgr., Dept. B, 4545 Augusta Blvd., Chicago 51, Illinois

An equal opportunity employer.



MOTOROLA inc.

ON READER-SERVICE CARD CIRCLE 892

Digital readouts

A new line of digital readouts produces characters in clear white light with a minimum brilliance rating of 500 foot-lamberts. This is accomplished through the use of

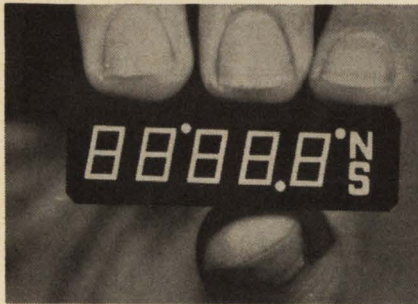

incandescent lamps and "light pipe" segments that transmit the light from the lamps directly to the viewing surface. The standard character is composed of seven segmented bars capable of displaying 20 standard signs—the 10 numerals and the letters A, C, E, F, G, H, J, L, P and U with provision for a decimal point or degree sign after each digit. Special characters can easily be added.

Tung-Sol Electric Inc., One Summer Ave., Newark, N. J. Phone: (201) 484-8500.

Circle No. 377

Hall effect device

A new addition to the "HALL-PAK" series of Hall effect devices has an effective air gap of only 2.5 mils. The Model BH-702 consists of a temperature-stable indium ar-

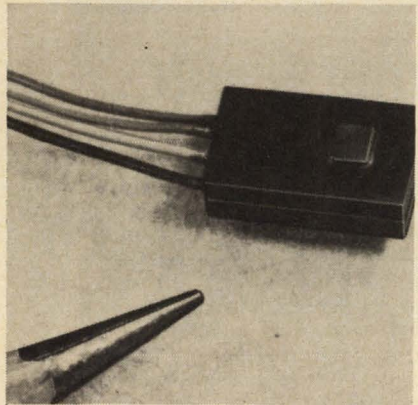

senide Hall plate sandwiched between two high-permeability ferrite plates and encapsulated in epoxy.

Sensitivity of the Hall element is listed at 0.15 V/A-kG minimum. Open circuit Hall voltage of the unit suspended in a field of 100 oersteds and 200 mA control current is 9.0 mV minimum. In a closed magnetic circuit driven with 2.5 ampere-turns, V_H is at least 8 mV with 200 mA control current.

P&A: \$35.00 single units—\$24.00 100 or more; stock. F. W. Bell, Inc., 1356 Norton Ave., Columbus, Ohio 43212. Phone: (614) 294-4906.

Circle No. 378

Vacuum thermocouples

A matched set of two standard pattern, vacuum thermocouples,

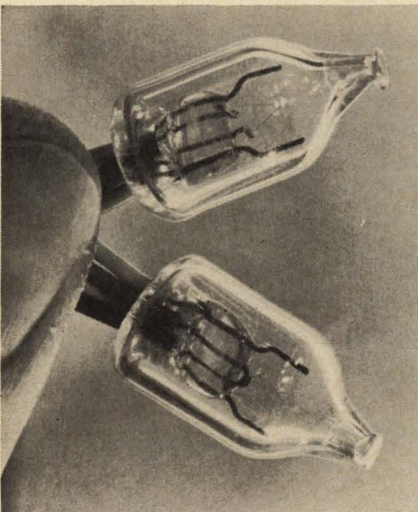

Model MP1S.7, are designed for use in true rms voltmeters or for converting digital voltmeters to measure true rms. Matching for temperature and tracking effects is rated better than 0.5% over a 50°C range, accurate for frequencies from a few cps to 10 MHz. Characteristics of the individual Model MP1S.7 couples are as follows: heater current, 5 mA; heater resistance, 90 ohms $\pm 10\%$; couple output, 7 mV $\pm 12\%$, and couple resistance, 8 ohms $\pm 10\%$.

Price: \$24.95 per pair. Harry Levinson Co., 1211 East Denny Way, Seattle, Wash. Phone: (206) 323-5100. TWX: (206) 998-1047.

Circle No. 379

Experimenter's kits

Three experimenter kits will build fourteen electronic control circuits, using transistors, SCRs, thermistors, and photocells.

Basic kit KD2105 contains one SCR, five silicon rectifiers, and two transistors. Ten separate circuits can be built with the parts in this kit.

Two "add-on" kits, KD2110 with high, low, and room-temperature thermistors, and the KD2106 with one photocell, can be used with the basic kit for more exotic constructions. An eighty-page manual, KM-70, gives instructions for each control circuit.

P&A: KD2105—\$9.95, KD2106—\$2.75, KD2110—\$2.45, and KM-70—\$.95; in stock. RCA, 30 Rockefeller Plaza, New York, N. Y. Phone: (212) 689-7200.

Circle No. 380

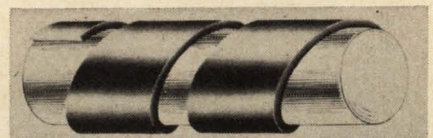

Computer memory

Twistor wire, used in the memory section of digital computers, is composed of a fine copper wire, 0.003-in. diameter, helically wound with a flat molybdenum-permalloy tape. In memory applications it is said to lower cost per bit, give faster switching speed, smaller temperature variation, and greater ease of fabrication.

Recently announced prices range as low as \$0.18 per foot. Arnold Engineering Co., Box G, Marengo, Ill. Phone: (815) 568-7251. TWX: (815) 568-7042.

Circle No. 381

Ceramic capacitors

A subminiature ceramic capacitor line is available with capacitance values to 0.1 μF in the CK06 case, and to 0.01 μF in the CK05 case with radial or axial leads. Temperature characteristic is $\pm 15\%$ from -55°C to $+125^\circ\text{C}$; with working voltage of 50 dc.

Republic Electronics Corp., 176 E. 7th St., Paterson, N. J. Phone: (201) 279-0300.

Circle No. 382

New

From
Master
Specialties
Company...

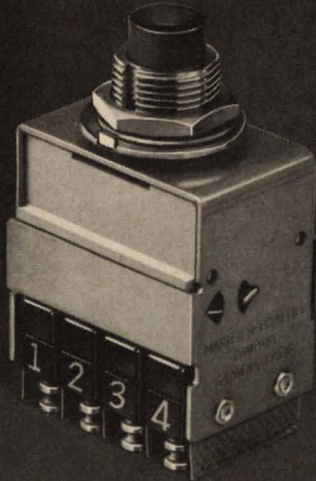

Simultaneity

in multiple
switch
contact
transfer

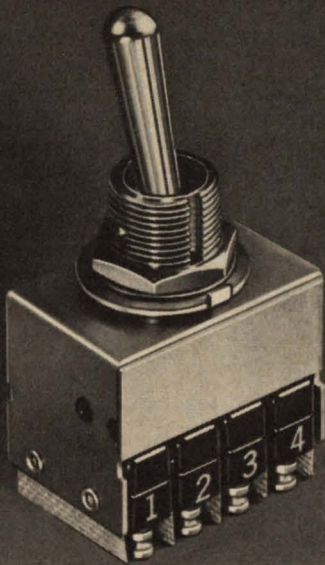

MSC



TWO NEW SWITCH ASSEMBLIES DESIGNED TO TRANSFER ALL CONTACTS IN MULTIPLE SWITCH MODULES SIMULTANEOUSLY!

Two new solutions to the problem of precision manual switching! Designed and produced to conform to rigid aerospace specifications, both series offer new standards of reliability to marine, industrial and commercial equipment. Designed from top to bottom to add extra-margin performance, durability and ease of installation, these switches are ready now for the most critical applications.

SERIES 14 PANEL-MOUNT PUSHBUTTON SWITCHES

True "Snap-action" operation results from this new switch mechanism design that makes contact transfer instantaneous . . . prohibits dangerous "tease" operation . . . provides a positive tactile indication you can feel through your fingertip! The detent force requirement is sufficient to require deliberate action . . . no chance for accidental switching. Select this switch for precision construction and precise operation . . . plus these added features:

A. Enclosed switch mechanism to protect against dust and dirt collection. B. Concave "no-slip" buttons in red or black. C. Universal anti-rotation mount for panels to 3/16" thick. D: Identified switch modules for quick assembly. E: Double-turret, long terminals for two wire connection . . . ease of soldering. F: Flexible, no-burn/no-odor switch insulators. G: Stainless steel and plastics throughout for any environment.

Available in 2PDT or 4PDT Alternate or Momentary Contact Arrangements . . . Rated to 5 amps @250VAC.

SERIES 16 TOGGLE SWITCH ASSEMBLIES

A new design featuring a switching mechanism so precise that all contacts of multiple switch modules transfer within a 1° segment of the toggle lever 34° travel arc! Coupled with a force requirement that precludes accidental switching and a positive full-travel lever action that prohibits "tease" operation, this switch offers new performance standards for any application. Alternate action maintains contacts in the normally open or normally closed position under shock and vibration as specified in MIL-STD-202. Ruggedly constructed, this series also offers these features:

A: Corrosion resistant, stainless steel lever . . . long enough to provide sufficient leverage for comfortable operation of any switch grouping. B: Universal, anti-rotation mounting . . . all hardware supplied. C: Plated, double-turret, long terminals for two wire connection. D: Identified switch modules for quick assembly. E: Flexible, no-burn/no-odor switch insulators. F: Environment resistant stainless steel and plastic throughout.

Switch Rated to 5 amps @ 250VAC.

Literature Detailing These New Precision Manual Switches is Now Available on Request.

MASTER SPECIALTIES COMPANY

1640 MONROVIA, COSTA MESA, CALIFORNIA
TELEPHONE AREA CODE 714: 642-2427

REGIONAL OFFICES AND TELEPHONE

ALABAMA: Huntsville 205-536-7415
CALIFORNIA: Costa Mesa 714-642-0114
CALIFORNIA: Sunnyvale 408-245-9292
FLORIDA: Winter Park 305-647-0100
ILLINOIS: Chicago 312-282-7112
NEW YORK: Syracuse 315-479-9191
NEW YORK: Valley Stream, L.I 516-561-2334
TEXAS: Dallas 214-357-9459

**±1% tracking
plus taut-band
in 20 models,
9 styles---with
many in stock**

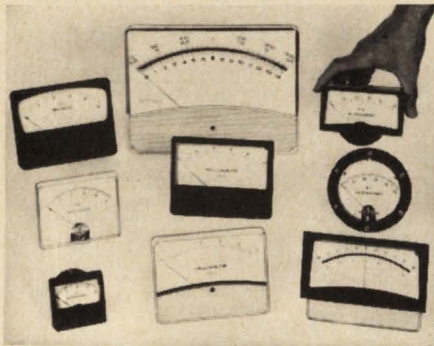

API offers 1 percent tracking, at no extra cost, in virtually every popular DC panel meter style, size and sensitivity—clear plastic, black phenolic, or ruggedized-sealed.

As long as you specify taut-band construction, you'll automatically get ±1 per cent tracking—in all but the smallest and most sensitive API meters.

Taut-band is a bonus in sensitive meters

You don't even have to specify taut-band if you order meters in ranges from 0-3 to 0-50 microamperes and from 0-3 to 0-25 millivolts. These meters just naturally come with taut-band. Besides responding best to exceptionally small signals, this friction-less design is much more resistant to damage from shock and vibration.

(Taut-band costs a little extra for less sensitive meters than those named above. There's also a slight charge for 1 per cent tracking in sensitive ranges of 0-10 μ a or 0-3 mv, or better.)

Immediate delivery for 10 models

Ten API panel meter models, in the most popular taut-band ranges, are now being stocked for off-the-shelf delivery.

**New Bulletin 47 has full information
on all
API panel meters and pyrometers**

api
INSTRUMENTS CO.
Formerly Assembly Products, Inc.
CHESTERLAND, OHIO · PHONE: 216-423-3131
ON READER-SERVICE CARD CIRCLE 61

COMPONENTS

Wirewound resistors

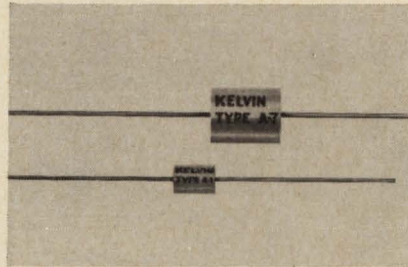

Commercial wattage ratings from 0.12 to 1 watt are provided by a series of wirewounds with a 0.0025% absolute tolerance at 25°C. Resistance ranges from 1k to 1 M Ω .

Kelvin, 5907 Noble Ave., Van Nuys, Calif. Phone: (213) 782-6662.

Circle No. 383

Stepping switch

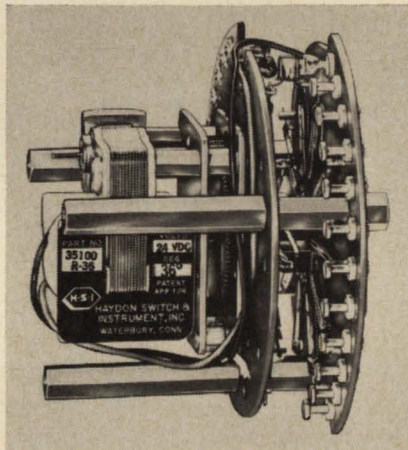

Designed for extremely long life at high switching rates, a disc type stepping switch provides 10-step double-pole operation and is driven at rates from zero to 40 steps per second. This unit may also be supplied with 3-wire stepper motor for higher stepping rates or furnished with synchronous ac motor or brushless dc motor where this type of drive is desired.

Haydon Switch & Instrument Inc., 1500 Meriden, Waterbury, Conn. Phone: (203) 756-7441. TWX: (710) 477-2580.

Circle No. 384

Cable connector

This "slide-on" connector mates by sliding the male and female units together. Adjusted for "pull-

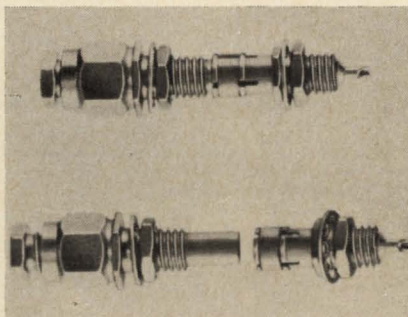

out" from 1/2 pound up, this provides positive junction where frequent module or cable changes warrant a quick-disconnect feature.

Available at 50 or 75 ohm impedance, with crimp or clamp cable connections, these units include straight, right-angle, and bulkhead designs. Teflon insulation isolates the gold-plated brass elements.

Sealectro Corp., 225 Hoyt St., Mamaroneck, N. Y. Phone: (914) 698-5600. TWX: (710) 566-1110.

Circle No. 385

Low-level switch

Types FT and SFT relays have 2 form-C contacts, rated at 10 μ A, 10mV, and 2 amps resistive, 28 Vdc. The FT has 4 coil resistances from 35 to 2450 ohms, with must-operate voltages of 3.2 to 24.5 Vdc. The SFT has 3 coil resistances from 340 to 5000 ohms, must-operate voltages from 4.1 to 15.5 Vdc. Must-operate

times, at nominal voltages, are 5 ms for the FT, 8 ms for the SFT. Release times are 1.75 ms for the FT, and 4.5 ms for the SFT.

Metal modules allow PC mounting. Other mountings are also available.

C.P. Clare, 3101 W. Pratt, Chicago, Ill. Phone: (312) 262-7700.

Circle No. 386

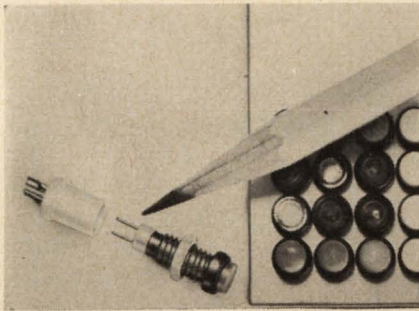

Submin display

A new SDL series subminiature display lite with separate connector is now available with a .240-in. diameter mounting on 1/4-in. centers horizontally and vertically. A choice of connector hook-up (SDL-A series), or wire lead (SDL-B series) is available. Terminals for the SDL-A series are two 0.018-in. diameter gold plated pins for insertion in the connector that is supplied with the indicator. The SDL-B series has 6-in. long nylon coated leads stripped 3/16-in. Other wire lead terminations can be provided to fit specific requirements.

Transistor Electronics Corp., Box 6191, Minneapolis, Minn. Phone: (612) 941-1100. TWX: (910) 576-2860.

Circle No. 387

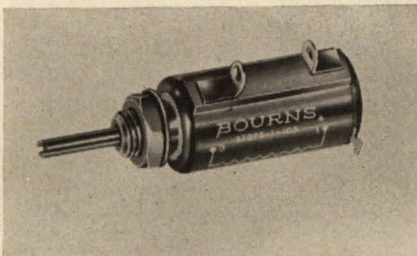

Low-cost potentiometer

A 10-turn 1/2-in. diameter precision potentiometer for industrial uses is available at about half the cost of military-type 1/2-in. diameter units.

The model 3707 is encased in a compact plastic case measuring 1-in. long and uses the manufacturer's silverweld termination. A special rotor design assures wiper stability under 50G shock and 10G vibration. Standard resistance range is 100 to 100 K with a tolerance of $\pm 5\%$ max.

Price: \$10.00. Bourns, Inc., 1200 Columbia Ave., Riverside, Calif. Phone: (714) 684-1700. TWX: (714) 682-9582.

Circle No. 388

General Electric... Top Source for Semiconductor Parts



General Electric is geared to produce a broad line of semiconductor parts. Make G. E. your one source for all components such as:

Component Assemblies—Semiconductor lead-in wires—Dumet "slug" leads—molybdenum "slug" leads—whisker welds and other 2 or 3 part welded lead wires—molybdenum diode slugs—plastic transistor headers—plastic integrated circuit packages.

Lead and Interconnection Wires—Tungsten, molybdenum, and borated Dumet wire for glass to metal sealing—unborated and gold plated Dumet for interconnections and "pigtail" leads—tungsten and molybdenum whisker wire, bare or gold plated.

Sheet and Discs—Molybdenum and tungsten sheet—molybdenum and tungsten discs (punched, pressed and sintered, cut from rod).

Evaporative Sources for Functional Coatings—Stranded tungsten metallizing wire and coils—tungsten and molybdenum boats.

And More! Get all the data. Write or call for our new booklet "Products for the Semiconductor Industry." General Electric Lamp Metals & Components Dept., 21800 Tungsten Rd., Cleveland, Ohio 44117. Tel: (216) 266-2970

Progress Is Our Most Important Product

GENERAL  ELECTRIC

ON READER-SERVICE CARD CIRCLE 62

ENGINEERS SCIENTISTS

EXPLORE COMMUNICATIONS AND ELECTRONIC FRONTIERS AT **JANSKY & BAILEY** rapidly expanding division of **ATLANTIC RESEARCH**

CORPORATION

Jansky & Bailey, a trusted name in electronic communications for over 30 years, is expanding rapidly worldwide. We now offer several unusual and outstanding career opportunities to engineers and physicists who have the experience and creative ability to direct new programs and projects.

INSTRUMENT ENGINEER — TEST OPERATIONS

Design, select, modify and supervise the operation of instrumentation components and systems used in testing propulsion units. Plan, organize and direct activities of electronic and test technicians in calibration of transducers. BS in EE or physics, 1 year experience preferably in rocket instrumentation or rocket test operations. Supervisory aptitude required. (NOTE: For this position only, please send your resume to: Personnel Manager, Atlantic Research Corporation, Pine Ridge Plant, Gainesville, Virginia) (35 miles west of Washington, D. C.)

ELECTROMAGNETIC WAVE PROPAGATION GROUP HEAD

Responsible for technical direction of an engineering group solving radio wave propagation problems from large scale research programs to small state-of-art predictions. Must be able to direct computations in propagation modes such as ionospheric, tropospheric, and line of sight. MSEE/PhD.

SYSTEMS ENGINEER

To analyze and design communications systems and evaluate electronic countermeasure techniques, navigation systems, and satellites for communications; determine user requirements and translate them into technical specifications. BSEE, 1 year experience.

APPLICATIONS ENGINEER

To represent ARC in sales of products and R&D services for telegraph, telephone and data handling equipment; contact customers and potential customers, and formulate and execute advertising and mailing programs for new products. BSEE, several years experience in communications industry.

Please send your resume to: Director, Professional Personnel, Dept. 853, Atlantic Research Corporation, Alexandria, Virginia 22314 (suburb of Washington, D. C.). An equal opportunity employer M&F.



SYSTEMS

(continued from p 108)

Decade counter

Model F1831 decade counter operates on 1 watt. Integrated circuits and IN-PLANE display are

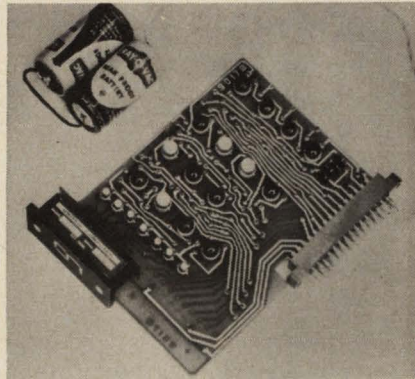

mounted on epoxy printed circuit board.

Input is 1.5 volts in positive pulses. Four outputs include ten-line coincidence for preset circuits, 1248 BCD for printer driver, analog staircase, and carry-out to drive similar decades. The unit has 3 MHz frequency response, and a +2 volt power source for reset to zero count. It operates to +72°C.

P&A: \$63.00 each in production quantities; 2 weeks. United Computer Co., 4504 N. 16 St., Phoenix, Ariz. Phone: (602) 266-8682.

Circle No. 389

Compound timing device

A 60-position Actan programming switch features two drums geared together for sequencing remote sensing apparatus.

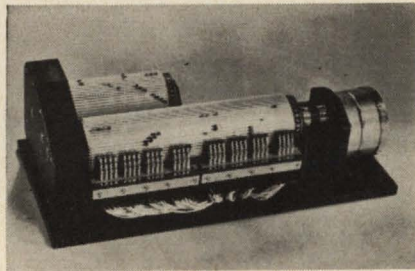

In applications, for example, where a requirement is to send and record the noise level of various equipments and machinery at different locations, the integeread switch makes it possible to make a recording at location 1, turn off the recorder for time T, then switch to location 2 with the second drum, and then turn on the recorder again with the first drum.

Sealectro Corp., 225 Hoyt St., Mamaroneck, N. Y. Phone: (914) 698-5600. TWX: (710) 566-1110.

Circle No. 390

Incremental recorder

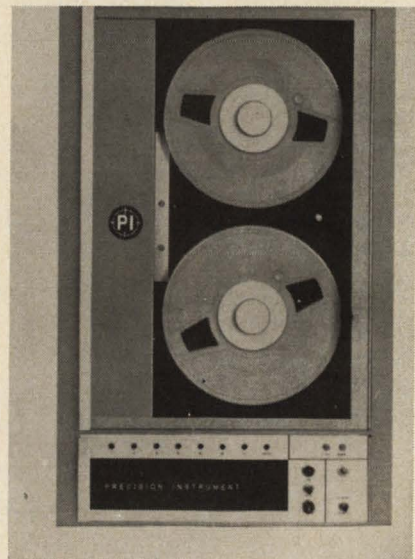

A new incremental digital recorder accepts randomly occurring digital data at rates from zero to 200 steps per second. The low-cost PII167 recorder can also record digital characters received synchronously at 500 steps per second.

With selectable odd or even parity generation, the PI-1167's logic circuitry converts, for even parity, BCD-0 data to BCD-10, thus producing a fully compatible tape without further programming.

P&A: \$3,650; 45 days. Precision Instrument Co., 3170 Porter, Palo Alto, Calif. Phone: (415) 321-5615. TWX: (415) 492-9444.

Circle No. 391

It's Time To Renew Your Free Subscription To **ELECTRONIC DESIGN**

When you receive your renewal letter application please fill it in completely...and mail it immediately to insure uninterrupted receipt of **ELECTRONIC DESIGN**.

Our circulation policy requires that all subscribers requalify each year to continue receiving their free subscription to **ELECTRONIC DESIGN**.

Please help us serve you better by requalifying as soon as you receive the renewal letter.

26 ISSUES IN **'66**

PLUS 3

**SPECIAL
REFERENCE
ISSUES**

If you are not now a subscriber and would like to receive your own copy each month circle Reader Service Number 800.

Design Brochure Cable Assemblies & Coaxial Delay Lines

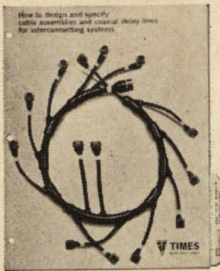

This 4-page brochure details specifications and multiple design possibilities of cable assemblies and coaxial delay lines. It also follows through with evaluation, production and test procedure info.

For your copy write or phone:
Times Wire & Cable, Wallingford,
Conn. (203) CO 9-3381

ON READER-SERVICE CARD CIRCLE 181

Seamless Metal Tube Sheathed Coaxial Cable

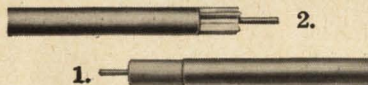

Times' new semiflexible coaxial cable with seamless aluminum tube sheath conductor is available in two standard versions:

1. ALUMIFOAM® — Foam polyethylene dielectric where pressurizing isn't practical.
2. ALUMISPLINE® — Air dielectric where pressurizing is practical. These cables offer more isolation—at 80 < db more than ordinary coax. Uniformity average — VSWR 1.1 or less. Stability — 10 times better. Lower loss — 30% less. Pulse reflection — less than 1%. Less distortion. Also avail. in solid dielectric and high temp. constructions.

For prices & data write or phone:
Times Wire & Cable, Wallingford,
Conn. (203) CO 9-3381

ON READER-SERVICE CARD CIRCLE 182

Connectors for Solid Sheathed Cable

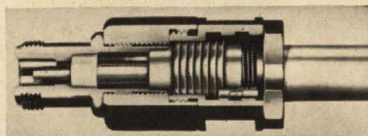

Only one step required to use the new one-piece TIMATCH® Connector with its own pat. CoilGrip® clamp—just unpack it. Its reusable and repeated assembly and disassembly does not impair either the RF or physical characteristics of the connector or the cable. Available in all popular sizes and fits all metal tube sheathed coaxial cables.

For prices & data write or phone:
Times Wire & Cable, Wallingford,
Conn. (203) CO 9-3381

ON READER-SERVICE CARD CIRCLE 183

SYSTEMS

Flexible response plots

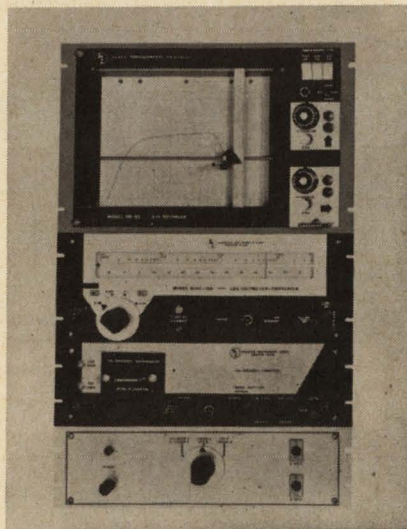

Series 140 systems yields log or linear curves from either ac or dc signals. Selectable conversion circuits allow XY plotting of the following variables on either axis in any combination: time, linear or log amplitudes, or log frequency.

Signals from 1 mv ac or dc, from 5 Hz to 200 Hz ac can be plotted with accuracies of 2% for log amplitude, 2% for log frequency, 0.5% for linear ac, 25% for linear dc, and 1% for time sweeps.

P&A: \$2500-\$4500, 30-40 days.
Houston Omnigraphic, 4950 Terminal Ave., Bellaire, Tex. Phone: (713) 667-7403. TWX: (713) 571-2063.
Circle No. 392

Logic card amplifier

A two photo-diode amplifier logic

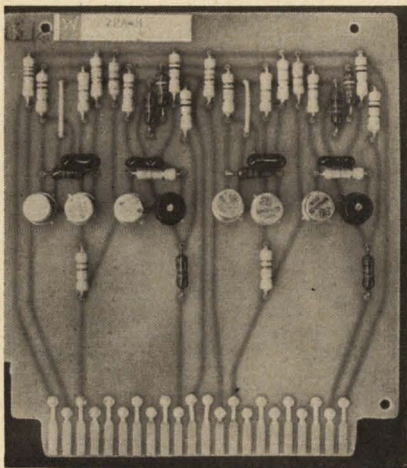

card designed for use with photo-voltaic or photo-current diodes is designated 2PA-M. It has two amplifiers with input frequencies of 10 kHz max, and output levels of -0.2 ± 0.2 volts (dark), and -10 ± 2 volts (light), and operates at temperatures from 0° - 50° C.

The logic card is constructed of 1/16-in. thick, flame resistant glass impregnated epoxy, and measures 4-1/2-in. x 5-in. It is designed for 9/16-in. center-to-center mounting.

Wyle Products Div., 133 Center St., El Segundo, Calif. Phone: (213) 322-1763. TWX: (213) 348-6283.
Circle No. 393

Bi-directional recorder

A portable instrumentation recorder has 1:10:100 speed ratios in both directions, enabling time-base expansion or contraction. Recording up to 16 hours per channel, on up to

eight channels, permits 128 hours of constant monitoring.

Signal-to-noise ratio at 0.375 ips is 35 dB; at 3.75 ips, 38 dB, at 37.5 ips, 42 dB. Frequency range is from dc to 100 kHz.

Weighing from 55 to 90 pounds, depending on the number of modular channels, and measuring 19 x 22 x 12.5 inches, the unit operates at temperatures to 120° F and 95% humidity. External power supplies may range from 100-220 volts ac (48-440 Hz), and 12 volts dc.

P&A: One channel, \$4565; four-channel, \$6990; eight-channel, \$10,990; 45 days. Precision Instrument Co., 3170 Porter Dr., Palo Alto, Calif. Phone: (415) 321-5615. TWX: (415) 492-9444.

Circle No. 394

FM recorder adapter

The BRC FM recorder adapter stores two channels of data with frequency components from dc to 500 Hz at levels to ± 2 volts, on any high-quality stereo tape recorder.

The data inputs frequency modulate two 10 kHz carriers; a microphone input (separate voice channel for commentary) is frequency limited, then mixed with one carrier. Signals are fed to the recorder as normal stereo inputs. On later playback, the adapter feeds the voice signal to a speaker, demodulates the information signals from the carrier, and delivers them to output terminals with unity gain since inception, regardless of tape recorder level variations.

P&A: \$819 f.o.b. Cambridge, 4-6 wks. Beaver Research, Box 467, Cambridge, Mass. Phone: (617) 491-3267.

Circle No. 395

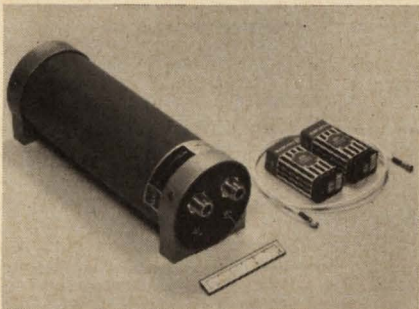

S-band TWT amplifier

A battery-powered low-noise amplifier has been designated WJ-353. This traveling-wave tube unit has its own integral power supply operating from a nominal 26 Vdc source. Power consumption is less than 0.6 watts, drawing 25 milliamperes.

Typical saturated power output of ± 6 dBm, and has a minimum small-signal gain of 25 db, across a full octave bandwidth, from 2-4 GHz. Terminal noise figure is guaranteed less than nine dB.

The tube meets environmental characteristics of MIL-E-5400, class 2. The cylindrical housing is 3.4 x 9.5 in. long, and the entire unit weighs five pounds.

Applications Engineering, Watkins-Johnson Co., 3333 Hillview Ave., Palo Alto, Calif. Phone: (415) 326-8830. TWX: (910) 373-1253.

Circle No. 396

NOW...MEPCO IS MASS-PRODUCING FILM HYBRID MICROCIRCUITS

New unique production techniques, developed by Mepeco, have resulted in a major break-through in mass-producing Thick and Thin Film Hybrid Microcircuits. Consider these exceptional product features . . .

- *Reduce your existing logic to micro-packaging.*
- *Applicable to linear or digital circuits.*
- *Switching time of 10 nanoseconds.*
- *Clock rates of 10 megacycles are available.*
- *Tracking temperature coefficient characteristics of 10 PPM for a typical resistance ratio of 3 to 1.*
- *Shorter preparatory time for prototypes and initial production.*
- *Surprisingly low costs . . .*



For full details write or call today
for TFMC Data Sheet.

MEPCO, INC.

COLUMBIA ROAD, MORRISTOWN, NEW JERSEY
07960 (201) 539-2000

HAVING
FREQUENCY
PROBLEMS?



GET IN
TUNE
WITH THE
60KC

**PHASE COMPARATOR
RECEIVER**

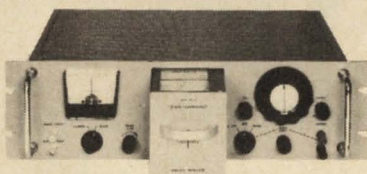

Low Cost • Easy to Operate • Accurate

The Model SR-60 is the first low cost VLF Phase Comparison Receiver designed to permit phase comparison measurements between a local oscillator and the National Bureau of Standards transmitted 60 Kc/s from WWVB, Fort Collins, Colorado. The receiver is a straight-forward Tuned Radio Frequency receiver and can be used in any location in the United States with highly satisfactory results.

The SR-60 permits accuracy measurements to parts in 10^6 with relative short measurements. Phase difference is displayed on a front panel meter or on a strip chart when more precise measurements are made over a long period of time.

Antenna input through a specially designed antenna coupler is made from the rear chassis. The antenna coupler allows the use of a high impedance antenna. Provisions are made to tune the coupler for any antenna. Connections are also available for scope monitoring the incoming signal (output of RF Amplifiers) the multiplied RF carrier signal and the multiplied (or divided) local oscillator signal.

PRICE: \$850.00

Write, wire or phone for
complete catalog information.

Specialists in Frequency Management

**SPECIFIC
PRODUCTS**

P.O. BOX 425
21051 COSTANSO STREET
WOODLAND HILLS, CALIFORNIA
AREA CODE: 213 340-3131



New Literature

Switch catalog

Switches available from regional distributors are described in a six-page catalog and supplement. The expanded distributor line includes several varieties of pushbuttons, levers, slides and rotaries. These are to be stocked items in all areas for immediate delivery.

Oak Electro/netics Corp.

Circle No. 700

Power supply handbook

A well illustrated book on regulated power supplies places emphasis on programming concepts, systems control applications, testing, and circuitry. Send letterhead request to: Publication Mgr., Kepco, Inc., 131-38 Sanford Ave., Flushing, N. Y., 11352.

Amplifier catalog

Brochure PM-109 describes a line of L-band and C-band frequency amplifiers with power output levels from 1 kW to 10 kW. Units described are designed for wideband data transmission and scatter communications. Sierra/Philco.

Circle No. 704

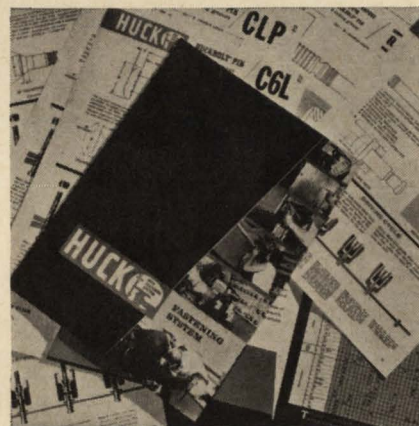

Fastener catalog

A new loose-leaf style catalog lists a wide variety of alloys and types with general and specific applications. Huck Mfg.

Circle No. 701

Wavesoldering

A new 6 page brochure gives features and specs of wavesoldering and associated processing machinery for printed circuitry. It explains applications, principles, and theories of hot-dip tinning. Electrovert Inc.

Circle No. 705

Rectifiers

A four-color sheet gives the manufacturer's specifications, prices and color codes for copper-oxide instrument rectifiers. Included sheets give specs and pricing on other lines by the same manufacturer. Conant Laboratories.

Circle No. 702

High-speed computer

A 12-page brochure describes the PDP-7 general-purpose, solid-state, digital computer designed for high-speed data handling in scientific laboratories, computing centers or real-time process control systems. The brochure outlines processor, memory, and input/output sections and lists optional equipment and instructions. Digital Equipment Corporation.

Circle No. 706

Transistor regulator

The 8-page 2762-8 bulletin describes transistor regulators for automotive and fleet use. Transistor-relay comparison and diagrams showing the function of various circuitry elements are included along with a chart containing regulator test data. Leece-Neville Company.

Circle No. 703

Electronic grade chemicals

Individual analysis and prices of more than 200 electronic grade chemicals are listed in a new catalog. Included are chemicals commonly used for etching, doping and cleaning in semiconductor processing. Nitine, Inc.

Circle No. 707

ON READER-SERVICE CARD CIRCLE 65

Living space and outer space ... lots of both in Milwaukee

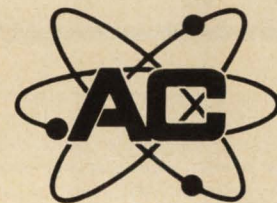
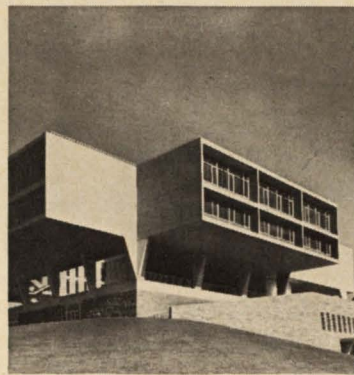
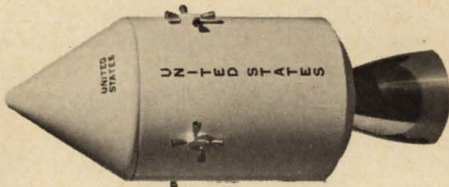
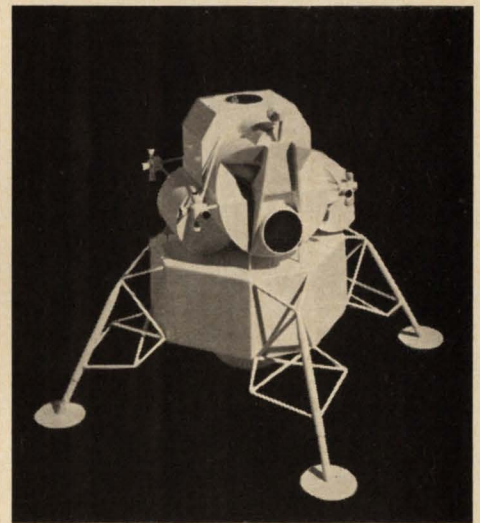

AC ELECTRONICS
Division of General Motors, Milwaukee, Wisconsin 53201

You are invited to investigate a challenging career with AC Electronics Division in Milwaukee, the cosmopolitan city surrounded by the midwest's favorite vacationland. On the job you'll work on such vital projects as the guidance/navigation system for the Apollo Command Module and the LEM, an avionics system for supersonic aircraft and the guidance system for the Titan III space launch vehicle. On the town, try the Symphony or a famous Milwaukee restaurant. On weekends, try fishing one of many beautiful lakes a half-hour away. If you're a scientist, mathematician or engineer why not look into the opportunities that await you at AC Electronics. For more information regarding positions listed opposite write: Mr. R. W. Schroeder, Director of Scientific and Professional Employment, Department #5753C, AC Electronics Division, Milwaukee, Wisconsin 53201. An equal opportunity employer.

Current positions available at AC Electronics Division in Milwaukee:

- DIGITAL SYSTEMS ENGINEERS
- RADIATION EFFECTS SPECIALISTS
- OPTICAL SYSTEMS ENGINEERS
- SEMICONDUCTOR CIRCUIT DESIGN ENGINEERS
- FIRE CONTROL DIGITAL SYSTEMS ENGINEERS
- SCIENTIFIC PROGRAMMERS
- SYSTEMS INSTRUMENTATION ENGINEERS
- SYSTEMS ANALYSIS AND MECHANIZATION ENGINEERS
- SYSTEMS EVALUATION ENGINEER

Positions are also available at AC's Advanced Concepts Laboratories in Boston and Los Angeles:

- DIGITAL SYSTEMS ENGINEERS
- SOFTWARE DEVELOPMENT ENGINEER
- SENIOR PHYSICIST (SENSING DEVICES)
- PROGRAMMER (SCIENTIFIC/REAL TIME)
- SYSTEMS ANALYSIS AND MECHANIZATION ENGINEERS

Aladdin[®] electronics ADJUSTABLE INDUCTORS

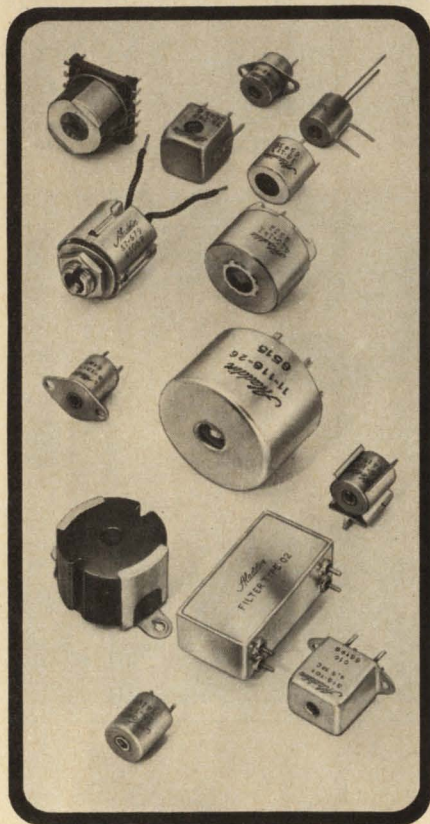

If your problem is one of packaging inductive components, then the answer can probably be found in one of the Aladdin Electronics configurations shown above. As specialists in inductive components for frequency generation or selectivity, we can confidently recommend our products for your exacting applications. The units shown above may be used as fixed and adjustable inductors, fixed and adjustable transformers (either tuned or untuned), and as filter elements. They have been designed to help you solve both the problem of making your equipment more compact and also the problem of improving performance through the use of more stable inductive components.

For help concerning component selection for FREQUENCY SELECTIVE NETWORKS or for free literature on Aladdin inductive components write to:

Dept. 3-A

Aladdin[®] electronics

where the magic of magnetics is a science*

Nashville, Tennessee 37210
615-242-3411 TWX: NV252

*T.M.

ON READER-SERVICE CARD CIRCLE 66

NEW LITERATURE

HV rectifier stacks

Six pages of information on general processing and specifications of HV rectifier stacks is presented with advertising sheets on the company's line.

Attention is paid to details of double-diffusion processing, stack assembly, and test specifications. Atlantic Semiconductor.

Circle No. 708

NBS test service

National Bureau of Standards miscellaneous publication 250 lists test and calibration services performed by BuStand and the fees involved. Newly revised, the booklet also has provisions for keeping abreast of future changes.

This book is available for \$1.00, from Supt. of Documents, U.S. Govt. Printing Off. Wash., D. C.

Variable drives

A one-page bulletin provides information on ac and dc motor-driven mechanical differentials. A typical unit is detailed and instructions for designer's inquiries are provided. Globe Industries.

Circle No. 709

Motors and controls

A new annual catalog supplement lists synchronous motors, gear motors and speed reducers along with fractional horsepower controllers and motors. Included in the publication are technical data and specifications of a variable speed generator feedback system with $\pm 1\%$ accuracy. B & B Motor & Control Corporation.

Circle No. 710

Magnetic tape

Dropouts and head wear are among the topics discussed in Magnetic Tape Trends No. 10. The new application engineering bulletin concentrates on various procedures connected with the use of magnetic tape in wideband instrumentation recording. Ampex Corp.

Circle No. 711

Thin-film production

Pilot-line production of thin-film microelectronic circuits at the Indianapolis Naval Avionics Facility is described in depth in a 285-page manual available to industry. The facility, built to serve as model for a Navy industry preparedness program of in-line vacuum deposition process and equipment, uses some of the latest techniques and equipment. Order AD-621 065 from Clearinghouse, U.S. Dept. of Commerce, Springfield, Va. 22151. Cost: \$6.00.

Acrylic optics

Acrylic optical components, precision ground and polished in sizes up to 60 inches at costs ranging from less than one half to less than one tenth that of glass, are discussed in Bulletin 102. Included are specifications and transmittance curve for a recently developed optical grade acrylic with optical quality equal or superior to that of Grade B glass. Fostoria Corporation.

Circle No. 712

MW Instruments and coax

A catalog of precision coaxial and microwave instrument devices includes 38 pages of material. The catalog covers attenuators, connectors, power ratio and other instrumentation, and substitution systems. Weinschel Engineering.

Circle No. 713

Silicon semiconductors

Specifications for more than 500 silicon semiconductors are given in a new, condensed catalog. Included are integrated circuits, FETs, npn and pnp transistors, diodes, rectifiers, SCRs, and dual and Darling-ton amplifiers. Raytheon Company.

Circle No. 714

15-122 GHz Klystrons

A brochure on millimeter wave klystrons covers several models, giving characteristics and specifications. A broad range of frequencies, power, and voltage characteristics are included. OKI Electric Industry Co.

Circle No. 715

Solid State Newlyweds

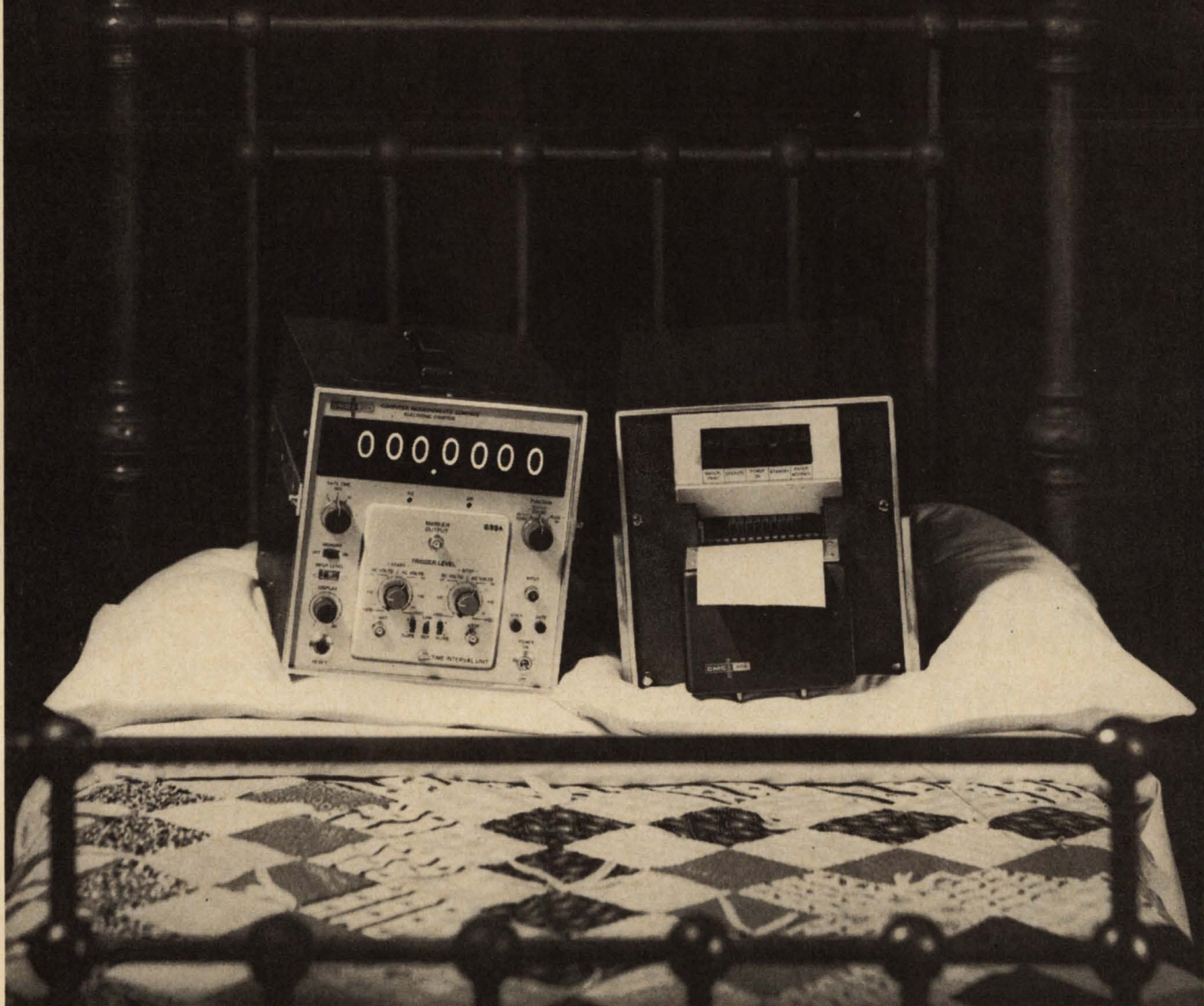

It's the ideal marriage! The CMC 616A frequency meter with the CMC 410A digital printer. Each being half-rack size and rugged all-silicon design, these two perfect rack-mates cozily fit just about anywhere you want to put them.

By blissfully joining these two instruments, we offer you an unbeatable combination for measuring and recording. The 616A measures up to 225 mc without plug-ins by means of a unique built-in pre-scale. With some clever plug-ins we added, you can even measure time interval, and frequency up to 1,000 mc, 3000 mc and (get this) 12 gigacycles!

Keeping up with this whizzing counter

is no problem for the 410 printer. It fires out up to 12-digit columns using electronic logic conversion and 35-millisecond data-gathering.

It's a first off-the-shelf "systems" thinking from CMC. Being first to offer you all-silicon instruments just wasn't enough. We have to make sure we are going to stay ahead of high-powered Hewlett-Packard and big, bad Beckman.

Systems have been a part of our capability for a long time. So don't

be surprised to see a lot more revolutionary combinations from us in the future. And, isn't it about time you started thinking systems too? Be daring... break that old habit of thinking one instrument at a time.

Ask us for the specs on both these half-rack-size-go-togethers. And don't forget, we're still challenging all engineers to compare our specs to those of the other two "leaders."

We'll send you the specs, so you can earn one of our glorious Crusading Engineers' medals for thinking double. If you don't want to wear it... have it framed or stuffed! It'll be great for your ego.



12973 Bradley • San Fernando, California • Phone (213) 367-2161 • TWX 213-764-5993

COMPUTER MEASUREMENTS COMPANY IS A LEADING DESIGNER AND MANUFACTURER OF ELECTRONIC INSTRUMENTATION TO COUNT, MEASURE, AND CONTROL.

Speed Inquiry to Advertiser via Collect Night Letter
ON READER-SERVICE CARD CIRCLE 67

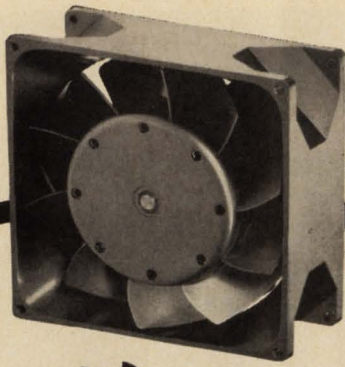

New
4 1/2"

SHADED-POLE Model 2500 PAMOTOR Miniature Axial Fans

- 20,000+ operational hours at 45°C
- Low-cost design
- All metal construction
- Unexcelled performance and reliability
- Universal 4 1/2" mounting for interchangeability
- 50-60 cycles at 110 or 220 vac
- In stock for immediate delivery

Write for technical data on the Model 2500 and other PAMOTOR axial fans to:

PAMOTOR, INC.
312 SEVENTH STREET • SAN FRANCISCO, CALIF.

ON READER-SERVICE CARD CIRCLE 68

NEW LITERATURE

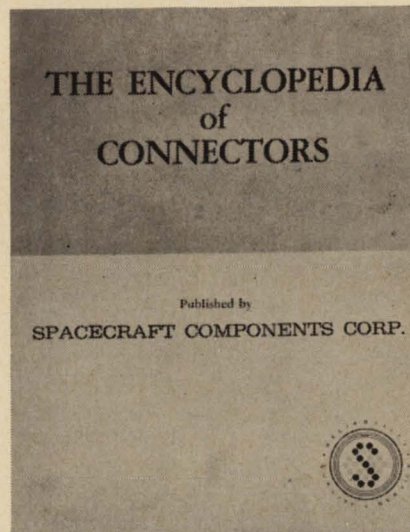

Connector reference

A new booklet serves as a cross-reference and compilation of major electrical connectors. It indexes prefixes, explains nomenclature, illustrates Mil-C-26482 and Mil-C-5015, explains selection, and indexes inserts and contact configurations. Spacecraft Components.

Circle No. 716

Piezoelectricity

Four technical papers deal with the concepts, functions and effects of piezoelectricity and ferroelectricity.

TP-217 is a 9-page "Primer on Ferroelectricity and Piezoelectric Ceramics." The 13-page TP-23 discusses "Measurement of Piezoelectric Coupling in Odd Ceramic Shapes." "Effects of High Static Stress on the Piezoelectric Properties of Transducer Materials" is the topic of TP-220, and the 8-page TP 24 is entitled "On the Meaning of Piezoelectric Coupling." Piezoelectric Division, Clevite Corp.

Circle No. 717

Ferrite and garnet materials

Ferrite and garnet materials available from stock for microwave applications are described in a 12-page catalog. The publication lists type and composition of a wide selection of materials and gives performance curves showing temperature characteristics of selected garnet materials. Sperry Microwave Electronics Co.

Circle No. 718

Chemical milling

An eight page, illustrated brochure describes the process of chemical milling, and gives specifications for the associated photographic etching equipment.

Uses are in production of small metal parts, printed circuits, and nameplates. Colight Inc.

Circle No. 719

Instrument catalog

Twelve types of instruments are set forth in an illustrated four-page brochure. Included are: voltmeters, phase sensitive converters, ac and dc ratio boxes, complex voltage ratiometers, resolver/synchro simulators and bridges, digital to resolver/synchro, and resolver/synchro to digital converters, angle position indicators, as well as special sets and systems. North Atlantic Industries.

Circle No. 720

Fans and motors

The Sangamo line of precision motors has been added to the catalog of fans, blowers, and motors of this manufacturer. The loose-leaf punched brochure presents servo motors, induction tachometers, synchronous motors, etc. Rotating Components, Inc.

Circle No. 721

Instrument catalog

A catalog describes in brief the test and measuring equipment carried by this distributor. Inquiry cards are included for complete specifications on individual units. Rhodes and Schwartz.

Circle No. 722

Vacuum pumps

Specifications, efficiency ratings and prices for a new, expanded line of mechanical, internal vane vacuum pumps are given in bulletin No. 650. The line includes models ranging in capacity from 25 to 1,500 liters per minute. Vacuum fittings, and pump and system accessories are also described. Precision Scientific Company.

Circle No. 723

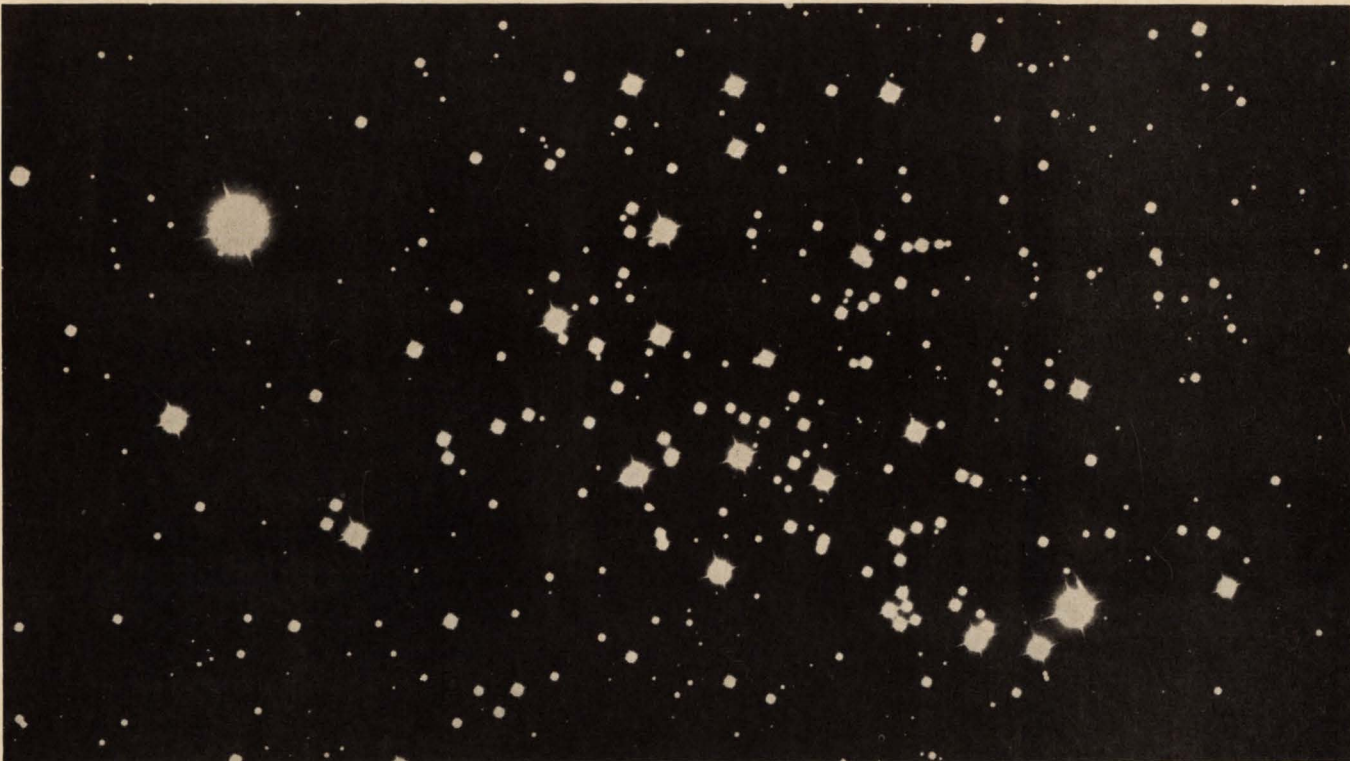

You are standing on the threshold of the future. Take that giant step.

Step into a world of challenge and excitement. A world of intellectual stimulation. A world of real and meaningful personal rewards.

How? By joining IBM's Federal Systems Center in Bethesda, Maryland.

It's here, near the pulse of our nation's Capitol, that you'll be asked to contribute to the design and development of:

Tactical switching systems using advanced electronic circuits • Special-purpose oceanographic data processing and control equipment • Systems for data handling requirements during the coming decade • Communications systems utilizing pseudonoise modulation,

speech compression, data compaction and error control coding • ASW signal processing equipment.

Sound fascinating? It is. And we need qualified engineers right now who are "turned on" by questions like these. Engineers who are concerned about our country's achievements—and their own. Who want to grow and thrive with a growing company.

There are immediate openings in the disciplines listed below. Take a look and see if your talents and training are needed. Then fill in the coupon and mail it today. Take that giant step. It only takes a minute.

Sonar systems design • Advanced communications systems design • Digital and analog circuit design •

Digital systems logic design • Mechanical packaging design • Electrical systems design • Optical mechanical design.

IBM is an Equal Opportunity Employer

Mr. W. R. Van Eysden
Dept. 555N3
Federal Systems Center
Federal Systems Division
7220 Wisconsin Avenue
Bethesda, Maryland

IBM[®]

I am interested in a career with the Federal Systems Center.

name

address

city state zip code

ON READER-SERVICE CARD CIRCLE 893

Want to design for
INSTANT STARTING?...
SPLIT-SECOND ACCURACY?
REVERSIBILITY?...
MIXED SPEEDS?...

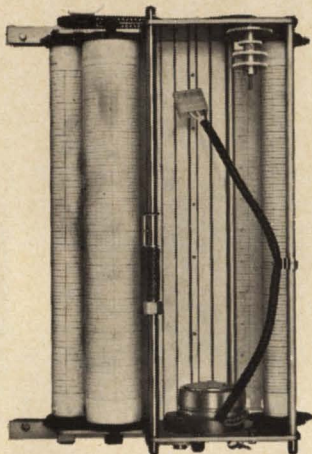

turn the
job over to
SYNCHRON® MOTORS!

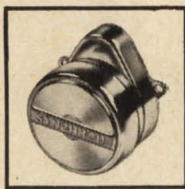

No matter whether you want a motor to withstand swiftly changing temperatures, meet fast-reversing stresses, turn a small part with exact accuracy to 1 Rev. per week or 600 Rev. per minute, there's a SYNCHRON Motor that can do it! It can do a hundred other things as demanding as these — if you tell us how you want it to function. Before you start any design that calls for small drive or timing motors, think of SYNCHRON Motors, and call or write us at Hansen Manufacturing Company. We'll be there at once to help — with experience. Better still — don't wait till you face a problem. Write us now — let us tell you about SYNCHRON Motors and the ways we design them to work for you.



HANSEN REPRESENTATIVES: CAREY & ASSOCIATES, Houston, Tex., R. S. HOPKINS CO., Sherman Oaks, Calif., MELCHIOR & MACPHERSON, INC., San Carlos, Calif., THE FROMM CO., Chicago, Ill., H. C. JOHNSON AGENCY, INC., Rochester, N. Y., WINSLOW ELECTRIC CO., Essex, Conn., Narberth, Pa., and New York, N. Y. EXPORT DEPARTMENT, 64-14 Woodside Ave., Woodside, N. Y.

ON READER-SERVICE CARD CIRCLE 69

Application Notes

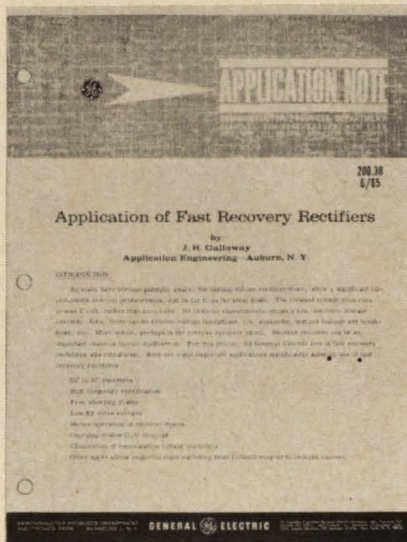

Fast recovery rectifiers

In the introduction to an 11-page application note on fast recovery rectifiers, J. H. Galloway of General Electric Semiconductors says; "As many have become painfully aware, the normal silicon rectifier diode, while a significant improvement over its predecessors, can be far from the ideal diode. The forward voltage drop runs around 1 V, rather than zero volts. Also, there can be reverse voltage limitations . . . Reverse recovery can be an important cause of circuit malfunction". The note goes on to provide detailed design information on fast recovery rectifiers in a wide range of circuits.

General Electric.

Circle No. 724

Infrared heating

A kit of application data sheets aid in planning installations of electric infrared heating-lighting fixtures.

The 18-page kit includes tracing paper sheets that can be used to copy application layouts for any of the individual specification sheets. Information concerning the number of units required and proper placement for efficient coverage can be derived in a matter of minutes. Luminator Inc.

Circle No. 725

Volt-ratio dialer

Application notes VRD-106, describe in detail the newly-introduced Model 300 ac volt-ratio dialer, a portable, multi-purpose, secondary-standard instrument.

Idalee Electronics Corp.

Circle No. 726

Surface-treated oxides

Surface-treated oxides are described in a technical report which lists typical magnetic and physical properties as well as suggested applications. New designation codes have been assigned to facilitate identification of various types of magnetic oxides by particle shape, particle size and coercive force. Chas. Pfizer & Co., Inc.

Circle No. 727

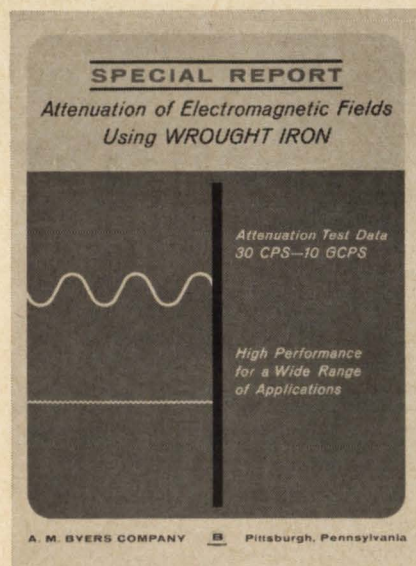

EMI report

Attenuation of electromagnetic fields using wrought iron is the subject of a 12-page report. The report describes how wrought iron was tested to determine its shielding ability from magnetic energy and radio frequencies in the 30 Hz to 10 GHz range. Measurement techniques are described. Charts and graphs are shown.

A. M. Byers Co.

Circle No. 728

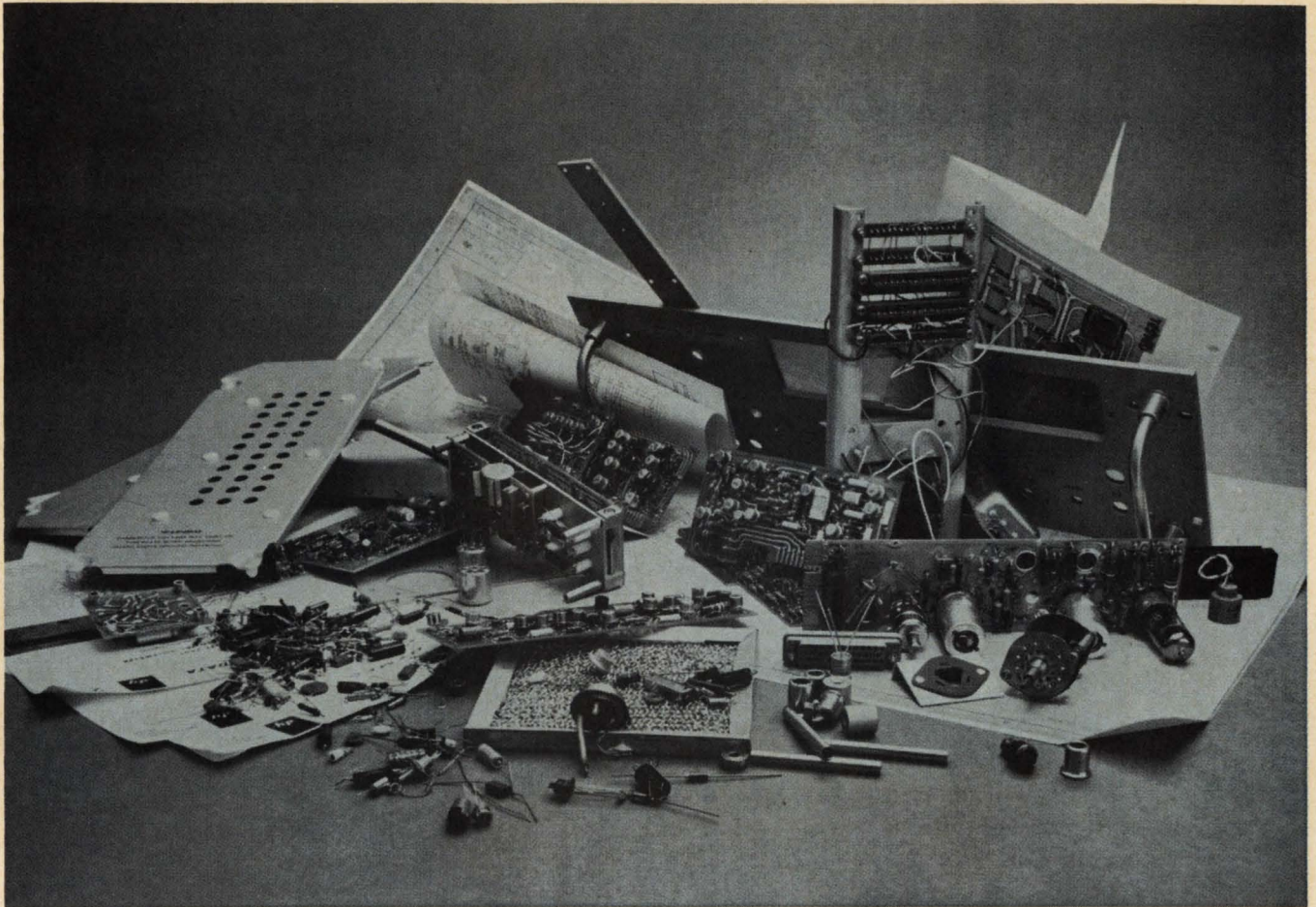

135 REASONS WHY

The 2401C Integrating Digital Voltmeter is your best buy. The Hewlett-Packard 2401C DVM keeps improving and improving. Just about everybody in the hp organization ...engineers, test personnel, production line people... and, of course, marketing people, who know what you want and who want to offer it...keep making this instrument better.

That's why the 2401C has been changed 135 times since it became the world's first DVM to use the integrating principle...lets you make low-level measurements in the presence of extreme noise.

Some changes you've seen: A sixth digit to get maximum use out of the instrument's built-in 300% over-ranging capability. Optional autoranging at 6 msec per range, the fastest available. Integration around zero with a reversing counter...no zero foldover, even with positive/negative-going noise on the signal you want to measure. Improved accuracy of 0.01% of reading +0.005% of full scale ± 1 digit.

And a lot of changes you haven't seen: New, advanced components for increased performance and/or reliability. New engineering to keep the 2401C ahead in performance. New production techniques to keep the price in line (there has never been an increase in price). The 2401C offers tested and proved RFI performance. It has a Federal stock number for easy specification, too.

Nobody at Hewlett-Packard lets this DVM rest...it just keeps getting improved. That's why it's so far ahead. If you have a measurement problem, involved with getting accurate dc measurements (0.1-1000 v full scale) in the presence of a frustrating amount of noise, you shouldn't let the 2401C rest, either. You should have it on your bench. Your Hewlett-Packard field engineer will put it there...and put it through its paces. Or you can write for complete specs (though a lot of the 135 changes aren't spec'd) to Dymec Division of Hewlett-Packard, 395 Page Mill Road, Palo Alto, California 94306, Tel. (415) 326-1755; Europe: 54 Route des Acacias, Geneva.

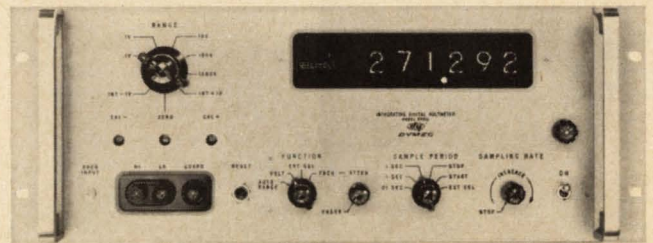

The machine costs \$3950. Ask for a demonstration.
Data subject to change (135 so far) without notice.
Price f.o.b. factory.

**HEWLETT
PACKARD**  **DYMEC
DIVISION**

ON READER-SERVICE CARD CIRCLE 70

VACTEC ART + SCIENCE

Vactec blends art and science to produce the ultimate in photo-sensitive devices. Cadmium sulfide, cadmium selenide and selenium photocells available from stock or we will design to meet your specific needs. Get more engineering per photocell dollar. Specify Vactec.

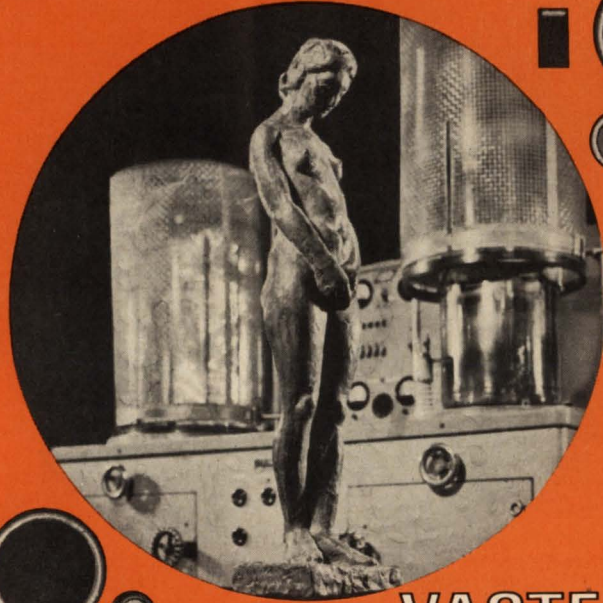

Sculpture by Rudy Torrini

Write for Bulletin SPV-4 for selenium, Bulletin PCD-3 for cadmium sulfide and selenide types.

VACTEC
1209 OLIVE WAY
St. Louis, Mo. 63130
Phone Area 314, PA. 6-0633

ON READER-SERVICE CARD CIRCLE 71

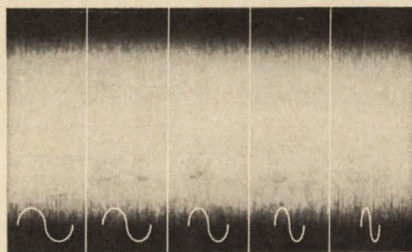

Acton

magnetostrictive filters

Sharp, Highly Stable, Light and Small, Permanently Tuned, Shock Resistant, 15kc-450kc, High or Low Impedance, Q's 2,000-30,000, Single or Multi-unit Arrays. Temperature Coefficient-0.1ppm/°C.



For spectrum analysis instrumentation, telemetry systems, encoding, decoding, and wherever you need high accuracy, narrow bandwidth capabilities AND the unique advantages of magnetostrictive design. COMPLETE DATA ON REQUEST.

ACTon starts with AC. If you use it, call us.

© 1966

ACTON®

Laboratories, Inc.

531 Main Street • Acton, Massachusetts
A subsidiary of Bowmar Instrument Corporation

ON READER-SERVICE CARD CIRCLE 72

APPLICATION NOTES

Thermosetting powders

Thermosetting powders that provide a tough, durable finish with a single application are the subject of a new brochure. It describes important considerations in the use of these coatings. Included are descriptions of the various application methods, advantages and limitations of powders, powder selection criteria, and information on storage and handling of powders.

The brochure, IMF-26, describes powders which adhere to a wide variety of substrates and eliminate expensive surface preparation of a wide range of metal products.

General Electric Insulating Materials Dept.

Circle No. 729

Depth measuring

The operation and advantages of a microscope specially designed to determine the surface quality of many types of finished and semi-finished parts and products are described in a new catalogue. The 8-page catalogue, covers a microscope that permits quick and accurate measurement of the depth of surface depressions.

Carl Zeiss, Inc.

Circle No. 730

Microwave measurements

A 15-page application note deals with the primary use of attenuation measurements to calibrate microwave components and devices.

Narda Microwave Corp.

Circle No. 731

Analog computers

A 12-page booklet provides a practical approach to analog computers. Written as background material for an education and training group, it describes the basic principles of analog computation and briefly explains how this problem-solving technique can be used to increase engineering efficiency. Several types of computing modules are described and sample problems are given and solved.

Electronic Associates, Inc.

Circle No. 732

PICK YOUR TEAM



Hughes Aeronautical Systems Division, active with many major contracts such as CORDS, TOW, PHOENIX, MAVERICK, and other advanced airborne weapon systems, has dozens of openings for graduate Engineers.

Desired background should include: familiarity with airborne missile and fire control systems and the associated AGE and maintenance equipment; the definition

of test equipment requirements; the development of integration testing; thorough academic preparation in control systems, electronic circuits, analog and digital computers and advanced mathematics or a familiarity with airborne pulse radar and pulse doppler fire control.

All openings require a B.S. or advanced degree in EE or Physics, a minimum of three years of related professional experience and U.S. citizenship.

Please airmail your resume to:

Mr. Robert A. Martin
Head of Employment
Hughes Aerospace Divisions
11940 W. Jefferson Blvd.
Culver City 31, California

HUGHES

HUGHES AIRCRAFT COMPANY
 AEROSPACE DIVISIONS

An equal opportunity employer

Engineers interested
in developmental aviation
have 3 ways to go at
Lockheed-California.

Subsonic.



Supersonic.

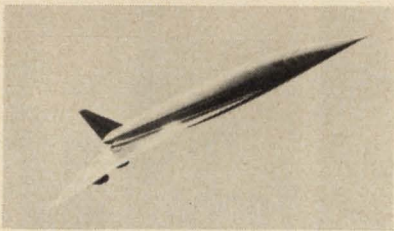

Hypersonic.

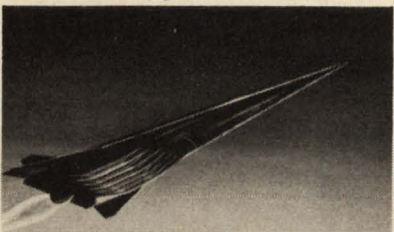

Lockheed's company speedometer spans speed regimes from 0 mph through Mach 12.

In subsonic airborne systems, Lockheed is deeply involved in STOL and V/STOL short-haul transports for mass travel between major cities. Under development — many helicopter projects including advanced rotary-wing craft able to stop, fold, or start blades in forward flight.

Lockheed's supersonic efforts are also expanding. Its SST program alone is a major and growing endeavor.

Manned hypersonic test and cruise vehicles, using the SCRAMJET approach, are under development at Lockheed. They point to the day of Mach 12 travel.

Engineering positions are now open in all technical disciplines. For information: Write Mr. E. W. Des Lauriers, Professional Placement Manager, Dept. 1301, 2402 N. Hollywood Way, Burbank, Calif. An equal opportunity employer.

LOCKHEED-CALIFORNIA CO.
A DIVISION OF LOCKHEED AIRCRAFT CORPORATION

ON READER-SERVICE CARD CIRCLE 894

Advertisers' Index

*PARTICIPANTS IN NIGHT LETTER PROGRAM

Advertiser	Page	Advertiser	Page
AC Electronics, Division of General Motors	141	Johanson Manufacturing Corp.	127
*AMP, Incorporated	40	Lambda Electronics Corp.	28, 29
*API Instruments Co.	134	*Litton Industries, Electron Tube Division	4
Acromag, Incorporated	151	Lockheed California Co.	150
Acton Laboratories, Inc.	148	Lockheed-Georgia Co.	126
Airtron, A Division of Litton Industries	99	Lockheed Missiles & Space Company	113
Aladdin Electronics	142	Master Specialties, Inc.	133
Allen-Bradley Co.	16	Mepco, Inc.	139
Amperite	98	Mite Corp.	86
Art Wire & Stamping Co.	122	Motorola, Inc.	131
Atlantic Research Corporation	136	*Motorola Semiconductor Products, Inc.	7, 100, 101
Augat, Inc.	113	Mullard, Ltd.	129
B & B Motor & Control Corp.	84	Pamotor, Inc.	144
*Beckman Instruments, Inc., Helipot Division	85	Parsons Electronics Company, The Ralph	36
Belden Manufacturing Company	117	*Philco, Lansdale Division	60
Bendix Corporation, The	84	Photocircuits Corporation	81
Bendix Corporation, The, Semiconductor Division	19	Polaroid Corporation	121
Bud Radio, Inc.	152	Printed Motors Inc.	81
*Clare & Co., C. P.	104, 105	Pyrofilm Resistor Co., Inc.	45
*Clifton Precision Products, Division of Litton Industries	Cover II	RCA Electronic Components and Devices	5, Cover IV
Cohu Electronics, Inc.	94	*Radiation, Incorporated	25
Communication Electronics, Incorporated	151	*Redcor Corporation	2
*Computer Control Company, Inc.	6, 72A-Z	Scientific Atlanta, Inc.	97
*Computer Measurements Company	143	Silicon Transistor Corporation	119
Control Logic, Inc.	61	Specific Products	140
*Dale Electronics, Inc.	Cover III	Sprague Electric Company	10, 20
Delco Radio, Division of General Motors	110, 111	Syntron Company	125
ESI/Electro Scientific Industries	102	*Systron-Donner Corporation	12
Eastman Chemical Products, Inc.	130	TRW Capacitors	38
Electro-Motive Mfg. Co.	83	Taber Instrument Corp.	115
Electronic Communications, Inc.	108	Teletype Corporation	33, 35, 37
Electronic Design	137	Telrex Laboratories	86
Executone, Printact Relay Division	116	*Texas Instruments Incorporated Metals & Controls Inc., a corporate division	62, 63
Fairchild Instrumentation, A division of Fairchild Camera and Instrument Company	103	Texas Instruments Incorporated, Semiconductors-Components Division	64, 65
Fairchild Semiconductor, A Division of Fairchild Camera and Instrument Corporation	8, 9	Times Wire and Cable	138
General Electric Company	91	Towne Laboratories Inc.	67
General Electric Company, Lamp Metals & Components Dept.	135	Transistor Electronics Corp.	90
General Precision, Kearfott Division	46, 47	Triplett Electrical Instrument Company	30
General Radio Company	1	United Control Corporation	128
*Globe Industries, Inc.	67	U.S. Components, Inc.	89
Hansen Manufacturing Company, Inc.	146	Vactec, Inc.	148
*Heinemann Electric Company	27	*Victoreen Instrument Company, The	107
Hewlett-Packard	23, 92, 93	Warlock Systems, Inc.	112
Hewlett-Packard, Dymec Division	147	Regional Advertising	
Hewlett-Packard, Moseley Division	109	*Arnold Engineering Company, The	112A
Hewlett-Packard, Sanborn Division	15	*Brush Instrument, Division of Clevite	112C
Hopkins Engineering Company	123	Burndy Corporation	112H
Hughes Aircraft Company, Aerospace Divisions	149	*Dale Electronics Inc.	112G
IBM, Federal Systems Division	145	*JFD Electronics Corporation	112B
*IRC, Inc.	87	Leach Corporation	112D
		*Magnetics Inc.	112F
		Sorensen, A Unit of Raytheon Company	112E

Electronic Design

Advertising Representatives

New York 10022
Robert W. Gascoigne
Thomas P. Barth
George W. Fleck
John F. Gilbert, Jr.
Rick A. Brough
850 Third Avenue
(212) PLaza 1-5530
TWX: 867-7866

Philadelphia 19066
Fred L. Mowlds, Jr.
P. O. Box 206
Merion Station, Pa.
(215) MO 4-1073

Marblehead 01945
Richard Parker
7 Redstone Lane
(617) 742-0252

Chicago 60611
Thomas P. Kavooras
Berry Conner, Jr.
720 N. Michigan
(312) 337-0588

Cleveland 44107
Robert W. Patrick
8410 Treetower Drive
Chagrin Falls, Ohio
(216) 247-7670

Los Angeles 90005
Stanley I. Ehrenclou
Terrance D. Buckley
3275 Wilshire Blvd.
(213) DUnkirk 2-7337

San Francisco 94306
Ashley P. Hartman
445 Sherman Avenue
Suite Q
Palo Alto, California 94306
(415) 327-6536

Southwestern 75235
Tommy L. Wilson
Exchange Bank Bldg.
Dallas, Tex.
(214) FLettwood 1-4523

London W. 1
Brayton C. Nichols
44 Conduit Street

Tokyo
Yoshihiro Takemura
International Planning
Service, Inc.
Room No. 512 Nikkoh
Mita Building
1, Nishidaimachi, Shiba-
Takanawa
Minato-ku, Tokyo



AMERICAN BUSINESS PRESS, INC.

NEW THERMOCOUPLE REFERENCES WITH 25 CHANNELS ONLY \$259.00!

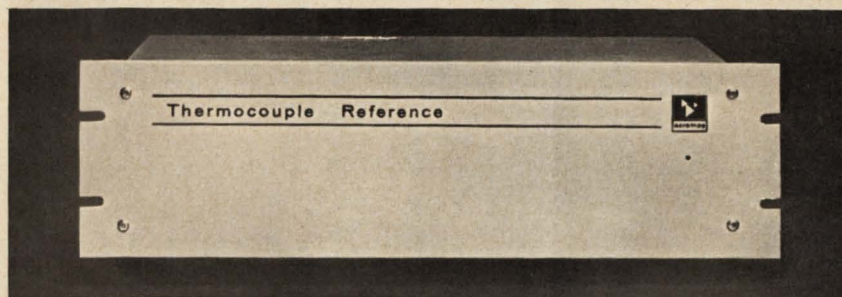

Now — ACROMAG Series 330 Thermocouple References with 25 channels of 0°C ice-point compensation for only \$259.00, including ALL 25 thermocouples! Uniformity 0.05°C, one-second warmup, easy to use. Ideal for scanned TC systems, DDC, and laboratory use. Series 340 References (150°F oven-type) with 25 channels for \$289.00! Both Series stocked in ISA Types, J, K, T, R & S. Others to order.

Request Technical Data 32

ACROMAG
INCORPORATED

15360 Telegraph Road • Detroit, Michigan 48239
Phone (313) 538-4242 • Teletype (313) 583-4536

Makers of Precision Instrumentation and Controls



ON READER-SERVICE CARD CIRCLE 73

EXTENDING THE CEI LINE

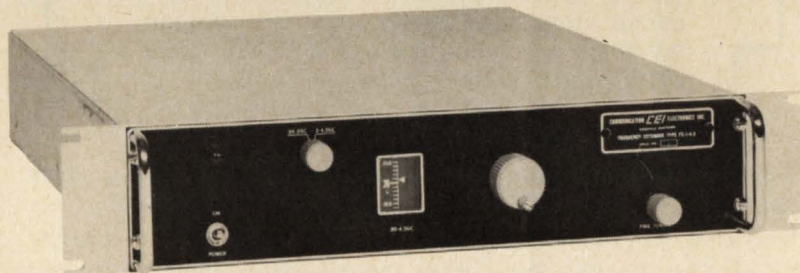

OF SUPERIOR FREQUENCY EXTENDERS

Meet the FE-1-4.5, newest and most versatile in our line of YIG-tuned frequency extenders. Covering the entire 1-4.5 gc range in 2 bands, it converts signals to a 160 mc IF output (optionally 60, 30 or 21.4 mc when used with CEI IFC-21 frequency converter). Each band has its own YIG preselector which is tracked electronically throughout its range, avoiding complex mechanical drives. A 27 inch spring steel tape dial assures greater resolution, ultra-precise tuning and permits resetability to $\pm 0.5\%$.

Completely solid state except for the ceramic triode in the highly stable local oscillator, the compact FE-1-4.5 offers high reliability and ease of operation with superior performance characteristics in a package just 3½" high. Image rejection is 70 db and noise figures are typically 16 db with 18 db maximum.

For further information on the FE-1-4.5 or other CEI frequency extenders, please write:

COMMUNICATION ELECTRONICS INCORPORATED

6006 Executive Blvd., Rockville, Md. 20852 Phone: (301) 933-2800 TWX: 710-824-9603



ON READER-SERVICE CARD CIRCLE 74

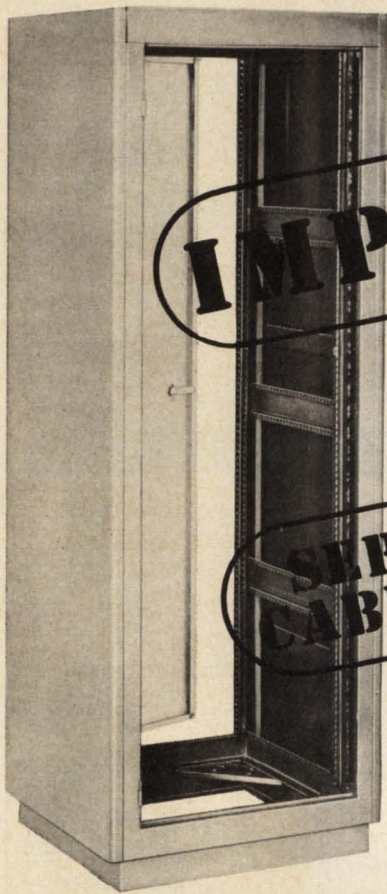

IMPROVED

**SERIES SIXTY
CABINET RACKS**

CHANGED FOR THE BETTER

Illustrated are cross sections of the former and present horizontal struts. The structural changes from the design on the left to that on the right resulted in a tremendous increase in load bearing capacity. Independent testing laboratory tests proved that the horizontal struts now being used will support 2,240 pounds while the old style supported 670 pounds.

Additional structural changes include fabricating the upright members into box-like members and adding a flange to the top of the uprights where they are welded to the frame top. The improvements make the Series Sixty Cabinet Racks more rugged with greater capabilities. NOTHING HAS BEEN CHANGED TO DISTURB THE COMPATIBILITY IN APPEARANCE.

The Series Sixty still provides the most practical and economical means for housing of electronic equipment or instrumentation systems. With all their improvements, the price remains the same. Inspect the new models at your Bud Distributors and you'll see the important differences.



BUD RADIO, INC.
WILLOUGHBY, OHIO

ON READER-SERVICE CARD CIRCLE 75

Designer's Datebook

JANUARY						
S	M	T	W	T	F	S
2	3	4	5	6	7	8
9	10	11	12	13	14	15
16	17	18	19	20	21	22
23	24	25	26	27	28	29
30	31					

FEBRUARY						
S	M	T	W	T	F	S
	6	7	8	9	10	11
12	13	14	15	16	17	18
19	20	21	22	23	24	25
26	27	28				

Jan. 25-27

Annual Reliability Symposium (San Francisco), Sponsor: IEEE, ASQC; J. W. Thomas, Jr., Vitro Labs, 14000 Georgia Ave., Silver Spring, Md.

Jan. 30-Feb. 4

Winter Meeting on Aerospace and Electronic Systems (Los Angeles), Sponsor: IEEE, G-AES; IEEE Office, 3600 Wilshire Blvd., Los Angeles.

Jan. 31-Feb. 2

International Symposium on Information Theory (Los Angeles), Sponsor: IEEE, G-IT; A. V. Balakrishnan, Dept. of Electrical Engineering, University of California, Los Angeles.

Feb. 3-8

International Exhibition of Electronic Components (Paris, France), Sponsor: F.N.I.E. (Electronic Industries Assn. of France); Gen'l Commissioner: Robert Foucaul, 16 Rue de Presles, Paris.

Feb. 9-11

International Solid-State Circuits Conference (Philadelphia), Sponsor: IEEE, University of Pennsylvania; J. D. Meindl, U. S. Army Electronics Command, Ft. Monmouth, N. J.

Reprints Available

The following reprints are available free and in limited quantities. To obtain single copies, circle the number of the article you want on the Reader-Service Card.

1965 Semiconductor Directory (No. 740)

First aid for ailing speakers (No. 741)

Guidelines for selecting laser materials (No. 742)



RELIABILITY

TOTAL CAPABILITY IN
PRECISION RESISTANCE

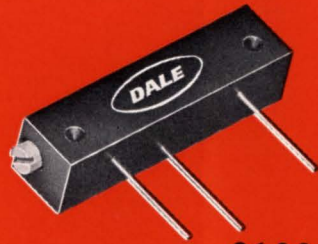

2100 Series



2200 Series



...2 very good reasons why Dale sells so many Commercial Wirewound Trimmers

PERFORMANCE: Dale's 2100 and 2200 series are the commercial counterparts of RT-11 and RT-10 respectively. They can be sealed for just a few cents per unit, yielding mil-level performance in all areas except temperature.

PRICE: Competitive and then some! Check Dale's new lower commercial prices. They were made possible through an extensive value analysis program which actually improved overall unit quality.

DELIVERY: New automated production facilities plus a factory stocking program combine to put your order in your plant without delay.

Simplify trimmer ordering—a call to Dale will do it.

SPECIFICATIONS

	2100	2200
CASE DIMENSIONS	.28 high x .31 wide x 1.25 long	.18 high x .32 wide x 1.00 long
STANDARD MODELS	2187 —printed circuit pins, 21 AWG gold plated. 2188 —28 AWG stranded vinyl leads. 2189 —solder lug, gold plated.	2280 —printed circuit pins, 22 AWG, gold plated. 2292 —solid wire, 26 AWG gold plated. 2297 —28 AWG stranded vinyl leads.
POWER RATING	1 watt at 70° C, derating to 0 at 125° C	
OPERATING TEMPERATURE RANGE	-65° C to + 125° C	
ADJUSTMENT TURNS	25 ± 2	15 ± 2
RESISTANCE RANGE	10 ohms to 100K ohms	10 ohms to 50K ohms
STANDARD TOLERANCE	± 10% standard (lower tolerances available)	

WRITE FOR NEWLY EXPANDED CATALOG B



DALE ELECTRONICS, INC.

1328 28th Avenue, Columbus, Nebraska
Also Sold by Dale Electronics Canada, Ltd., Toronto, Ontario, Canada







Speed Inquiry to Advertiser via Collect Night Letter
ON READER-SERVICE CARD CIRCLE 243

RCA HOMETAXIAL-BASE MEANS NO ELECTRICAL COLLAPSE

HOMOGENEOUS-BASE DESIGN REDUCES RISKS OF SECOND BREAKDOWN...

simplicity for applications from 1 mA to 30A

 TO-5 I _C (Max) TO 1A	 TO-66 I _C (Max) TO 4A	 TO-3 I _C (Max) TO 15A	 TO-3 I _C (Max) TO 30A
40347 $h_{FE} = 20-80$ @ I _C = 450 mA $V_{CEV} (Max) = 60V$	40250 $h_{FE} = 25-100$ @ I _C = 1.5A $V_{CEV} (Max) = 50V$	40251 $h_{FE} = 15-60$ @ I _C = 8A $V_{CEV} (Max) = 50V$	2N3771 $h_{FE} = 15-60$ @ I _C = 15A $V_{CEO} (sus) (Min) = 40V$
40348 $h_{FE} = 30-100$ @ I _C = 300 mA $V_{CEV} (Max) = 90V$	2N3054 $h_{FE} = 25-100$ @ I _C = 0.5A $V_{CEV} (Max) = 90V$	2N3055 $h_{FE} = 20-70$ @ I _C = 4A $V_{CEV} (Max) = 100V$	2N3772 $h_{FE} = 15-60$ @ I _C = 10A $V_{CEO} (sus) (Min) = 60V$
40349 $h_{FE} = 25-100$ @ I _C = 150 mA $V_{CEV} (Max) = 140V$	2N3441 $h_{FE} = 20-80$ @ I _C = 0.5A $V_{CEV} (Max) = 160V$	2N3442 $h_{FE} = 20-70$ @ I _C = 3A $V_{CEV} (Max) = 160V$	2N3773 $h_{FE} = 15-60$ @ I _C = 8A $V_{CEO} (sus) (Min) = 140V$

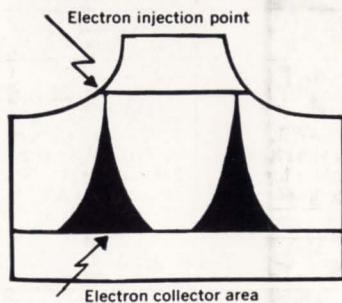

Hometaxial-Base means uniform junctions and homogeneous base construction free of fields in an axial direction.

- Power-Rating Tested (PRT) at maximum power level for 1 second.
- Low saturation voltage for greater switching efficiency.
- Sharp saturation voltage knee for greater circuit efficiency.
- Mechanically rugged—proved after long experience in Mil-approved and demanding aerospace applications.
- Improved beta characteristics for less distortion during operation.
- From a family of single diffused types manufactured by RCA since 1957 and backed by more than 50 million hours of operational life tests.



The Most Trusted Name in Electronics

RCA Electronic Components and Devices

For prices and delivery information see your RCA Representative. For technical data, and your copy of SMA-35, 12-volt Audio Amplifier and Converter Designs using RCA Silicon Power Transistors, and a copy of the new 4-page folder describing RCA's Hometaxial-Base transistor line, write: RCA Commercial Engineering, Section 1-G-1-3, Harrison, N. J.