

Electronic Design 20

VOL. 14, NO.

THE MAGAZINE OF ESSENTIAL NEWS, PRODUCTS AND TECHNOLOGY

AUGUST 30, 1966

A tiny stream of air controls missiles in flight, giant balers that squeeze cars into little cubes and blow-molding machines that pop out plastic milk bottles. New,

rugged fluid amplifiers are immune to rf jamming, vibrations and radiation. And they're very reliable. Fluidics might help turn the tide in your next design if you turn to p. 17.

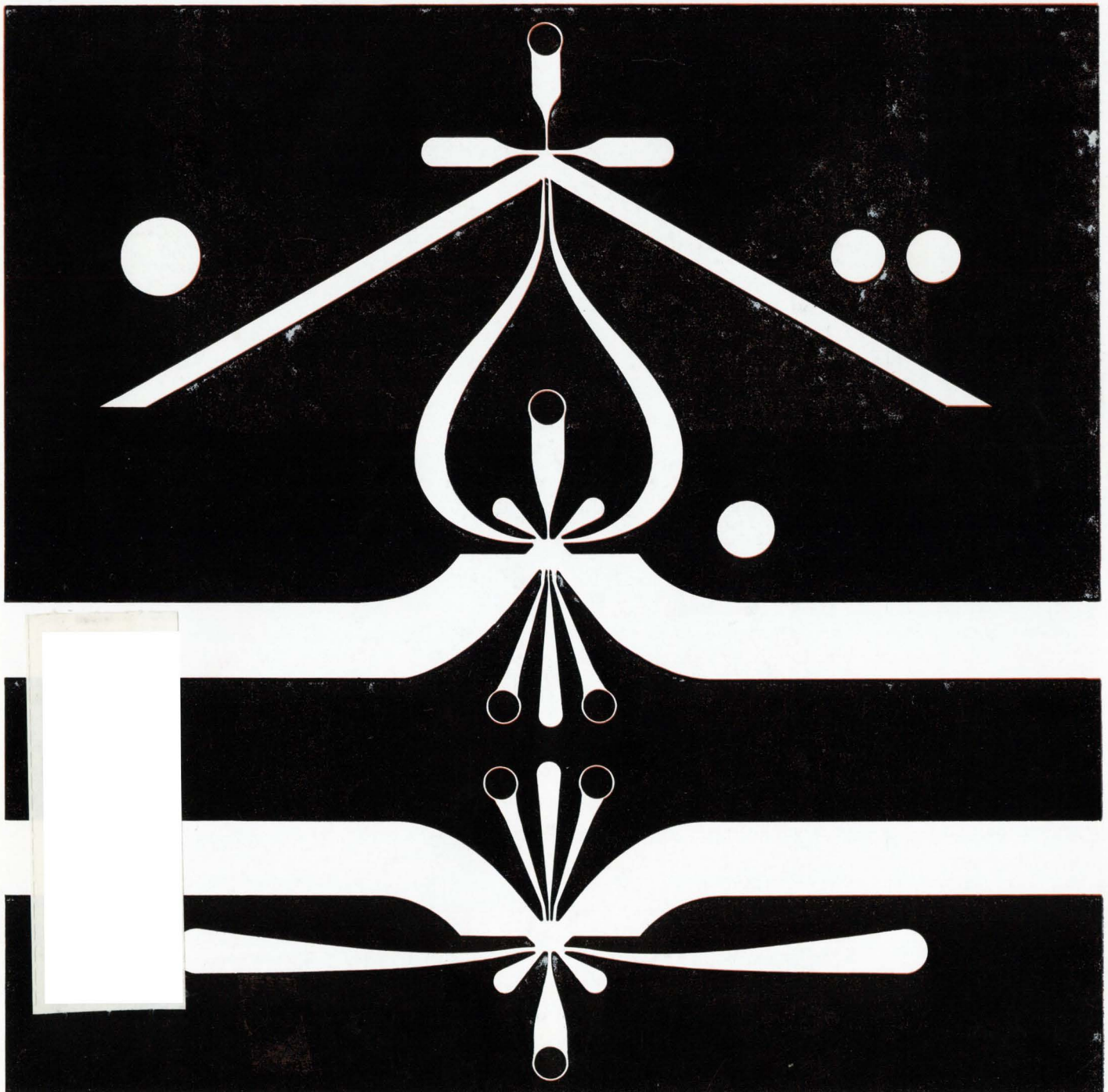

PRESS!

1	2	3	4	5	6
PROGRAM	PROGRAM	PROGRAM	PROGRAM	PROGRAM	PROGRAM



READ!



SPEED TESTING & INCREASE PRODUCTION OUTPUT *New hp Model 155A/1550A Push-Button, Programmable Oscilloscope*

Speed production line testing of circuits and components with an easy, fast press / read on the new hp Model 155A/1550A Push-Button Programmable Oscilloscope! This 5 mv/cm, 25 MHz scope—the first designed specifically for production and automatic systems applications—increases production output by reducing test time per unit, simplifying test procedures, minimizing operator errors and fatigue, and shortening training time.

You can insert up to 18 test programs in each 1550A digital programmer, or cascade programmers for additional capability. Each test program can control any or all major scope functions—including calibrated vertical positioning, sensitivity, input coupling, sweep time, trigger source, and trigger slope. Change test programs in only a few minutes by changing diode pin settings or by interchanging programmers. Diode-controlled, digital programming makes the 155A / 1550A fully compatible with any contact-closure-to-ground programmer for high speed, automatic check-out systems.

Confidence in measurements is substantially increased because the unique DC stabilizer circuitry eliminates DC drift. The trace stays where it is positioned, regardless of

sensitivity or sweep. Calibrated vertical positioning over ± 25 cm dynamic range allows waveform to be accurately offset, magnified, and viewed in detail. Magnification with accurate offset gives big display for ease of reading and greater accuracy.

Confidence in test results is increased by push-button programming because it makes complex tests easier to make. Tests are complete—you have full confidence that you are shipping only good units and rejecting only bad units.

Find out how the new hp Model 155A/1550A Push-Button, Programmable Oscilloscope can increase your production output. Call your nearest hp sales office for a demonstration. Or, write to Hewlett-Packard, Palo Alto, California 94304, Tel. (415) 326-7000; Europe: 54 Route des Acacias, Geneva. Price: hp Model 155A Oscilloscope, \$2450.00; hp Model 1550A Programmer, \$600.00, f.o.b. factory.

HEWLETT  **PACKARD**
An extra measure of quality

ON READER-SERVICE CARD CIRCLE 2

Choose the bridge that's best for you



Whether you want to measure one capacitor to parts-per-million resolution or capacitors by the barrelful, one of these GR bridges has the right balance of speed and accuracy for your work. Choose the bridge to match the job — manual operation for laboratory accuracy, a comparator for laboratory or production-line versatility, a fully automatic instrument for the confidence of 100% inspection.

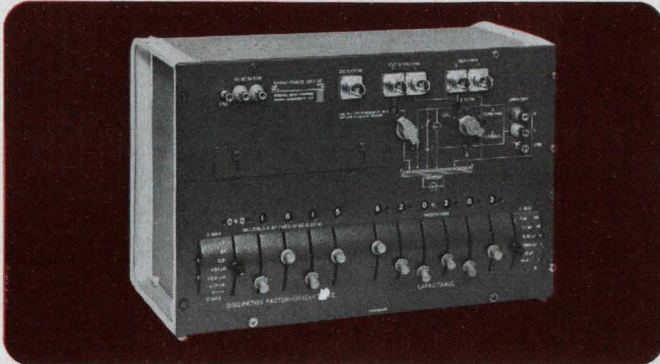

For High Accuracy 0.01% Direct-Reading, 1-PPM Resolution

This is the most precise capacitance bridge you can buy. It contains eight stable standards, has convenient lever-type balance controls, in-line digital readout of C and D (or G) and automatic decimal-point positioning. Internal shielding permits two- and three-terminal capacitance measurements from 50 Hz to 10 kHz (to 100 kHz with slightly reduced accuracy). Capacitance range is 10^{-17} to 10^{-6} farad, 0.000001 to 1.0000 for D, 10^{-6} to 100 μmho for G.

Type 1615-A Capacitance Bridge . . . \$1575 in U.S.A.

Type 1620 Capacitance-Measuring Assembly . . . \$2235 in U.S.A.
(includes bridge detector and generator)

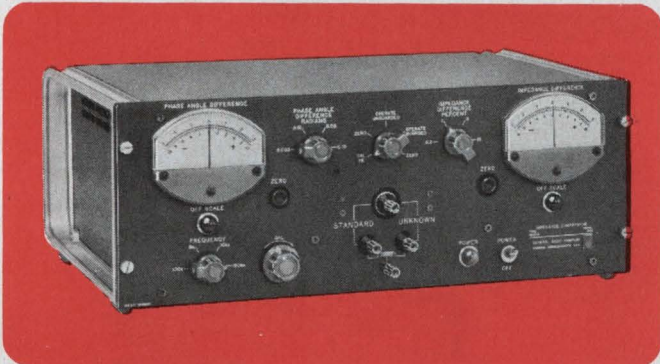

A Popular Go, No-Go Test Instrument High-Speed Meter Indication, No Manual Balancing, 0.009% Comparison Accuracy

GR Impedance Comparators are widely used for rapid testing, sorting, and matching of components, etched boards, and subassemblies, and for measuring environmental effects on components, with continuous indication. Two meters indicate the difference in magnitude and phase between the unknown and a standard sample. Components can be measured as rapidly as an operator can plug them into a test jig. Impedance range is wide, 2Ω to 20 M Ω . Internal frequencies are 100 Hz, 1 kHz, 10 kHz, and 100 kHz; detector is built in, as well.

Type 1605-A Impedance Comparator . . . \$995 in U.S.A.

Type 1605-AH Impedance Comparator (greater sensitivity, narrower range) . . . \$995 in U.S.A.



For Automatic Measurement with Digital Readout 0.1% Accuracy, Data Outputs for Use in Fully Automated Systems

Here is a completely automatic capacitance bridge. On command, it selects the range, makes the balance, displays measured values of C and D (or G), and presents digital data — all in $\frac{1}{2}$ second, under worst conditions. You just insert the capacitor and read the C and D values, and/or the information can be fed to printers, data-handling equipment, etc. Internal passive standards ensure 0.1%-of-reading accuracy. This instrument will also track or sample changing capacitance (for example, in environmental studies). At 400 Hz and 1000 Hz, ranges are: 0.01 pF to 100 μF for capacitance (parallel), 100 pmho to 1.0 mho for conductance (parallel), and 0.0001 to 1.00 for dissipation factor; at 120 Hz, ranges are 100 pF to 1000 μF , 0.1 μmho to 1.0 mho, and 0.0001 to 1.00, respectively.

Type 1680-A Automatic Capacitance Bridge Assembly . . . \$4975 in U.S.A.

GR also manufactures capacitance bridges for more specialized measurements. Among these are a 1-MHz capacitance bridge, a 120-Hz bridge for electrolytic-capacitor measurements, and audio, rf and uhf multipurpose impedance bridges. Write for complete information.

BOSTON • NEW YORK • CHICAGO • PHILADELPHIA • WASHINGTON, D.C.
SYRACUSE • DALLAS • SAN FRANCISCO • LOS ANGELES • ORLANDO
CLEVELAND • TORONTO • MONTREAL

BOURNE END, ENGLAND

ZURICH, SWITZERLAND

GENERAL RADIO

WEST CONCORD, MASSACHUSETTS

ON READER-SERVICE CARD CIRCLE 212

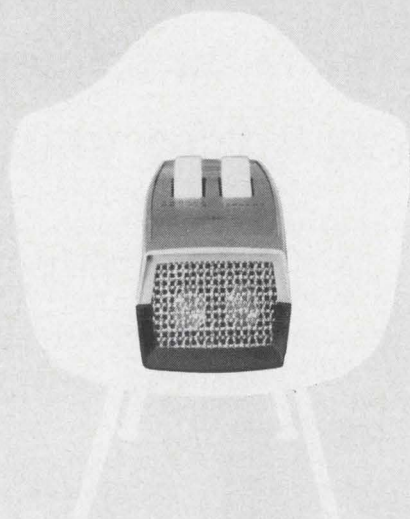

**The only
available wireless
remote control
system**

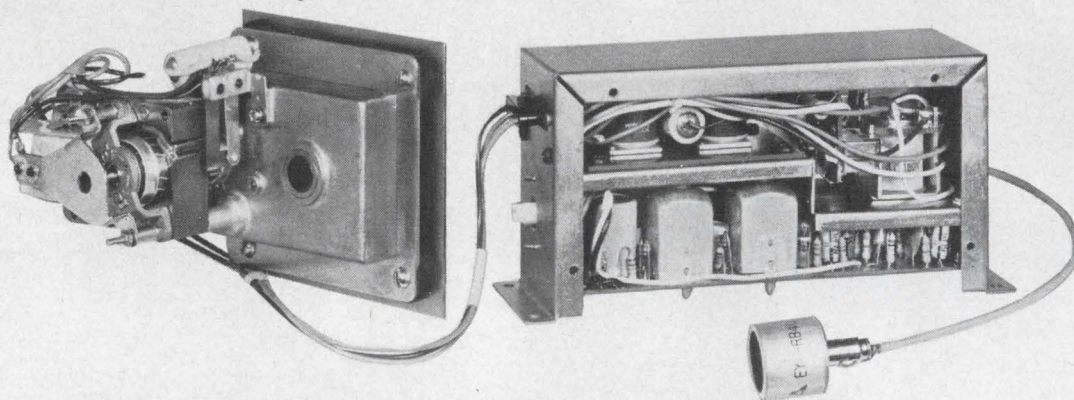

**featuring solid state, multi-channel,
complete with transmitter and receiver.**

Designed for ultra-sonic remote control of TV receivers, stereo systems, lighting, burglar alarms, garage door openers, or whatever else requires remote control operation.

Transmitter can generate from 1 to 8 ultra-sonic signals which, in turn, are picked up by microphone installed in equipment. Receiver unit activates built-in relays. Each channel can be designed independently to control any number of functions. Tuner driving motor assembly supplied (with programmer) for TV application. All solid state. Compactly designed. Operates on AC, DC or battery indoors or out. Adaptations made to suit specific application requirements. Immediate delivery. Complete details on request.

Price \$25.00 when ordered in quantity of fifty or more.

Matsushita Electric Corporation of America
Electronic Components & Devices Dept. • 200 Park Avenue, New York, N.Y. 10019 • Telephone: 973-5710

NEWS

- 13 News Scope
 - 17 **Fluidics: simple pipeline to rugged control**
Growing market forecast for liquid-gas devices that can be incorporated in standard electronics.
 - 22 **Evolution not revolution is Wescon keynote**
Additions and refinements to established trends rather than startling developments greet visitors during Wescon week.
 - 24 Liquid laser uses inorganic fluid.
 - 27 Washington Report
 - 31 **Editorial:** Man looks to science for his future happiness.
-

TECHNOLOGY

- 34 **Design Directions:** Computer-aided design: promise and problems
 - 38 **Thyristor triggering is sure-fire** with the SUS and SBS. These planar, pnpn switches provide reliable, stable turn-on signals.
 - 46 **Want stable audio amplifier gain?** Use this guide to predict the circuit's thermal behavior. It shows how to bias audio power stages properly.
 - 54 **Measure transistor y-parameters** the right way and get improved hf designs. Five basic instruments are compared.
 - 62 **Short-cut to spliced resonators** by using a graphical design approach that helps optimize lengths of line segments at the resonant frequency.
 - 65 Ideas for Design
-

PRODUCTS

- 74 **Microelectronics:** Economy DTL logic cards shrink digital systems.
 - 77 Semiconductors
 - 78 Materials
 - 80 Test Equipment
 - 82 Components
-

Departments

- 86 Design Aids
 - 88 New Literature
 - 90 Advertisers' Index
 - 92 Designer's Datebook
-

DESIGNER'S

P. R. MALLORY & CO. INC., INDIANAPOLIS, INDIANA 46206

Type TLS (CL64/65) Tantalum capacitors pass 10,000 hour life test

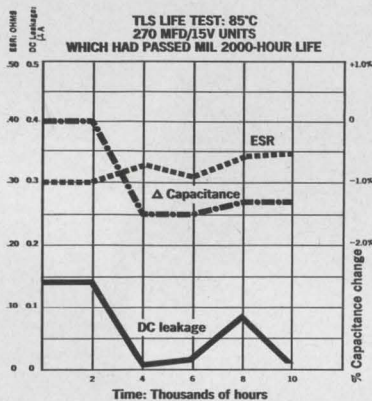

10,000-hour data at 85°C for typical group of TLS capacitors.

Mallory Capacitor Company engineers recently completed a series of life tests to evaluate the stability of electrical parameters of the Type TLS wet slug tantalum capacitors beyond the MIL 2000 hour requirement. These capacitors, which are the equivalent of CL64 and CL65

per MIL-C-39006, demonstrated excellent retention of performance up to the 10,000 hours of the test, both at 85°C and at 125°C . . . and confirm the long term life capability of the Mallory TLS design.

DC leakage performance remained well below specification limits. Equivalent series resistance of all TLS capacitors tested measured in the order of one-tenth of specification values. Capacitance changes were relatively small, and these, too, stayed well within spec limits.

Tests were made both on capacitors which had previously passed 2000-hour MIL life test, and on excess MIL screening units which had not been life tested. Good correlation of results was observed for both tested and untested lots. Typical values are shown here for one of the several different C-V values tested in this series. A copy of our Engineering Report is available on request.

CIRCLE 191 ON READER SERVICE CARD

Avalanche rectifiers can take 80% overvoltage

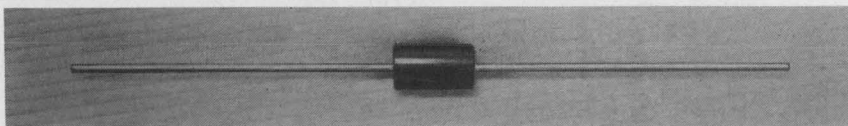

Because of their ability to withstand switching and line transient voltage spikes well above steady state rated values, Mallory Type LA controlled avalanche rectifiers prove an ideal means of protection for power supply circuits of phonographs, calculating machines, instruments and other industrial and commercial electronic products.

The overvoltage capability of the Type LA is comparable to that of selenium rectifiers, without the aging characteristic of selenium. A

special diffusion technique produces a silicon junction which can rectify safely over a broad range of applied voltage. Current ratings of $\frac{3}{4}$, 1, 2 and 3 amperes are supplied. Maximum spike which can be tolerated safely is 80% above nominal voltage rating. Bv values, at 25°C, are 200, 300, 400, 500 and 600 volts.

Type LA is supplied in a molded case .375" long and .200" in diameter, with axial leads.

CIRCLE 192 ON READER SERVICE CARD

New 65°C computer grade capacitors have increased ripple rating, more C-V



The new CGS aluminum electrolytic filter capacitors line looks exactly like our former CG capacitors . . . same case and top construction . . . but it's different inside.

You can now get about twice as much capacitance in a given case size as was formerly available in Mallory capacitors. Maximum capacitance is now 280,000 mfd at 3WVDC, or 1,800 mfd at 450WVDC in the 3" diameter by 5 $\frac{7}{8}$ " case.

A completely new set of specifications for ripple current has been established for this line. The new values are based upon Mallory tests of many hundreds of capacitors under a variety of environmental conditions. Maximum ripple current ratings stated as the proved values to which you can design with *full confidence of long, reliable life*. And they are higher than our previous values; for comparable case size, about four times higher . . . for comparable capacitance-voltage ratings, better than twice as high. ESR (equivalent series resistance) values are considerably lower.

You have 882 ratings from which to choose from 3 to 450 volts. Complete data on the new line is summarized in our new Bulletin 4-80.

CIRCLE 193 ON READER SERVICE CARD

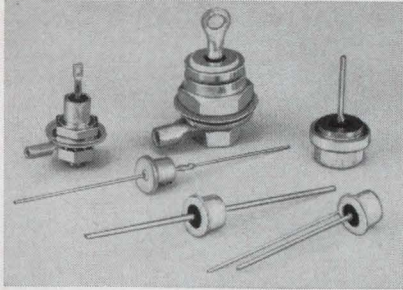

New line of medium power sealed silicon rectifiers

The new Mallory HC rectifiers cover the complete range of current ratings from $\frac{3}{4}$ to 25 amperes. All ratings are 75°C ambient. They use true hermetic glass-to-metal sealed cases, with either single-ended or axial lead construction. A passivated silicon die affords superior high temperature stability.

The $\frac{3}{4}$, 2 and 3 ampere types are in top-hat style flange cases, .450" diameter at the flange .350" body diameter. The 5, 10, 15, 18 and 25 ampere ratings come in press fit, solder fit and conductive epoxy case configurations. All current values are available in Peak Inverse Voltage ratings from 50 to 1000 volts.

CIRCLE 194 ON READER SERVICE CARD

"O" Ring-type switches in Mallory controls give long life, high reliability

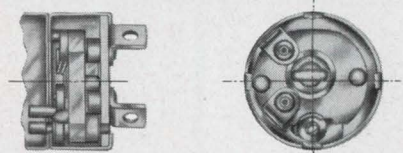

The line switches supplied attached to Mallory volume controls have a unique O-ring design which provides exceptional performance. Contact is made by a freely rotating ring element that snaps into place between stationary contacts. There are no current-carrying springs. The ring rotates slightly as the switch is operated, so that a new contacting

Improved performance for Mallory Alkaline Batteries

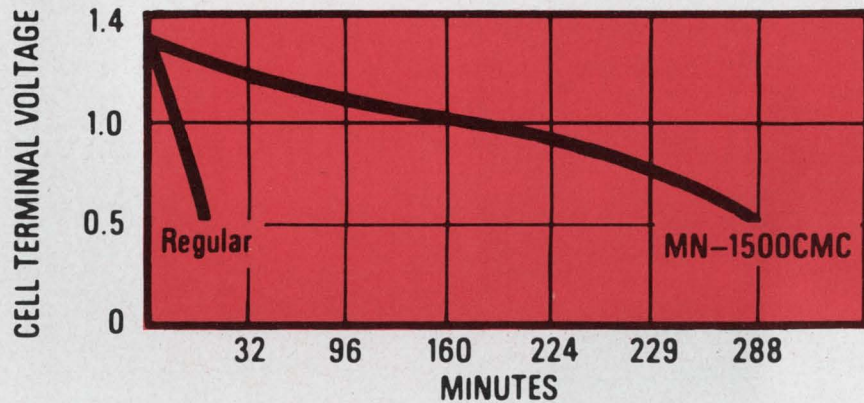

Discharge characteristic of "AA" size Mallory Alkaline Batteries at 31°F. Two cells in parallel feeding into 8 ohm lamp load.

Now, standard Mallory manganese-alkaline batteries (sizes "D", "C" and "AA") have completely new performance ratings when operating at freezing temperatures or under relatively high current drains.

For example, the graph compares service life of the new Mallory MN1500 (size "AA") versus the old when cells are discharged continuously through a PR-4 bulb at 31°F. This dramatic improvement in battery life was accomplished through changes in the battery's internal de-

sign (see cut-away), which increase the effective anode area in relation to cell volume and reduce internal

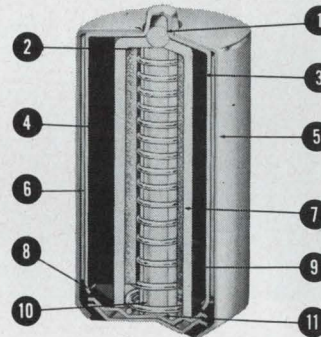

- | | |
|---------------------------------------|------------------------|
| 1. INSULATOR | 6. OUTER CAN |
| 2. ABSORBENT AND ALKALINE ELECTROLYTE | 7. ZINC ANODE |
| 3. MANGANESE DIOXIDE DEPOLARIZER | 8. CELL SEAL (GROMMET) |
| 4. INNER CAN | 9. BARRIER |
| 5. ADAPTER SLEEVE | 10. CONTACT SPRING |
| | 11. DOUBLE CELL TOP |

New internal construction of Mallory Alkaline Cells.

surface is presented each time and contact wear is distributed around the entire periphery. The result is long switch life, freedom from contact failure and ample ability to handle overloads.

These switches, designated Type OAC, are available in SPST, SPDT and DPST configurations, with UL ratings of 3, 5 or 6 amps AC at 125 volts, in rotary, push-push or push-pull action. Terminal arrangements can be supplied, identical with those of the volume control, for point-to-point wiring or printed circuits.

CIRCLE 195 ON READER SERVICE CARD

impedance of the cell. Added refinements in case and seal construction have also been made to insure reliability of the seal under even the most severe vibration.

The new Mallory alkaline batteries are ideal for lighting, photoflash, motor driven applications and other heavy drain service.

CIRCLE 196 ON READER SERVICE CARD

Solitron

announces

V_{CEO} (SUS)
325 v
300 v
250 v
225 v
200 v



*in a 10 Amp. NPN Silicon
 Planar Power Transistor
 Plus
 50 mcs 150 pfs*

Type Number	Pkg. Size	DESIGN LIMITS						PERFORMANCE SPECIFICATIONS					
		T _J	θ	P _T	BV _{CBO}	V _{CEO} (SUS)	BV _{EBO}	h _{FE}		V _{BE} (sat)	V _{CE} (sat)	I _{CBO}	f _T
		°C	°C/W	Watts	Volts	Volts	Volts	@I _C = 5A V _{CE} = 5V		Volts	Volts	μA	mc
		Max.	Max.	Max.	Min.	Min.	Min.	Min.	Max.	Max.	Max.	Min.	
MHT7201	TO-3	200	1.5	65	225	200	8	20	60	1.2	0.5	1.0	50
MHT7202	TO-3	200	1.5	65	250	225	8	20	60	1.2	0.5	1.0	50
MHT7203	TO-3	200	1.5	65	275	250	8	20	60	1.2	0.5	1.0	50
MHT7204	TO-3	200	1.5	65	325	300	8	20	60	1.2	0.5	1.0	50
MHT7205	TO-3	200	1.5	65	350	325	8	20	60	1.2	0.5	1.0	50

TRANSISTOR DIVISION

Solitron DEVICES, INC.

1177 BLUE HERON BLVD. / RIVIERA BEACH, FLORIDA / (305) 848-4311 / TWX: (510) 952-6676

Leader in Germanium and Silicon Power Transistors, Cryogenic Thermometers, High Voltage Rectifiers, Hot Carrier Diodes, Temperature Compensated Zeners, Voltage Variable Capacitors, Random/White Noise Components, Microelectronic Circuits, and High-Pac Interconnection Systems.

Speed Inquiry to Advertiser via Collect Night Letter
 ON READER-SERVICE CARD CIRCLE 4

Types 561A & RM 561A oscilloscopes

easily adapted to particular needs

Here's a Tektronix oscilloscope featuring operational simplicity and versatility through a new series of plug-in units. Presently, you can select from 17 amplifier units and 7 time-base units.

Knowing your application area, you select units to fit your needs. Some of the plug-in unit combinations available include those for low-level, differential, multi-trace, sampling, and spectrum analysis applications. Plug-in units offer capabilities from 100 $\mu\text{V}/\text{cm}$ deflection factor (3A3) and 15 MHz bandwidth (3A5) to 0.5 $\mu\text{sec}/\text{cm}$ sweep rate (3B1, 3B3) and sweep-delay applications (3B1, 3B2, 3B3).

With any combination of plug-ins including the same type amplifier units in both channels for X-Y displays — this oscilloscope provides you with no-parallax displays for accurate reliable measurements.

features

- crt with an internal graticule and controllable edge lighting
- regulated power supplies
- regulated dc heater supply
- Z-axis input
- 3.5-kV accelerating potential
- amplitude calibrator
- and operation from 105 V to 125 V or 210 V to 250 V. (The Type 561A operates from 50-400 Hz and the Type RM561A operates from 50-60 Hz.)

Type 561A Oscilloscope \$500

Plug-ins Illustrated:

Type 3A74 Four-Trace Unit \$590
(4 identical channels, bandwidth DC-to-2 MHz, deflection factor 20 mV/cm to 10 V/cm)

Type 2B67 Time-Base Unit \$210
(Sweep range 1 $\mu\text{s}/\text{cm}$ to 5 s/cm, 5X magnifier, single sweep, flexible triggering facilities)

Type RM561A (7" rack height) . . . \$550

Plug-ins illustrated:

Type 3A1 Dual-Trace Amplifier Unit \$450
(2 identical channels, bandwidth DC-to-10 MHz, deflection factor 10 mV/cm to 10 V/cm)

Type 3B3 Time-Base Unit \$585
(Normal and delayed sweeps 0.5 $\mu\text{s}/\text{cm}$ to 1 sec/cm, calibrated sweep delay 0.5 μs to 10 sec, single sweep, flexible triggering facilities)

U. S. Sales Prices
f.o.b. Beaverton, Oregon

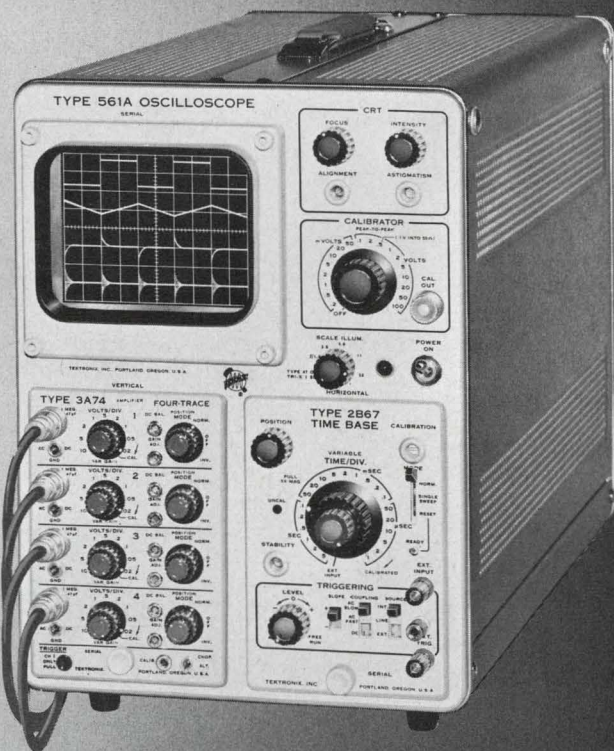

Tektronix, Inc.

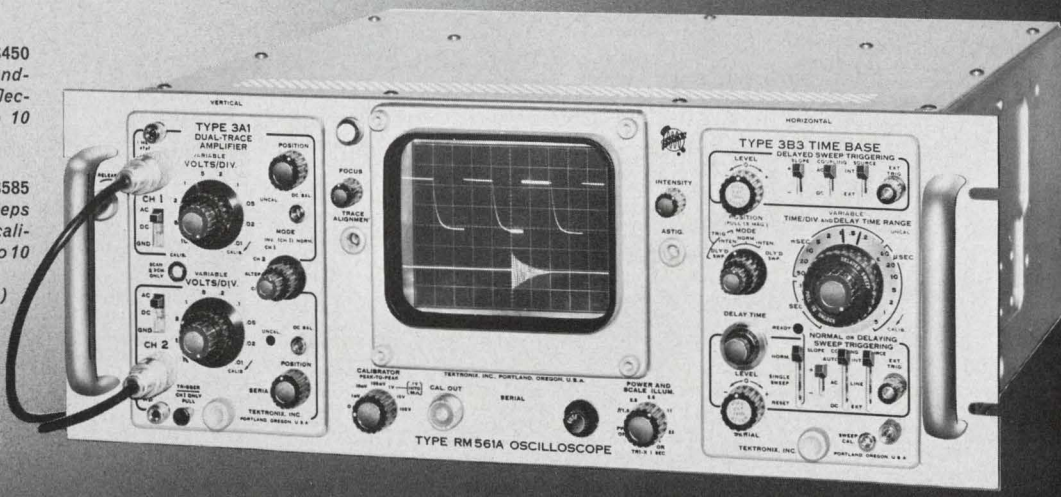

FOR MORE INFORMATION ON EITHER MODEL OF THIS NEW OSCILLOSCOPE AND ANY COMBINATION OF PLUG-IN UNITS, PLEASE CALL YOUR TEKTRONIX FIELD ENGINEER.

ON READER-SERVICE CARD CIRCLE 5

The wire that's specially-made for feeding automated wiring systems:

Brand-Rex Turbowrap^{T.M.}

Turbowrap runs like silk in automatic and semi-automatic wiring machines and tools, because it's *unusually uniform*. Foot by foot, and lot by lot — consistent quality in electricals, physicals and mechanicals reduces the chance of jammed or erratic feeding, nicks, strains, cuts or shorts.

And Turbowrap, in a broad choice of insulations and sizes, gives you almost unlimited design freedom. Standard insulations include semi-rigid PVC and PVC/nylon, Teflon FEP and FEP/nylon, Teflon TFE, Kynar and Polysulfone. Sizes as small as #30 AWG, and walls as thin as .004", help you put more wire in less space.

Various Turbowrap types have been expressly engineered for the world's leading manufacturers of computers and business machines. They're one reason why Brand-Rex has chalked up more UL approvals for business machine wire than any other company.

Want to get more out of automated, high-density wiring? Write us for details on Turbowrap.

AMERICAN ENKA CORPORATION

BRAND-REX DIVISION

WILLIMANTIC, CONNECTICUT 06226
PHONE 203 423-7771



Speed Inquiry to Advertiser via Collect Night Letter
ON READER-SERVICE CARD CIRCLE 6

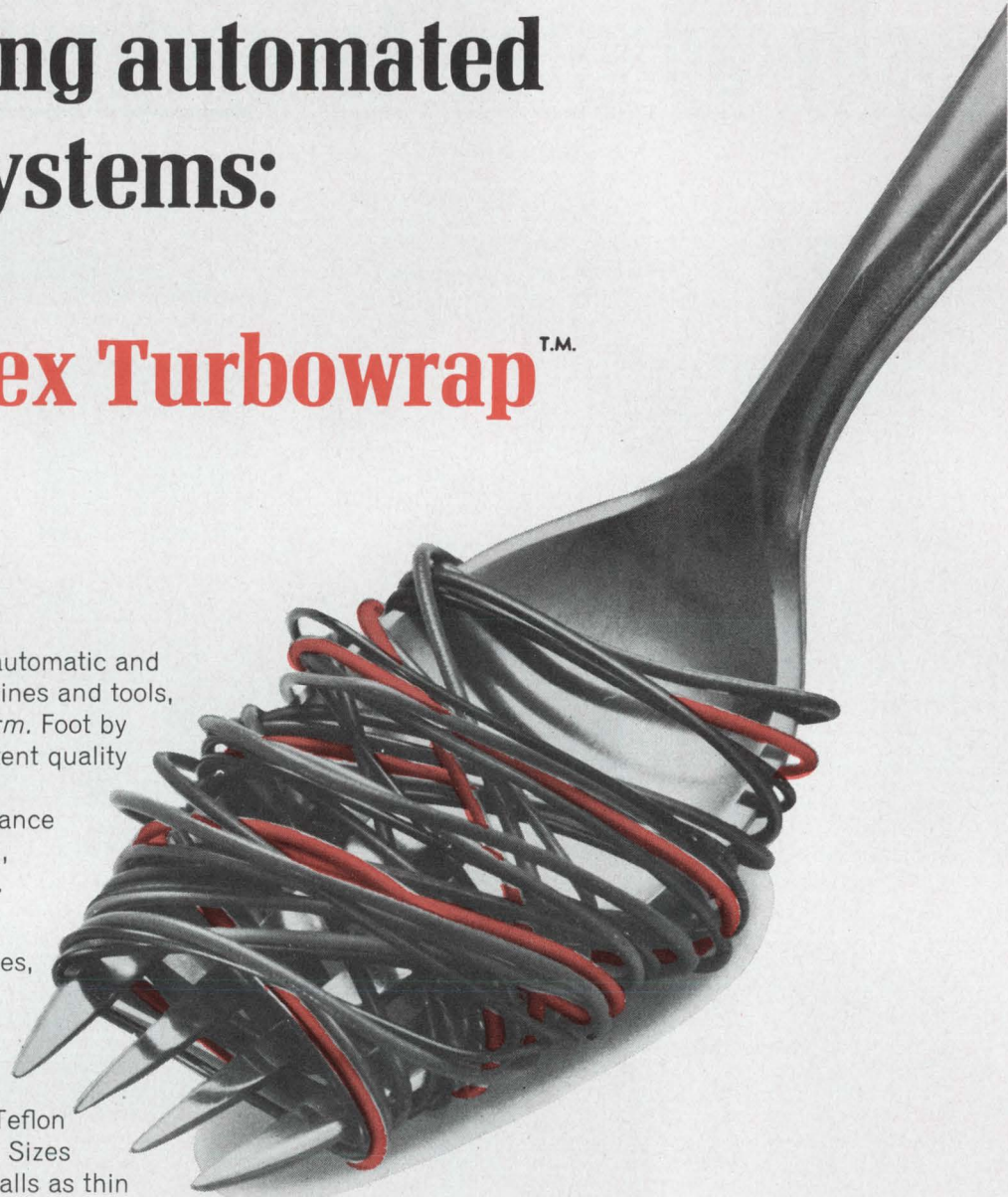

RF AMPLIFIERS

2.5 dB @ 60 MHz

Fairchild low-noise NPN Planar transistors. If you design amplifier circuits in the IF, VHF, or UHF bands, this new series of Fairchild transistors is what you've been waiting for. Low noise, low reverse capacitance, and high stable gain make this the best amplifier family on the market up to 800MHz. Available for military service (2N4134, 2N4135) and for industrial-commercial use (SE5050, SE5051), these transistors are stocked for immediate delivery. See our sample specifications below. Then see a Fairchild Distributor for pricing information and samples. Or write for our data sheets.

FAIRCHILD
SEMICONDUCTOR

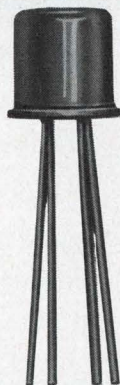

Sample Specifications — 2N4135

NF @ 60MHz	2.5dB max.
NF @ 450MHz	5.0dB max.
Power gain @ 60MHz (unneutralized)	20dB min.
Power gain @ 450MHz	8dB min.
C_{re} (guarded C_{obo})	0.5pf max.
V_{CEO}	30V min.

Planar is a patented Fairchild process

FAIRCHILD SEMICONDUCTOR / A Division of Fairchild Camera and Instrument Corporation ■ 313 Fairchild Drive, Mountain View, California (415) 962-5011 ■ TWX: 910-379-6435

ON READER-SERVICE CARD CIRCLE 7

You Can Get All These Microcircuits from Sprague Electric:

SERIES SU300, LU300 UTILOGIC



K Package

For use in commercial, industrial, ground support applications. Available in two operating temperature ranges, -20°C to $+85^{\circ}\text{C}$, and $+10^{\circ}\text{C}$ to $+55^{\circ}\text{C}$. Propagation delay of 15 to 40 nanoseconds.

*Trademark of Signetics Corp.

ON READER-SERVICE CIRCLE 883

*SERIES SE400, NE400 LOW POWER LOGIC

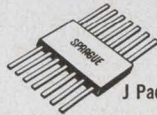

J Package

Operating temperature ranges: -55°C to $+125^{\circ}\text{C}$, and 0°C to $+70^{\circ}\text{C}$. For use in Aerospace and other applications where low power drain is required. Optimized speed, noise margin.

ON READER-SERVICE CIRCLE 884

*SERIES SE100, NE100, US700 DTL LOGIC

(Signetics CS700)

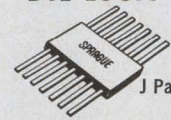

J Package

Eighteen functions in two operating temperature ranges: -55°C to $+125^{\circ}\text{C}$ and 0°C to $+70^{\circ}\text{C}$. Circuits include NAND/NOR gates, clock and line drivers, gate expanders, RST and JK binary elements, one-shot multivibrator.

ON READER-SERVICE CIRCLE 882

*SERIES SE500 LINEAR AMPLIFIERS



K Package

Operating temperature range: -55°C to $+125^{\circ}\text{C}$. Two linear circuits available in 10-lead low silhouette TO-5 case. SE501K is a video amplifier, SE505K is a general purpose differential amplifier.

ON READER-SERVICE CIRCLE 885

UNICIRCUIT® RCTL LOGIC

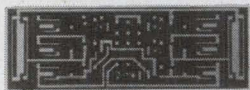

(8x actual size)

Sprague Series US-0100 . . . a complete line of silicon monolithic digital building blocks featuring low power consumption (2 mW typ.)

ON READER-SERVICE CIRCLE 886

UNICIRCUIT® mW RTL LOGIC



TO-5 Case

Types US-0908 through US-0921 . . . Fully interchangeable mW digital building blocks featuring power consumption of 2 mW/node and propagation delay of 40 nsec.

ON READER-SERVICE CIRCLE 887

UNICIRCUIT® CUSTOM HYBRID CIRCUITS

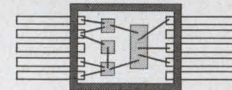

Combine monolithic silicon circuits with tantalum or Ni-Cr alloy resistors. Close resistance tolerances, low temperature coefficient. Resistor matching, $\pm 1/2\%$.

ON READER-SERVICE CIRCLE 888

DIGITAL-TO-ANALOG CONVERSION CIRCUITS



UT-1000—Four-bit ladder network
UD-4001—Ladder switch for driving resistor ladder networks
UD-4024—Buffer amplifier

ON READER-SERVICE CIRCLE 889

*Series SE100, NE100,
CS700, SU300, LU300,
SE400, NE400, SE500
are all available
from Sprague Electric
under technology interchange
with Signetics Corp.

For data sheets on the microcircuits in which you are interested, write to:

Technical Literature Service
Sprague Electric Company
347 Marshall Street
North Adams, Mass. 01247

SPRAGUE COMPONENTS

INTEGRATED CIRCUITS
THIN-FILM MICROCIRCUITS
TRANSISTORS
CAPACITORS
RESISTORS

PULSE TRANSFORMERS
INTERFERENCE FILTERS
PULSE-FORMING NETWORKS
TOROIDAL INDUCTORS
ELECTRIC WAVE FILTERS

CERAMIC-BASE PRINTED NETWORKS
PACKAGED COMPONENT ASSEMBLIES
BOBBIN and TAPE WOUND MAGNETIC CORES
SILICON RECTIFIER GATE CONTROLS
FUNCTIONAL DIGITAL CIRCUITS

SPRAGUE®
THE MARK OF RELIABILITY

*Sprague' and '@' are registered trademarks of the Sprague Electric Co.

News

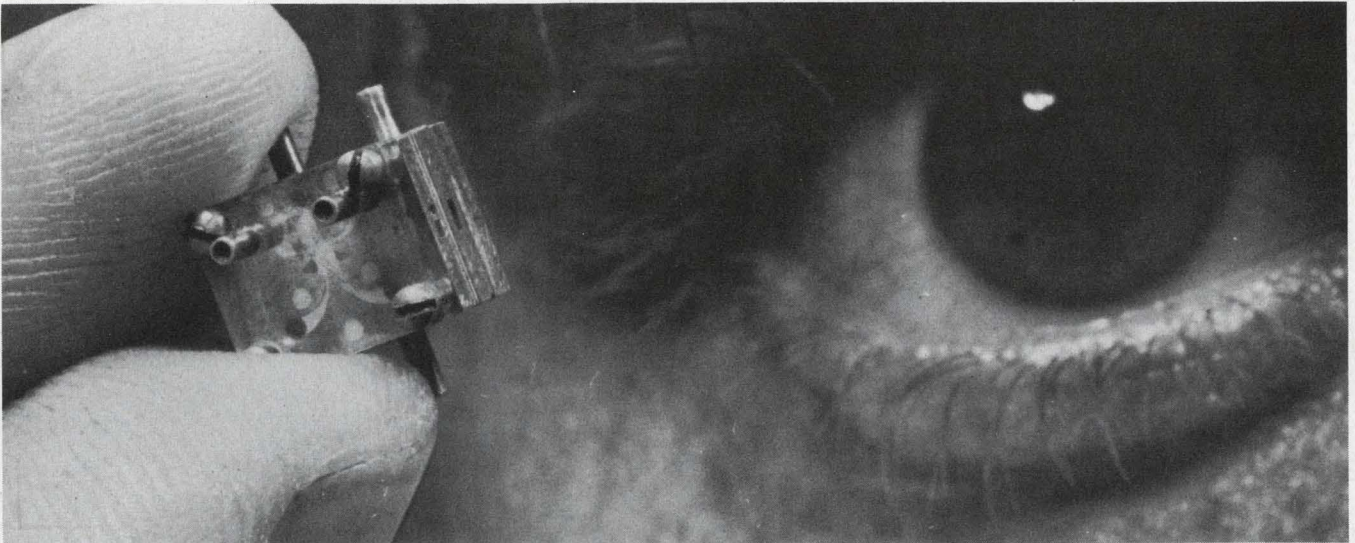

Growing market forecast for fluidics. Many devices are already available. Page 17.



Components and test equipment displayed at Wescon this year were for the most part ad-

ditions and refinements to previously established trends. Page 22.

Also in this section:

Liquid laser uses inorganic fluid. Page 24.

News Scope, Page 13 . . . **Washington Report**, Page 27.

Editorial: Man looks to science for his future happiness. Page 31.

Tina proves that anyone can measure microwave frequencies with a Systron-Donner counter



"What's this?"



"Twist it onto this little piece of pipe."



"Now write down what it says here."



"That's right."

Tina is a fashion model. We lured her to our lab to show you that technically unskilled people can now measure microwave frequencies with our Counter/ACTO[®] system.

True, we set the trigger level and the gate time for her. But that's what you do with any simple frequency counter. The rest went just as you see. And Tina produced the correct answer accurate to eight significant figures.

Microwave measurements of this

speed and simplicity are possible only with ACTOs,[®] our Automatic Computing Transfer Oscillator plug-ins. Three plug-ins cover the full range from 0.3 to 12.4 GHz. They fit into any Systron-Donner 50 MHz or 100 MHz counter and produce measurements of counter accuracy because the input is phase locked.

Though we didn't design ACTOs for other brands of counters, we find that a slightly modified ACTO will work beau-

tifully with an HP5245L frequency counter. So if you already have an HP counter, you don't have to buy another counter to get ACTO performance.

Send for complete technical data on Counter/ACTO systems.

Expansion has created many professional opportunities in engineering and marketing at Systron-Donner. Interested engineers may phone Ronald Abdo, Personnel Manager, collect at (415) 682-6161.

Integrated-circuit flip-chips in small desk-top AM radio

As part of a full-scale invasion of consumer electronics, integrated circuits have established a beach-head in the table-top radio market.

The Philco Consumer Products Group of the Ford Motor Co. has announced a small battery-powered AM radio that contains two integrated-circuit chips. These contain all the active circuit elements and most of the passive components. Over 50 resistors, 26 transistors and two diodes are diffused on the silicon chips, which are flipped upside down and soldered to a board.

This development comes a matter of weeks after a similar announcement by General Electric. The GE radio, introduced as part of a clock-radio package, used only one integrated-circuit chip. The GE chip was mounted in a dual-in-line package.

The Philco chips are mounted on a small board, which is then epoxied to a larger board. The chips are covered with epoxy and capped with a flat metal can.

In both radios, only a few passive components, the tuning filter, the antenna, the speaker and bat-



Flip-chips tumble into Philco radio.

tery are added to the integrated circuitry. The Philco radio can deliver 100 mW to its speaker.

RCA has announced the use of integrated circuits in television receivers. With three major electronic companies using these devices, observers foresee widespread use of integrated circuits in consumer products and equipment.

University to analyze flying-saucer puzzle

Growing public interest in the sighting of unidentified flying objects (UFOs) has prompted the Air Force to engage a leading university to study the problem. Recently the Air Force has been criticized for refusing to make public the information it collects on UFOs at its Wright-Patterson AFB.

The Air Force has not announced the name of the university, but it said that the investigating team would include one physical scientist and one psychologist. The team will study about 100 sightings in great detail.

UFOs—popularly called flying saucers, because most observers who report them say they are so shaped—have been spotted by many technically trained people, including scientists, air pilots and engineers. Explanations by the Air Force of what the public is seeing have ranged from weather balloons to phenomena caused by swamp gas.

The Air Force said it would publish the results of the planned investigation, which is expected to cost about \$300,000.

Sea-missile detector takes to its test bed

A complex radar system being developed to detect ballistic missiles

launched by submarines is about to enter the test-bed stage.

The prime contractor—Avco Corp., Electronics Div., of Cincinnati, Ohio—has set up the test facility at an undisclosed site not far from its plant. The aim is to integrate the new sea-warning system with the SAGE air-defense system.

Under an Air Force contract, Avco is to replace the present height-finder radar on SAGE—which is shaped something like the peel on a wedge of orange—with a dish-shaped radar antenna that will perform both search and tracking functions. A computer unit is to be mated to the radar to handle information on the submarine-launched missiles.

When completed, the new system will monitor the coastal waters of the continental United States from seven SAGE radar sites. Data-processing facilities at the sites will convert radar return signals into digital form for transfer to and display at the North American Air Defense Command headquarters, Colorado Springs, Colo.

“We have been at work on this important new defense system for more than a year,” said O. E. Bassett, vice-president and general manager of the Avco division. “We received notification of the contract in December of last year, and up to now have received awards totaling \$12 million.”

Politics blamed for color TV discord

A recent meeting of the Comité Consultatif International des Radiocommunications in Oslo, Norway, has elicited charges of “political rigging and maneuvering” from some of the participants. It had been hoped that some semblance of agreement on color TV standards for Europe could be reached during the meeting. Instead, the proponents of competing systems stood pat, with the result that each country is expected to choose at its own discretion the color TV system it deems suitable.

What was particularly galling to the British and Germans, who wanted the PAL system adopted, was an eleventh-hour proposal by the French and Russians for adoption of the SECAM IV system as a

compromise. This system was developed by the Russians as a variant of the French SECAM system and is still in the early stages of development. The Russians and French themselves admitted at the beginning of the conference that many of the features of the new system are still largely unknown.

As a result of the Oslo agreement to disagree, 41 million Europeans will ultimately watch color TV by the PAL system. Countries adopting PAL include Great Britain, Germany, Italy, Denmark, Finland, Norway, Sweden and Switzerland. The other main competing system, SECAM III, will be used by countries with 25 million viewers. Most of these, such as the Soviet Union, Hungary and Poland, are Eastern Bloc countries. Only three countries of Western Europe have adopted SECAM III. They are France, Greece and Monaco.

New time-sharing software announced

The broad use of time-shared computers for the solution of engineering problems (See Design Directions, this issue, p. 34 ff.) has moved a step closer with IBM's announcement of a new computer program, Remote Access Computing System (RACS). Using FORTRAN, RACS will give time-sharing capabilities to three medium-scale versions of the company's system/360 (Models 30, 40 and 50).

Communications with RACS-equipped computers can be either through a keyboard terminal or through a combination video/keyboard terminal. Up to 63 terminal consoles can be connected to a system/360 using RACS, depending on the computer model.

IBM has scheduled RACS to be available to its customers in the second quarter of 1967.

Atomic power asked for missions in space

"One of the major constraints on U.S. space operations is the limited

capability of on-board electrical power supplies." This was the contention of Edward C. Welsh, executive secretary of the National Aeronautics and Space Council.

Solar cells, batteries and fuel cells, he argues, are "not suited for the high-power, long-life requirements for planetary exploration spacecraft."

His solution: "The development of nuclear power supplies appears to be our only option in meeting this type of requirement."

Welsh gave his views in an address to the Armed Forces Communications and Electronics Association in Washington.

West Coast survey set

A four-month research study to draw "a profile of the western electronics industry" has been announced by Wescon and the Western Electronic Manufacturers' Association (WEMA). The study, run by Attitude Research Associates of Los Angeles, is already under way and will define closely the western market and manufacturing capacity for electronic components, products and systems in the eight major categories used at Wescon.

Senate grounds F-111B; bars procurement funds

The Senate—apparently convinced that the Navy version of the all-purpose F-111 has serious limitations—has barred the use of any of the funds set aside for its procurement in the \$58 billion Military Appropriations Bill.

The F-111B's excess weight limits its patrol time to about 1-1/2 hours. Moreover, a heavy aircraft is hard to land in strong winds on the deck of an aircraft carrier.

In wartime conditions a typical ship-launched patrol would reconnoiter in the air for up to eight hours. The Navy had hoped that its version of the F-111 would stay aloft at least for four hours.

The F-111B carries six Phoenix missiles supported by their related electronic tracking and computing gear. This missile instrumentation replaces the fuel tanks of the Air Force version of the F-111.

The House passed its version of

the appropriations bill without objection to the F-111B. As we go to press, committees from the House and the Senate meet to reconcile differences between their two versions of the funding measure.

Informed sources expect the procurements for the F-111B to be delayed but not eliminated.

Close approach to Moon improves Orbiter photos

Hopes that Orbiter I will complete most of its mission have been raised now that the satellite has been moved closer to the Moon. It sent back only two clear high-resolution pictures of the lunar surface before this maneuver was accomplished.

The principal objective of its mission is to obtain clear views of nine potential Apollo and Surveyor landing zones along the Moon's equator. Unfortunately, apparent difficulties with the high-resolution camera earlier led to double exposures and smeared images. It was believed that the camera's shutter was opening at the wrong time.

On Aug. 21, Orbiter was successfully brought to within 35 miles of the Moon's surface from a higher orbit with a perilune of 133 miles. The apolune of both orbits was about 1150 miles.

Engineers took the two shots by disabling a sensor circuit that was intended to move the film slightly to compensate for spacecraft motion. This way they obtained clear pictures from the high-resolution cameras. Experiments were begun to change the camera's shot intervals and shutter speeds as soon as the satellite had been repositioned.

Fortunately for the scientists, the medium-resolution lens worked well and returned high-quality pictures. At the lower altitude, the camera is designed to resolve objects larger than 25 feet in diameter.

This the space scientists say, is sufficient to permit them to eliminate those sites that have slopes too steep for safe spacecraft landings.

Secondary objectives of Orbiter I include gathering data on micrometeoroid activity, on radiation in the vicinity of the Moon, and on the nature of the lunar gravitational field.

WE CHALLENGE YOU TO TEST AND COMPARE THESE GENERAL INSTRUMENT EPOXY TRANSISTORS WITH HERMETICALLY SEALED UNITS IN YOUR OWN LABORATORY.

FREE!

We'll send you these 4 GI epoxy transistors FREE:—

Test them against these:—

2N4140 vs 2N2221
2N4141 vs 2N2222
2N4142 vs 2N2906
2N4143 vs 2N2907

**PROVE FOR YOURSELF THAT THE GI EPOXY ENCAPSULATED TRANSISTORS ARE DIRECTLY INTERCHANGEABLE*
—ELECTRICALLY AND MECHANICALLY—WITH THE HERMETICALLY SEALED UNITS.**

PLUS (for introduction to you)
we'll also send:

GENERAL INSTRUMENT'S
NEW COMPLEMENTARY PAIR

2N4227
2N4228

featuring: $h_{FE} \dots 75-150$ @ $I_c = 150$ mA

Fill out & mail this coupon for
your free 6 PAK today.

GENERAL INSTRUMENT CORPORATION
SEMICONDUCTOR PRODUCTS GROUP
600 West John Street, Hicksville, New York

Please send me my FREE 6 PAK of epoxy transistors consisting of one sample each of the 2N4140, 2N4141, 2N4142 & 2N4143; also GI's new complementary pair, 2N4227 & 2N4228 complete with data & specifications.

Name _____

Job Title _____

Company _____

Address _____

City _____ State _____ Zip _____

*Maximum Dissipation: 300 mW

For further information on GI's broad line of epoxy transistors, contact your local GI sales representative.

GENERAL INSTRUMENT CORPORATION

600 West John Street, Hicksville, L. I., N. Y.

ON READER-SERVICE CARD CIRCLE 9



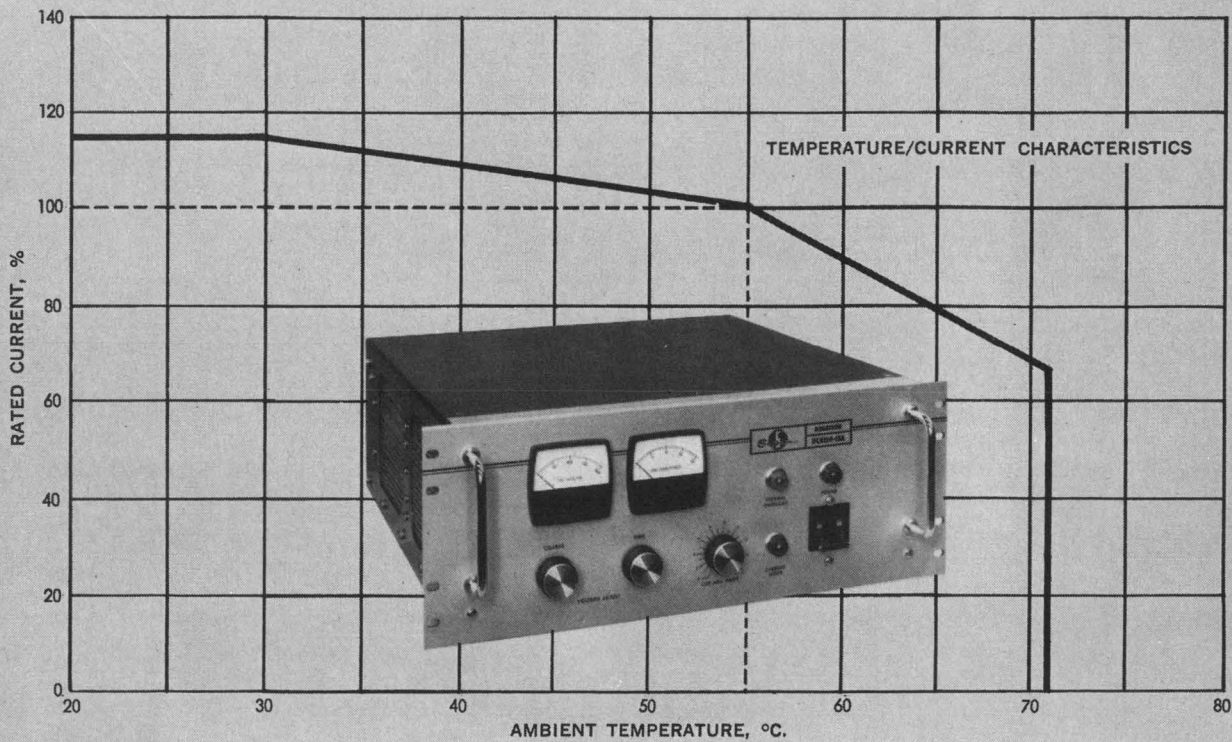

Sorensen DCR Series now with temperature capability to 71°C.

Sorensen Wide Range Power Supplies to 20 kW.

Sorensen's wide range DCR Series has been up-dated and improved. What's new about the DCR's? They are now 100% silicon; ambient temperature capability is now to 71°C. • Four 3-phase models have been added extending power capability to 20 kW; 24 models are now available with ranges up to 300 volts. • Multiple mode programming—voltage/current/resistance. • Voltage regulation, line and load combined, is $\pm .075\%$ for most models • Constant current range 0 to rated current. • DCR's meet MIL-I-26600 and MIL-I-6181

specifications and conform to proposed NEMA standards. • Front panel indicator for voltage/current crossover. These features of the improved DCR (model numbers will have an "A" suffix) are offered at no increase in price. For DCR details, or for data on other standard/custom power supplies, AC line regulators or frequency changers, call your local Sorensen rep, or write: Raytheon Co., Sorensen Operation, Richards Avenue, Norwalk, Connecticut 06856. Tel: 203-838-6571.

MODEL SELECTION CHART

Voltage	Amps.	Model	Price	Amps.	Model	Price	Amps.	Model	Price	Amps.	Model	Price
0- 20	125	DCR 20- 125A	\$1055	250	DCR 20- 250A	\$1495	—	—	—	—	—	—
0- 40	10	DCR 40- 10A	325	20	DCR 40- 20A	525	35	DCR 40- 35A	\$ 710	60	DCR 40-60A	\$925
0- 40	125	DCR 40- 125A	1350	125	DCR 40 -125A	1995	500	DCR 40-500A	2950	—	—	—
0- 60	13	DCR 60- 13A	525	25	DCR 60- 25A	710	40	DCR 60- 40A	900	—	—	—
0- 80	5	DCR 80- 5A	325	10	DCR 80- 10A	525	18	DCR 80- 18A	710	30	DCR 80-30A	875
0-150	2.5	DCR 150- 2.5A	325	5	DCR 150- 5A	525	10	DCR 150- 10A	710	15	DCR 150-15A	825
0-300	1.25	DCR 300-1.25A	325	2.5	DCR 300- 2.5A	525	5	DCR 300- 5A	710	8	DCR 300- 8A	825

RAYTHEON

Fluidics: a simple pipeline to rugged control

Air or liquid amplifiers have no moving parts; foolproof logic is made from standard circuits.

Roger Kenneth Field
News Editor

Fluidics—a new generation of logic and control elements developed during the last decade—is still an infant in the market place. But its proponents hope to change that in the next ten years. Both industry and the Federal Government are sponsoring research and development work in this field. Those familiar with its progress feel certain that by the mid-Seventies fluidics will take its place along with electronics, pneumatics and hydraulics in space, industry and consumer products. The advantages of their technology, they say, make this inevitable.

Fluidic controls are more rugged and foolproof than electronic controls. And they are faster, cheaper and more reliable than either pneumatic or hydraulic controls.

The term "fluidics" refers to the control of one fluid stream (liquid or gas) with another like stream. Unlike either pneumatic or hydraulic devices, fluidic devices have no moving parts.

Fluid devices, circuits and systems are readily designed using standard electronic techniques. Most of the terminology used to describe fluid devices comes directly from electronics (e.g., gain, bias, input impedance) and many of the companies engaged in fluidics are electronic firms (General Electric, Martin, Honeywell, Giannini Controls). Though much slower than electronic devices, these fluid devices are far more rugged and reliable in adverse environments than electronic devices.

Charles L. Davis, vice-president of Honeywell's Military Products Group, predicts a gross market for fluidics of \$250 million by 1970.

Meanwhile Eugene Humphreys, editor of an extensive fluid-device market survey, estimates that by 1975 the value of U.S. fluid-compo-

nents sales should range between \$460 million and \$860 million.

Prodded by this optimism, clever researchers are churning out a stream of fresh ideas. Recently, for example, the Astromechanics Research Division, Giannini Controls Corp., Malvern, Pa., developed a fluidic flip-flop that remembers its setting even if all power is disconnected (see Fig. 1).

This device is particularly important because it can be designed with an infinite input impedance; nothing flows except during switching. It could well be as important to fluidic logic as complementary switching pairs are to transistor logic. Here's how it works:

An hourglass-shaped receptacle contains a bead of liquid that nearly fills one of its two compartments. If air pressure is introduced into that compartment through orifices at its end, the bead will be forced through the constriction into the other half of the device. There it closes off a

tiny, pressurized sensing tube, causing an output from the tube.

The trick to good performance is to use a light liquid bead with high surface tension. Mercury was tried, but after much experimenting Giannini settled on a more suitable combination of materials. A glycerine bead rolled in very fine gold dust or diatomaceous earth is light and holds together well. When the inside walls of the cavities are coated with Zepel (a Dupont repellent that is commonly applied to rainwear), the device can withstand vibrations that exceed even human tolerance and the bead remains intact. Tests at NASA's Electronic Research Center, Cambridge, Mass., show that the bistable memory device responds to 30 Hz.

No moving parts in pure fluidics

Most fluid units have no moving parts at all. Pure fluid devices are simply channels through which streams of a single fluid flow. Most of them depend on the Coanda effect—the tendency for a stream of moving fluid to adhere to any adjacent smooth surface. This effect,

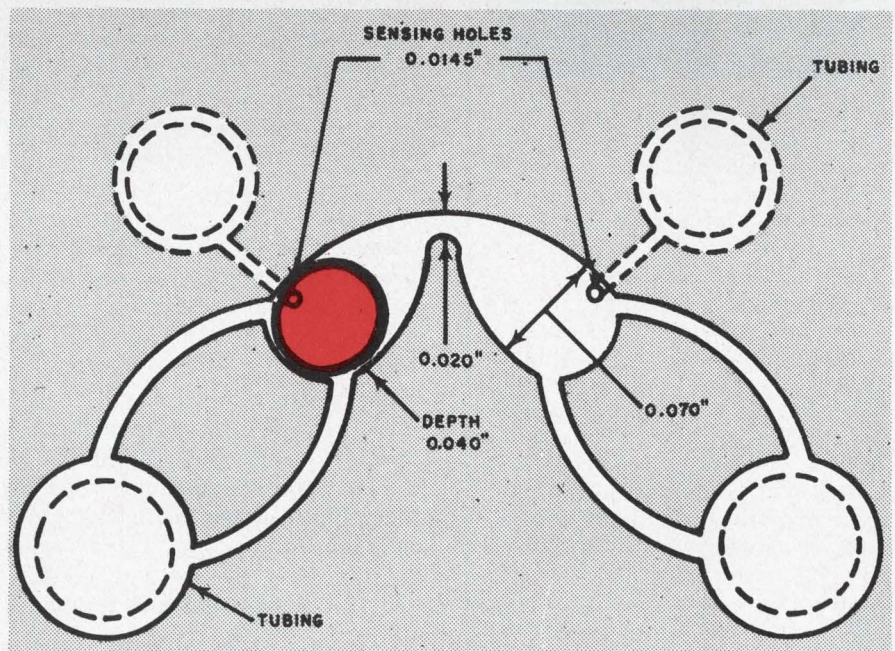

1. This fluid flip-flop remembers its setting even if all power fails. Its glycerine ball is covered with very fine gold dust, so that it rolls in its Zepel-coated hourglass cavity like a drop of rain on a dusty road.

(fluidics, continued)

discovered in 1932 by Henri Coanda, was used in the first fluidic bistable amplifier made in 1958 at the Harry Diamond Laboratories, Washington, D. C. (see Fig. 2).

When a stream of air flows into a perfectly symmetrical forked channel, it does not, as one would expect, divide evenly. Tiny turbulences make up low-pressure regions on each side of the stream as it emerges from the supply tube into the interaction region and approaches the two output channels. Here we have a mild instability that is eliminated when the stream flutters toward one side or the other. Then the turbulences keep the stream adhering to that wall until a control stream fills the low-pressure region and the main stream switches to the other wall.

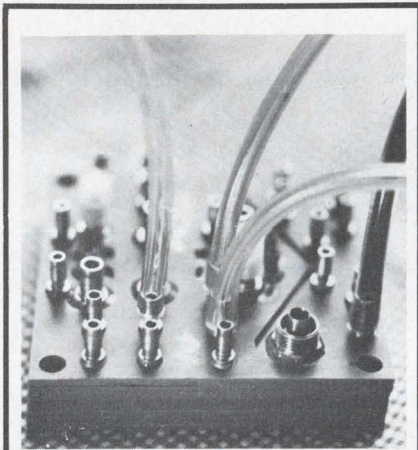

The pattern on the cover is an enlargement of a 4-in.-by-4-in. etched glass slide. It and six others like it fused into a solid stack make up part of the fluidic missile guidance system for a small Army rocket.

A sensor (classified) at the rocket's gyro plugs into this ceramic-glass stack. Its output then controls the supersonic flow of exhaust through a huge bistable amplifier. The single block contains a sawtooth-wave generator, a summing junction, a proportional amplifier and two flip-flops. And nothing moves, except the stream of air. The Corning Glass Co., Corning, N. Y., made this integrated stack from a circuit diagram supplied by the Army's Redstone Arsenal, Huntsville, Ala.

This bistable device is a fundamental fluid element. By adding extra input ports and connecting the output of one device to the input of the next, the engineer can make many different logic elements. And often a single element is the logical equivalent of many electronic components. For example, the electronic equivalent of the simple fluid flip-flop contains eight resistors and two transistors. Thus, in certain cases, fluid logic can take up even less space than its electronic counterpart.

To make a proportional analog amplifier, the component designer need only reshape the interaction region to discourage the main stream from adhering to the walls (see Fig. 3). Then the small fluctuations in the control signal emerge as large fluctuations in the output. With no control signal, the main stream divides equally into the output channels. Another analog device operates somewhat differently. In the vortex amplifier, a control stream impinges on the supply stream causing it to spiral around the output tube. A small control signal causes a substantial decrease in output much as the addition of a small amount of negative charge to the grid of a triode causes a substantial decrease in its plate current (see Fig. 5).

The big electronic analogy

It is somehow ironic that fluid devices and systems are dealt with in electronic terms. In the early years of electricity, the then mysterious movement of current through conductors was explained by the analogy of water flowing through a pipe. Now the tables have turned. Fluidics people "wire" discrete components together (they use plastic tubing, of course). And nearly every device and technique is described by analogy to electronics.

There are even analogies to passive components. A capacitor, in fluidics, is merely a container like an air tank. A resistor is a porous block in a passage. An inductor is a long fine tube.

Slow response restricts fluidics

The slow speed of fluid travel is the major factor that prevents fluidics from eliminating most electronics. The ratio between the

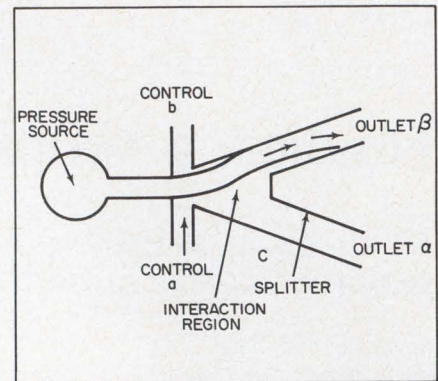

2. Bistable amplifier operates on the Coanda effect. Fluid from the pressure source adheres to the walls of B until a control signal is applied to b. Flow then switches to C.

speed of electromagnetic propagation and the speed of sound is roughly one million. This means that fluid logic will probably never get above the 100-kHz range. But millisecond response times are splendid for use with many big machines, where the inertia of moving parts prevents faster response anyway. Such times are also adequate where man is a component in the system, and in certain operations that must be manually controlled.

Because of these speed limitations, most fluidics manufacturers view their products as complementary to electronics. Fluidics are most suitable for the control of machines that use pneumatic or hydraulic power for motion. But many interesting applications will use fluidics as a companion technology in hybrid systems.

If a system demands fast response in some parts and great reliability under adverse conditions in others, a hybrid approach may work wonders. Fluidic-electronic interfaces are being developed.

The Massachusetts Institute of Technology has created turbulence in a laminar flow of air with spark discharges. Though inefficient, this would be a good interface where conservation of electrical power is of no particular importance (see Fig. 4).

International Computers and Tabulators, Ltd., Putney, England, is developing an inexpensive electronic-fluid digital interface. The company has demonstrated that sound waves from an ordinary loudspeaker can induce fluid switching when directed into the control jet of a fluid OR/NOR element.

As comfortable as an old shoe.

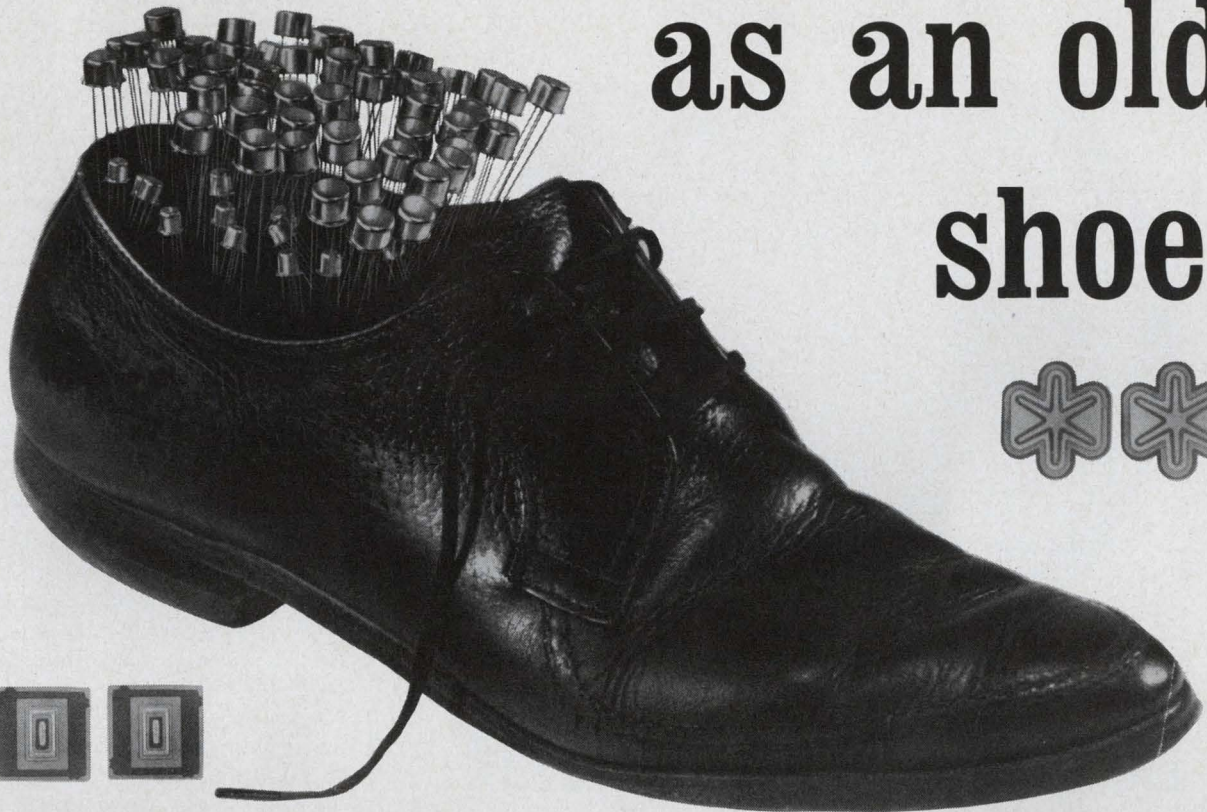

That's the way most engineers feel about using these 28 popular Motorola silicon annular complementary transistors in their designs.

NPN	PNP	APPLICATION
2N2218-18A 2N2219-19A 2N2221-21A 2N2222-22A	2N2904-04A 2N2905-05A 2N2906-06A 2N2907-07A	Complementary high performance STARS* for medium level switch and amplifier applications.
2N3946 2N3947	2N3250-50A 2N3251-51A	Complementary high performance BOX for low level switch and amplifier applications.
2N3252 2N3253	2N3467 2N3468	Complementary high performance SNOWFLAKES for high level switching applications.
2N2369	2N3546	Complementary high performance low level high speed switch applications.

Why?

Because they are *versatile*. They fit anywhere — do all jobs well. If there were such a thing as a “universal” transistor, these would all be top candidates for the title.

Secondly, they're *reliable*. That's what makes it so comfortable for the designer. He knows he can depend on each and every device with patented annular structure that he uses.

He also knows he has a *dependable supply*. Motorola has been making these types by the millions for years.

And the prices? They're comfortable, too. That is the nicest part.

So, why don't you get yourself some old shoes — and *get comfortable!* Your local Motorola semiconductor distributor has them all *in stock* in up to 1000 quantities. Larger requirements can be handled by your nearest Motorola district office. For complete technical data write: Motorola Semiconductor Products Inc., Dept. TIC, Box 955, Phoenix, Arizona 85001.

*Trademark of Motorola Inc.



MOTOROLA Semiconductors

— where the priceless ingredient is care!

Speed Inquiry to Advertiser via Collect Night Letter
ON READER-SERVICE CARD CIRCLE 10

New from Sprague!

**5 Times the Resistance of
a Conventional Metal-Film Resistor
of Equal Size!**

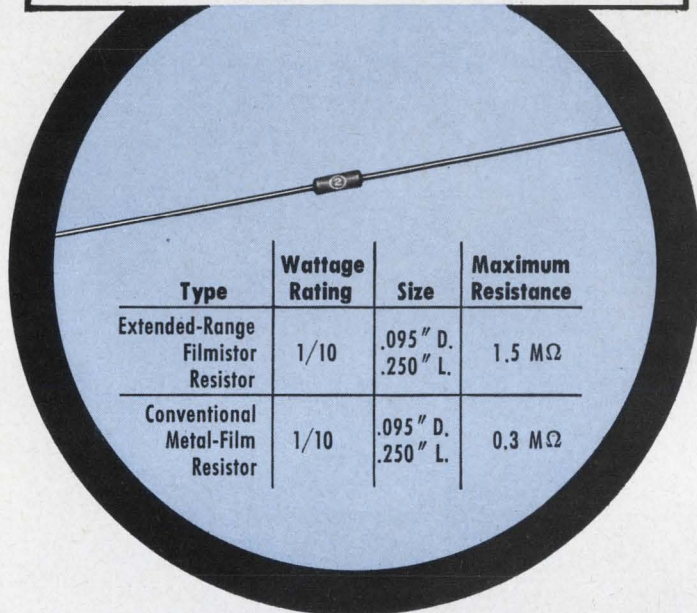

EXTENDED-RANGE FILMISTOR[®] METAL-FILM RESISTORS

**Substantial saving of space in all wattage ratings —
1/20, 1/10, 1/8, 1/4, 1/2, and 1 watt —with
absolutely NO SACRIFICE IN STABILITY!**

Extended-Range Filmistor Resistors now offer, in addition to accuracy . . . stability . . . reliability . . . resistance values in size reductions which were previously unobtainable. Size and weight advantages of Filmistor Resistors now make them ideal for applications in high-impedance circuits, field-effect transistor circuits, etc. Many designs which previously had to settle for the higher temperature coefficients of carbon-film resistors in order to obtain required resistance values can now utilize the low and controlled temperature coefficients of Filmistor Metal-Film Resistors.

Other key features are $\pm 1\%$ standard resistance tolerance, low inherent noise level, negligible voltage coefficient of resistance, and tough molded case for protection against mechanical damage and humidity.

For complete technical data, write for Engineering Bulletin 7025C to Technical Literature Service, Sprague Electric Co., 347 Marshall Street, North Adams, Massachusetts 01247.

SPRAGUE COMPONENTS

RESISTORS
CAPACITORS
TRANSISTORS
INTEGRATED CIRCUITS
THIN-FILM MICROCIRCUITS
INTERFERENCE FILTERS
45R-6139

PACKAGED COMPONENT ASSEMBLIES
FUNCTIONAL DIGITAL CIRCUITS
MAGNETIC COMPONENTS
PULSE TRANSFORMERS
CERAMIC-BASE PRINTED NETWORKS
PULSE-FORMING NETWORKS



'Sprague' and '®' are registered trademarks of the Sprague Electric Co.

ON READER-SERVICE CARD CIRCLE 11

NEWS

(fluidics, continued)

Dr. Ronald Rosenweig at Avco, Cambridge, Mass., has developed a ferromagnetic liquid. The liquid is attracted to a magnet just like permeable solids. It is a colloid of tiny ferromagnetic particles suspended in kerosene. If it were desirable to use a ferromagnetic liquid in a fluidic system, then it should be very easy to have two coils switch the stream. Their magnetic field could attract the liquid itself, according to Dr. Rosenweig, switching it from one wall to the other.

A number of the companies in fluidics are turning out pressure-actuated switches for the electrical read-out of fluid logic outputs.

Fluids flow in many materials

In theory, the fluid devices could be made from any solid that is not soluble in, and not porous to, the fluid it transports. It is common rumor that an air amplifier has been made from a bar of soap. Martin-Orlando has made very small integrated devices with stacks of etched, thin beryllium copper plates. Corning Glass successfully etches and fuses its integrated stacks made of glass layers. Aviation Electric, Ltd., Montreal, Canada, injection-molds its components out of polycarbonate thermoplastic. One of these is a vented diode, in which the fluid can move only forward. In general, materials are chosen with regard to intended environment, ease of fabrication and cost.

Just two years ago there were hardly any working applications of fluid controls; they were considered interesting laboratory oddities. Now scores of applications have already proved that fluidics can do many big jobs reliably. One fluid device was recovered from a rocket after impact. It was tested and worked perfectly.

At this moment Martin/Baltimore is testing the radiation and temperature limits of fluid components to see if they could be used in a solar probe that will pass within 30 million miles of the sun. Fluidics are also controlling beer levels in vats at a Schaefer brewery in Brooklyn, N. Y. ■ ■

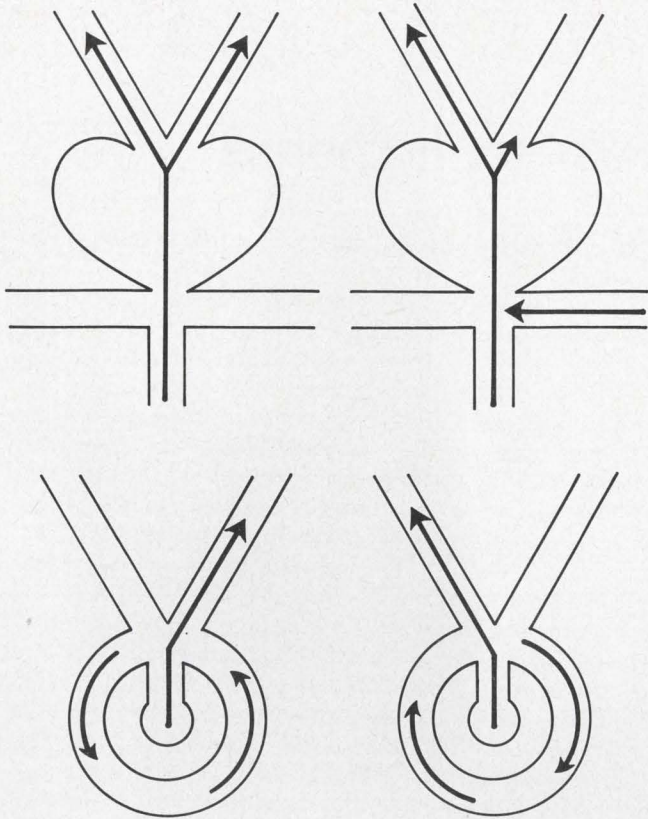

3. **Proportional analog amplifier** (above) has a heart-shaped interaction region. Its contours prevent the main stream from adhering to either wall, and the output through the left leg is proportional to the momentum of the right control flow. **Oscillator** (below) uses part of output flow to switch itself periodically.

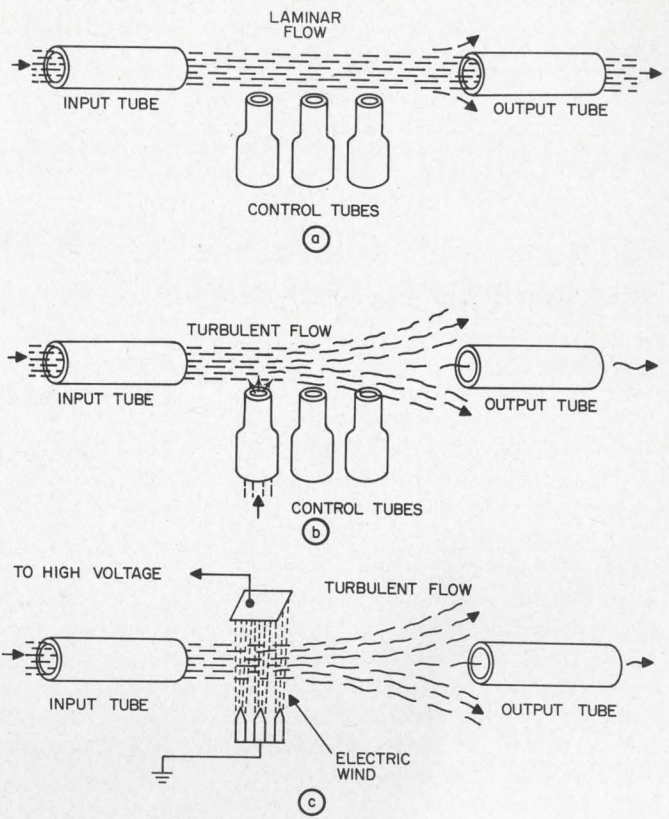

4. In the turbulence amplifier (a and b) there is an output only if no control flow turns the laminar main stream turbulent. This NOR element, made by the Howie Corp., Norristown, Pa., can be used as a building block to make other logic functions. M.I.T. has worked on the electrophoretic method of making a laminar flow turbulent (c).

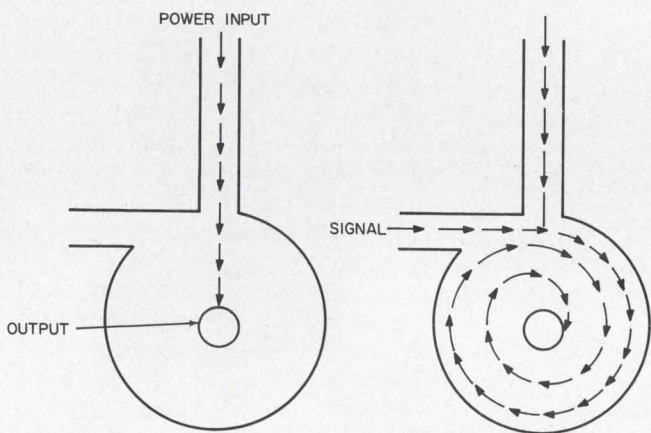

5. **Vortex amplifier** (analog) works much like a triode. Control flow modulates main stream by orbiting it.

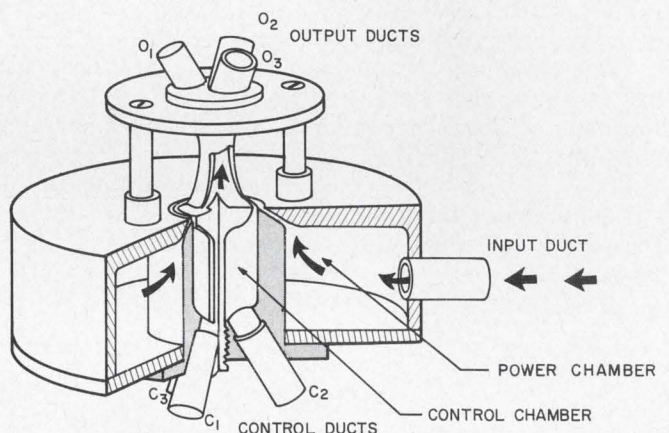

6. **Three-dimensional logic device**, by Sperry-Utah, has three outputs. Each control cancels opposite output.

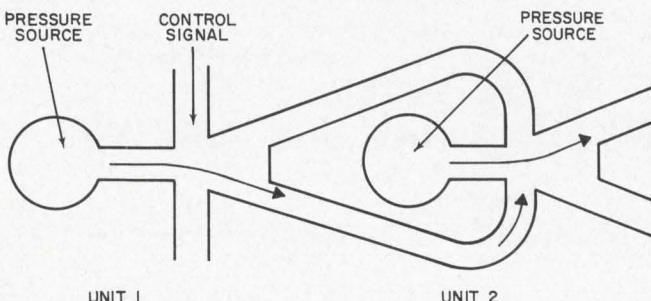

7. **One bistable fluid unit** can trigger another.

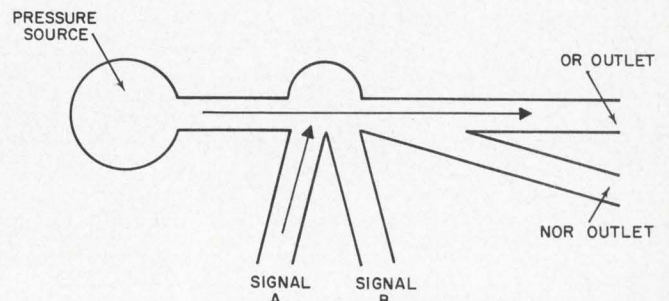

8. In **OR/NOR fluidic unit**, a bias directs flow to NOR.

Evolution not revolution is Wescon theme

Additions and refinements to established trends were apparent in many product areas.

Frank Egan
News Editor

The 1966 Western Electronic Show and Convention is now history and thousands of engineers who attended are back home digesting what they saw and heard.

One very apparent note observed at the show was that component and equipment manufacturers as well as designers are following and expanding on previously established trends. One of the most noteworthy of these is the plastic encapsulation of semiconductors.

Plastic devices coming on strong

Those who attended Technical Session 18 heard glowing predictions about plastic semiconductors and the impact they will be having on the industry. The four authors from major semiconductor manufacturers described how the low-cost, high-performance and improving reliability of plastic units are responsible for a growth rate unrivaled by any other product innovation in the semiconductor field.

Doubts about these rosy predictions were quickly dispelled on the floor of the Sports Arena where at least half a dozen manufacturers

displayed their latest in plastic semiconductor technology.

General Electric, whose first plastic unit was introduced in 1963, making it an old-timer in the business, displayed its first plastic power transistor. The device, a high-voltage npn-type, can handle up to 300 volts and sells in the 40- to 50-cent price range. GE also displayed the rest of its plastic semiconductor line, which includes a broad range of signal transistors, diodes, SCRs and specialty devices. GE spokesmen enthusiastically discussed the company's entrance into the plastic IC field. The recently announced GE clock-radio uses a single plastic IC chip encapsulated in an "economy" 14-lead, dual-in-line package. Although the devices are now made only for in-house use, GE expects to market a number of plastic encapsulated linear ICs early in 1967.

Another plastic unit that made a big splash at the show was Bendix Semiconductor's 25-watt B-5000 power transistor. The company's confidence in plastic units in general and the B-5000 in particular was apparent from the fact that Bendix devoted much of its booth space to the B-5000. In high-vol-

ume quantities the B-5000 costs less than 40 cents.

A relative newcomer to the plastic semiconductor market, General Instrument, also displayed its plastic line, with units priced as low as 15 cents in large quantities. The series covers the frequency range from dc to uhf and includes six EIA-registered power amplifier/switching devices.

The General Instrument devices include the 2N4140 and 2N4141 (nnp), which are electrical equivalents of the standard 2N2221 and 2N2222; the 2N4142 and 2N4143 (pnp), which are equivalent to the 2N2906 and 2N2907; and the 2N4227 and 2N4228, which are pnp and npn complementary devices with tighter gain specs (75 to 150 at 150 mA) than the first four units.

Other semiconductor manufacturers who participated in the plastic parade were Sprague Electric, Motorola Semiconductor and Signetics. Sprague exhibited its "Econoline," which consists of 48 epoxied, silicon, small-signal devices produced under license from GE. Sprague, incidentally, is now tooling up for an anticipated epoxied dual in-line flat-pack for September marketing.

Motorola displayed its "Unibloc" transistors, "Cermetic" diodes and a dual in-line, 14-pin flat pack. Approximately 120 transfer-molded, house-numbered devices were shown in all.

The Signetics exhibit included nine dual, in-line product families, five of which were shown for the first time. At the present time the entire Signetics' line, except for linear circuits, has been put into plastic. The company expects to have its total line in plastic by early 1967.

More true-rms meters shown

Another continuing trend evident at Wescon this year was the true-rms-reading voltmeter. Two more companies added instruments with such capabilities to their line to join John Fluke Man-

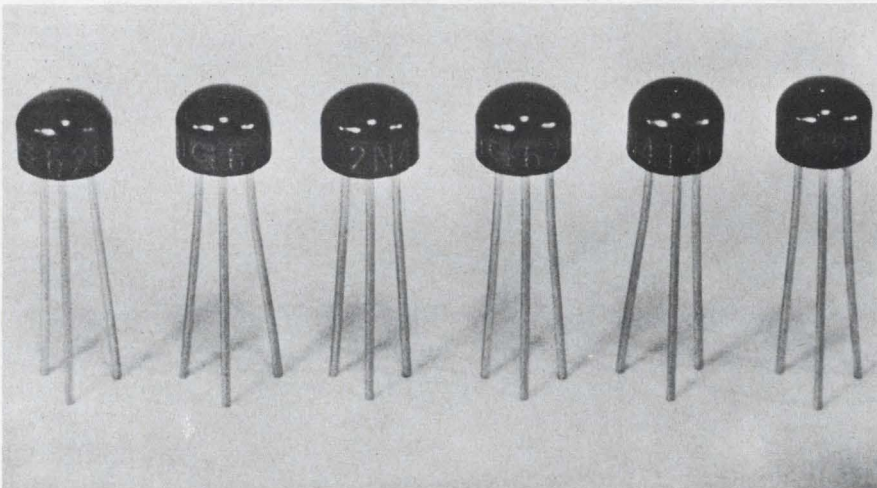

Epoxy silicon transistor line was displayed by General Instrument. All units are packaged with the three leads in a 100-mil circular configuration.

Transistor Parameter Measurements with the hp 8405A Vector Voltmeter

Measurement of transistor h, y or z parameters becomes increasingly difficult above 100 MHz through an inability to obtain consistently good open- and short-circuits. Tedious adjustment of tuning stubs is usually required for each measurement frequency, and unwanted circuit oscillations often occur.

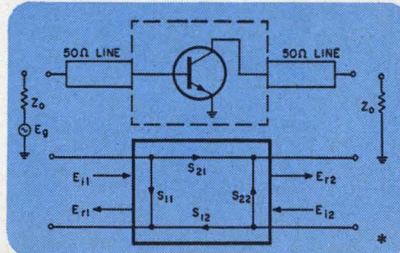

With the 8405A Vector Voltmeter, however, it is easy to measure a slightly different set of parameters—the “s” or scattering parameters. Measurement is simple over a wide frequency range and since the parameters are measured with a Z_o load, there is little chance for oscillation. The measured s parameters can be plotted directly on a Smith Chart and easily manipulated to establish optimum gain with matching networks. Or the s parameters can be translated into h, y, or z parameters if desired.

*NPN Transistor in common emitter configuration and its equivalent 2 port scattering diagram.

Free Application Data

Hewlett-Packard has prepared an application note on s parameter measurements. Write today for your copy of Application Note #77-1, “Transistor Parameter Measurement”, to 1501 Page Mill Road, Palo Alto, California 94304, Tel. (415) 326-7000; Europe: 54 Route des Acacias, Geneva.

The hp 8405A Vector Voltmeter is a new, wideband, 2-channel RF millivoltmeter-phasemeter. With the 8405A, measurements that were formerly difficult or impossible can now be made quickly, easily and accurately.

Major Specifications, HP 8405A Vector Voltmeter

Frequency Range is 1 to 1000 MHz in 21 overlapping octave bands; automatic tuning within each band.

Voltage Range for Channel A (synchronizing channel), 300 μ V to 1 v rms (5-500 MHz), 500 μ V to 1 v rms (500-1000 MHz), 1.5 mv to 1 v rms (1-5 MHz).

Voltage Range for Channel B (input to Channel A required), 100 μ V to 1 v rms, full scale. Full-scale meter ranges from 100 μ V to 1 v in 10 db steps. Both channels can be extended to 10 v rms with 10214A 10:1 Divider.

Phase Range of 360° indicated on zero-center meter with end-scale ranges of $\pm 180^\circ$, $\pm 60^\circ$, $\pm 18^\circ$, $\pm 6^\circ$. Phase meter OFFSET of $\pm 180^\circ$ in 10° steps permits use of $\pm 6^\circ$ range for 0.1° phase resolution at any phase angle.

Price: \$2500.

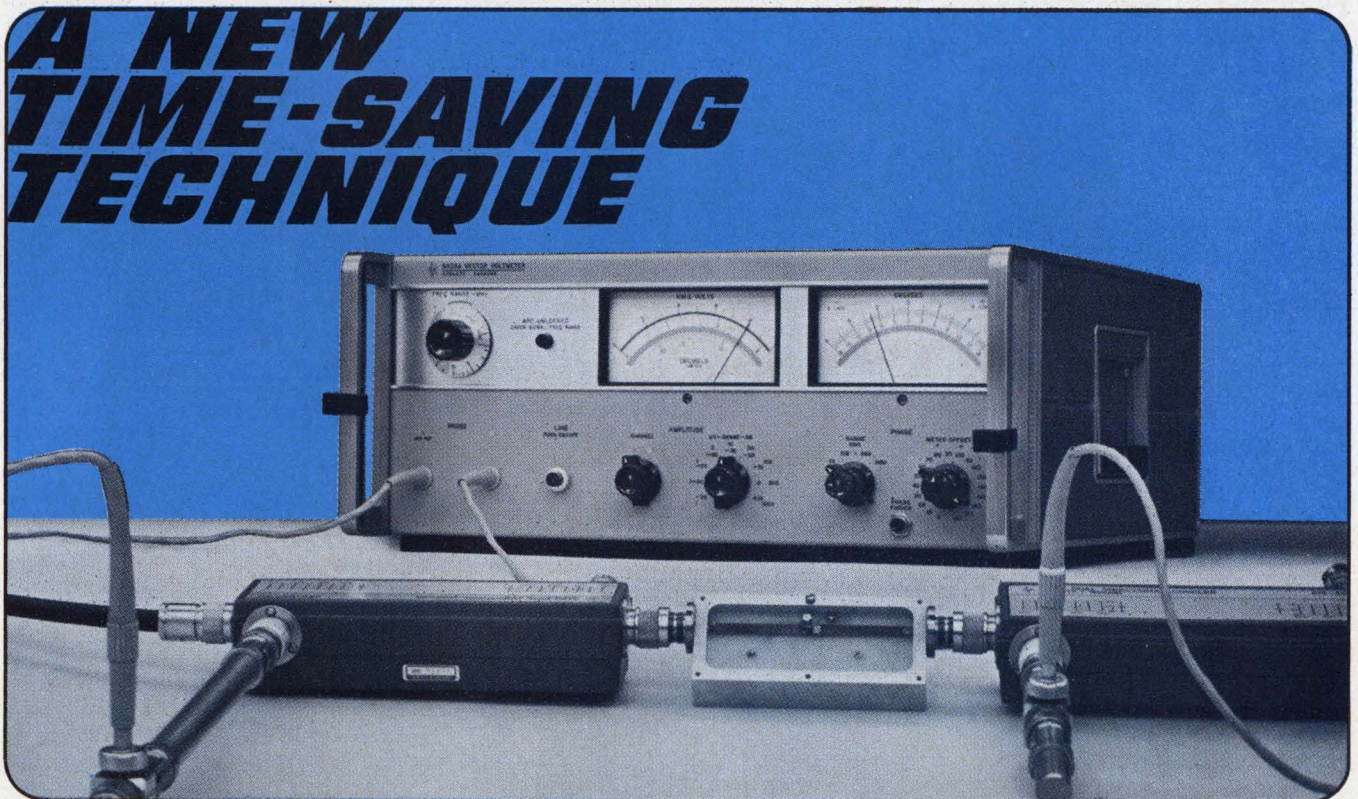

Data subject to change without notice. Price f.o.b. factory.

HEWLETT  **PACKARD**
An extra measure of quality

ON READER-SERVICE CARD CIRCLE 12

(Wescon, continued)

ufacturing Co., Hewlett-Packard and others.

One of the new true-rms meters was displayed by Ballantine Labs, Inc. It covers the voltage range from 300 μ V to 330 V, with null indicator range of 100 to 300 μ V. The frequency range of the meter is 10 Hz to 20 MHz, with an accuracy of 2 per cent of reading from 50 Hz to 10 MHz. The other meter was displayed by Millivac Instruments, Inc. This instrument covers the frequency range from 10 kHz to 1.2 GHz in four steps. Seven voltage ranges cover the span from 3 mV to 3V, or to 300 V with a 100/1 divider. Response of the meter is true rms up to 30 mV and peak above that, or true rms up to 3 V with the divider.

MOS ICs form computer blocks

The trend towards more complex functions on an IC chip were in evidence this year, with one particularly noteworthy example being the MOS device introduced by General Instrument. The new micro-circuit, designated MEM 5021, is a digital differential analyzer (DDA) constructed on an 86- by 72-mil chip.

When used in conjunction with a companion MOS dual-shift register, the chip forms a complete DDA integrator. The DDA is designed to be used in parallel operations and performs rectangular integration.

The MEM 5021 is packaged in a 24-lead flat pack measuring 1/4 by 3/8 inch. It contains 230 active

elements on the single chip. Both the MEM 5021 and its companion shift register have a power dissipation of less than 50 milliwatts.

Other integrated circuit manufacturers also continued the trend to greater complexity level in ICs. Following its initial announcement in March 1966, Sylvania Electric Products, Inc., added a 16-bit integrated scratch-pad memory to its line of monolithic digital functional arrays. At the same time, Signetics Corp. announced its official entries in this market: two counter/storage registers.

The Sylvania unit, SM-30, consists of a complete 4 x 4 matrix of R-S flip-flops on a monolithic silicon chip. Read and write times are specified as 25 ns and 35 ns and the power consumption is 250 milliwatts. Available in either a dual, in-line or flat package, this unit rounds out Sylvania's line of complex functions.

The Signetics units each consist of four J-K flip-flops and 13 gates on single silicon chips. The S1280A is a 4-bit decade counter and the S1281A is a 4-bit binary counter. These particular units are available in plastic dual in-line plug-in packages.

Portability gets a boost

A giant step in the trend toward more portable test equipment was taken by Tektronix, Inc., with the introduction of a compact, completely self-contained spectrum analyzer. The new unit, designated Type 491, is 7 x 12 x 22 inches and weighs less than 40 pounds. It operates over the range from 10 MHz

to 40 GHz, with a resolution of 1 kHz to 100 kHz. Dispersion range is 10 kHz to 100 MHz, while cw sensitivity is -110 to -70 dbm.

Small leakage detected

Measurement of picoampere leakage currents of transistors or FETs is possible with a programed system introduced by EG&G, Inc., Las Vegas. A programmer cycles automatically through the following sequence for a transistor:

I_{CBO} , I_{EBO} , I_{CEO} , I_{CES} , I_{CEX} and I_{CBX} . For an FET, the sequence is: I_{DSS} , I_{GSS} and I_D . A knob controls V_G so that pinch-off voltage can be read directly (when $I_D \cong 1$ pA). Gain can be read directly on the I_{DSS} position.

The programmer will be priced in the \$1500-2000 range.

Read-out can be on the Model ME920 picoammeter (\$2435) with an analog meter, or on a digital picoammeter, the Model ME930 (\$3575). Accuracy is $\pm 5\%$ on the 0-10 picoampere range. All three instruments are attache-case size.

VIDEODISC shown

Sports fans at Wescon examined with interest the device used by television networks to provide instant replays during football and baseball broadcasts. The device, called a VIDEODISC Recorder by its developers, MVR Corp. of Palo Alto, Calif., uses a 12-inch metallic disc for recording and reproducing TV signals. In operation, the disc rotation is synchronized with the TV signal so that one complete frame (two interlaced fields) is recorded for each revolution of the disc. ■ ■

Liquid laser uses inorganic fluid

The first liquid laser to use an inorganic fluid as the light-amplifying medium, and only the second known liquid laser of any kind, has been built at General Telephone and Electronics Laboratories, Inc., Bay-side, N. Y.

The new laser emits in the infrared region at a wavelength of 1.06 microns. In tests performed, the device has been pulsed at room temperature and produced an output energy comparable to that of solid-state lasers of similar size under identical operating conditions.

According to Dr. Alexander Lempicki and Dr. Adam Heller of GT & E, the laser solution's gain is so high that in certain modes laser action can be achieved without the usual end-mirrors. Normally such mirrors are essential for a laser to operate.

The developers say that making the liquid laser is an uncomplicated and noncritical 10-minute procedure. A bluish powder of neodymium oxide is simply dissolved in a solution of selenium oxychloride. The liquid is then transferred to a

glass tube, which can be any shape or size.

The laser operates on the principle that solvents like selenium oxychloride do not contain light atoms, like hydrogen. This absence of light atoms greatly increases the brightness of solutions, since the active ions, neodymium in this case, are more likely to emit photons of light than dissipate their energy in heating the solvent. The new principle may generate a whole family of liquid lasers using other rare-earth ions and heavy-atom solvents. ■ ■

No other RF transistor can offer this performance

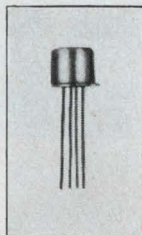

ACTUAL SIZE

- ✓ 5 dB max. NF at 450 MHz
- ✓ 11.5 dB min. gain at 450 MHz
- ✓ Hermetically sealed metal case for high temperature capability
- ✓ low-leakage silicon construction

at this price... \$1.60 2N4259 in quantities of 1,000 and up

RCA's new 2N4259 low-noise, low-capacitance RF transistor simplifies the design of UHF/VHF receiver circuits... offering more gain... less noise... at frequencies up to 500 MHz!

APPLICATIONS INCLUDE: Commercial, industrial and military communications equipment such as: mobile and aircraft radio, expendable military equipment, telemetry equipment, amateur equipment, wide-band amplifiers in industrial, military and nuclear applications.

The RCA 2N4259 silicon RF transistor is hermetically sealed in a 4-lead metal case for added high temperature capability. Shielding, achieved by grounding the case with the fourth lead, provides these extra advantages:

- reduced spurious signal pickup and device radiation
- reduced feedback capacitance
- higher usable gain

RCA skill and experience in silicon technology and mass production economy techniques make the 2N4259 RF transistor a unique combination of top performance and top value. For complete information, pricing and delivery, call your RCA Field Representative. For technical data, write RCA Electronic Components and Devices, Commercial Engineering, Section EG8-5, Harrison, N. J.

SEE YOUR RCA DISTRIBUTOR FOR HIS PRICE AND DELIVERY

ELECTRICAL SPECIFICATIONS

High Breakdown Voltage

$BV_{CEO} = 30V$ min.

High Beta

$h_{FE} = 60$ min.

High Gain Bandwidth Product

$f_T = 750$ MHz min.

Low Feedback Capacitance

$C_{cb} = 0.55$ pF max.

Low Collector-To-Base Time Constant

$r_b'C_c = 8$ ps max.

High Dissipation

$P_T = 175$ mw max. at 25°C Ambient

High Temperature Capability

T_J (Junction Temp.) = 175°C max.



The Most Trusted Name in Electronics

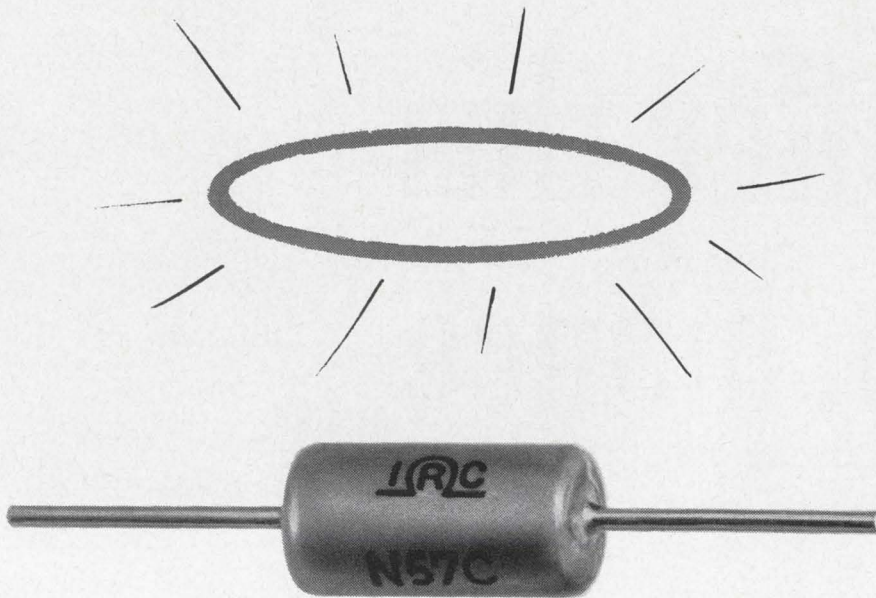

Reliability is a halo some companies wear better than others

IRC type XLT resistors have undergone over a 1/2-billion unit hours of testing to various stress levels without a single failure. Documented failure rate is less than 0.0003%/1000 hours, full load at 125°C. This far exceeds the toughest MIL-R-55182 requirements.

Since 1959, IRC has supplied over 2 million XLT resistors for critical circuit use in Minuteman, Saturn, Surveyor, Agena, Apollo, LEM, Mariner and many others. Not a single failure.

We have earned our halo. For no one can match IRC's record of reliability—or its experience in achieving it.

Most XLT resistance values are available

from stock. And, production lead time is fully geared to your needs. Write for data and prices. IRC, Inc., 401 N. Broad Street, Philadelphia, Pa. 19108.

CAPSULE SPECIFICATIONS

	
STYLE	RNR57C, E, G
ESTABLISHED F.R.	<0.0003%/1000 hrs. @ 60% conf.
WATTAGE	1/8 W @ 125°C
TOLERANCES	±0.5% and ±1.0%
RESISTANCE	10 Ω to 200K
TEMPERATURE COEFFICIENT	±25, 50 and 100ppm/°C
CONSTRUCTION	evaporated metal film, hermetically sealed



Speed Inquiry to Advertiser via Collect Night Letter
ON READER-SERVICE CARD CIRCLE 13

Master computer for urban aid

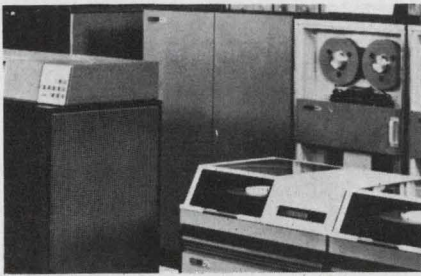

Washington Report

S. DAVID PURSGLOVE,
WASHINGTON EDITOR

Big computer for government

The consensus among government observers is that Washington should soon get its giant master computer, for all its Orwellian overtones. The latest proposal is given a good chance of being approved because it does not appear to invade individual privacy, it aims specifically to help cities and save them some money, and it bears the magic name of Kennedy.

Sen. Edward M. Kennedy (D-Mass.) has enlisted the support of a distinguished group of powerful senators for his plea for a study of the feasibility of the vast computer. The computer would keep track of each city's problems, keep track of federal aid programs for the cities, and match the programs to the cities' needs. The idea appeals to Congress because it may well pinpoint overlapping aid programs so that they can be trimmed to size. The Administration likes the idea because planning and building such a computer and its satellites would be clear evidence of intent to help the cities without embroiling the Federal Government in local politics. Mayors and city managers favor the idea because it would guide them toward funds without controlling them.

Kennedy wants the feasibility study to be supervised by the Senate Subcommittee on Intergovernmental Relations. This group has already carried out a preliminary study with Xerox Corp.'s Basic Systems, Inc., and University Microfilms, Inc. Kennedy envisions "a computer-based information system, using satellite centers, which would provide each state and local government with detailed information on which programs were available to it and which would be most appropriate to it. With a profile of each community, a satellite computer could be programed to inform the community of what new programs are available, what programs have filled their quotas, what programs have changed, and what programs have been discontinued."

The Senator points out that "such a

program has been used with great success by the National Aeronautics and Space Administration in their Technology Utilization program to provide private industry with detailed information on technological advances that may be of benefit to particular industries." He adds that the advantages of such computer systems have already been proven by the Census Bureau, the Internal Revenue Service, the Post Office and, of course, the Department of Defense.

Kennedy says that several months' consultations with representatives of such firms as IBM and Diebold Associates have made him optimistic that such a system could be built. The first study he wants undertaken would be to determine what kind of system is needed and what form its construction should take. IBM has already completed one study for Kennedy and has come up at least with the questions that need to be asked, he says. Kennedy favors incremental development and construction so that new developments can be incorporated as the system evolves.

Industry slow to adopt space technology

Several recent reports conclude that U.S. industry is not exploiting fully the technology that is being generated by the nation's space program and military R&D projects.

Denver Research Institute, in a study made for NASA, reports that the reason for this slowness is not so much a lack of information from the Government as obstacles that the private firms themselves erect. Among these it lists their reluctance to change, lack of knowledge, shortage of capital, organizational rigidity, and unwillingness to take what they deem to be risks. The institute also mentions Government regulations and security restrictions.

But Dr. Charles Kimbal, president of the Midwest Research Institute, puts it more bluntly: "The real barriers are neither financial nor technical. The barriers are outdated

Washington Report

CONTINUED

institutional practice, lack of entrepreneurship, and reluctance to accept new ideas and new practices."

The comments are quoted in a report made to the National Commission on Technology, Automation and Economic Progress by Richard L. Leshner, NASA Deputy Assistant Administrator for Technology Utilization, and George J. Howick, of the Midwest Research Institute.

Hospital EDP systems get check-up

A Public Health Service study of hospital automated communications systems is expected to show the way to an improved "second generation" of such systems for wider hospital use. The PHS is conducting the study with Tulane University, New Orleans. It is being financed with \$234,000 in Hill-Burton funds.

Specifically, PHS and Tulane will study the input-output devices with an eye on possible modifications or new arrangements. At the PHS New Orleans hospital the study will survey the whole gamut of communications systems and EDP systems that maintain records from a patient's weight at the time of his admission to his most recent temperature check. Special emphasis will be placed on graphic outputs and on keyboard input devices that would open the systems to use by every physician in a hospital.

Air Force resumes emergency radio net tests

The Air Force has resumed testing what it hopes will become an emergency Defense Department communications network. It will use the carrier signal of commercial broadcast stations without interfering with regular programs. The Pentagon, Civil Defense officials and broadcasters are exuberant about the results of their analysis of the system's first real test, which was precipitated by the massive Northeast power blackout last year.

During the blackout, carrier frequencies were shifted at a teletype rate without distorting the AM broadcast signal. The stations were able to provide news to the population of the blacked-out area, while the Defense Department was able to maintain its communications

without interruption. (Pentagon officials point out that there would have been no interruption in any event; several alternative systems were available, but the blackout provided a good test under realistic conditions.)

Cooperating stations may in the future be able to receive a small federal subsidy for part of their operations. The stations all lie in an area bounded by Rochester, N. Y., Boston, Washington, and Wheeling, W. Va. A Defense Department-Federal Communications Commission program that existed before the system was conceived has already provided 12 stations with stand-by power generators and fall-out shelters. The agency responsible for testing the system is the Air Force Research and Technology Division's Rome Air Development Center, Griffiss AFB, N. Y.

New "tactical move" in Pentagon R&D

A major Pentagon R&D appointment is expected to give new impetus to the switch from big strategic systems to smaller tactical hardware—a policy that has been picking up speed steadily for five years. This is how Washington is interpreting the promotion of tactical expert Marvin L. McNickle to lieutenant general and his appointment as Deputy Director of Defense Research and Engineering in charge of administration, evaluation and management.

What has elicited comment is that McNickle will also have supervisory control over the operational test and evaluation of new weapons systems. This is a function added when John S. Foster, Jr., recently took over as Director of Defense Research and Engineering. The fact that Foster selected a tactical man to fill the slot is considered a clear indication of his view of the Pentagon's new R&D role.

System Development Corp. has made a study predicting what kind of computers will be on the market in 1971. Based on present data processing systems, the SDP team's study spotted a number of problems ahead. The study implies that software people devote too much effort to optimizing or maximizing the sophistication of the software alone. Instead, they will have to take an over-all view of the entire system and make optimum use of hardware plus software. The report, AD-632 477, is available from the Commerce Department's Clearinghouse, Springfield, Va. 22151.

CLIFTON

steps in to the Stepper Motor field



CLIFTON STEPPER MOTORS

SIZE	8	10	11	11	8	8	8	11	8	15
LENGTH (M.F.)	0.770	0.770	1.215	1.215	1.062	1.112	0.770	1.215	1.062	1.535
WEIGHT (OZ.)	1.0	1.6	3.2	3.2	1.5	1.5	1.0	3.2	1.5	6.4
INERTIA (GM-CM ²)	0.19	0.19	0.77	0.37	0.18	0.45	0.19	0.77	0.10	2.4
INDEX ANGLE	90° ±3°	90° ±3°	90° ±3°	15° ±1°	90° ±3°	90° ±3°	45° ±2°	45° ±2°	15° ±1°	90° ±3°
TYPE	PM 2Ø	PM 2Ø	PM 2Ø	VR 3Ø	PM 2Ø	PM 2Ø	PM 2Ø	PM 2Ø	VR 3Ø	PM 2Ø
RATED D.C. VOLT.	28V	28V	28V	28V	28V	28V	28V	28V	28V	28V
RESISTANCE (OHMS/PHASE)	300	300	300	150	300	300	135	130	150	150
NO LOAD RESPONSE RATE PULSE/SEC	320	350	185	600	360	280	500	440	950	150
NO LOAD SLEW RATE PULSE/SEC	930	700	190	1600	375	650	2700	1200	1800	150
HOLDING TORQUE OZ-IN ONE PHASE	0.35	0.50	1.4	0.60	0.80	0.58	0.60	1.5	0.54	3.2
DETENT, OZ-IN ZERO INPUT	0.05	0.05	0.24	—	0.17	0.10	0.05	0.12	—	0.8
TYPE NUMBER	MSA-8-1	MSA-10-A-1	MSA-11-A-1	RSA-11-A-1	MSM-8-A-1	MSL-8-A-1	MSA-8-A-3	MSA-11-A-2	RSA-8-A-1	MSA-15-A-1

EXCITATION MODE: TWO PHASES PARALLELED ALTERNATELY. TYPICAL CHARACTERISTICS

After careful testing and having already had units in end-use equipment in the field, we are now ready to announce a full line of size 8, 10 & 11 stepper motors and the controllers that go with them.

Steppers are gaining popularity rapidly in digital systems because of their quick response, high resolution, and many other distinct advantages over the con-

ventional servo motor.

We'd like to step in to your stepper motor picture with Clifton Precision quality, reliability and application knowledge.

Clifton Precision Products, Division of Litton Industries, Clifton Heights, Pa., Colorado Springs, Colo. Area 215 622-1000; TWX 215 623-6068.

cppe

CLIFTON PRECISION PRODUCTS
DIVISION OF LITTON INDUSTRIES



WHO PINNED A MEDAL ON THIS

TRW-608

TINY TRW CAPACITOR?



... nearly everybody!

For your next design where there's too little room for components and *no room for compromise*... turn to "tiny but tough" TRW Type 608 Mylar* capacitors.

Excellent electrical characteristics and exceptionally small size make the Type 608 ultra-miniature a good capacitor for exacting military and instrument applications. Add the remarkable record of space-proven reliability and TRW Type 608 becomes a great capacitor!

Look at these outstanding features!

- 50% smaller than MIL-C-27287
- 4½ lb lead pull capability
- Mylar-foil, tape-wrapped construction
- Exceeds characteristics of many larger units
- MIL-C-27287 performance
- 50V and 100V, .001 to 2.0 mfd
- Temp. range -55 to +85°C; to 125°C with derating
- Tolerance to ±1% available

Contact TRW Capacitor Division, Box 1000, Ogallala, Nebraska, or phone (308) 284-3611. TWX: 910-260-0321

*DuPont's trademark for polyester film.

TRW CAPACITORS

ON READER-SERVICE CARD CIRCLE 15

Co-Publishers

James S. Mulholland, Jr.
Robert E. Ahrensdoerf

Editorial Director

Edward E. Grazda

Editor

Howard Bierman

Managing Editor

Robert C. Haavind

Technical Editors

Joseph J. Casazza
Rene Colen
Maria Dekany
Mark B. Leeds

News Editors

Frank Egan
Roger K. Field

East Coast Editor

Neil Sclater

West Coast Editors

Ralph Dobriner
Peer Fossen

Copy Editor

Peter Beales

New Products Editors

David Surgan
Genevieve Adee

Washington Editor

S. David Pursglove

Editorial Production

Dollie S. Viebig
Mary Lou Goldstein

Art Director

Clifford M. Gardiner

Art Assistant

William Kelly

Technical Illustrators

Lewis D. Hill
Cheh Nam Low
Douglas Luna
Robert Ranta

Production Manager

Thomas V. Sedita

Asst. Production Manager

Helen De Polo

Production Assistants

Carl Merkin
Bernard Wolinsky

Circulation Manager

Nancy L. Merritt

Reader Service

Diane Pellechi

EDITORIAL



Man looks to science for his future happiness

"Science and engineering, more than any other forces, are responsible for removing the isolation between men and nations." So said C. Lester Hogan, vice-president and general manager of Motorola Semiconductor Products, Phoenix, Ariz., in a recent keynote address at a St. Louis microelectronics symposium.

The evidence in support of his contention is clearer almost day by day. Whenever an astronaut is launched into space, his achievements are a matter of concern right around the world. When athletes compete for Olympic medals, they draw the almost simultaneous attention and enthusiasm of many millions of fans in scores of different countries. A royal coronation, a papal election, a world leader's funeral, an international soccer match, a presidential inauguration—all these things are watched or listened to or read about within a few hours at most of their occurrence.

Orbiting satellites, television broadcasting, worldwide teleprinter networks and other communications media have made the rapid spread of information possible and have in turn been made possible largely by electronics. It is a simple matter to pick up a telephone and talk to someone half a world away. A cancer victim can hope for relief from his suffering through skillful application of a radioactive isotope. Man can fly higher than any bird, sail farther than any fish, ride faster than any horse. Man's debt to science is inestimable.

The growth of communications has made it easier for the average man to take the measure of his leaders. Increasingly complex controls are needed by a minority if it wishes to fool most men most of the time. Communications have also become a powerful force for education. A film of a distant land, showing its people, customs, beliefs, way of living, quickly shatters myths of "pagan hordes" or "slave empires" in so-called backward societies.

Conflicts between men and nations persist, but science and engineering that refine the destructiveness of weaponry also are reducing little by little the perils of wholesale global war. Even the most ambitious dictator's hand is restrained by his awareness of the cost of a victory that would be Pyrrhic at best.

Science and technology have reached heights of respect and appreciation that they have never attained in the past. Governments, private enterprise, public and parochial institutions court scientists and engineers for service or counsel as never before. The veil of superstition and fear in which they used to be wrapped has been lifted once and for all. Regard for them is slowly surpassing that traditionally reserved for such professions as the law.

The achievements and successes of science are manifest and incalculable. But this is not the time for self-congratulation and complacency. We must continue to strive to make worthwhile progress in the hope that eventually the lives of all men may be truly happy, fruitful, prosperous and peaceful.

MARK B. LEEDS

Send us a cable.



Send us a small sample, at least one foot, of the coaxial cable you're using and tell us what you're using it for. Then we'll install the Burndy crimp removable coax contact that'll do the job best. Guaranteed.

A tough job? Not really.

Remember, crimp removable contacts began at Burndy. As a result Burndy offers the most complete line of coaxial connectors for standard, miniature and sub-miniature coaxial cables. And

they're available for all rectangular, rack and panel and terminal block configurations.

Send your sample along to Mr. M. Elkind, Product Manager, Burndy, Norwalk, Conn. He'll see that the job is done and returned quickly. You'll receive our latest coax connector catalog, too.



INTERNATIONAL SALES HEADQUARTERS AND MANUFACTURING FACILITIES:

CANADA: Scarborough, Ontario / ENGLAND: St. Helens, Lancs. / BELGIUM: Mechelen / MEXICO: Naucalpan de Juarez / BRAZIL: Sao Paulo / JAPAN: Tokyo / Sales Offices in Other Major Cities

ON READER-SERVICE CARD CIRCLE 16

ON READER-SERVICE CARD CIRCLE 236 >

Yes—Allen-Bradley hot molded potentiometers cost more, but—



**for critical applications
they prove themselves far superior—and well worth the price**

■ When a potentiometer in your equipment does not provide the kind of service expected of it—or fails completely—it is only natural for the user to blame you, the manufacturer of the respective instrument. After all, you selected the lower cost component, and your engineer or your purchasing agent decided that “it was good enough.” Correcting the mistake usually runs into real money—it does not necessarily eliminate your customer’s dissatisfaction. However, you can protect yourself and your customers against such potentiometer failures by joining the ever growing list of the nationally recognized equipment manufacturers who are standardizing on Allen-Bradley potentiometers.

The resistance track of all Allen-Bradley potentiometers is hot molded—a process developed and used only by Allen-Bradley. Resistance adjustment is always smooth—never an abrupt change. Though the initial noise level is very low, it is still further improved with use. The long life of all A-B potentiometers is a fact, established by

performance during the many years that these controls have been on the market. For instance, on “speeded up” tests this “life” will exceed 100,000 complete operations, with less than 10% resistance change. And during the 30-year history of this control there has never been recorded a single catastrophic failure.

Protect your reputation as a quality equipment manufacturer by having your purchasing specification call for Allen-Bradley hot molded potentiometers. They are available in single, dual, and triple units. Can be equipped with a 2 ampere 125 volt line switch. Dual units can be supplied with vernier control that provides 20 times finer setability than obtainable with a single control. Units for T, L, and Bridged T and H attenuators are also available. Yes—Allen-Bradley controls *cost slightly more*, but they are *worth much more*. For more details please write: Allen-Bradley Co., 222 W. Greenfield Ave., Milwaukee, Wisconsin 53204. In Canada: Allen-Bradley Canada Ltd. Export Office: 630 Third Ave., N.Y., N.Y., U.S.A. 10017.



ALLEN-BRADLEY
QUALITY ELECTRONIC COMPONENTS

ALLEN-BRADLEY Type J
Hot Molded Variable Resistor
rated 2.25 watts @ 70°C
shown 2 times
actual size.

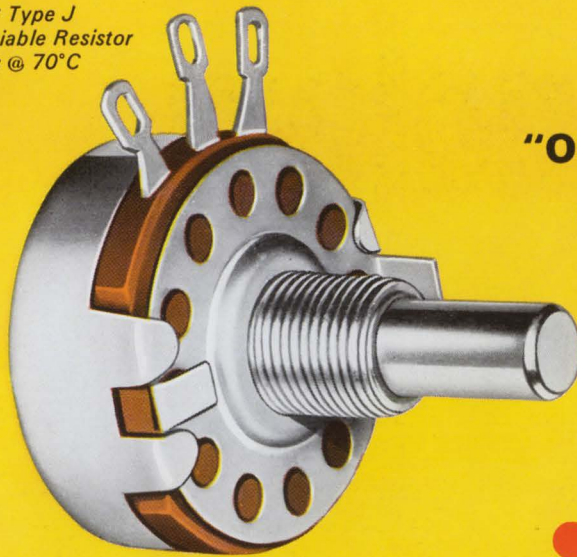

"Only Allen-Bradley Type J pots
give us the smooth control
to maintain the high calibration
accuracy of our instruments"

Krohn-Hite Corporation

● This quickly locates the positions of the Type J potentiometers in the illustration below.

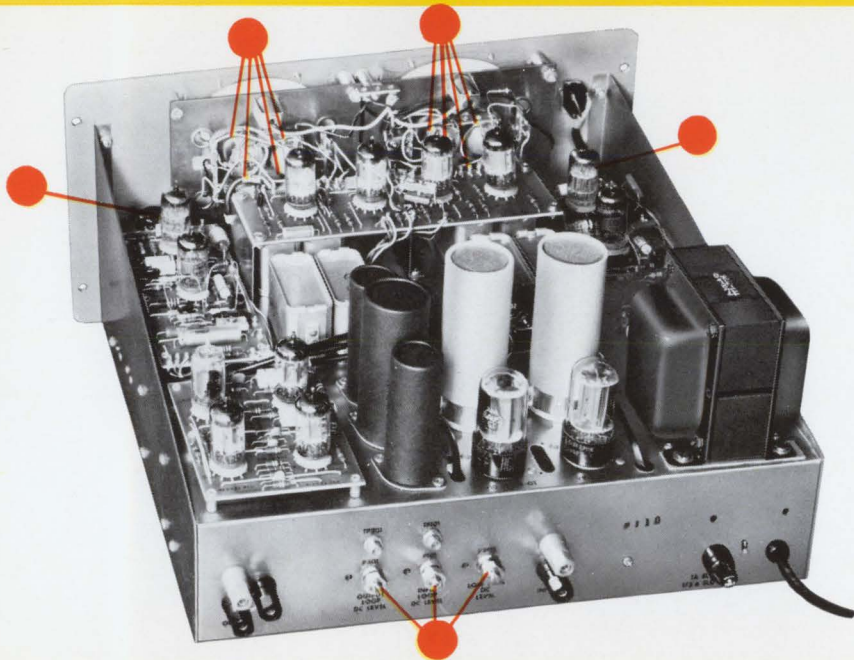

THIS KROHN-HITE VARIABLE FILTER provides low-pass, high-pass, band-pass, and band-reject operation with high and low cutoff frequencies independently adjustable from 0.02 cps to 20 kc.

IN THE MODEL 335, continuous tuning of the high and low cutoff frequencies is accomplished by simultaneously varying four potentiometers with a single knob. Only A-B Type J controls have been found to provide the smooth control and precise tracking without discontinuities to achieve the required calibration accuracy.

■ Krohn-Hite engineers have found that only Allen-Bradley Type J potentiometers provide the smooth control, low noise, long term stability, and low temperature coefficient they require for their precision instruments such as the variable electronic filter.

The Type J control has the resistor, terminals, faceplate mounting bushing, and insulating material hot molded into a solid integral unit. The solid resistance track assures smooth, quiet control that is free from the undesirable discrete steps of wire-wound units. On accelerated tests, Type J exceeds 100,000 complete operations with less than 10% resistance change.

Insure the performance of your equipment by insisting on Allen-Bradley Type J hot molded potentiometers. Besides, when you use Allen-Bradley fixed and variable hot molded composition resistors you provide your apparatus with the label of "quality." For more complete specifications, please write for Publication 6024: Allen-Bradley Co., 222 West Greenfield Ave., Milwaukee, Wis. 53204. In Canada: Allen-Bradley Canada Ltd. Export Office: 630 Third Ave., New York, N.Y., U.S.A. 10017.

ADDITIONAL ALLEN-BRADLEY HOT MOLDED VARIABLE RESISTORS

TYPE G CONTROLS are only 1/2" in diameter. Quiet, stepless operation. Rated 1/2 watt at 70°C. Values to 5 megohms. Type L are similar in construction but rated 1/2 watt at 100°C.



TYPE F CONTROLS are for mounting directly on printed wiring boards by means of their terminals. Rated 1/4 watt at 70°C. Values to 5 megohms. Type O are similar but rated 0.4 watt at 70°C.

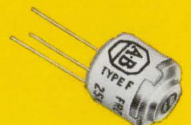

TYPE R ADJUSTABLE FIXED RESISTORS are built to withstand environmental extremes. Only 1 1/4" in length. Have stepless adjustment. Watertight and can be encapsulated. Rated 1/4 watt at 70°C. Values to 2.5 megohms. Type N for less severe environments are rated 1/2 watt at 50°C.

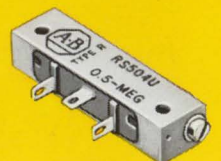

ALLEN-BRADLEY
QUALITY ELECTRONIC COMPONENTS

Technology

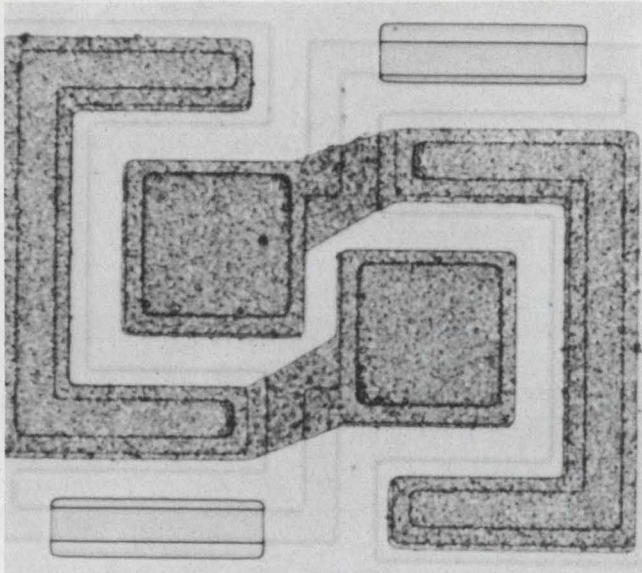

SUS and SBS devices are sure-fire triggers for all your Triac and SCR circuits. Page 38

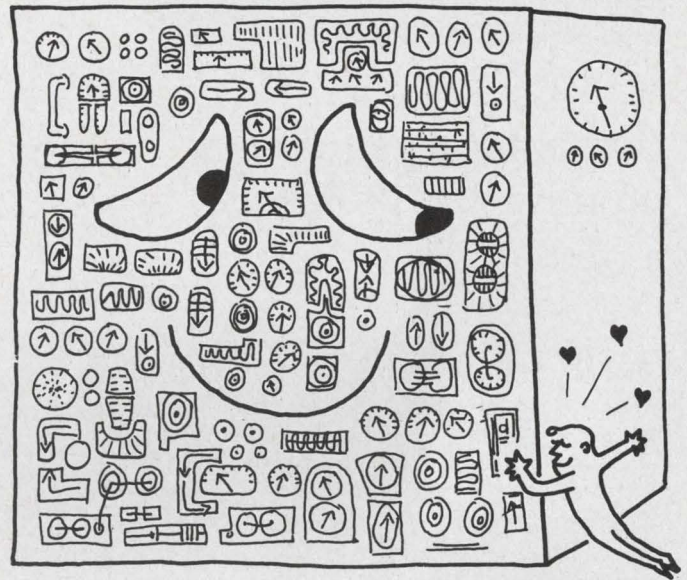

The computer may become the engineer's best friend once he starts using it. Page 34

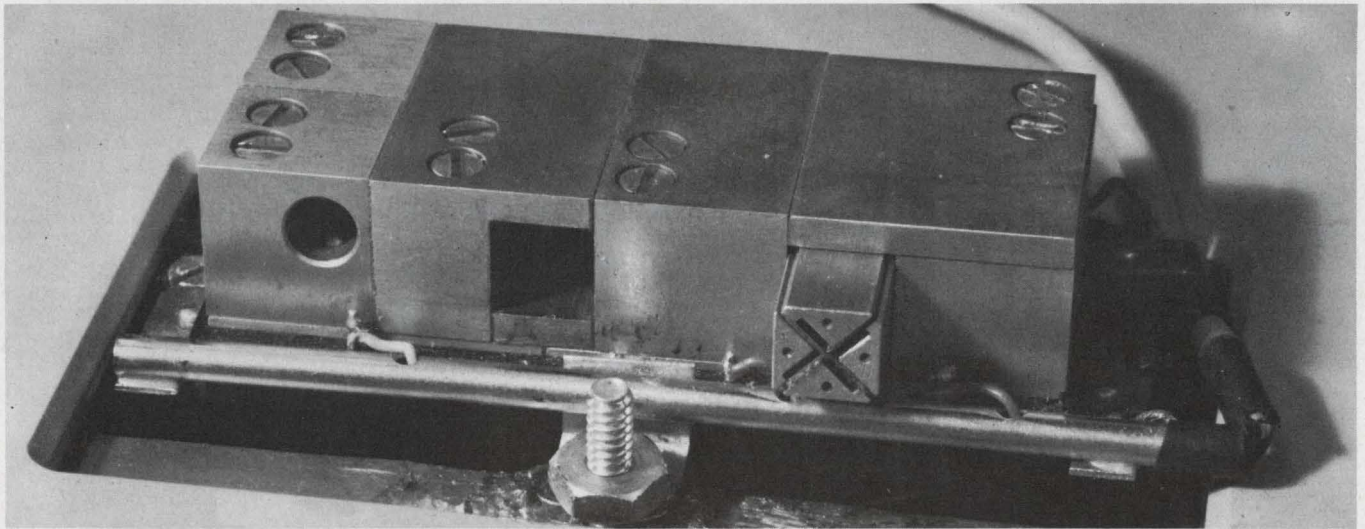

Equipment that measures y-parameters of transistors and can help to improve high-

frequency design includes the WK601 loader. Five basic units are compared. Page 54

Also in this section:

Avoid unstable audio amplifier performance by predicting thermal behavior. Page 46

A graphical approach helps the design of spliced transmission lines. Page 62

Ideas for Design. Pages 65 to 68.

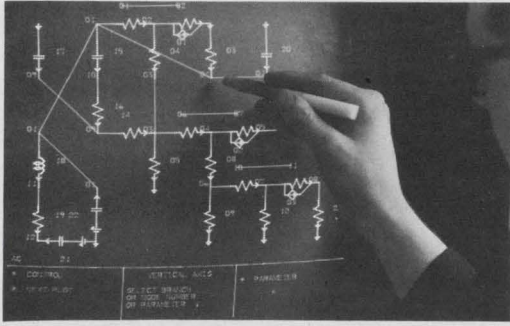

The light pen facilitates computer use.

Computer-aided design: promise and problems

Joseph J. Casazza
Technical Editor

Probably no single technological development since the transistor will have as universal an effect on the efforts of the design engineer as computer-aided circuit design.

Although the digital computer has been in wide use for well over a decade, the engineer has in fact been among the last to make real use of the tool he has created. Banks, insurance companies, and other nontechnical groups have integrated the digital computer into their day-to-day operations. But until now, engineering applications of digital computers have been limited pretty much to the solution of black-box interconnection problems, circuit analysis that would have been onerous by manual methods, and other essentially straightforward but time-consuming operations that are hardly conducive to maintaining engineering creativity at its peak.

Times have changed. Digital computers are being used to design as well as analyze electronic circuits. Such use is not yet widespread and for several very good reasons:

- Computers and computer time are expensive.
- Engineer-computer dialogue has not reached the "conversational" level.
- There are a number of design jobs that computers as yet are simply not capable of doing.

Each of these stumbling blocks is important enough to be looked at in detail. Such a look should also provide some insight into what we may expect to see in the future.

Time sharing may lower cost

Access to the computer is naturally limited because of the demands on its time made by other departments, and the engineer is often at

Design Directions

... AN EDITOR'S COMMENTARY

the bottom of the priority list. While a growing number of organizations now make computer services available to their engineers, in most cases the engineer is restricted to analysis-type information on a batch-processing basis (i.e., plug the information into the machine and wait hours for the data to be processed and printed out). Even after his problem has been run, the engineer is usually faced with a mountain of print-out to comb through.

There are, of course, the various "desk-top" computers that are available to engineers. While these machines fill a definite need, they are not intended to be substitutes for the more versatile, full-scale machines.

These obstacles to wider use of digital computers for design purposes should be surmounted with the advent of relatively low-cost, random-access, time-shared systems. With these new systems the problem of computer-access time will be all but eliminated since decisions on machine-time priorities will be made by the machine itself.

Furthermore, when "information utilities" become a reality (where a company will provide computing services from a centralized computer much as telephone companies now provide telephone service), smaller firms which could not economically justify purchase or rental of their own machine will be in a position to participate in a time-shared arrangement. Desk-top data sets will make large-scale-computer time a few button-pushes away.

From a cost standpoint, we must consider how computer-aided design will affect a company's profits. In the highly competitive electronics industry, managers can be expected to take a long, hard look at the dollar benefits that might accrue from the use of computer-aided design. Right now, design engineers are saving engineering man-hours by relegating many routine calculations to computers. This considerable saving in expensive engineering time is bound to be reflected favorably in a

company's profit and loss statement.

Also, design by computer curtails, and sometimes eliminates, the need for breadboard construction and testing. This, too, can provide significant savings.

Finally, consider the fact that by using computers, design engineers can subject circuits and systems to exhaustive analyses that simply were not possible by manual methods. The resulting improvements in the final design are a real asset to a company's position in the market.

Dialogue problems must be overcome

Even though we may justify design-by-computer on a cost basis, there's still the problem of inducing the designer to use the computer. In large measure, this problem is one of language. Engineers and computers don't always understand each other.

A large part of an engineer's training and experience consists of expressing himself with symbols, be they schematics, equations or graphs. Such symbolic communication makes for faster, more efficient dialogue between engineers and also enables the creative designer to express his ideas concisely with a minimum of lost "mental motion." Put the engineer face to face with a digital computer, however, and he must master a set of unfamiliar symbols for communication before the machine can be made to do his bidding.

Many practicing designers have never received any training in the use and programming of digital computers. It is only very recently that engineering schools have instituted compulsory courses in computer programming and problem solving.

There is a widespread feeling in the industry that until the creative design engineer can sit down and "converse" with computers in a language that is almost completely "plain

English" he just won't use them. This is one area where the analog and analog/digital (hybrid) computers have an advantage over digital machines.

Analog-based systems allow an engineer to express himself in terms that he has grown up with. They enable him to be his own programmer. The programs he writes are in language that contains no stylized "words" to stumble over. Trouble-shooting an analog program is thus less of a problem because the engineer can think and reason in terms of amplifiers, connections, multipliers, etc.

Analogs, furthermore, offer the designer a speed advantage. Change a circuit parameter, by simply twisting a pot, for instance, and out pops the new result, either in graphic or digital read-out form or both. This is a hard method to beat for many engineering problems.

But the digital computer, too, has advantages. Some problems can't be stated simply in the form of differential equations suitable for solution on an analog machine; for example, statistical analyses, logic design and wiring patterns. You can also "design in" the degree of accuracy that you desire from a digital solution; with an analog computer, you just have to accept whatever accuracy it offers.

A few examples will illustrate what's being done today with digital machines. At Bell Telephone Labs., Murray Hill, N. J., engineers can turn over a schematic diagram or sketch to nontechnical assistants who have the circuit analyzed by a computer. Norden Div., United Aircraft Co., Norwalk, Conn., is using digital computers to help determine the electrical variations resulting from changes in integrated circuit component layout. One British firm, Racal Research Ltd., Tewkesbury, England, gave a graphic demonstration of computer-aided design recently, according to "Electronics Weekly," a British journal. A visitor to Racal was asked to specify characteristics of a three-stage video transistor amplifier. The specifications were fed into a computer and out came a list of component values and frequency response characteristics. Within two hours, the amplifier had been computer-designed, built and tested in the laboratory.

At least three major computer manufacturers, (IBM, Honeywell, Scientific Data Systems) are using programs that will do the logic design of a digital computer. In these cases, the programs are reported to be able to transform the designer's logic expressions into optimum hardware configurations. Programs of this type

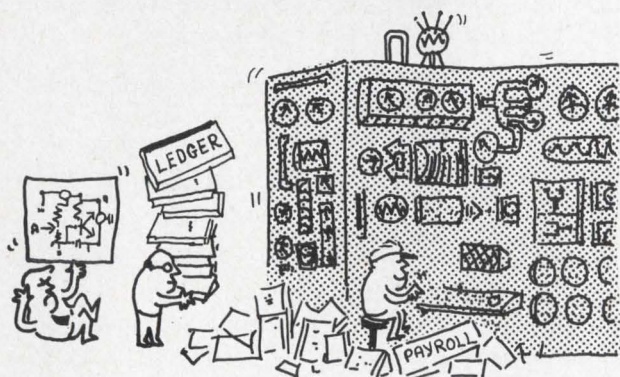

The engineer may have designed the computer but he is among the last to exploit its usefulness in his own work. Even then he usually has to wait in line.

Design Directions

CONTINUED

may become generally available in the not too distant future.

Computers can't do all

That "computers are really 'stupid' and can only do what they're told to do," has practically become a cliché. Self-evident though this fact may be, it is worth while to examine the limitations it imposes on the digital computer as an electronic design tool.

First, the design engineer must know exactly what he's trying to accomplish when setting up a problem for the computer. Procedures that were once intuitive, or circumvented by handy rules of thumb or short-cuts, must be spelled out in detail. Anyone familiar with solving simple equations using FORTRAN can understand the irksome detail that this can involve.

The data that an engineer receives from a computer run will require him to know exactly what to look for in order to interpret numerical results intelligently. Solving equations is no hardship for a computer, but interpretation of the solution is still a challenge to the designer.

What device model to use

A major problem facing design engineers who use computers is just how to describe a transistor to a computer. Development of the right transistor model is often hampered by a lack of manufacturer's data. This is especially true in the case where a designer may want to try a transistor in an application other than that for which it was designed—a switching transistor as an amplifier, for example. In these cases, the characteristics specified for the

original application are often unsuitable for the new purpose. This leads to a time-consuming process of parameter measurement that is not a productive part of the design process. Device manufacturers ought to pick up a greater portion of this load by specifying a wider range of data for their products.

Light pen may show the way

It is reasonable to expect an increasing effort by computer manufacturers to develop and market programs that can do a wider variety of design jobs. Concurrently a large effort is likely to be aimed at making the programs themselves easier to use.

Graphic input/output devices, such as the light pen and display tube, offer the most useful and direct means of putting circuit data into, and reading performance data out of, a computer. It is unlikely that these devices will be on every engineer's desk in the near future, but they will get increasing use as their development progresses and their cost is reduced. This type of graphic input can eventually take the place of much breadboarding and offers great possibilities for nondestructive testing.

Demand by design engineers for computer facilities is bound to increase as more and more engineering schools introduce the computer into their curricula. Computer-aided circuit design and analysis will be part of the graduate engineer's repertoire and he will expect his employer to provide him with the same facilities that he had access to in the academy.

Engineering societies will not be untouched by the swing to computer-aided design. Look for new specialist groups to form. Seeds for these have already been planted on both coasts.

In the Boston area, design engineers led by William Happ of NASA's Cambridge Research Center and Fred Decker of Honeywell's EDP group at Waltham, Mass., have held several meetings to exchange ideas and explore the whole area of computer-aided design.

On the West Coast, a group of designers, led by Clint Purdue of Sandia Corp. in Albuquerque, N. M., met during WESCON to explore the IEEE's role in this rapidly expanding field.

Also on the West Coast, the University of Santa Clara has scheduled a Computer-Aided Solid-State Design Institute, to be held on Sept. 15-16 of this year. According to Richard C. Dorf, chairman of the school's Electrical Engineering Dept., the Institute will provide an introduction to computer-aided solid-state circuit design. ■ ■

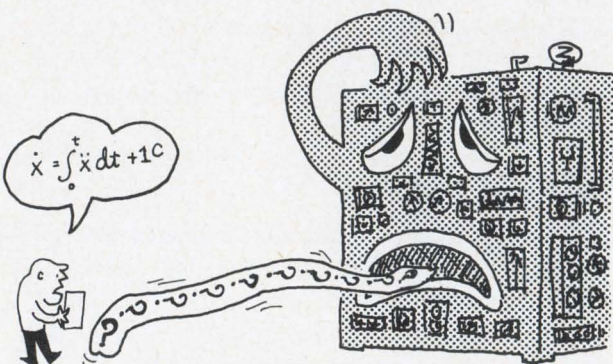

Computers must be taught to converse with engineers in language that the engineer already knows and understands. Graphic input devices may help.

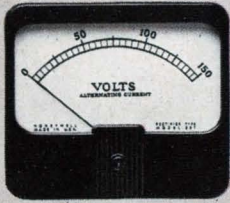

Make sure Honeywell's revolutionary new Auto-Torque mechanism is inside. It's the first substantial improvement in meter technology in ages — a new kind of band-type meter — first to be machine manufactured. Auto-Torque is more reliable (since there are 50% fewer parts, you can practically wave

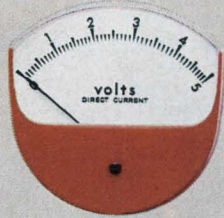

good-bye to service problems). Auto-Torque is more durable (since the moving system is suspended on metal bands under tension, there's no friction and wear). Auto-Torque is more accurate (since the mechanism is self-shielded, it can be mounted on any panel without special calibration — without worrying about "sticks", either).

Auto-Torque is more economical (quantity-order prices for volume buyers are below comparable pivot and

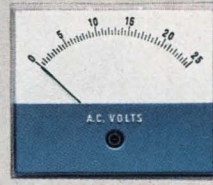

jewel meters). Auto-Torque is under the hood of the world's smartest-looking meters. And there are plenty of styles to choose from. In fact, Auto-Torque meters come to you in the widest selection of band-type meters available today . . .

For more information on Auto-Torque, write to Honeywell Precision Meter Division in Manchester, N. H. 03105.

Honeywell Auto-Torque Meters

**Before you
pick out a new meter,
better look under the hood.**

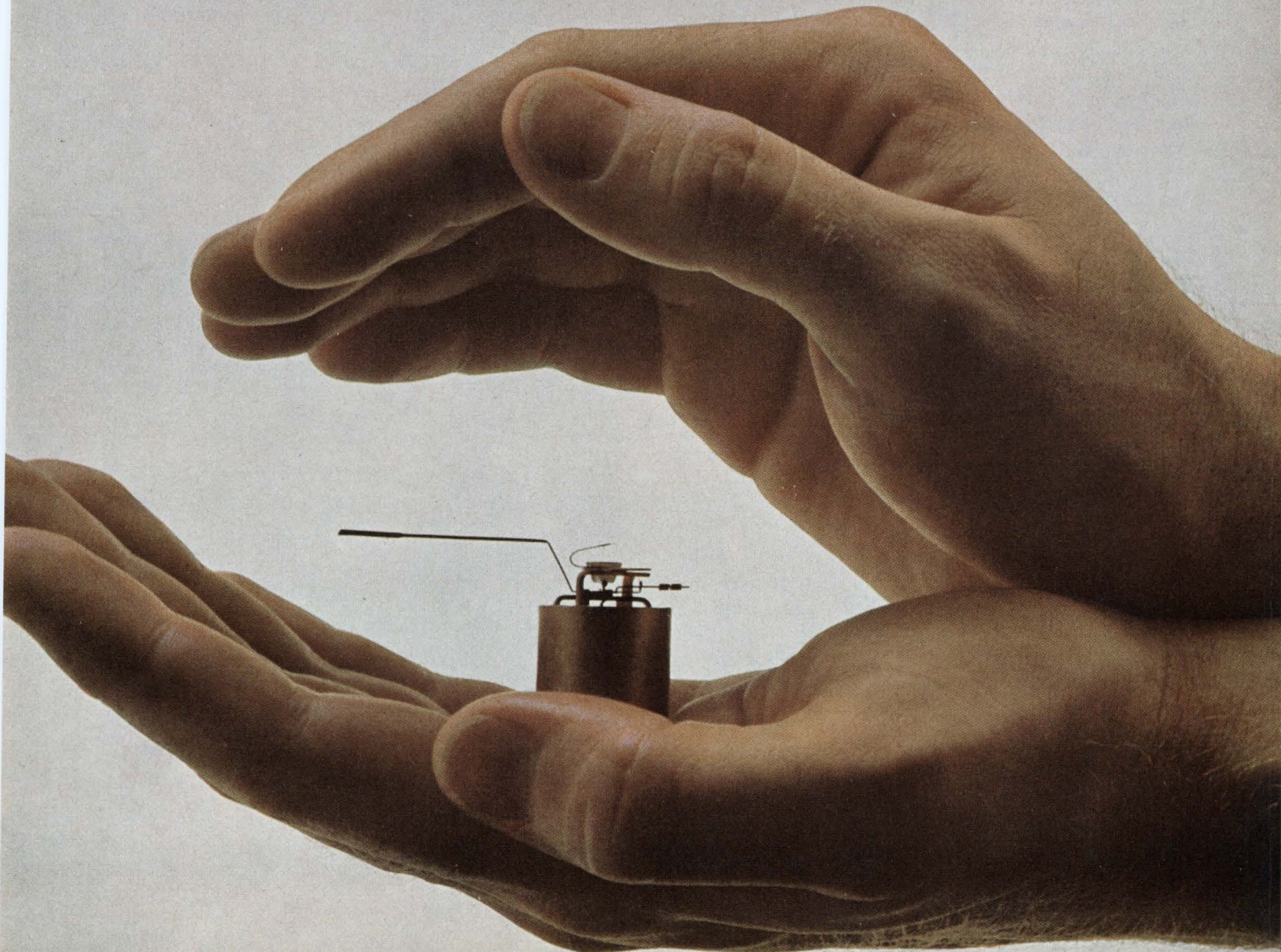

Thyristor triggering is sure-fire with the SUS and SBS. These planar, pnpn integrated switches provide reliable, stable turn-on signals.

Don't settle on a conventional triggering device for your thyristor power switching or control system without a close look at the SUS and SBS. These recently introduced (Jan. '66) four-layer silicon switches (U for unilateral and B for bilateral) require very little power and feature an extremely stable firing voltage characteristic.

Unlike other semiconductor triggers, which rely on leakage current and equivalent transistor-betas to set the switching voltage, the SUS and SBS feature a less varying firing mechanism. It's a zener diode, integrated as part of the SUS pellet, and its breakdown voltage establishes the switching potential.

The silicon bilateral switch (SBS) consists of two SUSs connected in a reverse-parallel configuration. It provides a symmetrical, bidirectional triggering function. Both devices exhibit a near ideal V-I characteristic and should be considered as a new generation of the popular and useful discrete version of the four-layer diode.

A look at the properties of these switches and some examples of their application will underline their advantages for the triggering of SCRs, Triacs and other thyristors.

Construction: 4 layers and then some

The SUS equivalent circuit (Fig. 1a) helps to explain the unique characteristics of the device.¹ Those familiar with four-layer devices will recognize the basic pnpn structure of a pnp and an npn transistor connected in a positive-feedback configuration.² Added to this structure are a resistor shunting the npn base-emitter junction and a zener diode connected from the base of the pnp transistor to the npn emitter terminal.

As shown, the pnp emitter is the anode terminal

and the npn emitter is the cathode terminal. The zener breakdown voltage is designed to be eight volts. The voltage from anode to cathode is raised toward a positive potential, and when it exceeds the zener breakdown level, the emitter-base junction of the pnp becomes forward biased. At this point, collector current begins to flow in the pnp and produces a voltage drop across R_B of sufficient magnitude to cause base current to flow in the npn. In turn, npn collector current flows and produces a further source of base drive for the pnp, thereby turning on the device.

The gate lead can also be used to trigger the device into conduction for anode voltages lower than the zener breakdown potential. Note that



No trace of hysteresis is shown by the CRO. Author Spofford makes waveform measurements on his SBS phase-control circuit. Gate lead on device permits operation without snap-on effect associated with other semiconductor triggers.

W. R. Spofford, Semiconductor Applications Engineer, General Electric Co., Semiconductor Products Dept., Syracuse, N. Y.

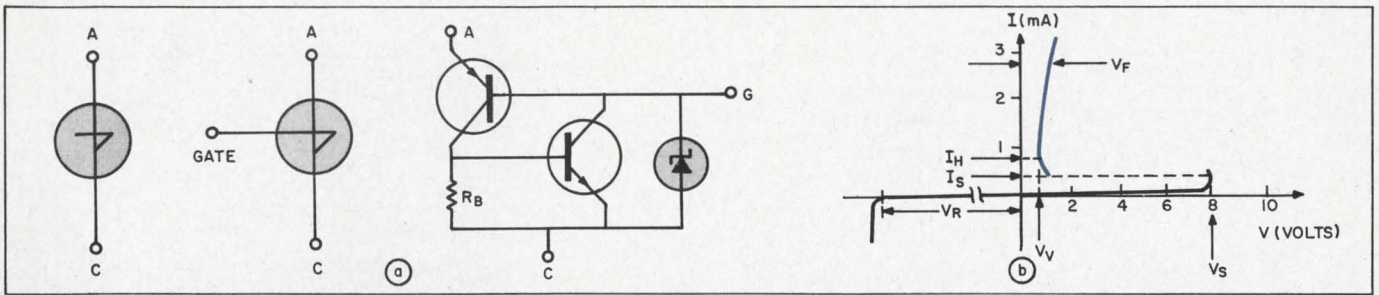

1. Silicon unilateral switch (SUS) symbols (a) show optional gate lead for nonbreakdown triggering. Equivalent circuit contains a pnp-npn transistor pair arranged in a positive-feedback configuration and a zener diode. Potential of the diode determines switching action when

gate lead is not utilized. V-I characteristic (b) resembles that of the four-layer diode. Saturation resistance (slope of V-I curve in the ON portion) is very low and temperature coefficient (flatness and stability of V_s point) is less than 0.05% per degree C.

this gate lead is connected to the npn transistor collector and is therefore useful as an output terminal in a number of circuit applications other than thyristor triggering.

The V-I characteristics (Fig. 1b) reflect the SUS properties—they are similar to the four-layer diode characteristic curve. Typically, the reverse voltage is specified at 30 volts at a leakage current of $0.1 \mu\text{A}$.

The SBS (Fig. 2a) is easily recognized from its equivalent circuit (Fig. 2b) as two SUSs connected in antiparallel with the gate leads in common. This accounts for the symmetrical, bilateral characteristics of the SBS. As with the SUS, the gate lead can be used to trigger the SBS in either polarity. It should be noted at this point that the gate lead of the SBS always is closest in potential

to the most positive anode. In other words, if anode 1 is more positive than anode 2, then the gate lead is one pn junction away from anode 1; if anode 2 is positive with respect to anode 1, then the gate lead is one pn junction away from anode 2. Proper use of the gate lead is essential in the application of these trigger devices.

Low r_{sat} , T_c values key trigger use

The saturation resistance (slope of the V-I characteristic in the ON state) is extremely low in the SUS and SBS. Typically, this resistance is 2.0 ohms and the devices are specified in such a way that a unit with a saturation resistance as high as 5.0 ohms would be unusual. Figure 3a shows a circuit used to plot the curve family of peak-pulse amplitude vs R_L and C shown in Fig. 3b.

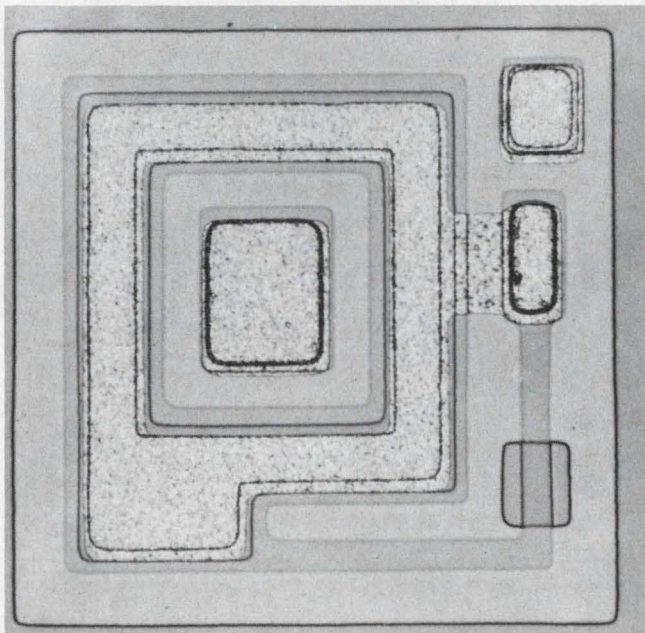

Gem of a trigger—SUS pellet geometry is used to explain functioning facets. Small contact in center is anode p-region; substrate is n material. Peripheral pn diffusions form the npn base-emitter junction; contact is made to the n region to form the cathode (see Fig. 1). The small p-channel running along the outside with a heavy n-diffusion overlay form the buried resistor R_B .

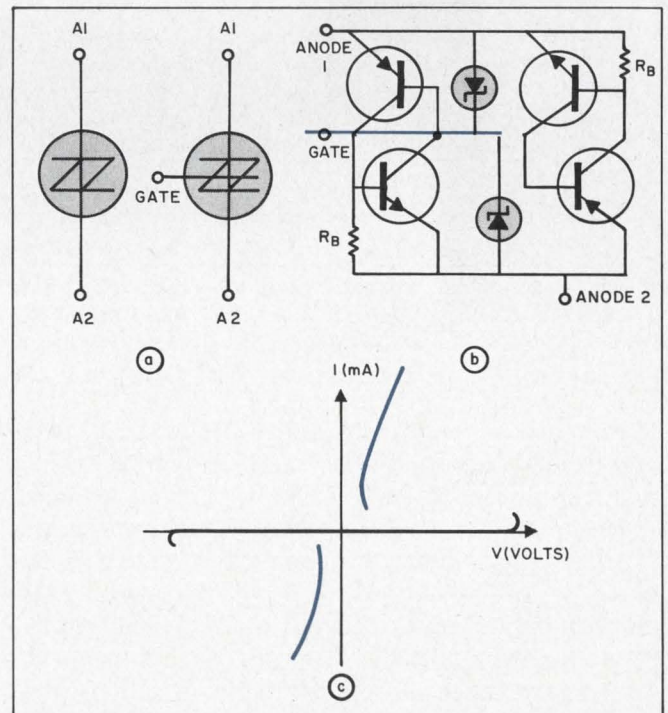

2. Silicon bilateral switch (SBS) is two SUSs connected in parallel opposition (a). Equivalent circuit (b) shows common gate lead. V-I characteristic (c) exhibits symmetry between forward and reverse directions.

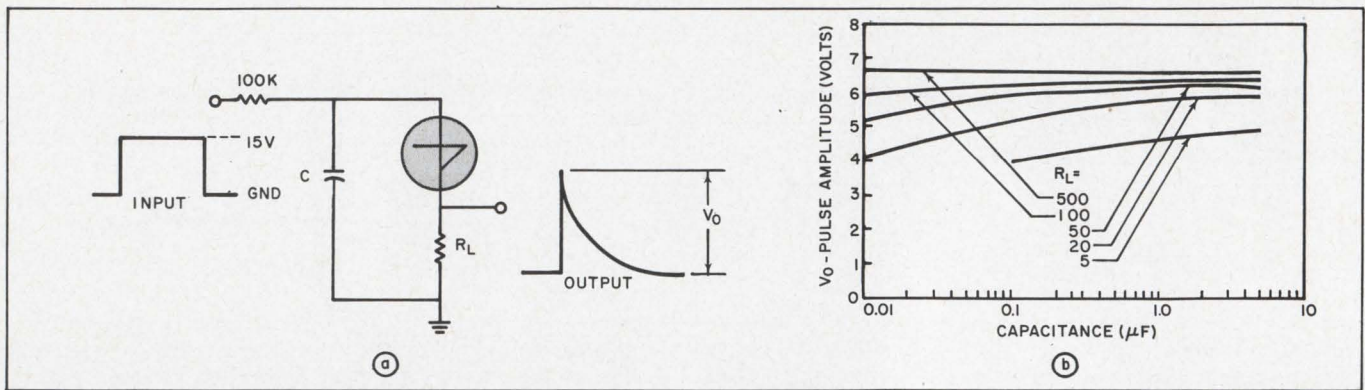

3. Test circuit used to obtain performance characteristics of SUS (a) is extremely simple. Key design components are R_L and C. Because of the device's low saturation-

resistance, the plot of peak output-pulse amplitude as a function of both the R_L and C values (b) is very broad and reasonably flat.

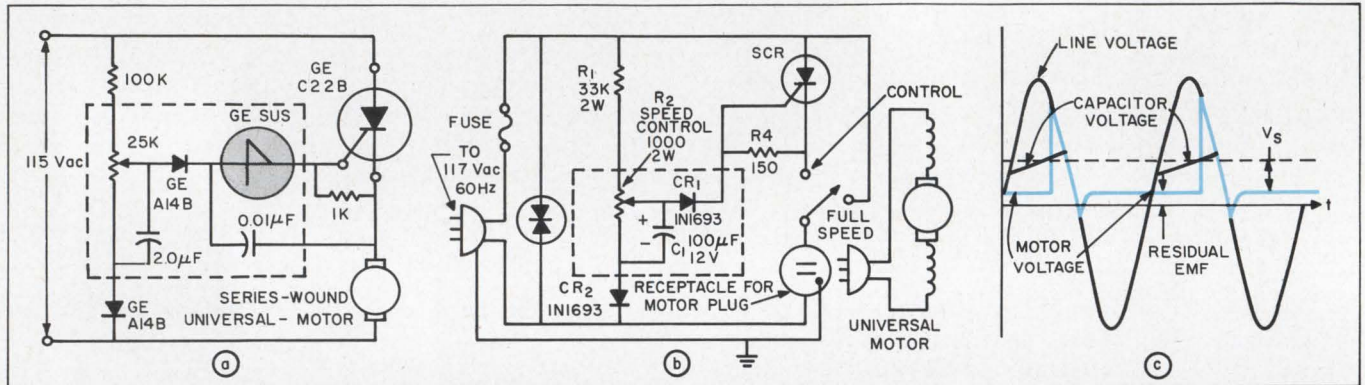

4. Universal-motor-speed control circuit (a) using SUS to trigger SCR requires less power and less bulky components than older version (b). Note the difference in

capacitor values. Key waveforms appear in (c). Observe stability of firing point as demonstrated by the smoothness of the waveshapes and their repetitiveness.

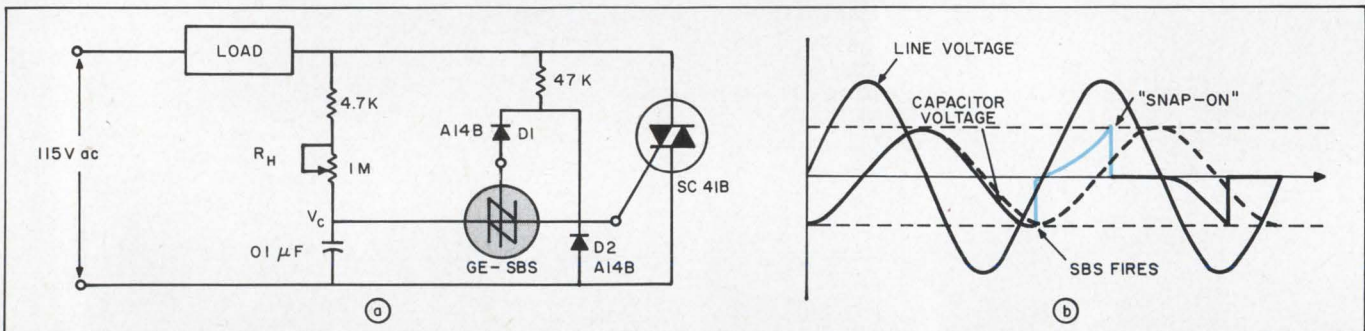

5. Full-wave phase control circuit uses SBS to trigger Triac (a). Operation here has a hysteresis-free option which depends on the potentiometer setting. Snap-on, a

hysteresis effect, occurs when R_H value does not permit capacitor to be reset at the end of the positive half cycle (via the gate lead as shown in waveform diagram 'b').

For a load resistor as low as 5 ohms, the pulse amplitude is nearly 4 volts and is fairly flat from a tenth of a microfarad all the way up to 5 microfarads. For values of R_L equal to 20 ohms or higher, the pulse amplitude exceeds 4 volts and is flat over the range of 0.01 to 5 μ F. Excellent pulse amplitude hold-up of this nature is peculiar to the SUS and SBS devices, and it is this property existing at such a low switching voltage that makes these semiconductors such excellent triggers for SCR and Triac circuits. The exceptional stability of V_s (see Fig. 1b) lends itself to very predictable device performance over wide varia-

tions in temperature. Typically, the temperature coefficient, T_c , is less than 0.05%/°C.

A good example of how these unique features are put to work appears in Fig. 4. This circuit was derived as a slight modification of the universal motor control circuit.^{3, 4}

Lower power needs, small size accrue

In the original circuits, the SUS and the 0.01- μ F capacitor were not used and the A14 diode was connected directly between the potentiometer arm and the gate lead of the SCR. A comparison of

typical component values shows that the 100-k Ω resistor in the modified circuit was a 3.3-k Ω in the original, the 25-k Ω potentiometer was a 1000- Ω , and the 2.0- μ F capacitor was a 100- μ F electrolytic. Hence, a fair amount of power was dissipated in the older speed control and relatively bulky components were necessary.

The addition of an SUS in series with the diode and of a small 0.01- μ F capacitor raised the circuit impedance values and stabilized the reference level. This modified circuit uses a cosine ramp and pedestal arrangement to control the average voltage applied to the universal motor.

Circuit operation is as follows (see Fig. 4c): The residual magnetism left in the series field at the end of the cycle produces a back emf on the armature which is used as speed-feedback information. With the motor at standstill, there is no back emf. As the 25-k Ω potentiometer setting is increased, the pedestal height increases and the voltage appearing at the top of the capacitor eventually rises above the switching point of the SUS. When this occurs, the SUS is turned on and discharges the 0.01- μ F capacitor into the gate of the SCR. The SCR fires and supplies starting torque to the motor. As the motor speed increases, the trigger angle retards, and the average voltage applied to the motor decreases because of the increasing back emf and ultimately arrives at a stable point. Motor speed is increased by rotating the 25-k Ω potentiometer further towards the 100-k Ω resistor. As the motor shaft is loaded down, the back emf across the motor decreases, reducing the total triggering point and causing the ramp and pedestal circuit to fire the SCR earlier in the half cycle. This action applies a larger average voltage to the motor to compensate for the effects of shaft loading.

Hysteresis-free operation with SBS

Because of its symmetrical firing characteristic and its ability to be triggered on at the gate lead, the SBS lends itself to use in a very simple, hysteresis-free, full-wave phase-control circuit (Fig. 5a). Hysteresis, or "snap-on effect," usually ensues when the potentiometer is decreased from its maximum value and the capacitor voltage, which is 90 degrees out of phase with the applied voltage, decreases in phase and increases in amplitude to a point where it fires the SBS and thereby triggers the Triac (Fig. 5b).

The SBS will then fire much sooner in the next half cycle, because the capacitor now starts its charging from zero volts instead of some finite value as it goes into the opposite half-cycle. Therefore, the Triac state changes from no-triggering to triggering for a substantial portion of the cycle.

This effect can be eliminated by simply discharging the capacitor at the end of each cycle to

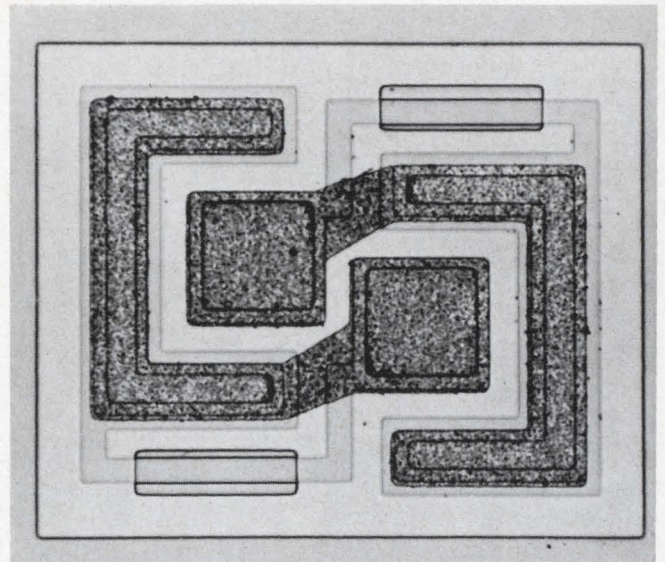

Back-to-back SUS (reverse-parallel connection) devices comprise the SBS (silicon bilateral switch). Anode contacts of each SUS make contact with cathode n-regions of neighbor device via the aluminum overlays. The p-channel extending out from each npn base region provides the buried resistors (see Fig. 2).

zero volts for those values of resistance for which Triac triggering is not to take place. Figure 6 depicts the waveforms seen across the capacitor during different stages of turn-on. Curve 'a' is simply the applied voltage; curve 'b' is the voltage seen across the capacitor for values of R such that the capacitor voltage never reaches the switching voltage of the SBS.

At the end of each positive half cycle the capacitor is discharged back to zero volts; from there it begins to charge into its negative half cycle. This reset action is accomplished by use of diodes $D1$ and $D2$ and the 47-k Ω resistor. As the applied voltage drops below the capacitor voltage, gate current is drawn out of the gate through the 47-k Ω . When this gate current reaches a sufficient value to trigger the SBS, the capacitor discharges to ground.

The gate current required to trigger the SBS is of the same order of magnitude as the original switching current of the device and is a function of this current and the pnp transistor's beta. The pnp betas for these devices (refer to Fig. 1a) are of the order of two at the switching current, so it is safe to assume a minimum beta of unity. If it is taken for granted that the maximum switching current for the SBS in this application is 250 μ A and that a beta of 1 exists, then the gate current required to trigger on the SBS will be $250/(1+\beta)=125 \mu$ A. Thus, half of the supply current flows into the gate and the other half (125 μ A) becomes the collector current of the pnp stage. Note that no current is drawn by the npn stage or the zener diode.

It is desirable to reset the capacitor prior to the applied line voltage going below ground, since

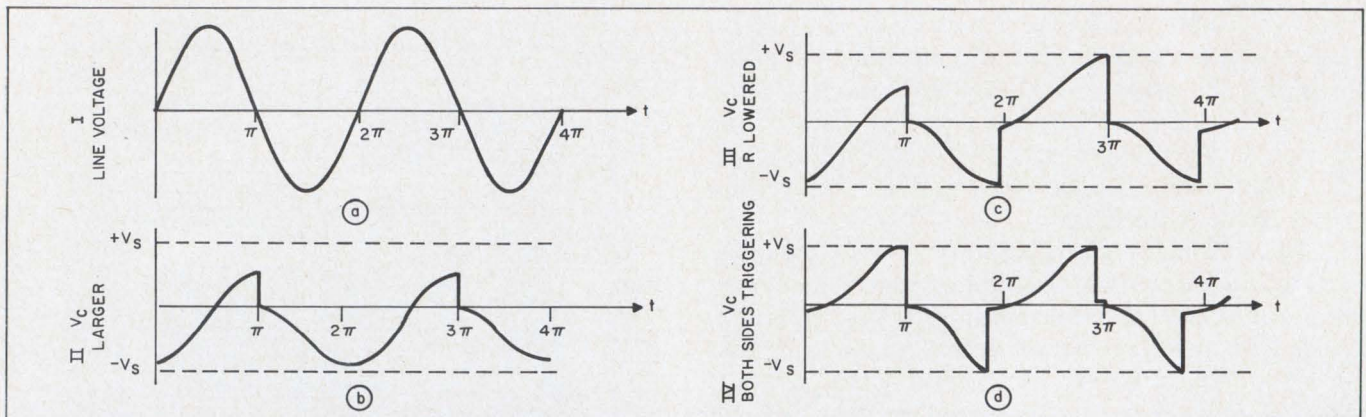

6. Phase control waveforms for hysteresis-free operation of the circuit of Fig. 5a are shown. Exhibited are line voltage (a), capacitor voltage with SBS on the verge of firing (b), capacitor voltage with SBS firing Triac in

negative half cycle (c), and capacitor voltage with firing of Triac in both half cycles (d). Note that, as R_H is lowered, capacitor reaches SBS firing point sooner, because the phase angle is decreased.

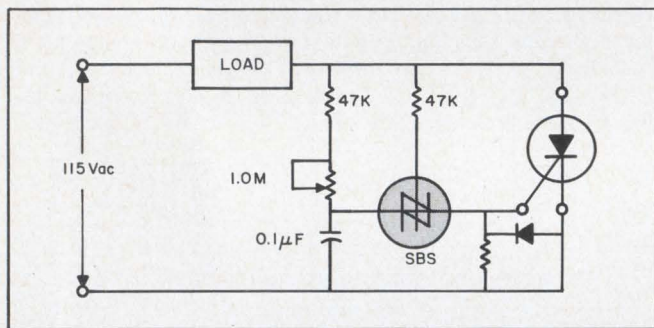

7. Half-wave control circuit uses SBS for hysteresis-free operation. SCR gate protection against reverse biasing is afforded by diode.

Triac triggering is possible in all four quadrants of anode voltage vs gate current. With the above assumptions and the use of a 47-k Ω gate-triggering resistor, it is assured that the SBS will always fire prior to the line voltage going negative.

Half- and full-wave phase control possible

Diode $D2$ clamps the 47-k Ω resistor to ground in the negative half cycle so that, in conjunction with the diode drop across $D1$, no gate current can be drawn out of the SBS gate during this half cycle. The SBS is triggered before V_c reaches the switching voltage V_s . Curve 'c' of Fig. 6 depicts the capacitor voltage for a slight decrease in potentiometer resistance from curve 'b'. The amplitude of the cosine wave in the negative half cycle is now sufficient to trigger the SBS and Triac combination just prior to the end of the negative half cycle. In the next positive-going half cycle the capacitor starts out from approximately zero volts and charges towards the switching voltage of the SBS.

However, for the first few degrees of triggering in the negative half cycle the voltage across the capacitor is not sufficient in the positive half cycle to trigger the SBS (which is still resetting at the

end of the positive half cycle). This is because in the negative half cycle the capacitor begins charging from zero volts, whereas in the positive half cycle the capacitor begins charging from a small negative offset voltage. Hence, for the first 10 or 15 degrees of firing, the Triac anode voltage is somewhat asymmetrical because the Triac is being fired only in the negative half cycle. As the phase angle is decreased further, the SBS begins firing in the positive half cycle as depicted in curve 'd'. Hereafter the symmetry improves as the phase angle is decreased through the full range.

If desired, this slight asymmetry for initial firing values can be symmetrized by the addition of a resistor (on the order of 47 k Ω) across diode $D1$. This tends to discharge the 0.1- μ F capacitor back to ground at the beginning of the positive half cycle.

Figure 7 shows the same sort of circuit for a half-wave phase-control application. This, too, is a hysteresis-free phase-control system. Note that no diodes are needed to clamp the 47-k Ω gate resistor to ground during the negative half cycle. Why? Because the SCRs do not conduct with an applied negative potential. The SBS is in conduction for the full negative half cycle and therefore the small diode connected from the cathode to the gate of the SCR is required to protect its gate junction from being reverse-biased. The SUS could have been used in this circuit with a diode in series with the SUS instead of in its present location. This diode would, however, require a higher reverse voltage rating than the diode used with the SBS device. ■ ■

References:

1. R. M. Muth, "Using the Silicon Bilateral/Unilateral Switch," *EEE*, XIV, No. 3 (March, 1966).
2. *SCR Manual* (3rd ed. Auburn, N.Y.: G.E. Co., 1964).
3. F. W. Gutzwiller, *Universal Motor Speed Controls*, G. E. publication no. 200.4, June, 1961.
4. F. W. Gutzwiller, *A Plug-in Speed Control for Standard Portable Tools and Appliances*, G. E. publication no. 201.1, Apr., 1964.



LOOK TO THE LEADER
IN INTEGRATED CIRCUITS

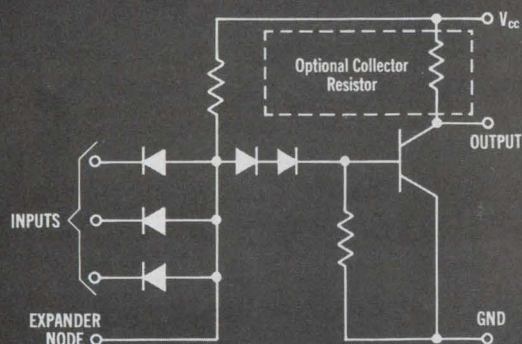

Propagation delay —	25 nsec
Power dissipation —	7.5 mW/gate
Fan-out —	11
D-c noise margin —	1 V
Supply voltage —	6 V
Temperature range	
Series 14200	-55° to +125°C
Series 14300	0° to 75°C

200-series DTL

Device Number	Circuit function
SN14224/SN14324	Expandable 8-input NAND/NOR Gate
SN14231/SN14331	Dual Expandable 4-input NAND/NOR Gate
SN14261/SN14361	Dual Expandable 4-input NAND/NOR Gate, with R _C
SN14206/SN14306	Triple NAND/NOR Gate, inputs 3/3/2+ expander
SN14226/SN14326	Triple NAND/NOR Gate, inputs 3/3/2+ expander, with R _C
SN14216/SN14316	Triple 3-input NAND/NOR Gate
SN14236/SN14336	Triple 3-input NAND/NOR Gate, with R _C
SN14246/SN14346	Quadruple 2-input NAND/NOR Gate
SN14266/SN14366	Quadruple 2-input NAND/NOR Gate with R _C
SN14286/SN14386	Hex Inverter
SN14296/SN14396	Hex Inverter, with R _C
SN14227/SN14327	Triple Diode Expander, inputs 4/3/3
SN14213/SN14313	Pulse Binary Counter
SN14215/SN14315	J-K Flip-flop
SN14210/SN14310	Dual 3-input Driver

Immediately available from Texas Instruments... 200-series DTL integrated circuits

If your system is designed around 200-series integrated circuits you can save money and trouble by switching to TI for your production requirements. TI's unmatched production facilities assure top reliability, uniform high quality, minimum device cost, and delivery to meet your most critical production schedules.

TI uniformity and reliability are now available for your immediate 200-series integrated circuit requirements. The new family, designated Series 14200/14300, includes 15 equivalents of competitive types. Since the TI circuits are electrically and mechanically interchangeable with competitive DTL devices you can utilize them in many digital systems presently in production, including computers, controls and instrumentation.

The new DTL circuits are available in two

temperature ranges. Series 14200, with an operating range of -55° to +125°C, is suited for military and aerospace applications. Series 14300, with an operating range of 0° to 75°C, is recommended for industrial and commercial environments.

Another advantage of importance to many users is that gates and inverters are available with or without collector resistors. (See circuit schematic). This gives the system designer an option to trade power consumption for capacitive drive capability.

Standard package for Series 14200 and 14300 is TI's 14-lead welded and hermetically sealed TO-84 flat pack.

Circle 90 on Service Reader card for complete data sheet specifications on all Series 14200/14300 circuits.



TEXAS INSTRUMENTS
INCORPORATED
13500 N. CENTRAL EXPRESSWAY
P. O. BOX 5012 • DALLAS 22, TEXAS

SEMICONDUCTOR PLANTS IN BEDFORD, ENGLAND • NICE, FRANCE • FREISING, GERMANY • DALLAS, TEXAS

New TTL complex-function for lower-cost,

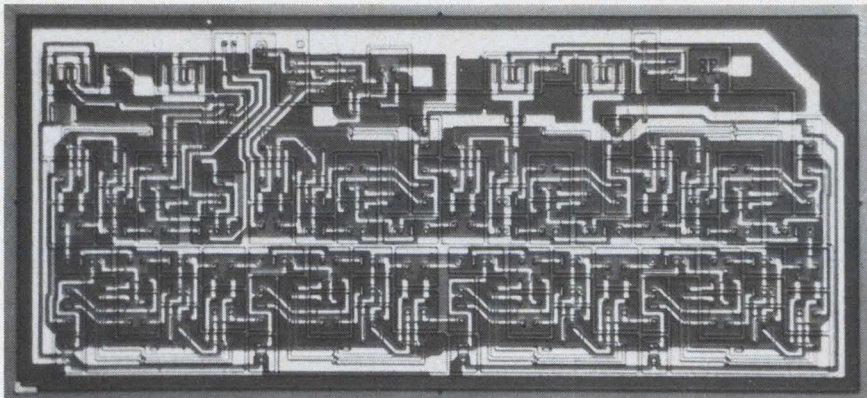

Figure 1. 8-bit shift register uses 144 component elements to perform 11 circuit functions.

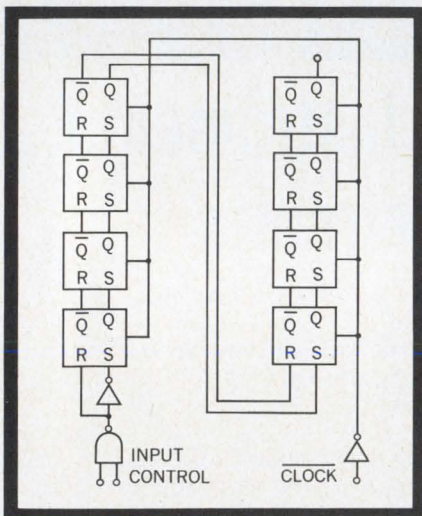

Figure 2. Shift frequency of 8-bit shift register is 15MHz, an order of magnitude faster than comparable MOS circuits.

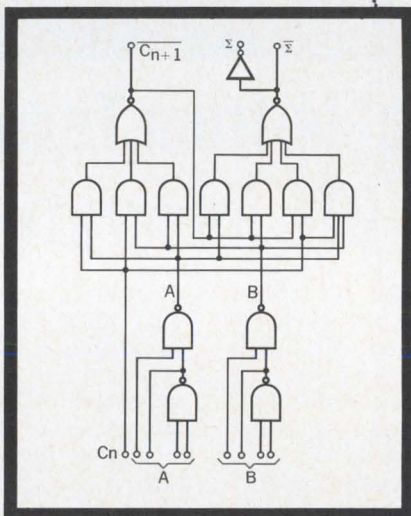

Figure 3. Gated Full Adder eliminates need for extensive "look-ahead" and "carry-cascading" circuitry, greatly improving performance.

Your equipment designs can now take advantage of the latest integrated-circuit technology with TI's new TTL complex functions. These units include more than ten circuit functions interconnected on a single silicon bar.

These new complex circuits make possible reductions of 50 percent or more in parts alone, with one package now doing jobs formerly requiring five to nine standard TTL integrated-circuit packages. Additional savings are realized through simplified board layout and reduced handling and assembly.

The new complex functions are the initial units of a family now being designed which complements and expands TI's standard Series 54 TTL logic line. The full benefits of Series 54 performance are retained, along with improvements in speed and power drain. Most of the new complex functions are available both in military (Series 54) and industrial (Series 74) versions.

SN5491/SN7491 8-bit Shift Register

This high-speed 8-bit serial shift register replaces nine standard TTL units. Power dissipation at 190 mW is one-third that of the equivalent nine packages. Shift frequency is 15 MHz, two orders of magnitude faster than comparable MOS circuits. The 60 by 130-mil silicon bar uses 144 component elements to perform 11 circuit functions, including eight flip-flops, input gating, and a clock buffer.

The serial-in/serial-out shift register requires only one signal input, since an inverter is included internally. The SN5491 can also be used for delay-line applications.

SN5480/SN7480 Gated Full Adder

The SN5480 is a single-bit, high-speed, binary full adder with gated complementary inputs, complementary sum outputs, and inverted carry output. The adder is designed for medium-to-high-speed, multiple-bit, parallel-add/serial-carry applications, and is compatible with both TTL and DTL circuits. The need for extensive "look-ahead" and "carry-cascading" circuitry has been eliminated. Performance is substantially better than can be attained with five standard TTL integrated circuits connected to perform comparable full-adder functions. Speed (70-nsec add time, 8-nsec carry time) is about 35 percent faster, and power dissipation (105 mW) is 20 percent lower. Price of the SN5480 is less than half that of the equivalent five multi-function packages, with additional savings in circuit boards, assembly, and inventory.

SN7490 BCD Decade Counter

The SN7490 is a decade counter with binary-coded decimal output. It can be used as a divide-by-five circuit, a divide-by-two circuit, or a divide-by-ten circuit with symmetrical square-wave output. This flexibility is achieved by external connection of the leads. The counter

integrated circuits from TI better-performing systems

can be reset to zero or a BCD count of nine. Count frequency is 12 MHz, and power dissipation is 150 mW. In addition to counters, applications include frequency synthesizers and digital test and readout equipment. Versions of this unit which will divide by 12 and 16 will be available soon.

New Multi-function Circuits Also Available

In addition to the new circuits with "third generation" complexity, TI also has expanded the family of standard Series 54 TTL multi-function circuits to 13. These multi-function units incorporate up to four circuit functions, with all inputs and outputs brought outside the package.

SN5453 - Quadruple 2-input AND/OR/INVERT Gate. This unit performs the OR function internally. It is expandable to 24 inputs using the SN5460 expander. Propagation delay is 30 nsec, power dissipation is 40 mW, and fan-out is 10.

SN5472 Master/Slave Flip-flop. This circuit features two 3-input AND gates at the J and K inputs. It has reset capability independent of the clock state. Propagation delay is 30 nsec, power dissipation is 40 mW, and fan-out is 10.

SN5473 Dual Master/Slave Flip-flop. This is a dual version of the SN5472. When supplied in the 16-pin plug-in package, separate inputs are provided for preset, clear, and clock lines for each flip-flop. Power dissipation is 40 mW per flip-flop.

SN5474 Dual Latch. The unit consists of two single-input master/slave flip-flops with set and reset. The gated latches are clock-controlled. Propagation delay is 30 nsec, power dissipation is 40 mW per latch, and fan-out is 10.

New Molded Package Gives You Broad Selection

Most of the 130 standard TI integrated circuit types are now available in a variety of packages. The newest addition is a molded package with 14 plug-in pins on 100-mil centers, with the rows spaced 300 mils apart. The new package is designed for economical high-speed assembly and testing, with an index notch for automatic insertion. The solid, molded construction provides maximum protection against shock and vibration. Reliability of the transfer-molding technique and the encapsulating material has been proved by TI's production of millions of SILECT™ transistors over the past two years.

Design Trends Toward TTL

TI's new complex-function and multi-function units emphasize the current design trend toward TTL for high-speed saturated logic. For an optimum combination of high performance and low cost, specify TI Series 54 TTL integrated circuits.

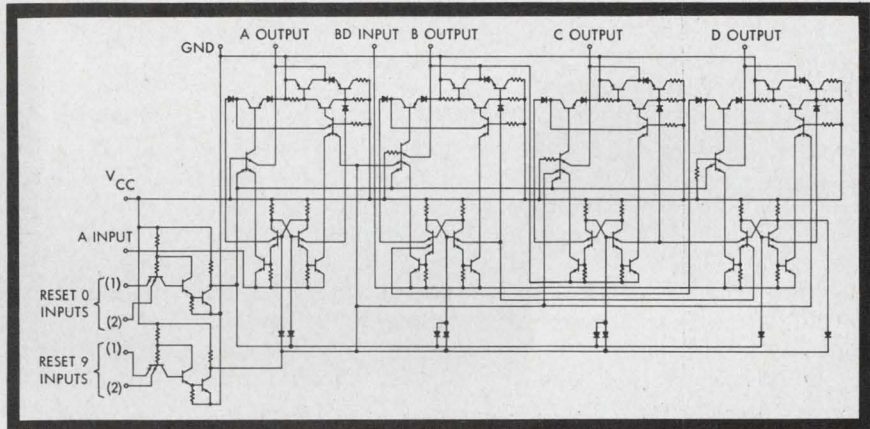

Figure 4. BCD decade counter can also be applied as divide-by-five, -two or -ten circuit.

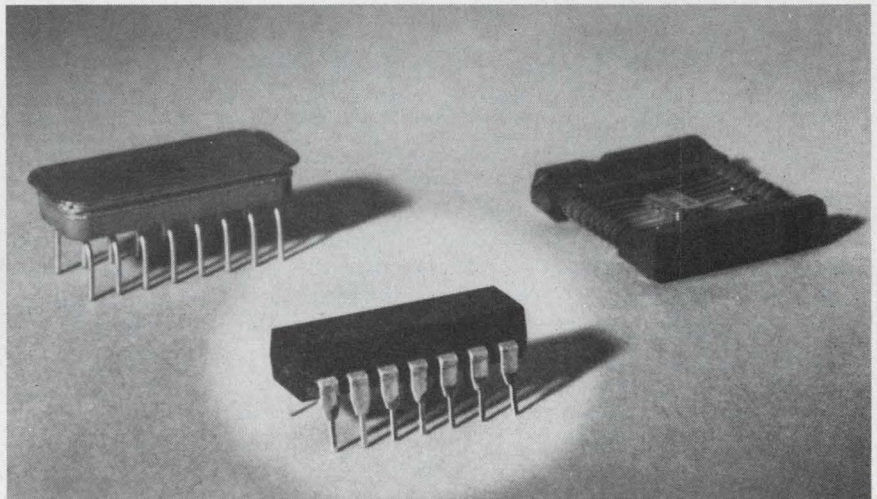

Figure 5. New package with solid molded construction is TI's newest addition to a full line of packages for every integrated-circuit application.



TEXAS INSTRUMENTS
INCORPORATED
13500 N. CENTRAL EXPRESSWAY
P. O. BOX 5012 • DALLAS 22, TEXAS

Want stable audio amplifiers? Use this guide to predict the circuit's thermal behavior. It shows how to bias audio power stages properly.

A key factor that establishes the reliability of any transistor audio amplifier is thermal stability—particularly in the dc bias current parameter. The following construction method provides the needed stability and also ensures that thermal runaway will not occur.

Basically a graphical technique incorporating rules of thumb, this predictive approach takes into consideration all the factors that influence the circuit's temperature behavior. The most important of these are I_{CBO} , gain, V_{BE} , thermal resistance and voltage-supply variations.

The method is applicable to Class A and Class B audio amplifier stages; the analysis involved embraces both silicon and germanium devices. Its forte is that it ties together all the information needed to secure safe thermal design over the temperature ranges encountered in most amplifiers.

I_{CBO} a biasing circuit determinant

The change of the collector-to-base leakage current, I_{CBO} , with temperature variation is the most important design consideration in the biasing circuit. Figure 1 shows the typical change of I_{CBO} with temperature for a number of different power transistors. The measurements were made at one-half-rated BV_{CEO} to show the effects of surface conditions that would be present in a practical application. Curves 1 and 2 refer to the same type of germanium power transistor with approximately the same 2-volt ($V_{CB} = 2$ V) I_{CBO} . However, this transistor, as shown by Curve 2, has a high surface-leakage component, and that causes the difference in I_{CBO} variations. Curve 3 refers to a larger-junction germanium transistor with a higher initial I_{CBO} . The dotted line indicates the increase in I_{CBO} due to the rule-of-thumb doubling of I_{CBO} for every 10°C increase.

Curve 4 shows the typical increase in I_{CBO} for a 7.5 ampere-rated diffused silicon power transistor. It is apparent from the shape of this curve that most of the I_{CBO} measured at room temperature is derived from surface effects. It is also apparent that the small change in I_{CBO} for silicon would not be an important consideration unless a very high source impedance is used in the biasing network.

When the 2-volt I_{CBO} for a germanium transis-

tor is doubled for every 10°C rise in temperature, and the surface component caused by operating at higher voltage is added to it, the value obtained is not far from the actual measured value.

A much closer prediction of the change of I_{CBO} with temperature in germanium transistors, however, can be made by using a normalized I_{CBO} curve. (Fig. 1b). This plot is based upon the similarity of the slopes of the I_{CBO} curves for most germanium transistors as indicated by the low-surface-leakage devices in Fig. 1a. The 2-volt I_{CBO} at room temperature is multiplied by the values shown on the vertical scale to obtain the 2-volt I_{CBO} at other temperature levels. Surface components must be added as a constant at every temperature level to obtain accuracy at higher voltages. This method is satisfactory although it ignores the small positive temperature coefficient which is apparent in the surface component.

Current gain follows temperature rises

Because the change of gain with temperature is a characteristic that influences the change of bias for the transistor, these current changes with temperature should be the second consideration in the initial design, especially when high source impedances are used in the biasing network. Figure 2a shows the variation of I_C vs I_B for a germanium power transistor over a temperature range of -40 to $+100^\circ\text{C}$. The dotted line indicates the actual base-current readings obtained at 100°C . However, because I_{CBO} is flowing through the base in the opposite direction, we must add the I_{CBO} current to the meter reading in order to obtain the actual gain component of base current, shown by the solid line. This solid-line curve is more useful in determining the increase in transistor-gain characteristics with temperature because it does not contain the highly variable I_{CBO} component. The graph shows that transistor gain increases approximately 50 per cent in the Class-B biasing-current range when the temperature is raised from 25 to 100°C .

Moreover, the gain of the transistor increases as the voltage across it is increased, and is directly related to the output impedance of the device. Because output impedance will also change with temperature, this same germanium transistor will show an approximately 100-per-cent increase in gain at a voltage level equal to $1/2 BV_{CEO}$ over the same temperature increase (25 to 100°C). If

Howard F. Weber, Applications Engineer, Motorola Semiconductor Products, Inc., Phoenix, Ariz.

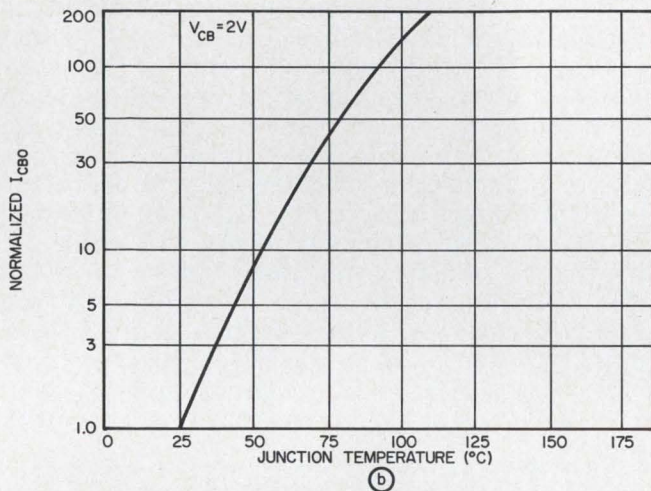
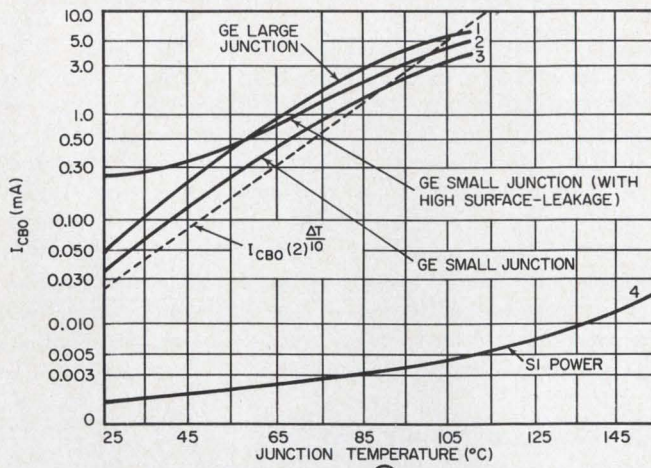

1. Changes in I_{CBO} with junction temperature for a number of different power transistors is evident (a). Ge here refers to germanium types; Si to silicon units. Measurements were made with a voltage of one-half the BV_{CEO} rating and with $V_{CB} = 2$ volts. The dotted curve [$I_{CBO} (2)^{\Delta T/10}$] refers to leakage doubling for every 10°C increase in temperature, and serves as a comparison standard. The plot of normalized I_{CBO} vs junction temperature (b) may then be used to predict I_{CBO} variation in germanium units.

these data are not stated on the specification sheet for the device, the foregoing predictions can be used for most germanium power transistors at Class-B bias current levels.

Figure 2b illustrates the I_C vs I_B data for a typical diffused silicon power transistor over the temperature span, -40 to $+175^\circ\text{C}$. It shows that in the range of Class-B biasing currents there will be an approximate increase of 100 per cent in current gain when the temperature is raised from 25°C to 175°C . At higher voltages this change will be somewhat greater. But the effect of output impedance variations will be less than with comparable germanium devices.

V_{BE} a key in biasing

Turning to voltage, we note that the change of V_{BE} with temperature is another major factor in determining bias design. Figure 3a shows the transconductance curve vs temperature for a

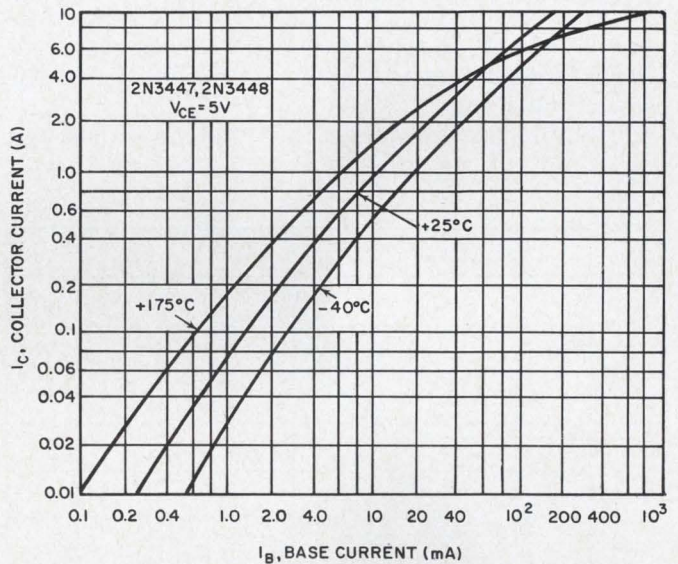
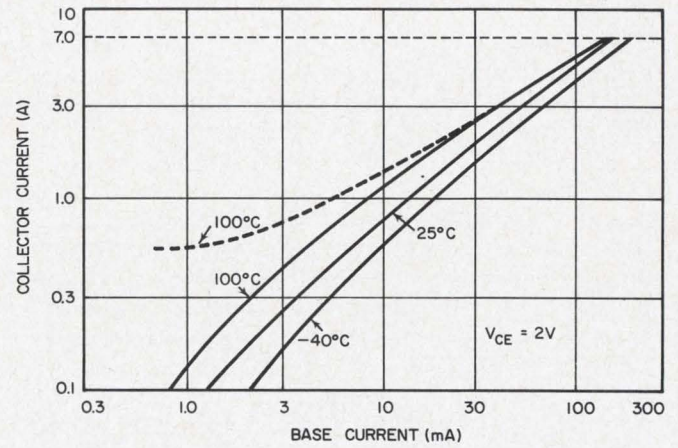

2. Collector current vs base current for a small-junction germanium unit is a function of temperature (a). The dotted line shows the I_B values at 100°C with I_{CBO} included. Solid lines refer to I_B exclusively. With silicon power transistors (b) the changes in current gain are greater, although a wider ambient range is tolerated.

typical germanium power transistor at current levels within the range of Class-B biasing currents. The solid-line curves indicate the change in V_{BE} (at $V_{CE} = 2$ volts) from 25 to 100°C . In the range of 30 -mA to 300 -mA collector current, V_{BE} changes at the rate of approximately 2 mV/ $^\circ\text{C}$.

Although the V_{BE} values are modified by increases in collector voltage, the slope of the V_{BE} curve is generally not greatly affected at 25°C over the collector-current ranges that are important in Class-B biasing. However, if the slope of the V_{BE} curve is changed at higher temperatures because of a temperature effect on the output impedance at high voltage levels, this must be taken into account. The dotted lines in Fig. 3a show the change in V_{BE} with temperature for a high output-impedance germanium transistor when the device is operating at a collector voltage equal to half the BV_{CEO} rating. They indicate that the rate of change for this transistor is increased to 2.2 mV/ $^\circ\text{C}$ at higher voltage levels. If

these characteristics at higher voltage levels do not appear on the data sheet, the 2.2 mV/°C figure can be taken as a useful temperature coefficient for V_{BE} predictions in the biasing range.

Figure 3b displays the effects of temperature on transconductance for a typical diffused silicon power transistor. This information shows that in the range of collector currents most important in biasing Class-B audio amplifiers, the V_{BE} changes 2.2 mV/°C (approximately) over a temperature span of 25 to 175°C. This change takes place at a collector voltage of 5 V. Because of the very high output impedance of silicon power transistors in the range of Class-B biasing-current levels, the 2.2 mV/°C index should be valid everywhere but at very high voltage levels. At the higher current levels associated with Class-A biasing, this does not always hold true, and the characteristics of the transistor must be examined to determine the actual variation.

The thermal resistance of junction-to-ambient

(Θ_{JA}) plays an important role in thermal-stability design. For each incremental increase in power dissipation of the transistor there will be a resultant increase in the junction temperature. This in turn produces a change in the temperature-dependent characteristics of the transistor. When transistors are used with heat sinks, the long thermal time constant of most heat sinks will cause the characteristic changes to be very slow. The thermal resistance of the transistor and heat sink should therefore be known if thermal stability is to be properly evaluated.

Developing a stability criterion

When all the temperature-dependent factors are obtained, some simple mechanism is needed to combine them into a single predictor of thermal stability. The transconductance curve (Fig. 4) is proposed as the starting point. Because the data sheet values are usually obtained by pulsing, we must modify this transconductance plot by the effects of increasing junction temperature as dc collector current is increased. The power dissipated at all collector-current levels will cause an increase in transistor junction temperature from the reference temperature, depending on the thermal resistance to the reference point. It, too, must be included. Thus, the V_{BE} curve is reduced at any particular collector-current level by:

$$\Delta V_{BE} = 0.0022 I_C V_{CE} \Theta_J \quad (1)$$

where 0.0022 in volts is the change in V_{BE} per °C change in temperature and is a rule of thumb; I_C is the collector current; V_{CE} is the collector-to-emitter voltage; and Θ_J is either Θ_{JA} or Θ_{JC} (the thermal resistance of junction-to-ambient or of junction-to-case, respectively depending on the reference point chosen).

The curve in Fig. 4 shows dc power dissipation modifying the V_{BE} curve based on two arbitrary thermal resistances, 1°C/W and 4°C/W. In addition, the pulse V_{BE} curve is presented at 100°C by reducing V_{BE} at the rate of 2.2 mV/°C. These modified transconductance curves become the starting point for predicting the biasing-current levels at different operating temperatures.

After the transconductance curve has been established, the next step is to construct the biasing load line (Fig. 5). With reference to the equivalent circuit, it can be seen that the base-to-ground voltage is:

$$V_{BG} = V_{BB} + I_{CBO} R_S - I_B R_S \quad (2)$$

The vertical scale of the transconductance curve shows that there is a direct linear relationship between collector current, base current and junction temperature that is due to power dissipation and thermal resistance.

The biasing load line will start at some voltage level on the horizontal scale at $I_B = 0$, dependent on V_{BB} and the initial value of $I_{CBO} R_S$ when the emitter switch is open. When the emitter switch is closed, the V_{BG} value will undergo a change determined by the base current and by the change of I_{CBO} as collector current increases the junc-

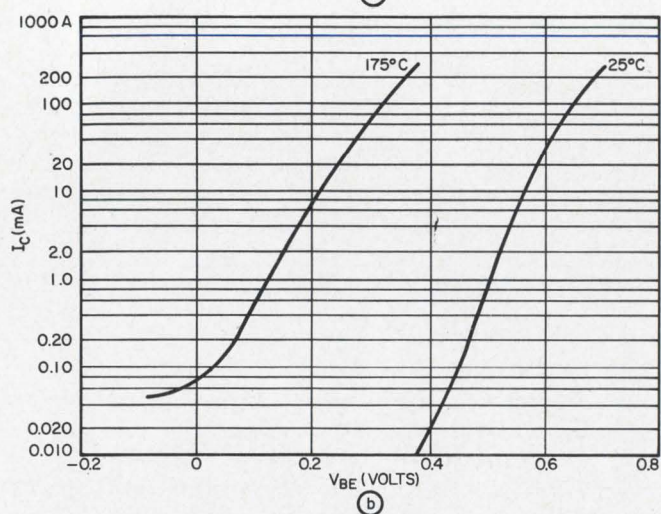
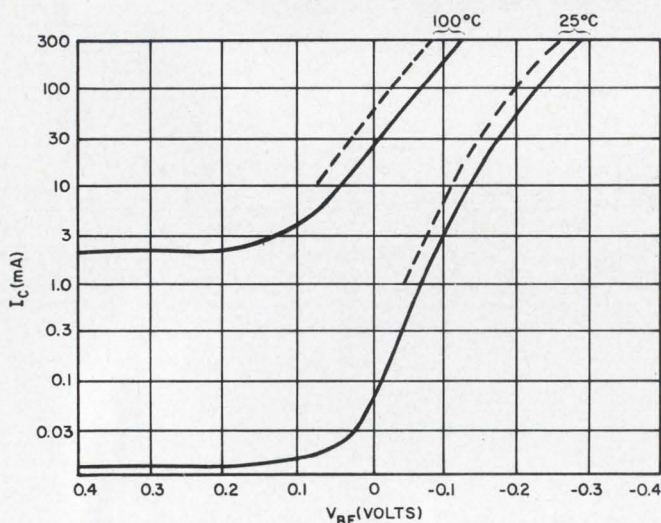

3. Transconductance vs temperature plot shows how V_{BE} changes in temperature affect biasing (a). Dotted lines refer to a V_{CE} value of 25 volts (transistor in OFF state) and solid lines are for $V_{CE} = 2$ volts (ON state). With a silicon power device (2N3447) operating at $V_{CE} = 50V$ (b), the ΔV_{BE} rate is 2.2 mV/°C between 25 and 175°C.

tion temperature. Thus, the bias load line is constructed by inserting the values of I_{CBO} and I_B for each temperature level into Eq. 2. The point at which this constructed bias load line intersects the constructed V_{BE} curve will determine the collector current of the transistor.

If there were neither a significant increase in I_{CBO} nor a decrease in I_B due to temperature, the bias load line would be a straight line for a linear-gain transistor. However, the change in I_{CBO} due to each incremental increase in collector current will, in many cases, overcome the change in base current and give an increasing voltage characteristic for the biasing load line.

How to determine thermal behavior

To illustrate, the basic circuit and graph of Fig. 6 are used to show the method for determining the thermal stability of a particular transistor operating with a 2-volt collector supply and with a thermal resistance of $1^\circ\text{C}/\text{W}$. In this case, the change in V_{BE} per degree change in temperature was measured to be $2\text{ mV}/^\circ\text{C}$. The transistor had a dc gain of 100 with a measured increase of 50 per cent over the temperature range of 25 to 100°C , at 2 V.

In most practical cases, emitter resistance is used in Class-B audio circuits to reduce the change in bias current with temperature. Thus, the transconductance curve in Fig. 6 includes the $I_C R_E$ voltage drop across a $0.5\text{-}\Omega$ resistor.

Referring to the circuit (Fig. 6), we see that if the switch in the emitter is closed and R_2 is adjusted to give a 50-mA collector current through

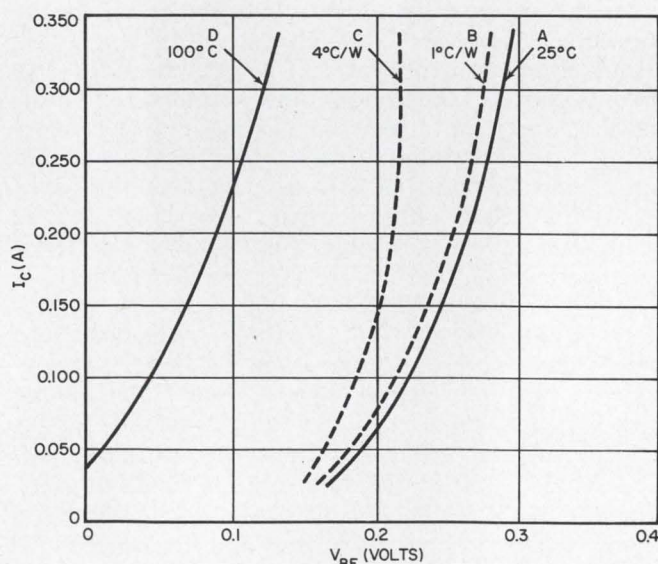

4. Transconductance may be used as a catch-all criterion for predicting thermal stability. It relates I_C to V_{BE} , and is the basis for constructing a biasing network that takes in the combined effects of I_{CBO} , I_C vs I_B , and thermal resistance. This is typically Class-C pulse operation at $V_{CE} = 25$ volts. Curve A refers to V_{BE} at 25°C ; B and C show the effects of V_{BE} modified by thermal resistances of $1^\circ\text{C}/\text{W}$ and $4^\circ\text{C}/\text{W}$, respectively; curve D exhibits V_{BE} at 100°C , where the $2.2\text{ mV}/^\circ\text{C}$ reduction has been accounted for.

the transistor at 25°C , we will have base current flow through the equivalent bias-source resistance R_s (which is equivalent to R_1 and R_2 in parallel). If we open the switch in the emitter we will have an interruption of this base current and a resultant rise in voltage between the base point and ground, dependent on the bias-source resistance and the value of base current and I_{CBO} that were flowing.

In this case the source impedance is $10\ \Omega$ and the transistor has a dc gain of 100 with a 0.5-mA base current flowing at the 50-mA point of intersection with the 25°C transconductance curve. The bias-voltage (V_{BG}) change will be 5 mV, since the change in I_{CBO} is very small at these low temperatures. Constructing a bias load line from the 50-mA point with this voltage change has already been discussed.

If the temperature of the transistor case is raised to 100°C , the change in I_{CBO} will be approximately 3 mA. This is based upon an I_{CBO} of $22\ \mu\text{A}$ at room temperature and the normalized curve of Fig. 1b. This I_{CBO} current flowing through the biasing-source resistance will increase the bias voltage on the horizontal scale. When the switch is closed, a bias load line is constructed to intersect the 100°C dc current gain, the increase in I_{CBO} , and the bias-source resistance. The dc gain at 100°C is 150—this means that there will be a 10-mV drop in V_{BG} for every 150-mA increase in collector current. Because there is a further increase in I_{CBO} as collector current flows when the emitter switch is closed, the bias load line is constructed to intersect the 100°C transconductance curve based upon $V_{BG} = V_{BB}$

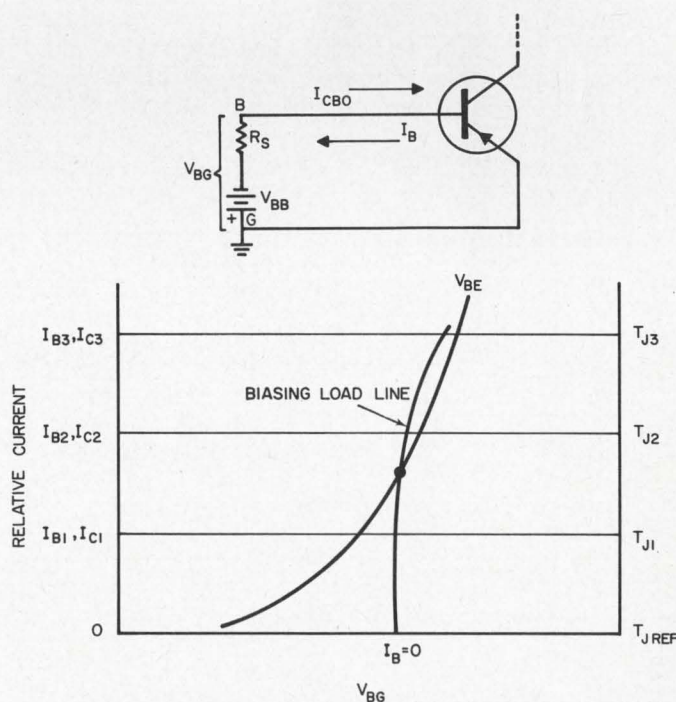

5. Biasing load line is constructed by using the transconductance curve related to the equivalent circuit. It starts at $I_B = 0$ and exhibits the effect of $V_{BG} = V_{BB} + I_{CBO}R_s - I_B R_s$ as temperature is changed.

+ $I_{CBO}R_S - I_B R_S$. The construction of this load line using the incremental change in I_{CBO} and I_B is shown by the load-line intersection of the 100°C transconductance curve.

Rule of thumb aids prediction

Actual measurements on the circuit showed that the biasing current changed from 50 mA at 25°C case temperature to 242 mA at 100°C case temperature. The graph predicted that this transistor would reach a final value of 237.5 mA, which is very close to the actual value. When the collector voltage is raised to 25 volts, the measured change was from 50 mA to a value of 290 mA. Using a 2.2 mV/°C change in V_{BE} and a 100-per-cent increase in gain over this temperature span, we can again predict the change very closely. The graph (Fig. 6) also shows the results of using the rule of doubling I_{CBO} for ever 10°C rise.

It is obvious that with the low biasing-source resistance and the low I_{CBO} at high temperature for the device used, the change in V_{BE} was the major cause of collector-bias-current change. On the other hand, higher leakage currents, higher bias-source resistance and higher thermal resistance will cause I_{CBO} to be a major determinant for collector-bias-current changes.

If the same transistor is used with a 3°C/W heat sink at 25 volts' collector voltage, the device will be very near thermal runaway at these temperature levels. The effects of a total thermal resistance of 4°C/W on thermal stability are shown in Fig. 7. The V_{BE} curve is constructed and modified by the 4°C/W change owing to a varying power dissipation as the collector current is increased. The biasing-current changes are graphically predicted by the same procedure outlined for Fig. 6, except we use 2.2 mV/°C and a 100-per-cent gain increase. Because of the high Θ_{JA} , the reference temperature is raised from 25°C to only 80°C.

It can be seen that the slope of the intersecting high-temperature biasing-source load line is

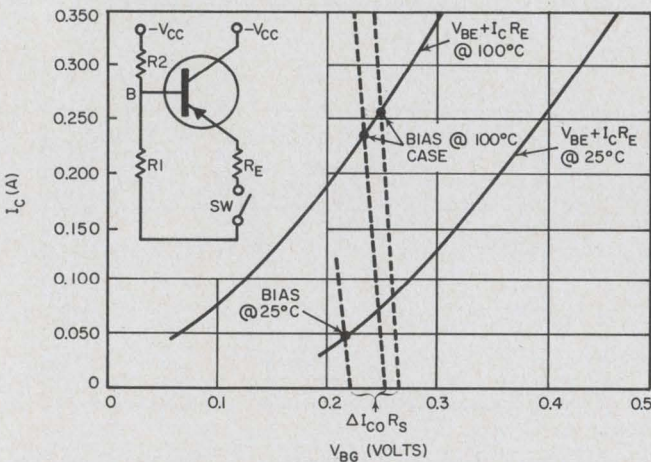

6. Thermal stability is determined by this graph and basic circuit. Bias load lines which account for all variables are constructed for the temperature extremes. This is for a two-volt collector supply, a thermal resistance of 1°C/W and with $R_S = R_1 R_2 / (R_1 + R_2)$.

greatly affected by the rapid rate of increase of I_{CBO} for each incremental increase in collector current. Because there is a tendency to predict a slightly lower change in biasing collector currents at high collector voltages, we consider this case to be a border-line condition. This is because a very small increase in temperature will make the load line miss intersecting the V_{BE} curve. It is also important to note that, because of the long thermal time constant of the heat sink, it again takes a considerable length of time before the collector biasing current will reach the final value.

This technique for graphing the thermal stability of the biasing-current levels eliminates the need for determining the highly variable R_{BB} in the transistor. For germanium devices, this method requires that the circuit be designed for the lowest possible bias-source resistance. Then, the thermal stability using the highest gain, lowest input impedance and highest leakage transistor for the expected ambient-temperature change is graphed. Emitter resistance can be added to improve stability if improvement is needed. Clearly, a bias-source impedance that changes with temperature can greatly increase the stability. With this method of predicting biasing changes with temperature, the desired temperature coefficients can be easily determined.

Power supply may be source of instability

Up to this point, we have ignored the effects of power-supply variations on the bias-voltage levels. In the next example, this important effect will be shown for a silicon transistor. But it must be considered in all designs, including germanium.

Because I_{CBO} changes with temperature for silicon units are generally low enough to be ignored, graphing the transistor stability is a somewhat simpler procedure. The graph (Fig. 8) shows the dc transconductance curves for minimum battery voltage at 30°C case and for maximum battery voltage at 60°C. It is evident that a 25 Ω biasing load line will not intersect the high-battery-voltage, high-temperature V_{BE} curve without even considering the effects of battery voltage level on bias-source voltage. If we increase the bias-source resistance to 250 Ω , it can be seen that we intersect both V_{BE} curves, even when the bias-source voltage is increased in direct proportion to battery-voltage change. The slope of the biasing load line is based upon a gain of 100 at 30°C case, and 125 at 60°C case, for this particular device. At 100 mA with a 60°C case temperature and a 30°C/W thermal resistance, the junction temperature will be approximately 105°C.

This particular Class-B amplifier was designed for two watts' output. Biasing power dissipation will be the determining factor for heat-sink design whenever collector currents are over 50 mA. It is desirable either to add an emitter resistor or to increase the bias-source impedance for a lower collector-current change. When the transistor is driven from a higher source impedance, biasing-current levels for minimum crossover distortion

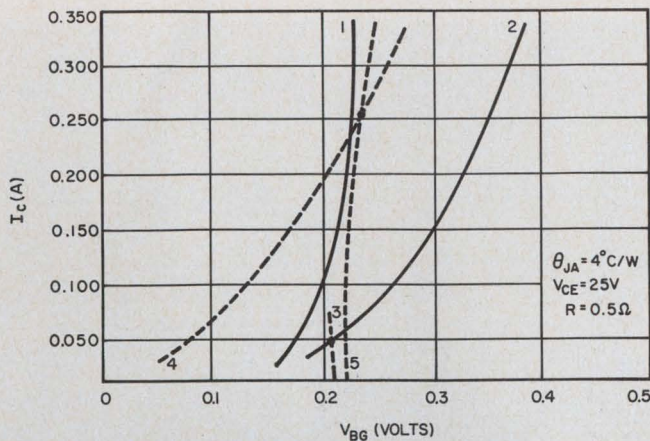

7. Use of heat sink may inadvertently result in thermal runaway! If a $3^{\circ}\text{C}/\text{W}$ sink is used with the device of Fig. 6, the biasing load line (#5) may miss the V_{BE} curve (#1) altogether. Note that curve #1 is for the dc V_{BE} at 25°C and #2 is #1 modified by the $I_C R_E$ drop. Curve #3 is the bias load line at 25°C , #4 is the dc $V_{BE} + I_C R_E$ at 80°C and #5 is the bias load line at 80°C . The bias load line's slope is also influenced by I_{CBO} .

can be somewhat lower.

Figure 8 indicates that silicon transistors can be made to have the best stability when biased with a high bias-source impedance. The highest value for this impedance is dependent upon when the I_{CBO} component begins to cause significant change in the input bias voltage. Some silicon transistors may have a high surface-leakage component that may be temperature dependent and must therefore be considered if accurate collector-current changes are to be predicted.

Step-by-step prediction procedure

Predicting the thermal stability of audio-amplifier bias can be a snap if the temperature-dependent characteristics can be determined or closely predicted by the simple rule-of-thumb procedures outlined. For a more detailed analysis, the method of graphing the biasing stability can be summarized as follows:

- Obtain the pulse transconductance curve (I_C vs V_{BE}) for the transistor to be used from the data sheets. Modify the curve for the dc power dissipation within the bias-collector-current range by reducing V_{BE} in accordance with $0.0022 V_{CE} I_C \theta_{JA}$. If an emitter resistance is used, construct the final room-temperature transconductance curve by adding $I_C R_E$ at all collector-current levels.

- Determine collector-biasing level as established by either the Class-A power output or the elimination of crossover distortion in Class-B circuits. Determine the change in bias-source voltage with and without base current plus I_{CBO} . Construct the bias-source load line from this source-voltage change to intersect the bias-current point on the room-temperature transconductance curve and the zero current point on the horizontal scale (use $V_{BG} = V_{BB} + I_{CBO} R_S - I_B R_S$).

- Determine the change in temperature to be encountered and construct a new transconductance

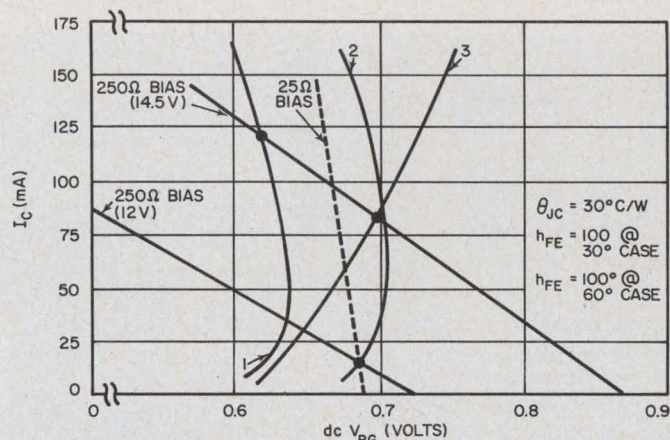

8. With small-signal silicon devices, thermal stability predictions by the graphic method are simpler to make than with germanium units. The three non-linear curves here are the transconductance relationships. #1 is the dc V_{BE} for minimum battery voltage (12 V) at a 30°C case; #2 is the dc V_{BE} for maximum battery voltage (14.5 V) at a 60°C case; #3 is #2 modified by the I_C drop across the 10Ω resistor in the base-emitter circuit.

tance curve at the higher temperature. This is accomplished by reducing V_{BE} by a constant equal to $(T_{MAX} - T_{25^{\circ}\text{C}}) \times 0.0022$. If there is a possible collector-voltage change, modify this curve for the ensuing highest power dissipation.

- Determine the change in I_{CBO} for the change in ambient or case temperature. Multiply this change by the bias-source impedance and add it to the open-circuit bias-source voltage (V_{BG}) on the horizontal scale. If there is an increase in bias-source voltage due to power-supply variations, add this change to the open-circuit bias voltage too. If there is a temperature coefficient in the bias-source impedance, subtract this from the open-circuit bias voltage that had been obtained up to this point. The change in I_{CBO} can be obtained using the rule of thumb—doubling I_{CBO} for every 10°C rise in temperature or by use of a normalized I_{CBO} curve (see Fig. 1b).

- Construct a new bias-source load line, based upon the gain at high temperatures, the bias-source impedance and any additional change in I_{CBO} due to power dissipation, at each incremental increase in collector current.

- If the modified bias-source load line does not intersect the high-temperature transconductance curve or does intersect with a slope that is almost tangent to the curve, the thermal stability is considered inadequate at these temperature levels. If an insufficient degree of stability exists, either of three improvement measures may be taken. These are: a change in the biasing source impedance, the addition of series emitter resistors, or, the lowering of the thermal resistance.

The accuracy of predicting thermal stability is dependent upon the precision and comprehensiveness of the temperature-dependent characteristics of the transistor used. In most cases, it will be predicted about 10 per cent low at high voltage levels. This is close enough for design purposes if worst-case design factors are used. ■ ■



**The 766 HF simulates
a dual-beam scope
at a single-beam price.**

**It's a 100 MHz scope
with 100 mV/div sensitivity,
(10 mV at 90 MHz)
6 by 10 cm scan,
13 kV HV,
and algebraic add.**

**It operates in
12 different modes
on a single time base,
without changing plug-ins.**

What more can you ask for?

Our data sheet.

FAIRCHILD
INSTRUMENTATION

Measure transistor y-parameters

the right way and get improved hf designs.

Five basic instruments are compared.

Transistor two-port parameters provide the design engineer with one of the simplest methods for evaluating high-frequency transistor design.

In particular, y -parameters, because they are measured under short-circuit conditions at both the input and output ports, lend themselves well to high-frequency (>250 kHz) characterization. However, though y -parameters sometimes are found on transistor specification sheets, it is more often the engineer's job to measure and record them. This is not an easy task; the equipment used, the frequency of measurement and the parameters measured become very important in obtaining the most accurate readings.

The discussion that follows concerns itself with five well-known pieces of equipment that can measure y -parameters at high frequencies. These are:

- General Radio (Type 1607-A) transfer-function and immittance bridge.
- Wayne Kerr (Type 801) vhf admittance bridge.
- Wayne Kerr (Type 601) radio-frequency bridge.
- Boonton RX meter (Type 250-A) and transistor adapter (Type 13510A).
- Rohde and Schwarz Diagraphs (Types ZDD and ZDU).

Each piece of equipment is separately investigated and examples of the y -parameters that each measured are given. Since it is important to the design engineer to know the variations that can be expected from typical y -parameters, the tolerances, relative to the typical y -parameters of silicon, planar, high-frequency transistors, are indicated as a function of frequency and biasing levels.

The difficulty and time involved in the measurement of y -parameters varies from one instrument to another. The set-up and calibration time are appreciable and usually require the service of a qualified person who is familiar with the instruments used. Table 1 lists some of the pertinent characteristics of these pieces of equipment, including the all-important biasing limitations.

With the exception of the RX meter, all of the other instruments need an external signal genera-

tor. In addition, all of them, except for the RX meter and the Rohde & Schwarz units, need an external detector. The GR1607-A, WK801 and WK601 units can measure directly the forward and the reverse transfer admittance and, of course, the input and output admittances. The RX and Rohde & Schwarz units measure only y_{11} and y_{22} directly. The other parameters, y_{12} and y_{21} , must be calculated from a number of other parameters that are measured. The accuracy of such calculated values is very much in question.

To measure small-signal, high-frequency parameters on any one of these instruments, one must keep the applied signal voltages low enough

Two-port network y-parameters

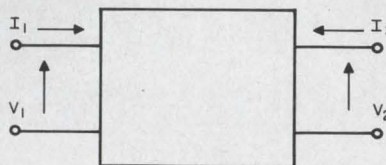

The parameter equations for a two-port linear network are:

$$I_1 = y_{11} V_1 + y_{12} V_2,$$

$$I_2 = y_{21} V_1 + y_{22} V_2,$$

where, in the common-emitter configuration,

$$y_{11} = y_{ie}; \left. \frac{I_1}{V_1} \right|_{V_2=0}; \text{ input admittance with output short-circuited,}$$

$$y_{12} = y_{re}; \left. \frac{I_1}{V_2} \right|_{V_1=0}; \text{ reverse transfer admittance with input short-circuited,}$$

$$y_{21} = y_{fe}; \left. \frac{I_2}{V_1} \right|_{V_2=0}; \text{ forward transfer admittance with output short-circuited,}$$

$$y_{22} = y_{oe}; \left. \frac{I_2}{V_2} \right|_{V_1=0}; \text{ output admittance with input short-circuited.}$$

In terms of the real and imaginary components, any of the y -parameter values may be written as,

$$y = g + jb,$$

where g is the conductance and b , the susceptance.

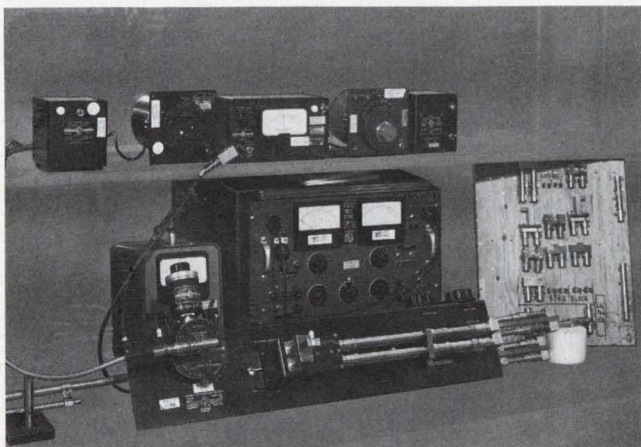

1. Test setup, using General Radio 1607-A imittance bridge, requires external signal generator and detector.

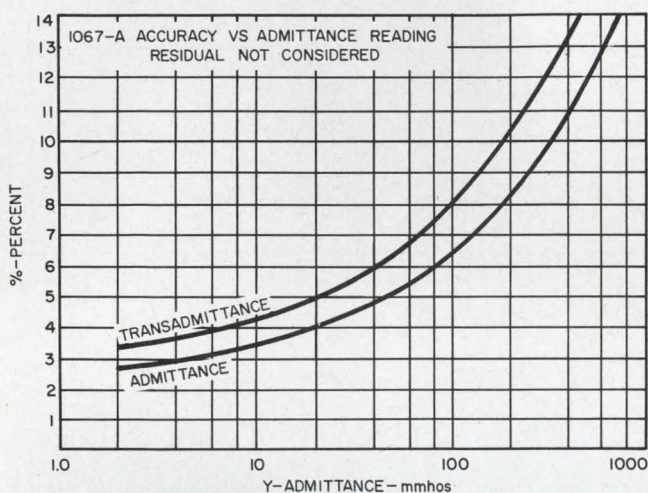

2. Accuracy of reading for the 1067-A decreases greatly as the magnitude of the admittance increases.

Table 1. Instrument characteristics

Instrument	Operating frequency	Measured parameter	Dc bias range
GR1607-A	25 MHz to 1.5 GHz	0-400 mmhos	250 mA; 400 V.
WK801	5 MHz to 100 MHz	G=0 to ± 100 mmhos C=0 to ± 230 pF	30 mA; 30 V.
WK601	15 kHz to 5 MHz	R=0.1 to 12 M Ω C=0.01 pF to 0.02 μ F L=0.5 μ H to 50 mH	1 mA; 6 V.
RX250A	500 kHz to 250 MHz	R=15 to 100 k Ω C=0 to 20 pF (extends to 120 pF)	50 mA; 30 V.
R&S ZDU and ZDD	30 MHz to 2.4 GHz	R=1.2 Ω to 3 k Ω atten.-0 to -30 dB phase=0 to $\pm 180^\circ$	60 mA; 150 V.

to ensure small-signal conditions. For the measurement of y_{11} and y_{21} , a voltage level of approximately 5 mV per milliampere of collector current is satisfactory. For the measurement of y_{22} and y_{12} , the voltage levels at the collector should not exceed 500 mV. This is just a rule of thumb, but its validity may be verified by reducing the voltage and taking the measurements over again. The new readings will be the same as the original ones if the initial signal voltage did not affect the linearity of the device. Since the amplitudes of the real and imaginary components of y_{11} and y_{21} , are much larger than the amplitudes of y_{22} and y_{12} , one can expect less error in y_{11} and y_{21} readings, even though the instrument accuracy is basically the same for all four parameters. In some readings the residual error of the equipment is as large as the values of y_{22} and y_{12} and the error can then be quite high.

GR unit has broad frequency capability

The GR1607-A easily measures all four y and h transistor parameters in the frequency range of 10 MHz to 1.5 GHz. Since it operates on a principle of full, half, and quarter wavelengths, the requirements of both high-frequency open circuits and high-frequency short circuits are easily met. Specially made adapters for various transistor-lead configurations, such as TO-5, TO-18 and TO-50/51, and for various transistor-circuit configurations, such as common-emitter and common-base, are necessary.

These adapters minimize the stray capacity and inductance effects on the measured parameters and also serve to maintain known line lengths. A typical instrument setup with associated generators, detectors, adapters and coaxial tubing is shown in Fig. 1.

Once the setup is complete and the measuring frequency adjusted, the readings are made directly off the face of the tuning head. Should detection become difficult, two sets of multipliers allow for phasing and size reduction, and a number of attenuation plates increase the sensitivity of the detector. All of the readings are referenced to 50 Ω and measured in percentages of the reference; they are then easily converted to millimhos.

The initial setup and calibration of the GR-1607-A instrument requires appreciable technical know-how, but the taking of data is in itself quite simple, since the instrument will stay in calibration with various currents and voltages applied to the transistor. Note, however, that the final interpretation of data depends greatly on the instrument accuracy. The curves in Fig. 2 indicate the amount of error possible with this instrument. An example of y -parameters measurements on the GR1607-A, for a 2N3855 transistor, is given in Table 2.

Individual device data are meaningless; to be useful, a good statistical sample of transistors must be evaluated. This will provide a typical value of the y -parameters at a given frequency and bias point.

The GR1607-A high-frequency bridge is a real boon for such evaluation. A large number of transistors can be tested on the instrument relatively rapidly. It is also the only commercially available piece of equipment that can directly measure all four y -parameters above 100 MHz.

A few facts and observations about the

GR1607A bridge warrant mention at this point. Approximately every two years the instrument needs cleaning and replacement of all 874 connectors. At the same time, its readings should be compared for accuracy, with a reference instrument. When the transistors are tested, the leads of each transistor must be perfectly straight and in line with the transistor mount contacts to prevent damage to the transistor mounts. It is also a good idea to coat the external surfaces on the transistor short lead mounts with an epoxy material (Emerson & Cuming's EC-210 for example) whenever the transistor lead is likely to make contact.

Table 2. 2N3855 y -parameter measurements

Instrument	(in mmho)	y_{ie}		y_{fe}		y_{re}		y_{oe}	
		g	b	g	b	g	b	g	b
GR1607-A*	min.	10.02	9.07	18.7	-35.6	0	-0.08	0.07	2.13
	max.	11.58	10.53	21.7	-41.2	-0.54	-1.12	0.89	3.07
WK-801‡ (WK-601 for y_{fe})	min.	1.20	1.41	141	-94.5	0	0.007	0	0.16
	max.	1.46	1.55	147	-97.5	0.1	-0.09	0.2	0.26

*f = 100 MHz; V_{ce} = 10 V; I_c = 5mA

‡f = 5 MHz; V_{ce} = 10 V; I_c = 5mA

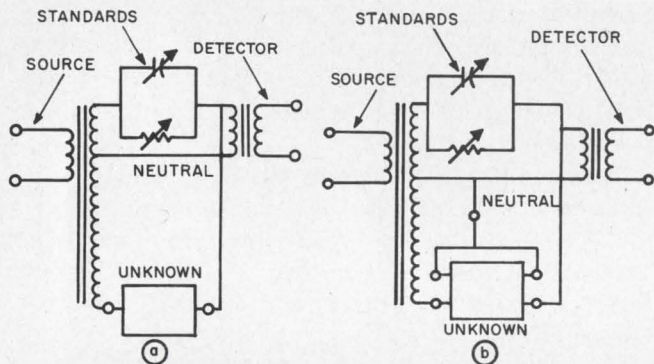

3. Transformer ratio arm bridge is used in Wayne Kerr 801 vhf-admittance-bridge. The two-terminal measurement is made with setup in schematic a. Three-terminal measurements are made with setup in schematic b.

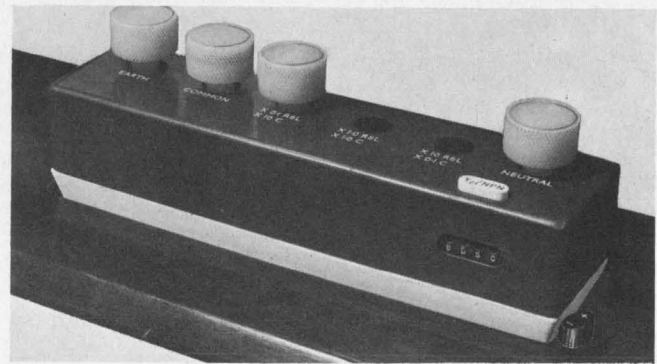

5. Adapter for WK601 unit measures just y_{21} parameter for npn transistor. Other adapters are available for other parameter measurements. Note the in-line socket arrangement which requires a socket adapter to mount transistor.

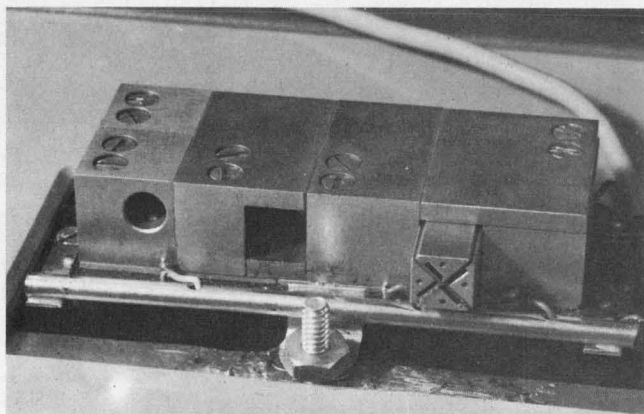

4. Inserting the KW601 loader (block with diagonal grooves) into either opening of the adapter unit determines the y -parameter that is to be measured.

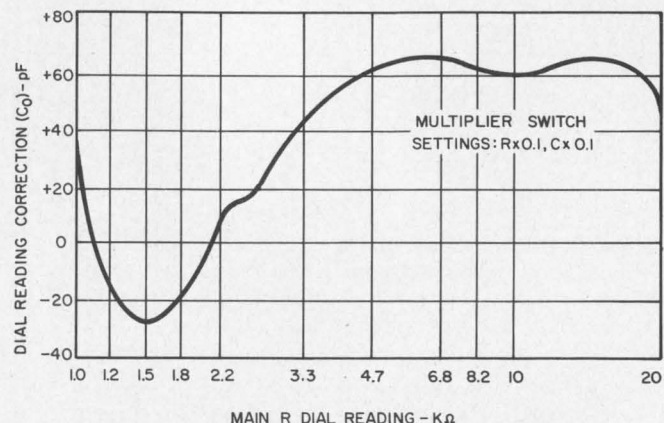

6. Each individual WK601 requires a correction curve, which must be added to all calculations to obtain correct answers.

Two units from Wayne Kerr can be used

The WK801 is a transformer ratio arm bridge that can measure all four y -parameters in either the common-emitter or common-base mode. In the frequency range from 5 to 100 MHz, it simplifies measurement by reducing the number of controls to five: a conductance dial, two conductance decade switches, a main capacitance dial, and a vernier capacitance dial. There are no multiplier terminals, multiplier switches, or correction curves for the instrument. The WK801, and the WK601 that is discussed later, use two basic bridge circuits to make two-terminal and three-terminal transistor measurements. These are shown in Figs. 3a and 3b.

The transistor loader for this instrument is unique. The small, square block with diagonal lines on its face shown in Fig. 4 is the loader. Each triangular section is color-coded and accepts one of the transistor leads, i.e., the emitter, collector, base or shield leads, depending on which parameter is being measured. The type of parameter that is measured also dictates whether the loader is to be inserted into the front or the rear of the terminal block, and whether it is to go into the right or left opening.

When many transistors are under test, the three-terminal balance needs to be checked often, especially if the bias point of the transistor is changed. Though the two-terminal balance will keep its null for a longer time, it should be rebalanced each time a new two-terminal y -parameter is to be measured. The loading of the transistor, correctly oriented and in place in the terminal block, can be quite time-consuming.

The WK801 does have some limitations. For example, the magnitude of the scale for conductance is limited to 100 mmhos. This prevents the measurement of y_{fe} at higher current levels, where g_{fe} can be much larger than 100 mmhos. In practice, we noted that the g_{fe} reading was actually limited to about 40 to 50 mmhos. If the dust shield is removed and the grounding connections

are improved, the readings can be enhanced to $g_{fe} = 70$ mmhos. In some cases, the imaginary term may also be limited by the fact that the scale goes only to 260 pF; at low frequencies and higher bias-current levels, readings above 260 pF are very common. A final drawback is the use of tape to hold the transistor loader together; some kind of internal epoxy bonding would be more desirable. The g_{fe} limitation is seen in the data recorded in Table 2, where a 2N3855 was tested. Note that both the real and imaginary terms had to be measured on the WK601.

The WK801 lends itself fairly readily to the measurement of a large number of devices but, as mentioned, a lot of time is required for balancing and checking. Once the preliminaries are set, however, reading of transistors is a rapid process.

Since the WK601 used the same measurement principles as the WK801, the schematics for the two-terminal and three-terminal measurement also apply to this instrument. The WK601 readings are made in terms of R and C or L over a frequency range of 15 kHz to 5 MHz. All four y -parameters are read directly on the instrument; however, a different transistor adapter must be used for each individual y -parameter. Adapters such as the one shown in Fig. 5 are available for both npn and pnp transistors. Note the in-line transistor socket which requires an intermediate socket to accommodate most transistors. Stray capacities introduced by the additional sockets can be tuned out by the bridge. The bridge can measure all four y -parameters in the common-emitter configuration and the input admittance in the common-base configuration.

After initial nulling and adjustment of the bridge, the transistors are measured by direct readings from the R or C-L dials. By use of the multiplier switch and terminals provided, the readings can be made on an optimum portion of the dial scale. A correction curve, individually developed for each WK601 unit, provides correction values for the dial reading. The values on this correction curve, such as the one shown in Fig. 6, are either added to, or subtracted from, the dial reading.

If a large number of transistors are to be measured on the WK601, the instrument must be frequently nulled, particularly when the bias conditions of the transistor are changed.

Well-known RX meter has extended capability

The operation of the Boonton RX meter, a popular piece of test equipment, is enhanced by the introduction of a transistor adapter. The RX meter, however, can only measure a two-terminal setup and consequently the adapters are designed to measure y_{ie} , y_{ib} , and y_{oe} . Figure 7 shows the RX meter with the adapter mounted in place.



7. Boonton RX meter has extended capability with the addition of relatively low-cost transistor adapter plates.

When transistor measurements are made on the RX meter, a potentiometer must be mounted on the instrument. This control adjusts the signal voltage applied to the transistor. For input-parameter measurement, the input signal level must be low (in the 10-20 mV range). For output-parameter measurement, it should not exceed 100 mV. Another board, in conjunction with the parameter boards, has a set of terminals available for external bias. The adapters are designed to work in the frequency range of 500 kHz to 250 MHz, (i.e., up to the limits of the RX meter). A diagram of one of the circuit boards is shown in Fig. 8.

The RX meter and the adapters are useful for quick evaluation work. Since the price for the adapters is very reasonable, most companies can use this equipment for correlation purposes and a quick check of input and output parameters. Forward and reverse transadmittance could be approximated if the high-frequency value of h_{21} were also measured.

As for many instruments, correction charts are provided for both the RX meter and the adapters. The charts are usually needed when measurements are made near the instrument's frequency-range extremes.

Rohde & Schwarz units are quite complex

The instrument that requires the greatest mathematical manipulation and mechanical maneuvering to obtain all four y -parameters is the R&S Diagraph. The most distinctive feature of the instrument is its read-out, shown in Fig. 9: the values of the y -, h - or z -parameters are read on a Smith chart by a moving light spot.

The instrument uses an unbalanced line, a tapered line and a variable-length standard line to make the high-frequency measurements. Because the R&S Diagraph uses harmonic tuning, there is a great sensitivity of tuning that makes the instrument difficult to set up.

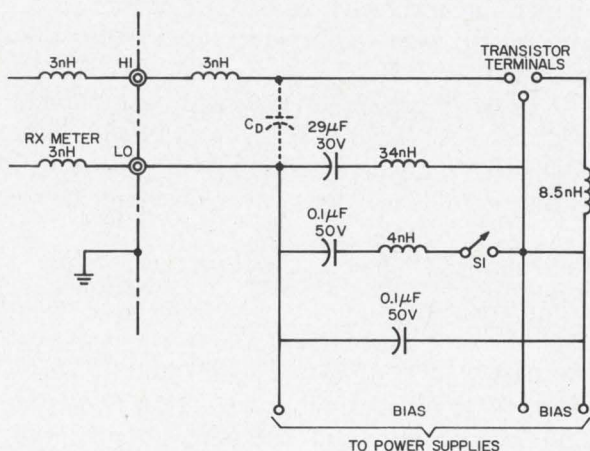

8. Schematic of Boonton 13510A transistor adapter. Dc bias must be supplied by external power supply.

Though the R&S unit can measure common-emitter, base and collector parameters, (using an exterior dc bias source) the values of transadmittance must be calculated from the two terminal parameters.

The complexity of the technique may be understood by examining the equation for forward transadmittance, given as:

$$y_{21} = \frac{1}{2Z_0} \frac{1}{\mu_{Bf}} (1 + y_{11}Z_0 + y_{22}Z_0 + y_{11}Z_0^2 h_{22}).$$

One sees that to calculate this value, y_{11} , y_{22} , h_{22} , and μ_{Bf} (the transmission factor based on the forward transfer constant) must first all be measured. A similar process must be followed in order to arrive at the value for reverse transadmittance. Keep in mind also the fact that y and h values are all complex numbers.

Of all the instruments available to measure y -parameters, the R&S Diagraphs are least suited for quick evaluation work and extended operation by inexperienced personnel. The set-up time, calculations, use of the Smith chart and relative unfamiliarity make these hard instruments to use.

Finding a usable standard is a real problem

It is clear that each of these five instruments is a case unto itself. Standards that are provided with one instrument, are useful with only that particular instrument. There is no cross-matching between any of the instruments. At times, the transistor can become a "standard" for checking pieces of equipment where there is a frequency overlap between two instruments. But actually no transistor should ever be used as a standard; the variations of the transistor parameters as a function of temperature, stray capacity, lead inductance and age eliminate it as a possible reference element. If a standard can be made for these instruments, it must be a passive network. Admittedly, standards for two-terminal measurements can be and are being used. The main problem is in



9. Rohde & Schwarz unit is most complex of all. Read-out is on a Smith chart and, though working at high frequencies, is limited to the input and output parameters. Transadmittance figures must be calculated by a complex and lengthy formula.

obtaining standards for three-terminal measurements. There are three main objections to using a passive network as a standard. These are:

1. The amplitude of the readings of the standard will be much lower than it would be for a typical transistor, and the accuracy of the instrument will vary with amplitude.
2. Physical layout of the passive standard must be such as to fit all transistor adapters and not introduce any stray inductance or capacitance in the sockets.
3. The passive standard will be designed to work at one particular frequency.

Because of this lack of standards, the readings on equipment (even the same equipment) will vary from company to company, place to place. Because of the inaccuracies of the reading instruments and their residual errors, wide variations of y -parameters relative to typical values can be expected.

Expect large variations of measurements

Up to now this discussion has dealt mainly with the instruments, their specifications, and some observations on their operation and use. Regardless of the nature of the equipment and its operation, however, the interest lies principally in obtaining usable y -parameter data.

The raw data that are obtained from the initial measurements of the y -parameters can be very misleading. The measurements may have been taken at different times under various, and at times extreme, environmental and spurious-noise conditions. The data may have been taken by different people, and there is the possibility of initial inaccuracies in nulling and adjusting the instruments. Add to all this the inherent inaccuracy of the instruments and their residual errors. Obviously, a wide range of y -parameter variation can be expected. An example of this is shown in Table 3.

Table 3. Parameter variation with frequency.

		≤5 MHz	5 to 30 MHz	30 MHz to 1 GHz
y_{ie}	g_{ie}	±35%	±30%	±50%
	b_{ie}	±35%	±30%	±35%
y_{re}	g_{re}	±35%	*	*
	b_{re}	±20%	±35%	±35%
y_{fe}	g_{fe}	±10%	±40%	±40%
	b_{fe}	±10%	±30%	±30%
y_{oe}	g_{oe}	±20%	±100%	±100%
	b_{oe}	±15%	±25%	±15%

*Readings are either out of range of instruments or are so low that residual error dominates.

As one measures transistors over a large frequency range, some definite trends in the behavior of the y -parameters may be expected. As the frequency increases:

- g_{ie} increases and b_{ie} tends to rise slightly and then go negative.
- g_{re} and b_{re} gradually increase, but at high frequencies a sharp increase is observed.
- g_{fe} decreases and b_{fe} rises steadily. At high frequencies, b_{fe} flattens out and starts decreasing.
- g_{oe} and b_{oe} both increase.

The behavior of the parameters is further affected by biasing. At low collector bias voltages, all of the y -parameters measure higher than at high bias voltages. All parameters also vary directly with collector bias current, except for forward active transistors. As the collector bias current increases:

- g_{ie} rises rapidly and b_{ie} rises slowly.
- b_{re} is not affected by bias current and, though g_{re} increases with current, the change may only be observed at low frequencies where the instruments can discern these small readings.
- g_{fe} rises more slowly than b_{fe} .
- g_{oe} increases rapidly with current and b_{oe} increases with a slight slope.

The transistor parameters will vary somewhat from unit to unit. The pellet geometry, starting material, diffusion cycles, packaging, lead lengths, lead inductances, lead capacitance, and beta spreads contribute to this variation. Of the few production variables mentioned, beta spreads are the easiest to measure and to classify. A definite correlation exists with beta and the y -parameters. As beta increases, y_{ie} increases rapidly, y_{oe} decreases rapidly, y_{fe} has a slight increase, and y_{re} stays fairly constant.

The y -parameters that appear on the transistor specification sheet are always typical. Since such y -parameters include beta spreads of at least 2:1, and even as high as 10:1, it is important for the design engineer to be able to predict the approximate variations of the y -parameters relative to typical values. For a silicon, planar transistor having a beta spread of 10:1, the parameters will have the following approximate tolerances relative to the typical listed values:

$$g_{ie} \pm 50\% \quad g_{re} \pm 35\% \quad g_{fe} \pm 25\% \quad g_{oe} \pm 80\%$$

$$b_{ie} \pm 25\% \quad b_{fe} \pm 25\% \quad b_{re} \pm 25\% \quad b_{oe} \pm 35\%$$

For a beta range of 2:1, the tolerance on typical value in a given beta group is approximately as follows:

$$g_{ie} \pm 15\% \quad g_{fe} \pm 12\% \quad g_{re} \pm 20\% \quad g_{oe} \pm 30\%$$

$$b_{ie} \pm 15\% \quad b_{fe} \pm 12\% \quad b_{re} \pm 20\% \quad b_{oe} \pm 20\%$$

The above statements are intended to be general and should be used as a guide only. Specific information on a given device should be available from the transistor manufacturer. ■ ■

Versatile DTL pulse binary counter features 12 mc clock rate, 40 ns switching time.

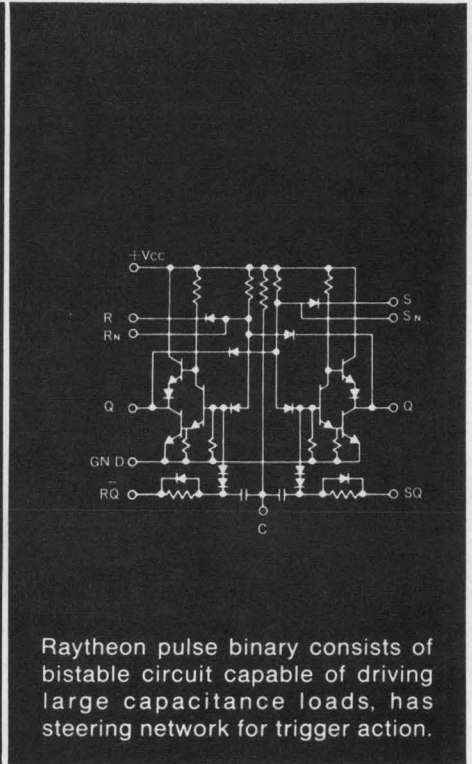
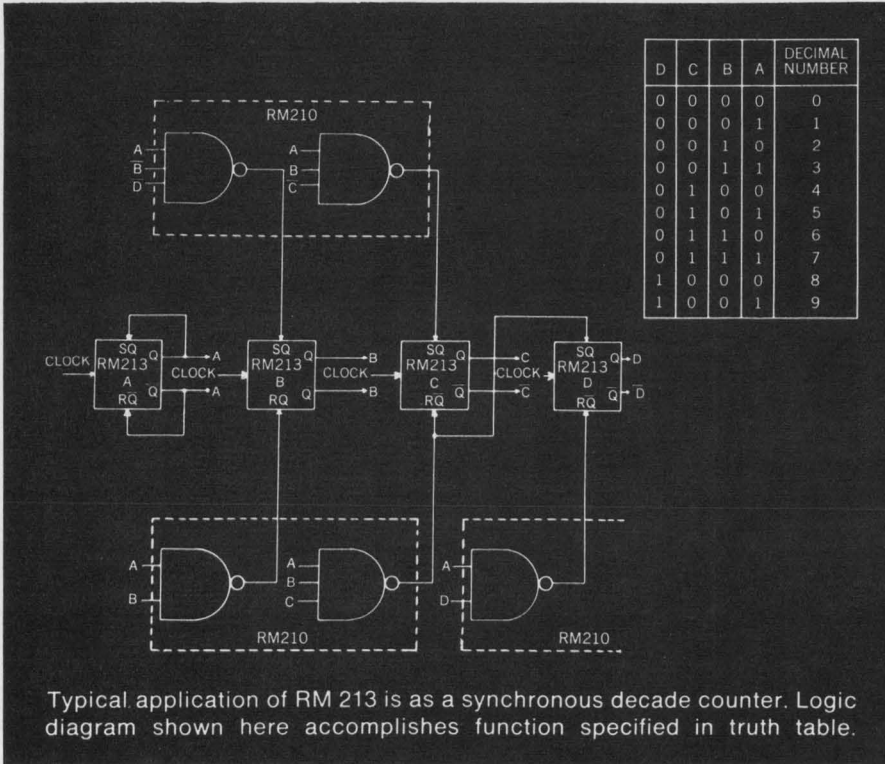

You can use this versatile and highly reliable Raytheon RM 213 DTL as a binary counter element, shift register element, clocked RS flip-flop or as a direct RS flip-flop. Besides high speed, this pulse binary counter features: fan-out of 8 over full MIL temperature

range; low power consumption; operation from a single 6-volt power supply.

Thirty-nine additional DTL circuits are available—including a broad range of NAND gates, NAND line drivers, hex gates, JK and RS flip-flops, and diode arrays.

For complete data on Raytheon's DTL integrated circuits, send reader service card. Or write: *Raytheon Company, Components Division, 141 Spring Street, Lexington, Massachusetts 02173.*

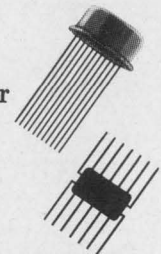



Technical achievement for you... better living for you and your family

We are particularly anxious to meet you if you are a Circuit Design Engineer; Packaging and Mechanical Engineer; Electron Optics, Vacuum Technology or Materials and Process Specialist. But whatever your technical strengths, if "roll-up-the-sleeves" engineering appeals to you, we'd like to hear from you.

Here you'll find an environment that emphasizes the individual, and his personal contribution to technical development—contribution by working on projects, not writing about them. Your work will benefit advanced engineering throughout the world. *You* will benefit from technical association with specialists experienced in developing state-of-the-art instrumentation, components and devices.

All Tektronix R & D—financed entirely from our annual sales of over \$100 million—is directed toward *commercial* products. Our community is prosperous, balanced, with a stability of employment not typical of every industrial center. And as for the Green Land we live in—it speaks for itself.

If you're seeking technical advancement and better living for you *and* your family, why not investigate Tektronix?

Write to D. A. Thompson, Tektronix, Inc., P. O. Box 500E, Beaverton, Oregon 97005, or send in the coupon.

Professional Placement Mgr., Tektronix, Inc.
P. O. Box 500E, Beaverton, Oregon 97005.
Please send me your Booklet, "Tektronix" Application Form

NAME: _____

ADDRESS: _____

CITY: _____

STATE: _____

I am interested in: _____

Tektronix, Inc.

An Equal Opportunity Employer.



Short-cut to spliced resonators by using a graphical design approach that helps optimize lengths of the line segments at the resonant frequency.

Here is a simple and quick graphical approach to the design of spliced quarter-wave resonant transmission lines. The graphs help to select the lengths of the line segments for the shortest resonator at a specific frequency and also provide the proper segment-length-to-wavelength ratios for an arbitrary total length at any desired frequency.

The advantage of a spliced quarter-wave resonator (Fig. 1) is that it operates at a lower frequency than an equal length of uniform transmission line. Therefore it is much easier to use, especially at the lower microwave frequencies, where the latter becomes unwieldy.

Such resonators are built by splicing together two low-loss lines of different characteristic impedances. Usually the line segment with the higher characteristic impedance forms the shorted end of the stub.

The actual total length required for resonance, $l_1 + l_2$, is a fairly complex function of the ratio of the characteristic impedances of the two line segments, the length of the shorted segment, and the wavelengths of the desired frequency in the two lines, λ_{g1} and λ_{g2} :

$$l_1 + l_2 = l_1 + (\lambda_{g2}/2\pi) \cot^{-1} \left[(Z_{01}/Z_{02}) \tan (2\pi l_1/\lambda_{g1}) \right]. \quad (1)$$

It can be shown that, for a given frequency and a given Z_{01}/Z_{02} ratio, the minimum resonant length for the spliced resonator is achieved when the individual lengths are:

$$l_1 = (\lambda_{g1}/2\pi) \cot^{-1} (Z_{01}/Z_{02})^{1/2}, \quad (2)$$

$$l_2 = (\lambda_{g2}/2\pi) \cot^{-1} (Z_{01}/Z_{02})^{1/2}. \quad (3)$$

Since $2\pi l/\lambda_g$ is the electrical length, θ , of either line segment alone, Eqs. 2 and 3 can be restated as:

$$\theta_1 = \theta_2 = \cot^{-1} (Z_{01}/Z_{02})^{1/2}. \quad (4)$$

Eq. 4 has been plotted in Fig. 2, showing θ_1 and

θ_2 vs Z_{01}/Z_{02} .

For example, a quarter-wave resonant spliced line is to be made from 50-ohm and 10-ohm coaxial cables. Then $Z_{01}/Z_{02} = 5$, and Fig. 2 shows that $\theta_1 = \theta_2 = 0.42$ radians. If both lines have relative dielectric constants of 2.1 and the desired frequency is 120 MHz, then:

$$l_1 = l_2 = (\lambda_g/2\pi) (0.42) = 11.53 \text{ cm.}$$

In this case, each line would be 11.53 cm long, with the 50-ohm line at the shorted end. The total length of 23.06 cm is much shorter than the 43.13 cm required in a uniform line. Since higher ratios of Z_{01}/Z_{02} can be obtained rather easily, the resonant length could be made even shorter if necessary.

Find proper length-to-wavelength ratios

In some applications, it is desirable to resonate a spliced line of some given total length, either longer or shorter than the resonant length in uniform line. For the case of equal wavelengths in both lines, Eq. 1 can be written as a ratio of total line length to wavelength:

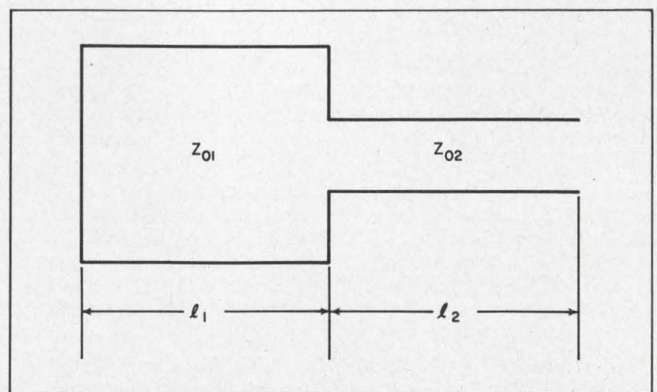

1. Spliced quarter-wave resonator is built from two low-loss lines of different characteristic impedances. It operates at a lower frequency than an equal length of uniform transmission line.

John R. Lembke, Assistant Senior Engineer, The Bendix Corp., Kansas City, Mo.

$$(l_1 + l_2)/\lambda_g = l_1/\lambda_g + (1/2\pi) \cot^{-1} [(Z_{01}/Z_{02}) \tan (2\pi l_1/\lambda_g)] \quad (5)$$

With the aid of this equation we plotted $(l_1 + l_2)/\lambda_g$ vs l_1/λ_g for various values of Z_{01}/Z_{02} in Fig. 3. Consider again the spliced line consisting of 50-ohm and 10-ohm coaxial cables ($Z_{01}/Z_{02} = 5$). If a 120-MHz resonant line is required with a total length of 31 cm, then $(l_1 + l_2)/\lambda_g = 0.180$. Fig. 3 indicates that either of two values of l_1/λ_g will give the required length: 0.02 or 0.16. If we choose 0.02, then $l_1 = 3.45$ cm and $l_2 = 31.00 - 3.45 = 27.55$ cm.

In this example, the required resonant length was less than the resonant length in uniform line (43.13 cm). Therefore the 50-ohm cable would be used at the shorted end. If a resonant length longer than that in a uniform line had been required, the 10-ohm line would be used at the shorted end. In that case $Z_{01}/Z_{02} = 0.2$, and the right portion of Fig. 3 would be used to determine l_1/λ_g .

The graphs are based on the assumption that the lines are lossless. However, if good quality low-loss lines are used, only very minor corrections in line lengths will be required. ■ ■

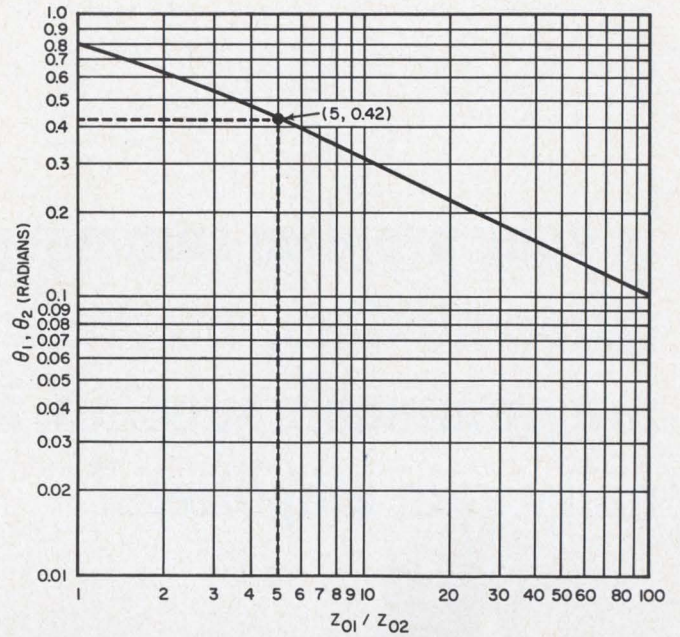

2. Electrical length of each line segment depends on the ratio of the two characteristic impedances. The plot helps minimize the total resonator length required for a given frequency by offering the shortest useable line lengths.

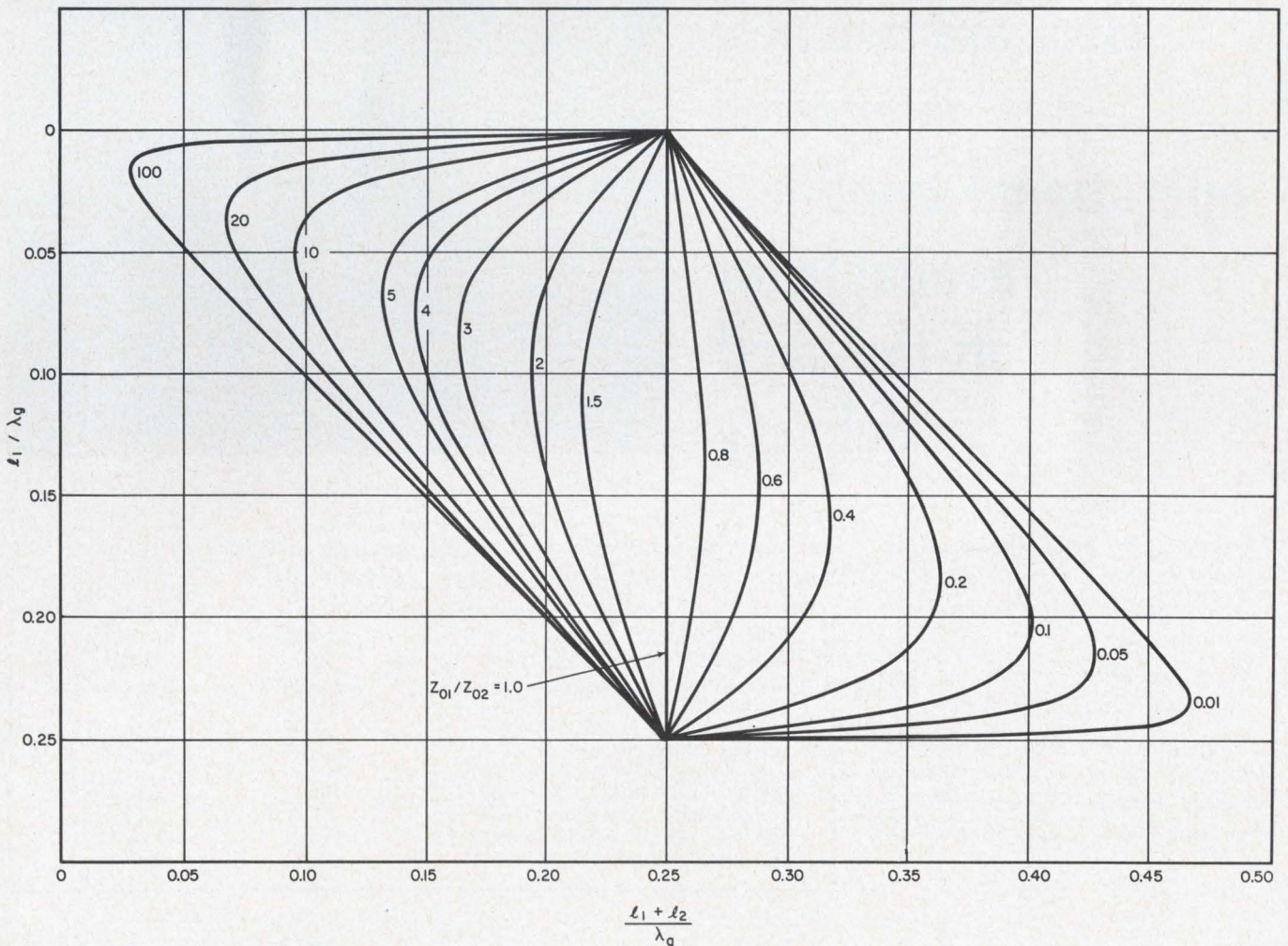

3. Plots of the electrical length of the spliced resonator vs the electrical length of one segment are functions of the ratios of impedances. The curves are useful when the total

length is given, along with the resonant frequency, and the problem is to find the lengths of the segments. There are two solutions for each frequency.

Is your problem summing amplifiers, differentiators, integrators, programmable supplies, inverters, unity gain amplifiers?

Here are two new NSC integrated operational amplifiers available for off-the-shelf delivery

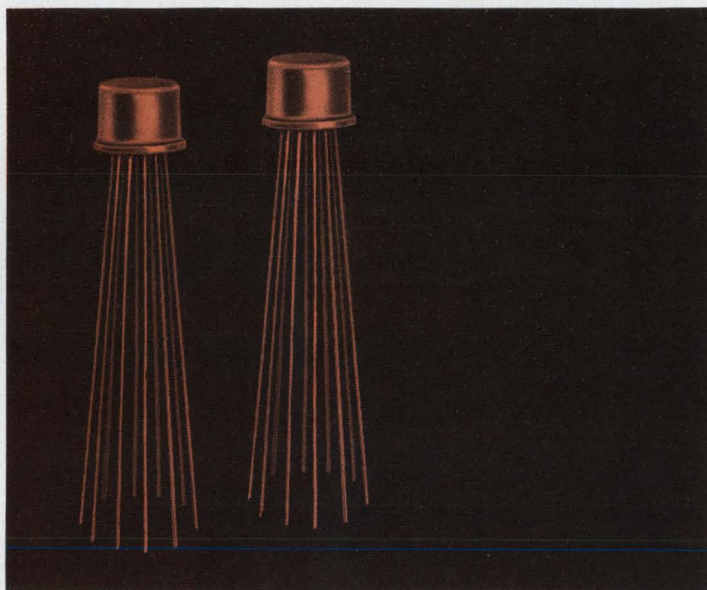

Features: • low input currents • low differential input currents • high output current capability • low standby power • TO-5 package.

Check the specifications at the right—and then get in touch with us.

Other integrated linear amplifiers. Also available from NSC are: a versatile *audio amplifier*—with efficient operation from 1 mW to over 50 mW out-

put . . . a two-stage, wide band *video amplifier*, with extremely constant gain

characteristics . . . and a line of *integrated choppers*.

SPECIFICATIONS	NS 7560	NS 7560 A
High Open Loop Voltage Gain (Typical)	2000	5000
High Loaded Output Voltage Swing (RL equal 100 Ω)	-5 to +5 v	-5 to +5 v
Low Input Offset Voltage (Maximum)	10 mv	3 mv
Low Input Offset Voltage Temperature Coefficient (Maximum)	20 μ v/ $^{\circ}$ C	10 μ v/ $^{\circ}$ C
Low Input Bias Current (Maximum)	100 na	25 na
Low Differential Input Current (Maximum)	50 na	2 na
Low Input Temperature Coefficient (Max.)	2 na/ $^{\circ}$ C	1 na/ $^{\circ}$ C
Low Standby Power (Typical)	60 mw	60 mw



NATIONAL SEMICONDUCTOR CORPORATION, DANBURY, CONN.
(203) 744-0060

Extra transistor gives Schmitt monostable multi capabilities

The addition of one transistor to an ordinary Schmitt trigger transforms it into a circuit with the functions of both the Schmitt and a monostable multivibrator. This new circuit has a number of advantages over the two standard circuits that it combines:

- The input signal may now drop below the triggering level once action has started, because the circuit is regenerative.
- The offset inherent in the standard Schmitt is negligible in the new circuit.
- The duty cycle is greater than 98%, because recovery is through a low impedance.
- Fast turn-on and turn-off occur because of the complementary configuration.
- The timing is relatively independent of supply voltage.

In the modified circuit (see schematic), *P1* sets the triggering point. Transistor *Q1* is normally OFF and *Q2* and *Q3* are normally ON. *C2* is charged to the supply voltage minus three diode drops. When the input signal exceeds the bias needed to turn ON *Q1*, *Q2* turns OFF. A negative step is transmitted through *C2* and turns OFF *Q3*. *D3* is added to avoid breaking down the base-emitter junction of *Q3*. The reverse bias turning *Q3* OFF is about 5 volts.

If the input signal drops out before the timing cycle is ended, *Q1*'s turning OFF would tend to turn ON *Q2*. However, *Q3* is OFF and the current provided by *R3* is drained through *D4* and *R9*, thereby maintaining *Q2* in a cut-off state. This current through *D4* and *R9* causes an offset of 260 mV which is negligible in most applications.

The turn-off time is rapid (200 ns) because of the negative step transmitted through *C2* which, when *Q2* cuts off, backbiases *Q3*. The turn-on due to the regeneration of the circuit is extremely fast (40 ns), because, when *Q3* turns ON, *Q2* also turns ON, providing overdrive base-current to *Q3*.

The duty cycle of the circuit is greater than 95 per cent because *C2* recharges through the satu-

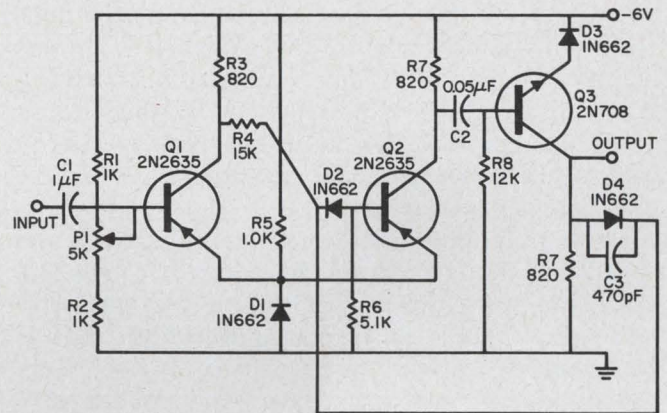

Monostable-Schmitt trigger, a "dual-type" multivibrator, is made by the addition of one extra transistor stage to the standard Schmitt circuit. The result—less stringent input requirements, negligible offset, higher duty-cycle capabilities, faster turn-on and turn-off, and greater immunity to power supply variations.

rated impedances of *D3*, *Q3*, *Q2* and *D1*. The presence of *C3* across *D4* improves the turn-on of *Q2* by overdriving its base when *Q3* turns ON. *D1* minimizes the hysteresis of the circuit and speeds up the recovery of timing capacitor *C2*.

The length of time *Q3* remains OFF is determined by observing that the initial charge on capacitor *C2* in steady state will be:

$$V_{init} = V_{cc} - 3V_d - V_{sat} \quad (1)$$

At the instant of switching, the collector of *Q2* will drop to:

$$V_{Q2} = V_{cc} R8 / (R8 + R7), \quad (2)$$

which is approximately equal to V_{cc} . This negative step will be transmitted through *C2* to the base of *Q3*, turning *Q3* OFF. *Q3* will then remain OFF until the potential at its base is raised to $V_{cc} - 2V_d$. Therefore the length of time that *Q3* remains OFF is:

$$t_{off} = R_T C2 \ln \left\{ \frac{[V_{cc}(1 + \alpha) - 3V_d - V_{sat}]}{(V_{cc} - 2V_d)} \right\}, \quad (3)$$

where $R_T = R7 + R8$. If the diode drops are neglected and $\alpha \approx 1.0$, then the time *Q3* remains OFF is:

$$t_{off} \approx 0.69 R_T C2. \quad (4)$$

There are a number of applications in which this circuit might be used—frequency division,

VOTE! Circle the Reader-Service-Card number corresponding to what you think is the best Idea-for-Design in this issue.

SEND US YOUR IDEAS FOR DESIGN. Submit your IFD describing a new or important circuit or design technique, the clever use of a new component, or a cost-saving design tip to our Ideas-for-Design editor. If your idea is published, you will receive \$20 and become eligible for an additional \$30 (awarded for the best-of-issue Idea) and the grand prize of \$1000 for the Idea of the Year.

frequency measurement, shaping and pulse stretching, and generating clean pulses from a switch in the presence of bounce.

The monostable Schmitt is particularly useful in frequency-division applications. The fast recovery of the timing capacitor provides reliable frequency division to ten; whereas the standard monostable's limit stops at division by four.

In frequency-measurement uses, because the pulse width is independent of frequency, the duty cycle will be proportional to frequency. The output can be fed to a meter calibrated to give a direct linear measure of frequency. With a proper metering circuit, this technique of frequency measurement can be made exceptionally sensitive to frequency variations.

In shaping and pulse-stretcher applications, the circuit is useful as a pulse generator. It converts a harmonic wave into a square wave with good rise and fall time and an output pulse width that is independent of input pulse width.

Mechanical switches have the undesirable feature of bouncing contacts which play havoc with logic circuitry. This circuit can be designed so that the timing will be long enough for the last bounce to end before the timing cycle ends. The circuit thus generates a clean pulse free of bounce, with fast edges for triggering of logic circuitry.

Gilbert Marosi and Neal Vinson, Design Engineers, Link Group, General Precision, Inc., Sunnyvale Calif.

VOTE FOR 110

Second-breakdown testing need not be destructive

Here is a relatively simple circuit for the non-destructive testing of silicon npn transistors in the open-base condition. Designed for use with a Tektronix 575 curve tracer, the circuit gives a vital index of over-all device capability.

Every transistor when swept to a high enough collector current will show second breakdown. The trick is to sweep the transistor to its maximum collector current, or second breakdown point, without destroying or partially damaging the device.

In the test circuit (see schematic) Q2 and Q3 are in the conducting state because of the base current supplied by V1 through R1, R2 and R3; Q1 is OFF. The voltage drop across R3 due to the base current of Q2 is not sufficient to exceed the Zener voltage of D2; that is why Q1 is nonconducting. D1 is used to block the voltage of the curve tracer and keep the curve tracer current from flowing over V1 and R3. D3 is used to block

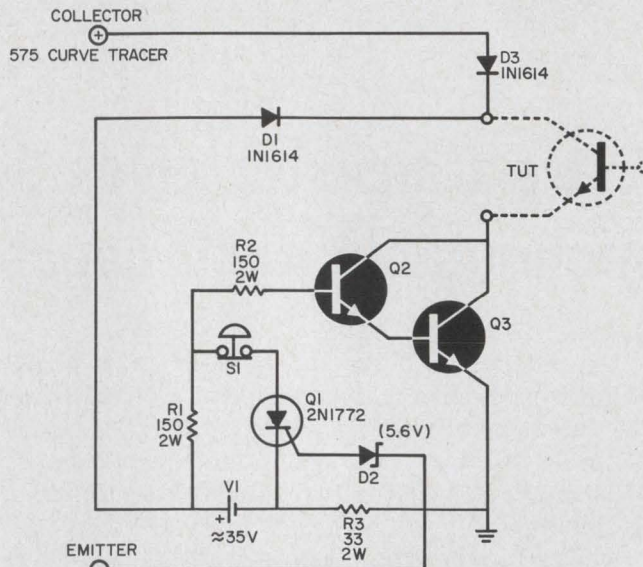

575 CURVE TRACER
Circuit tests second-breakdown of transistors without any danger of device damage. Transistor Q2 and Q3 absorb excess test energy; TUT refers to transistor under test.

the voltage of V1 and keep its current from flowing over the curve tracer.

The transistor under test (TUT) is placed in the socket and the voltage across it increased until the device avalanches and reaches its second-breakdown point. When this occurs, the voltage of the test transistor drops rapidly toward a low value. When this voltage reaches that of V1, current from V1 starts to flow over D1, the TUT, Q2, Q3 and R3.

This continues until the current through R3 is sufficient to supply a voltage drop high enough to exceed the Zener voltage of D2. When this happens, gate current flows through Q1, triggering it. Q1 now becomes a low impedance path, which decreases the base current of Q2-Q3. Base current will no longer flow over the much higher impedance of R2; Q2, and Q3 are thus turned OFF. Q2 and Q3 then block the current and drop most of the voltage of the curve tracer, hence protecting the TUT from destruction. Before starting the next measurement the voltage of the curve tracer is reduced to zero and Q1 is reset via S1.

Robert Bolvin, Applications Engineer, Bendix Semiconductor Div., Holmdel, N. J.

VOTE FOR 111

Raysistor-bipolar network protects auto starter

A simple, inexpensive circuit employing a Raysistor and three bipolar transistors prevents electrically induced damage to an automobile's

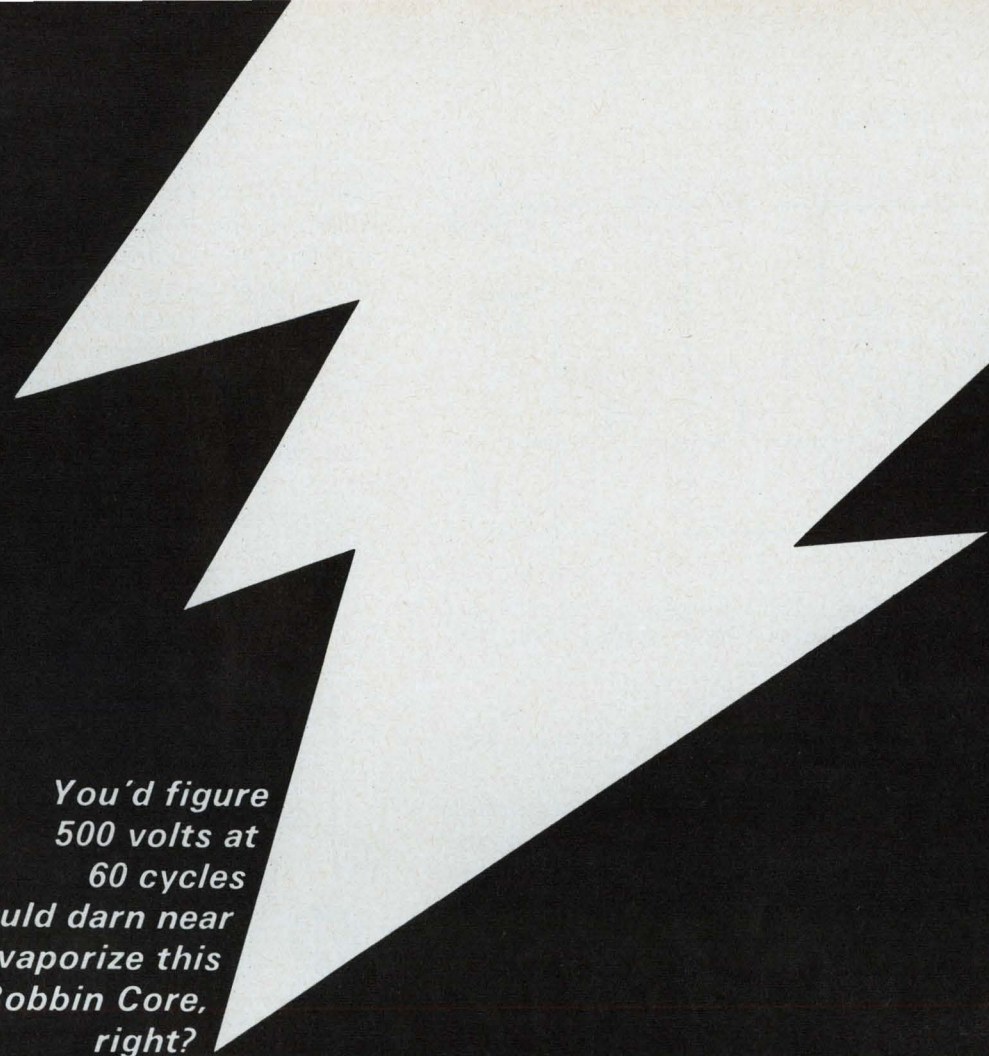

*You'd figure
500 volts at
60 cycles
would darn near
vaporize this
M.A. Bobbin Core,
right?*



Wrong! Its got GVB*. Even at more than 1500 volts, tests show no breakdown on M.A. bobbin cores with GVB. In addition to guaranteeing the core's ability to withstand at least 500 volts between bare winding and bobbin, GVB finish also seals the bobbin to withstand a ten-inch mercury vacuum.

It seals against potting material, provides a resilient, non-slip base for winding, and its epoxy skin protects the core against wire cuts. Abraded wire problems are eliminated and no prior taping is required.

GVB has proven itself on thousands of cores . . . and now Magnetics has applied it to the bobbin core, the

miniature workhorse of computers, high frequency counters, timers, oscillators, inverters and magnetic amplifiers.

Made from ultra-thin permalloy 80 and Orthonol® (0.001" to 0.000125"), Magnetics' bobbin cores are available in tape widths from 0.023" to 0.250" or wider on request. Core diameters range down to less than 0.100" with flux capacities down to several maxwells.

For more information on GVB Bobbin Cores, write Magnetics Inc., Dept. ED-42, Butler, Pa. 16001.



*Guaranteed voltage breakdown

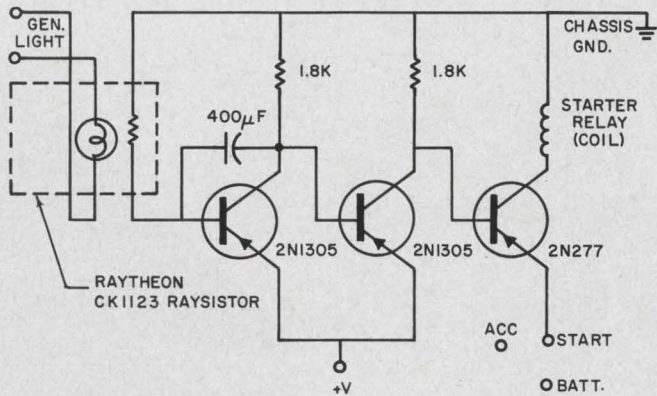

Auto-starter protection network consists of Raysistor and three bipolar stages. Starter relay is isolated from "double-start" inducers.

starter or fly wheel. The network functions as a "positive disconnect."

With automatic transmissions, double starting may occur in either the park or neutral gears. With manual-type shifts, double starting may occur in any gear. In either case, this phenomenon results in mechanical wear and if it arises often enough, eventual breakage of the starter parts.

With the safety circuit (see schematic), the key switch is disconnected from the starter relay and the Raysistor isolates the car regulator whenever the car has started. Thus when the ignition key is inadvertently turned on again, the engine is precluded from overdriving the starter. Here is the circuit operation in detail:

When the key is first turned to the ON position, current flows through all stages but the one containing the starting relay. When the generator light comes ON, this remaining stage conducts. The starter relay functions and remains closed until the generator light goes out. The Raysistor impedance change then shuts down the network stages, including, of course, the one containing the starter relay. The auto, which is now running, thus cannot experience a double start.

Daniel Seltzer, Circuit Designer, Cox Coronary Heart Institute, Dayton, Ohio.

VOTE FOR 112

Dc-bootstrapped UJT circuit has linear, variable output

A circuit was needed that would provide a sawtooth of current with excellent linearity under both varying loads and changing supply voltages. It was also necessary to control both the ac and dc components of the load current. A dc-boot-

strapped UJT generator filled the need.

When a capacitor is charged through a constant current source, a linear ramp is developed. However, any parallel path of current flow will introduce an exponential component to the capacitor's voltage ramp. If a high-impedance amplifier is driven with the ramp and an in-phase voltage is fed back to the constant-current source, a useful, highly linear ramp is generated at the collector of the amplifier.

In the circuit (see schematic) the unijunction transistor has been added to make a free-running sawtooth generator. The ramp across the timing capacitor is applied to the base of a split-load

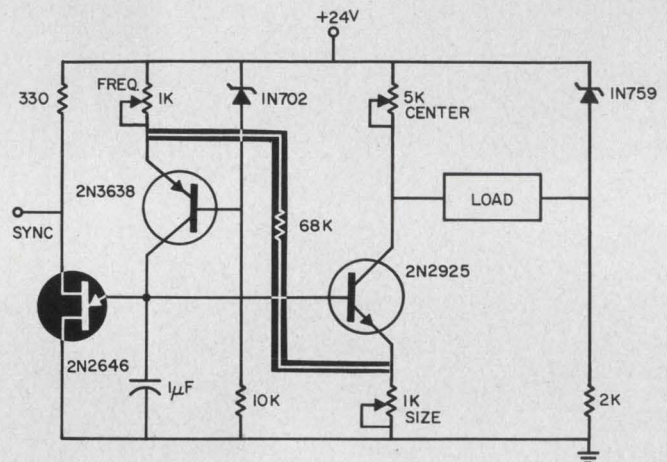

UJT added to high-impedance amplifier in a dc-bootstrapped configuration and feedback arrangement provide circuit with a linear, variable-output capability.

amplifier. The sampling voltage is taken from the amplifier's emitter and returned to the constant-current source transistor. Amplifier current gain is controlled by the resistance in the emitter of the amplifier. Dc positioning of the ac component is accomplished by making the amplifier transistor and its collector resistor one-half of a balanced bridge, with the load connected across the bridge.

Parker R. Cope, Manager, of Electronics, and Jack D. Ferrall, Associate Engineer, Maryland Telecommunications, Inc., Cockeysville, Md.

VOTE FOR 113

IFD Winner for May 24, 1966

James J. Klinikowski, Design Engineer, Burroughs Corp., Plainfield, N. J.

His idea, "SCS and UJT form count generator," has been voted the \$50 Most Valuable of Issue Award.

Cast Your Vote for the Best Idea in this Issue.

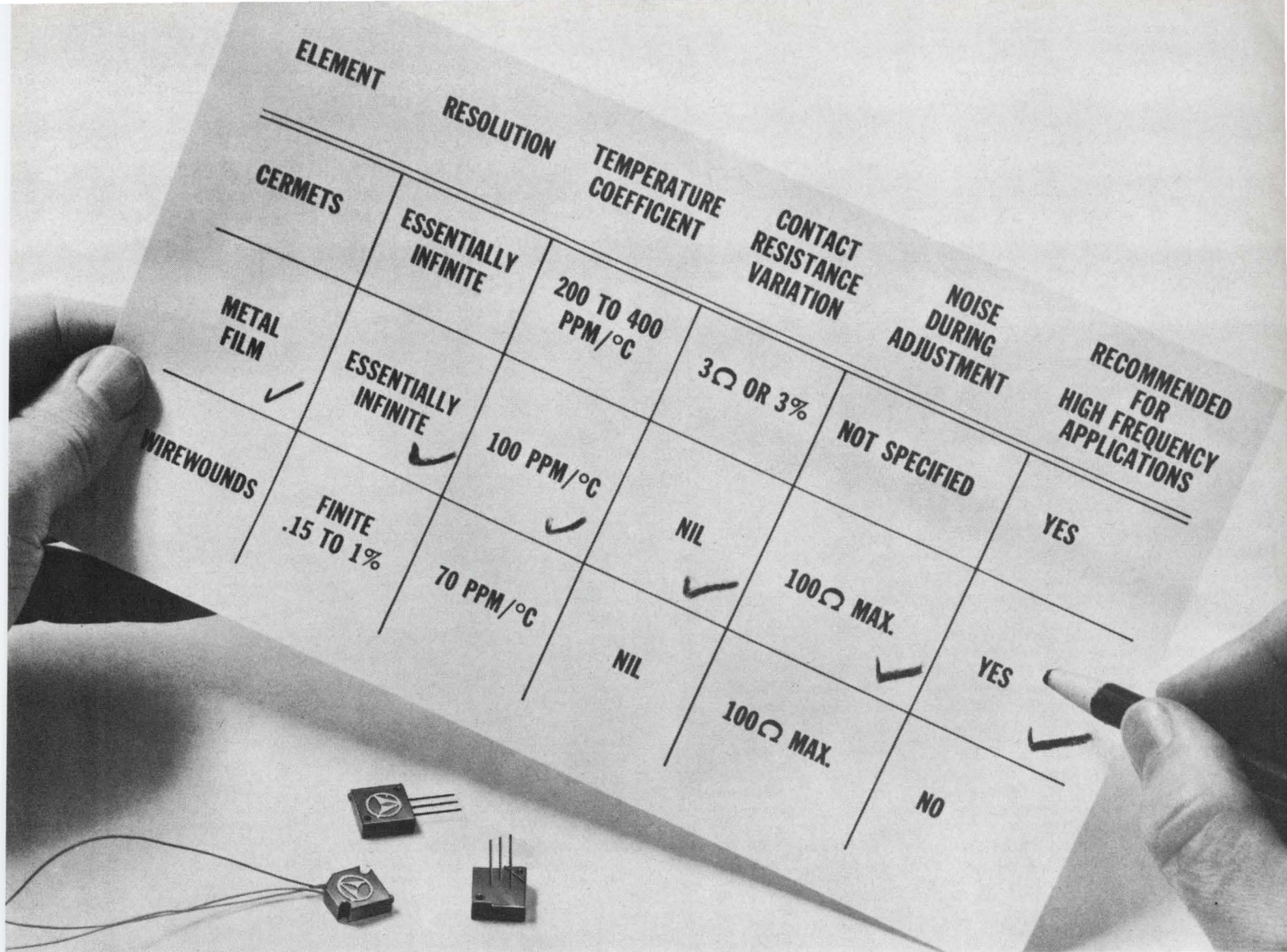

Amphenol metal-film trimmers outperform cermets and wirewounds

Compare metal-film trimmers to cermets and wirewounds and you get a picture like the one above. It makes a convincing story for Amphenol metal-film.

First note that Amphenol metal-film provides the temperature coefficient and noise characteristics of wirewound trimmers. (Check the high TC and noise levels of cermets.) Next note that metal-film offers the essentially infinite resolution of cermets.

Put the two together and you've got yourself quite a trimmer—one, for example, like Amphenol's 2901 metal-film trimmer. It's the only infinite resolution trim-

mer with a TC as low as 50 ppm/°C and zero noise level at the trimmed position. You just set it and forget it.

Other features of the half-inch square 2901 include a humidity-, vibration- and shock-proof case (it maintains setting through 50 g's). Silicon "O" Ring shuts out dust and humidity. Precious metal contact assures low contact resistance.

The 2901 is now available from your Amphenol Industrial Distributor. For more technical information, call your Amphenol Sales Engineer. Or write us in Janesville, Wisconsin.

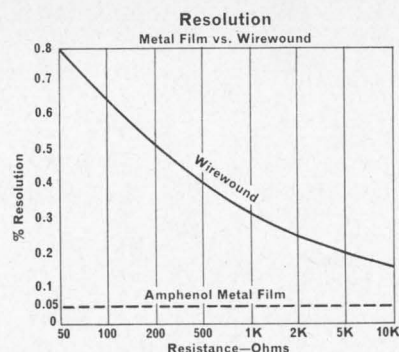

NEW LOW-OHM VALUES

Amphenol has just added three new low-ohm values—50, 100, and 200 ohms. The chart above shows how wirewound trimmers lose resolution rapidly in the lower ohmic values. Yet metal-film maintains infinite resolution across the entire resistance range.



AMPHENOL CONTROLS DIVISION
AMPHENOL CORPORATION

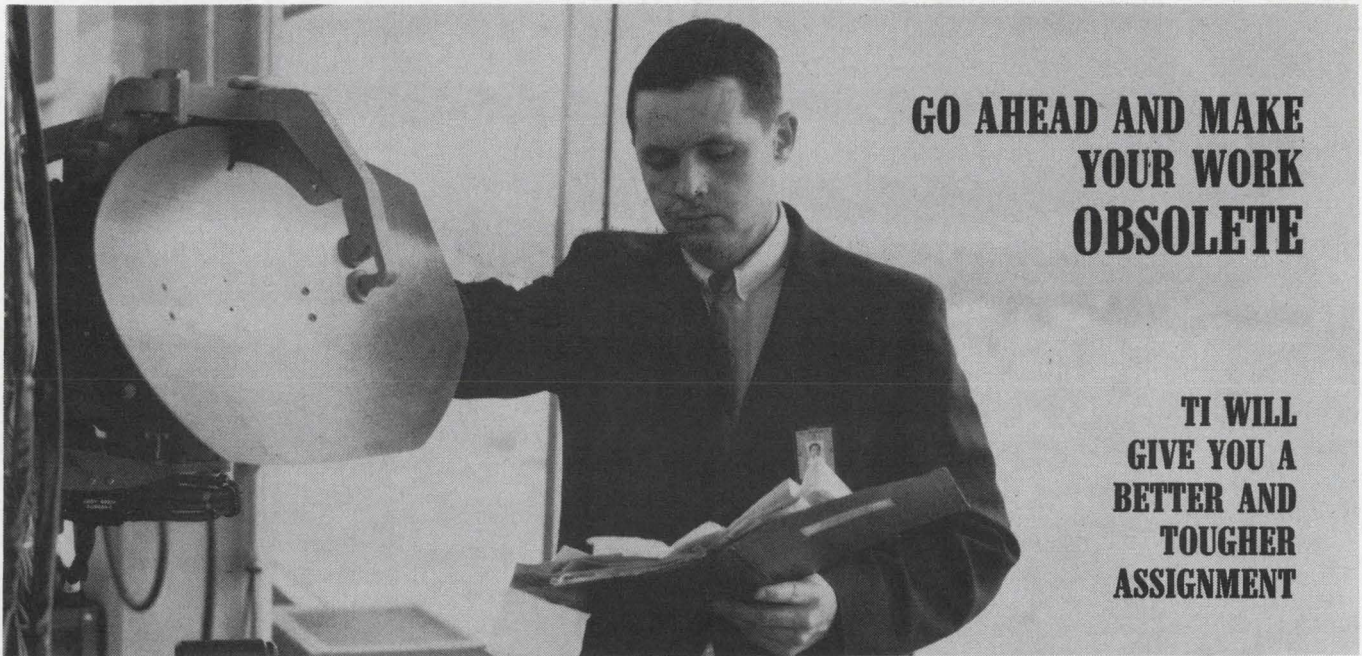

**GO AHEAD AND MAKE
YOUR WORK
OBSOLETE**

**TI WILL
GIVE YOU A
BETTER AND
TOUGHER
ASSIGNMENT**

Key men at Texas Instruments deliberately and consistently are moved from one kind of job category to another and upward from one level to the next. This movement is not whimsical or in response to expedient pressures, but a deliberate fabric for TI growth and development. It is aimed at the self-development of the individual on the job.

In the Apparatus division, broad systems-type assignments in system and project engineering are available with an abundance of specialized in-depth assignments to develop unusual proficiency in a special area of interest. A full-fledged business diversified within itself with both government and industrial products and markets, the division provides

growth potential in many areas in addition to the individual field of specialization.

Almost immediately upon joining the Apparatus division, you will have your own area of project responsibility which will enable you to make an important contribution to the total technical effort. Experienced, knowledgeable technical and administrative support together with a unique environment fosters professional advancement.

Should you settle for less? To learn how you can grow with the Apparatus division of TI, fill in the time-saver form below. We'll send more information by return mail and the form will be held in confidence.

IMMEDIATE GROWTH OPPORTUNITIES:

Engineers
Antenna
Circuit Design
Guidance Design
Guidance System
Industrial
Manufacturing
Mechanical Design
Microwave
Radar
Weapons and Fire Control

Scientists
Detection, Sensing and Control
Infrared
Laser and Optical
Phased Array Control
Phased Array and/or Conventional Antennas
Radar Systems Synthesis and Analysis
Real Time Digital Signal Processing
Space Mission Analysis and Planning
Spacecraft Configuration Studies
Spacecraft Subsystem Design

APPARATUS DIVISION

MATERIALS
COMPONENTS
CIRCUITS
EQUIPMENTS
SYSTEMS
SERVICES



**TEXAS INSTRUMENTS
INCORPORATED**

An Equal Opportunity Employer

Mail to: Claud Kincannon, Dept. 656, P. O. Box 6015, Dallas, Texas 75222

Name _____ Phone _____

Home Address _____ City & State _____ Zip _____

Education: BS MS PhD Major Field _____

Primary Experience Area: _____ Number of Years _____

Present Position: _____

I would like to receive application form

CAREER INQUIRY - confidential

Respond to the career opportunities advertised in this issue. Fill out and send us this handy resume. **Electronic Design** will do the rest - neat copies of this form will be mailed to the companies of your choice, indicated by the circled Career Inquiry Numbers at the bottom of this page.

20

Name Home Phone

Home Address (Street) City State ZIP Code

Age U.S. Citizen Security Clearance
 Yes No

Prime Experience	Secondary Experience

Desired Salary Availability Date

Employment History - present and previous employers

Company	City, State	Dates	Title
		to	
		to	
		to	

Education - indicate major if degree is not self-explanatory

Degree	College	City, State	Dates
			to
			to
			to

Additional Training - non-degree, industry, military, etc.

Professional Societies

Published Articles

Career Inquiry Numbers:

900	901	902	903	904	905	906	907	908	909
910	911	912	913	914	915	916	917	918	919

ELECTRONIC DESIGN
 850 Third Avenue
 New York, New York 10022

what's so great about Hoffman's controlled avalanche rectifier? it's what we've got up our sleeve.

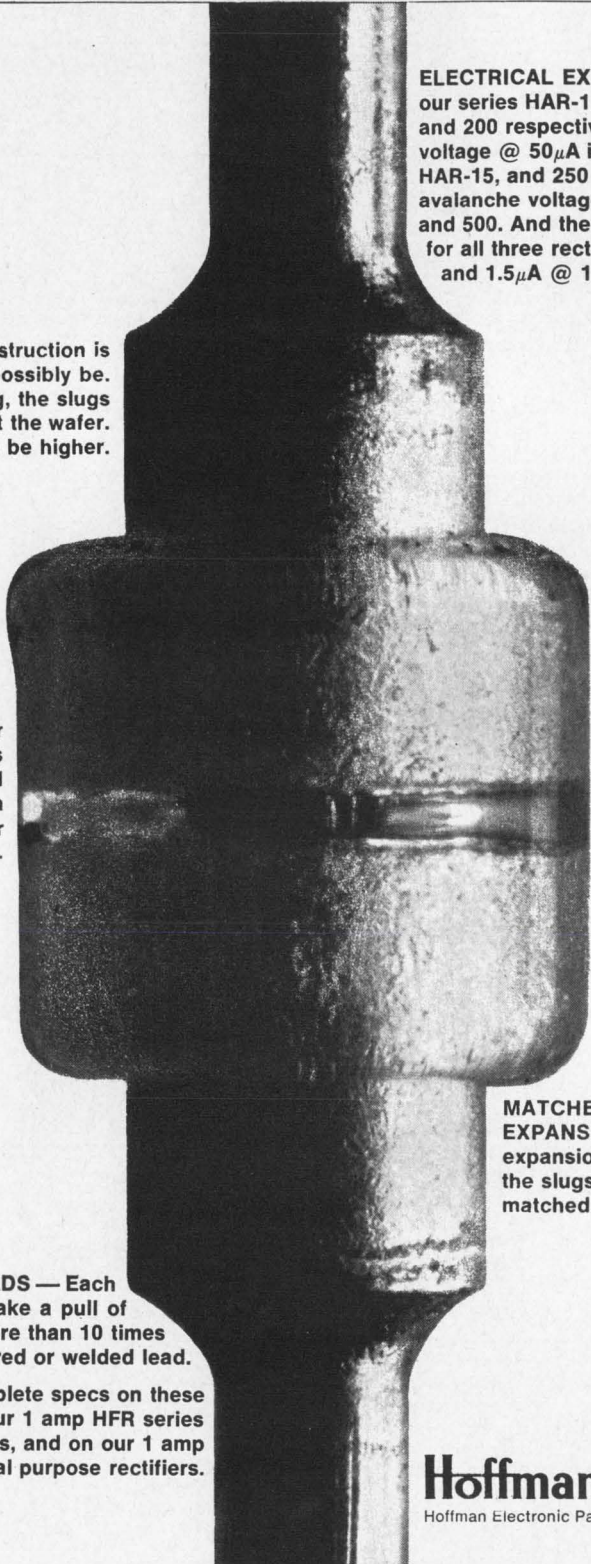

ELECTRICAL EXCELLENCE — PRV's for our series HAR-10, 15, and 20 are 100, 150, and 200 respectively. Minimum avalanche voltage @ $50\mu\text{A}$ is 125 for HAR-10, 175 for HAR-15, and 250 for HAR-20. Maximum avalanche voltage @ $500\mu\text{A}$ is 250, 350, and 500. And the maximum reverse current for all three rectifiers is $0.1\mu\text{A}$ @ 25°C , and $1.5\mu\text{A}$ @ 100°C .

BUTTED SLUGS — Construction is as simple as it could possibly be. In a body only 0.160" long, the slugs butt right up against the wafer. Reliability couldn't be higher.

PASSIVATED WAFER — Our passivating technique forms an impenetrable shield wrapped around the silicon wafer creating a lifetime barrier against electrical enemies.

COMPRESSION GLASS SEAL — No fusion of the metal-glass interface takes place. All contaminants are sealed out. No trapped impurities are sealed in. And the sleeve doesn't touch the wafer anywhere.

MATCHED COEFFICIENTS OF EXPANSION — The contraction and expansion properties of the glass, the slugs, and the wafer are matched to less than 5%.

BRAZED LEADS — Each terminating wire can take a pull of 12 lbs. This is more than 10 times the strength of a soldered or welded lead.

Ask us for complete specs on these devices; also on our 1 amp HFR series fast recovery rectifiers, and on our 1 amp HGR series general purpose rectifiers.

Hoffman Semiconductor

Hoffman Electronic Park, El Monte, California 91734 • 686-0123

Products

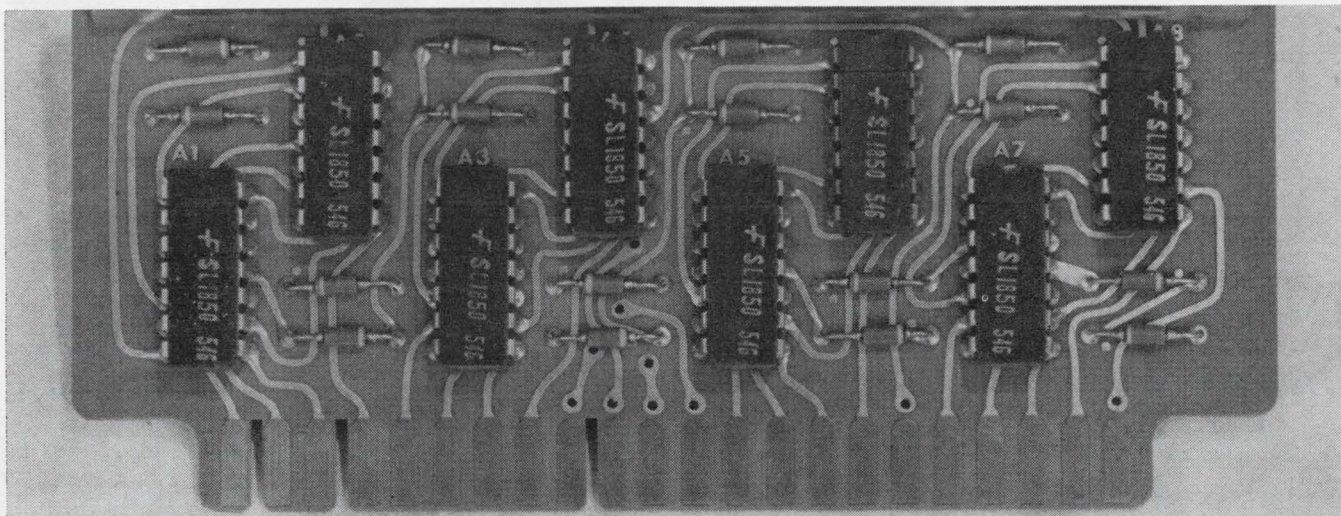

Compact DTL logic cards shrink digital sub-systems at analog costs. Page 74

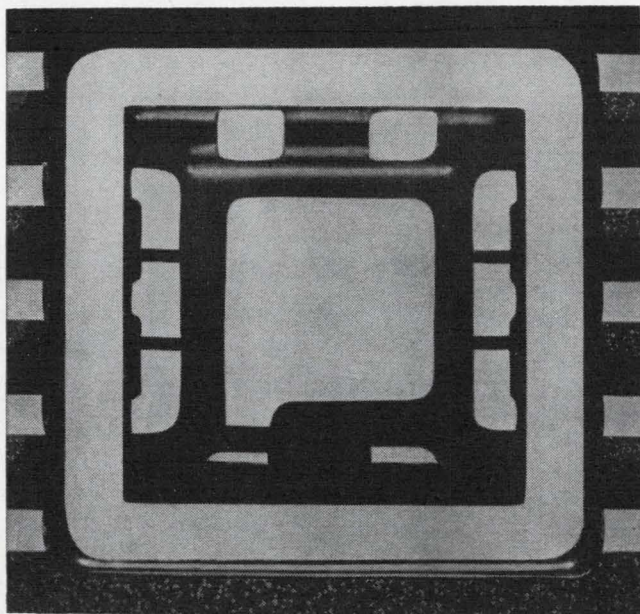

Brazed 10-lead flat-pack allows low-temperature (350°C) final production seal. Page 76



Complementary IGFETs are designed for low-power enhancement-mode switching. Page 77

Also in this section:

- GaAs Gunn-effect oscillator generates 70 mV cw in the 2- to 3-GHz range. Page 77
- Battery-powered preamp has FET input for high-Z transducers. Page 82
- Self-amplifying accelerometer is complete vibration measuring system. Page 84

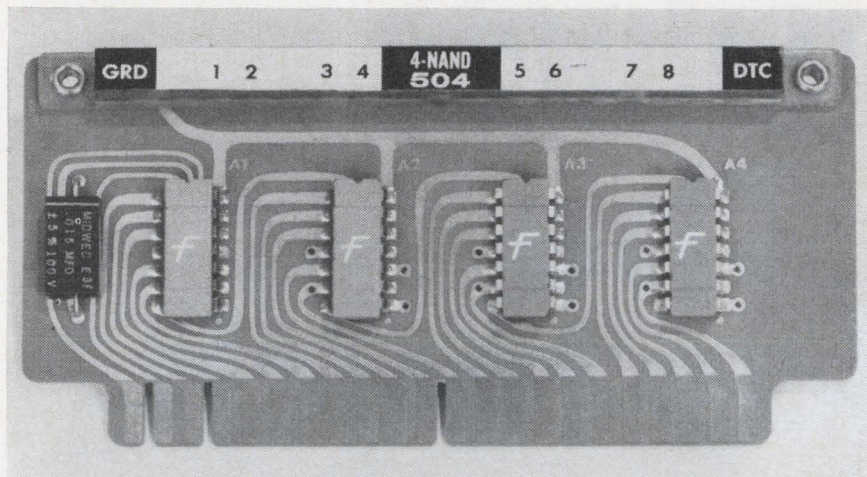

DTL logic modules shrink systems costs

A line of compact DTL logic modules makes possible digital subsystems at analog costs. The Blue Chip line reportedly costs 40% less than its predecessors. Typically, the cards measure slightly less than half the size of existing units (9.72 in.² vs 20.35 in.²).

Economies are achieved through mass production and elimination of rarely needed premium fan-out and temperature range capabilities. Series 400 cards operate over a temperature range of 0 to 50°C with a fan out capability of five standard loads. The premium series 500 cards operate over 0 to 70° with a fan-out of seven standard loads. Both are completely compatible.

All cards utilize two basic elements: the NAND and the flip-flop. All feature the ability to parallel NAND outputs (wired OR), an input threshold of 1.4V at 25°C, per-

formance to 5 MHz and $\pm 0.15\text{-}\mu\text{F}$ capacitive voltage decoupling. A single +5-V supply is used.

Other design features include photoetched 44-pin gold-plated connectors and numbered test points. Wherever feasible, provisions are made on the boards to accommodate additional collector resistors in order to increase rise time.

Card types available include inverters, NANDs (2, 3, 4 and expandable units), power NANDs, flip-flops, registers, counters, decoders, oscillators, delay multivibrators, Schmitt triggers, input/output level converters and power drivers.

High-density mounting hardware is available.

P&A: about \$40 (4-NAND); stock. Data Technology Corp., 2370 Charleston Rd., Mountain View, Calif. Phone: (415) 326-5372.

Circle No. 260

Thin film ladder network

Metal film ladder networks are fabricated with output accuracy available to 0.01% and 1 ppm/°C in a wide range of input impedances. The film resistors used offer a rise time of less than 50 ns. The completed module is vacuum transfer molded to all environmental requirements of MIL-R-55182. The LNH series features up to 14-bit

function in a module only 1.1 x 1 x 0.1875-in. Standard leads of the current summing network, suitable for soldering or welding, are #22 AWG gold plated dumet.

P&A: about \$77 for 35; 4 to 6 wks. Angstrom Precision Inc., 7811 Lemona Ave., Van Nuys, Calif. Phone: (213) 873-6130.

Circle No. 261

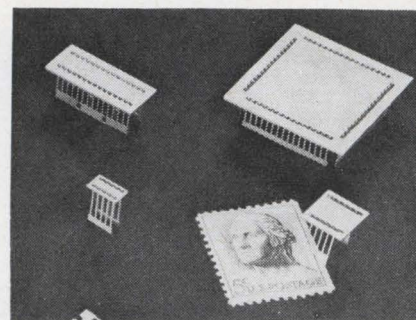

Package vies with TO-5 flat pack for single chip

Used as an axial- or peripheral-lead flat pack, "Axpaks," receive their final seal by means of a single-shot resistance weld. Their "double-duty" nature allows one ceramic or weldable package to take the place of both types of packages. The devices are primarily 50-mil centers of lead spacing unless otherwise requested. All models contain encompassed, clear, matched-glass seals in a gold-plated metal base. They provide excellent thermal dissipation with a high resistance to both mechanical and thermal shock. The final hermetic seal is achieved by a single shot resistance weld similar to that used in TO-5s. Currently stocked are a 10-lead 1/4- x 1/8-in. and a 10 or 14-lead 3/8-in.² model. The units are suitable for butt solder, strip board, planar board, through board or double-sided pocket mounting.

P&A: about \$0.44 (large volume); stock. Flying L Corp., 108 S. Saginaw Blvd., Saginaw, Texas. Phone: (817) 232-1226.

Circle No. 262

Darlington-input op-amp

With single-ended and differential outputs and a Darlington input stage permitting the use of M Ω -range scaling resistors, this op-amp is useful in general-purpose instrumentation, integration and summation. With feedback, the amplifier can be used as a transducer amplifier, preamp voltage comparator or bandpass or buffer amplifier. Differential gain is 2200V/V. Input impedance is 300 k Ω and output impedance is 40 Ω . Drift is 10 $\mu\text{V}/^\circ\text{C}$ and 1 nA/°C.

P&A: \$39.50 (1 to 49), \$29 (50 to 499); stock. Westinghouse, Molecular Electronics Div., P. O. Box 7377, Elkridge, Md. Phone: (301) 796-3666.

Circle No. 263

The Midas touch in a new solid tantalum capacitor

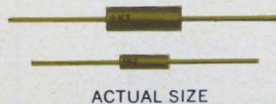

The KEMET Golden Z-Series gives you up to three times the capacitance and voltage of standard solid tantalums... cuts space requirements up to 67%. Has gold-flashed lead wires—at standard prices. Two subminiature case sizes, ideal for cordwood modules, printed circuits, and other high density packaging.

Case lengths of 0.250" and 0.375" match standard resistors and diodes... diameters of 0.085" and 0.127" are as much as 67% smaller than other solid tantalums. Other

features: excellent stability; very low leakage, dissipation factor, and impedance over a wide range of frequency and temperature. Meets electrical environmental characteristics of MIL specs C-39003 and C-26655B. Available from 0.0047 to 22 microfarads; in 6 to 125 VDC; to operate from -80 to +125°C. Want more details on the new Z-Series solid tantalum capacitors? Get the new KEMET Engineering Bulletin from our sales office or representative nearest you—or mail the coupon.

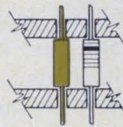
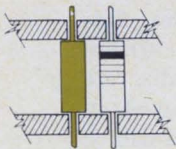

KEMET Golden Z-Series solid tantalum capacitors—sized to match resistors and diodes in cordwood modules, with maximum packing density. Case A2 (left) is 0.127" dia. x 0.375" long. Case A3 (right) is 0.085" dia. x 0.250" long.

Regional Sales Offices

East Coast: J. G. Egan, 1341 Hamburg Turnpike, Wayne, New Jersey 07472. Phone: 201-696-2710.
 Mid-Atlantic: R. H. Robecki, 1341 Hamburg Turnpike, Wayne, New Jersey 07472. Phone: 201-696-2710.
 Mid-West and South: K. S. Collart, P. O. Box 6087, Cleveland, Ohio 44101. Phone: 216-221-0600.
 West Coast: B. G. Bryant, 701 East Whittier Blvd., Whittier, California 90605. Phone: 213-698-8077.

KEMET is a registered trade mark of Union Carbide Corporation.

Clip, fill in name and title, attach to letterhead

Union Carbide Corporation
 Linde Division, Dept. ED-85
 270 Park Avenue, New York 10017

Please send Engineering Bulletin #6, on
 KEMET Golden Z-Series Polar Solid
 Tantalum Capacitors

Name _____

Title _____



ON READER-SERVICE CARD CIRCLE 22

**Isolation from
high-speed line transients
is your assurance
of ultimate performance**

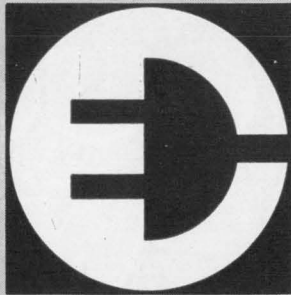

The ELGAR family of AC Line Conditioners eliminate high-speed transient disturbances, provide near-perfect isolation of equipment and assure design performance for a single instrument or complete system. Applications for ELGAR Line Conditioners are nearly as numerous as the applications of AC power—from laboratories to industrial process control, from standards and calibration work to infrared, electro-optical or nuclear research.

Circle our number on the reader reply card or write us direct. An ELGAR representative will provide demonstration proof in your application.

SPECIFICATIONS

Input: 95 VAC to 135 VAC, 47 cps to 420 cps
Output: 115 VAC, 1 KVA to 5 KVA
Response Time: Less than 50 microseconds
Regulation: $\pm .05\%$ (line & load)
Output Harmonics: Less than .25%
Input/Output Isolation: 100 db

230 VAC Models Available On Request



PRECISION POWER BY

ELGAR
CORPORATION

8046 ENGINEER RD., SAN DIEGO, CALIFORNIA 94111
TELEPHONE: AREA CODE 714 279-0800

ON READER-SERVICE CARD CIRCLE 23

MICROELECTRONICS

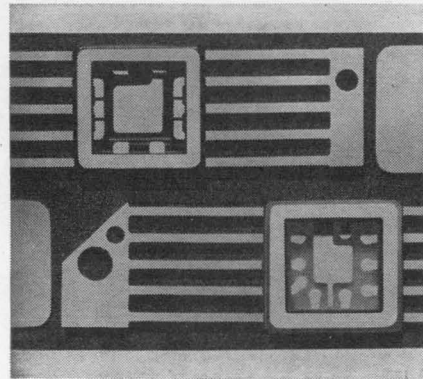

Brazed flat packs for low-temperature seal

IC packages can be final sealed in standard production belt furnaces at temperatures as low as 350°C with this brazed "Flat-Pak." The 1/4-in.² 10-lead brazed packages are available in flush and recessed pad versions. The all-glass packages have gold-plated Kovar frames and lids which can be brazed with either gold, germanium, eutectic preform (88% gold, 12% germanium) or gold-tin eutectic preform (80% gold, 20% tin).

GTI Corp., 725 Branch Ave.,
Providence, R. I. Phone: (401) 831-
6800. *Circle No. 264*

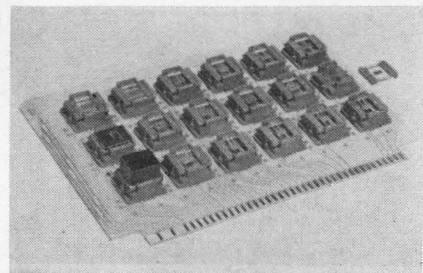

Interconnect system

Employing a standard carrier and connector, this interconnect system is a welded subassembly of devices encapsulated in a header compatible with the connector.

Flatpack ICs in carriers, program and switching modules, flatpack dual transistors in carriers and flatpack monolithic and discrete diode arrays can be employed in plug-in module configurations. Printed wiring patterns may be changed by a programming module which establishes a wiring layout. This layout is completed by plugging in a coded programming module.

Texas Instruments, 34 Forest St.,
Attleboro, Mass. Phone: (617) 222-
2800. *Circle No. 265*

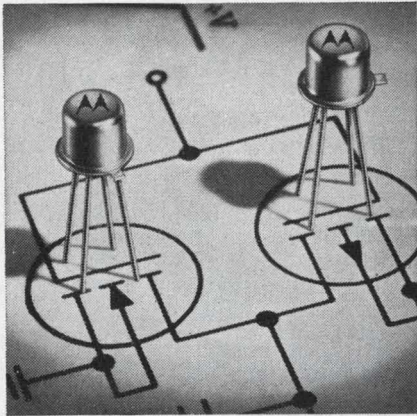

Complementary IGFETs

An EIA-registered complementary pair of insulated gate field-effect transistor switches are designed for enhancement mode operation in low-power switching applications. The 2N4351 is an n-channel enhancement-mode IGFET to be used with the complementary 2N4352. I_{DSS} is 10 nA dc for the 2N4351 and 5 nA dc for the 2N4352 with 0 V on the gate for low power drain in the "off" condition. Maximum channel resistance of 300 Ω (2N4351) and 600 Ω (2N4352) and a specified maximum on V_{DS} (on) of 1 V for the 2N4351 and 3 V for the 2N4352 assure low FET dissipation in the "on" condition. The pair provide a large fan-out capability and almost no loading of the driver. Forward transfer admittance (y_{fs}) is 1000- μ mho. Drain-to-source breakdown voltage for each device is 25 Vdc and -25 Vdc. The devices are packaged in a TO-72 can.

P&A: \$4.50 (over 100); stock. Motorola Semiconductor, P. O. Box 955, Phoenix. Phone: (602) 273-6900.

Circle No. 266

High-gain transistor

This npn silicon planar epitaxial transistor has a gain-bandwidth product of 1500 MHz typically and h_{FE} of 100 at 2 and 20 mA. Noise figure is 3.4 dB at 200 MHz and 4.5 dB at 450 MHz. Typical intermodulation distortion rating is -53 dB. Collector capacitance is 1.5 pF max and collector saturation voltage is 0.25 V max. Applications include use in small signal RF amplifiers, telemetry and test equipment.

Amperex Electronic Corp., Slattersville, R. I. Phone: (401) 762-9000.

Circle No. 267

Power SCRs

The new power silicon controlled rectifiers in TO-66 cans are designed for average loads up to 3.2 A. The 2N3228 (200 V) and 2N3525 (400 V) units are for use in 120 and 240 V line supplies respectively. Each handles one-cycle surge currents of up to 60 A.

P&A: under \$1; stock. Transistron Electronic Corp., 168 Albion St., Wakefield, Mass. Phone: (617) 245-4500.

Circle No. 268

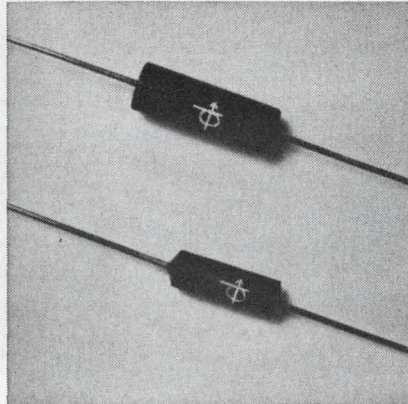

Silicon resistors

Encapsulated silicon resistors in 1/8- and 1/4-W packages range in value from 10 Ω to 2.2 k Ω and offer a positive temperature coefficient of $\pm 0.7\%/^{\circ}\text{C}$. The resistors are available in two series having standard tolerances of 20%, 10% and 5%. Axial leads are #22 AWG nickel-clad copper. As temperature compensating elements, typical stabilizing applications include gain in amplifiers, sensitivity in transducers, frequency in oscillators and pulse width in pulse generators.

Dickson Electronics Corp., 310 S. Wells Fargo Ave., Scottsdale, Ariz. Phone: (602) 947-5751.

Circle No. 269

Germanium diodes

For computer and switching circuit applications, these gold-bond diodes are packaged in a DO-7 glass case. The units are rated at 200 mA at 1 V forward current. Leakage is 100 mA at 50 V, voltage is 125 PIV and capacitance is 1 pF. Maximum temperature is 90 $^{\circ}\text{C}$, power dissipation is 80 mW and peak surge current for 1 Hz is 0.5 A.

Nucleonic Products Co., Inc., 3133 E. 12 St., Los Angeles. Phone: (213) 268-3464.

Circle No. 270

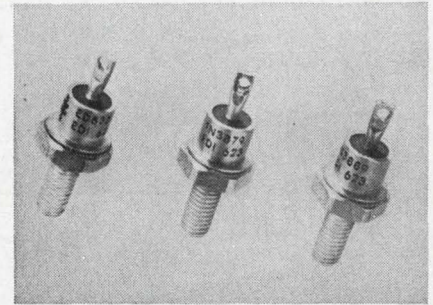

Silicon rectifiers

This series of silicon rectifiers combines recovery capabilities of 100 to 200 ns with reverse ratings of 1000 V max. The 12-A units have peak reverse ratings ranging from 50 to 400 V. Both offer reverse voltages from 0.4 to 1 kV. Peak 1-kHz surge at 100 $^{\circ}\text{C}$ for 6-A types is 75 A and for 12-A types, 150 A. Dc reverse current at PIV and 25 $^{\circ}\text{C}$ is 15 μA for 6A and 25 μA for 12-A types. Static forward voltage at 25 $^{\circ}\text{C}$ for both series is 1.4 V at rated current.

P&A: \$3 to \$30; stock to 4 wks. Electronic Devices, Inc., 21 Gray Oaks Ave., Yonkers, N. Y. Phone: (914) 965-4400.

Circle No. 271

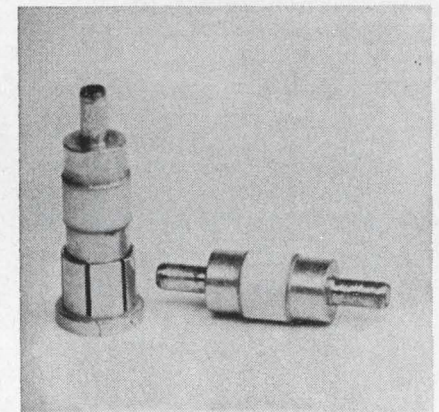

GaAs Gunn oscillator

Microwave frequencies are generated directly by these GaAs Gunn effect oscillators when dc bias is applied. The unit generates 50 to 70 mV of cw power in the 2- to 3-GHz range. Dc input range is 14 to 30 Vdc or pulse. Efficiency is 5 to 6%. Oscillations take place at a temperature of 25 $^{\circ}\text{C}$. The units can be used as local oscillators and amplifiers.

P&A: \$175; 2 to 5 wks. International Semiconductor, Inc., 1 Charles St., Newburyport, Mass. Phone: (617) 465-9302.

Circle No. 272

Life before the PVB

Mr. Sy Rubin—Quality Assurance Manager of United Aero Test Laboratories, Deer Park, N. Y.—describes his working life before and after our Model 300 PVB (Portametric Voltmeter Bridge).



"Before the PVB, the same measurement capabilities would have cost us thousands."

"We're one of the largest testing labs in the country with complete metrology labs on the East and West coasts. As we grow, our calibration work keeps increasing. Invention of the PVB saved an outlay of many thousands of dollars. For \$750, we answered many of our needs in this single portable instrument.

"I use the PVB for all dc calibrations on the order of a half percent. We calibrate our environmental chambers with it using a certified thermocouple. It's also handy for digital voltmeters, to assure one digit resolution, and for ac measurement with thermal transfer equipment.

"For anyone with calibration responsibilities, I'd say the PVB has the all-round usefulness of an MD's little black bag." *ESI, 13900 NW Science Park Drive, Portland, Oregon (97229)*

In a single battery-operated unit, the PVB combines the functions of a potentiometric voltmeter, voltage source, ammeter, guarded Kelvin double bridge, resistance comparison bridge, ratiometer and electronic null detector. Accuracy: $\pm 0.02\%$ of reading or 1 switch step on virtually all ranges.

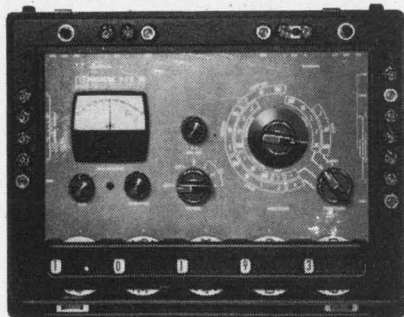

esi[®]

Electro Scientific Industries, Inc.

ON READER-SERVICE CARD CIRCLE 38

MATERIALS

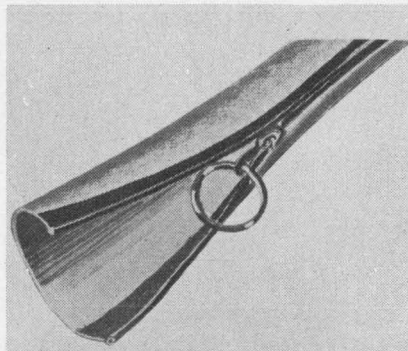

Cable jacketing

Using this flexible cable jacketing, cable can be reworked, modified or repaired by unzipping and re-zipping the track. Type VNH "Zipper-tubing" is an abrasive-resistant jacketing made from vinyl-impregnated nylon cloth and has a temperature range from -40 to 221°F . Jacketing is resistant to oils, aromatic hydrocarbons, accelerated weathering, moisture and flame.

Zippertubing Co., 13000 S. Broadway, Los Angeles. Phone: (213) 321-3901.

Circle No. 273

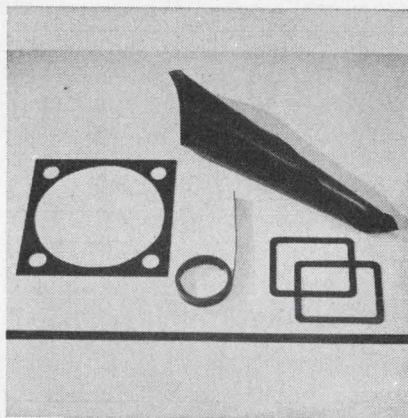

Conductive plastic sheet

A moderate amount of RF shielding is provided by this conductive plastic sheet when used as a flat gasket. Flexible and tough, it is resistant to jet fuel and common hydraulic fluids and has a volume resistivity of $5 \Omega\text{-cm}$. As a gasket this material provides a hermetic seal as well as an RF seal. It can be joined to itself or to metals, ceramics, glass and plastic. It can also be butt-joined for greater lengths or continuous loops.

Price: \$5 to \$12/ft². Emerson & Cuming, Inc. Canton, Mass. Phone: (617) 828-3300.

Circle No. 274

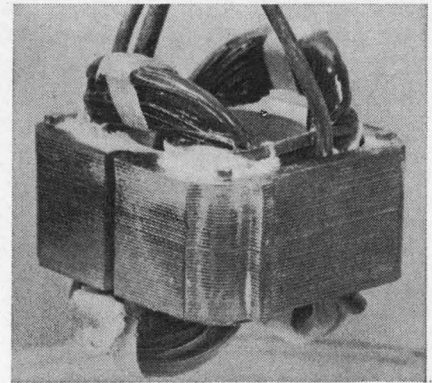

Powdered epoxy resins

This series of powdered epoxy resins impregnates and encapsulates coils and windings by resistance heating. Number 265 is a clear low melt viscosity powdered epoxy system. Numbers 262 and 263 have good cut-through resistance. A current of 5 to 40 A applied for 15 to 20 s melts and cures the powdered resin which is then applied by spraying or immersion in a fluidized bed. Then, a protective coating of one of the encapsulating resins is applied and cured by additional resistance heating or oven heating.

3M Co., 2501 Hudson Rd., St. Paul. Phone: (612) 733-4033.

Circle No. 275

Anti-static computer tape

An anti-static property is built into this computer tape to eliminate the use of surface dopes and coatings. The grit-free tape requires no oiling. Tensile strength is 8.53 kg/cm, tear strength in machine direction is 70 to 80 gm and in cross direction is 80 to 90 gm. Electrostatic conductance is 830 p Ω /cm.

Price: \$0.48 to \$0.68 per spool. Thames Paper Supplies Ltd., 13-21 Curtain Rd., London E.C.2, England.

Circle No. 276

Polyimide film

A transparent amber-colored film "Kapton" has no commercial solvent and won't melt. Dielectric strength at 25°C is 7000 V/mil and dielectric constant is 3.5. Dissipation factor is 0.003, volume resistivity is $10^{15} \Omega\text{-cm}$ and surface resistivity $10^{16} \Omega$. Corona start voltage is 465 V/mil and insulation resistance is 100 G Ω .

E. I. DuPont DeNemours & Co., Wilmington, Del. Phone: (302) 774-1000.

Circle No. 277

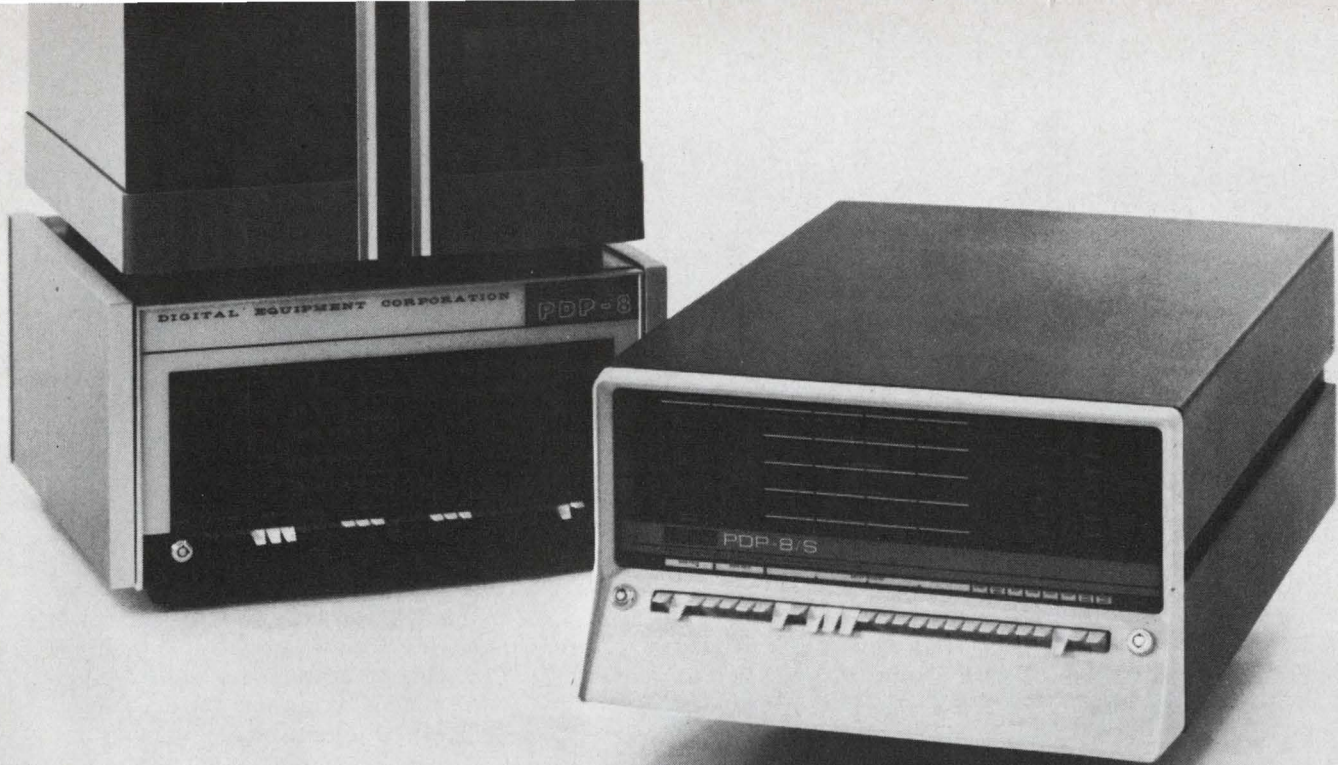

And Now, the \$10,000 Computer

PDP-8/S: A new high speed general purpose digital computer. Modular construction for repackaging. Field proven reliability. 4,096 word core memory. Microsecond speeds. Complete software including FORTRAN. Flexible input/output bus. Deliverable 90 days ARO. Teletype included.

The single unit price for the PDP-8/S is \$10,000, and there are liberal OEM discounts for multiple units.

Designed to be used in instruments or systems, the PDP-8/S can be rack mounted or repackaged.

The new PDP-8/S is a close relation of DIGITAL's PDP-8, the most successful on-line, real time computer in the history of the scientific community. At a base price of \$18,000, more than 500 PDP-8 systems have been sold. Its success results from a design concept that makes it the most flexible, versatile, adaptable digital computer ever made.

The PDP-8/S uses the same programs, the same instructions, the same operations, and the same basic design as the parent PDP-8. It has the same size memory, is equally expandable, and indeed, uses the same line of modules and components.

But the PDP-8/S is a bit slower. It takes 32 microseconds to add. For process control and analysis, you probably won't even notice.

But you'll notice the price.

digital
COMPUTERS • MODULES

TEST EQUIPMENT

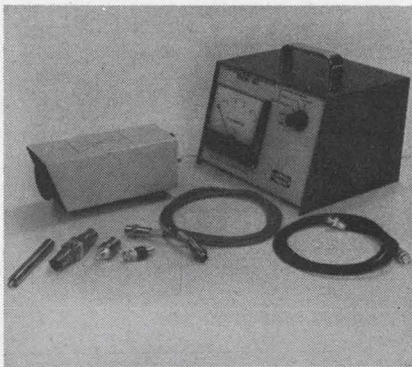

Calorimeter

Cw and pulsed laser outputs can be measured by this calorimeter. Model LA31 can be used with laser emission from 2000 to 12,000 Å with appropriate detector tubes. Power measuring range is 1 μW to 10 GW peak or average. With a Tektronix 519 scope, pulses having rise times of 0.3 ns can be viewed. Cw power can be read out on a power meter in the control head or by connection to scopes.

P&A: \$2000; 60 days. Raytheon Co., 130 Second Ave., Waltham, Mass. Phone: (617) 862-6600.

Circle No. 278

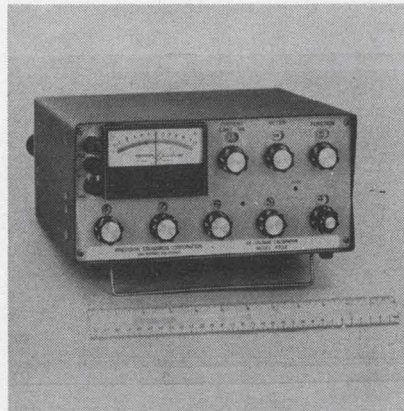

Dc voltage calibrator

Output setting accuracy of this dc voltage calibrator is ±0.5% +5 mV from 0 to 1.1 kVdc at 0 to 30 mA. Regulation no load to full load is 0.005% +2 mV and regulation for a 10% line change is 0.005% +1 mV. Zener references provide accuracy and stability of 30 ppm/hr and 50 ppm/200 hr. The unit has a front panel current limit control for the 5- to 30-mA range. Ripple is 1 mV rms and resolution is 100 μV.

Precision Standards Corp., 2663 N. Lee Ave., South El Monte, Calif. Phone: (213) 448-6254.

Circle No. 279

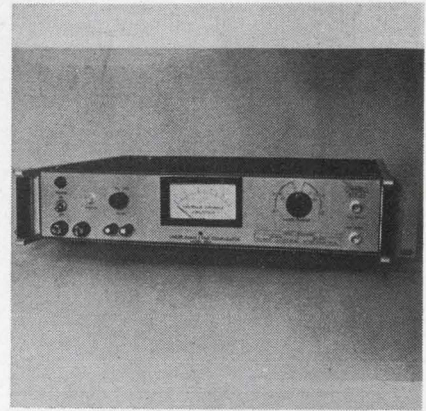

Phase/time comparator

Relative time difference between two signals is read by this linear phase/time comparator. The 895A accepts frequency signals in the 1- to 5-MHz range (in the Δt mode) or of a different nominal frequency without changing or abridging the scale of the resulting record. Input frequencies are 1 Hz to 1 MHz in the Δθ mode and any integer sub-multiple of 10 MHz from 100 kHz to 5 MHz in the Δt mode.

P&A: \$950; 30 days. Tracor, Inc., 6500 Tracor La., Austin, Tex. Phone: (512) 926-2800.

Circle No. 280



*Quality and economy
in servo motors
and motor-tachs
depend on the
manufacturer's
experience*

...and CEDAR has it!

When it comes to sizes 8, 10 and 11 servo motors and motor-tachometers both with and without gear heads, Cedar is the leader, currently building at a higher rate than any other manufacturer in the country.

Because Cedar's volume is big and production techniques have been perfected and standardized, you are assured of the most economical price available. At the same time, the reliability testing and quality assurance programs built up on these units through years of experience guarantee you the finest quality and dependability.

When you need a servo motor or motor-tach, remember that the most advanced designs built with the most modern production techniques come from Cedar. Write or call us for complete information. You'll be glad you did.



5806 W. 36th St., Minneapolis, Minn. 55416 Phone (612) 929-1681

ON READER-SERVICE CARD CIRCLE 24



EYELETS

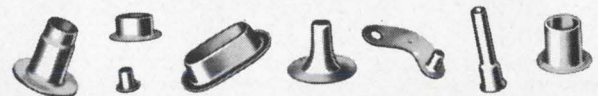

OF EVERY DESCRIPTION



If you use eyelets send for Catalog No. 110-E — over 1300 eyelets are shown with dimensions.

Automatic attaching machines.



ON READER-SERVICE CARD CIRCLE 25

ELECTRONIC DESIGN, August 30, 1966

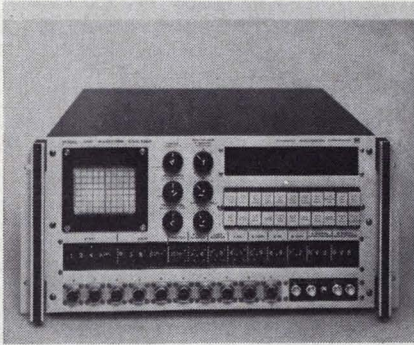

Waveform analyzer

Up to 200 measurements/s can be made by this waveform analyzer using serial-by-character alphanumeric program language. A 0.1% differential digital voltmeter and dual-trace analog display including automatic reference marks for measurement and programing verification are included. Up to 10 remotely programable high-Z sampling probes with built-in attenuation may be used. System rise time is 1 ns max.

Price: \$11,500. Automated Measurements Corp., 638 University Ave., Los Gatos, Calif. Phone: (408) 354-6491.

Circle No. 281

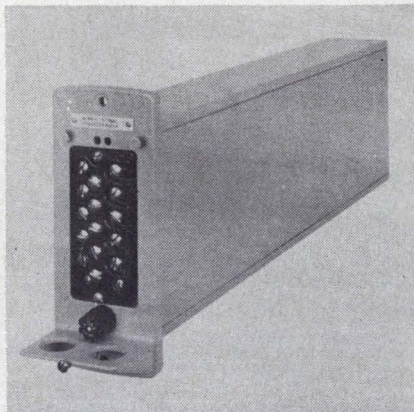

50-mA current converter

Capable of generating analytical or arbitrary functions of one variable, this converter accepts a 10- to 50-mA dc input and produces a 10- to 50-mA dc nonlinear function of the input. Internal jumper connections permit location of the shaping circuit in the forward or feedback circuit of the op-amp. Up to eight slope and eight break-point adjustments are provided. Break points are field adjustable from 0 to 100% of span and slopes are adjustable from 0 to ± 5 .

The Foxboro Co., Foxboro, Mass. Phone: (617) 543-8750.

Circle No. 282



5% TIME DELAY RELAYS

Shown here is one of a family of BetaMite solid state time delay relays. The RT-175 pictured waits from 0.050 second to 22 minutes after application of B+ to the input. Timing accuracy is $\pm 5\%$. Fixed or adjustable delay models are available, with either relay or solid state contacts. The unique termination header shown features insertable/removable environment-free crimp contact terminals. Send for details on this and other BetaMite solid state devices.

- PHASE SEQUENCE DETECTORS
- VOLTAGE LIMIT DETECTORS
- TIME DELAY RELAYS
- FREQUENCY LIMIT DETECTORS



BETAMITE ELECTRONIC DEVICES

7001 W. Imperial Highway • Los Angeles, Calif. 90009
(213) 673-5080 • TWX 213-673-1000
Airport Station P. O. Box 90920



A Division of The Deutsch Company — ECD

COMPONENTS

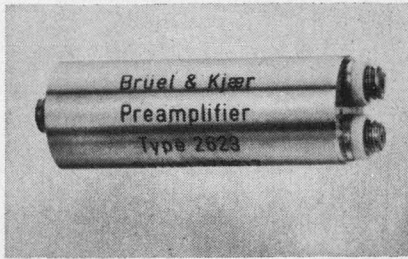

FET preamp

For high-impedance transducers such as accelerometers, this preamp features a FET input stage. The unit will operate for a week from an external 28-V battery. Input impedance is 2000 M Ω at 25°C and 200 M Ω at 100°C. Dynamic range is greater than 120 dB with 1000 pF across the input. Maximum output voltage is 20 V p-p with a 40- Ω output impedance. Frequency range is 0.5 to 500,000 Hz. Model 26-23 has a rise time of less than 10 ms and an overload recovery time of less than 50 ns.

P&A: \$235; stock. B&K Instruments Inc., 5111 W. 164th St., Cleveland. Phone: (216) 267-4800.

Circle No. 283

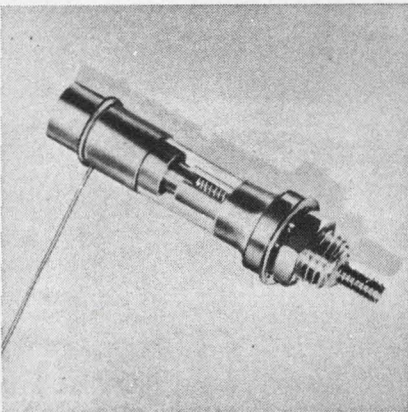

Trimmer capacitors

Rotating piston trimmer capacitors use the internal arms of the bushing for a smooth sliding contact to the piston to provide low resistance, low inductance and RF ground connection to the bushing. The RB/RV4 has a range of 0.4 to 4.5 pF. The RB/RV30 has a range of 1 to 30 pF. Temperature coefficients of ± 50 ppm/ $^{\circ}$ C and 300 to 500 ppm/ $^{\circ}$ C are available. The trimmers have no self resonance to above 1200 MHz.

P&A: from \$1.68 (100 lots); 3 to 4 wks. Voltronics Corp., 296 Route 10, Hanover, N. J. Phone: (201) 887-1517.

Circle No. 284

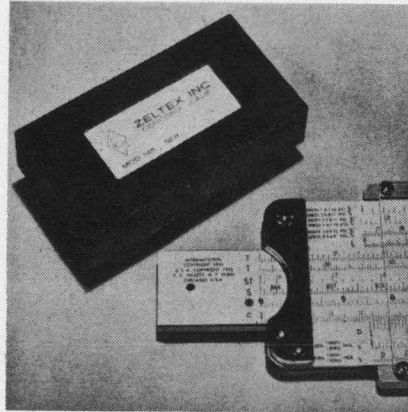

Low-drift op-amp

Voltage drift of 0.2 μ V/ $^{\circ}$ C within -25 to 85 $^{\circ}$ C is provided by this chopper-stabilized op-amp. Average drift is 1 μ V/ $^{\circ}$ C and current drift is 1 pA/ $^{\circ}$ C. Minimum slew rate is 100 V/ μ s, gain-bandwidth product is 100 MHz and output is 25 mA. Chopper drive circuitry (150 Hz) is built-in and power supply levels required are ± 15 V. 60-Hz pickup will not influence input voltage offset.

Price: \$155 (1 to 9). Zeltex, Inc., 1000 Chalomar Rd., Concord, Calif. Phone: (415) 686-6660.

Circle No. 285



Pressure transducers

These pressure transducers operate at -420 to 1200 $^{\circ}$ F and in radiation environments of 10²⁰ NVT (neutron velocity x time) and 10¹³ radiation absorption doses. Temperature and zero shift with temperature is 0.01%/ $^{\circ}$ F max over the entire range with compensation to 0.007%/ $^{\circ}$ F for specific temperature ranges. The units employ convoluted diaphragms and variable reluctance pickoffs and operate from a 6-V 5-kHz source.

P&A: \$625 to \$695; 6 wks. Physical Sciences Corp., 314 E. Live Oak Ave., Arcadia, Calif. Phone: (213) 445-2611.

Circle No. 286

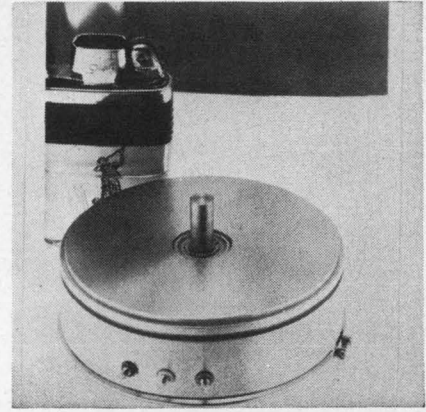

6-W gangable pot

This single-turn servo-mounted pot is gangable to 8 units. Power rating is 6 W at 85 $^{\circ}$ C derated to zero at 150 $^{\circ}$ C. The 2590 offers $\pm 5\%$ independent linearity with a resistance tolerance of $\pm 3\%$ min. Resistance ranges are from 20 Ω to 200 k Ω . The pot is in an anodized aluminum case and has a machined one-piece bearing mount and housing. The one-piece steel shaft prevents backlash and maintains high unit-to-unit indexing accuracy.

P&A: \$27 (1 to 9); 4 to 6 wks. Amphenol Corp., 120 S. Main St., Janesville, Wisc. Phone: (608) 754-2211.

Circle No. 287

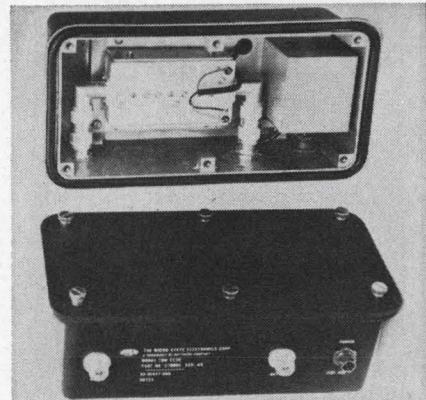

Transistor amplifier

Gain of 25 dB with a 3-dB max noise figure over a range of 225 to 300 MHz is offered in this transistor amplifier. Model TQN2230 has a MTBF of 50,000 hours. Saturation level is -30 dBm of power input. It incorporates a limiter with a max RF input of 2 W cw. Third order intermodulation products are at a -90-dBm max output level.

Micro State Electronics Corp., 152 Floral Ave., Murray Hill, N. J. Phone: (201) 464-3000.

Circle No. 288

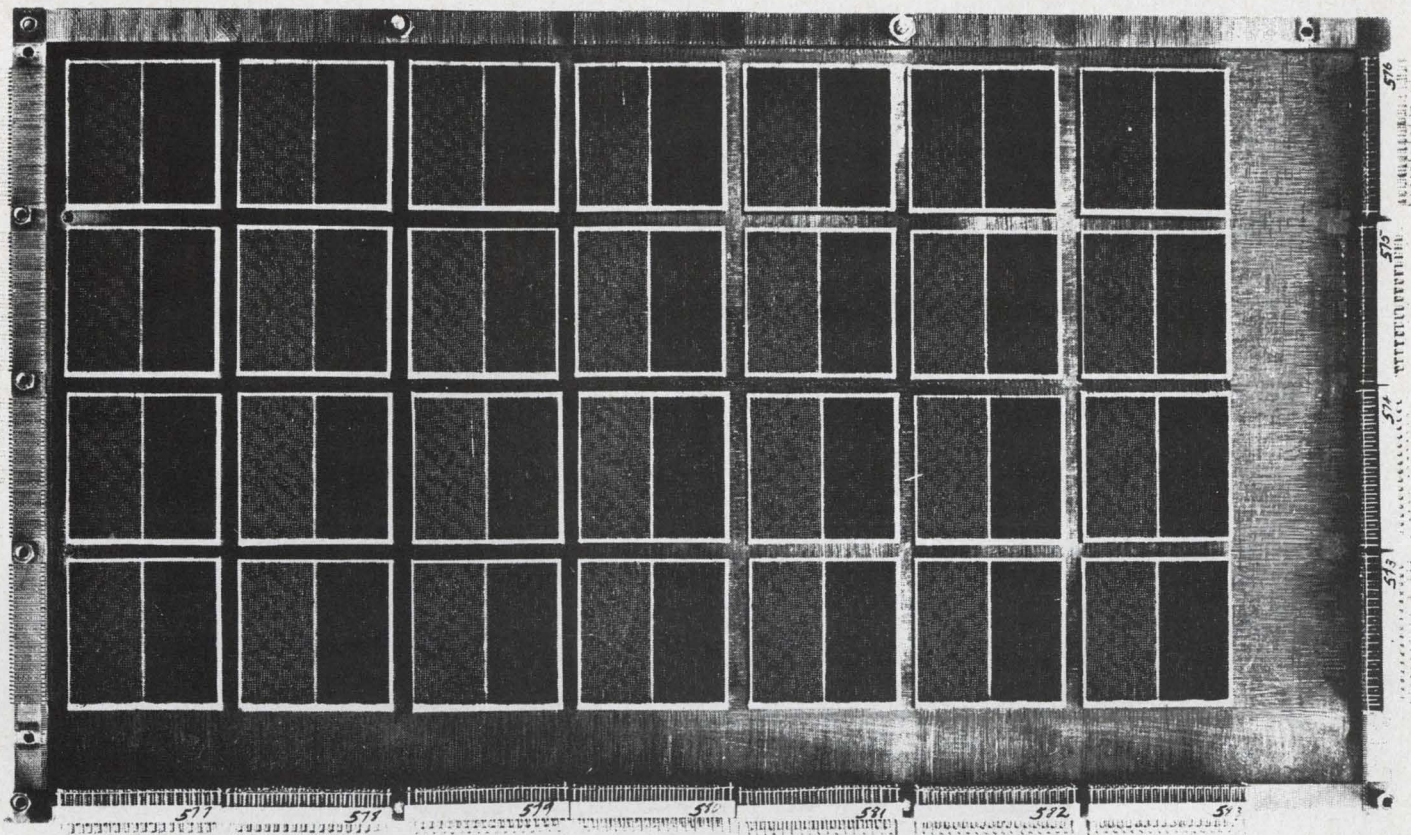

**six months ago we developed the first 2 $\frac{1}{2}$ D stack.
everybody else is still six months behind.**

why wait?

Everybody's talking about 2 $\frac{1}{2}$ D stacks. **electronic**
We're delivering them. **memories**
Write or phone for the complete story.

Memory systems, stacks and cores for commercial, military & space applications
12621 Chadron Avenue, Hawthorne, California, (213) 772-5201

HIGH-VOLTAGE CABLE INSULATED WITH G-E SILICONE RUBBER SURVIVES 3 TOUGH CONDITIONS

One, it carries high currents at 7,000 volts rms. in an airborne power supply.

Two, it withstands temperatures that continuously fluctuate between -55°C and 125°C .

Three, it operates at altitudes as high as 70,000 feet.

Of all the cable insulating materials checked by the manufacturer, G-E silicone rubber proved reliable under every condition. Resisting ozone and corona, it extended cable life to at least 1,000 hours.

Saves \$2.00 per unit

By using silicone rubber as both a dielectric and a potting sealant for a standard connector, the manufacturer got a bonus — a void-free, all silicone system with a minimum of labor.

Compared to installation of individual insulating sleeves for connector contacts, cost savings amounted to \$2.00 a unit. And reliability was improved.

FREE NEW DATA BOOK

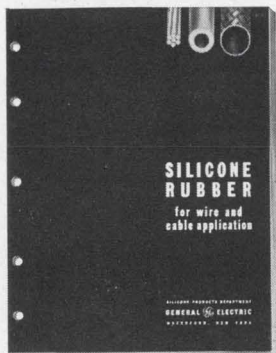

For more ways on how G-E silicone rubber can save money, get Technical Data Book CDS-592, a comprehensive 36-page guide to high performance wire and cable.

Write to Sect. L8204, Silicone Products Dept., General Electric Co., Waterford, N. Y. 12188.

GENERAL ELECTRIC

ON READER-SERVICE CARD CIRCLE 27

COMPONENTS

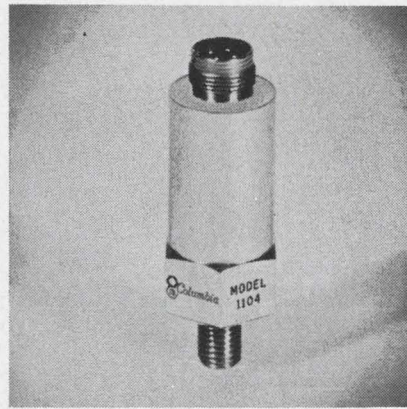

Accelerometer system

The work of a complete vibration measuring system is done by this self-amplifying accelerometer. The unit combines a piezoelectric seismic system and solid-state amplifier in a stainless steel case. Sensitivity is unaffected by cable capacitance and fixed temperature response does not vary with load. Frequency response is 2 to 10,000 Hz $\pm 5\%$ with a sensitivity of 220 mV/G over a range of 20 G.

Columbia Research Laboratories, Inc., MacDade Blvd. & Bullens La., Woodlyn, Penn. Phone: (215) 532-9464.

Circle No. 289

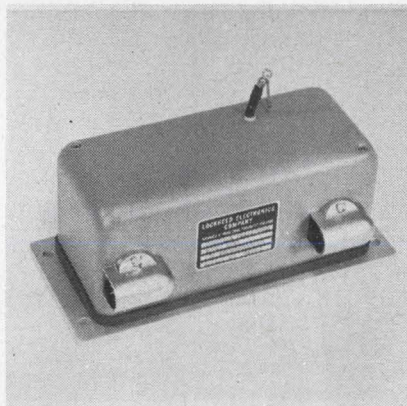

Position transducer

A combination position-velocity transducer monitors relative position and measures the velocity of the relative movement. Position is measured by rotation of an infinite-resolution pot actuated by a spring-loaded cable drive. Velocity is measured by a tach which generates a dc voltage proportional to the rate of translation. Accuracies are 0.25% and life exceeds 100,000 cycles.

Lockheed Electronics Co., 6201 E. Randolph, Los Angeles. Phone: (213) 722-6810.

Circle No. 290

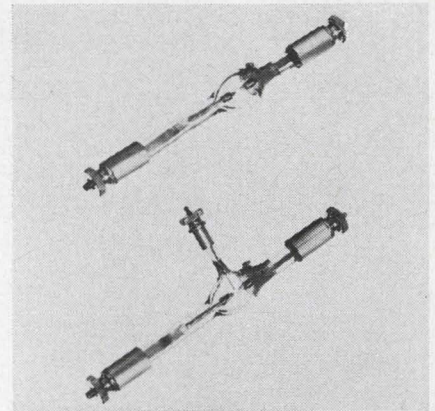

200-W Hg short arc lamp

Intense ultraviolet and visible radiation is provided by these 200-W high pressure ac/dc lamps. The convection-cooled lamps are constructed of clear fused quartz with tungsten electrodes. Typical arc size is 0.10 x 0.07 in. and average luminance is 33,000 candela/cm². Typical luminous flux is 10,000 lumens/W for model 202 and 9500 lumens/W for model 203. Lamps operate at an internal pressure approaching 40 atmospheres.

Illumination Industries Inc., 610 Vaqueros, Sunnyvale, Calif. Phone: (408) 738-2744.

Circle No. 291

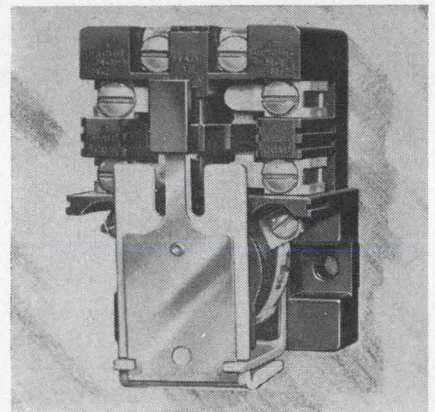

600-V dp relay

General purpose 2-pole relays, UL listed and industrially rated up to 600 V, have double-break, silver cadmium oxide contacts. Available with 2-pole single throw, double throw or with auxiliary contacts, the relays have contacts rated for ac or dc control loads. The devices are rated 16 A inductive to 30 A resistive at 600 Vac or 15 A, 230 Vdc. Coils are rated 6 V ac or dc to 600 Vac.

Cutler-Hammer, Inc., Milwaukee. Phone: (414) 442-7800.

Circle No. 292

Our Microstack® will provide the memory for the Lunar Excursion Module's abort guidance system. During the round trip from the Apollo spacecraft to the moon the crew will constantly sample the Microstack memory, call up critical data, and align the LEM abort guidance system with the Apollo's primary guidance system. If required, the Microstack memory will help the Apollo's abort guidance system bring everyone back home.

Obviously, TRW was concerned with reliability when they wrote the LEM memory system specifications. Like: random vibration—Operating 20cps @ .070G²/cps to 2400cps @ .070G²/cps. Microstack's unique design met all specifications. It's a folded-array, developed by Indiana General. The "X" and "Y" axis are wired continuously, reducing failure-prone solder connections 80% and size and weight.

Indiana General leads in developing and

producing memory stacks and cores. We invented the ferrite memory core and still make and sell more of them than anyone.

If you need Mil. Spec. type memory units find out about Microstacks and our core capabilities. Write Mr. Thomas Loucas, Manager of Sales, Indiana General Corporation, Electronics Division/Memory Products, Keasbey, N.J.

INDIANA GENERAL 

**When the LEM gets ready to leave the moon
Indiana General will know the way back home.**



You
can display
anything
with IEE
series 10
rear-projection
readouts

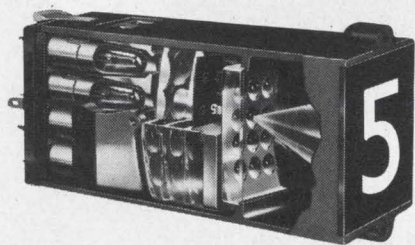

numbers,
letters,
words, symbols,
even colors!

IEE readouts display anything that can be put on film, even colors! Single-plane presentation makes for visual crispness; bright, bold characters (up to 1" in height) for remarkable clarity. So if readability and versatility are what you're after, look into IEE Series 10 Readouts. Five other models available with maximum character heights from 3/8" to 3 3/8".

Send today for complete information on IEE rear-projection readouts and accessories!

IEE INDUSTRIAL ELECTRONIC ENGINEERS, INC.

7720 Lemona Avenue, Van Nuys, California
Phone: (213) 787-0311 • TWX (910) 495-1707
Representatives in Principal Cities ©1966 IEE

ON READER-SERVICE CARD CIRCLE 28

Design Aids

For Included Angle of.	Line Load	By Constant	Resultant
0°		2.00000	
2°		1.99970	
4°		1.99874	
6°		1.99712	
8°		1.99484	
10°		1.99190	
12°		1.98830	
14°		1.98404	
16°		1.97912	
18°		1.97354	
20°		1.96730	
22°		1.96040	
24°		1.95284	
26°		1.94462	
28°		1.93574	
30°		1.92620	
32°		1.91600	
34°		1.90514	
36°		1.89362	
38°		1.88144	
40°		1.86860	
42°		1.85510	
44°		1.84094	
46°		1.82612	
48°		1.81064	
50°		1.79450	
52°		1.77770	
54°		1.76024	
56°		1.74212	
58°		1.72334	
60°		1.69990	
62°		1.67580	
64°		1.65104	
66°		1.62562	
68°		1.59954	
70°		1.57280	
72°		1.54540	
74°		1.51734	
76°		1.48862	
78°		1.45924	
80°		1.42920	
82°		1.39850	
84°		1.36714	
86°		1.33512	
88°		1.30244	
90°		1.26910	
92°		1.23510	
94°		1.19944	
96°		1.16312	
98°		1.12614	
100°		1.08850	
102°		1.05020	
104°		1.01124	
106°		0.97162	
108°		0.93134	
110°		0.89040	
112°		0.84880	
114°		0.80654	
116°		0.76362	
118°		0.72004	
120°		0.67580	
122°		0.63090	
124°		0.58534	
126°		0.53912	
128°		0.49224	
130°		0.44470	
132°		0.39650	
134°		0.34764	
136°		0.29812	
138°		0.24794	
140°		0.19710	
142°		0.14560	
144°		0.09344	
146°		0.04062	
148°		0.00000	
150°			
152°			
154°			
156°			
158°			
160°			
162°			
164°			
166°			
168°			
170°			
172°			
174°			
176°			
178°			
180°			

Deflected line calculator

A 2-color "Deflected Line Calculator Table" finds the resultant load on a sheave when a line passes over it at an angle and the line load is known. Conversely, using the chart, if the resultant load is known, the line load can be determined by dividing the resultant by the constant opposite the number of degrees involved. Chart includes angles of 0 to 180° in 2° steps. The constants run from 0.00000 to 2.00000. Martin-Decker Corp.

Circle No. 293

Silicon steel data

Information on oriented silicon steel coils and nonoriented sheets and rolls is offered in chart form: Data are compared by manufacturer and trade names for AISI standard electrical steels M-4 to M-45 are given. Core loss guarantees are included for currently available material thicknesses. Magnetic Metals Co.

Circle No. 294

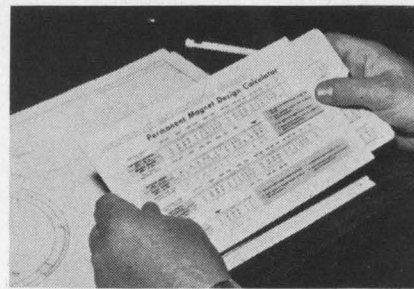

Permanent magnet design

A precision plastic slide-rule calculator enables designers to quickly compute permanent magnet data. Only the magnetic requirements of a specified air gap are needed to determine the length and area of the required permanent magnet. All other factors are automatically brought into position on the calculator. In addition, equivalent formulas in the MKS and CGS systems are listed, basic characteristics of permanent magnet materials are illustrated and a °C to °F conversion scale is incorporated.

Available for \$1 from General Magnetic Corp., 10001 Erwin Ave., Detroit.

Conductor coil sizes

Two new standards list recommended coil sizes for aluminum conductors. The publications detail standard-size coils for the smaller conductors and list the length and total conductor weight for each coil size. The two standards are "Standard Coil Sizes for Covered Aluminum Conductor and ACSR and Neutral-Supported Secondary and Service Drop Cable" (4 pages) and "Standard Coil Sizes for Bare Stranded Aluminum Conductor and ACSR." Aluminum Association.

Circle No. 295

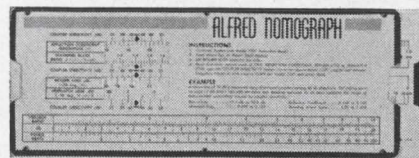

Microwave measurements

The vswr/incident power scale of this slide-rule provides values of reflected power, given vswr and incident power. A second scale indicates attenuation at known input and load vswr. The reverse side of the rule incorporates a voltage ratio/dB/power rating conversion scale. Alfred Electronics.

Circle No. 296

SAVE

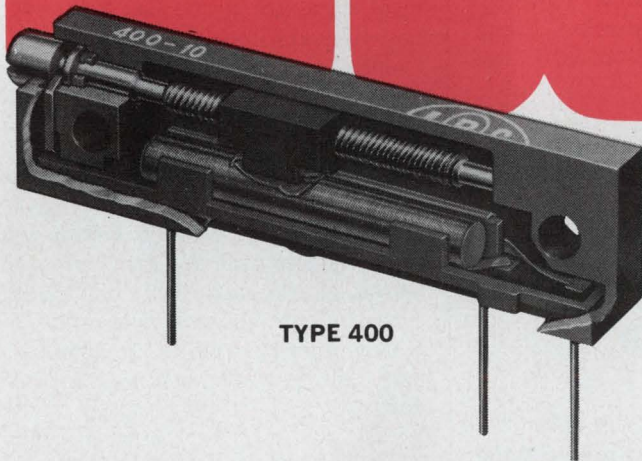

TYPE 400

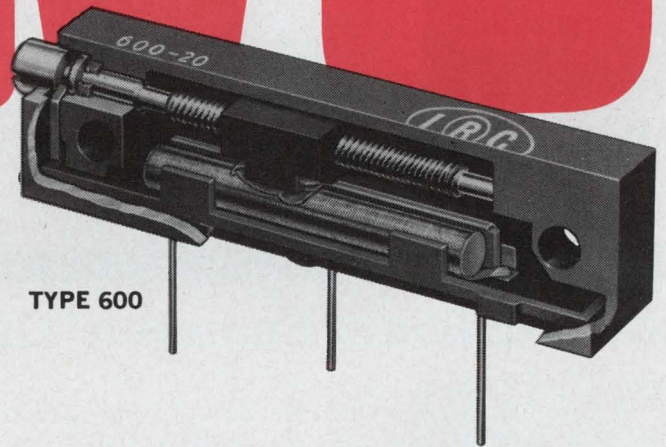

TYPE 600

Military quality at industrial prices

IRC wirewound rectangular trimmers save space and dollars

IRC's CIRCUITRIM potentiometers offer MIL characteristics at the same price as industrial types. Benefit by upgraded performance and reliability for your industrial needs and impressive savings for your MIL applications.

Both series are designed to perform under environmental requirements of MIL-R-27208. Molded diallyl phthalate cases are rugged, light and practical for use in any military or high grade industrial application. A one-piece, corrosion-resistant shaft and specially designed wiper block system isolate electrical elements and assure "set-and-forget" stability.

The 600 series is designed to MIL-Style RT-11 and is offered with staggered P.C. pins or teflon insulated leads. The 400 series is designed to MIL-Style RT-12 with P.C. pins in-line or teflon insulated leads. It is also available in a thin-line version of RT-11 (Type 400-20) with staggered P.C. pins which offer 30% space savings and complete interchangeability on pre-printed boards.

These low-cost MIL-type units are the result of IRC's years of experience in building high-quality trimmers. Samples available

from local sales offices. For prices and data, write: IRC, Inc., 401 N. Broad St., Philadelphia, Pa. 19108.

ONLY IRC OFFERS ALL 4 POPULAR STYLES
Wirewound or infinite resolution elements



CAPSULE SPECIFICATIONS

	TYPE 400	TYPE 600
MIL STYLE	RT-12*	RT-11
POWER	1 W @ 70°C	1 W @ 70°C
TOLERANCE	± 5%	± 5%
RESISTANCE	10Ω to 50KΩ	10Ω to 50KΩ
TEMPERATURE	-55°C to 150°C	-55°C to 150°C

*Plus thin-line version of RT-11 (Staggered P.C. pins)



Speed Inquiry to Advertiser via Collect Night Letter
ON READER-SERVICE CARD CIRCLE 29

Design Data from Manufacturers

Advertisements of booklets, brochures, catalogs and data sheets. To order use Reader-Service Card.

(Advertisement)

Incremag Solid State Precision Counter



A new six page catalog presents the first fully reliable solid state magnetic counting device with memory. Details of performance, characteristics, applications of Haydon/General Time Incremag include temp, range, count rate, divide ratios, inputs, outputs, impedance, power requirements and options. Diagrams of connections, multiple counting stages, binary chain comparison; charts on how fixed count Incremag operates. Performance in Tiros weather satellites recounted. Ideas on applications to regulate production flow, cut waste and improve quality.

Haydon/General Time Industrial Controls Division

Thomaston, Connecticut 06787

Telephone: 203-AT 3-5881

171

Terminal Board Engineers' Guide

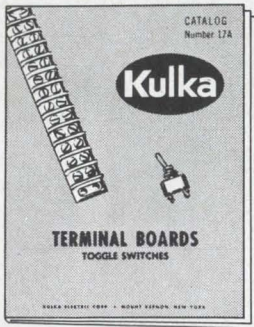

"Broadest Line of Terminal Boards in the Industry"—the new Kulka Catalog 17A is designed for the Specifying Engineer and Purchasing Agent. It contains 56 pages of exhaustive data on every type of terminal board in current use, including "Kliptite," High Heat, Closed Back, High Barrier, Stud and Turret, Pressure Contact, Wire-Wrap, Screw Clamp, and Military Terminal Boards. Free copy on request.

Kulka Electric Corporation

520 South Fulton Ave.

Mount Vernon, N. Y. 10551

172

Books For The Electronics Engineer

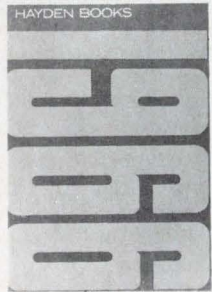

The 1966 Hayden Book Company, Inc., catalog contains such new titles as "Microelectronic Design," "100 Ideas for Design '66," "The Electron in Electronics," "Synthesis of RC Networks with Arbitrary Zeros," "Transistor and Diode Network Calculations," and "Matrix Algebra for Electronic Engineers." As well as the expanded list for design engineers, the catalog includes Hayden and John F. Rider Publisher training texts at all levels. Send for your free catalog today.

Hayden Book Company, Inc.

116 West 14th Street

New York, N. Y. 10011

173

New Literature

Resin selection chart

The task of choosing the correct type of resin for electrical or electronic applications is eased by this chart. Each resin is fully described as to type, characteristics and advantages. The method of application, reactor or catalyst, color, temperature class, dielectric strength, hardness, shrinkage during cure and mixing ratio are shown. Other technical data are given for viscosity, pot life and cure time. John C. Dolph Co.

Circle No. 297

Varactor diodes

Frequency multiplication using varactor diodes is described in a 4-page brochure. The behavior of these devices and the properties of stored charge are fully explained. The brochure shows how control of stored charge results in efficient multiplier performance. Varian, Bomac Div.

Circle No. 298

Semiconductor catalog

A line of semiconductors is described in this 60-page catalog. SCRs, Triacs, ICs and hybrid circuits, plastic-capped transistors, diodes, rectifiers, assemblies and injection lasers are included along with 130 outline drawings with dimensions. General Electric Co.

Circle No. 299

Ceramics terminology

This 12-page brochure defines and gives technical details on 23 commonly used electronic ceramics terms. The glossary includes graphs and illustrations which are listed alphabetically. M&T Chemicals Inc.

Circle No. 300

Pressure sensing devices

A 4-page summary list of over 40 products, consoles, and systems available for precise control and calibration of pressure sensing devices is offered. Descriptions and prices are given for pressure-volume controls, volumetric micrometers, pressure transfer standards for lab and field use and automatic calibration systems. Volumetrics.

Circle No. 301

Subscription Policy

ELECTRONIC DESIGN is circulated free of charge to qualified design engineers in the U.S., Western European Continent and Britain. To establish your qualifications, send ELECTRONIC DESIGN the following information on your company's letterhead: Your name, engineering title, description of your design duties and a list of your company's major products. The letter must be signed by you personally.

Subscription rates for nonqualified subscribers—\$25 a year in the U.S., \$35 in all other countries. Single copy, \$1.50.

Change of Address

A subscriber's change of address requires a restatement of his qualifications. To expedite the change, and to avoid missing any issues, send along a label from a back copy.

Microfilm Copies

Microfilm copies of all 1961, 1962, 1963, 1964 and 1965 issues of ELECTRONIC DESIGN are available through University Microfilms, Inc., 313 N. First Street, Ann Arbor, Mich.

For fast delivery of Specialty Motors

the new
call 

We don't know what *your* recollection of Diehl's delivery is. But with small motors in short supply we think you'll want to hear about delivery from the *new* Diehl. We are now supplying motors much faster than the industry average. Some of our current accounts tell us we move *three to four times faster* than other well known motor suppliers. Diehl has been building motors since 1888. But now we're building them faster! Try us again, East Coast or West, at the numbers below. THE SINGER COMPANY, Diehl Division, East: FINDERNE Plant, Somerville, N. J. 08876 (201) 725-2200; West: LA Plant, 2221 Barry Ave., Los Angeles, Cal. 90064 (213) 478-0896. Also, representatives in all major cities.

ON READER-SERVICE CARD CIRCLE 41

ELECTRONIC DESIGN, August 30, 1966

IF THIS
HIGH VALUE METAL
FILM RESISTOR
DOESN'T CHANGE YOUR
design ideas

...try one of these

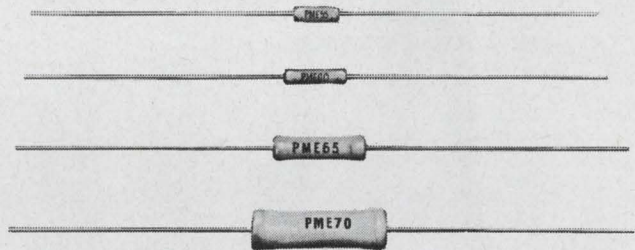

Part No.	Power	Ohms	Tol.	Temp. Coef.
PME 50	1/20 W	10Ω to 1M	±1% to .1%	T-0, T-2, T-9
PME 55	1/10 W	10Ω to 3M	±1% to .1%	T-0, T-2, T-9
PME 60	1/8 W	49Ω to 7.5M	±1% to .1%	T-0, T-2, T-9
PME 65	1/4 W	49Ω to 20M	±1% to .1%	T-0, T-2, T-9
PME 70	1/2 W	24Ω to 30M	±1% to .1%	T-0, T-2, T-9
PME 75	1 W	49Ω to 50M	±1% to .1%	T-0, T-2, T-9

The stability and accuracy of Pyrofilm's PME metal film resistors makes their use ideal in applications where before only wire wound resistors could be used. These resistors are virtually unaffected by environmental conditions and withstand constant exposure to high moisture conditions without change in specifications. PME resistors meet or surpass all requirements of MIL-R-10509F.

Send for fact-filled literature sheet!

**PYROFILM RESISTOR
COMPANY, INC.**

3 SADDLE ROAD • CEDAR KNOLLS, NEW JERSEY • 201-539-7110

ON READER-SERVICE CARD CIRCLE 42

Advertisers' Index

*PARTICIPANTS IN NIGHT LETTER PROGRAM

Allen-Bradley Co.	32 A-B
*Amphenol Controls Division, Amphenol Corporation	69
Beta Mite Electronic Devices	81
*Brand Rex, Div. of American Enka Corporation	8
Burndy Corporation	32
Cedar Engineering Division, Data Control Corporation	80
*Clifton Precision Products, Division of Litton Industries	29
Computer Logic Corporation	90
*Dale Electronics, Inc.	Cover III
*Digital Equipment Corporation	79
ESI/Electro Scientific Industries, Inc.	78
Electronic Development Corporation	91
*Electronic Memories, Inc.	83
Elgar Corporation	76
Fairchild Instrumentation, A Division of Fairchild Camera and Instrument Company	52, 53
Fairchild Semiconductor, A Division Fairchild Camera and Instrument Corporation	9
General Electric Company, Sillicone Products Department	84
General Instrument Corporation	15
General Radio Company	1
Hayden Book Company, Inc.	92
Haydon Products/Industrial Controls Division, General Time	88
Hewlett-Packard	23, Cover II
Hoffman Semiconductor	72
Honeywell, Precision Meter Division	37
IRC, Inc.	26, 87
Indiana General Corporation	85
Industrial Electronic Engineers, Inc.	86
Kulka Electric Corp.	88
*Magnetics, Inc.	67
*Mallory & Co., Inc., P. R.	4, 5
Matsushita Electric Corporation of America	2
*Motorola Semiconductor Products, Inc.	19
National Semiconductor Corporation	64
Pyrofilm Resistor Co., Inc.	89
RCA Electronic Components and Devices	25, Cover IV
Raytheon Company, Components Division ..	60
Singer Company, The, Diehl Division	89
*Solitron Devices, Inc.	6
Sorensen Operation, Raytheon Company ..	16
Sprague Electric Company	10, 20
Stimpson Co., Edwin B.	80
*Systron-Donner Corporation	12
TRW Capacitors	30
Tektronix, Inc., Oscilloscopes	7, 61
Texas Instruments Incorporated, Semiconductors-Components Division	43, 44, 45
Union Carbide Corporation, Linde Division ..	75
Regional Advertising	
JFD Electronics Corporation	76B
Leach Corporation	76A
Career Advertising	
Texas Instruments, Incorporated	70

*A thrifty fifty would be nifty...
You've been getting ten.
Thirty though, is really great
and saves you 3 times 10!*

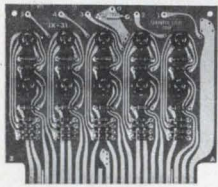

30 FAN-OUT FROM ALL SOURCES WITHOUT POWER DRIVERS

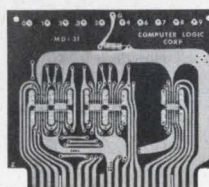

Why pay \$7 to \$13 for power drivers you don't need? CLC customers drive 20 flip-flops and 10 gates directly. Why don't you?

How can CLC integrated logic be so DIFFERENT? Easy. Instead of merely putting devices on cards like everybody else, we did our own thinking. In one card family, we intermix devices from TI, Fairchild, Westinghouse, etc. Ergo fan-out of 30, noise immunity improved, sheer gating magic, and more. Check with CLC and see.

PRICE & THE BIG FOUR

	CLC	COMPANY C1	COMPANY D1	COMPANY E1
JK Flip-Flop	\$13.20	\$14.95	\$18.00	\$16.25
Storage Bit	5.50	6.38	8.00	6.87
BCD Counter Decade	53.00	64.88	62.50	55.50
Shift Bit	10.67	14.50	11.25	15.00
2-in Hi-True Nand	4.65	5.95	4.70	4.75
2-in Lo-True Nand	3.00	Not Available	Not Available	Not Available
Power Drivers	Not Needed	13.00	7.75	6.75

The Big Four use DTL for DC to 5 MC at comparable temperatures and capacity. Unit prices per function are from recent catalogs.

CLC COMPUTER LOGIC CORP.
1528 20th Street • Santa Monica, Calif.
Telephone (213) 451-9754

INTEGRATED LOGIC CARDS

Advertising Representatives

New York 10022
 Robert W. Gascoigne
 Thomas P. Barth
 Samuel M. Deitch
 Richard W. Nielson
 850 Third Avenue
 (212) PLaza 1-5530
 TWX: 367-7866

Philadelphia 19066
 Fred L. Mowlds, Jr.
 P. O. Box 206
 Merion Station, Pa.
 (215) MO 4-1073

Marblehead 01945
 Richard Parker
 7 Redstone Lane
 (617) 742-0252

Chicago 60611
 Thomas P. Kavooras
 Berry Conner, Jr.
 720 N. Michigan
 (312) 337-0588

Cleveland 44107
 Robert W. Patrick
 8410 Treetower Drive
 Chagrin Falls, Ohio
 (216) 247-7670

Los Angeles 90303
 Stanley I. Ehrenclo
 Terrence D. Buckley
 W. James Bischof
 2930 W. Imperial Highway
 Inglewood, Calif.
 (213) 757-0183

San Francisco
 Ashley P. Hartman
 P. O. Box 1106
 Los Altos, Calif. 94022
 (415) 327-6536

Southwestern 75206
 Tommy L. Wilson
 6200 North Central Express-
 way
 Dallas, Tex.
 (214) EMerson 1-2311

London W. 1
 Brayton C. Nichols
 44 Conduit Street

Tokyo
 Yoshihiro Takemura
 International Planning
 Service, Inc.
 Room No. 512 Nikkoh
 Mita Building
 1, Nishidaimachi, Shiba-
 Takanawa
 Minato-ku, Tokyo

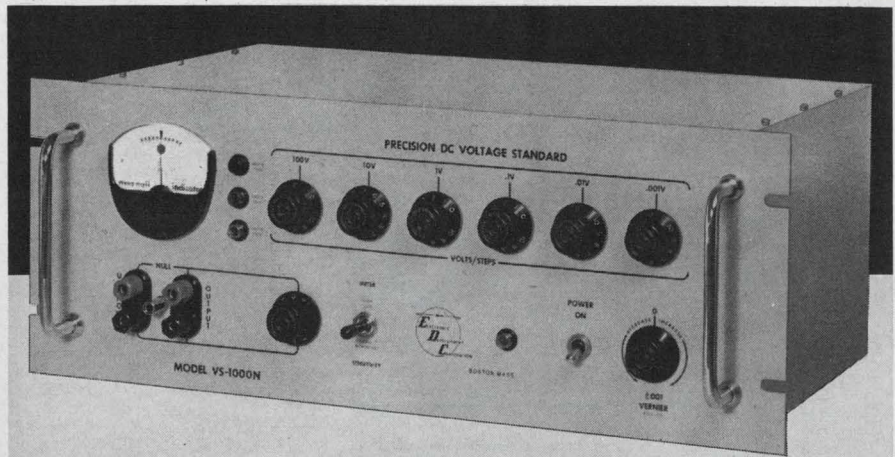

1000_{vdc} STANDARD*

COMPARE
 performance
 value

EDC's High Voltage Reference Source Model VS-1000-NR, is the only all-solid-state high precision printed circuit 6-decade dc portable standard with . . .

- **Absolute Accuracy** $\pm 0.01\%$ or ± 1 mv (NBS traceability)
- **Output Voltages** ± 1111.110 vdc (full scale)
- **Stability** $\pm 0.001\%$ (short term — 8 hrs)
- **Output Current** 10 ma
- **Delivery** from stock
- **Price** \$995

Model VS-1000-NR has: automatic recovery . . . short-circuit and overload protection . . . output as well as measuring capability . . . direct reading . . . ready to use within 30 sec (no balancing or zeroing). Designed for production line and laboratory applications — for use as a voltage source and a potentiometer measuring device. Fits standard rack, weighs only 20 pounds, guaranteed for one full year including calibration and stability.

*Other models from 1 μ volt.

**ELECTRONIC
 DEVELOPMENT
 CORPORATION**



423 WEST BROADWAY • BOSTON 27, MASSACHUSETTS
 Tel: 617 268-9696

HAYDEN BOOKS FOR DESIGN

Designer's Datebook

SEPTEMBER						
S	M	T	W	T	F	S
				1	2	3
4	5	6	7	8	9	10
11	12	13	14	15	16	17
18	19	20	21	22	23	24
25	26	27	28	29	30	

OCTOBER						
S	M	T	W	T	F	S
						1
2	3	4	5	6	7	8
9	10	11	12	13	14	15
16	17	18	19	20	21	22
23	24	25	26	27	28	29
30	31					

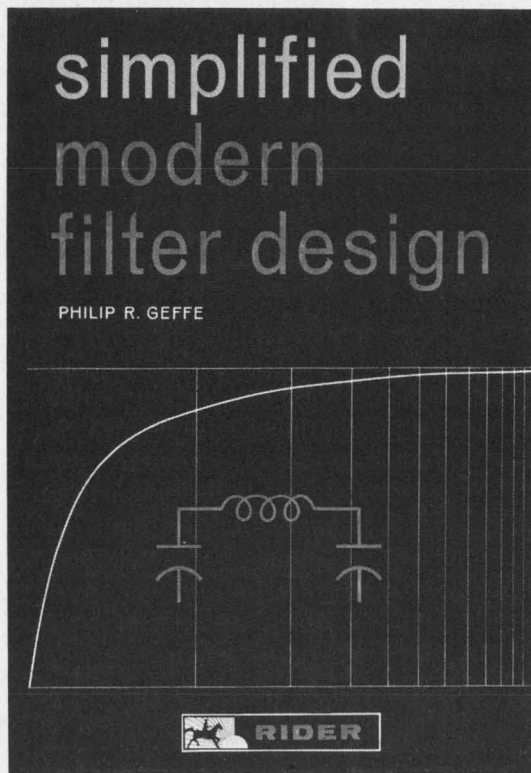

Simplified Modern Filter Design

PHILLIP R. GEFPE

An excellent guide to modern network synthesis design for the circuit design engineer who requires sophisticated technical results without the use of higher mathematics. Performance predictions for physical filters are given, and modification possibilities and methods described. Coverage includes high-Q inductors, bandpass filters, and electric wave filter measurements. The difficult subject of delay equalizers is treated to a full and complete exposition.

CHAPTERS: Lowpass Filters. Highpass Filters. Simplified Bandpass Design. Refinements in Bandpass Design. Bandstop Filters. Attenuation Equalizers. Linear-Phase Filters - Delay Equalizers. Some Useful Measurement Techniques. Inductor Design. Appendix.

182 pages Illustrated Clothbound \$8.75

Dept. ED-83, HAYDEN BOOK CO., INC. 116 W. 14 St., N.Y. N.Y. 10011

Please send me "Simplified Modern Filter Design" for a 10-day Free Examination period. At the end of the ten days I will remit payment plus postage or return the book.

#0317, Simplified Modern Filter Design, \$8.75

Name _____ Title _____

Company _____

Address _____

City _____ State _____ Zip _____

Check if payment enclosed. Publisher pays postage, with same return guarantee. (Foreign orders, except Canada, must include payment in \$ U.S.)

Sept. 15-16

Computer Aided Solid-State Design Institute (Santa Clara, Calif.) Sponsor: University of Santa Clara, Department of Electrical Engineering, Santa Clara, Calif. 95053.

Sept. 20-22

Eighth Annual Conference on Tube Techniques (New York City) Sponsor: IEEE, G-ED; R. J. Bondley, General Electric Company, Schenectady, N. Y.

Sept. 22-24

IEEE Broadcast Symposium (Cedar Rapids, Iowa) Sponsor: IEEE, G-B; Serge Bergen, 10828 Fairchester Drive, Fairfax, Va.

Sept. 26-27

Joint Engineering Management Conference (Wash., D. C.) Sponsor: IEEE, G-EM et al; Homer Sarsohn, IBM, Armonk, N. Y.

September 27-29

13th Annual Air Force Science and Engineering Symposium (Arnold Air Force Sta., Tenn.) Sponsor: Air Force Systems Command and Office of Aerospace Research; Lt. P. Klute, Air Force Systems Command, Andrews AFB, Md.

October 3-5

Aerospace & Electrical Systems Convention (Wash., D.C.) Sponsor: IEEE, G-AES; Harold Schutz, Westinghouse Electric, P. O. Box 746, Baltimore, Md.

October 3-5

National Electronics Conference (Chicago, Ill.) Sponsor: IEEE et al; J. C. Hancock, Purdue University, Lafayette, Ind.

October 18-20

Seventh National Symposium of the Society for Information Display (Boston, Mass.) Sponsor: S.I.D.; Glenn Whitham, Society for Information Display, P. O. Box 413, Wayland, Mass.

A circuit design "first"



Expanded housed D series opens new design areas for precision power metal film resistors

Dale's expanded D Series combines heat sink housings already proven by Dale Wirewounds with precision power metal film elements. The result:

1. As FILM RESISTORS, Dale's D Series offer power/size ratio unmatched by conventional parts (see chart).
2. As HOUSED RESISTORS, Dale's D Series offer higher maximum resistance values and low reactance at high frequencies.

D SERIES SPECIFICATIONS

- **Resistance Range:** 50 Ω to 1 Megohm (D5), 50 Ω to 2 Megohms (D10), 50 Ω to 2.6 Megohms (D15)
- **Tolerance:** $\pm 0.1\%$, 0.25%, 0.5%, 1% and 2%
- **Power Rating:** D5=4 watts, D10=8 watts (mounted on 4"x6"x.040" aluminum chassis) D15=12 watts (mounted on 5"x7"x.040" aluminum chassis).
- **Temperature Coefficient:** ± 25 and ± 50 ppm/ $^{\circ}$ C (-55 $^{\circ}$ C to +175 $^{\circ}$ C). Higher T.C.'s on request.

FILM RESISTOR POWER/SIZE COMPARISON

CHARACTERISTIC	D SERIES			2-WATT METAL FILM	5-WATT CARBON FILM	4-WATT TIN OXIDE
SIZE						
	D5 .334 W X .600 L	D10 .420 W X .750 L	D15 .550 W X 1.062 L			
Power Rating	4 Watts	8 Watts	12 Watts	2 Watts	5 Watts	4 Watts
Volume	0.064 in. ³	0.123 in. ³	0.320 in. ³	0.242 in. ³	0.600 in. ³	0.145 in. ³
Power Density (25 $^{\circ}$ C)	62.0 w/in. ³	65.0 w/in. ³	37.5 w/in. ³	8.3 w/in. ³	8.3 w/in. ³	27.6 w/in. ³
Power Density (125 $^{\circ}$ C)	20.4 w/in. ³	21.4 w/in. ³	12.4 w/in. ³	8.3 w/in. ³	2.1 w/in. ³	13.8 w/in. ³
Life Stability (Typical)*	.1%	.1%	.1%	0.5%	0.5%	3%
Temp. Coefficient	25 or 50 ppm/ $^{\circ}$ C			50 ppm/ $^{\circ}$ C	500 ppm/ $^{\circ}$ C	300 ppm/ $^{\circ}$ C
Max. Operating Temp.	175 $^{\circ}$ C	175 $^{\circ}$ C	175 $^{\circ}$ C	175 $^{\circ}$ C	150 $^{\circ}$ C	200 $^{\circ}$ C

*Maximum resistance shift in 1000 hours of operation at rated power.

- **Maximum Working Voltage:** 500 (D5), 600 (D10), 700 (D15)
- **Dielectric Strength:** 1000 VAC (D5), 1500 VAC (D10), 2000 VAC (D15)
- **Construction:** Aluminum screw-mount radiator housing with resistance element molded inside for complete environmental protection. Meets all applicable requirements of MIL-R-18546C and MIL-R-10509E.

For complete details, write today
or phone 402-564-3131



DALE ELECTRONICS, INC.
1328 28th Avenue, Columbus, Nebr.
In Canada: Dale Electronics Canada Ltd.



Speed Inquiry to Advertiser via Collect Night Letter
ON READER-SERVICE CARD CIRCLE 36

For only **\$1.75***



you can buy

this silicon

power transistor

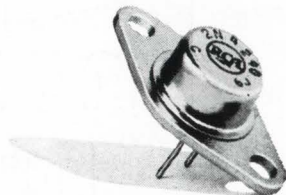

with **400 V** $V_{CER(sus)}$
5 A $I_C(peak)$
15 Mc/s $f_T(min)$

probably the most "electrifying" offer you've had today

Check into RCA-2N4240 further. It gives you big performance with real economy...and it's in a quantity price class that's just right for mass-production applications. In high-current, high-voltage, high-frequency designs, 2N4240 improves circuit reliability—each transistor is 100 per cent tested to assure freedom from second breakdown in both forward- and reverse-bias conditions.

Evaluate the new 2N4240 and its companion types 2N3583, 2N3584 and 2N3585 for use in:

- High voltage inverters and switching regulators
- Line-operated or high-voltage amplifiers
- Operational amplifiers
- Electrostatic or magnetic deflection circuits

*\$1.75 each in quantities of 1000 and up.

		2N3583	2N3584	2N3585	2N4240
h_{fe}	@ $I_C = 100 \text{ mA}$, $V_{CE} = 10 \text{ V}$ @ $I_C = 1 \text{ A}$, $V_{CE} = 10 \text{ V}$ @ $I_C = 0.75 \text{ A}$, $V_{CE} = 10 \text{ V}$	40 Min 10 Min	40 Min 25-100	40 Min 25-100	40 Min 30-150
$h_{fe} @ 5 \text{ Mc/s}$	@ $I_C = 200 \text{ mA}$, $V_{CE} = 10 \text{ V}$	3 Min	3 Min	3 Min	3 Min
I_{Sb}	@ $V_{CE} = 100 \text{ V}$	350 mA Min	350 mA Min	350 mA Min	350 mA Min
$V_{CER(sus)}$	@ $I_C = 200 \text{ mA}$ @ $R_{BE} = 50 \text{ ohms}$	250 V Min	300 V Min	400 V Min	400 V Min
$V_{CE(sat)}$	@ $I_B = 125 \text{ mA}$, $I_C = 1 \text{ A}$ @ $I_B = 75 \text{ mA}$, $I_C = 0.75 \text{ A}$		0.75 V Max	0.75 V Max	1.0 V Max
I_C		5 A peak 2 A continuous	5 A peak 2 A continuous	5 A peak 2 A continuous	5 A peak 2 A continuous

For full price and delivery information, check with your RCA Representative. For technical data on specific types, write: RCA Commercial Engineering, Section IG8-5, Harrison, N.J.

Also available through your RCA Distributor



RCA ELECTRONIC COMPONENTS AND DEVICES

The Most Trusted Name in Electronics

ON READER-SERVICE CARD CIRCLE 234