

# Electronic Design 28

VOL. 14, NO.

THE MAGAZINE OF ESSENTIAL NEWS, PRODUCTS AND TECHNOLOGY

DECEMBER 6, 1966

## A FET and relay in a TO-5?

It's been done. This new device operates directly off low-level microcircuit logic. The n-channel FET—or if preferred a bipolar

transistor—boosts tiny currents to the level required to trip the relay. The bantam driver-and-relay unit helps eliminate the problem of interconnections. (Page 118.)



# AUDIO TRANSFORMERS

DO-T No.	Pri. Imp.	D.C. Ma.† in Pri.	Sec. Imp.	Pri. Res. DO-T	Pri. Res. DI-T	Mw Level	DI-T No.
DO-T44	80 CT 100 CT	12 10	32 split 40 split	9.8	11.5	500	DI-T44*
DO-T29	120 CT 150 CT	10 10	3.2 4	10		500	
DO-T12	150 CT 200 CT	10 10	12 16	11		500	
DO-T13	300 CT 400 CT	7 7	12 16	20		500	
DO-T19	300 CT	7	600	19	20	500	DI-T19
DO-T30	320 CT 400 CT	7 7	3.2 4	20		500	
DO-T43	400 CT 500 CT	8 6	40 split 50 split	46	50	500	DI-T43*
DO-T42	400 CT 500 CT	8 6	120 split 150 split	46		500	
DO-T41	400 CT 500 CT	8 6	400 split 500 split	46	50	500	DI-T41*
DO-T2	500 600	3 3	50 60	60	65	100	DI-T2
DO-T20	500 CT	5.5	600	31	32	500	DI-T20
DO-T4	600	3	3.2	60		100	
DO-T14	600 CT 800 CT	5 5	12 16	43		500	
DO-T31	640 CT 800 CT	5 5	3.2 4	43		500	
DO-T32	800 CT 1000 CT	4 4	3.2 4	51		500	
DO-T15	800 CT 1070 CT	4 4	12 16	51		500	
DO-T21	900 CT	4	600	53	53	500	DI-T21
DO-T3	1000 1200	3 3	50 60	115	110	100	DI-T3
DO-T45	1000 CT 1250 CT	3.5 3.5	16,000 split 20,000 split	120		100	
DO-T16	1000 CT 1330 CT	3.5 3.5	12 16	71		500	
DO-T33	1060 CT 1330 CT	3.5 3.5	3.2 4	71		500	
DO-T5	1200	2	3.2	105	110	100	DI-T5
DO-T17	1500 CT 2000 CT	3 3	12 16	108		500	
DO-T22	1500 CT	3	600	86	87	500	DI-T22
DO-T34	1600 CT 2000 CT	3 3	3.2 4	109		500	
*DO-T51	2000 CT 2500 CT	3 3	2000 split 2500 split	195	180	100	DI-T51*
DO-T37	2000 CT 2500 CT	3 3	8000 split 10,000 split	195	180	100	DI-T37*
*DO-T52	4000 CT 5000 CT	2 2	8000 CT 10,000 CT	320	300	100	DI-T52*
DO-T18	7500 CT 10,000 CT	1 1	12 16	505		100	
DO-T35	8000 CT 10,000 CT	1 1	3.2 4	505		100	
*DO-T48	8,000 CT 10,000 CT	1 1	1200 CT 1500 CT	640		100	
*DO-T47	9,000 CT 10,000 CT	1 1	9000 CT 10,000 CT	850		100	
DO-T6	10,000	1	3.2	790		100	
DO-T9	10,000 12,000	1 1	500 CT 600 CT	780	870	100	DI-T9
DO-T10	10,000 12,500	1 1	1200 CT 1500 CT	780	870	100	DI-T10
DO-T25	10,000 CT 12,000 CT	1 1	1500 CT 1800 CT	780	870	100	DI-T25
DO-T38	10,000 CT 12,000 CT	1 1	2000 split 2400 split	560	620	100	DI-T38*
DO-T11	10,000 12,500	1 1	2000 CT 2500 CT	780	870	100	DI-T11
DO-T36	10,000 CT 12,000 CT	1 1	10,000 CT 12,000 CT	975	970	100	DI-T36
DO-T1	20,000 30,000	.5 .5	800 1200	830	815	50	DI-T1
DO-T23	20,000 CT 30,000 CT	.5 .5	800 CT 1200 CT	830	815	50	DI-T23
DO-T39	20,000 CT 30,000 CT	.5 .5	1000 split 1500 split	800		50	
DO-T40	40,000 CT 50,000 CT	.25 .25	400 split 500 split	1700		50	
DO-T46	100,000 CT	0	500 CT	7900		25	
DO-T7	200,000	0	1000	8500		25	
DO-T24	200,000 CT	0	1000 CT	8500		25	

†DCMA shown is for single ended usage (under 5% distortion—100MW—1KC) . . . for push pull, DCMA can be any balanced value taken by .5W transistors (under 5% distortion—500MW—1KC) DO-T & DI-T units designed for transistor use only. U.S. Pat. No. 2,949,591; others pending.  
 §Series connected; §§Parallel connected → \*Units newly added to series

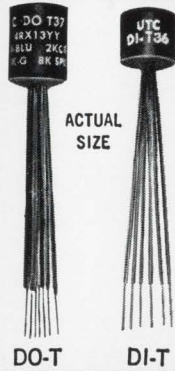

# DO-T & DI-T<sup>TM</sup>

## Transistor TRANSFORMERS and INDUCTORS

**ALL ITEMS SUCCESSFULLY TESTED TO COMPLETE MIL-T-27B ENVIRONMENTAL REQUIREMENTS**

**\*16 New Items Added to Stock Line IMMEDIATE DELIVERY FROM STOCK**

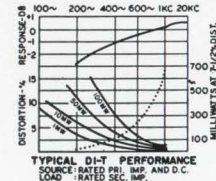
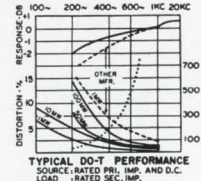

- High Power Rating ..... up to 10 times greater
- Excellent Response ..... twice as good at low end
- Low Distortion ..... reduced 80%
- High Efficiency ..... up to 30% better . . . compare DCR
- Moisture Proof ..... hermetically sealed to MIL-T-27B
- Rugged ..... Grade 4, completely metal cased
- Anchored Leads ..... will withstand 10 pound pull test
- Printed Circuit Use ..... (solder melting) nylon insulated leads
- Suited to Clip Mounting ..... use Augat #6009-8A clip

### INDUCTORS

DO-T No.	Inductance Hys @ ma	DO-T DCR Ω	DI-T DCR Ω	DI-T No.
*DO-T50 (2 wdg.)	\$.075 Hy/10 ma, .06 Hy/30 ma \$.018 Hy/20 ma, .015 Hy/60 ma	10.5 2.6		
DO-T28	.3 Hy/4 ma, .15 Hy/20 ma .1 Hy/4 ma, .08 Hy/10 ma	25	25	DI-T28
DO-T27	1.25 Hys/2 ma, .5 Hy/11 ma .9 Hy/2 ma, .5 Hy/6 ma	100	105	DI-T27
DO-T8	3.5 Hys/2 ma, 1 Hy/5 ma 2.5 Hys/2 ma, .9 Hy/4 ma	560	630	DI-T8
DO-T26	6 Hys/2 ma, 1.5 Hys/5 ma 4.5 Hys/2 ma, 1.2 Hys/4 ma	2100	2300	DI-T26
*DO-T49 (2 wdg.)	\$.20 Hys/1 ma, 8 Hys/3 ma \$.5 Hys/2 ma, 2 Hys/6 ma	5100 1275		

### POWER TRANSFORMERS

*DO-T400	Pri 28V 380-1000 cycles, Sec 6.3V @ 60 ma
*DO-T410	Pri 28V 380-1000 cycles, 2-Sec 6.3 @ 30 ma each
*DO-T420	Pri 28V 380-1000 cycles, Sec 28V @ 20 ma (Isol. Electrostatic Shld.)

Write for catalog of over 1,300 UTC TOP QUALITY STOCK ITEMS IMMEDIATELY AVAILABLE from your local distributor.



# UNITED TRANSFORMER CO.

DIVISION OF TRW INC. • 150 VARICK STREET, NEW YORK, N. Y. 10013

# OUTSTANDING PERFORMANCE... AT REASONABLE COST HIGHEST ACROSS-THE-BOARD

PERFORMANCE AVAILABLE FROM A WIDEBAND DIFFERENTIAL DATA AMPLIFIER

New Hewlett-Packard 2470A Differential Data Amplifier...\$585

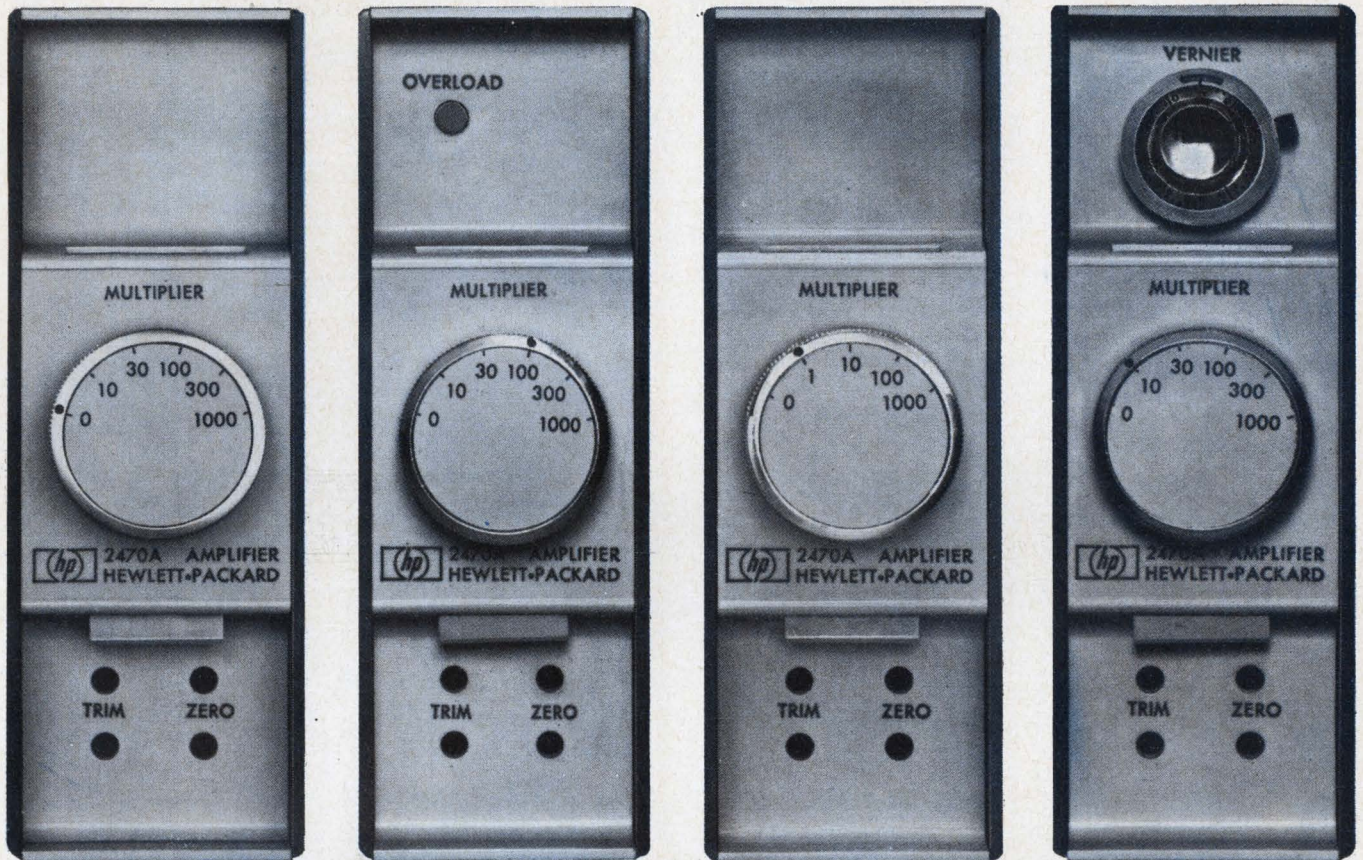

**Top electrical performance:** Compare, spec to spec—DC gain X10 to X1000 (optional precision vernier, X1 gain), output  $\pm 10$  v, 0-100 ma. Gain accuracy  $\pm 0.02\%$  range; constant 50 kHz bandwidth. Differential input for low drift, high cmr (120 db at 60 kHz on gains down to x30, 90 db at x1). Full output across full bandwidth ( $10^7$  v/sec RTO). High 1000-meg input impedance all gain settings, output impedance 0.1 ohm  $\pm 10 \mu$ h. DC linearity of 0.002% on both polarities; dc gain stability of 0.005% per month achieved without chopper stabilization. Low drift and noise. Fast 100 microsecond settling, 100 microsecond overload recovery, excellent overload protection, optional overload indicator. Input and output isolated by internally driven guard shields; dual output available with fixed 2-pole filter.

**Built-in reliability:** The predicted MTBF of the 2470A is in excess of 20,000 hours. Silicon transistors are used throughout, and passive and active components are selected for dependability, as well as performance. Amplifier meets spec at 95% humidity at 40°C. Critical parameters (zero drift, full-scale accuracy, common mode rejection) are verified after 100 hours of "run-in" at elevated temperature.

**Packaging for value, compactness:** Amplifier and self-contained power supply are enclosed in a unique, rugged molded dielectric case. Combining case, bench stand, power and signal cables, plus many other accessories, are available.

**Use if for:** Amplifying signals from low-level resistive transducers, such as thermocouples, strain gages. High input and low output impedance make it ideal for amplification over long transmission lines; use it, with resistive or reactive loads, such as x-y, strip-chart or oscillographic recorders, digital voltmeters, null detectors and servo systems, telemetry systems... or use it as a high-performance bench amplifier.

Call your Hewlett-Packard field engineer for complete information or write the Dymec Division of Hewlett-Packard, 395 Page Mill Road, Palo Alto, California 94306, Tel. (415) 326-1755; Europe: 54 Route des Acacias, Geneva.

Price f.o.b. factory.  
Data subject to change without notice.

**HEWLETT  
PACKARD**  **DYMEC  
DIVISION**

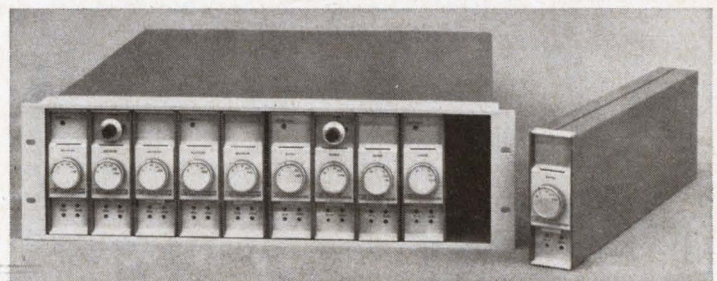

ON READER-SERVICE CARD CIRCLE 2



## Our new Mother...all-silicon solid state

We're normally a hard-nosed, unsentimental bunch at CMC, dedicated to giving the other two major makers of electronic counters (Hewlett-Packard and Beckman) a run for their money. So you wouldn't think we'd have time for motherhood or advancing the counter art. **But**, we've scored on all three with our new 600-Series. (1) It's the first all-silicon solid state counter. (2) We're the first of the big three to use the advanced "Mother-Board" technique. So we've cut size, weight, and components while increasing reliability and ease-of-maintenance. (3) Operating temperatures from  $-30^{\circ}$  to  $+75^{\circ}\text{C}$  are available. (Other folks we know strain to claim  $-25^{\circ}$  to  $+65^{\circ}\text{C}$ ). Model 607 provides a frequency range of 0 to 5 Mc and period measurement of 0 to 1 Mc. Other models have readout from 2 cps to 2.5 Mc. That's eight times faster than any competitive counter at the price. All this, and a price that's competitive with ordinary germanium counters. **Something free!** We give a glorious Crusading Engineers' medal to engineers who have the courage to compare **everyone's** performance specs before buying a counter. Get yours by writing today for our new stimulating technical catalog. It's free, too. And your Mother will be so proud of your shiny medal.



12973 Bradley • San Fernando, California • Phone (213) 367-2161 • TWX 213-764-5993

# Electronic Design 28

VOL. 14, NO.

THE MAGAZINE OF ESSENTIAL NEWS, PRODUCTS AND TECHNOLOGY

DECEMBER 6, 1966

---

## NEWS

- 13 News Scope
- 17 **LSI chips away at computer hardware costs**  
Powerful logic functions on a single slice promise higher reliability as well as size and cost reductions.
- 21 Memory process puts 645 million bits on a square inch.
- 24 **Electronics flies, dives, swims**  
Aircraft, submarines and other miniatures shown at New York's National Hobby and Craft Exposition can do almost anything their prototypes do.
- 27 Washington Report
- 33 Computers to aid in designing computers.
- 38 Microprobe checks tiny magnetic domains.
- 46 Letters
- 51 **Editorial: Who's complaining now . . . and who's listening?**

---

## TECHNOLOGY

- 54 **Evaluate the thermal runaway point** of transistor audio output stages using experimental data and a set of simple calculations.
- 62 **Don't gamble on system performance!** Statistics and random sampling will give an accurate picture of a transmission system's behavior.
- 68 **Get ultralinenarity from ramps.** Charging the timing capacitor from a constant current source improves and simplifies ramp generators.
- 76 **Avoid relay misapplication.** Case histories show that this can be done by giving the manufacturers more specs and applications data than is sometimes done.
- 82 **Try low-resistance trimmers.** If applied correctly, they can provide not only high resolution but other advantages as well.
- 86 **Get rid of cross-polarization** in edge-shunt slotted array antennas with only a partial grating placed across the center of the array.
- 90 **Read off the life of pilot lights** as a function of the operating voltage, current and candlepower with a simple nomograph.
- 92 **Reduce paperwork on MIL designs** with this index of items that are cross-referenced to military approval requirements.
- 106 Ideas for Design

---

## PRODUCTS

- 118 **Cover Feature: Strange bedfellows** in a TO-5—an spdt relay and a FET amplifier.
- 144 Test Equipment
- 148 Systems
- 150 Power Equipment
- 152 Semiconductors
- 154 Materials
- 156 Microwaves
- 160 Microelectronics

---

## Departments

- |                       |                         |
|-----------------------|-------------------------|
| 96 Book Reviews       | 166 New Literature      |
| 162 Design Aids       | 174 Advertisers' Index  |
| 164 Application Notes | 176 Designer's Datebook |

---

**ELECTRONIC DESIGN** is published biweekly by Hayden Publishing Company, Inc., 850 Third Avenue, New York, N. Y. 10022. James S. Mulholland, Jr., President. Printed at Poole Bros., Inc., Chicago, Ill. Controlled-circulation postage paid at Chicago, Ill., Cleveland, Ohio, and New York, N. Y. Application to mail at controlled postage rates pending at St. Louis, Mo. Copyright © 1966, Hayden Publishing Company, Inc. 60,777 copies this issue.

# There's a G-E silicone

## Bonding

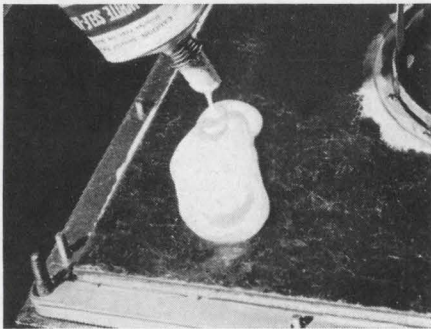

Laminated layers of mica sheeting are securely bonded with G-E RTV silicone sealant. Ready to use, it bonds to most materials.

## Insulating



G-E RTV translucent sealant provides excellent see-thru insulation instantly. UL-recognized, the sealant also comes in colors.

## Damping

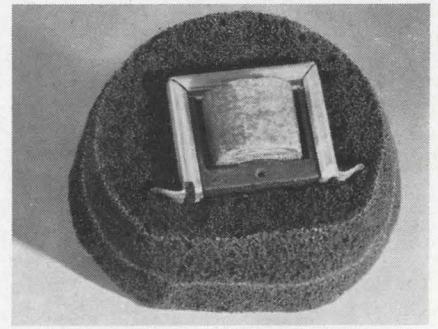

G-E RTV-7 silicone rubber foams on the spot to provide mechanical support, shock and vibration damping, and light weight electrical insulation.



Screws and drilling are eliminated by adhering identification plates with RTV sealant. It won't harden, soften, crack or shrink.

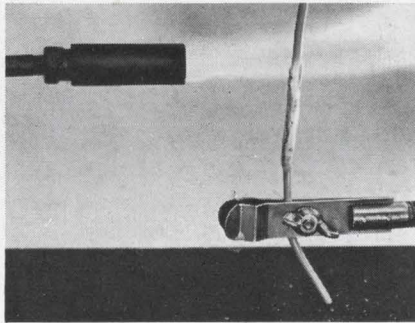

Silicone rubber wire and cable insulation passes UL vertical flame tests and is frequently used in high-voltage circuits.

## Sealing

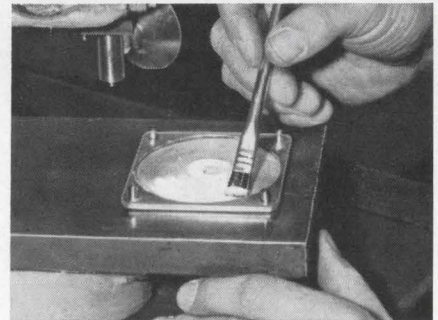

G-E two-part RTV, available in a range of viscosities, seals filament condenser plate in dielectric heater. Also protects against vibration.

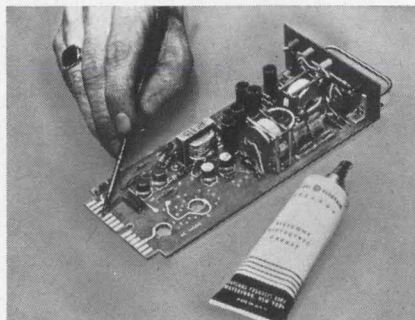

G-E silicone dielectric greases, ideal heat transfer media, are easily brushed, painted, sprayed, dip-coated or applied directly from tube.

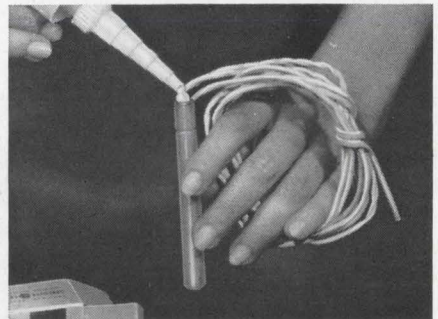

G-E RTV is ideal for high temperature moisture sealing of heating elements. It withstands temperatures as high as 600°F, as low as -75°F.

# design solution for:

## Moldmaking

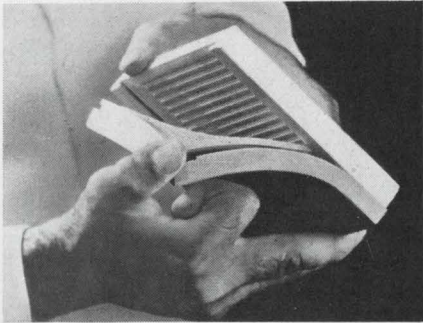

Tough, flexible G-E RTV silicone for moldmaking reproduces detail accurately and minimizes tooling costs.

## Potting and Encapsulating

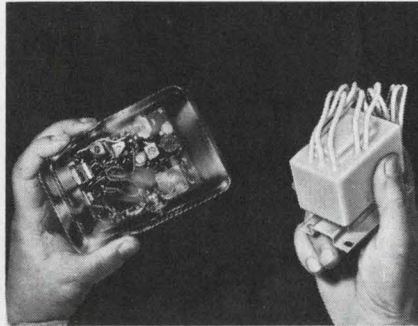

Many G-E RTV silicone compounds are available—all with good strength, outstanding electrical properties and resistance to temperature extremes.

## Fluids Applications

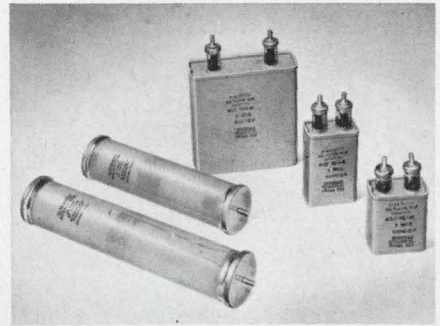

G-E silicone dielectric fluids provide excellent electrical properties and thermal stability for many types of components.

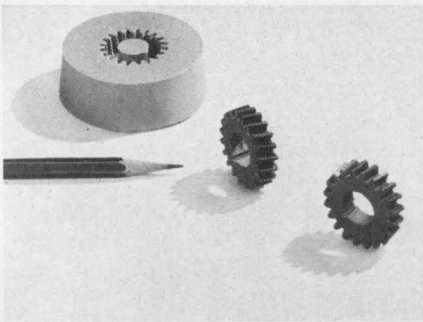

For prototypes or short-run parts production, G-E RTV is an excellent flexible moldmaking material. And it needs no release agent.

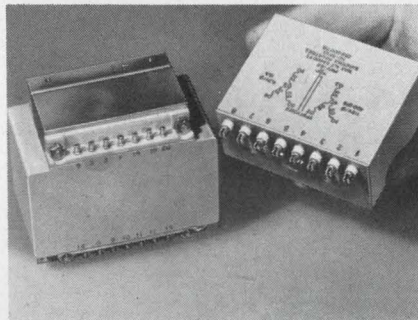

Impregnation of transformer coils with G-E RTV provides electrical insulation and environmental protection at high temperatures.

## Fabricating

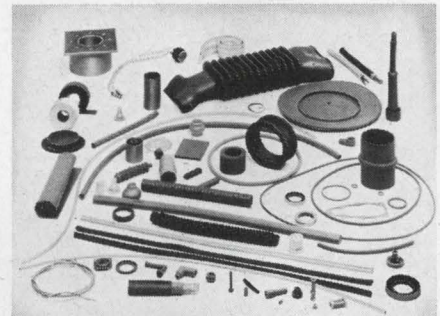

G-E silicone elastomers are easily used to make numerous silicone rubber parts by standard rubber fabricating techniques.

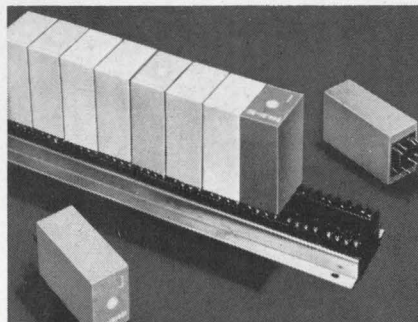

G-E RTV provides attractive, protective packaging for components. Each unit is encapsulated in a different color RTV for easy identification.

## If you can't find it here, write for our Silicone Selector Guide:

Section L12254, Silicone Products Dept., General Electric Company, Waterford, New York 12188.

**GENERAL**  **ELECTRIC**

ON READER-SERVICE CARD CIRCLE 4

**These  
are the  
hands of  
an artist.  
At  
Burroughs  
they produce  
quality  
memory  
components.**

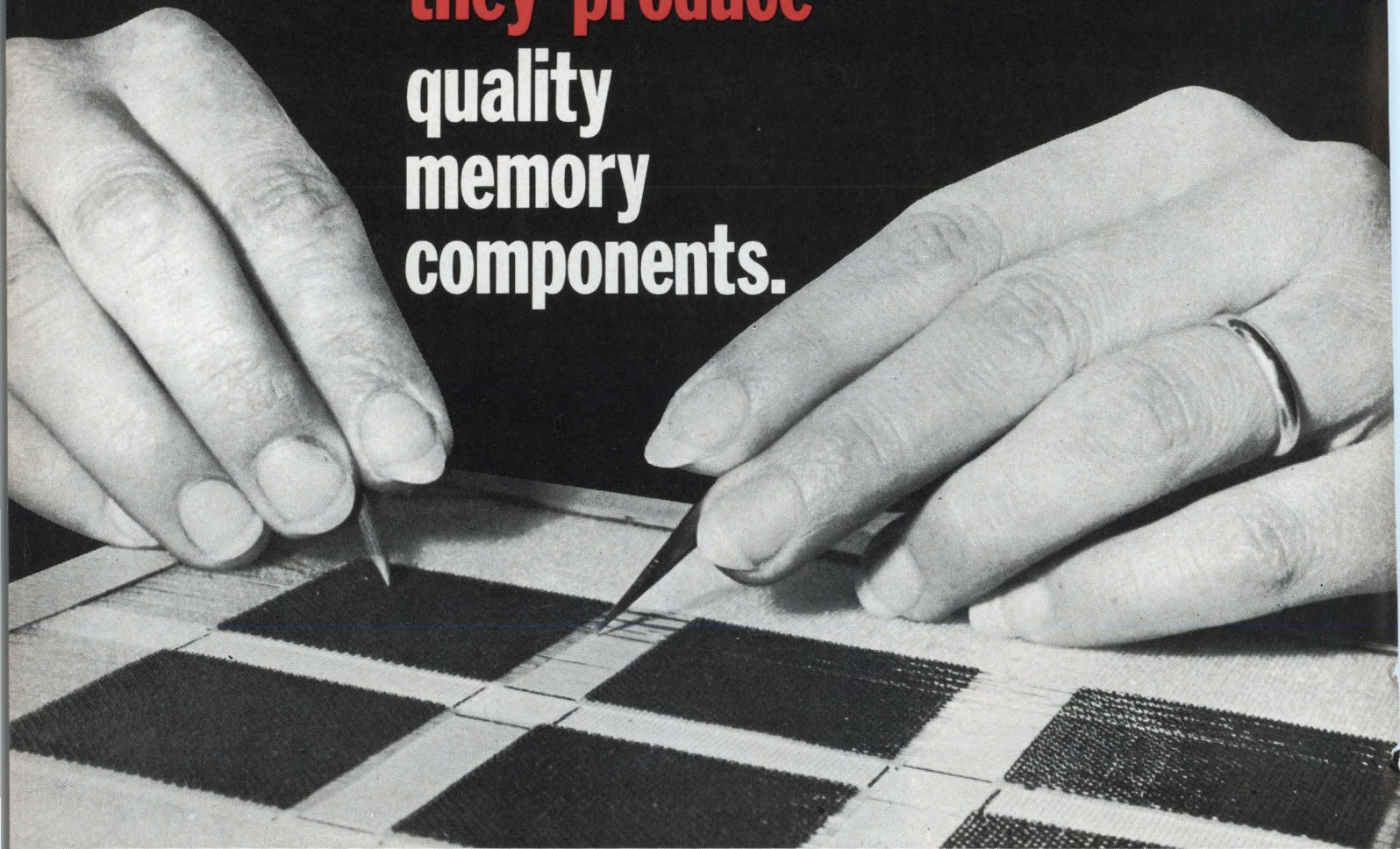

**With many hands like these . . .**

- Burroughs manufactures a complete product line of 20, 30 and 50 mil ferrite cores.
- Burroughs manufactures temperature stable ferrite cores (for operation over a 100°C range in an environment of -50°C to +100°C).
- Burroughs manufactures 2 ½ D memory stacks.
- Burroughs manufactures mass memories.
- Burroughs manufactures the highest quality memory products (cores, planes and stacks) under a Zero Defects Program.
- Burroughs now makes complete memory systems available for your computers.



**Burroughs Corporation**

ON READER-SERVICE CARD CIRCLE 5

ELECTRONIC COMPONENTS DIVISION

PLAINFIELD, NEW JERSEY 07061



# New MOS hybrid microcircuits

An industry first. General Instrument, the leading producer of both hybrid and MOS ICs, has combined both technologies to create the most advanced line of hybrid ICs yet produced. The PC-250 is the result of this marriage of high performance MOS transistors and high performance bi-polar transistors used in conjunction with GI's proven hybrid assembly techniques.

The PC-250 is an ultra-high input impedance amplifier which can be used not only as a general purpose amplifier, but is designed for use wherever electrometer type high input impedance circuits are required—as in infrared detectors, high impedance transducers and crystal cartridges—thereby eliminating the need for the much larger, more complex, less reliable electrometer tube. The PC-250 and the PC-251 (the short-circuit-proof version of the PC-250) are immediately available in hermetically sealed ceramic-metal flatpacks from your authorized General Instrument Distributor. Write for full information.

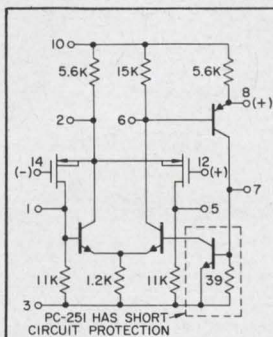

#### CIRCUIT DIAGRAM:

- The high impedance MOSFETS matched in a differential pair form the front end of the amplifier—resulting in an electrometer type performance input circuit.
- No external frequency stabilization is required in most normal closed loop amplifier configurations.
- This circuit is indicative of the many types possible with this new combined technology.

#### FEATURES:

Input resistance . . . .  $10^{14}$  typical  
 Voltage Gain . . . 50dB, 44dB min.  
 Input Leakage Current . . . .3 pA



GENERAL INSTRUMENT CORPORATION • 600 WEST JOHN STREET, HICKSVILLE, L. I., NEW YORK  
 ON READER-SERVICE CARD CIRCLE 6

# new Tektronix plug-in simplifies reflectometry measurements

## Type 1S2 Sampling Unit for time domain reflectometry and general-purpose sampling

You can test transmission lines, cables, connectors, broad-band devices with ease and accuracy with the new Type 1S2 Sampling Plug-In Unit. It can be used in any Tektronix oscilloscope that accepts letter and 1-series plug-ins.

The  $\leq 90$ -ps risetime of the vertical channel, and deflection factors to 5 mV/div make the Type 1S2 useful in many general-purpose sampling measurements. For this general-purpose use, a pretrigger or delay line is required. System risetime as a reflectometer is  $\leq 140$  ps.

The illustration shows a Type 1S2 in a Tektronix Type 549 Storage Oscilloscope being used to test a 50- $\Omega$  delay line. Information obtained from the upper trace includes electrical length of the line, nominal impedance, location and type of discontinuities. Lower trace is magnification of the discontinuity shown near the center of the upper trace. Deflection factors:

Upper trace — Vertical 0.25 p/div  
Horizontal 20 ns/div  
Lower trace — Vertical 0.025 p/div  
Horizontal 5 ns/div

The Type 1S2 Manual Scan display mode was used in storing both traces to obtain optimum resolution.

With the Type 1S2, positions of discontinuities in a line under test can be read directly from a dial in units of time or distance. Accuracy of round-trip time readings is within  $\pm 1\%$  of full scale.

Dual, full-scale 10-division horizontal calibration is in distances of 10 m, 100 m, and 1 km, and in times of 0.1  $\mu$ s, 1  $\mu$ s, and 10  $\mu$ s. The display can be expanded by a 7-step, calibrated, X1 through X100 magnifier for detailed examination of any discontinuities.

Illuminated readout of the horizontal scale factor, including any magnification, adds to the operating ease. And testing of either short or long lines is facilitated by internal generators that provide a 50-ps, 250 mV pulse and a 1-ns, 1-V pulse.

A front-panel switch provides for matching the horizontal calibration to the types of lines most commonly tested—air, TFE, and polyethylene. A variable control permits matching the calibration to lines using other dielectrics.

Vertical calibration is in both  $\rho$  (rho) and in volts, from 0.005/div to 0.5/div, in 7 steps, with an accuracy within  $\pm 3\%$ . It is also variable between steps, uncalibrated. A  $\pm 2$ -V offset voltage, monitorable at the front panel, allows amplitude measurements, using slide-back techniques, with an accuracy within  $\pm 1\%$ .

Vertical and horizontal outputs of 1 V/div of displayed signal are available at front-panel connectors.

Type 1S2 . . . . . \$1300  
Includes: 2X and 5X attenuators, 50- $\Omega$  termination, 20-cm airline, 5-ns RG 8/AU cable, 2 GR elbows, 18" patch cord, and 2 manuals.

U. S. Sales Price f.o.b. Beaverton, Oregon

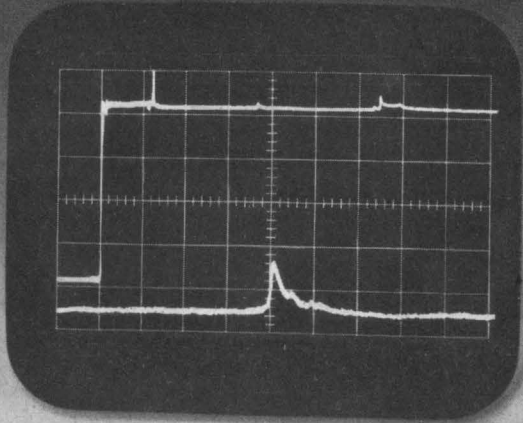

**Tektronix, Inc.**



For complete information, contact your nearby Tektronix field engineer or write: Tektronix, Inc., P.O. Box 500, Beaverton, Oregon 97005

ON READER-SERVICE CARD CIRCLE 7

**PRECISION MOLDED MONOBLOCS**

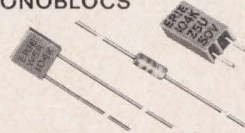

**PHENOLIC COATED MONOBLOCS**



**HERMETICALLY SEALED-IN-GLASS MONOBLOCS**



**"NEW FLAT-PACK MONOBLOCS"**  
Five 10,000 pF. capacitors in one package



**NEW HIGH VOLTAGE MONOBLOCS**  
1400 pF. at 3 K Volts...  
in only .003 cu. in.



**NEW BUTTON-TYPE MONOBLOC FILTER-CAPACITORS**



**MONOBLOC CHIPS**  
Any SIZE and shape available



**WORLD'S MOST COMPACT TRIMMER CAPACITOR...**  
5 to 25 pF. 100 WVdc



**UNMATCHED for VOLUMETRIC EFFICIENCY, STABILITY and RELIABILITY**

In today's microcircuitry, Erie's unique MONOBLOC Ceramic Capacitors provide the answer to difficult packaging problems... particularly where high capacitance, demanding stability, great reliability and severe environmental conditions are deciding factors.

Monobloc Subminiature Capacitors are available now for a wide variety of microcircuit applications. Currently, Monoblocs are used extensively in aerospace and military control equipments, communications computers and other areas requiring the reliability of performance so characteristic of Erie Monoblocs.

*You name the capacitance problem and Erie will provide a Monobloc Capacitor with better reliability... in a smaller package. Write for Monobloc Ceramic Capacitor literature.*

Another Series of Components in Erie's Project "ACTIVE"  
Advanced Components Through Increased Volumetric Efficiency



**IF YOU NEED SMALLER**

**Quality CAPACITORS... Specify**

**ERIE MONOBLOCS**®

**ERIE**

**TECHNOLOGICAL**

**PRODUCTS, INC.**



Erie, Pennsylvania

ON READER-SERVICE CARD CIRCLE 8

**Now from Sprague!**

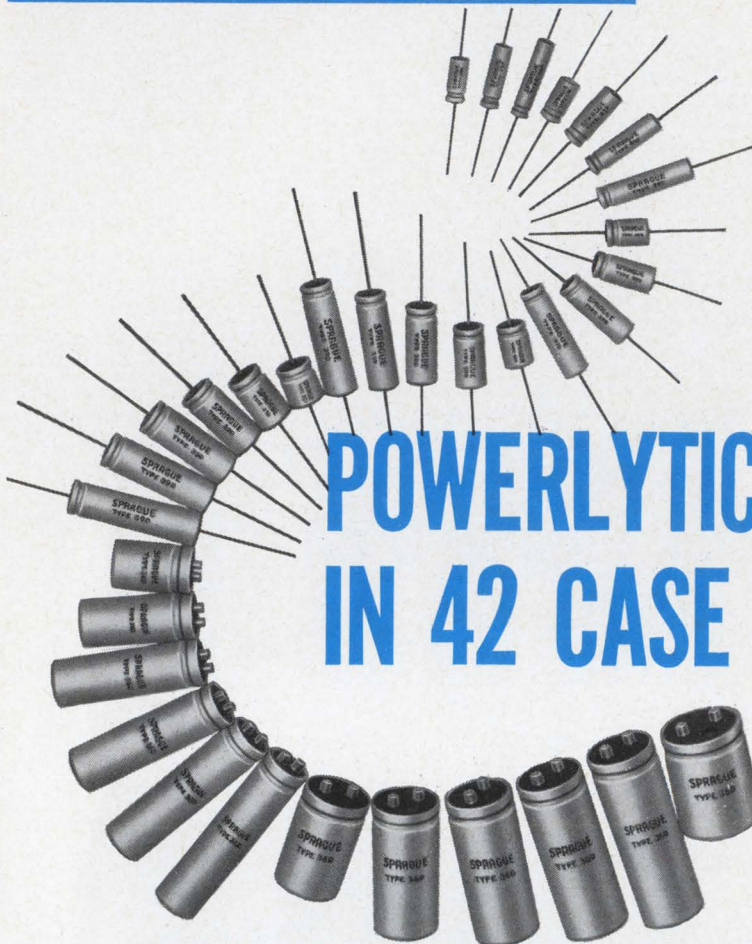

# POWERLYTIC® CAPACITORS IN 42 CASE SIZES...

**for maximum capacitance in minimum space!**

## Type 36D Cylindrical Case

Designed specifically for space economy, in applications such as computer power supplies, industrial controls, high gain amplifiers, etc. Case sizes from  $1\frac{3}{8}'' \times 2\frac{1}{8}''$  to  $3'' \times 5\frac{5}{8}''$ . Improved temperature capabilities—may now be operated at 85 C. Low equivalent series resistance, low leakage current, excellent shelf life, high ripple current capability. Superior seal employs molded cover with recessed rubber gasket. Reliable safety vents. Solder lug or tapped terminals. Standard ratings from 3 to 450 VDC, capacitance values to 270,000  $\mu$ F.

## Type 39D Tubular Case

Smaller companion to proven 36D capacitor, possessing same outstanding performance. Case sizes from  $\frac{1}{2}'' \times 1\frac{1}{8}''$  to  $1'' \times 3\frac{5}{8}''$ . Designed for operation at temperatures up to 85 C. Unique construction—anode and cathode terminals are welded—no riveted or pressure connections—prevents open circuits, even in microvolt signal range. Improved molded phenolic end seals contribute to unusually long life (expectancy, 10 years or more). Low effective series resistance, low leakage current. Standard ratings include capacitance values to 18,000  $\mu$ F, voltages from 3 to 450 VDC.

*For complete technical data on Type 36D or Type 39D Powerlytic Capacitors, write for Engineering Bulletins 3431B and 3415, respectively, to Technical Literature Service, Sprague Electric Co., 347 Marshall Street, North Adams, Mass. 01247.*

**Popular ratings are now available for fast delivery from your Sprague Industrial Distributor.**

### SPRAGUE COMPONENTS

CAPACITORS  
TRANSISTORS  
RESISTORS  
INTEGRATED CIRCUITS  
THIN-FILM MICROCIRCUITS  
450-5131R2

PULSE TRANSFORMERS  
INTERFERENCE FILTERS  
PULSE-FORMING NETWORKS  
TOROIDAL INDUCTORS  
ELECTRIC WAVE FILTERS

CERAMIC-BASE PRINTED NETWORKS  
PACKAGED COMPONENT ASSEMBLIES  
BOBBIN and TAPE WOUND MAGNETIC CORES  
SILICON RECTIFIER GATE CONTROLS  
FUNCTIONAL DIGITAL CIRCUITS



'Sprague' and '®' are registered trademarks of the Sprague Electric Co.

# News

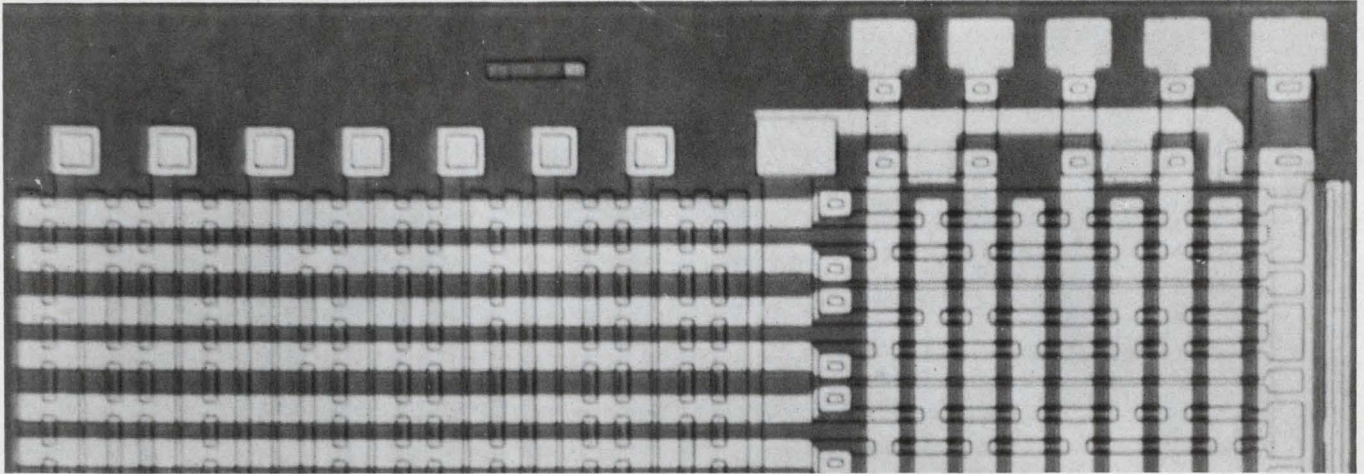

**Large-scale integration** makes a great impact on digital computers by upping the reliability

of systems and power of data processors, while also cutting hardware costs. Page 17



**Electronic systems** put new zip into tiny models. Page 24

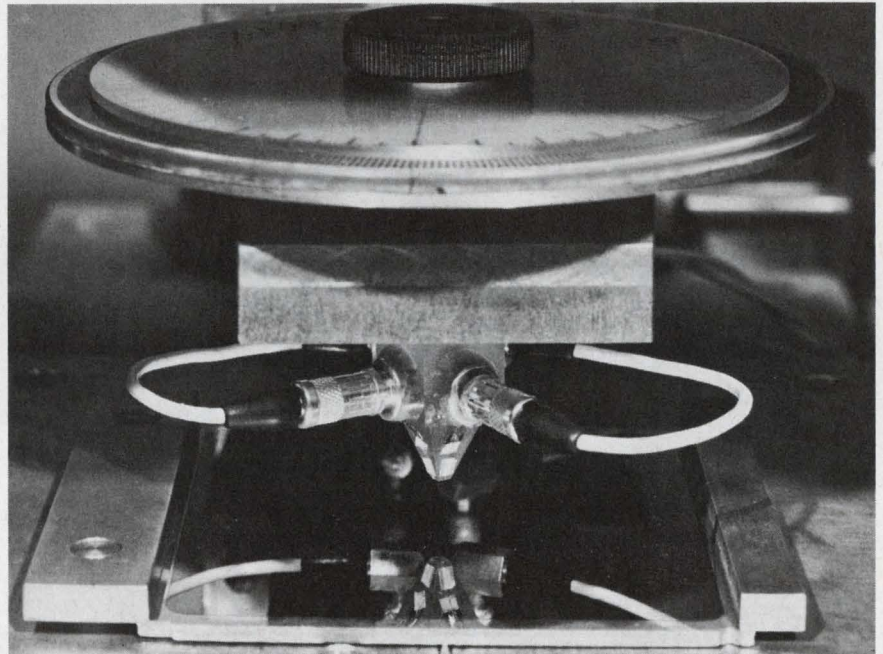

**Microprobe** is able to check tiny magnetic domains in order to judge the suitability of films for computer memories. Page 38

## Also in this section:

**Computers aid in the design** of computers. Page 33

**New technique seals thousands** of semiconductors at once. Page 44

**News Scope**, Page 13 . . . **Washington Report**, Page 27 . . . **Editorial**, Page 51

**In High-Volume Production!**

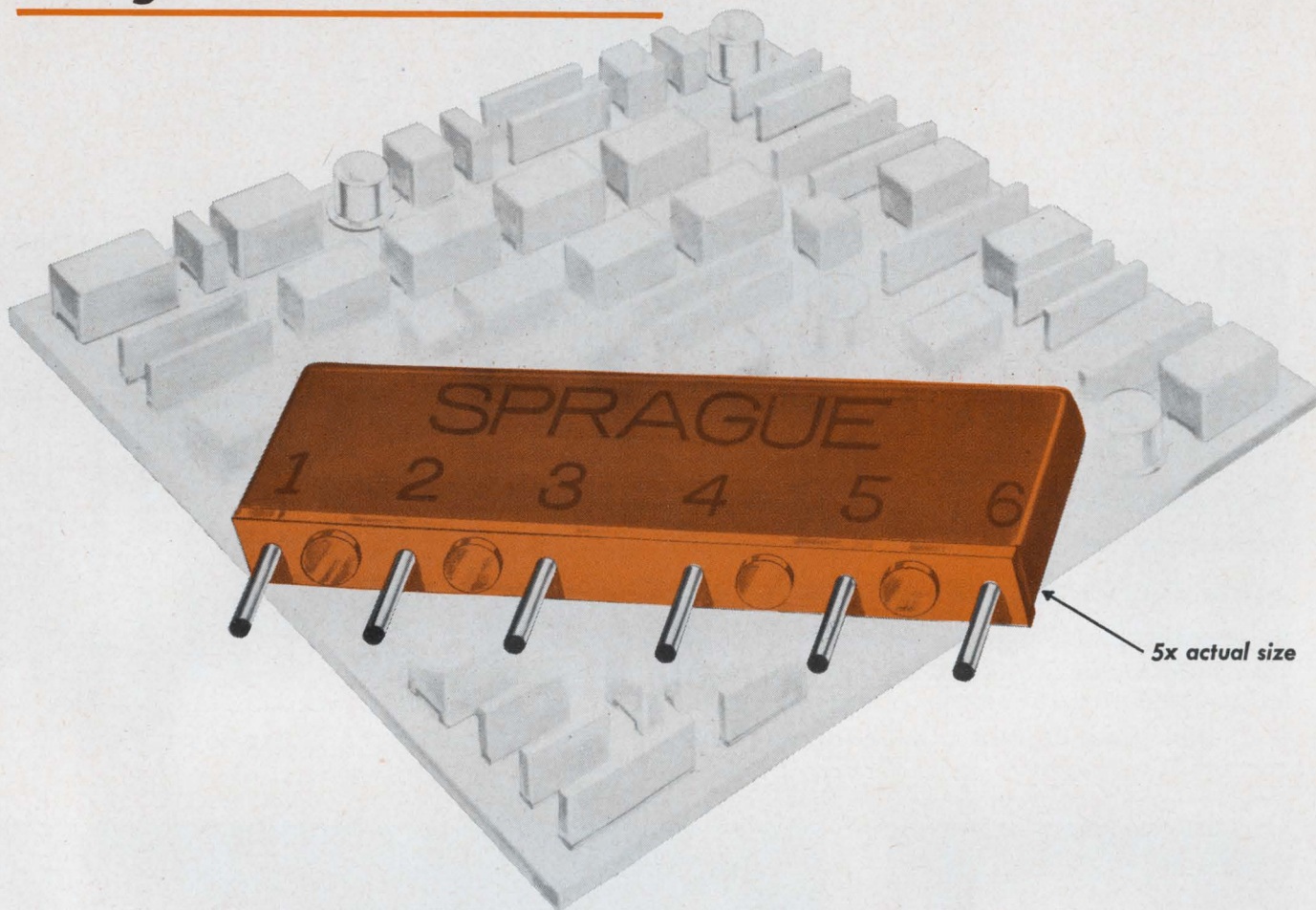

# **METANET<sup>®</sup> TRUE METAL-FILM NETWORKS** **PRECISION RESISTOR**

## **Save Space, Time, and Money**

- High packaging density—4 to 8 times that of individual components.
- Fewer components to stock, handle, inspect, install. Entire module can be hand-inserted faster than one axial-lead component.
- Permit substantial savings over equipment assembled with individual components.
- Epoxy terminal board keeps pin terminals free of resin coating, unlike conventional dipped components, and provides uniform lead spacing.
- Stand-off bosses permit efficient flux removal after soldering. Also prevent dirt and moisture traps around leads.
- Extremely stable and reliable. Meet performance requirements of MIL-R-10509E. Resistance tolerances to  $\pm 1\%$ .
- Ceramic capacitors can be incorporated for further savings and size advantages over individual components



For complete technical data, write for Engineering Bulletin 20,000 to Technical Literature Service, Sprague Electric Company, 347 Marshall Street, North Adams, Massachusetts 01247.

### **SPRAGUE COMPONENTS**

RESISTORS  
CAPACITORS  
TRANSISTORS  
INTEGRATED CIRCUITS  
THIN-FILM MICROCIRCUITS

PULSE TRANSFORMERS  
INTERFERENCE FILTERS  
PULSE-FORMING NETWORKS  
TOROIDAL INDUCTORS  
ELECTRIC WAVE FILTERS

CERAMIC-BASE PRINTED NETWORKS  
PACKAGED COMPONENT ASSEMBLIES  
BOBBIN and TAPE WOUND MAGNETIC CORES  
SILICON RECTIFIER GATE CONTROLS  
FUNCTIONAL DIGITAL CIRCUITS

**SPRAGUE<sup>®</sup>**  
**THE MARK OF RELIABILITY**

\*Sprague' and '®' are registered trademarks of the Sprague Electric Co.

ON READER-SERVICE CARD CIRCLE 10

ELECTRONIC DESIGN 28, December 6, 1966

# News Scope

## Tubeless TV cameras oust vidicon? not yet!

Despite increased effort by large companies to develop a solid-state tubeless television camera, it is still too early to predict the demise of the vidicon.

The developmental efforts received added impetus with the recent announcement by the Radio Corp. of America of a new solid-state TV camera, designed by Dr. Paul K. Weimer and associates at the company's laboratories in Princeton, N. J. Both Fairchild and Westinghouse disclosed comparable cameras in October during the IEEE Electron Devices Meeting in Washington, D. C.

The RCA thin-film unit is experimental; it was developed for the Air Force, hopefully for incorporation in reconnaissance systems. It consists of 32,400 microscopic dots of photoconductive material arranged in a 180-by-180 array on a square-inch glass side. Along two of the four edges of the image-sensing

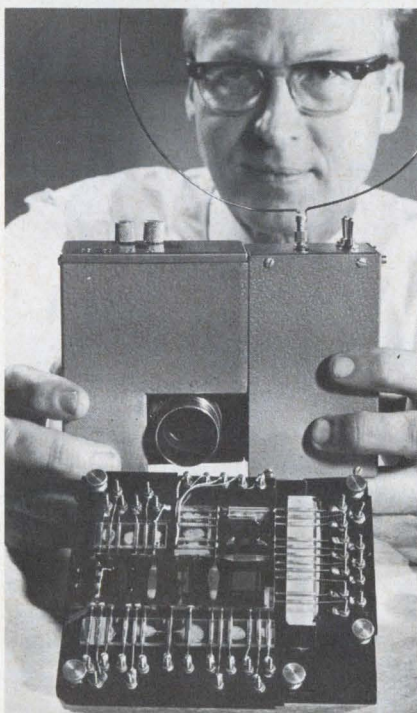

RCA's hand-sized, tubeless TV camera

slide are two other slides, each with 540 thin-film transistors. The transistor networks are connected to the horizontal and vertical grid lines of the array. A fourth slide carries additional thin-film circuits required for various control functions.

The camera is battery-powered. It draws only 3 watts at 14 volts dc, including the transmitter unit.

Dr. Weimer described the operation this way:

As the scene is focused on the sensing array, the electrical resistance of various photoconductive dots varies in proportion to the amount of light falling on them. A train of pulses sequentially applied to all 180 vertical grid lines produces current in each dot in proportion to the incident light intensity—the weaker the light, the weaker the current.

At the same time the transistors in the second array sequentially sample each of the horizontal grid lines. This discloses the conductivity pattern in the photoconductive dots to create the electrical facsimile of the original scene.

The sensing array is scanned in this fashion 60 times every second, a rate consistent with that of a conventional television camera.

Every time the array is scanned, the many currents and their relative positions are sensed and combined into a single fluctuating current that forms the output of the experimental camera. This output, amplified and converted to a microwave signal in the transmitter, is sent to a television receiver for display.

At present, according to Dr. Weimer, the experimental camera is inferior in resolution, sensitivity and speed to a conventional TV camera. However, he adds:

"We expect to overcome many of these limitations in the future, by adopting new circuit ideas and by developing photoconductive arrays with as many as 10 times more

light-sensing elements as are used in this first, experimental model."

The Fairchild camera was described by researcher Gene Weckler at the IEEE meeting. It consists of 10,000 phototransistors and 10,000 MOS-FETs on a single chip a half-inch square.

Westinghouse's unit, Gene Strull told the same meeting, is an array consisting of 50-by-50 phototransistors, also a half-inch square. Strull indicated, however, that his work showed that an array with resolution of 200 lines per inch was entirely feasible.

But all of the new devices have a way to go before they can match the vidicon's resolution of 400 to 500 lines per inch, as well as its sensitivity and speed. The advantages of a solid-state vidicon are such, however, that a concerted effort to develop a successful one will undoubtedly continue.

As Dr. James Hillice, vice president of RCA Laboratories in Princeton, observes:

"Eventually cameras of this type could find the widest possible application in the military, in space, in medicine, in home and industry. There is still much work to be done, but the promise is definitely there."

## Space-guidance laser will undergo testing

The practical laser spacecraft guidance system will move a step closer to realization as a result of a recently awarded contract.

NASA's Marshall Space Flight Center, Huntsville, Ala., awarded the contract to ITT's Federal Laboratories at Nutley, N. J. Simulated tests will be made of a prototype light-beam system intended to guide space vehicles in rendezvous and docking maneuvers.

ITT officials say that the optical system will be lighter and more compact, accurate and efficient than radar systems used.

Gallium arsenide laser arrays are used on each spacecraft for rendezvousing. After initial acquisition, one vehicle's optical system becomes passive.

The maneuvering spacecraft's laser pulses are returned by a reflective array on the passive craft. Angle, range and rate-of-closure information are converted by the maneuvering craft's computer into

# News Scope

CONTINUED

signals for controlling its attitude and propulsion systems.

ITT plans to use a mountain-top laboratory to house the passive vehicle's system and an aircraft flying over the laboratory to simulate the maneuvering spacecraft.

Upon successful completion of the mountain-top tests, the laser system will be tested in NASA's Gemini rendezvous simulator and Lunar Excursion Module simulator.

## 80-kW accelerator being used by NBS

One of the world's most intense electron beams is being produced by a new linear particle accelerator (linac) at the National Bureau of Standards laboratory complex at Gaithersburg, Md.

With an electron power output of more than 80 kW—an intensity 200,000 times greater than any previously available at the bureau—the beam can infuse materials of all kinds with extremely high radiation doses.

The linac is basically a 100-foot pipe through which electrons are accelerated on the crest of a traveling

radio-frequency wave. Individually powered accelerator sections are coordinated and used to impart high energy to the electrons by means of repeated voltage applications. The NBS linac has nine such accelerator sections that the beam passes through.

Since it is hard to maintain steadily the high RF power necessary for an intense linac beam, the NBS linac beam is pulsed. Each electron pulse is synchronized with a burst of RF energy within the accelerator sections. The electron bunches within a pulse travel on the crests of the RF field as they are moving down the accelerator.

The linac wing occupies two basement levels at the NBS complex. On one level are the linac chamber, a magnet room and measurement rooms; on the other level are cooling, power and control rooms.

The linac's well-defined beam, highly stable and extremely small in energy spread, can be controlled by magnetic fields and made to interact directly with various materials. Alternatively, it can be directed at certain targets to generate other radiations, such as X-rays, positrons or neutrons.

## Are Russians checking Theory of Relativity?

The Soviet Union may be conducting experiments in space to check Einstein's Theory of Relativity.

This speculation arose from the recent publication of a brief article in *Pravda*. It announced that the Russians had orbited an atomic clock of the ammonia type in Cosmos 97, launched Nov. 26, 1965.

Explaining possible uses of an ammonia frequency standard in a satellite, Soviet Academician N. G. Basov said that it "permits carrying on communications with space devices, control over them and transmission of telemetric information for very great distances."

"In addition," he noted, "there is in this case a considerable increase in the operating precision of program timer devices and systems for determining the trajectory of the satellite's movement."

U.S. observers are speculating that the Cosmos 97 payload may be a prelude to checking Einstein's theory, by comparing the difference in performances of a space-born

and a ground-based atomic clock. Such experiments have been suggested in the past by both Soviet and U.S. scientists.

The frequency of the satellite standard has been telemetered for comparison with a ground-based standard, *Pravda* reported. However, no quantitative data were reported, to show the amount of deviation experienced.

## DOD will issue catalog for space experimenters

For researchers with an experiment that simply "must" be carried into space aboard the next Titan or Saturn launch vehicle, the Defense Dept. has just the thing: a new semiannual catalog of secondary payload space and flight opportunities for experimenters.

The catalog will be issued shortly by the Directorate of Defense Research and Engineering, according to Dr. Finn J. Larsen, deputy chief of the directorate. He told a recent meeting of the National Space Club that the publication would be part of a move to establish a central operating agency to manage flight support for all DOD space experiments. The program will be conducted in cooperation with a similar NASA effort to utilize unprogramed secondary payload space, Dr. Larsen said.

## Integrated circuit used in FM receiver IF stage

H. H. Scott, Inc., announced that for the past month it has been using Fairchild Semiconductor integrated circuits in the IF amplifier stage of its higher-priced FM receivers. This is the first use of ICs in a high-fidelity home entertainment product, according to H. H. Scott.

Designated  $\mu A703$ , the amplifier consists of five transistors and two resistors deposited on a single silicon chip mounted in an epoxied package. Four amplifiers are used in each FM.

The use of an integrated circuit as an IF amplifier will, H. H. Scott says, improve the FM receiver's capture ratio (the ratio of desired signal to unwanted interference and other stations on the same channel).

Fairchild Semiconductor says that it plans to offer the device on the regular off-the-shelf market.

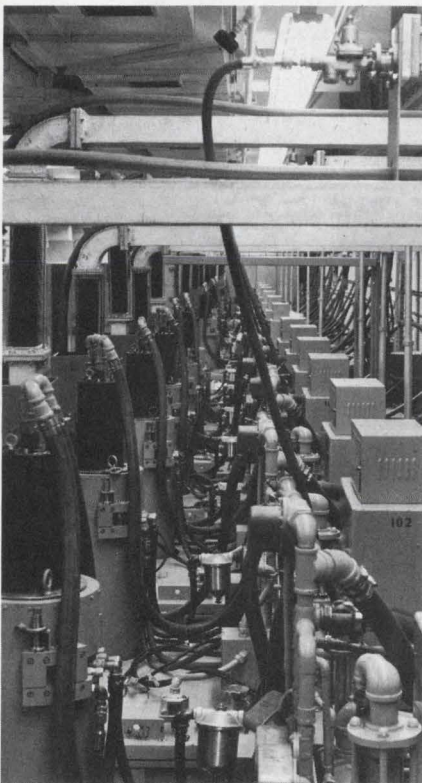

A long look at 100-foot accelerator



# Westinghouse makes IC's faster than you can buy them

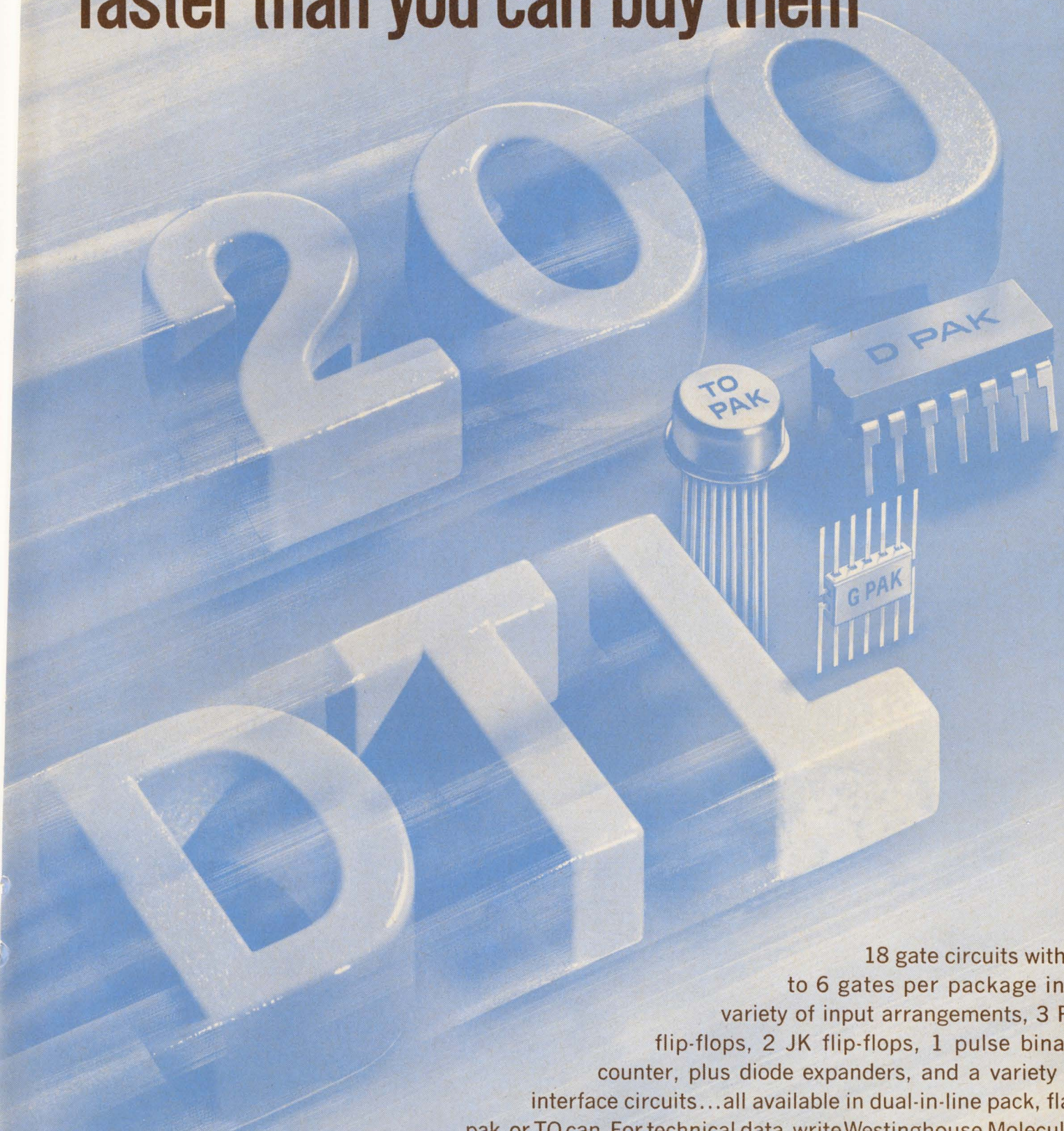

18 gate circuits with 1 to 6 gates per package in a variety of input arrangements, 3 RS flip-flops, 2 JK flip-flops, 1 pulse binary counter, plus diode expanders, and a variety of interface circuits...all available in dual-in-line pack, flat-pak, or TO can. For technical data, write Westinghouse Molecular Electronics Division, P.O. Box 7377, Elkridge, Maryland 21227.

**Call your Westinghouse Electronic Distributor now.**

You can be sure if it's Westinghouse

J-09136



# MODEL CW-1 BOXCAR INTEGRATOR

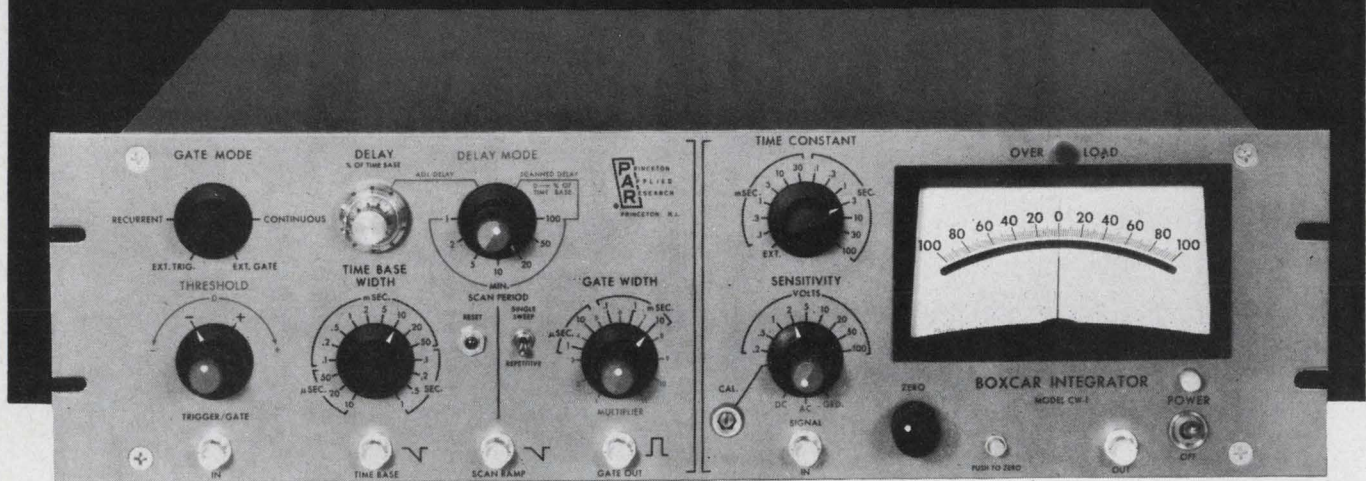

The Model CW-1 Boxcar Integrator is a gated signal averaging device useful for the recovery of either complete repetitive waveforms or incremental portions thereof from noise. The input to the Boxcar Integrator is sampled by a variable width, variable delay gate which can be fixed at any point on, or slowly scanned across, the repetitive waveform. The sampled portion of the input waveform is averaged by a variable time constant integrator, displayed on the panel meter, and made available for external recording or other use. Because the mean value of random noise is zero, the output of the integrator will asymptotically approach the average value of that portion of the input waveform being sampled at any moment, with a corresponding suppression of the accompanying noise. The Model CW-1 may be used in such widely varied applications as pulsed nuclear resonance, laser excitation decay, and biological evoked response experiments. In general, this instrument should be of value in any application where noise interferes with the recovery of repetitive waveforms.

## SPECIFICATIONS

### SIGNAL CHANNEL —

**Input Sensitivity:**  $\pm 2$  volt to  $\pm 100$  volts in 1, 2, 5, sequence for  $\pm 10$  volts output.

**Dynamic Range:** Will accept inputs 15 times full scale requirement without overloading.

**Integration Time Constants:** 100 microseconds to 100 seconds in 1, 3, 10 sequence.

**Holding Time:** At least  $10^6$  times integration time constant for 10% F.S. change in output, up to  $10^5$  sec.

**Output:** (a)  $\frac{1}{2}\%$  Panel Meter,  $\pm 10$  volts.

(b)  $\pm 10$  volts provided at front panel at an impedance of 1 K.

(c) Recorder Output — suitable for most galvanometric and servo recorders.

### GATE TIMING CIRCUITS —

**Operating Modes:** (a) Ext. Trigger

(b) Ext. Gate

(c) Recurrent: Time Base triggered automatically and repetitively.

(d) Continuous: Gate on continuously.

ON READER-SERVICE CARD CIRCLE 12

**Time Base Widths:** 10 microseconds to 1 second in 1, 2, 5 sequence.

**Gate Pulse Width:** Continuously adjustable from 1 microsecond to .11 second.

**Delay:** (a) Manual adjustment from 0% to 100% of Time Base Width.

(b) Automatic scanning from 0% to that % of Time Base Width selected by setting the Manual Delay Dial.

**Automatic Delay Scan Periods:** 1, 2, 5, 10, 20, 50, and 100 minutes.

### GENERAL —

**Power Requirements:** 105-125 volts or 210-250 volts; 50-60 Hz; approximately 15 watts.

**Size:** 19"W x 5"H x 14"D.

**Price:** \$1,950.00. Export prices approximately 5 per cent higher (except Canada). Request Bulletin No. 127.

**PRINCETON**  
APPLIED RESEARCH CORP.  
Dept. E  
Box 565, Princeton, N. J., Tel. (609) 924-6835

# LSI chips away at computer hardware costs

**Powerful logic functions on a slice promise higher reliability as well as size and cost reductions.**

**Joseph J. Casazza**  
Technical Editor

Successful development of large-scale integration (LSI) technology is making significant changes in digital computers. Some of these changes, according to Richard L. Petritz, director of Texas Instruments' Semiconductor Research and Development Laboratory, Dallas, are:

- Lower system hardware costs.
- Higher system reliability.
- More powerful data processors.
- Incorporation of software into hardware, with a resultant simplification of software.

## Slice holds complete function

Incorporation of a complete function (adder, register, etc.) on a single circuit chip will have a great impact on computer design, Petritz points out. The present integrated-circuit approach permits incorporation of only a sufficient number of

logic circuits to perform a part of some logic function. But as more complex logic functions are placed on a single slice of semiconductor material, computer software, too, can be simplified. The software will employ hardware to perform specialized operations that would otherwise require complex and expensive programs.

Integrated-circuit chips which contain a complete logic function are referred to by Petritz as integrated equipment components (IECs) to distinguish them from single-function ICs. The difference between these is illustrated in Fig. 1, which shows the relationship between a single device, IC and IEC.

There is general agreement that LSI, or "complex arrays," will be the big difference between third-generation and fourth-generation computers.

What are the logic functions that can be handled by LSI? According

to L. C. Hobbs, president of Hobbs Associates, Inc., Vista del Mar, Calif., many functions that are presently handled by programed sub-routines can be implemented easily with special-purpose circuits to perform the logic. Some of the functions that could be dealt with in this manner include:

- Binary-to-decimal and decimal-to-binary conversions.
- Code conversions.
- Co-ordinate conversions.
- Format control.
- Table look-up operations.
- Scaling.
- Mathematical operations such as square root, trigonometric functions and matrix operations.

## MOS or bipolar?

While the future role of LSI may be well established, the choice of device to implement this technology efficiently remains a major question. Will it be the MOS or the bipolar transistor? In answer, Petritz points out that MOS devices provide five times the amount of circuitry possible with bipolar transistors for a given surface area. "But," says Petritz, "the bipolar has a speed and power advantage." This, he believes, will offset the MOS device's size advantage in high-performance computer applications. This speed/power capability will give the bipolar transistor a role in the large, general purpose computer.

For those applications where MOS has sufficient speed and current handling capability, it should be used on the basis of achieving higher complexity per unit of chip area. Examples today include shift registers in the megacycle speed range where the capacity loading of devices is small because the fan-out is basically one. Some remarkable achievements have already been made in employing serial logic with MOSs for small processors such as desk calculators.

On the other hand, says Petritz, bipolar will be the choice for the

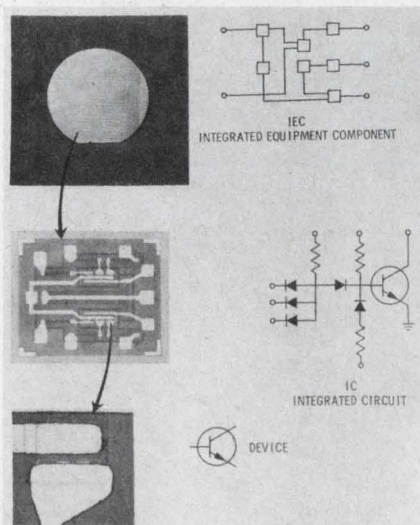

**1. Integrated equipment components perform complex logic functions (top) as opposed to conventional integrated circuits (middle) which perform simple logic functions. These, in turn, are compared with the single transistor (bottom) which cannot perform any function independently.**

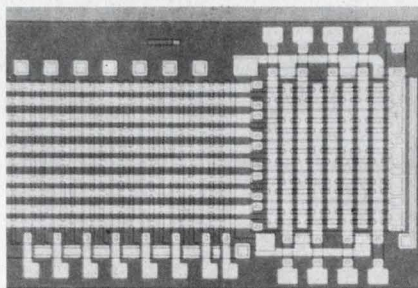

(a)

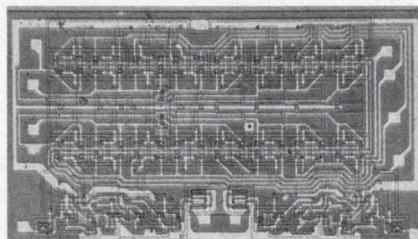

(b)

**2. Examples of present-day IECs include this eight-bit shift register (a) and this binary-decimal decoder (b), both built by Texas Instruments.**

## NEWS

### (LSI chips, *continued*)

more general applications, particularly if speed is a factor. The basic advantage of the bipolar is its inherently high transconductance ( $g_m$ ); therefore, it is superior where appreciable capacitance must be charged as in parallel logic.

Comparison of the size and performance characteristics of both bipolar- and MOS-based IECs is shown in the table. Two of the devices listed—an eight-bit bipolar shift-register and a binary-decimal decoder—are shown in Fig. 2.

### Designer's role changing

As the complexity of integrated circuits changes, the computer designer can reasonably expect to find his own role in the design process changing. Wendell B. Sander, of Fairchild Semiconductor's Research and Development Laboratory, Mountain View, Calif., believes that the designer will still have to make the decision to "buy standard, design custom, or build your own." This is a problem that must be faced when dealing with both conventional integrated circuits and their more complex counterparts. Where a computer designer had easy access to a number of complete integrated-circuit families incorporating the basic logic functions (AND, OR, etc.), he could adapt standard components to meet his needs. With complete functions on a single chip,

however, the designer is now faced with the problem of using a readily available function and modifying his original design, or on the other hand proceeding with his original design and having special integrated circuits designed and built for him.

The question of whether or not to standardize complex logic-function families is of primary concern both to device and system manufacturers. Cost will certainly play a large role in any decision. Pointing to the large savings from the standardization of conventional integrated circuits, Dr. Robert N. Noyce, vice president of Fairchild Camera and Instrument, states that "the appearance of more standard arrays seems inevitable."

Increasing use of complex integrated computer circuits should simplify the designer's job and permit him to build a more powerful, more compact and less costly machine. There will be even less emphasis on the design of individual circuits and more on the synthesis of complex logic functions that are at present contained in software.

Another effect of LSI on the designer's job will be to increase the importance of design by computer. According to Petritz there are two approaches to computer-aided design of complex integrated circuits. One of these involves computer-aided design directly at the device level

—that is, designing IECs by computer directly from device parameters. This is essentially the procedure followed by engineers today when approaching LSI through device-based design. Petritz believes, however, that a more useful approach will be to use computer-aided design at the circuit-function level. In this case the designer defines a set of logical circuits such as gates, flip-flops, etc., and uses the computer to design circuit layouts which minimize crossovers, area, etc.

Design by computer should benefit system manufacturers by shortening the time it takes for a device manufacturer to respond to system requirements. Another advantage of automated design techniques is that more accurate simulation for circuit analysis is possible with digital computers than with breadboarding. Normal breadboarding techniques do not simulate the actual conditions on a slice of silicon sufficiently well.

The material in this article is based on a series of papers delivered at the Fall Joint Computer Conference, held in San Francisco, November 8 through 10. Copies of the Conference proceedings may be purchased from the Scientific and Technical Division of Spartan Books, Inc., 432 Park Avenue South, New York, N.Y. 10016. A cumulative index is available also at a cost of \$3.00. ■ ■

## Table. Comparison of integrated equipment components

Mfr.	Component	Device	Area (in <sup>2</sup> )	No. of devices	Device density (devices/in <sup>2</sup> )	Speed	Power (mW)	Pads
*TI	Series-53 array	Bipolar	0.7	1200	1720	35 ns	1200	60
TI	8-bit shift reg.	Bipolar	0.006	160	26,500	15 MHz	190	6
TI	Honeywell memory	Bipolar	0.0071	100	14,000	25 ns	250	14
TI	Parallel-load serial shift	Bipolar	0.01	150	15,000	25 ns	270	22
†GME	100-bit shift reg.	MOS	0.0065	613	94,500	1 MHz	200	12
‡GI	21-bit shift reg.	MOS	0.0042	158	37,600	500 kHz	150	11
TI	22-bit shift reg.	Bipolar	0.0126	350	27,800	3 MHz	35	8
TI	B-to-D decoder	MOS	0.0057	152	26,700	200 kHz	25	26

\*Texas Instruments, Inc.

†General Micro-Electronics, Inc.

‡General Instrument Corp.



## Like Popcorn.

The other day one of our engineers said, "We're turning out those Unibloc\* plastic transistors like popcorn." And, boy did we jump all over him!

Sure, it's one way of saying we're making them by the millions (by the tens of millions as a matter of fact). And, we suppose it even reflects the fact that we produce them so fast right here in Phoenix that we can compete price-wise with devices made anywhere in the world.

But, that's not the point.

The trouble with likening them to "popcorn" is that

it doesn't give you the true picture about the precision and quality that's built into each and every device we make.

As a matter of fact, we advertising guys are the ones who dubbed them "no compromise" transistors because you get the same premium performance with Unibloc devices that you've always associated with metal-can transistors.

That is the reason we were so upset.

So, on your next new design, grab a handful of popcorn and live it up.

\*Trademark of Motorola Inc.

*- where the priceless ingredient is care!*



**MOTOROLA**  
**Semiconductors**

MOTOROLA SEMICONDUCTOR PRODUCTS INC. • P. O. BOX 955 • PHOENIX, ARIZONA 85001 • (602) 273-6900 • TWX 910-951-1334  
ON READER-SERVICE CARD CIRCLE 13

ELECTRONIC DESIGN 28, December 6, 1966

# 0.5 db

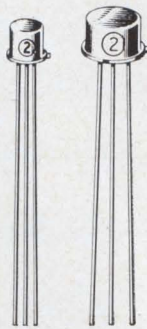

This is the typical wideband noise figure of Sprague Types 2N4383 and 2N4384 high-gain, low-level NPN silicon epitaxial planar transistors. Maximum NF is 2.0 db, one db lower than the type that has been the industry's most popular high-gain, low-level transistor.

Sprague Electric also offers Types 2N4385 and 2N4386, with noise figures of 1.0 db typ., 3.0 db max.

Characteristic	Conditions	2N4383 (TO-5 Case)	2N4384 (TO-18 Case)	2N4385 (TO-5 Case)	2N4386 (TO-18 Case)
$BV_{CBO}$	$I_C = 10 \mu A$	40V min.	40V min.	40V min.	40V min.
$BV_{CEO}$	$I_C = 10 mA$	30V min.	30V min.	30V min.	30V min.
$I_{CBO}$	$V_{CB} = 30V$	10nA max.	10nA max.	10nA max.	10nA max.
$I_{EBO}$	$V_{EB} = 5V$	10nA max.	10nA max.	—	—
$h_{FE}$	$V_{CE} = 5V, I_C = 1 \mu A$	60 min.	60 min.	—	—
$h_{FE}$	$V_{CE} = 5V, I_C = 10 \mu A$	100 min.	100 min.	40 min.	40 min.
$h_{FE}$	$V_{CE} = 5V, I_C = 1 mA$	120 min.	120 min.	100 min.	100 min.
NF	$V_{CE} = 5V, I_C = 10 \mu A, r_g = 10K\Omega$ , Bandwidth = 10 Hz to 15.7 kHz	2db max.	2db max.	3db max.	3db max.

Evaluate these devices without delay. They're available **now** in production quantities. Call your nearest Sprague Electric district office or sales representative for prices and delivery. Or, write Marketing Dept., Semiconductor Division, Sprague Electric Company, Concord, N.H. 03302.

## SPRAGUE COMPONENTS

TRANSISTORS  
CAPACITORS  
RESISTORS  
INTEGRATED CIRCUITS  
THIN-FILM MICROCIRCUITS  
INTERFERENCE FILTERS

PACKAGED COMPONENT ASSEMBLIES  
FUNCTIONAL DIGITAL CIRCUITS  
MAGNETIC COMPONENTS  
PULSE TRANSFORMERS  
CERAMIC-BASE PRINTED NETWORKS  
PULSE-FORMING NETWORKS



\*Sprague' and Ⓢ are registered trademarks of the Sprague Electric Co.

## NEWS

### Spinning ball-heart of inertial system

A spinning ball in place of a conventional gyroscope at the heart of a new airborne inertial guidance system has overcome a lot of friction and drift problems. The beryllium golf-ball-sized rotor "floats" in an electrostatic field as it spins at 60,000 rpm and furnishes a stable reference.

The use of electrostatic suspension combined with the elimination of the contact surfaces of the conventional gyro permit the ball to spin undisturbed in an evacuated chamber for periods up to three years.

The gyro was developed by Honeywell, Inc., under contract to the Air Force's Avionics Laboratory at Wright-Patterson AFB, Ohio. It is intended as part of the stabilized platform on C-124 aircraft.

Air Force engineers say that the electrostatic suspension eliminates friction, the main source of inaccuracy in conventional gyroscopes, and gives a high degree of reliability.

The position of the spin axis of the sphere with respect to the gyro case indicates the orientation of the gyro in inertial space. A beam of light focused on lines inscribed on the sphere gives this reference. The platform's guidance computer uses data on the relative positions of the lines and the case. ■ ■

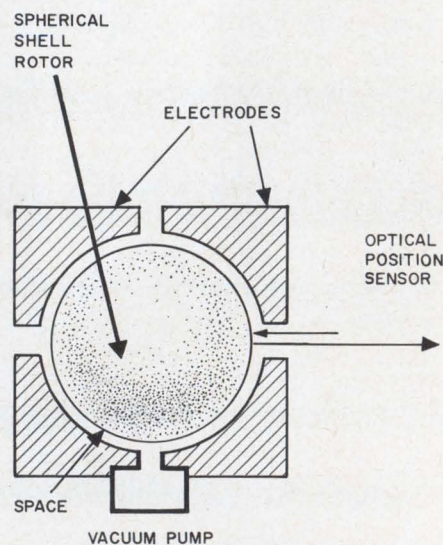

Ball replaces wheel as the rotor in a new electrostatic gyroscope.

## Memory process puts 645 million bits on a square inch

A new laser memory process is said to be able to pack 645 million bits of digital data on one square inch area of plastic tape. The laser burns minute craters in the tape, as the tape is drawn at high speed past an aperture.

The process was developed under Dr. Carl Becker of the Precision Instrument Co., Palo Alto, Calif. A laboratory model, without the tape-moving mechanism, has demonstrated the functions, but a complete system has yet to be built.

A one-watt cw argon laser, gated by an electro-optical modulator, burns the minute pits in the tape's opaque coating. The holes or the lack of them correspond to digital input data. A hole represents logical 1 and no hole is a logical 0 bit.

The operating system will move polyester tape around an imaging circle of the laser aperture. The aperture is formed by objective lenses rotating at 1800 rpm.

The laser creates one-micron holes (0.0039 inch) in the opaque coating of the tape, leaving the clear backing intact. The holes are burned in successive parallel lines slanted at a slight angle across the tape. This permits the entire tape surface to be used and results in the high storage density.

A locating track in binary code is used to locate each individual track for readout.

Light passing through the clear spots in the tape is used to verify the accuracy of the process. A plexi-

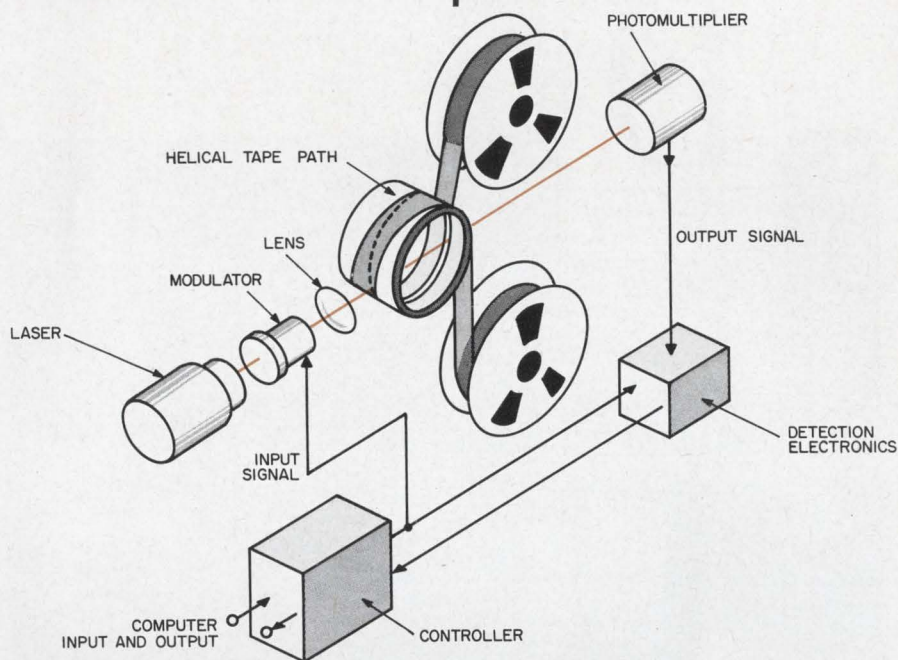

**Mass memory process** uses lasers to write, check and read records. The laser burns minute data bits on fast-moving opaque plastic tape.

glass "light pipe" collects and transports light passing through the tape to a photomultiplier, where it is translated to electrical impulses. The impulses are then compared with the input data to verify the recording.

The tape is read by the reverse of the writing process. A lower-powered cw laser beam illuminates the tape as it rolls by. Light shines through the holes and is translated into an electrical pulse. The reading laser does not alter the tape. Pulses can then be fed to a computer, printer or other recorder.

According to the Precision Instrument Co., the new process is unique in the following ways:

- The capacity is 645 million bits per inch. This compares with about 5600 bits per square inch for standard magnetic tape.
- The speed-recording rate is 12 million bits per second.
- Permanence-holes cannot be erased and do not fade.
- The accuracy of the recording is verified instantly, and an alarm indicates lack of correspondence between input and output. ■ ■

## Bureau of Standards calibrating peak-pulse instruments

Need to have your peak-pulse voltmeter calibrated? Try the Radio Standards Laboratory of the National Bureau of Standards, Boulder, Colo.

The bureau recently announced a new service, which it said is capable of calibrating various types of instruments, such as meter and digital units and oscilloscopes. Pulse generators can also be calibrated, provided their controls can be set accurately to some reference position.

Peak voltages, the bureau said, can be determined over the range of 5

to 1000 volts. Measurements are made to  $\pm 1\%$  with accurate fast rise, unidirectional, trapezoidal pulses.

The parameters of these pulses for the different voltage ranges are as follows:

<b>Voltage Range</b>	<b>5 to 100 V</b>
Rise and Fall Time	10 ns (each)
Pulse Duration	0.02 to 100 $\mu$ s
Pulse Rep. Rate	60 to 2 X 10 <sup>6</sup> pps
Max. Duty Cycle	0.1
<b>Voltage Range</b>	<b>100 to 1000 V</b>
Rise and Fall Time	30 ns (each)

Pulse Duration	0.06 to 5 $\mu$ s
Pulse Rep. Rate	60 to 1.66 X 10 <sup>6</sup> pps
Max. Duty Cycle	0.01

Any questions about calibrations within these specifications or about special calibrations not covered in the two voltage ranges should be directed to Philip A. Simpson, High Frequency Calibration Services, Engineering Division, Radio Standards Laboratory, National Bureau of Standards, Boulder, Colorado 80302. ■ ■

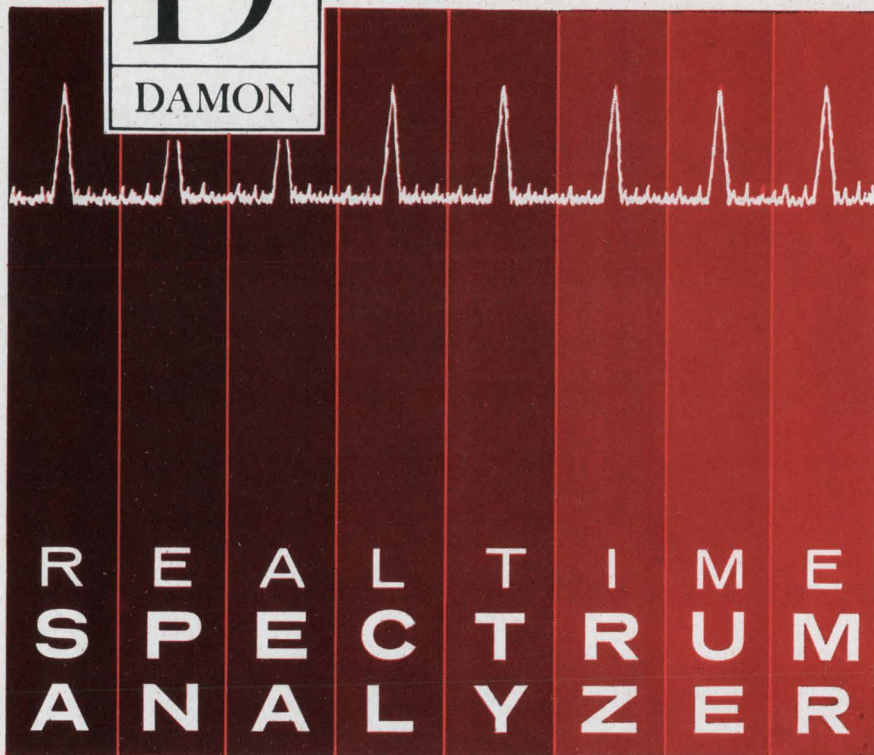

**Gaussian or Chebyshev Crystal Filters  
Solid State Electronic Commutation  
Uniform Frequency Response**

Damon's Multifilter Spectrum Analyzers are adaptive to signal rate, filter time constant or display response. A unique frequency-sharing principle permits optimum utilization of filters for maximum economy. In analysis bands from 100 cps to 10 Mc, multipole crystal filters with bandwidths from 5 cycles to 100 Kc resolve closely spaced signals having large amplitude ratios.

These state-of-the-art Analyzers are illustrative of Damon's capabilities in frequency information retrieval and analysis. Other significant examples include the Telstar Comb Filter and the SPASUR Detection Preselector.



**Spectrum Analyzer  
Model 5187A**

**Write for Real Time Multiple Filter  
Spectrum Analyzer Brochure.**

**DAMON ENGINEERING, INC.**

240 HIGHLAND AVENUE  
NEEDHAM HEIGHTS, MASS. 02194 (617) 449-0800  
ON READER-SERVICE CARD CIRCLE 15

NEWS

**Dual magnetometers help search for oil**

If you happen to see a helicopter flying low with two bomb-shaped devices dangling below it on a cable, don't be alarmed. Its intentions are peaceful. It is merely looking for oil.

The new airborne surveying instrument, known as a geomagnetic gradiometer, has been developed by Varian's Quantum Electronics Div., Palo Alto, Calif. The instrument system is capable of mapping hundreds of square miles of subsurface terrain a day. It is said to be superior to the single magnetometer, now in common use.

The gradiometer system furnishes detailed data for use in determining the location of geological structures that trap petroleum under the ground. It is made up of two rubidium magnetometers in streamlined pods, suspended 100 feet apart vertically below an aircraft.

Each magnetometer senses changes in the earth's magnetic field as small as 0.01 gamma (about one part in five million) of the earth's magnetic field. Instrumentation within the aircraft simultaneously records the output of the lower magnetometer and the difference in signals between both.

By using two magnetometers, the new gradiometer is said to have the following advantages over the single magnetometer:

- Vertical measurement sensitivity to determine the character of the deep layers and their relation to probable oil-bearing strata.
- A sensor configuration that cancels the daily changes in the earth's magnetic field and prevents their distribution of measurement.

The basic element in each magnetometer is a glass cell containing vaporized rubidium. Optical pumping is used to excite the vapor. Changes in the vapor's energy level as the magnetometers pass through the earth's variable magnetic field are monitored optically.

Varian scientists are working on even more sensitive cesium and rubidium magnetometers expected to have a twentyfold improvement over current magnetometers. ■ ■



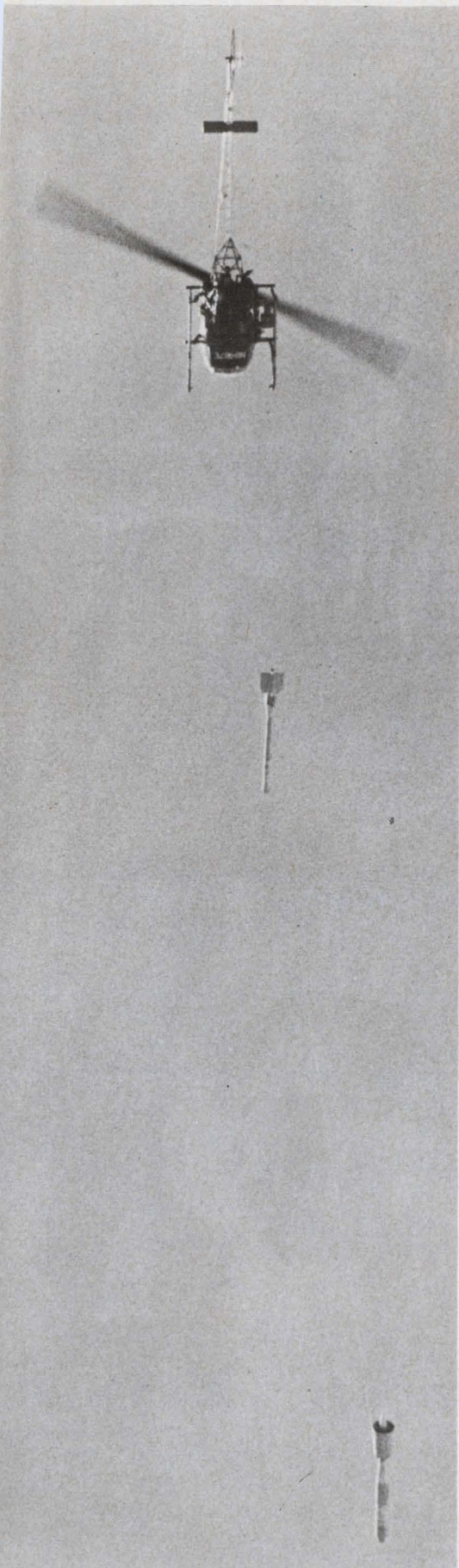

**Bombs on a string?** No, two magnetometer sensors. They are part of Varian's new geomagnetic gradiometer for finding oil deep in the ground.



*basic measuring tools from*  
**HEWLETT  
 PACKARD**

## *Field-proven hp 3400A RMS Voltmeter*

Measure true rms value, 100  $\mu$ v to 300 v, 10 Hz to 10 MHz  
 Accuracy is  $\pm 1\%$  full scale  
 High crest factor for accurate pulse, noise measurement  
 DC output 1 v at full scale  
 High maximum input, 1000 v peak

### *Use it to:*

Measure level of noise with a crest factor of 100  
 Measure rms value of pulse trains  
 Measure true rms current, using hp 456A Current Probe  
 Make frequency response tests  
 Convert ac to dc for recorder or DVM operation

The Hewlett-Packard 3400A RMS Voltmeter measures the actual root mean square of ac voltages which are sinusoidal or nonsinusoidal and have crest factors (ratio of peak to rms) as high as 10 at full-scale deflection and as high as 100 at 10% of full scale. Overload protection to 30 db or 1000 v peak, whichever is less, on each range. Input resistance 10 megohms. Scale calibrated in both rms volts and db, the latter permitting

measurement  $-72$  to  $+52$  dbm. Price 3400A, \$525; Option 01 (db scale uppermost for better resolution), \$550.

Call your Hewlett-Packard field engineer for a demonstration of the 3400A or write for complete specifications: Hewlett-Packard, Palo Alto, Calif. 94304, Tel. (415) 326-7000; Europe: 54 Route des Acacias, Geneva.

*Data subject to change without notice.  
 Prices f.o.b. factory.*

**HEWLETT**  **PACKARD**  
*An extra measure of quality*

1044

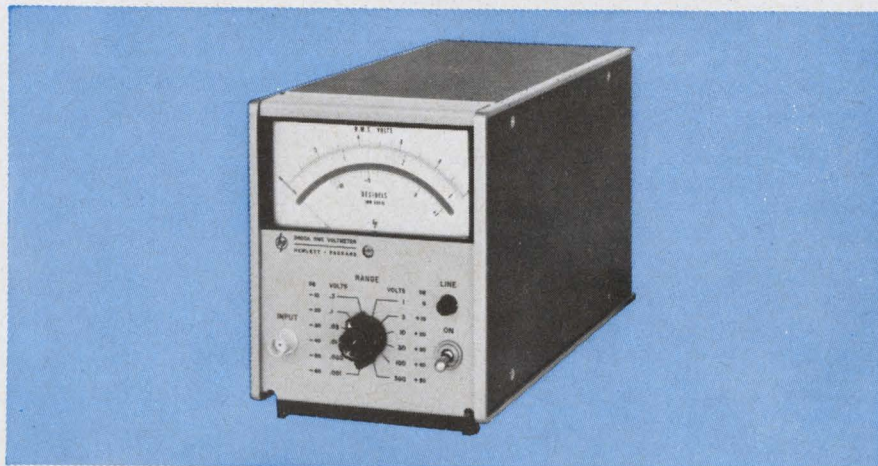

ON READER-SERVICE CARD CIRCLE 16

## Model-makers race, fly and sail with electronics

If you think that electronics is all work and no play, you weren't at the National Hobby and Craft Exposition held in New York's Coliseum at the end of October.

From finely detailed "slot racers" to a plastic, radio-controlled duck, electronically operated models drew considerable attention from show visitors of all ages. Not only are these pint-sized replicas accurate reproductions of the real thing but they can duplicate many of their prototypes' movements. Most of these were home projects. But the racing cars, such as the one shown here, and the Norelco kit (\$25) are on the market.

Joseph J. Casazza, Roger Kenneth Field

It'll never fly, but this colorful little bird will paddle about a pond under command from a miniature radio transmitter. Containing a tiny radio receiver, the duck is propelled by a small, battery-driven electric motor coupled to a propeller in its "stern." Rudder position is controlled by a miniature servo. He mixes well with other ducks.

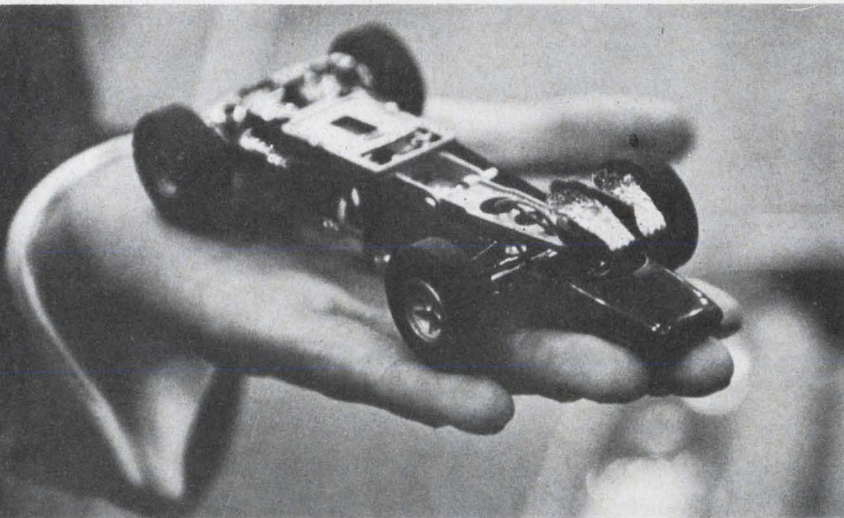
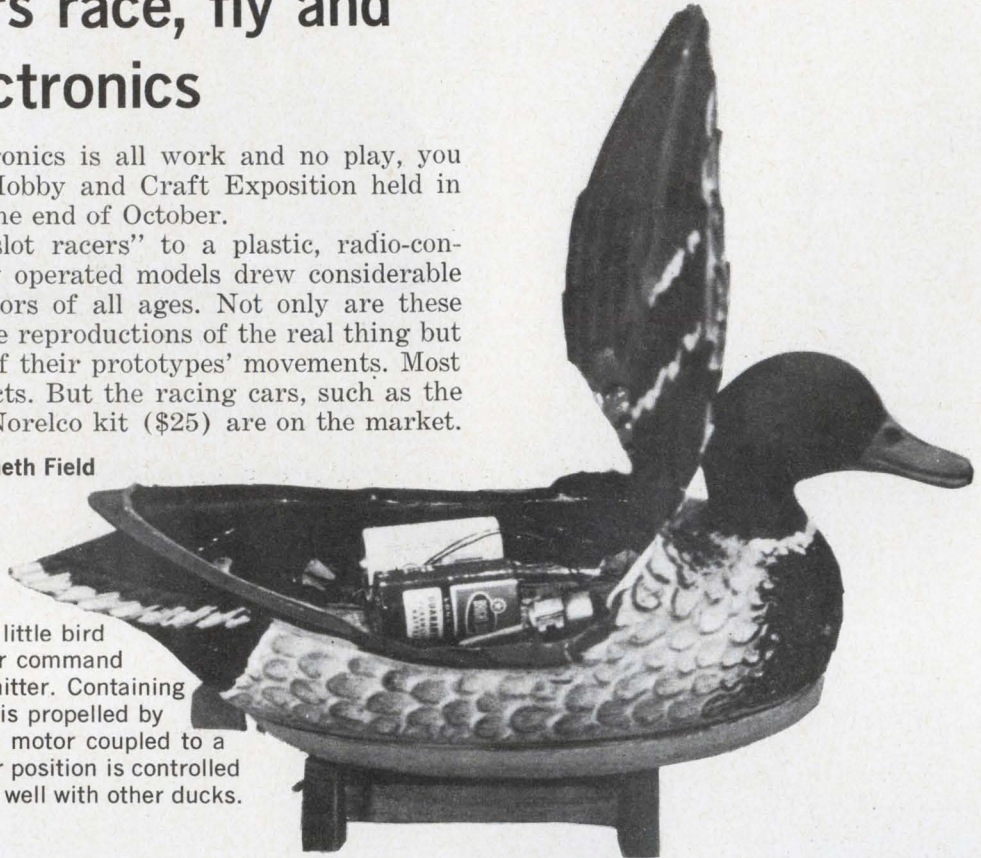

Answer to the parking problem? Not really. This little car is one of the very popular slot-racers. Propelled by miniature dc motors and receiving their 12-volt power from metal-covered track "slots," these Lilliputian machines whiz around the track at blurring speeds. The next step may be radio-control. Integrated circuits could provide sufficiently small receivers, but nobody has yet come up with servos that can steer the car yet are at the same time small enough to fit "under the hood."

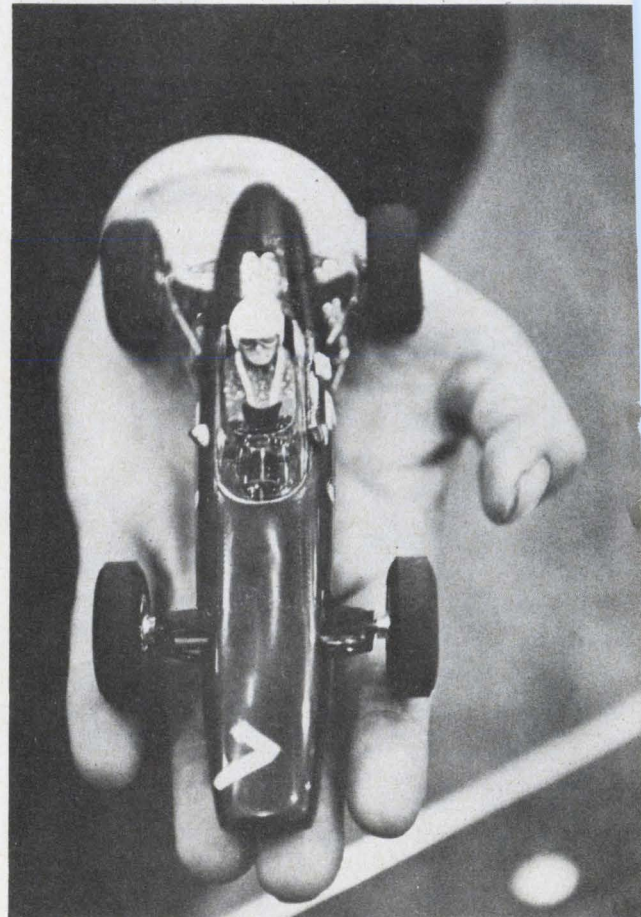

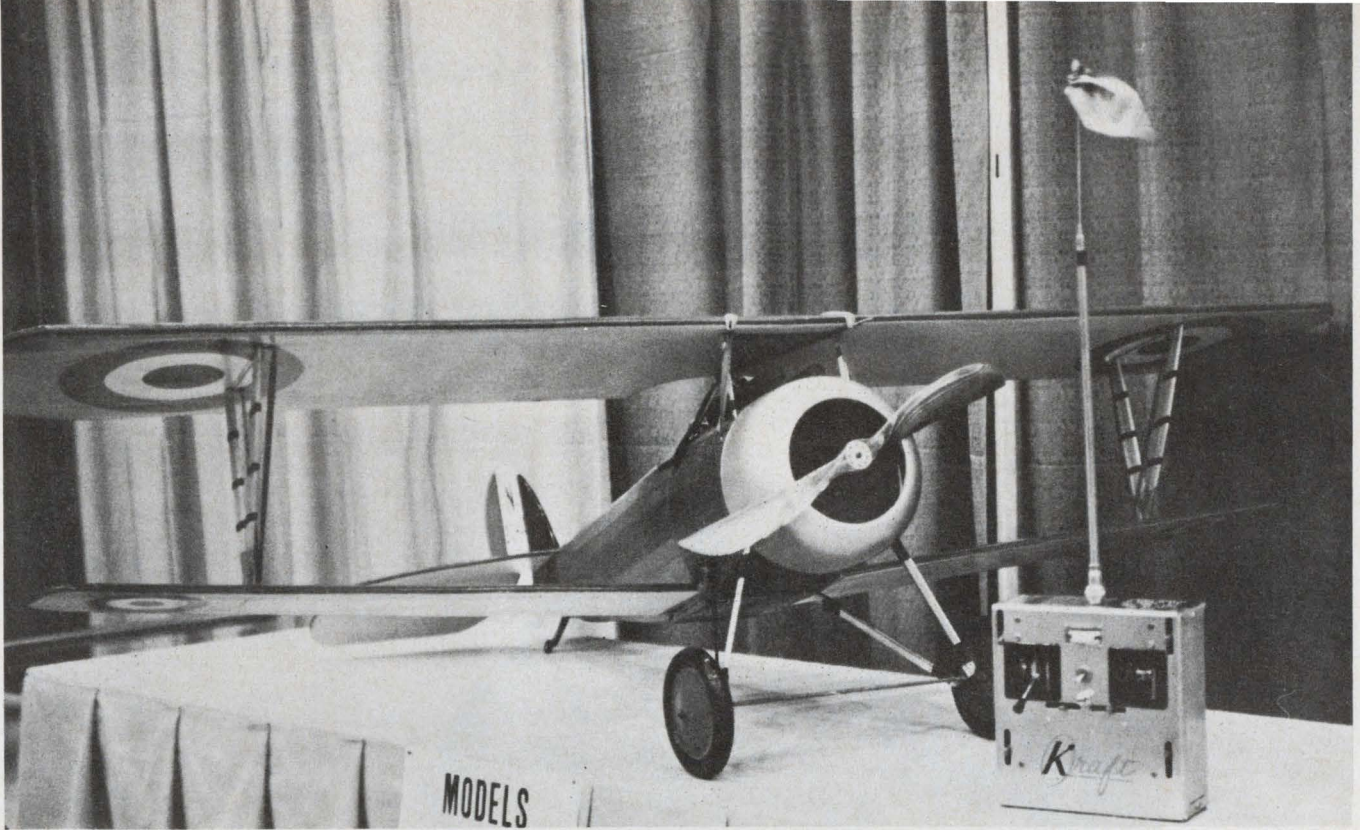

**Blending past and present**, this model of a World War I fighter contains electronic equipment that was unheard-of in the days of flying goggles and white silk scarfs. All control functions, including engine speed and wheel

brakes, are incorporated in model aircraft such as this. The "pilot" flies his "bird" using the transmitter shown on the right. The little pennant on top of the antenna prevents spectators from poking an eye out.

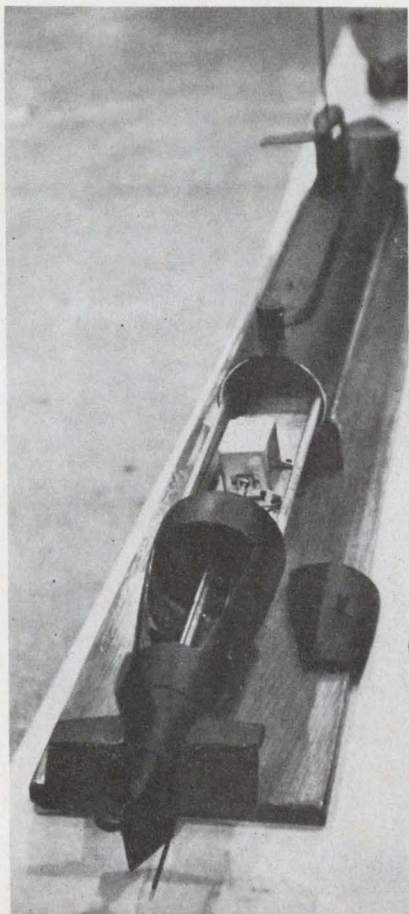

**For the man who wants something different**, here's a radio-controlled submarine that will dive and surface. Small servos, operating at the command of a land- or rowboat-based transmitter, control the speed, direction and diving planes of this battery-driven undersea model.



**Coauthor Casazza fingers a tune** on this organ, built from a Norelco electronic projects kit. Armed with transistors and diodes, the experimenter can build a number of different gadgets by plopping a wiring diagram over the spring clips and hooking away.

# Custom blended for highest performance

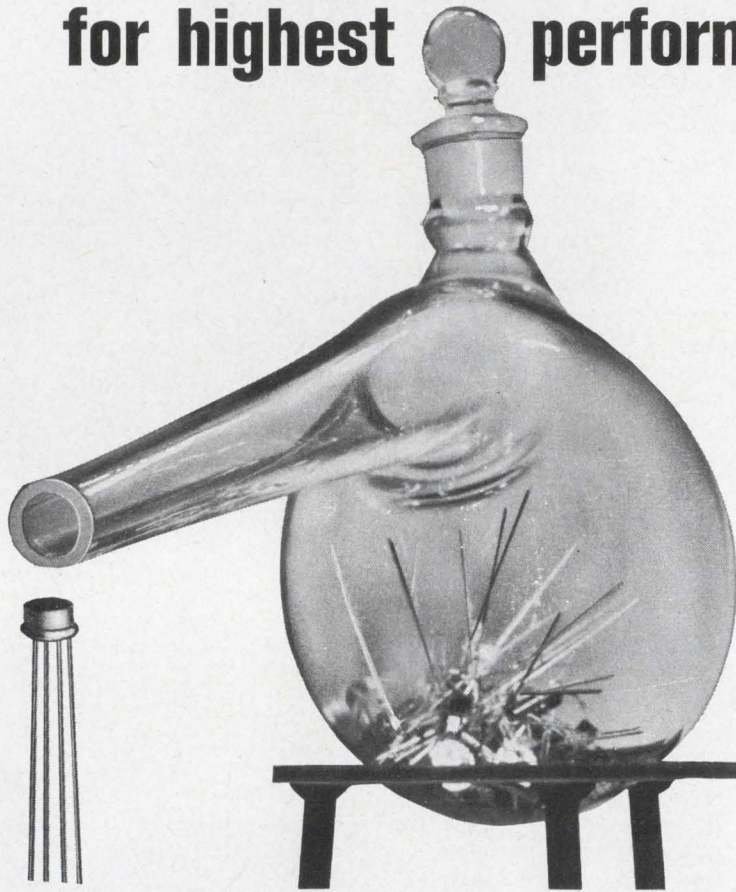

## G-E microminiature hybrid circuits

■ Custom microminiaturization is yours with General Electric solid-state hybrid circuits, designed and built specifically for your application.

G-E hybrids combine the best technologies of discrete active elements and thick film techniques to offer performance advantages often unavailable in a lone integrated circuit. A blend of transistor, diode, and tunnel diode pellets selected from standard General Electric lines puts proven reliability in every hybrid. And G.E. can vary the components of each hybrid to provide a device specially built for your particular need.

In the last two years G.E. has built over 400 hybrids for a wide range of applications, including highly specialized military and aerospace proj-

ects. That same high capability can work for you—producing hybrids for microminiature linear or digital circuits with high voltage or power re-

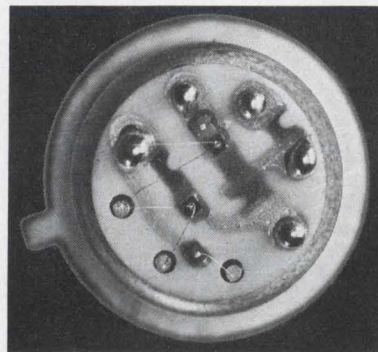

G-E hybrid circuit for multi-vibrator applications.

quirements . . . or high speed, low volume digital circuits . . . or circuits demanding high frequency/high speed capability . . . or in many other applications.

It's all a result of General Electric's total electronic capability.

For more information on custom microminiaturization with G-E hybrids, get the free brochure "Monolithic and Hybrid Integrated Circuits". Ask your G-E engineer/salesman for publication 450.40. Or, write to Section 220-42, General Electric Company, Schenectady, New York. In Canada: Canadian General Electric, 189 Dufferin St., Toronto, Ont. Export: Electronic Components Sales, I.G.E. Export Division, 159 Madison Ave., New York, N.Y.

SEMICONDUCTOR PRODUCTS DEPARTMENT

**GENERAL  ELECTRIC**

ON READER-SERVICE CARD CIRCLE 17

ELECTRONIC DESIGN 28, December 6, 1966

A third slash for military R&D?



## Military R&D faces another cut

Pentagon R&D programs face the budget axe for the third consecutive year. The military R&D slash in the 1968 fiscal budget, which will be presented next January and take effect in July, is expected to be the stiffest yet. Both the President and Defense Secretary McNamara have said that the new budget aims to eliminate every cent of Pentagon spending that is not absolutely essential. Budget Bureau officials say this generally means "not absolutely essential to the war in Vietnam." Marginal R&D programs face a death sentence.

McNamara underscored the policy of frugality at the time he announced Poseidon production. He said: "We considered the basic policy which we will follow as a foundation for the defense program in fiscal 1968, and, upon the President's instructions, will defer every possible element of the defense program that can be deferred without adversely affecting our security." Still, the total defense budget for 1968, not including an expected supplemental, is expected to rise \$2 billion. Most of the increase will go to prosecute the war in Vietnam.

## Congress to probe Federal computer use

The 90th Congress will take a careful look at the Government's use of computers, and the members of at least one committee hope improved application of computers will greatly cut the mounting pile of paperwork. More important, though, they hope to reduce the cost of using the computers.

Rep. Robert N. C. Nix (D-Pa.), chairman of the House Census and Statistics subcommittee, and Rep. Tom Murray (D-Tenn.), chairman of the parent Post Office and Civil Service Committee, are expected to introduce legislation that will greatly influence the Government's use of computers. For one thing, they want agencies to apply source data-automation methods more often. This should, they say, reduce the cost of preparing data to feed secondary computers. They point out that

# Washington Report

S. DAVID PURSGLOVE,  
WASHINGTON EDITOR

it now costs \$550 million a year to program the input for the Government's computers.

They will also recommend a broad program of research on paperwork practices and systems. A new Federal center for research into paperwork may be set up. The Nix subcommittee recently issued a report on Federal paperwork and indicated strongly that all too often the use of computers in Government is creating more paperwork instead of cutting it. Nix singled out the storage problem created by computers that generate stacks of records 100 times faster than typewriters can. Research that would permit agency heads to forecast more accurately the implications of computerization is among the goals of the \$500,000-a-year program recommended by the committee.

## FCC may regulate computer rentals

The Federal Communications Commission plans to hold hearings that may lead to regulation of computer and computer-time rentals. The commission feels it has jurisdiction because input and output often are transmitted over telephone lines.

The FCC will try to determine under what circumstances computer services are subject to regulation under existing law, whether public policy requires the regulation of computer rental, and whether the Commission should recommend new legislation. It is especially concerned over the privacy of input and wants to find out what security measures the service companies take to protect their clients.

So far, says FCC chairman Rosel Hyde, there have been no reports of abuses. But he says the commission wants to avoid them in advance.

## Holifield seeks procurement study

A two-year Congressional investigation of Federal procurement policies and practices will be proposed by Rep. Chet Holifield (D-Calif.) when Congress returns in January. Holifield is

# Washington Report

CONTINUED

chairman of the Military Operations subcommittee of the House Government Operations Committee. He will introduce a bill to set up a two-year investigatory panel to study all aspects of Government buying.

As Holifield envisions it, the special commission would include representatives of Congress, the Executive and public life. It would have the power to examine virtually all records of Government contractors.

## Billions in work up for grabs

As already disclosed, the electronic industry is expected to receive most of the \$2.6 billion that probably will be spent over the next five years to refit Polaris submarines for Poseidon missiles. But the big questions are: Who will do the work? And where?

Officials at both the Pentagon and at Lockheed, the prime contractor on both Polaris and Poseidon missiles, say it is far too early to talk about electronics contractors for the modification program. However, they admit that present Polaris and Poseidon contractors undoubtedly have the edge, especially since the Defense Dept. apparently wants the work done quickly and at the lowest cost possible.

Aside from Lockheed, Aerojet and Hercules are associate contractors for Polaris power plants, and Thiokol and Hercules are associates for the Poseidon propulsion system. General Electric and Hughes are associates for Polaris guidance, as they are for Poseidon. Of the subcontractors selected so far, many of those for the Poseidon program filled the same roles in Polaris.

In the Polaris program, GE has a special relationship with the Navy as a separate contractor on the Mark 80 and Mark 84 fire-control subsystems, while Hughes is the fire-control subcontractor under Lockheed. Interstate Electronics, Inc., of Anaheim, Calif., is subcontractor for instrumentation. Five organizations hold a position called "sub-prime" for missile guidance: Raytheon, Massachusetts Institute of Technology, GE, Hughes Aircraft and Honeywell. Responsible for communications are Sylvania, RCA's Princeton Laboratories, Bell Telephone Laboratories and ITT Laboratories. Missile check-out is handled by Northrop's Nortronics

Div. Sperry Gyroscope is responsible for the navigation subsystem.

Defense Secretary Robert S. McNamara says it will cost somewhat more than 60 per cent of the original cost of the subs to refit them. The Navy has 41 Polaris submarines, and the average cost of each is \$104 million. Early models will need the most extensive modifications. Later subs were built to carry and launch the A-3 Polaris, and the Poseidon will be only three feet longer and 18 inches greater in diameter. Navy sources say the modifications to the launching tubes will be minor compared with the necessary changes in the electronics—guidance, check-out (in-tube status sensors) and arming systems. The decision to produce and deploy Poseidon is viewed here as McNamara's answer to the Soviet Union's antimissile system, now being made operational. The precept is that the best defense is a good offense. No official decision has yet been made public on whether to proceed with development of our own nuclear antimissile system, the Nike-X. Pentagon officials speculate that McNamara will not request production funds for it in fiscal 1968.

McNamara still feels that a massive, costly fallout shelter program must accompany the deployment of any system like the Nike-X system, because it will pepper as much radioactive fallout over the U.S. as invading enemy missiles would.

## New experiments in space

Five Applications Technology satellites (designated AT-Bs officially) are to be launched by NASA, starting this month. An Atlas-Agena rocket will lob the spin-stabilized payloads into stationary orbits at the equator, 22,300 miles above the Pacific Ocean at 151 degrees West longitude.

The spacecraft will be capable of transmitting television (black and white and color) and narrowband communications between stations at Rosman, N. C.; Mojave, Calif.; Kashima, Japan, and Toowoomba, Australia.

A number of firsts will be among the experiments to be carried out on the satellite.

They include:

- VHF experiment for voice transmissions via the satellites to airplanes in flight.
- Transmission of high-quality cloud-cover pictures of the earth from synchronous orbit.
- Transmission of weather data (weather maps and nephelanses) over a long-distance system.

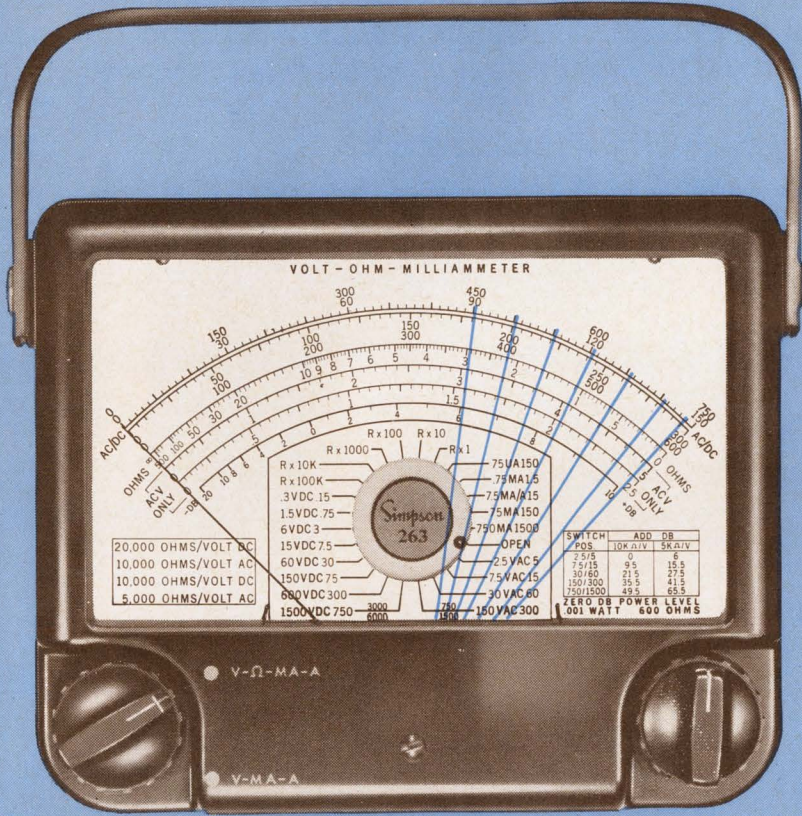

**RANGES**

**DC VOLTS:** 0-0.15/0-.75/0-3/0-7.5/0-30/0-75/  
0-300/0-750/0-3000 @ 20K $\Omega$ /V; 0-0.3/0-1.5/0-6/  
0-15/0-60/0-150/0-600/0-1500/0-6000 @ 10K $\Omega$ /V.

**AC VOLTS:** 0-2.5/0-7.5/0-30/0-150/0-750 @ 10K $\Omega$ /V;  
0-5/0-15/0-60/0-300/0-1500 @ 5K $\Omega$ /V.

**DC MICROAMPS:** 0-75 @ 150MV; 0-150 @ 300MV.

**DC MILLIAMPS:** 0-0.75/0-7.5/0-75/0-750 @  
150MV; 0-1.5/0-15/0-150 @ 300MV.

**DC AMPS:** 0-7.5 @ 150MV; 0-1.5/0-15 @ 300MV.

**DB SCALE (11MW-600):** -20 to +75.5 db in  
10 ranges.

**OUTPUT:** 0.1 mfd capacitor in series with all  
AC Voltage ranges through 300 Volts.

**RESISTANCE:** R $\times$ 1, 0-500 $\Omega$ ; R $\times$ 10, 0-5000 $\Omega$ ;  
R $\times$ 100, 0-50K $\Omega$ ; R $\times$ 1K, 0-500K $\Omega$ ; R $\times$ 10K,  
0-5 meg $\Omega$ ; R $\times$ 100K, 0-50 meg $\Omega$ (4.5 $\Omega$ center).

**ACCURACIES**

**DC VOLTS:** 0-0.15 to 1500  $\pm$ 1 $\frac{1}{2}$ %;  
0-3000 to 6000  $\pm$ 2 $\frac{1}{2}$ %.

**AC VOLTS:**  $\pm$ 3%.

**DC CURRENT:**  $\pm$ 1 $\frac{1}{2}$ %

**RESISTANCE:** R $\times$ 1,  $\pm$ 3 $^\circ$  of Arc; R $\times$ 10 and  
R $\times$ 100K,  $\pm$ 2 $\frac{1}{2}$   $^\circ$  of Arc.

**TWO OTHER SIMPSON DC/AC VOMS WITH INTERESTING CAPABILITIES**

100,000 OHMS/VOLTS  
SENSITIVITY  
MODEL 269-2  
\$90.00

33 RANGES  
BIG 7-INCH SCALE  
MODEL 262-3  
\$70.00

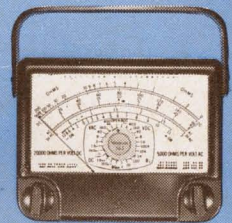
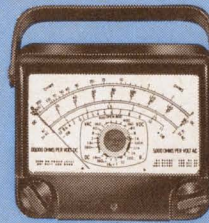

**NEW SIMPSON 64-RANGE, 7-INCH SCALE VOM Model 263—in stock for immediate delivery**

With the improved, overlapping range coverage of Simpson's new 263 VOM, almost any value you want to measure can be read on the upper half of the scale (half to full scale). This results in a four to five times greater accuracy of reading. Other things you'll like about the 263 are its diode overload protection which prevents movement burnout at 200,000% overloads . . . 1 $\frac{1}{2}$ -volt alkaline battery that keeps low ohms readings extra stable . . . and its high accuracy. Sensitivities are 20,000 and 10,000 ohms/volt DC; 10,000 and 5,000 ohms, AC. The 263 is the newest member of Simpson's great family of VOM's with 7-inch meters. Order one from your Electronic Distributor, or write for Catalog 2074. Model 263, complete with test leads and operators manual, only . . . . . **\$85<sup>00</sup>**

**TWO OTHER NEW SIMPSON DEVELOPMENTS!** New contest for "260<sup>®</sup> VOM Applications" . . . new edition of "1001 Uses For Your 260 VOM" book. See your electronic distributor for details, or write direct.



**SIMPSON ELECTRIC COMPANY**  
5202 W. Kinzie Street, Chicago, Illinois 60644 • Phone: (312) 379-1121  
Representatives in Principal Cities . . . . . See Telephone Yellow Pages  
**Export Dept.:** 400 W. Madison St., Chicago, Ill. 60606 Cable, Simelco  
**In Canada:** Bach-Simpson Ltd., London, Ontario  
**In India:** Ruttonsha-Simpson Private Ltd., Vikhroli, Bombay

**WORLD'S LARGEST MANUFACTURERS OF ELECTRONIC TEST EQUIPMENT**





# New 1, 2 and 3 pole relays for nearly every application in the 5 and 10 amp range.

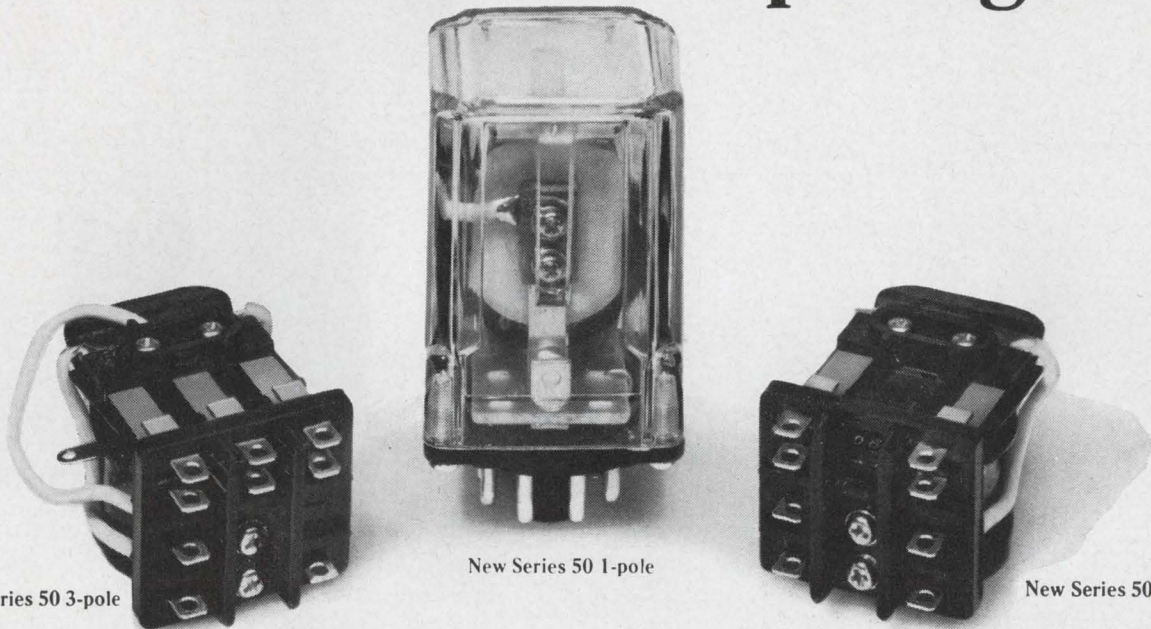

New Series 50 3-pole

New Series 50 1-pole

New Series 50 2-pole

## Try one—or any Sigma relay—absolutely free.

We want to give you a new Series 50—or any standard Sigma relay—to use in an application you're working on now. We think it will outperform any other brand you may be using.

If you select the new Series 50 you can choose from 12 versions that cover every combination of its 1, 2 or 3 poles, 5 or 10 amp AC or DC power ratings, enclosed and open types, plug-in and soldered connections. These versatile relays are designed for the broadest variety of general purpose industrial applications ranging from output relays in sensing controls to photocopiers and vending machines.

The Series 50 is U. L. listed and includes such quality features as: Adjustable armature hinge for precise contact alignment. Heavy-duty contact base material for improved dielectric strength and insulation resistance. Single molded plug assembly with high temperature resistant polycarbonate housing.

Put the new Series 50, or any Sigma relay, to the test yourself, free of charge. Just send for the new Preferred Standard and Stock Relay Catalog of the expanding line of Sigma relays. Then select the relay you want to test and compare, and your Sigma representative will see that you get it. Offer limited to original equipment manufacturers having applications for relays.

SIGMA DIVISION  SIGMA INSTRUMENTS INC  
Assured Reliability With Advanced Design / Braintree, Mass. 02185

Need Sigma relays fast? Call your Sigma distributor for off-the-shelf delivery of our most popular types.

ON READER-SERVICE CARD CIRCLE 18

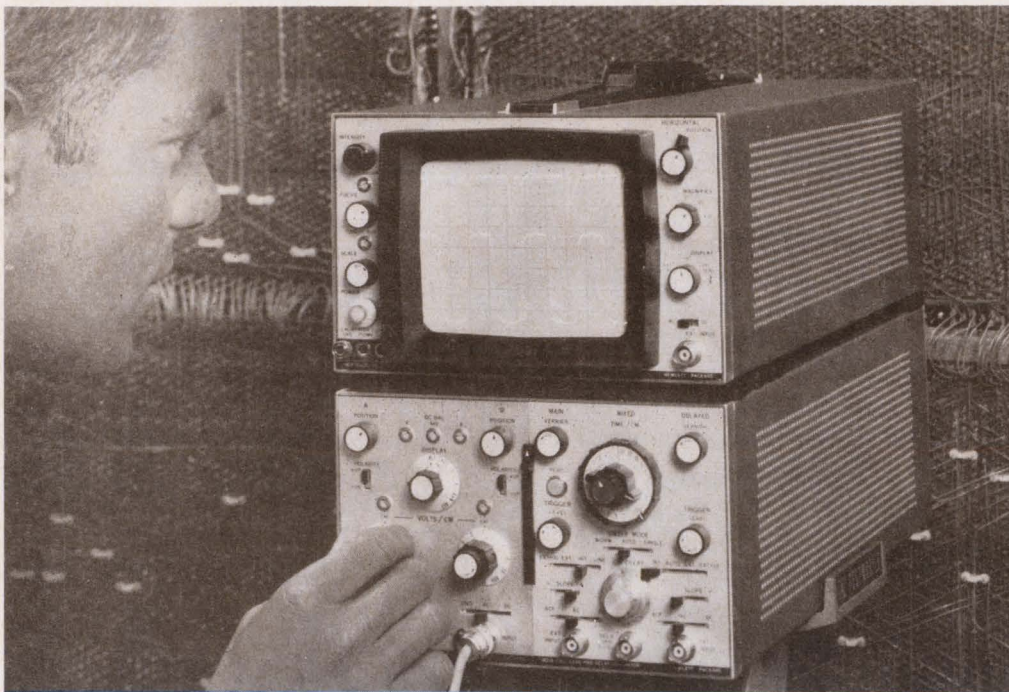

## NEW hp 180A OSCILLOSCOPE

You can see *more*, do *more* with this 30-pound oscilloscope that goes anywhere—field, laboratory, or production line. Designed from the user's viewpoint in, this new dual-trace 50 MHz scope is packed with new ideas and innovations to give you big picture CRT, plug-in versatility, step-ahead all-solid-state performance, minimum weight and rugged design. These features add up to *more total performance, more usability than any other scope on the market!*

The hp 180A mainframe is the first with power supplies specifically designed for solid-state circuitry—gives you full performance benefits from solid-state devices in all present and future plug-ins. With hp's all-new big-picture 8 x 10 cm CRT, you have an extra-large display area—get bigger displays, make accurate measurements easier!

Vertical amplifiers drive the CRT vertical deflection plates directly, allowing even greater bandwidth capabilities in future plug-ins. Vertical amplifiers have low drift FET input stages for accurate DC measurements . . . plus quick 15-second warm-up. Time base plug-ins offer new easy to use delayed sweep for examining complex waveforms in detail. Tunnel diode triggering circuits lock in waveforms to 90 MHz. Exclusive hp mixed sweep feature combines display of first portion of trace at normal sweep speeds, and simultaneously expands trailing portion of trace at faster delayed sweep speed to allow magnified examination.

See the back of the actual size color photo at the right for abbreviated specifications and price. For full specifications and a demonstration of how you can see *more*, do *more* with this new, versatile, go-anywhere scope, call your nearest hp field representative. Or, write to Hewlett-Packard, Palo Alto, California, 94304. Tel. (415) 326-7000; Europe: 54 Route des Acacias, Geneva.

**HEWLETT**  **PACKARD**  
An extra measure of performance

▷  
**SEE  
MORE!  
DO  
MORE!**

▷  
Tear out actual photo of 180A Oscilloscope. Set it on your bench. See what the big picture display will mean to your work. ▶

**180A OSCILLOSCOPE**

**INTENSITY**

**ASTIGMATISM**

**FOCUS**

**TRACE ALIGN**

**SCALE**

**POWER**

**CALIBRATOR**  
GND 250MV 10V

**HORIZONTAL POSITION**

**MAGNIFIER**  
X1 X5 X10

**DISPLAY**  
INT EXT SENS

**AC** **DC**

**EXT INPUT**

**HEWLETT - PACKARD**

**1801A DUAL CHANNEL VERTICAL AMPLIFIER**

**A POSITION**

**B POSITION**

**DC BAL**  
A+B B

**POLARITY**  
+UP -UP

**DISPLAY**  
A A+B ALT B TRIGGER

**VOLTS / CM**

**ACF** **AC** **DC**

**INPUT** **PROBE POWER** **INPUT**

**HEWLETT - PACKARD**

**1821A TIME BASE AND DELAY GENERATOR**

**MAIN VERNIER**

**MIXED TIME / CM**

**DELAYED VERNIER**

**RESET**

**TRIGGER LEVEL**

**SWEEP MODE**  
NORM AUTO SINGLE

**EXT+10** **EXT** **INT** **LINE** **CM DELAY** **INT** **AUTO** **EXT** **EXT+10**

**- SLOPE +**

**ACF** **AC** **DC**

**EXT INPUT** **DEL D TRIG OUTPUT** **EXT INPUT**

**HEWLETT - PACKARD**



hp 180A Oscilloscope  
is shown here ACTUAL SIZE:

## COMPARE DISPLAY!

See how the new 180A Big Picture Display can make it easier for you to get accurate measurements. Punch out this actual size CRT area on the perforations. Place the punched-out portion over the screen of your existing high-frequency scope. You will find the hp 180A Oscilloscope has 30% to 100% larger viewing area for easier-to-see, easier-to-read traces!

## COMPARE SPECIFICATIONS! (Condensed)

### 180A Oscilloscope

#### Horizontal Amplifier:

**External Input:** DC coupled, dc to 5 MHz; AC coupled, 5 Hz to 5 MHz. Input RC, 1 megohm shunted by approximately 30 pf.

**Sweep Magnifier:** X1, X5, X10; magnified sweep accuracy  $\pm 5\%$ .

**Calibrator:** 1 kHz square wave, 250 mv and 10 v p-p,  $\pm 1\%$ .

**Cathode-ray Tube:** 8 x 10 cm parallax-free internal graticule marked in centimeter squares. Post-accelerator tube, 12 kv accelerating potential; aluminized P31 phosphor.

**Beam Finder:** Pressing Beam Finder control brings trace on CRT screen.

**Intensity Modulation:** Approx. +2 volts, dc to 15 MHz, will blank trace.

**Active Components:** All solid state, except CRT.

**Environment:** 180A scope with plug-ins operates within specs over the following ranges. Temperature:  $-28^{\circ}\text{C}$  to  $+65^{\circ}\text{C}$ . Humidity: To 95% relative humidity to  $40^{\circ}\text{C}$ . Altitude: To 15,000 ft. Vibration: Vibrated in three planes for 15 min. each with 0.010" excursion from 10 to 55 Hz.

**Power:** 115 or 230 volts,  $\pm 10\%$ , 50-1000 Hz, 95 watts, convection cooled.

**Dimensions:** Cabinet, overall dimensions with feet and handle: 8" x 11" x 22½" deep. Rack mount: 5¼" x 19" x 19½" deep behind front panel.

**Weight:** With plug-ins, net 30 pounds.

**Outputs:** Main and delayed gates, main and delayed sweeps.

**Accessories Furnished:** Two 10:1 voltage divider probes, mesh contrast filter.

**Price:** Without plug-ins, Model 180A, \$825.00; Model 180AR (rack), \$900.00.

### 1801A Dual Channel Vertical Amplifier

**Modes of Operation:** Chan. A alone; Chan. B alone; Chan. A and B displayed on alternate sweeps; Chan. A and B displayed by switching at 400 kHz rate, with blanking during switching; Chan. A plus Chan. B (algebraic addition).

**Deflection Factor (Sensitivity):** 0.005 v/cm to 20 v/cm; attenuator accuracy,  $\pm 3\%$ .

**Bandwidth and Rise Time:** DC coupled, dc to 50 MHz; AC coupled, 2Hz to 50MHz; rise time,  $< 7$  nsec.

**Input RC:** 1 megohm shunted by approx. 25 pf.

**Polarity Presentation:** + or - Up.

**Triggering:** Provides sufficient signal to the time base to trigger from dc to 50 MHz.

**Price:** Model 1801A, \$650.00.

### 1820A Time Base

**Sweep Range:** 24 ranges, 0.05  $\mu\text{sec/cm}$  to 2 sec/cm in a 1,2,5 sequence; accuracy,  $\pm 3\%$ ; to 5 nsec/cm with X10 magnifier. Also single sweep.

#### Triggering:

Internal: See vertical amplifier.

External: dc to 50 MHz from signals 0.5 v p-p, 90 MHz with 1 v p-p.

Automatic: Bright base line displayed in absence of input signal. Triggers from 40 Hz to  $> 50$  MHz.

Trigger point and slope: Controls allow selection of level and pos. or neg. slope; trigger level on external signal adjustable  $\pm 5$  v,  $\pm 50$  v in  $\div 10$  position.

Coupling: AC, DC, ACF.

**Variable Holdoff:** Permits variation of time between sweeps to allow triggering on asymmetrical pulse trains.

**Price:** Model 1820A, \$475.00.

### 1821A Time Base and Delay Generator

**Main Sweep:** 22 ranges, 0.1  $\mu\text{sec/cm}$  to 1 sec/cm in 1,2,5 sequence; accuracy,  $\pm 3\%$ ; to 10 nsec/cm with X10 magnifier. Also single sweep.

#### Triggering:

Internal: See vertical amplifier. External: dc to 50 MHz from signals 0.5 v p-p, 90 MHz with 1 v p-p.

Automatic: Bright base line displayed in absence of an input signal. Triggers from 40 Hz to  $> 50$  MHz.

Trigger point and slope: Controls allow selection of level and pos. and neg. slope; trigger level on external signal adjustable  $\pm 5$  v,  $\pm 50$  v in  $\div 10$  position. Coupling: AC, DC, ACF.

**Trace Intensification:** Used for setting up delayed or mixed sweep. Increases in brightness that part of main sweep to be expanded full screen in delayed sweep or made magnified part of display in mixed sweep.

**Delayed Sweep:** Delayed time base sweeps after time delay set by main sweep and delay controls. 18 ranges, 0.1  $\mu\text{sec/cm}$  to 50 msec/cm in 1,2,5 sequence; accuracy,  $\pm 3\%$ .

**Triggering:** Applied to intensified Main, Delayed, and Mixed Sweep modes. Automatic: Delayed sweep starts at end of delayed period. Internal, External, Slope, Level, and Coupling: same as Main Sweep.

**Delay Time:** (before start of delayed sweep); Continuously variable from 0.1  $\mu\text{sec}$  to 10 sec; accuracy,  $\pm 1\%$ ; linearity,  $\pm 0.2\%$ ; time jitter,  $< 0.005\%$  of maximum delay of each range.

**Trigger Output:** (at end of delay time): approx. 1.5 v pulse.

**Mixed Sweep:** Dual sweep display in which main sweep drives first portion of display and delayed sweep completes display at speeds up to 1000 times faster.

**Price:** Model 1821A, \$800.00.

## Light pen to mask via computer

Using a computer, a TV-like display screen, and a "light pen" to draw images on the screen, IBM engineers have significantly reduced the time between a design idea and a finished scale drawing of a micro-circuit.

Instantaneous communication between engineer and computerized display does away with many tedious steps associated with circuit design and creation of an engineering drawing: the computer turns a light pen drawing into a finished circuit mask. Thus, intermediate drawings, which must be redrafted when the engineer modifies his design, can be eliminated. Engineers using the display screen and light-sensitive pen can change their designs simply by manipulating the computer-generated images of transistors, diodes, resistors and other components.

When the design is in final form, a computer-controlled printer produces a precise, scale-drawn layout of the circuit. This hard-copy drawing is then photomechanically reproduced to make a printing mask. The mask is used in actual printed-circuit fabrication.

IBM has also experimented at its East Fishkill, N. Y., facility with computer-assisted logic design, using the display screen to map out logic blocks representing computer functions. By repositioning the

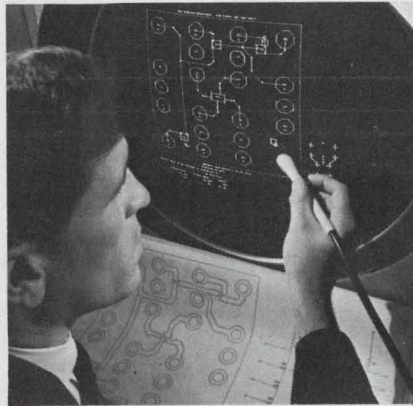

**Computer-aided computer design**—with a computer-controlled graphic display and light-pen. Final hard-copy drawing is used to make mask for actual fabrication.

blocks, the engineer modifies the computer's operating scheme. The designer can then question the computer to determine how to interconnect components to perform the desired logic operation.

According to IBM engineers, the technique could be applied to large-scale integration, where the objective is to create many computer circuits within a single chip of silicon. Computerized design could minimize interconnections within and among circuits on the chip to achieve maximum circuit use without increasing the size of the unit. The work was described at the 1966 Fall Joint Computer Conference in San Francisco. ■ ■

## Airport visibility measured by laser

A laser technique reported to offer the first practical means of measuring visibility along aircraft glidepaths is now under study by the Federal Aviation Agency.

The new method being developed at the Sperry Rand Research Center, Sudbury, Mass., uses a photomultiplier receiver to analyze the "signature" of the light scattered back by the atmosphere from a pulsed-ruby laser beam.

The technique uses a 10-MW, Q-switched laser and an optical receiver, mounted with their axes parallel

and separated by from one to six feet. The laser transmits a 20-ns pulse, which is scattered and absorbed by dust or water vapor particles along its path. In smoke, haze, or fog, the more numerous particles scatter more light back to the receiver.

The receiver converts the returned light into an analog electrical signal, which is then viewed on an oscilloscope. The displayed trace shows the back-scattered energy as an increasing, peaking, and exponentially decaying curve. ■ ■

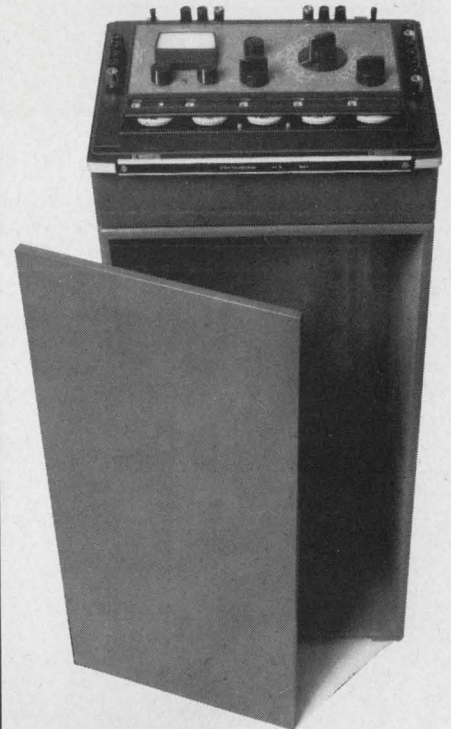

**We thought of putting a false bottom on it.**

We toyed briefly with the idea of making our PVB (Potentiometric

to be. We were worried about the skeptics who wouldn't believe we could combine seven high-accuracy measurement functions in a portable case the size of a typewriter.

But we resisted temptation. We designed the PVB as compact as solid-state technology permits. And we said to the skeptics, "Seeing is believing. If you don't think that one \$750 instrument can deliver 0.02% accuracy or better on voltage, resistance, current and ratio measurements—just watch."

The skeptics watched and they became believers. They passed the word along to friends and made the PVB one of our best sellers. (If word hasn't reached you yet, write us direct.) They showed us this instrument has more uses than even we knew—including potentiometric temperature measurement, checking of dc power supplies, measuring pH and calibration applications galore.

We should have known that false bottoms went out with the bustle. ESI, 13900 NW Science Park Drive, Portland, Oregon 97229.

Electro Scientific Industries **esi**<sup>®</sup>  
ON READER-SERVICE CARD CIRCLE 20

# This NEW G-V

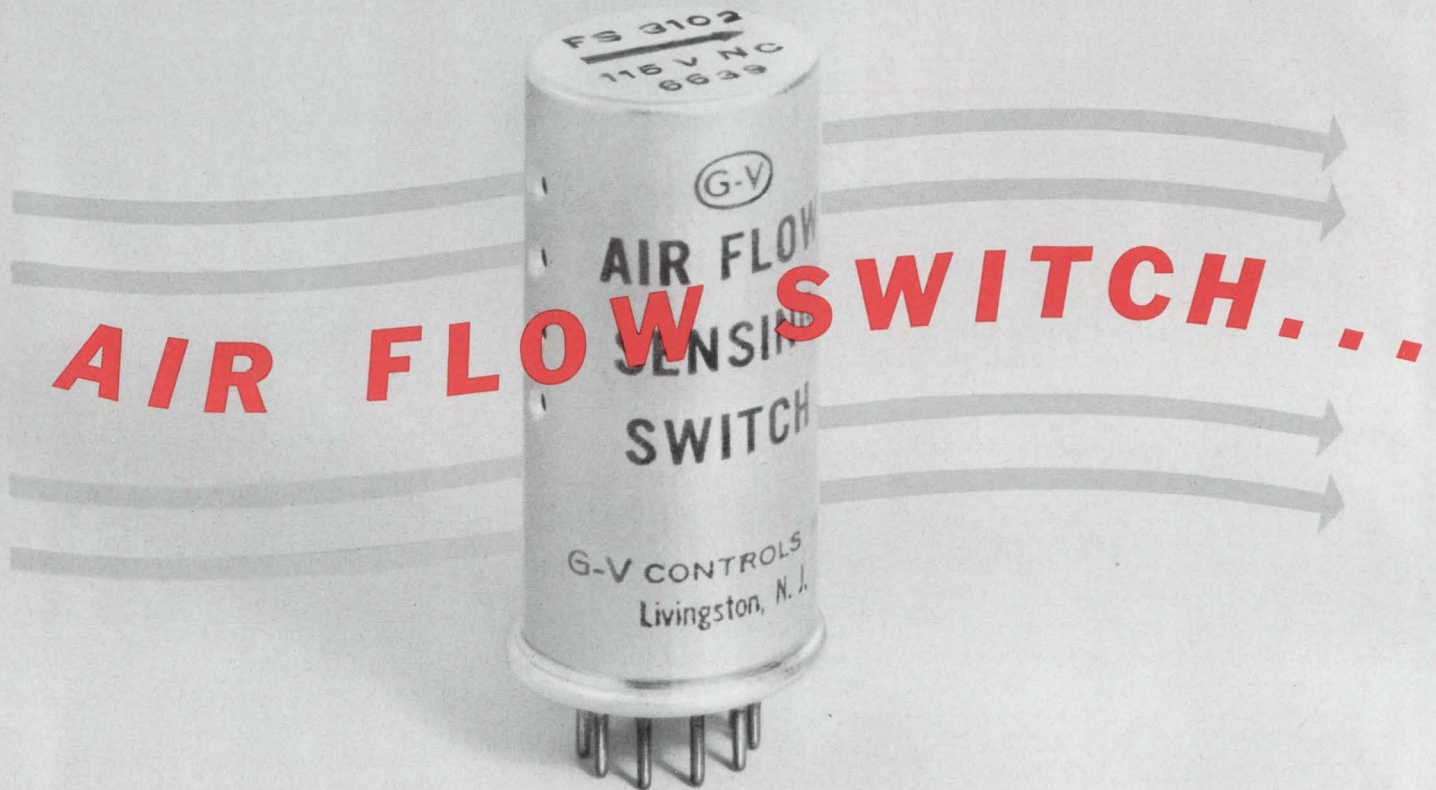

## SEALED THERMAL TIME DELAY RELAYS

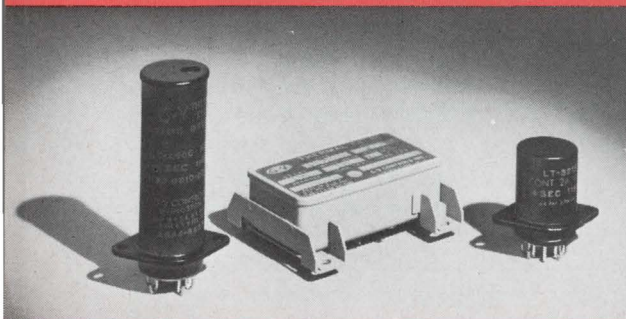

G-V is the largest source and offers the widest variety. Several types are hermetically sealed and still adjustable. All meet requirements of Mil-R-19648. Available in a wide variety including: sub-miniature, miniature, octal and missile types. **Features:** delay time, 0.1 sec. to 3 min.; heater voltages to 230 V; ambient operating temp.,  $-55^{\circ}\text{C}$  to  $+125^{\circ}\text{C}$ ; vibration to 2000 Hz; shock to 50g.

G-V

ON READER-SERVICE CARD CIRCLE 92

## INDUSTRIAL THERMAL TIME DELAY RELAYS

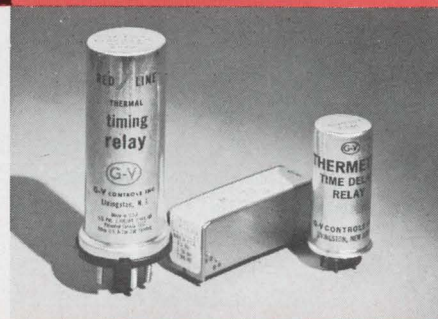

G-V industrial relays are designed and built to the quality standards of military types. They are available in miniature, octal plug-in and printed circuit board mountings. **Features:** delay time, 0.5 sec. to 3 min.; heater voltages to 230V; operation in any plane.

G-V

ON READER-SERVICE CARD CIRCLE 93

## INSTANT RESET THERMAL TIMING DEVICES

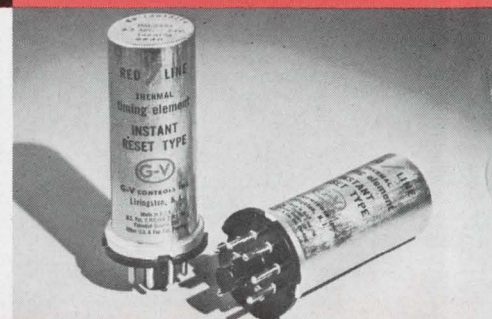

Instant reset during or after timing is available, by combining G-V's unique instant reset timing element with a magnetic relay. Widely used in communication systems and data processing equipment. **Features:** Delay time, 2 sec. to 5 min.; ambient operating temp.,  $32^{\circ}\text{F}$  to  $185^{\circ}\text{F}$ .

G-V

ON READER-SERVICE CARD CIRCLE 94

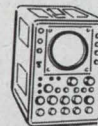
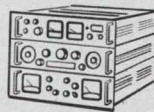
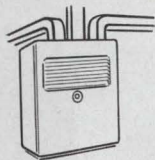

# works when airflow stops!

**UNIQUE APPROACH TO AIR FLOW SENSING OFFERS POSITIVE PROTECTION... *it's from G-V***

The G-V Air Flow Sensing Switch uses a new design concept and technique in monitoring the presence of air flow. The device utilizes a thermal principle which eliminates all moving parts, allows operation in any plane and eliminates maintenance and sensitive adjustments. It features a built-in time lag to disregard brief transient interruptions. It operates an alarm or automatic shut-down if the air flow drops below a safe level in electronic equipment, cooling packages, air conditioners, computers and wherever an air-flow cooling system is used. Military versions and mountings for industrial equipment are available.



**G-V CONTROLS INC.**

LIVINGSTON, NEW JERSEY 07039  
(201) 992-6200

ON READER-SERVICE CARD CIRCLE 91

## SEALED ELECTRICAL THERMOSTATS

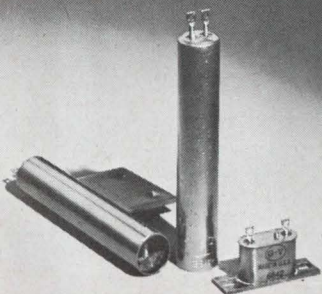

**Cartridge Type:** Series C8 hermetically sealed and still adjustable. Contact rating up to 5 amps. **Crystal Can Size:** Series VE-2 hermetically sealed. Contact rating up to 3 amps. **Features:** Rapid rate of response; minimal differential; operating range,  $-65^{\circ}$  to  $+300^{\circ}$ F; vibration to 2000 Hz; shock to 50g.



ON READER-SERVICE CARD CIRCLE 95

## SOLID STATE TIME DELAY

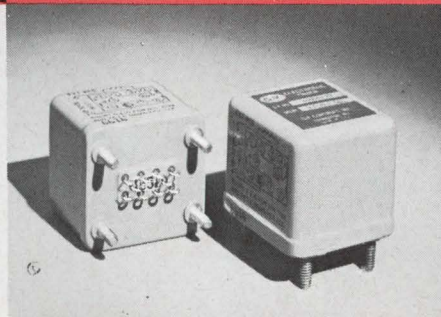

Series 900-064 has been accepted as a standard for many military and aerospace applications where high quality, reliability and cost are requirements. **Features:** hermetically sealed; fixed or adjustable time delays 0.1 to 60 sec.; solid state or relay output; vibration to 2000 Hz; shock, 50g.



ON READER-SERVICE CARD CIRCLE 96

## DIRECT-LINE FIELD ENGINEERING SERVICE



G-V assistance is always available to help you design and produce a better product. G-V Regional Field Engineers in your area will assist you and your design group in new applications and proper selection of your controls. G-V Product Engineers will help you with special applications. When you require experience, products and services in electro-mechanical and solid-state controls . . . call your man from G-V.



ON READER-SERVICE CARD CIRCLE 97

## Laser system counts railroad freight cars

Counting the cars in an ordinary freight train, as any rural youngster knows, is a tedious job—and one that is subject to human error. But supposing you were asked to count—and identify—every car in a busy railroad yard . . . ?

Westinghouse has come up with a simple solution: a laser system that detects and identifies the railroad cars at the entrance and exit to the yard. The system, installed beside the tracks, provides a continuous inventory of cars in the yard. It is fast enough to pick out and identify the cars as they travel at any speed up to 80 mph. The Association of American Railroads will begin testing the method on the Pennsylvania Railroad this month.

The system uses a 300-milliwatt helium-neon gas laser. Its output is directed through a small hole in a fixed mirror, reflected off a rotating mirror and onto a binary-coded sign attached to the side of a passing railroad car.

The binary-coded light from the sign is reflected off the rotating and fixed mirrors, through a condenser lens and onto the lens of a photo field-effect transistor. The output of the FET is amplified, checked to ensure its validity and used to operate any standard

punch or printer, or it can be used as a computer input.

The six-inch-wide car signs are made from retroreflective tape and coded into five-level binary numbers or letters with 10 characters per sign. The tape is similar to that used on auto bumpers and some highway signs. Two tape widths are used, one to represent the binary zero and the other the binary one.

The retroreflective nature of the tape causes the reflected light to follow the same path as the projected beam. A slight divergence of the reflected light does occur, however, and is important for proper system operation. The divergence allows the returned light to reflect off the fixed mirror rather than enter the small hole through which the laser beam was first projected.

The first system built used an eight-sided rotating mirror, but the system to be tested will have a 15-sided mirror, a Westinghouse spokesman said. The rotating mirror provides a vertical scanning arc of 45° to 90° depending on how far the system is located from the tracks. The system can scan a sign that is traveling past at 80 mph at least 4 times; however, only two scans are required to check the validity of returned binary information. ■ ■

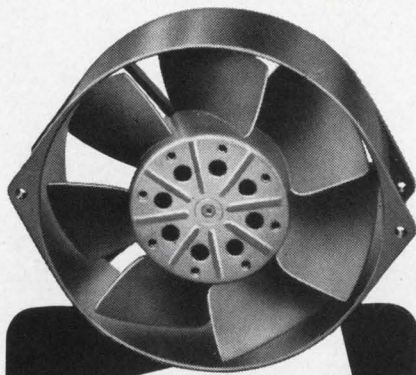

**300 cfm  
in a  
5 1/2" Package!**

### **PAMOTOR Model 6500 SHADED-POLE Axial Fans**

- Over 20,000 operational hours without maintenance
- Outstanding performance at moderate cost (under \$30.00 for single units)
- Only 2" deep
- 110 v or 220 v operation

**IN STOCK FOR  
IMMEDIATE DELIVERY!**

Write for technical data on the Model 6500 and other PAMOTOR axial fans to:

**PAMOTOR, INC.**  
312 SEVENTH STREET • SAN FRANCISCO, CALIF.

ON READER-SERVICE CARD CIRCLE 22

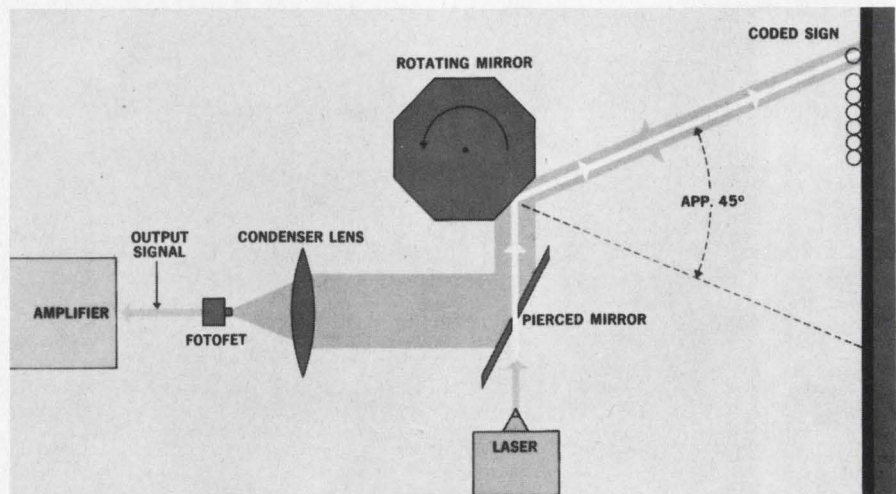

Laser beam reads signs on the side of box cars by focusing the binary-coded reflected light onto a photo field-effect transistor. The transistor output is amplified and fed into a computer or printer.



# Today, Only Motorola Offers Integrated Circuits With The Speed Potential Required For Your "Next Generation" Computers!

*Let's look at the facts.*

First of all, consider that the computer systems of tomorrow are going to require greater and greater speed. And, as you get below 5 ns, today's so-called "high-speed" logic approaches are not *practical* for driving transmission lines due to impedance mismatching problems. MECL\* integrated circuits offer the solution.

Then, remember that with most saturated logic systems internally generated "large noise spikes" become a problem as you go to higher and higher speeds. Not with MECL.

And, when you consider the need for reduced "can count" for lower system costs you'll want for the future, the "simultaneous complementary logic function at each gate" feature is a strong inducement. (In fact, our coming new multi-function MECL series will provide the lowest can count per system of any logic family.) Only MECL offers it.

When you sift through all the confusion about "best speed/power product" only one system is best at high speeds. That's MECL.

Today five of the major computer companies in the United States are designing or developing new systems utilizing MECL integrated circuitry . . . compelling evidence that MECL is indeed the direction of the future.

You can start getting familiar with tomorrow's systems *today* by designing your newest prototype from this wide selection of MECL types — the largest number of circuit functions available in *any* integrated circuit line:

TYPE ††	FUNCTION	Prop. Delay @ 25°C ns Typ		Total Power Dissipation mW Typ.
		t <sub>d1</sub>	t <sub>d2</sub>	
MC301/MC351	5-Input OR/NOR Gate	7.5	7.5	37
MC302/MC352A	R-S Flip-Flop w/Buffered Outputs	10.5**	11.5†	43
- /MC352	R-S Flip-Flop	10.5**	11.5†	40
MC303/MC353	Half-Adder	7.0	8.0	63
MC304/MC354	Bias Driver	—	—	18
MC305/MC355	Gate Expander	5.0	4.0	—
MC306/MC356	3-Input OR/NOR Gate	7.5	7.0	37
MC307/MC357	3-Input OR/NOR Gate	7.5	7.0	15
MC308/MC358A	AC-Coupled J-K Flip-Flop w/Buffered Outputs	8 ***	10 †	87
- /MC358	AC-Coupled J-K Flip-Flop	8 ***	10 †	50
MC309/MC359	Dual 2-Input NOR Gate	6.5	8.0	54
MC310/MC360	Dual 2-Input NOR Gate	6.5	8.0	54
MC311/MC361	Dual 2-Input NOR Gate	6.5	8.0	41
MC312A/MC362A	Dual 3-Input NOR Gate w/Buffered Outputs	7.5	7.0	70
MC312/MC362	Dual 3-Input NOR Gate	7.5	7.0	54
MC313F/MC363F	Quad 2-Input NOR Gate	6.5	8.0	125
MC314/MC364	AC-Coupled J-K Flip-Flop	12 **	13 †	118
MC315/MC365	Line Driver	14	12	270
MC316/MC366	Lamp Driver	—	—	135
MC317/MC367	Level Translator — MECL to Saturated Logic	30 **	25 †	63
MC318/MC368	Level Translator — Saturated Logic to MECL	17	16.5	105
- /MC369F	Dual 4-Input Clock Driver/High-Speed Gate	3	3	250
- /MC369G	Dual 2-Input Clock Driver/High-Speed Gate	3	3	250

†† MC300 Series -55 to +125°C  
MC350 Series 0 to +75°C

\*\*t<sub>d1</sub>  
†t<sub>d2</sub>

One other point. The new, faster multi-function types we're developing today for future introductions (we've already demonstrated a 200 MHz Frequency Counter — using our soon-to-be-announced 1.5 ns MECL series) will be completely compatible with existing types. Thus, they'll fit right in with the designs you develop using today's MECL types.

Call your Motorola semiconductor distributor and order evaluation units of the above MECL integrated circuit types. Our field representative has complete application information on use of MECL circuits in system applications. Contact him.

\*Trademark of Motorola Inc.

*— where the priceless ingredient is care!*



**MOTOROLA**  
Semiconductors

MOTOROLA SEMICONDUCTOR PRODUCTS INC. • P.O. BOX 955 • PHOENIX, ARIZONA 85001 • (602) 273-6900 • TWX 910 • 951-1334

ON READER-SERVICE CARD CIRCLE 23

**for fast  
delivery of  
cables up to  
2" in diameter  
with virtually  
any number  
and any type  
of conductors**

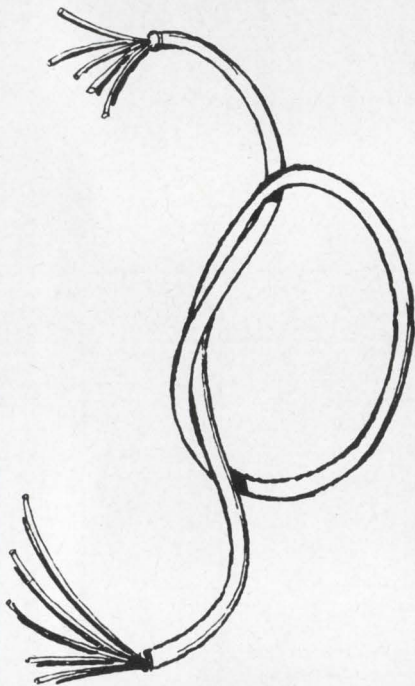

**tie-in with  
Columbia Wire,  
they deliver  
what you need.**

write for our fully-illustrated catalog



**Columbia**   
**WIRE PRODUCTS COMPANY**  
2850 Irving Park Rd. • Chicago, Ill. 60618

ON READER-SERVICE CARD CIRCLE 24

## Microprobe checks tiny magnetic domains

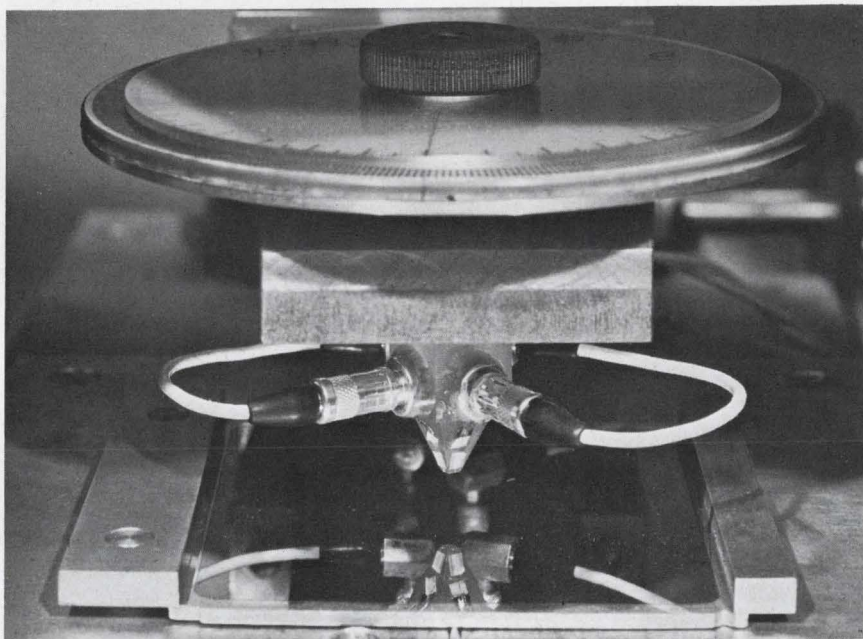

The microprobe can be rotated to test H-B relationships in any direction.

Some companies have a serious interest in evaluating the suitability of experimental magnetic films for computer memories. But the estimate of a film's ability to store information at extremely high density requires the testing of mil-sized areas at high resolution.

IBM has devised a tester that makes just such measurements. It consists of a special probe, a 10-MHz signal generator, a 20-MHz tuned amplifier and an oscilloscope. The probe is simply a nonconductive needle around which are wrapped two fine wires.

One wire is connected to the signal generator and transmits a 10-MHz magnetic field to the surface of the magnetic film under test. The other wire is the receiver: its turns convert the oscillating magnetic field of the film into a voltage. The tuned receiver amplifies the second harmonic of the sensing coil. (It filters out the fundamental, because

if it did not, the transmitting coil would merely resonate with the receiving coil and there would be no interaction at all with the magnetic film.) The unit tests the film by displaying the imposed field,  $H$ , on an axis perpendicular to the sensed field,  $B$ . This provides information about the film's saturation point and hysteresis.

The unit can even analyze magnetic films coated with oxides, metals and other nonmagnetic materials. Tests can also be performed in arbitrary magnetic fields produced by a pair of Helmholtz coils.

One square inch of magnetic film may contain 10,000 bit positions or more. These films, typically 4 micro-inches thick, are made by plating a nonmagnetic substrate with a magnetic alloy.

Most measurement techniques now use optical methods which require bulky equipment and special darkrooms. ■ ■

# OKAY. MAYBE YOU HAD A REASON FOR NOT USING PNP SILICON DEVICES.



## Fairchild PNP Epoxy Devices

Number	$h_{FE}$	at	$I_C$	$V_{CEO}$	$f_T$	$t_{on}$	$t_{off}$	at	$I_C$	Price*
	Min.—Max.			Min.	Min.	Max.	Max.			
2N3638	30		50mA	25V	100MHz	75ns	170ns		300mA	\$.28
2N3638A	100		50mA	25V	100MHz	75ns	170ns		300mA	.43
2N3639	30-120		10mA	6V	500MHz	25ns	25ns		50mA	.31
2N3640	30-120		10mA	12V	500MHz	25ns	35ns		50mA	.35
2N3644	100-300		150mA	45V	200MHz	40ns	100ns		300mA	.43
2N3645	100-300		150mA	60V	200MHz	40ns	100ns		300mA	.55
2N4121	70-200		10mA	40V	400MHz	40ns	150ns		50mA	.38
2N4122	150-300		10mA	40V	450MHz	40ns	150ns		50mA	.41
2N4248	50		100 $\mu$ A	40V	40MHz	---	---		---	.25
2N4249	100-300		100 $\mu$ A	60V	40MHz	---	---		---	.38
2N4250	250-700		100 $\mu$ A	40V	50MHz	---	---		---	.40
2N4257	30-120		10mA	6V	500MHz	15ns	15ns		10mA	.29
2N4258	30-120		10mA	12V	700MHz	15ns	20ns		10mA	.35
2N4354	50-500		10mA	60V	100MHz	100ns	400ns		500mA	.42
2N4355	100-400		10mA	60V	100MHz	100ns	400ns		500mA	.55
2N4356	50-250		10mA	80V	100MHz	100ns	400ns		500mA	.55
2N4389	30-180		10mA	12V	400MHz	20ns	90ns		50mA	.28

\*In quantities 1000-9999

## NOW WHAT'S YOUR EXCUSE?

FAIRCHILD SEMICONDUCTOR / A Division of Fairchild Camera and Instrument Corporation ■ 313 Fairchild Drive, Mountain View, California (415) 962-5011 ■ TWX: 910-379-6435

ON READER-SERVICE CARD CIRCLE 25



FAIRCHILD INTEGRATING DIGITAL METER MODEL 7100A

Another  
**FAIRCHILD**  
precision instrument  
made with  
silicon Planar  
solid state  
devices.

**The 7100A measures  
volts, ohms, and ratio.**

**It has 0.01% accuracy  
10 $\mu$ V resolution,  
fully guarded input,  
Dual-slope integration,  
automatic ranging  
and polarity. It's the only  
one that has everything.  
For \$2,100.**

**Our new brochure  
shows all it has.  
For free.**



# 150 db Common Mode Rejection SHIELDED TRANSFORMERS

by **JAMES**®

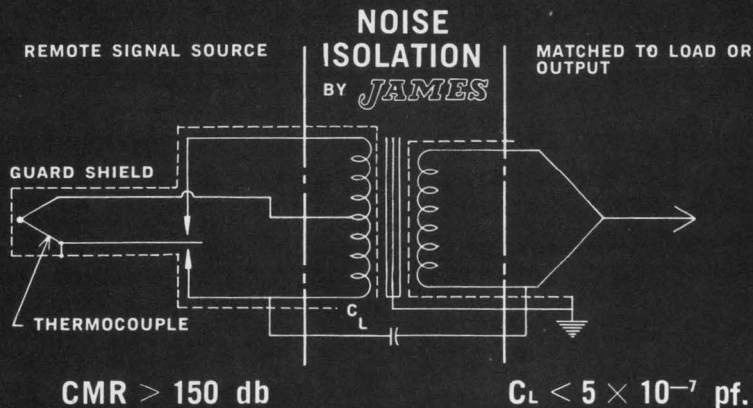

## SIGNAL-GUARD TRANSFORMERS

Low and Medium Frequency (DC to 100 KC) response

Designed for use in analog acquisition and computation equipment use. Signal Guard provides isolation, voltage comparison, impedance matching, and common mode rejection.

## DATA-GUARD TRANSFORMERS

High Frequency Signal (1 kc—20 mc)

Designed and shielded to isolate and terminate high frequency signal data in the form of pulses, AM and FM modulated carriers, multiplexed signals, and other low to high frequency data.

## ELECTRO-GUARD TRANSFORMERS

Power (1 watt to 100 VA)

Electrostatically shielded for use in signal conditioners, bridge supplies, and Zener reference supplies to isolate circuits from noise transients and undesirable common mode voltages commonly carried on electrical power lines.

*Write for complete technical details and specifications.*

KEY SUPPLIER  
OF COMPUTER  
CONTROLS

# JAMES

**ELECTRONICS INC.**

4050 North Rockwell • Chicago, Illinois 60618 • 312-463-6500 • TWX 312-222-0745

ON READER-SERVICE CARD CIRCLE 27

NEWS

## Ultrasonics check on pressure leaks

A new three-pound ultrasonic leak detector will accompany each production F-111 to its tactical base. With it, a technician can accurately check out the integrity of the pressurized electronic and radar systems up to ten times faster than if he used soap solutions, according to General Dynamics' Aerospace Ground Equipment Group.

It is extremely important to spot leaks immediately, as the aircraft's several radar systems are kept under pressure by a single air source.

The tester, built by the Delcon Div. of Hewlett-Packard Co., Palo Alto, Calif., consists of an ultrasonic microphone responding to 36—44 kHz, a frequency shifter that makes ultrasonic sounds audible, and a pair of earphones. So equipped, the operator can "hear" ultrasonic sounds emanating from pinhole leaks. Since the microphone is insensitive to sounds that are ordinarily audible, the earphoned operator is not distracted by the usual hissing and buzzing sounds of an operating aircraft.

In the past, mechanics have made such tests by crawling into barely accessible spaces, liberally spreading soapy water on joints and crevices, and watching for little soap bubbles. The process could take days to check one aircraft thoroughly. ■ ■



As the microphone nears a leak, an audible hiss gets louder. The leak detector also has a meter and volume control.

ON READER-SERVICE CARD CIRCLE 28 ►

# RCA announces 40429 and 40430 6A TRIACS

- With high gate sensitivity
- With symmetrical triggering characteristics ( $I_{GT}=25$  mA max)
- With surge current protection up to 80A
- and the price on the 40429 is only..... **\$1.50\***

RCA 40429  
controls 720 watts  
at 120 volts  
( $V_{BOM} = 200$  V).  
\*\$1.50 each  
in quantities of  
1,000 and up.



RCA 40430  
controls 1440 watts  
at 240 volts  
( $V_{BOM} = 400$  V).  
\$1.98 each  
in quantities of  
1,000 and up.



RCA brings you a new generation of control devices! Each of these 6-amp Triacs can provide the same full-wave function as *two* SCRs...with the option of using either positive or negative gate-trigger signals. Hermetically sealed in an all-welded TO-66 package, RCA 40429 and 40430 can simplify your control circuits...reduce costs...add reliability and efficiency.

Evaluate these new RCA Triacs for AC motor controls, heat controls, universal motors, dc power supplies, or solenoid or relay controls. They could very well be the key to next year's model improvements.

For complete information including price and delivery, contact your RCA Field Representative. For technical data,

write RCA Electronic Components and Devices, Commercial Engineering, Section RG12-1, Harrison, N. J. 07029.

CHECK YOUR RCA DISTRIBUTOR FOR HIS PRICE AND DELIVERY

GATE FIRING CHARACTERISTICS								
Quadrant	I +		I -		III +		III -	
	typ.	max.	typ.	max.	typ.	max.	typ.	max.
mA @ 25°C	10	25	20	25	20	25	10	25

RCA ELECTRONIC COMPONENTS AND DEVICES



The Most Trusted Name in Electronics

## Laser system helps delay RF and microwave signals

A continuously variable delay line that operates on signals in the RF and microwave ranges has been successfully tested at United Aircraft Research Laboratories, Norwalk, Conn. A laser beam interacts with an acoustical wave to provide delays up to 10  $\mu$ s at 1 GHz and 500  $\mu$ s at 30 MHz.

The delay system should find its greatest use in radars, information processing and electronic countermeasures, according to its devel-

opers, Drs. Mike J. Brienza, research physicist, and Anthony J. DeMaria, principal scientist.

Essentially, the system consists of a laser beam, an acoustic delay medium and a photodetector (see figure). The input to the acoustic medium, through a thin-film cadmium sulfide transducer, is the signal to be delayed, at the frequency  $f_2$ . The time needed for the generated acoustical wave to propagate down to the point where the laser

beam enters the rod determines the delay. This time depends on the distance,  $D$

The delay may be varied continuously by changing the location of the intercept point. This is done either by changing the direction of the laser beam or by moving the rod.

The interaction of the laser beam and the acoustical wave results in a frequency shift (by  $f_2$ ) of the output light beam. Optical heterodyning with the aid of a photodetector (pin in this case) recovers the delayed signal.

The acoustical material depends on the frequency range, says De Maria: "The ideal material is lithium niobate. It is small and can operate continuously from 30 MHz up to 2 GHz with delays from 0 to 10  $\mu$ s. However, the material is quite unreliable now. At room temperature, we use fused quartz up to about 60 MHz and crystalline quartz up to about 800 MHz."

The bandwidth depends on the transit time of the acoustical wave. A typical value is about 19 MHz at 500 MHz. Better focusing of the laser improves the bandwidth by decreasing the transit time. ■ ■

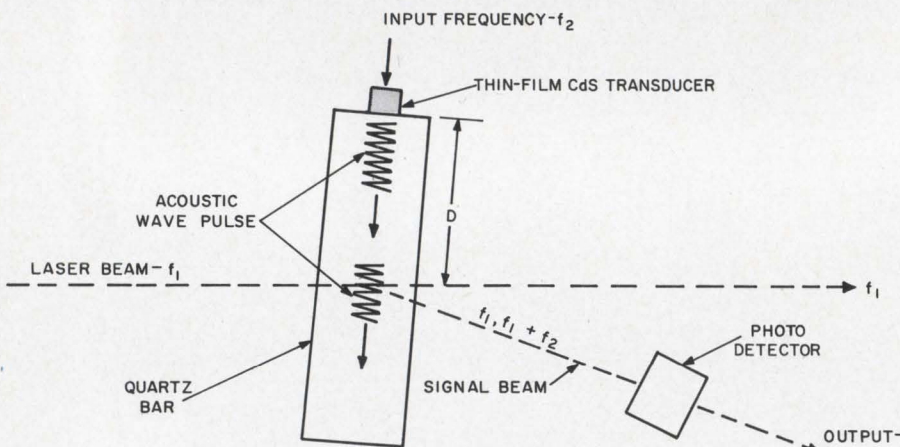

Laser beam interacts with acoustical wave to provide continuously adjustable delay for RF and microwave signals. The delay depends on the distance  $D$ .

## New technique seals thousands of semiconductors at once

A new sealing technique which will make it possible to encapsulate thousands of silicon semiconductor devices while they are still on a single silicon wafer has been reported by scientists at Bell Telephone Laboratories, Murray Hill, N. J.

The seal is formed by application of a layer of silicon nitride and beam lead contacts to the silicon dioxide layer of the transistor and integrated circuit device.

With standard encapsulation methods, the silicon slice must be cut into individual circuits and each circuit encapsulated separately—usually in vacuum-tight metal cans for high-reliability devices.

Deposition of the silicon nitride layer is accomplished by mixing two gases, silicon hydride (diluted in

hydrogen) and ammonia, near a heated silicon slice. The silicon nitride adheres to the slice to form a protective barrier against penetration of sodium and other metallic ions. Beam lead contacts, are then applied to the device.

The contacts form a strong mechanical bond with the silicon nitride layer, thus sealing the required contact areas against ion penetration and preventing the leads from becoming detached.

The completed wafer is finally etched apart. The individual devices and circuits are impervious to acids that would ruin canned devices, and can withstand accelerations of 300,000 G.

"Actually we have yet to see a failure due to shock," says the in-

ventor of the process Martin Lep-selter, "but our centrifuges don't go any higher." ■ ■

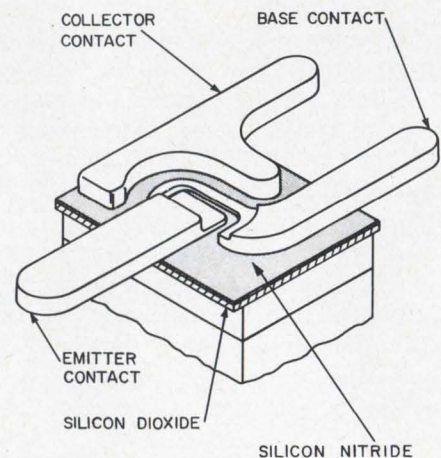

New junction seal shown on epitaxial silicon transistor.



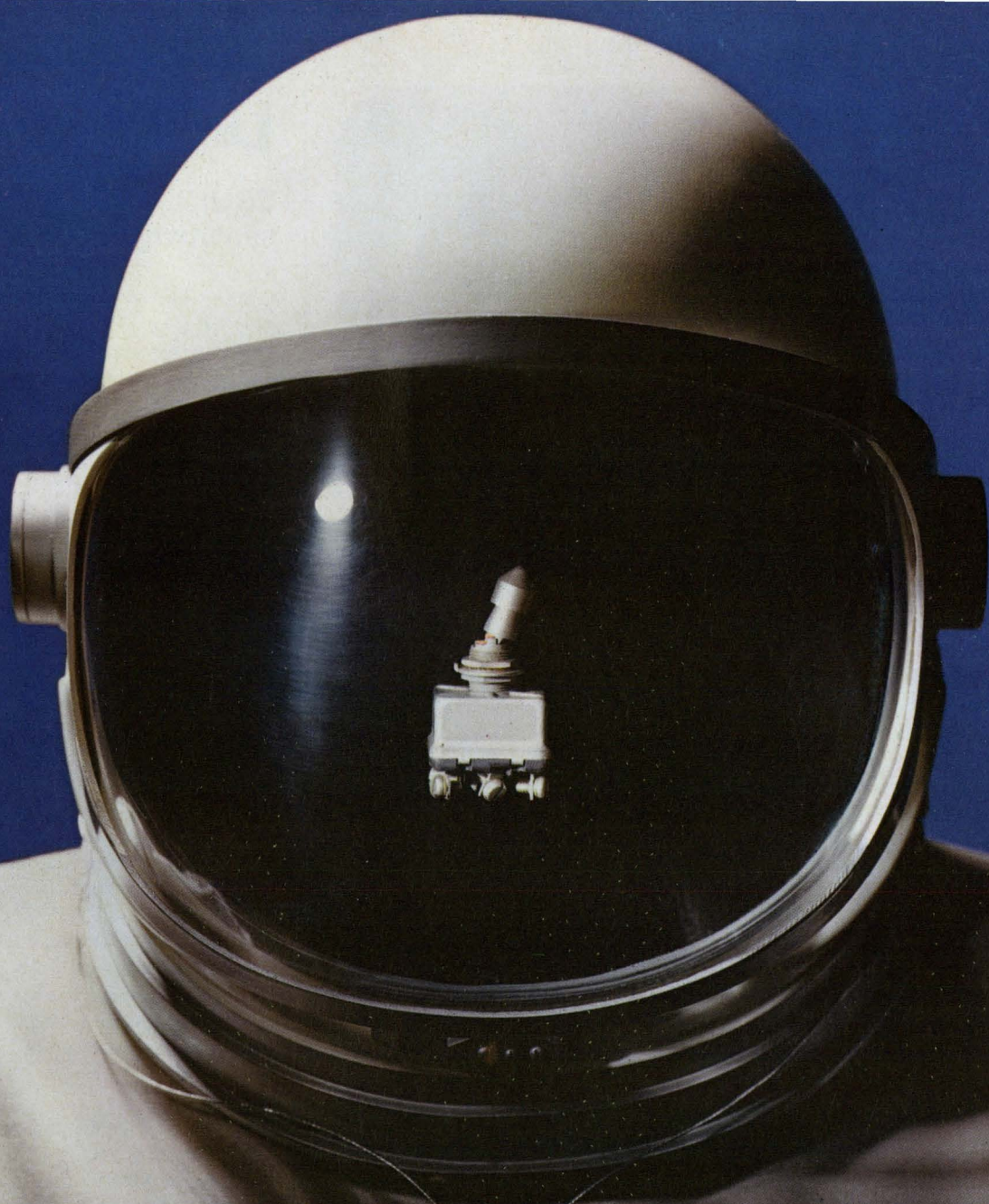

## Customers have proved our switches... all around the world!

Who are these customers? The Gemini family—and all of the U.S. manned space vehicles before them.

We've earned our part in aero-space projects. Starting in 1920, when we designed the first line of switches especially for airborne use. Today, nearly everything that flies uses Cutler-Hammer positive-action switches—full size and miniature.

For fast local service contact your nearby Cutler-Hammer Sales Office or Distributor. Or write for our comprehensive catalog, designed especially for military-switch users.

**CUTLER-HAMMER**  
Milwaukee, Wisconsin 53201



# We're switching 5 amps— 50 va for 1 million operations with a reed switch!

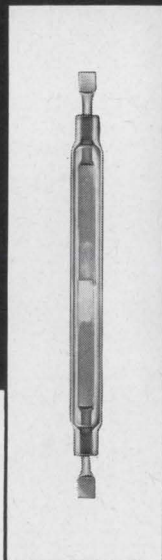

We've opened up some new possibilities for design engineers to consider when using reed relays. Power parameters for reed relay operations can now be considered to extend into the 5 amp switching range, thanks to ADC's remarkable new switch that can handle 5 amps—50 VA—and rated in excess of 1 million operations. ■ Write for more information.



**ADC PRODUCTS**

A DIVISION OF MAGNETIC CONTROLS CO.

6405 CAMBRIDGE STREET ■ MINNEAPOLIS, MINN. 55426

ON READER-SERVICE CARD CIRCLE 30

## Letters

### SQUID magnetometer's sensitivity questioned

Sir:

Your source of information about magnetometer state of the art ["Sensitive SQUID measures minute magnetism," ED 17, July 19, 1966, pp. 35-37] must be confused. There are several instruments commercially available that can measure magnetic fields in the order of  $10^{-8}$  gauss. There are at least 100 magnetic observatories around the world that continuously monitor the "tiny fluctuations in the earth's magnetic field." The term usually used in geophysical work is a gamma, which is  $10^{-5}$  gauss. We are presently working with microgamma units several orders of magnitude below the SQUID sensitivity.

Your statement about measuring from zero to 50 microgauss is extremely misleading since 50 microgauss is a rather large unit and there are no units that can measure zero field intensity.

The major problem with magnetic measurements using sensitive instruments is caused by the ambient magnetic noise. I doubt seriously that any measurements were made on the SQUID or any other instrument at the levels you indicate. It takes special techniques to get these environmental levels controlled well enough to permit measurements.

Our standard magnetometers have 10-milligamma sensitivity. We also make special magnetometers for magnetic research with much lower sensitivity. Varian Associates of Palo Alto, Calif., advertise a rubidium magnetometer with 0.002-gamma resolution.

While the SQUID may represent a new technique, it certainly is not a sensitivity breakthrough.

Fred J. Morris  
President and Director of Research  
The Electro-Mechanics Co.  
Austin, Tex.

### The authors reply

Sir:

We were most interested to learn that Fred Morris is selling magnetometers of  $10^{-8}$ -gauss sensitivity and that he has developed  $10^{-9}$ -

# IRG

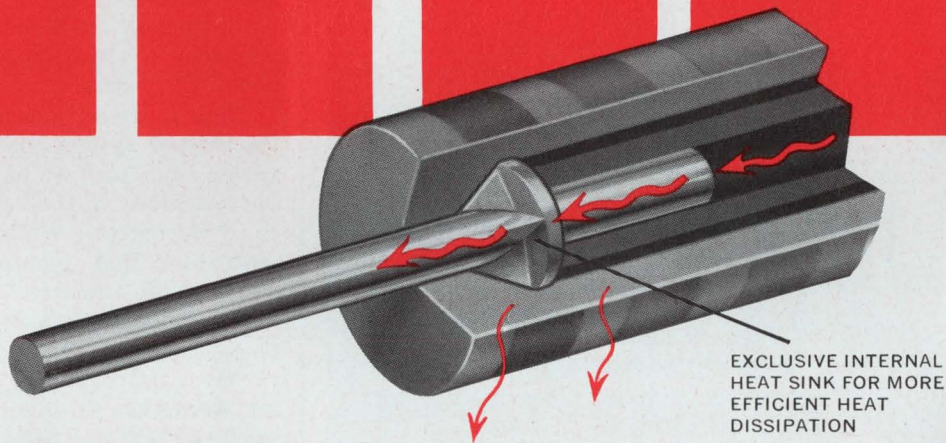

**Fixed composition resistors offer**

## **Lower changes at high temperatures**

When tested for prolonged periods at high temperatures, IRC fixed composition resistors clearly established their superior high temperature and high overload characteristics.

Even after 1,000 hours at 100°C and full rated power, resistance changes are less than the 10% MIL allowance. After 1,000 hours at 150°C, no load, resistance changes are still well within MIL limits. At 200% rated power at 70°C ambient, resistance changes are less than 10% after hundreds of hours of operation. Resistance temperature coefficient is typically less than 0.064%/°C over the range of 25°C to 150°C.

**Here's why.** IRC's resistance element is a carbon composition film that is bonded to a glass substrate at approximately 1,000°F. This results in superior high temperature performance. And, IRC's exclusive talon leads go deep into the body and act as heat sinks to conduct heat out of the resistors.

For better load life and long term stability, specify IRC fixed composition resistors. Write for catalog, prices and sample to:  
IRC, Inc., 401 North Broad Street, Philadelphia, Pa. 19108.



### **IRC COMPOSITION RESISTORS ALSO OFFER**

- Greater moisture protection
- Superior high frequency characteristics
- Stronger lead assembly
- Excellent solderability
- Values to 100,000 megohms



ON READER-SERVICE CARD CIRCLE 31

# VITRO

## Micro Modules

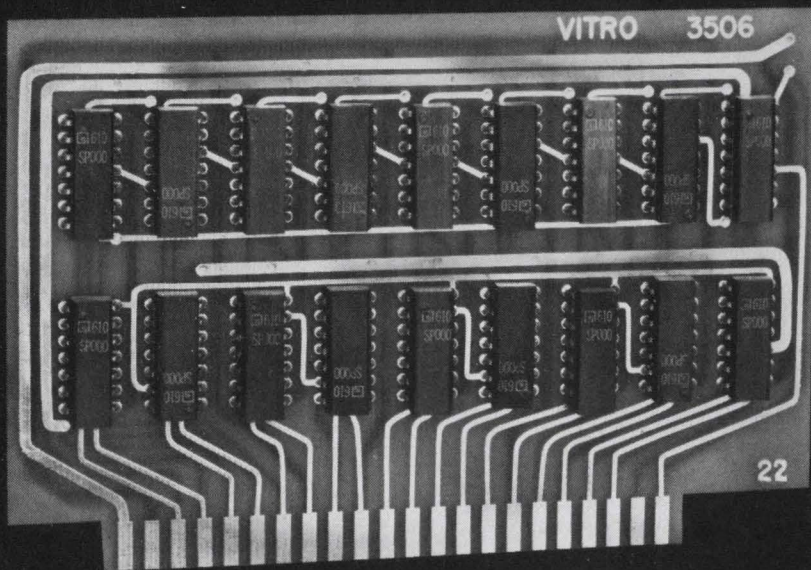

- all-new, highly competitive prices
- built-in drivers, inverters and buffers eliminate most interconnecting wiring
- up to 18 microcircuits per card enable high density and lower costs
- boards designed to meet MIL- and NASA standards
- boards keyed to assure proper mounting
- dual in-line packages easily replaced for ease of maintenance
- off-the-shelf delivery

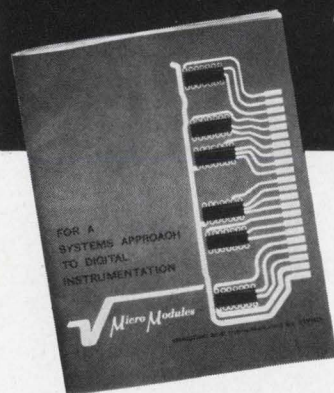

WRITE for this FREE 36 page catalog describing our complete line of card-mounted digital microcircuits. Brochure contains logic diagrams, connections, performance data, power supplies and card drawers. NEW price sheet is also included.

V-31

# Vitro ELECTRONICS

Producers of NEMS-CLARKE Equipment  
A Division of Vitro Corporation of America  
919 Jesup-Blair Drive • Silver Spring, Maryland (301) 585-1000  
2301 Pontius Avenue • Los Angeles 64, California (213) 477-6717

ON READER-SERVICE CARD CIRCLE 32

## LETTERS

gauss sensitivity in special-order units. Accordingly, he is correct in stating that  $10^{-7}$ -gauss in a rubidium-vapor magnetometer is "state of the art."

Members of our staff here in Dearborn, however, have used laboratory versions of the SQUID magnetometer to make scientific studies in which the sensitivity of  $10^{-8}$  gauss was achieved.

In our Cryogenics Devices Dept., which is located in Newport Beach, Calif., we have a research program under way to determine the limiting sensitivity of SQUID magnetometers and we have now developed a system in which the noise level is about  $10^{-10}$  gauss.

Thus it would appear that both the SQUID system and Mr. Morris' variable- $\mu$  method have comparable sensitivity in their present state of development. While we agree with him that making measurements with sensitive magnetometers is difficult because of ambient magnetic noise, we have developed elaborate, laboratory-type systems for reducing this noise and the numbers that we provided for the article are based on actual measurements that we have recorded.

Peter B. Spender  
Scientific Research Staff  
Ford Motor Co.  
Dearborn, Mich.

## Accuracy is our policy

In the Application Note, "Piezoelectric Accelerometer," ED 25, Nov. 8, 1966, p. 202, two equations were misprinted. In paragraph 4, line 11, the equation should read:

$$F = Ma.$$

The equation three lines below this should read:

$$q = dF = dMa.$$

In "A 35-lb radar set destined for Vietnam," ED 24, Oct. 25, 1966, p. 40, the name of the radar's manufacturer was wrongly stated. It is made by the Radio Receptor Div. of the General Instrument Corp., Hicksville, N. Y.—not by the General Radio Corp.

# **Solitron**

announces another **FIRST:**

*a family of high voltage **60 Amp NPN Silicon Power Planar Transistors** featuring  $V_{CE0}$  ranges from **200V to 300V**, capable of  $P_T=350W@25^\circ C!$*

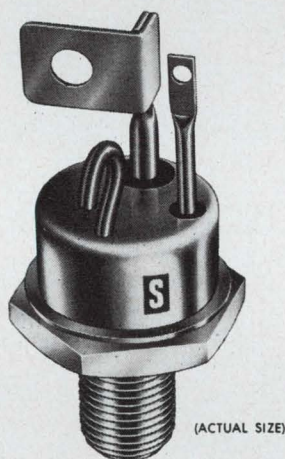
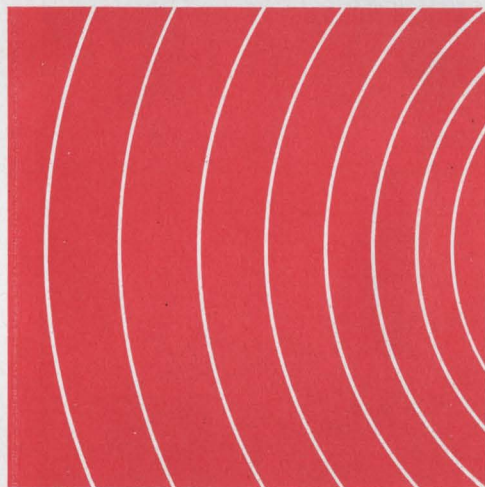

Type Number	DESIGN LIMITS				PERFORMANCE SPECIFICATIONS					
	$P_T$	$BV_{CBO}$	$V_{CE0}$ (SUS)	$BV_{EBO}$	$h_{FE}$		$V_{BE}$ (sat)	$V_{CE}$ (sat)	$I_{CBO}$	$f_T$
	Watts	Volts	Volts	Volts	$I_C = 40A$	$I_C = 60A$	Volts	Volts	$\mu A$	MH <sub>z</sub>
	25°C Case	$I_C = 1mA$	$I_C = 0.2A$	$I_E = 1mA$			$I_C = 40A$	$I_B = 6A$	$V_{CB} = 100V$	
Max.	Min.	Min.	Min.	Min.	Min.	Max.	Max.	Max.	Typ.	
SDT8951	350	200	200	8	10-40	5	2.0	2.0	10	20
SDT8952	350	225	225	8	10-40	5	2.0	2.0	10	20
SDT8953	350	250	250	8	10-40	5	2.0	2.0	10	20
SDT8954	350	275	275	8	10-40	5	2.0	2.0	10	20
SDT8955	350	300	300	8	10-40	5	2.0	2.0	10	20

TRANSISTOR DIVISION  **Solitron** **DEVICES, INC.**

1177 BLUE HERON BLVD. / RIVIERA BEACH, FLORIDA / (305) 848-4311 / TWX: (510) 952-6676

Leader in Germanium and Silicon Power Transistors, Cryogenic Thermometers, High Voltage Rectifiers, Hot Carrier Diodes, Temperature Compensated Zeners, Voltage Variable Capacitors, Random/White Noise Components, Microelectronic Circuits, and Power-Sink Interconnection Systems.

ON READER-SERVICE CARD CIRCLE 33

## TRW Metallized Capacitors



### ...stand tall

Type X601PE Metallized Mylars typify TRW's stature in advanced metallized dielectrics.

They're smaller and lighter... *metallized!* Tough and rugged...

*epoxy sealed!* Ideal for printed circuits...*save space!*

TRW offers many additional styles and dielectrics for demanding Military and Instrument needs.

Product information is available from TRW Capacitor Division, TRW INC., Box 1000, Ogallala, Nebraska. Phone (308) 284-3611. TWX: 910-620-0321.

# TRW

ON READER-SERVICE CARD CIRCLE 34

ELECTRONIC DESIGN 28, December 6, 1966

**Co-Publishers**

James S. Mulholland, Jr.,  
Robert E. Ahrendorf

**Editorial Director**

Edward E. Grazda

**Editor**

Howard Bierman

**Managing Editor**

Robert C. Haavind

**Technical Editors**

Peter N. Budzilovich  
Joseph J. Casazza  
Rene Colen  
Maria Dekany  
Frank Egan

**News Editors**

Ralph Dobriner, News Chief  
Roger K. Field

**East Coast Editor**

Neil Sclater

**West Coast Editors**

Ron Gechman

**Copy Editor**

Peter Beales

**New Products Editor**

David Sorgan

**Washington Editor**

S. David Pursglove

**Editorial Production**

Dollie S. Viebig  
Karen L. Sherman

**Art Director**

Clifford M. Gardiner

**Art Assistant**

William Kelly

**Technical Illustrators**

Cheh Nam Low  
Douglas Luna

**Production Manager**

Thomas V. Sedita

**Asst. Production Manager**

Helen De Polo

**Production Assistants**

Bernard Wolinsky  
Robert M. Henry

**Circulation Manager**

Nancy L. Merritt

**Reader Service**

Diane Pellechi

**EDITORIAL**

## Who's complaining now. . . and who's listening?

If you are a supervisor or manager, how do you react to a constant griper? Do you dismiss him as a pest who wastes valuable time? Or do you welcome an opportunity to identify, and—hopefully—rectify, an employee's problem?

If you report to an engineering manager, do you feel comfortable about airing your complaints to him? Or are you convinced that you would be wasting your time and possibly jeopardizing your job security?

Grappling with gripers is not an easy battle for several reasons. First, reason and logic often go by the board as tempers rise. Second, the two parties involved both tend to talk and argue—neither seems to listen. And third, both parties may be right, but expressing the same ideas differently.

Here are some tips for the griper:

- Get the facts. Don't quote uninformed sources on such matters as company policy, plant relocation or cutbacks in design projects.

- Organize your complaints. Don't jump from one subject to another. Keep to the main points, and avoid quibbles.

- Be open to suggestions and explanations. It's pointless to relate your opinions and conclusions and then close your ears to the manager's side of the story.

And here's some advice for the manager:

- Listen and listen attentively. Don't miss any facts. Hold off phone calls and other interruptions until the air is cleared.

- Summarize the points made. Show the griper that you have clearly identified his message and allow him the opportunity to correct any misinterpretations.

- Be honest—admit mistakes where they exist. If you indicate action will be taken, make sure action is taken soon. Don't make excuses or shift the blame.

- Clearly explain questions relating to company policy. Use written policy statements whenever possible to add weight to your statements.

- Be human. Listen to the griper and delve a bit into his home situation. Don't pry—but try to determine whether personal problems are disturbing him on the job.

Gripers and managers share one common burden—neither can perform effectively in a hostile environment. And it's not really that difficult to resolve differences intelligently.

HOWARD BIERMAN

# Replace 80% of all FET types with one!

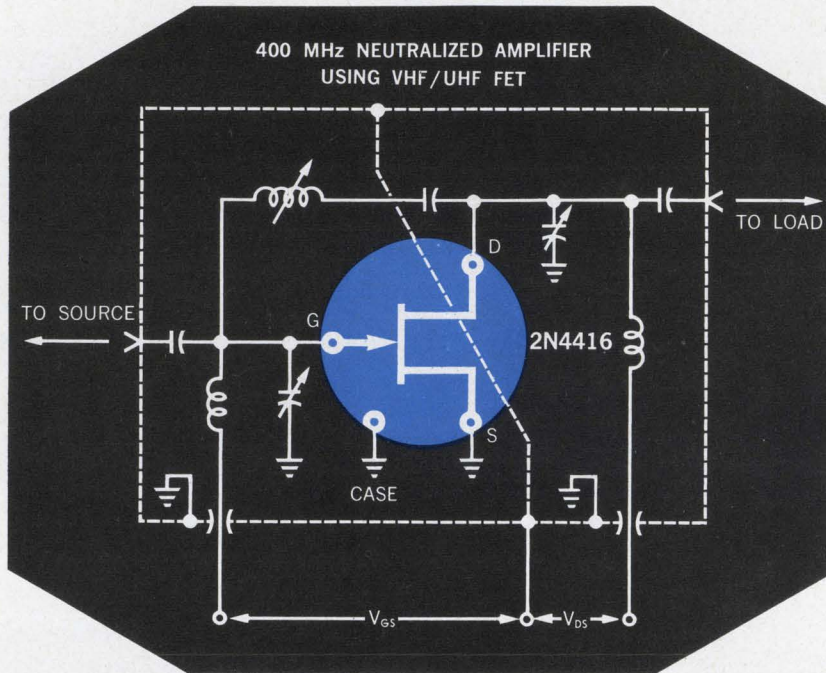

**Here's how:** Buy the Union Carbide 2N4416 universal FET in quantity, and you can select transistors over the entire frequency range covered by 80% of all field effect types. The 2N4416 is specified below as a VHF/UHF amplifier. However, from any class lot of this device you can select (1) general purpose, low noise, high gain amplifiers from D.C. to 900 MHz, or (2) ultra low noise devices for low frequency applications. This device is also available in a ribbon lead ceramic package (.138" dia.) as the low capacitance 2N4417. Use for TV tuners, FM sets, IF strips, mixers, oscillators, or even switches. Write for complete specifications.

CHARACTERISTICS Small Signal, Common Source @ 25°C	2N4416 TO-72	Frequency
Forward Transconductance $RE (Y_{fs})$ (min.)	4000 $\mu$ mhos	400 MHz
Input Capacitance, $C_{iss}$ (max.)	4.0 pf	1.0 MHz
Output Capacitance, $C_{oss}$ (max.)	2.0 pf	1.0 MHz
Reverse Transfer Capacitance, $C_{rss}$ (max.)	0.8 pf	1.0 MHz
Spot Noise Figure (Neutralized), NF (max.)	4.0 dB	400 MHz
Spot Noise Figure, NF (max.) (Neutralized)	2.0 dB	100 MHz
Power Gain, $G_{ps}$ (min.) (Neutralized)	10.0 dB	400 MHz

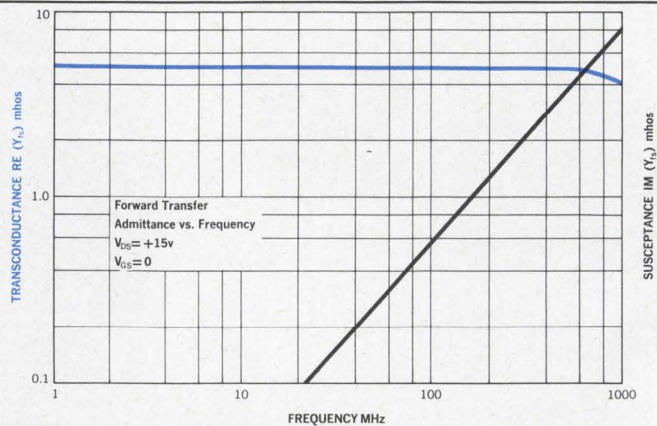

**ELECTRONICS**

**UNION CARBIDE CORPORATION** 365 Middlefield Road, Mountain View, California 94040 TWX: 910-379-6942; Telephone: (415) 961-3300

ON READER-SERVICE CARD CIRCLE 35



# Technology

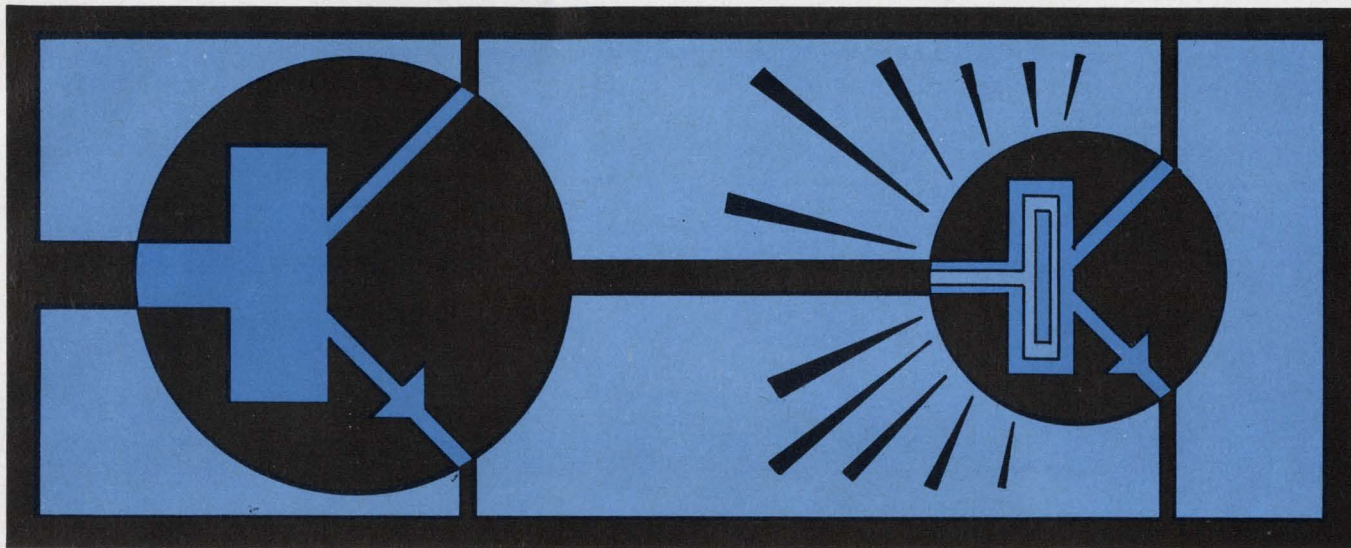

The **thermal runaway point** of transistor audio output stages evaluated by a combination

of experiments and computations is found accurately with little effort. Page 54.

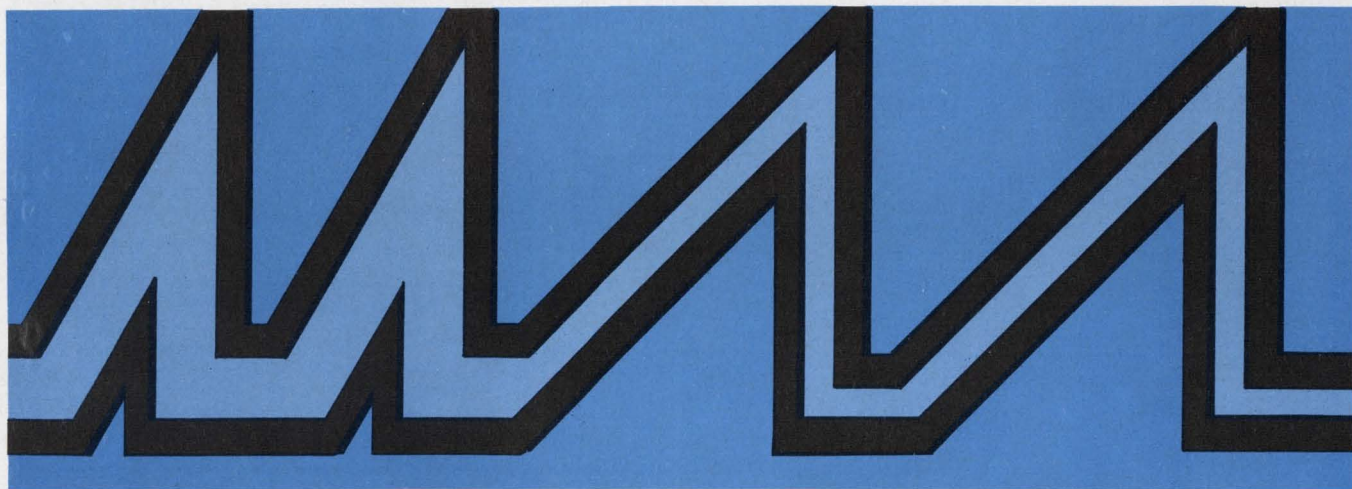

**Fast ramp generators** with ultralinearity and great flexibility in varying slope and amplitude

are obtained by charging the timing capacitor from a constant current source. Page 68

## Also in this section:

**Transistor systems' behavior** is given by statistics and random sampling. Page 62

**Proper specifications** allow the relay manufacturer to give maximum service. Page 76

**Correctly applied, low-resistance trimmers** offer numerous advantages. Page 82

**Cross-referenced index** reduces the paperwork on MIL designs. Page 92

# Evaluate thermal runaway point

of transistor audio output stages using experimental data and a set of simple calculations.

Determination of the thermal runaway point of a transistor circuit can be difficult and the result may be vague. The approach described below does away with much of the work and many of the sources of error inherent in a pure mathematical calculation. It combines experiments and computations in such a fashion as to arrive at an accurate solution with minimum effort. It applies to a wide variety of circuits that meet several general requirements, which will be defined.

## What is thermal runaway?

The basic concept of thermal runaway is the following: as ambient temperature increases, it causes a rise in the junction temperature of a transistor. The higher junction temperature causes an increase in transistor dissipation, and this, in turn, results in a change in temperature rise between junction and ambient.

The total effect can be compared to a closed-loop system which is stable only for certain values of loop gain. When the loop gain is less than unity (i.e., if the increase in temperature rise is less than the induced change), even though the junction temperature increases more than the ambient temperature, a stable point is reached.

## Experimental analysis for transfer curve

To determine whether the loop gain is high enough to initiate runaway, two factors must be known:

- The rate of change of dissipation with respect to junction temperature.
- The change in temperature rise which results from a given change in dissipation.

The second factor can easily be determined as the product of the increase in power dissipation,  $P_C$ , and the thermal resistance,  $\Phi$ . Under dc conditions, the first factor can be determined from the

## Glossary of terms

$\Phi$	– thermal resistance
$\Phi_{J-\infty}$	– thermal resistance between the junction and infinity
$\beta$	– common-emitter forward current transfer ratio
$P_C$	– collector power dissipation
$P$	– maximum non-regenerative dissipation at high signal levels
$I_C$	– collector current
$I_0$	– collector idling current
$I_{CO}$	– collector cutoff current
$V_{BE}$	– base-to-emitter voltage
$V_{CE}$	– collector-to-emitter voltage
$D$	– degrees required to double $I_C$
$T_C$	– case temperature
$T_J$	– junction temperature
$T_\infty$	– temperature at infinity point
$T_{J-\infty}$	– temperature rise between the junction and infinity
$T_{JR}$	– junction temperature at which runaway occurs
$T_{RR}$	– temperature rise at the runaway condition
$T_{AR}$	– ambient temperature which causes runaway
$T_{A\ ext}$	– actual external ambient temperature

collector-to-emitter voltage (assumed constant in an output stage where dc resistance is negligible) and the transfer characteristic between collector current and junction temperature. This transfer characteristic is a function of the circuit configuration, component values and device parameters (such as common-emitter current transfer ratio,  $\beta$ , collector-cutoff current,  $I_{CO}$ , base-to-emitter voltage,  $V_{BE}$ , and others).

The difficult and imprecise part of the analysis occurs when an attempt is made to develop this transfer characteristic from theory. The transfer characteristic can, however, be determined experimentally, if the circuit under consideration is

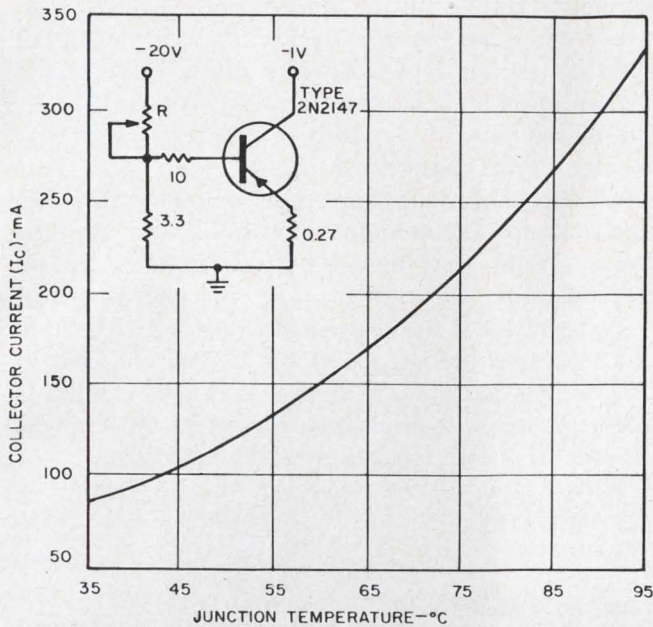

1. The collector resistance of an audio output stage should be small as shown in the above typical output-stage dc bias arrangement. Note the nonlinearity in the collector current vs junction temperature.

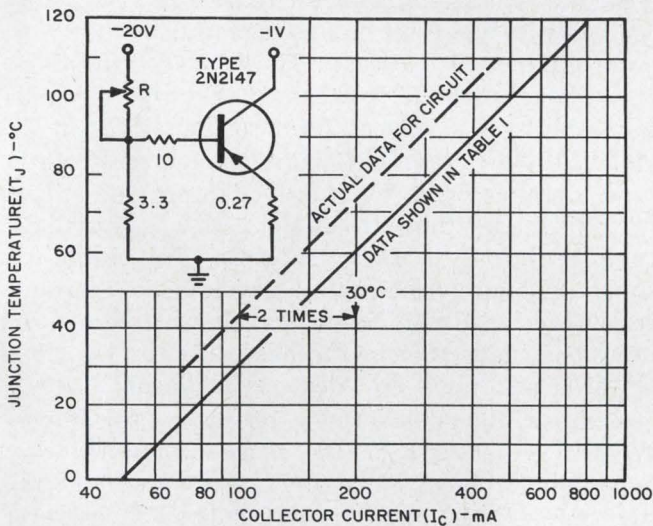

2. Collector current doubles for every 30°C increase in the junction temperature for this circuit. The transfer characteristic is a pure exponential.

operated at a low collector-to-emitter voltage,  $V_{CE}$ , to avoid dissipation, and the case temperature,  $T_c$ , is varied (in an oven or heat controller) to provide the desired values of collector current,  $I_c$ , as a function of junction temperature,  $T_j$ .

Figure 1 shows a transfer characteristic determined experimentally for a typical output-stage dc bias arrangement using a 2N2147 transistor. The curve is plotted on linear co-ordinates to illustrate the nonlinearity of the transfer characteristic. At low junction temperatures, the slope (or change in  $I_c$  for a given change in  $T_j$ ) is small. As junction temperature increases, the slope increases, and thus the loop gain also increases.

When the curve of Fig. 1 is replotted on semilog graph paper, as shown in Fig. 2, it can be seen that the transfer characteristic is a pure exponential over the range of interest. (This relationship exists because of the exponential nature of  $I_c$  as a function of  $V_{BE}$  and the exponential nature of  $I_{CO}$ .) For the curve in Fig. 2, collector current doubles for every 30°C increase in junction temperature.

The junction temperature at which thermal runaway will occur can be determined for dc operating conditions by use of a chart such as that shown in Table 1. For the example shown, collector current  $I_c$  is assumed to be 0.1 ampere at a junction temperature of 30°C. The transfer characteristic is assumed to be parallel to that obtained in Fig. 2 (i.e., to have the same slope so that  $I_c$  doubles for every change of 30°C in  $T_j$ ). Data for  $T_j$  and  $I_c$  are given in Columns 1 and 2, respectively. Column 3 shows the collector dissipation,  $P_c$ , which is equal to  $I_c$  (from column 2) times the collector-to-emitter voltage,  $V_{CE}$  (assumed to be 20 volts in the example). Column 4 shows the temperature rise between the junction and infinity,  $T_{j\infty}$ , which is equal to the dissipation (from column 3) times the thermal resistance from junction to infinity,  $\Phi_{j-\infty}$  (assumed to be 5°C/W). The infinity point is defined as the ambient point at which no temperature change results from a change in dissipation.\* Column 5 shows the temperature at the infinity point  $T_\infty$ , which is equal to  $T_j$  (from column 1) minus the temperature rise (from column 4). Column 6 shows the change in  $T_\infty$  between a row and its preceding row divided by the corresponding change in  $T_j$ . For instance,  $T_\infty$  increases by 20°C from row 1 to row 2, while  $T_j$  increases by 30°C; therefore, column 6 for row 2 is +20/30.

As junction temperature increases, the increase in  $T_\infty$  required to produce a given increase in  $T_j$  becomes smaller, because the slope of the transfer characteristic increases with junction temperature (i.e., loop gain increases). By the time row 4 is reached ( $T_j = 120^\circ\text{C}$ ),  $T_\infty$  is decreasing for increases in  $T_j$ , column 6 is negative, and runaway has occurred. The point at which thermal runaway occurs is the point at which  $\Delta T_\infty/\Delta T_j$  in column 6 is zero. For the data shown in Table 1, it can only be determined that this point occurs somewhere between temperatures of 60°C (where  $\Delta T_\infty/\Delta T_j$  is positive) and 120°C (where  $\Delta T_\infty/\Delta T_j$  is negative). A closer determination can be made by use

\*It should be noted that the infinity point is not the ambient in the immediate vicinity of the device, especially if the device is enclosed and the air is still, because the immediate ambient temperature can change as a result of dissipation. A runaway problem can exist when an amplifier is placed in a closed environment because of the high thermal resistance to infinity.

of smaller increments between the rows, or by mathematical analysis.

### Mathematical analysis gives runaway point

In order to derive an equation for the junction temperature at which thermal runaway occurs, it is necessary first to derive an expression for the transfer characteristic which was plotted from the experimental data. Such an expression is derived in Appendix 1-A for a pure exponential in terms of  $D$ , the number of degrees required to double the current. The current,  $I_0$ , at zero junction temperature can be determined by extrapolation of the curve to zero or by solution for  $I_0$  at known values of  $I_C$  and  $T_J$ . For the data plotted in Fig. 2, the value of  $D$  is  $30^\circ\text{C}$  and the value of  $I_0$  is 0.05 ampere. Collector current  $I_C$  is then given by:

$$I_C = 0.05 \epsilon^{(0.69)(T_J)/30}. \quad (1)$$

It should be noted that  $D$  is the slope of the exponential curve plotted on semilog paper, as shown in Fig. 2. If  $D$  is not a pure exponential (i.e., varies with junction temperature), the value of  $D$  is obtained from the slope of the curve at the junction temperature of interest.

As already stated, the point at which runaway occurs can be determined by use of smaller and smaller increments of  $T_J$  until the following condition is reached:

$$\lim_{\Delta \rightarrow 0} \frac{\Delta T_\infty}{\Delta T_J} = 0 \quad \text{or} \quad \frac{dT_\infty}{dT_J} = 0.$$

When this definition is used for thermal runaway and zero collector resistance is assumed, an expression can be derived for the junction temperature at which thermal runaway occurs,  $T_{JR}$ . This expression, which is derived in Appendix 1-B, is as follows:

$$T_{JR} = (D/0.69) \ln [(D/0.69)/I_0 \Phi_{J-\infty} V_{CE}]. \quad (2)$$

For the data shown in Table 1, the following solution is obtained by use of this equation:

$$T_{JR} = (30/0.69) \ln [(30/0.69)/(0.05)(5)(20)] = 94^\circ\text{C}.$$

### Effects of changes in various parameters

Examination of Eq. 2 reveals that idling current  $I_0$ , collector-to-emitter voltage  $V_{CE}$ , and thermal resistance  $\Phi_{J-\infty}$ —all have the same effect. Therefore, if the values of two or more of these parameters are changed but the product of the three remains the same, the value of  $T_{JR}$  does not change. For example, in a given circuit with fixed values of  $D$  and  $\Phi_{J-\infty}$ , the voltage could be doubled if the idling current were cut in half, and the runaway temperature would not change.

The factor  $D$  appears in two places in the numerator. A higher value of  $D$  (more junction-temperature change required to double the collector

current) results in a higher value of  $T_{JR}$ , as would be expected for a circuit with a higher stability factor. However, if a circuit that has a higher value of  $D$  is operated near the limit of its thermal-runaway capability, greater variability results from changes in  $I_0$ ,  $\Phi_{J-\infty}$ , or  $V_{CE}$ . This effect can lead to smaller safety margins for high line voltages, component tolerances, and the like for a circuit that has a better stability factor. Reasons for this effect are discussed below.

Appendix 1-C derives equations (A-15 through A-22) that show the effect on  $T_{JR}$  of changes in the various parameters in Eq. 2. These equations are used below to illustrate the effect of changes of a factor of two from the original condition:

If the value of  $D$  is doubled, the new value of  $T_{JR}$  is given by:

$$T_{JR_2} = 2(T_{JR_1} + D). \quad (3)$$

That is,  $T_{JR}$  increases more than twice.

If the product  $I_0 \Phi_{J-\infty} V_{CE}$  is doubled (by changes in any or all of the three parameters), the new value of  $T_{JR}$  is given by:

$$T_{JR_2} = T_{JR_1} - D. \quad (4)$$

That is, a change by a factor of two in  $I_0 \Phi_{J-\infty} V_{CE}$  (possibly as the result of a change of  $2^{1/3} = 1.26$  in each parameter) decreases  $T_{JR}$  by  $D^\circ\text{C}$ .

As an example, it is assumed that two circuits have similar  $T_{JR}$  values of  $100^\circ\text{C}$ , but different  $D$  values of  $30^\circ\text{C}$  and  $60^\circ\text{C}$  (the latter circuit must have a higher  $I_0 \Phi_{J-\infty} V_{CE}$  product to provide a  $T_{JR}$  of  $100^\circ\text{C}$ ). In either circuit the  $I_0 \Phi_{J-\infty} V_{CE}$  product could change by a factor of two as a result of supply-voltage variations or a change in thermal resistance resulting from transistor tolerances, improper connection to the heat sink, or location of the circuit in a crowded environment.

Because the value of  $T_{JR}$  decreases by  $D$  degrees in either case, in the circuit where  $D$  was originally  $30^\circ\text{C}$  the value of  $T_{JR}$  becomes  $70^\circ\text{C}$ . In the "more stable" circuit where  $D$  is  $60^\circ\text{C}$ , however,  $T_{JR}$  is reduced to  $40^\circ\text{C}$ . This example illustrates the fact that a circuit cannot be judged for stability by the  $D$  factor alone. Only a complete analysis in terms of thermal runaway under worst-case conditions reveals the actual safety margin.

(It will be shown later that, of the two circuits in the example, the one that has the higher value of  $D$  will also "run away" at a lower ambient temperature. This result emphasizes that the analyses must be carried to a solution for ambient temperature before a true evaluation of the thermal capability is achieved.)

### Dc conditions for thermal runaway

Appendix 1-D shows how  $T_{JR}$  can be eliminated from the equations to provide an expression for

# Chart for determining thermal runaway point

( $I_C = 0.1 \text{ A}$  at  $T_J = 30^\circ\text{C}$ ;  $\Phi = 5^\circ\text{C/W}$ ;  $V_{CE} = 20 \text{ V}$ )

	Column 1 Junction Temperature $T_J$ — $^\circ\text{C}$	Column 2 DC collector current $I_C$ — $\text{A}$	Column 3 DC collector dissipation $P_C$ — $\text{W}$	Column 4 Temperature rise $T_{J-\infty}$ — $^\circ\text{C}$	Column 5 Temperature at infinity $T_\infty$ — $^\circ\text{C}$	Column 6 $\Delta T_\infty/\Delta T_J$
Row 0	0	0.05	1	5	-5	—
Row 1	30	0.1	2	10	20	+25/30
Row 2	60	0.2	4	20	40	+20/30
Row 3	90	0.4	8	40	50	+10/30
Row 4	120	0.8	16	80	40	-10/30

the operating conditions at the point where thermal runaway occurs. Eq. A-26 demonstrates that the point of thermal runaway is reached for the following conditions:

$$\Phi_{J-\infty} I_C V_{CE} = T_{RR} = D/0.69. \quad (5)$$

In other words, thermal runaway occurs if the temperature rise due to direct current and voltage equals the  $D/0.69$  factor. It should be noted, however, that the collector current,  $I_C$ , in this equation is the value obtained when the junction temperature has increased to  $T_{JR}$ .

It may take some time, even hours, for the temperature (and thus the collector current) to rise to this value and for runaway to occur. It is desirable, then, to determine what dc conditions must exist at the time of initial turn-on to cause eventual increase of the junction temperature to  $T_{JR}$ , and thus to cause runaway. Appendix 1-E derives this condition with the assumption that there is no temperature rise at the first instant (because of the thermal capacitance) so that the junction temperature is equal to the ambient temperature. The result shows that the initial ( $t = 0$ ) dc conditions required to cause eventual thermal runaway (when there is no change in ambient temperature) are given by:

$$\begin{aligned} V_{CE} I_{C(t=0)} &= D/(0.69) (\epsilon) (\Phi_{J-\infty}) \\ &= D/(0.69) (2.72) (\Phi_{J-\infty}). \end{aligned} \quad (6)$$

It should be emphasized that this expression cannot be used if the ambient temperature changes. It can be used only if the dc conditions at time zero are measured at the maximum expected ambient temperature. Even under these conditions, the expression does not give an indication of the safety margin in terms of changes in the ambient temperature.

The ambient temperature which produces thermal runaway under dc conditions,  $T_{AR}$ , can be determined by combining Eqs. 2 and 5:

$$T_{AR} = T_{JR} - D/0.69. \quad (7)$$

This ambient temperature,  $T_{AR}$ , is of most con-

cern to the circuit designer. Equation 7 shows that  $T_{AR}$  is lower than  $T_{JR}$  by  $D/0.69$  degrees under dc conditions.

## Ac conditions are obtained from dc analysis

Although only dc operating conditions have been considered thus far, the results of the dc analysis can also be used to analyze an audio output stage that develops ac power.

As mentioned previously, thermal runaway, in its fundamental form, is a closed-loop phenomenon in which an induced change in junction temperature causes a change in dissipation, which causes a change in temperature rise which, in turn, causes a further change in junction temperature.

Under dc conditions, the change in dissipation is the result of a change in the dc collector current caused by the increased junction temperature. When an ac signal is present, there is no collector current, but there is still a change in dissipation. This is a result of the change in the operating load line which results from a changed junction temperature. Just as the rate of change of collector dissipation with respect to junction temperature under ac conditions differs from that under dc conditions, so too the temperature at which runaway occurs is different. In both Class-A and Class-AB operation, however, the worst-case conditions occur during dc (idling) conditions. Hence, both Table 1 and Eqs. 1 through 7 can still be used.

In a Class-A output stage, dissipation is always highest when there is no ac power output. For this dc condition, therefore, the equations may be applied directly. For experimental verification, a Class-A output stage should be checked out by increasing the ambient temperature while the output stage is idling.

Equation 4 shows that  $T_{JR}$  decreases by  $D^\circ\text{C}$  when the product  $I_C \Phi_{J-\infty} V_{CE}$  is increased by a factor of two. Under dc conditions, this lower junction temperature reduces the idling current to half the original value (because current doubles

every  $D$  degrees), with the net result that the temperature rise at the new value of  $T_{JR}$  remains the same (see Eq. 5). In a Class-A amplifier, therefore, a decrease of  $D$  degrees in  $T_{JR}$  causes a decrease of  $D$  degrees in  $T_{AR}$ , the ambient temperature required to cause thermal runaway.

In a two-transistor Class-AB push-pull output stage, two factors make the analysis more complex. First, maximum dissipation occurs at decreasing signal levels as idling current increases toward Class-A push-pull. Second, the rate of change of dissipation with respect to junction temperature at high signal levels is very low. (These relationships can be demonstrated by drawing the different load lines that occur at different idling currents and performing the integrations necessary to find average power.)

Two cases must be considered for the two-transistor AB stage. In the first case, operation is such that, when the junction is near  $T_{JR}$ , maximum dissipation occurs at high signal level (because of low initial idling current). In this case, the value of  $T_{JR}$  calculated from dc considerations may be exceeded as a result of the dissipation at high signal levels; yet runaway will not occur, because the dissipation is less regenerative. However, if the signal is cut off and operation returns to dc while the junction temperature is higher than  $T_{JR}$ , thermal runaway will then occur. In other words, thermal runaway can be made to occur if the ambient temperature is increased, some power is dissipated at high signal levels to heat the junction above  $T_{JR}$ , and the signal is then cut off to return the stage to dc conditions.

In the second case, operation is such that, when the junction is near  $T_{JR}$ , maximum dissipation occurs during idling (because of high idling current). In this case, maximum temperature rise occurs during idling and operation is as for the Class-A stage. Therefore, runaway is made to occur simply by increasing the ambient temperature.

In either case, runaway occurs at the dc condition, and Table 1 or Eq. 2 may be used to determine  $T_{JR}$ . In the first case, however, the effective ambient temperature (which is the ambient temperature listed in Table 1) is much greater than the actual ambient temperature because of the temperature rise caused by the nonregenerative dissipation. The actual external ambient temperature  $T_{A( ext{ext})}$  is determined as follows:

$$T_{A( ext{ext})} = T_{JR} - P\Phi_{J-\infty}, \quad (8)$$

where  $P$  is the nonregenerative maximum dissipation at the high signal level.

Because operation of a Class-AB stage may be as described for either case, experimental verification involves the following tests. First, the ambient temperature is increased in steps. At each

step, temperature is brought to equilibrium provided runaway does not occur. Next, the signal level is varied to determine the signal which causes the highest dissipation (the signal level required may change slightly as heat-sink temperature changes). If temperature equilibrium is obtained, the signal is then cut off and the idling current is observed for a decrease (stable) or an increase (unstable).

In either of the two cases described, when  $T_{JR}$  is decreased by  $D$  degrees as a result of increasing the product  $I_0 \Phi_{J-\infty} V_{CE}$  by a factor of two (as in Eq. 4), the external ambient temperature required to reach  $T_{JR}$  also decreases by  $D$  degrees. In the first case, Eq. 8 shows that  $T_A$  must change by the same number of degrees as  $T_{JR}$  because  $P\Phi_{J-\infty}$  is a constant. In the second case, the analysis is the same as for the Class-A stage because dc conditions exist.

Appendix 2 shows sample calculations for the various conditions described.

As a final comment it must be noted that the table and equations developed in this article describe thermal runaway under dc conditions. The table can be used even if collector resistance is present. The equations, however, are valid only for zero collector resistance. In either case, the concept described can be applied to an entire system analysis because the results are based on an experimental  $D$  factor for the system rather than a set of equations describing the system. The use of this  $D$  factor makes the analysis accurate and practical.

## Appendix 1—Derivation of Equations

**A. Required**—To derive an expression for collector current as a function of junction temperature from experimental data.

**Procedure**—Assume that the data show that the equation is a pure exponential function in which current increases by a certain ratio every time junction temperature increases by a certain increment. Arbitrarily select a ratio of two for current, and determine the increment of junction temperature that corresponds to a doubling of current. The expression can be written:

$$I_C = A \epsilon^{xT_J/D}, \quad (A-1)$$

where  $x/D$  is a constant that provides the required slope of two for every temperature increment  $D$ . The value of  $x$  necessary for the expression to double in value for an increment of  $D$  degrees is determined:

$$\epsilon^{x(T_J+D)/D} = 2 \epsilon^{xT_J/D}. \quad (A-2)$$

When the natural logarithm is taken of both sides of Eq. A-2, the following relation is obtained:

$$\ln \epsilon^{x(T_J+D)/D} = \ln 2 \epsilon^{xT_J/D}. \quad (A-3)$$

This equation can be simplified as follows:\*

$$x(T_J + D)/D = \ln 2 + xT_J/D. \quad (\text{A-4})$$

The value of  $x$  is then given by

$$x = \ln 2 = 0.69. \quad (\text{A-5})$$

When  $T_J = 0$ , the exponential  $e^0$  is unity and  $I_C = A$ . However,  $I_0$  is defined as the current when  $T_J = 0$ . Therefore,  $A = I_0$ . The final equation can then be written as follows:

$$I_C = I_0 \epsilon^{(0.69)(T_J)/D}. \quad (\text{A-6})$$

**B. Required**—To derive an equation describing the junction temperature at which thermal runaway will occur.

*Procedure*—Assume that there is negligible resistance in the collector-to-emitter circuit and that collector current  $I_C$  is a function of junction temperature  $T_J$ , as described by Eq. A-6. Collector power  $P_C$  then becomes:

$$P_C = V_{CE} I_C = V_{CE} I_0 \epsilon^{(0.69)(T_J)/D}. \quad (\text{A-7})$$

If infinity is defined as the point nearest to the junction at which the temperature does not change as a result of dissipation, then temperature rise  $T_R$  between the junction and infinity is given by:

$$T_R = \Phi_{J-\infty} V_{CE} I_0 \epsilon^{(0.69)(T_J)/D}. \quad (\text{A-8})$$

The junction temperature,  $T_J$ , is given by:

$$T_J = T_R + T_\infty, \quad (\text{A-9})$$

where  $T_\infty$  is the temperature at infinity.

Equation A-8 can be substituted into Eq. A-9:

$$T_J = \Phi_{J-\infty} V_{CE} I_0 \epsilon^{(0.69)(T_J)/D} + T_\infty. \quad (\text{A-10})$$

Equation A-10 can then be rearranged in the form:

$$T_\infty = T_J - \Phi_{J-\infty} V_{CE} I_0 \epsilon^{(0.69)(T_J)/D}. \quad (\text{A-11})$$

Thermal runaway has been defined as occurring when  $dT_\infty/dT_J = 0$ . Therefore, Eq. A-11 is differentiated to obtain the expression:

$$\frac{dT_\infty}{dT_J} = 1 - \frac{\Phi_{J-\infty} V_{CE} I_0 (0.69)}{D} \epsilon^{(0.69)(T_J)/D}. \quad (\text{A-12})$$

This expression is then set equal to zero to obtain the  $T_J$  required for runaway,  $T_{JR}$ :

$$[I_0 \Phi_{J-\infty} V_{CE} (0.69)/D] \epsilon^{(0.69)(T_J)/D} = 1; \quad (\text{A-13})$$

$$T_{JR} = (D/0.69) \ln [(D/0.69)/(I_0 \Phi_{J-\infty} V_{CE})]. \quad (\text{A-14})$$

**C. Required**—To show the effect of changes in parameters by a given ratio,  $N$ .

*Procedure*—Let the original condition be indicated by the subscript 1 and the new condition by the subscript 2.

(a) Changes in  $D$ . The original condition is given by:

$$T_{JR_1} = (D_1/0.69) \ln [(D_1/0.69)/(I_0 \Phi_{J-\infty} V_{CE})]. \quad (\text{A-15})$$

If the value of  $D$  is changed to  $D_2 = ND_1$ , Eq. A-15 becomes:

$$T_{JR_2} = (D_2/0.69) \ln [(D_2/0.69)/(I_0 \Phi_{J-\infty} V_{CE})] \\ = (ND_1/0.69) \ln [(ND_1/0.69)/(I_0 \Phi_{J-\infty} V_{CE})]. \quad (\text{A-16})$$

Equation A-16 can be rewritten in the following forms:

$$T_{JR_2} = (ND_1/0.69) \ln [(D_1/0.69)/(I_0 \Phi_{J-\infty} V_{CE})] + (ND_1/0.69) \ln N; \quad (\text{A-17})$$

or

$$T_{JR_2} = N[T_{JR_1} + (D_1/0.69) \ln N]. \quad (\text{A-18})$$

(b) Changes in the product  $I_0 \Phi_{J-\infty} V_{CE}$ . The original condition is given by:

$$T_{JR_1} = (D/0.69) \ln [(D/0.69)/(I_0 \Phi_{J-\infty} V_{CE})_1]. \quad (\text{A-19})$$

If the value of  $I_0 \Phi_{J-\infty} V_{CE}$  is changed to  $(I_0 \Phi_{J-\infty} V_{CE})_2 = N(I_0 \Phi_{J-\infty} V_{CE})_1$ , Eq. A-19 becomes:

$$T_{JR_2} = (D/0.69) \ln [(D/0.69)/(I_0 \Phi_{J-\infty} V_{CE})_2] \\ = (D/0.69) \ln \{ (D/0.69)/[N(I_0 \Phi_{J-\infty} V_{CE})_1] \}. \quad (\text{A-20})$$

Equation A-20 can be rewritten in the forms:

$$T_{JR_2} = (D/0.69) \ln [(D/0.69)/(I_0 \Phi_{J-\infty} V_{CE})_1] \\ - (D/0.69) \ln N; \quad (\text{A-21})$$

or:

$$T_{JR_2} = T_{JR_1} - (D/0.69) \ln N. \quad (\text{A-22})$$

**D Required**—To eliminate  $T_{JR}$  from the equations.

*Procedure*—If the transistor is biased to the steady-state current which causes runaway ( $I_{CR}$ ), then the junction temperature is at  $T_{JR}$  and Eq. A-6 may be written:

$$I_{CR} = I_0 \epsilon^{(T_{JR})(0.69)/D}. \quad (\text{A-23})$$

Equation A-23 can then be solved for  $T_{JR}$ :

$$T_{JR} = (D/0.69) \ln (I_{CR}/I_0) \quad (\text{A-24})$$

Because Eqs. A-14 and A-24 are both expressions for  $T_{JR}$ , they may be equated to obtain:

$$(D/0.69) \ln [(D/0.69)/(I_0 \Phi_{J-\infty} V_{CE})] \\ = (D/0.69) \ln (I_{CR}/I_0). \quad (\text{A-25})$$

If the  $D/0.69$  and  $I_0$  terms are canceled and the logarithm is removed from each side, Eq. A-25 can be solved for  $\Phi_{J-\infty} V_{CE} I_{CR}$ :

$$\Phi_{J-\infty} V_{CE} I_{CR} = D/0.69. \quad (\text{A-26})$$

Equation A-26 shows that the product  $I_{CR} \Phi_{J-\infty} V_{CE}$ , which is the temperature rise at the runaway condition, is given by:

$$T_{RR} = D/0.69. \quad (\text{A-27})$$

**E. Required**—To find, for a constant am-

\* $\ln AB = \ln A + \ln B$ .

IF THIS  
METAL FILM  
RESISTOR  
DOESN'T FIT  
YOUR DESIGN

Try These ... high megohm resistors

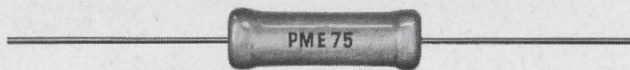

Or These ... resistor networks

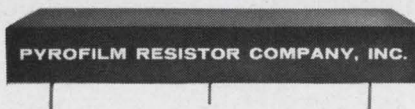

Or These ... high reliability  
carbon film resistors



Pyrofilm's resistors are changing a lot of design ideas. Perhaps your design needs the small size and high performance (1/8 watt rating) of the PME 50 Pyromet metal film resistor . . . or the extremely high resistance (25 megohms) of the Pyromet PME 75 high meg metal film resistor . . . or the compact-size resistor networks matched within .01% . . . or the stability and reliability of the long accepted PyroSeal carbon film resistors.

There's a Pyrofilm resistor for your most precise circuit designs. Send for free data file which provides complete specifications on the entire Pyrofilm line.

**PYROFILM RESISTOR  
COMPANY, INC.**

3 SADDLE ROAD • CEDAR KNOLLS, NEW JERSEY • 201-539-7110

bient temperature, the current at time zero (with  $T_J$  assumed equal to  $T_A$ ) which will provide the final steady-state current (at junction temperature  $T_{JR}$ ) necessary to cause thermal runaway.

*Procedure*—At time zero, the junction temperature  $T_J$  is lower than the junction temperature for runaway  $T_{JR}$  by an amount equal to the temperature rise  $T_{RR}$  which occurs when the collector current reaches  $I_{CR}$ . The value of  $T_{RR}$  is given by Eq. A-27. The collector current  $I_C$  at time zero can be written in the following forms:

$$I_{C(t=0)} = I_0 \epsilon^{(T_{JR}-D/0.69)(0.69/D)}; \quad (\text{A-28})$$

or

$$I_{C(t=0)} = [I_0 \epsilon^{(0.69)(T_{JR})/D}] / \epsilon. \quad (\text{A-29})$$

Equation A-23 can then be solved for  $I_0$  and the result substituted in Eq. A-29:

$$I_{C(t=0)} = I_{CR} / \epsilon = I_{CR} / 2.72. \quad (\text{A-30})$$

Equation A-30 can then be substituted into A-26 to obtain the following relation:

$$V_{CE} I_{C(t=0)} = D / (0.69) (2.72) (\Phi_{J-\infty}). \quad (\text{A-31})$$

## Appendix 2—Sample problems

A. *Required*—To determine the value of  $T_{JR}$  from the data given in Table 1.

*Procedure*— $T_{JR}$  is calculated from Eq. 2:

$$T_{JR} = (30/0.69) \ln (30/0.69) / (0.05) (5) (20) = 94^\circ\text{C}.$$

B. *Required*—To determine the value of  $T_{AR}$  for the data given in Table 1 under dc conditions.

*Procedure*— $T_{AR}$  is calculated from Eq. 7:

$$T_{AR} = 94^\circ\text{C} - (30/0.69) = 50.5^\circ\text{C}.$$

C. *Required*—To determine the value of  $T_{AR}$  for the data given in Table 1 for a Class-A output stage or a Class-AB output stage in which dissipation during idling at  $T_{JR}$  is greater than the fixed dissipation at high signal level.

*Procedure*— $T_{AR}$  is calculated from Eq. 7:

$$T_{AR} = 94^\circ\text{C} - (30/0.69) = 50.5^\circ\text{C}.$$

D. *Required*—To determine the value of  $T_{AR}$  for the data given in Table 1 for a Class-AB output stage in which there is a fixed dissipation at high signal level which is greater at  $T_{JR}$  than the dissipation during idling.

*Procedure*—Let the fixed power  $P$  equal 10 watts.  $T_{AR}$  is then calculated from Eq. 8:

$$T_{AR} = 94^\circ\text{C} - (5) (10) = 44^\circ\text{C}.$$

In this case, runaway will occur when the junction temperature reaches  $94^\circ\text{C}$  and signal is then cut off. ■ ■



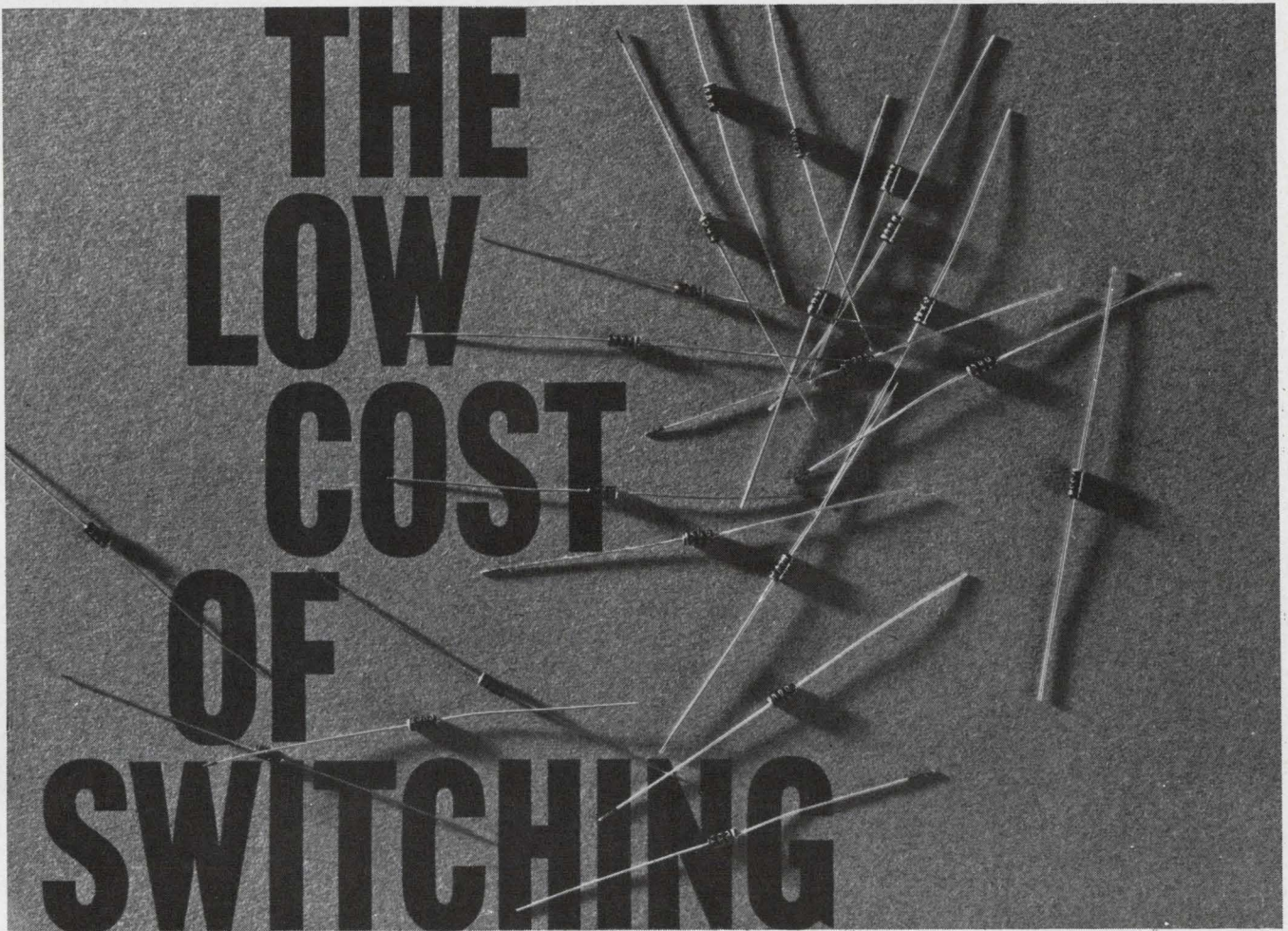

... new value  
from new pricing  
on hot carrier diodes  
from HPA

Ultra-fast switching with HP Associates 2900 Hot Carrier Diode is now more economical than ever. New production techniques and experience have reduced the cost of these popular devices, and the savings is passed on to you.

The performance characteristics and pricing listed in the chart make the HPA 2900 ideally suited for use in TV tuners, commercial communications limiters, detectors and mixers, and multiplexing in signal processing.

Contact your Hewlett-Packard field engineer for complete data or write HP Associates, 620 Page Mill Rd., Palo Alto, California 94304, Tel. (415) 321-8510.

997R

TYPICAL SPECIFICATIONS, HPA 2900		
<b>Forward Current</b> $I_{F1}$	<b>Breakdown Voltage</b> $BV_R$	
20 ma min. @ $V_F = 1.0$ v 1.0 ma min. @ $V_F = 0.4$ v	10 v @ $I_R = 10$ $\mu$ a	
<b>Leakage Current</b> $I_R$	<b>Lifetime</b> $\tau$	<b>Price</b>
100 na @ $V_R = -5.0$ v	120 ps	1 to 99, \$3.00 100 to 999, \$2.25

Data subject to change without notice. Prices f. o. b. factory.

**HEWLETT  
PACKARD**  **HP  
ASSOCIATES**

ON READER-SERVICE CARD CIRCLE 37

# Don't gamble on system performance!

Statistics and random sampling will give an accurate picture of a transmission system's behavior.

Statistical measuring techniques provide realistic performance data on transmission channels that process such random or near random signals as voice or music. The addition of random sampling to statistics broadens the range of frequencies over which statistical techniques are useful.

In the design of channels that are to process random or almost random signals, stimulation/response tests with single-frequency sine waves may yield deceptive or incomplete measures of system performance. Equal-probability signals and wide-band Gaussian noise are the logical choice as test signals for a statistical examination of system performance.

In the statistical description of periodic signals, the amplitude probability density distribution must be carefully related to the actual waveform, since there is an infinite number of waveforms that can exhibit the same density distribution. The probability density distribution function is a measure of the likelihood of finding a waveform at any particular point within a wave's peak-to-peak amplitude excursion. For the periodic signal this function takes a form which is proportional to the inverse of the slope of the waveform.

As an example, consider the triangular wave, a waveform which has the characteristic of being equiprobable. A recording of the actual function (the triangle) and its density distribution is shown in Fig. 1. The statistical description plotted on the left has been rotated 90° clockwise to show the relationship between the probability density distribution and the real-time function. The vertical axes in both plots represent waveform amplitude. The probability density is represented horizontally in the recording on the left. Another example of a time function and its density distribution is shown in Fig. 2. The signal

shown is random noise and its distribution is the familiar normal, or Gaussian, curve. In fact, Gaussian noise takes its name from this curve.

The obvious curvature of the distribution of Fig. 1b indicates that the triangle in this plot departs somewhat from the ideal. This distortion is less apparent from an examination of the original signal alone (Fig. 1a).

The sensitivity of the density distribution to irregularities in the ideal waveform appears more clearly in Fig. 3, which shows the triangle wave of Fig. 1 after it has been processed by an amplifier exhibiting crossover distortion.

The probability density distribution has certain characteristics which can be identified and related to the signal being analyzed. In the time domain, a complex signal can often be decomposed into two or more simpler signals for analysis and the superposition used to reconstruct the original signal. The summation of two time signals results in the convolution of their respective density functions. For simplicity of illustration, two deterministic signals (i.e., signals whose values are exactly known at every point in time) are

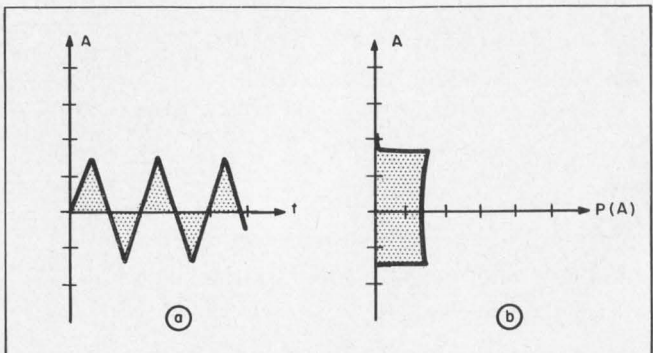

1. The triangular waveform (a) is an equiprobable signal. Its probability density function (b) is a measure of the likelihood of finding the waveform at any particular point within a wave's peak-to-peak amplitude range. Note that (b) has been rotated 90° clockwise from its conventional position.

## Conventional ac measurement techniques

Probably the most widely used measurement technique that combines acceptable accuracy and reasonable cost is the absolute-average method. Figure A shows a typical arrangement for making an average measurement. The input signal is amplified (or attenuated) and fed to the meter circuit through the diode bridge. For good linearity the amplifier should exhibit low output conductance at all frequencies of interest. Typical performance limits for this technique restrict the bandwidth to some 10 MHz and sensitivities to a few hundred  $\mu\text{V}$  full-scale. Absolute-average-measuring instruments are generally calibrated in the rms value of a sine wave and are relatively insensitive to harmonic distortion.

Peak-detecting measuring schemes, one of which is shown in Fig. B, are probably simplest of all and can be performed over a bandwidth extending to several thousand MHz. Good linearity is possible for input sinusoidal signals of one volt and above; for signals smaller than one volt, special compensation techniques must be used to achieve linear read-out. For sinusoidal signals of less than about 30 mV rms, semiconductor diodes will recover the mean square value of the signal being measured rather than the peak value. As in the case of the average-reading instrument, these devices are usually calibrated in the rms value of a sine wave. Peak-reading instruments are generally quite sensitive to harmonic distortion and care

must be taken in the interpretation of the measured peak value of a nonsinusoidal waveform.

The true rms measurement technique is most often used when a high degree of accuracy is required or when it is necessary to make sensible measurements of nonsinusoidal signals. The block diagram of Fig. C indicates one form of a true rms instrument that makes use of a servo-loop to yield a linear output display.\* The thermocouple elements form a bridge which is initially unbalanced by the signal current present in the heater winding in the ac amplifier output. The couple unbalanced is amplified by the dc amplifier and fed back to the heater winding in the second thermocouple, re-establishing bridge balance. The dc current flowing in the one heater winding is then directly proportional to the rms value of the ac signal current in the other winding and may be read out directly on a dc meter.

The performance limitations of this type of instrument are generally imposed by the ac amplifier and are similar to those of the average-measuring instrument mentioned previously. Since the true rms value is measured, independent of the waveshape†, distortion is not an "error-contributing" factor.

\*Arrangement used in Hewlett-Packard Model 3400A rms Voltmeter.

†Provided that peak excursions of the measured waveform do not exceed the dynamic range of the instrument.

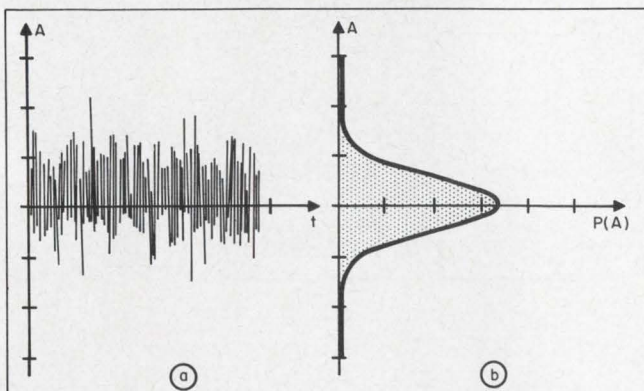
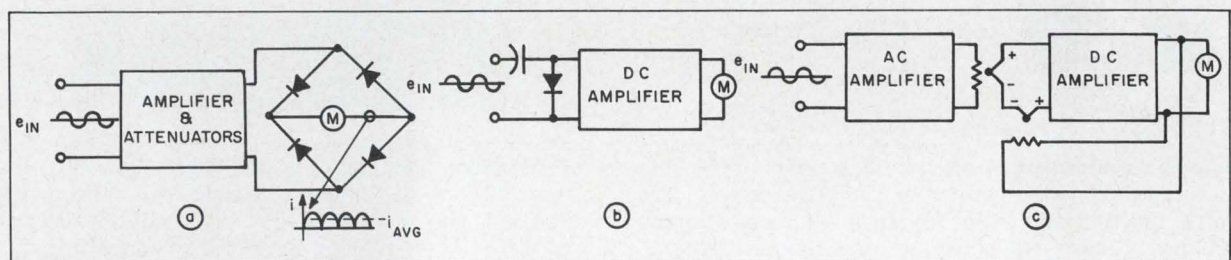

2. Gaussian noise (a) is described statistically by the familiar normal, or Gaussian, distribution curve (b). It is from this description that Gaussian noise gets its name.

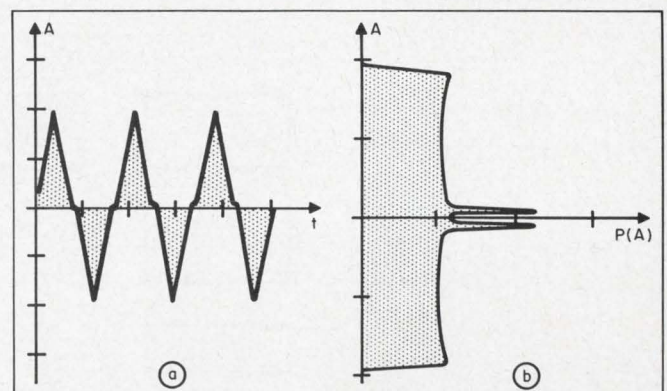

3. Crossover distortion of the equiprobable triangular waveform (a) is easier to detect if the signal's density function (b) is examined.

added and the resulting density distribution is shown in Fig. 4. The two signals used are a sine wave and square wave.

Severe band limiting, either in the processing channel or in the analyzer, will alter the shape of the signal's waveform and will also change the shape of the signal's probability density distribution. Using a test signal such as Gaussian noise is therefore advantageous because the shape of its density distribution is not affected by bandwidth limitation.

### Random sampling preserves signal's statistics

The capability of present equipment is a few megahertz. The usefulness of the statistical approach may be extended beyond this, however, if use is made of recently developed sampling techniques. If the signal to be analyzed is periodic, it is possible to use "synchronized" or coherent sampling actually to reproduce the high-frequency waveform at a much lower frequency—a technique used in the sampling oscilloscope. For purposes of statistical analysis it is not necessary to preserve the actual waveform; therefore the

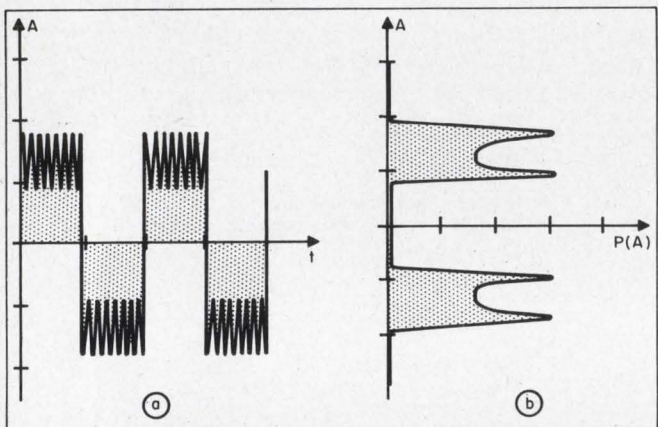

4. Complex waveforms can often be described as the sum of two simpler signals in order to simplify analysis. The sum of a sinusoid and a square wave (a) results in the convolution of their respective density functions (b).

sampler need not be synchronized with the incoming signal. The output of the sampler (retained by a zero-order hold circuit) in this case is a series of pulses of apparently randomly oriented amplitudes. Examination of the process will show that, even though the order of the "stretched" samples bears no coherent relationship to the original signal, the amplitude distribution is identical to that of the wave being measured. That is, although the sampling process is random, the statistics of the signal are preserved.

The upper portion of Fig. 5 shows the original sinusoidal signal which has been randomly sampled. The collection of samples is plotted in the lower trace of the same figure. Note that all time information about the waveshape is lost, but a statistical analysis of each trace would result in the same density distribution.

A simplified block diagram of the sampler, the Hewlett-Packard 3406A sampling voltmeter, is shown in Fig. 6. The pulse generator and the sampling bridge in the probe are designed to sample signals which may extend beyond 1000 MHz. The sample is taken in a very short interval; after proper amplification, the value of the sample is

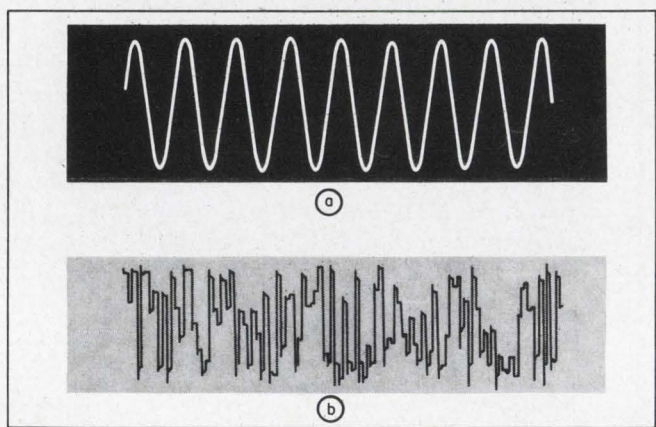

5. Random sampling of a sinusoidal signal (a) results in the collection of samples shown in (b). All time information about the original waveshape is lost but the probability distribution of both waveforms is identical.

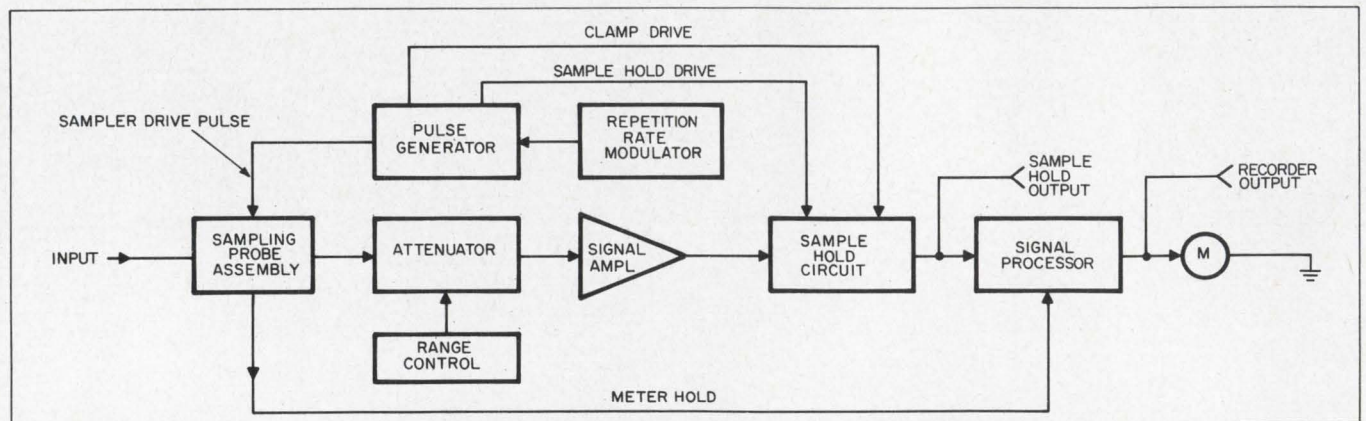

6. Waveform sampling can be accomplished by using a sampling voltmeter. A block diagram of an instrument of

this type is shown above. Note the relative simplicity of the over-all system.

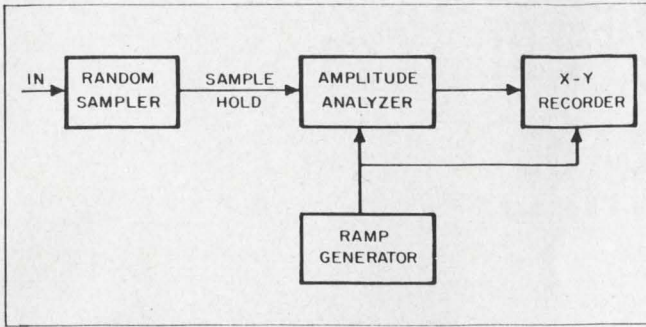

7. Recording of the sample waveshape can be obtained using the setup shown.

held in the zero-order hold circuit until the next sample is taken. The interval between samples averages about  $60 \mu\text{s}$ . The stretched samples are available at the sample-hold output for connection to other measuring equipment. Since the statistics at this point are the same as those of the input signal, properties such as peak, average and rms can be measured with instruments of only moderate bandwidth capability. Statistical measurement can be made on extremely wide-band signals with a simple, inexpensive analyzer. A block diagram of

the setup used to make the recordings shown here is shown in Fig. 7.

Figure 8a displays a portion of the sample-hold output and the density distribution of the noise present at the output of a wide-band amplifier. The noise is essentially "white" over a bandwidth of about 150 megacycles; that is, the noise contains components of all frequencies in this range. The same noise is shown in Fig. 8b, but this time with the amplifier overdriven slightly so that a small amount of clipping occurs. Note the sensitivity of this clipping exhibited by the density distribution.

Extension of the use of statistical signal description to the design and testing of voice communication channels, including multi-channel multiplexed systems can be readily seen. The use of such techniques in the optimum choice of quantization levels is a must. In short, any linear of quasilinear channel that is required to handle signals with the characteristics of a random variable lends itself to examination and synthesis by these statistical measurement methods. Proper care in measuring and data interpretation must be exercised, however, to assure accurate results. ■ ■

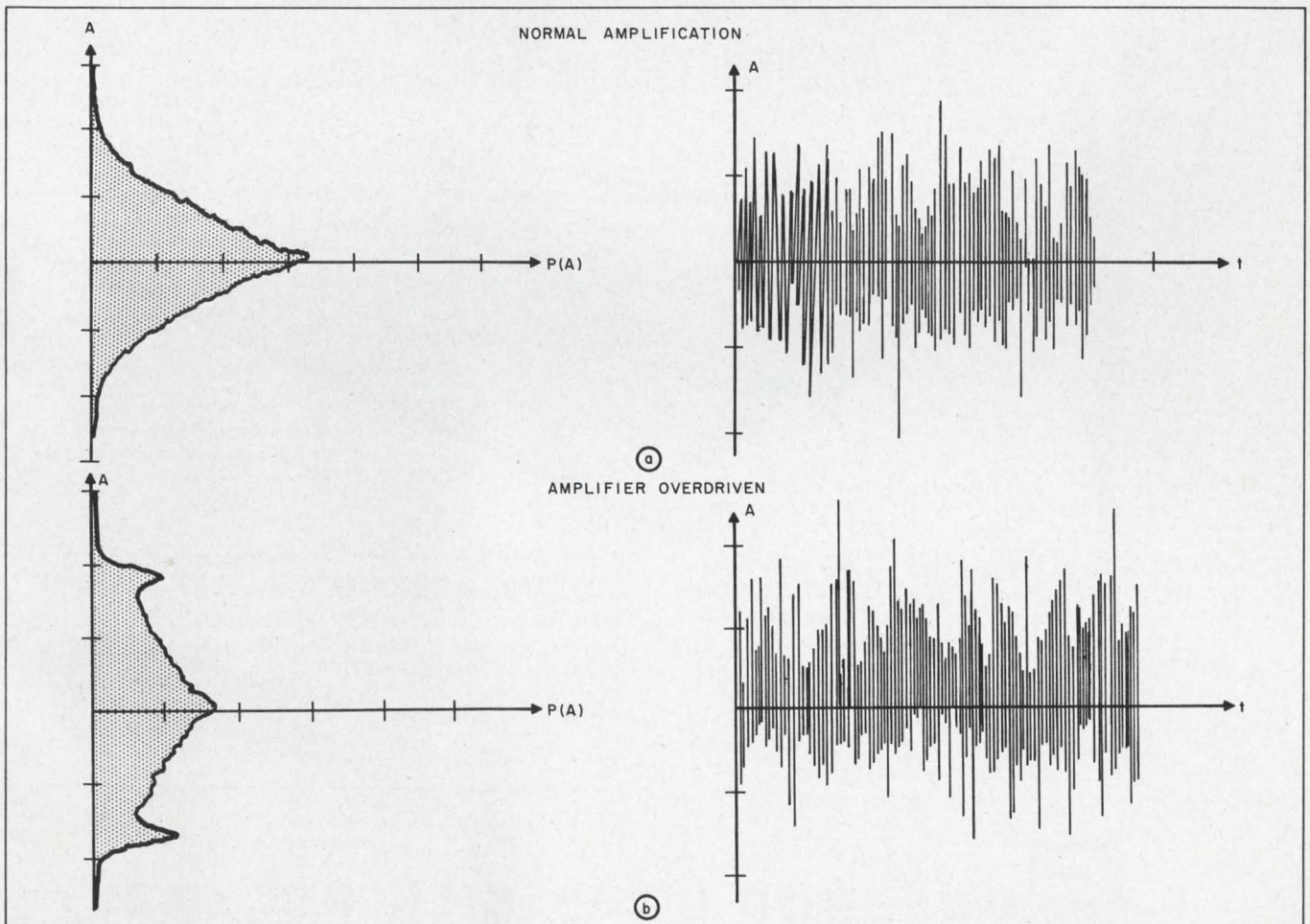

8. Output of a wide-band noise source amplified 40 dB and its probability density are shown in (a). The noise was plotted using a sampling oscilloscope. The same

noise source was used to obtain the trace shown in (b) but in this case the amplifier was overdriven. Note the distortion in the probability density for the latter case.

# MIL-T SPECS call for 22% to 32% wax coating on LACING TAPE.

• But what really is the right amount  
for trouble-free, tight-knot lacing?

• **GUDEBROD KNOWS.** They make yard after  
yard after yard exactly right!

• **GUDEBROD TAPE** cuts harness costs!

• Send for a sample.



Give the sample any comparative test  
you want. Let your harness crew try it.  
Send it to your lab. It's exactly what  
you'll get when you order Gudebrod  
tape—everytime.

You are often required to lace with tape that meets MIL-T Specs—  
with a specified range of wax content. But that's no assurance that  
you are using a tape that ties tight, holds tight, that probably won't  
be rejected—unless, of course, you have Gudebrod Gudelace. Like  
all Gudebrod Lacing Tapes it's manufactured under strict quality  
control including the wax coating. Every yard of Gudelace is im-  
pregnated exactly the same, exactly right. You can count on that—and on  
speedier, easier, better harnessing. That's where you save real  
money. Want to know more? Get in touch with Gudebrod.

#### GUDEBROD CABLE-LACER

The first hand tool engineered for wire harnessing.  
Handle holds bobbins, feeds tape as needed,  
grips tape for knotting. Speeds, eases  
harnessing. Pays for  
itself in time saving.



Area Code 215, WA 2-1122



## GUDEBROD BROS. SILK CO., INC.

FOUNDED IN 1870

*Electronics Division*

12 SOUTH 12th STREET, PHILADELPHIA, PENNSYLVANIA 19107

ON READER-SERVICE CARD CIRCLE 38



## SPEAKING OF STEPPERS

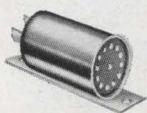

Series 705

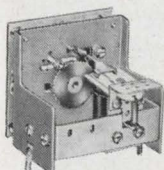

PC

Suppose you built this robot. (You might as well build it to look like this one.)

Anyway, suppose you set her stride at 24 inches and controlled her gait with a Guardian stepper (one step per step). You could program her to walk from New York to Los Angeles and on into the Pacific, with complete assurance that her Guardian stepper would still be clicking away.

You have no robots on the drawing board? No matter. The important things to remember are that Guardian steppers *average* over ten million operations on the life test rack—and that Guardian makes more steppers, and more different types of steppers than anybody else in the business.

It's a good idea to have all the specs on all the Guardian steppers in your file. Write for bulletin F32. Guardian Electric Mfg. Co., 1550 W. Carroll Ave., Chicago, Ill. 60607.

**Guardian makes the most steppers and the most dependable steppers**

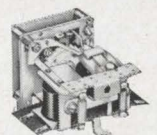

MER

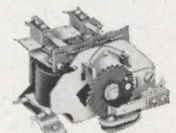

MAS

**GUARDIAN<sup>®</sup> ELECTRIC**

ON READER-SERVICE CARD CIRCLE 39

# Get ultralinearity from ramps.

Charging the timing capacitor from a constant current source improves and simplifies ramp generators.

Fast ramp generators with linearity better than 0.1% can be obtained by use of a constant-current source in addition to a current-sensing circuit in a feedback configuration. Three basic designs enable the engineer to choose the approach best suited to his particular need. Furthermore, ramp slope and amplitude variations of 200 to 1 and 20 to 1, respectively, have been demonstrated with ramp retrace times of better than 1 microsecond.

In comparison with conventional circuits using the Miller and bootstrap effects, these circuits afford the following advantages:

- Equal or better linearity.
- Greater slope range.
- Faster recovery time.
- Higher load handling ability.

The circuits' uses cover:

- Pulse width modulation.
- Analog-to-digital conversion.
- Accurate monostable operation.

## Constant-current source is linear

The constant-current source constitutes the basic building block for all the ramp generators.

Its basic circuit is shown in Fig. 2. As operation starts, timing capacitor  $C$  is assumed to be initially discharged with  $Q3$  ON. A step input of the desired ramp duration turns  $Q3$  OFF, and  $Q1$  starts charging  $C$ . The current through  $C$  develops a proportional voltage change across  $R$ , which is essentially in series with  $C$ . This voltage modifies the emitter current of  $Q2$ , which is equal to the base current of  $Q1$ .

The over-all effect of  $Q2$  and  $R$  is to compensate for any load current variations. Should  $I_L$  decrease, for instance,  $I_c$  will tend to increase, if the collector current of  $Q1$  is constant. The increase in  $I_c$ , however, will drive  $Q2$  toward cut-off. This will decrease the base current of  $Q1$ , thus dropping its collector current and compensating for the decrease in  $I_L$ . This sequence of events is reversed for an increase in  $I_L$ .

Since the emitter current of  $Q2$  is in general

two orders of magnitude less than the current through  $C$ , the change in emitter current of  $Q2$  will accurately follow changes in capacitor current, and by means of the current amplifying action of  $Q1$  will cause  $C$  to charge linearly.

The effect of current through  $R_L$  is minimized by the current gain of  $Q4$  (emitter-follower action). The bootstrapping action of  $R3$  further improves the linearity by providing a feedback input to the base of  $Q2$ .

The linearity error factor is defined as:

$$L_e = (A_p - A_a) / A_p, \quad (1)$$

where  $A_p$  is the ideal amplitude at time  $t$  and  $A_a$  is the actual amplitude.

By making reasonable approximations, Eq. 1 can be reduced\* to:

$$L_e = t / 2\beta R_L C, \quad (2)$$

where  $t = 1$  s,  $R_L = 1$  M $\Omega$ ,  $C = 10$   $\mu$ F,  $\beta = 100$ ,  $L_e = 0.05\%$ .

It will be observed that the constant-current sources used in these three ramp generators are different from the general one presented above. The difference is that the bases of the current-

\*The complete analysis of the circuit can be obtained by circling 309 on the Reader-Service card.

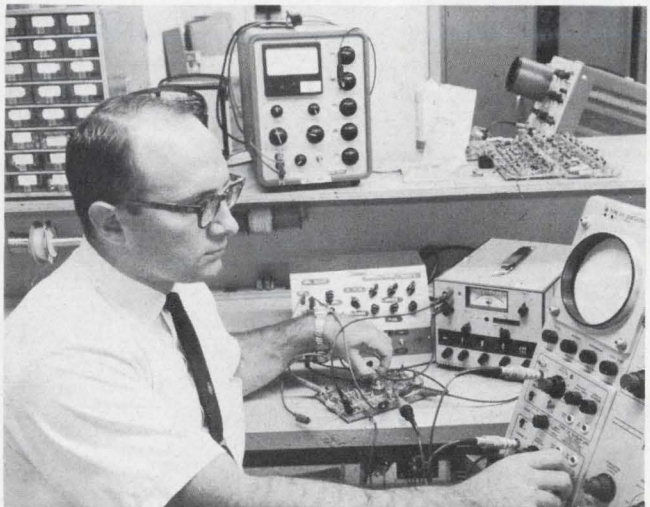

1. The slope of the ramp of the Type-III generator (visible on the scope face) can be adjusted over a wide range, as the author demonstrates.



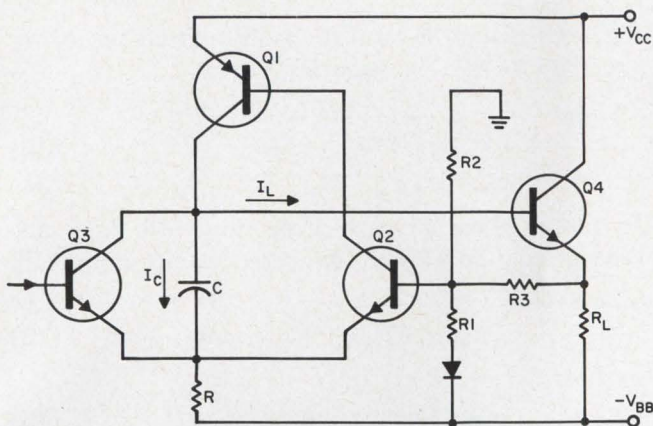

2. **Ultralinear current source** uses only four transistors. All transistors should be high-speed, high-beta, low-leakage. In particular, Q2 should have high beta at low collector currents. Timing capacitor C should have flat characteristics over the operating temperature range.

sensing transistors of each constant-current source are connected to ground in all three cases. The reason for this is the need to discharge the timing capacitor at the end of each cycle rapidly and fully. Any base resistance will slow down the operation or result in an incomplete capacitor discharge. This latter effect would eventually prevent the operation of a generator altogether.

### Type-1 ramp generator uses Schmitt trigger

The complementary Schmitt trigger in conjunction with the linear current source make up a versatile ramp generator with both ramp amplitude and slope control as well as gate outputs. In Fig. 3, Q4 and Q5 comprise the complementary Schmitt trigger. Q1 and Q2 perform the linear charging of timing capacitor C1 and Q3 is an emitter-follower that furnishes a low-impedance drive to the complementary Schmitt and minimizes load current variations.

In the stable state Q4 and Q5 are ON. The emitter of Q2 is at +18 volts while the collector of Q5 is at +19.6 volts. Q2 is therefore OFF, and D1 is forward-biased. The supply voltage for Q1 is provided by Q5. Q1 is turned ON by the -20-V supply's causing an emitter current to flow through it. With Q4 ON, the base of Q3 is at +0.3 volt and C1 is discharged. Since the emitter of Q3 is essentially at 0 volts, the current needed to turn on Q4 is provided by Q5 through R8.

A negative trigger through C4 and D3 turns OFF Q4 which in turn turns OFF Q5. Since there is then no base drive for Q4, it remains OFF. With Q5 OFF and the emitter of Q2 at +18 volts, D1 is back-biased. C1 is then charged linearly by the constant-current source Q1 and Q2. A linear rise in voltage occurs at the base as well as the emitter of Q3 owing to the charging of C1. When the voltage at the emitter of Q3 reaches the point at which the current through R4 exceeds the current through RA and R5 by the amount of base current needed to drive Q4 into the active region, Q4 starts to turn ON. This turns Q5 ON, which supplies additional base drive to Q4 and turns it ON harder. Consequently, both Q4 and Q5 saturate.

C1 now discharges rapidly through the base-emitter junction of Q1, and through D4 and the saturated Q4. D5 ensures a rapid ramp retrace at the emitter of Q3 in the case of a capacitive load, since the charge on the external capacitor would back-bias the base-emitter junction of Q3 whenever C1 discharges. In such a case a path to ground is provided through D5 and D4. A maximum step of 0.3 volt at the start of the ramp is made certain by D7, which clamps point A and the emitter of Q1 to ground. D7 also prevents the back-biasing of Q1 by a sudden rush of current through C1 due to any delay in the constant-current source action.

The period of the generator is obtained from:

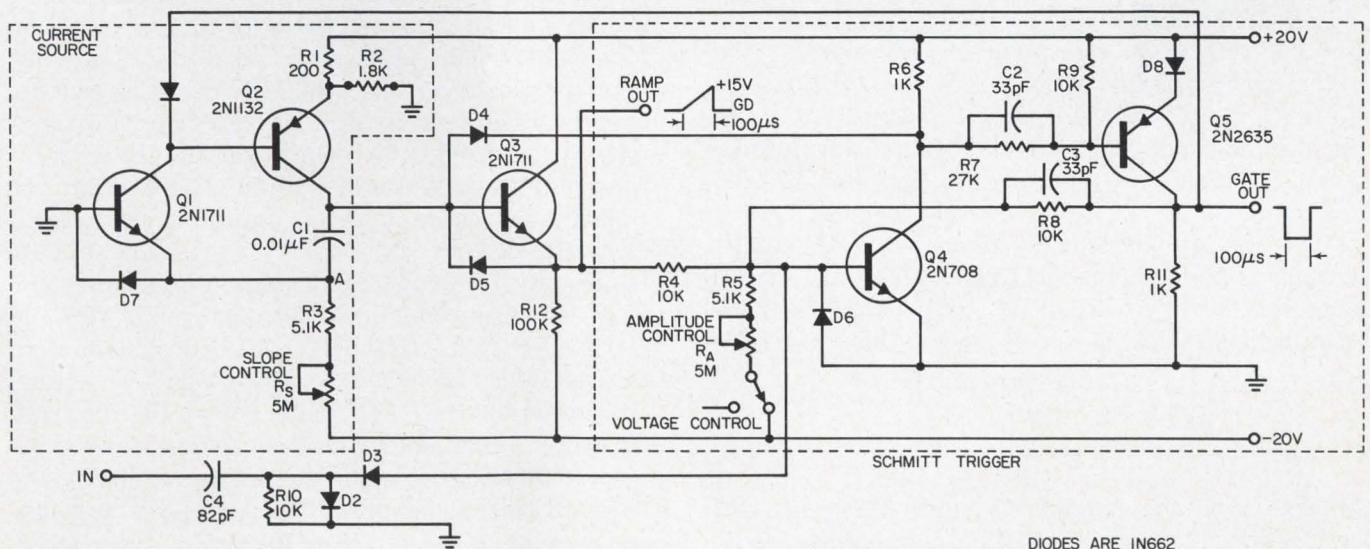

3. **Type-1 ramp generator** has ramp and gate outputs. Pulse width modulation can be obtained by applying a

control voltage to amplitude control potentiometer RA. Note separate slope and amplitude controls.

$$T = \Delta VC/\Delta I. \quad (3)$$

where  $\Delta V$  is the increment of voltage across  $C1$ , and  $\Delta I$  is the increment of current through  $C1$ . The end of the ramp occurs when the current through  $R4$  exceeds the current through  $R_A$  by the base current of  $Q4$ .  $\Delta V$  may therefore be expressed in terms of  $R_A$ ,  $R4$ , the current gain of  $Q4$  and the various drops in the circuit. The following equations can be derived:

$$\begin{aligned} (\Delta V - V_{be3} - V_{be4})/R4 &= [(V_{bb} - V_{be4})/R_A] \\ &+ (I_{c4}/\beta) \\ &+ [V_{be4}/(R8 + R11)]. \end{aligned} \quad (4)$$

Assuming  $I_{c4}/\beta$  and the current through  $R8$  and  $R11$  both to be small compared with the current through  $R4$  and  $R_A$ :

$$\Delta V = [(V_{bb} - V_{be4})R4/R_A] + V_{be3} + V_{be4}. \quad (5)$$

Assuming that the base-emitter drops of the transistors are equal:

$$\Delta V = (V_{bb} - V_{be})(R4/R_A) + 2V_{be}, \quad (6)$$

$$\Delta I = (V_{bb} - V_{be1})/R_s. \quad (7)$$

The period of the ramp generator may now be calculated by substituting Eqs. 6 and 7 into Eq. 3.

$$T = [(V_{bb} - V_{be})(R4/R_A) + 2V_{be}]C / [(V_{bb} - V_{be})/R_s]. \quad (8)$$

It is seen from Eq. 8 that the period is inversely proportional to  $R_A$  and directly proportional to  $R_s$ . The amplitude of the ramp may be varied over a range of 20 to 1 either by potentiometer  $R_A$  or a control voltage at the bottom of  $R_A$ . The period in the latter case is:

$$T = [(V_c - V_{be})(R4/R_A) + 2V_{be}]C / [(V_{bb} - V_{be})/R_s], \text{ or,} \quad (9)$$

$$T = (V_c R4/R_A) / (V_{bb}/R_s), \quad (10)$$

if base-emitter voltage drops are neglected. The generator may then be readily pulse-width-modulated. The slope of the ramp may be varied over a range of 200 to 1 by  $R_s$ , with the period of 1 to 200 microseconds.  $C4$  should be selected for the worst case, which here means the inability of  $C4$  to block the current through  $R8$  (with  $R_A$  at its maximum range) and any additional current for rapid turn-off of  $Q4$ . The ratio between  $C1$  and  $C3$  should be 20 to 1 for proper discharge of  $C1$ .

The design of the complementary Schmitt trigger is accomplished as follows.  $R11$  and  $R6$  are chosen according to the load current and rise time requirements.  $R9$  is selected according to  $I_{co}$ .

$$I_{b5} = [(V_{cc} - V_{ds} - V_{cs})/\beta R11] + [(V_{ds} + V_{be5})/R9]; \quad (11)$$

$$R7 = (V_{cc} - V_{ds} - V_{be5})/I_{b5}, \quad (12)$$

where  $I_{b5}$  is the current through  $R7$ . Since  $R4$  will essentially be connected across the base-emitter junction of  $Q4$  at the end of the cycle, the current through  $R8$  will have to be equal to the

current through  $R_A$  and the base current necessary to turn ON  $Q4$ . In equation form:

$$I_{R8} = (V_{be4}/R4) + [(V_{bb} + V_{be4})/R_A] + (V_{cc}/\beta R6); \quad (13)$$

$$R8 = (V_{cc} - V_{ds} - V_{cs5})/I_{R8}. \quad (14)$$

$R4$  has to allow at least three times the base current at the minimum expected ramp amplitude ( $V_{R \text{ min}}$ ); namely:

$$I_{R4} = 3(V_{cc} - V_{cs4})/\beta R6, \quad (15)$$

so that:

$$R4 = (V_{R \text{ min}} - V_{be})/I_{R4}. \quad (16)$$

Since  $Q2$  should be back-biased when the circuit is in the stable state, the emitter of  $Q2$  should be set to some value lower than  $V_{cc}$  so that  $Q2$  may be cut off and to allow for maximum ramp amplitude. A divider consisting of  $R1$  and  $R2$  and capable of carrying 10 times the maximum capacitor charging current serves this purpose.  $R1$  and  $R2$  may then be determined as follows:

$$R1 = (V_{cc} - V_e)/10 I_{c \text{ max}}; \quad (17)$$

$$R2 = V_e/10 I_{c \text{ max}}, \quad (18)$$

where  $V_e$  is the maximum ramp voltage.

There are several important features associated with this circuit. First, the current drawn by the load does not affect the linearity of the ramp. By contrast, the normal method of using a transistor in the common emitter configuration as a current source results in a marked degradation in linearity as the load current increases. Second, the retrace of the ramp is typically no greater than 1 microsecond; this allows a high duty cycle (95%) and frequency division up to 20 to 1. Third, pulse width modulation is simply achieved by applying a control voltage to the amplitude control resistor.

## Type-2 ramp generator depends on UJT

The design of the generator depicted in Fig. 4 hinges on the characteristics of the unijunction transistor. One particular advantage of this configuration over the others is the fact that no current is drawn by the unijunction transistor until it has fired, which improves the linearity of the ramp. In this circuit,  $Q3$  and  $Q4$  constitute the constant current source.  $Q1$  and  $Q2$  are connected as a flip-flop which, together with unijunction transistor  $Q5$ , allows monostable operation.

In the circuit of Fig. 4,  $Q2$  is normally ON and  $Q1$  is OFF. With  $Q1$  OFF,  $D6$  is forward-biased; this in turn cuts OFF  $Q3$  since this transistor's emitter is held at +18 volts. With  $D6$  forward-biased,  $V_{cc}$  furnishes collector voltage for  $Q4$  by way of  $R13$ .  $Q4$  is set in the active region by the forward-biasing action of  $R_s$  and  $V_{bb}$ . The collector current of  $Q4$  is  $(V_{bb} - V_{be4})/R_s$ . When  $Q2$  is ON,  $C3$  is held in a discharged state and  $Q5$  is off. A negative pulse through  $D5$  cuts OFF  $Q2$  and

turns ON  $Q1$ . With  $Q1$  ON, the voltage at the anode of  $D6$  is +16 volts and the voltage at the base of  $Q3$  is +17.3 volts. Thus  $D6$  becomes back-biased. The combination of  $Q3$  and  $Q4$  linearly charges  $C3$  up to the firing point of unijunction transistor  $Q5$ . The firing of  $Q5$  rapidly discharges  $C3$  and, at the same time, sends a positive pulse through  $D3$ , turning  $Q2$  ON and  $Q1$  OFF.  $Q1$  turns OFF  $Q3$ , and the circuit is back to a stable state.

Using the definition of Eq. 3,  $\Delta V$ ,  $\Delta I$  and the period for this case may be calculated as follows:

$$\Delta V = aV_{cc}, \quad (19)$$

where  $a$  is the stand-off ratio of  $Q5$ .

$$\Delta I = (V_{bb} - V_{be})/R_s. \quad (20)$$

Substituting Eqs. 19 and 20 into Eq. 3:

$$T = (aV_{cc})R_sC/(V_{bb} - V_{be}). \quad (21)$$

The flip-flop is designed as follows:  $R7$  and  $R14$  are chosen in the same manner as  $R1$  and  $R2$  of Fig. 3.  $R13$  and  $R1$  are selected so as to back-bias  $D6$  by 2 volts when  $Q1$  is ON, as well as to allow some current to be drawn from the collector of  $Q1$  when it is OFF. Accordingly:

$$R13 = (V_{cc} - V_{e3} - V_{be3} - \Delta V)/I_{c1}; \quad (22)$$

$$R1 = (V_{e3} - V_{be3} - \Delta V)/I_{c1}, \quad (23)$$

where  $V_{e3}$  is the voltage at the emitter of  $Q3$  and  $\Delta V$  is the desired  $D6$  back bias with  $Q1$  ON.

### Type-3 ramp generator is based on phantastron

The ramp generator shown in Fig. 5 is a modification of the transistorized phantastron.<sup>1</sup>  $Q4$ ,  $Q1$  and  $Q6$  comprise a monostable whose

transient state is determined by the transfer of current from  $Q1$  to  $Q6$  through  $Q5$  at a rate proportional to the linear rise in voltage across timing capacitor  $C3$  and a back-biasing current set by  $R_A$  and the negative supply.

$Q4$  is normally ON, and  $Q6$  is OFF. With  $Q6$  OFF, the voltage at the anode of  $D6$  is +20 volts.  $Q3$  is ON, with a collector current set by  $R_s$  and  $V_{bb}$ . The supply voltage for  $Q3$  is furnished through  $D6$ . The emitter of  $Q2$  is held at +18 volts by  $R2$  and  $R10$ . With  $D6$  conducting, the base of  $Q2$  is at +19.8 volts;  $Q2$  is therefore OFF. With  $Q4$  ON,  $C3$  is discharged at +0.3 volt with  $D5$  forward-biased.  $Q1$  is an emitter-follower providing low output impedance drive to external loads. The emitter of  $Q1$  is at -0.7 volt with  $Q4$  saturated.  $Q5$  is normally OFF because  $D5$  and  $Q1$  are forward-biased. With  $Q5$  OFF,  $D3$  is forward-biased by the current through  $R_A$ , and with  $D3$  forward-biased, the base of  $Q6$  is at -0.3 volt;  $Q6$  is therefore cut OFF. A negative pulse through  $D4$  and  $C1$  cuts  $Q4$  OFF. The emitter of  $Q1$  then goes up to -20 volts, forward-biasing  $Q5$ , the base of which is still momentarily at +0.3 volt. The instantaneous current through the emitter of  $Q5$  is essentially  $V_{cc}/R6$ . This current minus the current through  $R_A$  goes into the base of  $Q6$  and turns it ON. In equation form:  $I_{b6} = (V_{cc}/R6) - (V_{bb}/R_A)$ .

When  $Q6$  is ON, the voltage at the anode of  $D6$  drops to +15 volts. Since the voltage at the emitter of  $Q2$  is +18 volts,  $D6$  is now back-biased. The constant-current source ( $Q2$  and  $Q3$ ) now linearly charges  $C3$ . As in the other two generators,  $Q3$  monitors the current through  $C3$ , compensat-

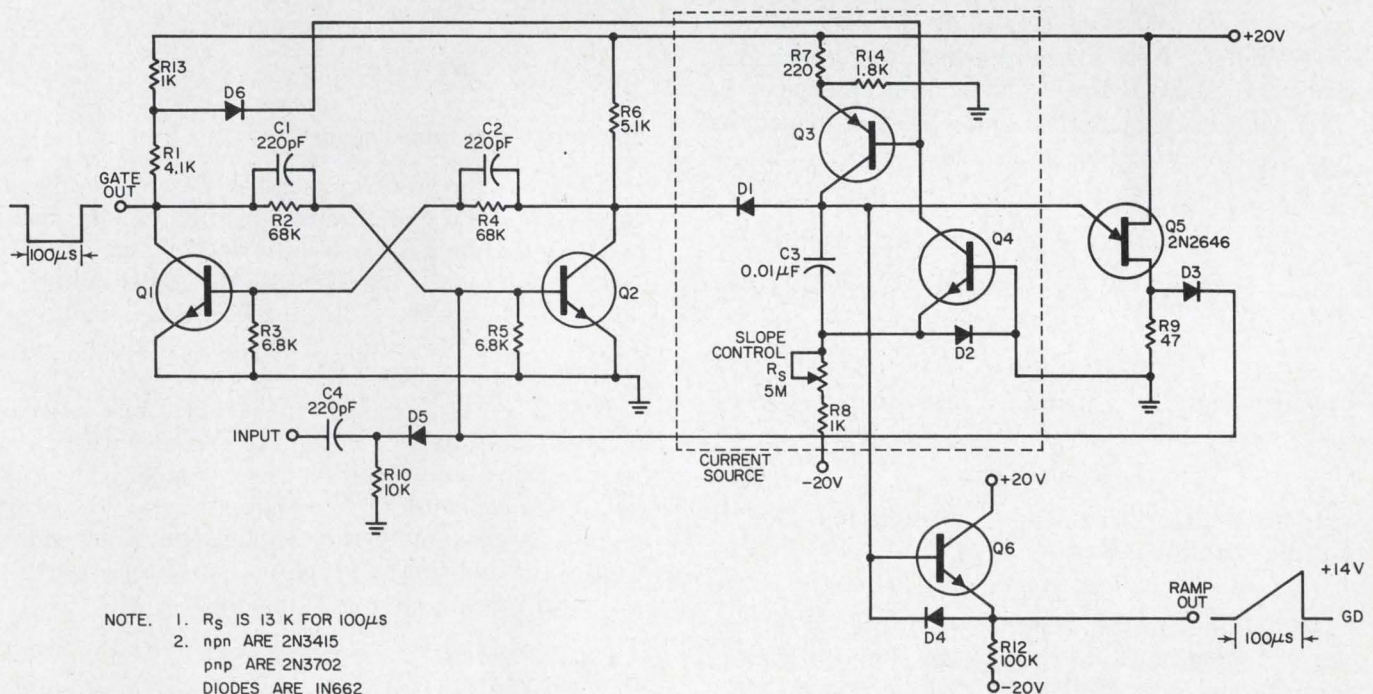

4. Type-II ramp generator uses a unijunction transistor to improve linearity. This circuit is particularly useful for

generating long (up to 1 minute), accurate gates. Ramp amplitude is determined by the firing point of  $Q5$ .

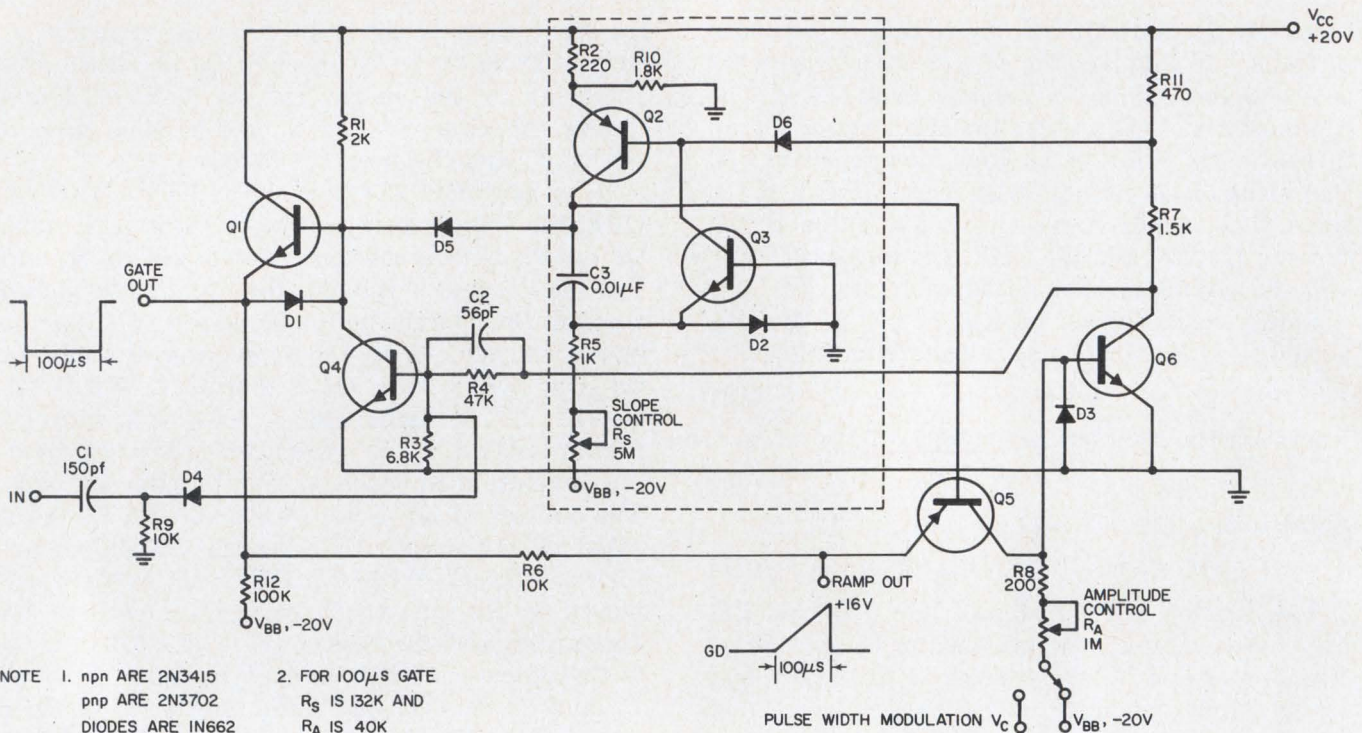

NOTE 1. npn ARE 2N3415  
pnp ARE 2N3702  
DIODES ARE IN662

2. FOR 100μs GATE  
R<sub>s</sub> IS 132K AND  
R<sub>A</sub> IS 40K

5. Type-III ramp generator is slightly more complex than the Type-I (Fig. 3). While basically the same as the Type-I,

it has greater slope range and better gate driving ability. Note that it is a modified phantastron.

ing for any changes due to load. The constant-current charging of  $C_3$  causes a linear rise in voltage at the emitter of  $Q_5$ . This causes the emitter current of  $Q_5$  to decrease, since the emitter of  $Q_1$  is at +20 volts during this time. When the decreasing current of  $Q_5$  essentially equals the current through  $R_A$ , the base current of  $Q_6$  drops to zero.  $Q_6$  then cuts OFF, turning ON  $Q_4$  which discharges  $C_3$ . At the same time  $Q_2$  is turned OFF to guard  $Q_4$  against an excessive collector current due to the base current supplied by  $Q_3$  and amplified by  $Q_2$ . With  $C_3$  discharged,  $D_5$  is forward-biased, cutting OFF  $Q_5$  and ending the cycle.

where  $V_c$  is the control voltage. The slope may be varied in this circuit over a range of 500 to 1, with the period of 1 to 500 microseconds, and the ramp amplitude of 50 to 1. A 20-to-1 ratio should be maintained between  $C_3$  and  $C_2$  for proper discharge of  $C_3$ .

The period calculations may be performed as follows (the notation of Eq. 3 is used):

$R_{11}$  and  $R_7$ ,  $R_2$  and  $R_{10}$  are selected in the same manner as in the Type-2 generator.  $R_6$  is chosen so that the current through it at the maximum expected ramp amplitude is at least three times larger than the base current of  $Q_6$ . Or:

$$R_6 = (V_{cc} - V_{max}) / 3 I_b. \quad (31)$$

$$\Delta I = (V_{bb} - V_{be}) / R_s; \quad (24)$$

$$I_{c5} = I_{R_A} \text{ at the end of the timing period.} \quad (25)$$

$$I_{c5} = [V_{cc} - (\Delta V_c + V_{be})] / R_6 = V_{bb} / R_A; \quad (26)$$

$$\Delta V_c = [V_{cc} - (V_{bb} R_6 / R_A)] - V_{be} \\ = (V_{cc} - V_{be}) - (V_{bb} R_6 / R_A). \quad (27)$$

Substituting Eqs. 24 and 27 into Eq. 3:

$$T = [(V_{cc} - V_{be}) - (V_{bb} R_6 / R_A)] C / \\ [(V_{bb} - V_{be}) / R_s]. \quad (28)$$

If the emitter-base drops are neglected, Eq. 28 may be simplified:

$$T = [V_{cc} - (V_{bb} R_6 / R_A)] C / (V_{bb} / R_s). \quad (29)$$

Pulse width modulation may be achieved in this circuit by maintaining  $R_A$  constant and applying a control voltage to  $R_A$ . Eq. 29 then becomes:

$$T = [V_{cc} - (V_c R_6 / R_A)] C / (V_{bb} / R_s), \quad (30)$$

### Suit circuits to your needs

While all the generator types described above can be used in a wide variety of applications, each has been designed for a specific need. Thus, Type-1 and -3 generators are particularly suited for applications in pulse width modulation, analog-to-digital converters, high-frequency dividers and accurate monostables.

Type-2 is well suited to applications where accurate gates up to 1 minute long and with rapid retrace times are required. It is especially useful for timing capacitors up to 100 μF. Types-1 and -3 are not as efficient in this application, since they require the addition of speed-up capacitors for the discharge of the timing capacitors. ■ ■

### Reference:

1. Gilbert Marosi, "Modified Multi Forms Phantastron Oscillator," ELECTRONIC DESIGN, XIII, No. 14 (July 5, 1965), pp. 46-48.

NEW family  
of medium-  
power  
silicon NPN  
transistors  
packs BIG  
performance  
at mass  
production  
prices

Here's A Typical Value: RCA 40458

$h_{FE}$ ..... 50 min. at 300 mA  
 $V_{CE0}$  (SUS)..... 40 V min. at 100 mA  
 $V_{CE}$  (sat)..... 0.3 V max. at 300 mA  
 $f_T$ ..... 150 MHz min.  
 $I_C$ ..... 1A  
 Dissipation: 2 W at 75°C Case Temp.

only 47¢\*

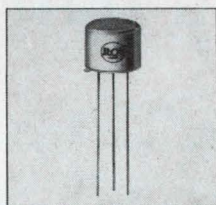

Hermetically sealed  
in a metal case

now examine the entire family of value-packed industrial types

RCA 2N3241A Silicon Epitaxial Planar Transistor Family Characteristics									
	2N3241A	2N3242A	2N4074	40397	40398	40399	40400	40458	
$BV_{CE0}$	25	40	40	25	25	18	18	40	max. volts
$h_{FE}$ 10V, 10mA	100-200	125-300	75-300	165-600	75-300	165-600	75-300	100-300 (50 min. @ 300mA)	
$f_T$ typ.	175	175	80	80	80	80	80	150 min.	MHz
$V_{CE}$ (SAT)	0.25 at 200mA $I_C$	0.3 at 300mA $I_C$	0.3 at 300mA $I_C$	0.25 at 200mA $I_C$	0.25 at 200mA $I_C$	0.2 at 100mA $I_C$	0.2 at 100mA $I_C$	0.3 at 300mA $I_C$	max. volts
Turn-on $I_C = 150mA$	75	75	—	—	—	—	—	75	max. nanoseconds
Dissipation** at 25°C Ambient	0.5	0.5	0.5	0.5	0.5	0.5	0.5	0.5	max. watts
$I_C$	Limited by $P_T$	Limited by $P_T$	0.3	0.2	0.2	0.2	0.2	1.0	max. amperes
Price*	\$0.44	\$0.50	\$0.44	\$0.40	\$0.36	\$0.33	\$0.30	\$0.47	

\*In quantities of 1,000 and up.    \*\*All types available with integral heat radiator for 1 watt dissipation at  $T_A = 25^\circ C$ . Add 4¢ per unit for these versions.

The new RCA 2N3241A family of NPN epitaxial planar transistors, designed for amplifier and switching service in audio and video frequency ranges, is as versatile as it is reliable. Applications include • relay drivers • video amplifiers • high current audio drivers • saturated switches • TV deflection drivers • medium power audio output amplifiers. All devices offer exceptionally low leakage, low saturation voltages, and high minimum beta. Check the chart for specifications...and note the low prices!

See your RCA Distributor for his price and delivery

Double the 25°C free air dissipation capability from ½ watt to 1 watt by specifying integral heat radiator versions of the devices listed above.

You won't find another family of medium-power silicon transistors with so much performance, at so little cost, available immediately in production quantities. Call your local RCA Field Office for complete information. For technical data sheets write: RCA Commercial Engineering, Section EG12-1, Harrison, N.J. 07029.

\*Price in quantities of 1,000 and up.



RCA Electronic Components and Devices

The Most Trusted Name in Electronics

**Everybody's  
getting started in  
Complementary Symmetry...  
Everybody but AmpereX!**

**We got started  
four and a half years ago.**

**Today we're delivering  
the broadest line of  
complementary symmetry  
transistors and accessories  
in the business...  
delivering them off-the-shelf,  
in production quantities,  
at production prices.**

Complementary Symmetry, the ultimate in economical, reliable circuitry for audio applications, will be found in most of the latest home entertainment equipment.

While not a new engineering approach, Complementary Symmetry remained a textbook approach until early in 1962 when Amperex announced it had the tools to make the textbook dream come true.

Today Amperex is delivering the broadest line of Complementary Symmetry transistors in the business... off the shelf, in production quantities, at production prices. We have the matched transistors, heat-sinks, circuits and application reports. Where required, breadboarded prototypes will be provided.

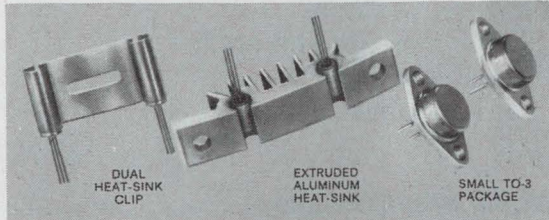

Complementary Symmetry achieves enormous manufacturing savings with no sacrifice in reliability, by using transistors as they should be used—as low

voltage, low impedance, low temperature devices for Class B push-pull.

Low voltage eliminates need for bottom plates, interlocks, etc. Low temperatures mean longer, more reliable component life. Simple mounting clip eliminates need for expensive heat sinks, mica insulating washers and mounting hardware. Low output impedance of emitter follower output circuit obsoletes impedance-matching output transformer and related protective devices.

**2N2707** matched pair **2N2430** (NPN) and **2N2706** (PNP) for power up to 1 watt for low cost phonos, amplifiers and radio; TO-1's in dual heat-sink clip.

**2N4136** matched pair **2N2430** (NPN) and **2N2431** (PNP) for power up to 2.5 watts; TO-1 cases in dual heat-sink clip.

**2N4107** matched pair **2N4105** (NPN) and **2N4106** (PNP) for power up to 7 watts; TO-1 cases in extruded aluminum heat-sink.

**2N4079** matched pair **2N4077** (NPN) and **2N4078** (PNP) for power up to 12 watts; TO-3 cases.

FOR AUTO RADIO OUTPUTS  
(5 watts at 13.6 volts)  
THE 2N4079 PAIR IS IDEALLY SUITED

#### New Audio Designer's Slide Rule

Ingeniously handy slide rule provides instant design data on seven most basic Complementary Symmetry circuits and all the scales and formulae you rely on in your daily work (on the reverse side). Use coupon for ordering and please enclose 50¢ in coin or stamps to cover costs of mailing and handling.

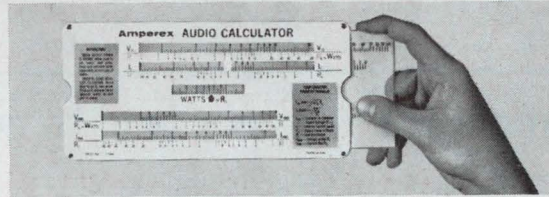

#### AMPEREX OFFERS YOU TWO WAYS TO GO WITH COMPLEMENTARY SYMMETRY... OFF THE SHELF ASSEMBLIES — OR — OFF THE SHELF TRANSISTORS

You can get immediate delivery on any of these printed circuit assemblies, starting as low as \$2.73 \* Add your signal source, speakers, cabinets, etc., and you're in production:

MODEL	DESCRIPTION
PCA-1-9	1W, 9V D.C., 4 Transistor Amplifier
PCA-1LDC-14	PCA-1-9 less rectifier and filter capacitor
PCA-1-14	2W, 14V D.C., 4 Transistor Amplifier
PCA-2-9	3/4W, 9V D.C., 3 Transistor Amplifier
*PCA-2SLDC-9	Same as PCA-2-9 with off-on switch, less rectifier diode and filter capacitor
PCA-2-14	1W, 14V D.C., 3 Transistor Amplifier
PCA-2S-14	Same as PCA-2-14 with switch
PCA-2LD-14	Same as PCA-2-14 less rectifier diode
PCA-3B-18-1	4W/Channel Stereo Amplifier
PCA-6B-18	PCA-3B-18-1 with pre-amp for ceramic
PCA-4-9	1W, 9V D.C., 4 Transistor Amplifier for radio and ceramic cartridge
PCA-4-9A	Same as PCA-4-9 with tone control circuit
PCA-4-14	2W, 14V D.C., 4 Transistor Amplifier for radio and ceramic cartridge
PCA-4-14A	PCA-4-14 with tone control circuit
PCA-5A-14	2W/Channel 14V D.C. Stereo Amplifier with balance tone volume
PCA-6A-25	8W/Channel Stereo Amplifier
PCA-6A-25SCS	PCA-6A-25 with separate control strip
PCA-7B	Tape cartridge pre-amplifier, stereo
PCA-8	20W Mono Amplifier
PCR-1-9	9V-2 Transistor AM Tuner

Amperex welcomes the opportunity to quote on production of your own designs or to design to your specifications... printed circuit assemblies for any industrial, commercial or audio application.

For immediate action, use the coupon below or phone Product Manager Murray Barlowe, in Hicksville, Long Island, 516-WE 1-6200.

AMPEREX ELECTRONIC CORPORATION  
Attention: Murray Barlowe  
Hicksville, Long Island, N. Y. 11802

Please send without delay, items checked off:

- Circuits and Data Brochure on Complementary Symmetry Audio Amplifiers
- Audio Designer's Slide Rule (Please enclose 50¢ for handling and mailing)
- Set of individual spec sheets on assemblies

NAME \_\_\_\_\_

COMPANY \_\_\_\_\_

STREET ADDRESS \_\_\_\_\_

CITY \_\_\_\_\_ STATE \_\_\_\_\_ ZIP \_\_\_\_\_

# Amperex®

TOMORROW'S THINKING IN TODAY'S PRODUCTS

# Avoid relay misapplication.

Case histories show that this can be done by giving the manufacturer more specs and applications data than sometimes meet the eye.

Thomas E. Castaldi, RBM Controls, Logansport, Ind.

The best way to order a relay is, obviously, to give the manufacturer complete specifications\* and circuit information. He then not only can offer the best relay but, based on his expertise, provide circuit and application tips as well. But what constitutes "complete" specifications? They vary from application to application, making hard-and-fast guidelines difficult to establish.

Experience may be the best teacher here. Some specific examples show how "complete" information allowed a relay manufacturer to help a user to avoid misapplication. These case histories should give you some insight into the variety of data that the manufacturer needs, if he is to help you fully.

## Example 1. Full specs lead to economy

A relay for a relatively straightforward application was required by Company A. After analyzing the electrical, environmental and reliability requirements, these specifications were sent to the relay manufacturer:

- SPDT pilot duty: 110 volts ac.
  - Button contacts: make before break.
  - Pickup: 85 to 95 volts.
  - Ambient temperature: 0° to 140°F.
  - Life expectancy: 100,000 operations.
  - Must operate with minimum of noise.
- It happened that the relay manufacturer

had three standard relay types capable of meeting these requirements. One of these was an economical, enclosed general-purpose relay that could be adjusted precisely during production to meet the pick-up and make-before-break requirements. This relay was entirely adequate for the user's needs, since his specifications covered all the important aspects of his application. Although this is a simple example, it demonstrates a point: Complete specifications frequently lead to substantial cost savings.

## Example 2. Circuit diagram contains useful data

Company B needed a motor-starting relay for an application employing a single-phase motor. The motor to be controlled had the following characteristics:

- Full-load current: 25 A.
- Locked-rotor current: 132 A.
- Start capacitor: 400  $\mu$ F.
- Run capacitor: 30  $\mu$ F.

The company requested samples of poten-

tial units from the relay manufacturer, based on the following specifications:

- Continuous coil voltage: 336 V.
- Pick-up voltage: 340 to 360 V (hot).  
317 to 345 V (cold).
- Maximum drop-out voltage: 170 V.
- To be used in the position recommended by the manufacturer.

With these specifications alone, the relay

\*For a comprehensive guide to writing complete relay specifications, see ELECTRONIC DESIGN's Relay Applications Directory, Nov. 29, 1965. Copies are still available at \$5 each. Payment must accompany order.



(Example 2., continued)

engineer could have supplied a sample relay. The customer, however, submitted his circuit diagram (below left) along with the above specifications. As it turned out, the circuit was the key to the proper application.

From this schematic and a description of the machine on which the motor was to be used, the relay engineer learned that a short ON time was characteristic of the motor's operation. This limited ON time would not allow sufficient time for the start capacitor to

discharge internally. The normally closed contacts of the motor-starting relay might therefore weld when the motor was shut off, because of the discharging of the start capacitor. There could be serious motor damage.

Before furnishing a relay, the supplier discussed the situation with the customer. As a result, a bleeder resistor was added to the circuit (below right), to provide a discharge path for the start capacitor. Complete information in the hands of the supplier thus averted what could have been a costly breakdown.

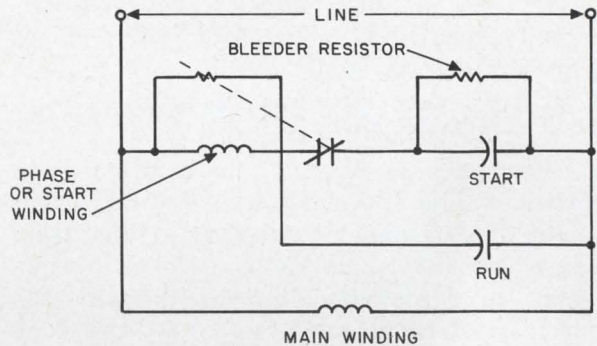
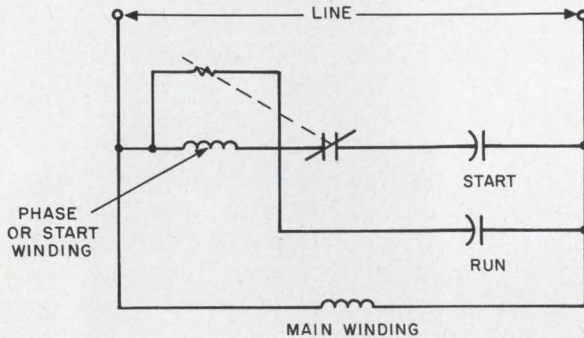

### Example 3. Environment is important, too

For some time a relay manufacturer had been supplying Company C with a contactor to control an air-conditioning condenser fan. Company C then began using a new-style room-temperature thermostat control. After the thermostat was brought into use, the customer started to complain about contacts welding on the load-handling contactors. The company informed the relay manufacturer of the problem, submitted the circuit diagram (below left) and asked if there was a solution.

From the supplied data, the relay engineer determined that the room thermostat controls had very light contact pressure, and were susceptible to chattering contacts

caused by normal shock and vibration in the environment. The chattering contacts of the thermostat transmitted electrical pulses to the contactor, causing its contacts to chatter and ultimately to weld.

After the circuit had been studied, it was recommended that a thermal time delay be used between the thermostat contacts and the contactor's contacts or coil. This would prevent the contactor from following the thermostat contact chatter.

A time-delay relay was consequently installed (below right). It had normally open contacts, which closed when the heater coil was energized. Thus environment was a key factor in the solution of this problem.

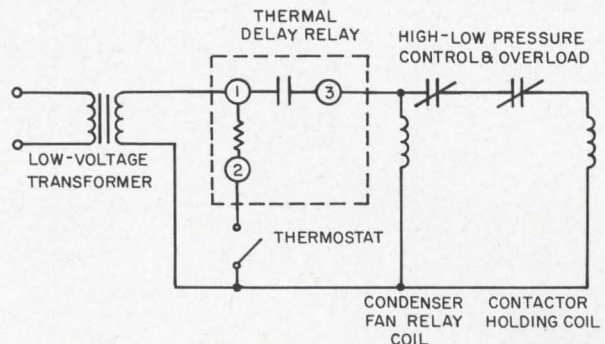
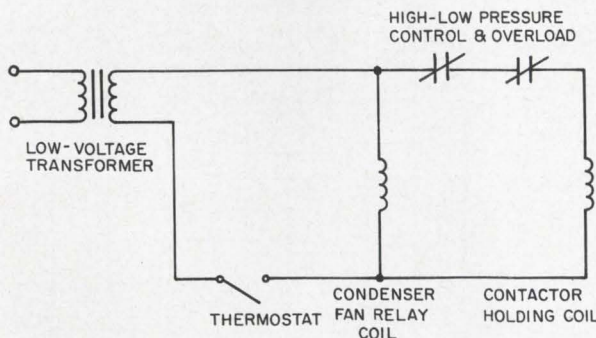

(continued on p. 78)

## Example 4. Circuit simplifications are possible

Company D submitted the following specifications to a relay manufacturer when requesting a time-delay-relay for a control application:

- Type of delay: time delay on pick-up.
- Input voltage: 24 volts dc  $\pm 10\%$ .
- Timing range: 7 seconds  $\pm 10\%$ .
- Method of initiation: remote.
- Termination: octal pin.
- Contacts: SPNC, low-current crossbar.  
SPDT, low-current crossbar.
- Temperature requirements: ambient range of 50° to 80°F.
- Reset time: 100 milliseconds.
- Life: 100,000 operations.

Although no circuit information was provided, the specifications were very complete. The customer was using a time delay on pick-up but had not considered a time delay on drop-out. This complicated the circuitry, which employed a pre-set time delay to control the amount of tape fed into a machine. Opening the tape switch started the timing action; at the end of the delay period a knife cut the tape to the correct length. The operation of the customer's circuit was as follows (below left):

The electromechanical tape switch is closed when the start switch is actuated, causing relay A to pick up. The closure of contact A3 energizes relay B, which latches through its contact B1. Relay B then supplies power to the remaining circuit through contact B2, but since all branches have open contacts, no relay (C, D, or E) will energize.

When the tape switch is opened by the ad-

vancing tape, relay A drops out, closing contacts A1 and A2, and opening A3. This causes relay E to pick up and starts the time delay. Upon closure of contact E2, relay D picks up, opening one branch to both relay E and the time delay. Power is still applied to E and the time delay, though, through contact E3. At the end of the time delay, C picks up, breaking power to relay E. The de-energizing of relay E removes power from the time delay and coil C, and permits A to pick up if the tape switch is closed. This will not be the case, however, since the tape must be advanced before the tape switch can close. When A is energized, it removes power from D.

The time-delay relay was supplied as requested: no problems were reported. Later, however, the circuit diagram was submitted along with a request for additional samples. After examining the circuit, the relay engineer advised Company D that a single unit featuring time delay on drop-out could eliminate relay E. The revised circuit (below right) would operate as follows:

The electromechanical tape switch is closed when the start switch is actuated, causing relay A to pick up. The closure of contact A3 energizes relay B, which latches through its contact B1. The lock-out relay, B, supplies power to the rest of the circuit through B2, but since all branches have open contacts no relay will energize.

When the tape switch is opened by the advancing tape, relay A drops out, closing contacts A1 and A2, and opening A3. This causes C to pick up and start the time delay. Upon closure of contact C2, relay D picks up, opening one branch to the time delay.

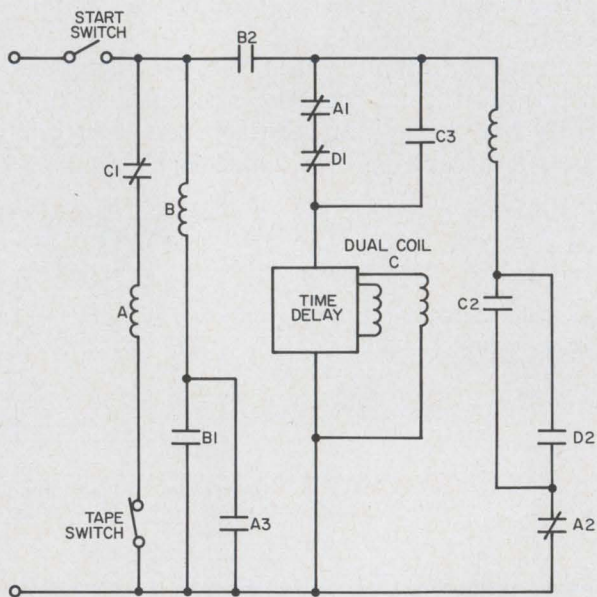
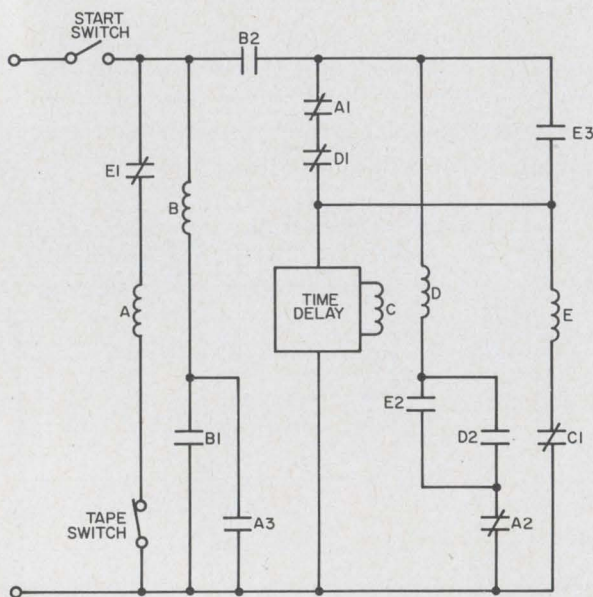

Power is still applied to the time delay, though, through contact *C3*. At the end of the time delay, *C* drops out by application of power to the bucking coil of the dual-coil relay. This in turn removes power from the time delay and coil *C*, permitting *A* to pick up if the tape switch is closed. This will not be the case, however, since the tape must be advanced before the tape switch can close. Energizing *A* then removes power from *D*.

This same circuit could be simplified further, with consequent cost reductions, by elimination of one relay coil, two normally open and two normally closed contacts. This was, in fact, done through the use of a dual-coil relay that operates on continuous duty without overheating. The actual unit used combines relays with solid-state components and offers a versatile time-delay range. The circuit, shown below, operates as follows:

The electromechanical tape switch is closed when the start switch is actuated, causing relay *A* to pick up. The closure of contact *A3* energizes relay *B*, but again no other relay will energize.

When the tape switch is opened by the advancing tape, relay *A* drops out, closing contact *A1* and opening *A3*. This causes *C* to pick up and start the time delay. At the end of the time delay, *C* drops out through application of power to the bucking coil of the dual-coil relay. This in turn closes *C1*, permitting *A* to pick up if the tape switch is closed. If the tape switch is not closed—which will be the case until the tape is advanced—power remains on both coils of *C*. When the tape is advanced and the tape switch closes, relay *A* picks up, removing power from *C*. ■ ■

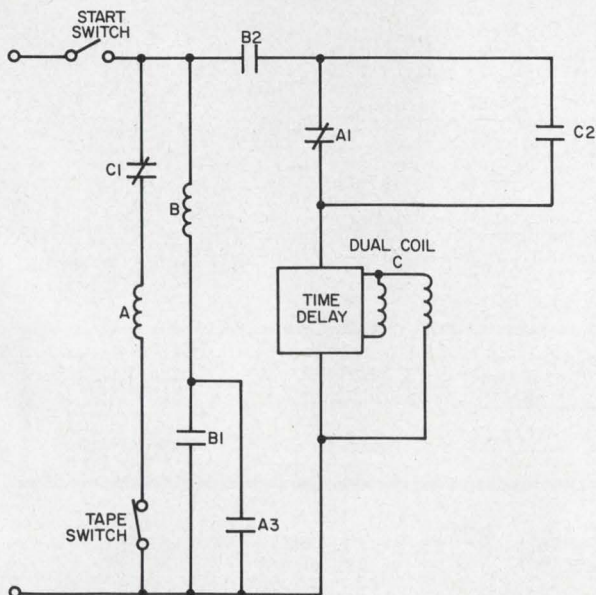

## Cedar Standard Motor-Tachs give you **TOP QUALITY FAST DELIVERY REAL ECONOMY**

Nine out of ten of our size 8 or 10 motor-tachometers use identical housings, stacks, shaft and rotor assemblies, tuning plugs and bearings.

And yet, they still meet a wide variety of our customers' specifications. For, each unit has a different winding and pinion. Each unit performs in a different way—any way you prescribe. You still set the parameters. You still get the torque, speed, input voltages, pinions, tachometer gradients and other parameters you want.

What does this mean to you?

Standardization permits large volume manufacture . . . allows more intensive engineering and testing . . . and provides an on-hand inventory for immediate use.

This standard hardware approach has made Cedar the nation's largest manufacturer of size 8 and 10 motor-tachometers. We can deliver prototypes of standard size 8 or 10 motor-tachs in two weeks. Let's talk about it. Call or write Cedar today.

**CEDAR** **CONTROL DATA**  
ENGINEERING DIVISION CORPORATION

5806 West 36th Street, Minneapolis, Minn. 55416  
Phone (612) 929-1681

ON READER-SERVICE CARD CIRCLE 42

# Now...think smaller!

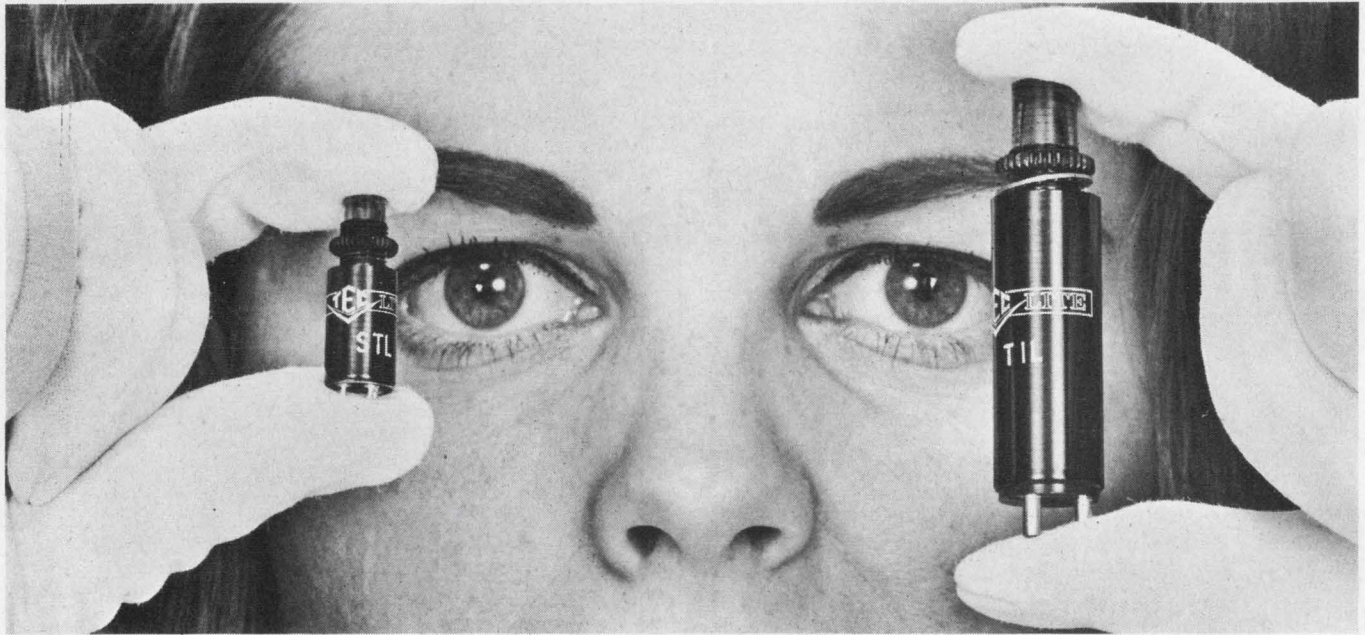

## New subminiature TEC-LITE Indicators...

**1/6 SIZE\* OF PRESENT TRANSISTOR-CONTROLLED INDICATORS**  
*for integrated circuits... discrete component circuitry, too.*

Function remains the same... only the size has changed... Now 18 self-contained transistor controlled indicators fit on the panel where only eight standard size units fit. Back panel length is reduced up to 50%. This size reduction is essential to meet the demand for high density display requirements in subminiature computers, portable programming and maintenance consoles, airborne systems and similar applications. Subminiature STL



**NEW STL SERIES**  
**Compared with standard size TEC-LITE MTL and TIL Series**  
 With permanently wired neon or 100,000 hour incandescent T-1 type lamps. Flat top lens with choice of 13 colors and optional legends. Terminals are silver finish turret lug and isolated from the body. Mounts in  $\frac{1}{8}$ " holes on centers as close as  $\frac{3}{8}$ " in panels from  $\frac{1}{16}$ " to  $\frac{3}{16}$ " thick. Price: As low as \$6.00 in 100-499 quantities.

Series Indicators are controlled by low level signals present in integrated or discrete component systems. The neon or incandescent lamp, transistor and related circuitry are mounted in a body .360" diameter by .600" long... with the entire indicator only  $1\frac{1}{8}$ " long.

For information on a complete line of information display panels, digital readouts, indicators, switch-indicators and new Electronic Keyboard Systems contact your TEC-Rep or write direct.

\*By volume

**NEW SIL SERIES**  
**Compared with standard size TEC-LITE MDL Series**

Non-driven indicator has the same space saving design as STL Series above, but its body is only .250" long —  $1\frac{1}{16}$ " long overall. Uses permanently wired neon (with optional internal current limiting resistor) or 100,000 hour T-1 incandescent lamps. Has lens and terminal options to match STL Series. Price: As low as \$2.00 in 100-499 quantities.



INDICATORS & SWITCHES	DATA-PANEL DISPLAY SYSTEMS	DIGITAL READOUTS	ELECTRONIC KEYBOARD SYSTEMS

## Transistor Electronics Corporation

Box 6191 • Minneapolis, Minnesota 55424 • Phone (612) 941-1100

ON READER-SERVICE CARD CIRCLE 43

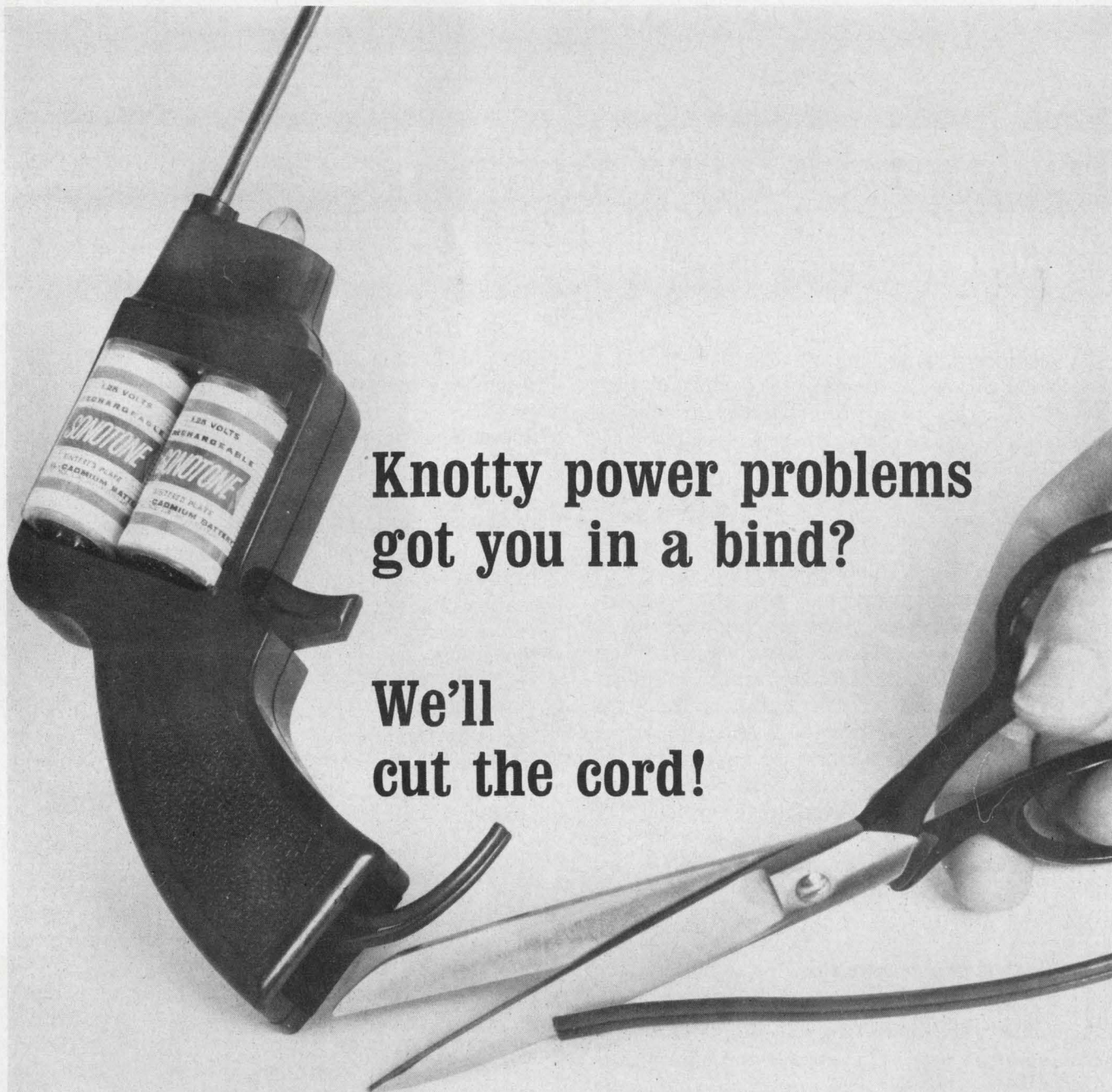

**Knotty power problems  
got you in a bind?**

**We'll  
cut the cord!**

At Sonotone, we'll clip 4 to 6 feet off your idea and make it infinitely more salable, to boot. How? By eliminating the power cord. And equipping your new product design with Sonotone rechargeable portable power.

That's no problem to the engineers at Sonotone. As a leading producer of sintered-plate, nickel-cadmium cells and batteries, Sonotone has well over 167 batteries of all sizes and shapes to choose from . . . to supply your pet project with the portable power it needs.

We're an experienced hand at this highly specialized science. For example, Sonotone low weight, constant discharge nickel-cadmium batteries are supplying power to a broad range

of cordless applications, many as sophisticated as Titan boosters and NASA satellites, others as best selling as electric carving knives and toothbrushes.

Whatever your power problem, Sonotone's top-rated team of nickel-cadmium battery specialists will find the answer for you. Or design a new battery that does!

So . . . if you've got an idea in need of portable power, bring it over to Sonotone. We'd like to cut in on it while it's still new.

**Sonotone Batteries** 

portable power—from Titan to toothbrush  
SONOTONE CORPORATION, BATTERY DIV., ELMSFORD N. Y. 10523

Aircraft, Missile and Satellite Batteries • Power Supplies • Battery Charger/Analyzer

Looking for a more challenging opportunity? Join Sonotone's fast-growing engineering team in the skyrocketing field of nickel-cadmium battery design and development. *An equal opportunity employer.*

ON READER-SERVICE CARD CIRCLE 44

# Try low-resistance trimmers.

If applied correctly, they can provide not only high resolution but other advantages as well.

By definition, a trimming potentiometer is a "set-it-and-forget-it" device, used for making circuit adjustments to compensate for normal system variations. As such, there is frequent need for it to produce the smallest possible incremental change in voltage—or in other words, it must have good resolution.

When choosing a wirewound trimming potentiometer for a particular application, designers normally apply conventional resolution theory, which for the most part equates high resolution with high resistance. This is not always the best approach, however, since low-resistance units can frequently meet all system design parameters while at the same time providing other important advantages. In such an alternate approach, fixed resistors are used with the potentiometer to provide the total circuit resistance required. The potentiometer resistance can then be relatively low, with its total resistance range being just sufficient to provide the desired output voltage swing.

## Resolution depends on wire size

The resolution obtainable with a wirewound potentiometer is limited by the diameter of the resistance wire used. The smaller the wire diameter, the better the electrical resolution, since more turns of finer wire can be wound on a given mandrel length or angle.

But as wire diameter decreases, its resistance increases for a given alloy and configuration of the winding form. The result is a trade-off between resolution and resistance, with high-resolution potentiometers normally being in the high-resistance range.

Let us consider an example showing the advantages and pitfalls inherent in the selection of a high-resistance trimming potentiometer. Then let's examine the alternate approach, in which a relatively low-resistance unit is chosen. (Some

basic definitions of resolution are given in the accompanying box as well as in Fig. 1.)

## Conventional approach meets requirements . . . but!

Assume that a system designer is faced with the problem of selecting a trimming potentiometer based on the circuit parameters shown in Fig. 2. He normally would consult a catalog or specification sheet to find a standard potentiometer that fits his needs. In this example, one possible choice would be a standard unit (such as Weston's Model 301 squaretrim), which has a total resistance of 50 K and a theoretical resolution of 0.086%.

But what exactly has the designer obtained by his selection of a 50-K potentiometer? From the stated resolution of 0.086%, the smallest incremental change in voltage possible can be calculated from:

$$E_2 = \text{Resolution} \times \text{applied voltage} \\ = 0.00086 \times 200 = 0.172 \text{ volt.}$$

Therefore, as the potentiometer wiper is rotated across the resistance element, each turn of resistance wire will produce a change of 0.172 volt. And theoretically the desired output voltage of 100 volts  $\pm 5\%$  (95-105 V) can be obtained in steps of 0.172 volt.

The selected potentiometer has an electrical angle of  $336^\circ$ , and so, with a total input of 200 volts, will produce a change of 0.595 volt per degree of wiper rotation. The desired output variation of 10 volts (100 V  $\pm 5\%$ ) will therefore be obtainable with an angular wiper rotation of 16.8 degrees.

It is obvious from the above data that the selection of the 50-K potentiometer was theoretically correct and that the system's electrical requirement can be fulfilled. However, there is a potential flaw that the designer must make known to production, test and field-maintenance personnel. This flaw lies in the fact that the mechanical and electrical limits associated with the potentiometer make it possible for the design output voltage of 100 volts  $\pm 5\%$  to be exceeded. The potentiometer can produce an output voltage variable from zero to 200 volts. And should it mistakenly be set too far outside the desired

James A. Cunningham, Manager, Components Application Engineering, Weston Instruments, Inc., Weston-Archbald Div., Archbald, Pa.

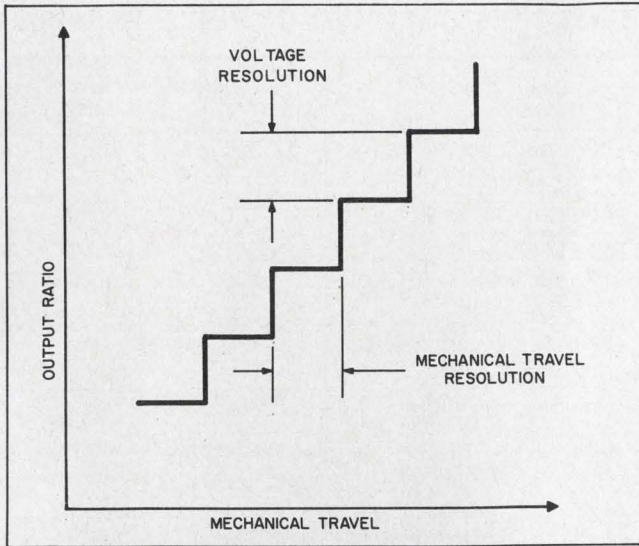

1. Both mechanical and electrical resolution in a potentiometer depend on the diameter of the resistance wire used in the unit.

## Definitions of resolution

**Theoretical resolution:** Used in wirewound linear potentiometers only. It is the reciprocal of the number of turns of the resistance winding in the actual electrical travel, and is expressed as a percentage.

Theoretical resolution =  $(1/N)100$  in per cent, where:  $N$  = Total number of resistance-wire turns.

**Mechanical resolution:** In any specific portion of the resistance element, the maximum value of shaft travel in one direction per incremental voltage step. The relationship between mechanical and electrical resolution is shown in Fig. 1.

**Voltage resolution:** In any specified portion of the resistance element, the maximum incremental change in output ratio with wiper travel in one direction.

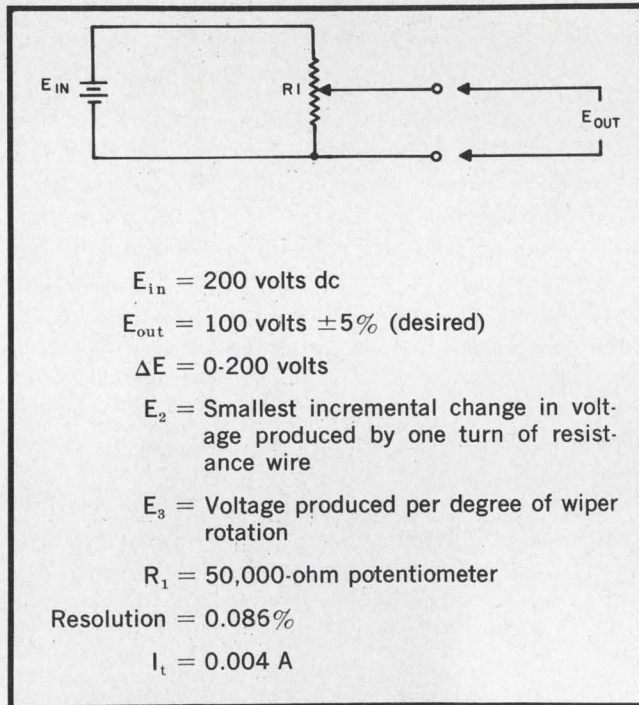

2. Conventional approach for applying a trimming potentiometer for high-resolution applications normally results in selection of a high-resistance unit. Although circuit requirements can be met with such a unit, improper setting can result in circuit failure.

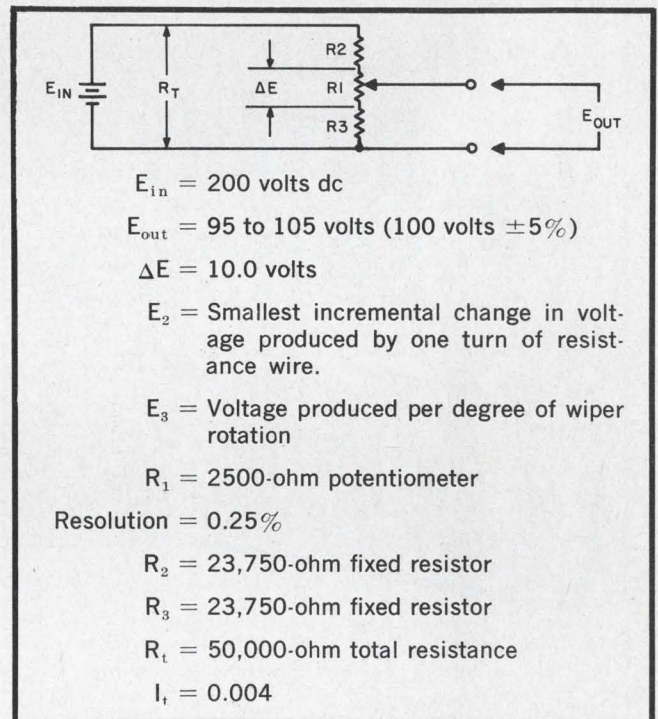

3. Low-resistance trimming potentiometers, when applied properly, can provide high system resolution as well as protection from catastrophic system failure in the event of improper setting.

range, system failure can occur.

### Alternate approach eliminates failure risk

Potential failures caused by improper setting of the potentiometer in the previous example can be avoided by selection of a lower-resistance potentiometer. The principal feature of this alternate approach is that it establishes suitable voltage end-limits that are within the system's reliable opera-

tional range.

To illustrate the alternate approach, we will maintain the original system parameters, including the required total resistance of 50 K (see Fig. 3 for circuit and parameters). The potentiometer used, however, will be a 2500-ohm unit, with a resolution of 0.25%.

A 2500-ohm value is selected on the following basis: The total  $\Delta E$  required is only 10 volts (95 to 105 V). Therefore the total variable-resistance

# NOW..

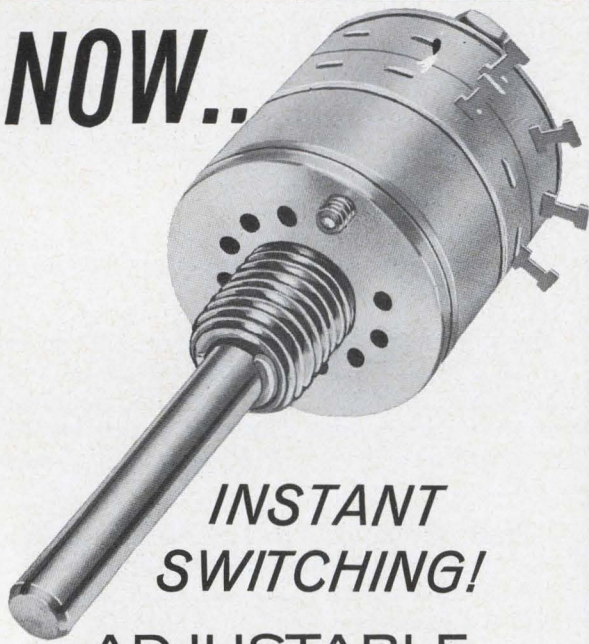

## INSTANT SWITCHING!

### ADJUSTABLE STOPS NOW AVAILABLE IN

# 1/2" ROTARY SWITCHES

**"Off-The-Shelf" shipments for INDUSTRY'S BEST DELIVERY!**

- • from 2 to 12 positions (shorting or non-shorting) available merely by moving external plate!
- • up to 6 poles available on one deck!
- • Instant switching to any desired number of circuit positions!
- • ideal for breadboard setups, laboratory stock, and prototype work—where rapid circuit modification may be desired.

Write for complete engineering information.

# RCL ELECTRONICS, Inc.

General Sales Office:

One Hixon Place, Maplewood, New Jersey 07040

## Normal vs alternate design approach

Parameter	Theoretical values	
	Normal	Alternate
Potentiometer resistance (R)	50,000	2500
Applied voltage $E_{in}$ (volts)	200	200
Desired output voltage $\pm 5\%$ (volts)	100	100
Maximum output voltage possible ( $\Delta E$ )	0-200	95-105
Nominal resolution (per cent)	0.086	0.25
Smallest increment of voltage (volts)	0.172	0.025
Voltage change/degree of wiper rotation	0.592	0.029
Actual electrical angle for desired output voltage (degrees)	16.8	336

element can be computed as follows:

$$\Delta R = \Delta E / I = 10 / 0.004 = 2500 \text{ ohms}$$

The 50-K system requirement is then satisfied by placing the 2500-ohm potentiometer in series between two fixed resistors of 23,750 ohms each. Now, not only is the desired 100-volt  $\pm 5\%$  output produced, but the output is limited to the range of 95 to 105 volts regardless of the potentiometer setting. Note here that the fixed resistance values used are for the purpose of this example. In actual practice, standard values could be used, provided that when added to the value of the selected potentiometer, they meet the total resistance requirement.

Other improvements besides increased reliability also accrue from this alternate approach. The smallest incremental voltage obtainable with the 2500-ohm potentiometer ( $E_2$ ) can be determined from the value of  $\Delta E$  as:

$$E_2 = \text{Resolution} \times \Delta E$$

$$E_2 = 0.0025 \times 10.0 = 0.0250 \text{ volt.}$$

Therefore, as the wiper is moved across the resistance element, each turn of resistance wire will produce a change of 0.025 volt. Theoretically the desired output voltage of 100 volts  $\pm 5\%$  can be obtained in increments of 0.025 volt.

If we assume an electrical angle of 336 degrees for the 2500-ohm potentiometer, each degree of wiper rotation will theoretically produce a 0.029 incremental voltage change. Thus the entire electrical angle of the potentiometer is used to produce the output voltage variation of 10 volts.

The results of both methods just described are summarized in the table. It is evident that the alternate design approach offers attractive advantages that make it well worth considering. ■ ■



# Philco talked to 409 engineers before designing these two 930 DTL circuits.



Dual RS Flip Flop



Transfer Gate Function

Two of the problems most of these engineers mentioned were: a large package unit count; and an excessive amount of external wiring on breadboards. That's why we designed these two circuits. They give you flexibility in design, 930 compatibility, and added utility to the entire 930 series.

**DUAL RS FLIP FLOP:** Two 3-input NAND gates. A basic memory operation with a double set and reset capability—all in one package.

**TRANSFER GATE:** Has four 2-input NAND gates and one inverter. It will transfer logic functions—even octal—with ease. And you won't have to use an additional package unit for phase change. This has an inverter built right in.

Philco has a complete line of 930 DTL integrated circuits—packaged in flat pack, dual inline, ceramic flat pack, and TO-5 cans. Military and limited temperature range. We would be happy to talk with you about any of these, which include: Dual 4-input Gate, JK or RS Binary, Dual Buffer, Dual 4-input Expander, Dual Power Gate, Clocked Flip Flop, Quad Gate, Binary, Hex Gate, and a one-shot Multi-vibrator. Available now.

Call for the name of your nearest distributor. **Philco Microelectronics Division Sales Offices:** 2920 San Ysidro Way, Santa Clara, California (408-245-2966) / 999 North Sepulveda, El Segundo, California (213-772-6226) / Northwest Industrial Park, Second Avenue, Burlington, Mass. (617-272-1600) / Benson Manor, Suite 114B, Washington Lane, Jenkintown, Pa. (215-885-0430) / 1215 Drew Street, Clearwater, Florida (813-446-0124) / 815 Connecticut Avenue, N.W., Washington, D.C. (202-298-7810).



PHILCO-FORD CORPORATION  
Microelectronics Division  
Santa Clara, California • 95051

ON READER-SERVICE CARD CIRCLE 46

# Get rid of cross-polarization

in edge-shunt slotted array antennas with only a partial grating placed across the center of the array.

Slotted waveguide array antennas have no back radiation or spill-over radiation. An edge-shunt slotted array antenna, which has inclined slots in the narrow wall for horizontal polarization, on the other hand, has the inherent disadvantage that the inclination of the slots produces a cross-polarized component, i.e., a vertical component. This induces fairly large lobes at approximately  $45^\circ$  on either side of the main beam in the horizontal plane. These cross-polarized radiation beams, which create false echoes when navigating in narrow channels or near massive targets, are suppressed by partial grating.

The edge-shunt slots are inclined with respect to the waveguide axis to couple to the field within the guide. Successive slots have opposite inclinations and the distance between slots is  $\lambda_g/2$  in order to preserve the proper phase relations, as shown in Fig. 1 ( $\lambda_g$  is the wavelength in the guide). Thus the horizontal components of adjacent slots are in phase, but the cross-polarized components are out of phase. A group element factor,  $E_g$ , that indicates the interaction between adjacent slots by yielding the cross-polarized component, may be expressed as:

$$E_g = E_a(\phi) [E_A \exp j(\psi + \delta_A) - E_B \exp -j(\psi + \delta_B)], \quad (1)$$

where

$$\begin{aligned} E_a(\phi) &= \text{element factor of slots,} \\ E_A, E_B &= \text{amplitude of electromagnetic field} \\ &\quad \text{across the slot,} \\ \psi &= 2\pi d/\lambda \sin\phi, \\ d &= \text{slot spacing,} \\ \phi &= \text{angle from normal to array axis,} \end{aligned}$$

$\lambda$  = wavelength in free space, and  
 $\delta_A, \delta_B$  = phase difference of electromagnetic field between adjacent slots.

For a resonant type of uniform array, we can, for the sake of simplification, assume that the element factor is equal to 1. Then  $E_a(\phi) = 1$ ,  $E_A = E_B = E_0$ ,  $\delta_A = \delta_B = 0$ . The group element factor,  $E_g$ , may be expressed as follows:

$$E_g = E_0 \sin(\psi/2), \quad (2)$$

which may be normalized with respect to  $E_0$ :

$$E_{g0} = \sin(\psi/2). \quad (3)$$

Consider an array with  $2N$  slots. Each pair of slots forms a group element. Therefore the number of group elements is  $N$ , and the group element spacing is  $2d$ .

The cross-polarized radiation beams,  $E_{ce}$ , of an end-fed array are obtained as the product of Eq. 2 and the array factor of the group elements:

$$E_{ce} = [\sin N\psi \sin(\psi/2)]/N \sin\psi. \quad (4)$$

In the case of center-fed arrays, the array factor of the group element is the product of the array factor of the  $N/2$  group elements on one side of the feeding point, the synthesis array factor,  $E_s$ , of both sides of the feeding point, and the group element factor  $E_{g0}$ . The synthesis array factor depends on the feeding branch. The conventional approach is to use a coaxial-to-waveguide adapter because of its small and simple construction. Then the horizontal components of the slots on both sides of the array are in phase and the cross-polarized components of the group elements on both sides of the array are out of phase. The synthesis array factor,  $E_s$ , of the group elements is estimated as follows:

$$E_s = \sin(N\psi/2). \quad (5)$$

The cross-polarized radiation beams,  $E_{ce}$ , of a center-fed array may be expressed as:

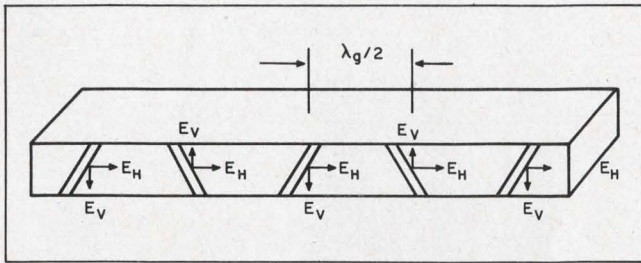

1. In an edge-shunt slotted waveguide array antenna the horizontal field components,  $E_H$ , are in phase and the cross-polarized components,  $E_V$ , are out of phase for adjacent slots. The spacing between slots depends on the half-wavelength in the guide,  $\lambda_g/2$ .

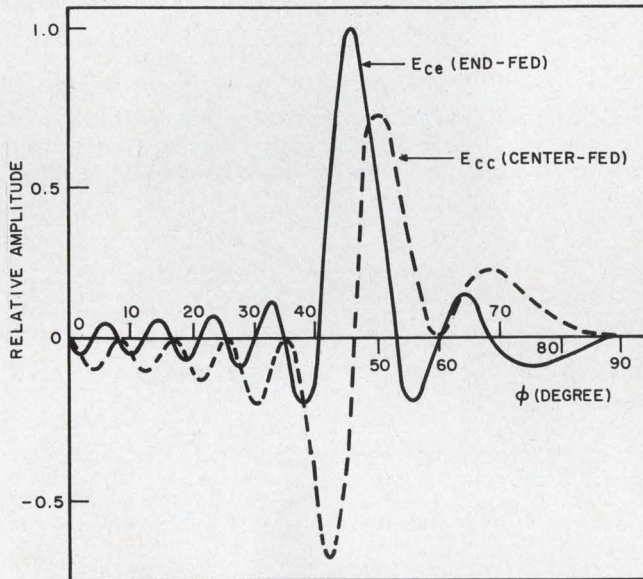

2. Calculated cross-polarized radiation pattern shows difference between end-fed and center-fed arrays. The array has 20 slots, the wavelength is 32 mm and the distance between slots is 22.35 mm.

$$E_{cc} = \frac{[\sin^2(N\psi/2) \sin(\psi/2)]}{(N/2) \sin \psi} \quad (6)$$

$$= \frac{[\sin^2(N\psi/2)]}{N \cos(\psi/2)}$$

The cross-polarized radiation beams, calculated from Eqs. 4 and 6, are given in Fig. 2, where  $\lambda = 32$  mm,  $d = 22.35$  mm and  $2N = 20$ .

### Partial grating removes cross-polarization

Gratings, acting as a filter, can effectively suppress cross-polarization, even if applied only across certain sections of the array rather than across its entire length.

In an array with the partial grating on  $2n$  slots of its center part, as shown in Fig. 3, assume that the cross-polarized radiation field from  $2n$  slots is suppressed perfectly. In this case, the array factor,  $E_a$ , of  $(N-n)/2$  group elements on one side of the array may be expressed as follows:

$$E_a = \{2 \sin[(N-n)\psi/2]\} / [(N-n) \sin \psi]. \quad (7)$$

The array factor of both sides of the array  $E_{aa}$  (for the end-fed type) is estimated as follows:

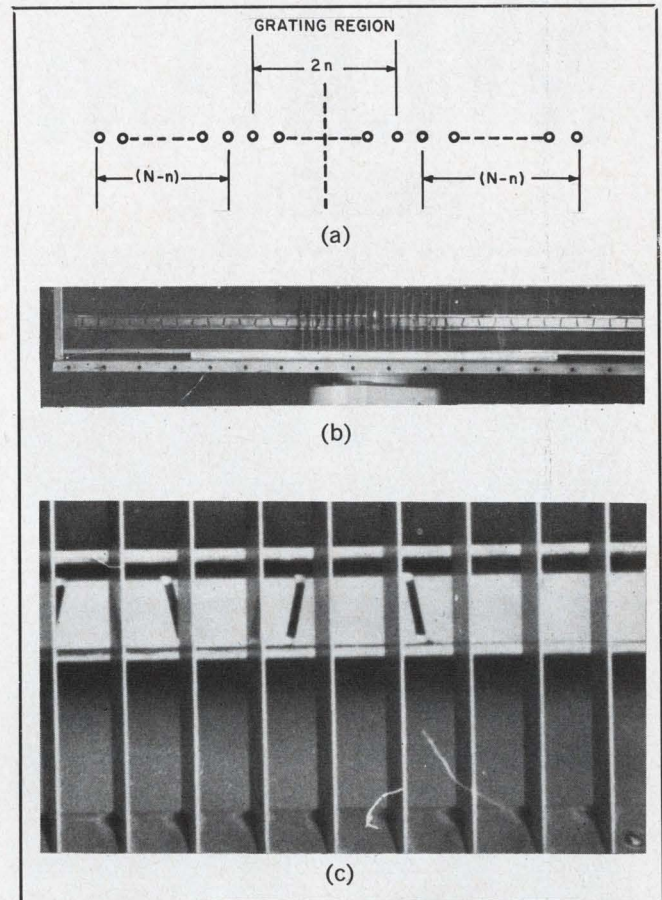

3. Partial grating across the center section (a) and (b) suppresses cross-polarization. For example, a grating, consisting of 16-mm wide and 0.5-mm thick metal plates, placed 12.5 mm apart, yields  $-20$  dB attenuation (c).

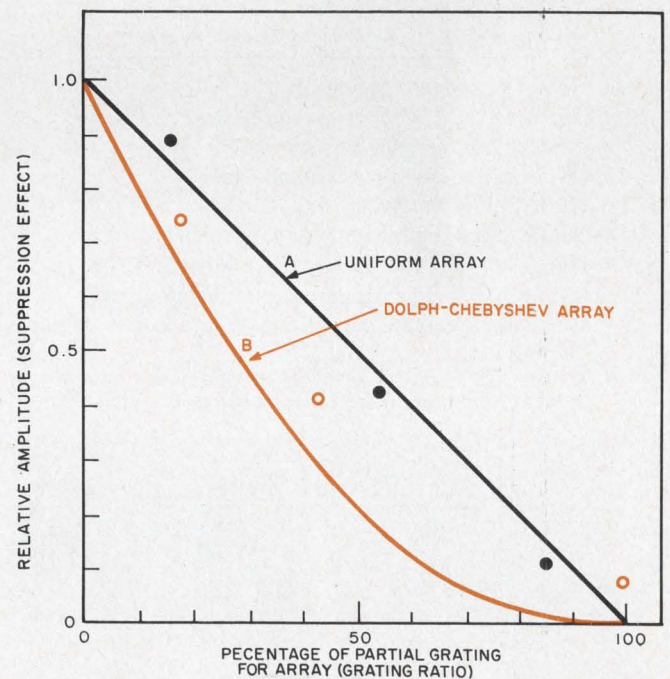

4. Measured suppression effects show good correlation with calculated values. Dots indicate measured results, solid lines represent calculated ones. The effect is more pronounced for Dolph-Chebyshev arrays (in color). The results are valid for an array having 38 slots and operating at 9375 MHz.

# NYLATCH®

## FASTENER

LOW COST • TOP QUALITY • RAPID INSTALLATION

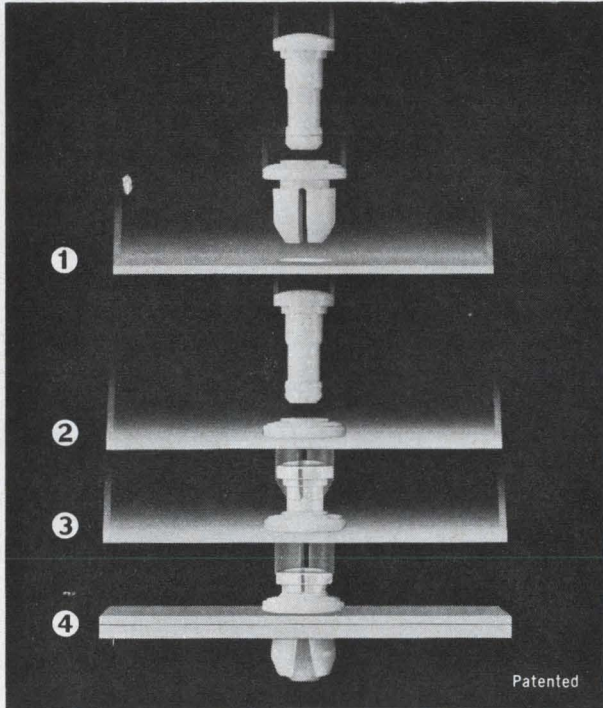

- ① PUNCH A STANDARD HOLE.
- ② PUSH IN GROMMET — CAPTIVATED!
- ③ PUSH IN PLUNGER — CAPTIVATED!
- ④ PUSH TO LATCH — PULL TO UNLATCH.

- Instant push/pull operation
- Improves your product — cuts costs
- Positive interference design
- 10-second installation without tools
- 60-pound minimum tension load
- 30,000 cycle-tested without failure
- Choice of 3 plunger head styles in black or white
- Accommodates variable material thicknesses
- Special adaptations can be engineered to your requirements
- Thousands used in electronics, business machines, lighting, vending machines, neon signs, etc.

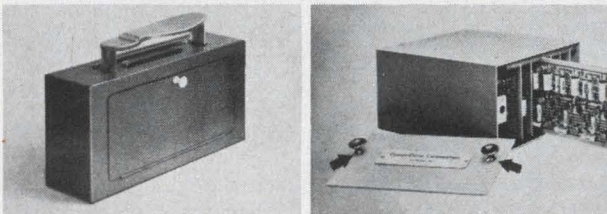

Nylatch is replacing many fasteners used in metal, wood and synthetics. The shoeshine kit and the electronic equipment package shown above are typical applications.

Write for sample and literature.

**THE HARTWELL CORPORATION**  
 9035 Venice Boulevard, Los Angeles, California 90034  
 Branch Offices: Hackensack, Fort Worth, Chicago

ON READER-SERVICE CARD CIRCLE 47

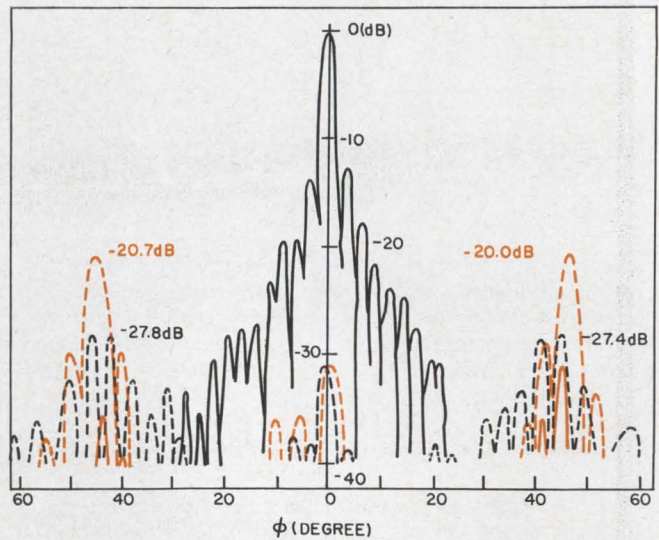

5. Cross-polarized radiation has been reduced from  $-20$  dB (color) to  $-27.4$  dB with partial grating. The grating ratio is 54%. The tested array has 34 slots and operates at 9375 MHz.

$$E_{aa} = \cos [(N + n)\psi/2]. \quad (8)$$

The cross-polarized radiation beams with the partial grating are obtained as the product of Eqs. 7, 8 and 2:

$$E_{cp} = 2 \frac{\sin [(N - n)\psi/2] \cos [(N + n)\psi/2] \sin (\psi/2)}{(N - n) \sin \psi} \\ = (\sin N\psi - \sin n\psi) / [2(N - n) \cos (\psi/2)]. \quad (9)$$

The suppression effect of the partial grating is measured and calculated as shown in Fig. 4. Curve A is calculated from a uniform array, whereas curve B represents the case of a Dolph-Chebyshev array, designed with  $-30$ -dB sidelobes. The results of the pattern measurements are shown in Fig. 5, where a thin, vertical, parallel metal-plate grating designed for  $-20$ -dB attenuation is used.

Because the slot inclinations of the center part of the tapered distributed array are larger than those at the ends, the cross-polarized radiation fields are greater from the center part of the array than from the ends. If a 60% partial grating is used, the cross-polarized radiation beams will be suppressed to near the  $-38$ -dB level. The suppression effect is nearly equal to  $-16$  dB, as shown in Fig. 4. The cross-polarized radiation field from the ends of the array therefore becomes negligible, and it is both unnecessary and uneconomical to install the grating across the entire length of the array aperture. The percentage of the partial grating of the array must be gauged according to system requirements. ■ ■

#### Acknowledgement:

The author wishes to thank Drs. S. Nishitake and S. Matsuda for their guidance and Y. Isogai for his assistance with the measurements.

ON READER-SERVICE CARD CIRCLE 48 ➤

# WE MAKE EPOXIES FOR JUST ABOUT ANYTHING YOU CAN THINK OF.

Critical electronic parts often require epoxies for low outgassing and outstanding heat resist-

ance. Plaskon® epoxies are currently being specified in a wide range of parts, including some that have been designed to meet or exceed the proposed military specifications.

ENCAPSULATION  
GRADE  
PLASKON EPOXY  
1960

HIGH HEAT  
RESISTANCE  
GRADE  
PLASKON EPOXY  
1914

However, if epoxies are not what you need, we have a complete line of other thermosets to provide the right product for the job: Diallyl, Phenolics, Alkyd, Urea and Melamine. But all you have to worry about is a good idea. It's our job to find the right epoxy or other thermoset to make it a reality.

HIGH IMPACT  
GRADE  
PLASKON EPOXY  
1988  
(previously 1288)

CONNECTOR  
(OR ELECTRONIC)  
GRADE  
PLASKON EPOXY  
1906

PLASTICS  
DIVISION  
POST OFFICE BOX 365  
MORRISTOWN, N. J.

Allied  
Chemical

Please send me complete information on the right epoxy for \_\_\_\_\_ application.

Name \_\_\_\_\_

Address \_\_\_\_\_

Company \_\_\_\_\_

City \_\_\_\_\_ State \_\_\_\_\_ Zip Code \_\_\_\_\_

# Read off the life of pilot lights

as a function of the operating voltage, current, candlepower from a simple nomograph.

Even the humble incandescent lamp may create intriguing problems if its lifetime must be evaluated rigorously in terms of its operating characteristics. The questions are: To what degree the voltage, the current and the candlepower change the life factor of the pilot light? The accompanying nomograph supplies the answers in a few simple steps.

Manufacturers recommend that the rated voltage of the lamps be 10 to 20% higher than

intended applied voltage. This obviously does not apply where the duty cycle of the applied voltage is such that the lamp will be on for only short periods, where brightness is not important, and where blue lenses are used, since the blue-light output is low for low-temperature lamps.

To illustrate the use of the charts, consider this problem. A lamp is operated at 0.8 times its rated voltage. How will the life factor, current and candlepower change? From the graph we can read off the following: The life factor increases to 14.5 times its rated value, the current decreases to 0.88 of its rating and the candlepower drops to 0.46 of the rated value. ■ ■

**Max H. Applebaum**, Technical Writer, Thomas Organ Co., Sepulveda, Calif.

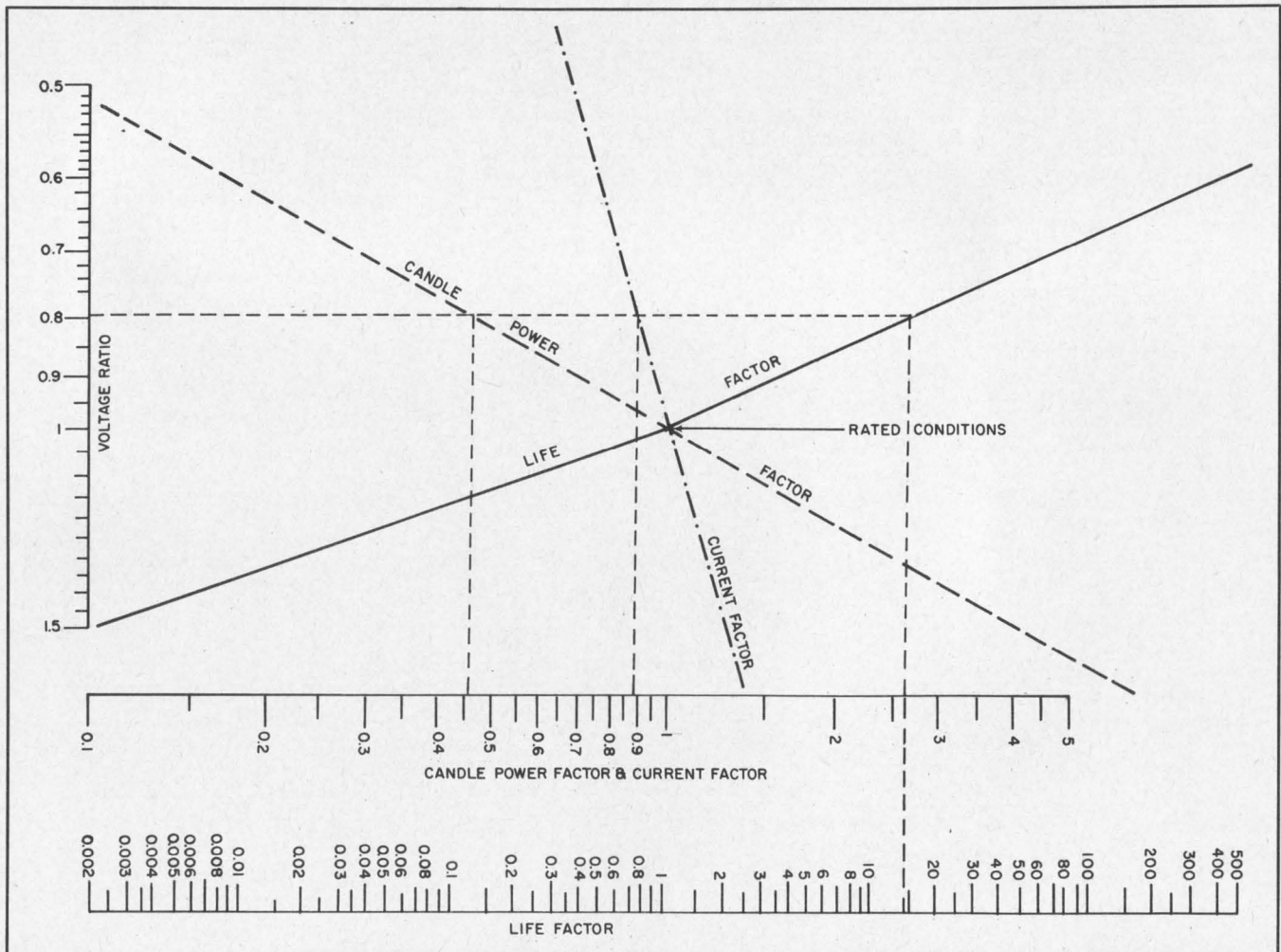

# The closer you get to a Bendix Pancake connector, the more innovations you see.

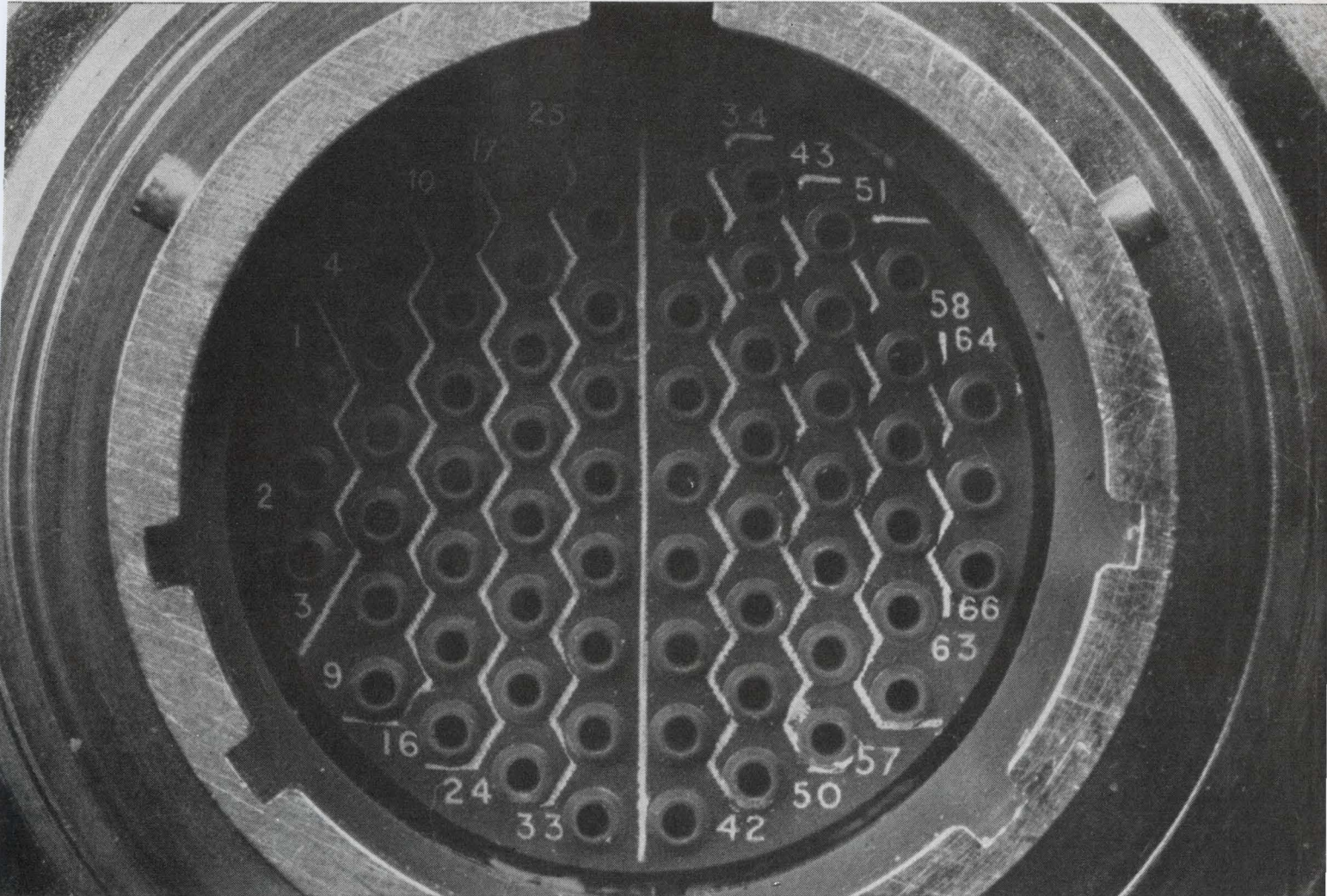

You're looking at room for up to 66 contact pins in our Size 18 Double Density model, for example. Look further and you'll see Bendix® JT Pancake™ connectors cut weight up to 60%, length up to 50%, making them the lightest, smallest miniature cylindricals available.

You'll see nine major connector improvements, too. Included are greater

resistance to pin contact splay and bending. Design simplicity. Increased reliability. A wide, wide temperature range (cryogenic to 392°F). Hard face socket inserts to prevent pin contact dielectric piercing. Alternate keying to eliminate cross plugging. Better sealing. Improved contact identification, too.

What about design versatility?

Choose from crimp, solder, grommetted, potted and hermetic versions. Eight shell types and nine shell sizes—8 through 24; 34 insert patterns; 16-, 20-, 22- and 24-contact sizes that will accept a wire range of 16 through 28 gage.

Like to look even further into Bendix JT Pancake connectors? Just write us in Sidney, New York.

Scintilla Division



# Reduce paperwork on MIL designs

with this index of items that are cross-referenced to military approval requirements.

You are bound to get into trouble on a military contract if you use a part that is not "preferred" or "approved." One way to avoid this is to know exactly what parts are preferred for any particular job. An impossible task? Not so, thanks to this cross-referenced index of the general equipment specifications.

General equipment specifications are included in practically all military contracts. Though they differ from service to service because each service has its own product and environment requirements, they always provide standards for selecting parts, materials, processes, design and construction of electronic equipment.

Nine of the commonly found specifications are:

- MIL-I-983**— Interior Communication Equipment, Naval Shipboard; Basic design requirements for
- MIL-E-4158**— Electronic Equipment, Ground; General requirements for
- MIL-E-5400**— Electronic Equipment, Aircraft; General specification for
- MIL-P-11268**— Parts, Materials, and Processes used in Electronic Communication Equipment
- MIL-E-11991**— Electronic, Electrical and Electro-Mechanical Equipment, Guided Missile Weapon Systems; General specification for
- MIL-E-16400**— Electronic Equipment, Naval Ship and Shore; General specification
- MIL-T-17296**— Test, Checkout and Evaluation Equipment, Guided Missiles (Fixed Installations); General specification
- MIL-F-18870**— Fire Control Equipment, Naval Ship and Shore; General specification
- MIL-T-21200**— Test Equipment for use with Electronic and Fire Control Systems; General specification for

These documents differentiate between those items considered best suited for an application and those regarded as less desirable. The acceptable items are classified as preferred or standard; all other items are not considered to be standard.

---

**Martin Franchina**, Senior Engineer, Radiation Division, Sperry Gyroscope Co., Great Neck, N. Y.

While the former require no official approval, a written request, accompanied by supporting documentation, is required for all nonstandard items.

Knowing which items require written approval prevents the indiscriminate use of parts that may later cause delays and complicate the job.

## Using the tables

Table 1 is a compilation of contract items that will often be examined for preferability. The list is separated into four sections:

- A. Parts.
- B. Materials.
- C. Design, construction, processes, finishes.
- D. Documentation, tests, identification.

A cross-reference number is listed against each entry and is keyed to Table 2, which lists the approval paragraphs for each specification. Note that paragraph numbers followed by two periods indicate that the approval requirements are detailed in a number of sub-paragraphs.

Given a military specification, one can quickly determine the required approvals.

As an example, assume you want to find the items that require approval in military specification MIL-I-983D(1). You would:

1. Find MIL-I-983D(1) in Table 2.
2. Note the paragraph numbers and corresponding Item Numbers (i.e., paragraph 3.6.4 corresponds to Item Number A6).
3. Note from Table 1, that A6 refers to electrolytic capacitors.
4. If the job calls for electrolytic capacitors, look up paragraph 3.6.4. in MIL-I-983D(1) and determine the approval requirements.

The table can also be used in reverse to check the coverage of particular items by a general equipment specification. For example, to find the approval requirements of connectors for MIL-E-5400H, refer to Table 1 and find the Item Number for connectors—A7. In Table 2, look up A7 in the Item Number list and MIL-E-5400H in the specification columns—paragraph 3.1.5\* of MIL-E-5400H lists approval requirements for connectors. The asterisk (\*) indicates that paragraph 3.1.5 refers to another military specification where the detailed requirements are listed; in this case, MIL-STD-454, Requirement 10. ■ ■



# Table 1. Item Names and Numbers

Item No.	Item Name	Item No.	Item Name
<b>Parts</b>			
A1	Adjusting devices using special threads	B28	Tape
A2	Batteries	B29	Thermoplastic material (rigid)
A3	Bearings, sleeve type	B30	Toxic material
A4	Boots for push switches in watertight applications	B31	Unacceptable material
A5	Capacitor, air dielectric	B32	Wire (insulated hookup)
A6	Capacitor, electrolytic	<b>Design, construction, process, finish</b>	
A7	Connectors	C1	Antijamming
A8	Control of parts design	C2	Control panel layout (operating controls)
A9	Control shafts and couplings	C3	Cooling with heat exchangers
A10	Crystals	C4	Design approval and design changes
A11	Electron tubes (tube selection)	C5	Deviations from specific design requirements
A12	Electron tube sockets	C6	Dial illumination
A13	Fluorescent lamps	C7	Dielectric strength and insulation resistance clearance
A14	Fuseholders, clip type	C8	Drip-proof enclosures
A15	Gears, fiber construction	C9	Electrical requirements
A16	Knife switches	C10	Electronic tubes mounted horizontally
A17	Locking devices (tube thread)	C11	Equipment weighing over 150 pounds
A18	Meters, high-sensitivity	C12	Factory adjustment controls
A19	Miniature parts	C13	Finishes and special finishes
A20	Nonstandard parts	C14	General requirements
A21	Nuts, sheet spring	C15	Impregnating, encapsulating and embedding
A22	Power-plug locking devices	C16	Interchangeability
A23	Relays	C17	Interference reduction (filters)
A24	Selection of parts; standard parts	C18	Maintenance
A25	Self-tapping screws	C19	Mechanized production (including printed circuits)
A26	Selenium rectifiers	C20	Mock-ups
A27	Semiconductor devices; transistors	C21	Modulator construction
A28	Set screws using other than hexagon socket heads	C22	Nonrepairable assemblies
A29	Shock mounts and vibration isolators	C23	Overload protection, equipment protection and time delays
A30	Terminal boards; terminal strips	C24	Parts and unit mountings
A31	Transformers	C25	Preferred circuits
<b>Materials</b>		C26	Power requirements
B1	Aluminum and aluminum alloys (chemical treatment)	C27	Processes; deviation from specified processes; nonstandard processes
B2	Antiseize compound	C28	Protection against corrosion (dissimilar metals)
B3	Cable (application and treatment)	C29	Reliability
B4	Castings; metals; alloys	C30	Ship's hull (chassis or enclosure for active circuits)
B5	Ceramics	C31	Soldering
B6	Cotton fabric laminates	C32	Special tools
B7	Cotton- or wood-filled molding compounds	C33	Threads in plastics
B8	Critical materials	C34	Through-bolting or threading into watertight enclosures
B9	Electrical insulation; solventless varnish	C35	Tropicalization
B10	Fiberboard	C36	Waveguides and waveguide assemblies
B11	Fungus-inert material	C37	Working drawings
B12	Glass	<b>Documentation, tests, identification</b>	
B13	Glass-bonded mica	D1	Circuit labels
B14	Insulated hook-up wire	D2	Documentation; drawings; manuals
B15	Insulating sleeving	D3	Equipment errors
B16	Laminates (sandwich core material)	D4	General requirements for identification
B17	Magnesium; magnesium alloys	D5	Identification markings and labels
B18	Nonslip surface coating	D6	Preproduction (or design approval tests)
B19	Nonstandard material (unspecified material)	D7	Printed wiring
B20	Organic material	D8	Nameplates; nameplate facsimile; nomenclature
B21	Plastics (selection, color application)	D9	Test equipment provisions; test sets
B22	Radioactive material	D10	Test point plan
B23	Rope	D11	Test procedures
B24	Rubber	D12	Through-bolting in watertight enclosures
B25	Solder and soldering flux	D13	Use of equipment subjected to shock test
B26	Standard material (material selection)	D14	Wire coding; external wiring
B27	Substitution of materials		

(Table continued on p 94)

## Table 2. Approval Requirements of Common Military Specifications

Item No.	MIL-I-983D(1)	MIL-E-4158C(2)	MIL-E-5400H	MIL-P-11268D(2)	MIL-E-11991B	MIL-E-16400F	MIL-T-17296D	MIL-F-18870C	MIL-T-21200F
A1						3.4.28.3			
A2						3.4.6		3.4.16.4	
A3						3.4.7.3			
A4	3.6.12.4								
A5		3.2.3*	3.1.3.1*		3.2.3.2.2.1*	3.4.9.2.1			3.1.4.1*
A6	3.6.4		3.1.3.2		3.2.3.2.1	3.4.9.1.1		3.4.16.13..	3.1.4.2
A7		3.2.16.8	3.1.5*	3.38		3.4.11*			
A8				3.3..					
A9								3.4.5.2	
A10							3.8.12		
A11		3.3.1.1.2	3.1.1.2.2	3.70..	3.2.3.38.2	3.4.31..*	3.8.22*	3.4.16.25.2	
A12						3.4.32			
A13								3.4.16.36.3	
A14						3.4.17			
A15					3.2.3.11	3.11.5.1	3.9.5.1		
A16								3.4.16.54.2	
A17	3.7.22.1					3.4.29.5			
A18						3.4.20.5			
A19		3.2.17				3.4.5			
A20	3.6.1.1	3.3.2..	3.1.1..		3.1.7	3.4.1..	3.8.1	3.4.16.2	3.1.1..
A21			3.1.27.5			3.4.28.15			3.1.27.5
A22	3.7.22.1.2								
A23	3.6.7.2			3.58	3.2.3.21	3.4.24	3.8.16		
A24		3.3.1			3.1.6		3.8.1	3.4.16.2	
A25				3.60.4		3.4.28.10		3.6.8.2	
A26					3.2.3.20.1				
A27	3.6.2*	3.3.1.1.2	3.1.1.2.2		3.2.3.38.1	3.4.31*	3.2.24*	3.4.16.48.5	
A28						3.4.28.12			
A29			3.2.3		3.2.3.24.4	3.11.8.4			
A30						3.4.11			
A31				3.67.1					
B1					3.2.1.10.1.1	3.6.3			
B2	3.7.11.5								
B3				3.7.1.2					
B4	3.4.8.3			3.17.2	3.2.1.13.3	3.11.1		3.7.19..	
B5	3.4.10				3.2.1.15				
B6	3.4.9.1								
B7	3.4.9.1								
B8							3.7.2		
B9	3.8.12..								
B10				3.14					
B11		3.4.4.1*	3.1.12*						3.1.13*
B12					3.2.1.16				
B13					3.2.1.16.1				
B14				3.22.2	3.2.1.21.1.2				
B15				3.33.7					
B16		3.5.7.2.1							
B17	3.4.8.2	3.4.12			3.2.1.10.2	3.5.7.2	3.7.6.3	3.7.19.10	
B18					3.2.1.18				
B19		3.4	3.1.1..		3.1.7				3.1.1..
B20								3.7.20	
B21	3.4.9.4							3.7.21..	
B22								3.7.9	
B23					3.2.1.9.6				
B24				3.20					
B25						3.11.3	3.7.4	3.7.10	
B26								3.7.1	

\*Approval information will be found in another specification that is referenced in this paragraph.

Item No.	MIL-I-983D(1)	MIL-E-4158C(2)	MIL-E-5400H	MIL-P-11268D(2)	MIL-E-11991B	MIL-E-16400F	MIL-T-17296D	MIL-F-18870C	MIL-T-21200F
B27 B28 B29 B30 B31	3.4.2   3.4.6 3.4.3.1	3.4.1						3.7.7   3.7.10	
B32 C1 C2 C3 C4			3.2.10	3.22.2	3.2.1.21.1.2		3.7.4	3.7.10	
C5 C6 C7 C8 C9		3.2.6	3.2.5	3.39.8		3.13.14		3.4.5.2 3.5.6.3	
C10 C11 C12 C13 C14	3.9.3.2	3.2		3.3.3					
C15 C16 C17 C18 C19	3.8.11 3.8.13			3.2.3..					
C20 C21 C22 C23 C24	3.7.22.1.1	3.2.32				3.13.10		3.4.5.3.1	
C25 C26 C27 C28 C29	3.2.3..			3.26	3.2.1.12 3.1		2.3		
C30 C31 C32 C33 C34	3.4.11.2					3.5.9.2 3.4.4..			
C35 C36 C37 D1 D2	3.8.4.2	3.2.16..	3.2.12.. 3.2.1..						3.2.1.1
D3 D4 D5 D6 D7						3.9.2.2	3.11		
D8 D9 D10 D11 D12 D13 D14		3.2.16.4			3.3.10.2	3.3.2	3.4.6	3.5.14..	
						3.9.2			
	3.3.. 3.4.15..	3.5.1 3.2.7*	3.1.8*		3.1.7 3.1.9*				3.1.8*
	3.8.5 3.8.6.3..	3.5.5* 3.2.31.2	3.1.23.1 3.1.28						
	3.7.11.7 3.7.7				3.3.19.2	3.11.17	4.5..		
				3.31..	3.3.20* 3.2.3.35.1		3.7.5.1		
	3.9.3	3.6.9.2							
	3.9.7.2							3.3.4.3.2	
			3.1.19.2 4.3			3.14..		4.3.1	
	3.6.17								
		3.6.1.. 3.2.30.1.1	3.4.1		3.5.3 3.3.18.1		3.6.3	3.13* 3.2.3.4	3.4.1
			4.5						4.4
	3.7.7 4.4.18			3.3.11					

\*Approval information will be found in another specification that is referenced in this paragraph.

# MOVE AHEAD IN INTEGRATED CIRCUITS

Engineers with a BS in Physics or an EE and two years' experience in semiconductor technology or circuit design can move up fast in product engineering at Signetics.

Work involves analysis of circuit function and component characteristics, relating electrical parameters to process variables. Experience in measurement of electrical properties of devices is helpful. Experience with small-signal transistors is acceptable, though knowledge of linear or digital integrated circuits is desirable.

You'll find salaries and benefits attractive. And we pay relocation expenses.

Signetics is in Sunnyvale, California—less than one hour from San Francisco.

You're near the nation's top education, recreation and culture centers. Climate is excellent.

May we set up a headquarters interview for you? Direct your inquiry to:

■  
**Signetics Corporation**  
811 East Arques Avenue  
Sunnyvale, California  
Attention: Mr. Charles Westover



A subsidiary of Corning. A leader in  
I/C development and growth.

## Book Reviews

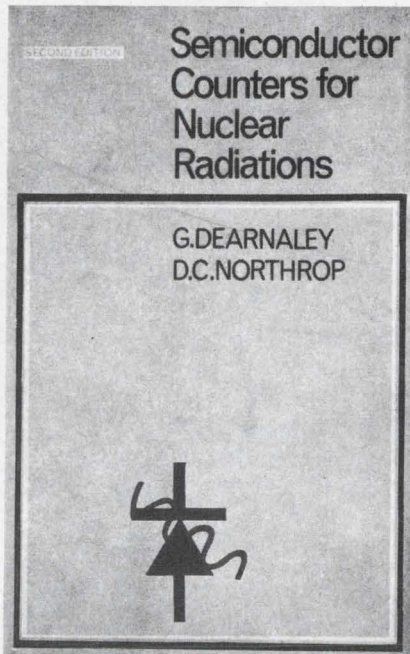

### Radiation and design: A helpful guide offered

*Semiconductor Counters for Nuclear Radiations*. G. Dearnaley and D. C. Northrop (John Wiley & Sons, Inc., New York) 459 pp. \$12.75.

While the major purpose of this book is to describe techniques to analyze nuclear radiation, a design engineer concerned with the effects of radiation on semiconductors should find it helpful.

Thus Chapter 1, which describes the nature of radiation, can serve as a basic introduction. This information, combined with Chapter 10 ("Radiation Damage in Semiconductor Detectors") should prove helpful in predicting the effects of radiation on semiconductors in spacebound hardware. A discussion about the silicon p-n junction photocells (Chapter 9) can be applied in analyzing radiation damage to solar-cell panels.

For those designing instruments, both laboratory and industrial, the book is a good compendium of the latest radiation-measurement tools in the field. Reading the measurement requirements, one can spot and envision the needs for equipment and, possibly, develop a new

instrument line.

The authors have demonstrated a rare ability to describe complex physical phenomena by simple mathematical treatment.

The book deserves a prominent place on the desks of nuclear physicists, nuclear-reactor control engineers and instrument designers. It could also serve as valuable background in designing for high-radiation environments.

—Peter N. Budzilovich

### Electronics

*Having Fun In Electronics*, Leo G. Sands (Howard W. Sams & Co., Inc., Indianapolis). 160 pp. \$3.25.

This book is for the person interested in learning about electronics through experimental construction projects. Several basic circuits, such as audio, communications, and power supply units, are presented to help the reader to develop his construction skills and understanding of basic circuits. As well as the projects to build, the book explains basic principles of operation, so that the reader can understand the circuit action.

### Amplitude modulation

*Understanding Amplitude Modulation*, Irving M. Gottlieb (Howard W. Sams & Co., Inc., Indianapolis). 160 pp. \$3.25.

The author sets out the principles used in the amplitude modulation of a carrier signal and describes the various types of systems, both tube and transistor, used to accomplish it. Various levels of modulation are discussed, and switching modulators are explained and illustrated. The various improvements that can be made in a basic system are also explained. Written for advanced amateurs, broadcast technicians, engineering students, and others, the text is more than an introduction but not a full engineering-level treatment.

# CAREER INQUIRY – confidential

Respond to the career opportunities advertised in this issue. Fill out and send us this handy resume. **Electronic Design** will do the rest – neatly typed copies of this form will be mailed to the companies of your choice, indicated by the circled Career Inquiry Numbers at the bottom of this page.

28

Name		Home Phone	
Home Address (Street)		City	State   ZIP Code
Age	U.S. Citizen <input type="checkbox"/> Yes <input type="checkbox"/> No	Security Clearance	

Prime Experience	Secondary Experience

Desired Salary	Availability Date
----------------	-------------------

**Employment History – present and previous employers**

Company	City, State	Dates	Title	Specialty
		to		
		to		
		to		

**Education – indicate major if degree is not self-explanatory**

Degree	College	City, State	Dates
			to
			to

**Additional Training – non-degree, industry, military, etc.**

**Professional Societies**

**Published Articles**

--

**Career Inquiry Numbers:**

- |     |     |     |     |     |     |     |     |     |     |
|-----|-----|-----|-----|-----|-----|-----|-----|-----|-----|
| 900 | 901 | 902 | 903 | 904 | 905 | 906 | 907 | 908 | 909 |
| 910 | 911 | 912 | 913 | 914 | 915 | 916 | 917 | 918 | 919 |

**ELECTRONIC DESIGN**  
850 Third Avenue  
New York, New York 10022

# career opportunities in nuclear power engineering

## AT THE WORLD'S LARGEST SHIPBUILDING COMPLEX

### For nuclear power, electrical, chemical, general, marine and mechanical engineers.

The San Francisco Bay Naval Shipyard offers both newly graduated and experienced engineers of many categories a chance to work today in what will be tomorrow's source of industrial power.

The Shipyard is engaged in important programs in all aspects of nuclear propulsion, including:

**Reactor Engineering**

**Fluid Systems and Mechanical  
Engineering**

**Control Engineering  
(Instrumentation)**

**Test Engineering**

**Nuclear Quality Engineering**

**Radiological Control**

**Nuclear Refueling**

Starting salaries are commensurate with academic achievement, experience and training.

Job locations: San Francisco Bay Naval Shipyard has two work sites located 40 miles apart: San Francisco and Vallejo, California. Each location has ready access to the full cultural advantages of San Francisco and the mild year-round climate of the Bay Area. All types of recreation from ocean surfing to skiing on the slopes of the Sierras are within easy driving distance.

Send your resume or Standard Form 57, Application for Federal Employment, to:

**Coordinator, Professional and Technical Recruitment (Code 174A13)  
Employment Division  
San Francisco Bay Naval Shipyard  
Vallejo, California 94592**

AN EQUAL OPPORTUNITY EMPLOYER

MUST BE A U.S. CITIZEN

ON CAREER-INQUIRY FORM CIRCLE 903

## BOOK REVIEWS

### General study of amplifiers

*Amplifier Handbook*, Richard F. Shea (McGraw-Hill Book Company, New York). \$37.50.

This volume gives comprehensive information on amplifier basics, amplifying devices and amplifier circuits to help solve everyday amplification problems. It is intended as a standard reference for practicing engineers, scientists and technicians on amplifying techniques in general and on specific circuits for a wide range of applications. It includes material that should permit the design of circuits, other than those presented, to fit individual needs. The text is divided into three major sections: fundamentals, devices and circuits. Emphasis throughout is on practical application, with theory and mathematics held to the minimum necessary for usability. With almost 1500 pages the book contains a profusion of reference material, including tables, specifications and similar data, compiled with a multitude of sources to help locate desired information quickly and easily. Over 1500 illustrations demonstrate important principles and procedure.

### Dynamic programming

*Introduction to Dynamic Programming*, George L. Nemhauser (John Wiley & Sons, Inc., New York). 256 pp. \$7.95.

This book deals with the theory and computational aspects of dynamic programming. It is an applied book designed for operations researchers, management, scientists, statisticians, engineers and social scientists. It tries to show when dynamic programming can be used and how to develop applications. The basic theory and computational methods are extended to cover stochastic and competitive models, nonserial processes and infinite stage systems. Applications to inventory theory, allocation problems, control theory and chemical engineering design are illustrated with numerous exercises.

# INFRARED ENGINEERS AND SCIENTISTS:

Can you contribute to the development of products like these?



Homing guided missile seeker head.

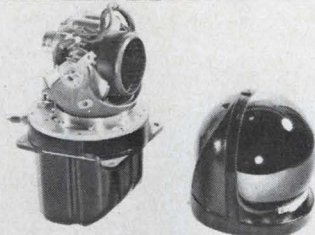

Interceptor IR search/track set.



Anti-tank missile controller.

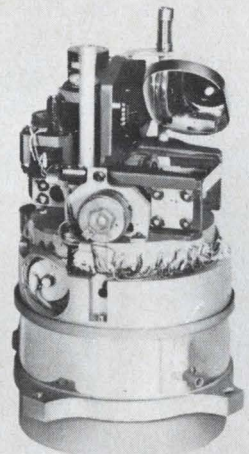

Star tracker for SURVEYOR spacecraft.

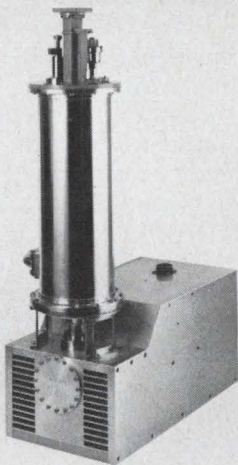

Cryogenically cooled parametric amplifier.

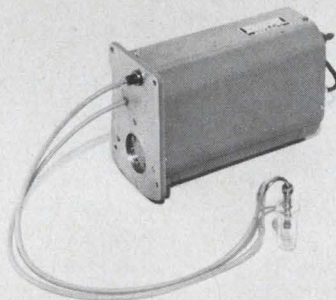

Miniature closed-cycle cryogenic refrigerator.

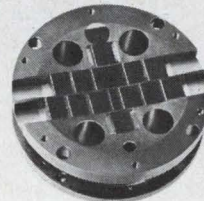

20-element Ge:Hg detector array.

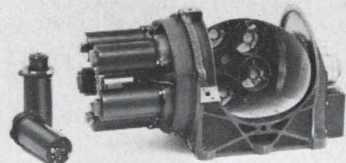

Radiometer for NIMBUS weather satellite.



Multi-element cooled IR detector.



Cast silicon IR optical components.

Rapid growth of Hughes infrared activities in the Aerospace Divisions and the Santa Barbara Research Center has created many responsible positions for qualified engineers and scientists in all phases of IR systems development from conception through production engineering.

Immediately available assignments include openings in such diverse technologies as optical design, semiconductor physics, cryogenics, mechanical engineering, precision electro-mech-

anisms, electronic circuit design, servo systems... and many other areas.

Current Hughes IR contracts include advanced systems for: space exploration, weather satellites, anti-ballistic missile defense, night reconnaissance, aircraft and space vehicle defense, and tactical weapon guidance and fire control.

Professional experience, an accredited degree and U.S. citizenship required.

For immediate consideration, please air-mail your resume to:

**Mr. Robert A. Martin**  
**Head of Employment**  
**Hughes Aerospace Divisions**  
**11940 W. Jefferson Blvd.**  
**Culver City 21, California**



HUGHES AIRCRAFT COMPANY  
 AEROSPACE DIVISIONS

An equal opportunity employer

### Oscilloscope measuring

*Oscilloscope Measuring Technique*, ("Philips Technical Library") J. Czech (Springer-Verlag New York, Inc.) 620 pp. \$15.80.

Theory and design techniques relating to modern oscilloscopes with information on means of using the instrument, photographic recording and large-screen projection of oscillograms are covered in this text. Eighteen chapters are devoted to

detailed descriptions of measuring techniques in different fields. This is thus a handbook on uses of the modern cathode-ray oscilloscope in research, development and control.

A valuable feature is the extensive collection of reproduced oscillograms from the author's collection, showing examples from work in electronics, acoustics, optics, mechanics and other branches of pure and applied science.

### Control systems

*Automatic Control Systems Engineering, Vol. I.* A. W. Langrill, Jr. (Prentice-Hall, Inc., Englewood Cliffs, N. J.) 376 pp. \$17.25.

The first two volumes devoted to automatic control systems engineering deals with linear control theory, while the second is concerned with nonlinear control systems theory. Volume I comprises two main sections: Part I, Dynamic Systems Analysis, and Part II, Basic Control Systems Theory. This text concludes with Appendix A, a table of Laplace transform pairs and Appendix B, the Routh stability criterion. Engineering personnel desirous of a working knowledge of control systems engineering will find this book a source of reference.

### Digital tape drives

*Digital Tape Drives*, James E. Taunt (The Business Press, Elmhurst, Ill.), 161 pp. \$7.45.

This book is intended for people associated with digital computers—operators, programmers, analysts, managers and consultants. This text is directed to those individuals who want to learn about digital tape drives. Found at the end of each chapter is a summary as well as questions to further the readers' understanding. The information made available in this book is particularly useful when investigating an unknown computer system, when trying to increase the efficiency of an existing computer system, or when planning increased capacity.

### Engineering management

*Successful Engineering Management*, Tyler G. Hicks (McGraw-Hill Book Company, New York). 287 pp. \$8.50.

This is a guide for the engineer or scientist who holds, or seeks to hold, a managerial position. It devotes special attention to practical problems of delegating, instructing, guiding and controlling people. It aims to show what to do, when to do it, and how to do it. The book

## WHEN YOU TALK SIMULATION, YOU'RE TALKING CONDUCTRON

Conductron is the company that developed the Gemini Simulator and the Mercury Trainer, the 737 Simulators and Trainers, the Orbital Timing Device, the Lockheed C5A Simulator, and the Bio-Medical Critical Monitoring Device. From our aircraft and spacecraft avionics come auto-pilots for missiles, side-looking radar displays and Marine battlefield coordination computers. Current projects include making simulators for commercial aircraft, an operation which is expanding into helicopter and engineering flight simulators.

Conductron has facilities in St. Louis, Los Angeles, Houston and Ann Arbor, with programs in Airborne Collision Avoidance Systems, Airborne Digital Navigation Aids and Holography.

Right now Conductron needs experienced simulator specialists who want above-average compensation, generous benefits and liberal tuition aids. Current opportunities include openings in the following categories:

- ELECTRICAL ENGINEERS • ELECTRONIC ENGINEERS**
- DESIGN ENGINEERS • MECHANICAL ENGINEERS**
- OPTICS • SCIENTIFIC PROGRAMMERS**
- COMMUNICATIONS SPECIALISTS**

Send your resume in complete confidence to:  
Mr. Richard Ayres, Personnel Office, Dept. E



**CONDUCTRON - MISSOURI**

Division of Conductron Corporation

2600 N. Third Street • Box 426 • St. Charles, Missouri 63301

*We are and always have been an equal opportunity employer*

ON CAREER-INQUIRY FORM CIRCLE 904



# Anticipation Engineering Done Here

It is one thing to talk about designs ahead of their time. It's another thing to apply today's technology to the problems of tomorrow . . . and get results.

Matching achievement to future applications is both an art and a science. It only happens when imagination and reality meet head-on.

We call it "Anticipation Engineering". Engineering that leads out of the laboratory and into practicality. Engineering that answers questions soon to be asked.

In the 1950's, Anticipation Engineers at McDonnell began to develop the designs and equipment that made possible the successful Phantom Aircraft and Mercury, Gemini, and ASSET Spacecraft programs that have dominated the Sixties. Disciplined thinkers at McDonnell with an innate creativity, boundless enthusiasm, and an intense curiosity are today anticipating the technological requirements of the Seventies.

If you are a graduate engineer who finds success and satisfaction in creative departures from convention, you would fit in well with the men and the requirements at McDonnell. Opportunities exist in virtually every area of aerospace technology. Corporate expansion and diversification generate open-ended possibilities for your advancement.

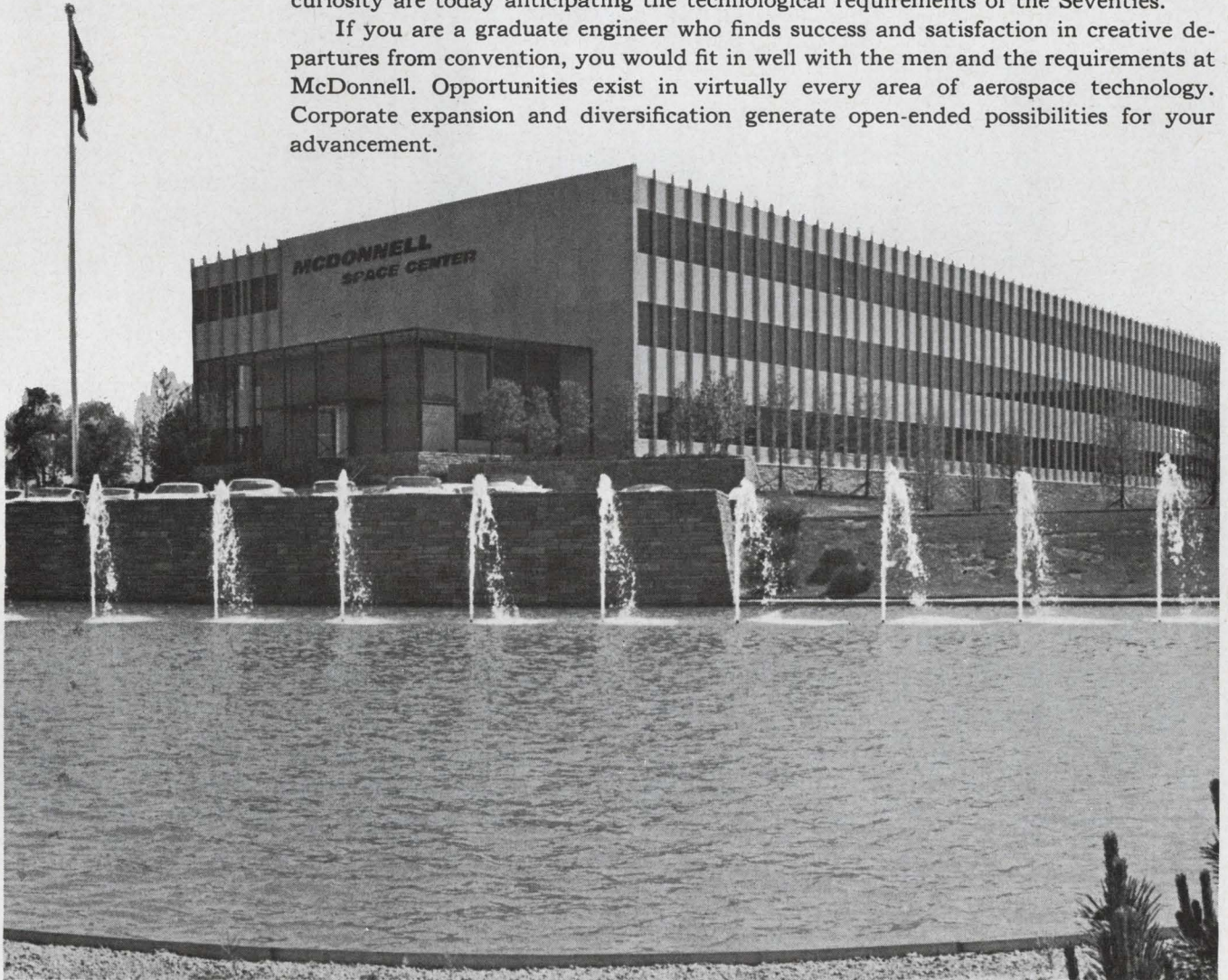

## MCDONNELL

Mail This Form To: W. R. Wardle, McDonnell Employment Dept. R-12 Box 516, St. Louis, Mo. 63166

Name \_\_\_\_\_ Home Address \_\_\_\_\_

City & State \_\_\_\_\_ Zip \_\_\_\_\_ Phone \_\_\_\_\_ Age \_\_\_\_\_

Education: BS \_\_\_\_\_ MS \_\_\_\_\_ PhD \_\_\_\_\_ Major Field: \_\_\_\_\_  
Date Date Date

Primary Experience Area: \_\_\_\_\_ Present Position: \_\_\_\_\_

\_\_\_\_\_ Number of Years \_\_\_\_\_ I would like to receive application form

An Equal Opportunity Employer.

ON CAREER-INQUIRY FORM CIRCLE 905

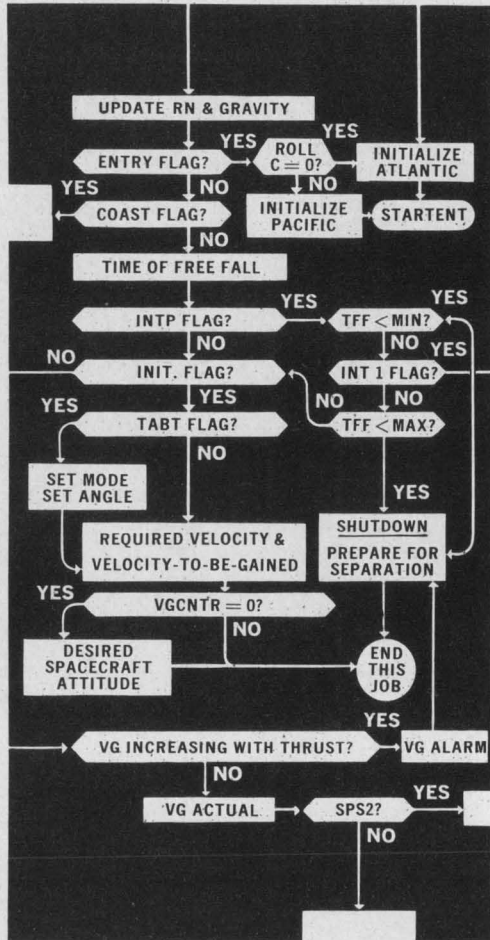
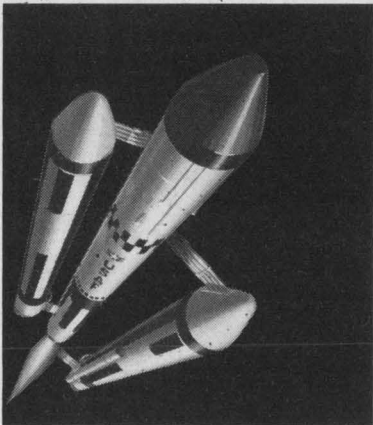
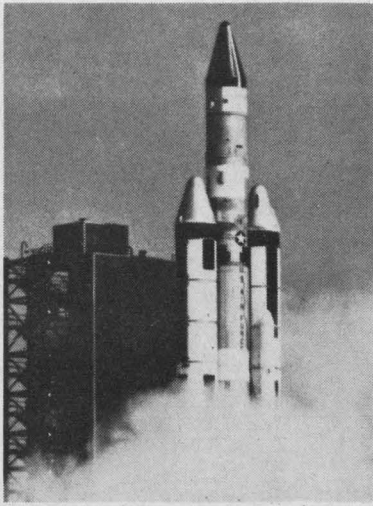

## Challenge:

# “Fly” a Titan III mission by equation formulation, simulation, validation.

We're helping to guarantee a payload gets where it's going before a Titan III mission begins. How? By evolving guidance equations, and computer programs for the many and varied Titan III missions. This is typical of the growing number of space guidance and navigation assignments for AC Electronics in "controlled software" . . . the establishment of equatable simulations for various missions.

This is just one of many new and exciting challenges awaiting scientists, mathematicians and engineers at AC Electronics. The new programs recently assigned to AC include SABRE, a new reentry system for missiles, and the new Ships Self-Contained Navigation System (SSCNS). Other projects include: MOL; the guidance and navigation systems for Apollo and the Lunar Module; navigation systems for supersonic aircraft; ILAAS (Integrated Avionics Systems); a computerized fire-control system for the new Main Battle Tank, a joint U.S.-Federal Republic of Germany program. If these fields interest you, we invite you to contact us regarding a career with AC at one of three excellent locations—Milwaukee, Boston, Santa Barbara. Send resume including salary requirements to: R.E. Schroeder, Dir. of Scientific & Professional Employment, Dept. 5753, AC Electronics Div., Milwaukee, Wis. 53201.

**PRODUCTION ENGINEERS**  
**LOGIC DESIGN AND DIGITAL CIRCUIT ENGINEERS**  
**MANUFACTURING DEVELOPMENT ENGINEER**  
**PHOTO OPTIC ENGINEER**  
**INERTIAL INSTRUMENT TEST ENGINEERS**  
**MECHANICAL DESIGN ENGINEERS**  
**ELECTROMECHANICAL PACKAGING ENGINEERS**  
**STRESS/VIBRATION/THERMAL ANALYSTS**  
**SCIENTIFIC PROGRAMMERS**  
**GUIDANCE/NAVIGATION EQUATION ANALYSTS**

**COMPUTER SYSTEMS ANALYSTS**  
**DIGITAL FLIGHT CONTROL ENGINEERS**  
**DIGITAL CIRCUIT DESIGNERS**  
**COMPUTER LOGIC DESIGNERS**  
**ELECTRONIC DESIGN ENGINEERS**  
**DIGITAL SYSTEMS ENGINEERS**  
**SYSTEMS DESIGN ENGINEERS**  
**SYSTEMS ANALYSIS ENGINEERS**  
**OPTICS SYSTEMS ENGINEERS**  
**SYSTEMS MECHANIZATION ENGINEERS**

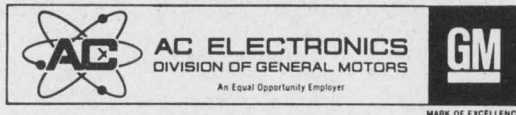

ON CAREER-INQUIRY FORM CIRCLE 906

## BOOK REVIEWS

deals with engineering management in all areas of modern technology, including engineering design, manufacturing, plant operation and maintenance, and construction projects. Numerous checklists, organization charts, control forms, and tabulations are included. The author attempts to show the reader how to evaluate his chances for advancement, to begin his rise up the management ladder, to check his progress, and what to do if his advancement is slower than he thinks it should be

## Plasmas

*The Particle Kinetics of Plasma*, I. P. Shkarofsky, T. W. Johnston, and M.P. Bachynski (Addison-Wesley Publishing Company, Inc., Reading, Mass.). 518 pp. \$17.50.

This book describes the fundamentals of particle kinetics as they apply to a gaseous plasma. It applies these ideas to develop basic equations for plasmas under various conditions. Although only the behavior of gaseous plasmas is discussed explicitly in this book, some of the concepts are equally applicable to plasmas in the liquid or solid state.

This volume is intended both as a reference for research and as a text for a graduate course on plasma kinetics. Where possible, the subject matter is developed from first principles in sufficient detail to enable the reader to follow the derivation closely. A knowledge of vector and matrix calculus, differential equations, atomic physics, and electromagnetism is assumed.

## Sweep generators

*101 Ways To Use Your Sweep Generators*, Robert G. Middleton (Howard W. Sams & Co., Inc., Indianapolis). 160 pp. \$2.95.

This book comprehensively covers the practical uses of a sweep generator. Specific sections cover the use of audio and RF generators for checking and calibrating test equipment, making audio amplifier tests,

# CHALLENGE

"an invitation to join in a contest"

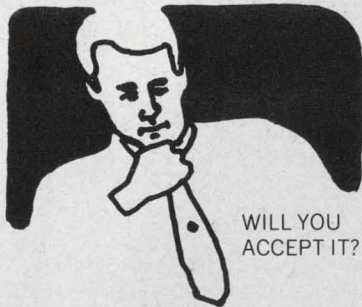

WILL YOU  
ACCEPT IT?

The challenge offered by a career with LTV Electrosystems is not unlike an invitation to a contest. This "contest" — an intense, high-spirited competition within a framework of unlimited opportunity. At LTV Electrosystems you'll also be an indispensable part of a larger challenge: to help us compete in a crowded marketplace by producing a better idea, a better product. That we have met this challenge with success is a matter of record. Combining

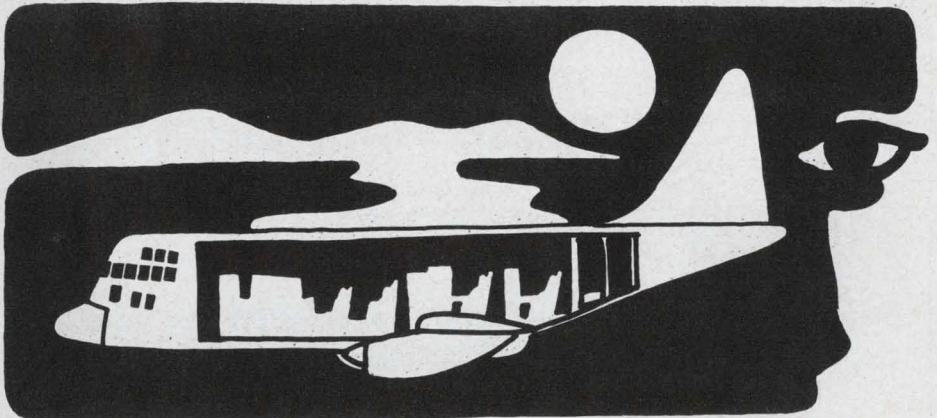

youth with experience we have grown on all fronts: a sales curve shooting off the top of the chart, new facilities, expanded

tronics systems for ground, air and space environments; nuclear detection; command and control; communications; information processing and display; antennas; electronic warfare; range instrumentation and tracking; satellite tracking, and more. R & D capabilities are channelled into four basic technical fields: systems analysis, information collection, information processing and vehicle support. Our place in the sun is Greenville, Texas (near Dallas), in a pleasant region of great recreational, cultural and educational opportunity. (For example, an exclusive closed circuit TV system will soon link our Greenville facility with special graduate engineering classes beamed from Southern Methodist University in Dallas.) If you are a family man, you will appreciate the superior educational system, the suburban hospitality and the serene and easy living in Greenville.

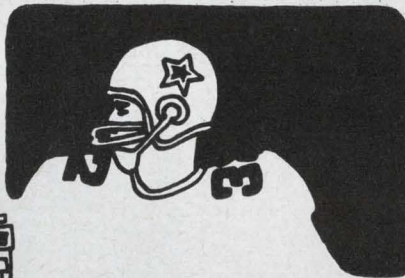

R & D programs, a growing backlog. All of this points to greater opportunity for the individual scientist and engineer. Programs include sophisticated elec-

Consider this an invitation to join us — a once-in-a-lifetime challenge to get in on the ground floor of something great. Right now we are interviewing specialists in the following disciplines:

RF SYSTEMS ANALYSIS	DIGITAL SYSTEMS ANALYSIS
DIGITAL CIRCUITS DESIGN	ANTENNA SYSTEMS DESIGN
RADAR SYSTEMS	AIRCRAFT STRUCTURES DESIGN
MECHANICAL SYSTEMS	STRESS ANALYSIS
ELECTRO-OPTICS	SCIENTIFIC AND BUSINESS PROGRAMMING
RF CIRCUIT DESIGN	

Please write or send resume (including telephone number with dates and times we may reach you) to: Mr. C. L. Waller, Professional Placement, P.O. Box 1056, Greenville, Texas 75401.

GREENVILLE DIVISION

**LTV ELECTROSYSTEMS, INC.**

A SUBSIDIARY OF LING-TEMCO-VOUGHT, INC.

AN EQUAL OPPORTUNITY EMPLOYER — M/F

ON CAREER-INQUIRY FORM CIRCLE 907

# electronic engineers

Do you have a flair for unusual work?  
Electronic Warfare • Anti-Submarine Warfare

If you have a background in any of the following fields  
we would be interested in talking to you:

## COMMUNICATIONS • MICROWAVE RADAR • SONAR • TELEMETRY

If you are an Electronic Engineer with a BS or MS Degree, and your engineering career has advanced to the point where you would like to apply your experience to technical management as well as having responsibility for program formulation, then you may wish to consider stepping up to an engineering position with the Naval Ship Systems Command.

The Naval Ship Systems Command is responsible for research and development and project management for all electronic systems and equipment utilized aboard ships of the U. S. Navy. In directing laboratory and contract activity in support of this research and development, experienced engineers are required in all phases of electronics.

**Starting salary range—\$9,500 to \$15,000 per year**

Call Mr. Crowley on Area Code 202, OXford 6-3652, OXford 6-2353, or OXford 6-3619, or send your application to:

Naval Ship Systems Command, Code 20325-H  
Main Navy Building, Room 2422  
18th and Constitution Avenue, N.W.  
Washington, D. C. 20360

An Equal Opportunity Employer

ON CAREER-INQUIRY FORM CIRCLE 908

## BOOK REVIEWS

and performing RF and IF alignment and tests. It also discusses special uses in color-TV receivers. Each application includes full data on connections required, additional equipment needed, proper test procedure and evaluation of results. There are more than 250 illustrations, waveforms and diagrams.

### Control systems

*Introduction to Nonlinear Automatic Control Systems.* Rajko Tomovic (John Wiley & Sons, New York). 172 pp. \$7.50.

The stress is on the fact that the presence of nonlinearities causes important qualitative changes in system behavior. Therefore, the parallel between linear and nonlinear mathematical models is always kept in mind. An important part of this book is devoted to experiments with simulation models. The analog computer is used experimentally to give insight into the physical characteristics of nonlinear systems.

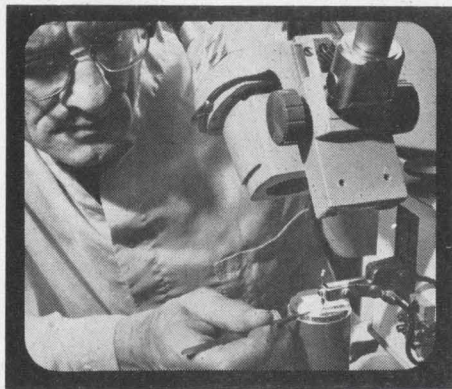

To  
**ELECTRONIC  
ENGINEERS**  
with a sense  
of timing...

## BENDIX (KANSAS CITY DIV.) IS ON THE *MOVE!*

This is the opportune moment to investigate your career potential at Bendix, Kansas City Division. As prime contractor for the AEC, we have enjoyed an enviable, orderly 16-year growth. Now we are entering a unique developmental phase, opening new fields of activity in microminiaturization, microwave and logic circuitry. This situation adds up to a ground-floor opportunity in a well-established corporation noted for advanced engineering. Cooperative, professional atmosphere, plus excellent living conditions. Let us hear from you promptly so we may detail more clearly the many advantages we can offer you.

Please mail résumé at once to:

Mr. T. E. Mason, Tech. Personnel Repr.  
THE BENDIX CORPORATION, Box 303-NE  
Kansas City, Missouri 64141

AN EQUAL OPPORTUNITY EMPLOYER



ON CAREER-INQUIRY FORM CIRCLE 909

## Circuit Design Engineers

Don't answer this ad unless you personally want the challenge of an enormous variety of circuit design problems—and the freedom to seek out the solutions—with a growing midwest electronics OEM.

If you're interested, salary range is from \$8,000 to \$15,000, depending on type and amount of experience. Reply in confidence to:

Electronic Design  
Box-100-DP

850 Third Ave.  
New York, N.Y. 10022

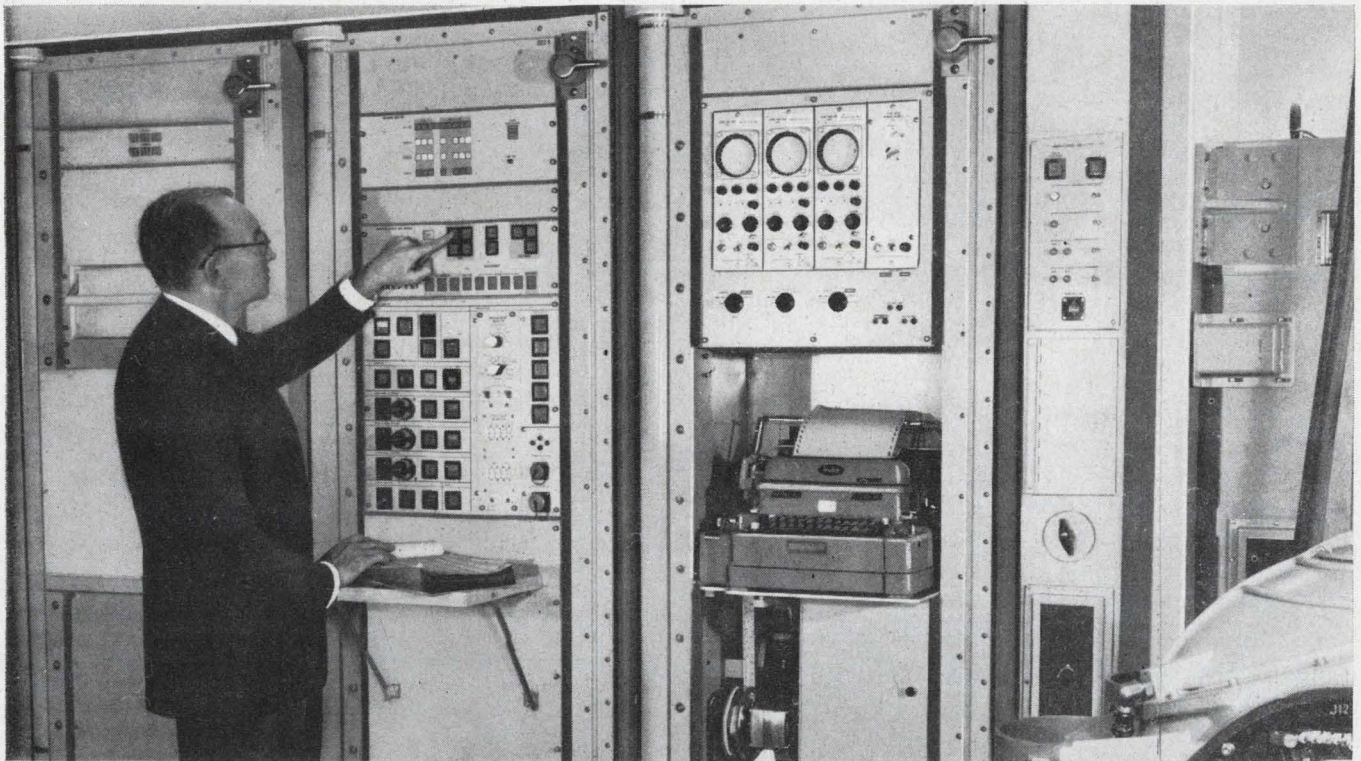

## Remember when complex support and simulation systems were developed AFTER the prime systems were completed?

*Forget it.* When you're working on systems as formidable as the continuously evolving fleet ballistic missile system, the challenge to the support equipment engineer is at least equal to that faced by the primary systems or product engineer. Maybe more. More, because our people are not only conceiving and developing their equipment to evaluate and exercise the multiplicity of systems and subsystems of the prime system... they're also creating simulators for the primary equipment so that the evaluating systems can be exercised... all in parallel with or ahead of the development of the missile guidance and fire control system itself! ■ The equipment is then used to simulate flight control loops in the development stage of the missile. Later, you're likely to find this same equipment on the launching pads, firing developmental missiles. ■ All in all, our way is admittedly tougher than the "after the fact" support systems work you may have experienced someplace else at some other time. But if you've outgrown that experience, we promise you the kind of new assignments that will help you forget it. Like these:

### ELECTRONIC CIRCUIT ENGINEERS . . .

Develop, design, package and evaluate digital and analog circuits to meet requirements of Weapon Control and guidance systems. Analyze, design and evaluate circuits and packaging techniques—using both discrete solid-state components and integrated micro-electronic circuits for applications such as submarine based missile fire control, gun mount and antenna drives, digital servos, sophisticated space power conversion and control equipments.

**PRODUCT DESIGN ENGINEERS . . .** Electrical or mechanical engineering graduates to be responsible for the conception of mechanical, electro-mechanical and electro-optical designs from customer and systems specifications. Applications include panels, displays, packaging, cabling, switches, automatic wiring on tactical and evalua-

tion equipment for the POSEIDON fleet ballistic missile system. Extensive liaison with the customer, sub-contractors and manufacturing.

### DIGITAL SYSTEMS DESIGN ENGINEERS . . .

Responsible for the concept and development of digital computational and control systems for inertial guidance and fire control evaluation equipment. Establish system design requirements utilizing state-of-the-art knowledge in digital data handling and mechanization techniques. Perform trade-off analysis, determine optimum mechanization approach. Position requires knowledge of techniques for tolerance partitioning and real-time input/output equipment.

### DIGITAL LOGIC DESIGN ENGINEERS . . .

Responsible for the sub-system mechanization of developmental digital control sys-

tems. Keep abreast of new knowledge about digital memory design, software techniques and microminiature modules and apply this knowledge to the logic design of control systems. Experience in mechanization techniques, tape readers, printer and compiler organization desired. **RELIABILITY ENGINEERING AND HUMAN FACTORS . . .** Openings in these activities for work on POSEIDON fire control, guidance and support equipments.

**TECHNICAL WRITERS . . .** To keep pace with each technological break-through and innovation on major defense programs and effectively bridge the gap between the designer and user. Background in fields of electronics, digital and analog computers and/or servomechanisms, plus and interest in developing competence in technical communications and publications is desired.

If you have the qualifications, and interest, please send full details, including salary requirements, to: Mr. D. F. Kline, Room 59-R, Ordnance Dept., General Electric Co., 100 Plastics Avenue, Pittsfield, Mass.

**GENERAL  ELECTRIC**

An equal opportunity employer

M&F

ON CAREER-INQUIRY FORM CIRCLE 911

# Phase-shift oscillator cuts cost and size of VCO

A phase-shift oscillator and a frequency-determining circuit, combined in the configuration shown below, yield a simple voltage-controlled oscillator. Transistors with very low betas can be used in the phase-shift oscillator, since the bias network is not a part of the frequency-selecting circuit. (When it is, as in conventional phase-shift oscillators, the designer usually has to degrade the beta of the transistor in order to maintain the network's stability.)

The circuit (see schematic) is particularly useful in telemetry systems and some analog-to-digital conversion schemes, where full advantage can be taken of its compact size and not too critical component tolerances.

The center frequency is given by the conventional formula:

$$f = 1/2 \pi RC,$$

which may be adjusted with  $R_3$ .

The frequency is varied by controlling the resistance of the emitter of the phase-shift oscillator. The emitter leg of  $Q_1$  is the transistor  $Q_2$ , which acts as a voltage-sensitive resistor. The center control voltage and the range of dc control voltage may be varied by the proper selection of  $R_1$  and  $R_2$ . Their exact values depend on the

**VOTE!** Circle the Reader-Service-Card number corresponding to what you think is the best Idea-for-Design in this issue.

**SEND US YOUR IDEAS FOR DESIGN.** Submit your IFD describing a new or important circuit or design technique, the clever use of a new component, or a cost-saving design tip to our Ideas-for-Design editor. If your idea is published, you will receive \$20 and become eligible for an additional \$30 (awarded for the best-of-issue Idea) and the grand prize of \$1000 for the Idea of the Year.

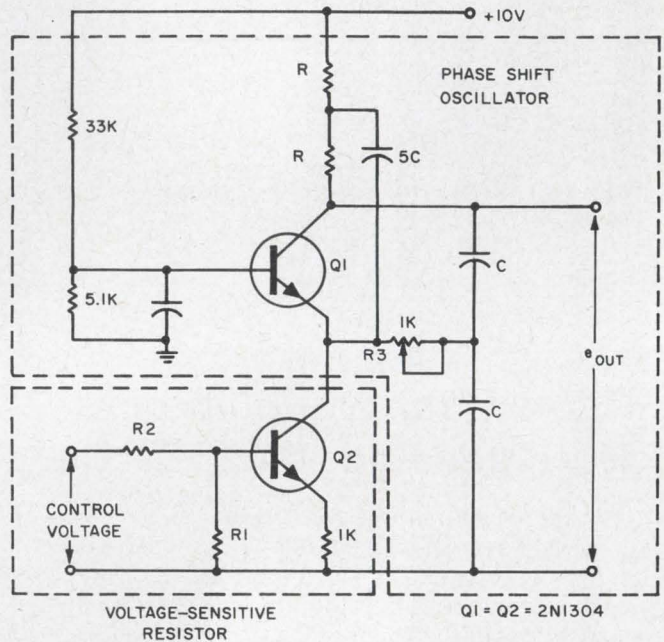

**Phase-shift VCO** is designed with separate bias and frequency-selecting circuits, to permit the use of transistors with very low betas.

source characteristics.

The linearity of this circuit, designed for a center frequency of 9.5 kHz, is about  $\pm 3\%$ . The components are all standard. The replacement of transistors will generally require readjustment of  $R_3$ .

*Saul A. Ritterman, Assist. Professor, Bronx Community College, N.Y.*

VOTE FOR 110

## Microcircuit plus capacitor make simple one-shot

A microcircuit logic block with one external capacitor can be used to provide a fixed pulse whenever an input goes from a high to a low state. The circuit (see schematic), is implemented with an RTL block (Fairchild 910 or 914 would be suitable), although DTL or other logic forms could also be used. Note that the small numbers at

junctions refer to pin connections on a TO-5 or epoxy package.

Basically, the operation is as follows.

Initially, assume the input voltage is high (1 V is used for illustration).  $Q_1$  and  $Q_3$  are ON and  $Q_2$  is OFF; thus  $V_o$  is low. When  $V_i$  switches to the low state (at  $t_i$  in timing diagram)  $Q_1$  and  $Q_3$  turn OFF, and  $V_o$  immediately goes high, since both  $Q_2$  and  $Q_3$  are now OFF. Capacitor  $C$  starts to charge through  $R_{c1}$ . When the voltage across  $C$  reaches  $V_t$ , the turn-on voltage for  $Q_2$ ,  $Q_2$  turns

Testing integrated circuits is a key step in their production. At the Molecular Electronics Division of Westinghouse Electric Corporation, Tally perforators are used to log data as each module is run through a series of parameter checks. Data logged on the tape is then analyzed by computer.

According to W. DeLauder, Foreman of the Instrumentation Section at Westinghouse, the five Tally Model 420 perforators worked extremely well

during a fifteen month period just ended. Fewer than eight calls per perforator were made to keep all five perforators on duty over the entire period. The average time per call was 2.23 hours with an average cost for parts of \$3.05.

During the fifteen month period, the five perforators punched with precision over 478 miles of tape. There are a lot of good solid engineering reasons why Tally perforators are extraordi-

narily reliable. For all of them, please address Ken Crawford, Tally Corporation, 1310 Mercer Street, Seattle, Washington 98109. In the U. K. and Europe, address Tally Europe, Ltd., Radnor House, 1272 London Road, London, S. W. 16, England.

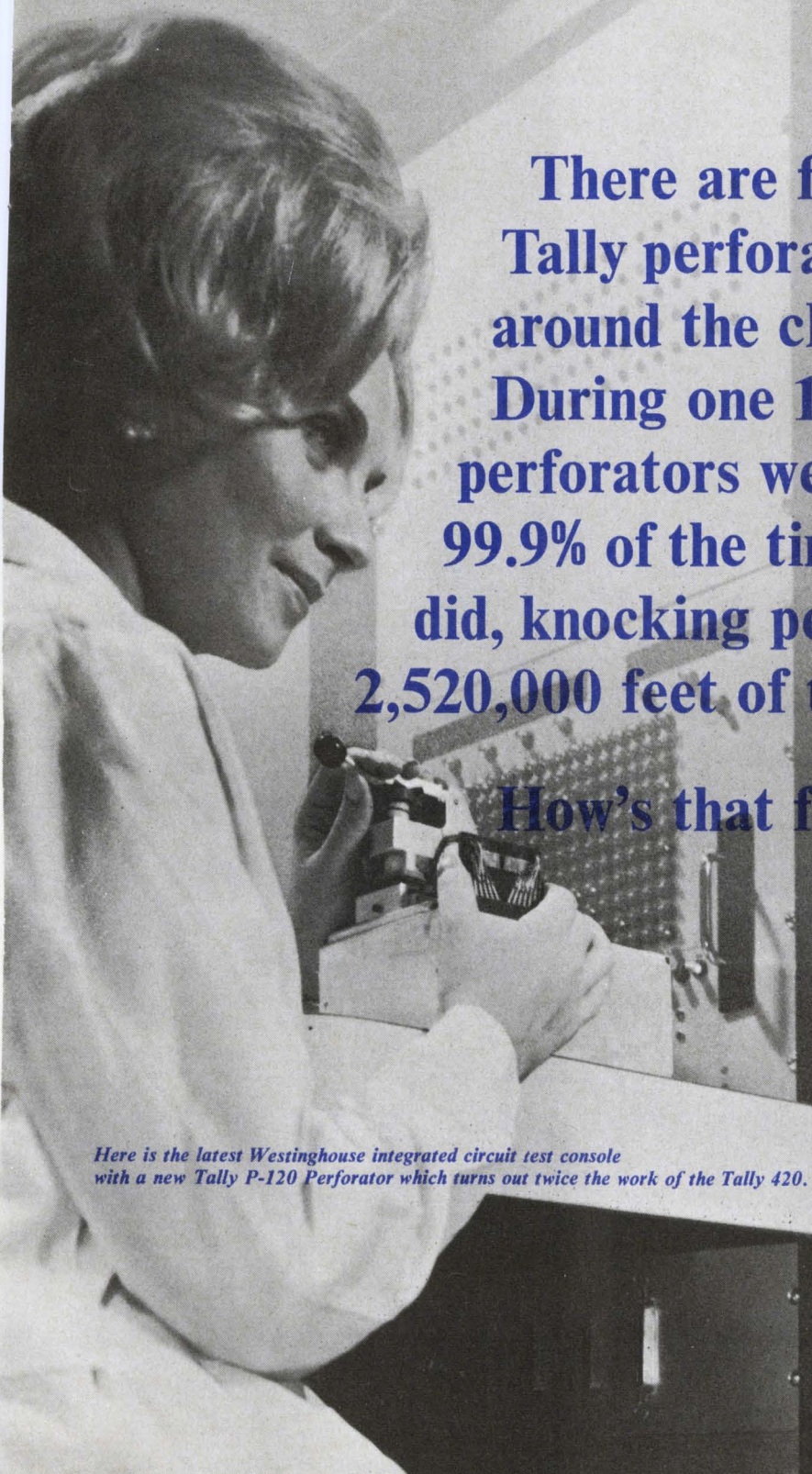
A black and white photograph of a woman with short, light-colored hair, wearing a white lab coat. She is looking down and to the right, focused on a piece of equipment. Her hands are near a control panel or a tape mechanism. The background is slightly blurred, showing what appears to be a laboratory or industrial setting.

**There are five hard working  
Tally perforators on the job  
around the clock at Westinghouse.  
During one 15 month period, these  
perforators were ready for work  
99.9% of the time...and work they  
did, knocking perfect chad out of  
2,520,000 feet of tape!**

**How's that for reliability?**

*Here is the latest Westinghouse integrated circuit test console  
with a new Tally P-120 Perforator which turns out twice the work of the Tally 420.*

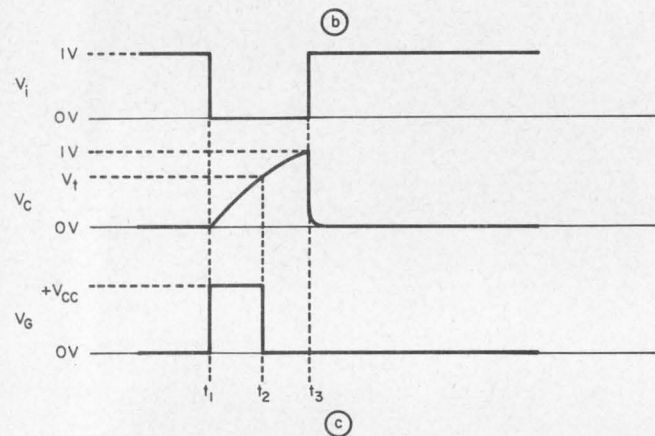
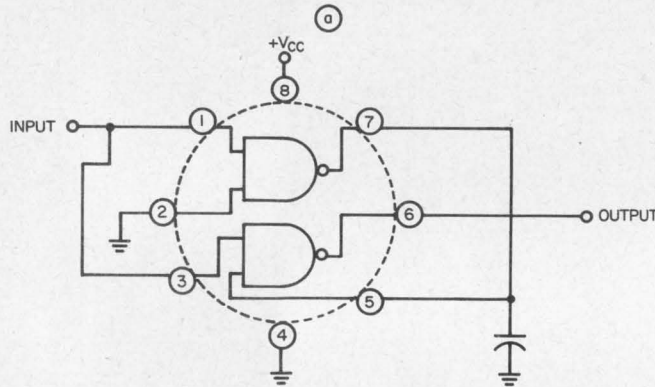
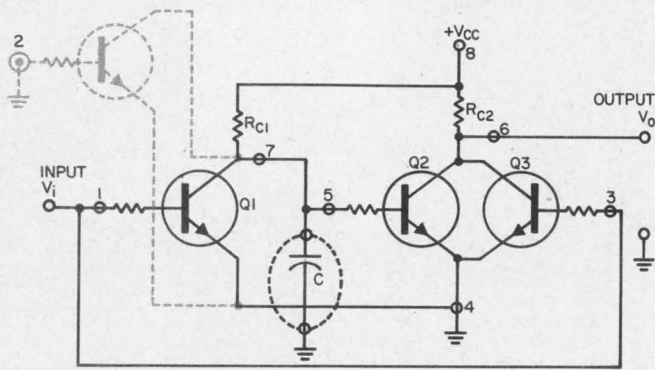

**RTL microcircuit**, with the addition of a capacitor (dotted loop), produces a pulse of period  $t_2 - t_1$  when the input voltage shifts from a high to a low state. An RTL block (top) is connected as shown below with the pin 2 input grounded.

ON and  $V_o$  returns to the low state. At some time later, when  $V_i$  returns to the high state,  $Q1$  and  $Q3$  will be turned ON again, capacitor  $C$  will discharge,  $Q2$  will turn OFF, and the circuit will be ready to repeat operation.

The pulse period depends on the time constant,  $CR_{c1}$ , and can be set according to the choice for  $C$ . Also,  $t_3$  must be greater than  $t_2$ .

If two such circuits are cascaded, the result is a pulse delayed in time from  $t_1$  by  $t_2 - t_1$ . This might be useful to avoid time race or to establish settling times in analog circuitry.

Robert H. Katzive, Design Engineer, Varian Associates, Palo Alto, Calif. VOTE FOR 111

## Simple circuit multiplies frequency up to 40 times

High-order frequency multiplication can be quite a problem at low frequencies, say below 5 kHz, because inductors and capacitors become bulky and unwieldy, especially if high  $Q$ s are needed.

A conventional  $Q$  multiplier circuit is the designer's answer. The circuit shown can efficiently multiply the frequency 40 times or more with very little envelope decay. Hence the output can be amplified with a little filtering for clean wave-shapes.

Normally such circuits are used to obtain greater selectivity by multiplying the  $Q$  of a tank circuit and narrowing the bandwidth. The frequency multiplication is best illustrated with an example. Assume that the 20th or greater harmonic of a 1-kHz signal is needed.  $L1$  is selected from a catalog to have a high  $Q$  at 20 kHz. Then  $C1$  is selected to resonate with  $L1$  at the desired frequency, according to the equation:

$$C1 = 1/L(2\pi f)^2, \quad (1)$$

where  $f$  is the multiplied frequency (Hz).

The value of resistor  $R_f$  should be below that required for oscillation. It may be a potentiometer, for maximum selectivity, or a fixed resistor. The feedback voltage through  $R_f$  is enough to compensate for the losses inherent in the tank circuit. Hence  $R_f$  can be adjusted to the point where the circuit will oscillate at frequency  $f$ . Any value below this initial value will increase the  $Q$  of the tank. If it is assumed that the input impedance of the emitter follower stage  $Q1$  is infinite and there is no loading on the tank, the critical value of  $R_f$  is:

$$R_f = 0.5 \pi f L Q,$$

(continued on p. 110)

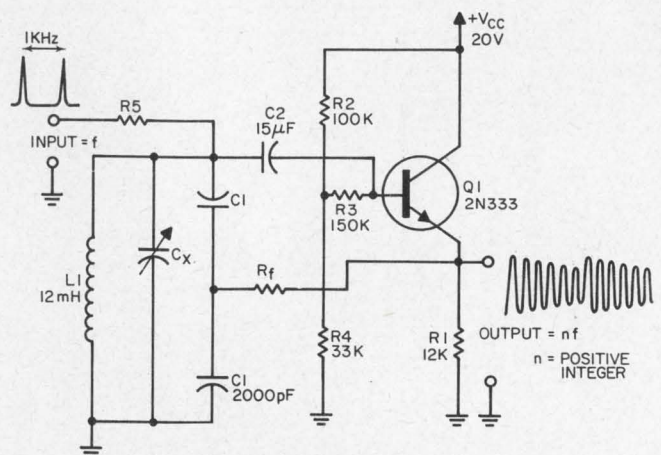

**Conventional  $Q$  multiplier circuit** performs efficient high-order frequency multiplication.



**ALSiMAG<sup>®</sup>**  
**THIN FLAT CERAMIC**  
**S N A P - S T R A T E S**  
**IN PREFERRED STYLES**

*Substantial production economies may result from monolithic but separable alumina ceramic substrates as pioneered and developed by American Lava. The user snaps the parent part into individual substrates AFTER all film and circuit work is completed.*

We suggest you consider presently available preferred style Snap-Strates. They involve no tooling charges and are more promptly available. These Snap-Strates can be supplied in ALSiMag 614, a dense 96% alumina ceramic with a natural finish highly desirable for thick film or screened circuitry. Where a smoother natural surface is required, as in thin film, ALSiMag 772, a dense ultra-smooth 99½% alumina ceramic is supplied.

Tooling is presently available for preferred style Snap-Strates in a thickness of .020" in these sizes:

Snap-Strate ALSiMag 614 1" x 2"  
yielding four ½" x 1"  
Snap-Strate ALSiMag 614 1" x 2"  
yielding eight ½" x ½"  
Snap-Strate ALSiMag 772 2" x 2"  
yielding four 1" x 1"  
Snap-Strate ALSiMag 772 1½" x 2½"  
yielding sixty ¼" x ¼"

**New bulletin No. 661 on Ceramic Substrates and Snap-Strates will be sent on request.**

The tooling is interchangeable between ALSiMag 614 and ALSiMag 772 if a slight difference in size is not critical.

As new requirements in volume are established, Snap-Strates will be made available to meet these new needs. If you have special requirements, we will be glad to make Snap-Strates to your blueprint or to work with you to find the most economical design.

CODE IDENT. NO. 70371

PHONE 615 265-3411 • CHATTANOOGA, TENNESSEE 37405, U.S.A.

**American Lava Corporation** **3M**  
A SUBSIDIARY OF **COMPANY**

For service, contact American Lava representatives in Offices of Minnesota Mining and Manufacturing Company in these cities (see your local telephone directory): Atlanta, Ga. • Boston: Needham Heights, Mass. • Chicago: Bedford Park, Ill. • Cleveland, Ohio • Dallas, Tex. • Laurens, S. C. • Los Angeles, Calif. • Metropolitan New York: Ridgefield, N. J. • Up-State New York and Canada: Baldwinsville, N. Y. • Philadelphia, Penn. • Roanoke, Va. • St. Louis: Lees Summit, Mo. • South San Francisco, Calif. Troy, Michigan • 3M International: c/o American Lava Corporation, Chattanooga, Tenn. 37405, U.S.A., Phone 615/265-3411.

65th  
YEAR  
OF  
CERAMIC  
LEADERSHIP

where  $Q$  = loaded  $Q$  of the coil and  $f$  = multiplied frequency.

The emitter-follower stage is designed for Class-A operation.  $R3$  should be as large as possible to avoid loading the tank with the parallel combination of  $R2$  and  $R4$ , and the transistor input impedance. The input wave can be a sawtooth, or pulse wave with high harmonic content. This is fed to the base circuit of  $Q1$  through resistor  $R5$ , which is also selected so as not to load the tank circuit. A capacitor  $C_x$  can be inserted across  $L1$  to obtain exact tuning to the desired harmonic and can also serve to tune to higher or lower harmonics.

The circuit performed good frequency multiplication of 1 kHz up to 40 kHz at temperatures above 60°C.

A. L. Plevy, Designer, East Brunswick, N. J.

VOTE FOR 112

## For higher gain, diode network reduces negative feedback

If the gain of an amplifier is increased as the signal level increases, it will linearize transducers' nonlinear outputs and enhance selected portions of a video signal.

The inclusion of two diodes in the emitter feedback loop (Fig. 1) helps to reduce the negative feedback. This leads to an increase in stage gain.

The diodes are biased into conduction whenever the signal excursions at the emitter reach a certain amplitude (about 0.9 V p-p). Then  $R_F$ , in parallel with the emitter resistor, reduces the negative feedback. The signal level at which this nonlinearity occurs may be increased by the

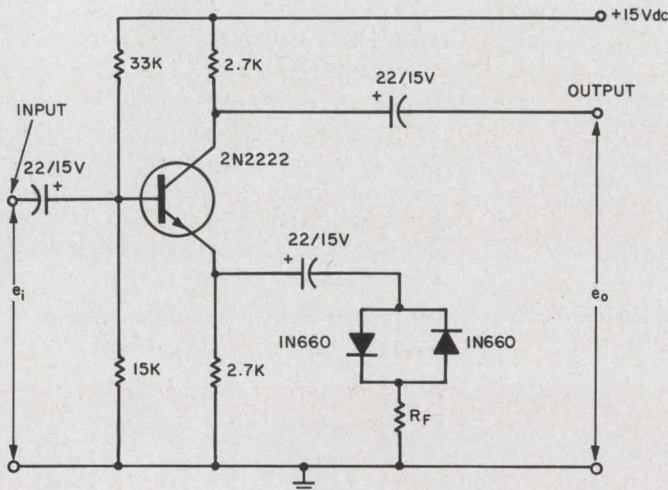

1. Gain of nonlinear amplifier increases with increasing signal levels because of the diodes in its emitter feedback loop.

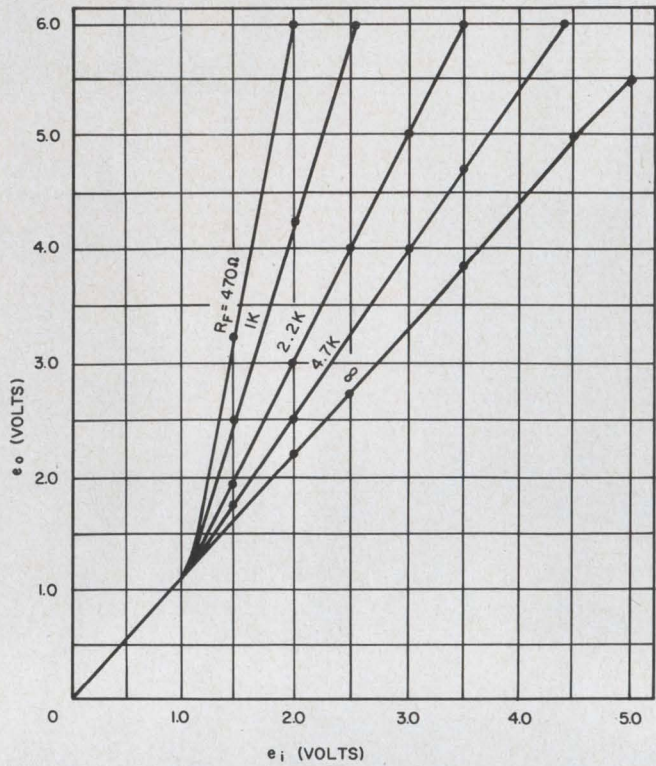

2. The transfer characteristics of the amplifier may be adjusted by varying  $R_F$ . The diodes are biased into conduction at the break point of 1 volt.

inclusion of more than one diode in each leg of the parallel feedback network. As shown in the plot of the transfer characteristics (Fig. 2), the gain above the break point may be adjusted by varying the value of  $R_F$ .

If the diodes are placed in the collector-to-base feedback network, the gain will be reduced (see "Complementary diode feedback produces nonlinear gain," ELECTRONIC DESIGN, XIII, No. 12 (June 7, 1965), p. 42).

Jack K. Hickman, Engineer, Texas Instruments, Inc., Apparatus Div., Dallas.

VOTE FOR 113

## Synchronized one-shot built with three SCRs

A useful, synchronized one-shot can easily be built with silicon-controlled rectifiers.

Operation of the circuit (see figure) is as follows: Assume that the line voltage has been connected for some length of time and the reset button  $S2$  has been activated. Then  $SCR2$  is the only SCR conducting. During the positive half cycle  $SCR2$  conducts through paths  $R2 - D9 - SCR2$  and  $D7 - R1 - SCR2$ , and  $C1$  charges through  $S1 - D11 - C1 - R5$ . During the negative half cycle,  $SCR2$  is

**TRW**  
*Varicap\**

JAN 1N4801A  
JAN 1N4802A  
JAN 1N4803A  
JAN 1N4804A  
JAN 1N4805A  
JAN 1N4806A  
JAN 1N4807A  
JAN 1N4808A  
JAN 1N4809A  
JAN 1N4810A  
JAN 1N4811A  
JAN 1N4812A  
JAN 1N4813A  
JAN 1N4814A  
JAN 1N4815A

## The first JAN voltage-variable capacitor!

TRW's newest addition to the broadest line of voltage-variable capacitors...JAN 1N4801A-1N4815A Varicaps to MIL Spec 19500/329B!

Outstanding characteristics are extremely low leakage (less than 0.005  $\mu$ A at MWV) and the widest

capacitance change per volt available anywhere!

Optimum uniformity and tracking is assured by TRW proprietary alloy junction process—ideal for VCO, VCXO and delay lines. Capacitance range from 6.8 to 100 pF nominal.

Contact any TRW distributor or TRW Semiconductors Inc., 14520 Aviation Blvd., Lawndale, Calif. 90260. Phone: 679-4561.

# TRW

\*VARICAP IS THE TRADEMARK FOR SILICON VOLTAGE-VARIABLE CAPACITORS MANUFACTURED BY TRW.

ON READER-SERVICE CARD CIRCLE 52

ELECTRONIC DESIGN 28, December 6, 1966

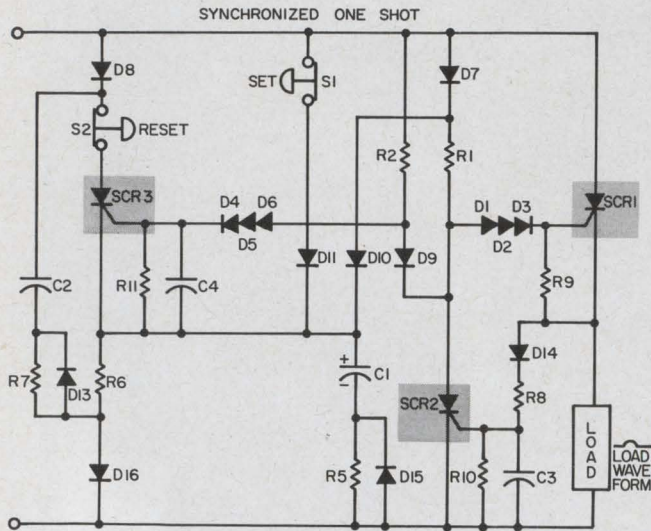

SCRs are used to build a synchronous one-shot useful for dispensing-system and electric welding applications.

held in conduction by capacitor  $C1$ 's discharging through path  $D10 - R1 - SCR2 - D15$ .

The time constant  $R1 - C1$  must be chosen such that a discharge current greater than the holding current of  $SCR2$  flows for more than one half cycle but less than two half cycles.  $R5$  is chosen such that it safely limits the charging current of  $C1$  during the positive half cycle through  $S1 - D11 - C1 - R5$ .  $SCR1$  and  $SCR3$  are prevented from triggering into conduction by the IR drop across  $R1$  and  $R2$  and by the fact that the series combinations of diodes  $D1 - D2 - D3$  and  $D4 - D5 - D6$  combine to form a junction whose breakdown is higher than the voltage drop across  $SCR2$ .

If set button  $S1$  is depressed,  $C1$  is no longer charged during the positive half cycle.  $C1$  will discharge such that, at the beginning of the next positive half cycle,  $SCR2$  will be OFF and  $SCR1$  will be triggered through path  $D7 - R1 - D1 - D2 - D3$  to its gate. Similarly  $SCR3$  will be triggered through  $R2 - D6 - D5 - D4$  to its gate, but later than  $SCR1$ , since  $R2$  must first charge  $C4$  to  $SCR3$ 's gate breakdown voltage. When  $SCR1$  began conducting, a delayed triggering path ( $SCR1 - D14 - R3$ ) for  $SCR2$  was established.  $R8$  and  $C3$  must be chosen such that  $SCR2$  will always be triggered ON after  $SCR3$  for proper operation.

When  $SCR3$  conducts, it functions as an  $S1$  bypass which will supply a charging path for  $C1$  ( $D8 - S2 - SCR3 - D12 - C1 - R5$ ), regardless of how many cycles the operator holds  $S1$  open.  $SCR3$  locks in by virtue of  $C2$ 's being charged during the positive half cycle through path  $D8 - C2 - R7 - D16$ ; during the negative half cycle,  $C2$  discharges through  $S2 - SCR3 - R6 - D13$ , maintaining  $SCR3$  in conduction till the line reverses on it and it re-

sumes its blocking state. In the following positive half cycle,  $SCR1$  is prevented from triggering ON by  $SCR2$  as described earlier.  $SCR1$  then conducts synchronously for a complete half cycle and provides the operation expected of it.

The circuit has potential application in several areas such as electric welding or industrial dispensing systems.

Alexander Prokop, Research Dept., Skil Corp., Chicago, Ill.

VOTE FOR 114

## FETs in balanced modulators improve linearity and band

A balanced modulator made with field-effect transistors offers the best trade-off among conventional modulator types. It consumes less power than tube types, is less expensive than diode types and has a broader band than both the saturating and mechanical switching types. It is more linear than most bipolar transistor modulators, and its high degree of harmonic rejection eliminates the need for the filters used in switching modulators.

Almost any standard balanced-modulator application can be met with the circuit shown in Fig. 1, so long as the power and frequency limitations of the FETs are not exceeded.

The bridge is initially balanced with  $R7$  to give a minimum output signal with the modulating signal input grounded. During most of one half cycle of the modulating signal, diode  $D1$  is back-biased, and the gate of  $Q1$  is grounded through  $R3$  (typically about 1 M). This turns  $Q1$  on. At the same time the resistance of  $Q2$  is being modulated by the gate voltage, unbalancing the bridge to change the carrier level. During the other half

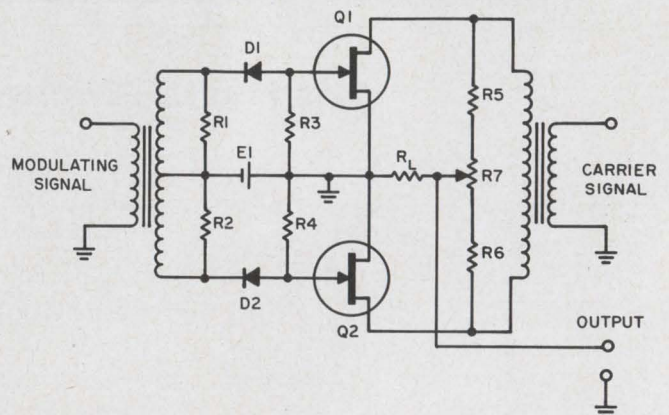

1. FET balanced modulator gives 180° zero-crossing phase shifts as the resistances of  $Q2$  and  $Q1$  are modulated during the first and second half cycles, respectively.



**Put out because you can't get a reliable 10 amp magnetic latch relay?  
Next time call Leach!**

Our 10-amp, 2 pdt, CL Series is just the answer. Of course we can't deliver bundles right now (it's just going into production), but we can meet your prototype requirements. And immediately.

This relay not only meets MIL-R-5757, but it's been tested against all your previous magnetic latch relay complaints. And it more than stands up to all of them.

For example, the CL magnetic assembly is a closed loop design which minimizes interaction with magnetic fields or other relays. And it only takes a 15msec pulse to switch and hold—no continuous power is required

It's the smallest (1.100 high). The lightest (1.6 oz.). And directly interchangeable with other magnetic latch relays.

The CL Series is rated at 50g shock; 30g at 2000 cps vibration. Pretty tough. And construction is all welded and sealed, contaminant free, with an electron beam.

So don't be soured by other types you might have tried.

Order ours. You'll get them. No ifs, ands, or...

Call Leach Corporation, Relay Division, 5915 Avalon Blvd., Los Angeles, California 90003.

Phone Area code (213) 323-8221

Export: LEACH INTERNATIONAL, S. A.

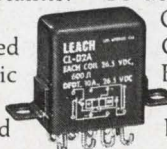

**LEACH**

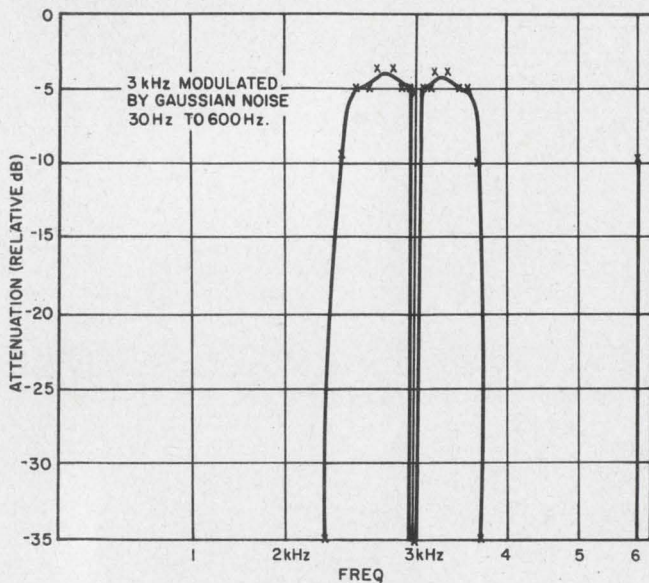

2. Spectrum of noise-modulated signal is essentially flat from  $f_c - f_1$  to  $f_c + f_1$  with a hole at  $f_c$ . The swept-frequency bandwidth is 10 cps.

cycle of the modulating signal,  $Q2$  is on and the bridge is unbalanced in the opposite direction. The  $180^\circ$  zero-crossing phase shift results, characteristic of a balanced modulator.  $E1$  biases the gates of the FETs slightly down, improving linearity during the time when the modulating signal is near zero, much like the biasing circuitry of a class-AB amplifier. A good value for  $E1$  is 5 to 10% of  $V_p$ .  $R1$  and  $R2$  minimize the effects of nonlinear transformer loading; they should therefore be much smaller than  $R3$  and  $R4$ .

The FETs should be matched for  $g_m$  or  $r_{on}$  and  $v_p$ . The modulating signal level should be kept small enough so that the FET's transfer function is approximately linear. If greater linearity is desired, a nonlinear function generator may be inserted in the gate lead to compensate for the nonlinearity of the FET transfer function. The transformers can, of course, be replaced with active phase splitters and suitable isolating capacitors, if the designer wishes.

The circuit values are noncritical and will vary with the FETs and transformers used, but here is a sample set:

$R5 + R6 + R7$  should be about equal to  $20 r_{on}$  of the chosen FET; so for a 2N4303,  $R5 = R6 = 3.3$  k $\Omega$  and  $R7 = 5$  k $\Omega$ .  $R_L$  should not load the bridge severely—27 k $\Omega$  is a good value.  $R3 = R4 = 1$  M $\Omega$ .  $D1 = D2 =$  any silicon signal diode (for silicon FETs), for example, 1N461.  $E1 = 1/2$  V with the 2N4303s.  $R1 = R2$ , and these should be selected to match the transformer, or vice-versa, but they should not be so large that 1 M $\Omega$  will provide significant loading. To conserve modulating power, values as high as 68 k $\Omega$  may be used for audio-frequency work.

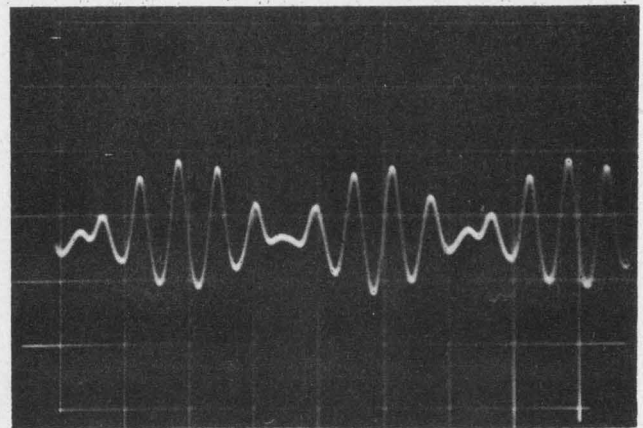

3. Typical output waveform shows the modulation of 3-kHz signal by a 300-Hz one. The vertical scale is  $-50$  mV/cm, and the horizontal,  $500 \mu\text{sec/cm}$ .

Of course, system constraints,—such as input and output impedance, required frequency range, etc.—must be considered in the selection of element values and transistors.

The carrier rejection of the circuit is greater than 35 dB, as is the second harmonic rejection. Linearity in the 1-2% region can be obtained without function generators if signal levels are kept low and the FETs and diodes are fairly closely matched. Extremely close matching is not required—about 5% for  $r_{on}$  and 10% for  $V_p$ .

The unit is broadband with respect to both the carrier and the modulating signal, which is a distinct advantage over a class-C balanced modulator in many applications.

If the modulating signal is noise that has been passed through a low-pass filter with cut-off frequency  $f_1$ , and the carrier frequency is  $f_c$ , the resultant spectrum (Fig. 2) will be essentially flat from  $f_c - f_1$  to  $f_c + f_1$  (with a hole at  $f_c$ ). This flatness is a result of the modulator's carrier-rejection properties. The band of noise may be varied in frequency by varying  $f_c$ .

A typical output waveform of a 3-kHz sinusoidal signal modulated by a 300-Hz signal is shown in Fig. 3.

*James M. Kasson and John L. Stewart, Research Associates, Santa Rita Technology, Inc., Menlo Park, Calif.*

VOTE FOR 115

**IFD Winners for Aug. 30, 1966.**

**Gilbert Marosi and Neal Vinson**, Design Engineers, Link Group, General Precision, Inc., Sunnyvale, Calif.

Their Idea, "Extra transistor gives Schmitt monostable multi capabilities," has been voted the \$50 Most Valuable of Issue Award.

**Cast Your Vote for the Best Idea in this Issue.**

# POWER SUPPLIES FOR LOGIC CARD SYSTEMS.

# Now available in any current to 40 amps.

**0.5 amps**  
12 volts  
Model HT12-0.5A  
\$75

**1.5 amps**  
12 volts  
Model HT12-1.5A  
\$99

**4.0 amps**  
12 volts  
Model HT12-4.0A  
\$138

**8.0 amps**  
12 volts  
Model HT12-8.0A  
\$198

**14.0 amps**  
12 volts  
Model HS12-14.0  
\$268

**20.5 amps** 12 volts  
Model HS12-20.5 \$340

**40.0 amps** 12 volts  
Model FS12-40.0 \$515

## CONSOLIDATED AVIONICS



800 Shames Drive, Westbury, L.I., New York, (516) ED 4-8400

TWX: 510-222-6151

The modules shown on this page, designed specifically for logic card systems, are just part of Con Avionics' line of power supplies. Those shown all operate at 12 volts. (We make just as many at 3, 6, 18 or any other logic card voltage.) The modules have a combined line and load regulation of  $\pm 0.05\%$ .

Like all Con Avionics power supplies, these are unconditionally guaranteed for five years. Models with a current rating below 10 amps have a typical M.T.B.F. of 100,000 hours. Others have an M.T.B.F. of 35,000 hours.

You'll find Con Avionics supplies for relay applications, IC systems, or any systems requirement, all listed and priced in our Catalog 66A. For your copy, circle card, or write, call or TWX Mr. Gerry Albers.

ON READER-SERVICE CARD CIRCLE 54

Here's the first AC-powered, high sensitivity Null Detector that won't upset circuit balance!

# New Honeywell 3990 with True Differential Input

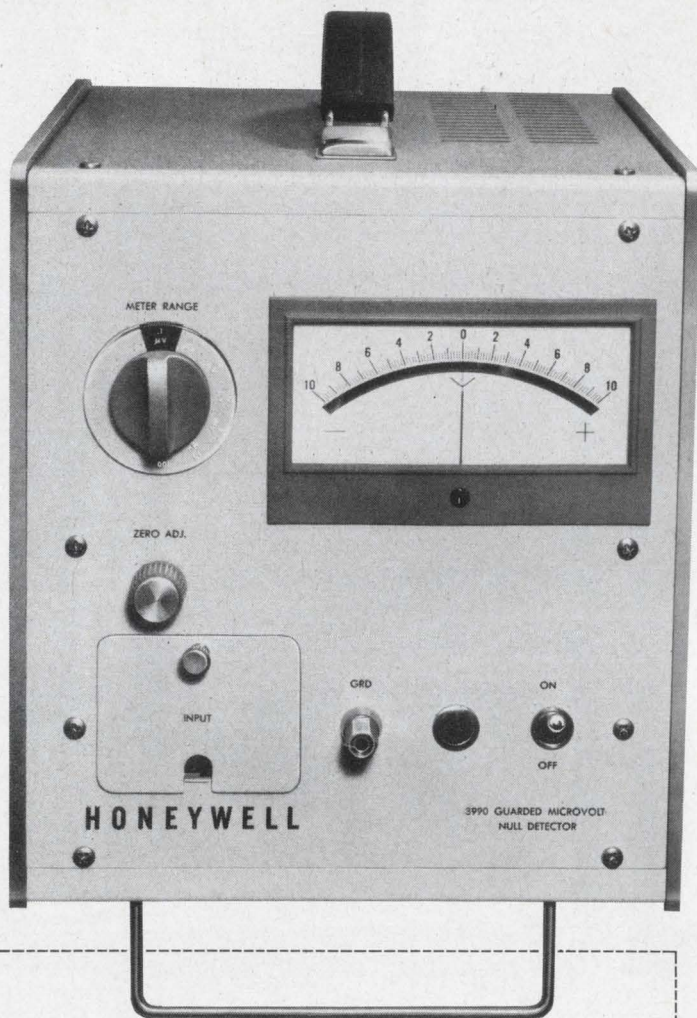

The new Honeywell 3990 Null Detector's true differential, symmetrical input permits AC operation while providing isolation and common mode rejection comparable to similar battery powered units. When reversing polarity, absolutely no Zero Offset is experienced. A wide performance range is assured by sensitivity of better than 20 nanovolts, with seven full scale ranges from  $\pm 0.1$  microvolts to  $\pm 100.0$  millivolts. And, the new 3990's high input impedance allows its use with source impedances or unbalance as high as 6000 ohms without degradation of performance.

The Honeywell 3990 eliminates these common measurement problems:

- False balance when reversing polarity
- Inaccuracies due to ground loops
- Large decrease in sensitivity due to high source impedances
- High noise levels due to high source impedances
- Stray noise pickup
- Poor common mode rejection on AC operation

These features make the 3990 the most versatile Null Detector you've ever used:

- Failsafe operation with excessive input overload
- AC operation – no battery replacement
- Chopper stabilized operational amplifier assures excellent stability
- High CMR; greater than 160 db @ 60 Hz
- Expanded scale meter for greater resolution
- Grounded recorder output, completely isolated from input.
- Available as bench or rack-mounted model

All these outstanding features, yet the new 3990 is as easy to use as a galvanometer and you don't have to worry about vibration! For complete information, contact your Honeywell Representative, or mail the coupon for fully illustrated literature.

**LABORATORY STANDARDS**  
**Honeywell**

Carl Boyer  
Mail Station 12-12A  
Honeywell Test Instruments Division  
Denver, Colorado 80217

Please send Model 3990 Null Detector literature to:

Name \_\_\_\_\_

Company \_\_\_\_\_

Address \_\_\_\_\_

City \_\_\_\_\_ State \_\_\_\_\_ Zip \_\_\_\_\_

ON READER-SERVICE CARD CIRCLE 55



# Products

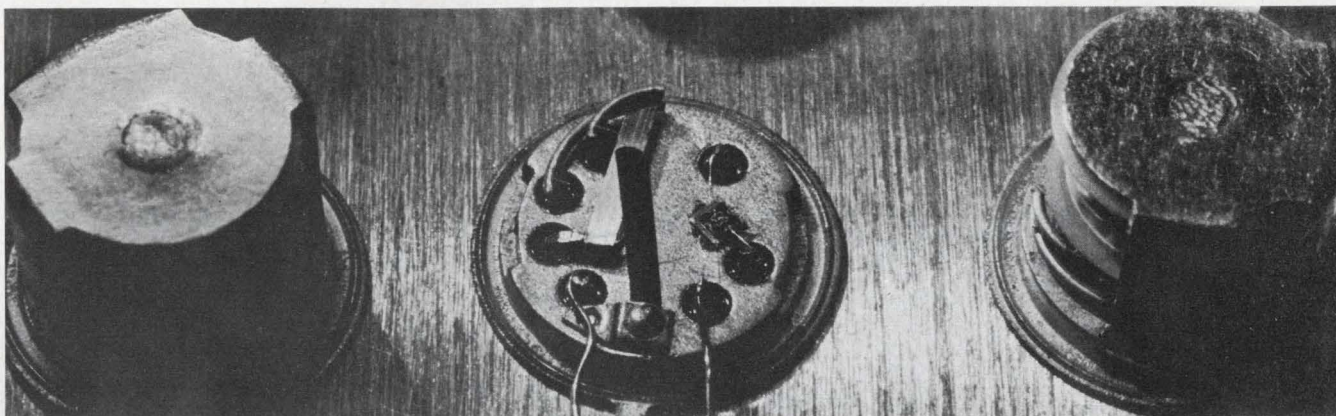

A relay and a FET in a TO-5 can? For operation off low-level micrologic, this spdt relay has its

own integral solid-state amplifier. Strange partners in a TO-5 can? Page 118.

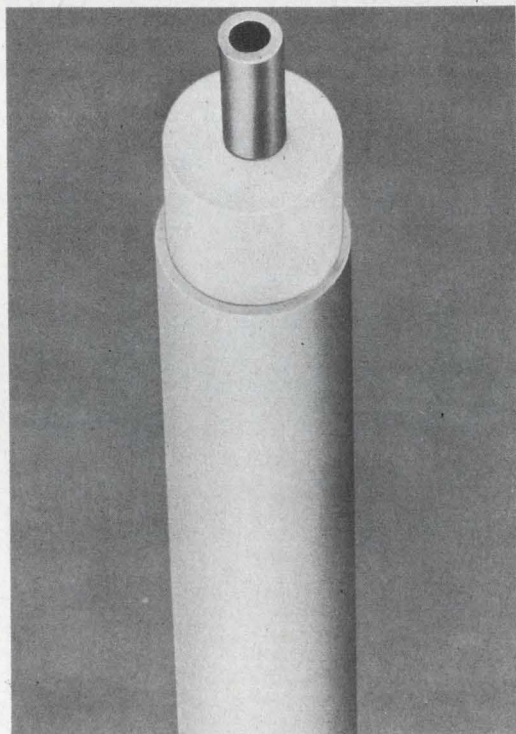

Low-loss cable uses foam dielectric, tubular outer conductor. Page 156.

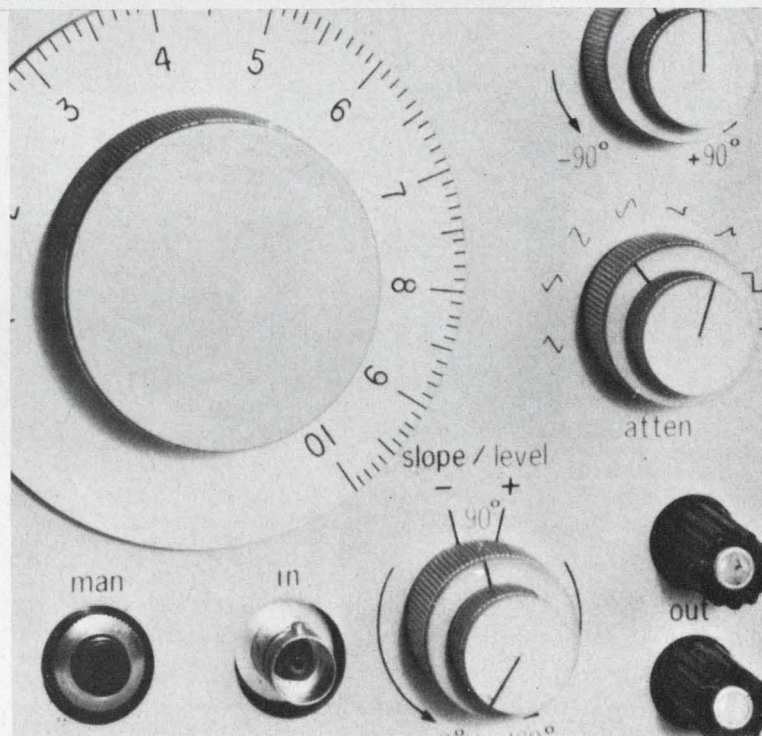

Portable function generators operate triple-mode—triggered, gated or phase-locked. Page 144.

## Also in this section:

**Tiny inductors** are tuned from the top. Page 122.

**Submin silicon diodes** lose their whiskers. Page 152.

**Unijunction transistors** for long time-delay circuit design. Page 153.

## FET amplifier and relay in a TO-5 can operates directly off low-level microcircuitry

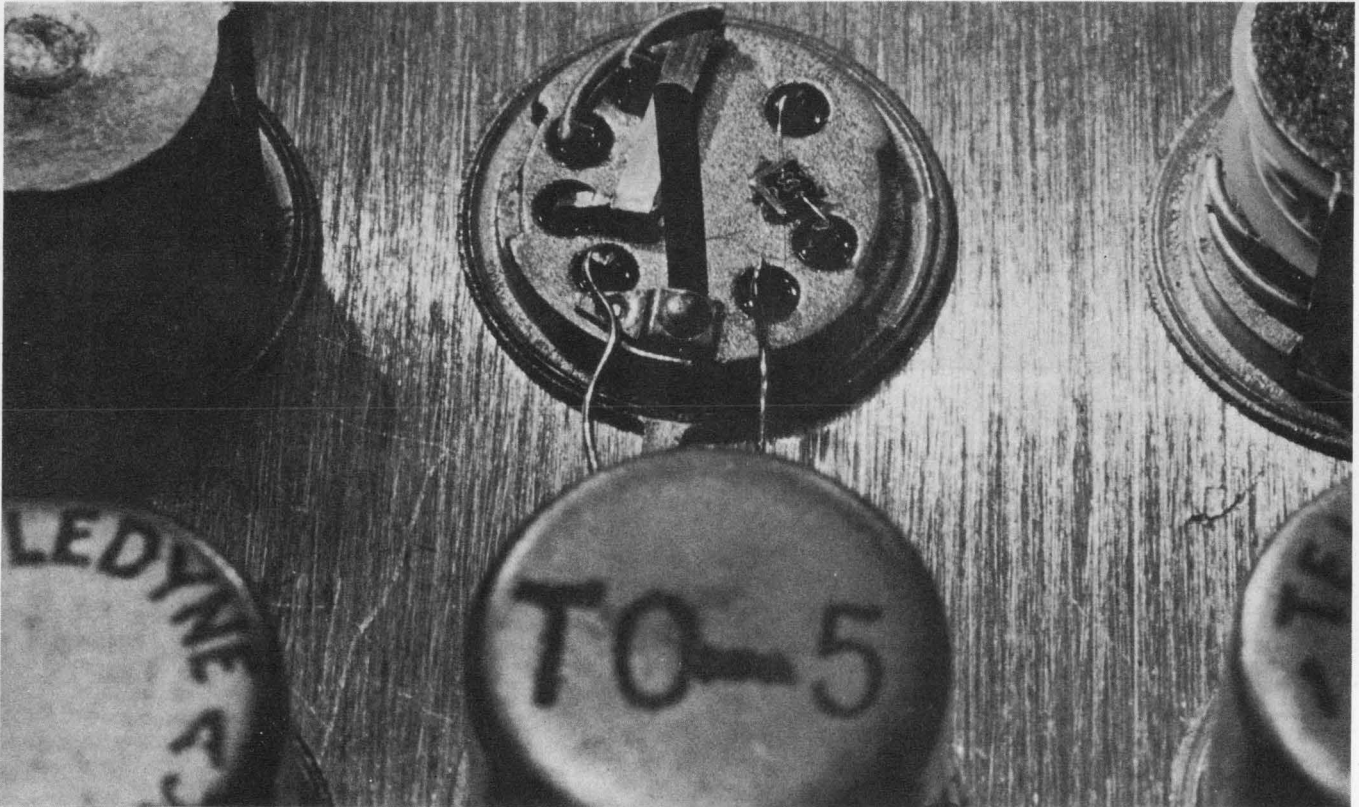

Teledyne Precision, Inc., 3155 El Segundo Blvd., Hawthorne, Calif. Phone: (213) 679-2205. P & A: \$29.85 (1 to 99), \$22.50 (500) for FET, \$27.90 (1 to 99), \$20.90 (500) for bipolar; 6 wks.

Proponents of solid-state technology have been declaring the mechanical relay passé. Opponents, on the other hand, say that relays have isolation and environmental advantages that solid-state switching devices cannot match. Teledyne Precision, Inc., has paused long enough in the scuffle to combine the best of the two technologies: it has put its TO-5 relay and a FET or bipolar transistor amplifier in the same TO-5 can.

Formerly the circuit engineer could design in a relay that would be tripped directly (requiring a comparatively large amount of current). Or he could use a transistor in conjunction with the relay to reduce the amount of current needed for activation. The new Teledyne line provides the relay and amplifying device inside the standard

TO-5, so that, for the same space and weight, the designer has a relay that requires only tiny drive currents for operation directly off low-level logic circuits.

Two devices are being introduced. The relay-FET amplifier requires only nanoamps to trip the relay. The relay-bipolar transistor amplifier offers

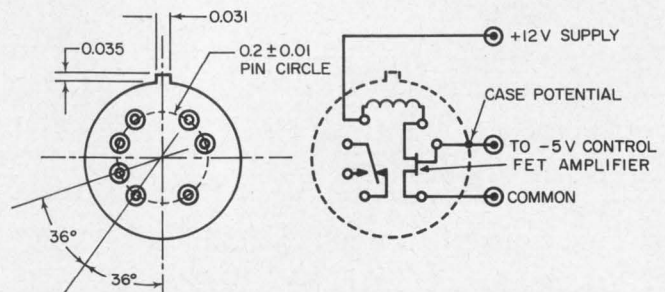

Spdt relay and FET driver are mounted in standard TO-5 can. Supply voltage is 12 Vdc nominal and relay coil is rated at 500  $\Omega$ .

# NEW LOWER PRICES

## NEW TEST DATA FOR CTS INDESTRUCTIBLE CERMET SEMI-PRECISION RESISTOR NETWORKS

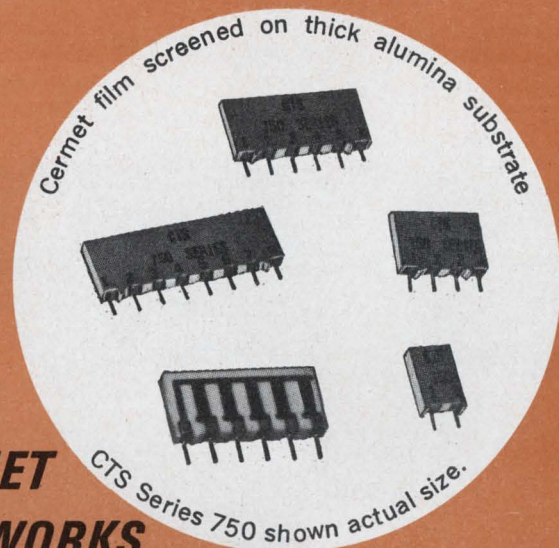

Series 750	2-Pin (1 Resistor)	4-Pin (3 Resistors)	6-Pin (5 Resistors)	8-Pin (7 Resistors)
Total Module Load	0.5 Watts	1.0 Watts	1.5 Watts	2.0 Watts
Approx. 10,000 cost	<del>20¢</del> <del>\$0.22 ea.</del>	<del>21¢</del> <del>\$0.24 ea.</del>	<del>23¢</del> <del>\$0.26 ea.</del>	<del>29¢</del> <del>\$0.31 ea.</del>
Approx. 100,000 cost	<del>18¢</del> <del>\$0.20 ea.</del>	<del>19¢</del> <del>\$0.22 ea.</del>	<del>21¢</del> <del>\$0.24 ea.</del>	<del>26¢</del> <del>\$0.28 ea.</del>

STANDARD MODULE SPECIFICATIONS FOR ALL SIZES	
Resistance Range	50 Ω to 100K Ω
Resistive Tolerance	±5.0%
TC	±300 ppm/°C
Load Life: 0.1 W per resistor at 70°C, 1000 hrs. (Over 4,000,000 resistor hours)	±0.40% Δ R max. ±0.20% Δ R av.
Moisture Resistance: .1 rated wattage at 70°C, 90-98% humidity, 1000 hrs.	±0.50% Δ R max. ±0.20% Δ R av.
Insulation Resistance: measured wet after moisture resistance test, 200 VDC	500 meg. Ω
Thermal Shock: 5 cycles, -63°C to +125°C, no load	±0.10% Δ R max. ±0.03% Δ R av.
Short Time Overload: 2.5 times rated voltage, 5 sec.	±0.25% Δ R max. ±0.05% Δ R av.
Low Temperature Exposure: -63°C, 4 hrs.	±0.10% Δ R max. ±0.04% Δ R av.
Terminal Strength: 5 lb. tensile & compression, 30 sec.	±0.10% Δ R max. ±0.03% Δ R av.
Effect of Soldering: 63/37 solder, 246°C, 2 sec.	±0.10% Δ R max. ±0.05% Δ R av.

The data speaks for itself. Examine and judge its value for your application:

Extreme Stability and Reliability
High Power Capability: (Up to 1 watt per resistor)

- Space saving—a single module replaces up to 7 discrete resistors.
- Available in an infinite number of circuit combinations.
- Custom-built to your exact requirement.
- Ideally suited for cost-saving automatic handling.
- Cover coating unaffected by solvents.



founded 1896 Request Cermet Catalog

**CTS**  
**OF BERNE, INC.**  
**BERNE, INDIANA**

SUBSIDIARY OF  
CTS CORPORATION • ELKHART, INDIANA

Extra cost options	
Resistance Range	10 to 49 Ω, 101K to 1 meg. Ω
Resistive Tolerance	±0.5%, 1%, 2.5%
TC	±150 ppm/°C

ON READER-SERVICE CARD CIRCLE 56

**Designed  
for  
Advanced  
Data Systems...**

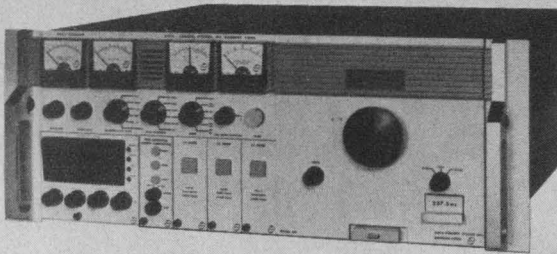

**The  Series 400  
TELCOM Receiver**

**Look at these features...**

- All solid state design
- Superior performance
- Completely modular, plug-in construction
- RF heads for VHF and S-Band telemetry, sweep tuned and wide band heads for surveillance applications
- Plug-in pre-detection recording converter, spectrum display, electrically switchable IF Filters

**Interested?** Get the detailed specifications. Write for your free copy of the DCS Series 400 TELCOM Receiver brochure.

Would you like an appointment to see a TELCOM Receiver for yourself? Just call the DCS office below nearest you...

Dept. ED-10-66 East Liberty Street, Danbury, Conn. 06813  
Telephone: 203-743-9241 • TWX 744-1990



**DATA-CONTROL SYSTEMS INC.**  
*Instrumentation for Research*

Sales Offices  
Silver Spring, Md., Huntsville, Winter Park, Long Beach, Santa Clara,  
Albuquerque

Copenhagen London Rome Paris Munich Amsterdam

ON READER-SERVICE CARD CIRCLE 57

COVER FEATURE

**Component characteristics**

**FET (Amelco U1526)**

$BV_{(DS)} = 40 \text{ V}$  ( $V_{DS} = 0, I_D = 0.001 \text{ mA}$ )  
 $I_{DSS} = 20 \text{ mA}$  ( $V_{DS} = 20 \text{ V}, V_{GS} = 0$ )  
 $I_{DGO}, I_{SGO} = 1 \text{ nA}$  ( $V_{DG} = 25 \text{ V}, I_S = 0$ )  
 $I_D(\text{off}) = 1 \text{ nA}$  ( $V_{DS} = 20 \text{ V}, V_{GS} = 11 \text{ V}$ )  
 $V_p = 2 \text{ to } 10 \text{ V}$  ( $V_{DS} = 20 \text{ V}, I_D = 10 \text{ nA}$ )  
 $R_{DS(\text{on})} = 100 \Omega$  ( $V_{GS} = 0, I_D = 1 \text{ mA}$ )

**Bipolar transistor (Amelco A1341)**

$h_{FE} = 50$   
 $P_c = 200 \text{ mW}$   
 $V_{CBO} = 75 \text{ V}$   
 $T_j = 150^\circ\text{C}$   
 $I_{co} = 0.01 \mu\text{A}$

**Relay**

Contacts: 1 Form C (spdt)  
 Contact rating: low-level to 1 A, 28 Vdc  
 Contact resistance: 0.1 to 0.2  $\Omega$   
 Life:  $10^5$  cycles at 1 A,  $10^8$  cycles at low-level  
 Insulation resistance: 10,000 M $\Omega$  at 500 Vdc  
 Operate time: 2 ms max  
 Contact bounce: 1.5 ms max

the same benefits in those cases where the FET's input impedance is not a consideration. Prices here are slightly lower.

The relay itself, which Teledyne believes to be the world's smallest, has been available in the TO-5 can for about two years. It is rated at 1-A 28-Vdc resistive in an spdt contact arrangement. Supply voltage is 12 Vdc and load resistance (coil) is  $500 \Omega \pm 10\%$ . Initial contact resistance is 1  $\Omega$ , increasing to a maximum of 2  $\Omega$ . The operating time is 2 ms.

The addition of the chip inside the same can produces some obvious design benefits: compared with the use of a discrete relay and discrete solid-state amplifier, the new units cut volume in half, reduce weight by the same factor and increase reliability (one header and a whole set of interconnections are eliminated).

The unique package has not compromised TO-5 can or relay reliability either. The devices meet MIL-R-5757 over an ambient range of  $-65$  to  $125^\circ\text{C}$ . They withstand 80-G, 11-ms shock and 30-G, 100- to 3000-Hz vibration with no opening of closed contacts in excess of 10  $\mu\text{s}$ .

The solid-state chips are being produced by Teledyne's Amelco Semiconductor Div. The FET, an Amelco U1526, is an n-channel silicon planar device. The bipolar, Amelco A1341, is a general-purpose silicon npn audio amplifier. Specs on the FET, the bipolar and the relay are tabulated in the table above.

CIRCLE NO. 159

# equipment shrinker's magic

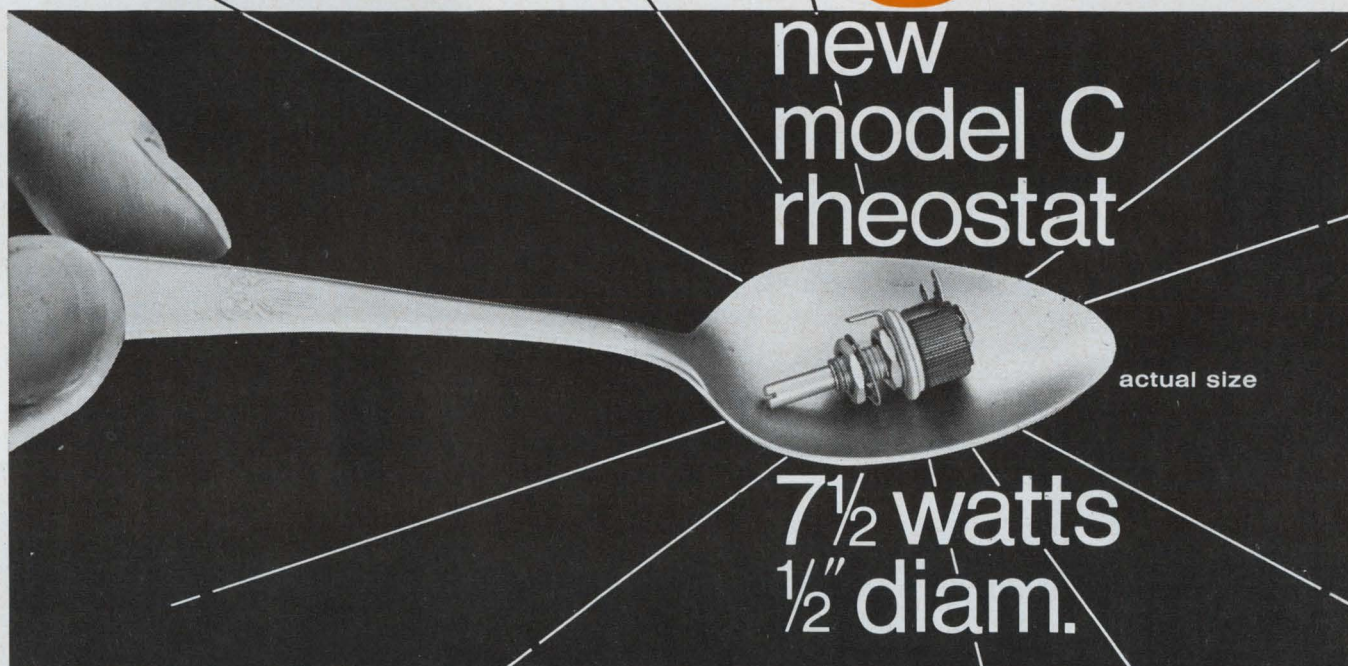

Quick, Watson, the magnifying glass! You'll need it when you examine this newest addition to Ohmite's family of wire-wound, ceramic rheostats.

The Model C follows the basic, rugged construction of Ohmite's bigger-wattage jobs which have been specified by industry for 35 years. Yet it measures only  $\frac{1}{2}$ " in diameter, and projects only  $\frac{15}{32}$ " behind the panel.

For its rating, you won't find anything that compares with the Model C rheostat. Specify it for extra design flexibility in equipment miniaturization.

**Rating:**  $7\frac{1}{2}$  watts\* at 40°C ambient.

**Resistance Values:** 10 to 5000 ohms.

**Shafts:** Standard type; locking-bushing type; also a high-torque shaft which holds its setting under conditions of shock and vibration.

\*Mounted on metal panel.

SEND FOR BULLETIN 203C

Ohmite . . . World's Largest Selection  
of Power Rheostats:  $7\frac{1}{2}$  to 1000 Watts

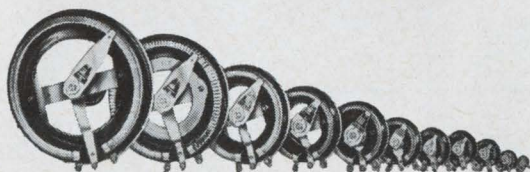

**RHEOSTATS • POWER RESISTORS • PRECISION RESISTORS • VARIABLE TRANSFORMERS • RELAYS  
TAP SWITCHES • TANTALUM CAPACITORS • SEMICONDUCTOR DIODES • R.F. CHOKES**

# OHMITE

MANUFACTURING COMPANY  
3633 Howard Street • Skokie, Illinois 60076  
Phone: (312) ORchard 5-2600



ON READER-SERVICE CARD CIRCLE 58

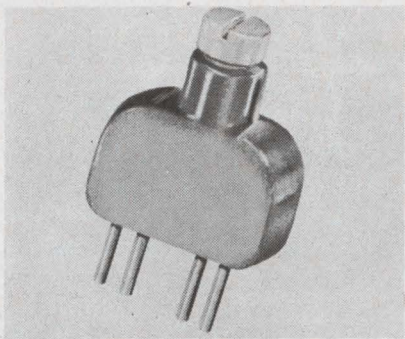

### Tiny inductors are tuned from the top

*Piconics, Inc., North Billerica, Mass. Phone: (617) 663-4862. P&A: from \$9.50; 2 weeks.*

Inductances from 0.006 to 5800  $\mu$ H are available in top-tuning TT inductors that measure 0.280 x 0.97 x 0.450-in. From 2:1 to 10:1 variance ranges are provided depending on the value of the inductance. A stability of 65 ppm/ $^{\circ}$ C is typical. All types of auto transformers, balancing transformers, bifilar transformers, fixed and tunable are available in the design.

CIRCLE NO. 160

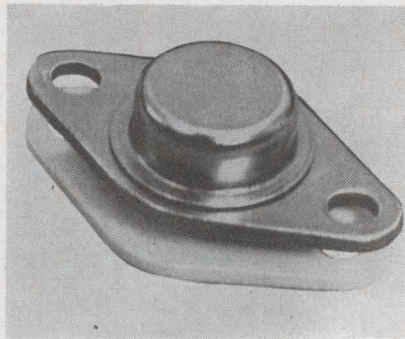

### BeO washer insulates TO-66 transistors

*Thermalloy Co., 8717 Diplomacy Row, Dallas. Phone: (214) 637-3333.*

For insulating many of the newer high-frequency high-voltage transistors, the 4066 washer is designed for TO-66 packages. The beryllium oxide washer is offered as an option to mica or anodized aluminum. Its insulation breakdown is typically 700 V/mil. Heat transfer is comparable to bare aluminum at 140 Btu/hr.ft. $^{\circ}$ F at 72 $^{\circ}$ F. Typical dielectric constant is 6.

CIRCLE NO. 163

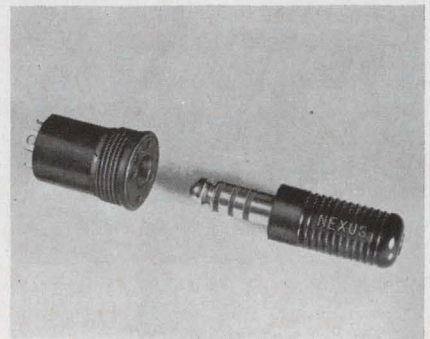

### Audio plugs and jacks accept 4 or 5 leads

*Nexus Inc., 700 Canal St., Stamford, Conn. Phone: (203) 325-1501.*

For intercoms, language labs and similar applications, here is a standard line of small 4- and 5-line plugs and jacks. One-piece contacts eliminate all soldered or welded joints in the line and plug contacts are nickel-plated brass molded into the grey plastic case (DuPont Delrin). Jacks have nickel-plated beryllium grabber contacts and phosphor bronze finger contacts.

CIRCLE NO. 165

The Kodak Instamatic M6 Movie Camera's battery-powered electric eye, with Vactec Cadmium Sulfide photocells, operates through the lens for high exposure accuracy.

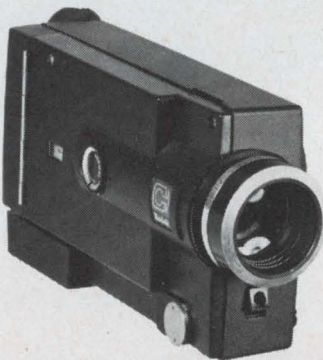

## Part of Kodak's automatic ease

"You aim through here, and press here." That's the simplicity of Kodak Instamatic Cameras. And Vactec furnishes part of the ease—photocells that automatically control exposure settings. Come to think of it, that's controlling quite a lot.

# vactec photocells

Vactec Selenium photocells are among the important components that help the Kodak Instamatic 804 Camera automatically integrate film speed, shutter speed, lens aperture and existing light to compute and set exposures faster than you could yourself.



You can always expect the finest in light sensitive devices from Vactec. A complete line of photocells is available for your products. Or, we will custom design units to meet special needs.

Write for Bulletin PCD-3 for Cadmium Sulfide and Selenide types; Bulletin SPV-4 for Selenium photoelectric types.

2423 Northline Industrial Blvd.  
Maryland Hts., Mo. 63045  
Area Code 314, HE. 2-4200

**VACTEC**

**INC.**

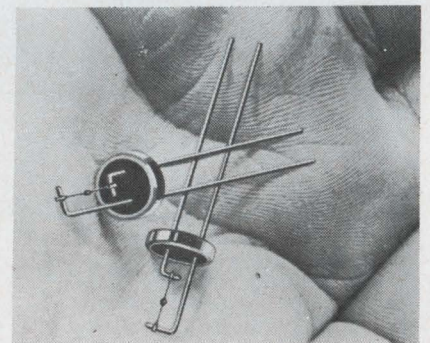

### Thermistors matched in current, voltage

*Fenwal Electronics, Inc., 63 Fountain St., Framingham, Mass. Phone: (617) 875-1351.*

Gas chromatographic equipment and other thermal conductivity gas analysis instruments are among the suggested applications for three voltage-current matched thermistors. The units are revised versions of the manufacturer's G112, G126 and G128 thermistors. A new method of mounting the thermistor bead is said to improve stability and reduce noise.

CIRCLE NO. 161

See Vactec's listing under "Semiconductors" in EBG, and in Sec. 3700 of EEM.

ON READER-SERVICE CARD CIRCLE 59

# ARNOLD IS



## **SILECTRON CORES**

### **Standard and Custom Designed Cores With Highest Performance Characteristics**

Arnold Silectron cores are fabricated from the highest grades of grain-oriented silicon steel. We maintain complete control over all phases of fabrication . . . processing, rolling, slitting, winding, annealing and final test are all "in plant" functions. Many are in stock ready for same day shipment.

Arnold is also ■ Permanent Magnets ■ Tape Wound Cores ■ Bobbin Cores ■ MPP Cores ■ Iron Powder Cores ■ Electrical Alloy Transformer Laminations ■ Transformer Cans & Hardware ■ Magnetic Shields ■ Special Magnetic Materials

Our facilities are complete



**ARNOLD**  
SPECIALISTS in MAGNETIC MATERIALS

THE ARNOLD ENGINEERING COMPANY, Main Office MARENGO, ILL.  
BRANCH OFFICES and REPRESENTATIVES in PRINCIPAL CITIES

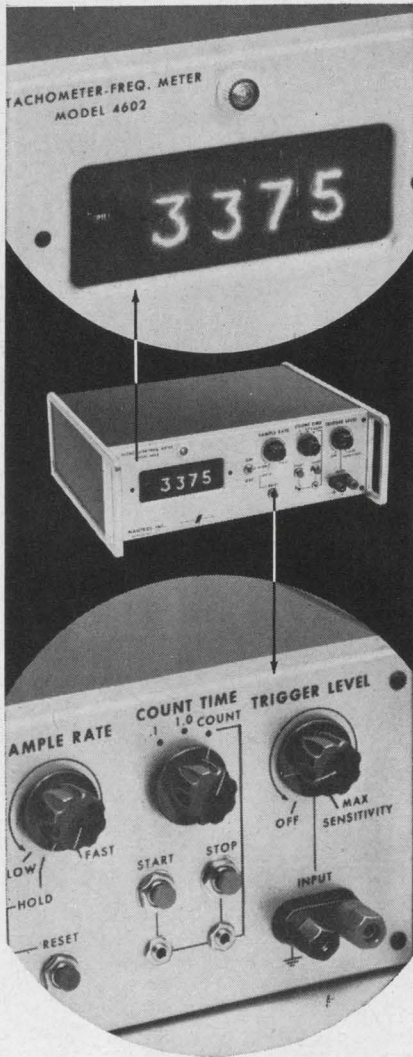

**SPEED MEASUREMENT  
FREQUENCY MEASUREMENT  
BATCH COUNTING  
TIME/INTERVAL MEASUREMENT**

- Proven Dependability
- Laboratory Accuracy

Magtrol's newest frequency counter uses all silicon transistors to provide utmost reliability, long life. Accuracy equals that of the line frequency, usually .05% or better. Nixie readout; spill indicator; external gating provision. \$575. For specifications and other data, ask for bulletin 101.

**MAGTROL INC.**  
240 SENECA ST. • BUFFALO, N. Y. 14204  
716 — 856-7451

ON READER-SERVICE CARD CIRCLE 62

COMPONENTS

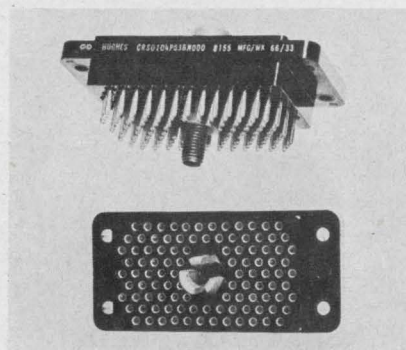

**Rectangular connector uses 16-gauge contacts**

*Hughes Aircraft Co., 500 Superior Ave., Newport Beach, Culver City, Calif. Phone: (714) 548-0671.*

A rectangular connector for OEM computer applications uses #16 contacts. It is offered in sizes from 10 to 212 contacts with a maximum contact density of about 50/sq-in. The over-all mated length of the CRS connector ranges from 1.675 to 2.875-in. Components of the 212-contact CRS connector will fit through a mounting hole 2.310 x 2.175-in.

CIRCLE NO. 162

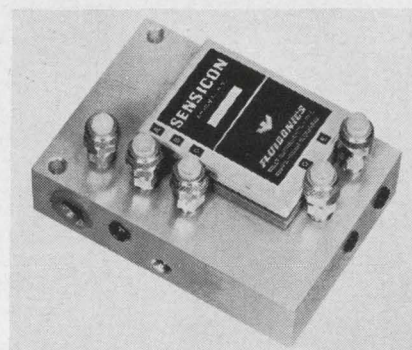

**Fluidic devices sense and control**

*Fluidionics Div., Imperial-Eastman Corp., 6300 W. Howard St., Chicago, Ill. Phone: (312) SP 4-1700.*

Circuit-sensing and control is offered by a line of fluidic devices called "Sensicon". The series is compatible with any control system requiring digital pressure output. The initial Sensicon uses an interruptible gap for proximity sensing, providing a digital on-off. The complete line will include devices designed for proximity, interruptible, temperature, noise, light or magnetic sensing.

CIRCLE NO. 164

# Photocell Decay Problems?

*Typesetter  
lost a zero.  
This should be  
.0006*

Try Type 7H

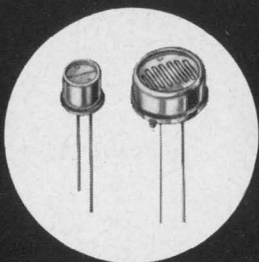

Clairex Type 7H Photocells now offer decay times of .006 sec @ 100 ft-c. Couple this with 240 ohms @ 100 ft-c, CdS stability, and your problems are solved. Available in TO-18 and TO-5 cases. And 6 resistance ranges.

**CLAIREX**  
"The LIGHT Touch in Automation and Control"  
1239 Broadway, New York, N.Y. 10001  
212 MU 4-0940

ON READER-SERVICE CARD CIRCLE 60





This is a naked YAES terminal.



We've stripped it to show why  
Burndy YAES Insulug® terminals  
are unique.

Once the insulation is off, it's easy to see that this terminal is a one-piece unit. That's a Burndy exclusive. Look closely and you'll see that the seam on the terminal body has been brazed. Another unique Burndy feature. And all YAES terminals are *fully* plated. You won't find any exposed copper edges. In fact, there are no unplated edges where the terminal is separated from the carrier. Look inside the terminal body, too. The surface has been serrated to insure intimate contact.

Additionally, each terminal is marked with the range of wire acceptable. As a double check, the tough, nylon insulation is color-coded to indicate wire size.

Installation is quick and easy with either MS 25037 or MR 8-83 ratchet-controlled hand tools.

Automatic installation tools are available, too. Burndy's Bandolug® equipment, the SME and the SME 10, handles wire ranging from 22 to 10. And they handle them quickly, simply and inexpensively. More so than any other tools.

Burndy YAES terminals meet both the Class I and II requirements of MIL-T-7928 when installed with appropriate tools.

There really is more than meets the eye when it comes to Insulug terminals and tools. Write for Bulletin YAES-66 and see for yourself.



INTERNATIONAL SALES HEADQUARTERS AND MANUFACTURING FACILITIES:

CANADA: Scarborough, Ontario / ENGLAND: St. Helens, Lancs. / BELGIUM: Mechelen / MEXICO: Naucalpan de Juárez / BRAZIL: São Paulo / JAPAN: Tokyo / Sales Offices in Other Major Cities

ON READER-SERVICE CARD CIRCLE 63

## COMPONENTS

### Rotary sampler below 50 microvolts in noise

*I.D.M. Electronics Ltd., Arkwright Road, Reading, Berkshire, England. Phone: Reading 82557. Price: from \$645.*

Extremely long life and very low noise are the leading features of a rotary sampling switch from Britain. Life is specified for 100 million revolutions minimum before servicing and noise is said to be below 50  $\mu$ V, too low to measure with

accuracy. In design the unit is a conventional multifinger wiping contact switch. Its features are credited to a special insulating material that eliminates tracking or leaks between contacts through grains of contact material that adhere to the insulator surface.

Max sampling speed with ten switch-disks is 640 points per second at a speed of 600 rpm. The insulation resistance is 200 Meg at 500 Vdc.

CIRCLE NO. 166

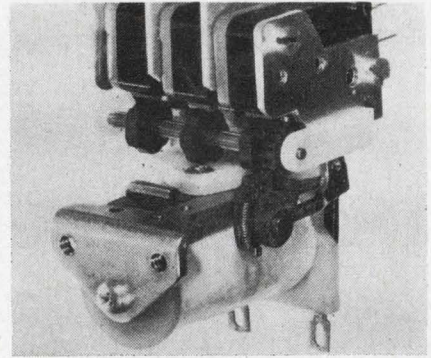

### Programed relay switches 15 amps

*Cornell-Dubilier Electronics, 50 Paris St., Newark, N. J. Phone: (201) 624-7500.*

Switching capability is rated at 15 A, 125-250 Vac for the 1460 series programed relays. The unit mounting up to 3 form-C switches, is intended for use in sequential controls in the industrial and commercial market. Programing is provided by cam geometry. The cam is driven by a small ratchet and pawl mechanism. Optional items, such as a coil harness to accept 1/4-in. quick-connect terminals, are available.

CIRCLE NO. 167

## Here's a tiny gang capacitor . . .



### that's rugged, precise, modular

True modular versatility permits a wider-than-ever range of applications for the new, ultra-compact Johanson Type 6100 gang capacitor. Specify from one to five sections . . . each section can be supplied in different capacitance ranges and in the following capacity variations: straight line capacity, straight line frequency, butterfly or split stator. Mounting versatility is another big feature — a special bearing mount permits easy direct panel mounting.

Functional simplicity is the keynote of the 6100. Exceptionally high shock and vibration resistance are the result of a new design utilizing an exclusive spring-type bearing and special alumina support of the rotor and stator. In addition the new 6100 series features low temperature coefficient, low torque and smooth tuning.

Save space . . . save cost. Get all the facts on the Johanson 6100 before you design your next project.

Write for full details, specifications

**Johanson** MANUFACTURING CORPORATION

400 Rockaway Valley Road, Boonton, N.J., Phone (201) 334-2676

ON READER-SERVICE CARD CIRCLE 64

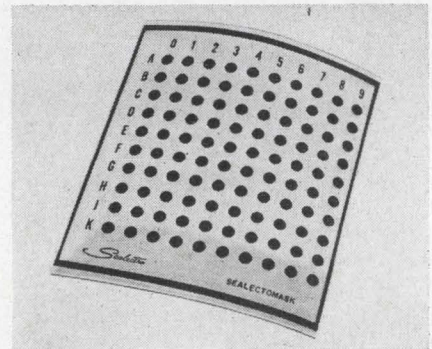

### Matrix mask guides programing

*Seaelectro Corp., 225 Hoyt St., Maroneck, N. Y. Phone: (914) 698-5600.*

A 10 x 10 program mask is offered as a means of insuring error-free programing of complex functions on matrix program boards. Called Seaelectomask, the template is made of Mylar film 0.005-in. thick. In use, it is pre-punched to allow a shorting-pin only at the correct points. Masks for larger programing boards or multiple boards are also available.

CIRCLE NO. 168



## *Open These Gifts First*

For those dreaming of computers for Christmas, or instrumentation using digital techniques, we have two free gifts for you — that really should be opened first.

Just published is a 540-page Handbook of Small Computers, which begins with a primer (or, what everyone should know about small computers), and goes on to describe, in detail, three of the most exciting small computers in the industry. The PDP-8/S, the PDP-8, and the LINC-8 are general purpose, on-line, real time, Fortran-speaking machines that are

friendly, approachable, creatively adaptable . . . Prices begin at \$10,000 for a complete computer.

The 330-page Digital Logic Handbook describes four series of Flip Chip™ modules, which are not only ideal for interfacing with the computers, but from which most digital instrumentation can be made. The handbook describes the logic in detail, as well as applications.

Write for your presents.

**digital**  
COMPUTERS • MODULES



## NEW/FROM NORTRONICS

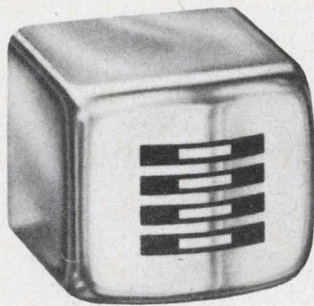

### 8-CHANNEL CAPABILITY ON 1/4" TAPE WITH LOW-COST MODEL BQL TAPE HEADS

For maximum information storage at minimum cost, Nortronics recommends the new Model BQL. Providing instrumentation head quality at audio head prices, the Model BQL is designed for high speed 8-track stereo duplicating and 4- or 8-channel instrumentation applications.

The Model BQL head is designed with four in-line tracks, spaced so that a pair of staggered heads will produce an interlaced pattern of eight channels on 1/4-inch tape. Track width is .021 ± .001, and head track spacing is .127 ± .001 between centers. Complete technical data is available on request.

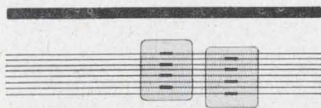

*The new Model BQL displays the quality, engineering, ingenuity, and responsiveness to every recording need that have made Nortronics the world's largest manufacturer of laminated core tape heads and the standard-setter for the industry.*

**If you're using heads, use your head . . . and check Nortronics first!**

**Nortronics**  
COMPANY, INC.

8101 Tenth Avenue North  
Minneapolis, Minnesota 55427

ON READER-SERVICE CARD CIRCLE 66

## COMPONENTS

### 25 and 50 Q-factors for varactor line

*Eastron Corp., 25 Locust St., Haverhill, Mass. Phone: (617) 373-3824. P&A: \$3.50-\$25.00; stock-30 days.*

With capacities of 1 to 5 pF at 4 Vdc, the MC200-205 and MC300-305 voltage-variable capacitors have a minimum Q-factor of 25 and 50 respectively. Minimum inverse current for both series is 0.1  $\mu$  amp at 50 V and PIV rating is 60 V. The components are available in 5, 10 and 20% tolerances. They are glass encapsulated in an axial-lead package 55% smaller than the DO-7.

CIRCLE NO. 169

### Trio-pentode tube for TV application

*General Electric, 2100 Gardiner Lane, Louisville, Kentucky. Phone: (502) 459-4323.*

Designed for use in color television receivers, the Compactron 6AG9 contains a triode and a high-transconductance frame-grid pentode. The pentode is intended for video output use and the triode for such applications as agc, sync separation or video amplification. Pentode performance is 30,000  $\mu$ mhos at 28-mA plate current and dissipation of 10 watts at the plate, 1.5 watts at the screen. The amplification factor of the triode is 39 with a transconductance of 4600  $\mu$ mhos and a plate current of 6.2 mA.

CIRCLE NO. 211

### Crystal oscillator instantly "on"

*MF Electronics Corp., 118 E. 25 St., New York. Phone: (212) 674-5360.*

"On-off" control of the 403A gated crystal oscillator is accomplished by grounding a contact, avoiding the stabilizing time required when power-control is used. The 403A is modularly constructed and is repairable in the field. It uses 28 Vdc and generates 2 V rms into 600  $\Omega$  at fixed frequencies from 3.5 Hz to 80 kHz with a tolerance of  $\pm 0.01\%$ , 0 to 60°C.

CIRCLE NO. 212

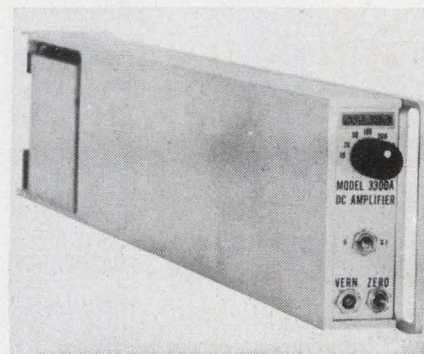

### Differential amplifier accepts microvolt input

*California Instruments Corp., 3511 Midway Dr., San Diego, Calif. Phone: (714) 224-3241. P&A: \$385-\$545; 30 days.*

With gains from 0.5 to 2500, the five models of the 3300A differential amplifier series accept microvolt level signals from dc to 50 kHz. The compact packaging allows 12 of the 3300A series units to fit into a single 19-in. rack adapter only 3-1/2-in. high. Linearity is +0.01% of full scale and accuracy is +0.1% at fixed-gain points. The basic unit has a single fixed-gain setup between 10 and 2500, and the four other models have seven fixed-gain points plus vernier.

CIRCLE NO. 213

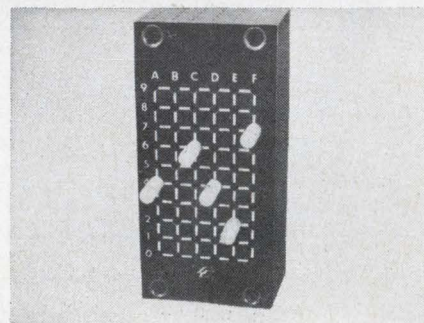

### Coded output switches stress flexibility

*Co-Ord Switch, 102-48 43 Ave., Corona, N. Y. Phone: (212) 899-5588. Price: from \$6.95/decade.*

A wide variety of binary codes are offered by the 63030 computer coded-output switches. Insertion of a single pin provides a 3-, 4-, 5- or 6-bit word output. Decades can be provided in 1248, 1247, 1125, 1224 and other codes specified. The switches are offered as an option to standard thumbwheels.

CIRCLE NO. 214

**ALLEN-BRADLEY Type J**  
Hot Molded Variable Resistor  
rated 2.25 watts @ 70°C  
shown 2 times  
actual size.

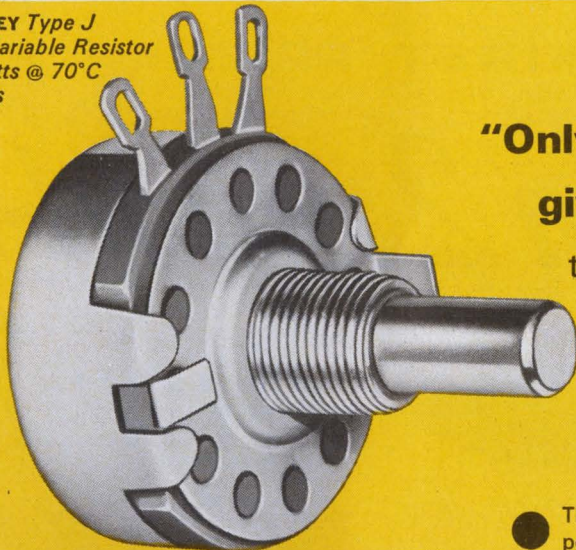

**"Only Allen-Bradley Type J pots**  
**give us the smooth control**  
to maintain the high calibration  
accuracy of our instruments"

Krohn-Hite Corporation

● This quickly locates the positions of the Type J potentiometers in the illustration below.

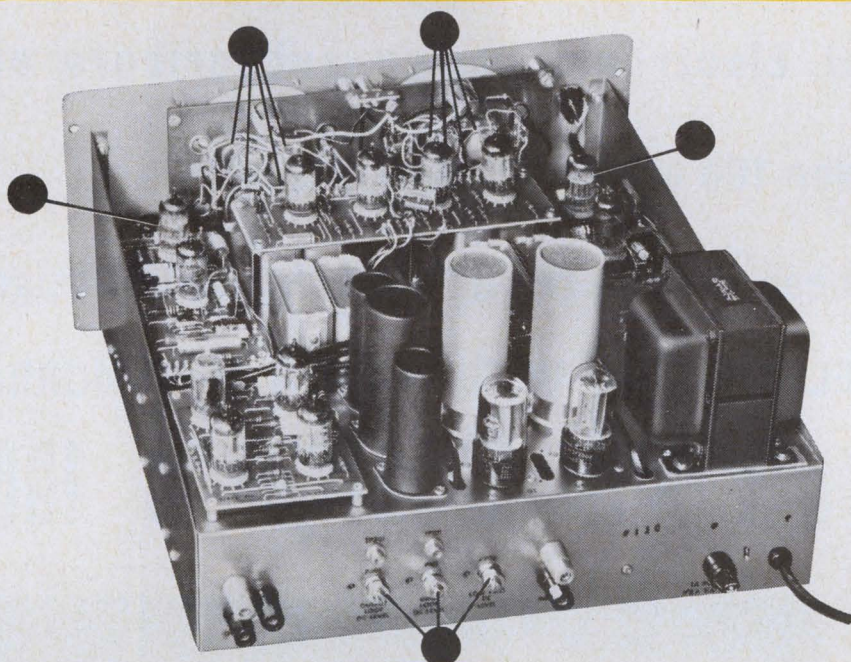

**THIS KROHN-HITE VARIABLE FILTER** provides low-pass, high-pass, band-pass, and band-reject operation with high and low cutoff frequencies independently adjustable from 0.02 cps to 20 kc.

**IN THE MODEL 335**, continuous tuning of the high and low cutoff frequencies is accomplished by simultaneously varying four potentiometers with a single knob. Only A-B Type J controls have been found to provide the smooth control and precise tracking without discontinuities to achieve the required calibration accuracy.

■ Krohn-Hite engineers have found that only Allen-Bradley Type J potentiometers provide the smooth control, low noise, long term stability, and low temperature coefficient they require for their precision instruments such as the variable electronic filter.

The Type J control has the resistor, terminals, faceplate mounting bushing, and insulating material hot molded into a solid integral unit. The solid resistance track assures smooth, quiet control that is free from the undesirable discrete steps of wire-wound units. On accelerated tests, Type J exceeds 100,000 complete operations with less than 10% resistance change.

Insure the performance of your equipment by insisting on Allen-Bradley Type J hot molded potentiometers. Besides, when you use Allen-Bradley fixed and variable hot molded composition resistors you provide your apparatus with the label of "quality." For more complete specifications, please write for Publication 6024: Allen-Bradley Co., 1344 S. Second St., Milwaukee, Wis. 53204. In Canada: Allen-Bradley Canada Ltd. Export Office: 630 Third Ave., New York, N.Y., U.S.A. 10017.

**ADDITIONAL ALLEN-BRADLEY HOT MOLDED VARIABLE RESISTORS**

**TYPE G CONTROLS** are only 1/2" in diameter. Quiet, stepless operation. Rated 1/2 watt at 70°C. Values to 5 megohms. Type L are similar in construction but rated 1/2 watt at 100°C.



**TYPE F CONTROLS** are for mounting directly on printed wiring boards by means of their terminals. Rated 1/4 watt at 70°C. Values to 5 megohms. Type O are similar but rated 0.4 watt at 70°C.

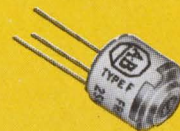

**TYPE R ADJUSTABLE FIXED RESISTORS** are built to withstand environmental extremes. Only 1 1/4" in length. Have stepless adjustment. Watertight and can be encapsulated. Rated 1/4 watt at 70°C. Values to 2.5 megohms. Type N for less severe environments are rated 1/3 watt at 50°C.

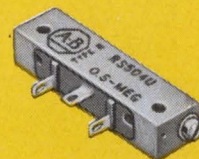

**ALLEN-BRADLEY**  
QUALITY ELECTRONIC COMPONENTS

166-9AB

ON READER-SERVICE CARD CIRCLE 67

FIRST PRIZE:

*win 2 round-trip  
New York*

- ▶ All Electronic Design subscribers are
- ▶ Over 100 other valuable prizes!
- ▶ Guess the top ten ads in Electronic Design's
- ▶ "ELECTRONICS IN THE WORLD OF TOMORROW"

## Electronic Design's 1967

### SEPARATE CONTEST FOR MANUFACTURERS AND ADVERTISING AGENCIES

Not forgotten in the "Top Ten" contest, advertisers and their agencies may also enter. In addition to prizes of a **flight to Paris, color TV, and electronic timepiece**, the top 10 ads, and the winning advertiser's ad (if run January 4, 1967) will be re-run in the April 1st issue. Watch for the special "Top Ten" contest rules and entry blanks appearing January 4, 1967



### 2ND PRIZE HOFFMAN COLOR TV CONSOLE

Hoffman 23" console, featuring 26,000 volts of picture tube power . . . 4" x 6" front-firing speaker . . . easy vision camera control for sharp color movies and positive, black and white picture shading . . . InstaVision on-off control . . . 32" x 29" x 19½" cabinet. (Retail value: \$600.00.)



### 3RD TO 8TH PRIZES BULOVA ACCUTRON® ELECTRONIC TIMEPIECES

The "Spaceview" is an ideal timepiece for electronics engineers. Its clear-view dial reveals transistorized electronic circuit and tuning fork assembly. The tuning fork, advertising symbol and unique frequency standard of Accutron® timepieces, is the reason Bulova guarantees an in-use, on-the-wrist accuracy of within 60 seconds a month. (Retail value: \$150.00.)

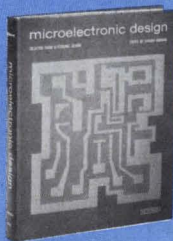

### PLUS 100 ADDITIONAL PRIZES MICROELECTRONIC DESIGN

This clothbound, 8½ x 11, 320-page, 1966 edition will be given free to 100 winners. "Microelectronic Design" offers a thorough overview of the field in six sections—has almost 90 outstanding articles compiled from the pages of *Electronic Design*. Edited by Howard Bierman. (Retail value: \$11.50.)



*tickets between*  
*and* **PARIS**  
**VIA AIR FRANCE**

**eligible!**

**January 4 issue**

**“Top Ten” contest**

**HERE'S ALL YOU HAVE TO DO TO ENTER:**

Rate the ads appearing in the January 4, 1967 issue of *Electronic Design*. Select the “Top Ten” . . . the ads that, in your opinion, will be best remembered by readers. Your choices will be measured against the 10 ads ranking highest in the “Recall-Seen” category of Reader Recall—Electronic Design’s scientific method of measuring readership. In making your predictions, be sure to consider your 54,000 fellow engineers’ interest in the subject matter of the ads, their effectiveness, impact, and attention-getting values.

Entry blanks and complete contest rules will appear in the January 4th issue. Don’t miss this opportunity to win one of the many valuable prizes shown at left. The first prize winner will receive round-trip tickets for two, between New York and Paris via Air France!

# VICTOREEN SPARK GAPS



protect  
circuits  
from  
transients

*Firing Time 75 nanoseconds to 1 microsecond  
Tolerance  $\pm 5\%$  or better*

**Victoreen Type VX-96 Spark Gaps** now provide creative designers with circuit protection never before possible by simple, economical means. Because of extremely fast firing time, Victoreen Spark Gaps ward off catastrophic effects of pulses, spikes, even transients with extremely steep wave fronts. Available in any desired firing voltage from 150 — 5000 volts  $\pm 5\%$ . Low interelectrode capacitance enhances use in HF applications where wave deformation cannot be tolerated.

**For Ignition Applications**, as a "hold-off" device, Victoreen Spark Gaps prevent current flow until circuit voltage has reached breakdown voltage of gaps. Their excellent repeatability and long life enhance operation in continuous duty systems. Ambient temperature range  $-65^{\circ}$  to  $125^{\circ}\text{C}$ , shock resistance to 100g for 11 milliseconds, vibration resistance 10g from 55-2000 cps. Write or wire for full details. Or call Applications Engineering Department, (216) 795-8200, Ext. 306.

6400-A

**THE VICTOREEN INSTRUMENT COMPANY**  
10101 WOODLAND AVENUE • CLEVELAND, OHIO 44104



ON READER-SERVICE CARD CIRCLE 68

## COMPONENTS



### Hermetically sealed subminiature connectors

*Deutsch Co., Electronic Components Div., Municipal Airport, Banning, Calif. Phone: (714) 849-6701.*

Said to be ideally suited for use in transducers, transmitters, radars and submersible units, the MD plug and receptacle connectors are hermetically sealed. The mated pair is 1-in. long with a 5/8-in. diameter mounting flange. They are made of corrosion resistant alloys in a variety of mounting styles . . . solder, square flange, weld or jam nut.

CIRCLE NO. 215

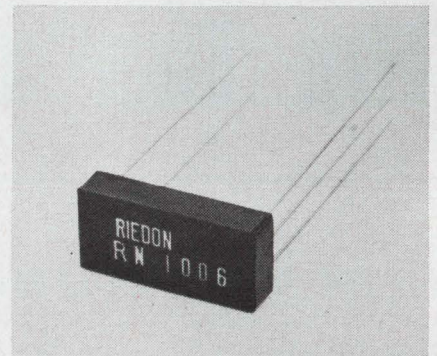

### Voltage references accurate to $\pm 0.01\%$

*Riedon Avionics, Inc., 7932 Haskell Ave., Van Nuys, Calif. Phone: (213) 873-3464. P&A: \$100; 4 weeks.*

A voltage reference network that can be produced to your specifications features accuracies as close as  $\pm 0.01\%$ . Stability rating for the design is better than  $\pm 0.002\%$  under load for 1000 hours. Regulation can be held to 0.03% with an input voltage change of 0.5%. The reference networks can be produced to your exact specifications and are also available in manufacturer's standard models.

CIRCLE NO. 216



# BROAD BAND OPERATION HIGH POWER L BAND UP CONVERTER

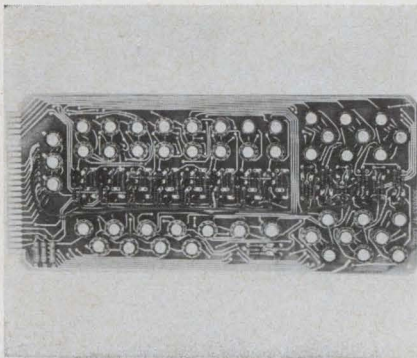

## Convert digits to phase information

Servo Corp. of America, 111 New S. Rd., Hicksville, N. Y. Phone: (516) 938-9700.

The solid-state digital-to-synchro converter, model 201 is offered as a stock item in production quantities. The converter is designed to accept parallel 11-bit words representing shaft angles and convert them to 400-Hz, 3-wire or 4-wire resolver information. The system's 4-5/8-in. cards are also available individually. The 201 consists of three of these cards, and logic.

CIRCLE NO. 217

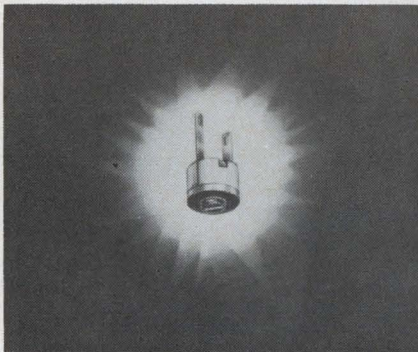

## Ceramic trimmer occupies 0.007-in.<sup>3</sup>

Erie Technological Products, Inc., 6444 West' 12 St., Erie, Pa. Phone: (814) 456-8592.

A capacitance range of 5 to 25 pF is packed into the 0.007-in.<sup>3</sup> model 518 ceramic trimmer. The component is rated at 100 Vdc to 85°C and 50 Vdc to 125°C. The unit's range and capacity are said to be the result of a construction process in which ceramic film dielectrics are fired into solid structures of one or more layers. Dielectric strength is rated 200 Vdc.

CIRCLE NO. 218

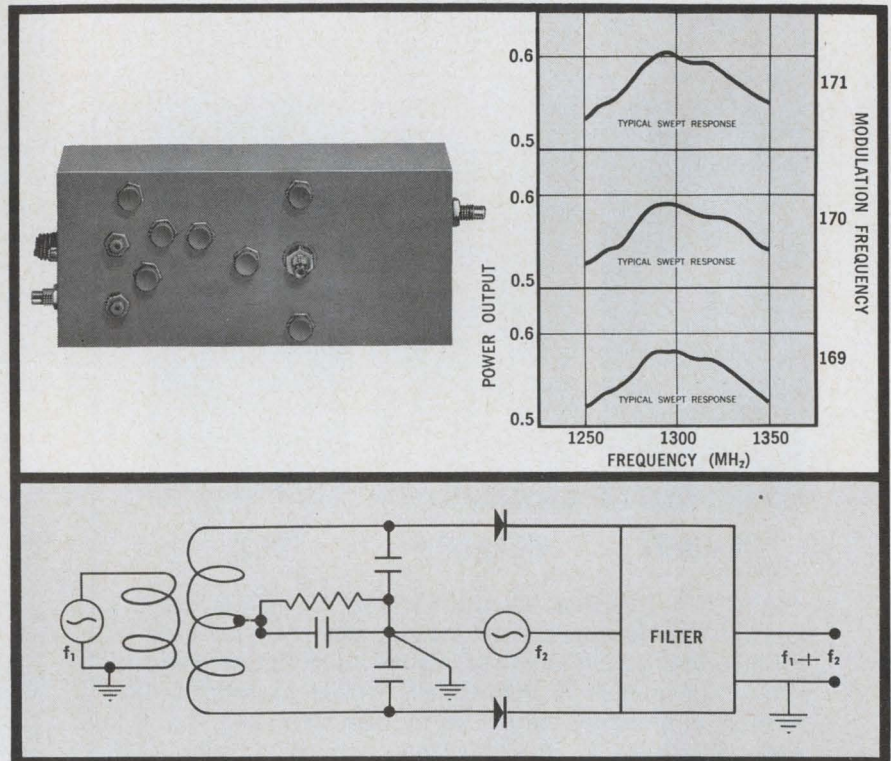

### FLAT PERFORMANCE

$\pm 1$  db over 10% bandwidth of  $f_2$ . Factory adjustment allows operation from 1000 MHz to 1500 MHz.  $f_1 + f_2$  must be at least 20% removed from  $f_2$ .  $f_1$  bandwidth is two percent.

### HIGH POWER

0.5 watts minimum output.

### EFFICIENT OPERATION

-6 db conversion efficiency. For 0.5 watt output, inputs of 2.0 watts at  $f_2$  and 1.0 watts at  $f_1$  are required.

### SPURIOUS SIGNALS

Fundamental and lower sideband 30 db below output signal.

For further information regarding custom units, other frequencies, bandwidth or power levels, contact Mr. Joseph Brumbelow, Director of our Solid State Department at the address below.

WRITE FOR OUR FREE CATALOG ON SOLID STATE CIRCUITS

## MICROWAVE DEVELOPMENT LABORATORIES • INC.

87 Crescent Road • Needham Heights • Massachusetts 02194  
Telephone: 617-449-0700 • TWX 617-444-2695

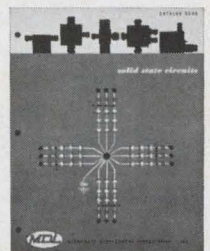

ON READER-SERVICE CARD CIRCLE 69

# GENALEX REED CAPSULES FOR ENVIRONMENTAL VERSATILITY

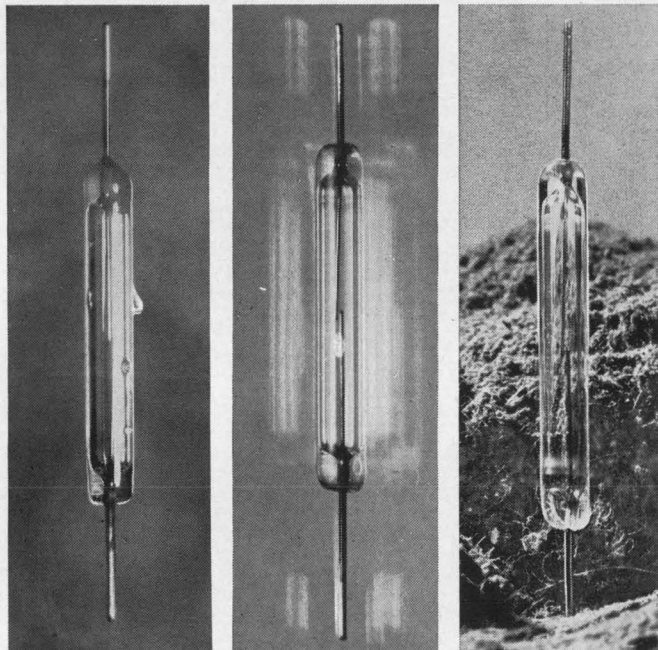

**HUMIDITY**

**VIBRATION**

**DUST**

The M-O V RCI Reed Capsule is ideal for all fast low-level switching applications where reliability and long life are required. Offering high resistance to vibration and shock, its contact is hermetically sealed to protect it from environmental influences of humidity and dust. M-O V Reed Capsules are to British Post Office specifications.

Maximum overall length of Capsule	46.1mm
Maximum switched voltage, resistive load	50 V a.c. or d.c.
Maximum switched current, resistive load	100 mA a.c. or d.c.
Maximum current through closed contact	1 A a.c. or d.c.
Capacitance	less than 0.2 pF
Operating time (including bounce)	less than 2 milli secs.
Release time	less than 0.5 milli secs.
Contact resistance	less than 100 milli ohms.
Field strength to operate switch	73 gauss
Life expectancy when operated by solenoid	10 <sup>7</sup> -10 <sup>8</sup> operations
Coil to operate switch	58 A turns

Our technical information centre is ready to help with your application problems.

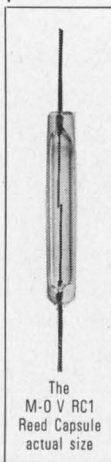

The  
M-O V RCI  
Reed Capsule  
actual size

# Genalex

THE M-O VALVE CO LTD

North American Sales Manager · David LaFrenais  
P O Box 5000 · Don Mills · Ontario · Canada · Tel: 291-1985

ON READER-SERVICE CARD CIRCLE 70

## COMPONENTS

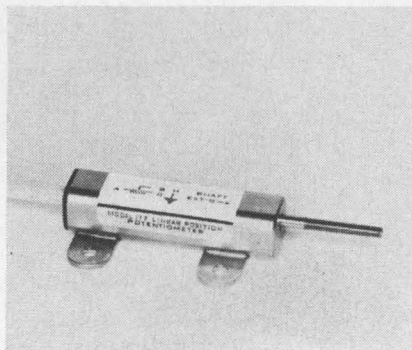

### Infinite resolution from a linear transducer

*Bourns Inc., 1200 Columbia Ave.,  
Riverside, Calif. Phone: (714) 684-  
1700.*

Chief feature of the Model 177 linear position transducer is the use of the "Infinitron" resistance element, providing continuous resolution. This element is also said to provide a longer life expectancy than comparable wirewound elements. Ranges are 0.5 and 1.0 inch with resistances of 250 to 15 kΩ and a tolerance of ±5%.

CIRCLE NO. 219

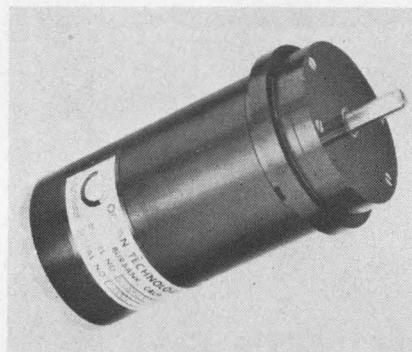

### Synchro-input servo housed in 23 frame

*Ocean Technology Inc., 777 Front  
St., Burbank, Calif. Phone: (213)  
849-6477. P&A: \$750; stock to 60  
days.*

A miniaturized synchro-input servo mechanism is housed in a size 23 frame. The unit includes its own error or follow-up synchro, power supply, servoamplifier and motor. Designated OTR-23, it provides zero-backlash operation with an accuracy of 0.25°. It is directly interchangeable mechanically and electrically with any 23TR synchro and accepts either 60- or 400-Hz inputs.

CIRCLE NO. 220

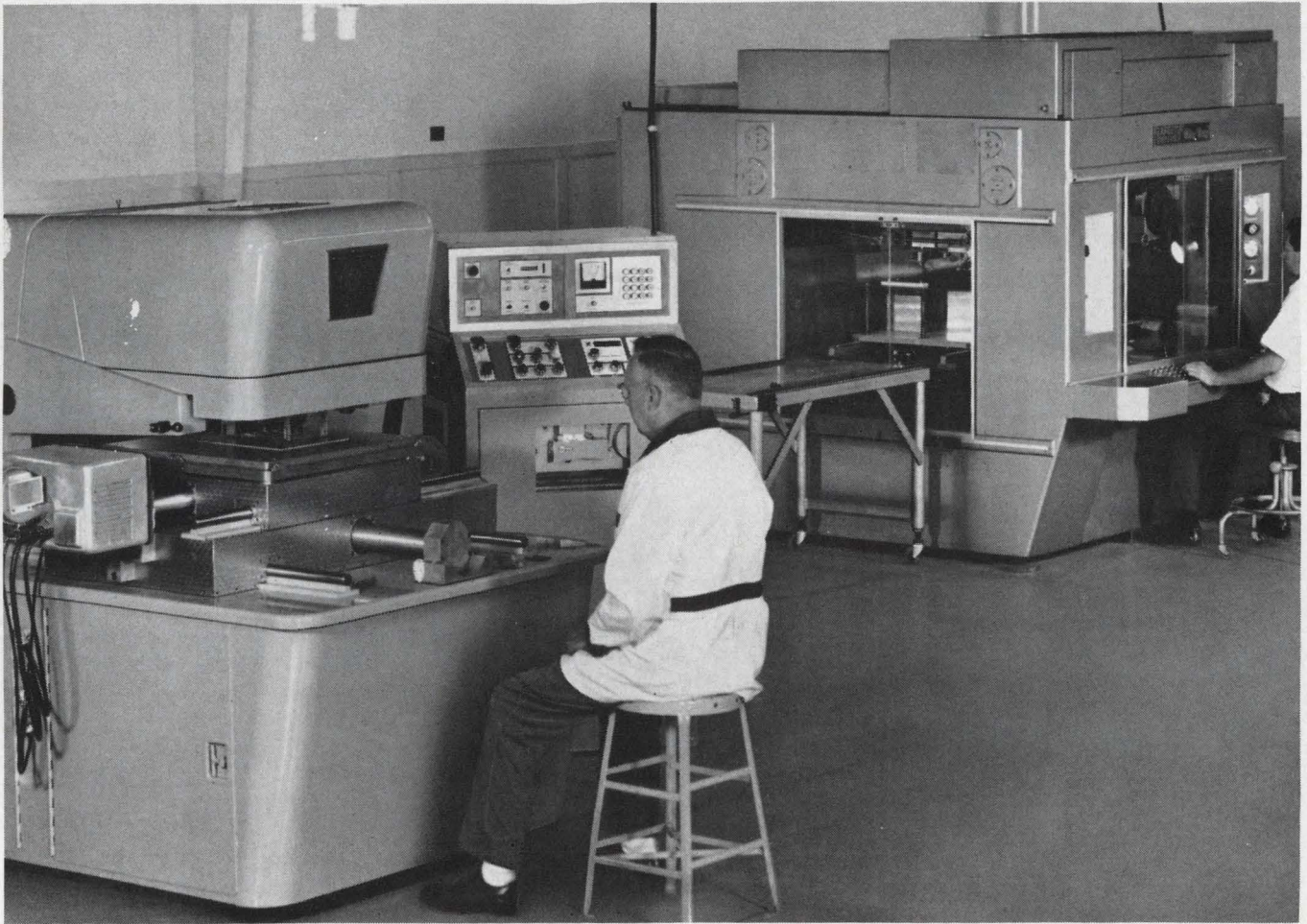

Time on these unique machines is now available through Gardner-Denver contract service. At left is a Grid-Drill machine. One of the automatic "Wire-Wrap" machines is at right.

## Now available . . . Gardner-Denver contract service with these advanced production machines

**Increase your product reliability . . . decrease cost.** For the first time, Gardner-Denver offers a contract service utilizing its high-production Grid-Drill™ for printed circuit board drilling . . . and automatic "Wire-Wrap"® machines for back plane wiring. The new service offers these advantages:

1. Production experience in advance of actual delivery. You'll have a chance to use "Wire-Wrap" machines and the Grid-Drill in actual production situations, including prototype and preproduction runs.

If you have one of these machines on order, the contract service offers you a valuable opportunity to get operating experience before the machine is delivered. If you are considering the purchase of these machines, you can see what they can do on your parts, at a very reasonable cost.

2. Expert application engineering services available to users of the "Wire-Wrap" machine. These services, in the area of hardware, design and development, assure you unrivaled reliability in electrical connections, lowest possible wiring cost, and smooth, speedy integration into your total production facilities.

3. Prototype-stage proof of the merits of the machines on your products. Give yourself the lead time to design for

the latest in electronic technology, and know it will work.

### PERFORMANCE CHARACTERISTICS

"Wire-Wrap" machines make solderless wrapped connections, with 24-gauge through 30-gauge wire, on terminal spacings down to .100". Complete programming services for developing the punched cards used to program the automatic "Wire-Wrap" machine.

Grid-Drills will handle panels up to 30" x 40" with hole sizes from .010" to .125" in diameter. Exceptional hole quality for multi-layer and through-hole plating. Extreme accuracy provides hole registration to all data points. The highly efficient tape-controlled Grid-Drill makes prices attractive on 10 pieces or 10,000.

**Want to know more?** Write Don Brouwer, Manager, "Wire-Wrap" Division, Gardner-Denver Company, Grand Haven, Michigan. Tell him what you want, how many pieces are involved and your delivery schedule. He'll supply the facts promptly.



SEE WHAT AIR IS DOING NOW...SEE  
**GARDNER - DENVER**

Gardner-Denver Company, Quincy, Illinois

ON READER-SERVICE CARD CIRCLE 71

**BRUSHLESS  
SYNCHROS  
DON'T HAVE  
THESE  
TROUBLE-MAKERS**

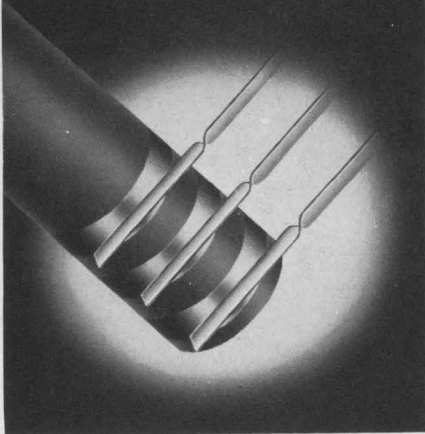

**OR THESE TROUBLES:**

Brush wear • Arcing • RFI emission  
• Contact bounce • Bearing contamination from brush-wear particles • Brush friction error

We left out all these synchro problems by leaving out the brushes. Rotary transformers couple signals into rotors without contact. Result is far longer synchro life—which can exceed 10,000 hours—with performance equal to the best of brush types.

Patented Harowe brushless synchros are available for all common functions, in sizes 5, 8, 10, and 11 as standard; larger sizes as special. All types meet applicable requirements of MIL specs. Request complete data from—



Servo, Stepper &  
Synchronous Motors  
Motor Generators • Synchros  
Resolvers • Pancakes • Gearheads

**HAROWE SERVO CONTROLS, INC.**

22 Westtown Road  
West Chester, Pa. 19380  
(215) 692-2700

ON READER-SERVICE CARD CIRCLE 72

**COMPONENTS**

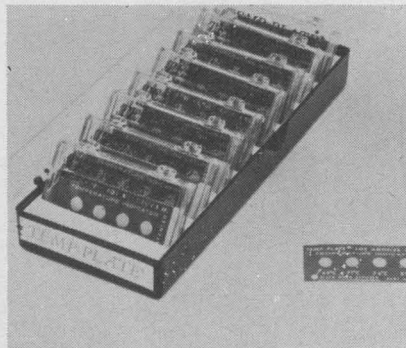

**Decals record peak ambient temperatures**

*William Wahl Corp., 1001 Colorado Ave., Santa Monica, Calif. Phone: (213) 393-6419.*

"Temp-Plate" temperature recording decals provide an irreversible reading when specified peak temperatures are reached. The range of temperatures available is from 100 through 1100°F, normally in 10° gradients with a  $\pm 1\%$  accuracy factor. Kits have been selected for such industries as electronics, aircraft and aerospace. Complete lot control and traceability is provided with each indicator.

CIRCLE NO. 221

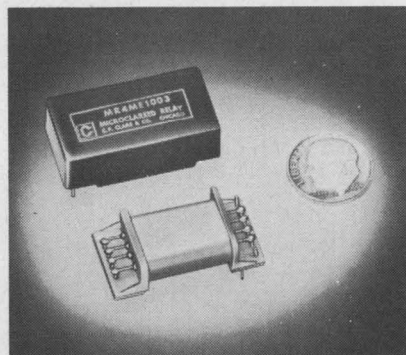

**Miniature reeds switch up to 750 mA**

*C. P. Clare & Co., 3101 Pratt Blvd., Chicago. Phone: (312) 262-7700.*

In PC board use, "MicroClareed" relays Type MRME and MRMC offer switching capability up to 750 mA. The MRME molded epoxy module and the MRMC open-coil module provide for 1 to 5 Form A contacts and occupy a max of 0.406 in.<sup>3</sup> of board space. Voltage rating is 200 Vdc, 110 Vac max and load is 10 VA. Coil voltages range from 6 to 48 Vdc.

CIRCLE NO. 222

**IF YOU DON'T  
RECOGNIZE  
THIS**

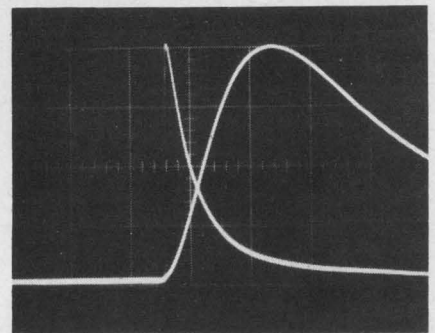

**IT'S NO WONDER,**

because you've probably never seen 2940 feet of coaxial cable measured this way before.

**HOW COULD YOU?**

We used the TRW Model 46A Trigger Delay Generator, just coming on the market. It's brand new, with some inherited virtues of its predecessor, TRW Model 2A—**nanosecond accuracy**, high power trigger to override random noise, clear digital display, selectable triggering threshold—**plus plug-in capability** so you buy exactly the triggering input you need, exactly the sensitivity and spectral range your application calls for.

**ASK US FOR A TECHNICAL  
DATA BULLETIN AND  
APPLICATION NOTES**

giving the characteristics of the TRW Model 46A and the plug-ins, and illustrating how you can use the TRW Trigger Delay Generator, as we did, to make direct measurement of delay lines, to generate fiducial marks, calibrate oscilloscopes, and trigger the TRW Image Converter Camera or countless other laboratory instruments.

**TRW INSTRUMENTS**

139 Illinois Street, El Segundo, California  
AC 213, 679-9101 Extension 22884.

*Developers and manufacturers of state of the art diagnostic instruments for basic and applied research.*

ON READER-SERVICE CARD CIRCLE 73

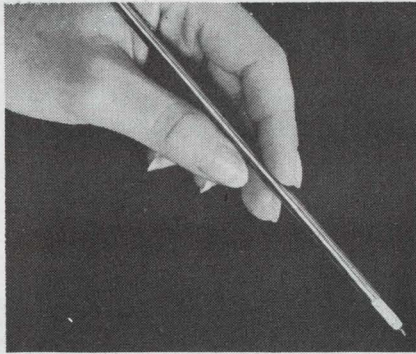

### Probe-type transducer repeatable at $\pm 1\%$

*Thermal Systems, Inc., 15100 South Broadway, Gardena, Calif. Phone: (213) 321-4350.*

Precision platinum temperature transducers are offered for a range of 100 to 400°C with a repeatability factor of  $\pm 1\%$ . Probes consist of reference grade platinum with a resistance factor of 100  $\Omega$  at 0°C wound strain-free on a mandrel. Long-term reliability is assured by a thermal shock test. Applications are seen in commercial process control equipment.

CIRCLE NO. 223

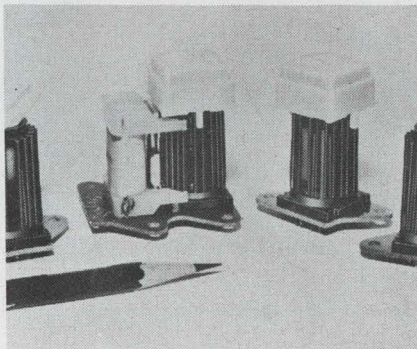

### Pushbuttons, toggles meet esthetic specs

*American Zettler, Inc., 697 Randolph Avenue, Costa Mesa, Calif. Phone: (714) 540-4190. Price: \$0.75 to \$2.70.*

Designed with esthetics in mind, the Series T-500 pushbutton and toggle switches are also panel space savers. Overall depth behind the panel is 1.5 in. The switches can be mounted directly with other electronics so that the front panel serves only as a cover plate. Square and round pushbuttons of the line can be illuminated.

CIRCLE NO. 224

# gotta crazy curve?

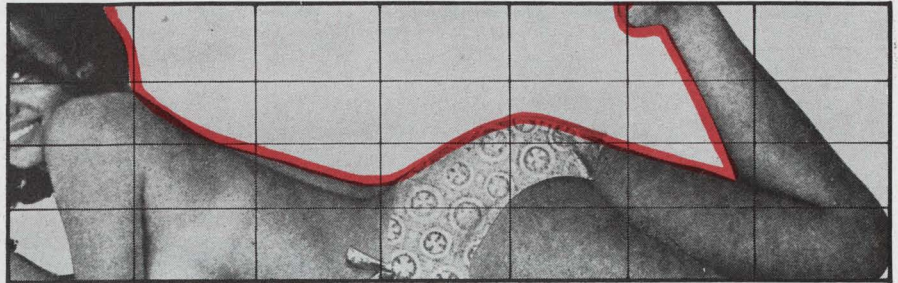

## A DUNCAN NON-LINEAR POT CAN MATCH IT!

Even if your non-linear function looks like the Playmate of the Month in profile, Duncan can build a pot to match it. All you have to do is use the new "DUNCAN DO-IT-YOURSELF NON-LINEAR FUNCTION KIT," which we'll send you without obligation if you'll fill out and mail the coupon below. The kit includes a fabulous French curve\* plus all other necessary ingredients and instructions. You supply us with the non-linear trace of your function and other supporting data. We'll feed it to our high-speed computer and analyze the data defining the pot's desired function. Then we'll enter the output tape into our servo-controlled machines to produce the variable-pitch winding to meet your function.

To be sure the output of the pot conforms to the specified tolerances, we'll compare it with the theoretical function on our unique conformity tester.

The result? A precision, accurate pot exactly to your specifications.

Our applications engineers can help solve your problems quickly and economically. In many cases they'll be able to match your function using pre-calculated data from our extensive tape library.

So forget about cams, differentials, and non-linear gears. For the direct approach to a complicated non-linear potentiometer problem — for airborne data computation or matching thermocouple curves — depend upon Duncan. You'll have more time to check out other interesting curves!

Send for your free Duncan "do-it-yourself" kit today. For literature only, circle the appropriate number and mail the inquiry card enclosed in this magazine.

#### DUNCAN ELECTRONICS INC.

Please send me my free "DUNCAN DO-IT-YOURSELF NON-LINEAR FUNCTION KIT" and complete technical literature on Duncan's family of non-linear potentiometers.

I understand that there is no obligation on my part.

Name \_\_\_\_\_ Title \_\_\_\_\_

Company \_\_\_\_\_

Address \_\_\_\_\_

City \_\_\_\_\_ State \_\_\_\_\_ zip \_\_\_\_\_

\*French curve ruler by Birule Co.



DUNCAN electronics, inc.

2865 Fairview Rd., Costa Mesa, California 92626 Tel.: (714) 545-8261 TWX: 910-595-1128  
ON READER-SERVICE CARD CIRCLE 74

# SPEED SEQUENTIAL

## Push a Button..



### CONDENSED SPECIFICATIONS

#### MODEL 155A OSCILLOSCOPE

- Vertical Deflection System**
- Deflection Factor (Sensitivity):** 5 mv/cm to 20 v/cm.
  - Bandwidth:** DC coupled: DC to greater than 25 MHz. AC coupled: 2 Hz to greater than 25 MHz.
  - Position:** Base line can be offset  $\pm 25$  cm from center screen of CRT in calibrated steps.
  - Signal Delay:** Signal is delayed so that leading edge of fast rise signals is visible at start of sweep.
  - Input Impedance:** 1 megohm shunted by approximately 50 pf.
- Horizontal Deflection System**
- Internal Sweep:** From 0.1  $\mu$ s/cm to 50 ms/cm.
  - Magnification:** X 5 expansion available on all ranges.
  - Slow Sweeps:**  $\div 10$  slows sweep to 0.1 sec/cm, 0.2 sec/cm, or 0.5 sec/cm.
  - Triggering:**
    - Automatic:** Internal, external, or from line.
    - Trigger Slope:** Positive or negative.

**Amplitude Selection:** Internal, or external.

**Trigger Point and Slope:** Internally from any point on the displayed wave form; externally from any point between  $\pm 5$  volts, positive or negative slope.

**Single Sweep:** Front panel switch selects single sweep operation.

**Remote Programming** Programming is accomplished by contact closures to an isolated common line. Programmable functions are listed below.

**Vertical:** Deflection factor (sensitivity). Input coupling. Vertical positioning.

**Horizontal:** Sweep time. Trigger source. Trigger slope.

**Price:** \$2450.00.

#### MODEL 1550A PROGRAMMER

Up to 18 programs can be preset in the 1550A Programmer. Plug-in diodes provide the means for programming vertical sensitivity, vertical positioning, vertical input coupling, sweep time, trigger source, and trigger slope in the 155A Programmable Oscilloscope. **Price:** \$600.00.

# WAVEFORM TESTS

## Read a Trace!

### NEW PUSH-BUTTON, PROGRAMMABLE OSCILLOSCOPE

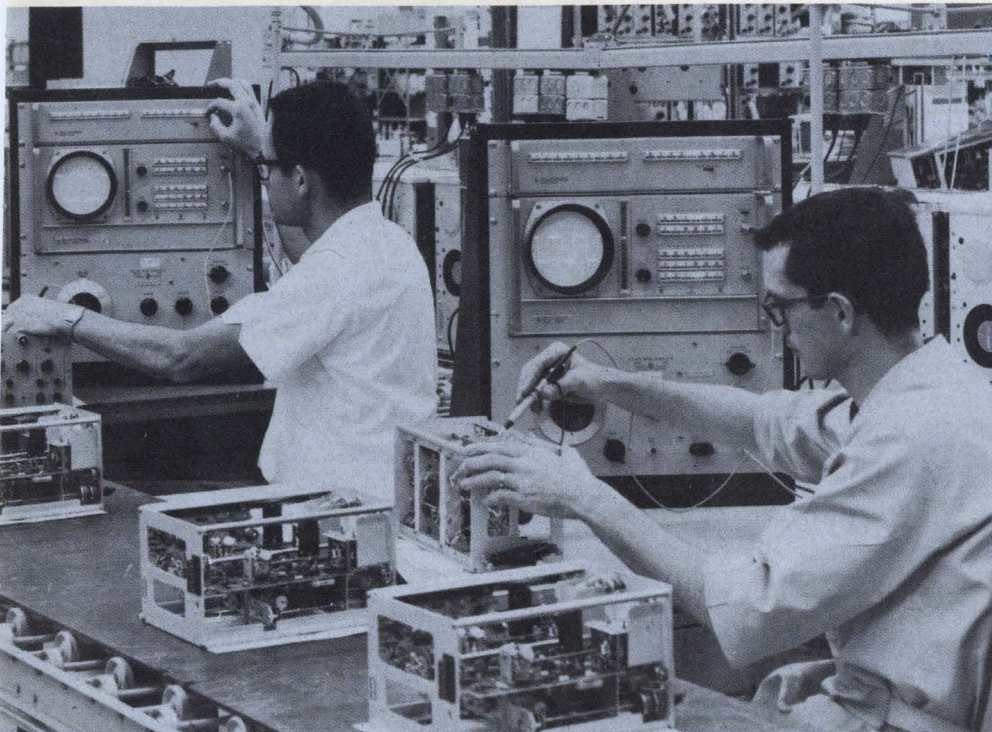

- Push-Button Speed
- All Major Functions Digitally Programmed
- No DC Drift
- $\pm 25$  cm Calibrated Positioning
- High Sensitivity 5 mv/cm
- Wide Bandwidth 25 MHz

Sequential testing is now a one-two procedure with the new hp Model 155A/1550A Push-Button, Programmable Oscilloscope! All you do is select a test point, then — *push a button . . . and read a trace.*

This new automated hp oscilloscope is the first scope specifically designed for production line and automatic systems applications. It will reduce test time per unit, simplify test procedures, minimize operator errors, shorten training time — and can even reduce the number of required test stations! Check-out routines in automatic systems are speeded by eliminating all manual adjustments.

The 155A oscilloscope embodies all the features of a conventional laboratory instrument, with push-button convenience. Most frequently used controls are located on the front panel. All other controls are located behind the swing-down access door.

You can insert up to 18 test programs in each 1550A digital programmer, or cascade programmers for additional capability. Each test program can control any or all major scope functions — including vertical positioning, sensitivity, input coupling, sweep time, trigger source, and trigger slope — with the press of a button! Each programmed function can

be manually over-ridden at any time. Back-lighted indicators show program, sweep, sensitivity, and vertical position for error-free readout.

Only a few minutes are required to insert diode pins for setting up programs in the all-digital programmer. Diode-controlled, digital programming makes the 155A/1550A fully compatible with any contact-closure-to-ground programmer for high speed, automatic check-out systems.

Measurements are repeatable, because the unique hp DC stabilizer circuitry eliminates DC drift. The trace stays where it is positioned for measurement confidence, regardless of sensitivity or sweep. Calibrated positioning over  $\pm 25$  cm dynamic range can eliminate need for voltmeters. Typical DC measurement accuracy is  $\pm 2\%$  of reading.

To find out what this *new measure of scope performance* means to you in speeding your sequential testing, call your nearest hp sales office for a demonstration of the new hp Model 155A/1550A Push-Button Programmable Oscilloscope. Or, write Hewlett-Packard, Palo Alto, California 94304, Tel. (415) 326-7000; Europe: 54 Route des Acacias, Geneva. Price: hp Model 155A Oscilloscope, \$2450.00; hp Model 1550A Programmer, \$600.00, f.o.b. factory.

HEWLETT  PACKARD  
An extra measure of quality

ON READER-SERVICE CARD CIRCLE 75

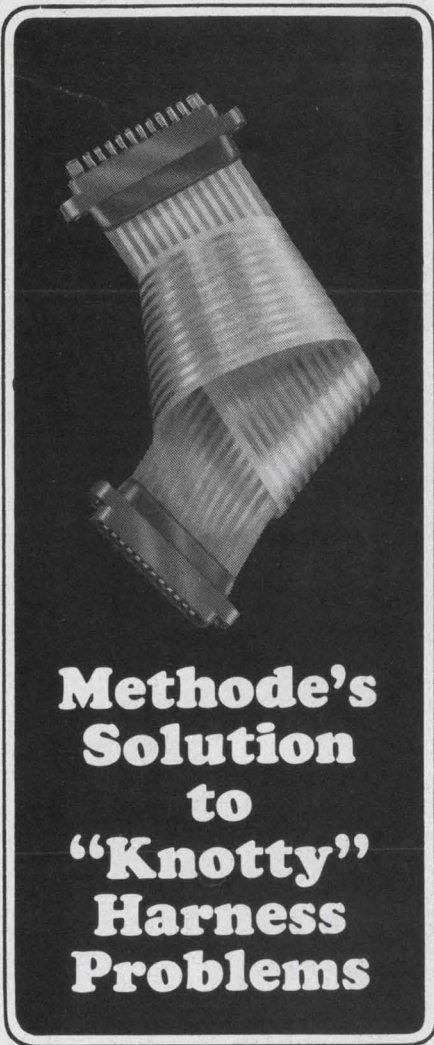

## Methode's Solution to "Knotty" Harness Problems

Methode's unique Plycon harnesses can solve many of your design problems quickly, efficiently!

Available in both straight jumper and extensible styles, Plycon harnesses are ideal for use in drawers or racks or as jumpers between points on a chassis.

Plycon harnesses are a combination of two superior products: long-life Plyo-Duct multi-conductor wiring systems and Reli-Acon connectors.

Through an unusual Methode design, Plyo-Duct has memory characteristics, so that extensible harnesses will extend, then always retract to their original position.

Reliable male or female Reli-Acon connectors are available in a variety of standard sizes and number of contacts to meet your design requirements.

Both single and twin-layer harnesses with from 6 to 48 conductors, and any combination of connector style and number of contacts are available.

Write today for a new, fully-illustrated catalog with complete engineering data.



Connector Division

**Methode Electronics, Inc.**

7447 W. Wilson Ave. Chicago, Ill. 60656

312/867-9600

## COMPONENTS

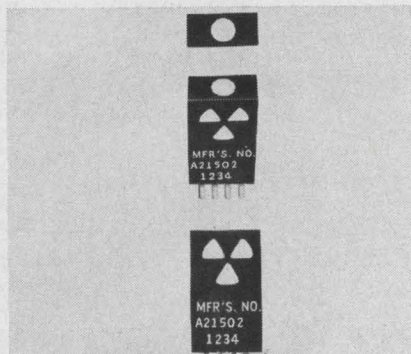

### "Bite" indicator monitor in avionics

A. W. Haydon Co., 232 N. Elm St., Waterbury, Conn. Phone: (203) 756-4481.

To meet DOD requirements for fault-indication in avionics equipment, a line of microminiature units is now available. Called Bite indicators for Built In Test Equipment, the units indicate a fault visually through a window on the side and front of the 0.7 x 0.2 x 0.4-in. module. They operate over a range of 17 to 29 Vdc and are activated by pulses down to 15 msec.

CIRCLE NO. 225

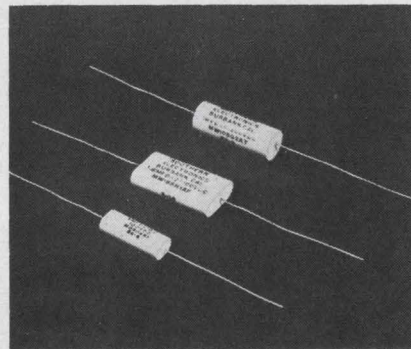

### Polycarbonate caps operate to 125°C

Southern Electronics Corp., 150 W. Cypress Ave., Burbank, Calif. Phone: (213) 849-3193.

Metallized polycarbonate capacitors of the ML line are specified for operation up to 125°C. The components are available in 200, 400 and 500-volt ranges with values from 0.001 mfd. Retrace stability is less than 0.05% and insulation resistance is beyond 100,000 Meg at 25°C. The units are oval in shape for high-density applications. Hermetically sealed tubular versions are optional.

CIRCLE NO. 226

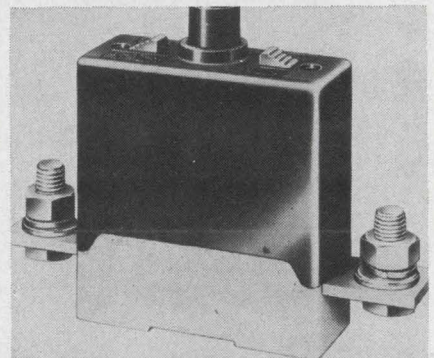

### Circuit breaker has "off-on" switch

ETA Products of America, 6284 N. Cicero Ave., Chicago. Phone: (312) 545-1553.

An off-on switch mechanism on the 44-7-S-H-N breaker prevents reset during overload conditions. The breaker is available in standard current ratings from 125 to 400 A at 28 Vdc. The breaker button can only be operated in conjunction with the slider latches to prevent accidental operation. Max interrupting capacity is 10,000 A at 28 Vdc.

CIRCLE NO. 227

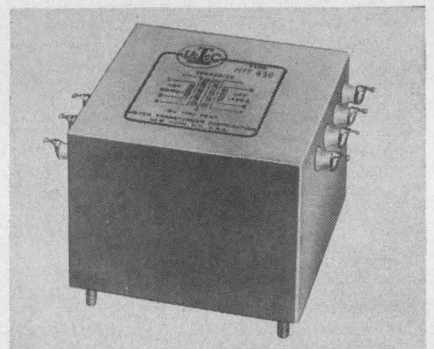

### Shielded transformers transfer below 0.1 μF

United Transformer Co., 150 Varick St., New York. Phone: (212) 255-3500.

For critical circuitry, isolation close to that of battery power is claimed for the HIT 450 ultra-shielded power-line isolation transformers. The rated capacity coupling between primary and secondary windings is less than 0.1 μF which can be reduced even farther by the circuit design. For 400-Hz operation, MIL power rating is 80 W and specifications of MIL-T-27B are guaranteed.

CIRCLE NO. 228



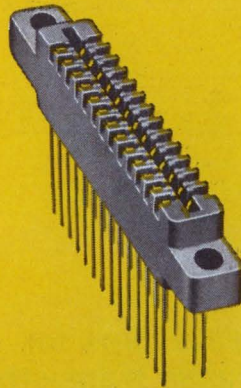

# Cinch gives you the tail stability you need for programmed wire wrapping— in a miniature p.c. connector

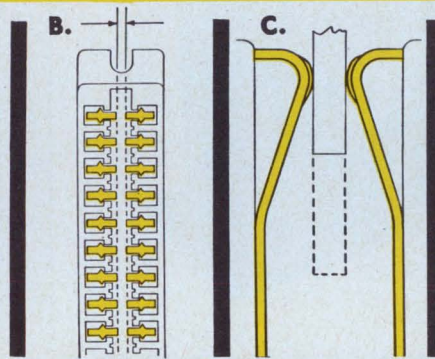
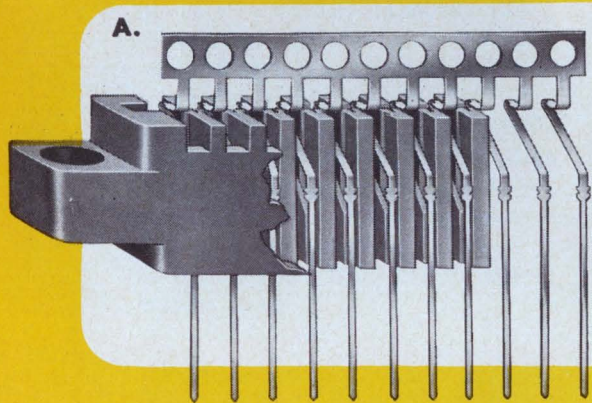

**A.** Tail stability is provided by the comb contact construction which permits force fit through the insulator.

**B.** Gap uniformity is achieved through preloading contact against insulator stop.

**C.** Contact pressure is independent of P-C board insertion depth because of contact profile.

Cinch has combined cantilevered contact reliability with .025" square tail wrapping speed. This new Cinch high contact density printed circuit board connector can be wired at a rate of up to 750 net wires per hour with a Gardner-Denver automatic wire wrap machine. This is more than 15% faster than for .045" square tail connectors.

This new connector uses a comb contact assembly which provides the gap uniformity of preloaded cantilever construction and contact pressure which is independent of printed circuit board insertion depth. Contacts are on .125" centers. Construction combines minimum insertion force with maximum contact pressure.

The connector is especially suited for programmed automatic wire wrap applications and is particularly well designed for use with the latest packaging techniques, particularly the dense packaging currently being developed for electronic data processing equipment. For cost reduction in volume applications the precision contacts can be *selectively gold plated*. This Cinch developed technique substantially reduces the amount of gold required, resulting in lower connector costs.

These precision tooled comb contacts are precisely and automatically preloaded with insertion of the comb into the insulator. The true tip location in the required position for automatic wrapping equipment is assured by the comb assembly technique. This technique employs a force fit to the insulator, assuring rigid, exact positioning. Cinch also manufactures .045" square tail rectangular terminal and other wire wrap terminated printed circuit board connectors suitable for use with the automatic wire wrap equipment manufactured by Gardner-Denver.

For additional information, write to Cinch Manufacturing Company, 1026 S. Homan Avenue, Chicago, Illinois 60624.

CM6619

**CINCH**  
DIVISION OF UNITED-CARR



**Take a good look...**

TELEDYNE TELEMETRY COMPANY  
 DYNAPLEX DIVISION • AEROSPACE  
 TELEDYNE TELEMETRY COMPANY  
 DYNAPLEX DIVISION • AEROSPACE  
 TELEDYNE TELEMETRY COMPANY  
 DYNAPLEX DIVISION • AEROSPACE  
 TELEDYNE TELEMETRY COMPANY  
 DYNAPLEX DIVISION • AEROSPACE  
 TELEDYNE TELEMETRY COMPANY  
 DYNAPLEX DIVISION • AEROSPACE  
 TELEDYNE TELEMETRY COMPANY  
 DYNAPLEX DIVISION • AEROSPACE  
 TELEDYNE TELEMETRY COMPANY  
 DYNAPLEX DIVISION • AEROSPACE

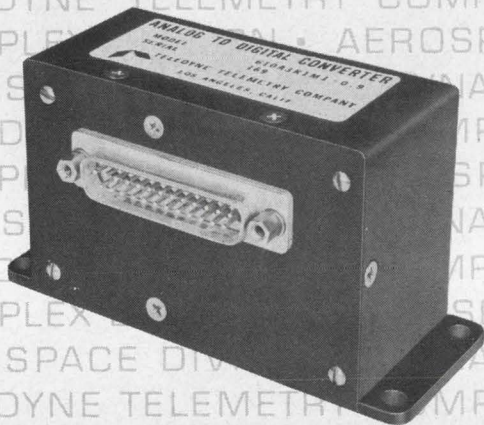

at our TYPE 610  
**MICROCIRCUIT AIRBORNE A-D CONVERTER**

Space age designed . . . for space age applications, Type 610 Analog-to-Digital Converters use only reliable integrated circuits and military approved parts to provide the optimum in performance for critical missile, satellite, space probe or aircraft A-D conversion requirements.

- Throughput rates from 1 to 100,000 words per second
- Up to 10-bit resolution
- Overall accuracy up to ±0.1 percent
- Choice of output formats, parity and synchronization codes
- Lightweight-small size
- High reliability under extreme environmental conditions

Next time you have an analog-to-digital conversion requirement, contact your local TELEDYNE TELEMETRY COMPANY Sales Representative or contact us directly . . . and TAKE A GOOD LOOK AT OUR TYPE 610 MICROCIRCUIT AIRBORNE A-D CONVERTER.

**TELEDYNE TELEMETRY COMPANY**  
 A Division of Teledyne, Inc.

**AEROSPACE DIVISION**

12964 Panama Street  
 Los Angeles, California 90066  
 Telephone (213) 870-9831  
 TWX: 910 343 6855

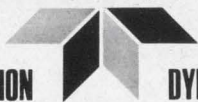

**DYNAPLEX DIVISION**

P.O. Box 341 Alexander Road  
 Princeton, New Jersey 08540  
 Telephone (609) 452-2550  
 TWX: 510 685 2379

ON READER-SERVICE CARD CIRCLE 78

COMPONENTS

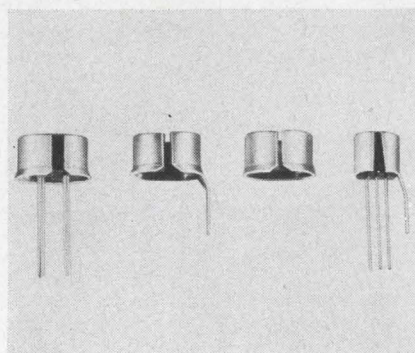

**Brass clips for plastic transistors**

Wakefield Engineering, Inc., Wakefield, Mass. Phone: (617) 936-3069. P&A: \$7.25 to \$8.50/M; stock.

For use as an electrostatic shield and/or thermal retainer, three types of brass clips mate plastic transistors. Type 256-ST shield mounts a single device. Type 256-DT is also a shield but mounts two devices. Type 256-D is a thermal retainer without a shield and holds two transistors at equal temperature. The clips are formed of 1/2 hard brass.

CIRCLE NO. 229

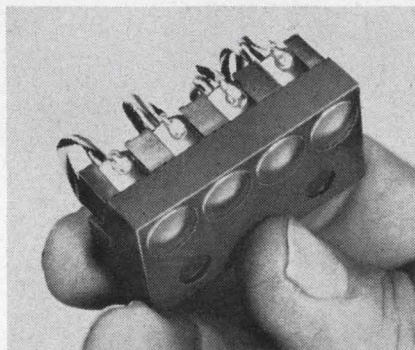

**Proximity switch uses Hg-wetted contacts**

General Equipment & Mfg. Co., 3300 Fern Valley Rd., Louisville, Ky. Phone: (502) 969-2386.

Mercury-wetted contacts are credited with providing reliable, bounce-free operation in a miniature proximity switch by General Equipment and Mfg. Unit-life is said to run into billions of cycles and operation at 3600 cycles per minute is possible. In a typical application, the switch is used in 64 circuits on a 14-in. magnet, and each switch is operated only by its individual operator.

CIRCLE NO. 230

# Fast, convenient direct reading measurements of impedance and phase angle 500 kHz to 108 MHz...

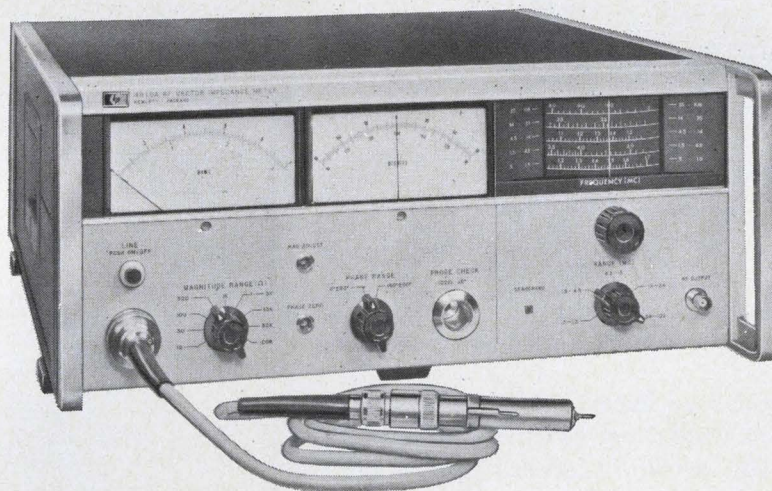

## THE 4815A RF VECTOR IMPEDANCE METER

This new Vector Impedance Meter is a versatile instrument that provides fast, direct reading measurements of impedance and phase angle over the frequency range from 500 kHz to 108 MHz. It is continuous tuning over this frequency range, and does not require balancing or data interpretation. Thus, it is an extremely useful tool for the evaluation of the complex impedance of both active circuits and components. The convenience of probe measurement, ease of operation, and direct reading features make the instrument equally useful for laboratory, receiving inspection or production line measurements.

The 4815A is a convenient and powerful measuring tool for any application involving measurements over a band of frequencies or in-circuit measurements. It may be used to determine the self-resonance point of capacitors, the series and parallel resonance points of crystals, or the characteristics of high frequency transformers and transducers. Price: \$2650 f.o.b. factory. For complete specifications, contact your local Hewlett-Packard field engineer or write Hewlett-Packard, Rockaway Division, Green Pond Road, Rockaway, N. J. 07866; Europe: 54 Route des Acacias, Geneva.

### Advantages:

- Fast, continuous tuning from 500 kHz to 108 MHz**
- Provides data directly in impedance and phase angle, 1 ohm to 100K ohms 0 to 360°**
- Convenient probe for in-circuit measurements**
- Analog outputs permit permanent data recording**
- Self calibration check provides measurement confidence**
- Low-level test signal minimizes circuit disturbance**

**HEWLETT**  **PACKARD**  
An extra measure of quality

ON READER-SERVICE CARD CIRCLE 79

# NEW CAPACITOR TESTER SAYS EXACTLY WHAT IT MEANS



## MODEL 5340 DIGITAL CAPACITOR TESTER

- Measures true series capacitance
- Direct digital display with long-life Nixie® tubes
- Tests capacitance, leakage, DF, and ESR
- Test frequencies of 120 cps and 1 kc
- Internal dc bias supply with electronic current limiting

The dual-frequency 5340 provides an exceptionally flexible instrument for accurately measuring a wide range of capacitance, leakage, dissipation factor and equivalent series resistance values. Results (in picofarads, nanofarads, microfarads) are displayed immediately on a 4-digit Nixie® readout, with a separate 3-digit readout of DF or ESR. Five terminal guarded measurements prevent stray capacitance and lead resistance errors. A 25% over-range capability facilitates test operation procedures. Since capacitors are always specified in terms of series capacitance by the manufacturer, direct series capacitance measurements on the Model 5340 DCT are therefore much faster and easier. No need for conversion formulae. No table look-ups. Reduced operator error. Priced at \$4500.00. Single frequency capacitor testers from \$1995.00.

For complete information, including a new 4-page technical paper entitled "Theory and Application of Capacitance Measurements", contact the Micro Instrument representative near you or write directly to us.



12901 CRENSHAW BLVD., HAWTHORNE, CALIFORNIA 90250  
TELEPHONES: (213) 679-8237 & 772-1275

ON READER-SERVICE CARD CIRCLE 80

## TEST EQUIPMENT

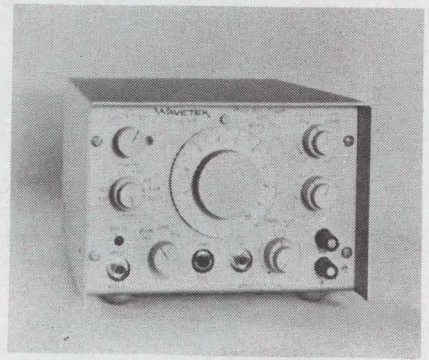

## Portable generators operate in 3 modes

Wavetek, 8159 Engineer Rd., San Diego, Calif. Phone: (714) 279-2200. Price: \$745 to \$945.

Triggered or gated operation as well as phase-lock capability are offered in the Model 115 function generator. In the trigger mode, a manual or external voltage generates one cycle. In the gated mode, a discrete number of cycles are keyed by a  $\pm 5$ -V gate. The unit will lock to any input within 10:1 of dial frequency and phase-lock to the fundamental of the dial frequency within specified accuracy.

CIRCLE NO. 231

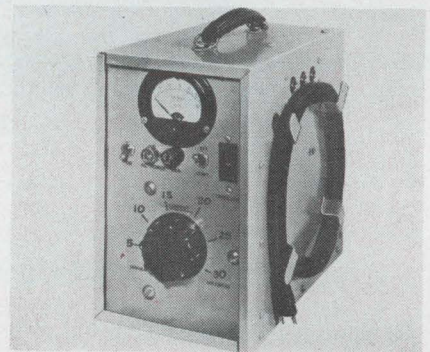

## Tracing transmitter for fault location

Hipotronics, Inc., Route 22, Brewster, N. Y., Phone: (914) 279-8484.

Location of faults, cable and phase identification, and continuity testing is accomplished by the Model 8030-30TC low-voltage tracing current transmitter. The instrument delivers 30 Vdc at 30 A pulse-coded into a three-phase cable, in a system called directional impulse tracing. It is designed to be hand carried and has continuously adjustable output control.

CIRCLE NO. 232

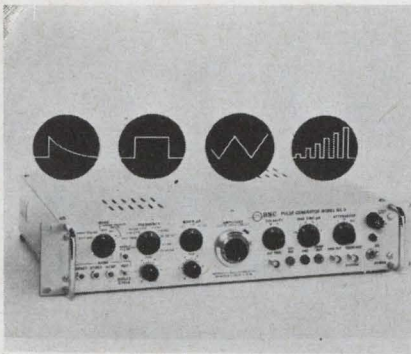

## Sliding pulser gives ramp-effect trains

Berkeley Nucleonics, Berkeley, Calif. Phone: (415) 848-1457. P&A: \$1460; 30 days.

The GL-3 provides a pulse train of linearly increasing amplitude for applications such as testing differential linearity of amplifiers and pulse-height analyzers. The instrument also generates precision amplitude pulses for conventional testing. In the sliding pulse mode, linearity is rated better than  $\pm 0.25\%$  with a pulse rep-rate of 1 Hz to 1 MHz. Stable pulse mode linearity is  $\pm 0.1\%$ .

CIRCLE NO. 233

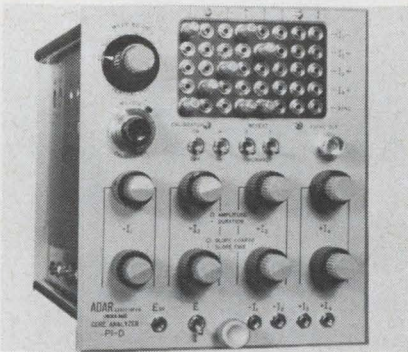

## Analyzer evaluates magnetic materials

Adar Associates, Inc., 73 Union St., Somerville, Mass. Phone: (617) 623-3131.

Evaluation of magnetic materials is the function of a multi-channel current-pulse-train generator. The solid-state instrument features programable operation, variable pulse current/voltage calibration and operational speed. Called the P1-D<sub>1</sub> core analyzer, the generator is packaged as a plug-in to fit Tektronix scopes.

CIRCLE NO. 234

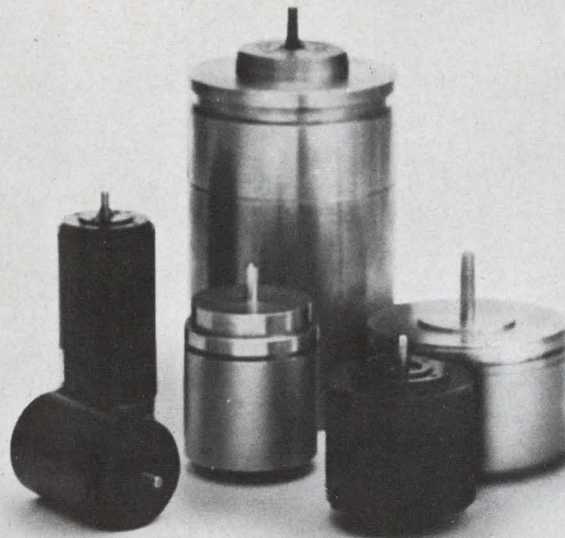

You'll replace six of theirs  
for every one  
of ours.



Litton's solid state optical encoders offer six times the life expectancy of tungsten element encoders.

Rugged, durable gallium arsenide light-emitting diodes make the difference. By eliminating tungsten bulbs — prime cause of optical encoder failure — MTBF is increased to 30,000 hours for a 2<sup>13</sup> binary encoder.

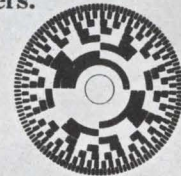

Environmental performance is just as exceptional. Litton's GaAs encoders recover from 115g shock and operate dependably during 70g shock. Still higher requirements can be met.

Our solid state encoders are ideal for applications where access is difficult or for systems where reliability is paramount. For information, write Encoder Division, 20745 Nordhoff St., Chatsworth, Calif. 91311, or telephone 213 341-6161.

Europe: Schwamendingenstrasse 5, Zurich 8050, Switzerland.

**ENCODER DIVISION  
LITTON INDUSTRIES**

ON READER-SERVICE CARD CIRCLE 81

# Coaxial Cables do double duty with **POMONA** BNC Adaptors

You can increase the flexibility and utility of your laboratory test equipment—and reduce the quantity and variety of coaxial cables—by using BNC Adaptors from Pomona Electronics.



**MODEL 1269**  
BNC Receptacle to  
Double Banana Plug



**MODEL 1296**  
Binding Posts  
to BNC Plug

Select from these popular adaptors to cover most of your needs... or choose from ten different combinations listed in our General Catalog, sent free upon request.



**MODEL 1645**  
BNC Receptacle to  
Shielded Banana Plugs

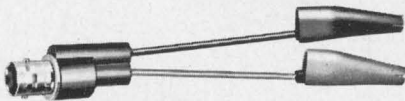

**MODEL 2631 "BREAKOUT"**  
BNC Receptacle to Minigator Clips

Select from these popular adaptors to cover most of your needs... or choose from ten different combinations listed in our General Catalog, sent free upon request.

**POMONA**  
**ELECTRONICS CO., INC.**  
1500 East Ninth Street, Pomona, California 91766  
Telephone (714) 623-3463

ON READER-SERVICE CARD CIRCLE 82

## TEST EQUIPMENT

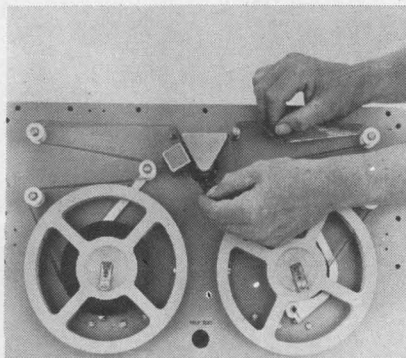

### Photoelectric reader lives in a suitcase

*Electronic Engineering Co., 1601 E. Chestnut Ave., Santa Ana, Calif. Phone: (714) 547-5501.*

For airborne, mobile or suitcase use, the 3002 photoelectric punched tape reader is completely ruggedized. The unit's direct coupled stepping motor drives the tape in either direction at rates up to 200 ch/s. The tape advances one character for each read-command, stopping on a character at all speeds. Design meets environmental specs of MIL-T-21200, Class 2.

CIRCLE NO. 235

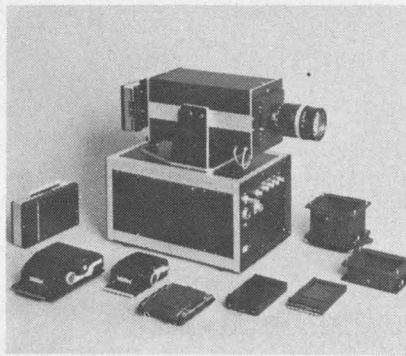

### Modular camera nets flexibility

*Electro-Optical Instruments, 441 Whisman Rd., Mountain View, Calif. Phone: (415) 968-6220. Price: from \$4950.*

For quantitative nanosecond photography, the modular "building-block" image converter camera X500 records at speeds from 5 to 1000 ns. Pictures recorded are up to 3-1/2-in. in diameter with 760 resolved line pairs across the field. X500 system components are interchangeable, including three heads and controls for single- or multi-frame configurations.

CIRCLE NO. 236

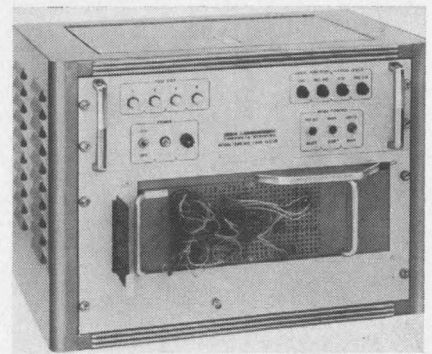

### IC card tester patch programmed

*Wyle Laboratories, 133 Center St., El Segundo, Calif. Phone: (213) 322-1763.*

Rapid go-no-go testing of IC cards is provided by the Model 1569. The instrument is programmed by a front panel patch-cord board and for high-volume repetitive testing, prepatched panels can be provided. A check of both logic function and voltage level is provided by the instrument and a counter indicator allows you to determine the exact malfunction.

CIRCLE NO. 237



### Time-code generator uses integrated logic

*Parabam, Inc., 12822 Yukon Ave., Hawthorne, Calif. Phone: (213) 679-3393. Price: \$2,000.*

The Series M digital clock time code generator features IC logic. It provides times information in BCD form for time transmission, range timing, time display and data systems. Time base is developed from the power line frequency or from optional internal oscillators. A variety of BCD output formats are available. Options for special applications such as controlling output at an external clock rate, remote start-stop and special pulse outputs are also offered.

CIRCLE NO. 238

**Do you have to  
"ride herd" on drifting  
oscillators?**

**... and need to check  
frequency periodically,  
monitor regularly, or  
adjust to a standard?**

Then the TRACOR direct-reading Model 527B Frequency Difference Meter is just what you need. It determines instantly—with an accuracy of  $10^{-10}$ —the fractional frequency difference between two stable oscillators.

It includes most of the features of its "big brother", the 527A, but costs much less. You read directly on a zero-center front-panel meter fractional frequency difference in parts per  $10^7$ ,  $10^8$ ,  $10^9$  or  $10^{10}$ . The meter movement continuously follows your oscillator adjustment — provides instantaneous reading of oscillator correction.

You may change the input frequencies without switching ..... frequencies of the two input signals need not be the same. The 527B accepts inputs of 100 kHz, 1.0 MHz, 2.5 MHz and 5.0 MHz; it is ideally suited for rating crystal oscillators. The 527B, when used with your counter, will allow you to measure differences of parts in  $10^{12}$ .

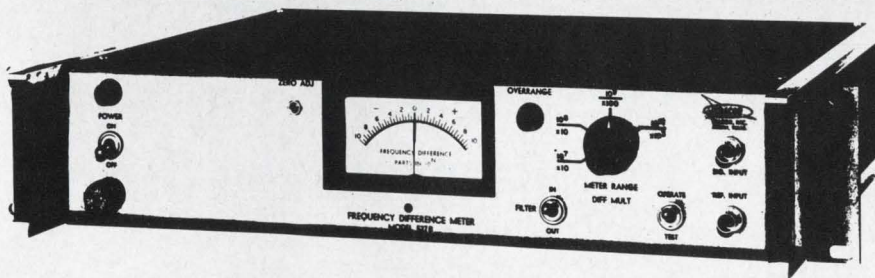

The Model 527B sells for \$2,250. For more information on this advanced-technology product, please write or call: TRACOR, INC., 6500 Tracor Lane, Austin, Texas 78721 AC 512 926-2800.

**Time & Frequency Instruments by**

**TRACOR**

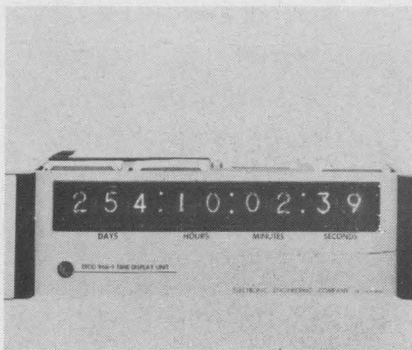

**Time-display units operate remotely**

*Electronic Engineering Co., 1601 E. Chestnut Ave., Santa Ana, Calif. Phone: (714) 547-5501. Price: from \$850.*

It is possible to have time information as produced by a time-code generator visible at any location in a test facility. A series of time display units, using Nixie displays can be located at any distance up to several miles from the generator. Models are available to operate from time codes in either serial-modulated carrier form or in parallel form.

CIRCLE NO. 239

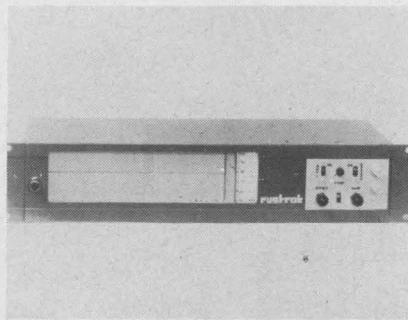

**Recording systems have extended view**

*Rustrak Instrument Co., Inc., Municipal Airport, Manchester, N. H. Phone: (603) 623-3596.*

An extended-view design of the manufacturer's recording systems allows up to 17-in. of recorded information to be examined. The systems consist of a miniature strip-chart recorder plus an amplifier or other accessories. The recorder uses an inkless dry-writing process. Chart speeds vary from 1/16 in. to 1800 feet per hour. At 1 in. per hour, 17 hours of recording is visible at a glance.

CIRCLE NO. 240

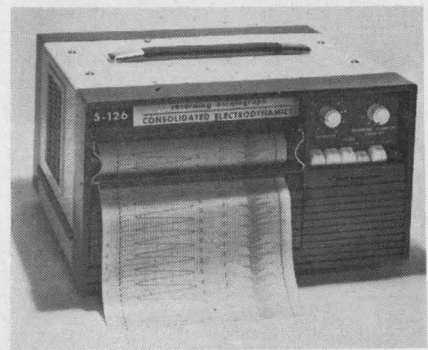

**Low-cost oscillograph operates light-beam**

*Consolidated Electrodynamics Corp., 360 Sierra Madre Villa, Pasadena, Calif. Phone: (213) 796-9381.*

Light-beam oscillography is said to be put into more modest budget ranges by the type 5-126 recording oscillograph. This is a 35-lb portable instrument that uses a high-intensity tungsten source, galvanometers and an optical system to produce up to 9 channels of data on 7-in. printout paper. Recording speeds range from 0.25 to 64 ips and range is dc to 1 KHz.

CIRCLE NO. 241

**GLOBE NEW 1 1/4" PM D.C. MOTOR GIANT TORQUE**

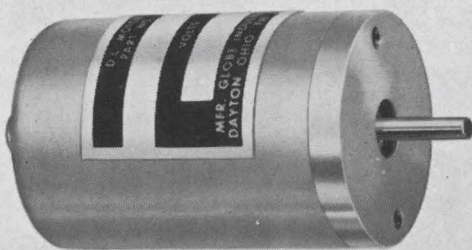

ACTUAL SIZE

Representing a new generation in d.c. motors, Globe's Type JM motor can bring your projects big benefits in a small package. This muscular little motor is only 1 1/4" dia. x 2 1/32" long, weighs only 5 ounces, yet delivers 1/65 HP continuous, 6,000-12,000 rpm. Outstanding voltage/speed features make the Type JM excellent for servo systems and control applications. A 50:1 voltage range is easily handled. Use as a low ripple, low friction generator, too. MIL spec quality throughout. 4 to 115 v.d.c. Options include planetary gear-train, governor, brake, etc. Request Bulletin JM.

Globe Industries, Inc., 2275 Stanley Avenue. Dayton, Ohio 45404 Tel.: 513 222-3741

ON READER-SERVICE CARD CIRCLE 84

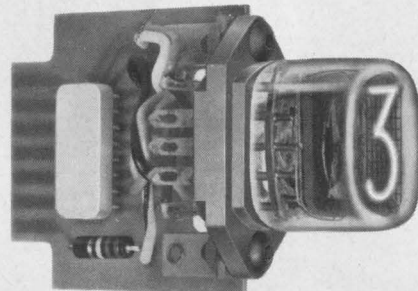

**NATIONAL® Readout Tube Drivers**

TTL Integrated Circuit Drivers designed for National Readout Tubes.

Now available: Decoder/Driver and Decimal Counter/Driver.

- 15 MHz Counting Rate
- Compatible with all side view and end view readout tubes.

**NATIONAL**

REQUEST BULLETIN

**ELECTRONICS, INC.**

a varian subsidiary

PHONE: (312) 232-4300 · GENEVA, ILLINOIS, U.S.A.

ON READER-SERVICE CARD CIRCLE 85

ELECTRONIC DESIGN 28, December 6, 1966



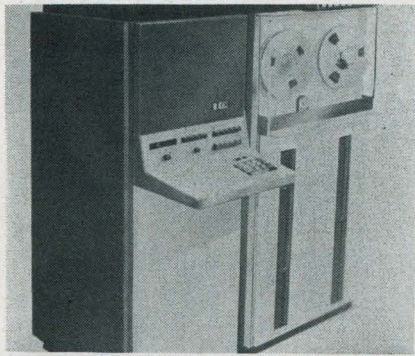

## Data system has core memory unit

*Information Control Corp., 138 Nevada St., El Segundo, Calif. Phone: (213) 322-6930.*

A stored-program data acquisition system, the SPDAS, offers sophisticated capabilities over a wide range. The system samples as many as 100 channels, performs A/D conversions, formats data for computer compatibility and records data on magnetic tape. Key to the system is a core memory with a 4,000-word 8-bit unit capability. Conversion rates run as high as 100,000/s.

CIRCLE NO. 242

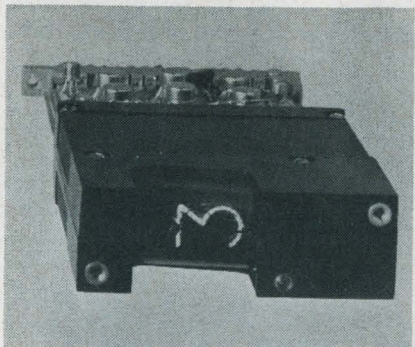

## Decade counter display modular, based on ICs

*Janus Control Corp., 296 Newton St., Waltham, Mass. Phone: (617) 891-4700. P&A: \$96.90; stock.*

The modular, 3-MHz display module Model IC-803 is based on integrated circuits. The forward-backward counter display provides in-line numerical display, base preset and 8-4-2-1 bipolar BCD outputs. It will accept forward, backward and reversing signals, either periodic or aperiodic. Modular packaging measures 3 x 1 x 6-3/4-in.

CIRCLE NO. 243

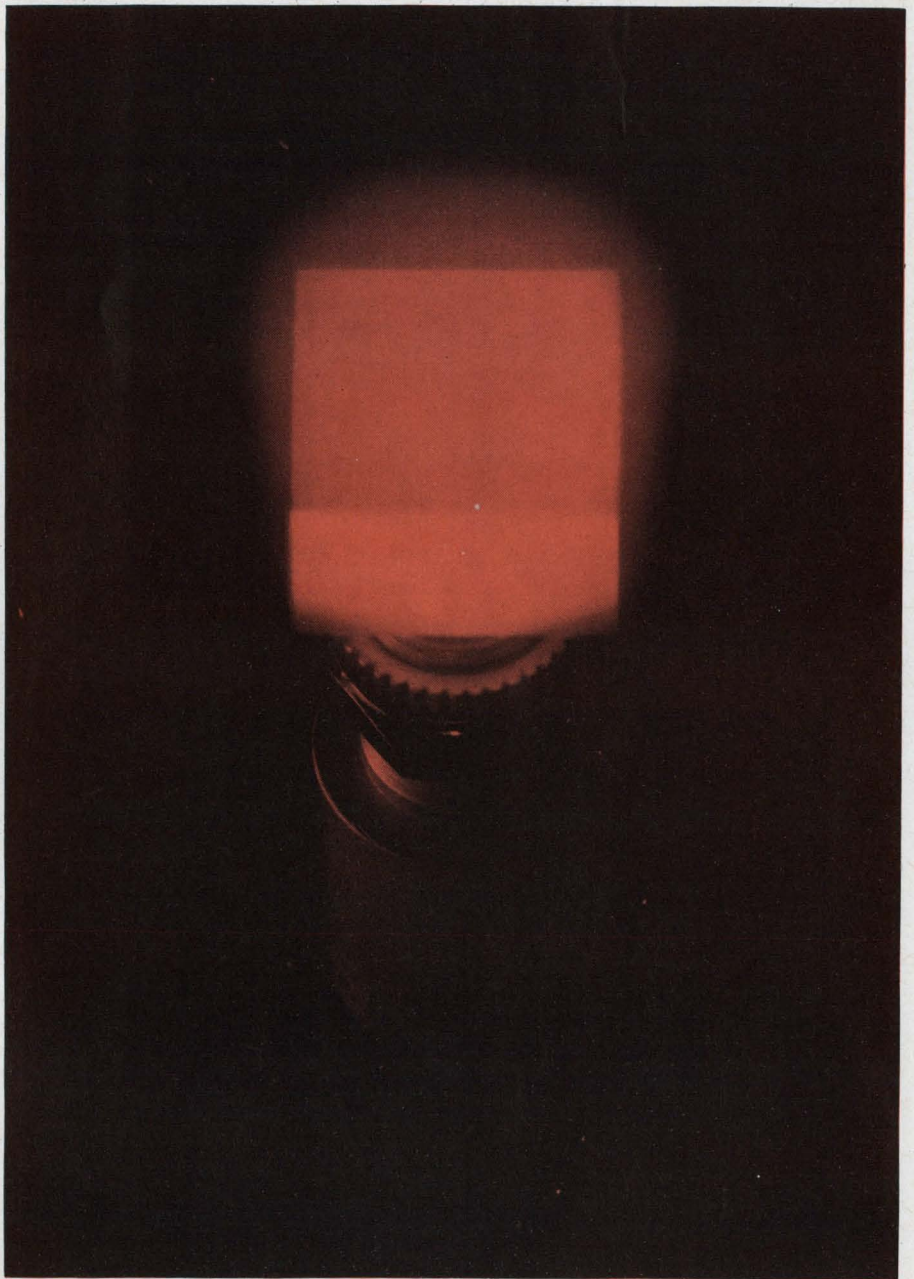

## new light on control panel design

Marco-Oak Presslite® switches give you instant light and color check of system status. They're the smallest illuminated pushbuttons available with contact ratings of 5 or 15 amps up to 120 vac...maximum body width or diameter is less than 3/4." Independent and isolated lamp circuits to indicate switch mode or remote system status mean less panel space, greater design latitude. Snap-action assures long contact life with a wide safety margin even beyond rated currents.

Presslite switches are available with a variety of options: SPDT or DPDT, alternate or momentary action, midget flange base, incandescent or neon lamps (with ballast resistors built into switch base). Ten basic cap styles (including Press-in caps in six sizes and shapes) give you a full color range. Matching indicators and recess panel mounting adaptors also available. Write today for the new S-66 Presslite catalog.

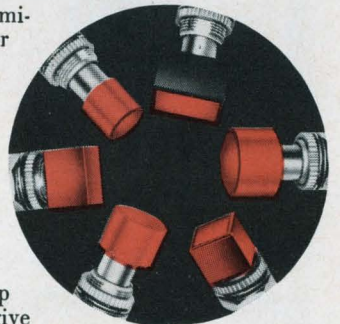

**MARCO-OAK**

A division of OAK ELECTRO/NETICS CORP  
207 S. Helena St., Anaheim, California 92805

ON READER-SERVICE CARD CIRCLE 86

# BURR-BROWN operational amplifiers

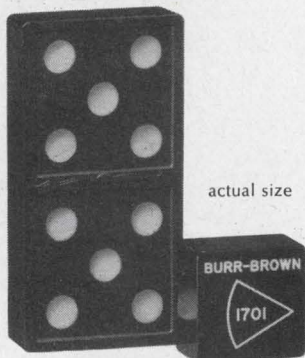

less than  
2/10 cubic inch  
in size

This new family of Burr-Brown general purpose operational amplifiers is just the ticket for thousands of applications where space is at a premium. Each one is a complete solid-state amplifier, requiring only external power to operate. Features include: built-in frequency compensation, input-output protection and output booster stage for  $\pm 10$  V at 10 mA.

**Model 1701** - Integrated Circuit Operational Amplifier, state-of-the-art performance

**Model 1706** - Discrete Component Operational Amplifier, low current offset and drift

**Model 1752** - FET Input Operational Amplifier, high input impedance

**Model 1719** - 50 mA Power Booster for use with above models



These amplifiers may be used in any of the typical circuits shown in Burr-Brown's Handbook on Operational Amplifier Applications and the Handbook of Active RC Networks.

**FOR COMPLETE INFORMATION**  
Wire, write or phone Burr-Brown

# BURR-BROWN

RESEARCH CORPORATION  
INTERNATIONAL AIRPORT INDUSTRIAL PARK  
BOX 11400, TUCSON, ARIZONA 85706  
PHONE: 602-294-1431 • TWX: 910-952-1111

ON READER-SERVICE CARD CIRCLE 100

## POWER EQUIPMENT

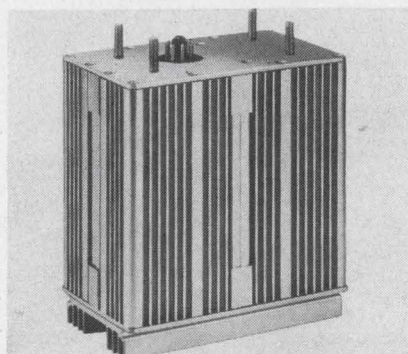

### Modular supplies transistor regulated

Mid-Eastern Electronics, Inc., 15 Brown Avenue, Springfield, N. J. Phone: (201) 376-7130. P&A: \$198; stock.

With neither forced air nor heat sinking, HT series transistor regulated supplies will function reliably at ambients up to 40°C. Units are available in ratings from 6 V at 4 A to 100 V at 0.75 A. Line regulation is 0.025% for a  $\pm 10$ -V change. Load regulation is 0.02% zero to full. Standard models have an MTBF of over 35,000 hours. MTBFs of 60,000 hours are available as a special option.

CIRCLE NO. 244

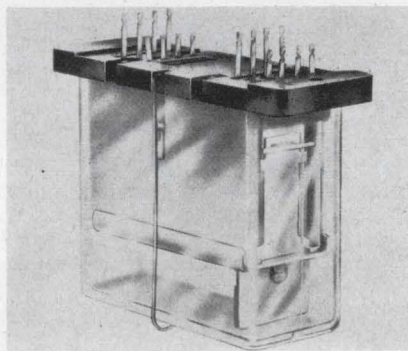

### French power module designed for IC use

Sodilec Co., 4, Rue Simone Bigot, Neuilly-Plaisance (Seine-et-Oise), France.

The French-manufactured SDT 144 power module is designed specifically for use with integrated circuits. Features include constant voltage/constant current operation with automatic crossover and regulation in either mode to 0.01%. Voltage is continuously adjustable from 0 to 4 A and remote programming and regulation are also possible.

CIRCLE NO. 245



### Automatic regulators stabilize to 100 mV

Superior Electric Co., Bristol, Conn. Phone: (203) 582-9561. P&A: \$370-\$1740; stock.

Output voltage is held within a 100-mV band regardless of line and load through the IES stabiline regulators. Time constant response for a 63% return is 30 ms. Frequency range is either 50 or 60 Hz  $\pm 10\%$ , and efficiency is rated up to 95%. Units are offered for 115- or 230-V service with ratings up to 15 kVA.

CIRCLE NO. 246

### Master outlet box monitors power line

Waber Electronics Inc., 2000 N. Second St., Philadelphia, Pa. Phone: (215) 634-3200. Price: \$7.50-\$9.50.

A series of master power outlet boxes continuously monitors its ac line voltage. The units, called the 230 M series, feature illuminated voltmeter readings from 0 to 150 V. Power ratings are 15 amp at 130 V continuous. Units are available with either fuse or circuit-breaker protection and with varying lengths of cord.

CIRCLE NO. 247

### 16 power modules regulated to $\pm 0.005\%$

Raytheon Co., Norwalk, Conn. Phone: (203) 838-6571.

Line and load combined regulation as tight as  $\pm 0.005\%$  is available in the 16 models of the QSB series power supplies. The dc units have ripple held to 250  $\mu$ V with 1 mV peak-to-peak and a transient response of  $< 40$   $\mu$ s. Stability is 0.025% for eight hours. Change in output voltage as a result of ambient temperature change is less than 0.015%/°C. The 6-28 Vdc series includes 25-200-W units.

CIRCLE NO. 248

# Announcing the Brush Mark 250, first strip chart recorder for the perfectionists of the world.

Shown with 1  $\mu\text{v}$  preamplifier RD 4215-70; event markers optional.

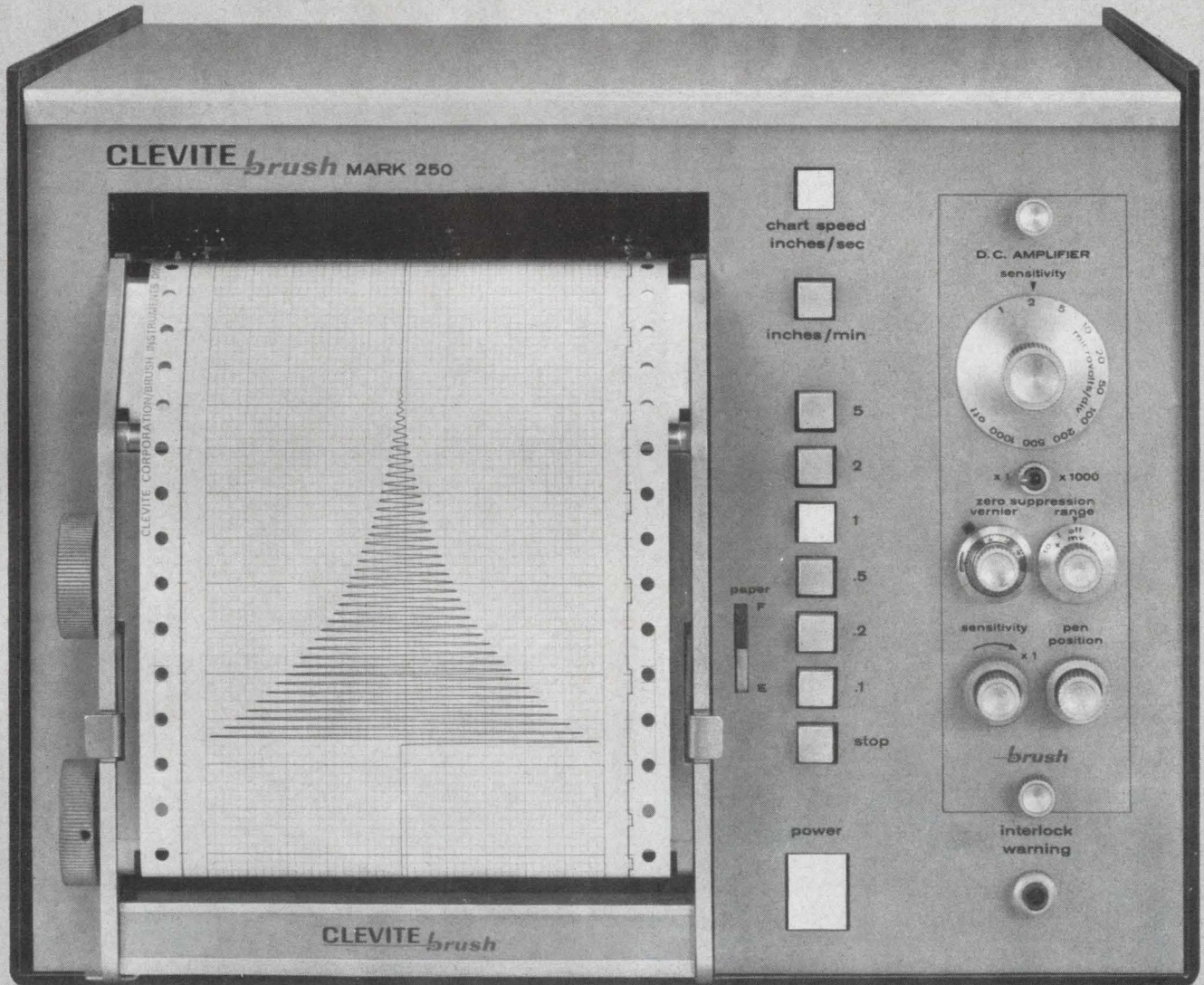

Meet the fastest, most accurate strip chart recorder on record: The new Brush Mark 250. When you read about all the features you'll know why we call it the first recorder for the perfectionists of the world!

**1 Unmatched frequency response.** Flat to 10 cycles on full 4½" span! Useful response to 100 cycles. Nobody has a strip chart recorder in the same league.

**2 Wide selection of signal conditioners.** Choose from 21 interchangeable preamps. Use one today; plug in a different one when your recording requirements change.



**3 Crisp, clean rectilinear writing.** Patented, pressurized inking system puts smudge-proof trace *into* the paper not just on it.

**4 Contactless, non-wearing feedback system.** Same one used in our multi-channel Mark 200 recorders. (No slide wires!) Accuracy? Better than ½%!

**5 Multiple chart speeds.** Pushbutton choice of twelve . . . from 5 inches/second to 1/10 of an inch/minute (up to 8 days of continuous recording).

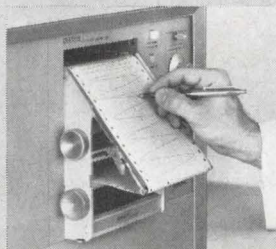

**6 Portable or Rack mounting.** And either way you get the exclusive new dual position writing table.

**7 Removable chart paper magazine.** Great for desk top record reviews. Man-sized manual winding knobs let you roll chart forward *and* back. Chart re-loading is a cinch.

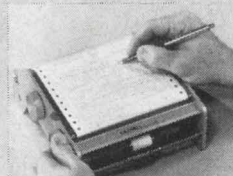

See what we mean? The Mark 250 is for the perfectionists of the world. Ask your Brush Sales Engineer for a demonstration. Or, write for chart sample and specifications. Clevite Corporation, Brush Instruments Division, 37th & Perkins, Cleveland, Ohio 44114.

**CLEVITE**  
—brush— INSTRUMENTS DIVISION  
The Brush Mark 250 First recorder for perfectionists

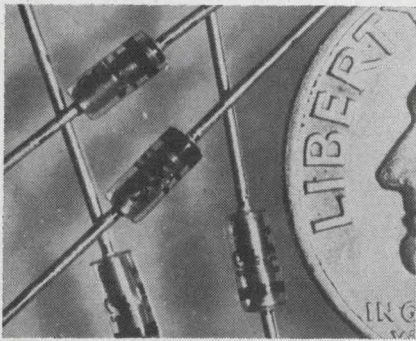

### Submin diode made "whiskerless"

Hughes Aircraft Co., Centinela Ave. & Teale St., Culver City, Calif. Phone: (213) 391-0711. P&A: from \$0.37; stock.

Here's a silicon planar epitaxial diode that features whiskerless construction. Called WOW diodes (WithOut Whiskers), the subminiature devices are said to provide high mechanical strength and stability for critical circuits. They are high-conductance types designed for high-speed switching and core driver applications.

CIRCLE NO. 249

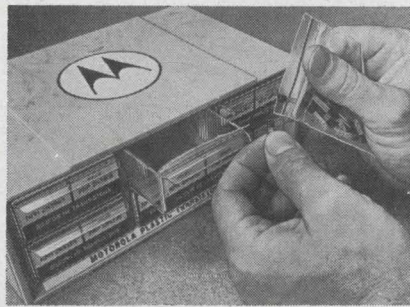

### Semiconductor selection contains 300 devices

Motorola Semiconductor Products, Inc., P. O. Box 955, Phoenix. Phone: (602) 273-6900. Price: \$49.50.

Circuit designers, prototypers and experimenters are offered a package containing 300 "Uniblock" semiconductors. Called HANDY-Lab, the 6-drawer package contains 11 different general-purpose npn and pnp plastic transistor types and 25 plastic dual switching diodes. Types included, 25 each, are: 2N3903, 2N3905, 2N4124, 2N4126, 2N4264, 2N4400, 2N4402, MPS706, MPS918, MPS6520 and MSD6100.

CIRCLE NO. 250

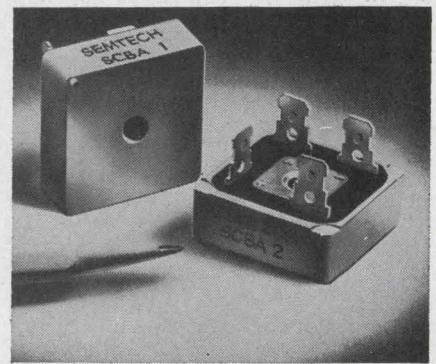

### Rectifier circuit housed in aluminum

Semtech Corp., 652 Mitchell Rd., Newbury Park, Calif. Phone: (213) 628-5392.

The "Alpac" power bridge rectifier circuit is housed in an aluminum case for rugged applications. The case measures 1.125 x 1.125 x 0.406-in. and is designed for simple installation. Ratings range up to 25 A average rectified current and PIV ratings range from 50 to 600 V. The device is rated at a max thermal resistance of 1.5°C/watt.

CIRCLE NO. 251

**LOOK WHAT'S HATCHED AT  
LITTELFUSE**

**The world's smallest fuse—Picofuse.  
1/8 thru 5 amps...1/6 gram...125 v.**

**LITTELFUSE**  
DES PLAINES, ILLINOIS

ON READER-SERVICE CARD CIRCLE 102

**IDENTIFY WIRES AND CABLES  
WITH INDESTRUCTIBLE PVC**

**'S' MARKERS**

**'Z' MARKERS**

**'Z' and 'S' MARKERS**

Here are marking systems that will last the life of wire and cable under all conditions. Can't rub-off, peel-off or fall-off...can't slip or slide, yet are easily removed when necessary...are guaranteed to resist abrasion, grease, oil and chemicals!

"Z" markers for wires up to 1/2" diameter and "S" markers for bundles of wires or cable over 1/2" diameter. Write for free samples today.

**OTHER ELECTROVERT PRODUCTS:** wire and cable harnessing systems; grommet strip, wavesoldering systems.

Sold Coast-to-Coast through Authorized Distributors.

**ELECTROVERT INC.**  
86 Hartford Ave., Mt. Vernon, N.Y. 10553  
Burbank, California; Milwaukee, Wisconsin

ON READER-SERVICE CARD CIRCLE 103

ELECTRONIC DESIGN 28, December 6, 1966

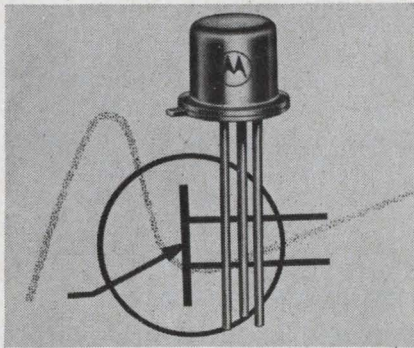

### Unijunction line for long-period oscillators

Motorola Semiconductor Products, Inc., Box 955, Phoenix, Ariz. Phone: (602) 273-4560. P&A: \$0.80-\$1.50; stock.

In the design of long time-delay circuits, use of the 2N4851-53 unijunction transistors is said to allow the use of comparatively small and inexpensive capacitors. Key specs on the new devices are emitter reverse and peak-point current. Both 2N4851 and 52 have an emitter reverse current rating of 0.10  $\mu$ amp and a peak-point of 2.0  $\mu$ amp. Intrinsic standoff ratio is 0.75 and 0.85 respectively. 2N4853 has an emitter reverse of 0.05  $\mu$ amp and a peak-point of 0.4  $\mu$ amp with an intrinsic standoff ratio of 0.85. Emitter saturation voltage for all three units is 2.5 V.

CIRCLE NO. 252

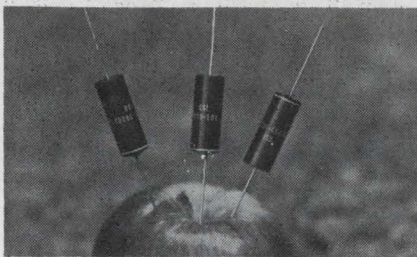

### Current regulators act like zeners

General Semiconductors, 230 W. 5 St., Tempe, Arizona. Phone: (602) 966-7263.

A line of precision current regulators act in-circuit much like zener diodes. The two-terminal devices are suggested in such applications as squaring, timing, sweep, pulse integrators, filters, TC reference diode sources, biasing and circuit protection. Package dimensions are 0.375-in. diameter, 1-in. length with gold-plated leads. Ratings range 0.5 to 10 mA.

CIRCLE NO. 253

## DO YOU MAKE THESE FIVE COMMON MISTAKES IN EVALUATING CAREER GROWTH OPPORTUNITIES?

1. Do you consider only the largest companies in your particular field? Size of opportunity is not necessarily proportional to size of company. Many medium size companies, such as ECI, offer faster achievement of professional recognition and personal satisfaction than do the "industry giants."
2. Do you fail to consider breadth of product/customer base? It's difficult to achieve career stability in a company that is closely tied to a narrow range of products and technologies and which sells them to a limited number of customers. You'll do better at ECI, where major projects in VHF/UHF communications, multiplex, space instrumentation, microelectronics, systems integration and advanced communications techniques are in progress simultaneously. ECI's broad customer base includes Army, Navy, Air Force, Marine Corps, NASA and foreign governments.
3. Do you consider joining a company which has insufficient R&D programs? Lack of aggressive R&D could mean future trouble for the company... and you. ECI has a wide range of Company and customer-funded development programs, particularly in the promising fields of microelectronics, telemetry, space instrumentation and digital switching systems.
4. Are you overly impressed with "boom" growth conditions? Growth that's too fast can point to future instability. Look for a record like ECI's, where years of stable, predictable growth demonstrate management's ability for both sound planning and successful execution.
5. Do you settle for less-than-optimum living conditions in the name of opportunity? You needn't! In addition to all the foregoing advantages, a career at ECI will let you and your family enjoy life to the fullest in St. Petersburg, Florida. This segment of Florida's Gulf Coast offers an unequalled combination of sunshine, beaches, golf, boating, and fishing plus cultural, educational and professional engineering opportunity.

### RF ENGINEERS SYSTEMS INTEGRATION ENGINEERS DIGITAL SWITCHING ENGINEERS

Make a new career evaluation today! Investigate the immediate and attractive opportunities at ECI by sending your resume, in confidence, to K. S. Nipper, Director of Professional Placement, Electronic Communications, Inc., Box 12248D, St. Petersburg, Florida 33733. (An equal opportunity employer.)



St. Petersburg Division  
Electronic Communications, Inc.

**BRANSON**

**DPDT  
1/6 SIZE**

**RELAY**

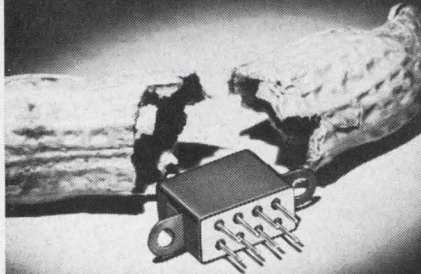

**Meets Requirements  
of MIL-R-5757/19**

**NEW FROM BRANSON**

This small 1/6 crystal can size DPDT relay, Type JR, handles low level up to 1 full ampere . . . withstands high shock and vibration . . . meets MIL-R-5757/19. Coil and header styles available to meet all applications!

**OTHER BRANSON PRODUCTS**

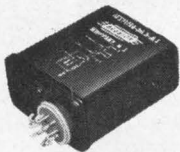

**TIME DELAY  
RELAYS**

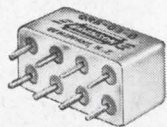

**SOLID STATE  
TIME DELAY RELAY**



**6 POLE CRYSTAL  
CAN RELAY**

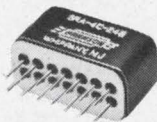

**4PDT HALF CRYSTAL  
CAN RELAYS**

*Relays...  
Our Only Business*

**BRANSON CORP.**

VANDERHOOF AVENUE  
DENVER, NEW JERSEY  
(201) 625-0600

ON READER-SERVICE CARD CIRCLE 205

**MATERIALS**

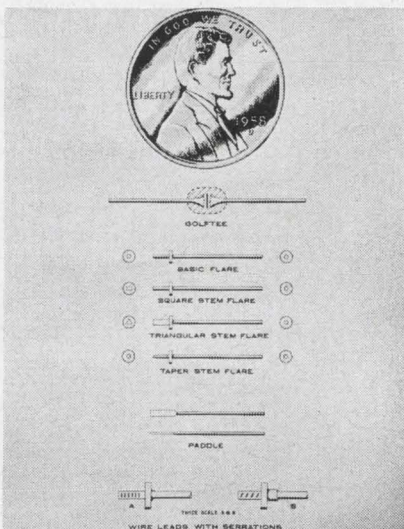

**Wire lead line  
for semicon devices**

Wire Forms Division of Emporium Specialties Co., Austin, Pa. Phone: (814) 647-8691.

A complete line of wire leads is now available, formed by cold-heading the ends of wires ranging between 0.008-0.060-in. These leads are offered for use as leads and terminals in resistors, transistors, diodes, etc. Wire material selection includes gold, silver, copper, tantalum, nickel and various seal materials.

CIRCLE NO. 254

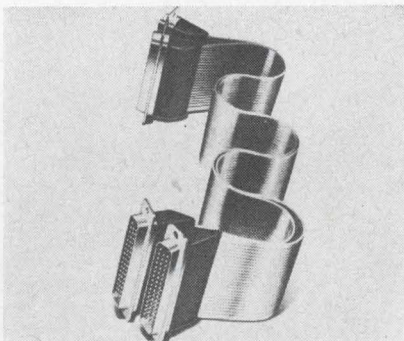

**Flat-cable units  
need no stripping**

ITT Cannon Electric, 3208 Humboldt St., Los Angeles, Calif. Phone: (213) 225-1251.

Welding is performed through the insulation of the Flex-Weld flat-cable assemblies. These assemblies consist of multiple ribbons of flat copper conductors uniformly spaced and laminated between Mylar or Teflon insulation, straight or corru-

gated. The design is said to provide up to 50% combined weight and size reduction of comparable round-wire systems and the flat conductors dissipate more heat.

CIRCLE NO. 255

**Ag-plated wire  
Teflon insulated**

Tensolite Insulated Wire Co., W. Main St., Tarrytown, N. Y. Phone: (914) 631-2300.

Ultra-fine sizes of both mono- and multifilament Teflon insulated copper wire, silver plated, are offered for off-the-shelf delivery. The UT wires range in diameter from 0.23-0.135-in. in standard 500- and 1,000-ft spools. The Teflon insulation is chemically inert and will tolerate extremes from -90° to +200°C. The insulation is rated for 300 V.

CIRCLE NO. 256

**Epoxy tape bonds  
honeycomb or metals**

Adhesive Engineering, 1411 Industrial Rd., San Carlos, Calif. Phone: (415) 591-2686.

In both metal-to-metal and honeycomb bonding, Aerobond 3030 meets MIL-A-132 types I (class 3) and II as well as MIL-A-25463, types II and III. Aerobond 3030 is multi-purpose and can be used for both large and small-area bonding. Useful temperature is up to 550°F. Lap shear strength ranges from 2700 psi at -67°F to 800 psi at 500°F.

CIRCLE NO. 257

**Chromium sources  
for sputtering**

Materials Research Corp., Orangeburg, N. Y. Phone: (914) 359-4200.

For more depositions before replacement, sizes up to 1/4 x 3-1/2 x 3-1/2-in. are available in a line of high-purity chromium sputtering sources. These sources are prepared by arc casting to a purity of 99.996% nominal, including gas content. The higher purity is also said to increase production yield by eliminating impurities that affect device performance.

CIRCLE NO. 258

# 0.0004 seconds

**A breakthrough  
in torque  
response**

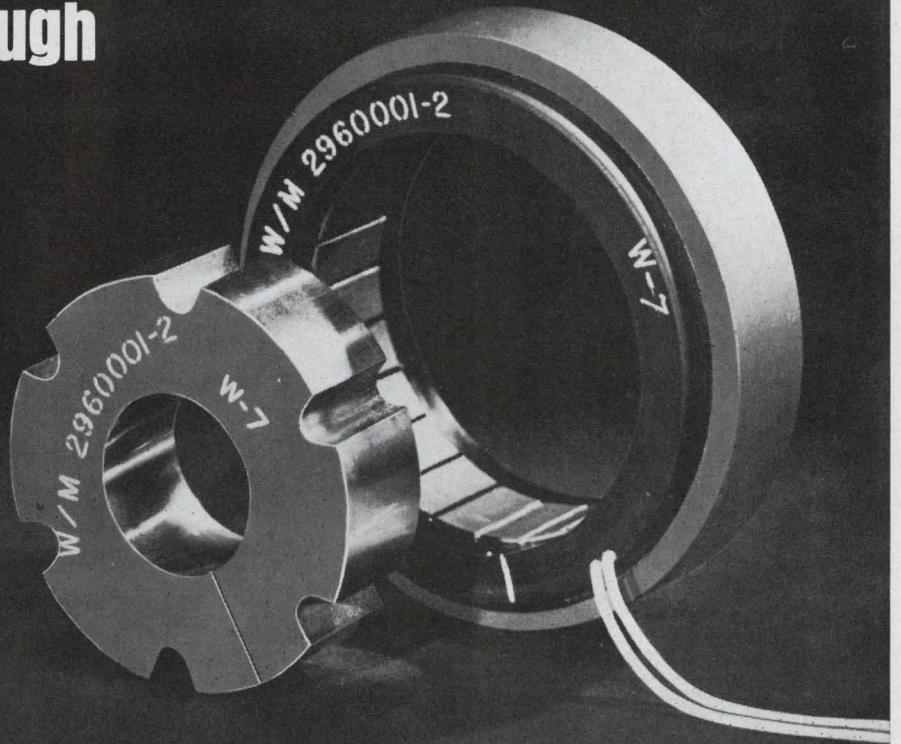

*Torque motors with a response of four hundred millionths of a second are now a reality. And this breakthrough is only one of several benefits offered you in a new line of torquers by Wright Division of Sperry Rand.*

## Reliability

No contacts. No brushes. No commutation bars. Simplified winding. Permanent magnet.

## Better Performance

Direct Drive. No friction. No ripple torque.

## What does a Wright torque motor do?

It holds, clamps, stabilizes, drives, opens, closes, cracks, shuts, pushes, picks up, moves, rotates, nulls, controls, actuates.

Design engineers are invited to write or telephone for details. Comparison will show you that on applications where incremental rotation is needed, this new Wright concept in torquers offers substantial advantages.

SIZE	O.D.	Watts at Peak Torque	Design					
			2 Pole 180°		4 Pole 90°		6 Pole 60°	
			Peak Torque Oz.-In.	Electrical Time Constant L/R (Secs.)	Peak Torque Oz.-In.	Electrical Time Constant L/R (Secs.)	Peak Torque Oz.-In.	Electrical Time Constant L/R (Secs.)
10C	.9650	9.5	6.5	.0004	—	—	—	—
14C	1.3400	19	12	.0007	24	.0004	—	—
18C	1.8000	35	23	.0013	46	.0007	—	—
23C	2.3000	60	40	.0022	80	.0011	—	—
27C	2.6093	71	47	.0026	94	.0013	140	.0007
40C	4.000	180	100	.0055	200	.0028	300	.0019
50C	5.000	183	120	.007	240	.004	360	.0025
70C	7.000	377	250	.015	500	.0075	750	.005
100C	10.000	545	360	.020	720	.010	—	—

**WRIGHT**   
Division of Sperry Rand Corporation

Durham, North Carolina ■ Telephone 919-682-8161 ■ TWX 919-682-8931

ON READER-SERVICE CARD CIRCLE 106

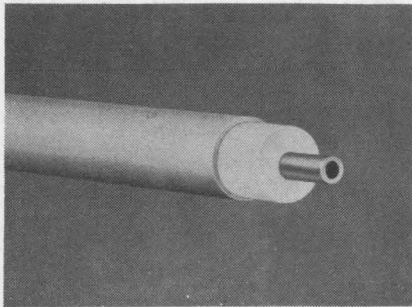

### Low-loss cable has foam dielectric

Phelps Dodge Electronic Products Corp., 60 Dodge Ave., P.O. Box 187, North Haven, Conn. Phone: (203) 239-3311. P&A: \$0.64/ft; stock.

With foam polyethylene dielectric and a tubular aluminum outer conductor, "Aircraft Foamflex" is rated for less than half the loss of conventional RG-213/U and RG-214/U coax. Designated RG-231/U by the Air Force, the coax has an impedance of 50 Ω, capacitance of 27 μμF/ft, velocity of 81% and a loss of 3.5 dB/GHz. A full line of adaptors is available.

CIRCLE NO. 259

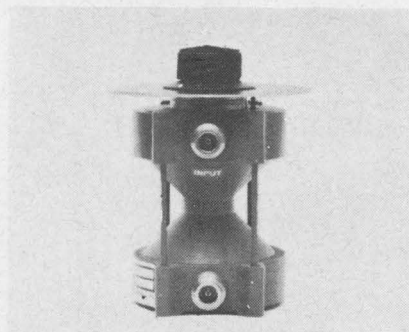

### Variable attenuator covers 4 to 5, 8 to 10 GHz

Arra Inc., 27 Bond St., Westbury, N. Y. Phone: (516) 334-8710. P&A: \$900; 8 wks.

Called "Space-Track" type attenuators, the model 5-6684-100C delivers 0- to 100-dB attenuation at both 4 to 5 and 8 to 10 GHz. The hand-sized unit has a power capacity of 10 W average and 5 kW peak. Other specs include a max input vswr of 1.50 and on insertion loss rating of 1.5 dB. A variety of connector-styles are offered at the customer's request.

CIRCLE NO. 260

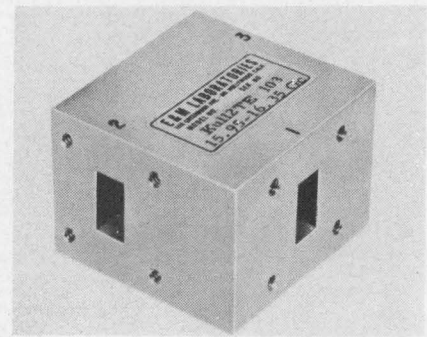

### E-plane circulators cover X, Ku bands

E&M Laboratories, 7419 Greenbush Ave., North Hollywood, Calif. Phone: (213) 983-0912.

Particularly suited for duplexer applications, the E-plane "T" circulators cover the X and Ku bands. Typical of the type, the X128TE operates from 8.8 to 9.2 GHz with 20-dB min isolation, 0.4-dB max insertion loss and a vswr of 1.2 max at 100-kW peak and 100-W average power. Body size is 2 x 1-3/4 x 1-3/4-in. Units are also available in 4-port configuration in all bands.

CIRCLE NO 261

### PLASTIC SEALLESS PUMP

... for etching acids with no leakage  
Standard capacities are from 1/3 to 40 gpm

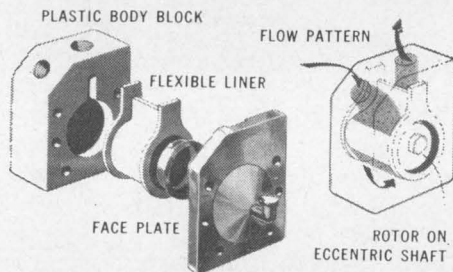

A rotor, mounted on an eccentric shaft in this plastic pump, rotates within a liner to create a progressive squeezing action on fluid trapped between the liner and the body block. All metal parts and mechanical action takes place inside the liner where fluid never reaches. This completely eliminates the need for stuffing boxes or shaft seals, guaranteeing no leakage.

The pump is self-priming, operates wet or dry and is suitable for extremely corrosive fluids, abrasive slurries or viscous materials. Applications include pumping of acids, alkalis, distilled water, diatomaceous earth slurries, electroplating solutions, ceramic tile glaze as well as shear sensitive emulsions.

Standard capacities are from 1/3 to 40 gpm with discharge pressure up to 50 psi. Materials of construction include Teflon, polypropylene, linear polyethylene, Bakelite or stainless steel for body blocks and Viton-A, Kel-F elastomer, Hypalon, Neoprene and Buna-N for the liner. These are the only parts in contact with the fluid.

For additional information, write Vanton Pump & Equipment Corporation, Hillside, New Jersey or telephone Area Code 201 926-2435.

ON READER-SERVICE CARD CIRCLE 107



## ARNOLD / TOROIDAL COIL WINDER

sets up quickly...easy to operate...  
takes wide range of wire sizes

#### SPECIFICATIONS:

- Min. finished hole size: .18 in.
- Max. finished toroid O.D.: 4.0 in.
- Winding speed: 1500 turns/min.
- Wire range: AWG 44 to AWG 26
- Dual, self-checking turns counting system
- Loading (wire length) counter
- Core range: 9/32" I.D. to 4" O.D. to 1 1/2" high

#### LABORATORY USE

- Change wire and core size in 45 sec.

#### PRODUCTION USE

- 1500 turns per minute
- Insert core and load in 20 sec.

\$890.00 includes all rings, counters and accessories



immediate delivery. literature on request

**ARNOLD MAGNETICS CORP.**

6050 W. Jefferson Blvd., Los Angeles, Calif. 90016  
(213) 870-6284

ON READER-SERVICE CARD CIRCLE 108

ELECTRONIC DESIGN 28, December 6, 1966



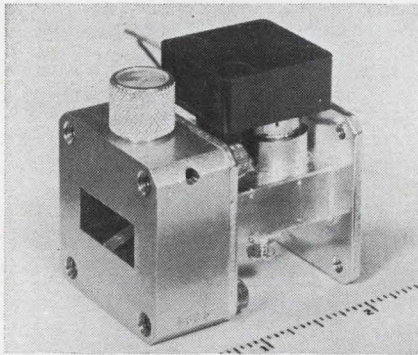

### Solid-state/gas tube hybrid for radar use

Varian Bomac Division, Salem Rd., Beverly, Mass. Phone: (617) 922-6000.

Primary applications for the TR-Limiter BTL-001 are seen in radar-receiver spike elimination. The unit is a combination of a gas-switching TR with shutter and a solid-state limiter. It is designed to operate over the 9.0- to 9.4-GHz range. In addition, the BTL-001 can be used for protection of tunnel-diode amplifiers and similar units can be supplied for any 500-MHz range from 8.5 to 10.0 GHz.

CIRCLE NO. 262

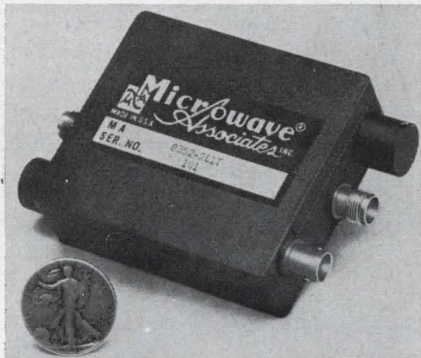

### 805 MHz shifter is varactor controlled

Microwave Associates Inc., Burlington, Mass. Phone: (617) 272-3000.

Designed as an error correction element in a linear accelerator, the MA-8352-2LIT phase shifter is varactor controlled. Among the component's features is a drive power requirement of 0-120 V at less than 100  $\mu$ A. Phase shift is continuously variable from 0 to 180 degrees. Maximum insertion loss is 1.5 dB, vswr is 1.5 and power level is rated at 100 mW.

CIRCLE NO. 263

AMERICAN MACHINE & FOUNDRY CO. • AVCO •  
 BEECH AIRCRAFT • BELL & HOWELL • BOEING •  
 BURROUGHS • CHRYSLER CORPORATION •  
 CONTROL DATA CORPORATION • CORNING  
 ELECTRONICS • DOUGLAS AIRCRAFT COMPANY •  
 DOW CHEMICAL • FMC • GENERAL ELECTRIC CO. •  
 THE GOODYEAR TIRE & RUBBER COMPANY •  
 ITT FEDERAL LABORATORIES • LITTON INDUSTRIES •  
 LOCKHEED AIRCRAFT • MCDONNELL •  
 MARTIN COMPANY • NORTH AMERICAN AVIATION,  
 INC. • NORTHROP • RADIO CORPORATION OF  
 AMERICA • RAYTHEON • SIKORSKY AIRCRAFT •  
 SOLAR DIVISION OF INTERNATIONAL HARVESTER  
 CO. • TEXAS INSTRUMENTS • T R W •  
 UNION CARBIDE • WESTINGHOUSE  
 ELECTRIC CORPORATION.

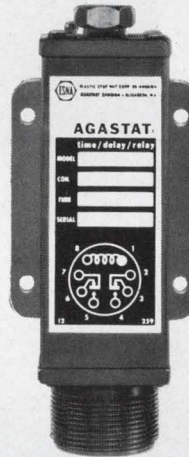

## why is the miniature AGASTAT®

time/delay/relay  
 the only MIL-SPEC pneumatic?

Some of our best customers know it's the only one that offers . . .

- **RUGGEDNESS** . . . exceeds MIL E-5272 specs for vibration, shock, acceleration.
- **HERMETIC SEALING** . . . recirculates its own inert gas supply—free of dust and moisture.
- **COMPACTNESS** . . . no other pneumatic t/d/r packs so much into a 1.52" x 1.52" x 4.4" can.
- **WIDE TIMING RANGES** . . . nine models, from .03 seconds to 3 minutes.

- **EASY ADJUSTMENT** . . . exclusive dial head for true linear adjustment—no needle-valve "cut and try."
- **PLUS** . . . freedom from transient effects . . . voltage-and-temperature resistance . . . maximum weight 16 oz. . . instant recycling . . . high repeat accuracy . . . broad terminal selection; solder lug, octal plug, "AN" connector or to your order . . . wide range of AC or DC operating voltages . . . unsealed models for industrial applications, too. Write today for complete specifications. M9

**AGASTAT TIMING INSTRUMENTS**  
 ELASTIC STOP NUT CORPORATION OF AMERICA  
 AGASTAT DIVISION • ELIZABETH, NEW JERSEY  
 IN CANADA: ESNA LIMITED, 271 PROGRESS AVENUE, SCARBOROUGH, ONTARIO

ON READER-SERVICE CARD CIRCLE 109

# STANDARD FREQUENCY RECEIVERS

FREQUENCY STANDARDIZATION TO THE  
NATIONAL BUREAU OF STANDARDS

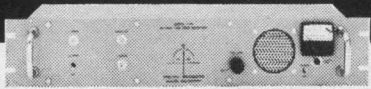

**Model T-60 60 KHZ Time Code Receiver**  
Round The Clock WWVB 60 KHZ Binary Time Code Broadcasts • Most Accurate Time Signal Available • Can Be Recorded Continuously  
Radio Station WWVB is broadcasting complete time information using a level shift carrier time code (10 db level changes). This code, which is binary coded decimal (BCD) is broadcast continuously and is synchronized with the 60 khz carrier signal. \$480.00

**Model T-60A Rack Model (3½" H x 19" W x 5" D)**

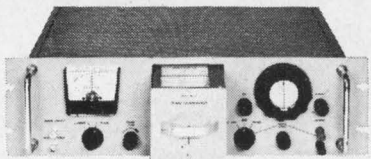

**Model SR-60 Price: \$850.00**  
Model SR-60. WWVB-60 khz. Will calibrate any local standard up to  $5 \cdot 10^{10}$  within a short period. Can be easily operated by any technician and performs in any part of the Continental United States.

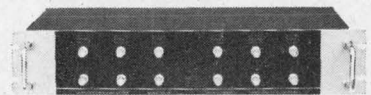

**Model SFD-6R Modular Construction:**  
A complete system for distribution of standard frequency throughout a plant. All solid State—fail safe—reasonably priced. Price depends upon Modules selected (\$90.00 each). Several Modules available.

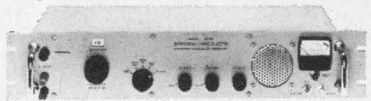

**Model WVTR Mark II All Silicon Transistor**  
Five different models of Receivers for WWV and WWVH are available. They receive all frequencies transmitted by WWV and are all crystal controlled double conversion superheterodynes. \$590.00

Special Antenna Assemblies for both VLF and HF are in stock.

**Model WWVT \$590.00**

**Mark II All Silicon Transistor**  
Over All Size  
7¼" x 9½" x 5"  
Approx. Weight  
7 lbs.

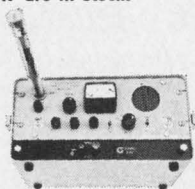

**Model 45 \$98.50**  
A pocket size battery powered Time Base Calibrator, complete with internal battery.

Send for complete specifications. Prices and specifications subject to change without notice. F.O.B. Woodland Hills, Calif.

## SPECIFIC PRODUCTS

P.O. Box 425 / 21051 Costanzo Street  
Woodland Hills, California  
Area Code: 213 340-3131



ON READER-SERVICE CARD CIRCLE 181

## MICROWAVES

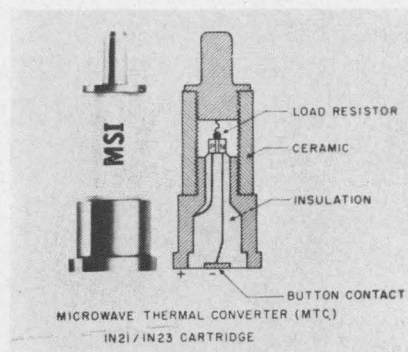

### Microwave converter goes to 12.4 GHz

MSI Electronics Inc., 34-32 57 Street, Woodside, N. Y. Phone: (212) 672-6500. P&A: \$22.50 to \$45; stock.

RF energy is measured by conversion to heat by the MSI series of microwave thermal converters. In absorbing RF power in the 10-kHz to 12.4-GHz range, the converter's load resistor rises in temperature, producing a dc potential through a thermocouple. This output voltage is proportional to the RF power absorbed regardless of waveform or duty cycle.

CIRCLE NO. 264

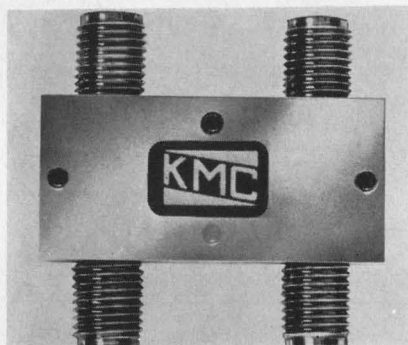

### 3-dB coax hybrids operate as 90° shifters

Kevin Mfg. Co., Inc., 24 Conn St., Woburn, Mass. Phone: (617) 935-0100.

Two miniature 3-dB coaxial hybrids cover octave bandwidths as classical 90° hybrids. They can be used simply to obtain a relative 90° shift or as a part of a comparator or shifter network. Model 0-106 covers 2-4 GHz with 18 dB isolation, a vswr of 1.35 and an insertion loss of 0.1. Model 0-107 covers 4-8 GHz. Its specs are identical except it has an 0.25 insertion loss.

CIRCLE NO. 265

### Pulsed X-band TWT suitable for radar

The M-O Valve Co. Ltd., Brook Green Works, London W.6, England. Phone: 01-603-3431.

The pulsed traveling-wave tube, type TWX16 for radar applications gives over 40 dB gain at 5 kW peak output power. Mean power is 30 W and saturated peak rating is 20 kW. Unit band-width is 500 MHz in the 8-9.3 GHz region. The tube is of metal-ceramic construction and it uses a ring and bar slow-wave structure that is said to limit unwanted oscillations. Helix is at dc potential.

CIRCLE NO. 266

### Dispersive delays simplify PC radar

Control Electronics Co. Inc., 153 Florida St., Farmingdale, N. Y. Phone: (516) 694-0125.

A prime application area for a new line of dispersive strip lines is pulse-compression radar. In this application, the delays are said to eliminate expensive and bulky filter components, and increase both range and resolution. At compression ratios of 21, 100 and 160, bandwidths run 2.1, 1.67 and 4 MHz respectively. Delay changes here are 10, 60 and 40 μs.

CIRCLE NO. 267

### Isolation switch uses electro-optics

Philco Microelectronics Div., Philco-Ford Corp., 2920 San Ysidro Way, Santa Clara, Calif. Phone: (408) 245-2966. Price: from \$200 (switch), \$50 (isolator).

For applications requiring extremely high levels of isolation to extraneous signals, the P651A provides simplex low-level or timing-signal switching. Output-input isolation is over 100 dB from dc to 1 GHz. Similar isolation is realized in the passband with a signal-to-noise margin of 20 dB. The switch is designed for use with the manufacturer's photon-coupled isolator.

CIRCLE NO. 268

# Still the best YIG Filters available

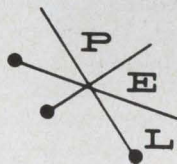

Physical Electronics Laboratories  
1185 O'Brien Drive • Menlo Park, California

PEL is continuing to make YIG filters built to the tightest specs in the industry.

Compare specs of PEL's YIG filters and you'll find PEL's clearly superior.

In L through Ku band, our dual channel units track within .1% of the tuning range.

Individual channel bandwidths are maintained within 1 or 2 MHz. Linearity of better than  $\pm 0.1\%$  is standard.

High tracking accuracy makes PEL filters ideal for pre or postselection filters.

Because individual frequencies can be offset, PEL YIG filters can be used as tunable discriminators.

Either way, PEL YIG filters take MIL-Spec environments.

PEL has the capability to produce YIG band-pass or band-reject filters, discriminators, or limiters in small quantities or in volume runs.

We welcome the opportunity to quote on non-standard models too.

See for yourself. Our new catalog has the full story. For your free copy, please write.

ON READER-SERVICE CARD CIRCLE 182

With **EASTMAN 910<sup>®</sup> Adhesive...**

## Rubber-to-glass bonds— in seconds.

To protect the television receiver's delicate cathode ray tube during shipping and through years of normal use, EASTMAN 910 Adhesive is used to bond a protective rubber strip around the implosion shield.

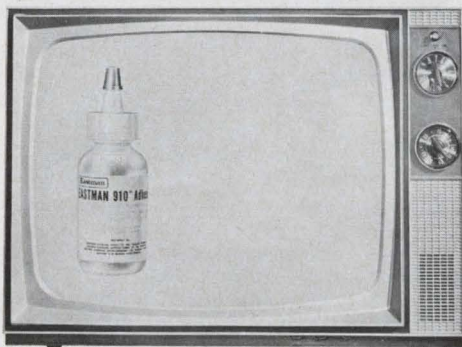

The rapid set of EASTMAN 910 Adhesive is ideally suited for this production line operation. Just a few drops of EASTMAN 910 Adhesive for pennies a drop and only hand pressure gives a strong, long lasting bond.

EASTMAN 910 Adhesive will form bonds with almost any kind of material without heat, solvent evaporation, catalysts, or more than contact pressure. Try it on your *toughest* bonding job.

For technical data and additional information, write Chemicals Division, EASTMAN CHEMICAL PRODUCTS, INC., subsidiary of Eastman Kodak Company, Kingsport, Tennessee. EASTMAN 910 Adhesive is distributed by Armstrong Cork Company, Industry Products Division, Lancaster, Pa.

### Here are some of the bonds that can be made with EASTMAN 910 Adhesive

Among the stronger: steel, aluminum, brass, copper; vinyls, phenolics, cellulose, polyesters, polyurethanes, nylon; butyl, nitrile, SBR, natural rubber, most types of neoprene; most woods. Among the weaker: polystyrene, polyethylene (shear strengths up to 150 lb./sq. in.).

ON READER-SERVICE CARD CIRCLE 183

ELECTRONIC DESIGN 28, December 6, 1966

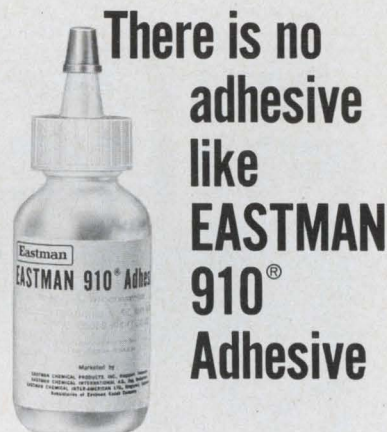

There is no adhesive like **EASTMAN 910<sup>®</sup> Adhesive**

**SETS FAST**—Makes firm bonds in seconds to minutes. **VERSATILE**—Joins virtually any combination of materials.

**HIGH STRENGTH**—Up to 5,000 lb./in.<sup>2</sup> depending on the materials being bonded.

**READY TO USE**—No catalyst or mixing necessary.

**CURES AT ROOM TEMPERATURE**—No heat required to initiate or accelerate setting.

**CONTACT PRESSURE SUFFICIENT.**

**LOW SHRINKAGE**—Virtually no shrinkage on setting as neither solvent nor heat is used.

**GOES FAR**—One-pound package contains about 30,000 one-drop applications. (Or in more specific terms, approximately 20 fast setting one-drop applications for a nickel.)

The use of EASTMAN 910 Adhesive is not suggested at temperatures continuously above 175°F., or in the presence of extreme moisture for prolonged periods.

See Sweets' 1967 Product Design File 6a/Ea.

Now available! EASTMAN 910 Surface Activator. When certain surface conditions inhibit rapid bond formation, use of EASTMAN 910 Surface Activator is suggested to restore the rapid polymerization of EASTMAN 910 Adhesive.

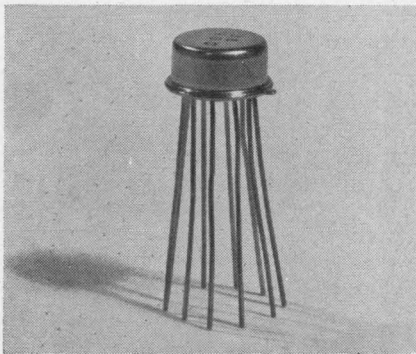

### IC op-amps offset only 3 mV

Amelco Semiconductor Div., Tele-dyne, Inc., 1300 Terra Bella Ave., Mountain View, Calif. Phone: (415) 968-9241.

Of silicon planar epitaxial construction, the 805B and 806B operational amplifiers feature typical input offset voltage of 3 mV, with 7.5 mV as maximum. The similar 805C and 806C also have 3-mV input offset ratings but their max is 10 mV. All four types specify max supply ratings of  $\pm 18$  V.

CIRCLE NO. 269

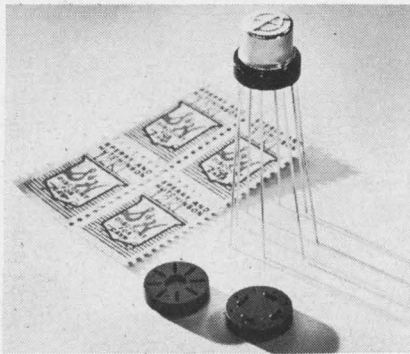

### Mounting pads expand IC circles

Milton Ross Co., 511 Second St. Pike, Southampton, Pa. Phone: (215) 355-0200.

For both ease in wiring and reliability, the Transpad #10277 expands the lead-circle of TO-5 ICs and lifts the package. The pad converts the lead diameter to 0.350-in. Elevated feet permit air ventilation and allow space for flushing away excess solder flux. The pads are molded of black diallyl phthalate and meet applicable MIL specs.

CIRCLE NO. 270

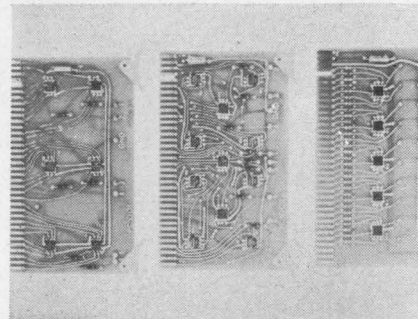

### Hybrids, IC modules aid system design

Information Control Corp., 138 Nevada St., El Segundo, Calif. Phone: (213) 322-6930.

A family of 5-MHz logic modules are offered to systems designers as a means of avoiding circuit-design problems. Called "Interlogic," the line features operation to 5 MHz on 5-V supplies at 2 to 25 A. All modules are mounted on PC boards measuring 3.5 x 5.75 x 0.062-in with 72-pin connectors. Components are silicon ICs or ICs and discrete components where required.

CIRCLE NO. 271

Live Better Electronically With  
**LAFAYETTE RADIO ELECTRONICS**

**FREE!** Now **BETTER THAN EVER**



**LAFAYETTE**  
**1967 CATALOG**  
**670**

**512 Pages**

Featuring Everything in Electronics for

- HOME • INDUSTRY
- LABORATORY

from the "World's Hi-Fi & Electronics Center"

**Stereo Hi-Fi • Citizens Band • Ham Gear •  
Tape Recorders • Test Equipment • TV and Radio  
Tubes and Parts • Cameras • Auto Accessories  
• Musical Instruments • Tools • Books**

LAFAYETTE Radio ELECTRONICS 29-7  
Dept. 29-7 P.O. Box 10  
Syosset, L. I., N. Y. 11791  
Send me the Free 1967 Lafayette Catalog 670

Name .....

Address .....

City ..... State ..... Zip .....

ON READER-SERVICE CARD CIRCLE 184

**152 REED RELAYS**  
**IN STOCK for immediate delivery**

Described in Catalog 267

Available thru Authorized Distributors at Factory Prices

The greatest selection of Mercury-Wetted and Dry Reed Relays stocked by any manufacturer and 248 other stock Relays are described and priced in Stock Relay Catalog 267.

The most complete Reed Relay information available anywhere is provided in the new 80-page DESIGNERS' Handbook & Catalog of Reed and Mercury-Wetted Contact Relays

Contact the **MAGNECRAFT REPRESENTATIVE** in your area or send for your free copies of Catalog 267 and the **DESIGNERS' Handbook & Catalog NOW.**

**MAGNECRAFT** Electric Co.

5575 N. Lynch, Chicago, Ill. 60630

Ph 312-282-5500

ON READER-SERVICE CARD CIRCLE 185

ELECTRONIC DESIGN 28, December 6, 1966

## Differential amplifier in "IC cube" form

Zeltex, Inc., 1000 Chalomar Rd., Concord, Calif. Phone: (415) 686-6660. P&A: below \$50; stock.

Analog scaling and buffering applications are seen for the Model 161 differential amplifier. The hybrid IC design, allowing dimensions to be reduced to 0.5 x 0.5 x 0.4-in., makes it particularly attractive where space is a major consideration. Output range is  $\pm 10$  V at 4 ma and dc open-loop gain is rated at 80,000. Gain bandwidth product is 2 MHz and frequency for full output is 150 kHz. At a band-width of 20 kHz, noise rating is 30  $\mu$ V peak-to-peak. Narrow-band, 2-50 Hz, noise is 5  $\mu$ V.

CIRCLE NO. 272

## Micrologic cards function dc-20 MHz

Control Logic, Inc., 3 Strathmore Rd., Natick, Mass. Phone: (617) 655-1170.

A complete family of Micro Logic cards are represented in the C-120 line. Capabilities include counting, shifting and control functions at input or clock rates from dc to 20 MHz. Eight different card types are immediately available, they include multiple flip-flops and gates, an 8-stage shift register, a line driver and a crystal controlled clock unit. The C-120 line is compatible with the manufacturer's 5-MHz line, extending its capabilities.

CIRCLE NO. 273

## Miniature inductors for integrated circuits

Delevan Electronics Corp., 270 Quaker Rd., East Aurora, N. Y. Phone: (716) 652-3600.

Inductors small enough to be placed inside a miniaturized package are available in the "Micro i" line. Units of the "Micro i" line range in size from 0.1 to 0.25-in. square and provide inductance ratings from 0.1 to 1000  $\mu$ H. Each inductor is magnetically shielded to prevent interaction within the module and current capabilities are compatible with levels in most transistorized circuitry.

CIRCLE NO. 274

APPLIED RESEARCH Inc.

# PRESENTS THE ULTIMATE IN 'MICRO-NOTCH' BANDREJECT FILTERS

30 to 12,000 Mc

- HIGH REJECTION
- LOW INSERTION LOSS
- TUNABLE NOTCHES
- MULTIPLE NOTCHES



A series of *Micro-Notch Bandreject FILTERS* have been developed by APPLIED RESEARCH Inc. to provide high rejection for specific frequencies over the frequency range of 30 to 12,000 Mc. Undesired signals within one percent or less of the operating frequency are eliminated. Various models are available including octave bandwidth units with tunable reject notches and low VSWR throughout the operating range.

### GENERAL CHARACTERISTICS

Frequency Range:	30 to 12,000 Mc
Bandwidths:	As narrow as one-quarter percent depending upon frequency
Insertion Loss:	As low as 0.5 db depending upon frequency and bandwidth
In-Band Rejection:	As great as 75 db or more
Power Rating:	Up to 1.0 KW (cw)

APPLIED RESEARCH Inc.

76 S. BAYLES AVENUE

PORT WASHINGTON, NEW YORK

Phone: 516-767-8707

TWX: 516-466-0503

ON READER-SERVICE CARD CIRCLE 186

**µVL** is fast

**µVL** is reliable

**µVL** is MicroVersaLOGIC

**µVL** has plenty of output power

**µVL** comes only from Decision Control

**µVL** rejects noise like crazy

**µVL** is friendly. It talks with discrete logic

**µVL** works first time, every time

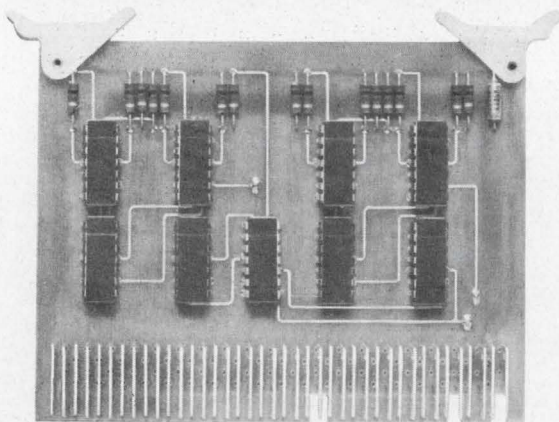

So, if you want your next digital system to work well, build it with  $\mu$ VL. We'll show you how—in our MicroVersaLOGIC applications brochure. Send for it today.

**(dci) DECISION CONTROL, INC.**

1590 Monrovia Avenue, Newport Beach, Calif.  
Tel. (714) 646-9371 TWX (714) 642-1364

ON READER-SERVICE CARD CIRCLE 187

# Design Aids

**HUDSON WIRE COMPANY**  
OSSINING, NEW YORK • (914) 941 8500



Single & Stranded, Bare & Plated Copper & Copper Alloy

STRANDED COPPER CONDUCTOR										
AWG	Con-struct.	Type	Lay (in. max.)	Diameter		Max. DC Resist. (Ohms/M ft. 20°C)		Weight (lbs./M ft.)		Max
				Nom.	T Max.	SPC	NPC	Nom.	Max	
4	19x7/25	Conc.	3.00	2604	2682	263	274	136	139	139
4	19x7/25	Unilay	3.00	2551	2627	263	274	136	139	139
6	19x7/27	Conc.	2.50	2086	2128	418	435	86.0	87.7	87.7
6	19x7/27	Unilay	2.50	2024	2086	418	435	86.0	87.7	87.7
8	19x7/29	Conc.	2.00	1644	1693	661	689	54.6	55.7	55.7
8	19x7/29	Unilay	2.00	1610	1659	661	689	54.6	55.7	55.7
10	37/26	Conc.	1.50	1102	1124	119	124	29.7	30.3	30.3
10	37/26	Unilay	1.50	1080	1101	119	124	29.7	30.3	30.3
12	19/25	Conc.	1.00	8886	9095	1.76	1.83	19.2	19.6	19.6
12	19/25	Unilay	1.00	8841	8967	1.81	1.85	18.7	19.1	19.1
14	19/27	Conc.	88	6703	6715	2.80	2.92	12.1	12.3	12.3
14	19/27	Unilay	88	6687	6681	2.87	2.99	11.8	12.0	12.0
16	19/29	Conc.	75	5559	5570	4.43	4.61	7.64	7.80	7.80
16	19/29	Unilay	75	5531	5542	4.54	4.73	7.46	7.60	7.60
18	7/26	Conc.	62	4877	4891	6.01	6.26	5.52	5.63	5.63
18	19/30	Conc.	62	4895	4905	5.65	5.89	5.99	6.11	6.11
18	19/30	Unilay	62	4870	4879	5.79	6.03	5.84	5.96	5.96
20	17/28	Conc.	50	4378	4389	9.56	9.96	3.27	3.54	3.54
20	19/32	Unilay	50	4396	4405	8.87	9.44	3.83	4.13	4.13
22	7/30	Conc.	50	4376	4384	9.10	9.68	3.73	3.83	3.83
22	19/34	Conc.	33	3300	3309	15.2	15.8	1.9	2.03	2.03
22	19/34	Unilay	33	3312	3320	14.4	15.3	2.37	2.45	2.45
22	19/34	Unilay	33	3296	3302	14.8	15.7	2.31	2.39	2.39
24	7/32	Conc.	33	3240	3247	23.9	25.4	1.40	1.48	1.48
24	19/36	Conc.	33	3248	3255	23.0	24.5	1.50	1.58	1.58
24	19/36	Unilay	33	3235	3240	23.6	25.1	1.46	1.52	1.52
26	7/34	Conc.	25	2189	2195	38.7	41.2	0.865	0.893	0.893
26	19/38	Conc.	25	2198	2205	36.4	40.0	0.952	1.00	1.00
26	19/38	Unilay	25	2188	2192	37.3	41.0	0.928	0.975	0.975
28	7/36	Conc.	25	2150	2154	62.0	66.0	0.546	0.568	0.568
28	19/40	Conc.	25	2153	2160	61.5	67.6	0.577	0.613	0.613
28	19/40	Unilay	25	2146	2149	63.1	68.3	0.563	0.588	0.588
30	7/38	Conc.	25	2120	2124	97.5	107	0.350	0.367	0.367
30	19/42	Conc.	187	1124	1130	96.1	109	0.374	0.404	0.404
32	7/40	Conc.	20	2093	2096	166	182	0.211	0.221	0.221
32	19/44	Conc.	187	1099	1105	153	174	0.240	0.264	0.264
34	7/42	Conc.	125	1075	1077	298	293	0.136	0.147	0.147
34	7/42	Unilay	125	1060	1062	412	488	0.0925	0.0962	0.0962

**Stranded Conductor Construction Definitions**  
A central core surrounded by one or more layers of helically laid strands assembled in a geometric arrangement of concentric layers.

Unilay ..... Having the same direction and length of lay.

Concentric ..... Having differing lengths and/or direction of lay.

**American Wire Gauge Shortcuts**  
Change of 3 AWG numbers doubles or halves resistance or wgt.  
Change of 6 AWG numbers quadruples or quarters resistance or weight and halves or doubles diameter.

**Properties of Copper**  
Soft, Tensile 34,000 PSI—Resistivity, 10.371  $\Omega$  CM/FT.  
Hard, Tensile 68,000 PSI—Resistivity, 10.630  $\Omega$  CM/FT.  
Break Strength, Lbs. = Area, Sq. In. x No. Strands x Tensile, PSI

## Pocket size wire guide

A pocket size reference contains data on single-end annealed copper wire (8 to 56 AWG) and stranded silver- or nickel-plated copper conductors (4 to 36 AWG). Tables include diameter, cross-section and resistance as well as construction and lay of concentric and unilay stranded conductors. The guide also contains a summary of wire formulas. Hudson Wire Co.

CIRCLE NO. 275

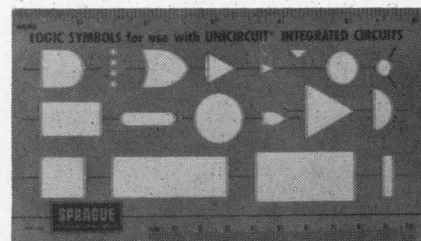

## IC logic template

This logic template is designed with reproductions of recommended MIL-806 symbols for use in electronic systems. The versatile template has all of the usual logic symbols AND, NAND, OR, NOR—and many other useful geometric shapes. Top and bottom edges are scaled in inches and centimeters for convenience.

Available on company letterhead from Sprague Electric Co., North Adams, Mass.

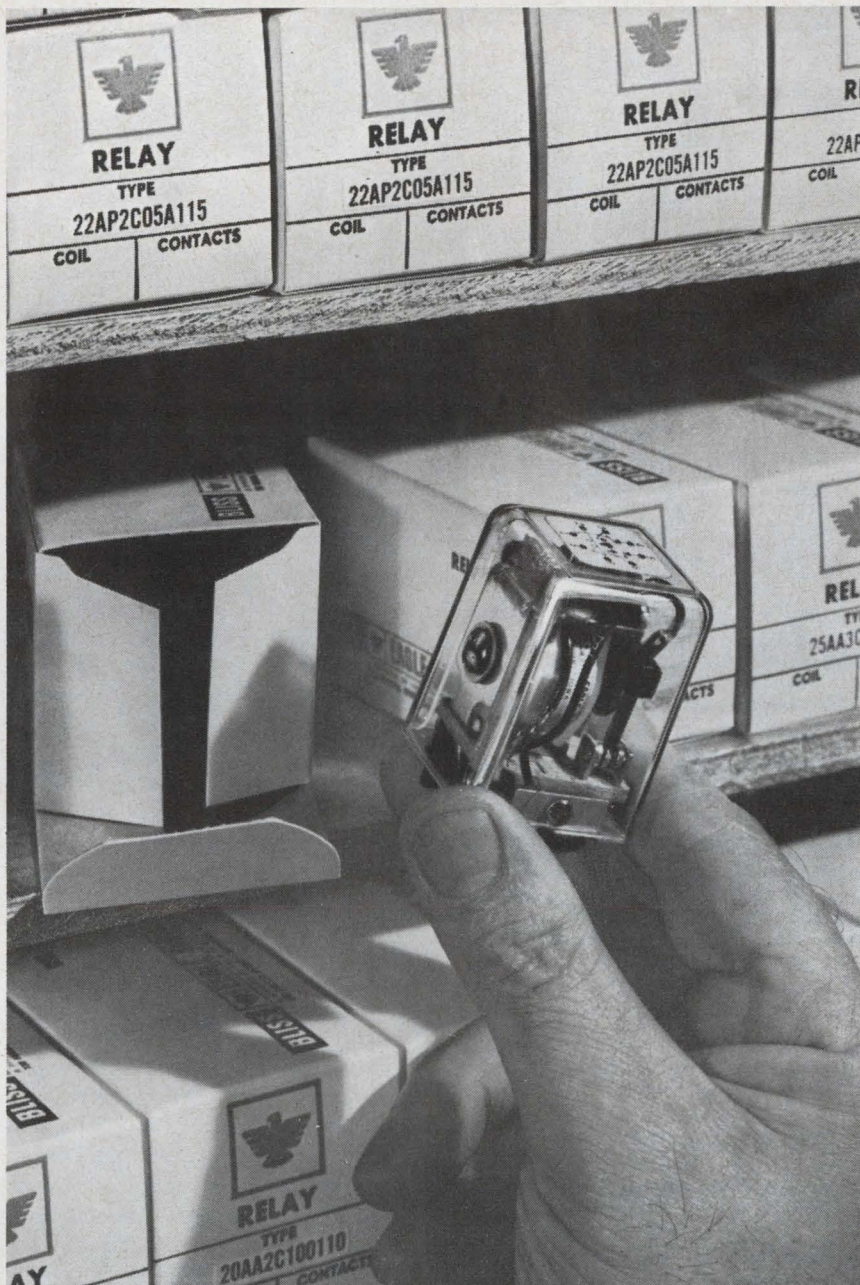

## INSTANT EAGLE RELAYS

*Test Them Immediately...*

***Get Production Quantities in Two Weeks!***

That's right . . . Eagle challenges you to compare them with any relay on the market. NOW you can get immediate delivery on these general-purpose or medium-power relays. Test results prove they're the finest of their kind in the world. Eliminate your relay delivery problems. Call your "Man from E.A.G.L.E.". . . listed at the right. You'll find he has full details and specifications on Eagle relays.

**BLISS**  **EAGLE SIGNAL**

A DIVISION OF THE E. W. BLISS COMPANY  
736 Federal Street, Davenport, Iowa

ON READER-SERVICE CARD CIRCLE 188

## YOUR "MAN FROM E.A.G.L.E."

### Distributors

Burlingame, California  
415-697-6244  
Glendale, California  
213-245-1172  
Englewood, Colorado  
303-781-0912  
Hamden, Connecticut  
203-288-9276  
Orlando, Florida  
305-855-3964  
Baltimore, Maryland  
301-484-5400  
Newton Highlands, Massachusetts  
617-969-7140  
Minneapolis, Minnesota  
612-922-7011  
Clifton, New Jersey  
201-471-6090  
Haddonfield, New Jersey  
609-429-1526  
Albuquerque, New Mexico  
505-265-1020  
Albany, New York  
518-436-8536  
Depew, New York  
716-684-5731  
Endwell, New York  
607-723-8743  
Fairborn, Ohio  
513-878-2631  
Fairview Park, Ohio  
216-333-4120  
Dallas, Texas  
214-363-1526  
Houston, Texas  
713-649-5756  
Seattle, Washington  
206-725-7800

### Representatives

Scottsdale, Arizona  
602-947-4336  
Pasadena, California  
213-681-4421  
Jacksonville, Florida  
305-388-7656  
Orlando, Florida  
305-422-4295  
Roswell, Georgia  
404-993-6498  
Chicago, Illinois  
312-775-5300  
Chicago Illinois  
312-784-7314  
Baltimore, Maryland  
301-276-1505  
Norwood, Massachusetts  
617-769-3600  
Minneapolis, Minnesota  
612-922-0243  
St. Louis, Missouri  
314-428-5313  
Hackensack, New Jersey  
201-342-2602  
Latham, New York  
518-785-5032  
Rochester, New York  
716-436-4410  
Skaneateles, New York  
315-685-6172  
Fairfield, Ohio  
216-333-4120  
Havertown, Pennsylvania  
215-528-6640  
Dallas, Texas  
214-748-7788  
Houston, Texas  
713-224-9715  
Bellevue, Washington  
206-454-5200  
Charleston, West Virginia  
304-342-2211

# 4-6 WEEKS DELIVERY

*in Production Quantities or Prototypes*

## Netic & Co-Netic Magnetic Shields

Fabricated to your exact specifications in any size or configuration. Two typical applications shown. 2-3 weeks delivery on special order.

Permanently effective Netic and Co-Netic are the recognized world standard for dependable shielding. About 80% of all magnetic shield designs in use originated here. Netic and Co-Netic are insensitive to ordinary shock, have minimal retentivity, never require periodic annealing. Total quality is controlled during manufacture. Design assistance gladly given.



Photomultiplier & CRT Shields

## MAGNETIC SHIELD DIVISION

Perfection Mica Company

1322 N. ELSTON AVENUE, CHICAGO, ILLINOIS 60622

ORIGINATORS OF PERMANENTLY EFFECTIVE NETIC CO-NETIC MAGNETIC SHIELDING

ON READER-SERVICE CARD CIRCLE 189

## Application Notes

### Sweep oscillator applications

Twelve distinct applications for using a linear/logarithmic sweep oscillator in research and product development work, quality-control testing and production-line check-out are contained in an 8-page applications manual. Each application is presented in problem/solution form, with a simplified block diagram of the main and support instruments to be used. Typical of the simpler applications is the determination of the hysteresis or variation in output of a relay, switching circuit or dc amplifier due to a varying dc applied in a bidirectional sweep fashion. More complex applications include automatic plotting of the Fourier components of a periodic signal and the automatic display of the power spectral density associated with an arbitrary random waveform. Spectral Dynamics Corp.

CIRCLE NO. 276

### Amplifier stabilization

"Practical Closed-Loop Stabilization of Solid-State Amplifiers" discusses such aspects as input capacitance compensation, driving capacitive loads and operation with boosters. Examples, illustrations and charts are included. Other topics include inside-outside followers, adder-subtractor work, full-swing capabilities, nonlinearities, noise and dynamics. A self-conducted exam completes the 30-page note. Philbrick Researches, Inc.

CIRCLE NO. 277

### Photoconductive cells

"Selecting Photoconductive Cells" is a 24-page designer's guide which discusses considerations in the application of photoconductive cells. The illustrated publication contains seven basic design considerations in selecting, principles and advantages over photovoltaic cells, characteristics of photoconductive materials, sample schematics using photocells and a list of typical applications. General Electric Co.

CIRCLE NO. 278

**Requirement:**  
Maximize radiation coverage  
and at the same time minimize  
aerodynamic problems in missile  
telemetry and command opera-  
tional tests.

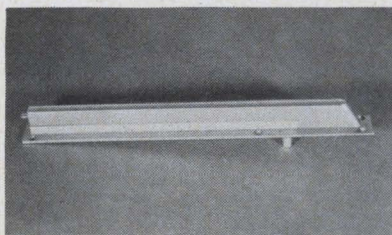

**Solution:** Amecom's Blade Antennas that provide horizontal and vertical polarization; 2% bandwidths tunable over a 15% band, with less than 2.0:1 VSWR.

Units are currently available for 250, 400 and 1000 megacycle operation.

The simple construction of these antennas gives them excellent reliability in missile environments with no change in VSWR or bandwidth.

Their low silhouette configuration minimizes drag and instability effects on a missile.

Present units have operated during missile reentry conditions, and designs that use Amecom's spacecraft reentry antenna construction techniques are available for even higher temperatures.

The Problem Solvers of Amecom's Antenna Systems Department will be pleased to review the hard-to-meet antenna requirements in your missile, rocket or space program.

Call or write: Amecom Division, 1140 East-West Highway, Silver Spring, Md. 20910, Tel: (301) 588-7273.

ON READER-SERVICE CARD CIRCLE 190

**AMECOM** |   
DIVISION OF LITTON INDUSTRIES



# Simplify your source selection for 930 DTL

## Specify

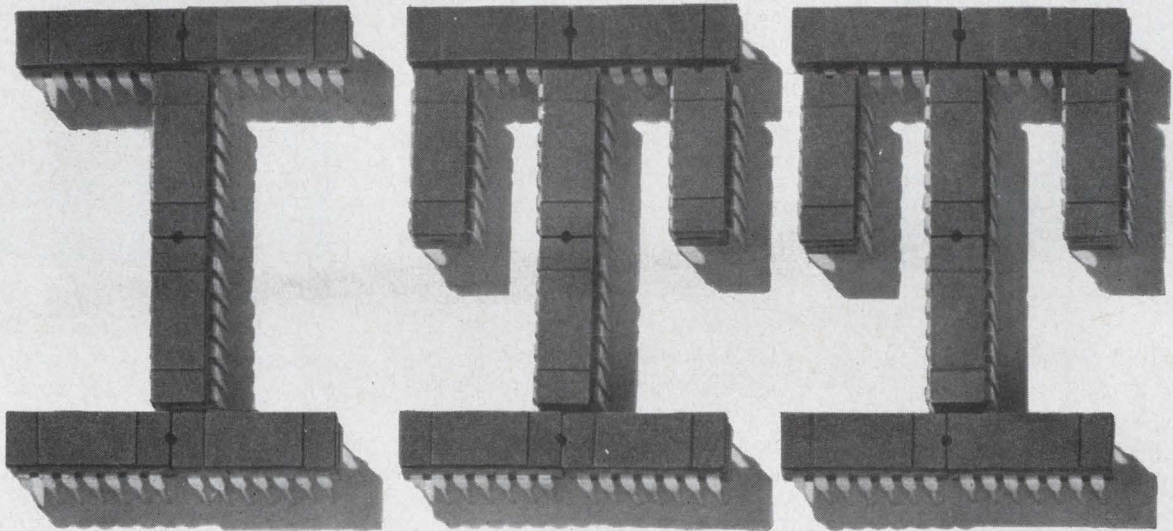

You eliminate series 930 DTL evaluation, delivery, packaging and single source troubles. Here's why:

**Evaluation** — Our 930 DTL circuits and test limits are identical to those of the other leading manufacturer.

**Delivery** — Our on-time delivery helps you eliminate manufacturing scheduling headaches.

**Packaging** — Your choice of dual in-line, flat pack, or TO-5 packages.

**Alternate Source** — With ITT added to your print, you eliminate the potential headaches of single source procurement.

Let us prove it to you. A phone call will get you off-the-shelf 930 DTL delivery from your ITT distributor. For volume procurement, ask your ITT field salesman for a quotation.

ITT SEMICONDUCTORS  
3301 Electronics Way  
West Palm Beach, Florida

Please send me a copy of "ITT's New Unabridged DTL Design Data Book" containing complete information and specifications on all ITT 930 DTL circuits.

NAME \_\_\_\_\_

TITLE \_\_\_\_\_

COMPANY \_\_\_\_\_

ADDRESS \_\_\_\_\_

CITY \_\_\_\_\_ STATE \_\_\_\_\_ ZIP \_\_\_\_\_

**ITT**  
SEMICONDUCTORS

ITT SEMICONDUCTORS IS A DIVISION OF INTERNATIONAL TELEPHONE AND TELEGRAPH CORPORATION, 3301 ELECTRONICS WAY, WEST PALM BEACH, FLORIDA. FACTORIES IN WEST PALM BEACH, FLORIDA; PALO ALTO, CALIFORNIA; LAWRENCE, MASSACHUSETTS; HARLOW AND FOOTSCRAY, ENGLAND; FREIBURG AND NURENBERG, GERMANY

ON READER-SERVICE CARD CIRCLE 191

# New Literature



## Microwave catalog

This 57-page catalog includes four pages of useful microwave charts and graphs plus two information forms for switches and antennas. A plastic loose-leaf catalog contains complete specifications and dimensions on coaxial switches, waveguide switches, airborne antennas, and microwave components. Transco Products Inc.

CIRCLE NO. 279

## Report on hybrid op-amps

"The New Breed Micro-Hybrid Operational Amplifiers—A Status Report" covers hybrid operational amplifier technology in some depth. This 12-page monograph explores Philbrick Researches' reasons for taking this approach and the advantages accrued by it. Philbrick Researches, Inc.

CIRCLE NO. 280

## Coax catalog

Described and shown in this 24-page catalog is a complete line of coax cables, connectors, cable accessories, rigid line, delay lines and coax cable assemblies. Also included are full listings of electrical characteristics, performance and specs, and the computation methods applicable to selection of cable size and type. Phelps Dodge Electronic Products Corp.

CIRCLE NO. 281

## Servo hardware

Described in this 28-page, 2-color catalog are panel-mounted dial assemblies, phase-sensitive voltmeters, phase shifters, servo clamps, and bellows couplings. Applications, specifications, and descriptive data are given. Theta Instrument Corp.

CIRCLE NO. 282

## Precious metal components

Precious metal-clad precision components for the electrical, electronic and chemical industries are presented in an 8-page bulletin. In color, the brochure provides illustrations and information on strip, wire, contact tape and parts, welded assemblies, semiconductor materials and waveguide and custom tubing. Engelhard Industries, Inc.

CIRCLE NO. 283

## Thermocouple alloys

A four-page bulletin describes the physical and mechanical properties of Chromel/Constantan Type E thermocouple alloys. Included in the bulletin are application data and emf reference tables. Hoskins Mfg. Co.

CIRCLE NO. 284

## The tip-off

The Tip-Off is a fascinating, historically oriented periodical that is published by Schweber Electronics.

The last two issues trace the development of semiconductors. Edited by Sam Kass, the pale-blue components conjuring letter is entertaining, informative, clear and camp. Schweber Electronics, Westbury, N. Y.

CIRCLE NO. 285

## Potentiometer brochure

A complete line of precision wirewound nonlinear potentiometers are described in a 4-page brochure. The brochure details functions, output equations and circuit diagrams for single and multiturn units. Duncan Electronics, Inc.

CIRCLE NO. 286



## Components catalog

The entire Johnson electronic components line is described in this 26-page catalog. Prepared for design engineers, the catalog presents complete product descriptions, pictures, dimension drawings, catalog numbers, prices and mechanical and electrical specs. Products listed are capacitors, tube sockets, connectors, terminals, insulators, pilot lights, inductors and miscellaneous hardware. E. F. Johnson Co.

CIRCLE NO. 287

## SCR temperature control

Use of Powertemp SCR systems in industrial temperature control is the subject of a new 12-page brochure. Information is provided on basic operating principles, selection, and operating features. Systems described control power from 1 kVa through 4100 kVa. Robicon Corp.

CIRCLE NO. 288

## Step switch applications

This 10-page bulletin covers the use of step switches for programmed sequence control of industrial processes. In addition to providing details on how the switches work, the bulletin includes numerous diagrams of applications and ordering information. E. W. Bliss Co., Eagle Signal Div.

CIRCLE NO. 289

# Learn why

Please send me a FREE copy of "VHF/UHF Power Transistor Amplifier Design" along with complete specifications for ITT's 2N3375.

Name ..... Title .....

Company .....

Address .....

City ..... State ..... Zip .....

## every ITT 2N3375 gives you 66% more $P_{OE}$ than EIA specs demand

28V CLASS B POWER OUTPUT VS FREQUENCY

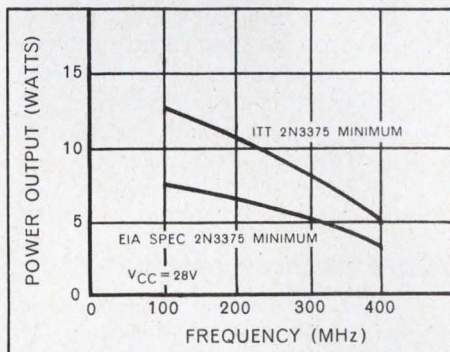

When you apply ITT 2N3375s, you get 5 watts minimum saturated power output at 400 MHz and  $V_{CC} = 28V$ , tested 100%.

The secret lies in ITT's unusually close control of resistivity, combined with interdigitated construction.

To find out more about the superior performance of the ITT 2N3375, write today for your free copy of "VHF/UHF Power Transistor Amplifier Design" and complete 2N3375 specs. Or see for yourself — order sample quantities off-the-shelf from your ITT distributor or factory representative. ITT Semiconductors is a division of International Telephone and Telegraph Corporation, 3301 Electronics Way, West Palm Beach, Florida.

**ITT**  
SEMICONDUCTORS

FACTORIES IN WEST PALM BEACH, FLORIDA; PALO ALTO, CALIFORNIA; LAWRENCE, MASSACHUSETTS; HARLOW AND FOOTSCRAY, ENGLAND; FREIBURG AND NURENBERG, GERMANY

ON READER-SERVICE CARD CIRCLE 192

# Why is this MKTR Miniature O.E.M. Relay so remarkable?

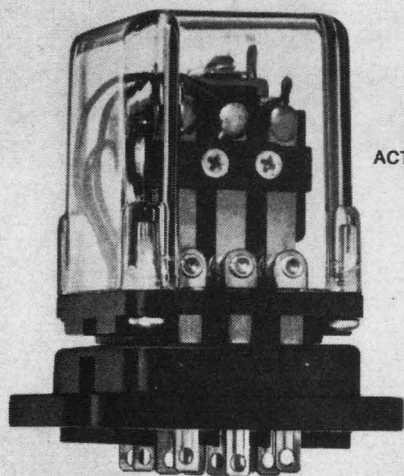

ACTUAL SIZE

**Because it has thirty quality features for only \$2.05\***

- Size** Low profile. 1-3/16 x 1-3/8 x 1-3/8  
A real space saver.
- Sensitivity** Down to 60 milliwatts per pole D.C.  
Ideal for plate circuits.
- Contact Ratings** 5 amperes and 10 amperes  
(AC & DC).
- Contact Selections** Fine silver (gold flashed) Silver  
Cadmium Oxide (gold flashed) Gold  
diffused (for low level switching).
- Pole Configurations** Available in 1, 2 and 3 pole double  
throw combinations.
- Covers** Plastic dust covers made of Styrene,  
Butyrate or Polycarbonate. Clear,  
Translucent and Opaque in a variety  
of colors (no extra charge).  
Hermetically sealed.
- Indicator** Spotlights available to indicate coil  
normally open or normally closed.
- Terminals** Solder lug, Plug-in, Printed Circuit  
and .110 Snap-on.
- Sockets** True 10 amp construction socket. Can  
be used in printed circuit boards.  
Solder terminals which accept .110  
Snap-on terminals standard.
- Mountings** Available with side or base studs for  
chassis mounting.

**Applications** General purpose. Medium power.  
Practically unlimited.

**U. L. File No. E36213**

For a prototype (specify coil and  
contact requirements) and for more  
information ask for our Bulletin No. 16.

**LINE**  
RELAYS

AMERCON  
company

LINE ELECTRIC COMPANY  
Division of Industrial Timer Corporation  
205 River Street, Orange, New Jersey  
In Canada: Sperry Gyroscope Ottawa Ltd. Ont.

ON READER-SERVICE CARD CIRCLE 193

## NEW LITERATURE

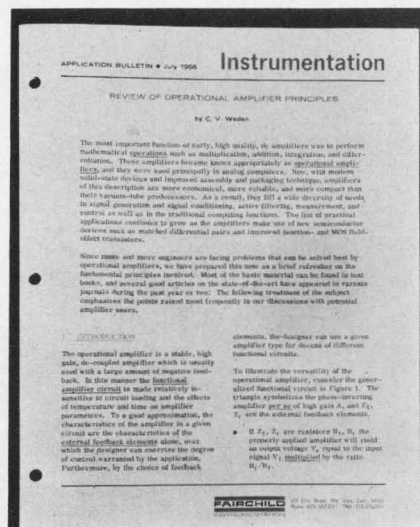

### Review of op-amp principles

This 20-page booklet presents a simplified introduction to operational amplifiers. Sections include the definition of terms used in manufacturer's specs, analysis of feedback amplifiers, a discussion of closed-loop gain, gain stability and frequency response and a comparison of performance characteristics for amplifier types such as chopper-stabilized, FET-input and linear IC. The report ends with a 5-page summary of common applications for operational amplifiers. Fairchild Instrumentation.

CIRCLE NO. 290

### Thin-film production

A complete line of thin-film production equipment is described in a 6-page brochure. Capabilities covered include: deposition thickness control, deposition rate control, source power control, electron beam supplies, automated deposition, environment control and verification. Sloan Instruments Corp.

CIRCLE NO. 291

### Core memory brochure

Called the fastest random-access large-scale memory system available, the Nanomemory 650 is described in a 10-page illustrated brochure. Among the items covered are the use of 2-1/2D selection techniques, input and output pulses and levels, electrical characteristics, timing requirements and charts and a functional diagram. Electronic Memories.

CIRCLE NO. 292

### Op-amp design data

A series of design-data sheets provide information on the manufacturer's line of operational amplifiers, types 805, 806 and 807. Performance features, applications, specifications and pricing information are included. Amelco Semiconductor.

CIRCLE NO. 293

### PC packaging system

A low-cost printed-circuit board system is described in an 8-page illustrated catalog. The material consists of exploded-view drawings of the system, performance charts, specifications and general descriptive material. ITT Cannon Electric.

CIRCLE NO. 294

### IC system catalog

The "Chico pac" module is described in a six-page catalog. This integrated circuit packaging system is shown in terms of its capabilities in aerospace applications. ITT Cannon Electric.

CIRCLE NO. 295

### NAND module system

Based on NAND logic, the 13-Series microcircuits have a noise rejection greater than 1 volt. The complete line is described in an 8-page short form catalog. A "Logic Primer" on the use of the system is also available. Canoga Electronics Corp.

CIRCLE NO. 296

### Basic logic primer

A handbook to help the logic designer in logic implementation, the "13-Series Logic Implementation Primer" is intended to help both new and experienced engineers. Part one of the handbook, intended for the new engineer, describes symbology and covers basic logic rules including AND gates, inverters, NAND gates and NAND ganging. The rules of logic and logical notation, including elementary Boolean algebra are developed in this section. Part two covers the application of logic to flip-flops, "0"-level trigger control, NAND-ganging, positive load gating and special applications. Canoga Electronics Corp.

CIRCLE NO. 297

# UP TO 200 MILLION OPERATIONS!

# doranic<sup>®</sup>

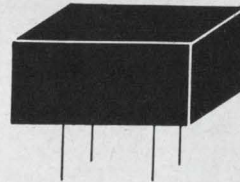

**Reed Relays**  
**Logic Modules**

## Mercury Wetted Contact Relays

Economical Doranic products simplify your circuit design, production and assist you in obtaining system reliability. Life up to 200 million operations is achievable at nominal loads.

Douglas Randall's design team is experienced in custom circuit packaging; and special relay design and production. They will assist your design engineers in component selection and specifications.

For a comprehensive catalog of our complete line of standard relay products, write:

**douglas randall, inc.**

**K**  
**Kidde**

A SUBSIDIARY OF WALTER KIDDE & COMPANY, INC.

6 Pawcatuck Avenue, Westerly, Rhode Island 02891

Tel.: Area Code 203 599-1750 (Pawcatuck, Conn.)

ON READER-SERVICE CARD CIRCLE 194

NOW...

Color-code and Teflon-wrap  
in one operation with

Dilectrix "Fluorofilm"<sup>†</sup>

# COLORED TEFLON\* TAPES

FULLY SINTERED  
FUSES TO ITSELF. UNFUSED TFE  
OR TO FEP

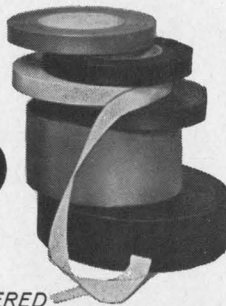

- Minimal pigmented layer protectively encapsulated within normal PTFE laminations
- Lowest pigment content for highest electrical and physical properties
- Will not peel, crack, wear or fade
- Void and pinhole-free multilaminar construction
- Low shrinkage after fusion—greater surface coverage POUND FOR POUND
- Choice of TEN permanent, vibrant mil-spec colors
- AVAILABLE FROM STOCK in various thicknesses and widths, and in SPLICE-FREE lengths to 500 ft.

Dilectrix "Fluorofilm" color interlaminated tapes and films are *ideal* for color coding and wrap-insulation applications, or as a low-friction surfacing material. Several types are supplied in plain PTFE, pressure-sensitive, and one side weldable for wrapping circular or rectangular conductors using *standard* fusion heat-seal equipment. **WRITE FOR BULLETIN 1066.**

COLORS: White, Black, Grey, Yellow, Green, Blue, Purple, Red, Orange and Brown.  
\*DuPont trademark † Dilectrix trademark

## Dilectrix

CORPORATION

FARMINGDALE, NEW YORK 11735 • TEL: (516) 249-7800 • TWX: 694-1884

Advanced fabricators of Teflon—producers of multilaminar autodeposited Teflon tapes, films and sheets

ON READER-SERVICE CARD CIRCLE 195

INTEGRATED LOGIC CARDS

Why pay for

FREE WIRE — AND

# FREE

# GATES

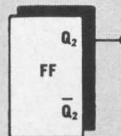

$x_1 = \text{HIGH} = Q_1 \cdot Q_2$

The rejection of noise on the outputs of JK's, shiftbits, binary and decade counters is **larger** than the logic swing. So, you can wire the Flip-Flop outputs together, and you have **FREE GATES**—we also supply application data sheets!

Other **FREE LOGIC** is available by wiring gates directly together.

Why not use our **FREE LOGIC** and **EXCELLENT NOISE REJECTION.**

C/C

## COMPUTER LOGIC CORP.

1528 20th Street • Santa Monica, Calif • Phone: 213 - 451-9754

A COMPLETE FAMILY OF COMPATIBLE TRUE-BLUE LOGIC CARDS

ON READER-SERVICE CARD CIRCLE 196

## NEW LITERATURE

### Silicon transistor catalog

The complete STC silicon transistor line is covered in the 16-page condensed catalog '66. Included are specs and outlines on all STC devices which include military types, pnp's, triple diffused npn power devices. The material is organized according to power ratings. Silicon Transistor Corp.

CIRCLE NO. 298

### Servo components

Shaft position encoders, servo systems and components, electro-mechanical commutators and slip ring assemblies are all included in this 40-page illustrated catalog. Details as design features, specs, application, readout characteristics, electrical and mechanical performance and environmental specs are included for each piece of equipment listed, in addition to detailed specification charts. Northern Precision Laboratories.

CIRCLE NO. 299

### Microwave oscillator catalog

A short form catalog is available describing microwave oscillators. Primary products are triode and solid state strip transmission line oscillators in L- and S-bands. Also described is a C-band coax triode oscillator. In addition the catalog includes a chart describing power capabilities. Terra Corp.

CIRCLE NO. 300



A service of MICROWAVES and laser technology

### Laser warning signs

"Danger-laser light!" The message on this 6 x 8 in. warning sign gets across clearly. The handy poster is a safety must for all facilities using lasers. Hayder, MicroWaves Corp.

CIRCLE NO. 301

## Digital and linear ICs

A 16-page condensed catalog is a source for key features of Signetics' digital and linear IC line. Listings for each element include typical performance characteristics, schematics, power supply requirements, packaging, operating temperature range and primary area of application. The catalog is divided by circuit type and broken down within the types by operating temperature range and applications. Signetics Corp.

CIRCLE NO. 302



## Miniature component catalog

A 52-page engineering catalog presents a wide selection of miniature pushbutton and rotary switches, binding posts, test jacks, sockets and module cases. Also included is such data as useful life and failure criteria, contact and insulation resistance, rotational torque or actuating force, effect of ambient temperature and effects of altitude. Grayhill, Inc.

CIRCLE NO. 303

## Pot catalog

This 72-page catalog describes precision potentiometers, trimmers, dials and servo system components. The 1966-67 catalog contains photographs, drawings and detailed specifications on Beckman's complete pot line. Beckman Instruments, Inc.

CIRCLE NO. 304

# DUAL-IN-LINE SOCKETS

for testing and packaging plug-in IC's

LOW COST • HIGH PERFORMANCE • WIDE APPLICATION

- Sockets for 14 and 16 lead packages having flat or round leads
- Large contoured entry holes for easy IC insertion
- Gentle wiping leaf contacts provide high reliability
- Available with or without mounting saddle for panel mount or printed circuit applications
- Molded diallyl phthalate body; beryllium copper, gold-plated contacts

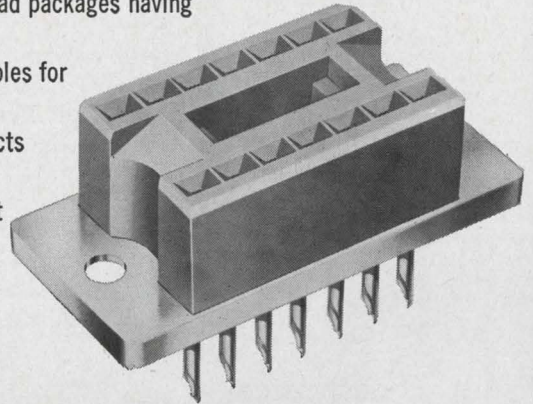

Request Catalog 364 describing our complete line of integrated circuit products for Testing, Breadboarding, and Packaging.

## AUGAT

INC. 31 PERRY AVE., ATTLEBORO, MASS. 02703

ON READER-SERVICE CARD CIRCLE 197



## miniature solenoids...



do big jobs  
in small space

- Completely tested
- Proven reliable
- Mounting furnished to meet your requirements.
- Hundreds of other designs for both AC and DC application.
- Push or pull units to 200 lbs. force.
- Send your specifications today.



The trademark on millions of solenoids since 1927

## WEST COAST ELECTRICAL MFG. CORP.

233 W. 116TH PLACE • DIVISION 110 • LOS ANGELES 61, CALIFORNIA • PLYMOUTH 5-1138  
ON READER-SERVICE CARD CIRCLE 198

# Design Data from Manufacturers

Advertisements of booklets, brochures, catalogs and data sheets. To order use Reader-Service Card.

(Advertisement)

## Schweber Guide To Mylar® Capacitors

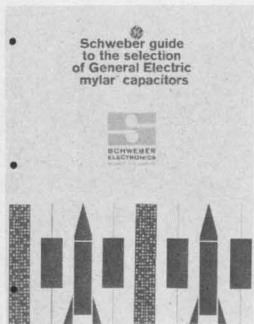

The G.E. mylar capacitors listed in the Schweber guide meet the requirements of MIL-C-27287 (USAF). As with all Schweber capacitor guides, the listing is in numerical sequence by microfarads (MFD). Voltage rated at 125C, the failure rate at 90% confidence level is less than 0.1% per 1000 hours. No impregnants to leak out, no glass bushings to crack, no solder seals to fail—investigate this modern capacitor for the utmost in modern requirements.

### Schweber Electronics

Westbury, New York 11591  
516—334-7474

# 171

## Engineers' Relay Handbook

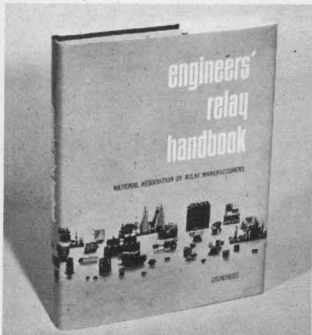

A definitive work that is fast becoming a standard reference text for the relay user. Prepared and edited by the National Association of Relay Manufacturers, this book is a complete guide to the principles, properties, performance characteristics, application requirements, specifications, and testing of relays. Systems and product engineers will find the *Handbook* an indispensable help in determining the correct types of relays for their applications. For further information about this unique sourcebook, write Dept. ED

### Hayden Book Co., Inc.

116 W. 14th Street  
New York, N. Y. 10011

# 172

## How To Write Technical Articles

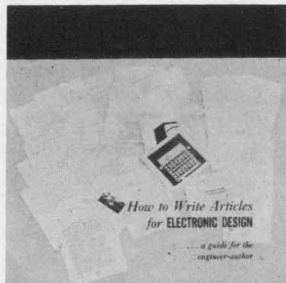

A guide for the engineer-author, "How to Write Articles for Electronic Design" shows how easy it is to write for publication—once the engineer knows what to write and how to write it. The Author's Guide includes a complete run-down of the types of articles published by Electronic Design—plus detailed instructions on how to prepare technical articles and short special features. A **MUST** for every "would-be-writer" in the electronics industry. Send for your complimentary copy by circling the number to the right.

### Electronic Design

850 Third Avenue  
New York, N.Y. 10022

# 173

## NEW LITERATURE

### Magnetic skew effects

"Skew and its effect upon Magnetic Recording" covers the definition of skew, its effect on magnetic recording, the causes of skew and measurement techniques. Dartex, Inc.

CIRCLE NO. 305

### Reprints Available

The following reprints are available free and in limited quantities. To obtain single copies, circle the number of the article you want on the Reader-Service Card.

*A FET operating at uhf?* (No. 306)

*Rid mixers of spurious signals* (No. 307)

*Designers Challenge—High Volume, Low Cost* (No. 308)

### Accuracy Policy

It is the policy of ELECTRONIC DESIGN:

To make reasonable efforts to insure accuracy of editorial matter.  
To publish promptly corrections brought to our attention.

To reserve the right to refuse any advertisement deemed misleading or fraudulent.

All editorial correspondence should be sent to:

Howard Bierman, Editor  
ELECTRONIC DESIGN  
850 Third Avenue

### Subscription Policy

ELECTRONIC DESIGN is circulated free of charge to qualified design engineers in the U.S., Western European Continent and Britain. To establish your qualifications, send ELECTRONIC DESIGN the following information on your company's letterhead: Your name, engineering title, description of your design duties and a list of your company's major products. The letter must be signed by you personally.

Subscription rates for nonqualified subscribers—\$25 a year in the U.S., \$35 in all other countries. Single copy, \$1.50.

### Change of Address

A subscriber's change of address requires a restatement of his qualifications. To expedite the change, and to avoid missing any issues, send along a label from a back copy.

### Microfilm Copies

Microfilm copies of all 1961, 1962, 1963, 1964 and 1965 issues of ELECTRONIC DESIGN are available through University Microfilms, Inc., 313 N. First Street, Ann Arbor, Mich.



# Electronic Design

## Advertising Representatives

**New York 10022**  
 Robert W. Gascoigne  
 Thomas P. Barth  
 Samuel M. Deitch  
 Richard W. Nielson  
 850 Third Avenue  
 (212) PLaza 1-5530  
 TWX: 867-7866

**Philadelphia**  
 Fred L. Mowlds, Jr.  
 P. O. Box 206  
 Merion Station, Pa. 19066  
 (215) MO 4-1073

**Boston**  
 Richard Parker  
 7 Redstone Lane  
 Marbelhead, Mass. 01945  
 (617) 742-0252

**Chicago 60611**  
 Thomas P. Kavooras  
 Berry Conner, Jr.  
 720 N. Michigan  
 (312) 337-0588

**Cleveland**  
 Robert W. Patrick  
 8410 Treetower Drive  
 Chagrin Falls, Ohio 44107  
 (216) 247-7670

**Los Angeles 90303**  
 Stanley I. Ehrenclou  
 Terrence D. Buckley  
 W. James Bischof  
 2930 W. Imperial Highway  
 Inglewood, Calif.  
 (213) 757-0183

**San Francisco**  
 Ashley P. Hartman  
 175 South San Antonio Rd.  
 Ste. 243  
 Los Altos, Calif. 94022  
 (415) 941-3084

**Southwestern 75206**  
 Tommy L. Wilson  
 6200 North Central Express-  
 way  
 Dallas, Tex.  
 (214) EMerson 1-2311

**London W. 1**  
 Brayton C. Nichols  
 44 Conduit Street

**Tokyo**  
 Yoshihiro Takemura  
 International Planning  
 Service, Inc.  
 Room 231 Tokyu-Mita Bldg.  
 1, Shiba-Mita Koun-cho  
 Minato-ku, Tokyo



## Lundey Clinch-Loc® Terminals... use a million (or more)? Some of our customers do!

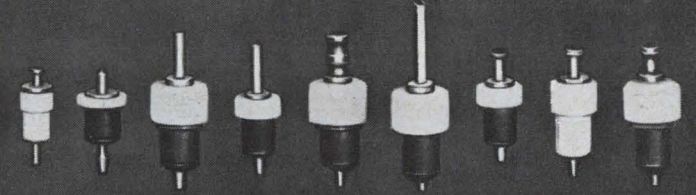

609-TH 499-LP 599-W-3 499-W-2 599-DTH 599-WW 499-TH 601-TH 599-TH

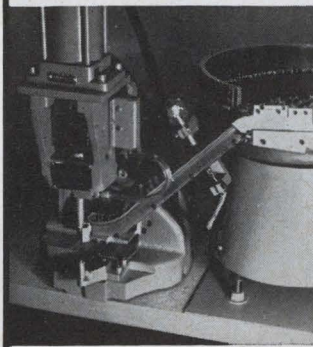

This automatic machine was developed to assemble Clinch-Loc Terminals with speed and flexibility for volume users. With an alternate track any Clinch-Loc Terminal can be used in this machine.

A unitary assembly (no loose parts) for significant assembly cost reduction.

Lundey Clinch-Loc Terminals guarantee substantial savings because of low initial cost, significant assembly cost reduction and elimination of loose parts.

Our engineering facilities for standard, special and production applications are at your disposal. Write for detailed information or send special requirements for quotes.

<b>U. S. Patents</b> 3,047,653 3,126,445 3,166,634	<b>Canadian Patents</b> 622,120 727,204	<b>Patents applied for</b> in France, Italy, Germany and Japan
---	---	--

High Quality Products of The Lundey Line

## Lundey Associates, Inc.

694 Main Street Waltham, Mass. 02154  
 Phone 893-6064

ON READER-SERVICE CARD CIRCLE 199

Now — the most adaptable, reliable

## DATALITE® SYSTEM OF INDICATION

For computers, data processing,  
 and other readout applications

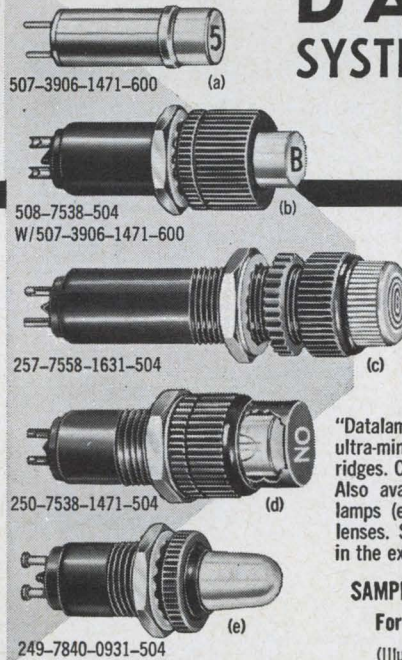

Build your light indicators with a system—the DATALITE system. Here's how: Choose a "Datalamp" Cartridge (a) and combine it with a "Datalamp Holder" (b); or use a screw-on "Data Cap" with a rotatable readout lens (c, d)... For multi-indications, "Datalamp" Cartridges may be mounted on a "Data Strip" or "Data Matrix" in any required configuration.

"Datalamp" Holders accommodate DIALCO's own plug-in ultra-miniature Neon or Incandescent "Datalamp" Cartridges. Complete assembly mounts in 3/8" clearance hole. Also available with permanent (not replaceable) Neon lamps (e). Legends may be hot-stamped on cylindrical lenses. Styles shown here are only typical components in the extensive DATALITE system of light indication.

SAMPLES ON REQUEST—AT ONCE—NO CHARGE.

For complete data, request current Catalog.

(Illus. approx. actual size)

Foremost Manufacturer of Indicator Lights

## DIALIGHT CORPORATION

60 STEWART AVENUE, BROOKLYN, N.Y. 11237 212 HYACINTH 7-7600



ON READER-SERVICE CARD CIRCLE 200

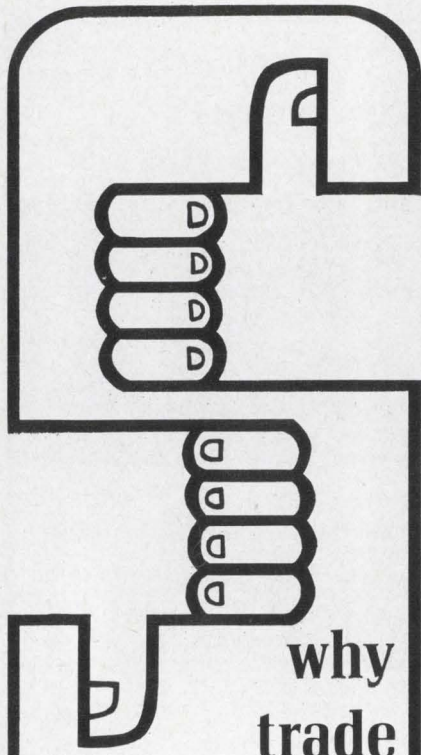

why  
trade  
reliability  
for small size  
in ceramic  
capacitors?

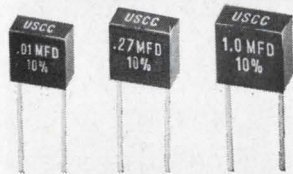

Capacitance range... 1pF to 10 Mfd  
Working voltage..... 100 at 125°C

USCC introduces the C12 Series of radial lead ceramic capacitors. No sacrifices here. The most reliable miniature ceramic capacitors available with performance that meets MIL-C-11015... and is competitively priced. Check the advantages you get with the C12 Series.



U. S. CAPACITOR CORPORATION  
2151 LINCOLN STREET ■ BURBANK, CALIFORNIA 91504  
(213) 843-4222 ■ TWX: 213-846-0904

ON READER-SERVICE CARD CIRCLE 201

## Advertisers' Index

Advertiser	Page	Advertiser	Page
ADC Products, A Division of Magnetic Controls Co. ....	46	Kidde & Company, Inc., Walter .....	169
Acton Laboratories, Inc. ....	176	Lafayette Radio Electronics .....	160
Agastat Timing Instruments, Elastic Stop Nut Corporation of America .....	157	Leach Corporation .....	113
Allen-Bradley Co. ....	129	Line Electric Company, Division of Industrial Timer Corporation .....	168
Allied Chemical, Plastics Division .....	89	Littelfuse .....	152
Amecon Division, Litton Industries .....	164	Litton Industries, Encoder Division .....	145
American Lava Corporation .....	109	Lundy Associates, Inc. ....	173
Amperex Electronic Corporation .....	74, 75	M-O Valve Co., Ltd. ....	134
Applied Research, Inc. ....	161	Magnecraft Electric Co. ....	160
Arnold Engineering Company, The .....	123	Magtrol, Inc. ....	124
Arnold Magnetics Corp. ....	156	Marco-Oak Industries/Division of Oak/Electro/Metrics Corp. ....	149
Augat, Inc. ....	171	Method Electronics, Inc. ....	140
Bendix Corporation, The, Scintilla Division .....	91	Micro Instrument Company .....	144
Branson Corp. ....	154	Microwave Development Laboratories, Inc. ....	133
Burndy Corporation .....	125	Motorola Semiconductor Products, Inc. 19, 37	
Burr-Brown Research Corporation .....	150	National Electronics, Inc. ....	148
Burroughs Corporation .....	6	Nortronics Company, Inc. ....	128
CTS of Berne, Inc. ....	119	Ohmite Manufacturing Company .....	121
Cedar Engineering Division, Data Control Corporation .....	79	Pamotor, Inc. ....	36
Cinch, Division of United Carr .....	141	Perfection Mica Company .....	164
Clairex Corporation .....	122	Philco-Ford Corporation .....	85
Clevite, Brush Instruments Division .....	151	Physical Electronics Laboratories .....	159
Columbia Wire Products Company .....	38	Pomona Electronics Co., Inc. ....	146
Computer Logic Corporation .....	170	Princeton Applied Research Corp. ....	16
Computer Measurements Company .....	2	Pyrofilm Resistor Co., Inc. ....	60
Consolidated Avionics, A Division of Condec Corporation .....	115	RCA Electronic Components and Devices .....	Cover IV, 43, 73
Cutler-Hammer .....	45	RCL Electronics, Inc. ....	84
Damon Engineering, Inc. ....	22	Schweber Electronics .....	172
Data Control Systems, Inc. ....	128	Sigma Instruments, Inc. ....	30, 31
Decision Control, Inc. ....	162	Simpson Electric Company .....	29
Dialight Corporation .....	173	Solitron Devices, Inc. ....	49
Dilectrix Corp. ....	170	Sonotone Corporation .....	81
Digital Equipment Corporation .....	127	Specific Products .....	158
Duncan Electronics, Inc. ....	137	Sprague Electric Company .....	10, 12, 20
ESI/Electro Scientific Industries, Inc. ....	33	TRW Capacitors .....	50
Eagle Signal, A Division E. W. Bliss Company .....	163	TRW Instruments .....	136
Eastman Chemical Products, Inc. ....	159	TRW Semiconductors .....	111
Electronic Design .....	130, 131, 175	Tally Corporation .....	107
Electrovert, Inc. ....	152	Tektronix, Inc., Oscilloscopes .....	8
Erie Technological Products, Inc. ....	9	Teledyne Telemetry Company .....	142
Fairchild Camera and Instrument Fairchild Instrumentation, A Division of Fairchild Camera and Instrument Corporation .....	40, 41	Tracor, Inc. ....	147
Fairchild Semiconductor, A Division of Fairchild Camera and Instrument Corporation .....	39	Transistor Specialties, Inc. ....	80
G-V Controls, Inc. ....	34, 35	Union Carbide Corporation .....	52
Gardner-Denver Company .....	135	United Transformer Corp. ....	Cover II
General Electric Company, Electronic Components Division .....	26	U.S. Capacitor Corporation .....	174
General Electric Company, Silicone Products Department .....	4, 5	Vactec Inc. ....	122
General Instrument Corporation .....	7	Vanton Pump & Equipment Corp. ....	156
Globe Industries, Inc. ....	148	Victoreen Instrument Company, The .....	132
Gudebrod Bros. Silk Co., Inc. ....	66	Vitro Electronics, A Division of Vitro Corporation of America .....	48
Guardian Electric Manufacturing Company .....	67	West Coast Electrical Mfg. Corp. ....	171
H P Associates .....	61	Westinghouse Molecular Electronics Division .....	15
Harowe Servo Controls, Inc. ....	136	Wright/Div. of Sperry Rand Corporation .....	155
Hartwell Corporation, The .....	88	Career Advertising:	
Hayden Book Company, Inc. ....	172	A C Electronics Division of General Motors .....	102
Hewlett-Packard .....	1, 23, 32, 32A-B, 138, 139, 143	Bendix Corporation, The .....	104
Hickok Electrical Instrument Co., Inc., The .....	Cover III	Conductron-Missouri .....	100
Honeywell Test Instrument Division .....	116	Electronic Communications, Inc. ....	153
IRC, Inc. ....	47	General Electric Company Apollo Support Division .....	105
ITT Semiconductors .....	165, 167	Hughes Aircraft Company Aerospace Divisions .....	99
James Electronics, Inc. ....	42	LTV Electrosystems, Inc. ....	103
Johanson Manufacturing Corp. ....	126	McDonnell .....	101
		Naval Ship Systems Command .....	104
		San Francisco Bay Naval Shipyard .....	93
		Sarkes Tarzian .....	104
		Signetics Corporation .....	96

# SIEMENS AMERICA INCORPORATED ASKED 596 OF THEIR CUSTOMERS "WHICH MAGAZINE DO YOU READ REGULARLY?"

PUBLICATION	Rank	Read Regularly	
		No.	%
ELECTRONIC DESIGN	<b>1</b>	135	69.6
ELECTRONIC INDUSTRIES	<b>2</b>	105	54.1
ELECTRONICS	<b>3</b>	100	51.5
ELECTRICAL DESIGN NEWS	<b>4</b>	98	50.5
IEEE SPECTRUM	<b>7</b>	66	34.0
ELECTRONIC EQUIPMENT ENGINEERING	<b>8</b>	63	32.5
ELECTRO-TECHNOLOGY	Not included.		
ELECTRO-MECHANICAL DESIGN	Not included.		
ELECTRONIC PRODUCTS	<b>5</b>	75	38.7
ELECTRONIC NEWS	<b>6</b>	69	35.6

#### READERSHIP STUDY BOX SCORE

STUDY NUMBER	NUMBER OF STUDIES TO DATE	NUMBER WON BY ELECTRONIC DESIGN
<b>47</b>	<b>47</b>	<b>43</b>

Again and again and again, when electronics manufacturers ask their OEM customers and prospects which publications they read—the overwhelming response is “*Electronic Design*”!

Siemens America made such a study in the Fall of 1965. *Electronic Design* received top score, almost 70% “read regularly” . . . over 15 percentage

points higher than the second ranking publication.

Siemens has considered these results carefully in their media programs. Studies, like Siemens’, point the way to most efficient ad expenditures, confirm the value of *Electronic Design*’s audience. When Siemens buys *Electronic Design*, they *know* that they are buying *readership*!

## Electronic Design RANKS 1st in READERSHIP

a HAYDEN publication 850 Third Avenue, New York, N.Y. 10022 (212) PL 1-5530

Latest techniques in real-time signature analysis for ASW and other applications . . .

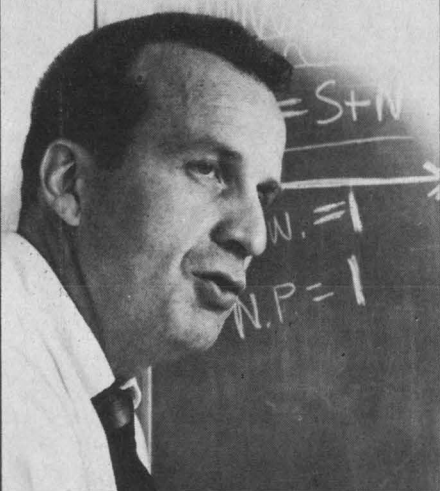

"Recognition and analysis of transient, noisy waveforms requires a system that both stores and filters information. A simple, reliable method of accomplishing both is to excite a bank of filters, contiguously tuned to cover the frequency range of interest. This filter bank will perform a Fourier analysis of any signal, regardless of duration. The signal-to-noise ratio is improved due to the inherent bandwidth reduction, and storage is inherent in the filters. The output of the filter bank is sampled rapidly by means of an electronic commutator. A frequency-amplitude display is obtained which represents all input signals, including brief transients . . . the essence of real-time analysis."

**Thomas Beling**  
Vice President of Engineering  
Acton Laboratories, Inc.

**TECHNIQUES & INSTRUMENTATION  
FOR MEASURING & PROCESSING OF SIGNALS**

**ACTON**

**LABORATORIES · INC.**

Subsidiary of Bowmar Instrument Corporation

531 Main Street • Acton, Massachusetts 01720 (617) 263-7756 (Boston) 542-0284

Latest Acton Labs instrumentation for real-time high-resolution spectrum analysis

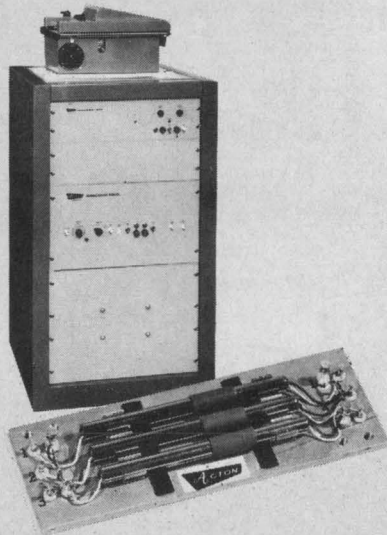

Acton Laboratories' latest Rayspan™ spectrum analyzer designs combine sharp, stable, magnetostrictive filters with solid state switching to make real-time analysis practical in rugged environments. A frequency-amplitude display allows for operator analysis or digitization of the output for computer analysis. Great flexibility is possible in filter bandwidth and analysis band. Current Rayspan designs cover 1 Hz to 100 Hz in filter bandwidth, and 30 Hz to 50 KHz in analysis band.

Acton Labs' magnetostrictive filters can be supplied separately as single units, dual units, or arrays, with center frequencies from 15 KHz to 450 KHz and Q's from 2000 to 22,000.

## Designer's Datebook

DECEMBER						
S	M	T	W	T	F	S
				1	2	3
4	5	6	7	8	9	10
11	12	13	14	15	16	17
18	19	20	21	22	23	24
25	26	27	28	29	30	31

JANUARY						
S	M	T	W	T	F	S
1	2	3	4	5	6	7
8	9	10	11	12	13	14
15	16	17	18	19	20	21
22	23	24	25	26	27	28
29	30	31				

### Dec. 7-9

**15th Annual Wire and Cable Symposium** (Atlantic City, N. J.) Sponsor: Army Electronics Command; J. Spergel, Wire and Cable Symposium, U.S. Army Electronics Command, Fort Monmouth, N. J. 07703

### Dec. 7-9

**International Scientific Radio Union (URSI)** (Palo Alto, Calif.) Sponsor: U.S. National Committee of the International Scientific Radio Union; Prof. R. A. Helliwell, Radioscience Lab., Stanford University, Stanford, Calif. 94305

### Dec. 26-31

**133rd Meeting of the American Association for the Advancement of Sciences** (Washington, D. C.) Sponsor: AAAS; Mrs. Thelma C. Heatwole, 5110 W. Franklin St., Richmond, Va. 23226

### Jan. 4-7, 1967

**Winter Meeting of the National Society of Professional Engineers** (San Juan, P. R.) Sponsor: NSPE; Kenneth E. Trombley, National Society of Professional Engineers, 2029 K. St., N.W., Washington, D. C. 20006

### Jan. 10-12

**1967 Annual Symposium on Reliability** (Washington, D. C.) Sponsor: NASA; John E. Condon, Reliability and Quality Assurance (KR), NASA Headquarters, Washington, D. C. 20546

### Jan. 19-20

**Institute—Computer Aid for Reliability Analysis of Electronics** (Milwaukee) Sponsor: University of Wisconsin; C. L. Brisley, Director, Engineering Center for Postgraduate and Professional Development, The University of Wisconsin, 600 W. Kilbourn Ave., Milwaukee, Wis. 53203

# Brand **NEW** FROM **HICKOK**

## DMS-3200 Digital Measuring System

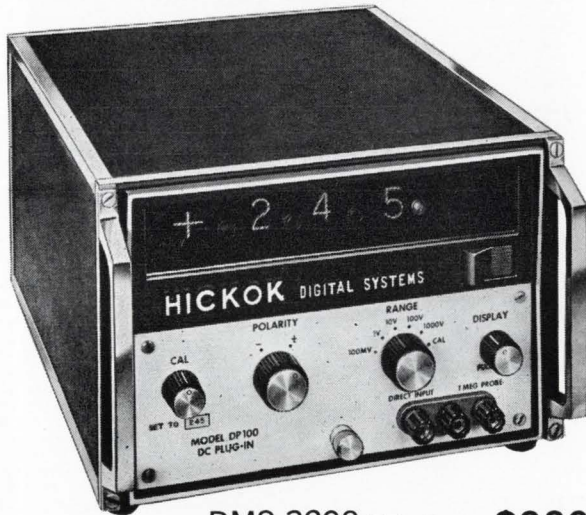

DMS-3200 Main Frame **\$320**  
(shown with DP-100)



DP-100  
DC Voltmeter  
Plug-in  
**\$175**

DP-150  
1 MC Counter  
Plug-in  
**\$195**

DP-170  
Ohmmeter  
Plug-in  
**\$240**

DP-200  
Capacity  
Meter  
Plug-in  
**\$240**

DP-140  
Event Counter  
and  
Slave Plug-in  
**\$75**

### HIGHLIGHT FEATURES

- 3-digit Biquinary Tube Read-out
- Plug-in Flexibility
- All-electronic
- Fully-transistorized
- Modular Design
- Fully Field-tested
- Automatic Polarity Indication
- Automatic Decimal Point Indication

#### AS A DIGITAL DC VOLTMETER (DP100 Plug-in)

Range 0.1 millivolts to 1000 volts  
Accuracy  $\pm 0.1\%$  FS,  $\pm 0.1\%$  of reading  
True integrating voltmeter design  
10 megohms input impedance at all times

#### AS A DIGITAL 1 MC COUNTER (DP150 Plug-in)

$\pm 0.005\%$  accuracy: Resolution 1 part in  $10^7$   
(Overrange capability with sector read-out permits 3-digit display to be equivalent of a 7-digit instrument)

Frequency measurement range 0.1 cps to 1 mc  
Period measurement range 0.1 ms to 999 seconds

#### AS A DIGITAL OHMMETER (DP170 Plug-in)

Range 0.01 ohm to 1,000 megohms  
Accuracy  $\pm 0.1\%$  FS,  $\pm 0.2\%$  of reading

#### AS A DIGITAL CAPACITY METER (DP200 Plug-in)

Range 1.0 picofarad to 10,000 microfarads  
Accuracy  $\pm 0.1\%$  FS,  $\pm 0.2\%$  of reading

#### AS AN EVENT COUNTER AND SLAVE (DP140 Plug-in)

Event counting speed: 1,000,000 pps  
Alternate use as slave to DP-150 to provide 6-digit display

The DMS-3200 is designed for rugged industrial and laboratory applications. By utilizing a design which has the optimum combination of accuracy capability and number of digit display, the DMS-3200 meets the general purpose measurement needs of industry for reliable, precision digital measurement equipment in the \$400-\$500 price range.

For critical  
chopper applications...  
RCA's new MOS transistor  
will even work

# UPSIDE DOWN



**RCA's new 40460 is an N-channel, depletion type, insulated-full-gate MOS which, because of its symmetry, can be operated "upside down"...works equally well with either positive or negative incoming signals...does the work of two bipolar transistors.**

RCA's full-gate MOS is especially useful for chopper applications at extremely low voltage levels...handles input signals from microvolts to volts. It has an inherent offset voltage of zero. This means that the RCA 40460 has none of the tracking problems of matched bipolar devices, caused by temperature changes and extended operation.

A high "off" resistance of 1000 megohms and a low "on" drain-to-source resistance of only 250 ohms make the RCA 40460 perform like a mechanical chopper, without its drawbacks. And you get all the advantages of solid-state reliability. In addition, long-term stability is assured by a fully metallized gate and a hermetically sealed JEDEC TO-72 4-lead metal case.

*TO GET THE MOST FROM YOUR RCA 40460 CHOPPER, use the new RCA 40461 MOS transistor in your chopper amplifier stage, as well as for other critical audio and wideband applications.*

Try these devices and see how they improve your chopper design. Check your RCA Field Representative for complete information. For technical bulletins, write RCA Commercial Engineering, Section CG12-1, Harrison, N. J. 07029.

ALSO AVAILABLE THROUGH YOUR RCA DISTRIBUTOR  
RCA's New 40460 MOS Transistor Features ZERO OFFSET VOLTAGE\*

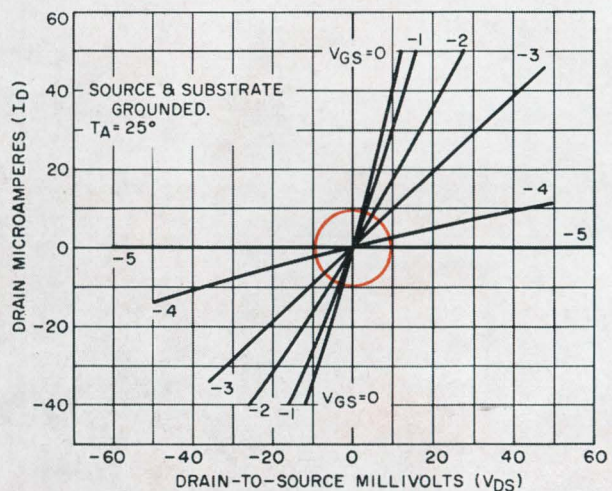

\*Thermocouple effects and contact potentials may cause erroneous readings



RCA ELECTRONIC COMPONENTS AND DEVICES

The Most Trusted Name in Electronics

ON READER-SERVICE CARD CIRCLE 204