

Electronic Design 25

FOR ENGINEERS AND ENGINEERING MANAGERS

VOL. 15 NO.

DEC. 6, 1967

Dolphins challenge the designer. Experiments to unravel nature's mysteries are now revealing how they communicate and sense the environment. Existing electronics

doesn't meet the needs, since it wasn't designed for research on animals. Necessary innovations, notably in systems engineering, are outlined starting on page 49.

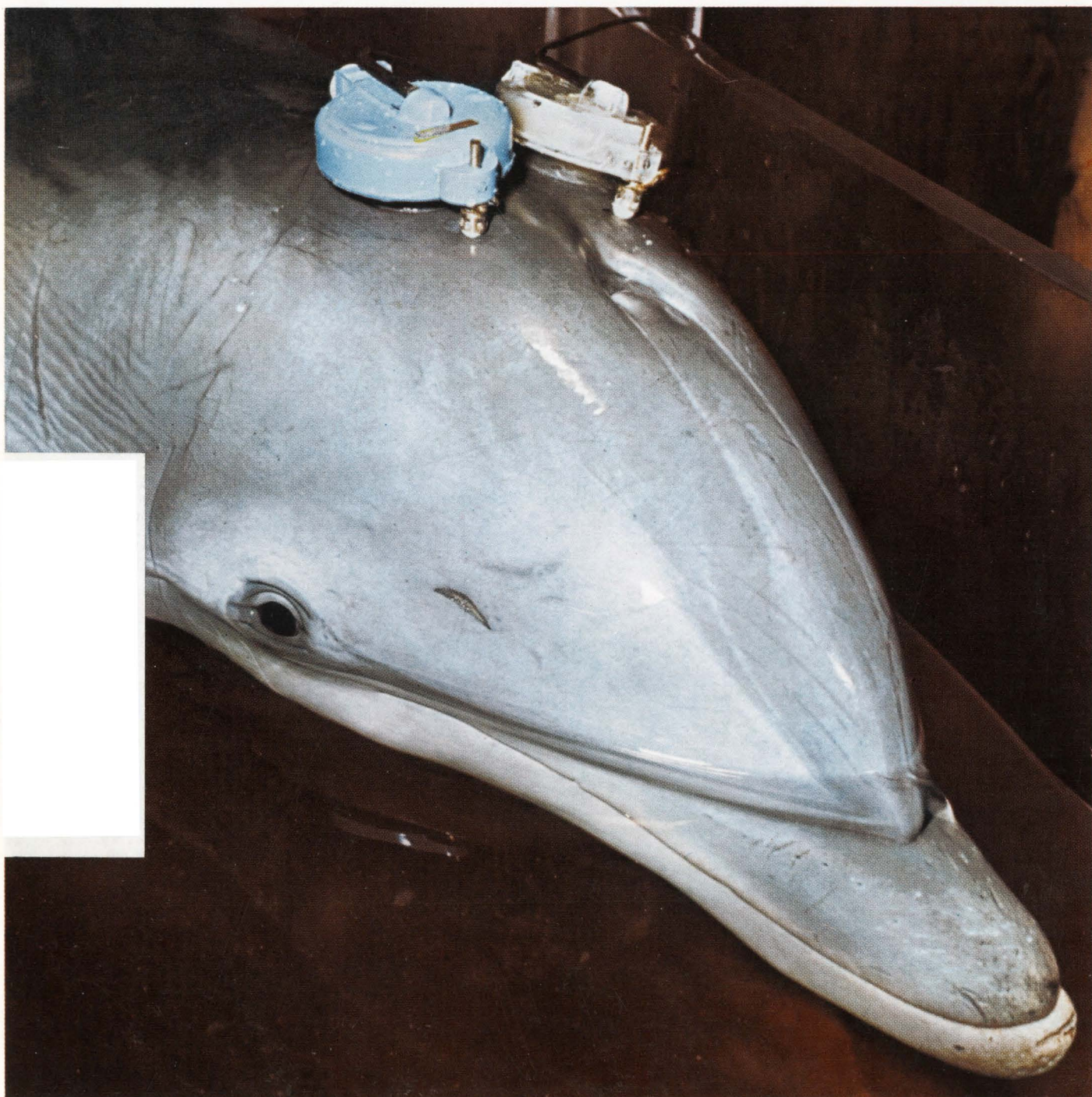

**TRW ANNOUNCES
NEW MILITARY MYLARS**



14-53

Up to 72% smaller than MIL-C-25C paper capacitors!

MIL-C-19978B/2 reduces capacitor size drastically—down to .125" diameter by 1/2" long. At the same time electrical characteristics are upgraded sharply.

MIL-C-19978B/2 hermetically sealed mylar* capacitors are available now from TRW with immediate delivery in production quantities.

- **REDUCED SIZE**—35% to 72% smaller than MIL-C-25C.
- **VOLTAGE CHOICE**—30V, 50V, 100V, 200V, 600V, 1000V.
- **CAPACITANCE CHOICE**—.001 mfd through 10.0 mfd.
- **TOLERANCE CHOICE**—±10%, ±5%, ±2%, ±1%.

Product information is available from TRW Capacitor Division, TRW INC., Box 1000, Ogallala, Nebraska. Phone (308) 284-3611. TWX: 910-620-0321.

*Du Pont registered trademark

TRW®

HP Counters are now a better buy than ever before!



Hewlett-Packard's 5245 Series Electronic Counters, and their plug-ins, have steadily become the standard of quality and versatility wherever there is a need for precision electronic measurement. Always economical, always your best cost-for-performance buy, there are now more models and more plug-ins to choose from. And, with lower prices, they're a better buy than ever before.

5245L Counter: highly versatile instrument that measures frequency (0 to 50 MHz), period, multiple period average and frequency ratio. 8-digit readout and time base aging rate of < 3 parts in 10^9 /day. Input impedance of 1 megohm 25 pF on all ranges. Accepts all HP counter plug-in accessories and has BCD output... NEW PRICE: \$2450.

5245M Counter: almost identical to the 5245L (above) but with a rapid warm-up ultra-stable time base with performance equalling that of many secondary standards: < 5 parts in 10^{10} /day aging rate. Warms up to within 1 part in 10^8 of previous frequency in 1 hour (after 24 hours off)... NEW PRICE: \$2750.

5246L Counter: a stripped-down version of the 5245L, with only 6-digit readout and time base aging rate of < 2 parts in 10^7 /month. Extra-cost options include 7- or 8-digit readout, BCD output; uses all 5245L plug-ins... NEW PRICE: \$1750.

5247M Counter counts directly to 135 MHz but, while it's similar to the 5245M, measures frequency only. Range can be extended to 18 GHz by means of the converter plug-ins; accepts prescaler plug-ins, too. Optional BCD output... NEW PRICE: \$2800.

5244L Counter: this counter doesn't accept plug-ins but has the basic measurement versatility of the 5245L—frequency, period and ratio. Range is to 50 MHz with 7-digit readout and BCD output. Time base aging rate is $< \pm 2$ parts in 10^7 /month... NEW PRICE: \$1850.

For more information on the lowest-priced deluxe counters you can buy, call your local HP field engineer or write Hewlett-Packard, Palo Alto, California 94304; Europe: 54 Route des Acacias, Geneva.

Plug-ins to use with these counters:

- | | |
|--|--|
| 5256A Heterodyne Converter, 8 GHz to 18 GHz (and 1 to 200 MHz), \$1750. | 5258A Prescaler, 1 to 200 MHz, 1 mV, \$825. |
| 5255A Heterodyne Converter, 3 GHz to 12.4 GHz (and 1 to 200 MHz), \$1650. | 5261A Video Amplifier, 1 mV RMS, 10 Hz to 50 MHz, \$325. |
| 5251A Plug-in Converter, 20-100 MHz, \$300. | 5262A Time Interval Plug-in, \$250. |
| 5252A Prescaler, DC to 350 MHz, \$685. | 5264A Preset Unit for normalized measurements, \$650. |
| 5253B Plug-in Converter, 50 to 512 MHz, \$500. | 5265A Digital Voltmeter, 6-digit presentation of 10, 100 and 1000 V full scale with 5% overrange capability, \$575. |
| 5254B Plug-in Converter, 0.2 to 3 GHz, \$825. | |

HEWLETT  PACKARD
ELECTRONIC COUNTERS

ON READER-SERVICE CARD CIRCLE 2

NANO 2 SECOND



VARIABLE RISE PULSE GENERATOR WITH PRECISION DC BASELINE OFFSET

The Datapulse Model 111 extends general purpose pulse generator technology a full octave in rise time capability, with full control over every major pulse parameter. No other pulse generator is so ideally suited for high speed integrated circuit testing and digital logic circuit design

SPECIFICATIONS — 2 ns to 500 ns linear rise, 4 Hz to 40 MHz repetition rates, $\pm 5V$ output into 50 ohms, precision baseline offset to $\pm 5V$ with $\pm 50mV$ accuracy, single or double pulse operation, 50 MHz simulated rep rates on double pulse, and 8 ns to 500 μs pulse widths. ■ PRICE: \$1480.00

TYPICAL APPLICATIONS —

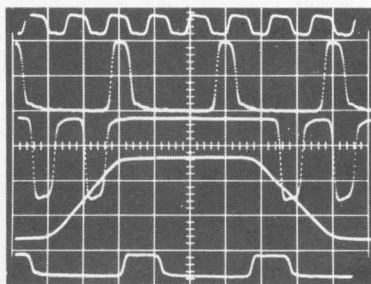

20ns/cm, 1V/cm

The 111's fully controllable fast pulses permit construction of a nearly limitless number of test waveforms for the design and test of high speed components, integrated circuits, analog devices, and other elements.

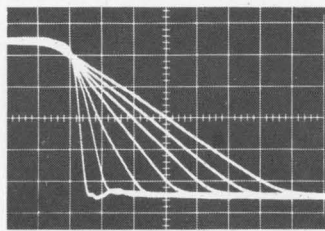

0.3V/cm, 5 ns/cm

Independently variable, linear rise and fall times permit marginal testing and exact simulation of pulse circuit rise and fall times.

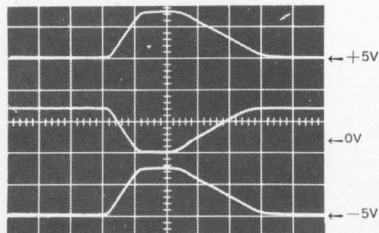

2V/cm, 20 ns/cm

Precision variable baseline level provides dc biased outputs for off-ground logic simulation; also for worst case tolerancing of logic circuitry and noise susceptibility analysis.

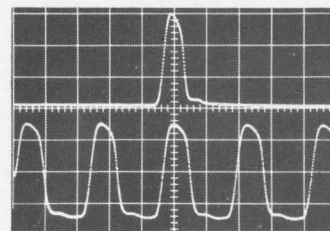

10 ns/cm, 0.5V/cm

Narrow pulse output to 8 nanoseconds provides impulse type signals for high speed circuit development, high frequency complex impedance analysis, and other transient tests.

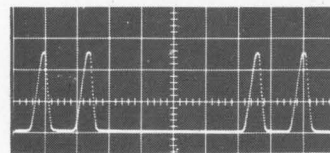

2V/cm, 0.1 μs /cm

Double pulse operation provides two identical pulses in each cycle. Ideal for flip-flop resolution checks, navigational signal simulation.

The 111 is available NOW! Ask your Datapulse representative for a demonstration! Write for complete technical literature!

DATAPULSE®



Datapulse Incorporated — A Subsidiary of Systron-Donner Corporation, 10150 West Jefferson Blvd., Culver City, California 90230. Telephone: (213) 836-6100, 871-0410. TWX: 910-340-6766. CABLE: Datapulse • Microwave Division: DeMornay-Bonardi.

NEWS

- 21 News Scope
- 25 **The FFT computer: Designer's 'missing link'**
Fast-Fourier-transform black boxes are revolutionizing signal processing.
- 34 **Civilian markets beckon microwave ICs**
Military research dominates as designers seek best approach to economical units.
- 41 Washington Report
- 49 **Special Report: Dolphins challenge the designer**
Animals' echo-locating outperforms sonar; sound outputs push equipment limits.
- 68 Letters
- 76 Sidelights of the Issue
- 79 **Editorial: No engineer is an island unto himself.**
-

TECHNOLOGY

- 82 **Counter designs swing without gates** if you use this method to eliminate them. And gateless counters will lower your component costs.
- 92 **Use tunnel diodes in threshold logic.** An actron—a discrete component gate—can be built to realize a variety of functions.
- 100 Test your IC IQ
- 104 **Rising sales don't always raise profits.** There are three indicators to sound income planning, and wise managers know how to manipulate them.
- 113 NASA Tech Briefs
- 120 Ideas for Design
-

PRODUCTS

- 132 **Test Equipment:** Analyzer converter displays 90 GHz.
- 144 **Components:** Mini-relay in TO-5 skirts adjustment.
- 160 **Production Equipment:** Subminiature coaxial contacts made in 20 s.
- | | |
|----------------------|--------------------|
| 142 Microelectronics | 170 Materials |
| 162 Systems | 171 Semiconductors |
| 166 Microwaves | |
-

Departments

- | | |
|-----------------------|-------------------------|
| 172 Design Aids | 178 Reprints |
| 173 Application Notes | 180 Advertisers' Index |
| 174 New Literature | 183 Designer's Datebook |

Reader Service card inside back cover

Win \$1,000

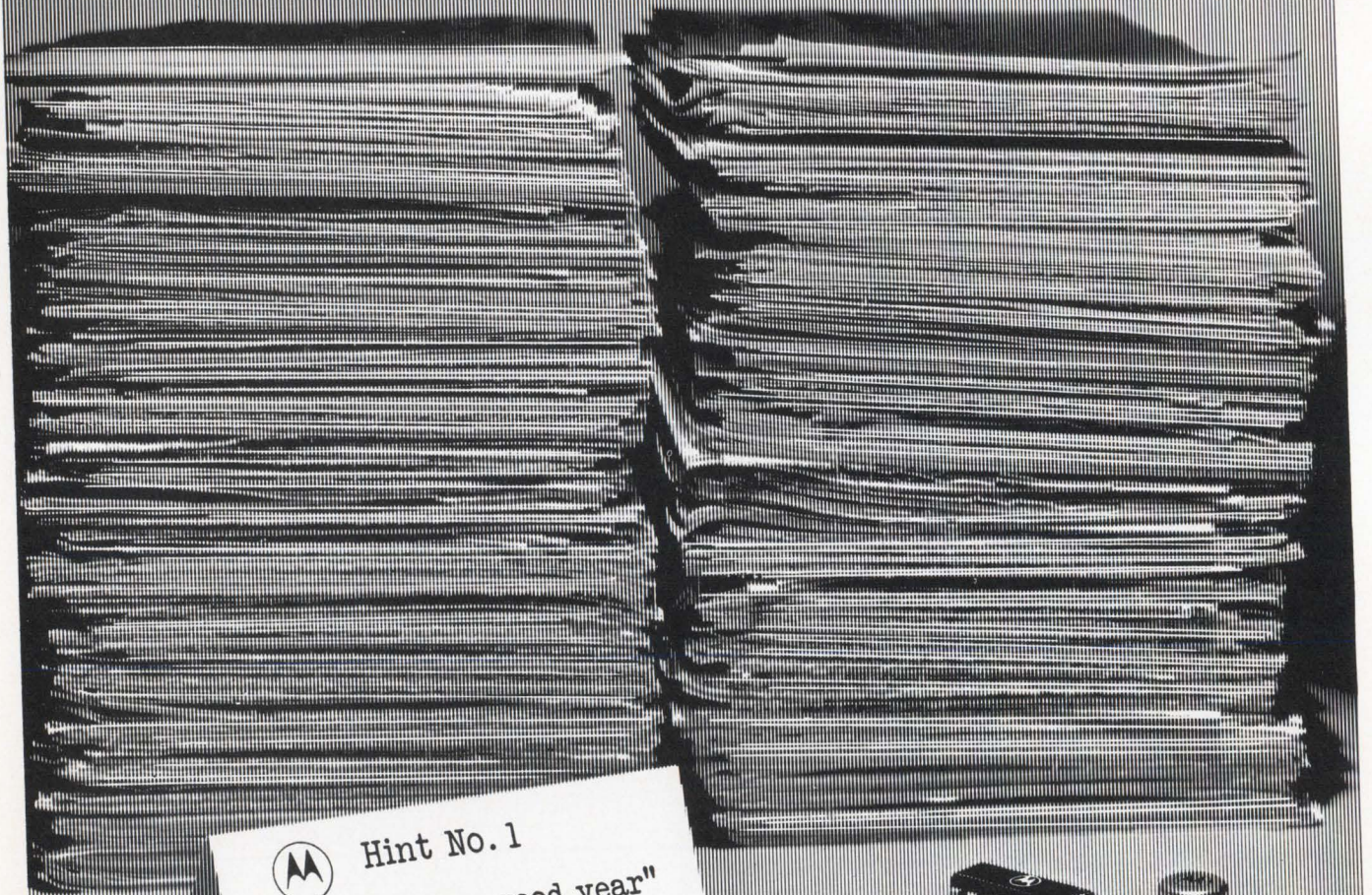

 Hint No. 1
"It was a very good year"
for MOTOROLA
Integrated Circuits

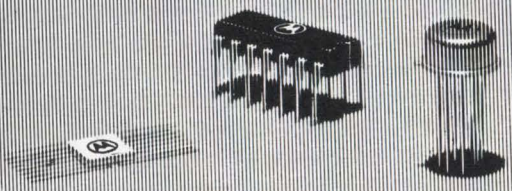

-where the priceless ingredient is care!



In Motorola's "It was a very good year" Integrated Circuits Contest

Here's your chance to win \$1,000 cash. And, it's almost as easy as writing your own name! Simply fill out the coupon below with your best guesses of the number of standard integrated circuits Motorola has formally introduced this year through its franchised distributors, in each linear and logic family.

HERE ARE SOME ADDITIONAL HINTS TO HELP YOU WIN \$1,000

- As of October 31, Motorola has introduced 11 new MDTL logic circuits this year. More to come!
- As of November 30, Motorola has introduced 18 MECL integrated logic circuits. Still more on the way!
- Motorola has introduced 15 MTTL integrated logic circuits as of November 15 — and still more coming!

The entry that provides the exact or most nearly exact figures for each circuit category, and the resulting correct grand total, will be declared the winner. In case of ties, the Grand Prize will be divided equally among the winners. (Decision of the Motorola judges will be final, of course.)

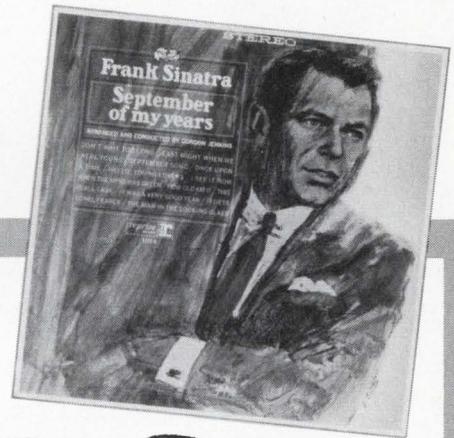

I think that Motorola will have introduced the following numbers of new integrated circuits during the past year:

Circuit Family	Number of Circuits:	Circuit Family	Number of Circuits:
MDTL (diode-transistor logic)	_____	MHTL (high-threshold logic)	_____
MRTL (resistor-transistor logic)	_____	I/C Operational Amplifiers	_____
MTTL (transistor-transistor logic)	_____	I/C Diff./Sense Amplifiers	_____
MECL (emitter-coupled logic)	_____	I/C Video, RF & IF Amplifiers	_____

GRAND TOTAL.....

NAME _____ TITLE _____
 COMPANY _____ DIV/DEPT _____
 ADDRESS _____
 CITY _____ STATE _____ ZIP CODE _____

Bonus Prizes

Everyone who guesses the correct grand total (even though the individual circuit categories may be inaccurate) will receive a copy of the Frank Sinatra stereo album, that features "It Was a Very Good Year." So, enter your guesses now (one per entrant, please) . . . just make sure that your entry is postmarked no later than December 23, 1967. Winning totals will be announced after the contest closes.

MOTOROLA Semiconductors

P. O. BOX 955, PHOENIX, ARIZONA 85001

Employees of Motorola Semiconductor Products Inc. and Motorola Inc., Semiconductor Products division, and its distributors are not eligible. Contest is void where prohibited by law or by participant's company policy.

OTHER 2, 4 AND 6 POLE 2 AMP RELAYS MIGHT BE AS GOOD AS THE NEW SIGMA SERIES 62.

If they were built as well.

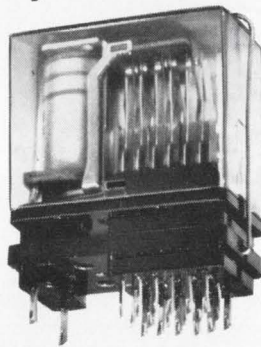

Versatile, miniature Sigma Series 62 general purpose relays outperform their competitive counterparts because they are built better three ways:

Larger Contacts For Longer Life: The larger contacts (.093" & .058" dia.) used in the Series 62 assure superior thermal and electrical conductivity and a life expectancy of 1 million operations at rated load.

Thicker Base For Greater Contact Stability: The Series 62 base, in the terminal area, is twice as thick as competing types. This provides a much higher degree of mechanical support assuring long-term stability of the stationary contact members.

More Durable Lifter For Better Contact Action: The contact actuator of the Series 62 is made of

fabric-filled phenolic rather than paper-based phenolic. It is extremely durable, rigid, and not subject to cracking even after extended use.

We'd like to give you a new Sigma Series 62—or any of our other standard relays. Test and compare it against the brand you may now be using. It's the best way we know to prove what we say about Sigma relay performance. Just circle our reader service number on the reader service card. We'll send you the new Sigma relay catalog and a "free relay" request form. Return the form to us and your Sigma representative will see that you get the relay you need.

Need fast delivery? The Series 62 is available off-the-shelf from your Sigma distributor.

SIGMA DIVISION  SIGMA INSTRUMENTS INC
Assured Reliability With Advanced Design / Braintree, Mass. 02185
Sigma Instruments (Canada) Ltd., P.O. Box 43, Toronto 18

ON READER-SERVICE CARD CIRCLE 5

ELECTRONIC DESIGN 25, December 6, 1967

AC MICROVOLT METER SEES THROUGH NOISE!



*New hp 3410A Measures
300 nanovolts
Buried in Noise*

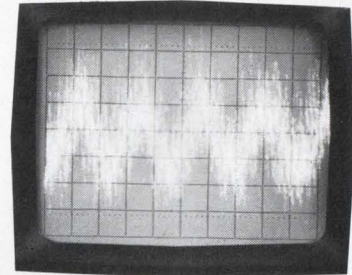

Measure 1 μV , 500 kHz signal out of 40 dB noise.

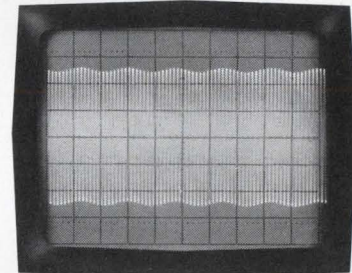

Measure 10 mV, 5 Hz amplitude modulating
1 V, 400 Hz.

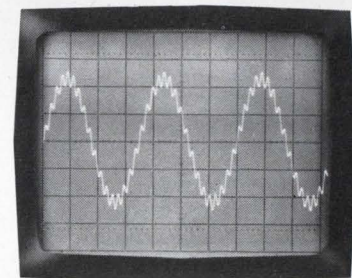

Measure 300 nanovolts, 10 kHz.
signal superimposed on 10 μV , 1 kHz

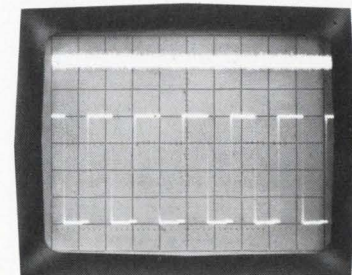

Measure frequency of signal in noise up to 560 kHz
by using square wave output,
i.e. as a counter preamplifier.

New hp Model 3410A AC Microvoltmeter measures low level repetitive signals obscured by noise—3 μV to 3 V full scale—accuracy $\pm 3\%$. RMS noise voltages up to 20 dB above full scale *do not* affect readings. Sensitivity, low cost and ease of operation are the 3410A's contribution.

This new microvoltmeter uses an hp designed phase-locked synchronous detector to separate effects of noise from signal. The detector is an electronic gate controlled by an oscillator phase-locked to the input signal. No external reference is required to lock to the input signal. Simply adjust front panel tuning control within 1% of signal frequency and phase-lock circuits *lock-on and track* input signal with $\pm 5\%$ variation in the 5 Hz to 600 kHz frequency range. Phase-lock circuits track 0.5%/sec change in signal frequency without a change in voltmeter accuracy. Input impedance is 10 M Ω shunted by 20 pF.

The new Model 3410A has two outputs on the rear panel. One is a dc recorder output for monitoring long term drifting ac voltage amplitudes. The other is an output for driving an electronic counter to make precise frequency measurements.

For full specifications on the new hp Model 3410A AC Voltmeter, call your hp field engineer. Or, write to Hewlett-Packard, Palo Alto, California 94304. Europe: 54 Route des Acacias, Geneva. Price: hp Model 3410A, \$800.00.

HEWLETT  **PACKARD**
An extra measure of quality

097/11

ON READER-SERVICE CARD CIRCLE 6

nobody else,

that's who

delivers all these epoxies.

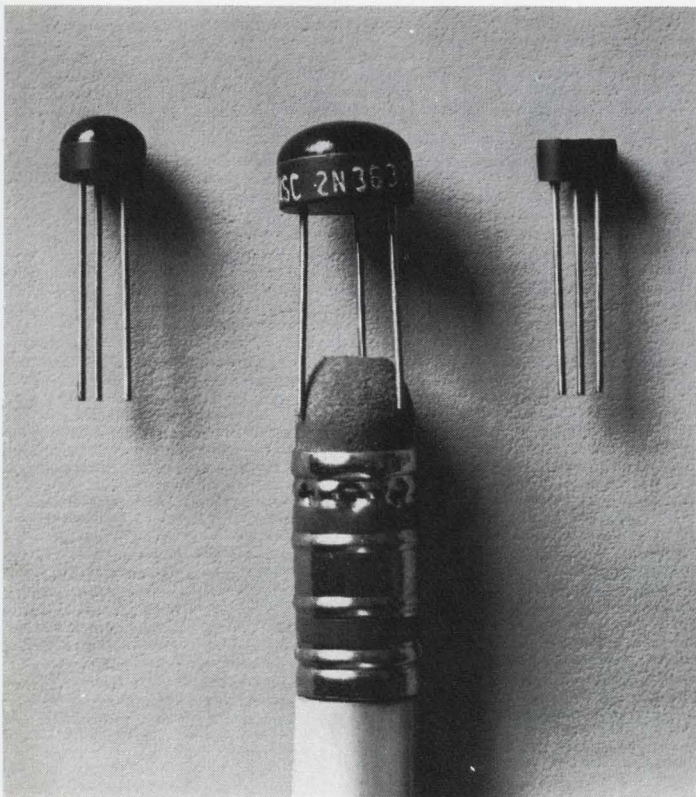

TO-105, TO-106, or In-Line. We make them all. From us, you get what you *need*, not just what we have to offer. Choose from over 100 different small signal, medium-power silicon transistors, either NPN or PNP.

So why waste a lot of time skipping between company A which offers only one epoxy package and company B or C which only makes one or two other types?

We're big in the epoxy business and getting bigger, but who knows it. Write for data and distributor list, then tell your friends.

National Semiconductor Corporation, 2975 San Ysidro Way, Santa Clara, California 95051 (408) 245-4320.

National Semiconductor

ON READER-SERVICE CARD CIRCLE 7

How to keep relay contact forces balanced at 30 G's.

Picking a relay for an extreme shock/vibration environment is a tough problem for many a circuit designer. Few relays are designed to meet the problem head on. There is now one notable exception — a 4PDT, 10 ampere relay in a one-inch cube.

Using a new design principle — balanced-force — this relay withstands severe shock, vibration or acceleration while maintaining high contact and overload capabilities. It will take more than 30 G's to 3000 Hz vibration, a shock of 100 G's and has a minimum life of 100,000 cycles. This one-inch cube is all welded, weighs 2.5 ounces, and is rated at 2.9 watts coil power.

EFFICIENT MAGNETIC CIRCUIT

In the conventional relay motor, forces for open and closed contacts are unequal. Energized coil power causes the armature to close the normally open contacts. But, when the coil power is removed and the contacts return to the normally closed position, only the spring forces of the contacts and the return spring provide the force. These combined spring forces are usually low, allowing the contacts to bounce. In addition, the low spring force allows the armature to rebound off the armature stop, again knocking the contacts open — sometimes, for as long as several milliseconds after they have initially closed.

Force-Stroke Curve of Typical Relay and Balanced-Force Relay.

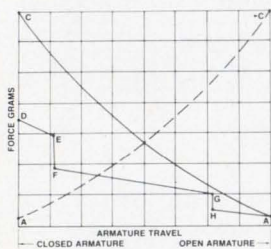

Curve CA — Balanced-Force Relay normally closed contacts.
Curve AC — Balanced-Force Relay normally open contacts.
Curve DEFGH — Typical Relay.

Leach Balanced Force Relay by use of an extremely efficient magnetic design. It has to be to

An obvious method of getting rid of a bounce condition is to balance the armature forces exactly. This is achieved in the

keep the forces balanced while ignoring 30 G's. Basically it is a controlled application of magnet and coil flux. In the de-energized position, a permanent magnet flux flows between the armature and the tip of the adjacent pole piece, resulting in a high holding force. The motor is, therefore, relatively immune to shock and vibration. When coil power is applied, the flux from the permanent magnet is nullified by the coil flux flowing in an opposite direction. The armature closes with a rapid build-up of magnetic force driving it against the contact overtravel forces and into a sealed position.

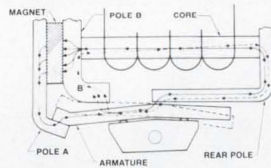

Balanced-Force Motor De-Energized

When coil power is removed and the armature returns, the

restoring force of the permanent magnet builds up quickly. The armature is then driven against the overtravel forces of the normally closed contacts and into its de-energized sealed position. With this type of force-displacement, the armature isn't about to rebound.

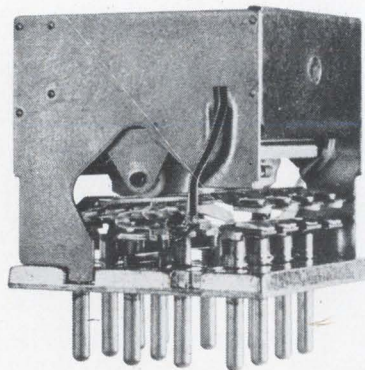

New Leach Model k employs balanced-force concept.

BUFFERED CONTACTS

The moving contacts are mounted to an armature, which is held firmly at the end of each stroke by high magnetic forces. Since the armature can't move during shock

or vibration, undesirable contact opening is eliminated.

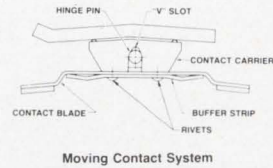

Moving Contact System

Reinforcing the moving contact is a buffer strip which assumes a

variety of chores. It has a bow in the center to act as a spring load while serving as a rivet plate. It works as a heat sink. It will break the contact strip free from a weld if one occurs because of excessive overload. It makes contact with the moving blade which results in excellent low contact drop. It serves as an electrical contact between the moving blade system and the header. And, as the name implies, it buffers the contact blade against extreme shocks and vibrations.

WELDED ASSEMBLY

In assembling the relay all detail parts are welded. No part is solder assembled. There is no possibility of contamination from solder flux. The unit is then pressed into a can and electron-beam sealed, leaving only an evacuation hole. After a high temperature bake, the relay is filled with a dried inert gas, and the hole is welded shut. Here, ready for shipment, is a relay with a magnetic circuit designed so the force without coil power applied is equal to the force with coil power applied, but in exactly the opposite direction. And you can rest assured those forces stay balanced no matter how you shake them.

Complete Motor and Contact Assembly

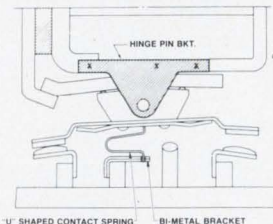

Write for your copy "Tomorrow's Relay Today", a technical paper presented at the National Relay Conference. Leach Corporation, Relay Division, 5915 Avalon Boulevard, Los Angeles, California 90003
LEACH (213) 232-8221.

COMING

from **S**olitron

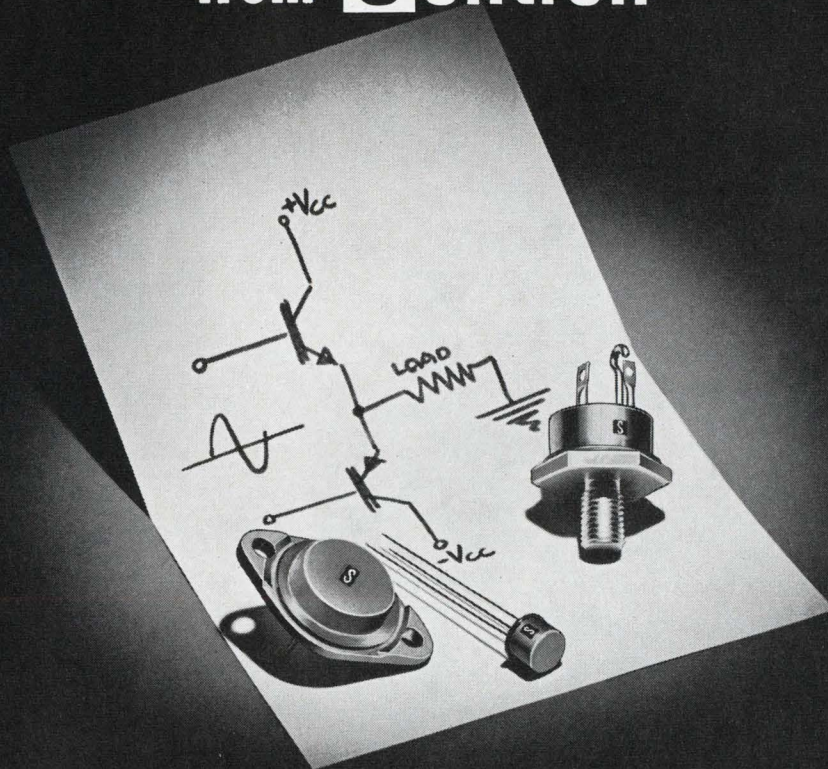

PNP SILICON POWER Transistors with Collector Currents up to 10 AMPS!

DIAL 1-800-327-3243 FOR A "NO CHARGE"
TELEPHONE CALL AND FURTHER INFORMATION

When you think of semiconductors...think Solitron!

Solitron
DEVICES, INC.

1177 BLUE HERON BLVD. / RIVIERA BEACH, FLORIDA / (305) 848-4311 / TWX: (510) 952-6676

ON READER-SERVICE CARD CIRCLE 9

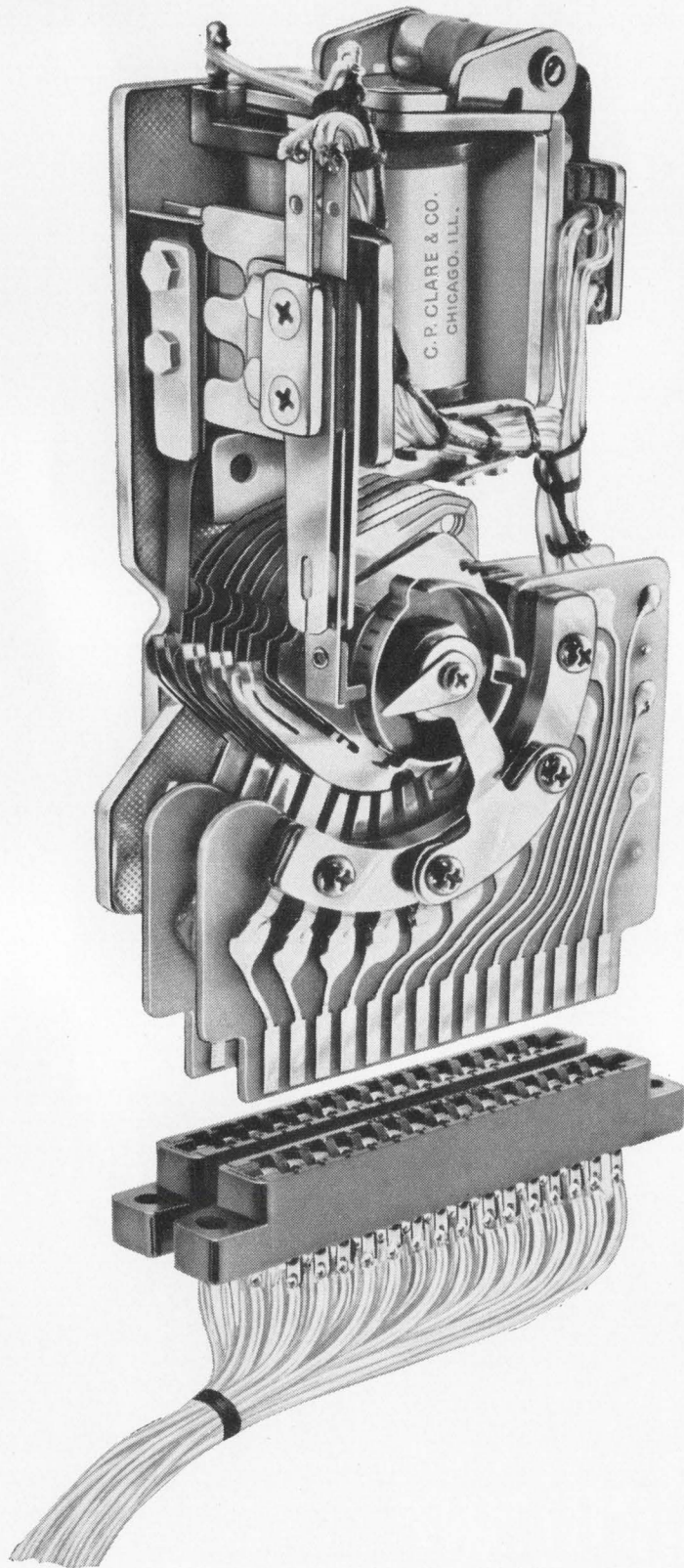

quick-mount

adds new *plug-in* simplicity to the mass sequential switching advantages of Clare Stepping Switches.

The exclusive Clare Quick-Mount brings the speed and ease of plug-in connectors to stepping switch application... makes mass sequential switching more economical... easier to use. Fast unit-for-unit replacement assures continuous service where minimum downtime is required. Clare Quick-Mount is available with all Clare spring-driven switches, using standard 15, 22 or 28-pair connectors.

For complete information, circle reader service number—or ask Clare for Bulletin 651-3... Write Group **12A6**

C. P. Clare & Co., Chicago, Ill. 60645



a GENERAL INSTRUMENT company

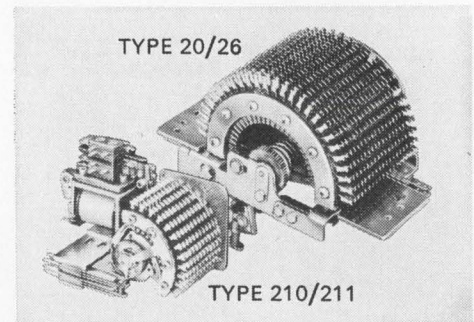

- Low cost scanning and counting
- Maximum switching density
- Long service life
- Special purpose shorting switches—"All But One", "Progressive", "Alternate" operations
- Special high voltage switches are available

CLARE QUICK-MOUNT STEPPING SWITCHES

for mass sequential switching, counting, totalizing,
scanning, sequence control, circuit monitoring

ON READER-SERVICE CARD CIRCLE 10

ON READER-SERVICE CARD CIRCLE 11 ►

Now—the broadest line of convection-cooled, all silicon, .015% regulated power supplies

For test equipment and lab use 0-10,-20,-40,-60,-120 VDC, from 0-.5 amp to 0-66 amps

Features and Data

- Rack or bench use
- Full five year guarantee on materials and labor
- Convection Cooled
- Remote Programing
- Regulation—.015% or 1 MV (Line or Load)
- Temp. Coef. .015%/°C
- Completely Protected—Short circuit proof—Continuously adjustable Automatic current limiting
- Remote Sensing
- Constant I./Constant V. by automatic crossover
- Series/Parallel Operation
- No Voltage Spikes or Overshoot on "turn on", "turn off" or power failure
- Ripple—LK models—500 μ V RMS
LH models—250 μ V RMS, 1 MV P-P
- Meet MIL Environment Specs

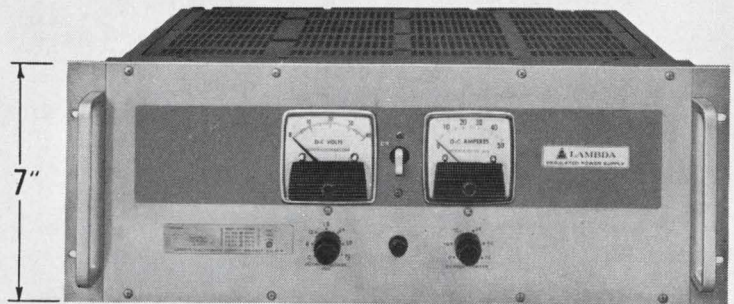

Full Rack 7" LK Series



1/4 Rack LH Series

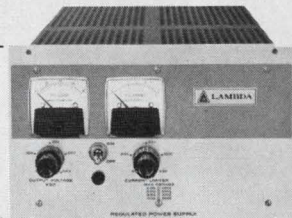

1/2 Rack LK Series-LH Series

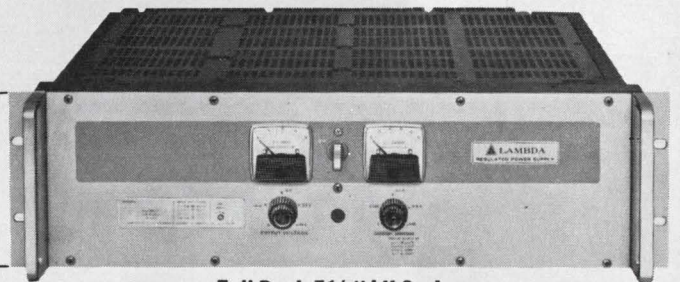

Full Rack 5 1/4" LK Series

3 Full-rack Models — Size 7" x 19" x 18 1/2"

Model ²	Voltage Range	CURRENT RANGE AT AMBIENT OF: ¹				Price ²
		40°C	50°C	60°C	71°C	
LK 360 FM	0-20VDC	0-66A	0-59A	0-50A	0-40A	\$995
LK 361 FM	0-36VDC	0-48A	0-43A	0-36A	0-30A	950
LK 362 FM	0-60VDC	0-25A	0-24A	0-22A	0-19A	995

11 Half-rack Models — Size 5 3/16" x 8 3/8" x 15 1/2"

Model ²	Voltage Range	CURRENT RANGE AT AMBIENT OF: ¹				Price ²
		40°C	50°C	60°C	71°C	
LK 340	0-20VDC	0- 8.0A	0- 7.0A	0- 6.1A	0-4.9A	\$330
LK 341	0-20VDC	0-13.5A	0-11.0A	0-10.0A	0-7.7A	385
LK 342	0-36VDC	0- 5.2A	0- 5.0A	0- 4.5A	0-3.7A	335
LK 343	0-36VDC	0- 9.0A	0- 8.5A	0- 7.6A	0-6.1A	395
LK 344	0-60VDC	0- 4.0A	0- 3.5A	0- 3.0A	0-2.5A	340
LK 345	0-60VDC	0- 6.0A	0- 5.2A	0- 4.5A	0-4.0A	395

3 Full-rack Models — Size 5 1/4" x 19" x 16 1/2"

Model ²	Voltage Range	CURRENT RANGE AT AMBIENT OF: ¹				Price ²
		40°C	50°C	60°C	71°C	
LK 350	0-20VDC	0-35A	0-31A	0-26A	0-20A	\$675
LK 351	0-36VDC	0-25A	0-23A	0-20A	0-15A	640
LK 352	0-60VDC	0-15A	0-14A	0-12.5A	0-10A	650

Model ²	Voltage Range	CURRENT RANGE AT AMBIENT OF: ¹				Price ²
		30°C	50°C	60°C	71°C	
LH 119	0-10VDC	0- 9.0A	0- 8.0A	0- 6.9A	0-5.8A	\$289
LH 122	0-20VDC	0- 5.7A	0- 4.7A	0- 4.0A	0-3.3A	260
LH 125	0-40VDC	0- 3.0A	0- 2.7A	0- 2.3A	0-1.9A	269
LH 128	0-60VDC	0- 2.4A	0- 2.1A	0- 1.8A	0-1.5A	315
LH 131	0-120VDC	0- 1.2A	0- 0.9A	0- 0.8A	0-0.6A	320

5 Quarter-rack Models — Size 5 3/16" x 4 3/16" x 15 1/2"

Model ²	Voltage Range	CURRENT RANGE AT AMBIENT OF: ¹				Price ²
		30°C	50°C	60°C	71°C	
LH 118	0-10VDC	0-4.0A	0-3.5A	0-2.9A	0-2.3A	\$175
LH 121	0-20VDC	0-2.4A	0-2.2A	0-1.8A	0-1.5A	159
LH 124	0-40VDC	0-1.3A	0-1.1A	0-0.9A	0-0.7A	154
LH 127	0-60VDC	0-0.9A	0-0.7A	0-0.6A	0-0.5A	184
LH 130	0-120VDC	0-0.50A	0-0.40A	0-0.35A	0-0.25A	225

¹ Current rating applies over entire voltage range.

² Prices are for non-metered models (except for models LK360FM thru LK362FM which are not available without meters). For metered models, add suffix (FM) and add \$25 to price of LH models; add \$30 to price of LK models.

³ Overvoltage Protection: add suffix (OV) to model number and add \$60 to the price of LH models; add \$70 to price of half-rack LK models; add \$90 to price of 5 1/4" full-rack LK models; add \$120 to price of 7" full-rack LK models.

⁴ Chassis Slides for full rack models: Add suffix (CS) to model number and add \$60 to the price.



LAMBDA ELECTRONICS CORP.

TERMINAL DRIVE • PLAINVIEW, L.I., NEW YORK 11803 • 516-681-8300

A  SUBSIDIARY

LA-182A

circuit problems?

Signalite Glow Lamps have solved problems in these areas:

- Voltage Regulation & References • Photo-Cell Drivers • SCR Triggering
- Timing • Photo Choppers • Oscillators • Indicator Lights • Counters
- Voltage Dividers • Surge Protectors • Logic Circuits • Flip-Flops
- Memory • Switching • Digital Readouts

Signalite glow lamps combine long life, close tolerance and economy, and are manufactured with a broad range of characteristics to meet individual application requirements. For a creative approach to your design problem . . . contact Signalite's Application Engineering Department.



PHOTO-CELL APPLICATIONS

The A074 and A083 have been designed for use with Cadmium Sulfide or Cadmium Selenide photocells. Applications include photo choppers, modulators, demodulators, low noise switching devices, isolated overload protector circuits, etc. Speed of operation is limited only by the photo-cells.

**SEE Signalite Application News
for TYPICAL APPLICATIONS**



VOLTAGE REGULATORS BETTER THAN 1% ACCURACY

These subminiature voltage regulators are used in regulated power supplies, as reference sources, photomultiplier regulators, oscilloscope calibrators, etc. They are available in voltages from 82 to 143 V. They are used in multiples as regulators in KV ranges.

**SEE Signalite Application News
for TYPICAL APPLICATIONS**

SIGNALITE APPLICATION NEWS



is used to communicate new and proven techniques and applications of Signalite's neon lamps and gas discharge tubes. Signalite Application News provides a forum for an exchange of ideas to keep the design engineer aware of the versatility of neon lamps and their many applications. Copies are available from your Signalite representative or by contacting Signalite.

ON READER-SERVICE CARD CIRCLE 248



NEON TIMERS The bi-stable characteristics and high leakage resistance of Signalite's special glow lamps make them ideal as a component for timing circuits. The basic circuit resembles a relaxation oscillator network.

**SEE Signalite Application News
for TYPICAL APPLICATIONS**



MEMORY SWITCHES Neon lamps have proven to be an excellent memory switch since they store information and provide visual indication. The properties of neon lamps provide a large differential between breakdown and maintaining voltages, stable electrical characteristics and high "off" resistance (20,000 meg ohms). Other applications include switching, information storage, timing circuitry, etc.

**SEE Signalite Application News
for TYPICAL APPLICATIONS**



Signalite

INCORPORATED
NEPTUNE, NEW JERSEY 07753
(201) 775-2490



SUBSIDIARY OF
GENERAL INSTRUMENT CORPORATION

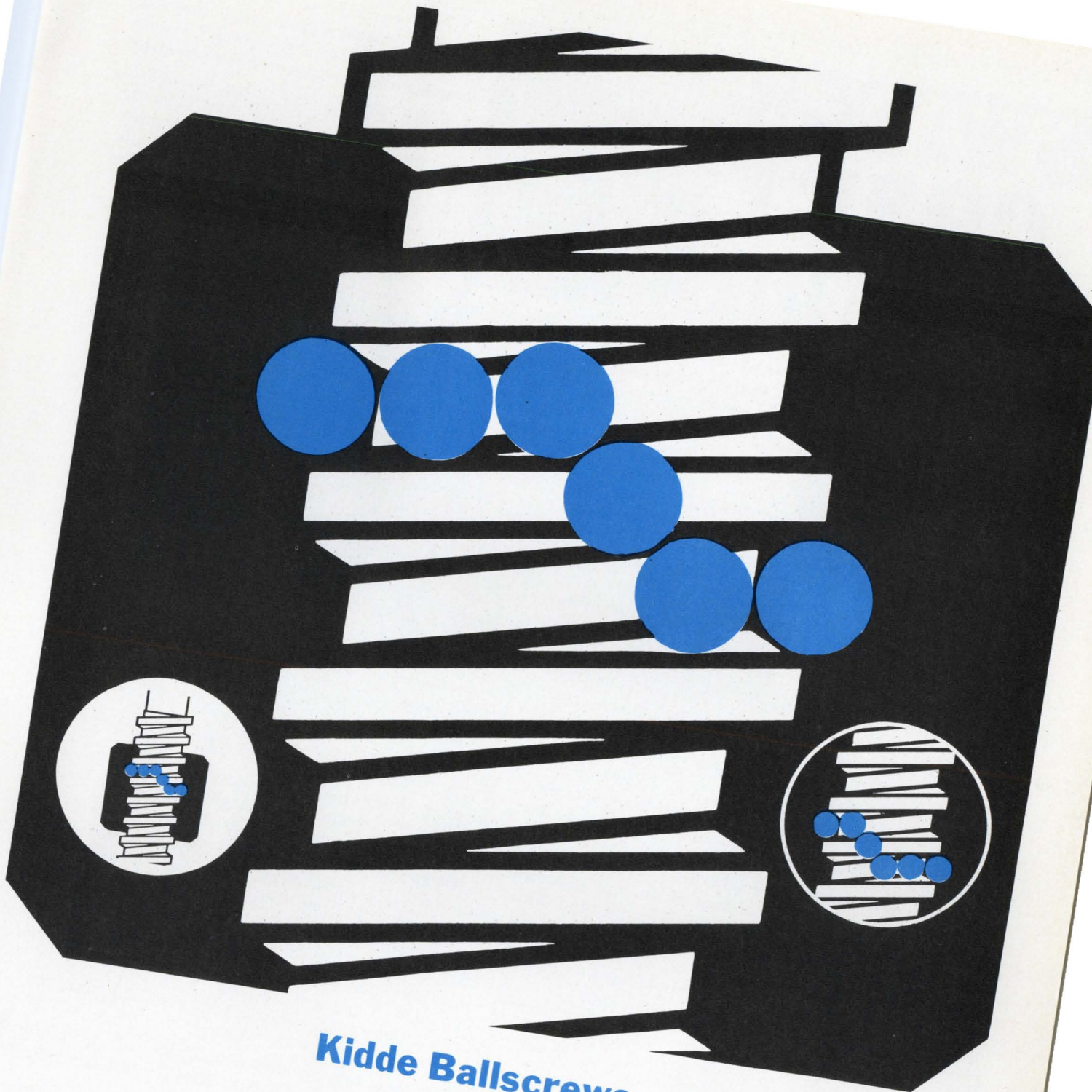

Kidde Ballscrews

SIZE AND WEIGHT PROBLEM SOLVERS

Kidde Ballscrews do more than solve friction problems of prime movers and drives. They can solve size and weight problems, too—and meet the demands for high efficiency transfer of motion and power. Here's why:

Their compact design results in smaller envelope dimensions. Weight is reduced because external tubes and fittings are eliminated. Kidde designs allow optimum usable power, due to extremely high efficiencies.

To solve these major problems, Kidde has designed a

wide range of Ballscrew sizes—from units less than 1" long to 32 foot custom assemblies. From 6" diameters down to 1/8"; sizes 3/16" to 1-1/2" (with various lead) are stocked.

Learn how Kidde Ballscrews can become your problem solver. Write for your free copy of "Standard and Precision Ballscrews." Walter Kidde & Company Inc., 675 Main Street, Belleville, New Jersey 07109.



SWITCH CRAFT FORUM

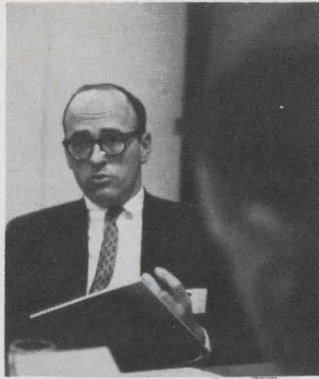

O.K., I'm convinced you've got something new. But, what if I need a miniature size lever switch, or special lighting? Would these have to be engineered from scratch?

Actually, Switchcraft makes a greater variety of lever switches than anybody else. (Just circle the reader service number for proof). Let's look at your requirements and see if we can match your specs from our regular line of switches.

Miniaturization poses no problems. Our miniature "Feather Lever" switch (Fig. 2.

left) uses only 7/16" front panel mounting space. It's only 1 3/4" deep, and that's a lot less than the conventional type. When your behind-the-panel space really gets critical, just shift to our Series 12000 type (Fig. 2 right) that has the springs mounted parallel to the mounting surface. Behind-the-panel depth is only 7/8".

When you need lighted switches, take a close look at Switchcraft's "Lever-Lite" Series. They let one lamp do

Look, a lever switch is a lever switch is a lever switch. As far as I know, there hasn't been anything new or different in lever switch design since the old telephone type that was introduced over seventy years ago.

How about a totally new telephone type lever switch? Switchcraft recently intro.

Sorry to interrupt, but when I say "new", I don't mean just changes in the properties of materials or construction changes brought on by the value analysis people. Unless your lever switch is compatible with modern circuit procedures, then in my book it isn't "new".

Fair enough. Let's just look at one of the compatibility problems regarding lever switches and solid state switching devices.

Manual switching devices often introduce transients into the controlled circuit because of contact bounce, etc. Semi-conductor circuits are highly susceptible to these transients and false triggering can easily result.

The new Switchcraft Series 41000 "LT" Switch (Fig. 1) is a new telephone type lever switch that has a specially designed damping block to reduce contact bounce and a rugged "U" shaped frame for increased spring stack stability under conditions of vibration. Another feature is a unique "Can't Cheat" detent guide that prevents accidental actuator by-pass of a switching position. This protects your equipment from damage and guards against programming failures, too. Besides, this new switch extends only 2 1/2" behind the panel, providing the smallest telephone-quality lever switch on the market.

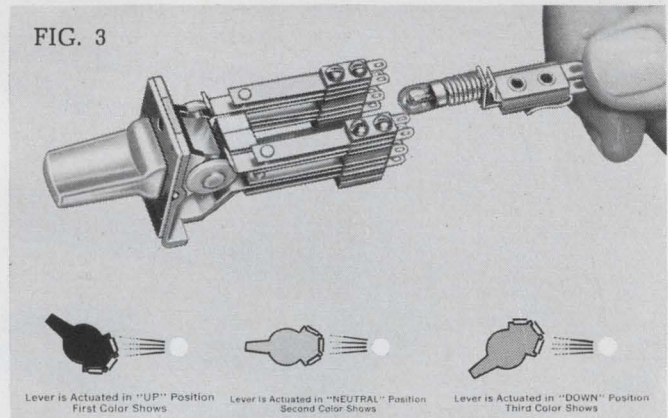
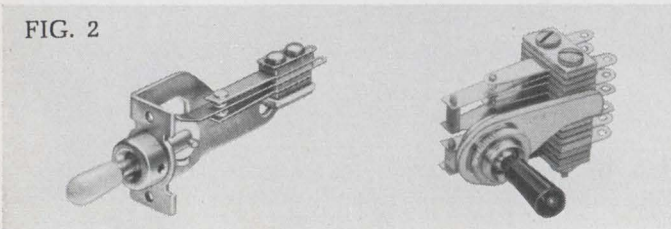
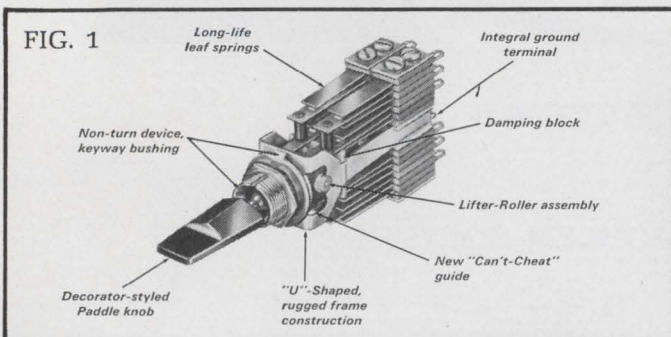

the work of three by a unique system of color filters. You can have a complete color change for each position, and need provision for only one light circuit. Fig. 3 shows how it works and, incidentally, the lamp assembly snaps out for quick replacement and has a spring loaded socket just to keep the lamp from jarring loose.

If you really want flexibility, then check the Switchcraft Series 16000 "Telever" switches. You can convert it from locking to non-locking right in the field, in just a matter of minutes. It requires only one mounting hole, too, and that's being pretty versatile for a standard telephone type switch. What more can we say?

Just make sure my staff gets all the back-up information on your lever switch line. They'll want complete technical details.

All we need is their request on your company letterhead for our "FORUM FACTS on Lever Switches" handbook. We'll also add their name to our TECH-TOPICS mailing list. This engineering-application magazine is received by over 10,000 design engineers every other month and features informative, technically oriented application stories on switches and related products.

SWITCHCRAFT
INC.

5529 North Elston Avenue • Chicago, Illinois 60630



ACKNOWLEDGED as the MOST TEMPERATURE STABLE MINIATURE CAPACITORS in the ELECTRONICS INDUSTRY . . . SUPERIOR to GLASS and MICA CAPACITORS

If your circuits require capacitance stability, high Q, and close tolerance, there's only one line of miniature capacitors to consider...ERIE NPO High Stability Ceramic Capacitors. These ultra-stable ceramic dielectrics are considerably superior to glass and mica... *for ERIE produces the most nearly perfect ceramic in the industry.*

NPO (temperature coefficient) miniature capacitors are available in a variety of physical types as illustrated at right. Capacitance range and capacitance tolerance (as close as $\pm 1\%$ or $\pm .1$ pf.) to suit your circuit requirements. Units are conservatively rated... flash test 3 times WVDC, life test 2 times WVDC.

In addition to these NPO High Stability Ceramic Capacitors, Erie offers a full line of Temperature Compensating types (P100 through N5600) and General Purpose type capacitors...all produced from the most nearly perfect ceramic in the industry.

Write for information TODAY about Erie NPO High Stability Ceramic Capacitors. A helpful Erie Field Sales Engineer will be happy to discuss your specific requirements...no obligation of course.

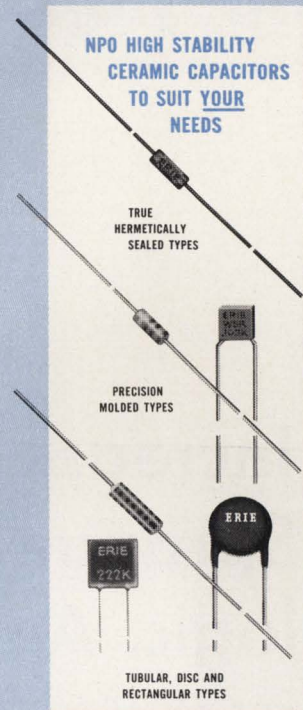

ERIE

TECHNOLOGICAL

PRODUCTS, INC.

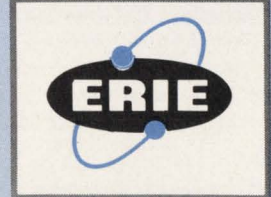

Erie, Pennsylvania

CAPACITANCE CHANGE VS. TEMPERATURE

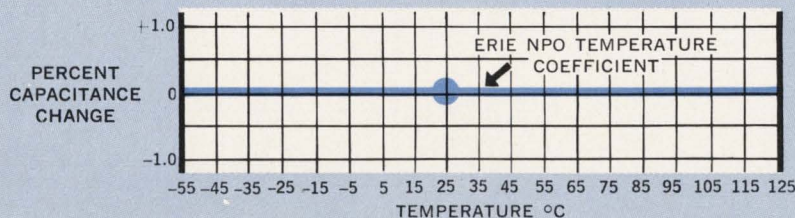

Another Series of Components in Erie's Project "ACTIVE"... Advanced Components Through Increased Volumetric Efficiency

ON READER-SERVICE CARD CIRCLE 15

gates

5

nsec

flip-flops

60

MHz

**Increase your system speed.
Sprague SSL* is the fastest saturated
logic. And it's pin compatible
with series 8000.
You should call us fast.**

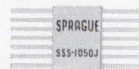

*For additional information on
Sprague SSL Super-Speed Logic, write to:
Semiconductor Division
Sprague Electric Company
115 Northeast Cutoff
Worcester, Mass. 01606*

*Trademark for Super-Speed Logic



News

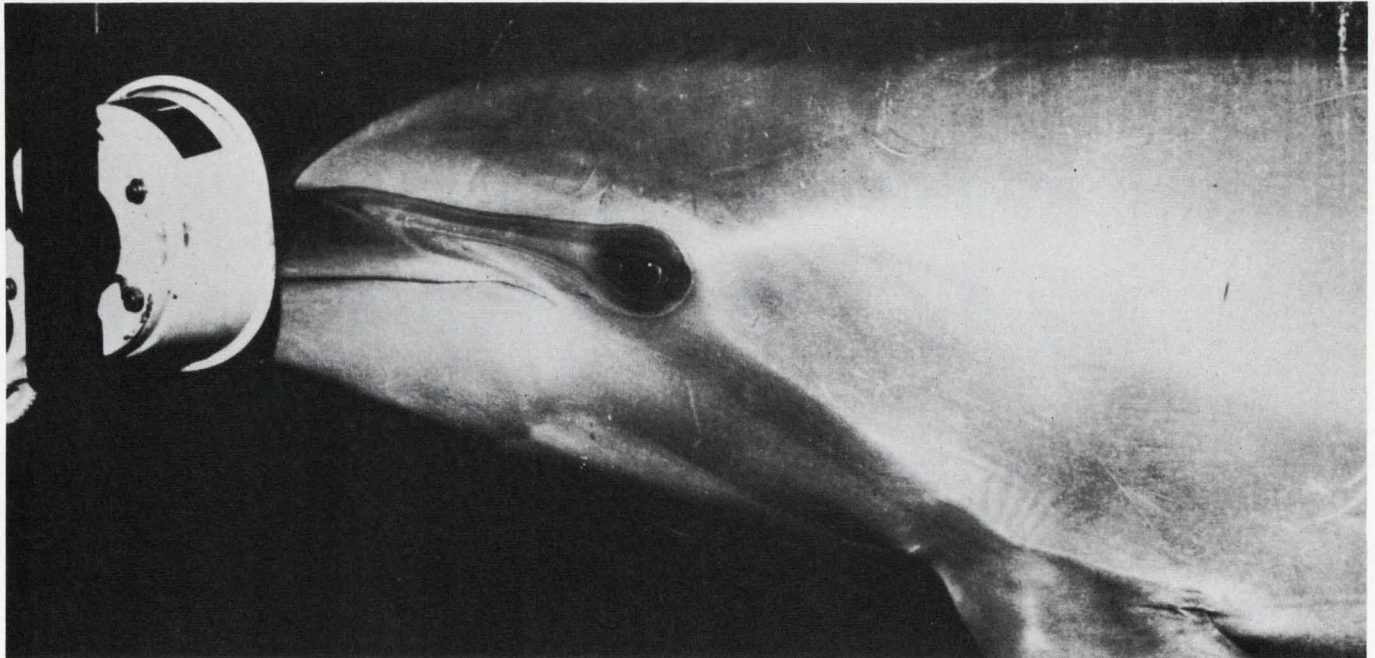

Dolphins push the state of the art in sound detection and projection devices for use

under water. A feature traces research into their communication and navigation. Page 49

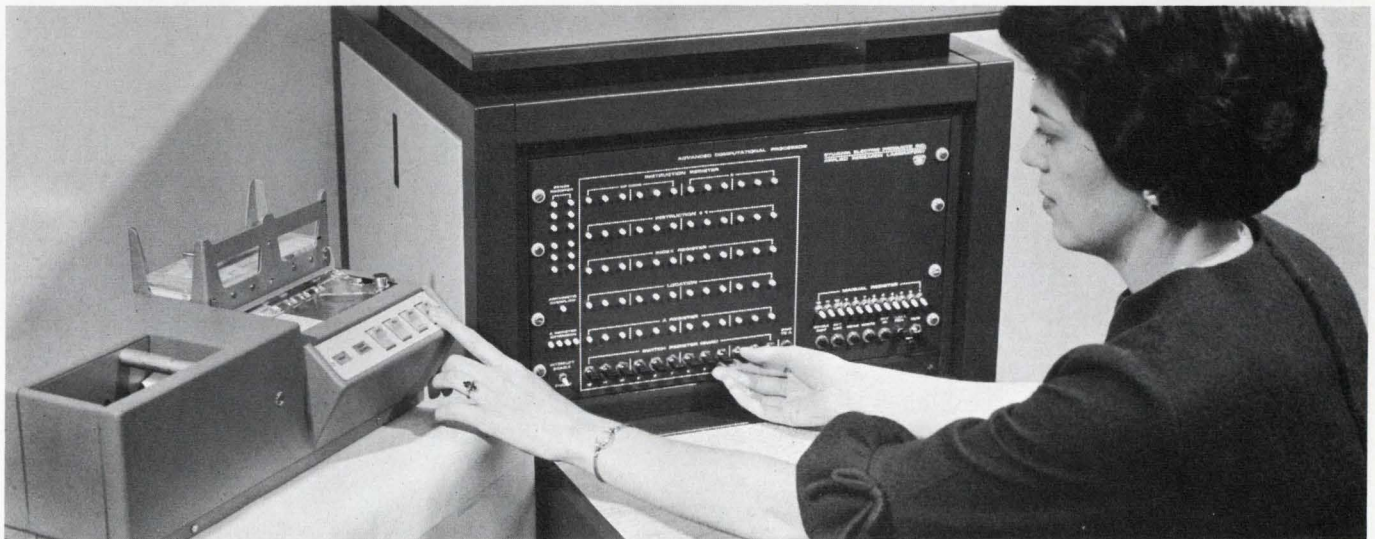

Signal processing is being revolutionized from audio frequencies to microwaves by

fast Fourier transforms—mathematical tricks that permit real-time computation. Page 25

Also in this section:

Civilian markets beckon microwave ICs despite military dominance. Page 34

News Scope, Page 21 . . . **Washington Report**, Page 41 . . . **Editorial**, Page 79

Obviously from Sprague Electric!

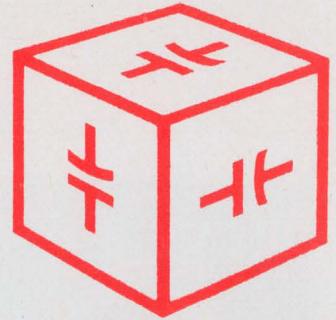

**Higher CV product per cubic inch
than any other solid tantalum capacitor!**



Red Top[®] Miniature Solid-Electrolyte Tantalex[®] Capacitors

Red Top[®] Capacitors are TOPS when your circuit design calls for reliable, low-cost, commercial/industrial solid tantalums for printed wiring boards, packaged circuit modules, and other applications where miniaturization is a must.

Their special construction employs a metal case and plastic resin end seal, providing the price advantages but eliminating the mechanical disadvantages often associated with molded capacitors, such as "off-center" units with consequent "thin" walls, secondary cathode connection prior to molding, and limited humidity resistance.

Red Top[®] Capacitors are ideally suited for today's circuit design requirements which demand filtering at specific locations. Their small size permits "salting" or "sprinkling" wherever needed.

With capacitance values that range from 68 μF to .016 μF in voltage ratings from 2 to 100 WVDC, Sprague Red Top[®] Capacitors are available with axial or "single-ended" leads.

For complete technical data, write for Engineering Bulletin 3536A to Technical Literature Service, Sprague Electric Company, 347 Marshall Street, North Adams, Massachusetts 01247.

SPRAGUE COMPONENTS

CAPACITORS	PULSE TRANSFORMERS	CERAMIC-BASE PRINTED NETWORKS
TRANSISTORS	INTERFERENCE FILTERS	PACKAGED COMPONENT ASSEMBLIES
RESISTORS	PULSE-FORMING NETWORKS	BOBBIN and TAPE WOUND MAGNETIC CORES
INTEGRATED CIRCUITS	TOROIDAL INDUCTORS	SILICON RECTIFIER GATE CONTROLS
THIN-FILM MICROCIRCUITS	ELECTRIC WAVE FILTERS	FUNCTIONAL DIGITAL CIRCUITS



Sprague and 'S' are registered trademarks of the Sprague Electric Co.

ON READER-SERVICE CARD CIRCLE 17

LSI and the computer: New designs predicted

What will large-scale integrated circuits (LSI) do for computers? Speakers at the Fall Joint Computer Conference in Anaheim, Calif., agreed that two trends are in view: the design of computers will change radically, with better performance as a result, but there will be no significant reduction in system costs.

Speaking in a session on advances in computer circuits, Martin G. Smith, a researcher of International Business Machines, Yorktown Heights, N.Y., asserted that even with an order-of-magnitude reduction in logic-circuit costs, the eventual saving to a computer user would be only 7 per cent or less. Supporting this forecast was Rex Rice of Fairchild Semiconductor, Palo Alto, Calif., who was chairman of a later panel discussion on the impact of LSI. Rice argued that LSI hardware would most likely account for less than 6 per cent of the over-all user cost and that even order-of-magnitude reductions in logic costs would result in only a few percent reductions in total system costs.

These reductions, Smith pointed out, would allow the addition of significantly more circuitry at no increase in cost. "More functions per dollar, may be expected with LSI," Smith said. He contended that about three times as much logic and twice as much special memory could be expected for the same price as older IC hardware.

On the new computer architecture that will emerge, Henry S. Miiller of RCA Laboratories, Princeton, N.J., noted that LSI would be available in very regular arrays of gates. However, only about 40 per cent of the computer associated with the data path requires regular-array logic circuits. The control logic is often very irregular. Miiller suggested making

the control logic regular by partitioning the central processor control into simplified units. Scientists at RCA Laboratories have already succeeded in reducing the control logic of a computer to less than 30 per cent, Miiller reported.

Another supporter of the new computer architecture, Prof. David Evans, head of the Department of Computer Science at the University of Utah, suggested that LSI might lead to an associative computer in which the processor and memory characteristics would be defined by the program at the time the program was run. Thus the programmer would be in control of the machine organization and could adapt it to suit his needs.

Sounding a warning among the LSI enthusiasts was Robert Creech of the Burroughs Corp., Pasadena, Calif., who feared there was too much "idol worship" of LSI. "We mustn't merely find a use for LSI. Find the best machine organizations first, and then see if LSI can be used to implement them." Computer designs are difficult and expensive to modify and should be hardened before manufacturing starts.

Copies of the Proceedings of the 1967 Fall Joint Computer Conference may be obtained from the Thompson Book Co., National Press Building, 14th and F Streets N.W., Washington, D.C. 20005. The price is \$20.70 with a 50 per cent discount to members of affiliates of the American Federation of Information Processing Societies.

Semiconductor makers see strong 1968 sales

More than 400 electronic buyers and engineers assembled in the warehouse of Schweber Electronics, Westbury, N.Y., to get the

word from the top on the outlook for the semiconductor market. Four speakers poured it out with unhesitating optimism: integrated circuits, large-scale integration and plastics—all add up to a bright market in 1968.

On the podium in the makeshift auditorium last month were Keith Sueker, marketing manager of the Westinghouse Semiconductor Div., Youngwood, Pa.; Thomas Connors, vice president of Motorola Semiconductors, Phoenix, Ariz.; George Farnsworth, general manager of the General Electric Semiconductor Div., Syracuse, N.Y., and Jerry Sanders, director of marketing of Fairchild Semiconductor, Mountain View, Calif.

The gathering was billed by Schweber, an electronic parts distributor, as a private "summit meeting," called to unravel "the inside story on semiconductors and integrated circuits."

Connors predicted: "Discrete semiconductors will gain 10 per cent and ICs will gain 50 per cent in 1968. This compares with a 10 per cent drop in sales for the discrettes and a 50 per cent rise in ICs in 1967."

Sanders looked for sales of 130 million ICs in the United States next year. He indicated that large-scale integration devices would move closer to off-the-shelf status. "At Fairchild we have 90 professional people working in LSI," he reported.

From Sueker, whose company specializes in high-power semiconductors: "More accurate and efficient control, simply not possible several years ago in process industries, transportation, steel mills, electroplating and others, is a reality today. The future will see development of high-frequency, high-power transistors, faster-recovery [100-ns] thyristors and more and more plastic units. By 1969 we expect all devices under 50 amperes to be in plastic."

The rapid gains being made by plastic types were further emphasized by Farnsworth. "It is reasonable to expect that 70 per cent of all discrete small signal transistors in 1968 will be in plastic," he said. "Due to significant improvements in plastics, these devices will be sold not only to the consumer markets, but also to industrial and

military users. Even today 50 per cent of industrial silicon sockets are filled by plastic devices."

What of formal acceptance of plastic devices by the military? Connors observed: "It seems that the biggest stumbling block here is generating a specification." "It'll take at least another year," Farnsworth said.

As in the past, semiconductor prices will continue to fluctuate, the speakers agreed. Connors put it: "How can you stabilize prices if the industry is surrounded by new and growing markets? Automobiles, appliances, home entertainment—we have barely scratched the surface. We expect a 50 per cent growth by 1971."

U.S. Army favors TWTs for Nike X-Arrays

The U.S. Army is expected to decide this month on the transmitter power sources to be used on the Nike X (Sentinel) perimeter array radar (PAR). (See "Nike-X: A merger of radars and computers," ED 22, Oct. 25, 1967 pp. 17-24). It is believed to prefer new high-power traveling-wave tubes to solid-state devices or gridded triodes.

Sources close to the program believe that the Army prefers uhf traveling-wave tubes because of their past record of reliability and efficiency. They say the chances are about three to one that the Army will opt for traveling-wave tubes.

The General Electric Co.'s Heavy Military Equipment Div., Syracuse, N.Y., the contractor for PAR, will need scores of the selected power sources to feed the elements of the PAR's transmitting aperture. New, longer tubes will have to be developed for traveling-wave tubes are not normally used at the PAR transmitters' low frequencies.

The length of traveling-wave tube oscillators and amplifiers is related to frequency. The delay-line element, usually a tungsten helix, may be 2 to 3 feet long for low microwave frequencies.

Varian Associates of Palo Alto, Calif., known to be a participant in the Sentinel program, recently consolidated its TWT production and development facilities, and is believed to be a strong contender for TWT production contracts. Another company capable of fulfilling the Army's requirements is Raytheon Co. of Waltham, Mass.

Advocates of high-power transistors, such as Texas Instruments, Dallas, will try again to sell the Army on the merit of all-solid-state transmitters in advanced over-the-horizon radar programs, if their proposals for the PAR transmitters are unsuccessful.

The Air Force's FPS-85 phased-array radar at Elgin AFB, Fla., for tracking and cataloguing spacecraft uses gridded triodes in its transmit array.

More details on Venus 4 revealed in Soviet press

An article in *Pravda* has shed further light on technical aspects of last month's Soviet Venus 4 spacecraft, which landed a capsule on the Venusian surface.

The article disclosed that the instrument package entered the planet's atmosphere at a velocity of 6.9 miles per second. It had then to decelerate at rates up to 300 g and withstand temperatures approaching 11,000°C. In spite of these extremes, all electronics worked without the use of a redundant system, the article stated.

Another interesting aspect of the flight was that trajectory correction was carried out when the spacecraft was some 12 million

kilometers from Earth. Only one correction was made, though there was enough liquid fuel for two.

The internal temperature of the craft was maintained by forced circulation of a cooling gas around hot components and through an external heat exchanger. The craft also carried an atmospheric-entry thermal shield made of insulating material, optical coatings and "other substances."

During the flight to Venus, the instrument-package battery was charged by the solar cells of the mother craft. During descent through the Venusian atmosphere power was supplied by the battery.

Pravda also reported the apparent linear relationship of temperature vs altitude measured by the descending package. The linear temperature gradient was measured at 10°C/km, reaching about 280°C on the planet's surface.

Radiation may announce new one-chip 709 unit

A new 709 dielectrically isolated IC operational amplifier may shortly be put on the market by Radiation, Inc., of Melbourne, Fla.

Believed to be a one-chip unit, it comes after the company's development earlier this year of a dielectrically isolated two-chip amplifier. The one-chip unit was to have been displayed at Wescon but production problems prevented this.

Isolation in the new 709 is said to allow a reduction in the number of stages from three to two, improving the circuit's phase stability and simplifying its compensation network at closed loop gains near unity. The isolation is also reported to improve slew rate by about one-third and frequency response by nearly 20 per cent. Thin-film feedback resistors are believed to be included on the same chip.

Though the circuit is expected to cost more than the current 709, which is priced at about \$15 for the military version, the improvements are expected to be worth the price to many customers.

The circuit, however, will have to compete in the market with Union Carbide's dielectrically isolated monolithic operational amplifier (UC4000) and National Semiconductor's two-stage operational amplifier (LM 101).

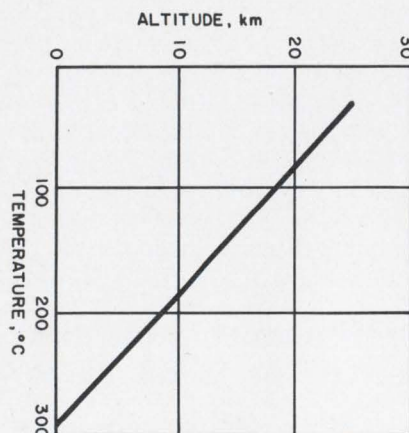

Linear temperature gradient was revealed by Venus 4 during its descent through the Venusian atmosphere.

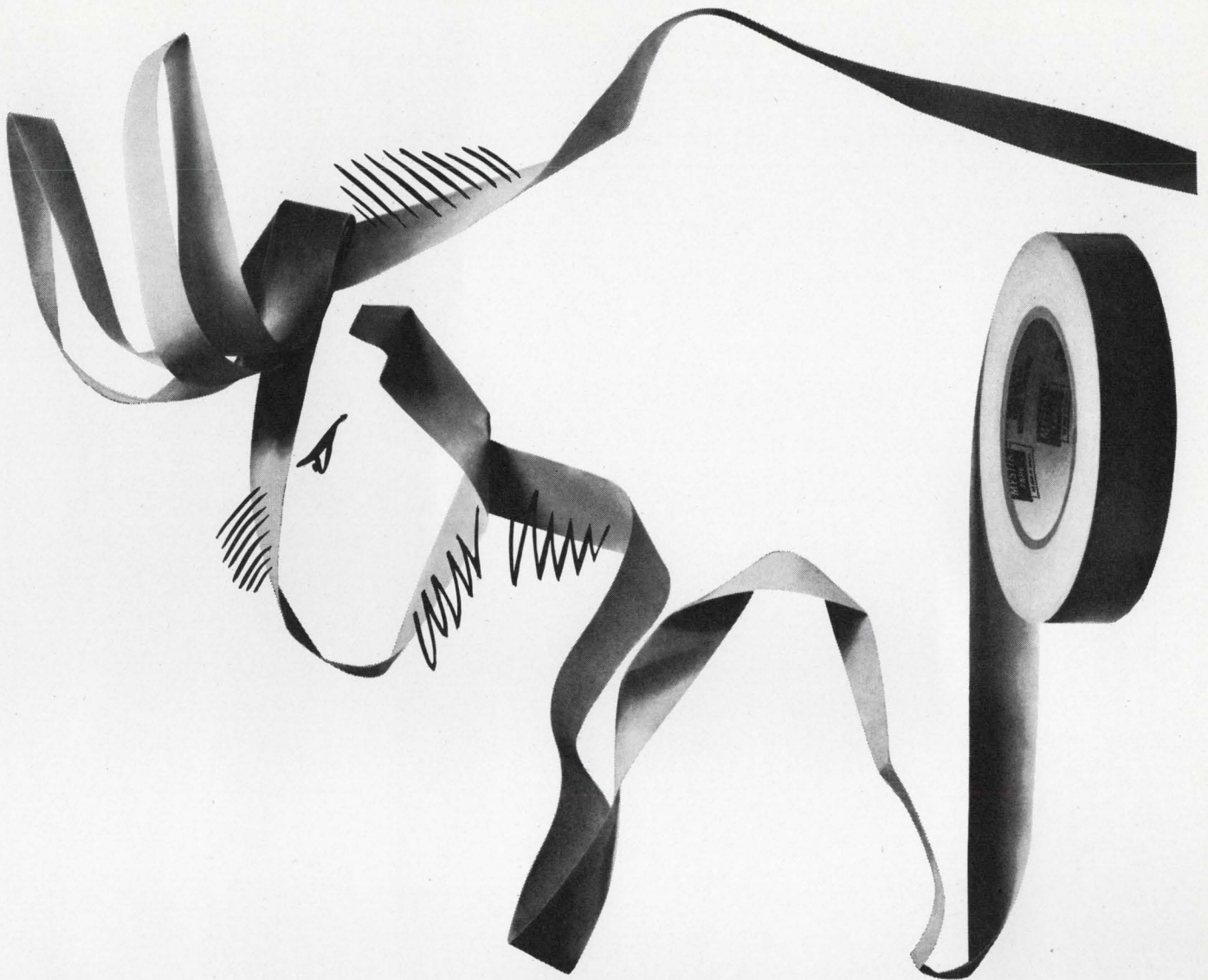

What's gnu? Mystik NOMEX[®], KAPTON[®] and TEDLAR[®], that's what!

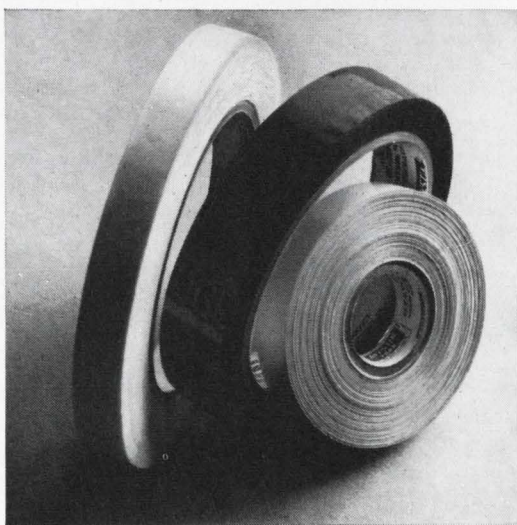

Mystik scores again by being the first to utilize three new materials ... Nomex, Kapton and Tedlar ... and add them to their already extensive line of pressure-sensitive tapes.

NOMEX — a highly conformable tape that offers excellent holding power and dielectric strength characteristics.

KAPTON — the featherweight of wire insulations ... excellent high temperature applications which require low weight structures.

TEDLAR — ideal for electrical applications because of high dielectric strength combined with excellent weather and hydrolytic resistance.

If you would like more information on these or any other Mystik special-purpose tapes, contact your local Mystik distributor. He is listed in the yellow pages under "Tapes—Adhesive". Or, write Mystik Tape Division, The Borden Chemical Company, 1700 Winnetka Avenue, Northfield, Illinois 60093.

® DuPont registered trademark



**BORDEN
CHEMICAL**

Investigate Random or Periodic Processes with Correlation Function Computers

Correlation functions occupy a cardinal position in modern information theory and are basic to the analysis of random or periodic processes and the complex signals they produce. In many application areas, autocorrelation analysis allows noisy periodic or random signals to be defined, whereas crosscorrelation can determine the degree of conformity between two different noisy signals as a function of their mutual delay.

PAR™ Models 100 or 101 Correlation Function Computers simultaneously compute 100 points of the auto- or crosscorrelation function in real time over delay spans from 100 microseconds to 10 seconds. The Model 101 includes the capability for insertion of fixed delay increments ahead of the 100 computed points of the function, thereby providing greater resolution. The correlation function readout which may be obtained continuously as it is computed, is available at various rates consistent with the speed of the external readout device, e.g. oscilloscope or X-Y recorder.

Vibration analysis, radio astronomy, laser research, geophysics, radar, plasma physics, aero- and hydrodynamics, and biophysics are only a few of the fields where correlation techniques are useful.

Price of the Model 100 is \$8,500. The Model 101 is priced at \$9,500 to \$12,900. Export prices are approximately 5% higher (except Canada).

For additional information, write Princeton Applied Research Corporation, Department E, P.O. Box 565, Princeton, New Jersey 08540 or call 609-924-6835.

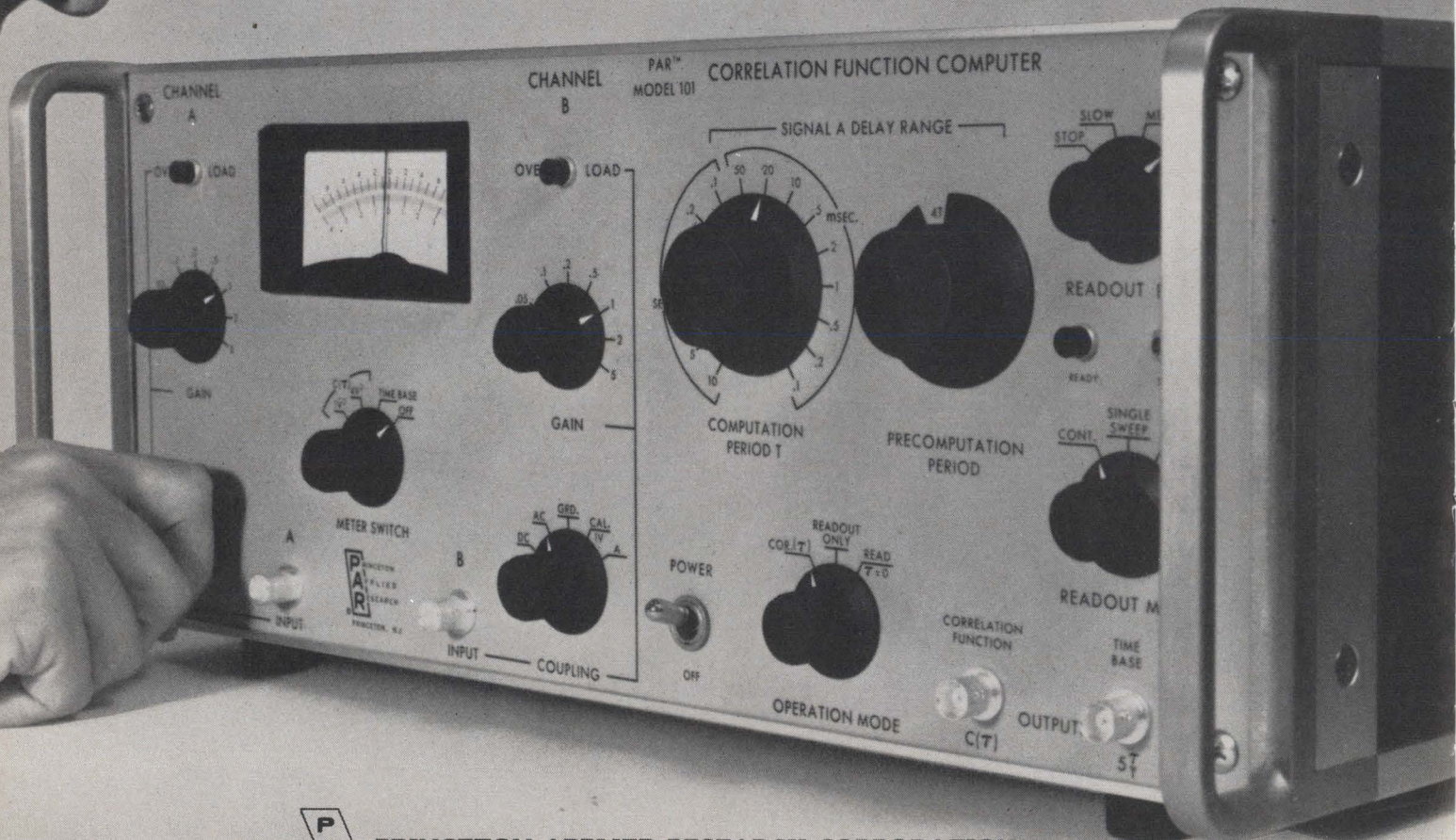

PRINCETON APPLIED RESEARCH CORPORATION

The FFT computer: Designer's 'missing link'

Fast-Fourier-transform black boxes capable of real-time results, are altering signal processing

Robert Haavind
Managing Editor

Some mathematical sleight of hand, called fast Fourier transforms (FFT), is revolutionizing the field of signal processing—from the audio range to microwaves. The underlying theory for many types of signal-processing systems is being reworked.

One small special-purpose digital computer designed to do real-time Fourier transforms is on the market and several more are on the way. The next round of military systems will make use of FFT black boxes for several purposes. Antisubmarine warfare, a field where the signals are audio and can be processed easily even by fairly slow processors, will be the first big user. The Sperry Gyroscope Co., of Great Neck, N.Y., for example, will include an FFT proc-

essor in its proposal for a new Navy antisubmarine aircraft, the VSX, when requests for bid are issued around the first of the year. IBM's Federal Systems Div., on another contract, has proposed an FFT processor capable of handling up to 90,000 thirteen-bit samples with 1024-point resolution.

But microwave applications may not be far behind. The Sylvania Electronic Systems Div. of Waltham, Mass., has built an FFT processor that will generate real-time transforms for signals ranging to 1 MHz. There is no inherent reason, except for cost at this point, why future designs could not push up the frequency limitation.

Why all this activity? The answer is that a machine that performs Fourier transforms in real time is a "missing link" for many types of systems engineers and for researchers in a broad variety of

disciplines. Up to 1965, it took long, expensive, time-consuming runs on big digital computers to generate Fourier transforms for even a small time-slice of waveform. Because the transforms were so impractical to produce, the mathematical concepts of signal processing were based on power spectra. Workers in signal processing simply assumed that Fourier transforms were not feasible in systems applications.

Then, in 1965, J. W. Cooley of IBM Research Laboratories, and J. W. Tukey of Bell Telephone Laboratories and Princeton University, reported a programming technique that greatly reduced the computing time for Fourier transforms.¹ The old method required computer time proportional to N^2 , where N samples of the waveform are to be converted into N spectral components. The Cooley-Tukey algorithm required computing time proportional to $N \log_2 N$. For $N = 1024$, this represents a computation that is over 100 times faster. As N gets even bigger, the savings get much greater. Furthermore the old method loses accuracy as N increased. The Cooley-Tukey algorithm retains its accuracy.

A radical time-saver

It soon became apparent that Cooley-Tukey was far more than a programming aid. It suddenly made real-time Fourier transforms feasible. And the algorithm showed how a designer might design a set of microcircuit chips to do the necessary calculations.

A Bell Laboratories' experimental FFT processing system is the one that has been most completely described.²

The system includes a special-purpose FFT processor, an IBM 1800 process-control computer, and a graphic display system. The 1800 was chosen because of its ability to input, process and output data concurrently, and because of its programming flexibility and its multi-

(continued on p. 26)

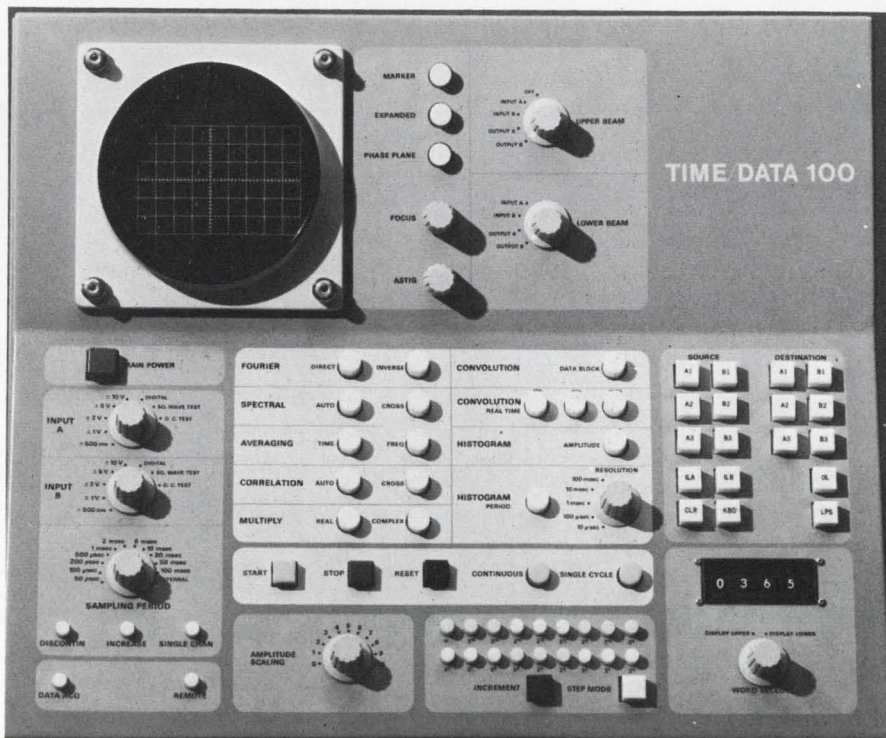

First commercial Fourier transform computer can generate a spectrum of 1000 complex values from 1000 samples in 1 second. The Time/Data 100 uses a variation of the FFT, called the Rapid Fourier Transform (RFT). The machine sells for \$63,425.

What is the fast Fourier transform?

There are actually a number of mathematical tricks that are variations on the basic theme of the fast Fourier transform. Although the current wave of activity is based on the Cooley-Tukey algorithm,¹ it is agreed that some of the basic notions were worked out previously.^{3, 4}

The continuous Fourier integral transform, familiar to all electronic engineers, is compared below with the discrete Fourier transform:

Continuous

$$F(\omega) = \int_{-\infty}^{+\infty} f(t) \exp(-2\pi i \omega t) dt.$$

Discrete

$$A_r = \sum_{k=0}^{N-1} X_k \exp(2\pi i r k / N)$$

$$= \sum_{k=0}^{N-1} X_k W^{rk}$$

where: $i = \sqrt{-1}$

$W = \exp(2\pi i / N)$

$N =$ number of samples

$r =$ harmonic number $= 0, 1, \dots, N-1$

$k =$ time-sample number $= 0, 1, \dots, N-1$

Thus, A_r is the r^{th} coefficient of the Fourier transform. X_k is the k^{th} sample of the time series.

This discrete transform involves a couple of assumptions. Equal spaced time samples are assumed. Also the sampling rate must be above the Nyquist rate, that is, at twice the frequency of the highest frequency in the waveform being sampled. When these criteria are met, the discrete Fourier transform has parallel properties to the continuous transform. The original waveform can be completely recreated from the samples. Transformations between the time and frequency domains are performed by using the discrete transform and its inverse.

The samples, X_k , may be complex, and the coefficients, A_r , are almost always complex.

Working through an example in which $N = 8$ will illustrate some of the calculation short cuts.*

In this case: $j = 0, 1, \dots, 7$
 $k = 0, 1, \dots, 7$

To put these into binary form:

$$j = j_2 (2^2) + j_1 (2^1) + j_0$$

$$k = k_2 (2^2) + k_1 (2^1) + k_0$$

where: $j_0, j_1, j_2, k_0, k_1, k_2 = 0, 1$

Thus:

$$A(j_2, j_1, j_0) = \sum_{k_0=0}^1 \sum_{k_1=0}^1 \sum_{k_2=0}^1 X(k_2, k_1, k_0) W^{j_0 k_2} W^{(j_1 + j_0) k_1} W^{(j_2 + j_1 + j_0) k_0}$$

$\underbrace{\hspace{10em}}_{X_1(j_0, k_1, k_0)}$
 $\underbrace{\hspace{15em}}_{X_2(j_0, j_1, k_0)}$
 $\underbrace{\hspace{20em}}_{X_3(j_0, j_1, j_2)}$

$$A(j_2, j_1, j_0) = \sum_{k_0=0}^1 \sum_{k_1=0}^1 \sum_{k_2=0}^1 X(k_2, k_1, k_0)$$

$$[(k_2, k_1, k_0) W^{(j_2 + j_1 + j_0)(k_2 + k_1 + k_0)}]$$

Now the W can be broken down further:

$$W^{(j_2 + j_1 + j_0) k_2} = [W^8]^{(j_2 + j_1) k_2} W^{j_0 k_2}$$

$$W^{(j_2 + j_1 + j_0) k_1} = [W^8]^{j_2 k_1} W^{(j_1 + j_0) k_1}$$

$$W^{(j_2 + j_1 + j_0) k_0} = W^{(j_2 + j_1 + j_0) k_0}$$

Since $W^8 = [\exp(2\pi i / 8)]^8 = \exp(2\pi i) = 1$, the bracketed terms equal one, and can be dropped from the computation. (Note that $[\exp(2\pi i)]^2 = 1^2 = 1$.) This saves many calculations.

This leaves the expression at the bottom of the page. Note that as each summation proceeds, one of the k terms becomes a dummy variable.

Then $A(j_2, j_1, j_0)$ can be obtained by sequentially calculating the X s as follows:

$$X_1(j_0, k_1, k_0) = \sum_{k_2=0}^1 X(k_2, k_1, k_0) W^{j_0 k_2}$$

$$X_2(j_0, j_1, k_0) = \sum_{k_1=0}^1 X_1(j_0, k_1, k_0) W^{(j_1 + j_0) k_1}$$

$$X_0(j_0, j_1, j_2) = \sum_{k_0=0}^1 X_2(j_0, j_1, k_0) W^{(j_2 + j_1 + j_0) k_0}$$

$$A(j_2, j_1, j_0) = X_3(j_0, j_1, j_2)$$

Once these computation savings were found, even more savings were spotted. For example, the W or weighing values, have an equal but negative value. This means that the lower half, or shaded portion of the circle (below), can be eliminated from the computation, since those values produce the same complex values differing only in sign.

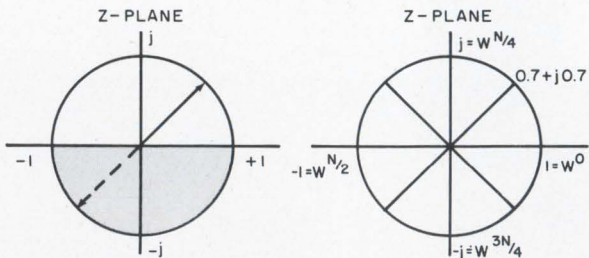

Other symmetries also exist. The major axis values are exploited by using a base-4 rather than a base-2 radix. The symmetries in the 45-degree axes can also be used, (circle at the right.)

*Derivation based on private communication from G. D. Bergland of Bell Laboratories.

Helipot dials

help your panels put up a good front

Here's something you ought to think about. A lot of your effort, and a bundle of dough, goes into the circuitry behind the panel. Is \$4.50 asking too much to make it look better up front? We don't think so, and a lot of people seem to agree. Or else they wouldn't have made Helipot's Duodial® turns-counting dials the most widely used in the industry. There are two reasons: they look better and work better than the rest.

The design considerations you can see for yourself... gleaming satin chrome finish, black nylon knob, and precision machined cover. (Can you name any other manufacturer who *machines* the dial cover?) The mechanical advantages may not be quite so obvious, but they're there. If you turn the knob, you can *feel* the quality. Helipot dials are precision components that provide setting accuracy with a minimum of play and zero backlash. They're easier to read, too, because we've put big numerals in a wide window. That means you get maximum viewing angle and can see ad-

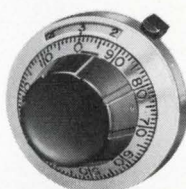

RB SERIES - 15 turn, 1-13/16" diameter - 5 standard models, priced as low as \$4.50 in quantity.

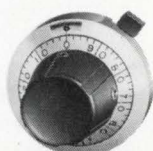

2600 SERIES - 15 turn, 7/8" diameter - 3 standard models, priced as low as \$6 in quantity.

jacent numbers and direction of travel. (Compare this with the dials that have tiny peek-a-boo windows.) Even the Helipot locking mechanism is to your advantage. Unlike other dials, the Helipot locking lever is independent of the knob so you won't disturb the dial setting when you lock it. We thought of just about everything - so you wouldn't have to.

Here's another reason economical Helipot dials make good sense: your local Helipot sales representative stocks them by the *thousands*, so you can have same-day delivery when you need it. Call Helipot now for information on the complete dial line, including new digital dials.

Beckman®

INSTRUMENTS, INC.

HELIPOT DIVISION

FULLERTON, CALIFORNIA • 92634

INTERNATIONAL SUBSIDIARIES:
GENEVA; MUNICH; GLENROTHES, SCOTLAND; TOKYO; PARIS; CAPE TOWN; LONDON; MEXICO CITY

NEWS

(FFT computers, continued)

plexing of analog inputs. The 1800 has nine data channels with independent address registers that operate concurrently, only stealing memory cycles. The core memory stores 32,000 sixteen-bit words.

The FFT processor itself has two memories. A table memory stores weights, or sine and cosine values, and a record memory stores inputs, intermediate values and final results.

The system is capable of operating on several independent audio-frequency signals simultaneously. The sine-cosine weighting values required in the FFT processor are pre-computed to increase accuracy and to save time. The data or record memory, a 1-microsecond-cycle-time store for 8192 words, holds intermediate values generated as the computation proceeds.

Although the Bell Laboratories processor is essentially a fixed-point machine, researchers there refer to it as a "poor man's floating-point" computer. This is because it checks the immediate values before a set of multiplications takes place. If it finds that any single multiplication will result in an overflow, it divides the entire array by two and maintains a record of this to derive a common scale factor for the results.

The first commercial machine is the Time/Data 100, which uses a modified approach to computation called the rapid Fourier transform (RFT).

The RFT is actually designed by use of a modified version of a method for computing Fourier transforms. The method, which preceded the Cooley-Tukey approach, was developed for hand calculation of Fourier coefficients for X-ray diffraction studies of liquids. It was published by G. C. Danielson and C. Lanczos in 1942.³ Details of the modified procedure are not available, because the Time/Data Corp., Palo Alto, Calif., has applied for patents on its approach.

There was a good reason for using this approach rather than the Cooley-Tukey algorithm, according to Edwin Sloane, vice president of Time/Data Corp. and conceptual designer of the machine. "Our approach," he says, "does not suffer from the cumulative error inherent in the nested multiplication used in the Cooley-Tukey approach."

A small, fast general-purpose computer just introduced by Sylvania Electronic Systems of Waltham, Mass., has been used to do Fast Fourier Transforms. This Advanced Computational Processor has a 0.125- μ s, nondestructive-read-out, integrated-circuit memory. It can do a Fourier transform on 246 samples in 8 to 8.5 ms, according to Dr. Edmund Cohler, manager of Sylvania's Computer Research Dept.

A much faster machine, capable of handling signals up to 1 MHz, has been built in prototype under the supervision of Joseph Fisher, manager of the Digital Signal Processing Dept. of Sylvania's

Eastern Div.

The key to the high speed, Fisher says, is that a mechanization of the Cooley-Tukey algorithm has been accomplished with a single memory.

Fisher predicts that Sylvania and other manufacturers will go much higher in speed with future FFT computers. Two radar applications that he cited are pulse-compression and side-looking radar.

In pulse compression a fairly long radar pulse—coded in some manner, such as by frequency sweeping or by digital coding—is transmitted. Then any return pulse is fed into a matched filter, which performs a cross-correlation between the return pulse and the transmitted pulse. When there is a perfect "match" between the two, an output pulse is generated; otherwise the filter output is near zero. This greatly increases the radar resolution, since two objects close together in range would generate separate pulses.

This matched filter characteristic can be implemented digitally within a fast Fourier transform computer. It is the Fourier transform of the impulse response of the matched filter. When this transform is multiplied by the Fourier transform of the return pulse, the cross correlation is performed.

Analog filters suffer from drift. Also they are tricky to design, and once designed, they have fixed characteristics. The digital implementation of such filter character-

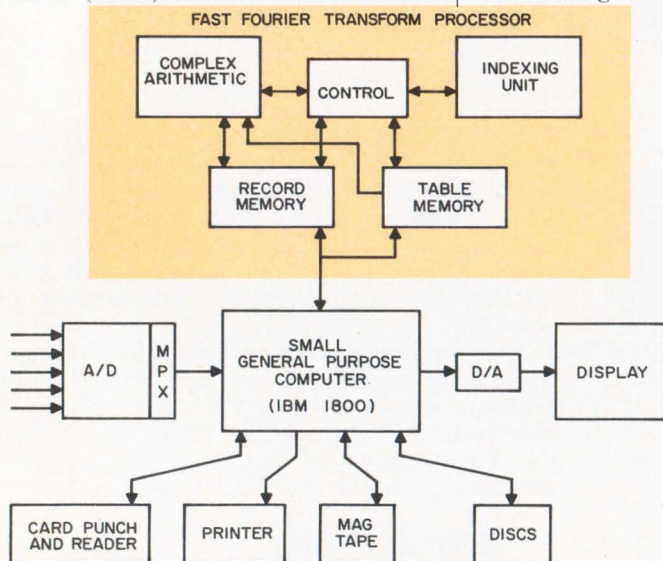

Bell Laboratories' experimental FFT processing system includes an IBM 1800 process control computer. It can

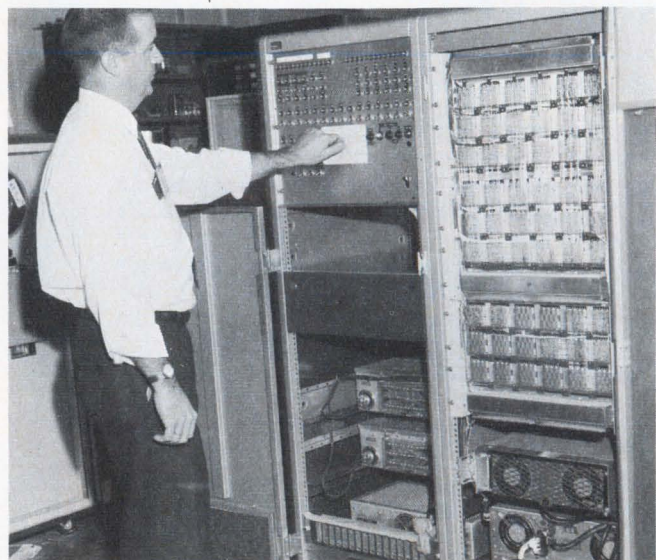

calculate the Fourier transform of 1024-samples in 30 milliseconds. FFT processor is at right.

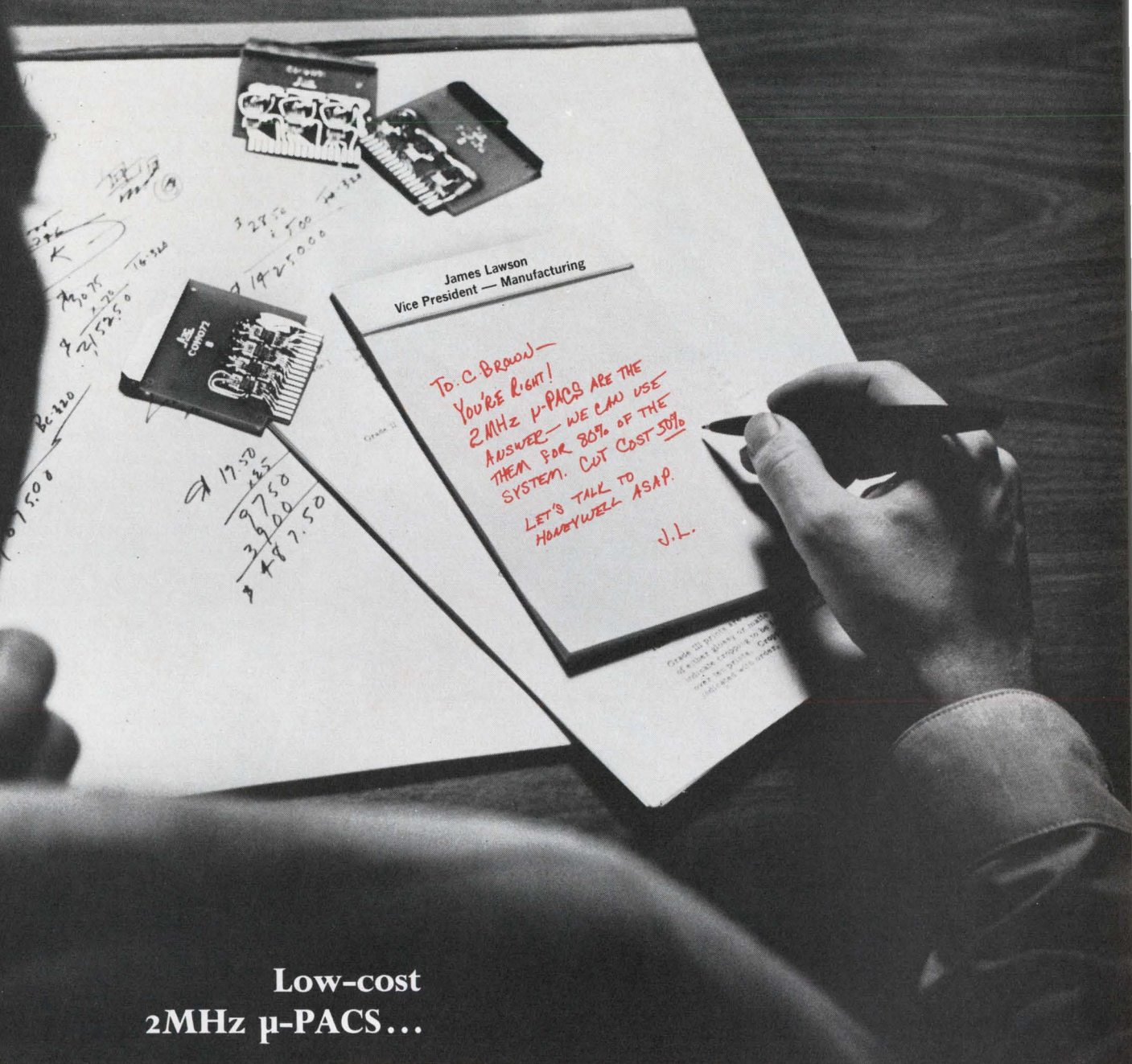

**Low-cost
2MHz μ -PACS...**

**...let you save
up to half the cost
of system logic.**

If you face a make-or-buy evaluation for system logic, maybe you've considered μ -PACS. Now, you can use new I/C 2MHz μ -PACS for up to 80% of your logic needs. Cut costs as much as 50%.

Take another look at your make-or-buy: Think μ -PACS at half the cost. Add more savings for volume discounts. Forget the people and equipment you'd need just to begin making your own. Remember μ -PAC quality and reliability. (Both 2MHz and 5MHz μ -PACS are compatible.) If this changes your cost analysis, write for new spec/price brochure. Honeywell, Computer Control Division, Old Connecticut Path, Framingham, Massachusetts 01701.

Honeywell

 **COMPUTER CONTROL
DIVISION**

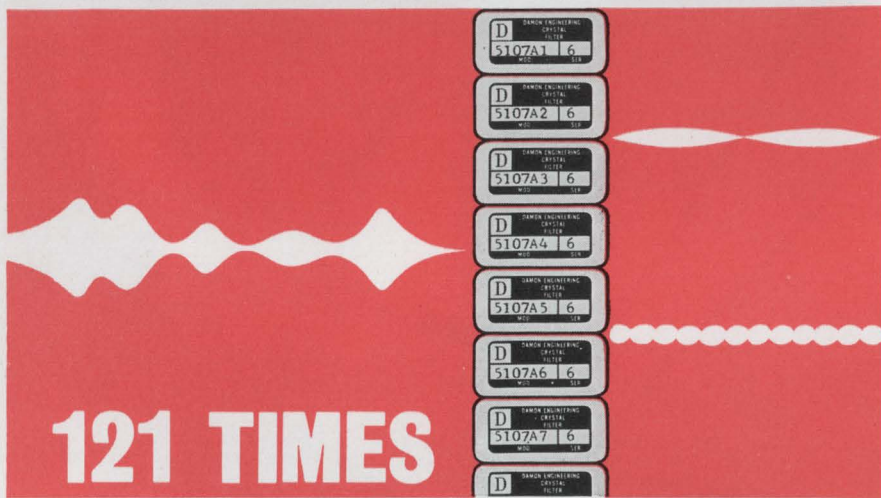
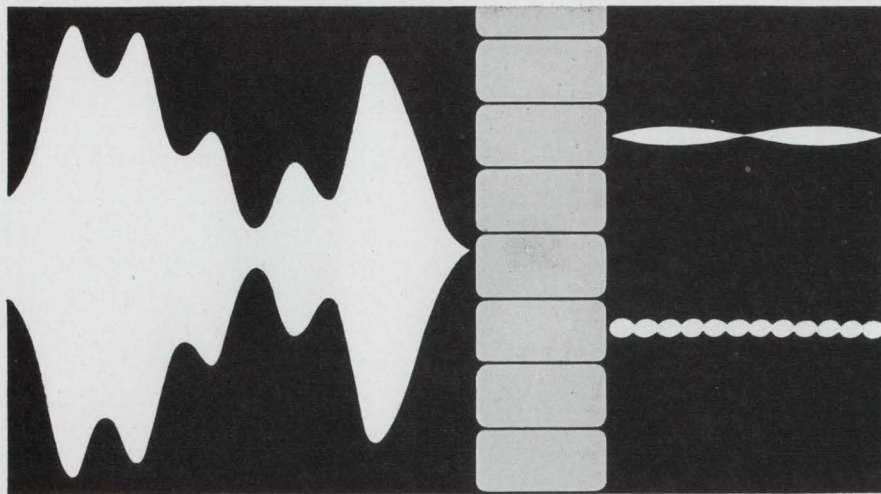

**121 TIMES
LESS DRIVE
POWER**
with Contiguous Comb
Filter Sets
by Damon



Typical Contiguous Comb Crystal Filter, Model 5107A is 1 1/8" L x 3/8" W x 7/8" H.

Damon has produced a bank of 200 contiguous comb crystal filters that requires a total of 6.6 watts of drive power to obtain 10 milliwatts from each of the Gaussian (non-overshoot) response filters. This is only 1/121 of the 800 watts of drive power normally required to achieve the same output using conventional resistive padding techniques.

This significant achievement is the result of two advances in crystal filter technology: high efficiency contiguous comb crystal filters combined with new synthesis techniques. These advances permit the adherence to both frequency and time response specifications and offer a

new concept in the design of radar and other spectrum-based systems. Contiguous comb crystal filter banks are also the most reliable, efficient, compact and economical precision systems available for multichannel signal processing of all kinds.

Write for data on Gaussian Response Contiguous Comb Crystal Filters to Damon Engineering, Inc., Needham Heights, Mass. 02194, Tel. (617) 449-0800.

DAMON

ON READER-SERVICE CARD CIRCLE 22

NEWS

(FFT computers, continued)

istics by a FFT computer allows any desired variation, and there is no drift problem.

In side-looking radar systems, an FFT computer could do in real time the computation task now performed by a combination of an optical and film system and by computers on the ground. The same techniques might be used in side-looking sonar to produce real-time displays of bottom terrain.

FFT processors could be used in several ways in antisubmarine systems. In passive sonar the sounds of quiet submarines could be detected and recorded. The sampled signal thus obtained might be treated by taking the logarithms of all values. This serves to emphasize fundamental frequencies and to diminish the values of higher harmonics. Then a Fourier transform of this new log-series is taken. The result is known in signal processing circles as "cepstrum" made up of "quefrequencies."

Then a matched filter characteristic could be digitally synthesized and stored.

In active sonar, a system designer might take Fourier transforms of natural ocean sounds, such as those of whales and dolphins, and from these synthesize sonar emissions that could not be detected, as the normal "ping" would be, by an approaching submarine.

Frequency sweeping of the type required in electronic countermeasures equipment can be implemented with FFT computers. Digital vocoders can be built in which pitch extraction, a vital step in good reproduction of a voice, is achieved by use of an FFT computer. ■■

References:

1. J. W. Cooley and J. W. Tukey, "An algorithm for the machine calculation of complex Fourier series," *Math. of Comput.*, XIX, April 1965, 297-301.
2. R. R. Shively, "A digital processor to generate spectra in real time," *First Annual IEEE Computer Conf. Digest of Papers* (1967).
3. G. C. Danielson and C. Lanczos, "Some improvements in practical Fourier analysis and their application to X-ray scattering from liquids," *J. Franklin Inst.*, CCXXXIII, April 1962, 365-380 and 435-452.
4. I. J. Good, "The interaction algorithm and practical Fourier analysis," *J. Roy. Statist. Soc.*, Ser. B, XX, 1958, 361-372; Addendum, XXII, 372-375.

The Hughes/NASA Syncom stands still at 6875 mph to talk to a billion people.

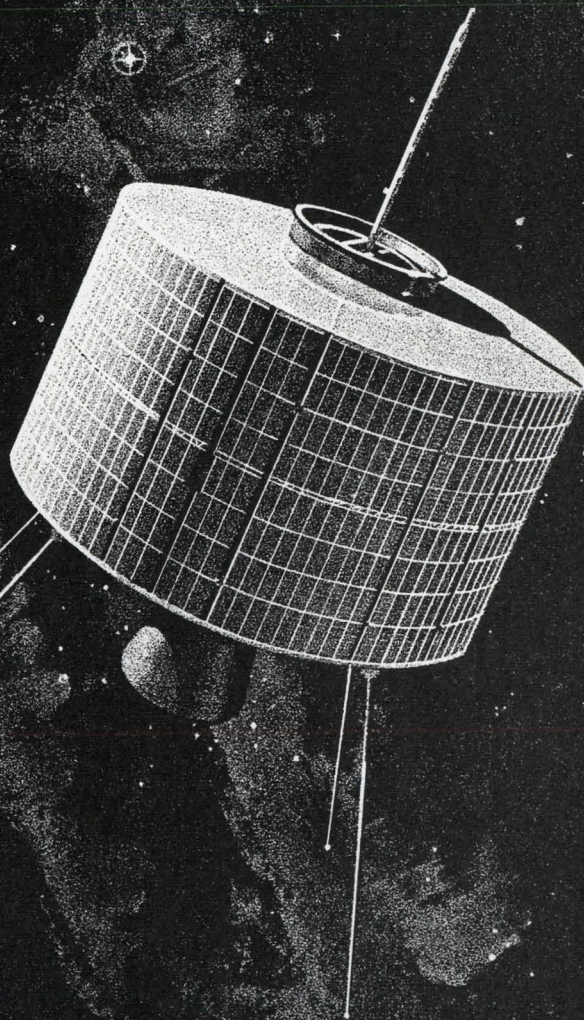

CIRCUIT DESIGNERS... is your appointment in space with Hughes?

Today, Hughes is one of the nation's most active aerospace/electronics firms: Projects include: F-111B PHOENIX Guided Missile System, TOW Anti-Tank Missile System, Communication Satellites, ATS-Advanced Technology Satellites, VATE, Hard Point Defense and others.

This vigor will assist the qualified engineers and scientists towards more and better opportunities for both professional and personal growth.

Many immediate openings exist. The engineers selected for these positions will be assigned to the following design tasks: the development of high power airborne radar

transmitters, the design of which involves use of the most advanced components; the design of low noise radar receivers using parametric amplifiers; solid state masers and other advanced microwave components; radar data processing circuit design, including range and speed trackers, crystal filter circuitry and a variety of display circuits; high efficiency power supplies for airborne and space electronic systems; telemetering and command circuits for space vehicles, timing, control and display circuits for the Hughes COLIDAR (Coherent Light Detection and Ranging).

If you are interested and believe that you can contribute, make your appointment today.

For immediate consideration, please airmail your resume to:

Mr. Robert A. Martin
Head of Employment, Dept. 32
Hughes Aerospace Divisions
11940 W. Jefferson Blvd.
Culver City, California 90230

Creating a new world with electronics

HUGHES

HUGHES AIRCRAFT COMPANY

AEROSPACE DIVISIONS

An equal opportunity employer.

U.S. CITIZENSHIP REQUIRED

PRECISION SWITCHES

for accurately controlled switching in electrical circuits...

Unlimited applications—C.D.I. thumbwheel and rotary switches offer fast, sure settings and quick read-out for computer, automated machine control consoles, check-out equipment, test equipment, programming applications, etc.

Quick Serviceability—In five seconds, any wafer of a C.D.I. rotary switch can be removed. No soldering, disassembling or wiring required. The entire module on thumbwheel switches is removable for equally fast maintenance or replacement.

Extreme versatility—Regardless of size or shape, C.D.I. is well prepared to meet your every switch requirement. Our comprehensive line of thumbwheel and rotary switches is supplemented by an engineering capacity that will custom design any switch to your precise specifications.

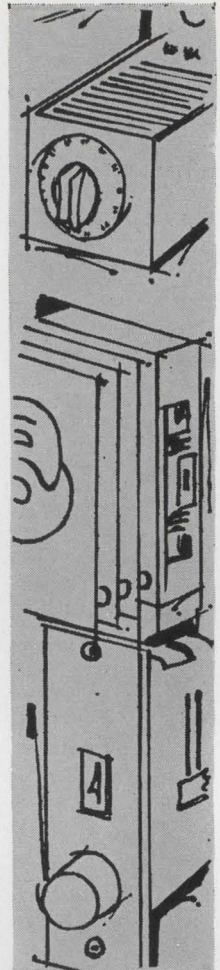
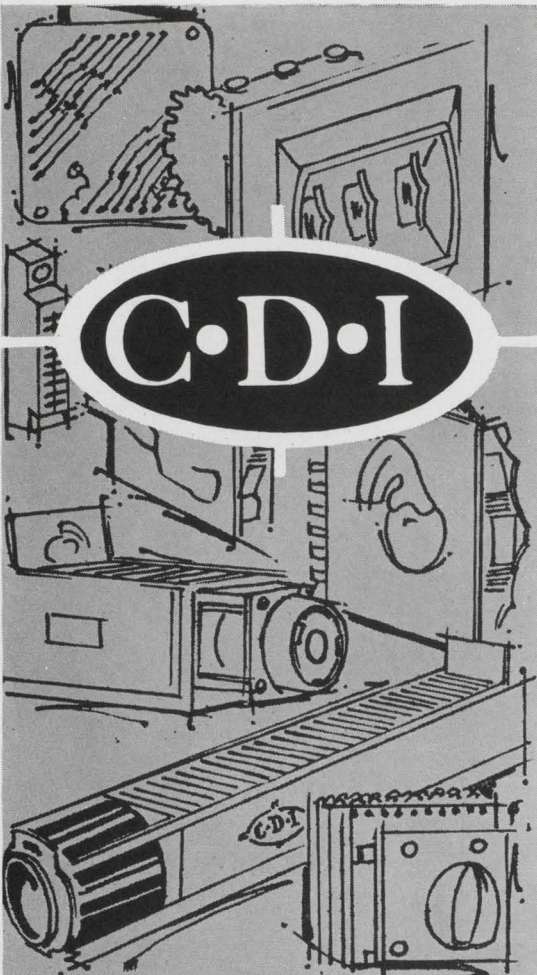
3 THUMBWHEEL SWITCHES

Digital & Binary. Meet MIL-S-22710.

- For Critical Reliability Applications.
- Available with Internal Lighting MIL-L-25467A.



Switch Modules provide *Complete Protection* against hostile environments because both panel and switching elements are separately sealed.

Aluminum Bezel has no visible screws when rear-mounted on miniature and standard type switches.

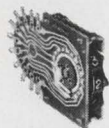

Permanent wafer type miniature decimal switch modules for limited panel space applications.

Removable wafer type switch modules for applications where maintenance time is valuable and rapid servicing is required.
TABEL U.S. Patent 2,841,660

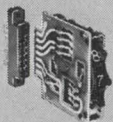

No down-time in rotary switches

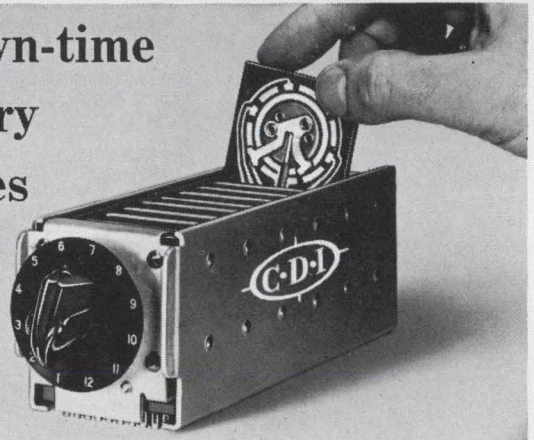

Unique 5-second wafer replacement obsoletes other switches. Simply lift out old wafer, slip in new wafer. No unsoldering . . . no disassembling . . . no wire removing.

CDI patented switches with dust covers are available in sizes 2" x 2", 3" x 3", and 4" x 4" with lengths to accommodate up to 36 wafers. Switches can be customized to your specifications.

Operation may be manual, motor or solenoid for use in any rotary selector switch application. Now supplied for numerous military and commercial applications.

Mfd. under Tabel U. S. Patents 2,841,660, 2,971,066, 3,015,000, 2,956,131, 2,988,607.



CHICAGO DYNAMIC INDUSTRIES, INC.

PRECISION PRODUCTS DIVISION 1725 Diversey Blvd., Chicago, Illinois 60614 Phone: WEllington 5-4600

ON READER-SERVICE CARD CIRCLE 24

**"Now we've put
two I/C op amps
on ONE chip
and, in one package!"**

We've put two of our popular MC1709 (μ A709) integrated circuit operational amplifiers in a single 14-pin dual in-line Unibloc* plastic package. We call it the MC1437P.

The result? A staggering 1,600,000,000-voltage gain figure, among other things. Enough gain to permit design of the most stable summing amplifiers, integrators, or other uses where external feedback is used. It is particularly useful for chopper-stabilized applications where extremely high gain is required with excellent stability.

With both MC1709 op amps on the same chip, you get superlative matching and tracking characteristics, too. (The MC1437P offers a low-

temperature drift of only $\pm 3 \mu\text{V}/^\circ\text{C}$, for example.) It also has the ability to swing almost the entire supply voltage — $V_{\text{out}} = \pm 14 \text{ V}$ typical @ 15 V supply. And, output impedance (Z_{out}) is only 30 ohms typical.

While you can't quite get two op amps for the price of one this way, it's pretty close — only \$8.50 (100-up) vs. \$6.00 for comparable single op amps!

For complete details on the MC1437P, or its 36,000,000-gain cousin, the MC1435P, drop us a note at Box 955, Phoenix, Arizona 85001. We'll include a copy of the WESCON paper, "A Dual Monolithic Operational Amplifier."

*Trademark of Motorola Inc.

where the priceless ingredient is care!



MOTOROLA Semiconductors

MOTOROLA SEMICONDUCTOR PRODUCTS INC. / P.O. BOX 955 / PHOENIX, ARIZONA 85001 / (602) 273-6900 / TWX 910-951-1334
ON READER-SERVICE CARD CIRCLE 25

Civilian markets beckon microwave ICs

But military research still dominates as designers seek the best approaches to economical devices

Neil Sclater
East Coast Editor

Several years from now, underdeveloped countries unable to afford telephones may find a convenient substitute: small, light microwave terminals for voice communications. Cheap enough to be mass-produced, they could be set up easily and carried by one man.

Factories everywhere may get new low-cost supervision and control aids for their machine operations: microwave measurement systems that could determine motion to an accuracy of 0.0002 inch.

These applications and more are envisioned by microwave integrated-circuit manufacturers as

they press their present development programs for the military. Microwave technology is being revolutionized by the introduction of integrated circuitry. But because of special problems, miniaturization at microwave frequencies has, for some time, trailed the advances being made at lower frequencies. This gap is being closed rapidly, however.

Recent gains were noted at this fall's International Electron Devices Meeting in Washington. In describing the optimism with which manufacturers view the future, Tom C. Hyltin, manager of the microwave products branch at Texas Instruments, Dallas, said the microwave "telephone" for under-

developed countries could be set up this way:

"Two stations, each containing about a dozen low-frequency and microwave integrated circuits, can establish a two-way voice-channel communication link over several miles. With these few circuits, the cost will be less than that for building an open telephone line across the same distance. The time-to-failure of the microwave link will be longer than the time-to-failure of the open telephone line.

"A slightly more complex version of these stations could provide 10 or 15 channels over 10 or so miles. Powered by solar cells and storage batteries, these stations could provide emerging nations with economical and reliable communications in powerless areas."

Automatic measuring envisioned

As for the microwave measurement system of the future, Hyltin said:

"Using a 94-GHz interferometer, the position of a tape-controlled milling machine table could be determined automatically, without backlash, to an accuracy of 0.0002 inch through several feet of travel."

Up to now, the barriers to fuller miniaturization at microwave frequencies have included:

- Incomplete knowledge of the transmission-line characteristics suitable for integrated circuits.

- Lack of satisfactory solid-state active components.

- Difficulties in controlling and using the distributed inductive and capacitive effects that turn up in circuitry whose dimensions are close to those of the wavelengths propagated.

Hyltin says these problems have been largely solved; other industry sources tend to be more cautious. But the trend is forward.

Present work to push up the upper frequency limits of integrated circuitry has been largely devoted to miniaturizing radars. In addition to a major program to create small reliable modules for an all-

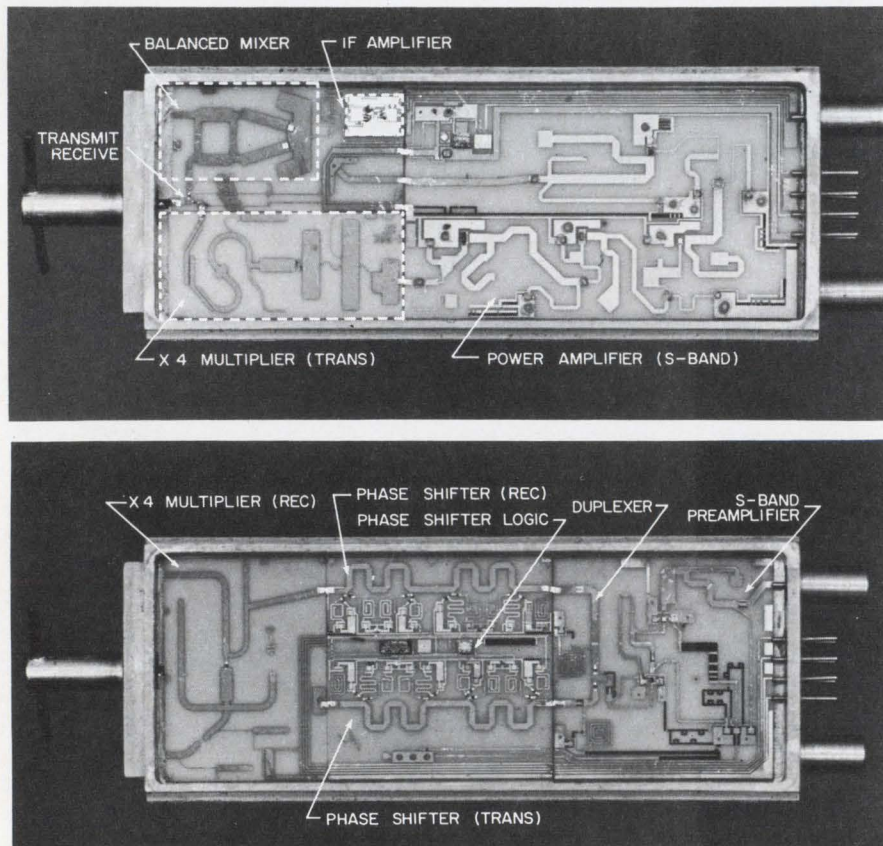

A wide range of microwave integrated circuits is shown on both sides of this phased-array module built by Texas Instruments (output side top, input side below). Many of these circuits could be adapted for commercial microwave applications. Individual circuit substrates are mounted back-to-back on the approximately 2-1/2-by-1-inch mounting plate. Most are thin-film hybrids.

solid-state airborne phased-array radar, other efforts aim to furnish miniature component replacements for existing radars. These programs will furnish circuitry that will be useful for all microwave applications. They will lead to the solution of many materials and design problems.

"Microwaves have been limited in the past to select applications where their high cost could be justified," Hytlin says. Equipment to generate and detect at microwave frequencies has cost up to 10 times more than the cost of performing similar functions at audio, ultrasonic, infrared and lower radio frequencies.

Microstrip key to design

Microwave integrated-circuit devices have been built that operate successfully at frequencies up to 94 GHz. The designs are based on microstrip transmission lines that are formed by metal film printing, deposition and plating techniques on dielectric substrates. The designer has computer-aided design programs to help remove the trial and error. He has the option of forming active and passive devices as part of a complete fabrication process, or of attaching the devices after the microstrip is formed. His choice depends on the complexity of the circuitry desired, the economics of development and production, and, to some extent, the operating frequencies.

Fabrication techniques for microwave microcircuits now are much the same as those for lower-frequency integrated circuits: thick-film hybrid, thin-film hybrid and monolithic.

Hybrid techniques used

The thick-film hybrid circuits use thick conductive coatings bonded to insulating substrates, and they are comparable to conventional printed circuits. The microstrip transmission lines are usually silk screen printed on a porous ceramic substrate and fired so that the metal film becomes part of the substrate.

Passive and active devices are bonded, or "outboarded," to the substrate. Films range from tenths of a mil to several mils in thickness. This category also includes metallic films on a wide variety of

other insulating materials, including Teflon and epoxy board. Most microwave-circuitry today is made by this technique.

Thin-film hybrid circuits generally use depositions of several layers of metallic and dielectric films on dielectric substrate to form all the passive circuitry. Other deposition techniques permit more precise formation of microstrip transmission lines, components, capacitors and resistors. Capacitors are typically in the range of 0.5 to 1.0 pF/mil,² and resistors, 10 to 100 Ω square.

Masking during deposition, or selective etching after deposition, is used to achieve the desired network topology. The substrates used in this technique are nonporous — glass, glazed ceramic, quartz or silicon, for example. Active devices, however, are bonded to the

circuit in chip form, as in thick-film hybrids.

The monolithic approach makes use of masking, deposition and diffusion, etching and growth techniques. Both active and passive devices are formed as part of the complete process.

Application dictates technique

Probably the most ambitious microwave microcircuitry is intended for use in phased-array radars. One program is developing integrated circuits for an airborne terrain-avoidance radar. The circuits are assembled in miniature modules that are effectively miniature radars. Each consists of power and i-f amplifiers, frequency multipliers, a TR switch, balanced mixer, modulator, phase shifters and phase-shift logic.

For proper formation of a radar

Microstrip: The basis for microcircuitry

A form of transmission line known as microstrip (a) is used in most microwave integrated circuits because it can be easily formed by printing and deposition methods. It is a flat center conductor, separated from a ground plane by a dielectric material. It has impedance transfer properties that permit the designer to form many waveguide and coaxial cable components in microcircuitry, such as filters, transformers, couplers and cavities.

To take advantage of the properties of microstrip, the designer must know three parameters: characteristic impedance, wavelength on the transmission line, and the attenuation.

Propagation along microstrip, however, is not in a mode as pure as that found in either coaxial cable or waveguide, thus complicating the designer's problem. It is similar to the

transverse electric magnetic mode (TEM) found in coaxial cables (b). A popular microstrip configuration (c) shows that there is an appreciable amount of fringe capacitance that propagates microwave energy. Also, the boundary between the high dielectric substrate and the surrounding material is indefinite.

Useful formulas have been derived to relate microstrip's characteristic impedance and wavelength to the ratio of conductor width (W) to dielectric height (h).

In the case where the dielectric constant (ϵ_r) of the substrate equals 10 and both the width of the conductor and thickness of the substrate are 20 mils (thus making $W/h = 1$), the wavelength in microstrip is reduced by a factor of 2.46. This is slightly longer than the wavelength for a pure TEM mode with the same dielectric.

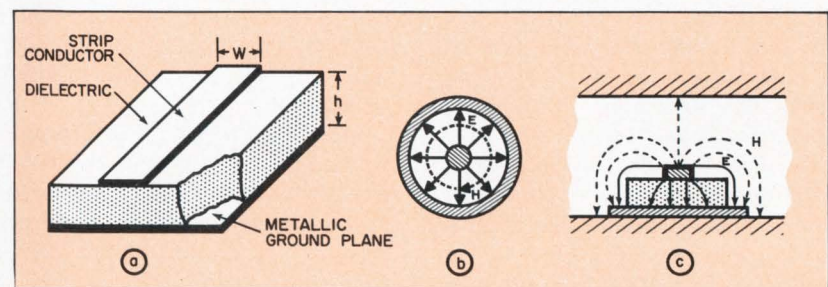

(Microwave ICs, continued)

beam, the amplitude and phase transfer characteristics of all modules must be identical. This requirement for uniformity, along with consideration for the thousands of modules that must be produced, has encouraged serious consideration of automated production methods.

Texas Instruments, as part of its MERA (Molecular Electronics for Radar Applications) program for the Air Force, has developed these complex modules for evaluation. Economic and technical difficulties have ruled out the monolithic approach, so that the modules in their present form are thin-film hybrids, with both monolithic and discrete circuit devices bonded to glazed alumina ceramic substrates. Texas Instruments assembles the various circuit substrates back-to-back in a module frame, complete with connectors and adaptors.

The MERA program, is being supported by the Avionics Laboratory at Wright-Patterson Air Force Base, Ohio.

Integrated-circuit phase shifters and phase-shift logic have been developed by a number of organizations, including Bell Telephone Laboratories of Murray Hill, N.J., and Microwave Associates of Burlington, Mass., for possible use in large-scale, ground-based phased arrays.

Another representative application for microwave microcircuitry is a front end for an airborne X-band weather radar. The Army's Electronics Command at Fort Monmouth, N.J., wants it to replace a heavy, bulky waveguide-and-vacuum-tube assembly, so it can fit a standard weather radar on light reconnaissance aircraft.

Less ambitious than a MERA module, this design provides only preamplification, mixing and local oscillator functions. However, the Army will make practical use of this development in the very near future. The developer, Microwave Associates, has built workable models despite initial difficulties.

Vladimir Gelnovatch, who designs ICs and supervises microwave IC development contracts for the Army Electronics Command, recently reviewed some of the cur-

rent design problems.

He said that the designer, in choosing the method for making the microcircuit, considers the numbers and types of active and passive components that he wants on the substrate, the function of the circuit and, to some extent, the operating frequency.

Breadboards point way

Preliminary designs are frequently built with a variety of techniques as thick-film breadboards, the Army engineering supervisor said. Most designers, he added, use computers to assist in the design. The computer offers optimum solutions for active and passive circuit elements and microstrip.

Many manufacturers, he said, have programs that will permit their designers to feed in noise figure, gain, and bandwidth and have the computer search for the microstrip network that will yield the desired characteristics.

Some circuits, particularly at uhf and L band, may remain thick-film hybrids, Gelnovatch said, because it is more economical to "outboard" both active and passive devices. In addition there is the possibility of higher yields than with other methods. On the other hand, he said, where the quantity of circuits is great enough to justify it, the breadboard designs may be advanced to thin-film hybrids. In these cases it usually is desirable to include the fabrication of passive elements, particularly resistors and capacitors, in successive deposition operations.

Active elements bonded

Provision is made in the circuit design for the bonding of such active elements as diodes and transistors and for complete monolithic chips for i-f amplification and phase shifting.

The more complex passive elements, such as circulators and inductors, may also be outboarded or built up by various deposition techniques.

Most engineering work in microwave ICs is directed toward including as many active and passive devices as are economical and practical in the manufacturing process, Gelnovatch said.

"All waveguide and coaxial com-

ponents have now been synthesized in microstrip with electrical performance more or less equal to the original components," he noted. These include matched loads, filters, hybrid rings, couplers and transformer sections.

The decision to use the monolithic approach is based on two engineering considerations, Gelnovatch said.

The first takes into account materials that can be used. To minimize electrical losses and to eliminate processing problems, the substrate and the active device should be made from the same material. However, the best dielectric substrate materials are not necessarily the best for active devices.

The second consideration is the high cost of gearing for monolithic production. The quantities to be produced must be great enough to justify the additional expense and must cover the cost of expected higher production losses.

"Calculations have shown that semi-insulating gallium arsenide and silicon of resistivity greater than 1000 Ω /cm have a loss sufficiently low to fabricate microcircuitry," Gelnovatch said.

Texas Instruments, for one, reports that in addition to 500-MHz amplifiers, it has made X-band balanced mixers and TR switches, using silicon as a substrate.

Hyltin reports that a number of basic problems must be solved when monolithic techniques are used. He lists these as:

- Conductivity modulation of the silicon substrate by dc currents. This introduces rf leakage to the ground plane and leads to excessively high insertion loss.

- Difficulty in obtaining low resistance contacts between the microstrip conductor and active devices.

- Unwanted diffusions of metals into the substrate, as a result of high processing temperatures. ■■

Bibliography:

- Hyltin, T. "Microstrip Transmission on Semiconductor Dielectrics," *IEEE Trans. on Microwave Theory and Techniques*, Vol. MTT-13, No. 6 (Nov. 1965), 777.
- Wheeler, H. A. "Transmission Line Properties of Parallel Strips Separated by a Dielectric Sheet," *IEEE Trans. on Microwave Theory and Techniques*, Vol. MTT-13, No. 2 (March 1965), 172.

New Generation

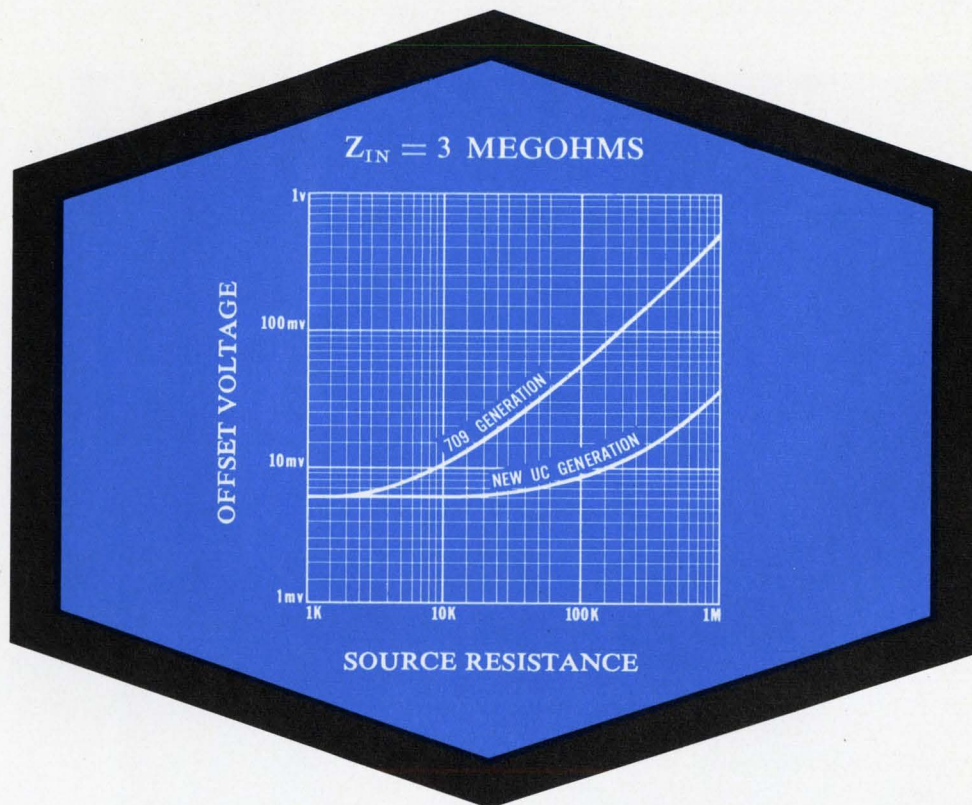

in IC op amps!

 UC709/ $\pm 15\text{V}$ POWER SUPPLY  UC4200/ $\pm 24\text{V}$ POWER SUPPLY

- High Input Impedance: 3 megohms (typ)
- Output is short circuit proof
- Low power dissipation
- Balanced supply current
- Temperature coefficient: $6\mu\text{V}/^\circ\text{C}$ (typ)
- Output Swing: $\pm 10\text{V}$ (UC709); $\pm 20\text{V}$ (UC4200)
- Gain: 25K min (UC709); 50K min (UC4200)
- Output current: 5 mA min (UC709); 4 mA min (UC4200)
- Operating Temperature: -55°C to $+125^\circ\text{C}$
- Package: 8-lead JEDEC TO-99

Applications: Ideal for airframe and aerospace use • Infrared sensors
PM sensors • Piezoelectric transducers • Ionization gauges • EEG and EKG pre amps
Analog integrators and electrometric type voltage followers.



Semiconductor Department/365 Middlefield Road, Mountain View, California 94040, (415) 961-3300

ON READER-SERVICE CARD CIRCLE 26

Magnetic eyes...exciting new

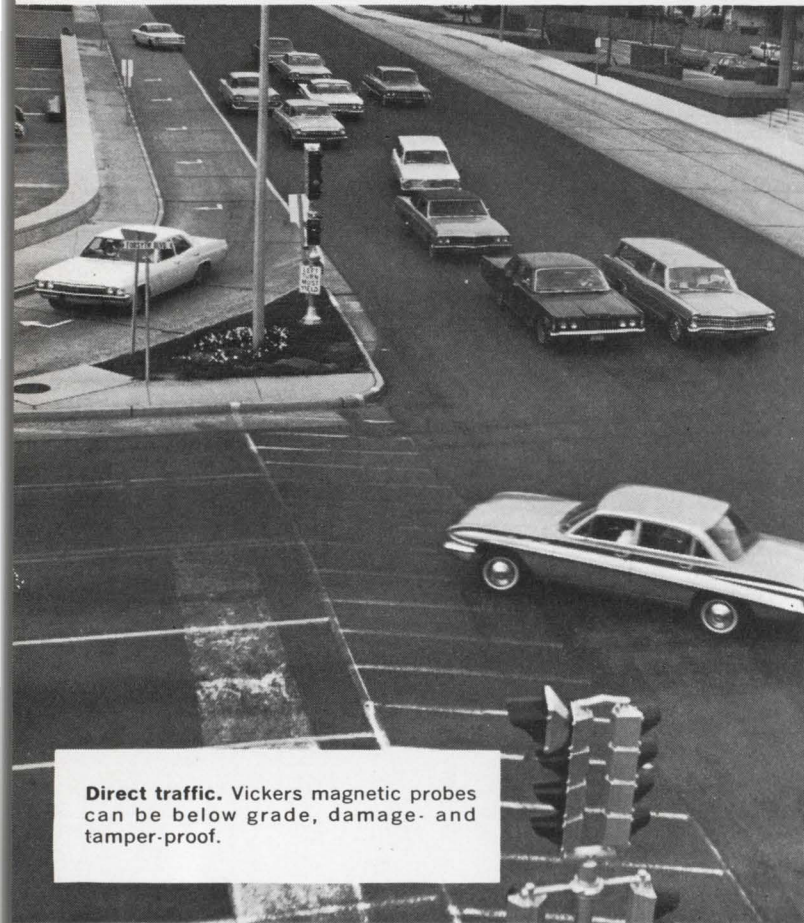

Direct traffic. Vickers magnetic probes can be below grade, damage- and tamper-proof.

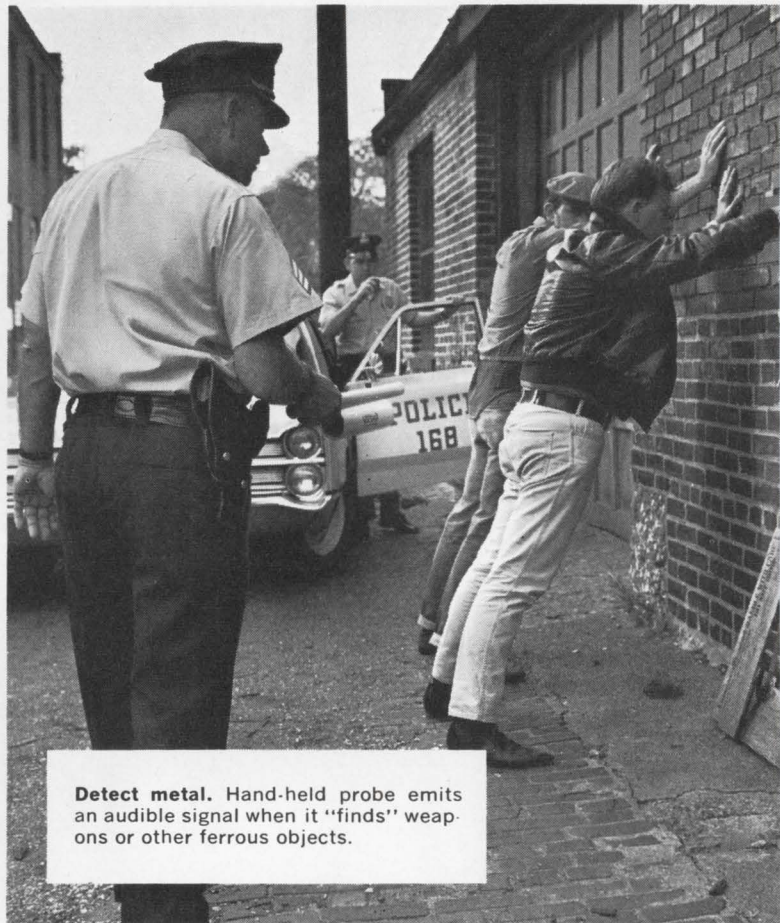

Detect metal. Hand-held probe emits an audible signal when it "finds" weapons or other ferrous objects.

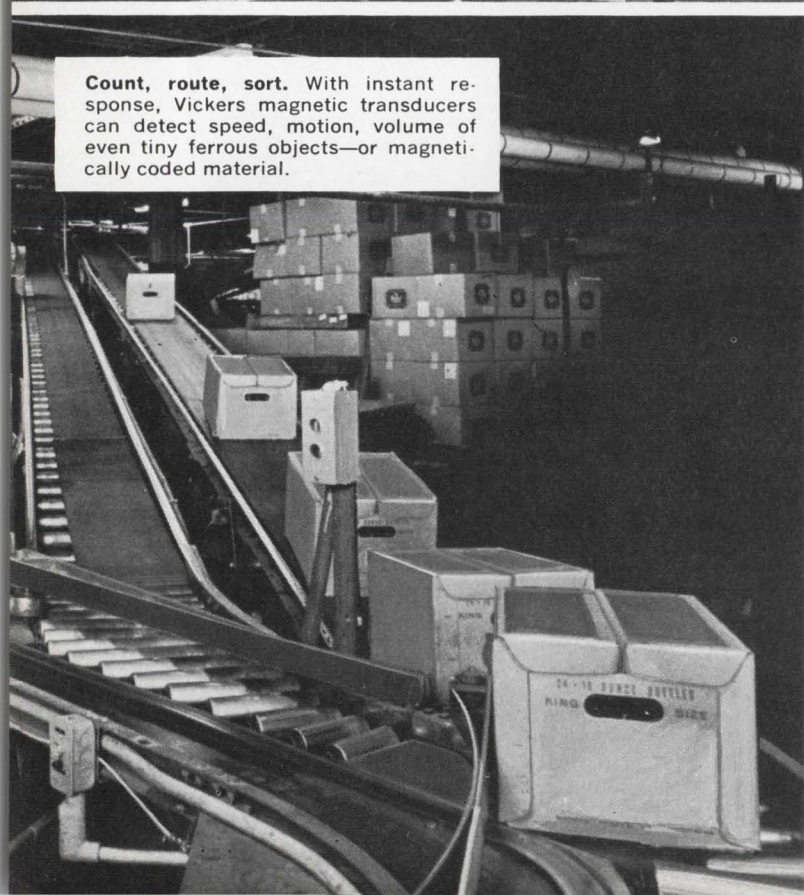

Count, route, sort. With instant response, Vickers magnetic transducers can detect speed, motion, volume of even tiny ferrous objects—or magnetically coded material.

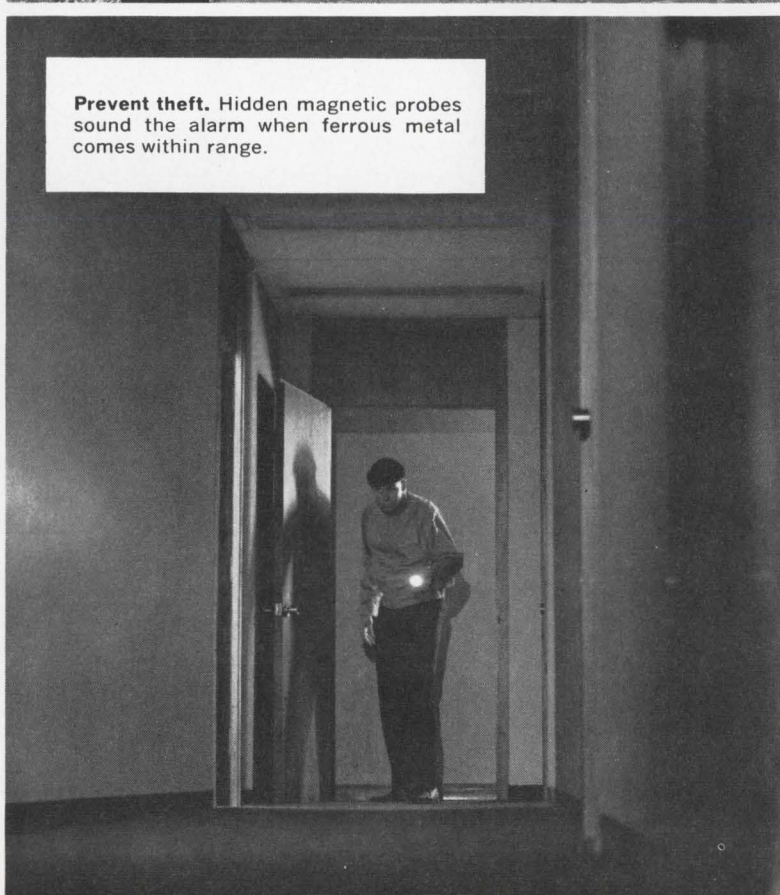

Prevent theft. Hidden magnetic probes sound the alarm when ferrous metal comes within range.

Vickers transducers

Vickers challenges your imagination with a new generation of magnetic transducers. More precise. More reliable. Free from wear! Vickers magnetic transducers are helping to create new, higher-performance equipment. They're replacing older, bulkier, more complex transducers in numerous industries. Perhaps yours.

Without physical contact, Vickers sensors can transduce the presence, speed, motion or mass of any ferrous object, part or material. No mechanical linkages. No moving parts or maintenance.

Our transducers simply read the changes in the low-intensity magnetic ambient and amplifies it. Instantly. Out of our solid-state amplifier comes a useful analog signal that can trigger alarms, operate recorders or digital counters, run heavy equipment, make precise measurements, govern sensitive controls—the possibilities are endless.

HOW VICKERS UNITS WORK

Sensitive gradiometer or magnetometer, combined with a solid-state amplifier, reads the weak-field magnetic environment, producing an analog signal. Any change in the magnetic environment, no matter how small or brief, results in an instant, proportional change in the signal. This effect is produced by such diverse things as metal in pockets, the passage of automobiles or metallic parts, miniscule shifts in magnetic ambients and other phenomena. Units can be made as sensitive as the application requires.

It's time you put this challenging new tool to work. For more detail, contact Magnetic Products Department, Vickers, 1841 Locust Street, St. Louis, Mo. 63103.

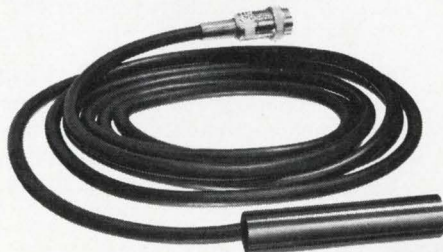

VICKERS
ELECTRIC PRODUCTS DIVISION

ON READER-SERVICE CARD CIRCLE 27



Find, measure, survey. Vickers equipment reads magnetic ambient, detects changes in increments as low as 0.01 millioersteds.

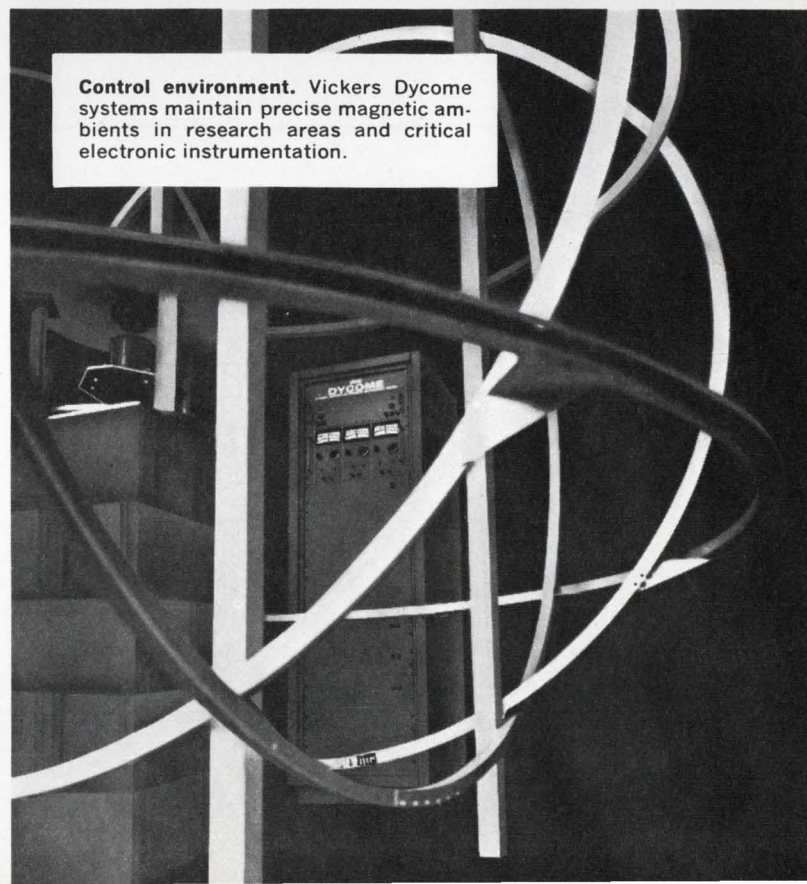

Control environment. Vickers Dycome systems maintain precise magnetic ambients in research areas and critical electronic instrumentation.



SEMICONDUCTORS

NEW IDEAS IN APPLICATION AND DESIGN

■ **FRUSTRATED WITH UNIJUNCTION SPECS? WANT TO DESIGN YOUR OWN UJT? IT'S A CINCH!**

Just start with a new GE D13T Programmable Unijunction Transistor (PUT), housed in GE's TO-98 epoxy package. Now connect it up in the following fashion:

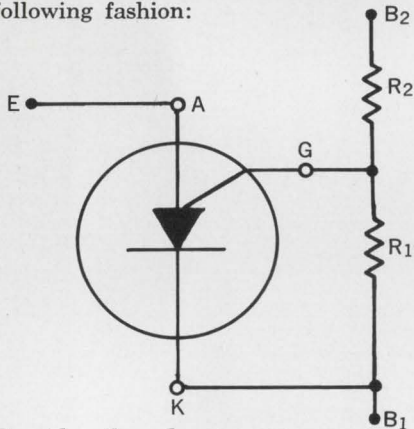

Consider the advantages:

- η can be set at any desired value by selecting R_1 and R_2 .
- R_{BB} can be made high for low power consumption.
- I_p can be reduced to less than 150 nA for long time delay applications by increasing R_G . ($R_G = \frac{R_1 R_2}{R_1 + R_2}$)
- I_V can be adjusted to higher values for relaxation oscillator applications by lowering R_G .
- 80 nanosecond rise to 6 volt output pulses is guaranteed.
- I_{EO} is less than 10 nA.
- 2-volt to full line voltage operation is possible.
- Less than 35¢ in volume.

That's what you get with General Electric's new "PUT". Order some today from your local General Electric distributor and join the exciting world of UJT design engineers. Want specs and other details? **Circle Number 811.**

More metal-cap transistors are going epoxy. Result: equivalent performance and cost savings up to 50%

You receive the same high performance levels as electrically equivalent metal-cap units. GE epoxy transistors also have comparable hermetically sealed stability. Latest types to make the change are these high grade devices for critical industrial and military applications:



Metal-Cap Type	GE Epoxy Equivalents	Device Description
2N759,A 2N760,A 2N915,6 2N2220-22	D33A Series	general purpose amplifiers
	D33B Series 2N4951-4	medium current, general purpose switch/amplifier/driver
2N697, 2N1613, 2N1711, 2N2192, 2N2193	D33D Series	high gain driver
2N706, 2N708, 2N914, 2N753, 2N834	D33E Series 2N3605A 2N3606A	high speed digital switch
2N2368,9, 2N743,4	D33G Series 2N5029 2N5030	low current, high speed digital switch
Also	D33K	high current core driver and medium current, high speed switch
	D33L	low voltage, very high speed switch

For our latest epoxy transistor reliability report, **Circle Number 813.**

■ **C106 ECONOMY SCR LINE ADDS 300-VOLT SELECTION**

Now you can choose from several 2-amp C106 voltage ratings: C106Y at 30 volts; C106F at 50 volts; C106A at 100 volts; C106B at 200 volts; and finally our new 300-volt selection, C106C.

GE C106 SCR's are priced, in volume, from 35¢ to 60¢ depending on voltage selection. Standard lead configuration is in-line, with several



Actual size C106 SCR with flat leads and heat sink tab.

alternate lead configurations offered to meet special mounting requirements. The C106 is plastic encapsulated, planar passivated, and features excellent gate sensitivity and up to 300-volt blocking voltage. *Readily available in volume.* **Circle Number 812.**

These are just three more examples of GE's total electronic capability. For more information, call your GE engineer/salesman or distributor. Or write to Section 220-61, General Electric Com-

pany, Schenectady, N.Y. In Canada: Canadian General Electric, 189 Dufferin St., Toronto, Ont. Export: Electronic Components Sales, IGE Export Division, 159 Madison Ave., New York, N.Y., U.S.A.

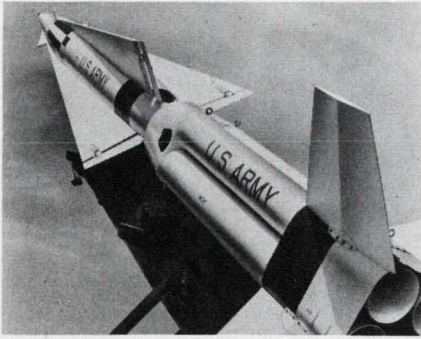

ICBM parity predicted by 1970

With clarity and frightening logic, Rep. Craig Hosmer (R-Calif.) gave to the House, and later to the Subcommittee on Military Applications, a statement describing the present and future balance of strategic power between the U.S. and the Soviet Union.

On the basis of Pentagon statistics on U.S. and Soviet strategic-missiles strengths, Rep. Hosmer predicted that the U.S. total of 1454 land-based ICBMs and on-station sea-launched IRBMs could be surpassed by the Soviet Union by 1970. The U.S.S.R. could then have 1540 comparable missiles at its present rate of adding 300 weapons a year to its arsenal. He cited these estimates as evidence that Defense Secretary Robert S. McNamara's reliance on massive retaliation to destroy Soviet war capability completely was not necessarily sound. Present U.S. deployment plans count on 1054 operational land-based missiles and approximately 400 of the nation's 656 Polaris or Poseidon missiles to be on station at all times. Since these figures are to be essentially stable between now and 1970, said Hosmer, it can be presumed that parity will occur. It can also be assumed, he said, that, as Soviet technology improves, missile accuracy will fall within a 2000 foot CEP (circular error probability). Based on these figures, he reported that the Rand Corp.'s "bomb damage effect computer" had calculated a 92 per cent destruction probability from a first Soviet strike at U.S. land-based ICBMs—that is 970 of the 1054 would be destroyed leaving only 84 missiles available for retaliation. Of the 25 Polaris submarines at sea, 79 per cent should survive, leaving 316 missiles available for use.

Of the 400 surviving missiles, 200 might get through to their targets if the Soviet ABM defense is only 50 per cent effective. Hosmer estimated the total actual damage

Washington Report

CHARLES D. LAFOND
WASHINGTON BUREAU

to the Soviet Union would be only 16.8 per cent: it would not be totally incapacitated. He then pointed out that purges of the Thirties accounted for up to 15 per cent of the Soviet population and in World War II the Russians lost 40 per cent of their industrial capacity, yet the U.S.S.R. survived. A 16.8 per cent loss would be a "bargain basement price for world domination," Hosmer declared.

FOBS impact only partially disclosed

Defense Secretary Robert S. McNamara's recent announcement of the Soviet FOBS (Fractional Orbital Bombardment System) development revealed only part of the military capability of such a weapon, Rep. Hosmer told the House. McNamara stressed the dubious role of FOBS for attacking U.S. manned bombers on the ground; Hosmer pointed up two other major missions: the destruction of Sentinel acquisition radars, and the destruction of retaliatory U.S. ICBMs in their silos.

Full details of the Russian Scrag were given in a May 29, 1967, issue of the *Washington Report* of the American Security Council by Dr. Stefan T. Possony, director of the Hoover Institution on War, Revolution, and Peace at Stanford University. Possony stated that FOBS's Scrag (roughly meaning garrote in Russian) warhead in orbital configuration could be in the 30-megaton class. McNamara insisted, however, that Scrag orbital-warhead yields are only in the one-to-three-megaton range.

More importantly, Possony suggested that Scrag could offer a three-pronged attack capability: as a conventional ICBM with up to a 50-megaton warhead, as a fully orbiting space bomb, or as a fractional orbiting weapon with a 30-megaton warhead. There is also no reason to believe that any of these weapon configurations might not be provided

Washington Report

CONTINUED

with 20 to 30 multiple warheads or that these might not be capable of maneuvering after separation. Scrag, he declared, "provides the Soviets with a genuine capability to hit every spot on earth with very short notice." High-altitude, high-yield explosions by suborbital or orbital Scrag's detonated sequentially could establish and maintain an X-ray screen and could keep U.S. electronics and communications inoperable, Hosmer said. Scrag, he emphasized, represents the the first genuine global weapon.

Need for on-board processing critical

NASA's Goddard Spaceflight Center at Greenbelt, Md., is pressing development of a standardized spacecraft digital processor, to help reduce the incredible problem posed by the masses of data currently received at ground stations from scientific satellites. A three-module unit to perform in-orbit reprogramming and high-speed instruction execution, under development by the Space Electronics Branch, includes a central processor memory unit and an input/output device.

The plated-wire, random-access memory unit of the 18-bit processor is being built for Goddard by the Librascope Group of General Precision, Inc. Considered the heart of the processor, it combines woven-wire and nondestructive readout techniques with power switching to obtain a word cycle time of 2 microseconds at a power dissipation of 6 to 7 watts. The memory may contain up to eight storage modules with each six-pound unit having a capacity of 8192 eighteen-bit words. Power does not increase with added modules.

The central-processor module employs low-power integrated circuits, requires 5 watts, and weighs about 4 pounds. The input/output module interconnects all applicable spacecraft sensors and electronic subsystems with the memory unit.

Apollo systems pass rigorous test

The highly intricate mission of the recent Apollo/Saturn V test flight provided a

comprehensive and practical exercise for the Apollo guidance and control systems. Both apparently lived up to expectations. During the early part of the mission, the guidance system in the Saturn V vehicle was in control with the Apollo guidance system serving as a continuous monitor and backup system.

Following the second burn of the Saturn's third-stage engine, to boost the Apollo into the long, 11,330-mile elliptical orbit, and that stage's separation from the Apollo spacecraft, the Apollo guidance and control system took over. Working together, the AC Electronics guidance and navigation system and the Honeywell stabilization and control system provided steering and attitude orientation, service engine ignition, and full control for reentry sequences.

The flight profile was intricate and provided the first attempt at skip reentry. After four hours in the elliptical orbit, the service engine fired, boosting speed to 25,000 mi/h for the earth-atmosphere intercept. At about 400,000-ft altitude a partial reentry was effected and then the spacecraft skipped back out of the atmosphere, simulating the method that would be used on return from a lunar mission to reduce spacecraft velocity. The planned full reentry brought the spacecraft down within six miles of target in the Pacific. The near perfect launching may result in the first manned Apollo flight's being moved up from some time in 1969 to late next year.

EIA to review foreign electronic market

A new monthly publication by the Electronic Industries Association will be available hereafter on a subscription basis to provide marketing data on a country-by-country basis. It will review trends in worldwide trade in electronics and analyze the current state of business within individual nations, EIA disclosed.

The first issue carrying an October date covered Sweden; November and December editions will cover Japan in a two-part series. The report, called *Electronic Trends/International*, will regularly provide up-to-date information on all nations previously reported in depth, EIA said. Subscriptions are available from EIA's Marketing Services Dept., 2001 Eye Street, N.W., Washington, D.C. 20006, at \$250.00 per year.

GOOF-
PROOF

VOM



Here's the most foolproof volt-ohm-milliammeter ever made. Protection approaches 100%. It's the VOM you will want to have on hand where inexperienced people are running tests . . . or will reach for yourself on those days when you're all thumbs. The 260-5P will save you all kinds of headaches from burned out meters and resistors, bent pointers, and inaccuracies caused by overheating.

Combined Protection You Won't Find In Any Other VOM

1. Reset button pops out to indicate overload.
2. You cannot reset circuits while overload is present.
3. Protective circuit does *not require* massive overloads which can cause hidden damage to the instrument.
4. All ranges are protected except those not feasible in a portable instrument—1000 and 5000 volts DC and AC; 10 amp DC.

SIMPSON
260-5P

ONLY \$88.00

Write for Bulletin 2076

Ranges—The 260-5P has the same ranges and takes the same accessories as Simpson's famous 260-5 volt-ohm-milliammeter.



DIVISION



SIMPSON ELECTRIC COMPANY

5200 W. Kinzie Street, Chicago, Ill. 60644 • Phone: (312) 379-1121

Representatives in Principal Cities See Telephone Yellow Pages

Export Dept.: 400 W. Madison St., Chicago, Ill. 60606 Cable, Simelco

In Canada: Bach-Simpson Ltd., London, Ontario

In India: Ruttonsha-Simpson Private Ltd., Vikhroli, Bombay

WORLD'S LARGEST MANUFACTURER OF ELECTRONIC TEST EQUIPMENT

ON READER-SERVICE CARD CIRCLE 28

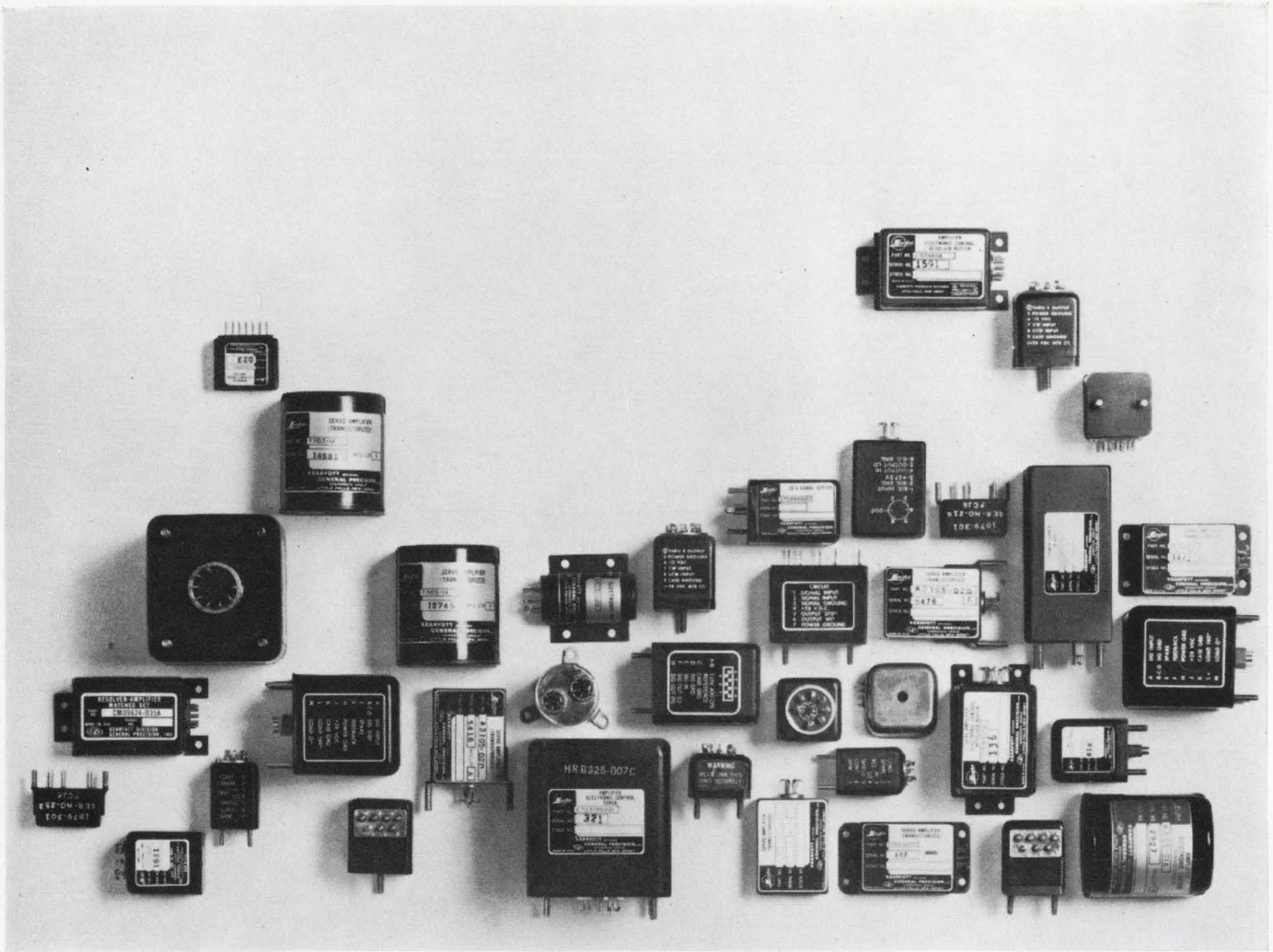

We make a pile of electronic assemblies at

KEARFOTT

SERVO AMPLIFIERS, PREAMPLIFIERS QUADRATURE REJECTION CIRCUITS, SOLID STATE CHOPPERS, MODULATOR / DEMODULATORS, AMPLIFIER-DEMODULATORS, BUFFER AMPLIFIERS, ISOLATION AMPLIFIERS, SUMMING ISOLATION AMPLIFIERS, AC-DC AMPLIFIERS, SIGNAL SENSORS, COMPARATOR AMPLIFIERS, MAGNETIC AMPLIFIERS, STEPPER MOTOR DRIVERS AND LOGIC.

In fact, we have just added another 24 new units in our latest catalog on electronic assemblies bringing the total to over 115 miniature solid state problem solvers. Among the units added is a 50-watt-output, 90°-phase-shift servo amplifier that weighs only 14 ounces. We also have a 16-watt unit for less demanding applications. We've been producing solid state half-wave and full-wave choppers for some time, and to these we've now added DC-to-AC modulators and AC-to-DC demodulators featuring full-wave modulation or demodulation at frequencies from 50-5000 Hz. Major new additions to the product line are fourteen new stepper motor driver/logic assemblies to

satisfy almost every size 8, 11, or 15 stepper motor. Like all our electronic modules, these are transistorized, lightweight, potted in high-strength epoxy and can operate over a wide temperature range. Typically, these driver/logic assemblies consist of sequential logic controlled by CW or CCW input pulse commands and output drivers to control motor-winding current.

Operating in the switching mode, these drivers minimize internal power dissipation.

For further information write Kearfott Products Division, General Precision Systems Inc., Kearfott Group, 1150 McBride Avenue, Little Falls, N.J. 07424 Dept. 3-1450.

**GENERAL
PRECISION
SYSTEMS INC.**

KEARFOTT PRODUCTS DIVISION
A SUBSIDIARY OF GENERAL PRECISION EQUIPMENT CORPORATION

ON READER-SERVICE CARD CIRCLE 29

number one in complete products and capabilities for automatic wire-wrap* assembly

SERIES AW

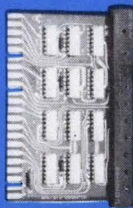

DC TO 30MC AW CIRCUIT CARDS

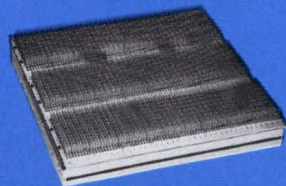

120 CARD AW BASE PLATE



120 CARD AW DRAWER CAGE

* "Wire-Wrap" is the registered trademark of the Gardner-Denver Company, Grand Haven, Michigan.

From Control Logic . . . to help you utilize the benefits of automatic wire-wrap assembly in the electronic systems you want! Benefits like reducing wiring errors by a factor of 100:1. Simplifying (even eliminating) expensive direct wire testing. Making reliable, fast, numerous (600 to 1200 per hour) gas-tight electrical connections with a failure rate that is less than 1 in 100,000 connections. Eliminating confusing, unfathomable wire build-up rat's nests with every wire in a known position . . . and a 50% reduction in wiring costs!

Control Logic help begins with a complete Series C family of automatic assembly products to satisfy all aspects of systems construction: a *complete* choice of DTL and TTL circuit cards with speeds of DC through 30 MC; *complete* packaging products from breadboarding to full system design, including connector baseplates and card cage housings designed for optimum utilization of automatic wire-wrap processes — 7 package assemblies for automated design for up to 120 card systems!

Control Logic offers complete services in design and specification of the system you want. Control Logic can generate a wiring list from your logic network diagrams. Can help you construct prototypes utilizing standard Series C components with any type of connection terminal. Can help you convert to automatic wire-wrap processes at any phase in a program.

Control Logic, to complete the picture, offers *production* of the wire-wrap systems you want . . . in part or *complete*: systems tested, checked-out and ready to serve your function. Yes, even if you have a small volume, low budget job . . . or you don't want to invest in automatic wire-wrap equipment, now . . . Control Logic can help you achieve automatic assembled systems! Call or write for BROCHURE 12 on SERIES AW products and services, today!

 **CONTROL LOGIC, INC.**

3 Strathmore Road, Natick, Massachusetts 01760
Tel: (617) 235-1865 or (617) 235-1170

ON READER-SERVICE CARD CIRCLE 30

We're constantly drumming up new business.



Even though we have a staff of nearly 2,000, do business in the tens of millions, and occupy 264,000 gross square feet of floor space for our research, engineering, manufacturing and other activities, we enjoy a reputation for technical excellence and on-time—or ahead of schedule—delivery. Our company pride wouldn't let us have it any other way.

All things considered, that's saying quite a lot when you think that Conductron pioneers in the design, development and manufacture of special-purpose electromechanical systems, interface equipment and components, including micro-miniaturized circuits. We're a volume hardware producer of avionics and ground support checkout equipment. We're involved in advanced communications and micro-electronic circuitry. And we've just entered the institutional field with PARAMETRON®, the most flexible bio-medical critical monitoring device yet offered to hospitals.

For our customers, who range from companies in the defense and space industries to those in the commercial and institutional markets, Conductron engineers developed and produced such diverse items as McDonnell Mercury and Gemini simulators for training our astronauts, and the Orbital Timing Device—standard equipment in all Gemini space capsules.

At the present time, Conductron is producing flight training simulators for the Boeing 747, 737, 727, Douglas DC8, DC9, and Lockheed C5A. Customers include Eastern, United and Piedmont Airlines and Lockheed for the U.S. Air Force. We are also putting our know-how to work for other customers in the areas of data systems, communications and a wide spectrum (140 separate checkout systems) of aerospace ground support equipment. Then, too, we're producing visual and radar landmass training simulators and developing holo-

graphic techniques to produce a three dimensional aspect for pilot training.

We like our work. So do our customers. We think you will too.

Conductron-Missouri's facilities are located in suburban St. Charles, Mo., just 22 Freeway miles from Downtown St. Louis and close to excellent cultural, educational and recreational facilities.

If you are a graduate engineer with 2 to 5 years' experience, who is interested in an outstanding growth opportunity with a leader in the electronics industry, we have current openings in these categories:

**SYSTEMS, ELECTRONIC or ELECTRICAL ENGINEERING
MATH MODELING • SCIENTIFIC PROGRAMMING
LOGIC DESIGN • MECHANICAL, RELIABILITY or
MAINTAINABILITY ENGINEERING • MANUFACTURING
ENGINEERING • OPTICS • COMMUNICATIONS
ENVIRONMENTAL TESTING • AERODYNAMICS
VALUE ENGINEERING**

Send your résumé in complete confidence to Mr. Thomas Walenga, Professional Employment Office, Dept. E.D.-126.

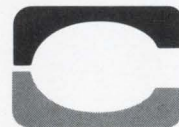

CONDUCTRON-MISSOURI

Division of Conductron Corporation

2600 N. Third Street, Box 426, St. Charles, Missouri 63301

For WESCON Interviews contact Jim Hoose at the Thunderbolt Hotel, 101 Bayshore Freeway, Milbrae, Calif. Telephone: 415-697-7700

We are and always have been an equal opportunity employer.

INTRODUCING!

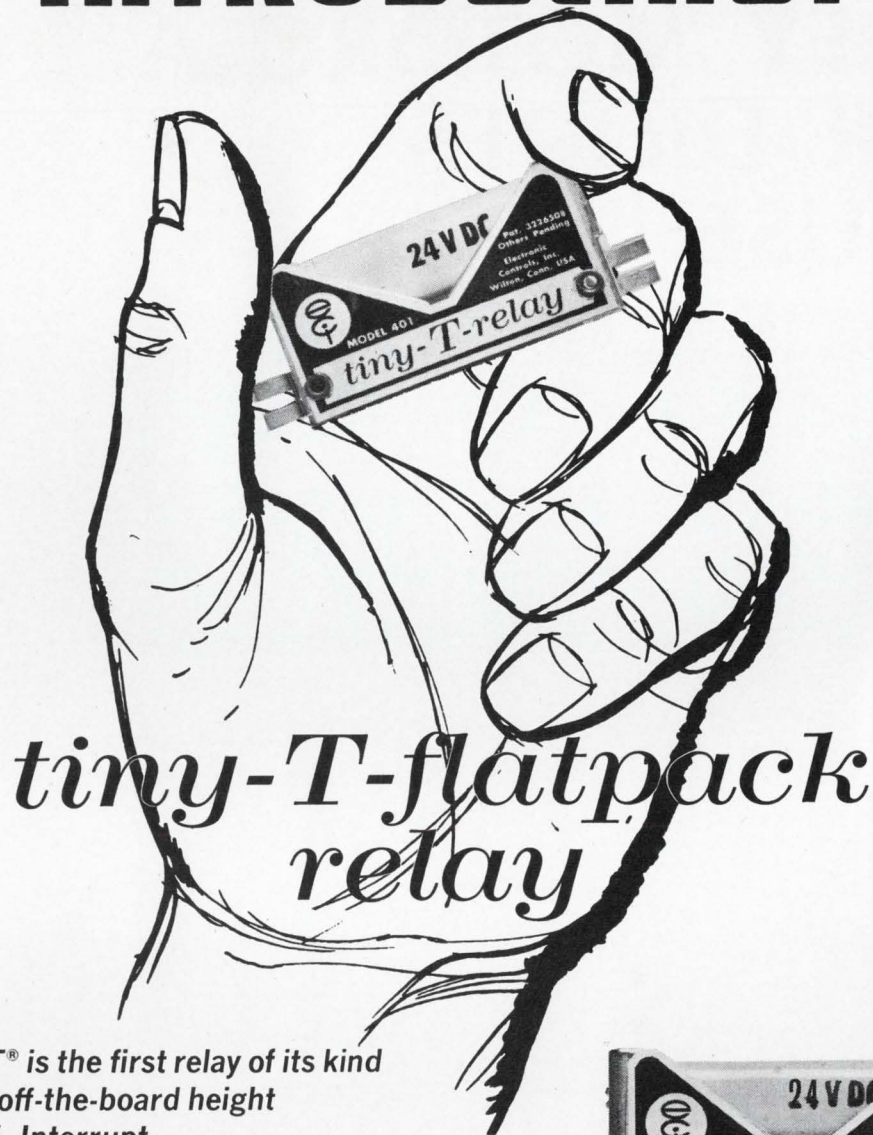

tiny-T-flatpack relay

- **TINY-T® is the first relay of its kind**
- **.340" off-the-board height**
- **1000V. Interrupt**
- **10 Milliohms or less contact resistance**
- **Switches 150W. per contact**
- **100-Million operating cycles**
- **Inexpensive cost and operation**

OPERATIONAL SAMPLES AVAILABLE!

At last . . . here's the Four Pole flatpack relay that everyone has asked for! Offering the ideal dimension off-the-board (.340"), the Tiny-T® features a standard .100 x .100 grid terminal layout, making it ideal for printed circuit board applications. ■ We'll gladly send you a sample at a special \$4.00 introductory price so you can put Tiny-T® to the test. Our representatives are ready for your orders in all quantities. So are we! ■

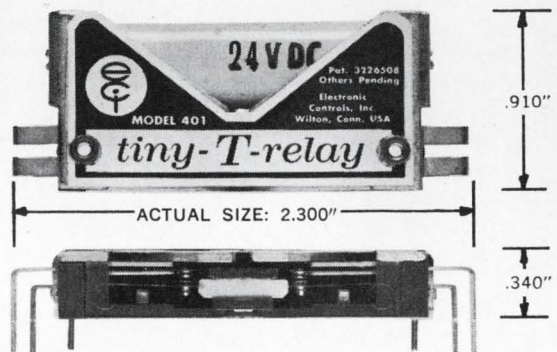

Electronic Controls, Inc.
Switch/Relay Division
Danbury Road
Wilton, Connecticut 06897

- Enclosed is our Purchase Order for \$4; please rush a Tiny-T Relay Sample.
- Have a representative call with more details.
- Send Bulletin #TB401 on the Tiny-T.

I anticipate using the Tiny-T Relay for _____

NAME _____ TITLE _____
DIVISION _____
FIRM _____
STREET _____
CITY _____ STATE _____ ZIP _____



electronic controls, inc.

T-Bar Switch/Relay Div. • Danbury Road, Wilton, Conn.

phone (203) 762/8351

ON READER-SERVICE CARD CIRCLE 32

SHOULD YOU SPECIFY MOTOROLA ZENER DIODES BECAUSE:

OF THEIR
UNIQUE
HANDBOOK

?

THEY'RE
HIGHLY
RELIABLE

?

THEY
FIT ALL
DESIGNS

?

ABSOLUTELY.

There are lot of good reasons for specifying Motorola zener diodes for your next equipment design. Most of them get down to one basic ingredient — quality.

For a look at the broadest line of zener and temperature-compensated reference diodes with the highest industry-recognized quality, write to Box 955, Phoenix, Arizona 85001.

We'll send along data on the newly revised, time-saving zener diode applications aid, too — the Motorola Zener Diode Handbook . . . absolutely the only one of its kind available.

- where the priceless ingredient is care!



MOTOROLA
Semiconductors

Dolphins challenge the designer

Animal's echo-locating outperforms sonar, while sound outputs push limits of detection electronics

Richard N. Einhorn
News Editor

In the Fourth Century B.C., Aristotle began to observe the dolphin. He noted its intelligence, social organization and apparent friendliness toward man. In the intervening 23 centuries very little else was learned about this intriguing animal. Recently, however, scientists in various disciplines have converged on it. The application of electronic equipment—the hydrophone to penetrate the dolphin's environment, the tape recorder to accumulate data and computers to analyze it—has enabled them in the last 15 years to make the first real advances since Aristotle's original observations.

The scientists are seeking answers to such questions as:

- Does the dolphin have a language comparable to a human one?
- Can the dolphin be taught to communicate with man and vice versa?
- What lessons can we learn from the dolphin as a bionic model—for example, can engineers learn how to design improved sonar from the dolphin's echo-location techniques?
- Will dolphins become the "Es-kimo dogs of the deep" to aid man in his explorations under the sea?

It is a truly international venture. Research is being carried out in laboratories on both coasts of the United States, as well as in the Caribbean, Mediterranean and Black Seas. In this country there are several major research centers:

- Naval Missile Center, Point Mugu, Calif. (about 60 miles up the coast from Los Angeles).
- Communication Research Institute, Miami, Fla.

Dolphin pushes paddle with beak during test of its hearing response. This triggers automatic fish feeder.

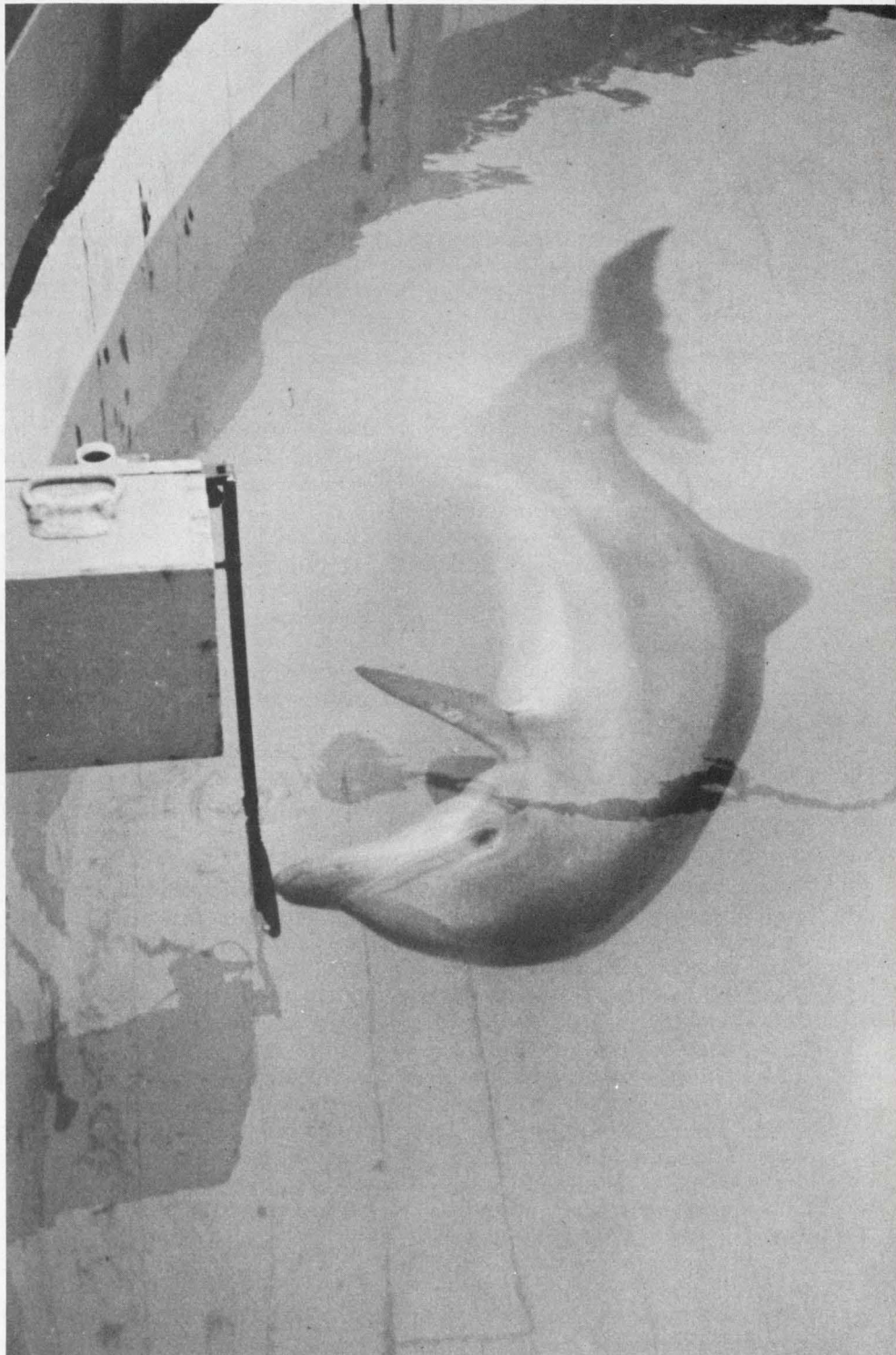

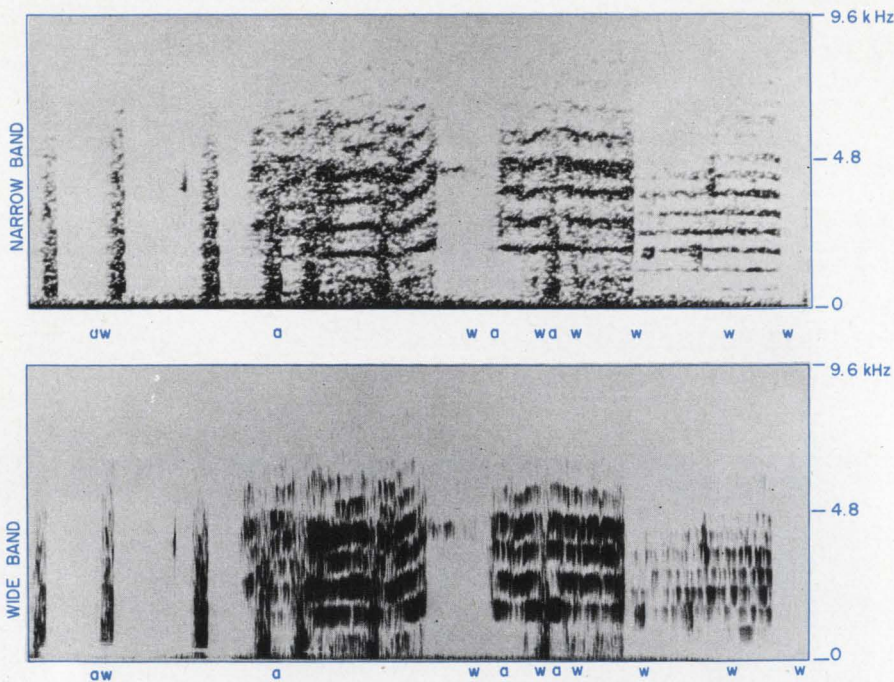

1. Dolphin's sounds produced in air (a) and under water (w) alternately are displayed on sonagram. Vertical axis represents frequency and the horizontal, time. The two traces represent the same information recorded with a 45-Hz bandpass filter (top) and a 300-Hz filter (bottom). The broad traces represent a banjo-like sound and the narrow ones barks, according to Dr. John C. Lilly. (Reprinted from *Proc. Amer. Philo. Soc.*, CVI, No. 6 (December 1962), 523)

■ Oceanic Institute, Sea Life Park, Oahu, Hawaii.

In addition, delphinologists (as experts on dolphins are known) use the facilities of such aquaria as Marineland in St. Augustine, Fla., and Marineland of the Pacific in Palos Verdes Estates, Calif., after visiting hours.

Research with dolphins is more than just a matter of scientific curiosity. It involves the most sophisticated electronic technology used by natural scientists. Already the inventory of equipment includes hydrophones, transducers, instrumentation tape recorders, spectrum analyzers, oscilloscopes, telemetry equipment and computers. It also includes such specialized equipment as man-to-dolphin and dolphin-to-man translators (devices with which scientists attempt to make the English language more comprehensible to dolphins and delphinese more so to them).

But this is only a beginning. What is learned about the limitations of existing equipment—especially the wide-band hydrophones, which many scientists have criticized—will spur the design of a new generation of instruments for field work. It embraces the dolphin (a system), the sensory apparatus (subsystems) and

the environment. Many of the signals cannot be seen or heard. Improved instrumentation is essential.

Often the data gathered cannot be reduced to real-time observations. At present the scientists struggle with jerry-rigs. Most of the fallout from the aerospace program has proved overly expensive and overly complex. The delphinologists need help from the systems engineer.

Dolphins are toothed whales

What is a dolphin? The question is by no means obvious, for there seems to be a great deal of confusion among nonscientists. A dolphin is any one of more than fifty species of small, toothed whales that range from the killer whale down to the freshwater dolphin of the Amazon. They are air-breathing mammals that live in the ocean but must surface every few minutes. If kept out of water for prolonged periods, they would die because they cannot support their own weight on land. The porpoise is only one variety of dolphin, although many Navy men call all dolphins "porpoises." In this report, by dolphin is meant the Atlantic bottlenose dolphin (*Tursiops truncatus*). This species is bright, articulate and docile, and

thrives better than most in captivity.

Dolphins have large brains that compare favorably with man's in size (20 to 40 per cent larger) as well as in degree of convolution. They are thought to be intelligent, though only the most foolhardy scientist would try to assign an IQ range to them now.

They are friendly to humans, and will endure more abuse from a person without biting than they will from another dolphin. In captivity, even the killer whale is gentle and can be trained for circus performances. They appear to be noisy and gregarious, with an active social life.

Since they are vocal animals, anyone studying them needs a hydrophone and tape recorder at the very least. At times the instrumentation must be highly complex. Many studies have been performed on the dolphin's sound production. Among the abilities discovered by scientists are the following:

- The dolphin emits sounds in a spectrum from about 200 Hz to 150 kHz. Waveforms range from steep pulses (clicks) to almost pure sine waves (whistles).

- The dolphin has at least two (possibly three) independent sound sources and can use them separately or in conjunction.

- The dolphin apparently knows how to beat waveforms to produce sum and difference frequencies that are useful in echo-location as well as communication.

- The dolphin can convey not only emotion but also information about the environment to other dolphins.

- Each dolphin has its own signature whistle (like call letters).

- The dolphin naturally emits sounds underwater, and in captivity learns to vocalize in air.

- The dolphin can mimic human speech in a "Donald Duck" fashion.

I. Sound-production

At Communication Research Institute, where Dr. John C. Lilly is the director as well as the principal scientist, a great deal of electronic equipment is brought to bear on the dolphin's sound output.

Sounds in the dolphin's repertoire are variously described as whistles, squeaks, clicks, buzzes, racks, squawks, barks, yelps and chirps.



1

1 Echoless mud bottom of Hawaiian inlet favors tests from houseboat laboratory.

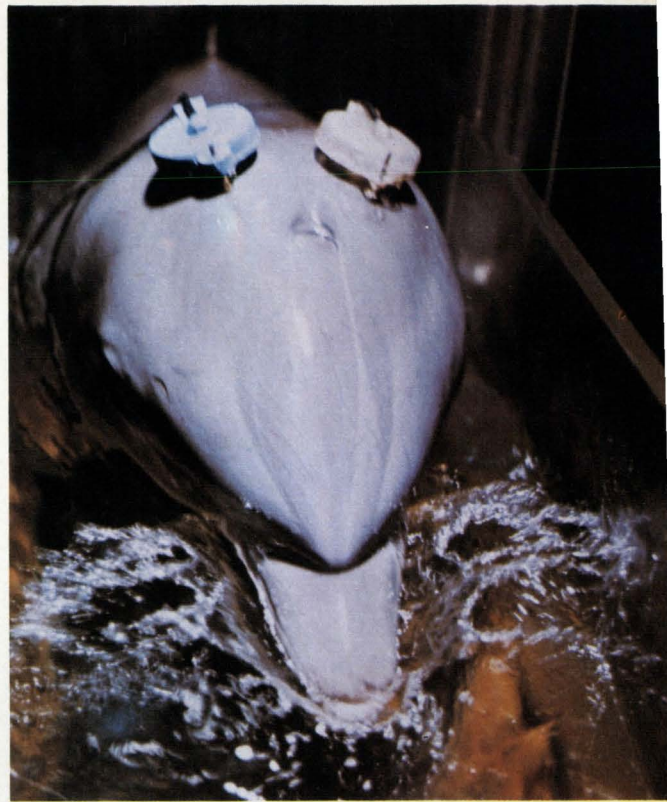

2

2 Lady playfully splashes Hasselblad from tank where dolphin voices are recorded.

3 Doris vocalizes into hydrophone held by Airman Brian Bates at Point Mugu.

3

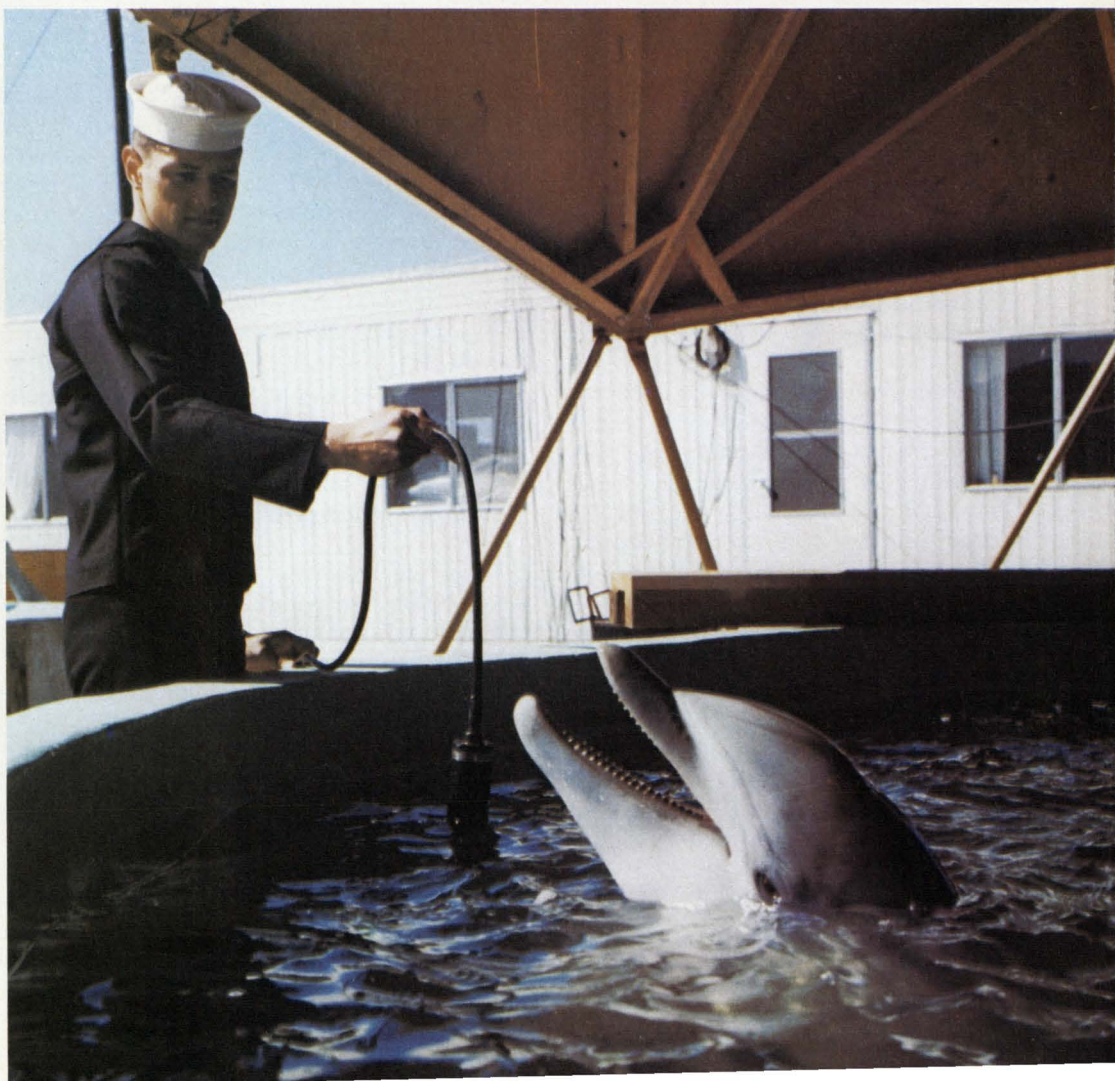

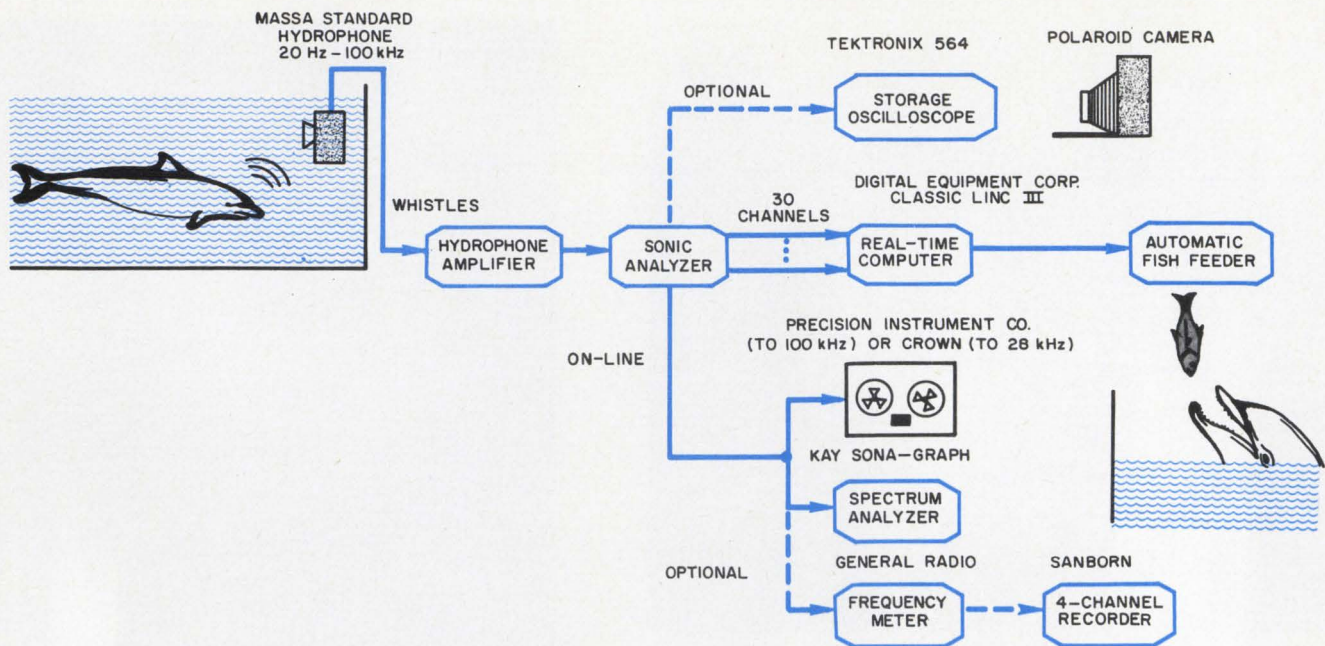

2. Dolphin undergoes programmed tests of its vocalization. If the computer determines that the animal has given a correct response, it actuates an automatic fish feeder that

plops a thawed fish into the tank. Sonic analyzer divides spectrum into 30 bands in real time. Computer sorts frequencies to form bar graph of their distribution.

But these terms are as subjective as "moo" or "meow." Delphinologists recognize this and generally include oscillograms and sound spectrograms in their papers.

Form sonic spectrograms

Exchanges between two dolphins or between a dolphin and a human can be displayed on sonagrams (Fig. 1). The Sona-Graph is manufactured by the Kay Electric Co., Pine Brook, N.J., under license from Bell Telephone Laboratories. It analyzes sound signals in the range from 85 to 8000 Hz and provides a graphic contour on facsimile paper. Any portion of this frequency range may be examined on an expanded scale. The frequency response can be extended by slowing down the playback of any magnetic tape that is used as an input to the Sona-Graph. Bandpass filters permit analysis of 45- and 300-Hz bands. The output of the analyzing filter is then recorded on dry facsimile paper, which is wrapped around a smooth drum. A high-frequency current applied to the stylus is varied according to the amplitude of the signal. Time is displayed on the abscissa, frequency on the ordinate, and intensity as shades of gray or black.

In one setup (Figs. 2, 3), the dolphin's outputs are divided into frequency bands by a sonic analyzer (Kay Sonaizer) which operates in

real time. The Sonaizer routes these signals simultaneously to a tape recorder, a spectrum analyzer, a storage oscilloscope with Polaroid camera attachment, a four-channel recorder and a digital computer that operates in real time.

A relatively wide-band ammonium dihydrogen phosphate crystal hydrophone is used to pick up the dolphin's outputs. Dr. Lilly complains that his Massa M-115C Standard hydrophone has a poor signal-to-noise ratio and rings at 130 kHz. At this frequency it can be shock-excited by the dolphin's sonar emissions, and an input attenuator has to be used to prevent overload. Because the amplitude of the dolphin's signals is high, the hydrophone is run at a level of -30 dB.

Hydrophones are criticized

"We very definitely need a better wide-band hydrophone, he says. "We have other hydrophones, smaller ones, that can go up to 150 kHz. But I think commercial ones in general have too high a noise level."

Another investigator, the late Dwight W. Batteau, agreed with Dr. Lilly that dolphins can produce ringing in wide-band hydrophones. (These criticisms of equipment, like many others made, are specific to dolphin research. While the instruments may be adequate for their

intended applications, the intensity and wide bandwidth of the dolphin's sound emissions, coupled with stringent environmental demands, often require special-purpose devices that simply are not available. In some cases the cost of suitable electronics far exceeds the budget of the delphinologists.)

Asked about Dr. Lilly's problem, Batteau, who was a professor of mechanical engineering at Tufts University, Medford, Mass., and president of Listening, Inc., at nearby Arlington, said:

"He shouldn't be using that hydrophone if it's the same type of Massa hydrophone we were using. It has a poor signal-to-noise ratio, and it may be too large for this application. I think that for the extremely broad-band frequency analysis Lilly is trying to do with rack (click) sounds he needs a 1/10-inch hydrophone, like the Atlantic Research instruments that go up to 500 kHz. The use of FET preamplifiers mounted as close as possible to the hydrophones would cut down on cable-induced microphonic noise. The cable is capacitive. It eliminates hum pickup from fields in the wire. There are 2 feet of cable to the pre-amplifier. There may now be some hydrophone units available with an integrated preamplifier."

Other delphinologists, however, complain that small hydrophones generally fall off at the lower end,

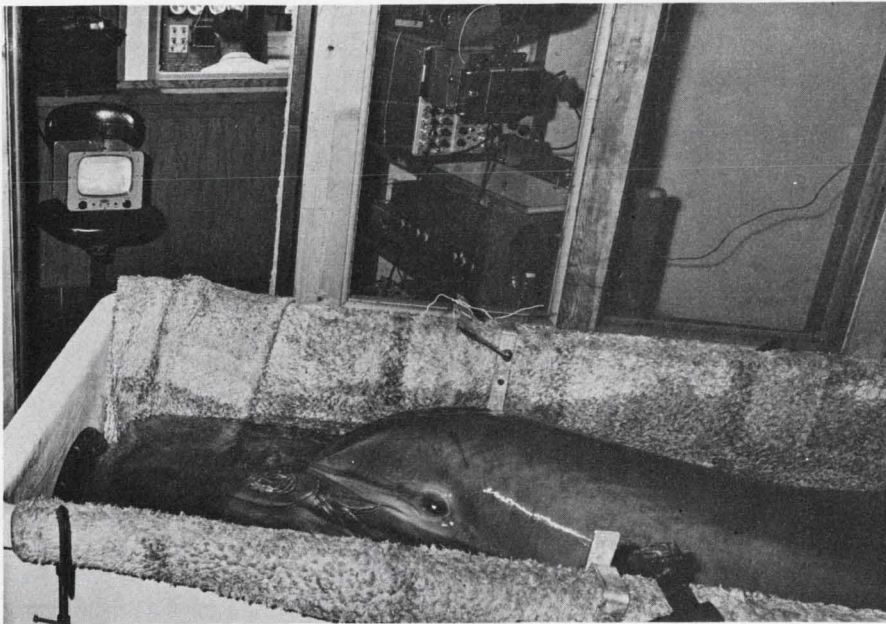

3. Dolphin rests in isolation tank for study of the sounds produced in its head. Either a hydrophone suspended in tank or small transducers mounted on its head may be used. Behavior is monitored over TV. Toweling reduces echo.

that is, frequency response is inversely proportional to size. Also, they tend to be less sensitive than the larger units.

Dr. Lilly also uses transducers with telemetry transmitters that are held on the animal's head with suction cups (see cover). They pick up sonic and ultrasonic outputs directly from the dolphin's head, thus avoiding echoes and giving more accurate timing. In addition, the tighter coupling causes less loss of amplitude than the path through the tank to a receiving hydrophone. The devices are made by Sensory Systems Inc., Tucson, Ariz.

"They're useful for certain special things, for example, if you want to know when the dolphin is transmitting in the human-speech bands," Dr. Lilly comments. "The bandwidth is 500 Hz to 60 kHz. The hydrophone in the tank can pick up higher frequencies."

Dr. Lilly is not satisfied with the transmitting hydrophones used for projecting sound into the dolphin tanks, either.

"A separate hydrophone is needed for active use," he says. "It requires 50-watt peaks to give effective transmissions. The dolphins, by the way, are very curious about the transmitting hydrophones. If the amplitude is too high, they will try to throw the hydrophones out of the tank."

One approach to remedying the

deficiencies of transmitting hydrophones has been tried by William Evans and Jarvis Bastian, two scientists at the Naval Missile Center at Point Mugu. They use an array of hydrophones connected like a multiple-loudspeaker hi-fi audio system. Crossover networks divide the sounds among the hydrophones, each covering a specific band. This gives equal intensity of signals over a wide band. Its only shortcoming is that it does not present a point source to the dolphin, but even that problem exists only in the near sound field.

Filters distort nonlinearly

Dr. Lilly is also critical of the commercial filters used in his laboratory.

"Both the active and the passive filters leave something to be desired," he says. "The Spencer-Kennedy variable electronic filters that we have give too high a noise level for large-amplitude signals. They are nonlinear. Not only do they go into harmonics, but they also change the waveforms."

Referring to Allison Laboratories narrow-passband nickel magnetostrictive filters, he says, "We must use a matching transformer, which introduces 60-cycle hum. What we really need is a filter with high input-output impedance, with no noise or microphonics."

The filters are necessary to cut out any portion of the dolphin's emissions that may act as a noise source in a given experiment. Variable skirts in cascade therefore are needed to change the slope of the filter. They have to be sharp—something like 45 dB per octave, Dr. Lilly says.

Working with the miniature dolphin-mounted transducer pickups, Dr. Lilly was able to make discoveries about what he calls the dolphin's stereophonation. If the transducers are positioned correctly, a listener with stereo headphones (Fig. 4) can notice the sounds moving back and forth from left to right. The apparent sound source seems to move through the listener's head.

According to Dr. Lilly, the dolphin's blowhole (an orifice just in front of its forehead) is used both for breathing and for emitting sounds. Like the human nose, it is divided internally. The right nasal passage is usually slightly larger than the left. Air sacs in the nasal passages function as sound emitters.

Dolphins blow in stereo

How does the dolphin use this system? Dr. Lilly speculated that because of the asymmetry of the nasal passages, there are frequency differences: the right channel is slightly lower in pitch.

The dolphin might use the left side to generate a sound that rises in pitch with time, and the right side to generate one that falls in pitch with time. Since the rise and the fall start and end simultaneously, the change in pitch for both channels resembles a less-than sign (<).

The two straight-line outputs that form the (<) output beat to form sum and difference frequencies. Since the algebraic sum of corresponding values along the left and right traces is always twice the initial frequency, the slope of the sum frequency line is zero, so the output looks like a dash (—); Dr. Lilly calls this the "bar call." The difference frequency, however, increases with time, starting with zero and ending with the initial frequency value. The difference output resembles a slash (/); Dr. Lilly calls this the "slash call."

For example, if the dolphin emits one call in the left nasal passage

starting at 10,500 Hz and rising to 15,000 Hz, and another in the right channel starting at 9500 Hz and falling to 5000 Hz, the sum frequency is always 20,000 Hz (a straight-line trace). The difference frequency starts at 1000 Hz (10,500 — 9500) and ends at 10,000 (15,000 — 5000).

The effect is to put the difference frequency trace (the slash call) entirely within the human hearing range (below 10,000 Hz) and the sum frequency trace (the bar call) entirely out of the sonic range (20,000 Hz throughout).

This beating of frequencies causes no problems for the dolphin: it can recognize the three sounds (<), (—), and (/); in fact, to the dolphin (<) is equivalent to (—/), the sum and difference frequency components taken separately.

The human, on the other hand, can hear the slash (/) call easily, the (<) call faintly and the (—) not at all, since it is out of his hearing range.

Computer rewards dolphin

In analyzing the dolphin's output, Dr. Lilly uses the Classic Linc (Laboratory Instrumentation Compiler), a small digital computer developed specifically for biomedical research. It is produced commercially by Digital Equipment Corp., Maynard, Mass. It generates stimuli under program control, digitizes the dolphin's analog responses (sound

outputs), stores data on tape, calculates distributions, performs correlations and compiles histograms.

Frank Grissman, Dr. Lilly's engineer, says that the Linc computer "in effect gives a survey of where the sound components lie. It is a new way to look at it in real time—we aren't concerned with amplitudes."

In essence, the outputs of a sonic analyzer are fed into the computer. There are 30 channels of inputs. In real time, the computer tracks a pulse traveling through the sonic analyzer and gates each channel. The serial outputs are stored. Each time a threshold for a channel is reached, a 1 is stored.

The output of the computer is a bar graph, not of amplitude vs frequency of the dolphin's outputs, but of the distribution of the frequencies. The height of each bar depends on the number of times the threshold amplitude for that frequency is reached. Values below the threshold are rejected and do not appear.

Since the outputs of the sonic analyzer are computed and displayed in real time, it is possible to run tests on the dolphins without human intervention. The Linc computer is programmed to deliver a sound or other stimulus (making use of the other electronics shown in Fig. 2). If the computer recognizes the proper response, it triggers an automatic fish feeder, which plops a thawed fish into the tank.

Frank Grissman says that the Communication Research Institute

plans to replace its Classic Linc with Digital Equipment Corp.'s PDP-8, an advanced model with a more flexible memory that converts from the user's mnemonics to machine language. Neither model is a high-speed device, but Grissman thinks that versatility is more important for this application than brute calculating power.

Dr. Lilly described another use of the computer — analysis of tapes made during the experiments. He uses a Precision Instrument Co. tape recorder with an upper limit of 100 kHz.

"We really need 150 kHz because the dolphin's clicks go up there," he says. "On the other hand, with this machine it is convenient and relatively easy to decrease playback speed to one-tenth by turning a switch."

A tape loop that repeats selected segments is used when the computer is required to scan data with different parameters, such as different bands of frequencies.

"With a single click, you have to determine what band you are in," Dr. Lilly points out. "You record the click on tape, and put it through the Sonalyzer, which gives the frequency-vs-amplitude plot of the click."

"Then the computer provides outputs which are the distribution of frequencies within a narrow band of frequencies. The computer looks at each band and detects the number of above-threshold signals. By such means you can show the dolphin's control over the frequency of click trains. As you go from one segment of tape to another you can show the peaks shifting. It is possible to see that during a click train, the peak or dominant frequency can shift up or down dramatically. We have been doing this for only the last two years."

A General Radio frequency meter is used in the analyses.

"It is especially good for whistles," Dr. Lilly says. "We can plot the frequency of the fundamental very rapidly from a tape. The output is put on a four-track Sanborn recorder. This recorder has a nice black trace that is good for photography."

Asked what he would be able to do with more nearly ideal equipment in general, Dr. Lilly said: "Eventually we will be able to specify the physics of the dolphin's voice pro-

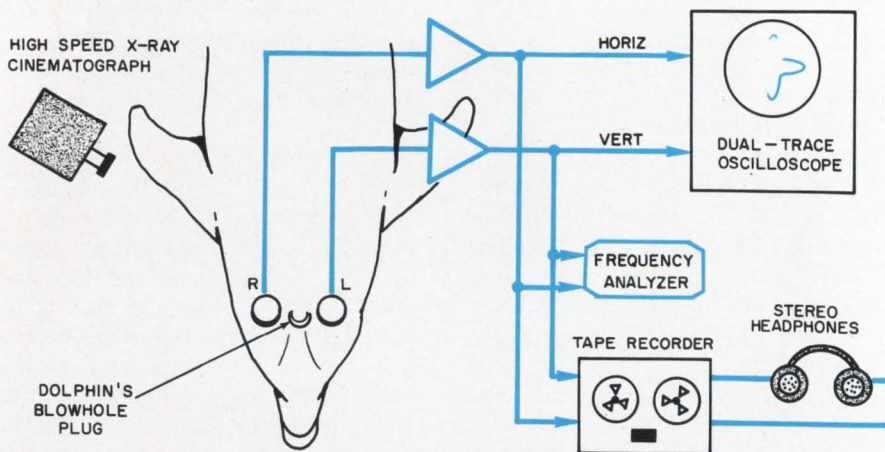

4. Dolphin can produce sounds in "stereo," Dr. Lilly asserts. If it clicks or whistles only with the left side, only a vertical trace appears on the oscilloscope. If only with the right side, there is only a horizontal trace. If there are two separate emissions, a cruciform pattern (shown in diagram) results. When the two sound sources are coupled, there are complex, shifting ellipses. Listener with stereo headphones senses apparent sound source shifting. Cinematograph takes high-speed X-ray motion pictures of the blowhole to reveal the dolphin's independent control of two emitters.

duction. I predict this will take place in less than five years, but in more than one year. However, improved equipment is not the whole answer. We have to know more about our own human perception of these sounds."

II. Echo-locating

One area in which human perception very definitely takes a back seat to instrumentation is the study of the dolphin's echo-locating. The sounds are emitted under water and the peak energy is out of the human sonic band.

Several unusual features have been discovered about the dolphin's sonar:

- The dolphin can vary the repetition rate and frequency, to select general-environmental-scanning and fine-discrimination modes.

- The dolphin can use some of its anatomical structures to beam its sonar.

- The dolphin takes advantage of beat frequencies to gain information.

- The dolphin can discern differences between dissimilar materials, even when they give returns with the same sound intensity.

Man has yet to produce the multi-function, omnidirectional sonar set. But nature, in the form of the dolphin, seems to have solved the problem in a highly compact apparatus.

At present, engineers are forced to design specialized sonars because of the conflict between power and frequency requirements. Thus they end up with various kinds: low-frequency, high-power for long-range search; high-frequency for short-range, high-resolution identification; and intermediate frequencies for sea-floor contour-mapping.

The mechanical and electrical properties of transducers are an obstacle to the operation of sonars over broad frequency ranges. The dolphin is versatile: it can vary the frequency, propagate energy either in a beam or omnidirectionally, and couple its sound sources to produce either pulsed or modulated signals. Mechanical transducers simply cannot match the characteristics that the dolphin can produce merely by flexing its muscles.

How important is the dolphin's echo-location? Take it away and it cannot survive. At night or in

murky water it can't see more than a few inches in any direction. How can the dolphin tell what's up ahead while cruising at 10 knots? Is it another dolphin, something as unsavory as a shark or sawfish, the keel of a boat, the sea bottom? How can the dolphin locate a school of fish, or surface in the trough of a wave (not its crest) to breathe?

Poker faces are out

Dr. Lilly tells what it might be like if men were dolphins and looked at one another underwater by means of sonar:

"Sound waves in water penetrate a body without much external reflections or absorptions. Skin, muscle and fat are essentially transparent to the sound waves coming through the water. The internal reflections are from air-containing cavities and from bones. Thus we see a fuzzy outline of the whole body plus the bones and teeth fairly clearly delineated; the most sharply delineated objects are any gas-containing cavities."

In other words, we could "read" a person's emotions from the bubbles in his stomach. We wouldn't need facial expressions, which we couldn't see anyway. In fact, in the course of evolution dolphins have lost the ability to vary their seemingly perpetual smiles.

The dolphin's sonar signals serve two main functions: orientation to the general features of the environment, and discrimination of objects that have already been located. The signals vary, depending on what is going on.

Scans its environment

As a dolphin swims in the ocean, even in the clearest, most sunlit parts, it generates short, plosive pulses with a lot of air pressure behind them. We would hear them as loud clicks. If these clicks are recorded on magnetic tape and analyzed, it could be seen that they vary widely in repetition rate — so much so that they appear sporadic. Individual clicks last a millisecond or more, and may be uttered singly or in short series.

These are orientation clicks. With them the dolphin gets a quick-and-dirty look at large objects in its vicinity. The captive dolphin does

this even in its own tank, which it may have traversed a million times.

When it detects a target of interest, say, a mackerel thrown into its tank, the pulse repetition rate increases from the 20 or 30 or 80 pps the dolphin was using for orientation to several hundred a second. The plosive clicking signals become so closely spaced that in aggregate they sound like a creaking door or a rusty hinge.

The dolphin is now operating in its discrimination (fine-resolution) mode. The trains last anywhere from 1 to 10 seconds, depending on the difficulty of discrimination. To a human observer at poolside, the intensity of the clicks seems to drop when discrimination starts. This happens because the animal is displacing much of the energy from the (human) sonic region to the ultrasonic.

Kenneth S. Norris, a professor of zoology at the University of California, Los Angeles, who has spent years studying the dolphin's echo-location capabilities, both in the laboratory and at sea, says that the clicks have a broad energy band. The majority of the energy in a typical click lies below 30 kHz, but there are significant outputs up to 80 kHz, and some outputs well above 100 kHz. The discrimination clicks are very short—typically, 0.2 to 0.7 ms—and have a rise time as steep as 10 microseconds.

Only the rapid click trains are involved in echo-location, Norris says. As far as is known, true echo-location trains are produced with a closed blowhole in water. The open-blowhole sounds may be related to communication and are largely of frequencies audible to humans.

An echo-locating dolphin scans the environment by swinging its head, Norris says. While this enables the animal to scan with trains of directional sound pulses, it also changes the position of the dolphin's ear for fine direction-finding. Another possibility is that the dolphin might be scanning with some other pickup structure as well. Norris and others suggest that the dolphin's lower jaws may serve as sound pickups and waveguides.

Dr. Lilly theorizes that the dolphin scans with two separate sound sources and can move back and forth between them. More precisely, it can shift its sound source anywhere it

desires between the two outer limits. It may thus be introducing a Doppler effect into its own sound production, and may be controlling its near-field and far-field amplitudes as it shifts from monopole to dipole modes.

In echo-location, this could be extremely useful. With this angular information, however slight, the dolphin could triangulate for more accurate target-location.

The gist of Dr. Lilly's theory is that, unlike a frequency-modulated radar, the dolphin emits two signals simultaneously, one rising in pitch with time, the other falling. The dolphin is able to use the beating of these two signals to gain information.

The dolphin's slash call is most likely used for the omnidirectional long-wavelength orientation sonar, Dr. Lilly says. What evidence is there? Dr. Lilly reports that when he placed dolphins in new surroundings, they emitted the slash call. But once they had mapped their environment, they stopped, or at least emitted it less frequently. This agrees with Norris' observations on orientation. Dr. Lilly also claims that the dolphin uses its larynx as a third sound source to produce a narrow, fan-shaped beam of high frequency (about 100 kHz) sonar. The beam is shaped by the dolphin's head, which serves as a variable acoustic lens, and is used for fine discrimination.

Discrimination is fine

How good is the dolphin's sonar? Several recent experiments have tested it. Two of the most active investigators have been Norris and a former student of his, William E. Evans, now working for the Naval Undersea Warfare Center.

Norris and Evans blindfolded a captive dolphin with suction cups that fitted over the eyes. Next they trained the dolphin to close in on two nickel-steel bearings and to specify which of the two was larger by pressing a lever on the correct side.

Their dolphin achieved a perfect score when one sphere was 2-1/8 inches in diameter and the other was 2-1/2 inches, but it was right only 77 per cent of the time when the spheres were 2-1/4 inches and 2-1/2 inches, respectively.

At one stage they tried to make the dolphin choose between two identical bearings, but the animal wasn't stupid. It would simply turn away from the problem.

How did it know that an impossible problem had been presented, yet know at other times that it was faced with a possible but difficult problem? One explanation is that a single click might return from both ball bearings with a mixture of two different lower frequency limits and different intensities. Then the dolphin would at least know that it had a problem.

During these tests, the scientists recorded the dolphin's sound production, so that they could correlate it with the dolphin's successful discriminations. They verified that most of the energy is concentrated between 16 and 30 kHz. They found that for the simplest discriminations the click trains were uniform and ranged from 1.1 to 2.9 seconds. For more difficult tasks, the longest train was 4.7 seconds. The dolphin usually started a test at a repetition rate of from 80 to 100 pps and went as high as 230 pps.

Detects different materials

Evans went on to prove that dolphins can distinguish between different metals, even when they exhibit the same reflectivity to sound waves and therefore have echoes of the same intensity. (The two ball bearings of different sizes varied the frequency content of the reflected pulses as well as the intensity.) He and Bill A. Powell of the Naval Undersea Warfare Laboratory prepared target disks of different metals of various thicknesses. They had plotted the reflectivity of these metals with a computer and determined that 0.22 cm of copper could be used as a standard target.

They trained a female dolphin named Scylla to swim blindfold down a runway and select the standard target in preference to comparison targets of copper, brass and aluminum. Scylla was unable to distinguish copper or brass targets that were close to the standard in thickness, but she could distinguish a 0.64-cm copper target from the 0.22-cm standard with an accuracy of 85 per cent. With much thicker aluminum targets, she always scored better than 90 per cent, even when

the reflectivity was theoretically identical to that of the standard.

This puzzled them until a coworker, C. Scott Johnson, deduced that the dolphin must be using information other than relative echo intensity. He concluded that phase differences, produced by reflections from the back of the target by sound waves entering the front, supplemented the dolphin's information.

Norris and Evans say that the dolphin uses time relations within click trains to derive information about targets. The rate change of the repetition rate itself can become a measure of gross closing rate. A much more precise measure is the time interval between the end of an outgoing click and the beginning of reception of the echo. Knowing its own speed within reasonable limits, the dolphin should be able to gauge the relative speed of the target by assessing the rate of change of echo placement.

Evans thinks that the dolphin uses built-in mechanisms to overcome noise and jamming signals. He says the animals single out important echoes in a complicated ensemble just as easily as human beings can pick up one conversation at a party or one stringed instrument in a quartet. Well-developed directional hearing and the ability to emit sound in a narrow, fan-shaped beam from its forehead could account for the dolphin's success even in noisy environments.

Dolphin wears antenna

Recently Evans demonstrated his equipment (and his star, Scylla) to ELECTRONIC DESIGN. Evans maps the sound fields around Scylla's head by telemetering the outputs of miniature hydrophones fastened to her head by suction cups. The hydrophone is an Atlantic Research Corp. LC-10 lead zirconate titanate device. The telemetry units are solid-state fm transmitters designed by Gary Blanc of the Naval Weapons Center, China Lake, Calif. Each transmitter is housed in a little hinged plastic parts box. The transmitter box and the hydrophone are both cemented directly to the suction cup (Fig. 5).

The unit consists of three stages of amplification (FETs are used in the first two) and a modified Colpitts oscillator stage tuned to 55 MHz. The amplified signals from the

1 Dolphins lug tools and messages on Navy's Sealab project and can be summoned by acoustic signals.

2 Frank Grissman studies frequency distribution of dolphin's output with aid of Linc digital computer.

3 Curious, Pequod surveys scene at Communication Research Institute after splashing the author.



1

2

3

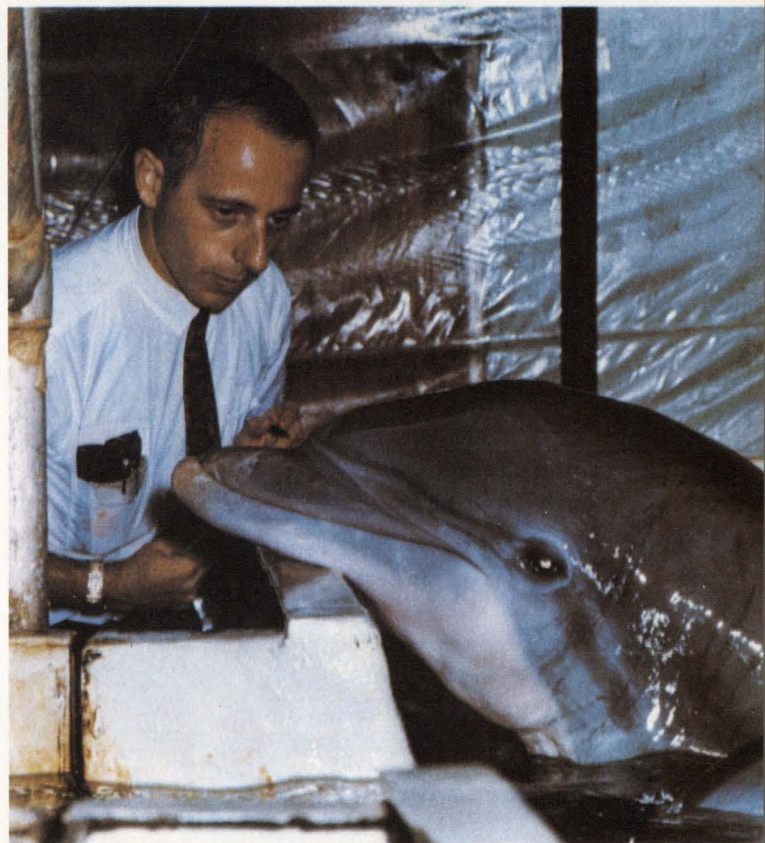
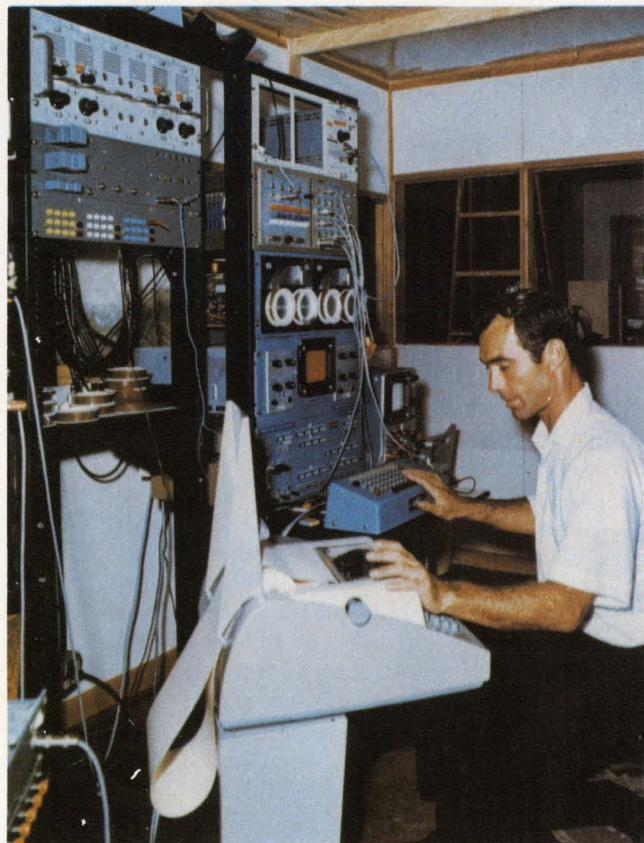

hydrophone frequency-modulate the output of the oscillator. Use of a 55-MHz carrier necessitates a monopole antenna that is always in the air even when the dolphin is submerged. Otherwise, the high-frequency signals would not penetrate the water.

Blanc says that he selected a 55-MHz operating frequency because it can be accommodated at the lower end of the high-quality wide-band telemetry receiver available for the experiment. He says that a much lower transmitting frequency would be desirable, since then the rf could be transmitted directly through the salt water medium. This would eliminate the antenna, which Evans feels is objectionable.

Blanc has the basic design down to the point where he can build

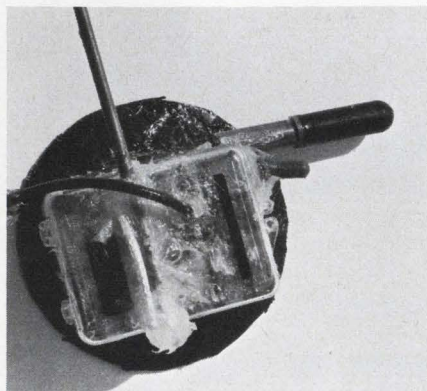

5. Dolphin's sonar pulses are telemetered with unit designed by Gary Blanc of U.S. Naval Weapons Center. Hydrophone and a transmitter packaged in a plastic box are cemented to suction cup that fits on the animal's head. Monopole antenna sticks up out of water even when dolphin is submerged.

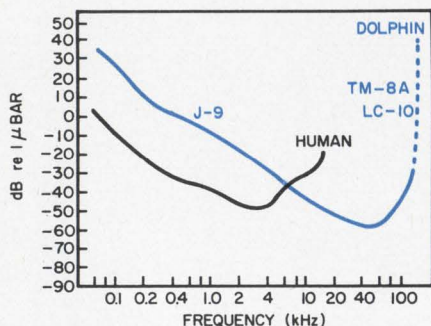

6. Hearing of dolphin is mapped with sine waves. Three hydrophones (Atlantic Research LC-10, Apeldo TM-8A and U.S. Navy J-9) are used because no one projector covers the band.

transmitters in about half a day. He is currently designing a transmitter to operate at an fm carrier frequency of about 1 MHz, but he points out that no commercial receiver can handle the signal because the dolphin's pulses have such broad frequency spectra (at least 150 kHz). Therefore, he must either design a receiver or modify an existing one.

"We have to make compromises," Evans says, "but all in all, it works nicely with the animal."

Receiver bandwidth poor

Evans also uses a larger hydrophone suspended in the tank. Since no telemetry link is used with this hydrophone, the output goes directly to an amplifier. The telemetered outputs of the miniature transducers (Evans uses two or four of them positioned to provide phase information as well as frequency and amplitude) first have to be demodulated by an fm receiver.

"I would like to be able to use fm at 1 MHz because I could feed the output directly into a tape recorder like the Ampex FR 1400, which has a 1.5-MHz bandwidth," Evans comments. "I could simply slow down the fm tape to get it digitized. That way I can avoid some of the noise pickup, because 1-MHz receivers usually aren't much good."

Evans doesn't have an FR 1400 predetection tape recorder in his inventory, although he wishes he did. In his usual setup, the amplified hydrophone or transducer signals from the receiver are amplified and filtered with a Krohn-Hite variable filter, model 3202R.

"We also have a Spencer-Kennedy filter," Evans says. "The Krohn-Hite does the same job, only with slightly less noise."

From there the signals are applied to an Ampex FR 1300 tape recorder operating on multiple tracks at 60 in./s. This machine goes up to at least 300 kHz and can accommodate every signal of interest. Sometimes the signals are also displayed on a storage oscilloscope.

"We're fortunate in being able to get some time on a large computer for analyzing the runs on a target. We really need this computer because we're dealing with very short duration transients that are difficult to analyze. We also run the hydro-

phone signals through a sound spectrum analyzer like the Kay Sona-Graph. This doesn't give the full frequency response, but it's handy as a sort of index to what I want to look for later on. I paste the sonagrams right into my data book.

"We send the tapes from the instrumentation recorder to China Lake. The tapes are records of the animals' sounds as a function of time. We enter timing pulses on the tapes using IRIG format-B range timing, as in space telemetry. There is a modulated 1-kHz time base that gives Greenwich Mean Time from the month down to the millisecond."

Digitize sonar sounds

At China Lake, an engineer by the name of Robert Stirton uses a NODAC analog-to-digital converter to digitize the signals for analysis by a Univac 1108 computer.

Stirton commented: "We sample the tapes with NODAC, which was developed at the Naval Ordnance Test Station. The computer does a Fourier analysis of frequency and transforms it into spectral density. The output shows the energy in the signal as a function of frequency. This analysis is similar to sonagrams, except that it is done on a computer."

Asked about the cost of such a procedure, Stirton said, "The amount of computer time varies. A typical recent run might be 0.2 or 0.3 second using a high-speed Fourier analysis method. It takes only a few minutes of human labor. It is extremely economical, and probably less expensive than making sonagrams for this program."

There is one decided advantage to this method: the full bandwidth of the transducer can be captured and analyzed, whereas sonagrams are limited in frequency response to 8 or 16 kHz, depending on the model.

Despite his success in recording echoes, Evans is not totally satisfied with the instruments at his disposal.

"By now I'm used to the concept that what I have to work with is usually the fallout from the defense and aerospace field. And that fallout isn't always useful to the people doing biological or medical research because industry doesn't do anything to help them.

"For example, when Ampex or

Lockheed builds a recorder or amplifier, they don't tell you what transducer to use and how to match equipment. They leave it up to you. Well, this may be all right for engineers who work with missiles, but the biologist, the veterinarian, or the physiologist needs help from the systems engineer."

Evans outlined the improvements he wanted. "We need a wider range of underwater transducers and hydrophones. I mean both in frequency response and in physical size.

"Then, we need improved sensitivity of the smaller barium titanate devices. When a transducer is made so small that it can fit in the dolphin's blowhole, the sensitivity tends to be extremely poor. So far, the animals have produced enough sound, but I am thinking about other research where this sensitivity is needed.

"A really big need is for good, high-quality battery-operated field equipment at a reasonable price: recorders, amplifiers — not only for scientists studying dolphins and sea lions, but also for the bird people and the bat people.

"As a minimum, I'd like to see two- and four-channel, reliable instrumentation-quality tape recorders with good response up to at least 100 kHz, with matched amplifiers.

"Lockheed makes a very fine battery-operated instrumentation recorder, but it costs 12 to 14 grand, almost as much as a Rolls Royce. These may be realistic prices for the quality, but let's hope that the price can come down some day to where we can afford them.

"Field units like the Uher, which have a response up to about 20 kHz are all right for recording whistles and hearing them, but for analyzing the signals from 20 kHz up, where much of the signal energy lies, we need something like the Lockheed.

"On field trips with a special glass-bottomed boat we got usable readings with the Ampex FR1300, but we had batteries with a converter on board and we picked up converter noise. The Ampex sopped up half a kilowatt and the batteries were used up quickly. It's equipped with handles, but you need two very strong guys to lug it. It is portable only in the sense that it isn't cemented down. A unit I could carry by myself would be useful."

Prof. Batteau commented that equipment used in this type of environment should be rugged.

"One of the severe problems of working in sea water is that it gets into everything," Batteau said. "We have to be careful that cables don't leak and short out. And the sea air is full of salt, which corrodes equipment. Besides, the dolphins chew on the hydrophones and the cables, and they have sharp teeth.

"Our tape recorders are subject to water damage. A tape recorder that is immune to salt spray and water damage and records to 30 kHz would be adequate for our immediate purposes, although we have used Ampex machines that go up to 300 kHz for recording racks (clicks)."

If dolphins are to use these echolocation techniques, they must be able to hear and interpret a range of signals over a wide frequency band.

Map hearing curves

C. Scott Johnson, a physicist working for the Naval Undersea Warfare Center at Point Mugu, has been plotting threshold hearing curves for the Atlantic bottlenose dolphin, much like the audiometer hearing curves used in human hearing.

Johnson treats the dolphin as a black box, say, like an amplifier. His basic technique is to measure thresholds, determine the minimum sound fields the dolphin can detect, and then make the tones shorter and shorter in duration to see what happens to the thresholds. Of course, the amount of energy decreases as the pulse is shortened.

Johnson says: "I use pure sine waves and try to duplicate the results logged with humans because we're the animal that scientists know best. When these tests are completed, the dolphin will be the animal with the second best-known hearing curve."

According to Johnson, dolphins can hear sounds in water with approximately the same sensitivity as human hearing in air, except that the upper frequency limit is about ten times higher than the point where our hearing cuts off — about 150 kHz as compared with 15 kHz for humans. The lower cut-off is about 75 Hz compared with about 20 Hz for humans (Fig. 6).

Johnson qualifies this by pointing out that all his work has been done with one animal. However, he finds reasonably good agreement with results of other tests published in the 1950s. Johnson thinks that his own results are the most reliable because he uses up-to-date equipment, and because his dolphin is trained to listen for the signals.

In general, it's an exacting process to measure the hearing thresholds of aquatic animals, Johnson says.

One reason is that it is difficult to determine the sound field accurately. Since a high background noise level is present and even redwood-lined Fiberglas tanks reflect sound waves, the only way to hold the sound field relatively constant (within ± 5 dB) is to induce the animal to stay still in one spot. Another problem is that at low levels, the farther the subject is from the sound source, the greater the loss. Therefore, for a uniform sound field, the dolphin has to be stationed as close as possible to the projector, but not so close as to cause problems with the near field.

Still another problem is to know unambiguously when the animal has detected the sound — he may be hearing but not responding.

The final problem concerns the limitations of existing equipment, Johnson says. Hydrophones are built mainly for underwater detection, not sound projection. It's not easy to find one that covers the frequency range from 200 Hz to 200 kHz. Barium titanate piezoelectric devices, which offer superior performance at high frequencies (they generally resonate at about 200 kHz), fall down badly at the low-frequency end. On the other hand, many magnetostrictive hydrophones have a resonant frequency that is too low to test the upper range.

Johnson finds one hydrophone particularly useful as a projector. That is the J-9, a moving-coil transducer that was developed by the Navy's Underwater Sound Reference Laboratory, Orlando, Fla. Several companies are licensed to manufacture the J-9 (including Chesapeake Instrument Corp., Shadyside, Md.).

"The response is supposed to be 40 Hz to 20 kHz, but I've used it up to 100 kHz. Above that, I've got to go to the barium titanates."

Johnson has also used a circular-piston barium titanate transducer (Apelco TM-8A) and a cylindrical barium titanate transducer (Atlantic Research LC-10). William Evans says the LC-10 performs well as a pickup device that can be attached to the dolphin, but Johnson has been using it as a projector, an application that Atlantic Research Corp. did not intend.

Johnson points out that it is all right for him to use a variety of projectors. "I use pure tones, and I use them one at a time," he says. "All I have to do is calibrate at each frequency. I'd run into problems if I were feeding in click trains, which are extremely broad-band pulses."

Johnson's experiment was set up as follows (see photo on p. 49). The dolphin, a nine-year-old male named Salty, swims into a stall-like enclosure in his tank. When a light comes on, he pushes a paddle with his beak and hears a tone—a 1-second series of sine waves. Now the dolphin has to push another paddle in order to hear another tone. By varying the intensity of a sound at a given frequency, it is possible to tell from his responses whether he is hearing anything. Meanwhile, Johnson watches the action over closed-circuit television.

In reality, what is being measured is the sound level at which Salty is willing to respond. How closely this approximates the true threshold one cannot say.

There are times when Salty just won't work. He hears the tone but doesn't respond.

"There's nothing you can do about it except put him through a training session where you know he can hear every tone," Johnson said.

"If he doesn't respond to a tone you make him sit there for 5 minutes until the next tone comes on, which he doesn't enjoy very much," Johnson explained.

III. Communicating

"Eventually it may be possible for humans to speak with another species." So said Dr. John C. Lilly in 1961. And what better place to tackle the problem of communication with an intelligent species than here on earth with dolphins?

Communicating with dolphins re-

quires electronic compensation for disparities in sound frequencies and modes, in hearing and in environment. Two approaches in electronic converters are:

- Voice coders that shift human speech upward in frequency to lie more comfortably within the dolphin's hearing range, and vice versa. With these devices, the delphinologists speak in English to the dolphins and hear the dolphin's natural responses shifted down in frequency to the human speech band.

- Man-to-dolphin translators that convert human speech into sine-wave whistles of different pitch. The dolphin, in turn, learns the meaning of each whistle and is taught to reply with similar whistles. What the human hears is synthetic speech (selected "nonsense" words) that are the "translation" of the whistles.

The inherent physical problems in communication—underwater versus in-air modes, and differences in hearing range and sound production—result in subtle difficulties. The meaningful portions of the human voice lie below 3500 Hz; fundamentals and harmonics above this frequency (over which humans have less control) tend only to confuse the dolphin. For example, Dr. Lilly says, humans have an appreciable output in the ultrasonic range. Men cannot hear it and it is of no use to them, but dolphins can hear it. How can you explain to the dolphin that you don't want it to pay attention to these harmonics?

In Dr. Lilly's experiments he prefers operating in real time so that he can relate responses to events and cues. While it is possible to figure things out from the retrospective analysis of tapes, it is like listening to someone on Mars over an rf link—a lot can happen during a pause.

Dr. Lilly therefore uses electronic speech translators that enable the two species to communicate on more even terms. These devices are variants of the Vocoder (voice coder) developed by Homer Dudley of Bell Telephone Laboratories in 1936 to permit the compression of speech for transmission and the reconstruction at the other end of the line.

A typical setup is shown in Fig. 7. Dr. Lilly sits in an observation booth and speaks into a microphone. His voice signals are stepped up in pitch by a factor of 10 in a man-to-

dolphin coder that was designed for him by Will Munson. (He is one half of the duo that published the Fletcher-Munson curve of human hearing while at Bell Telephone Laboratories.) Only the band of speech between 200 and 3500 Hz is processed by the coder (that portion of the spectrum over which humans have most control and which is therefore most meaningful to the dolphin). At the same time, his original speech is recorded directly onto one track of a four-channel tape recorder.

10-channel Vocoder used

The voice signals are divided into 10 channels by bandpass filters, amplified, the pitch extracted, rectified and low-pass-filtered. At this point the signals are modulated by a pitch-rate chopper. A pitch circuit provides the timing for the switch that does the chopping. The modulated human voice signals are amplified and bandpass-filtered once again. The final output to the dolphin consists of the intelligence in the band from 200 to 3500 Hz, only shifted upward in frequency by a factor of 10.

The reverse process is used with the dolphin's vocalizations. The same 10 high bands are used, the envelope is stripped, and the signals are used to modulate 10 lower bands. Thus two 10-channel Vocoders are used back-to-back to present the dolphin with high-pitched signals and the human with low-pitched ones.

How much is lost in translation? This can be ascertained by leaving the dolphin out of the loop. The receiving hydrophone in the tank picks up the output of the underwater loudspeaker and feeds the stepped-up human speech frequencies into the dolphin-to-man translator, which reconstructs the input with synthetic speech. Dr. Lilly estimates intelligibility to be 95 per cent.

"It's good enough for you to be able to recognize whether a man or woman is speaking," he says.

A completely different approach to communicating with dolphins was taken by Prof. Batteau. He reasoned that dolphins are equipped to cope with whistles much better than they are with words. Therefore, instead of giving them commands in English, why not in the more familiar whistle format? He chose whistles

over clicks "because whistles are easier to produce."

Batteau went to work with Stephen L. Moshier, chief electronics designer at Listening Inc., Arlington, Mass. They devised instrumentation with which human voice sounds are converted into frequency-modulated whistles—a man-to-dolphin translator (Fig. 8) that translates into quasi-dolphinese instead of shifting English words up in frequency, as the Vocoder does.

The speaker's words are picked up by a microphone and routed to two sections of the man-to-dolphin translator: the vocal pulse detector and the voice-to-dc converter.

"We measure the time delays in speech rather than the frequencies," Moshier says. "Speech is produced when the vocal cords chop the air flow from the lungs into a series of sharp, acoustical pulses or clicks with fast rise times and relatively long decay. These pulses are reflected—bounced around in the mouth and throat cavities. Information is put onto the pulses as a series of time delays depending on the length of the throat, the position of the tongue and lips, and so forth. The resultant speech signal is a series of exponentially decaying wave trains."

The first step in the analysis of this signal is to extract the time at which the vocal-cord click (as distinct from the reflections) occurs in each wave train. This is done in the vocal-pulse detector, which generates a series of positive-going pulses that correspond to the detected vocal-cord clicks.

The voice-to-dc converter measures one particular time delay in the speech output—the first formant, lying in a resonance band of roughly 500 to 800 Hz. It is produced by the portion of the vocal tract that extends from the back of the throat to the middle of the tongue. The rest of the speech signal is removed by a 1-kHz low-pass filter. The output is a dc voltage proportional to the measured interval.

The whistle generator is a voltage-controlled oscillator that transforms the dc level into a tone with a frequency that depends on the characteristic time interval of the first formant. The logic and whistle gate defines a minimum and maximum interval between successive vocal pulses for which the whistle output

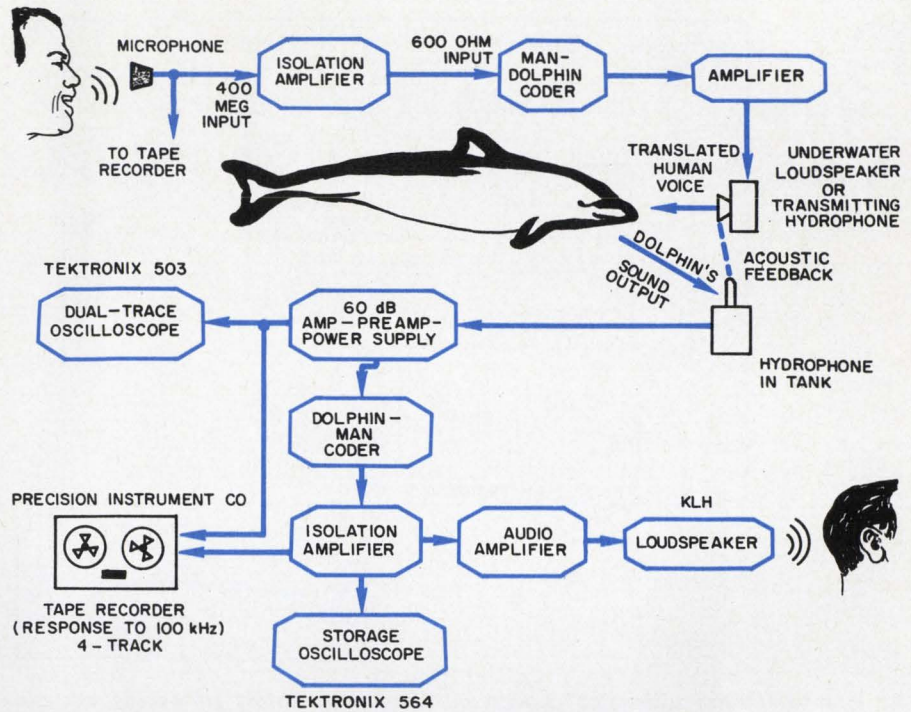

7. Electronic frequency converter "translates" human band of speech into higher frequency band. Reverse is done with dolphin's output. Four-track recorder tapes unmodified human speech, translated dolphin output, and unmodified dolphin output on separate tracks.

Table: Relation of whistle and phonetic sounds

Sound	Symbol	Whistle frequency (Hz)
ah	A	7000
a as in bait	E	10,000
i as in sit	i	11,000
r as in burr	R	11,500
oo as in boot	U	12,000
ee as in beet	I	14,000
i as in Spanish si	Y	15,000
b as in boy	B	(B and P used for distinct beginning and ending of words)
p as in tap	P	

will be gated on. This ensures that a whistle will be produced only when there is a voice input. The gate is turned on as soon as the pulse detector recognizes speech. The whistles are amplified and coupled into the dolphin's tank through a transmitting hydrophone. The whistle amplitude is approximately constant, but the pitch is modulated.

The whistle outputs have been formed into a language of sorts by Batteau. There is a definite, repeatable pitch that corresponds to each acceptable sound. The functional relationships for the sounds in Bat-

teau's language are given in the above table.

Batteau (who passed away in October) and his trainer worked with several dolphins at Coconut Island, Haw., because the sea bottom there is muddy, without much echo. The dolphins respond to a number of words that they learned by means of simultaneous exposure to the word and to the appropriate object or action.

Whenever the dolphin repeats the whistle word (or gives a reasonable approximation), it hears "BIYIP" (the word of acknowledgment)

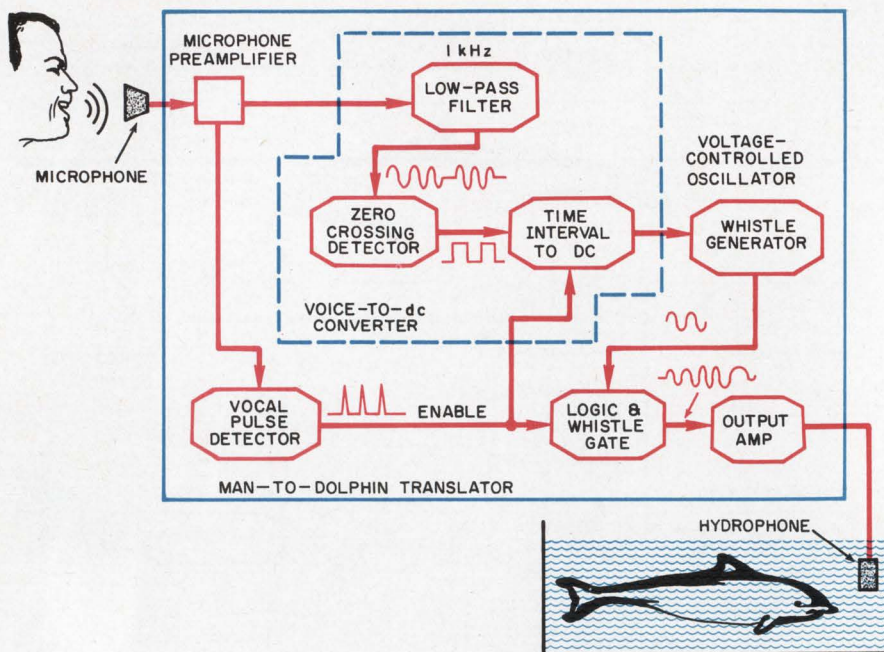

8. **Man-to-dolphin translator** converts artificial vocabulary to whistle outputs separated in pitch. The device, developed by Listening Inc., Arlington, Mass., detects speech and measures time delays of vowels in real time. Dolphin's own whistles are converted into synthetic speech by dolphin-to-man translator.

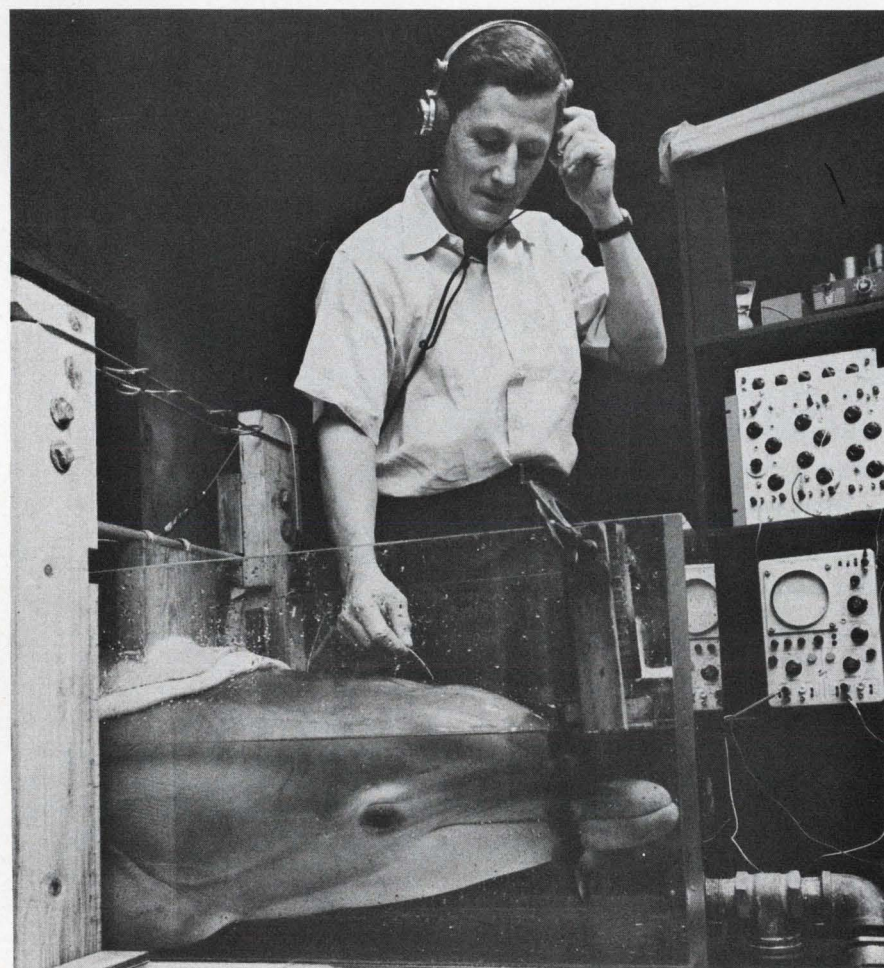

9. **Dr. Lilly stimulates a dolphin's brain electrically** to induce it to emit a variety of sounds. The operation, which is not dangerous to the animal, has also been performed on monkeys and on men ("Probing the Mind's 'Computer'," ED 11, May 24, 1967, p. 36). The sounds are picked up in air by a microphone.

from the trainer—in the whistle language—and it is given a fish to eat. The vocabulary is limited and artificial. If too many words are used, the human observers might be unable to recognize what the dolphin is saying.

In one experiment a male dolphin named Dash was tested on how well he could identify two objects, a ball and a hoop floating in his pool. He picked out the object named in 85 per cent of the trials. Later, he learned to use the correct whistle word himself in 74 per cent of the trials.

Other words for which Dash learned the whistle equivalents were BAEP, begin echo-locating; BUR-RAP, wait at the other side of the pool; UEIAP, go through the hoop.

Listening Inc. has also developed a dolphin-to-man translator and a spectrum analyzer.

The dolphin-to-man translator converts the dolphin's whistles into synthetic speech that corresponds to the artificial language—the reverse of what the man-to-dolphin translator does. It has been breadboarded, but not refined.

Batteau was asked whether he had encountered any difficulty in recognizing the repetition of whistles by the dolphin as they come through the speech synthesizer.

"Yes, but not nearly as much as three years ago, when we used only two pulses. You get used to it after a while. I can recognize BAIEP and BIYIP and all the rest, but it's still a far cry from human speech."

Moshier interrupted to say: "We've programmed dolphins in sequences in which the initial command was to repeat the word the trainer spoke. So here's the trainer's word BAIEP and the dolphin immediately replies with a whistle. It's lower than the trainer's but the shape has been reproduced. As you sit with the spectrum analyzer in the training session, you see immediately what the dolphin's saying from the tape spilling out. This is done in real time, which is why we've developed the analyzer."

The spectrum analyzer is a 30-line analog frequency meter and multiple-pen recorder. Each line is traced by one of the 30 pens. Since all the pens move horizontally, the contour lines are not joined, and the over-all impression is gray. Batteau said that this spectrum analyzer is more

useful than commercially available apparatus.

The analyzer has two channels. One channel includes a 4-to-20-kHz bandpass filter, which minimizes noise. The second channel is unfiltered and is normally connected directly to the output of the man-to-dolphin translator, to obtain an undistorted record of the transmitting hydrophone signal.

Do you read me dolphin?

Despite the responses Batteau has elicited from his test dolphins, some question remains whether he was communicating with the dolphins or conditioning them to exhibit a type of behavior. In other words, it leaves unanswered the question whether the dolphin is a bright animal that can learn tricks extremely rapidly or an intellect comparable to the human mind.

The criterion would appear to be this: Are the problems interesting to the dolphins in that they engage their intelligence and curiosity, and meaningful in that they involve the right symbols, frequencies and environments? Or is the experimenter unconsciously training to a higher grade of stereotype?

For a clearer picture of the problems that the dolphin's sound emissions pose for the electronic designer, it is helpful to know something about the animal's physics and anatomy.

In the wild, most of the dolphin's sounds are produced under water. The animal generates them with a vocal apparatus that is unorthodox by human standards. To begin with, it talks and breathes through its blowhole. The mouth is for eating and grasping, and serves the dolphin in place of a hand.

When the dolphin is submerged the blowhole is covered by a crescent-shaped plug. The two sides of the plug (called tongues) can be used independently. Not only can the two nasal passages be used separately to emit complex pulses and near-sine waves in the range roughly from 400 Hz to 150 kHz, but the dolphin can also intermix the two simultaneously.

"The sounds are used for both sonar and communication," Dr. Lilly says. "We no longer separate the two."

The dolphin's whistles consist of

a sine-like fundamental in the range from 4 to 22 kHz, and a number of harmonics. The clicks, on the other hand, are short pulses with steep leading edges. Since the dolphin can vary the repetition rate, and since the pulses have both sonic and ultrasonic components, the emissions are rich in signal content.

Kenneth Norris suggests that, to imitate dolphin clicks, you try this:

Press your lips tightly together, then force air out as a stream of small bubbles. The tighter your lips, the shorter and sharper the signals, and the richer the high frequencies. Also, the harder you blow, the faster the repetition rate.

Peter Purves, a zoologist from the British Museum of Natural History, London, reports that all of the noises belong to a particular class of vibrations known as relaxation oscillations. Frequency is dependent not on the customary ratio of elasticity and mass, as in the human vocal cords, but on some form of resistance, which, on reaching some critical value, suddenly relaxes and builds up again. The human counterpart is the raspberry or Bronx cheer—made by blowing air through tightly pursed lips.

Bottlenose dolphins "talk" to each other, Dr. Lilly reports. During these formal conversations they exchange whistles and clicks. According to Dr. Lilly they always answer in the mode in which they are addressed and they are very "polite." Each animal waits until the other stops, in the case of the whistles, or there is opportunity to alternate within the train in the case of the clicks.

Whistle sweet nothings

There is also a special phenomenon that Dr. Lilly calls a duet, in which the animals whistle simultaneously. They have the uncanny knack of synchronizing these whistles so accurately that one can hear a beat signal.

Dr. Lilly says that the two sonic modes—whistles and clicks—do not occur at the same time. This means that dolphins can talk with whistles and click trains, so that the whistles and clicks are completely out of phase with each other. Thus dolphins can fill the silences of the whistle exchange with a click exchange and the gaps in the click

train with whistles—without interrupting in either mode. To the uninitiated a pair of dolphins gabbing away can sound like four.

Dr. Lilly speculates that dolphins communicate information about objects to other dolphins by transmitting the proper frequency pattern in clicks and whistles. In other words, they can describe a size of shark, say, at a given distance.

"If we are ever to break delphinese and convert it into human language," Dr. Lilly says, "we thus have many hints on which to proceed. At least we have testable hypotheses to either bear out or disprove."

Jarvis Bastian, a psychologist at the Davis campus of the Univ. of Calif., decided to test the hypothesis that dolphins could convey information about an artificial environment to one another.

He partitioned a tank so that two dolphins, a male named Buzz and a female named Doris, could hear but not see each other. He trained them to perform tasks in cooperation when a pair of lights came on. Doris could see both lights, but Buzz only one. The dolphins worked out a signaling system so that they could get their rewards.

Bastian analyzed tape recordings of their vocal outputs and found both clicks and whistles. He concluded that, although the whistles seemed to hold emotional context for Buzz and Doris, they did not account for the correct performance. The state of the lamps was conveyed by click trains. Thus Bastian seemed to prove that dolphins can communicate arbitrary environmental information.

But what of all the other sounds that the person who spends a great deal of time near the dolphin tanks eventually gets to hear?

Dr. Lilly says that barks, blats and the like are common only during intense emotional excitement on the part of the animal. He has tried electrical stimulation of the dolphin's brain to induce the animal to emit a variety of sounds (Fig. 9).

When dolphins have been in close contact with man for a length of time, they somehow learn to vocalize in air with an open blowhole.

Dr. Lilly is convinced that this transition from making sounds under water to making sounds in air is in response to hearing hu-

mans' consistent use of air sounds.

"If we talk to them under water, they answer us under water," he says. "If we talk to them in air, they answer us in air."

Dr. Lilly reports that the best humanoid sounds he recorded were made with the slash call. If so, then the dolphin deliberately produces these difference frequencies in order to imitate human sounds in air.

Thus, he concludes, when dolphins learn to make humanoid sounds, they are definitely trying to communicate with us in our own mode.

Dr. Lilly made tape recordings of dolphins mimicking humans by means of sounds emitted from the blowhole opened in air. When he played the tapes back to other scientists, he failed to convince them that they were hearing mimicry. He contends that the skeptics were honest, but that they were not accustomed to these sounds.

If Dr. Lilly is right, then the ability can be learned, just as one can learn to make sense of distorted voice transmission on an aircraft radio in a noisy background.

Since his first attempts, Dr. Lilly has spent considerable effort on "shaping up" the vocal behavior of his dolphins so that they become more and more humanoid. He devised lists of nonsense syllables that he emits in sequence. The dolphin listens and then repeats the list in a Donald Duck sort of voice. Dr. Lilly claims that in tests the dolphins matched the number of sounds made by the human, either exactly or plus or minus one, in 92% of the trials.

How does the dolphin know it is its turn to vocalize? Dr. Lilly surmises that it discerns a change of inflection whenever the reader comes to the last word. This, he says, "is a convincing demonstration of the quality of the mind listening at the other end of this system."

While he does not claim to have cracked the dolphin's own language, or proved that the dolphin understands us, Dr. Lilly asserts that at least he has proved that dolphins are trainable.

"The next step, a long one, is demonstrating that the dolphin can meaningfully use these sounds as we use language and speech," he says.

Dr. Lilly's views are shared by few other investigators. Some scientists openly sneer at his theories. Yet he persists. He has not suc-

ceeded in making the dolphins learn English, but he has discovered many surprising things that shed light on dolphins and men.

IV. The future

What is the future of this research? It will become more and more ambitious as existing programs are completed. Already psychologists and social scientists are involved as well as biologists and engineers. Several investigators have been studying the behavior of dolphins at Sea Life Park in Oahu, and at the Communication Research Institute. The animals are rewarded for every display of new behavior. Dolphins respond to this treatment because they seem to get bored by simple, repetitious tasks like swimming through the same plastic hoop. Some day psychologists may devise meaningful tests of intelligence for these animals.

It is expected that the dolphin will make significant contributions to man's progress in the development of the sea, especially of the continental shelves. This has been proved on Sealab II, the Navy's man-in-the-sea program, in which a dolphin was harnessed to carry tools to aquanauts 200 feet under the surface.

There has been some speculation in the popular press about the use of dolphins as military combatants. One hears of dolphins being trained to survey enemy waters and return with intelligence reports, to listen for the approach of enemy submarines and to fight frogmen. For example, one reporter suggests that "lethal dolphins" equipped with dynamite on their harnesses could ram submarines.

These speculations cannot be dismissed out of hand, since a knowledgeable trainer can work wonders with these animals. However, analysis of the known physical limitations of dolphins reveals:

- Dolphins are not fast enough to intercept nuclear submarines. In tests conducted for the Naval Ordnance Test Station by Thomas G. Lang, it was found that the fastest dolphin could not exceed 22 knots in a short sprint — a far cry from the 30 knots reported by many sailors. (There is an explanation for this discrepancy: dolphins know how to ride the bow waves from ships, and

thus they are in part coasting with a boost from the ship's power plant.)

- Nor can they dive deep enough. The deepest descent reported was 550 feet by Tuffy on the Sealab program in a 2-3/4 minute round trip. Dolphins cannot hold their breath for more than 6 minutes.

- Their sonar is good for only a few hundred feet in horizontal layers of the ocean. Whether it could scan a sector perhaps a thousand feet down is not known.

What does seem feasible is the towing of targets for the training of sonar operators, and towing of experimental devices to test their performance. This, of course, is all speculation.

The attempt to communicate with dolphins is continually pointing up the inadequacy of electronic equipment. Present research may lead to the development of superior receiving and transmitting hydrophones, and in turn advance the technology of antisubmarine warfare.

The research should certainly lead to the development of much-needed field equipment that will aid investigators in many of the life sciences.

Finally, it may cause us to crystallize our ideas on how to communicate with extraterrestrial intelligence. We may never find it on our future interplanetary and interstellar expeditions, but we may be overlooking something right under our own noses because of our preconceptions about how intelligent beings should look. 

Bibliography:

- Busnel, René-Guy (ed.). *Les systèmes sonars animaux (Animal Sonar Systems)*. 2 vols. Jouy-en-Josas (Seine), France: INRA - CRNZ Laboratoire de Physiologie Acoustique, 1966.
- Lilly, John C. *Man and Dolphin*. New York: Doubleday & Co., 1961.
- . "Vocal Behavior of the Bottlenose Dolphin." *Proc. Amer. Philosophical Soc.*, CVI, No. 6 (December 1962), 520-529.
- . *Mind of the Dolphin*. New York: Doubleday & Co., 1967.
- Norris, Kenneth S. (ed.). *Whales, Dolphins and Porpoises*. Los Angeles: University of California Press, 1966. (Photographs courtesy of George Musil, Dale Beatty, Dwight Batteau, Black Star and the U.S. Navy)

Free reprint

A copy of this report, "Dolphins challenge the designer," will be sent free of charge to readers who circle Reader-Service No. 250.

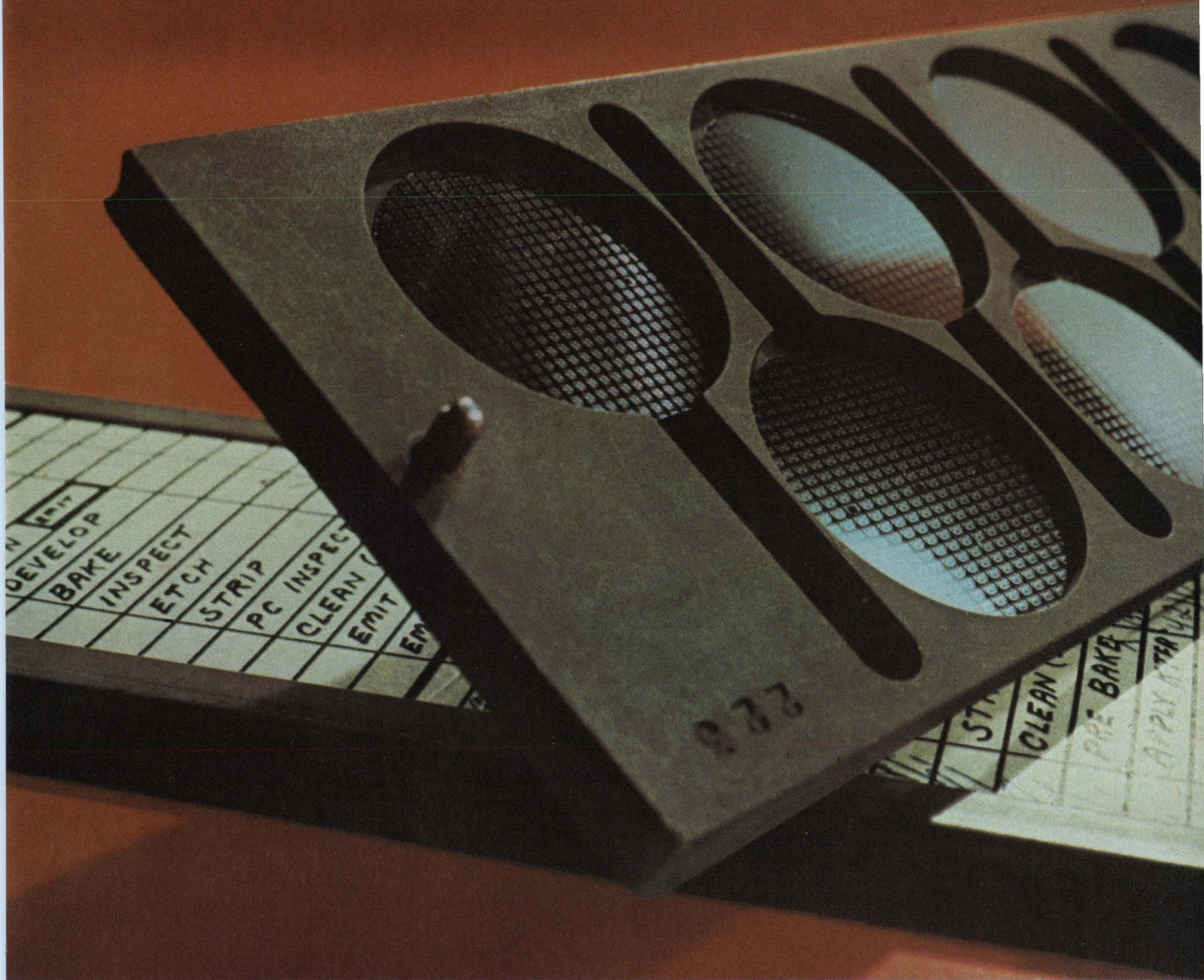

Even the biggest IC order you give us is made in small pedigreed batches.

Mistakes don't get far at Sylvania. By making ICs in small batches and logging their performance on charts that follow them through every step of production, we spot trends and make corrections early. You get reliable ICs, on time.

To assure reliability, vendors' materials must pass stringent tests. Parts made within Sylvania must pass the same tests.

For reliability, processing areas are designed to eliminate contamination. Ceilings, floors and

furnishings are impervious to dirt. Temperature, humidity and air are precisely-controlled.

We've virtually eliminated damage to chip substrates, metallizations and bond wires with mechanized handling equipment. And to make certain we achieve reliability, every IC must survive 100% testing in 12 steps during production. And 100% testing again at the very end.

Sylvania Semiconductor Division, Electronic Components Group, Woburn, Mass. 01801.

SYLVANIA

SUBSIDIARY OF

GENERAL TELEPHONE & ELECTRONICS GTE

ON READER-SERVICE CARD CIRCLE 34



Now! Cutler-Hammer
puts up to six heavy-duty
oiltight units...

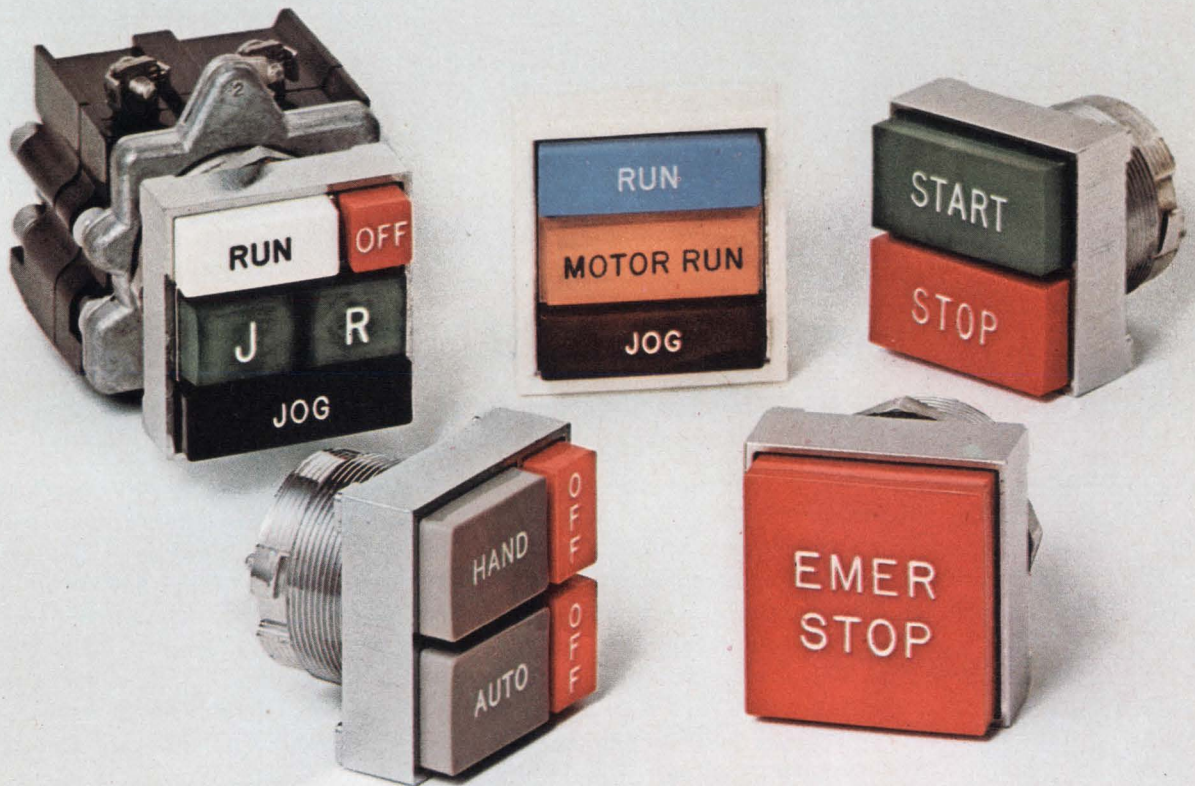

New Cutler-Hammer compact pushbuttons
use the same $1\frac{3}{16}$ " round industry-standard
mounting holes as your present
full-size oiltight pushbuttons.



...in one
compact pushbutton.
(We've gone square!)

It took a little squeezing. Some pushing and pulling. And a lot of design savvy.

But we did it.

We developed a new compact oiltight pushbutton line with up to six heavy-duty control functions in the space of a single operator, only $1\frac{7}{16}$ " square.

Think of the space you'll save on the panel!

But note we said "square." Why a new square shape? Some people simply reduce the size of their full-size pushbuttons and call them "miniature" pushbuttons. The result is: they're reduced in voltage ratings and limited in circuitry and terminal types. They can be difficult to operate, too.

Not so with our new compact pushbutton line.

By going to a new square shape, we not only give you more pushbuttons in less space. But you get full 600-volt construction. Unlimited circuit flexibility (you can stack the contact blocks in the field). Both screw type and quick connect terminals. And easier operation.

You also get a full selection of pushbuttons and indicating lights, in a wide range of sizes, shapes and colors of buttons and lenses.

And of course the same protection against oil, dust, dirt or coolants you've always had with Cutler-Hammer full-size oiltight pushbuttons.

Get the full story and start saving now! Your Cutler-Hammer Distributor or Sales Engineer will square you away.

See your Cutler-Hammer Distributor—the man who has everything.

CUTLER-HAMMER

Milwaukee, Wisconsin 53201



ON READER-SERVICE CARD CIRCLE 867

COOL

KLYSTRONS • MAGNETRONS • TRANSFORMERS
TRAVELING-WAVE TUBES • SWITCH TUBES
WAVE GUIDES • DUMMY LOADS • LASERS

with New **ELLIS and WATTS**
Liquid-to-Air Heat Exchangers*

One of the new Ellis and Watts Heat Exchangers may be the answer to a need for tailoring a cooling system to your type of electronic equipment. Minimum space, low noise level and optimum performance have been achieved in each of a wide range of designs which include indoor/outdoor types in ratings from 5 to 300 KW. Proved in military, aerospace and commercial applications, these designs offer flexibility for quick modification to meet any specific cooling requirements.

Why not put the widely recognized Ellis and Watts custom-cooling "know-how" to work for you. Write us at the address below.

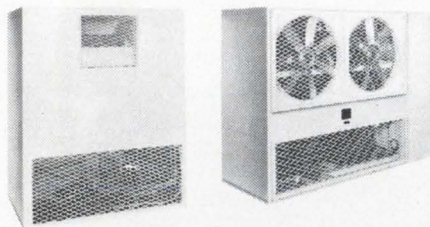

*Liquid-to-Liquid Heat Exchangers also available.

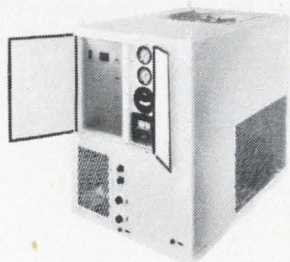

ELLIS AND WATTS COMPANY
Ellis and Watts Company, P.O. Box 36033
Cincinnati, Ohio 45236

ON READER-SERVICE CARD CIRCLE 35

Letters

Challenge to design of random generator

Sir:

The circuit shown on p. 98 of the June 7, 1967, issue of *ELECTRONIC DESIGN*, "Random-signal generator uses Zener diode" [ED 12, Ideas for Design], will not operate with the voltage and Zener-diode polarity given.

To make it operate, either the Zener and power-supply polarity must be reversed, or the transistors must be exchanged and the Zener reversed from the way it is shown in the diagram.

I also found it necessary to place an $0.01\text{-}\mu\text{F}$ ceramic-disk capacitor between the collector and ground of the emitter follower in order to prevent oscillation.

C. W. Potter

Avionics Laboratory
General Dynamics
Fort Worth, Tex.

The designer responds

Sir:

I should like to thank Mr. Potter for his comments. An error did indeed slip into the circuit diagram. The correct diagram is shown in Fig. 1. It is also possible to use an npn transistor for $Q1$ and a pnp for $Q2$ by inverting the power supply.

I have noted no tendency for the emitter-follower stage to oscillate. Should this occur, however, four methods of eliminating it are shown in Fig. 2.

Roger Damaye

Electrical Engineer
Fontenay aux Roses (H. de S.)
France

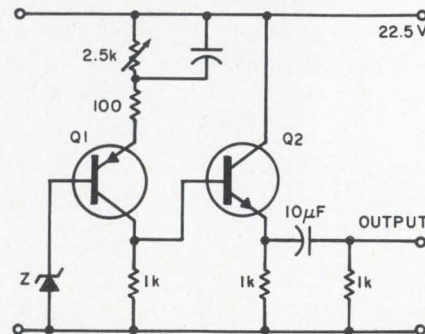

1. Random-signal generator has Zener diode as noise source.

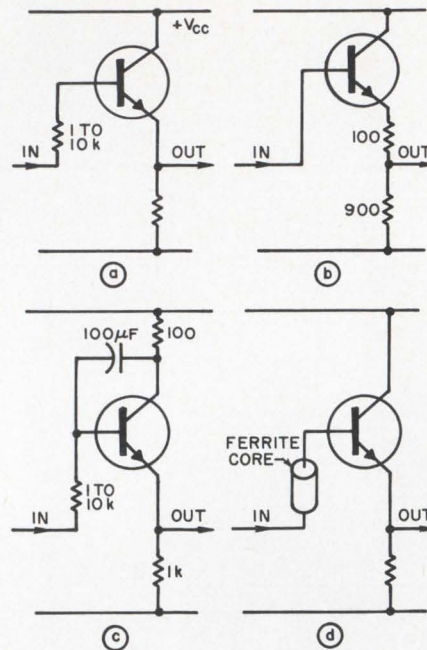

2. Oscillation in emitter follower of random-signal generator can be eliminated by four methods.

'Tiny flaws' plague all instrumentation

Sir:

Ron Gechman's article ["The Tiny flaws in medical design can kill," ED 18, Sept. 1, 1967, pp. 22-26], is an excellent beginning on a subject that has been ignored far too long! The problems he cites in the design of medical equipment have existed, in latent form, in general instrumentation for many years.

After more than 30 years in this field I am struck by the ability of some engineers to isolate themselves from factual knowledge of anything but their own narrow field of interest. Thus we have designers acting as though their products were operated only in solitary environments, where any tests they may make clearly show how well they work—alone!

Take a case in point. Consider the archaic practice of the bypass capacitors connected from each side of an ac line to instrument chassis ($C1$, $C2$ etc. in the figure on p. 24 of Gechman's article). These capacitors are "carefully" chosen to limit the maximum current to a "safe value." This is fine for the solitary instrument—but sheer nonsense for a multiple system composed of many such instruments neatly in-

(continued on p. 72)

6 off-beat 2½ D stacks.

1 HEATED STACK — Built for a process control application, this has an extremely large bit length. (16K x 25 bits). Heaters keep the temperature a constant 55°C ±3°C; but the whole stack with heaters and large capacity only takes up 750 cubic inches.

2 FOLDED STACK — We've built hundreds of these for SDS computers over the past year. With a 4K x 9 bit capacity, the stack uses our 20 mil cores, and turns out a cycle time of 830 nanoseconds.

3 HIGH/LOW TEMP STACK — This 8K x 18 bit 2½ D, built for RCA, uses our special lithium cores. They have a low temperature coefficient and excellent stability over a 10°C to 55°C range. The beauty of this is that the customer doesn't have to bother with temperature compensation.

4 COMPACT STACK WITH LARGE CAPACITY — For Honeywell, we put together a 32K x 18 bit prototype stack in a space of 600 cubic inches (10" x 20" x 3"). This stack uses our

20 mil cores and has a cycle time of less than 650 nanoseconds.

5 SPLIT MODULE STACK — This was a tricky one for Raytheon. It was a special 16K x 18 bit stack, and two sets of diode modules in the word direction had to be placed on each side of the stack. (Usually, they're all on one side.) The whole stack was designed, built, and shipped in 8 weeks.

6 NANOSTACK™ — We use this one in our large capacity NANOMEMORY system, but we've also been making a modified version for over a year and a half for Digital Equipment Corp. The stack has an 8K x 18 bit capacity and measures only 10½" x 20½" x 2".

If your 2½ D requirements are off-beat, call us, and we will see what we can do for you. Or write for Litpak 100 describing our stack capability.

EM electronic memories

12621 Chadron Avenue, Hawthorne, California 90250
(213) 772-5201

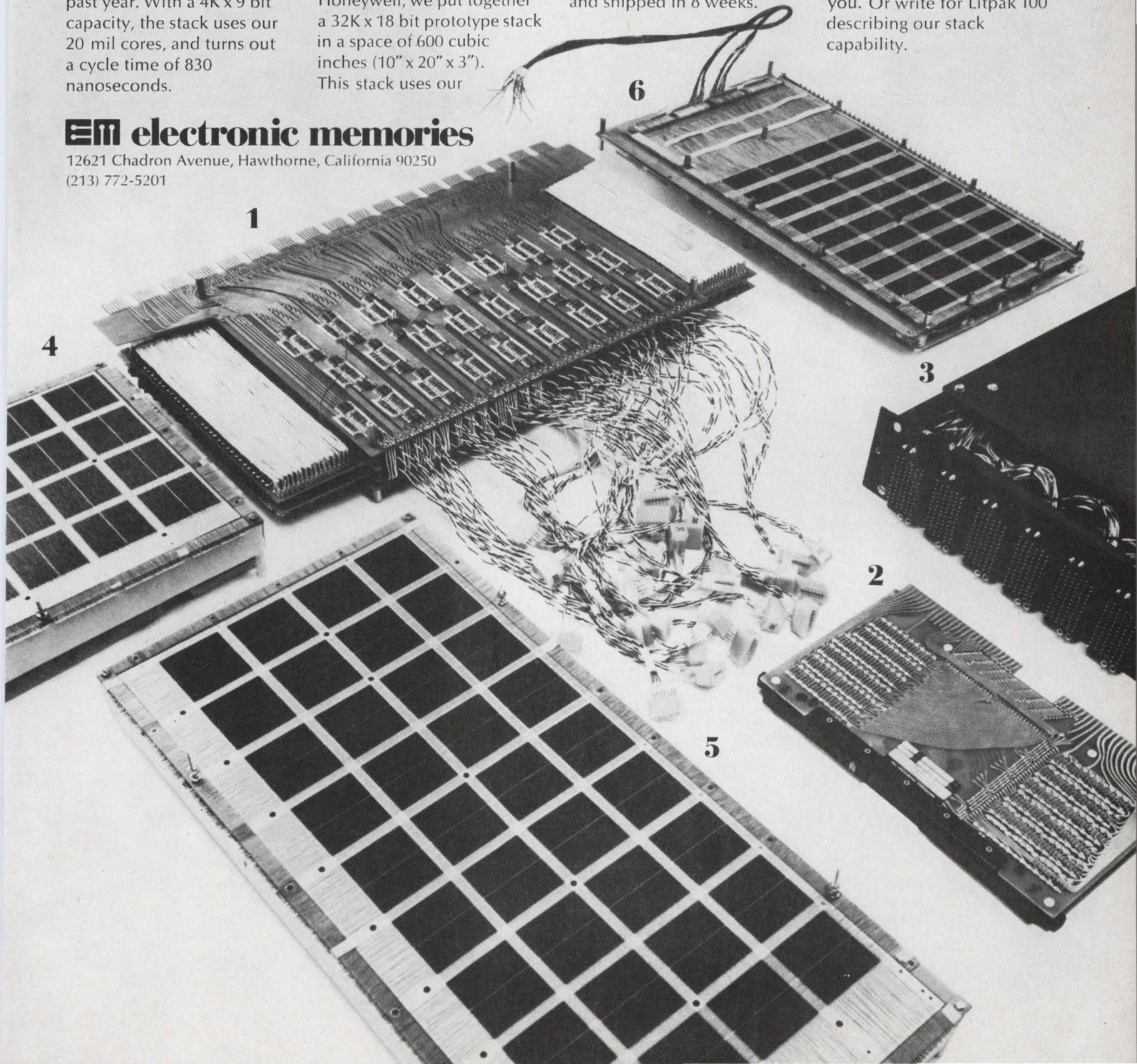

Portrait of a most reliable family



More accurately, the portrait shows only *part* of a most reliable family. The E. F. Johnson Company makes hundreds of fine quality electronic components, including:

CAPACITORS—A dozen basic series of air variable capacitors, each in a wide choice of capacity values. They range from sub-miniature machined plate capacitors with maximums of 4.2 to 24.5 pf., to larger, heavy-duty types with capacity values to 1700 pf. and voltage ratings to 9000 volts peak.

There is a reliable Johnson capacitor to fit your application. Whatever the size, it offers excellent stability, high Q, low temperature coefficient, uniform capacitance, and excellent overall performance at competitive prices.

CONNECTORS—The Johnson line of jacks, plugs and terminals meets the needs of both military and commercial designers effectively and economically. For printed circuit applications, there are sub-miniature insulated tip plugs and jacks, plus the unique Test Point Strip/Handle for fast, efficient circuit testing.

Johnson's line of standard insulated connectors includes tip, banana and dual banana plugs, tip and banana jacks, military tip jacks, and binding posts.

RIB-LOC™ components consist of new miniature, one-piece, insulated terminals and jacks that press-mount with excellent retention characteristics.

TUBE SOCKETS, INSULATORS, PILOT LIGHTS, RF COMPONENTS AND HARDWARE—Dependable Johnson tube sockets include HF, VHF and UHF types for tubes of various power levels.

Low-loss, high-voltage-breakdown insulators are available in either steatite or porcelain.

Johnson offers 47 pilot light assemblies in neon and incandescent types. Standard and wide angle lens caps are available in glass and acrylic.

Other hardware includes panel bearings, shaft couplings, crystal sockets and RF chokes, plus a number of heavy-duty RF components for broadcast transmitting, RF heating, antenna phasing and other commercial applications.

FREE CATALOG gives complete details and specifications, including net prices, of E. F. Johnson quality electronic components. Write for your copy today, or ask us about your specific application requirements. Special components, to your exact requirements, may be available in production quantities.



E. F. JOHNSON COMPANY

3333 Tenth Ave. S. W., Waseca, Minnesota 56903

Providing nearly a half-century of communications leadership

ON READER-SERVICE CARD CIRCLE 37



Feedback AGC
using the . . .

VCR* FET

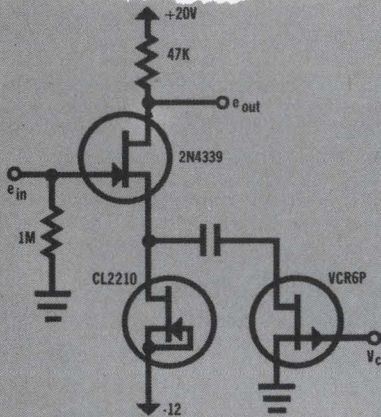

Siliconix assumes no responsibility for the circuit shown, nor do they represent or warrant that it does not infringe any patents.

Here's a common-source FET amplifier, with a current-limiter diode as a source resistor and a VCR FET gain control. With $V_C = 0$, the gain is 32 dB. Gain decreases as V_C approaches pinch-off for the VCR. Maximum gain depends on r_{ds} at $V_{GS} = 0$ for the VCR6P. Gain with full AGC ($V_C = V_P$) is controlled by the current limiter. Variations in maximum gain are due to variations in r_{ds} .

If you'd like to investigate this and other VCR FET designs, order your VCR FET Designer's Kit from a Siliconix distributor. For just \$19.50 you'll get 6 different VCRs (worth \$30) plus data. More information? Just write us.

* VCR - Voltage Controlled Resistor - a FET bilateral resistance whose value is voltage controlled from one high-impedance terminal.



Siliconix incorporated

1140 W. Evelyn Ave. • Sunnyvale, CA 94086
Phone (408) 245-1000 • TWX: 910-339-9216

ON READER-SERVICE CARD CIRCLE 38

LETTERS

(Continued from p. 68)

stalled in a "grounded" relay rack or metal cabinet. How many instruments (that is, bypass capacitors) does it take to build up a dangerous situation, should the "ground" actually become open or develop resistance due to corrosion, etc? Whose responsibility is this?

Old-timers will recognize this situation as the cause of "burned-out"

attenuators, "ground loop" errors, and similar features.

Can we afford to continue this farce where lives are at stake? The solution is complicated by the mere existence of large numbers of such equipment, let alone by the steps necessary to correct new designs.

Charles A. Cady

Consultants Associates
Wayland, Mass.

Accuracy is our policy

In "Go-no-go comparator uses complementary addition," in the Ideas for Design section of ED 17, Aug. 16, 1967, pp. 274-276, the following errors should be corrected in the labels on the left side of the figure:

I_θ should be L_θ ;

G_N should be G_H (gate high limit);

G_L means gate low limit.

The following truth table mentioned in the text was omitted:

C_n low	C_n high	Result
1	0	in limits
0	0	below
1	1	above
0	1	invalid

In "Use the signal flow graph technique," ED 17, Aug. 16, 1967, pp. 254-256, author Glenn DeBella has noted five inaccuracies:

On p. 254, right-hand column:

The definition of *Forward path* should read: "A flow graph may have more than one forward path" (not "forward step" as printed).

The definition of *Feedback loop* should show as a second example: x_4, x_5, x_4 (not x_4, x_3, x_4 , as printed).

The definition of *Self loop* should read: "A branch originating and terminating on the same node" (not "on the same model" as printed).

On p. 256:

In Eq. 9 the fourth equation should be:

$$v_2 = [(i_1 - i_2)R_L] - [a_o R_L v_{b'e}/R_L],$$

where R_L in the first element is a multiplier, not a divisor as printed.

In Fig. 3c, the transmittance of the branch directed to node $v_{b'e}$ from node i_2 should be $-1/C_{ob}s$, not a positive quantity as printed.

In "Push-button switches for circuit boards," in the Components listing of the Products section of ED 22, Oct. 25, 1967, p. 178, the price should read: \$2.08 per unit in 1000 lots," not "\$208 in 1000 lots" as printed.

In "Computer talks to the circuit designer," ED 21, Oct. 11, 1967, pp. 58-63, author Richard McNair draws attention to the following errors:

On p. 61 left-hand column, in the list of definitions of the eight parameters that describe the transistor model, the definition of V_{SAT} should read: "the collector voltage at $I_{c(sat)}$ and $I_{B(sat)}$ " (not $I_{B(act)}$, as printed).

On p. 61, right-hand column, the third line should read: ". . . V_{SAT} is measured. A separate parameter, I_{CBO} is . . ." (inserting the dropped I).

On p. 61, Table 1, the output quantities for the TRANSistor element should read: "Base, collector and emitter currents, power dissipation, forward base-emitter, collector-emitter and base-collector voltage drops and circuit gain, I_C/I_B " (inserting the dropped words "collector-emitter").

On p. 60, Fig. 7b, the load line was omitted from the curves. The corrected figure is republished below:

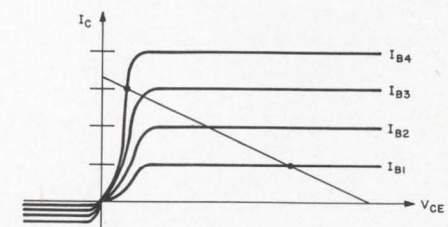

(b)



Nearly everything that flies... flies with Cutler-Hammer power relays!

You've made us Number One. And we thank you.

For years, you've been buying more Cutler-Hammer power relays for your airborne projects than anybody else's.

Probably because our relays combine the utmost in small size, light weight and resistance to severe environmental conditions.

Now, we'd like to tactfully remind you that more and more of your fellow engineers are using our relays in ground support as well. And in ordnance and shipboard electronics, too.

Like in the tank above, and in trucks, radar, power systems and fire-control systems.

We're delighted. But not surprised. Because the relays are very much the same.

Same proved reliability under severe environmental conditions. Same in-process inspection and rigid quality control.

On your next project—ground, marine or airborne—specify Cutler-Hammer power relays. Call our local stocking distributor, or write for new Catalog **LL-292-Y217**



Typical of Cutler-Hammer's full line are these 25-, 50-, and 100-amp hermetically sealed power relays (front), our new 175-amp hermetically sealed generator contactor, and a 400-amp environmentally sealed relay.

Switch
to No. 1

More than just products:
prompt availability,
field help, innovation,
quality assurance too.

CUTLER-HAMMER
Milwaukee, Wisconsin 53201

Guess how many different JT connectors Bendix makes.

Guess again. It's closer to 1,000,000 in all—and increasing every day. Bendix makes crimp, solder, grommeted, potted and hermetic versions. In eight different shell types and nine shell sizes—8 through 24. You can choose from 40 different insert patterns in 16-, 20-, 22- and 22M-contact sizes, that will accept a wire range of 16- through 28-gage. And they feature temperature capabilities that range to 392°F. continuous operation.

Somewhere in all that, there's bound to be the Bendix® JT connector that's right for you. (Especially if you're concerned with aircraft, rockets, missiles, submarines, torpedoes or ground support equipment.)

Why the wide acceptance of Bendix JT connectors? They cut weight up to 60%, length up to 50%. They're the smallest, lightest of their type in the industry. They're readily available from our jobbers or the plant. They're loaded with the latest connector innovations, many of which are sure to become industry standards.

Like more information?

Contact: The Bendix Corporation, Electrical Components Division, Sidney, New York 13838.

Bendix

Electronics



... IT's the MOST ...
EXCEPT FOR PRICE

NEW **KH** ALL-SILICON
R-C OSCILLATOR
holds PERFORMANCE but
LOWERS PRICE

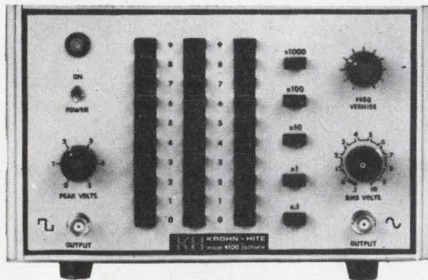

MODEL 4100, brand new R-C Oscillator with push-button frequency control. Sine- and Square-Wave simultaneously from 0.01 Hz to 1 MHz. Price \$550. Provides performance of higher priced units. 5 $\frac{3}{8}$ " H x 8 $\frac{3}{8}$ " W x 14 $\frac{1}{2}$ " D.

Using advanced circuit techniques, Krohn-Hite has produced a new R-C Oscillator, at a medium price, with traditional K-H Quality.

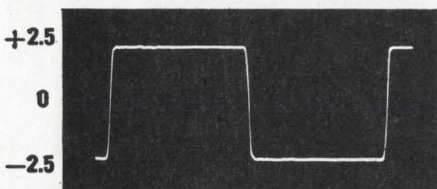
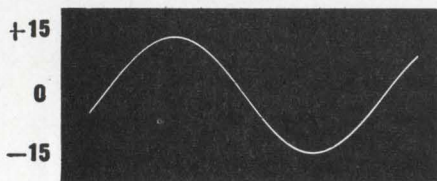

SIMULTANEOUS SINE AND SQUARE-WAVE outputs pack real power (up to $\frac{1}{2}$ watt into 50 ohms). Photos show open circuit output voltages at 1 MHz.

These outputs typify the performance of the Model 4100. Add to this half-watt output, 0.5% frequency accuracy, 0.03% distortion, 0.02% hum and noise, 0.02 db frequency response and 0.02%/hr. amplitude stability and you get a clearer picture of what we're talking about.

There's much more in KH Data Sheet 4100
Write for a copy

KH KROHN-HITE
CORPORATION
580 Massachusetts Avenue, Cambridge, Mass. 02139
Telephone: 617/491-3211

ON READER-SERVICE CARD CIRCLE 41

Dolphins receive top billing



Einhorn and Pequod size each other up.

With a dozen years' experience in technical publishing before he joined our editorial staff this year, News Editor Richard Einhorn found his latest major project both intriguing and exasperating. Dolphins, he discovered, are not only friendly but also very mischievous. He recalls how one named Pequod once seized his notebook and practically blotted out an interview with researcher Dr. John Lilly. In fact, regular wettings are an occupational hazard of working with dolphins, and a pair of black shoes permanently bleached by seawater is Einhorn's enduring reminder of this fact.

Nevertheless, out of the amicable working relationship that Einhorn established both with the dolphins themselves and their investigators comes the second feature this year on electronics and the life sciences (the first was "Probing the mind's 'computer,' ED 11, May 24). It took him to Florida, California and Massachusetts, and includes some of the very last ideas on dolphin communications of a noted researcher, the late Prof. Dwight Batteau, President of Listening, Inc., of Arlington, Mass.

New column makes its bow

A new regular feature makes its first appearance in this issue. It grew out of an editorial discussion of how to answer the tremendous number of readers' questions about integrated circuits. ELECTRONIC DESIGN has launched a cooperative effort with Integrated Circuit Engineering, Inc., of Phoenix, Ariz., who give courses on microelectronics all over the world. Technical Editor Roger Field is in charge of this end of the project, which will draw on our many sources and ICE's experience to answer the most interesting questions we receive.

NIKON HASN'T MADE MICRO-CIRCUIT MASK-ALIGNMENT EASY.

JUST EASIER.

Mask alignment is still the painstaking visuo-mechanical procedure it always was. The Nikon Mask-Alignment Microscope hasn't changed that. But it has reduced the element of human error to where relatively unskilled personnel, with minimum training, can be relied upon for higher registration accuracy in less time.

The reasons are inherent in the basic design of the Nikon Mask-Alignment Microscope. First, the quality of optics: the use of special, high-resolution lenses which give maximum visual acuity with minimum distortion, eyestrain and fatigue. Second, the use of an integrated, point light source on the optical axis of each objective system for optimum illumination efficiency. And third, the degree of flexibility provided by the operating controls.

The optical head, for example, is equipped with two objective lenses and a split-field prism. This prism has a push-pull rod control which permits the user to blank out the image of either of the objectives, or to observe both adjacent to each other in any ratio of field coverage he may desire. Furthermore, the distance between the two objectives can be continuously varied from 0.475" to 1.535", axis to axis.

The binocular eyepiece head, furnished as standard equipment, is inclined at an angle of 45° to the optical axis. It can be rotated 360° to any position most favorable for viewing, and is supplied with matched wide-field, high-eye-point oculars. It also offers facilities for interpupillary adjustment and diopter compensation. Monocular and trinocular heads can be interchanged for photographic and other special applications.

Four interchangeable eyepieces are available (5X, 10X, 15X and 20X), and three interchangeable pairs of objectives (4X, 10X, 13X and 20X) for an overall magnification range from 20X to 400X. A ball bearing, rack-and-pinion focusing mount is also available, where required. In addition, the left objective can also be individually adjusted for focus to provide precise tracking of both objectives.

Price of the basic Nikon Mask-Alignment Microscope is \$806 including step-down transformer equipped with power switch and pilot light. For complete details, write: Nikon Inc., Instrument Division, Garden City, N.Y. 11530 Subsidiary of Ehrenreich Photo-Optical Industries, Inc. (In Canada: Anglphoto Ltd., Instrument Division, Ont.)

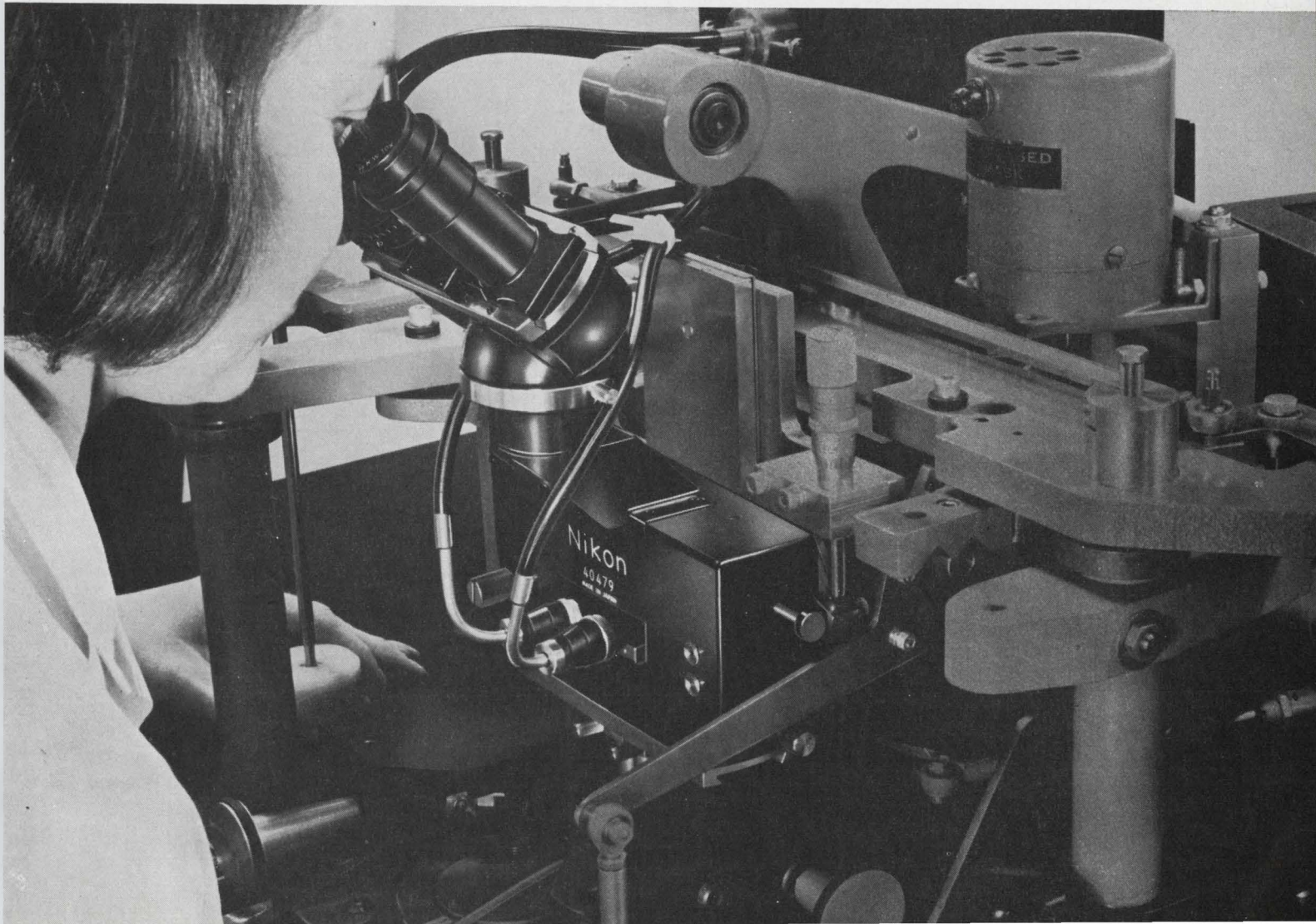



This is a multi-contact connector. Type MS-M. It works with standard, subminiature and twisted pair contacts.

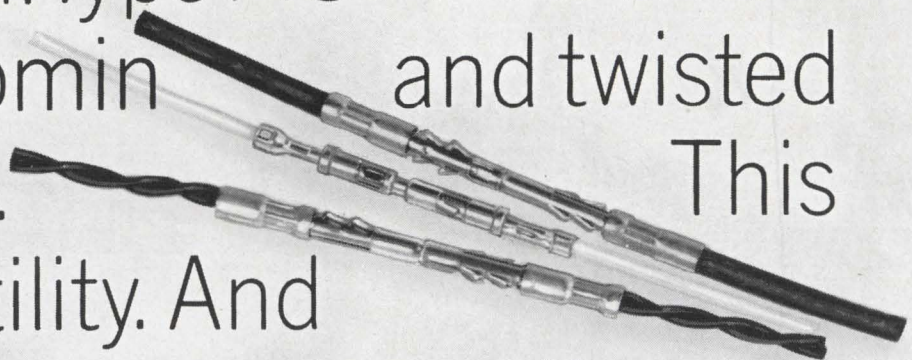

This means versatility. And using one block insures uniform shop instructions; quality controls.

That saves time and money. For extra safety add polarizing guides,

jack screws, strain relief hoods and pin protect-ing skirts.



Also available with low cost formed contacts.



Get the complete story. Write for your new MS-67 catalog.



INTERNATIONAL SALES HEADQUARTERS AND MANUFACTURING FACILITIES:
CANADA: Scarborough, Ontario / ENGLAND: St. Helens, Lancs. / BELGIUM: Mechelen
MEXICO: Naucalpan de Juarez / BRAZIL: Sao Paulo / JAPAN: Tokyo / Sales Offices in Other Major Cities.

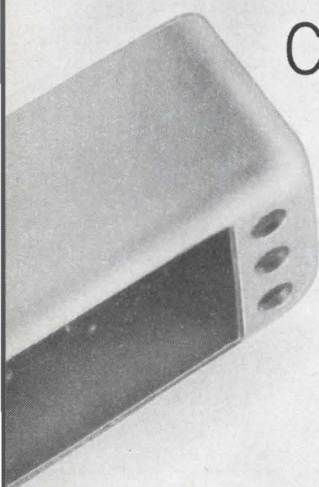

Co-Publishers

James S. Mulholland, Jr.
Hugh R. Roome

Editor

Howard Bierman

Managing Editor

Robert C. Haavind

Technical Editors

Jeffrey N. Bairstow
Peter N. Budzilovich
Roger K. Field
David H. Surgan

Management and Careers Editor

Howard S. Ravis

News Editors

Ralph Dobriner, Chief
Richard N. Einhorn

Washington News Bureau

Charles D. LaFond, Chief

East Coast Editor

Neil Sclater

West Coast Editor

Ron Gechman

New Products Editor

Steven B. Futterman

Copy Editor

Peter Beales

Editorial Production

Dollie S. Viebig
Phyllis Gura
Marian Arkin

Art Director

Clifford M. Gardiner

Art Assistant

William Kelly

Technical Illustrators

Cheh Nam Low
Sheila F. Ward
William Alvarez

Production Manager

Thomas V. Sedita

Asst. Production Manager

Helen De Polo

Production Assistants

Bernard Wolinsky
Gregory A. Bannon

Circulation Manager

Nancy L. Merritt

Reader Service

Diane Mandell

EDITORIAL



Engineers are no longer islands unto themselves

The United States has spent some \$50 billion on space and space-related activities in the 10 years since Sputnik. The 'fallout' from these programs has spread in many directions—from Teflon-coated cooking utensils to cigarette-pack-sized transistor radios to communications satellites that make possible instant television and telephone communications around the world.

The most important result of the past decade, however, cannot be measured simply in dollars or in numbers of new products for the consumer market. What has happened is that the role of the engineer has changed. Once there were mechanical and civil engineers—jacks-of-all trades—who were called on to find practical solutions to problems in almost all engineering areas. Then came the day of the rigid engineering specialty. Now, says the National Society of Professional Engineers, we are "back to the concept that an engineer is a man of the modern world who can and will tackle any problem to which application of scientific principles offers a possible solution."

"The 10 years since Sputnik jarred the U.S. out of its scientific complacency have brought the evolution of a new kind of engineer, who must take a broad look at a whole problem, so that he can dream and dare well beyond the strictness of his training," says Paul H. Robbins, the executive director of the society.

The task of constructing and launching a space vehicle the size of Saturn/Apollo, which stands some 36 stories high and that holds vast quantities of fuel, equipment, controls and a living environment for men, requires an engineer who, according to Robbins, "can back away from his own specialty and his own field, for a better look at what his peers are doing in other areas."

He has to learn the language of other disciplines, learn more of their problems, see what is being done or what could be done elsewhere that would help him solve his design problem.

If the metallurgical engineer can develop a lighter, stronger metal, then the structural engineer can design a more advanced spacecraft; if the chemical engineer can come up with a better, tougher, lighter plastic, then the electronic designer could do a better job miniaturizing components.

The engineer who really gets ahead today is the engineer who knows what his colleague in an allied field is doing. The two, by cooperating, may solve a problem that has stumped each alone.

RALPH DOBRINER

variable viewing time 5 cm/ μ s stored writing speed

split-screen displays

all in the Tektronix Type 549 Storage Oscilloscope

Waveform display showing train of pulses. Upper screen in the stored mode shows three pulses with falltime of the pulse trailing edge showing system deficiency. Lower screen in conventional display mode shows the same pulse train with corrections applied to provide a well formed pulse shape. Pulse width shown is 8 μ s with risetime of 0.1 μ s. Vertical deflection factor is 0.5 volts/cm. Horizontal deflection factor is 10 μ s/cm. Repetitive sweep used for both displays.

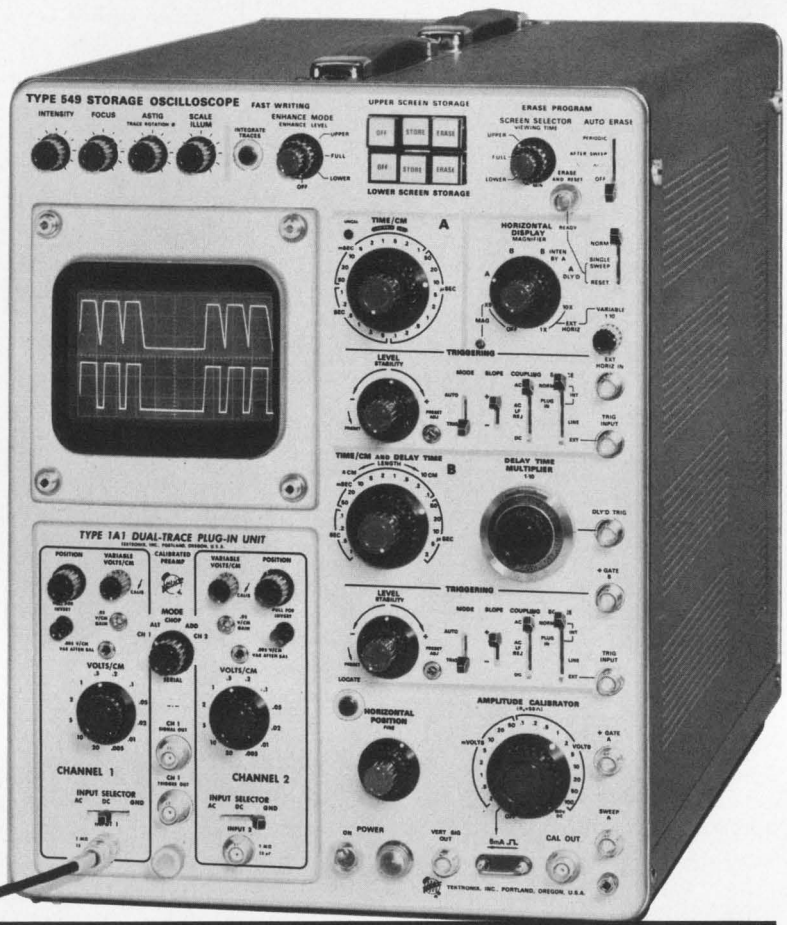

The Type 549 allows up to one hour of continuous visual storage, giving you ample time in most applications to measure and analyze stored waveforms. Stored displays can be erased in less than one-quarter of a second.

Split-screen displays

Unique with Tektronix storage oscilloscopes, split-screen displays bring you many advantages in waveform-comparison applications. You can use either half of the 6 cm by 10 cm display area for stored displays, the other half for nonstored displays, with independent control of each half. You can also use the entire screen for either type of display.

Variable viewing time

Variable viewing time — an outstanding feature of the Type 549 — allows you to automatically store displays, view them for a selected time, then automatically erase them on either or both halves of the screen. Two modes of operation are possible. In the After-Sweep Automatic Erase Mode, the selectable viewing time of 0.5 s to 5 s begins at the end of each complete sweep. After the viewing time, the display is automatically erased and the cycle begins again when the next sweep is triggered by a signal.

In the Periodic Automatic Erase Mode, the sequence of storing, viewing time and erasure is continuous and independent of the sweep or signal. In this mode, the viewing time can also be varied from 0.5 s to 5 s.

There is no degradation of stored traces during the selected viewing time, in either mode, and you can retain or erase displays manually whenever desired.

For a demonstration, contact your nearby Tektronix field engineer or write: Tektronix, Inc., P. O. Box 500, Beaverton, Oregon 97005.



Multi-trace, differential, sampling and spectrum analysis

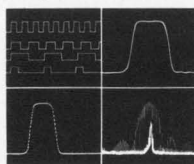

... in all Tektronix 530-540-550-series plug-in oscilloscopes

Bistable storage advantages

With bistable storage oscilloscopes, such as the Type 564 and Type 549, the contrast ratio and brightness of stored displays are constant and independent of the viewing time, writing and sweep speeds, or signal repetition rates. This also simplifies waveform photography. Once initial camera settings are made for photographs of one stored display, no further adjustments are needed for photographs of subsequent stored displays.

Tektronix bistable storage cathode ray tubes are not inherently susceptible to burn-damage and require only the ordinary precautions taken in operating conventional oscilloscopes.

Plug-in unit adaptability

Vertical deflection characteristics of the Type 549 are extremely flexible through use of any of the Tektronix letter- or 1-series plug-in units. These include multi-trace, differential, sampling, and spectrum analyzer units. Depending upon the plug-in being used, bandwidth of nonstored displays extends from DC to 30 MHz.

Among other features of the Type 549 are 5 cm/ μ s stored writing speed, calibrated sweep delay from 1 μ s to 10 s, sweep speeds to 20 ns/cm, amplitude calibrator from 0.2 mV to 100 V and a locate zone for easy positioning of stored traces.

Type 549, without plug-in units \$2475

Type 1A1 Dual-Trace Plug-In Unit \$ 625

DC to 30 MHz at 50 mV/cm; DC to 23 MHz at 5 mV/cm.
2 Hz to 14 MHz at 500 μ V/cm, single-channel.

U.S. Sales Prices, FOB Beaverton, Oregon

Technology

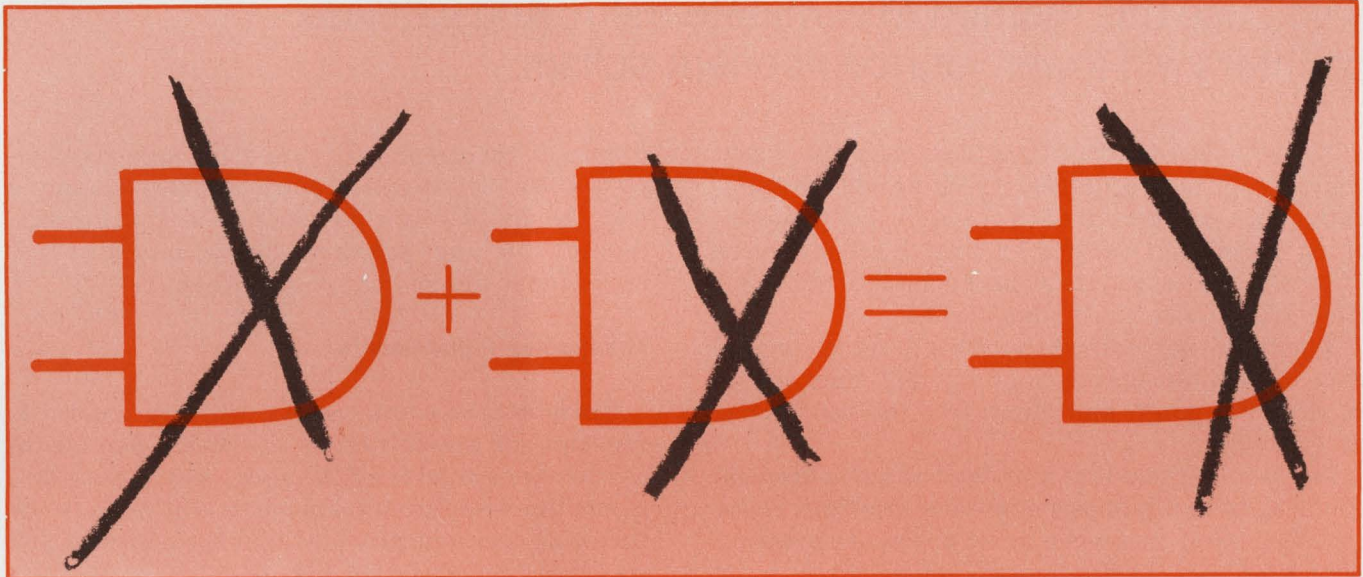

Counters can be designed without gates or a central clock. The use of only J-K flip-flops

with an asynchronous counting system cuts component costs and design time. Page 82

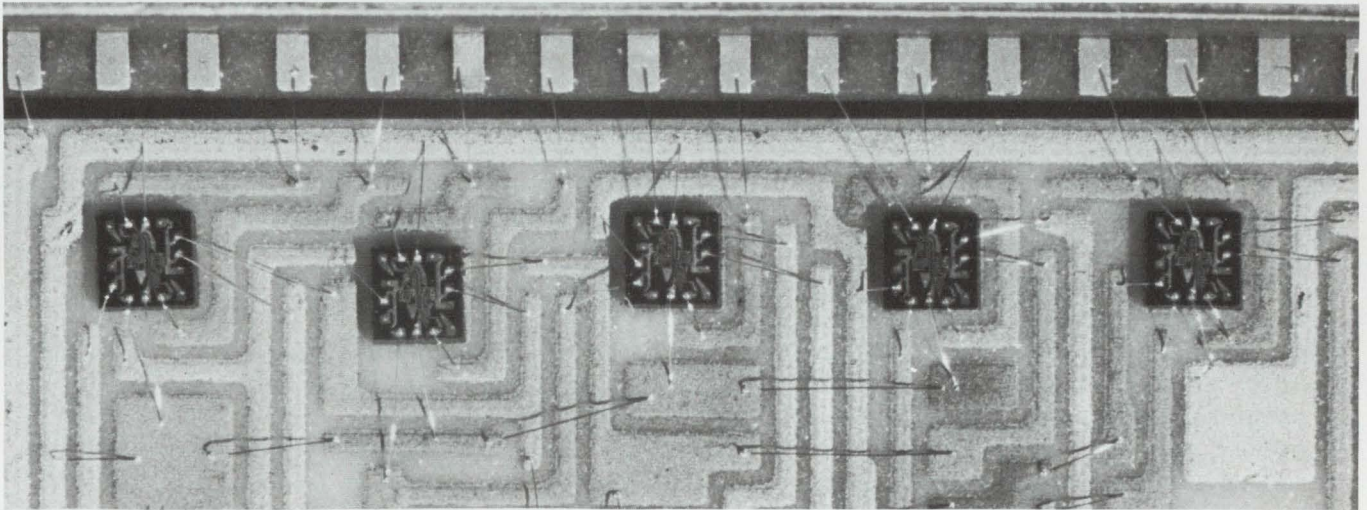

Are you abreast of latest developments in microelectronics? "Test your IC IQ," a new

regular feature, answers your questions. It makes its first appearance on page 100.

Also in this section:

The actron, a tunnel-diode gate, realizes threshold-logic functions. Page 92

Rising sales do not necessarily mean an increase in profits. Page 104

NASA Tech Briefs, Page 113 . . . Ideas for Design, Page 120

Counter designs swing without gates

if you use this method to eliminate them. And gateless counters will lower your component dollars.

Nearly every computing system uses frequency counters. Binary counters, which provide division ratios that are powers of two, are the least complicated to design. Counting by anything but powers of two, however, can consume a good deal of design time and require many components.

The following method enables a designer to produce a counter that counts by any number. It requires no gates, and eliminates the need for a central clock.

In essence, then, it is a method of asynchronous counting with flip-flops alone—J-K flip-flops. These counters count only when input pulses are present; between pulses the flip-flops do not switch.

The output of these counting circuits is simply the input divided by the integer that the circuit is designed to count by. For example, in counting by seven the counter would produce an output pulse for every seventh pulse on its input.

The method uses an extra flip-flop or two to eliminate two gate networks per stage; each network usually consists of two to five gates. In other words, a given counter may well have "counters" within it.

The method differs from simple synchronous counting in that its counters do not always count in a simple, uninterrupted binary sequence. And, unlike simple counters, the input flip-flop is not always prepared to take another input pulse immediately after the preceding pulse switches it. For some counter transitions, certain input pulses have to be timed no more closely than a length of time determined by the particular counter's maximum recovery factor. That is, several flip-flops may have to flip in sequence owing to the various feedback loops. Thus the input pulses must be spaced at intervals greater than the propagation delay of one stage multiplied by the greatest number of stages that may have to flip in sequence. That is:

$$t_{MAX} = F_{R(MAX)} t_d,$$

where t_d is the propagation delay of the flip-flop, and $F_{R(MAX)}$ is the largest recovery factor between

counts as the counter is pulsed through its complete cycle. (If the maximum recovery factor is one, the counter is equivalent to a synchronous counter and input pulses can be fed into it as fast as its input flip-flop can handle them.)

The flip-flop requirements

There are, of course, many ways to build J-K flip-flops and a wide variety of J-K flip-flop microcircuits are available off the shelf. Any J-K circuit, monolithic or discrete component, will work in the following counters, provided that it performs these standard functions (see Fig. 1):

- With logic zeros on both J and K inputs, a pulse to C input causes no change at the output.
- With a zero on K and one on J, a pulse to C forces the flip-flop to a SET state regardless of its previous state.
- With a one on K and zero on J, a pulse to C forces a RESET state.
- With ones on both J and K, each pulse to C causes the flip-flop to change state.
- An R input RESETS the flip-flop and has priority over all other inputs.

Find the elusive clock

In some logic families there is no clock, C, input. An input marked trigger, T, may sometimes be used to perform this function. Where there is neither clock input nor trigger input, there are inevitably two (or more) J and two (or more) K inputs. In these units a trigger is formed merely by connecting one of the J inputs to one of the Ks. (Motorola's

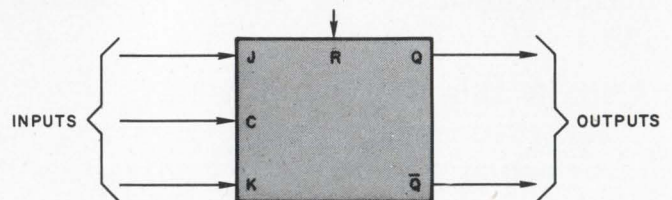

1. The sole part that counts is this J-K flip-flop. The clock input, C, is often called the trigger input, T. R overrides all other inputs and resets the flip-flop. Unused inputs must be terminated according to the manufacturer's recommendations.

Peter S. Duryee, Senior Engineer, Motorola Government Electronics Div., Scottsdale, Ariz.

high-speed emitter-coupled logic, for example, has just such an arrangement. In addition, its inputs are inverted. In this special case, then, the designer should use the same wiring diagrams but be sure to interchange Q and \bar{Q} and wire J and K input to logic zero wherever the diagrams call for connection to the logic one bus voltage.)

Regardless of the logic used, be sure to follow the manufacturer's recommendations for the disposal of unused inputs. Some manufacturers require their connection to supply voltage; some to the return line; some to a logic bus; some to a similar, but operating, input. Some logic families may not operate properly if unused inputs are left dangling, or if they are improperly connected.

Table 1 does the legwork

Table 1 tabulates all the information needed to design quickly a gateless counter that counts by any number from two to 100. Schematics, and alternative schematics were applicable, give the designs for the most commonly used integers, namely one through 20.

The first column (on the left) indicates the

counting unit (the input-output frequency ratio).

The second column shows the number of J-K flip-flops required for gateless counting by that integer.

Column three indicates the minimum number of flip-flops required even if the designer uses gates. Notice that gateless counting never requires more than two flip-flops more than gated counting, except for the case of counting by 59s, where three additional flip-flops are needed for gateless counting. In many cases, gateless design requires no additional flip-flops.

The fourth column gives the arithmetic in the form of a number group, which can be easily translated into a logic design. (An example is given below.) Schematics are included for the common counting integers, two to 20.

Column five pinpoints the type of feedback used by the logic circuit. The numbers refer to feedback loops that appear in Table 2.

How to derive a number group

The number groups are extremely easy to derive.

(text continued on p. 88)

Table I. Schematics for gateless counting

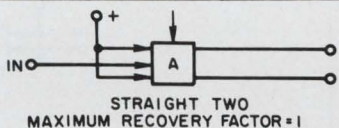
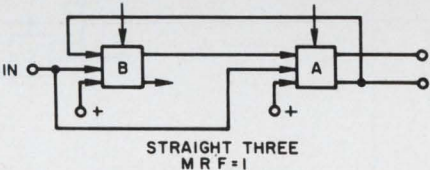
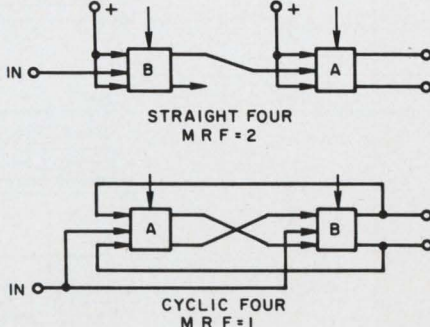
Input Output	No. F-F Gateless counters	No. F-F Gated counters	Form for wiring	Type of counters
2	1	1	2 	
3	2	2	(2 + 1) 	I
4	2	2	4 	

(continued on next page)

Input Output	No. F-F Gateless counters	No. F-F Gated counters	Form for wiring	Type of counters
5	3	3	$(4 + 1)$  <p>STRAIGHT FIVE MAXIMUM RECOVERY FACTOR = 2</p>	I
6	3	3	$2(2 + 1)$  <p>STRAIGHT SIX MRF = 2</p> <p>CYCLIC SIX MRF = 1</p>	I
7	4	3	$2(2 + 1) + 1$  <p>MIXED SEVEN MRF = 2</p>	II
8	3	3	8  <p>STRAIGHT EIGHT MRF = 3</p> <p>SEMICYCLIC EIGHT MRF = 2</p> <p>CYCLIC EIGHT MRF = 1</p>	I
9	4	4	$(8 + 1)$ OR $(2 + 1)(2 + 1)$  <p>STRAIGHT NINE MRF = 3</p> <p>MIXED NINE MRF = 2</p>	

Table I. continued

Input Output	No. F-F Gateless counters	No. F-F Gated counters	Form for wiring	Type of counters
10	4	4	$2(4 + 1)$  <p>STRAIGHT TEN MRF=3</p> <p>CYCLIC TEN MRF=1</p>	I
11	5	4	$2(4 + 1) + 1$  <p>MIXED ELEVEN MRF=3</p>	II
12	4	4	$4(2 + 1)$  <p>MIXED TWELVE MRF=2</p>	I
13	5	4	$4(2 + 1) + 1$  <p>MIXED THIRTEEN MRF=3</p>	II
14	5	4	$2[2(2 + 1) + 1]$  <p>MIXED FOURTEEN MRF=3</p>	II
15	5	4	$(2 + 1)(4 + 1)$  <p>MIXED FIFTEEN MRF=3</p>	I

(continued on next page)

Table I. continued

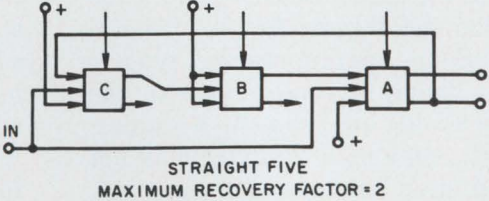
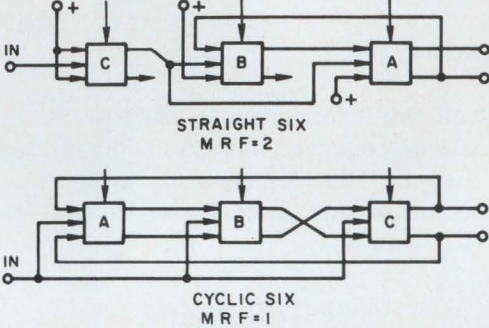
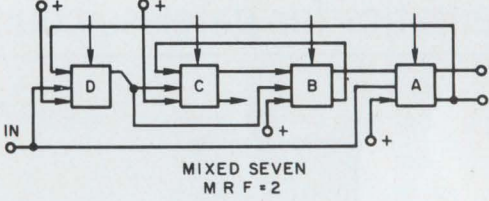
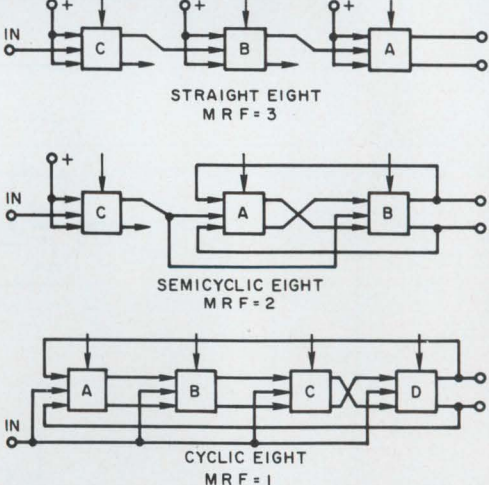
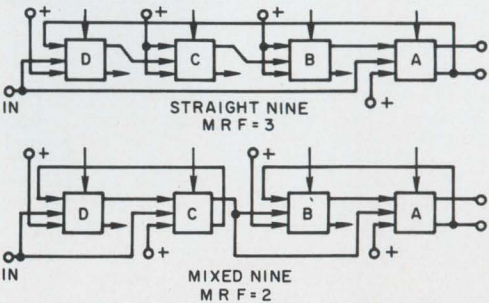
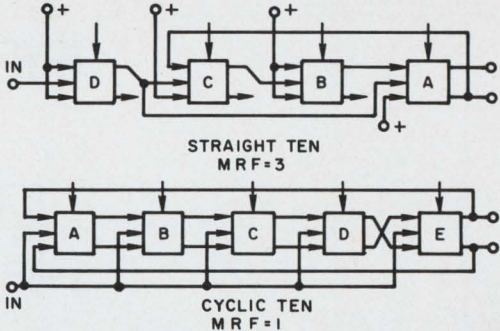
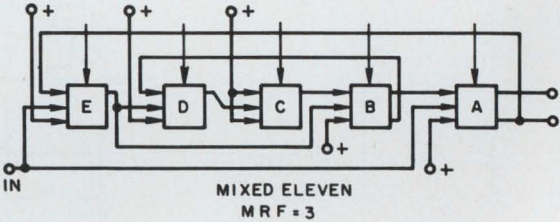
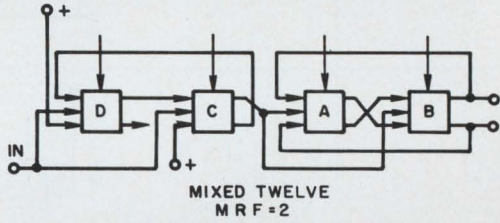
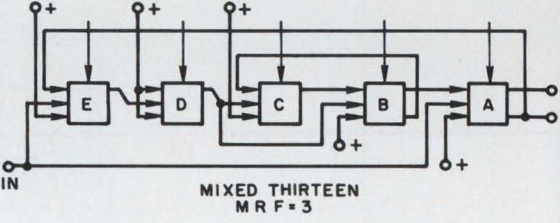
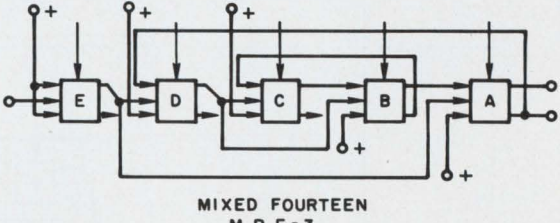
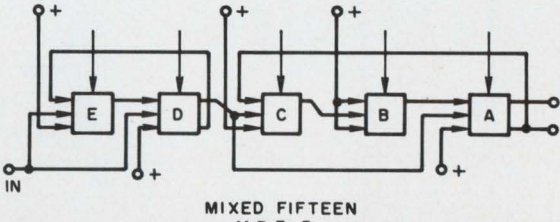
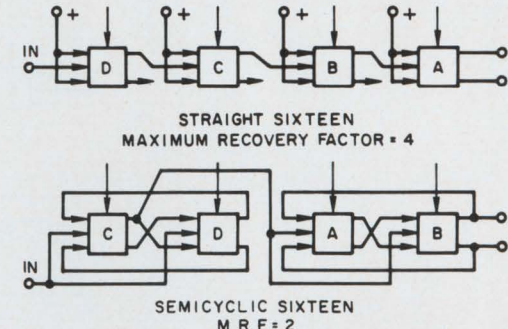
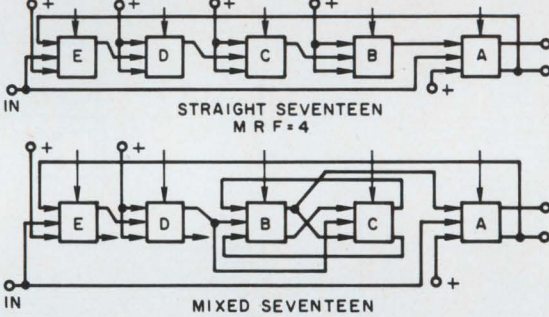
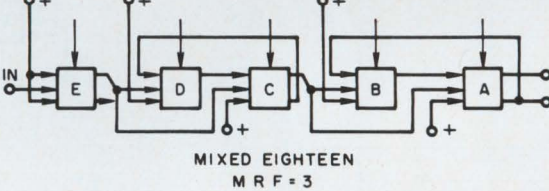
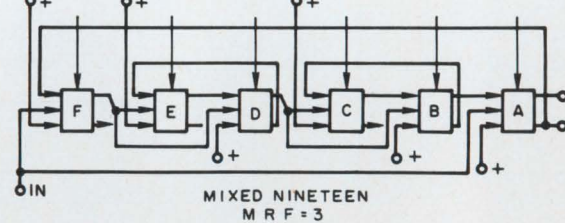
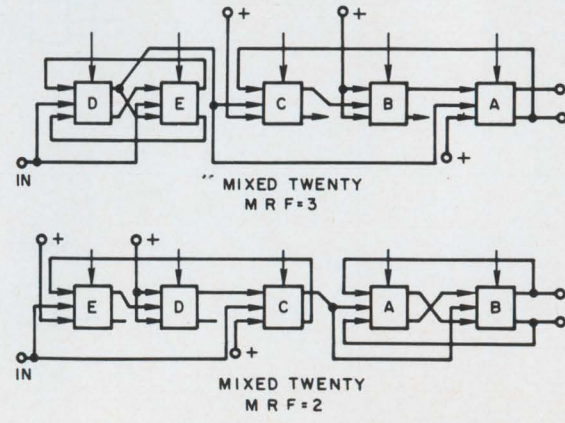
Input Output	No. F-F Gateless counters	No. F-F Gated counters	Form for wiring	Type of counters
16	4	4	<p>16</p>  <p>STRAIGHT SIXTEEN MAXIMUM RECOVERY FACTOR = 4</p> <p>SEMICYCLIC SIXTEEN MRF = 2</p>	
17	5	5	<p>(16 + 1)</p>  <p>STRAIGHT SEVENTEEN MRF = 4</p> <p>MIXED SEVENTEEN MRF = 3</p>	I
18	5	5	<p>2(8 + 1) OR 2(2 + 1)(2 + 1)</p>  <p>MIXED EIGHTEEN MRF = 3</p>	I
19	6	5	<p>2(8 + 1) + 1 OR 2(2 + 1)(2 + 1) + 1</p>  <p>MIXED NINETEEN MRF = 3</p>	II
20	5	5	<p>4(4 + 1)</p>  <p>MIXED TWENTY MRF = 3</p> <p>MIXED TWENTY MRF = 2</p>	I

Input Output	No. F-F Gateless counters	No. F-F Gated counters	Form for wiring	Type of counters
21	6	5	$(2 + 1) [2(2 + 1) + 1]$ OR $4(4 + 1) + 1$	II
22	6	5	$2[2(4 + 1) + 1]$	II
23	7	5	$2[2(4 + 1) + 1] + 1$	II
24	5	5	$8(2 + 1)$	I
25	6	5	$8(2 + 1) + 1$ OR $(4 + 1)(4 + 1)$	II or I
26	7	5	$2[4(2 + 1) + 1] + 1$	II
27	6	5	$(2 + 1)(2 + 1)(2 + 1)$ OR $(8 + 1)(2 + 1)$	I
28	6	5	$4[2(2 + 1) + 1]$	II
29	7	5	$4[2(2 + 1) + 1] + 1$	II
30	6	5	$2(2 + 1)(4 + 1)$	I
31	7	5	$2(2 + 1)(4 + 1) + 1$	II
32	5	5	32	
33	6	6	$(32 + 1)$	I
34	6	6	$2(16 + 1)$	I
35	7	6	$(4 + 1)[2(2 + 1) + 1]$	II
36	6	6	$4(2 + 1)(2 + 1)$ OR $4(8 + 1)$	I
37	7	6	$4(2 + 1)(2 + 1) + 1$ OR $4(8 + 1) + 1$	II
38	7	6	$2[2(8 + 1) + 1]$	II
39	8	6	$2[2(8 + 1) + 1] + 1$	II
40	6	6	$8(4 + 1)$	I
41	7	6	$8(4 + 1) + 1$	II
42	7	6	$2(2 + 1)[2(2 + 1) + 1]$	II
43	8	6	$2(2 + 1)[2(2 + 1) + 1] + 1$	II
44	7	6	$4[2(4 + 1) + 1]$	II
45	7	6	$(2 + 1)(2 + 1)(4 + 1)$ OR $(8 + 1)(4 + 1)$	I
46	8	6	$2\{2[2(4 + 1) + 1] + 1\}$	II
47	8	6	$[2(2 + 1)(2 + 1)(2 + 1) + 2]$	
48	6	6	$16(2 + 1)$	I
49	7	6	$16(2 + 1) + 1$	II
50	7	6	$2(4 + 1)(4 + 1)$	I
51	8	6	$2(4 + 1)(4 + 1) + 1$	II
52	7	6	$4[4(2 + 1) + 1]$	II
53	8	6	$4[4(2 + 1) + 1] + 1$	II
54	7	6	$2(8 + 1)(2 + 1)$	I
55	8	6	$(4 + 1)[2(4 + 1) + 1]$ OR $2(8 + 1)(2 + 1) + 1$	II
56	7	6	$8[2(2 + 1) + 1]$	II
57	8	6	$8[2(2 + 1) + 1] + 1$	II
58	8	6	$2\{4[2(2 + 1) + 1] + 1\}$	II
59	9	6	$2\{4[2(2 + 1) + 1] + 1\} + 1$	II
60	7	6	$4(2 + 1)(4 + 1)$	I

Suppose, for example, counting is to be done by a number that does not appear in Table 1, say, 117. The goal is to reduce 117 to numbers that are either unity or powers of two:

$$\begin{aligned}
 117 &= 116 + 1 \\
 &= 2(58) + 1 \\
 &= 4(29) + 1 \\
 &= 4(28 + 1) + 1 \\
 &= 4[4(7) + 1] + 1 \\
 &= 4[4(6 + 1) + 1] + 1 \\
 &= 4\{4[2(3) + 1] + 1\} + 1 \\
 &= 4\{4[2(2 + 1) + 1] + 1\} + 1 \quad (\text{This is the number group}) \\
 &\quad \downarrow \downarrow \downarrow \downarrow \downarrow \downarrow \downarrow \downarrow \downarrow \downarrow \\
 &2 + 2 + 1 + 1 + 1 + 1 + 1 + 1 + 1 = 10 \quad (\text{Number of flip-flops})
 \end{aligned}$$

One and twos in the number group can each be implemented with one flip-flop. Higher powers of two can be implemented with a number of flip-flops equal to the power itself. For instance, a four requires two flip-flops; an eight requires three. It is fairly easy to translate the number group into a pin-to-pin schematic. Take a number group such as 59, for instance. Table 1 suggests $2\{4[2(2+1)+1]+1\}+1=59$. Start from the center:

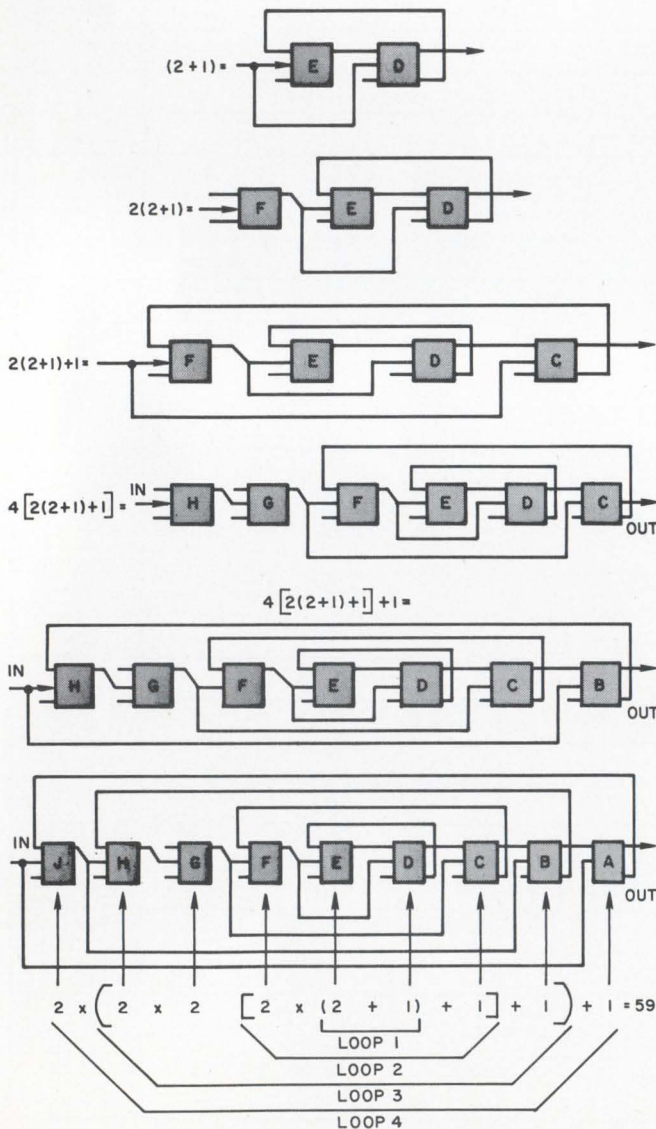

Straight binary counting is accomplished by cascading the flip-flops, so that the Q output is connected to the C input of the following stage. (For examples, see the straight two, straight four and straight eight counters in Table 1.) To perform other than straight binary counting with few components, various feedback forms are used. For example, to add one to a subcount, the following feedback (called type I) is useful:

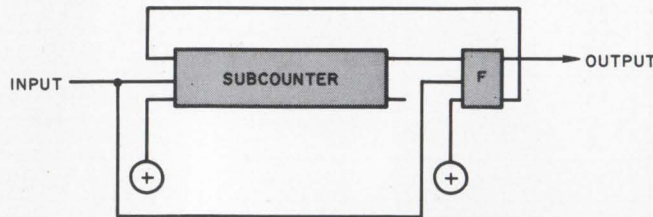

To add one to a subcount, y , to which one has already been added and the sum multiplied by any two integers, x and z , use a type II enclosed loop feedback:

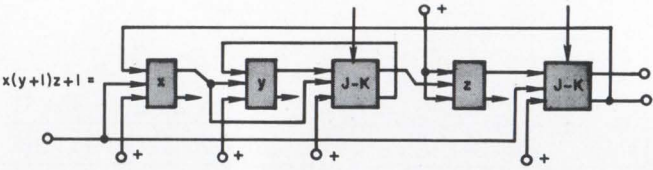

Unlike types I and II, the more complex feedback schemes cannot implement all integers, but occasionally they offer a slight reduction in the number of flip-flops. For example, type I or type II implementations of 47 and 94 each require nine and ten flip-flops, respectively. A more complex feedback mented by this same feedback. And often the more exotic feedbacks increase the maximum recovery factor. ■ ■

Test your retention

Here are questions based on the main points of this article. They are to help you see if you have overlooked any important ideas. You'll find the answers in the article.

1. Does a counter with a high maximum recovery factor count slower than one with a recovery factor of unity?
2. How many extra flip-flops will usually be needed to rid a counter design of all gates?
3. What is the maximum recovery factor that a synchronous (clocked) counter can possess?
4. What are the necessary and sufficient properties of the flip-flops in these gateless counter designs?
5. To what terms must the counting number be reduced to determine the flip-flop configuration?

The RCA-TA2628 solid-state laser with threshold current of less than 15A at room temperature needs only a simple solid-state circuit and a small battery for a typical power output of ... **3 crazy watts!**



There's nothing crazy or complicated about putting RCA's new GaAs injection laser to work in your circuits today! This tiny, highly efficient unit is one of the more practical laser diodes around.

It operates at room temperature and all you need to drive it is a low cost transistor or SCR, a couple of resistors and capacitors, and a triggering diode. No expensive or cumbersome cryogenic hardware or high-current power supplies.

The peak emission wavelength of the TA2628 is $9050 \pm 50 \text{ \AA}$ and you can get a typical output of 3 watts if you drive it with a pulse current of 30A. It is backed by life test data in excess of 1000 hours and its range of applications is limited only by your imagination.

We have just published a brand new Application Note (AN-3439) on this unit, which we would like to send you. At the same time we will forward you data sheets on RCA's other solid-state optical devices—the TA2930, a 50-watt laser, and the TA7008, IR emitting diode. Write: RCA Commercial Engineering, Section SG 12-1, Harrison, N.J. 07029.

Also available through your RCA Distributor

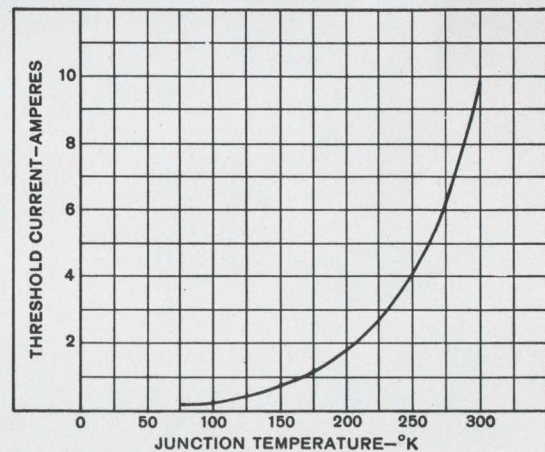

RCA Electronic Components and Devices

The Most Trusted Name in Electronics

ON READER-SERVICE CARD CIRCLE 44

Reduce circuit costs with 16 new plastic-package transistors from TI

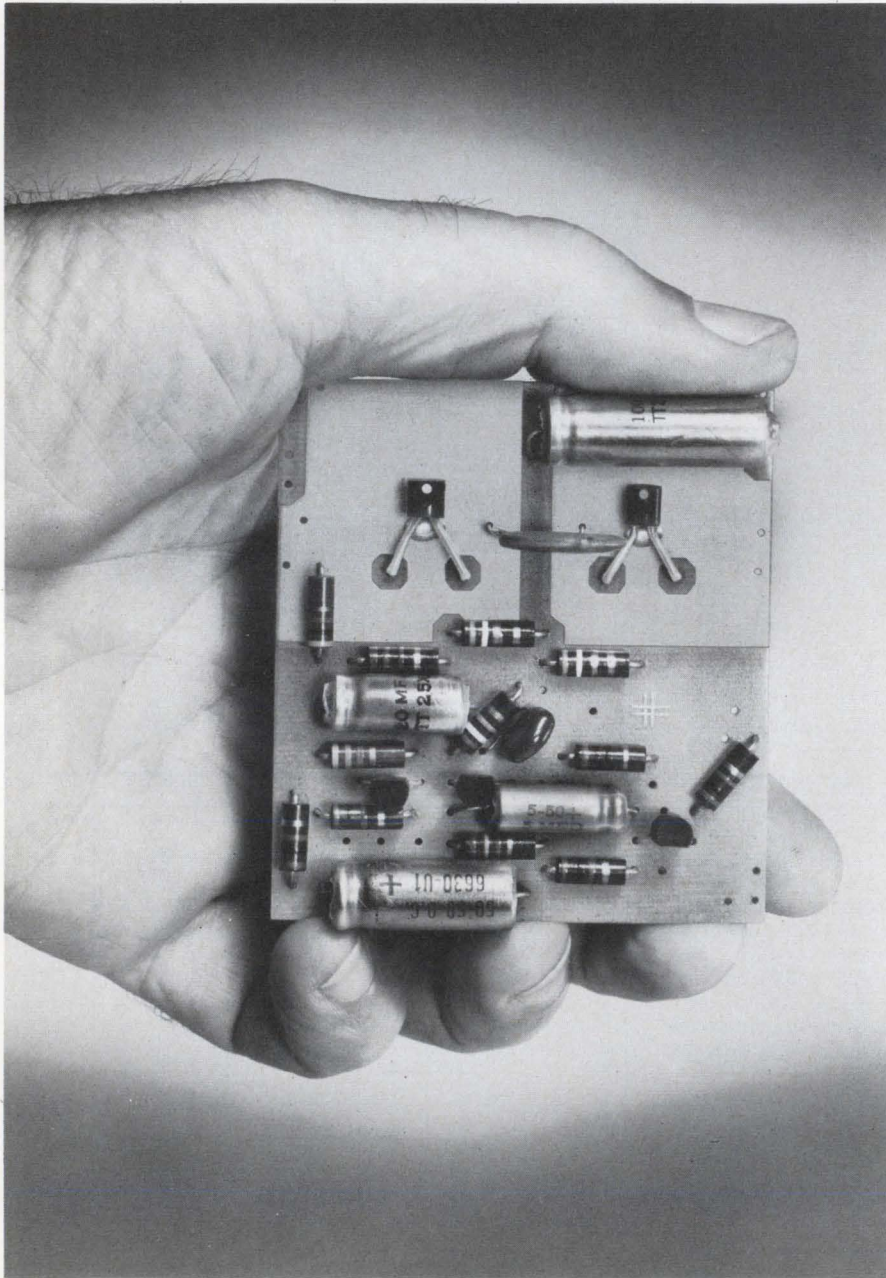

Texas Instruments announces 16 new transistors to improve performance, simplify circuitry and reduce your product costs. Included are silicon amplifiers, oscillators and switches. An economy version of the 2N4416 FET is available, too.

All the new transistors are offered in TI's exclusive SILECT™ economy plastic package. Lead configurations include: in-line, TO-18, and high-frequency. The new HF arrangement provides improved isolation and lower feedback capacitance for VHF and UHF devices.

TI's SILECT package, backed by 30,000,000 hours of testing, is fully capable of meeting military specifications. Reliability has been found to be equivalent to metal-can devices tested under the same conditions.

High-dissipation SILECT package eliminates heat sinks

Here are the first economy small-signal transistors to feature power dissipation of 1.6 watts at 25°C case temperature — nearly twice that of devices with comparable packages. Specially processed, high-thermal conductivity leads achieve this added dissipation. Designated as NPN types TIS90 and TIS92, and PNP types TIS91 and TIS93, these complementary devices are also available in matched pairs (TIS90M/TIS91M and TIS92M/TIS93M).

The new, high-dissipation packaging allows plastic transistors to be used in applications formerly

restricted to metal-case, medium power devices or to the use of elaborate and expensive heat sinks.

An effective heat sink can be obtained *at no extra cost* by leaving an area of copper on the face of the etched circuit board and connecting the high-conductivity collector lead to it (as shown at left).

The complementary pairs are designed for low-cost audio driver and output circuits up to two watts for phonograph applications.

Electrical characteristics are similar to the 2N2222 NPN and 2N2907 PNP families.

Circle 213 for data sheet.

New high-frequency FET doubles previous frequency capability

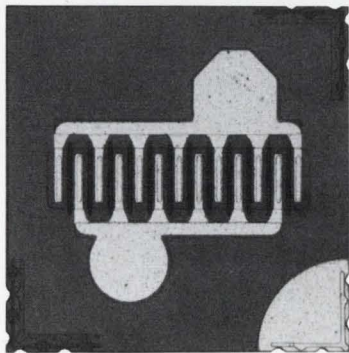

The new TIS88 silicon FET—plastic-encapsulated equivalent of the 2N4416 also offered by TI—features a frequency capability twice that of similar devices previously available in low-cost plastic packages. The high-performance FET operates up to 400 MHz with 10 dB minimum power gain. High transconductance and low feedback capacitance make this new

device especially useful for consumer, industrial and military applications, including FM RF amplifiers, cascode-connected VHF amplifiers and sonobouy input amplifiers. Performance characteristics include a low noise figure (4 dB maximum at 400 MHz) and low leakage ($I_{GSS} = 1\text{nA}$ maximum).

Circle 214 for data sheet.

New low-cost NPN devices for TV and audio applications

TIS83. Designed for use in UHF tuners, the new TIS83 transistor features a high injection current ($I_{osc} = 2.5\text{ mA}$ minimum at 930 MHz). Transconductance is high ($Y_{fs} = 70\text{ mmhos}$ at 200 MHz), permitting use with Schottky-barrier or AFC diodes.

Circle 215 for data sheet.

TIS84-85. New TIS84-85 transistors are designed for RF amplifiers and first and second video IF applications. They feature low noise figures (3.3 dB max @ 200 MHz for the TIS84), low feedback capacitance (0.4 pF maximum) and excellent forward AGC characteristics. The AGC control-voltage range is narrow, making only one device necessary for both IF sockets. The 100-mil B-E-C high frequency pin configuration isolates input and output circuitry.

Circle 216 for data sheet, which includes 10 performance curves and two application circuits.

TIS86-87. New TIS86-87 high-frequency silicon transistors are designed for such TV applications as mixers, reverse-AGC IF, and third IF. Feedback capacitance is

low at 0.45 pF maximum, permitting unneutralized IF-stage design. Real and imaginary parts of y-parameters at 45 and 200 MHz simplify circuit design. Pin configurations are 100-mil, B-E-C.

Circle 217 for data sheet.

TIS94-99. This is a complete family of low-noise, low-to-medium current SILECT transistors for use in hi-fi audio amplifiers and general purpose low-frequency applications. They feature excellent Beta linearity to 100 mA, high current gain, low noise figures and high breakdown voltage (65 V min $V_{(BR)CE0}$ for the TIS96 and TIS99).

Circle 218 for data sheet.

Benefits of SILECT construction

Moisture resistance—SILECT transistors meet MIL STD 202C, Method 106B.

Stability—Transfer molding gives maximum stability...with no detrimental effect on the wafer.

Solderability—The plastic withstands all normal soldering temperatures without deformation.

Ruggedness—Solid package protects against vibration and shock.

Indexability—The flat surface may be used to index leads for automatic insertion.

Two lead configurations...both TO-18 pin-circle and TO-92 in-line are available for all standard devices.

See your TI sales representative or authorized distributor for more information, including price and delivery quotations.



TEXAS INSTRUMENTS

Use tunnel diodes in threshold logic

An actron — a discrete component gate — can be built to realize a variety of functions.

Recent promising practical^{1,2,3,4} and theoretical^{5,6,7} developments in threshold logic indicate that its application will lead to significant simplifications and cost savings in the design and construction of logic circuits. While many believe that the ultimate success of threshold logic systems will hinge on the development of integrated-circuit threshold gates⁸, many useful threshold logic circuits can be built with discrete-component gates.

In particular, gates built with tunnel diodes have been found extremely practical. This article, then, will describe operation, design and applications of such a two-diode gate. Since this gate has no counterpart in the familiar Boolean class of gates (it is simultaneously an AND, OR, and EXCLUSIVE OR), it will be called an Actron. Its versatility will be demonstrated by showing how to use it in several typical logic circuits.

The actron — what is it?

An actron is a threshold logic element built with two tunnel diodes the state of which (high or low) is determined by the input current amplitudes. It bears a strong similarity to Crane's neuristor^{9,10} hypothesis which describes a structure called a T-S junction (see sketch below).

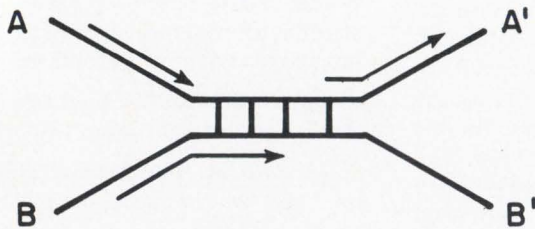

It functions in such a way as to inhibit the flow of information on a line by the passage of a pulse on an adjacent line. As is shown in the sketch, a pulse traveling along line A triggers the junction producing an output at A'. The action of A excites B in such a manner as to obliterate any pulse occurring on line B during the time of excitation on line A or until line B has recovered. The same is also true of

the relationship between B and A.

In a sense, then, the actron is a modified tunnel-diode EXCLUSIVE OR circuit. The neuristor-like action is achieved by arranging the diodes so that turning on one of them automatically disables the other, by operating the actron in a monostable mode, and by using a relatively large propagation period. Specifically, the propagation period is selected to be approximately one-half the on time of the monostable mode for proper switching.

Analyze actron's operation

To describe the actron's electrical characteristics, it is necessary to define certain circuit parameter symbols, which are listed in the box.

Figure 1 illustrates the composite characteristic curves of the two tunnel diodes, TD1 and TD2. The only difference between the two curves is that the peak current, I_{p1} , of TD1 is greater than that of TD2, I_{p2} —an essential factor for operating the actron.

To simplify the operating explanation of the actron (Fig. 2), backward diodes* CR1 through CR4 have been added to ensure unidirectional

*Backward diodes: GE trade name for tunnel rectifiers. They exhibit minimum voltage drop in the reverse direction and maximum drop in the forward direction—typically 90 and 550 mV, respectively.

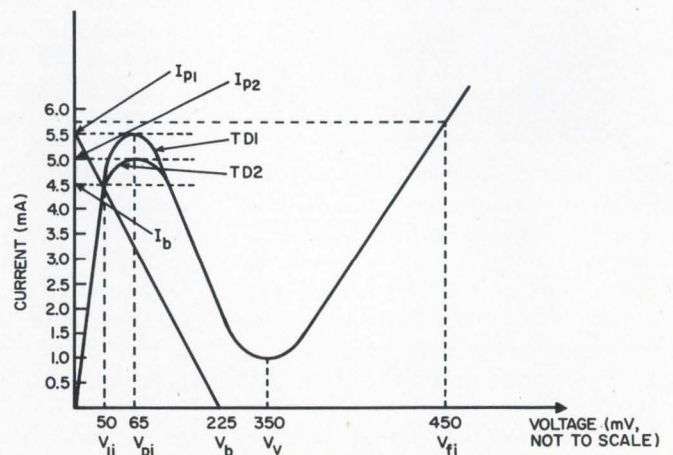

1. The difference between peak currents, I_{p1} and I_{p2} , of the two tunnel diodes, TD1 and TD2, is the necessary condition for the successful operation of the actron. Other symbols are defined in the box.

Carl A. Budde, President, Diginetics, Glendale, Calif.

current flow, but the voltage drop they introduce will not be taken into consideration. Inductances in the input wires are there to provide necessary delays.

I_{p1} is chosen to be greater than I_{p2} (Fig. 1) and I_b to fall below I_{p2} as determined by $R5$ (Fig. 2). Before application of the input voltage both tunnel diodes are in their low state, as determined by the bias current I_b . A voltage, e_2 , applied to either A' or B' will produce an input current to $TD2$ of I_{2a} or I_{2b} which, when added to I_b , will result in a total current flowing through both $TD1$ and $TD2$, the magnitude of which is insufficient to switch either $TD1$ or $TD2$. If, however, e_2 is applied to A' and B' simultaneously, a current, $I_{2t} = I_{2a} + I_{2b}$, will flow and be added to I_b . This current ($I_{2t} + I_b$) is greater than I_{p2} , but less than I_{p1} . Therefore, $TD2$ will switch to the high state, V_{f2} , producing an output at D . No output will be present at C at this time. It has been shown, then, that:

$$\left. \begin{aligned} I_{p2} &> I_b + I_{2a} \\ I_{p2} &> I_b + I_{2b} \end{aligned} \right\} \text{no output (logic 0);}$$

$$I_{p2} < I_b + I_{2a} + I_{2b} = I_b + I_{2t},$$

so there is an output at D (logic 1), which satisfies a simple AND function. In Boolean notation, $A'B' = D$, which means that there is an output when a signal is applied to both A' and B' .

Consider $TD1$ next. If a voltage, e_1 , is applied to either A or B , then a current, $I_{1t} = I_{1a} = I_{1b}$, will be added to I_b and flow into $TD1$. This resultant current is greater than I_{p1} and so will cause $TD1$ to switch to the high state, V_{f1} . With $TD1$ in the high state, an output will be present at C for an OR function. So:

$$I_{1t} + I_b > I_{p1}.$$

Using Boolean notation for OR, this can be written:

$$A + B = C,$$

where a dotted plus sign means OR.

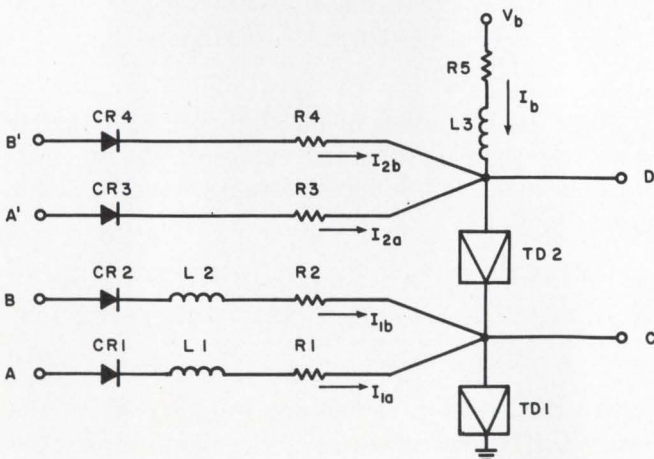

2. **EXCLUSIVE OR** is obtained from the actron when A' and B' are connected to A and B , respectively. Backward diodes $CR1$ through $CR4$ assure unidirectional signal flow. See text for the explanation.

Now examine the actron when A and B are connected to A' and B' , respectively, and the output is taken at C (Fig. 3). With an input at either A or B , output C will be high, V_{f1} . When both A and B receive inputs simultaneously, C will remain low because $L1$ (Fig. 2) is in series with $R1$ and $L2$ in series with $R2$. These provide delay in the current build-up (I_{1a} and I_{1b}) to $TD1$. This guarantees that $TD2$ will switch first when A and B both have inputs. Thus:

$$C = A\bar{B} + \bar{A}B,$$

where the bar over a symbol means NOT.

Don't forget the diode interaction

This basic actron configuration is capable of performing AND, OR and EXCLUSIVE OR functions. One factor must, however, be taken into consideration at all times if both C and D outputs are used. Owing to the nature of the tunnel diode, a nonisolation feature is always present: whenever an output is present at C , so will it be at D . In other words, during the OR operation both C and D will appear in the high state. In some cases, depending on the over-all function of the system using actrons, this may be a problem—a problem, however, that is not insoluble.

Normally, when the actron is used as a solid-state realization of a neuron or the hypothesized neuristor, false outputs are not a problem, since the actron performs in the EXCLUSIVE OR mode with the output taken at C only.

Before the actron is defined mathematically, two more important factors need clarification. Firstly, the actron performs in the monopulse mode, that is, there is one output pulse for each input pulse. The monopulse mode is secured by selecting V_b to be below $\sum_{j=1}^2 V_i + V_v$, that is, the tunnel diode

Circuit parameters

- I_b Bias current
- I_{pj} Peak current of tunnel diode
- I_{vj} Valley current
- V_{1j} Quiescent voltage across tunnel diode
- V_{pj} Peak voltage
- V_{fj} Forward voltage (during switching)
- V_{tr} Voltage drop across backward diode
- V_{vj} Valley voltage
- I_{ja} } Input currents to tunnel diodes
- I_{jb} }
- V_b Bias voltage

In the above, the subscript j denotes either 1 or 2, depending on which tunnel diode is under discussion.

will always switch back to its low state on removal of the input current. Secondly, backward diodes are used where current steering and unidirectional information flow are need. Regardless of the function, however, they must be in series with the "primed inputs" (see Fig. 2). This is to block nondelayed current from flowing back to any input stages.

Building a practical actron

For analysis of the actron, two hypothetical tunnel diodes with the following characteristics are assumed:

$$\begin{aligned} I_{p1} &= 5.5 \text{ mA}, \\ I_{p2} &= 5.0 \text{ mA}, \\ V_{vj} &= 350 \text{ mV}, \\ V_{1j} &= 50 \text{ mV}, \\ V_{fj} &= 450 \text{ mV}, \\ V_{pj} &= 65 \text{ mV}. \end{aligned}$$

The only difference between $TD1$ and $TD2$ is that $TD1$ has a 10% higher I_p , making it equal to 5.5 mA. In experiments a pair of matched General Electric TDP-3 tunnel diodes were used. $TD1$ was shunted by a resistor to raise the effective peak-to-valley ratio, but this did not seem to affect the over-all performance. The TDP-3 has an I_p spread of from 4.2 to 5.2 mA. For simplicity, the tunnel diodes were all assumed to have either 5.0- or 5.5-mA I_p .

The biasing point, which must be set below I_p of $TD2$, depends on a number of factors such as peak current distributions, variations anticipated in ambient temperature, and component tolerance. Since the distribution of tunnel diodes supplied by GE was within $\pm 2\%$ of 4.7 mA, it was possible to bias at 10% below I_{p2} for a greater safety margin and assume all components good to within $\pm 2.5\%$. Environment? Strictly room temperature, 25°C, although tunnel diodes, in general, can be used in extreme temperature conditions. While the characteristic shifts with respect to its axis, and the high-voltage region shifts with respect to the low-voltage region, the general nature of the characteristic will remain the same. The bias voltage, current and resistor $R5$ are calculated as follows:

$$V_b = \left[\sum_{j=1}^2 V_{1j} + V_v \right] / 2 = 225 \text{ mV}. \quad (1)$$

$$I_b = I_{p2} - (10\% \text{ of } I_{p2}) = 4.5 \text{ mA}. \quad (2)$$

$$R5 = \left[V_b - \sum_{j=1}^2 V_{1j} \right] / I_b = 25.5 \Omega. \quad (3)$$

Five years' experience has shown that it is generally quite satisfactory to use simple equations to determine such time constants as the on time of a monopulse oscillator. An on period, τ_ω , of approximately 400 ns is arbitrarily chosen and $L3$ is determined from $L3 = \tau_\omega R5 \approx 10 \mu\text{H}$.

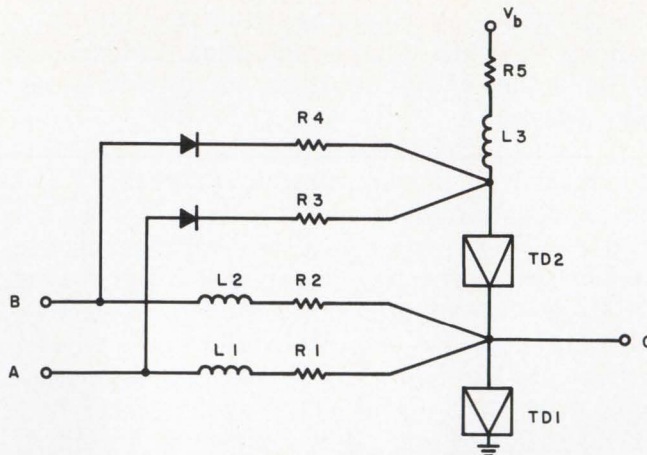

3. $TD2$ switches before $TD1$ when an input is applied to either A or B because of the slight delay due to $L1$ and $L2$.

In determining values for the input resistors, $R1$ through $R4$, the input voltage, e_a , applied to either A or B is assumed to come from another actron, and is taken as V_{fj} or 450 mV. Starting from the top, $R3 = R4$ is solved for first. A 5% overage on input current to either $TD1$ or $TD2$ is assumed, to ensure switching. Then:

$$I_{2a} = I_{2b} = (I_{p2} + 0.05 I_{p2}) / 2 = 0.375 \text{ mA}; \quad (4)$$

hence:

$$\sum_{n=a}^b I_{2n} + I_b = 5.25 \text{ mA}, \quad (5)$$

which is greater than I_{p2} (5 mA) but less than I_{p1} (5.5 mA).

Now, with only one input, say A, the current flowing through $TD1$ will be:

$$I_b + I_{2a} + I_{1a},$$

and should exceed I_{p1} by 5% for switching, or:

$$I_{p1} + 0.05 I_{p1} \approx 5.75 \text{ mA}. \quad (6)$$

Therefore:

$$\begin{aligned} I_{1a} = I_{1b} &= (I_{p1} + 0.05 I_{p1}) - I_b - I_{2a} \\ &= 5.75 \text{ mA} - 4.5 \text{ mA} - 0.375 \text{ mA} \\ &= 0.875 \text{ mA}. \end{aligned} \quad (7)$$

Since the resistance of either $L1$ or $L2$ is small with respect to anticipated values of $R1$ and $R2$, it can be neglected. The resistors can then be calculated as follows:

$$R1 = R2 = (e_a - V_{11}) / I_{1n} = 465 \approx 470 \Omega, \quad (8)$$

$$\begin{aligned} R3 = R4 &= [e_a - V_{tr} - (V_{11} + V_{12})] / I_{2n} \\ &= 695 \approx 680 \Omega, \end{aligned} \quad (9)$$

where the resistor values are rounded off to the nearest standard value; V_{tr} , the drop across the backward diode due to I_{2n} , is taken to be 90 mV, and the subscript n denotes either a or b .

For a value of L , the delay or propagation period, τ_0 , was taken as one-half the on period of

the actron, or 200 ns. It is given by:

$$L1 = L2 = \tau, R1 = (200 \times 10^{-9}) (470) = 94 \mu\text{H}. \quad (10)$$

To summarize the actron's operation, look at Fig. 3. With the application of a step input at A, TD2 and TD1 experience an almost simultaneous rise in current. This current increase is due to the action of R3 but is insufficient to rise above the peak current of either TD1 or TD2. At the moment the input is applied, the current flowing in L1 and R1 is equal to zero. It starts rising exponentially toward a maximum value of I_{1a} . When it reaches a point where, when added to I_{2a} and I_b , the total equals I_{p1} , TD1 switches on and output C rises from 50 to 450 mV. If, on the other hand, inputs are applied to both A and B, the current increase down through TD2 is sufficient to switch it to the high state, V_{f2} .

With either TD1 or TD2 in the high state, bias current I_b starts to collapse in L3 toward a value of I_{vj} . When I_{vj} is reached, the on tunnel diode switches off. The current then begins to increase in L3, until it returns to I_b . A good rule of thumb is that this period of time, known as the recovery period or refractory period, is about 3.5 times the pulse width, or on time.

Figure 4a illustrates two actrons, with alternate inputs applied to A, B or C; Fig. 4b shows the anticipated waveforms referenced to zero time, t_0 . The following can be observed:

- With either A or B inputs present, an output will result at 3, provided an input at C did not occur one time period after the application of A or B.
- With inputs A and B appearing simultaneously, no output will be present at 1 or 3. If C is present, however, an output can be generated at 3. While it is possible for current to flow from 3 back into 1, it will have no effect because point 2 is switching.
- If an input is provided to C only, an output will be present at 3 after $t_{03} + 1$ and at 1 after $t_{03} + 2$.

How many inputs or outputs?

Ideally as many lines would be accommodated in and out of the actron as required. Certain practical limitations, however, prevent this. Since no backward diodes are used for the lower input tunnel diode, it is shunted by the input resistors. This raises the effective peak current while at the same time degrading the peak-to-valley current ratio. For instance, the current component I_x that flows away from tunnel diode TD1 is:

$$I_x = V_{11}/R_i/N, \quad (11)$$

where R_i is the input resistor = 465 Ω , N is the number of input/output lines = 3. Therefore, $I_x = 322 \mu\text{A}$, and the current flowing through TD1 is actually:

$$I_b - I_x = 4.178 \text{ mA}. \quad (12)$$

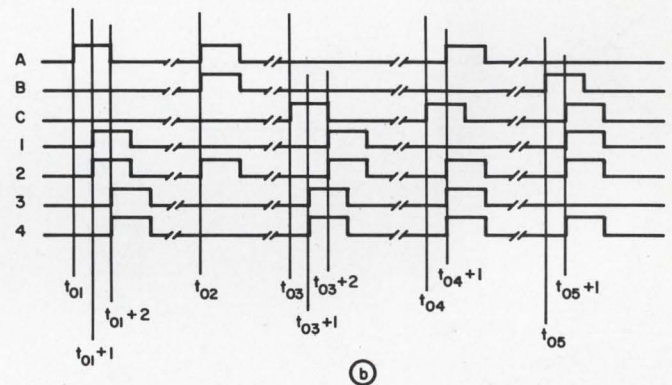
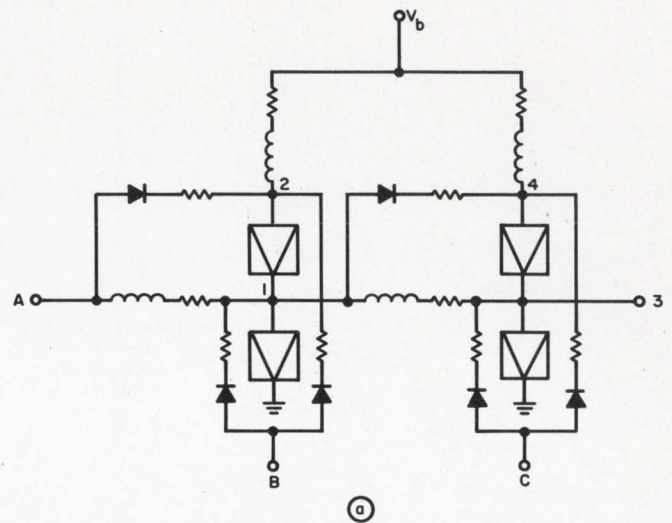

4. Practical considerations limit the number of input and output lines entering an actron to about four (a). The action of this double-actron circuit (b) is described in text. Component values are omitted because they are the same as in the basic actron (Fig. 2).

This, of course, is only at bias point V_{1j} and will change as I_{pi} is approached. The change is quite tolerable in view of the many variables and their accompanying distributions. At V_{pj} , which was set at 65 mV, the dynamic resistance of the tunnel diode with a 5-mA I_p is equal to 13 ohms. Therefore to raise the effective peak current 10 per cent, a shunt, R_{sh} , of 130 ohms is required. Since input resistance R_i is equal to 465 ohms, the maximum number of input and output lines that may be accommodated is:

$$R_i/R_{sh} = 3.57. \quad (13)$$

so the maximum number of lines that can be conveniently tolerated is three. In actual practice, it is possible with a little care to accommodate up to four lines. It might be added at this point that the goal is to develop a structure that would theoretically accommodate an infinite number of lines.

New logic symbols are needed

Although for the most part the actron would be used in the EXCLUSIVE OR configuration with-

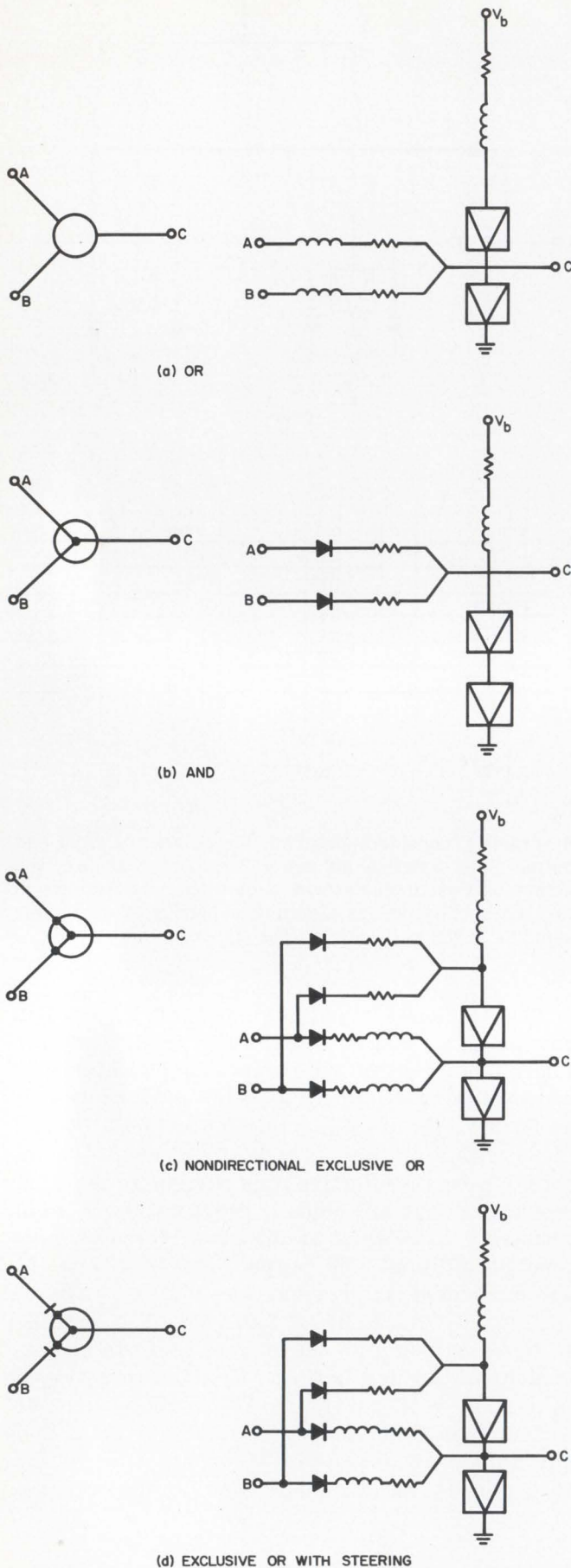

5. Actron's versatility in realizing a variety of logic functions is demonstrated with the new logic symbols and corresponding circuit schematics. Once again, component values are those of Fig. 2.

out benefit of steering diodes, other cases will arise from time to time where simple logic decisions such as AND and OR will be required. For this reason a set of logic symbols has been devised.

The symbols (Fig. 5) provide all the basic circuit configurations. The central circle may be considered the top tunnel diode, *TD2*, with the actron viewed from the top. An OR junction (Fig. 5a) is formed beneath *TD2*, and an AND junction (Fig. 5b) is formed above *TD2*. For the nondirectional EXCLUSIVE OR, the top lines are led to the bottom by dots at the crossing of the lines and the edge of the circle (Fig. 5c). Steering diodes are shown as a short bar crossing an information line (Fig. 5d). If a line is brought out of the circle, it is taken to be the top of *TD2*, etc.

Some circuit configurations using these logic symbols will give a better understanding of the actron.

Build a half-adder with carry

In Fig. 6, owing to the nonisolating nature of the tunnel diode, there will be an output from *TD2*, actron 1, only when A and B are both present. This output acts as a single input to actron 2, which in turn produces an output (carry). The carry will occur at $t_0 + 1$.

... and a binary counter

In Fig. 7b four pulses should have been applied to the input A. However, a pulse was deliberately dropped (illustrated by dashed lines) from the series. This was done to show the actron's insensitivity to errors in the input data and to test the logic. With the outputs taken, say, at 3 and 6 (Fig. 7a), both are present for a total binary count of three. The output at 3 is missing after the arrival of the second pulse to line A, but the output at 6 is present, giving a binary two.

It can be added here that, unlike conventional flip-flops, in actron counters outputs can be taken from a number of points.

In the line coupling 1 to 3 and 4 to 6 in Fig. 7a, the wiggle is an additional delay period introduced to prevent the output of 3 from obliteration when it arrives at 1 while 1 is still in the refractory stage.

Just what happens? With a pulse present at A, actron 1 fires in the OR mode, producing two outputs. These two outputs are coupled to actron 7 which appears as an EXCLUSIVE OR and no output is generated. The output of actron 1 is also coupled to actron 2 (in the OR mode), which is in turn coupled to actron 3, also in the OR mode. The output taken from actron 3 is delayed so that it reaches actron 1 after the latter has had time to recover. If no additional input is present at A when an input arrives at actron 3, the cycle will be repeated as above. If, however, a pulse does

exist at *A*, actron 1 will assume the EXCLUSIVE OR configuration and no output will be available for coupling to actron 2. On the other hand, only one input will now be provided for actron 7 by actron 1. This causes actron 7 to behave as an OR function, producing an output on line *B*. This output on line *B* is coupled to actron 4 in the same manner as *A* was coupled to actron 1, and the same procedure is followed as above. Figure 7c is a schematic representation of the logic circuit of Fig. 7a.

What about neuristor hypothesis?

The realization of Crane's neuristor hypothesis by the actron is accomplished by the connection given in Figs. 8b and 8c. The logic model of the neuristor is shown in Fig. 8a. A pulse applied to *A* at t_0 fires actron 1 at $t_0 + 1$. Two outputs are present from actron 1 at $t_0 + 1$; they propagate to actrons 2 and 3, producing simultaneous outputs from them at $t_0 + 2$. Outputs from actron 3 are produced on line *A'* and also on the line to actron 4. No output is generated by actron 4 since pulses from actrons 2 and 3 arrive together and actron 4 performs in the EXCLUSIVE OR mode. If a pulse

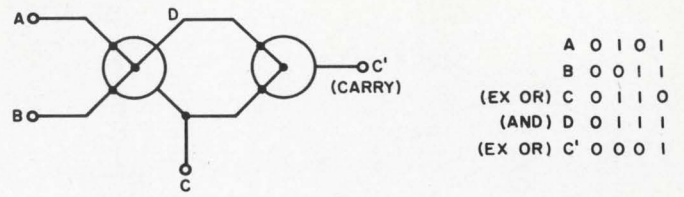

A	0	1	0	1
B	0	0	1	1
(EX OR) C	0	1	1	0
(AND) D	0	1	1	1
(EX OR) C'	0	0	0	1

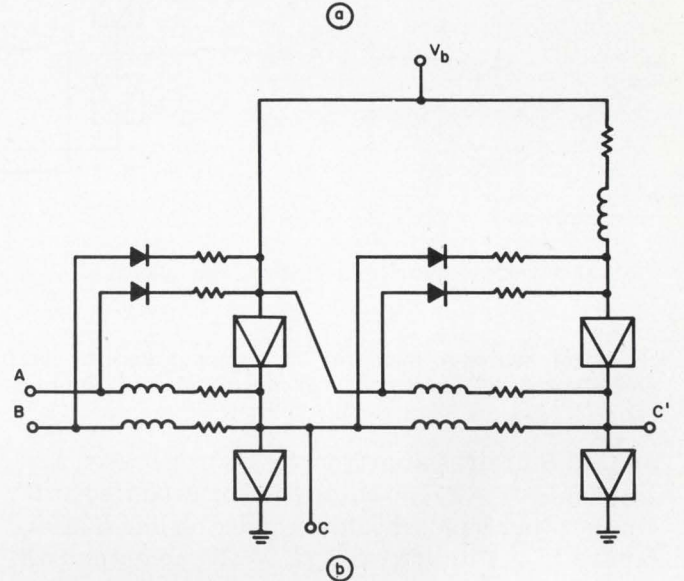

6. Half-adder with carry can be built with only two actrons. The truth table describes the operation.

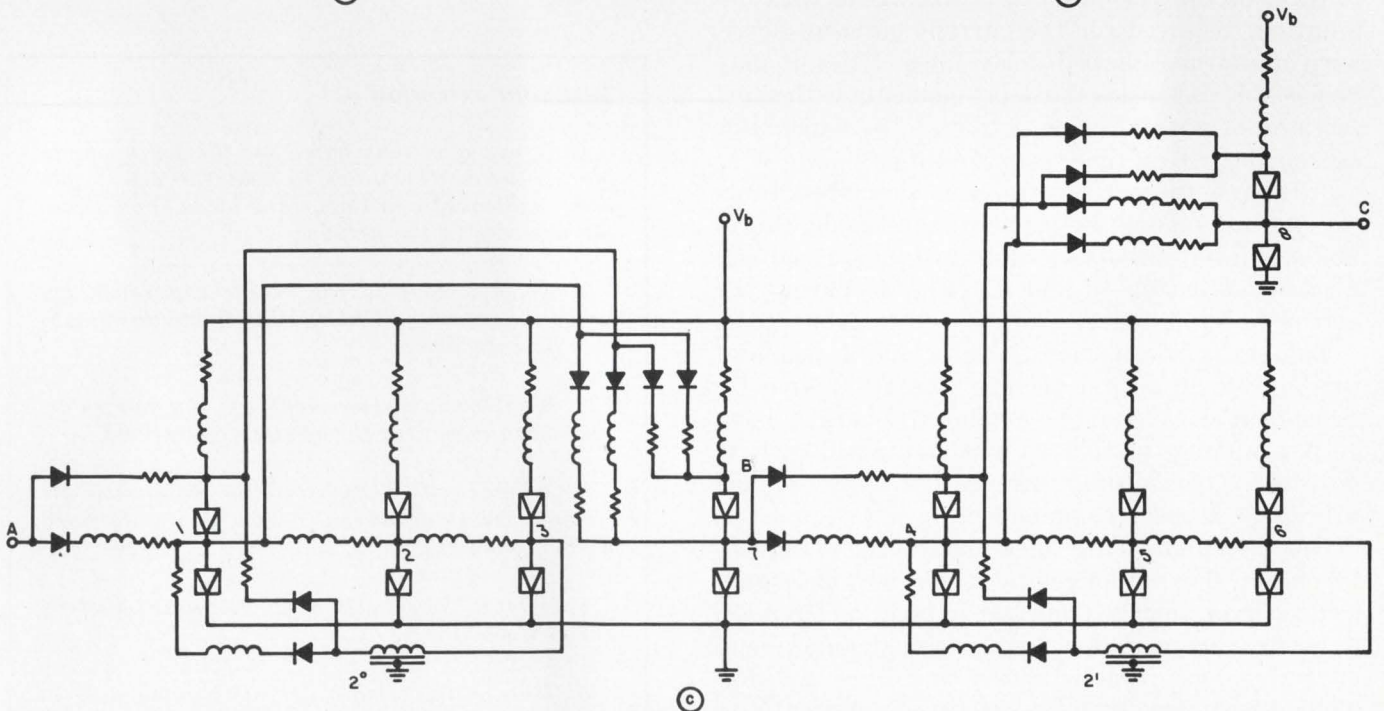
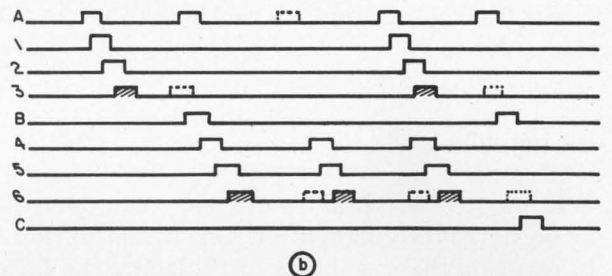
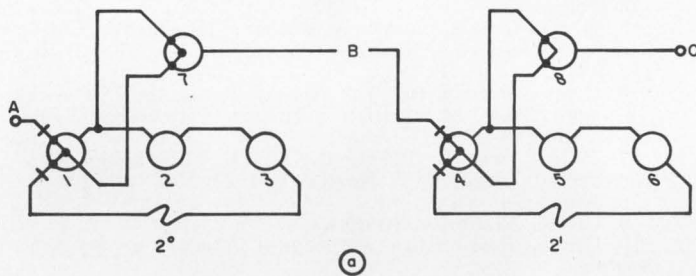

7. Binary counter (a) uses eight actrons. See text for the step-by-step explanation of the action (b), shown in (c).

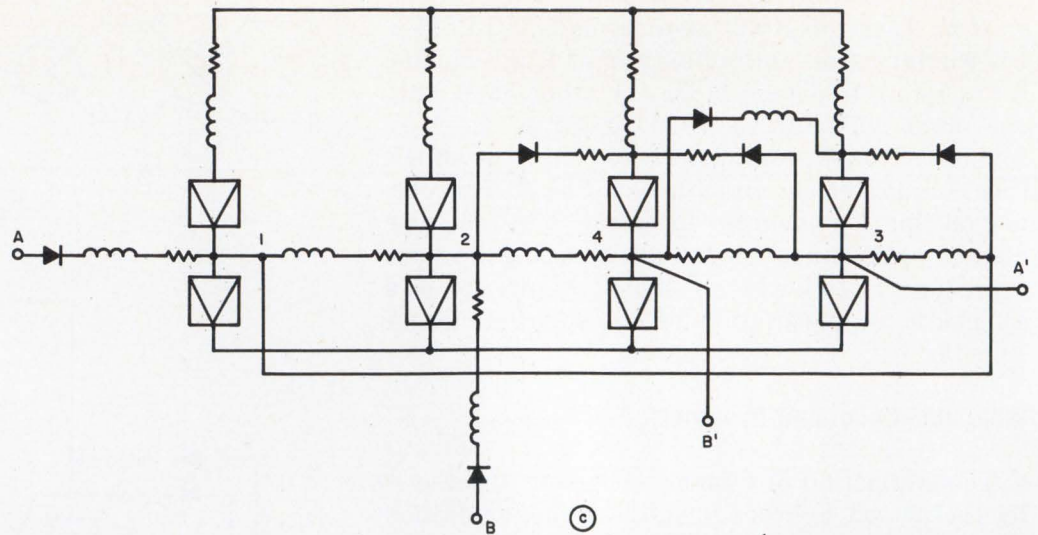
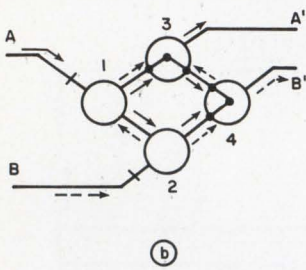
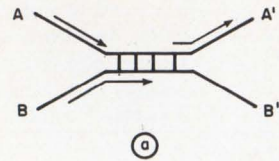

8. **Actron-neuristor similarity** is demonstrated by first considering T-S junction^{5,6} (a) operation: the informa-

tion flow on a line *B* arrives at actron 2's input between $t_0 + 1$ and $3.5 (t_0 + 2)$, no output will be produced at *B'*. On the other hand, should the pulse on line *B* arrive before $t_0 + 1$ or after $3.5 (t_0 + 2)$, no output will be produced by actron 3, but an output will be present at *B'* because of the action of actron 4.

Exactly the same is true of the effect of *B* on *A'* when a pulse on line *B* arrives at t_0 .

An interesting feature of this circuit is that if *A* and *B* are both present at t_0 , outputs are present from both *A'* and *B'* at $t_0 + 2$.

It's not 'blue-sky'

Enough preliminary work has been done on the basic actron configuration for investigation now to focus on the possibility of replacing the *LR* combination, required for the current build-up delay, with miniature lumped delay lines. Later it may be possible to replace the delay elements with short sections of coaxial cable, while at the same time decreasing the on time to around 5 ns.

Although the actron has been described functioning in a monopulse asynchronous mode, this is not absolutely necessary. For instance, removing *L3* and increasing *V_b* and *R_s* (Fig. 2) permit the actron to be biased to operate in a bistable mode.

To obtain information transfer and a means of turning off an actron after a transfer, a two- or three-beat clock would be employed. There is, however, a number of serious disadvantages, such as no reverse or multiple information paths, so this procedure is not recommended.

One difficulty facing the actron's user is that information flow no longer takes place in an organized fashion, that is, from left to right or from top to bottom. Instead, it is free to flow along any and all active lines, that is, those that have not previously been fired or have recovered sufficiently to support another discharge. ■ ■

tion flow on a line, say, *A*, is inhibited by the passage of a pulse on an adjacent line. Actron equivalent is in (b), (c).

References:

1. C. A. Budde, "Threshold Stimulated Logic in Digital Circuits," *ELECTRONIC DESIGN*, XII, No. 20 (Sept. 28, 1964), 36-41.
2. Budde, "Pulse Width Converted to Pulse Sequence," *Electronics*, XXXVIII, No. 4 (Feb. 22, 1965), 86-87.
3. Budde, "Neurons Generate Parity," *ELECTRONIC DESIGN*, XIV, No. 15 (June 21, 1966), 70-73.
4. J. J. Amodei *et al.*, "An Integrated Threshold Gate," *International Solid-State Circuits Conference Digest of Technical Papers*, X (1967), (New York: Lewis Winner), 114-115.
5. H. D. Crane, *Neuristor Studies* (Stanford, Calif.: Stanford Research Institute, Tech. Report No. 1506-2, July 11, 1963).
6. Crane, *Possibilities for Signal Processing in Axon Systems* (Stanford, Calif.: Stanford University Press, 1964), pp. 138-153.
7. P. M. Lewis II, "Practical Guide to Threshold Logic," *ELECTRONIC DESIGN*, XV, No. 22 (Oct. 25, 1967), 65-88.
8. Amodei *et al.*, *op. cit.*
9. Crane, *Neuristor Studies*.
10. Crane, *Possibilities for Signal Processing in Axon Systems*.

Test your retention

Here are questions based on the main points of this article. They are to help you see if you have overlooked any important ideas. You'll find the answers in the article.

1. Briefly, what is the major difference between the actron EXCLUSIVE OR and an equivalent Boolean gate?
2. What basic requirement for the tunnel diodes must be met for the actron's operation?
3. What is the most striking difference between a two-stage actron counter and a standard flip-flop counter?
4. What is the purpose of the backward diodes? Series inductances?
5. Why is an actron's operation analogous to that of a neuristor T-S junction?

How to improve your memory: Part II

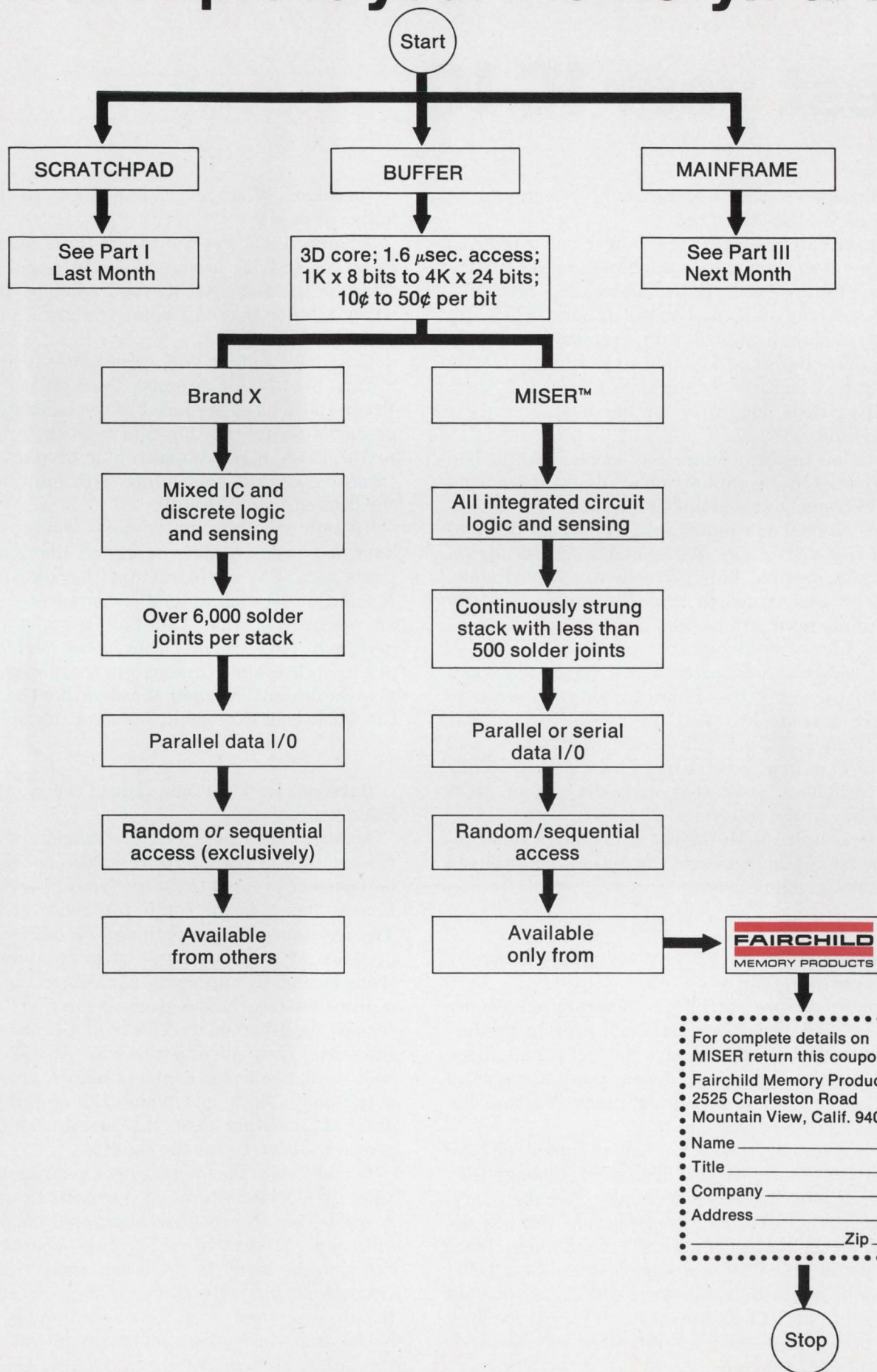

ON READER-SERVICE CARD CIRCLE 45

Test your IC IQ

Question: To what degree are MOS arrays now accepted by the industry?

Answer: MOS arrays are now being produced by many large companies, such as General Instruments, Philco-Ford, RCA, Fairchild, Motorola, Texas Instruments, and many others. They are rapidly being designed into systems, especially those that operate at low power and below 1-MHz clock rate, despite early stigmata attached to their stability, their longevity in the field and their producibility.

Most of the problems that caused early, bad experiences in the application of MOS arrays were once extremely serious. Oxide instability, for example, seemed unconquerable. It caused drift of the threshold voltage which had a magnitude on the order of volts. This problem was solved when the drift was traced to oxide impurities—chiefly sodium contamination—and drift is now reduced to the order of millivolts.

The gates are delicate: a few dozen volts can “punch through” the oxide, causing the gate to rupture permanently and the device to fail. But Zener protection, built into most input stages, and careful handling have reduced such failure. Thus most problems associated with the use of MOS array have been solved.

This, coupled with the entry of major semiconductor manufacturers into the market, has allayed the fears of many users.

Question: Why do TTL microcircuits generally cost more than DTL?

Answer: At present, TTLs generally cost more than DTLs because they have not been in production as long and so they have not yet achieved the DTLs' high volume. In addition, there are several suppliers producing DTL lines, many of whose circuits are interchangeable.

TTL circuits, however, were designed to take advantage of microcircuit processing. Though they generally offer higher performance than their DTL counterparts, TTL puts more severe process demands on the control of inverse beta. Even so, there is no doubt that TTL will soon cost less than DTL. The slope of the demand curve for TTL is steeper than DTL, so TTL should reach DTL's price level long before it develops comparable volume. (See facing page, above.)

Question: What ever happened to thin-film active devices?

Answer: About two years ago there was a great flurry of activity accompanied by predictions of thin-film transistors that would offer performance comparable to that of bipolar transistors at a considerably lower price.

Cadmium sulfide and cadmium selenide have always held better promise than silicon dioxide. Prototype devices produced in the laboratory were unstable. So far no thin-film transistor has been produced in high volume on a production line. Intensive work is continuing with high hopes for the desired breakthrough.

Though thin-film transistors would probably have had a considerable impact on the market two years ago, it is doubtful that they would today. Monolithic bipolar and MOS integrated circuits are delivering what thin-film transistor arrays promised. Now, even if they were perfected and put in high-volume production, they would simply give the designer another choice rather than change the whole course of semiconductor development.

Question: How can one reduce the r_{sat} of monolithic transistors?

Answer: When microcircuit transistors are fabricated by the planar process, the collector contact must be brought to the surface of the chip. This necessitates a longer path for collector current. The resistance of this path can be reduced by the presence of a buried layer of n^+ material selectively located by appropriate masking and a heavy n diffusion (see facing page, below) or it can be formed by growing n^+ epitaxial silicon on the p substrate, then etching it away except between emitter and collector contacts before growing the n epitaxial silicon into which the circuit is to be diffused. In either case, the subsequent epitaxial grown n silicon forms the collector.

In addition to the formation of a buried n^+ layer, a heavily-doped deep-diffused collector contact can be used. This also requires additional masking and diffusion. Integrated saturation characteristics can thus be made to approach those of discrete transistors, but only at the cost of several additional processing steps. These techniques are now being used throughout industry particularly for the faster, high-performance circuits. ■■

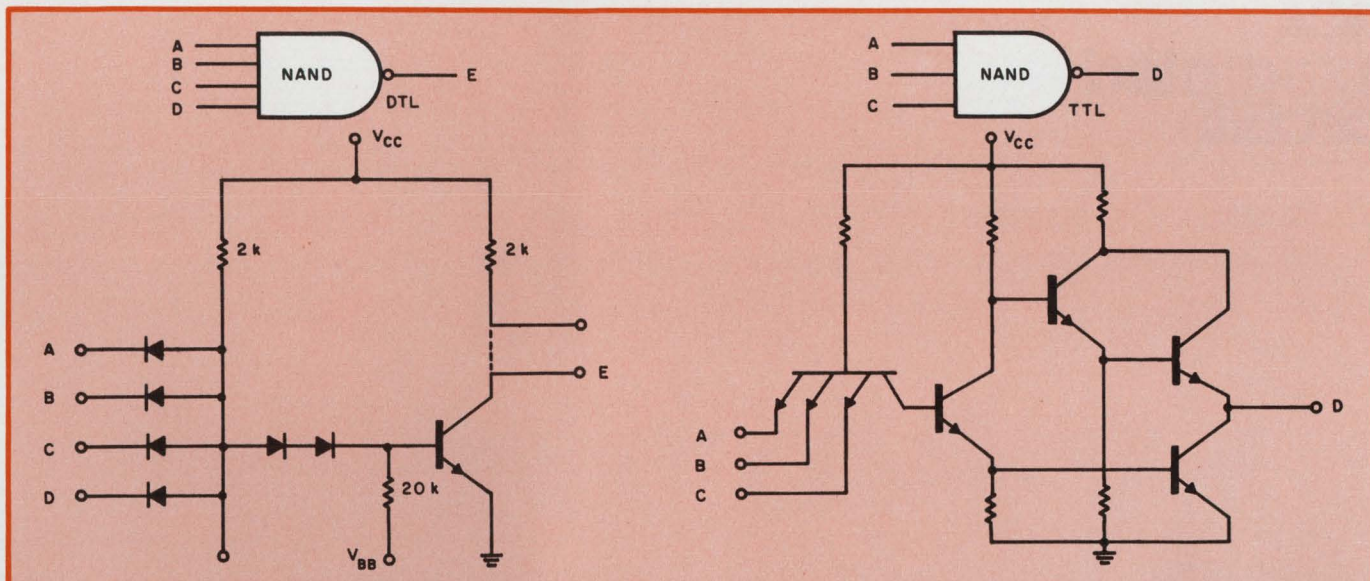

A typical DTL NAND gate (left) contains many more diodes and far fewer transistors than a typical TTL NAND gate (right). Ultimately, when TTL production reaches present

DTL production, it should cost less for the same functions. This is true in spite of the fact that TTL requires closer control of inverse beta.

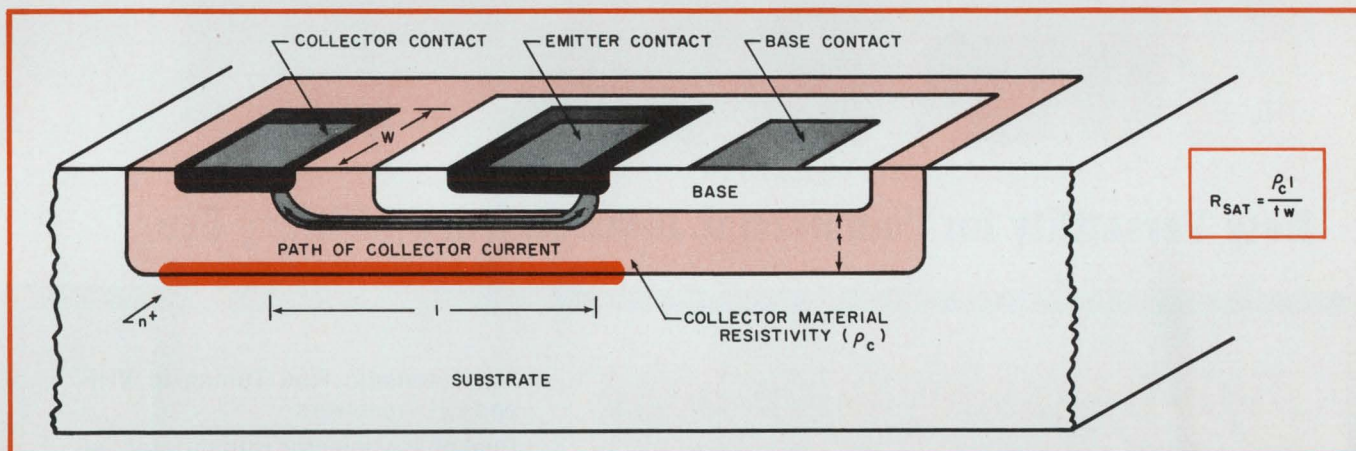

The microcircuit transistor's longer collector-current path usually produces a higher saturation resistance than its discrete counterpart. In the standard process, a buried

layer of n+ silicon produces a low-resistance path for this current. Its saturation resistance can thus be made almost as low as that of a discrete transistor.

A new forum for the discussion of ICs

Today the questions that engineers most frequently ask the editors of *ELECTRONIC DESIGN* relate to the design, production and marketing of integrated circuits.

There is good reason. Integrated transistor circuits—both monolithic microcircuits and thick- and thin-film hybrids—represent the most sweeping, radical design departure the industry has made since its enthusiastic adaptation of the transistor itself.

To keep its readers abreast of this rapidly evolving technology, *ELECTRONIC DESIGN* presents, in addition to its normal reports, this new regular column.

The column is the result of collaboration between ICE (Integrated Circuit Engineering Co., Phoenix, Ariz.) and the editors of *ELECTRONIC DESIGN*. ICE is an institution that is well equipped to handle such questions—it runs week-long seminars on integrated circuitry all over the world.

Readers are invited to send questions to Integrated Circuits, *ELECTRONIC DESIGN*, 850 Third Ave., New York, N.Y. 10022. Those who submit questions chosen for publication will receive a complimentary copy of *Microelectronic Design*. (Earliest postmark wins in event of identical questions.)

Build with 3 more linear IC innovations from RCA...

New Versatility for Commercial, Industrial, and Military Use

High-frequency wide-band amplifier/phase detector

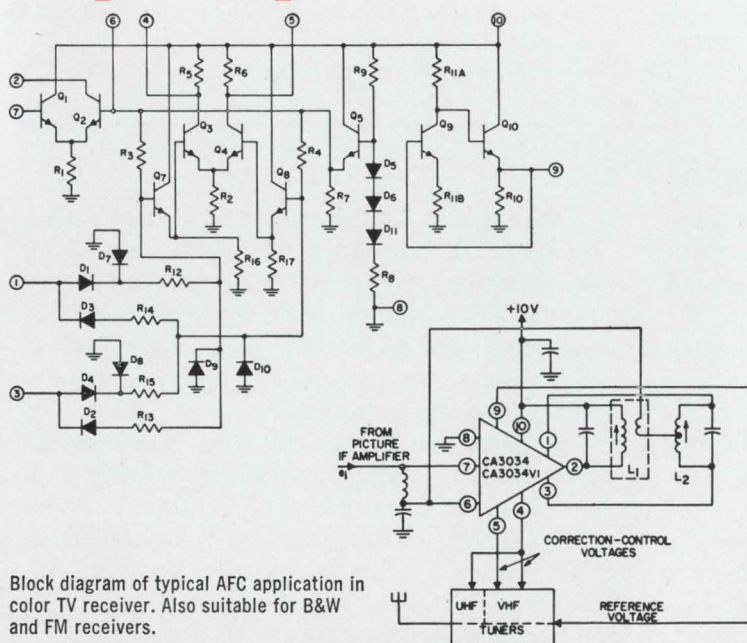

- For Automatic Fine Tuning in VHF and UHF receivers
- Dual phase detector with differential output amplifier
- Compensated reference voltage supply
- Operating temperature range -55°C to $+125^{\circ}\text{C}$
- Total current drain 9 mA (type) @ $V_{\text{CC}} = 10\text{V}$
- Output offset voltages between terminals #4 and #5 1.5V max. @ $V_{\text{CC}} = 10\text{V}$
- Input impedance 2K Ω typ

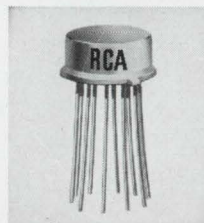

RCA CA3034 in 10-lead TO-5 package. Price \$1.75 (1000+)



RCA CA3034V1 with preformed leads. Price \$1.75 (1000+)

3-in-1 wide-band amplifier array— 132 dB (typ) Gain!

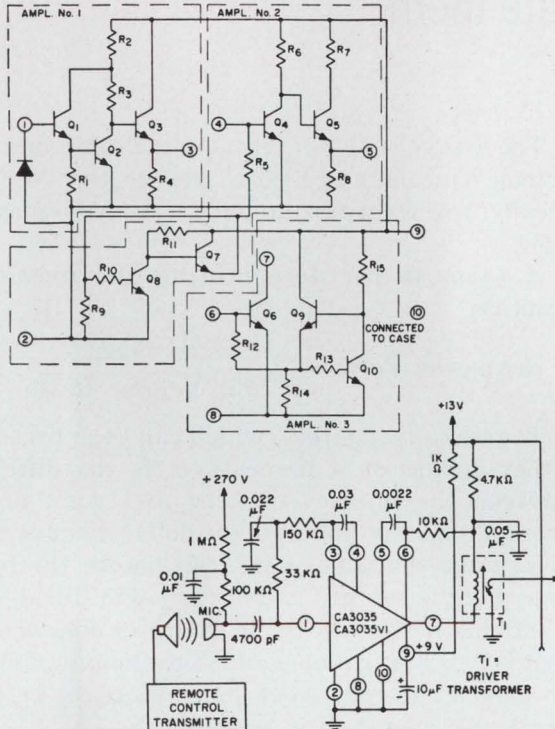

Low noise performance and outstanding wide-band response make this three-in-one unit general purpose amplifier array ideal for TV remote control.

- Three separate amplifiers; gain and bandwidth for each adjustable by external circuitry
- Can operate as individual units—or in cascade for 132 dB gain (typ) @ 40 KHz
- Voltage gain—Ampl. #1 44dB typ
Ampl. #2 46dB typ
Ampl. #3 42dB typ
- Bandwidth @ -3 dB point—Ampl. #1 500 KHz
Ampl. #2 2.5 MHz
Ampl. #3 2.5 MHz
- Operating temperature range -55°C to +125°C
- All three amplifiers single-ended, only one power supply needed
- Typical applications: TV remote control; IF systems; instrumentation amplifiers; chopper amplifiers

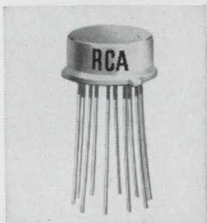

RCA CA3035 wide-band high-gain ampl. in TO-5 package. Price \$1.50 (1,000+)



RCA CA3035V1 with preformed leads. Price \$1.50 (1,000+)

Dual Darlington amplifier array

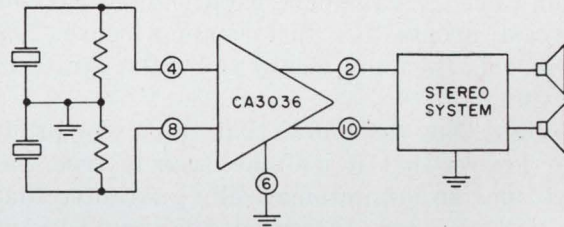
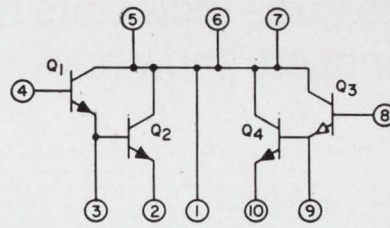

Block diagram of application as stereo phono pre-amp. Cartridges designed around the CA3036 can provide enhanced fidelity, low hum pick-up without shielding. Response flat to 1MHz @ $R_L = 1K\Omega$

- Voltage gain for either pair 26 dB (typ)
- Power gain for either pair 47 dB (typ) @ $f = 1$ KHz
- Gain-bandwidth product for either pair 200 MHz
- f_{HE} for either pair 4540 typ. @ $I_{C1} + I_{C2} = 1$ mA
- Operating temperature range -55°C to +125°C
- $V_{CE0} = 15$ V max.
- $V_{CB0} = 30$ V max.
- $V_{EB0} = 5$ V max.
- I_C (each transistor) = 50 mA max.
- Emitter-follower output
- Typical applications: stereo phono amplifiers; differential amps; op amp driver; mixer

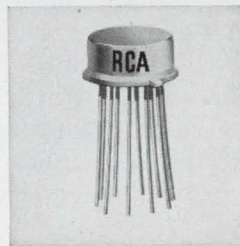

RCA CA3036 Dual Darlington Array in 10-lead TO-5 package. Price 98¢ (1,000+)

Ask your RCA Distributor for his price and delivery.

For Technical Data write to RCA Commercial Engineering Section ICG12-1, Harrison, N.J. 07029.



RCA ELECTRONIC COMPONENTS & DEVICES

The Most Trusted Name
in Electronics

Rising sales don't always raise profits.

There are three indicators to sound income planning, and wise managers know how to manipulate them.

Part 3 of a three-part series

Listen to an inexperienced businessman:

"I don't need any financial expert to tell me how to increase profits. It's just common sense. The more you sell, the more money you make. Any fool knows that."

He's right. Any fool knows that. But a wise profit planner knows that it isn't necessarily true. Increased sales do not automatically guarantee that profits will rise, too. Increased sales could result in decreased profits, or even a loss.

Wise businessmen—including smart engineer managers—use three barometers to plan profits. They are the profit/volume ratio, the breakeven point and the margin of safety.

[This article on how costs and sales volume are interrelated to effect a company's profit or loss is the third of a three-part series on cost analysis, budgeting and profit/volume analysis. The first ("Profit by learning cost analysis," ED 23, November 8, 1967, pp. 96-101) reviewed the need to analyze, identify and formulate the various types of costs. The second ("Good budgeting can boost profits," ED 24, Nov. 22, 1967, pp. 88-93) showed how this cost information is used in setting up effective budgets.]

The *profit/volume ratio* tells you how much of each sales dollar is available after direct or variable costs are paid to help absorb overhead—the fixed costs. Once the overhead is absorbed, the balance of the sales dollar contributes to profits. Ideally, you want the P/V ratio to be as high as possible, thus absorbing overhead costs as quickly as possible.

One formula* for determining the P/V ratio is this one:

$$P/V \text{ ratio} = \frac{\text{Profit} + \text{Fixed Costs}}{\text{Sales}}$$

*Another method of determining the P/V ratio is:

$$P/V \text{ Ratio} = \frac{\text{Sales Income} - \text{Variable Costs}}{\text{Sales Income}}$$

In this article, however, all calculations will follow the formula cited in the text.

Lawrence M. Matthews, Vice President, Stevenson, Jordan & Harrison Management Consultants, Inc., New York.

The *breakeven point* tells you the minimum sales volume (income) needed to absorb the overhead. Ideally, you want this amount to be as low as possible.

A formula for determining the breakeven point is:

$$\text{Breakeven Point} = \frac{\text{Fixed Costs}}{\text{Profit/Volume Ratio}}$$

The *margin of safety*, which can be expressed in either dollars or a percentage, is the difference between the breakeven point and your present average sales volume. It is the dollar amount or the percentage that sales can drop before the breakeven point is reached and losses begin. Ideally, you want this margin to be as great as possible. If a company is losing money, it is the amount of dollars or percentage that sales must increase before a breakeven operation is achieved.

Table 1. Monthly profit and loss statement

Sales			
	70,000 units @ \$10 apiece		\$700,000
Expenses	Fixed	Variable	Total
Material		\$200,000	\$200,000
Direct labor		230,000	230,000
Indirect labor	\$ 20,000		20,000
Instruments	25,000	25,000	50,000
Operating supplies	15,000	15,000	30,000
Depreciation, taxes, insurances, etc.	60,000		60,000
Selling expenses	40,000	10,000	50,000
Administrative expenses	40,000		40,000
	\$200,000	\$480,000	\$680,000
Total expenses			680,000
Profit			\$ 20,000

John O'Brien (right), manager, special products, Semiconductor Department, EG&G, Bedford, Mass., discusses his department's profit/volume chart with William Dolan (left), the department controller.

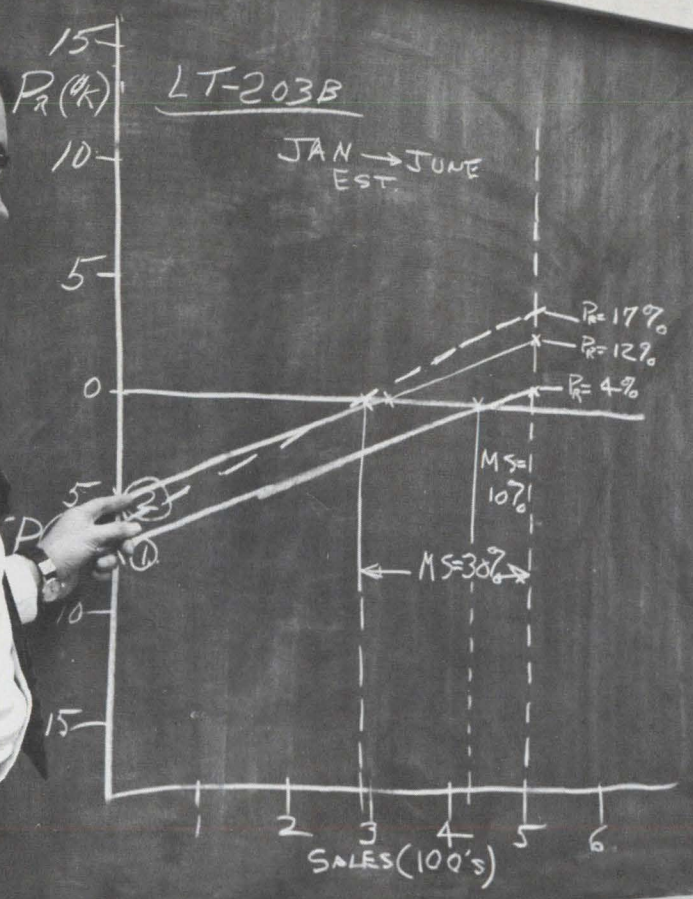
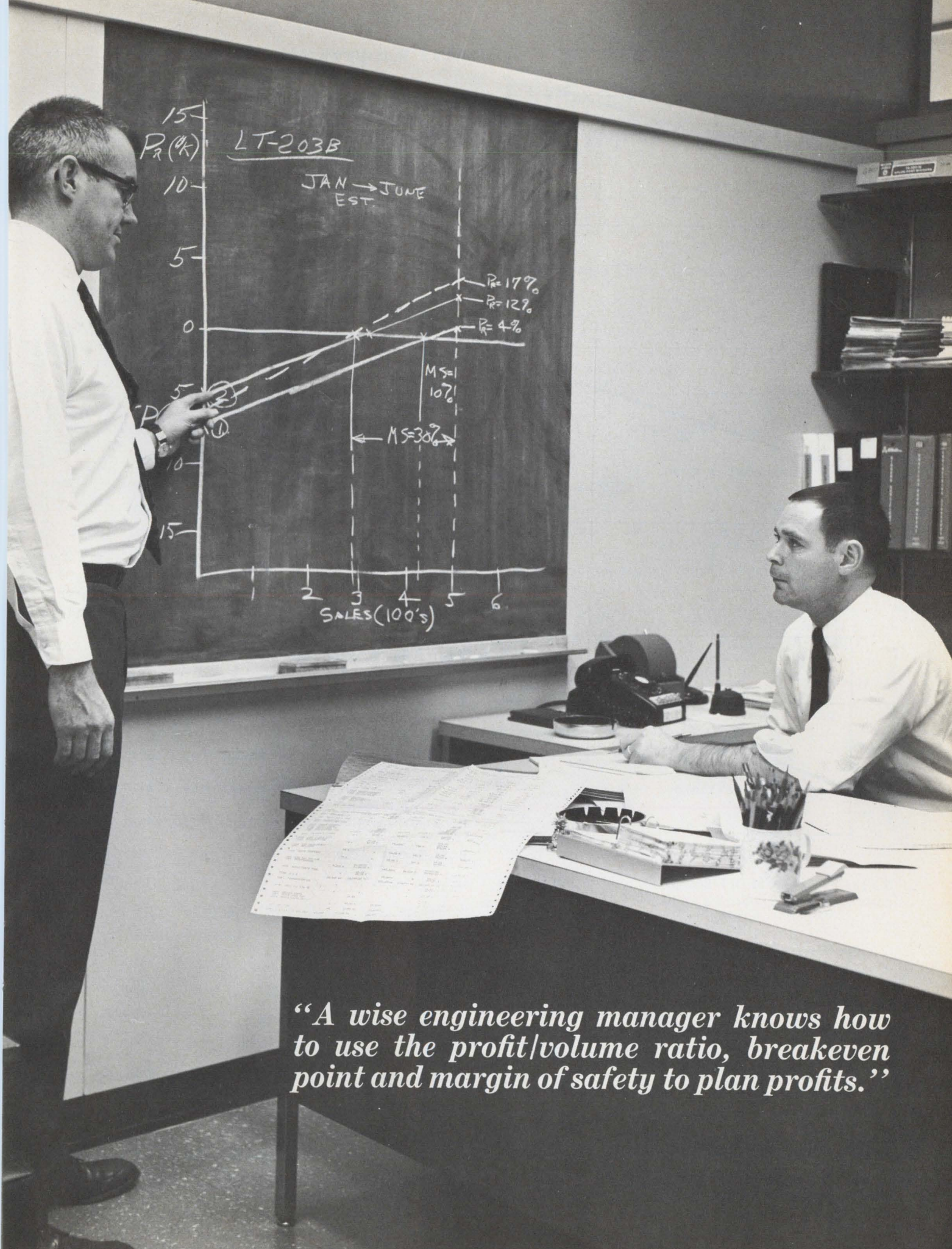

“A wise engineering manager knows how to use the profit/volume ratio, breakeven point and margin of safety to plan profits.”

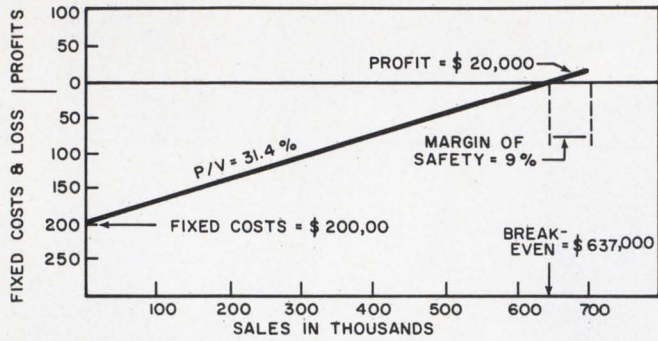

1. The monthly profit/volume chart of DEF Electronics Co., before reducing any costs.

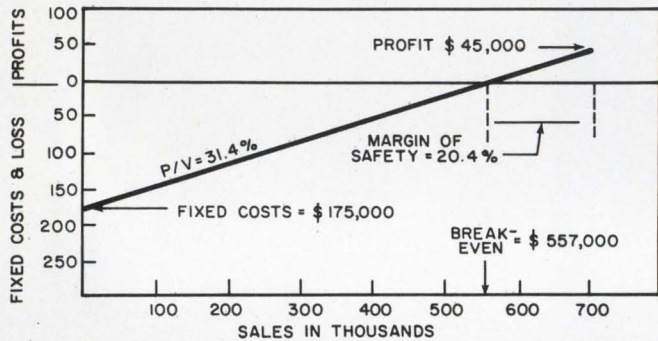

2. The P/V chart of DEF Electronics after fixed costs have been reduced.

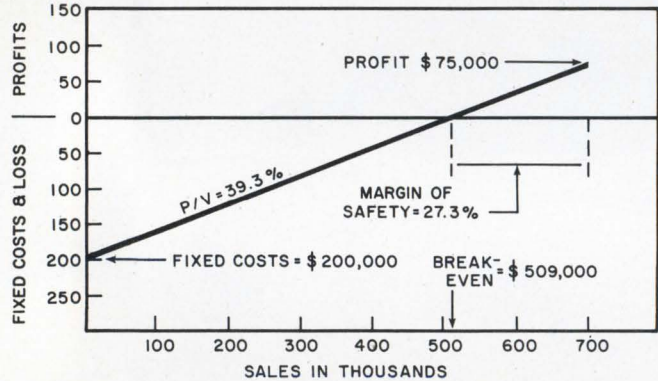

3. The P/V chart of DEF Electronics after restoring fixed costs and reducing variable costs.

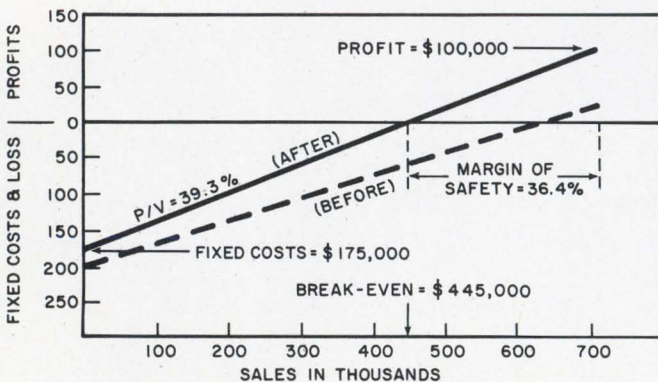

4. The P/V chart, as it looked initially (broken diagonal line) and after cost reductions were made.

Table 2. Monthly profit and loss statement

A. Action taken:

- (a) Applied ratio-delay study findings and reduced crew by 2 men.
- (b) Started small instrument requisition system, improved test set-up design, obtained certain purchase price reductions.
- (c) Installed monthly flexible budget, installed a supply requisition system.
- (d) Reviewed insurance coverage and costs, reduced monthly expenses.
- (e) Tightened up on entertainment and travel costs, combined two territories.
- (f) Through a secretary-typist pool, saved one girl, reduced certain miscellaneous expenses.

B. Results of the action:

Income - sales				\$700,000
Expenses	Fixed	Variable	Total	
Material		\$200,000	\$200,000	
Direct labor		230,000	230,000	
Indirect labor	\$ 11,000(a)		11,000	
Instruments	22,500(b)	25,000	47,500	
Supplies	13,500(c)	15,000	28,500	
Deprec., insur., taxes, etc.	56,000(d)		56,000	
Selling expense	37,000(e)	10,000	47,000	
Administrative expense	35,000(f)		35,000	
	\$175,000	\$480,000	\$655,000	
Total expenses				655,000
Pre-tax profit				\$ 45,000

Table 3. Monthly profit and loss statement

A. Action taken:

- (a) Purchasing action and value-analysis studies reduced material cost by 10%.
- (b) Overtime reduction drive, work measurement and budgets reduced labor by 11%.
- (c) Instrument requisition system, purchasing action and better design reduced test equipment costs.
- (d) Monthly budgets and supply requisition system reduced supply costs.

B. Results of the action:

Income - sales				\$700,000
Expenses	Fixed	Variable	Total	
Material		\$180,000(a)	\$180,000	
Labor		205,000(b)	205,000	
Indirect labor	\$ 20,000		20,000	
Instruments	25,000	20,000(c)	45,000	
Supplies	15,000	12,000(d)	27,000	
Deprec., insur., taxes, etc.	60,000		60,000	
Selling expenses	40,000	8,000(e)	48,000	
Administrative expenses	40,000		40,000	
	\$200,000	\$425,000	\$625,000	
Total expenses				625,000
Pre-tax profit				\$ 75,000

The formulas for determining the margin of safety dollars and percentage are:

$$\begin{aligned} \text{Margin of Safety } \$ &= \text{Sales} - \text{Breakeven Point} \\ \text{Margin of Safety } \% &= \frac{\text{Sales} - \text{Breakeven Point}}{\text{Sales}} \end{aligned}$$

Let's calculate the P/V ratio, breakeven point and margin of safety for a hypothetical company called DEF Electronics and interpret our findings.

Table 1 shows its monthly profit and loss statement.

This company makes one product selling at \$10 a unit. With 70,000 units sold in the average month, sales income is \$700,000. Analyzing its costs, we determine that at that sales volume, its variable costs are \$480,000 and its fixed costs \$200,000 more. Subtracting \$680,000 in costs from \$700,000 of income, we have a \$20,000 profit.

From these three knowns—monthly sales volume, monthly fixed costs and monthly profit—we can develop the P/V ratio, breakeven point and margin of safety.

The profit/volume chart (Fig. 1) shows sales income scaled along the x axis. The y axis, however, is bisected with a zero intercept. Above this intercept on the y axis are scaled dollars of profit. Below the zero intercept are scaled both dollars of loss and dollars of fixed costs.

We know the company has \$20,000 profit at the current monthly sales income of \$700,000. Therefore above the \$700,000 sales point on the x ordinate, we go past the zero intercept to \$20,000 on the profit scale of the y axis. Thus we have one point.

From our analysis, we determine that fixed costs total \$200,000 a month. Therefore at zero sales income we go below the zero intercept to \$200,000 on the fixed cost scale of the y axis. We now have a second point.

We can now draw a straight line connecting the fixed cost point on the y axis that is below the zero intercept with the point of profit above both the zero intercept line and the average monthly sales income. This is our *profit/volume line*. Where this line crosses the zero intercept is our breakeven point. The linear distance along the x axis between the breakeven point and the average monthly volume is our margin of safety.

Though you can read these three items off the chart, you obtain more precise answers by doing the actual calculation.

First, get the P/V ratio

You start the calculation by determining the P/V ratio. Using the previously mentioned formula:

$$\text{P/V Ratio} = \frac{\text{Profit} + \text{Fixed Costs}}{\text{Sales}}$$

and using the data for DEF Electronics, we calculate:

$$\begin{aligned} \text{P/V Ratio} &= \frac{\$20,000 + \$200,000}{\$700,000} \\ &= 31.4\% \end{aligned}$$

Thus \$31.40 of every \$100 of sales is available for the absorption of overhead and, once overhead is absorbed, for additions to profit.

Next, find breakeven point

Knowing the P/V ratio, we can calculate the breakeven point, which is reached when the overhead or fixed costs are totally absorbed. With the formula:

$$\text{Breakeven Point} = \frac{\text{Fixed Costs}}{\text{Profit/Volume Ratio}}$$

we calculate:

$$\begin{aligned} \text{Breakeven Point} &= \frac{\$200,000}{0.314} \\ &= \$637,000 \end{aligned}$$

Finally, determine margin of safety

With the breakeven point, it is a simple deduction to obtain the margin of safety for DEF Electronics:

$$\begin{aligned} \text{Margin of Safety } \$ &= \text{Sales} - \text{Breakeven Point} \\ &= \$700,000 - \$637,000 \\ &= \$63,000 \end{aligned}$$

$$\begin{aligned} \text{Margin of Safety } \% &= \frac{\text{Sales} - \text{Breakeven Point}}{\text{Sales}} \\ &= \frac{\$700,000 - \$637,000}{\$700,000} \\ &= 9\% \end{aligned}$$

Planning improvements

Obviously DEF Electronics is not doing too well. In a month when sales are 9% below the monthly average, a loss is likely. Its margin of safety is dangerously thin. Also, DEF is making only \$20,000 on \$700,000 sales volume, a profit margin of slightly less than 3% before taxes.

So we institute a course of action that will improve this situation. We will first take action to reduce fixed costs and see what effect these reductions have on the P/V ratio, breakeven point and margin of safety. Note that we will do nothing to increase or decrease sales; the only change will be in reducing fixed costs.

Table 2 shows the revised profit and loss statement after making cost improvements.

Comparing this with the first profit and loss statement, we see that costs have been reduced from \$200,000 to \$175,000. As a result, our profits increase from \$20,000 to \$45,000.

We now revise the P/V chart (Fig. 2).

Table 4. Monthly profit and loss statement

Income — sales		\$700,000	
Expenses	Fixed	Variable	Total
Material		\$180,000	\$180,000
Labor		205,000	205,000
Indirect labor	\$ 11,000		11,000
Instruments	22,500	20,000	42,500
Supplies	13,500	12,000	25,500
Deprec., insur., taxes, etc.	56,000		56,000
Selling expense	37,000	8,000	45,000
Administrative expense	35,000		35,000
	<u>\$175,000</u>	<u>\$425,000</u>	<u>\$600,000</u>
Total expenses			600,000
Pre-tax profit			\$100,000

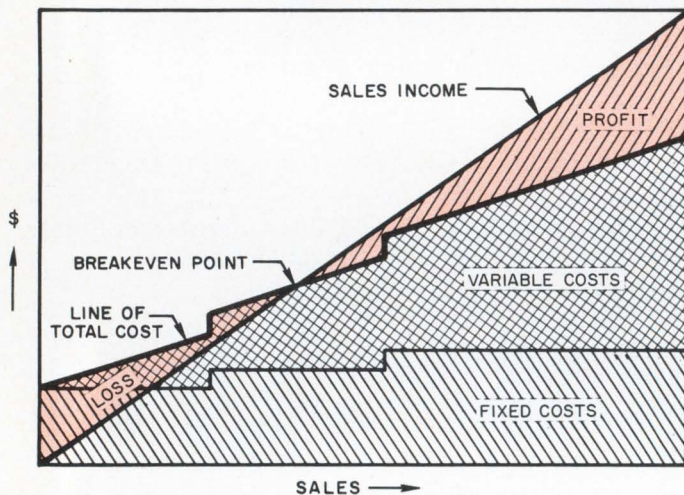

5. A standard breakeven chart. Note that the fixed costs are not fixed ad infinitum, while the variable cost line is both linear and step.

The new P/V ratio calculation is:

$$\text{P/V Ratio} = \frac{\$45,000 + \$175,000}{\$700,000} = 31.4\%$$

Thus reductions in fixed costs have no effect on the P/V ratio. They did, however, affect both the breakeven point and the margin of safety:

$$\begin{aligned} \text{Breakeven Point} &= \frac{\$175,000}{0.314} \\ &= \$557,000. \\ \text{Margin of Safety \$} &= \$700,000 - \$557,000 \\ &= \$143,000. \\ \text{Margin of Safety \%} &= \frac{\$700,000 - \$557,000}{\$700,000} \\ &= 20.4\%. \end{aligned}$$

Thus the breakeven point has been improved — lowered by \$80,000. The margin-of-safety dollar figure has been increased from \$63,000 to \$143,000,

while the margin of safety percentage jumped from 9 to 20.4%.

Reducing variable costs

Suppose we return the fixed costs to their pre-reduction level of \$200,000 and initiate a series of actions to reduce variable costs. What effect will this have on the P/V ratio, breakeven point and margin of safety? Again, we neither increase nor decrease sales; the only change is the reduction in variable costs.

Table 3 shows the revised profit and loss statement after reducing the variable costs and returning the fixed costs to their original levels.

At the same \$700,000 monthly sales volume, we have reduced variable costs by \$55,000 to \$425,000. As a result, our profits rose from \$20,000 to \$75,000. Thus we have a revised P/V chart for DEF Electronics (Fig. 3).

The P/V ratio calculation now is:

$$\begin{aligned} \text{P/V Ratio} &= \frac{\$75,000 + \$200,000}{\$700,000} \\ &= 39.3\%. \end{aligned}$$

Reductions in variable costs have increased the P/V ratio, which means that the contribution to overhead absorption and to profits has been increased. In this instance, we now have \$39.30 instead of \$31.40 of every \$100 of sales available to cover overhead and eventually to add to profit, once all overhead is covered.

These reductions in variable costs also improve the breakeven point and the margin of safety:

$$\begin{aligned} \text{Breakeven Point} &= \frac{\$200,000}{0.393} \\ &= \$509,000. \\ \text{Margin of Safety \$} &= \$700,000 - \$509,000 \\ &= \$191,000. \\ \text{Margin of Safety \%} &= \frac{\$700,000 - \$509,000}{\$700,000} \\ &= 27.3\%. \end{aligned}$$

The breakeven point has been reduced by \$128,000. The margin of safety dollars and percentage go up threefold.

Combining all reductions

Now, we shall combine the reductions in both fixed and variable costs.

Table 4 shows the new profit and loss statement for DEF Electronics.

For the same average monthly sales volume of \$700,000, we have increased profits to \$100,000 — a rise of \$80,000 — by reducing costs by \$80,000.

The “before” and “after” P/V chart is shown in Fig. 4.

And here are our new calculations:

$$\begin{aligned}
 \text{P/V Ratio} &= \frac{\$100,000 + \$175,000}{\$700,000} \\
 &= 39.3\% \\
 \text{Breakeven Point} &= \frac{\$175,000}{0.393} \\
 &= \$445,000. \\
 \text{Margin of Safety \$} &= \$700,000 - \$445,000 \\
 &= \$255,000. \\
 \text{Margin of Safety \%} &= \frac{\$700,000 - \$445,000}{\$700,000} \\
 &= 36.4\%.
 \end{aligned}$$

By reducing the fixed and variable costs of DEF Electronics, we have effected these improvements:

- The P/V ratio has increased from 31.4% to 39.3%.

- The breakeven point has been reduced from \$637,000 to \$445,000.

- The margin of safety dollars has risen from \$63,000 to \$255,000.

- The margin of safety percentage has increased from 9 to 36.4%.

By effectively controlling costs, we have greatly improved the company's profit picture.

From this experience we can draw some rules.

When fixed costs are reduced:

1. Profits are increased.
2. The breakeven point is reduced.
3. The margin of safety is increased.
4. The profit/volume ratio is unaffected.

When variable costs are reduced:

1. Profits are increased.
2. The breakeven point is reduced.
3. The margin of safety is increased.
4. The profit/volume ratio is increased.

Using the P/V ratio

The P/V ratio is a measure and control that has a great many applications for management. It may, for example, be used to evaluate the following:

- The relative effectiveness of two plants making similar products.

- The relative performance of divisions within a corporation.

- The company's performance versus the competition's.

- Current operating performance compared with past periods.

- The effect of cost changes. If, for instance, a new labor contract has been negotiated, P/V analysis can show the effect of the increases upon the company.

- What sales volume increase, what cost improvement action or what combination of the two will be needed to maintain the past company profit position in the face of increased costs.

- The net effect of proposed capital-investment projects that will increase fixed costs but reduce variable costs.

- The net effect of proposed marketing actions, such as:

1. Price reductions that will reduce income per unit but yield a greater unit sale. ("How many more units must we sell if we reduce prices 10%?")

2. Advertising and sales campaigns calculated to increase volume. ("What increase in sales will we need to cover an advertising campaign costing \$100,000 or to pay for four additional salesmen?")

- The relative contributions to overhead absorption and profit of products, territories and/or customers.

Applying breakeven knowledge

A company may feel itself comfortably past the breakeven point. "Of what importance is it to know the breakeven point?" the neophyte may ask.

The reply: Every management should know the effects of its decisions and actions upon the corporate breakeven point. Management should establish its own desired margin of safety and then make a concerted effort to assure that the company maintains that margin.

More than one engineering manager has been caught unawares when the company's breakeven point and margin of safety deteriorated. Disaster often resulted. ■ ■

Test your retention

Here is a problem based on the main points of this article. You'll find the solution on page 178.

The Sensor and Control Co. had the following operating results for a 12-month period:

Month	Sales	Profit or (Loss)
Jan.	\$375,000	(\$ 25,000)
Feb.	350,000	(10,000)
Mar.	275,000	(75,000)
Apr.	325,000	(50,000)
May	400,000	15,000
June	500,000	75,000
July	525,000	50,000
Aug.	750,000	200,000
Sept.	800,000	175,000
Oct.	700,000	125,000
Nov.	575,000	135,000
Dec.	425,000	(15,000)
	<u>\$6,000,000</u>	<u>\$600,000</u>

Estimate the monthly fixed costs. Then calculate the company's profit/volume ratio, breakeven point and margin of safety in both dollars and percentage.

Move With Advanced Computer Technology At NCR Electronics Division

SYSTEMS FORMULATION

Analysis and development of advanced systems specifications; consultation on systems design, hardware configuration, software trade-offs; analysis of competitive systems. Applicant should have familiarity with very high speed memories, large-scale integration, disc files, drum files, communications and time sharing plus related BS degree and 3 to 5 years' experience in one or more areas mentioned.

SOFTWARE SYSTEMS

Programmers to develop executive and operating systems for third-generation computer systems. Desire experience with medium- and large-scale general-purpose systems employing high speed peripheral units, tapes, random-access files, disc files, drum files, on-line, time sharing and multi-programming. Requires related BS degree and 3 to 5 years' directly related experience. Positions also open for hardware-oriented programmers to do systems diagnostic work.

EDP ANALYST/PROGRAMMERS

Analyst position entails systems analysis in financial and administrative areas. One year of EDP experience required, degree desirable. Programming positions involve accounting and manufacturing systems. Degree and recent experience on medium- to large-scale systems desired.

OPTICAL SYSTEMS

To do computer-aided design of specific elements in complex optical systems, such as field and condenser, as well as image-forming elements.

NCR Electronics Division is the largest commercial computer manufacturing facility in Southern California and one of the most advanced in the world. The Los Angeles plant and laboratories have recently been doubled, and an additional manufacturing facility is now under construction in San Diego. At NCR you will enjoy stable, non-defense activity in a

thoroughly professional environment. Your job and your future: the creation of advanced business automation for NCR markets in 121 countries.

MEMORIES RESEARCH

To design high-speed magnetic memory circuits. Requires knowledge of nanosecond pulse techniques and magnetic memory organization. Familiarity with plated-wire and mass-storage memory concepts desirable. Requires BSEE plus five years' experience.

SYSTEMS ENGINEER

For systems design on advanced computers. Requires extensive knowledge of memory technology, systems logic and large-scale integration as applied to medium- to large-scale general-purpose computing systems. Minimum of BSEE and five years' direct experience required.

LOGIC DESIGN

Several positions available for EE's with 2-5 years' experience in logic design on either special- or general-purpose equipment. Positions require thorough knowledge of logic as related to real-time hardware development or automatic test equipment.

CIRCUIT DESIGN

Positions for both systems- and device-oriented circuits men to work either in developmental projects or standard circuits group. BSEE required plus 3-5 years' design experience and thorough understanding of IC technology. Knowledge of large-scale integration concepts and

ramifications desirable. Projects include thin-film memories, IC utilization and development, project/vendor liaison, systems applications.

FACILITIES/LAYOUT

Work entails projecting needs of expanding division, development of proposals, program implementation. Requires three years of facilities and layout experience, preferably in electronics industry; BSIE or equivalent; ability to deal effectively with all levels of personnel. Knowledge of safety codes desirable.

MACHINE DESIGN

Creative mechanical engineer capable of designing sophisticated manufacturing hardware and of developing machines to do jobs which heretofore have not been encountered. Requires BSME and minimum of two years' experience.

CHEMICAL PROCESSES

Positions in both engineering and manufacturing for man with BSChE and 2-5 years' experience in electroplating and electrodeposition in thin and thick films. Thorough knowledge of related materials, pre-plating surfaces, plating equipment required. Work entails development of advanced processes and techniques for computer development and production.

QUALITY ASSURANCE ENGINEERS

Q.C. assignments include process capability, studies, failure analysis, design reviews, establishment of inspection standards. Position requires 2-3 years' experience with EDP equipment, knowledge of magnetic materials, BSME degree. Reliability positions involve planning, conducting and reporting reliability tests of electronic components, assemblies and units. BSEE required plus experience with reliability mathematics, computer circuitry. Positions also available in systems test.

TO ARRANGE A CONFIDENTIAL INTERVIEW send resume including salary history to: TOM E. LYON

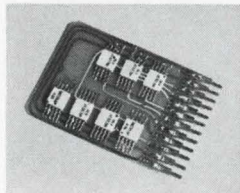
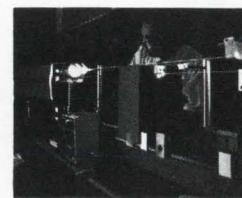

The National Cash Register Company[®]
ELECTRONICS DIVISION
2817 W. El Segundo Blvd., Hawthorne, Calif.
Telephone: (213) 777-7296
An equal-opportunity employer

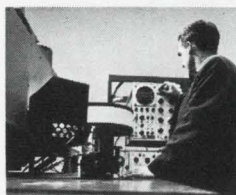

ON READER-SERVICE CARD CIRCLE 901

Free Career Inquiry Service

Absolutely Confidential

Respond to the career opportunities advertised in this issue. Fill out and send us this handy resume. **Electronic Design** will do the rest – neatly typed copies of this form will be mailed to the companies of your choice, indicated by the circled Career Inquiry Numbers at the bottom of this page.

25

Name		Home Phone	
Home Address (Street)		City	State
		ZIP Code	

Age	U.S. Citizen <input type="checkbox"/> Yes <input type="checkbox"/> No	Security Clearance
------------	---	---------------------------

Prime Experience	Secondary Experience

Desired Salary	Availability Date
-----------------------	--------------------------

Employment History – present and previous employers

Company			
City, State			
Dates	to	to	to
Title			
Specialty			

Education – indicate major if degree is not self-explanatory

Degree			
College			
City, State			
Dates	to	to	to

Additional Training – non-degree, industry, military, etc.

Professional Societies

Published Articles

- Career Inquiry Numbers:**
- | | | | | | | | | | |
|-----|-----|-----|-----|-----|-----|-----|-----|-----|-----|
| 900 | 901 | 902 | 903 | 904 | 905 | 906 | 907 | 908 | 909 |
| 910 | 911 | 912 | 913 | 914 | 915 | 916 | 917 | 918 | 919 |

ELECTRONIC DESIGN
850 Third Avenue
New York, New York 10022

Whatever your specialty, chances are TI has the opening.

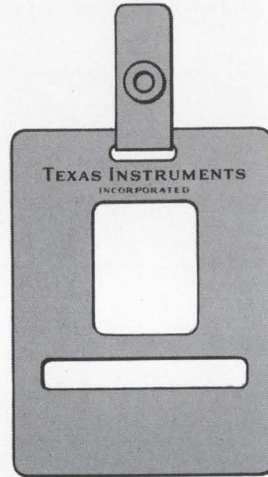

Now all we need
is your name.

We'll shoot the photo later. So just send us your name on the coupon.

Add anything you want about yourself.

Things like what your degree is. What you've been doing for the past two to five years. What you'd like to be doing for the next five or ten.

The adjoining column lists some of our current openings.

We can assure you of this.

Whatever your specialty, chances are we have an important job. Important to the company. Important to you as an individual. And when you look at our growth record, plus what we have planned for the future, you'll see why.

Since World War II, TI has grown 200-fold to a \$580-million annual billings level. Our present growth

goal is to reach \$3-billion in annual sales in the next decade.

Even though TI is a big, diversified company, with plans to get bigger, you won't get lost here.

One of the things that management is accomplishing is that you retain your individuality and can relate your own personal goals to those of the company.

How we achieve this retention of individuality is told in a comprehensive brochure. It's yours by return mail for the asking.

It gives you a look at what we do. It shows why we can offer you meaningful growth opportunities in a wide range of disciplines.

Don't be surprised to find that we have an opening with your name on it.

Tom Dudley E.D.
P. O. Box 5474
Dallas, Texas 75222

Please send me the story of TI.

Name _____

Address _____

City _____

State _____ Zip _____

My degree is: _____

My area of interest is: _____



An Equal
Opportunity Employer

TEXAS INSTRUMENTS
INCORPORATED

ON CAREER-INQUIRY FORM CIRCLE 902

TI openings

SYSTEMS ENGINEER
Specifications and customer liaison for cryogenic cooler test equipment. BSME, EE, or Physics.

QA ENGINEER
Develop and implement QA disciplines. BS plus experience in quality engineering or design.

CHEMICAL ENGINEER
Control quality and process of chemical handling facility. BS plus related experience.

COMPUTER ANALYST
Experience in systems analysis, programming, diagnostic programming of monitors and arithmetic routines.

MECHANICAL ENGINEER
Design hydraulic test equipment. BSME plus experience in aircraft hydraulic design.

DESIGN ENGINEER
Engineer design and packaging for power sources. BSEE plus 3-5 years' design on low frequency power supplies.

MANAGEMENT SYSTEMS MANAGER
Direct implementation of advanced management information system. Broad operating and supervisory experience.

ELECTRICAL ENGINEER
Design circuits for space instrumentation. MS plus 1-5 years' experience.

TEST ENGINEER
Build radar systems. Experience in pulse compression and phased array.

PATENT ATTORNEY
LLB plus BSEE, Physics or Chemical Engineering. 3-5 years' electronic experience.

MARKETING ENGINEER
Manage marketing for product line. BSEE or equivalent technical marketing experience.

COMPUTING SYSTEM ANALYST
Design and execute programs for IBM 7074, 1401, 1440, 1460 and 360. BS plus 2-4 years' experience.

ELECTRICAL ENGINEER
Design and develop proximity fuze circuits and special test equipment. BS or MSEE plus 5 years' experience.

TECHNICAL WRITER
Write and edit technical manuals and reports. Coordinate print production. BSEE or Physics, plus 3-5 years' experience.

LOGISTICS ENGINEER
Prepare data relative to TI equipments. BA plus 3 years' logistics or related experience.

R&E ADMINISTRATOR
Help administer cost control, reporting, plans, and implementation of projects. Business and technical background.

WRITE FOR COMPLETE LIST OF CURRENT OPENINGS

An Equal Opportunity Employer



TEXAS INSTRUMENTS
INCORPORATED

NASA TECH BRIEFS

Circuit duplicates sound of heart

Problem: Design an instrument that can duplicate the sounds of the human heart. Its output, a phonocardiogram, has become a very important tool in physiological monitoring of astronauts in flight and during flight simulation. To calibrate and check such a device, it is necessary to simulate, with accurate control, the timing and amplitude of heart activity.

Solution: Build a phonocardiogram simulator with the circuitry in the accompanying diagram. It produces a pattern of electrical signals that duplicate exactly in time and amplitude, the sounds of the human heart. The waveforms are adjustable to simulate all known ranges of human heart activity.

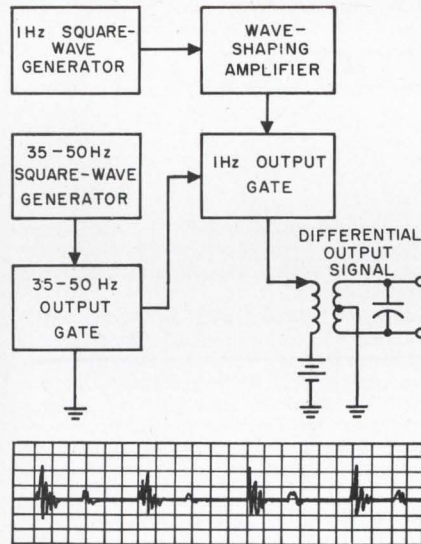

The 1-Hz square-wave multivibrator generates the basic repetition rate of the signal complex. The 35-to-50-Hz multivibrator generates the frequency within each "heart sound" pulse. Circuit resistances are used to control pulse amplitude, and a potentiometer is used to regulate output voltage level.

This innovation can be used to check telemetry systems and instrumentation systems for phonocardiogram monitoring in

hospitals and for training personnel to use such systems.

Inquiries about this invention can be made to: Technology Utilization Officer, Kennedy Space Center, Kennedy Space Center, Florida 32899. Reference: B67-10239.

Small computers analyze circuits

Problem: Design a set of linear circuit analysis programs to be used on a small computer system such as the IBM 1620/20K version with a 1311 disk storage drive.

Solution: CIRCS is a modification of the original IBSNAP circuit analysis program. Only the basic dc, transient analysis, and input language formats have been retained.

CIRCS can solve a linear network containing a maximum of 15 nodes (excluding ground) and 45 branches. Transistors and diodes can be included in the network as linear models and a special data card allows the user to describe the base, collector, and β or g_m characteristics of the transistor.

The analysis portion of the ac and dc programs (ACNOD1 and DCNODE) have been so radically changed that only a similarity remains between CIRCS and IBSNAP. A Mandex worst-case analysis was added to the dc program in preference to the original dc worst case. The card processing program links (AC, DC, TR) were written for use on the IBM 1620/1311 data-processing system.

By modifying the necessary input parameter information with the partials as criteria, one can establish a true worst-case solution. The sensitivities computation in CIRCS gives the user an idea of the percentage effect that a particular input parameter has on a particular node voltage with respect to the remaining input parameters.

Linear approximations are



Pretty soon, GM's Mark of Excellence will be on the moon... of all places.

You can help put it there . . . with the AC Electronics Division of General Motors.

General Motors has a reputation for doing big things. And doing them well. So it's not surprising that when the first Astronauts travel to the moon, they'll be guided there and back by guidance and navigation systems from GM's AC Electronics Division.

Project Apollo is typical of the challenging career programs you'll work on as a member of the AC Electronics guidance, navigation, control, and computer team.

If you're a qualified Engineer, Scientist, or Mathematician, there may be a position for you now at one of AC's three locations—Milwaukee, Boston, or Santa Barbara. Look over the opportunities listed. Then write, phone, or wire: Mr. R. W. Schroeder, Dir. of Professional and Scientific Employment, Box 705, AC Electronics Division, Milwaukee, Wisconsin 53201.

Digital Test Equipment Design Engineer (Milwaukee)—Responsible for design of advanced digital test equipment. Technical degree, plus familiarity with large computer interface requirements, logic design, production test requirements and time sharing.

Industrial Engineer (Milwaukee)—Establish work standards, using time and delay studies, work sampling and standard data. Process routings and reports to control

standard hours. Research and apply new techniques to existing practices. Prefer B.S., I.E., with methods and standards experience.

Research Engineer—Thin Films (Milwaukee)—Development of materials and processes for fabrication of thin film passive components and insulating films by vacuum deposition and sputtering. Analyze thin film passive components, monolithic integrated circuits and multilayer interconnections, processed over silicon wafers provided with large arrays (L.S.I.).

Circuit Design Engineer (Boston)—Experienced in design of AC and DC amplifiers in the audio-frequency range, precision DC differential amplifiers, DC and AC power supplies, A/D and D/A converters. Familiarity with feedback and control theories. B.S.E.E., minimum 3 years' experience.

Electro-Optical Design Engineer (Milwaukee)—Design, development and testing of visual optics and electro-optics viewing systems for applications to tactical combat vehicles. Substantial activity in these areas supplemented by company-sponsored R & D.

AC ELECTRONICS

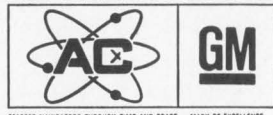

An Equal Opportunity Employer

NASA TECH BRIEFS

substituted for the differentials and integrals in the transient program, so reducing the system of differential equations to a system of algebraic equations. The trapezoidal rule is used in approximating the integrals. In order to model diodes, ramp functions, sawtooth functions, etc., switching is built into the program. The programming language is Fortran II.

Complete details of this program are available from: COSMIC Computer Center, University of Georgia, Athens, Ga. 30601. Reference: B67-10173.

Fluid digital systems are found practical

Long life and environmental tolerance make the use of fluid amplifiers highly desirable in digital computation systems, a study prepared for NASA has found.

The fluid amplifier's tolerance to both nuclear and electromagnetic radiation and to extreme temperature ranges appears limited only by the fabrication material. Shock and vibration tolerances also appear excellent; fluid amplifiers have withstood vibration levels as high as 50g at 5000 cycles per second. Moreover the production costs of fluid-amplifier components may be low, because of the lack of close-fitting moving parts and bearing surfaces.

The digital integrator is the basic building block in digital differential analyzer systems, just as the operational amplifier is in analog computational systems. For that reason, the digital integrator was chosen as the most appropriate target to investigate.

The study found that digital computation systems with fluid amplifiers are practical. Their response speed is adequate for many space applications. Their

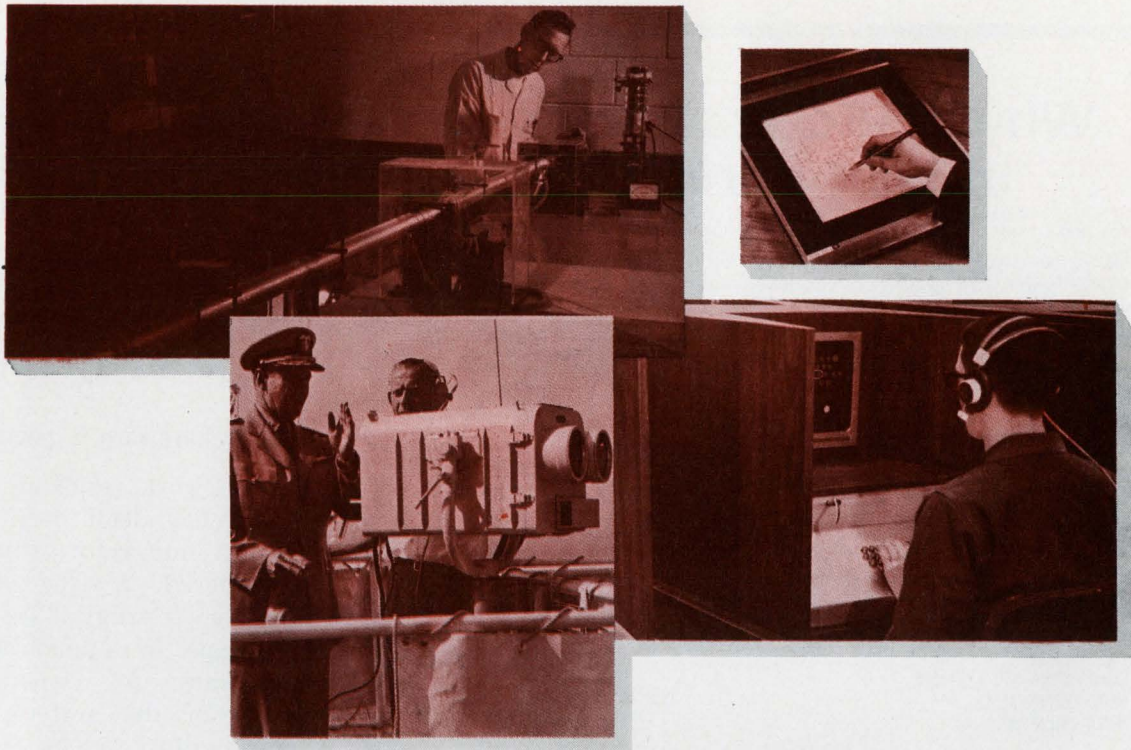

in tomorrow's communications systems

the IN basket is OUT!

Electronic memory banks, built into your office walls, will replace file cabinets. Your home computers will automatically order from supermart computers. Enormous data loads will be carried by laser lines through underground "light pipes". Long-range communications will be handled by satellite links.

When? Sylvania scientists and engineers are developing these systems today. Typical developments include: the Data Tablet for simplified man-to-computer communications; long range laser and millimeter wavelength systems with greatly increased capacity; satellite data handling equipment; and digital vocoders that eliminate the paperwork between you and the computer.

You can help to build this tomorrow. Forward your resume to Manager, Professional Staffing, Sylvania Electronic Systems, Sylvania Electric Products Inc., 40 Sylvan Road, Box 1005, Waltham, Mass. 02154.

*Opportunities in suburban Boston,
Buffalo or San Francisco.*

An equal opportunity employer

SYLVANIA
A SUBSIDIARY OF
GENERAL TELEPHONE & ELECTRONICS

RESEARCH • SYSTEMS DEVELOPMENT • PRODUCT & FIELD ENGINEERING
ON CAREER-INQUIRY FORM CIRCLE 904

Why Make Trade-offs in Your Career?

You make trade-offs all the time in engineering—giving up cost advantages, say, for miniaturization and light weight. But are you making trade-offs with your personal career, too? Giving up a pleasant place to live for a good salary? Or submerging yourself in a mammoth engineering staff so you can work on big aerospace projects? You don't have to, you know! Look into L.S.I. We design and produce advanced flight reference, navigation, communication and display systems. As a result, we have a team of 450 crack engineers making important contributions to every major aerospace program. They've gained recognition—and are well rewarded, too—because everybody here knows that our engineers are the backbone of the company. And our men live in a pleasant, medium-size city just minutes from the office and high-rated schools, in the heart of Michigan's year 'round vacationland. If you'd like to have your cake and eat it too, write in confidence to L. A. Mellinger, Professional Employment Manager. Some of the many opportunities now available include these disciplines:

COMMUNICATION SYSTEMS
RECEIVER SYSTEMS
NAVIGATION SYSTEMS

CIRCUIT DESIGN
ELECTRONIC PACKAGING
SYSTEMS ANALYSIS

LEAR SIEGLER, INC.



AN EQUAL OPPORTUNITY EMPLOYER

INSTRUMENT DIVISION

4141 EASTERN AVE., S. E., GRAND RAPIDS, MICHIGAN 49508

ON CAREER-INQUIRY FORM CIRCLE 905



PLAY IT SAFE:
Start now
to save
their hearts

Help your children form good health habits now to reduce risk of heart attack later:

- Encourage normal weight; obesity in youth may persist throughout life;
- Build body health through regular physical activity;
- Serve them foods low in saturated fats;
- Teach them that cigarette smoking is hazardous to health;
- Make medical check-ups a family routine.

Set a good example. Follow the rules yourself and guard your heart, too.

GIVE...
so more will live
**HEART
FUND**

Contributed by the Publisher

NASA TECH BRIEFS

potential for reliability in adverse environments, such as nuclear radiation, heat and vibration, is superior to electronic circuitry. Applications that have been considered as a result of these findings include a satellite control and a guidance computer for an escape "lifeboat" for manned orbital stations.

Better hardware is needed

The work resulting from the study has dealt only with the digital integrator, since it was considered a key feasibility problem for digital systems. For any specific application, it is necessary to consider other parts of the system, such as power supply, sensors, displays and digital-analog converters.

So far as the digital integrator itself is concerned, the following represent areas where additional study is recommended:

- Miniaturization.
- Speed.
- Power consumption.
- Packaging design and fabrication techniques.
- Instrumentation.

The work in these areas is closely interrelated. Miniaturization is required to improve speed and to reduce power consumption, for example. The degree of miniaturization will also affect the instrumentation requirements for monitoring and testing, and it will dictate certain fabrication methods. The package design must permit very close coupling of elements to achieve high operating speeds.

Complete details of the study are contained in: *NASA Contractor Report, Fluid Amplifier Digital Integrator*, prepared by General Electric, NASA, CR-61092, September 1965. Copies of the report are available from: Technology Utilization Officer, Marshall Space Flight Center, Huntsville, Ala., 35812. Reference: B67-10181.

At ECI in St. Petersburg, Florida . . .
RF Communications Opportunities

For a special breed of engineer

If you're one of that special breed of communication engineers who finds a challenge in projects beginning with applied research and advanced development and continuing through prototype and product design, you may well be the kind of person we're looking for.

Check this partial list of RF engineering activities at ECI. If you'd like to help push the state-of-the-art in any of these or other areas in communications, send us your resume. You'll design systems and equipment for satellite communications, multiplexing, electronic switching, command and control and advanced radio communications for some of the nation's major defense and space programs.

RF Communication Engineering Activities:

- Modulation and Demodulation
- Frequency Synthesis
- Solid State Power Amplification
- Hi Power Amplification
- Power Supply Technology
- Receiver Front End Design
- Packaging and Cooling
- Microelectronic Applications
- Reliability Techniques

CHALLENGE, GROWTH . . . and LOCATION TOO!

At ECI your job will be challenging. At ECI you'll find real opportunity for growth instead of just another confining groove — two-thirds of all advanced development is done in regular engineering development areas. And, at ECI you'll like where you're living just as much as you'll like your job. We'll match subtropical, sunny St. Petersburg against any location in the U. S. for stimulating, comfortable living.

SEND YOUR RESUME TODAY — in confidence — to K. D. Nipper, Supervisor of Professional Placement, Electronic Communications, Inc., P. O. Box 12248, St. Petersburg, Florida 33733.
(An equal opportunity employer, M & F.)



ELECTRONIC COMMUNICATIONS, INC.
ST. PETERSBURG DIVISION

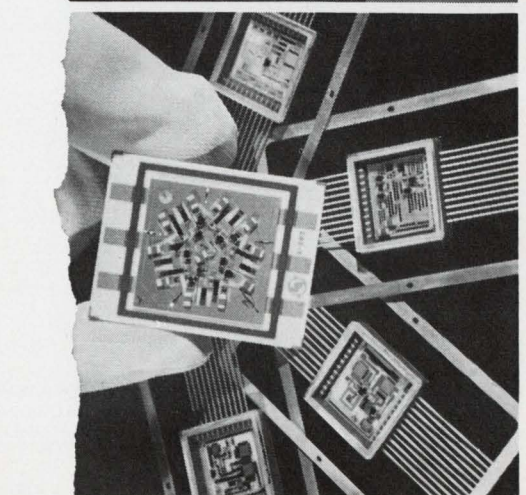
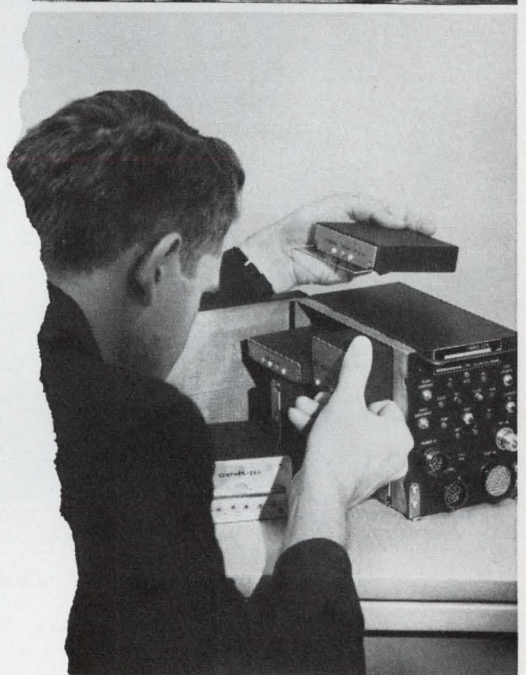

ON CAREER-INQUIRY FORM CIRCLE 906

EE openings on Boeing aerospace programs.

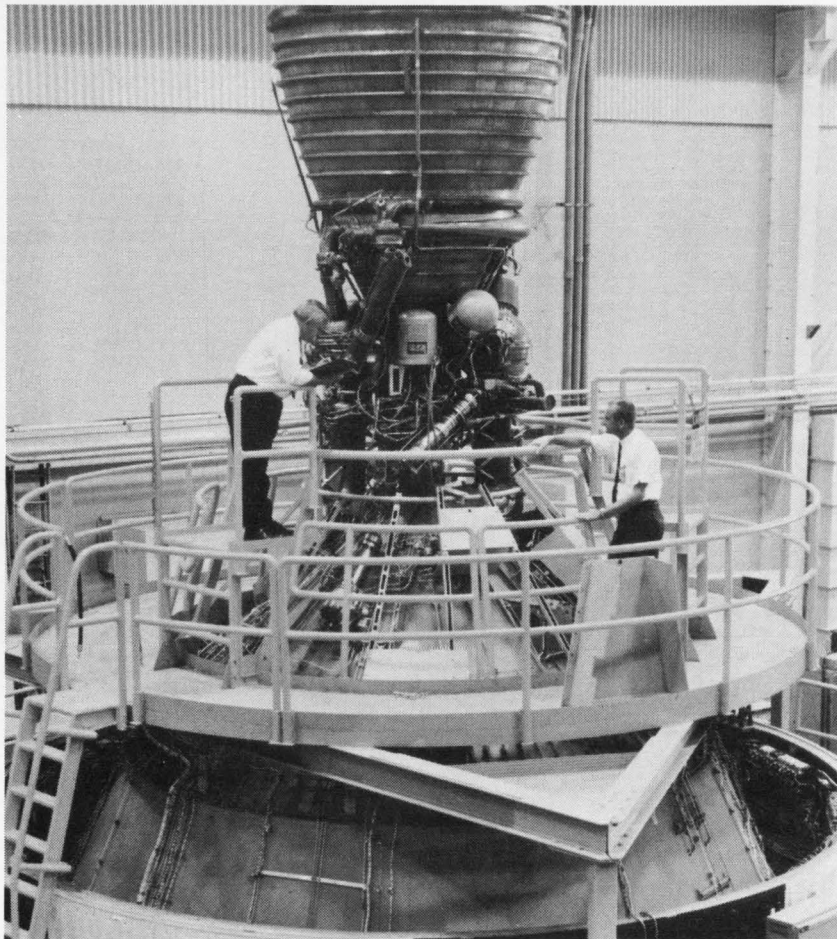

Electronic-mechanical simulator of the Kennedy Space Center's Saturn V launch control center. It is used by Boeing-Huntsville engineers and technicians to check out all components of Apollo/Saturn V vehicle.

The Boeing Company's deep involvement with the nation's major missile and space programs provides immediate career opportunities for electrical/electronic engineers at Seattle, Huntsville, and Kennedy Space Center.

At Seattle, Boeing is engaged in a number of company-funded and government-contracted programs which are advancing the technologies developed for such highly successful programs as NASA's Lunar Orbiter, U.S. Air Force's Minuteman II and Burner II, and U.S. Navy's PGH-2 (patrol gunboat hydrofoil).

Boeing is a major mission-support contractor to NASA on the Apollo/Saturn V program. At Huntsville, the company is performing systems engineering and integration functions on Saturn V. At Kennedy Space Center, Boeing is assisting NASA in systems analysis and basic modification and design of launch support equipment.

Immediate electrical/electronic engineering openings at Seattle exist in test technology (data systems and instrumentation, test data handling and processing), flight technology (flight control, flight mechanics), developmental design (airborne control systems, ground system electrical power systems, environmental control), and electronic packaging.

Openings at Huntsville are immediately available in flight mechanics and flight evaluation (operational trajectories, mission analysis, trajectory analysis, post-flight trajectories, flight simulation development, flight dynamics). Other electrical/electronic assignments are open at Kennedy Space Center.

Qualifications for these positions include a B.S., M.S., or Ph.D. in electrical engineering with two to five years experience. Salaries are commensurate with experience and educational background. Moving and travel allowances are paid to newly employed personnel. Boeing is an equal opportunity employer.

Please fill in and mail the coupon to the location of your choice and field of interest. A Boeing representative will get in touch with you.

BOEING
AEROSPACE GROUP

Other Divisions: Commercial Airplane • Vertol
Wichita • Also, Boeing Scientific Research Laboratories

I'm interested in a Boeing aerospace career; please contact me with details.

Name _____

Address _____

Phone (incl. area code) _____

City _____ State _____ Zip _____

I'm usually home between _____ and _____ (hours) on _____ (days)

Degree/Field of Interest _____

Please mail to the location of your choice and field of interest:
SEATTLE: Mr. J. T. Cartwright, The Boeing Company, P.O. Box 3999-EDI, Seattle, Washington 98124. HUNTSVILLE and KENNEDY SPACE CENTER: Southeast Staffing Manager, The Boeing Company, P.O. Box 1680-EDI, Huntsville, Ala. 35807.

*Its digital mind,
its analog environment:*

Opportunities for EEs to grow on

. . . all in a tightly-integrated, multi-disciplinary environment . . . for our major product—today's and tomorrow's nuclear submarine—is probably the most sophisticated vehicle extant—bar none.

Which places a lot of responsibility on the architects of her 'nervous system': our electrical and electronic engineers. For without their efforts, a submarine would be merely a pressure-proof hull containing an incredible assortment of complex hardware, instead of a smoothly functioning network of systems, capable of many diverse missions.

If you're getting the idea that being an engineer here is like being an EE nowhere else, you're beginning to see things the way we do. The difference starts with the building blocks you work with—which are in themselves systems. One of the main tasks you'll tackle is interfacing a variety of subsystems . . . which can have you running the gamut from liaison with subcontractors to installation supervision and checkout, to designing A/D or other hardware. Or participating in setting the parameters for systems so advanced you'll be making more precedents than following them.

And this is only the beginning. What makes things even more interesting is the elasticity or nonexistence of interdisciplinary barriers. In a setup where one

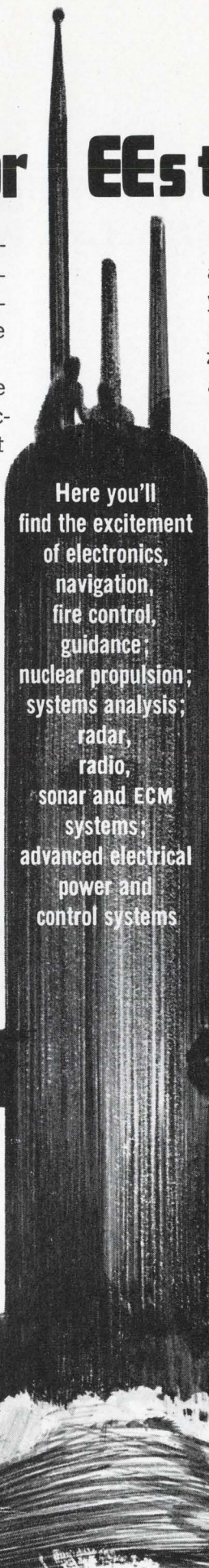

Here you'll
find the excitement
of electronics,
navigation,
fire control,
guidance;
nuclear propulsion;
systems analysis;
radar,
radio,
sonar and ECM
systems;
advanced electrical
power and
control systems

PhD astronomer can and does do systems analysis, modelling and feasibility studies, you can expect—and find—the transdisciplinary growing room of a research organization combined with a competitive industry's advancement potential.

If these sound like promises you've heard before, look again. We have a policy—in writing—that mandates this idea to every manager. To move up, he has to develop his own replacement. And to give you a better crack at the job, we back up your talent with the money for advanced-degree education—and with a variety of in-house courses as well.

There's more, too, but we'd like to tell you about it face-to-face. If you're interested in the areas of solid state low frequency circuits; the design of servomechanism and computer circuitry; military applications of digital computers; systems analysis; integration and test development of shipborne radio, radar, sonar and ECM; and the design of low-voltage power plant systems and associated shipborne equipment, we'd like to talk to you about them—and us. Send a resume now to Mr. Frank L. Whitman. U.S. Citizenship is required.

GENERAL DYNAMICS

Electric Boat Division

159K Eastern Point Road, Groton, Connecticut

An Equal Opportunity Employer (M&F)

Curve gives minimum-weight design for waveguide-fed horns

The antenna designer frequently faces the problem of reducing the weight of antennas. Many waveguide-fed antennas use horns to shape a beam. The commonest application is an H-plane sectorial horn used to form the vertical-plane beam of a linear- or slotted-waveguide marine radar antenna. The horn of such an antenna often supports the rest of the structure as well as shapes the vertical beam. Minimizing horn weight will cut antenna weight, which is a design goal for rotating, scanning, or transportable antennas.

The 3-dB beam width of a horn is a function of both the horn flare angle and its total length. To achieve a particular 3-dB beam width, a range of combinations of horn flare angle and length may be used. Many of these combinations are wasteful because they require more material than is necessary for the required beam width. The combination that takes the least horn material is usually found by cut-and-try methods. The curve given here eliminates this cut-and-try process; horns can be designed from the start to use a minimum of material.

For example, a minimum-material H-plane sectorial horn giving a 25° 3-dB beam width should have a flare angle of 32.5° and a side length of 3 wavelengths. A smaller flare angle would require a greater side length to achieve the required 25° beam width, while a shorter side length would result in a greater beam width. The combination

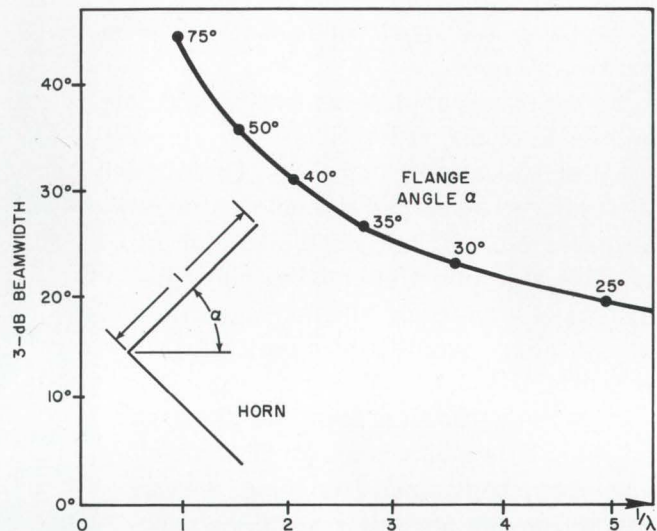

Curve for minimum weight in an H-plane waveguide-fed sectorial horn. The 3-dB beam width is measured in the plane containing the horn flare. The curve can also be used for the H-plane diagram of pyramidal and biconical horns.

of a 32.5° horn flare angle and a 3-wavelength side length is then the minimum weight design.

M. Michael Brady, Research Engineer, NERA A/S, Oslo, Norway.

VOTE FOR 110

Reliable one-shot has high repetition rate

Conventional monostable multivibrators suffer because their repetition rate is limited by their recovery time. After a one-shot is triggered, the circuit must return to its quiescent state before it will trigger again. A method of ensuring reliable triggering is shown in the accompanying figure.

A command pulse is coupled to an AND gate, the other input of which is enabled when $M2$ is off. This produces a positive trigger that triggers $M1$. This one-shot produces a delay, T_1 ; the trailing edge of this pulse triggers $M2$ through the inverter. $M2$ now produces a pulse, also of duration T_1 , during which the AND gate is inhibited, so that it cannot receive or respond to an improper trigger. By the time $M2$ has produced its pulse, $M1$ will have recovered and so can be triggered again. The duration of $M1$'s output pulse is such that $M2$ will be



VOTE! Go through all Idea-for-Design entries, select the best, and circle the appropriate number on the Reader-Service-Card.

SEND US YOUR IDEAS FOR DESIGN. You may win a grand total of \$1050 (cash)! Here's how. Submit your IFD describing a new or important circuit or design technique, the clever use of a new component or test equipment, packaging tips, cost-saving ideas to our Ideas-for-Design editor. You will receive \$20 for each accepted idea, \$30 more if it is voted best-of-issue by our readers. The best-of-issue winners become eligible for the Idea Of the Year award of \$1000.

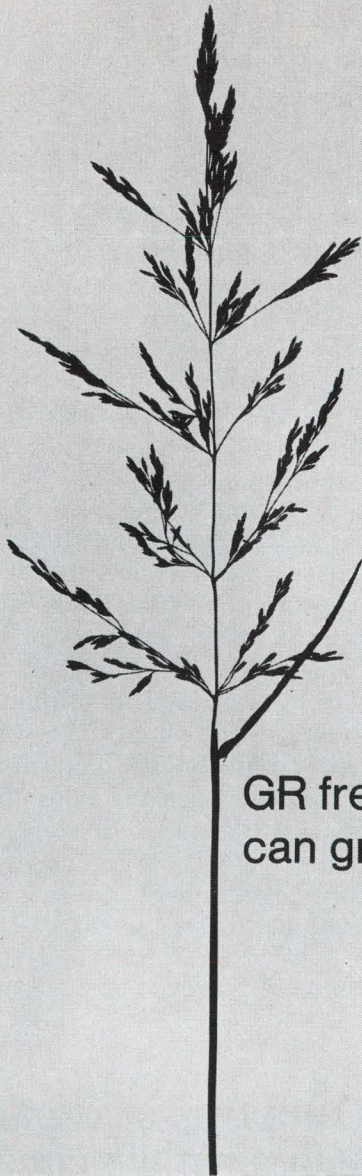

GR frequency synthesizers can grow on you.



Start with the basic package . . . a 3-digit synthesizer . . . in a 70-MHz, 12-MHz, 1-MHz, or 100-kHz model for as little as \$3640 . . .

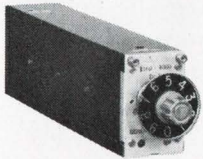

add additional digits (\$455 each) as you need them for up to 7-digit resolution and . . .

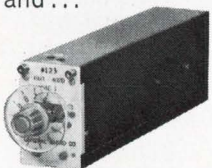

at any time add a continuously adjustable decade (\$550) for 2 extra figures of resolution or for continuous, manual control of frequency . . . sweep it electrically with your own external sweep signal or . . .

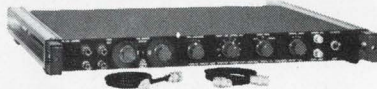

get the sweep, and frequency markers too, by adding our new sweep and marker generator (\$495).

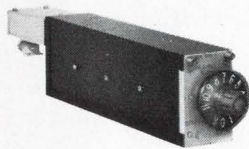

Want to go programmable? . . . use programmable decades (\$545-\$575) . . . new units now provide stepped programming up to 12 MHz . . . programming can be controlled by simple switch closures . . .



or, if you'd rather not flip switches, add our new preset-frequency programmer (20 channels for \$1000; 40 channels for \$1825) with a storage capability of up to 40 preset 7-digit frequencies per tray. Actual storage capability is unlimited if you don't mind switching trays . . .



and, if you need exceptional long-term stability, add an external frequency standard (\$2050) and improve it by three orders of magnitude to better than 1×10^{-10} . . .

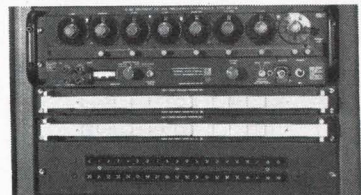

or, if you're bothered by growing pains, why not outline your needs and we'll recommend the right system . . . at off-the-shelf prices. Write General Radio Company, W. Concord, Massachusetts 01781; telephone (617) 369-4400; TWX (710) 347-1051.

GENERAL RADIO

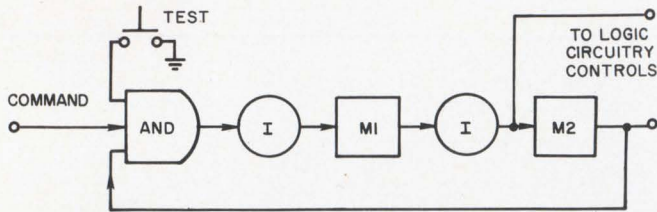

The second one-shot ensures that the first will have returned to its quiescent state before it can be triggered again.

triggered by its trailing edge. The grounding of a test lead left at the input of the AND gate also enables the gate and causes *M1* to trigger. When *M2* triggers, the trailing edge's positive transition couples through the AND gate and inverter, and again triggers *M1*.

The result is a continuous train of pulses that can be used to debug any following logic. It needs no external pulse generator or command input from another subsystem.

Robert Scott, Consulting Engineer, East Brunswick, N.J.

VOTE FOR 111

Voltage-to-frequency converter built with one UJT oscillator

The circuit shown is a low-cost voltage-to-frequency converter. It is appreciably simpler than conventional converters made with a blocking oscillator.

It consists of a UJT oscillator in which the rate of charge of timing capacitor *C2* is linearly de-

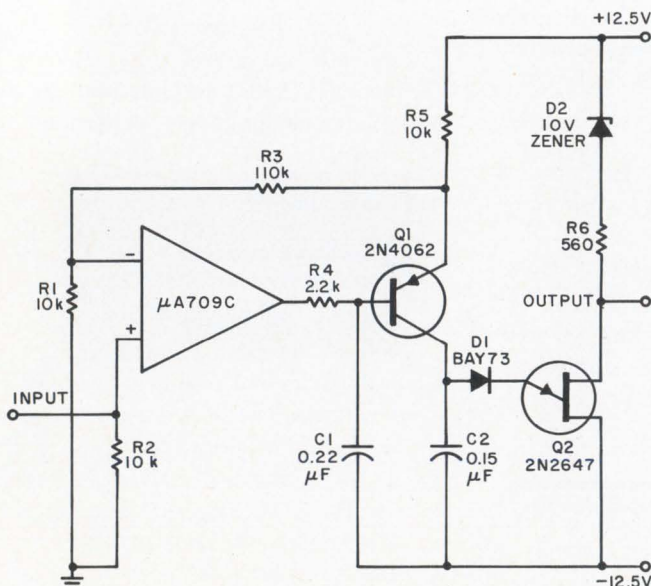

Two decades of frequency range are obtained with this simple VCO (voltage-controlled oscillator).

pendent on the input signal voltage. The charging current is set by the voltage across resistor *R5*, which is accurately controlled by the amplifier.

The range of permitted charging currents is limited by the peak point and valley currents of the UJT. Provided transistor *Q1* has a gain of at least 200 over the charging-current range, linearity is limited by the leakage current of the UJT (effectively reduced by diode *D1*) and the oscillator's minimum duty cycle.

The amplifier is selected to give the required gain at the appropriate input impedance. The combination *R4C1* is used to limit the high-frequency response of the amplifier. The Zener diode is used to adjust the peak-point voltage of the UJT within the output voltage range of the amplifier.

Since the amplifier output is taken with respect to the positive supply, the over-all performance depends on the supply stability. Assuming a typical regulated transistor power supply and the components indicated, however, linearity is better than $\pm 0.5\%$ over a frequency range of two decades, for a signal range of 0 to 1 volt. The temperature coefficient is typically $0.05/^{\circ}\text{C}$ from 10° to 40°C .

S. G. Johnson, Physicist, Regional Medical Physics Dept., Sheffield, England.

VOTE FOR 112

Compress or expand pulses with a simple circuit

The length of the output pulse is proportional to the length of the input pulse, and the output pulse is delayed for the duration of the input pulse in this circuit (see figure). The ratio of the input to output pulse widths is adjustable over a wide range.

With the length of the input pulse varying, but input-to-output-pulse-width ratio fixed, the length of the output pulse follows changes in the length of the input pulse linearity. Maximum deviation from linearity is 2% for output pulses of 50 μs to 25 ms (this range depends on the value of capacitor *C*). Ratios for input to output pulse width were kept fixed within the 0.1-to-10 range for tests.

When a pulse is applied to the input, it acts through *Q1* to switch off *Q2* and so disconnect one side of (*A*) of *C* from ground. Adjustable constant-current supply consisting of *Q3*, *R1*, *R2*, *R4*, *R5* will charge *C* for the duration of the input pulse. During this time, a second constant-current supply consisting of *Q4*, *R6*, *R7*, *R8* delivers sufficient current to the base of *Q5* to saturate it. *Q5* and *Q6* form a Schmitt trigger and *Q7* is used for inversion, so the output is at its low level while *Q5* is saturated.

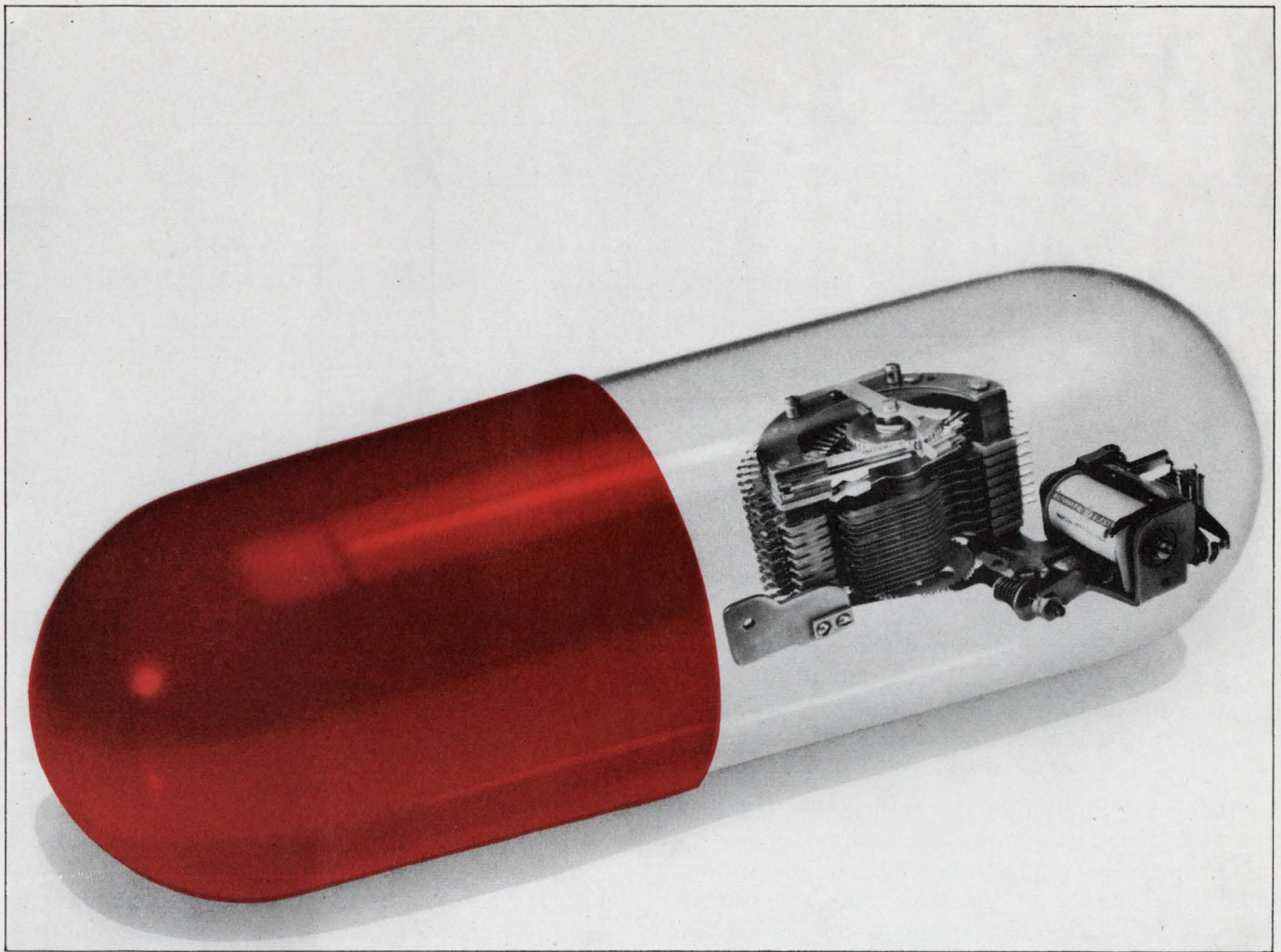

Remedy for nightmares: AE's Type 45NC stepping switch with "shorting" levels.

Many of today's complex switching circuits look like an engineer's nightmare. Why not simplify them? You can replace whole groups of components with an AE Type 45NC "stepper."

This switch has normally closed ("shorting") levels. It's designed so that pairs of contacts *open* successively when the rotor is stepped.

The Type 45NC can solve almost any circuit-transfer or testing problem.

It's ideal for self-interrupted hunting, and you don't need auxiliary relays.

You get one or two electrical levels of either 26 or 52 point normally-closed contacts. For extra versatility, you can specify addi-

tional levels of *normally-open* contacts—on the same switch.

Contacts are gold-plated phosphor bronze. Contact resistance: a maximum of 50 to 100 milliohms, measured at 6 volts 100 milliamperes.

When you specify AE rotary stepping switches, you get the benefit of our continuous research—in design, in metals and insulating materials. All this plus *positive positioning* — a unique AE design

feature that locks the rotor and makes overthrow impossible.

Find out more about AE rotary stepping switches—an economical, rugged and reliable way to simplify switching circuits. There's a lot of helpful application information in our new reference circular 1698-L. To get your copy, just ask your AE representative. Or write to the

Director,
Relay Control Equipment Sales,
Automatic Electric,
Northlake,
Illinois
60164.

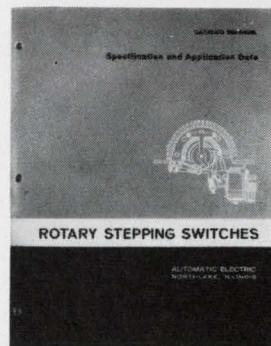

AUTOMATIC ELECTRIC
SUBSIDIARY OF
GENERAL TELEPHONE & ELECTRONICS **GTE**

ON READER-SERVICE CARD CIRCLE 49

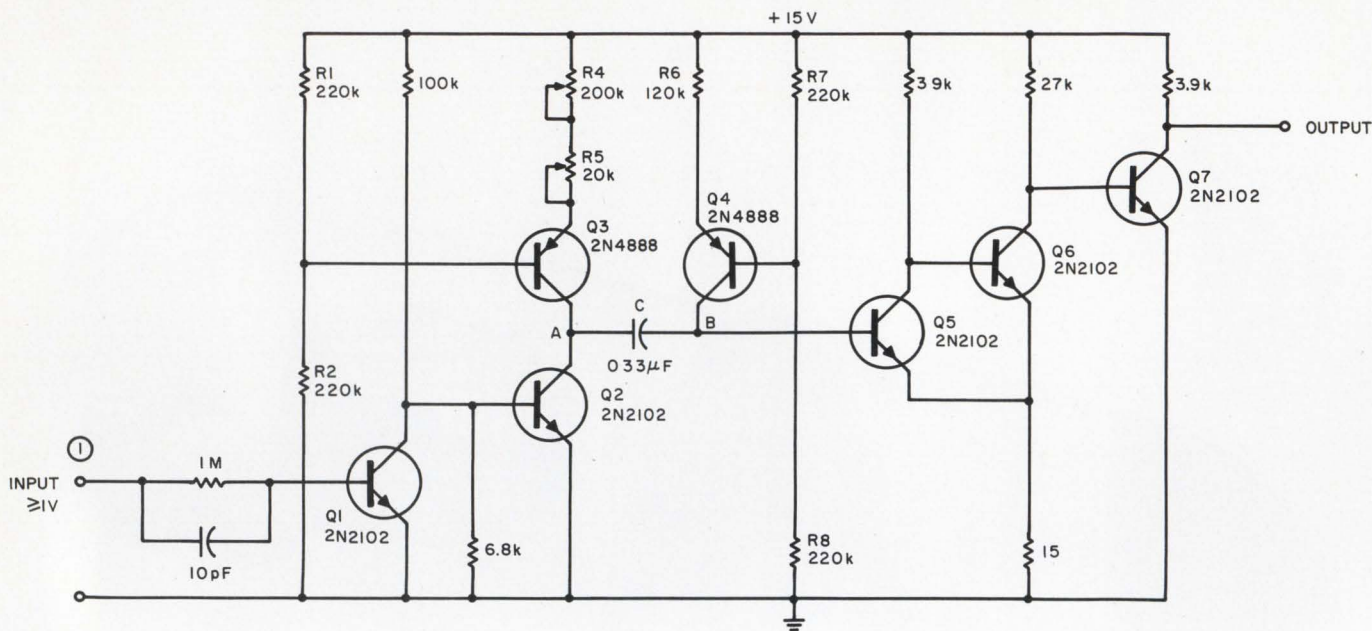

Length of the output pulse linearly follows changes in the input pulse length. Maximum deviation from linearity is

2% for output pulses of 50 μ s to 25 ms. The speed of the circuit can be adjusted by changing C.

At the termination of the input pulse, Q2 saturates and connects point A to ground. Since the voltage across C cannot be changed instantaneously, the voltage at the other side (B) of the capacitor will dip below ground, cutting off Q5. Q5 and Q7 work in phase, so the output voltage will be switched to its high level when the input pulse terminates. Constant current from the supply Q4, R6, R7, R8 will begin discharging the capacitor at this instant, for current cannot flow into the base of Q5 because this transistor is cut off. When voltage at point B reaches a level sufficient to turn on Q5, the output voltage will fall back to its low level, both ends (A and B) of C will be at voltages near ground level with Q2 and Q5 conducting; the circuit is at rest, ready to receive the next pulse.

Transistors Q2 and Q5 were selected for their low leakage current to improve linearity.

The ratio of input to output pulse width is adjusted with the current from constant-current supply Q2, R1, R2, R4, R5. When output from this supply equals the output from constant-current supply Q4, R6, R7, R8, the length of the output pulse equals the length of the input pulse. When current from Q3 is larger than the current from Q4, the length of the output pulse is larger than the length of the input pulse and vice versa.

The circuit lends itself to pulse-width modulation if adjustment of current from Q2 is made proportional to a second input signal.

Thomas Weisz, Electronics Engineer, University of Michigan, Ann Arbor, Mich.

VOTE FOR 113

Simple circuit protects loudspeaker and audio amplifier

Fuses and circuit breakers are too slow to give reliable protection to a loudspeaker system and the amplifier that drives it. The high cost of complementary output transistors in contemporary designs makes protection against inadvertent short-circuit, undervoltage and overcurrent conditions necessary.

This is effected by diminishing the supply voltage to zero. The complete circuit appears in

Fig. 1a; a simplified schematic in Fig. 1b.

Under normal conditions, point A is positive and transistor Q2 is cut off. When an overcurrent or an undervoltage condition occurs, the $+E_{REG}$ voltage decreases to a value less than E_z , diode CR1 becomes nonconductive, and point A becomes negative. A negative voltage at point A switches transistor Q2 on. This in turn reverse-biases transistor Q3, diminishing $+E_{REG}$.

Voltage divider R3, R4 is selected such that the voltage at the base of Q1 is slightly positive, to prevent spurious turn-on of Q1. Time constant

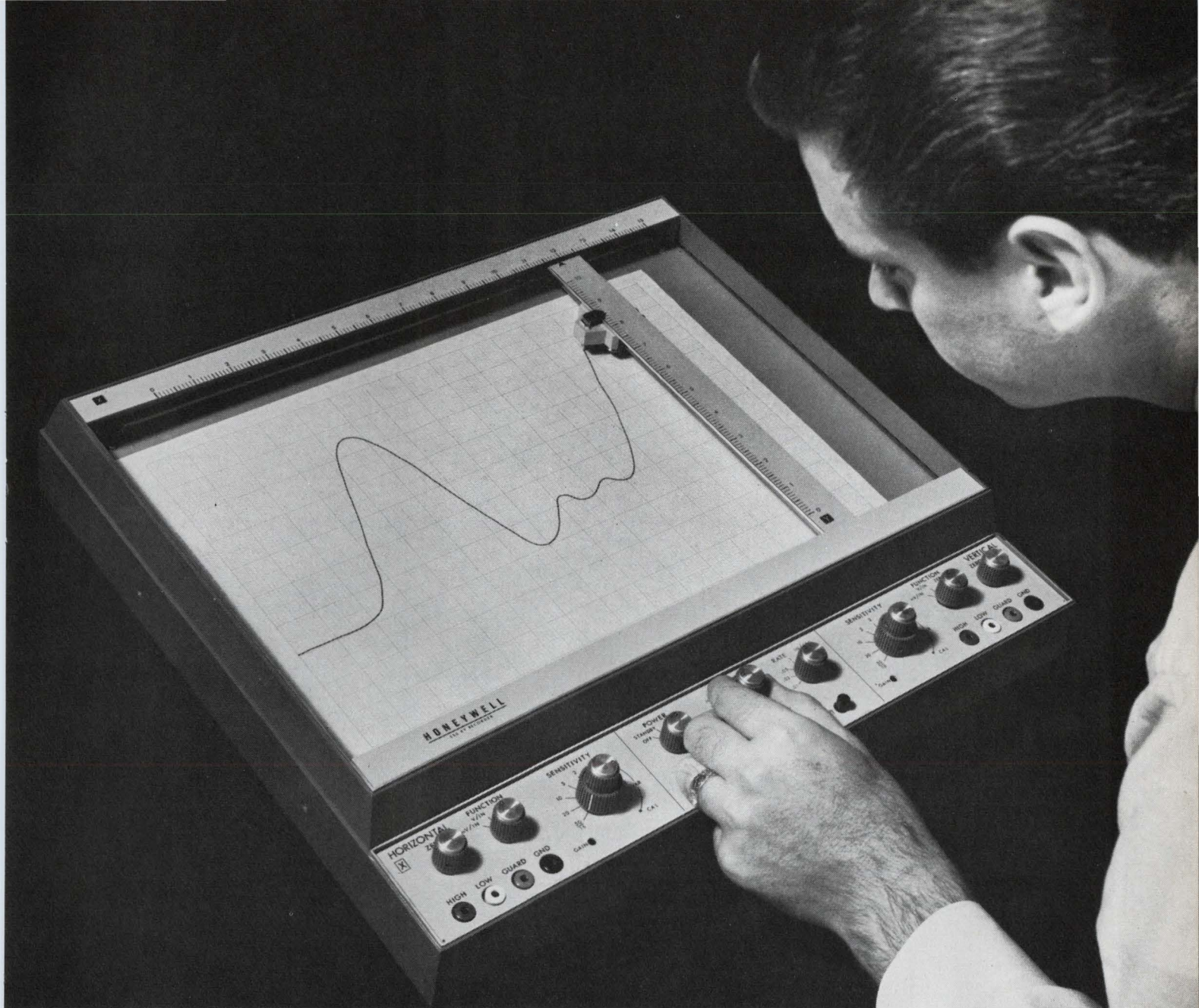

Self-supported at a 30° angle, the new Honeywell 550 offers convenient bench operation — converts to rack mounting easily.

It's rugged, portable, and it works when other X-Y recorders fail. Meet our new Model 550!

We've used X-Y differential recorders around our plant for years. Most have been mechanical dropouts, balking or clogging when we really needed a record. So we decided to build one ourselves. One that worked.

The result is the new Honeywell 550—a slim, crisply designed instrument that overcomes the mechanical problems that plague other X-Y's. Its built-in reliability is protected by a tough, molded base that seals working parts from dust and dirt, even when the 550 is rack-mounted. You get smooth, quiet operation, and you get it for a long, long time.

With true differential input, high sensitivity to 100 $\mu\text{v}/\text{in.}$, and accuracy of 0.15%, the dependable 550 takes a back seat to no one in the performance department. And, it's convenient to use — there's a standby position for quick, easy paper loading, a zero check position, and rear inputs and remote capability built in.

Other 550 features include: a stainless steel pen with non-clogging polished sapphire tip; sealed potentiometers for maximum field reliability; snap-on ink cartridges; a handy zero check, and a built-in event marker. There's lots more, yet the 550 is moderately priced!

If you've been bugged by your current X-Y recorder, look into the new 550. It's another example of how Honeywell's broad line, backed by local sales and service, can provide the *precise* solution to your instrumentation problems. For full details on the 550, call your local Honeywell Sales Engineer, or write: Honeywell, Test Instruments Division, 4800 East Dry Creek Road, Denver, Colorado 80217.

Honeywell

Honeywell engineers sell solutions

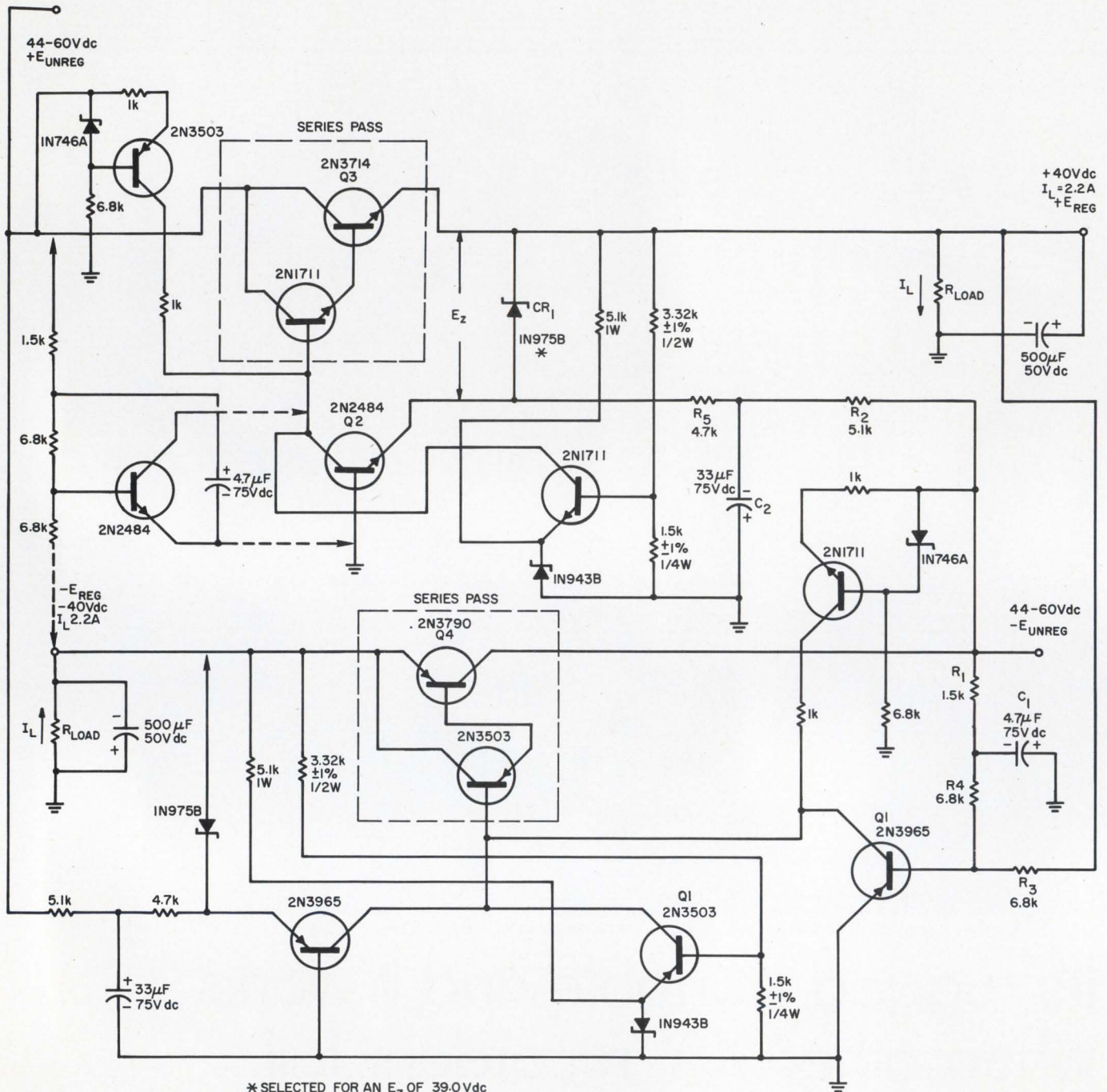

- * SELECTED FOR AN E_z OF 39.0Vdc
- 1. Q3 AND Q4 ARE MOUNTED ON A COPPER PLATE (4 IN. X 2 IN. X 1/8 IN.)
- 2. ALL RESISTORS ARE 1/2w

ⓐ

1. Loudspeaker and audio amplifier protection circuit operates by dropping voltage to zero.

$R_1 C_1$ prevents switching transients from turning $Q1$ on when power is applied.

Should $+E_{REG}$, the positive regulated supply fail, the loss kicks $Q1$ on. This in turn forces $Q4$, off. With $Q4$ off, the $-E_{REG}$ voltage decreases to zero.

The circuit shown operates for an overload on

the positive supply. Operation for the negative supply is shown by dotted lines.

Once the faulty condition has been removed, manual reset is necessary. To reset, the operator sets the power switch to off position for approximately ten seconds and then moves it to the on position.

In Making Masks for Electronic Components there's no Margin for Error!

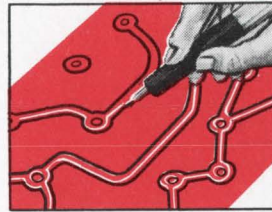

With sharp blade, outline the areas to be masked. Do not cut through the backing sheet. The Ulano Swivel Knife does the job quickly, easily.



Now carefully peel off the film as outlined leaving a completed photo mask, positive or negative, that corresponds exactly to the desired pattern.

**THAT'S WHY EXPERIENCED DESIGNERS
AND ENGINEERS ALWAYS INSIST ON...**

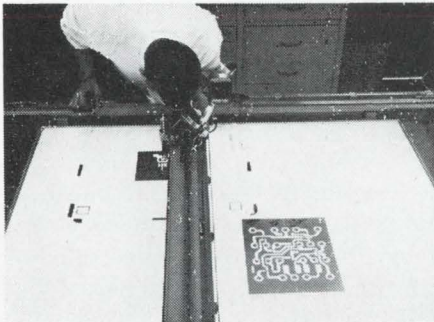

RUBYLITHTM

HAND-CUT MASKING FILM FOR THE GRAPHIC ARTS

**THE KNIFE-CUT, LIGHT-SAFE MASKING FILM
LAMINATED TO A STABLE POLYESTER BASE**

The most versatile line of hand-cut masking films, including

**.0075—RUBYLITH 75 DR* .005 RUBYLITH 5 DR
.005 AMBERLITH 5 DA**

These new, thick Ulano films provide the positive answers where exact register assumes a critical importance.

** Available in sheets only, cut to your specifications.*

by

UlanoTM

ulanoTM

610 DEAN STREET, BROOKLYN, N. Y. 11238

NEW YORK • CALIFORNIA • CHICAGO • ZURICH

In Europe: ULANO A. G., Untere Heslibachstrasse 22, Kusnacht 8700, Switzerland

Write on your letterhead for special electronic test kit (no charge) No. 4127

ON READER-SERVICE CARD CIRCLE 51

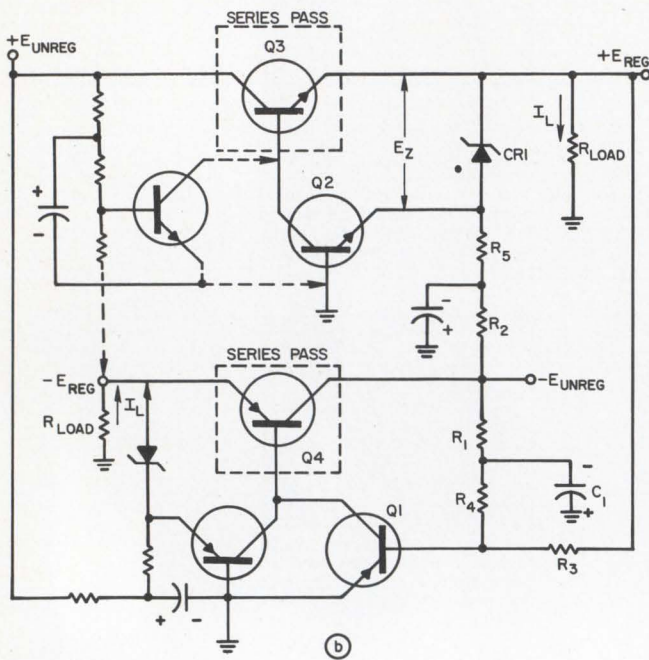

2. Action of the circuit of Fig. 1 is explained with this simplified schematic.

The design criteria for the circuit are:

$$E_Z = E_{REG} - \Delta E_{REG};$$

$$R_2 C_2 \approx 5R_1 C_1;$$

$$I_{Z(rated)} = E_{unreg} / (R_2 + R_5).$$

Melvin W. Kyle, Jr., Senior Circuit Engineer, Hughes Aircraft Co., Culver City, Calif.

VOTE FOR 114

Long-duration monostable fabricated with ICs

Monolithic integrated monostables are generally limited in pulse width by the requirement for low impedance levels in the charging path. For long delays, large-value polarized capacitors are necessary, seriously affecting the temperature stability of the output. In general, monostable multivibrators built with low-level integrated logic gates suffer from the same maladies.

The low-cost circuit in Fig. 1a uses small capacitors to obtain long pulse widths. Short reset times are possible because of the large ratio between timing and reset impedances. In addition, the output pulse width is independent of input pulse width.

The circuit combines a high-beta low-leakage transistor with a DTL quad dual-input gate. In this configuration, the charge path of R_1 , C_1 and R_{sat} (saturation resistance of G_4 output transistor) controls the base of Q_1 . Circuit operation is explained in the timing diagram (Fig. 1b).

Since Q_1 is turned off very quickly by the leading

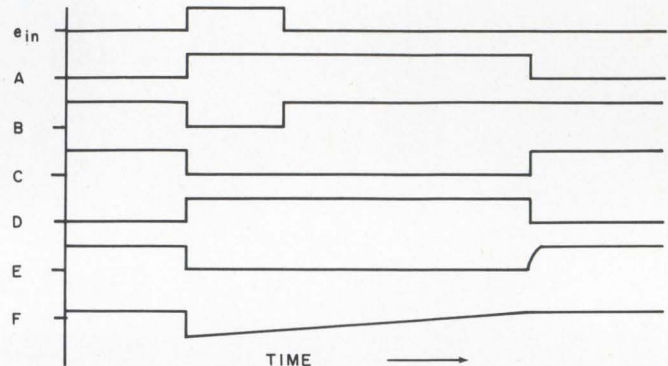
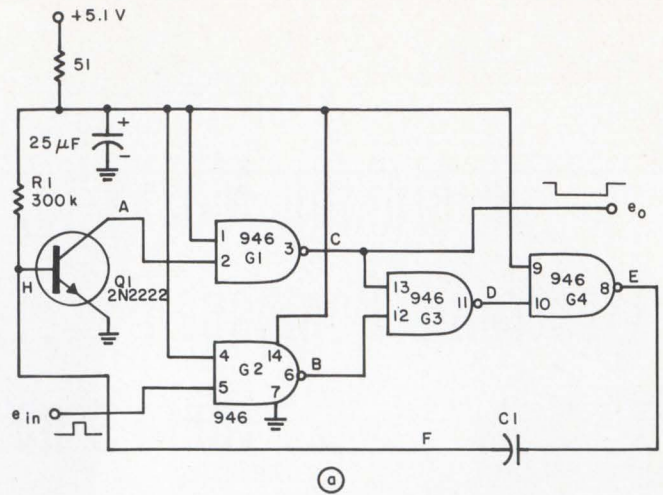

100-ms to 10-s pulse widths are obtained from this simple monostable (a) using DTL quad dual-input gate and a high-beta, low-leakage transistor. Circuit action is described in (b).

edge of the negative-going waveform at point H, duty cycle limitations are imposed by the rest time of C_1 . C_1 resets by charging from the collector load of G_4 through the on input impedance of Q_1 . The pulse width $T_0 \approx 0.7R_1C_1$. Since the input impedance of Q_1 when in its saturated region is much smaller than the charging resistor R_1 , duty cycles to 94% are easily obtained.

Output pulse widths from 100 ms to 10 s were obtained with this circuit by varying C_1 . No change in a given output pulse length was observed for input pulse lengths varying over a wide range of pulse widths. The price of the components in unit quantity is under \$5.00.

George C. Kuipers, Senior Research Engineer, AC Electronics, Goleta, Calif.

VOTE FOR 115

IFD Winner for September 1, 1967

Allan G. Lloyd, Project Engineer, Avion Electronics, Inc., Paramus, N. J.

His Idea, "Constant-current regulator has low dissipation," has been voted the \$50 Most Valuable of Issue Award.

Cast Your Vote for the Best Idea in this Issue.

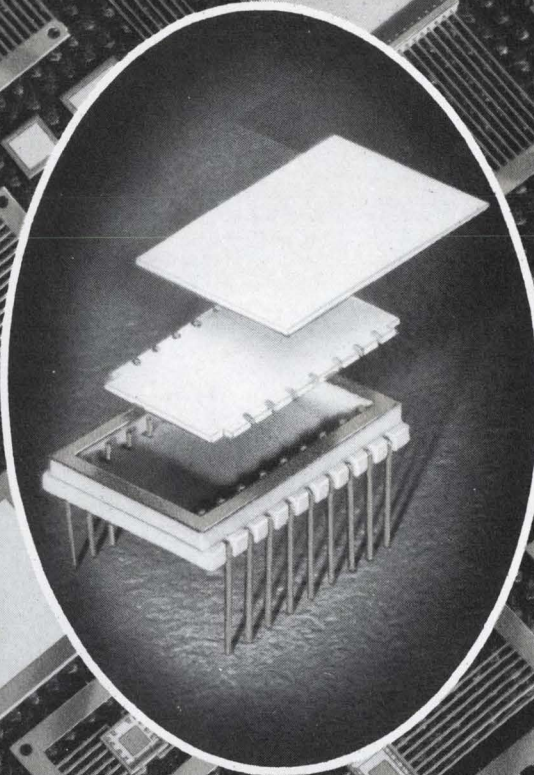

ALSiPAK[®]

CERAMIC PACKAGES feature NEW PLUG-IN

The RELIABILITY of ALSiPak CERAMIC PACKAGES for electronic circuits has resulted in their ever-increasing use. "Preferred Style" flat packages are available in the more widely used sizes with minimum device areas ranging up from .148" x .148" to .710" x .710" with as many as 60 leads if desired. They involve no tooling charges and have several low cost options on leads, inside depth, pads, etc., to adapt them to individual needs. Chip mounting pad package designs can be supplied with nickel-iron-cobalt pad brought directly off one lead down onto the floor of the package. Enlarged facilities and specially trained personnel now permit more favorable delivery schedules on the full line of Preferred Style or Custom Made packages.

The newest preferred style package is a surprisingly rugged ALSiPak plug-in package .750" x 1.000" outside dimensions with 18 leads. It is designed for monolithic

circuit needs. High alumina precision substrates with .510" x .855" usable area to match the leads are available. Leads can be soldered direct to conductor lines which run into the notched areas. Thus you can minimize or eliminate wire bonding from device area to leads. This direct soldering also holds the substrate in position.

The plug-in package is designed for hand or automatic insertion in printed circuit boards and it can be probed from top or bottom of the circuit board. Easy substitution of units after assembly on the board is a feature of this design. The 18 leads are on 100 mil centers which are most adaptable to wave soldering techniques.

Prototype quantities of all preferred style packages are available at nominal prices. Suggestions on custom designs will be made on request giving details of operating requirements. Write for new Bulletin No. 676.

CODE IDENT. NO. 70371

PHONE 615 265-3411, CHATTANOOGA, TENN. 37405

American Lava Corporation **3M**
A SUBSIDIARY OF COMPANY

For service, contact American Lava representatives in Offices of Minnesota Mining and Manufacturing Company in these cities (see your local telephone directory): Boston: Needham Heights, Massachusetts • Chicago: Glen Ellyn, Illinois • Cleveland, Ohio • Dallas, Texas • Laurens, S. C. • Los Angeles, Calif. • Metropolitan New York: Ridgefield, N. J. • Up-State New York and Canada: Baldwinsville, N. Y. • Orange, Conn. • Philadelphia, Penna. • Roanoke, Virginia • St. Louis: Lee's Summit, Missouri • San Francisco, Calif. • Troy, Mich. • 3M International Co./American Lava Corp., Chattanooga, Tenn. 37405, U.S.A. 415/265-3411

66th
YEAR
OF
CERAMIC
LEADERSHIP



WE'RE THE 61st COMPANY TO SELL DRY REED RELAYS

(SO WE MUST HAVE SOMETHING SPECIAL TO OFFER YOU)

And we do. A complete line of dry reed relays in both standard and miniature sizes. Single, double, and 4-pole designs. Plus—and here's where we really separate ourselves from the other 60—design and application

assistance early in the planning stages.

You see, we didn't decide overnight to go into this business. We've been making relays since 1933, and have today the world's most complete line of mercury-displacement and mercury-wetted relays. Now, we can

handle even more of your relay requirements.

Write today for our new catalog of dry reed relays. And give "Number 61" a try on your next circuit design problem.



THE ADAMS & WESTLAKE COMPANY

A SUBSIDIARY OF **ALLIED** PRODUCTS CORPORATION

Elkhart, Indiana 46514 • 219 264-1141 • TWX 219 522 3102 • TELEX 25-8458 • CABLE ADLAKE

ON READER-SERVICE CARD CIRCLE 53

Products

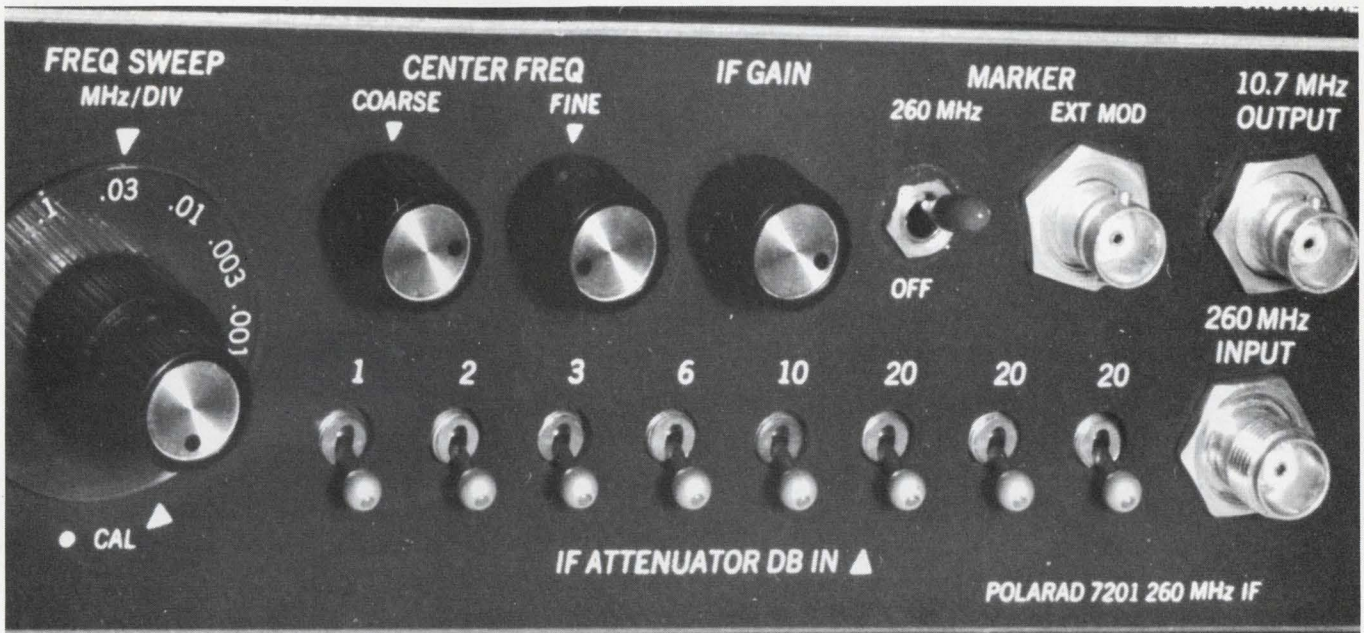

Spectrum analyzer converter mates to all small-, large- or storage-screen oscilloscopes.

The unit covers 10 MHz to 90 GHz with a 105-dBm sensitivity. Page 132

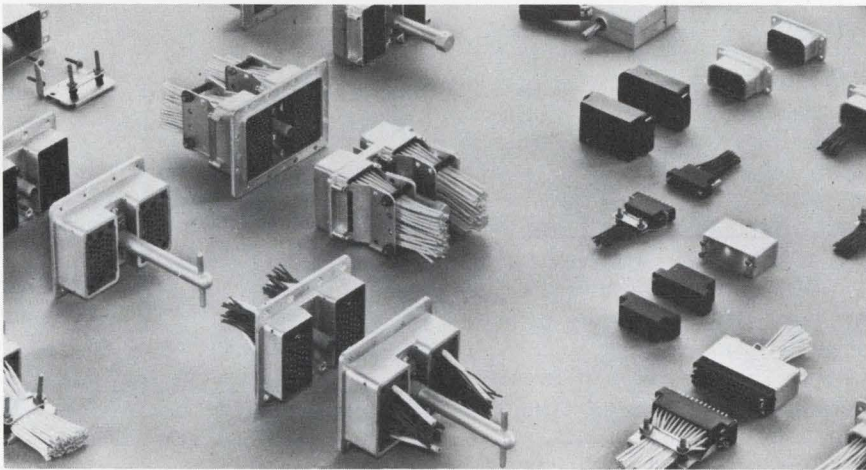

Subminiature coaxial contacts can be made in 20 seconds. The finished contacts have an OD of 0.11 in. Page 160

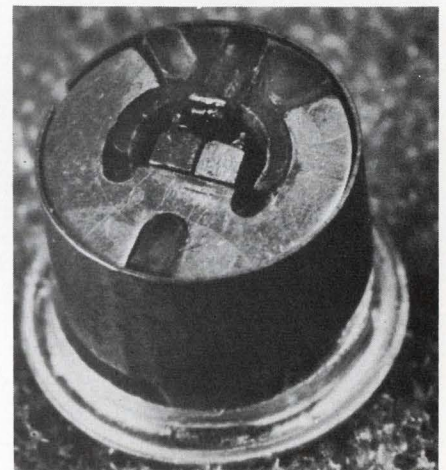

Relay enters TO-5 and needs no adjustment. Page 144

Also in this section:

Digital optical tachometer spans 100 to 99,000 rpm with one mark on wheel. Page 138

Segmented lamp indicates 4 messages. Page 154

Design Aids, Page 172 . . . **Application Notes**, Page 173 . . . **New Literature**, Page 174

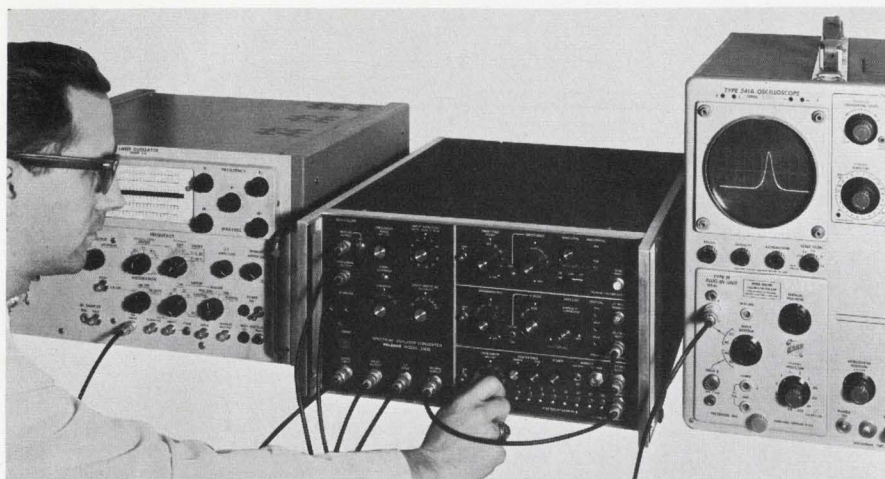

Analyzer converter displays to 90 GHz

Polarad Co., 43-20 34th St., Long Island City, N.Y. Phone: (212) 392-4500. Price: \$2990.

With a 70-dB, full-screen display and a -105 -dBm sensitivity, the Polarad model 2400 calibrated Spectrum Analyzer Converter makes precise signal measurements over a frequency range of 10 MHz to 90 GHz. The unit makes it possible to mate a signal generator or oscillator to any large-, small- or storage-screen oscilloscope.

The first mixer accepts signals from 10 MHz to 14 GHz. Flat frequency response is provided to make it easier to measure signal amplitudes at different frequencies. High sensitivity comes from the low-noise mixer, followed by an i-f amplifier with a low noise figure. Any local oscillator may be linked up, so that the operator can choose his frequency. On fundamental mixing, which can be performed anywhere in the frequency range, the sensitivity is better than ± 4 dB to 12.4 GHz. Second-harmonic mixing is ± 9 dB over the same range. The operator can use low-fm signal generators to make measurements at narrow bandwidths.

The analyzer converter has been designed to eliminate spurious responses and to afford a range of dispersions (frequency sweeps) to 500 MHz maximum, image free.

The adjustable voltage output of the sweep from 20 V to 0 V accommodates common-sweep generators.

The unit is said to combine the best features of a front-end swept analyzer with a narrowband i-f and a swept i-f for narrow dispersions. Dispersions of 3 MHz down to 10 kHz are achieved with a swept i-f. Above 3 MHz the dispersion is controlled by the sweep generator that is being used as the first local oscillator. The controls are set for a nominal maximum dispersion of 500 MHz (images are 520 MHz apart). Since the sweep generator is under the operator's control, he can generate very wide dispersions. With common-sweep generators, dispersions of 4 GHz are easily generated.

Signals are easily identified in the higher bands generated by the local oscillator harmonics. The identification as to band and upper or lower mixing product is made from a front panel control by movement of the signals on the display.

The analyzer converter is a triple superheterodyne receiver. An i-f attenuator with an 82-dB range and 1-dB steps provides for expansion of dynamic range in measuring signal amplitudes and for the precise setting of signal level points on the display. In addition, to adjust system gain for measurement about the noise level,

there is a continuous amplitude control with a dynamic range of more than 40 dB.

Calibrated bandwidths from 1 kHz to 1 MHz are included to allow for resolution between adjacent signals and to make reproducible power level measurements. Bandwidths can be set from selector switches or from an AUTO position.

The display mode can be selected from three possibilities: logarithmic, linear or square law (power). The logarithmic display has a 70-dB range, accurate to ± 2 dB for a full screen display. Sweep rates are calibrated and may be internally free run, single sweep, external synchronized or line synchronized. A base line suppressor is also available for adjusting signal brightness when photographing displays. The calibrated vertical output and horizontal output are directed to the front panel for use with an oscilloscope chosen by the operator. Large screen displays, storage oscilloscopes, or just an ordinary oscilloscope may be employed. The power required is 115 or 230 V $\pm 10\%$, 50 to 1000 Hz and less than 100 W.

CIRCLE NO. 298

Operational filter ranges to 11.1 kHz

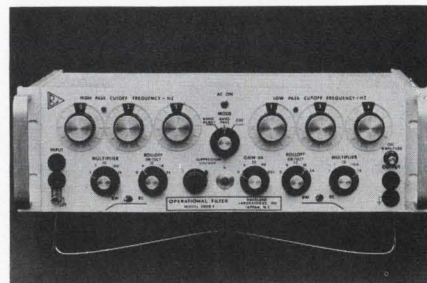

Rockland Laboratories, Inc., Box 57, Tappan, N. Y. Phone: (914) 358-7688. P & A: \$1,495; 30 to 45 days.

The model 1000F, operational filter functions as a variable filter and low noise amplifier, or as a sine wave oscillator over the frequency range from 0.001 Hz to 11.1 kHz. Overall gain is adjustable to 40 dB max. High pass and low pass rolloffs are adjustable to a max. of 24 dB octave. The impedance is 1 M Ω . It is available with either ac or dc operation.

CIRCLE NO. 299

you get a choice,

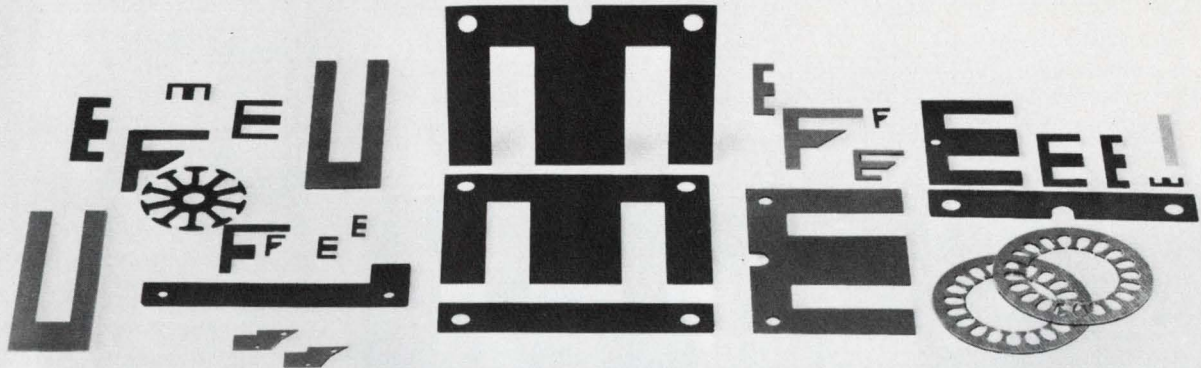

not a challenge

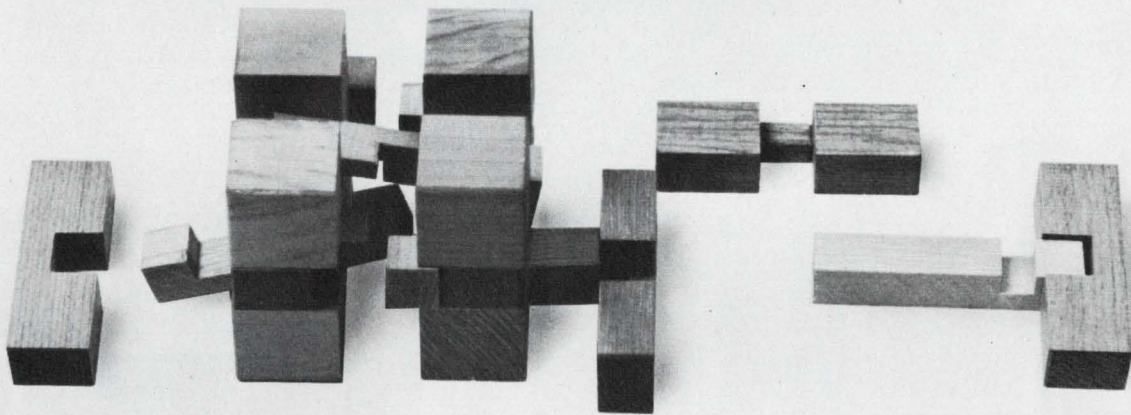

51 standard shapes of laminations simplify solid-state circuit design

Magnetics maximizes your chances of finding laminations that dovetail precisely into your designs for transformers, chokes, reactors and transistor circuits. We offer 51 standard shapes in Permalloy 80, Alloy 48 and Orthonol®. Thicknesses of 0.004", 0.006", and 0.014" are available, with sizes ranging from DU-87 and EI-12 down to the

solid-state circuitry sizes—EI-093, EE-30-31, DU-63 and F-094.

All Magnetics' laminations are hydrogen-annealed and manufactured to guaranteed minimum permeability limits. In addition to the catalog shapes and sizes, we have the capability to make special shapes to fit specific needs, including rotors, stators and recording head laminations. Our photo-etch process is ideal for making

prototype-run laminations and small intricate configurations.

Furnishing a broad spectrum of shapes, sizes and materials is Magnetics' way of saving you valuable design time—we believe in giving our customers a choice, not a challenge. Complete information on Magnetics' laminations can be had by writing today for our Catalog ML-303-R, Magnetics Inc., Butler, Pennsylvania 16001



TEST EQUIPMENT

Ac power amplifier produces 200 VA

California Instruments Corp., 3511 Midway Dr., San Diego, California. Phone: (714) 224-3241. P&A: \$595; 30 days.

This solid-state ac power amplifier furnishes 200 VA of ac power over a frequency range of 10 to 10,000 Hz. Performance features include 0 to 130 V output, total harmonic dis-

ortion of 0.25%, line regulation of 0.02% per V, and load regulation adjustable to zero. Plug in fixed and variable frequency oscillators are furnished in a companion package of the same size. Six different oscillators are offered. One, a 3-phase oscillator can be combined with three model 2200's to produce 600 VA of power. The oscillator-amplifier combination is 3-1/2 in. high.

CIRCLE NO. 251

Capacitance tester accurate to 0.1%



Micro Instruments Co., 12901, Crenshaw Blvd., Hawthorne, California. Phone: (213) 772-1275.

This capacitance test system is for sorting or grading semiconductors, voltage-variable capacitance diodes, packaged circuits, and all thin-film capacitors. Designated the model 1201-DS-2, the system includes a 1 MHz, direct reading, 4-digit, solid state capacitance tester and two 4-digit comparators. It also measures two and three terminal capacitance values, to MIL specs, up to 1,000 pF in two ranges.

CIRCLE NO. 252

Frequency counter spans 3 Hz to 200 kHz



Anadex Instruments, Inc., 7833 Haskell Ave., Van Nuys, Calif. Phone: (213) 782-9527.

The all-silicon frequency counter is used for measuring frequency or totalizing the number of input cycles or events. Max. input sensitivity is 10 mV rms for frequencies from 3 Hz to 200 kHz, permitting operation from low-level sine-wave signals. Gate times of 0.1, 0.6, 1, 6, and 10 s are derived from 60-Hz line frequency. Variable display time is from 0.2 to 6 s and hold.

CIRCLE NO. 253

**80
ohms/cmf
gold
pot
wire**

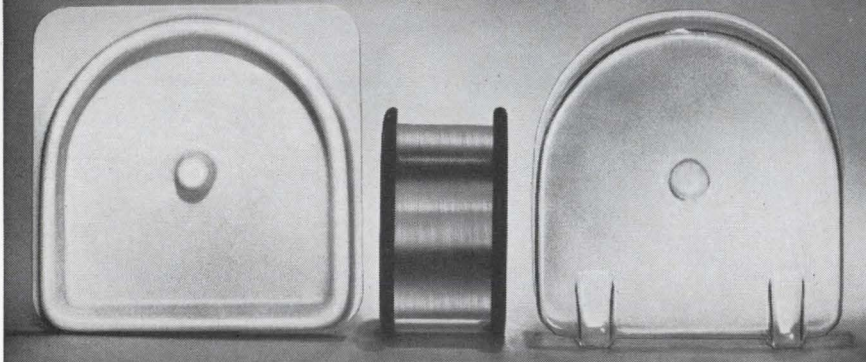

We've Never Made it Better *(neither has anyone else!)*

We've been producing the finest quality 80 ohms/cmf gold potentiometer alloy since 1958. It is available as round premium grade potentiometer wire as small as .0004". Uniformly heat-treated for maximum linearity and consistency of both specific resistance and TC.

Enamelling is done in our own

plant — to your most exacting specifications.

If your requirements are for high quality, fine potentiometer wire, you should write for a copy of our comprehensive brochure on wire for the potentiometer industry.

Please write on your letterhead; no obligation of course.



7 INTERVALE STREET, WHITE PLAINS, NEW YORK 10606 • (914) 949-4757

ON READER-SERVICE CARD CIRCLE 55

Electronics tester generates to 10 GHz

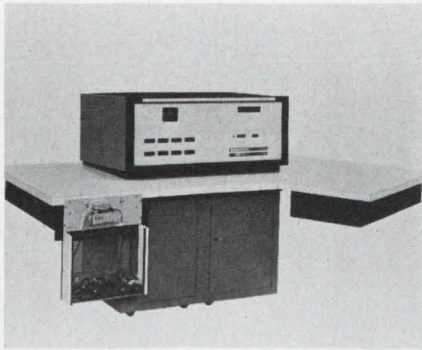

Continental Device Corp., 12515 Chedron Ave., Hawthorne, Calif. Phone: (213) 772-4551.

The SCAT 28 is a fully expandable automatic testing system. It tests anything, from diodes to ICs to large scale integration, and from modules through printed circuit cards to complete sub-assemblies. The unit uses a 20-line coaxial switch, new oscillographic techniques, high speed A-to-D converters, along with programmable power sources that sink and load. Programmable pulse generators and complete random access techniques from dc to 10 GHz are used as well to assure sources that can stay up between measurements to solve special shift-register and memory-test problems. The device measures all types, shapes and lead configurations of electronic parts. Standard features and capabilities of this tester include: dc tests, ac tests, rf tests, tape or disc-programming, dc parameters and switching time in same socket; all relays dry switched, ston-on-failure, go-no-go, random access to 20-scope probes, random access of any connection on the DUT to any stimulus supply, programmable time-base, max. number of tests unlimited programmable pulse generator, fully automatic and Kelvin connections. Options include: data output, disc program 1% reading, 0.1% reading, 0.05% reading, additional scope probes, real-time measurement capability, probe reference choppers, programmable probe attenuators, high-temperature measurements, expansion greater than 20 levels, computer control, auto transport, auto temperature control, auto segregation, auto failure analysis and auto part failure location.

CIRCLE NO. 254

OBSOLETE

1948

Power: 250 VDC at 50 watts
Weight: 17 lbs.
Size: 12" x 8" x 8" high

Model GA6D

1968

Power: 250 VDC at 60 watts
Weight: 4 lbs.
Size: 6" x 6" x 4" high

Are You Buying Obsolete Power Supplies for Your Space-Age Equipment?

The Abbott power module shown above has 20% more power, 1/4 the weight, 1/10 the size — and it is hermetically sealed!

Power supplies have come a long way since the heyday of the vacuum tube. Abbott solid state power modules have more reliability and performance at less cost than their tube-type cousins of yesterday.

MIL SPEC QUALITY — Designed to meet the severe environmental conditions of the space age, modern solid state power modules *should* be built ruggedly to meet the stringent requirements of MIL-E-5272C for temperature extremes and conditions of altitude, vibration, shock, sand, dust, humidity, salt spray, fungus, sunshine, rain, and explosion. The Abbott power modules are hermetically sealed and encapsulated in heavy steel containers to meet tough environments.

REGULATED — Most of today's missile systems require a well regulated power module to provide practically "fixed" output voltages against variations of the line input voltage and frequency as well as changes in the output load. The Abbott unit shown above (Model GA6D-247A) has a conservative line regulation of 0.2% and a load regulation of 1% — and an output voltage screwdriver adjustment for compensating to the exact voltage needed.

SIZE and WEIGHT — Today's airborne and ground equipment require a minimum weight and size. High density electronic packaging and good design permit Abbott

power modules to have minimum size and weight for a given power. For example, one of the Abbott DC to DC regulated models is only slightly larger than a pack of cigarettes and weighs less than a pound. Other models described in the new Abbott catalog have correspondingly small sizes and weights.

QUALITY COMPONENT PARTS — The quality and reliability of a power supply for the space age is no better than the component parts used in its construction. Abbott power modules used only the highest quality semiconductors and MIL-T-27A transformers in their construction. Where heat sink temperatures of 100°C are required, all silicon devices of highest quality are used exclusively.

WIDE RANGE OF OUTPUTS — The Abbott line of power modules include output voltages from 5.0 VDC to 10,000 VDC with output currents from 2 milliamperes to 20 amperes. They are all listed *with prices* in the new catalog with various types of inputs:

- 60 \AA to DC, Regulated
- 400 \AA to DC, Regulated
- 28 VDC to DC, Regulated
- 28 VDC to 400 \AA , 1 ϕ or 3 ϕ
- 60 \AA to 400 \AA , 1 ϕ or 3 ϕ
- 60 \AA or 400 \AA to DC, Unregulated
- 28 VDC to DC, Hi-Temp
- 400 \AA to DC, Hi-Temp

Please write for this new catalog or see **EEM** (1967 **ELECTRONICS ENGINEERS MASTER Directory**) Pages 1665 to 1678.

abbott transistor

LABORATORIES, INCORPORATED
5200 W. Jefferson Blvd. • Los Angeles 90016
Area Code 213 • WEbster 6-8185

TO: Abbott Transistor Labs, Inc., Dept. 43
5200 W. Jefferson Blvd.
Los Angeles, California 90016

Sir:
Please send me your latest catalog on power supply modules:

NAME _____ DEPT. _____
COMPANY _____
ADDRESS _____
CITY & STATE _____

ON READER-SERVICE CARD CIRCLE 56

VARIAN MILLIMETER CONFERENCE

CANADA

60 GHz
70 GHz
93 GHz
45-220 GHz

S.F.D

30-35 GHz
93 GHz

PALO ALTO

26.5-40 GHz (BWO)
34-35.6 GHz
up to 44 GHz

BOMAC

35 GHz
50-60 GHz
70 GHz
93 GHz

Socket
200-1

'67
'66

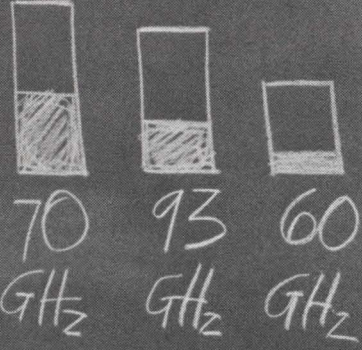

70 GHz
93 GHz
60 GHz

DUAL FREQ.
SYST. / LONG & SHORT

93 GHz / SPACE PLASMA SHEATH PENETR.

INVERTED M...
30-35 GHz @ 20 K
93 GHz @ 20 K

60 GHz / HARD TO JAM!

15 W @ 60 GHz

Beam Size { smaller ant. (vs array)

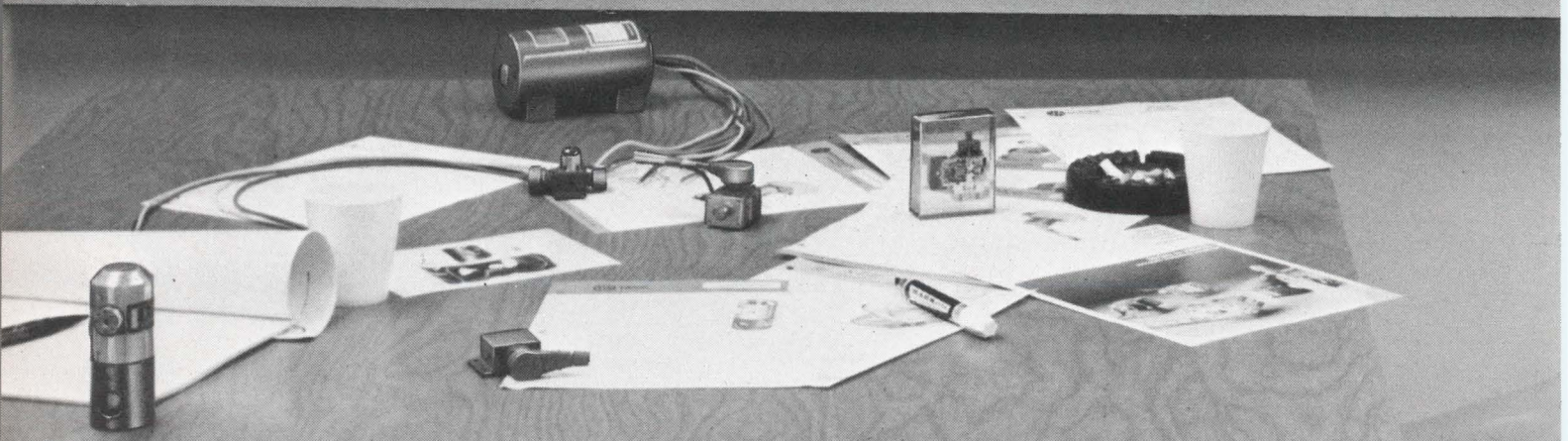

We were talking about you the other day...

VARIAN ASSOC. OF CANADA, LTD.
PALO ALTO TUBE DIVISION
S-F-D laboratories
BOMAC

MILLIMETER APPLICATIONS

RADAR

MISSILE GUIDANCE
OBSTACLE AVOIDANCE
CW PHASE COHERENT
ALTIMETERS
HIGH DEFINITION
SURVEILLANCE
TERRAIN AVOIDANCE
MAPPING
TARGET ANALYSIS
FUZING

COMMUNICATION

RELAY
SATELLITE
TELEMETRY

INSTRUMENTATION

DIODE TESTING
METEOROLOGICAL
DOPPLER
RADIOMETRY
REFLECTOMETER
SPECTROSCOPY
NOISE MEASURING
INTERFEROMETER
PWR. & FREQ. STANDARDS
ANT. MODEL TEST
DISTANCE MEASURING
OTHERS
PLASMA DIAGNOSTICS
RESEARCH

Specifically . . . your Millimeter applications and how we can help you make better use of our combined capabilities and broad range of components.

BOMAC . . . "pulsed magnetrons . . . duplexers (dual TR/balanced) . . . crystal protectors . . . solid state sources . . . stalo cavities"

PALO ALTO TUBE DIVISION . . . "reflex and 2-cavity klystron oscillators . . . multi-cavity klystron amplifiers . . . BWO's"

S.F.D. LABORATORIES, INC. . . . "inverted coaxial magnetrons"

VARIAN ASSOCIATES OF CANADA, LTD. . . . "reflex klystrons: high, medium and low power (wide tuning in medium power series)"

AT VARIAN, YOU CAN TALK TO A SINGLE SOURCE . . . for a broad range of components, covering a wide range of Millimeter frequencies . . . to start, circle Reader Service Card numbers below.



ELECTRON TUBE AND DEVICE GROUP
611 Hansen Way • Palo Alto • California 94303

HIGH Q LOW TC

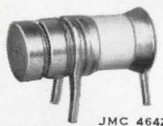
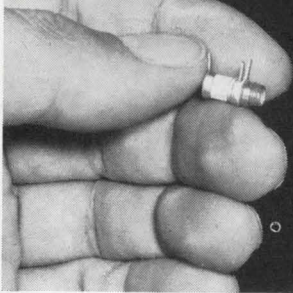

JMC 4642



JMC 4640

New Miniature Series Variable Air Capacitors

High capacity in a small package — exclusive round nut permits installation in tight places or miniaturized packaging. Ultra-rugged construction.

Specifications

- **Small Size:** .220" dia. 15/32" length
- **Q @ 100 mc:** > 5000
- **Capacity Range:** .4 pF — 6 pF (> 8 Turns)
- **Working Voltage:** 250 VDC (Test Voltage 500 VDC)
- **Insulation Resistance:** > 10⁶ Megohms
- **Temperature Coefficient:** 50 ± 50 ppm/°C
- **Temperature Range:** -65°C to +125°C

Features 570° Solder. Prevents distortion. Not affected by conventional soldering temperatures.

Call or write for complete information.

Johanson

**MANUFACTURING
CORPORATION**

400 Rockaway Valley Road
Boonton, N. J. 07005 • (201) 334-2676
Electronic Accuracy Through Mechanical Precision

ON READER-SERVICE CARD CIRCLE 58

TEST EQUIPMENT

Frequency processor makes a square wave

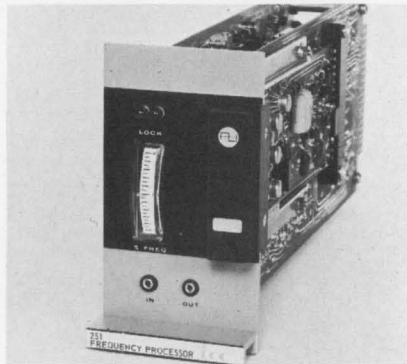

Interstate Electronics Corp., 707 E. Vermont Ave., P.O. Box 3117, Anaheim, Calif. Phone: (714) 772-2811.

The model-251 frequency processor cleans up contaminated signals, and presents it in the form of a clean high level square wave output. The unit also multiplies the signal frequency by decade and binary factors up to 128, and it demodulates wideband am/fm/pm signals. The input frequency range is 1 to 240 kHz in six plug-in steps; bandwidth range is 10 Hz.

CIRCLE NO. 255

Optical tachometer reacts to 99,000 rpm



Clary Corp., Military Products Div., 320 W. Clary Ave., San Gabriel, Calif. Phone: (213) 287-6111.

The useable range of the digital optical tachometer is from 100 to 99,000 rpm with one mark used on the test wheel. Greater resolution may be achieved by using additional marks. Pulse and analog outputs are also supplied which can be fed to other electronic instruments. Measurement is made by the photo-reflective probe.

CIRCLE NO. 256

Interference microscope has 100 or 200 power

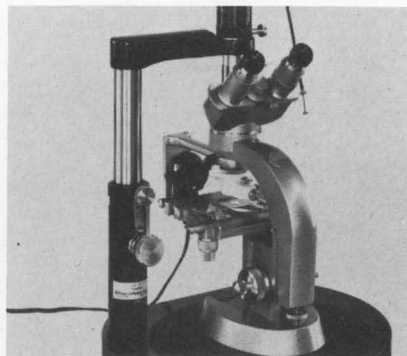

William J. Hacker & Co., Inc., P.O. Box 646, West Caldwell, N.J. Phone: (201) 226-8450.

This instrument has interference objectives of 8 and 16 mm focal length, of 20x and 10x initial magnification with resolving powers within the range of 0 to 6 microns horizontally and less than 1/10th fringe vertically. The 8 mm objective gives a 0.65 mm field of view at a magnification of 200x and a clear working distance of 0.5 mm. A sodium lamp can be supplied.

CIRCLE NO. 257

Temperature checker spots the heat

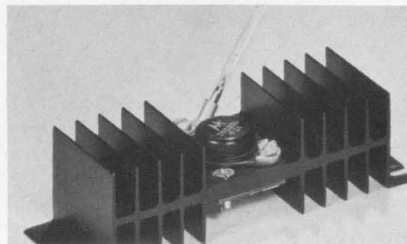

Computer Logic Corp., 1528 20th St., Santa Monica, Calif. Phone: (213) 451-9754. Price: \$9.95.

A 4-in. glass mercury thermometer with a high conductivity ferrule that attaches to transistors, heat sinks, and power supplies is available. The thermometer has a range of -20 to +120°C with 5 divisions, and an accuracy of -1°.

CIRCLE NO. 258

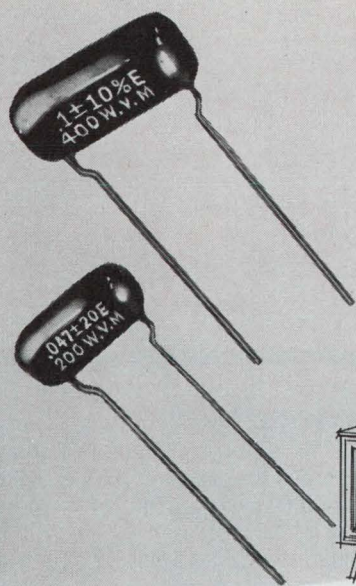

Proof Positive of High Reliability of EL-MENCO *MYLAR-PAPER DIPPED Capacitors

OVER 330,000,000 OF THESE HIGH QUALITY UNITS USED IN TV SETS SINCE 1959!

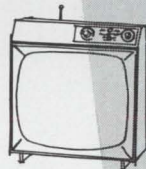
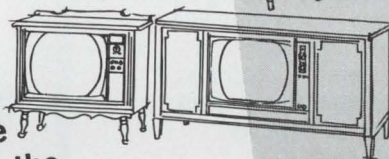
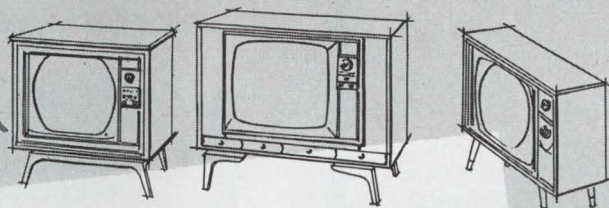

Imagine!
Over 330 million EL-MENCO Mylar* Paper Dipped Capacitors have been used in black and white and in color TV sets since 1959! These capacitors of the highest quality and reliability help bring programs to millions of people who have invested in TV sets . . . and 330 million is just a drop in the bucket! For the demand for EL-MENCO capacitors still far exceeds the supply!

The number of EL-MENCO capacitors in TV sets is truly amazing. This figure of 330,000,000 represents more than the total population of the following countries:

- United States and Possessions
- United Kingdom and Canada
- Argentina Belgium
- Denmark Ecuador Chile

299,813,929 people (1960 Census)

Even with this tremendous mass production the quality of EL-MENCO capacitors has not suffered. Here's a fine tribute of the high reliability of EL-MENCO capacitors from a leading TV manufacturer:

"... I am certain that you are aware of the enthusiasm our Engineering and Quality people have displayed for this unit, for to us it represents the virtual elimination of capacitor field problems in the future ..."



Write dept. AE for descriptive bulletin #MPD

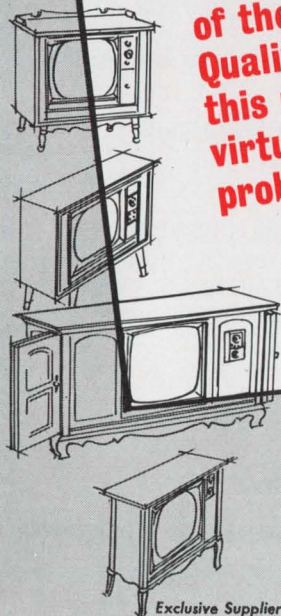

El-Menco
Capacitors

DIPPED MICA
MOLDED MICA
SILVERED MICA FILMS
MICA TRIMMERS & PADDERS
MYLAR* PAPER DIPPED
PAPER DIPPED
MYLAR* DIPPED
TUBULAR PAPER

*Registered Trade Mark of DuPont Co.

THE ELECTRO MOTIVE MFG. CO., INC.
WILLIMANTIC, CONNECTICUT

Exclusive Supplier to Jobbers and Distributors in the U. S. and Canada

West Coast Manufacturers Contact:

ARCO ELECTRONICS, INC., COMMUNITY DRIVE,
GREAT NECK, L. I. NEW YORK

COLLINS & HYDE CO., 900 N. SAN ANTONIO RD., LOS ALTOS, CALIFORNIA
5380 WHITTIER BOULEVARD, LOS ANGELES, CALIFORNIA

ON READER-SERVICE CARD CIRCLE 59

RCA "overlay" Transistors ... for Total RF Power

New Plastic Design for SSB Communications



TA2758
(Molded Silicone Plastic)

75 Watts PEP Output (Min.)
@ 30 MHz,
IMD—30 dB (Max)
Intended for 2- to 30-MHz SSB
power amplifiers operating from
a 28-volt supply, this high gain
transistor is encased in RCA's
new plastic package with
isolated pin-pad electrodes. It
uses an internally mounted
diode for temperature
compensation.

READER-SERVICE 121

High Power Performance at 400 MHz



2N5016 (TO-60)
TA7036 (TO-60)

Both types are in the popular,
time-tested TO-60 package. The
RCA 2N5016 is designed for
Class-B and -C rf amplifiers and
offers 15 watts (min.) at 400
MHz. The TA7036 is a higher
power version and provides 20
watts (min.) at the same
frequency.

READER-SERVICE 122

Microwave Coaxial Package



TA7003
(Coaxial Lead Package)

1 Watt Output with 5 dB Gain
@ 2 GHz
2 Watts Output with 10 dB Gain
@ 1 GHz
Low-inductance package for UHF
and microwave oscillator,
frequency-multiplier, and
rf-amplifier service.

READER-SERVICE 125

High Gain UHF driver or oscillator



2N5108 (TO-39)

1 Watt Output (Min.)
@ 1 GHz, 5 dB Gain
High gain device for Class B or C
operation in final, driver, and
pre-driver amplifier stages in
UHF equipment and as a
fundamental frequency
oscillator at 1.68 GHz.
Specifically designed for L-Band
pulse radar, mobile, and
telemetry applications.

READER-SERVICE 126

High-Reliability types available off the shelf

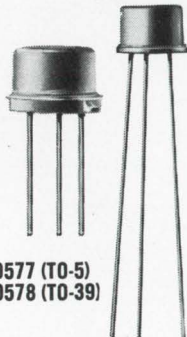

40577 (TO-5)
40578 (TO-39)

40577 is electrically similar to
RCA 2N3118; 40578 has as its
parent type RCA-2N3866. Both
devices add to RCA's expanding
high-reliability line which
includes 40305, 40306, 40307
(parent types 2N3553, 2N3375
and 2N3632).

READER-SERVICE 129

JAN types with off-the-shelf availability

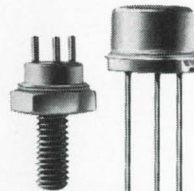

JAN-2N3553 (TO-39)
JAN-2N3375 (TO-60)

Tested to MIL-S-19500/341,
these RCA "overlay" types
conform to JAN specifications
and are available right now in
quantity.

READER-SERVICE 130

Circuit Coverage

For Military and Industrial Applications



2N5070 (TO-60)
2N5071 (TO-60)

2N5070
25 Watts PEP Output with
13 dB Gain (Min.) @ 30 MHz and 28 V

2N5071
24 Watts Output with 9 dB Gain (Min.)
@ 76 MHz and 24 V

The RCA 2N5070 is designed specifically for 2- to 30-MHz single-sideband military and ham transmitters. The 2N5071 is intended as a high-power, Class B and C rf amplifier for FM communications in wideband and narrowband circuits.

READER-SERVICE 123

Load Mismatch Protection for Aircraft Transmitters



2N5102 (TO-60)

15 Watts Output (Min.) @ 136 MHz
RCA-2N5102 is intended as a high power device for Class C, AM amplifier service (for aircraft VHF) in the 108- to 150-MHz range. Each unit is individually tested at worst-case conditions (full modulation and no current limiting) for complete load mismatch protection.

READER-SERVICE 124

Class A Linear Amplifier for VHF—UHF



2N5109 (TO-39)

$f_T = 1200$ MHz (Min.)
@ $I_C = 50$ mA, $V_{CE} = 15$ V
New generation "overlay" transistor featuring low distortion, low noise for wideband applications in CATV, MATV, Class A, or linear amplifiers with large dynamic range.

READER-SERVICE 127

Famous 2N3866 Performance in TO-60 case



2N5090 (TO-60)

1.2 Watts Output (Min.)
@ 400 MHz, 7.8 dB Gain
1.6 Watts Output (Typ.)
@ 175 MHz, 12 dB Gain
Intended for Class A, B, or C amplifier, frequency-multiplier, or oscillator circuits, 2N5090 may be used in output, driver, or pre-driver stages in VHF and UHF equipment.

READER-SERVICE 128

27-MHz Output Transistors for Citizens-Band Transmitters



40581 (TO-39)
40582 (TO-39)

These two new devices are designed specifically for output stages of 5-watt CB equipment. The 40581 has an output of 3.5 watts at 27 MHz with $P_T = 5$ watts; the 40582 has an output of 5 watts with $P_T = 10$ watts and is equipped with a factory-attached mounting flange for improved heat-sinking.

READER-SERVICE 131

For more information on these and other RCA "overlay" transistors, see your RCA Representative or your RCA Distributor. For technical data on specific types, write: Commercial Engineering, Sec.IG12-1, RCA Electronic Components and Devices, Harrison, N.J. 07029.



RCA Electronic Components and Devices

The Most Trusted Name in Electronics

Micro flat packs have 10 to 14 leads

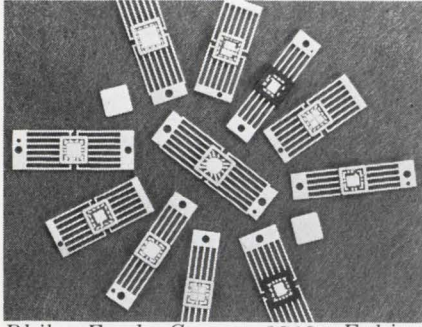

Philco-Ford Corp., 3939 Fabian Way, Palo Alto, Calif. Phone: (415) 326-4350.

Supplied in both 10- and 14-lead configurations with ceramic, metal or glass bottoms, these 1/4-in.-square flat packages are available in all material combinations and capable of any method of closure. On glass-bottom types, a grounded pad is provided for device-mounting. On ceramic-bottom types, up to four electrically isolated metalized pads are available. The package can also be obtained without metalization.

CIRCLE NO. 259

IC fm detector thresholds at 400 mV

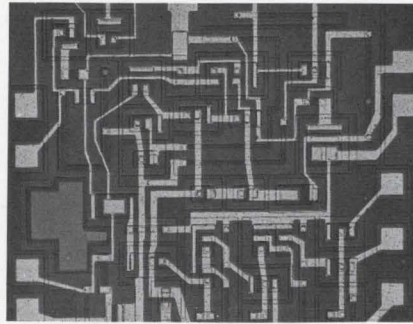

Sprague Electric Co., North Adams, Mass. Phone: (413) 664-4411.

An IC fm detector and limiter operates by a technique featuring linear gating and balanced discriminator action with an a-m rejection of 46 dB. The frequency range of the unit extends from 5 kHz to 50 MHz. It has outputs of 0.6 V with a total distortion of less than 1% with a limiting threshold voltage of 400 mV rms. A 12-V power supply is required for operation of the IC.

CIRCLE NO. 260

Op-amp ranges to 30-kHz unity gain

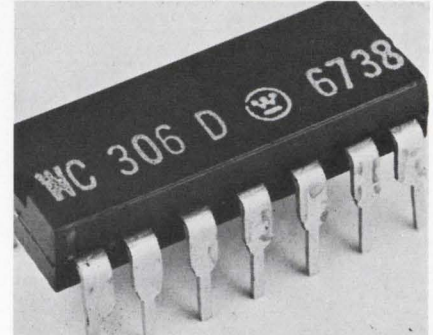

Westinghouse Electric Corp., Molecular Electronics Div., Box 7377, Elkridge, Md. Phone: (301) 796-3666. P&A: \$9.90 (1 to 49); stock.

The WC-306 IC chip has vertical pnp as well as npn transistors. Inputs include a high impedance 300 KΩ pair. Bandwidths are available up to the 30-kHz unity gain of the 306. Using the low-input impedance terminals, you can achieve 40 dB of gain at 10 MHz. Most of the units 1100 to 4400 open loop gain can be used without exceeding 0.2% distortion.

CIRCLE NO. 261

**EASTMAN 910® Adhesive....
reduces assembly time of airborne data system.**

Encoder assemblies for digital recording systems manufactured by Lockheed Aircraft Company, Ontario, California are assembled with EASTMAN 910 Adhesive at a significant time saving. The completed system supplies data on in-flight engine performance and other important functions.

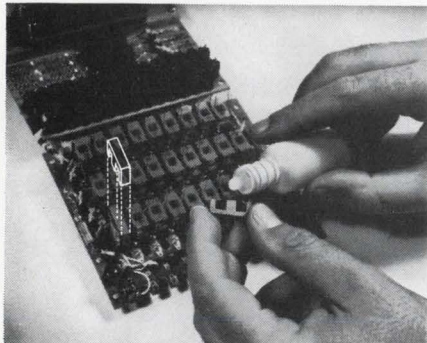

One half of a ferrite "E" core transformer is bonded to a glass epoxy board with one drop of EASTMAN 910 Adhesive. Coding wires are installed around the core. The second half of an "E" core is bonded to the first with two droplets of the adhesive. Bonding procedures take from 10-15 seconds.

EASTMAN 910 Adhesive will form bonds with almost any kind of material without heat, solvent evaporation, catalysts, or more than contact pressure. Try it on your toughest bonding jobs.

For technical data and additional information, write to Chemicals Division, Eastman Chemical Products, Inc., Kingsport, Tennessee. EASTMAN 910 Adhesive is distributed by Armstrong Cork Company, Industry Products Division, Lancaster, Pa.

Here are some of the bonds that can be made with EASTMAN 910 Adhesive

Among the stronger: steel, aluminum, brass, copper, vinyls, phenolics, cellulose, polyesters, polyurethanes, nylon; butyl, nitrile, SBR, natural rubber, most types of neoprene; most woods. Among the weaker: polystyrene, polyethylene (shear strengths up to 150 lb./sq. in.).

ON READER-SERVICE CARD CIRCLE 61

There is no adhesive like EASTMAN 910® Adhesive

- SETS FAST**—Makes firm bonds in seconds to minutes.
- VERSATILE**—Joins virtually any combination of materials.
- HIGH STRENGTH**—Up to 5000 lb./in.² depending on the materials being bonded.
- READY TO USE**—No catalyst or mixing necessary.
- CURES AT ROOM TEMPERATURE**—No heat required to initiate or accelerate setting.
- CONTACT PRESSURE SUFFICIENT.**
- LOW SHRINKAGE**—Virtually no shrinkage on setting as neither solvent nor heat is used.
- GOES FAR**—One-pound package contains about 30,000 one-drop applications. (Or in more specific terms, approximately 20 fast setting one-drop applications for a nickel.)

The use of EASTMAN 910 Adhesive is not suggested at temperatures continuously above 175°F., or in the presence of extreme moisture for prolonged periods.

See Sweet's 1968 Product Design File FAS-5/Ea.



Dual 50-bit register built on single chip

National Semiconductor Corp.,
2975 San Ysidro Way, Santa Clara,
Calif. Phone: (408) 245-2310.
Price \$40 (100 lots).

The MM 402 is a dual 50-bit unit built on a single silicon chip utilizing MOS P channel enhancement mode transistors. It is designed to operate over a wide frequency spectrum and can be used in any sequential digital system that uses a two phase clocking system. The MM 402 features 1 MHz frequency operation, 0.8 mW/bit at MHz power consumption, 10 kHz at 125°C minimum operating frequency, -55 to +125°C operating temperature range and 500 Ω output impedance.

CIRCLE NO. 262

Monolithic flip-flop toggles at 25 MHz

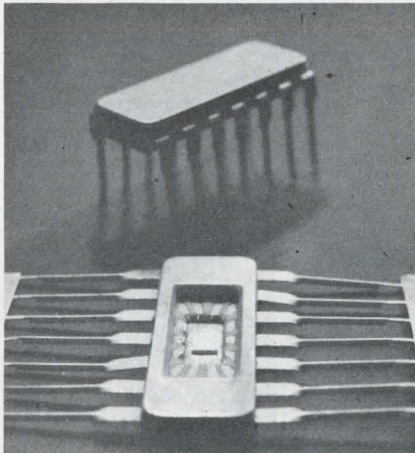

National Semiconductor Corp.,
2950 San Ysidro Way, Santa Clara,
Calif. Phone: (408) 245-4320.
Price: \$4 to \$13.10.

The DM 7501 is designed for high speed control and counting applications where multiple data inputs are not required. The unit features special clock line clamping to reduce ringing and simplify device usage. The dual binary has a toggle rate of 25 MHz, 1 V noise immunity, a guaranteed clock skew of fifteen ns, and meets all electrical and mechanical requirements of the SN5473 type dual flip-flop. It is hermetically sealed in its package.

CIRCLE NO. 263

Lamb Electric engineering turns your product on.



Example: the whole world of floor care

If your product has got to vacuum, scrub or polish, you need Lamb engineering. Lamb products turn on the whole range of equipment that cares for floors.

For example, you might be interested in our gear motors customized from standard Lamb parts . . . or one of our many vacuum motors that assure you of the right combination of performance, life and cost. Whatever floor care product you manufacture, Lamb Electric has the motor that will do the job for you.

Let Lamb engineers turn your product on. Write for motor details and performance curves. Put us to the test. We'll turn your product on . . . with exactly the motor that you need. Ametek, Inc., Lamb Electric Division, Kent, Ohio 44240.

AMETEK / Lamb Electric



ON READER-SERVICE CARD CIRCLE 62

Wedge-Action*

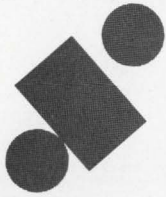

Relays

Hermetically-sealed, electromagnetic relays that provide high performance and reliability under the most difficult operating conditions in dry-circuit to 2 amp applications.

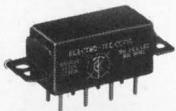

2 PDT
MARK II, SERIES 500
MIL-R-5757/9



2 PDT
MARK II, SERIES 400
(1.35" high)
SERIES 410 (1" high)
MIL-R-5757/8



6 PDT 4 PDT
(1" x 1")
MARK II, SERIES 300
(6 PDT).
SERIES 350 (4 PDT).
MIL-R-5757/1 and
MIL-R-5757/7



6 PDT
MARK II, SERIES 085
(-55°C to +85°C)
SERIES 100
(-65°C to +125°C),
SERIES 200
(-65°C to +200°C).
MIL-R-5757/1.

*Wedge-Action



The moving contacts are mounted between two stationary contacts. On actuation, they drive into the stationary contacts, creating high pressures and low

contact resistance at all current levels. In addition, wedge-action contact wipe provides self-cleaning of the precious-metal contacts.

*Patent No. 2,866,046 and others pending.

For complete data write Relay Sales and Engineering Office, P. O. Box 667, Ormond Beach, Fla. 32074, Phone 904-677-1771, TWX 810-857-0305.

Electro-Tec Corp.

SLIP RINGS • RELAYS • SWITCHES

ON READER-SERVICE CARD CIRCLE 63



Mini-relay in TO-5 skirts adjustment

Hi-Spec Electronics Corp., 14713 Keswick Ave., Van Nuys, Calif. Phone: (213) 781-0936. Price: \$50.

This microminiature relay in a TO-5 can never needs adjustment. Smaller than a dime, the device has an 0.335 in. diameter and 0.275 in. height. The 1 A, 28 V relay is designed to meet the performance requirements of MIL-R-5757. It has an operation and release time of 1.5 ms. Pilot production samples have attained 10,000,000 operations at low-level currents and 250,000 at full load.

Until now relays had to be adjusted during production by "tweaking" or bending contacts to adjust contact pressures, or applying dielectric nonmagnetic actuating materials to achieve the desired operating characteristics. With the new technique, should a relay batch not meet specifications during testing, the fix is made in the tooling, not on the individual relays.

Hi-Spec's relay has its gold alloy contacts directly connected to the armature. As the armature responds to the magnetic force of the energized coil, the contacts move with it. The absence of dependent movement of parts within the relay makes it possible to establish a single datum point for the location of fixed and moving mating surfaces, with more positive contact pressures and lower contact resistance than standard relays.

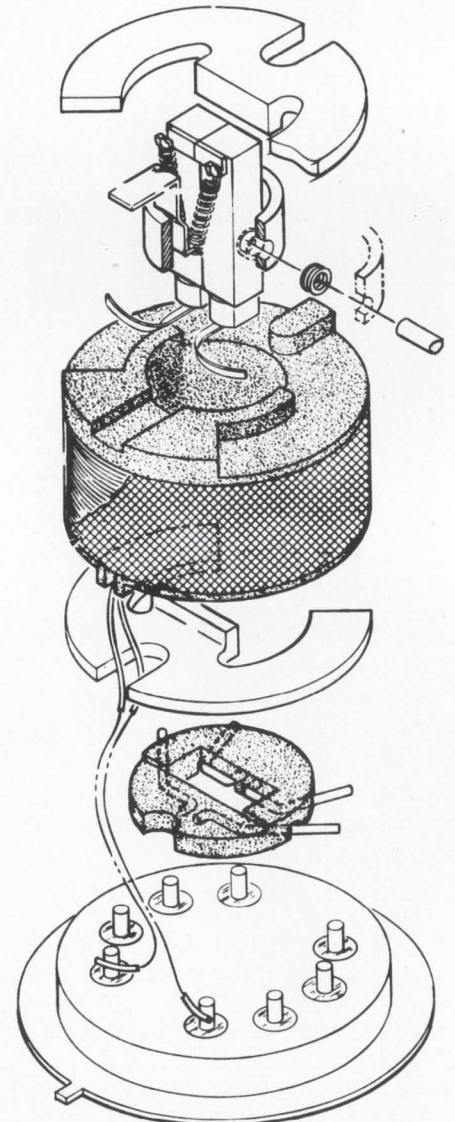

This exploded view of the TO-5 shows how the parts are arranged to achieve a 1 A relay in a can.

CIRCLE NO. 312

tricky tapers...

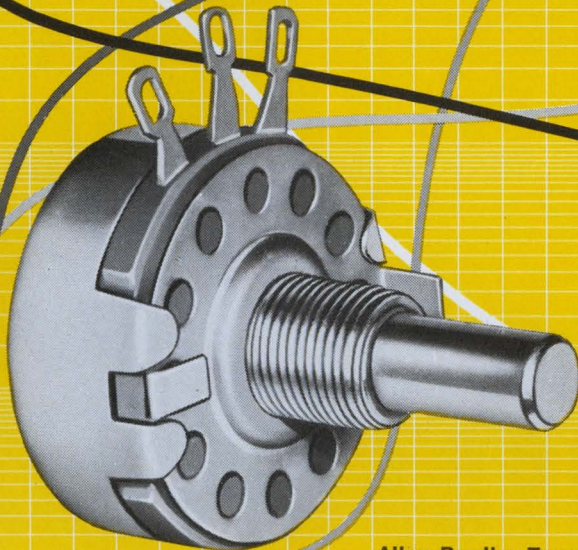

Allen-Bradley Type J
hot molded variable resistor
shown twice actual size

Allen-Bradley Type J potentiometers offer tapers designed to your special needs!

■ When standard tapers fail to provide the control you desire, Allen-Bradley Type J potentiometers have the unique capability to provide a virtually limitless variety of curves to meet your specialized requirements. While not a precision device that is continuously taper-trimmed to very close tolerances, Allen-Bradley's control of the resistance-rotation characteristics during production assures a high degree of conformity.

Allen-Bradley Type J potentiometers have a solid hot molded resistance track made by an exclusive process which was pioneered and perfected by A-B. This solid resistance track assures smooth adjustment at all times—with none of the discrete changes in resistance that are encountered in wire-wound units. And being essentially noninductive, Type J controls can be applied in high frequency circuits where wire-wound units are useless.

Furthermore, A-B's solid molded resistance track assures low noise and long life. On accelerated tests, Type J potentiometers exceed 100,000 complete operations with less than 10% change in resistance.

For more complete details, please write: Allen-Bradley Co., 1344 S. Second St., Milwaukee, Wis. 53204. In Canada: Allen-Bradley Canada Limited. Export Office: 630 Third Ave., New York, N.Y., U.S.A. 10017.

ADDITIONAL ALLEN-BRADLEY HOT MOLDED VARIABLE RESISTORS

TYPE G CONTROLS are only ½" in diameter. Quiet, stepless operation. Rated ½ watt at 70°C. Values to 5 megohms. Type L are similar in construction but rated ½ watt at 100°C.



TYPE F TRIMMERS are for mounting directly on printed wiring boards by means of their terminals. Rated ¼ watt at 70°C. Values to 5 megohms. Type O are similar but rated 0.4 watt at 70°C.



TYPE R ADJUSTABLE RESISTORS for trimming applications are built to withstand environmental extremes. Only 1¼" in length. Have stepless adjustment. Watertight and can be encapsulated. Rated ¼ watt at 70°C. Values to 2.5 megohms. Type N for less severe environments are rated ½ watt at 50°C.



ALLEN-BRADLEY
QUALITY ELECTRONIC COMPONENTS



867-3AB

ON READER-SERVICE CARD CIRCLE 64

NEW
KEMET D's

The "DIET
CAPACITORS."

They take off inches.

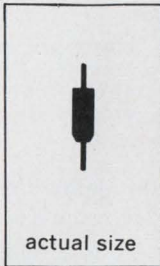
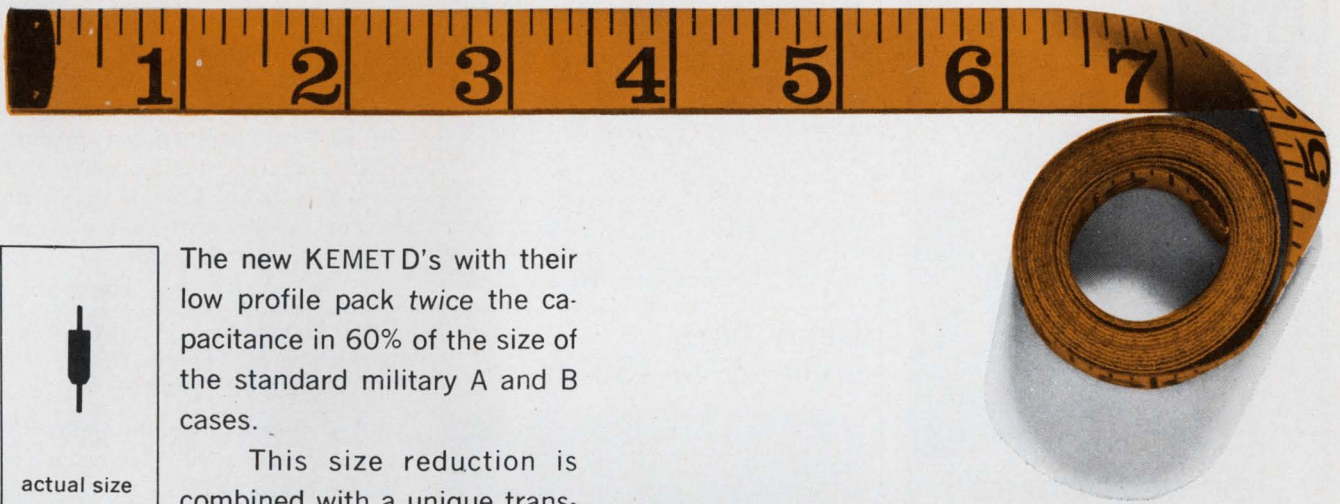

The new KEMET D's with their low profile pack twice the capacitance in 60% of the size of the standard military A and B cases.

This size reduction is combined with a unique transfer molding technique to produce a 3 case line (A², A¹ and B¹) especially suited for high speed automatic insertion equipment. These new KEMET D's can be punched readily, along with resistors and diodes, onto computer cards and printed circuit boards.

Typical applications of the new KEMET D's are commercial computers and peripheral equipment, communications systems and many other areas of electronics requiring high density packaging.

With an impedance rating of less than 1 ohm at 10 MHz for 12 μ F, the new KEMET D's are just great for computer applications with high clock rates that require low impedance at high frequencies.

Other important performance characteristics of the new KEMET D's are as follows:

Capacitance Range . . . from .0047 μ F to 68 μ F.

Voltage Range from 6V to 35V.

Temperature Range . . . from -55° C to $+85^{\circ}$ C.

D.C. Leakage Current . . . less than 1 μ a at 25 $^{\circ}$ C.

Temperature Cycling . . . exceeds MIL-STD-202.

There's a new products catalog that explains the new KEMET D's in great detail. To get your copy simply contact your local Union Carbide Representative or write us direct.

The new KEMET D's, the diet capacitors, from Union Carbide, The Discovery Company.

**UNION
CARBIDE**
ELECTRONICS

ON READER-SERVICE CARD CIRCLE 65

The Lightweights From Glenair

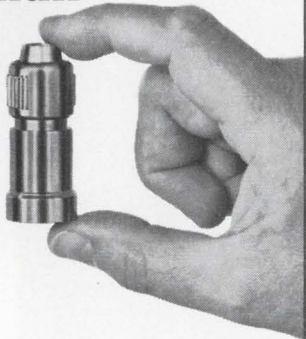

...a "new breed" of adapters!

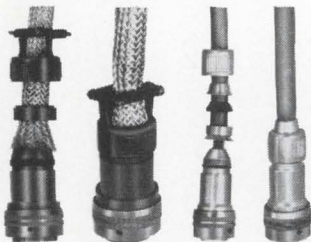

Designed to provide reliable 360° RFI shield termination for the "new breed" of high-density microminiature circular connectors, these lightweight adapters from Glenair insure connector performance and integrity under the most restrictive weight limitations.

Available in environmental or non-environmental versions, these adapters come in a choice of cable entry sizes for each connector and accommodate overall shielded cables and harnesses, or shielded and jacketed cables alike.

These new adapters are easy to assemble and are available for all circular connectors including such high-density microminiatures as Amphenol Astro 348, Bendix JT-JTRE, Cannon Centi-K, Deutsch STK, Matrix Mini-Mate, Microdot Marc 53 and others. They are also available for MIL-C-26482, MIL-C-26500, MIL-C-38300, NAS 1599 and similar connectors.

For more information, write, wire or phone today.



GLENAIR, INC. / 1211 AIR WAY
GLENDALE, CALIFORNIA 91201

Phone: (213) 245-8587 • TWX: 910-497-2066

COMPONENTS

Heat flow sensors respond in 50 ms

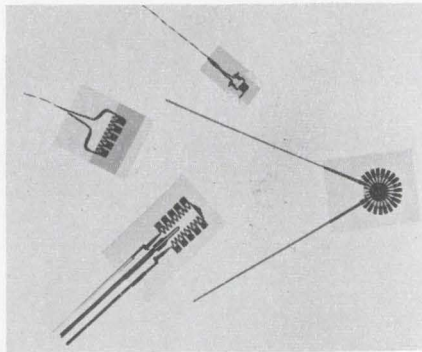

RdF Corp., 23 Elm Ave., Hudson, N.H. Phone: (603) 882-8115.

These sensors are designed for measurement of convective, conductive or radiant heat transfer with response times in the order of 50 ms. The thermal junctions of the new multi-element units have a cross-sectional thickness of 0.0002 in. and can be installed on flat or curved surfaces using conventional adhesives. They provide the capability of independent controlled heat sinks for each junction.

CIRCLE NO. 275

Delay lines span 15 to 150 ns

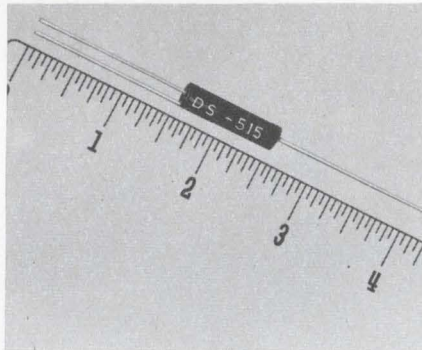

JFD Electronics Co., 15th Avenue at 62nd St., Brooklyn. Phone: (212) 331-1000. P&A: \$10; 2 wks.

Distributed constant delay lines consist of 16 models ranging from delays of 15 to 50 ns in 5 ns steps. Each delay value is available in either 500Ω or 1000Ω impedances. All models in the series have a delay accuracy of ±5%. They are resin encapsulated. Typical applications are radar, computer circuits and communications equipment, up to 100 MHz.

CIRCLE NO. 276

Compact pushbuttons rated to 600 V

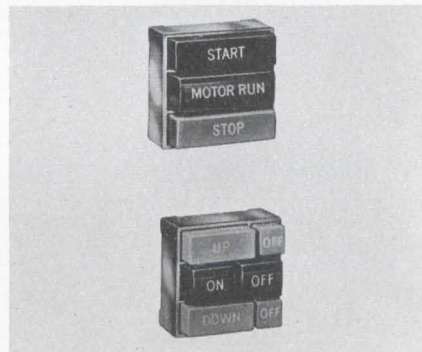

Cutler Hammer, Inc., P.O. Box 463, Milwaukee, Wisc. Phone: (414) 442-7800.

Heavy-duty oil tight compact pushbuttons permit one to six operating or indicating functions in a single case 1-7/8 in.². The pushbuttons' eighteen different contact blocks are rated at 600 V and carry full heavy duty ac ratings. The blocks are available with screw type or quick connect terminals. Snap-on buttons are offered in nine colors and eight different configurations.

CIRCLE NO. 277

Circuit deck switch combines networks

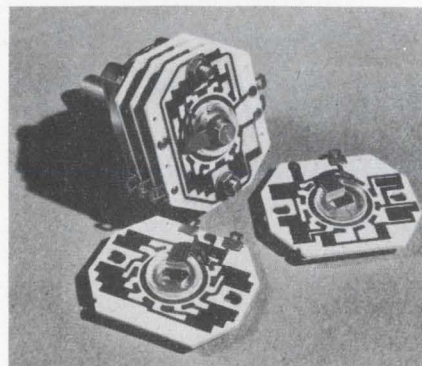

Beckman Instruments, Inc., 2500 Harbor Blvd., Fullerton, Calif. Phone: (714) 871-4848.

Circuit deck series 1390 combine switch and resistor-capacitor networks in one unit. From five to ten 1/4 W resistors can be screened on each side of the wafer. Performance features include: ±5% to ±0.2% resistance tolerance; 10,000:1 ratio range; ±0.5% to ±0.1% ratio tolerance; 5 PPM/°C ratio stability over temperature range; and 0 to +65°C ambient temperature range.

CIRCLE NO. 278

HIGH VOLTAGE HIGH POWER PNP SILICON TRANSISTORS

	V_{CER}	V_{CEO}	V_{EBO}	h_{fE}	$I_{CEX} < .25MA @ V_{CEX}$	$V_{CE(SAT)} @ 1A, .100MA$		ft
						TYP	MAX	
TRXP-2017	200	200	5V @ 5MA	> 20 @ 1A, 10V	200	1.5V	3V	15MHZ
TRXP-3017	300	325	5V @ 5MA	> 20 @ 1A, 10V	300	1.5V	3V	15MHZ
TRXP-4017	400	400	5V @ 5MA	> 20 @ 1A, 10V	400	1.5V	3V	15MHZ

	V_{CER}	V_{CEO}	V_{EBO}	h_{fE}	$I_{CEX} < .25MA @ V_{CEX}$	$V_{CE(SAT)} @ 1A, .100MA$		ft
						TYP	MAX	
TRXP-2027	200	200	5V @ 5MA	> 10 @ 2A, 10V > 30 @ 1A, 10V	200	1.5V	3V	15MHZ
TRXP-3027	300	325	5V @ 5MA	> 10 @ 2A, 10V > 30 @ 1A, 10V	300	1.5V	3V	15MHZ
TRXP-4027	400	400	5V @ 5MA	> 10 @ 2A, 10V > 30 @ 1A, 10V	400	1.5V	3V	15MHZ

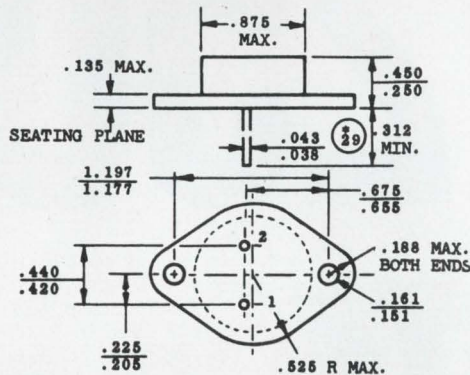

TO-3 PACKAGE

The Industro TRXP series are PNP triple diffused Silicon Power Transistors for use in high voltage applications. The high V_{CBO} and V_{CEO} ratings make it practical to operate directly from a rectified 117 volt or 220 volt AC line. This device is ideal for use in switching applications of all types. The case is electrically connected to the collector, and the package is hermetically sealed. Mechanical construction conforms to the standard JEDEC TO-3 outline.



INDUSTRO TRANSISTOR CORPORATION
35-10 36th AVENUE/LONG ISLAND CITY, NEW YORK 11106, (212) EX 2-8000

ON READER-SERVICE CARD CIRCLE 67

Brushless dc motor produces 6 oz. in. torque

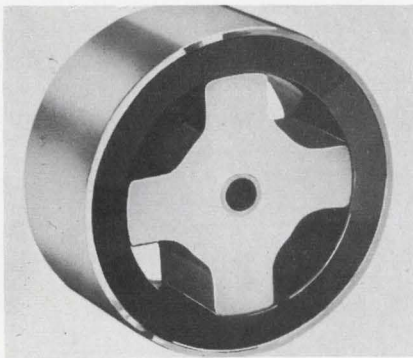

Aeroflex Labs., Inc., South Service Rd., Plainview, N.Y. Phone: (516) 694-6700.

Brushless dc torque motor that provides 6 oz in. continuous torque for 8 W of power over a 50° angle has infinite resolution. The series TQ18 has a linear torque output vs current input, and a peak torque capability as high as 20 oz. in. A special stator winding enables the TQ18 to develop smooth, step-free torque without friction.

CIRCLE NO. 279

Liquid level control senses 0.0001 in.

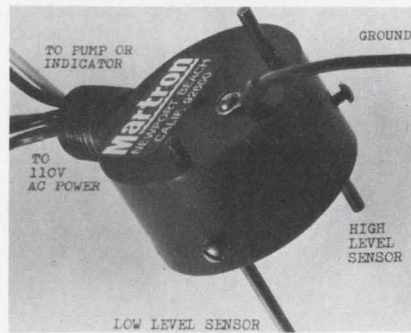

Martron, Inc., 875 West 15th St., Newport Beach, Calif. Phone: (714) 646-7151.

Liquid level control with no moving parts automatically senses and controls levels of liquids to within 0.0001 in. in any environment. When the control's sensor-probes are set at the desired high and low liquid levels a 110 V ac switch functions automatically to activate or deactivate electrical devices. Control options from 4 to 150 A, 220 or 440 V ac.

CIRCLE NO. 280

Miniature connectors meet MIL C 22557

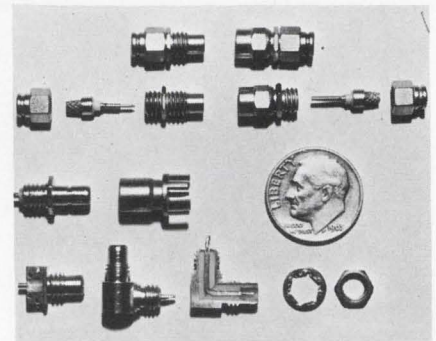

Mi-Kro Connector Corp., 40-09 21st St., Long Island City, N.Y. Phone: (212) 392-8814.

The connectors take three mating forms: screw-on, push-on and slide-on. Variations in the basic design include straight bulkhead and right-angle cable connectors, as well as printed circuit board and tee connectors. Parts are virgin teflon, brass and beryllium copper. All metal parts are copper flash and gold plated. All meet MIL C 22557.

CIRCLE NO. 281

lowest price D V M

reliability proven by 20,000 units in use

- Multi-Range DC Measurements from 1 MV to 1 KV
- 0.1% FS Accuracy
- Simple rugged design provides high MTBF
- 1 year warranty



model 201

\$ 250

1 thru 49

Other DVM's and Thermometers comparatively priced. Send for NEW catalog and price list.



Stocked world wide for 24 hour delivery

DIGITEC

by UNITED SYSTEMS CORPORATION

918 Woodley • Dayton, Ohio 45403

Instrument relays span 6 to 115 V dc

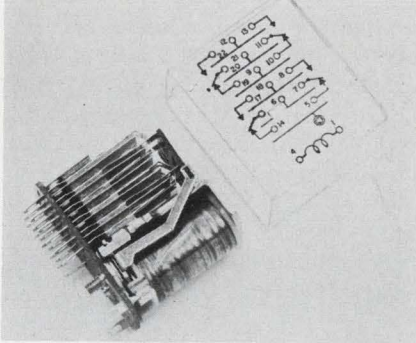

Parelco, Inc., 26181 Avenida Aero-
puerto, San Juan Capistrano, Calif.
Phone: (714) 493-4507. Price:
\$9.60.

The model R11 instrumentation relay has a guarded construction which keeps the capacitance between contacts to a maximum of 0.15 pF. A separate guard plate is located between each set of contacts. Each guard has an isolated terminal allowing connection to an instrument guard to maintain high common-mode rejection in the instrument. The relay contacts are rated to 200 mA with a thermal emf of less than 1 μ V.

CIRCLE NO. 355

DPDT switch passes 25 A

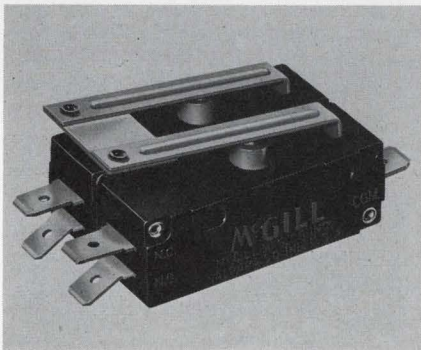

McGill Manufacturing Co., Inc., Val-
paraiso, Ind. Phone: (219) 462-2161.

A tandem arrangement of two 2650 series 20-A snap action switches with a common actuator provides a 25 A, DPDT assembly. They have a differential travel of less than 0.005 in. Other features include: high-strength beryllium copper springs, heavy-duty silver contacts and dimensionally stabilized housings.

CIRCLE NO. 356

READOUTS

We also make indicators, switches, keyboards,
panel displays, in-line displays and CRT displays.

WHICH TYPE FOR YOU?



NEON DISPLAY TUBE

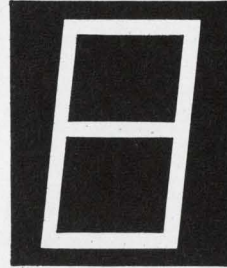

SEGMENTED DISPLAY



PROJECTION DISPLAY

NO MATTER...TEC-LITE DRIVERS CONTROL THEM ALL!

TEC-LITE Digital Readouts (the type is up to you) offer almost limitless circuit flexibility to fit your needs. For integrated or discrete component circuitry. Usually designed to operate from decimal input or from 8-wire or 4-wire 1, 2, 4, 8 binary coded decimal input. Nearly all input codes can be accommodated.

Solid state gated memory available to fit virtually any circuit or system requirement, accommodating negative or positive logic and strobe pulses. Special techniques substantially reduce assembly time—and prices.

TNR SERIES—Transistorized Digital Readout and NIXIE® Tube

Pick the quality to fit your specs: TNR-10 and 30 Series are completely enclosed, military quality devices with metal can transistors; TNR-40 and 50 Series—computer quality—offer same functions, but simplified design and epoxy/ceramic encased transistors reduce price 40%; TNR-41 and 51 Series control low cost side viewing NIXIE tube. TNR Readouts are priced as low as \$23.51 with tube in 100-299 quantities.

©BURROUGHS CORP.

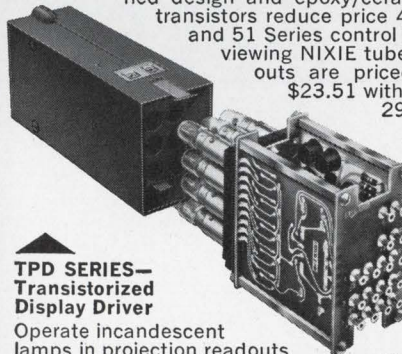
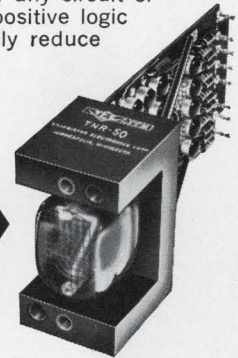

TPD SERIES— Transistorized Display Driver

Operate incandescent lamps in projection readouts directly from logic levels as low as 1 ma.—special relays, level converters or power amplifiers not required. Fast, silent, highly reliable. Does not create transients on signal lines normally found with relay-type lamp control devices. Drivers priced from \$41.25 in 100-249 quantities.

TSR SERIES— Transistorized Segmented Readout

From the front, side, above or below—better, brighter digital display. Greater wide angle visibility with bright no-gap characters. High, constant illumination level. Priced from \$32.25 in 100-299 quantities.

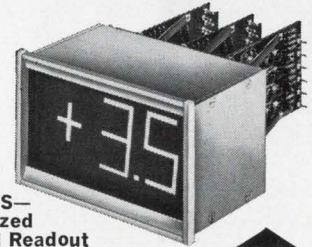

INFORMATION DISPLAY
AND CONTROL DEVICES

TRANSISTOR ELECTRONICS CORPORATION

Box 6191 • Minneapolis, Minnesota 55424 • Phone (612) 941-1100

ON READER-SERVICE CARD CIRCLE 69

PERMACOR[®]

powdered iron cores

...unequalled for design and prompt delivery!

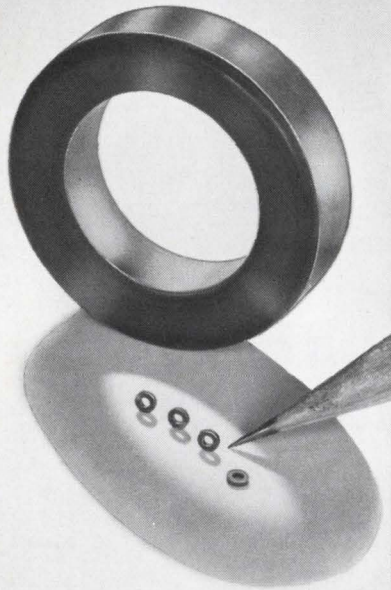

Illustrated: TOROIDAL IRON CORES available from 1/8" to 2" O.D.

As the largest maker of iron cores in the world, we offer unequalled production and design facilities for any core design problem. AND, we stock a full line of standard cores at all times.

Need the best in cores . . . Plain, Hollow, Threaded, Insert, Tuning, Cup, and Toroidal Iron Cores, Iron Coil Forms, Sleeves, Flexible Magnetic Shielding, Bobbins and special shapes . . . write and find out why we are unequalled.

PERMACOR[®]

A Division of Radio Cores, Inc.

9540 Tulley Ave., Oak Lawn, Ill. 60454
Phone: 312-422-3353

ON READER-SERVICE CARD CIRCLE 70

COMPONENTS

Detector switch needs no contact

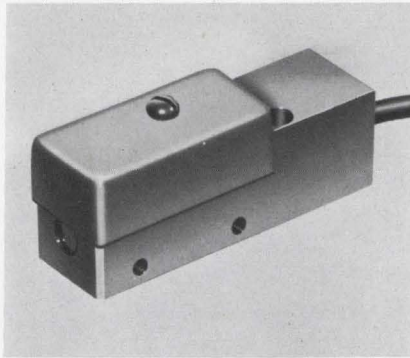

Electro Tec. Corp., P.O. Box 667, Ormond Beach, Fla. Phone: (904) 677-1771.

A line of magnetic detector switches designed to sense ferrous metals operates because of the proximity of magnetic metals, and no physical contact is necessary. Operating medium is the smallest possible to give maximum air gap, and switching repeatability is generally ± 0.002 . Switches are sealed housing units completely water, oil, spray, dust, and dirt proof.

CIRCLE NO. 282

Dual power supply has two 9 V outputs

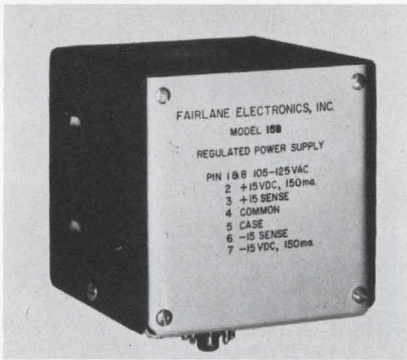

Fairlane Electronics, Box 335, Long Valley, N.J. Phone: (212) 691-2530. P&A: \$100; stock.

The model-150 power supply is designed for use with operational amplifiers. Two separate outputs of ± 9 V dc at 600 mA each are floating and either polarity may be grounded. The dual supplies track each other to within 0.01%. Regulation is 0.05% with zero to full load changes. Long term stability is less than 10 mV with a ripple of less than 1 mV.

CIRCLE NO. 283

Potentiometers use conductive plastic

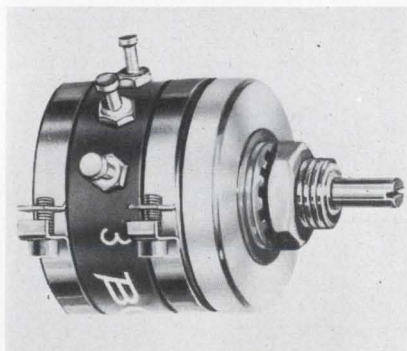

Bourns, Inc., 1200 Columbia Ave., Riverside, Calif. Phone: (714) 684-1700. Price: \$39.12 up.

The new models 3536 bushing mount and 3586 servo mount single-turn potentiometers have In-finitron conductive plastic elements. The conductive plastic element provides a dither life of 1000 hours at 60 Hz and a rotational life of 50,000,000 shaft revolutions. They have a resistance range of 100 Ω to 1 M Ω and a power rating of 1 W at 70°C.

CIRCLE NO. 284

Time delays respond to 1 GHz

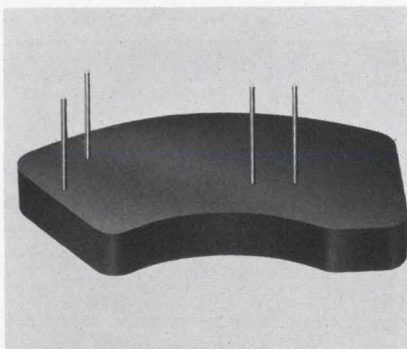

RCL Electronics, Inc., 700 South 21st St., Irvington, N.J. Phone: (201) 374-3311.

These delay packages have a delay time range from 1 ns to 1000 μ s. The devices have a frequency response greater than 1 GHz and a range of impedance from 50 to 2000 Ω . Delay tolerances of $\pm 2\%$ or better, are available, with a full temperature range from -55 to $+125^\circ\text{C}$. Output pulse distortion of $+10\%$ maximum is maintained with coefficients of less than 50 PPM/ $^\circ\text{C}$.

CIRCLE NO. 285

Report from

**BELL
LABORATORIES**

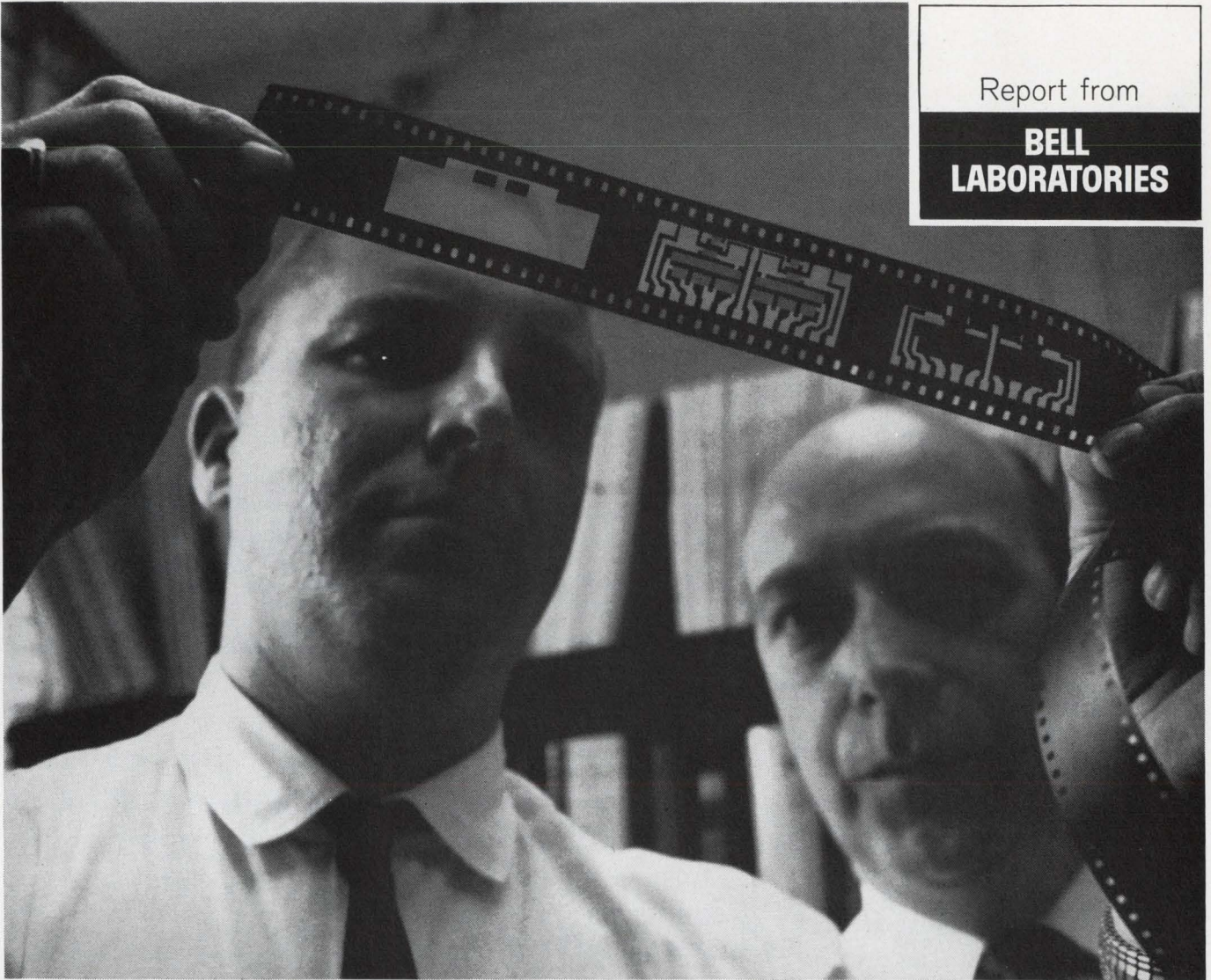

Thin films: faster by computer

Arthur G. Gross and Harry M. Kalish of Bell Telephone Laboratories have developed a computer program whose end product is a set of correctly sized photographic "masks" for making prototype thin-film networks. The masks control the deposition and shapes of various widths and thicknesses of conductive, resistive, and dielectric materials that make up such circuits. (These frequently begin as tantalum, deposited onto a glass or ceramic substrate and chemically treated to produce desired electrical properties.)

Controlled by the new program, a computer feeds a precision microfilm plotter which prints the masks on 35mm film (photo above).

With this system, a prototype can be ready in a day, as against the weeks that may be involved in making high-

precision masks for volume circuit production. Usually, for example, a draftsman must make rough sketches and prepare a list of numbers (coordinate points) accurately describing the geometry of the final circuit. Then the actual shapes—greatly enlarged—are

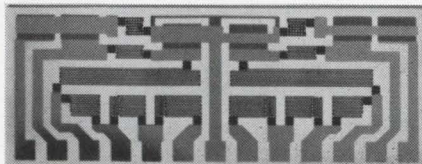

An experimental thin-film filter network—in actual size—made from 35mm film masks. In the top photo, A. G. Gross (left) and H. M. Kalish hold three of the masks used. Each mask controls the formation of a layer of conductive, resistive, or dielectric material. The circuit is built up of a number of such layers.

cut into plastic sheets on a "coordinatograph." Later, the plastic patterns are photographically reduced to circuit-sized masks, perhaps 1/2 by 1 inch.

In addition to reducing time and handling, Bell Laboratories' new program relieves the engineer of another tedious job: designing the meandering lines that constitute resistors in these circuits. And the computer resistors are "optimized" . . . fitted into the smallest possible area.



To give the engineer freedom to use irregular plane shapes, the program includes a subroutine which closely approximates geometric figures used in making thin-film circuits.



Bell Telephone Laboratories
Research and Development Unit of the Bell System



NEW / FROM NORTRONICS

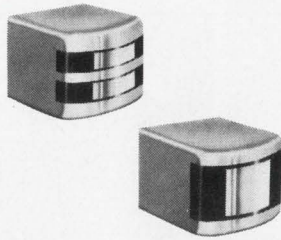

HIGH PERFORMANCE PROFESSIONAL AUDIO TAPE HEADS

FOR 1/4" TAPE

20 Hz to 20 KHz Response

The new Nortronics PR Series tape heads provide a new standard of audio reproduction for broadcast equipment and other critical applications. Frequency response is within *one* DB from 20 Hz to 20 KHz in a mu-metal case. Even better response can be obtained with modified case shielding. In 7.5 and 15 ips playback applications the PR Series extends the usable low frequency response a full octave.

The PR Series is available in production quantities for full track and half track stereo, with other types supplied on special order. All heads feature the Nortronics deposited quartz gap

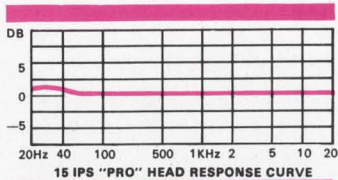

and laminated precision-lapped, low loss cores. They can be provided in a broad range of electrical specifications.

Standard "B" cases and terminal pin arrangements are used in the PR Series. Thus they are compatible with existing Nortronics mounting accessories and connector plugs.

Complete technical data is available on request.

Nortronics
COMPANY, INC.

8101 Tenth Avenue North
Minneapolis, Minnesota 55427

ON READER-SERVICE CARD CIRCLE 71

COMPONENTS

Segmented lamp indicates 4 messages

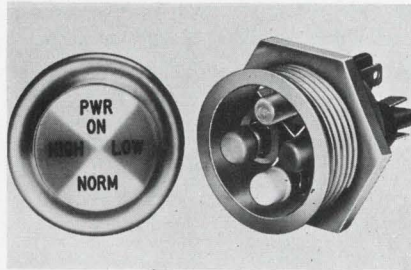

H. R. Kirkland Co., 8-10 King,
Morristown, N.J. Phone: (201)
538-2777.

Four-lamp indicator has a 1 in. dia lens and up to four different messages can be shown on a single face. Each S600 unit consists of a housing in which four separate and independent sockets are mounted. Partitions in the lens cap provide for the segmets. Lamp bulbs are available from 6 to 120 V, eliminating the need for external voltage dropping devices. Markings on the lens is by engraving or Mylar inserts.

CIRCLE NO. 286

Rf connector withstands 100 g

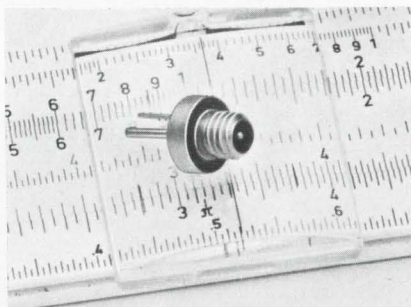

Glass Technology, 1644 Whittier
Ave., Costa Mesa, Calif.

A subminiature, hermetically sealed, coaxial rf connector designed for the C5A, services as the input connector from an accelerometer to an amplifier in a vibration monitoring system, and mates with an encased socket. It will withstand vibration in excess of 1.8 g²/Hz from 400 to 2000 Hz and shock in excess of 1000 G. Other specifications include an insulation resistance of 1000 M Ω at 50 Vdc, a leak rate of 1 x 10⁻⁹ cc of helium/s.

CIRCLE NO. 287

FOUND: A low cost miniature ceramic capacitor that is stable. (213) 843-4222

FOUND: cyno... (213) 843-4222

.100 dia.

.250

39,000 pF
Actual Size

Did low cost miniature ceramic capacitors turn up missing?

No longer. USCC has them for you. ■ The new, C22 Series low cost transfer molded ceramic capacitors, utilizing the exclusive Ceramolithic® process for stability and reliability, are now available off-the-shelf and at a price that is geared to solve design cost problems. ■ The C22 Series is ideal for cordwood stacking and versatile enough for printed circuit boards and point-to-point wiring. ■ Capacitance values range from 10 pF to 120,000 pF with DC voltage ratings of 50 and 100 at 125°C. Tolerances are ± 5 , 10 or 20%. Test it to MIL-C-11015 or MIL-C-39014. ■ If you have been waiting for the price of ceramic capacitors in quantity to drop where you can economically use them, wait no longer. The time is now. Find out about the C22 Series Ceramolithic® capacitors, today.

CERAMOLITHIC®

... advanced design in ceramic capacitor construction

For complete technical information
on the new C22 Series, contact:

USCC

U. S. CAPACITOR CORPORATION
2151 NO. LINCOLN STREET • BURBANK, CALIFORNIA 91504
(213) 843-4222 • TWX: 910-498-2222

ON READER-SERVICE CARD CIRCLE 72
ELECTRONIC DESIGN 25, December 6, 1967

Four pole relays flat pack mounted

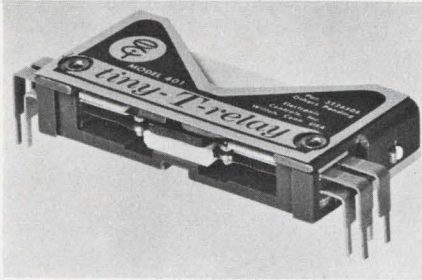

Electronic Controls, Inc., Danbury Rd., Wilton, Conn. Phone: (203) 762-8351. Price: \$5.35 form A, \$6.85 form C.

In 4-pole make or transfer arrangement, the series 401 printed-circuit mounted relay stands 0.34 in. off the board. The units use an electromagnetic arrangement that allows it to transfer 3A at 28 Vdc., or interrupt up to 1000 V ac at 100 mA. Typical dry circuit resistance is from 10 to 20 m at 1 mV and 1 mA. Life at 100 mA is 100 million cycles.

CIRCLE NO. 288

Voltage standards isolate 0.01 pF

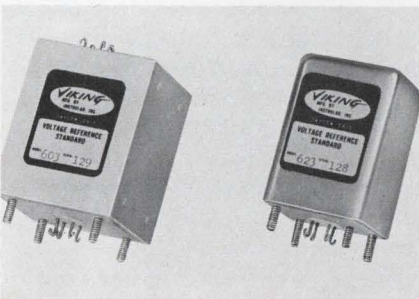

Instrulab, Inc., 1205 Lamar St., Dayton, Ohio. Phone: (513) 223-2241.

Reference standard model 603 offers line isolation of less than 0.01 pF. Model 623 shown in case style 24 offers line isolation of less than 20 pF. Both models offer 0.0003% regulation, 0.0002%°C temperature coefficient and 0.001% month long term stability. They have electrostatic shielding, are short circuit proof, and operate over a temperature range of -25° to +75°C. The units operate from an ac source of 117 V.

CIRCLE NO. 289

McDonnell Phantom: the hot one

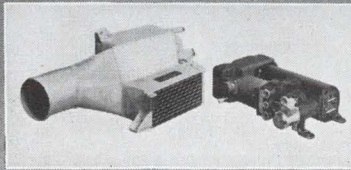
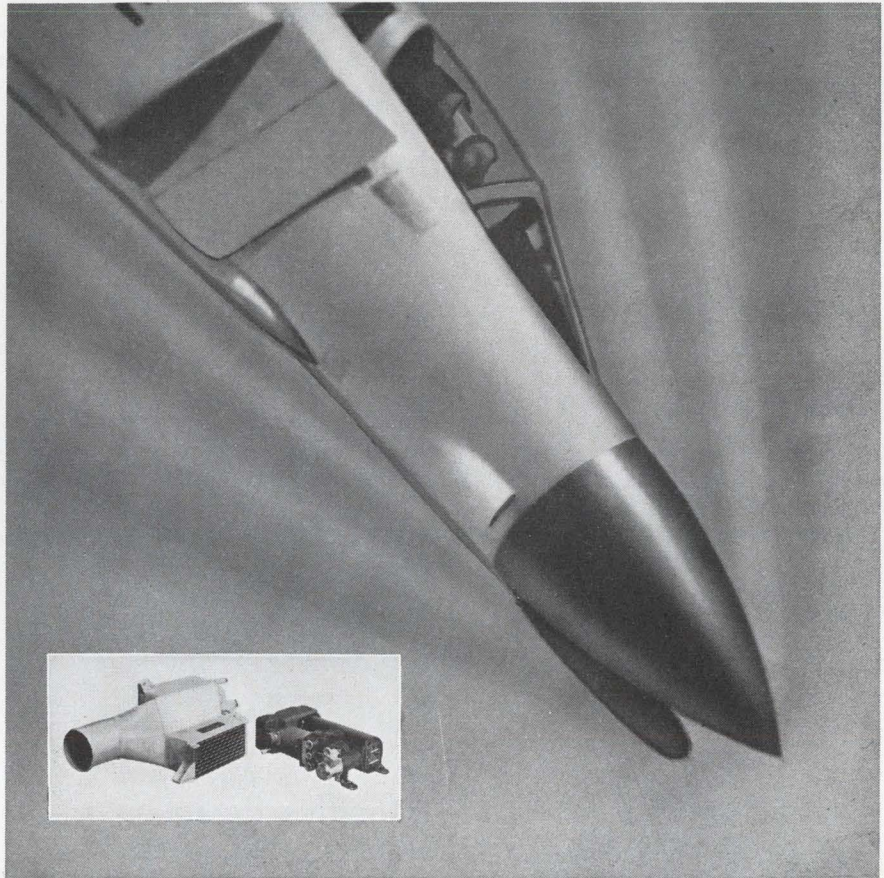

Eastern keeps its radar cool

Each day of flight operation continues to confirm the McDonnell "Phantom" as the most advanced all-around fight aircraft in the world today. But high density electronics and the heat loads of high speed flight would soon put the radar nose of the Phantom out of business.

That's where Eastern Industries' cooling systems come in. A liquid-to-air heat exchanger and hydraulic pack combine to remove over 8 KW from the radar, keeping it within safe temperature limits under all flight conditions. For all its performance, the total system weighs less than 17 lbs. and is remarkably compact (hydraulic pack: 3 $\frac{1}{16}$ " x 6 $\frac{1}{16}$ " x 11" and exchanger: 6 $\frac{5}{8}$ " x 8" x 17").

Other Eastern cooling systems are now under development or in production for such aircraft as the Lockheed AH-56A, North American RA5C and F-104.

Write for new literature on Eastern capabilities in thermal control — or for the answer to your particular problem. We may have some cool answers.



EASTERN INDUSTRIES

A Division of Laboratory For Electronics, Inc.
100 Skiff Street • Hamden, Connecticut

ON READER-SERVICE CARD CIRCLE 73

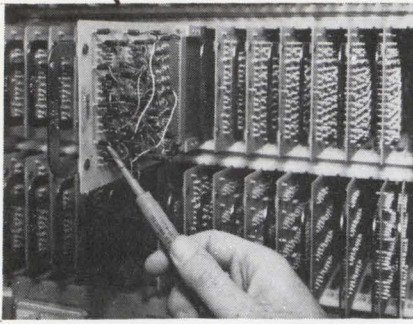

You're right on top with pluggable/patchable Cambi-Cards®

This new idea in logic card make-up lets you go from original function patch-up to final system check-out without tear-down or breadboard change. What's more, your final system configuration built with Cambi-Cards is ready for production — no breaking down or production re-design is required. All three steps — initial IC logic function assembly to intermediate rack mounting to system incorporation — are possible with Cambi-Cards.

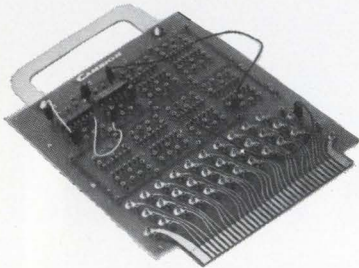

Because patching and IC pluggability are both on the same side of the card, you can see what you are doing — no mis-wiring. Find out how successfully and quickly your design and system ideas can prove their value with Cambi-Cards. Ask for a demonstration, contact: Cambridge Thermionic Corporation, Digital Products Division, 433 Concord Avenue, Cambridge, Massachusetts 02138. Phone: (617) 491-5400.

®REG. U.S. PAT. OFF.

CAMBRIDGE THERMIONIC CORPORATION
CAMBION®

Standardize on CAMBION . . .
21,541 guaranteed electronic components

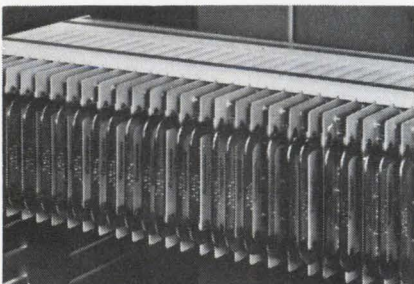

ON READER-SERVICE CARD CIRCLE 74

COMPONENTS

Ceramic capacitors span 0.12 to 1 μ F

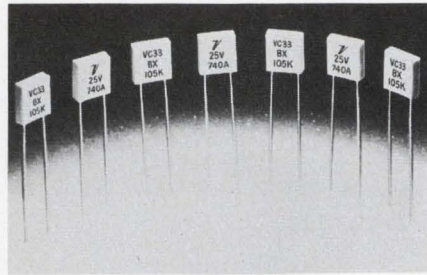

Vitramon, Inc., Box 544, Bridgeport, Conn. Phone: (203) 268-6261.

VEE CAL ceramic capacitors have capacitance values from 0.12 to 1 μ F in a 0.3 x 0.3 x 0.1 in. envelope. The units have no external encasements. The devices operate within the temperature range of -55 to $+125^{\circ}$ C. Voltage ratings are 100, 50 and 25 V dc, and capacitance tolerances are $\pm 10\%$ and $\pm 20\%$.

CIRCLE NO. 290

Analog multiplier responds to 4 MHz

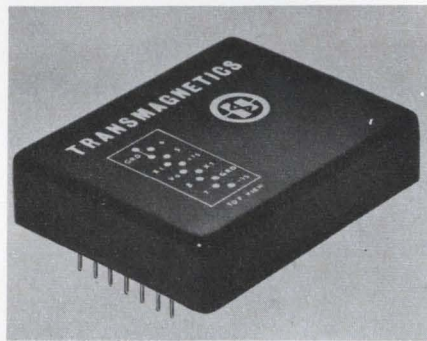

Transmagnetics, Inc. 134-25 Northern Blvd., Flushing, N.Y. Phone: (212) 539-2750.

An analog multiplier offers a frequency response of dc to 4 MHz. The device is for multiplexing telemetry data, video signals and scope-presentation drives. Gain unit is flat to 0.8 dB at 1 MHz and 3 dB at 4 MHz. Phase is less than 1 at 1 MHz and 30° at 4 MHz. Its input impedance is 10 k Ω resistive shunted by 50 pF maximum.

CIRCLE NO. 291

Sensitive dc relay reacts to 20 mW

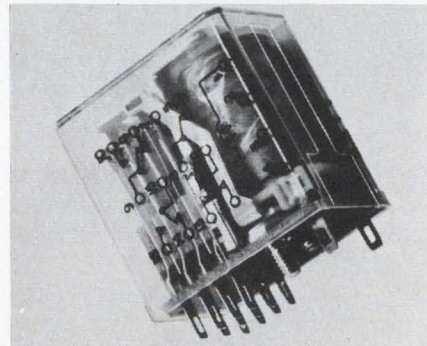

Parelco, Inc., 26181 Avenida Aeropuerto, San Juan Capistrano, Calif. Phone: (714) 493-4507. Price: \$3 to \$6.

20 mW per pole is required to pull in this relay. At this power level, the relay can be driven directly by existing microcircuits. A variety of contacts are available to switch low level to 2-A loads. Coil voltages range from 2 to 48 V dc. No-charge samples are available to qualified designers.

CIRCLE NO. 292

Ceramic capacitors in 100 V dc W package

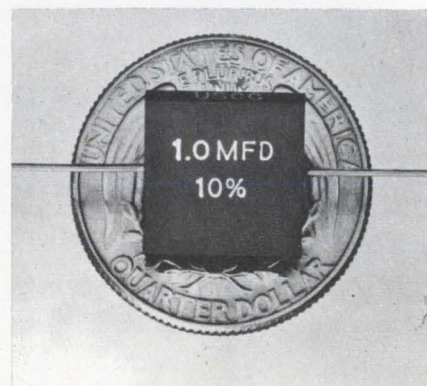

U.S. Capacitor Corp., Burbank, Calif. Phone: (213) 843-4222. P&A: \$1.46 ea.; 10 days.

Designated the C27 series, the units are available in either 50 or 100 V dc W versions. The 50 V dc capacitors range from 0.01 μ F in a 0.2 x 0.2 x 0.1 in. thick package, to 2.5 μ F in a 0.5 x 0.5 x 0.25 in. thick package. The 100 V dc units range from 0.01 to 2.5 μ F, in slightly larger sizes. Temperature range is -55 to 125° C. Standard tolerance is 10%; 5% and 20% types are also available.

CIRCLE NO. 293

PLASTIC SEALLESS PUMP

Standard capacities are from $\frac{1}{3}$ to 40 gpm

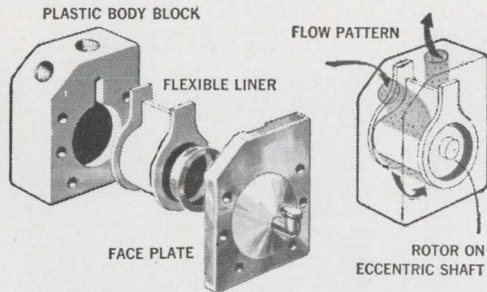

A rotor, mounted on an eccentric shaft in this plastic pump, rotates within a liner to create a progressive squeezing action on fluid trapped between the liner and the body block. All metal parts and mechanical action takes place inside the liner where fluid never reaches. This completely eliminates the need for stuffing boxes or shaft seals, guaranteeing no leakage.

The pump is self-priming, operates wet or dry and is suitable for extremely corrosive fluids, abrasive slurries or viscous materials. Applications include pumping of acids, alkalies, distilled water, diatomaceous earth slurries, electroplating solutions, ceramic tile glaze as well as shear sensitive emulsions.

Standard capacities are from $\frac{1}{3}$ to 40 gpm with discharge pressure up to 50 psi. Materials of construction include Teflon, PVC, linear polyethylene, Buna-N, Bakelite or stainless steel for body blocks and Viton-A, Kel-F elastomer, Hypalon, Neoprene and Buna-N for the liner. These are the only parts in contact with the fluid.

For additional information, write Vanton Pump & Equipment Corporation, Hillside, New Jersey or telephone Area Code 201 Murdock 8-4120.

ON READER-SERVICE CARD CIRCLE 75

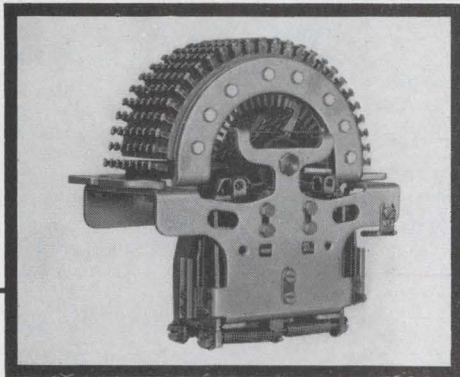

2 WAY

Genalex Precision Stepping Switch

for circuits which require a switch that steps positively, in either direction, around a bank of 25 contacts.

FEATURING:

- self-cycle or remote control operation
 - 65 steps per second on self-interruption
 - bridging or non-bridging wipers
 - 20 steps per second from external impulses
- Over 10,000,000 steps in each direction without replacement.

for complete data on this and other unique GENALEX switches, write:



P.O. BOX 46, 151 MYSTIC AVE., MEDFORD, MASS. 02153
U.S. Agents for the General Electric Company, Ltd. of England

ON READER-SERVICE CARD CIRCLE 76

How good is Line Electric?

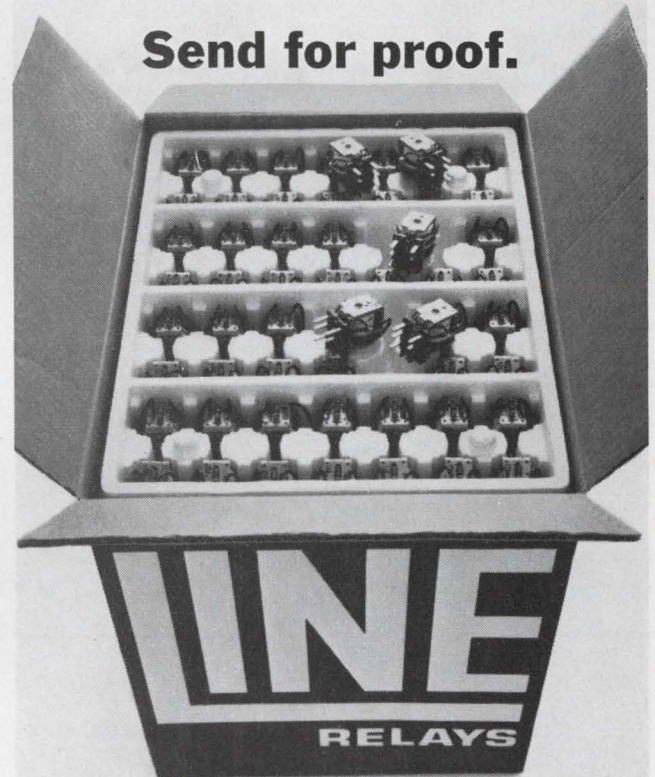

We could toot our horn and tell you that our prices are the best in the industry. And that we guarantee delivery within six weeks; maybe less, but never more.

And we could tell you that our people are the most knowledgeable and the most courteous in the business.

We could also tell you that our growth speaks for itself: This year's shipments are 80% ahead of last year's and our sales volume has quadrupled in the past six years.

We could tell you all those things and more. But we'd only sound like we're patting ourselves on the back and you probably wouldn't believe us anyway.

So how do we prove how good we are? Send us an order. By the time we're finished, you'll have all the proof you need.

The Line Electric Company/Division of Industrial Timer Corp.,
Manufacturers of relays and the best service in the business.

Send for 64 page catalog:
305 U.S. Highway 287, Parsippany, N.J. 07054

ON READER-SERVICE CARD CIRCLE 77



POWER/MATE CORP., is your one source for dependable, low cost, variable voltage, regulated power supplies. Our UNI-POWER universal power supply modules come in a range of voltage and current ratings, both single and dual outputs, that have been designed to cover your needs. Check the supplies below — any or all of them are available off-the-shelf.



UNI-76 • single output
 Input — 105-125 V, 47-420 cps.
 Output — continuously adjustable from 0 to 34 volts at 0.5 amps.
 Regulation — Better than $\pm 0.005\%$.
 Ripple — Less than 250 microvolts.
 Overload and Short Circuit Protection — Solid state circuit, instantaneous recovery, automatic reset.
 Operating configuration — Series, Parallel or Series/Parallel.
 Price — \$76.00 f.o.b. Hackensack, N.J.

UNI-88 • single output
 Input — 105-125 V, 47-420 cps.
 Output adjustable from 0 to 34 volts at 1.5 amps in 6 ranges with internal fine and coarse controls.
 Regulation — better than $\pm 0.005\%$.
 Ripple — less than 250 microvolts.
 Overload and Short Circuit Protection — solid state circuit, instantaneous recovery, automatic reset.
 Operating configuration — Series, Parallel or Series/Parallel.
 Price — \$88.00 f.o.b. Hackensack, N.J.

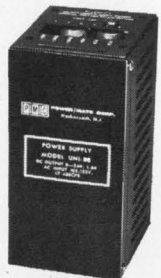

UNI-128 • single output
 Input — 105-125 V, 47-420 cps.
 Output — 0 to 26 V @ 4.5 amp; 26 to 31 V @ 4.0 amp; 31 to 34 V @ 3.5 amp.
 Regulation — better than $\pm 0.005\%$.
 Ripple — less than 250 microvolts.
 Overload and Short Circuit Protection — solid state instantaneous recovery; automatic reset.
 Operating configuration — Series, Parallel or Series/Parallel.
 Price — \$128.00 f.o.b. Hackensack, N.J.

UNI-TWIN 164 • dual output
 Input — 105-125 V, 47-420 cps.
 Output adjustable 0 to 25 volts at 0.75 amps in four ranges with internal fine and coarse control.
 Regulation — better than $\pm 0.01\%$.
 Ripple — less than 500 microvolts.
 Overload and Short Circuit Protection — solid state, instantaneous recovery; automatic reset.
 Operating configuration — Series, Parallel or Series/Parallel.
 Price — \$164.00 f.o.b. Hackensack, N.J.



FREE LITERATURE

For complete specifications on these or any of the other 4,000 power supplies we manufacture, write today to:

POWER/MATE CORP. PIMC
 163 Clay Street, Hackensack, N. J. 07601
 Telephone 201-343-6294

ON READER-SERVICE CARD CIRCLE 78

COMPONENTS

Electronic delay triggers devices

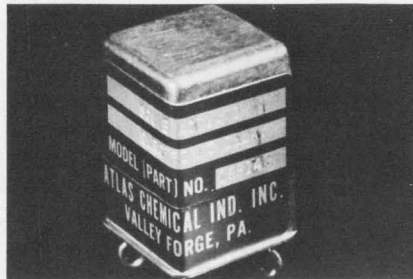

Atlas Chemical Industries, Inc., Aerospace Components Div., Valley Forge, Pa. Phone: (215) 666-0700.

A solid-state electronic time delay firing module can be used for triggering explosive actuated units for locking devices, releasing devices to permit linear or rotary motion, pushing mechanical loads, cutting wires, cables, rods or bolts, firing a primer, indicating the presence of unwanted electrical pulses, operating a gyroscope and disconnecting a plug. The time delay can be specified to be set at the factory anywhere between 50 ms and 45 s, with an accuracy of $\pm 5\%$ in the temperature range from -65 to 200°F . It will function reliably during or after rigorous shock, vibration or acceleration up to 200 g.

CIRCLE NO. 294

Subcarrier oscillators span 500 Hz to 100 kHz

Industrial Electronics Corp., P.O. Box 862, Melbourne, Fla. Phone: (305) 723-5382.

Subcarrier oscillators identified as the SCO 10 are packaged in a solid molded cylinder $1\frac{3}{4}$ in. in dia. by $\frac{3}{4}$ in. long. The units, available in a range of subcarrier frequencies from 500 Hz to 100 kHz, provide data bandwidths up to 30 kHz. Powered from any 9 V source and using a period linear frequency modulation technique these provide accurate data at ambient temperatures from -40 to $+175^\circ\text{C}$, at accelerations to 20,000 g. Applications include single channel or multiple channel data transmission systems using either wire lines or radio links. The systems will provide data to 5% of full scale over the full range of environments.

CIRCLE NO. 295

ECCOMOLD® EPOXY MOLDING COMPOUNDS



Comparative physical, electrical and processing properties of Eccomold transfer molding compounds are in colorful chart. Typical applications are indicated.

ON READER SERVICE CARD CIRCLE 181

ECCOSIL® RTV SILICONE DIELECTRICS

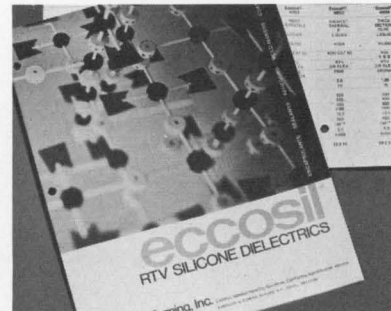

New illustrated folder describes and gives properties for 13 Eccosil RTV silicone dielectrics including new see-thru encapsulants, sealants, adhesives, mold-makers, coatings and even lightweight foams.

ON READER SERVICE CARD CIRCLE 182

STYCAST®

CASTING RESINS CHART COMPLETELY REVISED

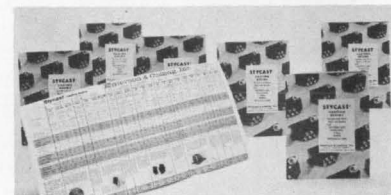

This chart for notebook or wall mounting has just been brought up to date. It contains comparative property data on over 20 Stycast® epoxies and urethanes.

ON READER SERVICE CARD CIRCLE 183

Emerson & Cuming, Inc.



**CANTON, MASS.
 GARDENA, CALIF.
 NORTHBROOK, ILL.**
 Sales Offices
 in Principal Cities

EMERSON & CUMING EUROPE N.V., Oevel, Belgium

Adjustable coils
span 1 to 100 μH

TOP VIEW

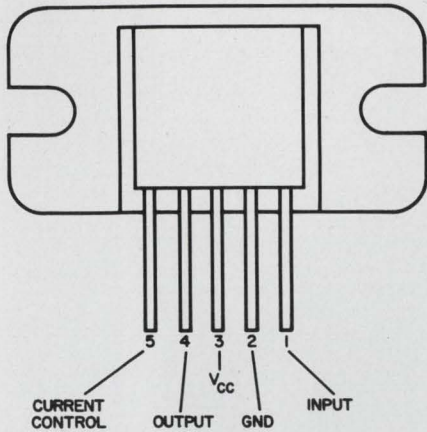

North Hills Electronics, Inc., Alexander Pl., Glen Cove, N.Y. Phone: (516) 671-5700. P&A: \$4.50; stock.

Subminiature adjustable coils designated the 600 series, are shielded and designed for printed circuit applications. These inductors cover the inductance range from 1 to 1000 μH and can be employed over the 100 kHz to 30 MHz range. Typical standard values are 1 μH , Q 90 at 7900 kHz and 1000 μH , Q 90 at 790 kHz. Adjustment is +10% of nominal value.

CIRCLE NO. 296

Rectifier stacks handle 20 A

Amperex Electronic Corp., Slatersville, R.I., Phone: (401) 762-9000.

Silicon rectifier stacks consist of three families designated as the OSB-9210, OSM-9210 and the OSS-9210. The OSB-9210 can be used in single phase full circuits or two-phase half-wave circuits. The OSM-9210 can be used in single phase or three phase bridges or in voltage doubler circuits. Both the OSB-9210 and the OSM-9210 are available with peak reverse voltage ratings from 2 to 15 kV in 1 kV steps. The OSS-9210 can be used in single phase half wave circuits and is available with peak reverse voltage ratings from 3 to 30 dV in 1 kV steps. The OSS-9210 family can also be used to construct any circuit configuration.

CIRCLE NO. 297

Columbia Components Thick-film hybrids.

Send us your specs for fast action.

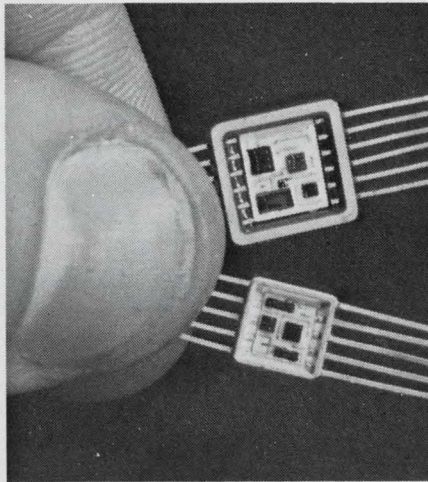

The answers to your micro-packaging problems are as close as this coupon.

The hybrid circuit is a versatile tool in the hands of the design engineer faced with problems in high power ratings, thermal tracking, precision component tolerances, intermixing monolithic IC's and other interfacing circuitry and components. In applications where the design may undergo changes up to the first production article, the hybrid offers the designer freedom to institute necessary changes with minimal cost and time.

Columbia Components Corporation's Thick-Film Hybrid Circuits are capable of reproducing any given circuit without degradation in circuit functions. These hybrids also present the most economical approach to most problems.

Please sketch schematic (or print, if available) and attach.

Application _____

Customer Print # _____

Rev: _____ Lead Forming _____

Is qualification acceptance required? _____

Is lot acceptance required? _____

Package style & size: _____

Body Material: _____

Lead materials: _____

MAXIMUM RATINGS

Storage Temp. Range _____ Operating Temp. _____

Ambient Temp. _____ Power Dissipation of 25°C _____

- Have your engineer call.
 Send descriptive literature.

Name _____ Title _____

Company _____

Address _____ Telephone _____



City _____ State _____ Zip _____

COLUMBIA COMPONENTS CORP.

A Subsidiary of Computer Instruments Corp.,

92 Madison Ave., Hempstead, N.Y. 11550. Tel: (516) 483-8200.

R	Value	Tol.	T.C.	Wattage	Q	Generic Type	Tol.
R1					Q1		
R2					Q2		
R3					Q3		
R4					Q4		
R5					Q5		
R6					Q6		
R7							
R8							
R9							
R10							

C	Value	Tol.	Rated Voltage	CR	Generic Type	Tol.
C1				CR1		
C2				CR2		
C3				CR3		
C4				CR4		
C5				CR5		
C6				CR6		
C7						
C8						
C9						
C10						

Environmental Specifications _____

Military Specs., if any _____ Frequency _____

Other applicable specs _____

Voltages _____

ON READER-SERVICE CARD CIRCLE 79



KEPCO

TRACKED VOLTAGES DUAL, PLUS / MINUS VOLTAGE SUPPLIES

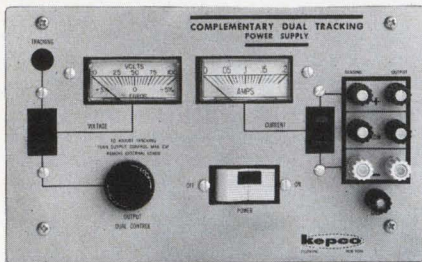

Model CDT 100-0.2 M

Kepeco's new series of CDT Dual Power Supplies offer tracked voltages from 0-±15V to 0-±100V. Each supply is fully regulated: <0.01%; with low ripple: <0.25 mV rms; and an excellent temperature coefficient: <0.01% per °C.

The two sections function with a common reference and a single voltage control (with locking feature). They may be loaded separately, or in series for double output voltage. Metering includes (2) recessed taut band meters, measuring the current drawn from each section, and their output voltage. A unique differential metering function enables the voltmeter to monitor the voltage difference between the two sections.

Three instruments are available:

CDT 15-1.5 M	+15 V @ +1.5 A -15 V @ -1.5 A
CDT 40-0.5 M	+40 V @ +0.5 A -40 V @ -0.5 A
CDT 100-0.2 M	+100 V @ +0.2 A -100 V @ -0.2 A

CDT models are ideal for powering operational amplifiers, servoamps, position transducers, and balanced or differential circuits requiring maintenance of a common center point.

FOR COMPLETE SPECIFICATIONS AND APPLICATIONS NOTES, WRITE DEPT. S-5



131-38 SANFORD AVE. • FLUSHING, N.Y. 11352
(212) 461-7000 • TWX # 710-582-2631

ON READER-SERVICE CARD CIRCLE 81

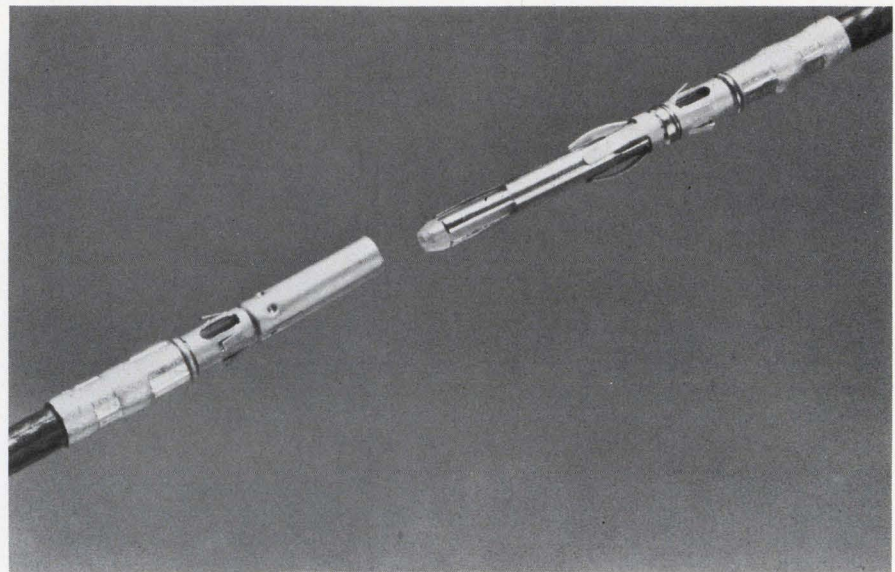

Miniature coaxial contacts start to finish in 20 seconds

AMP, Inc., Harrisburg, Pa. Phone: (717) 564-0101.

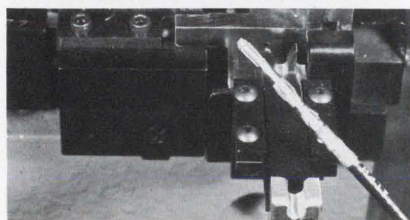
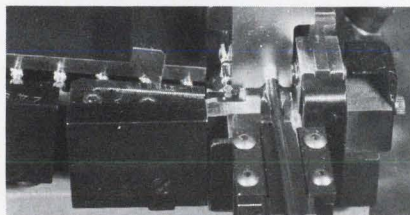
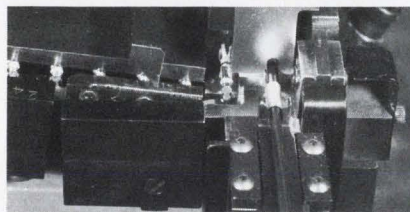
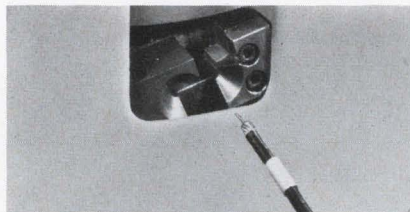

Start with a cable insertion. It comes out stripped with the ferrule applied. Next it is positioned in the die. The center conductor, braid, and outer conductor are crimped to give a good coaxial connection.

Not too long ago it was necessary to prepare coaxial cable laboriously before assembling it to a solder-type coaxial connector. Now, in 20 seconds, it is possible to prepare subminiature coaxial cable (strip jacket, cut and flare braid, strip and trim center conductor) and install a coaxial connector. The contacts are supplied on reels of 5000 for use in a bench-mounted crimping press. A companion machine, called a ferrule applicator, prepares the cable for crimping. Designed for high-density multiple circuit connector applications, the 0.11-in. OD Coaxicon contact will fit into any AMP connector housing that accepts size-16 pin-and-socket contacts. Either pin-and-socket or coaxial contacts will fit into any of the 14 to 156 positions of the 19 connector styles. The contact body, or outer conductor, is stamped and formed from strip brass conforming to MIL-B-50. Usable over a temperature range of -55° to +85°C, the impedance of these contacts is rated at 50 Ω nominal. The capacitance per mated pair is 4.36 pF max (inner conductor to outer conductor) and the contact has a VSWR of less than 1.3 at 500 MHz.

CIRCLE NO. 311

Encapsulation system uses cold welds

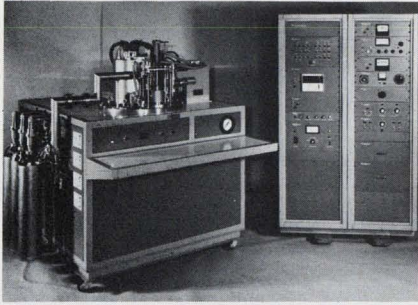

Varian, 611 Hansen Way, Palo Alto, Calif. Phone: (415) 326-4000.

An automatic vacuum encapsulation system capable of hermetically sealing as many as 1000 crystals or other components every seven hours employs a cold weld technique, is fast cycling, and is automatic. Crystal units are pre-heated to a temperature of 125°C before cold welding. This guarantees cleanliness without the extremely high, and sometimes harmful, temperatures required by other vacuum encapsulation sealing techniques.

CIRCLE NO. 313

Impedance comparator matches within 0.05%

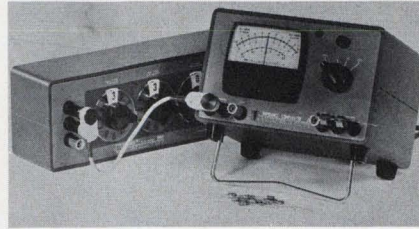

Electro Scientific Industries, 13900 W. Science Park Dr., Portland, Ore. Phone: (503) 646-4141. P&A: \$250; 30 days.

A solid-state impedance comparator bridge for resistor, capacitor and inductor comparison checking measures within 0.05% of the reference standard value. The comparator may be used for sorting resistors with values of 10 Ω to 2 M Ω , capacitors from 0.001 to 100 μ F and inductors between 30 mH and 5 kH. The deviation range selections are +1%, 5% and 25%. Operating speed is limited by the rapidity with which components can be inserted and sorted.

CIRCLE NO. 314

Wire bonder uses ultrasonics

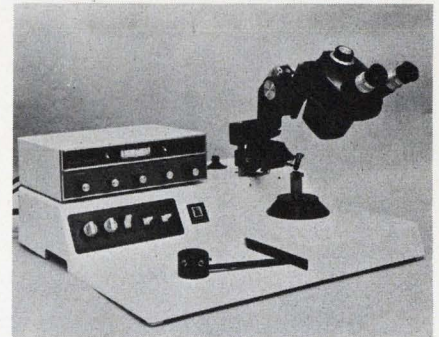

Hugle Industries, 750 N. Pastoria Ave., Sunnyvale, Calif. Phone: (408) 738-1700.

This device enables ultra-sonic bonding techniques to be applied to the production of hybrid microcircuits. In automatic operation, the unit bonds at constant heights at a typical speed of 16,000 bonds per shift. In the manual mode, bonding height can be governed with a motorized control with an accuracy of ± 100 mils. Stitch bonding is possible.

CIRCLE NO. 315

MAGNETIC SHIELD REFERENCE GUIDE

SHEET STOCK

TO STOCKED NETIC & CO-NETIC
MAGNETIC SHIELDING FOIL AND
SHEETS FOR YOUR FABRICATION



THICKNESS	NETIC S3-6 SHEET WIDTH	CO-NETIC AA SHEET WIDTH	CO-NETIC AA FOIL IN COILS: (Specify length desired)	BLUE NETIC FOIL* IN COILS: (Specify length desired)	Both BLUE NETIC and CO-NETIC AA foils, plain and adhesive backed, can be furnished slit to any desired width, at additional cost—Ask for prices.
.014"	30"	30"	.010" thick x 15" wide	.004" thick x 19 $\frac{3}{8}$ " wide	Request Catalog SG-1
.020"	30"	30"	.006" thick x 15" wide	.004" thick x 4" wide	
.025"	24"	30"	.004" thick x 15" wide	*BLUE NETIC foil not available in .002" thick	
.031"	26"	30"	.002" thick x 4" wide		
.049"	26"	30"	All foil also available adhesive backed. Other widths available to maximum above.		
.050"	26"	30"			
.062"	26"	30"			
.095"	26"	30"			

Maximum length is 120".
Also sold in 15", 30" and 60" lengths.
After fabrication, shields made from sheet must be heat treated for maximum shielding. No further annealing required.
Pre-annealed stock also available.

• Non-shock sensitive; requires no periodic annealing
• DELIVERY TIME—normal delivery time on stock widths is 1 to 2 days after receipt of order. For adhesive backed foils, approximately one week, and for foils slit to desired width, approximately 1 to 2 weeks.



MAGNETIC SHIELD DIVISION

Perfection Mica Company

1322 N. ELSTON AVENUE • CHICAGO, ILLINOIS 60622

Phone: 312, EV 4-2122 • TWX 910 221-0105

ON READER-SERVICE CARD CIRCLE 82

Bulova ovens are the smallest going

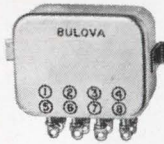

—but they do a big job!

Simply stated, the Bulova BDX series is the smallest and most versatile in the miniature oven field!

Now, for the details. External dimensions are just 1.5" x 1.19" x .46" (or up to .9375", for larger models). Yet, the BDX can hold 1 to 6 tubular devices such as diodes, capacitors or resistors, up to .25" in diameter and length.

Controller is an RFI-filtered snap-action thermostat, meeting MIL-I-6181B. You get the BDX with your components installed and encapsulated in fluoro-carbon blown polyurethane foam insulation and hermetically-sealed. Result: a unit with minimal thermal leak that will withstand the most severe shock and vibration specifications.

The BDX is available with stud mounting, printed circuit board mounting, flange mounting or captive nut. Temperature settings from 50°C to 100°C are available, with a range of operating voltages from 6.3 to 117 VAC or DC. Temperature stabilities are as fine as .5°C over a -55°C to 90°C with a power drain as low as 5 watts.

This is just one of a complete line of Bulova ovens, including bi-metal thermostat, transistat, solid state switched mercury, and AC or DC proportional controls. For more information, write today to Dept. ED-28.

Try Bulova First!

FREQUENCY CONTROL PRODUCTS

ELECTRONICS DIVISION
OF BULOVA WATCH COMPANY, INC.

61-20 WOODSIDE AVENUE
WOODSIDE, N.Y. 11377, (212) DE 5-6000

ON READER-SERVICE CARD CIRCLE 83

PRODUCTION EQUIPMENT

Optical comparisons to find errors

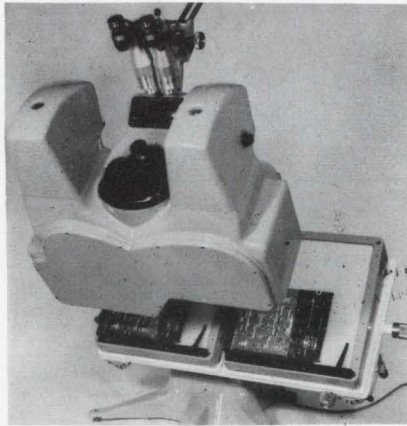

Radiation Equipment Co., Inc., 1825 Willow Rd., Northfield, Ill. Phone: (312) 446-4406. Price: \$4500.

The comparascope makes use of a split beam polarized optical system with a variable rate scanner, or chopper that visually superimposes, alternately, the master assembly on the test assemblies. The intermittent viewing of one, and then the other, creates a continuous image — except for the points of difference (errors) where a flickering image is easily identified as to a variance from the master.

CIRCLE NO. 316

Circuit engraver runs automatically



Graphic Electronics, Inc., La Salle, Ill. Phone: (815) 223-1489. Price: \$3,750.

The boards are produced by placing hand-drawn pen and ink or pencil copy on a cylinder, scanning the image and simultaneously cutting it into a copper clad epoxy or fiberglass blank sheet that has been attached to a second revolving cylinder. Because the machine takes about 3 to 4 hours to scan the 12 x 18 in. area, the machine is for producing prototype and test boards.

CIRCLE NO. 317

FLAT DRAWER CABLE

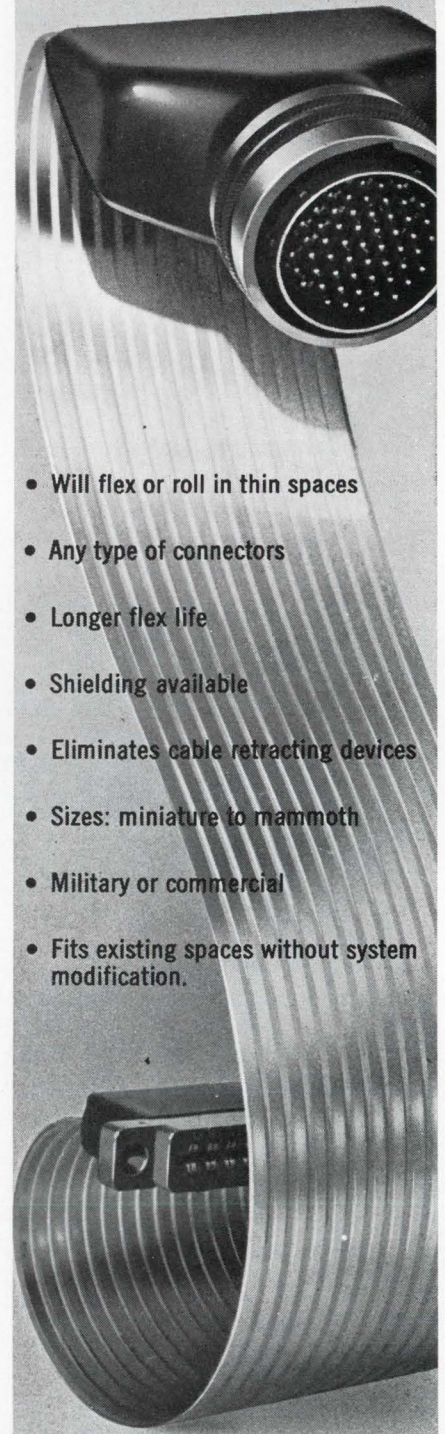

- Will flex or roll in thin spaces
- Any type of connectors
- Longer flex life
- Shielding available
- Eliminates cable retracting devices
- Sizes: miniature to mammoth
- Military or commercial
- Fits existing spaces without system modification.



FLEX-WELD

DIGITAL SENSORS INC.
4127 N. Figueroa Street
Los Angeles, California 90065
(213) 223-2333 • TWX 213-226-1230

ON READER-SERVICE CARD CIRCLE 84

Flat-pack sealer works through thick and thin



GTI Corp., 1399 Logan Ave., Costa Mesa, Calif., Phone: (714) 546-0411.

The GTI model FP-VP-1 bench-type, single-head, flat-package sealer seals ICs and thin and thick film packages. It will seal glass, Kovar, and ceramic packages and will handle, with proper tooling, packages from 1/4 × 1/8 in. through 1-3/4 in. A data sheet containing a description of the sealer's operating procedures, features and specifications is available.

CIRCLE NO. 319

Fluorocarbon tongs handle substrates

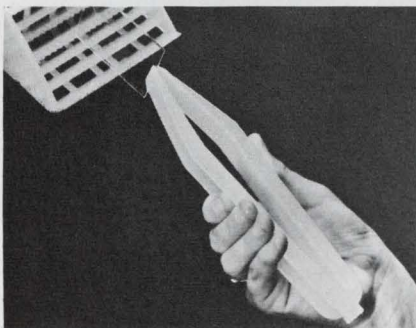

Fluoroware, Inc., Chaska Industrial Park, Chaska, Minn. Phone: (612) 448-3131. Price: \$8.50.

Multiple-purpose tongs, 10 in. in length are molded of CTFE (a fluorocarbon material with special heat and acid resistant properties). The tongs have square off 3/4 in. wide tips suited to handling large substrates and similar components during chemical processing operations. Also manufactured is a complete line of specialized tanks, trays, dippers, tweezers and racks.

CIRCLE NO. 318

CHUBBY IS CHEAPER!

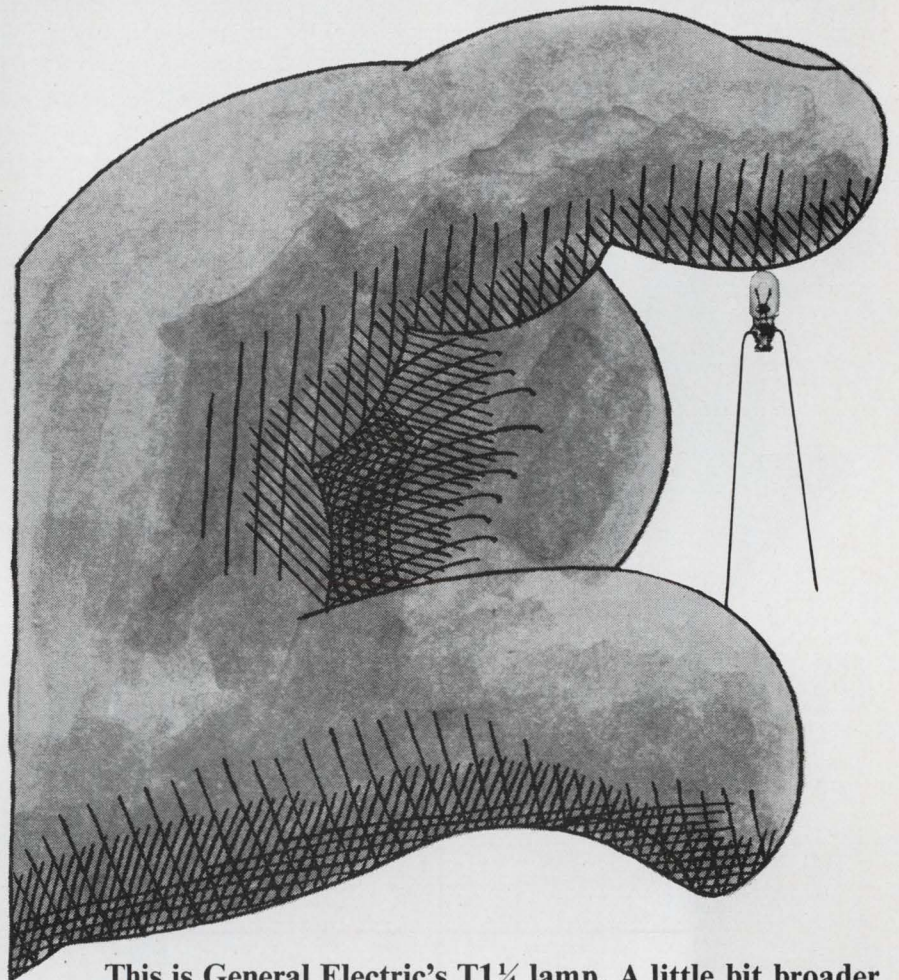

This is General Electric's T1 $\frac{1}{4}$ lamp. A little bit broader around the middle than the GE T1. Just about 40 thousandths broader. Otherwise, identical in nearly every way. Except price. The General Electric T1 $\frac{1}{4}$ costs just one-third as much as the T1! So if you've got space in your design for a little bit of extra bulk, you can save a bundle. For aircraft indicators, computers, photo-chopper and photoexcitation jobs, check up on the chubby T1 $\frac{1}{4}$. Economy-rated General Electric performing T1 $\frac{1}{4}$ lamps:

GE Lamp Number	Design Volts	Design Amps	Approx. Mean Spherical Candlepower	Filament Designation	Max. Overall Length (Inch)	Rated Average Lab. Life (Hours)
583	5	.06	.05±25%	C-2R	¼	100,000+
580	5	.06	.03±25%	C-2R	¼	100,000+
515	5	.115	15±25%	C-2R	¼	40,000+

Miniature Lamp Department

GENERAL  ELECTRIC

ON READER-SERVICE CARD CIRCLE 85

Do you
need a
reliable
**CERAMIC
CHIP
CAPACITOR?**

Pick any one

R12 R14 R16 R23 R25 R27 R29 R31

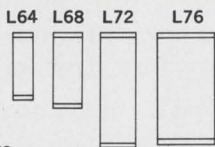
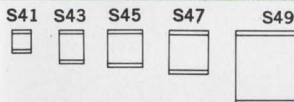

Actual Size

CAPACITANCE RANGE:
10 pF to 1.5 Mfd

WORKING VOLTAGES:
50/100/200 VDC

TEMPERATURE COEFFICIENT:
±15% max. -55° to 125°C

Write for Bulletin No. 120

Monolithic Dielectrics Inc.

P.O. Box 647
Burbank, California 91503
(213) 848-4465

PRODUCTION EQUIPMENT

Pincer gun welder operates from ac or dc



Thermospot, Inc., 7713 S. Western Ave., Chicago, Ill. Phone: (312) 778-0766.

The model 1766 hand-operated pincer gun is one of a group, consisting of pincer, series, probe and push guns, which can be used with either stored-energy (dc) or ac welding supplies for resistance-welding. It features a single quick-adjust to preset electrode force. The electrode diameter is 0.125 in., and the unit weighs 8 oz.

CIRCLE NO. 320

Diffusion furnace handles 24-in. wafers

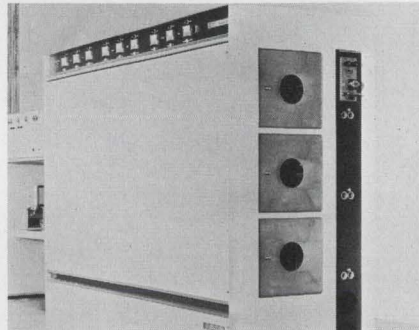

Thermco Products Co., 1465 N. Batavia St., Orange, Calif. Phone: (714) 639-2340.

Semiconductor diffusion furnaces are designed for high-volume production of large-diameter wafers. This unit features uniform heated zones of 20 to 24 in. within ±1/2°C, using process tubes up to 4-1/2 in. in dia. Modular power components simplify servicing. The furnace has throw-away heating chambers, convenient tube heights and second-generation all-solid-state control instruments.

CIRCLE NO. 321

Ultrasonic cleaner has 2 frequencies

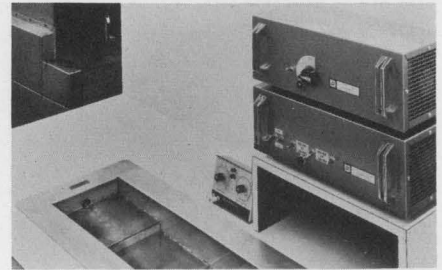

Delta Sonics, 12918 Cerise Ave., Hawthorne, Calif. Phone: (213) 772-1409.

The equipment is available with any number of tanks, though 3 to 5 is most usual. Sizes range from 1 to 10 gallons per tank. The tanks have thermostatically controlled heaters, and recirculating and filtering systems. Two frequencies, 25 kHz or 45 kHz, are available. Some of the models have dual frequency. This system is applicable to the semiconductor industry.

CIRCLE NO. 322

Electron beam welder has 50 kV output

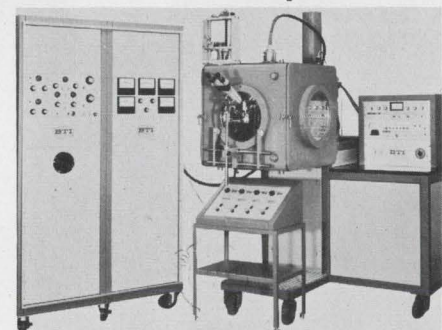

Brad Thompson Industries, Inc., Box CCCC, Indio, Calif. Phone: (714) 347-0637.

A 10-in diffusion pump is standard in this system and is adequate for 10 kW of beam power. A choice of several mechanical pumps is offered, including 50 and 140 ft³/min. Electron guns in several sizes and shapes are available: 0 to 30 and 0 to 50 kV with ratings of 5, 10, 15 and 20 kW. The power package provides automatic regulation of the beam for constant kilovolts, current and focus.

CIRCLE NO. 323



**INDUSTRIAL
TAGS**
Metal or Plastic

MULTI-PURPOSE & ELECTRICAL

**INVENTORY TAGS
TOOL CHECKS
PROPERTY TAGS**

Aluminum, Brass, Steel, Colored
Aluminum, etc. Consecutively
or special sequence numbered.

*Write for Free
Complete Catalog*

SLOT & TONGUE

Single or double slot and tongue
patterns.
Identify groups of wires posi-
tively.

WRAP AROUND

Perfect for single wire identi-
fication.

STRAP-ON TAGS

For items of large diameter.

NATIONAL BAND & TAG CO.

721 York St., Newport, Ky. • Phone 261-2035

ON READER-SERVICE CARD CIRCLE 87

"IT'S GOOD BUSINESS
TO HIRE THE HANDICAPPED."

ISN'T THAT A GREAT IDEA, SNOOPY?



THE PRESIDENT'S COMMITTEE ON EMPLOYMENT
OF THE HANDICAPPED, WASHINGTON, D. C.

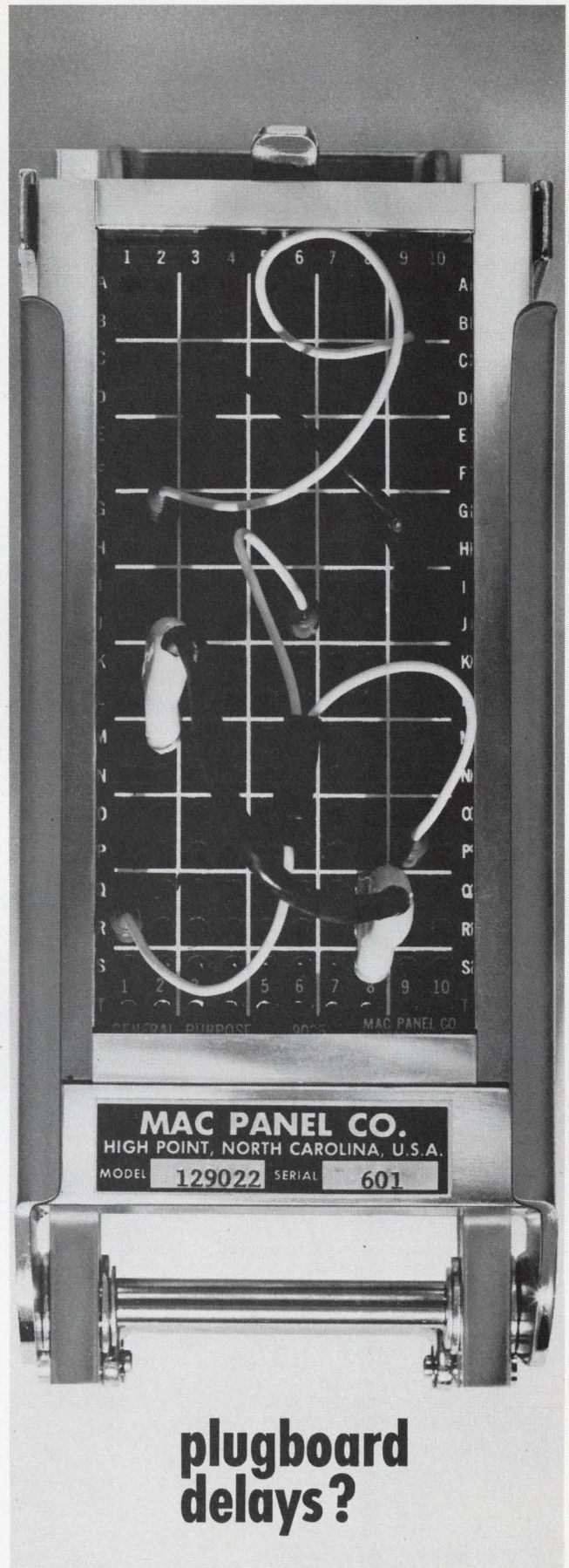

MAC PANEL CO.
HIGH POINT, NORTH CAROLINA, U.S.A.
MODEL 129022 SERIAL 601

**plugboard
delays?**

MAC ships off-the-shelf!

ON READER-SERVICE CARD CIRCLE 88

GREAT NEW WAY TO BUY DC POWER

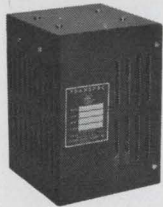

ERA's Wide-Range, Variable, All-Silicon DC Power Modules at Low, Low Prices

ERA's new Value-Engineered DC Transpac® power modules provide all-silicon, DC power in a wide-range, variable, low cost module.

Stocking problems are reduced to a minimum and power module obsolescence is practically eliminated. Design changes are easily accommodated since all units can be set to desired voltages by a simple external tap change.

Output Voltage (DC)	Current (71°C)	Model	Price
4-32	0-750 ma	LC32P7	\$ 89.00
4-32	0-2 amps	LC322	\$115.00
4-32	0-5 amps	LC325	\$179.00
4-32	0-10 amps	LC3210	\$215.00
30-60	0-1 amp	LC601	\$145.00

Over-Voltage Protector Option: Add \$35.00 to above prices and Suffix V to Model No. (i.e. LC325V, etc.).

SPECIFICATIONS

Input: 105-125 VAC, 50-400 cps
Ripple: Less than 800 microvolts RMS or .005%, whichever is greater
Line Regulation: Better than $\pm 0.01\%$ or 5 mv for full input change
Load Regulation: Better than 0.05% or 8 mv for 0-100% load change
Voltage Adjustment: Taps and screwdriver adjustment
Short Circuit Protected: Automatic recovery
Vernier Voltage: External provision
Transient Response: Less than 50 microseconds
Operating Temperature: -20°C to + 71°C free air, full ratings
Maximum Case Temperature: 130°C
Temperature Coefficient: Less than 0.01% per degrees C or 3 millivolts
Long-Term Stability: Within 8 millivolts (8 hours reference)

Write Today for Catalog #147



ELECTRONIC RESEARCH ASSOCIATES, INC.

Dept. ED-12, 67 Sand Park Road
 Cedar Grove, N. J. 07009 • (201) 239-3000
 Subsidiaries: ERA Electric Co. • ERA Acoustics Corp.
 ERA Dynamics Corp. • ERA Pacific, Inc.

ON READER-SERVICE CARD CIRCLE 90

MICROWAVES

Color filter passes 12 kV

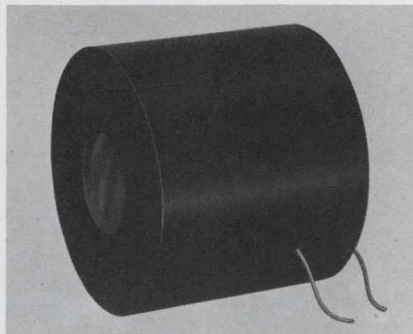

Electrochrome Corp., 11 Commercial St., Plainview, N.Y. Phone: (516) 433-0808. P&A: \$350; 3 wks.

Electronically variable optical color filter is useful in the field of lasers, television, optical data processing, graphic arts and display systems. It is voltage tuneable over the visible spectrum and can be modulated from dc to 8 MHz. Capacitance is approximately 6 pF. The model 755S passes cyan from 0 to 2 kV, magenta from 5 to 7 kV and yellow from 10 to 12 kV.

CIRCLE NO. 324

Coax switches function to 4 GHz

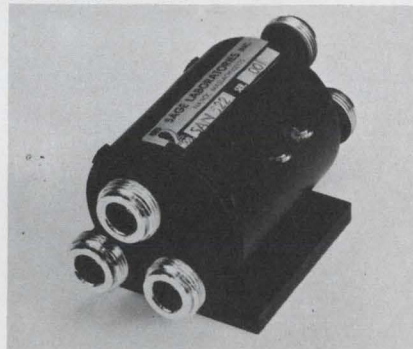

Sage Laboratories, Inc., 3 Huron Dr., Natick, Mass. Phone: (617) 653-0844. P & A: \$150 to \$165.75 ea.; stock.

Linear solenoid fail safe coaxial switches cover dc to 4 GHz. Over the full range, the insertion loss is less than 0.2 dB and VSWR is less than 1.3. Isolation is greater than 40 dB from dc to 2 GHz, and greater than 20 dB to 4 GHz. Power capability is 50 W CW and 3 kW peak. These units feature 10 ms switching time. Available connector types are female N, TNC, BNC, HN and C.

CIRCLE NO. 331

**FOR HIGHEST
INSULATION
RESISTANCE**

Stabelex "D"
CAPACITORS

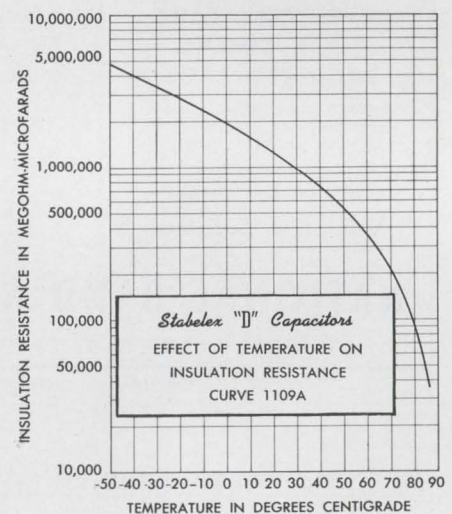
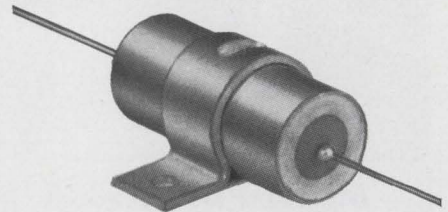

Insulation resistance of STABELEX Capacitors can reach 10,000,000 megohm-microfarads or more at room temperature or above under certain operating conditions. This feature, plus their low temperature coefficient of capacity, low power factor and extreme stability, makes STABELEX Capacitors the logical choice for instrumentation and other advanced circuitry.

When you need more than either laboratory type or commercial capacitors can offer, specify STABELEX!

OUTSTANDING CHARACTERISTICS OF *Stabelex* CAPACITORS

- Extremely high insulation resistance
- Low temperature coefficient of capacity
- Extreme low losses and power factor
- Extremely low dielectric absorption
- High "Q"
- Hermetically sealed

For complete specifications, write for STABELEX Catalog No. 1117C

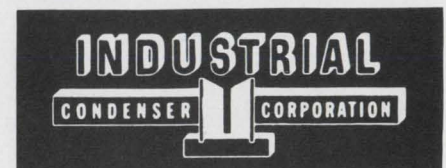

3243 No. California Ave.
 Chicago, Illinois 60618

ON READER-SERVICE CARD CIRCLE 91
 ELECTRONIC DESIGN 25, December 6, 1967

Diode switch has 12 ranges

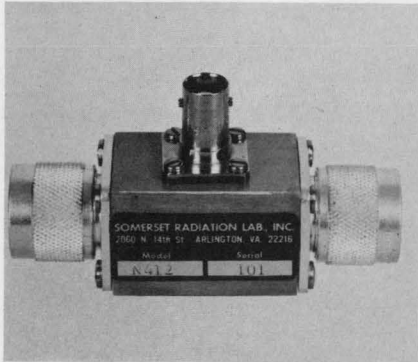

Somerset Radiation Lab., Inc., 2060 North 14th St., Arlington, Va. Phone: (703) 525-4255. P&A: \$330; 20 days.

The N412 diode switch with Type N plug connectors cover the WR75, WR90, WR112, WR137, WR159, WR187, WR229, WR284, WR340, WR430, WR510 and WR650 waveguide bands. From 1.12 to 15 GHz the device has 45-dB isolation, 2 dB insertion loss and 2 W CW and 100 W peak power. It is hermetically sealed for radar, satellite, missile, and target enhancement service.

CIRCLE NO. 332

Radar simulator checks receivers

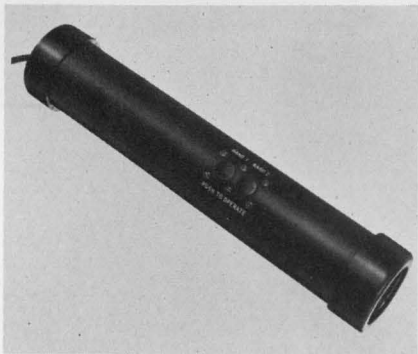

Trak Microwave Corp., Tampa, Fla. Phone: (813) 884-1411.

This radar transmitter simulator eliminates the necessity of turning on the radar transmitter to check receiver performance. It is self contained, except for the dc power requirement of 28 V at 1 A and can be hand held. The 2960 includes two oscillators plus power supply/modulator and antenna. It operates on two microwave bands which are selected by momentary on switches.

CIRCLE NO. 333

This is our 3 step. Give us a call and see all the steps in our routine.

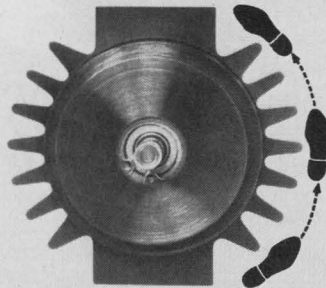

If you really want to swing you can also step 4, 8, 12, 24, 48, and 200 increments without gears.

Or to Indicate, Measure and Control using flag and remote angle indicators, synchros, resolvers, steppers, or solenoids. They are in stock at IMC Magnetics Corp., Western Division. For quick service contact the Applications Section at Western Division, 6058 Walker Ave., Maywood, Calif. 90270. Phone 213 583 4785 or TWX 910 321 3089.

If you need data sheets for references or consideration for future projects, write IMC's Marketing Division at 570 Main Street, Westbury, New York 11591.



ON READER-SERVICE CARD CIRCLE 92

Why you won't get burned with an IMC vaneaxial fan.



Airmoving capability. A vaneaxial fan is the most versatile of all the airmovers. It has a high aerodynamic efficiency over a wide range of specific speeds and offers the lowest noise level of any airmover when used properly. Primarily because of high efficiency. Delivers exceptionally well against high back pressures. **Mechanical** and other advantages. Long life—the motor is cooled by the air passing over it. Exceptionally good resistance to shock and vibration because there are no overhanging

parts. Good mechanical balance. Because of the rigidity of the moving parts and easy mounting in duct work (can be flanged at both ends). **Cost** is competitive with other types. **Competence.** IMC designs and produces the entire airmover (motors, impellers, housings, gas bearings) to the demanding requirements of the Minuteman, TFX, and other advanced projects. We also produce standard vaneaxials ranging from the IMCube (1-inch cube) to real big blasters, producing thousands of cfm.



IMC Magnetics Corp., Eastern Division, 570 Main St., Westbury, N.Y. 11591
Phone (516) 334-7070 or TWX 510 222-4469

ON READER-SERVICE CARD CIRCLE 93

PRECISION 1000.000 KHz

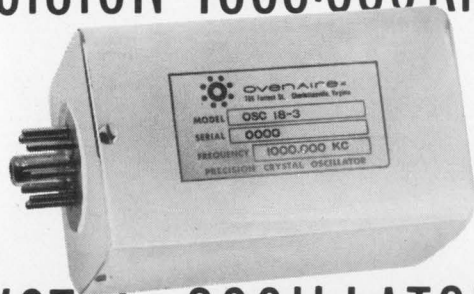

OSC 18-3

CRYSTAL OSCILLATOR

STABILITY*

Long term: Aging rate 3×10^{-9} /day

Short term: $\pm 5 \times 10^{-10}$

*Complete specifications for this oscillator available in brochure. Other stabilities and frequencies available to published specifications.

- Excellent solid state oscillator design utilizes proportional control oven.
- Oven temperature matched to crystal turn provides exceptional stability for precise requirements.
- Oven ambient compensation techniques produce top performance over a wide temperature range.
- Each oscillator is preaged prior to shipment and guaranteed to specification.



OVENAIRE INC.

706 FORREST STREET
CHARLOTTESVILLE, VIRGINIA 22901

**FREQUENCY COMPONENTS DIVISION
WALTER KIDDE & COMPANY, INC.**

OVENAIRE, INC.
Charlottesville, Va.

CROVEN, LTD.
Whitby, Ontario, Canada

FILTAIRE, INC.
Charlottesville, Va.

ON READER-SERVICE CARD CIRCLE 94

MICROWAVES

Diode switch covers 400 to 1100 MHz



Microwave Associates, Burlington, Mass. Phone: (617) 272-3000.

The MA 8307 IL3S switch has been designed to protect radar receivers from high-power pulses. It operates in the 400- to 1100-MHz frequency range with a max insertion loss of 0.5 dB, VSWR of 1.4 max and isolation of 80 dB max. In the isolation state peak power is 20 kW and average power is 50 W; in the receive state peak power is 300 W and average power is 50 W. Switching speed is $2 \mu\text{s}$ max.

CIRCLE NO. 334

New high efficiency, high frequency Photochopper Modules

- High stability from -25 to $+75\text{C}$, efficiency varies less than 5% over temperature range
- 50% efficiency at 1000 Hz
- Internal electrostatic shielding
- CdS cells for fast warm up

Write for new Bulletin 201/ITD3-67

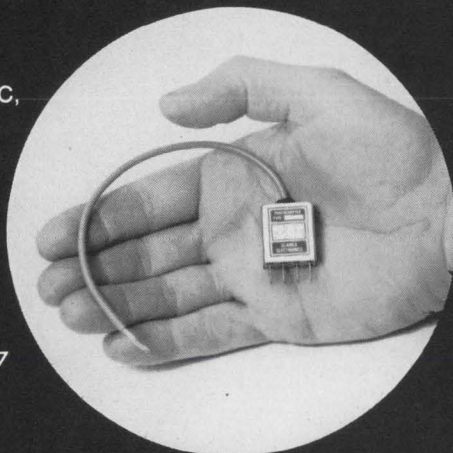

INC. ■ 1239 BROADWAY, NEW YORK, N.Y. 10001

ON READER-SERVICE CARD CIRCLE 95

Low-pass filter cuts from 20 to 10 GHz

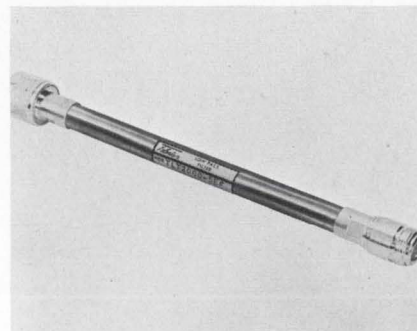

Telonic Engineering Co., Box 277, Laguna Beach, Calif. Phone: (714) 494-9401.

This low-pass filter may be specified for any cutoff frequency from 2 to 10 GHz, and is available in standard, off-the-shelf versions with cut-offs every 1000 MHz. The devices have a passband of $0.4 f_c$ to f_c , impedance 50Ω , max passband VSWR 1.5:1, and insertion loss from 0.23 dB to 1.13 dB, depending on the number of sections.

CIRCLE NO. 335

X-band isolators span 7.5 to 10 GHz

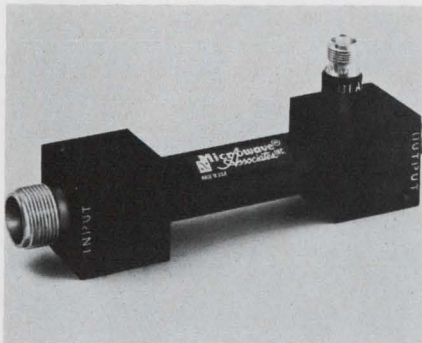

Microwave Associates, Burlington, Mass. Phone: (617) 272-3000.

This subminiature terminated circulator is for operation in the frequency range between 7.5 and 10 GHz. Featuring 20 dB isolation, 0.3 dB insertion loss, the model MA 7K 275 measures 1-1/4 × 19/32 × 27/32 in. overall. The isolator is capable of handling power levels up to 10 W with operation guaranteed over a temperature range from -40 to +75°C.

CIRCLE NO. 336

Crystal detector spans 18 GHz



Hewlett Packard, 1501 Page Mill Rd., Palo Alto, Calif. Phone: (415) 326-7000. P&A: \$160; 2 wks.

Frequency range of this detector, HP model 8472A, is from 10 MHz to 18 GHz, and its frequency response over this full band is better than ±1 dB. In the lower portion of this band (below 8 GHz), response is ±0.2 dB per octave. At 12.4 GHz, response variations are less than ±0.5 dB. The detector's VSWR is less than 1.2 at 4.5 GHz, below 1.35 at 7 GHz, under 1.5 at 12.4 GHz and less than 1.7 at 18 GHz.

CIRCLE NO. 337

VACTEC

PHOTOCELLS

Would you believe 48,000 per hour?



That's the capacity of this 4-ft. dia. high vacuum system. (And Vactec has two of them!) Just one example of the modern equipment in Vactec's new plant.

Facilities like this, plus engineering know-how and production skill have made Vactec one of America's largest photocell specialists. An ideal supplier if your applications demand prompt delivery of large quantities of photocells at competitive prices.

Standard Cds, CdSe, and Se types. Custom engineering to meet special needs. Catalogs and facilities brochure available on request.

VACTEC, INC.



2423 Northline Ind. Blvd.
Maryland Hts., Mo. 63042 AC 314, 432-4200

See Vactec's listing in EBG under "Semi-Conductors" and in EEM Sec. 3700.

ON READER-SERVICE CARD CIRCLE 96

IC PACKAGING PANELS

WITH CONNECTOR TAKE-OFF

for high density packaging

HIGH PERFORMANCE
FAST DELIVERY
LOW COST

PANELS For 14 and 16 Lead Plug-In IC's

- 30 and 60 patterns standard
- Double-sided board with power and ground planes at each pattern
- Wiping-action contacts assure high reliability
- Wire-Wrap® or solder pot terminations

®Trademark Gardner-Denver Co.

Request Complete I. C. Folder

AUGAT INC.

TEL: 617-222-2202
31 PERRY AVE., ATTLEBORO, MASS. 02703

ON READER-SERVICE CARD CIRCLE 97

Whatever your display application,
Dialco has the right

SUB-MINIATURE INDICATOR LIGHTS!

Designed to Meet or Exceed Environmental and
Operational Requirements of MIL-L-6723 and MIL-L-3661.

The chances are Dialco has the particular assembly you
require... and off the shelf for prompt delivery. Sub-
miniatures mount in 15/32" or 17/32" clearance hole—
accommodate Incandescent lamps for 1.35 to 28V circuits
—or Neon lamps for 105-125V AC-DC or 110-125V AC. In
Dialco units, the current-limiting resistor is built-in (U.S.
Pat. No. 2,421,321).

Other features available: water-tight construction;
anti-rotation (locked) construction; dimming or non-
dimming feature; and a wide array of lens shapes
and colors with or without hot-stamped or engraved
legends.

SAMPLES ON REQUEST—AT ONCE—NO CHARGE

For complete data—ask for our
new 12 page catalog today!

DIALCO

Foremost Manufacturer of Indicator Lights

DIALIGHT CORPORATION

60 STEWART AVE., BROOKLYN, N.Y. 11237

AREA CODE 212 497-7600

ON READER-SERVICE CARD CIRCLE 98

(Illus. approx. actual size)

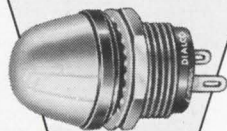

177-8430-0931-503

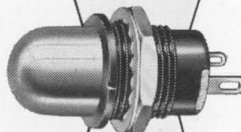

162-8430-0931-502



134-8430-0351-201

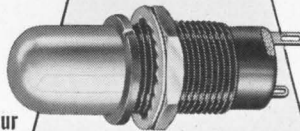

137-8836-0931-552

MATERIALS

Vinyl aerosol protects and seals



Quelcor Inc., Box 33, Media, Pa.
Phone: (215) 544-7710.

When the aerosol is applied, it
dries in minutes, encasing parts or
surfaces with a film of Vinyl Copoly-
mer. It seals out moisture and cor-
rosive fumes, provides excellent
moisture resistance, self adheres,
has a built in ultraviolet ray ab-
sorber, and high dielectric strength
for insulation. It is available clear
and in 12 colors and furnished in
bulk for larger surface applications.

CIRCLE NO. 338



has hundreds of Aircraft and Industrial solenoids



Look to WesCo engineers with your aircraft or industrial
solenoid problem. Hundreds of proven designs available.
WesCo will modify or furnish special designs to fit your
specifications.

Here are some of the features available:
High temp units tested past 600°F. • Adjustable plunger
travel • Plunger cavity pressure sealed • Push or pull types
12 to 115 volts • Miniature, medium and heavy duty types
• 400 cycle AC units also available.

Remember, when you need a solenoid, think of WesCo
AC INDUSTRIAL SOLENOIDS—full line. Write for brochure.
DC AIRCRAFT SOLENOIDS—send specifications, or write
for catalog.

The trademark on.
millions of solenoids since 1927



**WEST COAST
ELECTRICAL MFG. CORP.**

233 WEST 116TH PLACE • DIVISION 110
LOS ANGELES 61, CALIF. • PLYMOUTH 5-1138

ON READER-SERVICE CARD CIRCLE 99

Tailored graphite in 10 sample grades



POCO Graphite, Inc., P.O. Box
1524, Garland, Tex. Price: \$16.50.

Ten grades of graphite, each tai-
lored for a specific semiconductor
or metallurgical process, are avail-
able for testing. Applications for
the graphites include crystal grow-
ing and zone refining epitaxial
headers, connectors and hot press-
ing. They also find use in transis-
tors and other alloying, diodes and
flat package ICs. Each new grade
has been laboratory and field
tested.

CIRCLE NO. 339

SEMICONDUCTORS

TO 99 op amps operate on +24 V

Union Carbide Electronics, 365 Middlefield Rd., Mountain View, Calif. Phone: (415) 961-3300.

The UC 709 and UC 4200 are a family of operational amplifier ICs in 8 lead TO-99 packages. The UC 4200 IC op amp is a high-voltage circuit that makes it usable for aerospace and airframe applications. It will operate from a +24 V power supply. The UC 4200 has supply current of 2.3 mA. Both devices have an input impedance of 3 M Ω , are short circuit proof, have an average temperature coefficient of input offset voltage of 6 V/ $^{\circ}$ C typical, and operate in the temperature range of -55 to +125 $^{\circ}$ C. The UC 709 is designed for 709 application requirements. Significant features of this device are a power dissipation of 48 mW; operating supply voltage of +15 V; and supply current of 1.6 mA.

CIRCLE NO. 340

Power rectifiers handle 50,000 PIV

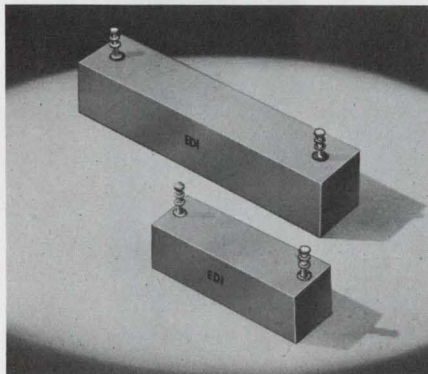

Electronic Devices, Inc., 21 Gray Oaks Ave., Yonkers, N.Y. Phone: (914) 965-4400. P&G: \$19.30 • (100 lot).

RVP series of silicon rectifiers have peak inverse voltages from 5,000 to 50,000 V and forward currents of 600 to 800 mA at 50 $^{\circ}$ C ambient. The rectifiers feature 300 ns recovery time when measured from 500 mA forward current to 250 mA reverse current. Available in molded block form, they are suitable for lasers, radio and radar transmitters.

CIRCLE NO. 341

200-A rectifier comes with heat-sink



International Rectifier, 233 Kansas St., El Segundo, Calif. Phone: (213) 322-3331. Price: from \$6.50 to \$17.80 (1-9).

A unique package has been designed for 200-A silicon rectifiers that are capable of handling 3500 A of surge current. The silver-plated, flat-tab anode terminal provides an excellent heat sink, as well as a convenient electrical connection. This allows cable to be connected directly to the device rather than to terminal or terminal blocks.

CIRCLE NO. 342

Square-law generator uses silicon carbide



Bourns, Inc., 1200 Columbia Ave., Riverside, Calif. Phone: (714) 684-1700.

The model 4107 Quadratron square-law function generator affords an accurate and economical means of obtaining a large class of nonlinear mathematical functions. The 10-V version, measuring 5/8 in. in dia and 21/64 in. high, and the 100-V version, measuring 5/8 in. in dia and 35/64 in. high, are applicable at low cost over a wide dynamic range. The device is capable of generating square-root, sine, cosine, tangent and many other functions.

CIRCLE NO. 343

Product of Sigmund Cohn Corp.

Beryllium Copper

"Memory"

Wire

- Bright
- Round
- Smooth
- Straight
- Quality-Controlled—through every step of production—to be certain that this Beryllium Copper Wire conforms to the high standards of performance maintained by our plant for over 67 years...

Write for Engineering Data

Sigmund Cohn Corp.

121 South Columbus Ave.,
Mount Vernon, N.Y. 10553



Since 1901



Delivered on
Special Spools

Orcon® Lighted Pushbutton Switches

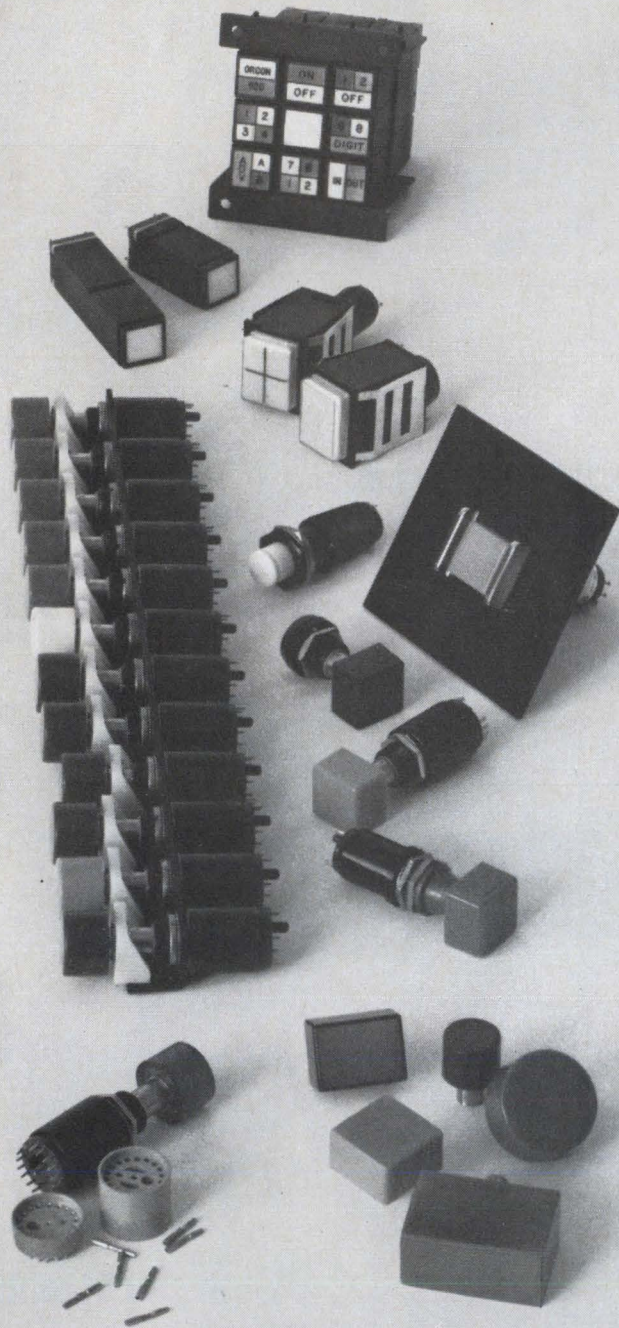

ORCON switches combine exclusive multicircuit capacity, isolated contacts, sliding-wiping action, independent light circuit and connector convenience in $\frac{3}{4}$ " and $\frac{1}{16}$ " diameter sizes. Standard, solenoid hold-in, square multilight, electroluminescent, crimp contact connector and custom switches available. Plus indicator lights, ganged assemblies, adapters and accessories. For new brochure, contact USECO, 13536 Saticoy Street, Van Nuys, California 91409. (213) 873-3520.



Division of Litton Industries



Design Aids

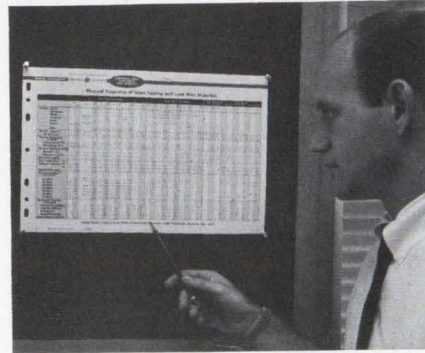

Glass and wire properties

A chart of physical properties for glass sealing and lead wire materials includes data on composition, density, thermal and electrical conductivity, electrical resistivity, curie and melting temperatures, specific heat, thermal expansion, mechanical properties, and elastic modulus for glass sealing materials, metal alloy lead wires, clad materials, and pure metals. GE manufactures tungsten, molybdenum, and Dumet wire, and furnishes these and other materials in lead wires for lamp, electronic semiconductor and other applications. General Electric Co.

CIRCLE NO. 344

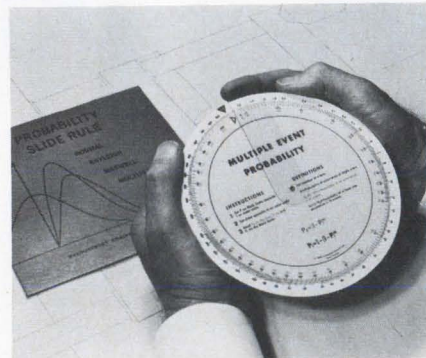

Probability slide rule

A rule that allows you to obtain numerical answers to a wide variety of problems in statistics and probability, especially useful to statisticians, mathematicians, students of probability and engineers is being offered. It provides computations to three or four decimal places, depending upon the scale used. It is useful for analysis of random data, testing of hypothesis and prediction of results.

Available for \$7.95 from TAD Products Corp., 639 Massachusetts Ave., Cambridge, Mass.

Application Notes

Applications for stainless wire

A brochure describing the use of a permeable mesh for boundary layer turbulence control around aerodynamic surfaces also cites triggering lanyards for aerial flares, the use of fine wire bundles in precise lengths for electronic clouds, and current research in super tensile stainless steel wire. Listed too are developments in high-resiliency wire used for wildlife radio-tracking antennae, fatigue-resistant wires used in medical applications, and high-temperature materials for space-vehicle parabrakes. Fort Wayne Metals, Inc.

CIRCLE NO. 345

Alloy guide

The shirt-pocket-size booklet contains the metal composition, physical properties, mechanical properties, fabrication characteristics and suggested applications for 22 commonly used alloys. Included are twelve common brasses and bronzes, tinned brasses and bronzes, a group of phosphor bronzes and a nickel-silver alloy. A special section discusses custom alloys designed to meet specific requirements and unusual specifications. Bridgeport Rolling Mills Co.

CIRCLE NO. 346

Basic circuits

Certain basic relay combinations and characteristics achieve specific circuit results in telephony. These basic circuits have become the building blocks of automatic telephone switching. Adaptable to other automated tasks, they are finding new and increasing uses in industry every day. This book depicts a few such basic circuits. It is recommended that the information in this book be used only as a guide to determine the availability of a circuit and its components. Automatic Electric Co.

CIRCLE NO. 347

EMI/RFI SHIELDED ENCLOSURES ... EIA CABINET MOUNTED

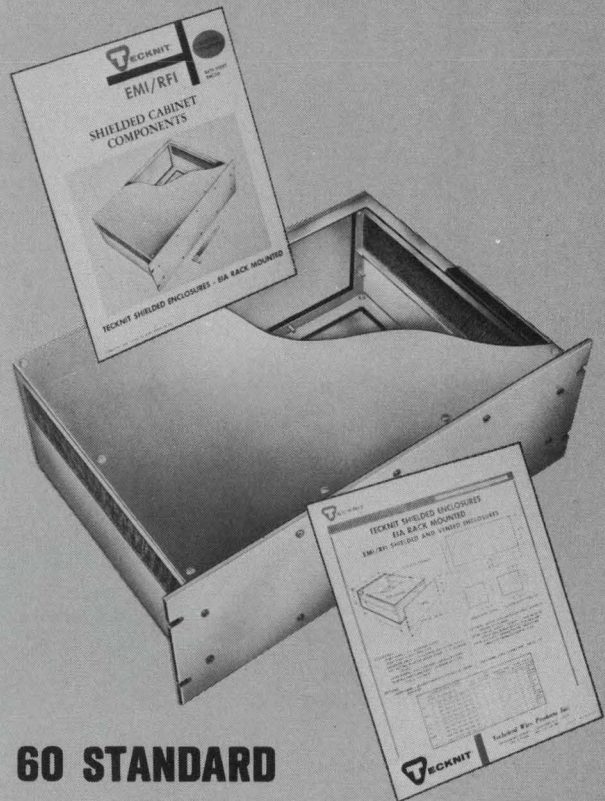

60 STANDARD ENCLOSURE SIZES AVAILABLE . . .

By-pass your EMI/RFI packaging problems by selecting from ten standard front panel sizes, each quickly available in six enclosure depths, from 12" to 27".

These sixty standard EIA shielded and vented enclosures are provided with removable top and bottom covers, front and rear panels. Every shielded enclosure features standard EMI/RFI-tight vents. All cover and panel seams are EMI/RFI gasketed. Captive fasteners and screws are included, properly spaced to insure effective shielding. The standard enclosures readily accommodate slides for drawer installation. Optional fabricated panels, ready-to-mount your components, as well as painting and marking are also available. . . . Save valuable time in your design and procurement activities.

TECHNICAL WIRE PRODUCTS, INC.



East Division • 129 Dermody St.,
Cranford, N.J. 07016 (201) 272-5500
West Division • 427 Olive St.,
Santa Barbara, Calif. 93101 (805) 963-1867

"SEE US IN THOMAS REG. AND EEM."

Technical Wire Products, Inc.

129 Dermody St., Cranford, N. J. 07016

Yes, I'm interested in your new EMI/RFI Shielded EIA Rack Mounted Enclosures. Please send me data sheets with parts information and effectiveness reports via Air Mail. INFO. No.-100

Name _____ Title _____

Company _____

Street _____

City _____ State _____

ON READER-SERVICE CARD CIRCLE 102

New Literature



RFI/EMI Kit

A designer's kit is available to assist engineers in the proper selection of rfi/emi and magnetic shielding materials. The kit contains samples of a wide variety of rfi/emi magnetic shielding materials, and is available free of charge. Primec Corp.

CIRCLE NO. 357

Thermal relays

An insert-type brochure which describes the manufacturer's line of hermetically sealed thermal relays, details reference curves, operational details, time ranges, applications and specifications. Included in the presentation are T, T, and H series miniature time delays, LT series subminiature time delays, and PT series high-precision time delays. G-V Controls, Inc.

CIRCLE NO. 264

Oscillators and testers

Recently published is a brochure describing the manufacturer's line of microwave oscillators, turnable coherent synchronizers, discrete frequency synchronizers, microwave stability testers, pulse jitter testers and MTI radar test sets. The catalog relates electrical specifications for models, pointing out the features of each instrument. A description of the development of the instrument line is also given. LFE Electronics.

CIRCLE NO. 265

Vacuum tubes treatise

A 19-page catalog containing charts and illustrations discusses special purpose vacuum tubes. Also covered in the presentation are multiplier phototubes, vacuum photodiodes, image dissectors, electron multipliers, image converters, correlation devices and accessories. ITT, Industrial Laboratories.

CIRCLE NO. 266

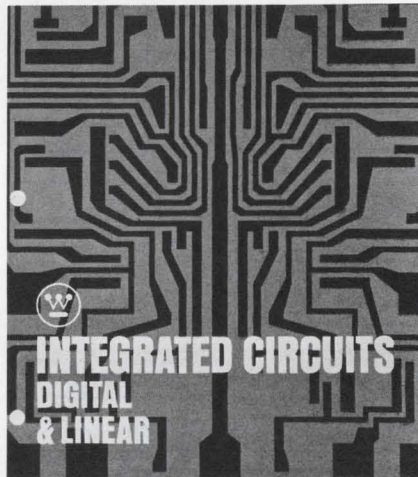

Digital and linear circuits

An 8-page reference guide presents schematic diagrams, design features, and model designations of various digital and linear ICs. The digital circuit line includes a range of DTL, TTL, and E²CL circuits such as NAND gates, flip-flops, line drivers, level detector/Schmitt triggers and diode arrays. The linear circuit line includes operational and differential amplifiers, power circuits, high-speed gates, and the resonant gate transistor. Westinghouse Molecular Electronics Div.

CIRCLE NO. 267

Guide to silicones

Contained in a recently issued brochure are products having federal stock numbers. The 56-page reference includes indexes of federal stock numbers, military specifications, products and product descriptions. The catalog is presented in an easily comprehended manner. Dow Corning.

CIRCLE NO. 268

Tube replacement release

A 16-page brochure on direct replacement of high-voltage, high-current rectifier tubes with the manufacturer's stackable silicon doorbell rectifier modules mated with tube-type bases and anode caps has been made available. Contained in the publication are: a listing of the advantages of using solid-state doorbell modules over rectifier tubes, details of the modules construction, a case history, and direct replacement data on over 50 rectifier tubes which includes the tubes' maximum ratings. Charts, schematics and illustrations are included in the presentation. Unitrode Corp.

CIRCLE NO. 269

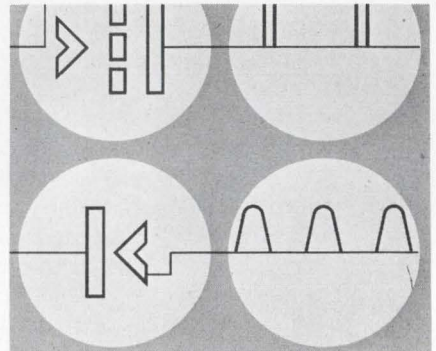

Power tubes treatise

Described in an illustrated 20-page quick reference guide is a line of high vacuum amplifiers, pulse tubes and diodes. A series of tables listing the electrical and mechanical characteristics of different tube types that comprise the power tube line is included. The types included in the booklet are amplifier and pulse tubes, both triode and tetrode; and rectifier, clipper and charging, control and current-limiting diodes. A dimensional diagram is given for the tubes listed. A cross reference lists each tube by number, gives the class of service in which it is normally used, and the page on which it is described. Westinghouse Electronic Tube Div.

CIRCLE NO. 270

40378
7A RMS current, 200V
(Surge current = 80A)
(2-lead TO-5)

2N3228
5A RMS current, 200V
(Surge current = 60A)
TO-66

2N3528
2A RMS current, 200V
(Surge current = 60A)
TO-8



These **3** RCA SCR's sell for only **98¢*** each

... and offer
circuit capability of
devices that
cost many times more!

ONLY FROM RCA... one low price plus a choice of current ratings *and* packaging... for a broad range of 120-V line-operated control circuits. For low-current power control without use of a heat sink, ask for the 2N3528... for medium-power loads with the lowest dollars per kilowatt ratio, ask for the 2N3228... and for a really small package adaptable to semi-automatic or batch mounting, ask for the 40378. They all offer cost and performance advantages that should be built into *your* control circuits!

400-volt versions of these SCR's are also available for as little as \$1.40*. Your RCA Field Representative will be happy to give you more details. *And ask him, too, about RCA's special heat-sinking techniques for TO-5 packages which gives you the power-handling capability of a press-fit without the added cost.* For additional technical data, write RCA Commercial Engineering, Sec. RG 12-1, Harrison, N.J. 07029.

See your RCA Distributor for his price and delivery.

*Prices in quantities of 1,000 and up

RCA Electronic Components and Devices



The Most Trusted Name in Electronics

ON READER-SERVICE CARD CIRCLE 103

CUSTOM-MADE

R-C Networks

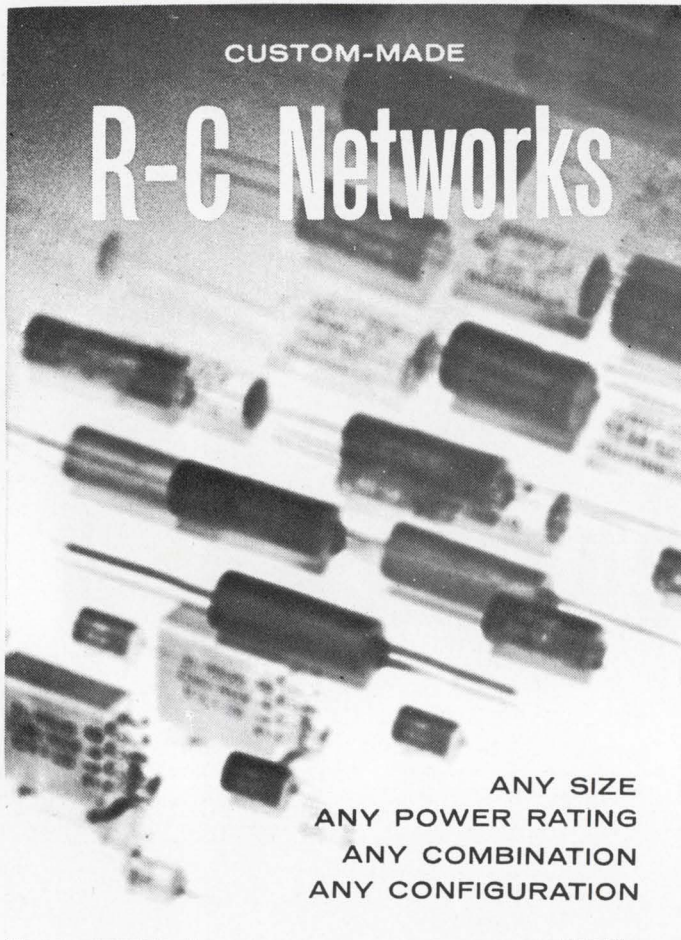

ANY SIZE
ANY POWER RATING
ANY COMBINATION
ANY CONFIGURATION

- For • RFI Suppression • Arc Suppression
• Relay Contact Protectors • Noise Filters
• Spark Suppression

R-C Networks available in any combination, for example:

Capacitor Section can be . . . Mylar, Metalized Mylar, Polystyrene, Polycarbonate . . . any voltage or tolerance.

Resistor Section can be . . . Composition, Wire-wound, Metal Film, Deposited Carbon . . . in any wattage or tolerance.

Total Networks available in tolerances as close as $\pm 1\%$.

All Networks are manufactured under rigid Quality Control to meet your specific requirements.

Send us your specifications for quotation. Prototype quantities furnished prior to production.

For Complete details write Dept. ED-II



1065 W. Addison Street, Chicago, Illinois 60613

ON READER-SERVICE CARD CIRCLE 104

NEW LITERATURE

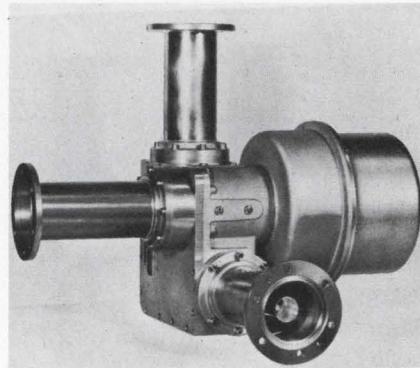

Coaxial switches

A comprehensive 106-page volume, covering instruments and components includes specifications and prices. The presentation covers a discussion of high-power coaxial switches for motor driven or manual applications, including militarized switches designed to withstand shock, vibration, extreme temperature ranges, humidity and salt spray. The CW rf power rating of the switches is equal to that of the mating transmission line with peak power ratings up to MW. Alford Manufacturing Co.

CIRCLE NO. 271



Engineering, design and research reference

A publication containing 4,000 chapters is directed at personnel in engineering, design, production, research and development departments. Instrument quality diffraction grating replicas reproduced from high quality imported masters, a six-power pocket comparator, and nickel cadmium batteries and cells, rechargeable and having almost unlimited lives, are among the subjects covered in the presentation.

Available on company letterhead from Edmund Scientific Co., 301 E. Gloucester Pike, Barrington, N.J.

MATERIAL	TENSILE STRENGTH (PSI)	CHARPY IMPACT RESISTANCE (IN. LBS.)
Alumina	18,000 to 35,000	6.5 to 8.0
Zirconia	10,000 to 12,000	5.5
Mullite	11,000	5.5
Steatite	10,000	4.0 to 5.0
Forsterite	10,000	4.0
Elec. Porcelain	6,000 to 8,000	4.0

Alumina and beryllia

A 17-page color catalog discusses ceramics and their specific characteristics. Such features as strength, hardness, stability, thermal conductivity and nuclear and electrical properties of the alumina and beryllia ceramics are detailed. Property charts and graphs are included in the presentation. Coors Ceramics.

CIRCLE NO. 272

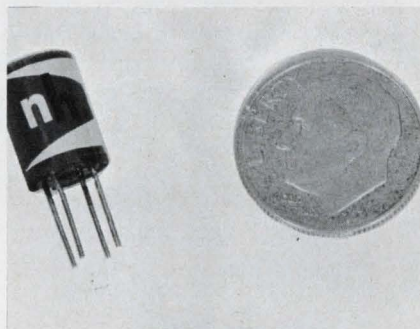

Relay lamp driver

A data sheet describing an integrated relay lamp driver is described in a literature being offered. The folder gives a description of the driver, contains schematic and connection diagrams, typical applications ratings and electrical characteristics. Also included are performance curves and definitions of terms. National Semiconductor Corp.

CIRCLE NO. 273

Instrumentation reference

A 32-page reference guide covers the manufacturer's line of electronic measuring and recording products. It provides information on instruments built by the division's three manufacturing plants. The guide can be used as a file folder or can be converted to a three-ring binder for bookshelf use. Special fasteners permit insertion of additional product information for up-dating purposes. The catalog also contains information about the division's nationwide network of meteorology laboratories that provide repair and calibration service to users of such equipment. Honeywell, Test Instruments Div.

CIRCLE NO. 274

**IF THIS
MINIATURE METAL
FILM RESISTOR
DOESN'T CHANGE YOUR
*design ideas***

...try one of these

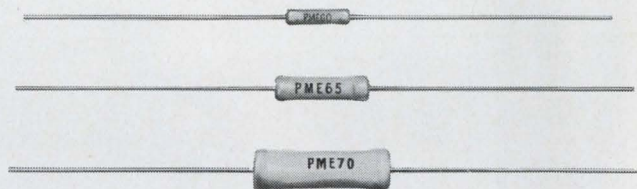

Part No.	Power	Ohms	Tol.	Temp. Coef.
PME 50	1/20 W	10Ω to 1M	±1% to .1%	T-0, T-2, T-9
PME 55	1/10 W	10Ω to 3M	±1% to .1%	T-0, T-2, T-9
PME 60	1/8 W	49Ω to 7.5M	±1% to .1%	T-0, T-2, T-9
PME 65	1/4 W	49Ω to 20M	±1% to .1%	T-0, T-2, T-9
PME 70	1/2 W	24Ω to 30M	±1% to .1%	T-0, T-2, T-9
PME 75	1 W	49Ω to 50M	±1% to .1%	T-0, T-2, T-9

The stability and accuracy of Pyrofilm's PME metal film resistors makes their use ideal in applications where before only wire wound resistors could be used. These resistors are virtually unaffected by environmental conditions and withstand constant exposure to high moisture conditions without change in specifications. PME resistors meet or surpass all requirements of MIL-R-10509F.

Send for fact-filled literature sheet!

**PYROFILM RESISTOR
COMPANY, INC.**

3 SADDLE ROAD • CEDAR KNOLLS, NEW JERSEY • 201-539-7110

ON READER-SERVICE CARD CIRCLE 105



NEW!

Direct reading punched tape programmers control—22, 42 or 82 load circuits. Less than \$600 (82 channels)

Expressly designed for multiple circuit industrial control applications, this new Tape Reader combines the durability of toggle switches, the flexibility of a patchboard, the repeat accuracy of a cam timer, with the

advantages of punched tape programming. For detailed information about this direct-reading low-cost Tape Programmer, write Mr. Kenneth Kraemer, Director of Marketing.



INDUSTRIAL TIMER CORPORATION

65 U.S. HIGHWAY 287, PARSIPPANY, NEW JERSEY
ON READER-SERVICE CARD CIRCLE 106



NEW

E-L CABLE TIES

DOUBLE LOCKS/DOUBLE STRENGTH

A completely new concept in cable ties now gives you double locks, double tensile strength — cable ties that can be applied easily by hand or any standard application tool. Built-in dual steel grips offer vise-like, non-reversible holding power. Coupled with the rugged molded nylon base material, these ties meet Mil Specs and readily outperform other ties. Ask for independent test lab results . . . or

Send for Free Samples

ELECTROVERT INC.

Components Division
86 Hartford Ave., Mt. Vernon, N. Y. 10553
Milwaukee, Wis. • Burbank, Calif.



SOLD COAST-TO-COAST THROUGH AUTHORIZED DISTRIBUTORS
ON READER-SERVICE CARD CIRCLE 107

Answer to problem on p. 109

The figure below shows the plot for 12 months of operating results, as given in the problem's profit-and-loss statement:—five months of loss below the zero intercept and seven of profitable operation above the zero intercept.

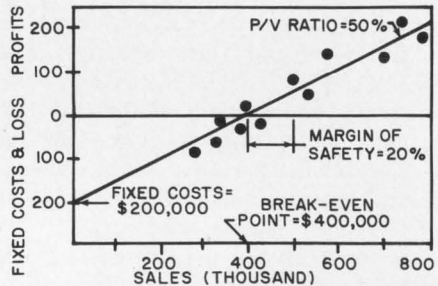

With these plotted points, we use the least-squares formula (see ED 23, Nov. 8, p. 99) to draw the line of best fit. This line intersects the Y axis below the zero ordinate at \$200,000, the company's estimated monthly fixed costs.

We now have the three factors needed to do a P/V analysis:

1. Monthly sales volume is

$$\frac{\$6,000,000}{12} = \$500,000$$

2. Monthly profit is

$$\frac{\$600,000}{12} = \$50,000$$

3. Monthly fixed costs are \$200,000 (estimated).

We can now calculate the following:

1. P/V Ratio =
$$\frac{\$50,000 + \$200,000}{\$500,000} = 50\%$$

2. Breakeven Point =
$$\frac{\$200,000}{0.50} = \$400,000$$

3. Margin of Safety (\$) =
$$\$500,000 - \$400,000 = \$100,000.$$

Margin of Safety (%) =
$$\frac{\$500,000 - \$400,000}{\$500,000} = 20\%.$$

Reprints Available

The following reprints are available free and in limited quantities. To obtain single copies, circle the number of the article you want on the Reader-Service card.

Predict Line Regulation Accurately. (No. 475)

A FET Operating at UHF? (No. 476)

Solid State competes with lasers (No. 477)

Electronic Design

Advertising Representatives

New York 10022

Robert W. Gascoigne
Thomas P. Barth
Samuel M. Deitch
Byron Adams
850 Third Avenue
(212) PLaza 1-5530
TWX: 867-7866

Philadelphia

William C. Repetto
P. O. Box 206
Merion Station, Pa. 19066
(215) MO 4-1073

Boston

Richard Parker
7 Redstone Lane
Marblehead, Mass. 01945
(617) 742-0252

Chicago 60611

Thomas P. Kavooras
Berry Conner, Jr.
720 N. Michigan
(312) 337-0588

Cleveland

(216) 247-7670

Los Angeles 90303

Stanley I. Ehrenclou
Terrence D. Buckley
W. James Bischof
2930 W. Imperial Highway
Inglewood, Calif.
(213) 757-0183

San Francisco

Ashley P. Hartman
175 South San Antonio Rd
Ste. 243
Los Altos, Calif. 94022
(415) 941-3084

Southwestern 75206

Tommy L. Wilson
6200 North Central Express-
way
Dallas, Tex.
(214) EMerson 1-2311

London W. 1

Brayton C. Nichols
44 Conduit Street

Verviers, Belgium

Andre Jamar
1, Rue Mallar, 1
(087) 253.85

Tokyo

Yoshihiro Takemura
International Planning
Service, Inc.
Room 231 Tokyu-Mita Bldg.
1, Shiba-Mita Koun-cho
Minato-ku, Tokyo



Isn't
this
the
darndest
cable
you
ever
saw?

It just goes to show you that Markel can make just about any cable you can dream up! We make not only a wide variety of standard constructions, including all standard RG/U coaxial cables, but also a tremendous number of special constructions to customers' specifications. These may provide single, twisted pair or multiple conductors—bare copper or with tin, silver or nickel coatings; may combine insulations of Teflon*, silicone rubber, fiberglass and nylon; braided metal shields; fillers, liners and jackets of various materials. Just give us your specs . . . we'll make your cable. For free samples, write:



L. FRANK MARKEL & SONS

Norristown Pa. 19404 • 215-272-8960

INSULATING TUBINGS AND SLEEVINGS
HIGH TEMPERATURE WIRE AND CABLE

*TM of DuPont

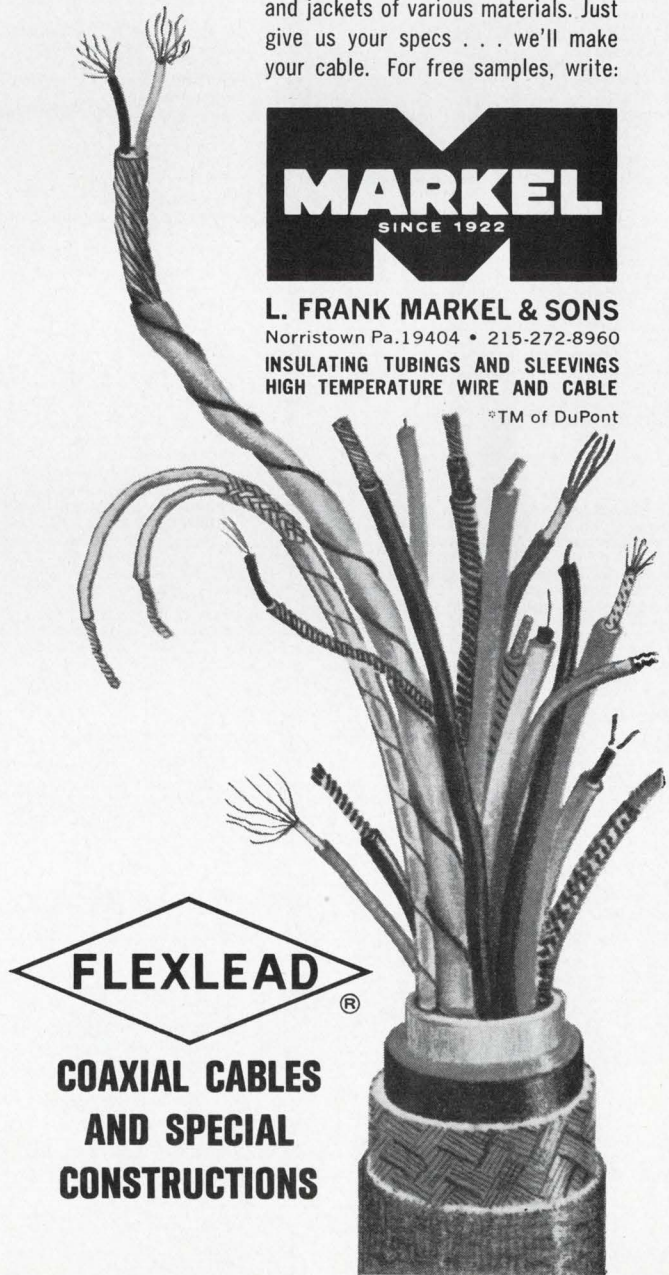

FLEXLEAD
**COAXIAL CABLES
AND SPECIAL
CONSTRUCTIONS**

ON READER-SERVICE CARD CIRCLE 108

Mixer Gems

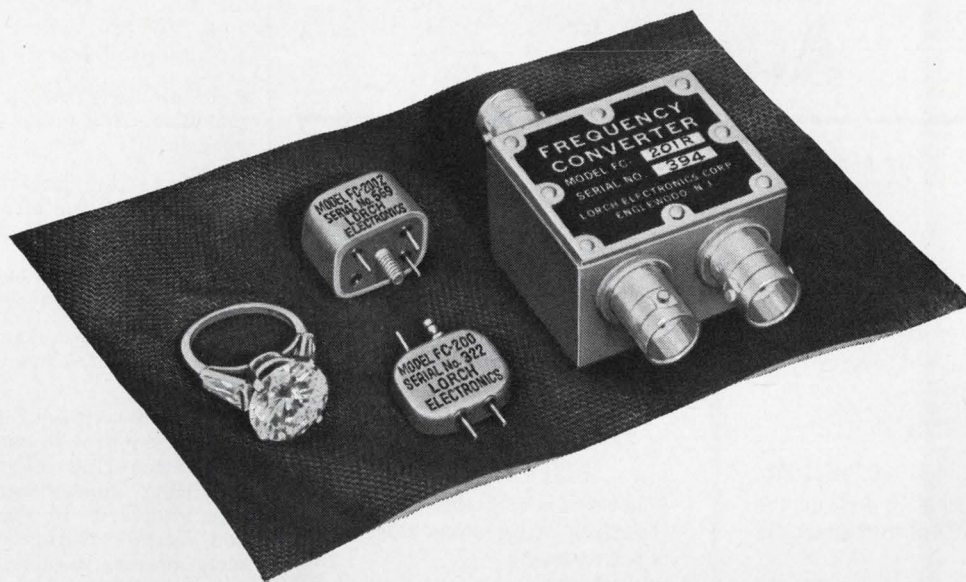

QUALITY FREQUENCY CONVERTERS from a DEPENDABLE SOURCE

Lorch Electronics manufactures a series of broad band frequency converters (double balanced mixers) for applications requiring high isolation, low intermodulation distortion and high signal handling capability. Although these mixers measure typically as little as 0.17 cubic inches (some considerably less), they have RF power handling capability to 16 dbm, dynamic range to 135 db and excellent isolation characteristics (50 db to 400 MHz). And conversion loss is only 6-8 db, depending on model and frequency.

Careful manufacturing techniques and painstaking

quality control assure the reliability of Lorch frequency converters in mixer, phase detector, product detector, switch, attenuator and modulator applications. For printed circuit use they are furnished as miniature pin packages, for laboratory or systems work, with BNC or TNC connectors. Other connector types are available.

Tabulated are seven of the many models we manufacture and stock for immediate delivery. We have many more...on our shelves and in our heads. Among them is one suited to your particular needs.

And our prices are right.

SPECIFICATIONS

Model No.	Pin Package Connector Version	FC-200 FC-201	FC-200R FC-201R	FC-200T FC-201T	FC-200W FC-201W	FC-200Y FC-201Y	FC-200Z FC-201Z	FC-210* FC-211*
Frequency Range*		0.25 to 225 MHz	0.2 to 500 MHz	0.2 to 600 MHz	0.2 to 600 MHz	0.05 to 200 MHz	2 to 1000 MHz	0.25 to 120 MHz
Conversion Loss		0.4-150 MHz: 6db Total range: 7db	0.4-150 MHz: 6db Total range: 8db	0.4-150 MHz: 6db Total range: 8db	0.4-150 MHz: 6db Total range: 9db	0.2-100 MHz: 6db Total range: 8db	50-400 MHz: 7db Total range: 8db	0.4-50 MHz: 7db Total range: 7.5db
Isolation LO at RF		50db to 10 MHz 40db to 40 MHz 25db to 225 MHz	60db to 10 MHz 50db to 50 MHz 35db to 500 MHz	60db to 10 MHz 50db to 50 MHz 30db to 600 MHz	50db to 400 MHz 40db to 600 MHz	50db to 30 MHz 35db to 200 MHz	40db to 500 MHz 30db to 1000 MHz	25db
Isolation LO at IF		50db to 10 MHz 40db to 40 MHz 25db to 225 MHz	60db to 10 MHz 50db to 50 MHz 25db to 500 MHz	60db to 10 MHz 50db to 50 MHz 25db to 600 MHz	50db to 40 MHz 40db to 200 MHz 30db to 600 MHz	40db to 30 MHz 25db to 200 MHz	30db to 500 MHz 25db to 1000 MHz	25db
Isolation RF at IF		35db to 100 MHz 25db to 225-MHz	20db to 500 MHz	25db to 50 MHz 15db to 600 MHz	30db to 50 MHz 20db to 600 MHz	20db to 30 MHz 15db to 200 MHz	25db to 500 MHz 12db to 1000 MHz	25db
Compression Level (for 2db compression)		+6dbm	+6dbm	+6dbm	+6dbm	+6dbm	+6dbm	+16dbm
LO Power		+7dbm	+7dbm	+7dbm	+7dbm	+7dbm	+7dbm	+20dbm
Dynamic Range (in 3KHz Bandwidth)		125db	125db	125db	125db	125db	125db	135db

*On all models except FC-210 and FC-211 one of the ports goes down to DC. Special versions of these two models are available with a DC port as Models FC-210DC and FC211DC.

Also available are Lorch broad band hybrid junctions and power splitters, from 80 KHz to 400 MHz, featuring low insertion loss, high isolation, low VSWR and good balance. These components can also be supplied from stock.

Want to know more about Lorch frequency converters and companion devices? Ask for our latest literature.



LORCH ELECTRONICS CORP.

105 Cedar Lane, Englewood, N.J. 07631 • 201-569-8282

ON READER-SERVICE CARD CIRCLE 109

Reduce your risk of Heart Attack!



CONTROL HIGH BLOOD PRESSURE

The higher your blood pressure, the greater your risk of heart attack and stroke.



WATCH YOUR DIET

A diet rich in saturated fats and cholesterol increases your chances of heart attack.



KEEP YOUR WEIGHT NORMAL

If you're 30% over normal weight, you run twice the risk of heart attack in middle age.



KEEP PHYSICALLY FIT

Exercise regularly and moderately. Physically active people have a lower heart attack risk.



DON'T SMOKE CIGARETTES

Heavy cigarette smokers get coronary disease at a rate 2 to 3 times higher than non-smokers.



SEE YOUR DOCTOR REGULARLY

Only he can help control blood pressure and advise on weight, exercise and the diet for you.

GIVE...so more will live HEART FUND

Contributed by the Publisher



Electronic Design

ELECTRONIC DESIGN's function is:

- To aid progress in the electronics manufacturing industry by promoting good design.
- To give the electronic design engineer concepts and ideas that make his job easier and more productive.
- To provide a central source of timely electronics information.
- To promote two-way communication between manufacturer and engineer.

Want a subscription? ELECTRONIC DESIGN is sent free to qualified engineers and engineering managers doing design work, supervising design or setting standards in the United States and Western Europe. For a free subscription, use the postfree application form inside the back cover. If none is included, write to us direct for an application form.

If you do not qualify, you may take out a paid subscription for \$25 a year in the U.S.A., \$35 a year elsewhere. Single copies are \$1.50 each.

If you change your address, send us an old mailing label and your new address; there is generally a prepaid postcard for this inside the back cover. You will have to requalify to continue receiving ELECTRONIC DESIGN free.

The accuracy policy of ELECTRONIC DESIGN is:

- To make reasonable efforts to ensure the accuracy of editorial matter.
- To publish prompt corrections whenever inaccuracies are brought to our attention. Corrections appear at the end of the Letters column.
- To refuse any advertisement deemed to be misleading or fraudulent.

Microfilm copies are available of complete issues of ELECTRONIC DESIGN and individual articles, published since the beginning of 1961. Complete issues cost 4¢ a page, articles cost 50¢ a page; shipping and handling charges are extra. The minimum charge is \$3. For further details and to place orders, contact University Microfilms, Inc., 300 N. Zeeb Road, Ann Arbor, Mich. 48106; telephone (313) 761-4700.

Want to contact us? If you have any comments or wish to submit a manuscript or article outline, address your correspondence to:

Howard Bierman, Editor,
ELECTRONIC DESIGN,
850 Third Avenue,
New York, N.Y. 10022.

Designer's Datebook

JANUARY						
Sun	Mon	Tue	Wed	Thu	Fri	Sat
	1	2	3	4	5	6
7	8	9	10	11	12	13
14	15	16	17	18	19	20
21	22	23	24	25	26	27
28	29	30	31			

FEBRUARY						
Sun	Mon	Tue	Wed	Thu	Fri	Sat
				1	2	3
4	5	6	7	8	9	10
11	12	13	14	15	16	17
18	19	20	21	22	23	24
25	26	27	28	29		

For further information on meetings, use Reader Service card.

Jan. 4-7

Conference on Solid-State Physics (Bristol, England)

Sponsor: Institute of Physics; Meetings Officer, Institute of Physics and The Physical Society, 47 Belgrave Square, London, S.W.1.

CIRCLE NO. 348

Jan. 16-18

Reliability Symposium (Boston)

Sponsor: IEEE; L. J. Blumenthal, Melpar, Inc., 7700 Arlington Blvd., Falls Church, Va. 22042.

CIRCLE NO. 349

Jan. 16-19

Dynamic Measurements in Ocean Sciences (Cocoa Beach, Fla.)

Sponsor: ISA; Ocean Sciences Short Course, ISA Headquarters, 530 William Penn Place, Pittsburgh, Pa. 15219.

CIRCLE NO. 350

Jan. 22-26

Marine Sciences Instrumentation Symposium (Cocoa Beach, Fla.)

Sponsor: Instrument Society of America; M. Reed, Meetings Coordinator, Instrument Society of America, 530 William Penn Place, Pittsburgh, Pa. 15219

CIRCLE NO. 351

Jan. 27

Quality Control Conference (Pomona, Calif.) Sponsor: San Bernardino Section of the American Society for Quality Control; W. J. Willey, 327 Cimmaron Trail, Glendora, Calif. 91740.

CIRCLE NO. 352

Jan. 28-Feb. 2

Winter Power Meeting (New York) Sponsor: IEEE; IEEE Headquarters, Technical Conference Services, 345 E. 47 St., New York, N.Y. 10017.

CIRCLE NO. 353

Design Data from Manufacturers

Advertisements of booklets, brochures, catalogs and data sheets. To order use Reader-Service Card. (Advertisement)

New "Tape Lift" Printed Circuit Drafting



Aids

No engineer or draftsman should be without the most up-to-date cross-reference guide to better Printed Circuit Drafting Catalog. It is complete with prices and illustrations of over 1200 sizes of "Tape Lift" pads, shapes and other aids for faster, more accurate, distortion-free printed circuit master drawings.

Write for FREE catalog.

By-Buk Company

4326 West Pico Blvd., Los Angeles, Calif. 90019

Telephone: (213) 937-3511

171

Quality Fasteners For All Design Applications

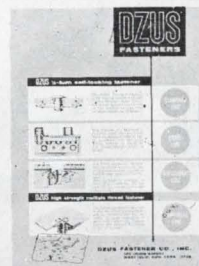

This 8-page catalog provides design data on the complete group of DZUS 1/4-turn self-locking fasteners for standard, high speed and panel applications, as well as universal high strength multiple thread fasteners for high tensile and shear stresses. Dzus stud assemblies, wire forms and receptacles offer an exceptional, wide variety of combinations from stock to fit specific fastening requirements. Diagrams and tables give full details for rapid, unlimited design selection. Condensed Catalog No. S-2 or comprehensive Catalog No. D-3 are available on request.

Dzus Fastener Co., Inc.

Division 32

425 Union Boulevard

West Islip, L. I., N. Y. 11795

172

Transistor Circuit Analysis

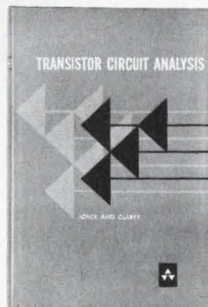

Here is a practical text and reference used successfully in more than 120 industrial classes across the country. (Adoption list available upon request.) Written by the late Maurice V. Joyce and Kenneth K. Clarke, Polytechnic Institute of Brooklyn, this book gives you the basic methods of analysis essential to the understanding and design of junction transistor circuitry. 461 pp, 362 illus (1961) \$11.75.

Send for your free 10-day examination copy by circling reader service number.

Addison-Wesley
Publishing Company, Inc.
Reading, Mass. 01867

173



WHO'S MOD·EST?

We are. Because we've designed the most modern 4PDT 3 amp plug-in relay available but feel constrained to admit that it is not a fantastic breakthrough in technology.

Our Series 1300 relay's modest superiority over others comes from combining a number of small advances in design. We've eliminated rivets by molding the armature and bobbin assembly of glass-filled polyester, and thereby gained a greater dielectric strength. We devised a flat armature return spring for a slightly better response than a conventional coil spring. Slightly longer than usual blades offer better contact and reliability.

Our proudest accomplishment is in keeping the cost of the Series 1300 relay thoroughly competitive with others.

The Series 1300 is available AC or DC, plug-in or quick disconnect, 6 to 115 VAC and 6 to 110 VDC. Contact rating 3 amps at 30 VDC or 115 VAC resistive. A complete brochure is yours on request.

Guardian Electric Manufacturing Company, 1550 W. Carroll Ave., Chicago, Ill. 60607

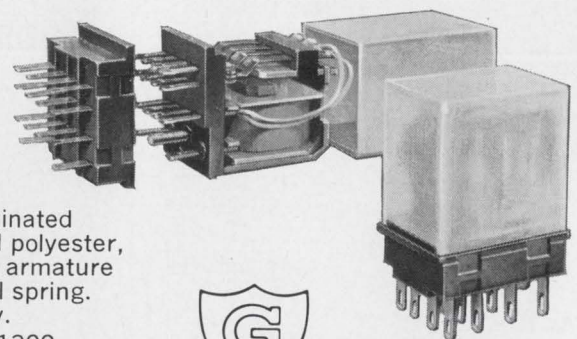

**GUARDIAN[®]
ELECTRIC**

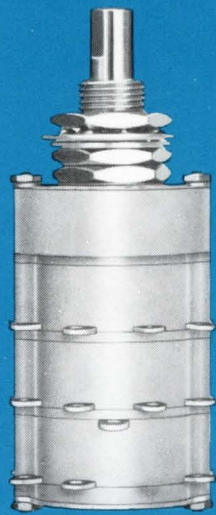

ACTUAL SIZE

JANCO BUILDS ROTARY SWITCHES JUST A LITTLE BETTER THAN TODAY'S REQUIREMENTS!

HERE'S THE INSIDE STORY

If you were to slice away half of a Janco Rotary Switch, you would see the reason why "Janco Builds Rotary Switches Just A Little Better Than Today's Requirements!"

CONSTRUCTION

Upon examination you would immediately recognize a design simplicity meticulously constructed into a totally enclosed, explosion-proof package affording you the highest degree of protection when operating in a volatile, chemically mixed atmosphere at sea level or altitudes. It is this same design simplicity that utilizes the U-shaped rotor concept which results in low contact resistance throughout the life of the switch.

MATERIALS

Before reaching the optimum in design simplicity a manufacturer must reach for the optimum in materials. Janco Rotary Switches are totally enclosed in high impact, glass-reinforced alkyd MAI-60 for superior mechanical and electrical characteristics. Current conduction is handled by Beryllium copper and solid silver alloy contacts.

FREE WALL CHART

If you are interested in rotary switches that are built to exceed present day requirements, Janco Corporation will send you a wall chart of basic Janco rotary switches. From this chart you can determine the correct switch for your requirements . . . the proper degree of indexing, exact make or break current capacity, and whether single or multi pole construction is available. This chart is your building block to a rotary switch that is built a little better than today's requirements. Send for it today.

JANCO
CORPORATION

3111 WINONA AVENUE ■ BURBANK, CALIFORNIA

Caught with their "ceramics" down

all similarly rated tubes are not equal

Construction of the high-gain Cermolox® RCA-4628 is far superior. For example, the G-1 and G-2 "cups" are locked together in a rigid assembly, then simultaneously electrically machined to produce grid wires precisely aligned with respect to each other. The result: a simplified, unitized construction. In SSB Communications and FM Broadcast service, particularly, the RCA-4628 delivers even more outstanding performance as a result of its compact coaxial structure, precision-aligned electronically-machined grids, and ceramic-to-metal seals.

RCA-4628, rated to 400 MHz, provides 10 kW PEP output in the 2 to 30 MHz range with lower distortion and better gain than its nearest counterpart. In FM Broadcast service, it offers higher gain with non-critical broadband neutralization techniques.

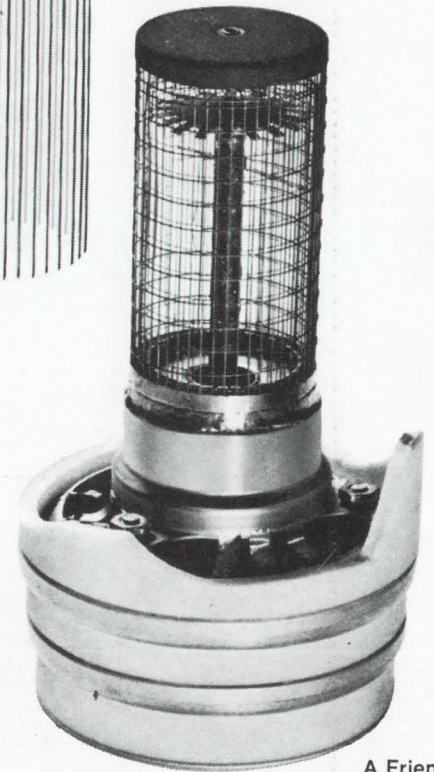
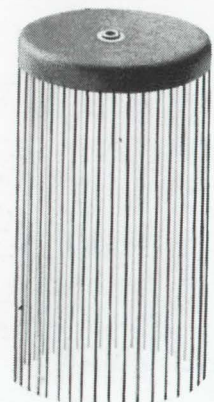
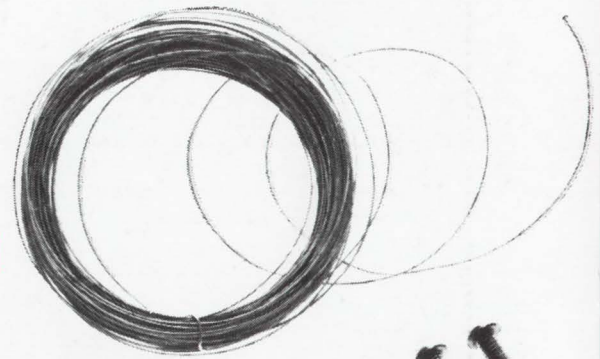

A Friend

From now on, look "inside" as well as outside when you need tubes. In the RCA-4628, you'll find ruggedness, compactness, and long-life reliability. Mechanically-induced noise is very low and, because of UHF capabilities, you have no need for complex neutralization circuits at HF. The RCA-4628 is your obvious choice.

For more information on this and other RCA Cermolox® tubes, see your RCA Representative. For technical data on specific tube types, write: RCA Commercial Engineering, Section L18Q-1, Harrison, New Jersey 07029.

ALSO AVAILABLE FROM YOUR RCA INDUSTRIAL TUBE DISTRIBUTOR

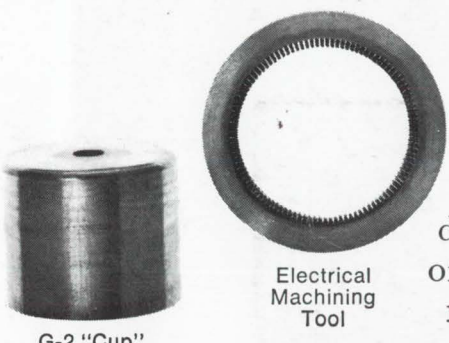

G-2 "Cup"

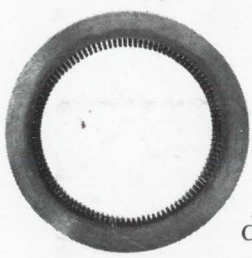

Electrical Machining Tool



G-1 "Cup"

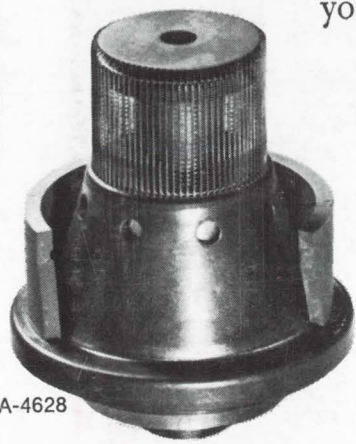

RCA-4628



RCA Electronic Components and Devices

The Most Trusted Name in Electronics