

# Electronic Design

FOR ENGINEERS AND ENGINEERING MANAGERS

VOL. 16 NO.

# 5

MARCH 1, 1968

## Will this integrated circuit fail?

A good part of the answer lies in its package. Make meaningful decisions at early stages, select materials and processes carefully

and you've gone a long way to filling the 'standards gap' for IC packages. Set your own package standards by following the logical procedure that starts on page 56.

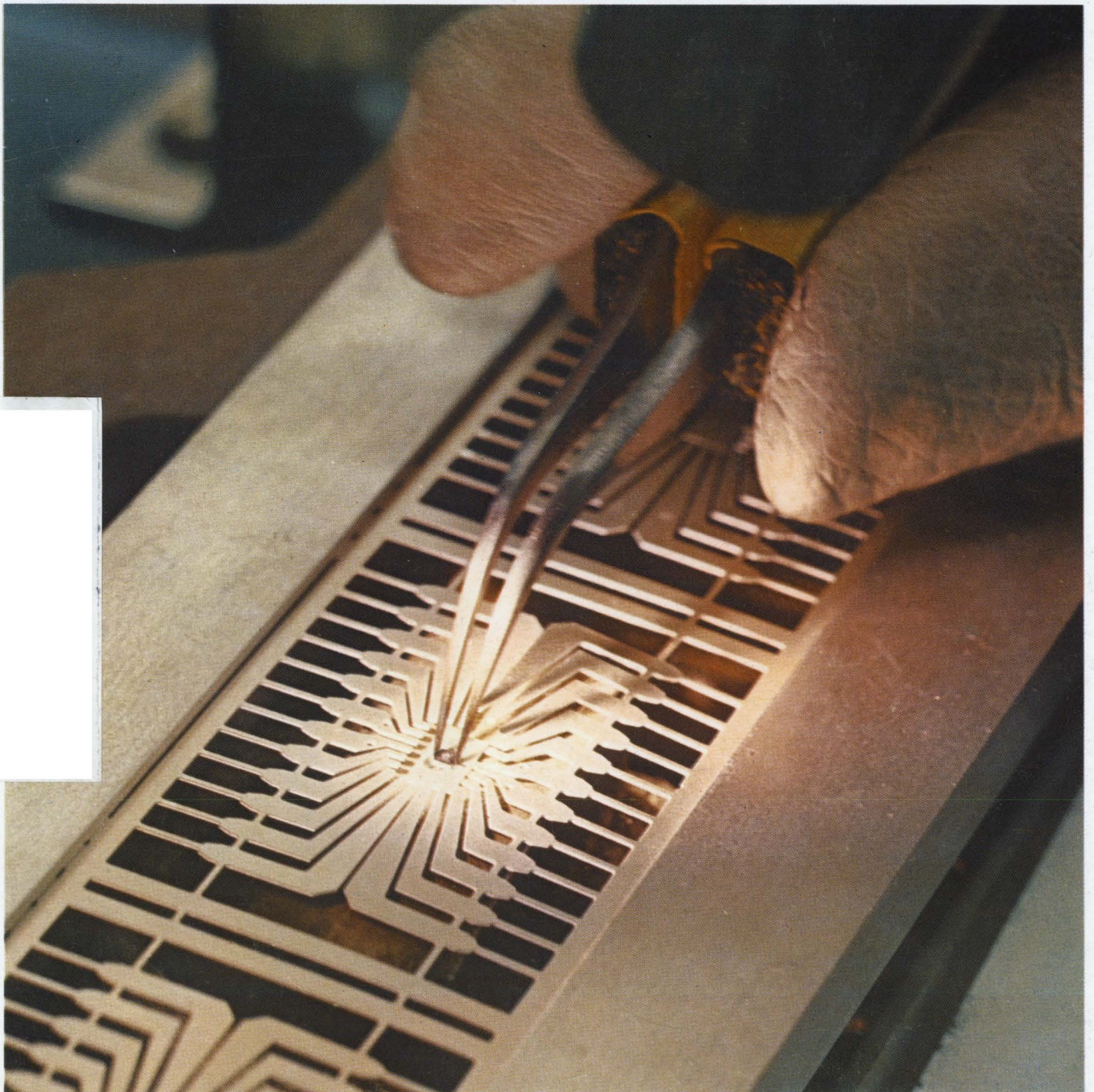



# NEW BIT-250™ LINE

## SMALLEST METAL-ENCASED TRANSFORMERS AVAILABLE!

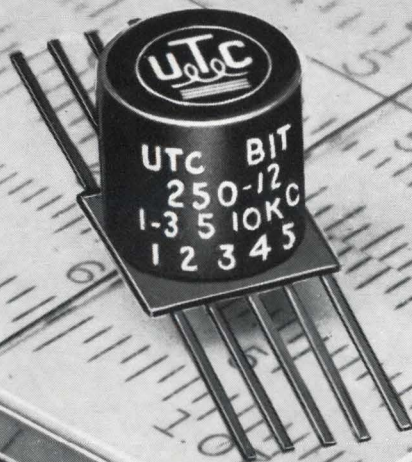

BIT-250's achieve outstanding reliability, in a profile compatible with Flat Packs and IC's, while maintaining response and power levels found only in larger units. MIL-T-27B, Grade 4, completely ruggedized. Seventeen items immediately available from stock, plus specials to your requirements. Patent applied for.

Write for descriptive brochure depicting ranges and capabilities. See it displayed at IEEE Show.

**UNITED® TRANSFORMER CO. TRW®**

DIVISION OF TRW INC. • 150 VARICK STREET, NEW YORK, N. Y. 10013

In CANADA: A. C. SIMMONDS & SONS LTD., Agincourt, Ontario

# CUT AC CALIBRATION TIME IN HALF

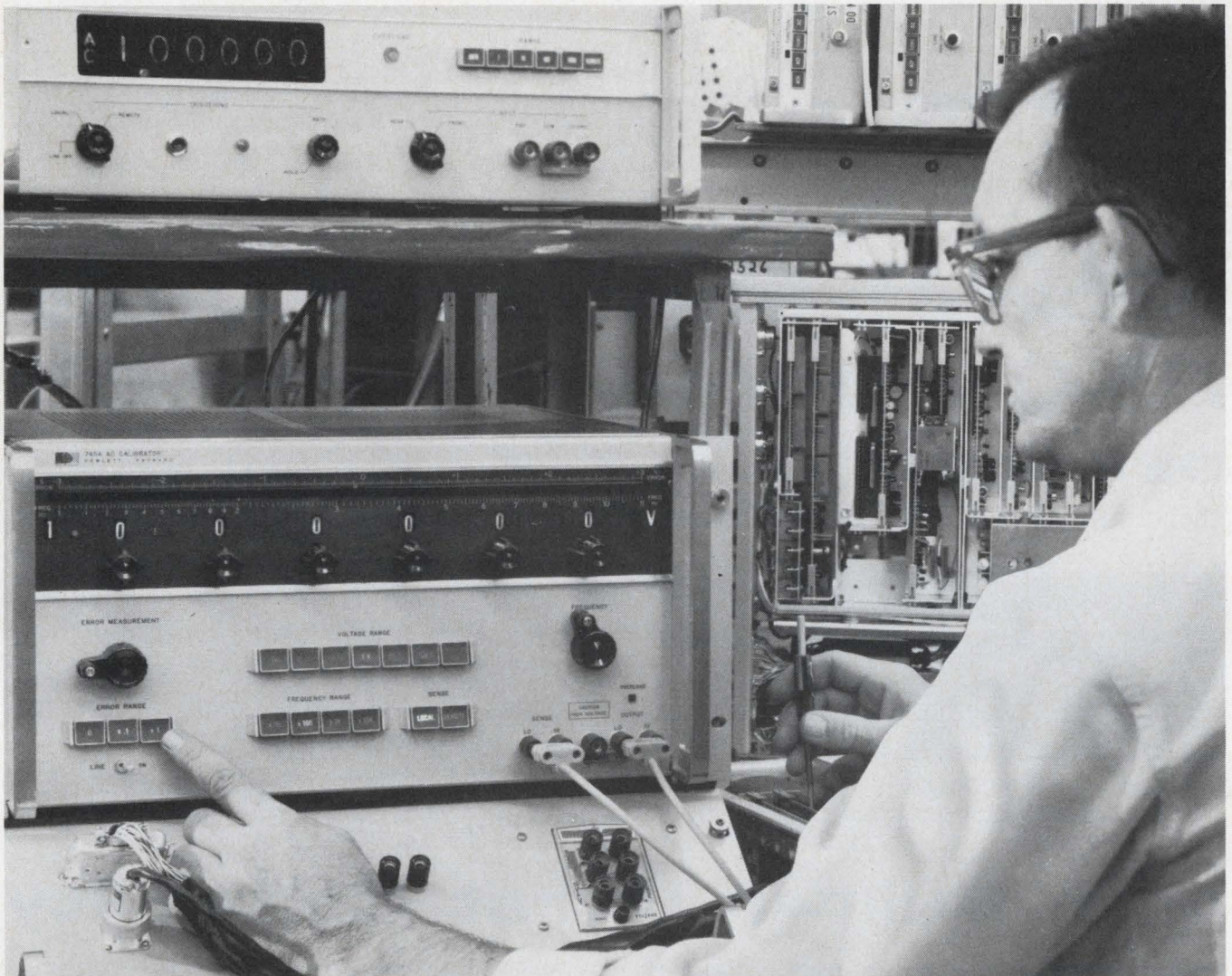

**NEW hp 745A AC Calibrator** is a self-contained AC calibration system that you can depend on for accuracy and stability in checking out digital, differential and analog ac voltmeters. Use it in production test areas and in calibration and standards labs to reduce calibration time by at least 50%—with push-button range selection . . . dial your voltage, dial your frequency. There is no external thermocouple, no nulling, no transients, no extra instruments to compound your set-up and increase your costs.

**Direct error measurement** in terms of percent-of-setting makes instrument calibration a simple set-read operation. To use it, press error range button and dial your plus or minus error until voltmeter under test reads the preselected voltage. Any error up to  $\pm 3\%$  is read directly on the top dial.

**Operator oriented** for easy, fool-proof measurements. Current limiting protects 745A from direct load short. Voltage range automatically resets to 1 mV range when 745A is turned off, to protect any instrument being calibrated from an accidental overload on turn-on. No need to disconnect instrument being tested, or turn off calibration when switching ranges, because there are no transients when ranges are being switched. Frequency, frequency range, and voltage range are programmable—an extra feature at no extra cost. Calibra-

tion of the 745A is simple using a high accuracy dc voltmeter, such as an hp 3420A, and an uncalibrated thermocouple to check flatness.

**0.02% accuracy** is possible because the output voltage is continually compared to an internal dc reference by a unique technique that makes an internal ac-to-dc transfer measurement twice each second. This also eliminates thermocouple drift and dc reversal error. Voltage accuracy and stability are further assured by precision inductive dividers. Calibrated ac voltages are available from 100  $\mu\text{V}$  to 110 V over the frequency range from 10 Hz to 110 kHz—with an absolute voltage accuracy in the midband of 0.02% of setting and 0.05% up to 110 kHz! Price: \$4500.00

To get full information on the lightweight (65 pounds) hp 745A AC Calibrator, call your nearest hp field engineer. Or, write to Hewlett-Packard, Palo Alto, California 94304. Europe: 54 Route des Acacias, Geneva.

097/19

HEWLETT  PACKARD

WORKING STANDARDS

INFORMATION RETRIEVAL NUMBER 2

INFORMATION RETRIEVAL NUMBER 242

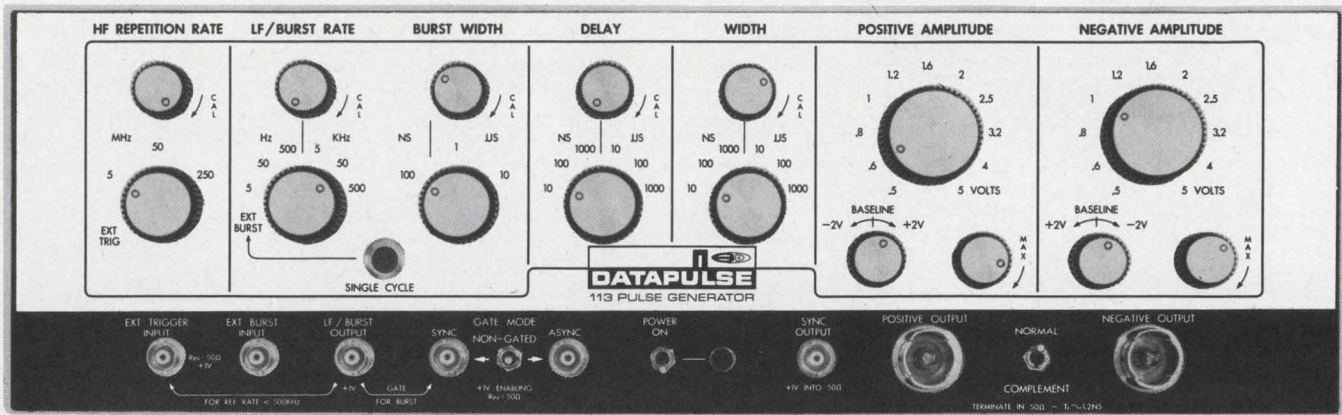

# 250 MILLION PULSES per second

A close check of the front panel on the new Datapulse 113 should convince you that it is the most versatile high frequency pulse generator yet designed.

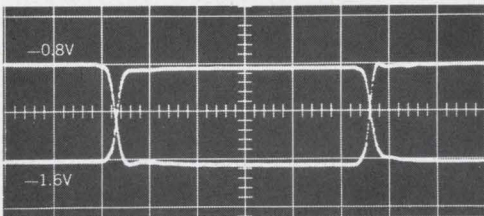

Complementary Output Simulates  
ECL F/F Output. 5 ns/cm, 500 mV/cm.

The 113 offers repetition rates from 0.5 Hz to 250 MHz, synchronous and asynchronous gating, simultaneous positive and negative outputs, and separate  $\pm 2V$  baseline offset (independent of high resolution amplitude controls). Both outputs may be complemented.

# with Built-in Burst Capability

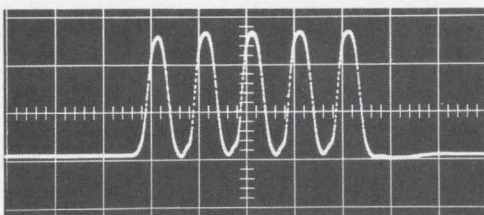

200 MHz Pulse Burst. 5 ns/cm,  
0.5 V/cm

The built-in burst capability is there because the 113 is really two pulse generators in one. An HF oscillator provides rep rates from 500 KHz to 250 MHz. An LF oscillator (0.5 Hz to 500 KHz) gates pulse bursts from 10 ns to 10  $\mu s$  and is used to trigger the unit for low rep rates.

See what we're talking about even better by asking for a demonstration of the 113. Or, write for complete specifications. Price: \$3375.00

See the 113. IEEE Booths 2B44-50

**Datapulse, Inc.**, A Subsidiary of Systron-Donner Corporation,  
10150 W. Jefferson Blvd., Culver City, California 90230.  
Telephone: 213-836-6100, 871-0410. TWX: 910-340-6766. Cable: Datapulse.  
EXPORT SALES OFFICE: Systron-Donner International, 888 Galindo Street,  
Concord, California. Telephone: 415-682-6161.  
IN EUROPE: Systron-Donner International S.A., 447, Avenue de  
Tervueren, Brussels 15, Belgium. Telephone: 71-76-84. Telex: 23606 (Belgium).

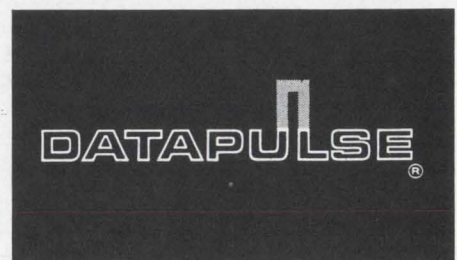

---

## NEWS

- 21 News Scope
- 25 **LSI impresses at solid-state conference**  
Subnanosecond digital circuits and memories on a chip surge as consumer and microwave ICs gain slowly.
- 34 **1969 U. S. Budget: Further electronic growth**  
\$186-billion document contains opportunities for industry to fill defense, NASA and FAA needs
- 40 Computer-TV-phone link teaches teachers
- 41 MOS flat pack converts A to D
- 45 Washington Report
- 49 **Editorial: We need innovators not stubborn 'changers'**
- 50 Letters
- 52 Sidelights of the Issue

---

## TECHNOLOGY

- 56 **Set your own IC package standards.** Follow the 'critical path' of material decisions and simplify your package selection.
- 66 **Integrate a shunt-compensated interstage** by replacing inductors with active devices to increase the gain-bandwidth product at no cost.
- 72 **Solve quartic equations quickly** with a new closed-form method of finding their roots to help speed circuit and system design.
- 78 Test your IC IQ
- 82 **Elude the traps to sound decisions,** and you're on your way to successful managing. But be prepared to shed some common biases first.
- 88 NASA Tech Brief
- 90 Ideas for Design

---

## PRODUCTS

- 100 **Components:** Differential dc op amp settles in 1  $\mu$ s.
- 104 Low-cost NIXIE tube is IC compatible.
- 108 **Production Equipment:** Assembly tool bends component leads.
- 114 **Microwaves:** Oscillators use IMPATTs to generate 60 mW at 10.525 GHz.
- 118 **Test Equipment:** Digital rf power meter has BCD and analog outputs.
- 106 Semiconductors
- 110 Systems
- 126 Materials

---

## DEPARTMENTS

- 14 Designer's Datebook
  - 128 Application Notes
  - 130 New Literature
  - 138 Advertisers' Index
  - 140 Information Retrieval Service
- Information Retrieval Service card inside back cover

# NOW...TWO GENERATIONS OF

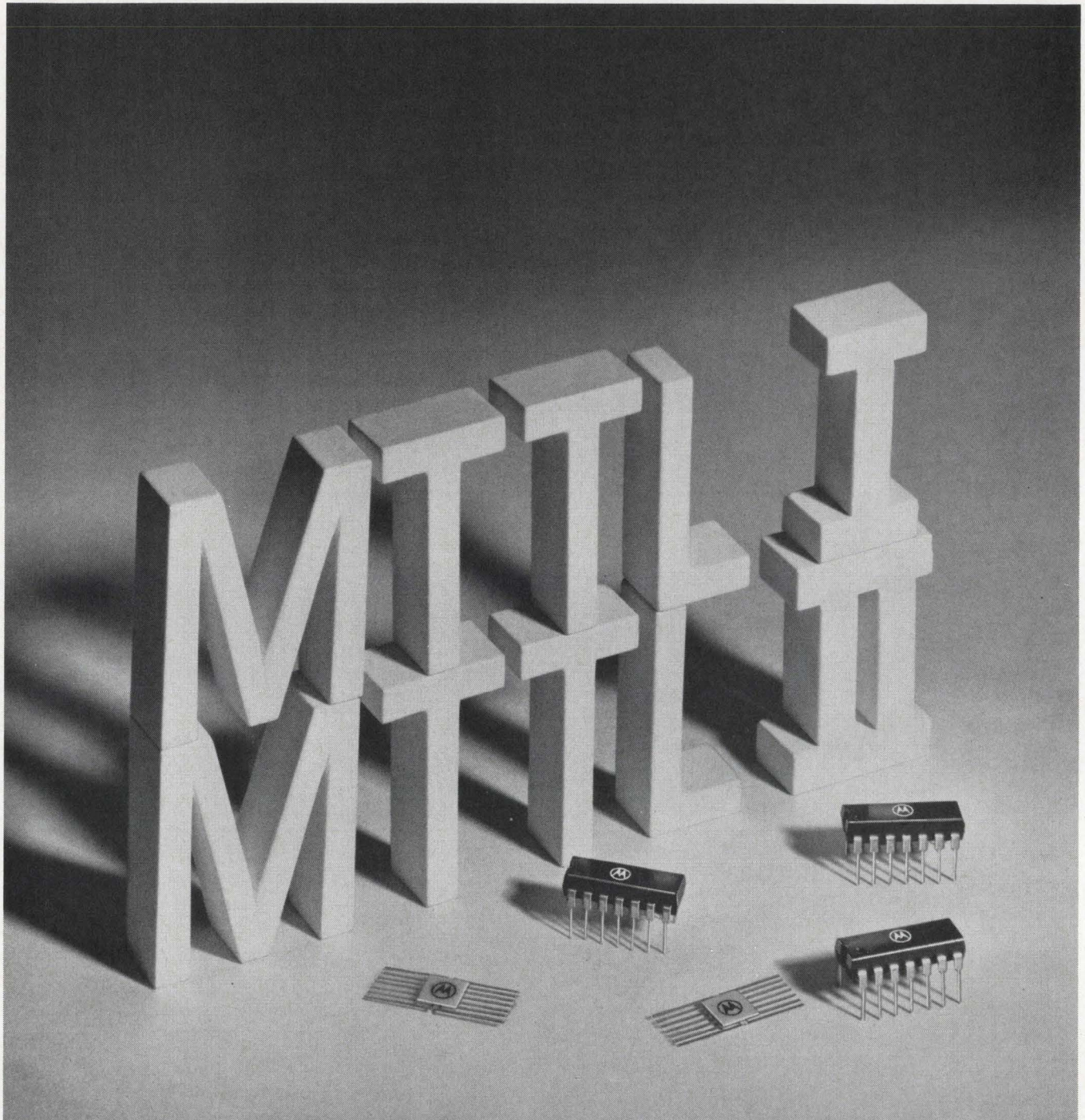

**MTTL<sup>†</sup> I & II OFFER A WIDE CHOICE OF T<sup>2</sup>L FUNCTIONS  
IN BOTH FLAT-PACKS & LOW-COST PLASTIC!**

†MTTL is a trademark of Motorola Inc.

*-where the priceless ingredient is care!*



# MOTOROLA T<sup>2</sup>L INTEGRATED CIRCUITS!

OPTIMUM SELECTION & DESIGN FLEXIBILITY AT LOW COST!

CIRCUIT DESCRIPTION **	-55° to +125° C						0 to +75° C					
	SUHL Type No.	Motorola Type No. F.O. = 15	Motorola Price 100-Up	SUHL Type No.	Motorola Type No. F.O. = 7	Motorola Price 100-Up	SUHL Type No.	Motorola Type No. F.O. = 12	Motorola Price 100-Up (F) 1000-Up (P)	SUHL Type No.	Motorola Type No. F.O. = 6	Motorola Price 100-Up (F) 1000-Up (P)
Dual 4-Input NAND Gate	SG-40-02	MC500F	\$5.45	SG-41-02	MC550F	\$4.35	SG-42-02 SG-42-03	MC400F MC400P	\$3.15 1.75	SG-43-02 SG-43-03	MC450F MC450P	\$2.50 1.40
Expandable 4-Wide 2-2-2-3-Input AND-OR-INVERT Gate	SG-50-02	MC501F	6.00	SG-51-02	MC551F	4.80	SG-52-02 SG-52-03	MC401F MC401P	3.50 1.95	SG-53-02 SG-53-03	MC451F MC451P	2.75 1.55
Single 8-Input NAND Gate	SG-60-02	MC502F	5.45	SG-61-02	MC552F	4.35	SG-62-02 SG-62-03	MC402F MC402P	3.15 1.75	SG-63-02 SG-63-03	MC452F MC452P	2.50 1.40
2-Wide 3-Input AND-OR-INVERT Gate with Gated Complement	SG-90-02	MC503F	5.45	SG-91-02	MC553F	4.35	SG-92-02 SG-92-03	MC403F MC403P	3.15 1.75	SG-93-02 SG-93-03	MC453F MC453P	2.50 1.40
Expandable 3-Wide 3-Input AND-OR-INVERT Gate	SG-100-02	MC504F	6.00	SG-101-02	MC554F	4.80	SG-102-02 SG-102-03	MC404F MC404P	3.50 1.95	SG-103-02 SG-103-03	MC454F MC454P	2.75 1.55
Expandable 2-Wide 4-Input AND-OR-INVERT Gate	SG-110-02	MC505F	6.00	SG-111-02	MC555F	4.80	SG-112-02 SG-112-03	MC405F MC405P	3.50 1.95	SG-113-02 SG-113-03	MC455F MC455P	2.75 1.55
Expandable 8-Input NAND Gate	SG-120-02	MC506F	6.00	SG-121-02	MC556F	4.80	SG-122-02 SG-122-03	MC406F MC406P	3.50 1.95	SG-123-02 SG-123-03	MC456F MC456P	2.75 1.55
Quad 2-Input NAND Gate	SG-140-02	MC508F	5.45	SG-141-02	MC558F	4.35	SG-142-02 SG-142-03	MC408F MC408P	3.15 1.75	SG-143-02 SG-143-03	MC458F MC458P	2.50 1.40
4-Wide 3-2-2-3-Input Expander for AND-OR-INVERT Gates	SG-150-02	MC509F	4.90	SG-151-02	MC559F	3.90	SG-152-02 SG-152-03	MC409F MC409P	2.85 1.20	SG-153-02 SG-153-03	MC459F MC459P	2.25 1.20
Dual 4-Input Expander for AND-OR-INVERT Gates	SG-170-02	MC510F	4.90	SG-171-02	MC560F	3.90	SG-172-02 SG-172-03	MC410F MC410P	2.85 1.20	SG-173-02 SG-173-03	MC460F MC460P	2.25 1.20
Dual 4-Input Expander for NAND Gates	SG-180-02	MC511F	4.90	SG-181-02	MC561F	3.90	SG-182-02 SG-182-03	MC411F MC411P	2.85 1.20	SG-183-02 SG-183-03	MC461F MC461P	2.25 1.20
Triple 3-Input NAND Gate	SG-190-02	MC512F	5.45	SG-191-02	MC562F	4.35	SG-192-02 SG-192-03	MC412F MC412P	3.15 1.75	SG-193-02 SG-193-03	MC462F MC462P	2.50 1.40
R-S Flip-Flop	SF-10-02	MC513F	6.00	SF-11-02	MC563F	4.80	SF-12-02 SF-12-03	MC413F MC413P	3.50 1.95	SF-13-02 SF-13-03	MC463F MC463P	2.75 1.55
AND J-K Flip-Flop	SF-50-02	MC515F	7.65	SF-51-02	MC565F	6.10	SF-52-02 SF-52-03	MC415F MC415P	4.40 2.80	SF-53-02 SF-53-03	MC465F MC465P	3.50 2.25
OR J-K Flip-Flop	SF-60-02	MC516F	7.65	SF-61-02	MC566F	6.10	SF-62-02 SF-62-03	MC416F MC416P	4.40 2.80	SF-63-02 SF-63-03	MC466F MC466P	3.50 2.25
Expandable 2-Wide 4-Input AND-OR-INVERT Gate	SG-210-02	MC2100F	7.20	SG-211-02	MC2150F	5.75	SG-212-02 SG-212-03	MC2000F MC2000P	4.20 2.35	SG-213-02 SG-213-03	MC2050F MC2050P	3.30 1.85
Quad 2-Input NAND Gate	SG-220-02	MC2101F	6.55	SG-221-02	MC2151F	5.20	SG-222-02 SG-222-03	MC2001F MC2001P	3.80 2.10	SG-223-02 SG-223-03	MC2051F MC2051P	3.00 1.70
4-Wide 3-2-2-3-Input Expander for AND-OR-INVERT Gates	SG-230-02	MC2102F	4.90	SG-231-02	MC2152F	3.90	SG-232-02 SG-232-03	MC2002F MC2002P	2.85 1.20	SG-233-02 SG-233-03	MC2052F MC2052P	2.25 1.20
Dual 4-Input NAND Gate	SG-240-02	MC2103F	6.55	SG-241-02	MC2153F	5.20	SG-242-02 SG-242-03	MC2003F MC2003P	3.80 2.10	SG-243-02 SG-243-03	MC2053F MC2053P	3.00 1.70
Expandable 4-Wide 2-2-2-3-Input AND-OR-INVERT Gate	SG-250-02	MC2104F	7.20	SG-251-02	MC2154F	5.75	SG-252-02 SG-252-03	MC2004F MC2004P	4.20 2.35	SG-253-02 SG-253-03	MC2054F MC2054P	3.30 1.85
Single 8-Input NAND Gate	SG-260-02	MC2105F	6.55	SG-261-02	MC2155F	5.20	SG-262-02 SG-262-03	MC2005F MC2005P	3.80 2.10	SG-263-02 SG-263-03	MC2055F MC2055P	3.00 1.70
Dual 4-Input Expander for AND-OR-INVERT Gates	SG-270-02	MC2106F	4.90	SG-271-02	MC2156F	3.90	SG-272-02 SG-272-03	MC2006F MC2006P	2.85 1.20	SG-273-02 SG-273-03	MC2056F MC2056P	2.25 1.20
AND J-K Flip-Flop	SF-250-02	MC2109F	9.20	SF-251-02	MC2159F	7.30	SF-252-02 SF-252-03	MC2009F MC2009P	5.30 3.35	SF-253-02 SF-253-03	MC2059F MC2059P	4.20 2.70
OR J-K Flip-Flop	SF-260-02	MC2110F	9.20	SF-261-02	MC2160F	7.30	SF-262-02 SF-262-03	MC2010F MC2010P	5.30 3.35	SF-263-02 SF-263-03	MC2060F MC2060P	4.20 2.70

\*Interchange with SUHL\*\* I & II types.

\*\*Trademark of Sylvania, Inc. "F" suffix denotes flat-pack. "P" suffix denotes dual in-line plastic package. Sylvania suffix -03 numbers denote dual in-line ceramic packages.

**S**election . . . Availability . . . Economy! Three good reasons why you should evaluate MTTL I (MC400/500 series) and MTTL II (MC2000/2100 series) . . . Motorola's answer to the T<sup>2</sup>L "availability" problem.

Whether you want the low-cost approach offered by the 14-pin dual in-line plastic package — or have more stringent temperature requirements calling for the 14-pin ceramic flat-pack (—55 to +125° C) — Motorola now offers the T<sup>2</sup>L circuit for every designer. In fact, you can choose from 24 different logic functions, offered in some 150 different types. More importantly, 15 more complex-function circuits, including a 50 MHz Flip-Flop, will be introduced in this line during the next few months.

Now, the computer/industrial system designer can combine the top performance of this highly-popular line with system costs that are competitive with practically any form of I/C logic. For example, the price of the MC2009P J-K AND Flip-Flop is just \$3.35, and the MC2001P Quad 2-Input Gate is \$2.10 (both 1,000-up). Production quantities are available for all types.

†MTTL is a trademark of Motorola Inc.

**MOTOROLA** Semiconductor Products Inc.

### Check These Other Design Advantages:

- Choice of fan-out — up to 15
- High-noise immunity — 1.0 volt (typ)
- High-capacitance drive — 600 pF (max)
- Low-power dissipation — averages 15 mW per gate (MTTL I) and 22 mW per gate (MTTL II)

Evaluation units are now available from your local distributor's warehouse stock. For production quantity pricing and schedules, contact your Motorola field representative. Write for details . . . P.O. Box 955, Phoenix, Arizona 85001.

# Now - any industrial data problem can be solved with one system -

## CEC's DG 5000

The reason is surprisingly simple. The DG 5000 series is an assembly of CEC standard products systematized into a *complete configuration*, resulting in outstanding capability for the acquisition and measurement of dynamic or quasistatic data for vibration and stress analysis to structural testing.

Furthermore, the DG 5000 System is uniquely versatile in the *three* ways so important to every industrial user.

1. CEC's building-block concept makes it possible to tailor-make the system to virtually any configuration. It will accept any of the following CEC oscillographs—the 5-126, 5-124, 5-119 and 5-133—and deliver up to 52 recording channels with lightbeam galvanometers.

2. Maximum application flexibility can be provided for variations of system configuration through a programable building-block interconnection.

3. The DG 5000 System may be *easily and economically* expanded to meet any future configuration requirements.

So if you're concerned with industrial testing problems—from event to readout—the DG 5000 can free you to be concerned about other things.

For complete information, call your nearest CEC Field Office. Or write Consolidated Electrodynamics, Pasadena, California 91109. A subsidiary of Bell & Howell. Bulletin DG 5000-X2.

**CEC / DATAGRAPH PRODUCTS**

 **BELL & HOWELL**

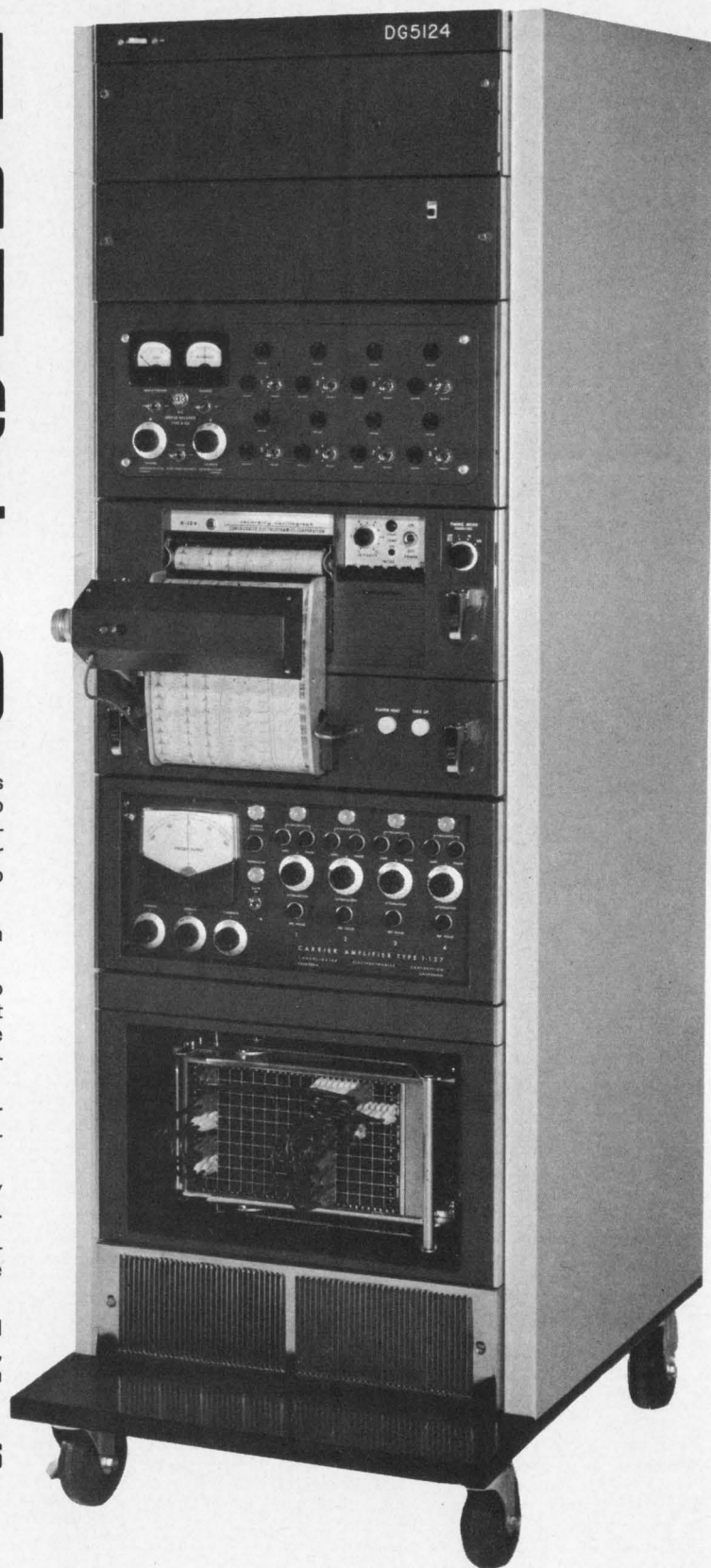



# PERFECT MATES

New Multiple Function Package Combines Accurate DC

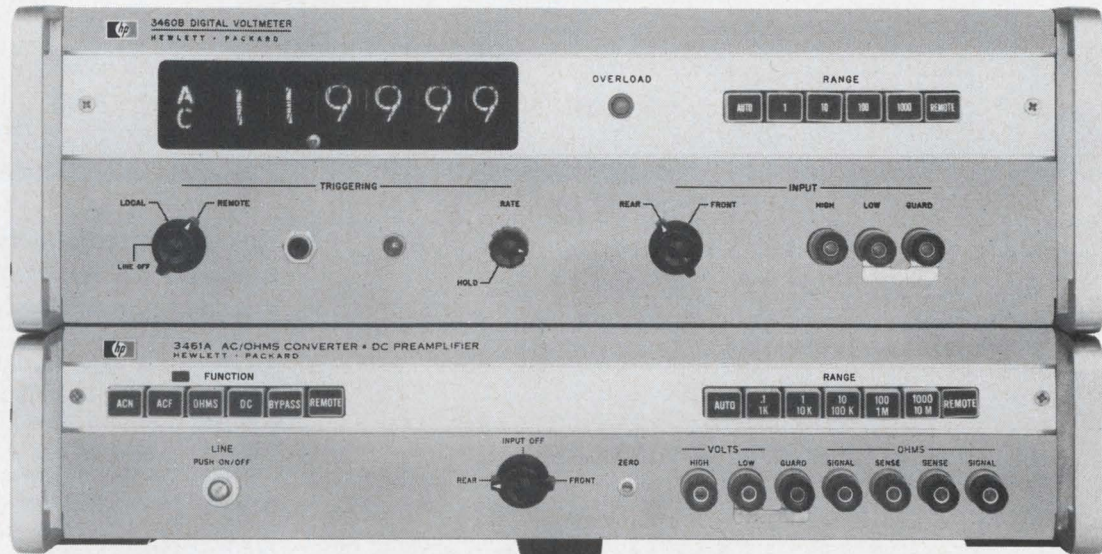

With Ohms, AC Volts, DC Microvolts

The hp 3460B Digital Voltmeter and hp 3461A AC/Ohms Converter-DC Preamplifier combine to make a multiple function DVM with high resolution, high accuracy, and high sensitivity. The package has a 20% over-ranging capability, and an accuracy of 0.005% of dc reading, 0.084% of midrange ac reading and 0.012% of ohms reading.

You can make low-level dc voltage measurements with 1  $\mu$ V sensitivity, wide-range ac voltage measurements from 50 Hz to 100 kHz with 10  $\mu$ V sensitivity, and accurate resistance measurements from 1 k $\Omega$  to 12 M $\Omega$  with 10 milliohm sensitivity on the lowest range.

**Optional Combinations.** To allow minimum investment with flexibility for meeting future requirements, the 3461A can be purchased to include a single function or a combination of functions. Functions not originally purchased can be ordered and easily installed.

**Systems Use.** High common mode rejection (160 dB at dc and 110 dB at 60 Hz), guarded inputs and speed of reading (2.5 readings/second for ac and 15 readings/

second on dc) make the combination ideal for use in digital data acquisition systems. Range, function, trigger and integration period are fully programmable for automated measurements. BCD output (1-2-4-8) contains 6 digits of data, polarity, decimal location and overload information.

To get the complete story on the versatility of this new multiple function combination, call your nearest hp field engineer. Or, write to Hewlett-Packard, Palo Alto, California 94304. Europe: 54 Route des Acacias, Geneva. Prices: hp 3460B Digital Voltmeter, \$3600; hp 3461A AC/Ohms Converter-DC Preamplifier (complete), \$2075. Prices of 3461A options on request.

097/20A

HEWLETT  PACKARD  
DIGITAL VOLTMETERS

# RCA Solid State Data for Designers

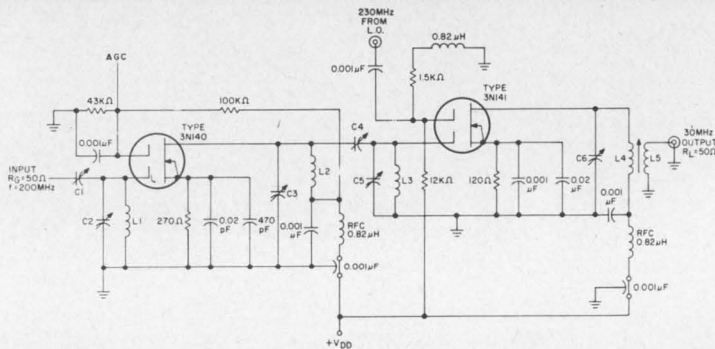

## Dual-Gate (Mos) Fet's for vacuum-tube front-end performance

Here are two of the most revolutionary transistors you can work with today—the 3N140 and 3N141 dual-insulated-gate depletion type MOS FET's. Used as an RF amplifier the 3N140 will give you an unneutralized 200MHz power gain of 19dB (typ), maximum feedback capacitance of 0.03pF, transconductance of 10,000 umhos, typically, and the flexibility of working with two independent input electrodes. The 3N141 offers a square law mixing characteristic and excellent isolation between the signal and local oscillator gates which minimizes oscillator pulling under strong signal conditions.

What more do you get? Improved cross modulation performance. Low spurious responses. Exceptional stability at VHF. Reduced oscillator feed-through and increased gain control range with cross-modulation characteristic actually improving near cut-off. Both units feature insulated gates for greater signal handling capability without diode-current loading, negligible AGC power requirement and improved thermal stability. You combine performance characteristics of two well-known devices—vacuum tubes and bipolar transistors—using the best attributes of each. Circle Reader Service #91.

## Get your "LINEAR DESIGN LAB" Kit Now

We have a new kit for you—with all the circuits and background materials you need to get your feet wet in linear integrated circuit applications design. For example, 11 different circuits—and with data sheets and application notes for each one. You get all these to work with: RF and IF amplifiers; wideband amplifiers; multi-function amplifiers; op amps; arrays of devices and amplifiers, and our famous "Universal" amplifier. There are 26 units in all—with replacements readily available from your RCA Distributor. Along with the units to make this "lab" complete, you will get the newest RCA Linear Integrated Cir-

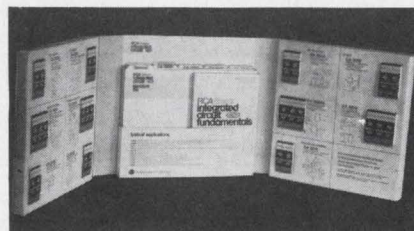

uits Manual. (IC-41)

You'll find this kit—\$39.95 at your Distributor's\*—has it all...in one complete, convenient package that's designed for designers. Circle Reader Service #92.

\*Suggested Resale Price.

## Noise problems? Check these OP AMP units!

Everybody's talking about OP Amp noise—but we've done something about it! Our new "A" family of units are quiet with a capital "Q" as you can see from the specifications. You can build your designs around any of *four* industry standard packages, too...TO-5; flat pack; plastic dual in-line and our new, exclusive ceramic dual in-line...and with either  $\pm 6V$  or  $\pm 12V$  supply.

Choose the "package"—and the parameters—from these two lists:

Package style	6-Volt Types	12-Volt Types
Flat pack	CA3008A	CA3016A
TO-5	CA3010A	CA3015A
Dual in-line plastic	CA3029A	CA3030A
Dual in-line ceramic	CA3037A	CA 3038A
Open loop voltage gain	60dB typ.	70 dB typ.
Common-Mode rejection Ratio	94dB typ.	103 dB typ.
Output voltage swing	6.75 V typ.	14 V typ.
Input offset voltage	0.9 mV typ.	1 mV typ.
Input offset current	0.3 uA typ.	0.5 uA typ.
Input bias current	2.5 uA typ.	4.7 uA typ.
Input impedance	20 K $\Omega$ typ.	10 K $\Omega$ typ.
Output impedance	160 $\Omega$ typ.	85 $\Omega$ typ.
Noise factor	12 dB max.	16 dB max.
	(@ $\pm 6V$ , 1KHz)	(@ $\pm 12V$ , 1KHz)

Circle Reader Service #93 for full details.

## Hermetic Metal Devices at Plastic Prices\*

Look what as little as 19¢ will buy\*.

The shielding—dissipation capabilities—hermeticity that only a metal package can give, for one thing. That's why we call these units our PHP line—combining **P**rice, **H**ermeticity and **P**erformance...and we have another name for them, too, the Max Value line because they give designers maximum value right across the board! Many of them meet the requirements of MIL-S-19500 (marked with + below).

Pick from any of these 11 PHP

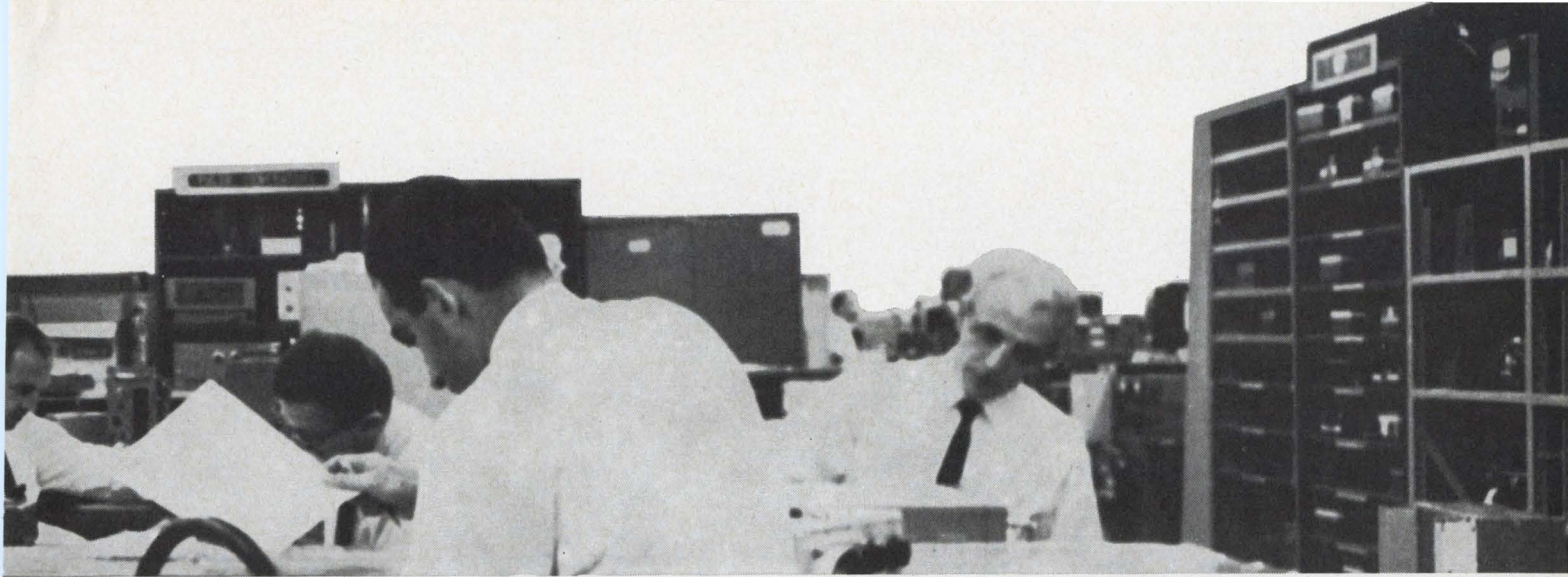

units for your designs (priced from 19¢ to 39¢\*):



- 2N5179+ Low noise UHF Amplifier
- 2N5180 Low noise VHF Amplifier
- 2N5181 High gain RF/IF Amplifier
- 2N5182 High gain RF/IF Amplifier for low current applications
- 2N5183 1 ampere General Purpose Amplifier
- 2N5184 High frequency high voltage amplifier
- 2N5185 High frequency high voltage amplifier
- 2N5186+ High speed switch
- 2N5187+ Medium current high speed switch
- 2N5188+ High speed high voltage 1/2 amp switch
- 2N5189 High speed high voltage 1 amp switch

\*1,000 units. See your RCA Distributor for his price and delivery.

For more information about this broad line which can satisfy most of your signal transistor needs, Circle Reader Service #94.

### AC Triggers (DIACS) for sale—Right now—in quantity!!

If you've been having delivery problems on Diacs, rest easy. RCA has a new trigger diode in a hermetic DO-26 case, and the big news is it's available right now in volume quantities. The same RCA assembly line that has been producing millions of lead-mount rectifiers is now rolling out "car loads" of top-quality Diacs. We pass the cost benefits of a mature production line right back to you... and you get the added plus of proven hermetic reliability at plastic prices.

Performance-wise, RCA's new Diac shapes up as follows; typical breakover voltage of 32 V (dc)... excellent breakover voltage symmetry of  $\pm 3$  V... Peak pulse current = 2 A... and low breakover current = 50  $\mu$ A at breakover voltage.

So if you have Triac circuits that are awaiting triggers, await no longer. Circle Reader Service #95 for details.

### RCA—Single source for audio power transistors

Today's audio circuit designer demands a broad line-up of silicon and germanium power transistors. And we'd like to suggest where he should look first for a single source of low cost reliable devices. RCA audio transistors feature the widest choice of silicon power units, making possible quasi-complementary circuits up to 70 watts rms! Matching this silicon capability, we have many fine germanium p-n-p transistors at attractive prices for designers working with the complementary-symmetry approach.

To you, this means an uncompromised choice of quality silicon power transistors (now with 2 pace-setting families in plastic, one having an industry-high dissipation rating of 83 watts, the other 36) for your designs requiring silicon... and a choice of quality germanium power transistors for your designs requiring germanium. We wrapped up the details on RCA's audio power transistor line in an attractive brochure which includes 11 ready-to-go circuits. Circle Reader Service No. 96 for your copy.

### Yes... RCA has photocells!!

And, we feel they're the finest in the industry! Why? Well, our devices right now are meeting the toughest demands in applications such as oil burner controls, coin changers, as well as millions of streetlight controls across the country. We have four basic hermetic packages for you to work with—a 1" diameter cell plus TO-5, TO-8 and TO-18 versions that bring solid-state engineering to light sensitive devices.

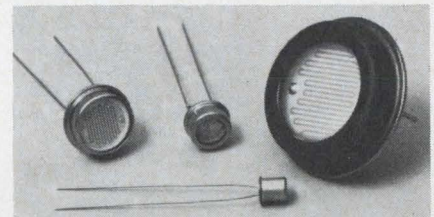

Use them in designs like automatic door openers, light flashers, storage level indicators, counters, door openers, tape card readers—wherever you need quality and performance in a photocell control. There are over twenty-five cadmium-sulfide and cadmium sulfo-selenide types in RCA's line... all of them are fully described in a new data sheet. Write in now and we'll also send you a 30-page application brochure packed with "now" ideas on how to use photocells!!

For product information on all items listed above, write RCA Electronic Components and Devices, Commercial Engineering Sec. QG3-1, Harrison, N.J. 07029. For price and delivery see your authorized RCA Distributor.

# RCA

FIVE GOOD WAYS TO LEARN ALL  
ABOUT THE LATEST IN MICROWAVES

- \*By visiting all the leading microwave plants and interviewing their best designers and researchers.
- \*By attending all major conferences on the subject.
- \*By developing and editing state-of-the-art articles covering latest design techniques.
- \*By writing extensively about new developments and trends.
- \*By working for Electronic Design... the magazine whose editors make it their business to know.

Good salary,  
excellent benefits, and  
association with top professional  
engineer-writers can be yours.  
If you are an engineer with  
experience in microwaves or  
communications systems, and are  
interested in the possibilities,  
call or write Robert Haavind,  
Managing Editor, Electronic  
Design, 850 Third Avenue,  
New York, New York 10022,  
(212) PL 1-5530

**MASTER SPECIALTIES COMPANY** offers a precision line of lighted pushbutton switches, word indicator lights, unlighted pushbutton and toggle switches, and complete Master Caution fault warning systems that have been specified for many of the nation's most exacting industrial, commercial, aerospace, and military applications. ■ Its line has pioneered such concepts as front of panel relamping without tools, easy legend and color filter change, as well as mounting innovations that reduce installation time and costs. ■ Before you select any such units for your application, all we ask is a fair trial, with you as the judge. As exhibit "A" the operational suitcase-type demonstrator pictured below will enable you to examine a representative selection of all MSC devices, mounted and ready to operate as they would be in your equipment. ■ Call the nearest MSC field office, listed below, today . . . and we will rest our case in your office. If you wish to review our brief beforehand, write today for our Short Form Catalog No. 2007 that details sixteen switch/indicator lines to prove our points.



Before you pass judgement on  
any lighted pushbutton switch...

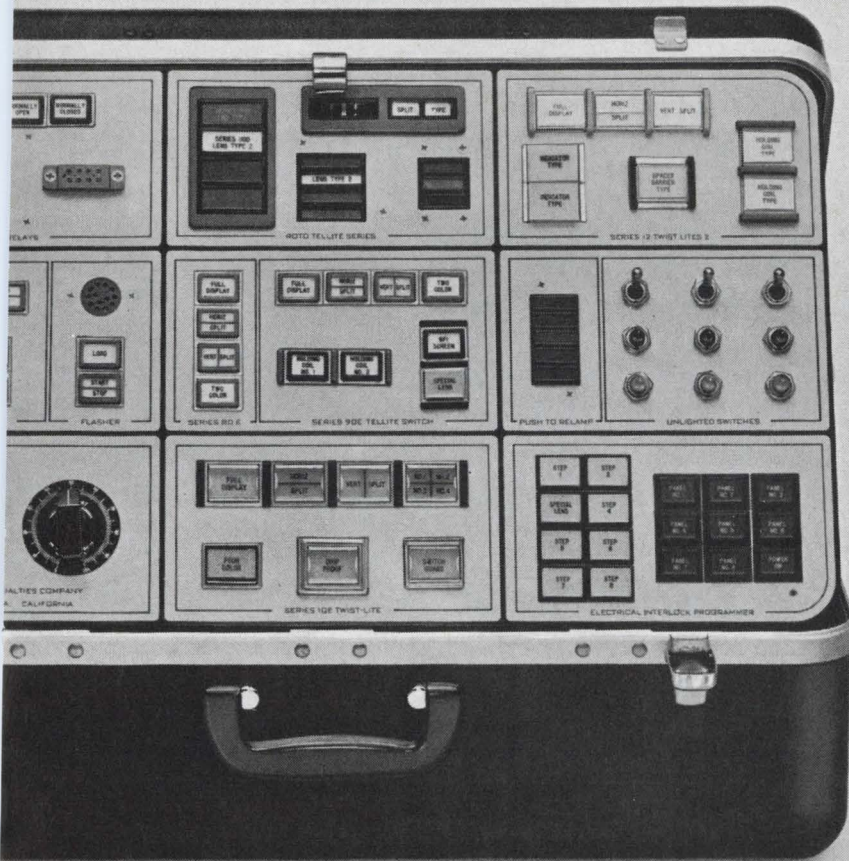

let's discuss  
the Master  
Specialties  
case in your  
chambers.

**MSC**

**MASTER SPECIALTIES COMPANY** 1640 MONROVIA • COSTA MESA • CALIFORNIA 92627 • (714) 642-2427 • TELEX 6-78433.

**Regional Offices:** Huntsville, Ala. (205) 536-7415 • Costa Mesa, Calif. (714) 642-0114 • Sunnyvale, Calif. (408) 245-9292 • Winter Park, Florida (305) 647-0100 • Chicago, Ill. (312) 282-7112 • Waltham, Mass. (617) 893-1020 • Haddonfield, N.J. (609) 428-0701 • Syracuse, N.Y. (315) 479-9191 • Valley Stream, L.I., N.Y. (516) 561-2334 • Cleveland, Ohio (216) 851-9700 • Dallas, Texas (214) 357-9459 • Houston, Texas (713) 228-2294 • Seattle, Wash. (206) 546-5161.

ALSO AVAILABLE FROM DISTRIBUTOR STOCK AT AVNET ELECTRONICS • WESTBURY, LONG ISLAND, NEW YORK (516) 333-5800 • CULVER CITY, CALIF. (213) 870-0111



## Happiness is an Acopian power supply . . . because it's shipped in only 3 days.

Whether your application is op amps, ICs, logic circuits, relays, lamps or electronic measuring equipment, look to Acopian to meet your needs for AC to DC plug-in power supplies. Acopian's new catalog lists over 62,000 different supplies . . . all available for shipment within 3 days. Get your 16 pages of happiness by writing or calling Acopian Corp., Easton, Pennsylvania (215) 258-5441.



INFORMATION RETRIEVAL NUMBER 8



Component  
space ?  
stuffed ●

## Get design room with the new space watchers' diet

Centralab's new, low cost SLIM TRIM Resistor is the ideal prescription for designers who have to make every fractional inch of space count. The Slim Trim takes so little room, it all but disappears in entertainment, military and industrial applications.

Out of sight, but not out of might. The Slim Trim is rated at 1/4 watt per section at 70° C, and offers resistance values ranging from 100 ohms to 15 megohms. Maximum voltage is 350 volts, which may be exceeded in special applications.

The unit is built on a .025" thick base plate of alumina to provide more effective heat dissipation. Carbon composition resistance is bonded directly to the plate for maximum reliability.

In addition to variable resistors, units can be supplied with fixed resistance as well. Multiple units with two, three or four sections are available. Single and multiple units are available with "hat" knobs, low profile knobs or without knobs. An edge adjust knob is available on single units only. Unit cost is as slim as under \$.07 in quantity.

When design spaces are bulging, a diet of Slim Trims is a space watcher's best friend.

FOR SAMPLES AND MORE INFORMATION ON SLIM TRIMS AND THE COMPLETE LINE OF CENTRALAB PRODUCTS, WRITE CENTRALAB, TODAY. CENTRALAB PRODUCTS ARE MARKETED THROUGH CENTRALAB INDUSTRIAL DISTRIBUTORS AND INTERNATIONALLY THROUGH GLOBE-UNION INC. —INTERNATIONAL DIVISION.

**SPECIAL NOTE:** Have you investigated the new, low cost of Centralab's 5TR miniature trimmer resistors?



**CENTRALAB**

Electronics Division  
GLOBE-UNION INC.

5757 NORTH GREEN BAY AVENUE  
MILWAUKEE, WISCONSIN 53201

M-6809

# A Smart Way to Beat Your Power Supply Size Problem

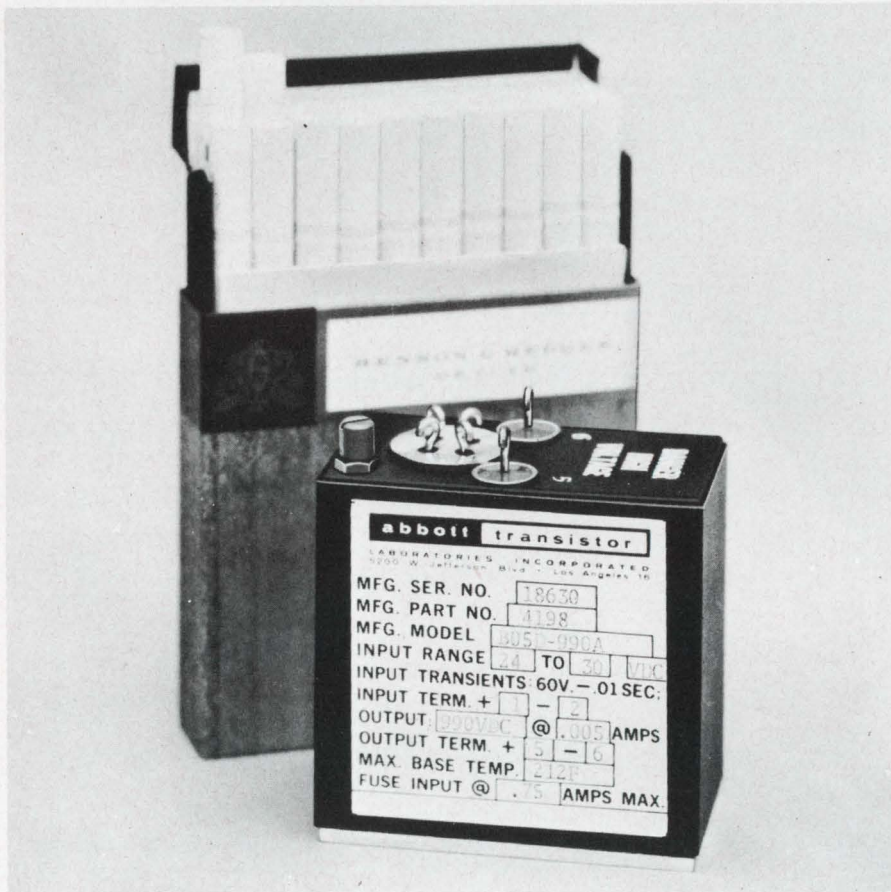

# abbott

1½" thin, 2¾" short, yet this converter produces 1000 volts DC, regulated, from a battery input of 28 VDC! It weighs less than 15 ounces. This is only one of our wide variety of many small light weight converters, inverters and power supplies — there are over 3000 models listed in our newest catalog, including size, weight, and prices. If you have a size problem, why not send for an Abbott catalog?

**MIL SPEC ENVIRONMENT** — All of the power modules listed in our new catalog have been designed to meet the severe environmental conditions required by modern aerospace systems, including MIL-E-5272C and MIL-E-5400. They are hermetically sealed and encapsulated in heavy steel containers. New all silicon units will operate at 100°C.

Please write for your FREE copy of this new catalog or see EEM (1967-68 ELECTRONIC ENGINEERS MASTER Directory), Pages 1665 to 1678.

**abbott transistor**

LABORATORIES, INCORPORATED

5200 W. Jefferson Blvd. / Los Angeles 90016  
(213) WEBster 6-8185 Cable ABTLABS

INFORMATION RETRIEVAL NUMBER 10

**RELIABLE** — Highest quality components are used in Abbott power modules to yield the high MTBF (mean time between failure) as calculated in the MIL-HDBK-217 handbook. Typical power modules have over 100,000 hours MTBF — proving that the quality was built in from the beginning.

**WIDE RANGE OF OUTPUTS** — Any voltage from 5 volts DC to 10,000 VDC is available by selecting the correct model you need from our catalog with any of a variety of inputs including:

- 60 $\phi$  to DC, Regulated
- 400 $\phi$  to DC, Regulated
- 28 VDC to DC, Regulated
- 28 VDC to 400 $\phi$ , 1 $\phi$  or 3 $\phi$
- 60 $\phi$  to 400 $\phi$ , 1 $\phi$  or 3 $\phi$

TO: Abbott Transistor Labs., Inc., Dept. 57  
5200 West Jefferson Blvd.  
Los Angeles, California 90016

Sir:  
Please send me your latest catalog on power supply modules:

NAME \_\_\_\_\_ DEPT. \_\_\_\_\_  
COMPANY \_\_\_\_\_  
ADDRESS \_\_\_\_\_  
CITY & STATE \_\_\_\_\_

# Designer's Datebook

MARCH						
S	M	T	W	T	F	S
					1	2
3	4	5	6	7	8	9
10	11	12	13	14	15	16
17	18	19	20	21	22	23
24	25	26	27	28	29	30

APRIL						
S	M	T	W	T	F	S
	1	2	3	4	5	6
7	8	9	10	11	12	13
14	15	16	17	18	19	20
21	22	23	24	25	26	27
28	29	30				

For further information on meetings, use Information Retrieval card.

**Mar. 18-21**

**IEEE International Convention and Exhibition (New York)** Sponsor: IEEE; J. M. Kinn, IEEE, 345 E. 47 St., New York, N.Y. 10017.

CIRCLE NO. 420

**Mar. 21-23**

**Symposium on Microwave Power (Boston)** Sponsor: International Microwave Power Institute; J. Sterling, Raytheon Company, Lexington, Mass. 02173.

CIRCLE NO. 421

**Apr. 3-5**

**International Conference on Magnetism (INTERMAG) (Washington, D.C.)** Sponsor: IEEE; Philip Cohen, Magnetics, Inc., Butler, Pa. 16001, or J. M. Lommel, General Electric R&D Center, Schenectady, N.Y. 12301.

CIRCLE NO. 422

**Apr. 9-11**

**National Telemetry Conference (Houston)** Sponsor: IEEE; Lewis Winner, 152 W. 42 St., New York, N.Y. 10036.

CIRCLE NO. 423

**Apr. 16-18**

**National Symposium on Law Enforcement Science and Technology (Chicago)** Sponsor: U.S. Dept. of Justice; S. A. Yefsky, IITRI, 10 W. 35 St., Chicago, Ill. 60616.

CIRCLE NO. 424

**Apr. 22-24**

**Frequency Control Symposium (Atlantic City, N.J.)** Sponsor: U.S. Army Electronics Command; M. F. Timm AMSEL-KL-ST, Director Electronic Components Lab., U.S. Army Electronics Command, Fort Monmouth, N.J. 07703.

CIRCLE NO. 425



# EECoLogIC® IC cards lock firmly...

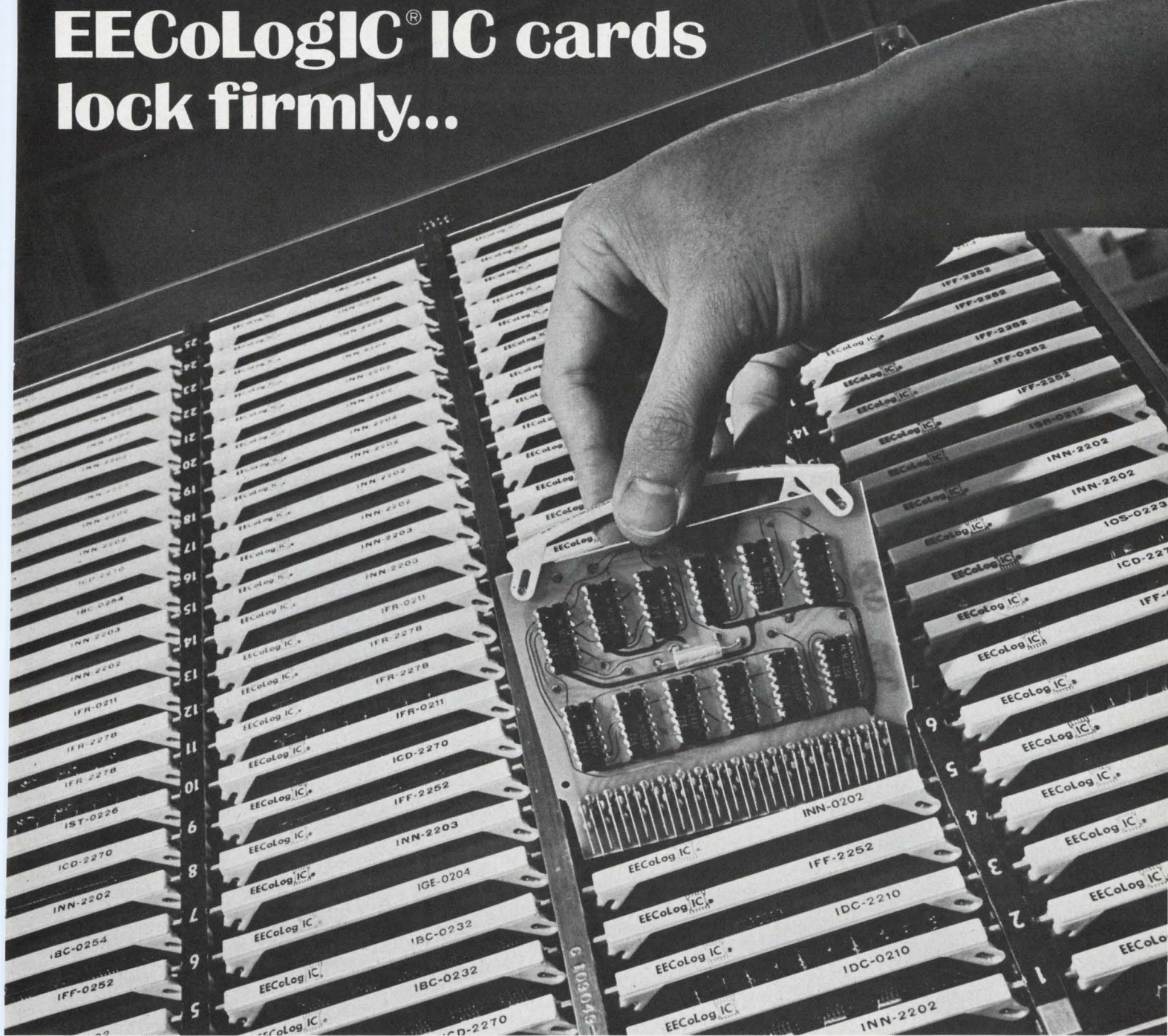

## extract easily with flexible handle

Forget about logic cards shaking loose in transit or mobile installations... or trying to find just the right card extractor during maintenance. The unique flexible EECoLogIC handle locks the card securely in your system. For servicing, it clearly identifies your circuit and becomes its own extractor.

These user-oriented details characterize the EECoLogIC line — the broadest selection of useful integrated circuit logic modules... including basic IC cards, 35 function modules (counters, shift registers, adders, many others), and special breadboard and prototype circuits.

Our 172 page EECoLogIC catalog describes the entire line, and includes 65 pages of practical application data. Send for your copy today.

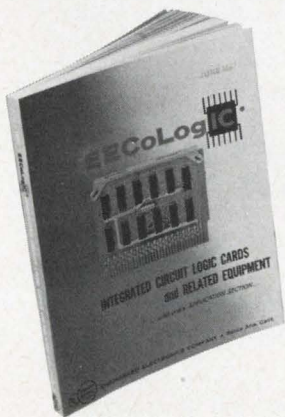

### **COMPONENTS DIVISION**

ELECTRONIC ENGINEERING COMPANY OF CALIFORNIA

1441 EAST CHESTNUT AVENUE • SANTA ANA, CALIFORNIA 92701 • (714) 547-5651

See the complete EECo Product Line at the IEEE Show, Booth No. 4J12-4J18

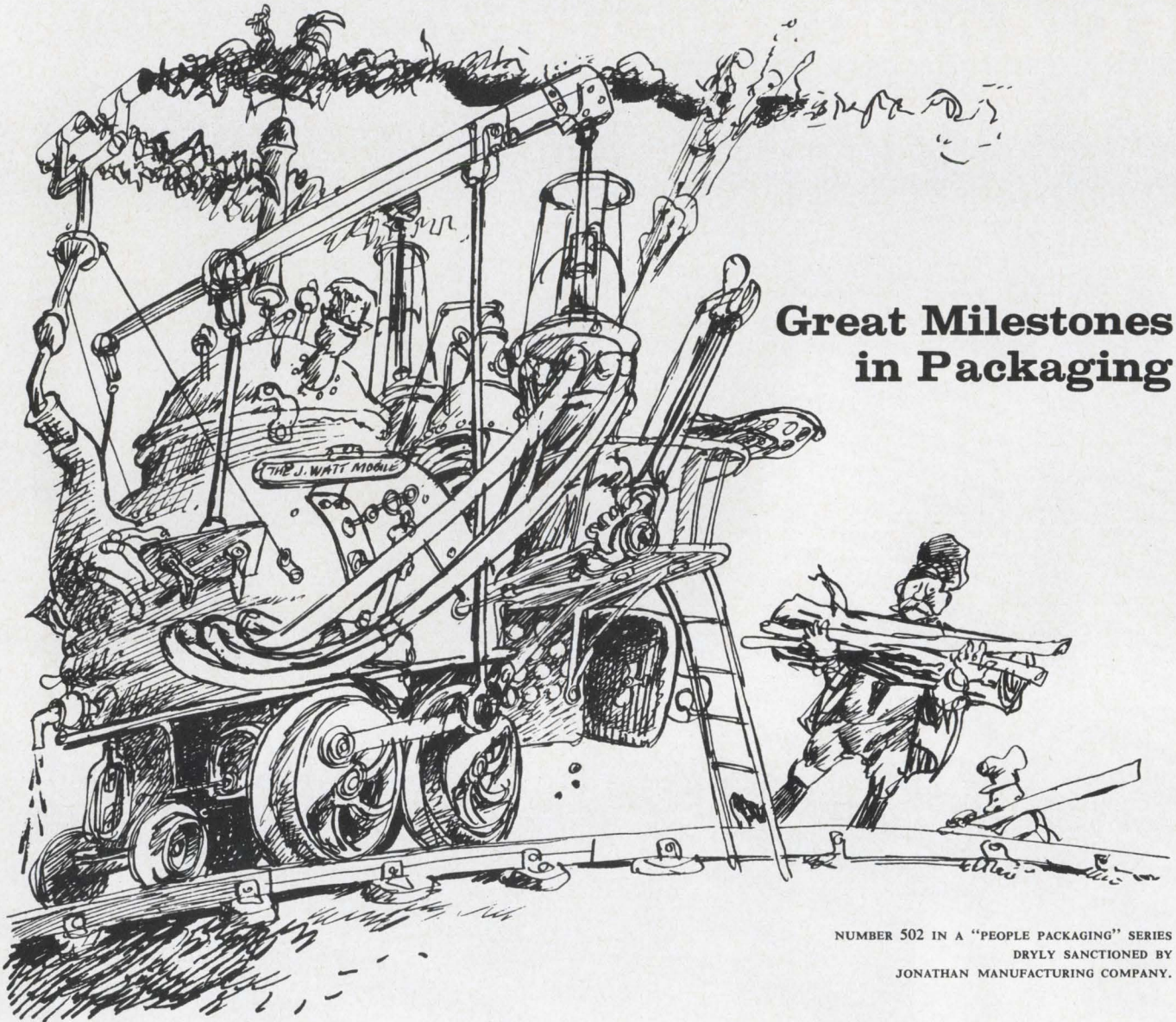

## Great Milestones in Packaging

NUMBER 502 IN A "PEOPLE PACKAGING" SERIES  
 DRYLY SANCTIONED BY  
 JONATHAN MANUFACTURING COMPANY.

A means of innovation from then existing methods of publicly pulling passengers was developed in the early 1800's by members of the Scottish Antipedestrianism movement. After considerable railery among the group, a plan was hastily put through that involved attaching a chassis to wheels and obtaining self-propulsion through utilization



of J. Watt's cylinder and vacuum idea. Due to the rather odd persons connected with the venture, the name given the vehicle, "Locomotive," was derived from this fact, not from the Latin word *Locus*, as was thought to be the case by Noah Webster. While ball bearings subsequently proved their worth by improving passage along the parallel steel rails, the need for steam power fortunately disappeared before Jonathan discovered that shifting electronic chassis in and out of cabinets in this manner could be a shrewd move.

By 1840, when people were being packaged in convenient, end-attached enclosures and hauled at a great rate toward the Golden West by the locomotive, the fore-

runners of the Jonathan people already had a gleam in their eyes. The net result of these historically-interlocked events is the company's new ultra-thin ball-bearing steel slide series. Combining practically all

the advantages once found only in custom-extruded aluminum types, Jonathan wisely produces both two and three section models that embody rather clever ball retainers for smoothest sliding and very long operational life. They are inexpensive, not cheap, starting at about six bucks the pair in reasonable quantities, and have keen weight vs. strength ratios.

**One FEL Swoop!** Frequency Engineering Laboratories will hand you a line of digitally programable synthesizers — complete with our steel Type 110 quick-disconnect-pivot slides attached. Turnable units from 950 Mhz to 12.4 Ghz feature internal modular construction to meet any measurement. The slide 90° pivot provision makes service and maintenance a breeze. (left)

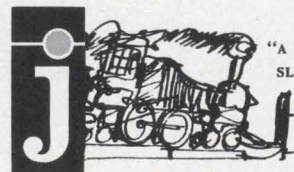
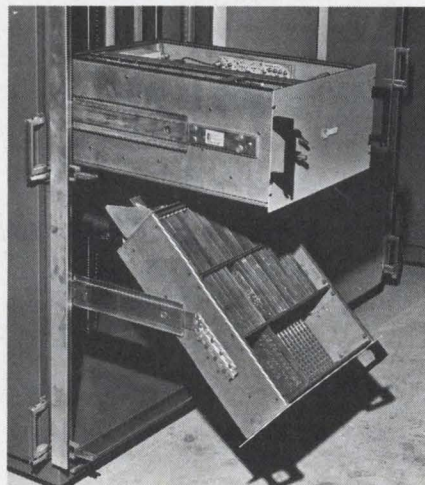

"A WELL TRAINED  
SLIDE"

**JONATHAN MANUFACTURING COMPANY**

720 E. WALNUT AVE., FULLERTON, CALIF. 92632 • 1258 TEANECK RD., TEANECK, N.J. 07666

"See the Jonathan Slide Show at IEEE, New York, Coliseum Booth No. 1F27"

INFORMATION RETRIEVAL NUMBER 12

INFORMATION RETRIEVAL NUMBER 212 ►

# THIS FREE NEW OPERATIONAL AMPLIFIER HANDBOOK WILL HELP YOU SOLVE APPLICATION PROBLEMS THREE WAYS:

- 1 REFERENCE SECTION** — Written by op-amp experts. Includes up-to-date theoretical and practical data on the proper selection and application of operational amplifiers. Invaluable aid to the engineer designing with op-amps.
- 2 SELECTION GUIDELINES** — Selection of the proper amplifier for every application is made easy. A new series of handy graphs show at a glance the interactions of various key parameters and how they affect circuit performance.
- 3 PRODUCT CATALOG** — Complete specifications (including prices) on hundreds of operational amplifiers and accessories. Many new products appear for the first time in print. An op-amp for virtually every application can be found here.



## AMONG THE NEW PRODUCTS IN THIS CATALOG

- |  |  |
|--|--|
| <b>FAST CHOPPER STABILIZED AMPLIFIERS</b>  | 0.2 $\mu$ V/ $^{\circ}$ C and 0.5pA/ $^{\circ}$ C, .01% settling in 1 $\mu$ s, \$165 |
| <b>LOW DRIFT CHOPPERLESS DIFFERENTIALS</b> | 1.5 $\mu$ V/ $^{\circ}$ C, \$65; 3 $\mu$ V/ $^{\circ}$ C, \$45; 1 $\mu$ V p-p noise  |
| <b>ECONOMY FOUR-QUADRANT MULTIPLIER</b>    | 400 kHz, 0.25% linearity, \$165  |
| <b>ACTIVE LOW-PASS FILTERS</b>             | 1 to 1000 Hz, 80db/decade attenuation, 20 $\mu$ V/ $^{\circ}$ C, \$75                |
| <b>LOW COST OP-AMP POWER SUPPLIES</b>      | miniature pc mounting, $\pm$ 15Vdc @ 40mA, \$39 (10 lot)                             |

AIR MAIL  
Permit No. 39342  
Cambridge, Mass.

### BUSINESS REPLY MAIL

No postage stamp necessary if mailed in the United States

POSTAGE WILL BE PAID BY

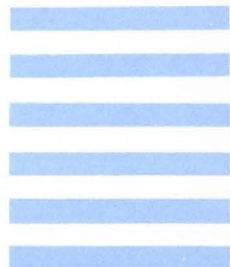

INSTANT

MAIL THIS POSTAGE PAID CARD DIRECTLY TO ANALOG DEVICES AND YOUR HANDBOOK WILL BE ON ITS WAY TO YOU WITHIN 3 DAYS.

ACTION



**ANALOG DEVICES INC.**  
221 FIFTH STREET,  
CAMBRIDGE, MASS. 02142

# DON'T BUY FET OP-AMPS UNTIL YOU'VE SEEN THESE

Best performance per dollar you can buy!

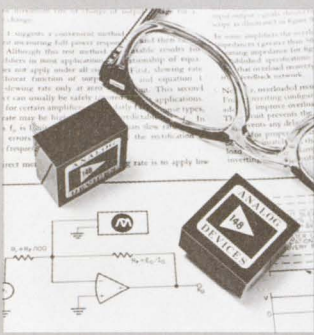

Analog Devices now announces a complete new family of FET operational amplifiers.

These amplifiers are the result of extensive research and the application of today's most sophisticated components and design techniques. They offer by far the most performance at the lowest cost of any FET op-amps presently on the market.

All models are in stock and evaluation samples are available.

## LOWEST COST

\$25 unit price

Low cost FET types from \$25 are best values where CMRR, voltage drift and speed are not critical. Low price tag brings good FET performance to many new applications where high cost of previously available FET op-amps has been the major limitation.

## BEST SPECS

$2\mu\text{V}/^\circ\text{C}$ ,  $3 \times 10^5$  CMRR

High gain, fast response, low-voltage drift and best CMRR are outstanding features of models 143 and 147. Chopper stabilized types can often be replaced by these models where low drift and differential inputs are required.

## FAST SETTLING

0.01% accuracy  $< 1\mu\text{s}$

Fast settling time of models 148 and 149 make them ideal op-amps for A/D and D/A converters, sample-and-hold circuits, and other applications where speed is the most important parameter. 0.01% settling time of  $1\mu\text{s}$  is the fastest available anywhere.

MODEL
OPEN LOOP GAIN
RATED OUTPUT ( $\pm 10\text{V}$ )
FREQUENCY RESPONSE
Unity gain, small signal
Full power response, min.
Slewing rate, min.
Overload recovery
Settling time to 0.01%
INPUT IMPEDANCE
CMRR
TYPE
VOLTAGE DRIFT ( $\mu\text{V}/^\circ\text{C}$ max.)
$I_{\text{bias}}$ @ $25^\circ\text{C}$ (pA max.)
PRICE (1-9)

141	142
$8 \times 10^4$	$8 \times 10^4$
2mA	20mA
3MHz	5MHz
50kHz	150kHz
3V/ $\mu\text{s}$	10V/ $\mu\text{s}$
1.4ms	1.5ms
—	—
$10^{11}\Omega$	$10^{11}\Omega$
1000	2000
A B C	A B C
75 40 25	50 25 15
50 30 30	50 30 30
\$25 \$30 \$35	\$30 \$40 \$55

143	147
$10^5$	$10^6$
20mA	10mA
5MHz	10MHz
100kHz	150kHz
7V/ $\mu\text{s}$	10V/ $\mu\text{s}$
1.5ms	400 $\mu\text{s}$
—	—
$10^{11}\Omega$	$10^{12}\Omega$
40,000	300,000
A B C	A B C
30 15 7	15 5 2
30 15 15	30 15 15
\$55 \$65 \$90	\$95 \$115 \$135

148	149
$3 \times 10^4$	$10^5$
20mA	15mA
10MHz	15MHz
500kHz	1.5MHz
50V/ $\mu\text{s}$	100V/ $\mu\text{s}$
15 $\mu\text{s}$	0.5 $\mu\text{s}$
1 $\mu\text{s}$	1.5 $\mu\text{s}$
$10^{11}\Omega$	$10^{11}\Omega$
2000	15,000
A B C	A B C
50 25 15	30 15 7
50 30 30	30 15 15
\$42 \$47 \$62	\$75 \$85 \$105

## INSTANT ACTION REQUEST

### Please send:

- 36 page operational amplifier catalog
- DATA SHEET
- EVALUATION SAMPLE
- FET Model (s) \_\_\_\_\_
- New Chopper Series
- Low Drift Differentials
- Four Quadrant Multiplier/Divider
- Active Low Pass Filters
- Op Amp Power Supply

### My interest is for:

- Immediate application
- Anticipated application
- Information only

- I am now using \_\_\_\_\_ Quantity per year \_\_\_\_\_
- Operational Amplifiers  1-50
- I expect to be using \_\_\_\_\_  50-250
- Operational Amplifiers  Over 250

My principal source of supply is \_\_\_\_\_

- Please add my name to AD mail list

Name \_\_\_\_\_ Title \_\_\_\_\_

Company \_\_\_\_\_

Dept./Mail Station \_\_\_\_\_ Phone \_\_\_\_\_

Address \_\_\_\_\_

City \_\_\_\_\_ State \_\_\_\_\_ Zip \_\_\_\_\_

FILL IN THIS AIR MAIL POSTAGE PAID INSTANT ACTION CARD FOR YOUR FREE NEW HANDBOOK, ADDITIONAL LITERATURE, OR EVALUATION SAMPLES.



221 Fifth Street,  
Cambridge, Mass. 02142

617/492-6000

# ANNOUNCING . . .

The *WORLD'S* most compact *QUALITY*

# CERAMIC TRIMMER CAPACITOR

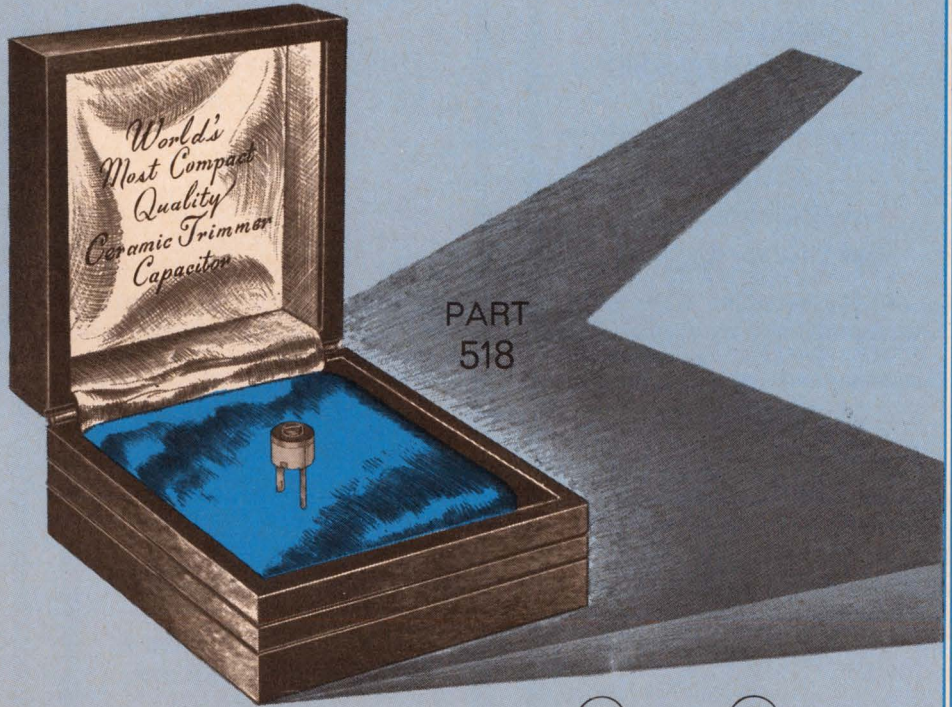

## AMAZING 1.0 to 25 pF. CAPACITANCE RANGE IN LESS THAN .007 CUBIC INCH

- Two mounting arrangements.
- Occupies less than .007 cubic inches.
- Has the ruggedness and range of much larger Trimmers.
- Unique design insures rigid mounting stability.
- Sealed-in-ceramic rotor electrode guarantees environmental stability.
- Precision lapped bearing surfaces insure smooth linear tuning.

### GENERAL SPECIFICATIONS

Capacitance Ranges..... 1.0pF - 3pF  
 2.5pF - 9pF  
 3.5pF - 20pF  
 5.0pF - 25pF

Operating Temperature Range..... -55°C to +125°C

Working Voltage..... 100 WVdc to 85°C  
 50 WVdc to 125°C

Dielectric Strength..... 200 Vdc 1 - 5 sec.

ERIE OFFERS THE MOST COMPLETE SUBMINIATURE TRIMMER CAPACITOR LINE IN THE INDUSTRY . . .



CERAMIC



AIR

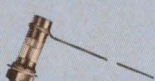

GLASS AND QUARTZ



PLASTIC



VERTICAL TUNING

HORIZONTAL TUNING

ERIE

TECHNOLOGICAL

PRODUCTS, INC.



Erie, Pennsylvania

# Did You Know Sprague Makes 21 Types of Solid-electrolyte Tantalex<sup>®</sup> Capacitors?

## HERMETICALLY-SEALED METAL-ENCASED TUBULAR CAPACITORS

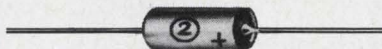

Type 150D, polarized  
Type 151D, non-polarized

**ASK FOR BULLETINS 3520F, 3521A**

INFORMATION RETRIEVAL NUMBER 882

## HERMETICALLY-SEALED METAL-ENCASED TUBULAR CAPACITORS to MIL-C-26655 and MIL-C-39003



Type CS12, uninsulated case  
Type CS13, insulated case  
Type CSR13, established reliability

**ASK FOR BULLETINS 3520.1, 3520.2**

INFORMATION RETRIEVAL NUMBER 883

## ULTRA-MINIATURE CAPACITORS For Hearing Aids and other Subminiature Circuits

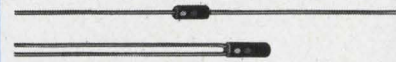

Type 160D, axial-lead  
Type 161D, single-ended

**ASK FOR BULLETIN 3515D**

INFORMATION RETRIEVAL NUMBER 881

## HYREL<sup>®</sup> ST HERMETICALLY-SEALED METAL-ENCASED TUBULAR CAPACITORS for Highest Reliability



Type 350D, polarized  
Type 351D, non-polarized

**ASK FOR BULLETINS 3520.5B, 3521A**

INFORMATION RETRIEVAL NUMBER 884

## SUBMINIATURE TUBULAR CAPACITORS specially sized for "cordwood" packaging



Type 172D, hermetically sealed  
in metal cases  
Type 165D, sealed in  
polyester-film tubes

**ASK FOR BULLETINS 3523A, 3535**

INFORMATION RETRIEVAL NUMBER 885

## 3-TERMINAL FEED-THRU CAPACITORS

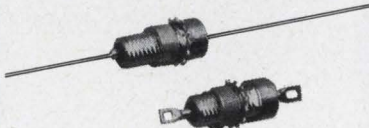

Type 180D, hermetically sealed in  
threaded metal cases

**ASK FOR BULLETIN 3525A**

INFORMATION RETRIEVAL NUMBER 886

## MINIATURE RED-TOP<sup>®</sup> TUBULAR CAPACITORS in Resin-sealed metal cases

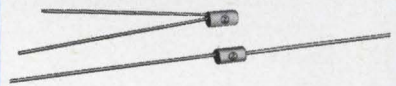

Type 162D, axial-lead, polarized  
Type 163D, axial-lead, non-polarized  
Type 169D, single-ended, polarized  
Type 170D, single-ended, non-polarized

**ASK FOR BULLETIN 3536A**

INFORMATION RETRIEVAL NUMBER 887

## EPOXY-DIPPED CAPACITORS

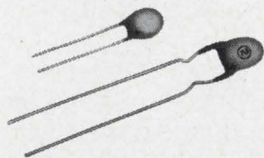

Type 196D, radial lead for  
printed wiring boards

**ASK FOR BULLETIN 3545**

INFORMATION RETRIEVAL NUMBER 888

## UNIPONENT<sup>★</sup> CAPACITORS in Flat-Pack Cases

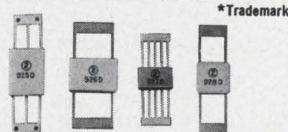

Type 925D, 6 lead, .265" x .375" x .065"  
Type 926D, 4 lead, .375" x .265" x .065"  
Type 927D, 10 lead, .265" x .160" x .050"  
Type 928D, 4 lead, .250" x .250" x .065"

**ASK FOR BULLETIN 3540**

INFORMATION RETRIEVAL NUMBER 889

For comprehensive engineering  
bulletins on the capacitor types  
in which you are interested,  
write to:

Technical Literature Service  
Sprague Electric Company  
347 Marshall Street  
North Adams, Mass. 01247

## SPRAGUE COMPONENTS

CAPACITORS  
TRANSISTORS  
RESISTORS  
INTEGRATED CIRCUITS  
THIN-FILM MICROCIRCUITS

PULSE TRANSFORMERS  
INTERFERENCE FILTERS  
PULSE-FORMING NETWORKS  
TOROIDAL INDUCTORS  
ELECTRIC WAVE FILTERS

CERAMIC-BASE PRINTED NETWORKS  
PACKAGED COMPONENT ASSEMBLIES  
BOBBIN and TAPE WOUND MAGNETIC CORES  
SILICON RECTIFIER GATE CONTROLS  
FUNCTIONAL DIGITAL CIRCUITS

# SPRAGUE<sup>®</sup>

THE MARK OF RELIABILITY

<sup>®</sup>"Sprague" and "®" are registered trademarks of the Sprague Electric Co.

# News

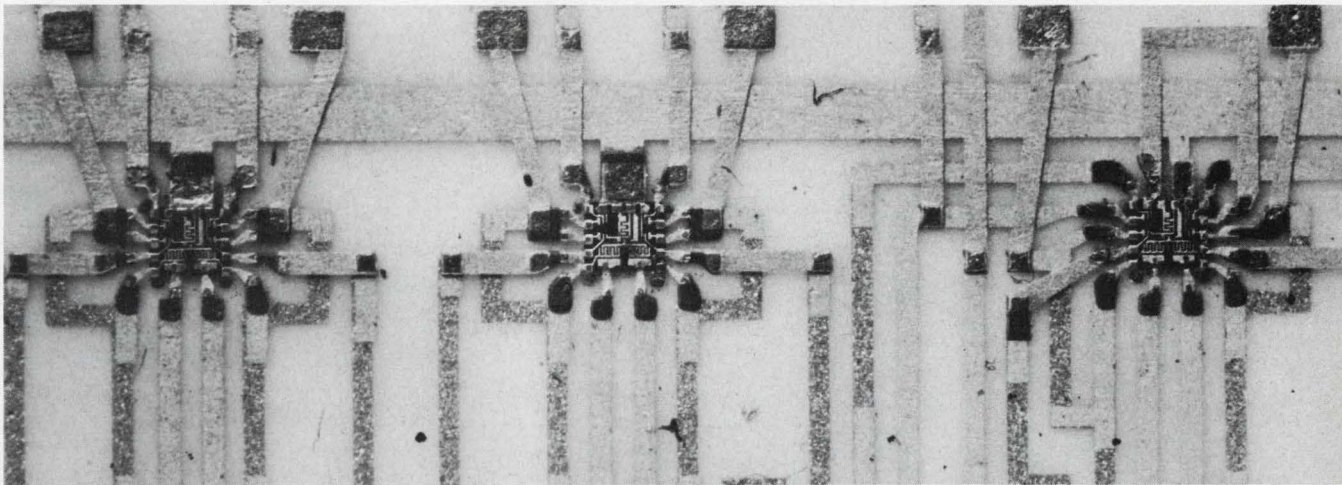

**Right-side-up flip-chip**, using Teflon dielectric, is an example of advances reported at

this year's International Solid-State Circuits Conference. Page 25



**The Federal Administration's 1969 budget** calls for \$76.7 billion to be spent on defense

needs. A large portion of money will go to next-generation weapon's systems. Page 34

## Also in this section:

**MOS flat pack** converts A to D. Page 41

**News Scope** Page 21 . . . **Washington Report** Page 45 . . . **Editorial** Page 49

# New from Sprague!

**5 Times the Resistance of  
a Conventional Metal-Film Resistor  
of Equal Size!**

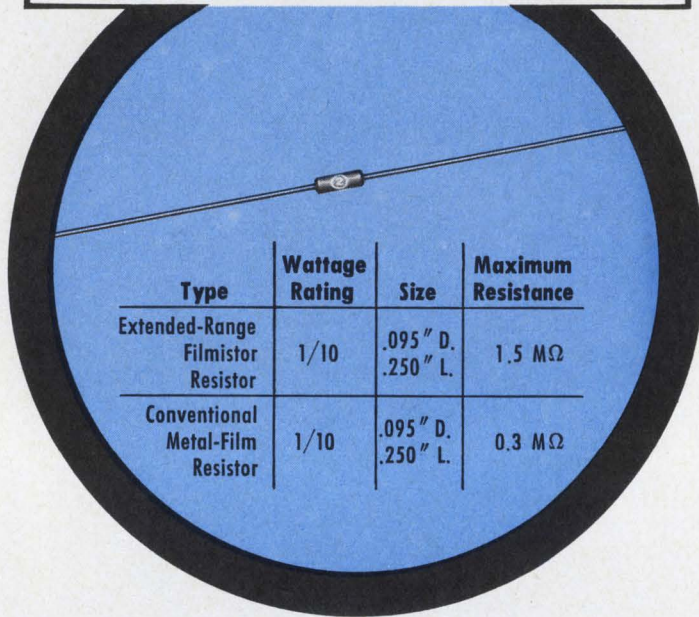

## EXTENDED-RANGE FILMISTOR® METAL-FILM RESISTORS

**Substantial saving of space in all wattage ratings —  
1/20, 1/10, 1/8, 1/4 1/2, and 1 watt —with  
absolutely NO SACRIFICE IN STABILITY!**

Extended-Range Filmistor Resistors now offer, in addition to accuracy . . . stability . . . reliability . . . resistance values in size reductions which were previously unobtainable. Size and weight advantages of Filmistor Resistors now make them ideal for applications in high-impedance circuits, field-effect transistor circuits, etc. Many designs which previously had to settle for the higher temperature coefficients of carbon-film resistors in order to obtain required resistance values can now utilize the low and controlled temperature coefficients of Filmistor Metal-Film Resistors.

Other key features are  $\pm 1\%$  standard resistance tolerance, low inherent noise level, negligible voltage coefficient of resistance, and tough molded case for protection against mechanical damage and humidity.

*For complete technical data, write for Engineering Bulletin 7025D to Technical Literature Service, Sprague Electric Co., 347 Marshall Street, North Adams, Massachusetts 01247.*

### SPRAGUE COMPONENTS

RESISTORS  
CAPACITORS  
TRANSISTORS  
INTEGRATED CIRCUITS  
THIN-FILM MICROCIRCUITS  
INTERFERENCE FILTERS

PACKAGED COMPONENT ASSEMBLIES  
FUNCTIONAL DIGITAL CIRCUITS  
MAGNETIC COMPONENTS  
PULSE TRANSFORMERS  
CERAMIC-BASE PRINTED NETWORKS  
PULSE-FORMING NETWORKS



Sprague® and ® are registered trademarks of the Sprague Electric Co.

INFORMATION RETRIEVAL NUMBER 81

## Epoxy-Dipped Tantalex® Capacitors for Applications Where Tantalum Capacitors Were Previously Too Expensive

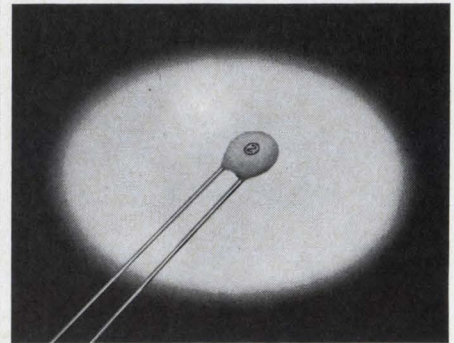

The advantages of tantalum, previously available only in expensive industrial capacitors, can now be had in a low cost capacitor — the new Type 196D Solid-Electrolyte Tantalex Capacitor, designed and developed by the Sprague Electric Company.

Intended for industrial electronic and communications applications where costs must be held at a minimum, Type 196D Tantalum Capacitors have a special epoxy-dip coating which insures circuit economy without any sacrifice in dependability. This epoxy coating positively seals the capacitor section while providing excellent electrical insulation. It also protects the capacitor against damage in handling and installation.

The radial lead design of these new solid-electrolyte capacitors is particularly well-suited for printed wiring board applications—their .250" lead spacing will fit standard .125" grids.

These low cost tantalums offer high stability — they exhibit very little capacitance change, even at the outer limits of their operating temperature range ( $-55\text{ C}$  to  $+85\text{ C}$ ). The low dissipation factor of Type 196D Capacitors permits higher ripple currents.

These capacitors meet the environmental test conditions of Military Specification MIL-C-26655B, and are available in a wide range of capacitance values in voltages from 4 to 35 volts d-c.

For complete data or application engineering assistance, write to Tantalum Capacitor Section, Field Engineering Department, Sprague Electric Company, 347 Marshall Street, North Adams, Massachusetts 01247.

INFORMATION RETRIEVAL NUMBER 82

ELECTRONIC DESIGN 5, March 1, 1968



# News Scope

## Low-budget moon trips will follow Apollo Craft

Despite the National Aeronautics and Space Administration's shrinking budget, a fairly healthy program for exploring the moon was outlined last week by George E. Mueller, NASA's associate administrator for manned space flight. He testified before the Manned Space Flight Subcommittee of the House Committee on Science and Astronautics.

Before he gave his testimony, a NASA spokesman said the U.S. would not send a man on a circumlunar flight, as it is rumored the Russians will do this fall, because we don't need to. Our unmanned Surveyor and Lunar Orbiter craft sent back enough pictures and data to enable NASA to select five suitable sites for landing men. The only reason our astronauts would take a nonstop trip around the moon, the spokesman indicated, is if a subsystem in the Apollo craft failed, making a descent to the moon unsafe.

A number of projects are planned for exploring the moon after the early Apollo's tasks are completed, Mueller told the subcommittee. The first flights in 1969 are intended to collect soil samples and to leave the initial geophysical package that will send back data on such phenomena as the inner structure of the moon, the near-surface layering, radiation environment, seismic measurements and heat flow.

Later missions, Mueller said, will be longer. The distance the astronauts can travel from their lunar module will be greater; the payload to the moon will be bigger, as will the payload of trophies they can bring back to earth.

To extend the radius of exploration on the moon, roving vehicles or flying machines are possibilities. Bendix and Boeing have each built roving vehicle prototypes and Bell Aerosystems Co. of Niagara Falls,

N.Y., has done a study of a flying craft.

The guidance accuracy must be improved, Mueller told the Congressmen, to ensure better landing accuracy. If this can be done, later missions can venture outside the established landing sites without using extra fuel.

Extended visits can be accomplished, Mueller said, by sending dual missions to the moon. One Saturn 5 can take supplies, while another sends up astronauts.

Eventually a manned mission just before descending to the moon's surface might eject a small scientific satellite to orbit the moon.

It would measure magnetic fields, radiation environment and the gamma-ray spectrum. It could be used for geodetic tracking and to relay communications.

### RCA now marketing its printed circuits

With production of printed-circuit boards more than adequate to supply its own needs, the Radio



New printed circuit line by RCA.

Corp. of America has raised its output and is going into the business.

With a new \$4-million facility at Moorestown, N.J., plus modernization of its old plant at Camden, the company has more than tripled its production capacity to 30,000 multi-layer circuits a month, in addition to 300,000 single- and double-sided circuits. The added capacity has been achieved principally by a high degree of mechanization, especially in the Moorestown plant.

Although RCA will still be its own biggest customer, it plans to sell 30 to 40 per cent of its circuit boards outside, mainly to industrial and aerospace users.

### NASA seeks advances in manned-space design

NASA's director of advanced space missions says that the U.S. has the basic technology to send man to the planets of the solar system but that significant changes in system design will be required before long missions can be conducted.

Dr. Franklin P. Dixon, speaking before the IEEE Winter Convention on Aeronautics and Electronic Systems in Los Angeles said that while lunar missions lasting from a few days to a few weeks might be accomplished with existing technologies, missions extending into years, would require more complex subsystems.

"For this reason," he added, "it appears necessary to provide on-board replacement of repair capability during the mission. This requirement will markedly change the design of our present generation of subsystems, to allow the astronauts to diagnose failures, change components and reverify system operation."

The system most affected by this requirement is the data-handling and display system, Dr. Dixon said. He stressed that a data rate of  $10^8$  bits a day could be generated by a moderately comprehensive experiment program, and that if high-resolution photographs are to be transmitted, the data rate could grow to  $10^{11}$  bits a day or higher.

This data rate may exceed present transmission capability by nearly an order of magnitude. A

simple solution to accommodate the difference, Dr. Dixon said, would be to have the crew edit out redundant or meaningless data prior to transmission back to earth.

To free the crew from routine tasks, automatic mounting or sub-systems will also be needed, Dr. Dixon said.

Another major system that will require substantial up-rating with longer flights and larger crews is the power supply, he went on. For a crew of six to nine men, Dr. Dixon estimated that more than 10 kw of power would be required. Two power sources are under consideration; the presently used solar-cell system array and an isotope-brayton-cycle dynamic generating system. The latter would use a plutonium-238 isotope to heat an inert gas, such as argon, which would then be expanded through a turbine to generate electrical power. Plutonium-238 is being considered because radiation protection from the alpha particles and secondary decay emissions require a relatively light weight shield.

## Color video recorder uses tape cartridge

A prototype of a color video tape-cartridge recorder and playback unit for the home-entertainment market has been demonstrated by Arvin Industries, Inc., of Indianapolis. The company expects the unit to be in production in 1969 or early 1970.

The CVR XXI recorder, which reportedly will sell for from \$1000 to \$1500, instantly plays back, in color, programs televised by a network. Push buttons control operation for both recording and playback, and all levels are set automatically. Up to one hour of material can be recorded on a single cartridge.

The unit employs a longitudinal scanning principle with a stationary head, as opposed to the more conventional helical or transverse, scanning with rotating heads. This is made possible by reversing di-

rection and changing tracks at the end of the 10-track tape in less than a second. The demonstration model used Dupont's CROLYN magnetic tape, though any good-quality, one-half-inch tape can be used, according to Arvin.

Though the transport was developed by Arvin, it employs some of the technology licensed to it by Newell Associates (See "Low-Cost Tape Transport Records 50-MHz," ED 13, June 21, 1967, p. 38).

## Telemetry aircraft may monitor missiles

The U.S. may use a fleet of telemetry-acquisition aircraft to receive test data from its new, more complex missile warheads during reentry and the last crucial seconds before they dive into the sea.

The Mitre Corp. at Bedford, Mass., is studying the feasibility of building such a fleet, called Telemetry Range Instrumentation Aircraft. The results of the study will be passed on to the Air Force's Electronic Systems Div., at Hanscom Field, Mass.

Aircraft can do the job better than ships, Mitre says, because they extend the range of line-of-sight transmissions. The improved coverage would permit one aircraft to receive telemetry data from several warheads landing in different places at the same time. With directional antennas, a plane should be able to reacquire the missile's telemetry signal after reentry blackout and provide coverage to impact. The system should also circumvent multipath problems and pick up weak signals.

## Enter, the DC-10; Exit the BAC-111?

American Airlines' announced intention to purchase the McDonnell-Douglas DC-10 Airbus is still reverberating throughout the aircraft and avionics industries. The possible buy, \$400 million for 25 aircraft delivered by late 1971 and a \$400 million option for 25 more delivered in 1973, could influence procurement by competitive airlines, observers feel. Principal losers at least initially, are General Electric and Lockheed Aircraft

and its suppliers for a similar Airbus, the L-1011. Also affected by the purchase are many suppliers of airborne electronics equipment.

Observers in Washington feel that a "deal" has been made. American Airlines apparently wants to dump its relatively new, but operationally disappointing British Aircraft Corp. BAC-111s—small twin-engine, short-range jets. It is believed that despite previous statements by a top McDonnell official that GE engines had been selected for the DC-10, Rolls-Royce engines will be purchased instead. Thus by a complex swap, the British would take back the unwanted BAC-111s from American Airlines if it demands British engines on the new Airbus.

Braniff and Mohawk airlines are also reported to dislike their BAC-111s, and both have expressed an intention to purchase an Airbus. The belief is that they, too, will then seek a similar arrangement with Rolls-Royce.

However, the engines may be built in the U.S. This negates any balance of payment argument.

## Comsat is soliciting bids for 2 advanced Intelsats

Comsat has let out requests for proposals on two Intelsat communications satellites that would be more advanced than the Intelsat 3 satellites being produced by the TRW Systems Group.

The first new satellite, Intelsat 3.5, would accommodate 1900 two-way voice circuits, compared with 1200 for Intelsat 3, and two prototypes would be launched in mid-1969.

The second proposed satellite, Intelsat 4, would have at least 5000 voice circuits and would provide greater operational versatility. The first of four vehicles would be launched in mid-1970.

When Comsat receives proposals for Intelsat 3.5 on March 9, it will be looking for 1400 circuits, available through narrow-beam antennas, and 500 circuits through global-coverage antennas.

Intelsat 4 will weigh 2430 pounds, in order to house two options: one with 12 transponders and the other with 16.

Proposals are due April 8.



## Toroid selection for pulse transformers used to be a nightmare.

But our ferrites have changed all that.

They're Pulse-Rated. A first for the industry.

The only toroids with specified characteristics for pulse transformer applications. Not just the usual irrelevant magnetic properties. Each part is designated as a pulse component, and listed by its pulse inductance, pulse magnetizing current and ET

product, according to ASTM methods.

We also guarantee all parameters. Every pulse transformer toroid we make is 100% tested. Performance reliability is assured from samples to production quantities. We make use of automatic high speed testers to guarantee these parameters.

It marks the end of trial and error spec'ing.

Especially for computer applications. The 230 mil diameter core is just the first in our series of PR toroids.

For literature or samples of our new PR toroids, write Indiana General Corporation, Electronics Division/Ferrites, Keasbey, N. J. Pleasant dreams.



**INDIANA GENERAL**

Making Magnetics Work

# “There’s another giant in Jolly Green’s Valley.” (ho ho ho)

Already people are saying that we’re much bigger in the relay and timer business than we claim to be. They’re saying there’s another giant up in the Jolly Green’s Minnesota Valley.

That’s a bunch of nonsense!

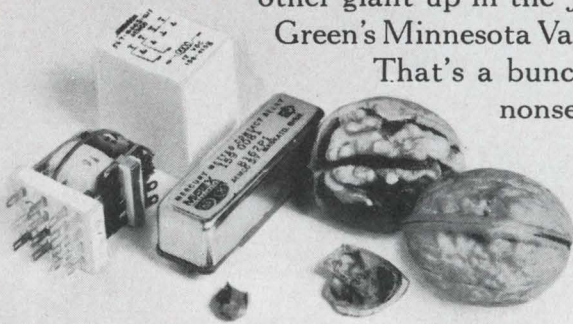

Sure we’ve cracked some tough nuts for people like 3M Company and Collins Radio and IBM, but that’s because we dove into their problems head first and didn’t come up until we had an answer. We kinda feel that our customers like that attitude when they come in with a timer or relay problem . . . instead of the Ho Ho Ho they get from some of the giants.

There’s usually not much Ho Ho-ing around here until later. Because you can bet that the first time a customer contacts us, it’s not with a fat, easy order. He’s usually been busting his knuckles for weeks with a tough, dirty little problem. He’s finally up against it, and he wants an answer fast.

Sure it’s tough!

But, we don’t expect people to come around passing out relay or timer orders like popcorn. In fact, when you’re a little guy, you expect ’em to come around with problems that will back you up against the wall a few times. But we don’t mind . . . we always remember what Pop used to tell us about the village rough-neck: “If you just lick ’em once, he’ll be your friend for life.”

Wanna fight?

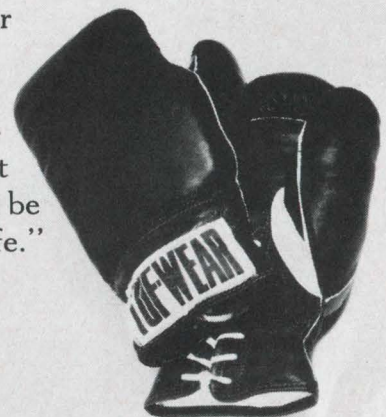

AEMCO DIVISION  
10 STATE STREET  
MANKATO, MINNESOTA 56001

PROGRAMMERS/TIME DELAY RELAYS/MINIATURE COAXIAL RELAYS/INDUSTRIAL RELAYS/MERCURY-WETTED CONTACT RELAYS

# LSI impresses at solid-state conference

## Subnanosecond digital circuits, memories on a chip surge, consumer, microwave ICs gain slowly

Large-scale integration was the theme of the 1968 International Solid-State Circuits Conference held in Philadelphia on Feb. 14-16. The main thrust was in the digital area, where computer designers are concerned about the need for ever-faster storage access times and logic. In fact, the experts foresee subnanosecond logic operation in the next generation of LSI.

The conference, which was divided into formal daytime sessions on the campus of the University of Pennsylvania and informal panel sessions at the Sheraton Hotel, also dealt with microwave and consumer ICs, novel circuit techniques, new devices and new materials, as described in the succeeding pages.

### MOS chips accessed at random

They are here.

Ever since the advent of MOS integrated circuits, computer designers have awaited the first random-access MOS memory arrays. Now several companies have shown their intentions:

- Radio Corp. of America, Somerville, N.J., will shortly offer a 16-bit X-Y select array using complementary MOS for customer evaluation.

- Philco-Ford Corp. will place on the market in 1969 a 256-bit chip using p-channel MOS. It will sell for \$10, or 4¢ a bit—equivalent to the cheapest cores.

- Fairchild Semiconductor Div. has developed a 64-bit coincident-select array for random-access storage. Fairchild has no present plans for selling these arrays, says Joseph F. Friedrich of Palo Alto, Calif., who presented a technical paper on this development.

These developments are far from evolutionary. Nothing like them has been available up to now. While it is possible today to buy monolithic shift registers handling 100 bits, they cost about \$50, or 50¢ a bit—an order of magnitude higher than the 256-bit random-access memory array described to ELECTRONIC DESIGN by Donald E. Farina of Philco-Ford's Microelectronics Div., Santa Clara, Calif.

Farina was one of the panelists in an informal session devoted to the status of MOS technology.

Farina said that this p-channel MOS array would occupy a single 9000-square-mil chip and would have a cycling time of 200 ns. He predicted that MOS bulk memories in the megabit range would be fabricated in the form of plastic packages, particularly flip-chips, at a cost of 2¢ a bit.

"Six months ago I would not have thought so," he said. He even envisions arrays selling for a penny a bit by 1972.

For the moment, monolithic shift registers, such as the dual 100-bit devices used in International Business Machines Corp.'s series 360, model 85, are faster than MOS random-access memory arrays.

David Lynch of Emerson Electric Co., St. Louis, said in a telephone interview:

"MOS arrays, on the other hand, while only fair in speed, are truly random access, potentially competitive in cost with cores, rugged, capable of high-density packaging, and high-temperature operation and have low power requirements.

Joseph R. Burns of RCA, a panelist at the informal session on computer memories, feels that complementary MOS technology promises access times that are competitive with shift registers. Thus he would "rule out bipolars except for very, very small high-speed registers."

However, the shift register, too, can be vastly upgraded by the rapidly changing LSI technology.

In a technical paper, Dr. Clare G. Thornton, director of R&D for Philco-Ford's Microelectronics Div., Blue Bell, Pa., predicted that by extending high-density MOS technology, "a 50,000-bit, 10-chip assembly will eventually be fabricated at a cost per bit of a few hundredths of a cent."

A complete digest of technical papers is available for \$8 from H. G. Sparks, Moore School of Electrical Engineering, Univ. of Pennsylvania, Philadelphia, 19104.

—R.N.E.

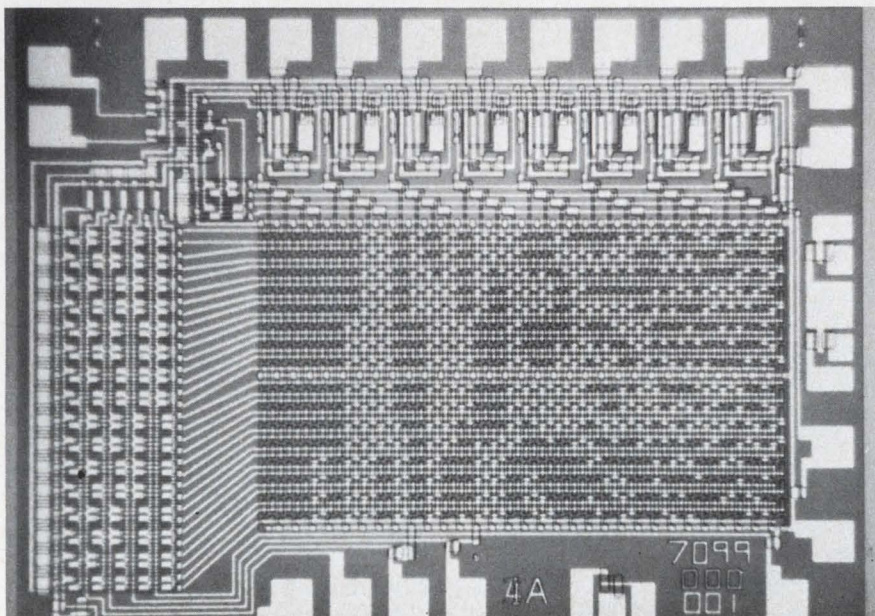

1024 bits of read-only memory on a chip is characteristic of the next generation of LSI using MOS technology. Each 70 by 100 mil chip contains 1250 transistors. Dr. Clare G. Thornton of Philco-Ford predicts 5000 bits on a chip.

# The LSI computers in your future

Wide variance in opinions marked spirited discussions at the Solid-State Circuits Conference of the role that large-scale integration (LSI) will play in future computers.

IBM's view was spelled out at an afternoon technical session through a description of "Computer X," a general-purpose LSI machine of the 1970s. Max Paley, director of advanced computing systems for the IBM Research Laboratory in San Jose, Calif., envisioned a processor capable of operating at 1000 times the instruction execution rate of the 7090 computer. To manage this extremely fast computation, he predicted that machines would be built with a hierarchy of memory types, each with different speed, capacity and access capabilities.

Dr. Gene M. Amdahl, IBM Fellow, who is generally known as the architect of the IBM 360, echoed this view at an evening panel session on future memory systems.

The emergence of memory as a key design element was also emphasized at another panel session on the impact of LSI on computer design. This panel, including a programmer, system designers and device designers, came up with other startling observations.

Total semiconductor-industry sales of logic for general-purpose computers might total only about \$30 million in the mid-'70s, despite a marked rise in central processing units (CPUs) to 50,000 a year, according to Charles Hobbs, president of Hobbs Associates, Del Mar, Calif., a consulting firm. His estimate was 20,000 gates in each CPU, with an average projected cost of 3 cents a gate.

He expressed surprise, in view of these projections, that the semiconductor industry has been pushing the cause of LSI for central-processor logic.

## Other chip markets

But he and other panelists suggested that other markets would prove much more lucrative for the chip suppliers. LSI memories, time-sharing terminals, small-scale computers, control computers for instrumentation systems, and other special-purpose machines — all were cited.

The data-terminal business, where a remote user is tied by a communications link to a distant central processor, looks promising, most panelists agreed. Since many similar terminals are expected, repetitive manufacturing was

deemed practicable. And, explained Dr. David Evans, director of computer sciences at the University of Utah, the terminals will, of necessity, be fairly complex for two main reasons:

- Memory and logic at the terminal will reduce communications requirements, and the cost tradeoff will be in favor of this choice.

- Central processors will be so loaded, it will be necessary to do as much of the auxiliary work as possible at the terminals.

Small consumer computers may become an important market also, both panelists and audience members speculated. Computers for the home, the car, the gasoline station, and the student were mentioned.

Machine organization and the role of the programmer in design were topics that brought the widest divergence of opinions. Some thought that many of the steps now taken in programming could be built into LSI machines. Dr. Mel Conway, director of advanced systems research for Univac, disagreed. He said that if industry knew how to build programming into the machines, it would do it now.

Several ideas for machine organization based on programming concepts were suggested, but the panelists did not appear very



"Every home, every car may have a computer," commented a Westinghouse device designer at the computer LSI session, as he tried to defend the great promise foreseen by semiconductor manufacturers for LSI logic.

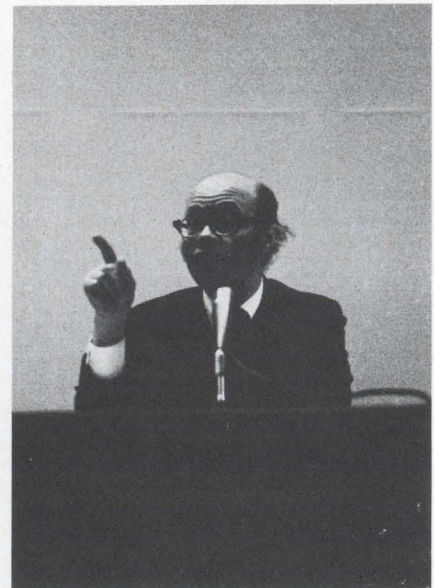

"Everybody talks about associative memories, but nobody sells them," complained panelist Ivan Flores.

# Super Zener

**\$4<sup>50</sup>**

Who would be mad enough to come into the market with a four-dollar-and-fifty-cent Zener when you can buy some cheaper than aspirin.

We would. And did.

Our new LM-103, Super Zener, has the sharpest low-current knee there is. It's a monolith, packaged in a two-lead TO-46 header.

Impressively, breakdown voltage changes less than 150 mV when the current is varied between 10  $\mu$ A and 10 mA or only 15 mV between 100  $\mu$ A and 1 mA. This is true for any of the 10 voltages available from 5.6V down to 2.4V.

The only way to get our \$4.50 Zener any cheaper is to buy them at \$3.00 for 100 or more. O.K. now, let's hear from the big spenders. National Semiconductor Corporation, 2975 San Ysidro Way, Santa Clara, California 95051 (408) 245-4320.

**National Semiconductor**

optimistic about most.

"There are about 60,000 computers in place today," Dr. Conway said, "and right now IBM is delivering about 15,000 a year—about 70 per cent of the market. In a matter of years, at this rate, three-fourths of all computers will be 360 models. This is enough of the total to force standardization."

Thus IBM's plans become a critical factor in all future computer design. And that is why attention was focused on the "Computer X" discussion.

In projecting the rate of computer technology advanced in the next decade, IBM's Paley explained the prediction of a machine with an instruction execution rate 1000 times that of a 7090 computer.

This extrapolation depends on a circuit speed of about 1 ns — about 20 times better than the 7090 and about five times better than even 1969's fastest expected circuits. Paley did not foresee the ability to achieve such speeds on a single wafer containing thousands of circuits. Thus multiple

chips will be needed. But to keep path lengths small, the packing density will have to stay within 200 circuits per square inch.

The designer will then face some new problems. At these densities cooling will then be a serious problem. Decoupling and noise elimination will also be difficult.

System level problems may be even more serious. Paley estimated that the peripheral gear would improve less than 50 times over that available for the 7090. "Computer X" will have to handle about 130 million instructions a second at a 10-to-20-ns clock rate. This implies a memory with under 50-ns cycle time. If tapes are used, this instruction rate would require 65 tape machines running continuously! On the average, 230,000 instructions would be expected between input-output requests. To meet these needs, Paley predicted, many peripheral functions will have to be built into the machine.

The hierarchical memory structure was proposed as a solution to this difficulty.

Dr. Amdahl elaborated at the memory panel session on this structure. He foresaw three general access-speed ranges for these various memories:

- High-speed storage with less than 50-ns access time. These will probably be integrated circuits.

- Medium-speed stores—of less than 500 ns. All major memory types are competitive in this speed range.

- Slower main memories—of less than 5  $\mu$ s. Ferrite cores, magnetic films and plated wire seem the most likely contenders here.

The 360-computer architect preferred faster small, "window" memories to ultra-high-speed main memories. These would be 8-to-16-word groups put together. Dr. Amdahl contended that on a statistical basis, the words used most recently were much more likely to be referred to than others.

Associative memories are not suitable for this window storage, he said. The speed is slower and the cost twice or three times higher per bit. —R.H.

## Half-amp voltage regulator fits on a chip

Down-to-earth devices and techniques, even in these days of LSI, still stir the greatest interest among designers at electronic conferences. Thus when T. M. Frederiksen of Motorola Semiconductor Products, Inc., Phoenix, described a simple, practical IC voltage regulator at a circuit-techniques session, the audience was enthusiastic. No wonder. Here are some of its characteristics:

- Max current output: 750 mA
- Minimum input voltage: 8 Vdc
- Output voltage: 2-30 Vdc
- Output Z (dc to 100 kHz): 0.015 ohm
- Transient recovery time: 2  $\mu$ s
- $V_{out}$ : 30 ppm/ $^{\circ}$ C

The temperature stability of the regulator is largely attributable to the stable bias reference circuit (see left shaded area in the schematic). Here the temperature drift of the zener diode and the transistor is compensated for by the two transistors in the emitter leg, connected as diodes. — P.N.B.

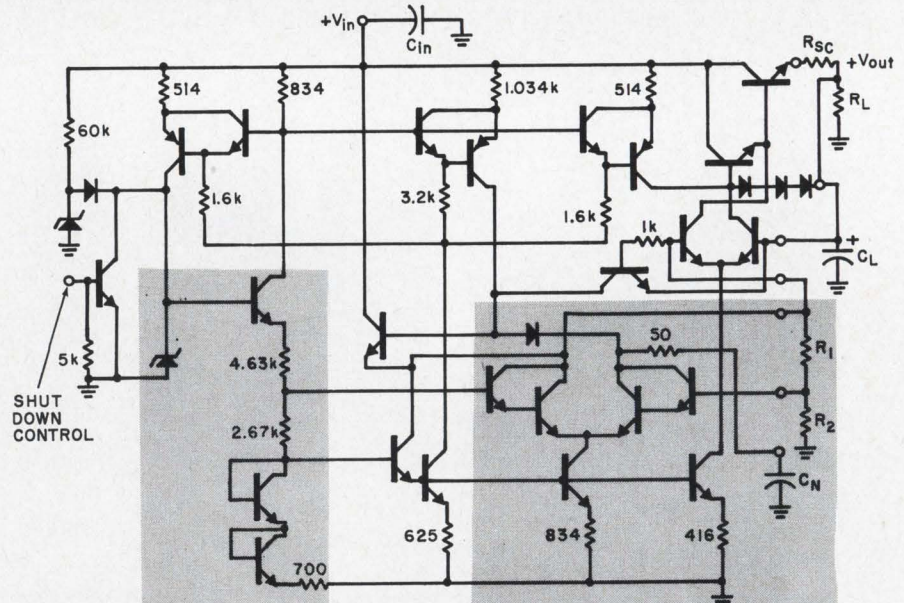

**500-mA, 2-to-30-Vdc voltage regulator on a 60-by-60-mil chip.** The dc reference shifting circuit (right shaded area) receives its reference voltage from the bias reference circuit (left shaded area). This bias circuit also supplies reference voltage to three single-transistor current sources (bottom). Output voltage is adjusted by selecting the ratio of R1 and R2. The supply can be turned on and off by applying a signal to the shutdown terminal. The company expects the unit to be on the market in two or three months in nine-pin TO-66 packages, selling for \$7 or \$8 in small lots.



# The follower leader.

The great thing about our new LM102 voltage follower is that it's the first monolithic amplifier that has combined low input current with high speed. A slew rate of  $10V/\mu s$  means fast operation. Yet, the maximum input current is an incredible 10 nA.

The circuit is designed so that leakage isn't a problem. Input currents better than 10 nA at  $125^\circ C$  can be guaranteed. Considering high temperatures, it even gives better performance than FET amplifiers.

The LM102 has an offset voltage less than 5 mV, a guaranteed accuracy of 0.1%, needs no external compensation and is short circuit protected. Plus, it's a plug-in replacement for both the LM101 and the 709 in voltage follower applications.

Although it's really not a complete operational amplifier, it's a dream in low drift sample and hold circuits. And it's a wonder as a buffer amplifier for high speed analog commutators, in active filters or as an impedance buffer in analog computation circuits.

The LM102 will cost you \$30.00 each for 100 or more pieces. For \$12.00 we'll give you an LM202, which works from  $-25^\circ C$  to  $+85^\circ C$ . If you're really pinched, the LM302 does it on a  $0^\circ C$  to  $70^\circ C$  temperature range for \$5.50. And you can get them all today.

National Semiconductor Corporation, 2975 San Ysidro Way, Santa Clara, California, (408) 245-4320.

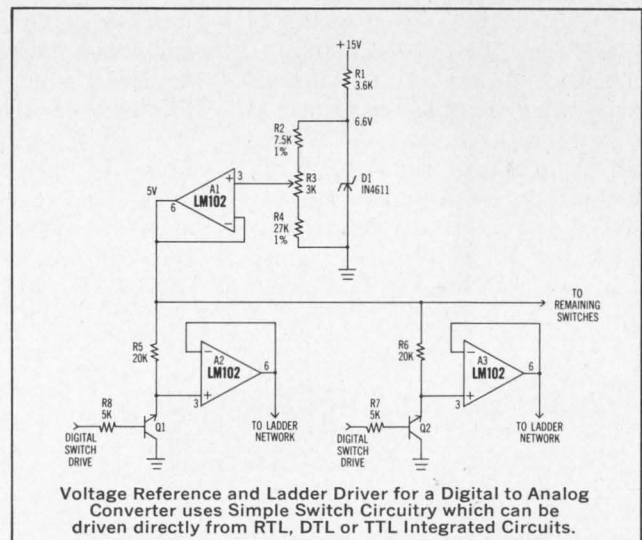

National Semiconductor

INFORMATION RETRIEVAL NUMBER 18

# Microwave ICs: Gains, but no revolution

While the microwave engineer attending the conference found no surprises, he did see a pattern of evolution, especially in microwave integrated circuits and solid-state power sources.

Dr. Rudolf S. Engelbrecht of Bell Telephone Laboratories, Murray Hill, N.J., outlined promising applications of solid-state bulk negative resistance effects in n-type gallium arsenide and cadmium sulfide. He cited pulse generators, voltage tunable oscillators and fixed and controlled waveform generators. These functions, he indicated in a technical paper, will depend on the formation of narrow traveling high electric fields or domains in the semiconductors when they are biased beyond a critical threshold.

Dr. Engelbrecht explained how functions could be performed with bulk semiconductors that are difficult, if not impossible, to obtain with pn junctions. He said, for example, that minute blocks of material could be tapered to form a voltage-tunable solid-state oscillator. The electric field, he said, decreases from the narrow, tapered cathode end to the wide anode end. Studies at Bell Laboratories show that as the bias is increased, the frequency decreases — a necessary feature for a tunable oscillator.

Dr. Engelbrecht said that octave-wide tuning has been obtained at uhf with a 1-mm-long device and that experiments had shown the feasibility of 8-GHz operation.

Pulse current trains can be generated in uniform blocks of materials by maintaining the bias above

threshold, he pointed out. A single negative output pulse is generated with a short trigger pulse. Complex current waveforms can be generated by shaping the device (see figure). The spikes occur when the domains reach the anode.

Controllable waveforms can be produced by using external resistive circuits, to allow additional current to flow through the device, Dr. Engelbrecht said. This occurs when the domain passes a region shunted by an external path. By variation of the switch positions, the current waveform can be altered.

According to Dr. Engelbrecht, this property can be used to make time-division multiplexers and two dimensional memory arrays, as well as to form circuits that perform AND, OR and inhibit logic.

Progress in integrated circuits was reported by Texas Instruments, Inc., Dallas; Sylvania Electric Products, Inc., Waltham, Mass.; Microwave Associates, Inc., Burlington, Mass.; and RCA, Camden, N.J. The work shows a trend toward more complex circuits and higher operating frequencies.

George Vendelin of Texas Instruments told of a thin-film hybrid integrated receiver operating at Ku band. It consists of a balanced mixer and a Gunn-effect local oscillator. Two versions were built: one with a rectangular cavity and the other with a circular cavity to form the Gunn oscillator.

The noise performance and operating frequency of the receivers showed minimum noise figures of 11.3 dB at 12.9 GHz for the rec-

tangular cavity, and 14.5 dB at 13.7 GHz for the oscillator with the circular cavity. Power was about 6 mW, with efficiencies of about 1.5 per cent.

Arnold Kramer of Sylvania discussed an experimental X band doppler radar transceiver that makes use of beam-leaded silicon Schottky diodes, direct microwave power generation and integral ferrite components.

The circuit uses a silicon avalanche diode oscillator within a miniature reentrant cavity to produce 30 mW of cw power.

Researchers at Texas Instruments showed that varactor-tuned integrated Gunn oscillators could be integrated in microstrip.

Gailon E. Brehm, now at Stanford University, said that the simple, electronically tuned oscillators use microstrip transmission lines to form the resonant circuits for mounting the Gunn oscillator and varactor diode. He said the TI team had obtained a tuning range of more than 10 per cent at 7.5 GHz.

Bell Telephone Laboratories, Murray Hill, N.J., achieved higher power gain by connecting impact avalanche transit time (IMPATT) diodes in series. Dr. Wolfgang Schlosser said that the series connection of the diodes increased the output level to the sum of the individual devices, without decreasing the impedance level.

Three 4.5-GHz IMPATT diodes biased in series were operated in a coaxial cavity. Each device was capable of 250 mW of cw power, and the series produced 750 mW.

—N.S.

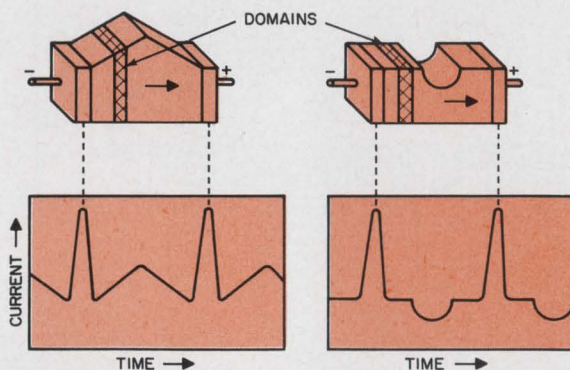

Domains in transit through shaped blocks of GaAs and CdS produce complex current waveforms.

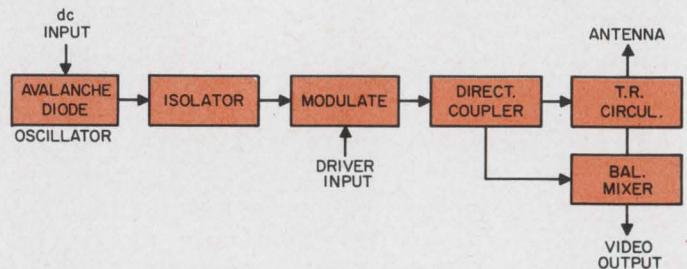

Sylvania X-band radar transceiver built of hybrid microcircuitry occupies less than 3 cubic inches.

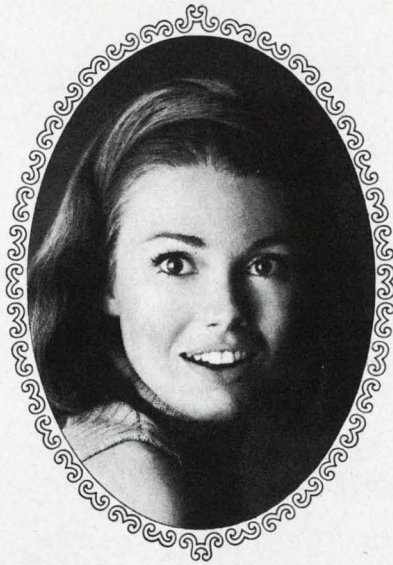

**Don't try to sell her  
on the challenging career  
Hughes has offered you.**

**Just mention . . .**

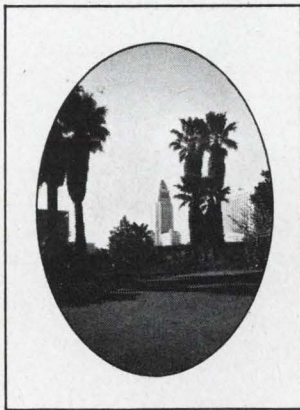

**The climate.** Often it's compared with the Riviera's. In truth, Southern California's is better. Drier in summer: no mosquitos, little mugginess. Balmy in winter: seven hours of sunshine a day. You'll save on galoshes!



**Family fun.** You literally can ski and sunbathe the same day here. Swimming pools and ski runs are an hour apart. The kids will love mountain climbing, surfing, sailing, desert rockhounding. Every weekend's a vacation.



**Great schools.** Some of America's most respected school systems are in the Los Angeles area. Also, many fine city colleges; three branches of California State; U.C.L.A., U.S.C., Caltech, Occidental, Loyola, and *more*.

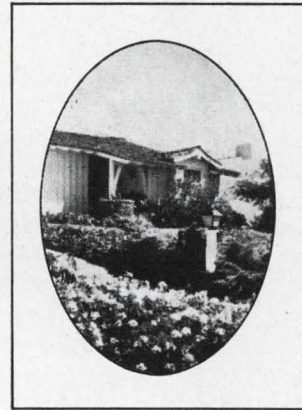

**The good life.** You can find it in communities like Westchester, Redondo, Playa del Rey. Or Sherman Oaks, Canoga Park or Pasadena. We have literally scores of beautiful residential areas within easy reach of Hughes plants.

**About that challenging career . . .** The Hughes Aerospace Divisions have over 200 openings now for graduate engineers. Opportunities exist on advanced projects and programs like ATS, VATE, TOW, PHOENIX, Communications Satellites, and many others. Please send resume to:

**Mr. Robert A. Martin  
Head of Employment, Dept. 31  
Hughes Aerospace Divisions  
11940 W. Jefferson Blvd.  
Culver City, California 90230**



# IC use in radio-tv market hinges on cost

Lower cost—not performance gains, not size reduction, not reliability improvement—is by far the dominant attraction ICs must offer the mass consumer electronic market.

This conclusion was offered by two panelists representing users at the Solid-State Circuits Conference—Donald Ruby of Zenith Corp., Chicago, and E. Q. Carr of General Electric, Utica, N.Y.

IC suppliers face considerable competition from the steady downward trend in discrete-device pricing, Ruby and Carr added.

Now that RCA's sound i-f audio IC chip in a tv set is no longer novel, Ruby argued, set manufacturers can no longer rely on ICs to glamorize sales—price and performance dictate the application.

Despite extensive efforts in the last two years, IC supplies are still limited to low-frequency, low-power chips for their cost-conscious customers, the two panelists noted. No gains have been reported for the high-power deflection circuits, high-level video amplifiers, high-level color demodulator sections or low-noise rf/i-f stages.

IC manufacturers, said Howard Bonner of Texas Instruments, Dallas, are turning to color TV set designers and picture-tube suppliers in hopes that signal-processing levels can be reduced below the

present 175-200-V demands; otherwise they will not be able to supply IC devices for luminance and chrominance output stages. Set and picture-tube designers are not rushing to alter their present approaches, the panelists agreed, since tubes and discrete devices are available to achieve their designs.

Circuit instability is another problem facing tv set designers, according to another panelist, J. J. Rangen of N. V. Philips, Nieuwegein, the Netherlands. Single-chip, 40-MHz i-f blocks with 100-dB gain for tv sets have been successfully fabricated, Rangen explained, but troublesome oscillation effects have developed when the chips are assembled on printed-circuit boards housing other circuits. He added further that cost reduction in i-f section design did not appear overly attractive with ICs, since only 30 per cent of the cost depends on the active devices; 70 per cent for tuned circuits.

Present efforts to use R-C selective filter designs to displace L-C circuits require high-tolerance, temperature-stable elements, and these are incompatible with monolithic processing, Derek Bray of Fairchild Semiconductor told the panel at the Sheraton. Present monolithic ICs cannot satisfy TV tuner demands for low-noise, high-frequency operation, he said; hy-

brid thick-film approaches have been developed to meet this need.

A third factor in the use of ICs involves the highly secretive nature of the consumer industry. Zenith's Ruby explained that each set manufacturer must maintain his proprietary designs, and thus cannot allow his IC chip design to be sold off-the-shelf to competitive set manufacturers. One approach to solve this problem, he suggested, might be a master slice approach, with interconnections left to the choice of each customer. Finally, he added, a set manufacturer would require several sources of supply for each IC subsystem in his design. Not only would several IC manufacturers have to agree to fabricate those chips; they also would have to agree on a standard processing approach. —H.B.

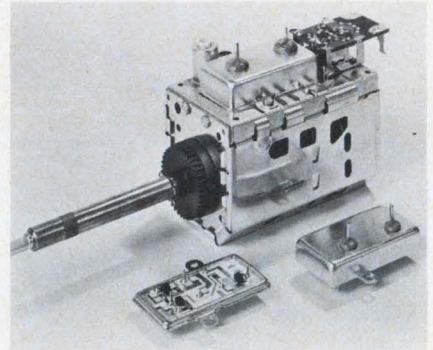

**Thick-film vhf tuner module** developed by Oak Mfg. Co., plugs into printed inductance selector switch.

## Right-side-up flip chip eliminates flying leads

A new technique has been developed for interconnecting IC chips right-side-up, without using flying leads. The face-up chips can be tested after assembly, and the cost and reliability problems of flying leads are avoided. This process permits the interconnection, at the chip level, of otherwise incompatible devices.

A thermoplastic, Teflon FEP, is employed as the dielectric and as bonding medium between chips, substrate and interconnection patterns. Two or more levels of interconnection are possible.

The incorporation of a variety of substrate materials, including alumina and beryllia, is permitted

by the new process, which was developed by General Electric, Syracuse, N.Y. Resistors and conductors are formed by selective etching on a Xerox substrate. A 2.5-mil layer of FEP is then applied over the entire substrate, and active devices are bonded, face-up, into it.

Connections to the chips are provided by a gold conductor pattern, which is deposited on the surface of the plastic film. Copper "mesas" serve as feed-throughs between the layers of conductor pattern.

The process is intended for use in both linear and digital circuits, and for frequencies from dc to microwave. —R.S.

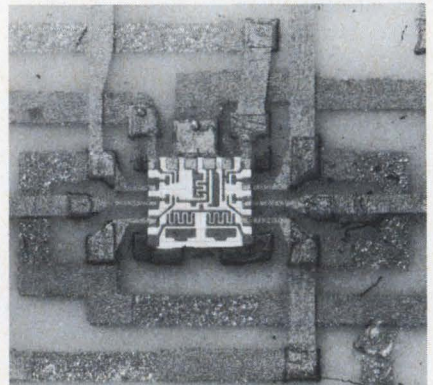

**A plastic film attaches this circuit chip** and its interconnections to the substrate material. The face-up configuration permits complete circuit testing. Deposited copper "mesas" serve as feed-throughs.

# with your reputation at stake, which resistor line would you specify?

take a close look—there'll be no question

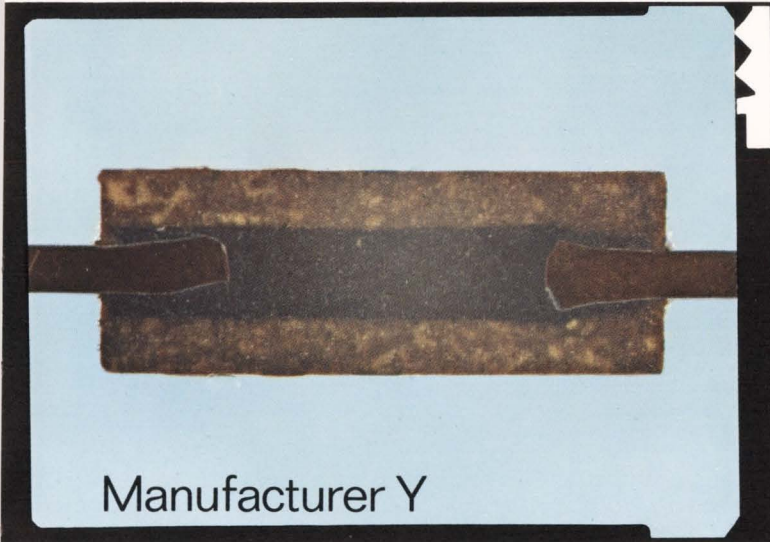
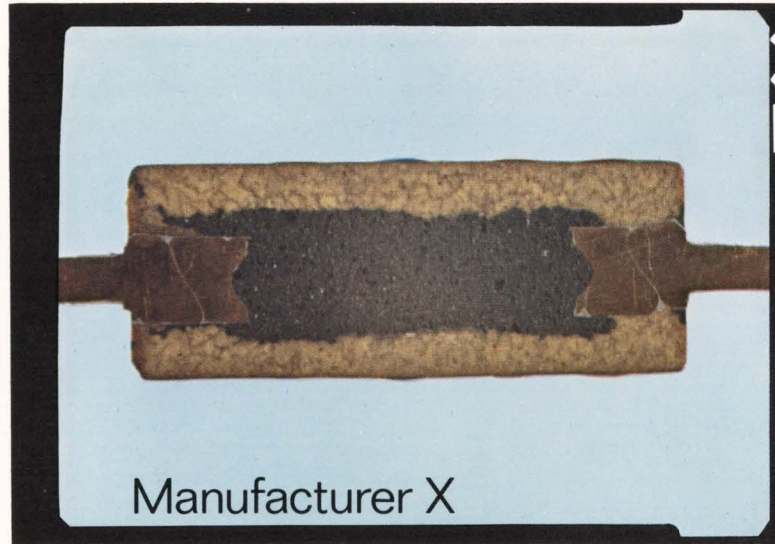
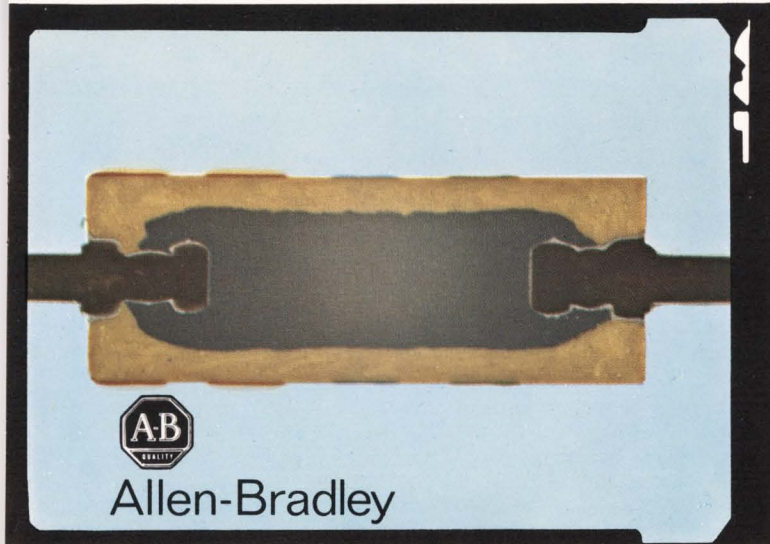

The above illustrations are from unretouched photomicrographs taken of four  $\frac{1}{2}$ -watt fixed resistors. Compare the anchoring of the leads, the seal provided by the insulating jacket at the ends, the homogeneity of the resistance material, the sharp color code bands—and decide for yourself.

For more details on Allen-Bradley hot-molded resistors, please write for Technical Bulletin 5000: Allen-Bradley Co., 222 W. Greenfield Ave., Milwaukee, Wis. 53204. In Canada: Allen-Bradley Canada Ltd., Export Office: 630 Third Avenue, New York, N. Y., U.S.A. 10017.

1067E-4

A-B hot-molded fixed resistors are available in all standard resistance values and tolerances, plus values above and below standard limits. **A-B hot-molded resistors meet or exceed all applicable military specifications including the new Established Reliability Specification.** Shown actual size.



QUALITY ELECTRONIC COMPONENTS



**ALLEN - BRADLEY**



## Here's your answer to shock and vibration problems

■ Allen-Bradley Type R adjustable fixed resistors are unexcelled for holding precise settings through extreme conditions of shock and vibration. This unusual ruggedness is the result of a manufacturing process—perfected and used only by Allen-Bradley—which hot molds the resistance and collector elements, terminals, and insulating material into an almost indestructible component. Thus, the controls can be mounted by their own rugged terminals *without* additional support.

The solid resistance track assures such smooth control that it approaches infinite resolution. Its smoothness cannot be compared with the abrupt wire-wound turn-to-turn resistance changes which may cause circuit transients. Since Type R controls are essentially non-inductive and have low distributed capacity, they can

be applied in high frequency circuits where wire-wound controls are impractical. The Type R molded enclosures are both dustproof and watertight, permitting encapsulation after adjustment.

Allen-Bradley Type R controls are suitable for use from  $-55^{\circ}\text{C}$  to  $+125^{\circ}\text{C}$  and are rated  $\frac{1}{4}$  watt at  $70^{\circ}\text{C}$ , 300 volts max. RMS. Available as standard in total resistance values from 100 ohms to 2.5 megohms with tolerances of  $\pm 10\%$  or  $\pm 20\%$ . As special, can be furnished down to 50 ohms. Technical Bulletin B5205 contains complete specifications. Please send for your copy today: Allen-Bradley Co., 222 W. Greenfield Ave., Milwaukee, Wisconsin 53204. In Canada: Allen-Bradley Canada Limited. Export Office: 630 Third Ave., New York, New York, U.S.A. 10017.

Allen-Bradley Type R Adjustable Fixed Resistors—Shown actual size

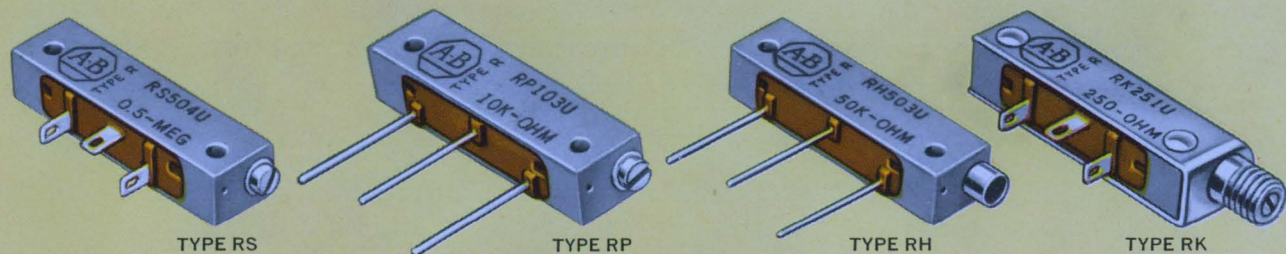

**ALLEN-BRADLEY**  
QUALITY ELECTRONIC COMPONENTS

# AFTER 10 MILLION SUCCESSFUL PERFORMANCES, WHAT DO YOU DO FOR AN ENCORE?



## Bring on Utilogic® II.

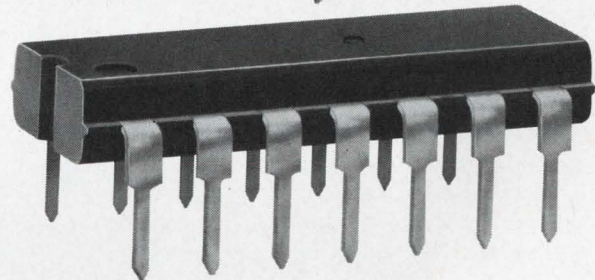

Signetics' new Utilogic II is a real show stopper—the most flexible, reliable, economical line in the business! Look at these features:

**New - DIP.** You asked for it, so we put the entire Utilogic II series in dual in-line silicone packages. Now you have convenience and ease of handling, in addition to the performance proven by over ten million Utilogic elements in the field.

**New - Multi-Function Elements.** Utilogic II now provides dual J-K binaries and triple and quadruple gates. Utilogic system design is now simpler, faster, more flexible ... and requires fewer packages.

**New - Low Prices.** Believe it or not, Utilogic II is actually priced at RTL levels! See for yourself:

TYPE NO.	DESCRIPTION	PRICE 1000-UP
300A	Dual 3-Input Expander	\$ .75
305A	Single 6-Input AND Gate	.75
306A	Dual 3-Input AND Gate	.75
314A	Single 7-Input NOR Gate	.75
317A	Dual 4-Input Expandable NOR Gate	.81
321A	Dual Master Slave J-K Binary	1.50
322B	Dual Master Slave J-K Binary (in 16 pin package)	1.66
333A	Dual 3-Input Expandable OR Gate	.81
370A	Triple 3-Input NOR Gate	.81
380A	Quad 2-Input NOR Gate	.81
356A	Dual 4-Input Buffer Element	1.25

Those figures should bring a standing ovation. But hold the applause—because we'd like to give you a hand! For data sheets giving all the facts and figures on Utilogic II, just write Signetics, 811 East Arques Avenue, Sunnyvale, California 94086. This production brought to you by:

**SIGNETICS INTEGRATED CIRCUITS**



A SUBSIDIARY OF CORNING GLASS WORKS

**SIGNETICS SALES OFFICES:** Fort Lee, New Jersey (201) 947-9870; Syracuse, New York (315) 469-1072; Richardson, Texas (214) 231-6344; Beverly Hills, California (213) 272-9421; Garden Grove, California (714) 636-4260; Wakefield, Massachusetts (617) 245-8200; Silver Springs, Maryland (301) 946-6030; Collingswood, New Jersey (609) 858-2864; Clearwater, Florida (813) 726-3734; Rolling Meadows, Illinois (312) 259-8300; Sunnyvale, California (408) 738-2710.

**DISTRIBUTORS:** Compar at all locations listed below. Semiconductor Specialists, Inc. (312) 279-1000; Terminal Hudson Electronics (212) 243-5200; Wesco Electronics (213) 684-0880; Wesco Electronics (405) 968-3475; Hammond Electronics (305) 241-6601; Avnet Electronics Corp. of Massachusetts (617) 272-3060; Pioneer Standard Electronics Inc. (301) 427-3300; Kierulff Electronics (206) RO 3-5510; G. S. Marshall (213) 684-1530.

**DOMESTIC REPRESENTATIVES:** Jack Pyle Company (415) 349-1266. Compar Corporation at the following locations: Alabama (205) 539-8476; Arizona (602) 947-4336; California (213) 245-1172; California (415) 697-6244; Colorado (303) 781-0912; Connecticut (203) 288-9276; Florida (305) 855-3964; Illinois (312) 692-4125; Maryland (301) 484-5400; Massachusetts (617) 969-7140; Michigan (313) 357-5369; Minnesota (612) 922-7011; Missouri (314) 542-3399; New Jersey (609) 429-1526; New Mexico (505) 265-1020; New York (518) 436-8536; New York (607) 723-8743; New York (516) 921-9393; North Carolina (919) 724-0750; Ohio (216) 333-4120; Ohio (513) 878-2631; Texas (214) EM 3-1526; Texas (713) 667-3420; Washington (206) 763-1711.

**INTERNATIONAL SALES:** France, Germany, Italy, Belgium, Holland, Luxembourg, Spain—Sovcor Electronique, 11, Chemin de Ronde, Le Vesinet, (S.-&O.) France. United Kingdom, Ireland, Sweden, Denmark, Norway, Switzerland, Austria, Portugal—Electrosil Ltd., Lakeside Estate, Colnbrook-Bypass Slough, Buckinghamshire, Great Britain. Australia—Corning, 1202 Plaza Building, Australia Square, Sydney, N.S.W. 27-4318. Canada—Corning Glass Works of Canada, Ltd., Leaside Plant, Ontario, Canada (416) 421-1500. Israel—Optronix, P.O. Box 195, Ramat-Gan, Israel 724-437. Japan—ASAHI Glass Co., Ltd., Corning Products Sales Dept. No. 2, 3-Chome Marunouchi, Chiyoda-ku, Tokyo, Japan.

"See us at IEEE, Booths 3A01-3A04"  
INFORMATION RETRIEVAL NUMBER 20

# 1969 U. S. budget: Further electronic growth

## \$186-billion document contains opportunities for industry to fill defense, NASA and FAA needs

**Charles D. LaFond**  
Chief, Washington News Bureau

President Johnson has described his record \$186-billion Federal budget request for fiscal 1969 as "austere" and as one that will still provide for both butter and guns. To some observers in the capital, it would appear that some guns will have to be cast from melted butter.

For the electronics industry, the bulk of planned expenditures for product purchases and contracted research and development will be generated by national defense needs. Most of the remaining major government electronics requirements will be accounted for by the National Aeronautics and Space Administration and the Federal Aviation Administration.

Other agencies such as the Commerce Department's Environmental Science Services Administration, the National Bureau of Standards and the Maritime Administration, have R&D funding but they perform nearly all in-house. Procurement for each is relatively low.

At present, the budget is a request to Congress for approval. It will be studied, spoken over, damned and possibly praised in spots—but in the end it is doubtful that severe reductions will be made. National security, fixed obligations and self-interest will prevail, as they do every year. The principal targets for budget cuts will be repeats from last year—the Defense Dept., NASA and FAA.

### \$3-billion rise for defense

Defense spending requested for the new year—\$76.7 billion—is up about \$3 billion over last year, with the majority of the rise accounted for by increased Vietnam War costs, certain fixed expenses and a nominal inflationary rise. Reportedly, the original requests to

the President by the various services exceeded \$100 billion, and thus, while this represented the largest initial request in history, so did the Presidential cutbacks.

In general, there are few new programs and surprises in the defense request. Major new projects that will move to the contract-definition stage include the Convair F-106X interceptor plane (instead of the highly advanced experimental Lockheed YF-12). Development of Minuteman III will also be pressed, as will a new super-hardened Minuteman silo concept. No procurement money is included for the Air Force's long-sought advanced strategic bomber.

Money is being requested all down the line for long-leadtime procurement, systems development and nuclear warhead development and testing for the Sentinel anti-ballistic missile program. The total requested is \$1.1 billion.

The Navy will receive limited,

but probably adequate, financing for its advanced-ships program. Considerable sums are being sought for procurement of the massive C-5A transport plane, due to start coming out of production in the second quarter of this year. Heavy spending is requested for both the fighter and bomber versions of the controversial F-111, particularly for the Air Force.

### Air Force, the big spender

The Air Force, as usual, heads the military budget list with a request for nearly \$13 billion for procurement and for research, development, testing and evaluation. Nearly \$10 billion of this is destined for procurement expenditures and about \$1.8 billion for electronic hardware.

Over half the Air Force procurement request will be for 919 aircraft. A considerable portion of this sum is earmarked for fighter and bomber versions of the F-111 swing-wing aircraft: \$1.1 billion for 163 F-111A's and \$550 million



**The Army budget request** calls for some \$700 million to be spent on communications and electronics. Rugged communications equipment for field use is expected to receive the bulk of the funds.



for 75 FB-111A's.

Just over \$1.5 billion will be spent by the Air Force for strategic and tactical missiles and spares and for associated ground-support systems. In addition to Minuteman III and Titan II missiles, the Air Force will make heavy purchases of Shrike and Standard ARM, both antiradiation missiles, and SRAM, the air-to-ground short-range attack missile. It will also replenish its air-to-air missile assortment.

One surprise is the indication in the budget of the intended procurement of the AGM-79A/80A air-to-ground missile, believed to be a highly improved version of the Bullpup. Both Martin-Marietta and Chrysler Corp. are known to have been working on the development of an improved Bullpup, but it was not known that production was so close at hand. Conventional Bullpups are electro-optically guided by the pilot, whereas in the new systems it is believed that an inertial capability has been added by Chrysler and that Martin has improved the electro-optical guidance. Both will permit the launching aircraft to fire and run.

One large unknown quantity in the Air Force request for procurement under missile systems is labeled "other support." Tabbed

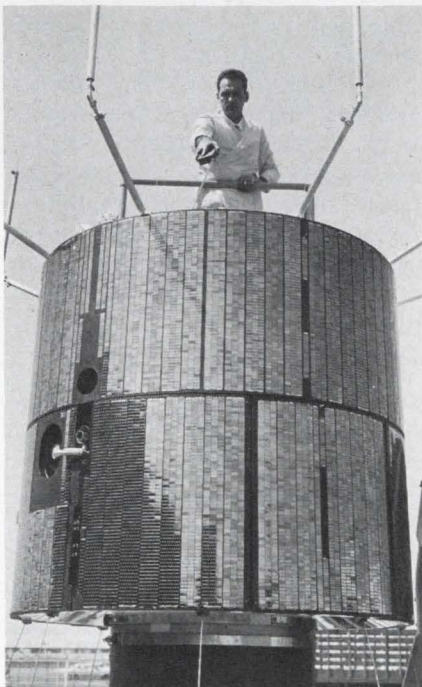

**Space applications programs**, as represented by the ATS-B above, will get a modest boost in funds.

for \$728 million, this activity is described as providing for classified projects, maintenance, Government-owned production facilities and support of operational space activities. It can be presumed that much of this effort is associated with the handling of data from the Air Force's orbital surveillance satellites and probably involves both optical and electronic data-handling and interpretation.

Other Air Force procurement includes over \$1.8 billion for munitions and associated equipment and \$296 million for electronics and telecommunications. The latter includes both tactical and strategic equipment and support items.

The Air Force research, development, testing and evaluation budget is set at \$3.5 billion, with principal expenditures for space and missile programs. A total of \$47 million is tabbed for use only for the Advanced Manned Strategic Aircraft program. Apparently the Air Force Manned Orbiting Laboratory program will be kept on schedule, with a significant increase (\$600 million) requested. Other major R&D efforts will be for the Minuteman III program, new fighter aircraft concepts and subsystems, and a continued strong effort to improve all-weather surveillance and weapons delivery.

The Air Force will stress development of military communications satellites and satellite-tracking capabilities. Final development will be sought for the long needed Airborne Warning and Control System, scheduled for operational status by late 1969 or early 1970.

The Air Force is requesting nearly \$425 million for construction, the bulk of which will probably go for the hardening of siloed ICBMs.

### **Ammunition heads Army costs**

Army expenditures exceeding \$7.3 billion are being projected for procurement and for military research and development. This is about \$800 million over the previous year's budget estimate. Of this total, \$269 million is requested for use only for Sentinel missile procurement.

The largest single Army outlay is for ammunition. Nevertheless, in the electronic category, subsystems

required for the Sentinel and other missiles, for aircraft and spares, and for communications and electronics call for spending \$1.3 billion.

The Army will continue to buy Redeye and Chaparral surface-to-air missiles for defense of the foot soldier against low-altitude aircraft. Improved Hawk missile systems will also be purchased, and the Nike-Hercules surface-to-air missile system will be improved for both U.S. and overseas air defense. Both Shillelagh and TOW anti-armored vehicle missiles will be procured in quantity. Finally, the Pershing missile system will be considerably modified to improve its ground-transport and mobile electronic-support systems.

For communications and electronics, some \$700 million is being sought for the Army, with emphasis on rugged tactical communications equipment to improve field-command control over dispersed forces and weapons systems. Additional funds are included for further updating of long-haul circuits in the global defense communications system.

Over \$500 million will be required to continue purchases of small Army aircraft, including the new AH-56 Cheyenne armed helicopter, a high-speed, highly mobile, flying gun platform that will be provided with a very sophisticated, automatic electro-optical fire-support system. In requesting funds to buy 1626 helicopters of all combat types, the Army is seeking to regain those craft cut from last year's budget.

A total of \$1.6 billion is being requested for Army research, development, testing and evaluation. The major emphasis will be on accelerating development of both the missile and ground electronic-support systems for the Sentinel antiballistic missile system. Continued efforts will be pressed to improve the accuracy of Army air-defense missiles. Nearly half of the total Army research expenditures will be for missile systems. Other emphasis will be placed on the development of improved tactical data-processing systems, communications and electronic warfare equipment, and for ground systems for use with a tactical communications satellite system.

(budget, continued)

Finally, the Army will seek nearly \$600 million for the construction of major facilities and for land acquisition. Nearly half this amount will be required for the Sentinel system.

**High Navy electronic spending**

The Navy budget for procurement and for research, development, testing and evaluation tops \$9.6 billion and includes relatively high spending for electronic hardware. Current estimates indicate that electronic procurement expenditures for aircraft, missiles, ships and communications will reach roughly \$2 billion. Closer estimates are difficult to obtain by examining the Navy budget, since the service includes all of its on-board electronics as a part of its ship and ship-conversion costs.

Heavy Navy expenditures are being requested for 720 tactical aircraft of all types, including patrol planes and helicopters for Marine assault missions. Included in the more than \$2.7 billion requested are items limited to the purchase only of F-111B fighters (\$350 million for 30 aircraft) and EA-6A electronic search and interceptor-control aircraft. Procurement will continue for fleet ballistic missiles and for all types of air- and surface-launched missiles. The latter include the new Standard missile,

which ultimately will replace the existing Tartar and Terrier air-defense missiles.

Six Polaris-armed nuclear submarines will be modified to permit installation of the new, longer-range Poseidon fleet ballistic missile, now in development. The Navy will also purchase seven new anti-submarine warfare ships that have a "long-range detection and weapon capability." Also, two nuclear-powered attack submarines will be built, and additional funds are being requested for long-lead-time items for two other submarines. Funds are being asked to begin construction of five high-speed DX destroyers. Long-lead-time items will be purchased for what will be the third U.S. nuclear attack carrier and for two nuclear guided-missile destroyers. The first four fast-deployment logistics ships will go into construction to improve the flexibility of military cargo forces.

Finally, and in addition to procurement of many smaller military vessels, the Navy will begin to construct a new general-purpose amphibious assault ship—believed to be the largest of its kind in the world. It is called an LHA (for Landing Helicopter Assault), and money is being sought to buy one ship plus long-leadtime items for three more. Each ship is estimated to cost \$123 million.

For communications and electronic systems not specifically destined for shipboard use, the Navy has requested \$390 million. In addition, the Marine Corps has requested \$149 million for communications and electronics, principally for tactical communications systems.

Naval expenditures of \$2.1 billion for research, development, testing and evaluation are being requested. Navy efforts will center on the new VSX carrier-based anti-submarine aircraft, with continued emphasis on advanced avionic subsystems. The Poseidon fleet ballistic missile continues as a high-priority developmental system. Also, the Navy's perennial search for improved antisubmarine detection systems and improved navigational systems will be continued. The Navy's oceanographic program, now centered on the deep submergence project for under-

\$ MILLIONS	
MANNED SPACE FLIGHT	2993
SPACE SCIENCE AND APPLICATIONS	644
SPACE TECHNOLOGY	425
AIRCRAFT TECHNOLOGY	120
SUPPORTING ACTIVITIES	394

2. **Manned space flight** will continue to get most of the \$4.57 billion requested by NASA. The Apollo Applications program was cut drastically.

\$ MILLIONS	
DOD-MILITARY	23,445
PROCUREMENT	22,793
MILITARY PERSONNEL	22,260
OPERATION & MAINTENANCE	7800
R & D	508
CIVIL DEFENSE, OTHER	MILITARY CONSTRUCTION, OTHER
ATOMIC ENERGY	2546
MILITARY ASSISTANCE	455
DEFENSE-RELATED ACTIVITIES	242

3. **Outlays for national defense** in 1969 will increase an estimated \$3.3 billion over fiscal 1968 and \$9.7 billion over 1967.

water search and rescue, will be well financed. Night vision and imaging devices for aerial reconnaissance are also considered high-priority projects.

**Defense agencies do with less**

Additional defense-oriented funds will be required by the various agencies and the Atomic Energy Commission. For the defense agencies, some \$50 million will be spent, a large portion of it for equipment purchases for the Defense Communications Agency and for several military security agencies. These purchasers are, in general, for automatic data-processing equipment and electronic communications equipment.

Over \$500 million is being requested for research, development, testing and evaluation within these agencies. No breakdown for either agency or equipment type is provided in the President's budget, but it can be presumed that a heavy percentage of these funds will be applied to advanced missile detection and discrimination techniques and for advanced electronic systems, principally in the computer and cryptographic fields. Electronic warfare is expected

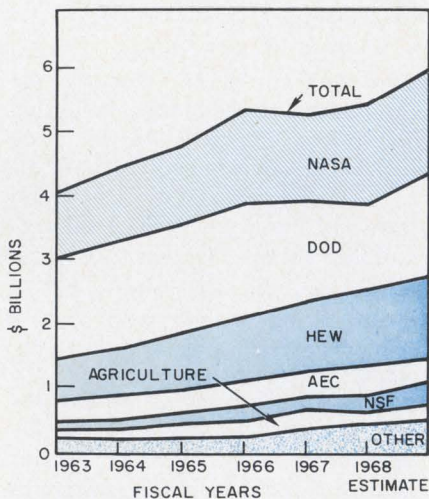

1. **Funds for basic and applied research** will increase from an estimated \$5.5 billion in 1968 to \$6 billion in 1969.

# DON'T SPEC A SINGLE TURN UNTIL YOU'VE SEEN THE SIX NEW CONDUCTIVE PLASTIC INFINITRON® ELEMENT PRECISION POTENTIOMETERS FROM BOURNS

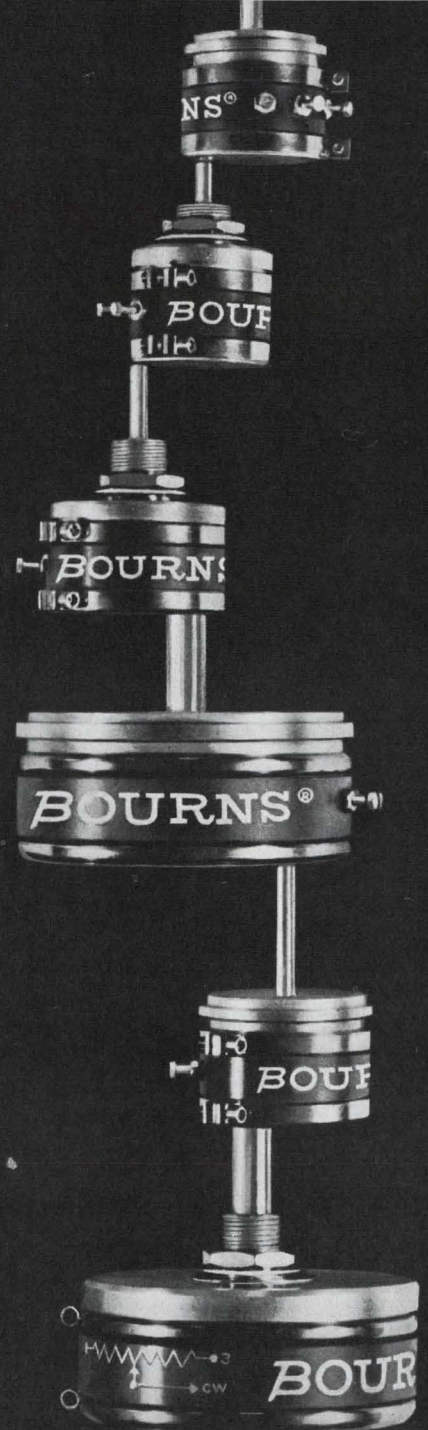

The new Bourns units are available in  $\frac{7}{8}$ ",  $1\frac{1}{16}$ " and 2" diameters with either bushing or servo-mount lids. Standard linearity is 0.5% with special linearities on request. Rotational life of the new conductive plastic units is 50,000,000 shaft revolutions and temperature range is  $-55^{\circ}\text{C}$  to  $+125^{\circ}\text{C}$ . All have outstanding resistance to humidity and exceed the moisture resistant requirement of MIL-R-39023. Most are available in ranges of 100 to 1,000,000 ohms. All models are manufactured to the stringent quality specifications you have come to expect from a Bourns product line. As with all products manufactured by Bourns, every single INFINITRON unit is guaranteed by the Bourns Reliability Assurance Program,

which includes individual inspection to published electrical and physical characteristics. Standard units are ready to ship off-the-shelf to fit your production or engineering requirements. . . special resistance values, taps, electrical angles and mechanical stops are available upon request.

Don't gamble in down-time, extended deliveries, etc., and don't speculate on quality and specifications! Investigate all the outstanding specs offered by the six new INFINITRON conductive plastic precision potentiometers from Bourns! For complete technical data contact your nearest Bourns office, representative or write the factory direct.



BOURNS, INC., TRIMPOT DIVISION • 1200 COLUMBIA AVE., RIVERSIDE, CALIF.  
TELEPHONE (714) 684-1700 • TWX: 910 332-1252 • CABLE: BOURNSINC.

(budget, continued)

also to receive a fair share of the budgeting.

Construction funds totaling \$85 million are being sought by the defense agencies, primarily to support activities related to intelligence and security.

Nearly half—\$1.28 billion—of the Atomic Energy Commission's total expenditures for 1969 will be for military applications. Of this total, \$841 million will be for the nuclear-weapons program, the rest largely for detection and measurement of nuclear detonations and radiation. While part of the weapons funds will be for nuclear stockpiling, the larger amount will be applied in direct support of the Sentinel antiballistic-missile system for the development and full-scale testing of nuclear warheads for both the Sprint and Spartan missiles.

The majority of funds requested for new AEC facilities and capital equipment also will go directly to the Sentinel program. About \$285 million will be spent for new facilities for advanced weapons production.

### Downward further for NASA

NASA's budget trend continues downward. While the President is requesting \$4.57 billion to sustain programs under a relatively austere budget, Congress is expected to demand further cuts, probably from \$200 million to \$300 million.

R&D expenditures of \$3.85 billion have been requested, along with only nominal construction costs of \$76 million. The remainder of the budget will go for administrative operations.

As expected, manned space flight carries the bulk of the requested appropriation, with \$2.1 billion being sought for the Apollo program and less than \$500 million for the follow-on Apollo Applications Program. The first manned Apollo/Saturn V flight is planned for late this year, and five more flights are planned during calendar 1969. The target still is, according to the President's budget request, to make the first manned lunar landing late in 1969.

The biggest reduction of all was suffered by the Apollo Applications Program. Expenditures for this year are less than half those originally planned by the space agency for fiscal 1969. The entire Apollo Applications Program has been revamped and stretched out, with the initial launching of an orbital workshop or space laboratory planned for 1970. The hope now is that the same vehicle will be periodically reused, and there is no firm time schedule for the launching of a second orbital laboratory by NASA.

A second major NASA program appears to have been more violently slashed. The planned \$2.4-billion Voyager program, which was to have explored comprehensively the Martian atmosphere and the planet surface, has been eliminated and is being replaced by a drastically reduced new program. Under a program expected to cost only \$500 million during the next five years, Mariner spacecraft will be flown in 1969 to Mars to perform high-resolution topographic data collection and atmospheric profile measurements. The program also includes a Mars orbital probe planned for 1971.

Also, to begin in 1969 is development of a new Mars spacecraft, modestly instrumented and planned for launching in 1973 aboard a Titan III vehicle. One indication of the limited hardware to be installed in the small Mars landing capsule is the lack of instrumentation designed to detect life on that

planet.

A modest increase has been given to NASA for its space applications programs. A limited effort will be conducted, looking ahead to a future Earth resources satellite. The 1969 effort will be confined essentially to the development of instrumentation and techniques, not to satellites. Aircraft will be used during 1968 and 1969 to test advanced sensors and data-acquisition systems. Funds will be included to perform studies leading to a definition of an Earth Resources Observation Satellite program.

The President is also seeking a modest increase in funds for development of a limited-thrust NERVA I nuclear engine, designed to provide propulsion augmentation for the massive Saturn V vehicle. This is a joint development program with the Atomic Energy Commission.

Other NASA expenditures will be to improve electronic systems for control, data acquisition and communications. Funds for tracking and data-acquisition support activities will be at approximately the same level as last year—a little over \$300 million.

Construction expenditures are relatively low and will be spread among NASA field centers and its global tracking network. Included in the plans is a special-purpose antenna for the deep space instrumentation station at the Goldstone complex in California. Also, 210-foot-diameter anten-

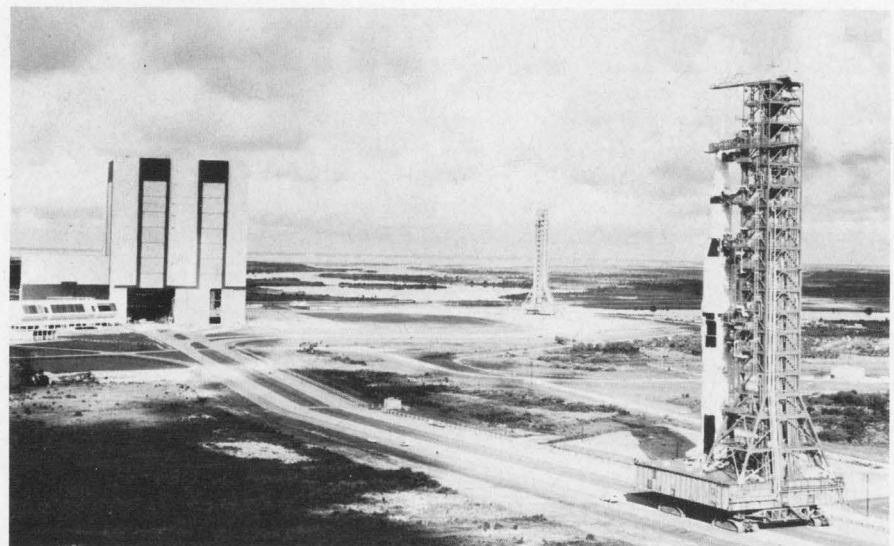

The first manned Apollo/Saturn-V flight is planned for late this year with five more flights called for in 1969. The first lunar landing, according to the budget request, is scheduled for the same year.



Coors flat pack conductors are metallized into the ceramic base. Conductor thickness is only 0.0005" under the frame—this minimizes stresses and resulting breakage during sealing.

Conventional flat packs use conductors ten times thicker (0.005") under the frame—increasing the likelihood of failure during subsequent sealing because of differences in rate of expansion of metal, glass, and ceramic.



*Another*  
**Take a closer look at flat pack reliability!**

Coors Ceramic MLD\* Flat Pack assemblies eliminate seal failures caused by differential expansion occurring between metal, glass and ceramic during sealing procedures and during operation. Coors flat pack leads are much thinner (0.0005" leads vs. 0.005" leads in conventional flat packs), so the forces induced by differential expansion are minimized. This means far fewer rejects from hermeticity failure—an expensive problem when both the flat pack and the assembled circuit components are lost. Coors Ceramic MLD Flat Packs (available in standard or special designs) provide high mechanical strength, excellent electrical properties and many times the thermal conductivity of electronic sealing glass. Write for Data Sheet 322-65 for complete information.

\*Micro Lead Design

**Coors**  
**CERAMICS**

ALUMINAS • BERYLLIAS • MAGNESIAS • SPECIAL OXIDES  
 Coors Porcelain Company, Golden, Colorado

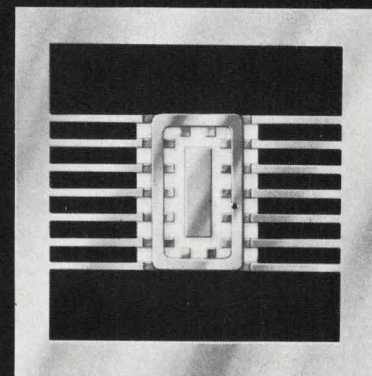

STANDARD COORS MLD  
 FLAT PACKS ARE AVAILABLE  
 FOR IMMEDIATE SHIPMENT

(budget, continued)

na systems will be installed at deep-space tracking facilities in Canberra, Australia, and Madrid.

Since the establishment of a national program to develop a civil supersonic transport plane, the Federal Aviation Administration's annual budget has produced some strange expenditure ratios. For example, one-half the fiscal 1969 budget of \$1.2 billion for the FAA will be for the agency's operating expenses. One-fourth will be for the SST program, to keep it on schedule.

The President has requested \$223 million more for SST development, and expenditures for the year, if approved by Congress, will be \$351 million—more than three times last year's estimated outlays. The goal, under the present program, is to produce two prototype aircraft for flight testing and evaluation in early 1970.

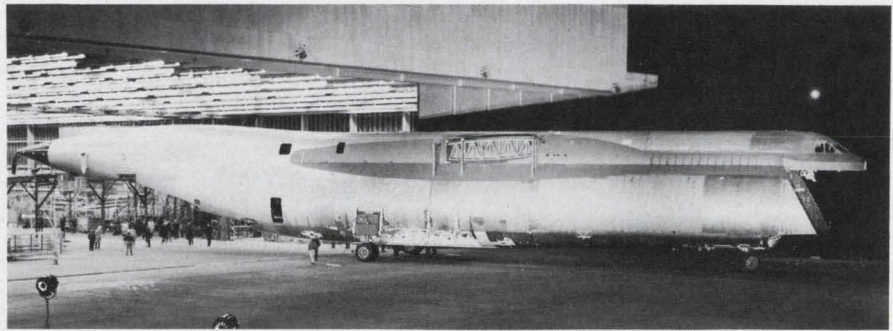

**Huge C-5A military transport** will get a considerable share of the Air Force's budget request. The plane is due to start coming out of production in the second quarter of this year.

Of more immediate effect on the electronics industry are expenditures of just over \$130 million for new FAA facilities and equipment and for R&D. Plans are to spend better than \$100 million for all types of air-traffic-control electronic hardware, with emphasis on automation equipment (\$62 million). Other major buys will include long-range radars, terminal-area radars, terminal-area computers and displays, and air

navigation instrumentation, including VORTAC, lf and mf radio facilities, instrument-landing systems and visual aids.

FAA research and development will center the improvement of air-traffic control, navigation and safety. The third area of major importance will be an attempt to advance weather-forecasting techniques and sensors and to improve techniques for the communication and display of weather data. ■■

## Computer-TV-phone link teaches teachers

International Business Machines Corp. has fostered a marriage of the computer, closed-circuit television and public telephone lines to provide teacher training for a parochial school system in Brooklyn, New York.

The setup, described as an experiment by Brother Austin David, technical consultant to the Roman Catholic Diocese in Brooklyn, is said to be the first embodying nearly all of the available educational electronic devices. Only the programed teaching machine has been left out.

Once a week, the teachers watch a half-hour lecture on classroom TV monitors. They then place a phone call to a digital computer at IBM's laboratory in Yorktown Heights, N. Y., some 50 miles away. The computer, which stores pre-recorded voice material in digital form, asks multiple-choice questions that a teacher answers by entering coded messages on the 12 buttons of a touch-tone telephone. After each response, the computer an-

nounces whether the answer was correct or incorrect.

The computer stores more than just the immediate content of the lecture. It can automatically select pictures stored in a slide projector at the educational TV studio operated by the diocese. The pictures are transmitted over four television channels with carrier frequencies between 2500 and 2900 MHz.

Since several teachers will be viewing the TV monitors at the same time, a number of pictures must be transmitted to serve individual needs. Thus it is necessary to equip each monitor with a device that captures and holds single images. The unit, called a keyed buffer, lies between the receiving antenna and the monitor. It records each new picture and retains it on the screen until the station transmits another picture. Norman Vogel of IBM's advanced development laboratory says that the keyed buffer makes it possible to transmit up to 30 pictures a second.

Preceding transmission, the

transmitter applies a coded address to the buffer. As soon as the address is decoded, the video signal is gated in and recorded. Now the gate is closed and the logic turned around to feed the signal back.

Vogel says the chief problem with any such device is the storage technique. IBM has tried endless tape loops, disks and image tubes. Since the images must be stored at the terminal—in this case, the Mater Christi High School in Queens, N.Y., where a demonstration was given—cost is crucial. An educational system like this cannot afford much.

Another IBM engineer, W. J. Levine, says that with magnetic tape, there is a problem in getting high enough bandwidth to accommodate 525 lines. Therefore, he says, it is necessary to maintain close spacing between the recording head and the recorded material—in fact, there is sometimes direct contact. This leads to head wear. If the gap is increased, the frequency response falls off. ■■

## MOS flat pack converts A to D

An eight-channel analog-to-digital converter, believed to be the first such device using MOS technology, is being developed in prototype form by TRW Systems, Redondo Beach, Calif.

According to Norman Grannis, a section head in the TRW Systems microelectronics center, a single flat pack converts inputs on eight lines sequentially to a digitized single-line output. Serial binary data are taken from each channel in turn. Any number of bits from 1 to 7 can be programed (actually, 8 including zero).

The converter consists of MOS capacitors, switches and amplifiers.

The device is said to be different from other linear semiconductor devices in that it does not require precision resistors, precision current devices, or such storage elements as flip-flops. Nor does it have to be used in conjunction with expensive adder-ladder devices.

The converter has been breadboarded and its feasibility demonstrated, but it is not yet in marketable form. One of the outstanding problems in the development program is how to assimilate it into LSI devices.

In its existing form, inputs can be cascaded in increments of eight. Or alternatively, converter outputs can be tied together to provide greater reliability. In essence, then, either the converters or the inputs to the converters can be paralleled.

Since the converter is not limited by the number of inputs, by iteration it can be expanded for larger system use, Grannis says.

Bud Johnson, applications manager at the microelectronics center, points out that transducer measurements from many remote points are transmitted in analog form along long lines. By using this converter, he says, the signal could be digitized and amplified.

Johnson claims that the converter dissipates less than half a watt of power. Therefore, it could easily operate on battery power.

Potential applications include process control, computer control, precision voltage measurement, medical instrumentation oceanography and deep-space technology. ■■

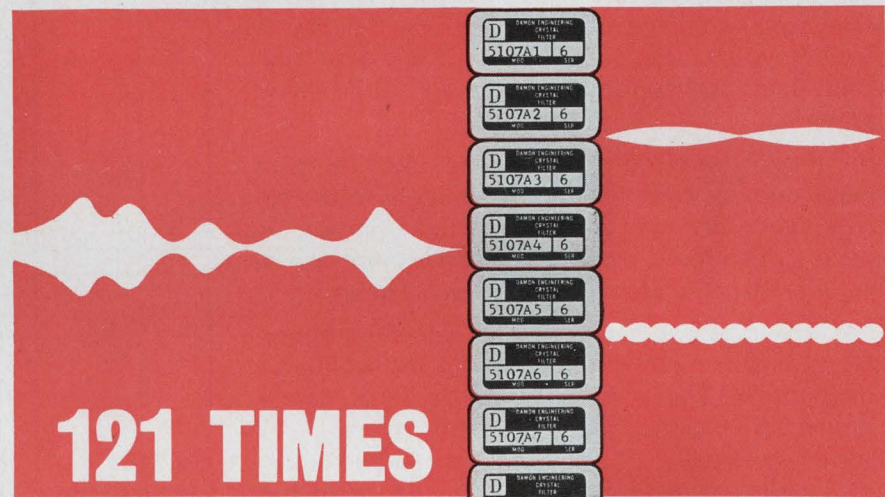
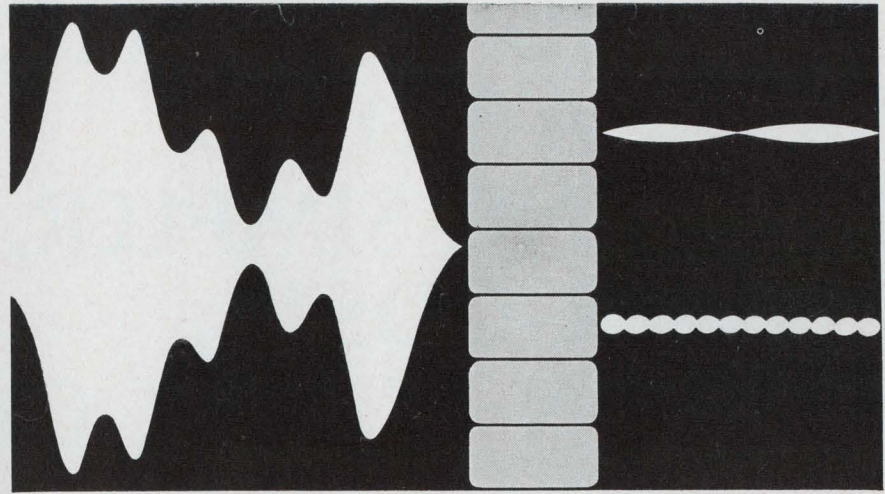

**121 TIMES  
LESS DRIVE  
POWER**  
with Contiguous Comb  
Filter Sets  
by Damon

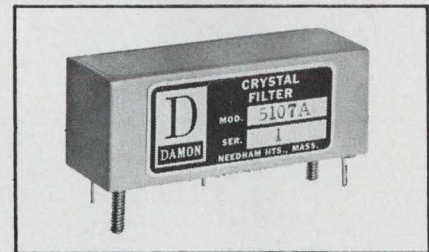

Typical Contiguous Comb Crystal Filter, Model 5107A is  $1\frac{1}{16}$ " L x  $\frac{3}{16}$ " W x  $\frac{7}{16}$ " H.

Damon has produced a bank of 200 contiguous comb crystal filters that requires a total of 6.6 watts of drive power to obtain 10 milliwatts from each of the Gaussian (non-overshoot) response filters. This is only  $1/121$  of the 800 watts of drive power normally required to achieve the same output using conventional resistive padding techniques.

This significant achievement is the result of two advances in crystal filter technology: high efficiency contiguous comb crystal filters combined with new synthesis techniques. These advances permit the adherence to both frequency and time response specifications and offer a

new concept in the design of radar and other spectrum-based systems. Contiguous comb crystal filter banks are also the most reliable, efficient, compact and economical precision systems available for multichannel signal processing of all kinds.

Write for data on Gaussian Response Contiguous Comb Crystal Filters to Damon Engineering, Inc., Needham Heights, Mass. 02194, Tel. (617) 449-0800.

**DAMON**

INFORMATION RETRIEVAL NUMBER 23

# TO YOU DESIGNERS DEDICATED TO BUILDING SIMPLER, LOWER-COST SILICON POWER CIRCUITS

Nowadays, complementary symmetry is the way to go when you're after more economy and less complexity in the power portions of your industrial circuit designs.

You get all the circuit-simplifying advantages of direct-coupled, complementary symmetry plus realize a higher degree of frequency stability in both ac and dc-driven loads without the addition of expensive, impedance-matching driver transformers.

And Motorola has the broadest 3-to-30-ampere, NPN/PNP silicon power transistor line available anywhere for the widest range of cost-cutting, direct-coupled application possibilities in the industry — 27 silicon power pairs . . . headed by the unique 30 A, 200 W units . . . in your choice of voltage, gain and power capability.



(AN225, AN230)

Complement your new design prototypes with one of Motorola's 3-to-30-ampere silicon power pair kits . . . available for a limited time for 30% below list price! We'll include two informative industrial application notes: "High-Performance All Solid-State Servo Amplifiers," and "Complementary Solid-State Audio Amplifiers" that discuss at length phase shift reduction and easy conversion to transformerless operation. Just fill in and mail the coupon to receive this outstanding "3-to-30 offer".

Pair up with silicon power!

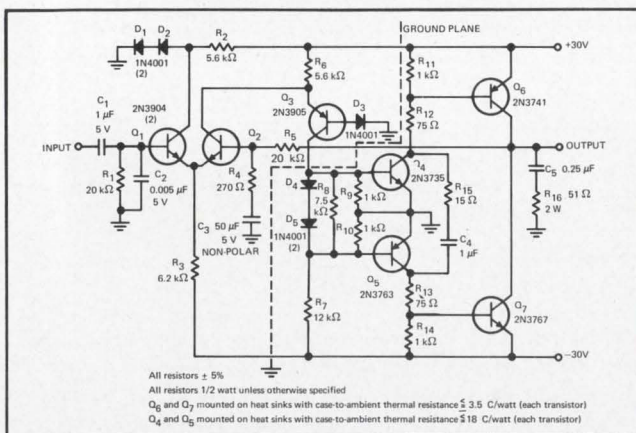

**COMPLEMENTARY SILICON POWER SERVO AMPLIFIER**  
Both ac and dc-driven loads can be utilized with this simple, compact amplifier which will drive 20 V (RMS) in a 40 $\Omega$  load, giving an output of 10 W. Voltage gain at 25°C is 37 dB and gain variation over  $-55^\circ$  to  $+100^\circ$ C operating range is within  $\pm 5$  dB. Power gain is 60 dB (min). Harmonic distortion is less than 5% at all levels up to 20 V (RMS) and is typically less than 1% at 25°C.

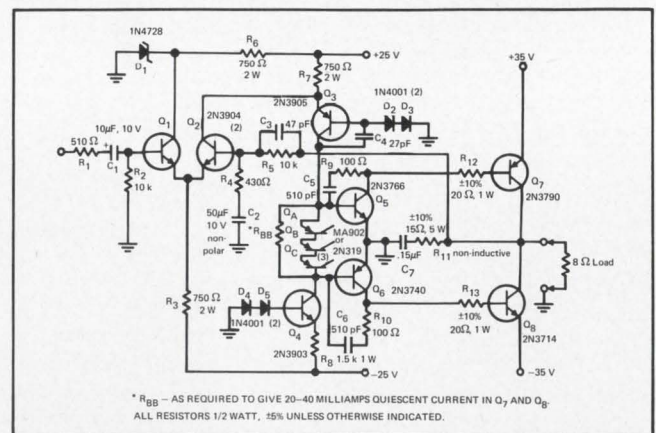

**COMPLEMENTARY SILICON POWER 50 W AUDIO AMPLIFIER**  
Excellent frequency response — 5 cycles to 300 kHz — is obtainable with this industrially-oriented amplifier. It can provide 65 W at 20 Hz, 72 W at 1 kHz and 68 W at 20 kHz. Flat frequency response results from 100 Hz to 20 kHz, being down only 0.35 dB at 20 Hz. Phase shift is 18° at 20 Hz and 6° at 20 kHz.

*—where the priceless ingredient is care!*





# ...OUR COMPLEMENTS.

## MOTOROLA 3-TO-30 A COMPLEMENTARY SILICON POWER

Ic Max. Amps	V <sub>CEO</sub> Volts (sus)	Package	Type		h <sub>FE</sub> @ Ic	P <sub>D</sub> Watts	V <sub>CE(sat)</sub> @ Ic Volts (max)	f <sub>r</sub> MHz	NPN/PNP Regular Combination Price (1-99)
			NPN	PNP					
3	40	Case 77	2N4921	2N4918	20/100 @ 500 mA	30	0.6 @ 1 A	3	\$ 2.98
	60		2N4922	2N4919					
	80		2N4923	2N4920					
	40	TO-5	2N3506	2N3867	40/200 @ 1.5 A	6	0.75 @ 1.5 A	60	26.50
	40		2N4237	2N4234	30/150 @ 0.25 A		0.6 @ 1 A	3	5.25
	60		2N3507	2N3868	40/200 @ 1.5 A		0.75 @ 1.5 A	60	29.95
60	2N4238		2N4235	30/150 @ 0.25 A	0.6 @ 1 A		3	6.35	
80	2N4239	2N4236	30/150 @ 0.25 A	0.6 @ 1 A	3	7.05			
4	40	Case 77	2N5190	2N5193	25/100 @ 1.5 A	30	0.6 @ 1.5 A	4	3.58
	60		2N5191	2N5194					
	80		2N5192	2N5195					
	40	TO-66	2N4910	2N4898	20/100 @ 0.5 A	25	0.6 @ 1 A	3	3.50
	60		2N4911	2N4899					
	80		2N4912	2N4900					
5	40	TO-3	2N4913	2N4904	25/100 @ 2.5 A	87.5	1.0 @ 2.5 A	4	5.75
	40		2N5067	2N4901	20/80 @ 1 A		0.4 @ 1 A		4.55
	60		2N4914	2N4905	25/100 @ 2.5 A		1.0 @ 2.5 A		7.05
	60		2N5068	2N4902	20/80 @ 1 A		0.4 @ 1 A		5.55
	80		2N4915	2N4906	25/100 @ 2.5 A		1.0 @ 2.5 A		9.80
	80		2N5069	2N4903	20/80 @ 1 A		0.4 @ 1 A		7.10
10	60	TO-3	2N3713	2N3789	25/90 @ 1 A	150	1.0 @ 4 A	4	13.30
	60		2N3715	2N3791	50/150 @ 1 A		1.0 @ 5 A		17.20
	80		2N3714	2N3790	25/90 @ 1 A		1.0 @ 4 A		15.35
	80		2N3716	2N3792	50/150 @ 1 A		1.0 @ 5 A		21.60
15	60	TO-3	2N3055	2N4908	20/70 @ 4 A	115	1.1 @ 4 A	1	11.15
30	40	TO-3	2N5301	2N4398	15/60 @ 15 A	200	1.0 @ 15 A	4	18.10
	60		2N5302	2N4399					21.10

### "3-30" PAIR-UP-WITH-SILICON-POWER OFFER

The silicon power pairs below are offered at 30% below regular, combination, NPN/PNP, 1-99 list prices. Pair me up with a:

# 3-



TO-3

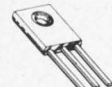

Case 77

- 3 A, 80 V 2N4923/4920 Kit . . . Special "3-30" kit price \$ 2.75
- 3 A, 80 V 2N4239/4236 Kit . . . Special "3-30" kit price \$ 4.95
- 4 A, 80 V 2N5192/5195 Kit . . . Special "3-30" kit price \$ 4.15
- 4 A, 80 V 2N4912/4900 Kit . . . Special "3-30" kit price \$ 3.50
- 5 A, 80 V 2N5069/4903 Kit . . . Special "3-30" kit price \$ 4.95
- 10 A, 80 V 2N3714/3790 Kit . . . Special "3-30" kit price \$10.75
- 30 A, 40 V 2N4398/5301 Kit . . . Special "3-30" kit price \$12.65

All kits include AN225 on Servo Amplifiers and AN230 on Audio Amplifiers.

Send me data sheets on the \_\_\_\_\_ A, \_\_\_\_\_ V devices.

Name \_\_\_\_\_ Title \_\_\_\_\_

Company \_\_\_\_\_ Div./Dept. \_\_\_\_\_

Address \_\_\_\_\_ City \_\_\_\_\_ State \_\_\_\_\_ Zip \_\_\_\_\_

(Be sure to include check for appropriate kit ordered payable to Motorola Inc. Mail to Motorola Semiconductors, Box 955, Phoenix, Arizona, 85001. Offer void after June 1, 1968.)

# 30



TO-66



TO-5

### "3-30" PAIR-UP-WITH-SILICON-POWER OFFER

# MOTOROLA Semiconductors

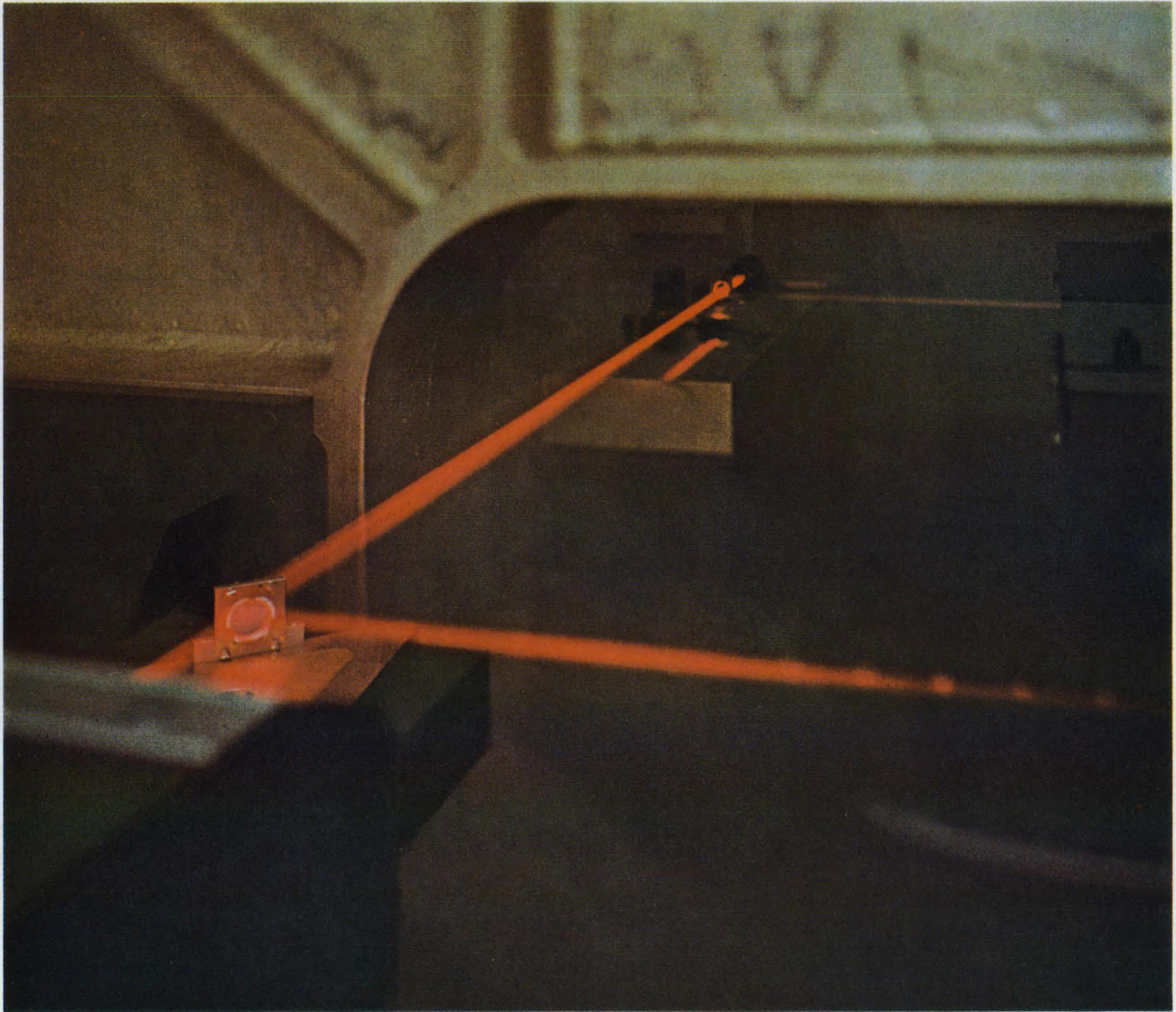

## Only ITT has laser-controlled IC mask making.

### Another reason to buy from "The Predictables."

Mask variations used to mean performance variations in Series 930 DTL. Now ITT initiative has eliminated the problem. An exclusive laser-controlled, fully automated mask making machine assures absolute repeatability of masks and of circuit performance.

ITT's machine, representing an order of magnitude improvement over older processes, holds mask registration tolerances to  $\pm 122$  silicon atoms (based on the crystal lattice constant). It is tape programmed, with memory storage capacity of 10,000 separate semiconductor devices, and it can complete a matched set of up to nine masks in as little as 10 minutes.

If you think all Series 930 DTL

circuits of the same type should act the same, the solution is simple: buy them from "The Predictables." ITT predictability also extends to diodes, rectifiers, and silicon planar transistors. Ask for a quote on any or all. They are on-the-shelf at your ITT distributor. ITT Semiconductors is a division of International Telephone and Telegraph Corporation, 3301 Electronics Way, West Palm Beach, Florida.

semiconductors **ITT**

FACTORIES IN FLORIDA • CALIFORNIA • MASSACHUSETTS • ENGLAND • FRANCE • GERMANY • PORTUGAL • AUSTRALIA

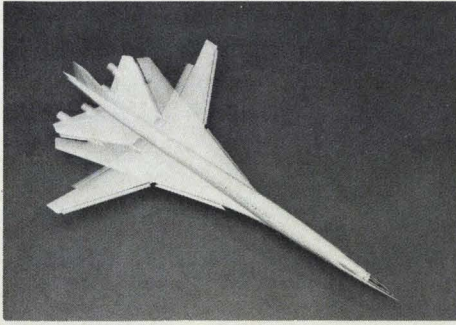

## SST pace up to Congress

Despite delays in the development of the Boeing 2707 supersonic transport, the program is back on course—for the time being anyway. The rate of future advances will depend largely on the mood of Congress. Last year Boeing was dissatisfied with the SST design and stepped back to take another look. It instituted significant design changes, and as of November, 1967, it accepted and essentially froze the over-all system design. The result of this delay will probably extend the time to the first prototype flight by about six months, or into 1971, according to Federal Aviation Administration officials.

The FAA is requesting \$223 million in new money for SST developments. Opposition surely can be expected in Congress, but informants here believe that sufficient support exists to continue the program. A steady increase in delivery-position reservations by U.S. and foreign airlines may strengthen the FAA/Boeing position. At present 122 SSTs have been reserved by potential buyers.

## The falcon, the hawk and the eagle

Once upon a time a lord and his two huntsmen had an argument. One huntsman, Usaf, begged for a new falcon; the other, Usnavy, earnestly believed he could be more effective with a new hawk. But the lord decided that both needs could be satisfied with commonality. He chose an eagle for each, to simplify problems of care and feeding. Immediately there was great consternation in the land, and both huntsmen openly expressed their dissatisfaction. They even carried their arguments to the elders in the castle. Nevertheless, it was ordered that each be given an eagle.

Later the lord, tired of squabbling, retired to his counting house, and a new master

# Washington Report

CHARLES D. LAFOND  
WASHINGTON BUREAU

took over. He found that Usaf had become fond of the eagle but that Usnavy was quietly attempting to breed a new winged hunter—a hawgle; it would have the innards of an eagle but the plumage of a hawk.

The new lord, who had already expressed indifference to ornithology in general, readily gave his permission. The long conflict ended, and there was great rejoicing by the huntsmen and their families.

The outcome might find a modern parallel. As is well known, the Navy is far from happy with its F-111B variable-geometry fighter, despite its request for \$350 million to buy 30 aircraft in fiscal 1969. And it has obtained strong support for its position in Congress.

Last October Grumman submitted a design proposal for a new Navy fighter, and additional proposals followed shortly thereafter, with competitive designs by McDonnell-Douglas, North American Rockwell and LTV, Inc. The new designs would employ essentially the same power plant and avionics now used in the F-111B, but the aircraft would have a newly designed, lighter, swing-wing airframe. Reportedly the Navy would like to settle on the final design by April and then move ahead with contract definition. It is doubtful that Congress would offer any resistance, but approval hinges on the new Secretary of Defense, Clark Clifford.

The betting in Washington is that the F-111B is dead and should be buried sometime this year.

## Profiteering opposition grows

There appears to be an increasing number of Congressional leaders in both houses who are exasperated with the high war profits consistently rung up by some segments of U.S. industry. Several bills recently have been introduced in the House of

Representatives, for example, to strengthen and make permanent the Renegotiation Board. To many in Congress, the time appears right to strengthen this watchdog body—what with the national budget soaring to new heights and the President pushing for a 10% income tax surcharge. On top of this, recent evidence has been uncovered by the General Accounting Office of industrial overcharges and apparent misuses of Government-furnished equipment.

A leader in the fight to strengthen the Renegotiation Board is Rep. Henry Gonzalez (D-Tex.). The board was created during the Korean conflict to watch over Defense Dept. purchasing and to recover overcharges. It is presently far under strength, with total personnel of less than 180. The Gonzales bill would greatly enlarge the staff and the scope of the board's reviewing powers. The Representative has pointed out that in the 14-year-period through June, 1966, the board spent \$47.7 million while regaining \$861 million in excess profits. Without Congressional action, the Renegotiation Board will pass into oblivion at the end of June.

## X-radiation bugging color TVs

In a preliminary report to a Congressional subcommittee, James G. Terrill Jr., director of the National Center for Radiological Health, stated that many of the 1200 home color television sets recently surveyed by the U.S. Public Health Service had emitted X-radiation in excess of the recommended limit of 0.5 mR per hour. Speaking before the House Commerce Committee's public health and welfare subcommittee, Terrill said that the survey of equipment, representing 27 brand names, should be completed this month. The study teams are from the Public Health Service and TV manufacturers (see this column ED No. 3, Feb. 1, 1968, page 37).

The survey began in December, and in a few cases, Terrill noted, there have been very high levels of measured radiation. He expressed satisfaction with the progress of

the tests and asserted that, even at this stage of the project, it is apparent that X-radiation by TV color receivers is a problem of concern to all manufacturers. In cooperation with the Electronic Industries Association and the television industry, a conference on the detection and measurement of TV-receiver radiation will be held here this month.

## The Pueblo: Questions, questions

Amid thunderous queries by everyone from Congress to the local trash collector, the Pueblo incident has the Pentagon and the State Department backed to the wall. So strong has been the national anger at the audacity of North Korea in seizing the American intelligence vessel, that Secretary of State Dean Rusk and Defense Secretary Robert S. McNamara took to the television podium to attempt clarification. They succeeded, at least in part, in explaining the U.S. position, but not to the satisfaction of most Congressmen. Demands are being made for a thorough airing before the Senate Foreign Relations Committee.

Secretary McNamara has stated three reasons for the lack of armament and other external protection on the Pueblo: (1) It would be a provocation act to arm such a spy vessel near the territorial waters of another nation; (2) The use of escort ships or aircraft might compromise the ship's mission, and (3) Protection of such a vessel automatically tends to lend itself to military escalation. What many inquirers want to know, though, is why it is less provocative to send out a partially armed spy ship than a fully armed one. Is not the act of spying near territorial waters provocative in itself?

Very shortly after the Pueblo seizure, the chairman of the Foreign Relations Committee, Sen. J. William Fulbright (D-Ark.), sent a four-page list of questions to Secretary Rusk concerning close-in surveillance by U.S. vessels in Asiatic waters.

## U.S. crime net to be expanded

The Justice Dept. announced last month an allocation of just under \$300,000 to expand the national crime data network. The new funds will allow 36 state and local law-enforcement agencies to link up with the National Crime Information Center.



## new 260<sup>®</sup> SERIES 5 VOM

We're at it again... making the 260<sup>®</sup> a better buy than ever. This latest improvement is built-in meter protection... standard on regular\* 260 volt-ohm milliammeters—Series 5 and 5M.

It prevents mechanical damage to the moving element in the movement from instantaneous overloads up to 1,000,000%, or steady state overloads up to 500,000%. It also stops overheating or burnout of the armature coil, damage to hair springs, and calibration change due to high overloads. Otherwise the famous 260 remains unchanged.

If you now have a Series 1, 2, 3, or 4, 260 VOM, you can install your own meter protection. Ask your electronics distributor for a Simpson meter "safe/guard<sup>®</sup>." It takes only minutes to install.

260-5 with new meter protection..... \$62.00

260-5M (mirror scale) with meter protection..... \$64.00

\*260-5P has both meter and circuit protection except on the 1000V and 5000 V DC and AC ranges, and the 10-amp DC range. Price \$94.00

**RANGES** (20,000 o/v DC; 5000 o/v AC)

**DC VOLTS:** 0-0.25; 0-2.5; 0-10; 0-50; 0-250; 0-1000; 0-5000

**AC VOLTS:** 0-2.5; 0-10; 0-50; 0-250; 0-1000; 0-5000

**DC MICROAMPERES:** 0-50 (250 MV Drop)

**DC MILLIAMPERES:** 0-1; 0-10; 0-100; 0-500

**DC AMPERES:** 0-10 (250 MV Drop)

**RESISTANCE RANGES:** RX1 0-2000 ohms (12 ohms center) RX100 0-200K ohms (1200 ohms center) RX10K 0-20 megohms (120K ohms center)

**ACCURACY:** DC, ±2% F.S., AC, ±3% F.S.

Write for Bulletin 2076 showing the entire line of Simpson VOM's



**SIMPSON ELECTRIC COMPANY**  
 5211 W. Kinzie Street, Chicago, Ill. 60644 • Phone: (312) ESTbrook 9-1121  
 Representatives in Principal Cities... See Telephone Yellow Pages  
 Export Dept: 400 W. Madison St., Chicago, Ill. 60606 Cable, Amergacc  
 In Canada: Bach-Simpson Ltd., London, Ontario  
 In India: Ruttonsha-Simpson Private Ltd., Vikhroli, Bombay

WORLD'S LARGEST MANUFACTURER OF ELECTRONIC TEST EQUIPMENT

INFORMATION RETRIEVAL NUMBER 26

## TRW Metallized Capacitors



### ...stand tall

Type X601PE Metallized Mylars typify TRW's stature in advanced metallized dielectrics.

They're smaller and lighter... *metallized!* Tough and rugged...

*epoxy sealed!* Ideal for printed circuits...*save space!*

TRW offers many additional styles and dielectrics for demanding Military and Industrial needs.

Product information is available from TRW Capacitor Division, TRW INC., Box 1000, Ogallala, Nebraska. Phone (308) 284-3611. TWX: 910-620-0321.

# TRW

INFORMATION RETRIEVAL NUMBER 31

**Publisher**

Hugh R. Roome

**Editor**

Howard Bierman

**Managing Editor**

Robert C. Haavind

**Technical Editors**

Jeffrey N. Bairstow  
 Peter N. Budzilovich  
 David H. Sorgan

**Management and Careers Editor**

Howard S. Ravis

**News Editors**

Ralph Dobriner, Chief  
 Richard N. Einhorn

**Washington News Bureau**

Charles D. LaFond, Chief

**Military/Aerospace Editor**

John F. Mason

**East Coast Editor**

Neil Sclater

**West Coast Editor**

Ron Gechman

**New Products Editors**

Steven B. Futterman  
 Robert Patton

**Editorial Production**

Dollie S. Viebig  
 Phyllis Gura

**Art Director**

Clifford M. Gardiner

**Art Assistant**

William Kelly

**Technical Illustrators**

Cheh Nam Low  
 Sheila F. Ward  
 William Alvarez

**Production Manager**

Thomas V. Sedita

**Asst. Production Manager**

Helen De Polo

**Production Assistants**

Bernard Wolinsky  
 Gregory A. Bannon

**Circulation Manager**

Nancy L. Merritt

**Information Retrieval Service**

Diane Mandell

## EDITORIAL



## We need innovators, not stubborn 'changers'

A company engineering department is responsible for creating profitable products. It needs innovators rather than "changers."

What's the difference?

Innovators examine existing products—their own and competitors'—with exhaustive care in a constant search for improvement. But a clever innovator doesn't just invent a better mousetrap, period. He tailors his design to allow for a profit.

"Changers" are the people in engineering departments who provide the steady, unending flow of engineering orders—some justifiable, many not—that change things with little regard for the effect on the profit picture. The most common change orders stem from poor engineering practices: (1) Improper documentation of specifications; (2) Inadequate purchasing instructions; (3) Poorly prepared test procedures; (4) Parts substitutions for the sake of "newness" but with minor improvement; (5) Parts replacements because the original design relied on a single source, incapable of delivering quantity supplies.

At a recent IC conference on Long Island the innovators were in obvious attendance. They cross-examined semiconductor engineers who gave papers on ICs, MSI and LSI: "What will it cost?", "When can we get delivery?", "How expensive will tooling be?", "Have you any field reliability figures?"

The "changers" were in evidence also. At lunch about a dozen systems engineers and an authoritative engineer from a leading semiconductor company gathered at one table. The authority warned the changers in the group that their "routine" changes in system designs would have to go once subsystems are made available as low-cost, large-scale arrays. He explained the prohibitive costs of altering mask designs and interconnection patterns. The changers were unconvinced (because if there is one thing a changer doesn't like to do, it's to change himself). They argued that the semiconductor supplier would have to accommodate the customer and learn to live with changes. Otherwise, they hinted, they just wouldn't rush to large-scale arrays and risk their careers. As one of the group put it: "An engineering change order a day keeps the unemployment away."

With enough heads like this stuck in the sand, it seems obvious that the companies with innovators to apply semiconductor and other advances profitably will dominate the companies staffed with changers.

Innovators, onward. Changers, outward.

HOWARD BIERMAN

**One company conceives, designs and builds systems consoles with integration of human engineering, industrial design, and value analysis too!**

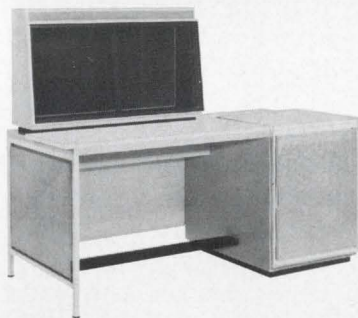

**Start at breadboard with Electronic Enclosures Inc**

225 South Aviation Boulevard  
El Segundo, California 90245  
(213) 679-0181

7825 Airport Highway  
Pennsauken, New Jersey  
(609) 665-6810

SEND FOR FREE BROCHURE

INFORMATION RETRIEVAL NUMBER 27

## Letters

### Neural hearing tested privately

Sir:

The report of Army tests of inducing hearing by coupling a-m-rf signals to the head ["Army tests hearing aids that bypass the ears," ED 26, Dec. 20, 1967, pp. 30-32] covers ground similar to that of some tests we made here in Pasadena over a year ago. We made these after reading an abstract of a government contractor report.

The principle worked, but:

- You could hear the sound quite clearly emanating from the head of the guy with the electrodes on—almost as well as he could hear it.

- You couldn't induce a subjective sound level high enough without using rf current levels so high as to cause discomfort.

- The effect would die away in a few seconds if you held the electrodes still in one place. To keep it working, you had to keep massaging the electrodes against your head. Furthermore, any asymmetry in the amplitude modulation of the carrier would generate audio-frequency currents large enough to be felt as electric shocks.

We concluded that human tissue is electrostrictive under certain rather unknown conditions of stress gradients, and that the subjective sensation of hearing sound was produced by nothing but sound itself—generated by the electrostrictive vibration of the tissue.

It did not seem worth while pursuing the idea further, although it is intriguing and suggests many avenues for research, such as the polarity question. A great many substances are electrostrictive or piezoelectric. It is a much more common property than we are apt to think, because most of these substances are also good conductors, and so short out any dc or low-frequency attempts to measure this property. It has been suggested, for example that the propagation of detonation in TNT is due

to its piezoelectric properties, which generate extremely high-voltages during the explosion process.

Lawrence Fleming

President  
Innes Instruments  
Pasadena, Calif.

### Antenna matching can be improved

Sir:

In the Ideas for Design section of your magazine of Jan. 4, 1968, [ED 1,] p. 138, Ronald Finger describes the use of series quarter-wave feed lines for antenna matching purposes ["Match antenna impedance with series Q-sections"].

An alternative, advantageous variation involves the use of parallel quarter-wave sections. Thus two 50-ohm quarter-wave lines in parallel would approximately match the assumed 22.5 ohms. This technique is more advantageous in the matching of still lower impedances where resistive losses in the series connection might be intolerable. For example, seven 50-ohm sections in parallel would match from 50 ohms down to 1 ohm with one-seventh in resistive line loss.

If  $n$  sections of line with a characteristic impedance equal to  $Z_i$  are paralleled, the expression for  $n$  is:

$$n = Z_i/Z_0.$$

James E. Taylor

Physicist-Engineer  
Xerox Corp.  
New York

### Accuracy is our policy

In "Capacitor leakage tester checks production units," ED 2, Jan. 18, 1968, p. 132, diodes CR7 through CR12 in the schematic are shown the wrong way around. All six should be reversed.



# All the dry reeds for your needs...with consistent high quality

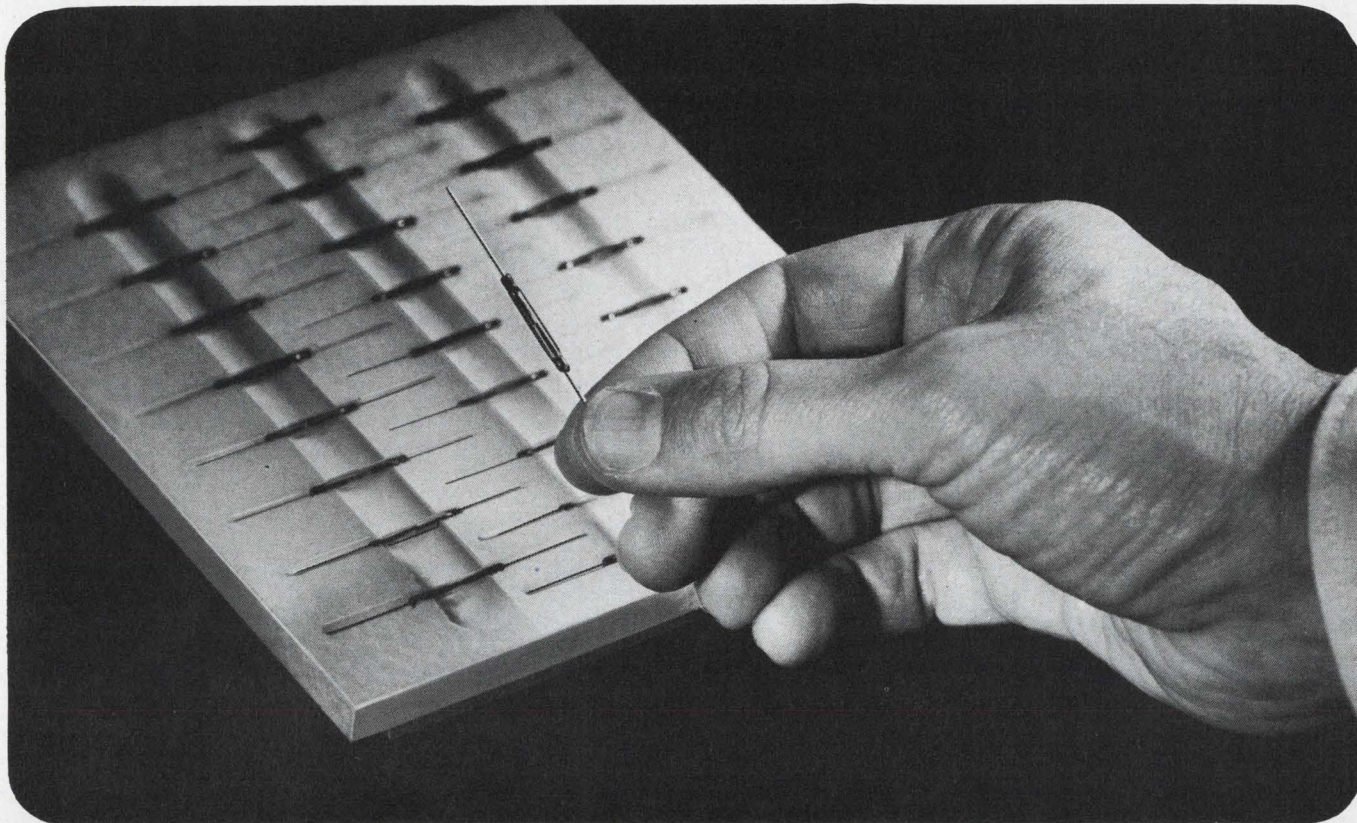

MICRO SWITCH offers you the reed switch combination you've been looking for: reliable delivery in mass production quantities; consistent high quality with precise operating characteristics; convenient new packaging that simplifies handling on your production lines.

All of this is the result of totally new automatic production equipment and quality test facilities set up exclusively for large volume, high quality dry reed switches.

And look what the new Form A, Series 1CS dry reed switches offer:

...Long Life!—100,000,000 operations at rated load. Even longer life as load decreases.

...Hermetically sealed contacts with dry gas fill for full protection against contamination or changes in atmosphere.

...Wide range of operate and release levels with controlled tolerances.

...Fast operating speed combined with high reliability.

...Micro-volt or micro-ampere dry circuits to ¼ amp at 48 vac.

...Miniature size—glass tube—.810 x .100 in.; overall switch length with round inleads—1.5 to 2.25 in.

New Series 1CS dry reed switches are ideal for a variety of applications: numerical control, proximity limit switching, logic relays, encoding-decoding-pulse applications.

For full details call a Branch Office (Yellow Pages, "Switches, Electric"). Or write for Product Sheet 1CS.

## MICRO SWITCH

FREEPORT, ILLINOIS 61032

A DIVISION OF HONEYWELL

HONEYWELL INTERNATIONAL • Sales and service offices in all principal cities of the world. Manufacturing in United States, United Kingdom, Canada, Netherlands, Germany, France, Japan.

INFORMATION RETRIEVAL NUMBER 28

# AMPERITE

## GLASS ENCLOSED Thermostatic DELAY RELAYS

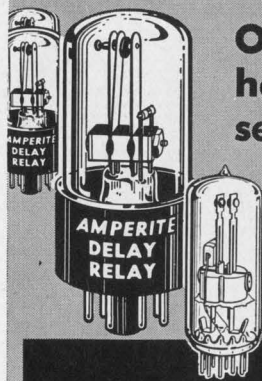

Offer true  
hermetic  
sealing—

— assure  
maximum  
stability  
and life!

### Delays: 2 to 180 seconds

Actuated by a heater, they operate on A.C., D.C., or Pulsating Current . . . Being hermetically sealed, they are not affected by altitude, moisture, or climate changes . . . SPST only — normally open or normally closed . . . Compensated for ambient temperature changes from  $-55^{\circ}$  to  $+80^{\circ}\text{C}$ . . . Heaters consume approximately 2 W. and may be operated continuously. The units are rugged, explosion-proof, long-lived, and inexpensive!  
TYPES: Standard Radio Octal and 9-Pin Miniature . . . List Price, \$4.00  
PROBLEM? Send for Bulletin No. TR-81.

# AMPERITE

## BALLAST REGULATORS

Hermetically sealed, they are not affected by changes in altitude, ambient temperature ( $-50^{\circ}$  to  $+70^{\circ}\text{C}$ ), or humidity . . . Rugged, light, compact, most inexpensive.

List Price, \$3.00

Write for  
4-page  
Technical  
Bulletin  
No. AB-51

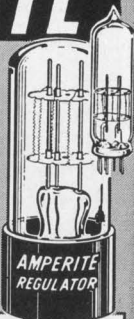
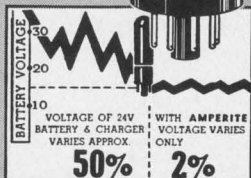

# AMPERITE

600 PALISADE AVE., UNION CITY, N.J.  
Telephone: 201 UNion 4-9503  
In Canada: Atlas Radio Corp., Ltd.,  
50 Wingold Ave., Toronto 10

## Someone up there likes us

A Jesse H. Neal Award is to the technical-magazine field what a Pulitzer Prize is to a general-circulation publication.

For the second year in a row, ELECTRONIC DESIGN has garnered a Neal Award for the best staff-written feature article in a technical magazine with a circulation of more than 50,000. Richard N. Einhorn, News Editor, won the award for his article "Probing the Mind's 'Computer'." His report on electrical stimulation of the brain appeared in the May 24, 1967 issue.

The article stirred great reader interest and was praised by such pioneering scientists as Dr. Blaine S. Nashold of Duke University, Dr. Robert Doty of the University of Rochester and Dr. José M. R. Delgado of Yale University.

Last year Managing Editor Robert C. Haavind won the same Neal Award for an article on guerrilla-warfare electronics in Vietnam.

## Nanosecond reporting (well, almost)



Approaching the print-out stage after the Solid-State Circuits Conference: (From the left) Einhorn, Budzilovich, Speer and Haavind. Sclater arrived, puffing, minutes later.

The emphasis was on speed at this year's International Solid-State Circuits Conference: subnanosecond ICs . . . discretes . . . hybrids . . . LSI. And emerging trends: fourth-generation computers, for instance, with over 200 circuits per square inch.

ELECTRONIC DESIGN's five-man reporting team found it hard to descend from such giddy heights. Working jointly after the close of the three-day Philadelphia conference, Richard (Doc) Einhorn, Pete Budzilovich, Ray Speer, Bob Haavind and Neil Sclater searched their own solid-state memories (and notebooks) and printed out all the highlights in roughly 19.6 trillion nanoseconds. For details of the significant—from the Sheraton Hotel's small, smoke-fogged rooms to the spacious Irvine Auditorium at the University of Pennsylvania—start reading on page 25.

# Latest in the line of Monsanto IC counter/timers.

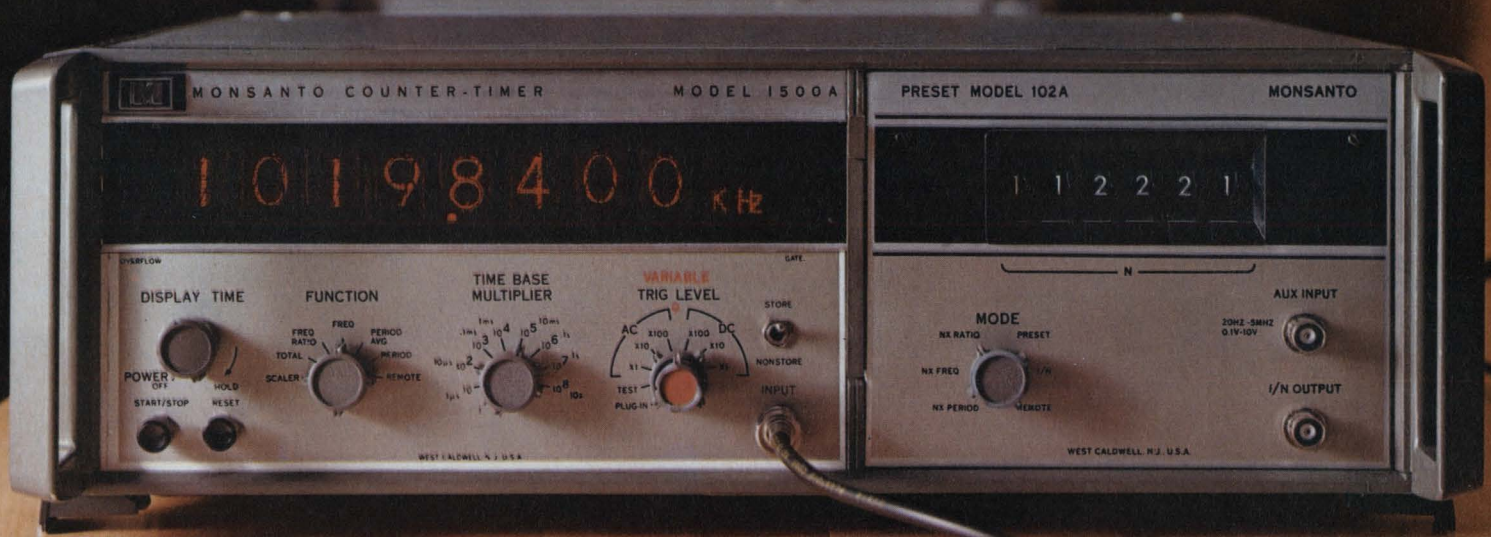

AVAILABLE PLUG-INS: TWO FREQUENCY CONVERTERS (50 MHz TO 500 MHz, 100 MHz TO 3 GHz); PRESCALER (dc TO 1 GHz); PRESET UNIT (20 Hz TO BEYOND 10 MHz); VIDEO AMPLIFIER (1 mV SENSITIVITY, 10 Hz TO 200 MHz); TIME INTERVAL UNIT (100 ns RESOLUTION); NON-COMMITTED PLUG-IN.

**With 90% integrated circuit construction this new "4th generation" instrument is the most advanced plug-in counter/timer yet.**

Our new model 1500A takes full advantage of IC capabilities to bring you: main-frame counting range from dc to over 125 MHz; to 3 GHz with a single plug-in. Remote programmability by either contact closure or voltage level. Provision for external time base up to 10 MHz. And nat-

urally, the inherent stability and reliability of integrated circuit construction, as indicated by our two-year warranty. All this for only \$2,850\*. Call our field engineering representative in your area for full technical details, or contact us directly at: Monsanto Electronics

Technical Center, 620 Passaic Avenue, West Caldwell, N. J. 07006. Phone: (201) 228-3800; TWX 710-734-4334. \*U. S. Price, FOB West Caldwell, N. J.

**Monsanto**  
ELECTRONICS

# Tektronix Type 453 oscilloscope has

- 50 MHz Performance
- Dual Trace ● Delayed Sweep
- Easy-to-Use Triggering

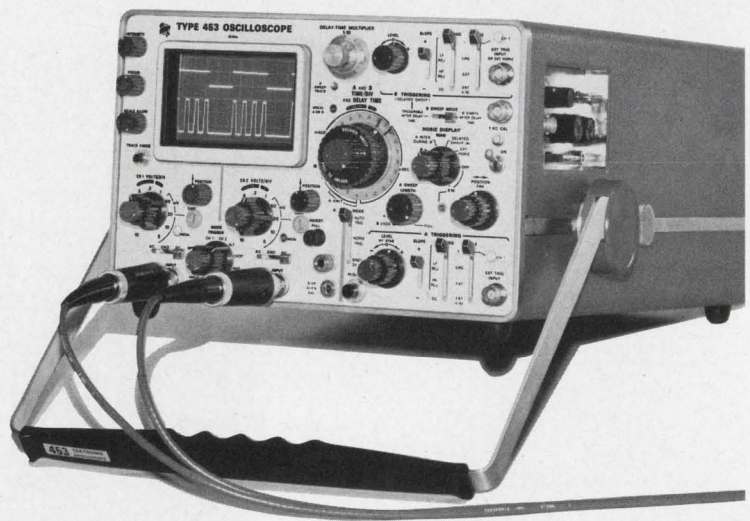

## and-----it's designed to be carried!

Pick it up and be convinced. The Type 453 weighs 28¾ pounds and is built to go when and where you go.

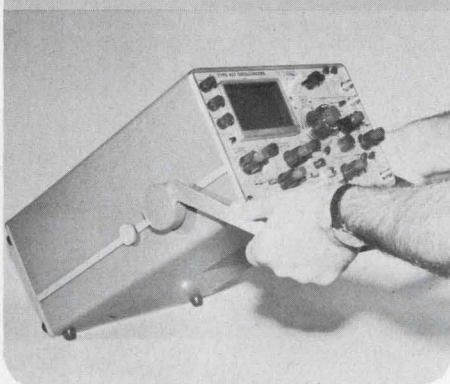

Don't worry about damaging the front panel and knobs—they're protected by a cover that also carries the accessories.

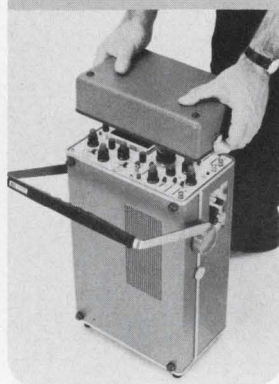

Take the Type 453 through tight places easily . . . the vertical carrying position increases portability.



Take it anywhere. The rain/dust cover is a standard accessory and carries the complete manual and optional viewing hood.



The Type 453 is a portable instrument with rugged environmental capabilities plus the built-in high performance normally found only in multiple plug-in instruments.

The vertical amplifier provides dual trace, DC to 50 MHz bandwidth with 7 ns risetime from 20 mV/div to 10 V/div. (DC to 40 MHz, 8.75 ns  $T_r$  at 5 mV/div.) The two included Type P6010 miniature 10X probes maintain system bandwidth and risetime performance at the probe tip—DC-50 MHz, 7 ns—with an increase in deflection factors of 10X. You can also make 5 mV/div X-Y and 1 mV/div single trace measurements.

The Type 453 trigger system takes the guesswork out of triggering. Pushing all the lever switches up provides a sweep and the most often used trigger logic. The sweep triggered light gives the operator a positive indication of a triggered sweep and the automatic triggering provides greater usability.

You can operate the delayed sweep with ease. Lever con-

trol to the right and HORIZ DISPLAY switch to A INTEN DURING B gives delayed sweep operation. Setting the B TIME/DIV and the DELAY-TIME MULTIPLIER to meet your requirements and switching to DELAYED SWEEP allows  $\pm 1.5\%$  delay measurements to be made.

The Type 453 is a continuation of the Tektronix commitment to quality workmanship. Its design and layout make it easy to maintain and calibrate. Transistors plug in and are easily removed for out-of-circuit testing. An accurate time ( $\pm 0.5\%$ ) and amplitude ( $\pm 1\%$ ) calibrator permits quick field calibration.

The front panel protection cover carries all the accessories with the complete manual carried in the rain and dust cover. The Type C-30 Camera and a viewing hood that fits in the rain cover also are available.

Type 453 (complete with probes and accessories) . . . \$1950.00  
 Type C-30 Camera . . . . . \$ 420.00  
 Collapsible Viewing Hood . . . . . \$ 7.50

U.S. Sales Prices, FOB Beaverton, Oregon

For a demonstration, contact your nearby Tektronix field engineer or write: Tektronix, Inc., P. O. Box 500, Beaverton, Oregon 97005.



*Environmental testing*



*. . . part of the Tektronix commitment to technical excellence*

# Technology

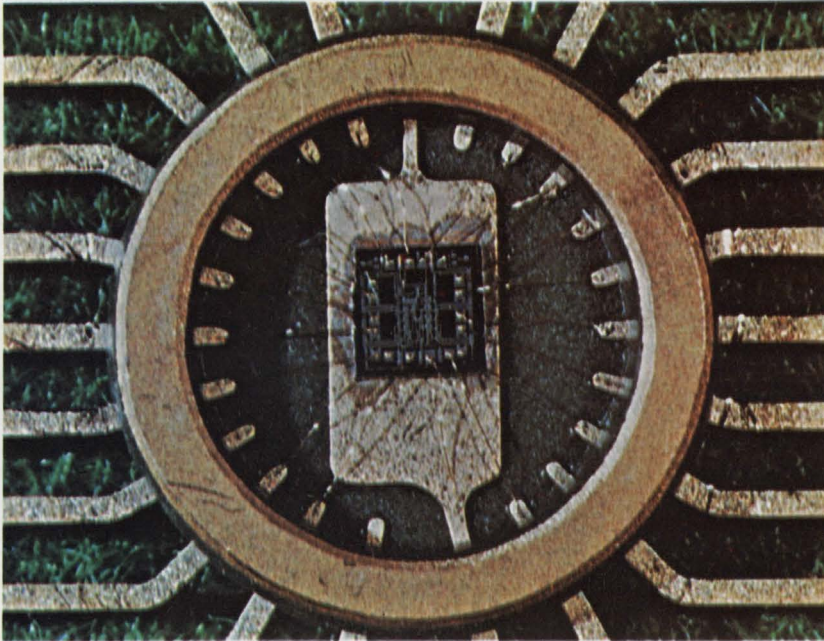

Selecting a microelectronic package is easy: Just follow a step-by-step "critical path" of materials decisions. Page 56

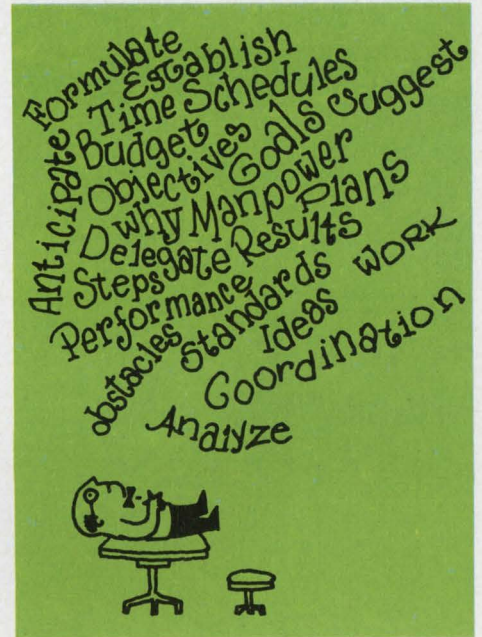

Making decisions? Think clearly, avoid the traps. Page 82

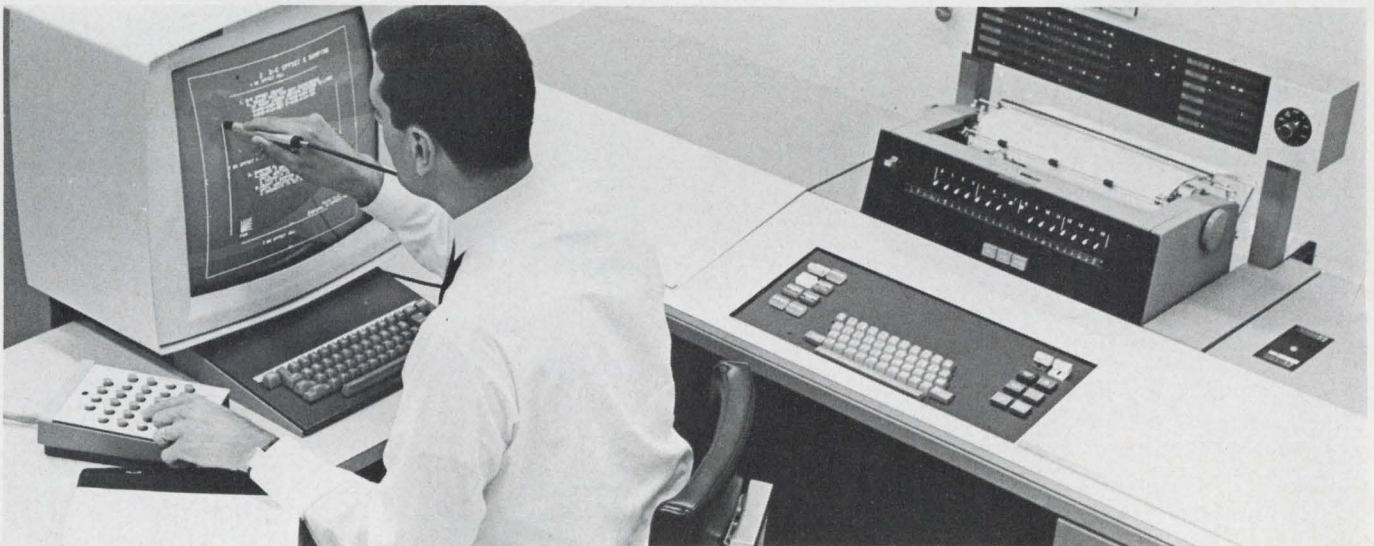

Fourth-order equations often appear in circuit analyses. A new, simple method of solu-

tion gives exact answers and is particularly suited to a solution by computer. Page 72

## Also in this section:

You can design an inductive circuit without inductors. Page 66

Test your IC IQ. Page 78 . . . Ideas for Design. Page 90

# Set your own IC package standards.

Follow the 'critical path' of material decisions and simplify your package selection.

At present, there are no standards for integrated circuit packages. But that doesn't mean that the selection, design or specification of an IC package cannot be treated in a logical way with a set of standardized decisions.

Whether an off-the-shelf package is being bought, a package designed or a custom package specified, the same decisions have to be made. Hermetic or nonhermetic? Metal, glass, or ceramic? Braze, solder or weld? Tackle each decision in the proper sequence and you've got your package specified. The "road map" on the opposite page can serve as your guide.

## Is hermeticity a must?

The actual selection begins with deciding whether the device must be hermetically sealed or not. If this is a requirement, as in military devices, then there is no question. If, however, there is some latitude, then it becomes a matter of economics to consider resin embedment or plastic encapsulation. Where a hermetic package may cost as much as four dollars, a plastic package such as those on the right can go as low as 20 cents. And a plastic package allows almost any material to be chosen for the device leads, since there are few compatibility problems. Plastic packaging is generally not considered hermetic. Since all resin systems in use have diffusion rates, the standard definition of hermeticity (leak rate not to exceed  $1 \times 10^{-8}$  cm<sup>3</sup>/s of helium) does not apply. Many claims are made for the "comparable" density of plastic to that leak rate, but opinions appear to be about equally divided.<sup>1</sup> There is no question, however, that plastic encapsulation is acceptable for devices meeting wider long-term electrical tolerances than called for under military requirements

**David Nixen**, Chief, Prototype Assembly, Microelectronics Pilot Line, Autonetics Div. of North American-Rockwell Corp., Anaheim, Calif.

for operation under temperature and humidity extremes. Acceptable plastics would be those that tend to be free of impurities, or where, if impurities are present, they tend not to migrate to the chip. Bipolar devices are more adaptable to plastic than are MOS devices because of the higher surface sensitivity of MOS. So, first consider the device, and then the plastic since available plastics have widely different characteristics.<sup>2,3</sup>

Presently, the best way to protect a chip to be packaged in plastic is to use a passivation layer. This is a barrier applied to the surface of the device to protect the sensitive areas of the die

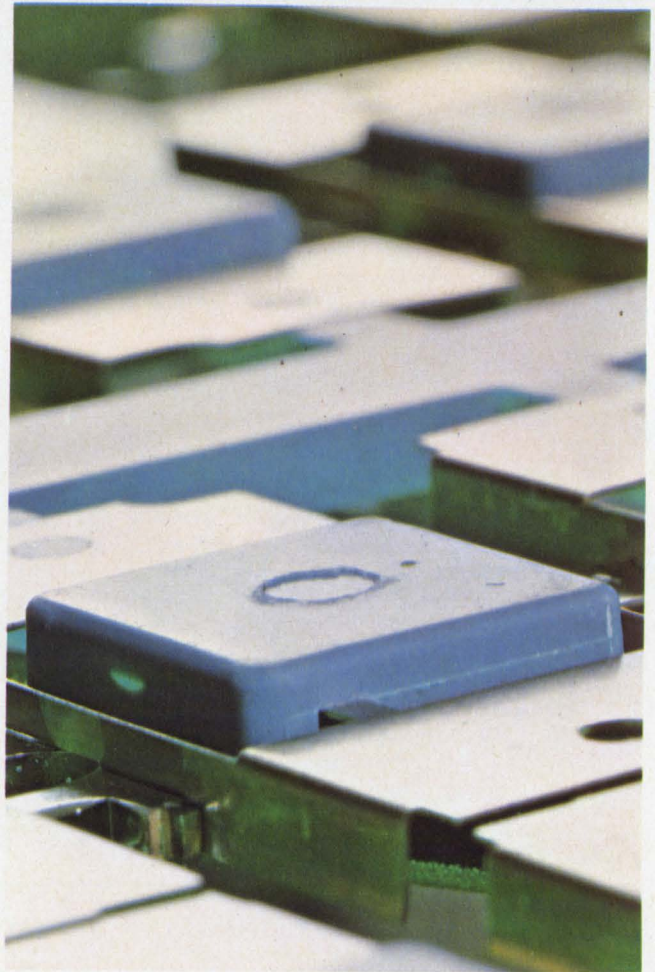

When hermeticity isn't critical, use plastic. These RCA ICs are packaged in a Dow Corning silicone material.

from chemical impurities. Such impurities may lie dormant in the encapsulant itself and diffuse through the body. It is only a matter of time before they ultimately reach the surface of the die and cause degradation of the unit. The passivation layer is an impervious, stable barrier that will not be affected by either time or subsequent processing. Some of the more popular passivation systems are borosilicate glass, thick, pure silica, silicon nitride and aluminum oxide. When evaluating a passivation material, bear in mind the density of the surface passivation material itself (it must be free of pin holes), the ease of application (the method of application should not be detrimental to the device) and whether the passivation material is chemically compatible with the device over a period of time. The methods of application of these systems range from the comparatively simple method of centrifuging fine glass frit onto the wafer, to the much more expensive vacuum-deposition process of silicon nitride or aluminum oxide. While one method may be inexpensive and simple to apply, the other may be far more impervious to impurities.

A nonpassivated surface has no externally applied materials to protect the surface of the ac-

tive device from the effects of an embedment material. The plastic is applied directly onto the surface of the die. The only protective barrier that may exist between the device and the plastic is an incidental layer of silicon monoxide or dioxide formed during fabrication of the device.

Single-layer application is simply a plastic encapsulant applied over the die. Since the flying leads interconnecting the die and the lead frame are exposed, however, stresses on the wire bonds are set up by the different coefficients of thermal expansion (Table 1, p. 58). Therefore many manufacturers apply another layer of encapsulant first. It is usually an organic material that does not cure a rigid mass but remains pliable. The inner layer is generally a silicone gel; the outer layer is usually an epoxy. The gel tends to damp out potentially harmful stresses on delicate wires and bonds.

The final step in fabricating a plastic package can be a simple inexpensive casting process. The packages are placed in molds or housings, the resin is applied, oven- or air-cured, and the mold is removed. Although casting requires little outlay on equipment, it does require time for curing and mold removal.

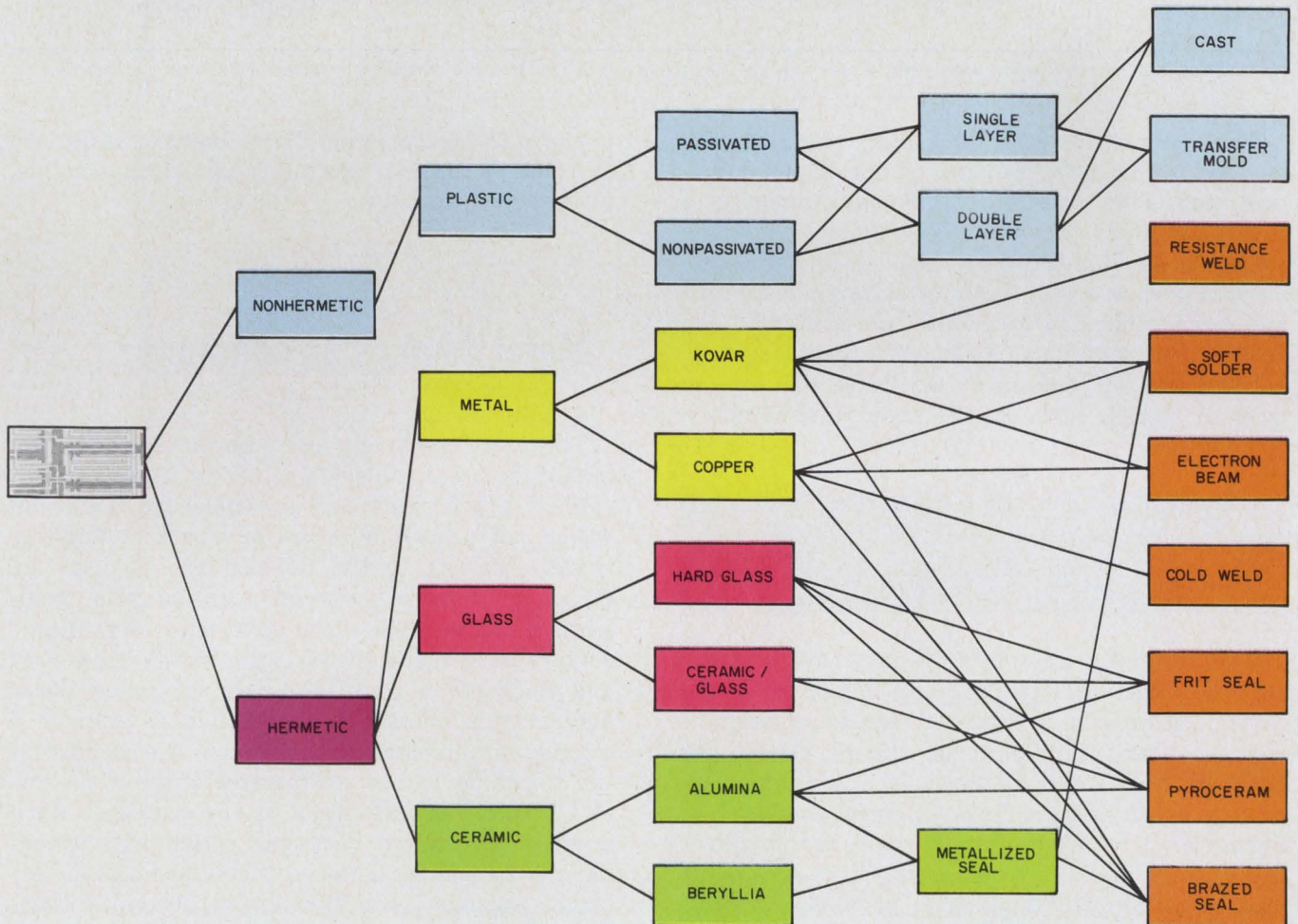

A series of step-by-step decisions is the key to the selection of a microelectronic package. The colored sections

correspond to colored section headlines in the text where all of the trade-offs involved are discussed.

# Table 1. Thermal expansions and conductivities

Material	Thermal expansion ( $10^{-7}/^{\circ}\text{C}$ )	Thermal conductivity (cal/cm <sup>2</sup> /cm/s/ $^{\circ}\text{C}$ )
Dumet	92 (radial) 65 (axial)	0.4
1010 steel*	135 (25–300°)	0.12
No. 52 alloy*	95 (20–500°)	0.04
Sylvania No. 4*	85 (25–300°)	0.032
Kovar	57.62 (30–500°)	0.0395
Molybdenum	55 (25–500°)	0.32
Tungsten	46 (0–500°)	0.476
7052 glass (borosilicate)	46 (0–300°)	0.0028
0120 glass (potash-soda lead)	89 (0–300°)	0.0018
Silica	8 (0–300°)	0.004
96% Al <sub>2</sub> O <sub>3</sub>	64 (25–300°)	0.084 (25°C) 0.041 (300°C) 0.026 (500°C)
99.5% BeO	60 (25–300°)	0.55 (25°C) 0.28 (300°C) 0.17 (500°C)
Epoxy (alumina-filled)	120-150	0.0009-0.0011
Epoxy (beryllia-filled)	250	0.021-0.073
Epoxy (unfilled)	180-600	0.0003-0.0006
Teflon	800-1000	0.0006
Polyethylene	1600-1800	0.0008
Sapphire	95	0.0061 (105°C)

\*1010 steel, No. 52 alloy and Sylvania No. 4 are basically nickel-iron mild steels. They are considered as acceptable hermetic standards.

The same resins used for casting can generally be used for transfer-molding as the final fabrication step. This process requires investment in a press and mold, however. The transfer-molding press is an accurately controlled low-pressure, low-temperature unit. It takes a steel mold which has been machined to accept the package lead frames. An individual mold can accept as many as 40 packs, depending on size, and requires an over-all process cycle of only about four minutes.

## When hermeticity is a must

The hermetic approach offers a much wider set of choices and is far more complex. Where plastic encapsulation gives a certain amount of leeway—nearly any material can be chosen for package leads, for instance—the hermetic approach involves rigid laws to meet the level of hermeticity required. For example, an engineer can choose, at best, from among five acceptable lead materials. Of these five, perhaps only two satisfy other requirements of his design. And the physical structure of the package may dictate the

use of a single material. Three basic families are in common use for hermetic packages—metals, glasses and ceramics.

## Metal doubles as conductor

The most commonly used hermetic packaging materials are metals. They serve as a current carrier, a heat sink and an enclosure body—an option not offered by glass or ceramic. Bonding the die directly to the floor of the package by means of a braze material such as gold, gold-germanium, or gold-silicon enables a direct ohmic contact to be made between the bulk silicon body and the outside world through the metal package. In this manner it is possible to achieve a common interconnection between the bodies of the silicon devices on a PC board without the use of internally bonded leads in the package. With a glass or ceramic package, a fine wire would have to be bonded between the silicon and an external package lead. This would necessitate another bond, an additional lead on the package and subsequent PC board interconnections.



## Table 2. Characteristics of package materials

Material	Density (g/cm <sup>3</sup> )	Thermal expansion (10 <sup>-7</sup> /°C)	Compressive strength (lb/in <sup>2</sup> )	Thermal conductivity (cal/cm <sup>2</sup> /cm/s/°C)	Dielectric Strength (V/mil at 60 Hz)
94% alumina	3.6	(25-300°) 62 (25-700°) 76 (25-900°) 80	315,000	(25°)0.073 (300°)0.035 (500°)0.024	230
96% alumina	3.7	(25-300°) 64 (25-700°) 75 (25-900°) 79	375,000	(25°)0.084 (300°)0.041 (500°)0.026	230
98% alumina	3.7	(25-300°) 60 (25-700°) 78 (25-900°) 80	325,000	(25°)0.084 (300°)0.036 (500°)0.026	230
98% beryllia	2.8	(25-200°) 58 (200-500°) 86 (500-800°) 105	225,000	(20°)0.49 (100°)0.37 (400°)0.17	250
99.5% beryllia	2.9	(25-300°) 60 (25-700°) 78 (25-900°) 85	185,000	(25°)0.55 (300°)0.28 (500°)0.17	240
7052 glass	2.3	(0-300°) 46	—	(0-300°)0.003	—
Kovar	8.4	(20-500°) 57-62	—	(30-500°)0.039	—
Copper	9.0	(0.100°) 166	—	(18°)0.918 (100°)1.04 (200°)0.969	—

\*As metals, kovar and copper are conductors thereby negating the importance of dielectric capabilities. Where compressive strength is concerned, the values for kovar and copper are so high as to be insignificant in their use in electronic packages. The compressive strength of glass, on the other hand, is infinity. The theoretical aspects of glass state that it cannot be broken in compression.

The commonest metal used in hermetic packages is a Kovar type of alloy. It is a low-cost, low-thermal-expansion material compatible with glass to achieve a hermetic seal. The usual mating glass is Corning Glass 7052.

Although Kovar gives a good hermetic seal, it also has certain disadvantages. When Kovar parts are prepared,<sup>4</sup> they must be carefully cleaned before an oxide layer can be grown. The cleaning is usually done in a sulphuric and chromic acid bath. This process must be precisely controlled, for too long immersion will result in a preferential etch of the parts. Once Kovar parts have been preferentially etched, they are write-offs. Another drawback is Kovar's hardness compared with other mild steels. Other steels may be machined and stamped fairly easily but Kovar wears tools down fast. Finally, Kovar's coefficients of electrical and thermal conductivity are low (Table 2).

Copper packages are growing in popularity because they can be lid-sealed by a cold-welding process. The entire package may be copper or the lid-sealing edge may have a copper flange. Another advantage of copper is its high thermal conductivity, which gives high thermal dissipation to the packaged device. Copper's disadvantages are in the area of thermal expansion.

Where an alumina substrate is bonded to the package floor, for example, very high stresses are caused by the thermal expansion mismatch between the alumina ( $64 \times 10^{-7}$  mm/mm/°C) and copper ( $160 \times 10^{-7}$  mm/mm/°C). Copper cannot be hermetically sealed to glass; Kovar eyelet seals must be soldered in place. Copper also readily oxidizes, so that additional caution is called for during processing. Copper should be considered over Kovar only when excellent thermal conductivity is called for, as in power integrated circuits.

### Glass halves material cost

Glass makes a package that is 50 to 75 per cent cheaper than metal or ceramic. Where a metal package requires a three-part seal (conductor/glass/metal body), the glass pack requires only a two-part seal (conductor/glass body). The basic process of assembling a glass package is also simpler than the metal one. Assembly can be performed either by hot-press molding, or through a controlled-atmosphere belt furnace in carbon fixtures.

Most glass packages are a borosilicate, hard glass such as Corning Glass 7052. This glass has good resistance to thermal and mechanical shock, and lends itself very well to hermetic-seal applications. The two components of the usual glass flat pack (7052 glass and Kovar ribbon lead material) have a long successful record. Lid-sealing the glass pack can either be done directly or by brazing to a Kovar ring. The choice between these alternatives must be made early in the design. If the choice is a direct seal between lid and glass body, the glass body is left bare. On the other hand, if a braze seal is to be made, then the glass body must have a gold-plated Kovar ring sealed onto its top edges. A disadvantage of a glass package is that it is translucent, and certain custom integrated-circuit devices are

photosensitive. This is not a problem with any of the commercially available devices, however.

The other glass body material used is ceramic glass such as Pyroceram. It has great mechanical strength and high resistance to thermal shock. Pyroceram's chief disadvantage is its resistance to chemical attack. Reducing acids or a hydrogen atmosphere in a furnace operation tend to attack and deteriorate the hermeticity of Pyroceram seals. A reducing atmosphere such as hydrogen or nitric acid might be used for plating leads with gold at the end of the packaging process, or for die-bonding a chip. In such cases a Pyroceram package should be used. On the other hand, if the leads are preplated or the die-bonding is done at an earlier stage of fabrication, Pyroceram may be used.

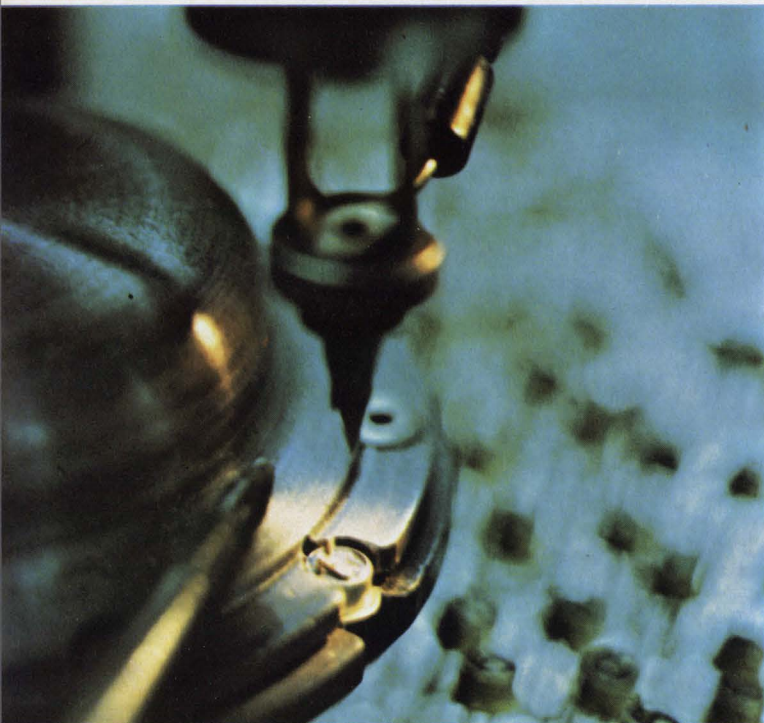

As this header rests in a heated holder, 1-mil-diameter gold leads are bonded from the chip to the terminal post. Such thermocompression bonding requires compatible materials. Photo courtesy Teledyne.

## Ceramic can be metalized

A ceramic package combines most of the advantages of metal and glass. It marries the strength of metal with the basic characteristics of glass, it is an excellent dielectric; it is chemically stable; it is composed of oxides formed at high temperature, and it can be selectively metalized. Metalization serves three functions:

- It acts as a base on which components or wires can be bonded.
- It acts as an electric conductor and therefore part of the circuitry.
- It permits a metal-brazing form of closure.

Two ceramics, alumina and beryllia are used.

Alumina, or aluminum oxide,  $Al_2O_3$ , probably has even more advantages than ceramics in general. Its mechanical strength is good, its resistance to thermal shock is fairly good, and its resistance to chemical or gaseous attack is excellent. Alumina is marketed for electronic applications in a range of 80 to 99.5 per cent aluminum oxide. Generally 94 to 96 per cent is used in microelectronic packages. This class of composition adds relatively good thermal conductivity (approximately that of Kovar) to its other properties.

What makes alumina so desirable is the fact that it may be metalized, usually with a molybdenum-manganese mix. When fired in a reducing atmosphere, the manganese forms a spinel type of interface\* on the surface of the alumina body, leaving a pure molybdenum surface on top. This surface is then plated with gold to achieve a

**Table 3. Joining methods**

Method	Joining Time(s)	Materials	Equip. Cost (\$)
Soldering	5-10	Incompatible	15
Resistance welding	ms	Compatible	650
Electron-beam	ms	Incompatible	90,000
Laser welding	ms	Incompatible	20,000
Thermocompression	2-4	Compatible	7000
Ultrasonic	2-4	Compatible	7000

\*A spinel type of interface is a manganese-alumina-silicate broad, diffused region in the alumina body, as opposed to a sharp, shallow line.

solderable or brazable area. The major advantage of this form of metalization is not only that it is mechanically very strong but it is also hermetic. A properly designed and fabricated hermetic joint made of "molytang" metalized alumina is probably the most reliable type of hermetic seal obtainable.

Alumina has another noteworthy advantage. A borosilicate glass can be hermetically sealed to the same alumina that has previously been metalized. This affords the designer the opportunity to use both means of making hermetic seals in different parts of the same package. For example, in a typical package the floor is 94% alumina on which screened "molytang" metalization is the conductor coming to the outside edge of the plate. A ring of borosilicate glass is then applied and

takes 0.03 inch of space after being brazed into place. The same 0.02-inch wire needs only 0.02 inch of space in a glass seal, since it goes directly to the glass body and not through an intermediate agent.

The last material to be considered for package bodies is beryllium oxide, BeO, or more commonly, beryllia. Like alumina, beryllia can also be obtained in compositions of 80 to 99.5 per cent; 98 to 99.5 per cent BeO is best for microelectronics. Beryllia's main advantage is its extremely high thermal conductivity—about ten times that of alumina. Where high power dissipation is required for device performance, beryllia is the obvious choice. It too can be metalized with "molytang" and has the same general characteristics of strength and resistance to thermal

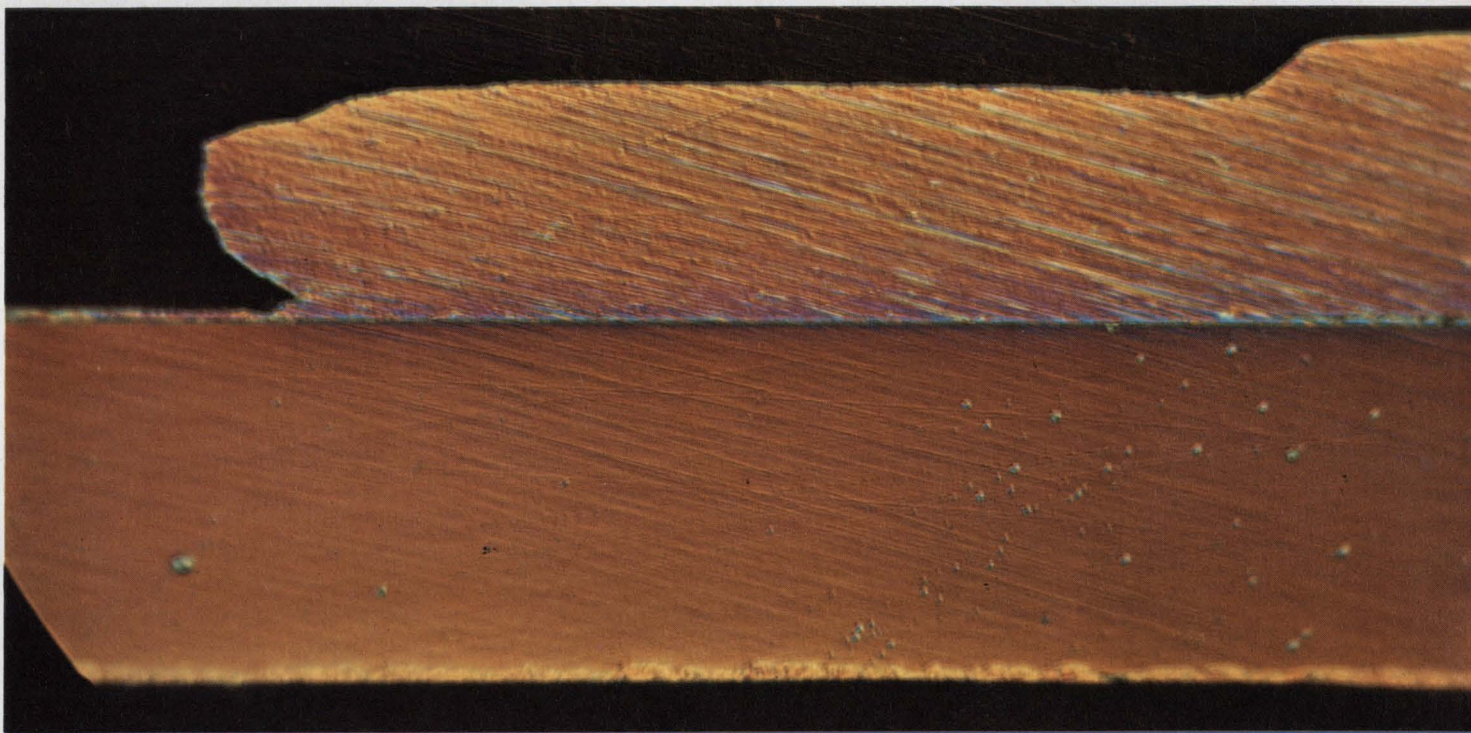

**Aluminum lead is ultrasonically bonded** to silicon which has been metalized with aluminum. This method of bonding does away with contaminants, evolves little heat or pressure, and gives a strong bond. Since ultrasonic

bonding requires compatible materials, this must be borne in mind when selecting the package. See Table 3 for a comparison of five bonding techniques. Photo courtesy Fairchild Semiconductor.

the wall of the package is sealed to it. The metalization coming under the wall is hermetic, as are glass-to-metalization and glass-to-alumina seals.

On the negative side, alumina is about twice as expensive as glass and requires higher initial tooling charges. In addition, certain package designs preclude the use of alumina because of lack of space. Where a glass seal may be made directly to the lead, an alumina package requires a metalized hole to accept the brazed-in lead. In order to seal a lead to the alumina, there must be room for metalizing, which must be thicker than 0.03 inch to be reliable. A 0.02-inch wire thus

shock and chemical attack as alumina. It is also a slightly better dielectric. The cost of beryllia, however, can be twice as high as that of alumina. Its high thermal conductivity can also be a drawback if assembly of the unit requires any hand-soldering on the beryllia floor. As the soldering iron is applied, the beryllia, due to its excellent thermal conductivity, acts as a "heat thief." It dissipates the heat across the whole floor instead of concentrating it in the desired spot. The iron thus becomes a localized heat source for the whole package and the usual result is a poor solder joint. To obviate this, it is necessary to

preheat the whole substrate or package, and then apply the soldering iron locally. But that can be detrimental, even fatal, to heat-sensitive microcircuits. So beryllia should be chosen over alumina only when the microcircuit is to be operated beyond its rated capability. Where a device in an alumina package would fail or be on the verge of failure, the beryllia package can extend its operation past its power rating.

## Lid-sealing finishes package

There are seven different methods of lid-sealing. Referring back to the "road map" it is obvious that the method chosen depends in part on the materials used in the package. Bear in mind this one axiom—use as little heat as possible.

*Resistance welding* uses high current (the members to be welded serve as conductors) to reach the melting point of the members while pressure is applied to them both. The electrodes may be opposing or both on one side. The weld is considered to be a true parent-to-parent weld when a "nugget" is formed of both members.

In packages specifically fabricated for resistance-welding of the lid, both the body and the lid are Kovar, or the lid may be nickel. Either metal is well suited to the process. The actual welding may be a single all-enveloping pulse, "stitch-welding," or a "rolling-electrode" process. Stitch-welding is a series of individually made weld pulses, each overlapping its predecessor. For example, there could be a series of 0.008-inch-diameter welds, each overlapping its neighbor by 0.002 inch and so forming a continuous running weld. Rolling electrodes literally roll along the materials to be joined. They remain stationary while the package travels through, and conduct the current while bearing down on the package lid. No matter which technique is used, the package body must have lip and the weld area must be as far away as possible from the glass-to-metal seal. This means a larger package than would otherwise be required. Once sealed, a resistance-welded package cannot be reopened.

*Soft-solder sealing* employs a lead-tin solder which melts at 190° to 225°C. The low temperature is the basic advantage of soldering. In addition, the seal is easy to reopen. Soldering is a particularly attractive method of packaging thin-film circuitry or organics. In either case, temperatures higher than 225°C could have detrimental effects on the performance of the device. Care must be taken if the seal requires to be fluxed before soldering, since flux residue could be trapped. Entrapment of impurities in hermetic

electronic devices is a major failure mechanism.<sup>5</sup> Where resistance-welding requires weldable metals for acceptable lid-sealing, soft soldering can be performed on a metalized alumina or beryllia, Kovar, copper, or mild steel body. The steel can be bare or plated to promote wetting.

*Electron-beam sealing* is a relative newcomer. As in the case of resistance-welding, a peripheral lip is designed on the package so that the "nugget" forms outside the body proper. This minimizes the possibility of a leak in the glass-to-metal seal because of thermal shock. Some packages are designed without the lip, when there is a large enough distance between the lid seal and glass to ensure that thermal shock will cause no failure. Electron-beam welding has two basic advantages: since the electron beam is in vacuum, external contaminants cannot enter the package, and, the operation can be completely automated.

Although high power is unnecessary, very fine registration and power controls are required since the parts to be welded are so small. Unlike the resistance welder, where electrode-positioning can be seen before the power is applied, electron-beam welding depends completely on instrumentation for registration. Disadvantages are the high initial cost of equipment, the initial pump-down time of the chamber (approximately 15 minutes), and the fact that the metal package must withstand 15 pounds of pressure. This may cause "oil canning,"† which in turn can crack substrates cemented to the floor of the package.

*Cold-weld sealing* uses pressure alone; no heat is used to form the seal. Since the first axiom in lid-sealing is to use the least amount of heat necessary, this process is very attractive for ductile-metal packages. A very high pressure is applied in a single pulse to force the two members into a hermetic joint. Since the material must be ductile, copper is just about the only material that can be used. Experiments, however, are being carried out to determine whether copper-clad, and even copper-plated metals, can be used.

Care must be taken in the initial design of the package so that the forces applied under the heavy pressure are not transmitted to other parts of the package. They would crack the body or even cause seal failure.

Presently, consistent, reliable production methods of cold-welding copper seals are available for packages up to 1-1/2-inch in diameter. Cold-welding has the same disadvantage as other welding techniques—it requires a peripheral lip and once the seal has been made, it cannot be reworked or repaired.

†"Oil canning" is that condition wherein the thin metal lid is long enough to be flexed inward on the package due to the difference of atmospheric pressure on the outside and vacuum on the inside.

*Frit-sealing* is used for glass and alumina. The glass frit may be of any type—low-expansion (higher temperature) or high-expansion (lower temperature). The choice depends on the thermal expansion of the body and lid materials, and the temperature that the microcircuit can withstand. The greater the dissimilarity in thermal expansions is, the greater will be the permanent strain that remains. Such residual strain determines the amount of thermal or mechanical shock needed to crack the seal. The glass frit is in the form of a sintered glass washer, which is pressed into the shape of the area to be sealed. The actual sealing operation is performed either by perimeter sealer or a belt furnace. A belt furnace requires jiggling and carbon fixtures, which push up costs, because fixtures wear out. This is not so with the perimeter sealer, where jiggling and heat-sinking are designed into the machine.

A *Pyroceram seal* is preferred to a glass frit, because of Pyroceram's lower maturing temperature. The active element can then be maintained

at a lower temperature. When maturing Pyroceram, an at least slightly oxidizing atmosphere should be maintained, to avoid the problems of a reducing atmosphere. If this is done, however, then the inert atmosphere normally preferred for the inside of the package cannot be achieved. Also wetting of parts is less easy with Pyroceram than with glass or braze material.

A *brazed seal* probably gives the most value for the least money. Brazed metal, glass or metalized ceramic members afford good hermeticity and mechanical strength, take only moderate processing, and cost little. The materials most commonly used are eutectic compositions of gold-tin or gold-germanium. Although gold-tin has the lower melting point (280°C vs 356°C for gold-germanium), it is comparatively fragile and tends to crack under mechanical shock. Gold-germanium, on the other hand, is ductile and resists cracking very well.<sup>6</sup> Where the microcircuit can take the higher temperature in sealing, gold-germanium should be used. ■■

## Is the package acceptable?

Before a hermetic package can be considered acceptable, specific tests must be performed. The following are reasonably standard:

- Lead fatigue—Leads should withstand two 90° bends (45° up and 45° down) with a 4-oz weight attached.
- Lead pull—Leads should withstand an 8-oz axial pull.
- Moisture resistance—The package must pass MIL-STD-202, method 106 (omit step 7B).
- Crazeing—Glass inside the header should have no crazeing.
- Internal radii—All internal radii should not exceed 0.0006 in.
- Solderability—The package must pass MIL-STD-202C.
- Flatness—The top surface of the ring frame should be flat and have a minimum width of 0.005 inch at the narrowest point.
- Plating—All plating should be free of blisters and discoloration, and have no spots larger than 0.002-inch diameter after baking in nitrogen atmosphere at 310° ±10°C for 48 hours. Minimum thickness should be 100 μin. of gold.
- Island area—An expanded lead (island) should have 0.100 × 0.175 in. free of glass.
- Lead ends—The lead ends inside the ring frame should be free of glass over an area of 0.01 × 0.20 in.
- Insulation resistance—Electrical leakage from leads to ring frame should not exceed 10 nA at 100 V (10 GΩ).
- Glass splatter—There should be no glass on the top of the ring frame or the bottom plate.
- Length of meniscus—The meniscus should be no longer than 0.012 in.

## Acknowledgment:

The editor wishes to thank the Semiconductor-Components Div. of Texas Instruments, Dallas, for the cover photograph and the Electronics Div. of Union Carbide for the photograph on page 55.

## References:

1. J. J. Licari and G. V. Browning, "Plastics for Packaging: Handle With Care," *Electronics*, April 17, 1967, pp. 106-107.
2. "Electronic Packaging with Plastics," *Electronic Packaging & Production*, October 1967, p. 21.
3. Charles A. Harper, "Resin Embedment of Electronic Assemblies," *ELECTRONIC DESIGN*, XV, No. 3 (Feb. 1, 1967), pp. 49-79.
4. David Nixen, "Package Fabrication and Evaluation," *Proceedings SAE Electronic Packaging Conference*, (Feb. 1967), pp. 13-21.
5. Philip H. Eisenberg and G. V. Brandewie, "The Process Origin of Impurities in Hermetic Electronic Packages," *Proceedings SAE Electronic Packaging Conference*, (Feb. 1967), pp. 135-143.
6. "Metallurgical Studies of Gold-Tin and Gold-Germanium for IC Case Sealing," Autonetics, Materials and Process Laboratories Report No. TR64-106, January 8, 1964.

## Test your retention

*Here are questions based on the main points of this article. They are to help you see if you have overlooked any important ideas. You'll find the answers in the article.*

1. *What is the drawback of using plastic encapsulation for MOS devices?*
2. *What is the main property of Kovar which suits it to making hermetic seals?*
3. *When would the high thermal conductivity of beryllia be a disadvantage?*
4. *What are the trade-offs between gold-tin and gold-germanium for brazing?*

We let the meter  
tell us how  
to draw its face.

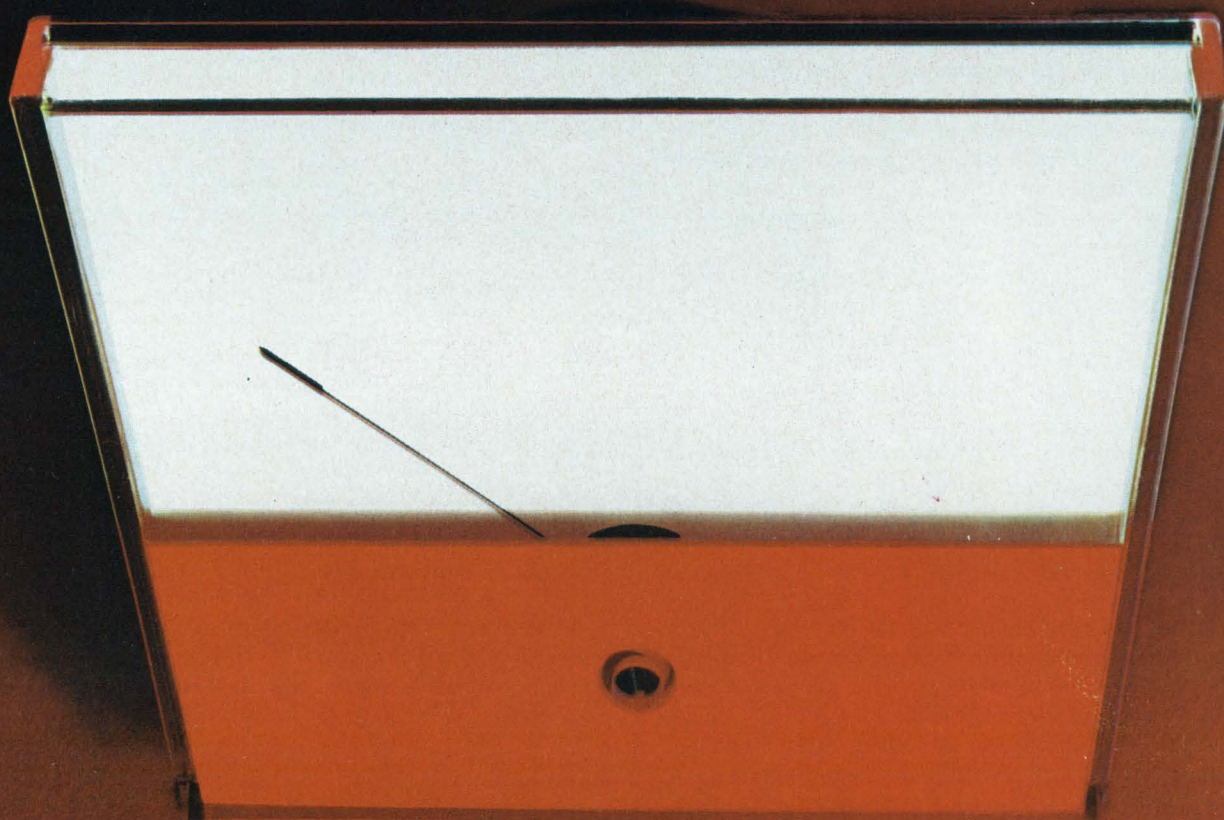

For our Honeywell Precision-Calibrated Taut-Band Meter, we want accuracy and tracking specifications of ½ of 1%, full scale. And we want repeatability of .2% or better, full scale.

We're finicky about it. Because we want a meter for the finickiest applications you have.

#### **The meter decides.**

We'd never get a meter like that by printing up one standard face and putting it on every single meter. Meters have idiosyncrasies.

So we leave the whole matter of how to draw the dial on the face entirely up to the individual meter itself.

We set up each meter in our special computer-directed dial-marking machine. Then we crank in the current or voltages — one increment at a time. As we do, the machine precisely marks the dial *exactly where the meter's pointer points*, for each increment.

#### **Custom-drawn.**

The face we end up with is actually custom-drawn to the meter's own specifications.

And behind it is our best Honeywell taut-band mechanism: Completely frictionless, so it responds to even the slightest inputs. Hysteresis-free, so its repeatability is near perfect.

#### **Finicky.**

Our Precision Calibrated Meter is finicky, all right. It's the most precise, closest-tracking meter in the Honeywell line. It comes in six body styles.

Certainly worth writing for a catalog about.

Honeywell Precision Meter Division, Manchester, New Hampshire 03105.

## **The Finicky Meter from Honeywell**

It takes all kinds of meters to make the Honeywell line.

# Integrate a shunt-compensated stage

by replacing inductors with active devices to increase the gain-bandwidth product at no extra cost.

The main purpose of compensation circuits in broad-band interstage design is to improve the gain-bandwidth product. Many types of compensation circuits or coupling networks are available: one example is shown in Fig. 1.

Since inductors are, at best, very difficult to fabricate in integrated circuits, shunt compensation is usually avoided, even though the shunt-compensated interstage has a potentially higher gain-bandwidth product than other existing compensating circuits.

Here's a method for achieving the advantage of shunt compensation without using inductors. The shunt branch of series resistance,  $R$ , and inductance,  $L$ , shown in a box in Fig. 1, may be replaced by an active circuit containing no inductor but having the inductive property. Such a circuit is the common-base transistor configuration with its output ac-short-circuited. Figure 2 shows a common-emitter interstage with a common-base transistor used for shunt compensation. This circuit thus affords the advantages of shunt compensation with no sacrifice of convenience.

The inductive input impedance of the common-base stage will exhibit relatively low  $Q$ s for the transistors ordinarily used in broad-band design. For broad-band and interstage design, however, the requirement is merely for low circuit  $Q$ s. For narrow-band design, on the other hand, the requirement is for high  $Q$ , which is not directly compatible with the present configuration.

## Calculate the input impedance

The input impedance (neglecting  $C_{ob}$ ), of the common-base transistor with shorted collector shown in Fig. 2 is resistive-inductive (see box for symbol definitions). This is due to positive feedback, which is characteristic of the common-base configuration. The positive feedback causes the decaying current gain response, due to the device cutoff frequency,  $f_a$ , to give rise to an increasing inductive response at the input terminals. To illustrate this effect, consider the small-signal model of

a common-base transistor, shown in Fig. 3a. The input impedance, ignoring  $C_{ob}$  temporarily, is:

$$Z_{in} = \frac{(1 - \alpha_0) [1 + (1 - \alpha_0) (j\omega/\omega_t)] R_B + r_e'}{1 + (j\omega/\omega_a)} \quad (1)$$

The standard approximation has been made that the common-base short-circuit current gain is:

$$\begin{aligned} \alpha &= \alpha_0 [\exp(-jm\omega/\omega_a) / [1 + (j\omega/\omega_a)]] \\ &\approx \alpha_0 [1 - (jm\omega/\omega_a) / [1 + (j\omega/\omega_a)]] \end{aligned} \quad (2)$$

for  $\omega \ll \omega_a/m$ .

The figure-of-merit frequency,  $\omega_t$ , used in Eq. 1, is related to  $\omega_a$  by:

$$\omega_t = \omega_a / (1 + \alpha_0 m), \quad (3)$$

where  $m$  is an excess phase factor, defined in the box. Writing the input impedance in terms of the complex variable,  $s = j\omega$ , and simplifying give:

$$Z_{in} = R_{in} [1 + (s/\omega_\beta) (1 + \delta)] / [1 + (s/\omega_a)], \quad (4)$$

where:

$\omega_\beta = \omega_t / (\beta_0 + 1)$  (the common-emitter 3-dB frequency which neglects the emitter-transition capacitance),

$$\left. \begin{aligned} R_{in} &= r_e' + [R_B / (\beta_0 + 1)], \\ r_e' &(\text{at } 300^\circ \text{ K}) = 26 / I_E \text{ (mA)}, \end{aligned} \right\} \quad (6)$$

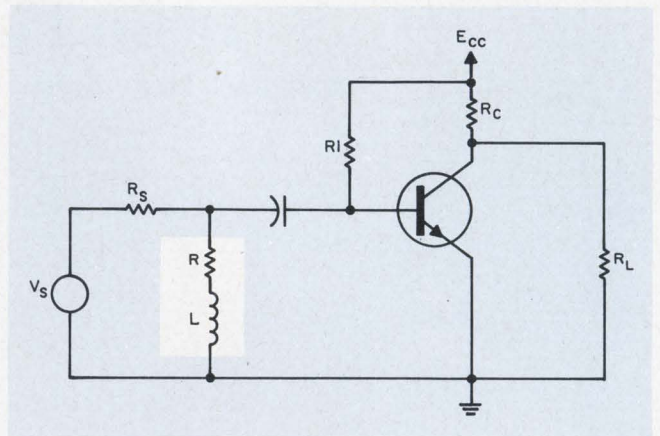

1. IC technology cannot be used to realize this circuit since it contains an inductor. Better gain-bandwidth products are obtained, however, with this type of compensation.

Dr. Gerald T. Volpe, Senior Project Engineer, Marchand Laboratories, Greenwich, Conn.



$$\delta = (\beta_0 + 1) r_e' / R_B. \quad (7)$$

The input impedance of the circuit of Fig. 3a, which is represented by Eq. 4 can be exactly realized by the RL circuit of Fig. 3b. The component values are:

$$R1 = R_B (1 + \delta) (1 + \alpha_0 m) / [\beta_0 (1 + m) - \delta], \quad (8)$$

$$R2 = R_B (1 + \alpha_0 m), \quad (9)$$

$$L1 = R_B (1 + \alpha_0 m) / \{\omega_\beta [\beta_0 (1 + m) - \delta]\}. \quad (10)$$

These expressions can be obtained by formal RL network synthesis.

The common-base transistor can thus be used in place of the series RL circuit, provided that there is sufficient  $Q$  available and that  $R2$  can be lumped in with the base resistance of the common-emitter interstage. The  $Q$  of the equivalent series RL branch for the common-base stage is:

$$Q_1 = \omega L1 / R1 = \omega / [\omega_\beta (1 + \delta)], \quad (11)$$

which can be made appreciably large (about 1) if sufficient  $R_B$  padding is used, say, 1 or 2 k $\Omega$ .

### Consider the effect of $C_{ob}$

The effect of the collector-to-base capacitance,  $C_{ob}$ , in the common-base stage can be obtained by recognizing that it is in parallel with  $R_B$  in Fig. 3. In Eq. 4,  $R_B$  is then replaced by:

$$R_B / (1 + s R_B C_{ob}),$$

so that the input impedance becomes:

$$Z_{in} = \left\{ \frac{[R_B + (\beta_0 + 1) r_e'] / (\beta_0 + 1)}{1 + [s(1 + \omega_\beta R_B C_{ob} \delta) / \omega_\beta (1 + \delta)]} \right\} \div (1 + s R_B C_{ob}) [1 + (s / \omega_a)]. \quad (12)$$

Equation 12 represents the driving-point impedance shown in Fig. 3c. The component values can be found by setting Eq. 12 equal to the input impedance of Fig. 3c, which is:

$$Z_{in}' = \frac{[R1' R2' / (R1' + R2')] (1 + s L1')}{1 + s [(L1' + R1' R2' C) / (R1' + R2')] + [s^2 L1' C R2' / (R1' + R2')]}. \quad (13)$$

The results are:

$$\left. \begin{aligned} R1' &= R_B (1 + \delta) (1 + \alpha_0 m) (1 + \gamma) \\ &\div \{ [\beta_0 (m + 1) - \delta] - \gamma [\beta_0 (1 + m) \delta - 1] \}, \\ R2' &= R_B (1 + \alpha_0 m) (1 + \gamma) / \\ &[1 + \gamma \beta_0 (1 + m)], \\ L1' &= R_B (1 + \alpha_0 m) (1 + \gamma)^2 / \\ &\{ \omega_\beta [(\beta_0 (m + 1) - \delta) \\ &- \gamma [\beta_0 (1 + m) \delta - 1]] \}, \\ C &= C_{ob} / [(1 + \gamma) (1 + \alpha_0 m)], \end{aligned} \right\} \quad (14)$$

where the quantity  $\gamma = \omega_t r_e' C_{ob}$  accounts for the effect of  $C_{ob}$  and is much less than unity.

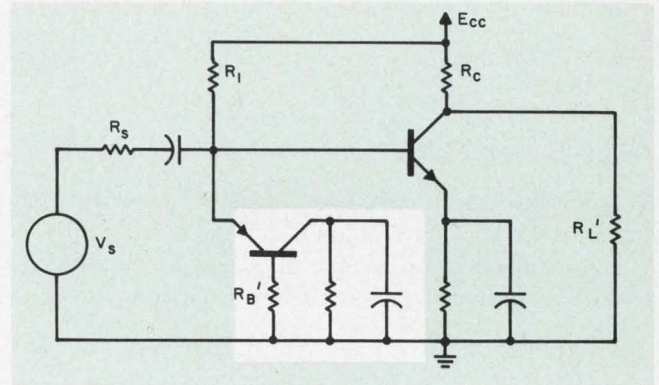

2. Common-base transistor circuit can be designed to replace the series RL shunt compensating network of Fig. 1a (in a box).

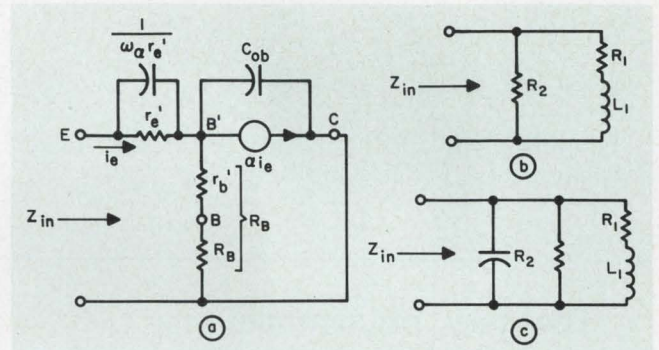

3. Inductive property of the common-base transistor connection is demonstrated by going from its small-signal model (a) to an approximate one (b) and an exact one (c). The effect of  $C_{ob}$  is neglected in (b).

From these values two major effects can be noted. The first is that the series-branch  $Q$  increases slightly from its value (Eq. 11) to:

$$Q1' = \omega L1' / R1' = \omega (1 + \gamma) / \omega_\beta (1 + \delta). \quad (15)$$

The second effect is due to the parallel combination of  $R2'$  and  $C$ , and is deleterious. The effect, however, is not serious, because the characteristic bandwidth of  $R2'$  and  $C$  is usually much larger than the 3-dB bandwidth. Within the required  $\omega_0$ . Furthermore, it is found that the loading effect produced by  $R2'$  can be offset by increasing  $R_B$ , which fortunately increases  $Q1'$ .

### Developing the design equations

A set of design equations can be derived for the circuit parameters of Fig. 1 directly in terms of midband current gain ( $A_i(0)$ ), 3-dB bandwidth ( $\omega_3$ ), the hybrid-pi device parameters, and a maximally flat-magnitude response. The results are:

$$\left. \begin{aligned} R_i &= (\beta_0 + 1) (r_e' + R_e) \\ &= r_b' \{ [(\omega_3^2 D / \omega_\beta) (1 + 1/\nu^2)^{1/2}] \\ &- [\omega_d + \omega_3 (1 + \nu^2)^{1/2}] / \omega_d, \\ \nu &= r_b' / \omega_d, \\ R &= [r_b' \omega_3 (1 + \nu^2)^{1/2}] / \omega_d, \end{aligned} \right\} \quad (16)$$

$$\left. \begin{aligned} \omega_d - \omega_3 \{ [2(1 + 1/\nu^2)^{1/2} + 1/\nu^2]^{1/2} - \\ [1 + \nu^2]^{1/2} \} \\ = \omega_\beta/D, \\ \nu = G/(\omega_t/D) = A_i(0) \omega_3/(\omega_t/D), \\ D = 1 + \omega_t R_L C_{ob}. \end{aligned} \right\} (17)$$

$R_e$  is an external unbypassed resistor in series with the emitter and is not shown in Fig. 1.

Equations 16 and 17 are obtained by consideration of the current-gain transfer function:

$$A_i(s) = [b A_i(0)/z] [s + z]/[s^2 + as + b], \quad (18)$$

where:

$$\left. \begin{aligned} z &= R/L, \\ a &= (\omega_\beta/D) + [(R + r_b')/L], \\ b &= [(R_i + r_b' + R)/L] [\omega_3/D], \end{aligned} \right\} (19)$$

$$A_i(0) = \beta_0 R/(R_i + r_b' + R). \quad (20)$$

The 3-dB bandwidth, subject to the maximally flat-magnitude, MFM, condition:

$$a^2 - 2b = (b/z)^2, \quad (21)$$

is:

$$\omega_3 = (b/z) \{ (1/2) [1 + (2z/b)^2]^{1/2} - 1 \}^{1/2}. \quad (22)$$

The coefficients  $a$ ,  $b$  and  $z$  may then be expressed in terms of  $A_i(0)$  and normalized bandwidth  $\nu$ , by means of Eqs. 20, 21 and 22, as:

$$\left. \begin{aligned} a &= \omega_3 \{ 2 [1 + (1/\nu^2)]^{1/2} + (1/\nu^2) \}^{1/2}, \\ b &= \omega_3^2 [1 + (1/\nu^2)]^{1/2}, \\ z &= \omega_3 (1 + \nu^2)^{1/2}, \end{aligned} \right\} (23)$$

so that when Eqs. 23 are equated with Eqs. 19 the results given by Eqs. 16 are obtained.

### Designing an actual circuit

The following specifications are given:

$$\begin{aligned} A_i(0) &= 10, \\ \omega_3 &= 2\pi \cdot 10 \text{ MHz}, \end{aligned}$$

MFM response with  $R_L = 50 \Omega$ .

These specifications are to be realized with a

## Glossary of symbols

$Z_{in}$  = circuit input impedance

$\alpha_0$  = short-circuit, low-frequency, common-base current gain

$\alpha$  = short-circuit common-base current gain

$\omega_t$  = intrinsic short-circuit radian bandwidth for common-base or figure-of-merit frequency (taken as equal to the transistor short-circuit radian gain-bandwidth).

$\omega_a$  = short-circuit common-base radian bandwidth

$\omega_\beta$  = short-circuit common-emitter radian bandwidth

$f_a$  = transistor cutoff frequency

$R_{B'}$  = external series base resistance

$R_B$  = total series base resistance

$r_e'$  = transistor emitter resistance

$R_e$  = external emitter ac biasing resistor

$m$  = excess phase factor—, that is, additional phase lag in radians that must be added to  $-45^\circ$  at  $\omega_a$  to account for the distributed effect.

$R_{in}$  = input resistance of common-base stage

$\delta, \gamma$  = design factors

$\beta_0$  = low-frequency, short-circuit common-emitter current gain

$R1, R2$  = equivalent network resistors, neglecting  $C_{ob}$

$R1', R2'$  = equivalent network resistors, including  $C_{ob}$

$L1$  = equivalent input inductance, neglecting  $C_{ob}$

$L1'$  = equivalent input inductance, with  $C_{ob}$

$C_{ob}$  = collector-to-internal-base reverse-bias capacitance with the emitter open

$Q_1$  = series circuit quality factor, neglecting  $C_{ob}$

$Q_1'$  = series circuit quality factor, including  $C_{ob}$

$r_b'$  = transistor series base-widening resistance

$R, L$  = resistance and inductance of shunt compensating network

$\omega_d$  = design frequency parameter

$G$  = circuit current gain-bandwidth

$\nu$  =  $\mu$  normalized gain-bandwidth

$A_i(0)$  = low-frequency current gain

$C$  = equivalent input capacitance of common-base stage.

$R_i$  = transistor input resistance

$D$  = bandwidth degradation factor

$\omega_3$  = current-gain 3-dB bandwidth

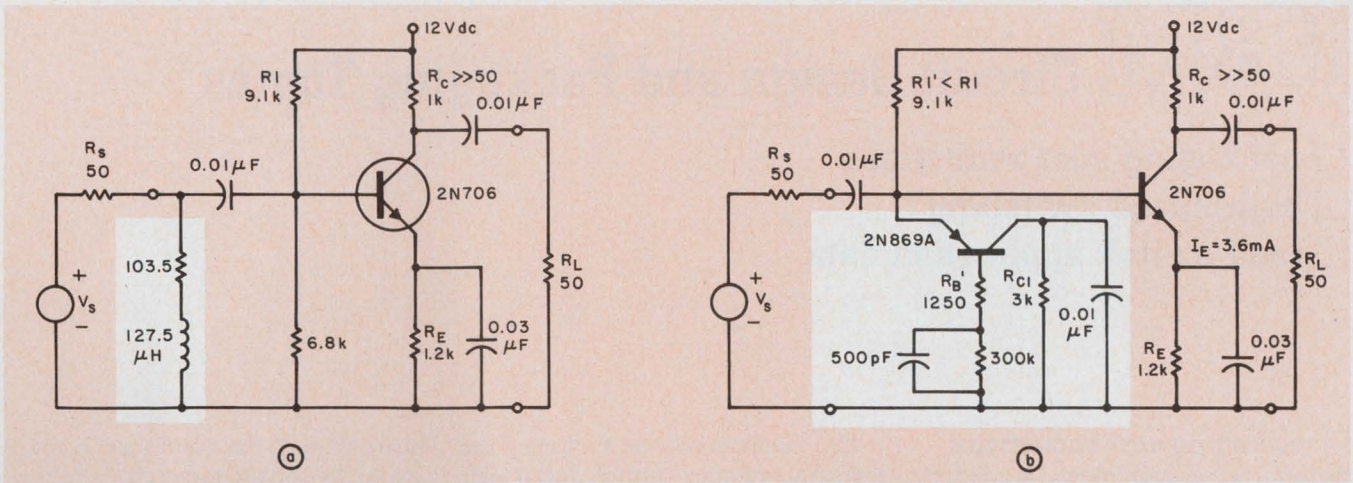

4. **Shunt-compensated network values** computed in the text result in a discrete circuit (a) and its active-device equivalent (b). The latter can be readily integrated, since the inductor has been replaced by a transistor, resistor

and capacitor. The computed component values can be rounded off to the nearest standard values. The base width of the common-base transistor should correspond to a cutoff frequency about 4 MHz.

device that has these characteristic parameters:

$$\begin{aligned} \beta_0 &= 49, & r_b' &= 50 \Omega, \\ \omega_t &= 2\pi \cdot 200 \text{ MHz}, & C_{ob} &= 5 \text{ pF}, \\ \omega_\beta &= 2\pi \cdot 4 \text{ MHz}, \end{aligned}$$

From Eqs. 17:

$$\begin{aligned} D &= 1 + 2\pi (2 \times 10^8) (50) (5 \times 10^{-12}) = 1.628; \\ \nu &= 0.814; \end{aligned}$$

$$\omega_d = 3.93 \times 10^7.$$

From Eqs. 16 the values for the conventional shunt network of Fig. 1 are:

$$\begin{aligned} L &= 50 / (3.93 \times 10^7) = 1.275 \mu\text{H}; \\ R &= [(50)(10)(1 + 0.66)^{1/2}] / 6.24 = 103.5 \Omega; \\ R_i &= 362 \Omega. \end{aligned}$$

Since  $R_i = 50 (r_e' + R_e)$ , when  $R_e = 0$ ,  $r_e' = 7.24$  ohms, which correspond to an emitter current of  $I_E = 3.6$  mA (see Eqs. 6). This completes the design of an ordinary shunt-compensated network as shown in Fig. 4a.

To proceed with the common-base design (Fig. 4b), form the ratio:

$$\begin{aligned} R_1/L_1 &= R/L = 103.5 / (1.275 \times 10^{-6}) \\ &= (1 + \delta) \omega_\beta = (1 + \delta) (4 \times 10^6) 2\pi, \end{aligned}$$

so that:

$$\theta = 3.23 - 1 = 2.23.$$

For an excess phase factor of  $m = 0.22$  and the calculated value of  $L = L_1$ , Eq. 11 gives:

$$R_B = [1.275 (2\pi) (4) (57.6)] / 1.2 = 1540 \Omega.$$

As a design check, this value of  $R_B$  may be substituted into the expression for  $R_1$  in Eq. 8 to yield  $R_1 = 103.5$  ohms. The value of  $R_2$  is found from Eq. 9 to be:

$$R_2 = 1540 (1.2) = 1848 \Omega.$$

The value of  $Q_1$  at the 3-dB frequency is computed with Eq. 11 to be:

$$Q_1 = 2\pi \times 10^7 (1.275 \times 10^{-6}) / 103.5 = 0.774.$$

The effect of  $C_{ob}$  has been neglected up to this point. To correct that fact, simply compute  $\gamma = 0.0455$  (see Eq. 14) and substitute that value into Eq. 14. The results are:

$$\begin{aligned} R_1' &= 103.5 \Omega \text{ and } L_1' = 1.275 \mu\text{H} \\ R_B' &= 1250 \Omega, & R_2' &= 426 \Omega, \\ \delta' &= 2.37, & C &= 4 \text{ pF}. \end{aligned}$$

The bandwidth due to  $R_2'$  and  $C$  is 93.4 MHz. The parallel combination of  $R_i$ ,  $R_1'$  and  $R_2'$  is 67.6 ohms. This resistance is larger, as required, than 50 ohms for an iterative design.

The complete schematics for the conventional and the active shunt-compensated circuits appear in Figs. 4a and 4b, respectively. The calculated component values shown were not rounded off. ■ ■

### Test your retention

Here are questions based on the main points of this article. They are to help you see if you have overlooked any important ideas. You'll find the answers in the article.

1. What property of a common-base transistor network contributes to its inductive behavior?

2. What is the advantage of replacing a series RL shunt compensating network with an active device?

3. Why is low Q not a disadvantage?

4. How is the effect of  $C_{ob}$  accounted for?

# IBM Circuit Design and Packaging Topics

- packaging cost reductions
- high-speed switching
- reed switch application data

## □ packaging cost reductions

Performance Measurements Co., Detroit, Michigan, reports significant savings in packaging their new electronic recording system. The packaging method previously employed required two gates to mount the components in the main console. Now, with IBM's modular packaging as pictured below, only one gate is needed. That's because the IBM technique makes the most efficient use of console space with compactly mounted and connected circuit boards, relays and hardware.

Mounting time has been saved too. Pluggable components, low-cost card receptacles and interlocking card guides have so simplified the packaging job, that Performance Measurements now saves 70% on the cost of mounting hardware. Fewer and shorter wires are needed in the compact console — eliminating three feet of 1½-inch cable and shortening a second cable by eight inches. The modular chassis gave designers freedom to experiment freely with various mounting configurations. It also permits easy access for servicing and diagnostic analysis.

The same design freedom, plus significant hardware and labor savings are available in many applications.

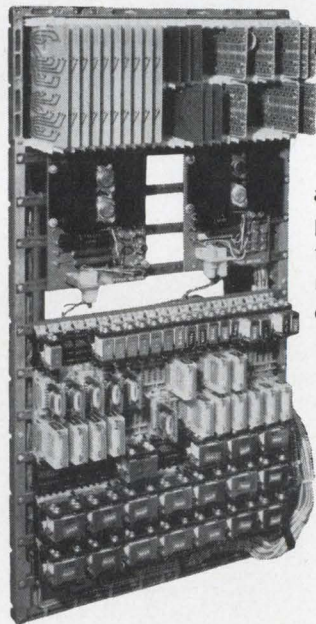

IBM components and packaging can help you in timing control, digital logic testing, telemetering, process or numerical control.

## □ high-speed switching

IBM wire contact relays were originally designed for data processing use. Now they are being used extensively in machine tool and assembly applications. One of these assembly applications is a numerically-controlled component insertion machine. It sequentially inserts random combinations of up to 24 different types of axial lead resistors and diodes into printed circuit boards. Such machines have been widely used, often on a round-the-clock, three-shift basis, in IBM's electronic assembly operations.

Insertion rates range from 3,000 to 4,500 components per hour, depending upon the type of components being inserted.

Instructions from an 8-channel punched paper tape provide the logic-input to the relay gate. The gate employs three rows of 6- and 12-pole IBM wire contact relays. These relays control the movement of each printed circuit

board through the X and Y axis positioning of the board for each component insertion. They also control the component feed, component insert, and cut-and-clinch cycles for each insertion operation.

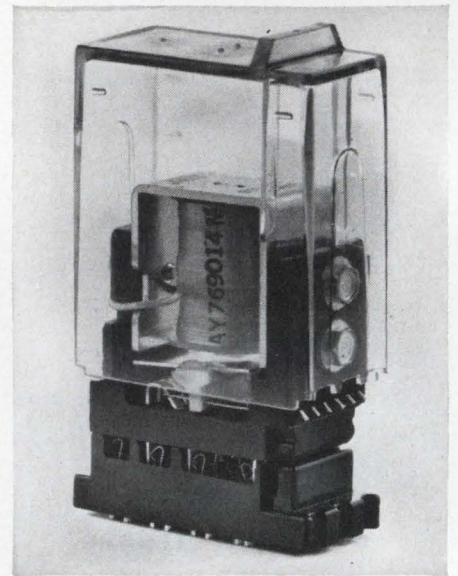

Dust covers are available for various types of IBM wire contact relays. The six-pole model above is shown with cover partially removed.

IBM wire contact relays can perform in excess of 200 million operations with an operate speed as fast as 4.5 ms, a release time of 5 ms maximum. The product line includes 4-, 6-, and 12-pole Form C relays, 4- and 6-pole latch models, all with compact, solderless,

pluggable mountings—with coil-voltages up to 100 VDC.

**reed switch application data**

Data on the magnetic switching characteristics of miniature dry reed switches is available to design engineers on request. The data was compiled from extensive tests conducted by IBM to help the design engineer use these switches most effectively. It can also help him determine the motion and position of the magnet required.

Simply described, a miniature dry reed switch operates under the influence of a permanent magnet. When the magnet is adjacent to the reed switch, the flux of the magnet flows through the cantilever beams, as illustrated. While this magnetic flux is being carried by the beams, a polarity exists across the beams. Look at the overlap area of the beams. The north pole of one beam and south pole of the other beam are in proximity. Since unlike poles of a magnet attract each other, when the magnetic force becomes great enough to overcome the physical mass of the beams, they "snap" together, thus switching.

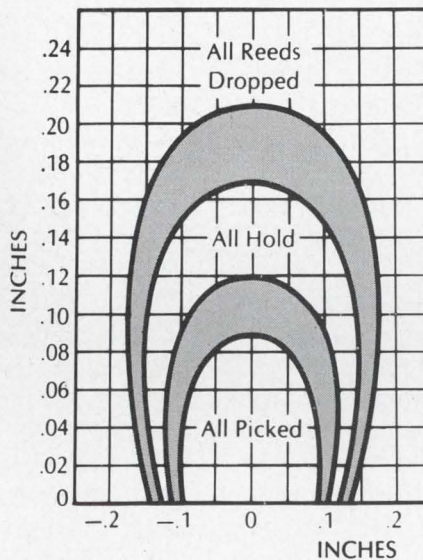
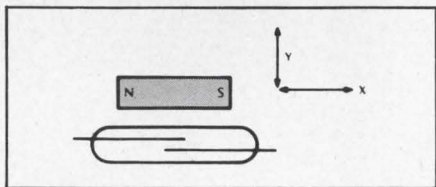

On the graph the X axis represents the displacement (in degrees for rotary motion, inches for lateral motion) of a magnet's center with reference to the center of the reed switch. The Y axis represents displacement (in inches) of

the magnet from the outer edge of the dry reed switch glass envelope. Dimensions shown along both axes represent displacement from the center of the magnet in alignment with the center of the reed switch.

There are some "gray areas" where performance varies due to minor differences in the characteristics of each switch.

Assume the zero point on the X axis is the magnetic center of an IBM reed switch. The magnet is positioned with its center at +.5 on the X axis, and .04 inches above the glass envelope. If the magnet is set in motion along the X axis toward the center of the switch, some reeds will pick when the center of the magnet reaches the point +.12 on the X axis. (The magnet has then reached the "gray area"). If motion is continued toward the center of the switch, all reeds will pick when the center of the magnet reaches the point +.09 on the X axis.

**IBM Industrial Products Marketing Dept. T1R  
1000 Westchester Avenue  
White Plains, New York 10604**

**IBM**  
INDUSTRIAL  
PRODUCTS

- packaging cost reductions
- high-speed switching
- reed switch application data

name \_\_\_\_\_

position \_\_\_\_\_

company \_\_\_\_\_

address \_\_\_\_\_

city \_\_\_\_\_ state \_\_\_\_\_ zip \_\_\_\_\_

ED31

# Solve quartic equations quickly

with a new closed-form method of finding their roots to help speed circuit and system design.

One of the oldest problems in mathematics and engineering is that of determining the roots of equations in circuit and system analysis. Many methods have been developed, most of them either approximate or graphical (see box). There are, however, also some closed-form (exact) solutions for quadratic, cubic and quartic equations, though the commonly used Ferrari method<sup>1,2</sup> is time-consuming, especially for manual calculation.

Now a new, extremely simple closed-form solution has been evolved for the quartic equation. It makes use of the cubic-equation solution developed more than 400 years ago by Tartaglia and Cardan<sup>3</sup>. A feature of the new method is that it can be used for both cubic and quartic equations and requires very little more numerical work than solution of a cubic equation. Another feature of this solution is that the problem may be solved by an alternate approximation method which is especially attractive for computer calculations. Many circuits involve quartic equations, particularly filters, so an example of filter design will be given after the method has been explained. Finally the computer solution will be described.

## Shift the roots for symmetry

The method of obtaining a closed-form solution to the quartic polynomial,  $F(s) = 0$ , may be best understood by using a graphical representation of the roots of the quartic (Fig. 1a).

The roots of the polynomial are first shifted (Eq. 2) in a direction parallel to the real axis to a point where the arithmetic sum of the roots is equal to zero (Fig. 1b). This transformation introduces symmetry into the problem and simplifies the solution that follows.

Figure 2a shows that if the roots are shifted again by any distance  $A$  to a position halfway between any two roots, and two roots  $z_5$  and  $z_6$  are added, the resulting equation will be symmetrical about the origin (Fig. 2b). All odd-term coefficients will then go to zero and the equation can be solved as a cubic equation.

The solution to this cubic equation, however, is not necessary. From the odd-term coefficients that go to zero it is possible to solve for  $A$  and for the two added roots  $z_5$  and  $z_6$ . Since the equation describing  $A$  is also a symmetrical cubic equation in  $A^2$  and since  $z_5$  and  $z_6$  are now equal to  $-z_3$  and  $-z_4$  respectively, it is sufficient to solve the cubic equation in  $A^2$  for only one real positive value of  $A^2$ . From this value all four roots of the original polynomial,  $F(s) = 0$ , are derived.

The cubic equation in  $A^2$  may be solved by any convenient method. Because a cubic equation always has one real root, the Newton-Raphson method (see box) is particularly attractive for computer calculation. In order to complete the closed-form solution of the quartic equation, however, Tartaglia and Cardan's closed-form solution of the cubic equation will be used in part.

## The general case solution

Let:

$$(1) \quad F(s) = s^4 + a_4s^3 + a_3s^2 + a_2s + a_1 = 0.$$

The arithmetic sum of the roots will be equal to zero if:

$$(2) \quad s = w - a_4/4.$$

Then:

$$(3) \quad f(w) = w^4 + b_3w^2 + b_2w + b_1 = 0,$$

where:

$$(4) \quad b_3 = 6(a_4/4)^2 - 3a_4(a_4/4) + a_3,$$

$$(5) \quad b_2 = -4(a_4/4)^3 + 3a_4(a_4/4)^2 - 2a_3(a_4/4) + a_2,$$

$$(6) \quad b_1 = (a_4/4)^4 - a_4(a_4/4)^3 + a_3(a_4/4)^2 - a_2(a_4/4) + a_1,$$

If  $b_2 = 0$ , the roots of  $f(w) = 0$  are symmetrical about the origin and may be found by application of the quadratic formula if desired. If the quadratic solution results in complex roots,  $w^2_n$ , applying the quadratic formula would mean taking square roots of complex numbers. The following solution will obviate the need to take square roots of complex numbers. The roots of Eq. 3 are shifted by an undetermined amount,  $A$ , and two as yet unknown roots,  $z_5$  and  $z_6$ , are added, so that the resulting root pattern is symmetrical about the

---

Richard L. Phares and Robert D. Darroch, Project Engineers, SPACO, Inc., Huntsville, Ala.

origin (Fig. 2b).

This may be done by making the substitution:

$$(7) \quad w = z + A,$$

and multiplying the resultant equation by:

$$(8) \quad z^2 + Bz + C = 0,$$

where Eq. 8 contains two roots which may be either real or complex. Simplifying the results obtained yields:

$$(9) \quad z^6 + d_6z^6 + d_5z^4 + d_4z^3 + d_3z^2 + d_2z + d_1 = 0,$$

where:

$$(10) \quad d_6 = 4A + B = 0,$$

$$(11) \quad d_5 = 6A^2 + b_3 + 4AB + C,$$

$$(12) \quad d_4 = 4A^3 + 2b_3A + b_2 + B(6A^2 + b_3) + 4AC = 0,$$

$$(13) \quad d_3 = A^4 + b_3A^2 + b_2A + b_1 + B(4A^3 + 2b_3A + b_2) + C(6A^2 + b_3),$$

$$(14) \quad d_2 = B(A^4 + b_3A^2 + b_2A + b_1) + (4A^3 + 2b_3A + b_2)C = 0,$$

$$(15) \quad d_1 = C(A^4 + b_3A^2 + b_2A + b_1).$$

Since it has been specified that Eq. 9 was to be symmetrical, the odd-term coefficients,  $d_6$ ,  $d_4$  and  $d_2$ , must be equal to zero. From these equations, the following formulas are obtained:

$$(16) \quad A^6 + (b_3/2)A^4 + [(b_3^2 - 4b_1)/16]A^2 - b_2^2/64 = 0.$$

$$(17) \quad B = -4A.$$

$$(18) \quad C = 5A^2 + b_3/2 + b_2/B.$$

The nature of the roots of Eq. 16 is interesting (Fig. 3). First of all, since the constant term is always negative in Eq. 16,  $A^2$  must have either one or three positive real values. If  $b^2 = 0$  and  $(b_3^2 - 4b_1) \leq 0$ ,  $A^2$  will have one positive and one negative value. If  $b_2 = 0$  and  $(b_3^2 - 4b_1) > 0$ ,  $A^2$  may have 0, 1 or 2 positive real values. The complete solution requires a positive real value of  $A^2$ , zero excluded and the first two cases meet this requirement. The third case, however, contains some examples for which zero is the only non-negative value of  $A^2$  and therefore will always be solved by quadratic formula to obtain real roots,  $w_n^2$ . There are six real solutions for  $A$  or three positive values of  $A^2$  when the original equation has all real roots (Fig. 3a). When the original equation contains complex roots (Fig. 3b, c), however,  $A^2$  has only one positive real value.

There are three special cases when the maximum value of  $A$  will be zero:

- Where all four roots  $w_n = 0$
- Where all four roots  $w_n$  are pure imaginary
- Where a pair of imaginary and a pair of real roots are symmetrical about the origin. With the positive value of  $A$  two of the roots may be found, while the other two may be obtained with the negative value of  $A$ . Only one positive real value

## The Newton-Raphson method

The Newton-Raphson method is a numerical solution for polynomial equations. The procedure is to guess at a root, then to use this guess to obtain a closer approximation to the actual root, and so on until the actual root is obtained to whatever accuracy is desired. The method is thus one of successive approximation. Suppose that for the given function  $f(x) = 0$ ,  $x_0$  is a guess at the root  $x = \alpha$  (see figure). Then the tangent to  $f(x) = 0$  at  $x = x_0$  gives a closer approximation at the intersection of the tangent with the  $x$  axis,  $x_1$ . This is used to find  $x_2, x_3$  and so forth, until a sufficiently close approximation to  $x = \alpha$  is found.

The equation for the first tangent is:

$$y = mx + c,$$

where  $m = f'(x_0)$  and  $c = f(x_0) - x_0f'(x_0)$ . Thus:

$$y = xf'(x_0) + f(x_0) - x_0f'(x_0),$$

where  $y = 0$  at  $x = x_1$ . Therefore:

$$0 = x_1f'(x_0) + f(x_0) - x_0f'(x_0)$$

$$x_1 = x_0 - f(x_0)/f'(x_0);$$

or in general:

$$x_{n+1} = x_n - f(x_n)/f'(x_n),$$

which is the classic form of the Newton-Raphson iterative method.

As a working example, calculate  $3^{1/2}$  to three decimal places:

Let  $f(x) = x^2 - 3 = 0$ , since the roots of the equation will be  $3^{1/2}$ . Then  $f'(x) = 2x$ .

As an initial guess, let  $x_0 = 1$

$n$	$x$	$f(x_n)$	$f'(x_n)$	$f(x_n)/f'(x_n)$	$x_{n+1}$
0	1	-2	2	-1	2
1	2	1	4	0.25	1.75
2	1.75	0.0625	3.5	0.0179	1.732
3	1.732	0.0002			

$3^{1/2} = 1.732$  (to three decimal places)

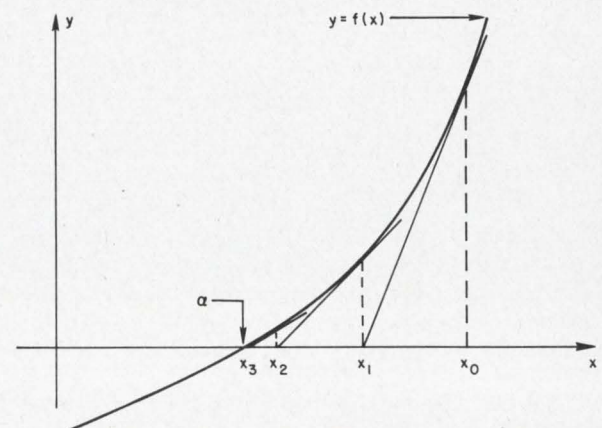

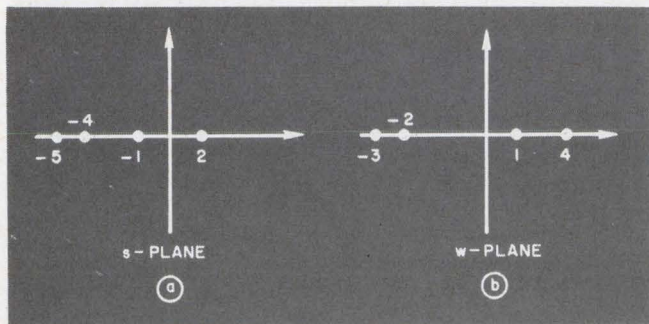

1. The roots of a quartic equation (a) are shifted parallel to the real axis until the sum of the roots is zero (b). This transformation from the  $s$  to the  $w$  plane is accomplished by  $s = w - a_4/4$ .

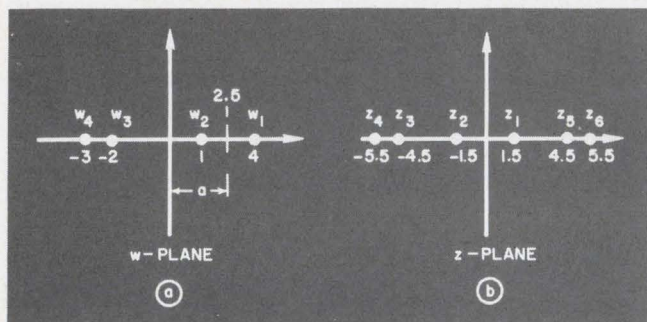

2. For symmetry about the origin, the quartic roots (a) are shifted so that the origin is halfway between any two roots. Two further roots are then added to make the set completely symmetrical about the origin (b).

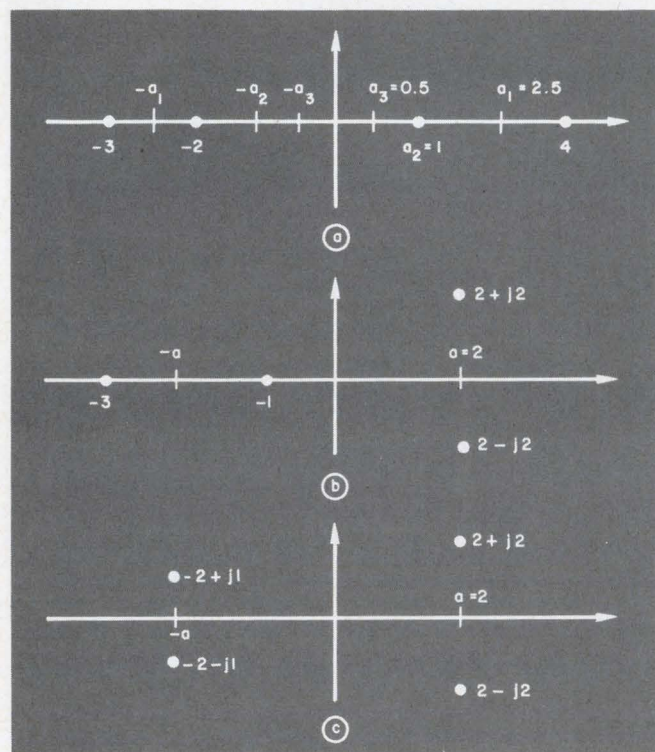

3. When the quartic has all real roots, there are six solutions for the transformation constant,  $A$ , (a). If the quartic has complex roots, there are only two real solutions for  $A$ , so only one real value of  $A$  is needed to obtain all four roots.

of  $A^2$  is therefore required.

Equation 16 may be solved by any method. Here Tartaglia and Cardan's method will be used to find the maximum positive value of  $A^2$  so that the closed-form solution can be completed. In order to solve Eq. 16 for  $A^2$ , Eqs. 19 through 25 are arranged to use Eq. 16's coefficients; they apply generally to any solution of this equation:

$$(19) \quad D = b_1/12 + b_3^2/144.$$

$$(20) \quad E = b_1 b_3/48 - b_2^2/128 - b_3^3/1728.$$

$$(21) \quad F = (E^2 - D^3)^{1/2}.$$

If  $E^2 - D^3 \geq 0$ , then:

$$(22) \quad G = (F - E)^{1/3} - (F + E)^{1/3};$$

$$(23) \quad A^2 = G - b_3/6.$$

If  $E^2 - D^3 < 0$ , then:

$$(24) \quad 3\theta = \cos^{-1}[-E/D^{3/2}] \quad (0 \leq 3\theta \leq \pi)$$

$$(25) \quad A^2 = 2(D)^{1/2} \cos \theta - b_3/6.$$

The square root of  $A^2$  is taken to find:

$$(26) \quad A_1 = +A \quad A_2 = -A;$$

then Eqs. 17 and 18 are used to calculate:

$$(27) \quad B_1 = -4A_1 \quad B_2 = -4A_2,$$

$$(28) \quad \begin{aligned} C_1 &= 5A_1^2 + b_3/2 + b_2/B_1, \\ C_{R2} &= 5A_2^2 + b_3/2 + b_2/B_2; \end{aligned}$$

#### Finding the added roots

The roots that were added earlier for the sake of symmetry may be found from Eq. 8 (where the coefficient of  $z^2$  is unity) and the quadratic formula:

$$(29) \quad \begin{aligned} z_{1,2} &= [-B_1 \pm (B_1^2 - 4C_1)^{1/2}]/2, \\ z_{3,4} &= [-B_2 \pm (B_2^2 - 4C_2)^{1/2}]/2. \end{aligned}$$

These roots are the negative of the desired roots,  $z_n$ . From Eq. 7 then:

$$(30) \quad w_{1,2} = A_1 - z_{1,2} \quad w_{3,4} = A_2 - z_{3,4},$$

and from Eq. 2:

$$(31) \quad s_n = w_n - a_4/4.$$

This completes the solution. Substituting Eqs. 26 through 30 into Eq. 31 and simplifying, the following four equations are obtained, where only the positive value of  $A$  is used:

$$(32) \quad s_1 = -A - a_4/4 + [b_2/4A - (b_3/2 + A^2)]^{1/2},$$

$$(33) \quad s_2 = -A - a_4/4 - [b_2/4A - (b_3/2 + A^2)]^{1/2},$$

$$(34) \quad s_3 = A - a_4/4 + [-b_2/4A - (b_3/2 + A^2)]^{1/2},$$

$$(35) \quad s_4 = A - a_4/4 - [-b_2/4A - (b_3/2 + A^2)]^{1/2}.$$

#### Applying the method to filter design

An example of the use of the exact-solution method is found in the transformation of a four-pole band-pass filter with coupling between the poles (Fig. 4a) to a configuration that has no coupling between the poles (Fig. 4b). This might be desirable where amplifier input and output capacity are both large. One such example is given by the complex Bessel Polynomial for a linear phase low-pass filter. This polynomial is used also for linear phase band-pass filters with some phase distortion depending on the bandwidth.



The Bessel polynomial is given by:

$$\frac{V_p}{V} = \frac{n!}{(2n)!} \sum_{r=0}^n \frac{2^r}{r!} \left( \frac{jk_n f}{f_3} \right)^r$$

where:

- $V$  = complex output voltage at  $f$ ,
- $V_p$  = peak output voltage in the pass band,
- $n$  = total number of resonant circuits,
- $f$  = frequency variable =  $(f/f_o - f_o/f) = f/f_o$  for band-pass filter
- $f_3$  =  $f_{3dB}/f_o$
- $j$  =  $(-1)^{1/2}$
- $k_n$ : = a constant such that  $f/f_3 = 1$  when  $[V_p/V] = 2^{1/2}$ .

Letting  $s = jf/f_3$  and expanding the series for  $n = 4$  and solving for  $k_4$  gives:

$$F(s) = 0.1899 (s^4 + 4.7318 s^3 + 10.0769 s^2 + 11.1277 s + 5.2655),$$

$$a_4 = 4.7318, a_3 = 10.0769, a_2 = 11.1277, a_1 = 5.2655, \\ a_4/4 = 1.1830, (a_4/4)^2 = 1.3994, (a_4/4)^3 = 1.6554, \\ (a_4/4)^4 = 1.9582.$$

From Eqs. 4, 5 and 6:

$$b_1 = 1.9582 - 4.7318 \times 1.6554 + 10.0769 \times 1.3994 \\ - 11.1277 \times 1.1830 + 5.2655 \\ = 0.3286;$$

$$b_2 = -4 \times 1.6554 + 3 \times 4.7318 \times 1.3994 \\ - 2 \times 10.0769 \times 1.1830 + 11.1277 \\ = 0.5298;$$

$$b_3 = 6 \times 1.3994 - 3 \times 4.7318 \times 1.1830 + 10.0769 \\ = 1.6807.$$

From Eqs. 19 and 20:

$$D = 0.3286/12 + 1.6807^2/144 \\ = 0.0470;$$

$$E = 0.3286 \times 1.6807/48 - 0.5298^2/128 \\ - 1.6807^3/1728 \\ = 0.0066.$$

Since  $E^2 - D^3 < 0$ , Eqs. 24 and 25, and 32 through 35 give:

$$3\theta = \cos^{-1} [-0.0066/(0.0470^3)^{1/2}] \\ = \cos^{-1} 0.6443 \\ = 130^\circ 6.8'$$

$$\therefore \theta = 43^\circ 22.27'$$

and  $\cos \theta = 0.72692$ ;

$$A^2 = 2(0.470)^{1/2}(0.72692) - 1.6807/6 \\ = 0.0351$$

$$\therefore A = 0.1873;$$

$$s_{1,2} = 0.1873 - 1.1830 \\ \pm [0.5298/(4 \times 0.1873) - (0.0351 \\ + 1.6807/2)]^{1/2}$$

$$= -1.3703 \pm j0.4102;$$

$$s_{3,4} = 0.1873 - 1.1830 \\ \pm [-0.5298/(4 \times 0.1873) - (0.0351 \\ + 1.6807/2)]^{1/2}$$

$$= -0.9956 \pm j1.2580.$$

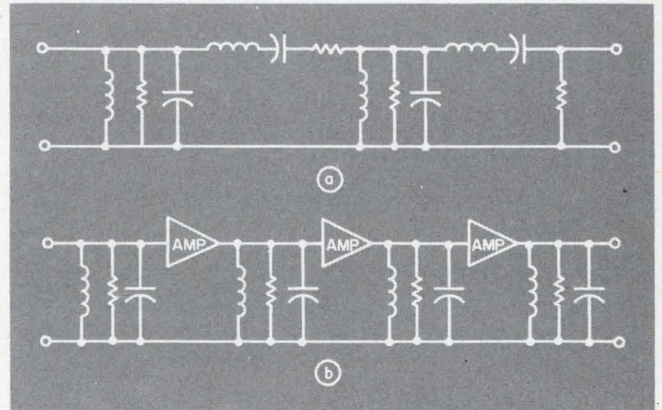

4. Band pass filters with identical transfer characteristics may be synthesized directly from the transfer function (a) or its roots (b).

#### Completing the solution by computer

Programming the solution of a fourth-degree equation by the foregoing method is fairly straightforward provided care is taken at certain points. Examination of Eqs. 22, 24 and 25 reveals that they contain cube roots, inverse cosine and cosine functions which all require approximations in the computer. Use of an approximate method to find the root takes less computer time and is easier to program than the closed-form method. The Newton-Raphson iteration method is better than other approximation methods because it converges faster. Since only one approximation is required, as opposed to two for the closed-form method, accuracy will not be sacrificed and may actually be enhanced by the Newton-Raphson method.

The minimum input data to the program are the coefficients of Eq. 1. If desired, the error limit and the initial testing interval for determining the guessed root for the Newton-Raphson method can both be included in the input data.

Several subroutines are desirable:

- *Function evaluation* — This subprogram computes the value of a function when an array of coefficients of the function and a value for the variable are given.

- *First derivative* — This subprogram computes the coefficients of the first derivative of a function when an array of coefficients of the function is given. The resultant coefficients are stored in another array.

- *Quadratic formula* — This subprogram uses the coefficients of a quadratic expression to determine its roots. The output consists of two arrays: one contains the roots, the other contains zeros if the roots are real or the imaginary part of complex roots.

After the input data and subroutines are entered, the main program begins. Equations 4, 5 and 6 are used to compute the coefficients of Eq. 3 after the change in variable. The resulting coefficients are stored in an array. The coefficients of  $w^3$  and

$w^4$ , namely 0 and 1 respectively, should be stored in the array in their proper locations.

$b_2$  and  $b_3 - 4b_1$  are tested. If  $b_2$  is zero and  $b_3 - 4b_1$  is not negative, Eq. 3 can be solved with the following equation:

$$(36) \quad w^2 = [-b_3 \pm (b_3^2 - 4b_1)^{1/2}]/2.$$

If  $b_2$  is zero and  $b_3 - 4b_1$  is negative, the equation is solved as though  $b_2$  were not zero, since solving Eq. 36 would involve taking square roots of complex numbers, and so would complicate the program further.

To determine the roots of Eq. 1,  $a_4/4$  must be subtracted from the real part of the roots of Eq. 3. The roots are printed out.

At any point in the program where a number's square root must be taken, the number must first be tested to see if it is negative. If it is negative, the sign is changed before the square root is taken, and the result is stored separately from other numbers in the expression. Upon printout, it is printed as the imaginary part of a complex number.

If  $b_2$  in Eq. 3 is not zero or if  $b_3 - 4b_1$  is negative, the EQ16 is used. Rewritten in terms of  $A^2$  Eq. 16 becomes:

$$(37) \quad G(A) = (A^2)^3 + e_3(A^2)^2 + e_2(A^2) + e_1 = 0.$$

The coefficients are computed with:

$$(38) \quad e_1 = -b_2^2/64,$$

$$(39) \quad e_2 = (b_2^2 - 4b_1)/16,$$

$$(40) \quad e_3 = b_3/2.$$

The coefficients of the first derivative of Eq. 37 are also calculated and stored. Equation 37 will have either one positive real root or three. If it has only one, Eq. 3 has at least one pair of complex roots. If Eq. 37 has three positive real roots, Eq. 3 has all real roots. It should be stressed that Eq. 37 always has at least one positive real root  $b_2 \neq 0$  or if  $b_2 = 0$  and  $b_3 - 4b_1 < 0$ .

#### Finding one root by the Newton-Raphson method

The problem is now to find a single positive real root that satisfies Eq. 37. The closed-form method, outlined in Eqs. 19 through 25, can be used. The Newton-Raphson iteration method was chosen for the program for the reasons already stated.

After the positive root is found, the roots of Eq. 1 are found by solving Eqs. 32, 33, 34 and 35 using only the positive value of  $A$ . These are printed out. The program must test the term under the radical and, if it is negative, handle it as an imaginary.

The analysis given here represents what is believed to be the simplest known general solution of the quartic polynomial. It has been programmed in FORTRAN II and converted to FORTRAN IV and has so far solved all equations with no trouble. The approximate running time including read-in and print-out time for a solution is one second once

the program has been loaded and compiled. This program is available to interested parties on request from the authors.\*

This analysis tends to corroborate the findings of the Norwegian mathematician, Niels Abel, who determined that a closed-form solution to equations of any degree higher than the fourth is impossible. The number of possible values for  $A$ , for instance, for a fifth-degree equation would be  $4 + 3 + 2 + 1 = 10$ . With a symmetrical tenth-degree equation a fifth-degree equation must still be solved. With a cubic equation the number of solutions is  $2 + 1 = 3$ , so no advantage is gained. It therefore appears that only a fourth-degree equation can be solved to advantage by this method. ■ ■

**Acknowledgment:** This work was performed for the Quality and Assurance Laboratory Marshall Space Flight Center, Huntsville, Ala.

#### References:

1. C. R. Seliger, "General Quartic Formula," *Instruments and Control Systems*, XL, No. 8 (August 1967), 113-114.
  2. C. R. Seliger, "Techniques for Finding Roots of Polynomial Equations of Degree Seven or Lower," *Instruments and Control Systems*, XL, No. 2 (Feb. 1967) 120-124.
  3. *Ibid.*
  4. S. Deutsch, "Maximally Flat-Time-Delay Filters," *IRE Trans. on Circuit Theory*, Vol. CT-6, June, 1959, 214-218.
- Bibliography:**
- Goldman, David S. "Polynomial Factoring by Root Locus," *Electro-Technology*, LXXVIII, No. 5 (November 1966), 60-61.
- Kurtz, Edwin B. and Corcoran, George F. *Introduction to Electrical Transients*. New York: John Wiley & Sons, 1948.
- Lass, Harry. "A Note on the Root Locus Method," *Proc. IRE*, XLIV, No. 5 (May 1956), 693.
- McCracken, D. D., and Dorn, W. S. *Numerical Methods and FORTRAN Programming*. New York: John Wiley & Sons, 1964.
- Milne, W. E. *Numerical Calculus*. Princeton, N.J.: Princeton University Press, 1949.
- \*Space, Inc., 3022, University Drive, M.S. 29, Huntsville, Ala. 35805.

#### Test your retention

Here are questions based on the main points of this article. They are to help you see if you have overlooked any important ideas. You'll find the answers in the article.

1. What is the effect of the two transformations needed for the closed-form solution?

2. Why is only one positive value of  $A^2$  needed to obtain a solution of the quartic?

3. Solve the equation:

$$x^4 - 3x^3 + 7x^2 + 21x - 26 = 0.$$

4. Why is the method described in the article not suitable for equations of higher order than four?

(The solution to question 3 is given on p. 135.)

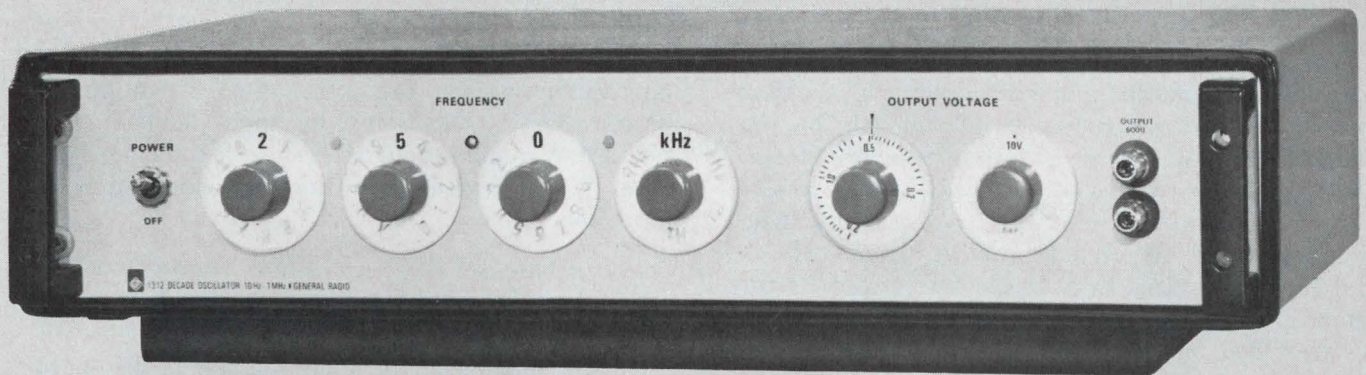

## Simple to set ... impossible to misread

For people who must constantly change and repeat oscillator-frequency settings, quick and accurate resettability is one of the most important features of an oscillator. With GR's new general-purpose 1312 Decade Oscillator, you can reset in a jiffy any frequency in the oscillator's 10 Hz-to-1 MHz range. Resettability is better than 0.005%, and it's virtually impossible to misread the in-line readout. The first two frequency digits are set with step decades; the third, with a detented continuously adjustable dial. One more control sets the decimal point and indicates the frequency unit, also in-line. Basic accuracy is  $\pm 1\%$  of the setting.

Up to 20 volts is available both at the front-panel OUTPUT terminals and at a rear-panel connector. Output is flat within  $\pm 2\%$  from 10 Hz to 100 kHz, and you can even short the output without clipping the waveform. The 1312 has a 100-dB output range, provided by a 20-dB continuously adjustable attenuator and an 80-dB step attenuator calibrated in 20-dB steps.

Output impedance is 600 ohms at all voltage levels, including the four intermediate zero-volt positions of the attenuator that allow you to reduce output to zero without touching the adjustable attenuator. A sync jack at the rear provides an isolated signal to trigger a counter or scope. Through this sync jack, the frequency of the 1312 can also be phase-locked to an external signal for extreme stability.

With excellent performance characteristics, ease of use even by unskilled operators, and a price of only \$415, the 1312 Decade Oscillator is ideal for any lab or production test station. Ask to see one in your own plant. Call your nearest GR Sales Office or write General Radio Company, W. Concord, Massachusetts 01781.

**GENERAL RADIO**

## Can bipolars and tunnel diodes or SCRs be put on the same chip?

The processing of tunnel diodes requires low material resistivities and high doping levels that can be obtained, as far as is known, only by the alloying process. These requirements are incompatible with the types of active devices normally used in integrated-circuit form. At present then, the possibility of including both tunnel diodes and bipolar devices in a single integrated-circuit monolithic is remote. Both types of devices can be provided in a single package, however, by multichip assembly techniques.

Four-layer npnps or SCRs and bipolar npn transistors normally require different diffusion schedules, but they are not completely incompatible. Combining npn and pnp transistors within a monolithic structure can be done if the circuit can tolerate the less-than-optimum characteristics that result.

### What are the temperature effects on diode capacitors in integrated circuits?

There is no first-order temperature effect on the capacitance of a junction-type unit in integrated circuits. There is, however, a second-order effect that involves generation of additional carriers, which affect the change of capacity per unit area. Normally, the second-order effect is small enough not to require consideration in circuit design.

### Is it possible to fabricate both field-effect and bipolar transistors on the same integrated circuit?

Yes. It is impossible, however, to optimize the characteristics of both the FET and the bipolar device. The FETs require high-resistivity channel material, while the bipolar devices require additional diffusion steps. Furthermore, the operational characteristics of the FET and bipolar devices dictate different voltage and current bias levels. Impedance matching is poor.

---

**Test your IC IQ** is a collaboration between the staff of ICE (Integrated Circuit Engineering Corp.) Phoenix, Ariz., and the editors of ELECTRONIC DESIGN. Readers are invited to submit questions to Test your IC IQ, Microelectronics Editor, Electronic Design Magazine, 850 Third Ave., New York, N.Y. 10022.

Although circuit designs that tolerate large parameter spreads and relatively inferior device characteristics can employ such devices, the necessary combination of design requirements is rare. These devices are therefore not generally available.

### Are integrated circuits breadboarded for prototype work?

Experienced designers do not generally need to breadboard integrated circuits. Most manufacturers and suppliers of integrated circuits have sufficient experience in translating circuit schematics into mask layouts for an average of two out of three attempts to be successful. Integrated circuits are, however, designed where the components are left unconnected on a die, so that a custom circuit may be produced by wiring them together in a suitable monolithic design. This is a quick and economical way of breadboarding a monolithic, although the component parameters are somewhat limited.

### How can process-control procedures be used to provide early indications of reliability degradation?

If a process-control pattern is fabricated at the same time, and in the same batch, as the desired circuits, life tests can be made on different suspected areas where reliability problems might occur. Since there is the possibility of accelerating the life tests on a special pattern, it is possible to get early indications of reliability degradation.

### What are the highest values of diffused resistors available in monolithic integrated circuits? How can they be made?

There is no upper limit to the value of diffused resistors that may be used in silicon monolithic integrated circuits. There are, however, practical limitations on the line widths that can be used and the area of die occupied. In practice, few manufacturers attempt by straight diffusion techniques to design circuits with individual resistor values of over 30 k $\Omega$ . There are other techniques, such as squeeze resistors, for

increasing the value by a factor of at least 10. However, a resistor made in this way has a poor temperature coefficient and poor tolerances in terms of absolute value, and has therefore not been used in any commercial circuit.

**With the advent of integrated circuits, what is going to happen to the circuit designer's job?**

The circuit designer's job will ultimately demand familiarity with integrated circuits. In order to optimize designs using integrated circuits, the designer will need to know the materials and the fabrication and assembly processes involved in their making. If he is presently designing with discrete components, he will be under increasing pressure to learn "building-block" techniques.

Component manufacturers will become increasingly involved in the manufacture of entire circuits. Perhaps this area will afford temporary refuge for those designers who do not acquire an IC capability.

**Is there a cost-versus-quantity crossover of thick-film versus monolithic silicon integrated circuits (including all tooling)?**

There is no definite crossover point in terms of dollars versus quantities. With present improved techniques, it is possible to tool up and build a custom monolithic circuit for as little as \$10,000. If circuit requirements can be met by both techniques, and if quantities are in the range of 1000 to 5000 pieces, it is probably more economical to go to silicon monolithic processes.

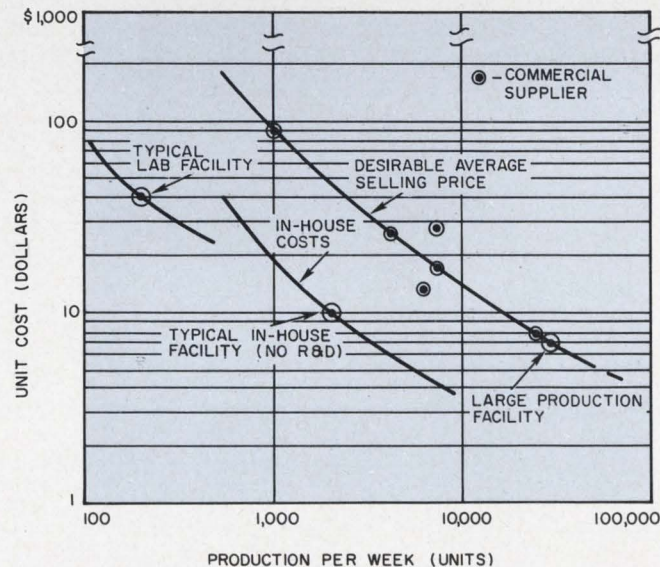

**Cost of in-house production** of integrated circuits is much lower than a commercial supplier's profitable selling price at the same volume. The primary reasons for this are absence of research and development costs and absence of allowance for profit in the in-house curve.

**What are photo masks and what is their significance?**

Photo masks are the fundamental tooling in integrated-circuit fabrication. They are used to transfer the geometric patterns that control component location, diffusion, metalization pattern, etc., to the surface of the silicon slice. Each such process step is controlled by a separate photo mask. A set of masks for integrated-circuit fabrication may number as few as five or as many as a dozen. They afford complete freedom of design with respect to the surface geometry of the components.

Producing these sets of precision microphotographic masks is now an essential part of circuit development, and of the manufacturing process. At present, because of its great versatility, photolithography is universally used as the mask making method.

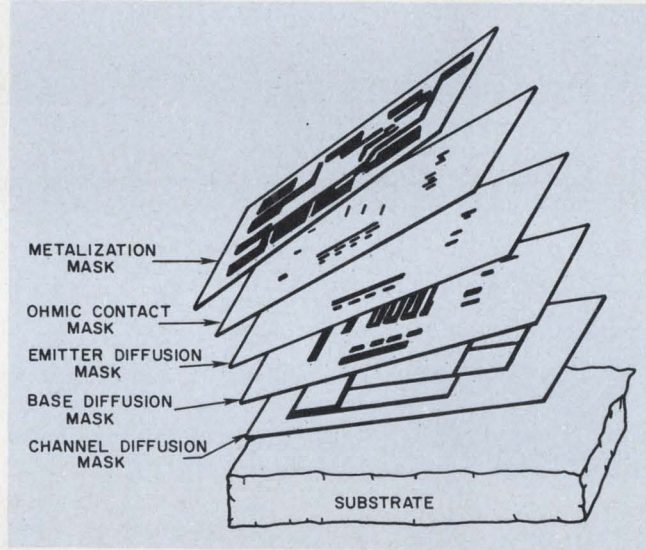

A series of patterned masks, each produced photographically, is employed to control process steps in integrated circuit fabrication.

**Which type of integrated circuit, TTL or DTL, has the potential for longer technological popularity?**

At present, it appears that the industry is turning toward the TTL logic series. For the last few years, DTL logic has been the most popular logic form for a typical digital system. This was a result of the long familiarity, on the part of the designers, with this form of circuit, and the fact that at least 11 different suppliers offer the basic DTL logic line. However, during the last year, the TTL logic line has shown a gain in popularity. This is primarily due to its higher speed operation, which results from the active turnoff characteristic caused by the multiple emitter input. The TTL line probably will receive the greatest emphasis in the next few years.



# COMPONENT CAPSULES

## General Electric VTM's develop over 500 watts to give you a better ECM device

No other electronically tuned device on the market today can match GE Voltage Tunable Magnetrans for power output (over 500W) and conversion efficiency (to over 70%).

Magnetic shielding virtually ends degaussing effects in GE VTM's. Tube/equipment inter-

## Highest volumetric efficiency at half the size—with GE wet slug capacitors

GE 69F900 wet slugs meet high-density application needs with highest volumetric efficiency of any capacitor. We halved the military (CL64) wet slug size, and essentially kept its electrical and performance traits.

The 69F900 has excellent capacitance retention at low temps . . . can be

## Alnico 5-7 magnetic material—a great improvement over Alnico 5

GE Alnico 5-7 improves or equals performance of conventional Alnico-5—with reduced magnet length, smaller cross-section.

Alnico 5-7 has great advantage where space and weight must be minimal, and high demagnetization resistance is required.

## Specify Volt-Pac® variable transformers for maximum life, minimum maintenance

Construction is the key to Volt-Pac's optimum performance. Here's why.

A spring-loaded, grain-oriented carbon brush means even contact, reduced wear. Self-lubricating nylon bearing lessens voltage selector friction.

Here are more features—Polyesterimide in-

## Bonded heater version of popular 7077/7486 tube now available

The new GE16411 may solve your most perplexing oscillator problem.

This small planar triode provides low levels of oscillator side-band noise. A bonded heater addition makes the GE16411 useful under high shock, vibration conditions.

GE16411 recently made possible significant im-

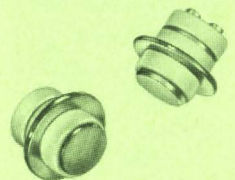
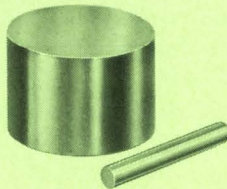
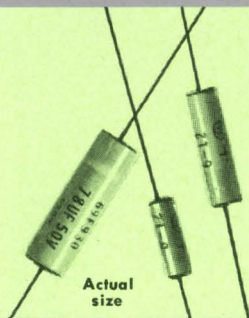
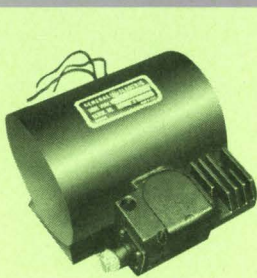

Actual size

Manual uncased unit, exposed terminals

Actual size

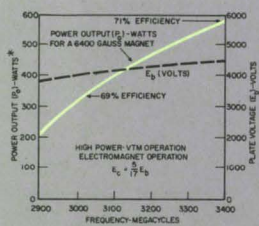

face problems are minimal—each VTM can have an integral isolator designed for your system.

Airborne application features are: linear electronic tuning, rapid modulation, minimal power variation over the band, temperature compensation, and light, compact packaging.

GE VTM's are offered in low-, intermediate-, and high-power configurations for other microwave applications. Circle Number 231 for more details.

\* Recent developmental model

stored to  $-65^{\circ}\text{C}$ . Operating range is  $-55^{\circ}\text{C}$  to  $+85^{\circ}\text{C}$ . It's tough too—withstanding vibration to 2000Hz; 15G acceleration!

GE's new capacitor is fully insulated; has low, stable leakage current. Ratings are available from 6 to 60 volts; capacitance ranges from 0.5 to 450  $\mu\text{f}$ .

RATING	CASE SIZE	VOLUME
<b>50V, 30 <math>\mu\text{f}</math></b>		
solid (CS12)	.341X.750	100%
wet slug (CL64)	.281X.681	58%
69F900	.145X.600	15%
<b>15V, 80 <math>\mu\text{f}</math></b>		
solid (CS12)	.341X.750	100%
wet slug (CL64)	.281X.681	58%
69F900	.145X.600	15%
<b>6V, 180 <math>\mu\text{f}</math></b>		
solid (CS12)	.279X.650	100%
wet slug (CL64)	.281X.641	100%
69F900	.145X.600	25%

Circle Number 232 for more data.

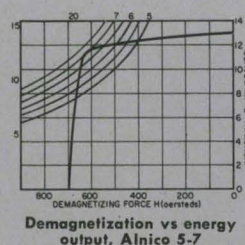

Demagnetization vs energy output, Alnico 5-7

Typical applications for Alnico 5-7 are high-density meter movements; electron tube devices; compact loud speakers; motors and generators.

Let our engineers work with you to design a Cast Alnico 5-7 magnet for your application. Circle Number 233 for technical and ordering information.

sulation of coil windings gives extra reliability. Aluminum radiator and base evenly dissipate heat, extend life. Gold-plated track reduces possible heat build-up at brush contact, minimizes burn-out risks.

A-c voltage range of these autotransformers is zero to 100%, or 117% of fixed-input voltage without waveform distortion.

Manual or motor-operated Volt-Pacs can be ordered with or without enclosures, and with exposed or covered terminals. For more Volt-Pac facts, Circle Number 234.

improvement in short-term, long-term stability characteristics in a spectrum-analyzer design.

It also provides direct retrofit fast warm-up capability for the 7077/7486 family—about 3 seconds to 90% of steady-state plate current.

The new triode is another example of how GE product improvements can aid you in designing reliable, top performing equipment. Circle Number 235 for more information.

# A TECHNICAL DIGEST FOR INNOVATORS OF ELECTRONIC EQUIPMENT

## High performance d-c motors for computer and peripheral jobs

New Hyper-Servo\* d-c motors meet needs of single-capstan tape transports, disc packs, high-speed printers, card sorters and similar equipment.

Hyper-Servo motors offer **instant response**—to one millisecond!; up to 50 times more **frequency response** (band width)

\*Trademark of General Electric Co.

## Don't miss this one—smallest 50 mW, 2-amp relay on the market

It just takes 50 milliwatts to operate this extra small, 2-pole, 2-amp relay.

Size-wise, this newest GE 150-grid relay is only 0.32" high, 0.31" wide, 0.61" long. And, it meets or exceeds MIL SPEC environmental, electrical requirements.

Micro-electronic circuit

## Check these Darlington amplifiers for high gain

GE D16P monolithic Darlington amplifiers (D16P1, 2, 2N5305-8) with current gains as high as 70,000 are available in 2 housings. They offer dissipation capability of 400 mW or (with heatsink package) 900 mW.

D16P's high gain is ideal for preamplifier input stages requiring input

## Nickel-cadmium batteries are rechargeable—last hundreds of times longer

Get lasting battery power and versatility suitable for many commercial and consumer applications. Types include sealed, pressure-relieved, and vented cells. Custom designs to your specifications are also available.

Nominal ratings range from 0.1 amp-hours to 4.0 amp-hours in sealed

## New catalog has full information on GE panel instruments

What's your special requirement for panel instruments? Taut band suspension, special scales or colors, one percent accuracy?

Check General Electric—we're now offering the biggest selection of sizes, ratings, and models ever!

The new GE catalog, GEC-1076, gives you



Model 5BLG32HA1  
(3.4" dia, 4.28" long)

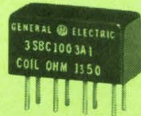

Actual size

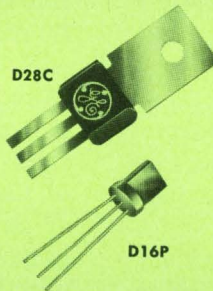

D28C



D16P



than standard d-c industrial motors.

Fast, repeatable acceleration is easy with: **low rotor inertia**, armature circuit inductance, resistance; **high torque-to-inertia ratio**, constant torque-per-ampere relationship, voltage constant. Circle **Number 236**.

### Model 5BLG32HA1

Rated Armature Voltage	12 volts
Current	8 amps
Rated Torque	32 oz-in.
Rated Speed	2700 rpm
Rated Output	64 watts
Shunt Field	PM shunt
Arm. Circuit Inductance	82 $\mu$ H
Resistance	.43 ohms
V Constant	.0291 V Sec./Rad
Torque Constant	4.0 oz-in./amp
Arm. Inertia	.0028 oz-in. Sec <sup>2</sup>
50 Milliseconds	
Pulse Torque	320 oz-in.
Pulse Current	80 amps
Time Constant	
Inertial	9.0 ms
Inductive	.19 ms
Torque/Inertia @ Rated V	40,000 Rad./Sec <sup>2</sup>
Continuous RMS Current Rating	8 amps

applications are ideal for this relay because of its low operate power and compatible size.

Like all GE 150-grid relays, this 50 mW version is available with options. You can choose coil ratings for a wide range of system voltages, plus popular mounting forms and header types.

Want more facts? Circle **Number 237**.

impedances of several megohms.

GE's D28C monolithic power Darlington also offers very high gain (60,000 typical at 200 mA) with higher power and current ratings. Dissipation is 1.2W in free air and 4.0W at 70C case. Continuous IC is 500 mA.

The high gain affords virtually unlimited applications including: power transistor drivers, touch switches, oscillators, amplifiers and buffers, plus audio output stages for TV, radio, and other audio equipment. Circle **Number 238**.

cells and up to 160 amp-hours in vented types at the one-hour rate.

GE nickel-cadmium cells feature unique construction providing a very high discharge rate capability. To find out more, Circle **Number 239**.

prices, technical and ordering information on the full line of General Electric panel meters, meter relays, controlling pyrometers and other related components. It also describes a sales and service army that backs up all your **SPECIAL** requirements. To order your free copy, Circle **Number 240**.

FOR THE NEW IDEAS IN ELECTRONICS, look to General Electric—your best single source for electronic components

ELECTRONIC COMPONENT SALES OPERATION

GENERAL  ELECTRIC

# Elude the traps to sound decisions, and you're on your way to successful managing. But be prepared to shed some common biases first.

Important decisions are harder to make than less important decisions.

Or are they?

Many people believe that they are, but in fact there is no direct correlation between magnitude and difficulty. The man making major decisions may have more going for him: in addition to his own qualifications that have put him where he is, he has greater access to information and the skills of others to help him make the "right" decision.

All decision-making leans on the same foundation—fact plus theory. All decision-makers face similar fundamental traps to success.

Decisions are choices made by interpreting things observed (fact) in the light of things believed (theory).

As a decision-maker, you start first with facts—the incontrovertible, irrefutable and unarguable. But keep in mind that not all facts are immutable. With progress and change, today's fact may be out of date tomorrow.

In the absence of fact, you must fall back on the best available information, which is often well laced with opinion. This is not necessarily bad, if your sources of information are reliable and if the opinions are well founded. But in accumulating data, all successful decision-makers must learn to avoid the traps for the unwary. These may involve the information itself or the way it is collected.

## Trap 1: Misdirection

Your real problem here is to ask the right questions. The questions must pinpoint the problem and properly focus the attention of the expert on it. The expert must know clearly what information is wanted from him. One of the easiest ways to misdirect him is to try to find out something from him without revealing anything significant to him. This will certainly be a

case of the blind leading the blind. Solution: Explain the problem to him clearly.

## Trap 2: Amateur sampling

Sampling is a legitimate and useful research tool—but only when it is handled by a qualified person. In sampling, you hope to learn about the thinking of the many by questioning the few. You can be successful if you ask the right questions of the right people.

Since a sample generally is kept as small as possible for economic reasons, the difficulty is in securing a sample that is both adequate and representative. There are usually so many human factors involved that it is extremely difficult to find individuals who can faithfully mirror the thinking of thousands. Thus you—the amateur poll taker—should be dissuaded from placing too firm a reliance on your own inexpert collection of data. A sample that is adequate in the hands of an expert may be woefully inadequate in the hands of an amateur. An error of 10 per cent may be disastrous to your findings.

## Trap 3: The ubiquitous average

The word average has several legitimate meanings, which may vary widely when applied to a particular item. If the number of units involved is small, the mean average may be far from the median or the mode.

Suppose you had to estimate the engineering manpower needs for a project, based on the figures for the year as shown in the table on p. 84. It would be misleading to use the median and to conclude that if the work load remains the same, you would need 75 engineers each month. In this illustration, 300 government engineers might have been on special assignment in the plant for the month of October to work on one phase of the project. The mode or mean

---

**Don Fuller**, Director, Engineering Div., Industrial Education Institute, New York.

**Analyzing data** that will lead to a decision is Perry A. Diederich, Engineering Manager, Fullerton Group, Electronics Instruments Div., Beckman Instruments, Inc., Fullerton, Calif.



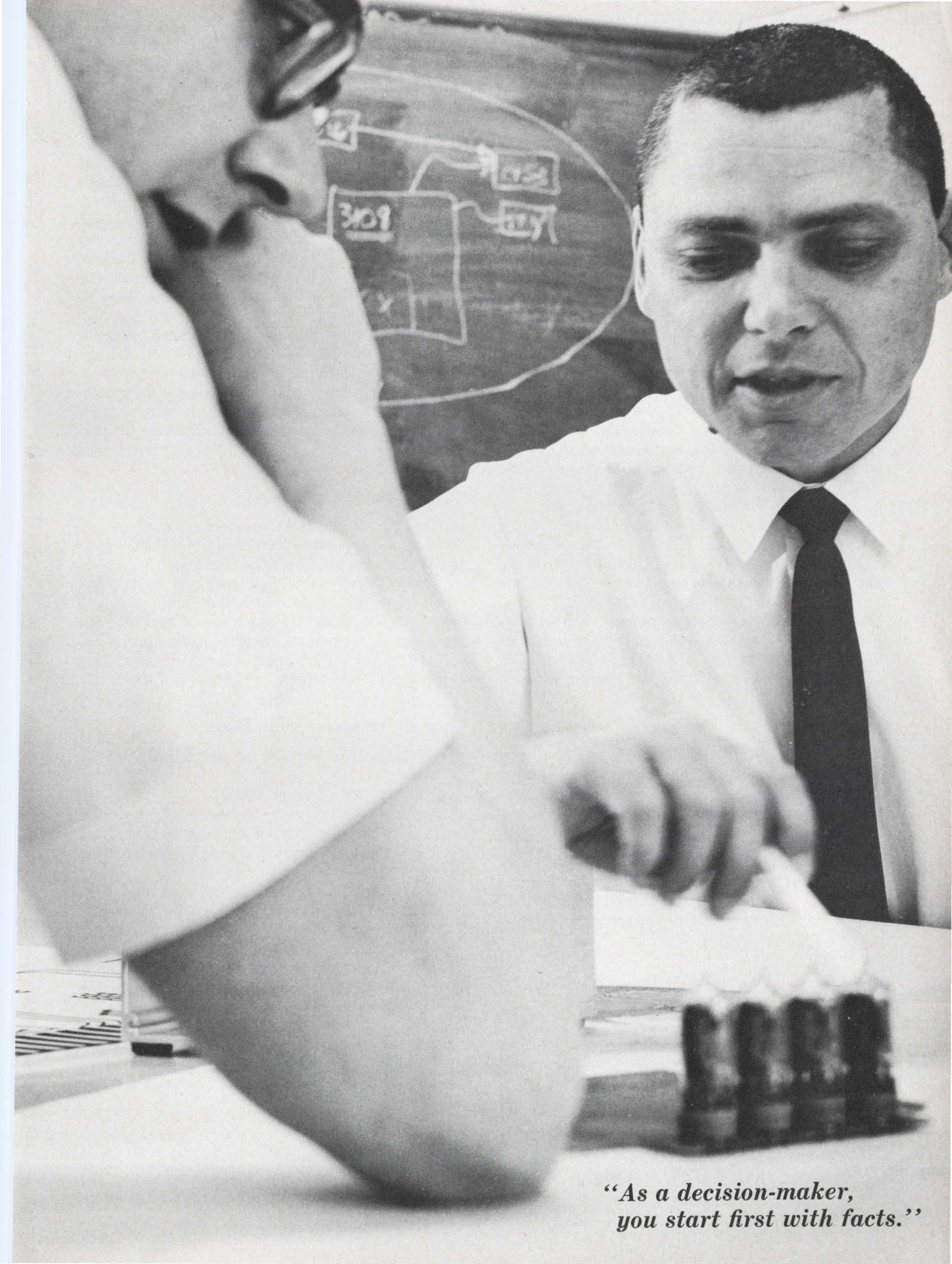

*“As a decision-maker,  
you start first with facts.”*

(both 50) would be a more accurate guideline for your usual monthly engineering needs.

Averages bury extremes. A man can drown in a river that is on the average two inches deep if he falls into the one spot that happens to be 50 feet deep.

#### Trap 4: Selecting only the favorable

If you hope to reach the right decisions, you must learn to recognize and curb your personal biases. Otherwise, in evaluating the facts, you may reject the unfavorable ones and accept only the favorable. Guard against selectivity by getting all the facts, including the figures swept under the rug.

Another case of selectivity is to correlate the general with the particular. If a general study of children indicates that the average age at which a child sits up is  $x$  months, don't necessarily conclude that your child is retarded if he falls short of the average. Before you make a frantic call to the child expert, find out how many children did not sit up after  $x$  months but still managed to win a Nobel Prize or sit on the Supreme Court.

Nor must you correlate the frequent with the normal and then quickly conclude, "What is normal must be right and therefore good." Cannibalism is frequent among cannibals. Anthropologists can tell you this is normal; theologians or lawmakers can say if it is right; whether it is good will depend on whether you are the eater or the eaten.

#### Trap 5: Interpreting it my way

The same set of data may be open to several interpretations. Unless you have special qualifications, you would be rash to dispute the interpre-

### Table. Monthly manpower needs

Month	Number of engineers
January	50
February	48
March	46
April	50
May	52
June	54
July	50
August	50
September	50
October	350
November	48
December	52

tations of qualified experts. Remember that in accepting their interpretations and weaving them into your decision, they become your interpretations when they go up to your superior.

Thus be wary of the interpretation that distorts the data. The distortion is not always deliberate; one man's distortion may be another's straightforward presentation. Your interpretation may be distorted only because you were misled. If your R&D budget has risen from 3 per cent to 6 per cent of the company's total budget, should you say it has gone up 3 per cent or 100 per cent? It may be best to avoid a percentage altogether and say it has doubled.

The mere physical layout of a graph, chart or table may distort. For example, if you are accustomed to thinking of something in terms of months, the reporting may be distorted by graphing it in weeks to slow down the movement of the curves, or in quarters to accelerate it (see figure).

#### Trap 6: Biased connotation

This bias is the implied emotional content you add to an explicit literal meaning. While it is natural to draw out all the meaning there is in a remark, don't draw out meanings that aren't there. Your boss says, "If it doesn't work as you expect, we'll have to make some changes." This may mean nothing more than a change of approach to the secure engineer, but it may imply a change of personnel to the insecure one.

#### Trap 7: The jumped-at-conclusion

This is a trap you set up and fall into all by yourself.

Consider these two premises:

Premise 1: More plane accidents occur during clear weather than during foggy weather.

What you can conclude from this information is simply that more plane accidents occur during clear weather than during foggy weather.

What you *cannot* conclude from this information is that it is safer to fly in foggy weather.

Premise 2: More plane accidents occur during clear weather than during foggy weather; however, the mortality rate is higher for flights made in foggy weather.

What you can conclude from this information is that it is safer to fly in clear weather.

Consider and interpret all the factors before making a decision. Don't take mere words and statistics at face value.

#### Trap 8: The meaningless difference

The meaningless difference and its twin, the meaningless similarity, are cases where a lot is

hoped to be done with practically nothing. You cannot create a difference where none exists nor make the insignificant seem significant.

Don't inflate minor differences to increase their importance or the validity of your decision.

### Trap 9: The status syndrome

The status barrier between superior and subordinate limits communication in either direction, because of fear of disapproval on the one hand and of a loss of prestige on the other.

The boss may fear to ask a question. To do so, he thinks, may suggest that he does not know his business. So he acts as though he already knew the answer.

The subordinate may fear to ask the boss a question. "Maybe I should know the answer," he thinks, "and if he finds out I don't, I may be in trouble."

### Trap 10: Ignoring failures

It's human nature to want to forget about past failures, but they do have a great value—as a warning. Assume that these failures occurred when intelligent men made the wrong decisions. If not reminded or warned, equally intelligent men in like circumstances might go astray again.

Profit from past mistakes. Find out how and why past failures—whose initial circumstances resemble your present problem—came to pass.

### Guidelines for decision-makers

Good decisions—which mean good programs—accomplish five things:

- Solve problems.
- Develop people.
- Improve the company's position.
- Encourage progress, in thinking as well as acting.
- Create opportunities.

The solving of problems is the first goal of decision-making and planning, but the degree to which the four other points are included distinguishes the pedestrian manager from the superior one.

The better you can answer the following questions, the better your final decision will probably be and the better it will accomplish the five points in good managerial decisions.

### Who?

Who *should* make the decision? Who *will* make the decision? Hopefully the answers are the

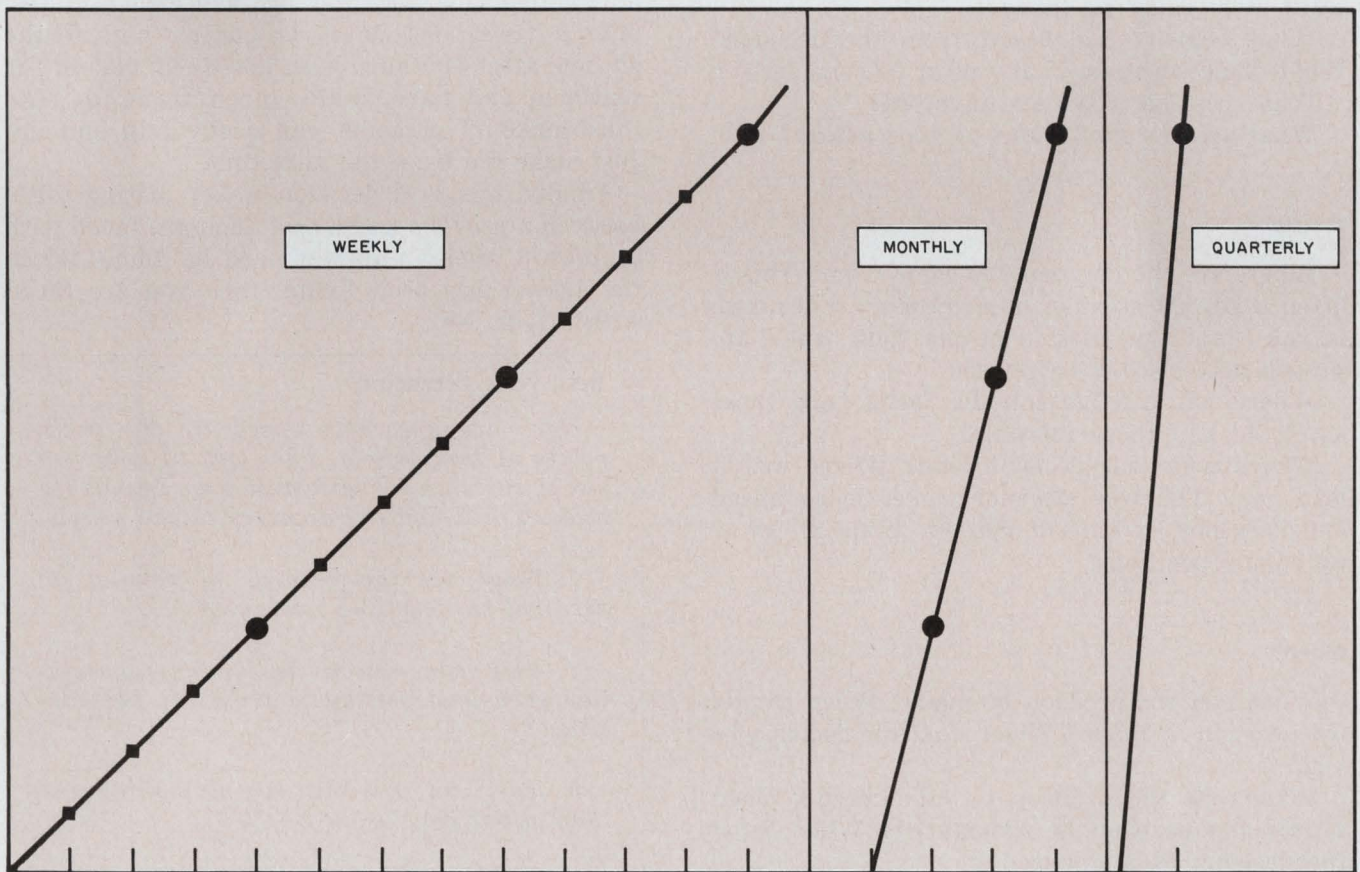

**Distorting the interpretation:** If your data are usually plotted monthly (center), the graph may be distorted

by plotting it weekly (left) to slow down the movement, or in quarters (right) to accelerate it.

same. If not, adjustments should be made.

Who should advise on the decision? Identify the specialized areas and consult the proper specialists.

Who should participate in the decision? Determine what other activities will be involved or affected.

Who should be informed of the decision? Never allow yourself to be accused of failing to keep people informed.

Who should implement the decision? In other words, once a decision has been made, how does it "get into the works?"

Who will be responsible for results? Responsibility must be fixed early, so that the man made responsible can be in on all phases of planning and performance.

### What?

What *should* be decided? What *must* be decided? What *can* be decided? "Should" is a maximum, the most you can wish for; "must" is a minimum, the least acceptable; "can" is what is currently possible, with the hope of expanding toward the maximum.

What information is needed? What facts are now available? What information is lacking?

What orders and requests are necessary? Will normal procedures take care of them? If not, what steps must be taken?

What benefits will result from the decision? What disadvantages, if any must be considered?

What possible risks are involved?

What are the limitations of your action?

### Where?

Where are the personnel to come from? This is often a key question in implementing a decision. If you cannot get certain people, your whole approach may have to be revised.

Where will you go for the facts, both those available and those missing?

Where will your decision lead? Where will it lead you? The wise decision-maker looks ahead and does not let himself get into blind alleys or untenable positions.

### When?

When *can* the decision be made? When *should* the decision be made? When *must* the decision be made?

When *can* the decision be announced? When *should* the decision be announced? When *must* the decision be announced?

When *can* the decision be followed up? When *should* the decision be followed up? When *must*

the decision be followed up?

In all three groups of questions, the key point is: Timing can be vital; make time work for you; try not to be too late, but at the same time be aware of the hazards of being premature.

### How?

How can you get the facts?

How can you get the participation?

How can you get the support?

How can you get the personnel?

How would you implement the decision? A good decision-maker makes decisions as if he personally will have to implement them. In other words, he has a plan and at least a general idea of the methods by which the desired results can be achieved.

Some managers think they are doing their planning job when they no more than meet and solve day-to-day problems as they arise. These men manage to achieve a "passing grade"—but just barely. They make their superiors nervous by being just within the acceptable limits of performance.

Superiors are made uneasy by the thin margin by which success is achieved and worry that the next job will fail by an equally thin margin. Such "just make-it" managers are fond of saying, "But I've never let you down yet, have I?" What they do not realize is that they are like men who leap onto a train just as it is pulling out of the station, after you have been nervously pacing the platform and have finally given them up. The "just-make-it" manager can easily trip and not just make the train the next time.

Finally, the good decision-maker distinguishes between a *problem* and a *task*. You are faced with a problem when an answer must be found. When the answer has been found, then you are faced with a task. ■■

### Test your retention

*Here are questions based on the main points of this article. They are to help you see if you have overlooked any important ideas. You'll find the answers in the article.*

1. *What are the hazards of relying on personal surveys and overages?*

2. *How can selectivity and interpretation each lead you away from the best decision?*

3. *How can you best avoid making the "jumped-at conclusion"?*

4. *What is the great value of not forgetting past failures?*

# **FREE!** **from Schweber**

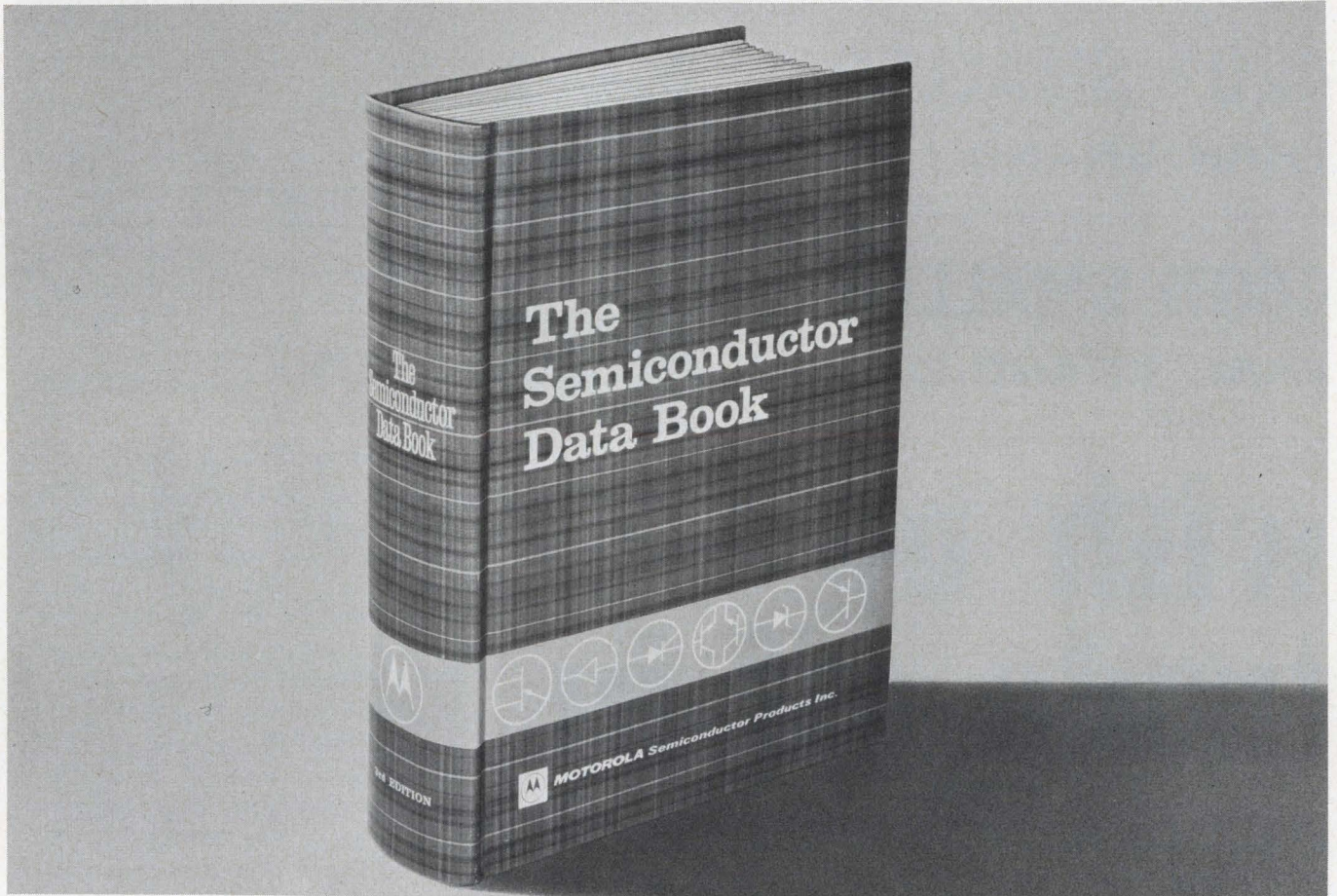

**The brand-new 1968 hard-cover edition of the Motorola Semiconductor Data Handbook...1792 pages of up-dated device specifications and latest applications. It's the bible of the semiconductor industry, it's yours free from Schweber with any order of \$100 or more for any Motorola device!**

Offer expires March 31, 1968

© Copyright 1968 Schweber Electronics Corporation

Your franchised Motorola distributor: **Schweber Electronics, Westbury, N.Y., 516/334-7474** ■ **Silver Spring, Md: 301/587-2900**  
Other Sales Offices: Waltham, Mass: 617/891-8484 ■ Cleveland, Ohio: 216/333-7020 ■ Huntsville, Alabama: 205/539-2756 ■ Toronto, Canada: 416/925-2471



INFORMATION RETRIEVAL NUMBER 36

# Wheelock's 442 SERIES RELAY 700% SMALLER

THAN  
BRAND E

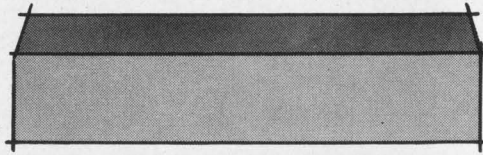

# 420% SMALLER

THAN BRAND I

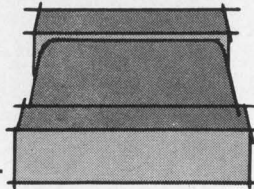

# 400% SMALLER

THAN BRAND D

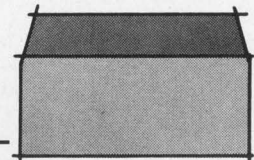

# with no trade off in specifications

Wheelock's 442 reed relays are the smallest, most sensitive multi-pole relays of their kind in the industry. Available in 1 thru 4 poles, the 442 series occupies only 0.055 cu. in. per pole, making it possible to mount 25 4-pole relays on a 3½" x 4½" pc board. Outstanding features: coil voltages, 6, 12, 18, 24 VDC; Contact Rating, 7 Watts; Weight, 1.9 grams per pole; Power Rating, as low as 35 mw.

Write for literature!

**WHEELOCK SIGNALS INC.**

273 Branchport Ave. • Long Branch, N. J. 07740 • (201) 222-6880

## Digital approach improves frequency discrimination

**Problem:** Improve the stability of stable frequency discriminators. In the conventional approach, the unknown frequency is compared with a circuit tuned to the desired center frequency. The accuracy of discrimination, in such a discriminator is the stability of the discriminator itself.

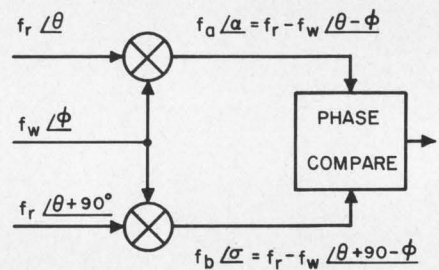

**Solution:** Replace the conventional discriminator with a digital frequency comparator, using a very stable reference frequency. This eliminates stability problems in the discriminator and raises accuracy to that of the reference frequency.

The unknown frequency,  $f_w$ , is mixed with the reference,  $f_r$ , at 0 degrees to form  $f_a$ . The reference is also mixed at 90 degrees, to form  $f_b$ . The outputs,  $f_a$  and  $f_b$ , of the two mixers are at the same frequency but are shifted in phase by 90 degrees. The phase-comparison circuit looks at the phase of  $f_b$  when  $\alpha = \theta - \phi = 0$  degrees. In this case, where  $f_w < f_r$ , the frequency  $f_b$  will lead  $f_a$  by 90 degrees, which will cause the output of the phase-comparison circuit to go to a "1" level.

To build a digital frequency comparator with such an operation requires a difference mixer capable of mixing two signals so that the difference frequency varies from 0 to 1.2 MHz.

Using a shift register element

as a mixer, with one signal on the shift input and the other on the steering line, we see that the maximum difference frequency is half that of the clock frequency. In this case, it is 1.6 MHz if the frequency of the clock is 3.2 MHz. Whenever the clock makes a negative transition, the shift register element transfers whatever logic condition exists on the steering line to the output.

The phase-comparison circuit is simply a shift register element with the  $f_a$  frequency on the

clock and the  $f_b$  frequency on the steering line. The negative transition of  $f_a$  during the "0" level of  $f_b$  would cause a "0" level to be transferred to the output. If  $f_b$  were at a "1" level during the negative transition of  $f_a$ , a "1" would be transferred to the output. The shift register might not generate the true difference frequency at all difference frequencies in the range of the frequency discriminator. However, as the difference frequency becomes

small compared with the clock frequency, the true value will be produced.

The fact that the true difference frequency is not produced does not limit the effectiveness of the frequency comparator, as both mixers will still produce the same frequency.

*Inquiries about this invention may be directed to: Technology Utilization Officer, Marshall Space Flight Center, Huntsville, Ala., 35812. Reference: B67-10151.*

---

### Circuit Engineers:

# Come to IBM and explore new technologies in memory circuits.

At IBM we are exploring new technologies in memory circuits, such as monolithic storage and bipolar or FET drive—sense circuits for magnetic core and film storage. We work with the newest computer-aided techniques for designing switching circuits, amplifiers and storage elements.

#### **Computer-aided design**

If you qualify, you'd work in such areas as: new circuit designs and storage technologies. You'd work as one of a small team in close association with our advanced semiconductor development groups. Complete technical support and computational services are available to optimize designs and define device and package needs. To qualify for these assignments you should have a BSEE or advanced degree and one to five years of relevant experience.

#### **Your future at IBM**

At IBM, you'll find challenge and professional growth opportunities to match your ambition and ability. IBM employees have a wide range of company-paid benefits, including life insurance, medical and hospitalization insurance and retirement income. IBM also offers job stability, and an exceptional educational-assistance program.

#### **Write to IBM now**

If you're interested in this career opportunity, send a brief outline of your educational background and experience to Mr. Philip Evangelista, Dept. QB5-P1, IBM Corporation, Boardman Road, P.O. Box 390, Poughkeepsie, New York 12590.

**IBM®**

An Equal Opportunity Employer

# Mix various signals by a simple method

The problem of using a differential operational amplifier for algebraically summing several signals with a mix of gain factors and polarities and calculation of the input, feedback and junction shunt resistances can become difficult and involved. The problem is compounded by the need to keep the junction input resistances balanced.

This method of calculating the resistance values provides the solution to both parts of the problem quickly and easily. Assume the following parameters:

Signal	Gain	Polarity
A	0.5	Inverted
B	0.75	Noninverted
C	1	Inverted
D	1.25	Noninverted
E	1.5	Inverted

**Step 1**—Set feedback resistor at value  $R$ . Calculate input resistors for correct ratio to feedback resistor as if all signals were to be inverted. For example (see Fig. 1a):

$$R_A = R/A_{gain} = R/0.5 = 2R$$

**Step 2**—Connect the signal input resistors to the correct-polarity amplifier terminal (Fig. 1b).

**Step 3**—Calculate parallel value of resistors at each amplifier input; include feedback resistor at inverting input:

$$R_{p(-)} = 0.25R \quad R_{p(+)} = 0.5R$$

$$\therefore R_{p(+)} > R_{p(-)}$$

**Step 4**—Calculate resistor value required to

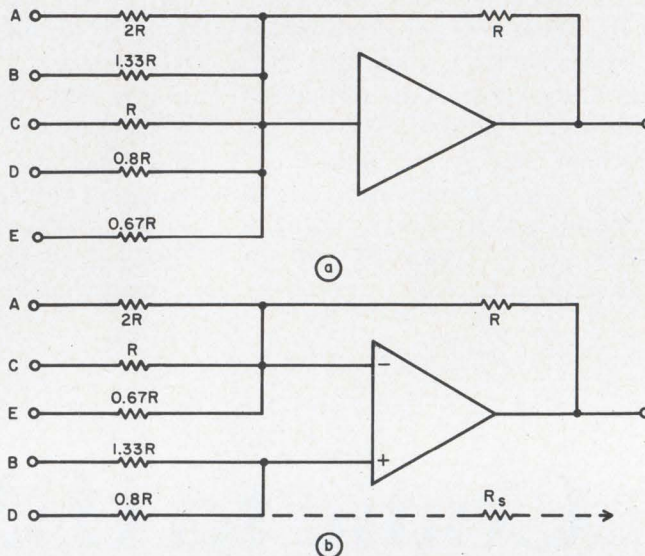

Signals of various gains and polarities (a) are summed as shown in (b). See text for details.

shunt the greater of the two groups, to make it equal to the lesser:

$$R_s = R_{p(+)} R_{p(-)} / (R_{p(+)} - R_{p(-)}) = 0.5R.$$

**Step 5**—Connect shunt resistor as calculated in Step 4 from proper junction to common. Circuit is now complete.

*J. C. Barber, Senior Project Engineer, Systems Engineering, Leeds & Northrup Co., Sumneytown Pike, North Wales, Pa.*

VOTE FOR 311

## An SCR and a UJT control relay on-time

A simple circuit turns off at low-current thyristor with a unijunction transistor which at the same time can be used to give variable pulse lengths. The circuit can be used or altered in many ways but here is shown to give a variable-time relay contact closure.

When the SCR is triggered, it will first draw a heavy current surge from  $C2$  which will then drop to approximately  $(V_s - V_F) / (R_L + R2)$ . The relay contacts close and the timer goes into action. After the lapse of time  $1 - 1/\exp(t/R1C1)$  the voltage at the input to the UJT will equal the intrinsic stand-off ratio of the UJT, and will fire and discharge  $C1$  through the common



**VOTE!** Go through all Idea-for-Design entries, select the best, and circle the appropriate number on the Reader-Service-Card.

**SEND US YOUR IDEAS FOR DESIGN.** You may win a grand total of \$1050 (cash)! Here's how. Submit your IFD describing a new or important circuit or design technique, the clever use of a new component or test equipment, packaging tips, cost-saving ideas to our Ideas-for-Design editor. You will receive \$20 for each accepted idea, \$30 more if it is voted best-of-issue by our readers. The best-of-issue winners become eligible for the Idea Of the Year award of \$1000.



# Boost IC op amp power with Helipot's miniature hybrid amplifier.

## Here's how it performs:

- 2.5 watt output
- 30 MHz bandwidth
- $\pm 16V$  voltage swing
- less than  $90^\circ$  phase shift
- $-55$  to  $+125^\circ C$  operation
- foldback short circuit immunity
- protects op amp and power supply from overload reflections

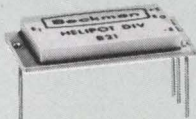
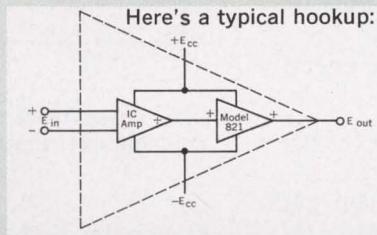

The new Model 821 is a hybrid, cermet thick film power amplifier which drives load resistances as small as 100 ohms to within 4 volts of the supply voltage from d-c to 30 MHz. Its combination of unity voltage gain and wide bandwidth permits boosting the power of an IC amplifier without affecting its other performance capabilities. In addition, the Model 821's ability to block all overload reflections results in the prevention of heat generated errors in the op amp and allows immediate recovery upon overload removal.

Completely self-contained, this fully sealed power amplifier is only 0.170" high, occupies just 0.5 sq. inches of board space, and is compatible with both flat pack and dual in-line IC packages.

Ask your local Helipot sales representative for complete information on the Model 821.

**Beckman**  
INSTRUMENTS, INC.  
HELIPOT DIVISION  
FULLERTON, CALIFORNIA • 92634

INTERNATIONAL SUBSIDIARIES: GENEVA; MUNICH; GLENROTHES, SCOTLAND; TOKYO; PARIS; CAPETOWN; LONDON; MEXICO CITY

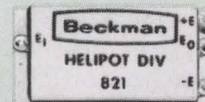

Actual Size

## Here's the price:

\$35.00—1 to 9 quantity. Delivered from stock

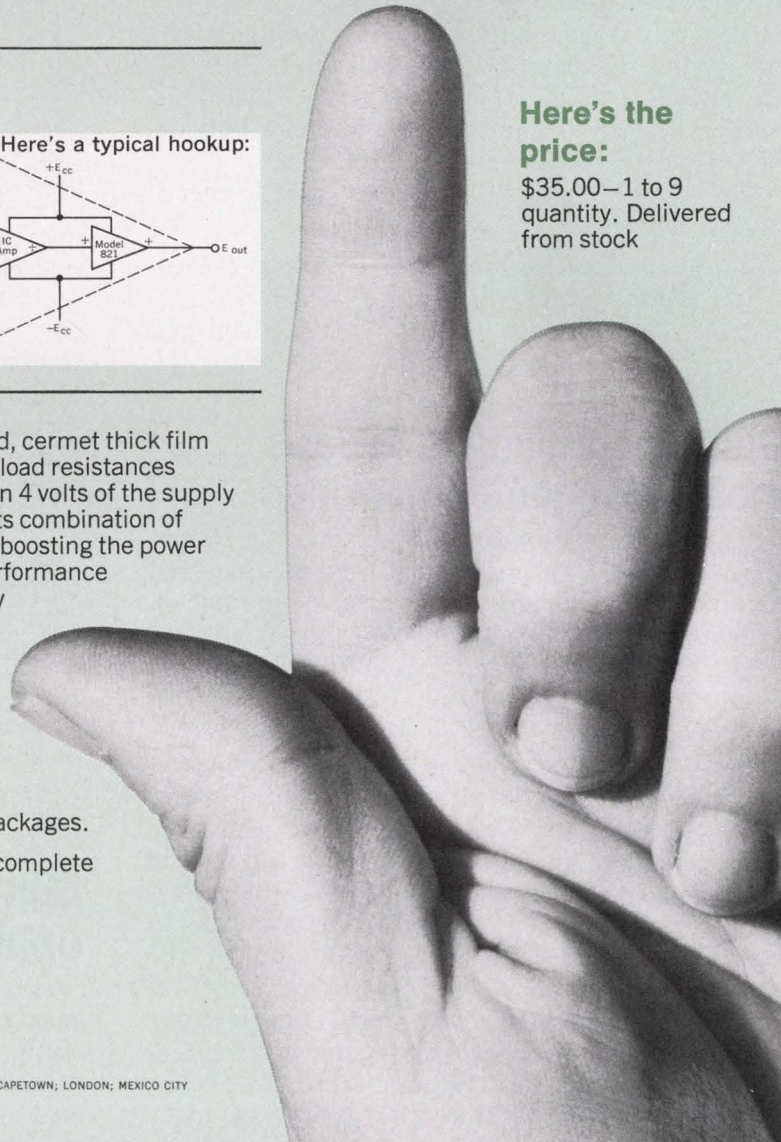

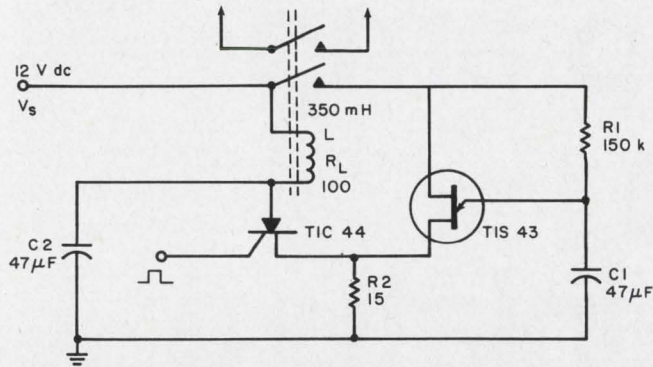

Variable relay contact closure time is obtained with an SCR and a UJT. Relay on-time depends on R1 C1 values.

resistor  $R2$ . Because of this rapid increase in potential at the cathode of the SCR, it will momentarily be reverse-biased and will turn off. When the cathode potential again decreases and the anode potential increases, the SCR will continue to be switched off.

$C2$  serves a double purpose: as a voltage memory during the short period when the SCR is being switched off, and with inductive loads as a voltage limiter or damper for the spike that occurs when the SCR is switched off.

The semiconductors are low-cost plastic-encapsulated devices.

Willy Heyman, Design Engineer, Texas Instruments Sweden A.B., Stockholm, Sweden.

VOTE FOR 312

## Oblong coupling apertures meet waveguide filter need

Waveguide band-pass and band-reject filters often employ apertures to realize required couplings. Circular apertures are limited in diameter to the full height of a rectangular waveguide. To obtain tighter couplings required for filters of wider bandwidths, oblong apertures can be employed.

The normalized susceptance of inductive coupling apertures is commonly used in waveguide filter design. Large susceptances provide loose couplings and small susceptances provide tight couplings. For the popular RG-52/U waveguide (width = 0.900 inch and height = 0.400 inch), measured data have been obtained for both circular and oblong apertures with an aperture thickness of 0.031 inch. For circular apertures, the normalized susceptance,  $l$ , for frequencies between 8.2 GHz and 11.0 GHz cannot be much below 4.0. Measured data (see plot) have also been obtained for the oblong aperture.

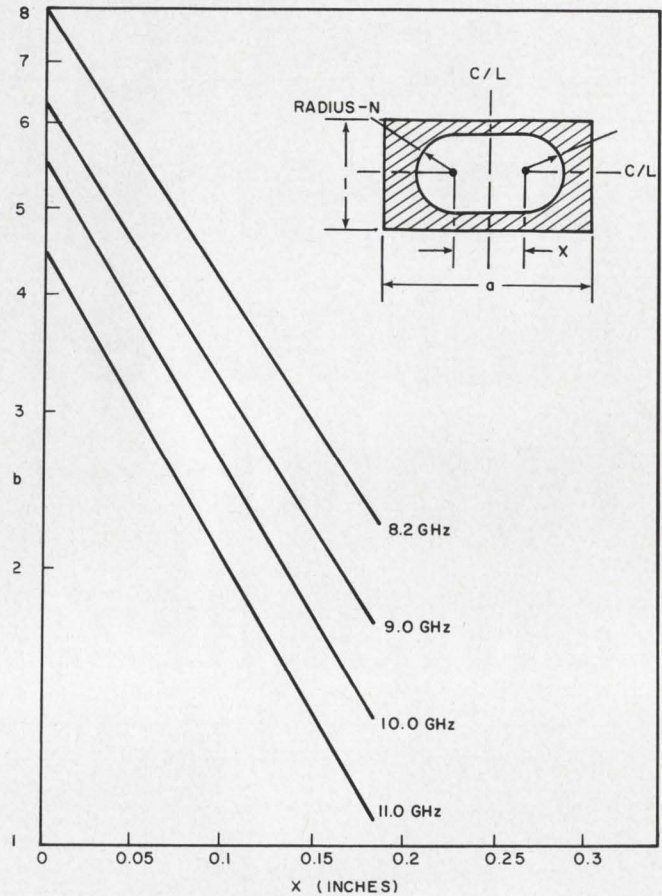

Low susceptance can be obtained when an oblong coupling aperture is used instead of a round one.

It can be seen that very small normalized susceptances are obtainable as the dimension  $x$  is increased. To implement a practical design, the radii,  $r$ , of the oblong shape have been fixed at 0.187 inch, so that a standard 3/8-inch end mill can be used.

Increasing  $x$  beyond a certain value can yield a normalized susceptance of zero. This is an indication of aperture resonance. Further increases in  $x$  will result in aperture susceptances that are capacitive rather than inductive.

Richard M. Kurzrok, Consulting Engineer, New York.

VOTE FOR 313

## Complementary sweep circuit improves linearity and flyback

A simple sweep generator that uses complementary transistors provides a positive-going ramp voltage with minimum components. The circuit shown in Fig. 1a gives very good linearity and negligible flyback time. Its peak-to-peak output voltage is almost equal to the supply voltage.

# Solve any CCTV problem with one of these seven basic systems from Cohu.



## High-fidelity color

1000 Series system includes the first CCTV camera with built-in references for correct registration and color balance. Compact, light, low-priced and easy-to-operate.

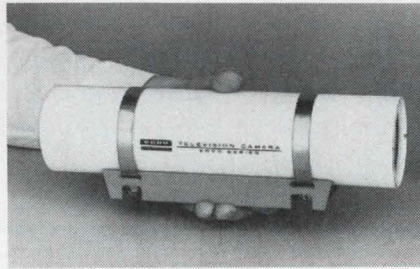

## Miniaturized

Series 2000 cameras feature 3" outside diameter cylindrical housings that will accommodate remote-controlled 4:1 zoom lens. Many lens options available, including 10:1 zoom. Operate on 10 or 20 megahertz bandwidths.

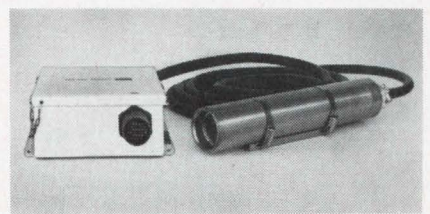

## Radiation-tolerant

Get top quality TV pictures from radiation environments up to a cumulative dosage of  $10^8$  roentgens and/or  $10^{12}$  neutrons/cm<sup>2</sup> with 3-inch diameter 2500 Series cameras. Readily de-contaminated.

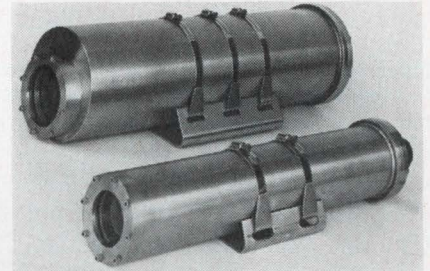

## Underwater

Tested to 10,000 PSI and up to 20,000 foot depth. Neutral buoyant. 70° view lens. Camera and cable independent.

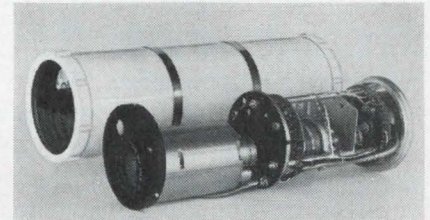

## Environment-resistant

3000 Series cameras provide continuous-duty operation in up to 100% humidity, at temperatures from -20°C. to +60°C., ocean depths to 250 feet and altitudes out to deep space. Meet military explosion-proof specifications. Operate on 10 or 20 megahertz bandwidths.



## High-resolution self-contained

Modular-designed 3200 Series offers choice of plug-in sync generators for EIA 525 or 729, 873 or 945-line scan rates. Compensates for light level variations to 10,000:1. Optional viewfinder.

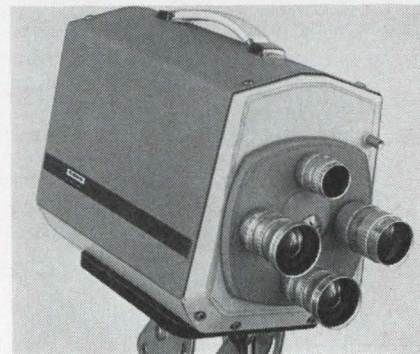

## Industrial self-contained

Complete with all camera control circuits, Model 20/20 cameras need only video cabling and any standard TV monitor to make a complete CCTV system. Highly versatile.

## Which one solves yours?

For details on the industry's most complete CCTV line – including monitors, accessories and video switching systems – contact your nearest Cohu representative or call Bob Boulio direct at 714-277-6700 in San Diego.

**COHU**  
ELECTRONICS, INC  
SAN DIEGO DIVISION

Write for 8-page illustrated bulletin of TV application studies ED 8-78.

BOX 623 · SAN DIEGO, CALIFORNIA 92112 · TWX 910-335-1244

INFORMATION RETRIEVAL NUMBER 39

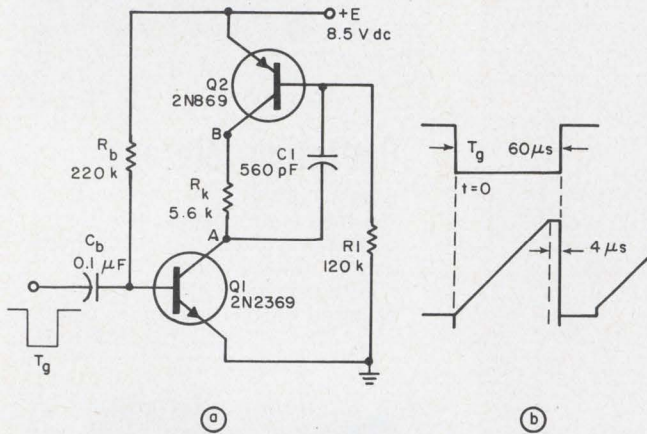

Linear sweep with small flyback time is obtained from this complementary circuit (a). The gating pulse,  $T_g$ , and the output ramp are in (b).

The waveforms obtained at point A (collector of Q1) are illustrated in Fig. 1b.

Starting from the quiescent condition when both transistors are saturated, the potential at A is negligibly small and the potential at B (Col-

lector of Q2) equals supply voltage  $E$ . With the application of the gating waveform at  $t = 0$ , Q1 is turned off. When  $R_k \ll R1$ , the capacitor  $C1$  is discharged at a constant current,  $I_{c1}$ , given by:

$$I_{c1} \approx \alpha_2 E / R1,$$

where  $\alpha_2$  is the common base current gain of Q2. The potential at A will change by approximately  $E$  in time  $T$ , where:

$$T = R1C1 / \alpha_2.$$

Q1 acts as a switch and Q2 supplies the constant current by which capacitor  $C1$  is discharged during time  $T$ .

The excellent linearity of this ramp generator is a result of the constant discharge current through  $C1$ .

Thus the circuit provides linear sweep with much less flyback period than the equivalent boot-strap circuit.

*Uma Shanker Singh, Electronic Engineer, Central Electronics Engineering Research Institute, Pilani, Rajasthan, India.*

VOTE FOR 314

## Free-running multi yields constant period after synch

In many applications where a free-running multivibrator is used, it is desirable to synchronize the device with a lower-repetition-rate pulse and maintain a constant period of oscillation from the instant the synchronization pulse is received into the free-running operation. This is useful in radar-range or time marking, where a train of equally spaced pulses must follow a main synchronization pulse.

Conventional multivibrators do not respond with constant periods until several cycles after the synchronization pulse because their timing depends on two to four varying voltages and the synchronization pulse resets only one. Thus several free-running cycles are needed to reestablish a constant period after synchronization.

This circuit gets around the problem by using one varying voltage in the timing element that is reset to ground with each free-running cycle and also with each external synchronizing pulse.

In the schematic  $V_{b1}$  increases as  $C1$  charges

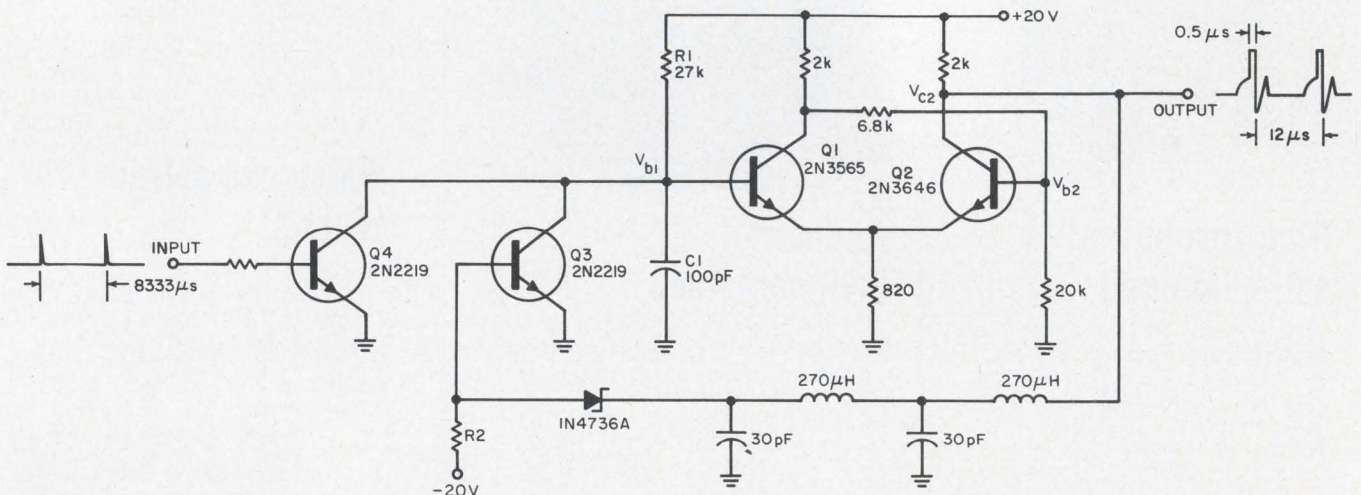

Constant-period output pulses are obtained from this circuit in response to synchronizing pulses.

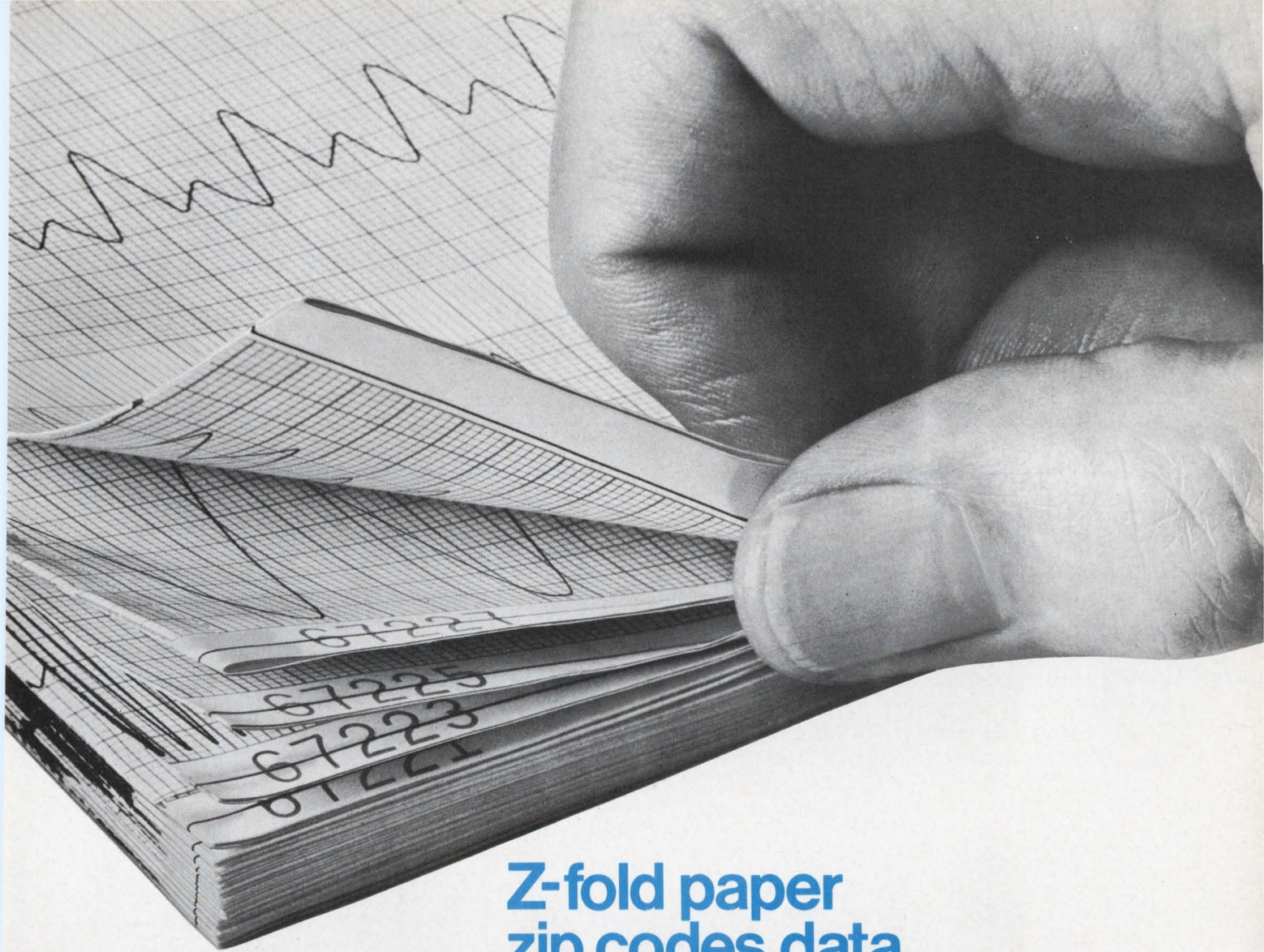

## Z-fold paper zip codes data for quick retrieval

Data recorded on Z-fold paper by the Hewlett-Packard 7800 Series Rectilinear Recorder is instantly retrievable. Each page is numbered to simplify reference to recorded data. Z-fold chart packs store easily in their original cartons.

Contactless pen tip sensing and a *modulated pressure ink system* produce traces of equal density from all signals and throughout the recorder's variable speed ranges of .025 to 200 mm. per second. *You get black ink reproducibility compatible to diazo or any similar process.*

Designed with modular, solid-state electronics, the 7800 Systems provide high-resolution, permanent, rectilinear recording of up to eight variables from dc to 160 Hz.

Eight 8800 Series Preamplifiers provide signal conditioning to the driver-amplifiers which drive the recording pens. The recording system is available with eight different or eight identical preamplifiers of your choice. Frequency re-

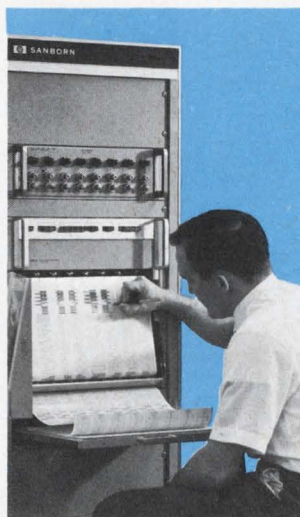

sponse of the recorder is 160 Hz for 10 div p-p deflection and 58 Hertz maximum for full scale deflection. Maximum ac or dc non-linearity is 0.5% full scale. Additional features include: choice of chart paper in Z-fold packs or rolls; 14 electrically-controlled chart speeds; built-in paper take-up; ink supply warning light; disposable plug-in ink supply cartridge that may be replaced while the recorder is in operation and complete modular construction for easy maintenance.

For complete information on the 7800 system, optional and related equipment, contact your local HP Field Office or write Hewlett-Packard, Waltham Div., 175 Wyman St., Waltham, Mass. 02154.

HEWLETT  PACKARD  
RECORDING SYSTEMS



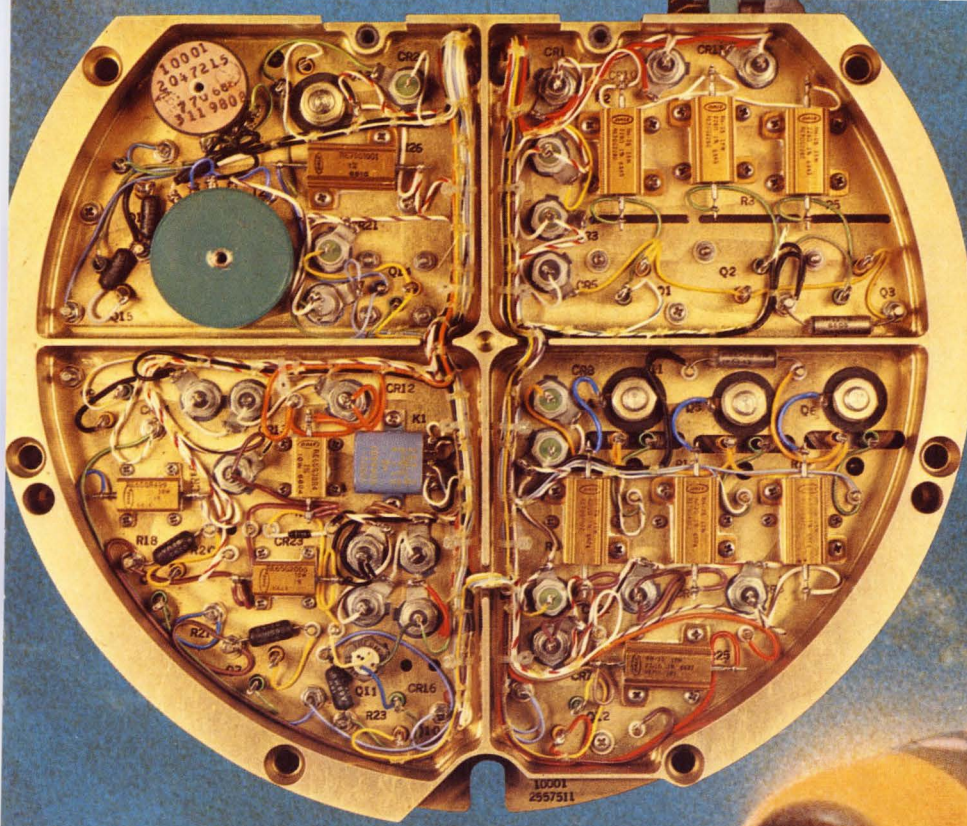

# How Bendix\* uses Dale's full range of precision power!

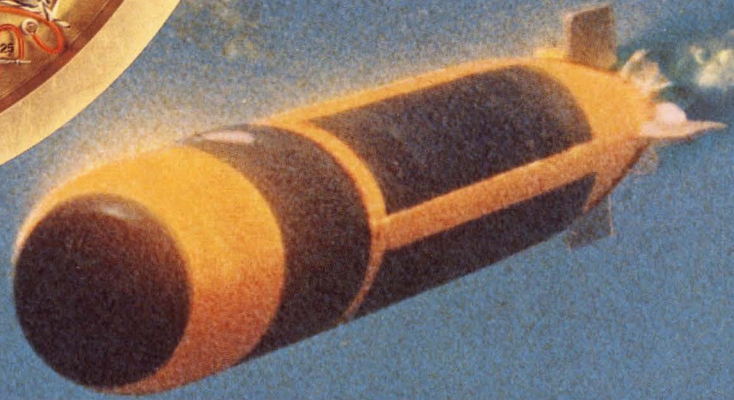

\*Electrodynamics Division selects Dale Wirewound Resistors for guidance system of Mark 46 submarine hunting torpedo.

Snaking down toward a hidden enemy, the Navy's Mark 46 torpedo provides a potent example of Dale wirewound versatility. Inside the guidance system, provided to Aerojet General by Bendix Corporation's Electrodynamics Division, a variety of Dale styles answer precision power demands.



**TYPE RS** Axial-lead, silicone-coated wirewound. Meets MIL-R-26D. Proven failure rate of .006%/1,000 hours backed by 32,000,000 unit test hours (full rated power, 60% confidence, 25° C, failure rate  $\Delta R$  1%).

**TYPE RH** Exceeds MIL-R-18546. Patented chassis-mount design provides: (1) Bonus power 25% to 108% above mil rating; (2) Exceptional stability when derated to mil levels.

**TYPE PH** Versatile through-chassis mounting with terminals on one or both sides. Meets electrical and environmental specs. of MIL-R-18546.

When you need precision wirewounds, call Dale. No other source offers as many models, as much design freedom or a stronger foundation for reliability.

Dale Resistors in Mark 46 Guidance System

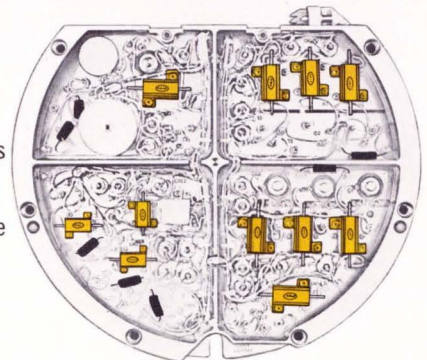

For action, phone 402-564-3131 or Circle 181 for Catalog A.



for optimum value in precision power wirewounds

DALE ELECTRONICS, INC. 1300 28th Avenue, Columbus, Nebraska 68601  
In Canada: Dale Electronics Canada, Ltd.



**DALE**





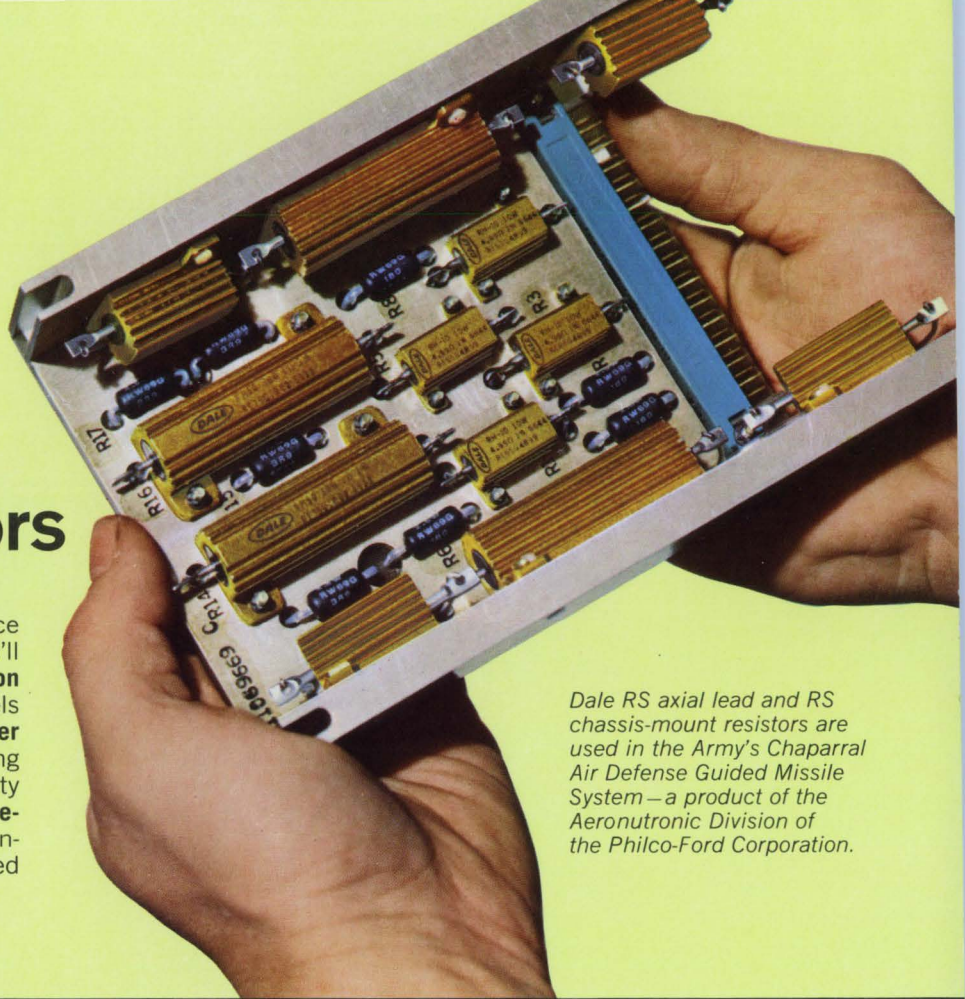



# ...a complete source for precision power resistors

Establish Dale as your complete source for precision power wirewounds. You'll gain added value from: **Broader Selection** ...10 different types, 64 different models ...up to 250 watts precision power. **Greater Design Versatility**...3 different mounting choices plus unmatched size/stability combinations. **Faster Reaction to your Special Needs**...more than 400 different non-standard variations are pre-engineered and ready for application in your circuit.



*Dale RS axial lead and RS chassis-mount resistors are used in the Army's Chaparral Air Defense Guided Missile System—a product of the Aeronutronic Division of the Philco-Ford Corporation.*

## CHECK DALE'S COMPLETE PRECISION POWER LINEUP...

	RANGE	SIZES	WATTAGES	TOLERANCE	FEATURES
<b>TYPE ARS</b> 	0.1 ohm to 40K ohms	3	2, 5, 10	1%	Established reliability, failure rate less than .00038% at 1000 hours of operation at 50% of rated power at 25° C.
<b>TYPE AGS</b> 	0.1 ohm to 12.4K ohms	4	1, 2.25, 4, 7	1%	Established reliability, failure rate .00051% per 1000 hours. Estimated failure rate after GARD screening .00009% per 1000 hours. Beryllium oxide core for greater stability and hot spot elimination.
<b>TYPE RS &amp; RLS</b> 	0.1 ohm to 273K ohms	11	¼, ½, 1, 2, 2½, 3, 5, 7, 10	0.05% to 3%	Meet functional requirements of MIL-R-26D which supersedes MIL-R-26C and MIL-R-23379. Silicone coating. Weldable leads available. RS has axial leads. RLS has radial leads.
<b>TYPE NS &amp; NLS</b> 	1 ohm to 136.5K ohms	10	½, 1, 2, 2½, 3, 5, 7, 10	0.05% to 3%	Silicone coated, non-inductive winding. Type NLS has radial leads. Weldable leads available.
<b>TYPE G &amp; GL</b> 	0.1 ohm to 273K ohms	10	1, 1½, 2¼, 4, 6, 7, 10, 15	0.05% to 3%	G & GL resistance units offer decreased size with increased heat dissipation. Silicone coated. Meet functional requirements of MIL-R-26D which supersedes MIL-R-26C and MIL-R-23379. GL has radial leads.
<b>TYPE GN &amp; GNL</b> 	1 ohm to 136.5K ohms				GN & GNL have identical construction but are non-inductively wound. GNL has radial leads. Weldable leads available.
<b>TYPE HG &amp; NHG</b> 	HG: 0.1 ohm to 273K ohms NHG: 0.1 ohm to 136.5K ohms	4	15, 20, 35, 50	0.05% to 3%	HG features maximum heat dissipation at no increase in size. Meets or exceeds requirements of MIL-R-18546. Chassis-mounted molded radiator housing. NHG has identical construction but is non-inductively wound.
<b>TYPE RH &amp; NH</b> 	RH: 0.1 ohm to 273K ohms NH: 0.1 ohm to 136.5K ohms	6	7.5, 12.5, 25, 50, 100, 250	0.05% to 3%	RH resistance unit molded into radiator housing. Meets requirements of MIL-R-18546. Mounts on chassis. NH has identical construction but is non-inductively wound.
<b>TYPE PH</b> 	0.1 ohm to 95.2K ohms	4	10, 25, 50, 100	0.05% to 3%	Established reliability units (ARH) available in 5, 10, 15, 30 watt sizes. Meet MIL-R-39009. Silicone-sealed resistance unit in radiator housing. Mounts through hole in chassis. Also available with non-inductive winding.

Circle 181 for Catalog A



**DALE ELECTRONICS, INC.**  
 1300 28th Ave., Columbus, Nebraska 68601  
 In Canada: Dale Electronics Canada, Ltd.



**DALE**

Printed in U.S.A.



ple firing of the timer when the input exceeds the length requirement.

If the discriminator is set for  $1 \text{ ms} \pm 5\%$ , and an input pulse of 1-ms duration is applied to the input, the circuit operates as follows.

The output of  $Q1$  changes from  $-20$  to  $0$  volts.  $D1$  is reverse-biased, and the charging rate of  $C1$  is influenced only by  $R1$  and the  $4.7\text{-k}\Omega$  resistor. The leading edge of the inverted input pulse sets the flip-flop. The output of  $Q1$  is  $-20$  volts which holds  $Q2$  cut off.  $Q2$  has no influence during the charging cycle.

The time constant  $C1$  ( $R1 + 4.7 \text{ k}\Omega$ ) has been set such that unijunction  $Q3$  will fire at  $0.95 \text{ ms}$ . This output triggers the monostable the duration of which has been set at  $0.1 \text{ ms}$ . Then line  $A$  of the AND gate is negated during the interval from  $0.95 \text{ ms}$  to  $1.05 \text{ ms}$ . The  $B$  line of the gate is negated at the end of the 1-ms input pulse ( $Q1$  is cut off in the absence of an input) and a  $0.05\text{-ms}$  pulse is generated.

If the input is of insufficient length, then the unijunction will never fire and no output will be initiated.

The output of the monostable also triggers the flip-flop, causing  $Q1$  to change state. That in turn forces  $Q2$  into saturation, preventing  $C1$  from recharging and causing a second firing of the unijunction when the input is much longer than  $1 \text{ ms}$ . This condition is maintained until the next input resets the flip-flop.

$D1$  prevents the accumulation of charge on  $C1$  when the input consists of a series of short pulses. If a pulse of insufficient length enters the discriminator,  $C1$  would start to charge, but  $Q3$  would not fire, the flip-flop would not be triggered and the unijunction emitter would not be clamped. When the output of  $Q1$  reverts to  $-20$  volts,  $D1$  is forward-biased and  $C1$  is quickly discharged.

The operating range and tolerance of the discriminator can be adjusted for a particular pulse width and tolerance. The circuit could be miniaturized by fabricating the respective stages from available integrated circuits.

*R. Alan Benson, Jr., and Frederick M. Cancelliere, U. S. Naval Station, Newport, R.I.*

VOTE FOR 316

## Complementary circuit switches high voltage

There are many applications that require a voltage pulse that switches rapidly between zero and some well-defined positive or negative dc level. One typical application involves the dc target voltage of a vidicon camera tube, which must be quickly switched from some positive operating voltage to ground during the retrace time and then rapidly back to the original voltage.

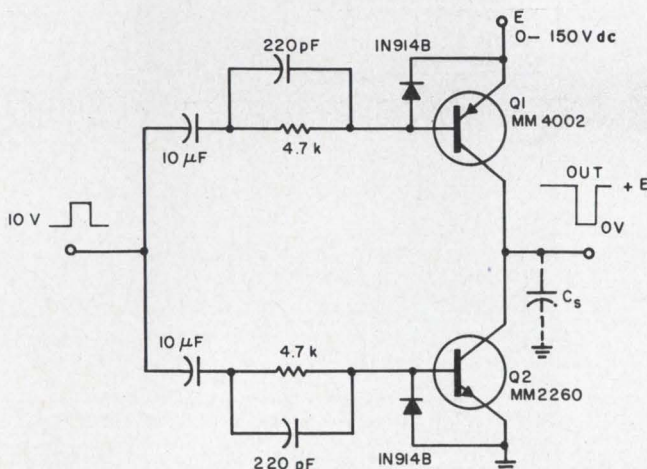

**1000-V/ $\mu\text{s}$  switching speeds** are possible with this simple circuit with very little power dissipation.

The dc load current is very small (typically  $100 \text{ nA}$ ) but the stray capacitance,  $C_s$ , may well be several hundred picofarads.

The circuit shown here accomplishes this switching. At any given time, either  $Q1$  or  $Q2$  is in saturation because of the input drive pulse, and the output voltage is therefore either at ground or at the applied potential,  $E$ . Since collector current flows only during the charging and discharging of the stray capacitance, the power dissipation of the circuit is very small, even though large fast-rise-time output pulses are being delivered. With currently available transistors, output speeds of almost  $1000 \text{ V}/\mu\text{s}$  can be obtained.

*John Schroeder, Design Engineer, RCA Labs, Princeton, N.J.*

VOTE FOR 317

### IFD Winner for November 22, 1967

**Jerry F. Foster**, Chief Engineer, Wavetek, San Diego, Calif. His Idea "Low cost op-amp integrator has range from dc to over  $1 \text{ MHz}$ ," has been voted the \$50 Most Valuable of Issue Award.

**Cast Your Vote for Best Idea in this Issue.**

# JFD announces . . . NEW delay Line SERIES...

\*

JFD Delay Lines are top quality, ruggedly constructed, precision components of proven dependability. A variety of models, having a wide range of electrical and physical parameters, are production items. Characteristics and mounting methods available in standard JFD units meet the requirements of a wide variety of circuit applications. Delay Lines for highly specialized applications are designed in JFD laboratories. A staff of skilled engineers employ proven techniques to limit development time to a minimum.

#### Distributed Constant

JFD distributed constant Delay Lines manifest minimum rise-time and distortion characteristics. Miniaturized and hermetically sealed models are available. Measured delay-time is within 5% of rating in most models.

#### Lumped Constant

JFD lumped constant Delay Lines are compact in size relative to delay-time. Attenuation, distortion and temperature coefficient of delay are minimized. Ratio of delay to rise time is excellent and delay tolerances may be held to within 0.2% when required.

#### Continuously Variable

JFD continuously variable Delay Lines are designed to withstand shock and vibration and meet military environmental requirements. Resolution is better than 1/1000th of maximum delay across the entire delay range, in most models.

For additional information, write for catalog DL-68.

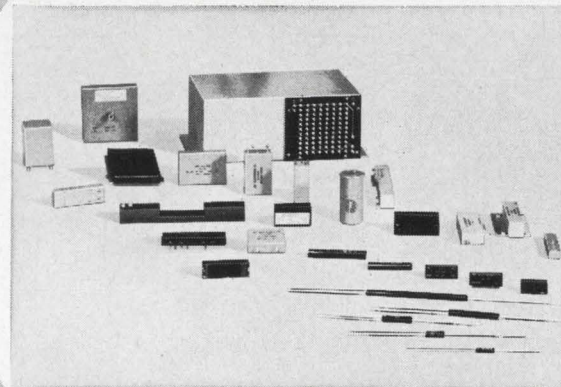

Illustrations shown 1/15 actual size.

"TODAY'S COMPONENTS BUILT FOR TOMORROW'S CHALLENGES"

**JFD**

JFD ELECTRONICS CO. / COMPONENTS DIVISION / 15th Avenue at 62nd Street / Brooklyn, New York 11219 / Phone 212-331-1000

Offices and subsidiaries in principal cities, world-wide.

"SEE US AT IEEE BOOTH 4E26". Also, March 27th-April 3rd, London Electronics Engineering Exhibition/April 1st-6th, Paris Components Show/April 27th-May 5th, Hannover Fair, Hannover, Germany."

INFORMATION RETRIEVAL NUMBER 41

# Products

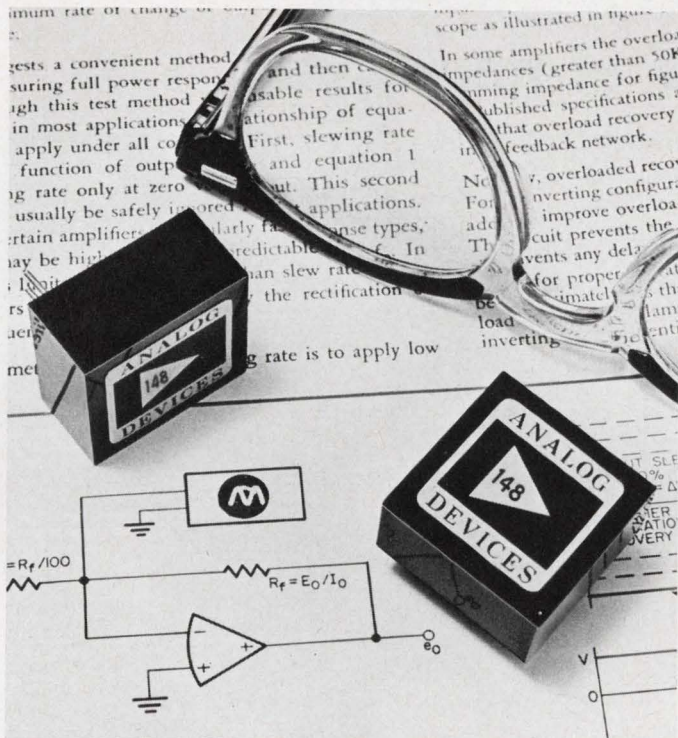

**Differential dc operational amplifier** settles to 0.01% of final values in one  $\mu$ s. Page 100

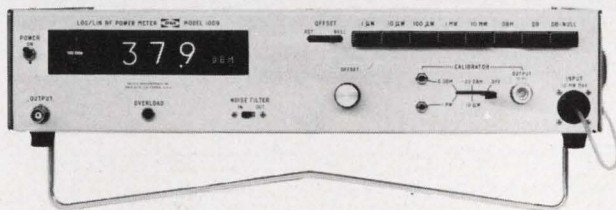

**Digital rf power meter** reads out on a linear or logarithmic scale to 12.4 GHz. Page 118

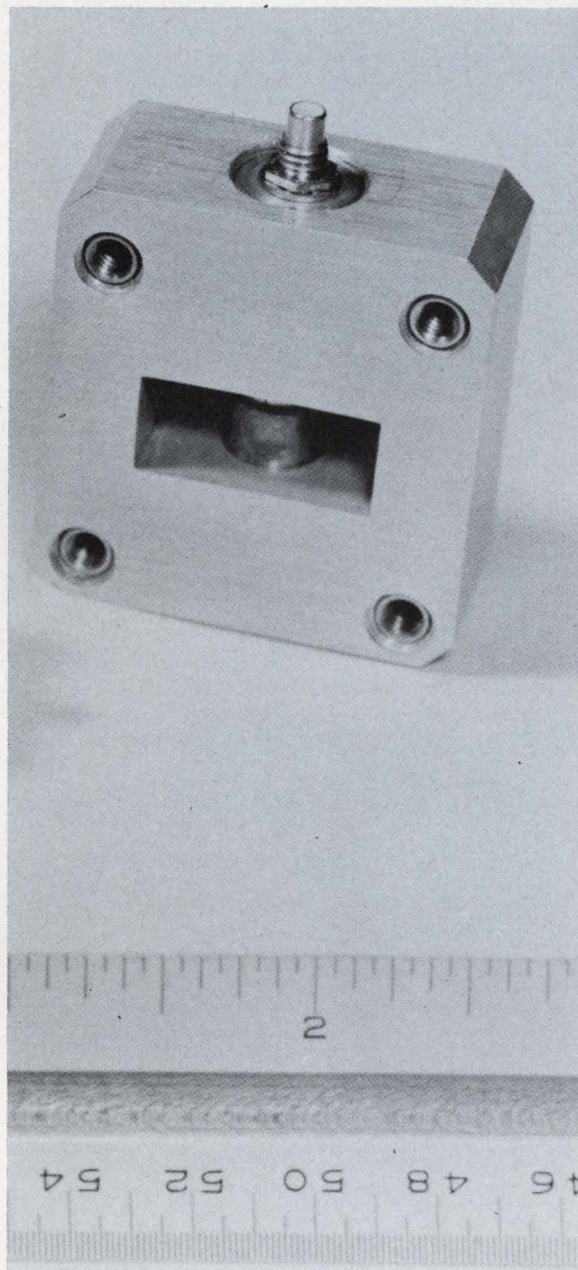

**Semiconductor microwave oscillators** deliver 60 mW cw at X band. Page 114

## Also in this section:

**Electrically conductive paper tape** seals out electrostatic interference. Page 126

**Component-lead bending tool** shapes leads to fit printed-circuit board layouts. Page 108

**Application Notes**, Page 128 . . . **New Literature**, Page 130

## Differential dc operational amplifier settles in $1\ \mu\text{s}$ to 0.01% of final value

Analog Devices, 221 5th St., Cambridge, Mass. Phone: (617) 491-1650. P&A: Model 148 A, \$42; 148 B, \$47; 148 C, \$65; Stock.

Analog Devices' new ultrafast model 148A differential dc operational amplifier gives digital circuits new levels of speed and accuracy. The unit's most noteworthy feature is its  $1\text{-}\mu\text{s}$  settling time for the output level to reach within 0.01% of its final value. Additional characteristics include a  $50\text{-V}/\mu\text{s}$  overload recovery time, 10-MHz small-signal bandwidth, and 500-kHz full power output. Drift specifications are  $50\text{-}\mu\text{V}/^\circ\text{C}$  max voltage drift, 30-pA max initial bias current at  $25^\circ\text{C}$ , and  $5\text{-pA}/^\circ\text{C}$  max drift averaged over the  $25^\circ\text{C}$ -to- $35^\circ\text{C}$  range. Output rating is  $\pm 10\text{ V}$ , 20 mA, and both the common-mode and differential input impedances are  $10^{11}\ \Omega$  shunted by 3.5 pF. The device also features a 30,000 open-loop dc gain.

By settling to within 1 part in 10,000 of the final output voltage value in less than  $1\ \mu\text{s}$ , this unit can form the basis for a 12-bit D/A or A/D converter capable of encoding or decoding at a rate approaching 1,000,000 conversions per second. The output attains its final 10-V value in two fairly distinct stages. It slews at a high rate to within about 17% of the final value, then takes considerably longer to settle this last 1%.

Three different models in the 148 operation-amplifier series are available. The differences lie solely in the price and drift specifications for the different models. The model 148A features a  $50\text{-}\mu\text{V}/^\circ\text{C}$  and 50-mA max voltage drift. The model 148B is identical, except maximum voltage drift and bias current are  $25\ \mu\text{V}/^\circ\text{C}$  and 30 pA. Finally the model 148C's maximum voltage drift and bias current are  $15\ \mu\text{V}/^\circ\text{C}$  and 30 pA.

CIRCLE NO. 321

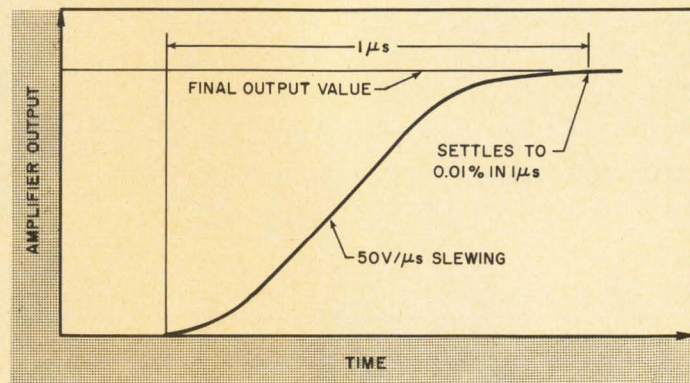
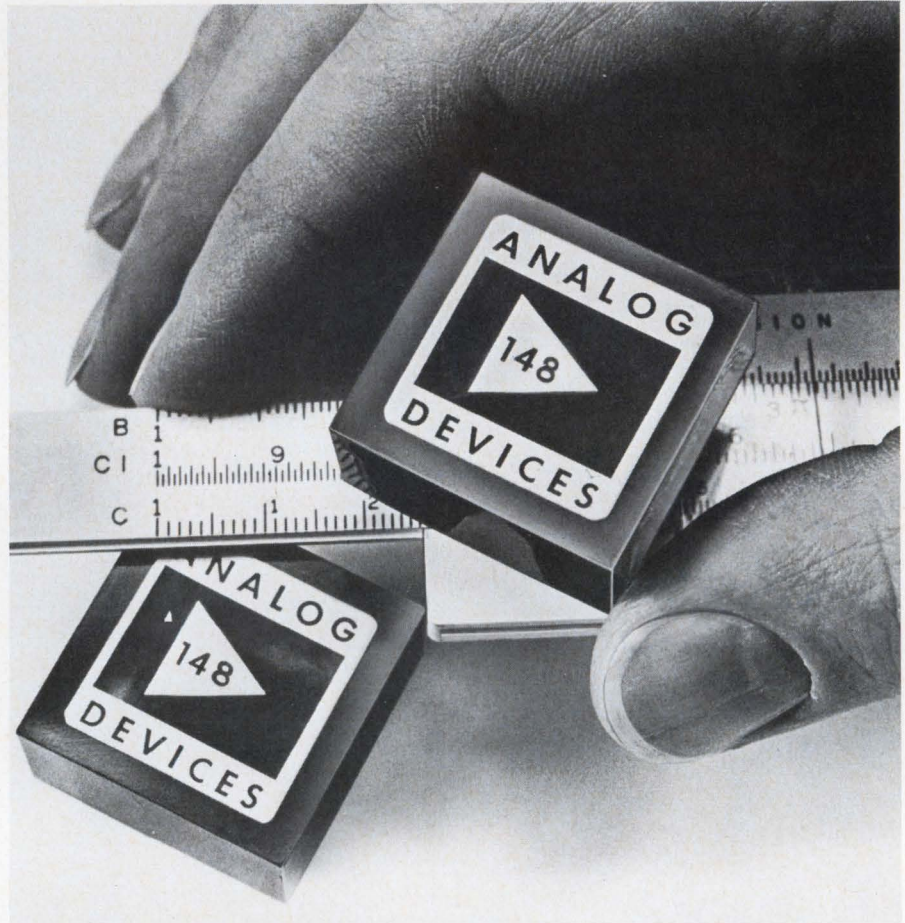

Differential dc operational amplifier settles to within 0.01% of final value in one  $\mu\text{s}$ . It also features a 30,000 open-loop dc gain.

# RCA "Overlay" Transistors

## at home anywhere in the RF power range

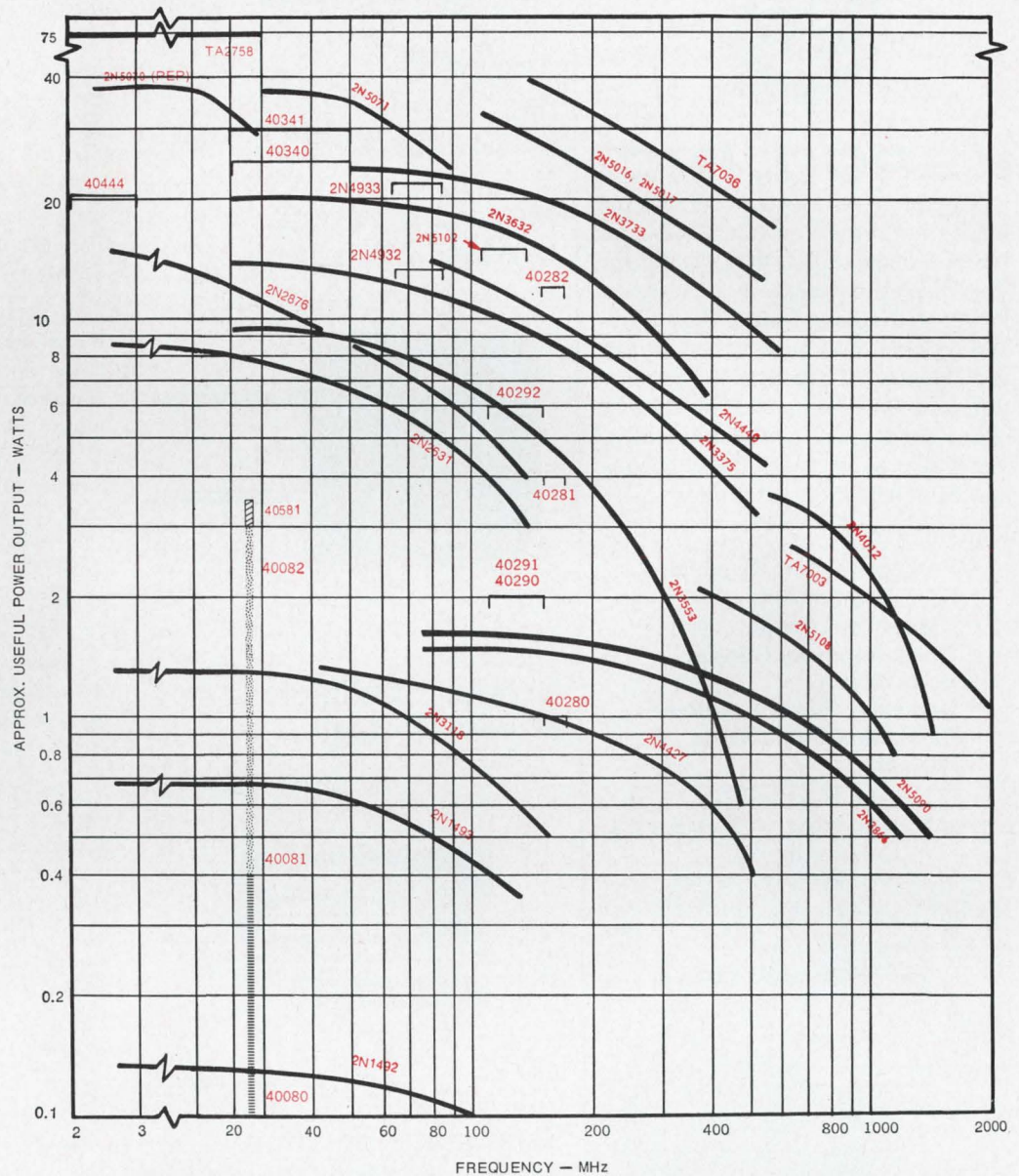
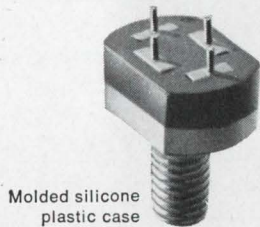
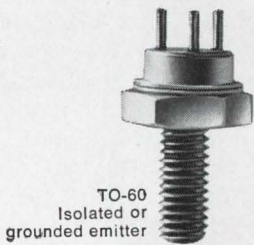

RCA offers you the broadest line of rf-power transistors in the industry. For more information on RCA "overlay" transistors see your RCA Representative or your RCA Distributor. For technical data on specific types, write: RCA Commercial Engineering, Section PG3-1, Harrison, N.J. 07029.

# RCA

INFORMATION RETRIEVAL NUMBER 42

# COME... ...HEAR The Latest in Power Supply Technology



## KEPCO, INC.

will again present its popular lecture/film series at the New York Coliseum (second floor) during the IEEE Show. The theatre entrance is adjacent to Kepco's display, Booth No. 2F51-2F53. Come hear qualified engineers and scientists discuss the new operational analog for power regulators, offset ratings and applications data. We'll also have new product seminars, demonstrations, and films.

Find out about:

- Precision Power Regulators
- Fast Programming
- Digital Techniques
- Quick Recovery Current Regulators
- Computer Power Supplies
- Redundant Overvoltage Protectors

All at the **KEPCO  
POWER SUPPLY THEATRE**

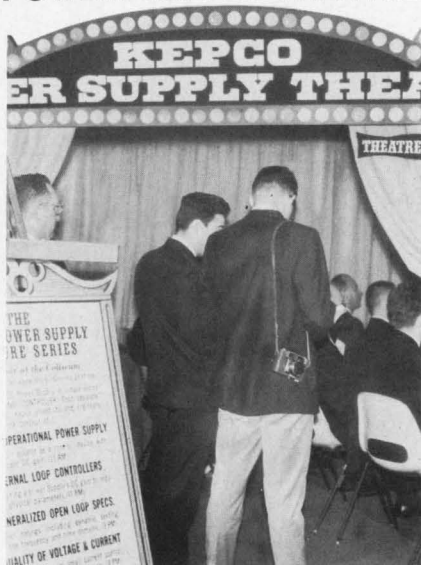

BOOTH 2F51



131-38 SANFORD AVENUE • FLUSHING, N.Y. 11352

INFORMATION RETRIEVAL NUMBER 43

## COMPONENTS

### Ten-inch dia CRT resolves 2 mils

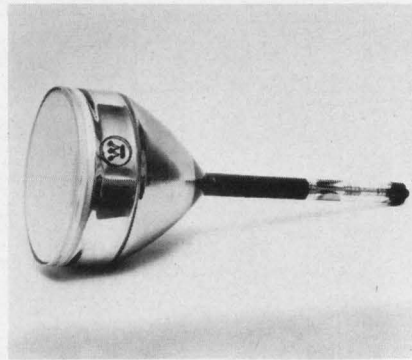

Westinghouse Electronic Tube Div.,  
Elmira, N.Y. Phone: (607) 739-  
3611.

A magnetically focused CRT features a 10-in. optically flat faceplate and line width of only 2 mils. Typical applications include data handling, film scanning for graphic arts equipment in the printing industry, and flying-spot scanning. The tube is aluminized and has 50 deg magnetic deflection. It can be supplied with most of the standard JEDEC phosphors.

CIRCLE NO. 322

### Miniature resistor carries 2-W rating

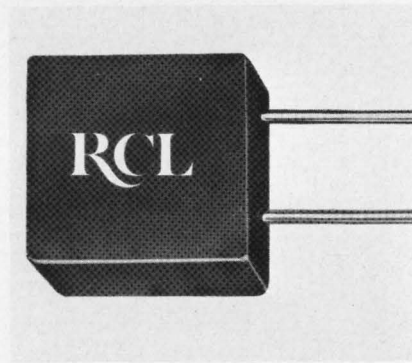

RCL Electronics, Inc., 700 S. 21st  
St., Irvington, N.J. Phone: (201)  
374-3311.

A rectangular resistor, with dimensions of 0.295 × 0.3 in., is fully encapsulated, has all-welded construction, and features a maximum resistance of 200 kΩ. Rated at 0.20 W, it is available in tolerances ranging from 0.01% to 1% and resistance values from 0.1 Ω. Operating temperatures are from -55°C to +125°C, derated to zero at 150°C.

CIRCLE NO. 323

### Crystal oscillator drives IC logic

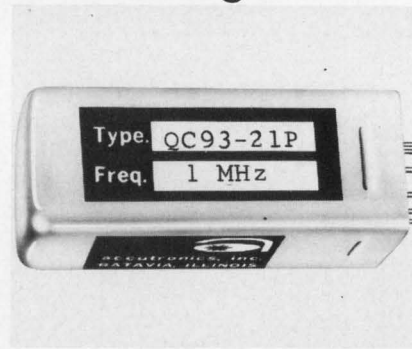

Accutronics, Inc., 628 North St.,  
Geneva, Ill. Phone: (312) 232-2600.  
Price: \$37.50.

Designed to drive all types of IC logic, a crystal oscillator develops square wave output voltages of 0 ±0.5 V to between 2 and 5 V peak with rise and fall times of under 60 ns. The oscillator is available in standard frequencies of 1, 2, 5, 10 and 20 MHz with a frequency stability of ±0.01% from +15°C to +45°C.

CIRCLE NO. 324

### Solid-state op amp drifts less than 0.1 μV



Julie Research Laboratories, Inc.,  
211 W. 61st St., New York. Phone:  
(212) 245-2727.

All-solid-state self-contained operational amplifiers are drift-free and low in noise content. Maximum short-term noise, flicker and drift are 0.1 μV pk-pk. Designed for dc applications where accurate and linear current amplification is required, one model has an output level of up to 40 mA into a 750-Ω load.

CIRCLE NO. 325

**Back up data on the  
smallest, fastest military memory weighs  
more than the  
smallest, fastest military memory.**

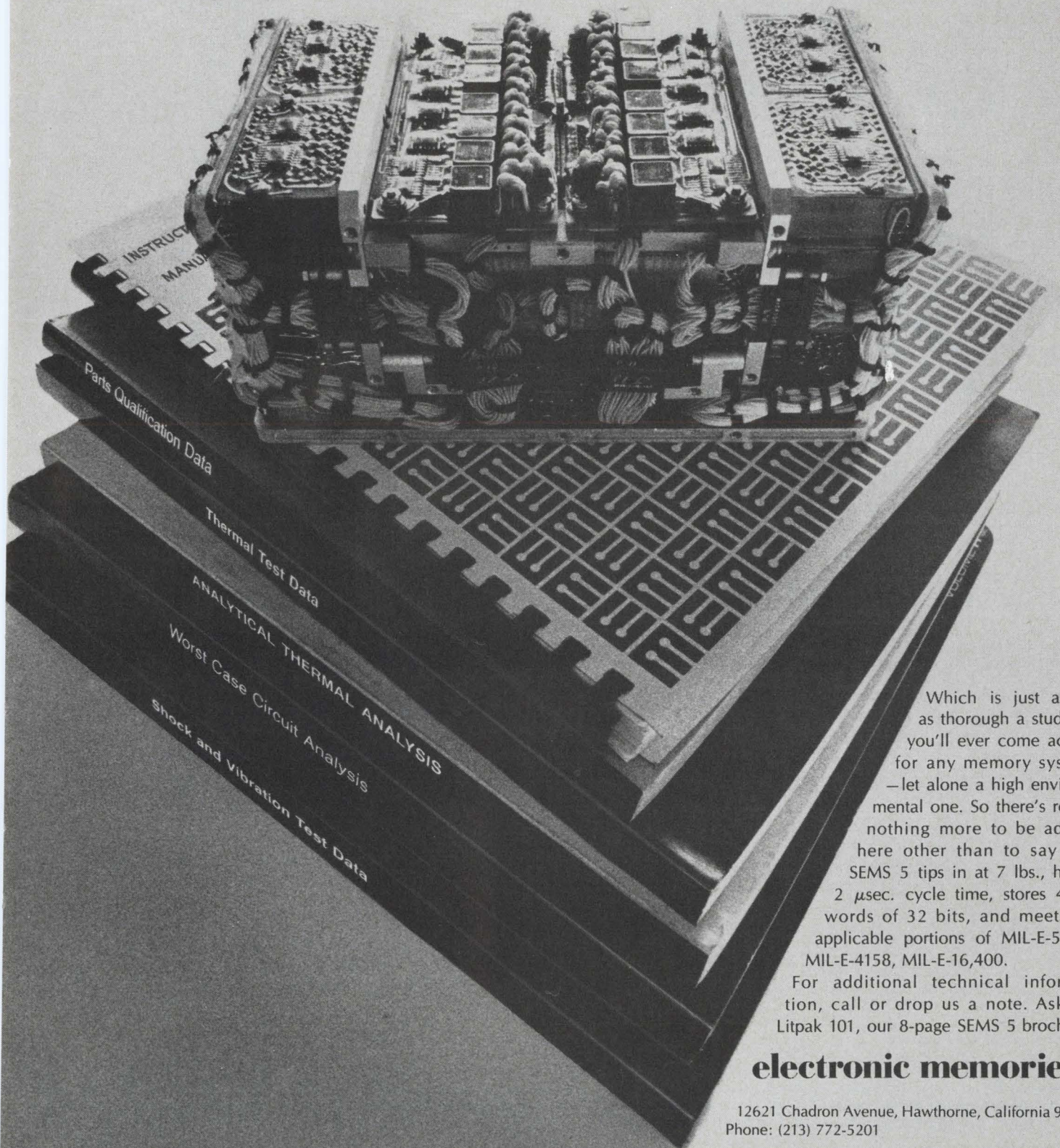

Which is just about as thorough a study as you'll ever come across for any memory system —let alone a high environmental one. So there's really nothing more to be added here other than to say our SEMS 5 tips in at 7 lbs., has a 2  $\mu$ sec. cycle time, stores 4096 words of 32 bits, and meets all applicable portions of MIL-E-5400, MIL-E-4158, MIL-E-16,400.

For additional technical information, call or drop us a note. Ask for Litpak 101, our 8-page SEMS 5 brochure.

## **electronic memories**

12621 Chadron Avenue, Hawthorne, California 90250  
Phone: (213) 772-5201

# At last, here's a full line of time-delay relays.



## (We took our time)

True, we weren't first with commercial time-delay relays. But now we're the most complete. With a tough, versatile line that gives you full choice, whether your specifications call for precision and long life, or economy.

Our low-cost thermal-time-delay line (background) includes both panel-mount and plug-in forms rated 2 amps resistive.

Our solid-state-timer designs (foreground) include our High Performance Line ( $\pm 2\%$  accuracy) rated 10 amps resistive, with a miniature unit rated 2 amps resistive. And a Standard Line ( $\pm 10\%$  accuracy) rated 10 amps resistive, at a lower price.

Whatever your needs, your Cutler-Hammer Sales Engineer or Stocking Distributor is ready to serve you now.



Circle the reader service number below for our free catalog.

**CUTLER-HAMMER**  
Milwaukee, Wisconsin 53201



INFORMATION RETRIEVAL NUMBER 45

## COMPONENTS

### Low-cost NIXIE tube IC compatible



Burroughs Corp., Electronic Components Div., Plainfield, N.J.  
Phone: (201) 757-5000. P&A: \$3.95 (1000 lots).

Measuring 0.53 in. in dia by 1.5 in. high with a numeral height of 0.5 in., Burroughs new cold-cathode indicator is compatible with ICs. The tubes are being built by the Japan Radio Company to Burroughs specifications under a joint engineering program.

Designated type B-5750, they are designed for low-cost digital voltmeters, calculators and counting instruments. A design twist allows the tube to be operated in time-sharing applications where higher than normal current is needed. This time-sharing operation permits all like numerals to be driven in parallel while the tube anode is strobed. Reduction in driver costs for many applications can be achieved. In addition to the digits, two decimal points are included.

Operating from 170 V dc, the tube illuminates with a brightness of 200 ft-lamberts. This is enough illumination for the readout to be viewed from as much as 24 ft away. A pin-spacer standoff, which is used to align the tube pins for ease of printed circuit insertion, is part of the tube assembly. The standoff also allows gas to escape during soldering operations.

It is designed to withstand 250 g for 1 ms and it has a life expectancy of 200,000 hours. Leads are pre-tinned for ease of soldering.

CIRCLE NO. 326



## Metal-film resistors span 1 to 4600 $\Omega$

Angstrom Precision Inc., 7811  
Lemona Ave., Van Nuys, Calif.  
Phone: (213) 989-3061. P&A:  
\$1.80; stock.

Adjustable metal-film resistors with no moving parts may be trimmed by the user before or after installation down to one-fifth their base value, with accuracies to  $\pm 0.02\%$ . Twelve base resistance ranges cover over 350 standard 1% values from 1 to 4600  $\Omega$ . The device size is  $0.085 \times 0.09 \times 0.02$  in. Its rating is 1/20 W at 125°C.

CIRCLE NO. 327

## Photocell and amplifier respond to 5750Å



Vactec, Inc., 2423 Northline Industrial Blvd., Maryland Hts., Mo.  
Phone: (314) 432-4200. Price: \$93.

A module that combines a selenium photocell detector with a matched solid-state amplifier provides high quantum efficiency and sensitivity at visible wavelengths. The radiometric response of the cell is  $0.3 \mu\text{A}/\mu\text{W}$  at 5750 Å. The 2-in.-dia-by-1.5-in. module provides an output from 0 to 10 V dc and is linear within 1% over five decades of illumination. High available gain allows the use of inexpensive meters for readout. The unit operates in a temperature range of up to 65°C with less than 0.2%/°C change in output. Low-voltage power supplies or batteries can be used. There is no warm-up time and a response of less than 100  $\mu\text{s}$  is typical of the photo-detector.

CIRCLE NO. 328

**A standard fastener from the WORLD'S MOST COMPLETE LINE will save you TIME and MONEY**

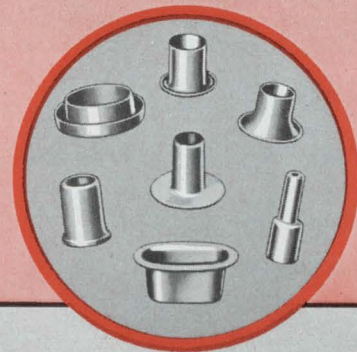

Instead of a special, perhaps one of our standard fasteners can meet your requirements.

We make a tremendous variety of eyelets, grommets, rivets, washers, snap fasteners, ferrules, hole plugs, terminals, and other similar fasteners. Tell us what you need and let us submit a standard fastener.

Send for our general catalog which illustrates over 1000 metal articles.



# Stimpson



70 FRANKLIN AVENUE,  
BROOKLYN, NEW YORK 11205

ULster 5-3131

1515 S.W. 13th COURT,  
POMPANO BEACH, FLA. 33060

WEbster 3-3355

See us at Booth 1D17  
INFORMATION RETRIEVAL NUMBER 46

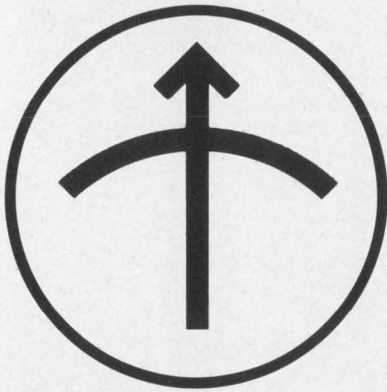

## MEASUREMENTS

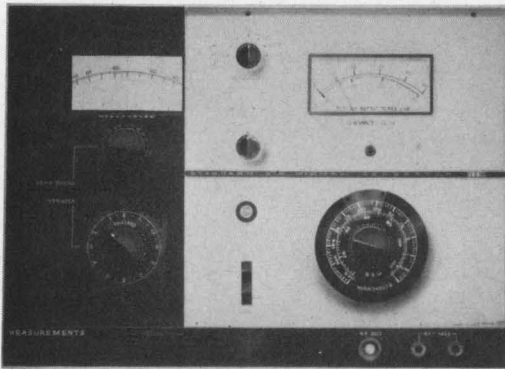

### MODEL 188 STANDARD FM SIGNAL GENERATOR

- Carrier frequency: 86-108 mcs.
- Frequency accuracy:  $\pm 0.5\%$
- Output voltage: 0.1 to 100,000 microvolts across 50 ohms
- Deviation: 0 to 300 kcs. in 3 ranges
- Source impedance: 50 ohms; low VSWR
- Distortion: Less than 0.5% at 75 kcs. deviation
- Modulation fidelity: Within 1db to 75 kcs; less than 3db down at 200 kcs.

10

Laboratory Standards



## MEASUREMENTS

A McGraw-Edison Division

P.O. Box 180, Boonton, N. J. 07005

Phone: 201-334-2131

INFORMATION RETRIEVAL NUMBER 47

## SEMICONDUCTORS

### Silicon MOS FET chops and multiplexes

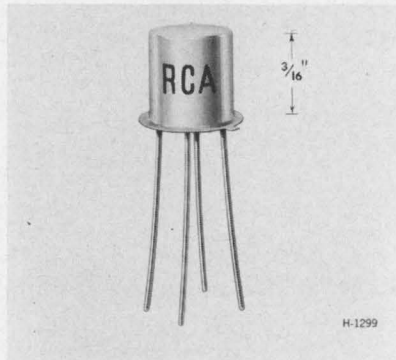

CIRCLE NO. 329

RCA Electronic Components and Devices, Harrison, N.J. Phone: (201) 485-3900. P&A: 96¢ (1000 pieces); stock.

A silicon MOS FET of the N-channel depletion types is intended for chopper and multiplex service. The MOS device features a terminal arrangement which provides maximum isolation between the output and the input terminals. Typical ratings are 200  $\Omega$  on resistance,  $10^{10}$   $\Omega$  off resistance and 0.34 pF feedback capacitance at zero drain-to-source volts.

### Silicon transistors carry 20 amperes



CIRCLE NO. 330

Solitron Devices, Inc., Transistor Div., Riviera Beach, Fla. Phone: (305) 848-4311.

A line of 20-A pnp silicon power transistors is packaged in a TO-61 case. These devices have breakdown voltages of up to 100 V. They offer a gain range of 30 to 90 at a collector current of 10 A. Collector saturation voltage is 1.75 V max and base saturation voltage is 2.5 V max. Similar 10-A devices are also available.

### Silicon rectifiers handle 2 A at 25°C

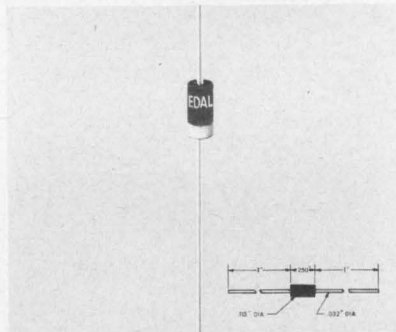

CIRCLE NO. 331

Edal Industries, Inc., 4 Short Beach Rd., East Haven, Conn. Phone: (203) 467-2591.

Miniature silicon rectifiers offer currents to 2 A at 25°C ambient temperature and voltages to 1200 PIV. Axial lead, tubular insulated construction and small size (1/4 in.  $\times$  0.115 in. dia) facilitate circuit board and point-to-point wiring. Weight is 0.4 g. Humidity requirements of MIL standard 202A, method 106, are met.

### Pnp alloy transistors packaged three ways

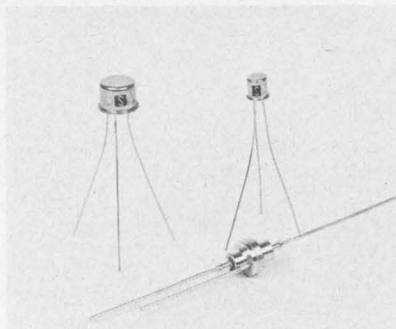

CIRCLE NO. 332

Solitron Devices, Inc., Transistor Div., 1177 Blue Heron Blvd., Riviera Beach, Fla. Phone: (305) 848-4311.

A line of small signal pnp silicon alloy amplifier and chopper transistors, available in TO-5, TO-18 and coaxial packages, exhibit high breakdown voltages, symmetrical breakdown voltages and high inverse gain. The coaxial package has a rating of 1 W in free air.

# HP isn't in the photocell business by accident.

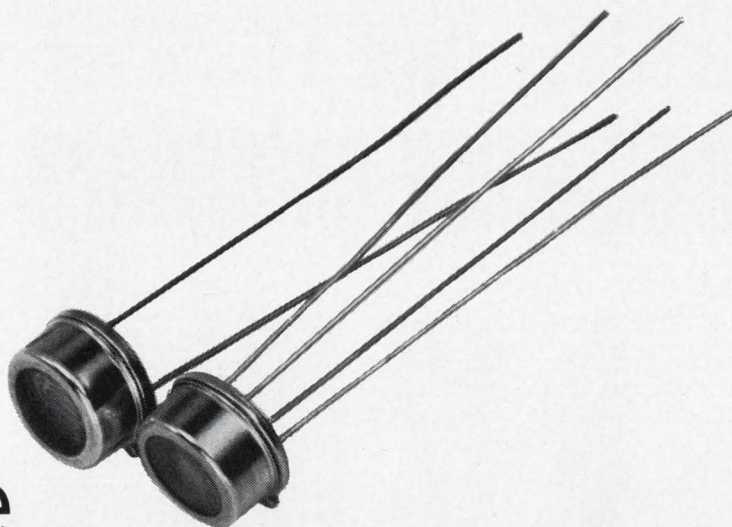

We're in it to deliver a superior line of products—and there's a lot of thought behind the current availability of photoconductors from Hewlett-Packard.

It all started ten years ago when HP found an urgent need for a reliable supplier of photocells for its instrumentation—a supplier who could deliver *and* keep the reject rate down. The decision was unavoidable—HP should produce its own photocells.

With the development by the HP engineering staff of new photoconductive materials that optimized speed and stability in early photoconductors, a whole new department was started at HP. It was charged with developing efficient production methods and close

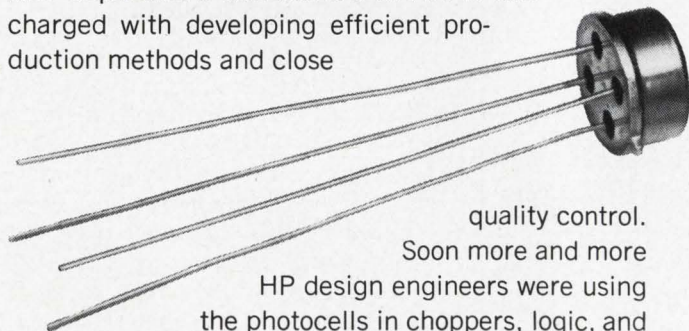

quality control. Soon more and more HP design engineers were using the photocells in choppers, logic, and circuit control applications, requiring growth in the size and capability of the photoconductor department and its ability to bring unique R & D efforts to the photocell business. With its own plant, a separate

applications group, complete production facilities and a vigorous new product program, this department no longer makes photoconductors only for HP—it's now *your* source, too.

HP's line of photocells, modulators, photo-controlled resistors and photochoppers represents the best optimization of overall photocell performance—and HP also has the engineering know-how to give you the customized "special" design attention you may require. HP experience provides the reliability you need, too.

If you're looking for a photoconductor product, check with HP before deciding on one. We can talk your own particular application language, giving appropriate performance data and specifications.

Write Bob Santos, Hewlett-Packard, 620 Page Mill Road, Palo Alto, California 94304; or call him collect at (415) 321-8510. In Europe write: 54 Route des Acacias, Geneva.

**HEWLETT  PACKARD**

**SOLID STATE DEVICES**

01713

INFORMATION RETRIEVAL NUMBER 48

NEW COVERAGE

# tuners and receiver frequency extenders

8-12 GHz  
4-8 GHz  
1-4.5 GHz  
2-4.5 GHz  
1-2 GHz

Tunable 4-section YIG preselectors • 21.4 and 160 MHz outputs • manual and motor-driven • Call or write for specifications.

NOW by CEI — 1 kHz  $\Rightarrow$  12 GHz



**COMMUNICATION ELECTRONICS**  
6006 Executive Blvd., Rockville, Md. 20852  
301/881-3300 • TWX 710-824-9603

SUBSIDIARY OF WATKINS-JOHNSON  
INFORMATION RETRIEVAL NUMBER 49

PRODUCTION EQUIPMENT

Assembly tool bends  
leads of component

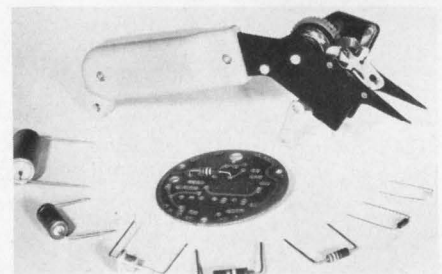
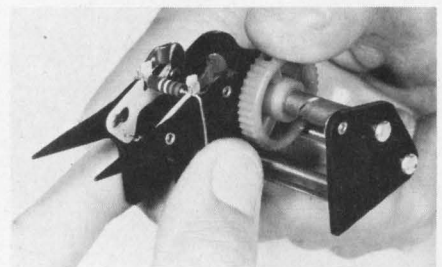
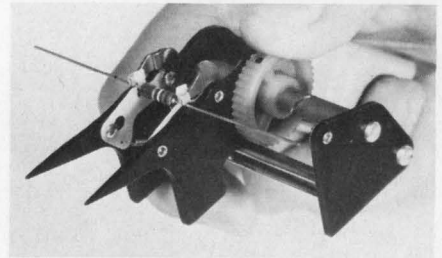
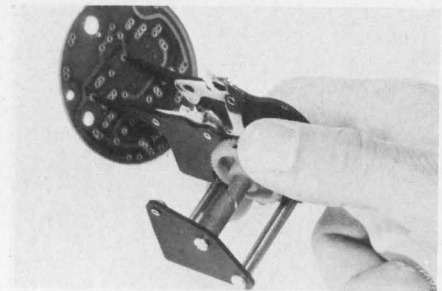

*Harvil Co., 1009 Montana Ave.,  
Santa Monica, Calif. Phone: (213)  
394-4710.*

A hand tool, model N-300, is used for fast, accurate bending of electronic component leads for insertion into printed-circuit boards and eliminates measurement and trial-and-error methods. Spinning a knurled wheel matches a pair of pointers with the holes in a circuit board. The bends are then formed by pressing leads against the sides of the pointers with thumb and forefinger. All axial lead components up to 1/2 in. dia  $\times$  1-1/2 in. long can be accommodated.

CIRCLE NO. 333

## Abrasive jet process cuts, trims or etches

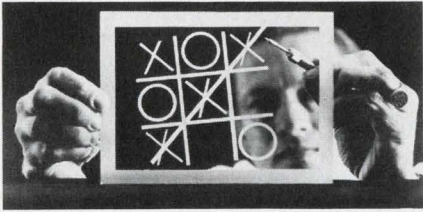

S. S. White Co., Industrial Div.,  
201 E. 42 St., New York. Phone:  
(212) 661-3320.

Applications include trimming trick-film resistors to thin sections of any fragile material. The work is done by a high-velocity stream of fine ( $27 \mu\text{m}$ ) abrasive particles such as silicon carbide, aluminum oxide, sodium bicarbonate, dolomite or ground glass. The tool may also be used to etch glass or metal.

CIRCLE NO. 334

## Tooling system deposits uniformly

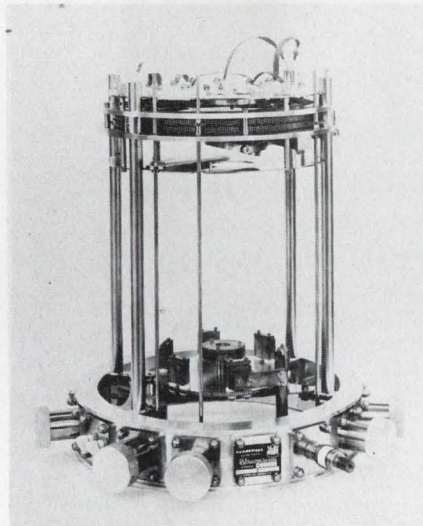

Allen-Jones Electronics, Div. of  
WEMS, Inc., 17171 S. Western  
Ave., Gardena, Calif. Phone: (213)  
321-9490.

A tooling system that offers uniform deposition for semiconductor applications permits the vertical adjustment of both evaporation source array and modulator to vary source-to-substrate distance as much as 20 in. A single planetary gear offers rotational speeds up to 100 rpm and a quartz-lamp substrate heater array provides controllable temperatures to  $400^{\circ}\text{C}$ .

CIRCLE NO. 335

dip  
soldering  
on  
a  
metal  
chassis

**PRESS-FIT<sup>®</sup>**

# CLOVERLEAF<sup>®</sup>

## TEFLON\* RECEPTACLES

Press-Fit Cloverleaf Receptacles provide new economies in production of hand-wired, metal chassis electronic assemblies. For the first time, metal chassis may be dip or wave-soldered just as you do P.C. boards and with uniformly perfect solder joints everytime.

The unique Cloverleaf configuration permits insertion of four or more wire leads plus an optional center post for mounting additional components or external leads. This design provides an encompassing hold on the leads while allowing excellent capillary flow of solder. The Cloverleaf receptacle is manufactured of virgin Teflon and precisely machined to "Press-Fit" into the chassis for fast, positive and economical installation.

The inherent reliability of Cloverleaf/metal chassis construction makes it ideal for use in high density electronic packaging. The low unit cost of the terminal and its simple installation provides a new and economical assembly technique for quality radio and television production.

\*Reg. T.M. E.I. DuPont deNemours & Co.

U.S. Patent No. 3,193,617

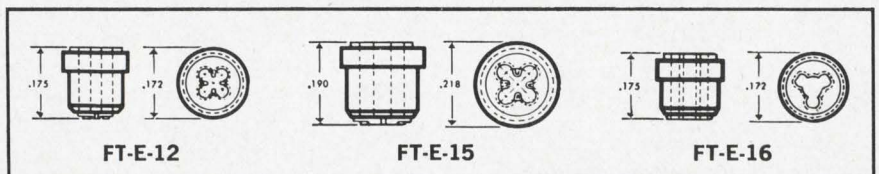

CIRCUIT HARDWARE DIVISION

**SEAELECTRO**

CORPORATION

MAMARONECK • NEW YORK

PHONE: 914 698 - 5600 TWX: 710-566-1110

Seaelectro Ltd., Portsmouth, Hants, England

See us at IEEE booths, 4C-20, 22 and 24

INFORMATION RETRIEVAL NUMBER 50

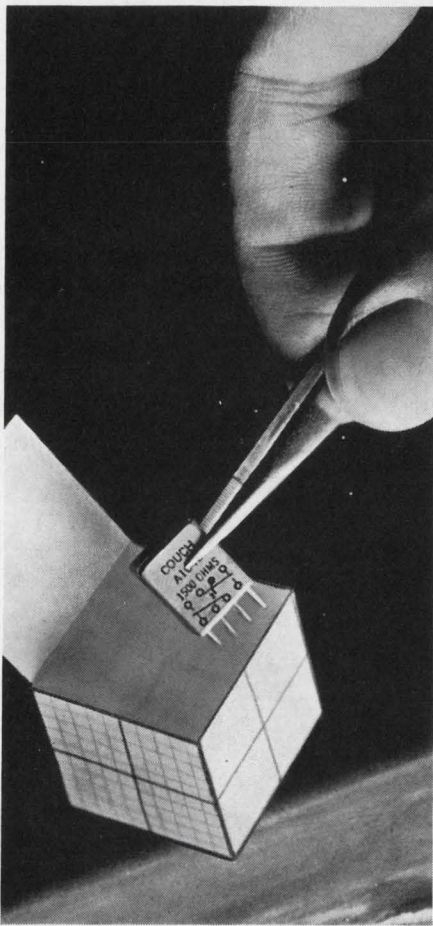

## Couch 2X 1/7-size relays meet MIL-R-5757D/19 in 1/25th of a cubic inch

The new, third generation Couch 2X relays solve switching problems where space and weight are critical. Thoroughly field-proven in electronic and space applications. Relays are delivered *fully tested*. Additional screening tests available at your option.

	2X (DPDT)	1X (SPDT)
Size	0.2" x 0.4" x 0.5"	same
Weight	0.1 ox. max.	same
Contacts	0.5 amp @ 30 VDC	same
Coil		
Operating Power	100 mw 150 mw	70 mw 100 mw
Resistance	60 to 4000 ohms	125 to 4000 ohms
Temperature	-65°C to 125°C	same
Vibration	20 G to 2000 Hz	same
Shock	75 G, 11 Ms	same

Broad choice of terminals, coil resistances, mounting styles. Write for detailed data sheets.

RUGGED ROTARY RELAYS  Dynamically and Statically Balanced

**Couch**  
1894

### COUCH ORDNANCE INC.

3 Arlington St., North Quincy, Mass. 02171  
Area Code 617 CYPRESS 8-4147

A subsidiary of S. H. COUCH COMPANY, INC.  
INFORMATION RETRIEVAL NUMBER 51

## SYSTEMS

### Time code generator reads out at 9 rates

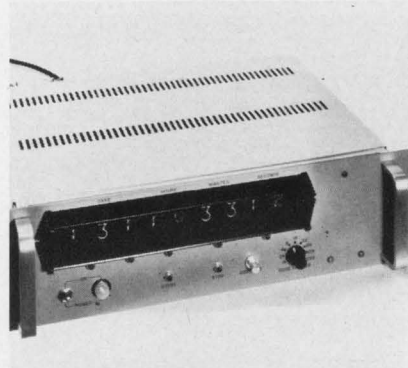

Flow Corp., 127 Collidge Hill Rd., Watertown, Mass. Phone: (617) 924-8505.

This time code generator generates the IRIG-B time-of-year code (days, hours, minutes and seconds) at nine selected digit rates and corresponding carrier frequencies for indexing magnetic tape at real time or at selected speed ratios up to (1/256 of real time). Used for time-indexing magnetic tape at high speed.

CIRCLE NO. 336

### Laboratory computer cycles in 1 $\mu$ s

Spear, Inc., 335 Bear Hill Rd., Waltham, Mass. Phone: (617) 899-4800. P&A: \$50,000; 90 days.

The Micro-Linc-300 offers a 1- $\mu$ s cycle time and a buffered tape, which permits parallel processing while tape instructions are being carried out. A RAM (rapid access to memory) feature has been added which, in conjunction with buffered tape, permits data logging at 6000 character/s rate. Other characteristics include a 4096-word core memory (expandable to 32,000); 3 million bits of tape storage, expandable to 12 million bits; alphanumeric CRT; 9-bit A/D converter with conversion rate of 7  $\mu$ s; 16 analog input channels (expandable to 32); and 12 digital sense lines and a 12-bit parallel input to the accumulator. Maximum analog sampling rate is 110,000 samples/s, continuous sampling rate is 6000 samples/s.

CIRCLE NO. 337

### Magnetic-core memory cycles in 900 ns

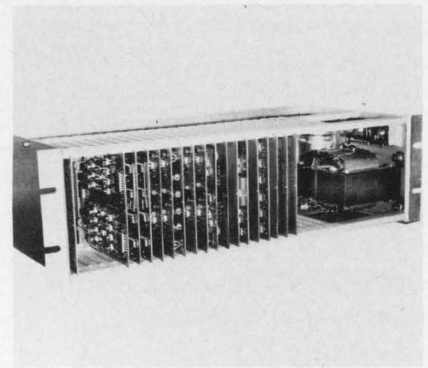

Datacraft Corp., 776 N.E. 40th Court, Ft. Lauderdale, Fla. Phone: (305) 565-9441. P&A: \$1210; 30 days.

The Model DC-31 magnetic-core memory is a compact, two-dimensional, high-speed, memory that features random-access operation with a full-cycle time of less than 900 ns. Memory access time is less than 450 ns. Maximum capacity of the unit is 1024  $\times$  12 in one-bit-per-word increments.

CIRCLE NO. 338

### Digital logger records analog data

Control Equipment Corp., 19 Kearney Rd., Needham Hts., Mass. Phone: (617) 444-7550. P&A: \$7500-\$15,000; 60 days.

A portable digital-data logger automatically measures and records signals from multiple installations of transducers or electrical pickups. The data are recorded in digital form for later computer entry or manual study. Complete in one package, the data logger scans, digitizes and records analog information. It can be used to measure and record any combination of physical parameters that is convertible by transducers to voltage, current, or resistance. Some examples are temperatures, pressures, velocities, accelerations, weights, displacements and positions. It also records digital data from keyboards, shaft encoders, counters and digital transducers, and generates time and identification information.

CIRCLE NO. 339

## ERA LC COMPACT MODULES

Output Voltage (DC)	Current (71°C)	Model	Price
4-32	0-750 ma	LC32P7	\$ 89.00
4-32	0-2 amps	LC322	\$115.00
4-32	0-5 amps	LC325	\$179.00
4-32	0-10 amps	LC3210	\$215.00
30-60	0-1 amp	LC601	\$145.00

### SPECIFICATIONS

**Input:** 105-125 VAC, 50-400 cps  
**Ripple:** Less than 800 microvolts RMS  
**Line Regulation:** Better than  $\pm 0.01\%$   
**Load Regulation:** Better than 0.05% for 0-100% load change  
**Transient Response:** Less than 50 microseconds  
**Operating Temperature:**  $-20^{\circ}\text{C}$  to  $+71^{\circ}\text{C}$  free air, full ratings  
**Temperature Coefficient:** Less than 0.01% per degree C

Write Today for Catalog #147A

## ERA WR ULTRA-COMPACT MODULES

Output Voltage (DC)	Current (71°C)	Model	Price
1-33	0-500 ma	WR33P5	\$120.00
1-33	0-1 amp	WR331	\$155.00
1-33	0-2 amps	WR332	\$185.00
1-33	0-4 amps	WR334	\$255.00
1-33	0-8 amps	WR338	\$305.00

### SPECIFICATIONS

**Input:** 105-125 VAC, 50-400 cps  
**Ripple:** Less than 800 microvolts RMS  
**Line Regulation:** Better than  $\pm 0.01\%$   
**Load Regulation:** Better than 0.05%  
**Transient Response:** Less than 50 microseconds  
**Operating Temperature:**  $-20^{\circ}\text{C}$  to  $+71^{\circ}\text{C}$  free air, full ratings  
**Temperature Coefficient:** Less than 0.01% per degree C

Write Today for Catalog #148A

## ERA ST SLIM PROFILE MODULES

Output* Voltage (DC)	Current* (71°C)	Model	Price
1-63	0-1 amp	ST1000	\$155.00
1-33	0-1 amp Dual	ST1000-2	\$195.00
1-33	0-2 amps	ST2000	\$175.00

### SPECIFICATIONS

**Input:** 105-125 VAC, 50-400 cps  
**Ripple:** Less than 800 microvolts RMS  
**Line Regulation:** Less than 0.01%  
**Load Regulation:** Less than 0.05%  
**Transient Response:** Less than 50 microseconds  
**Operating Temperature:**  $-20^{\circ}\text{C}$  to  $+71^{\circ}\text{C}$  free air, full ratings  
**Temperature Coefficient:** Less than 0.01% per degree C

Write for Catalog #149

# With these power modules you get wide VDC ranges—and set your own slot!

Frustrated by the narrow voltage ranges of conventional power modules? Now you can specify *wide range* ERA Transpac® modules and *set any module to any voltage slot* within its range!

- You automatically eliminate power supply obsolescence while you simplify your stocking problem
  - Three repairable 71°C wide range lines to choose from—low cost (LC) types, ultra-compact (WR) types and slim profile Slim Tran® (ST) types
  - Same precision ERA specs throughout.
- Send for literature today.

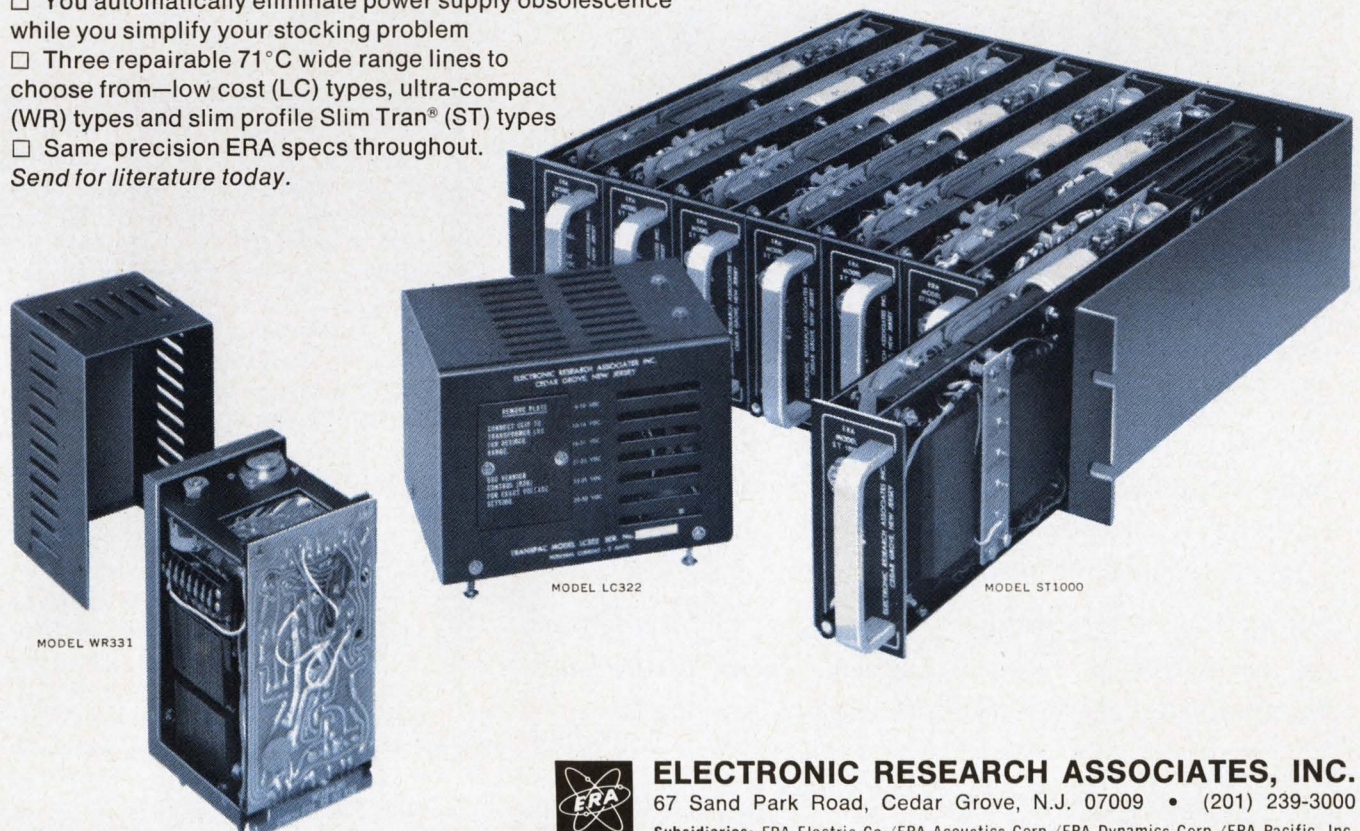

**ELECTRONIC RESEARCH ASSOCIATES, INC.**

67 Sand Park Road, Cedar Grove, N.J. 07009 • (201) 239-3000

Subsidiaries: ERA Electric Co./ERA Acoustics Corp./ERA Dynamics Corp./ERA Pacific, Inc.

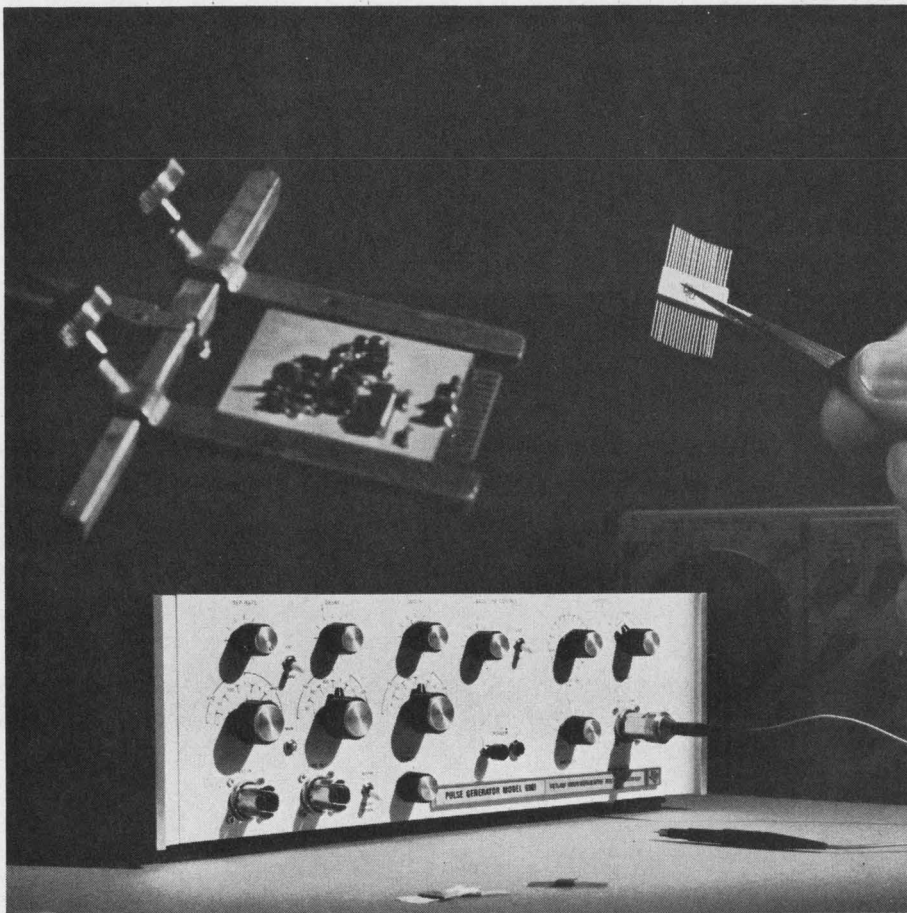

## Why You Need a Special Pulse Generator for State of the Art Circuit Design

With high speeds and critical design parameters, you need the best test instruments to be sure your designs will be optimum. The TI Model 6901 Pulse Generator gives outputs from 1 KHz to 0.1 GHz; independent amplitude and baseline controls; jitter less than 0.1% of period + 50 psec; and count-down synchronization output.

The 6901 makes your designing simpler, too. Because the pulse amplitude of the generator can be changed without affecting DC offset, you can use the offset instead of an external bias supply for your circuit.

For additional information, contact your TI Field Office, or the Industrial Products Division, Texas Instruments Incorporated, P. O. Box 66027, Houston, Texas 77006.

**TEXAS INSTRUMENTS**  
INCORPORATED

INFORMATION RETRIEVAL NUMBER 53

827 A

## SYSTEMS

### Portable data coupler for telephone use

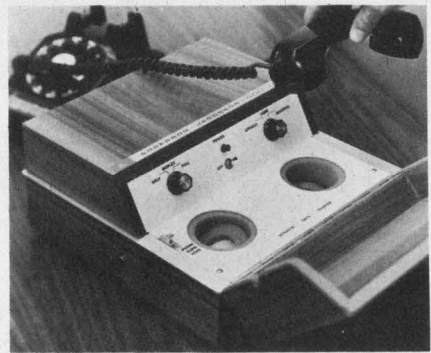

*Anderson Jacobson, Inc., 2235 Mora Dr., Mountain View, Calif. Phone: (415) 968-2400. Price: \$570.*

For sending and receiving data between a remote terminal and a time-shared computer, the Acoustic Data Coupler uses any telephone. It is used typically with a model 33 or 35 Teletype but can be used interchangeably with EIA RS-232 specification interface teleprinters that can operate with a 103A Dataphone. This includes the Friden 7100, Datel Thirty-10, IBM 2741 and various card readers. The teleprinter-coupler combination provides a remote computer terminal which can be moved from one place to another wherever a telephone is available. Coupling with the telephone system is acoustic both into and out of the telephone system, assuring compatibility with telephone handsets of various magnetic-field configurations. Operation is independent of signal level, above a required minimum, and no adjustment is required. A "carrier on" indicator is provided to help with system diagnostics. The ADC 260 is designed to handle a bit rate of approximately 300 Baud. It is used at a 110-Baud rate when used with a Model 33 or 35 Teletype. Transmission characteristics are fully compatible with using a 103A Dataphone at the computer end of the telephone line, with switches provided for both upright and inverted codes and full and half duplex. No special interface in the Teletype is required except to install a connection cable which is included. EIA Specification terminals plug in directly.

CIRCLE NO. 340



## Telemetry receiver powered by 12 V dc

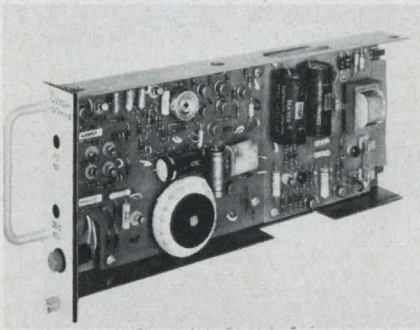

Quindar Electronics, Inc., 60  
Fadem Rd., Springfield, N.J.  
Phone: (201) 379-7400.

An analog telemetering receiver has been developed for use where ac power is not available. Normal operation is from a 12-V dc power source, but higher voltages may be accommodated by the addition of a voltage divider accessory. Completely solid-state, the unit requires no temperature control oven and its low power requirement of 2 W contributes to cool operation.

CIRCLE NO. 341

## Data switch makes 512 contact closures



3M Co., Instrument Products, 300  
S. Lewis Rd., Camarillo, Calif.  
Phone: (805) 482-1911.

A data switch offers up to 512 contact closures with no closure excluding the possibility of another. Programing format consists of an address signal followed by BCD characters to generate a three-decimal digit-interconnection number and a command number. The command column allows the data switch to be zeroed or interconnections to be made or opened.

CIRCLE NO. 342

Only the best  
panel meters have  
dual slope integration



actual size

## API's new digital panel meter

has it—which means the meter maintains its  $\pm 0.1\%$  accuracy (DC voltage) over long periods of time. Erroneous signal transients are eliminated also.

There are other digital panel meters, but this one has an exceptional combination of attributes. It doesn't flicker annoyingly. It counts fast and it reads fast, so that you are always seeing an up-to-the-split-second signal.

API's digital meter not only looks pretty, but its required panel space is only 3 inches high and 4½ inches wide. It has no "iceberg" configuration behind the panel. Standard ranges begin at 0 to 20 microamperes DC and 0 to 200 millivolts DC.

List price: \$320.00

See it at Booth No. 2G-34 and 36, IEEE Show.

Bulletin 61 has  
full details

# api

## INSTRUMENTS CO.

CHESTERLAND, OHIO 44026 • (CLEVELAND-216) 729-1611 • TWX: 810-427-9230

In Canada: Oshawa, Ontario • (416) 576-1541

INFORMATION RETRIEVAL NUMBER 54

# Wedge-Action\*

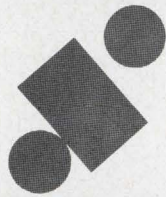

# Relays

Hermetically-sealed, electromagnetic relays that provide high performance and reliability under the most difficult operating conditions in dry-circuit to 2 amp applications.

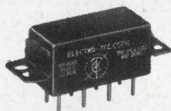

**2 PDT**  
MARK II, SERIES 500  
MIL-R-5757/9



**2 PDT**  
MARK II, SERIES 400  
(1.35" high)  
SERIES 410 (1" high)  
MIL-R-5757/8



**6 PDT 4 PDT**  
(1" x 1")  
MARK II, SERIES 300  
(6 PDT).  
SERIES 350 (4 PDT).  
MIL-R-5757/1 and  
MIL-R-5757/7



**6 PDT**  
MARK II, SERIES 085  
(-55°C to +85°C)  
SERIES 100  
(-65°C to +125°C),  
SERIES 200  
(-65°C to +200°C).  
MIL-R-5757/1.

### \*Wedge-Action



The moving contacts are mounted between two stationary contacts. On actuation, they drive into the stationary contacts, creating high pressures and low contact resistance at all current levels. In addition, wedge-action contact wipe provides self-cleaning of the precious-metal contacts.

\*Patent No. 2,866,046 and others pending.

For complete data write Relay Sales and Engineering Office, P. O. Box 667, Ormond Beach, Fla. 32074, Phone 904-677-1771, TWX 810-857-0305.

## Electro-Tec Corp.

SLIP RINGS • RELAYS • SWITCHES

INFORMATION RETRIEVAL NUMBER 55

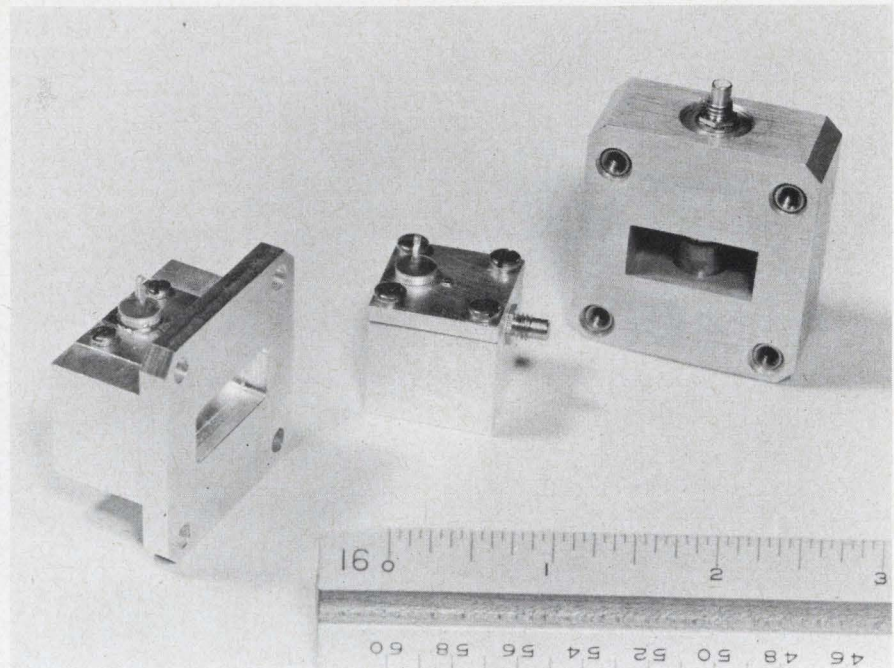

## Oscillators use diodes to generate at 10.525 GHz

Varian, Bomac Div., 8 Salem Rd., Beverly, Mass. Phone: (617) 922-6000. P&A: \$450; 60 days.

Semiconductor oscillators utilizing the (IMPATT) impact avalanche transit time principle deliver 60 mW cw at 10.525 GHz in the public service radio location band. Typical applications include use as local oscillators and in low-power railroad monitoring and police Doppler radar systems.

Earlier versions of IMPATT oscillators gained a reputation for being inherently noisy; avalanche breakdown gave rise to noise which took the form of amplitude and frequency modulation. In these devices a-m noise has been reduced enough to satisfy most system requirements. Although fm noise close to the carrier is still marginal, it falls off more rapidly with increasing displacement from the carrier than does the a-m noise. The noise figure of an X-band receiver that used the IMPATT oscillator has been compared with that of the same receiver using a low-noise tube oscillator. When a balanced mixer was used, the figures were within 0.2 dB of each other, although use of a single-ended mixer yielded an IMPATT noise figure that was 10

dB greater. The explanation of the discrepancy is that single-ended mixers respond to a-m as well as fm components of the local oscillator output.

The IMPATT diodes incorporated in these oscillators are constructed much like varactor diodes in terms of starting material, diffusion and packaging. The most notable difference is in the IMPATT diode's better thermal conduction. The surface of the active region of the silicon directly contacts the heat sink of the diode and the surface of the mesa, rather than the substrate, is bonded to the inner portion of the diode stud.

In operation, the diode of the X-band IMPATT oscillator is reverse-biased into breakdown by approximately 70 V, drawing a reverse current of about 40 mA. Under these conditions, the nominal 60-mW output is produced at a typical efficiency of 2%.

Weighing 4 oz, the oscillator can be mounted in any position. Dimensions are 1-5/8 x 1 in. deep—a volume less than 2-3/4 in.<sup>3</sup>. The output flange mates with UG-39/U and positive bias connection is made to a solder terminal. The oscillator case itself is negative.

CIRCLE NO. 343

# When reliability is the rule

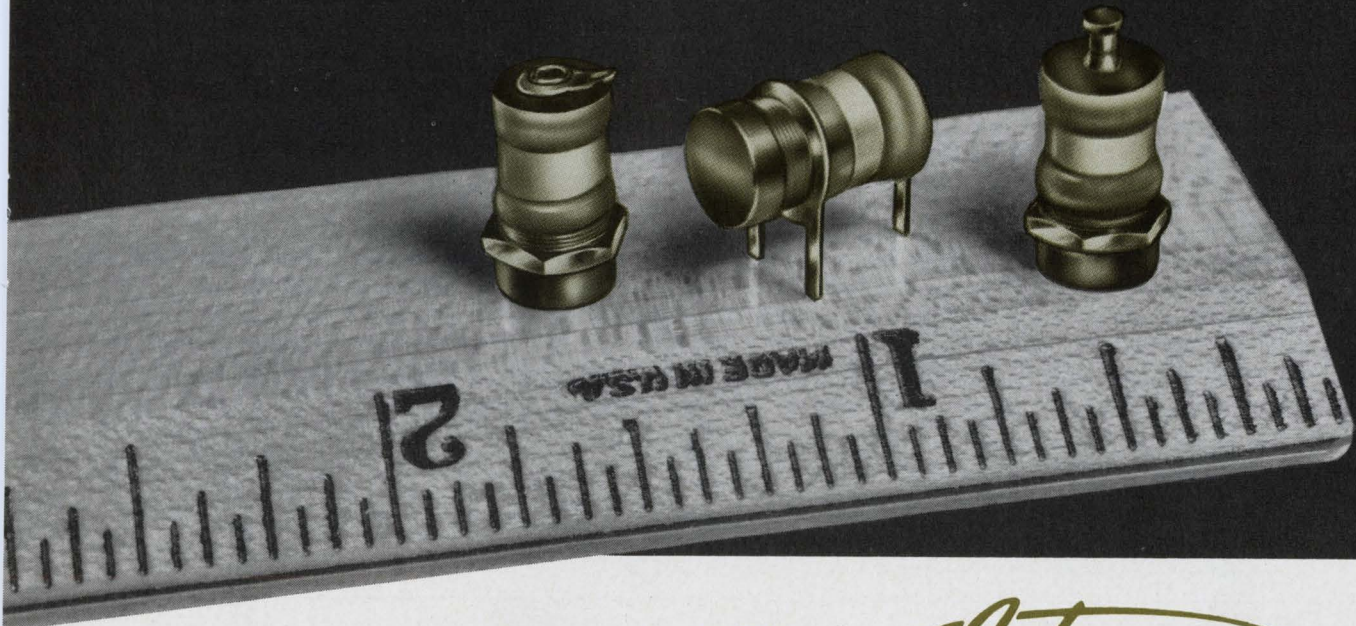

...specify *Johanson*

## HIGH Q, HIGH FREQUENCY VARIABLE AIR CAPACITORS

An extra margin of reliability is built into Johanson Miniature Variable Air Capacitors.

This versatile series provides, in miniature size, exceptionally high Q, superior ruggedness for protection against shock and vibration,  $-55^{\circ}\text{C}$  to  $+125^{\circ}\text{C}$  operating temperature range, protection against fungus, salt spray and humidity . . . plus all the other construction and performance features that have made Johanson capacitors the industry standard for excellence.

No compromise is made in materials, design or workmanship assuring, in all cases, the finest performance available for the price.

Test Johanson capacitors yourself — under your worst-case test conditions.

Write Today for Complete Catalog, Prices.

Features 570° Solder  
Prevents distortion. Not affected by  
conventional soldering temperatures.

### THE JOHANSON 2950 SERIES VARIABLE AIR CAPACITORS (ILLUSTRATED)

#### SPECIFICATIONS:

CAPACITANCE RANGE: . . . 0.8 — 10.0 pf.  
DIELECTRIC  
WITHSTANDING VOLTAGE: Rating 250 vdc  
Breakdown  $>$  500 vdc  
Q: . . . . .  $>$  2000 @ 100 mc  
TEMPERATURE  
COEFFICIENT: . . . . .  $0 \pm 20$  ppm/ $^{\circ}\text{C}$   
INSULATION RESISTANCE:  $>$   $10^6$  megohms @  
500 vdc  
ROTATIONAL LIFE: . . . . .  $>$  800 revolutions  
rotor screw  
THERMAL SHOCK: . . . . .  $65^{\circ}\text{C}$  to  $+125^{\circ}\text{C}$   
SHOCK: . . . . . 50 g's 11 millisecc.  
VIBRATION: . . . . . 15 g's 10-2000 cps

Complete data available on request.

The Complete Johanson line includes variable air capacitors ranging from .1-1 pf to 6.0 — 325 pf. also high-reliability and non-magnetic types.

*Johanson* MANUFACTURING CORPORATION

400 Rockaway Valley Road, Boonton, N. J. 07005

Phone (201) 334-2676

### Coaxial breakaway stretches 7 in.

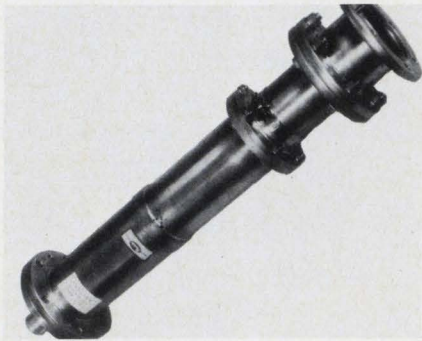

Prodelin, Inc., Hightstown, N.J.  
Phone: (609) 448-2800.

A coaxial line stretcher or breakaway maintains constant impedance over 7-in. travel with no adverse effects from high power. A VSWR not exceeding 1.02 at any frequency is maintained throughout the operating range. This design, featuring complete pressurization capability, makes it possible to break into a rigid transmission line system at any point.

CIRCLE NO. 344

### Black-body radiator measures 3/8 x 1/2 in.

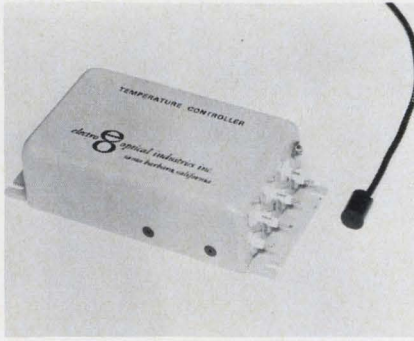

Electro Optical Industries, Inc.,  
P.O. Box 3770, Santa Barbara,  
Calif. Phone: (805) 968-2591.

This black-body radiation source measures only 3/8 in. dia by 1/2 in. long. Designated the model 111, the unit operates from 50°C to 600°C. It is available with either the temperature controller shown or as a conventional linear, proportional laboratory model. Long-term control stability is better than 0.1°C.

CIRCLE NO. 345

### Microwave stabilizer doubles as receiver

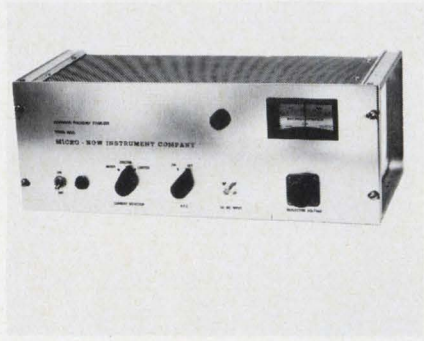

Micro-Now Instrument Co., Inc.,  
6124 N. Pulaski Rd., Chicago.  
Phone: (312) 282-0846.

Combining a high-gain 60-MHz i-f amplifier, limiter, discriminator, dc amplifier and a-m detector, this klystron-stabilizer/receiver is basically a stabilizer for microwave oscillators, but added features permit its use as a sensitive and versatile microwave receiver. Frequency range is limited by the external oscillator and mixer.

CIRCLE NO. 346

# MAGNETIC SHIELD REFERENCE GUIDE

SHEET STOCK

TO STOCKED NETIC & CO-NETIC  
MAGNETIC SHIELDING FOIL AND  
SHEETS FOR YOUR FABRICATION



THICKNESS	NETIC S3-6 SHEET WIDTH	CO-NETIC AA SHEET WIDTH	CO-NETIC AA FOIL IN COILS: (Specify length desired)	BLUE NETIC FOIL* IN COILS: (Specify length desired)	Both BLUE NETIC and CO-NETIC AA foils, plain and adhesive backed, can be furnished slit to any desired width, at additional cost—Ask for prices.
.014"	30"	30"	.010" thick x 15" wide	.004" thick x 19 3/8" wide	Request Catalog SG-1
.020"	30"	30"	.006" thick x 15" wide	.004" thick x 4" wide	
.025"	24"	30"	.004" thick x 15" wide	*BLUE NETIC foil not available in .002" thick	
.031"	26"	30"	.002" thick x 4" wide		
.049"	26"	30"	All foil also available adhesive backed. Other widths available to maximum above.		
.050"	26"	30"			
.062"	26"	30"			
.095"	26"	30"			
Maximum length is 120". Also sold in 15", 30" and 60" lengths. After fabrication, shields made from sheet must be heat treated for maximum shielding. No further annealing required. Pre-annealed stock also available.			<ul style="list-style-type: none"> <li>• Non-shock sensitive; requires no periodic annealing</li> <li>• DELIVERY TIME—normal delivery time on stock widths is 1 to 2 days after receipt of order. For adhesive backed foils, approximately one week, and for foils slit to desired width, approximately 1 to 2 weeks.</li> </ul>		



## MAGNETIC SHIELD DIVISION

Perfection Mica Company

1322 N. ELSTON AVENUE • CHICAGO, ILLINOIS 60622

Phone: 312, EV 4-2122 • TWX 910 221-0105

## Double balanced mixers range up to 2.4 GHz



Vari-L Co., Inc., 207 Greenwich Ave., Stamford, Conn. Phone: (203) 323-2176. Price: \$45 to \$350.

Double balanced mixers with frequency ranges from 0.05 MHz to 2.4 GHz are packaged in metal enclosures with coaxial connectors, or in miniature modules with pin terminals spaced for strip-line connections. The broad-band and hybrid transformers are used for input and output coupling. Carefully matched by Schottky barrier diodes comprise the mixer, or ring modulator portion.

CIRCLE NO. 347

## S-band noise source fires at -450 V

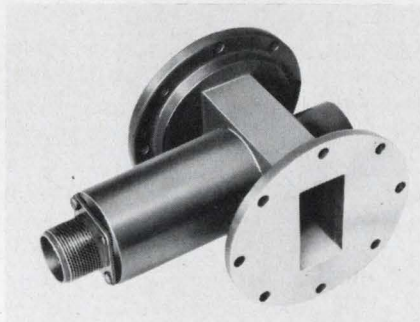

Signalite Inc., 1933 Heck Ave., Neptune, N.J. Phone: (201) 775-2490.

A gas-discharge noise source for use at frequencies from 2900 to 3100 MHz has a firing voltage of -450 V max applied to the cathode and rapidly attains its operating voltage level of  $35 \pm 4$  V dc. Designed for 90° E-plane mounting in a RG-75/U circuit, it incorporates an integrally mounted gas-discharge tube and features a built-in protective cell, to prevent firing by a stray high-energy rf signal.

CIRCLE NO. 348

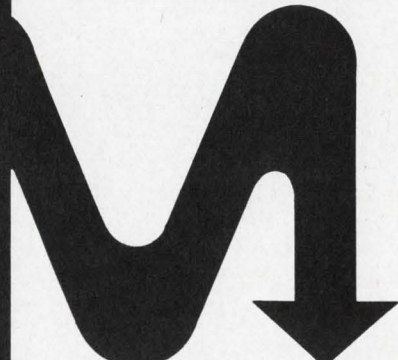

# CYCLIC A/D CONVERTER

For more than a decade, engineers have attempted to design a workable CYCLIC A/D converter. Bunker-Ramo has engineered and manufactured the first practical Cyclic A/D converter, the B-R 850.

- **CYCLIC!** Within the B-R 850, the signal is synthesized rather than successively approximated. Input data conversion is continuous, eliminating requirement for sample and hold. Output can be sampled continuously or on command.
- **FAST!** Worst-case conversion time: 1  $\mu$ sec. for 8-bit word. 1-bit changes as short as 60-nsec. When following a multiplexer, conversion time will add less than 1  $\mu$ sec.
- **ECONOMICAL!** \$1,348 (single unit price); POWER: max 7½ watts; SIZE: 3¾" x 4¾" x 7½"; WEIGHT: less than 2-lbs.

SPECIAL PROBLEMS? NEED HIGHER SPEED—GREATER RESOLUTION—LOWER POWER—SMALLER SIZE? TRY US FOR THE SOLUTIONS!

For more information on the BR-850 and on our upcoming line of components, (i.e.: 12-bit, 300 KHz; 8-bit, 3 MHz converter; 16-channel multiplexer and others) please contact Mr. W. G. Garner. Phone (213) 346-6000 or write:



See You at the IEEE Show, Booth 4E39-41

**THE BUNKER-RAMO CORPORATION**  
DEFENSE SYSTEMS DIVISION  
8433 FALLBROOK AVENUE • CANOGA PARK CALIFORNIA 91304

# New Dual-Tracking Power Modules from ERA



SILICON  
**71°C**  
FREE AIR  
RATING

## Ultra-Compact, High Temperature

Drive operational amplifiers, IC's and other devices requiring dual-tracking DC with ERA's fully repairable DV series Transpacs®. Two independent power sources provide continuously adjustable and proportional outputs,  $\pm 12$  VDC through  $\pm 15$  VDC, reducing variations in operational amplifier performance resulting from power supply changes.

### SPECIFICATIONS

**Input:** 105-125 VAC, 50-400 cps  
**Voltage output:**  $\pm 12$  through 15 VDC, Dual  
**Current rating:** See table  
**Ripple:** Less than 800 microvolts, RMS  
**Line, load regulation:** Less than 0.05%, full line or load change  
**Transient response:** Less than 50 microseconds  
**Operating temperature:**  $-20^{\circ}\text{C}$  to  $+71^{\circ}\text{C}$   
**Temperature coefficient:** 0.02% per degree C  
**Heat sinking:** Internal, convection cooled

### STANDARD MODELS

Output Voltage VDC	Current 71°C	Model	Price
+ (12-15) - (12-15)	0-60 ma 0-60 ma	DV60	\$96.00
+ (12-15) - (12-15)	0-500 ma 0-500 ma	DV500	\$149.00
+ (12-15) - (12-15)	0-1 amp 0-1 amp	DV1000	\$189.00

Write for Catalog #151



## ELECTRONIC RESEARCH ASSOCIATES, INC.

67 Sand Park Road, Cedar Grove, N. J. 07009  
(201) 239-3000

Subsidiaries: ERA Electric Co. • ERA Acoustics Corp.  
ERA Dynamics Corp. • ERA Pacific, Inc.

INFORMATION RETRIEVAL NUMBER 59

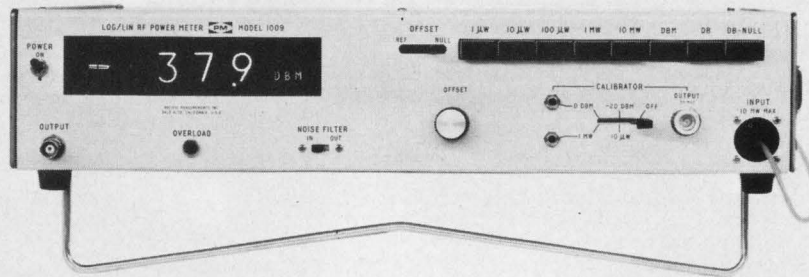

## Digital rf power meter has BCD, analog outputs

*Pacific Measurements Inc., 940 Industrial Ave., Palo Alto, Calif. Phone: (415) 528-0300. Price: \$1850.*

Offering an instantaneous digital display of rf power on either a logarithmic or linear scale, this rf power meter will make both swept and single frequency measurements from 10 MHz to 12.4 GHz. In addition to digital readout, the instrument offers BCD output for data acquisition systems and computers. BCD (digital) outputs are available on the rear panel, as an option. For computer use, the digital display rate may be triggered from an external source over a range of zero to 100 readings/s. An analog output is available to drive an oscilloscope or an X-Y recorder.

The high-gain direct-coupled input amplifier is chopper-stabilized, and temperature sensitive components are oven-mounted to minimize dc drift. Auxiliary inputs are provided on the back panel to allow the addition of frequency markers to a swept frequency display and to permit the connection of two instruments for ratio measurement.

Crystal-diode response in the rf detector is adequate for swept frequency measurements. The detector is compensated to permit accurate measurement (0.1-dB resolution) from  $-40$  to  $+10$  dBm between  $15^{\circ}\text{C}$  and  $45^{\circ}\text{C}$ . An over-range numeral, a unit annunciator and a

decimal point augment the three-digit standard readout to minimize the possibility of operator error.

Linear modes of 1, 10, 100, 10,000 and 100,000  $\mu\text{W}$  as well as logarithmic modes of dBm, dB and dB-null may be selected by pushbutton. In the dB and dB-null modes, an offset control permits zero adjustment of the analog output for any input level. The dB-null mode is used for swept frequency measurements when a dc-coupled oscilloscope is used to display a response curve. Digital readout can indicate the difference between reference and null offset. If these two offsets are used to bracket noise on a swept display, the digital display will indicate their magnitude in dB.

Precise power levels of 1 mW and 10 W at 30 MHz are internally generated for calibration of the instrument. Temperature compensation from  $15^{\circ}\text{C}$  to  $45^{\circ}\text{C}$  is provided by a thermistor in the detector mount. A nonlinear noise filter may be thrown in ahead of the DVM input by a front-panel switch, ensuring a clean display of noisy signals while allowing quick response to large changes in signal level.

The combination of wide dynamic range and digital display permits accurate microwave power measurement and eliminates the possibility of error in reading an analog meter.

CIRCLE NO. 349

## FET analyzer tests and classifies



Siliconix Inc., 1140 W. Evelyn Ave., Sunnyvale, Calif. Phone: (408) 245-1000.

A high speed go no-go tester sequentially makes up to 15 tests, at 33 ms per test, and classifies devices into five categories according to preset priorities. Counters on the front panel total each category. Using prepunched Mylar film and a pinboard-programming concept, the tester allows selection of junction or MOS FET dc parameters, at specific test conditions, and the establishment of limits on each.

CIRCLE NO. 350

## Laboratory amplifiers boost signals to 60 dB



AGAC-Derritron, Inc., 600 N. Henry St., Alexandria, Va. Phone: (703) 836-4641. P&A: \$295; 30 days.

Laboratory amplifiers that have a frequency response of 1 Hz to 100 kHz and offer a voltage gain of up to 60 dB feature small size and battery operation for portability. Good low-noise characteristics are due to a noise-canceling circuit that attenuates low-frequency semiconductor noise. Input impedance is 500 M $\Omega$  and dynamic range is 80 dBV at 40 dBV gain.

CIRCLE NO. 351

# Ballantine Solid State AC Voltmeter



Model 303

## 2 Hz to 6 MHz, with 1% Accuracy at Midband -- Operates from Built-in Rechargeable Battery or Power Line

### FEATURES:

- ★ Frequency range of 2 Hz to 6 MHz
- ★ Voltage range of 300  $\mu$ V to 350 V (100  $\mu$ V sensitivity, 10 Hz to 1 MHz)
- ★ Optional models with probe for voltage range 1 mV to 1000 V
- ★ 1% accuracy, 30 Hz to 1 MHz
- ★ Built-in rechargeable battery or power line operation (Optional version for power line only)
- ★ Logarithmic indicator for uniform accuracy and resolution over entire scale
- ★ Floating signal ground
- ★ 10 M $\Omega$  input resistance
- ★ Model 800 kit available for rack mounting without modifications

### Prices:

Model 303: Rechargeable battery/line, \$360  
Model 303-50: Rechargeable battery/line, with 1 kV 20 dB Probe, \$410

Model 303-01: Line powered only, \$305  
Model 303-51: Line powered only, with 1 kV 20 dB Probe, \$355

Write for complete technical data today



**BALLANTINE LABORATORIES INC.**

Boonton, New Jersey

CHECK WITH BALLANTINE FIRST FOR DC AND AC ELECTRONIC VOLTMETERS/AMMETERS/OHM METERS, REGARDLESS OF YOUR REQUIREMENTS. WE HAVE A LARGE LINE, WITH ADDITIONS EACH YEAR. ALSO AC/DC LINEAR CONVERTERS, AC/DC CALIBRATORS, WIDE BAND AMPLIFIERS, DIRECT-READING CAPACITANCE METERS, AND A LINE OF LABORATORY VOLTAGE STANDARDS FOR 0 TO 1,000 MHZ.

INFORMATION RETRIEVAL NUMBER 60

# VECO THERMISTORS

BEADS • DISKS • WASHERS • RODS  
BULBS • GLASS PROBES • SENSOR ASSEMBLIES  
CRYOGENIC • MILITARY GRADE • THINISTORS®



Thermistors provide precision measurement, compensation and control of temperatures, liquid levels, the flow of liquids and gases . . . WITH INSTANT RESPONSE. VECO Thermistors are available in a wide range of sizes, shapes, resistance values and temperature coefficients. VECO's staff of experienced engineers is available to assist you in product application and circuit design. Write for Condensed Catalog MGP681.

THERMISTORS • VARISTORS / VECO First in Progress • First in Service



**VICTORY ENGINEERING CORP.**

136 Springfield Ave., Springfield, N.J. 07081 Tel: 201-379-5900 TWX: 710-983-4430

J-8975

INFORMATION RETRIEVAL NUMBER 61

## ADD AND DIVIDE



0.5 - 150 MHz

ACTUAL  
SIZE



0.5 - 100 MHz

### WITH ASSURANCE

Obtain high isolation, low insertion loss, and excellent output balance . . . 0.5 to 150 MHz. Feed signals to common load without crosstalk. Drive isolated loads with single source . . . assured load variations will not be cross coupled . . . confident of coherent output signals. Ask for RELCOM hybrids isolation 45 dB; insertion loss 0.2 dB; VSWR 1.15; phase difference nominally 0°.

Space problems? The miniature H2A and H3 have all connectors on one side . . . occupy only 0.5 cubic inches.

Model H2A \$80; Model H3 \$150 in quantities 1-4. Discounts on larger quantities. Hybrids with BNC connectors also available.

**RELCOM**

2329 Charleston Road Mountain View, California 94040  
Telephone (415) 961-6265 TWX (910) 379-6979

INFORMATION RETRIEVAL NUMBER 62

## TEST EQUIPMENT

### IC multimeter displays 4 digits

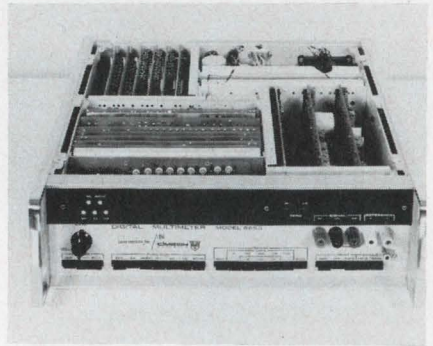

*Cimron Div. Lear Siegler, Inc.,  
1152 Morena Blvd., San Diego,  
Calif. Phone: (714) 276-3200.*

Holding an accuracy of  $\pm 0.01\%$  for six months, this digital multimeter features a 10% overrange on its 4-digit readout. It has an external sample rate of 1-5/s, automatic polarity, 3 manual ratio ranges of 1, 10, and 100 and 3 manual full-scale dc ranges of  $\pm 10.999$ ,  $\pm 109.99$ , and  $\pm 1099.9$ . Optional BCD or 10-line decimal outputs of voltage state, contact closure or DTL are offered.

CIRCLE NO. 352

### Silicon power supplies regulate to 0.01%

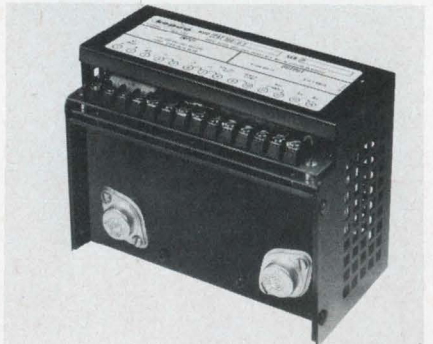

*Kepeco, Inc., 131-38 Sanford Ave.,  
Flushing, N. Y. Phone: (212)  
461-7000.*

A series of programmable all-silicon power supply modules, including six models from 0-7 V to 0-2 A, to 0-100 V at 0-0.2 A, features 0.01% line and load regulation, less than 100- $\mu$ V rms ripple and temperature coefficient of better than 0.01%/°C. Without external heat sinking, these supplies operate at 71°C without derating.

CIRCLE NO. 353



## Dc power supply has twin outputs

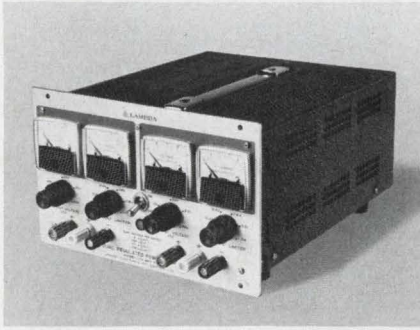

Lambda Electronics Corp., Terminal Drive, Plainview, L.I., N.Y. Phone: (516) 931-3300. Price: \$260.

Two independent dc outputs double the voltage and current yield of this laboratory power supply and allow its use in dual-output applications. The 13-lb portable unit holds ripple to 1.5 mV, pk-pk and regulates its output to 0.01% + 1 mV. It may be operated on a 105-132 Vac, 47-440-Hz line although its ratings are based on 60-Hz operation.

CIRCLE NO. 354

## Linear accelerometer incorporates ICs

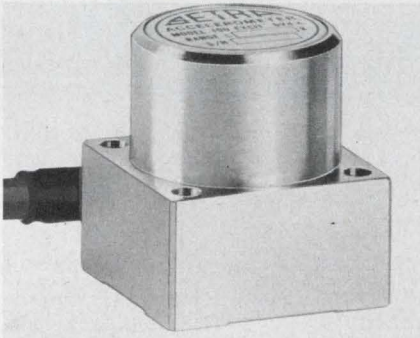

Setra Inc., 12 Huron Drive, Natick, Mass. Phone: (617) 655-4645. Price: \$345.

A high-level dc output ( $\pm 1.5$  V) linear accelerometer, whose output is proportional to an acceleration vector in the range of  $\pm 1$  g to  $\pm 250$  g, is a self-contained transducer that utilizes ICs. Gas squeeze-film damping ensures constant amplitude response over the temperature range of  $-65$  to  $+250^\circ$  F.

CIRCLE NO. 355

# Sweep

**IF FREQUENCIES  
2-WAY RADIO  
VHF-TV  
TELEMETRY BANDS  
COMMUNICATION BANDS  
COMMAND CHANNELS**



Designed for Telnic's SM-2000 Sweep Generator, this new Model 3003-1 plug-in oscillator provides frequency coverage from 5 to 500 MHz, sweeping this entire range in one pass or any portion of it down to 500 kHz wide.

Using electronic tuning and all solid state circuits, the 3003-1 virtually doubles the capabilities of the SM-2000 Sweep Generator. In addition to wide range and sweep width, it also features variable rate for permanent recording applications and a variable birdy-type marker, providing frequency identification from 5 - 500 MHz.

#### SPECIFICATIONS

Frequency Range	5 MHz - 500 MHz
Sweep Width	500 kHz - 500 MHz
Output	.5 v RMS
Sweep Rate	.01 to 100 Hz, variable
Vernier Attenuation Range	6 dB min.
Linearity	1.5:1
Flatness @ max. sweep	$\pm 0.75$ dB
@ 10% max. sweep	$\pm 0.5$ dB

Full details plus Application Data in Catalog 70-A. Send for your copy.

**Telnic** INSTRUMENTS Division of  
Telonic Industries, Inc.

60 N. First Avenue • Beech Grove, Indiana 46107 • Tel.: (317) 787-3231 • TWX - 810-341-3202  
INFORMATION RETRIEVAL NUMBER 63

## Robinson-Nugent:

THE PEOPLE WITH THE  
PHILOSOPHY OF  
THINKING SMALL  
SMALLER  
SMALLEST!

From Integrated Sockets to Miniature Sockets, our Total Capability concept is yours to use and specify whenever quality is critical.





802 EAST EIGHTH STREET / NEW ALBANY, INDIANA 47150  
AREA CODE: 812-945-0211  
Write or call for complete catalogs and information

MASTERS OF MINIATURIZATION

INFORMATION RETRIEVAL NUMBER 64

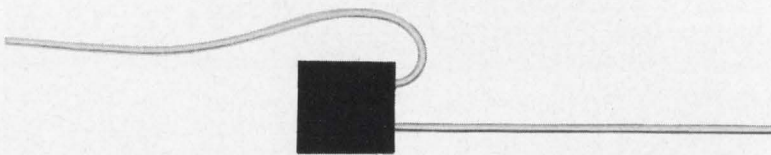
## TWISTING TOROIDS ISN'T NECESSARY



Instead, choose the toroid configuration to fit your circuit design: radial-lead (  ) or side-lead (  ). Saves assembly time. Halts lead breakage, during installation and when equipment is in use. Vanguard has your choice of styles with inductive values from 0.01 microhenries to 10 millihenries—all immediately available for the roughest environments, from  $-55^{\circ}\text{C}$  to  $+125^{\circ}\text{C}$ . And thanks to the toroid's low external magnetic field, you can package units closer than

with other types of inductive devices.

While we can't say which lead type is best for your design, we do have a pair of suggestions. (1) Use side lead toroids for your prototype. They mount fast and are quickly removable. (2) Before starting on your breadboard, write for data on Vanguard's broad toroid line. You might find it necessary.

Vanguard Electronics/A Division of Wyle Laboratories/930 West Hyde Park Blvd./Inglewood, Calif. 90302/(213) 678-7161/TWX: 910 328-6126.



## VANGUARD/WYLE

INFORMATION RETRIEVAL NUMBER 65

## TEST EQUIPMENT

### Integrating DVM exhibits 6 ranges



Vidar Corp., 77 Ortega Ave., Mountain View, Calif. Phone: (415) 961-1000.

Full scale ranges of this DVM are 10 mV, 100 mV, 1 V, 10 V, 100 V and 1000 V. The 10-mV range provides useful resolution of  $1 \mu\text{V}$  at up to 40 readings/s. Readings accurate to  $\pm 0.01\%$  full scale,  $\pm 0.004\%$  of reading  $\pm 1 \mu\text{V}$  are visible on a six-digit front-panel display, and available for direct recording with a printer connected to the 8421-coded electrical output.

CIRCLE NO. 400

### Pulse generator develops 3 outputs

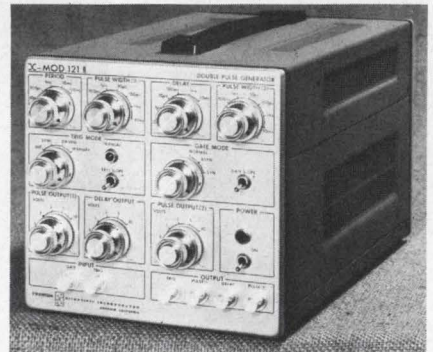

Preston Scientific Inc., 805 E. Cerritos Ave., Anaheim, Calif. Phone: (714) 776-6400. P&A: \$465; 90 days.

A double pulse generator develops an initial pulse upon receipt of command, a delay pulse generated when the pulse is turned on and a pulse which is generated at the end of the delay pulse. The unit provides six periods ranging from  $1 \mu\text{s}$  to 100 ms. Pulse width is variable from 10 ns to 10 ms. The delay between the leading edge of pulse 1 and the leading edge of pulse 2 may be set less than 10 ns. The magnitude of the delay output ranges from 0.2 V to 10 V peak and the unit features a delay signal rise and fall time of less than 10 ns. Delay output impedance is  $50 \Omega$ .

CIRCLE NO. 401

## Spring clamps aid circuit tests

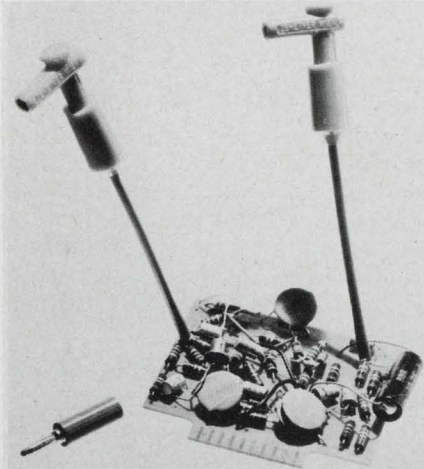

Hunter Associates, 182 Clairmont Terrace, Orange, N. J. Phone: (201) 672-0423. Price: \$1.50.

The Hunter universal test clamp has wide application in the entire field of electronic testing and production. It consists of a retractable spring clamp activated by light pressure on the handle. The clamp will grip the finest wire and then retract into the insulating sleeve, so that it can be used in high-density circuitry with no danger of short circuits. The head contains a standard banana plug jack which allows flexibility for rapid interconnection. It is available in red, black and green.

CIRCLE NO. 402

## Wave analyzer goes from 10 Hz to 60 kHz

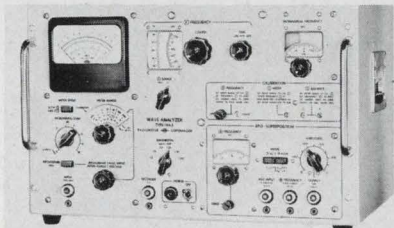

The London Company, 811 Sharon Drive, Cleveland. Phone: (216) 871-7980. P&A: \$2950; stock.

A solid-state heterodyne wave analyzer provides a choice of six bandwidths through the frequency range of 10 Hz to 60 kHz. It is suited for analysis of harmonic and noise components of periodic signals, selective measurements of frequency responses and intermodulation measurements.

CIRCLE NO. 403

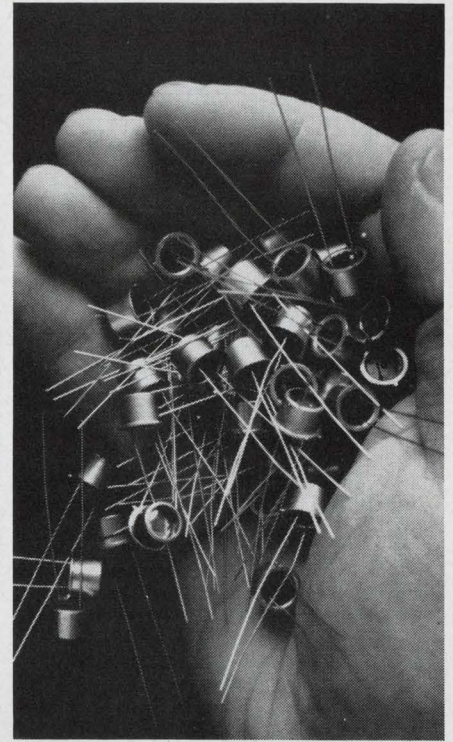
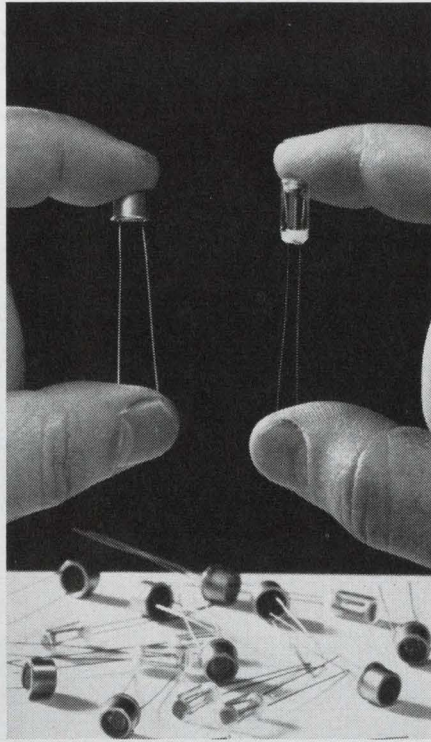

## Need thirty different photocells? Or thousands exactly alike?

In either case, specify "Raytheon." Raytheon now offers standard and special types with cadmium sulfide or selenide sensors, TO-5 case or glass vial packaging, and a wide range of operating characteristics. These photocells are interchangeable with competitive types, available to MIL specifications, priced from 90¢ to \$1.60 in production quantities.

**All Raytheon photocells feature:** rugged mechanical construction, small size, light weight. Low noise, completely ohmic light-dependent vari-

able resistors, their characteristics and high voltage capabilities ensure fast switching, temperature stability and linear response to illumination.

**Wide range of characteristics.** Our CK1201, for example, features 150 ohms resistance at 100 ft. candles, rise-fall time of 3 and 60 ms, 75 mw power dissipation (maximum). And our CK1266 features 2500 ohms resistance at 100 ft. candles, rise-fall time of 1.5 and .6 seconds, and power dissipation of 100 mw maximum.

Send reader service card for data on the complete line of standard Raytheon photocells. Or tell us about your special requirements.  
Raytheon Company, Components Division, Quincy, Mass. 02169.

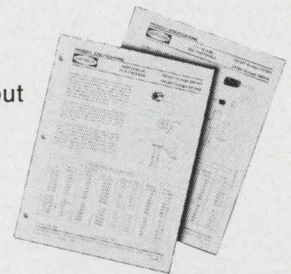

**RAYTHEON**

Industrial Components Operation — A single source for Circuit Modules/Control Knobs/Display Devices/Filters/Hybrid Thick-Film Circuits/Industrial Tubes/Optoelectronic Devices/Panel Hardware

INFORMATION RETRIEVAL NUMBER 66

# Need fast action on servo amplifiers?

Try Bulova first! Chances are, we can solve your problem better and faster than anyone else. Here's why:

1. We have the most complete line of Servo Amplifiers in the business—hundreds of standard designs to solve your problems! From 3.5 to 40 watts output power; 60 and 400 Hz.
2. Bulova Servo Amplifiers are engineered to reduce the number of components, producing low cost, high quality, trouble-free units. This frees you to concentrate on systems, rather than components.



3. High-density packaging—down to just 0.3 cu. in.! For example, Model S21220101: A 3.5 watt Servo Amplifier with gains of up to 5000—in the smallest package of its type on the market!

Another example: The smallest package ever for a stable solid state servo amplifier producing 40 watts of output power! Need a unit fast to put into a breadboard or prototype? We can probably supply it, meeting most military specs (MIL-E-5272, MIL-E-5400, MIL-I-26600, etc.) You'll get assembly by personnel trained and certified by NASA, if desired. You'll get amplifiers built for 10,000 hours of operating life! And perhaps equally important, you'll get the unit you need fast!

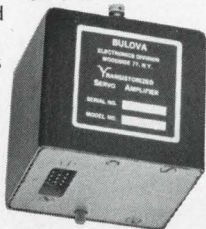

Write today for your free copy of our 8-page Bulletin No. 10, containing complete specifications and ordering information. Also ask about our Resolver Amplifiers, Demodulators, Quadrature Reject and AGC Amplifiers. Address: Dept. ED-24.

## Try Bulova First! SERVO PRODUCTS

ELECTRONICS DIVISION  
OF BULOVA WATCH COMPANY, INC.

61-20 WOODSIDE AVENUE  
WOODSIDE, N.Y. 11377, (212) DE 5-6000

INFORMATION RETRIEVAL NUMBER 67

## TEST EQUIPMENT

### Ac line conditioner responds in 50 $\mu$ s

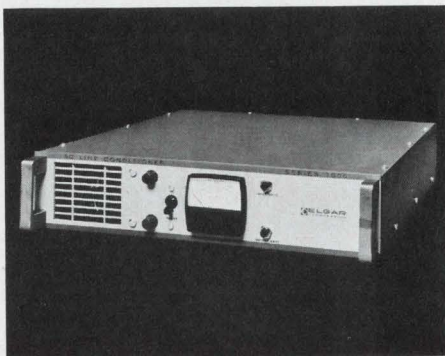

Elgar Corp., 8046 Engineer Rd., San Diego, Calif. Phone (714) 278-0800. P&A: \$925; 2 wks.

This silicon solid-state instrument is an ac line conditioner offering a response time of under 50  $\mu$ s. With up to 10% distortion on the line, the unit will deliver an output of 500 VA at 60 Hz with less than 0.25% distortion. The conditioner is 3-1/2 in. high and weighs 35 lb. It is equipped with detachable rack adaptaters to permit bench operation.

CIRCLE NO. 356

### Switchable preamp is charge-sensitive

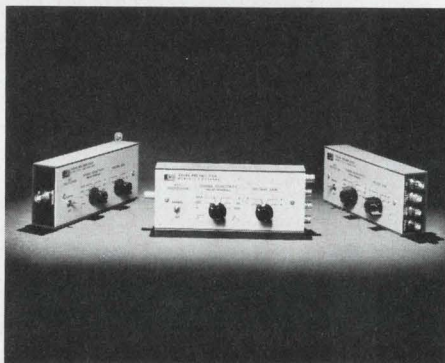

Hewlett-Packard, 1501 Page Mill Rd., Palo Alto, Calif. Phone: (415) 326-7000. Price: \$300.

A charge-sensitive preamplifier can accommodate scintillation, gas proportional, geiger and semiconductor detectors without requiring soldered circuit changes. User can select charge sensitivity, voltage gain and shaped or nonshaped pulses. The high-voltage decoupling circuit can be matched to a change in detector by replacing a bias resistor that is secured by snap-in clips.

CIRCLE NO. 357

### Impulse generator develops 1000 V



White Electromagnetics Inc., 670 Lofstrand Lane, Rockville, Md. Phone: (301) 424-2900. P&A: \$4950; 60 days.

This broadband signal source generates a 1000-V pulse that, varying in width from 0.6 ns to 100 ns, develops a spectrum amplitude density of 160 dB $\mu$ V/Hz below 5 MHz to 115 dB $\mu$ V/Hz at 1 GHz. Spectral density can be controlled by selection of pulse width and level.

CIRCLE NO. 358

### Noise source operates from 200 to 250 MHz

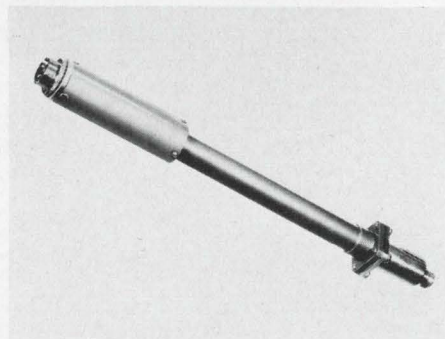

Signalite Inc., Special Products Div., 1933 Heck Ave., Neptune, N.J. Phone: (201) 775-2255.

A gas-discharge noise source for use at 200 to 250 MHz has an internally heated cathode and may be operated either pulsed or cw. Operating voltage is 200 V dc and operating current is 30 $\pm$ 5 mA dc. The excess noise ratio is 18.5 $\pm$ 0.5 dB and VSWR (fired or unfired) is 1.75 max. Firing voltage is -1500 V dc.

CIRCLE NO. 359

## Amplifier/null meter ranges in 20 steps



Preston Scientific Inc., 805 E. Ceritos Ave., Anaheim, Calif. Phone: (714) 776-6400. Price: \$295.

A floating differential amplifier/null meter, with an input range of 1  $\mu$ V to 1 V full scale in 20 calibrated steps, provides three bandwidth ranges of 10, 1 and 0.1 Hz, with a bandwidth accuracy of  $\pm 5\%$ . Featuring low drift of less than 0.1  $\mu$ V/ $^{\circ}$ C, input isolation greater than  $10^{12} \Omega$  and providing common mode rejection of greater than 120 dB at 60 Hz, the unit maintains less than 0.2- $\mu$ V noise with a 0.1-Hz bandwidth.

CIRCLE NO. 360

## Interval counter measures 0 to $10^9$ ns

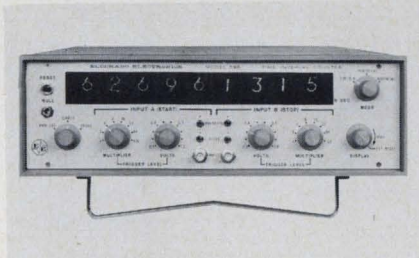

Eldorado Electronics, 601 Chalmar Rd., Concord, Calif. Phone: (415) 686-4200. P&A: \$6500; stock.

This time interval counter performs measurements from 0 ns min (for null measurements) to  $10^9$  ns. Long-term stability up to 1 part on  $10^9$  is provided by a variety of internal crystal oscillator options. Point of trigger is calibrated in volts from 0.1 to 128 V by combination of continuous trigger level and binary step-multiplier control.

CIRCLE NO. 361

# We've got good connections in high places



Surveyor, Mariner, F-111, OGO, X-15, Apollo, LEM, and most other high flying programs rely on Cinch-Graphik printed circuitry for dependable electronic interconnections. The lunar surface, or 6000 miles above Mars, isn't the place to find out that circuitry doesn't perform to specs. That's why Cinch-Graphik maintains complete in-house facilities for NASA and MIL Spec testing. Cinch-Graphik's unequalled competence in producing single and multilayer printed circuits to these stringent requirements uniquely qualifies them to produce circuits for applications where "it has to be right."

## CINCH-GRAPHIK

DIVISION OF UNITED-CARR



200 South Turnbull Canyon Road, City of Industry (Los Angeles), Calif. 91744 • Phone (213) ED 3-1201. Sales offices in 33 principal cities throughout the United States, Great Britain, Canada, Australia and West Germany.

CONSISTING OF CINCH MANUFACTURING COMPANY, CINCH-GRAPHIK, CINCH-MONADNOCK, CINCH-NULINE, UGINITE (ELECTRONICS) AND PLAXIAL CABLE DEPT.

INFORMATION RETRIEVAL NUMBER 68

# VCR\* FET performance

in a voltage-tunable  
oscillator

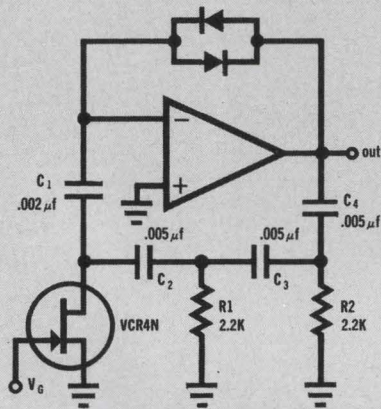

Siliconix assumes no responsibility for the circuit shown, nor do they represent or warrant that it does not infringe any patents.

Output frequency varies between 6 Kc and 18 Kc as  $V_G$  is varied from zero volts to pinchoff. The range can be shifted by changing  $C_1$ ,  $C_2$ , and  $C_3$ , and broadened by substituting VCR FETs for  $R_1$  and  $R_2$ . The diodes maintain proper amplifier gain throughout the entire frequency range and eliminate the VCR matching problem.

Interested? Build this and other VCR circuits with the VCR FET Designer's Kit DK6. You get 6 VCR FETs (\$30 value) for just \$19.50 from your distributor.

More information? Write us or check the inquiry card.

\*VCR: Voltage Controlled Resistor - a new family of FET devices offering variable resistance ranges on the order of 10,000 : 1.



## Siliconix incorporated

1140 W. Evelyn Ave. • Sunnyvale, CA 94086  
Phone (408) 245-1000 • TWX: 910-339-9216

INFORMATION RETRIEVAL NUMBER 69

## MATERIALS

### Polyester film heat-sealable

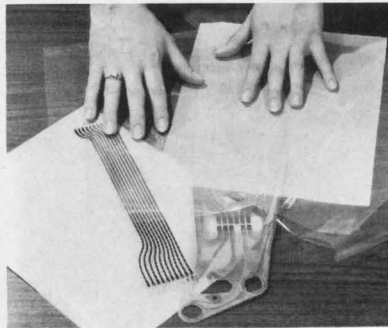

3M Co., St. Paul, Minn. Phone:  
(612) 733-4033.

Heat-sealable polyester films are designed for such applications as protective laminations for flexible printed circuitry, flat cable, standard wire and cable insulation, transformer layer insulation, coil cover wrappings, and to form laminates, tubing and component packaging. Heat sealability is achieved by applying a polyolefin surface to one or both sides of the polyester.

CIRCLE NO. 362

### Foam encapsulant will not burn



Emerson & Cuming, Inc., Canton, Mass. Phone: (617) 828-3300.  
Price \$20/lb.

Eccofoam EFF-14FR is a one-part free-flowing powder that can be poured into a cavity, and then cured in place to a rigid foam. It is classed as nonburning according to ASTM Test Method D-1692. The material was developed as a support medium for sensitive electronic components, particularly where low weight is needed.

CIRCLE NO. 363

### Paper tape is able to conduct electricity

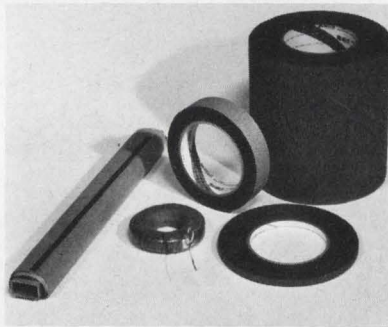

3M Co., St. Paul, Minn. Phone:  
(612) 733-4033.

Electrically conductive paper tapes for electrostatic interference shielding applications are available in three forms. Tape No. X-1175A is flatback and 12 mils thick; No. X-1175B is flatback and 7 mils thick, and No. X-1175C is a creped construction and 17 mils thick. The tapes are pliable, easily handled and compatible with common impregnating resins and varnishes.

CIRCLE NO. 364

### Epoxy remover a cool stripper

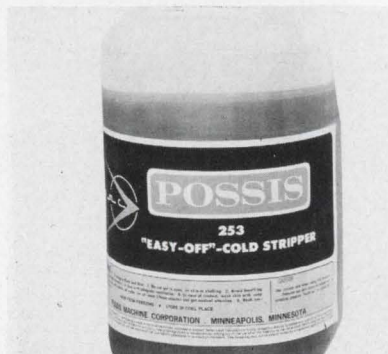

Possis Machine Corp., 825 Rhode Island Ave. S., Minneapolis. Phone:  
(612) 545-1471.

Easy-Off 253 cold stripper is a liquid preparation designed to remove epoxy resins, polymer vinyl coatings, acrylic paints, fluidized epoxy and other hard-to-strip coatings for small parts. It is used undiluted at room temperature. Parts to be stripped are soaked in it. When it reaches the base metal of the part, the coating is actually lifted off.

CIRCLE NO. 365

## Molding compounds pass the flame test

B. F. Goodrich Chemical Co., 3135 Euclid Ave., Cleveland, Ohio. Phone: (216) 818-8200.

Thermoplastics rated nonburning by ASTM tests have good molding characteristics. The ratings were derived from the ASTM D635 and ASTM D568 tests, with the use of samples as thin as 0.01 in. With the Aerospace Industries Association Flame Resistance Test Method, the materials were rated self-extinguishing in zero seconds. Parts molded from these materials retain shape and perform well, even at temperatures exceeding 200°F. The heat distortion ratings for injection-molded samples are 210°F to 225°F at 264 lb/in.<sup>2</sup>.

CIRCLE NO. 366

## Polyvinyl chloride is glass-fortified

LNP Corp., 412 King St., Malvern, Pa. Phone (215) 644-5200. Price: 61¢ to 63¢ (lb.).

Polyvinyl chloride (PVC) is available with 15, 25 and 35% glass fiber (VF-1003, VF-1005 and VF-1007, respectively). Thoroughly dispersed glass fiber significantly increases the strength and stiffness values of PVC. VF-1007, for example, has a tensile modulus of 1.8 million lb/in.<sup>2</sup> at room temperature, higher than any other nonburning, nondripping, flame-retardant thermoplastic.

The VF Series is most useful in the intermediate temperature range, where it retains good property values. The tensile modulus of VF-1007, for example, is 1.5 million lb/in.<sup>2</sup> at 140°F. In terms of equivalent stiffness, the VF series is nearly half the cost of other, flame-retardant thermoplastics.

Fortified PVC is available in black or in opaque colors. It can be painted and decorated easily. The molding shrinkage is exceptionally low, permitting injection molding to tight tolerances.

CIRCLE NO. 367

# Resistor Adjustment Problems? Automatic Solution...

## BR-670



Now you can lease Bunker-Ramo's unique precision **Film Resistor Adjuster, Model BR-670.**

For a low monthly charge plus a penny-a-pulse, you can use our proprietary thin-film processes. The equipment and processes have been thoroughly tested in daily production of custom microcircuits. We adjust thin-film resistors to .01% and match the temperature coefficient of resistance to track within  $\pm 5$ ppm/°C. Our substrates are also available, providing a complete microelectronics package with no investment in capital equipment.

Call our Microelectronics Operation for a demonstration; we are sure that one demonstration will convince you that the highest in precision can only be attained with the BR-670 Resistor Adjuster. Available for immediate installation. Please call Joe Crist, Marketing Manager, Microelectronics Operation at (213) 346-6000. Or write:

See You at the IEEE Show, Booth 4E39-41



**THE BUNKER-RAMO CORPORATION**  
DEFENSE SYSTEMS DIVISION  
8433 FALLBROOK AVENUE • CANOGA PARK, CALIFORNIA 91304

INFORMATION RETRIEVAL NUMBER 70

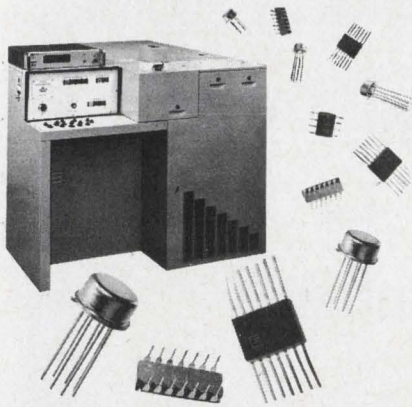

Would you believe 1 million devices per second?

Well, would you believe 100,000 per minute?

No? How about an easy 3,600 parts per hour, twenty-four hours a day, day after day? DELTA's ASTEC is a unique concept in handling electronic components at extreme temperatures. The ASTEC system will even sort your parts automatically on the basis of your measurement. Would you believe that? You should, it's true.

Send for our latest catalog.



Delta Design, Inc.  
8000 Fletcher Parkway  
La Mesa, California 92042  
Telephone (714) 465-4141  
INFORMATION RETRIEVAL NUMBER 71

## Application Notes

**Faster Risetimes In Wirewounds**  
PROGRESS IN RESISTORS

When wire-wound resistors are used in high-frequency applications, the rise time of the resistor is a critical factor. However, wirewound resistors are being made with resistance characteristics comparable with the film type. A new line of 20-ohm resistors is now being produced by RCL Electronics, Inc. These resistors have a temperature coefficient of resistance of  $\pm 1\%$  per  $100^\circ\text{C}$ . They are available in a wide range of values and are suitable for use in high-frequency applications. The resistors are made of a special alloy and are coated with a protective film. They are available in a wide range of values and are suitable for use in high-frequency applications.

When a temperature range from  $20^\circ\text{C}$  to  $125^\circ\text{C}$ , the wirewound resistors have a temperature coefficient of  $\pm 1\%$  per  $100^\circ\text{C}$ . Compare this with the  $50$  to  $100\%$  per  $100^\circ\text{C}$  for standard wirewound resistors. This is a major improvement. Stable resistors can be obtained with a temperature coefficient of  $\pm 0.1\%$  per  $100^\circ\text{C}$  for  $10$  to  $100$  ohm resistors. The wirewound resistors are made from a special alloy and are coated with a protective film.

Temperature-stabilized wirewound resistors have a stability of  $\pm 0.1\%$  per  $100^\circ\text{C}$  for  $10$  to  $100$  ohm resistors. This is a major improvement. Stable resistors can be obtained with a temperature coefficient of  $\pm 0.1\%$  per  $100^\circ\text{C}$  for  $10$  to  $100$  ohm resistors. The wirewound resistors are made from a special alloy and are coated with a protective film.

**General Electric and Resistor**  
An expanded version of the wirewound resistor is now available. It has a temperature coefficient of  $\pm 1\%$  per  $100^\circ\text{C}$ . It is available in a wide range of values and is suitable for use in high-frequency applications.

Illustrated from RCL Electronics, Inc., a subsidiary of General Design Electronics, Inc.

### Resistor articles

Technical articles from the Engineering and R&D Staff of RCL Electronics, Inc., are contained in one brochure. Among the articles are: "Faster Risetimes In Wirewounds," "How To Measure Resistor Self-Heating Effects," and "How To Measure Performance of Wirewound Resistors." In addition, the brochure includes specifications on silicone-coated radial-lead and standard precision power wirewound resistors. RCL Electronics, Inc.

CIRCLE NO. 368

### Delay measurements

A paper entitled "Progress in the Technique of Group Delay Measurements" covers in depth present methods of group delay measurement and difficulties encountered. Tel-Com Instruments, Inc.

CIRCLE NO. 369

### Quality-control manual

Practice problems and assignments in quality-control training are offered in a 120-page workbook. Besides the essentials of quality control, the manual also offers simplified data based on industrial applications and production. The manual is available without charge if requested on your company letterhead from: Advertising Department, General Instrument Corp., P.O. Box 600, Hicksville, N.Y.

Buy Bonds where you work.

They do.

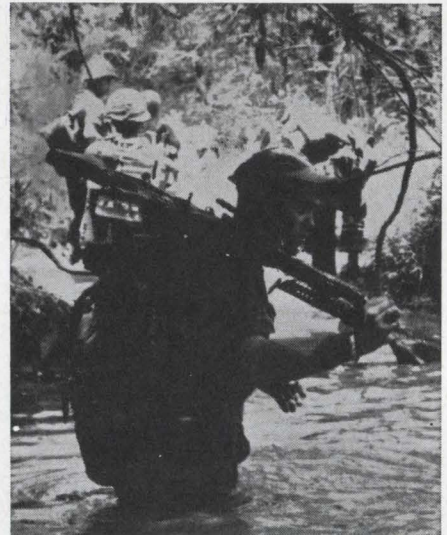

They work for freedom. And more than seven out of ten of them are supporting freedom with their dollars, too — through investment in U.S. Savings Bonds. When you buy Bonds, you can save up for a rainy day, a home, a free and comfortable future — and at the same time show these brave men you're on their side. Join the Payroll Savings Plan where you work or buy Bonds where you bank. You'll walk a bit taller.

### New Freedom Shares

Now, when you join the Payroll Savings Plan or the Bond-a-Month Plan, you are eligible to purchase new Freedom Shares. They pay 4.74% when held to maturity of just four-and-a-half years (redeemable after one year), and are available on a one-for-one basis with Savings Bonds. Get the facts where you work or bank.

Join up. America needs your help.

U.S. Savings Bonds, new Freedom Shares



The U.S. Government does not pay for this advertisement. It is presented as a public service in cooperation with the Treasury Department and The Advertising Council.



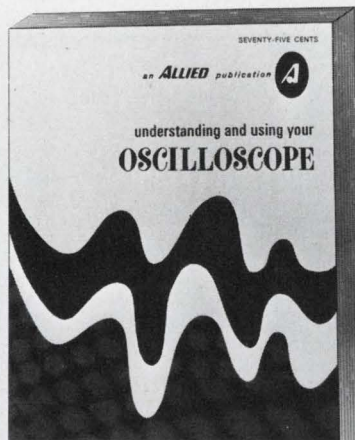

### Oscilloscope use

*Understanding and Using Your Oscilloscope* deals with one of the most useful and versatile pieces of electronic test equipment. It covers basic theory of the oscilloscope, its many uses, interpretation of wave forms and operation with associated equipment. Chapter headings: History of the Cathode Ray Tube; Basic Oscilloscope Controls and How to Adjust Them; How to Select an Oscilloscope; Auxiliary Equipment; Oscilloscope and Test Equipment Kits. *The 128-page paperback book is priced at 75¢ from Allied Radio Corp., 100 N. Western Ave., Chicago, Ill.*

### Sun-angle measuring

How accurate and reliable sun angle measurements can be obtained over a wide field of view is explained in a 20-page brochure entitled "Digital Solar Aspect Systems." Details are given of the use, operation, testing and alignment of attitude sensors. Also covered are solar gate sensors, pointing sensors, earth sensors and high resolution sensors — their design, capabilities and uses. Details are then provided on the two basic types of Digital Solar Aspect Systems: the single-axis systems (for spinning vehicles) and the two-axis types (for use on a variety of vehicles). Reticle arrangements for both types are illustrated, as are their fields of view and optimum placement. Adcole Corp.

CIRCLE NO. 370

MAKES EVERYONE LOOK GOOD...

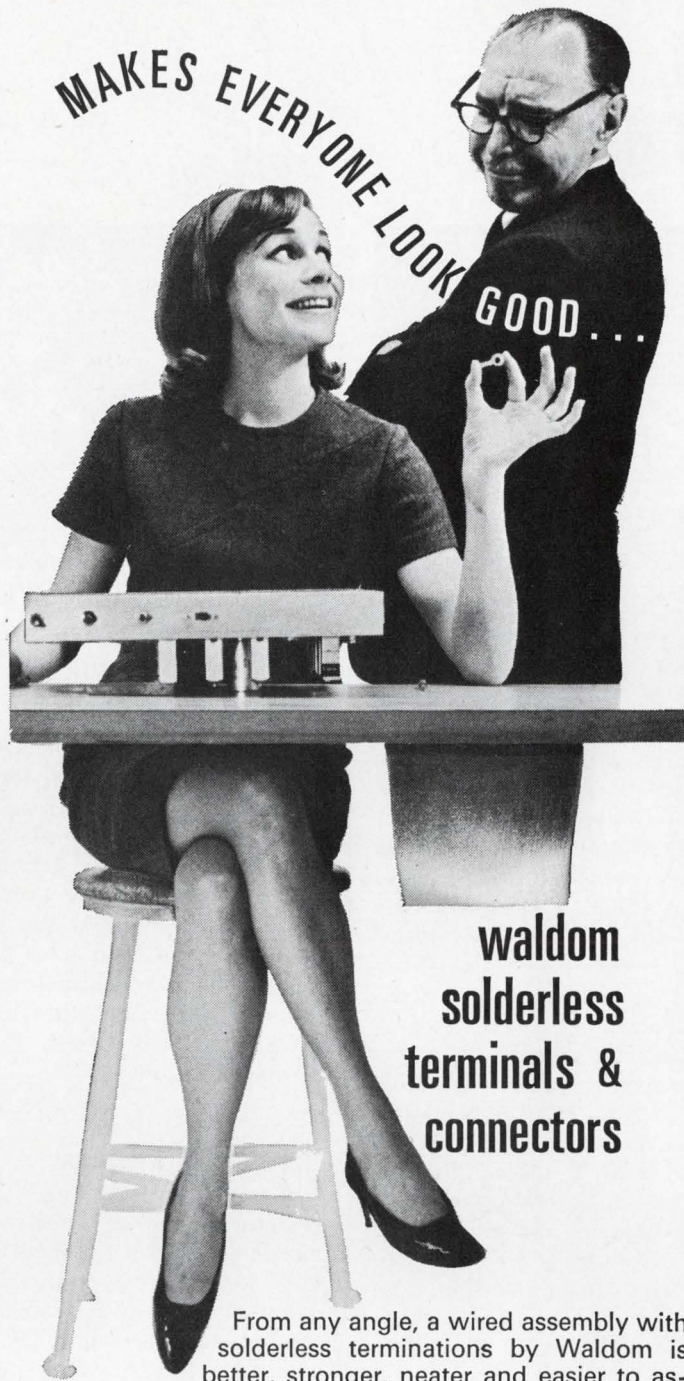

waldom  
solderless  
terminals &  
connectors

From any angle, a wired assembly with solderless terminations by Waldom is better, stronger, neater and easier to assemble. Everyone gains . . . the pretty assembler on the line, her foreman, the company officers and stockholders and, most of all, the user of the completed product.

Waldom Solderless Terminals and Connectors make positive connections, are vibration and temperature proof and they will never wear out or lose their grip. If that's not enough, check these other benefits. . . .

- \* Broad selection including Quick Disconnects. \* All construction styles. \* Absolute dependability. \* Saves time and labor. \* Easier servicing. \* All types made to military specs.

Fast delivery from your electronics or electrical distributor. Write for FREE Waldom catalog listing more than 3000 electronic hardware items.



**waldom** ELECTRONICS, INC.

4643 West 53rd Street,  
Chicago, Illinois 60632

INFORMATION RETRIEVAL NUMBER 72

# New Literature



## Fiber optics data

An information kit contains comprehensive information on fiber optics technology, products, and applications. A *Mosaic Fiber Optics Handbook* covers the theoretical aspects of fiber optics, explains various nuances of the new discipline such as optics and glass fiber properties. Also included are technical-note sheets treating various fiber optic applications such as mosaic fiber optic contact reflective readers for mark sensing in EDP; automotive applications of fiber optics; electro/fiber optic pressure transducers; and fiber optic viewfinder screens for reflex cameras.

Write on company letterhead to *Mosaic Fabrications Division, The Bendix Corp., Galileo Park, Sturbridge, Mass.*

## Copper conductors

"Coppermetal Electrical Conductors" is a 62-page booklet, that includes a section on hollow copper conductors, information on the new B-D Cu (Boron deoxidized copper) and other information. Sections cover copper and copper alloys for electrical purposes; bus conductor shapes; high-strength copper alloys; resistance materials and damper bars; special products; and dimensions, properties and ratings of Anaconda products for electrical uses. Anaconda American Brass Company.

CIRCLE NO. 371



## Finishing touch

"Total coating systems design" is the title of a brochure covering some 100 specialty coating systems. These include bonded solid dry-film lubricants, technical aerosols and adhesives. Each system is master-listed in one of 16 classes of prime environmental protection, with numerous secondary benefits also featured. The coating systems are designed to improve the old "industrial paint" functions of materials-protection against combinations of friction, heat, electricity, corrosion and weather. Products/Techniques, Inc.

CIRCLE NO. 372

## Harshaw's devices

A catalog describing radiation detectors, nuclear electronic devices and crystal products is available for use by researchers and manufacturers of industrial, medical and aerospace equipment. Products and technology spotlighted in this 88-page booklet have applications in fields such as crystal growth, materials research, nuclear physics, medical research, aerospace, well logging, solid-state research, optics and oceanography. Among the different types of material and equipment included in the catalog are scintillation crystals and assemblies, gas-filled nuclear radiation detectors and instrumentation, thermoluminescence dosimetry—instruments and materials, optical crystals and Hammer electronic instrumentation. The catalog is fully illustrated with charts, drawings and photographs. The Harshaw Chemical Co.

CIRCLE NO. 373

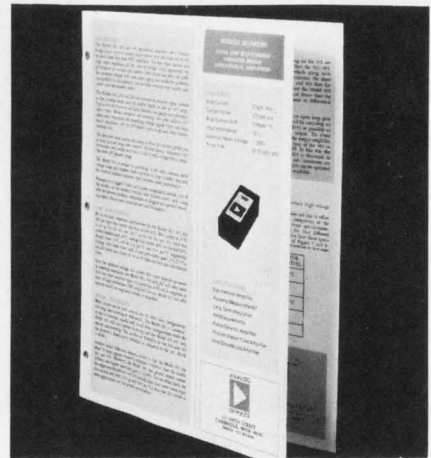

## Varactor op amps

A six-page foldout application-and-data sheet from Analog Devices gives specifications and circuits for use with varactor-bridge dc operational amplifiers, models 301, 302 and 303. All three units are able to measure low-level currents in the picoampere range. The note presents comprehensive specifications, provides graphs to illustrate gain, offset and noise performance, and charts the total output error of the varactor-bridge op amp. Circuits for improving closed-loop stability and reducing the effects of rf noise are also given, as well as a basic description of how the varactor-bridge unit works. Analog Devices.

CIRCLE NO. 374

## Phenolic molding

A folder detailing phenolic compounds for compression-, plunger- and injection-molding includes general-purpose, heat-resistant, electrical-insulating, improved impact- and chemical-resistant phenolics. The brochure — a handy, 3-hole punched fold-out — contains information on 31 phenolic molding compounds. In chart form, it describes the resin type and filler, and provides data on physical, mechanical, electrical and chemical properties. Indicated uses for parts molded of these phenolics include automotive, electrical, appliance and wet-dry applications. Union Carbide Corp.

CIRCLE NO. 375

# Celco

# DEFLECTION COMPONENTS

for the DISPLAY INDUSTRY

YOKES	AMPLIFIERS	INSTRUMENTS
<p><b>DEFLECTRONS</b> Ultra High Resolution Yokes Type HD</p>  <p>For 40° Flat Faced Scanners, Computer Readouts, Side-Looking Radar, Mapping.</p>	<p><b>20V ALL SILICON DRIVERS</b> Type DA-PPN-3</p>  <p>3, 6, 12 amp X-Y amplifiers matched to your yoke and response requirements. Available with regulated power supplies</p>	<p><b>DISPLAY MEASUREMENT LAB</b></p>  <p>Two-Slit CRT Spot Analyzer on X-Y Traverse quickly ascertains spot size, line width, and X-Y coordinates. Easily determines linearity and positional accuracies as well as phosphor characteristics.</p>
<p><b>PIN CUSHION CORRECTORS</b> Electromagnetic</p>  <p>Straight Sides to 0.1%.</p> <p>Use with CELCO Micropositioner for optimum accuracy</p>	<p><b>40 VOLT DEFLECTION DRIVER</b> All Silicon Type RDA-PP6N-1</p>  <p>With regulated Quadru-Power Supplies. 12 amp change in less than 9 <math>\mu</math>sec. 0.02% linearity.</p>	<p><b>X-Y TRAVELING MICROSCOPE</b> Mounted on X-Y Traverse.</p>  <p>Line Straightness, spot positions and line positions measured with a high degree of repeatability. Use for aligning yokes, focus coils and field correctors.</p>
<p><b>TV CAMERA COILS</b> for 3" Image Orthicons Type I.O.</p>  <p>Deflection Yoke, Focus and Alignment Coil Assemblies to meet your specs.</p>	<p><b>RASTER GENERATOR</b> All Solid State Type 2 SG-1</p>  <p>Two Ramp Units in one panel. Ramps from 20 <math>\mu</math>sec to 100 msec. Adjustable dc offset. Compatible with CELCO Drivers.</p>	<p><b>CRT DEFLECTION SYSTEM</b></p>  <p>Contains all deflection, focus and corrective coils, micro-positioners for each, your CRT, complete shielding from all stray magnetic fields. Use for automating assembly lines, a reader of bubble-chamber photos.</p>
<p><b>MAGNETIC LENS</b> for High Resolution CRT's Type NC</p>  <p>For correction of CRT distortions. Consists of static and dynamic focus and astigmatic coils.</p>		

**YOKES**  
**Celco**

*Constantine Engineering Laboratories Company*

MAHWAH, N. J.  
201-327-1123  
TWX 201-327-1435

UPLAND, CAL.  
714-982-0215  
TWX 714-556-9550

# M-O V GIVES RADAR A NEW LOOK

M-O V introduces some of the most advanced P.P.I. tubes for new radar applications. Take a new look at these brilliant features:

- \* narrow angle deflection
- \* flat face
- \* transistor drive
- \* high brightness
- \* narrow neck
- \* aluminised screen
- \* electrostatic focus

	Screen dia. ins.	Deflection angle °	Final anode voltage kV	Cut-off V
F16-10	7	37	14	- 44
F21-10	9	41	14	+45 cathode
3000R	12	40	16	+65 cathode
4100R	16	50	16	+65 cathode

For new catalogue with full specifications of M-O V cathode ray tubes range, write to:

## Genalex M-O V P.P.I. TUBES

THE M-O VALVE CO. LTD

Principal U.S. Distributor:  
Metropolitan Overseas Supply Corporation,  
468 Park Avenue South, New York 10016 Area 212  
Phone: Murray Hill 6-2120  
M-O V also have Area Distributors in North and South  
California and New England

INFORMATION RETRIEVAL NUMBER 74

## NEW LITERATURE

### HEAT RESISTING FLAT GLASS

PYREX® FLAT GLASS  
PYREX® FURNACE OBSERVATION BLUE GLASS  
PYREX® INFRARED REFLECTING GLASS  
PYREX® SIGHT GLASSES  
PYREX® TEMPERED SIGHT GLASSES  
PYREX® PRECISION GLASS FLAT  
PYREX® HIGH PRESSURE GAUGE GLASSES  
PYREX® RED LINE & HEAVY WALL GAUGE GLASS  
PYREX® A CORNING LUBRICATOR GLASSES  
PYREX® OIL CUP GLASSES  
PYREX® HEAT SHIELD  
CORNING® STANDARD GAUGE GLASSES  
MACBETH® FLAT GAUGE GLASSES  
VYCOR® 96% SILICA GLASS  
GLASS SPECIALTIES  
CORNING CORNING GLASS WORKS

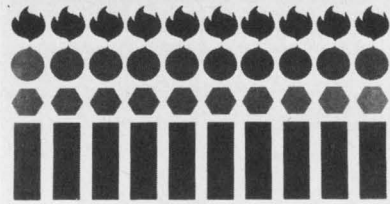

### Special glasses

PYREX high temperature glass products for science and industry are displayed in a 24 page publication. Among the heat-resistant flat glass products described are infra-red-reflecting glass, furnace observation blue glass, precision flat glass, sight glasses, VYCOR—96% silica glass and PYREX heat shields. Also included are fraction-to-decimal, inch-to-inch conversion charts. Complete specifications and price information accompany each entry. Kaufman Glass Company.

CIRCLE NO. 376

### Power transistor data

An 8-page data sheet provides detailed descriptive information on both the B-148000 and B-155000 series silicon transistors. SOAR (Safe Operating Area) charts and comprehensive specifications charts and graph are a particular feature. SOAR is defined for dc and pulsed operation, resistive, unclamped inductive and unclamped switching operation. Bendix Semiconductor Division.

CIRCLE NO. 377

### Strip chart recorders

Fifty different models of miniature strip chart recorders, all of which feature a dry writing process are contained in a 20-page catalog. Included is detailed information on chart paper, drive motor specifications, accessories, optional features, dimensions and weights for each. Rustrak Instrument Division, Gulton Industries, Inc.

CIRCLE NO. 378

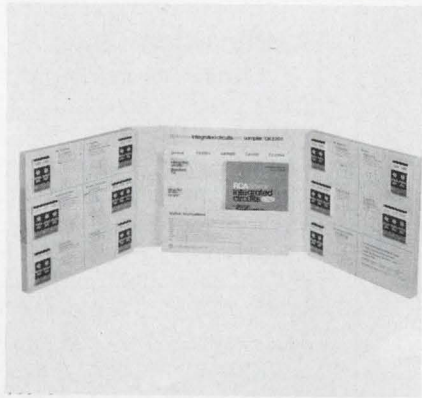

### IC sampler

A sampler kit, containing 26 RCA linear ICs plus complete technical data and application information on each type. In addition, an RCA Linear Integrated Circuit Fundamentals manual, RCA Integrated Circuits Product Guide and IC Mounting and Assembly Instructions are included. Eleven separate linear integrated circuit types are supplied in the kit, with two or three of each type provided.

Available for \$39.95 from RCA Electronic Components and Devices, Harrison, N.J.

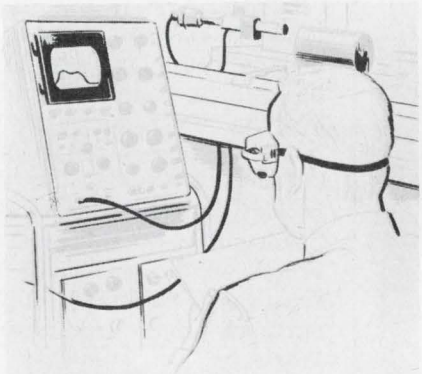

### Glass laser rods

Laser rods made of a new type of laser glass are available in five configurations. The ED-2 laser glass was developed as a result of research into the electronic phenomena of glasses, fluorescence and the doping of glasses with rare earths. ED-2 is a silicate glass doped with 3 per cent neodymium. The booklet contains data on the physical, spectral and lasing properties of ED-2, as well as information on dimensional tolerances for the five different rod configurations. Owens-Illinois, Inc.

CIRCLE NO. 379

the last time you used a 'scope,  
did you really need more performance  
than these Heathkit® models provide?



**Heathkit IO-17**  
... new 5 MHz  
3" 'scope ... only  
**\$79.95**

**IO-17 SPECIFICATIONS** — **VERTICAL CHANNEL:** Input impedance: 1 megohm shunted by 25 pf; x 50 attenuator position 1 megohm shunted by 15 pf. Sensitivity: 30mV P-P/div. (uncalibrated). Frequency response: 5Hz to 5MHz ±3 db. **HORIZONTAL CHANNEL:** Input impedance: 10 megohm shunted by 15 pf. Sensitivity: 300 mV P-P/div. Frequency response: 2Hz to 300 kHz ±3 db. **HORIZONTAL SWEEP GENERATOR:** Sweep generator: Recurrent type. Frequency: 20Hz to 200 kHz in four overlapping ranges. Retrace: Blanked by a pulse from blanking amplifier. Synchronization: Automatic type. **GENERAL:** Tube complement: (1) 3RP1 cathode ray tube, medium persistence, green trace; (3) 12AU7; (1) 12AX7; (1) 6GH8; (1) 6BH6; (1) 6BQ7. Power requirements: 105-125 volts 50/60 Hz or 210-250 volts 50/60 Hz. Power consumption: 60 watts. Overall dimensions: 9 1/2" H x 5 1/2" W x 14 1/2" L. (Dimensions include handle, knobs, etc.). Net weight: 12 lbs.



**Heathkit IO-14**  
... DC to 8 MHz  
5" 'scope ...  
triggered sweep  
... 0.25 sec  
delay line input ...  
assembled  
**\$399.00**  
kit  
**\$259.00**

**IO-14 SPECIFICATIONS** — **(VERTICAL)** Sensitivity: 0.05 V/cm AC or DC. Frequency Response: DC to 5 MHz — 1 dB or less; DC to 8 MHz — 3 dB or less. Rise time: 40 nsec (0.04 microseconds) or less. Input impedance: 1 megohm shunted by 15 pf. Signal delay: 0.25 microsecond. Attenuator: 9-position, compensated, calibrated in 1, 2, 5 sequence from 0.05 V/cm to 20 V/cm. Accuracy: ±3% on each step with continuously variable control (uncalibrated) between each step. Maximum input voltage: 600 volts peak-to-peak; 120 volts provides full 6 cm pattern in least sensitive position. **(HORIZONTAL)** Time base: Triggered with 18 calibrated rates in 1, 2, 5 sequences from 0.5 sec/cm to 1 microsecond/cm with ±3% accuracy or continuously variable control position (uncalibrated). Sweep magnifier: X5, so that fastest sweep rate becomes 0.2 microseconds/cm with magnifier on. (Overall time-base accuracy ±5% when magnifier is on.) **Triggering capability:** Internal, external, or line signals may be switch selected. Switch selection of + or — slope. Variable control on slope level. Either AC or DC coupling. "Auto" position. **Triggering requirements:** Internal; 0.5 cm to 6 cm display. External; 0.5 volts to 120 volts peak-to-peak. **Triggering frequency response:** DC to 2.5 MHz approx. **Horizontal input:** 1.0 v/cm sensitivity (uncalibrated) continuous gain control. **Bandwidth:** DC to 200 kHz ±3 db. **Power requirements:** 285 watts. 115 or 230 VAC 50-60 Hz. **Cabinet dimensions:** 15" H x 10 1/2" W x 22" D includes clearance for handle and knobs. **Net weight:** 40 lbs.



### FREE 1968 CATALOG

Describes these and over 300 kits for stereo/hi-fi, color TV, amateur radio, shortwave, test, CB, marine, educational, home and hobby. Save up to 50% by doing the easy assembly yourself. Mail coupon or write Heath Company, Benton Harbor, Michigan 49022.

**HEATHKIT**

**HEATH COMPANY, Dept. 520-26**  
Benton Harbor, Michigan 49022

Enclosed is \$ \_\_\_\_\_, plus shipping

Please send model (s) \_\_\_\_\_

Please send FREE Heathkit Catalog.

Please send Credit Application.

Name \_\_\_\_\_ (Please Print)

Address \_\_\_\_\_

City \_\_\_\_\_ State \_\_\_\_\_ Zip \_\_\_\_\_

Prices & specifications subject to change without notice. TE-178

INFORMATION RETRIEVAL NUMBER 75

**EXHIBITS**  
NEW YORK COLISEUM

**TECHNICAL SESSIONS**  
NEW YORK HILTON

Monday through Thursday

**PROGRESS IN AN EXPLODING TECHNOLOGY**

**Fluorocarbon tapes**

A 16-page brochure on "Chemfluor" Tapes" made of "Teflon"/"Halon"/"Tetran" TFE and "Teflon" FEP resins is available. The brochure describes the company's line of fluorocarbon tapes that meet a range of industrial needs. There are four basic tapes: Skived TFE . . . Extruded TFE . . . Glass-Fabric Coated with TFE . . . and Extruded FEP. Each is supplied as plain tape or in modified forms to meet special requirements. "Chemfluor" FEP tapes are extruded from fluorinated ethylene propylene resins ("Teflon" FEP) and offer the features of being heat-sealable, transparent, and thermoformable. Chemplast, Inc.

CIRCLE NO. 380

**Fused silica**

A booklet describing Corning U. L. E. (Ultra-Low-Expansion) fused silica has been released by Corning Glass Works. The 12-page publication says the recently developed material "offers the highest degree of stability ever achieved in an optical mirror . . . making possible a system that is basically limited only by diffraction of light." Fused silica exhibits virtually no thermal expansion from -100°C to +100°C. The two-color booklet includes the development history of fused silica and detailed charts of the material's thermal, chemical, mechanical, optical and electrical properties. Corning Glass Works.

CIRCLE NO. 381

**Servo assemblies**

Twenty-six servo assemblies are pictured and described in a booklet by Weston-Transicoil. The assemblies shown include data converters, function generators, incremental servos, computing servos and indicating-display devices. Illustrations include photos and block diagrams and the text indicates the types of components used and their specific operation in the system. Weston Instruments, Inc.

CIRCLE NO. 382

- 48 GENERAL SESSIONS at the New York Hilton. Hours: 10:00-12:30; 2:00-4:30.
- FOUR FLOORS OF EXHIBITS at the N. Y. Coliseum including over 750 firms. Hours: 10 a.m.-8 p.m. 4 Days.
- GALA ANNUAL BANQUET—Wednesday 7:15 p.m. N. Y. Hilton Grand Ballroom—\$16.00.
- FREE SHUTTLE BUSES between the Hilton and the Coliseum—every few minutes.
- REGISTRATION—Good all days—General Sessions and exhibits. In and out privileges.—IEEE Members \$3.00. Non-members \$6.00. Ladies \$1.00. High School Students \$3.00 if accompanied by an adult—One student per adult; Thursday only—limit of 3 students per adult.
- REG-IDENT CARD speeds request for exhibitors' literature. Ask for one when registering.
- ESCALATORS/EXPRESS ELEVATORS to the Fourth Floor.

**IEEE Exhibition MARCH 18-21, 1968**

INFORMATION RETRIEVAL NUMBER 76



**PLAY IT SAFE:  
Start now  
to save  
their hearts**

Help your children form good health habits now to reduce risk of heart attack later:

- Encourage normal weight; obesity in youth may persist throughout life;
- Build body health through regular physical activity;
- Serve them foods low in saturated fats;
- Teach them that cigarette smoking is hazardous to health;
- Make medical check-ups a family routine.

Set a good example. Follow the rules yourself and guard your heart, too.

**GIVE...  
so more will live  
HEART  
FUND**

Contributed by the Publisher

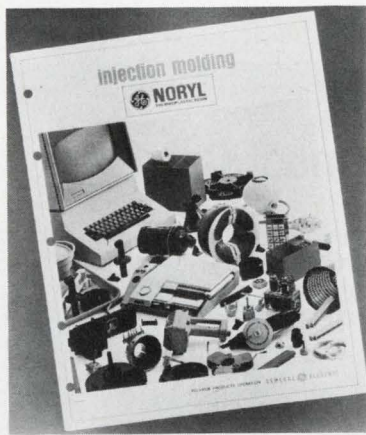

### Injection molding

A comprehensive, 28-page, four-color injection molding guide covering General Electric's four grades of Noryl thermoplastic resin is available. The bulletin is an in-depth guide for molding Noryl resins and covers such detailed information as product characteristics, typical molding conditions, effects of molding conditions on material properties, part design, mold design, as well as troubleshooting guides and price/properties comparisons of engineering thermoplastics. General Electric Company.

CIRCLE NO. 383

### Glass spheres

The advantages of solid-glass spheres as reinforcement filler for thermoplastics and thermosetting plastics are described in a brochure. Included are details of how the spheres may be used by molders to improve the physical properties of molded products. Potters glass spheres are used as reinforcement fillers in virtually all types of resin systems, including nylon, urethane, ABS and vinyl. A properties chart compares the physical properties of unfilled nylon with those of nylons containing various percentages of glass spheres. A properties chart shows how the addition of PBI glass spheres to a fiber glass-epoxy laminate increases flexural strength and modulus without significant loss of other properties. Potters Bros., Inc.

CIRCLE NO. 384

The solution to question 3 on p. 76 is:

$$x = 1, -2, \text{ or } 2 \pm j3.$$

# TRANSFORMERS FOR INDUSTRIAL APPLICATIONS MILITARY QUALITY AT COMMERCIAL PRICING

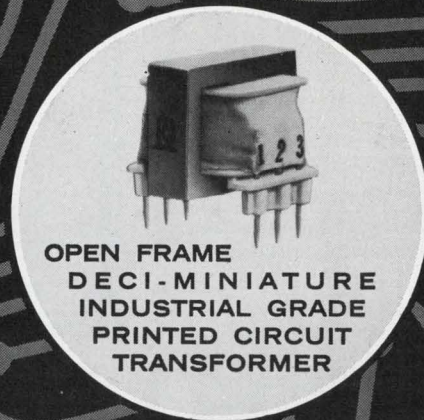

OPEN FRAME  
DECI-MINIATURE  
INDUSTRIAL GRADE  
PRINTED CIRCUIT  
TRANSFORMER

Miniature Printed Circuit Transformer specially designed for transistorized control and instrumentation • Molded-in terminals provide fixed mounting centers usually found only in expensive molded transformers • Size:  $\frac{3}{4}$ " x  $\frac{13}{16}$ " x  $\frac{1}{32}$ " —  $\frac{3}{16}$ " x .042 pins. Weight:  $\frac{1}{2}$  oz. • These units can be used as input, interstage, output and isolation applications.

Part No.	Primary Impedance	Secondary Impedance	Pri. D.C. Unbalance Ma.	Operating Level DBM
DCM1-PC	25000 C.T.	1200 C.T.	2	18
DCM2-PC	15000 C.T.	15000 C.T.	3	19
DCM3-PC	15000 C.T.	600 C.T.	3	19
DCM4-PC	10000 C.T.	5000 C.T.	4	20
DCM5-PC	10000	2500/625 Split	2	20
DCM6-PC	10000 C.T.	1500 C.T.	4	20
DCM7-PC	5000 C.T.	80,000 C.T.	6	15
DCM8-PC	4000 C.T.	1200 C.T.	6	20
DCM9-PC	4000 C.T.	600 C.T.	6	20
DCM10-PC	4000	600/150 Split	3	20
DCM11-PC	2500 C.T.	2500 C.T.	8	20
DCM12-PC	2500	2500/625 Split	4	20
DCM13-PC	2500 C.T.	625 C.T.	8	20
DCM14-PC	2500 C.T.	200 C.T.	8	20
DCM18-PC	600 C.T.	50,000 C.T.	16	20
DCM19-PC	600	8000/2000 Split	8	20
DCM20-PC	600 C.T.	200 C.T.	16	20
DCM21-PC	600 C.T.	600 C.T.	16	20
DCM22-PC	250 C.T.	600 C.T.	25	20

### DECI-MINIATURE — INDUSTRIAL GRADE — OPEN FRAME PRINTED CIRCUIT CHOKES

Part No.	Oma d.c.	Inductance rated current conditions	DCR
DCM51-PC	10 hy	5 hy-3 ma	300
DCM52-PC	5 hy	2 hy-5 ma	155
DCM53-PC	2.5 hy	1 hy-7 ma	75

Immediate Delivery from Franchised Distributors • Write for NEW 32 page catalog



# MICROTRAN

COMPANY, INC.

GARDENA, CALIF.

VALLEY STREAM, NEW YORK

See us at Booth 4B25, IEEE Show

INFORMATION RETRIEVAL NUMBER 77

# Electronic Design

ELECTRONIC DESIGN's function is:

- To aid progress in the electronics manufacturing industry by promoting good design.
- To give the electronic design engineer concepts and ideas that make his job easier and more productive.
- To provide a central source of timely electronics information.
- To promote two-way communication between manufacturer and engineer.

**Want a subscription?** ELECTRONIC DESIGN is sent free to qualified engineers and engineering managers doing design work, supervising design or setting standards in the United States and Western Europe. For a free subscription, use the postfree application form inside the back cover. If none is included, write to us direct for an application form.

If you do not qualify, you may take out a paid subscription for \$25 a year in the U.S.A., \$35 a year elsewhere. Single copies are \$1.50 each.

**If you change your address,** send us an old mailing label and your new address; there is generally a prepaid postcard for this inside the back cover. You will have to requalify to continue receiving ELECTRONIC DESIGN free.

**The accuracy policy** of ELECTRONIC DESIGN is:

- To make reasonable efforts to ensure the accuracy of editorial matter.
- To publish prompt corrections whenever inaccuracies are brought to our attention. Corrections appear at the end of the Letters column.
- To refuse any advertisement deemed to be misleading or fraudulent.

**Microfilm copies are available** of complete issues of ELECTRONIC DESIGN and individual articles, published since the beginning of 1961. Complete issues cost 4¢ a page, articles cost 50¢ a page; shipping and handling charges are extra. The minimum charge is \$3. For further details and to place orders, contact University Microfilms, Inc., 300 N. Zeeb Road, Ann Arbor, Mich. 48106; telephone (313) 761-4700.

**Want to contact us?** If you have any comments or wish to submit a manuscript or article outline, address your correspondence to:

Howard Bierman, Editor,  
ELECTRONIC DESIGN,  
850 Third Avenue,  
New York, N.Y. 10022.

# Design Data from

## Free Electronic Circuit Symbol Catalog

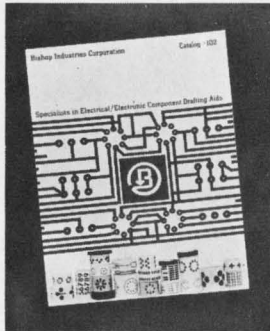

Save artwork and drafting time. Cut costs with thousands of electronic drafting aids and symbols featured in the new 28-page Catalog No. 102 from Bishop. In it is the industry's only complete selection of predrawn circuit component symbols: integrated circuits, logics, semiconductors, flat-packs, transistors, printed circuits, welded modules, etc. Also: tapes, pads, corners, connectors, schematic symbols, reference numbers and more. Included are illustrations, range of sizes and complete price information. Send today for your free copy.

**Bishop Industries Corp.**  
11728 Vose Street  
North Hollywood, California 91605

# 174

## A FREE Cross Reference Guide



to better Printed Circuit drafting

No engineer or draftsman should be without the NEW 1968 By-Buk Printed Circuit Drafting Aids P-45 Catalog with color-coded MIL-SPEC sizes. Also contains over 2000 pads, shapes, tapes, transistor tri-pads, spaced integrated circuit terminal pad sets and many other drafting aids for faster, more accurate, distortion-free printed circuit master drawings. Send for your FREE catalog.

**By-Buk Company**  
4326 West Pico Blvd., Los Angeles, Calif. 90019  
Telephone: (213) 937-3511

# 175

## ELECTRONIC DESIGN TECHNIQUES

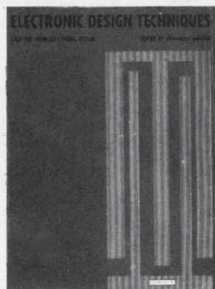

In this outstanding reference book, leaders in electronic design demonstrate for your immediate use new ideas and proven techniques that have solved difficult problems for themselves and their firms. Over 55 practical design studies selected from **Electronic Design** are presented. Vital sections of the book cover the use and design aspects of amplifiers, resistor networks, filters, control devices, power supplies, microwave systems, oscillators, and pulse and switching currents. Edited by Edward E. Grazda. Just published. 312 pages. 352 Illustrations. Large format, 8 1/2 x 11. \$12.75, clothbound. Examine for 15 days without obligation or ask for details.

**HAYDEN BOOK COMPANY, INC.**  
116 W. 14 St.  
New York, N.Y. 10011

# 176



# Manufacturers

Advertisements of booklets, brochures, catalogs and data sheets. To order use Reader-ServiceCard.  
(Advertisement)

## Quality Fasteners For All Design Applications



This 8-page catalog provides design data on the complete group of DZUS 1/4-turn self-locking fasteners for standard, high speed and panel applications, as well as universal high strength multiple thread fasteners for high tensile and shear stresses. Dzus stud assemblies, wire forms and receptacles offer an exceptional, wide variety of combinations from stock to fit specific fastening requirements. Diagrams and tables give full details for rapid, unlimited design selection. Condensed Catalog No. S-2 or comprehensive Catalog No. D-3 are available on request.

### Dzus Fastener Co., Inc.

Division 32  
425 Union Boulevard  
West Islip, L. I., N. Y. 11795

# 177

## Bus Bars For Noise Reduction

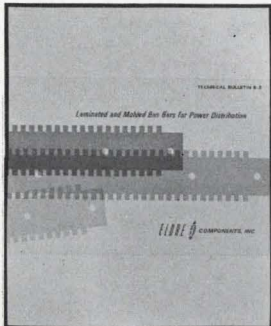

A 16 page Technical Bulletin is now available, describing a new concept in power or signal distribution. Basic mechanical and electrical design principles, along with descriptive pictures and diagrams, are included in this bulletin. These compact buses can replace bulky cable harnesses and repetitive wiring for computer or modular application. This method of construction satisfies the demanding requirements of low inductance and resistance of high speed, solid state systems, while controlling electrical noises.

IEEE Show Booth, 4G16-4G18

### Eldre Components, Inc.

1239 University Avenue  
Rochester, New York 14607

# 178

## MERCURY RELAYS FOR POWER CONTROL APPLICATIONS

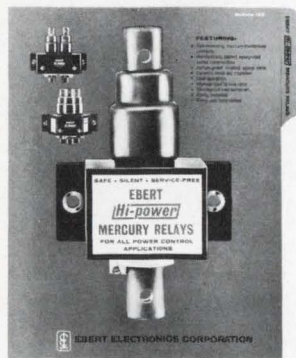

New comprehensive catalog fully describes the complete line of safe, silent, service-free Ebert Hi-power Mercury Relays. Available in 1, 2 and 3-pole units in several ratings to 60 kW., they offer greater load capacity, ease of installation, and guaranteed long life. Unaffected by adverse ambient conditions and physical or thermal shock they feature self-renewing mercury contacts, hermetically sealed epoxy-clad metal tube construction, and highest load to size ratio. Complete physical and electrical specifications are given.

Engineers will find this an excellent guide in selecting relays for all power control applications.

### EBERT ELECTRONICS CORP.

130 Jericho Tpke.,  
Floral Park, N. Y. 11002

# 179

# Electronic Design

## Advertising Representatives

### New York 10022

Robert W. Gascoigne  
Thomas P. Barth  
Samuel M. Deitch  
Byron Adams  
850 Third Avenue  
(212) PLaza 1-5530  
TWX: 867-7866

### Philadelphia

William C. Repetto  
P. O. Box 206  
Merion Station, Pa. 19066  
(215) MO 4-1073

### Boston

Richard Parker  
40 Webb Street  
Salem, Mass. 01970  
(617) 742-0252

### Chicago 60611

Thomas P. Kavooras  
Berry Conner, Jr.  
720 N. Michigan  
(312) 337-0588

### Cleveland

(216) 247-7670

### Los Angeles 90303

Stanley I. Ehrenclou  
Terrence D. Buckley  
W. James Bischof  
2930 W. Imperial Highway  
Inglewood, Calif.  
(213) 757-0183

### San Francisco

Ashley P. Hartman  
175 South San Antonio Rd  
Ste. 243  
Los Altos, Calif. 94022  
(415) 941-3084

### Southwestern 75206

Tommy L. Wilson  
6200 North Central Express-  
way  
Dallas, Tex.  
(214) EMerson 1-2311

### London W. 1

Brayton C. Nichols  
44 Conduit Street

### Verviers, Belgium

Andre Jamar  
1, Rue Mallard, 1  
(087) 253.85

### Tokyo

Yoshihiro Takemura  
International Planning  
Service, Inc.  
Room 231 Tokyu-Mita Bldg.  
1, Shiba-Mita Koun-cho  
Minato-ku, Tokyo



# STOP

Iron Core Problems

Call

## PERMACOR®

Iron Core Engineers

Whatever your iron core problems may be . . . space limitations, tolerances, delivery, or cost . . . PERMACOR can solve them quickly and efficiently.

Over the years, PERMACOR research, engineering, and production has solved countless military, commercial, miniature, and specialized applications. It can do the same for you.

Send us your problems today. Let us show you how PERMACOR "Engineered Economy" has made us the world's largest iron core producer. There's no obligation, of course!

## PERMACOR®

A Division of Radio Cores, Inc.

9540 Tulley Ave., Oak Lawn, Ill.

Phone: 312/GA 2-3353

INFORMATION RETRIEVAL NUMBER 78

We have been placing  
B.S., M.S. & Ph.D.

## ELECTRONIC ENGINEERS

in **FEE PAID** positions throughout the U.S. since 1959, through our **PERSONALIZED SERVICE.**

Over 1000 client companies rely on us to provide carefully screened, technical referrals. We are staffed by experienced graduate engineers . . .

**WORKING FULL TIME FOR YOU!**

**SEND RESUME TODAY**  
(if none, **SEND COUPON**  
for confidential application)



Name \_\_\_\_\_

Address \_\_\_\_\_

City \_\_\_\_\_

A. L. Krasnow, Member IEEE

**ATOMIC PERSONNEL, INC.**

Suite D-2, 1518 Walnut St.  
Philadelphia, Pa. 19102

AN EMPLOYMENT AGENCY FOR ALL TECHNICAL FIELDS

INFORMATION RETRIEVAL NUMBER 79

## Advertisers' Index

Advertiser	Page	Advertiser	Page
API Instruments Co. ....	113	ITT Semiconductors, A Division of	
Abbott Transistor Laboratories Incorporated. . .	14	International Telephone and Telegraph Corporation . . . . .	44
Acopian Corporation . . . . .	12	Indiana General Corporation . . . . .	23
Allen-Bradley Co. . . . .	32 A-B	JFD Electronics Co./Components Division . . . . .	98
Amperite . . . . .	52	Johanson Manufacturing Corp. . . . .	115
Analog Devices, Inc. . . . .	16 A-B	Jonathan Manufacturing Company . . . . .	16
Atomic Personnel, Inc. . . . .	138	Kepeco, Inc. . . . .	102
Ballantine Laboratories, Inc. . . . .	119	M-O Valve Co., Ltd., . . . . .	132
Beckman Instruments, Inc., Helipot Division . . . . .	91	Magnetic Shield Division, Perfection Mica Company . . . . .	116
Bishop Industries Corp. . . . .	136	Master Specialties Company . . . . .	11
Bourns, Inc. . . . .	37	Measurements, A McGraw Edison Division . . . . .	106
Bulova Electronics Division of Bulova Watch Company . . . . .	124	MicroSwitch, A Division of Honeywell . . . . .	51
Bunker Ramo Corporation, The . . . . .	117, 127	Microtran Company, Inc. . . . .	135
By-Buk Company . . . . .	136	Midtex, Incorporated, Aemco Division . . . . .	24
CELCO (Constantine Engineering Laboratories Co.) . . . . .	131	Monsanto Company . . . . .	53
Centralab, the Electronics Division of Globe-Union, Inc. . . . .	13	Motorola Semiconductor Products, Inc. . . . .	4, 5, 42, 43
Cinch-Graphik, Division of United-Carr . . . . .	125	National Semiconductor Corporation . . . . .	27, 29
Cohu Electronics, Inc. . . . .	93	Perfection Mica Company . . . . .	116
Communication Electronics, Incorporated . . . . .	108	Philips . . . . .	10
Consolidated Electrodynamics, A Subsidiary of Bell & Howell . . . . .	6	RCA Electronic Components and Devices . . . . .	8, 9, 101, Covers IV
Constantine Engineering Labs. Co. (CELCO) . . . . .	131	Radio Cores, Inc. . . . .	138
Coors Porcelain Company . . . . .	39	Raytheon Company, Components Division . . . . .	123
Couch Ordnance, Inc. . . . .	110	Relcom . . . . .	120
Cutler-Hammer . . . . .	104	Robinson Nugent, Incorporated . . . . .	122
Dale Electronics, Inc. . . . .	96 A-B	Schweber Electronics . . . . .	87
Damon Engineering, Inc. . . . .	41	Sealectro Corporation . . . . .	109
Datapulse, Incorporated . . . . .	2	Signetics Integrated Circuits, A Subsidiary of Corning Glass Works . . . . .	33
Delta Design, Inc. . . . .	128	Siliconix Incorporated . . . . .	126
Dzus Fastener Co., Inc. . . . .	137	Simpson Electric Company . . . . .	47
Ebert Electronics Corp. . . . .	137	Sprague Electric Company . . . . .	18, 20
Eldre Components, Inc. . . . .	137	Stimpson . . . . .	105
Electro Tec Corp. . . . .	114	TRW Inc., Capacitor Division . . . . .	48
Electronic Enclosures, Inc. . . . .	50	Tektronix, Inc., Oscilloscopes . . . . .	54
Electronic Engineering Co. of California . . . . .	15	Teleonic Instruments . . . . .	111, 118
Electronic Memories, Inc. . . . .	103	Texas Instruments Incorporated . . . . .	112
Electronic Research Associates, Inc. . . . .	111, 112	United Transformer Co., Division of TRW, Inc. . . . .	Cover II
Erie Technological Products, Inc. . . . .	17	Vanguard/Wyle . . . . .	122
General Electric Company, Electronic Components, Sales Operation . . . . .	80, 81	Victory Engineering Corporation . . . . .	120
General Radio Company . . . . .	77	Waldom Electronics, Inc. . . . .	129
Hayden Book Company, Inc. . . . .	136, 139	Wheelock Signals, Inc. . . . .	88
Heath Company . . . . .	133	<i>Career Advertising</i>	
Hewlett-Packard . . . . .	1, 7, 95, 107, Cover III	IBM Federal Systems Center . . . . .	89
Honeywell, Precision Meter Division . . . . .	64, 65		
Hughes Aircraft Company . . . . .	31		
IBM Industrial Products . . . . .	70, 71		
IEEE . . . . .	134		

# Looking for a book on Semiconductors? Here's a shelf-full from Hayden:

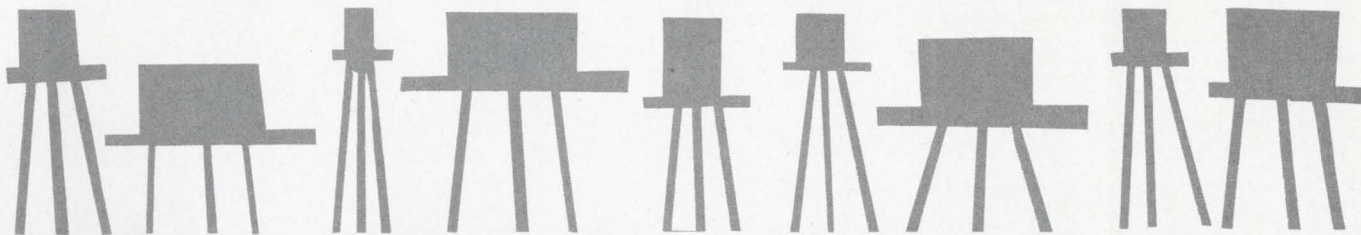

## TRANSISTORS FOR AUDIOFREQUENCY

Guy Fontaine

The companion volume to Fontaine's DIODES AND TRANSISTORS offers highly detailed treatment of the practical aspects of semiconductors in the audiofrequency range. The book provides thorough explanation of the parameters and characteristics furnished by the manufacturer, and their various applications in the design of an audiofrequency stage. #5641. 384 pages, illustrated, clothbound. \$7.95

## TRANSISTOR CIRCUITS IN ELECTRONICS

S. S. Hakim and R. Barrett

This indispensable sourcebook introduces the working principles of transistors in both amplifiers and oscillators, and linear and switching circuits. The book begins by discussing transistor characteristics and the functions performed by various types, then goes on to consider the transistor as a switch and to discuss regenerative switching circuits. In addition, the book shows how Boolean Algebra, the algebra of sets and binary arithmetic are applied in the study of computer and other logical circuits. #5034. 341 pages, illustrated, cloth. \$9.50

## DESIGN OF TRANSISTORIZED CIRCUITS FOR DIGITAL COMPUTERS

Abraham I. Pressman

Here is a book that provides the design engineer with a firm grasp of the principles and practices. Primarily concerned with the design of computer building blocks using transistors, the book employs "worst case" design calculations throughout. Circuit analysis and all aspects of output wave forms are calculated by treating the transistor as a current switch. #0215. 328 pages, illustrated, cloth. \$9.95

## PRINCIPLES OF TRANSISTOR CIRCUITS

S. W. Amos

Keeping pace with this rapidly advancing field, the updated Third Edition offers fifty per cent more information than its distinguished predecessor. The book includes new material on dc stabilization of amplifiers by direct-coupled feedback, phase shift and Weinbridge oscillators, blocking oscillators and transistor sawtooth generators. New appendices of transistor parameters and transistor manufacturers add to the completeness of this definitive work. #5649. 293 pages, illustrated, cloth. \$7.95

## ELECTRONICS FOUR: SEMICONDUCTORS

This self-contained unit-volume from Hayden's new ELECTRONICS 1-7 course, Harry Mileaf, Editor-in-Chief, was designed to meet the requirements of modern technical education. From first response it will be a standard text in schools teaching electronics. With unparalleled 2-color illustrations, review, and reinforcement, it promotes a complete understanding of the theory, operation, design, and functions of semiconductors, providing a concise background in atomic and electron theory. Equally valid for classroom use or as a self-study text for technicians, engineers will find it valuable also for updating themselves and as a convenient reference. #5556. 118 pages, illustrated, paper. \$3.45

## MICROELECTRONIC DESIGN

Edited by Howard Bierman

Almost 90 authoritative discussions of all aspects of microelectronics have been selected from **Electronic Design** and organized into a compact, convenient, and comprehensive reference. Each topic has been approached in practical and useful terms to provide a working overview of the field. #5762, 312 pp., illustrated, \$11.50

## DIODES AND TRANSISTORS

Guy Fontaine

Written to teach the language of semiconductors and its applications in all kinds of circuits, this popular work is divided into three comprehensive parts. The first section provides a thorough review of the principles underlying all semiconductor devices; section two covers diodes, the fundamental properties of point contact and PN junction diodes, plus an analysis of the performance characteristics of both; the balance of the book is devoted to transistors and gives a detailed presentation of all the parameters that could interest engineers. A final section deals with methods of designing circuits using transistors. #5500. 480 pages, illustrated, cloth. \$7.95

## TRANSISTOR AND DIODE NETWORK PROBLEMS AND SOLUTIONS

Harry E. Stockman

This two-way reference demonstrates the practical application of theory and serves as sourcebook of step-by-step mathematical solutions to practical problems. With schematic situations covering the entire field of transistor and diode networks, the reader develops effective techniques by comparing his own solution methods with the author's. #5694, 332 pp., illustrated, \$9.95

## TRANSISTOR BASICS: A SHORT COURSE

George C. Stanley, Jr.

For your own review, or for training technicians, here is a fast way to gain a practical understanding of transistors. Its simplified approach to transistor circuit analysis will enable the reader to determine desired values to an accuracy adequate for almost any practical situation. Includes material on working with and handling transistors and transistor troubleshooting techniques. #5819, 112 pp., illustrated, \$2.75

**Examine these  
outstanding  
new books  
for 10 full days...  
with no obligation!**

HAYDEN BOOK COMPANY, INC., 116 W. 14 St., New York, N.Y. 10011  
Send me the books circled below for a free ten-day examination. At the end of that time I will remit payment (plus postage) for those I wish to keep and return the rest.

5649	5500	5034	5556	5819
5762	5641	0215	5694	

Name \_\_\_\_\_

Title \_\_\_\_\_

Company \_\_\_\_\_

Address \_\_\_\_\_

City \_\_\_\_\_ State \_\_\_\_\_ Zip \_\_\_\_\_

Check here if payment enclosed. Publisher pays postage with same return guarantee. (On all foreign orders except Canada, payment in \$US must be enclosed.)

# Information Retrieval Service

All products, design aids (DA), application notes (AN), new literature (NL), and reprints (R) in this issue are listed here with Page and Information Retrieval numbers. Reader requests will be promptly processed by computer and mailed to the manufacturer within three days.

Category	Page	IRN	Category	Page	IRN	Category	Page	IRN
<b>Amplifiers</b>			non-burning molding compounds	127	366	silicon power supply	120	353
amplifier/null meter charge-sensitive pre-amp	125	360	paper tape, electrically conductive	126	364	spring-lock test probes	123	354
Design high frequency amplifiers (R)		408				strip chart recorders (NL)	132	378
laboratory 1 Hz to 100 kHz	119	351	<b>Microwave Devices</b>			sun-angle measuring (AN)	129	370
operational 0.1 $\mu$ V drift	102	325	balanced mixers	117	347	time-interval counter	125	361
operational, 1 $\mu$ s to 0.01% of final value	100	321	black body radiator	116	345	wave analyzer	123	355
photo cell and amplifier	105	328	coaxial breakaway	116	344			
			IMPATT diodes, 60 mW at 10.525 GHz	114	343			
			microwave receiver	116	346			
			nuclear electronic devices (NL)	130	373			
			S-band noise source	117	348			
<b>Components</b>						<b>New Literature</b>		
crystal oscillator differential dc op amp	102	324	<b>Production Equipment</b>			copper conductors	130	371
Inductor ups crystal bandwidth to 2% (R)		405	abrasive machining	109	334	fiber optics data	130	
NIXIE tube	104	326	depositing tool	109	335	finishing touch, 100 coatings	130	372
op amp, 0.1 $\mu$ V drift	102	325	FET tester	119	350	fluorocarbon tapes	134	380
photocell & amplifier	105	328	lead-bending tool	108	333	fused silica	134	381
resistor design articles (AN)	128	368				glass laserrods	133	379
resistors, metal film	105	327	<b>Semiconductors</b>			glass spheres	135	384
resistor, 2-W	102	323	alloy transistors, pnp	106	332	IC sampler	133	
servo assemblies (NL)	134	382	How, why and where to use FETs (R)		407	injection molding	135	383
ten-inch CRT	102	322	IMPATT diodes, 60 mW at 10.525 GHz	114	343	nuclear electronic devices	130	373
			Power-transistor data (NL)	132	377	phenolic molding	130	375
			silicon MOSFET	106	329	power transistor data	132	377
			silicon power transistors, 20-W	106	330	servo assemblies	134	382
			silicon rectifiers, 2 A	106	331	special glasses	132	376
			varactor op amps (NL)	130	374	strip chart recorder	132	378
						varactor op amps	130	374
<b>Data Processing</b>								
computer, 1 $\mu$ s cycling	110	337	<b>Test Equipment</b>					
data switching unit	113	342	ac line conditioner	124	356	<b>Application Notes</b>		
digital logger	110	339	accelerometer	121	355	group delay measurements	128	369
magnetic-core memory	110	338	amplifier/null meter	125	360	oscilloscope usage	129	
telemetry receiver	113	341	amplifier 1 Hz to 100 kHz	119	351	quality-control course	128	
telephone data coupler	112	340	charge sensitive pre-amp	124	357	resistor-design articles	128	368
time code generator	110	336	dc power supply	121	354	sun-angle measuring	129	370
			digital rf power meter	118	349			
			FET tester	119	350			
<b>Integrated Circuits</b>			fiber-optics data (NL)	130				
IC sampler (NL)	133		group delay measurements (AN)	128	369			
Planning to use MOS arrays?		408	impulse generator	124	358			
Use four-phase MOS IC logic (R)		406	integrating DVM	122	352			
			multimeter, 4-digit	120	352			
			noise source	124	359			
			oscilloscope usage (AN)	129				
			pulse generator	122	353			
<b>Materials</b>						<b>Reprints Available</b>		
epoxy remover	126	365				Inductor ups crystal bandwidth to 2%	405	
finishing touch, 100 coatings, (NL)	130	372				Use four-phase MOS IC logic.	406	
foam encapsulant	126	363				How, why and where to use FETs.	407	
glass fortified polyvinyl chloride	127	367				Planning to use MOS arrays?	408	
heat-sealable polyester film	126	362						
injection molding	135	383						

# bits in/volts out

10,000 TIMES FASTER THAN YOU CAN SAY HEWLETT-PACKARD

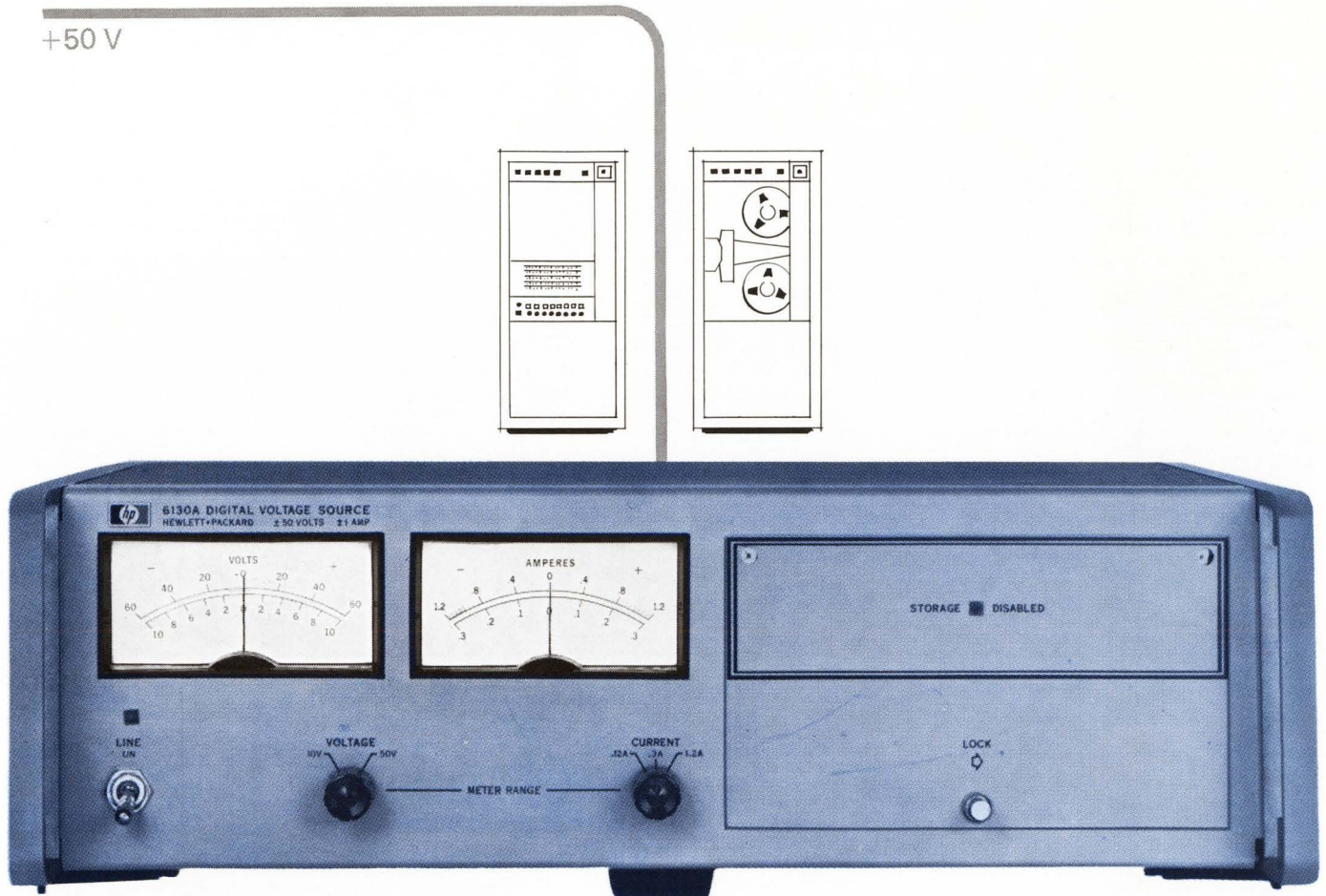

Digitally Program From +50 to -50 VDC. Up to 1 Amp in 100  $\mu$ Seconds!

Designed primarily for fast programming by digital computer, Hewlett-Packard's new 6130A Digital Voltage Source will deliver +50 to -50 VDC at hefty currents up to 1 amp—in less than 100  $\mu$ seconds. This means the user can program any voltage level in a  $\pm 50$  VDC range at 10,000 voltage steps a second. This digitally programmable supply consists of an accurate digital-to-analog converter followed by a fast power amplifier. Accuracy and resolution is 10 mV.\*

Complete interface, including input/output cards and the software, is available for use with the Hewlett-

\*1 mV on the 10 V range

Packard 2116A instrumentation computer. The Digital Voltage Source works with 8-4-2-1 BCD or binary number inputs. Plug-in board design allows fast and low-cost modifications to suit the coding and logic levels of any computer. At \$1500, the 6130A is the fastest and least expensive of its kind available.

For more information, call your local HP field engineer or write Hewlett-Packard Company, 100 Locust Avenue, Berkeley Heights, New Jersey 07922. Europe: 54 Route des Acacias, Geneva.

HEWLETT  PACKARD

POWER SUPPLIES

INFORMATION RETRIEVAL NUMBER 243

# No other 100W silicon power transistor in the industry can match this performance point

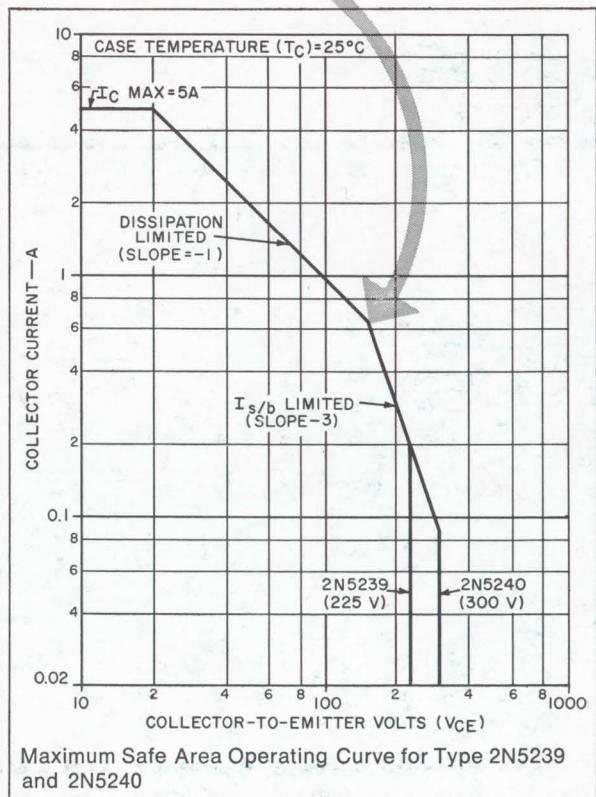
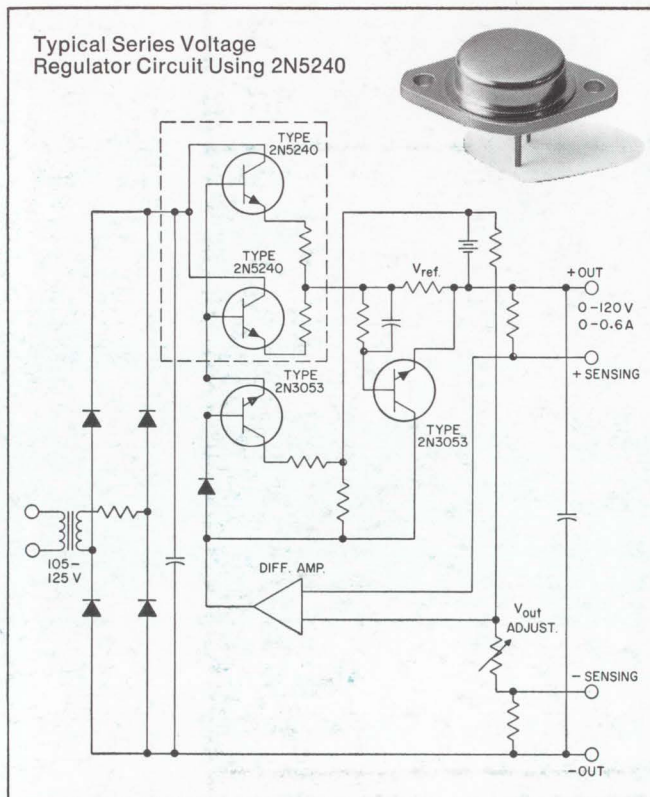

Now, full second breakdown protection up to 100 W dissipation and 150 volts, plus safe area rated up to 300 volts! That's a brand new level of power performance and reliability for high-voltage silicon transistors.

We made this capability possible by creating a unique pellet construction technique—multiple diffusion combined with the multiple emitter concept made famous by RCA "overlay." To you, this means better performing, more reliable circuits for high-voltage regulators, series regulators, high-speed inverters for off-the-line operation, switching bridge amplifiers for servo motor, controls, and ultrasonic power amplifiers.

Depending on your circuit requirements, you can choose between the 2N5240 with a  $V_{cer}$  (sus) of 350 volts or the 2N5239 with a 250 volt rating. Both transistors have an  $I_c$  (max.) of 5A and  $P_t$  of 100 W.

For more information consult your RCA Representative or your RCA Distributor. For technical data, write: Commercial Engineering, RCA Electronic Components and Devices, Section IG3-1, Harrison, N.J. 07029.

# RCA