

Electronic Design 13

VOL. 17 NO.

FOR ENGINEERS AND ENGINEERING MANAGERS

JUNE 21, 1969

Readout modules go solid state with light-emitting diodes arrayed in seven segments. New digital readout operates at IC power levels of 480 mW maximum.

Separated from its logic control, this alphanumeric device offers performance advantages and the promise of a new generation of instruments. Turn to page 138.

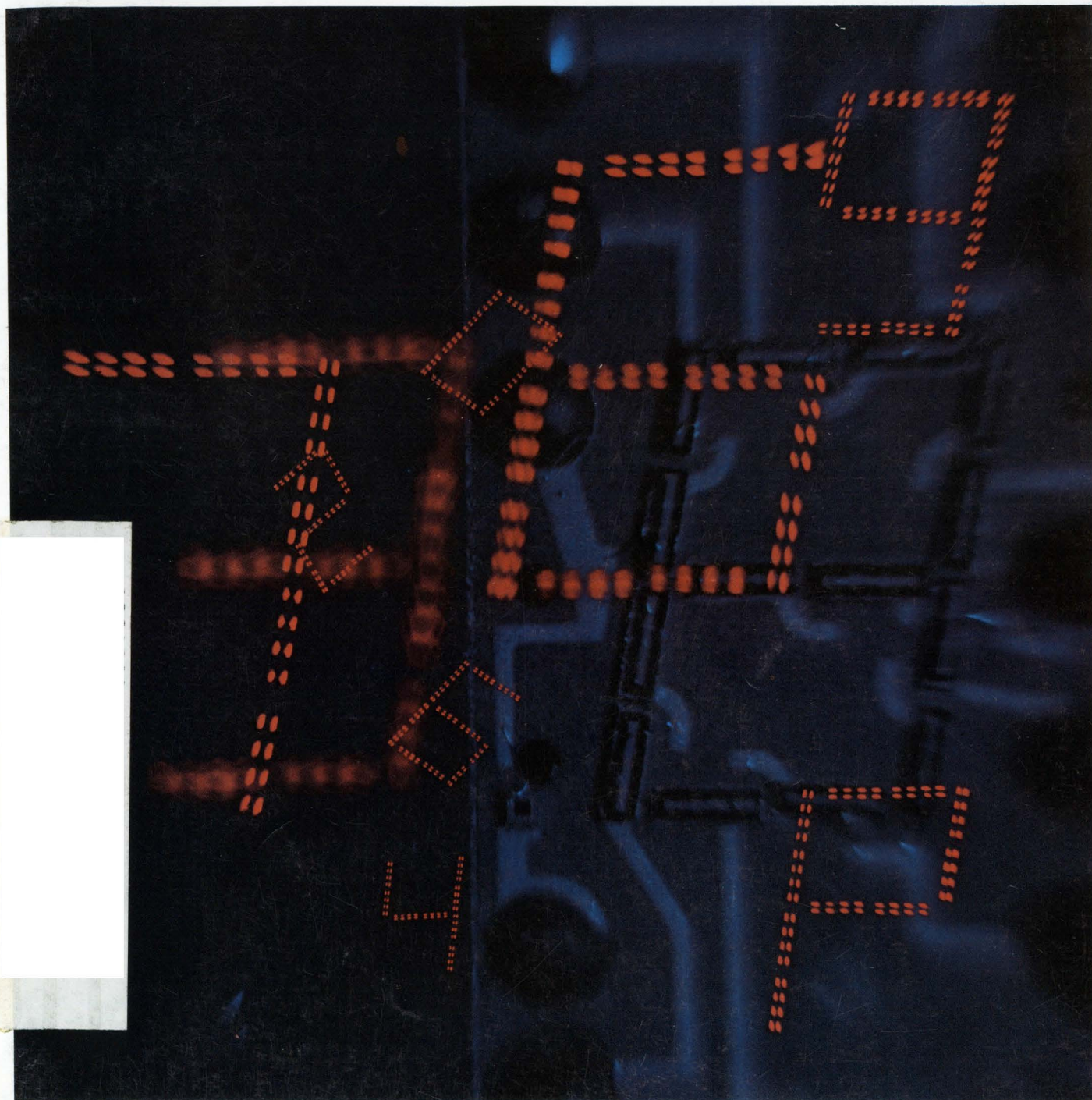

Inductors for all temperatures



UTC high Q coils give you better inductance stability over any temperature range

That's a tough claim to back up!

We do it by meticulously controlling every process variable that can affect temperature stability of an inductor. We pay special attention to every detail of design and manufacture—winding methods, materials compatibility, stabilization processes, assembly and impregnation—details other manufacturers ignore. Over any temperature range you specify, UTC inductors will outperform all others.

Available from our catalog are high Q inductors with guaranteed stability from -55°C to $+130^{\circ}\text{C}$. Adjusted inductance

tolerances are as tight as $\pm 1\%$ on standard inductors. Select from hundreds of inductors made to MIL-T-27B. If your specific need cannot be supplied, we'll tailor an item to your specifications.

When your designs call for better inductance stability, UTC is the answer. Check your local distributor for immediate off-the-shelf delivery or contact United Transformer Company, Division of TRW INC., 150 Varick Street, New York, New York 10013.

TRW
UNITED TRANSFORMER COMPANY

in 1-1000 MHz work

Voltage tells only half the story

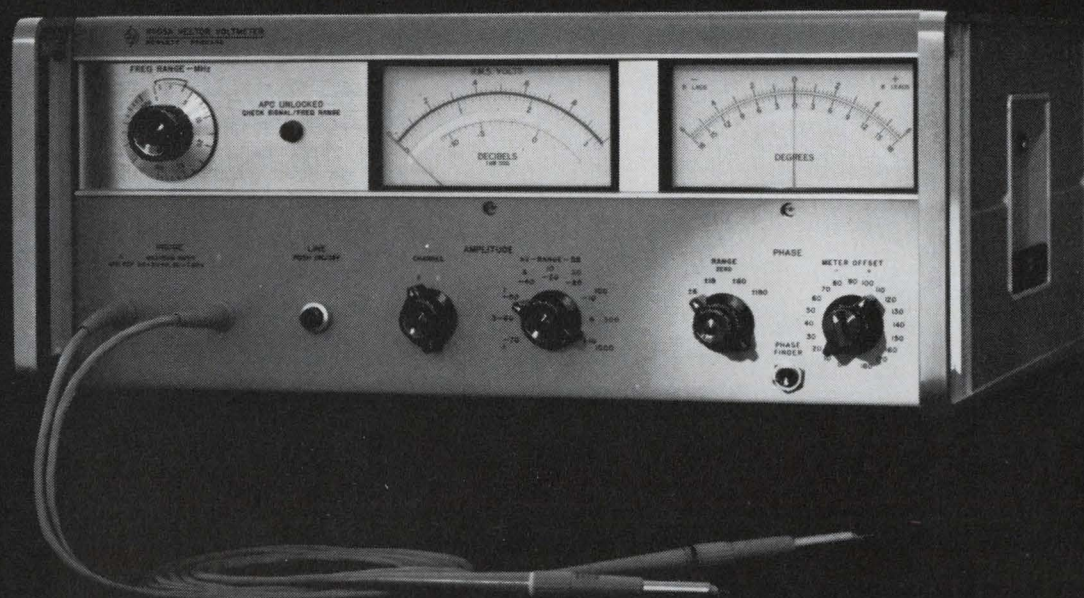

The HP Vector Voltmeter tells all.

"All" means *phase*, the key to every RF measurement. Especially the tough ones like open-loop gain of feedback amplifiers, electrical lengths, resonance characteristics, or filter pass and rejection bands. And this 2-channel millivoltmeter-phasemeter makes them directly, accurately and conveniently.

The Vector Voltmeter covers the frequency range from 1 to 1000 MHz and automatically locks onto the signal anywhere within an octave—no fine tuning required. It's extremely sensitive—full scale 100 μ V. With its 90 dB dynamic range, you can easily measure high gain and high loss networks. It has a 360-

degree phase range with 0.1° resolution.

The 8405A also serves as a "frequency translator." How? By transforming the RF inputs to 20 kHz outputs whose wave shapes, amplitudes and phase relationship remain identical to the original RF signals. You can use these outputs for further analysis with low frequency scopes.

You needn't waste time making a tough RF measurement any longer. The HP 8405A does it faster and more completely than ever before. Application Note 91 tells you how. Just call your HP field engineer for details, or write Hewlett-Packard, Palo Alto, California 94304; Europe: 54 Route des Acacias, Geneva.

MAJOR SPECIFICATIONS, HP 8405A VECTOR VOLTMETER

FREQUENCY RANGE is 1 to 1000 MHz in 21 over-lapping octave bands; automatic tuning within each band.

VOLTAGE RANGE FOR CHANNEL A (synchronizing channel), 300 μ V to 1 V rms (10-500 MHz), 500 μ V to 1 V rms (500-1000 MHz), 1.5 mV to 1 V rms (1-10 MHz).

VOLTAGE RANGE FOR CHANNEL B (input to Channel A required) 100 μ V to 1 V rms, full-scale. Full-scale meter ranges from 100 μ V to 1V in 10 dB steps. Both channels can be extended to 10 V rms with 11576A 10:1 Divider.

PHASE RANGE of 360° indicated on zero-center meter with end-scale ranges of $\pm 180^\circ$, $\pm 60^\circ$, $\pm 18^\circ$, $\pm 6^\circ$. Phase meter OFFSET of $\pm 180^\circ$ in 10° steps permits use of $\pm 6^\circ$ range for 0.1° phase resolution at any phase angle.

PRICE: \$2750.

HEWLETT  PACKARD

RF TEST EQUIPMENT

INFORMATION RETRIEVAL NUMBER 2

Systron-Donner's Model 6316A gives you automatic final-answer frequency readings non-stop from dc through X band.

It's the perfect systems counter — a completely programmable unit that mounts in a slim 1¾ inches of panel space and costs only \$4750. Before now you needed a collection of instruments totaling five times the bulk and costing half again as much to do the same job.

Model 6316A covers the full range by combining a dc-to-100 MHz counter with built-in automatic frequency extenders. Readings can be taken in milliseconds, and the extenders lock in phase with the input to preserve counter accuracy to 12.4 GHz. That accuracy depends only on time base stability—which can be an ultra-high 5 parts in 10^{10} per 24 hours.

Reliability is superb—proven by more than a year's operation in the field. For a prompt demonstration, phone or write Measurements Division, Systron-Donner Corporation, One Systron Drive, Concord, California 94520. Phone (415) 682-6161.

First counter to measure automatically from dc to 12.4 gigahertz!

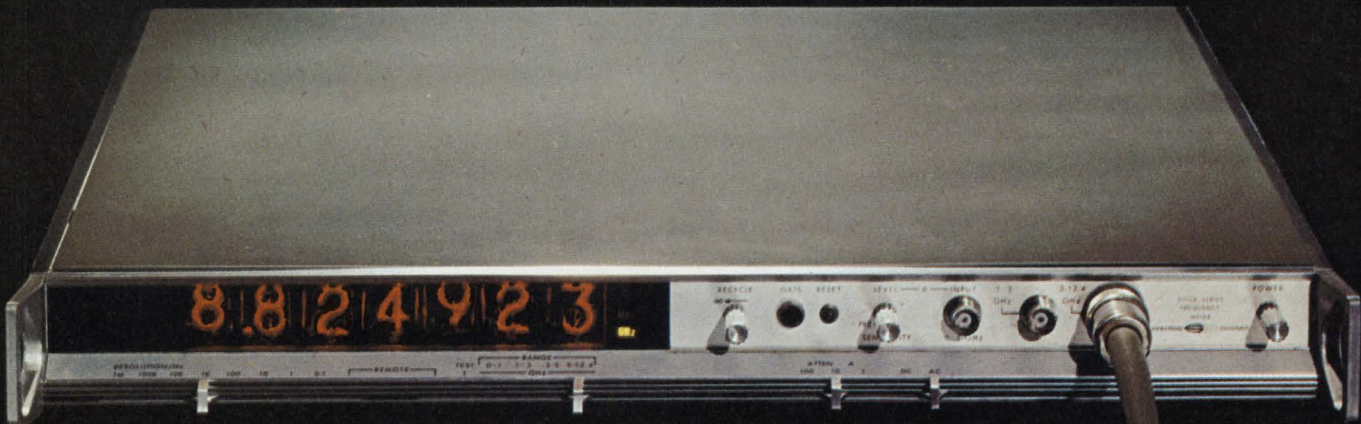

SYSTRON  DONNER

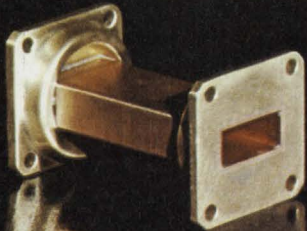

Another first. One of 144 Systron-Donner instruments

| | |
|--------------------------------|-----------------------------|
| Electronic counters | Digital voltmeters |
| Pulse generators | Digital panel meters |
| Microwave frequency indicators | Microwave signal generators |
| Digital clocks | Laboratory magnets |
| Memory testers | Data acquisition systems |
| Analog computers | Microwave test sets |
| Time code generators | |
| Data generators | |

NEWS

- 21 News Scope
- 25 **Amorphous semiconductors: Zowie? Or Zilch?**
The promise of revolutionary switching devices is great, but so are the reproducibility obstacles.
- 36 **The happy merger of fiber optics and lasers**
'Light knife,' cancer probe, microwelder and a communications net are all promising applications
- 45 Washington Report
- 52 **IBM tests holographic data storage**
- 58 Sidelights
- 61 **Editorial:** Learn to manage yourself before trying it on others
-

TECHNOLOGY

- 77 **Digital circuits and techniques: a special collection**
of Ideas for Design
- 78 Switching and control
- 82 Pulse shaping and generation
- 85 Counters and dividers
- 88 Timing
- 91 Miscellaneous
- 98 **Choose voltage-regulator op amps with care.** Output impedances, offset voltages, and common-mode effects all limit regulation.
- 106 **Don't waste drive power in microwave switching.** Reverse the direction of an inductor's current resonantly by using a capacitor.
- 114 **Get something extra in filter design.** One BASIC program works for Butterworth and Chebyshev low-pass or high-pass RC-active circuits.
- 124 **Play your way to better decisions** with management training games. Right 'choicemanship' is an art that requires group practice.
-

PRODUCTS

- 138 **Cover Feature:** Solid-state readouts are IC compatible.
- 140 **Components:** Tantalum chip capacitors resist high temperatures.
- 148 **Instrumentation:** Low-ohm digital voltmeters compute ac measurements
- 156 **Subassemblies:** New filters and delay lines enhance state of the art.
- 162 ICs and Semiconductors
- 168 Data Processing
- 174 Packaging and Materials
- 178 Microwaves and Lasers
- 182 Production
-

Departments

- | | | | |
|-----|---------------------|-----|-------------------------------|
| 16 | Designers' Datebook | 192 | Annual Reports |
| 135 | Books | 194 | New Literature |
| 184 | Evaluation Samples | 206 | Advertisers' Index |
| 187 | Design Aids | 208 | Information Retrieval Service |
| 188 | Application Notes | | |

Information Retrieval Service Card inside back cover

COVER PHOTO: a new solid-state readout module, courtesy of Monsanto Electronic Special Products.

ELECTRONIC DESIGN is published biweekly by Hayden Publishing Company, Inc., 850 Third Avenue, New York, N.Y. 10022. James S. Mulholland, Jr., President. Printed at Brown Printing Co., Inc., Waseca, Minn. Controlled circulation postage paid at Waseca, Minn., and New York, N.Y. Copyright © 1969, Hayden Publishing Company, Inc. 77,523 copies this issue.

**Everyone talks
correed reliability,**

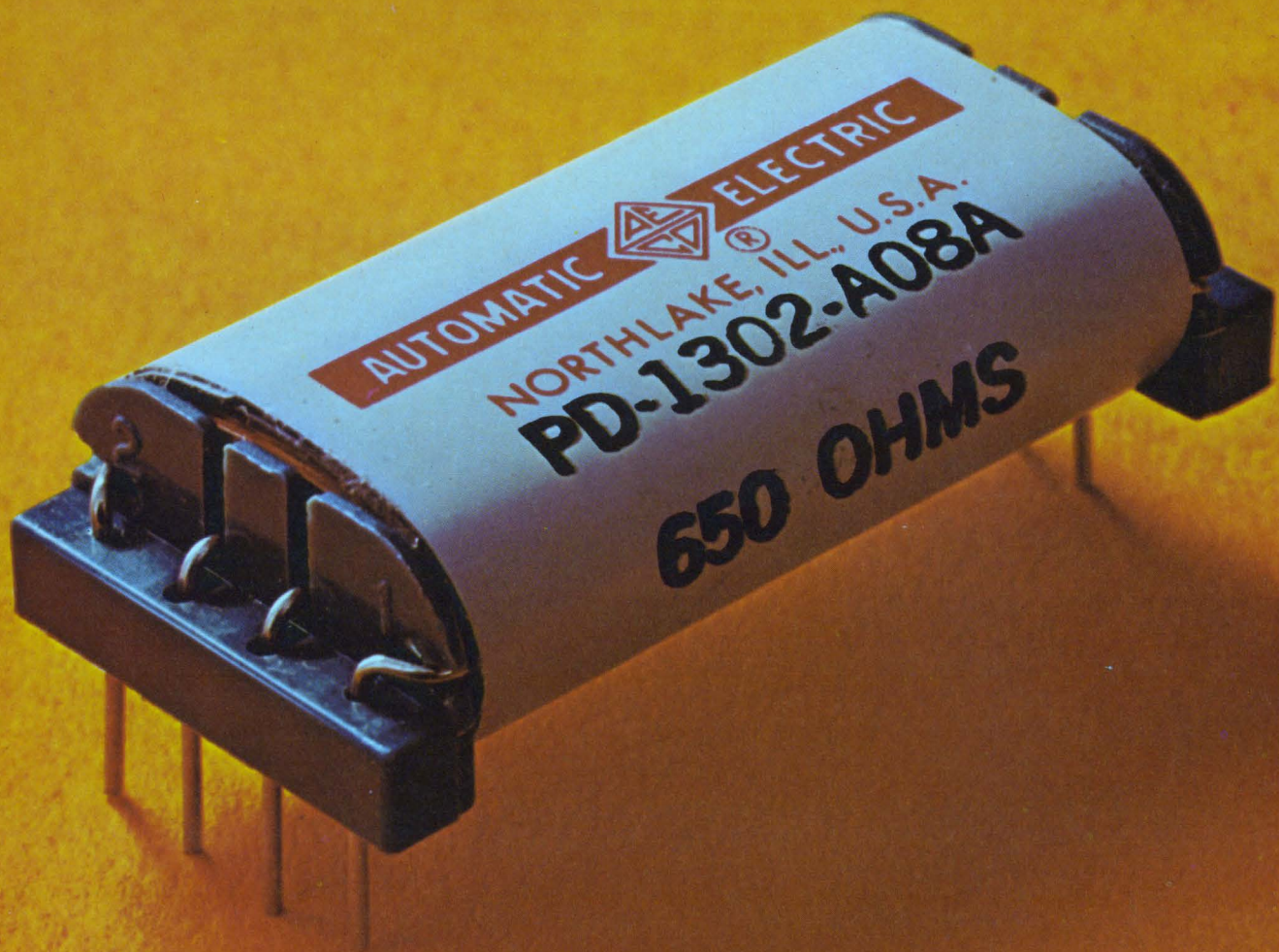

here's the way it looks.



Switches under glass.

The heart of every AE correed is a reed switch consisting of two overlapping blades. For protection, we seal them inside a glass capsule. But only after we pull out all the dirty air and pump in a special, pure atmosphere. That way there's no chance of contact contamination or oxidation. Ever.

Notice our terminals are one piece. A special machine delicately forms them to precision tolerances. It's a lot of work, but one-piece terminals have distinct advantages over the two- and three-piece kind.

For one thing, there's no extra joint so you're always assured of a positive contact. Also, one piece terminals are more reliable when the correed is used to switch low-level analog signals. That's because thermal EMF is reduced to practically zero.

A different kind of bobbin.

Since we go through so much trouble with our correed capsules, we designed a special bobbin to protect them.

It's molded of glass-filled nylon. (You know how plastic chips and cracks.) Moisture and humidity have no effect on this stubborn material. No effect means no malfunctions for you to worry about. No current leakage, either.

Running the full length of the bobbin are a series of slots. They pamper the capsules and keep them from getting damaged or jarred.

And to help you remember which terminal is which, we mold the terminal numbers into the end of the bobbin. You can read them at a glance.

Little things mean a lot.

Reliability means that we pay attention to the little things. Like the tiny pressure rods we use in every miniature correed. They're placed at

each end of the bobbin, across the one-piece terminals. What they do is prevent stresses from being transmitted from the terminals to the reed blades. This keeps the contact gap right on the button. All the time.

The contacts are normally open. To provide them normally closed, we employ another little device—a tiny magnet. It's permanently tucked into a slot next to the reedcapsule. The magnetic action keeps the contacts normally closed.

Coiled by computer.

Once all the parts are secure in the bobbin, we cover them with protective insulation. Around this, we wind the coil. You can be sure the coil winding is correct. It was all figured out for us by computer.

Our next step is to protect the coil. We do that with more protective insulation.

A coat of iron.

On top of the insulation goes a layer of annealed iron. It acts as a magnetic shield and minimizes interaction between coils. Also, it improves the sensitivity of the entire unit. A coat of iron is standard on all AE correeds.

Finally comes super wrap.

To wrap it all up, we use some very special stuff. A layer of mylar laminated material.

It's so tough we guarantee it to withstand all cleaning solvents known to man.

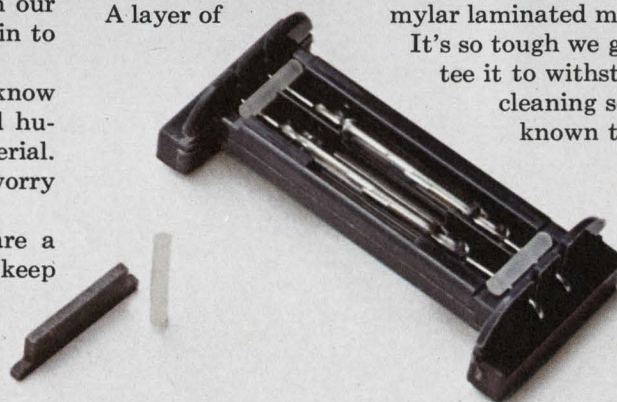

It's attention to detail that helps us keep our miniature relays miniature. Now we're just waiting to show you how perfectly it measures up to your specifications. Automatic Electric Company, Northlake, Illinois 60164.

AUTOMATIC ELECTRIC

SUBSIDIARY OF GENERAL TELEPHONE & ELECTRONICS

INFORMATION RETRIEVAL NUMBER 4

**the first
of the**

GIANTS™

GENERAL INSTRUMENT ADVANCED NITRIDE TECHNOLOGY PRODUCTS

the first static dual 16-bit shift register directly compatible with TTL, DTL and MOS is also the lowest priced* shift register

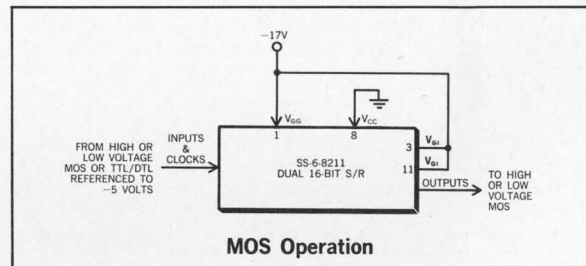
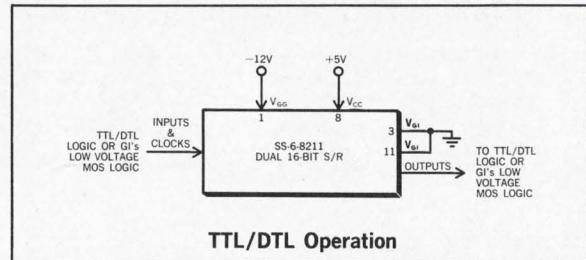
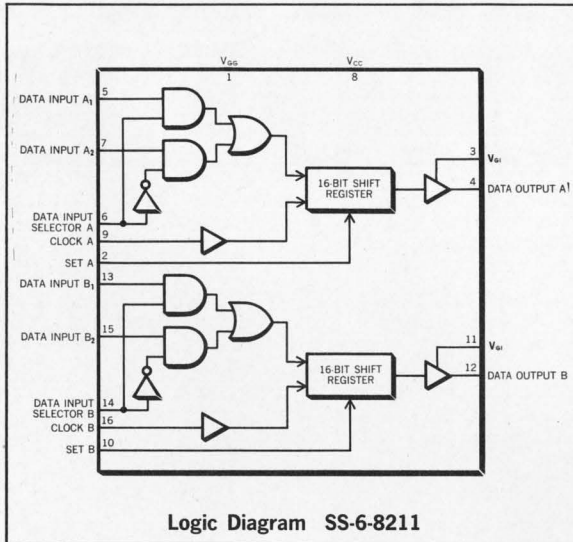

General Instrument's exclusive MTNS process has now been translated into a line of standard General Instrument LSI circuits.

The Dual 16-bit DC Shift Register is the first of the family of GIANTS (General Instrument Advanced Nitride Technology Products) to be introduced.

This giant step forward results in LSI devices which are totally compatible with TTL, DTL and MOS, and as in the case of the Dual 16-bit DC Shift Register, lower in price than any other such device available.

The well-known performance and reliability advantages inherent to MTNS devices are, of course, present in all GIANT LSI circuits. These advantages include: a reduction in the number of system power supplies required, the elimination of interface circuitry, a reduced parts count and fewer interconnections, lower power dissipation, increased operating frequency and an increased operating temperature range.

The most outstanding feature of General Instrument's Dual 16-bit DC Shift Register—and of every standard GIANT product—is the exclusive V_{GI} terminal, which gives the user a choice of interfacing directly with TTL/DTL or MOS (as shown in the block diagrams above).

This shift register contains two independent 16-bit DC to 2MHz shift registers constructed on a single monolithic chip utilizing MTNS P-Channel enhancement mode transistors. Independent

*\$7.50 each in quantities of 100 pcs. in a TO-72 package (GI part #SS-6-8212). Also available in a 16-lead dual in-line package (GI part #SS-6-8211) at \$13.80 each in quantities of 100 pcs.

single phase TTL/DTL compatible clock and data inputs are provided for both registers. Each shift register bit is implemented with a cross coupled flip-flop, so that data is stored indefinitely regardless of the logical level of the clock. Data on the input is sampled while the clock is at a "0" level and the register shifts on a "0" to "1" transition. Separate input data selector controls are provided on each shift register. They determine which of the two inputs shall be shifted into the register. Each shift register also has its own set input which forces all stages of the register to a "1" level.

Among the other features of the Dual 16-bit DC Shift Register are: power dissipation of 120 mW, full military temperature range of -55°C to $+125^{\circ}\text{C}$, high input impedance, stable threshold over time vs. temperature, multiplexible inputs, the need for fewer packages compared to equivalent TTL/DTL circuits, and set control.

The General Instrument Dual 16-bit DC Shift Registers are truly GIANTS among shift registers. They are immediately available from your authorized General Instrument Distributor.

For full information write, General Instrument Corporation, Dept. D, 600 West John Street, Hicksville, L.I., N.Y. 11802.

(In Europe, write to General Instrument Europe S.P.A., Piazza Amendola 9, 20149 Milano, Italy; in the U.K., to General Instrument U.K., Ltd., Stonefield Way, Victoria Road, South Ruislip, Middlesex, England.)



GENERAL INSTRUMENT CORPORATION • 600 WEST JOHN STREET, HICKSVILLE, L. I., NEW YORK

MAGNETICS BY ARNOLD

RUB-A-DUB-DUB... GOODBYE!

So who wants the hand crank on the washer and wringer?

On today's automatics you push the button and you're in business. Of course the timer requires an Arnold hard ferrite unit and so does the motor. But they get the job done with much less scrub. And a good many other appliances around the home lean on Arnold to get *their* job done.

Forward-looking manufacturers always look to Arnold for high-quality magnetic materials, design, technology and components. Magnetic cores. Powder cores. Laminations. You ask. We'll supply. The best in magnetic materials.



ARNOLD
SPECIALISTS IN MAGNETIC MATERIALS



The Arnold Engineering Company, Main Office: Marengo, Ill.
Branch Offices and Representatives in Principal Cities

Write for your free guide to the only complete line of magnetic materials.

Other Arnold products can also fit easily into the appliance industry: MPP and powdered iron cores • Tape and Bobbin Cores • Alnico and Arnox® permanent magnets • Supermendur transformer cores.

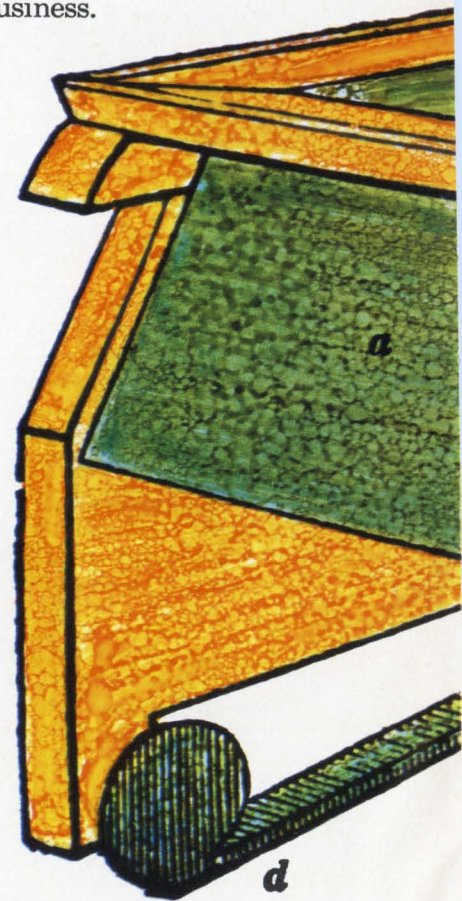

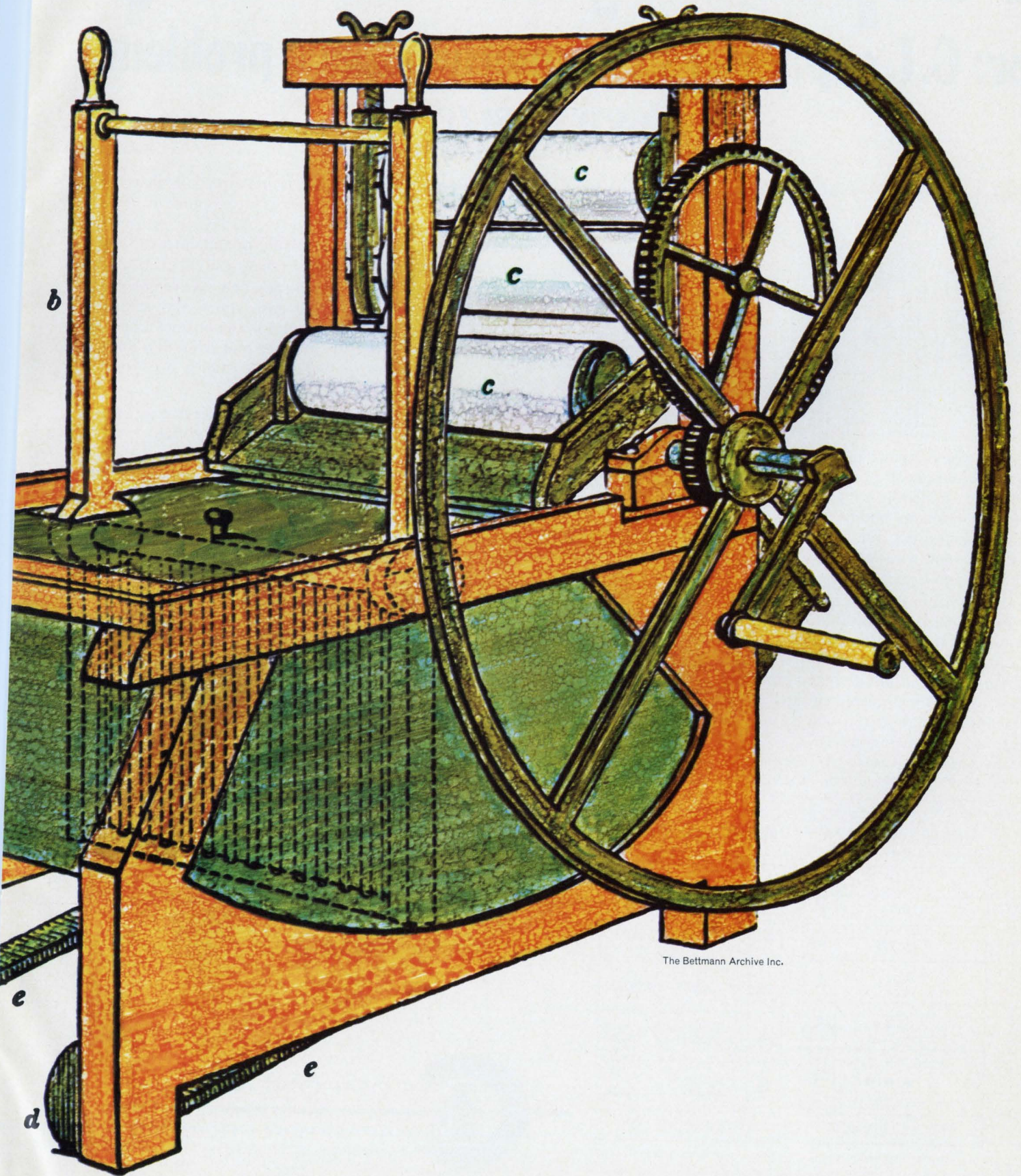

The Bettmann Archive Inc.

Propensity for density

or: C.I. capacitors cut another space problem down to size

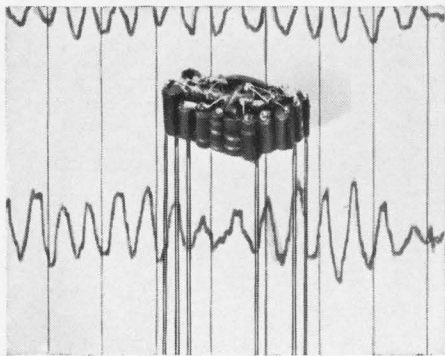

Enlarged approximately 1 1/2 times

When you convince more than 30 discrete components, including 10 electrolytic capacitors ranging from 0.01 to 2.2 mfd., to huddle together in a space somewhat smaller than 1/20 of a cubic inch, you've got yourself some pretty high-density packaging.

That's what engineers did at Signatron, Inc., Gardena, California, when they designed their miniature Model 2300-EEG differential amplifier — a potted, high-reliability unit designed primarily for use in their telemetry devices for physiological monitoring such as electro-encephalographs.

Of course they turned to Components, Inc. for the capacitors because, as

everybody knows, C.I. makes the smallest, most dependable solid tantalum capacitors available . . . anywhere. Results: No capacitor failures, no leakage problems, excellent performance.

The Minitan® Cordwood Series used in this application were specifically designed for miniature equipment. They are available in five different case sizes from 1/8" to 1/4" in length, with radial or axial leads, and capacitance values up to 47 mfd.

Performance is maximum, leakage is minimum, prices are optimum. Full reliability up to 125°C. Non-polar versions available in standard capacitance ratings.

C.I. . . . space race ace We offer more subminiature case styles and ratings than anyone else in the business. Samples, performance and reliability data, and application assistance are yours for the asking.

First in reliability . . . service . . . delivery. We prove it every day.

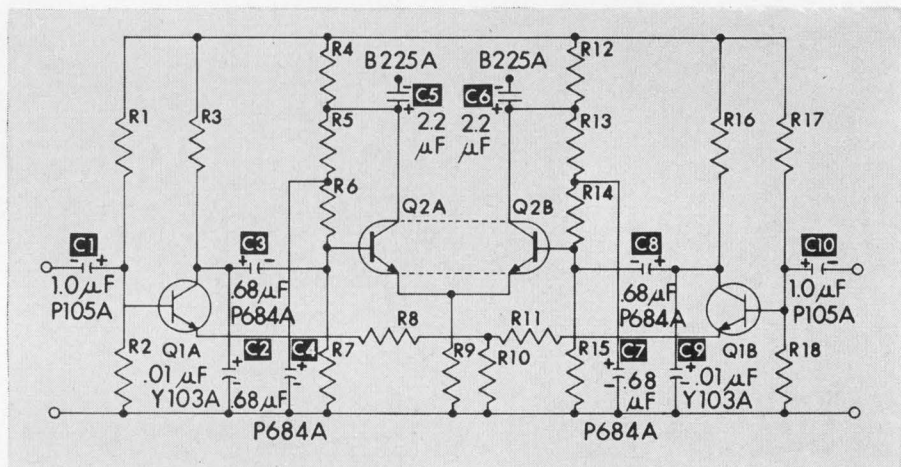

MINITAN MODULAR

(Also available with axial leads)

| | |
|--|---|
| | U |
| | F |
| | M |
| | L |
| | S |
| | J |

47 MFD @ 35 VDC to 220 MFD @ 3 VDC
(Cordwood Series available from .01 MFD @ 50 VDC)

(ACTUAL SIZE)

MINITAN CORDWOOD

| | |
|--|---|
| | Y |
| | P |
| | B |
| | A |
| | G |

.01 MFD @ 50 VDC to 47 MFD @ 3 VDC
(Modular Series available to 220 MFD)

(ACTUAL SIZE)



"The Pill"

for price control

TELEDYNE



TO-5 Relay

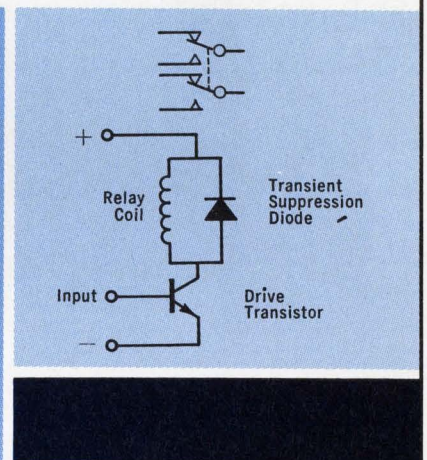
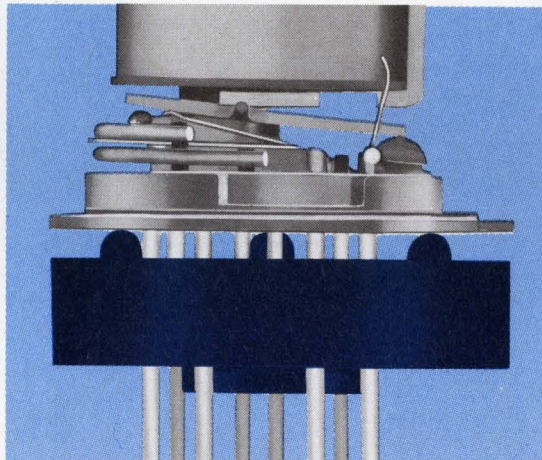

We keep our promises! Last month we promised a low-priced industrial application DPDT TO-5 case relay with an internal transistor driver. We call this new contraption "THE PILL." "THE PILL" contains a transistor driver and suppression diode, attaches externally to our DPDT industrial 712 relay to form the 712T . . . and does double duty as a transapad.

The 712T combines the advantages of relay operation, i.e., high isolation, low contact resistance, double throw contacts, high current and overload capability with the low signal drive requirement offered by the transistor front-end.

It's hermetically sealed; utilizes all welded construction; requires a turn on (trigger) power of only 200 microwatts or less depending on coil voltage; and may be driven directly from standard T^L or similar logic. The relay coil is paralleled with a diode to suppress transients.

The entire package is only 0.405 high by 0.370 in diameter (including "THE PILL"), and is available from stock at your local Teledyne Relay distributor or from the factory at the following price schedule:

| | | | |
|----------|---------|---------|---------|
| Quantity | 100 | 1,000 | 10,000 |
| Price | \$12.50 | \$10.40 | \$ 9.25 |

We call our first price control PILL the 712T . . . Look for an op-amp

PILL in July for DO-IT-YOURSELF time delays and level sensing applications.

No blue sky promises from us . . . just fast delivery for quick price relief.

Phone, wire or write for technical data.



TELEDYNE RELAYS
A TELEDYNE COMPANY

3155 West El Segundo Boulevard Hawthorne, California
90250 Telephone: (213) 679-2205

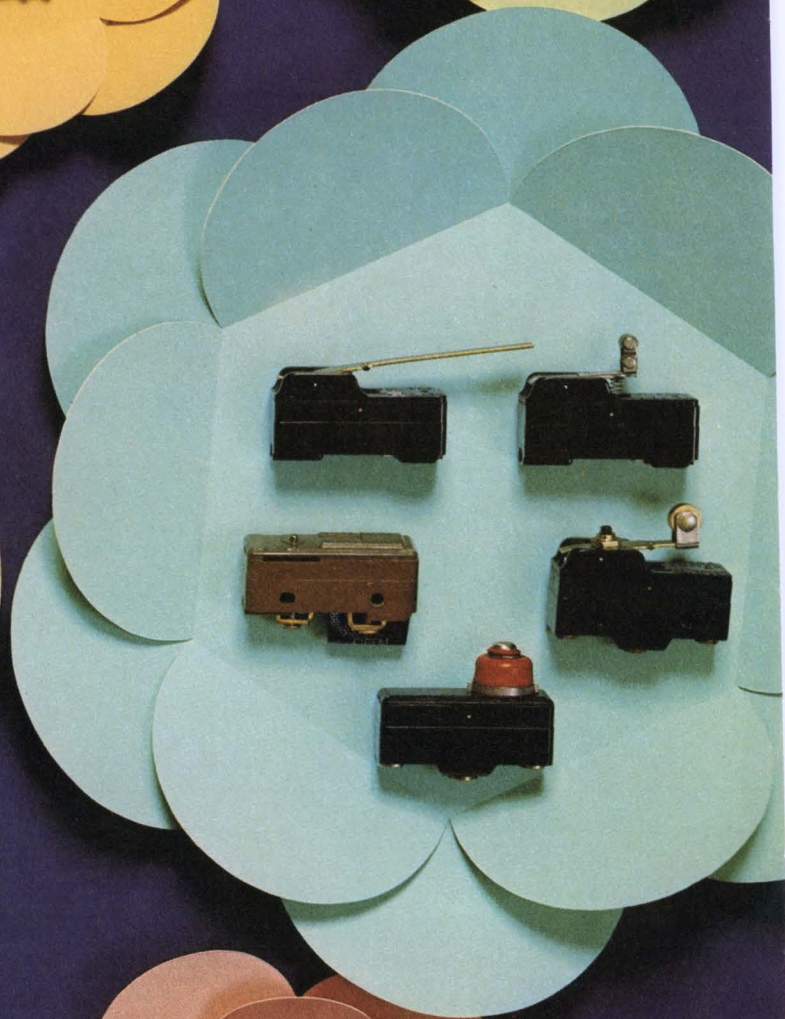
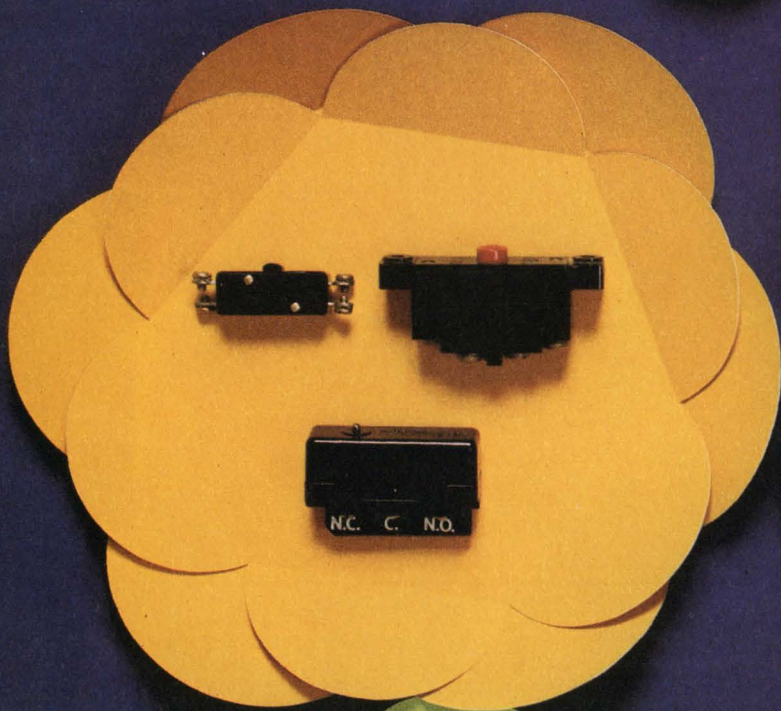
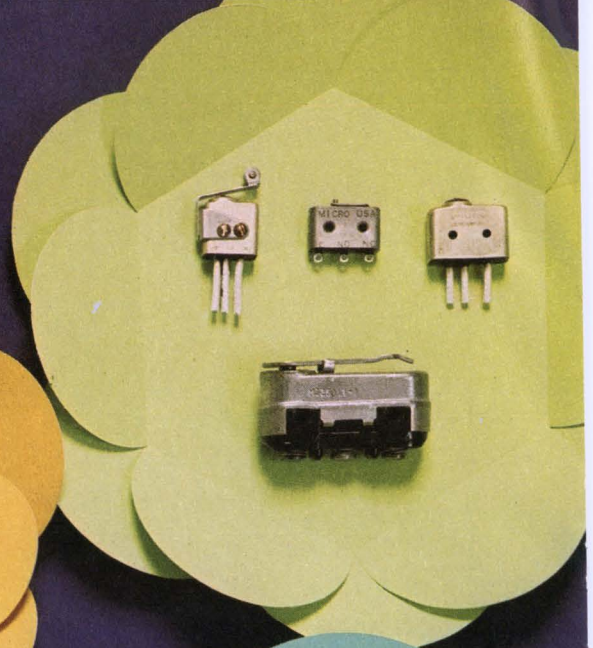
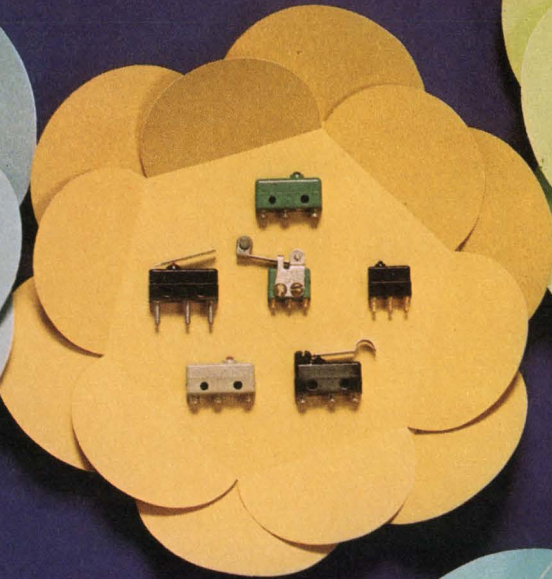
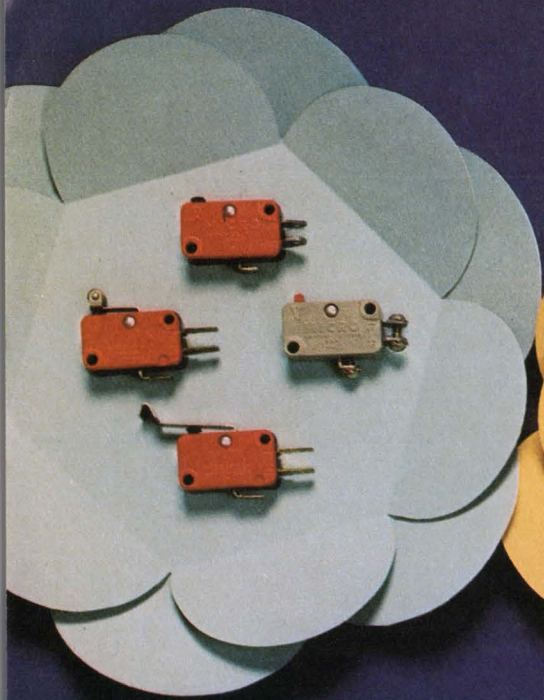

Basic Switches?

Go where you can pick from the whole blooming family.

You won't miss out on the latest in basic switches when you come to MICRO SWITCH. Here you can make your selection from the world's largest family. Thousands of subtle variations help you meet any combination of requirements—size, weight, circuitry, electrical capacity, actuation, termination and environmental resistance.

For example, there are switches especially sealed to do the job in highly contaminated environments; switches that operate efficiently at temperatures as severe as +1000° or -320°F; electrical loads from milliamp to 25 amps, 125 vac, or 10 amps, 125 vdc. A large number meet military specifications.

But you can expect much more when you come to MICRO SWITCH. For instance, extra assurance of consistent quality throughout a large quantity run. Or

the certainty that a switch will deliver precise operating characteristics throughout a long life. Perhaps what's essential to you is the convenience of local distributors with complete selections on the shelf—or, on the other hand, world-wide availability! If on-time deliveries are critical to you, you'll be interested in our computer-controlled ordering, inventory and production control system. Finally, should you have special design problems, our engineering field service—the largest in the industry—specializes in coming up with the right solutions.

Shown at left and described below are just a few members of our ever-blooming family of basic switches. For additional information, call a Branch Office or Distributor (Yellow Pages, "Switches, Electric"). Or write for Catalogs 50 and 52.

A. Type V3 Basic Switches—Small, versatile precision switches. Over 500 standard designs, including many actuator and terminal variations. Operating force as low as 10 grams, differential travel as small as .002 inch. Rating up to 15 amps 125 vac. SPDT, SPNO or SPNC. Temperature range up to 600° F. Military listed. Case size 1.09 x .62 x .40 inch.

B. Subminiature Basic Switches—Precision operation with minimum space and weight. Variety of actuators, terminals and characteristics. Silver or gold contacts, and bifurcated contact design for reliable low energy operation. Military listed. Type SM: Case size .78 x .35 x .25 inch, up to 10 amps 125 vac. Type ISX: Case size .50 x .35 x .20 inch, 7 amps 125 vac.

C. Sealed Basic Switches—Small switches for reliable military/aerospace use and other applications requiring environmental protection. Types XE and SE are classed watertight (Symbol 3, MIL-S-8805), with a corrosion-resistant metal housing, molded silicone rubber plunger seal, and terminals encased in epoxy resin. Types HM and HS feature true hermetic sealing (Symbol 5, MIL-S-8805), with metal-to-metal and glass-to-metal fusion. Solder or leadwire termination.

D. Special Circuitry Basic Switches—Simplify circuit design and eliminate extra wiring. Type "DT": DPDT. Type TB: 2-Ckt and 4-Ckt Double-Break. Type MN: 2-Ckt Double-Break. Also dual SPDT assemblies, make-before-break, pulse operation, and sequential action types.

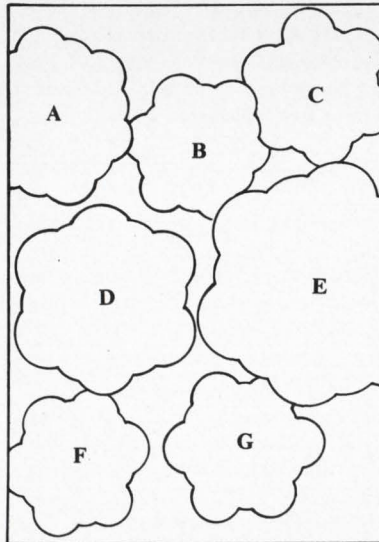

E. Standard Basic Switches—The maximum in precise operation, accurate repeatability, long life and high electrical capacity. Thousands of proven designs available. Variety of actuators and terminals. Case size: 1.94 x .95 x .68 inch. SPDT, SPNO or SPNC. Momentary or maintained contact. Type Z: 15 amps; Type A: 20 amps; Type M: 22 amps; Type E: 25 amps; each at 125 vac. Type MT: 10 amps 125 vdc.

F. High Temperature Basic Switches—Type HT switches withstand +1,000°F and -321°F. Available with panel-mount push-plunger or roller-plunger, or side-mount with auxiliary actuators. Corrosion and shock resistant.

G. Glass-Enclosed Switches—Hermetically sealed contacts for extra reliability and long life. Modern automatic equipment assures product uniformity in large quantity production. Type AS mercury switches: low force, tilt operation; SPST, SPDT, or 2-Ckt; rating up to 70 amps 30 vac; variety of operating characteristics. Type CS miniature reed switches: Form A or Form C; outstanding long life/high capacity combination—up to 100,000,000 cycles at 10 watts; and high reliability on micro-volt or micro-ampere circuits.

MICRO SWITCH

FREEPORT, ILLINOIS 61032

A DIVISION OF HONEYWELL

HONEYWELL INTERNATIONAL: Sales and service offices in all principal cities of the world. Manufacturing in United States, United Kingdom, Canada, Netherlands, Germany, France, Japan.

INFORMATION RETRIEVAL NUMBER 9

The long and the short of subminiature lamps

IEE manufactures over 500 varieties of subminiature lamps from 2.5 volts through 28 volts, all aged and selected and available at savings up to 50%.

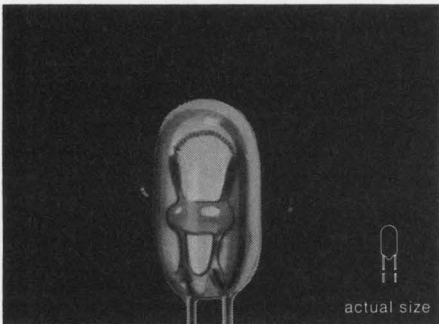

T-3/4 Space-saving, unbased (wire terminal) lamps, aged and selected to a $\pm 25\%$ MSCP tolerance at no extra cost. Hand-mounted filaments. Average life to 100,000 hours. Available up to 6 volts.

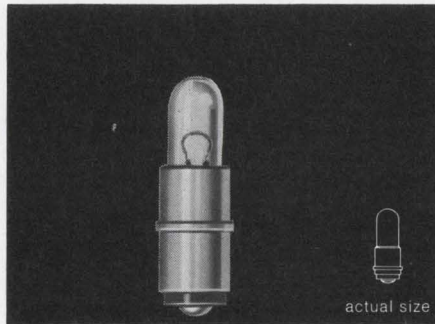

T-7/8 Developed by IEE, offering a price saving over the T-3/4. A high quality, low-cost lamp in based and unbased models: both standard and commercial grades. Available in 5 volts to 14 volts.

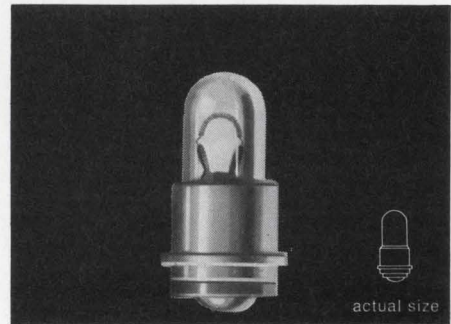

T-1 Save up to 50% over competitive lamps. OEM pricing regardless of quantity ordered. Available in all standard voltages and bases (bi-pin, sub-midget flange, wire terminal, etc.).

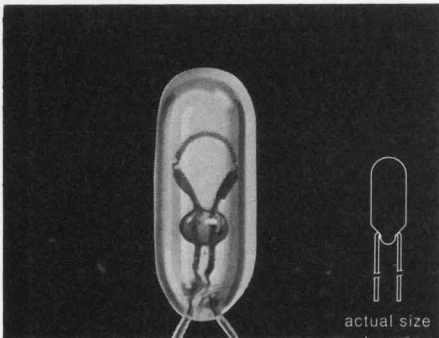

T-1 1/4 Industry standard types plus aging (between 24 and 36 hours) and selection. As low as 16¢ for a 6 volt .200 amp Model with an MSCP tolerance of $\pm 25\%$. Also available with T-1 filament at a cost saving.

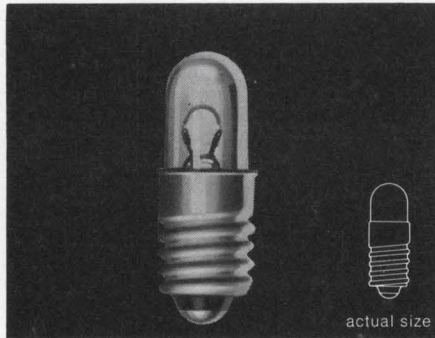

T-1 1/2 Custom lamp developed by IEE for commercial applications, meets the demand for top quality yet at a very low price. Midget screw and unbased. 7, 14 and 28 volt lamps available from stock.

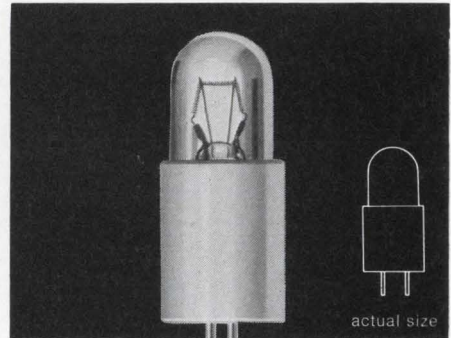

T-1 3/4 Low-cost, high quality lamps with life rated up to 5 times the industry standard. OEM price regardless of quantity. Variety of bases, including standard and commercial bi-pins. 2.5 volts to 28 volts.

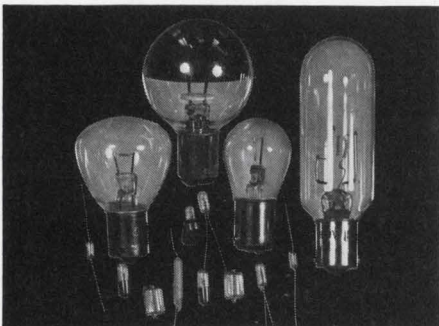

Special lamps In addition to the standard lamps, IEE designs and manufactures lamps with bases, filaments and envelopes to meet special needs. Let IEE solve your lamp problems - and still deliver price savings.

Tailored Aging IEE offers extra long aging at rated voltages to eliminate random burnouts and stabilize filaments. Rather than forced aging (which shortens lamp life), IEE prides itself on extra care in selection, providing for greater lamp life. All tipless and seamless lamps including lens type have Swiss tungsten filaments, hand-mounted for unsurpassed reliability. Production line, off-line and pre-shipment tests guarantee you long life and unsurpassed uniformity.

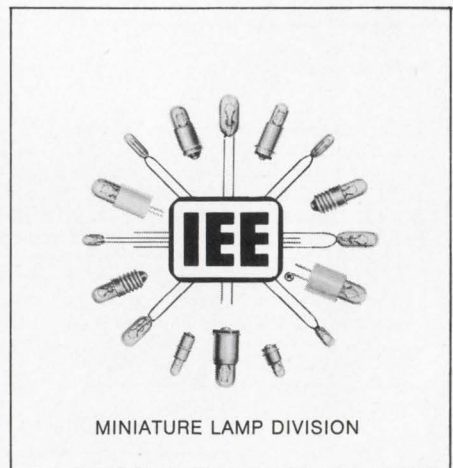

The long and the short of ^{shelf stock} Subminiature Lamps are found at **Industrial Electronic Engineers, Inc.**



7720 LEMONA AVENUE, VAN NUYS, CALIFORNIA 91405 • TELEPHONE: (213) 787-0311 • TWX 910-495-1707

INFORMATION RETRIEVAL NUMBER 10

NEW

from **Soliton**

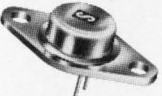
INDUSTRIAL PNP Power Transistors!

| | 1 AMP | 2 AMP | 5 AMP | 10 AMP |
|---|---|---|--|--------------------------|
|  TO-3 | <i>Special devices and packages not indicated are available to customer requirements.</i> | 2N3021-6 2N3171-4 2N3789-92 2N4901-3 SDT 3750-1 SDT 3752-6 | 2N3183-6 2N3195-8 2N4904-6 SDT 3757-61 SDT 3762-5 | SDT 3825-7 SDT 3875-7 |
|  TO-66 | 2N3740-1 2N4898-4900 SDT 3575-7 SDT 3578-9 | SDT 3701-2 SDT 3703-5 SDT 3706-11 SDT 3712-15 SDT 3716-20 SDT 3801-4 | SDT 3721-5 SDT 3726-8 SDT 3729-32 | SDT 3805-7 SDT 3850-2 |
|  TO-5 | 2N3660-1 2N3774-82 2N4234-6 SDT 3550-1 SDT 3552-4 | 2N3202-4 2N3719-20 SDT 3775-8 | <i>For additional information and specification data sheets, contact us today.</i> | |

Soliton DEVICES, INC.

1177 BLUE HERON BLVD. / RIVIERA BEACH, FLA. 33403 / (305) 848-4311 / TWX: (510) 952-6676

How To Solve Your Power Supply Problem—

Designer's Datebook

| JULY 1969 | | | | | | |
|-----------|-----|-----|-----|-----|-----|-----|
| Sun | Mon | Tue | Wed | Thu | Fri | Sat |
| | | 1 | 2 | 3 | 4 | 5 |
| 6 | 7 | 8 | 9 | 10 | 11 | 12 |
| 13 | 14 | 15 | 16 | 17 | 18 | 19 |
| 20 | 21 | 22 | 23 | 24 | 25 | 26 |
| 27 | 28 | 29 | 30 | 31 | | |

| AUGUST 1969 | | | | | | |
|-------------|-----|-----|-----|-----|-----|-----|
| Sun | Mon | Tue | Wed | Thu | Fri | Sat |
| | | | | | 1 | 2 |
| 3 | 4 | 5 | 6 | 7 | 8 | 9 |
| 10 | 11 | 12 | 13 | 14 | 15 | 16 |
| 17 | 18 | 19 | 20 | 21 | 22 | 23 |
| 24 | 25 | 26 | 27 | 28 | 29 | 30 |
| 31 | | | | | | |

For further information on meetings, use Information Retrieval Card.

July 20-25
Engineering in Medicine & Biology (Chicago) Sponsor: IEEE, L. Stark, Univ. of Illinois, Chicago 60612.

CIRCLE NO. 401

Aug. 5-7
Joint Automatic Control Conference (Boulder, Colo.) Sponsor: IEEE, G-AC, W. E. Schiesser, Dept. of Chemical Engineering, Lehigh Univ., Bethlehem, Pa. 18015

CIRCLE NO. 402

Aug. 12-15
International Photoconductivity Conference (Stanford Univ., Palo Alto, Calif.) Sponsor: ONR, American Physical Society, Robert J. Keyes, Massachusetts Institute of Technology, Lincoln Laboratory, Lexington, Mass. 02173

CIRCLE NO. 403

Aug. 19-22
Western Electronic Show & Convention (WESCON) (San Francisco) Sponsor: IEEE, WEMA, T. Shields, WESCON, 3600 Wilshire Blvd., Los Angeles, Calif. 90005



CIRCLE NO. 404

Aug. 24-27
Electronic Materials Technical Conference (Boston, Mass.) Sponsor: AIME, Edward L. Kern, Metallurgical Society of AIME, 345 E. 47th St., New York, N. Y. 10017

CIRCLE NO. 405

Aug. 19-22
Science and Technology of Information Display Seminar (Farmingdale, N. Y.) Sponsor: Polytechnic Institute of Brooklyn, Mrs. H. Warren, Adm. Officer, L.I. Grad. Center, Polytechnic Institute of Brooklyn, Farmingdale, N. Y. 11735

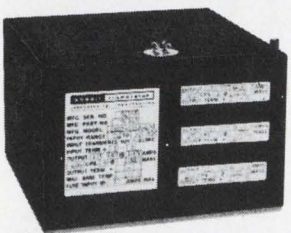
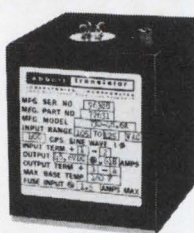
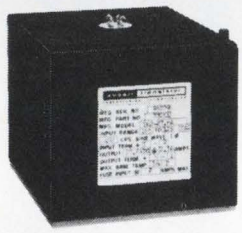
CIRCLE NO. 406

| | |
|--|---|
|  <p>28 VDC to 400 A 3ϕ Model Q10D-115A-400Y Size 6" x 6" x 4" — Wt. 8.3 lbs. Output 100 volt amps</p> |  <p>400 A to DC (Reg) Model T3D-48.6A Size 2$\frac{3}{4}$" x 3" x 3$\frac{1}{4}$" — Wt. 2.3 lbs. Output 48 VDC at 618 ma</p> |
|  <p>60 A to DC (Reg) Model V6D-27.6A Size 4$\frac{1}{2}$" x 6" x 4" — Wt. 10.3 lbs Output 28 VDC at 2.1 amps</p> |  <p>28 VDC to DC (Reg) Model AK1D-1970A Size 1$\frac{1}{2}$" x 2$\frac{3}{4}$" x 3" — Wt. 1 lb. Output 2000 VDC at 5 ma</p> |

NEW! Mil-Spec Quality Power Supply Modules for All Types of Power Conversion

Abbott has a new line of power supply modules. They are built to meet military environment-MIL-E-5272C. All types are available with any output voltage you need from 5 volts to 10,000 volts DC — and DC to 400 A inverters with either 1 ϕ or 3 ϕ outputs.

DC to 400 A, 3 ϕ — This new inverter changes 28 VDC battery voltage to three phase power with outputs of 33, 66, and 100 volt amps, 400 cycles or 800 cycles, as well as output voltages of 115 VAC or 27 VAC. All three phases are independently regulated at 1%. Also, 1 ϕ output units are available with powers of 30, 60, 120 and 180 volt amps, 400 cycles or 800 cycles, at 115 VAC or 27 VAC. All of these solid state inverters are completely described on Pages 13, 26 and 27 of our new catalog.

60 A to DC — These modules are the smallest, lightest weight 60 A to DC power supplies we have seen. They are well regulated for line and load changes. Hermetically sealed for military environment they will operate to 160°F heat sink temperatures. They are available in any output voltage you need — 5 volts to 10,000 volts,

with power outputs of 5, 10, 20, 30, 60, 120, and 240 watt sizes as standard catalog listings. You will find them completely described with prices on Pages 2, 3, and 4 of our new catalog.

400 A to DC (Reg) — Designed especially for 400 A input power, this line of converters is available with any output voltage you want — 5 volts to 10,000 volts DC. Power outputs of 5, 10, 20, 30, 60, 120, and 240 watt sizes are standard. Well-regulated and hermetically sealed, these units are described on Pages 5, 6, and 7 of our new catalog.

DC to DC (Reg) — Some of these DC to DC converters are as small as a package of cigarettes and weigh less than a pound. Output voltages from 5 volts to 10,000 volts are all listed as standard models in our new catalog. Power outputs come in standard sizes from 5 to 240 watts. These converter modules feature close regulation, short circuit protection and hermetic sealing for rugged applications found in military environment. They are listed in order of increasing output voltage on Pages 8, 9, and 10 of our new catalog.

If you need a power supply module in a hurry please check pages 1727 to 1740 in your EEM (1968-69 ELECTRONICS ENGINEERS MASTER Directory). Most of the above units are listed there. Or, for a complete list of our power supply line please send for your FREE 36-page catalog.

TO: Abbott Transistor Labs, Inc., Dept. 41
 5200 W. Jefferson Blvd.
 Los Angeles, California 90016

Sir:
 Please send me your latest catalog on power supply modules:

NAME _____ DEPT. _____

COMPANY _____

ADDRESS _____

CITY & STATE _____

abbott transistor

LABORATORIES, INCORPORATED
 5200 W. Jefferson Blvd. • Los Angeles 90016
 Area Code 213 • WEbster 6-8185

INFORMATION RETRIEVAL NUMBER 12

SEMICONDUCTOR NEWSBRIEFS

PUBLISHED BY MOTOROLA SEMICONDUCTOR PRODUCTS INC.

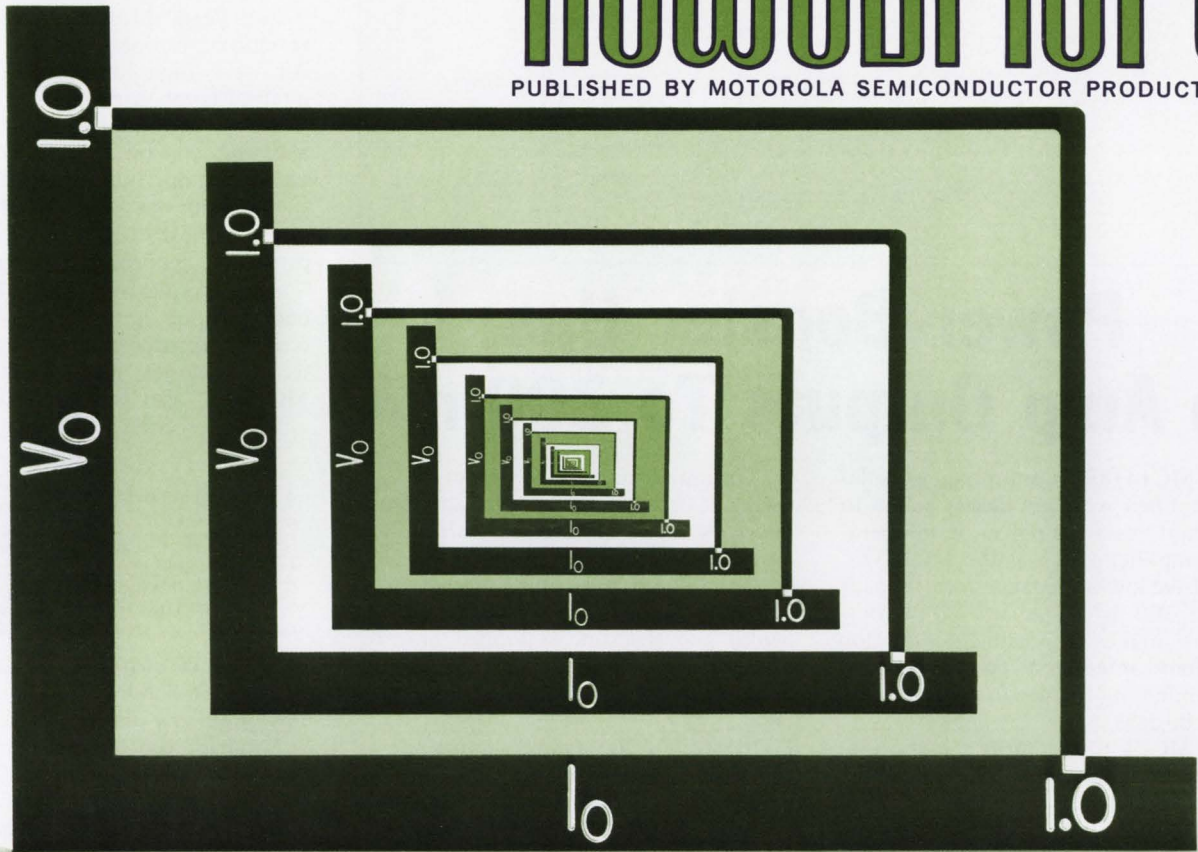

Now ICs That Regulate Voltages Set By External Transistors!

The latest additions to Motorola's growing family of integrated circuit regulators, the MC1566L/1466L, now makes it possible to **regulate any voltage** from zero up to a limit set only by the breakdown voltage of a series-pass transistor at the input (see schematic).

As a result, you can now use just one IC for all your regulation requirements, from millivolt levels to hundreds-of-volts!

Just like its predecessors in Motorola's expanding IC regulator line (MC1560/1460, MC1561/1461), the MC1566L/

1466L offers built-in short-circuit protection and an internal reference/regulator stage. The former protects the regulator under sustained output short-circuiting, while the latter provides regulating characteristics that are essentially independent of output voltage.

The MC1566L and its limited temperature-range counterpart (MC1466L) are ideal for broad-range adjustable power supplies. Line or load-voltage and current can now all be regulated, over a wide spectrum, all from a single system! And, these ICs have tight tolerances too. Line or load voltage regulation is spec'd at 0.01% + 1 mV while current regulation is 0.1% + 1 mA.

Both units are immediately available from distributor stock in the TO-116 14-lead ceramic dual in-line package. 100-up prices: MC1566L — \$24.50; MC1466L — \$8.50.

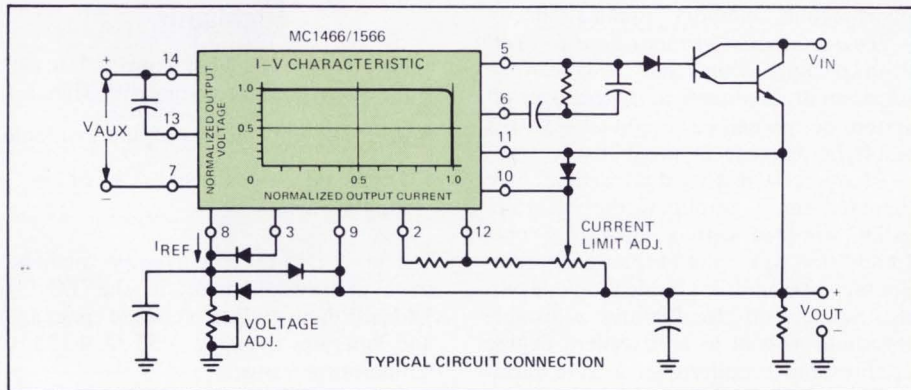

For details circle Reader Service No. 211



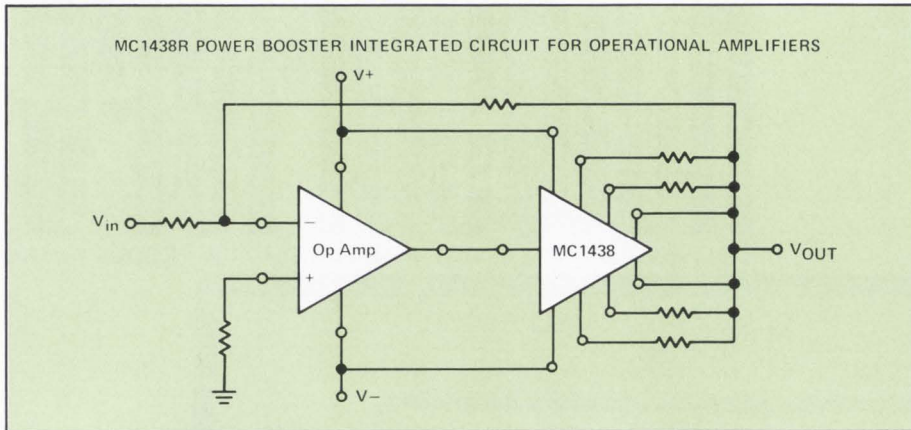

Power-Booster Ups Op Amp Outputs To 300 mA

The MC1438R is a unity-gain isolation amplifier, which is ideally suited to follow and boost the power of an operational amplifier (such as the MC1439). It can drive low-impedance current loads up to ± 300 mA. This new IC booster-amplifier makes it possible to develop completely integrated power systems, thus eliminating the need for discrete-IC hybrid designs.

The MC1438R features a high input impedance of 0.5 Megohm (typ), allowing the gain of an op amp to approach unloaded open-loop gain and thereby reducing thermal drift (the internal power dissipation of the op amp is independent of output voltage). Its low output impedance — 10 ohms, typ. — permits the MC1438R to drive greatly reduced phase-shift capacitive loads with

a substantial increase in output voltage swing. Current limit is adjustable from ± 5 mA to ± 300 mA. The MC1438R also exhibits a power bandwidth which is considerably higher than present operational amplifiers—1.5 MHz, typ. (bandwidth and slew-rate is limited only by the op amp itself). And, it has an excellent power rejection ratio of 1.0 mV/V, typ.

In addition to its ability to operate as a power-booster, the MC1438R can be combined with op amps to form such functions as ramp-generators, supply splitters and voltage-programmable power sources.

Units are available from distributor stock in the 9-pin TO-66 style package, which is capable of handling up to 17.5 Watts. Its 100-up price is just \$6.50.

For details circle Reader Service No. 212

Dual MECL-Output Sense-Amp IC Eliminates Core Memory Interfacing Problems

For the first time, the designer can “leapfrog” interfacing requirements between the sense-amplifier and core memory sections of even the highest speed computers!

The **MC1543L** — An IC Sense-Amplifier with MECL-outputs (emitter-coupled logic) makes it possible to eliminate the need for more costly linear-to-logic conversion circuitry! In addition, because this new circuit has two input channels, you can reduce by as much as one-half, the number of IC Sense-Amp packages required for 0.5

microsecond “memory” applications.

It's a combination that's hard to beat! Both package-count and costs can be substantially reduced and, the over-all system design can be simplified — with a resultant increase in reliability.

Characterized as a dual MECL core memory sense amplifier, the MC1543 is DC coupled with a separate strobe. In addition to having output levels compatible with emitter-coupled logic levels, this new circuit also features adjustable threshold as well as an excellent degree of threshold stability over a wide variation in power-supply voltage.

For details circle Reader Service No. 214

New MC1741C Op Amp Is Both Monolithic And Internally-Compensated!

For years Motorola has offered a variety of top-performance Op Amps. All were monolithic, yet they lacked internal compensation.

So, we introduced the MCH1539 — a hybrid version that featured built-in compensation. Still, it wasn't monolithic.

Now, with the MC1741C Motorola provides the best of both . . . internal compensation and monolithic construction!

As a result, no external frequency compensation is required — saving the cost of a resistor and a capacitor as well as eliminating interconnections. The MC1741C also provides built-in short-circuit protection which further reduces

A large capacitor and a resistor, right on the MC-1741C chip, eliminates the need for external compensation.

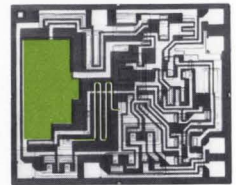

external circuitry requirements and increases reliability. In addition, “latch-up” problems are eliminated.

Some of the other outstanding features of MC1741C include: offset-voltage nulling; low power consumption; wide common-mode and differential-voltage ranges; and, it's pin-compatible with the MC1709.

It comes in the 8-lead, TO-99 metal-can and operates over the 0 to +70° range. Available from stock, the MC-1741C is 100-up priced at just \$3.25.

For details circle Reader Service No. 213

Highlights

- Threshold adjustable from 10 to 40 mV (for positive or negative signals)
- Both OR and NOR outputs available
- Threshold insensitive to + or — supply variations

The MC1543 is currently available from distributor stock, in the TO-116 14-lead dual in-line ceramic package; and, operates over the -55 to $+125^{\circ}\text{C}$ temperature range.

Price: \$18.00 (100-up).



New MRTL Trio Provides Total IC Digital Counting!

Designers can now utilize a new MRTL threesome to develop completely integrated digital readout systems which are smaller, faster, more reliable and

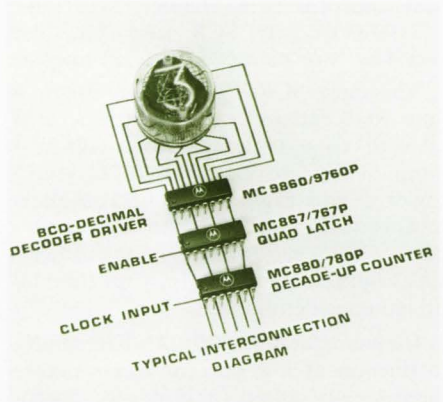

Only three MRTL circuits, costing roughly \$13.50, can actuate a complete decade readout system, thus reducing both design costs and size.

much less costly than discrete or hybrid approaches. The combination of just these three MRTL ICs — the MC9760/9860 BCD-Decimal Decoder/Driver, the MC867/767 Quad Latch and a Decade-Up Counter (MC880/780) — does the total job, thus reducing component density, wiring and PC board requirements (see illustration).

The MC880/780 is a monolithic 1-2-

4-8 Decade-Up Counter, consisting of four flip-flops, internally connected. Memory, or temporary storage is provided by the MC867/767 Quad Latch which "stores" the data while the MC880/780 is proceeding with the count. The MC9860/9760 converts the 1-2-4-8 code into a decimal output with sufficient voltage to drive a Nixie® or other gas-filled readout device.

These new MRTL circuits are supplied in Motorola's economical Unibloc dual-inline plastic package ("P" suffix); in 16-lead versions (MC9860/9760, MC867/767) and 14-leads (MC880/780). The MC700 series types operate over a temperature range of +15 to +55°C, while the MC800 series covers from 0 to 75°C.

All three of these new low-cost, plastic-packaged MRTL integrated circuits are immediately available from your local Motorola franchised distributor's warehouse stock. Order some of these combinations now and have them ready to reduce both the cost and size of your next digital-readout system design.

| MRTL Type | Description | Price (1 K-up) |
|---------------|----------------------------|----------------|
| MC767P/867P | Quad Latch | \$3.00/\$3.40 |
| MC780P/880P | Decade-Up Counter | 3.00/ 3.40 |
| MC9760P/9860P | BCD-Decimal Decoder/Driver | 7.50/ 8.70 |

For details circle Reader Service No. 215

Dionic Structure Yields New Radiation-Hardened MDTL ICs

Six MDTL radiation-resistant ICs, forerunners of a new line specifically developed for applications requiring a high degree of reliability under severe radiation environments, are now available off-the-shelf. Motorola's Dionic structure (dielectric isolation) minimizes the effects of gamma radiation. As illustrated, individual islands are electrically isolated from the poly-crystalline material (and each other) by a layer of silicon dioxide. In addition, nichrome resistors and a post-metalization passivation process are used to enhance overall radiation resistance.

The result . . . ICs which remain fully functional and meet all pre-radiation electrical specs, even when subjected to gamma dose rates of 10⁹ rads/sec. and cumulative gamma dosage in excess of 5 x 10⁸ rads — as well as neutron exposure levels of 7 x 10¹³ NVT.

They are available in the 14-lead, TO-86 ceramic flat-pack (-55 to +125°C).



| Type No. | Circuit Description | Price (100-Up) |
|----------|--------------------------------|----------------|
| MCE930F | Dual 4-Input NAND Gate | \$10.00 |
| MCE932F | Expandable Dual 4-Input Buffer | 10.95 |
| MCE933F | Dual 4-Input Expander | 7.30 |
| MCE945F | Clocked Flip-Flop | 18.00 |
| MCE948F | Clocked Flip-Flop | 18.00 |
| MCE962F | Triple 3-Input NAND Gate | 10.00 |

For details circle Reader Service No. 216

Parity-Trees Head List of Six New MTTL Complex Functions

Two new "parity-tree" circuits, which provide economical solutions to overall systems reliability, plus four memory

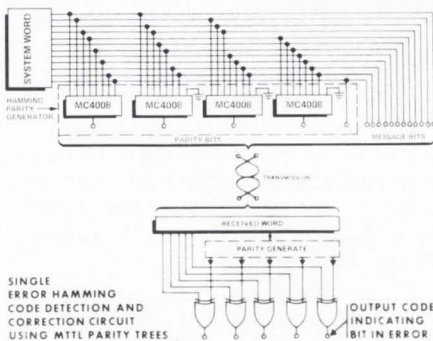

arrays, have been added to Motorola's fast growing MTTL complex functions line.

The MC4008L, an 8-bit parity-checker/generator, features an extra 2-input gate to expand the number of bits handled, or as a parity-bit input checker. The second, a dual 4-bit parity-tree (MC4010L), is ideal for checking 4-bit word lengths or increments of 4-bits. It consists of six 2-input exclusive NOR gates, connected to form two independent 4-bit parity-trees. Using these new MTTL ICs, sophisticated detection and correction systems can be developed (see illustration) which not only recognize that an error has occurred, but can also detect which "bit" is in error.

Both the MC4008L and MC4010L are expandable to as many bits as required without additional "gating" circuitry. These TTL/DTL compatible ICs come in the TO-116 14-pin dual in-line

ceramic package. The 100-up price is only \$7.75 for either unit.

XC-170 128-Bit ROM Derivatives

The MC4038P inverting/non-inverting 1-of-8 decoder has a 3-bit binary address which selects the desired word for the 8-bit output and exhibits address times of less than 45 ns, while the MC4039P is a seven-segment character generator for the direct operation of low-voltage indicators. The MC4040P decoder has two enable inputs and can transform any 4-bit binary number to a 2-of-8 bit code. The MC4041P single-error hamming code detector and generator is a programmed 128-bit ROM. Supplied in the 16-lead Unibloc plastic dual in-line package, the MC4038-41 are priced at \$5.10 each (1K-up).

For An Application Note and Data Sheets circle Reader Service No. 217



Both PNP and NPN monolithic Darlingtons, in plastic, provide greater low-cost design flexibility.

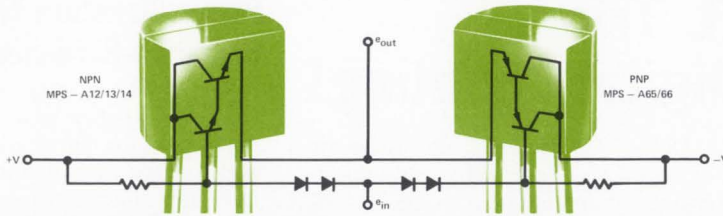

4 More PNP/NPN Unibloc Darlingtons Add Impetus To High-Gain Economy Designs

If you were enthused when Motorola announced its first low-cost Unibloc plastic Darlington Amplifier entry, the MPS-A12, in the fall of 1968 hold on — that was only the beginning!

Now Motorola makes available both PNP and NPN types (two new ones in each polarity), with minimum gains ranging from 5K to 75K, at unprecedented 20¢ - 30¢ price levels!

Whether you work with PNP or NPN polarities, or combine the two (as shown in the illustration), you can now achieve a substantial reduction in piece-parts, wiring and circuit size — not to mention individual transistor costs. For example, the PNP MPS-A65/A66 (which have minimum betas of 50K

and 75K, respectively), average out costing less than 15¢ per transistor — while the new NPN types, the MPS-A13/A14, cost even less. And, with a wide choice of betas available, you don't have to pay for more than you require.

Additional highlight parameters include: a high breakdown voltage of 30V (min) at 10 mA, low noise figures — 2dB (typ) at 1.0 mA, f_T (min) = 100 MHz (PNP) and 125 MHz (NPN) at 10 mA and leakages that do not exceed 100 nA.

| Type No. | Polarity | h_{FE} (min) @ $I_C = 10$ mA | Prices (5,000-up) |
|----------|----------|--------------------------------|-------------------|
| MPS-A65 | PNP | 50,000 | 27¢ |
| MPS-A66 | PNP | 75,000 | 29¢ |
| MPS-A13 | NPN | 5,000 | 22¢ |
| MPS-A14 | NPN | 10,000 | 25¢ |
| MPS-A12 | NPN | 20,000 | 32¢ |

For details circle Reader Service No. 218

First Micro-T RF FET Expands High-Density Design Options

With the introduction of the MMT-3823 RF N-Channel JFET — the first field-effect transistor to be incorporated into the subminiature Motorola Micro-T package configuration — designers of high-frequency circuits can realize substantial reductions in equipment size without sacrificing efficiency and reliability. The dimensions of the Micro-T's ultra-small body (0.080" dia. x 0.053" thick, nom.) along with its flat, radial leads make it well suited for high-density "drop-in" strip-line PC board mounting and thick-film fabrication.

Although the MMT3823 Depletion Mode (type A) Micro-T JFET can be used as a mixer and switch, its primary applications lie in the RF amplifier area. Among the key parameters of this micro-miniature high-frequency FET is a 100 MHz noise-figure of only 2.0 dB (typ), both low cross-modulation and low intermodulation distortion, a high power-gain of 16 dB (typ) @ 100 MHz, as

well as low transfer and input capacitances of just 1.0 pF and 4 pF (typ), respectively. In addition, its drain and source are interchangeable. And, the MMT3823, like other Micro-T devices, dissipates a full 225 mW @ 25°C, ambient.

| | |
|---|--|
| Low Noise-Figure (NF) @ 15V/1 Kohms/100 MHz | 2.0 dB (typ) |
| Low Input Capacitance (C_{iss}) @ 15V/1.0 MHz | 4 pF (typ) |
| Low Transfer Capacitance (C_{rss}) @ 15V/1.0 MHz | 1.0 pF (typ) |
| High drain current (I_{DSS}) @ 15V | 5 mA (min) 20 mA (max) |
| High Gate-Source Voltage (V_{DS}) | 30 V (min) |
| High Forward Transfer Admittance $ Y_{fs} $ @ 15V/1.0 kHz | 3000 μ mhos (min) 8000 μ mhos (max) |
| Price (100-up): | \$3.50 |

For details circle Reader Service No. 219

Now a 4A @ 95°C Plastic SCR That Turns-On At 200 μ A—for Only 51¢

Designed for low-cost, higher-current applications in rugged consumer/commercial and industrial speed, light and heat-control circuits, the new MCR406/407 sensitive-gate, SCR series has "the best Thyristor value" written all over it!

This new SCR series offers: **High, 4 Amp RMS ratings!** even when operated at +95°C, case temperature (other 4 Amp SCR's are rated at 20°C -75° lower)! This higher-current-at-higher-temperature performance means you can realize a substantial savings in heat-sink requirements and ease your thermal design considerations.

Triggering at only 200 μ A! The ability to turn-on at low current levels makes them ideally suited for use with photo-cells, thermistors and other small-signal transducer sources, without additional stages of signal amplification.

THERMOPAD package! It's the only plastic SCR package having a short 0.032" chip-to-heat-sink thermal path

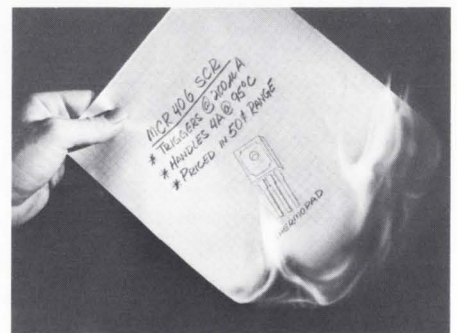

The MCR406 handles a full 4 Amps at 95°C and triggers at only 200 μ A levels — yet it's priced in the 50¢ area!

plus low 2.0°C/W thermal resistance for high dissipation. And, it's low-cost!

Annular die structure! Maximum, long-term dependability and performance, over a -40° to 110°C operating temperature range, is ensured through oxide-passivated junction protection and Annular construction. They also display a low 1.6V @ 4A @ 110°C forward voltage drop.

| Series No. | V_{RM} (Volts) | I_F @ 95°C | I_{FM} (Surge) | I_{GT} @ 25°C (max) | V_{GT} @ 25°C (max) | Price* (1,000-Up) |
|------------|--------------------|--------------|------------------|-----------------------|-----------------------|-------------------|
| MCR406 | 30, 60 100, 200 | 4 A | 20 A | 200 μ A | 0.8 V | 51¢ |
| MCR407 | 30, 60 100, 200 | 4 A | 20 A | 500 μ A | 1.0 V | 47¢ |

*30 V unit

For details circle Reader Service No. 220



Latest Silicon Power Lines Top 200/300W Class

50A, 60-80V Complements Cut Power Circuit Cost/Complexity

Now Motorola gives the designer of high power amplifier circuits a line of silicon power transistors that are the highest rated, TO-3 packaged, PNP/NPN

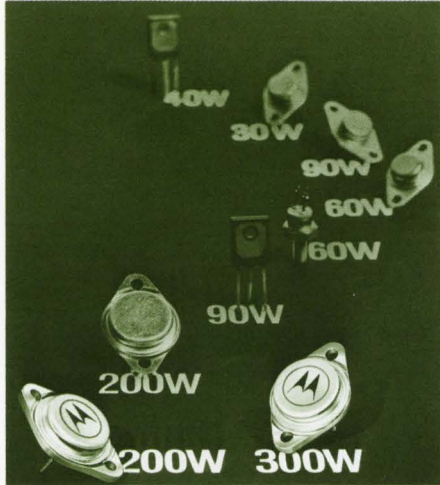

The latest additions to Motorola's ever-growing Silicon Power lines let you develop economical ultra-high wattage amplifier/switching designs.

complements available — the 2N5683-86 series!

This series offers continuous collector-current ratings to 50 Amps, power dissipation to 300 Watts, breakdown voltages of 60 to 80 Volts, high betas, fast switching speeds and low saturation

voltages — all at very high current levels. And, you're assured lighter, less-costly heat-sinking due to their low thermal resistance (θ_{JC}) of only $0.583^{\circ}\text{C}/\text{W}$, max. Used in complementary designs, they can serve to lower costs and complexity by eliminating the need for expensive, impedance-matching transformers in "heavy-muscled" amplifiers.

In addition, they exhibit saturation voltages of less than 1.0 V at 25 A — assuring efficient, low-power-loss performance in high-current applications. And, they are made using Motorola's exclusive EpiBase die-fabrication process which reduces costs while maintaining long-term reliability and stability.

| Highlights | 2N5683/84 | 2N5685/86 |
|--------------------|-------------------------------------|---------------|
| Polarity | PNP | NPN |
| High I_C (cont.) | 50 A | |
| High P_D | 300 W @ 25°C , case | |
| High h_{FE} | 15-60 @ 25 A | |
| f_r (min) | 2 MHz @ 5 A/10 V | |
| Prices (100-up): | \$15.00/18.00 | \$12.00/15.00 |

For details circle Reader Service No. 221

Now 100-140V, 10-16A, TO-3 Units Eliminate "Stud" Types

If "high-voltage silicon power" conjures up images of large, cumbersome — and costly "stud" transistors — look again!

Here's inherently-economical low-silhouette, TO-3 packaged, 100-140V, 10-16A — silicon power transistors that can put *tomorrow's* state-of-the-art performance in your rugged, audio/servo amplifier, inverter and chopper designs and switching and series-pass regulators *today* — the NPN 2N5629-31 and 2N5632-34 series!

With these compact, high voltage/high current silicon transistors you can reduce the size, cost and complexity of input, output and filtering componentry — plus lower your current requirements and eliminate step-down transformers.

Talk about high performance specs! How about P_D 's up to 200 W . . . I_C 's to 16A . . . 100-120-140V — V_{CEO} ratings . . . saturation voltages of one-volt and betas from 25 to 100 at 8 A.

They make nimble switches, too, with a minimum f_T of 1 MHz at 1A/20V (2N5629-31).

And, "punch through" (second breakdown) problems are minimized, due to Motorola's unique diffusion process which allows the transistors to accept very high voltages without detrimental effects.

| Highlights | 2N5629/30/31 | 2N5632/33/34 |
|--|--------------------------|--------------------------|
| High $V_{CE(sat)}$ | 100 V/120 V/140 V | |
| High I_C (cont.) | 16 A | 10 A |
| High h_{FE} | 25-100/20-80/15-60 @ 8 A | 15-60/20-80/25-100 @ 5 A |
| High P_D @ 25°C , case | 200 W | 150 W |
| Low $V_{CE(sat)}$ — (max) | 1.0 V @ 10 A | 1.0 V @ 7.5 A |
| Prices (100-up): | \$4.60/5.10/7.50 | \$3.95/4.35/5.10 |

For details circle Reader Service No. 222

Motorola Adds 25-Amp Muscles To Its MAC Triac Line!

There's a new, husky, 25-Amp addition to Motorola's popular MAC Triac line — and that heftier horse- or house-power control application you've had in mind can almost certainly be filled by one of its 25 to 500-volt versions!

Called the MAC21, this 25-Amp RMS series has been developed for the engineer who needs rugged, reliable versatility for a wide range of medium-power commercial/industrial thyristor-controlled applications. They're plug-in perfect for relay replacement, phase-control, zero-point and on-off switching, light-dimming, motor-speed control, motor starting, heater control, sequential light flashing, voltage regulation and temperature control designs.

Packaged in the low-silhouette, TO-41

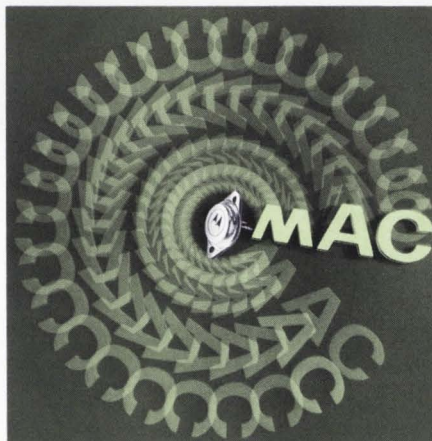

MAC21 Triacs, with 25-500V ratings, are packaged in low-silhouette TO-41 cases to provide currents to 25 Amps.

For copies circle Reader Service No. 223

case (TO-3 with lugs) the MAC21 series delivers outstanding performance, as exemplified by a low junction-to-heat sink value, low 1.5V (max) at 35A on-state voltage, a critical exponential dv/dt of 100 V/ μs (typ) at $T_J = 110^{\circ}\text{C}$ and a gate triggering current of 20 mA (typ). Use of all-diffused junctions provides enhanced parameter uniformity.

MAC21 prices start at only \$2.90, 100-up (25-volts). Contact your local distributor for delivery of prototype quantities and see for yourself how well these new 2.5-Amp Triacs perform in your critical, medium-current full-wave control designs.

Both a new application note on Triac circuits (AN466) and a data sheet on the MAC21 series are yours for the asking.



NEW LOW-THRESHOLD MOSFET SWITCHES/CHOPPERS

—Offer Stable, Ultra-High Speeds At Low Power Levels!

Combining Motorola-developed Silicon Nitride passivation — which assures stability under high temperature and reverse bias — with threshold-voltages in the low 0.5 - 3.0V area, fast switching times (maximum t_r of just 10 ns and t_f of 15 ns) and high immunity to transients, the new 3N169-171 N-channel enhancement mode (type C) MOSFETs are worthy candidates for a variety of critical low-power, high-speed switching applications. They are packaged in the 4-leaded, TO-72 case.

As demonstrated in the accompanying scope-trace illustration, showing a typical low input-voltage pulse (top trace) and a 4-channel multiplexed output (lower portion), these devices are ideally suited for low-level-input switching and chopper applications in a wide variety of multiplexing, modulation and analog-to-digital converter designs. Highlight parameters include a low r_{ds} (on) of just 200 ohms (max) and capacitance values as low as 1.3pF (C_{rss}) and 5.0pF (C_{iss}) at 1.0 MHz. Prices: 3N169 — \$4.90; 3N170 — \$4.20; and 3N171 — \$3.55 (1,000-up).

For details circle Reader Service No. 224

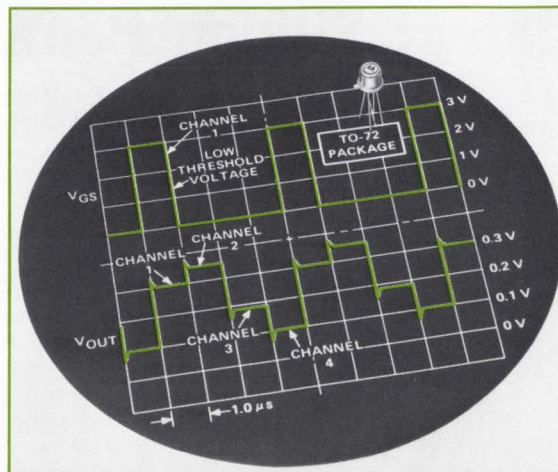

HIGH-CURRENT DARLINGTON-DRIVER HYBRID MICROCIRCUIT

— Provides High Pulse-Rate Power Gains To 1000!

Short-duration pulses up to currents of 5 Amps, from logic level inputs of only 5 mA, are now possible with Motorola's new MCH2005 Darlington-Driver hybrid microcircuit. A transistor-transistor logic input current level of just 5 mA, for example, yields a 5 Amp output pulse — more than adequate to drive high-current ferrite switches in phase-shifter or phase-array radar designs. And, its total turn-on/turn-off time is a fast 800 (max) nanoseconds (switching time spec'd at betas of 1,000)! Priced at only \$8.75, (100-up), this hybrid IC is packaged in a 6-lead, TO-86 ceramic flat-pack.

And, it's available immediately from "off-the-shelf" stock. Contact your local Motorola distributor for units and evaluate this Darlington-Driver hybrid IC now!

For details circle Reader Service No. 225

I/C Hybrid (Thin -Film) 5 Amp Darlington Driver

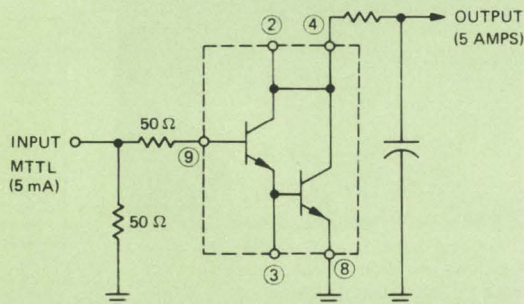

NINE NEW "BET" RF POWER TRANSISTORS

—Available In Ceramic "Stripline" Packages At Lower-Than-Ever Prices!

Nine newly EIA-registered Motorola BET (balanced-emitter) NPN silicon RF power transistors, all packaged in rugged ceramic "stripline" cases, now cover a broad range of output wattage requirements at VHF/UHF frequencies (175 MHz and 400 MHz), in both 13.6 V and 28 V categories. They also exhibit high minimum power-gain (see table), making them ideal for AM/FM power amplifier or oscillator designs in a variety of industrial and military equipment.

And, Motorola has been able to significantly reduce the prices for these new and improved types. For example, the 100-up price for the new 2N5643 is now only \$26.90 (over 30% less than for the previous MM1559).

Multiple-discrete-emitters, each with an attendant Nichrome resistor, provide protection against external destructive factors, such as secondary breakdown, load-mismatching, and mistuning. Their new "stripline" ceramic case structure lowers lead inductances and improves broadband tuning capabilities.

For details circle Reader Service No. 226

| EIA TYPE | REPLACES | V _{CC} | P _{out} (W) @ 175MHz | G _p (dB) (min) | CASE |
|----------|----------|-----------------|-------------------------------|---------------------------|------|
| 2N5589 | MM1601 | 13.6 V | 3.0 @ 175 | 8.2 | 1446 |
| 2N5590 | MM1602 | | 10 @ 175 | 5.2 | 155A |
| 2N5591 | MM1603 | | 25 @ 175 | 4.4 | 155A |
| 2N5635 | MM1549 | 28 V | 2.5 @ 400 | 6.2 | 1446 |
| 2N5636 | MM1550 | | 7.5 @ 400 | 5.7 | 1448 |
| 2N5637 | MM1551 | | 20 @ 400 | 4.6 | 155A |
| 2N5641 | MM1557 | 28 V | 7.0 @ 175 | 8.4 | 1448 |
| 2N5642 | MM1558 | | 20 @ 175 | 8.2 | 155A |
| 2N5643 | MM1559 | | 40 @ 175 | 7.6 | 155A |

LOW-VOLTAGE AVALANCHE ZENER DIODES

—Have Premium-Performance Specs, Tight Tolerances!

The 1N5518-46 low-voltage avalanche zener diode series is particularly well-suited for critical industrial/aerospace applications demanding the tightest possible regulation. These units feature ultra-low noise density (averaging less than one-half any previous available types), as shown in the comparison curves to the right. This premium series, covering a range of 3.3 to 33 Volts, also features zener impedances as low as 18 ohms (1N5521) and low maximum regulation factors (e.g. ΔV_Z down to 0.05 V), as well as leakage currents down in the 0.01 μA region.

In addition, these new precision zener diodes are available in five standard voltage tolerances — 20, 10, 5, 2 and even 1% — and their oxide-passivated junctions, combined with RamRod DO-7 "glass" package construction, assure long-term stable and reliable performance. Your distributor has units in stock.

For details circle Reader Service No. 227

MAXIMUM NOISE DENSITY (1N5518 SERIES VS. STANDARD TYPES)

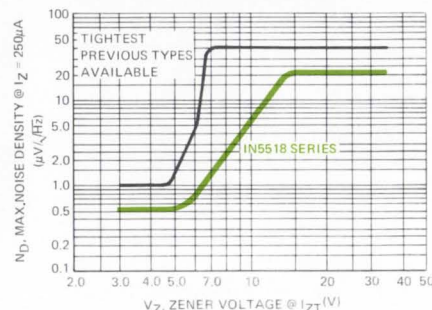

NEW LITERATURE BRIEFS

Over 12,000 Types Covered In Motorola's Most Complete, New 1969 Full-Line Catalog!

The most up-to-date and comprehensive listing of product data in the semiconductor industry has just been published — the 1969 edition of Motorola's full-line condensed catalog! Bigger and more inclusive than ever, it fills 84 pages (20 more than the 1968 edition) and includes over 850 new standard types!

The catalog is divided into sections for quick and efficient reference. For example, the first section consists of a complete alpha-numerical index listing of all standard Motorola types — including both discrete devices and ICs.

The next section (to which 13 pages have been added)



provides tabular listings with highlight characteristics grouped by general application and product areas.

For a copy circle Reader Service No. 228

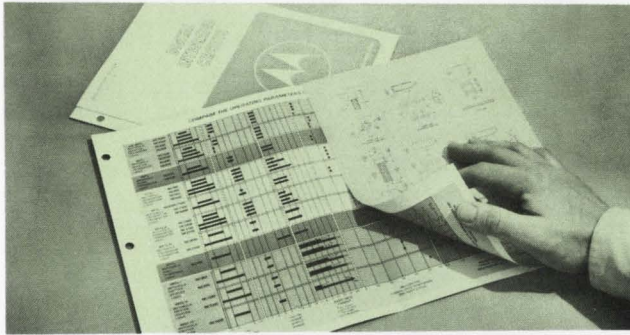

Eleven Logic Families Compared In New Motorola Digital IC Selector Guide!

Covering the broadest line of digital IC families in the industry, Motorola's new "first-of-its-kind" selector guide helps you choose the best possible logic form for your particular requirements . . . at a glance!

To ease comparisons of key parameters, all eleven Motorola logic families have been color-coded by category (MRTL, MDTL, MTTL, MECL, etc.).

Basic operating parameters are shown for the various logic forms and their functions, such as: operat-

ing temperature ranges, power requirements, fan-outs, propagation delay times, toggle-frequencies, power dissipation and noise-margins. In addition, basic "gate" and positive logic diagrams are provided for each of the digital IC families. Detailed package drawings, covering all Motorola's monolithic digital ICs, are also included.

This unique, 3-hole punched, multi-colored chart is flexible to use, too. It can be placed in a binder or mounted on a desk or wall.

For a copy circle Reader Service No. 229



LITERATURE ORDER FORM

NOTICE: Requests for literature on items described in this publication cannot be honored after November 1, 1969.

NEWSBRIEFS No. 6-69

Please circle the Reader Service number of item(s) you are interested in receiving.

| ED | | | | | |
|-----|-----|-----|-----|-----|-----|
| 211 | 212 | 213 | 214 | 215 | 216 |
| 217 | 218 | 219 | 220 | 221 | 222 |
| 223 | 224 | 225 | 226 | 227 | 228 |
| 229 | 230 | 231 | | | |

Please Print Clearly

NAME _____

TITLE _____

COMPANY NAME _____

DIVISION _____

DEPARTMENT _____

COMPANY ADDRESS (Street or P. O. Box) _____

CITY _____

STATE _____ ZIP CODE _____

If you wish to receive mail at a different address, fill out below:

ADDRESS _____

CITY _____

STATE _____ ZIP CODE _____

Do you wish a Motorola Representative to contact you?

VISIT

PHONE

Phone No. _____ Area Code _____

Tear Along Perforated Line and Drop in Mail (No Postage Required)

FOLD HERE

FIRST CLASS
Permit No. 2565
PHOENIX
ARIZONA

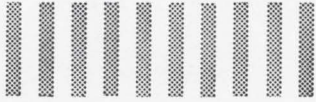

BUSINESS REPLY MAIL

No postage stamp necessary if mailed in the United States

POSTAGE WILL BE PAID BY

Semiconductor NEWSBRIEFS No. 6-69
Motorola Semiconductor Products Inc.
P. O. Box 20924
Phoenix, Arizona 85036

FOLD HERE

For Fast Action!

... on delivery of literature for items described in this publication — fill out this coupon, fold as indicated and drop in the mail.

(NO POSTAGE IS REQUIRED)

Seal Here

NEW LITERATURE BRIEFS

Selector Guide Now "Tunes-You-In" On Motorola's Broad Tuning Diode Line

Over 100 Motorola EPI-CAP abrupt-junction tuning diode types, in four different package configurations and representing nine distinct categories, are described in this first-time-available "Selector Guide." Both tuning-ratios and Q's are presented for every listed type, as are their maximum working voltages and nominal capacitance values. Highlight parameters, keyed to application requirements are also provided.

In addition, a brief yet thorough explanation of voltage-variable capaci-

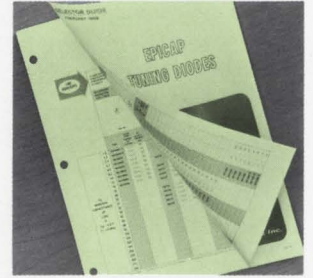

tance tuning diodes and how they operate, as well as a listing of Application Notes covering the subject, is provided on the back of this convenient, easy-to-use selector guide (suitable for use at desk or as a wall chart.)

For a copy circle Reader Service No. 230

New Selector Guide Helps You Find The FET That Fits, Fast!

A brand new comprehensive fold-out chart now provides a concise guide to over 100 Motorola JFET and MOSFET devices.

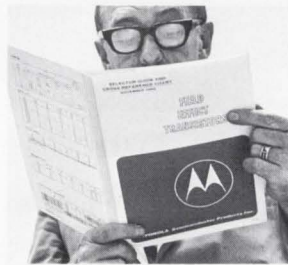

They are categorized by application, and highlight specifications facilitate selection at a glance. Classifications include multi-purpose amplifiers, RF

amplifiers and mixers, general switching, chopper, matched pairs, and tight (2:1 ratio) I_{DSS} ranges.

Ideal for desk, wall, or binder use, this design aid includes a cross reference listing of industrial types vs. Motorola's nearest equivalent and recommended preferred types. An introductory page describes the Silicon-Nitride passivation process (a Motorola exclusive) which makes high-stability MOS-FETs possible. Also included are FET parameter application charts and a listing of current available FET Application Notes.

For a copy circle Reader Service No. 231

Motorola Semiconductor Products Inc., P. O. Box 20924, Phoenix, Arizona 85036

SEMICONDUCTOR
NEWSBRIEFS

© Motorola Inc. 1969

MRTL, MDTL, MTL, MECL, MHTL, Unibloc, Thermopad, BET, EpiBase, RamRod, Micro-T, Dionic, Uniwatt and EPICAP used in this publication are trademarks of Motorola Inc. Annular Semiconductors are patented by Motorola Inc. Nixie is a registered trademark of Burroughs Corp.

NOTE: If coupon is missing use magazine's Reader Service numbers to order literature on items described in NEWSBRIEFS.



HAPPENINGS IN ELECTRONICS

July, 1969

The 1st Double-Regulated IC Voltage Regulator

Regulation of power supply voltages has always been a quality sign in electronics equipment. The recent rapid advance of monolithic IC regulators points to wider use of regulators because the IC approach is so much more compact.

| PART # | TEMP. RANGE | INPUT VOLTS | 1-24 | 25-99 | 100 up |
|---------|--------------|-------------|-------|-------|--------|
| MC1460G | 0 to +75C | 20 VDC | 5.25 | 4.35 | 3.50 |
| MC1460R | 0 to +75C | 20 VDC | 6.75 | 5.60 | 4.50 |
| MC1461G | -55 to +125C | 35 VDC | 6.75 | 5.60 | 4.50 |
| MC1461R | -55 to +125C | 35 VDC | 8.25 | 6.85 | 5.50 |
| MC1560G | 0 to +75C | 20 VDC | 22.50 | 18.75 | 15.00 |
| MC1560R | 0 to +75C | 20 VDC | 30.00 | 25.00 | 20.00 |
| MC1561G | -55 to +125C | 35 VDC | 30.00 | 25.00 | 20.00 |
| MC1561R | -55 to +125C | 35 VDC | 37.50 | 31.25 | 25.00 |

Motorola's MC1560 is an IC regulator in which every feature affecting regulation has been engineered for superlative performance. Some of these features are worth noting: *Load regulation of a monolithic regulator depends, among other things, on the type of package used.* Only Motorola offers the new 9-pin TO-66 case (R) which dissipates 10 watts at case temperatures up to +65C. *Output impedance is determined by the loop gain of the regulator.* Because of its novel design, the MC1560 is always operating at maximum loop gain, so the load regulation is independent of the output voltage.

The lower the output impedance, the better the regulator. The MC1560 has a Z_{out} of 20 milliohms typical and 80 max. It is the first regulator ever offered in which the output impedance is essentially independent of the DC output voltage as well as of frequencies up to 0.5 MHz. The unique feature which makes this possible is the built-in regulator-within-a-regulator. All models shipped from stock; data sheets available. Circle #241.

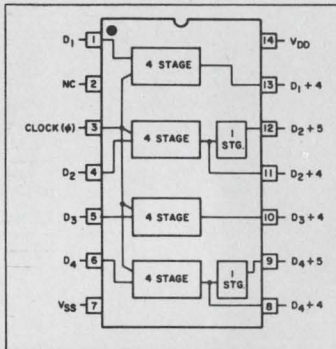

Economy powered and economy priced RCA/COS/MOS/MSI

RCA combines its MSI capability with its unique COS/MOS* technology to produce a complex function integrated circuit of wide versatility. CD4006D is described as a low-power 18-stage static shift Register. Versatility is provided by partitioning the register into multiple 4 and 5 stage segments which can be used separately or in combination. (See functional diagram.) Each section has a "single-rail" data path, and a common clock frequency is used for all stages. It operates over the full military temperature range —55C to +125C. Maximum clock frequency, a function of power supply voltage, is conservatively rated in the megahertz range. The RCA CD4006D, in a hermetically sealed 14-lead ceramic and metal dual-in-line package, is priced at 25.00 each in quantities of 1 to 99 and 20.70 each, 100 to 999. Shipment immediately from Schweber stock.

*Complementary-Symmetry-Metal-Oxide-Semiconductor

Review of new catalogs: Kemet's Condensed Catalog of Solid Tantalum Capacitors

The 1969 edition of Kemet's condensed catalog lists all fifteen solid tantalum lines from the A series (Super Capacitance) to the Z series (Miniature tantalums). Of particular interest is the N-series non-polar hermetic seal which is seldom met with in catalogs or in stock, for that matter, except at Schweber's where they are stocked across the board. Every capacitance value in every series is listed on a separate line complete with all the pertinent data necessary to make a well-informed choice. Added features not usually found in "condensed" catalogs are the many typical performance curves (fourteen to be exact); outline drawings suitable for blueprint reproduction; and military cross-reference list from superseded part number to latest mil spec (Mil-C-26655B to Mil-C-39003/1A). Circle #242.

Hottest Product of the Year #2

Motorola introduced a new precision wide-range integrated circuit voltage and current regulator, the MC1566L/1466L. This unique "floating" regulator can deliver hundreds of volts — limited only by the breakdown voltage of the external series pass transistor. Output voltage and output current are adjustable. It's designed to give "laboratory" power-supply performance. The 100-lot price commercial grade is 8.50 each, military grade 24.50 each. Circle No. 243.

Application & technical notes on hermetically Sealed Relays

A nine page bulletin with the above title has been prepared by the Specialty Control Department of the General Electric Co. It contains a short section headed "Why Use Relays?" which sums up the positive assets of relays. Under the heading "Applications & Misapplications" are listed some circuits of interest to relay users such as Coil Arc Suppression, Dropout Calibration, Motor Reversing, and (would you believe it?) the Cut-Throat Circuit. The second half of the bulletin lists Application Details by Relay Type which makes a valuable supplement to the relay catalog. Circle #244.

Schweber Glossary of Computer & Integrated Circuit Terms

A recent letter referred to the "alphabet hash" so prevalent in semiconductor literature, which often holds up the newcomer and the oldtimer from making a smooth entry into the expanding semiconductor field. Jargon also plays a part in mystifying the newcomer. The "Brute Force Filter Circuit" is not related to the "Cut Throat Relay Circuit", or didn't you know? One of our efforts to clarify the technical jargon used by engineers is an 8-page pocket-size glossary written for non-engineering personnel. Copies are still available. Circle #245.



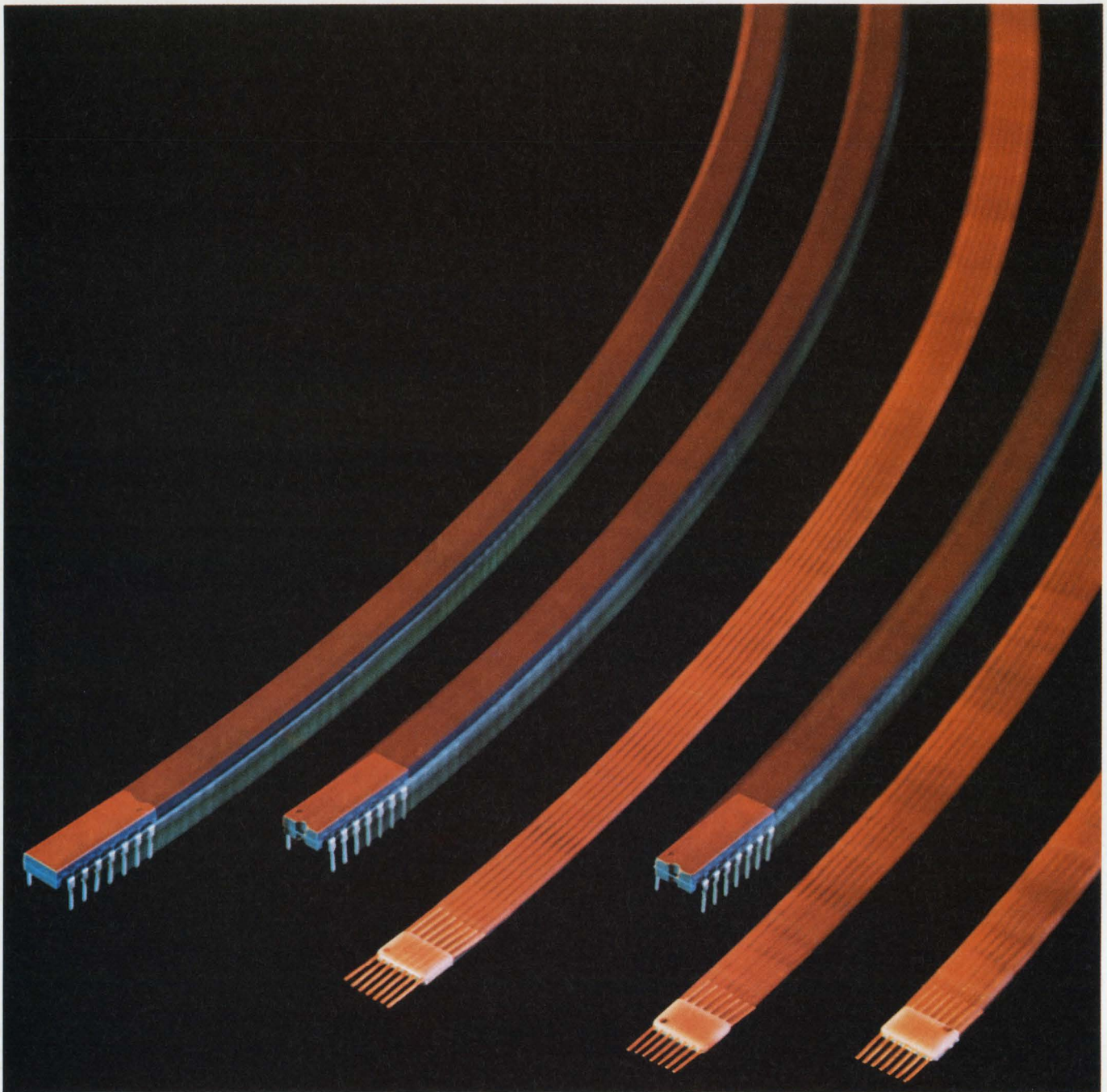

Sprague Digital ICs. Illustration: Series 54H/74H in flatpack and DIP

Just arrived. Series 54H/74H. The fast ones.

Just about the fastest saturated logic circuits around. Series 54H/74H from Sprague. The whole family. Flip-flops and all.

Use them in arithmetic and processing sections, where speed really counts. Mix and match them with Sprague's standard Series 54/74.

Get off to a fast start with Sprague Series 54H/74H.

| TYPICAL CHARACTERISTICS | GATES | FLIP-FLOPS |
|-------------------------|-----------------|------------|
| Propagation Delay | 6 nsec | 17 nsec |
| Power Dissipation | 22 mW | 80 mW |
| Noise Immunity | 1 V | 1 V |
| Temperature Range | -55 to +125° C | |
| Series 54H | 0 to +70° C | |
| Series 74H | DIP or Flatpack | |
| Packages | | |

Call Sprague Info-Central (617) 853-5000 extension 5474.

Or call your Sprague industrial distributor. He has them on the shelf.
For complete specifications, circle the reader service number below.

455-9127



News



Amorphous-state devices being fabricated. A new electronic device or a laboratory curiosity? p. 25

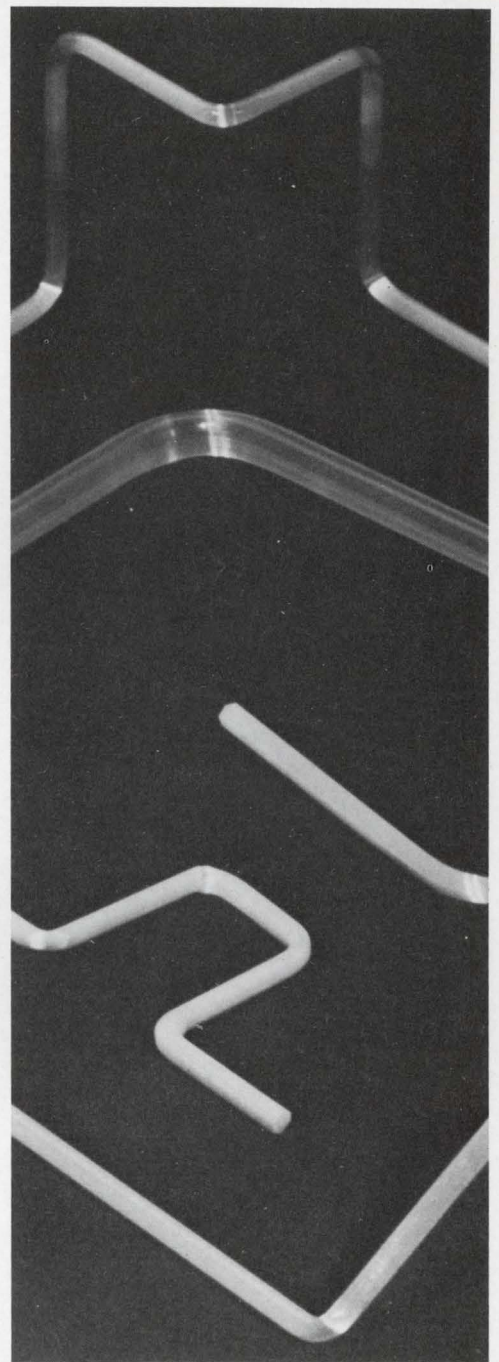

Fiber optic light pipes and lasers are getting together. p. 36

Also in this section:

IBM tests holographic data storage. p. 52

News Scope, p. 21 . . . **Washington Report**, p. 45 . . . **Editorial**, p. 61

All the advantages of tantalum...at low cost!

Type 196D Dipped Solid-Electrolyte Tantalex[®] Capacitors

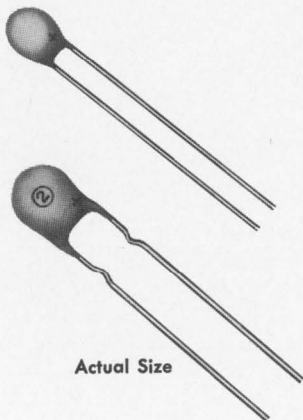

INFORMATION RETRIEVAL NO. 821

Here's a capacitor design that admirably fills the need for low-cost yet dependable solid tantalum capacitors suitable for printed wiring boards. Straight leads as well as crimped leads are readily available to meet your manufacturing needs.

Covering a broad range of capacitance values from .1 μF to 330 μF , with voltage ratings from 4 to 50 VDC, Type 196D Capacitors are protected by a tough insulating coating which is highly resistant to moisture and mechanical damage.

48C-9124

...need a reliable wirewound resistor?

Specify ACRASIL[®] PRECISION/POWER RESISTORS

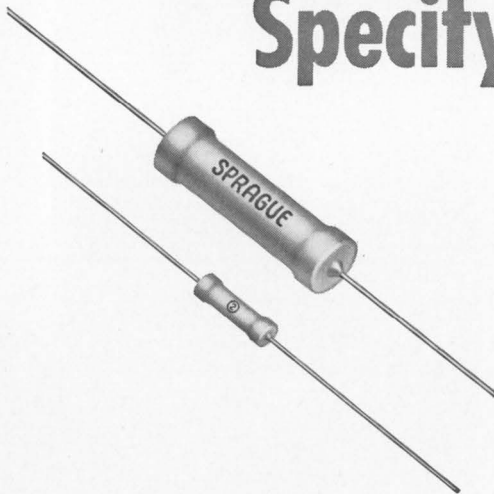

INFORMATION RETRIEVAL NO. 822

Excellent stability and reliability, even under extended load life, extremely high humidity, and other adverse operating conditions. Expansion coefficient of silicone coating is closely matched to that of ceramic base to insure against damage to resistance winding. Coating provides exceptional protection against moisture, shock, vibration, fungus. Available with standard and non-inductive windings. Resistance tolerances as close as $\pm 0.05\%$.

For engineering bulletins on 196D Tantalex[®] Capacitors or Acrasil[®] Resistors, or both—write to: Technical Literature Service, Sprague Electric Company, 347 Marshall St., North Adams, Mass. 01247.

THE BROAD-LINE PRODUCER OF ELECTRONIC PARTS



*Sprague' and '®' are registered trademarks of the Sprague Electric Co.

Deep-sea search vehicle being designed for Navy

A deep-sea craft that can submerge to 20,000 feet and will be used for Navy search missions and oceanographic studies is on the drawing boards. Lockheed Missiles and Space Co., after a two-year design study in competition with Westinghouse Electric Corp., has been chosen to proceed with the design and construction of a prototype Deep Submergence Search Vehicle.

Lockheed has received a \$500,000 letter contract to prepare a final design study.

The craft will carry a four-man crew and will be equipped with external TV cameras, a variety of navigational devices, near range-and-far-range sonar, and both

voice and data underwater communications.

Because of its relatively long endurance (30-hour vehicle operation and 80-hour life-support capability) the craft will use a large-capacity fuel-cell system for its primary electrical power. Two concerns, Allis-Chalmers Corp. and the Pratt & Whitney Div. of United Aircraft, will compete with different preliminary power-system designs. These are due for review by August, and the winner will then produce a final design and build the fuel-cell system. The power will be required for primary propulsion, plus all instrumentation, vehicle control, and environmental control.

U.S. official salutes information revolution

Delegates at the IEEE International Conference on Communications heard the present revolution in information processing and communications compared to the power revolution of the last century "which freed man from physical labor and drudgery."

The analogy was drawn by Myron Tribus, recently appointed Assistant Secretary of Commerce for Science and Technology, in a keynote address to the conference. More than 1500 engineers from around the world gathered in Boulder, Colo., for the meeting June 9-11.

Tribus pointed out that in 1945 it cost \$1000 to do a million operations on a computer keyboard in one month. "Today," he went on, "computers do the same job for 6 cents, and by the early 1970s that figure will drop to one-tenth of what it is now."

In speaking of the need for Government planning and regulation

of communications, Tribus said the policymakers must have "a solid research base and a system analysis capability" so they can consider the broad sense of "electro-space management" and not merely spectrum allocation. He said:

"We must now plan in terms of frequency, location, polarization, intensity and time and direction of propagation. We must regard all forms of communication as potentially interchangeable including cables, beamed microwaves, diffuse broadcasts, as well as combinations of sequenced channels."

Computer design spurs microwave IC growth

Improvements in the mathematical characterization of microstrip transmission line are making it easy to develop computer-designed microwave integrated circuits.

More than 15 companies displayed microwave ICs at Microwave Expo/East, an industry show spon-

sored by Micro/Waves magazine earlier this month in New York City.

"Our designs pretty much work the first time around," reported Ralph Herlin, president of Scientific Research Corp., Tampa, Fla. "We use a time-shared computer terminal and generally only have to do a little trimming to make our computerized designs work."

In addition final designs can be produced repeatably in large quantities with great savings in cost, Herlin said.

The best way to put together subsystems consisting of several microwave ICs, he indicated, is to build each on a separate substrate and then connect the separate modules. This approach was also exhibited at the show by Western Microwave Laboratories, Los Gatos, Calif.

Military moving to cure communications 'fluke'

With the help of space radio relay, the Pentagon can reach U.S. military commanders in seconds from nearly any place in the world. But the Army still has trouble communicating at times with forward units a few miles away in rugged battlefield terrain.

The seeming incongruity was described to delegates at the 23rd annual Armed Forces Communications & Electronic Association Convention in Washington.

The high quality and versatility of the space radio network was demonstrated when the military let the delegates listen in on tests of its Hughes Aircraft TACSAT I satellite. There was immediate response from stations as far away as the South Pacific. Voice quality was excellent.

Operational tests of the Lincoln Laboratory's LES-6 satellite were also reported to the delegates by Rollin G. Keyes, director of the Test and Evaluation Directorate of the Army Satellite Communications Agency. He said reasonable communications were maintained over a one-mile distance from one side of a mountain to the other in the jungles of Panama, as well as between Panama and Fort Monmouth, N. J., 2500 miles away. There were no failures, Keyes said, although signal strengths varied



Mobility for the terminal of tactical communication satellites is provided by 1-1/4-ton truck.

due to losses through the dense vegetation.

Speaking before the same conference, the Army's Chief of Staff, Gen. W. C. Westmoreland, observed:

"Within a matter of a few seconds, field commanders halfway around the globe can be reached by national command authorities in Washington. Paradoxically, it is still very often easier to communicate worldwide, or to the moon, than it is from one side of the hill to the other."

It was evident from this meeting that the Defense Dept. is making great strides to correct tactical communication deficiencies.

The LES (Lincoln Experimental Satellite) and LET (Lincoln Experimental Terminals) have provided much of the basic developmental data used to determine the design of tactical communications satellite systems. Six vehicles have been employed—three at shf and three at uhf.

The LES-6, launched late last year, is in synchronous orbit. It provides a teletypewriter and voice and digital data relay capability. The latter permits rates from 2.4 to 76.8 kilobits per second. It also is the first to use an electrically despun antenna. Coverage is essentially hemispheric.

The uhf ground terminals—land, sea, and airborne—have been largely assembled in-house by the three services, with many major subsystems produced by Electronic Communication, Inc., of St. Petersburg, Fla. The present channel width is 50 kHz, but Lincoln Laboratory's Paul Rose, head of the Communications Div., feels that for better spectrum utilization, this could be reduced to 10 kHz.

IBM's competitors await new software pricing

A new pricing plan on IBM computer software, due to be announced July 1, has competitors standing by in anxious expectation.

The plan is intended to separate the pricing of computer hardware and software. It follows suits by four competitors accusing IBM of antitrust violations and unfair trade practices because of its single-price package, or "bundle," deal. The Justice Dept. has also sued IBM over this and other trade practices.

The details of the new pricing plan are being guarded with customary IBM efficiency. However, competitive software houses have high hopes. Warren Spaulding, vice president of Applied Data Research, Inc., Princeton, N. J., anticipates substantial growth of the software industry if the plan is an equitable one.

Walter F. Bauer, president of Informatics, Inc., Sherman Oaks, Calif., predicts the switch in pricing might "double or triple or quadruple the software market in one or two years."

EIA seeks new markets to counter defense cuts

With big cuts in the defense budget looming, electronics manufacturers are under pressure to find new markets for their products, and that subject holds star billing at the 45th annual convention of the Electronic Industries Association in Chicago this week (June 23-26).

To help spotlight market possibilities, a special report has been prepared by the EIA Requirements Committee to analyze major issues affecting the country. According

to the committee chairman, Roy Ballard, an executive assistant with Litton Data Systems Div., the report aims at helping electronic industry decision-makers decide in what new areas they should establish priorities.

"We are not making any recommendations," Ballard told *ELECTRONIC DESIGN*. "But, for example a company with expertise in military command and control systems might see a future market in the area of police or fire department command-control systems."

The report contains chapters on space, marine sciences, social problems, housing, pollution, education, balance of payments, international security problems, health, and transportation.

Computers to help run California water system

A battery of 37 Hewlett-Packard computers will help to control water flow through the next link in California's \$2.8-billion state water project. The project will distribute water from northern California to the Los Angeles basin. The computers will be used on the link between the Sacramento River Delta and the Buena Vista pumping plant near Bakersfield.

Each of the two area controllers will completely scan, in less than a minute, every operational function at as many as 19 separate water control gate sites and four pumping plant sites. At an area control, human judgment controls the water. However, the system is entirely capable of unattended automatic operation for long periods.

Two Hewlett-Packard computers will act as central processors at area controls. These units, each with 16 core memory and 3 megabit disc memory, work with associated teletypewriters, cathode-ray tube displays, and other peripherals.

Computer symposium due

The Navy is sponsoring a Symposium on Parallel Processor Systems, Technologies and Applications this week (June 25-27) at the Navy Postgraduate School, Monterey, Calif.

United Aircraft

produces... stocks... sells

semiconductor dice

Some call 'em "chips," some call 'em "dice," and others call 'em "wafers"—but if you make hybrid circuits...or communications and microwave equipment...we've got the semiconductor devices to fit most of your needs. For example:

Hybrid Applications

Small signal, P-N diodes, N-P diodes, zener diodes, switching diodes, tantalum nitride resistor networks, silicon dioxide capacitors, TTL integrated circuits. And for...

Microwave Applications

High frequency, medium-power and high-power devices for communication and microwave stripline substrates.

In addition, we'll be happy to provide schedules and methods for the bonding, proper care and handling of these devices.

And we're ready to give you excellent service and fast delivery on any quantity—from a few devices to several million a month!

Contact us for full details.

Electronic Components DIVISION OF **United Aircraft**

TREVOSE, PENNSYLVANIA Tel. 215-355-5000 TWX: 510-667-1717

West Coast Office: 128 E. Katella Ave., Orange, Calif. (714) 639-4030

DESIGNERS AND PRODUCERS OF • RF AND MICROWAVE TRANSISTORS
• CUSTOM HYBRID CIRCUITS • MONOLITHIC INTEGRATED CIRCUITS

INFORMATION RETRIEVAL NUMBER 15

winning form

from the
form-factor
specialists
at Damon

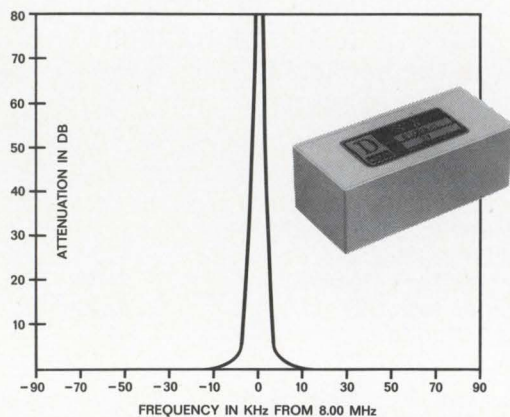

When your system calls for an ultra-sharp attenuation "spike" . . . specify a **Damon Model 6108A Band-Reject Crystal Filter**. Operating from a known source into a low-noise amplifier, the Damon Model 6108A filter rejects local oscillator and related feed-through — but preserves the system noise figure. With unwanted signals rejected before amplification, it also improves the system's dynamic range and reduces intermodulation from vibration and shock.

The Model 6108A has a center frequency of 8.00 MHz. Attenuation: not less than 75 db ± 240 Hz from f_r , and 11 db ± 4 db at -3 kHz and $+3$ kHz from f_r . Operates over -40°C to $+85^\circ\text{C}$ range with vacuum tube, transistor, or MOSFET amplifiers.

Whatever your signal-shaping need — from a narrow band-reject "spike" to a broad band-pass — you can rely on the form-factor specialists at Damon. Write: Electronics Division, Damon Engineering, Inc., 115 Fourth Avenue, Needham, Mass. 02194, or call (617) 449-0800.

 DAMON

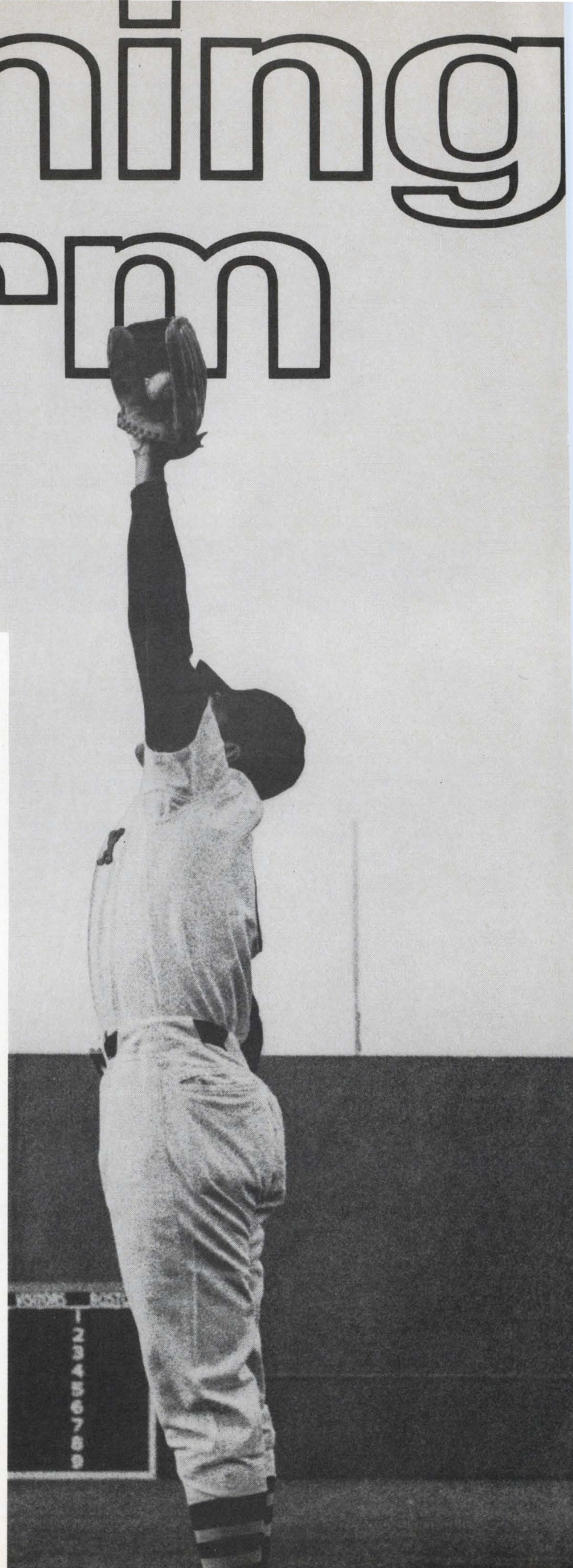

Amorphous semiconductor: Zowie? Or zilch?

The promise of revolutionary switching devices is great, but so are the reproducibility obstacles

John N. Kessler
News Editor

There was a time when "credibility gap" applied largely to politics, but the storm over amorphous materials and their role in the future of electronic devices has prompted this kind of accusation among the engineering elite. The clash is between those who claim that amorphous-state devices will find wide use in the electronics industry and those who believe such claims are false, misleading, ill-founded. The stakes are large: They involve not only scientific acumen and potentially dazzling electronic products, but huge financial gain.

For years it has been known that amorphous materials, like some glasses, can be made to change their conductive state suddenly with an applied electric field. But so far the work in this field has

been experimental; no practical devices or products have been produced and marketed.

Energy Conversion Devices, Inc., a small electronics concern in Troy, Mich., is determined to prove that amorphous-state devices can be manufactured commercially. Another company, Hartman Systems of Huntington Station, N.Y., has copyrighted the term Resistrets. But how the device works and whether it will ever be manufactured, Hartman won't say. Ira Ritow, engineering manager of the company, told ELECTRONIC DESIGN: "We are investigating the field of amorphous solids but have nothing to report at this time."

The rest of the electronics industry is sitting tight. A scattering of large companies have very small groups doing research in this field, and there are a number of university projects going on. But there

is no publicized development of devices except at Energy Conversion Devices.

What amorphous-state devices will do for the electronics industry depends on who's talking. And lately even the president of Energy Conversion Devices, Stanford R. Ovshinsky, has tried to tone down the visions of popular newswriters, some of whom have put amorphous-state devices on a par with the discovery of the transistor (see "Ovshinsky Displays Futuristic Thin Film Devices," ED 12, June 7, 1969, p. 30.)

Ronald Neale, vice president of Operations at Energy Conversion Devices, reports: "What we have established is that in most of the devices we were producing, the package influenced the stability of the characteristics of the device more than the material. Now we have a thin-film structure where we have removed the effects of packaging."

Laboratory models of amor-



Ron Neale, vice president of operations at Energy Conversion Devices: "... Now we have a structure where we have removed the harmful effects of packaging."



A. D. Pearson of Bell Telephone Laboratories: "... it is encouraging to see ... that glass may represent something more than a material to look through or drink from."

(amorphous, continued)

phous-state devices do work. But the questions are: How well? How reliably? And how reproducibly after you've found a reliable one?

The potential market is as big as the sky; telephone switches, computer memories, amplifiers, TV displays, and perhaps thousands of electronic components—if the best promises prove true. Otherwise amorphous materials could remain a laboratory curiosity.

Much of solid-state physics is based on the idea of crystalline periodicity—that atoms in solids have a known place in a three-dimensional lattice and that a knowledge of how one atom reacts in such a structural array permits us to predict where certain atoms are going to be and how they relate to one another.

The field of amorphous-state physics has no such methods of determining structure in materials. Scientists are now analyzing amorphous solids by X-ray spectrometry, differential thermal analysis, electron diffraction, infrared analysis, photomicrography and other techniques to try to bring some order to the understanding of inherently disordered materials. For amorphous solids, by definition, lack long-range order. They are non-crystalline. The arrangement of atoms in amorphous solids has been likened to the arrangement of pebbles in a pile.

Semiconductor glasses look best

There is a short-range consistency in the distances between nearest neighbor atoms in amorphous solids. But although a certain amount of structure is retained, as one moves away from the nearest neighbor atoms, this structure diminishes rapidly at distances of a few atomic diameters.

While the structure is the basic physical difference between amorphous and crystalline materials, the most characteristic difference is electrical. Solids can be classified according to their ability to pass current: metals, semiconductors, insulators. Among amorphous solids being studied today, those with active-device potential are semicon-

Crystalline vs amorphous materials

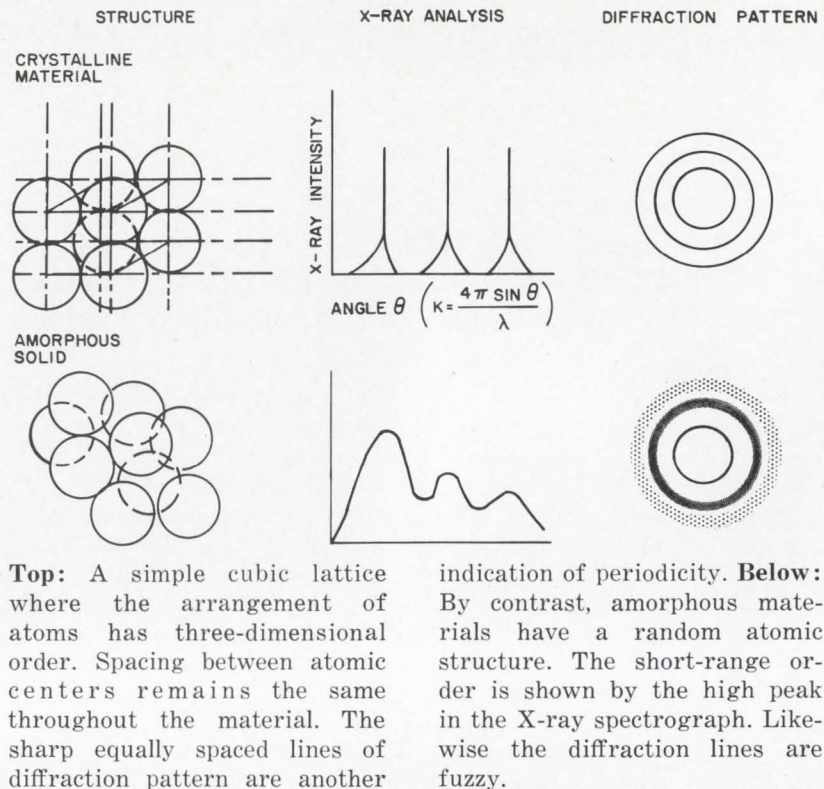

ductors. And the best of these are the glasses formed by the elements in Group IV, V and VI of the periodic chart.

Switching in this group of materials was first reported in 1962 by A. D. Pearson, J. F. Dewald and W. Northover of Bell Telephone Laboratories.¹ Prior to that—in 1958—Ovshinsky had reported switching in amorphous metal oxides.^{2,3} Earlier investigations of amorphous solids go back to the 1920's and even beyond.^{4,5}

The electrical characteristics of amorphous semiconducting glasses are typified by two basic types of switches:

1. Threshold switches:

■ **TURN ON**—As voltage is increased, behavior is ohmic until a critical threshold is reached. Then there is a sudden change from a high-resistance to a conducting state. The voltage drops and current increases sharply, almost parallel to the current axis. The conducting state is maintained as long as the current remains above a critical holding value.

■ **TURN OFF**—When the current is reduced below the holding value, the material reverts to its original high resistance state.

2. Memory switches:

■ **SET**—Once the device is turned on, current is increased until a current threshold is exceeded. This sets the device in the so-called memory state. Thereafter, even when the device is turned off, it remains conductive.

■ **RESET**—A current pulse greater than that required to set the device will turn it off—make it return to its original high-resistance state.

Ovshinsky also reports an “adaptive” memory device that has a large number, or continuous range, of resistance values between set and reset.⁶ The amount of energy put into the material determines an alterable resistive value; the device retains the information state even at zero bias.

The mechanism that produces the transition from high resistance to a conducting state has stirred a debate over whether the effect is caused by a thermal or electrical breakdown in the material. Basically the two theories may be summarized as follows:

Thermal breakdown. As the electric field increases, some of the electrons in the material are tossed out of equilibrium with the rest of

Signetics More complex magic from

All three logic diagrams fail to show you what's *really* important about our new DCL arrays. Things like increased system performance. Logic flexibility. Can count savings. And look what else they don't show... 1. 8230/8232 Digital Multiplexer: three-to-one can count reduction; address-to-output time, 22 ns typically. 2. 8266 Digital Multiplexer: three-to-one can count reduction; address-to-output time—18 ns typical—provides conditional complement function. 3. 8241/8242 Digital Comparator: four-to-one can count reduction; high speed TPD = 10 ns typical—8241; TPD = 18 ns typical—8242; 8242 expandable for word comparison up to 100 bits in length.

One final goof: the diagrams take up so much space, we can't show you 11 other MSI's available right now, today, from Signetics. So stop reading this magazine upside down, drop us a line, and we'll rush you all the specs!

Answer:

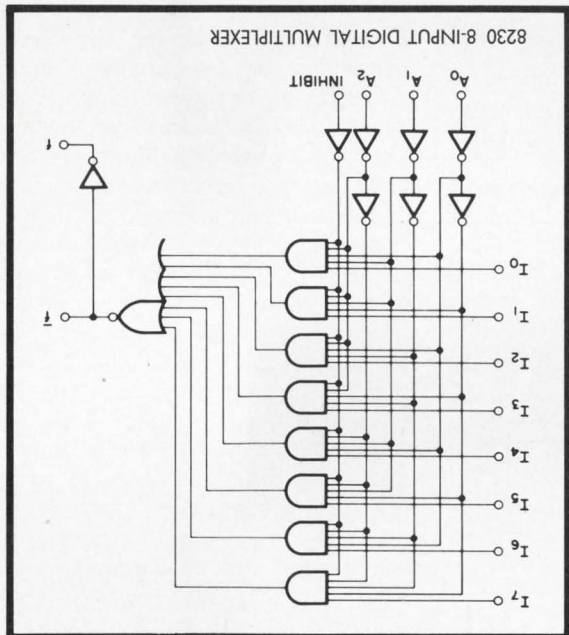
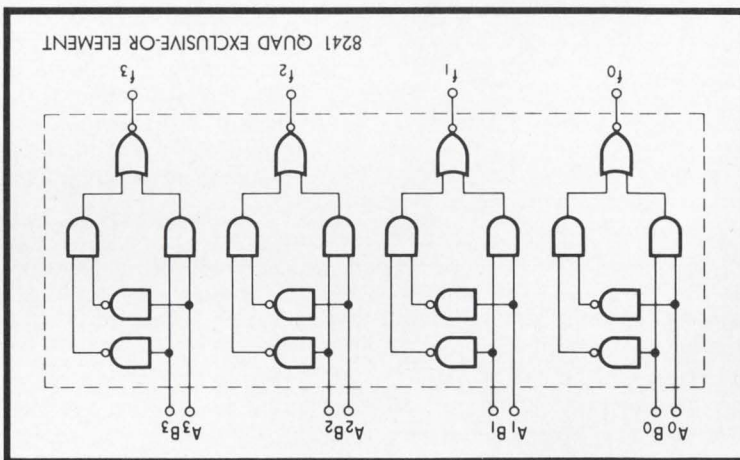
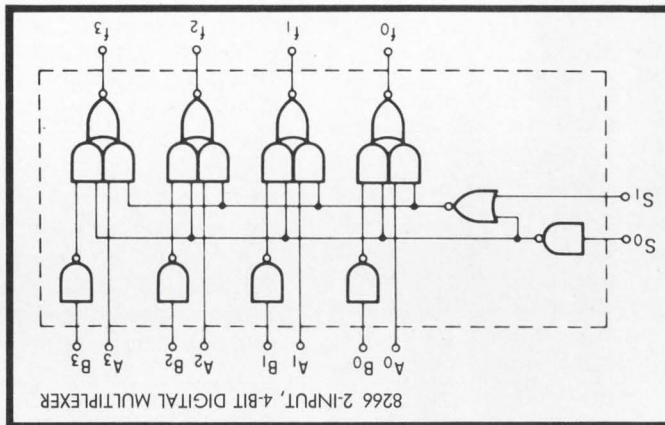

Shown below: three new DCL arrays from Signetics, the leader in MSI devices. Study them carefully to see if you can spot what's missing!

What's wrong with these diagrams?

NEWS

(amorphous, continued)

the lattice, and current flows. The result is joule heating. If this happens in a very small volume for a given amount of energy, large heating effects occur. If joule heating is sufficiently large and sufficiently fast, the thermal energy of the atoms becomes so great that ionization takes place. Electrons separate from their atoms, and the character of the material changes to one of high conductivity. Those advocating the development of amorphous switches tend to discount this explanation of the mechanism, because joule heating is considered to be a relatively slow process that cannot explain the fast switching times observed in amorphous materials.

Electrical Breakdown. Several types of electrical breakdowns are said to occur in amorphous solids. All such mechanisms are derived directly from solid-state physics. Two of the mechanisms suggested by a number of scientists are tunneling and avalanche breakdown. In both cases, an electric field of about 10^6 volts/cm is enough energy to reduce the quantum mechanical barrier between the valence band and the conduction band in a material. In the presence of such a field, electrons "tunnel" in 100-angstrom jumps through to the conduction band. In the case of avalanche breakdown, some of the electrons have enough energy to ionize some atoms, thereby creating more free electrons, etc. Recombination (electrons going back on the ions and creating atoms again) will dominate over re-emissions if the voltage drops.

What happens inside an amorphous semiconductor was dramatically depicted at the Symposium on Semiconductor Effects in Amorphous Solids, sponsored in New York City last month by the Picatinny Arsenal and the Army Research Office. At this meeting, Ronald R. Uttecht of Iowa State University and Charles H. Sie of Energy Conversion Devices showed, by microcinematography, the formation of a conducting filament 15 microns wide between two electrodes.⁶ The motion picture reported an obvious change of the reflectivity of the material as the latter underwent the change to a conduct-

ing state.

In the experiments depicted in the film, Uttecht and Sie used a black glass (As:55, Te: 35, Ge: 10 wt per cent) about 1-cm square

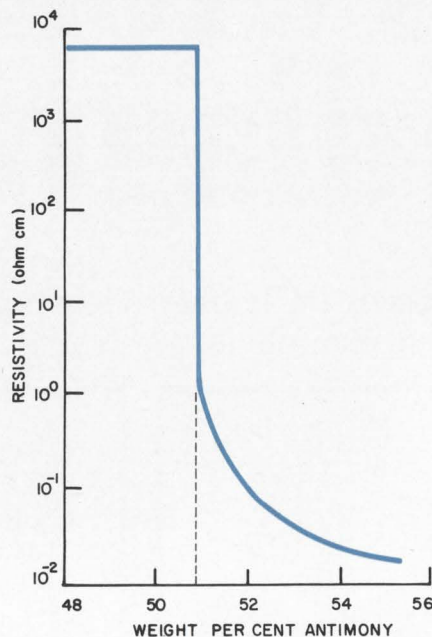

Example of a Mott transition recorded by Lee Gildart in crystalline antimony triselenide. Resistivity drops by six orders of magnitude as the stoichiometry of the compound is changed by the addition of antimony. The change in conductivity is accompanied by a shift in temperature coefficient of resistivity from negative to positive.

and 0.5-cm thick. They attached tungsten carbide point contact probes to the glass, so that the distance between the probes was 0.7 mm. Their experiment covered three states of an amorphous memory switch: (1) A voltage pulse turned on the material, (2) Once turned on, the pulse could be removed or reapplied without changing the material's conductive state, and (3) A current pulse turned off the material.

Electron microprobe studies were used to determine the composition of the conducting filament, and they indicated that there was a movement of elements: tellurium increased and germanium and arsenic decreased. There was a small build-up of germanium on either side of the filament. Uttecht thinks the composition of the filament may be As_2Te_3 .

After the film had been shown, Ovshinsky, who was at the symposium, told Uttecht: "This is the first time I've seen what I've been

working on for 10 years."

But Lee Gildart, professor of physics at Fairleigh Dickinson University, who also attended the symposium, regards the Uttecht-Sie motion picture as evidence of the inherent unreliability of amorphous switches. He contends that the movie proves that there is a gross movement of atoms within the material. Gildart concludes that a phase change must occur and that if the composition of the material changes when it is switched, it is impossible to be assured that the original material will remain the same after it is switched a number of times.

While agreeing that an atomic rearrangement occurs when a conducting filament is formed in memory switches, scientists from Energy Conversion Devices do not feel this implies an inherent failure mechanism.

Gildart says that the width of the conducting filament in memory switches is so small as to be almost valueless in practical devices.

Is the filament too small?

"In all bistable switches," he contends, "there is some kind of phase change produced as the device goes from the OFF state to the ON state. The current flows only in a conducting filament of very small diameter [about 25 microns], and this filament is no longer amorphous but is either crystalline or a Mott-type conductor. I think the fact that the filament has a positive temperature coefficient of resistivity supports the second supposition."

In commenting on the possibility of developing reliable commercial devices from amorphous material, Gildart told ELECTRONIC DESIGN: "I can't believe that a filament so small—one less than 1/10 the cross-section of a human hair—can be made the basis for truly valuable electronic devices."

However, most of the applications now being explored by Energy Conversion Devices use thin films, not the bulk material studied by Uttecht and Sie. And it may not be fair to relate bulk studies to thin films.

Squabbles over reliability

Ovshinsky reports: "some [mem-



and now...
UNITRODE
 invents the 12 amp
UCR—
 the industry's first
 fused-in-glass SCR.

It has so many superior features it
 deserves to be called "something else".

- Ideal for pulse modulator applications
- Smallest medium-power SCR
- Efficient switching of high pulse currents
- Peak repetitive pulse current 150A in high frequency modulators
- Anode voltage 100 to 600V
- Low forward voltage drop
- Forward current 12A
- Peak gate current 100A
- 3.5°C/watt thermal impedance

TAKE A LOOK AT THE WAY IT'S BUILT

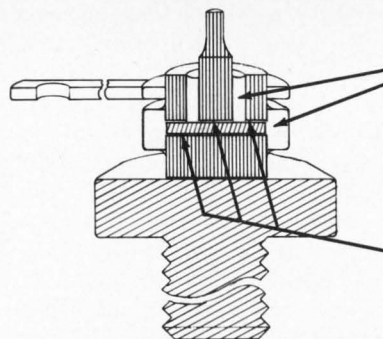

Two fused-in-glass seals melted, wetted and fused to both silicon and metal surfaces permanently protecting and stabilizing the SCR die in a voidless Unitrode package.

Thermal coefficients of glass, pins, and silicon are matched to withstand extremes in temperature shock and cycling.

True metallurgical bonds from terminal pins to the silicon provide rapid heat transfer and high current capability.

580 Pleasant Street, Watertown, Mass. 02172 (617) 926-0404

UNITRODE 



Check off the reply card now for a really comprehensive set of specs, charts, graphs, and curves. Or if you want really fast service, call John McCusker collect at (617) 926-0404.

(amorphous, continued)

ory] devices have been tested over 3×10^8 complete cycles without a failure."

E. J. Evans, J. H. Heblers and Ovshinsky have reported in their experiments with thin-film memory switches that there is an increasing degradation of sample OFF resistance and film appearance, which they attribute to oxidation.⁶ Also, their X-ray diffraction analyses have indicated that the conductive state is characterized by the presence of crystalline tellurium. But they add: "The RESET flash [used in their experiments instead of a current pulse to restore high resistivity was found to vitrify substantially all the crystallized tellurium and produce an X-ray pattern characteristic of a disordered material."

Can the conducting filament in memory switches be made wider? Gildart says it's doubtful. He also adds that the filament has no physical strength and will break under thermal change or mechanical shock. Also, he says that switching can occur at less than rated voltages if there is a steady voltage. "A switch rated at 20 volts is apt to switch at 10 volts if you wait long enough," Gildart notes.

Applications? If amorphous-state devices can be mass-produced, threshold switches would probably replace telephone relays. But here 99 per cent reliability cannot be tolerated. Device lifetimes on the order of 20 years are desirable; a 1 per cent failure in telephone relays would soon put a company out of business.

Flat screen TV? Certainly a possibility, and Energy Conversion Devices has developed switches that can be coated with electroluminescent phosphors. Arrays of these switches have been fabricated. The need exists: displays at airline terminals, closed-circuit educational TV and, of course, commercial television. But some very hairy problems must be worked out first. How do you command a switch to turn on? This is traditionally the function of an electron beam, but such devices can't be made flat. The obvious answer is a grid of wires. But this involves intricate wiring and ballast resis-

tors, arranged in arrays with each of the switches to prevent over-voltages. If such switches are small (as they would have to be), the

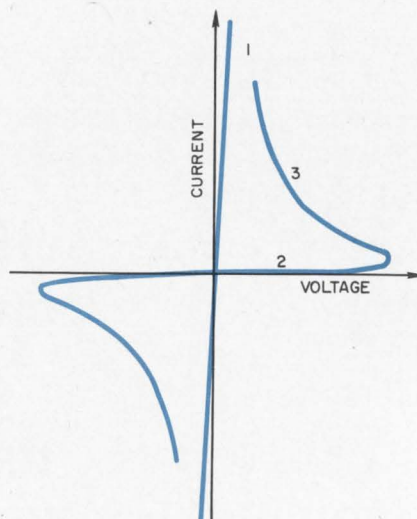

Electrical characteristics of amorphous glasses, as shown in curves filed with a patent application by A. D. Pearson in 1961: Region 1—a voltage is turned on, passes a threshold and drops off suddenly as current rises sharply almost parallel to the I-axis. Region 2—voltage is turned off and the material reverts to its original high-resistance state. Region 3—with a constant current, negative resistance occurs.

resistors would have to be very precise, and these can be expensive.

What has been built in the laboratory? Already D. C. Mattis of Yeshiva University has constructed a 10 MHz oscillator, and he is working on a number of other devices (see "Insulator-to-Conductor Discovery Reported," ED 11, May 24, 1969, p. 21). T. J. Kobylarz, professor of engineering at the Stevens Institute of Technology has used threshold switches from Energy Conversion Devices for experimental class C a-m modulators, an fm modulator, ternary switches, an audio linear amplifier, stable audio oscillators and high-frequency (100-kHz) oscillators.⁶ Kobylarz cautions, however, that although working laboratory models were breadboarded for each of these circuits, the hand-selection of devices from Energy Conversion Devices was required.

Amorphous semiconductors have a number of potential advantages over transistors.

- Two thresholds. They are symmetrical and can be turned on by a positive or negative voltage pulse.

- Very small capacitance. This makes possible very fast switching speeds.

- Very fast switching speed after an initial delay time. Ovshinsky reports speeds of 1.5×10^{-10} seconds (transistor switches operate at about 10^{-8} seconds).

- Ease of fabrication. Because amorphous materials lack long-range order, they may be fabricated with relatively impure materials and still maintain desired characteristics.

- Radiation hardness. This is a characteristic of amorphous material and could be a crucial factor in electronic missile components that must pass through clouds of radiation.

- Small volume. The size of amorphous semiconductor devices is limited only by the size of the contacts, except for extremely small (micron region) contacts.

- Low-power requirements.

- Memory retention at zero bias.

What are the problems?

The big problem with amorphous semiconductors is reliability. Another problem is the delay time preceding switching. It depends on the voltage and can vary from less than a nanosecond to about 20 microseconds. (As voltage increases, the delay decreases exponentially; but over-voltages cause the material to degrade.) And even the switching device is not consistently reproducible; Kobylarz reports switching speeds of 1 to 2 nanoseconds with the devices he obtained from Energy Conversion Devices.⁶

The range of materials that exhibit bistable behavior is vast. Brian Bagley, a physicist with Bell Telephone Laboratories, has found that all of the semiconducting glasses he has looked at—20 or 30 of them—switch.⁶

P. O. Sliva, G. Dir and C. Griffiths of the Xerox Corp. have reported finding bistable behavior in nine metal oxides and in Ga P, Zn S, Se, mica, As_2S_3 , As_2Se_3 , As-Te-Si-Ge mixtures and polystyrene and Saran Wrap.⁶ The cost of 1-mm of Saran Wrap would obvi-

ously be negligible.

The electrical properties of amorphous materials follow, to a large extent, a theory proposed in 1949 by Sir Nevill Mott, now director of the Cavendish Laboratory, Cambridge, England.⁷ Mott theorized that if one increased the density of ions in the lattice of an insulator, one would reach a critical density when that lattice became a metallic conductor. He also suggested that the transition from an insulating to a conducting state would be sudden and that it would vary with temperature.

Some scientists contend that switching in amorphous devices is a Mott transition. This is why the early investigations of Gildart are perhaps basic to amorphous-state physics. Gildart believes that the mechanism that causes a change in the conductivity of amorphous materials is the same as that in crystalline materials. In experiments begun in 1956, he confirmed that when antimony is added to crystalline antimony triselenide beyond the stoichiometric proportion (Sb_2Se_3), the resistivity drops abruptly by six orders of magnitude (Fig. 1) and the temperature coefficient of resistivity shifts from negative to positive, proof of metal-like conduction.

In later experiments with antimony trisulphide (Sb_2S_3) doped with antimony, Gildart found he could make the sample conductive with a voltage pulse (100 V for 30 ns) and restore high resistivity with a current pulse (50 mA for 1 μs).⁸ Some crystals could be cycled indefinitely, others degraded after a few tens or hundreds of cycles.

But Gildart has been concerned principally with crystalline materials and believes that crystalline solid-state switches may turn out to be better for certain applications than amorphous ones.

In 1962, Pearson and Dewald of Bell Laboratories reported the first investigations of switching in semi-conducting glasses.

Pearson said "the most novel feature" of these diodes was the fact that "they can be made to remain in either the high- or the low-resistance state even under zero bias. The observed effects thus contain the elements of memory as well as switching."

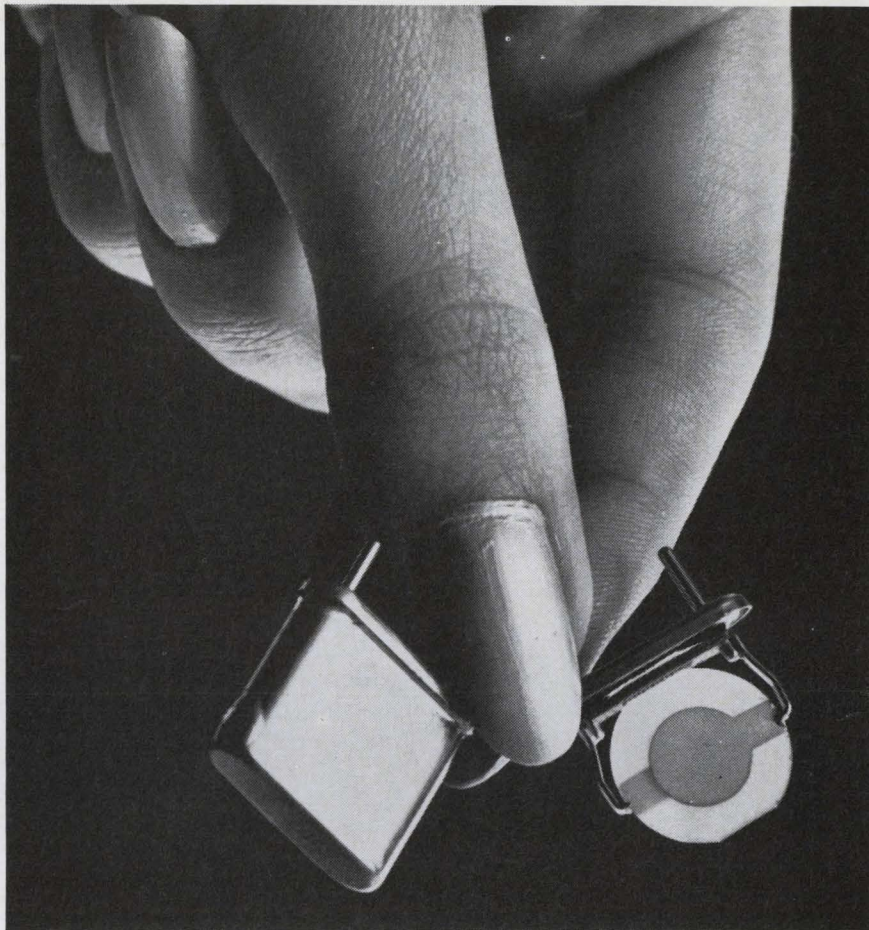

How do you get fast service on special, short-order or prototype crystals?

Tune Sherold in.

We've got the advanced crystal technology to analyze your unique crystal problems, design the solution, and manufacture a prototype or short order — quickly. And we have the facilities to put it into low-cost quantity production, too. No matter what special crystal techniques your application requires, Sherold can produce it in the 4 kHz to 175 megaHz range. Solder seal, cold weld, resistance weld or glass fusing. Custom packaging. High shock and vibration MIL specs. And we have several plants geographically located to give you this special crystal technology assistance quickly and locally. Tune us in on your problem. Send details to Sherold Crystal Products Group, Tyco Laboratories, Inc., 1510 McGee Trafficway, Kansas City, Missouri 64108. Or phone (816) 842-9792. TWX 910-771-2181.

tyco

INFORMATION RETRIEVAL NUMBER 19

(amorphous, continued)

Pearson found that all the compositions he examined, including those reported by Ovshinsky, showed both the switching and the memory effects. Yet Ovshinsky has made a distinction between switching and memory materials: "In the case of the threshold switch, elements are chosen to provide several functions, among which are the inhibition of crystallization and the introduction by their chemical bonds of large amounts of localized states bridging valves and conduction bands. Memory materials are chosen which allow for reversible structural changes. They are therefore balanced between ordered and disordered states."⁶

Pearson says today: "Regardless of whether glass switches turn out to be a commercial success or a laboratory curiosity, it is encouraging to see that the physics community has awakened to the fact that glass may represent something more than a material to look through or to drink from."

The results of Bagley's studies at Bell Laboratories indicate that the memory effect is due to crystallization or phase separation. He points out: "The crystallization of a glass, and thus the observation of a memory state in it, is a kinetically controlled process. Therefore an absolute classification of glasses

into memory- and non-memory forming cannot be made; we can only speak of tendencies, although the crystallization of some glasses may be very slow indeed."⁶

In an interview with ELECTRONIC DESIGN, Ovshinsky said he began investigating amorphous materials 11 years ago. In June, 1958, he made a switch of tantalum coated with an amorphous layer of tantalum oxide. This work was reported in the summer of 1959.^{7,8} A year later, Ovshinsky organized Energy Conversion Devices, which is today the only company presently convinced (or at least equipped to try to prove) that devices made of amorphous materials can be manufactured in commercial quantities for the electronics market. Giant electronic companies queried by ELECTRONIC DESIGN are skeptical. In all cases, they had few, if any, scientists working on amorphous materials, and none was developing devices.

But the many top amorphous-state physicists who are working full-time at, or as consultants to, Ovshinsky's small company lend stature to its optimism. The hassling between Energy Conversion Devices and much of the rest of the scientific-industrial community continues. But it appears to be more cajolery than bitterness.

Much of it was brought on by the publication last November of an Ovshinsky paper in *Physical Review Letters*.⁹ The daily press—notably The New York Times and The Wall Street Journal—ran stories calling Ovshinsky's work another transistor-type discovery. Wide fluctuations in the stock of Energy Conversion Devices followed—first upward under the initial impact of the news accounts and then downward as the public learned the work was still highly experimental and not close to assembly-line perfection.

This led Gildart to comment at the recent symposium in New York: "It still seems bistable and monostable switches are, as a class, subject to the diseases of instability, erratic performance and unpredictable demise. Whether or not cures can be found, it would seem the better part of wisdom to have a better understanding of the physics of switching before we say too much; I have in mind certain broad claims made recently . . . based on results 5 or 10 years old."

When ELECTRONIC DESIGN asked a director of engineering at a large research laboratory what he thought of amorphous semiconductors, he replied: "Zilch."

But Ovshinsky insists the outlook really is: Zowie! ■■

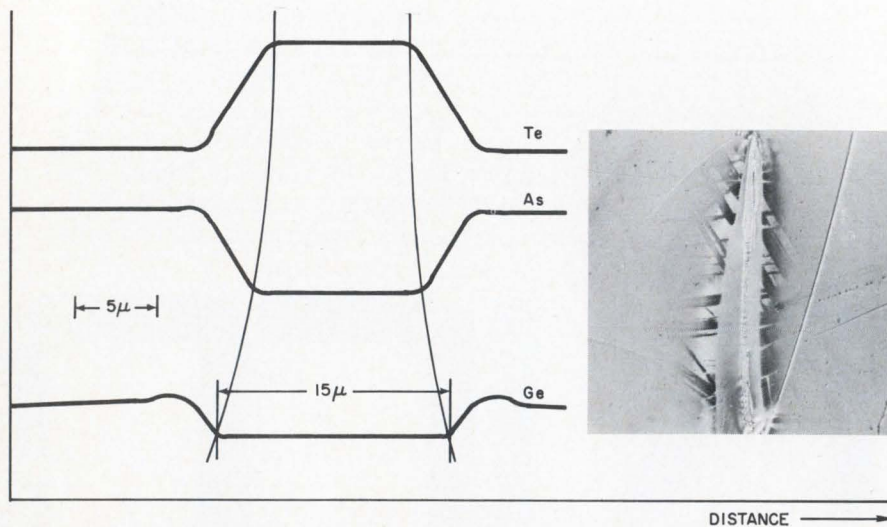

Frame from a microcinematographic view of a conducting filament passing through an amorphous glass semiconductor. An electron-probe and diffraction analysis of the conducting filament indicated crystallization and a redistribution of the elements.

References:

1. J. F. Dewald, A. D. Pearson, W. R. Northover, and W. F. Peck, Jr. "Semiconducting Glasses." Presented at the Los Angeles Meeting of the Electrochemical Society, May, 1962.
2. *Electronics*, 32, 76 (1950).
3. *Control Engineering*, 6, 121, July, (1959).
4. F. W. Lyle, *Phys. Rev.* (2), 11, p. 253 (1918).
5. A. T. Waterman, *Phys. Rev.*, 21, p. 540 (1923).
6. Paper presented at the first Symposium on Semiconductor Effects in Amorphous Solids, sponsored by Picatinny Arsenal and the Army Research Office, 14-17 May 1969 in New York, N. Y. To be published in the *Journal of Non-Crystalline Solids*.
7. N. F. Mott, *Proc. Phys. Soc. (A)* 62, p. 416 (1949).
8. Gildart and Powell, U. S. Patent No. 2,968,614 (1961).
9. S. R. Ovshinsky, *Phys. Rev. Letters*, 21, 20 p. 1450 (1968).

HYBRID MICROELECTRONICS

New video amplifiers pack power into small package.

Versatile amplifier has 700 mW output in a one-inch-square package.

You'll find a lot of applications for our versatile new MS-100 and MS-100A wideband video operational amplifiers. With varying associated circuitry you can use them as buffer amplifiers, video detectors, phase detectors, line drivers or as straight general purpose video amplifiers.

The high power capability of 700 mW (DC or squarewave) and small size (1.0" x 1.0" x 0.2") offer a unique combination. Designed primarily for video applications, these plug-in units are capable of driving 10 Volts peak-to-peak into a 50-ohm transmission line.

Both amplifiers offer a 0 to 20 MHz bandwidth, high impedance differential inputs and DC coupling with low offset and temperature drift. Both positive and negative outputs are available. The MS-100A offers a faster slewing rate—180 volts/ μ s as compared to 100 volts/ μ s for the MS-100 model.

Both types offer output short circuit protection and an operating temperature range of -55°C to $+80^{\circ}\text{C}$.

These wideband amplifiers are only part of our growing list of off-the-shelf hybrid microelectronic devices. And we're able to provide complete support for design of custom modules as well.

Our long experience in film and packaging technology allows us the flexibility to develop many variations on our basic designs as well as develop completely new designs to your specifications. Why not discuss your design problems with our engineers?

Typical wideband amplifier specifications

| | MS-100 | MS-100A | Units |
|--------------------------------|----------|----------|----------------|
| Open loop gain | 50 | 50 | dB |
| Slewing rate | 100 | 180 | volts/ μ s |
| Max. output voltage | ± 12 | ± 12 | volts |
| Power out (max.) | 700 | 700 | mW |
| Open loop output impedance | 33 | 33 | ohms |
| Input impedance (differential) | 9.0 | 4.0 | K ohms |

CIRCLE NUMBER 300

This issue in capsule

Integrated Circuits

MSI simplifies binary-to-decimal conversion.

Television

Square corners are "in" for '69 set design.

Circuit Modules

'Dual in-line pac' cuts module cost.

EL Displays

Two-input power supply drives EL devices.

Diodes

How planar diode arrays save you time and money.

CRT Modules

New 12-inch monitor fits popular niche.

Manager's Corner

What it takes to stay ahead.

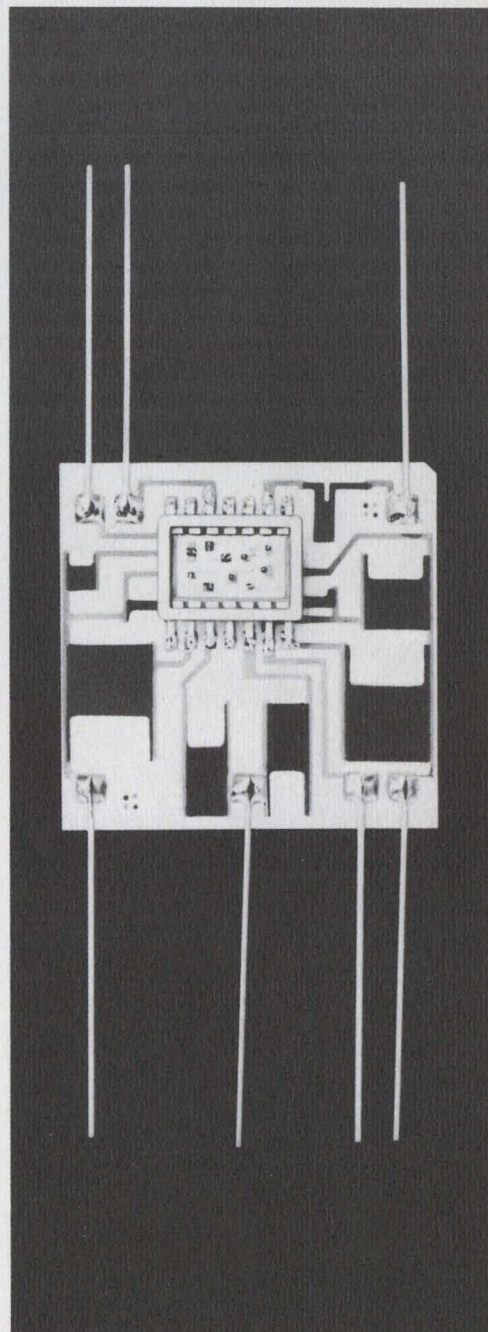

Wideband amplifier with 700 mW output is housed in one-inch-square package.

INTEGRATED CIRCUITS

MSI simplifies binary-to-decimal conversion.

Use of functional arrays cuts package count from 11 1/3 to 4 1/6.

Here's a simple way to decode 4-bit binary code into 16-line hexadecimal. It uses four SM-223 demultiplexer arrays and 1/6th of an SG-383 hex inverter. An SM-163 4-bit binary counter is used here to illustrate driving of the system. The circuit arrangement is shown in Fig. 1.

The outputs of the demultiplexers are the "true" states of the decimal number. That is, when a particular number is decoded, its corresponding output is at logic "1". All other outputs are at logic "0".

Propagation delay to any output is about 22 ns. This speed easily allows decoding at a 20 MHz rate. Thus, the system is compatible with the high-speed SM-163 4-bit binary counter or with discrete flip-flop counters.

An inverter is included between the 2³ output of the SM-163 and F₁ of the first SM-223 demultiplexer to generate the 2³.

If a hex inverter such as the SG-383 is used, maximum package count will be 4-1/6. Using conventional gates, the

most efficient design requires 11 1/3 packages when the false states of the four input bits are not available. In the conventional design, 8 dual 4-input gates and 3 1/2 hex inverters would be required.

It's our SM-223 demultiplexer array that makes the package savings possible. Using internal gates which are designed for high speed rather than drive capability, the SM-223 can produce outputs in less than 12 ns.

The logic arrangement of the SM-223 is shown in Fig. 2. The demultiplexer array consists of two decoding sections. In one section, the data input may be steered to any one of four identical outputs under control of two selection variables. In the other section, another data input may be routed to either of two identical outputs depending on the state of one selection line. The output inverter/drivers provide the "true" state of the input data allowing direct entry into subsequent stages without extra gate inversion.

The logic diagram of the SM-163 4-bit binary counter is shown in Fig. 3. The circuit consists of four J-K flip-flops interconnected as a binary (1248 code) up counter. The flip-flops are synchronously clocked through two input AND gates. These eliminate the need for restrictive clock waveshape requirements.

A logic "0" on the RESET input causes all four outputs to go to logic "0". A logic "0" on any SET line causes the corresponding output to go to a logic "1".

Both the SM-163 and SM-223 are available in 14-lead flat packs or in Sylvania's ceramic 14-lead dual in-line plug-in package.

CIRCLE NUMBER 301

Fig. 1. Circuit arrangement of binary-to-decimal (4 to 16) decoder.

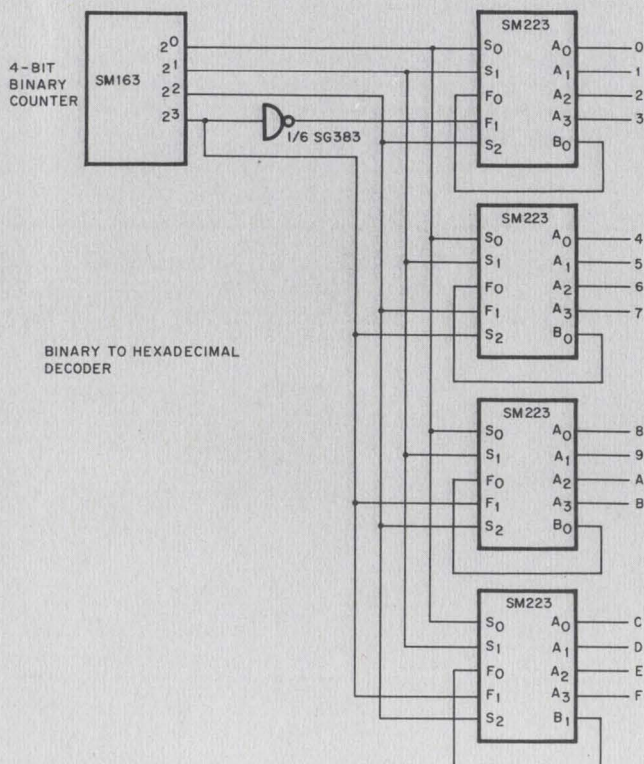

Fig. 2. Logic diagram of SM-223 demultiplexer.

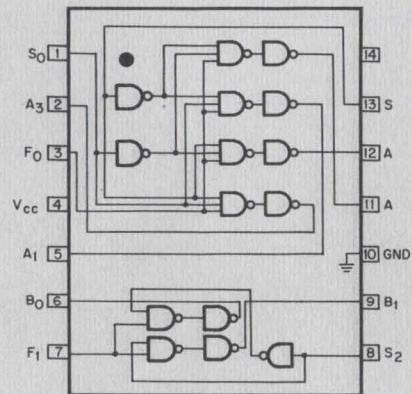
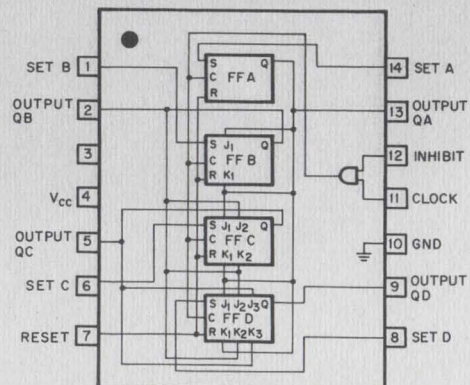

Fig. 3. Logic layout of SM-163 4-bit binary counter.



TELEVISION

Square corners are 'in' for '69 B&W set designs.

Ever see a 15-inch B&W tube with 100-square-inch viewing area? You can see it now in our modern bold-look tube.

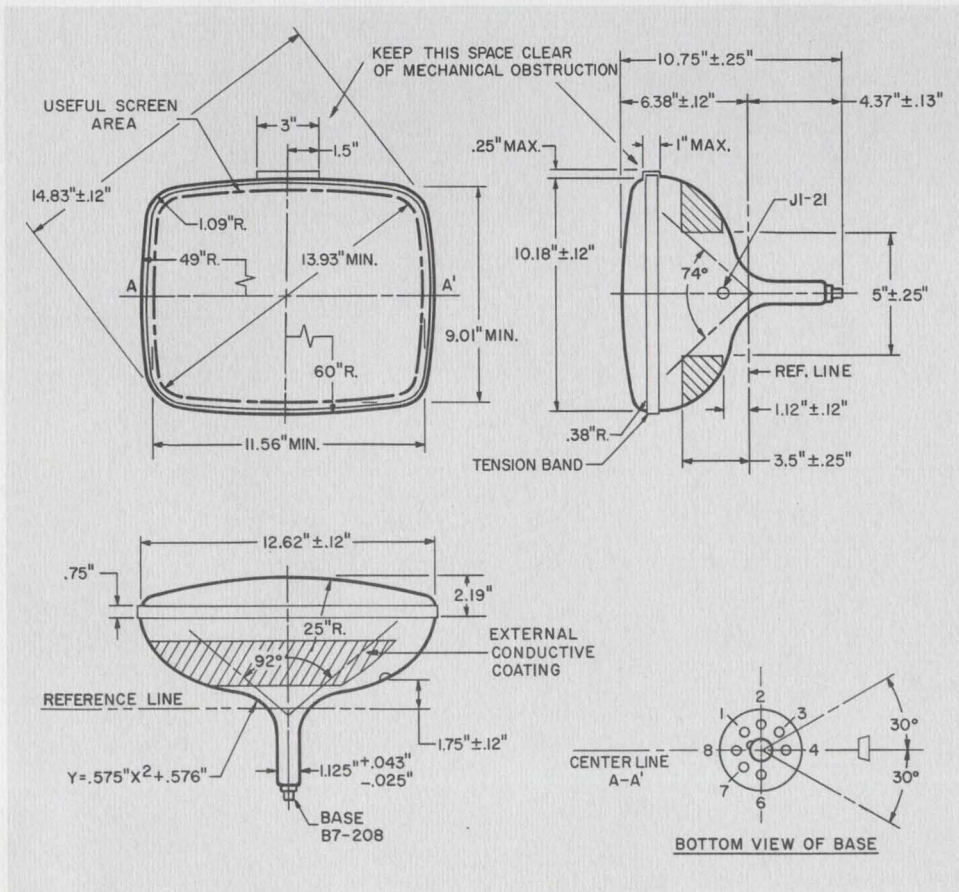
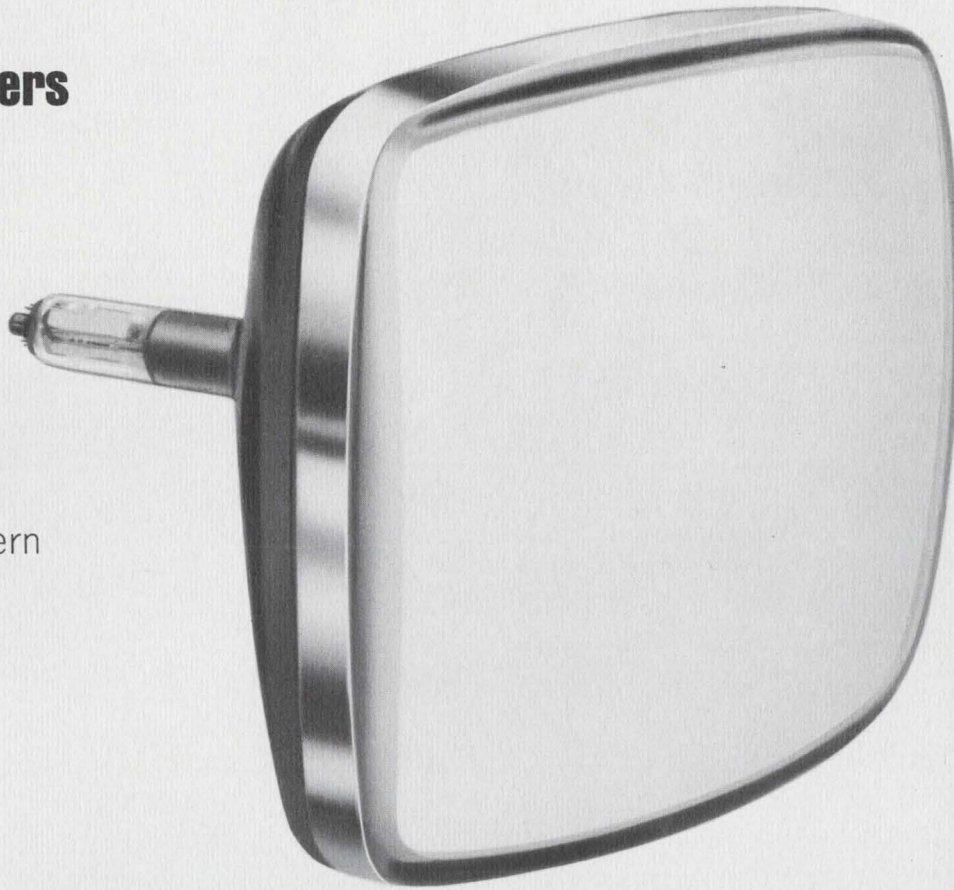

You can get that new look in your new TV set designs and you can get more usable viewing area by designing around Sylvania's new 15ADP4. Both the bold look of this tube and its larger viewing area come from the squared-off-corner construction that says "modern design."

And these are not the only features of our new 110° 15-inch tube. Its compact design and short overall length shrink cabinet size. The 15ADP4 also incorporates the 1 1/8" diameter neck that reduces your drive circuit requirements. T-band implosion protection comes as a standard feature.

Of course, our new tube incorporates all the same advances in tube design, materials and production techniques that have made Sylvania monochrome tubes the standard of the industry.

The Sylvania tube line, in fact, is one of the broadest in the industry. And our production flexibility allows custom design modifications to be made at minimum cost. Whether your need is off-the-shelf or custom design, Sylvania has the people who know how to handle the job.

CIRCUIT MODULES

'Dual In-Line Pac' cuts module cost.

New line of multilayer modules achieves high speed and low noise using dual in-line ICs.

We've got a whole new series of digital logic modules that combine low cost with the dual in-line integrated circuit package which has speed and noise properties similar to modules using flat packs.

The "Dual In-Line Pac" family is available in a wide variety of universally arranged gates and flip-flops. Included in the line of 48 modules are general gates, select gates, memories, registers, clocks, counters, decoders, drivers, and other functional types. All are capable of utilizing the 33 MHz speed of the ICs.

The circuit boards, each with positions for up to 12 IC packages, are of four-layer laminated construction. The boards utilize "buried" power and ground planes and two signal boards for lowest possible noise. Noise level is minimized by a module inductance of less than 1 nanohenry. The power/ground plane provides a built-in decoupling capacitance of 1000 pF.

Electrical interconnection from ground and power planes to the IC pins is made directly via plated-through holes. All circuit connections are terminated in a single 40-pin NAFI connector. The modules can be nested on 0.350" centers.

All modules undergo a 100% final electrical performance test to a specified test procedure. In addition, the circuit boards receive a 100% continuity test at 28 Volts and a 100% high pot test at 500 Volts before assembly.

A typical member of the "Dual In-Line Pac" family is the module type G20 shown in the photograph and logic diagram. The G20 module is a 12, 2-input gate inverting standard drive module. It is provided in eight different electrical configurations to give a variety of temperature and drive characteristics.

As with all the modules in the line, the G20 uses Sylvania's tried and proven SUHL logic circuits. The large number of device types available in this line gives us a wide flexibility in module design and permits many variations.

Our circuit board design is also compatible with other types of ICs and discrete components as well. We'll be glad to design custom modules to your exact specifications. Let us look at your designs. We'll show you how it can be realized in module form at lowest cost.

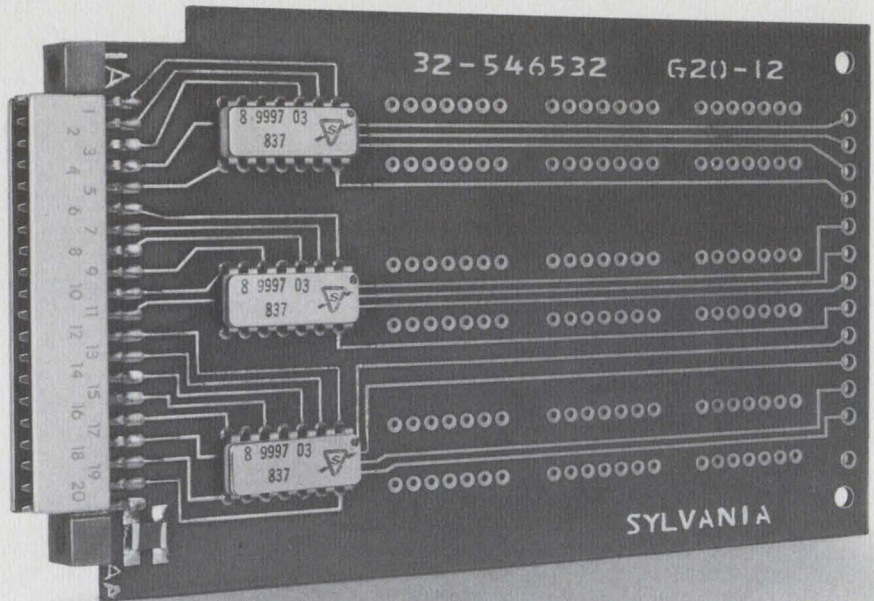

Dual in-line modules provide a fast logic at lowest cost.

Logic diagram of G20 inverting standard drive module with twelve 2-input gates.

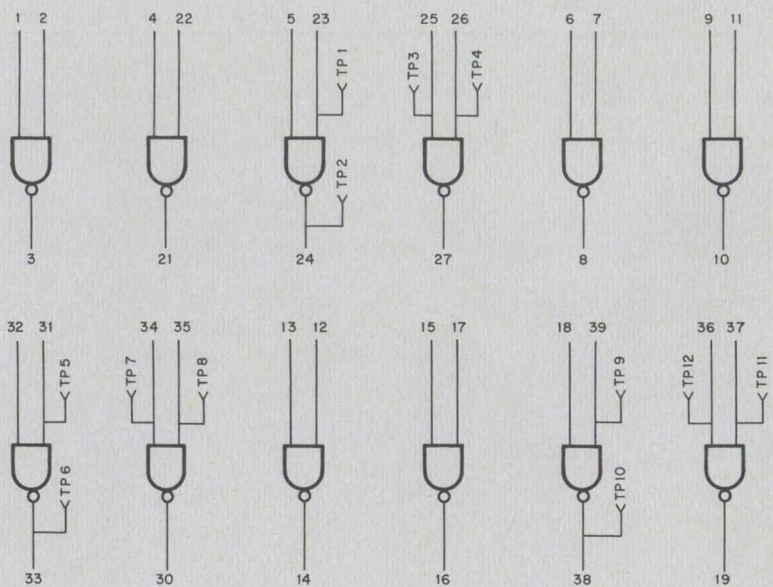

NOTE:
TP REFERS TO TEST POINT. OTHER NUMBERS ARE PIN NUMBERS.

EL DISPLAYS

Two-input power supply drives EL devices.

Compact solid-state package provides 250 V, 400 Hz power from AC line or battery.

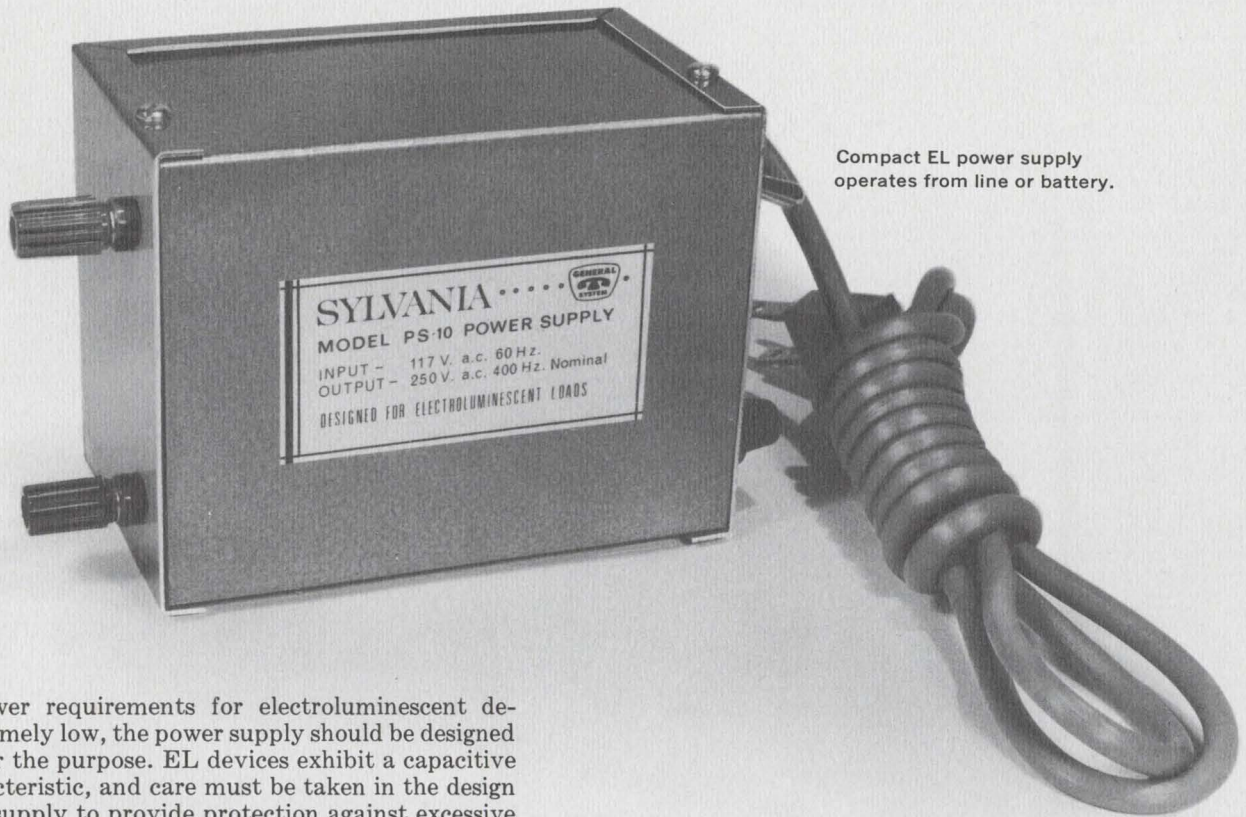

Although power requirements for electroluminescent devices are extremely low, the power supply should be designed specifically for the purpose. EL devices exhibit a capacitive loading characteristic, and care must be taken in the design of the power supply to provide protection against excessive current transients.

A special transformer design in our new PS-10 EL power supply provides this needed protection. The PS-10 is the first of a series of special power supplies designed specifically to handle electroluminescent loads. It can operate from either a 117 V AC, 60 Hz, line or from a 12 V battery. Nominal output voltage is 250 V AC at a frequency of 400 Hz. Maximum EL load current is 25 mA peak-to-peak.

The PS-10 can drive up to 10 square inches of electroluminescent panel at a 20% power factor with less than 10% decrease in output voltage or frequency. This is equivalent to driving 29 one-inch numeric characters fully illuminated or 8 two-inch characters fully illuminated.

The compact solid-state power supply is mounted in a 2 1/8" x 3" x 5 1/4" metal cabinet. The AC input is supplied by an integral line cord. For battery operation, a phone-jack type connector is used. When the battery jack is plugged in, the AC rectification circuit is disconnected. This arrangement provides a fast and flexible means of changing power sources as needed.

CIRCLE NUMBER 304

Circuit of EL power supply.

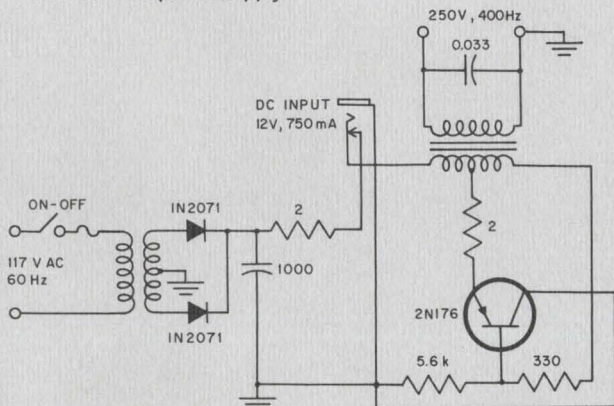

Specifications of EL power supply

| | |
|-------------------------------|----------------------|
| AC input voltage | 117V AC 60 Hz. |
| AC output voltage (nominal) | 700V P/P |
| AC output frequency (nominal) | 400 Hz. |
| Maximum EL load current | 25 mA P/P |
| Dimensions | 2 1/8" x 3" x 5 1/4" |
| Mounting position | Any |

DIODES

How planar diode arrays save you time and money.

Arrays of 2 to 16 diodes can cut core-driver assembly time, give ultrafast switching capability.

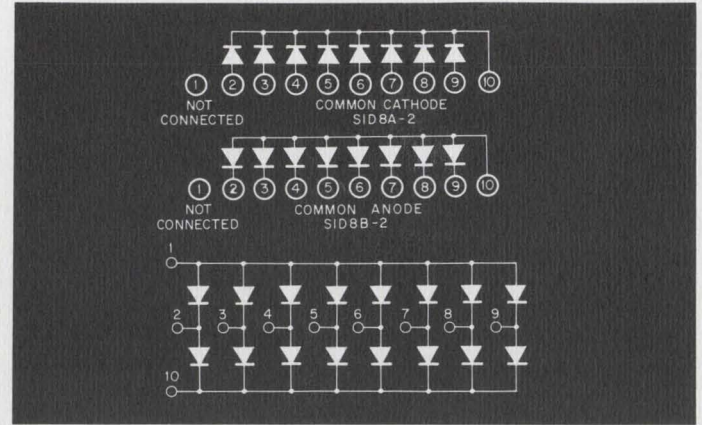

Configuration of 8- and 16-diode arrays.

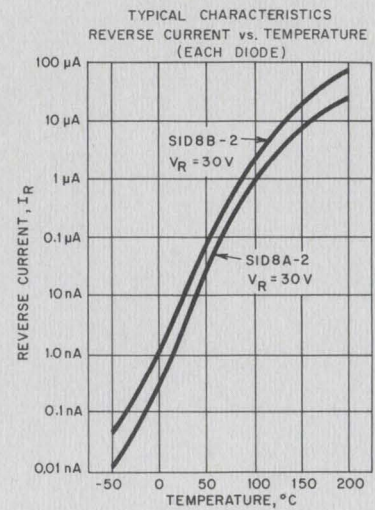
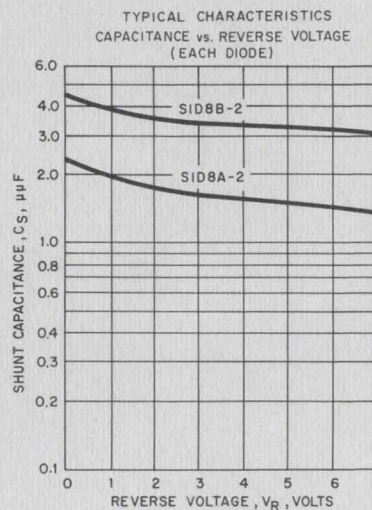
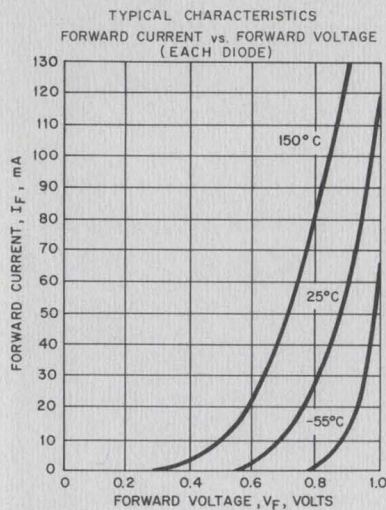

You'll find outstanding benefits in both performance and production by using our core-driver diode arrays.

In performance, you get high forward conductance, fast recovery, low capacitance, and tight tolerances. In production, you reduce your labor costs, shorten assembly time and cut external wiring in the manufacture of computer memory-core driver systems.

Take, for example, our popular 8- and 16-diode arrays. Both types of array are available in common cathode and common anode configurations. These units have a forward current rating of 300 mA and a power rating of 300 mW per diode.

As for speed, reverse recovery time is a maximum of 60 ns, even under extreme switching conditions of a forward

current of 300 mA and an I_r of 30 mA. Typical values for recovery time of I_f and I_r switching from 300 mA to 30 mA is 35 ns.

The manufacturing process used to produce these arrays results in diodes which have closely matched electrical characteristics over a wide temperature range.

The 8-diode arrays are available in 10-lead flat packs or dual in-line plug-in packages. The 16-diode array is also available in a flat pack configuration or in a 14-lead plug-in package. All of these arrays are designed to meet MIL-S-19500 standards.

Other core-driver diode arrays are available from Sylvania in units from 2 to 16 diodes connected as common cathode or common anode.

CIRCLE NUMBER 305

Maximum ratings at 25°C (each junction):

| | |
|----------------------------------|-------------------------------|
| Reverse voltage, V_R | 40 volts |
| Forward current, I_F | 300 mA |
| Peak forward current, I_{FP} | 1.0 amp (0.0 μ sec, 25% D.C.) |
| Average power dissipation, P_D | 300 mW (500 mW total package) |
| Junction temperature, T_J | -65°C to +150°C |
| Storage temperature, T_{stg} | -65°C to +300°C |

Note 1. Pulse test $\leq 300 \mu$ sec, $\leq 2\%$ duty cycle.

Electrical characteristics at 25°C (each junction):

| | Conditions | Min | Max | Unit |
|--------------------------------------|---|-----|------|------|
| Forward voltage drop, V_F (Note 1) | $I_F = 300$ mA | — | 1.25 | V |
| Forward voltage drop, V_F (Note 1) | $I_F = 500$ mA | — | 1.40 | V |
| Forward voltage drop, V_F (Note 1) | $I_F = 800$ mA | — | 2.00 | V |
| Reverse current, I_R | $V_R = 30$ V | — | 0.1 | μA |
| Peak inverse voltage, PIV | $I_R = 10 \mu$ A | 40 | — | V |
| Capacitance, C | $O_v = 1$ MHz | — | 6.0 | pF |
| Reverse recovery, t_{rr} | $I_F = 300$ mA $I_R = 30$ mA $i_r = 3$ mA $R_L = 100$ ohms | — | 50 | nsec |

CRT MODULES

New 12-inch monitor fills popular niche.

Universal display package meets a wide variety of needs from closed circuit TV to computer readouts.

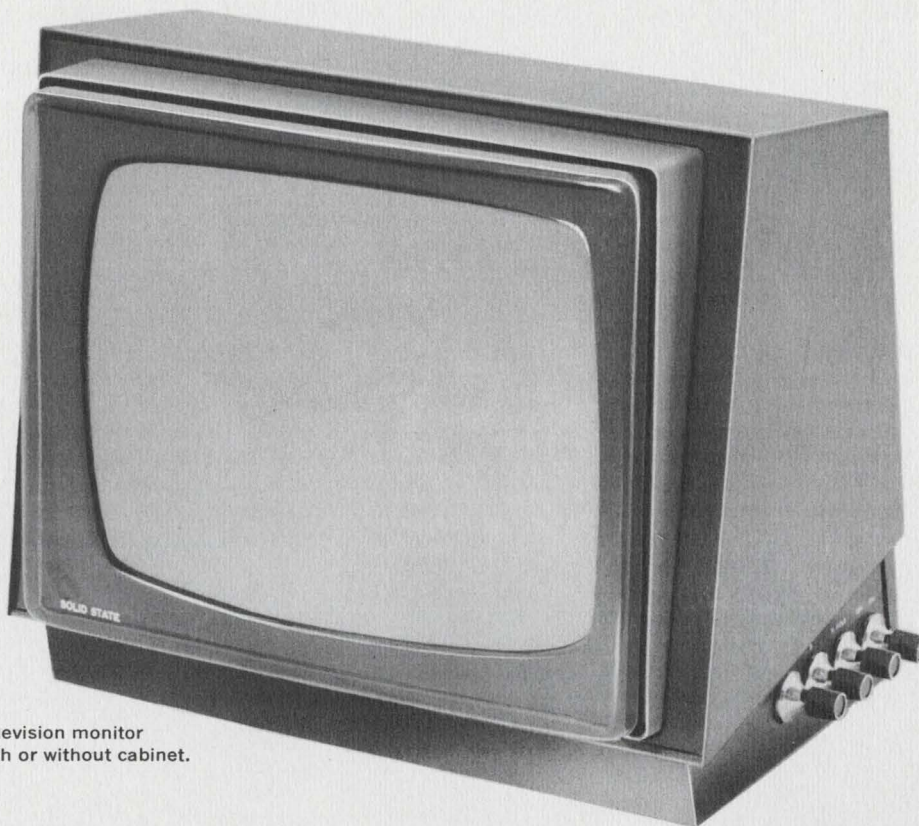

The 12-inch television monitor is available with or without cabinet.

Here's a 12-inch (diagonal) television monitor that gives you the most popular size display in a compact solid-state package. It can be used for computer terminals, airline status boards, stock-quotation displays, closed circuit TV, desk-type computers or anywhere else that a reliable high-quality display is required. And because we make it as a standard module, it means you get more performance for your money.

The module consists of circuit board, power supplies, and cathode-ray tube all packaged as a compact unit suitable for rack, console or cabinet mounting. Power supply for the module can be specified as either 117 V AC, or 22 V DC.

The display provides a standard 525 line raster and has bandwidth that is ± 1 dB from 15 kHz to 8 MHz. The composite video input signal can be from 0.5 to 1.5 Volts,

peak-to-peak.

The standard module comes with a 12CSP4 cathode-ray tube with a gray filter faceplate and bonded-frame implosion protection. If that tube doesn't meet your requirements we can easily substitute one that will.

Because we make a wide variety of cathode-ray tubes and have first-hand knowledge of drive circuit requirements, you'll find it relatively easy to get a display module that fits your needs to a tee. We can also provide custom module designs for any size CRT and to meet a wide range of circuit requirements.

The 12-inch monitor is available with or without cabinet. With cabinet, it takes up a small amount of desk space. Dimensions are 13½" wide x 11½" deep x 12" high.

CIRCLE NUMBER 306

SEE OUR SPECIFICATIONS IN
VSMF
MICROFILM CATALOG FILE

Use Sylvania's "Hot Line" inquiry service, especially if you require full particulars on any item in a hurry. It's easy and it's free. Circle the reader service number(s) you're most interested in; then fill in your name, title, company and address. We'll do the rest and see you get further information by return mail.

BUSINESS REPLY MAIL

No Postage Stamp Necessary if Mailed in the United States

FIRST CLASS
Permit No. 2833
Buffalo, N. Y.

POSTAGE WILL BE PAID BY

Sylvania Electric Products Inc.
Sylvania Electronic Components
1100 Main Street
Buffalo, New York 14209

Dept. D5 5 5 5

MANAGER'S CORNER

What it takes to stay ahead.

To remain a leader in a fast-moving field like electronics, a company must continually develop new products. To be a real innovator, such a company must develop new products even before the customer realizes that the need for the products exists.

We like to think of Sylvania as being the innovator in the industrial and military cathode-ray tube field. First of all, we have the organizational depth that makes such innovation possible. Our engineering staff has been closely associated with the development of CRTs for the home entertainment market. Here is where most of the innovations in CRTs have been made. New phosphor developments as well as improved processing techniques and materials are among our many developments in this field.

Our Industrial and Military Cathode-Ray Tube facility in Seneca Falls, N.Y. is able to translate these developments for use by our customers.

Secondly, we can draw upon the talents of the Sylvania manufacturing and marketing facilities to produce the special tubes we design and to tell us what the customer's needs are going to be.

As a result of these advantages the Sylvania I & M CRT Department has been able to lead the field in developing new products for the industrial and military user.

What are some of the new products which Sylvania has offered to the Industrial and Military marketplace?

Several years ago, as more and more display systems—such as ultrasonic testers—became portable, the need for a cathode-ray tube with a much reduced heater-cathode power was required. To fill that need, Sylvania designed the 1.5

Volt 140 mA heater. Today, it is the basis for many portable oscilloscopes.

In the display field, there has been a need for color without the problems and disadvantages of a shadow mask tube. Today, Sylvania can offer a multi-color display in almost any tube size with a resolution far superior to the standard TV type with a shadow mask.

There have been indications that the next generation of high density display tubes will require a new type of tube capable of higher brightness and higher resolution. Sylvania has just recently announced such a tube. It has seven beams with a common focus system and deflection yoke. In one horizontal sweep, it will generate one row of characters. The conventional tube requires seven horizontal sweeps to do the same job.

We have recognized in our display customers, a need to supply the tube and its immediate circuitry. To fill that need, a department has been formed which can supply, on custom specifications, an integrated display module which will include the tube, its mechanical mounting, its immediate power supply and deflection circuitry.

These are but a few of the new product needs which Sylvania has undertaken to fill in the marketplace.

The Industrial and Military Tube Department maintains its own development and production facilities, and we work closely with the Division's New Products Group to formulate new solutions. In addition, we can call upon the television-tube production facilities for large-volume production. With a total package capability like this, the I & M CRT Department is in an excellent environment to maintain its position as an innovator in CRT developments.

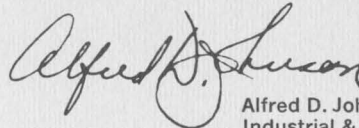

Alfred D. Johnson, Manager
Industrial & Military Cathode-Ray Tubes

This information in Sylvania Ideas is furnished without assuming any obligations.

SYLVANIA

GENERAL TELEPHONE & ELECTRONICS

NEW CAPABILITIES IN: ELECTRONIC TUBES • SEMICONDUCTORS • MICROWAVE DEVICES • SPECIAL COMPONENTS • DISPLAY DEVICES

D5

NAME _____ PLEASE PRINT

TITLE _____

COMPANY _____

ADDRESS _____

CITY _____ STATE _____ ZIP _____

Circle Numbers Corresponding to Product Item

| | | | | |
|-----|-----|-----|-----|-----|
| 300 | 301 | 302 | 303 | 304 |
| 305 | 306 | | | |

Please have a Sales Engineer call



HOT LINE INQUIRY SERVICE

Need information in a hurry? Clip the card and mail it. Be sure to fill in all information requested. We'll rush you full particulars on any item indicated.

You can also get information using the publication's card elsewhere in this issue. Use of the card shown here will simplify handling and save time.

We don't know who'll design it. But we know where he can get the batteries.

At the nearest Burgess Distributor. They're probably somewhere in his stock of batteries.

One's bound to be right for the electric spaghetti windlass. And one's exactly what you need for whatever you're designing. Another thing. Whether it's a standard or special, your Burgess Battery will be power-fresh. All distributor inventories are checked, rotated, and filled-in according to a systematic schedule.

So the battery you get comes on strong . . . and stays that way.

When you need batteries, check with your Burgess Distributor. He's a great source of power.

And when you need technical information, give us a call. Burgess has a library filled with the latest, most complete engineering data and technical battery material in the business.

Meanwhile, send for our new engineering manual and do a little window shopping. It's got comprehensive listings of all batteries available through Burgess. Clevite Corporation, Burgess Battery Division, Freeport, Illinois 61032.

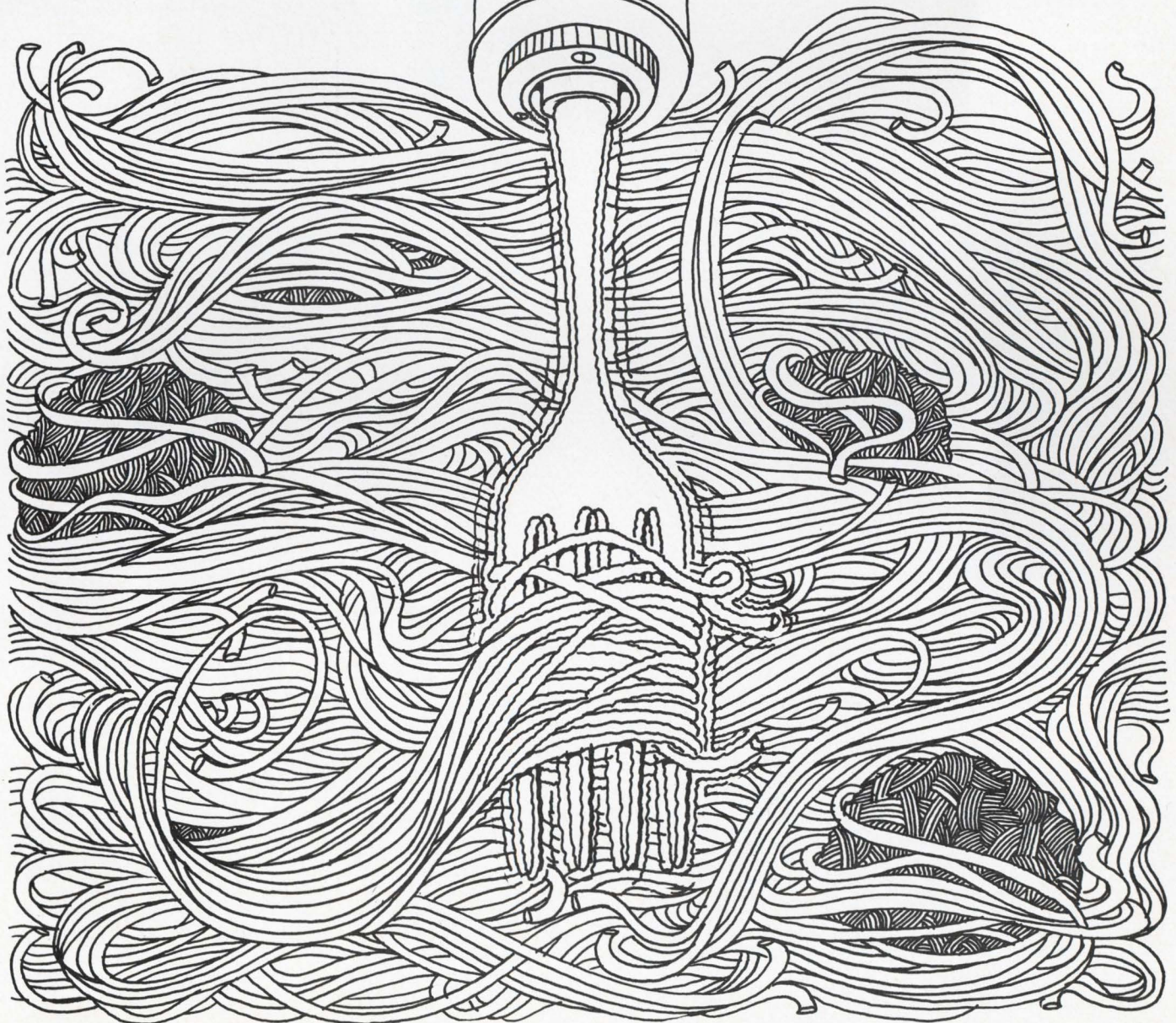
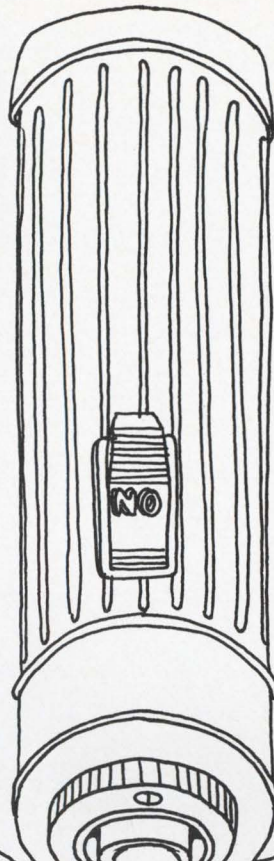

CLEVITE BURGESS



We make components for guys who can't stand failures.

There's no such thing as a little failure to some guys. Either your system will perform as you designed it, or it won't. Either the right answer comes out, or it doesn't. Anything less is too much to bear.

At Corning we make our resistors and capacitors like all your customers were just that demanding. We build in an extra measure of performance into everything we do. Because like you and the guys who use your equipment, we can't stand failures either.

Take our precision tin oxide resistors, for example. They're the best of the metal film class. Because the resistive tin film is completely oxidized and molecularly bonded to the glass substrate, our tin oxide resistors are impervious to moisture and environmental degradation. No other resistor can deliver the same stability and reliability over load life. They offer guaranteed moisture resistance across all ohmic values to set a standard of reliability that can't be matched by metal film, wire wounds, carbon comps or metal glaze resistors.

After a 56-day-long heat test in an environment of extremely high humidity, our tin oxide resistors

showed a resistance change of just 0.2 per cent. And in an ambient temperature test—now in its ninth year—not one of the 600 tin oxide resistors being tested has exceeded a resistance change of 1.5 per cent.

You can get this kind of extra performance in miniature size, too. With our CORNING® C3 Resistors, circuit designers are now reducing the volume and weight of their boards a full 65 per cent.

Our tin oxide resistors represent extremely good value. They offer long-term economy over metal film, precision wire wound and metal glaze resistors. And our miniature C3 resistors compete costwise with carbon comps.

And take our glass capacitors. In an extensive lab test program, the U.S. Air Force has found that our glass capacitors have much better stability and much higher insulation resistance than the ceramic, mica and the other capacitor-types they tested. That's why glass capacitors are being designed into so many major aerospace and missile projects.

Then there's our line of Glass-K™ capacitors that give you the volumetric efficiency and economy of monolithic ceramic

capacitors, but with the much improved stability and reliability that only a glass dielectric can add. They're now being used in a number of computer systems.

We have other developments, too. Like our flame proof resistors. Ideal for circuitry where functions, environments and duty cycles demand low power resistors with excellent frequency characteristics, our flame proof tin oxide resistors can withstand overloads of up to 100 times rated power without any trace of flame. And, because they open under overload, they provide protection for your other, more expensive components.

At Corning, we make components for guys who can't stand failures. Guys like your most important customers. Guys like you.

Next time you're designing a system, reach for your Corning capacitor and resistor catalogs and call your local Corning authorized distributor for off-the-shelf delivery. They'll help you design-in an extra measure of performance.

If you don't have our catalogs, ask your Corning distributor for copies or drop us a line at: Corning Glass Works, Electronic Products Division, Corning, New York 14830.

CORNING
ELECTRONICS

The happy merger of fiber optics and lasers

'Light knife,' cancer probe, microwelder and a communications net are promising applications

David N. Kaye
West Coast Editor

After seven years of investigation into the possibilities of blending fiber optics and lasers, practical devices are emerging.

The new tools have one thing in common: flexibility. They can reach locations never before accessible with large, fixed lasers.

Now available to surgeons, for example, is a fiber optic laser probe that can reach behind the eye to correct disorders. Other applications that are on the way include:

- A "light knife" for surgery.
- A probe that will kill cancer cells.
- A multiprobe laser microwelder.
- A laser communications system.

Fiber optics and lasers are combined in two ways: Glass fibers can be made to lase; the most common material used for this purpose is neodymium doped glass, which lases at 1.06 microns when pulsed with a flashtube. Fiber bundles can also be used as an optical waveguide to transmit laser light in a flexible manner.

The big advantage of the active fiber laser is that it is very small and can be built into a portable instrument. The optical fiber bundle is useful because it can transmit any type of laser light regardless of the source.

New scalpel for surgeons

The "light knife" is the most revolutionary development in the works, a survey by ELECTRONIC DESIGN of leading researchers shows. R. James Rockwell, directing physicist of the Laser Laboratory of the University of Cincinnati Medical Center, says:

"The development of high-power, continuous-wave laser systems has introduced the possibilities of the use of the laser as a surgical cutting and coagulating tool. The reaction in the tissues with such high-power beams is primarily thermal. When the laser energy is focused onto the tissue surface at high-incident power densities, the absorbed radiation raises the temperature of a small volume of tissue so as to cause vaporization and ablation of only that area.

"Because of the rapid response at high powers, the beam can be moved at a constant speed across the tissue surface, so as to produce a continuous 'cut.' Small, cut vessels are simultaneously coagulated. The proper laser surgical technique is one in which the laser energy delivered to the tissue is only the amount required to vaporize the small volume of tissue required for the cut."

Lasers used in current experiments include the argon, carbon-dioxide, and YAG-neodymium types. The experiments are using a fused fiber-optic bundle to deliver the laser energy. Powers of from 1 to 10 watts have been delivered.

Until now the only practical active fiber lasers made have been for pulsed applications. However, experiments by Dr. C. G. Young at the American Optical Corp., Southbridge, Mass., indicate that a cw active fiber laser may be in the offing. Mention has also been made in Soviet scientific circles of such a device. Therefore it would not be unreasonable to assume that active cw fiber lasers will provide the surgeon with the small flexible "laser knife" that he has so long sought.

Rockwell, who is working in conjunction with Dr. Charles Goldman, points to several other medical experiments that have been performed with fiber optics and lasers—removal of unwanted pigmentation from the skin, for example.

Pigmentation may occur naturally or it may be induced by artificial means. Natural forms of pigmentation include birthmarks, seborrheic keratoses (dark spots that develop on the skin of elderly people), and other vascular problems. Artificial pigmentation is found most commonly in the form of tattoos. Active fiber lasers have been used to remove unwanted pigmentation. It has been found that although the proper amount of laser energy will blanch the pigmentation, too much energy will

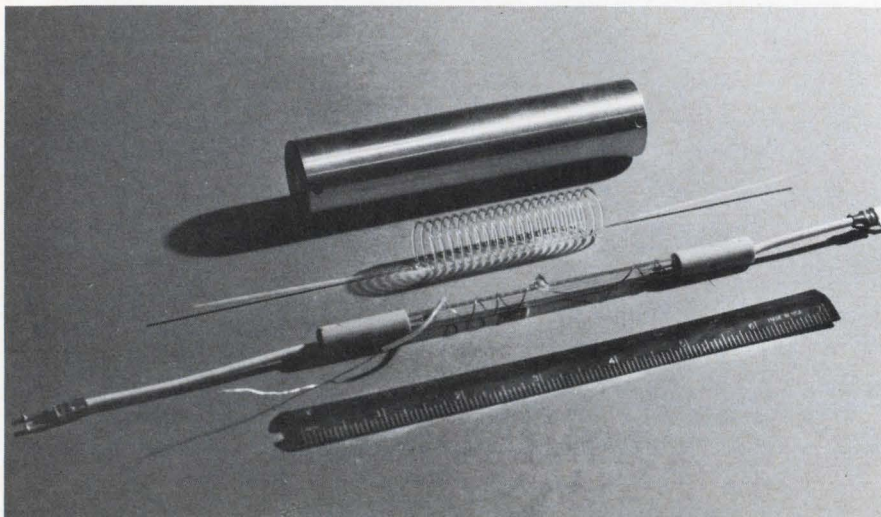

Early fiber laser consisted of a neodymium-glass helix that was placed around a xenon flashtube. This laser emitted 1.06 microns radiation.

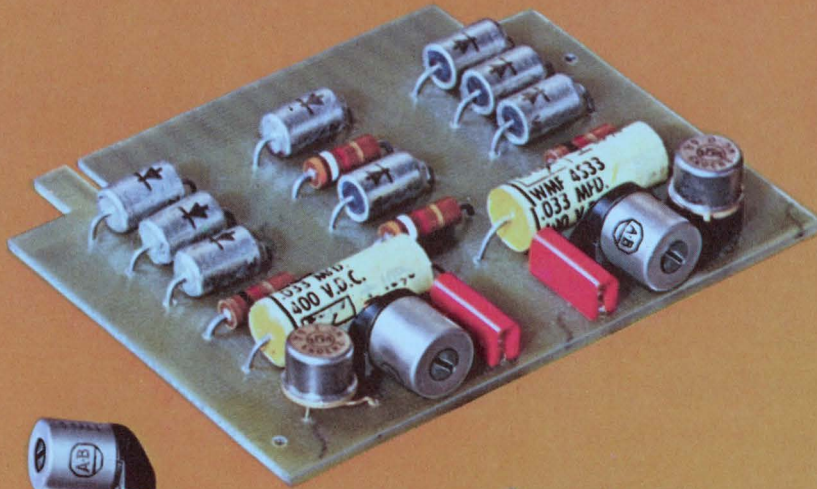

All components
shown actual size

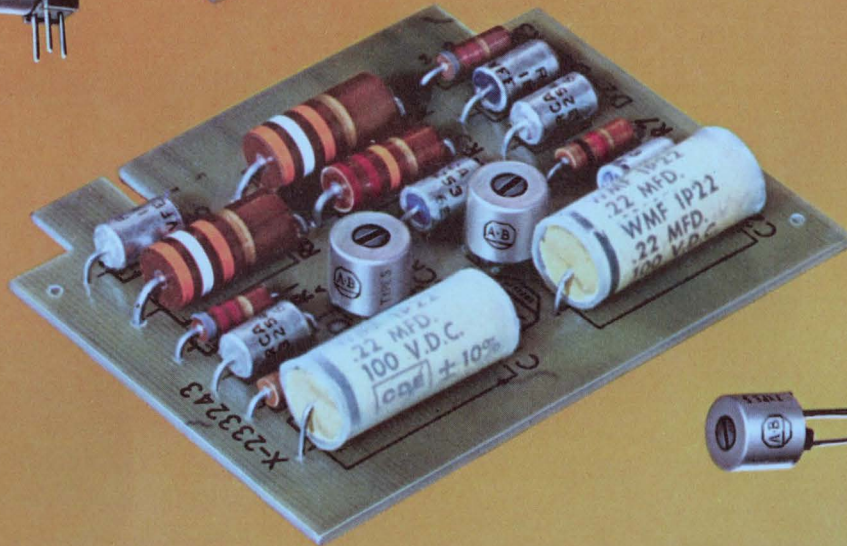

Only the new Allen-Bradley Type S cermet trimming resistors have all these features

Type S

shown twice actual size

for side
adjustment



for top
adjustment



The Allen-Bradley Type S is a one turn cermet trimmer in which you will find incorporated a wider range of features than in any other trimmer now on the market. Here are a few of the more important features.

- **COMPACT**—body is $\frac{3}{8}$ " dia.
- **BUILT FOR EITHER TOP OR SIDE ADJUSTMENT**
- **50 OHMS THRU 1 MEGOHM**
- **THE SEALED UNIT** is immersion-proof
- **TEMPERATURE COEFFICIENT** less than 250 ppm/ $^{\circ}$ C over all resistance values and complete temperature range
- **UNIQUE ROTOR DESIGN** provides exceptional stability of setting under shock and vibration
- **SMOOTH CONTROL**, approaches infinite resolution
- **PIN TYPE TERMINALS** for use on printed circuit boards with a 1/10" pattern

- **VIRTUALLY NO BACKLASH**
- **WIDE TEMPERATURE RANGE** from -65° C to $+150^{\circ}$ C
- **RATED $\frac{1}{2}$ watt @ 85° C**
- **EXCEPTIONAL STABILITY** under high temperature or high humidity
- **MEETS OR EXCEEDS ALL APPLICABLE MIL SPECS**
- **COMPETITIVELY PRICED!**

You'll find the new Type S trimmer equal to the traditional Allen-Bradley quality. You really ought to know more about the Type S. Won't you write for detailed specifications? Allen-Bradley Co., 1201 S. Second Street, Milwaukee, Wis. 53204. Export Office: 1293 Broad Street, Bloomfield, New Jersey, U.S.A. 07003. In Canada: Allen-Bradley Canada Limited.



(fiber optics, continued)

discolor the area once again.

Treatment of skin cancer is another major area of study. Dr. Goldman has proposed that a fiber laser built into a small probe could be used to kill cancerous cells anywhere on the skin. Such a probe

could conveniently treat cervical cancer, he notes.

When surgical hair removal is necessary, the fiber laser can also be used. The Cincinnati Medical Center team recently attempted to remove a hair at the root. The experiment was only partly successful, however, because the active fiber laser did not deliver enough

power to complete the job.

The research at the University of Cincinnati has been supported for several years by the John A. Hartford Foundation, and the fiber lasers have been supplied by American Optical.

Most highly publicized of the medical laser research has been the work with the eye. Dr. Charles

The 'what' and 'how' of fiber optic lasers

What are fiber optics and how can they be made to lase?

A fiber optic is a glass fiber that transmits light by multiple internal reflections along its walls. Prior to development of the fiber laser, the fiberoptic was the most important use of fiber optics.

The fiberoptic is in effect a flexible periscope. It operates by projecting the image of a scene onto the end of a fiber bundle and then transmitting the light at each point of the scene down an individual fiber. If the relative positions of the fibers at the entrance and the exit surfaces of the bundle are kept nearly identical to each other, the intervening section of the bundle can be arbitrarily fixed without impairing the transmission of light through the bundle. A second lens is then used to reimage the scene at the exit surface of the bundle onto a screen, or an eyepiece can be used for direct viewing.

In the fall of 1961, Dr. Elias Snitzer of American Optical Corp., Southbridge, Mass., combined the technologies of lasers and fiber optics. The low-loss properties of clad fibers were utilized to make high Q-cavities. In these cavities the core consists of a neodymium or other suitable laser glass. Spontaneous emission occurs from the laser material into the modes, which are totally internally reflected, with the result that laser light can build up in the cavity if end reflectors are also used opposite the ends of the fiber. This type of laser device is distinguished from the conventional Fabry-Perot interferometry cavity by the fact that one uses not only end reflectors, but, in effect, side reflectors. The latter are a result of total internal reflection associated with the high index of refraction core and the

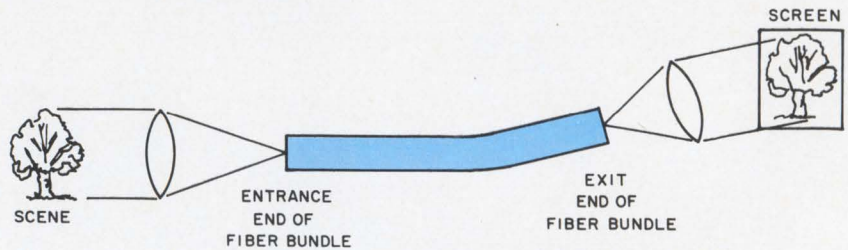

An array of fibers in this fiberoptic keeps an image received at one end in alignment for projection out the other end.

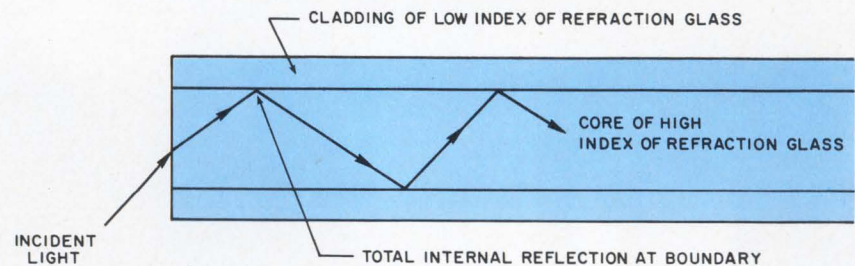

Fiber optics consist of a central core of high-index-of-refraction glass surrounded by a cladding of low-index-of-refraction glass.

low index of refraction cladding. If the fibers are made long enough (50 cm or more), the gain coefficient of the laser material is sufficiently high so just the 4% reflectance of the glass-air interface at the ends of the fibers is sufficient to give laser oscillation.

An alternative method of combining lasers with fibers is to generate the laser light in "conventional" laser configurations and then to focus the light onto a fiber bundle.

Although several hundred lasers have been made to operate in various materials, only five ions have been made to lase in glasses. The ions emit in only seven lines. Because of its high efficiency at room temperature, the most important has been trivalent neodymium, operating at 1.06μ ; this ion can also be made to lase at 0.92μ and 1.37μ . The next most important lasing glass is trivalent erbium,

which emits at 1.54μ . The importance of this ion derives from the fact that its wavelength of emission is in a region of the spectrum at which the eye is opaque, thereby obviating laser eye safety problems by preventing focusing of laser light onto the retina. In some laser systems it is desirable to have high-energy storage with a low gain coefficient per ion. This can be supplied by trivalent ytterbium operating at 1.06μ . In addition, by cooling to 77°K , Yb^{3+} can be made to emit at 1.015μ .

Finally, the other two ions that have been made to lase are trivalent thulium and trivalent holmium. The precise wavelength of emission depends on temperature, active ion concentration and the other rare earths that are used to sensitize the laser constituents in the glass. The wavelengths of emission of both these ions are in the range of 1.8μ to 2.2μ .

Beneath this calm exterior lurks... Supertetrode!

Eimac's sensational new water cooled 50 and 100 kW tetrodes are the world's finest for high power applications. They're ideal for transmitters in HF, FM and broadcast bands, for over-the-horizon radar, distributed amplifiers, high energy physics and high power voltage regulation.

Both tetrodes feature transconductance double anything even we've been able to offer. They have greatly reduced cathode lead inductance and a unique re-entrant anode, permitting a shorter stem and lower input capacitance. Feedback capacitance also is much lower, simplifying tube neutralization and eliminating

any need for a neutralization circuit. In both tubes the screen base is designed to serve as an electrostatic shield.

These tubes have 4 to 5 dB higher gain than comparable tetrodes, yet are very compact. The 4CW50,000E (50 kW model) weighs only 35 pounds. It has 310 pF input capacitance, 52 pF C_{out} and 0.06 pF feedback capacitance. The 4CW100,000E weighs 50 pounds, has 349 pF C_{in} , 60 pF C_{out} and 0.8 pF C_f . For data and application assistance contact your nearest Varian/Eimac distributor or ask Information Operator for Varian Electron Tube and Device Group.



(fiber optics, continued)

Campbell of the Columbia Presbyterian Medical Center in New York City has been experimenting with a fiber laser probe for photocoagulation of retinal tears. A neodymium-glass laser, built by Dr. Charles Koester and C. Hermas Swope of American Optical, has been used.

According to Swope, the small fiber probe was needed because "specific retinal areas of interest were those nearly inaccessible to a standard photocoagulator, because of vignetting of the coagulating beam by the eye's pupil." The probe is brought around to the rear of the eye and placed against the sclera (the tough white covering of the eye). Five illuminating fibers in the probe beam normal light through the sclera, and Dr. Campbell is able to locate the probe by looking through the pupil of the eye with an ophthalmoscope and observing the spot of light transmitted through the sclera. The probe can then be fired and the coagulation completed.

The probe is made of 36 laser fibers, each 100 microns in diameter, and five 50-micron passive illuminating fibers. The laser fibers

have been looped into a "U," so that both ends terminate in an 18-gauge, thin-walled stainless steel tube. The fibers that are pumped are enclosed in a glass tube, which is placed parallel to a 12-inch linear flashlamp and optically coupled to it with silver foil. The five conventional fibers are brought from the tip to an incandescent light source.

Rockwell says that "at least 5000 people walking around today have had laser work done on their eyes."

Additional work, being done both by American Optical and Optics Technology, Inc., of Palo Alto, Calif., includes investigation of an active fiber laser in an imaging device called an endoscope. Images transmitted by the endoscope would be used to locate diseased or damaged tissue in the body, and the fiber laser would be used to perform therapeutic surgery. This device would have such applications as seeking out and repairing bleeding ulcers in the body without cutting into the patient.

One clinical technique of analytical medicine is simply the use of intense light for soft-tissue transillumination. Rockwell at Cincinnati reports: "Preliminary investigation with lasers has been done for the visualization of foreign bodies, paranasal sinuses and

the transillumination of the infant skull. The lasers used have been both the helium-neon, operating at 70 mW, and the krypton-ion laser, at a power ranging from 125-300 mW. The beam has been delivered by fiber optics bundles, which were pressed into the soft tissue. Multiple scattering of the light beam in the tissues can, at these powers, illuminate to depths of at least 3 cm over an area of about 50 cm²."

The major limitations of fiber optics and lasers in medical work are:

- Limited durability of the fibers. An expendable passive fiber probe is being sought.

- Insufficient eye safety. Surgeons will generally object to wearing any form of eye protection.

In an attempt to alleviate the eye-safety problem, Dr. Elias Snitzer of American Optical proposes the use of erbium-glass lasers for medical and industrial use. These emit at 1.54 microns. At this wavelength the eye cannot focus the laser light onto the retina, thus eliminating the serious problem of retinal eye damage. This is fine for pulsed applications. However, for cw applications, the erbium light would be absorbed in the cornea, causing possible corneal damage.

The importance of the fiber laser to medicine is summed up this way by Rockwell: "For the laser to succeed, you have to develop it in a manner in which the average clinician can grab it and use it. If it's going to be a cumbersome box, which requires a Ph.D. in physics to understand, it's never going to have a place in medicine."

2 welding methods studied

Two techniques are being investigated for utilizing fiber optics and lasers in welding microcircuits. The first uses an array of several active fiber lasers, which can be lumped together and fired by a single flash lamp. Thus many welds can be made simultaneously by a very small laser bundle.

The second technique employs an ordinary laser and focuses its beam into a bundle of passive fibers. Each fiber can be aimed at the appropriate point, and the single laser can be fired.

Both of these techniques are

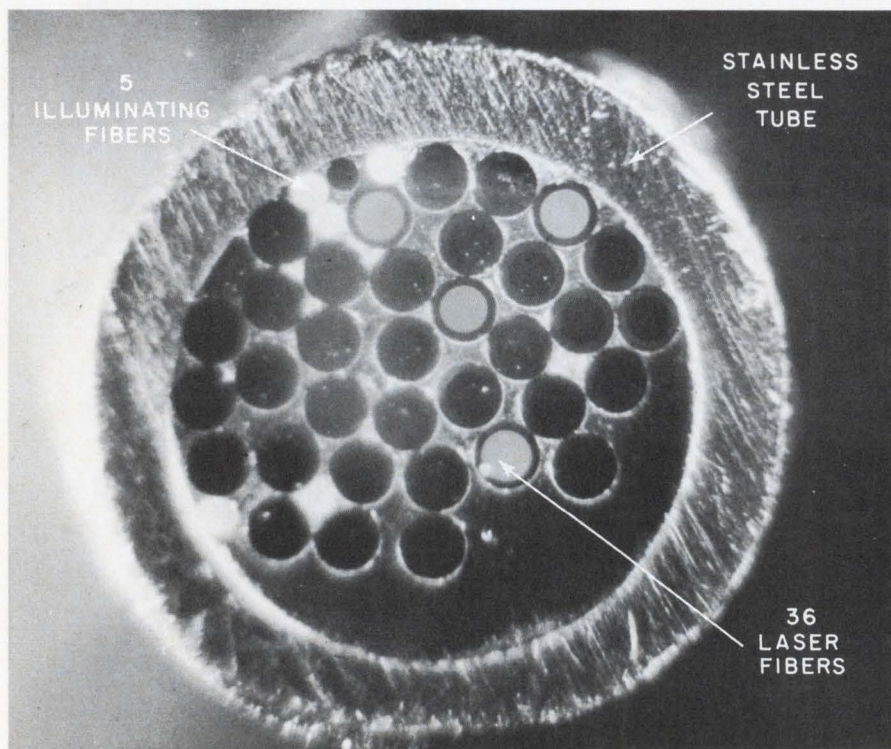

Cross-section of a fiber laser probe tip, with four of the laser fibers illuminated to show the core and the cladding.



Modular construction improves reliability, eliminates tolerance buildup

Precision-molded, acetal resin parts for increased reliability

Panel or back-of-panel mounting

Plug-in model for high density stacking

Speeds to 3000 cpm

New figure style for optimum readability

Unique reset mechanism plus electric reset option

Here's another cock and fire story from Veeder-Root

This is the Series 7440 reset electric counter. Like other counters in our new MOD 7400 line, it's the result of TOTAL ENGINEERING. From the positive action reset to its advanced concept of modular design. The result is exceptional reliability and unusually long life.

The unique spring-loaded cock and fire reset mechanism eliminates the problem of partial reset. And extends mechanism life beyond conventional designs.

Precision-molded, acetal resin pinions, wheels, verge, and reset components assure dimensional stability. Electronic tuning for speeds up to 3000 cpm means each

counter has exceptional performance reliability designed right into it. Pretested figures give maximum legibility. You get all these benefits because of its design simplicity, yet the cost is surprisingly low.

It's especially suited for analytical instruments, test equipment, and business machines. Whatever your application, you'll be sure of high-speed capability and long life.

The Series 7440 is just one of a full line of Veeder-Root counters and controls for data acquisition—mechanical, electrical and electronic. For complete information, write Veeder-Root, Hartford, Conn. 06102.

V E E D E R - R O O T

INNOVATORS IN NUMERICS: COUNTING/RECORDING/CONTROLLING



(fiber optics, *continued*)

deemed practical and will be used in experiments at American Optical.

Modulation is the message

The use of fiber optics and lasers in communications has its own unique problems. One unsolved problem is how to modulate efficiently at such high frequencies. Another—a problem that is closer to solution—is the transmission loss of fiber bundles in long communication links.

The potential of laser communications is, however, considered staggering. Since a light carrier would have about 100,000 times the bandwidth of a microwave link, it would be able to transmit 100,000 times the data transmitted at present.

J. F. Courtney-Pratt, a department head in the Acoustics, Speech and Mechanics Research Laboratory at Bell Telephone Laboratories, Murray Hill, N. J., notes that the Picturephone requires more than 125 times the bandwidth of a regular telephone transmission.

Conventional communications links are insufficient for nation-wide Picturephone service; wider bandwidth links are required. Laser links are an ideal solution, but there are technical difficulties to be worked out.

Courtney-Pratt says that to have practical fiber communication links, laser amplifier repeaters must be spaced no more than a mile apart. According to American Optical's Dr. Snitzer, if 1.06 microns is chosen as the carrier bandwidth, fiber loss on the order of 0.02%/cm would give practical fiber links of about one mile in length. Such loss factors have been achieved experimentally.

At the IEEE Conference on Laser Engineering and Applications, held in Washington, D. C., last month, T. Uchida and M. Furukawa of Nippon Electric Ltd., Kawasaki, Japan, and I. Kitano, K. Koizumi, and H. Matsumura of Nippon Sheet Glass Ltd., Itami, Japan, reported development of a light-focusing fiber guide with a potential of five to 10 times less loss than conventional fiber bundles. The glass fiber guide has a parabolic distribution of refractive index, which focuses the laser light down the center of the fiber, thus

eliminating multiple internal reflection and cutting down considerably on wall losses. Further refinements may solve the loss problem.

At the same conference Dr. Snitzer reported the use of an active fiber laser as a preamplifier in front of a laser detector (photomultiplier tube). Whereas present detectors require about 100,000 photons to detect a signal, a single-mode fiber laser preamplifier can reduce this figure to 5,000 photons. Further bandwidth reduction can cut the figure to 300 photons.

An array of fiber laser detectors could also be used for image amplification. The imaging fiber bundle could have fiber laser amplifiers built in to intensify the transmitted image.

Dr. Snitzer says American Optical is experimenting with phase and amplitude modulation in connection with a contract for the Underwater Sound Laboratory in New London, Conn. The contract calls for an optical image to be simulated from signals received by an array of hydrophones underwater. An array of single-mode fibers (fibers small enough to support only the dominant mode), one for each hydrophone, are illuminated by a helium-neon laser at one end. The signal received by each hydrophone is broken down by amplitude and phase.

The amplitude signal goes to a device that squeezes the fiber in two dimensions, creating birefringence in the fiber. This changes the general polarization state in the fiber. If the output of the fiber is viewed through a polarizer, the amplitude is dependent upon the internal polarization of the signal.

Phase modulation is imparted to the signal in the fiber by winding the fiber around a piezoelectric transducer. The phase signal is applied to the transducer. As the transducer expands, the fiber is stretched, changing the optical path length and thereby imparting phase information.

The output of each fiber is viewed through a lens in the far field. Effectively, the Fourier transform of the optical signal is thereby taken in an analog manner. When the outputs of all the fibers in the array are viewed together, the result is the image of whatever the hydrophones viewed. ■■

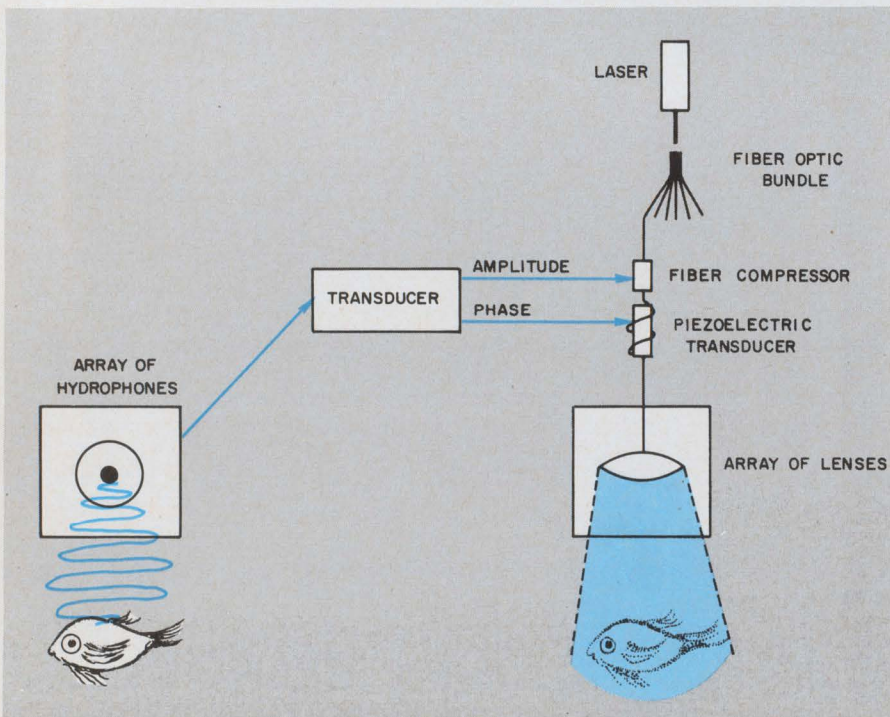

Sound-to-image transformation is performed by this system. A large array of hydrophones picks up an acoustical signal. The amplitude and phase of the resulting signals are impressed on a laser beam, and a corresponding array of lenses transmits the optical image.

**Unique, precise,
yet simplistic design;
priced modestly.**

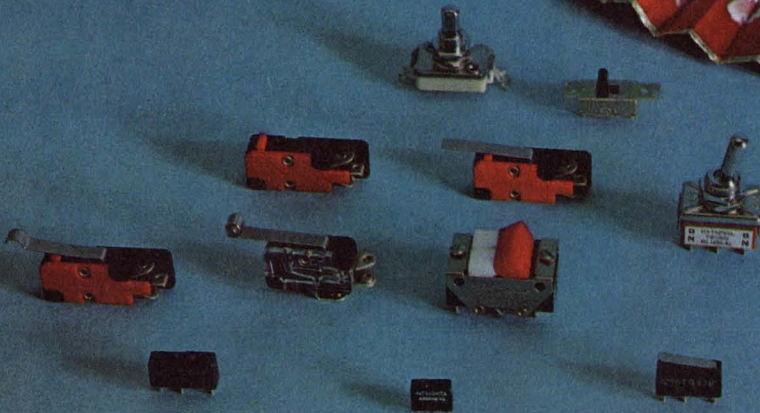

PRECISION SWITCHES — Five new types of precision switches are now available that will be of special interest to those users looking for savings in space and cost, along with long life and high performance characteristics. Design simplifications and unique constructions are such as to assure the switch buyer of large control capacities, the greatly reduced sizes notwithstanding.

TOGGLE SWITCHES; SLIDE, TUMBLER, & ROCKER SWITCHES — Six new patents explain the high performance, long life, and unique construction of four types of heavy-, medium- and light-duty toggle switches. High quality slide, tumbler, and rocker switches are also available in a variety of shapes and colors.

**PRECISION SWITCHES
SUB-MINIATURE MJ SERIES SWITCHES**

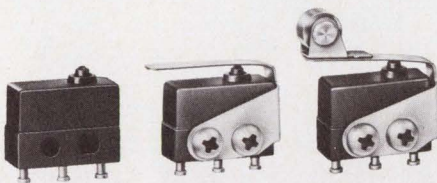

Basic type Leaf lever type Roller lever type

- Microscopic size and large capacity.
- Long life steel ball mechanism.
- Low contact resistance — gold flashed silver contact.
- Contact — SPDT.
- Ratings — 7A 125V AC/7A 250V AC/7A 28V DC.
- Mech. life, 250,000 operations min.
- Elec. life, 25,000 operations min.

**MINIATURE GENERAL PURPOSE
MV SERIES SWITCHES**



Solder type Screw type Q.C. (AMP #187) type

- Available in wide range of lock-in actuators, operating characteristics, and terminal designs.
- Extra long life: Mech. — 10⁶ operations min.; Elec. — 10⁴ operations min.
- Low price
- High quality
- Interchangeable
- Contact — SPDT
- Ratings — 5A 125V AC/10A 125V AC/3A 250V AC/6A 250V AC.

**MINIATURE APPLIANCE NA SERIES
SWITCHES**



Basic pin plunger type, guardless Hinge lever type, right-hand guard

- Available in wide range of lock-in actuators with right-hand guard, left-hand guard, and guardless.
- Low price, low operation force for appliance purposes.
- Safe, easy mounting because of molded insulation guard.
- Simple, exact spring mechanism.
- Contact — SPDT.
- Ratings — 3A 125V AC/2A 250V AC.
- Mech. life — 500,000 operations min.
- Elec. life — 50,000 operations min.
- Solder type, lock-in actuator.

**SUB-MINIATURE GENERAL PURPOSE
MS SERIES SWITCHES**

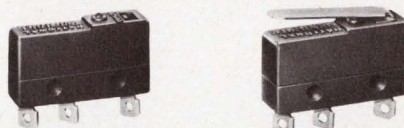

Basic type Leaf lever type

- Ultra-compact for use in limited space.
- UL — 5 types.
- CSA — 4 types.
- Contact — SPDT.
- Mech. life — 10⁵ operations min.
- Elec. life — 10⁴ operations min.
- Solder type, leaf, roller leaf & simulated leaf types.

**GENERAL PURPOSE MZ SERIES
MICROSWITCHES**



Basic type

- UL — 22 types
- CSA — 21 types
- Contact — SPDT
- Rating — 15A 125V AC/10A 250V AC/0.4A 115V DC
- Mech. life — 10⁵ operations min.
- Elec. life — 10⁴ operations min.
- Solder and screw types.

TOGGLE SWITCHES

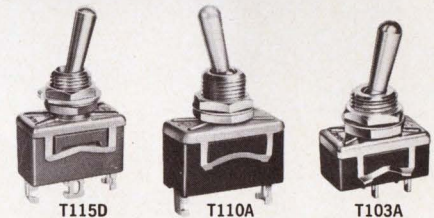

T115D

T110A

T103A

- T * 15 SERIES (HEAVY DUTY)**
- 15A 250V AC
 - SPDT, DPDT, 3PDT, 4PDT types

- T * 10 SERIES (MEDIUM DUTY)**
- 10A 250V AC
 - SPDT and DPDT types

- T * 06 & T * 03 SERIES (LIGHT DUTY)**
- 6A 125V AC/3A 125V AC
 - SPDT and DPDT types

**SLIDE, TUMBLER & ROCKER
SWITCHES**



Slide type
TL 101A
1A 250V AC

Tumbler type
TT 110D
10A 250V AC

Rocker type
TW 110D-C
10A 250V AC

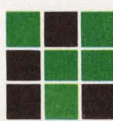

REMVAC COMPONENTS, INC.

37-55 61st Street, Woodside, Long Island, New York 11377 • (212) TW 9-6100

Agents for U.S. sales of components manufactured by Matsushita Electric Works, Ltd.

Call or write for details:



Ultramation: the memory that helps you forget.

Ultramation: the ultimate in automation with Honeywell. It means a new core memory system that helps you forget about initial costs – the Honeywell ICM-160. It delivers 4,096 words with 8, 12 or 16 bits per word for under 5¢ per bit and is field expandable.

And you can forget about downtime, too.

The ICM-160 has a calculated 40,000 hour MTBF from 0° to 50°C.

You can forget about space and maintenance problems. The ICM-160 is the smallest (2¾" x 5" x 9"), fastest (1.6 µsec full cycle time, 550 nsec access time), 4K-word memory in the under \$5K price range. Modular construction makes it

fast and easy to maintain.

No wonder it's a logical choice for use in mainframe applications as well as special systems – digital controllers, computer peripherals, data communication buffers. Delivery? 30 days is standard. And it arrives with complete documentation – the kind of detailed information you'd expect from a supplier who's been designing and producing core memory systems for over 10 years.

Find out about the memory that helps you forget. Write for complete specs.

Honeywell, Computer Control Division, Framingham, Mass. 01701.

Honeywell
AUTOMATION



Washington Report

CHARLES D. LAFOND
WASHINGTON BUREAU

Army buying methods assailed

The "incredible indifference or inordinate stupidity" of those responsible was blamed by Rep. William H. Harsha (R-Ohio) in a scathing denunciation of military waste through its procurement practices. And he declared the Army Electronics Command "one of the most consistent offenders, if not the worst."

This agency grants about 85% of its contracts behind closed doors, says the Congressman, and it does so in a "bizarre process" that protects favored companies in two ways. First, he says, the Command where possible avoids competitive bidding under cover of noncompetitive sole-source contract. And second, where necessary, the Electronics Command "permits competitive bidding but frequently ignores the low bidder, even the next lowest, and sometimes even the third lowest, under such flimsy claims as 'urgency of need'—any lack of such urgency notwithstanding."

Rep. Harsha, several months ago on the floor of the House, described a case in which the Army had negotiated noncompetitive contracts with Packard Bell. He estimated that they totaled \$8 million over a period of five years, and might have wasted taxpayers' money to the tune of \$6 million. Rep. Harsha says Packard Bell developed and produced a transponder test set, AN/APM-123, which never cost less than \$5000 per unit and in a final award reached \$6450 per unit. During this time, the Congressman says, the Electronics Command held an unsolicited and "obviously unwanted" lower bid from another contractor at \$4784 per unit. Later, due to pressure from the electronics industry, the Command opened the bidding for 241 units. The average bid from 26 manufacturers was \$3700 per unit, and the low bid was just over \$2000.

In his recent House floor discussion, Rep. Harsha revealed another program involving

\$75 million, of which he says "at least \$30 million was waste." This involved secret bids to the Electronics Command to develop a communications system described as "a secure forward area pulse code modulation terminal." Seven firms responded, and the lowest bid was \$370,024 from General Dynamics. The fourth lowest bid, from Raytheon, was \$652,673, Rep. Harsha revealed—and Raytheon won the contract. Then, the Congressman says, after a series of negotiations the Raytheon contract was nearly doubled.

Rep. Harsha noted that in follow-on contracts Raytheon produced a small multiplexer that cost \$13,800 per unit. The unit price was reduced under a subsequent contract to \$8000. Later, again following industry pressure, a competitive bidding was held for the same multiplexer. This time, the Congressman says, Raytheon bid \$4130 per unit, or next to the highest in a field of four bidders. The lowest was from Honeywell Inc., at \$3092.

The surprising part of all this, the Congressman noted, is that, despite Raytheon's losing that open bid for nearly 100 units, the story didn't end there. The crux, Rep. Harsha notes, is that the Army Electronics Command is today negotiating with Raytheon for another sole-source, noncompetitive contract for an additional 425 units of the same multiplexer.

Mastering the mascon problem

NASA's lunar flight controllers believe they now have the problem of mascons under reasonable control. Mascons—those mysterious concentrations on the moon that caused serious orbital deviations during Apollo 8—make it hard for lunar navigators to predict their position in space accurately. Errors of nearly three miles in each revolution

around the moon have been reported. But on the last successful flight—Apollo 10—NASA, using the new mathematical model of the effect of the mascons, shrank the navigational error to 2000 feet per revolution.

The performance of electronic systems in Apollo 10 also gives NASA officials cause for high optimism that Apollo 11—the first manned landing on the moon—will come off without a hitch this summer.

The guidance and control system in the command module was so nearly perfect that only a single small mid-course correction was required during the flight to the moon and during the return to the earth. Seven mid-course corrections had been planned—four out and three back. The rendezvous radar aboard the lunar module operated perfectly over a range of roughly 300 miles, or about three times the distance employed in the Apollo 9 Earth-orbital test.

For the first time a ranging subsystem, added by RCA to the Collins Radio VHF voice communication subsystem, was tested, and it reportedly functioned as designed. The ranging equipment was added to provide a positive backup to the rendezvous radar to assure a ranging capability at all times during a lunar mission.

The landing radar in the lunar module was used twice successfully during the descents to under 50,000-foot altitude and provided the crew, for the first time, with actual lunar approach experience. Also, the steerable high-gain 5-band antenna was tested during descent, and the only problem occurred when the attitude of the lunar module interfered with the proper aiming of the antenna.

Present plans—at least publicly—are for an Apollo 11 launching from Cape Kennedy on July 16. But a rumor persists that some members of the astronauts' office at the Manned Spacecraft Center in Houston might prefer a mid-August launching—so that the astronauts can spend an extra four weeks training with the lunar module simulator.

Soon after the safe landing of the Apollo 10 astronauts, NASA Administrator Thomas O.

Paine declared, "Today we see no obstacles on the path to the Moon . . . nothing so far that deters us from our plans of a July 16 launch readiness for Apollo 11." He stressed that he does not consider that date mandatory, and if anything occurs to make a delay necessary for the crew's safety or the success of the mission, a delay will be made.

Mars spacecraft contract is awarded

A \$280 million contract for two instrumented spacecraft, scheduled for launching to Mars in the summer of 1973, has been awarded to Martin Marietta Corp. Called the Viking Lander System, each spacecraft consists of a landing vehicle and an orbiting vehicle. The Viking program is a scaled-down version of what originally was called Voyager.

NASA's Langley Research Center will manage the entire project. The Jet Propulsion Laboratory, a NASA-supported, nonprofit element of the California Institute of Technology, is responsible for developing and building the Viking orbital spacecraft, and for all mission tracking and data acquisition. Martin's Denver division will produce the Lander. And NASA's Lewis Research Center will manage the launch-vehicle portion of the program, for which a Titan III-Centaur will be used.

The two spacecraft will be launched within a few days of each other and are expected to arrive and be inserted into different Martian orbits early in 1974. Each orbiter will provide communications relay between the Landers and Earth. They will also survey the Martian surface and collect a variety of other scientific data.

Equipment predicts epileptic seizures

Bio-telemetry equipment, when worn by epileptics, is expected to help doctors predict the onset of an epileptic seizure. The equipment, which weighs less than two pounds, transmits brain-wave (EEG) information to a continuously operated magnetic tape. Scientists and engineers from the Astropower Laboratories, Newport Beach, Calif., and the Veterans Administration Center, West Los Angeles, compare information from patients before, during and between seizures.

**MOST
RESISTORS ARE
PRETTY MUCH
ALIKE
IT'S THE NAME
BEHIND THEM
THAT COUNTS**

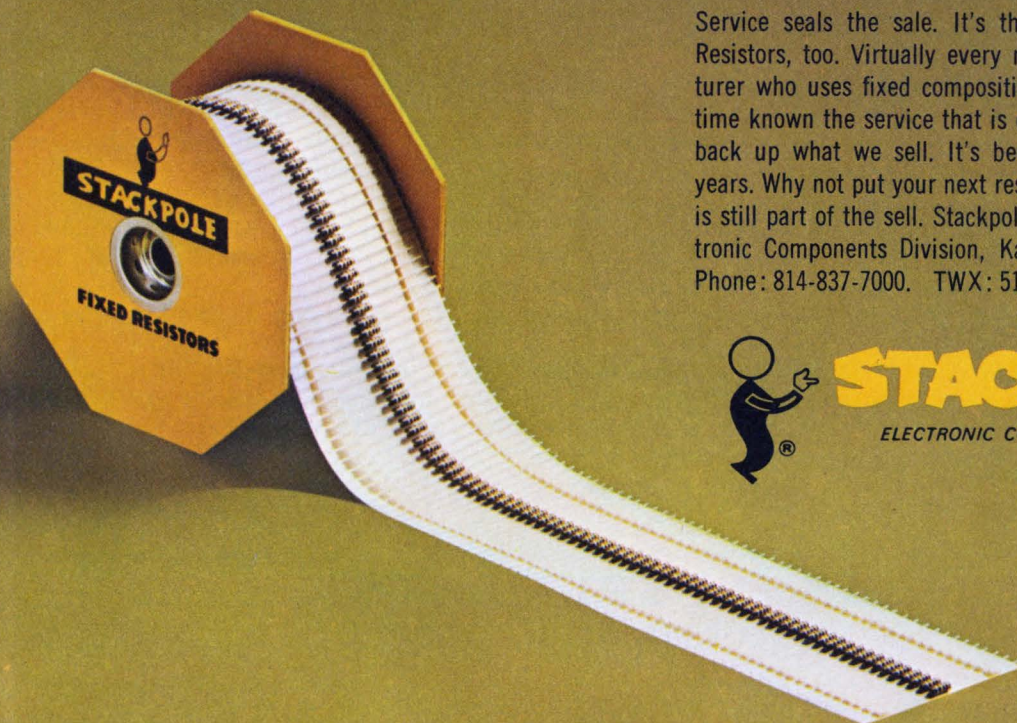

Service seals the sale. It's that way with everything. Resistors, too. Virtually every major domestic manufacturer who uses fixed composition resistors has at some time known the service that is distinctly Stackpole's. We back up what we sell. It's been that way for over 35 years. Why not put your next resistor order where service is still part of the sell. Stackpole Carbon Company, Electronic Components Division, Kane, Pennsylvania 16735. Phone: 814-837-7000. TWX: 510-695-8404.



STACKPOLE

ELECTRONIC COMPONENTS DIVISION

The Choice is TTL.
From TI...the leader in TTL.
83 MSI and SSI functions...plus
40% more this year.
3 compatible speeds for
optimum designs.

Why so many choices from TI TTL? To allow you to build your system to *your* specifications, not your supplier's.

You can get the best combination of compatible speeds to do the job—and the widest choice of functions within these speeds.

Use Series 54H/74H circuits in speed-critical sections of your sys-

tems. You get the benefits of the highest speed available in saturated logic.

In most systems areas, Standard Series 54/74 circuits offer the best speed/power ratio. And the complexity of MSI circuits provides substantial system cost and size reductions.

Then, where power dissipation is more critical than speed, use Series 54L/74L. It is twice as fast as other low-power circuits, and power consumption is only 1 mw per gate.

Low-power circuits greatly simplify power dissipation problems, and reliability problems associated with heat. In addition, they often help lower system cost by reducing cost of power supplies and cooling systems.

By using TI Series 54/74 TTL you can design by choice—a choice of 3 compatible speeds and 83 TTL functions.



TEXAS INSTRUMENTS
INCORPORATED

TI Series 54/74...industry's broad

Series 54/74

| | | | | | | |
|--|---|--|---|--|--|--|
| <p>SN5400N/SN7400N SN5400J/SN7400J Quadruple 2-input NAND gate</p> | <p>SN5401N/SN7401N SN5401J/SN7401J Quadruple 2-input NAND gate with open collector output</p> | <p>SN5402N/SN7402N SN5402J/SN7402J Quadruple 2-input NOR gate</p> | <p>SN5403N/SN7403N SN5403J/SN7403J Quadruple 2-input NAND gate with open collector output</p> | <p>SN5404N/SN7404N SN5404J/SN7404J Hex inverter</p> | <p>SN5405N/SN7405N SN5405J/SN7405J Hex inverter with open collector output</p> | <p>SN5406N/SN7406N SN5406J/SN7406J Triple 3-input NAND gate</p> |
| <p>SN5443N/SN7443N SN5443J/SN7443J Excess-3-to-decimal decoder</p> | <p>SN5444N/SN7444N SN5444J/SN7444J Excess-3-gray-to-decimal decoder</p> | <p>SN5445N/SN7445N SN5445J/SN7445J BCD-to-decimal decoder-driver with open collector outputs</p> | <p>SN5446N/SN7446N SN5446J/SN7446J BCD-to-seven-segment decoder-driver</p> | <p>SN5447N/SN7447N SN5447J/SN7447J BCD-to-seven-segment decoder-driver</p> | <p>SN5448N/SN7448N SN5448J/SN7448J BCD-to-seven-segment decoder-driver</p> | <p>SN5449N/SN7449N SN5449J/SN7449J Expandable AND-OR gate</p> |
| <p>SN5472N/SN7472N SN5472J/SN7472J J-K master-slave flip-flop</p> | <p>SN5473N/SN7473N SN5473J/SN7473J Dual J-K master-slave flip-flop</p> | <p>SN5474N/SN7474N SN5474J/SN7474J Dual D-type edge-triggered flip-flop</p> | <p>SN5475N/SN7475N SN5475J/SN7475J Quadruple bistable latch</p> | <p>SN5476N/SN7476N SN5476J/SN7476J Dual J-K master-slave flip-flop with preset and clear</p> | <p>SN5480N/SN7480N SN5480J/SN7480J Gated full adder</p> | <p>SN5481N/SN7481N SN5481J/SN7481J 16-bit ripple carry counter</p> |
| <p>SN5491N/SN7491N SN5491J/SN7491J 8-bit shift register</p> | <p>SN5492N/SN7492N SN5492J/SN7492J Divide-by-12 counter</p> | <p>SN5493N/SN7493N SN5493J/SN7493J Four-bit binary counter</p> | <p>SN5494N/SN7494N SN5494J/SN7494J 4-bit shift register</p> | <p>SN5495N/SN7495N SN5495J/SN7495J 4-bit shift register</p> | <p>SN5496N/SN7496N SN5496J/SN7496J 5-bit shift register</p> | <p>SN5497N/SN7497N SN5497J/SN7497J 8-bit shift register</p> |
| <p>SN54151N/SN74151N SN54151J/SN74151J 8-bit data selector/multiplexer</p> | <p>SN54180N/SN74180N SN54180J/SN74180J 8-bit parity generator/checker</p> | <p>SN5400/SN7400 Quadruple 2-input NAND gate</p> | <p>SN5401/SN7401 Quadruple 2-input NAND gate with open collector output</p> | <p>SN5402/SN7402 Quadruple 2-input NOR gate</p> | <p>SN5404/SN7404 Hex inverter</p> | <p>SN5405/SN7405 Hex inverter</p> |
| <p>SN5450/SN7450 Expandable dual 2-wide 2-input AND-OR-INVERT gate</p> | <p>SN5451/SN7451 Dual 2-wide 2-input AND-OR-INVERT gate</p> | <p>SN5453/SN7453 Expandable 4-wide 2-input AND-OR-INVERT gate</p> | <p>SN5454/SN7454 4-wide 2-input AND-OR-INVERT gate</p> | <p>SN5460/SN7460 Dual 4-input expander</p> | <p>SN5470/SN7470 J-K flip-flop</p> | <p>SN5472/SN7472 J-K master-slave flip-flop</p> |
| <p>SN5482/SN7482 2-bit binary full-adder</p> | <p>SN5486/SN7486 Quadruple 2-input exclusive-OR element</p> | <p>SN5490/SN7490 Decade counter</p> | <p>SN5491A/SN7491A 8-bit shift register</p> | <p>SN5492/SN7492 Divide-by-12 counter</p> | <p>SN5493/SN7493 Four-bit binary counter</p> | <p>SN5495/SN7495 4-bit shift register</p> |

line of TTL integrated circuits.

Series 54L/74L low power circuits

| | | | | | |
|--|--|--|---|---|--|
| <p>SN54H21N/SN74H21N SN54H21J/SN74H21J Dual 4-input AND gate</p> | <p>SN54L00N/SN74L00N SN54L00J/SN74L00J Quadruple 2-input NAND gate</p> | <p>SN54L10N/SN74L10N SN54L10J/SN74L10J Triple 3-input NAND gate</p> | <p>SN54L20N/SN74L20N SN54L20J/SN74L20J Dual 4-input NAND gate</p> | <p>SN54L30N/SN74L30N SN54L30J/SN74L30J Single 8-input NAND gate</p> | <p>SN54L51N/SN74L51N SN54L51J/SN74L51J Dual 2-wide 2-input/2-wide 3-input AND-OR-INVERT gate</p> |
| <p>SN54H54N/SN74H54N SN54H54J/SN74H54J 4-wide 2-2-2-3-input AND-OR-INVERT gate</p> | <p>SN54L54N/SN74L54N SN54L54J/SN74L54J 2-2-3-3-input AND-OR-INVERT gate</p> | <p>SN54L55N/SN74L55N SN54L55J/SN74L55J 2-wide 4-input AND-OR-INVERT gate</p> | <p>SN54L71N/SN74L71N SN54L71J/SN74L71J R-S master-slave flip-flop</p> | <p>SN54L72N/SN74L72N SN54L72J/SN74L72J J-K master-slave flip-flop</p> | <p>SN54L73N/SN74L73N SN54L73J/SN74L73J Dual J-K master-slave flip-flop</p> |
| <p>SN54H78N/SN74H78N SN54H78J/SN74H78J Dual J-K flip-flop with preset and clear inputs</p> | <p>SN54L78N/SN74L78N SN54L78J/SN74L78J Dual J-K master-slave flip-flop with common clear</p> | <p>SN54L91N/SN74L91N SN54L91J/SN74L91J 8-bit shift register</p> | <p>SN54L95N/SN74L95N SN54L95J/SN74L95J 4-bit shift register</p> | <p>SN54L00R/SN74L00R Quadruple 2-input NAND gate</p> | <p>SN54L04R/SN74L04R Hex inverter</p> |
| <p>SN54H01/SN74H01 Quadruple 2-input NAND gate with open collector output</p> | <p>SN54L10R/SN74L10R Triple 3-input NAND gate</p> | <p>SN54L20R/SN74L20R Dual 4-input NAND gate</p> | <p>SN54L30R/SN74L30R 8-input NAND gate</p> | <p>SN54L51R/SN74L51R Dual 2-wide 2-input/2-wide 3-input AND-OR-INVERT gate</p> | <p>SN54L54R/SN74L54R 2-2-3-3 input AND-OR-INVERT gate</p> |
| <p>SN54H30/SN74H30 8-input NAND gate</p> | <p>SN54H40/SN74H40 Dual 4-input NAND buffer</p> | <p>SN54L55R/SN74L55R 2-wide 4-input AND-OR-INVERT gate</p> | <p>SN54L71R/SN74L71R R-S master-slave flip-flop</p> | <p>SN54L72R/SN74L72R J-K master-slave flip-flop</p> | <p>SN54L73R/SN74L73R Dual J-K master-slave flip-flop</p> |
| <p>SN54H61/SN74H61 Triple 3-input expander</p> | <p>SN54H62/SN74H62 4-wide 3-2-2-3-input AND-OR expander</p> | <p>SN54L78R/SN74L78R Dual J-K master-slave flip-flop</p> | <p>SN54L91AR/SN74L91AR 8-bit shift register</p> | <p>SN54L95R/SN74L95R 4-bit shift register</p> | |
| <p>SN54H103/SN74H103 Dual J-K flip-flop with separate clocks</p> | <p>SN54H108/SN74H108 Dual J-K flip-flop with preset and clear inputs</p> | <div style="text-align: center;"> <p>TTL Integrated Circuits from Texas Instruments</p> </div> | | | |

New TTL Design Aid. We've just published a new 80-page color brochure that gives valuable data—including design information—on all Series 54/74 ICs. It's yours for the asking. Circle 199 on the Reader Service card for your copy... or write Texas Instruments Incorporated, P.O. Box 5012, M.S. 308, Dallas, Texas 75222.

Best line of TTL integrated circuits.

| | | | | | |
|--|--|---|--|---|---|
| <p>SN7410N/SN7410J Dual 2-input NAND gate</p> | <p>SN5420N/SN7420N SN5420J/SN7420J Dual 4-input NAND gate</p> | <p>SN5430N/SN7430N SN5430J/SN7430J 8-input NAND gate</p> | <p>SN5440N/SN7440N SN5440J/SN7440J Dual 4-input NAND buffer</p> | <p>SN7441AN SN7441AJ BCD-to-decimal decoder driver</p> | <p>SN5442N/SN7442N SN5442J/SN7442J BCD-to-decimal decoder</p> |
| <p>SN7450N/SN7450J Dual 2-wide 2-input AND-INVERT gate</p> | <p>SN5451N/SN7451N SN5451J/SN7451J Dual 2-wide 2-input AND-OR-INVERT gate</p> | <p>SN5453N/SN7453N SN5453J/SN7453J Expandable 4-wide 2-input AND-OR-INVERT gate</p> | <p>SN5454N/SN7454N SN5454J/SN7454J 4-wide 2-input AND-OR-INVERT gate</p> | <p>SN5460N/SN7460N SN5460J/SN7460J Dual 4-input expander</p> | <p>SN5470N/SN7470N SN5470J/SN7470J J-K flip flop</p> |
| <p>SN7481N/SN7481J Read/write memory</p> | <p>SN5482N/SN7482N SN5482J/SN7482J 2-bit binary full-adder</p> | <p>SN7483N SN7483J Four-bit binary full-adder</p> | <p>SN5484N/SN7484N SN5484J/SN7484J 16-bit read/write memory</p> | <p>SN5486N/SN7486N SN5486J/SN7486J Quadruple 2-input exclusive-OR element</p> | <p>SN5490N/SN7490N SN5490J/SN7490J Decade counter</p> |
| <p>SN54100N/SN74100N Dual quadruple bistable latch</p> | <p>SN54107N/SN74107N SN54107J/SN74107J Dual J-K Master-Slave flip-flop with preset and clear</p> | <p>SN54121N/SN74121N SN54121J/SN74121J Monostable multivibrator</p> | <p>SN54145N/SN74145N SN54145J/SN74145J BCD-to-decimal decoder-driver with open collector outputs</p> | <p>SN54150N/SN74150N SN54150J/SN74150J 16-bit data selector/multiplexer</p> | |
| <p>SN7405N/SN7405J Inverter with open collector output</p> | <p>SN5410/SN7410 Triple 3-input NAND gate</p> | <p>SN5420/SN7420 Dual 4-input NAND gate</p> | <p>SN5430/SN7430 8-input NAND gate</p> | <p>SN5440/SN7440 Dual 4-input NAND buffer</p> | <p>SN5449/SN7449 BCD-to-seven-segment decoder with open collector outputs</p> |
| <p>SN7472N/SN7472J Slave flip-flop</p> | <p>SN5473/SN7473 Dual J-K master-slave flip-flop</p> | <p>SN5474/SN7474 Dual D-type edge-triggered flip-flop</p> | <p>SN5477/SN7477 Quadruple bistable latch</p> | <p>SN5480/SN7480 Gated full adder</p> | <p>SN5481/SN7481 16-bit read/write memory with open collector outputs</p> |
| <p>SN7495N/SN7495J Shift register</p> | <p>SN54121/SN74121 Monostable multivibrator</p> | <p>SN54152/SN74152 8-bit data selector/multiplexer</p> | <p>SN54180/SN74180 8-bit parity generator/checker</p> | | |

TI Series 54/74...industry's broadest

Series 54H/74H high speed circuits

| | | | | | | |
|--|---|--|--|--|--|---|
| <p>SN54H00N/SN74H00N SN54H00J/SN74H00J Quadruple 2-input NAND gate</p> | <p>SN54H01N/SN74H01N SN54H01J/SN74H01J Quadruple 2-input NAND gate with open collector output</p> | <p>SN54H04N/SN74H04N SN54H04J/SN74H04J Hex inverter</p> | <p>SN54H05N/SN74H05N SN54H05J/SN74H05J Hex inverter with open collector output</p> | <p>SN54H10N/SN74H10N SN54H10J/SN74H10J Triple 3-input NAND gate</p> | <p>SN54H11N/SN74H11N SN54H11J/SN74H11J Triple 3-input AND gate</p> | <p>SN54H20N/SN74H20N SN54H20J/SN74H20J Dual 4-input NAND gate</p> |
| <p>SN54H22N/SN74H22N SN54H22J/SN74H22J Dual 4-input NAND gate with open collector output</p> | <p>SN54H30N/SN74H30N SN54H30J/SN74H30J 8-input NAND gate</p> | <p>SN54H40N/SN74H40N SN54H40J/SN74H40J Dual 4-input NAND buffer</p> | <p>SN54H50N/SN74H50N SN54H50J/SN74H50J Expandable dual 2-wide 2-input AND-OR-INVERT gate</p> | <p>SN54H51N/SN74H51N SN54H51J/SN74H51J Dual 2-wide 2-input AND-OR-INVERT gate</p> | <p>SN54H52N/SN74H52N SN54H52J/SN74H52J Expandable 4-wide 2-2-2-3-input AND-OR gate</p> | <p>SN54H53N/SN74H53N SN54H53J/SN74H53J Expandable 4-wide 2-2-2-3-input AND-OR-INVERT gate</p> |
| <p>SN54H55N/SN74H55N SN54H55J/SN74H55J Expandable 2-wide 4-input AND-OR-INVERT gate</p> | <p>SN54H60N/SN74H60N SN54H60J/SN74H60J Dual 4-input expander</p> | <p>SN54H61N/SN74H61N SN54H61J/SN74H61J Triple 3-input expander</p> | <p>SN54H62N/SN74H62N SN54H62J/SN74H62J 4-wide 3-2-2-3-input AND-OR expander</p> | <p>SN54H71N/SN74H71N SN54H71J/SN74H71J J-K flip-flop with AND-OR inputs</p> | <p>SN54H72N/SN74H72N SN54H72J/SN74H72J J-K master-slave flip-flop</p> | <p>SN54H73N/SN74H73N SN54H73J/SN74H73J Dual J-K flip-flop with separate clock inputs</p> |
| <p>SN54H87N/SN74H87N SN54H87J/SN74H87J 4-bit true/complement, zero/one element</p> | <p>SN54H101N/SN74H101N SN54H101J/SN74H101J J-K flip-flop with AND-OR inputs</p> | <p>SN54H102N/SN74H102N SN54H102J/SN74H102J J-K flip-flop with AND inputs</p> | <p>SN54H103N/SN74H103N SN54H103J/SN74H103J Dual J-K flip-flop with separate clock inputs</p> | <p>SN54H106N/SN74H106N SN54H106J/SN74H106J Dual J-K flip-flop with preset and clear inputs</p> | <p>SN54H108N/SN74H108N SN54H108J/SN74H108J Dual J-K flip-flop with preset and clear inputs</p> | <p>SN54H00/SN74H00 Quadruple 2-input NAND gate</p> |
| <p>SN54H04/SN74H04 Hex inverter</p> | <p>SN54H05/SN74H05 Hex inverter with open collector output</p> | <p>SN54H10/SN74H10 Triple 3-input NAND gate</p> | <p>SN54H11/SN74H11 Triple 3-input AND gate</p> | <p>SN54H20/SN74H20 Dual 4-input NAND gate</p> | <p>SN54H21/SN74H21 Dual 4-input AND gate</p> | <p>SN54H22/SN74H22 Dual 4-input NAND gate with open collector output</p> |
| <p>SN54H50/SN74H50 Expandable dual 2-wide 2 input AND-OR-INVERT gate</p> | <p>SN54H51/SN74H51 Dual 2-wide 2-input AND-OR-INVERT gate</p> | <p>SN54H52/SN74H52 Expandable 4-wide 2-2-2-3-input AND-OR gate</p> | <p>SN54H53/SN74H53 Expandable 4-wide 2-2-2-3-input AND-OR-INVERT gate</p> | <p>SN54H54/SN74H54 4-wide 2-2-2-3-input AND-OR-INVERT gate</p> | <p>SN54H55/SN74H55 Expandable 2-wide 4-input AND-OR-INVERT gate</p> | <p>SN54H60/SN74H60 Dual 4-input expander</p> |
| <p>SN54H71/SN74H71 J-K flip-flop with AND-OR inputs</p> | <p>SN54H72/SN74H72 J-K master-slave flip-flop</p> | <p>SN54H73/SN74H73 Dual J-K flip-flop with separate clock inputs</p> | <p>SN54H78/SN74H78 Dual J-K flip-flop with preset and clear inputs</p> | <p>SN54H87/SN74H87 4-bit true/complement, zero/one element</p> | <p>SN54H101/SN74H101 J-K flip-flop with AND-OR inputs</p> | <p>SN54H102/SN74H102 J-K flip-flop with AND inputs</p> |

The Trend is TTL.
TI is the leader in TTL.
In breadth of line. In technology.
In production capacity.
In availability.
Look first to TI.

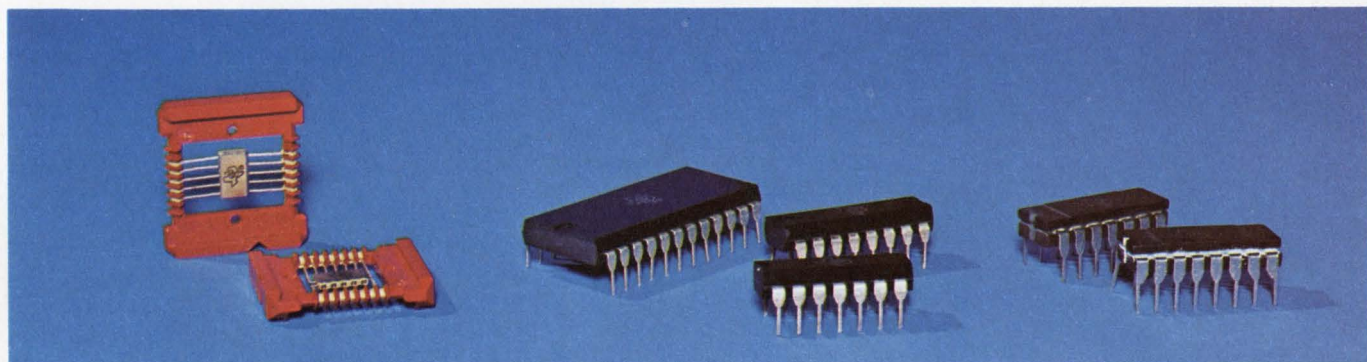

In addition to 83 different circuits, three speed ranges, and a broad selection of MSI circuits, Series 54/74 TTL from TI is offered in three package types.

TI's plastic dual-in-line packages are low in cost, yet rugged. And they are backed by millions of hours of reliability data. Series 54 plastic performance over the full temperature range (-55°C to $+125^{\circ}\text{C}$) is proven by customer usage in temperature critical systems.

Ceramic dual-in-line packages from TI provide all the benefits of

hermetic packages in a design suited to automatic insertion and soldering. Ceramic packages are ideal for severe environments where applications require validation of hermeticity.

TI's flatpacks—best for space-critical applications—are backed by ten years service in all types of military, space, and commercial systems.

When you design with Series 54/74, you have a lot in your favor. A broad range of MSI circuits... three compatible speeds... three package types. Also, good availa-

bility, and second-sources for most circuits.

The widest choice. The dominant trend. Series 54/74 TTL from Texas Instruments.

New TTL design aid

A new 80-page color brochure gives valuable data—including design information—on all TI series 54/74 IC's. Circle 199 on the Reader Service card for your copy...or write Texas Instruments Incorporated, P.O. Box 5012, MS 308, Dallas, Texas 75222.



TEXAS INSTRUMENTS
INCORPORATED

wire-wrapping termination connectors by CONTINENTAL...

.025 x .025 and .045 x .045
on .100, .125, .200 contact centers

ILLUSTRATIONS
ACTUAL SIZE

"BELLOWFORM"*
PRINTED CIRCUIT AND
RECTANGULAR PLUG
& SOCKET APPLICATIONS



CONTINENTAL CONNECTORS

CONTINENTAL CONNECTOR CORPORATION
WOODSIDE, LONG ISLAND, NEW YORK 11377
TELEPHONE: (212) 899-4422

For the Distributor or Sales Representative Nearest You,
See Our Listings in EEM and VMF Directories

*PATENT NO. 2,875,425

This is the world's smallest all-pluggable DPM.



Weston Model 1290
\$204

Then there's our less expensive model.



Weston Model 1260
\$99.50

We brought out our 3½-digit compact DPM* just last March. It's the one that plugs into a panel slot only seven inches square, and pulls out for servicing or replacement. If you need the accuracy of 3½ digits, Model 1290 is still your best buy. But if you can settle for a digit less, you can have our new Model 1260 at less than half the price. Don't be fooled by the price tag, though . . . there's nothing "cheap"

about this 2½-digit version. Housed in the very same plug-in case and fully compatible with its more sophisticated brother, Weston Model 1260 offers 0.5% ±1 digit accuracy—with far greater resolution capability than mechanical movements provide. Full scale reading is 199, with 25% over and under-range capability, remote command signal and Weston's usual high rejection characteris-

tics. In addition to the convenience of front panel pluggability and circularly polarized viewing, we've included front panel calibration as a built-in bonus feature on the 1260. Write to the originators of the DPM. WESTON INSTRUMENTS DIVISION, Weston Instruments, Inc., Newark, N.J. 01774.

a Schlumberger company
WESTON®

Prices for Models 1290 and 1260 based on quantities of 25.

*U.S. Pat. 3,051,939 and patents pending.

LOW-COST POWER SUPPLIES

FOR LAMPS AND RELAYS

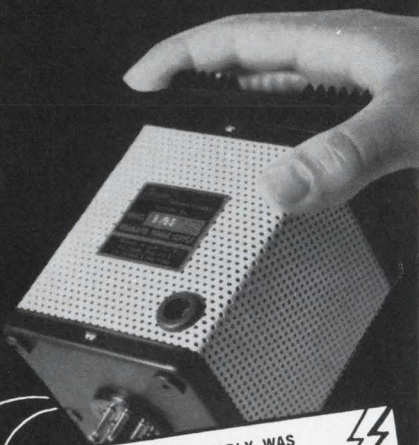

THIS POWER SUPPLY WAS
SHIPPED WITHIN
3 DAYS AFTER RECEIPT OF ORDER
Acopian

Acopian offers 62,000 different AC to DC plug-in power supplies, all available for shipment in three days, including these low-cost unregulated models specially designed for powering DC relays and lamps:

| MODEL | RELAY VOLTAGE | OUTPUT CURRENT (AMPS.) | VOLTS (NL TO FL) | RIPPLE (VOLTS, RMS) | PRICE |
|-------|---------------|------------------------|------------------------------|---------------------|---------|
| US6 | 6 | 2.0 | 7.7 to 4.8 | 2.0 | \$35.00 |
| U6 | 6 | 5.0 | 8.0 to 5.0 | 2.5 | 65.00 |
| US12 | 12 | 1.5 | 14.9 to 10.9 | 2.5 | 35.00 |
| U12 | 12 | 5.0 | 15.3 to 10.0 | 3.0 | 65.00 |
| US24 | 24 | 1.5 | 26.2 to 20.2 | 2.5 | 35.00 |
| U24 | 24 | 3.5 5.0 | 26.6 to 21.0 26.6 to 20.0 | 3.0 3.2 | 65.00 |
| US28 | 28 | 1.0 | 30.6 to 25.5 | 2.0 | 35.00 |
| U28 | 28 | 3.0 5.0 | 31.9 to 26.0 31.9 to 23.6 | 2.7 3.4 | 65.00 |

For your copy of the Acopian catalog listing all 62,000 models, write Acopian Corp., Easton, Pa. 18042 or call (215) 258-5441.



INFORMATION RETRIEVAL NUMBER 30

NEWS

IBM tests holographic data storage

As digital computers continue to grow in complexity and size, memory storage will have to be increased significantly at no sacrifice in speed. This means the information will have to be packed much more densely. How?

One technique that shows promise and is being investigated by a number of companies is holographic data storage (see "Holography: The Reality and the Illusion," ED 11, May 24, 1969, p. 59).

Why holograms? Because they overcome the shortcomings of optical techniques that employ conventional photography. With the latter, lenses must be used, and the microphotographs are vulnerable to dust and scratches, which can cause loss of data. Holograms don't require lenses; they are self-focusing.

The image can be easily read by a photodetector, and information is stored redundantly. Even if part of a hologram is destroyed or obscured, the remainder can still contain a complete record of the data stored in it.

An experimental high-density holographic computer storage system, developed at the IBM Systems Development Laboratory, San Jose, Calif., was described at the recent IEEE Conference on Laser Engineering and Applications in Washington, D. C.

According to an IBM engineer, Lester F. Shew, an electron beam is used to write computer-generated, binary Fourier holograms on strips of photographic film. Each hologram contains one byte of data made up of one clock bit and eight data bits. The holograms are or-

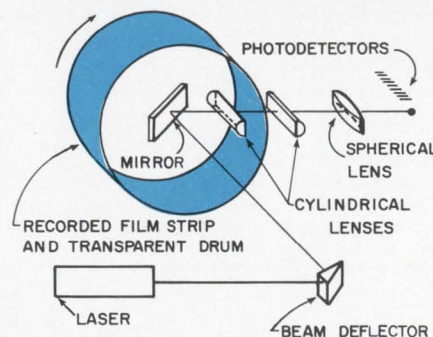
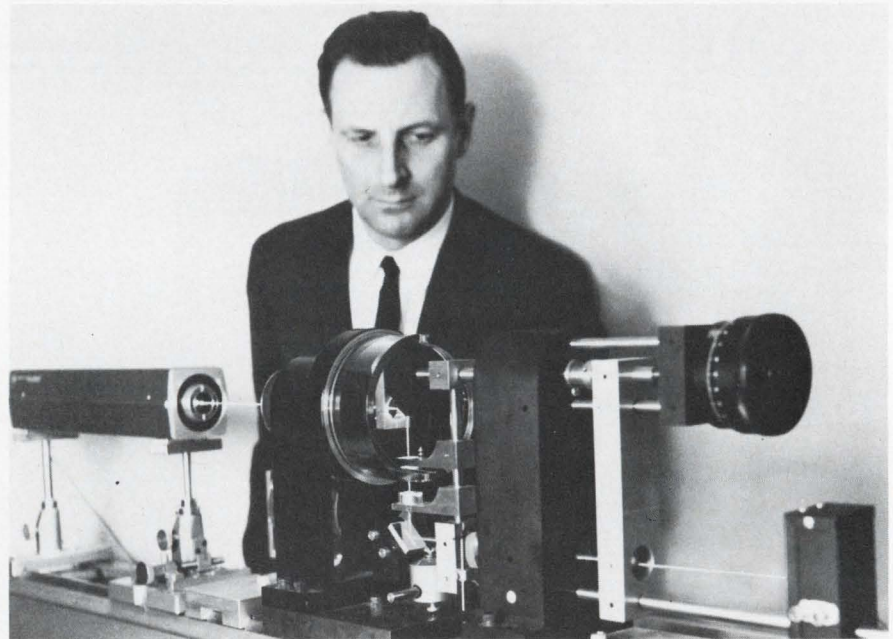

Holograms recorded on strips of photographic film placed on the inside surface of a rotating transparent drum are read out by a laser beam. The experimental device developed by IBM Systems Development Laboratory, has attained a storage density of over 2 million bits of information per square inch of recording surface.

INFORMATION RETRIEVAL NUMBER 31 ►

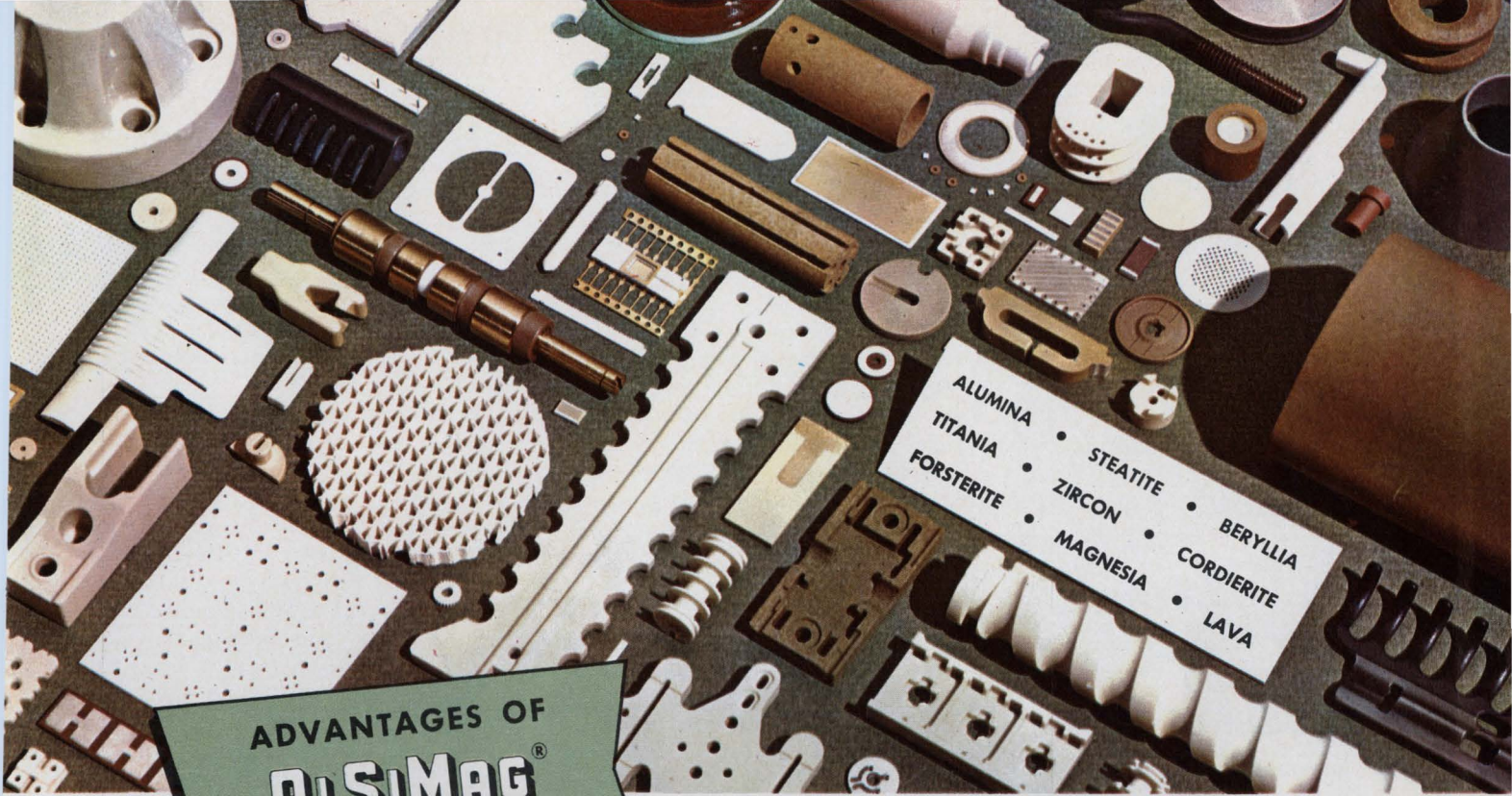

**ADVANTAGES OF
ALSIMAG[®]
TECHNICAL CERAMICS**

MORE MATERIALS

For many decades American Lava has worked with leading firms to develop special ceramics for their advanced designs. The result is the greatest number of special ceramic compositions available from any source. This wealth of ceramic materials can help in two ways. First, it may give you the exact performance you require. Second, it enables you to select the most economical material that meets your design requirements.

MORE PROCESSES

American Lava offers the broadest processing capabilities in the industry. These include forming ceramics by all modern methods including pressing, extrusion, injection molding, isostatic pressing, plus metallization, plating, chemical milling, machining, grinding, lapping, and hermetic bonding.

Many of these processes were pioneered by American Lava. Examples are (1) the ability to produce certain as-fired ceramics to precision tolerances and (2) the proprietary ALSiBase process for producing thin flat ceramics.

MORE SPECIALIZED ENGINEERING TALENT

American Lava, built on engineering ability, has demonstrated that it is the best source for any problem involving technical ceramics.

GREATER PRECISION

Technical ceramics play an increasingly important part in American industry because they can meet especially demanding requirements. American Lava has the experience, know-how and facilities to produce ceramics to the closest tolerances, and to measure and inspect them by agreed means.

MORE MODERN DESIGNS

Technical leadership at American Lava Corporation is based on working with its customers to give them what they want. This currently involves work on composite substrates, composite packages, buried metal patterns, super-smooth and flat substrates, special temperature compensating dielectrics, ceramic capacitors and new ceramic coatings for metal and low expansion glass.

VOLUME PRODUCTION

American Lava has the resources, know-how and the desire to make commitments required to meet volume requirements of its customers. A long parade of firsts in new manufacturing capabilities have allowed American Lava to keep pace with the ever changing need for technical ceramics in volume.

EXPEDITED PROTOTYPES

Special procedures speed the production of prototypes for your evaluation. A chart giving the characteristics of our most frequently used ALSiMag ceramic compositions will be sent on request. Suggestions are available from our specialized engineering staff.

CODE IDENT. NO. 70371

PHONE 615 265-3411 • CHATTANOOGA, TENNESSEE 37405, U.S.A.

American Lava Corporation **3M**
A SUBSIDIARY OF COMPANY

For service, contact American Lava representatives in Offices of Minnesota Mining and Manufacturing Company in these cities (see your local telephone directory): Boston: Needham Heights, Mass. • Chagrin Falls, Ohio • Chicago: Elmhurst, Ill. • Dallas, Tex. Indianapolis, Ind. • Laurens, S.C. • Los Angeles, Calif. • Metropolitan New York: Ridgefield, N.J. • Up-State New York and Canada: Phoenix, New York • Orange, Conn. • Philadelphia, Penna. • Roanoke, Virginia • St. Louis: Lee's Summit, Mo. South San Francisco, Calif. • International: c/o American Lava Corporation, Chattanooga, Tenn. 37405, U.S.A., TELEX 558432.



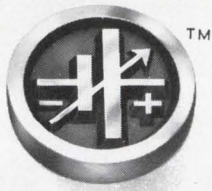

at your **COMMAND**



THE KEPCO PAT DESIGN GROUP

Six programmable power modules, 0-7V to 0-100V, 20 watts. They combine excellent line and load regulation—and low ripple with an extremely flexible programming arrangement.

| MODEL | VOLTS | AMPS | PRICE |
|-------------|-------|-------|----------|
| PAT 7-2 | 0-7 | 0-2 | \$121.00 |
| PAT 15-1.5 | 0-15 | 0-1.5 | 121.00 |
| PAT 21-1 | 0-21 | 0-1 | 121.00 |
| PAT 40-0.5 | 0-40 | 0-0.5 | 121.00 |
| PAT 72-0.3 | 0-72 | 0-0.3 | 121.00 |
| PAT 100-0.2 | 0-100 | 0-0.2 | 121.00 |

We call it "operational programming," meaning that the output can be precisely determined by simple resistor relationships expressing the ratio of an input (reference) to the feedback.

Like an OP-Amp, Kepco's PAT power supplies can be described in terms of the offsets of its integrated-circuit control amplifier. Example: The offset voltage and the offset current temperature coefficients are $20 \mu\text{V}/^\circ\text{C}$, and $5 \text{ nA}/^\circ\text{C}$. Or you can use conventional power-supply terminology to describe the exceptional (0.0005%) line regulation or (0.005%) load regulation.

Our spec sheet gives the full description in both ways, the conventional and operational notation. Send for a copy of our new Catalog B-693 and check out the PAT modules.

write Dept. CN-05



131-38 SANFORD AVE. • FLUSHING, N.Y. 11352
(212) 461-7000 • TWX #710-582-2631
INFORMATION RETRIEVAL NUMBER 32

NEWS

(memory, continued)

ganized into 256 tracks on each film strip, which are placed on the inside surface of a rotating transparent drum for readout by a laser beam.

As shown in the diagram, the readout is made parallel by byte through use of a light deflector system that directs the laser beam to one of the 256 tracks of data. Nine photodiodes detect simultaneously the nine data bits in each byte. Information is read out with a beam-positioning tolerance of ± 0.0025 inch.

A storage density of over 2 million bits of data per square inch of recording space, an average data read-rate of 16 million bits per second and average access time of 8.5 ms have been attained with an experimental model of the device, according to Shew.

The device, he says, has a potential storage density of 6 million bits per square inch, or the equivalent of 150,000 words on a surface smaller than a half dollar. The read rate could be raised to 160 million bits per square inch, and access time could be reduced to 1.3 ms,

Shew says.

The IBM engineer noted that the byte-oriented approach to holographic storage allowed economical use of a low-power laser. In addition only 256 holograms are needed for all the 8-bit combinations required to write the data bytes. The device successfully read holograms when up to 30% of their area was obscured.

Scientists at other companies such as Bell Telephone Laboratories at Murray Hill, N. J., and RCA, Princeton, N. J., have been investigating read-only memories in which an array of tiny, two-dimensional holograms is deposited on a glass substrate, accessed by a laser beam and read out by a matrix of photodetectors.

Writing into this type of memory can be compared to the formation of data masks for integrated circuits. Data masks are formed that might consist of binary-coded pinholes in a 100-by-100 matrix. Each mask, which might contain 10,000 bits, is placed between a lens-focused laser and a holographic medium (presumably a photographic emulsion). The film is exposed selectively through an aperture. ■■

Here's how to cool it

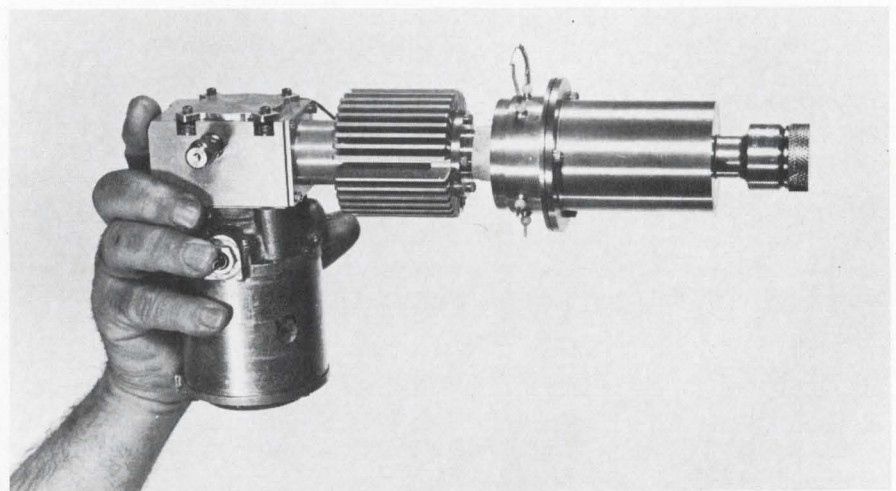

Miniaturized cryogenerator, which directly converts heat to cold, weighs just 5.7 pounds and measures 96 cubic inches. Developed by North American Philips Corp., Briarcliff Manor, N. Y., the device is designed to cool infrared detectors in surveillance, reconnaissance and communications systems. Its range of cooling extends from 300°K (80°F) down to 50°K (-370°F). Power consumption is 25 to 30 watts. The amount of refrigeration is 1/2 watt at 77°K .

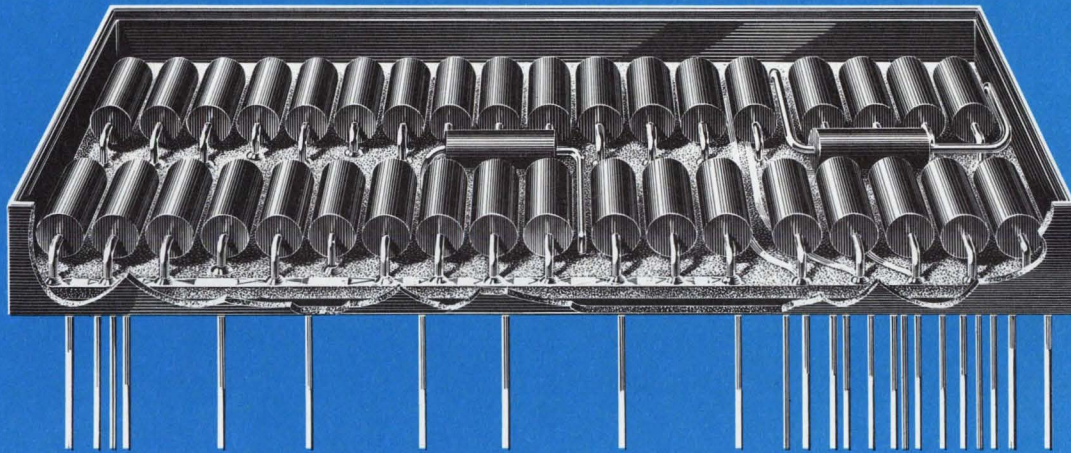

16 million hours of test time without a single failure.

ITC Riedon precision wirewound resistors combine this high reliability with close temperature coefficients, close tolerances, fast rise time and small size.

More specifically, they give you:

- Stability to 0.002%, provided by actually fusing resistance elements to terminations. Thermal emf is negligible.
- Standard temperature coefficient of 0 ± 10 ppm/ $^{\circ}\text{C}$ above 100 ohms to 0 ± 30 ppm/ $^{\circ}\text{C}$ for 0.1 to 9 ohms between -65°C and $+150^{\circ}\text{C}$.
- Standard tolerance range from 1% down to 0.005%, measured at 25°C .
- Operation to 175°C , made possible by unique hot encapsulation, which eliminates virtually all moisture and voids.
- Rise time as fast as 10 nanoseconds up to 100KHz frequency input. (This puts

wirewounds where metal film was once the only solution.)

This performance should come as no surprise. Riedon originated the molding process for encapsulating resistors in epoxy. They were first to produce a molded epoxy encapsulated precision wirewound resistor that exceeded MIL-R-39005 and MIL-R-38100. They have qualified to the latest military specifications covering "Hi-Rel" parts (a failure rate of less than 0.01%/1,000 hours at 125°C and 60% confidence level).

These same resistors go into Riedon networks. We design and package

them in ladders, voltage dividers, analog-to-digital converters, operational amplifiers or miniaturized components. Combined with capacitors, conductors or diodes in a hermetically sealed package, one ITC Riedon element can replace 20 or more individual items.

We have a new 12-page folder that tells the full performance story of Riedon resistors. Why not send for a copy? ITC Riedon, a division of Industrial Technology Corporation, a subsidiary of Republic Corporation, 7932 Haskell Avenue, Van Nuys, California 91406 (213) 873-3464.

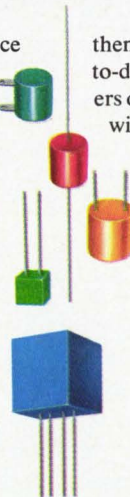

ITC RIEDON 

You've
 never seen
 a dry reed
 relay
 like this
 new one
 from P&B

JDT Series Dry Reed Relay

An entirely new magnetic structure makes possible an exceptionally low seated height of only 0.275 inch for high density board packaging. Circuit boards employing JDT relays may be spaced on 0.5 inch centers.

This design minimizes magnetic flux dispersion, resulting in a very efficient magnetic circuit. This decreases coil power requirements and often permits direct operation of JDT relays in low-power semiconductor logic circuits. An interfacing amplifier may be eliminated in many applications.

Terminals are similar to those on IC packages, permitting spot testing on either side of a circuit board. The dual in-line terminals on 0.1 inch centers simplify circuit board design. The reed switches are rated at 10 watts maximum resistive (50V or 0.5A DC maximum) switching.

A solid state time delay circuit may be incorporated in this small package. Or a Darlington amplifier can be included to compensate for low current applications. However, the number of available poles for switching is reduced by the addition of either of these circuits.

The JDT is completely encapsulated in epoxy, giving protection against environmental contamination. The Series is presently available in many combinations of Forms of A, B and C.

Get full information today by calling your local P&B representative or call direct to Potter & Brumfield Division of American Machine & Foundry Company, Princeton, Indiana. 812-385-5251.

SPECIFICATIONS

Power:

JDT 4000 Series: 310mw nominal
 JDT 8000 Series: 600mw nominal

Operate Time:

4 milliseconds maximum @ nominal voltage
 @ 25°C, including bounce

Temperature Range:

-50° to +85°C

Expected Life:

Approximately 20 million operations (resistive)

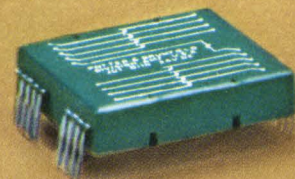
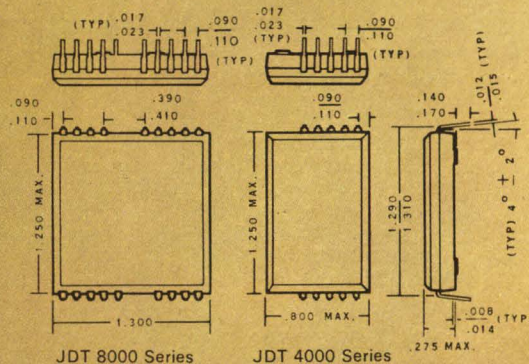

Introducing Potter & Brumfield's unique

dual thin-line dry reed relays

mounted height is only 0.275"

power requirements: only 75mw per pole
combinations of Forms A, B and C are available

Single lot prices are as low as \$7.65
for 4-pole version (JDT 4000 Series)
with 6 or 12-volt coils.
The 8-pole relays (JDT 8000 Series)
start at \$12.95. Quantity discounts
apply. Order sample quantities
today for evaluation in
your most sophisticated design.

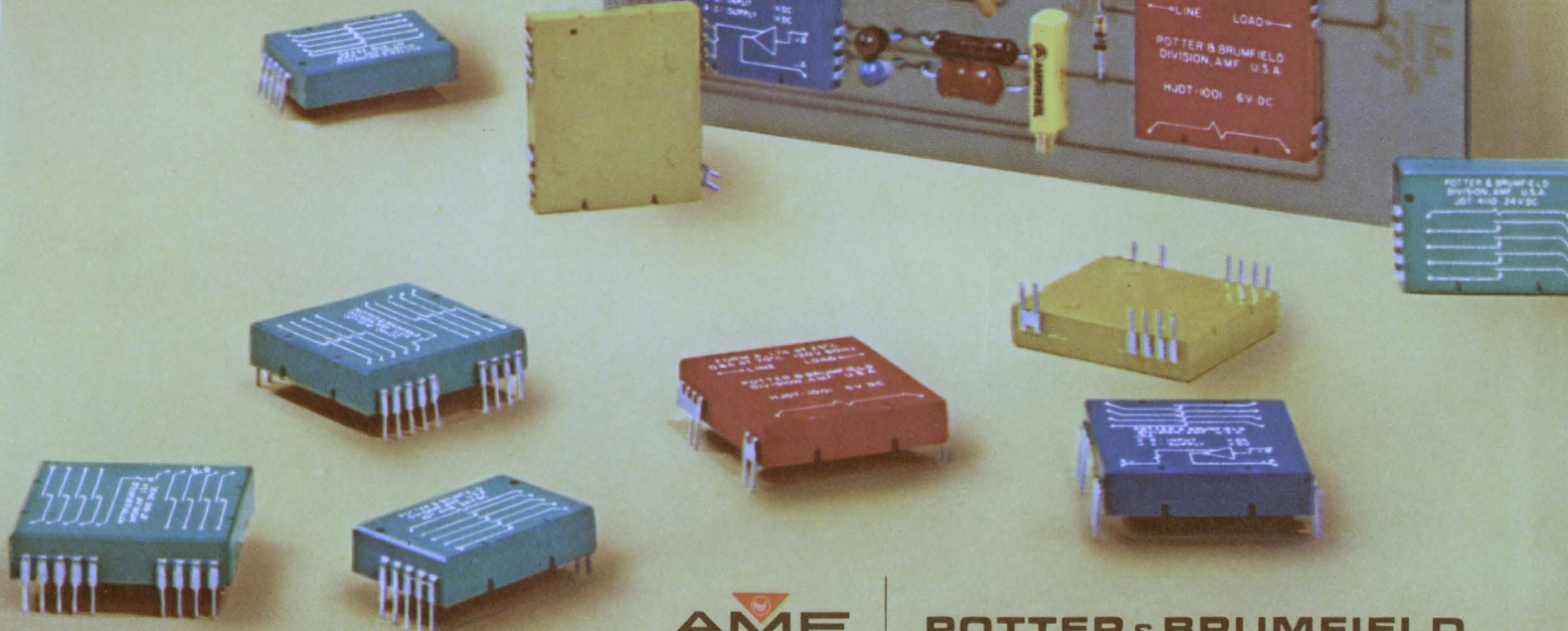
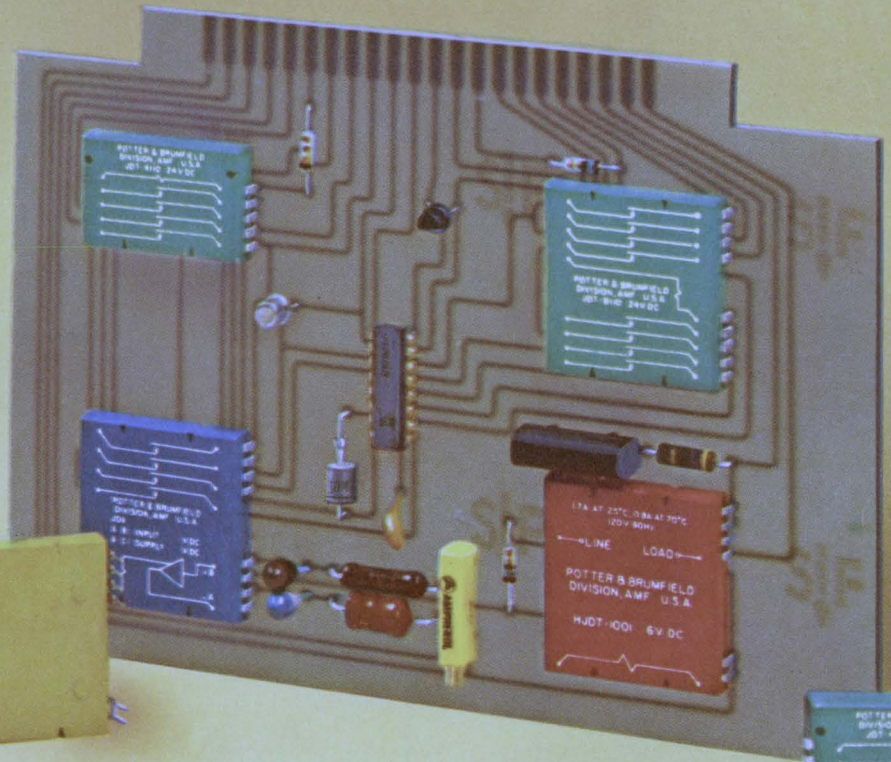



AMF

POTTER & BRUMFIELD

INFORMATION RETRIEVAL NUMBER 34

DIALCO DATALITES[®]

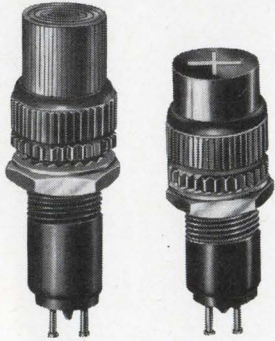
mount as close
as 1/2 inch center
to center



SHOWN ACTUAL SIZE

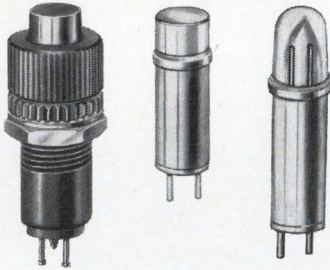

Designed to meet
or exceed requirements of
MIL-L-3661B.

Replaceable plug-in
cartridges: Incandescent for
1.35-120V; neon—high-brightness
operation 110-125V AC, and
standard brightness operation
105-125V AC-DC.

Wide range of lens
shapes, colors and finishes.

Broad selection of
positive or negative legends.

Available off-the-shelf
for prompt delivery.

Send for free catalog



SAMPLES ON REQUEST—AT ONCE
NO CHARGE

Dialight Corporation, 60 Stewart Ave.,
Brooklyn, N. Y. 11237. (212) 497-7600



INFORMATION RETRIEVAL NUMBER 45

SIDELIGHTS OF THE ISSUE

What's new in amorphous semiconductors?

Scientists and engineers are riled over a new field in electronics—amorphous-state physics. It strikes at the theory that semiconductors must be crystalline, and the quarrel usually centers on whether or not practical semiconductor devices can be made from amorphous—unstructured—materials. Our News Editor, John Kessler, has done a report, answering such questions as: What are amorphous materials? What are their properties? What are their potential uses in electronics? At a recent Symposium on Semiconductor Effects in Amorphous Solids held in New York City, Kessler talked with such men in the new field as A. D. Pearson, Bell Telephone Laboratories, L. Gildart, Fairleigh Dickinson Univ. and the most controversial figure in a controversial area—Stanford R. Ovshinsky, president of Energy Conversion Devices, Troy, Mich. For Kessler's report, see p. 25.



Between sessions at a recent symposium, News Editor John Kessler (left) interviews Stanford Ovshinsky.

ED expands western coverage

ELECTRONIC DESIGN has appointed a second West Coast Editor: David Kaye will cover the southwestern states from Los Angeles, while Elizabeth deAtley continues, from San Francisco, to handle the northwestern states.

Dave comes to ED from the Micromega Div. of the Bunker-Ramo Corp., in Venice, Calif., where he was a project engineer. Previously, he was a design engineer for the Airborne Instruments Laboratory, Cutler-Hammer Corp., in Deer Park, N. Y. He has had several articles published on microwaves, his special field.



David N. Kaye

What this country
needs is a good
nickel cigar...
and a $\frac{3}{8}$ " square
industrial
cermet
trimmer.

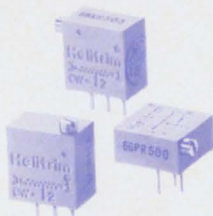

★
Helipot has the trimmer for \$3.50 list...
now available in local stock.

(But you'll have to find the cigar.)

Beckman®
INSTRUMENTS, INC.
HELIPOT DIVISION
FULLERTON, CALIFORNIA • 92634

INTERNATIONAL SUBSIDIARIES: AMSTERDAM; CAPE TOWN; GENEVA; GLENROTHES,
SCOTLAND; LONDON; MEXICO CITY; MUNICH; PARIS; STOCKHOLM; TOKYO; VIENNA

We Androids absolutely demand Guardian Steppers

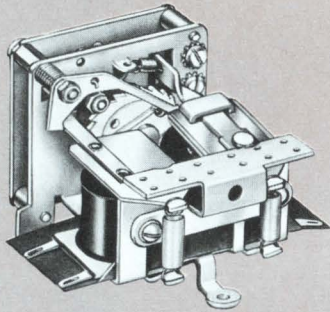

If there's one thing a robot hates it's that embarrassing maintenance check! That's why we want long-life components built for dependable operation. Like Guardian stepping relays (some humans call them rotary stepping switches). They average over five million operations on the life-test rack.

Then, too, Guardian steppers are compact . . . replace relays in series or banks of multiple circuitry . . . so we keep slim.

If you don't want a fat, broken-down android on your hands, specify Guardian steppers. Lots of types available . . . sequence selecting, automatic resetting, pulse multiplying, slave and master, etc., etc. Up to 52 contacts per deck . . . up to 8 undivided circuits. Write for Bulletin F32.

GUARDIAN[®]

GUARDIAN ELECTRIC MANUFACTURING COMPANY

1550 W. Carroll Ave. • Chicago, Ill. 60607



Publisher

Hugh R. Roome

Editor

Howard Bierman

Managing Editor

Frank Egan

Technical EditorsMilton J. Lowenstein
Michael J. Riezenman
Raymond D. Speer
Stella Lawrence**Management and Careers Editor**

Richard L. Turmail

News EditorsRalph Dobriner, Chief
John N. Kessler**Washington News Bureau**

Charles D. LaFond, Chief

Military/Aerospace Editor

John F. Mason

East Coast Editor

Jim McDermott

West Coast EditorsElizabeth deAtley
David N. Kaye**New Products Editor**

Lucinda Mattera

Copy Editor

Marion Allen

Editorial ProductionDollie S. Viebig
Phyllis Gura**Art Director**

Clifford M. Gardiner

Art Assistant

William Kelly

Technical IllustratorsWilliam Alvarez
Rita Jendrzewski
Lynn E. Thompson**Production Manager**

Thomas V. Sedita

Asst. Production Manager

Helen De Polo

Production AssistantsBernard Wolinsky
Carl A. Merkin**Circulation Manager**

Nancy L. Merritt

Information Retrieval

Genate Piccinetti

EDITORIAL



Learn to manage yourself before trying it on others

"If we could but see ourselves as others see us" is as pertinent an idea today as it was when Robert Burns put it in verse. The advice applies especially to the engineer who is on the brink of an advance in his career—a step forward accompanied by the responsibility for managing others. The transition can be difficult. And managing others without the ability to manage oneself is impossible.

We are not given many chances to see ourselves as others see us. We are seldom aware of how we impress our superiors, our peers and our subordinates—of how we are judged by others in conversation and in conflict. We don't always know when our motives are misinterpreted, our voice inflections misread and our words misunderstood.

How can the manager and prospective manager repair broken lines of communication? How can he be sure that he is producing the effect he wants on others?

There are workshops designed for the development of oneself. One session, in particular, that I attended recently stages its program in settings remote from newspapers, TV and the pressure of duty. In this atmosphere, the trainee is at ease, and this makes him more receptive to new ideas, new relationships and new experiences.

Each workshop group at the session was comprised of about 10 to 12 managers who had never met. During the five-day program the participants often found they were more strangers to themselves than to one another. Each man received feedback from the others on his behavior. Once aware of the negative impressions they made, trainees in the workshop found they could begin self-development more effectively.

ELECTRONIC DESIGN will explore the subject of self-development in a special two-part article titled: "Diary of a Leadership Trainee," which begins in the Management and Careers section of an early issue. You are invited to gain some insights on self-management—the first step to management of others.

RICHARD TURMAIL

fastest, most accurate resistor tester yet



Model 501 Resistance Deviation Bridge System: \$5750.

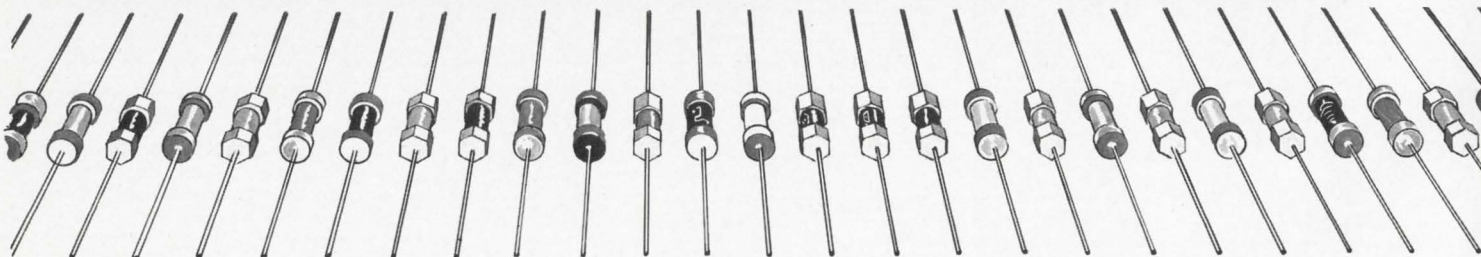

Everybody's talking "automatic-automatic", but we're doing it for resistor testing—and with the speed (100 milliseconds), accuracy (.01% or better) and reliability you're looking for (like our standards, for instance). We've even eliminated thermal emf problems.

Here's a new bridge system that provides all the automation, speed and accuracy you need for your resistor production line, or for any big volume testing, sorting, matching of resistors.

Called the Model 501, the system employs a fully automatic, Kelvin resistance deviation bridge which measures a component and displays its deviation digitally in percent from the setting of the system's standard. Standard measuring accuracy of the total system is 100 ppm, with 10 ppm available as an option.

The 501 completes a measurement cycle in 100 milliseconds, while at the same time cancelling out thermal emf's — through a unique auto zero circuit — and achieving excellent normal mode AC rejection (greater than 80db). The system verifies its connections to the component under test and stops if contact closure is not made.

Complete automation of the entire test

operation is available from ESI, including parts handlers, scanners, data couplers, data logging equipment and computerization.

Several different basic applications can be fulfilled by a 501 system and appropriate peripheral gear, including:

- a) rapid sorting of resistors of all accuracy classes (.005% down to 30% accuracy).
- b) automatic testing for environmental and temperature coefficient characteristics.
- c) computerized matching of resistors by value and temperature coefficients.
- d) automatic control of thin-film resistor manufacturing processes.

Only at ESI will you find the complete system capability you need, coupled with the warranted accuracy and reliability ensured by a leading designer of standards and calibration instruments.

Call us now, collect, or write for our brochure on "Automated Resistance Measuring."

TESTING FOR TEMPERATURE COEFFICIENTS

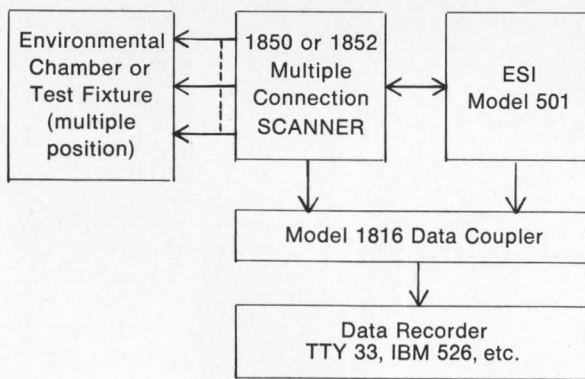

HIGH SPEED SORTING WITH DATA LOGGING

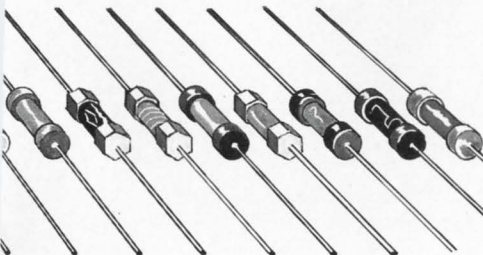
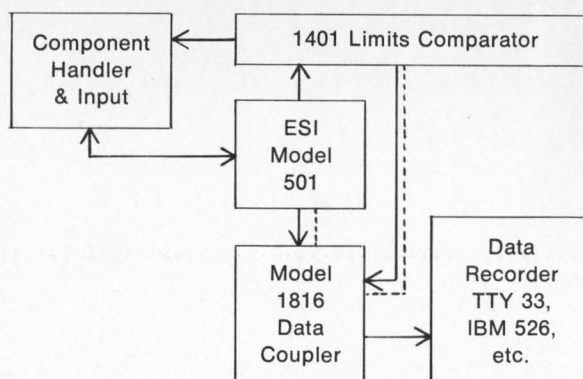

esi®

Electro Scientific Industries

13900 N.W. Science Park Drive

Portland, Oregon 97229 • Phone 503/646-4141

INFORMATION RETRIEVAL NUMBER 48



Room for improvement

General Electric's TO-5² transistor-size sealed relays give you more room for increased power, improved performance

We didn't cut any corners on this high-reliability, transistor-size sealed relay. We left them on so there'd be more room for a more powerful magnet—2½ times more powerful.

This added power means this type 3SBS, 2PDT, 1 amp relay gives you higher contact forces, larger contact gaps, and greater overtravel to minimize mechanical shifts. Shifts which usually increase early-in-life failures.

Though there's more room inside to give you all these advantages, the outside dimensions—top-to-bottom (.275") and side-to-side (.370")—are the same as any transistor-size relay.

So don't cut corners on your next transistor-size relay application. Specify GE's square Type 3SBS. For full details, write General Electric, Section 792-45, Schenectady, New York 12305.



ACTUAL SIZE

GENERAL  **ELECTRIC**

New Miniature Power Supplies for Op-Amps and IC Logic Circuits

Now at new low prices

(Model 904)

±15V @ 50mA ... \$39

(Model 902)

±15V @ 100mA ... \$49

(Model 903)

5V @ 500mA .. \$49

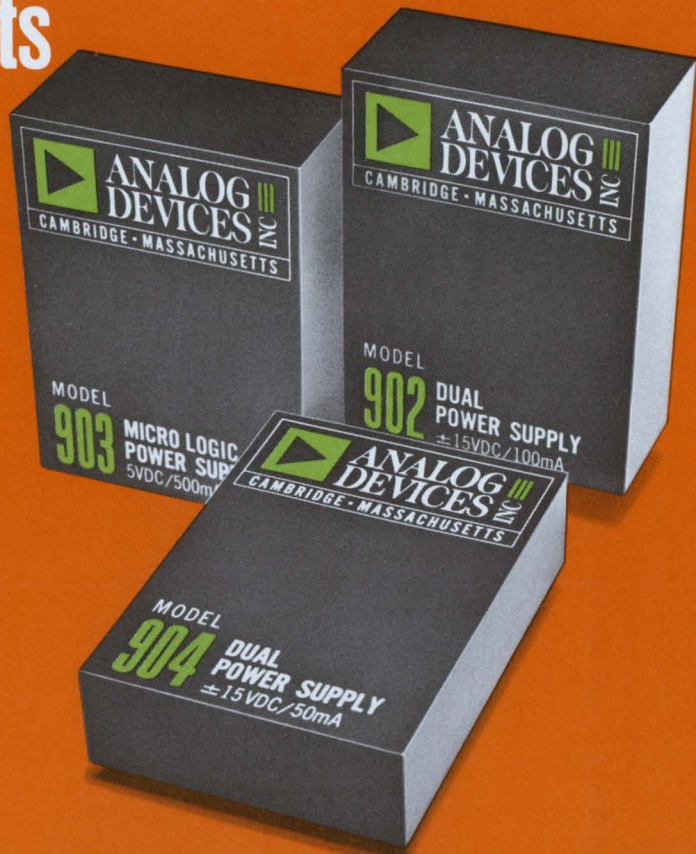

The circuit designer's best friend these days is the packaged circuit module. Engineers everywhere have discovered the convenience and economy of "plug-in" building blocks . . . op-amps, logic cards, miniature D/A converters, etc. Relatively new on the scene are power supply modules. The only problem, until now, has been the cost.

ANALOG DEVICES BREAKS THE PRICE BARRIER!

Special circuit design and high volume manufacturing techniques have led to dramatic cost savings . . . NOW YOU CAN BUY MINIATURE POWER SUPPLY MODULES, READY TO GO TO WORK FOR YOU, AT PRICES BELOW THE INTERNAL MANUFACTURING COST OF MOST OEM USERS! You get further cost savings (and reduced lead time) by eliminating engineering start-up and manufacturing lags. Just unpack and solder into your circuit board! (optional mating sockets are available for plug-in use). Meet your power supply requirements instantly, and with performance tested and guaranteed.

Designed by experts in op-amp and digital logic technology, these new supplies offer features (such as short-circuit and overvoltage protection) that you'd expect to find only in supplies of twice the size and cost. Ripple, noise and regulation are just right for almost all applications.

FREE TRIAL OFFER

We're so sure that once you see one of these great little supplies you won't want to part with it that we're prepared to send one to you for a free 30 day trial. At the end of the trial period you simply return the unit or send your purchase order. No risk to you and no obligation to buy, of course. USE THE INSTANT ACTION CARD.

**Instant
action card**

For detailed specs
Free trial offer
New catalog

BUSINESS REPLY MAIL
NO POSTAGE STAMP NECESSARY IF MAILED IN THE UNITED STATES

POSTAGE WILL BE PAID BY



**ANALOG
DEVICES** INC

221 FIFTH STREET • CAMBRIDGE • MASSACHUSETTS 02142

FIRST CLASS
Permit No. 39342
Cambridge, Mass.

| | MODEL 902 Op-Amp Supply | MODEL 904 Op-Amp Supply | MODEL 903 IC Logic Supply |
|---|---|---|---|
| INPUT VOLTAGE | 105 to 125VAC ¹ 50 to 400Hz 17VA max | 105 to 125VAC ¹ 50 to 400Hz 9VA max | 105 to 125VAC ¹ 50 to 400Hz 17VA max |
| OUTPUT VOLTAGE (fixed) | ±15V @ 0 to 100mA | ±15V @ 0 to 50mA | ±5V @ 0 to 500mA |
| ACCURACY | ±(15.0 to 15.3)V -15V within ±1% of +15V | ±(15.0 to 15.2)V -15V within ±¾% of +15V | Within ±1% of +5V |
| TEMP COEFFICIENT | 0.015%/°C max | 0.03%/°C max | 0.02%/°C max |
| REGULATION Line (105 to 125VAC) Load (0 to 100%) | 0.05% max 0.1% max | 0.1% max 0.1% max | 0.15% max 0.3% max |
| WARM UP DRIFT | ±0.3% (45mV) | ±0.25% (37mV) | ±0.3% (15mV) no overshoot on turn-on |
| RIPPLE | 0.5mV rms, 2mVp-p max | 0.5mV rms, 2mVp-p max | 1mV rms, max 5mVp-p max |
| OUTPUT IMPEDANCE | 2 ohms @ 10kHz | 0.2 ohms @ 10kHz | 25 milliohms @ 10kHz |
| SHORT CIRCUIT PROTECTION | Either output to common indefinitely 0 to 71°C | Any combination of output pins indefinitely 0 to 71°C | Output to common indefinitely. |
| OVERVOLTAGE PROTECTION | ————— | ————— | 6.5V max (internal fault) (Protected against reversed polarity) |
| OPERATING TEMPERATURE | 0 to 71°C derate 5mA/°C above 60°C derate 1mA/°C | 0 to 71°C derate 2mA/°C above 55°C derate 0.5mA/°C below 10°C | 0 to 71°C derate 12mA/°C above 50°C derate 10mA/°C below 15°C |
| STORAGE TEMPERATURE | -25 to +85°C | -25 to +85°C | -25 to +85°C |
| SURFACE TEMPERATURE RISE | 20°C above ambient @ full load | 25°C above ambient @ full load | 35°C above ambient @ full load |
| INPUT ISOLATION | 50 Megohms | 500 MΩ 100 pF | 500 Megohms |
| WEIGHT | 16 oz. | 10 oz. | 17 oz. |
| PRICE | 1-9 \$49. 10-24 \$47. | \$39. \$38. | \$49. \$47. |

1. Input voltage of 205 to 240VAC available. Specify Model 90...E. Mating Socket AC1013 \$3.75

Power Supply Bench Mount Manifold

The model 950 power supply manifold allows use of our modular power supplies on the design bench. In combination with either the model 904 or 902, it provides a safe, convenient, and inexpensive supply for breadboarding, testing, or general laboratory use.

The device incorporates a 3 wire power cord, line fuse, on-off toggle switch, and four universal terminals (+Vs, -Vs, output common, and power line ground). It is constructed in a rugged epoxy enclosure with four soft rubber feet. The power supply is simply plugged into mating receptacles and may be easily removed or replaced. Price is just \$16. (1-9), \$15. (10-24)

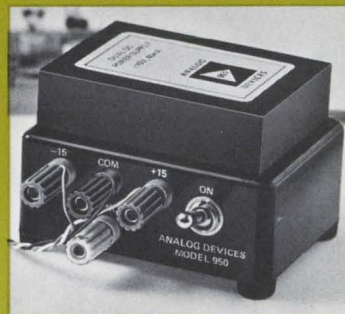

OUTLINE DIMENSIONS

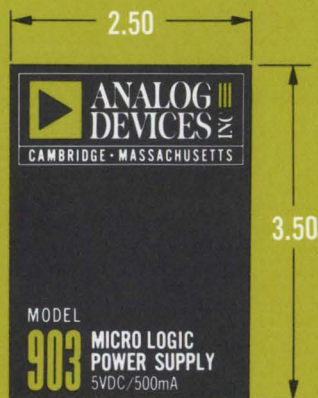

Height: Model 902-1.25" Model 903-1.25" Model 904-.875"

221 FIFTH STREET • CAMBRIDGE • MASS. 02142 • (617) 492-6000 • TWX: (710) 320-0326

INSTANT ACTION REQUEST

Please send free catalog

I am interested in model

904 Special

902 _____

903 _____

950 _____

My interest is for:

Immediate application

Anticipated application

Information only

Send OEM Quantity prices

Add my name to Mail List

Have salesman call

FREE TRIAL OFFER

Please send the following unit(s) for 30 day free trial:

Model _____ Quantity _____

Model _____ Quantity _____

I understand that at the end of the 30 day trial period, I will send a purchase order (based on the prices published herein) for any units I decide to keep. I further understand that I may return these units at any time within 30 days with no obligation to buy.

Advance P.O. # _____

P.O. will follow after my approval

Date _____ Initials _____

Name _____ Title _____

Company _____ Dept./Mail Station _____

Address _____ Phone _____

City _____ State _____ Zip _____

FREE NEW CATALOG

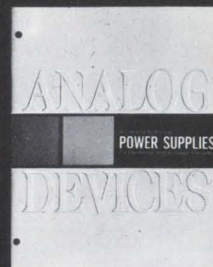

Analog Devices now offers an extremely broad line of op-amp, logic circuit, and special purpose power supplies. A free new 12 page catalog is now available with complete specifications, application data and prices. Get your copy now, use the instant action card.

Now from Philco!

10 standard MOS shift registers --instantly available!

Just pick up your phone. Ask us for MOS dynamic shift registers. You'll make your selection from the broadest line on the market, including the longest (256 bits) and the fastest (standard 5MHz clock rate) commercially available.

Best of all, you'll get them *now*. The Philco MOS shift registers listed here are all being made today in volume production at our Lansdale plant, which is one of the largest MOS facilities in the country. They're standard products, fully tested and proved, and ready to ship immediately from stock.

Another standard Philco MOS device instantly available is the 1024-bit read-only memory, programmed as a sine look-up table.

These are the first of a growing line of standard Philco MOS devices. We're the place to look when you want MOS *now*. Write or call MOS Marketing, Microelectronics Division, Philco-Ford Corporation, Blue Bell, Pa. 19422; telephone 215-646-9100.

These standard MOS dynamic shift registers and sine look-up table are available, now!

| Device | Description | Package |
|--------------|--|-----------|
| pL5R32C(1) | Dual 8/16-bit shift register | TO-5 |
| pL5R40C(1) | Dual 20-bit shift register | TO-5 |
| pL5R96C(1) | Dual 48-bit shift register | TO-5 |
| pL5R100C(1) | Dual 50-bit shift register | TO-5 |
| pL5R128C(2) | Dual 64-bit shift register | TO-5 |
| pL5R128AC(3) | Dual 64-bit shift register | TO-5 |
| pL5R250C(2) | 250-bit shift register | TO-5 |
| pL5R250AC(3) | 250-bit shift register | TO-5 |
| pL5R256C(2) | 256-bit shift register | TO-5 |
| pL5R256AC(3) | 256-bit shift register | TO-5 |
| pM1024 | 1024-bit read-only memory (sine look-up table) | Flat pack |

(1) Clock rate 500KHz (2) Clock rate 2MHz (3) Clock rate 5MHz

the NOW people in MOS

PHILCO



INFORMATION RETRIEVAL NUMBER 50

Clevite quartz & ceramic filters

for the man with designs on something better.

Clevite's full line of solid-state filters covers *all* your selectivity requirements. Whether it's adjacent channel interference . . . weak signals . . . 180 dB stopband rejection . . . single or double conversion . . . a smaller package . . . higher shock . . . or cost reduction . . . Clevite can supply the amount of selectivity your design requires at the frequency that serves you best.

■ And we can do it entirely in quartz, or combine the economy and shape factors of a ceramic ladder with a minimal number of quartz sections for the optimum performance/cost package. Either way, you're sure of getting the smallest, lightest, most rugged filters around.

■ Take our monolithic quartz filters, which are ideal for going to IC's and higher IF's. They're developed through advanced engineering techniques that use Clevite's original thin film

approach. Resonator isolation and spurious suppression are controlled by the trapped energy principle. Clevite quartz filters come in 2, 4, and 6 pole models, with a range

of center frequencies from 8 MHz to 75 MHz, in independent or coupled mode.

■ Clevite ceramic filters provide steep-sided selectivity . . . a large bandwidth range . . . high stopband rejection . . . and clean response.

They're permanently tuned . . . immune to magnetic fields. And they remain highly stable with both temperature and time. It's your choice of TCF, split ring, 11 or 17 disc ladder and fixed-tuned transfilter models in a range of bandwidths and characteristics to cover almost any communications application.

■ Clevite solid-state filters run the gamut from economy to mil spec grades, in 9 kHz through 75 MHz. With bandwidth capabilities to 80 kHz. And your choice of lumped or distributed selectivity. In a broad range of performance characteristics and prices.

■ Clevite . . . the single, reliable source for all your selectivity requirements. Call us for application assistance. Or write for descriptive literature on our complete filter line. Clevite

Corporation, Piezoelectric Division,
232 Forbes Road,
Bedford, Ohio 44146.

CLEVITE

Sock it to the 101B



...hermetically sealed hybrid

This FET op amp can take it. Fairchild hybrid ADO-101B is made for use in severe environments. It's hermetically sealed and shielded in a metal package. The use of hybrid thin film circuitry assures long term stability and permits greater packaging density. Less than 0.5 square inch of board area is required for mounting. Terminal pattern is the popular 14 pin dual-in-line.

Electrically, the ADO-101B features input offset voltage specified over the full temperature range of -55°C to 125°C . Maximum noise is $3\mu\text{V}$; common mode rejection is 88 dB minimum, and minimum open loop gain is 400,000.

Units are available from stock. Price: \$95 each in 1-24 quantities.

ADO-101B Specifications

| | | |
|---|--------------------------------|--|
| Open loop gain | $R_L = 2\text{K}\Omega$ | 1,000,000 (typ) 400,000 (min) |
| Common mode rejection | $\pm 5\text{Vcm}; 20\text{Hz}$ | 100 dB (typ) 88 dB (min) |
| Offset voltage drift vs. temperature (-55°C to 125°C) | $R_i = 50\Omega$ | $10\mu\text{V}/^{\circ}\text{C}$ (typ) $25\mu\text{V}/^{\circ}\text{C}$ (max) |
| Input bias current | | 19 pA (typ) 40 pA (max) |
| Noise | 0.1Hz to 1kHz | $3.0\mu\text{V}$ (max) |
| Output voltage swing | $R_L = 10\text{K}\Omega$ | $\pm 14\text{V}$ (typ) $\pm 12\text{V}$ (min) |
| Output current | $R_L = 2\text{K}\Omega$ | $\pm 8\text{mA}$ (typ) $\pm 5\text{mA}$ (min) |

FAIRCHILD
CONTROLS

A DIVISION OF FAIRCHILD CAMERA AND INSTRUMENT CORPORATION

Modular Products / 423 National Avenue / Mountain View, CA 94040 / (415) 962-3833

Standard Circuit of the Month

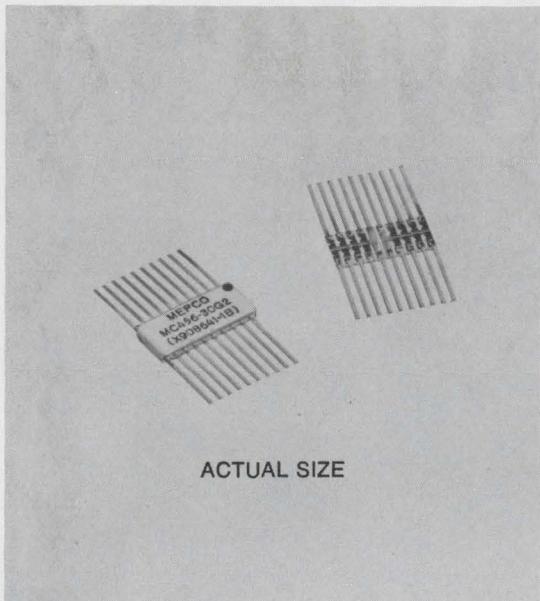

- Cermet Construction
- Ceramic Enclosure
- High Temperature Termination System
- Packages up to 13 Resistors

Ceramic Sandwich Resistor Flatpack

Maximum Ratings

Power Dissipation: .250 watts at 125°C
Operating Temperature: -55°C to +150°C
Storage Temperature: -65°C to +150°C
Resistance Range: 33Ω to 200 KΩ
Tolerance: 1%
Temperature Coefficients: less than 100 ppm/°C

Mepeco Ceramic Sandwich Resistor Flatpacks economically eliminate the need for stacking a variety of resistor types whenever a pattern of values is used repetitively throughout a resistor system. This new microcircuit provides up to 13 resistors preconnected in a single miniature package at a low price. Mepeco

is now equipped to quickly mass produce these unique flatpacks to comply with customer requirements.

For complete information, write for data sheet MC5-669

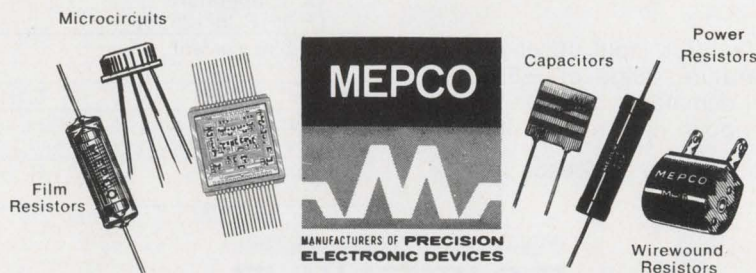

MEPCO INC., COLUMBIA ROAD, MORRISTOWN, N.J. 07960 • (201) 539-2000 • TWX: 710-986-7437

INFORMATION RETRIEVAL NUMBER 53

JAN2N3055/ JANTX2N3055

NOW FROM BENDIX.



The new Bendix JAN2N3055 and JANTX2N3055 silicon mesa power transistors conform to all characteristics of Mil-S-19500/407. Both offer you improved maximum ratings and greater optimum power handling capabilities for switching and regulator applications. Increased power ($P_T = 117W$), coupled with optimum "turn-on" and "turn-off" times (on = $6\mu\text{sec}$; off = $12\mu\text{sec}$) create a more desirable device for your military, audio amplifier and public address system applications.

Our JANTX2N3055 undergoes 100% screening to assure compliance with high-reliability requirements, as well as total "burn-in" processing. Both models are Safe Operating Area (SOAR) specified to prevent second breakdown—like our commercial 2N3055.

The JAN2N3055 and the JANTX2N3055. Two more reasons why we're called the real power in power. Two more reasons for you to call us.

Contact your nearest Bendix sales office for comprehensive data. Or, if you prefer, write us direct: The Bendix Corporation, Semiconductor Division, Holmdel, New Jersey 07733.

ELECTRICAL RATINGS

| Symbol | Characteristics |
|---------------------------------|-----------------------------|
| $V_{(BR)CEO}$ | 60V (min) |
| I_C | 15A |
| $P_T (@T_C = 25^\circ\text{C})$ | 117W |
| θ_{JC} | 1.5°C/W (max) |
| Turn-on time | $6\mu\text{sec}$ (max) |
| Turn-off time | $12\mu\text{sec}$ (max) |

Bendix **Electronics**

Chicago—(312) 637-4633; Denver—Electronic Component Sales, (303) 771-6200; Detroit—(313) 548-2120; Greenwich, Conn.—(203) 869-7797; Holmdel, N.J.—(201) 946-9400; Horseheads, N.Y.—(607) 732-1882; Lexington, Mass.—(617) 861-8350; Los Angeles—(213) 776-4100; Merriam, Kansas—Mid-America Marketing, (913) 432-8678; Minneapolis—(612) 926-4633; Orlando, Fla.—(305) 423-6048; Richardson, Texas—P. J. Scanlon Co., (214) 213-4661; Rochester, N.Y.—(716) 266-5550; Runnemede, N.J.—(609) 933-2550; Seattle—Ray Johnston Co., Inc. (206) 542-5170; Timonium, Maryland—(301) 828-6877; Export—Cable: "Bendixint," 605 Third Avenue, New York, (212) 973-2121; Ottawa, Ont.—Computing Devices of Canada, P.O. Box 508 (613) 829-1800; San Juan, Puerto Rico—Southern International Sales Co. 723-3879.

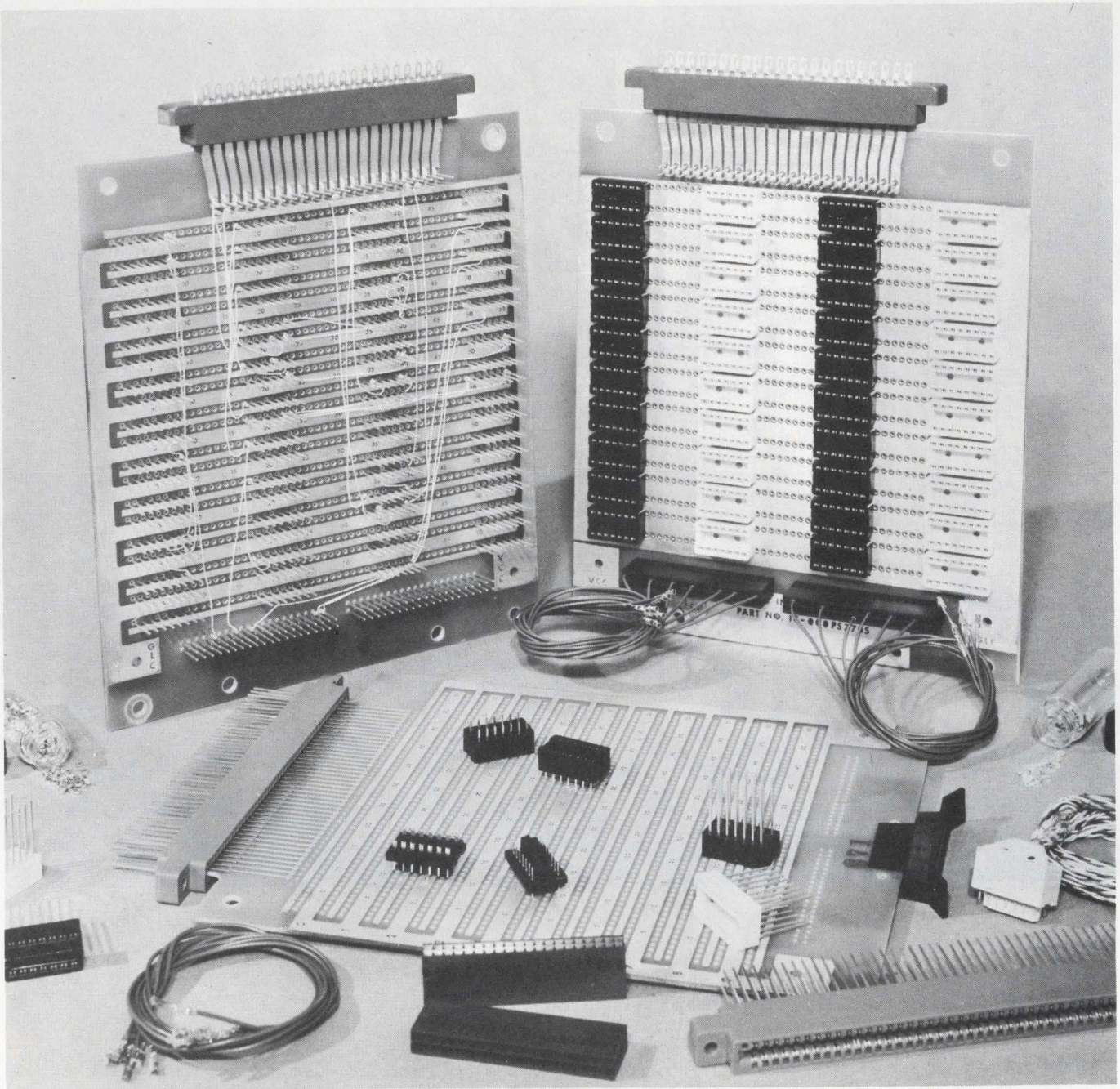

JUST ADD LOGIC

That's all you do with our Select-A-Wrap* panel. It's Texas Instruments exclusive do-it-yourself panel for prototyping and production packaging of integrated circuits. Once your new circuit design is set, just complete our Select-A-Wrap ordering form and TI will take it from there. You get all the features of custom-designed wire-wrap panels — minus tooling costs and with two weeks or

less turn-around-time. That's because Select-A-Wrap panels and their associated hardware are standard off-the-shelf items; ready for assembly to your specifications. Flexibility is the key with Select-A-Wrap. You can choose any combination of 14- and 16-pin sockets. Opposed ground and power planes surround all pins so that any pin may be soldered to power or ground. Pins are

individually replaceable without removing sockets from the panel. If you prefer to do your own breadboarding, TI offers its unique Select-A-Wrap panel prototyping kit. Write or call TI Connector Products Marketing, Attleboro, Mass. 02703, Phone 617-222-2800, or your local TI Distributor.



TEXAS INSTRUMENTS
INCORPORATED

*Trademark of Texas Instruments Incorporated

INFORMATION RETRIEVAL NUMBER 55

ELECTRONIC DESIGN 13, June 21, 1969

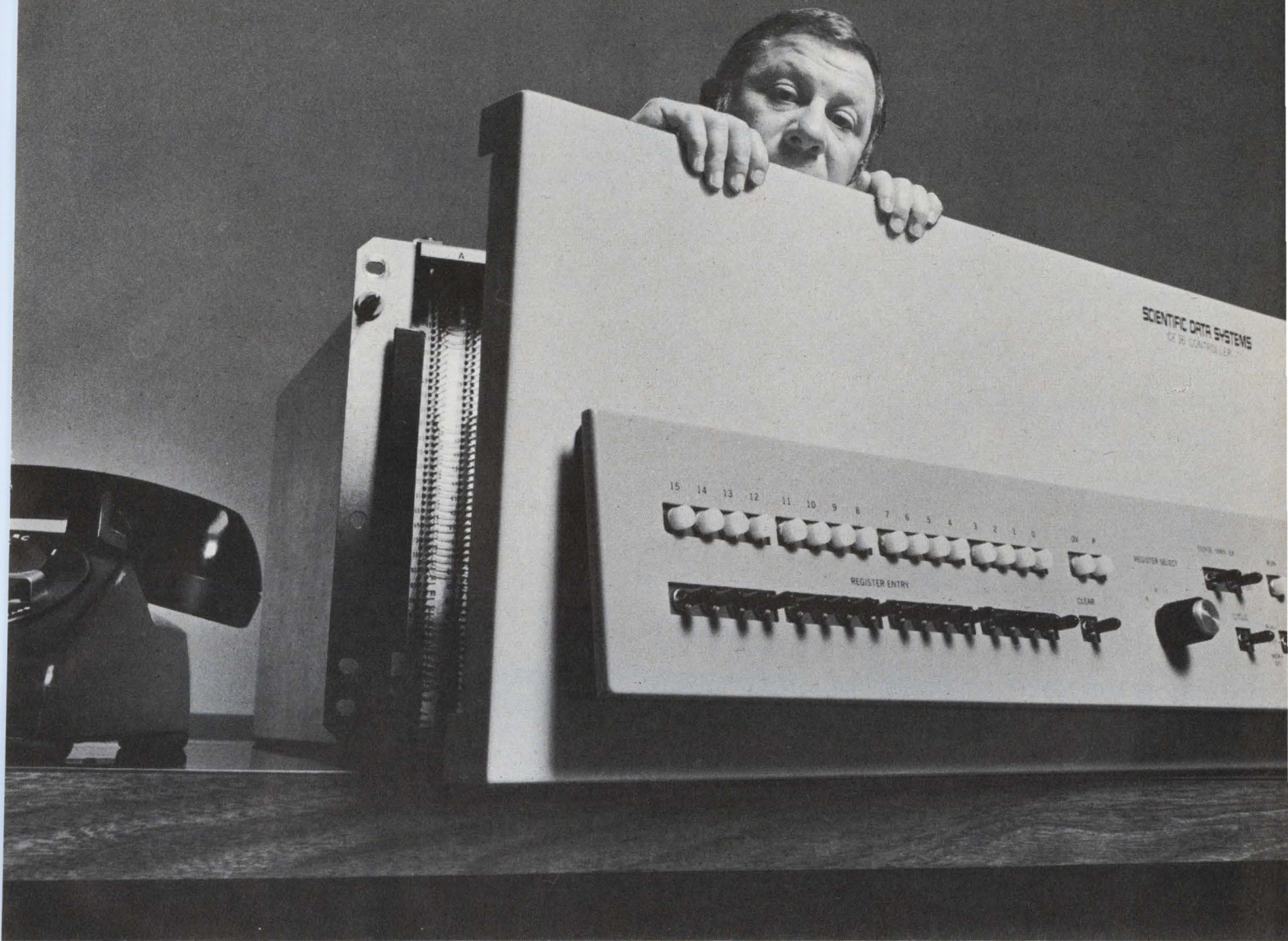

Our new mini-computers have built-in programmers.

Most small computers are designed for programmers. Ours are designed for people.

Just tell our 16-bit machines what you want done. The CE16 and CF16 will do it, because their "built-in programmers" (a comprehensive set of sophisticated instructions) let any engineer use them with ease. For example, the single instruction "scan memory" makes our machines compare a given number with the contents of the entire memory.

The CE16 and CF16 have 125 other heroic instructions that specify comprehensive maneuvers. So you give fewer instructions and use far less core memory than with any other small computer. Problem run times are shortened and Input/Output operations are simplified.

The CE16 and CF16 are designed to control and exchange information with a large number of external devices while doing related computation. Their "automatic I/O" enables them to talk back and forth between memory and a group of interrupting peripherals, in order of priority,

without needing attention from the on-going program.

Automatic I/O isn't a high priced option. Neither is a teletype, nor three priority interrupts, one of which is indefinitely expandable. They're all standard. The only thing you might pay extra for is speed. The CF16 can do a fully signed software multiply in 42 micro-seconds. But it costs a little more than the CE16 which takes 126 micro-seconds (which isn't bad) for the same job.

Don't take our word for all this. Drop us a line asking for:

- A brochure with straight from the shoulder specs so you can compare.
- A representative with more information than could fit in a brochure.
- Or a meeting between our sales engineer and one from any competitor you want, at your office. The competition can even bring a programmer along. We won't have to.

SDS
Scientific Data Systems,
El Segundo, California

Take a look... this counte



speaks for itself

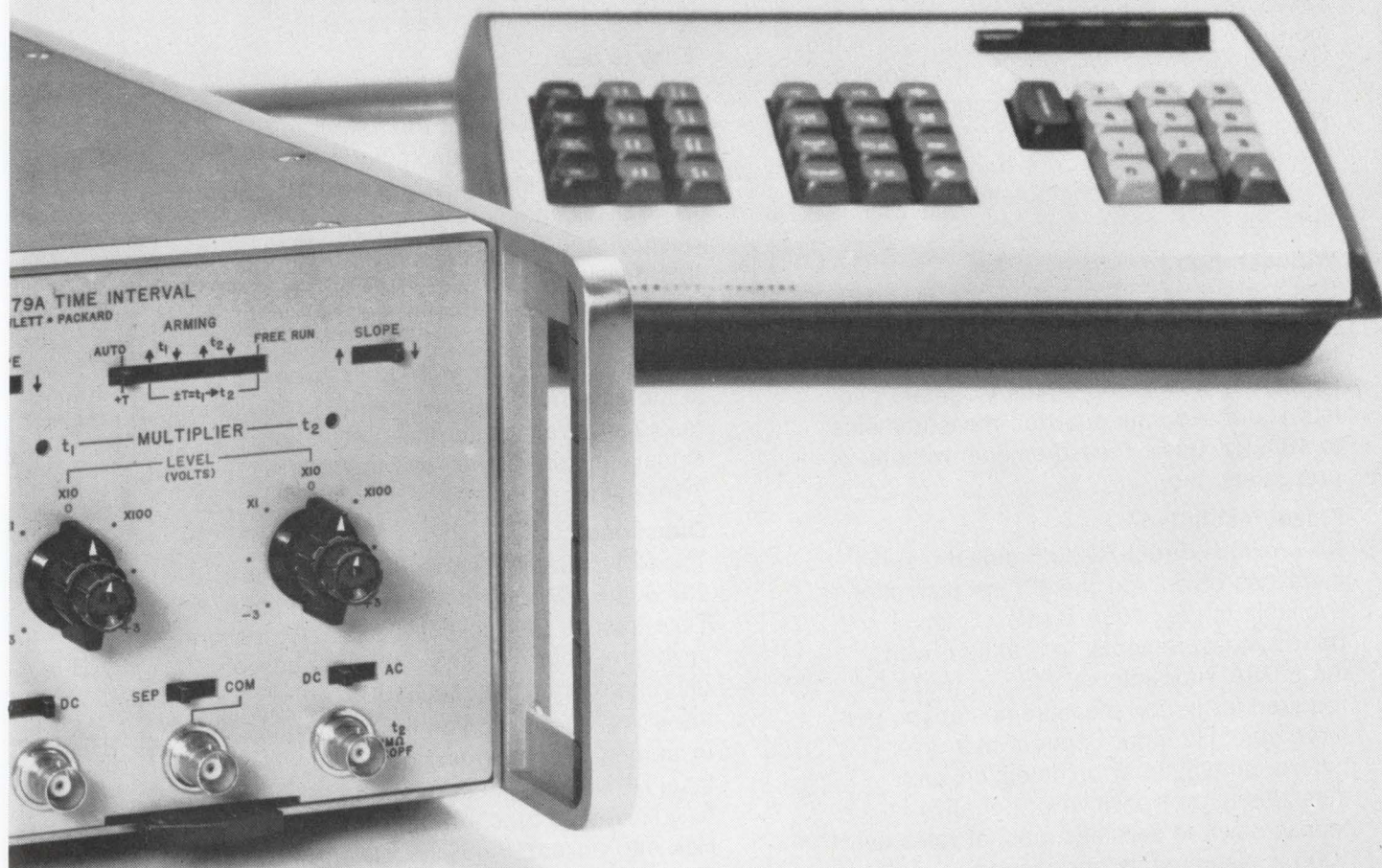

A word from the new HP 5360A Computing Counter:

Measurement and computation

The revolutionary new Hewlett-Packard 5360A Computing Counter, the most significant advance in counter technology since 1952, uses built-in interpolation with computation to eliminate the traditional ± 1 count ambiguity. It combines an IC period-measuring counter and an internal computer in a compact, easy-to-use package. Lets you measure frequency 1000 times faster, much more accurately and over a wider range than ever possible before. Basic measurements, 0.01 Hz to 320 MHz are automatic, with period and time interval resolution to 0.1 ns — a resolution never before offered in a counter. The 5360A's computing capability lets you automatically and in real time solve equations whose variables are the counter's measurements!

Fast and true

Take speed — the 5360A's up to 100 times more accurate than previous counters for the same speed. Take accuracy — it's 3 to 1000 times faster for the same accuracy. The previous ± 1 count accuracy limitation is decreased by a factor of 1000 by interpolators and digital computation within the 5360A.

Widest range

Besides the basic 0.01 Hz to 320 MHz measurement range, the 5360A accepts all the heterodyne converters of the popular HP 5245L, 5246L and 5248L Counters and lets you make spurious-free measurements to 18 GHz. Basic measurements without prescalers, too.

Finest resolution

No previous direct-reading digital instrument has given you the 0.1 ns resolution available in the 5360A for time interval and period measurements. In addition, with the 5379A Time-Interval Plug-in (not required for period measurements) you get more versatile input controls than ever before, automatic error detection and measurement of positive or negative intervals down to zero seconds, at rates over 1000 measurements per second.

Pulsed RF measurement

With none of the tedious transfer oscillator manipulation and calculation, the 5360A will measure pulsed signals up to 320 MHz with pulse length as short as 1 microsecond — and do it automatically and directly. Using the frequency converter plug-ins, you can measure pulsed carriers all the way to 18 GHz. And you can even measure a single burst of signal, which you can't do with transfer oscillators.

Computation

The 5360A and its accessory plug-in program module (available now) or its keyboard (available later this year) let you get direct answers in final form, real-time solutions to equations... without additional costly processing equipment and interface design. Two simple examples are direct readout measurements of phase or the rms value of a series of measurements.

Easy to use

Front-panel controls provide new dimensions of versatility, yet the 5360A is easy to use. There's a new minimum in the need to manipulate controls. Range selection, for example, is automatic over the entire frequency range, no matter what the setting of the Measurement Time switch. The 5360A gives you a fixed-decimal display, with automatic blanking — your reading is always in the same position, with up to three digits to the left of the decimal, up to 11 digits in resolution... all via internal calculation. It's virtually impossible to read the 5360A incorrectly.

Questions?

The 5360A Computing Counter with the 5365A Input Module costs \$6500. The 5367A Time-Interval Plug-in costs \$750. Accessory keyboard, approximately \$1000. Accessory plug-in program module, \$190.

For all the information on this break-through instrument in counter technology, call your local HP field engineer. Or write for our fully illustrated brochure and data sheet: Hewlett-Packard, Palo Alto, California 94304; Europe: 1217 Meyrin-Geneva, Switzerland.



ELECTRONIC COUNTERS
INFORMATION RETRIEVAL NUMBER 57

02907

Technology

IDEAS FOR DESIGN

Save design time with these digital techniques. More than 20 separate circuits and

design approaches have been grouped in one section for your convenience. p. 77

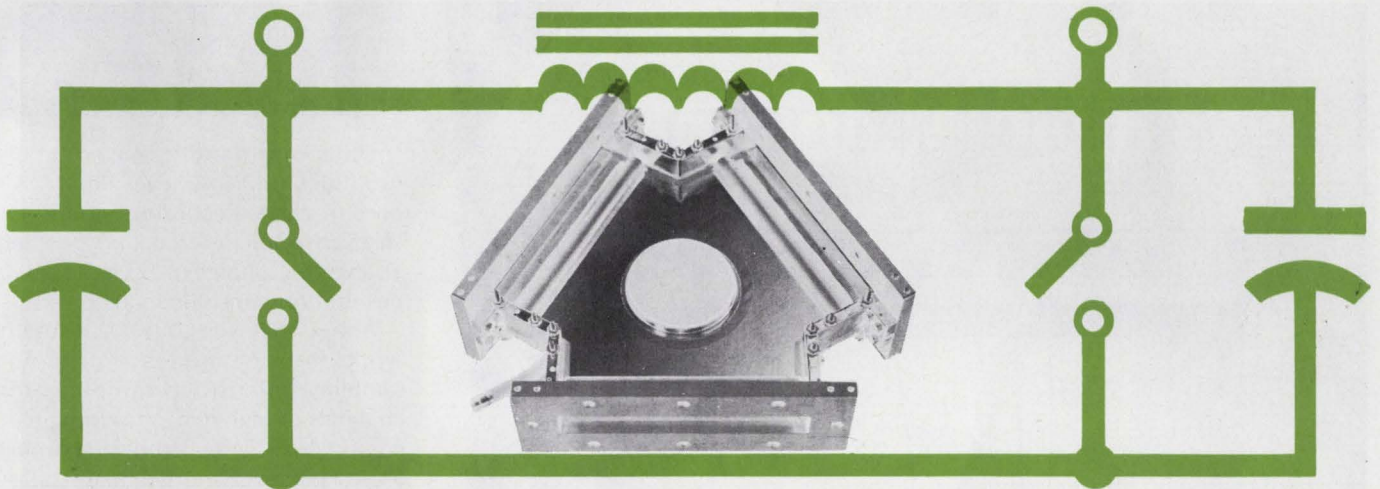

Don't waste drive power in microwave switching. Reverse the direction of an inductor's

current by temporarily storing the energy in a capacitor. p. 106

Also in this section:

Choose voltage-regulator operational amplifiers with care. p. 98

Design many filters with one BASIC program. p. 114

Play your way to better decisions with management training games. p. 124

**Meet Datapoint.
It's 20 times faster
than other multipoint recorders.
And infinitely more versatile.**

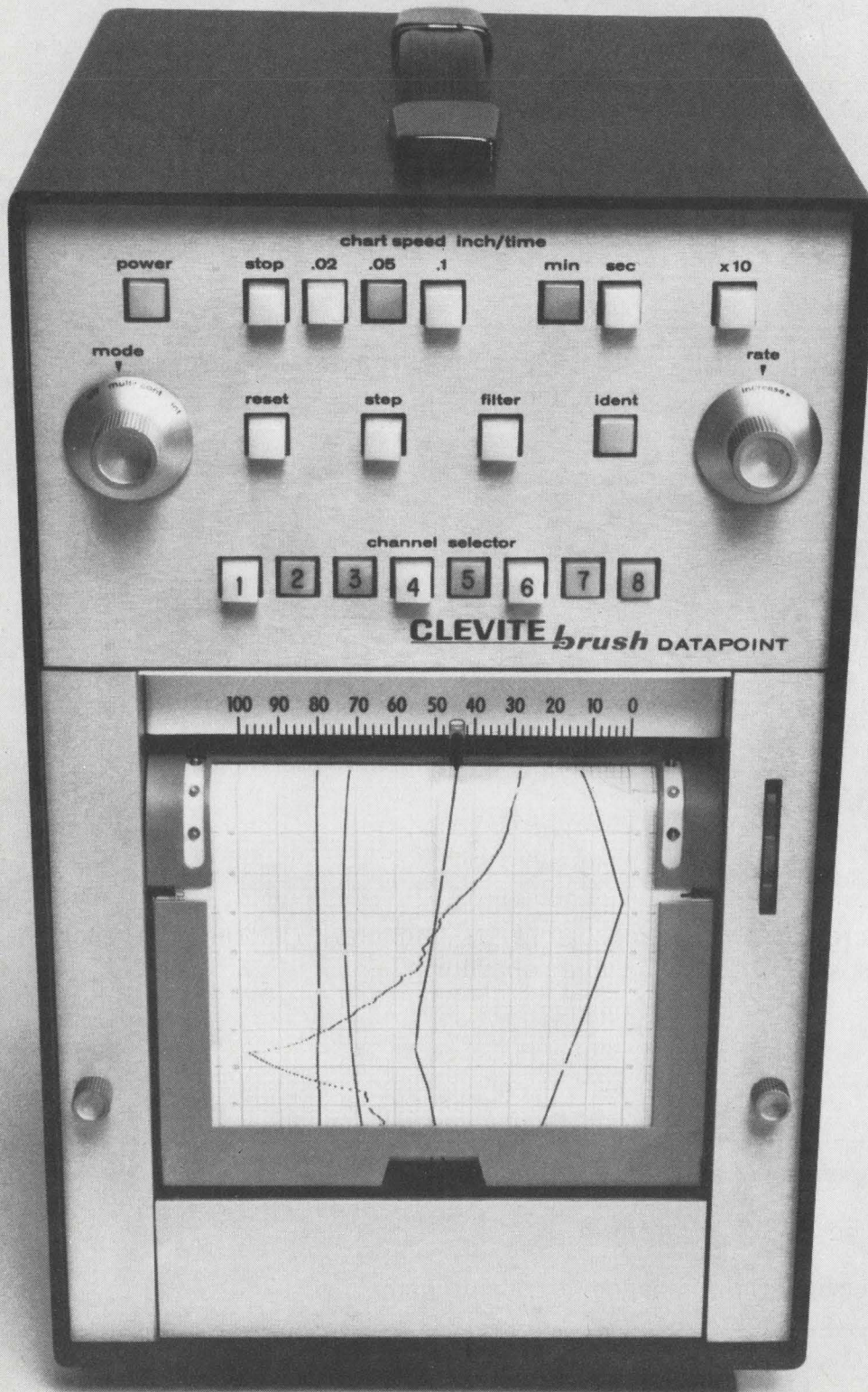

This new high-speed multipoint recorder by Brush runs off as many as 20 samples per second on 2 to 8 channels. So it's great for monitoring fast-changing variables in temperature, flow, pressure, strain, chemical processes, displacement dynamics and the like.

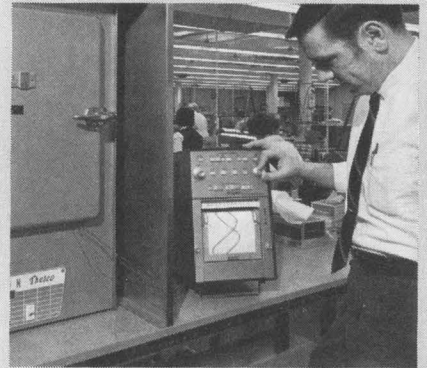

Datapoint handles mixed inputs from high and low level inputs. All on one chart. Recordings come out clear, crisp, uncluttered. And Z-folded. You've got a choice of 12 chart speeds, pushbutton controlled.

About that versatility. Datapoint works in three modes: multipoint sampling, intensified sampling, for channels of high dynamic content, or continuous single channel recording. So you get much more than just a fast multipoint recorder. Without paying more to get it.

And Datapoint is accurate, too. A full 99.5%, enforced by a non-contact position-feedback system. It's a first in this type of recorder. (But a proven success in countless Brush direct writing oscillographs.)

Speed. Versatility. Accuracy. These make Datapoint a new concept in recording. There's never been anything like it. You'll find more proof in the Datapoint brochure. Send for your copy today. Clevite Corporation, Brush Instruments Division, 37th and Perkins, Cleveland, Ohio 44114.

CLEVITE BRUSH
INFORMATION RETRIEVAL NUMBER 58

a special collection of

IDEAS FOR DESIGN

Digital Circuits and Techniques

Ideas for Design has been an extremely popular section of **Electronic Design** for many years, and one of its most popular categories is that of digital circuits and techniques. This special feature groups together, for easy reference, over 20 separate digital circuits and design approaches. Each item has a reader-service number to be used in voting for Best of Issue. The top five vote getters will be the winners. (See box at end of report for details.)

Following are the basic circuit categories used in the report:

| | |
|---|-----------|
| Switching and control | 78 |
| Pulse shaping and generation | 82 |
| Counters and dividers | 85 |
| Timing | 88 |
| Miscellaneous | 91 |

Switching and control

Circuit extracts single pulses from clock or pulse train

Here is a straightforward but precise method for extracting a single pulse from a clock or a varying pulse train. The technique utilizes two DT μ L946's and a few discrete components, and operates as follows:

The initial negative-going edge of the input pulse that occurs after the gate is applied activates LATCH A (see waveforms). The following

positive-going edge triggers LATCH B. The outputs of both latches are then combined to produce the single-pulse output.

The differentiating networks allow asynchronous gating without affecting the pulse width, t . In addition, this ac triggering method eliminates all ambiguity that could otherwise result from propagation delay in a dc triggering mode.

George Oshiro, Design Engineer, Teledyne Systems, El Segundo, Calif.

VOTE FOR 411

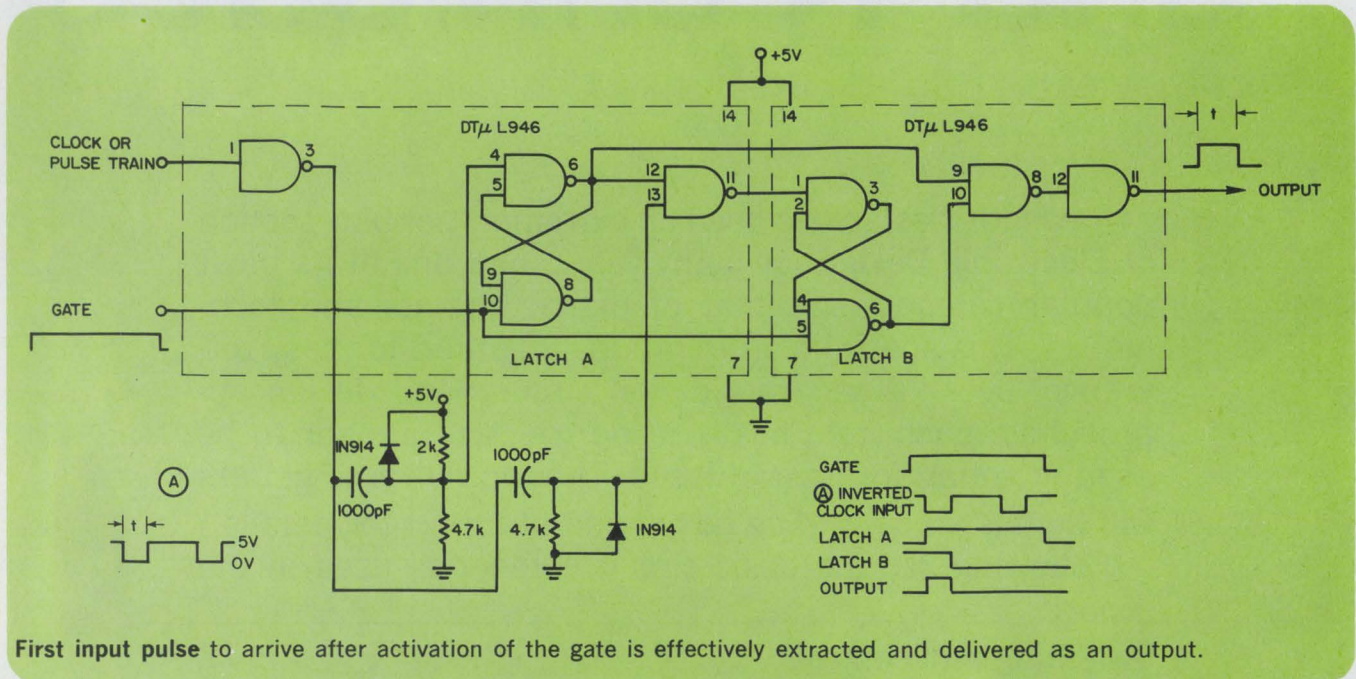

First input pulse to arrive after activation of the gate is effectively extracted and delivered as an output.

Simplify turn-on initialization of digital systems

When power is applied to a digital system, measures must be taken to ensure that the flip-flops in the system will be initially set to the correct state. Also, destruction of memory contents by the turn-on transient must be prevented. Currently, these functions are performed by various "system normalizers," "initial-condition drivers," and other more or less elaborate arrangements.

The initialization can often be done more

simply and economically with the power-switch arrangement shown. Here, the power switch is a two-pole, three-position rotary type with *shorting* contacts. The extreme positions of the switch are the OFF and ON while the middle position is traversed during every switching operation. One of the poles switches the power, while the other switches the initialization circuit.

In the OFF position, the power circuit is open but the initialization circuit is closed. With switching into the middle position, the power comes on, but the initialization is held, without interruption, by the shorting contacts. Switching

to the ON position opens the initialization circuit with no interruption to the power.

On turn-off, an analogous sequence takes place. Switching from the ON position to the intermediate actuates the initialization with no interruption in the power. Switching to OFF removes the power while holding the initialization during the turn-off transient.

The above description applies to an initialization circuit that closes to initialize. A circuit that opens to initialize would be connected differently, as shown. Additional initialization circuits could be connected to additional poles.

Ordinarily, solid-state power supplies come to equilibrium after turn-on in just a few cycles of the line voltage. Therefore, normal operation of the switch would give enough dwell time in the middle position to wait out the turn-on transient,

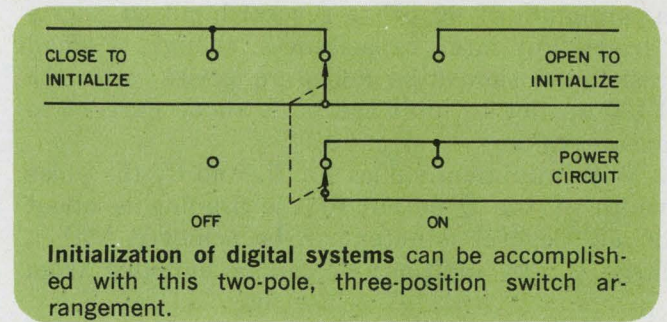

with no conscious pause or hesitation required.

This work was performed under the auspices of the U. S. Atomic Energy Commission.

Charles E. Cohn, Associate Physicist, Reactor Physics Div., Argonne National Laboratory, Argonne, Ill.

VOTE FOR 412

One-shot stays triggered until end of pulse train

A one-shot multivibrator, which returns to its steady-state condition only after a predetermined time has elapsed following the last pulse in a pulse train, can be built from two programmable unijunction transistors (PUTs) and a DTL 946 quad two-input gate package.

In operation (a), the steady-state condition is such that the input trigger level is LOW, the Q output of the R-S flip-flop is LOW, and PUT Q1 is in the nonconducting state. (Q1 is used as an SCR, with triggering produced by a negative-going pulse at the gate.) When the trigger input goes HIGH for at least 0.5 μ s, the R-S flip-flop is set and the Q output goes HIGH. Also, the negative-going pulse at the gate of Q1 turns Q1 on and discharges timing capacitor C_T .

Q1 turns off when its anode current falls below

the holding current, allowing C_T to charge to start the timing cycle. Q2 is operated as a unijunction transistor and is turned on when its anode voltage slightly exceeds the preset gate voltage.

When Q2 turns on, its gate potential approaches ground, resetting the R-S flip-flop. If a trigger pulse had been applied before Q2 turned on, C_T would have been immediately discharged by Q1, as explained above. Thus, should a train of pulses with a repetition rate greater than the time required to fire Q2 be applied, Q2 will turn on only after a predetermined time has elapsed following the last trigger pulse in the train. This is shown by the waveforms (b).

Using a +5-V supply, timing resistor R_T can vary from 150 k Ω to 470 k Ω . C_T can vary from

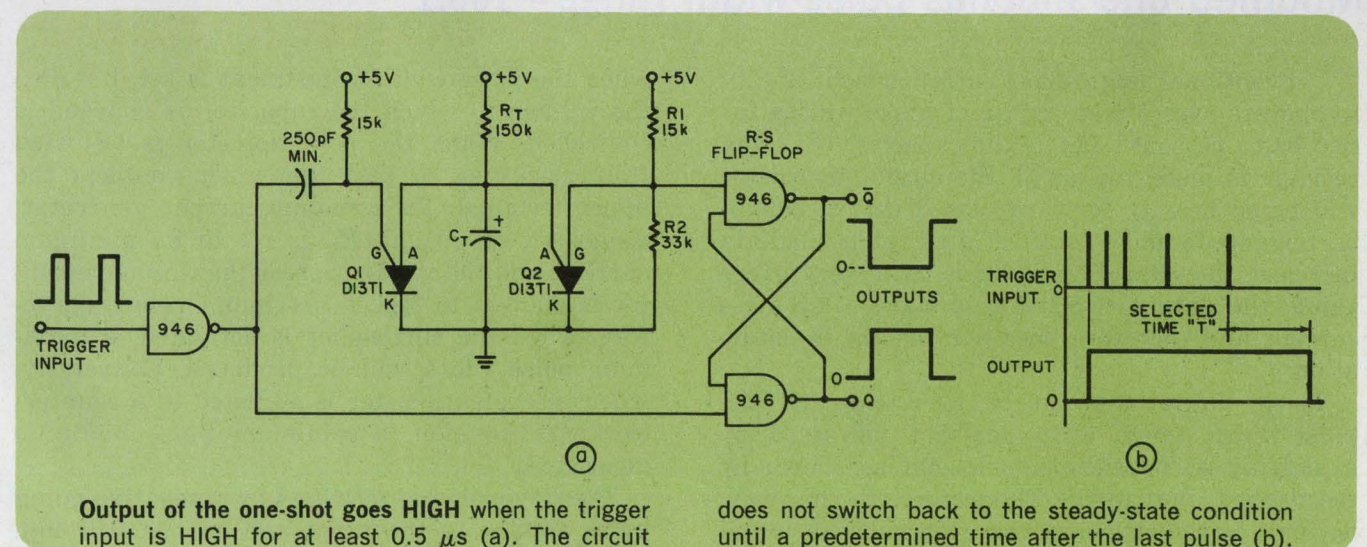

a minimum of 60 pF to several hundred microfarads. For large capacitances, though, a small resistance should be added in series with the PUT anodes to limit the peak anode current to a safe value.

With minimum values for R_T and C_T the pulse width of the Q output of the flip-flop is about 30 μ s. Several minutes can be achieved with a large C_T . In addition, R_T can be supplied from

higher voltages to obtain very long pulse outputs. Changing the ratio of R_1 and R_2 will also produce some variation in output pulse width. However, the ratio of $R_2/(R_1+R_2)$ should not produce a voltage less than 2.5 V at the input to the R-S flip-flop.

Dany P. Delaporte, Electrical Engineer, Control Data Corp., Rochester, Mich.

VOTE FOR 413

Get repetitive switch closures from inexpensive multivibrator

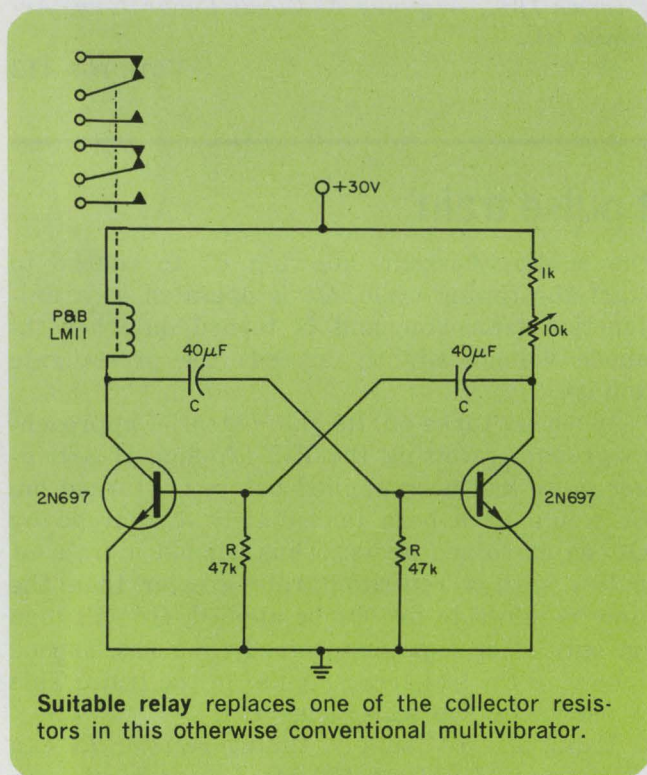

Many applications in analog computing and industrial control circuits require repetitive switch closures at intervals of several seconds. A simple solution to this requirement is to replace one of the collector resistors in an astable multivibrator with a relay.

The period, T , between successive switch closures is given by:

$$T \approx RC$$

More precise calculations would consider electromechanical relay characteristics, as well as other factors.

The circuit, as shown, permits variations in switch closures between 1 and 3 seconds, depending on the potentiometer setting. This time may be decreased by using a smaller resistor in series with the potentiometer. A large-value potentiometer permits longer intervals. If desired, additional capacitors may be switched in or out to provide coarse time adjustment while the potentiometer provides fine control.

Saul A. Ritterman, Bronx Community College, N. Y.

VOTE FOR 414

Modified one-shot has pulse-width range > 100:1

Conventional single shots suffer in their ability to operate over a wide range of pulse widths for two basic reasons: (1) if the capacitor-charging resistor is made too small, the output transistor will be so heavily forward biased that it cannot be triggered; and (2) if an attempt is made to increase the charging resistor to a very large value, the output transistor is starved for base current and therefore does not remain in saturation.

These limitations can be overcome and the pulse-width range of a one-shot increased by modifying a conventional one-shot as shown by the dashed lines in the illustration. In this way, not only is the capacitor-charging current varied

when the pulse-width adjustment is set, but also the voltage to which the capacitor is charged is controlled. When the potentiometer is adjusted fully clockwise so that the wiper contacts the upper terminal, the constant current generator, comprised of Q_3 and R_1 , is set to its minimum current, and the voltage across the timing capacitor is allowed to seek a maximum value. Therefore, when the single-shot is activated, a maximum pulse width will be produced. Conversely, when the potentiometer is adjusted to a counter-clockwise position, a minimum pulse width is generated.

The single-shot is activated by a negative-going pulse applied to the input and coupled through

$CR1$ to the base of $Q2$. This signal causes the normally ON $Q2$ to be turned off, and subsequently causes the normally OFF $Q1$ to turn on. The negative-going collector of $Q1$ is coupled through timing capacitor C_1 and further causes $Q2$ to remain off. As previously discussed, the magnitude of the voltage step, as well as the charging current to the capacitor, is determined by the potentiometer setting. After C_1 has been charged to allow $Q2$ to be forward biased, the circuit reverts to its normal state.

Assuming transistors with a high h_{FE} , and a power supply voltage of $V_{cc} \gg V_a$ and V_{BE} , then for the mid-range setting on the potentiometer the pulse width, t_{pw} , is approximately equal to $R_1 C_1$. The end range values of pulse width are determined by R_2 for the maximum and R_4 for the minimum; however, the minimum is limited by the forward drop of diode $CR2$. To provide a stable clamping source for the collector of $Q1$, R_5 is made considerably larger than $R_2 + R_3 + R_4$.

Jack L. Shagena, Jr., and Jack T. Shaul, engineers, Bendix Communications Division, Baltimore, Md.

VOTE FOR 415

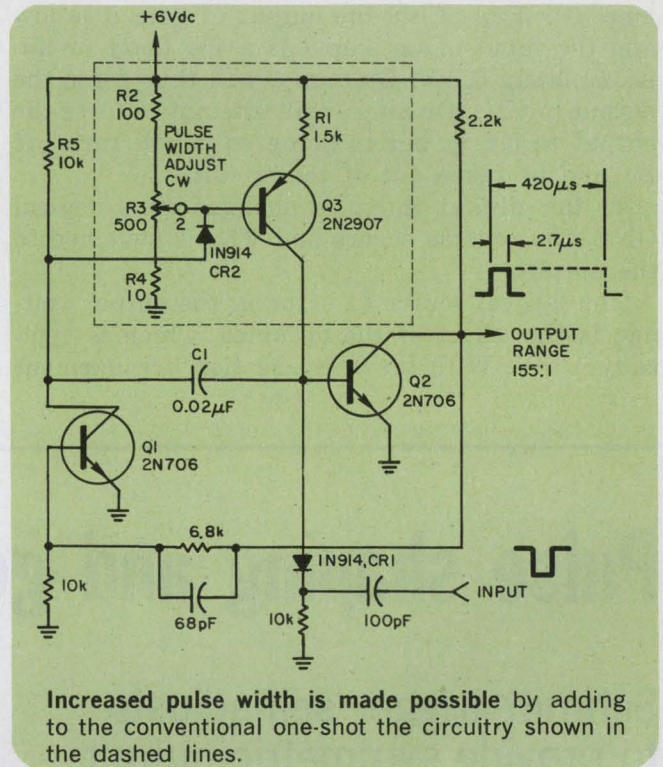

Increased pulse width is made possible by adding to the conventional one-shot the circuitry shown in the dashed lines.

IC voltage switch is digitally activated

Here is a circuit that provides two output voltages within the range of +0.1 to +10.0 V on receipt of input commands from either TTL or DTL logic.

Applications include digital IC testing, where programmable low and high voltages are required. It should be noted, though, that applications are not limited to digital circuits but include any situations where two or more voltages are to be controlled by digital logic.

The circuit uses two IC op amps and one digital IC (Fig. 1). The NAND gates have "bare" collector outputs, which represent either a very

high or low impedance, depending upon the digital input. The op amps provide effective buffering between the input and output.

In operation, if the digital input is a ZERO the output of gate A is high and the input to op

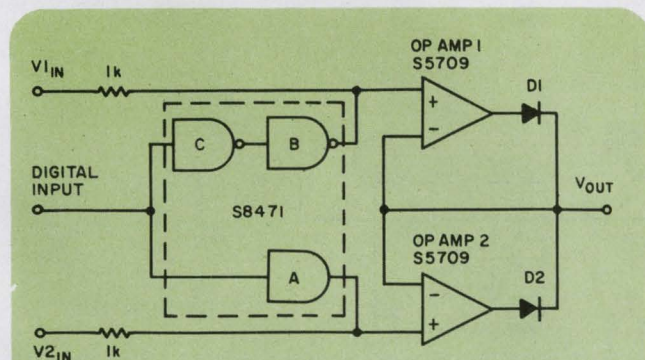

1. When the digital input is ONE, V_{out} equals $V1_{in}$; and when it is ZERO, V_{out} equals $V2_{in}$.

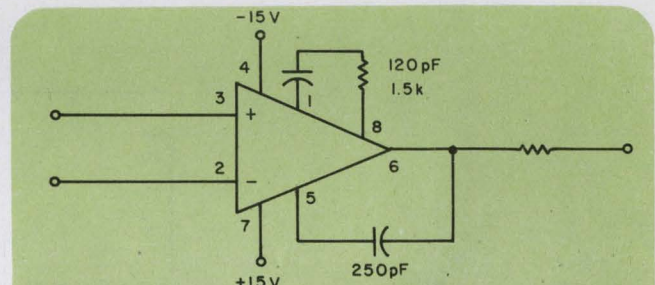

2. Frequency compensation of Signetics S5709T op amps results in the circuit waveforms shown in Fig. 3.

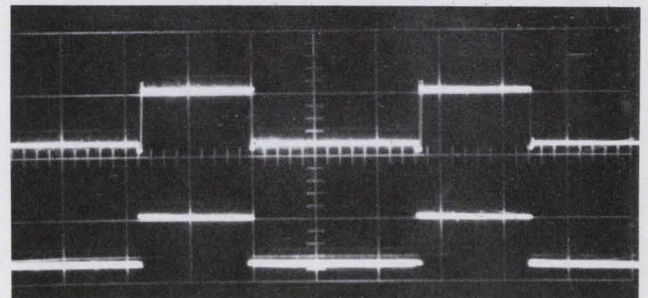

3. Operation of the switch is shown by the output (top) and input (bottom) waveforms. Vertical scale is 5 V/div. and horizontal scale is 1 ms/div.

amp 2 is V_{2in} . Also, the output of gate B is low and the input of op amp 1 is a V_{cc} (sat) or approximately 0.1 V. Op amp 2 will thus force the output to V_{2in} . Op amp 1 will attempt to force the output to 0.1 V, but in doing so it will turn off D1 and be taken out of the circuit.

If the digital input is changed to a logical ONE, the reverse occurs and V_{1in} is switched to the output.

The largest source of error in the output voltage is the offset of the op amps, which is typically 1 mV. With the compensation arrangement

shown in Fig. 2, the output of the circuit is as shown in Fig. 3.

It would be possible to switch n voltages to the output by simply replacing the gating circuit illustrated by a *one-in-n* decoder and using n op amps. Negative voltages could be switched by using a pnp transistor connected to the op-amp input in place of the npn transistor in the gate, and reversing the polarity of the output diodes.

Gary Mansperger, Engineer, Signetics Corp., Sunnyvale, Calif. VOTE FOR 416

Pulse shaping and generation

Schmitt trigger self-adjusts to provide symmetric output

A Schmitt trigger is very useful for converting a sine-wave input into square waves. However, if the sine wave should be distorted, so would the square waves. With suitable feedback, though, a Schmitt trigger can be made to deliver a symmetrical square-wave output, with no adjustment, regardless of the input sine-wave distortion.

A basic Schmitt circuit with positive feedback is used, as shown in Fig. 1. Transistors Q1 and

Q2 form the conventional Schmitt trigger, and Q3 buffers the Schmitt output and drives the low-pass feedback filter formed by $R_{10}-C_2$. Resistor R_{11} sets the bias current to Q1 in accordance with the voltage at C_2 , which is the average value of the output. When the output becomes asymmetric in the positive direction, the voltage at C_2 rises, re-biasing the Schmitt trigger to produce a symmetric output. Similar feedback corrects asymmetry in the negative direction.

Since there is no integrator in the feedback loop, the circuit will not maintain perfect symmetry of the output. It will, however, maintain

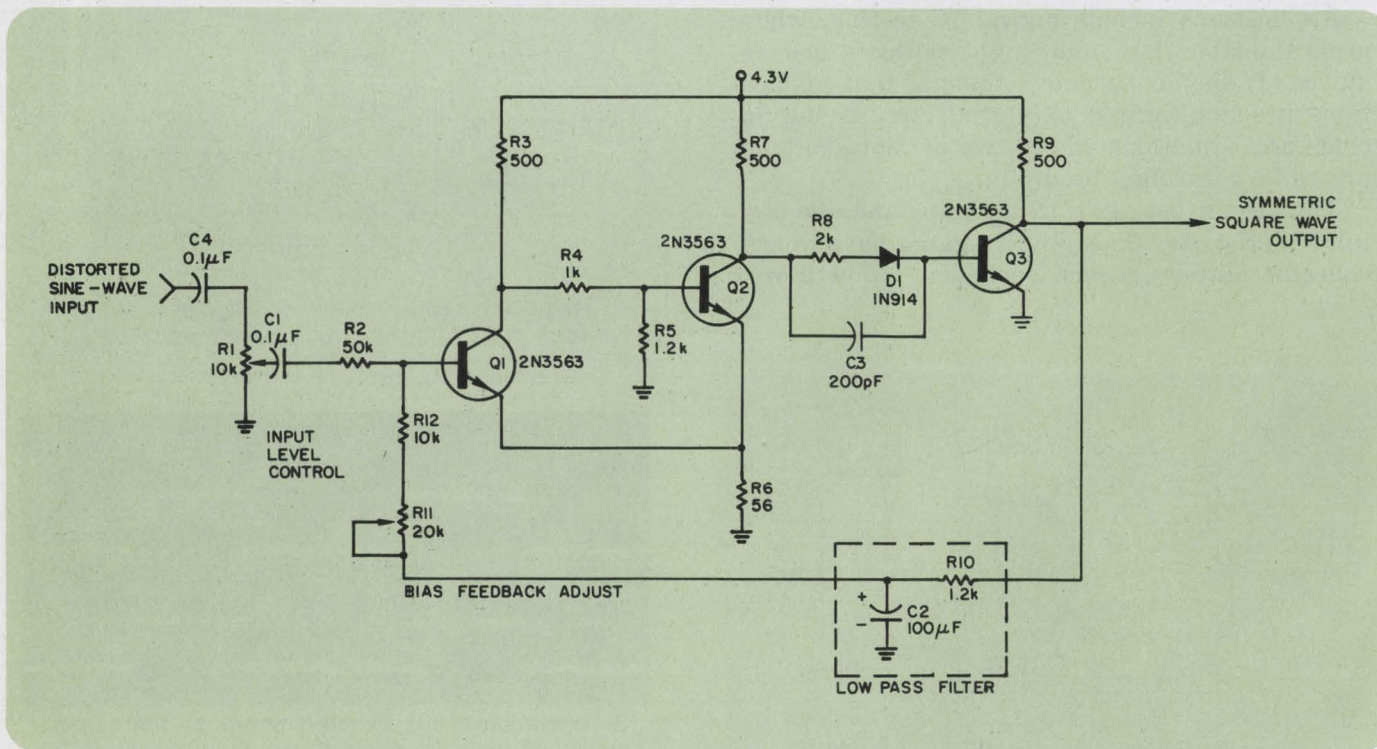

1. Asymmetry in the square-wave output is sensed by the C_2 - R_{10} feedback which controls Q1.

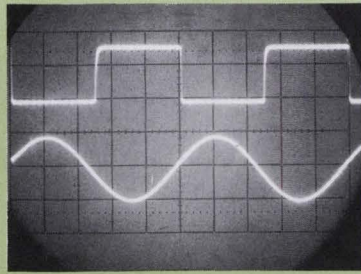

2.0 V/cm, 2 μ s/cm
0.2 V/cm, 2 μ s/cm
NORMAL SINE WAVE INPUT
AND SYMMETRIC OUTPUT

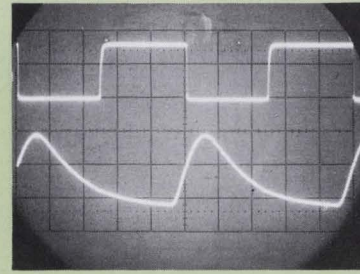

2.0 V/cm, 2 μ s/cm
0.2 V/cm, 2 μ s/cm
DISTORTED SINE WAVE INPUT
AND SYMMETRIC OUTPUT

2. Input and output waveforms are shown for a normal input (left) and a distorted one (right).

the output symmetrical to $\pm 2\%$ (at 100 kHz) with all sorts of distorted inputs in the range of 0.1 to 1.0 volt P-P at $C_1 - R_2$. Resistor R_{11} can be set to a different value to produce a constant output for any desired percentage of nonsymmetry.

The circuit waveshapes for both a normal and

distorted 10-kHz sine-wave input are shown in Fig. 2. The lowest operating frequency of the circuit is limited by coupling capacitor C_1 to about 50 Hz. The upper frequency is limited by Schmitt switching speed to about 4 MHz.

Lieut. D. A. Feldman, Chief, Loran-C Branch,
U. S. Coast Guard, Wildwood, N. J.

VOTE FOR 417

DTL astable multivibrator is fast and reliable

A compact and fast astable multivibrator can be built with a pair of high fan-out logic gates with expander and two feedback capacitors (Fig. 1). With 20-pF capacitors the circuit operates at a frequency of 10 MHz and has a rise and fall time of about 20 ns (Fig. 2a).

The expander is a direct connection to the base of the first transistor of the gate. With the feedback capacitors connected to the expander, the reverse bias voltage appears on the base of the transistor, assuring reliable operation. For lower frequencies (larger C), the rise time can be improved by connecting a small R in series with C (Fig. 2b and 2c). A duty cycle of about 1:20

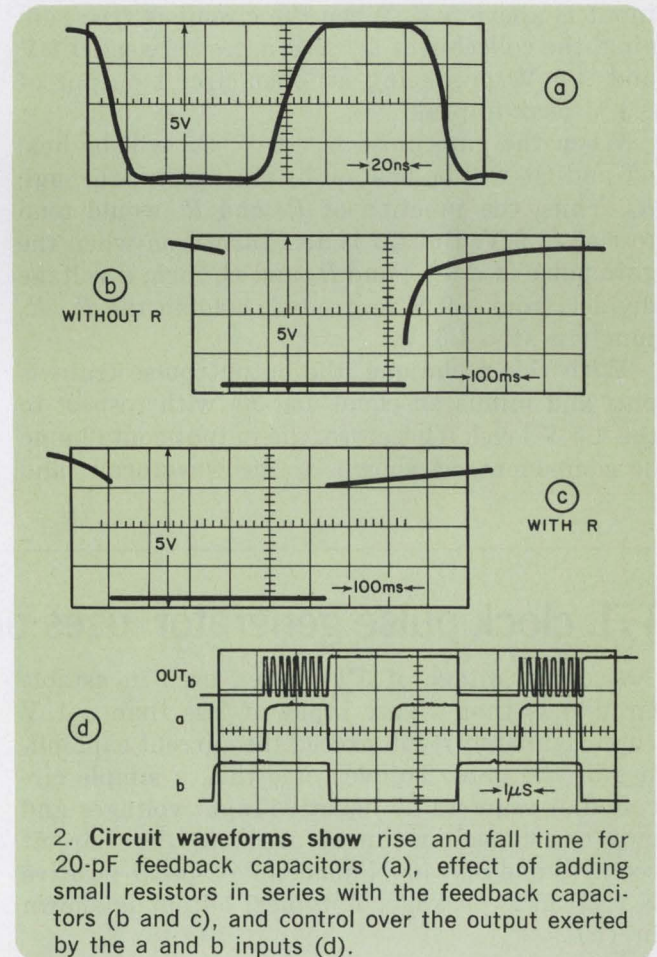
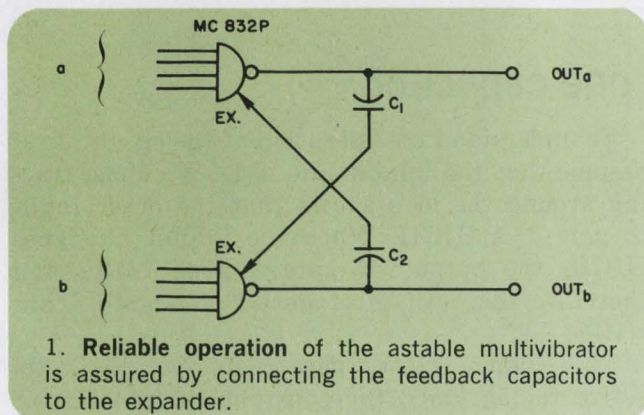

Truth table

| a | b | out _a | out _b |
|---|---|------------------|------------------|
| 0 | 0 | 1 | 1 |
| 0 | 1 | 1 | 0 |
| 1 | 0 | 0 | 1 |
| 1 | 1 | MV | MV |

1 = High; 0 = Low
MV = Multivibrator running

Keyed multivibrator produces ac output with no dc level shift

Keyed multivibrators are frequently used to produce a keyed train of pulses or a keyed tone. Unfortunately, such circuits normally produce a dc level shift, which causes severe distortion if the load must be ac-coupled.

The keyed multivibrator shown not only provides instant starting and a full-width pulse at the start, but it has an added transistor that removes the dc level shift from the output. In the circuit, *Q1* and *Q2* form the basic astable multivibrator. It is keyed by control of the charging voltage for the base coupling capacitor of *Q2*. The multivibrator free-runs at about 1 kHz when the gate input is 0 V, and is off when the gate input is above 5 V. When the circuit is free running, the collector of *Q2* alternates between 0.1 V and +9 V, producing an open-circuit output of 8.9 V peak-to-peak.

When the gate pulse is +9 V, *Q2* will be held off and *Q1* will be held on by the current through *R₂*. Thus, the junction of *R₃* and *R₄* would tend to rise to 9 V. But *Q3* is also turned on when the gate pulse is +9 V; and *R₃* and *R₄* form a voltage divider from +9 V to ground, holding the *R₃*, *R₄* junction at +4.5 V.

With this technique, the output pulse train is plus and minus an equal voltage with respect to the 4.5-V level. Therefore, the output contains no dc component, as shown by the waveforms, and

can be obtained.

The remaining inputs to the gates can be used for additional control, such as holding the multivibrator HIGH or LOW. (See Truth Table and Fig. 2d)

Wolfgang Nadler, Design Engineer, University of Pennsylvania, Philadelphia, Pa.

VOTE FOR 418

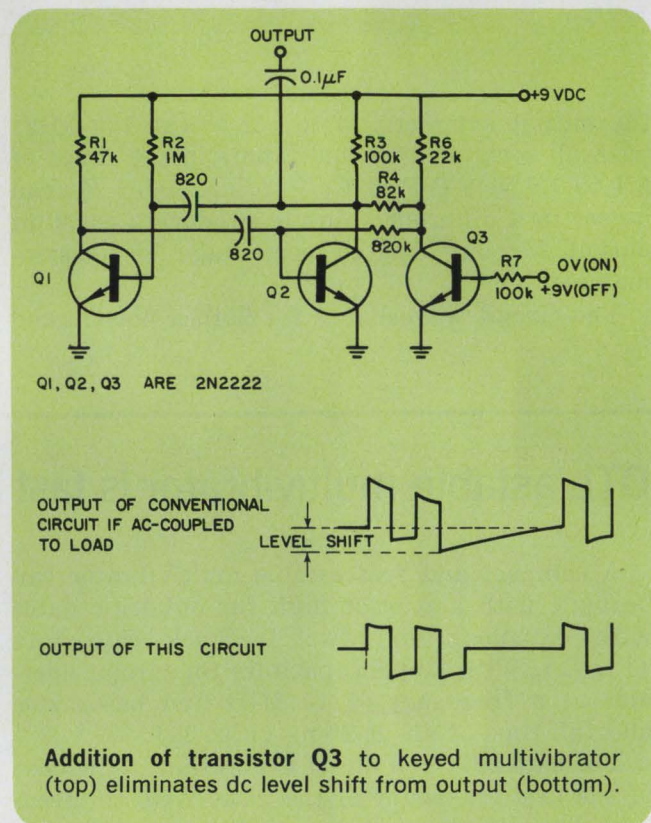

the load can be ac-coupled without introducing low-frequency level-shift distortion.

Merle E. Converse, Senior Research Engineer, Southwest Research Institute, San Antonio, Tex.

VOTE FOR 419

TTL clock pulse generator uses only one capacitor

A disadvantage of TTL when used in astable circuits is that a gate input of less than -1 V (approximately) will exceed the current capabilities of the gate. To overcome this, a simple circuit that requires no negative input voltages and only one capacitor can be used (a). The circuit requires one SN7400N quadruple 2-input positive NAND gate package. A typical output is shown in (b).

To understand the operation of the circuit, first assume that the inhibit line is LOW. Thus, tracing around the loop shows that the other input to gate 3 is HIGH. When the inhibit line goes HIGH, the output of gate 3 goes LOW, and therefore the outputs of gate 1 and gate 4 are HIGH.

This change causes gate 2 to operate in its active region, until the constant current out of

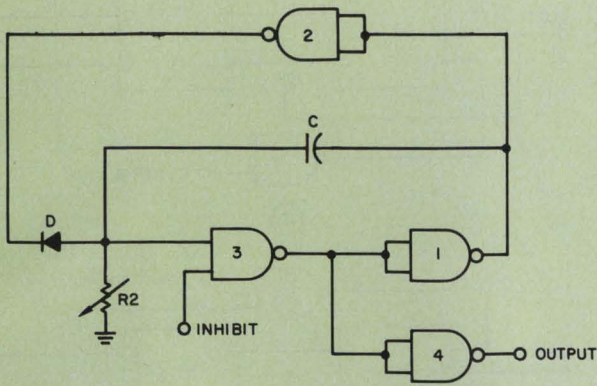

(a)

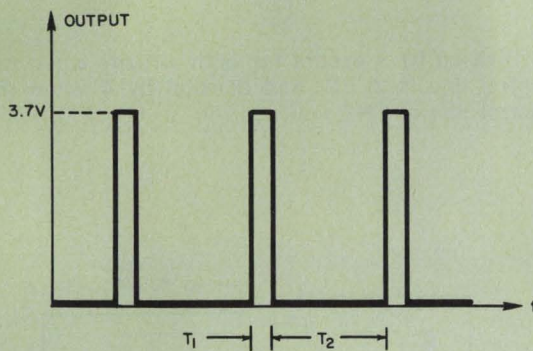

(b)

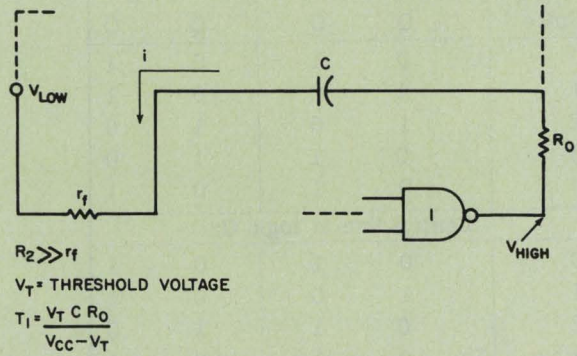

(c)

$R_2 \gg r_f$
 $V_T = \text{THRESHOLD VOLTAGE}$
 $T_1 = \frac{V_T C R_0}{V_{CC} - V_T}$

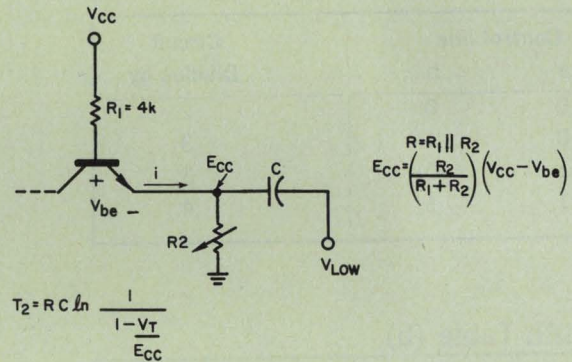

(d)

$T_2 = R C \ln \frac{1}{1 - \frac{V_T}{E_{cc}}}$

$E_{cc} = \frac{R_1 R_2}{R_1 + R_2} (V_{CC} - V_{be})$

TTL astable multivibrator uses only a single capacitor (a) and can produce a high on-off ratio (b).

The on-time T_1 (c) and off-time T_2 (d) can be calculated easily.

gate 1 into C allows the input of gate 3 to fall to the threshold voltage. When the input to gate 3 reaches threshold, in time T_1 , (Fig. C) gate 3 turns on, gates 1 and 4 turn off, gate 2 turns on, and diode D is reverse-biased. Capacitor C now charges up to the threshold voltage of gate 3 in time T_2 , as shown in (d). The sequence of events repeats as long as the inhibit line is high.

The output frequency of the circuit varies with temperature, depending on the variation of C and R_1 with temperature. Variable resistor R_2 allows easy frequency selection over a range determined by the value of C. Gate 4 provides an output that is isolated from the capacitor.

Chuck Osborn, Design Engineer, Texas Instruments, Houston, Tex. VOTE FOR 420

Counters and dividers

Divide by 3 or 4 .. or 2, 3 or 4 ... all with little hardware

Frequency division by 3 or 4 can be achieved by either of the circuits of Fig. 1, each of which uses only two J-K connected flip-flops and one

positive logic NAND gate. The circuits divide by 3 when the control line is at logical ZERO, and by 4 when the control line is ONE. Successive states during operation are shown by the respective truth tables. Fairchild LPDT μ L 9040 flip-flops (J-K-connected externally) and LPDT μ L 9046 NAND gates may be used.

Truth Table (a)

| Control line at logic 1: | | | | |
|--------------------------|------|-----------|------|-----------|
| Clock Pulse | FF-1 | | FF-2 | |
| | Q | \bar{Q} | Q | \bar{Q} |
| 0 | 0 | 1 | 0 | 1 |
| 1 | 1 | 0 | 0 | 1 |
| 2 | 1 | 0 | 1 | 0 |
| 3 | 0 | 1 | 1 | 0 |
| 4 | 0 | 1 | 0 | 1 |

| Control line at logic 0: | | | | |
|--------------------------|------|-----------|------|-----------|
| Clock Pulse | FF-1 | | FF-2 | |
| | Q | \bar{Q} | Q | \bar{Q} |
| 0 | 0 | 1 | 0 | 1 |
| 1 | 1 | 0 | 0 | 1 |
| 2 | 0 | 1 | 1 | 0 |
| 3 | 0 | 1 | 0 | 1 |

| Control line | | Circuit Divides by |
|--------------|---|--------------------|
| a | b | |
| 0 | 0 | 2 |
| 0 | 1 | 3 |
| 1 | 0 | 3 |
| 1 | 1 | 4 |

Truth Table (b)

| Control line at logic 1: | | | | |
|--------------------------|------|-----------|------|-----------|
| Clock Pulse | FF-1 | | FF-2 | |
| | Q | \bar{Q} | Q | \bar{Q} |
| 0 | 0 | 1 | 0 | 1 |
| 1 | 1 | 0 | 0 | 1 |
| 2 | 1 | 0 | 1 | 0 |
| 3 | 0 | 1 | 1 | 0 |
| 4 | 0 | 1 | 0 | 1 |

| Control line at logic 0: | | | | |
|--------------------------|------|-----------|------|-----------|
| Clock Pulse | FF-1 | | FF-2 | |
| | Q | \bar{Q} | Q | \bar{Q} |
| 0 | 0 | 1 | 0 | 1 |
| 1 | 1 | 0 | 0 | 1 |
| 2 | 1 | 0 | 1 | 0 |
| 3 | 0 | 1 | 0 | 1 |
| 4 | 1 | 0 | 0 | 1 |

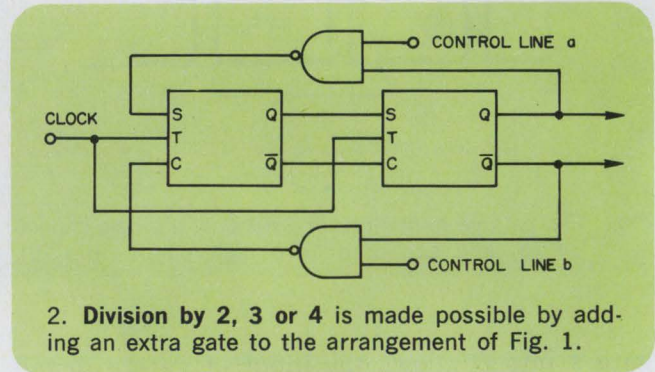
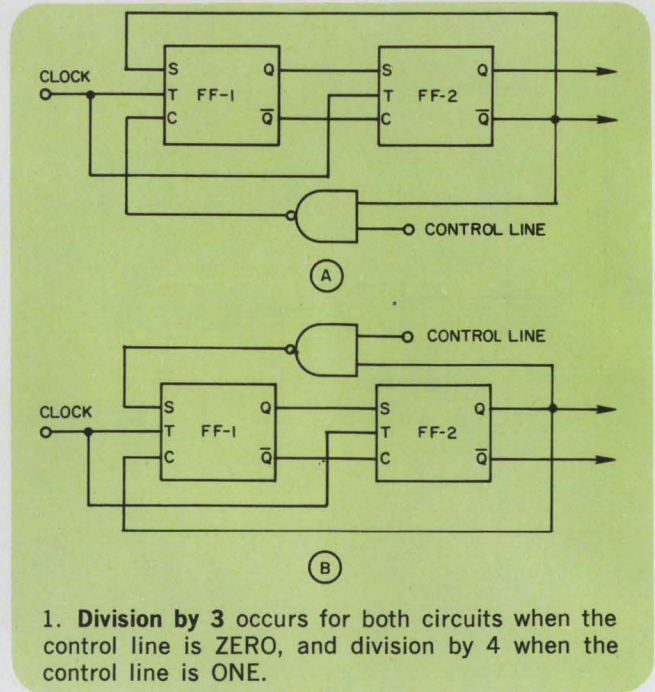

With the addition of a second NAND gate, division by 2, 3 or 4 is readily possible, as shown in Fig. 2.

J. V. Sastry, Engineer, Transportation Div., Westinghouse, Pittsburgh, Pa.

VOTE FOR 421

Up/down counter uses minimum interconnect wiring

A presettable up/down counter that uses minimum interconnect wiring is often desirable with today's crowded printed circuit boards. Such a counter can be constructed with integrated-circuit flip-flop packages which contain dual flip-flops having internal common clock pulse and reset connections. EXCLUSIVE OR packages further reduce the circuitry.

As shown, the first stage of each flip-flop package is controlled through its clock input,

while the second stage is controlled through its J-K inputs as well.

While presetting the counter, it is necessary to disable the clock pulse signals to inhibit erroneous setting of flip-flops. However, it is necessary to form only one inhibit signal for each flip-flop pair beginning with the second pair. Previous designs require the separate disabling of each flip-flop.

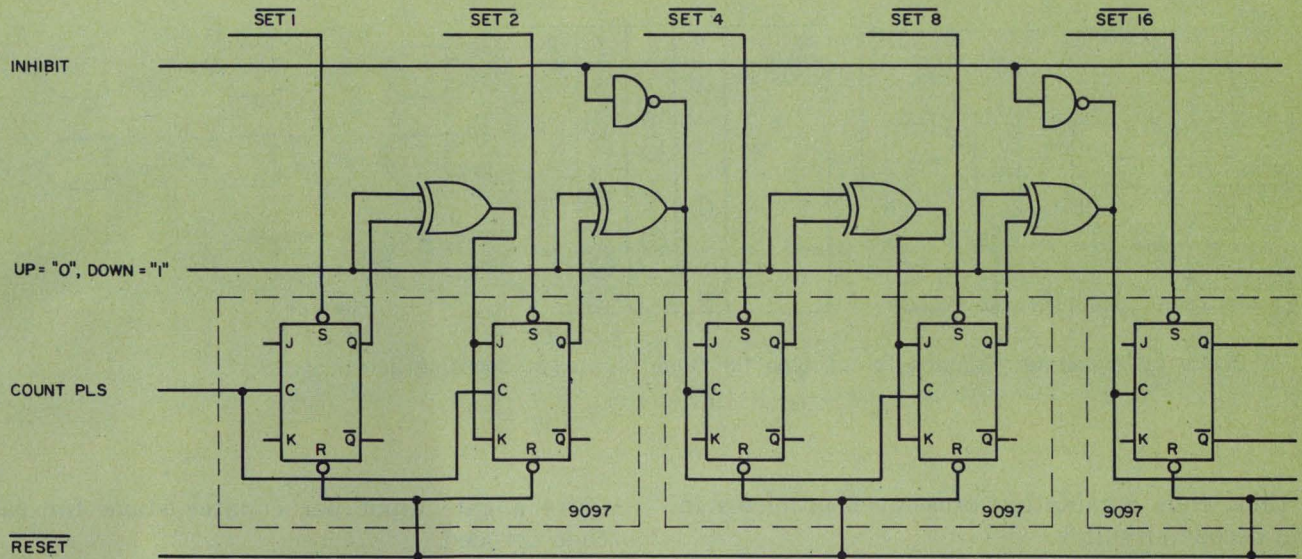

Flip-flops need not be disabled separately in this up/down counter.

When operating the counter, first the direction of counting is selected and the flip-flops are inhibited. Next the counter is reset with a ground pulse. Finally the counter is preset to the desired count by pulsing to ground the set inputs of the flip-flops required to be set. After removing the inhibit signal, the counter may be stepped

by pulsing the count pulse input.

The counter may be extended by repeating the two-stage pattern as required.

David M. Arkin, Senior Systems Engineer, Victor Electronics & Research Center, Des Plaines, Ill.

VOTE FOR 422

Build versatile counters with D-type flip-flops

A variety of extremely versatile shift-register counters can be built with TTL edge-triggered type "D" flip-flops. In addition to their versatility, these counters possess several other valuable characteristics often sought by logic designers. These include:

- At each count pulse, only one bit changes at

| COUNT | A | B |
|---------|---|---|
| CLEAR 0 | 0 | 0 |
| 1 | 1 | 0 |
| 2 | 1 | 1 |
| 3 | 0 | 1 |

COUNT OF 4

1. Divide by 4 counter requires two D-type flip-flops, plus four decoding gates (not shown).

| COUNT | A | B | C |
|---------|---|---|---|
| CLEAR 0 | 0 | 0 | 0 |
| 1 | 1 | 0 | 0 |
| 2 | 1 | 1 | 0 |
| 3 | 1 | 1 | 1 |
| 4 | 0 | 1 | 1 |
| 5 | 0 | 0 | 1 |

COUNT OF 6

2. Divide by 6 counter requires three D-type flip-flops plus six decoding gates (not shown).

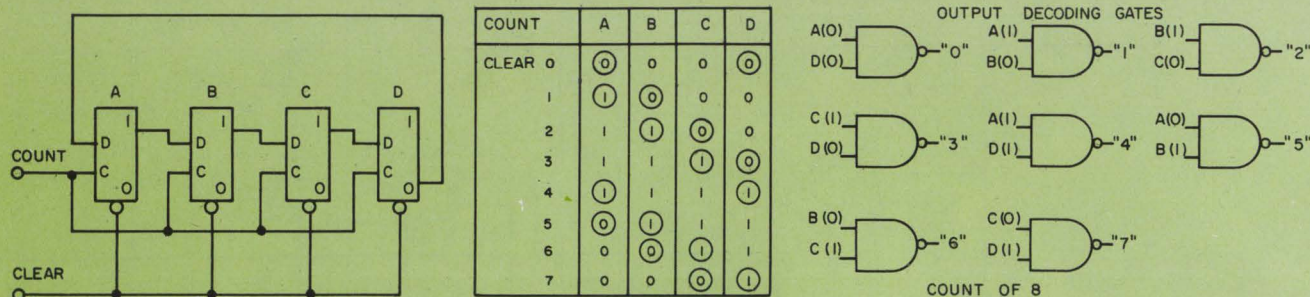

3. Divide by 8 counter requires four D-type flip-flops plus eight decoding gates.

a time, thus eliminating cross-over problems in the decode circuitry.

- If the scaler is read during a count transition, the maximum error of the reading would be 1 count. This eliminates the necessity for window circuitry for synchronous readout in some applications.

- Many count configurations can be obtained without external gating.

- Each count code can be decoded with a single two-input gate. Traditional binary counters re-

quire a gate input per counter stage for each code decoded.

Examples of divide by 4, 6, and 8 counters, together with their truth tables, are shown in Figs. 1-3. The circled bit conditions in the truth tables are used to decode each unique count. In Fig. 3, an example of the decode circuitry is shown for the divide by 8 counter.

Gerald V. Butler, Electronics Engineer, Digital Equipment Corp., Maynard, Mass.

VOTE FOR 424

Timing

One-shot has independent input and output pulse widths

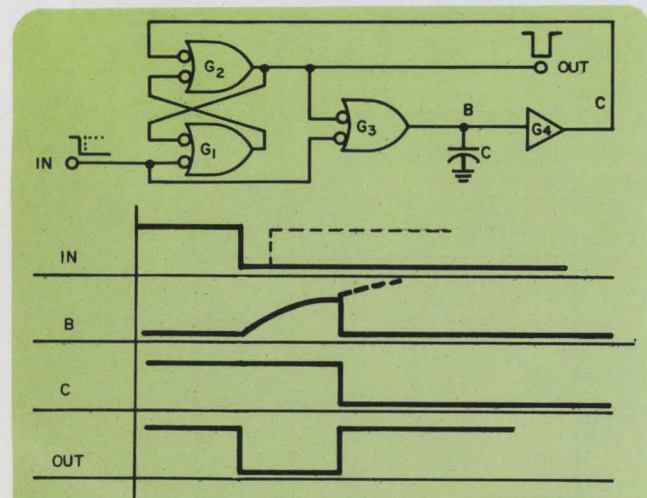

Output pulse duration depends mainly on the value of C. This output duration is independent of the input pulse width.

A one-shot multivibrator whose output pulse duration is independent of the input pulse duration is a not infrequent requirement. Here's one that can be built with a single IC and a capacitor.

Referring to the schematic, G_1 and G_2 form an R-S flip-flop. A negative trigger at the input of G_1 forces a low level at the output of G_2 and a high level at the output of G_3 . As a result, C starts to charge toward V_{cc} . When C is charged to the threshold voltage of G_4 (≈ 1.5 V for most DTL gates), the output of G_4 goes low and the R-S is cleared, thus bringing the output of G_2 high.

The duration (t) of the output pulse depends on the collector resistance (R_c) of G_3 , the external capacitor C , the supply voltage V_{cc} and the threshold voltage (V) of G_4 .

The formula $V = V_s + \Delta V(1 - e^{-t/RC})$, where

VOTE! After reading the digital ideas and techniques, select what you consider the best and circle the appropriate number on the Reader-Service card.

V_s is the saturation voltage of $G3$, and $\Delta V = V_{cc} - V_s$, can be used to calculate t .

For an MC 946 DTL chip, where $V_{cc} = 5$ V, $V_s = 0.3$ V, $R = 6$ k Ω and $V = 1.5$ V, the duration (t) of the output pulse is approximately $1800 \times C$.

It is important to note that the duration of the output pulse and the duration of the triggering pulse are independent of each other.

Basil Ioannou, Design Engineer, Picker Instruments, Cleveland, Ohio

VOTE FOR 425

Artificial delay line is inexpensive and small

Digital delay lines are often much larger than the integrated circuits associated with them. And, although small lines are now available, their small size is achieved only at increased cost. An inexpensive and small artificial delay line, which avoids both of these problems and has both asserted and negated outputs, may be realized by delaying the set and reset inputs of a latch with LC circuits so as to correspond with the leading and trailing edges of the input pulse.

Figure 1 shows the output of a gate for a cosine input, where $0 < t < \pi/2$. Since the gate switches at $V_i \approx +1.5$ V, the delay is slightly less than one-fourth of the cosine wave. Note that the slope of V_i at $+1.5$ V is such that variations in the threshold voltage of the gate due to tem-

perature changes have little effect on the delay time.

In the circuit (Fig. 2), diodes restrict the voltage swing at the latch inputs to between zero and five volts. One LC circuit provides the set pulse, and the other the reset pulse. Since the capacitors must recharge to $+5$ V between changes in the input signal, the delay time must be less than the minimum time between changes in the input signal.

Small pull-up resistors may be added between the outputs of the driving gates and $+5$ V to ensure 0 to 5 V operation over temperature.

D. W. Lewis, Development Engineer, General Electric Co., Binghamton, N.Y.

VOTE FOR 426

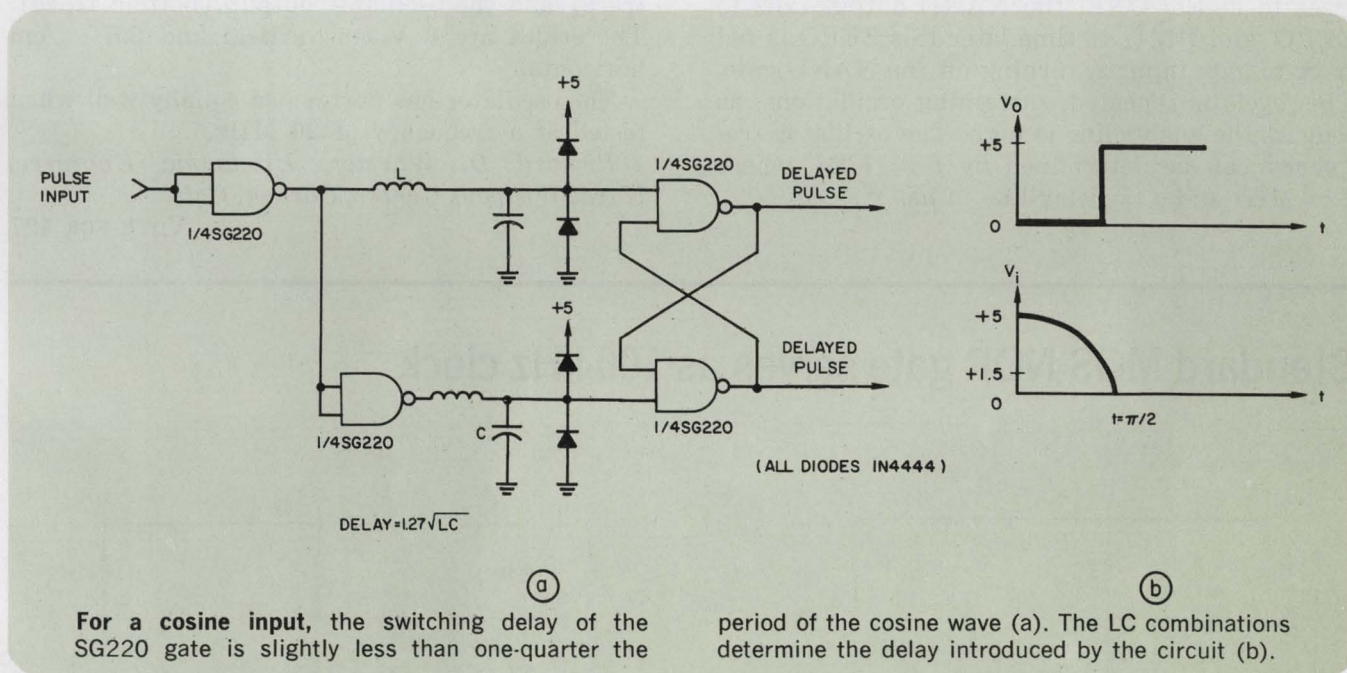

Simple oscillator can be keyed precisely

In radar applications the need often arises for a synchronized or pulsed oscillator. Many oscillators, unfortunately, such as the crystal type, cannot be easily synchronized with timing pulses. The simple circuit shown overcomes this short-

coming. It uses only one gate (the second gate is used as an inverter) of a quadruple 2-input NAND gate and a delay line. Turn-on and turn-off of the circuit occur in exact coincidence with the NAND gate, thus eliminating any range

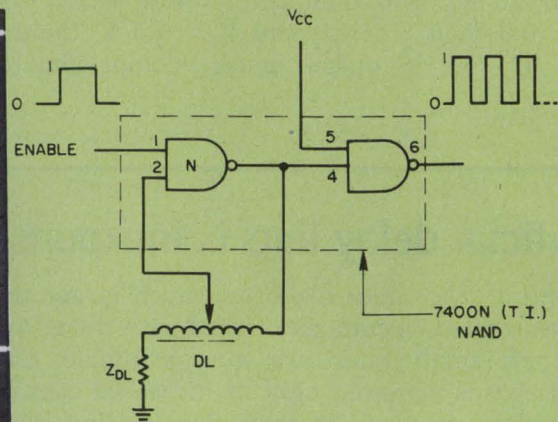
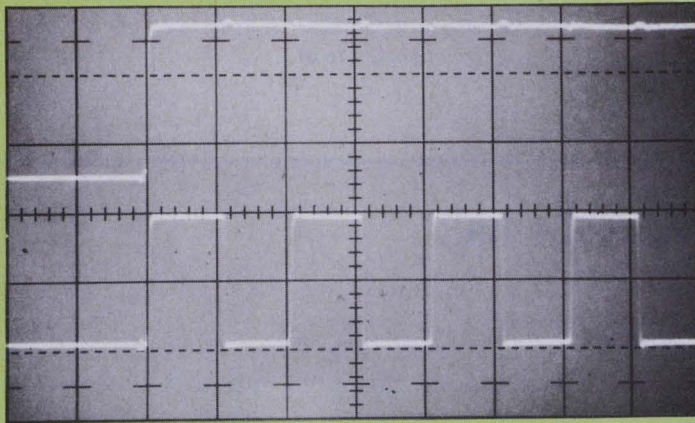

Simple keyed oscillator is made from a single integrated circuit and a delay line (right). The circuit

delivers an output only when the enable line is high (left).

error or jitter.

With the enable line at a logical ZERO, the output of the NAND gate is a logical ONE and the oscillator is turned off. Whenever the enable line rises to logical ONE, the NAND output falls to ZERO, and DL (μs) time later this ZERO is fed back to gate input 2, turning off the NAND gate. This cycle is repeated, sustaining oscillations, as long as the enable line is high. The oscillator frequency can be determined by $f = 1/2d$, where $f = \text{MHz}$ and $d = \text{delay-line in } \mu\text{s}$.

Waveforms of the circuit when operated at a frequency of 1 MHz with an oscillator on-time of approximately 450 μs are shown in the illustration. The waveforms show the enable line (top trace) and the oscillator output (bottom trace). The scales are 2 V/cm vertical and 0.5 $\mu\text{s/cm}$ horizontal.

The oscillator has performed equally well when tested at a frequency of 20 MHz.

Richard D. Wheeler, Electronic Engineer, Naval Weapons Center, Corona, Calif.

VOTE FOR 427

Standard MOS NOR gate serves as 100-kHz clock

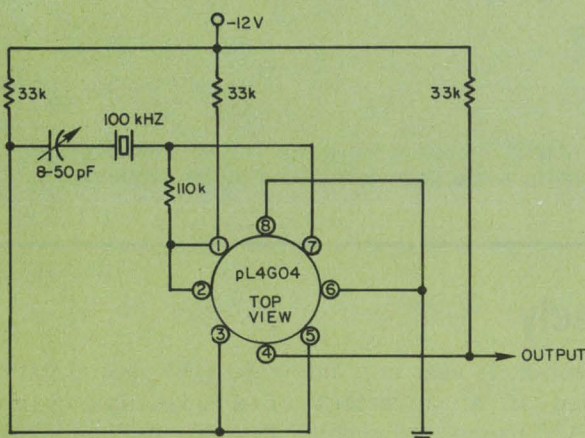

Standard MOS NOR gate (left) can be converted into a crystal oscillator by adding a few external

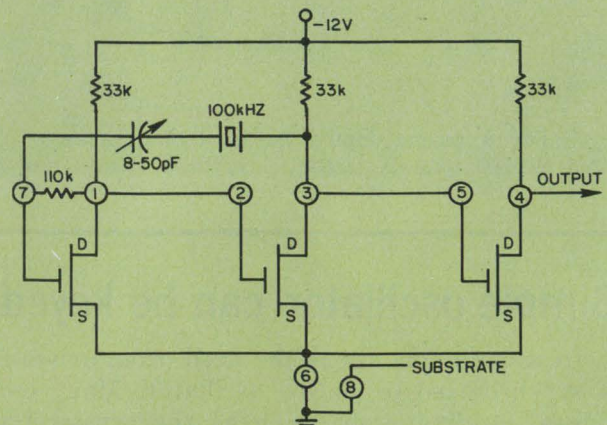

components. The complete circuit is shown in the illustration at right.

Techniques for building crystal clocks using RTL, DTL, TTL and ECL logic ICs are fairly widespread. But this does not hold for MOS devices. Here is a way (a) of using a standard MOS NOR gate (Philco-Ford pL4G04) as a crystal oscillator. Since MOS logic is relatively slow, 100 kHz as a clock rate should be adequate for most applications.

The circuit is basically a free-running multi-vibrator, which has the coupling capacitor re-

placed by a crystal and capacitor. The capacitor can be replaced by a short circuit, if the exact clock frequency is not critical. The 8-50 pF capacitor allows tuning to exactly 100 kHz with a Bliley BG9D crystal. The third gate section of the pL4G04 (pins 4 and 5) is used as an isolation amplifier (b).

Henry D. Olson, Research Engineer, Stanford Research Institute, Menlo Park, Calif.

VOTE FOR 428

Miscellaneous

ZEROs catcher senses presence of logical ZERO inputs

A simple, inexpensive "ZEROs catcher" can be built using one-half of a DTL hex inverter. The circuit output switches to a logical ZERO when a ZERO is received at the input, and stays a ZERO until a reset signal is applied.

The point to be monitored is connected to input A. Input B is the reset line, and is normally a ZERO. With a ONE at the input of inverter 1 (input A) and a ZERO at input B, the output of inverter 1 is a ZERO that is ANDed with the ONE output of inverter 3. The ZERO is inverted by inverter 2 and fed back to input A, where it is ANDed with the input ONE, giving a ONE at output A'.

When the input momentarily drops to a ZERO, the ONE output of inverter 1 is ANDed with the ONE output of inverter 3, producing a ONE to be inverted by inverter 2 and fed back to the input as a ZERO. The ZERO output of inverter 2 is also output A'.

When input A changes to a ONE, the output of inverter 2 remains a ZERO, thereby latching the circuit output at a ZERO. The complement of

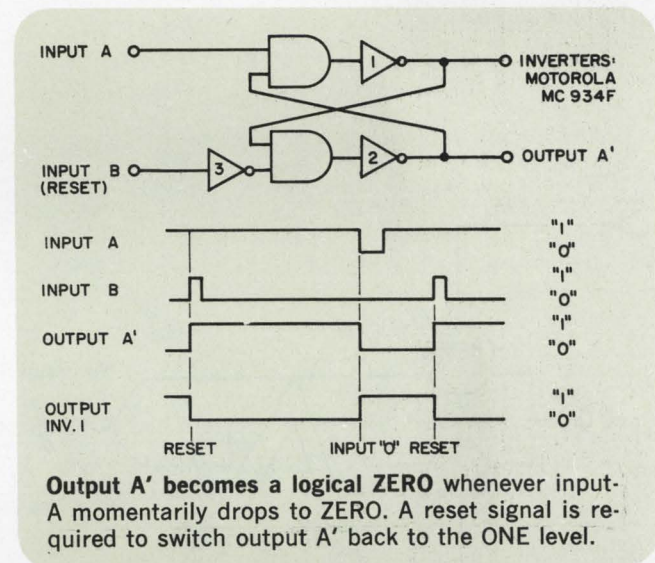

output A' is available at the output of inverter 1, therefore providing both logic levels without additional inverters.

George Barrowcliff, Design Engineer, Computer Industries, Inc., Dallas, Tex.

VOTE FOR 429

Compact line driver has high speed and high fan-out

High-speed pulse systems often require output circuits that are capable of distributing fast pulses to a number of points far enough apart so that the propagation delay times between them cannot be neglected. In such situations the technique shown can be used for line lengths up to 5 meters or more. The technique is especially suited for systems using high-speed emitter-coupled current-mode logic.

The basic circuit configuration is shown in the illustration for a system employing ECL logic. A current pulse from the current switch, composed of Q1 and Q2, is distributed to n pairs of receiving ends through n pairs of paired transmission lines and series termination resistors. At the receiving end, there is a pair of termination resistors, R_L, and m pairs of high-input-impedance level-shifting circuits (i.e., emitter follow-

ers) followed by current switches for amplitude restoration. Thus, a maximum fan-out of $n \times m$ is obtained. The distance between the m pairs of receiving points connected to each receiving end of the transmission line must be small compared with the signal transition time (less than several centimeters typical).

It can be shown that a matched condition at the end of every line is obtained when the values of resistances are:

$$R_s = \frac{n-2}{2n} \times Z_o \quad (n \geq 2)$$

$$R_L = Z_o/2$$

where Z_o is the characteristic impedance of the transmission line employed.

The differential signal amplitude at each pair of receiving points is given by the following equation

$$V_o = Z_o I_s / n$$

where I_s is the output current from the current source of the output stage. From this equation the maximum allowable n for a given output stage is obtained.

For example, the minimum differential signal amplitude required at the receiving ends of the lines to securely operate the system is 220 mV, and if I_s is 40 mA and Z_o is 165 k Ω , then the maximum allowable n is 30.

The maximum allowable m is determined by the input capacitance of the emitter followers and the physical distance between receiving points. Experience shows that at least four receiving-point pairs per receiving end are attainable for a typical system having a signal transition time of 2ns or greater. This would mean a total fan-out, $n \times m$, of 120 (30 \times 4) in this case.

Akio Tojo, Research Staff, Electrotechnical Laboratory, Tokyo, Japan. VOTE FOR 430

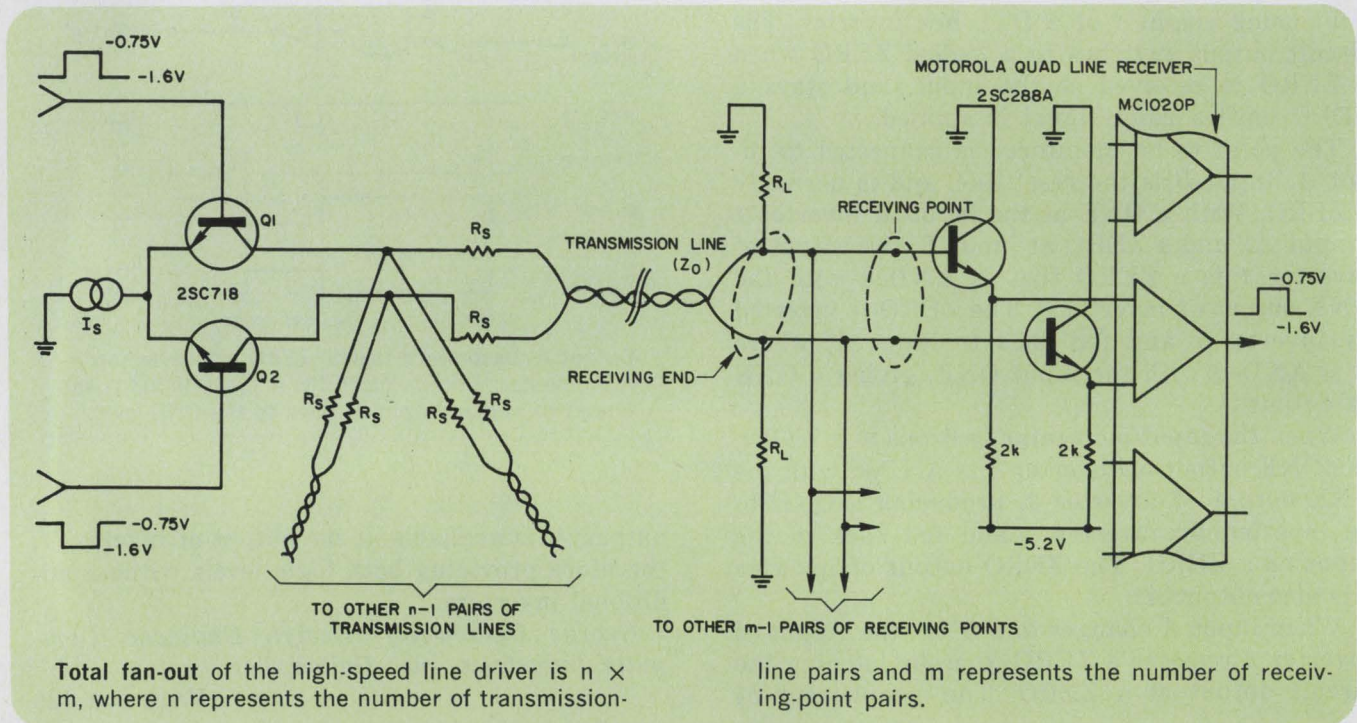

A > B or B ≥ A comparator uses adder carry logic

An interesting method for comparing two binary numbers, A and B , involves the use of the carry logic of an adder to sum A and the one's complement of B .

For example, let n = number of bits in A and B , so that the maximum count is $2^n - 1$. Then the one's complement of B is $2^n - 1 - B$, and the sum of this number and A is $2^n - 1 + (A - B)$. This sum has an overflow carry from the n th bit

when A is greater than B , but has no carry when B is equal to or greater than A . Thus, by implementing only the carry logic, one can construct a "greater than" comparator whose logic is as follows:

Let C_1 be the carry generated when adding A_o and $\overline{B_o}$, which are the least significant bits. Then,

$$C_1 = A_o \overline{B_o}$$

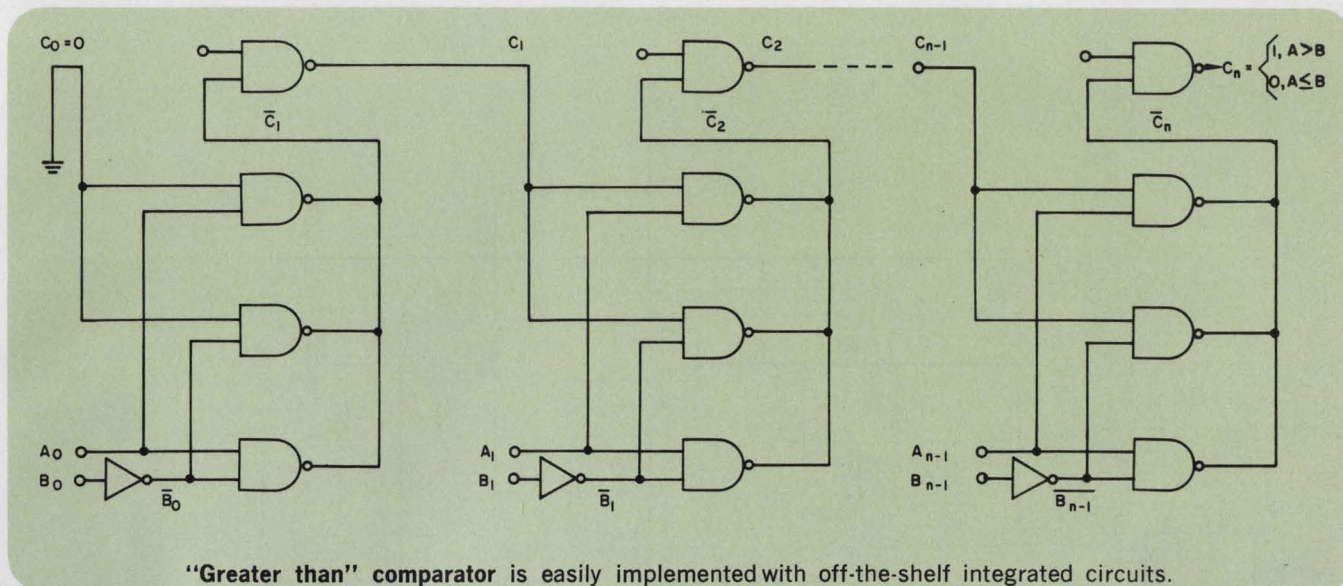

Similarly, let C_2 be the carry generated when adding A_1, \bar{B}_1 and C_1 . Then,

$$C_2 = C_1 (A_1 + \bar{B}_1) + A_1 \bar{B}_1$$

$$= C_1 A_1 + C_1 \bar{B}_1 + A_1 B_1.$$

In general, the j th carry is given by

$$C_j = C_{j-1} A_{j-1} + C_{j-1} \bar{B}_{j-1} + A_j \bar{B}_j.$$

The carry generator may be easily realized by using DTL NAND gates to implement the "wired-or." This is shown in the illustration for a comparator of length n . Note that two gates for the least significant bit could be eliminated,

but they are included to demonstrate the completely iterative nature of the logic. If the complements of B are available, the comparator requires one chip per bit when using an integrated circuit such as the MC846P.

This work was supported by the U. S. Atomic Energy Commission

Dr. M. Fishman and D. Horelick, Stanford Linear Accelerator, Stanford University, Stanford, Calif.

VOTE FOR 431

Technique simplifies strobing of BCD-to-decimal converters

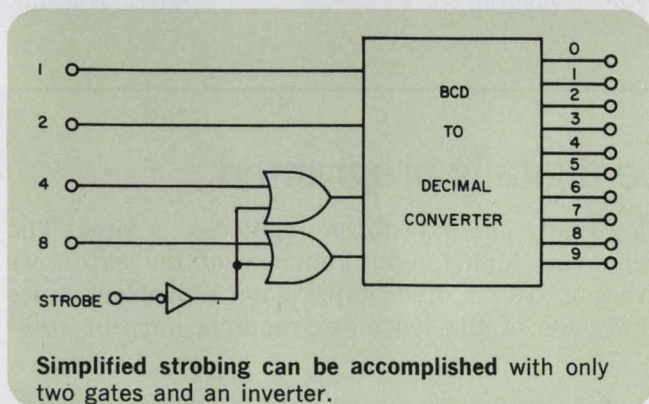

Many BCD-to-decimal converters consist of four inverters, to provide complements of the input signals, and ten 4-input gates appropriately connected to the inputs and complements. None of the ten gates will provide an output if the input is between 10 and 15, inclusive. This feature can be utilized to advantage when it is necessary to strobe the output of the converter. As shown, only two OR gates and an inverter are needed to force the input into the 12 to 15 range, thus suppressing the output.

Walter S. Friauf, Design Engineer, U. S. Dept. of Health, Bethesda, Md.

VOTE FOR 432

Dc voltage translator has wide capability

TTL logic packages are often used to drive circuits or devices having considerably different voltage requirements. The dc voltage translator shown can transform the 0-4 V TTL output to

any positive level from 5 to 45 V and any negative level from 0-45 V.

The output risetime with the components shown is better than 40 ns, and the falltime is

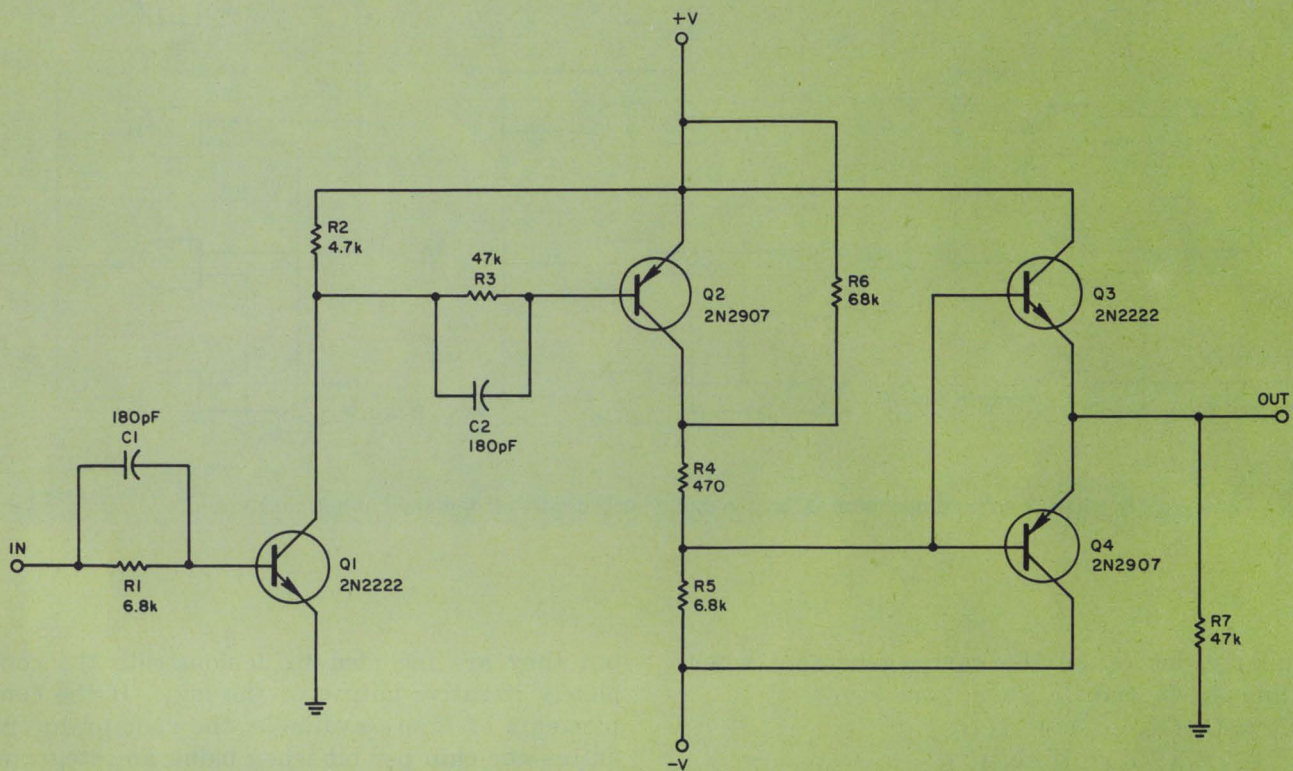

(+V) - (-V) < 45 VOLTS
 $5 \leq (+V) \leq 45$ VOLTS

Input signal controls conduction of Q2, which in turn drives either Q3 or Q4 into saturation.

better than 50 ns. Although +V can vary from 5-45 V and -V from 0-45 V, the difference between them, or (+V) - (-V), should not exceed 45 V.

For driving FETs, the emitter follower output may be omitted, as long as the driven load ca-

pacitance is low (<25 pF). Also, the 2N2222 may be replaced by a 2N3904 and the 2N2907 by a 2N3906 with a slight degradation in rise and fall times.

Gerald Lewis, Chief Engineer, Transmagetics Inc., Flushing, N.Y. VOTE FOR 433

Multichannel crystal oscillator can be digitally programmed

There are many applications where a frequency synthesizer, although desirable, cannot be justified from a cost standpoint. Here is a digitally-programmable multichannel crystal oscillator that can fill the bill in many of these cases.

The basic oscillator (Fig. 1) uses two TTL NAND gates in a feedback loop, which also contains a crystal and a series-resonant circuit to prevent harmonic modes of crystal oscillation.¹ One of the gates is biased for class-A operation with a 180-ohm resistor. This simple oscillator can be enabled or inhibited by a logic level.

The multichannel version of the circuit (Fig. 2) uses ten crystals. The gates of each channel are connected in parallel and a logic system al-

lows only one gate to be enabled at a time. The apparent high fan-out required of the gate (N) that drives ten other gates is not a problem, since only one of the ten gates requires current sink-

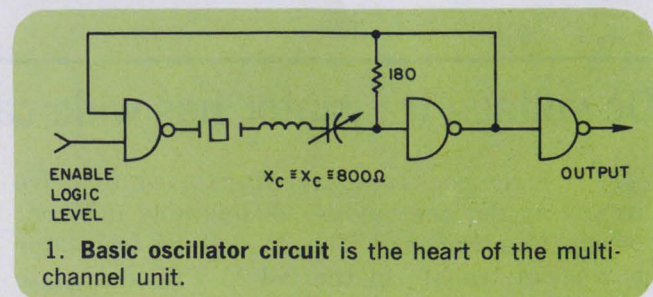

1. Basic oscillator circuit is the heart of the multichannel unit.

ing at a time. The series-resonant circuits are not critical and may be shared by up to five crystals, depending upon channel frequency spacing. The variable capacitor allows some adjustment of the crystal frequency.

A simple circuit that allows only one enable level to go high at once is a decade decoder IC, such as the Fairchild 9301, supplied with inverters on each output line. These logic levels are also available to run a channel number display.

The circuit, as shown, features a decade count-

er to program the entire oscillator. Any BCD logic level source will suffice. When a combination other than 0 through 9 appears, there is no output from the oscillator.

Reference:

1. H. Schmid and D. S. Buschanel, "Design a Pulse Generator with ten ICs," *ELECTRONIC DESIGN*, Nov. 8, 1967.

R. D. Hilton, Electronics Design Project Leader, F. C. Oropeza, Technical Advisor, Naval Ordnance Station, Indian Head, Md. VOTE FOR 434

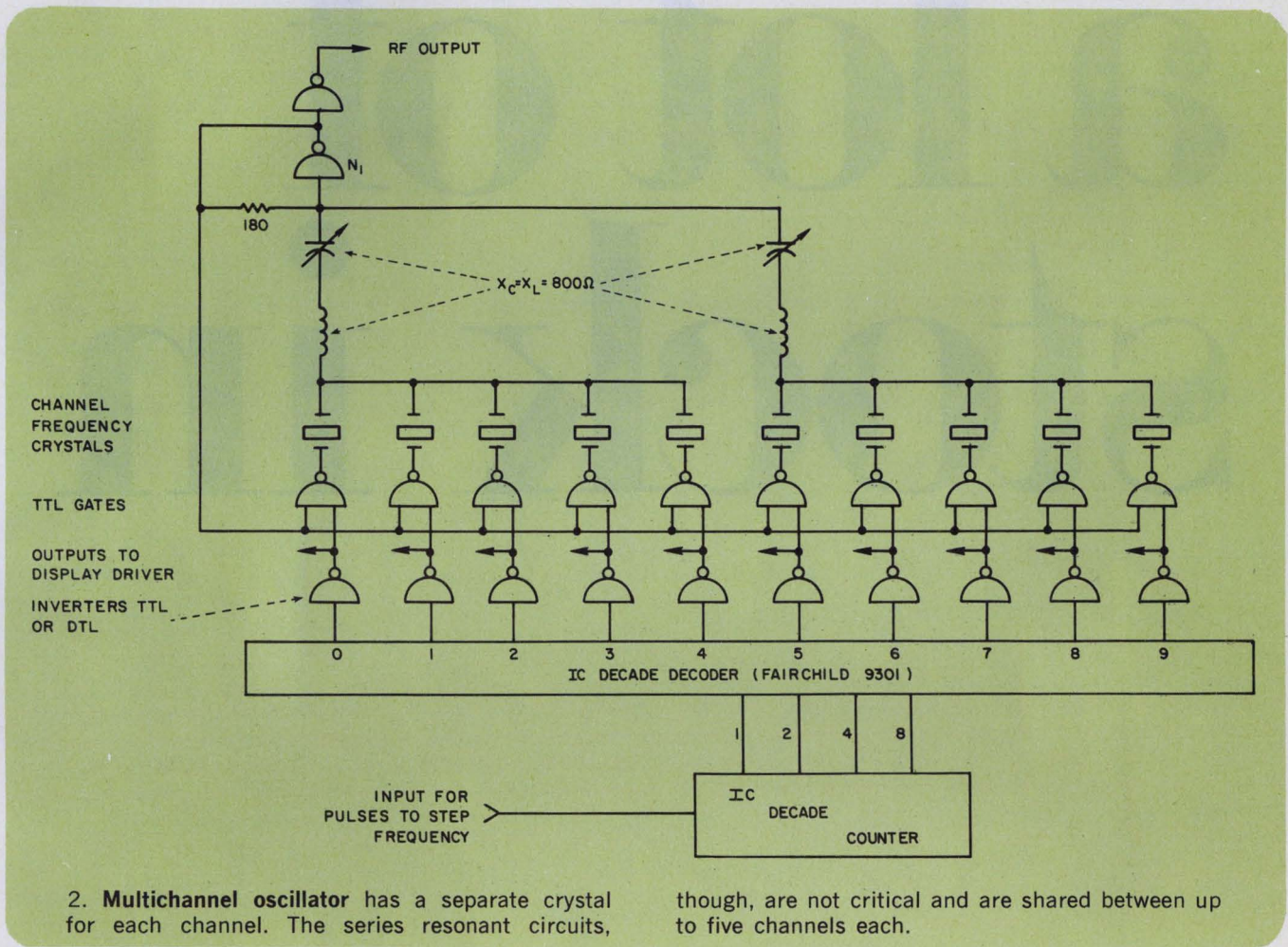

2. Multichannel oscillator has a separate crystal for each channel. The series resonant circuits,

though, are not critical and are shared between up to five channels each.

VOTE! After reading the digital ideas and techniques, select what you consider the best and circle the appropriate number on the Reader-Service card.

SEND US YOUR IDEAS FOR DESIGN. You may win a grand total of \$1050 (cash)! Here's how. Submit your IFD describing a new or important circuit or design technique, the clever use of a new component or test equipment, packaging tips, cost-saving ideas to our Ideas-for-Design editor. You will receive \$20 for each accepted idea, \$30 more if it is voted best-of-issue by our readers. The best-of-issue winners become eligible for the Idea Of the Year Award of \$1000.

**We put
a lot of
stock in**

883.

| | | 1-24 | 25-99 | 100-999 |
|-------------|--|---------|---------|---------|
| LM 101-883 | general purpose op amps | \$28.50 | \$23.00 | \$19.00 |
| LM 101A-883 | high performance op amps | 51.00 | 41.00 | 34.00 |
| LM 102-883 | voltage follower op amps | 28.50 | 23.00 | 19.00 |
| LM 104-883 | negative voltage regulators | 36.00 | 29.00 | 24.00 |
| LM 105-883 | positive voltage regulators | 28.50 | 23.00 | 19.00 |
| LM 106-883 | voltage comparators/buffers | 33.00 | 26.60 | 22.00 |
| LM 107-883 | high performance compensated op amps | 56.00 | 45.00 | 37.00 |
| LM 709-883 | general purpose op amps | 10.35 | 8.65 | 7.40 |

PARTS NOW. Off the shelf. All Mil-Std-883 Linear ICs, straight from National's special 883 production and testing lines. **GET THE WHOLE STORY.** Send for National's 883 Linear Software Package. A big, thick compilation of Mil-Std-883 literature. Includes detailed brochure on National's 883 program, specific specs on linear parts, full data sheets and price lists, plus complete 883 software—all the specs already written.

National/883

National Semiconductor Corporation
 2975 San Ysidro Way
 Santa Clara, California 95051

Please rush the big, thick, complete "883 Software Package" to

Name _____

Company _____

Address _____

City _____ Zip _____

Choose regulator op amps with care.

Output impedances, offset voltages, power-supply rejection ratios and common-mode effects all limit voltage regulation

Most designers are thoroughly familiar with feedback theory, and know that, if loop gain is increased in a dc voltage regulator, the output error is diminished. But many do not realize that loop gain is seldom the limiting factor in regulators that use op amps.

Loop gains of 100,000 or more are easily achieved with op amps, and theoretical regulation becomes extremely accurate. The ultimate limitations on regulator performance are imposed by other op-amp characteristics, such as finite output impedance, offset voltage and offset voltage drifts, limited power-supply rejection, and common-mode effects. Ground loops and voltage sensing arrangements in the regulator circuit can also cause output voltage error.

Review the basics

A regulator is essentially a feedback system, and it can be drawn in block form as shown in Fig. 1. The output voltage for this simplified system is given by the expression

$$V_o = V_{ref} (G / (1 + GH)) \quad (1)$$

where G is the amplifier gain and H is the fraction of V_o fed back to the summing point. The output voltage V_o is less than V_{ref} (for $H = 1$) by the amount

$$(V_{ref} - V_o) = V_{ref} (1 / (1 + G)) \quad (2)$$

Improved regulation in this circuit obviously results from higher amplifier gain. Since an ideal amplifier was assumed in the circuit of Fig. 1, its regulation is limited only by the gain.

The amplifier normally used in a regulator is an op amp with an additional emitter-follower stage to provide the necessary output current, as shown in Fig. 2. The output impedance for the emitter follower can be quite low, being approximately the impedance seen at the base of Q_1 divided by the beta of Q_1 . The source impedance seen by the base is the open-loop output impedance of the operational amplifier. Therefore, the open-loop output impedance of the regulator is given by the approximation

$$Z_o \text{ (open loop)} \approx Z_o \text{ (op amp)} / \beta_{Q_1} \quad (3)$$

However, when feedback is applied around the amplifier, Z_o drops by the amount of loop gain. For full feedback ($H=1$) the output impedance becomes:

$$Z_o \text{ (closed loop)} \approx Z_o \text{ (op amp)} / \beta_{Q_1} (1 + G) \quad (4)$$

As the amplifier gain is increased, the output impedance drops and regulator performance is improved.

For a second, more accurate, model, the regulator can be drawn as a voltage source with a finite output impedance as shown in Fig. 3. Output voltage and per cent regulation are now easily calculated as

$$V_o = (V' - I_L R_o) \text{ and} \quad (5)$$

$$\begin{aligned} \% \text{ reg.} &= [(V' - V_o) / V'] \times 100 \\ &= (I_L R_o / V') \times 100 \end{aligned} \quad (6)$$

For many applications these equations adequately describe the behavior of the regulator circuit. But where modern high-gain operational amplifiers are used (capable of gains in excess of 100,000), other factors affect performance.

Consider an op amp with an open-loop gain of 100,000, an output impedance of 1000 Ω , and an emitter follower with a worst-case beta of 20. With $V_{ref} = 10$ V, the expected no-load output voltage, from Eq. 2, will be low by an amount

$$\begin{aligned} (V_{ref} - V_o) &= 10 / (1 \times 10^5) \\ &= 0.1 \text{ mV} \end{aligned} \quad (7)$$

and regulation, from Eq. 6, will be:

$$\% \text{ reg.} = (I_L R_o / V') \times 100$$

Now, since $R_o \approx (10^3 / (20 \times 10^5)) = 0.5$ m Ω then $\% \text{ reg.} \approx ((I_L \times 0.5 \times 10^{-3}) / 10) \times 10^2$.

For $I_L = 100$ mA,

$$\% \text{ reg.} \approx 0.05 \times 10^{-2} = 0.0005\% \quad (8)$$

This is indeed good regulation, but our model does not include the effects of some very important parameters, and the measured regulation may vary by more than an order of magnitude from this figure. Voltage offsets, less than perfect common-mode and power-supply rejection, reference instability and ground loop effects can severely limit the regulator's performance.

Offset voltages cause error and drift

According to Eq. 7, the output voltage will be only 0.1 mV less than the reference. But this

Don Kesner, Applications Engineer, Motorola Semiconductor Products, Inc., Phoenix, Ariz.

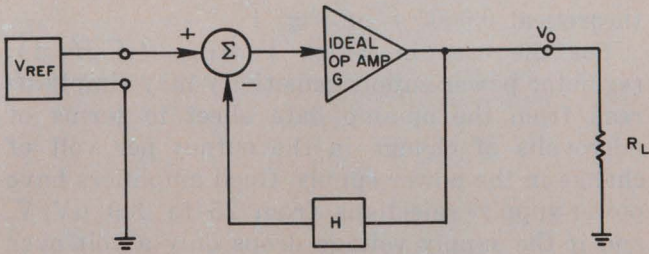

1. A dc voltage regulator is simply a feedback system. In this ideal circuit the regulation is limited only by the amount of gain available.

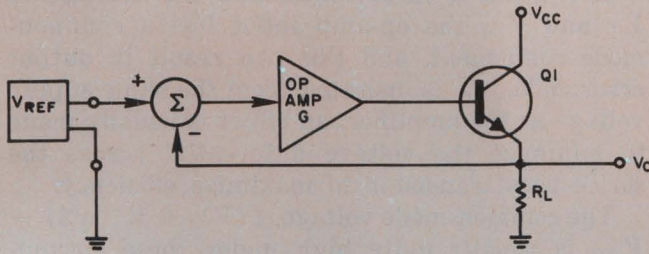

2. An emitter-follower stage is added to the circuit to provide a low output impedance and high current-drive capability.

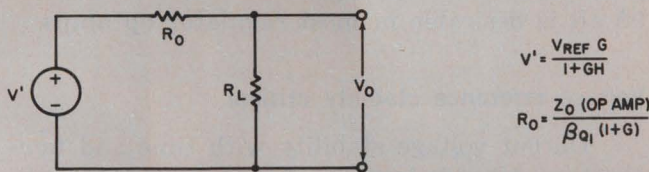

3. A simple model of the regulator includes only a voltage source and a series output impedance. For many applications, with low loop gain, the simple equations derived from this model adequately describe regulator behavior.

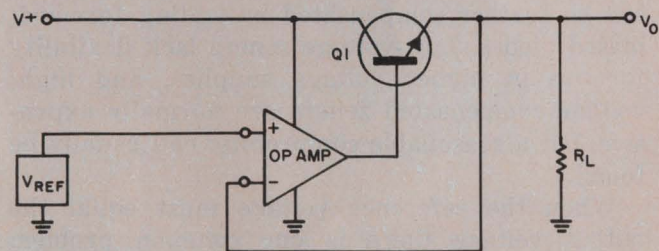

4. Power-supply ripple can feed through to the regulated output in this type of circuit, because the op amp has only finite power-supply rejection and it is powered directly from the unregulated source.

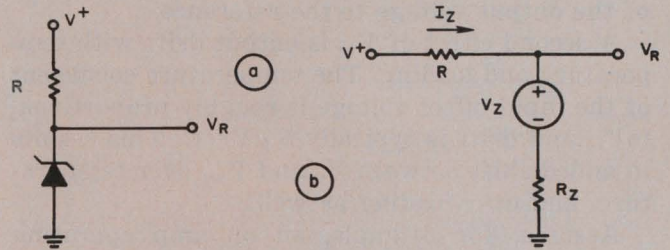

5. A simple zener voltage reference (a) gives good service, but the series resistance R_z (b), can cause output ripple if the zener current is not constant. A good, but expensive, solution is regulation of the zener bias current.

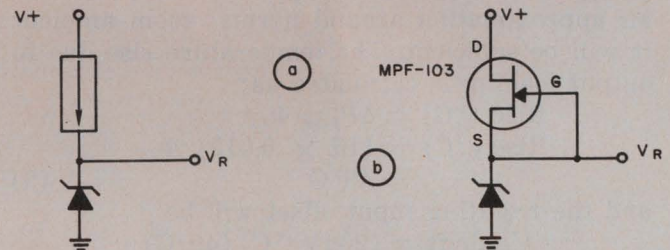

6. Zener-diode resistance effects are overcome if the zener is supplied with regulated current (a). A FET with gate and source pins externally shorted provides an inexpensive regulator.

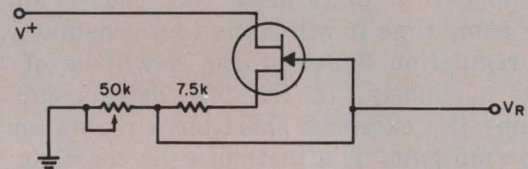

7. A FET current source and a resistor make an inexpensive voltage reference, with the FET providing current regulation only. The poor temperature coefficient of the FET may be a disadvantage, however.

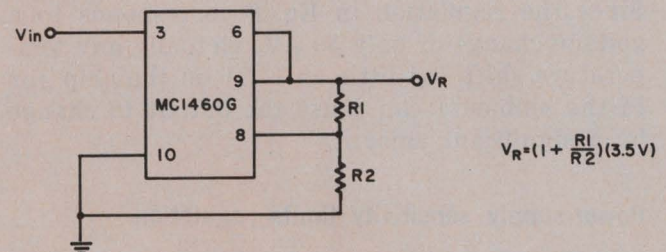

8. A typical IC regulator voltage-reference uses only the compensated reference portion of the MC1460G regulator IC and provides adjustable output reference voltages of up to 17 V.

small difference is usually masked by the op amp's offset voltage V_{io} , which typically runs from 1 to 10 mV for monolithic amplifiers. Increased gain alone, without a tight offset voltage specification, will not guarantee closer tracking of the output voltage to the reference.

A second effect of V_{io} is output drift with temperature and loading. The temperature coefficient of the input offset voltage is roughly proportional to V_{io} and drift is typically $5 \mu\text{V}/^\circ\text{C}$. This results in added shift between V_o and V_{ref} over temperature, and over loading as well.

Assume, for example, an op amp operating with a supply voltage of +15 volts, a V_{io} temperature coefficient of $20 \mu\text{V}/^\circ\text{C}$, a load current of 0 to 15 mA, and a thermal conductance from chip to ambient of $4.6 \text{ mW}/^\circ\text{C}$. The temperature coefficient of the input offset voltage V_{io} is not, of course, the simple linear function that the drift specification (usually an average or straight-line approximation) indicates, but for an approximation around normal room ambient it will be sufficient. The temperature rise due to output loading is calculated as:

$$\begin{aligned} \text{Rise } (^\circ\text{C}) &= \Delta P_{diss} / \Phi_{JA} \\ \text{Rise } (^\circ\text{C}) &= (15 \times 0.015) / \Phi_{JA} \\ &= 49^\circ\text{C} \end{aligned} \quad (9)$$

and the resulting input offset will be

$$\begin{aligned} V_{io} \text{ drift} &= (20 \mu\text{V}/^\circ\text{C}) (49^\circ\text{C}) \\ &= 0.98 \text{ mV}. \end{aligned} \quad (9a)$$

For $Q1$ base-current requirements approaching the maximum available op-amp current (usually 10-15 mA), the temperature rise in the op amp will become a factor, and the resulting drift will cause an error in regulation. The output voltage will appear to drift after the load is applied, after some time it will settle to a constant value. The regulation figure of Eq. 8 will be of little value, obviously, if the V_{io} drift completely swamps the excellent short-term regulation due to op-amp gain. The thermal time constant associated with chip temperature rise is on the order of 1 to 2 minutes, and temperature-rise drift can cause a gradually creeping output of at least this duration.

Temperature-rise drift often thwarts attempts to obtain good regulation over load, even though the output impedance of the op amp is excellent. Since the regulation in Eq. 8 corresponds to a voltage change of only $50 \mu\text{V}$, virtually any temperature shift (as little as 1°C) on the chip (or in the ambient) can cause the output to change by a significant amount.

Power-supply sensitivity limits regulation

If the op amp is connected directly across the supply voltage (Fig. 4), another type of error can occur, caused by power-supply sensitivity, making the regulation much worse than the

theoretical 0.0005% of Fig. 1.

For the case in which $V_o = V_{ref}$ (if $H=1$), regulator power-supply sensitivity may simply be read from the op-amp data sheet in terms of microvolts of change in the output per volt of change in the power supply. Good amplifiers have power-supply rejections from 25 to $200 \mu\text{V}/\text{V}$, and if the supply voltage drops only a volt over the regulator load range, the resulting output voltage drop due to power-supply sensitivity may exceed that predicted by Eq. 8.

Common-mode effects are a problem

If V_{ref} has a value other than the average of V^+ and V^- , the op-amp input has a common-mode component, and this can result in output error. When Q_1 is operated from the same supply voltage as the amplifier, an effort is usually made to minimize the voltage differential across the series pass transistor to maximize efficiency.

The common-mode voltage, $((V^+ + V^-)/2) - V_{ref}$, is usually quite high under these circumstances, and the error that results can become significant if the common-mode rejection ratio (CMRR) is less than 80 dB. Common-mode error appears as an offset, of either polarity, at the output, and it varies over temperature. For a CMRR of 80 dB, the error will be $+100 \mu\text{V}$ per volt of common-mode signal. A CMRR of at least 90 dB is desirable in most regulator op amps.

Voltage reference stability critical

Output voltage stability with time and temperature depends largely, of course, on the quality of the voltage reference—a tight op-amp drift specification alone will not guarantee a stable regulator over temperature. A good voltage reference should provide, in addition to stability, excellent line rejection, low cost, and perhaps ease of adjustment.

A good reference is a zener diode, which has a low temperature coefficient to begin with and can be further compensated by adding forward-biased diodes. Low-voltage zeners lack flexibility for use in higher voltage supplies, and high-voltage compensated zeners are normally expensive, but a reasonable compromise can usually be found.

When the reference voltage must equal the output voltage there is one common problem however: unregulated supply voltage must be used to excite the zener. Any ripple on the unregulated supply can feed through—attenuated, of course—to the output.

A simple zener circuit is shown in Fig. 5a. Since the diode exhibits a finite resistance at all current levels, an equivalent circuit may be drawn as Fig. 5b. The reference voltage V_R has

"Float" your IC regulator

Voltage regulators using monolithic op amps are often used for stabilizing voltages considerably higher than their ratings normally permit. This control is possible because the entire circuit is not referenced to ground, but rather is "floated" between ground and the supply voltage. A simplified version of the most popular circuit is illustrated in Fig. A.

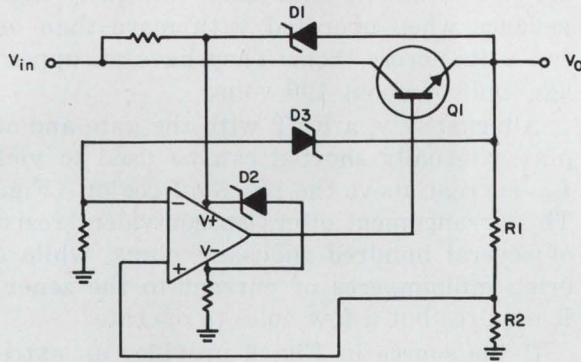

A. "Float" your regulator between ground and supply to increase its rating.

Zener D_1 ensures that positive IC supply is greater than the required output swing. Zener D_2 maintains a constant supply voltage for the unit ($|V_-| + |V_+| = V_{D_2}$). The voltage across the IC is thus tied to the output voltage by fixed constants.

Disregarding the power source for the op amp, the schematic can be simplified to that of Fig. B.

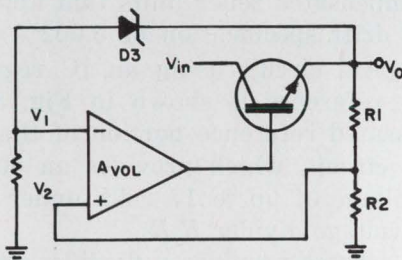

B. Simplify the circuit diagram for easy calculation of the transfer function.

The transfer function V_o/V_{D_3} may be simply derived if common-mode effects are neglected:

$$V_2 = (R_2/(R_1 + R_2))V_o,$$

and

$$V_1 = (V_o - V_{D_3}).$$

Then, since

$$V_o = A_{VOL} (V_2 - V_1),$$

$$V_o = A_{VOL} [(V_o R_2 / (R_1 + R_2)) - V_o + V_{D_3}],$$

$$V_o = A_{VOL} V_o [(R_2 / (R_1 + R_2)) - 1] + A_{VOL} V_{D_3},$$

$$V_o [1 + A_{VOL} (1 - (R_2 / (R_1 + R_2)))] = A_{VOL} V_{D_3},$$

and

$$V_o/V_{D_3} = A_{VOL} / [1 + A_{VOL} (R_1 + R_2)].$$

For $A_{VOL} (R_1 / (R_1 + R_2)) \gg 1$,

$$V_o/V_{D_3} = (R_1 + R_2) / R_1$$

$$\text{or } V_o = ((R_1 + R_2) / R_1) V_{D_3}.$$

The circuit responds as a zener "multiplier"; the output voltage V_o is a multiple of the reference voltage.

Another circuit that performs the same function is illustrated in Fig. C. The chief drawback

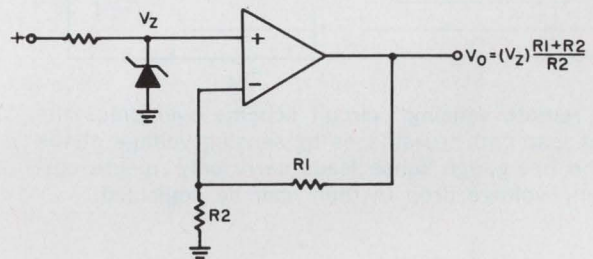

C. Common-mode limits restrict the output voltage in this circuit configuration.

of the circuit of Fig. C is that the output voltage is limited (for large multiplication ratios) by the permissible common-mode voltage V_z . For the floating regulators (Figs. A and B), the output voltage is not limited by either common-mode or differential voltage problems.

One limitation peculiar to this regulator is that regulation decreases for increasing output voltages. This is because the loop gain is dependent on the zener multiplication factor $R_1/(R_1 + R_2)$. For example, if $A_{VOL} = 50,000$, $V_{D_1} = 10$ V and $V_o = 100$ V, the loop gain is $A_{VOL}/10 = 5000$. This value may not be sufficient to support the desired regulation. The degradation of output impedance should be kept in mind for variable-voltage supplies constructed in this manner.

Also, zener diode voltage values cannot be chosen haphazardly. The value of V_{D_2} (Fig. A) is determined by the power-supply requirements of the op amp, but it will usually be 30 volts. The values of V_{D_1} and V_{D_3} are interdependent, and will be governed by the relative importance of loop gain (regulation) versus the ease of finding a good zener with a low temperature coefficient. Nominally, V_{D_1} may be chosen to be 10 volts. V_{D_3} should be chosen to place the op-amp input in a favorable common-mode range. ■■

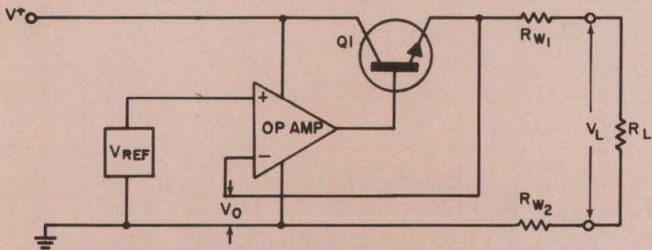

9. Load-path wire resistance R_{w1} and R_{w2} cause output error by introducing voltage drops between the load and the sensing circuit. A similar error can be caused by contact resistance or poor solder joints.

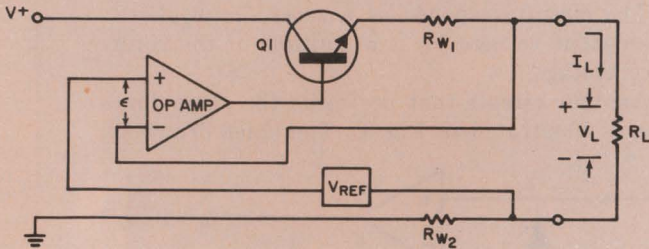

10. A "remote sensing" circuit scheme overcomes the effect of load-path resistances by sensing voltage at the load. The fine-gauge sense leads carry only minute currents, and voltage drop in them can be neglected.

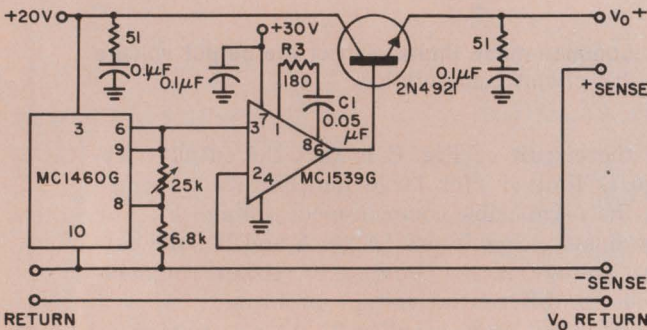

11. A typical regulator circuit uses an MC1539G op amp to provide loop gain and an MC1460G regulator to provide the reference voltage. The 2N4921 output transistor provides currents to 300 mA at the 15-V regulated output.

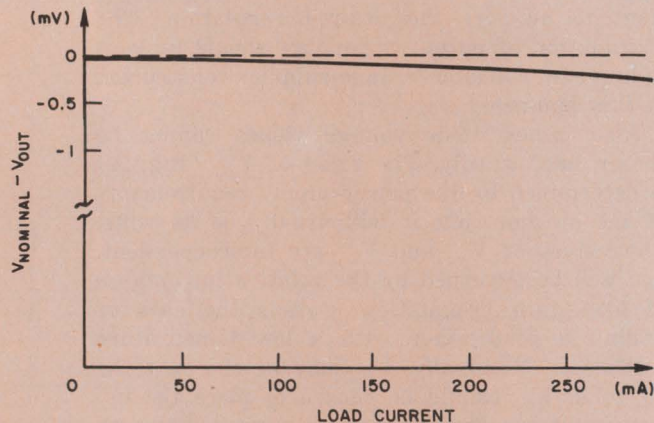

12. The measured regulation of the circuit of Fig. 11 exceeds the design specifications because worst-case or typical parameters were used in the design. Output voltage change is only 0.0003 V from zero load current to 300 mA, or 0.002%.

two components, V_z and $I_z R_z$, where $V_R = (V_z + I_z R_z)$ and

$$I_z = (V^+ - V_z) / (R + R_z) \quad (10)$$

if we assume $I_L = 0$.

Thus, $V_R = [V^+ - V_z] / (R + R_z) (R_z + V_z)$

$$\text{and } V_R = [V^+ R_z / (R + R_z)] + V_z [(1 - R) / (R + R_z)] \quad (11)$$

Note that a portion of the input voltage is coupled into V_R , due to R_z , causing input voltage influence at the output. By replacing the resistor R with a current source (Fig. 6), however, V_R may be rendered nearly independent of the input voltage. Two-terminal current regulator "diodes" are now available that have extremely high impedance when operated with more than one or two volts across them. They have an upper voltage limit of about 100 volts.

Alternatively, a FET with the gate and source pins externally shorted can be used to yield an I_{DSS} current above the pinch-off region (Fig. 6b). This arrangement offers an equivalent resistance of several hundred thousand ohms, while delivering milliamperes of current to the zener, and it requires but a few volts to operate.

If the source in Fig. 6 provides an extremely well regulated current, of course, the zener may be replaced by a resistor to establish a reference voltage with value I_{DR1} (Fig. 7). A completely variable reference can then be built by making R a potentiometer. The reference is now at the mercy of the temperature coefficient of the FET, which can be poor, but for short-term stability this approach offers flexibility of a variable V_R .

A stable, positive voltage reference can also be obtained from one of the currently marketed IC voltage regulators. These are priced well below compensated zener units that approach their typical drift specification of 0.002%/°C.

A typical circuit using an IC regulator as a voltage reference is shown in Fig. 8. Only the compensated reference portion of the IC is used in this circuit, which provides an output reference voltage of up to 17 volts under the control of the voltage divider $R_1 R_2$.

This scheme provides a flexible, stable voltage that should suffice for all but the most critical regulator applications. A high-voltage version of this circuit, using the MC1461-1561 IC regulator, offers outputs of 37 volts to satisfy most system reference needs. Note that the resistors R_1 and R_2 must be carefully chosen to ensure that their temperature coefficients match that of the IC device.

Lead resistance can be critical

So far, our discussion has been centered around devices and their effect on over-all regulator performance. But device parameters are

not the only consideration. Much regulator accuracy can be sacrificed by improper layout and wiring.

Load-path wire resistances, for instance, shown in Fig. 9, are most important simply because they carry the load current and thus can cause voltage drops. Even if $V_o = V_{ref}$ ($H=1$), and with $A_v = \infty$, the voltage across the load V_L will be less than V_o since

$$V_L = V_o R_L / (R_{W1} + R_{W2} + R_L). \quad (12)$$

The effects of wire resistance may seem insignificant at first glance but #20 wire exhibits a resistance of 10 mΩ/ft, which is 1 mV per 100 mA per foot. The wire resistance can thus seriously limit the regulation accuracy of a practical circuit.

An additional problem can be contact resistance, if the regulator output is a connector rather than a solder joint. Even solder joints can result in a drop of millivolts if not properly made.

Both of these conditions can be minimized (not eliminated) by "remote sensing" as shown in Fig. 10. When this technique is used, voltages at

the amplifier inputs are $V_{\epsilon}^- = V_L + I_L R_{W2}$ and $V_{\epsilon}^+ = V_{ref} + I_L R_{W2}$. The error voltage is then $V_{\epsilon}^+ - V_{\epsilon}^- = \epsilon = V_{ref} - V_L$ and

$$(13)$$

$$(V_{\epsilon}^+ + V_{\epsilon}^-)/2 = ((V_L + V_{ref})/2) + I_L R_{W2}. \quad (14)$$

The error given by Eq. 13 is the same as that for the circuit of Fig. 4, except that the common-mode voltage from Eq. 14 is increased by the value of $I_L R_{W2}$. If the common-mode rejection of the amplifier is good, this added voltage won't significantly affect the performance of the regulator. The sense lines may be fine-gauge wire since they carry very little current. Resistance R_{W1} increases the open-loop output impedance of the regulator, but in most instances an additional 10 or 20 mΩ will not significantly affect performance.

Build a better regulator

Suppose that your preliminary specification, or design goal, is 0.1% regulation in a +15-V regulator, for a current load change of 0-300 mA. The calculated output voltage change from no-load to full-load must be no more than 15 mV, which from Eq. 6 indicates a maximum regulator output impedance of 50 mΩ.

It is evident from Eq. 4 that some consideration must be given to the three primary factors that influence output impedance: series pass transistor gain β_{Q1} , op-amp open-loop output impedance, and op-amp open-loop A_{VOL} . A wide range of devices is available that will give the desired results, so the choice usually is made on

the basis of cost and availability. For good performance at moderate cost, a 2N4921 can be used as Q_1 and an MC1539 as the op amp. The pertinent device parameters are:

- $\beta_{Q1} = 20$ (min),
- A_{VOL} (op amp) = 50,000 (min),
- Z_o (op amp) = 4 kΩ
- CMRR = 100 dB
- Offset voltage = 4 mV (max),
- $TC_{vio} = 5 \mu V/^{\circ}C$, and
- Power-supply sensitivity = 150 $\mu V/V$ (max).

The regulator output impedance (Eq. 4) for this combination of devices is 4 mΩ, causing a voltage drop under full load of 1.2 mV, only a small part of the allowable error. The maximum current supplied by the MC1539G op amp is specified as 15 mA. For a single supply of +30 volts this results in an additional power dissipation (besides normal operating power) of 225 mW. Assuming the same Φ_{JA} as in Eq. 8, the chip-temperature rise will be 49°C, and the offset-voltage drift could be as high as 0.245 mV, which is negligible in this case. Since the output voltage is one-half the supply value of +30 volts and $V_{ref} = +15$ volts, no consideration need be given to common-mode effects. Power-supply variations affect the output only to the extent listed under "power-supply sensitivity," and can be assumed negligible.

As a reference for our regulator, an MC1460G is used to take advantage of its low temperature coefficient and excellent line rejection. Since ordinary carbon resistors are used to set the reference level, the over-all temperature coefficient will be determined by the temperature coefficient differences in the resistive divider. The regulation achieved by this circuit (Fig. 11), is shown in Fig. 12. ■■

Test your retention

Here are questions based on the main points of this article. Their purpose is to help you make sure you have not overlooked any important ideas. You'll find the answers in the article.

1. Name five causes of regulator error other than low loop gain.
2. Why is a regulator's output voltage often dependent on load current?
3. Why is it best for V_{ref} to have a value midway between V^+ and V^- ?
4. What method is suggested for avoiding the effects of lead resistance?

The Emancipator Becomes a Show-off!



The HP 9100A Calculator gave you
Freedom from waiting to get on the BIG computer;
Freedom from translating your problems into foreign computer languages;
Freedom from starvation-level computing with under-developed calculators;
Freedom from the drudgery of manual computation—
All for the one-time price of \$4900.

**NOW — EVEN GREATER COMPUTING FREEDOM IS YOURS.
GRAPHIC DISPLAY**

Add the new HP 9125A X-Y Recorder. Make your HP 9100A desk-top computing calculator a show-off. You will be liberated from the tediousness of hand-plotting, from the

omnipresent human errors and from inundating reams of data that go with point-to-point hand plotting.

Think back! Would a picture be worth a thousand figures, to you?...to your company? Be an innovator...be a producer...a picture producer.

The 9125A recorder automatically draws the answers as the calculator solves your problems—such as network response (photo shows Tchebysheff filter response expanded around f_c), differential equations, roots of polynomials and curve-fitting. It shows you the results of your calculations faster, easier, and more accurately than you can get with hand plots! It ends the gnawing frustration of interpreting the limbo between data points. And...it gives you a calibrated plot so you can read your units directly!

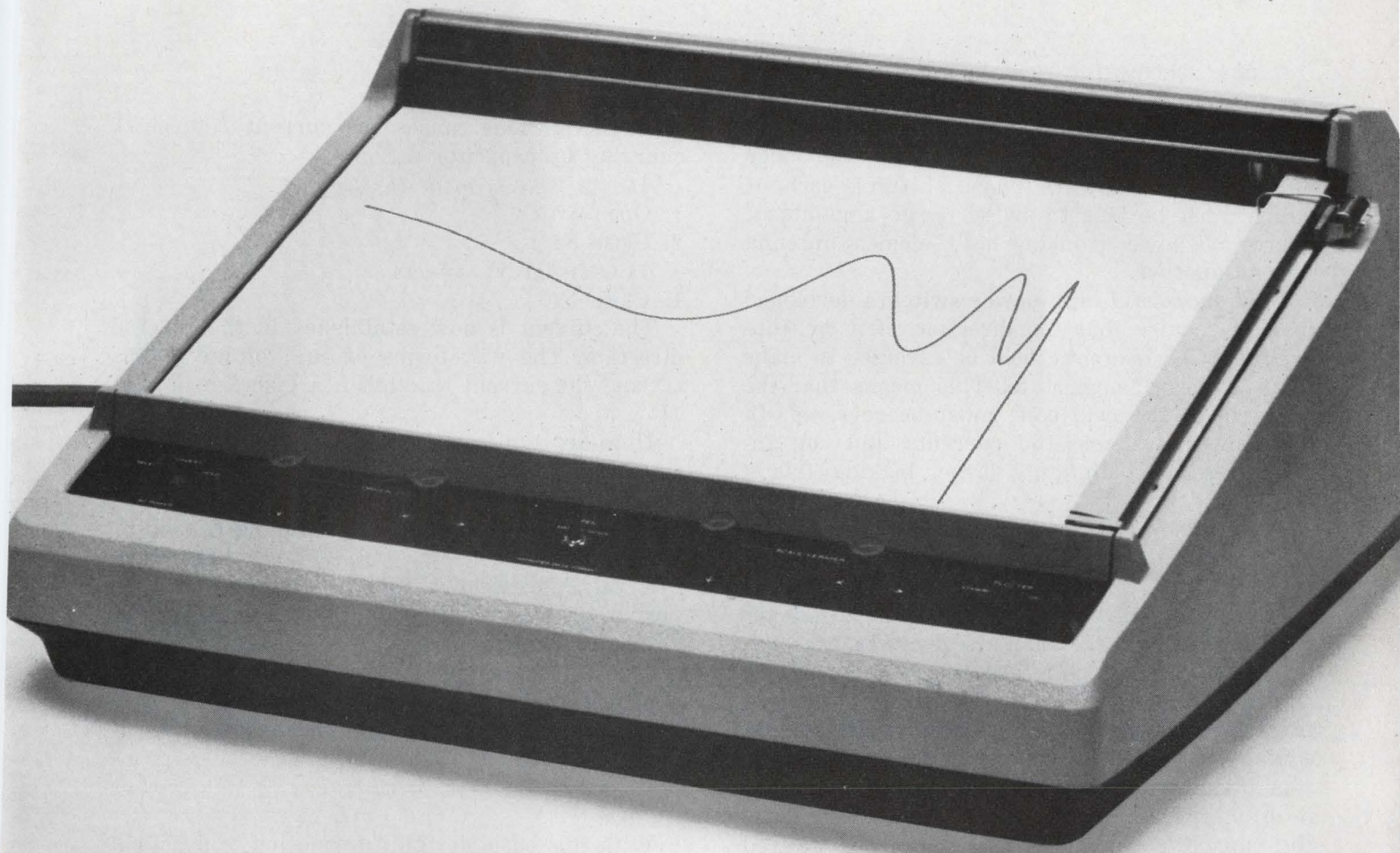

What's more, once the 9125A has given you a permanent graphic presentation, you can modify the input data, plot again, and immediately see the changes you have made. Nuances in areas of critical importance can be readily identified because of the pin-point resolution of the calculator/recorder combination—a resolution made possible by the four-digit calculator output that locates coordinate points with hair-splitting accuracy.

Completely documented programs for use with the HP 9100A Calculator and the HP 9125A X-Y Recorder are supplied with your instrument.

Show off with the 9125A for only \$2475. Add \$4900 if you don't already have the 9100A. Both are ready for immediate delivery.

Start your new liberation today. Call for a demonstration or send your purchase order to any Hewlett-Packard Sales and Service office (located in principal cities throughout the world). For a 22-page brochure, write Hewlett-Packard, P.O. Box 301, Loveland, Colorado 80537. Europe: 1217 Meyrin-Geneva, Switzerland.

9100A/9125A puts answers just a glance away!

099/20A
HEWLETT  PACKARD

INFORMATION RETRIEVAL NUMBER 60

Don't waste drive power in microwave switching.

Reverse the direction of an inductor's current by temporarily storing the energy in a capacitor

A new scheme for reversing the direction of the current in an inductor can substantially reduce power consumption and cooling problems in phased-array radars. These radars use large numbers of microwave phase shifters, each of which must be able to switch large amounts of microwave power from one multi-element antenna face to another.

Most successful high-power switches developed to date require that the direction of a continuously applied magnetic field be reversed to make the switches change state. This means that the currents in the field coils must be reversed. In high-power systems, the currents and coil inductances are both quite large, making this a formidable task.

The problem has commonly been attacked by first dissipating the energy stored in the magnetic field and then re-establishing the current in the desired direction. This has the disadvantage of wasting large amounts of power, especially when high switching rates are required. In addition, removing the heat in such a situation involves the use of complicated water-cooling equipment and its associated problems.

A better way to reverse the current is to use it to charge a capacitor—and then to discharge the capacitor back into the coil in the desired direction. To see how this is done, let's examine the highly schematized diagram of Fig. 1A. In any actual working circuit, the switches would, of course, be electronic, not mechanical.

Switch by the numbers

In the steady-state condition, $S2$ and $S3$ are closed and $S1$ and $S4$ are open. Current $I=I_0$ flows through L in the direction of the arrow, and all is serene.

Now let's say that, starting at time t_0 , we want to reverse the current in L . With the circuit of Fig. 1A, we follow this switching

sequence:

At t_0 :

1. Open $S2$. This causes the current I to start charging up capacitor C_1 .

At any time t_1 prior to t_2 :

1. Open $S3$.

2. Close $S4$.

At t_2 (when $V_{C1} = 0$):

1. Close $S1$.

The current is now established in the reverse direction. The waveforms of the voltage across $C1$ and the current through L are shown in Fig. 1B.

How are the important circuit parameters in this design related? One thing is perfectly clear: When the inductor current is zero, all of the energy in the system is stored in the capacitor. Therefore, $(C/2) V_{\max}^2 = (L/2) I_0^2$. The time interval T , between t_0 and t_2 is one-half of the period of sinusoidal oscillation determined by L and C . Thus, $T = \pi (LC)^{1/2}$. These two equations can be combined to give the capacitor value and peak-voltage requirements needed to meet a particular switching-time requirement for specified values of I_0 and L :

$$V_{\max} = \pi L I_0 / T \quad (1)$$

$$C = T^2 / \pi^2 L \quad (2)$$

With this basic design information, a practical circuit can be built. The circuit of Fig. 2 was designed, constructed and successfully operated with high-Q inductive loads. (Low-Q loads require additional circuitry to replace the energy dissipated in the switching process as we shall see later on.)

The circuit of Fig. 2 uses semiconductor devices with internal triggering of the switches except for the command information. $Q1$ and $CR5$, $Q2$ and $CR3$, $Q3$ and $CR6$, and $Q4$ and $CR4$ are the four switches of Fig. 1. $CR1$ and $CR2$ isolate $Q1$ and $Q3$ from high voltage developed across $Q2$ and $Q4$ during switching, thus allowing the use of low-voltage devices for the switches.

Capacitors $C1$ and $C2$ are placed somewhat differently in this circuit, but they perform the

Kenneth L. Ziegler, Quality Control Manager, Raytheon Co., Wayland Laboratories, Wayland, Mass.

same function as in the basic circuit. Their placement allows clamping by $CR5$ and $CR6$, which biases $Q2$ and $Q4$ off in the correct timing sequence. Resistors $R1$ and $R2$ have been added for current control in the stable states, and they may be temperature-compensated if the load should require it. The circuit operation is as follows:

Prior to t_0

1. $Q2$ is ON held by $Q3$ through $R5$.
2. $Q3$ is ON held by $Q2$ through $R1$, $R8$, and $CR1$.
3. I_0 is established in L by $B+/R2$.
4. $Q1$ is OFF held by $Q3$ through $R4$.
5. $Q4$ is OFF held by $Q2$ through $R1$, $R9$, and $CR1$.
6. $C1$ is charged to (i_b of $Q3$) ($R1$) (very small).
7. $C2$ is charged to $I_0 R2$ approximately $B+$ (3 to 10 volts).

At t_0

1. $Q2$ is turned OFF by external command.
2. V_{Q2} rises to $B+$ and $CR4$ and $CR5$ turn ON.
3. $Q3$ and $Q4$ turn OFF through $CR5$ and $R8$ and $R9$.
4. $Q1$ is turned ON by $Q4$ through $CR2$, $R2$, and $R4$.
5. $Q2$ is held OFF by $Q4$ through $CR2$, $R2$ and $R5$.
6. The resonant path is through $CR4$, L , $C1$, $CR5$, and the power supply.

At $I = 0$

1. With the reversal of current in L , the path is $Q4$, L , $C1$ and $Q1$.

At t_2

1. The voltage V_{Q2} returns to $B+$, $CR1$ turns ON, and the current $-I_0$ is established.

At any time t_3 the operation can be repeated to return the circuit to the original state.

Note that for the ideal case, little external power is required except to control the transistors. In an actual circuit there will be small losses because of the finite Q of the resonant circuit and the dc losses while in either state. However, the losses for a high- Q load will be small compared to the stored energy that is dissipated in conventional circuits.

The circuit can be packaged in a $2 \times 4 \times 8$ -inch package, excluding the power supply.

Make up the losses

The circuit of Fig. 2 is adequate for high- Q loads, but it does not compensate for the rather large amount of energy lost in loads with low Q s. Practical high-power rf switches developed to date are examples of loads requiring consideration of the energy lost during each transition.

These losses are in the order of 40 to 50 per cent of the steady-state stored energy. Most of

this loss is due to eddy currents in conductive paths linking the magnetic circuit. The conductive paths have been minimized in present rf switch designs, but they cannot be eliminated without seriously degrading rf performance.

The problem of adding energy to compensate for that lost during switching is closely related to the transfer or switching time. If one is not concerned with a limited switching time, the previous circuit for high Q s will still operate

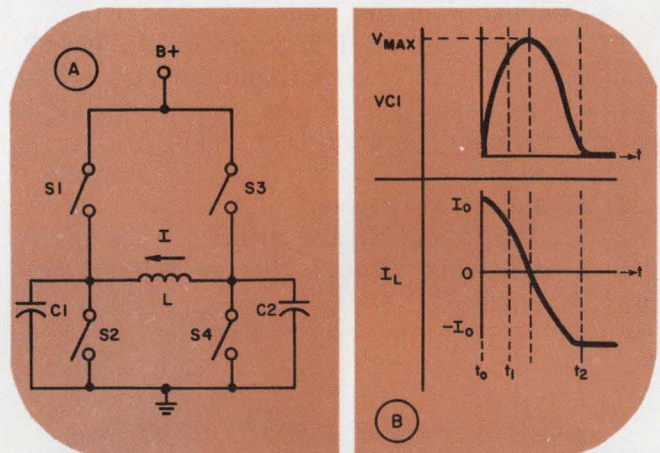

1. The capacitors are the key to conserving energy in this circuit for reversing the direction of the current in the inductor (A). The $B+$ power supply is current-limited to I_0 amps. The waveforms are shown in (B).

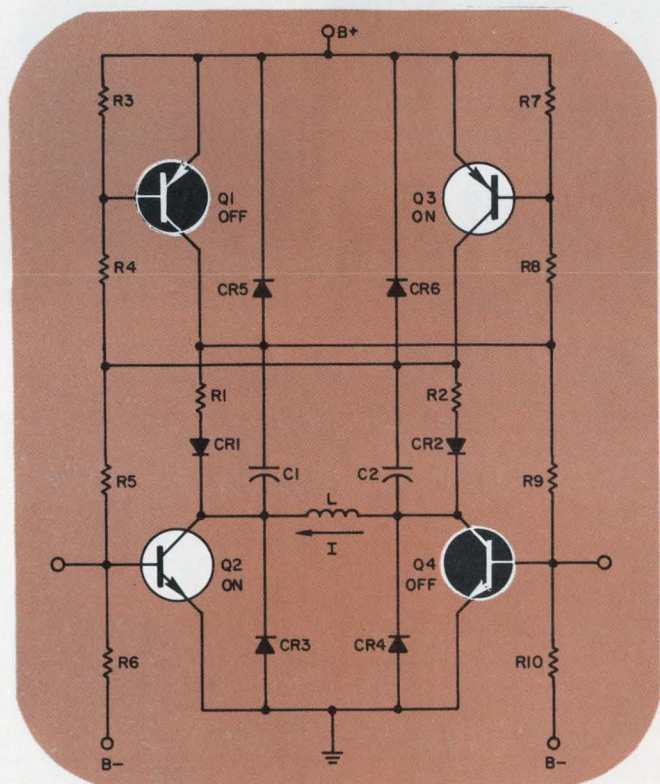

2. Self internal triggering is incorporated in this design by slightly modifying the positions of $C1$ and $C2$ from Fig. 1. The principle of operation is the same in both cases, however.

but with a severely degraded transfer time.

We at Raytheon have evaluated several approaches for replacing the lost energy. The resonant charging method is the most attractive.

Resonant charging adds energy to the circuit during its resonant switching period. The energy is supplied from a charging choke at the start of resonance with the load. This can be accomplished by the addition to the basic circuit (Fig. 1) of only two switches, a choke and a power supply. By this method, the capacitor used for energy storage obtains adequate energy so that at the end of the transition time the proper current is re-established in the load.

Fig. 3 is a simplified diagram of the circuit and the important current and voltage waveforms. The operation of the circuit during a current reversal operation is as follows:

Prior to t_0

1. $S2$ and $S3$ are closed.
2. $S1, S4, S5$ and $S6$ are open.
3. I_0 is flowing through the low-voltage supply, $S3, L$ and $S2$.

At t_0

1. $S2$ opens.
 2. $S5$ closes.
 3. Capacitor $C1$ charges from two paths:
 - a. Capacitor $C1$ charges resonantly through the low-voltage power supply, $S3$ and L .
 - b. $C1$ charges resonantly through the high-voltage power supply, $L1$ and $S5$. $C1$ receives enough energy from the high-voltage supply ($V1$) to make up for the energy lost during the switching cycle and thereby build the current back up to the design value (but in the opposite direction). The voltage $V1$ is approximately related to the lost switching energy in the following manner: $\text{Energy Lost} = C1(2V1)^2/2$. When the $L1-C1$ resonant period is much less than the $L-C1$ resonant period, the expression is correct.
- At $I = 0$ (t_1)
1. $S3$ opens.
 2. $S4$ closes.
 3. The resonant cycle continues.
 4. $C1$ discharges through L and $S4$, and current builds up to the original magnitude but opposite polarity.

At t_2

1. $S1$ closes.
2. B+ (a current regulated supply) maintains $-I_0$.

Let's examine a working circuit

The ideas of Fig. 3 have actually been put to use in a driver that can switch a 1.5-joule lossy load in 1.3 milliseconds. The load had a 50 per cent loss of energy every time it was switched. A diagram of the circuit, with the self-triggering circuitry eliminated for simplicity, is shown in Fig. 4.

$Q6$ and $Q16$ are gate-turn-off devices, which are similar to conventional silicon-controlled rectifiers except that they can be turned off by a current pulse on their control electrodes.

The high-voltage power supply is adjusted to compensate for the losses during switching and the (current-regulated) low-voltage power supply is set for 5.7 amperes dc during the steady-state condition.

Prior to t_0 , steady-state current flows from the low-voltage supply ($B+$) through SCR $Q10$, diodes $CR16$ and $CR17$, the rf switch coil, SCRs $Q4$ and $Q5$ and GCS $Q6$. At t_0 , a 10-microsecond negative trigger signal pulse of 2.5 amperes, is applied through $CR10$ to the gate of $Q6$ to turn the driver off. $Q6$ is a gate control switch with a voltage rating of 700 volts and a current rating of 8 amperes dc. Zener diodes $VR1, VR2$, and $VR3$ are across the anode to cathode of GCS $Q6$

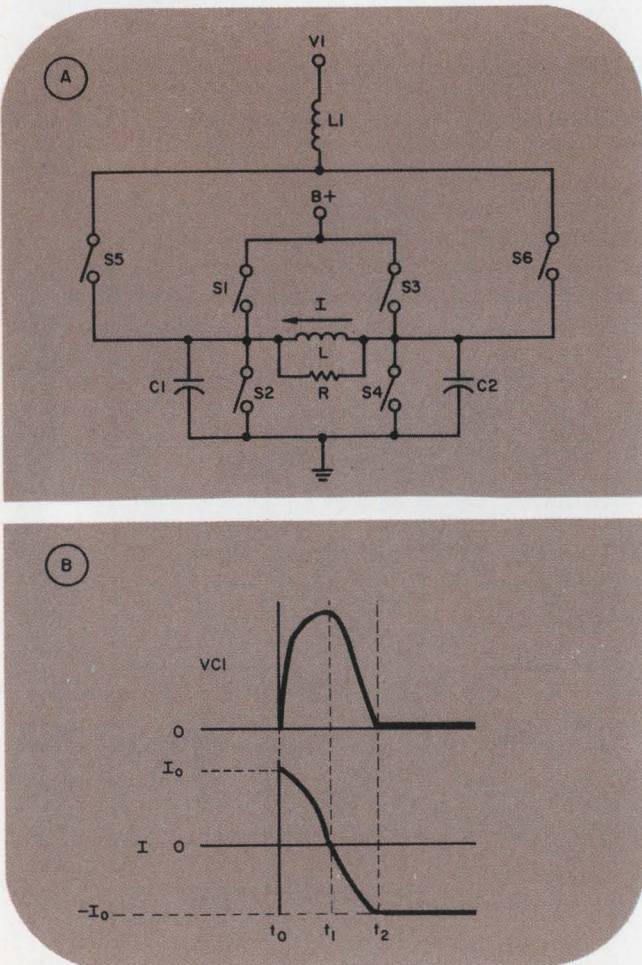

3. Lost energy is replaced from the high-voltage power supply, $V1$, through charging choke, $L1$ (A). The current and voltage waveforms are shown in (B).

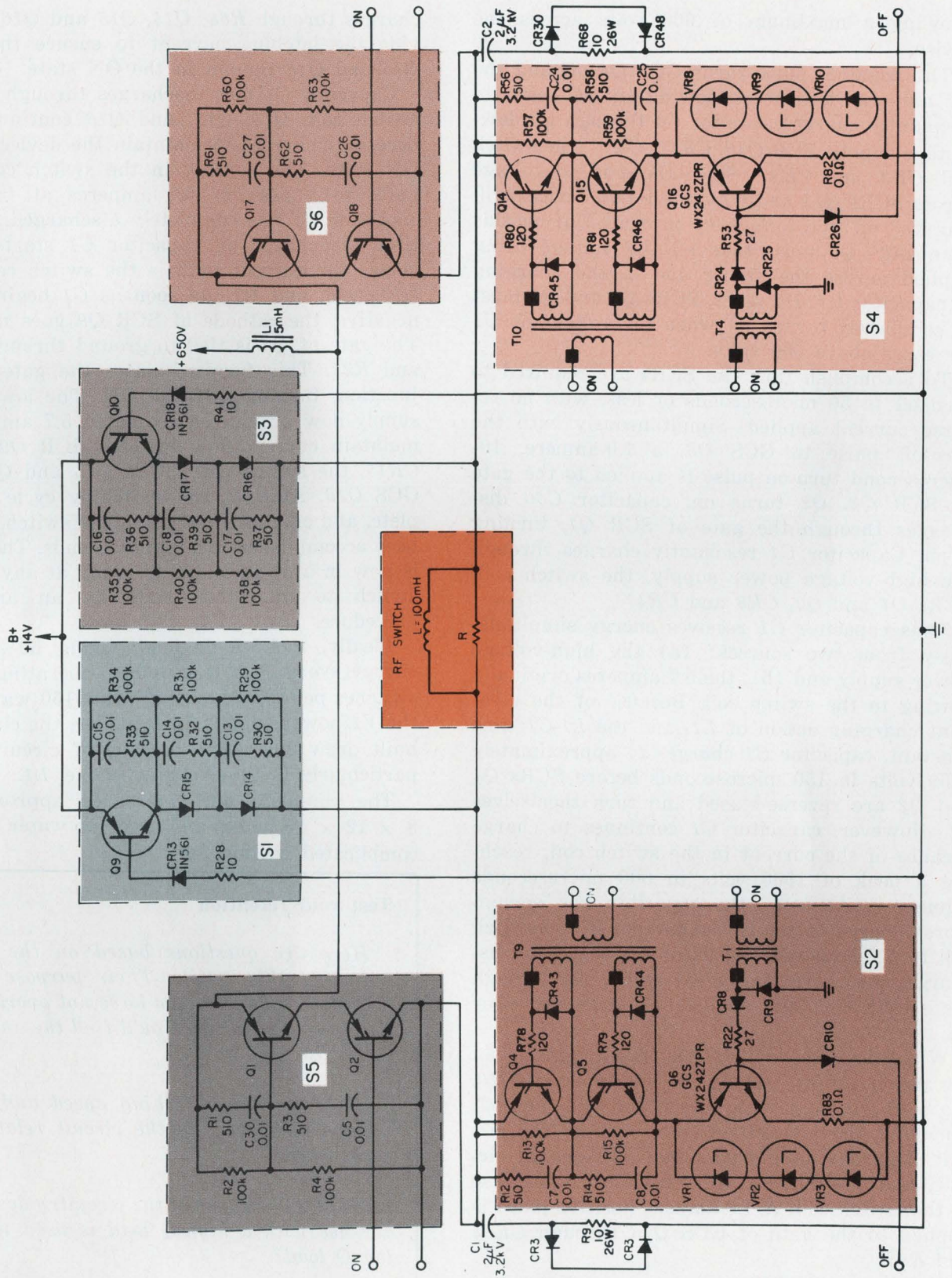

4. A low-Q load that dissipates one half of its 1.5 joules of stored energy with each transition, can be switched 200 times per second with this driver. Switching takes only 1.3 milliseconds. All of the unlabeled

SCRs are type 2N692. Diodes CR 8, 9, 10, 24, 25, 26, 43, 44, 45 and 46 are type 1N691. Diodes CR 3, 14, 15, 16, 17, 30, 47 and 48 are type 1N3673. Zener diodes VR 1, 2, 3, 8, 9 and 10 are type 1N3051B.

allowing a maximum of 600 volts across the device.

The negative pulse turns GCS $Q6$ off and the 5.7 amperes that were flowing in $Q6$ begin to resonantly charge capacitor $C1$ through the low-voltage supply, SCR $Q10$, $CR16$, $CR17$, the switch coil, $CR3$, and $CR47$. Since there is no voltage across SCRs $Q14$ and $Q15$, these two devices will "starve" off due to lack of current. During this time GCS $Q6$ must take all the voltage being applied across the string due to the charging of capacitor $C1$. However, SCRs $Q4$ and $Q5$ must be completely turned off when the voltage on $C1$ increases above 600 volts.

To accomplish this, the SCRs are required to turn off in 50 microseconds or less, with no reverse current applied. Simultaneously with the turn-off pulse to GCS $Q6$, a 1.0-ampere, 10-microsecond turn-on pulse is applied to the gate of SCR $Q2$. $Q2$ turns on, capacitor $C30$ discharges through the gate of SCR $Q1$, turning it on. Capacitor $C1$ resonantly charges through the high-voltage power supply, the switch coil, SCRs $Q1$ and $Q2$, $CR3$ and $CR47$.

Thus capacitor $C1$ receives energy simultaneously from two sources: (a) the high-voltage power supply and (b), the 5.7 amperes originally flowing in the switch coil. Because of the resonant charging action of $L1$, and the $L1$ - $C1$ time constant, capacitor $C1$ charges to approximately 1200 volts in 150 microseconds before SCRs $Q1$ and $Q2$ are reverse-biased and turn themselves off. However, capacitor $C1$ continues to charge because of the current in the switch coil, reaching a peak of 1500 volts in 600 microseconds (time t_1). At $t=t_1$, the capacitor has enough stored energy to return the current in the switch coil to 5.7 amperes. Capacitor $C1$ begins to discharge, the current reverses and flows through the switch coil, and begins to charge capacitor $C2$.

When the cathode of $Q10$ is raised higher than the power-supply voltage on the anode of $Q10$, the SCR will be reverse-biased and will turn off, removing the low-voltage supply from the circuit. This has no effect on the LC resonant circuit, and the current will continue to increase in the switch coil. A 1.0-ampere positive pulse is applied to the gate of GCS $Q16$ through $CR24$ and $R53$.

Simultaneously, 250-milliamperere positive pulses are applied through $R80$ and $R81$ to the gates of SCRs $Q14$ and $Q16$. Diodes $CR45$, $CR46$, and $CR25$ reduce backswing on the gates of the semiconductors. Simultaneous application of triggers turns on $Q14$, $Q15$ and $Q16$. Capacitor $C2$, having been charged to approximately 20 volts, dis-

charges through $R68$, $Q14$, $Q15$ and $Q16$ to provide the latching current to ensure that $Q14$, $Q15$ and $Q16$ remain in the ON state.

Capacitor $C1$ now discharges through $R9$, the switch coil, $Q14$, $Q15$, and $Q16$ continuing the necessary current to maintain the devices in the ON state. The current in the switch coil resonates to a peak of 5.7 amperes at $t=t_2$ and capacitor $C1$ has completely discharged. At this time the charge on capacitor $C1$ starts to reverse; the current path is the switch coil, $Q14$, $Q15$, $Q16$, and $R9$. As soon as $C1$ begins to go negative, the cathode of SCR $Q9$ goes negative. The gate of $Q9$ is tied to ground through $CR13$ and $R28$. This forward-biases the gate-cathode junction, turning SCR $Q9$ ON. The low-voltage supply now provides a regulated 5.7 amperes to maintain current flow through SCR $Q9$, $CR14$, $CR15$, the switch coil, SCRs $Q14$ and $Q15$, and GCS $Q16$. At $t=t_2$, the switching cycle is complete, and current reversal in the switch coil has been accomplished in 1.3 milliseconds. The circuit is now in a dc state and is ready at any time to switch to the other state by an analogous procedure.

Ideally, a 1.5-joule load, losing 50% of its energy every time it switches, operating at 200 switches per second, should draw 150 watts from the $V1$ power supply. In actuality, the circuit we built drew 200 watts because of circuit losses, particularly in the charging choke, $L1$.

The complete unit measures approximately $8 \times 12 \times 15$ inches and needs no water or other complicated cooling. ■■

Test your retention

Here are questions based on the main points of this article. Their purpose is to help you make sure you have not overlooked any important ideas. You'll find the answers in the article.

- 1. How are the switching speed and peak voltage developed by the circuit related to each other?*
- 2. What will happen if the circuitry designed for use with a high-Q load is used with a low-Q load?*
- 3. What is resonant charging?*
- 4. How should the sizes of the inductive load (L) and the charging choke ($L1$) be related?*

VIEW

The RCA WO-33A Super-Portable 3-Inch Oscilloscope helps solve virtually any electronics servicing problem, inside or outside the shop. Its combination of exceptionally low cost and high performance have already made it popular as a monitoring and trouble shooting 'scope in black and white and color TV broadcasting studios, and in professional service. And why not? Here's a 3-inch 'scope that meets your requirements for gain, bandwidth, transient response, accuracy, versatility, and portability. AND IT'S ONLY \$139.00.* Also available in an easy to assemble kit, WO-33A (K).

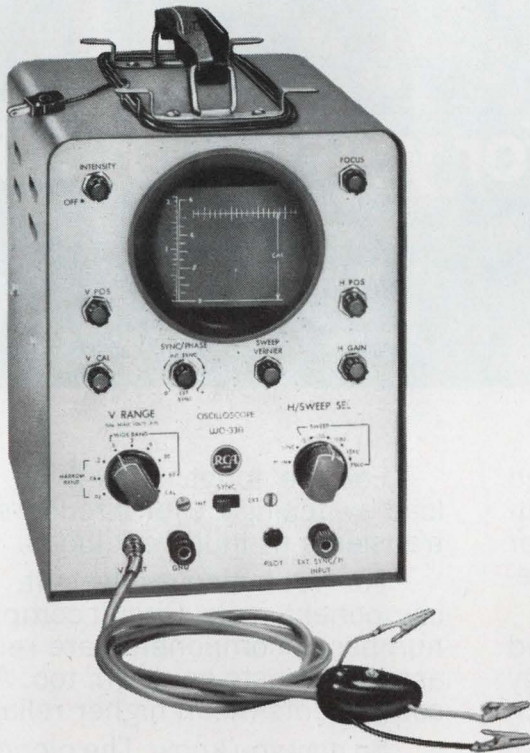

The RCA WO-91C 5-inch Dual Band Oscilloscope is a reliable, heavy-duty, precision 'scope in use in thousands of installations from classrooms to TV distribution systems...from service benches to broadcast stations. You probably can't find a better value. Applications include waveform analysis, peak-to-peak voltage measurement, square-wave testing, and observation of circuit characteristics. A front-panel switch gives you an easy choice of wide-band or narrow-band (high sensitivity) operation. It's easily portable, AND IT'S ONLY \$269.00.* The WO-91C-V1 is available for 240V operation, no increase in price.

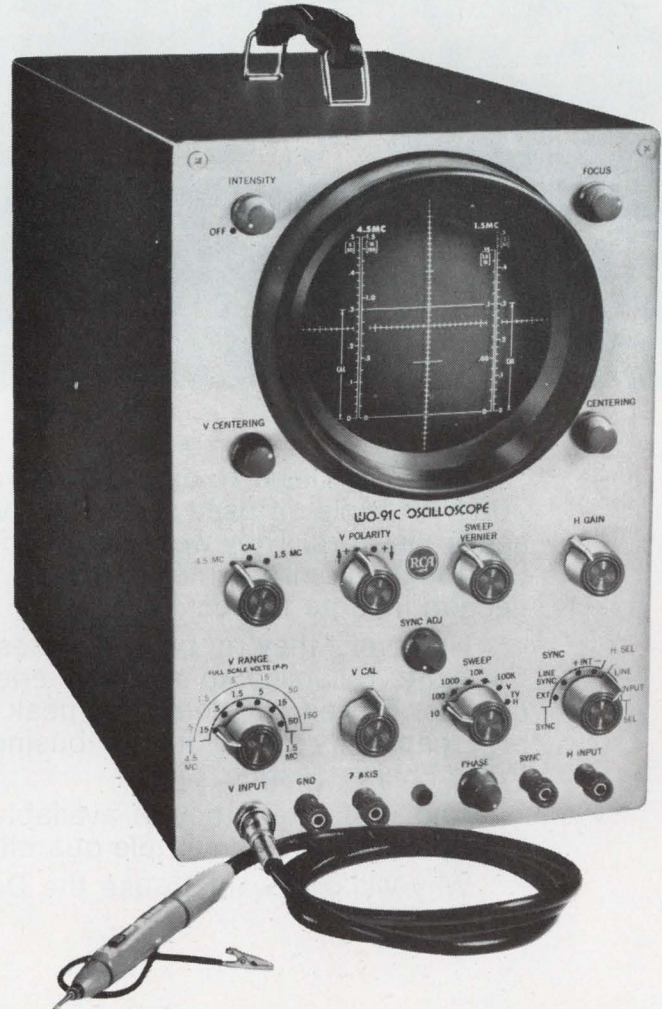

*Optional Distributor resale price. Prices may be slightly higher in Alaska, Hawaii, and the West.

Write for a catalog with complete descriptions and specifications for all RCA test equipment: RCA Electronic Components, Commercial Engineering, Department No. F-18W-3, Harrison, N.J. 07029

LOOK TO RCA FOR INSTRUMENTS TO TEST/MEASURE/VIEW/MONITOR/GENERATE

The RCA logo, consisting of the letters 'RCA' in a stylized, outlined font.

INFORMATION RETRIEVAL NUMBER 61



MARK OF EXCELLENCE

Now, ready for you in quantity.

The new Delco Radio DTS-701 and 702 NPN triple-diffused silicon high voltage transistors. They were designed for the tough requirements of off-line deflection in large screen TV.

However, they're built and tested for extra reliability in all high energy circuits. Proved by the surest peak energy capability rating in the business: Pulse Energy Testing.

And right now, they're available in both production and sample quantities.

Why will you want to use the Delco 701 or 702?

For the tough jobs—high inductive load switching or for circuits subject to transients or fault conditions.

For reduction of weight, size and component costs. Circuit complexity and number of components are reduced, so assembly costs go down, too. And fewer components mean higher reliability.

So now you know. The pioneer in high voltage silicon power has done it again.

For prices, samples or complete data, just call us or the nearest Delco Radio distributor listed below.

SEMICONDUCTOR DISTRIBUTORS: **EAST**—BALTIMORE, MD. 21201, Radio Electric Service Co., 5 North Howard St., (301)-539-3835 BINGHAMTON, N.Y. 13902, Federal Electronics, Inc., P. O. Box 1208, (607)-748-8211 CLIFTON, N.J. 07015, Eastern Radio Corporation, 312 Clifton Avenue, (201)-471-6600 NEWTON, MASS. 02195, The Greene Shaw Co., Inc., 341-347 Watertown St., (617)-969-8900 NEW YORK, NEW YORK 10036, Harvey Radio Co., Inc., 2 West 45th St., (212)-582-2590 PHILADELPHIA, PENN. 19114, Almo Electronics, Division of Sterling Electronics, Roosevelt Blvd. at Blue Grass Rd., Northeast Industrial Park, (215)-676-6000 PITTSBURGH, PENN. 15328, RPC Electronics, 620 Alpha Drive, RIDC Park, (412)-782-3770 WOODBURY, L.I., N.Y. 11797, Harvey Radio Company, Inc., 60 Crossways Park West, (516)-921-8700 **SOUTH**—BIRMINGHAM, ALA. 35233, Forbes Distributing Company, Inc., 1416 Fourth Ave., South, (205)-251-4104 MIAMI, FLORIDA 33142, Mountain Electronics, Division of Mountain National Co., 3730 Northwest 36th St., (305)-634-4556 RICHMOND, VA. 23220, Meridian Electronics, Inc., 1001 West Broad Street, (703)-353-6648 WEST PALM BEACH, FLA. 33402, Mountain Electronics, Division of Mountain National Co., 1000 N. Dixie Highway, (305)-833-5701 **MIDWEST**—CINCINNATI, OHIO 45237, United Radio, Inc., 7713 Reinhold Drive, (513)-761-4030 CLEVELAND, OHIO 44125, The W. M. Pattison Supply Co., Industrial Electronics Division, 4550 Willow Parkway, (216)-411-3000 DAYTON, OHIO 45414, F-J-R Ohio, Inc., 5212 North Dixie Dr., (513)-278-9411 INDIANAPOLIS, IND. 46204, Graham Electronics Supply, Inc., 133 S. Pennsylvania St., (317)-634-8486 KALAMAZOO, MICH. 49005, Electronic Supply Corp., P.O. Box 831, (616)-381-4626 KANSAS CITY, MO. 64111, Walters Radio Supply, Inc., 3635 Main Street, (816)-531-7015 MINNEAPOLIS, MINNESOTA 55401, Stark Electronics Supply Co., 112 3rd Ave., North, (612)-332-1325 ROSEMONT, ILL. 60018, F-J-R/Midwest, Inc., 9340 William St., (312)-678-8560 SKOKIE, ILL.



1200V - 3.0A
800V - 0.5A

| DTS-701 | |
|--|-----------|
| Collector to emitter voltage (V_{CE0}) | 800V |
| Sustaining voltage ($V_{CE0(SUS)}$) | 600V min. |
| Emitter to base voltage (V_{EBO}) | 5V |
| Collector current (I_C) | 500mA |
| Base current (I_B) | 100mA |
| Power dissipation (P_T) | 25W |
| DTS-702 | |
| Collector to emitter voltage (V_{CEX}) | 1200V |
| Collector to emitter voltage (V_{CE0}) | 1000V |
| Sustaining voltage ($V_{CE0(SUS)}$) | 750V min. |
| Emitter to base voltage (V_{EBO}) | 5V |
| Collector current (I_C) | 3A |
| Base current (I_B) | 1A |
| Power dissipation (P_T) | 50W |

Available in solid copper. JEDEC TO-3 package.

Kokomoan's Regional Headquarters

Union, New Jersey* 07083
 Box 1018 Chestnut Station
 (201) 687-3770

Chicago, Illinois* 60656
 5151 N. Harlem Avenue
 (312) 775-5411

Santa Monica, Calif.* 90401
 726 Santa Monica Blvd.
 (213) 870-8807

Detroit, Michigan 48202
 57 Harper Avenue
 (313) 873-6560

Kokomo, Ind. 46901
 700 E. Firmin
 (317) 459-2175 Home Office

*Office includes field lab
 and resident engineer
 for application assistance.



THE KOKOMOANS ARE IN POWER

DELCO RADIO

DIVISION OF GENERAL MOTORS

KOKOMO, INDIANA

60076, Merquip Electronics, Inc., 7701 N. Austin Ave., (312)-282-5400 ST. LOUIS, MISSOURI 63144, Electronic Components for Industry Co., 2605 South Hanley Road, (314)-647-5505 WEST—ALBUQUERQUE, N.M. 87108, Hyer Electronics Company, 130 Alvarado Drive, N.E., (505)-265-5767; 87106, Sterling Electronics Inc., 1712 Lomas Blvd., N.E., (505)-247-2486 COLORADO SPRINGS, COLO. 80902, L. B. Walker Radio Company, 9 E. Vermijo St., (303)-636-1661 DALLAS, TEXAS 75201, Adleta Electronics Company, 1907 McKinney Ave., (214)-742-8257 DENVER, COLO. 80219, L. B. Walker Radio Company, 300 Bryant Street, (303)-935-2406 ENGLEWOOD, COLORADO 80110, Hyer Electronics Company, 8101 E. Prentice Ave., (303)-771-5285 FORT WORTH, TEXAS 76102, Adleta Electronics Co., S. Expressway at E. Vickery, (817)-336-7446 HOUSTON, TEXAS 77001, Harrison Equipment Co., Inc., 1422 San Jacinto Street, (713)-224-9131 LOS ANGELES, CAL. 90015, Radio Products Sales, Inc., 1501 South Hill Street, (213)-748-1271 LOS ANGELES, CAL. 90022, Kierulff Electronics, Inc., 2585 Commerce Way, (213)-685-5511 OKLAHOMA CITY, OKLAHOMA 73102, Radio, Inc., 903 North Hudson, (405)-235-1551 PALO ALTO, CAL. 94303, Kierulff Electronics, Inc., 3969 East Bayshore Road, (415)-968-6292 PHOENIX, ARIZ. 85005, Sterling Electronics, Inc., 1930 North 22nd Ave., (602)-258-4531 SALT LAKE CITY, UTAH 84115, Hyer Electronics Company, 1425 South 2nd West, (801)-487-3681 SAN DIEGO, CAL. 92101, Milo of California, Inc., 2060 India Street, Box 2710, (714)-232-8951 SEATTLE, WASH. 98108, Kierulff Electronics, Inc., 5940 6th Ave., South, (206)-763-1550 TACOMA, WASH. 98402, C & G Electronics Co., 2502 Jefferson Ave., (206)-272-3181 TULSA, OKLA. 74119, Radio, Inc., 1000 South Main Street, (918)-587-9124 CANADA—SCARBOROUGH, ONTARIO, Lake Engineering Co., Ltd., 123 Manville Rd., (416)-751-5980

Get something extra in filter design.

One BASIC program works for Butterworth and Chebyshev low-pass or high-pass RC-active circuits.

A time-shared computer program can do much more than free the engineer from the tedium of routine calculations in filter design.¹ A single program in BASIC,² derived from two fundamental equations, can be used to design Butterworth or Chebyshev filters, and either low-pass or high-pass versions of each.

The program, written in a language resembling simple English, determines the component values for N -pole filters. The design uses two-pole active sections with only Rs and Cs, no Ls, as the basic building blocks for higher-order filters. N -pole filters are created by cascading $N/2$ two-pole sections. The R and C values in each section are selected to achieve the desired filter response.

Low-pass and high-pass sections^{3,4,5} used in the filters are shown in Fig. 1. Two capacitors, two resistors and a unity-gain active element (Table 1) serve to synthesize a complex pair of poles in the filter characteristic.

The filters described in this article are relatively inexpensive. They may be built as either discrete circuits or hybrid microcircuits and for either commercial or military use.

As hybrid microcircuit designs they possess the following advantages:

- Since they use no Ls, the resulting circuit is potentially smaller, more stable and has a higher Q at low frequencies than passive LC designs.

- The Cs can be chosen as standard values. Even though the Rs are non-standard, they are relatively easy to obtain.

- The frequency response can be adjusted by varying only the Rs. One filter can therefore be readily tuned into phase track with another, or trimmed to a given specification.

In addition this design approach:

- Uses a minimum of Rs and Cs to synthesize a two-pole function.

- Requires only one unity-gain active element for each filter section.

- Has low sensitivity to parameter changes.

Several of the many possible types of unity-gain active elements are shown in Table 1. The most important figure of merit for these voltage

follower elements is their current gain β because accurate filter synthesis requires a high input impedance and low output impedance. The equations used to calculate the filter component values assume a perfect active element, $\beta = \infty$. In practice the active elements are imperfect, especially at higher frequencies. Finite input impedance causes insertion loss and frequency response distortion; non-zero output impedance causes reduced stop-band attenuation; and variations from unity-gain change the resonant response of the section.

In view of these effects, it makes little sense to use 1% components to obtain a precise filter response, unless the input impedance of the active element is greater than $100R_2$ and the output impedance is less than $R_1/100$. It is also senseless to seek high stop-band attenuation in a frequency region where β is significantly decreased.

Align sections by adjusting only resistors

Component values (Fig. 1) for the basic low-pass or high-pass filter sections are computed from the equations for the pole locations ($\sigma_i + j\omega_i$) of the normalized functions:

$$\sigma_i = X1 \cos (P_i)$$

$$j\omega_i = jX2 \sin (P_i),$$

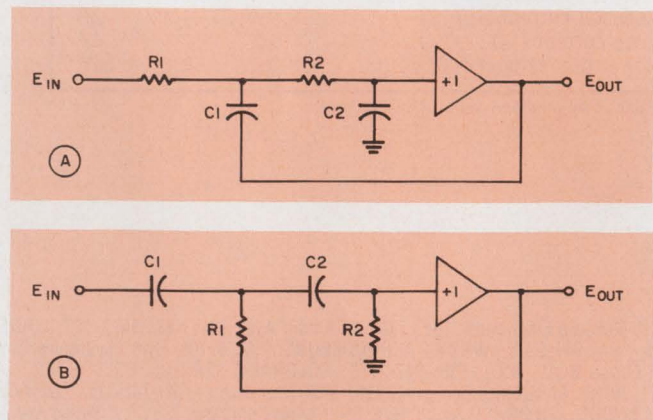

1. Two-pole circuit sections serve as basic building blocks that are cascaded to form multiple-pole filters, low-pass section above, and high-pass section, below. The component values in each section are computer-selected (to obtain either a Butterworth or Chebyshev response).

Russell Kincaid and Frederick Shirley, Technical Staff, Sanders Associates, Inc., Nashua, N.H.

where $X1 = 1$, $X2 = 1$, for Butterworth filters, and $X1$ and $X2$ depend on the passband ripple and number of poles for Chebyshev filters. The equations for the component values are shown in Table 1.

The over-all filter design is not limited to a particular ratio of component values. Each two-pole section may therefore be independently aligned by adjusting only the two resistor values. Three cases occur:

1. When the four component values of a section are fairly close to the design values, the filter alignment can be improved by nearly an order of magnitude by adjusting only one of the two resistors so that the desired response is obtained at the cut frequency. For thick-film or potted sections, the adjustment may be made externally by adding a series trim resistor either to R_1 of the low-pass circuit or to R_2 of the high-pass circuit (Fig. 1).

2. When both C values are out of tolerance by comparable large percentages, the section may be aligned by a two-step procedure. First, impedance-scale the section by off-adjusting the two resistors by the same percentage as the capacitors but in the opposite direction. This will improve the frequency response of the section. It will modify the section impedance level to accommodate the varied C values. Second, trim the response of the section at the cut frequency by adjusting one of the two resistors, as previously described. It is not advisable to trim both resistors since their effects on the frequency response are interdependent.

3. When the two C values are out of tolerance by different large percentages, the section response may best be improved by off-adjusting the Rs to recomputed values. The revised R values are obtained by rerunning the computer program with the actual C values inserted in place of the nominal ones. One of the two resistors may then be trimmed, if desired.

Sensitivity influences filter response

If the circuit component values are out of tolerance—due to initial selection error, environmental variation or aging—the filter response will vary from nominal. The variation of filter gain $\Delta G/G$ with component value variation $\Delta V/V$ is determined by the sensitivity factor S :

$$\Delta G/G = S \times \Delta V/V.$$

If $S = 1$, the equation shows that a component variation of 1% is equivalent to $20 \log_{10} (1-0.01)$, resulting in a gain variation of only 1 dB. For a large value of S —say, $S = 100$ —the same equation shows that a component variation of 1% is equivalent to $100 \times (0.01) = 1$ (or a 100% increase). As the component varies by 1%, G

Table 1. Unity gain active elements

| Circuit element | Approximate current gain (β) (at low frequencies) |
|--|---|
|  <p>Simple emitter follower</p> | 100 |
|  <p>Darlington emitter follower</p> | 4000 |
|  <p>Compound transistor follower</p> | 4000 |
|  <p>Operational amplifier follower</p> | >100,000 |
|  <p>Integrated circuit follower</p> | >100,000 |

Table 2. Filter component value formulas*

| Low-pass section | | High-pass section | |
|---|--------------------|--|--------------------|
| Formula | Eq. Nos. (see box) | Formula | Eq. Nos. (see box) |
| $C_1 = C$ | 14a | $C_1 = C$ | 18a |
| $C_2 = C/M$ | 14b | $C_2 = C$ | 18b |
| $R_i = \frac{-\sigma_i M}{2\pi F A_i C} \left[1 + \left(1 - \frac{A_i}{\sigma_i^2 M} \right)^{\frac{1}{2}} \right]$ | 15a | $R_1 = \frac{-\sigma_i}{2\pi F C}$ | 19a |
| $R_i = \frac{-\sigma_i M}{2\pi F A_i C} \left[1 - \left(1 - \frac{A_i}{\sigma_i^2 M} \right)^{\frac{1}{2}} \right]$ | 15b | $R_2 = \frac{-A_i}{2\pi F \sigma_i C}$ | 19b |
| $M \geq A_i/\sigma_i^2$ | 16 | | |

*Resistor values are scaled to cut frequency F.

increases 100%, or from G to 2G, a gain variation of 6 dB ($20 \log_{10} 2 = 6 \text{ dB}$).

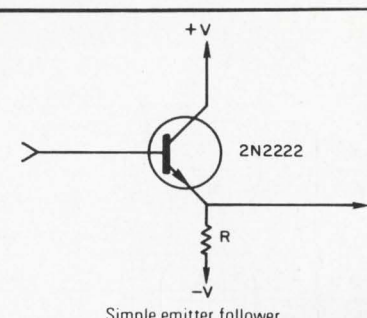
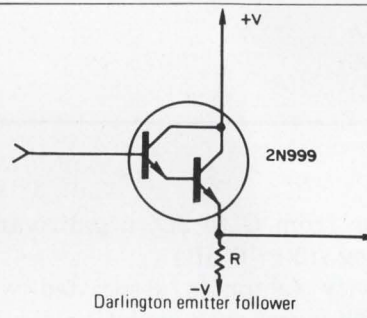
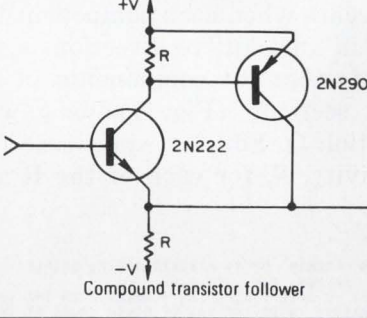
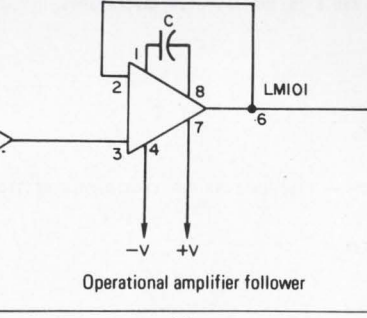
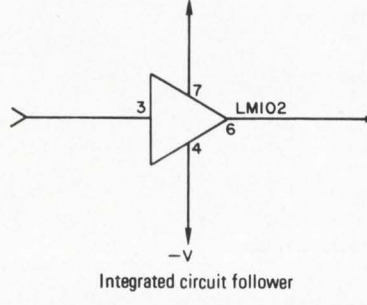
Since a sensitivity factor is associated with each component, the worst-case variation for the complete section occurs when each component has a maximum error in an additive direction.

The sensitivity factors for components in the basic active filter sections (Fig. 1) vary with frequency and section Q. For the worst-case frequency, the sensitivity, S, for each of the R and

C components (Fig. 1) is:

| | |
|---------------|------|
| $\frac{Q}{1}$ | S |
| 100 | 0.01 |
| | 0.3 |

and for variations in gain of the active element is

| | |
|---------------|-------|
| $\frac{Q}{1}$ | S |
| 5 | 0.02 |
| 8 | 1.0 |
| | 100.0 |

The high-gain sensitivity factor is not harm-

```

8 DATA 2,4,1,2.4,10
10
20 REM RC ACTIVE FILTER PROGRAM BY R. KINCAID AND F. SHIRLEY
30 REM SANDERS ASSOC. INC, NASHUA, N.H. 11/5/68
40 REM LINE # SHOULD BE: # DATA T,N,F,R,C -- WHERE T IS THE TYPE
50 REM (1=LOWPASS, 2=HIGHPASS); N IS THE NO. OF POLES (MUST BE EVEN);
60 REM F IS THE CUT FREQ IN KHZ; R IS THE PASSBAND RIPPLE IN DB (#
70 REM FOR BUTTERWORTH); AND C IS THE MAX C IN NANOFARADS.
80
90 READ T,N,F,R,C
100 LET Q0=6.28318531
110 LET Q1=2.30258509
120 DIM F(37),G(37),C(25)
130 PRINT
140 PRINT
150 PRINT
160 PRINT
170 GOSUB 2020
180
190 REM "I" ITERATION LOOP -- CALCULATIONS FOR EACH 2-POLE SECTION
200 FOR I=1 TO N/2
210 IF R=0 THEN 290
220
230 REM BUTTERWORTH CIRCLE
240 LET X1=1
250 LET X2=1
260 GO TO 350
270
280 REM CHEBYSHEV ELLIPSE
290 LET E=SQR(10+(R/10)-1)
300 LET D=(1/E+SQR(1/E+1))*(1/N)
310 LET X1=(D-1/D)/2
320 LET X2=(D+1/D)/2
330
340 REM ROOT PAIR LOCATIONS
350 LET P=Q0/4+Q0/4/N*(2*I-1)
360 LET S=X1*COS(P)
370 LET W=X2*SIN(P)
380 LET A=S+S*W*W
390 LET R0=-S/Q0/F/C*IE3
400 LET C1=C
410 IF T=1 THEN 650
420
430 REM LOWPASS C2 VALUE
440 IF I=1 THEN 500
450 DATA 6, 1.0, 1.5, 2.2, 3.3, 4.7, 6.8
460 READ K6
470 FOR K=1 TO K6
480 READ C(K)
490 NEXT K

```

```

500 LET N2=INT(LOG(C)/Q1)
510 FOR N1=-1 TO 99
520 FOR K=6 TO 1 STEP -1
530 LET C2=C(K)*10+(N2-N1)
540 LET M=C/C2
550 IF M>A/S/S THEN 600
560 NEXT K
570 NEXT N1
580
590 REM LOWPASS R1,R2 VALUES
600 LET R1=R0*M/A*(1+SQR(1-A/S/S/M))
610 LET R2=R0*M/A*(1-SQR(1-A/S/S/M))
620 GO TO 700
630
640 REM HIGHPASS C2,R1,R2 VALUES
650 LET C2=C
660 LET R1=R0
670 LET R2=R0*A/S/S
680
690 REM PRINTOUT
700 IF I>1 THEN 720
710 PRINT " COMPONENT VALUES (C IN NANOFARADS, R IN KILOHMS):"
720 PRINT
730 PRINT " SECTION";I
740 PRINT " ",C1=";C1, "R1=";R1
750 PRINT " ",C2=";C2, "R2=";R2
760
770 REM FREQ AND GAIN VALUES FOR GRAPH
780 FOR K=0 TO 36
790 IF I>1 THEN 870
800 IF T=1 THEN 830
810 LET F(K)=-F/25*(1+K)
820 GO TO 840
830 LET F(K)=-F*25/(37-K)
840 LET K7=2-INT(LOG(F(K))/Q1)
850 LET F(K)=-INT(F(K)*10+K7+.5)/10+K7
860 LET G(K)=0
870 IF T=1 THEN 900
880 LET G=(1-R1/C1+R2/C2*(Q0*F(K))+2/IE6)+2+((R1+R2)*C2*Q0*F(K)/IE3)+2
890 GO TO 910
900 LET G=(1-1/R1/C1/R2/C2/(Q0*F(K))+2/IE6)+2+(2/R2/C1/Q0/F(K)*IE3)+2
910 LET G(K)=G(K)-10*LOG(G)/Q1
920 NEXT K
930 NEXT I
940 GOSUB 4020
950 STOP
2000
2010 REM HEADING SUBROUTINE
2020 IF R=0 THEN 2050
2030 PRINT " ", "BUTTERWORTH ";

```

Table 3. BASIC commands

| Type | Word | Function |
|---------------|------------------|---|
| Nonexecutable | REM | Allows the insertion of remarks in the program listing |
| | DIM | Reserves extra memory room for large variable arrays |
| | DATA | Stores numerical data to be used in the problem solution |
| Input/Output | READ | Obtains numerical data from DATA statements |
| | PRINT | Types output statements and numerical answers |
| Computational | LET | Computes variable values according to algebraic formulas |
| Sequencing | GO TO | Alters the normal order of computation |
| | IF...THEN | Conditionally alters the order of computation |
| | FOR...TO NEXT | Causes the intervening commands to be repeated several times |
| | GO SUB RETURN | Routes computation to and from a subroutine (subsection) of the program |
| Termination | STOP | Stops computation (at any point in the program) |
| | END | Stops computation (this must be the last sequential command in a program) |

Table 5. Variables used in program

| Name | Definition |
|-------------|---|
| T | Type of filter (1 = Low-pass, 2 = High-pass) |
| N | Number of poles |
| F | Cut frequency (in kHz) |
| R | Chebyshev passband ripple (in dB) |
| C | Maximum circuit capacitance (in nanofarads) |
| $Q\phi$ | 2π (phase conversion constant from radians to degrees) |
| Q1 | $1n 10$ (gain conversion constant from natural logs to common logs) |
| I | Iteration index (I = 1 to N/2) for the 2-pole sections |
| F (37) | Frequency values (independent variable) |
| G (37) | Gain values (dependent variable) |
| C (25) | Standard capacitance values per decade |
| X1 | Minor Chebyshev ellipse radius |
| X2 | Major Chebyshev ellipse radius |
| E | Chebyshev ripple factor |
| D | Intermediate Chebyshev parameter |
| P | Root location phase angle |
| S | Real component (σ) of pole location |
| W | Imaginary component (ω) of pole location |
| A | Squared magnitude of pole location |
| R ϕ | Nominal resistance level |
| R1,R2,C1,C2 | Component values (kilohms and nanofarads) |
| M | Ratio of C1/C2 in low-pass sections |
| K6 | Number of standard capacitance values per decade |
| K,N1,I1 | Iteration loop indices |
| N2,K7 | Normalization constants |
| G,I2 | Intermediate variables used in graph routine |

Table 4. Program block outline

| Line numbers | What is accomplished |
|-------------------------------------|---|
| 0 - 90 | Data input and instructions to user |
| 100 - 120 | Constant definition and variable dimensioning |
| 130 - 170 | Heading print-out (using subroutine 2000 - 2230) |
| 180 - 670 | Calculations for each 2-pole section |
| 220 - 410 420 - 620 630 - 670 | Calculation of root pair locations Calculation of low-pass component values Calculation of high-pass component values |
| 680 - 750 | Component value print-out |
| 770 - 930 | Selection of frequency values and calculations of gain values for graph |
| 940 - 950 | Graph print-out (using subroutine 4000 - 4440) |
| 2000 - 2230 | Print subroutine for page headings |
| 4000 - 4440 | Print subroutine for graph |

a passband ripple of 2.4 dB and a maximum C value of 10 nF.

To solve the first filter design, we must retype line 0 as follows:

```
0 DATA 1, 6, 1, 0, 33.
```

The remark ("REM") statements in Fig. 2 explain how the desired filter specifications are entered into the program (see Table 4). The variables used are listed in Table 5. When the program is run with this "DATA" line, a two-page print-out (Fig. 3) is generated. Each page begins with a descriptive heading. Figure 3A shows the first page, which gives the component values, and Fig. 3B the second page, containing a graph of gain versus frequency.

For low-pass designs, the C_1 value in each of the sections is set equal to the maximum C value specified in the DATA line. In this case C_1 is 33 nF in each of the three sections. The C_2 value is then chosen as the largest value that can be realized from a standard decade list of C values

BUTTERWORTH LOWPASS RC FILTER

NUMBER OF POLES = 6
3-DB FREQ (KHZ) = 1

COMPONENT VALUES (C IN NANOFARADS, R IN KILOHMS):

SECTION 1
C1 = 33 R1 = 20.0192
C2 = 2.2 R2 = 17.4284

SECTION 2
C1 = 33 R1 = 9.76477
C2 = 15 R2 = 5.24051

SECTION 3
C1 = 33 R1 = 10.7214
C2 = 22. R2 = 3.25427

(A)

NUMBER OF POLES = 6
3-DB FREQ (KHZ) = 1

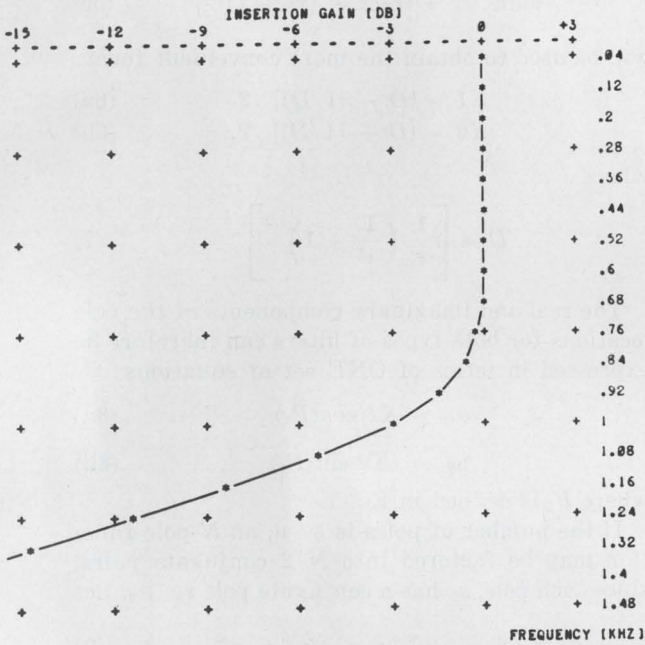

(B)

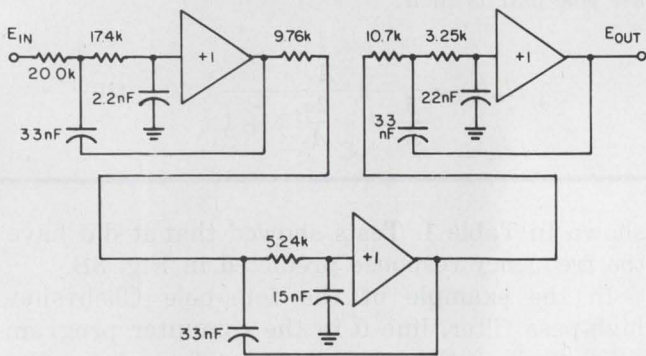

(C)

3. Computer printout of component values (A) and frequency response curve (B) for six-pole Butterworth lowpass filter (C) is shown above.

(contained in line 450 of the program, Fig. 2). The list may be changed, as required, to reflect available C values. The first number in the list (in this case, 6) is the number of values in the list. The following numbers, are the C values

CHEBYSHEV HIGHPASS RC FILTER

NUMBER OF POLES = 4
CUT FREQ (KHZ) = 1
PASSBAND RIPPLE (DB) = 2.4

COMPONENT VALUES (C IN NANOFARADS, R IN KILOHMS):

SECTION 1
C1 = 10 R1 = 1.52734
C2 = 10 R2 = 151.987

SECTION 2
C1 = 10 R1 = 3.68733
C2 = 10 R2 = 14.3802

(A)

NUMBER OF POLES = 4
CUT FREQ (KHZ) = 1
PASSBAND RIPPLE (DB) = 2.4

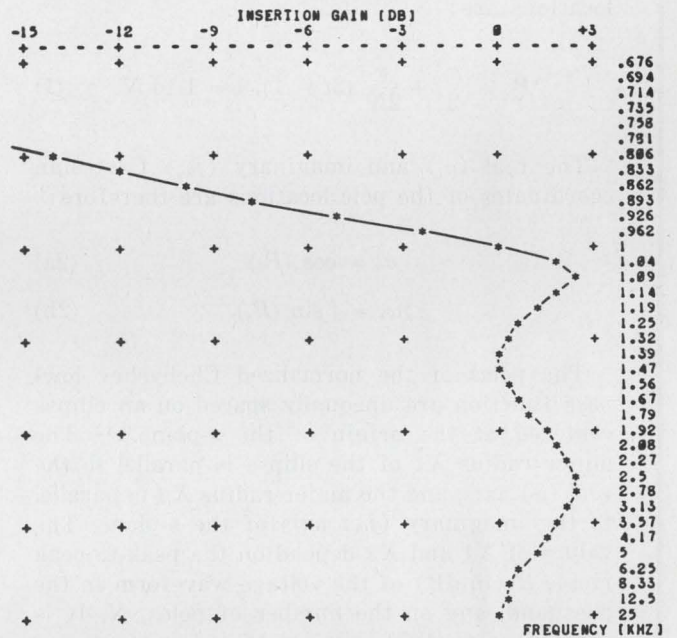

(B)

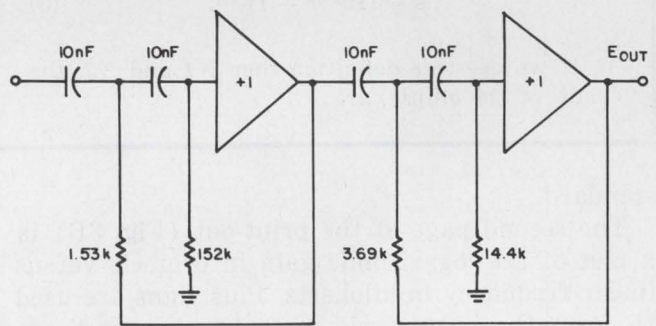

(C)

4. Computer printout of component values (A) and frequency response (B) for four-pole Chebyshev high-pass filter (C) is shown above.

arranged in increasing order of magnitude. In the print-out (Fig. 3A) the values of C₂ for the three sections are 2.2 nF, 15 nF and 22 nF. The R values, which are computed from these C values and the filter specifications, are non-

Deriving the fundamental filter equations

Modern filter design theory is based upon an analysis of the filter transfer function, the ratio of output to input in the complex frequency plane, the s -plane. Attention is centered on the location of the "poles" of the transfer function. The poles are the values of s for which the denominator of the transfer function vanishes, or is equal to zero.

The poles of the normalized Butterworth low-pass function are equally spaced on a unit circle centered at the origin of the s -plane.⁹⁻¹² For an N -pole function, the phase angles, P_i , of the pole locations are:

$$P_i = \frac{\pi}{2} + \frac{\pi}{2N} (2i - 1), i = 1 \text{ to } N. \quad (1)$$

The real (σ_i) and imaginary ($j\omega_i$) Cartesian coordinates of the pole locations are therefore:

$$\sigma_i = \cos(P_i) \quad (2a)$$

$$j\omega_i = j \sin(P_i) \quad (2b)$$

The poles of the normalized Chebyshev low-pass function are unequally spaced on an ellipse centered at the origin of the s -plane.⁹⁻¹² The minor radius $X1$ of the ellipse is parallel to the real (σ) axis, and the major radius $X2$ is parallel to the imaginary ($j\omega$) axis of the s -plane. The values of $X1$ and $X2$ depend on the peak-to-peak ripple R (in dB) of the voltage waveform in the passband, and on the number of poles, N . It is convenient to define a ripple factor, ϵ , in terms of R according to the following convention:

$$\epsilon \triangleq (10^{R/10} - 1)^{1/2}. \quad (3)$$

If we use this definition then $X1$ and $X2$, the radii of the ellipse, are:

$$X1 = \sinh \left[\frac{1}{N} \sinh^{-1} \left(\frac{1}{\epsilon} \right) \right] \quad (4a)$$

$$X2 = \cosh \left[\frac{1}{N} \sinh^{-1} \left(\frac{1}{\epsilon} \right) \right]. \quad (4b)$$

Since it is inconvenient to work with hyperbolic functions, the standard mathematical relations¹³

$$\sinh x = (e^x - e^{-x}) / 2 \quad (5a)$$

$$\cosh x = (e^x + e^{-x}) / 2 \quad (5b)$$

$$\sinh^{-1} x = \ln [x + (x^2 + 1)^{1/2}] \quad (5c)$$

will be used to obtain the more convenient form:

$$X1 = [D - (1/D)] / 2 \quad (6a)$$

$$X2 = [D + (1/D)] / 2, \quad (6b)$$

where

$$D = \left[\frac{1}{\epsilon} \left(\frac{1}{\epsilon^2} + 1 \right)^{1/2} \right]^{1/N} \quad (7)$$

The real and imaginary components of the pole locations for both types of filters can therefore be expressed in terms of ONE set of equations:

$$\sigma_i = X1 \cos(P_i) \quad (8a)$$

$$j\omega_i = jX2 \sin(P_i) \quad (8b)$$

where P_i is defined in Eq. 1.

If the number of poles is even, an N -pole function may be factored into $N/2$ conjugate pairs, since each pole, s_i , has a conjugate pole s_{N+1-i} . Let

$$A_i \triangleq (\sigma_i + j\omega_i) (\sigma_i - j\omega_i) = \sigma_i^2 + \omega_i^2. \quad (9)$$

The normalized transfer function $L_i(s)$ of a low-pass pole pair is then:

$$L_i(s) = \frac{1}{\frac{1}{A_i} s^2 - \frac{2\sigma_i}{A_i} s + 1} \quad (10)$$

standard.

The second page of the print-out (Fig. 3B) is a plot of the logarithmic gain in decibels versus linear frequency in kilohertz. Plus signs are used to form the graph grid, and asterisks indicate the data points. The lines connecting the asterisks were drawn in after the print-out was completed to make the response curve more legible. The curve in Fig. 3B agrees with the standard six-pole Butterworth characteristic.⁹

The complete circuit schematic for the six-pole low-pass filter is shown in Fig. 3C. Three basic low-pass circuits have been cascaded (Fig. 1), with the component values of each section determined from Fig. 3A. A laboratory model of the circuit was built using the last active element

shown in Table 1. Tests showed that it did have the frequency response predicted in Fig. 3B.

In the example of the four-pole Chebyshev high-pass filter, line 0 in the computer program (Fig. 2) is in the correct format for solving the filter design. The solution is shown in Fig. 4. Figure 4A gives the component values, Fig. 4B the frequency response, and Fig. 4C the complete circuit schematic.

The headings provided in the computer print-out (Figs. 4A and 4B) for the Chebyshev filter are similar to those for the Butterworth case, but they include the definition of an additional parameter—the passband ripple. The plot of Fig. 4B shows every data point (rather than every other point as in Fig. 3B), to more clearly define

where the constant factor $1/A_i$ in Eq. 10 normalizes the maximum value of $L_i(s)$ to unity gain. Since the low-pass section (Fig. 1) must have unity gain at dc, the factor $1/A_i$ cannot be accommodated by Eq. 12 for the Chebyshev case. Chebyshev filters designed in this way will have unity gain ripple minimums rather than the more conventional unity gain ripple maximums. This restriction also holds for high-pass design.

The normalized transfer function $H_i(s)$ of a high-pass pole pair is obtained by replacing the variable s in (10) by $1/s$:

$$H_i(s) = \frac{\frac{1}{A_i}}{\frac{1}{A_i s^2} - \frac{2\sigma_i}{A_i s} + 1} \quad (11)$$

The transfer function $L'(s)$ of the two-pole low-pass RC filter section (Fig. 1) is

$$L'(s) = \frac{1}{R_1 C_1 R_2 C_2 s^2 + (R_1 + R_2) C_2 s + 1} \quad (12)$$

To realize $L_i(s)$ with $L'(s)$, Eqs. 10 and 12 must be equated, term by term. If the constant factor is neglected, this leads to two equations in four unknowns, R_1 , R_2 , C_1 and C_2 :

$$R_1 C_1 R_2 C_2 = 1/A_i \quad (13a)$$

$$(R_1 + R_2) C_2 = -2 \sigma_i / A_i \quad (13b)$$

If C_1 and C_2 are selected as standard values,

$$C_1 = C \quad (14a)$$

$$C_2 = C/M, M > 1 \text{ for realizability,} \quad (14b)$$

then the normalized values of R_1 and R_2 are

determined from

$$R_1 = \frac{-\sigma_i M}{A_i C} \left[1 + \left(1 - \frac{A_i}{\sigma_i^2 M} \right)^{1/2} \right] \quad (15a)$$

$$R_2 = \frac{-\sigma_i M}{A_i C} \left[1 - \left(1 - \frac{A_i}{\sigma_i^2 M} \right)^{1/2} \right] \quad (15b)$$

From Eq. 15 it can be seen that the value of M selected in Eq. 14b must satisfy the inequality

$$M \geq A_i / \sigma_i^2 \quad (16)$$

The largest realizable standard value of C_2 may be found by first choosing $C_2 > C$ and then trying successively smaller standard values for C_2 until Eq. 16 is satisfied.

The transfer function $H'(s)$ of the two-pole high-pass RC filter (Fig. 1) section is

$$H'(s) = \frac{1}{\frac{1}{R_1 C_1 R_2 C_2 s^2} + \frac{C_1 + C_2}{C_1 R_2 C_2 s} + 1} \quad (17)$$

As in the low-pass case, $H_i(s)$ may be realized with $H'(s)$ by selecting standard C values and then computing the normalized R values. The latter are derived by equating the denominators of Eqs. 11 and 17:

$$C_1 = C \quad (18a)$$

$$C_2 = C \quad (18b)$$

$$R_1 = \frac{-\sigma_i}{C} \quad (19a)$$

$$R_2 = \frac{-A_i}{\sigma_i C} \quad (19b)$$

The component value formulas are summarized in Table 2.

the faster-moving Chebyshev response.

The standard decade list of C values is not utilized in the high-pass design (Fig. 4A) since both C_1 and C_2 are set equal to the maximum C value specified in the DATA line. The high-pass graph (Fig. 4B) uses an inverse-linear frequency scale to emphasize the inverse symmetry of the high-pass design with respect to its low-pass prototype. The two filter sections of the complete schematic (Fig. 4C) use the basic high-pass rather than the low-pass circuit. ■■

References:

1. Shirley, Fredrick R., "You Don't Have to be a Programmer," *Electronic Design*, April 12, 1967, pp. 54-60.
2. *BASIC Language Reference Manual*, General Electric Information Service Publication 202026A, April 1968.

3. Strunk, B., "Designing an Active Filter," *EEE*, October 1965, pp. 60-61.
4. Melsheimer, Robert S., "If You Need Active Filters," *Electronic Design*, April 12, 1967, pp. 78-82.
5. Sun, H. H. *Synthesis of RC Networks*, Hayden Book Co., Inc., New York, N. Y., 1967, pp. 106-112.
6. Kincaid, Russell, "RC Filter Design by the Numbers," *The Electronic Engineer*, October 1968, pp. 57-64.
7. Mollinga, Thomas, "Active Bandpass Filters," *EEE*, August, 1966, pp. 115-119.
8. *Command System Reference Manual*, General Electric Information Service Publication 229116A, April 1968.
9. Eggen, C. P. and McAllister, A. S., "Modern Low-Pass Filter Characteristics," *Electro-Technology*, August 1966, pp. 50-55.
10. Balabanian, Norman, *Network Synthesis*, Prentice-Hall, Inc., Englewood Cliffs, N. J., 1958, pp. 381-411.
11. Guillemin, Ernst A., *Synthesis of Passive Networks*, John Wiley & Sons, Inc., New York, N. Y., 1957, pp. 587-602.
12. Kole, William C., "Fewer Sections and Better Specs," *Electronic Design*, Feb. 15, 1968, pp. 84-89.
13. *CRC Standard Mathematical Tables*, Chemical Rubber Publishing Co., Cleveland, O., 1959, pp. 427-432.

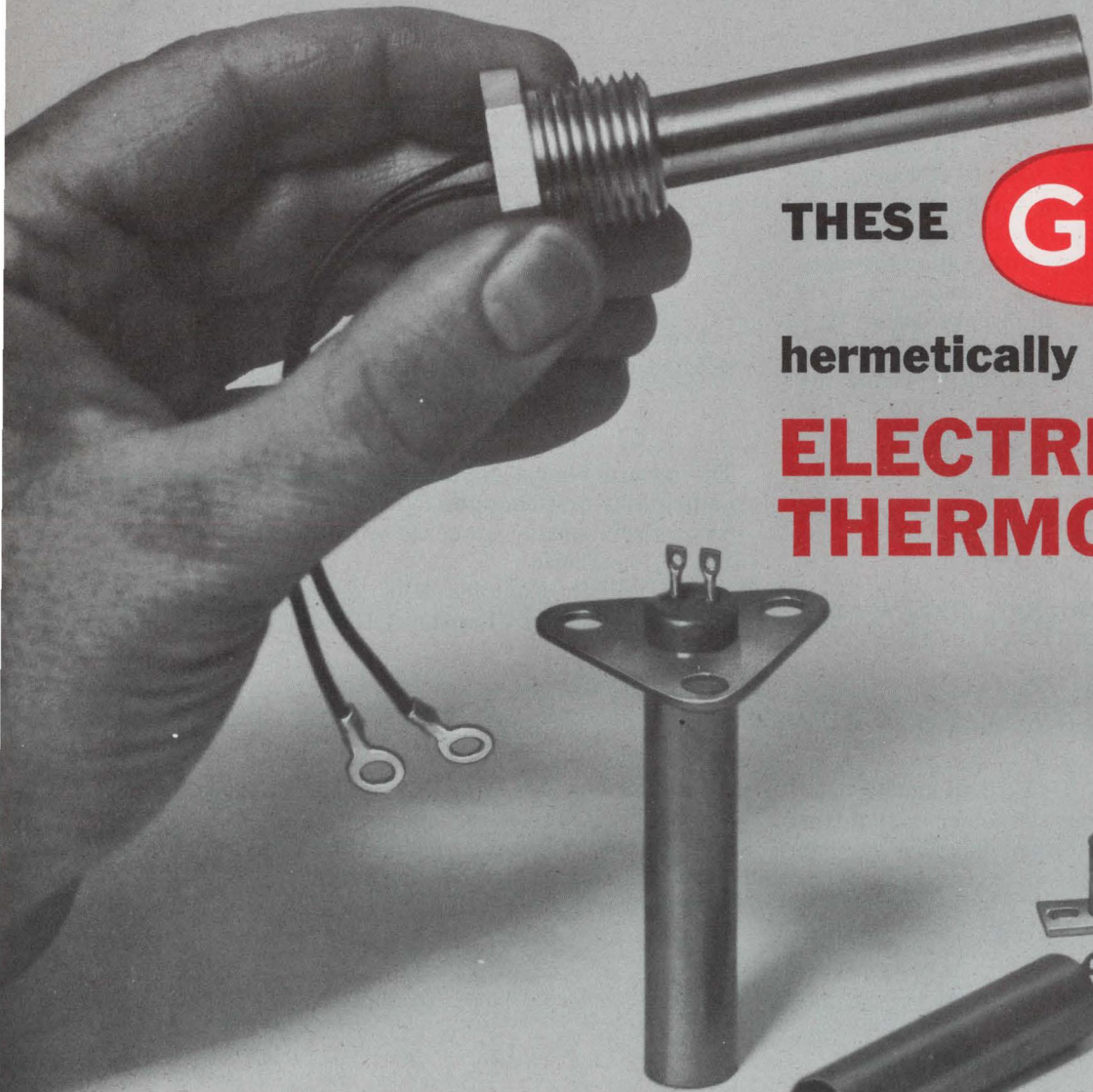

THESE



hermetically sealed

ELECTRICAL THERMOSTATS ...

QUICK CONNECT TYPE INDUSTRIAL THERMAL RELAY

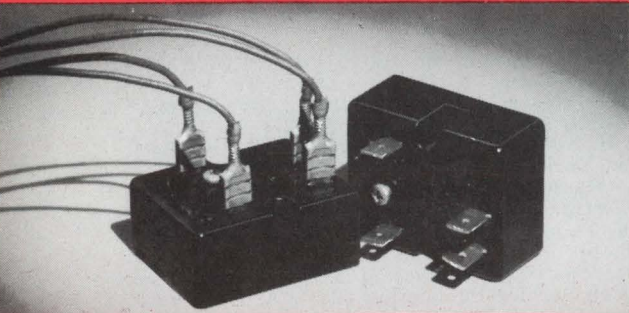

The Quick Connect thermal relays are designed to withstand the most demanding industrial applications. They reduce installation time and cost. Require only two mounting screws. Eliminates need for brackets, sockets, retainers. **Features:** time delays, 5 to 180 sec.; contacts, SPST, NO/NC; heater voltages, 6.3, 26, 115V AC or DC; resistive rating, 2A 115V AC or 1A 28V DC; mounts in any position.

Recognized Under The Components Program Of Underwriter's Laboratories, Inc.



INFORMATION RETRIEVAL NUMBER 162

SUBMINIATURE THERMAL TIMING RELAYS

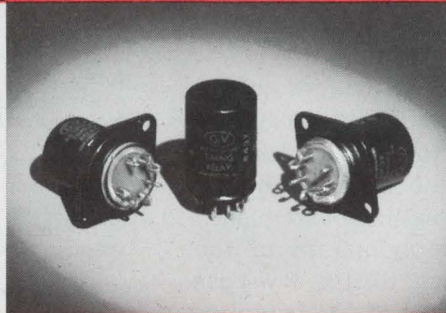

The LT Series relays provide hi-level performance in a subminiature hermetically sealed housing — space saving without loss of performance. Meets military standards. **Features:** height above mounting panel 40% of standard relays (7 pin flange mount); time delays, 2 to 75 sec.; operating temp., -65°C to +85°C; operating voltages, 6.3 to 115V. AC or DC.



INFORMATION RETRIEVAL NUMBER 163

SOLID STATE FREQUENCY SENSOR

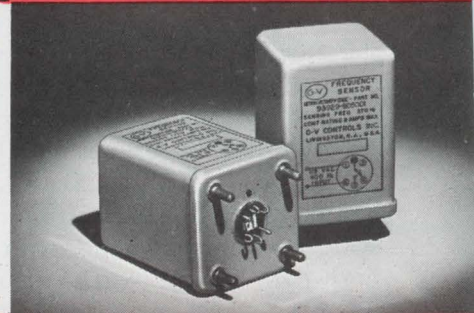

The Solid State Frequency Sensor, Series 905, protects 400 Hz equipment against under frequency conditions. **Features:** Operates over close tolerance of 10 Hz, operating temp. range -55°C to +125°C, operates over unusual broad spectrum of frequency inputs ranging from 50 to 2500 Hz, meets MIL specs.



INFORMATION RETRIEVAL NUMBER 164

solve temperature control problems

OFFER PRECISE TEMPERATURE CONTROL, RAPID RESPONSE, MINIMAL DIFFERENTIAL . . . *from G-V*

G-V offers a wide selection of electrical thermostats for over and under temperature indication, alarm or cut-off service. They are designed to meet the rugged and precise requirements of both military and commercial applications including missiles, data processing equipment, etc. Both surface sensing and immersion types are available. For surface temperature sensing, crystal can size VE Series features a tolerance of $\pm 3^{\circ}\text{C}$, a differential of $\pm 1.5^{\circ}\text{C}$. Various models cover settings between -55°C and $+150^{\circ}\text{C}$. The C8 Series cartridge immersion or air sensing thermostats are available with a variety of mounting brackets and terminals. They are supplied with a setting tolerance of $\pm 5^{\circ}\text{F}$ ($\pm 3^{\circ}\text{C}$), and repetitive operation within $\pm 1^{\circ}\text{F}$ can be expected. These units will withstand indefinite exposures to temperatures of -65°F to $+300^{\circ}\text{F}$ without damage. The C8 Series can be adjusted without damage to the hermetic seal. Contact ratings: VE Series, up to 3 amps; C8 Series up to 5 amps.

INFORMATION RETRIEVAL NUMBER 161



G-V CONTROLS INC.

LIVINGSTON, NEW JERSEY 07039
(201) 992-6200

AIR FLOW SENSING SWITCH



A new design concept and technique is utilized to monitor presence of air flow. When air flow drops below a safe level, it operates an alarm or automatic shut-off. Used in electronic equipment, cooling packages, air conditioners, computers, etc.

Features: Operates in any plane, no moving parts. No special adjustments.

only from **G-V**

INFORMATION RETRIEVAL NUMBER 165

SOLID STATE FLASHER



The unique solid state circuit design of the series 902 flasher permits it to operate interchangeably from either AC or DC power. Operating voltage: 24, 48 or 115 volts AC/DC. Flashing rates of standard units: 30, 60, 90 and 120 F.P.M. Contacts: SPDT. Min. life: 5 million cycles at rated load.

G-V

INFORMATION RETRIEVAL NUMBER 166

DIRECT-LINE FIELD ENGINEERING SERVICE



G-V assistance is always available to help you design and produce a better product. G-V Regional Field Engineers in your area will assist you and your design group in new applications and proper selection of your controls. G-V Product Engineers will help you with special applications. When you require experience, products and services in electro-mechanical and solid-state controls . . . call your man from G-V.

G-V

INFORMATION RETRIEVAL NUMBER 167

Play your way to better decisions with management training games. Right 'choicemanship' is an art which requires group practice.

When you play a game, you play to win by making the best possible score. When you play the game of decision-making, you play to win by making the best possible decision.

To play a game, you must know the rules; to make a decision, you must know the facts. And beyond the facts are countless behind-the-scenes influences—such as the unpredictability of changing conditions and the expectations of people involved. Although these influences make decision-making more exciting and challenging than any other game played, they also make the worthwhile decisions more difficult.

Practice is the name of the game

If you're wondering how you can learn to make better decisions, you can practice the techniques by participating in discussions, role-playing, "in-out basket training," case studies and simulations. The way that combines all methods, is "game-playing."

The Didactic Game Co., a division of R. B. Enterprises, Westbury, N.Y., has devised what it calls Didactic Games. By projecting trainees into a simulated environment, these games can be used as management-training laboratories.

Typical games involve collective-bargaining, inventory control, or a purchasing department program. The background of each situation is explained in advance, and within this context the trainee is asked to make decisions. Trainees may compete as individuals or as part of a team competing with other teams. In the latter case a trainee is frequently asked to discuss his decisions with his team-mates.

Before you compete, let's look at the steps involved in making effective decisions. You must:

- Sift relevant criteria from the less relevant and see which parts of the relevant factors are quantifiable (tangibles), and which are not (intangibles).

Erwin Rausch, vice president, Wing Manufacturing Co., Linden, N.J., and author of "Didactic Simulations for Management Training."

- Employ a logical process for selecting and evaluating data to find which alternative is best.

- Have a knowledge of group dynamics. This leads to competent conference leadership, sensitivity to the attitudes and opinions of group members, and the ability to convince others to accept your point of view.

A list of decided thoroughness

Consciously or intuitively, you follow a decision-making process like this every time you make a decision. But when you do it intuitively, you often are not as thorough as the decision may require. That doesn't mean that you should—or could afford to—do a thorough analysis every time you make a choice. But for the more important decisions, you should review these steps:

1. Clarify or define the problem. Tackle the problem's cause, not a symptom or a reflection.
2. Propose alternatives from which to choose.
3. Collect pertinent facts so you can evaluate the alternatives.
4. Evaluate each alternative on the basis of quantifiable data.
5. Balance tangible and intangible factors, side by side.
6. Make the decision.

To get the most out of the following "training experience," assemble at least two associates before you read on. Tell them to bring their own copies of ELECTRONIC DESIGN so each of you has one to read.

In this exercise you will assume that you are the supervisor of a small department of engineers and that you regularly meet with friends who are in similar positions to discuss common problems. If several such groups play the game at the same time, you are in competition with them. You also compete with associates within your group to achieve the best performance.

NEVER TURN THE PAGE UNTIL THE INSTRUCTIONS TELL YOU TO DO SO. Once your team has turned the page, you may not change the previous decisions.

(continued on page 126)

“By combining the advantages of role-playing, in-basket techniques, case studies and simulations, didactic games project trainees into an environment which is realistic enough to stimulate deep involvement without an elaborate, expensive model.”



Problem: Salary Administration

You supervise a department of several engineers. You have just hired two engineers for your department, one at a slightly higher pay rate and the other at the same rate as three engineers who have been with you between three and four years and who joined the company directly after graduation from college. The two new men are in the same age group as the three men on your staff. One of them has had specialized experience at another company in a field where your staff is weak. The other has exceptional promotion potential—he is very intelligent, enthusiastic, has a master's degree in engineering that he earned in night school and is now studying management.

The three employees already on the job are unhappy because the two newcomers will be getting the same or higher salary. They feel they should receive additional compensation for

their longer service with the company. The performances of the three were reviewed three months ago, and two received merit increases. The third man's performance was not considered good enough to warrant an increase, and he was told so. Job performance reviews are held annually in the company, and increases are usually given shortly thereafter. Rarely does the management grant merit increases at any other time.

The three dissatisfied men come to you and explain their complaint. What should you do? Review the alternatives below and, WITHOUT DISCUSSION with the other members of your team, select the one you like best. Indicate your choice with a check-mark in the "P" column for personal choice. As soon as all members of your team have made personal choices, DISCUSS them and agree on a group selection. Indicate this choice in the "G" column.

Possible Solutions:

(a) Listen to their story, explain the company's position and then tell them that there is nothing that you can do because company policy prevents you from giving them an increase—and stick by that even if it appears one or two will quit.

P G

(b) Listen to their story and then try to convince them that the pay rates are equitable in the light of the qualifications and the company's needs. Stick by that even if it appears one or more will quit.

P G

(c) Listen to their story and, after explaining the justification for the existing pay scale, promise to review the situation. (If you take this choice, assume that the review leads you to refuse any adjustment at this time and you so inform the men. You stick by that decision, even if it appears one or two will quit).

P G

(d) Listen to their story, explain the company's position and promise to take the matter up with your boss and to follow his suggestion, whatever it may be. (Assume that you expect him to lean toward not making any adjustment for the three unless you clearly recommend it.)

P G

(e) Listen to their story, explain the company's position and then promise to try to get all three modest salary adjustments immediately. (Assume that your recommendation will be honored by your superiors.)

P G

(f) Listen to their story, explain the company's position and then—in individual interviews with each man—promise to try to get the two better men modest increases immediately and the third man a raise as soon as he shows improvement. (Assume that your recommendations will be honored by your superiors.)

P G

(g) Listen to their story, explain the company's position, tell them that you can do nothing now but will see to it that they get somewhat greater increases at the next salary review—in approximately nine months.

P G

If you would prefer a different approach from those listed, write it on line "h." If you decide on one added by a team member on line "h," it must be accepted exactly as written.

(h) _____

Now, turn the page, NOT BEFORE.

COS/MOS integrated circuits—RCA's unique Complementary Symmetry MOS devices—offer designers a whole new approach to digital design! They give you a broad range of circuit functions which combine advantages and features no other logic circuitry offers. Like nanowatt quiescent power dissipation; 4-V noise margin; fanouts up to 50; single 6 to 15-V power supply; logic level swing from "0" to power supply voltage; -55° to

$+125^{\circ}\text{C}$ operating temperature; operation from DC to several MHz; single-phase clocking, and circuits with applications ranging from gate-level logic to MSI. Think of the ways COS/MOS can enhance the performance of your digital equipment. Then take the first step to get yourself started in this new area of circuit design—with RCA QK2201. You get six different circuit types (8 devices); a 20-power microscope and a sample MSI pellet with 116 transistors for close-up study. You get two each of RCA's CD4000D dual 3-input NOR Gate Plus Inverter; CD4001D dual 2-input NOR Gate Plus Inverter; CD4002D dual 4-input gate; CD4003D dual "D" type flip flop; and a CD4004T MSI 7-stage counter/frequency divider.

But that's only the beginning! QK2201 also brings you comprehensive product information . . . helpful application literature . . . background material. Best of all, your RCA Distributor has this kit—right now—for only \$75.00 (optional distributor resale price).
RCA Electronic Components, Harrison, N.J. 07029

Get acquainted with COS/MOS Digital IC's

Evaluate Complementary Symmetry MOS using RCA QK2201 Sampler



Solution Values:

Score the personal and group choices as follows:

- (a) Saying that "company policy" prevents your reviewing the situation in more detail will not ring true to the dissatisfied employees. It is likely to prompt at least one to quit and to leave the others disgruntled on the job. *Allow 0 points for choice "a."*
- (b) Making a serious effort to convince them that the pay rates are equitable is better than speaking in generalities, but still you are not likely to satisfy them without at least some recognition of their position. You will probably lose at least one employee. *Allow 2 points for "b."*
- (c) A promise to review the situation shows that you have some empathy with their position. The fact that your review will not produce results satisfactory to them, however, is likely to leave them quite dissatisfied, and one or two may quit, though the chances for this are a bit less than in "a" or "b." *Allow 4 points for "c."*
- (d) Passing the buck to your boss is not a wise thing to do, from your point of view. He is likely to feel, at the least, that you should come up with a recommendation and will probably ask you for one in any event. If you refuse to make one, he will probably assume that you don't feel strongly enough about it and will decline to make any salary adjustment, since he can always give one at a later time on your recommendation. Your men will be dissatisfied, you will probably lose one or two, and you will have lost a small amount of your superior's respect. *Allow 0 points for this choice.*
- (e) Making an effort to obtain a small salary adjustment immediately isn't a bad choice. If newly hired men with similar qualifications are indeed worth the same amount or possibly more, you should be able to pay a little better to capable employees already on the job. A small amount of additional pay for longer service with the company should be recognized as equitable. *Allow 10 points for choice "e."*
- (f) Giving only the better men some modest increases now is an even better choice than "e." It has all the advantages of "e" and adds some additional incentive to the third man to improve. *Allow 15 points for "f."*
- (g) Promising greater pay increases at the next periodic review is neither a particularly bad choice nor a good one. It will leave the men somewhat dissatisfied for a long time, and there will always be doubts in their minds about your sincerity in recognizing a valid grievance. *Allow 6 points for "g."*
- (h) If your group has accepted an alternative solution written by one of you, the "manager" who made the suggestion gets 15 points in his personal score, and the group also scores 15 points. Though there is no written standard for this decision, the assumption is that any suggestion that is agreed upon by the group must be a better one than any of the existing alternatives. If an individual solution is not accepted by the group, no points are awarded to the individual.

Minimize "snap-judgments"

In a complete didactic game, there are many situations like the one you have just played and all have a teaching objective. If you actually play this sample game with a few associates, you will notice their deep involvement. You will also notice how many different approaches to the problem are possible besides the ones that you thought of immediately.

The same is true of the day-to-day decisions

we make in our professions, and therein lies the real value of these games. They help explore alternatives to everyday problems and they show that careful analysis, preferably in conjunction with a colleague, will often bring about better results than those brought about via "snap-judgments."

© 1969, *The Didactic Game Co. Westbury, N.Y.*
All rights reserved. No part of this article may be reproduced in any form without permission, in writing, from the publisher.

Sharpen your circuit ingenuity

Work with RCA's Linear IC "Building Block" Sampler

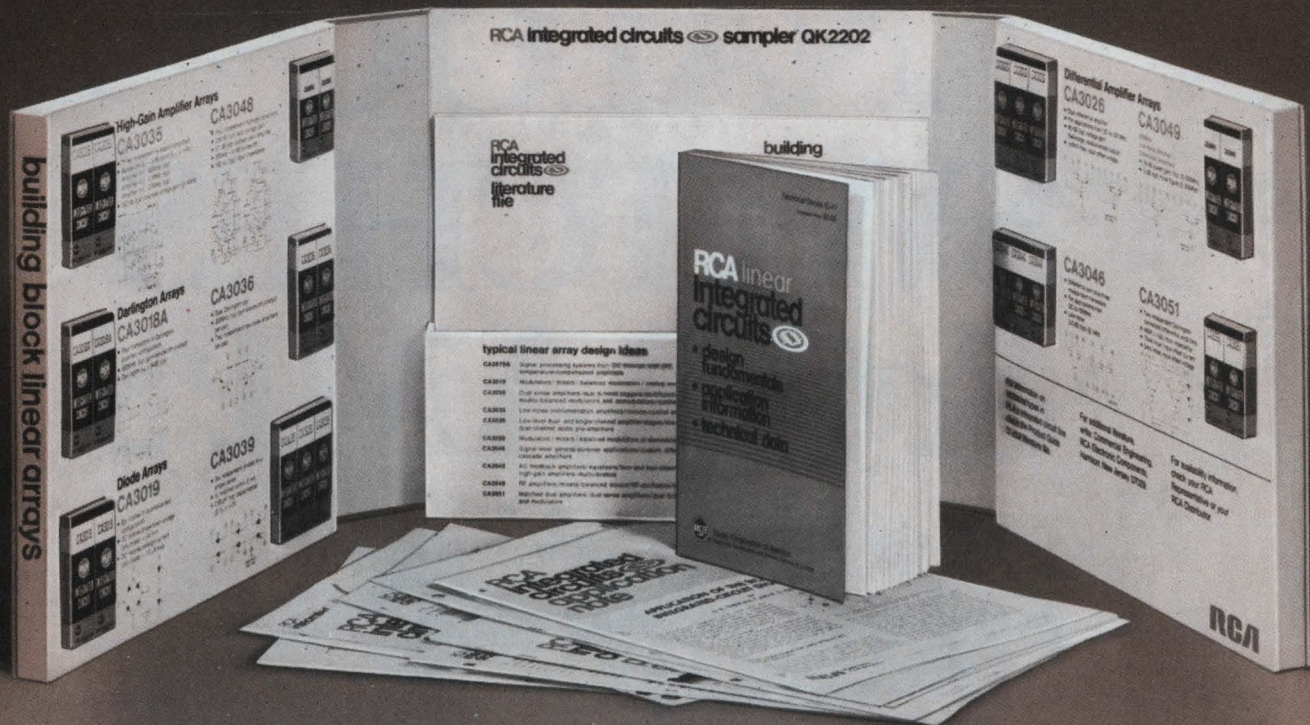

There's no better way to meet today's new circuit design challenges than with RCA's "building block" linear IC's. Evaluate them now for RF, IF, AF and DC amplifiers; sense amplifiers; multi-function circuits; Schmitt triggers; balanced multi-channel circuits and many others. Work with the RCA QK2202 Linear Array Sampler—a box full of linear integrated circuit "building blocks."

There are 10 types (23 devices in all) of virtually unlimited flexibility. You get high-gain amplifiers; differential amplifiers; Darlington and multi-transistor arrays, and diode arrays. You get wide design capabilities—from DC to 500 MHz. Of course, you get thorough documentation—technical and applications data—Linear IC Manual—mounting and connection techniques information—and a copy of ST-3895,

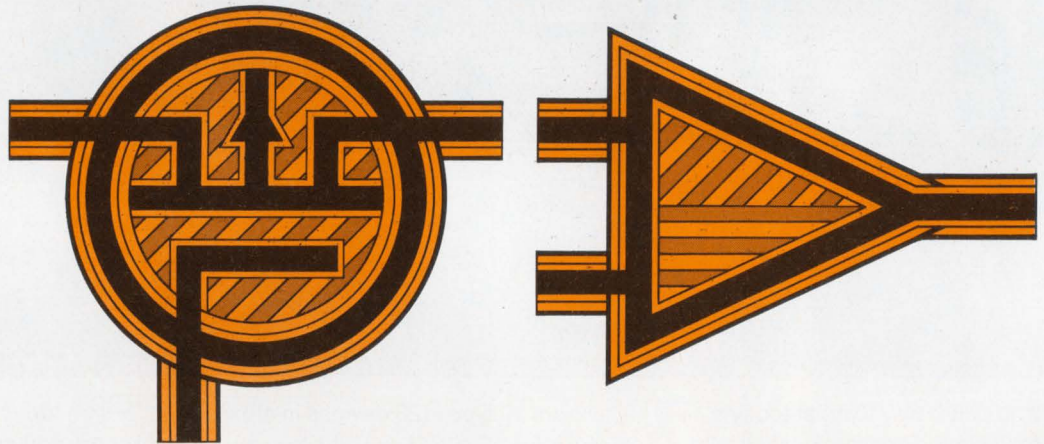

"Design Ideas for RCA Linear Arrays." In short, you get all you need to build your skills with RCA's dependable linear array "building blocks." Your RCA Distributor has RCA QK2202 Linear Array Sampler kits at \$37.95 (optional distributor resale price). Get yours—and get started—now. RCA Electronic Components, Harrison, N.J. 07029

more data
transmission
applications for
**ANALOG
SWITCHES
& OP AMPS**

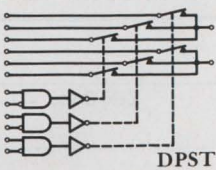
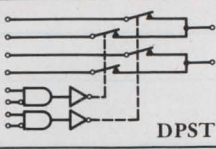

* Applications Power . . . A broad product line, an extensive network of stocking distributors and an experienced applications team waiting to serve you.

Here are two more examples that illustrate the versatility of Siliconix driver/FET switch packages in data transmission systems.

| Functional Description | Channels | Type | Max. $r_{DS(ON)}$ (ohms) | Switch Type |
|---|----------|-------|--------------------------|-------------|
|  DPST | 3 | DG120 | 600 | PMOS |
| | | 121 | 600 | PMOS |
|  DPST | 2 | DG122 | 600 | PMOS |
| | | 132 | 600 | PMOS |
|  DPST | 2 | DG126 | 80 | N |
| | | 129 | 30 | N |
| | | 140 | 10 | N |

Two and three channel packages are available with various ON resistances to meet your specific requirements. Drivers accept standard DTL, RTL, or TTL logic inputs.

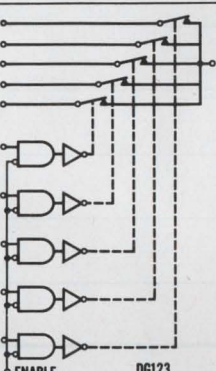
| Functional Description | Channels | Type | Max. $r_{DS(ON)}$ (ohms) | Switch Type |
|--|----------|-------|--------------------------|-------------|
|  ENABLE DG123 | 2 | DG110 | 600 | PMOS |
| | | 111 | 600 | PMOS |
| | | 112 | 600 | PMOS |
| | | 133 | 30 | N |
| | | 134 | 80 | N |
| | | 141 | 10 | N |
| | | 147 | 600 | PMOS |
| | | 148 | 40 | PMOS |
| | | 4 | DG116 | 600 |
| 118 | 600 | | PMOS | |
| 5 | DG123 | 600 | PMOS | |
| | 125 | 600 | PMOS | |

One of these driver/switch combinations may be used with your sample-and-hold circuit. These switches may also be used to implement your multiplexer/decoding functions.

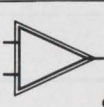
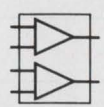
| SILICONIX OP AMPS | Max. input offset voltage -55 to +125°C | Max. input current | Min. open loop gain | Output voltage swing | Slew rate | |
|---|--|--------------------|---------------------|----------------------|-------------|---|
|  LM 101 LH 101 (Internally compensated) | 6 mV | 500 nA | 50K | ±12V | 0.25V/μsec. | <ul style="list-style-type: none"> • Operation from ±5 to ±20V power supplies • Low current drain • Continuous short circuit protection • Same pin configuration as 709 amplifier |
|  L 120 | 200 mV | 50 pA | 100 | ±12V | 20V/μsec. | <ul style="list-style-type: none"> • Low input leakage • High slew rate • Unity gain stable • Ideal for sample and hold, integrating and fast voltage comparisons |

Working on data transmission? Write today for complete data on any or all Siliconix driver/FET switch combinations and OP AMPS.

For instant applications assistance, call the number below. Ask for Extension 19.

Siliconix incorporated
 1140 West Evelyn Ave. • Sunnyvale, Calif. 94086
 Telephone (408) 245-1000 • TWX 910-339-9216

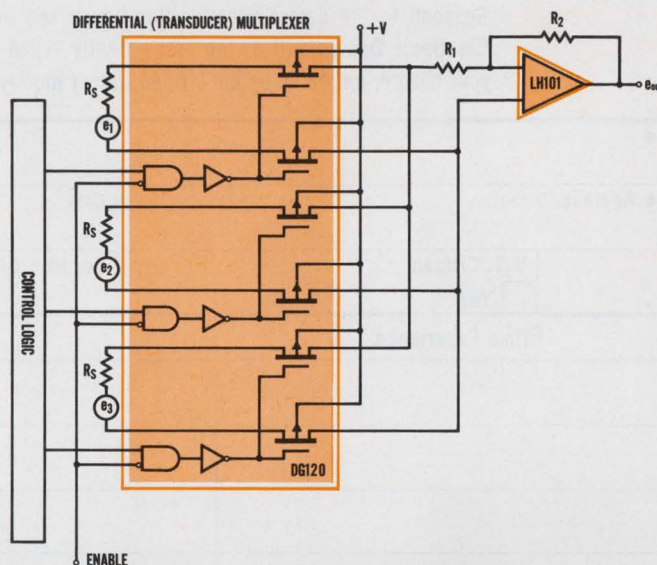

This three channel version of a transducer-multiplexer uses a single DG120 along with an LH101.

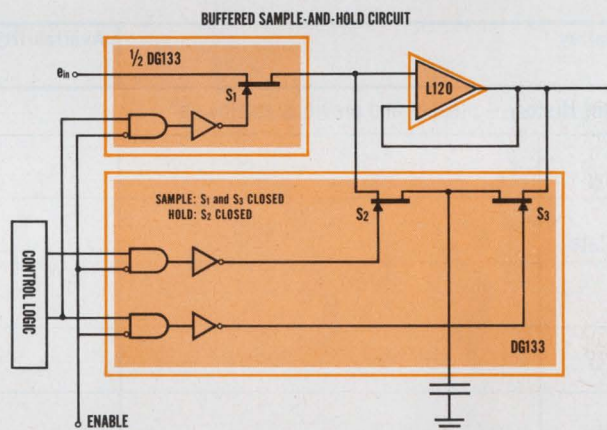

Low input leakage of the L120 OP AMP makes it ideally suited for sample-and-hold circuits. Two channels of this circuit require only three DG133s and one L120. An alternative approach would require two DG129s and one L120 for two channels.

Free Career Inquiry Service

Absolutely Confidential

Respond to the career opportunities advertised in this issue. Fill out and send us this handy resume. **Electronic Design** will do the rest – neatly typed copies of this form will be mailed to the companies of your choice, indicated by the circled Career Inquiry Numbers at the bottom of this page.

13

| | | | | |
|-------------|--|--|-------------------|--|
| Name | | | Home Phone | |
|-------------|--|--|-------------------|--|

| | | | |
|------------------------------|-------------|--------------|-----------------|
| Home Address (Street) | City | State | ZIP Code |
|------------------------------|-------------|--------------|-----------------|

| | | |
|------------|---|---------------------------|
| Age | U.S. Citizen <input type="checkbox"/> Yes <input type="checkbox"/> No | Security Clearance |
|------------|---|---------------------------|

| Prime Experience | Secondary Experience |
|------------------|----------------------|
| | |
| | |
| | |
| | |
| | |
| | |

| | |
|-----------------------|--------------------------|
| Desired Salary | Availability Date |
|-----------------------|--------------------------|

Employment History – present and previous employers

| Company | City, State | Dates | Title |
|---------|-------------|-------|-------|
| | | to | |
| | | to | |
| | | to | |
| | | | |
| | | | |

Education – indicate major if degree is not self-explanatory

| Degree | College | City, State | Dates |
|--------|---------|-------------|-------|
| | | | to |
| | | | to |
| | | | to |

Additional Training – non-degree, industry, military, etc.

| |
|--|
| |
| |

Professional Societies

Published Articles

Career Inquiry Numbers:

- | | | | | | | | | | | |
|-----|-----|-----|-----|-----|-----|-----|-----|-----|-----|-----|
| 900 | 901 | 902 | 903 | 904 | 905 | 906 | 907 | 908 | 909 | |
| 910 | 911 | 912 | 913 | 914 | 915 | 916 | 917 | 918 | 919 | 925 |

ELECTRONIC DESIGN
850 Third Avenue
New York, New York 10022

build with . . .

ALCOSWITCH™

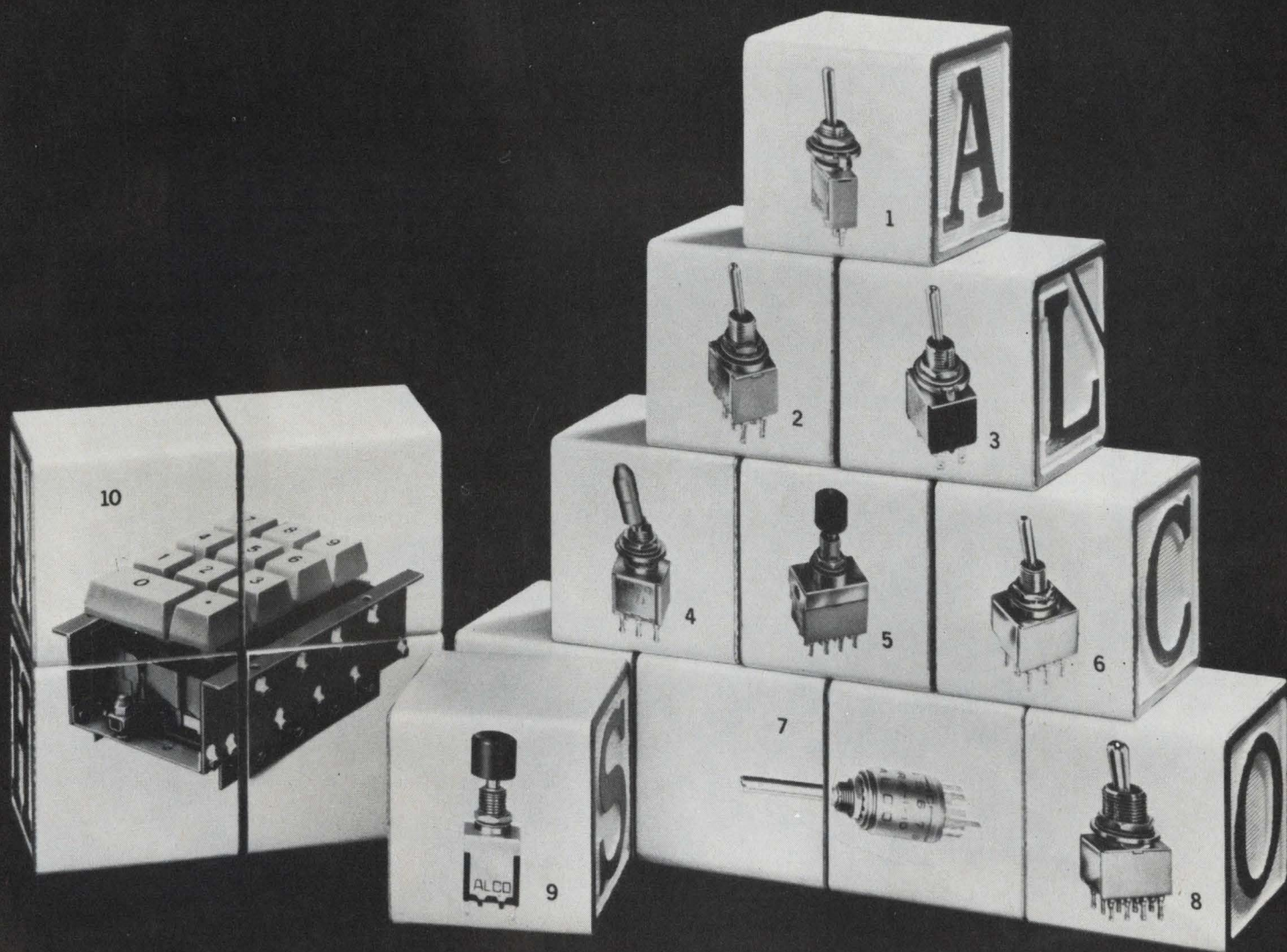

Build quality and reliability into your equipment with a top performing miniature Alcoswitch. Here are typical miniature switches from the many families of Alcoswitch which you can select: 1—SPDT “A” Series Toggle Switch, 2—DPDT “E” Series Toggle Switch, 3—DPDT “MST” Series Toggle Switch, 4—DPDT Locking Toggle Switch, 5—4PDT “E” Series Push Button Switch, 6—

3PDT “E” Series Toggle Switch, 7—“E” Series Waterproof Rotary Switch, 8—4PDT “Mustang” Toggle Switch, 9—DPDT “MST” Series Push Button Switch, 10—Reed Switch Operated Keyboard Assembly. Whatever your design problem or production budget, there is a miniature switch to fit your needs from Alcoswitch . . . the No. 1 choice in the U.S.A.

ALCO® ELECTRONIC PRODUCTS, INC. • LAWRENCE, MASS.

Circle 129 on reader service card



Extending man's senses:

Command joint forces from 20,000 feet.

Bounce a newscast around the world.

Navigate precisely from Cape Horn to the Cape of Good Hope.

Turn night into day with an airborne floodlight.

Set up a TACAN transceiver, anywhere, in minutes.

Airborne command and control stations. Communications satellite networks. The global Omega navigation system. Nighttime military and civilian operations. Portable TACAN.

All demand fail-safe technology — the finest electronics

and systems available.

That's our business.

LTV Electrosystems has the scientific and engineering talent, fast-reaction capacity and the production facilities (15 nationwide) to build the sophisticated, new-generation systems our customers need to extend their senses and capabilities into every environment.

Why don't you join us?

See the opposite page for a listing of current professional opportunities at LTV Electrosystems.

LTV ELECTROSYSTEMS, INC.

PO. BOX 6030, DALLAS, TEXAS 75222

A quality company of Ling-Temco-Vought, Inc. **LTV**

Book Reviews

Social engineering

Cure for Chaos: Fresh Solutions to Social Problems Through the Systems Approach, Simon Ramo (David McKay Co., Inc., New York) 116 pp., \$3.95.

This is a deceptively simple book, which uses examples and non-technical language to explain what the systems approach is, and why it should be applied to social problems. The argument is clearly presented and convincing. Imagine, Dr. Ramo urges his readers, what our telephone system would be like if it had been built up in scattered areas by numerous companies, each using different standards and different equipment. Today's telephone system would be a snarl, and because of the inefficiencies would probably be much more costly.

Yet such things as our transportation systems, medical services, urban complexes, and many similar large-scale efforts have developed—and are developing—in such a splintered fashion.

Dr. Ramo carefully explains that the systems methodology is not based on technology. Rather it is an organized approach to large-scale problem solving, merging the contributions of varied specialists into an integrated master plan. Since total data for such decision-making is rarely available—usually projections into the future are necessary—statistical methods and approximations must be used. Dr. Ramo goes even beyond this, and using such simple examples as a home heating and air conditioning system, advances through such ideas as stability, feedback and non-linearity. He discusses the use of the computer in systems analysis for such purposes as optimization and mathematical modeling.

Thus Dr. Ramo's book represents an excellent medium for convincing the non-technical layman—mayor, congressman, industrialist, taxpayer, housewife, even high-school student—that a systematic approach to large-scale problem

solving is good for us.

What he does not touch on at all is the biggest impediment to applying the systems approach more often in our nation. That is the necessity for labor unions; political machines; real estate operators; the automotive and other large industries; local, county and state government; and other powerful groups with vested interests to bend to the dictates of the systems analysts. Studies we have had aplenty. Action is another story. There is nothing in Dr. Ramo's book to convince these powerful interests that working together for optimum solutions will lead to the greatest benefit for all as individuals, rather than as representatives of this or that sub-group within the society.

Still, it might help a little if somebody sent copies of this book to some of the right people.

Robert C. Haavind

CIRCLE NO. 250

Steinmetz returns

Mathematics for Science and Engineering, 2nd Edition, Philip L. Alger, (McGraw-Hill) 369 pp. \$9.75.

This mathematics text, intended for self-study and reference use by engineers, is an extensive expansion and revision of *Engineering Mathematics* by Charles Proteus Steinmetz. It offers substantially all the mathematics used by practicing engineers in a single volume. This is the second edition of *Mathematics for Science and Engineering* and new sections have been added on preferred numbers that are useful in making standards, on Latin squares used in the design of experiments, and on modern digital computers and their uses. The book reflects the extensive experience of the author in the design of electrical machinery, but retains the clarity of exposition for which Steinmetz was well-known.

CIRCLE NO. 251



A new bulletin of professional opportunities at LTV Electrosystems.

Greenville Division

(Systems for strategic and tactical surveillance, reconnaissance, detection; tracking; command and control; airborne lighting systems; artificial intelligence; tactical warfare.)

Digital Systems Analysts
Digital Circuits Designers
Electro-Optics Systems Analysts
RF Systems Analysts
RF Circuits Designers
Scientific Programmers
Business Programmers

Facilities — Greenville, Texas; Greenville, South Carolina; Roswell, New Mexico

Garland Division

(Long-range digital communications; fluid mechanical systems for aircraft, missiles, spacecraft; high-precision antennas; guidance and navigation systems; space systems.)

RF Circuits Designers
RF Systems Analysts
Digital Circuits Designers
Digital Systems Analysts
Antenna Design Engineers
Scientific Programmers

Facilities — Garland and Arlington, Texas

Continental Electronics

(This subsidiary company builds super-power RF transmitters for radio communications, broadcasting, re-entry physics radars, radio astronomy, nuclear accelerators.)

Transmitter Design Engineers
RF Circuit Designers
RF Systems Engineers

Facilities — Dallas, Texas; Waltham, Massachusetts

Memcor Division

Portable and stationary TACAN systems, tactical radio systems, gyro systems, nuclear controls, resistance products.)

Project Engineers (TACAN Systems)
Electronic Design Engineers
Instrumentation Engineers
Mechanical Engineers
Digital Systems Engineers

Facilities — Huntington, Indiana; Boyne City, Michigan and Sali Lake City, Utah

Please call or write: Bill Hickey, Supervisor of Professional Placement, LTV Electrosystems, Inc., P. O. Box 6118, Dallas, Texas 75222, Telephone (214) 276-7111. An equal opportunity employer.

**LTV Electrosystems:
extending man's senses.**

INFORMATION RETRIEVAL NUMBER 902

The easy way to tell one microvolt from another... HP's new six-digit DVM



See microvolt readings, without knob twisting and delicate balancing. The new HP 3462A Digital Voltmeter measures dc voltages with $1 \mu\text{V}$ sensitivity, and greater than 1 ppm resolution—the easy way—automatically—for only \$4900!

The 3462A will meet the most exacting bench requirements, and is designed for fully automatic operation in any data acquisition system. It gives you six-digit readout of voltage measurements on any of four ranges, $\pm 1 \text{ V}$ to $\pm 1000 \text{ V}$, full scale. The

seventh digit provides up to 20% over-ranging on any range.

An input impedance of greater than $10^{10} \Omega$ on the 1 V and 10 V ranges allows you to make measurements with virtually no loading errors. You can even monitor standard cells and not have to worry about excessive

HEWLETT  PACKARD
DIGITAL VOLTMETERS

099/16

current drain. Add high accuracy, 160 dB common mode rejection at dc, and BCD outputs, and you have your best DVM buy.

Now is the time to start making your precision dc measurements the easy way with the HP 3462A. Get full information from your nearest HP Field Engineer. Or, write to Hewlett-Packard, Palo Alto, California 94304. Europe: 1217 Meyrin-Geneva, Switzerland.

INFORMATION RETRIEVAL NUMBER 67

Products

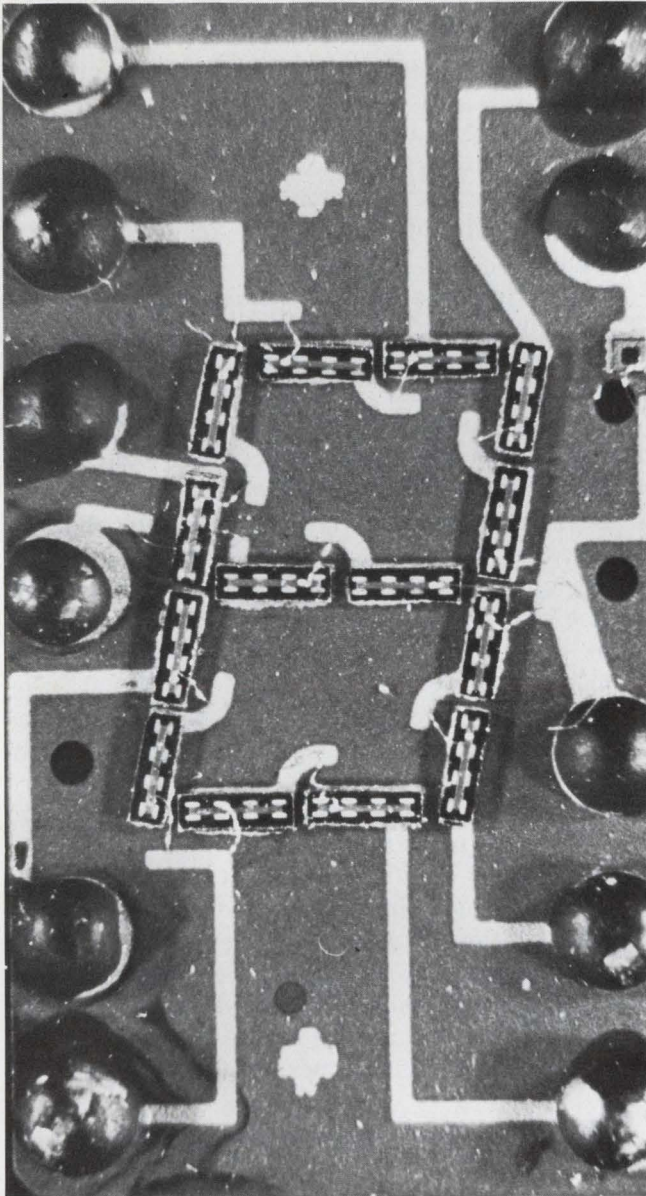

Solid-state seven-segment readout uses LEDs for direct compatibility with ICs. p. 138.

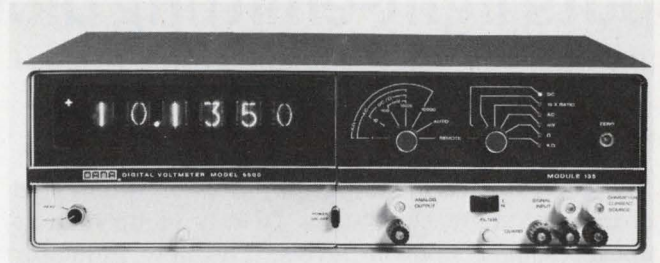

Low-ohm digital voltmeters compute ac measurements accurately in 300 ms. p. 148.

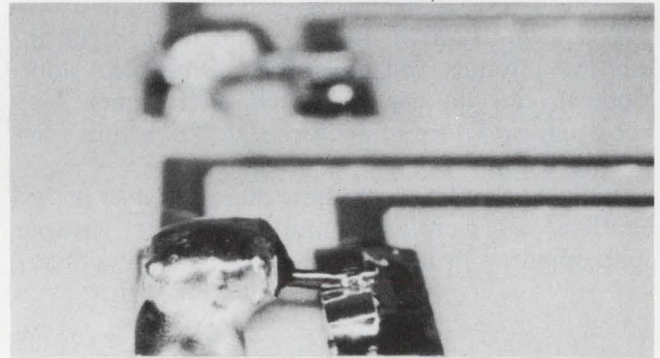

Solid tantalum chip capacitors end high-temperature limitation problems. p. 140.



New 2-1/2 digit panel meter with an accuracy of 0.5% has price tag of \$100. p. 158.

Also in this section:

Wideband filters and delay lines are state-of-the-art products, p. 156.

Plastic complementary transistor pair can handle 1 A at 0.5 V, p. 162.

Data terminal prints 40 characters/s on thermal-sensitive paper, p. 168.

Evaluation Samples, p. 184 . . . **Design Aids**, p. 187 . . . **Application Notes**, p. 188.

Annual Reports, p. 192 . . . **New Literature**, p. 194.

IC-compatible solid-state readout module puts light-emitting diodes in segmented array

Monsanto Electronic Special Products, 10131 Bubb Rd., Cupertino, Calif. Phone: (408) 257-2140. P&A: \$48; stock.

Offering direct compatibility with integrated circuits, a new solid-state DIP readout module operates at IC power levels. The new indicator arrays light-emitting diodes in a seven-segment format to provide a single-plane readout, plus wide-angle viewing.

With the inherent reliability and compactness of a solid-state device, this readout module promises a revolution in digital panel meters for industry, avionics and marine equipment. In addition, it can be used in such environments as submarines where indicators like Nixie tubes are prohibited.

Labeled the AN-1, the new indicator also means smaller, more reliable and eventually cheaper instruments. True all-solid-state instruments are

now no longer merely wishful thinking, but will be a likely reality by the year's end.

Model AN-1 has full numeric and partial alpha display capability. It can present any numeral from 0 to 9, plus the letters A, C, E, F, H, J, L, O, P and U. In addition, it has an integral decimal-point display.

Housed in a dual-in-line package that measures 0.71 by 0.375 in., the new device displays characters that are 0.25 in. high by 0.15 in. wide with a 10° slant. They are silhouetted against a black ceramic substrate, which has a metalized pattern for the digit and lead connections. The entire assembly has a clear epoxy cover.

To reduce complexity for high production yields, the AN-1 is separated from its decoder/driver circuitry. This approach is also said to increase circuit design flexibility since all applications do not require a decoder/driver for each numeric display.

The remote decoder/driver operates and controls the new readout module as it would any standard seven-segment display. The four-wire binary-coded decimal inputs are converted to seven-wire outputs to excite the appropriate segments.

Standard logic chips can perform the decoder/driver functions. Recommended ones include model 9317 from Fairchild Semiconductor, model 8T04 from Signetics Corp., and model SN7447 from Texas Instruments Inc. Approximate cost for these devices is \$10 per chip in quantities of 1000.

There are 15 die in each module—14 for the seven segments and one for the decimal point. Each segment consists of two half segments. These half segments are actually planar integrated circuits, equivalent to a light-emitting diode on a 25-mil chip.

Like a light-emitting diode, each half segment operates at 1.7 V dc. Two half segments in series require 3.4 V dc. Since equipment using integrated circuits normally operates with a voltage of 5 to 6 V, the 3.4-V requirement does not present any supply problems.

The remote logic chip can control only full segments, not half segments. Normal operating power is 68 mW (3.4 V at 20 mA) per segment, 480 mW for all seven segments. At the 20-mA level, typical brightness is 200 foot-lamberts.

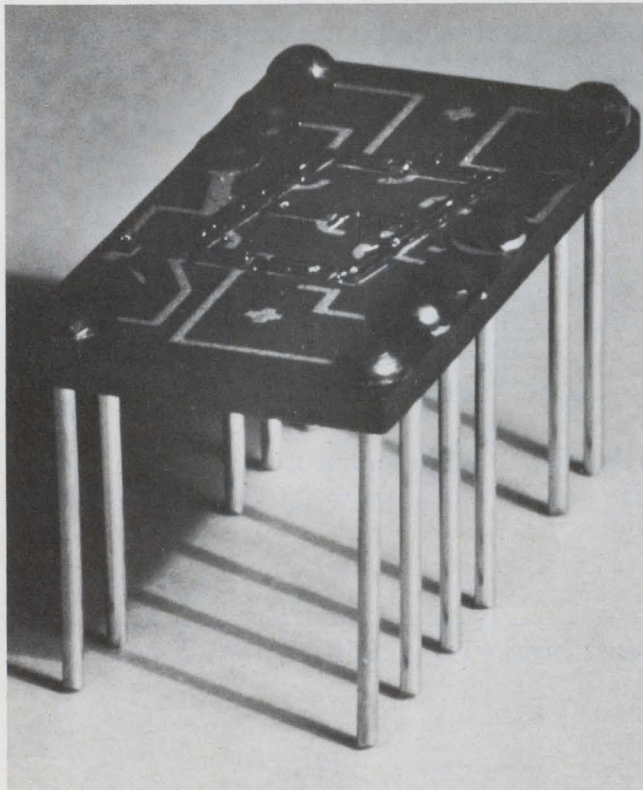

Directly compatible with ICs, a new solid-state readout module operates with 480 mW maximum. This new DIP indicator is remotely located from its decoder/driver logic control chip for circuit design flexibility.

CIRCLE NO. 252

**TRW/Globe
sells motion**



Application #3: intermittent motion.

Intermittent motion actuators—linear or rotary—vary as widely in design as the functions they perform. If you settle for modified off-the-shelf actuators, you pay a penalty in size, in weight, in power requirements.

Our actuators are designed for individual applications. They are matched both to the drive source and the end function. This is why Globe actuators meet the space weight restrictions of

your system without sacrificing performance or strength.

Globe engineers design motor systems. Because we make all our own motors and gear-trains, we can select and match the components to give precisely the output movement you need.

TRW Globe is in the business of solving problems in motion. Any kind of motion: intermittent or continuous, rotary or linear, gas or liquid or me-

chanical linkage. If you have a problem in intermittent motion, let Globe's motor *system engineers* find the answer. Contact Globe Industries, Division of TRW Inc., 2275 Stanley Avenue, Dayton, Ohio 45404. Phone: (513) 228-3171.

TRW[®]

INFORMATION RETRIEVAL NUMBER 72

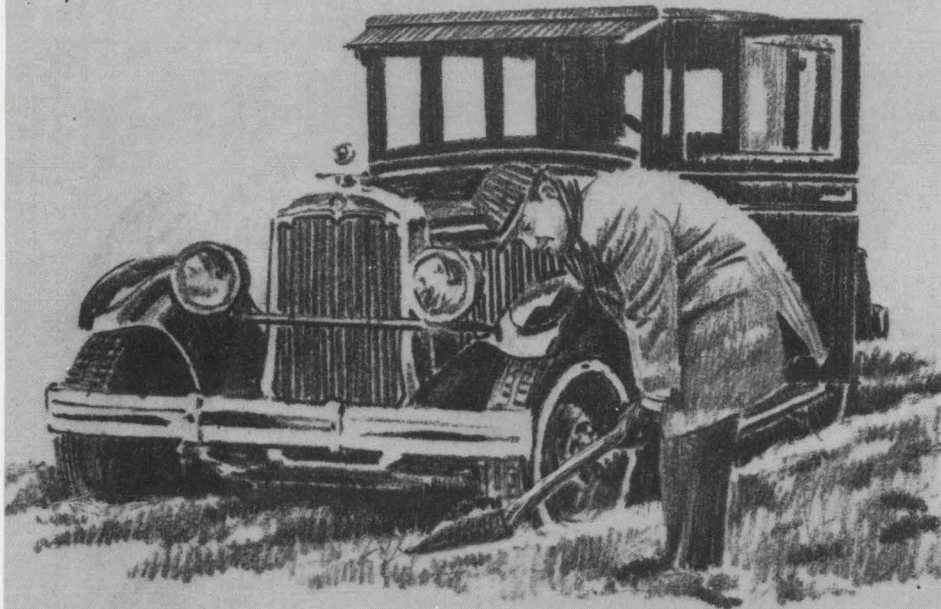

Slot supplies have you in a rut? GET OUT OF IT!

Replace obsolete, narrow-range slot supplies with POWER/MATE CORP.'s UniPower Series. These nine all-purpose, wide voltage range power supplies can replace thousands of narrow-range slot supplies and give you these big advantages: current output up to 34 amps • adjustable to any range from 0-34 volts • regulation to 0.005% • ripple a low 250 microvolts. The wide voltage range of the UniPower Series simplifies your power supply requirements because you can stock fewer units. In addition, these modules can be mounted in standard size racks or on any of three surfaces and in any position!



UNI-30F

The UniPower Series of Nine

- Uni-76 — 0-34 volts, 0.5 amps — \$76.00
- Uni-88 — 0-34 volts, 1.5 amps — \$99.00
- Uni-30C — 0-30 volts, up to 5 amps — \$134.00
- Uni-30D — 0-30 volts, up to 8 amps — \$151.00
- Uni-30E — 0-30 volts, up to 12 amps — \$174.00
- Uni-30F — 0-30 volts, up to 18 amps — \$205.00
- Uni-30G — 0-30 volts, up to 24 amps — \$265.00
- Uni-30H — 0-30 volts, up to 34 amps — \$315.00
- UniTwin-164 — dual output 0-25 volts, 0.75 amps — \$164.00

| MODEL | CURRENT vs. VOLTAGE OUTPUT | | | | | | | | | | | | | |
|---------|----------------------------|------|------|------|------|------|------|------|------|------|------|------|------|------|
| | 0-6V | 8 | 10 | 12 | 14 | 15 | 16 | 18 | 20 | 22 | 24 | 26 | 28 | 30 |
| Uni-76 | 0.05 amp throughout range | | | | | | | | | | | | | |
| Uni-88 | 1.5 amps throughout range | | | | | | | | | | | | | |
| Uni-30C | 5.0 | 4.6 | 4.4 | 4.2 | 4.1 | 4.0 | 3.8 | 3.6 | 3.4 | 3.2 | 3.0 | 2.8 | 2.6 | 2.5 |
| Uni-30D | 8.0 | 7.6 | 7.3 | 6.9 | 6.6 | 6.4 | 6.2 | 6.0 | 5.7 | 5.3 | 5.0 | 4.7 | 4.4 | 4.0 |
| Uni-30E | 12.0 | 11.2 | 10.8 | 10.3 | 9.8 | 9.5 | 9.2 | 8.8 | 8.3 | 7.9 | 7.4 | 6.9 | 6.4 | 6.0 |
| Uni-30F | 18.0 | 16.9 | 16.2 | 15.5 | 14.8 | 14.4 | 14.0 | 13.3 | 12.6 | 11.9 | 11.2 | 10.5 | 9.8 | 9.0 |
| Uni-30G | 24.0 | 22.5 | 21.6 | 20.6 | 19.6 | 19.1 | 18.6 | 17.7 | 16.7 | 15.8 | 14.8 | 13.8 | 12.9 | 12.0 |
| Uni-30H | 34.0 | 31.9 | 30.5 | 29.2 | 27.8 | 27.1 | 26.4 | 25.0 | 23.7 | 22.4 | 21.0 | 19.7 | 18.3 | 17.0 |

SPECIFICATIONS: Regulation — up to $\pm 0.005\%$ or 1 MV for line and load; Ripple — Less than 250 microvolts; Response Time — Less than 20 microseconds; Overload and Short Circuit Protection — Solid state. Instantaneous recover, and automatic reset. Cannot be damaged by prolonged short circuit or overload.

FREE: Send for complete catalog. Write to:



POWER/MATE CORPORATION
163 CLAY STREET, HACKENSACK, NEW JERSEY 07601
PHONE: (201) 343-6294 TWX: (710) 990-5023

COMPONENTS

Solid tantalum chips resist up to 800°C

Union Carbide Corp., Electronics Div., P.O. Box 5928, Greenville, S. C., Phone: (803) 963-7421. P&A: 35¢ to \$3; 6 wks.

By eliminating the silver paint normally used to contact the counterelectrode, a new series of solid tantalum chip capacitors end outgassing problems and can withstand temperatures as high as 800°C. Series T400 capacitors are as resistant to extreme high temperatures as monolithic ceramic units because they have a solid copper counterelectrode system.

Consisting of a series of layers, solid tantalum chips array tantalum metal as the positive electrode, tantalum pentoxide as the dielectric, and manganese dioxide and carbon as the counterelectrode. Since carbon cannot be soldered, silver paint is usually used to contact the counterelectrode.

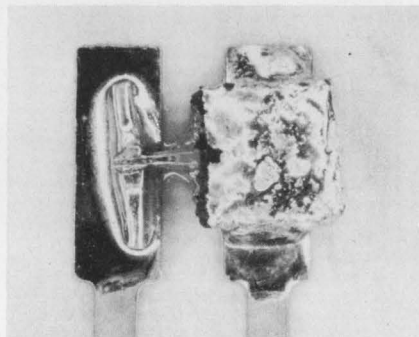

Solid tantalum chip capacitors end high-temperature limitations with copper counterelectrode system.

However, this painted silver layer is often destroyed at normal processing temperatures, or tends to outgas if heated in a sealed package. On the other hand, copper, which is used in the new devices to contact the counterelectrode, is immune to such problems.

Offering the design engineer exceptional volumetric efficiency, series T400 solid tantalum chip capacitors are available in several configurations. Capacitance values range from 0.001 to 220 μ F with full-voltage ratings of 2 to 50 V. Standard tolerances are $\pm 20\%$; tolerances of $\pm 10\%$ are optional. Operating temperature range is -80 to $+85^\circ\text{C}$ at full-voltage operation.

CIRCLE NO. 253

TRW METALLIZED POLYCARBONATE CAPACITORS



... small enough to fit!

TRW 50-volt Metallized Polycarbonate Capacitors are made to squeeze into tight places. Imagine 10 microfarads measuring .547" x 1¼" long... the smallest wound capacitor on the market!

Short on size and long on reliability, the X463UW series meets all requirements of MIL-C-27287.
VOLTAGE—50V, 100V, 200V, 400V
CAPACITANCE—.001 through 10 mfd
TOLERANCE—available to $\pm 1\%$.

INFORMATION RETRIEVAL NUMBER 70

For data, write TRW Capacitor Div., Ogallala, Neb. Phone (308) 284-3611. TWX 910-620-0321.

TRW®

A **NEW** APPROACH TO EMI FROM SPECTRUM CONTROL—
THE PEOPLE WHO THINK *Electromagnetic Compatibility*

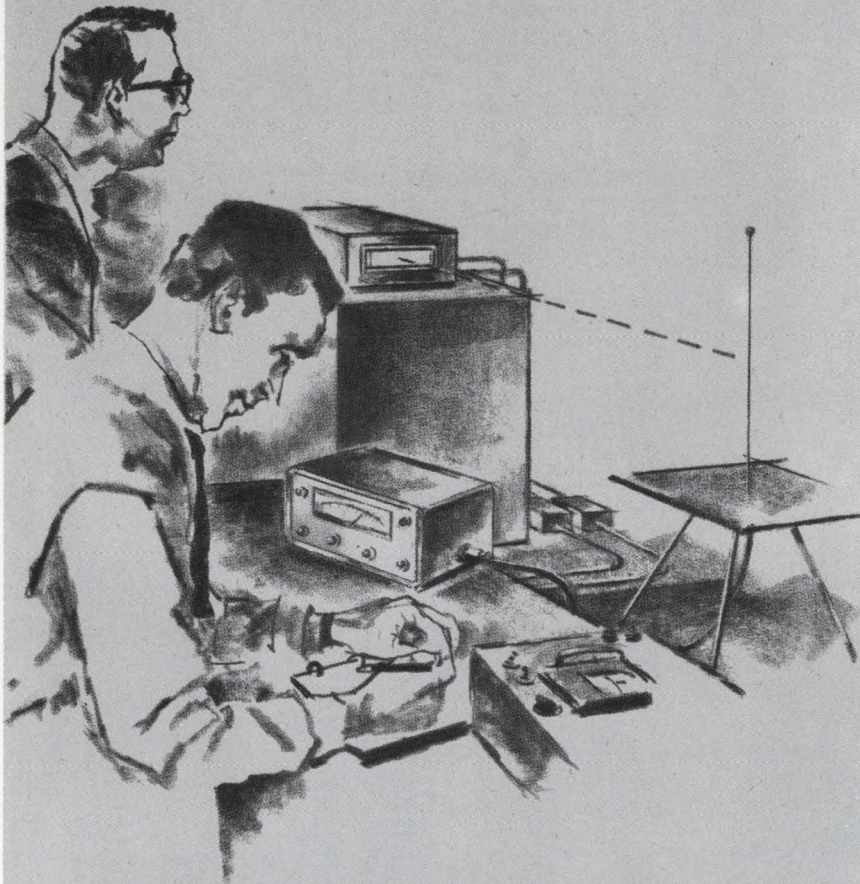

**Professional Testing and Consulting Services
For the Effective, Total Management of ...**

ELECTROMAGNETIC INTERFERENCE

Spectrum Control offers a unique combination of professional consulting services plus a broad range of electronic "hardware," instruments and components ... a capability encompassing the total management of electromagnetic compatibility. Spectrum predicts, identifies, measures and controls interference problems. Our staff engineers work closely with manufacturers ... at their plant site ... or at our fully equipped test facilities. Typical consulting services include, in addition to EMI program management, interference prediction, test plans, control plans, interference identification, and EMI test stand measurements. If you have an EMI problem, as most firms have, call in Spectrum Control TODAY.

Write for literature about
Spectrum's Consulting
Services or call
John R. Lane —
814/474-5593

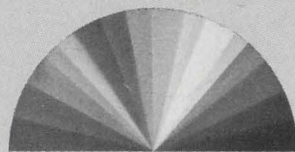

SPECTRUM CONTROL INC.
152 EAST MAIN ST • FAIRVIEW, PENNSYLVANIA 16415

COMPONENTS

Lever thumbwheels have toggle action

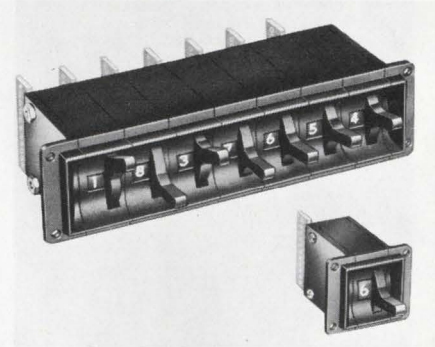

*Cherry Electrical Products Corp.,
1650 Old Deerfield Rd., Highland
Park, Ill. Phone: (312) 831-2100.
Price: \$7.40 or \$7.60.*

Said to set in less than half the time required by conventional units, a new line of lever-action thumbwheel switches, called Lever-wheel, features an extended lever that replaces the traditional thumbwheels. Moving the new lever through its 60° arc completes a 10-position cycle. Both miniature (L11) and subminiature (L20) units are available.

CIRCLE NO. 254

High-voltage neon lamp has 0.093-in. diameter

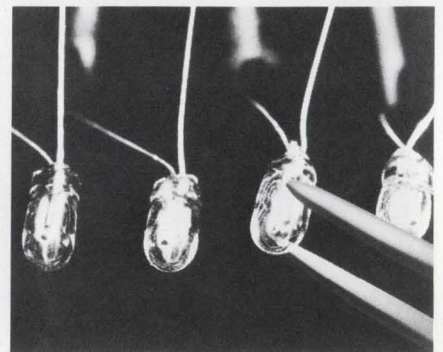

*Lamps, Inc., 17000 South Western
Ave., Gardena, Calif. Price: 41¢.*

Said to be the smallest of its kind, a new high-voltage neon lamp measures only 0.093 inch in diameter. Designated as a T-3/4 unit, it is available in either based or unbased designs. It operates at line voltages with a maximum current of 1 mA and a 100-k Ω 0.1-W series resistor. This new lamp can also be used as a voltage regulator. It meets the requirements of MIL-L-15098B.

CIRCLE NO. 255

**TRW Announces
40 Watts at 50 MHz
40 Watts at 175 MHz
20 Watts at 470 MHz**

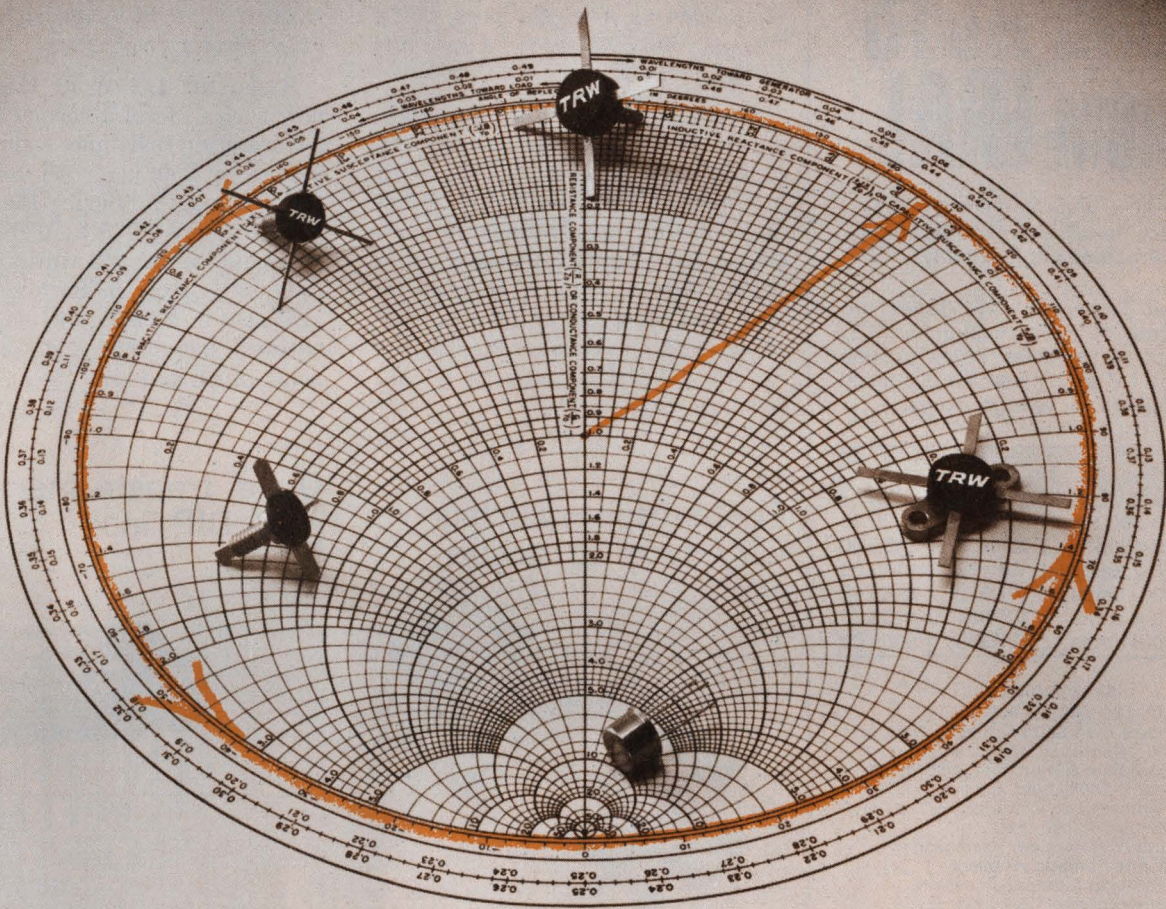

12.5 Volts...withstands infinite VSWR

TRW offers three new families of 12.5 volt RF transistors in a wide range of power levels. These rugged transistors will withstand severe mismatch—any load, any phase. Broken or shorted antennas are no longer a problem.

Complicated push-pull or parallel output stages are a thing of the past.

Using single output devices, you can design transmitters with up to 20 watts output at 470 MHz (2N5701), 40 watts at 175 MHz (2N5706) and 40 watts at 50 MHz (2N5691). Fifteen new devices provide complete RF line-ups.

Contact any TRW Distributor or Dept. MR-1, TRW Semiconductors.

14520 Aviation Blvd., Lawndale, Calif. 90260. TRW Semiconductors Inc., is a subsidiary of TRW INC.



INFORMATION RETRIEVAL NUMBER 68

Eliminate Power Supply
Obsolescence... Simplify
Stocking Problems
with these



NEW WIDE-RANGE COMPACTS FROM ERA!

**Small Size, Wide-Range DC Power
Modules Permit Improved Design &
Procurement Flexibility**

The new Transpac® WR Series are ultra compact, fully repairable, 71°C silicon power modules which provide regulated DC power over an extremely wide, adjustable voltage range.

| Output Voltage (DC) | Current (71°C) | Model | Price |
|---------------------|----------------|--------|----------|
| 1-33 | 0-500 ma | WR33P5 | \$120.00 |
| 1-33 | 0-1 amp | WR331 | \$155.00 |
| 1-18 | 0-2 amps | WR182 | \$170.00 |
| 1-33 | 0-2 amps | WR332 | \$185.00 |
| 1-33 | 0-4 amps | WR334 | \$255.00 |
| 1-33 | 0-8 amps | WR338 | \$305.00 |

SPECIFICATIONS

Input: 105-125 VAC, 50-400 cps
Ripple: Less than 800 microvolts RMS or 0.005%, whichever is greater
Line Regulation: Better than $\pm 0.01\%$ or 5 mv for 0-100% load change
Voltage Adjustment: Continuous (Taps and screwdriver adjustment)
Short Circuit Protection: Microseconds response, automatic recovery
Vernier Voltage: External provision
Transient Response: Less than 50 microseconds
Maximum Case Temperature: 130°C
Operating Temperature: -20°C to +71°C free air, full ratings
Temperature Coefficient: Less than 0.01% per degrees C or 3 millivolts
Long-Term Stability: Within 5 millivolts (8 hour reference)

Write Today for Catalog #148



ELECTRONIC RESEARCH ASSOCIATES, INC.

Dept. EDN, 67 Sand Park Road
Cedar Grove, N. J. 07009 • (201) 239-3000
Subsidiaries: ERA Electric Co. • ERA Acoustics Corp.
ERA Dynamics Corp. • ERA Pacific, Inc.

INFORMATION RETRIEVAL NUMBER 73

COMPONENTS

Low-profile capacitors match IC flatpacs



Engineered Components Co., 2134 W. Rosecrans Ave., Gardena, Calif. Phone: (213) 321-6565. Availability: stock to 2 wks.

Measuring only 0.225 in. high, a new line of low-profile flatpack capacitors offer compatibility with integrated-circuit packaging. Rated at 50 V, they are available in more than 100 standard capacitance values. Package width is 0.385 in. with lead breakout at 0.3 in. center to center; length varies from 0.1 in. for a 0.001- μ F unit to 0.9 in. for 1- μ F unit.

CIRCLE NO. 256

Pushbutton switches vary type of action

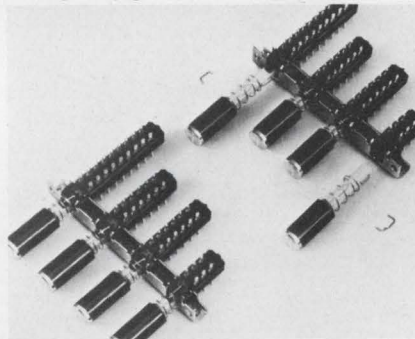

International Electro Exchange, 6529 Cambridge St., Minneapolis, Minn. Phone: (612) 929-9611.

Miniature modular pushbutton switches feature a new and unique design that permits simplified conversion from momentary to push-button action by the interchange of a short wire staple. This conversion can be accomplished without disturbing the switch module position or electrical connections. Series F units are available in double-throw configurations with 2, 4, 6, 8 or 10 poles.

CIRCLE NO. 257

Cermet chip resistors handle 1/8 W at 125°C

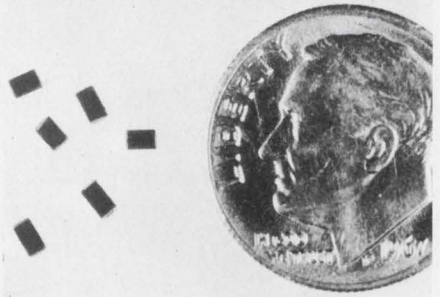

CTS Corp., 1142 W. Beardsley, Elkhart, Ind. Phone: (219) 523-0210. Price: from 18¢.

Rated for 1/8 W at 125°C, two new series of solid cermet chip resistors offer resistance values from 200 Ω to 350 k Ω with tolerances as low as $\pm 1\%$. Series 150 devices measure only 0.075 by 0.05 by 0.03 in., while series 151 units are 0.09 by 0.05 by 0.03 in. Both series are available in a variety of end terminations, including gold, platinum-gold, silver and tin.

CIRCLE NO. 258

Quad transformer gets DIP look

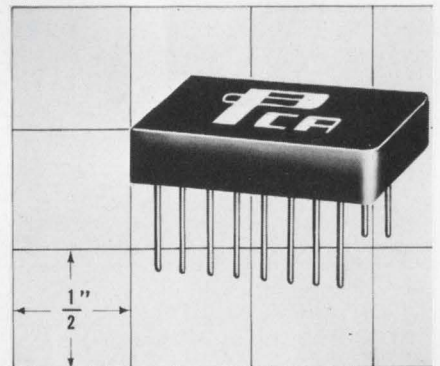

PCA Electronics, Inc., 16799 Schoenborn St., Sepulveda, Calif. Phone: (213) 892-0761. P&A: \$5; 4 wks.

Measuring only 1 in. long by 0.4 in. wide by 0.225 in. high, a new dual-in-line module contains four transformers that operate independently. Available in either 2:1 or 1:1 winding ratios, the typical transformer module has a primary inductance of 500 μ H, an interwinding capacitance of 24 pF and a leakage inductance of less than 1 μ H.

CIRCLE NO. 259

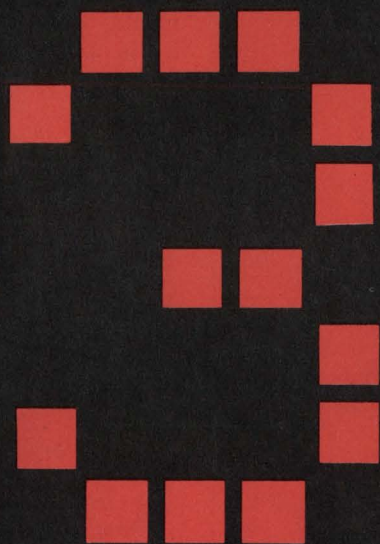

Display of strength

There are several sound reasons to use our solid state numeric displays. One of the most important is this: they're so strong, they won't die of shock. So they can be used in the most demanding applications.

Another decisive factor is size: each display package measures just 1"x 0.5"x 0.16". And that's all there is to it. In this tiny framework, you get everything necessary to display numerals 0-9. The chip includes an IC driver/decoder and gallium arsenide phosphide diodes that make the bright red numerals visible clear across a room, even at an acute angle.

The display needs less than 5 volts to drive it, and takes a straight-forward four line 8-4-2-1 BCD input. You can vary the brightness. And, as the modules are IC compatible, no special interfacing is required. You can buy our solid state numeric display in three-character packages, as well as the solo component. And our small displays of strength cost just \$42 each in 1000 quantities.

For all the bright details about this new technology for numeric indicators, call your local HP field engineer. Or write Hewlett-Packard, Palo Alto, California 94304; Europe: 1217 Meyrin-Geneva, Switzerland.

HEWLETT  **PACKARD**

SOLID STATE DEVICES

new
4 reasons why
USCC
chip capacitors
are best for
hybrid circuits

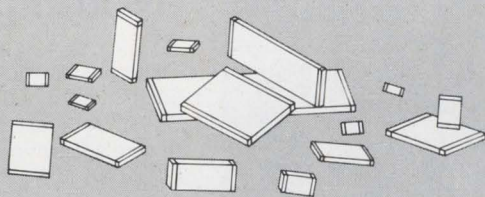

1. HIGH RELIABILITY

100% electrical testing on all units. Power screening available on all high rel units.

2. SMALLEST CHIP SIZES

Featuring the smallest chip available—only .075" x .035" x .040". 16 miniature sizes ranging from 10 pF to 3.3 Mfd.

3. MOUNTING PADS

Self leveling noble metal mounting pads for superior attachment, mounting stability and ultrasonic bonding.

4. MARKED CHIPS

Each chip individually marked for: capacitance value, tolerance and working voltage.

Do you need more reasons to use USCC chip capacitors?
 Ask your USCC sales representative or call or write us. We have a catalog full of chip information.

USCC

U. S Capacitor Corporation, 2151 No. Lincoln Street, Burbank California 91504 • Telephone: (213) 843-4222 • TWX 910-498-2222

COMPONENTS

Air trimmer capacitors swap Teflon for metal

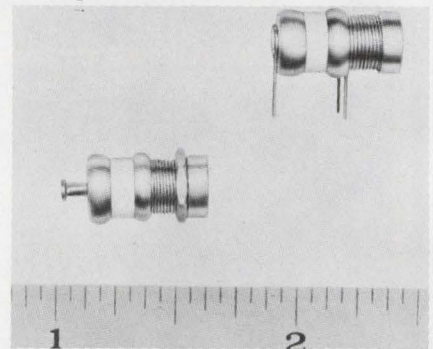

JFD Electronic Co., Components Div., 15th Ave. at 62nd St., Brooklyn, N. Y. Phone: (212) 331-1000. Availability: stock.

Providing smooth constant torque during and beyond life cycling, series MVM all-metal air trimmer capacitors have biased metal elements to replace the Teflon torque element that normally holds the rotor in place. These metal elements also help to reduce noise levels to a minimum. The new capacitors can be trimmed from 0.8 to 10 pF.

CIRCLE NO. 260

T-1 readouts have neon look

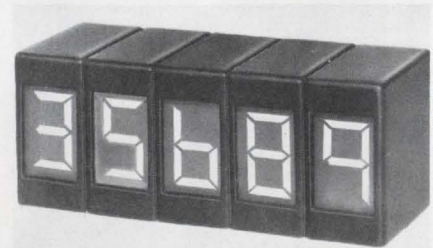

Alco Electronic Products, Inc., P.O. Box 1348, Lawrence, Mass. Phone: (617) 683-5771. P&A: \$6.45; stock.

Permitting true wide-angle viewing without distortion, new flat single-plane seven-segment readouts display characters that look like neon, have the long life of neons, but use miniature T-1 incandescent lamps. Their bright display is clearly read under all ambient lighting conditions, and contrast is further enhanced and glare minimized by a built-in red filter.

CIRCLE NO. 261

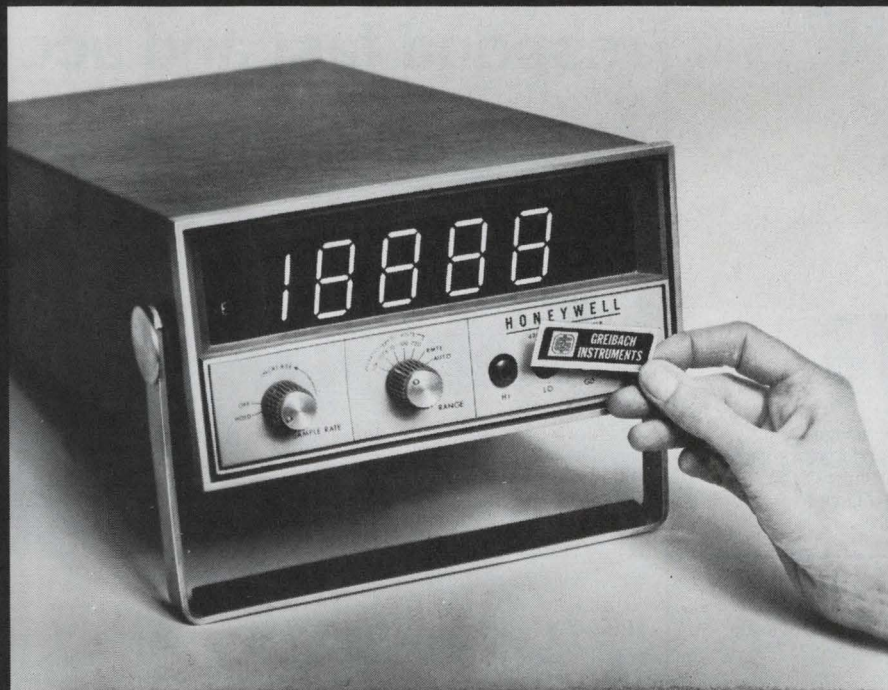

Meet one of Solitron's digital multimeters.

Solitron has broadened its instrument line by adding a number of precision multimeters which were formerly manufactured by Honeywell. One of them is the Model 620 digital volt meter.

Picture trying to read 18.888 on an Analogue meter and you'll see one of the immediate advantages that lead us to the DVM. All DVMs give this precision, of course, but Honeywell (now Solitron) gives something extra.

The extra is the exclusive AUTOJECT noise rejection feature. Simply described, this feature permits fast, accurate measurement in the presence of high noise levels. It analyzes the noise sources near which it will be working, and through synchronization reduces their effect to zero, irrespective of phase or frequency. The result: a common mode rejection of 140 db/min. and a normal mode rejection of 60db/min. at any noise frequency above 30 Hz. AUTOJECT "tunes out" the noises in your quality control or lab testing area, or in any production system.

Other meters in our new line include the Model 85 and Model 630, in addition to the phase-to-DC and ohms-to-DC converters. Plus a wide assortment of optional equipment that can tailor our instruments to your needs.

For spec sheets and prices, write to the address below.

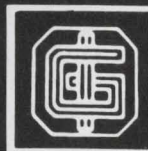

GREIBACH INSTRUMENTS
DIVISION OF SOLITRON DEVICES, INC.
37-11 47th Avenue, Long Island City,
New York 11101 (212) 937-0400

Wedge-Action*

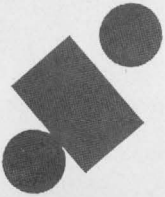

Relays

Hermetically-sealed, electromagnetic relays that provide high performance and reliability under the most difficult operating conditions in dry-circuit to 2 amp applications.

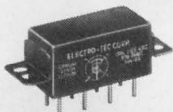

2 PDT
MARK II, SERIES 500
MIL-R-5757/9



6PDT 4PDT
(1" x 1")
MARK II, SERIES 300
(6 PDT).
SERIES 350 (4 PDT).
MIL-R-5757/1 and
MIL-R-5757/7



6PDT
MARK II, SERIES 085
(-55°C to +85°C)
SERIES 100
(-65°C to +125°C),
SERIES 200
(-65°C to +200°C).
MIL-R-5757/1.



4PDT, 10AMP
MARK X, SERIES 600-02
MSFC-339/22A

*Wedge-Action



The moving contacts are mounted between two stationary contacts. On actuation, they drive into the stationary contacts, creating high pressures and low contact resistance at all current levels. In addition, wedge-action contact wipe provides self-cleaning of the precious-metal contacts.

*Patented

For complete data write Relay Sales and Engineering Office, P. O. Box 667, Ormond Beach, Fla. 32074, Phone 904-677-1771, TWX 810-857-0305.

Electro-Tec Corp.

A DIVISION OF KDI CORPORATION **(KDI)**

Low-ohm 5-digit voltmeters respond fast and accurately



Dana Laboratories Inc., 2401 Campus Drive, Irvine, Calif. Phone: (714) 833-1234. P&A: \$2995 to \$4285; September, 1969.

A new line of digital voltmeters can accurately compute ac measurements in 300 ms, provide 80-dB noise rejection at line frequency, and measure resistances below 10 Ω. Series 5500 instruments use a novel economical ac voltage measurement technique that provides accurate measurements in the presence of distortion without sacrificing speed, sensitivity, low-frequency response and reliability.

The basic series 5500/135 DVMs can measure dc voltages and ratios. When equipped with the proper plug-in circuit card, like the model 31 computing ac converter or the model 21 average-responding converter, the instruments can perform ac measurements. The model 01 ohms-converter plug-in circuit card adds the capability of resistance measurement.

Using high-speed analog (curve fitting) computer techniques, the new voltmeters provide accurate rms ac measurements of square, triangle, sawtooth, and sine waves. Because the need for thermocouples is eliminated, ac measurements can be made in 300 ms with 100-μV sensitivity.

Solid-state switching and successive approximation permit the instruments to digitize a signal in less than 15 ms following a 15-ms

settling time. In the remote-command mode, the new meters can make up to 35 readings per second with full allowance for settling time.

There are eight full-scale resistance ranges, from 10 Ω to 10 MΩ, with 100-μΩ resolution. Small resistances can be measured accurately by utilizing a four-wire ohms configuration.

Incorporating a five-pole active filter, the new digital voltmeters are said to offer 30 times more normal-mode noise rejection than the most advanced integrating DVMs. Errors due to ground loops are minimized by a guarded input that shields the signal from power lines and other sources of common-mode voltage. Common-mode rejection is 120 dB at 60 Hz.

These five-digit instruments have a dc accuracy of ±0.005% of reading, plus one digit. The effect of temperature change on accuracy is less than ±0.0005%/°C of reading, ±0.0002%/°C of full scale.

The units can also measure real-time dc/dc ratios. Since both the signal and the reference are detected simultaneously, precise ratio measurements can be made independent of the stability of the external dc source.

Another new DVM family, series 5400, with a four-digit readout, that costs about \$1000 less is also available.

CIRCLE NO. 262



At home
on the
range.

417—the lightweight recorder for heavy duty field use

In the field or on a test range, the rugged, portable Lockheed 417 is right at home. Just as it is wherever there's data to record... in the air, on the seas and under them, in plants or labs or out in the wilds.

Weighs only 28 lbs. with battery—50 lbs. under any comparable recorder. Measures 14"x15"x6" (fits under a plane seat).

Runs on 110/220v AC/DC or internal battery. Power consumption as low as 10w.

Accuracy matches large rack machines. Has phaselock servo for precise speed control. Records on 7 channels, IRIG compatible.

Tagged as low as \$7,000.



Exclusive low-mass differential capstan drive gives precision recording even in rough field conditions. Simplified, maintenance-free mechanism works under vibration and in any position.

Frequency response: 100 kc direct, 10 kc FM.

Send for our catalog containing full details on the 417—one of a family of precision data recorders for land, ocean, air and space application. Write: Boyd McKnight, Dept. #ED-6H, Lockheed Electronics Company, Edison, New Jersey.

Questions about data recording? Let's discuss. Call (201) 757-1600.

LOCKHEED

Lockheed Electronics Company. A Division of Lockheed Aircraft Corporation



MONOLITHIC CRYSTAL FILTER FEVER

Spreading fast! It's understandable, when you consider the advantages brought to you by monolithic crystal filters.

MTBF computed to be improved 600% over conventional filters. Filter sizes reduced considerably. One instead of several different temperature coefficients. Greatly improved shock-and-vibration resistance.

THE CURE

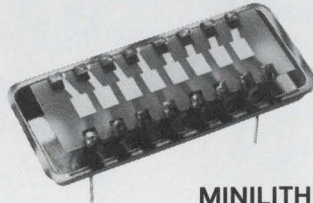

MINILITH®

Break that fever!
... with the practical cure, Reeves-Hoffman's Minilith crystal filter. Reeves-Hoffman is unsurpassed in engineering background and in actual monolithic crystal filter production performance:

- Frequencies 4 to 30 MHz
- Bandwidths 0.01% to 0.4%
- Attenuation to 80 dB
- Shape factors as steep as 2:1
- Spurious suppression to 50 dB

Reeves-Hoffman has been awarded the only Army Signal Corps production engineering measure for crystal filters employing the principles of coupled resonance.

Call, TWX, or write your requirements today.

craft-masters in crystal controls

REEVES-HOFFMAN

DIVISION, DYNAMICS CORPORATION OF AMERICA

400 WEST NORTH ST., CARLISLE, PENNSYLVANIA 17013 • 717/243-5929 • TWX: 510-650-3510
INFORMATION RETRIEVAL NUMBER 79

INSTRUMENTATION Digital panel meter costs only \$100



Weston Instruments, Inc. a Schlumberger Co., 614 Frelinghuysen Ave., Newark, N.J. Phone: (201) 243-4700. P&A: \$100; stock.

Truly competitively priced with its analog equivalent, a new 2-1/2 digit panel meter sells for less than \$100 in quantities of 25. The 1260 digital panel meter is intended for applications that do not require the high accuracy and high resolution of most 3-1/2- and 4-digit DPMs.

Offering an accuracy of 0.5%, the new instrument uses an economical design approach that has the simplicity of dual-slope integration, but with approximately half as many components. The 1260 employs a novel voltage-to-time converter that can be packaged, with its complete power supply and readout, on a 4 by 3 in. PC board.

This new design also eliminates much of the circuitry associated with dual-slope techniques. In particular, buffer storage, readout blanking, input analog switching and control logic circuits are no longer necessary. However, the new design still provides high normal- and common-mode rejection with a non-blinking readout.

The new meter can measure full-scale voltages from 199 mV to 100 kV and full-scale currents from 19.9µA and 199 mA.

CIRCLE NO. 263

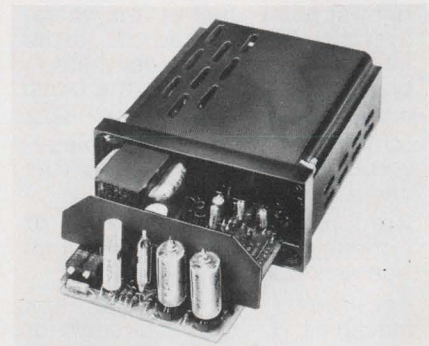

Using a novel economical design, a new low-cost digital panel meter fits on 4 by 3 in PC board.

LOW COST MULTIPLIER

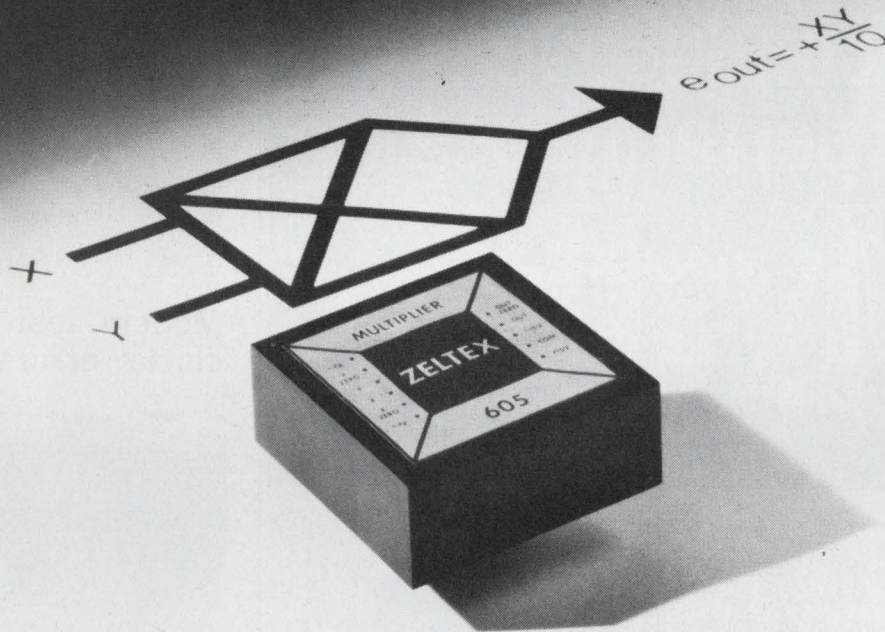

New from
ZELTEX!

A four-quadrant modular multiplier that requires no external amplifiers for

\$48*

- 1% Accuracy
- 10V, 4mA Output
- 1mV rms Noise
- 500 kHz Bandwidth
- 100 kHz Full Output Frequency
- 6V/ μ s Slew Rate

The Model 605 comes to you from the makers of the industry's most accurate multiplier—the Zeltek Model 601 with accuracy within 1mV (0.005%).

For complete information on these or any other Zeltek electronic products, write or phone today.

*In quantity.

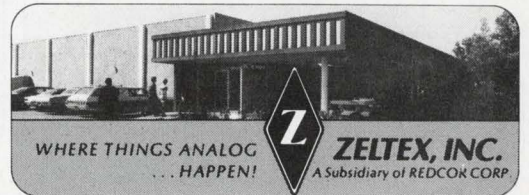

WHERE THINGS ANALOG
... HAPPEN!

ZELTEX, INC.
A Subsidiary of REDCOR CORP.

1000 Chalomar Road, Concord, Calif. 94520 / (415) 686-6660

INFORMATION RETRIEVAL NUMBER 80

WATERS
proudly introduces...
the
**Second
Generation**
in conductive
plastic performance...
MystR[®]

MIL-R-39023

Tomorrow is here today in the "Second Generation" performance of MYSTR — Waters' exclusive new Conductive Plastic resistance material. Compare these parameters!

- Infinite Resolution
- Resistance Ranges from 10 ohms to 5 megohms
- Excellent Linearities
- Output Smoothness — less than 0.1%
- Rotational Life — upwards from 10 million cycles.
- Dither Life in excess of 400 million cycles
- Operational temperature to 150°C
- Hysteresis <0.25°

From Waters now — a complete line of MIL Spec qualified potentiometers, standard or custom, wirewound, linear or non-linear or with MYSTR Conductive Plastic.

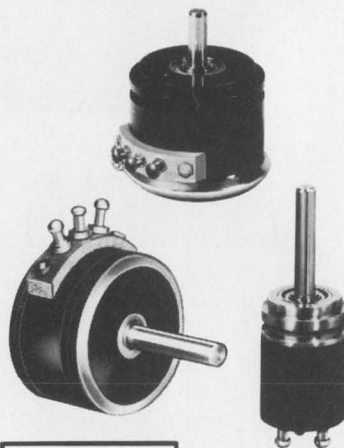

WRITE
FOR NEW
CATALOG

WATERS MANUFACTURING, INC. WAYLAND, MASS. 01778

INFORMATION RETRIEVAL NUMBER 81

INSTRUMENTATION

**Digital-system tester
times and identifies**

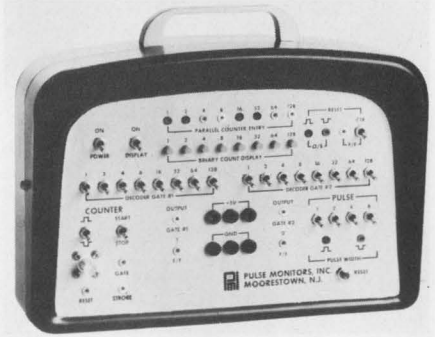

Pulse Monitors, Inc., sub. of Tele-Sciences, Inc., 351 New Albany Rd., Moorestown, N. J. Phone: (609) 234-0556. Price: \$950.

Able to break down and identify complex digital-system timing relationships and performance, a new analyzer includes provisions for decoding, counting, gating, enabling, pulse generation and display. By means of an adjustable window in the time domain, model 500 permits its probes and counters to sample at predetermined instants or during predetermined periods.

CIRCLE NO. 264

**Modem test set
clocks errors**



Rixon Electronics, Inc., 2120 Industrial Parkway, Silver Spring, Md. Phone: (301) 622-2121.

Model TS-100 modem error-rate test set is designed for performance testing of modems alone or on the communication channel over which they are operating. Error rate is clearly displayed on a decimal readout. Special features include extra length of the pattern generated—32,767 bits in duration—as well as an external error output to attach an external counter for long-duration testing.

CIRCLE NO. 265

Pick the
BEST IC
for the job

Problem: An accurate current-to-voltage conversion is required between a current source and a $2.0K\Omega$ load. Desired full-scale output is ± 12 volts (with a power supply of $\pm 15V$). The circuit must operate with a full-scale accuracy of 0.1% over the temperature range from $-55^{\circ}C$ to $+125^{\circ}C$. The output must be capable of slewing at $2V/\mu s$. Pick the best IC for the job.

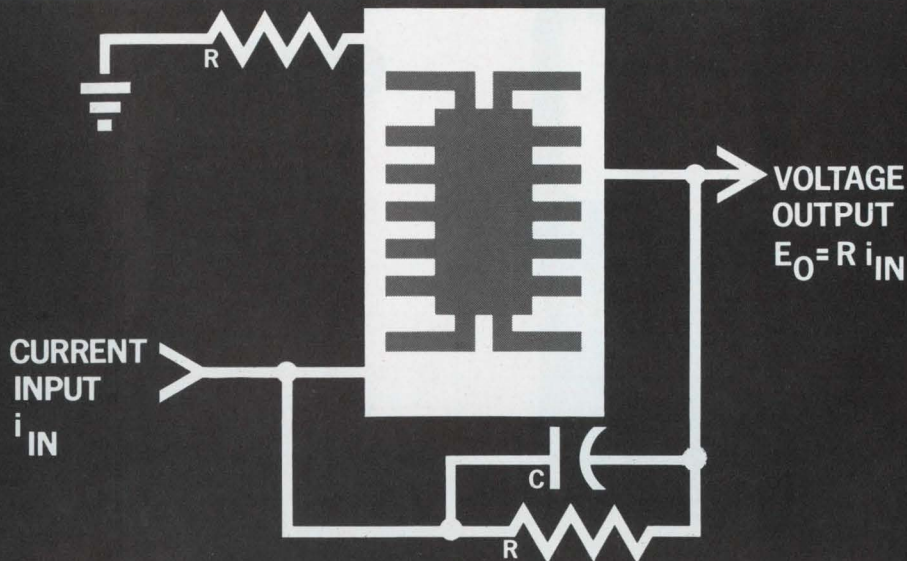

the **BEST** Solution:

THE RA-909 OPERATIONAL AMPLIFIER

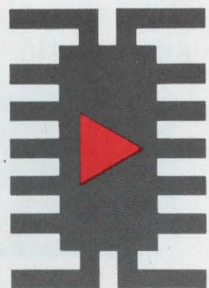

Pick the RA-909 Compensationless Operational Amplifier. Low offset current and offset voltage over the full temperature range allow design of the current-to-voltage converter within 0.1% full-scale accuracy. The RA-909, with dielectric isolation, eliminates the need for external compensation and ensures a slew rate of better than $2V/\mu s$. An added advantage over any 709-type op amp—maximum power dissipation is only 80mW. Obviously, the best IC for the job.

The RA-909 is a direct replacement for all 709-type op amps, so use it in existing current-to-voltage converter circuits and increase their performance, too. Available in both a TO-99 package and a TO-86 flatpack configuration, the RA-909 offers other features such as transient response of 40ns (10 to 90% points) with a 200 millivolt output into a $2K\Omega$ 100pF load in the worst-case unity gain configuration; and a maximum equivalent input noise of $5\mu V$ RMS.

Contact your nearest Radiation sales office. Let us help you pick The Best IC for The Job.

WE MAKE THE **BEST IC** FOR THE JOB



RADIATION
INCORPORATED
SUBSIDIARY OF HARRIS-INTERTYPE CORPORATION
MICROELECTRONICS DIVISION

RADIATION SALES OFFICES: P. O. Box 476, Lexington, Mass. 02173, (617) 862-1055 • 600 Old Country Road, Garden City, N.Y. 11530, (516) 747-3730 • 2600 Virginia Avenue N.W., Washington, D.C. 20037, (202) 337-4914 • P. O. Box 30667, Dallas, Texas 75230, (214) 231-9031 • 6151 W. Century Boulevard, Los Angeles, California 90045, (213) 670-5432 • P. O. Box 37, Melbourne, Florida 32901, (305) 727-5430 • International Sales: Marketing Department, P. O. Box 37, Melbourne, Florida 32901, (305) 727-5412

INFORMATION RETRIEVAL NUMBER 82



**World Famous
Simpson 260[®]
Millions now
in use!**

- SELF-SHIELDING, SHOCK PROOF . . . for outstanding accuracy and repeatability.
- VARISTOR PROTECTED against even 200,000% overloads.
- RUGGED DEPENDABILITY that has no equal.

New Taut Band 260[®]-5 complete with test leads, batteries, and 40-page operator's manual . . . \$62.00
 New Taut Band 260[®]-5M with anti-parallax mirror scale and knife-edge pointer . . . \$64.00
 New Taut Band 260[®]-5P with circuit breaker overload protection of VOM circuitry . . . \$94.00

GET "OFF-THE-SHELF" DELIVERY FROM
YOUR LOCAL ELECTRONIC DISTRIBUTOR

Simpson ELECTRIC COMPANY

5200 W. Kinzie Street, Chicago, Illinois 60644 • Phone (312) 379-1121
 Export Dept: 400 W. Madison Street, Chicago, Illinois 60606. Cable Simelco
 IN CANADA: Bach-Simpson Ltd., London, Ontario • IN INDIA: Ruttonsha-Simpson
 Private Ltd., International House, Bombay-Agra Road, Vikhroli, Bombay



INSTRUMENTS THAT STAY ACCURATE
 INFORMATION RETRIEVAL NUMBER 83

Better than ever

with New
Taut Band
Movement
cannot develop
error-causing
friction.

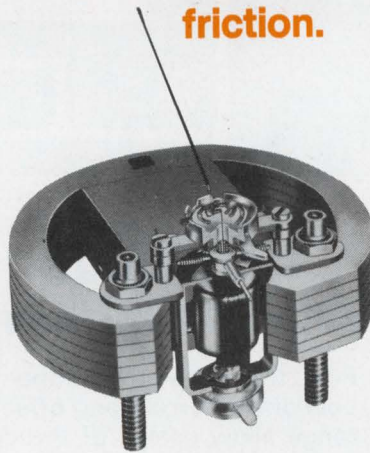

INSTRUMENTATION

Low-level multiplexer eases a/d interfaces

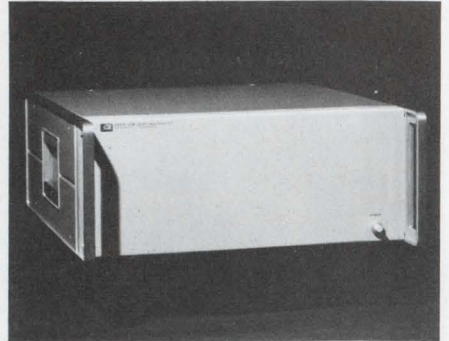

Hewlett-Packard, 1501 Page Mill Rd., Palo Alto, Calif. Phone: (415) 326-7000. Price: from \$3500.

Basically designed for high-speed computer-based data-acquisition systems, a new low-level multiplexer simplifies the interface between analog and digital instruments. Able to handle up to 64 analog inputs, model 2930A completely isolates analog signals from the digital circuits. Its fast settling time of 40 μ s allows input multiplexing at rates to 20 kHz.

CIRCLE NO. 266

Digital-system analyzer sees logic transitions

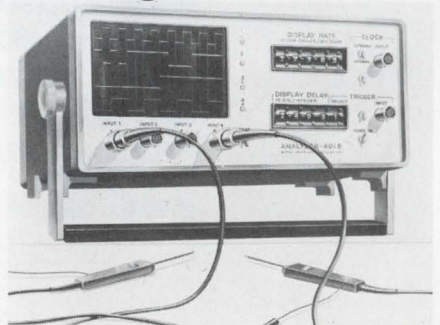

Data Display Systems, 140 Terwood Rd., Willow Grove, Pa. Phone: (215) 659-6900. P&A: from \$1595; stock.

Providing fast positive analysis of digital equipment and systems, a new portable multichannel analyzer measures both the direction and the spatial or temporal position of signals in transition from one logic level to another. Called DIANA, the new unit simultaneously displays multiple traces in different colors. Display timing is derived from an external system clock.

CIRCLE NO. 267

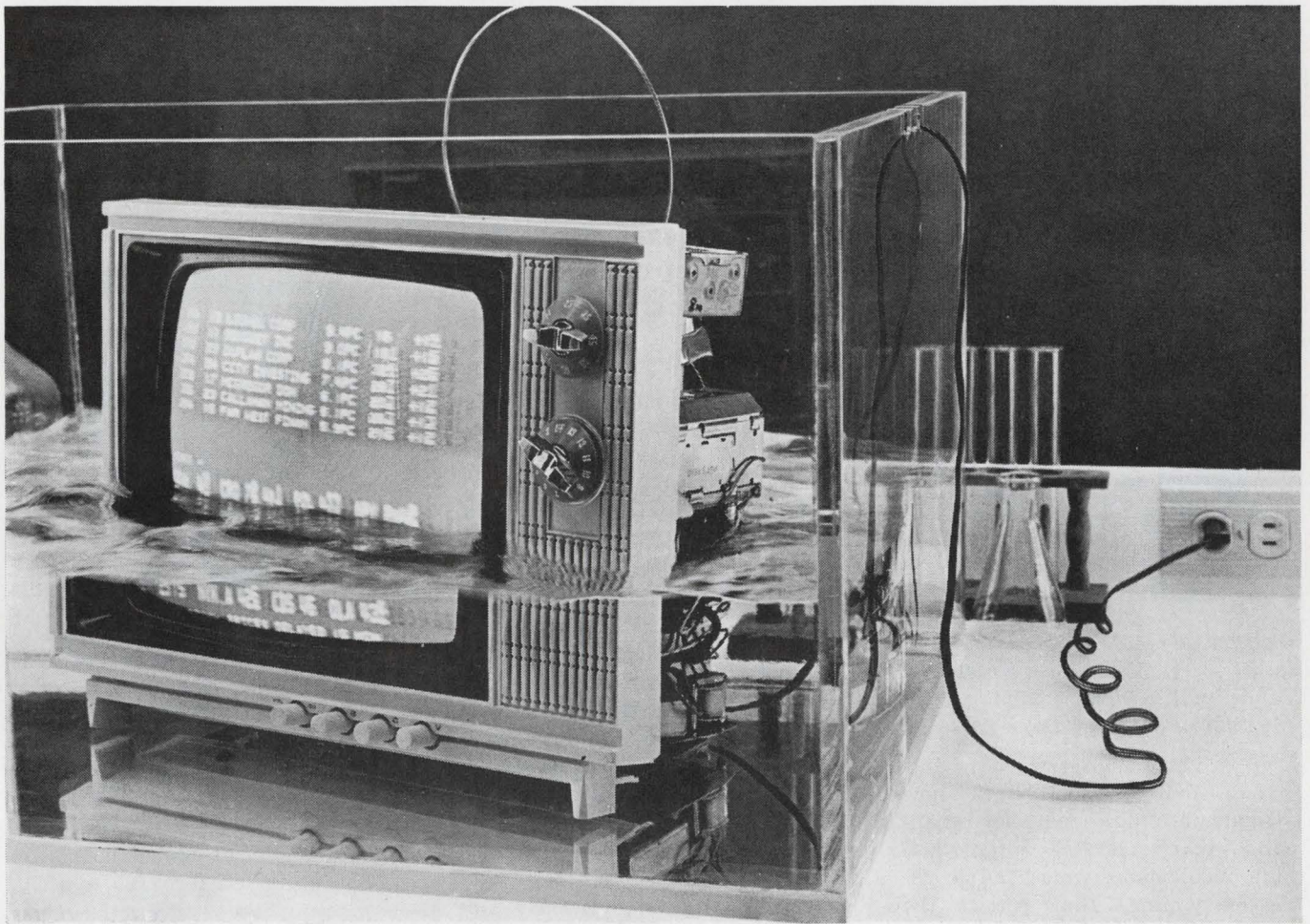

Our new dry test bath is getting a great reception

This should give you a pretty clear picture of what Fluorinert® Brand Electronic Liquids are all about.

They give you a dry test bath for temperature and gross leak testing of electronic and microelectronic units and integrated circuits. They detect flaws and leaks with great accuracy . . . and are efficient over a wide range of temperatures.

Fluorinert Liquids have high dielectric strength . . . which means you can safely test on-circuit. They do not react with the most sensitive of materials . . . which means you can test about anything.

Fluorinert Liquids drain clean, dry fast and leave no messy residue. You can use and ship units directly out of the test bath, without cleaning.

In fact, Fluorinert Electronic Liquids are now approved for the MIL-Standard 883 and the MIL-Standard 750A gross leak tests for microcircuits.

We have lots more information about this remarkable new test bath. The coupon will bring it all or call your local 3M representative.

Fluorinert® Electronic Liquids 3M BRAND COMPANY

3M Company, Chemical Division, 3M Center
St. Paul, Minn. 55101

Dept. KAP 6-69

Send me all the details about Fluorinert Brand Electronic Liquids.

Name _____

Company _____ Title _____

Address _____

City _____ State _____ Zip _____

High-performance filters and delay lines reflect true state-of-the-art advances

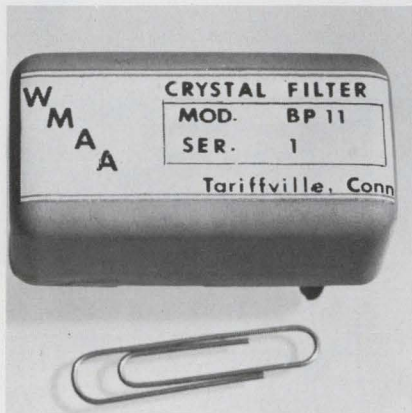

Walther M. A. Andersen and Associates, 4 Main St. Extension, Tarriffville, Conn. Phone: (203) 658-7666. P&A: see text; 60 to 90 days.

Two new product lines now available are high-frequency broadband quartz crystal filters and high-performance wide-band acoustic delay lines that reflect the

latest advances in their respective technologies.

Offered in both conventional and monolithic versions, the new crystal filters can operate at center frequencies as high as 60 MHz over bandwidths as large as 1 MHz. Bandpass, band-reject, high-pass, low-pass and single-sideband functions can be supplied.

Known as Microthin, the new filters contain very thin quartz crystals, about as thick as a human hair. These crystals perform at very-high-frequency fundamental modes and provide wide pole-zero spacing.

Typical specifications are: ripple of 0.1 dB, input and output impedance of 50 Ω , and package size of 1.5 cubic inches. Prices range from \$125 to \$350 per unit.

Also available are new wideband acoustic delay lines for both analog and digital applications. Em-

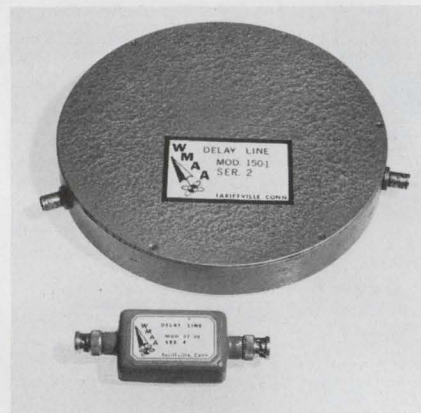

ploying a proprietary bonding technique, series 1001 units provide time delays as short as 0.5 μ s.

Typically, these new delay lines can operate at center frequencies of 30 MHz with 3-dB bandwidths of 16 MHz. Insertion loss is 25 dB, spurious response is 45 dB, and input and output impedance is 50 Ω . The units sell for \$125 to \$300.

CIRCLE NO. 268

IC-sized FET op amp senses 5-pA inputs

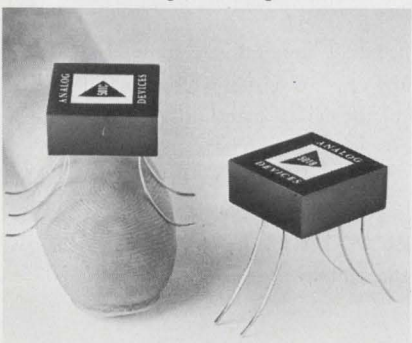

Analog Devices, Inc., 221 Fifth St., Cambridge, Mass. Phone: (617) 492-6000. P&A: \$50; stock.

Occupying only 0.09 cubic inch, a new FET-input microcircuit op amp guarantees 5-pA maximum bias current and 0.5-pA/ $^{\circ}$ C maximum current drift at 25 $^{\circ}$ C. Measuring 0.6 in. square by 0.25 in. high, model P501C comes close in size to monolithic ICs, in terms of the number of complete circuits for a given printed-circuit card area. Initial offset voltage is 1 mV.

CIRCLE NO. 269

Low-cost amplifier drifts 75 μ V/ $^{\circ}$ C

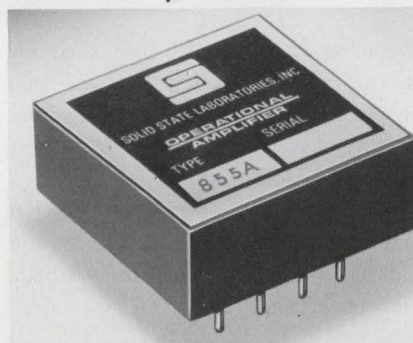

Solid State Labs., Inc., 495 E. 22nd St., Paterson, N. J. Phone: (201) 523-5501. P&A: \$12.25; stock.

Powered from a \pm 15-V supply, a new low-cost FET operational amplifier boasts a maximum voltage drift of only \pm 75 μ V/ $^{\circ}$ C. Model 855A exhibits a minimum open-loop gain of 10^5 at its rated dc load, and differential and common-mode input impedances of 10^{11} Ω . Its common-mode input voltage is \pm 11 V; minimum output is \pm 11 V at 5.5 mA.

CIRCLE NO. 270

Wideband op amp slews at 250 V/ μ s

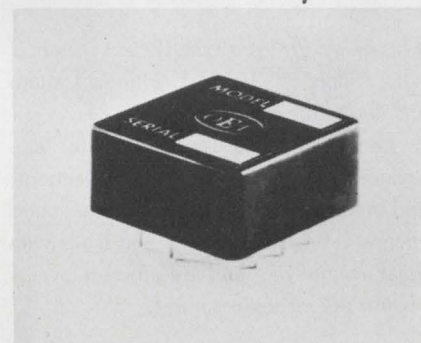

Optical Electronics Inc., P.O. Box 11140, Tucson, Ariz. Phone: (602) 624-3605. P&A: \$47; stock.

Offering full operational capability from dc to video frequencies, the 976A operational amplifier features a typical slewing rate of \pm 250 V/ μ s and a gain-bandwidth product of 300 MHz. The new device has a 50-dB minimum open-loop gain and a settling time of 30 ns to 0.3% residual error. It is packaged in a 0.5-in.³ module with a height of 0.5 in.

CIRCLE NO. 271

Hi-Reliability from Weston is no put on.

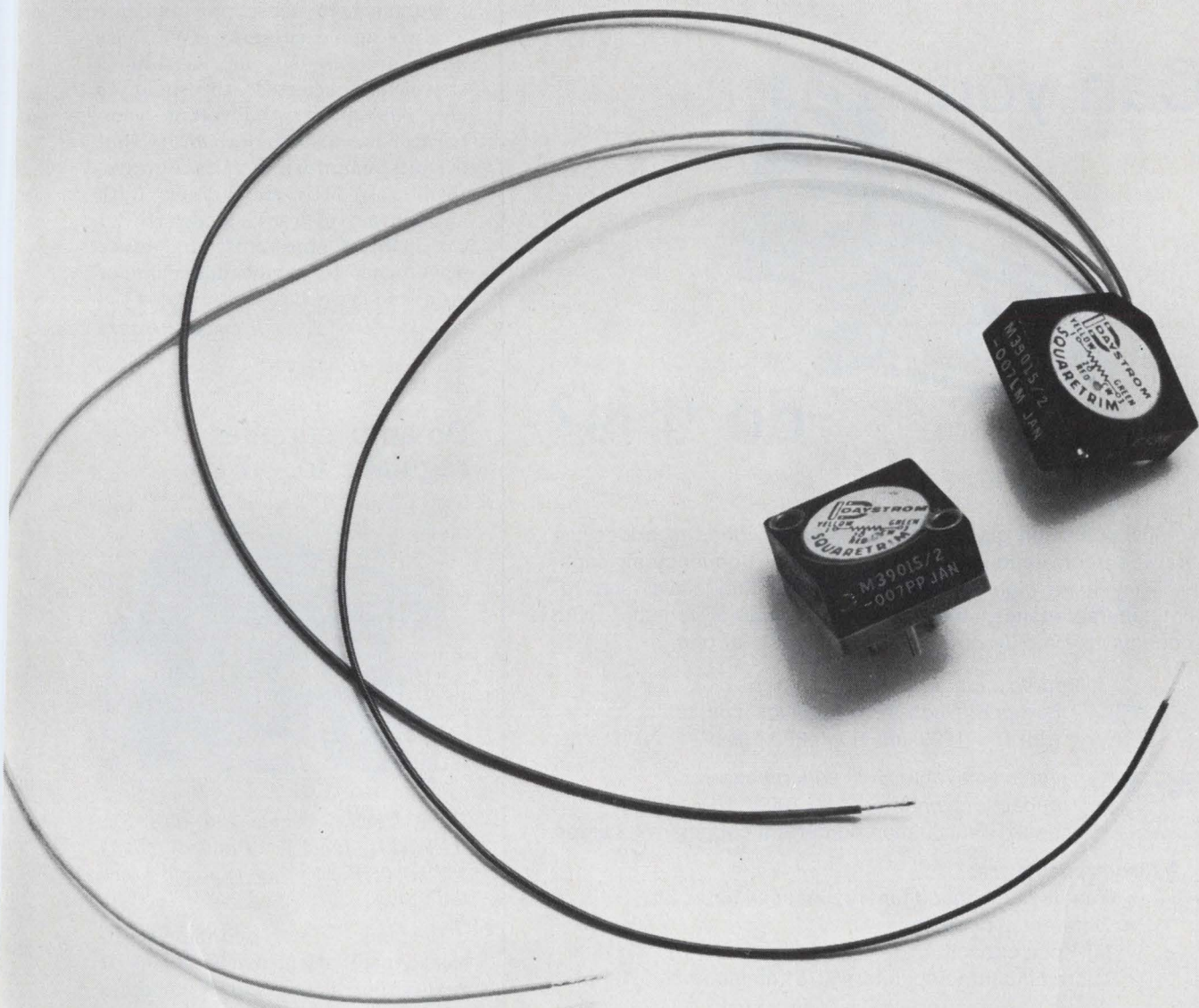

When we say Hi-Reliability, we mean it! Weston offers units designed, manufactured and tested in complete conformance with MIL-R-39015. You'll find a designator stamped on every Weston Squaretrim® Hi-Rel pot in the 200 ohm to 20K range. This number verifies its failure rate and confidence level at full $\frac{3}{4}$ watt operating power. Design, materials

and workmanship must be tops. Not to mention Weston's 45 to 1 adjustment ratio, patented wire-in-the-groove construction, and slip clutch mechanical protection which are standard features of these pedigreed models. Insist on the genuine item—Squaretrim Hi-Rel Model 313-160HS with flexible leads or 318-160HS with pins—in all critical applica-

tions. Contact the factory about other Hi-Rel values available, or see your local distributor. Daystrom potentiometers are another product of WESTON COMPONENTS DIVISION, Archbald, Pa. 18403, Weston Instruments, Inc. a Schlumberger company

WESTON®

Converter supplies regulate to 1%



Mil Associates, Inc., Dracut Rd., Hudson, N. H. Phone: (603) 889-6671. P&A: \$85; stock to 2 wks.

Designed specifically for a/d and d/a converters, series ST power supplies deliver outputs of 15 and 5 V dc regulated to $\pm 1\%$. The new units supply 3 W of output power from a printed-circuit plug-in package that occupies less than 3 in.³

CIRCLE NO. 272

Dual voltage comparator sees 5-MHz waveforms



MCG Electronics, 279 Skidmore Rd., Deer Park, N. Y. Phone: (516) 586-5125. P&A: \$58; 4 wks.

Intended to sense and indicate any voltage excursion, even those as short as 50 ns, within a specifically selected threshold, a new dual differential voltage comparator has a strobe capability that permits monitoring voltage waveforms to 5 MHz and higher. With an accuracy of 5 mV, model DVS-1 can monitor sine, pulse and other waveforms for amplitude changes on a one-cycle basis.

CIRCLE NO. 273

Can you

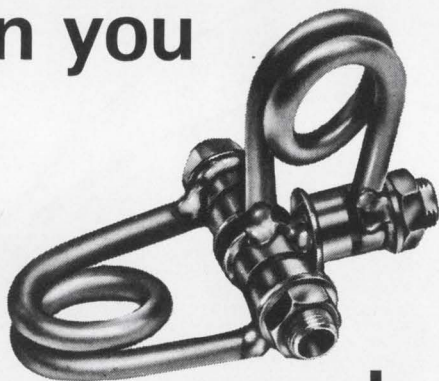

do this?

These new Johanson glass capacitors are designed to bridge the gap between conventional trimmers and high frequency air capacitors. They have high Q—low inductance; they have high RF current characteristics, they can be soldered together with components to simplify circuitry and they are *strong*.

Models include:



7330

Series II: High RF voltage low cost units with $Q > 1200$ and TC; 0 ± 50 ppm.



7168

Johanson 7168: High voltage quartz capacitors which feature 7000 VDC; 2500 V peak RF at 30 mc and current capacity > 2 amps.

Also available are:

- Tuners and ganged tuners; linear within $\pm 0.3\%$
- Differential capacitors
- Mil spec capacitors
- Microminiature capacitors .075" diameter and .1-1 pf

Write today for full catalog.

MANUFACTURING CORPORATION

400 Rockaway Valley Road, Boonton, N. J. 07005 (201) 334-2676

Electronic Accuracy Through Mechanical Precision

INFORMATION RETRIEVAL NUMBER 87

Op-amp supplies regulate to 0.01%



Data Device Corp., 100 Tec St., Hicksville, N. Y. Phone: (516) 433-5330. P&A: \$49 typical; stock to 3 wks.

Designed for printed-circuit-board installation, a new series of dual-output power-supply modules for operational amplifiers provide a line or load regulation of 0.01%. The units have outputs of ± 15 V at ± 40 , ± 60 or ± 100 mA. Ripple and noise is only 400 μ V rms, and temperature coefficient is as low as 0.01%/°C.

CIRCLE NO. 274

Tired of tweaking up your oscillator level every time you change frequency?

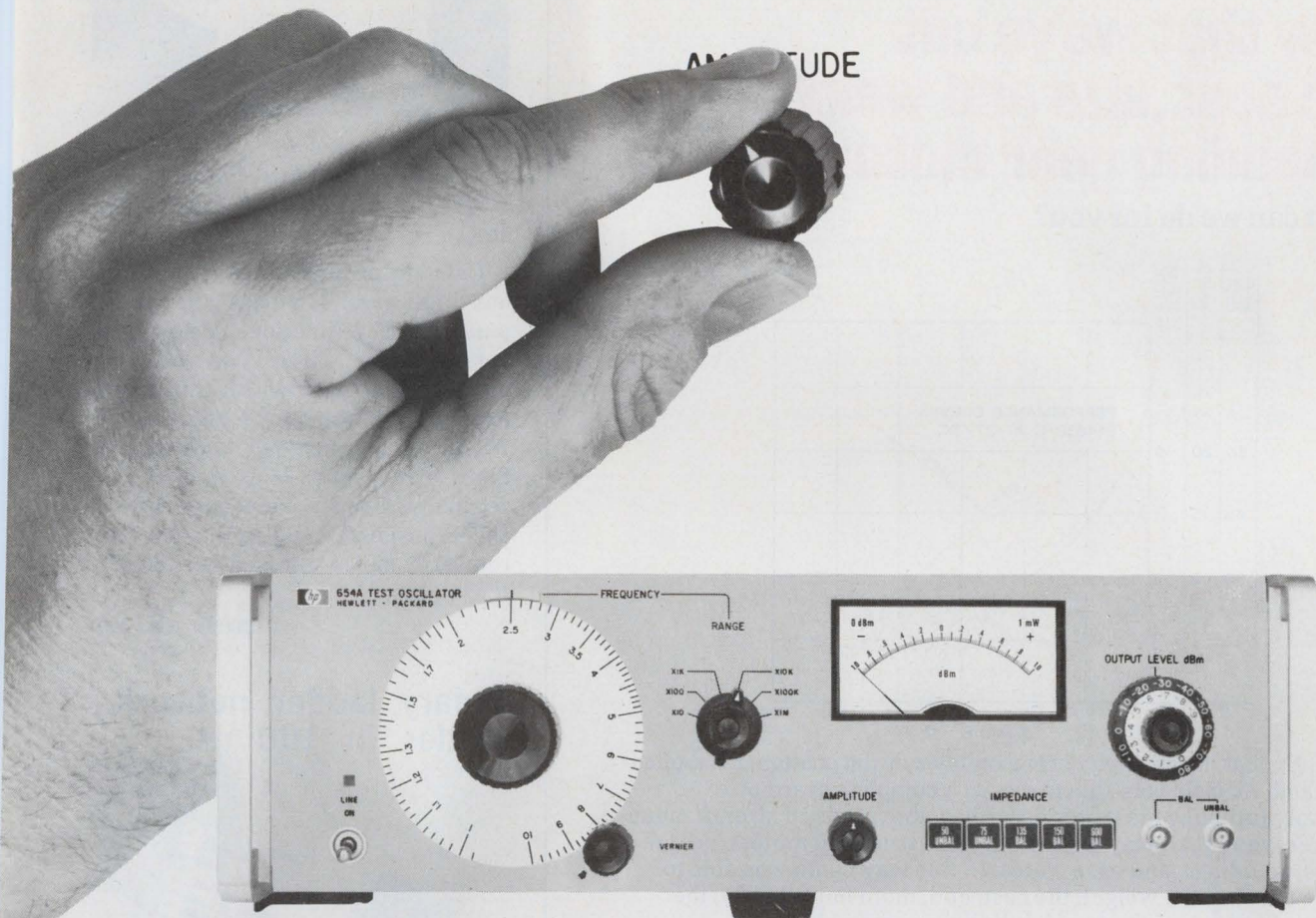

With the HP 654A Test Oscillator you don't have to adjust the output when you change frequencies. The automatically controlled 0.5% level flatness across the entire frequency range of 10 Hz to 10 MHz eliminates repetitive output level adjustments. And, with your system input automatically controlled, you are free to concentrate on system performance measurements.

Pushbutton selection of any of the balanced outputs of 135, 150, or 600 Ω eliminates the necessity of an external balance transformer—and the error due to transformer response. You have the additional advantage of 50 and 75 Ω unbalanced outputs when required.

The combination of an expanded meter scale (-1 dBm to +1 dBm) and a sensitive output level control assures you of extremely accurate output resolution. Put all these capabilities and more into a lightweight portable instrument that combines laboratory precision with field mobility, and you have the HP 654A—the ideal general-purpose test oscillator.

For specialized television applications — Ask for information on the HP 653A. It has the inherent accuracy and ease of operation of the 654A—plus special built-in

video capabilities required for A2 type television systems measurements.

Do your part to stamp out unnecessary knob twisting and superfluous equipment—call your local HP field engineer for more information. Or, write for data sheets to Hewlett-Packard, Palo Alto, California 94304. Europe: 1217 Meyrin-Geneva, Switzerland. Prices: HP 654A, \$875; HP 653A, \$990.

099/B

HEWLETT  PACKARD
S I G N A L S O U R C E S

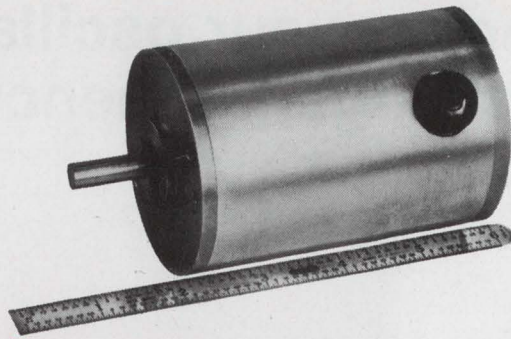

Now that we've cut the cost, size and weight of landing gear motors...

what can we do for you?

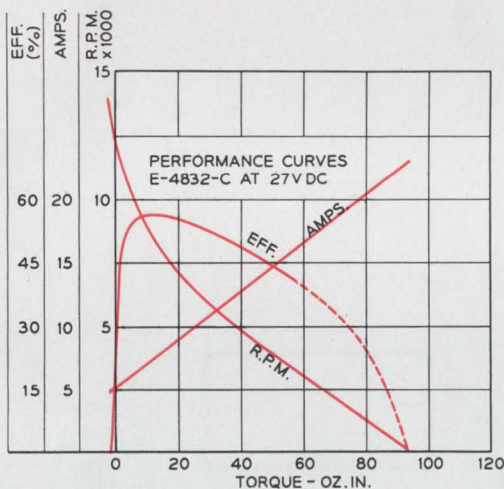

By making an engineering analysis of the customer's application Lamb Electric was able to design a complete gearmotor assembly (utilizing the motor described above) for an aircraft manufacturer who previously purchased and assembled motors, gear reducers, couplings, and base plates. In this way Lamb was able to reduce the size, the weight, the cost, and, more importantly, the chance of failure, of the total landing gear assembly.

This extremely successful design solution was made possible by Lamb's extensive engineering and manufacturing capability! Besides our complete line of fractional horsepower DC motors designed to meet commercial and MIL spec requirements and our line of gear reducers, an extensive stock of standard modular components is maintained. In addition, Lamb has an applications engineering group set up to work closely with the customer in analyzing his needs and applying the existing modular devices whenever possible.

Very few motor designers and manufacturers can match Lamb's success because few have Lamb's extensive capabilities. If you have a "need" may we assist you in solving it by evaluating the applicational requirements through an engineering analysis? Call us at (216) 673-3451 or write: Ametek, Inc., Lamb Electric Division, Kent, Ohio 44240.

AMETEK / Lamb Electric



INFORMATION RETRIEVAL NUMBER 89

MODULES & SUBASSEMBLIES

Universal active filter transfers 3 functions



Kinetic Technology Inc., 17465 Shelburne Way, Los Gatos, Calif. Phone: (408) 356-2131. P&A: \$97; stock.

Capable of providing simultaneous high-pass, low-pass and band-pass transfer functions, a new universal active filter can be frequency- and bandwidth-tuned via external resistors or FETs. Model FS-40 is a single-pole-pair active filter using multi-loop negative feedback. Proper connection of its three outputs enables the user to realize complex zeros anywhere in the s-plane.

CIRCLE NO. 275

Binary ladder network settles in 100 ns

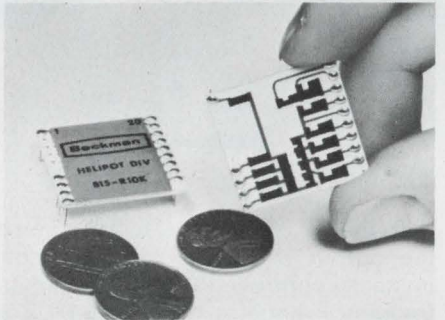

Helipot Div., Beckman Instruments, Inc., 2500 Harbor Blvd., Fullerton, Calif. Phone: (714) 871-4848. P&A: \$6.95; stock.

Selling for one-fourth the price of comparable units, a new 8-bit binary ladder network settles within 0.1% of the final output voltage value within 100 ns after application of an input step. Model 815 is a cermet microcircuit with a standard resistance value of 10 kΩ. Its maximum output voltage ratio error is 1952 PPM over the operating temperature range of -55 to +125°C.

CIRCLE NO. 276



ERIE

When you want radar as pure and coherent as a laser beam...

Symbolic electronic signal undistorted by EMI —
photographed by Howard Sochurek

bring ERIE in early.

31,000 feet... heavy traffic... ugly weather over the Plains. This isn't the time for "noise" in the radar. But, no sweat! RCA's exciting new AVQ-30X Weather Radar is up front, sweeping the sky... protected from EMI by 39 special ERIE filters. No other airborne radar has ever approached the single or dual system reliability of the AVQ-30. From the start, RCA has called on the outstanding research and component capability of ERIE TECHNOLOGICAL to help in the development of this great new unit. Proof, once again, that it pays to bring ERIE in early.

ERIE TECHNOLOGICAL PRODUCTS, INC.

644 West 12th Street, Erie, Pa. 16512
(814) 456-8592

Sine-function module holds error to $\pm 3\%$

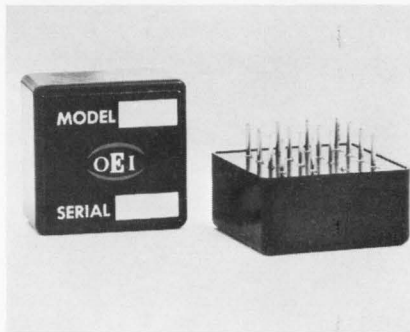

Optical Electronics Inc., P. O. Box 11140, Tucson, Ariz. Phone: (602) 624-8358. P&A: \$63; stock.

With a static accuracy of $\pm 1\%$, a new sinusoidal function module features a dynamic error of $\pm 3\%$ at 10 kHz. Model 5217A has a 100-kHz useful bandwidth and a dynamic output range of $-\pi/2$ to $+\pi/2$. Input impedance is 10 k Ω , and dynamic input range covers -10 to $+10$ V. It is a 0.5-in.³ module with a height of 0.5 in. The unit weighs 0.6 oz.

CIRCLE NO. 346

Discrete comparator differentiates ± 30 V

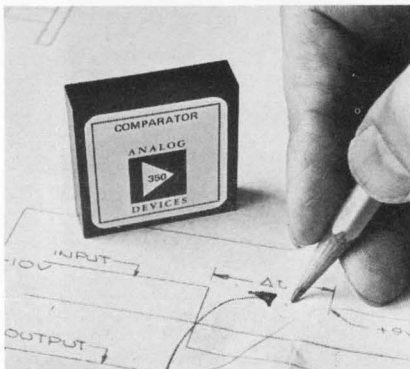

Analog Devices, Inc., 221 Fifth St., Cambridge, Mass. Phone: (617) 492-6000. P&A: \$40 to \$70; stock.

Usable in precision one-shots and pulse and ramp generators, a discrete-component FET-input comparator operates with up to ± 30 -V differential input over a ± 10 -V common-mode range. Model 350 offers a differential and common-mode input impedance of 10^5 M Ω . Its sensitivity is 20 V per 400 μ V, and output current is ± 7 mA for a 100- Ω open-loop output impedance.

CIRCLE NO. 347

Four-quadrant multiplier performs independently

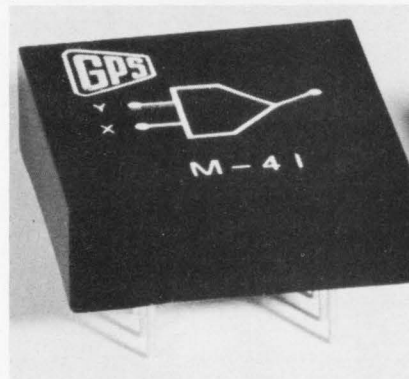

GPS Instrument Co., Inc., 14 Burr St., Framingham, Mass. Phone: (617) 875-0607. Price: \$75.

Model MU41 transconductance multiplier provides four-quadrant multiplication without the use of external amplifiers. Featuring medium linearity and bandwidth, it allows accuracy to be trimmed to $\pm 0.1\%$ with an external potentiometer. The unit is completely encapsulated in a 1.5 by 1.5 by 0.5 in. package designed for PC-board mounting.

CIRCLE NO. 348

Plug-in TO-5 mixer goes to 200 MHz

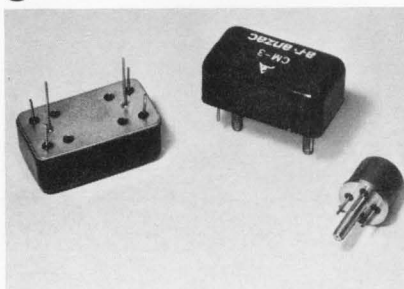

Anzac, div. of Adams-Russell Co., 39 Green St., Waltham, Mass. Phone: (617) 899-1900. P&A: \$55; stock to 30 days.

Intended for use with printed circuit boards and strip-transmission lines, a new miniature plug-in double-balanced mixer covers the frequency range of 200 kHz to 200 MHz. Supplied in a TO-5 can, model MAC-50 has receptacle pins that allow it to be easily removed or replaced without the need for soldering. Its isolation ranges from 25 to 35 dB.

CIRCLE NO. 349

DTL/TTL logic cards have 86 I/O pins

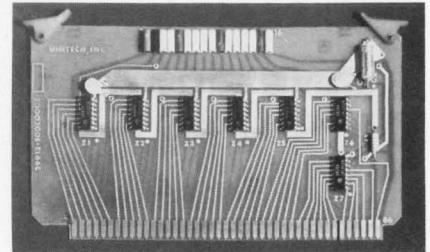

Unitech, Inc., 2209 Manor Rd., Austin, Texas. Phone: (512) 477-5921.

With 86 pin connections, a new line of general-purpose IC logic assemblies provide extra logic functions within a single card. Assemblies are available with DTL or TTL circuits that allow user selection to counter noise or speed problems. Each card measures 8 in. high by 4-7/8 in. deep and is keyed for proper connection.

CIRCLE NO. 350

Sine generator delays only 250 ns



Unigon Industries, Inc., 200 Park Ave., New York City.

Accepting an 8-bit number that specifies an angle between 0 and 89.65°, a new high-speed all-digital sine generator puts out, with a maximum delay of 250 ns, an 8-bit number that is the sine of the input. Both TTL and DTL compatible, model SC-90 requires an input power of 5 V at 1 A. Available options include sine or cosine output and/or four-quadrant operation.

CIRCLE NO. 351

400 Hz RCA Triacs— ready to take over!

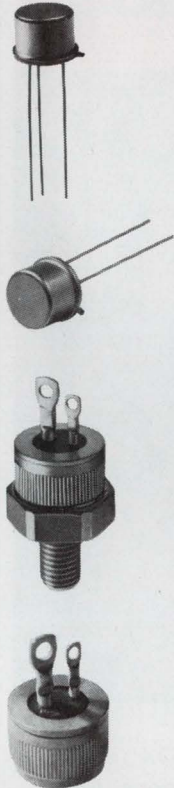

**120-V line operation and
200- and 400-V repetitive peak
off-stage blocking voltages**

Up in the air about 400 Hz controls? Would you like to forget electro-mechanical relays or switches for such aircraft applications as lighting controls for cabins and running lights; heater controls; motor controls; hydraulic valve controls? RCA has the answer: new 400 Hz triacs ready for your evaluation and inclusion in your circuit designs. Look at the tabulation of units you can work with—at RMS currents from 0.5 A to 40 A and repetitive peak off-state blocking voltages of 200 V and 400 V—all designed for 400-Hz operation and available in two and three-lead modified TO-5, press-fit and stud type packages.

Ask your local RCA Representative or your RCA Distributor for details. For preliminary technical data sheets to aid in your evaluation of these units for airborne controls applications, write RCA Electronic Components, Commercial Engineering, Section RG6-3, Harrison, N. J. 07029.

MAXIMUM RATINGS

| | | | | | |
|---|-------|----------------|--|-------|-----------|
| 0.5 A I_{rms}—In 3-lead modified TO-5 | | | TA7615 | 400 V | press-fit |
| TA7654 | 200 V | 10 mA I_{gt} | TA7616 | 200 V | stud |
| TA7655 | 400 V | 10 mA I_{gt} | TA7617 | 400 V | stud |
| TA7656 | 200 V | 25 mA I_{gt} | 15 A I_{rms}—press-fit or stud | | |
| TA7657 | 400 V | 25 mA I_{gt} | TA7618 | 200 V | press-fit |
| 2.5 A I_{rms}—2-lead modified TO-5 | | | TA7619 | 400 V | press-fit |
| TA7671 | 200 V | 25 mA I_{gt} | TA7620 | 200 V | stud |
| TA7672 | 400 V | 25 mA I_{gt} | TA7621 | 400 V | stud |
| 6 A I_{rms}—press-fit or stud | | | 25 A I_{rms}—press-fit or stud | | |
| TA7642 | 200 V | press-fit | TA7646 | 200 V | press-fit |
| TA7643 | 400 V | press-fit | TA7647 | 400 V | press-fit |
| TA7644 | 200 V | stud | TA7648 | 200 V | stud |
| TA7645 | 400 V | stud | TA7649 | 400 V | stud |
| 10 A I_{rms}—press-fit or stud | | | 40 A I_{rms}—press-fit or stud | | |
| TA7614 | 200 V | press-fit | TA7650 | 200 V | press-fit |
| | | | TA7651 | 400 V | press-fit |
| | | | TA7652 | 200 V | stud |
| | | | TA7653 | 400 V | stud |

RCA Thyristors

New VICTOREEN Mini-Mox Resistors for higher resistance/size ratios

max
1125

max
750

max
400

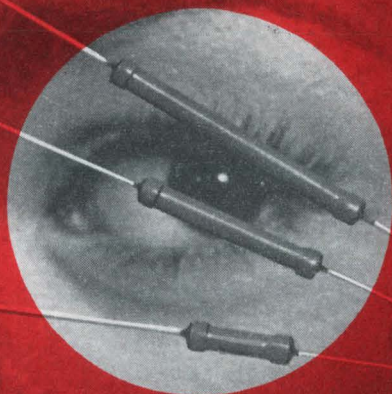

We promised you a wider range of quality Victoreen MOX (metal oxide glaze) resistors for sophisticated electronic applications. And we're delivering on our promises, too, for we're now in volume production on the subminiature Mini-Mox resistor line. Just eyeball these specifications:

| Model | Resistance | Rating @70°C | *Max. Oper. Volts | Length Inches | Diameter Inches |
|----------|---------------|--------------|-------------------|---------------|-----------------|
| MOX-400 | 1-2500 megs | .25W | 1000V | .420±.050 | .130±.010 |
| MOX-750 | 1-5000 megs | .50W | 2000V | .790±.050 | .130±.010 |
| MOX-1125 | 1-10,000 megs | 1.00W | 5000V | 1.175±.060 | .130±.010 |

*Max operating temp 220°. Encapsulation — Si Conformal.

*Applicable above critical resistance.

Stability is better than $\pm 2\%$ for 2000 hours at full load, shelf-life drift less than 0.1% per year. Standard tolerances are 1 to 10% depending on resistance value. $\frac{1}{2}\%$ resistors in limited values, on request.

So let your circuit design imagination run rife. Victoreen MOX and new Mini-Mox Resistors can satisfy all your requirements for ultra-critical applications involving high voltage... high impedance... high stability... high wattage. Check our Applications Engineering Department today. Call (216) 795-8200.

A-3876

VICTOREEN INSTRUMENT DIVISION
10101 WOODLAND AVENUE • CLEVELAND, OHIO 44104
EUROPE: ARNDAL HOUSE, THE PRECINCT, EGHAM, SURREY, ENGLAND • TEL: EGHAM 4887



INFORMATION RETRIEVAL NUMBER 91

ICs & SEMICONDUCTORS

Complementary pair
carries up to 1 A

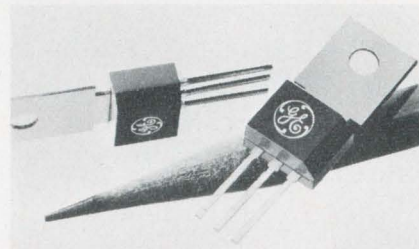

General Electric Co., Semiconductor Products Dept., 1 River Rd., Schenectady, N. Y. Phone: (518) 374-2211. P&A: from 33¢ or 38¢; stock.

Two new complementary silicon power-tab transistors offer very low collector saturation voltages, 0.5 V typical at 1 A. The D40D transistor is encapsulated with brown silicone for easy identification as an npn device; the D41D is encapsulated with black silicone for identification as a pnp device. Applications include oscillators, audio amplifiers and amplifier drivers.

CIRCLE NO. 277

Low-cost plastic SCRs
carry 4 A rms at 97°C



Motorola Semiconductor Products Inc., P.O. Box 20924, Phoenix, Ariz. Phone: (602) 273-6900. Price: 51¢ to 72¢.

Selling for less than \$1 in quantities of 1000, series MCR406 plastic SCRs can carry their rated forward current of 4 A rms at case temperatures as high as 97°C. The new devices withstand peak forward current surges of 30 A and can block peak forward voltages from 30 to 200 V. Gate sensitivity is 200 μ A. A relaxed-specifications series, the MCR407, is also available.

CIRCLE NO. 278

INFORMATION RETRIEVAL NUMBER 92 ►

SEMPER PARATUS

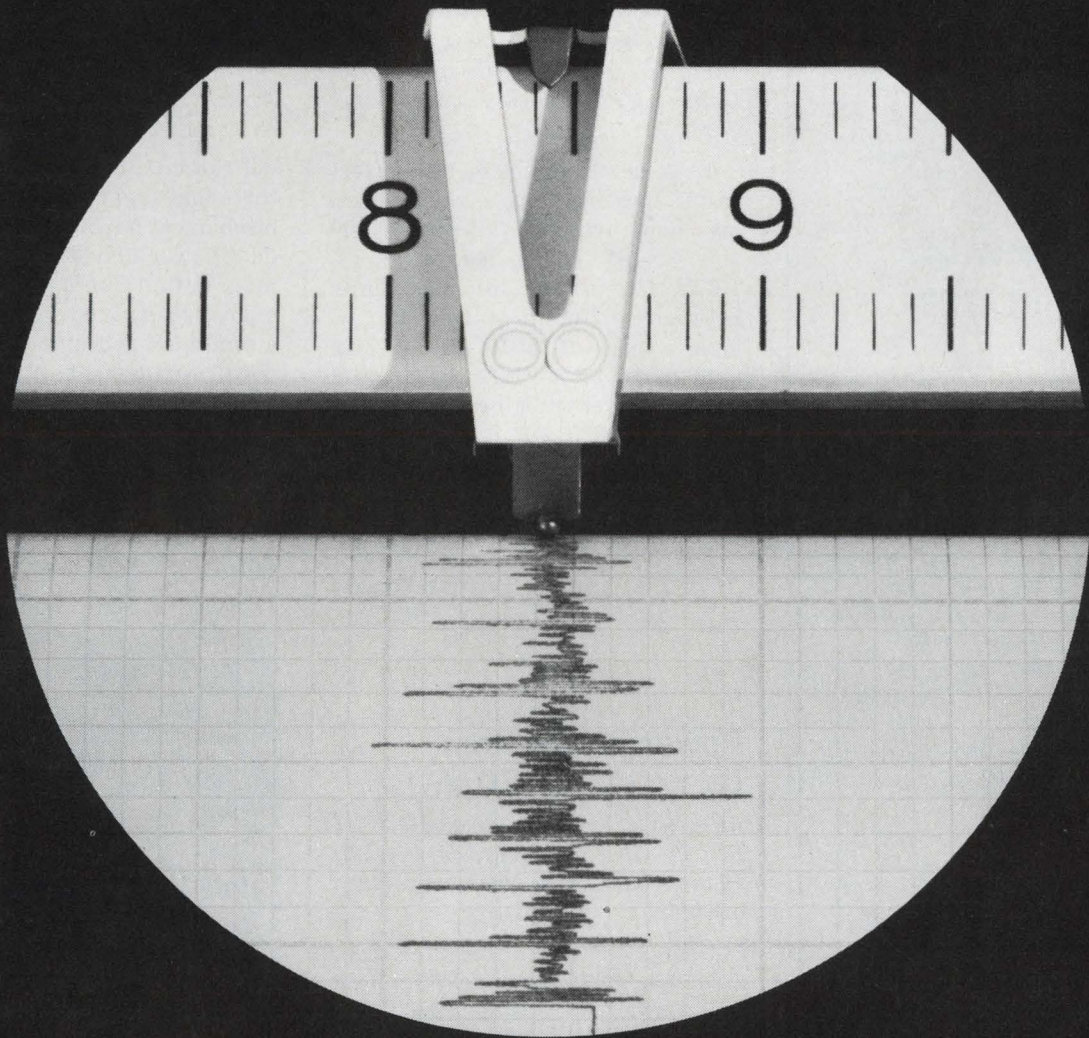

There are times when electric writing is best. Lots of times. Like when you can't be around to check your ink supply. When you've got an unattended station in a remote area. When your recorder may be on standby for long periods, yet must start and stop instantly to catch a one-shot event. When you have to be certain your records will be permanent. When environmental conditions may threaten the readability of your traces. Or, to put it more simply, when the odds are against a standard pen stylus.

Hewlett-Packard's electric writing option for strip-chart recorders is adding a new

degree of dependability to data gathering operations around the world. The technique uses special electrosensitive paper and a low-voltage writing stylus. It gives you records that are impervious to heat, pressure or light. Altitude and vibration can be tolerated; no priming is necessary before operation. With very low chart speeds you can record data 24 hours a day, seven days a week, for extended periods of time. Yet it costs only \$75 to add this option when you buy either the HP 680 five-inch recorder or the 7100 series ten-inch recorder.

Find out more about this remarkably sim-

ple way to make certain your records will be there even if you're not. Just call your local HP field engineer. Or write Hewlett-Packard, Palo Alto, Calif. 94304; Europe: 1217 Meyrin-Geneva, Switzerland. We'll send you a sample of electric writing.

11813

HEWLETT  **PACKARD**

GRAPHIC RECORDERS

LOGIC POWER FOR LESS

\$9960*

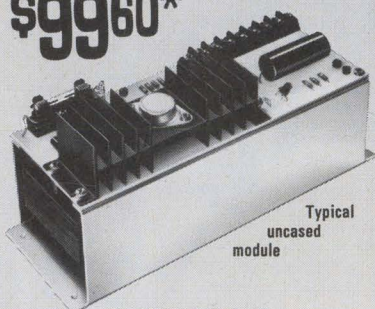

Typical
uncased
module

**COMPACT,
REGULATED
5-6V @ 3A**

DC POWER SUPPLY

Designed primarily for digital IC applications, but well qualified for many other applications.

- Adjustable from 4.8 to 6.3 VDC @ 0-3 amps
- Output fused to protect supply
- Overvoltage sensing circuit and SCR crowbar protect external circuits
- Remote sensing
- Convection cooled — heat sink included
- Regulation: Line, Load — 0.05% each
- Temp. Coeff. 0.05%/°C
- Only 3" x 3.7" x 8.4"
- Direct operation from 115VAC, ±10VAC, 60-400 Hz

MODEL PM 728

| | | |
|----------|---------|---------|
| 1-3 | *4-9 | 100 up |
| \$124.90 | \$99.60 | \$84.20 |

Shipment within 10 days ARO

Need less power? Try our small, encapsulated 5V 250 mA modules.

For complete information or fast delivery, call or write

Computer Products, Inc.
Post Office Box 23849
Fort Lauderdale, Florida 33307
Phone: 305/565-9565



**COMPUTER
PRODUCTS™**

FORT LAUDERDALE

INFORMATION RETRIEVAL NUMBER 93

ICs & SEMICONDUCTORS

Eight new FETs offer variety

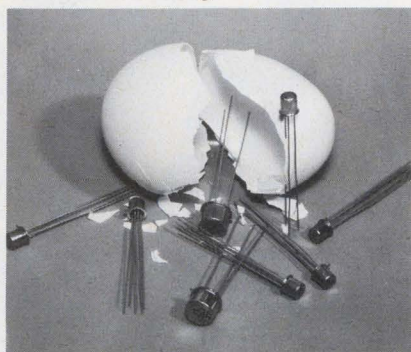

Texas Instruments Inc., Components Group, P. O. Box 5012, Dallas, Tex. Phone: (214) 238-2011. Price: \$2.50 to \$15.

Four new families of field-effect transistors, totaling eight devices, are now available. Types 3N160 and 3N161 are p-channel MOS-FETs for use as interface units between different forms of IC logic; types 2N5545 to -47 are dual n-channel FETs with good matching and tracking characteristics; type 2N5549 is a low-noise high-gain vhf amplifier; and types 2N5543 and -44 are high-voltage devices designed as vacuum-tube replacements.

CIRCLE NO. 279

Power transistors carry up to 30 A

RCA/Electronic Components, 415 S. Fifth St., Harrison, N. J. Phone: (201) 485-3900. Price: \$15 or \$20.

Using multi-emitter-site construction, two new epitaxial silicon npn power transistors for high-speed switching and amplifier circuits feature collector current ratings of 20 A continuous and 30 A peak. Maximum saturation voltage is 1 V at 12 A for the 2N5038 and 1 V at 10 A for the 2N5039. Switching times are less than 0.5 μ s for turn-on and 2 μ s for turn-off. Both transistors can be used as linear amplifiers at frequencies up to 5 MHz. They are supplied in the JEDEC TO-3 hermetic package.

CIRCLE NO. 280

Hybrid dual driver powers at 0.5 A

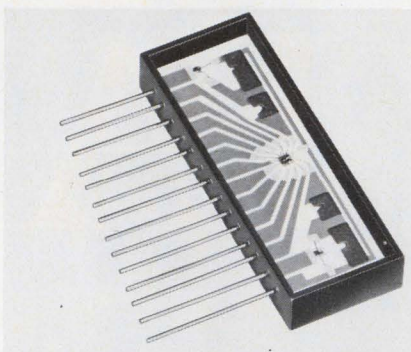

Motorola Semiconductor Products Inc., P.O. Box 20924, Phoenix, Ariz. Phone: (602) 273-6900. Price: \$7.60 or \$8.75.

Designed for interfacing high-threshold logic levels with electro-mechanical hardware, a new hybrid dual power driver supplies a maximum output current of 0.5 A. This microcircuit, model MCH2005, has a minimum collector-emitter breakdown voltage of 40 V. Typical turn-on time is 115 ns, and typical turn-off time is 260 ns.

CIRCLE NO. 281

MOS memory chip takes 2304 bits

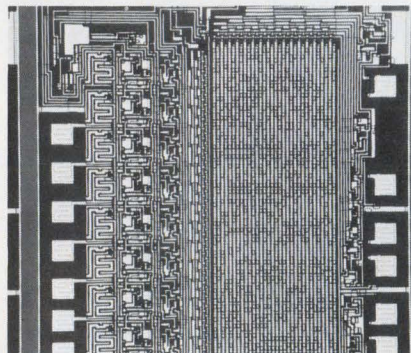

Electronic Arrays, Inc., 501 Ellis St., Mountain View, Calif. Phone: (415) 964-4321. P&A: \$76; stock to 6 wks.

Organized as 256 words with 9-bit lengths (2304 bits total), a new random-access read-only MOS memory holds power consumption to a minimum, typically 90 mW at 1 MHz. Model 3000 has an access time of less than 1 μ s over the temperature range of -55 to +85°C. It also features variable output buffer voltage.

CIRCLE NO. 282

You get true multi-function versatility with these NEW Philbrick/Nexus Non-Linear Modules

check the function:

4350/4351 LOG OPERATOR

Log of currents, log of voltages, antilog of voltage with three built-in sensitivities plus built-in amplifier.

- RAISING TO ARBITRARY POWERS OR ROOTS
- LOG RATIO OF TWO INPUTS
- "1/X" LAW COMPUTATION
- LOG COMPRESSION
- LOG EXPANSION



4352 VECTOR OPERATOR

Find $\sqrt{X^2 + Y^2}$ of two input voltages, average of an input voltage, or true rms of input voltage in a single module.

- MULTI-COORDINATE CONVERSION
- TRUE RMS POWER MEASUREMENT
- AC TO DC CONVERSION, AVERAGE OR RMS



4353/4354 SQUARE LAW ELEMENT

Used with an external amplifier to obtain output proportional to square or square root of input.

- TWO QUADRANT SQUARING
- MEAN-SQUARE AND QUARTER-SQUARE MULTIPLIER
- RMS COMPUTATION
- COMPUTE ABSQUARE OR ABROOT
(ABSQUARE(X) = X · |X|; ABROOT
(X) = X/√|X|)

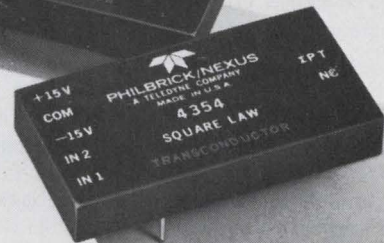
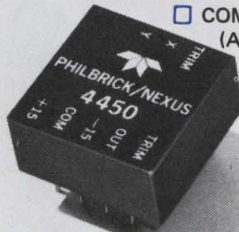

4450 FOUR QUADRANT MULTIPLIER

True four quadrant multiplier whose output represents the instantaneous product of two input signals. Built-in amplifier; only one external component required for operation.

- TRUE POWER MEASUREMENTS
- GAIN CONTROL
- MODULATION
- AUTO CORRELATION
- DIVISION

4850 GATED OPERATIONAL AMPLIFIER

Multipurpose module with operation modes such as Reset, Integrate, and Hold that may be controlled with external digital signals applied to two internal logic comparators.

- CONTROLLED INTEGRATION
- SUMMATION
- TRACKING
- HOLDING
- SWITCHING

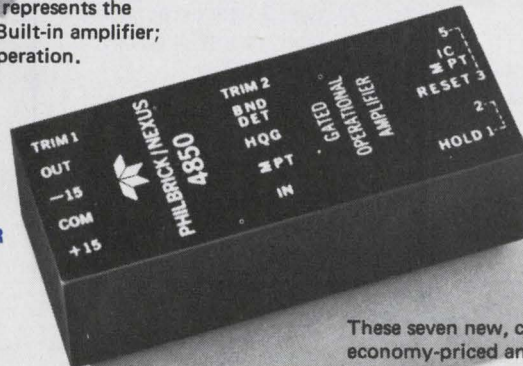

These seven new, compact, encapsulated modules are economy-priced and available immediately. For more information contact your local Philbrick/Nexus field-engineering representative, or write, Philbrick/Nexus Research, 46 Allied Drive at Route 128, Dedham, Massachusetts 02026.



PHILBRICK/NEXUS RESEARCH

A TELEDYNE COMPANY

NEW VACTEC "PLASTIC" PHOTOCELLS

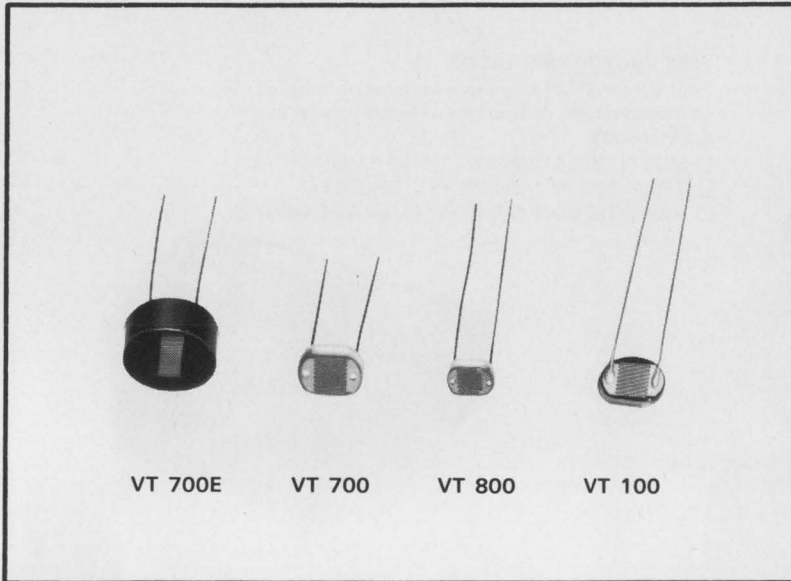

Actual size, priced as low as .25 each ($\pm 33\%$ tolerance) in 100,000 quantities.

Low Cost Way to Meet Most Photocell Requirements

Are you spending up to a dollar for photocells when Vactec can satisfy your needs for far less? Here's a complete line made the same, and with the same quality characteristics and precise tolerances as their metal cased counterparts. Yet they cost about *half* as much, because instead of sealing, they are protected by a thin transparent plastic coating.

Vactec "plastic" cells are conveniently controlled by ambient light, or from closely coupled low voltage lamps for remote control. Special processing provides resistance to humidity, making these devices suitable for indoor industrial and commercial applications like controlling relays in line voltage circuits; switching SCR's on or off; phase control in proportional circuits; or as feedback elements for motor speed controls in consumer appliances.

GENERAL SPECIFICATIONS

| | |
|----------------------------|---|
| Material | Two Cdse and three Cds materials, including the new type 3 with exceptionally high linearity and speed. |
| Voltage Maximum | (dark 300V.) |
| Dissipation at 25°C | 200 mw (VT 100) 250 mw (VT 700 and VT 700E) 125 mw (VT 800) |
| Ambient | -40°C up to +75°C |
| Resistance | Wide range as low as 600 Ω at 2 F.C. |

Write today for Bulletins PCD-41, 57, 57E, and 58.

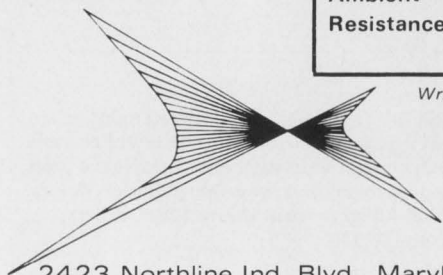

VACTEC, INC.

2423 Northline Ind. Blvd., Maryland Heights, Missouri 63042
(314) 872-8300

Specializing in standard Cds, Cdse, and Se cells. Custom engineering for every photocell need. Listed in EBG under "Semi-Conductors" and EEM Sec. 3700.

INFORMATION RETRIEVAL NUMBER 95

ICs & SEMICONDUCTORS

Pnp transistors carry up to 10 A

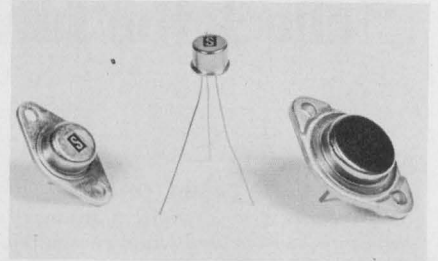

Solitron Devices, Inc., Transistor Div., 1177 Blue Heron Blvd. Riviera Beach, Fla. Phone: (305) 848-4311. Availability: stock.

Industrial pnp power transistors are now available with current ratings of 1, 2, 5 and 10 A. The new devices are supplied in three packages—the TO-3, TO-66 or the TO-5 metal can. Several popular series are included. These are the 2N3719 and the 2N3720, the 2N3740 and the 2N3741, as well as the 2N3789, 2N3790, 2N3791 and the 2N3792.

CIRCLE NO. 283

Sensitive photo-SCRs detect 10 ft-candles

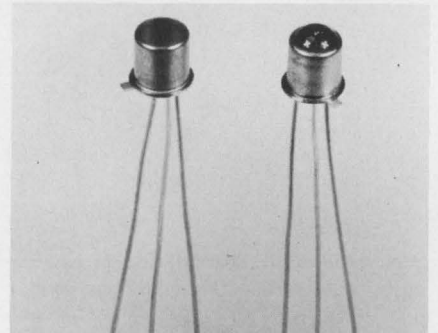

Solid State Products, 1 Pingree St., Salem, Mass. Phone: (617) 745-2900. P&A: \$2.05 or \$2.30; stock.

Able to carry 300-mA continuous dc current, two new photo-SCRs boast a maximum light trigger intensity of 10 (the PR30) and 50 (the PF30) foot-candles. Model PR30 has a round lens for maximum light sensitivity, while model PF30 has a flat lens for wide-angle response. Both units can withstand surge currents of 5 A and provide typical voltage slew rates of 50 V/s.

CIRCLE NO. 284

**BIG PRINT-OUT
CAPACITIES
COME IN SMALL
MDS PACKAGES**

22 or 32 print columns with speeds up to 40 lps... that's the story of the MDS Series 2200 and 3200 Digital Strip Printers.

These high-speed, parallel-entry printers offer a selection of several print drums, giving a variety of character choices. Both models provide numeric and alphanumeric printout.

The 3200 is supplied in a compact, easy-to-mount, two-chassis package with the printer in one chassis and the electronics in a matching chassis, for either local or remote operation.

Paper-loading on either model is easy because the printer mechanism slides forward on full-suspension, ball-bearing glide rails. Since the print drum is cantilever-mounted, paper can be easily slipped into position without being threaded. Either paper roll or fanfold stock is used in the 2200; only fanfold in the 3200.

The printer mechanism is built around a monolithic main body casting resulting in high mechanical stability and low maintenance. 120-day warranty. "Down-time" is the exception rather than the rule.

Ask for: Specifications and more information available in MDS folder-file on Series 2200/3200.



SERIES 2200
DIGITAL STRIP PRINTER

FOR MORE — MEET YOUR MAN FROM MDS

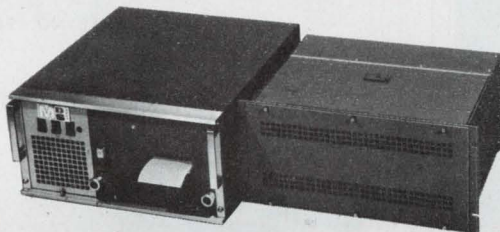

Series 3200
has dual chassis for local or
remote printer operation.

MOHAWK MDS
DATA SCIENCES CORPORATION
OEM MARKETING

P.O. BOX 630 • PALISADE ST. • HERKIMER, N.Y. 13350
Telephone 315/866-6800

Every MDS office is an OEM Marketing office

DIGITAL STRIP PRINTERS • BUFFERED TAPE UNITS
HIGH-SPEED AND LOW-SPEED LINE PRINTERS
CARD PUNCHES AND READERS
PAPER TAPE PUNCHES AND READERS

REGIONAL MANAGER OFFICES

Atlanta, Ga. Tel. 404/261-8036
Waltham, Mass. Tel. 617/891-4430
Des Plaines, Ill. Tel. 312/298-4141
S. San Francisco, Calif. Tel. 415/761-0750

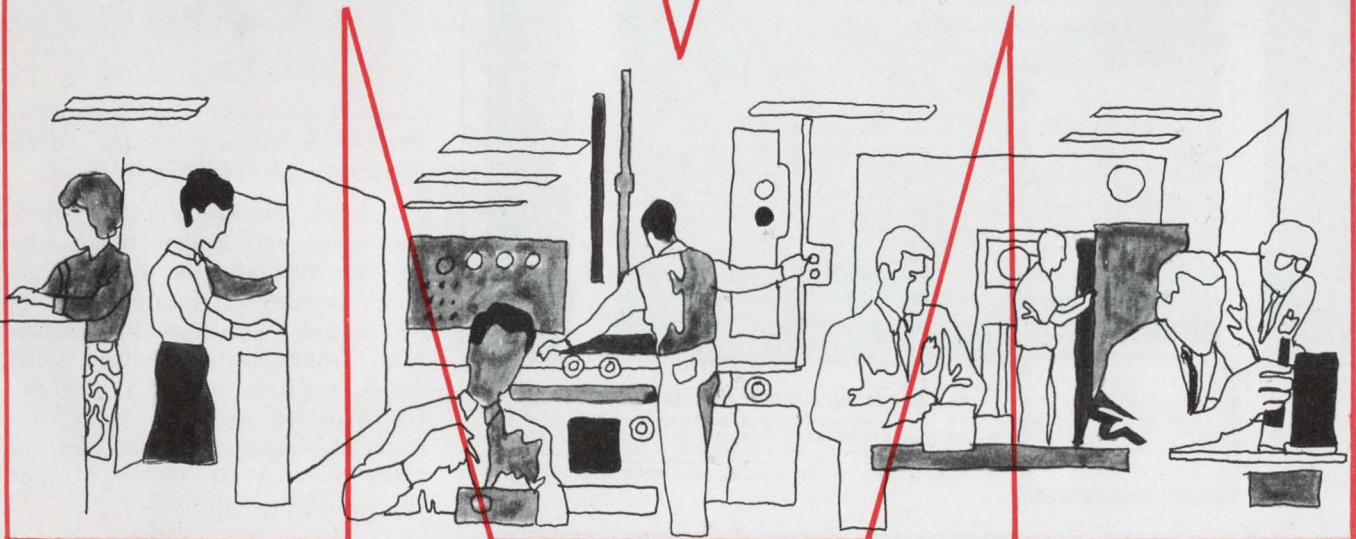

RMC DISCAPS

the complete Ceramic Disc line

Over the years Radio Materials Company has maintained its leadership in the production of ceramic disc capacitors. A complete line offering outstanding quality has been the key to continuing growth.

STANDARD

Type C, B, BA, JF, JL and JE

SUBMINIATURE

Type SM, BT, TA and Magnacaps

GREENCAPS

Type CG, JG, and BG

SPECIAL

U.L. Listed Discaps, T.C. High Voltage, High K High Voltage and Dual Section By-Pass

SOLDER-IN T.C. DISCAPS

For application in equipment where lead inductance effects must be reduced to an absolute minimum.

If your application requires special physical or electrical characteristics, contact RMC's Engineering Department.

U.L. LISTED T.C. DISCAPS

Should be specified when the use is an integral part of an antenna coupling network where compliance with Underwriters' Laboratories specifications are required.

RMC
.0039

DISCAP
CERAMIC
CAPACITORS

RMC

RADIO MATERIALS COMPANY

A DIVISION OF P. R. MALLORY & CO., INC.
GENERAL OFFICE: 4242 W. Bryn Mawr Ave., Chicago 46, Ill.
Two RMC Plants Devoted Exclusively to Ceramic Capacitors
FACTORIES AT CHICAGO, ILL. AND ATTICA, IND.

DATA PROCESSING

Fast data terminal prints electronically



Texas Instruments Inc., Industrial Products Div., P.O. Box 66027, Houston, Tex. Phone: (713) 526-1411.

Printing at rates to 400 words per minute (40 characters per second), a new electronic data terminal eliminates the noise and slow operation of impact printing with a monolithic solid-state printhead that produces characters on thermal-sensitive paper. Series 720 model 10 data terminal has a self-contained buffer memory.

CIRCLE NO. 285

Equalized data modem goes to 9600 bits/s



Codex Corp., 150 Coolidge Ave., Watertown, Mass. Phone: (617) 926-3000. Availability: 90 days.

Using a digital adaptive equalizer, a new data modem, model AE-96, can increase the capacity of single voice-grade lines to 9600 bits per second. Initial circuit equalization, which is pushbutton activated, requires only 3.5 seconds; the adaptive equalizer then continuously measures and compensates for circuit changes eight times each second.

CIRCLE NO. 286

Wide dispersion spectrum analysis without *unwanted* responses... Singer Model SPA-3000

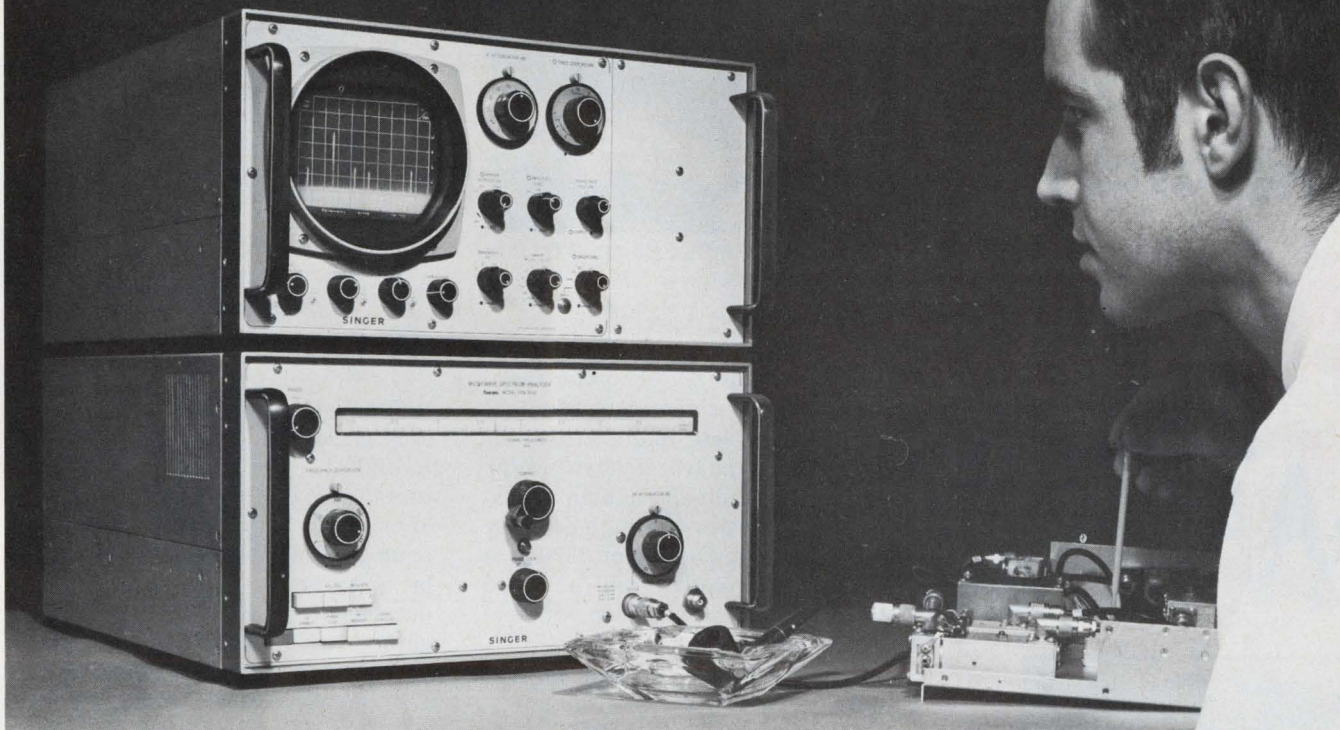

With some spectrum analyzers you have to play a guessing game, in order to identify the true responses from the ones which are analyzer generated and displayed.

The Singer Model SPA-3000 Microwave Spectrum Analyzer eliminates guesswork and displays *only* signal inputs. When aligning a communications band frequency quadrupler on the competition's equipment you could see as many as six extra (unwanted) responses. On the SPA-3000, with the analyzer set for 3 GHz dispersion around a 1.7 GHz center frequency, the 1.55 GHz quadrupler signal and its harmonics are displayed . . . *no more and no less*. The other unit set at its maximum dispersion of 2 GHz (ours is 3 GHz) around a 1 GHz center frequency displays six extra internally generated signals.

Only five of these responses are real.

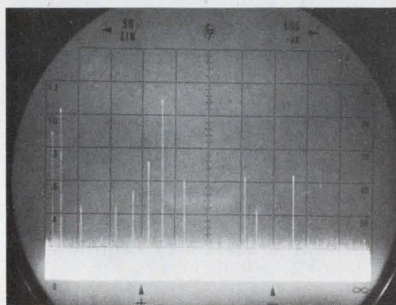

But which five?

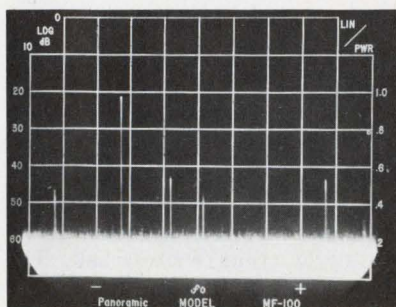

The five presented on the SPA-3000

- **Phased locked display**—for narrow-band signal analysis. It is fool proof, because there is only one control and a positive lock indicator light to observe. Signals can be displayed over the entire 10 MHz to 40 GHz band with 1 kHz of resolution.
- **Unique log amplitude scale**—enables the measurement of narrow band pulse spectrums in a 1 MHz bandwidth mode for maximum sensitivity and dynamic range.

Frequency domain measurements are explained in Singer Instrumentation's new Application/ Data Bulletin SA-11. Copies are obtainable by contacting your nearest Singer Field Representative or by writing directly to The Singer Company, Instrumentation Division, 915 Pembroke Street, Bridgeport, Connecticut 06608.

SINGER

INSTRUMENTATION

*if it's more
than precision
LAPPING
or GRINDING
you want . . .
Get Spitfire's*

NEW

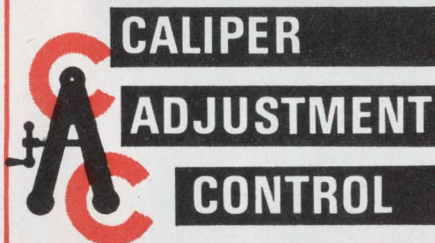

Now, at the turn of a screw crank, Spitfire's new "Caliper Adjustment Control" gives you precise adjustment of part retainer and conditioning rings on the lapping plate, and you'll do it faster and easier than ever before.

Unique, caliper designed holding arms, fitted with nylon-tired sealed bearings, cradle the rings, yet hold them securely in a fixed position on the lapping plate for maximum results. With

"CAC" no tools or other devices are needed, the complete adjustment is crank-controlled. Ring adjustments are made while the machine is in cycle . . . downtime is eliminated . . . production is increased.

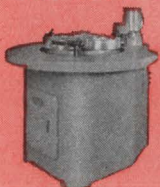

For the full story on this profit-building device, adaptable to all Spitfire Gyro-Matics, call or write today. It's another reason for Spitfire's industry leadership.



SPITFIRE LAPPING DIVISION

SPITFIRE TOOL & MACHINE CO.

4020 North Tripp Avenue

Chicago, Illinois 60641 Phone: 312/286-1610

DATA PROCESSING

CRT data terminal eases time-sharing

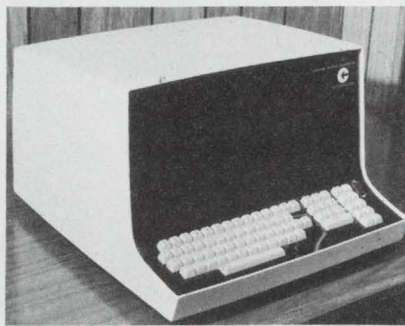

Computer Terminal Corp., P.O. Box 6967, San Antonio, Tex. Phone: (214) 351-3761.

Streamlining man/machine communications for the computer time-sharing user, a new data terminal features complete interchangeability with standard teletypewriter equipment, high-speed data transmission facilities and high-capacity CRT displays. Datapoint 3300 is a solid-state totally self-contained unit with a 64-character set keyboard.

CIRCLE NO. 287

Plug-in core memory expands to 32k by 18

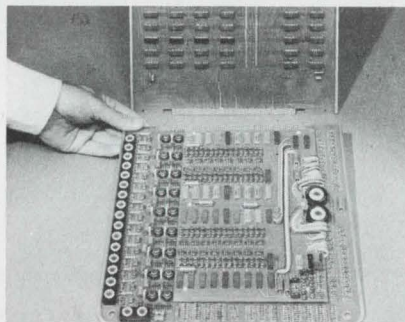

Sanders Associates, Inc., Memory Products Dept., 95 Canal St., Nashua, N. H. Phone: (603) 883-3321.

Able to cycle in 1.5 μ s, a new expandable PC-card core memory system offers a maximum capacity of 32,768 words by 18 bits. Mem-card 418 can perform read/restore, read/write and read/modify/write functions, as well as a unique hybrid cycle—read/write/mask. The total system is contained on two 12 by 12-in. plug-in circuit boards: one card provides all I/O driver electronics; the other contains the core storage.

CIRCLE NO. 288

A/d converter digitizes 13 bits

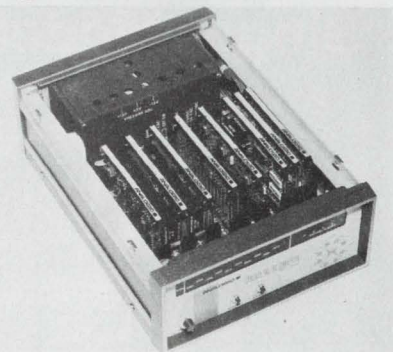

Analogic Co., Audubon Rd., Wakefield, Mass. Phone: (617) 246-0300. P&A: from \$2400; stock to 30 days.

Completely contained in a half-rack enclosure, a universal analog-to-digital conversion system features accurate 13-bit digitization of virtually any type of voltage analog input. Model AN5413 may be programmed to select any sequence of disparate analogs, together with appropriate internal or external reference voltage.

CIRCLE NO. 289

Digital data coupler ignores line variations

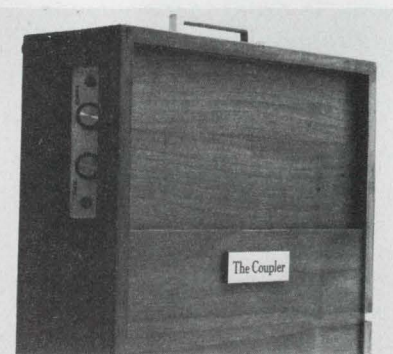

Communications Logic, Inc., 6400 Westpark, Houston, Tex. Price: \$495.

Designed to work with any commercial computer time-sharing terminal with a transmission rate of 300 baud, a new self-contained data coupler is immune to power-line variations, transients and noise. Available with either acoustic or magnetic pickup, the unit features all silicon semiconductors and integrated circuits. It will operate in either half- or full-duplex mode.

CIRCLE NO. 290

CROWBAR...?

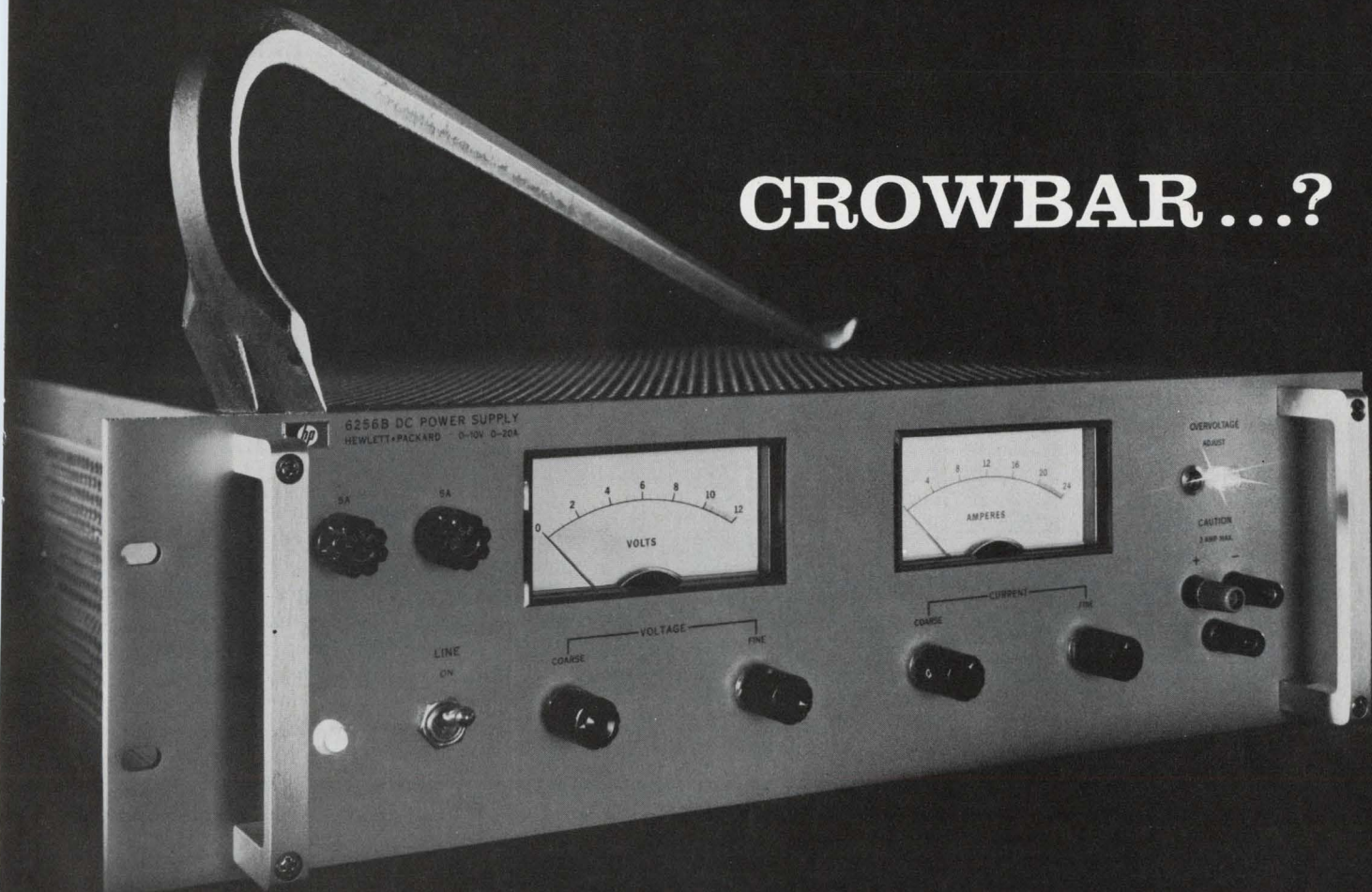

The One Inside is FREE

Not so many years ago, the prudent transmitter engineer discharged a high voltage capacitor bank by dropping a shorting "crowbar" across its terminals. Today's "crowbar" is a protective overvoltage circuit found on DC power supplies — usually at extra cost. Now HP includes a crowbar as standard on its recently updated series of low-voltage rack supplies . . . at no change in price.

Long established as preferred system supplies for component aging, production testing, and special applications, these supplies have now been redesigned and expanded to meet the stringent demands of today's power supply user. Advantages include low ripple (peak-to-peak as well as rms), well-regulated constant voltage/constant current DC with outputs to 60 volts and 100 amps.

Where loads are critical and expensive, the extra pro-

tection — say, against inadvertent knob-twiddling — from a crowbar is invaluable. On all internal crowbars in this series, the trip voltage margin is set by screwdriver at the front-panel.

Pertinent specifications are: triggering margins are settable at 1V plus 7% of operating level; voltage ripple and noise is 200 μ V rms/10mV peak-to-peak (DC to 20 MHz); current ripple is 5 mA rms or less depending on output rating; voltage regulation is 0.01%; resolution, 0.25% or better; remote programming, RFI conformance to MIL-I-6181D.

Prices start from \$350. For complete specifications and prices, contact your local HP Sales Office or write: Hewlett-Packard, New Jersey Division, 100 Locust Avenue, Berkeley Heights, New Jersey 07922 or call (201) 464-1234 . . . In Europe, 1217 Meyrin, Geneva.

HEWLETT  PACKARD
POWER SUPPLIES

Additional data sheets available upon request

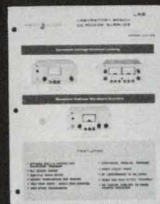

LAB SERIES
smaller package,
lower power,
optional crowbar



CROWBARS
A Technical
Discussion



1969 Power
Supply Catalog
— includes total
HP power supply line.

NOW!

5VDC at 1A

IC POWER SUPPLY

for... **\$24⁰⁰** IN SINGLE QUANTITY

The LIC5-1A is another of Elasco's new series of low-cost, high-quality plug-in power supplies. This power supply is designed to power approximately 25 IC's. The unit delivers 5 volts D.C. at 1 Ampere with regulation and ripple specifications commensurate with integrated circuit requirements. The power supply is manufactured to mount in a standard 5¼" basket, and is available with an overvoltage protection option.



The LIC5-1A power supply is designed for mounting either on a chassis or in a 5¼" IC Basket. As many as 9 units can be mounted in a standard Elasco basket.

FEATURES

- ▲ SHORT CIRCUIT PROOF
- ▲ 71°C OPERATION
- ▲ LOW COST OVERVOLTAGE OPTION
- ▲ DELIVERY: STOCK TO 2 WEEKS

WRITE FOR BULLETIN
269 FOR DATA ON THE LIC5-1A
POWER SUPPLY



ELASCO INCORPORATED

5 NORTHWOOD RD., BLOOMFIELD, CONN. 06002
(203) 242-0708

DATA PROCESSING

Data display terminals write cursive characters



Atlantic Technology Corp., 7th St. & New Hampshire Ave., Somers Point, N. J. Price: \$3600 or \$6500.

Applying the latest advances in medium-scale integration, a new family of real-time interactive data display terminals, which are compatible with IBM's 360 systems, can display up to 2000 cursive-stroke characters or graphs. Series 2000 terminals, which include the 2020 stand-alone display and the 2030 multi-station version, present cursive characters that look handwritten.

CIRCLE NO. 291

High-speed converter accesses 512 channels

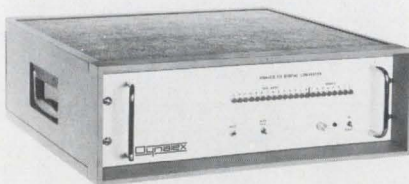

Dynalex, Inc., sub. of Ocean Technology, Inc., 885 Front St., Burbank, Calif. Phone: (213) 849-2221. Availability: 30 to 90 days.

With its companion differential input multiplexer, a new analog-to-digital converter provides random or sequential access to as many as 512 analog channels at a rate of 200,000 conversions per second for a 14-bit binary data word. Model ADX uses a unique simultaneous conversion technique, rather than a synchronous successive-approximation method.

CIRCLE NO. 292

Reader/printer sees ultrafiche



National Cash Register Co., Industrial Products Div., Dayton, Ohio. Phone: (513) 449-2150.

Capable of automatically copying images reduced 150 times, a new micro-image reader/printer selects any one of 3200 PCMI ultrafiche images stored on a single 4 by 6-in. transparency. Model 455-21 not only permits any page to be easily located and projected on its 11 by 11-in. viewing screen, but produces multiple electrostatic copies of a selected page at the touch of a button.

CIRCLE NO. 293

Graphic digitizer complements Teletypes



Tipco, 1523 E. Easter Circle, Littleton, Colo. Phone: (303) 794-4231.

Both hardware- and software-compatible with teletypewriters used in time-sharing computer systems, a new graphic digitizing terminal converts data from maps, graphs, charts, photographs and drawings to computer-compatible digital form. Model DT-1 can also prepare digital records by selecting items from lists or multiple-choice questionnaires. It offers an active area of 10 by 15 in.

CIRCLE NO. 294



We call it INCONNECT®. Our new Molex modular system that provides five ways of interconnecting electrical-electronic printed circuit assemblies: Two ways to connect circuit boards to chassis, three ways to interconnect printed circuit boards. It's a giant step forward in helping speed production and assembly techniques in the area of printed circuits. Unique flexibility enables you to tailor connector components to your specific product needs. Easily. Simplifies assembly, testing, servicing and model change requirements. It's another example of the Molex creative approach to circuitry problems. One that demonstrates just how reliable and economical printed circuit connections can really be. But see for yourself. Write for details. Or you can make connections by calling (312) 969-4550.



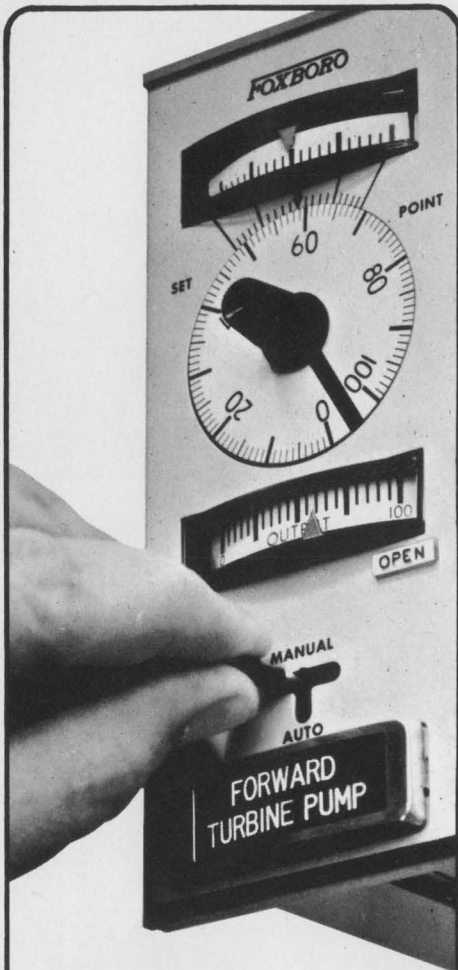

Capitol's 4HLB Switch at work

A unique transfer from automatic to manual operation and back again in the Foxboro 62H electronic controller

actuated by a Capitol switch

To specify Capitol is to specify Dependability

Write for our 24 page catalogue
Representatives in principal cities.

CAPITOL SWITCHES

THE CAPITOL MACHINE & SWITCH CO.
87 NEWTOWN RD. DANBURY, CONN. 06810

INFORMATION RETRIEVAL NUMBER 104

PACKAGING & MATERIALS

Transistor sockets abolish insulators



Molex Products Co., 5224 Katrine Ave., Downers Grove, Ill. Phone: (312) 969-4550.

Circumventing the need to wire transistors directly to PC boards, a new concept for transistor sockets uses PC-board-mounted terminals, inserted and wave soldered in a fixed pattern, to eliminate the socket insulator. Each series 1875 terminal has a flared mount for easy insertion of transistor wires. They are supplied in chain-link or loose form.

CIRCLE NO. 295

Transistor sockets eliminate chamfering

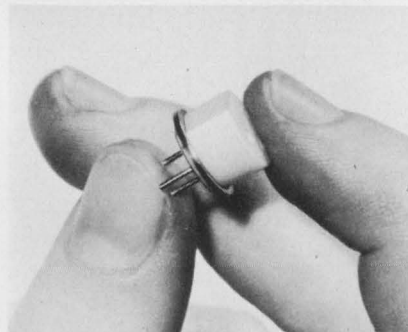

U. S. Terminal Inc., 7502 Camargo Rd., Cincinnati, Ohio. Phone: (513) 561-8145. Price: 4¢; 2 wks.

A new line of Teflon TO-5 and TO-18 transistor sockets with a unique rapid installation feature eliminates loose parts and the need for chassis-hole chamfering. Called Beltline, the sockets have a belt or band of metal around the outside diameter. Moderate pressure forces the socket through the belt and chassis hole, and the Teflon expands to lock the socket in place.

CIRCLE NO. 296

Socket receptacles take up to 10 lamps

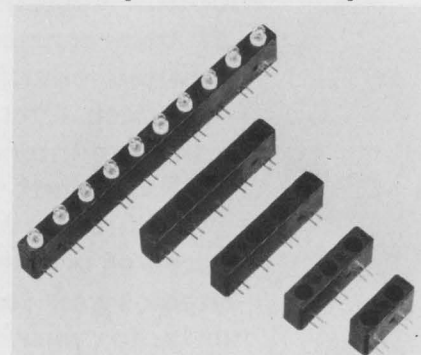

Chemelec Products, Inc., 8 Fellowship Rd., Cherry Hill, N.J. Phone: (609) 424-0514.

Called Multi-lites, a new series of multisocket receptacles for bi-pin subminiature lamps accepts 2, 3, 4, 5 or 10 T-1-3/4 lamps with a minimum of assembly time and expense. The units plug into PC boards having a 0.1-in. grid. They may be stacked horizontally and vertically in any combination until the desired readout pattern and number of indicators is achieved. The contacts are beryllium copper. The contacts are made of beryllium copper.

CIRCLE NO. 297

Op amp sockets accept 4 types

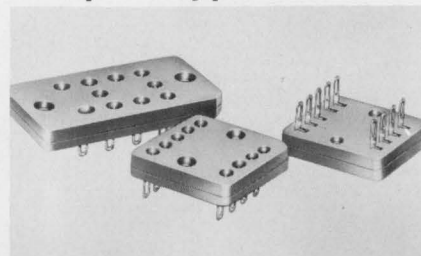

Barnes Corp., 24 N. Lansdowne Ave., Lansdowne, Pa. Phone: (215) 622-1525. P&A: 74¢ to \$1.90; stock to 2 wks.

Available with four different pin arrangements, a new line of low-profile sockets can be used with most standard module-type operational-amplifier packages. Series 041-015 sockets are 0.22 in. high and are molded of polysulfone for extended testing or use from -65 to +150°C. Typical life expectancy is 50,000 insertions.

CIRCLE NO. 298

INFORMATION RETRIEVAL NUMBER 105 ►

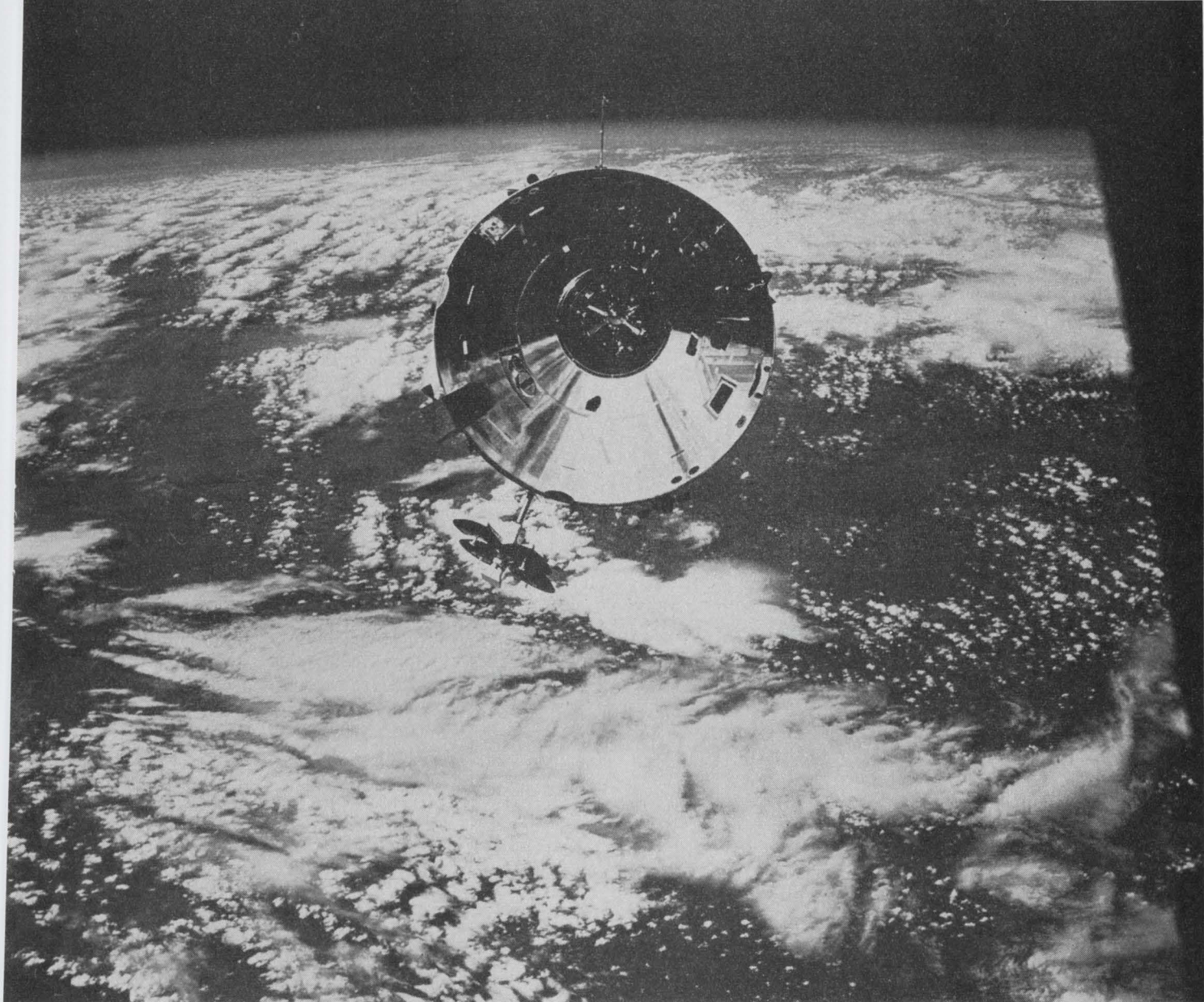

It takes good connections to make it to the moon.

Key to the success of lunar missions: the precise connections, disconnections or reconnections of the Apollo spacecraft modules. And one of the most critical of these connections in the whole NASA mission is when the Command and Service Modules reconnect with the Lunar Module.

All this takes good connections in another sense, too — good electrical connections to the millions of parts in the whole Apollo/Saturn vehicle. And that's where we come in, with a host of ultra-reliable connectors in every stage.

To name a few of the 18 types we supplied: Circulars (CV, RX, KPD, 5015), Rectangulars (D Subminiature, DPK, Double Density D), KPT Hermetic, Micro-D™ connectors and five different umbilical connectors.

The moral? When it comes to a unique combination of versatility and reliability, come to ITT Cannon. Whatever the connector application, you'll be on solid ground. For further information, write ITT Cannon, 3208 Humboldt St., Los Angeles, Calif. 90031. A division of International Telephone and Telegraph Corp.



CANNON ITT

dc voltage standards

THE FACTS ARE
IN THE
CARDS

ACCURACY

GOOD

Model 351 0.003% Accuracy

BETTER

Model 353 0.002% Accuracy

BEST

Model 355 0.001% Accuracy

COHU MEETS THE TEST

We could have said, "COHU BEATS THE REST," but the technically knowledgeable engineer will see the 0.001% of the Model 355 and ask "WHY STATE THE OBVIOUS?"

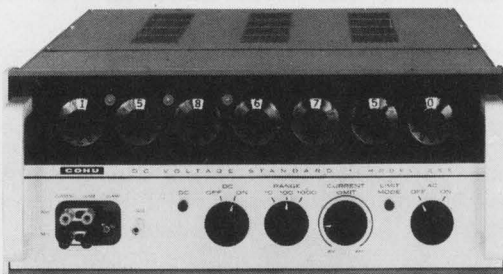

So, to get the DC Voltage Standard YOU need, it's obvious:

ASK COHU FOR IT



BOX 623, SAN DIEGO, CALIFORNIA 92112 • PHONE 714-277-6700 • TWX 910-335-1244

PACKAGING & MATERIALS

Self-stick metal tapes have conductive backs

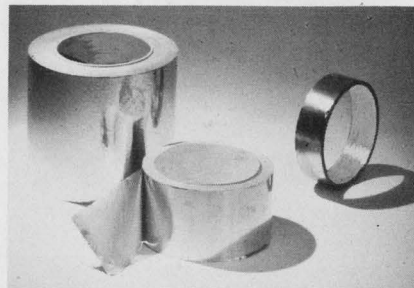

Emerson & Cuming, Inc., Microwave Products Div., Canton, Mass. Phone: (617) 828-3300.

Eccoshield PST pressure-sensitive metal-foil tapes feature electrically conductive adhesive backings. The new tapes can quickly seal troublesome rfi leaks on transmission lines or equipment enclosures. They can also seal joints in shielded rooms and can make components and transmission lines rf tight. Types P-A and C-A are aluminum tapes, while type C-C is a copper tape.

CIRCLE NO. 334

Push-on bus strips eliminate soldering

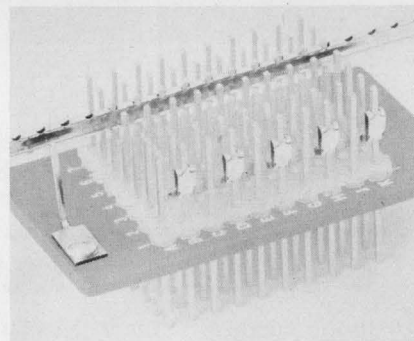

Bussco Engineering, Inc., 122 Penn St., El Segundo, Calif. Phone: (213) 772-1387. P&A: from 0.04¢/connection; 3 wks.

Requiring no special installation tools, new gold-plated bus strips, which have an equivalent current capacity of AWG #18 wire, can be simply pushed on to a row of wire-wrap posts with finger pressure. Because of their shape, the bus strips act like spring-loaded connectors on the wire-wrap posts. They are available in any length.

CIRCLE NO. 335

INFORMATION RETRIEVAL NUMBER 106

TDM SERIES POWER SUPPLY MODULES

BUILT-IN FEATURES...NOT EXTRA-COST OPTIONS

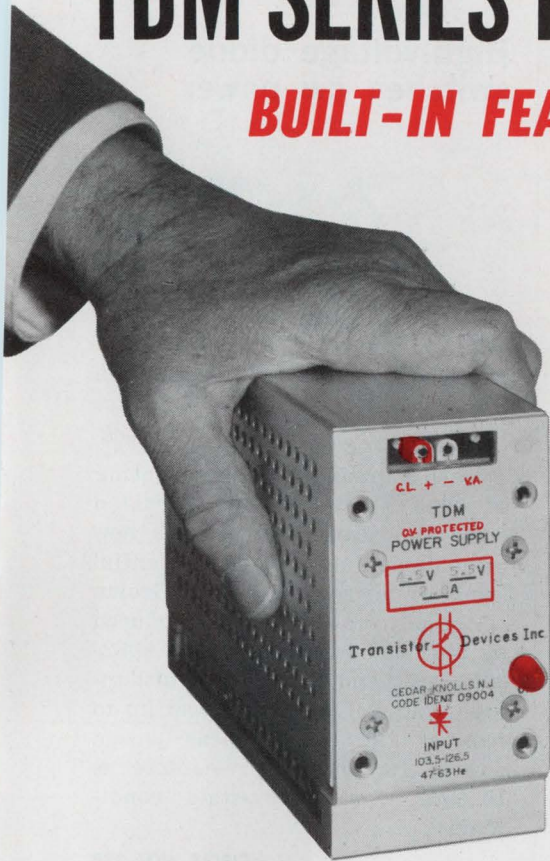

- Overvoltage Crowbar Protection
- Front Panel Test Points
- Front Panel Indicator Lamp
- Front Panel Mounting Provisions
- Multiple Units may be mounted on common 5 1/4" Front Panel
- Chassis Mounting Provisions
- Front Panel Voltage Adjust
- Front Panel Current Limit Adjust
- Military or Computer Grade Components and Workmanship
- Remote Sensing
- Polarity Floating

SPECIFICATIONS

- Input: 103.5 - 127.5 V, 47-63 Hz
- Output Current as selected
- Output Adjustment Range as selected
- Wide Range Adjustment optional (zero to rated voltage)
- Regulation, Line: .01% +5 MV
- Regulation, Load: .01% +5 MV
- Ripple: .001% +200 μ V RMS
- Transient Response 50 usec max. for 1/2 load or 3A whichever is less.
- Temperature Coefficient .01% ° C
- Ambient Temperature Range: -20 to +55° C at full rated current. Derate by .5 for 71° C operation.

ALL TDM SERIES UNITS ARE 4 7/8" IN HEIGHT AND 7 1/2" IN DEPTH

| DC OUTPUT VOLTAGE | OVERVOLTAGE MAXIMUM | CASE "A" MAX. AMPS. | CASE "B" MAX. AMPS. | CASE "C" MAX. AMPS. | CASE "D" MAX. AMPS. | CASE "E" MAX. AMPS. | CASE "F" MAX. AMPS. |
|-------------------|---------------------|---------------------|---------------------|---------------------|---------------------|---------------------|---------------------|
| TDM-3.5-4.5 | 6 | 2.8 | 5 | 9 | 12 | 17 | 30 |
| TDM-4.5-5.5 | 7 | 2.8 | 5 | 9 | 12 | 17 | 30 |
| TDM-5.5-8.5 | 10 | 1.7 | 5 | 9 | 10 | | 17 |
| TDM-8.5-11.5 | 13 | 1.7 | 5 | 9 | 10 | | 17 |
| TDM-11.5-13.5 | 15 | 1.2 | 3.5 | | 7 | | 12 |
| TDM-13.5-15.5 | 18 | 1.2 | 3.5 | | 7 | | 12 |
| TDM-15.5-18.5 | 21 | .9 | 3 | | 6 | | 10 |
| TDM-18.5-22.5 | 25 | .9 | 3 | | 6 | | 10 |
| TDM-22.5-26.5 | 30 | .7 | 2 | | 4 | | 7 |
| TDM-26.5-30.5 | 35 | .7 | 2 | | 4 | | 7 |
| WIDTH | | 2 1/2" | 3 1/2" | 5 1/4" | 7" | 8 1/4" | 13" |
| PRICE | | \$109.00 | \$135.00 | \$150.00 | \$185.00 | \$235.00 | \$315.00 |
| WEIGHT IN POUNDS | | 4 1/2 | 7 | 9 | 11 | 13 | 25 |

WHEN DOES 1 + 1 + 1 = 1?

When 3 Standard Power Supplies are combined as 1 Special.

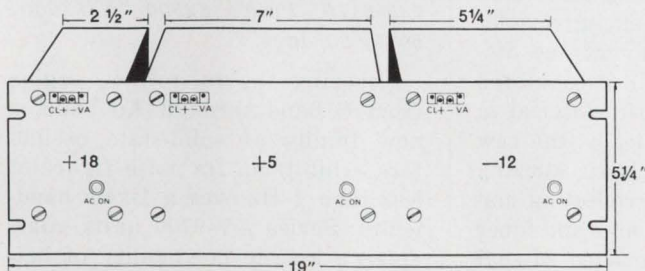

HOW TO PLAN YOUR SPECIAL MULTIPLE OUTPUT POWER SUPPLIES:

The TDM Series of Modules may be directly mounted onto a 5 1/4" front panel by means of four #10 screws. Clearance holes should be cut in the front panel for test points, voltage adjust, current limit adjust, and indicator lamp. Related Power Supply Modules may be mounted side by side (a minimum of 1/2" spacing should be left between modules for ventilation). The utilization equipment may also be mounted on a common front panel with the power supply. This permits the rapid and professional fabrication of special test and measuring equipment, displays, etc., to custom specifications at minimum cost with minimum design and engineering time.

Transistor Devices Inc.

85 HORSEHILL ROAD, CEDAR KNOLLS, N. J. 07927 • (201) 267-1900

INFORMATION RETRIEVAL NUMBER 107

WE MAKE PRECISION PRE-GAPPED
FERRITE RECORDING HEAD CORES.

Contact Us



ceramic magnetics, inc.

87 FAIRFIELD ROAD • FAIRFIELD, N. J. 07006 • (201) 227-4222

INFORMATION RETRIEVAL NUMBER 108

Totally Different!

"Quick 'n Easy" IC Breadboard

EASILY 300% FASTER!

- No Messy Wires or Patchcords
- No Cutting of Printed Leads
- No Special Tools or Accessories

Now you can create and test complex IC systems in a fraction of the former time! Even those with several ICs are "quick 'n easy". Planning and layout are simplified by ingenious worksheets, which can be transformed into hardware at better than two-hundred connections per hour!

Holds ten assorted ICs, both TO-5 and DIP, plus unlimited diodes, resistors, transistors, etc.

Older boards, with none of these features, cost up to \$10, but "Quick 'n Easy" is only \$6.95!

SPECIAL INTRODUCTORY OFFER: For a limited time you may purchase a sample for only \$5.95, plus 40¢ postage. (Calif. buyers add 5% tax.) PAYMENT WITH ORDER, please, no P.O.s, but satisfaction guaranteed, or return for full refund.

(Matching edge-pin socket, \$3 value, only 99¢)

ELECTRONIC ENTERPRISES

775 So. Madison, Pasadena, CA 91106

(Mfg. by Micro-Etch, 1515 E. Washington, Pasadena)

INFORMATION RETRIEVAL NUMBER 109

MICROWAVES & LASERS

Microwave transistor delivers 1 W at 2 GHz

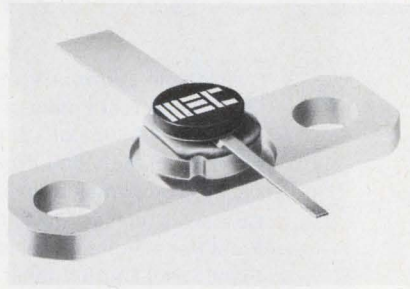

Microwave Semiconductor Corp.,
100 School House Rd., Somerset,
N. J. Phone: (201) 469-3311.

Socketing out 1 W at 2 GHz, a new epitaxial transistor is designed for class A, B and C microwave amplifier or oscillator applications. Model 2001 achieves maximum power gain and efficiencies at L- and S-band frequencies through a new matrix pellet structure. Its strip-line package offers low input Q for broadband applications, high power dissipation, simplified heat sinking and hermetic reliability.

CIRCLE NO. 336

Plastic laser head filters UV light

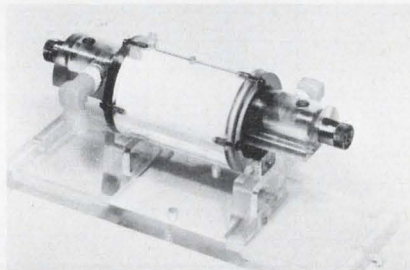

Hadron, Inc., 300 Shames Drive,
Westbury, N. Y. Phone: (516) 334-4402.

Capable of accepting input powers of 1 kW, a new plastic laser head that can filter ultraviolet light eliminates many of the disadvantages previously encountered with the use of plastic material in this application. Basically, the new head consists of a plastic housing and two end caps; a reflecting material separates the outer and inner housings. It is constructed so that one element can be used to perform the function of several elements, thus reducing the number of parts needed.

CIRCLE NO. 337

High-voltage diode switches cw power



Hewlett-Packard, 1501 Page Mill Rd., Palo Alto, Calif. Phone: (415) 326-7000. P&A: \$65; stock.

With a breakdown voltage rating of 1000 V and a low saturated series resistance of 0.3 Ω , a new p-i-n diode can switch substantial levels of microwave power. Grown epitaxially rather than produced by diffusion techniques, type 5082-3051 can handle up to several hundred watts of cw power and up to tens of kilowatts of peak pulsed power. Its thermal resistance is 16°C/W for steady-state conditions.

CIRCLE NO. 338

Solid-state oscillators reduce noise and drift

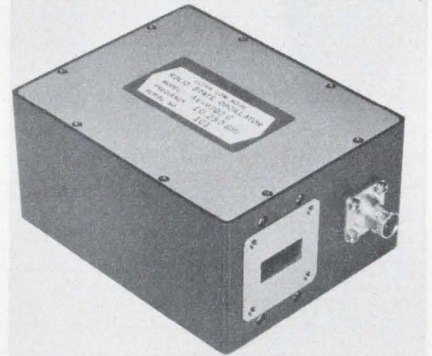

Avantek, Inc., 2981 Copper Rd., Santa Clara, Calif. Phone: (408) 739-6170. P&A: \$2500 to \$3500; 60 to 90 days.

Covering the microwave region from C band through Ku band, a new family of solid-state oscillators exhibits an fm noise figure of less than 1 Hz over a 1-kHz bandwidth. Series AV-9700 units guarantee a long-term stability of better than 10 kHz/°C. They offer output powers of 10 or 100 mW, with input powers of only 6 or 12 W.

CIRCLE NO. 339

Fluorocarbon Moldings Better Than Machined Parts!



**FREE
BROCHURE**

When tolerances are critical, parts machined from rod stock can be uneconomical. That's the time for a B & W quotation. B & W specializes in precision, intricate injection moldings to your specs. Materials include CTFE, Kel F, FEP, Kymar, Halon and others. We design and build all tooling.

Send part or print for fast, airmail quotation.

"World's largest custom Fluorocarbon molder"

BOOKER AND WALLESTAD DIV.

1202 So. 5th St., Hopkins, Minn. 55343
Area 612/938-7671

Subsidiary of Thermotech Industries, Inc.



DEPT. ED

INFORMATION RETRIEVAL NUMBER 110

Need Electrolytic Samples?

**CAPACITOR
IS OUR
MIDDLE NAME!**

We offer Quality Dry Electrolytics for OEM's in the Industrial, Entertainment and Instrument industries. *Exclusively!*

Please furnish complete specifications when requesting quotations and/or samples.



1081

WRITE FOR CATALOG!

SYNCRE Capacitor Corporation

HICKSVILLE, OHIO 43526 • (419) 542-2711 • TWX 810-490-2550

INFORMATION RETRIEVAL NUMBER 111

ELECTRONIC DESIGN 13, June 21, 1969

Oak Versatility



Now! One new exclusive switch replaces seven

You can easily eliminate tedious design engineering problems—just use versatile Multidex® switches. They're available in thousands of variations...are smaller than the switches they replace...yet provide more contacts (up to 36) at no additional cost.

Crisp Detenting... the patented Unidex™ detent offers uniform "feel" for long life in choices from 10° to 36° throw. Meets MIL-S-3786, SR32 requirements.

Superb Insulation... molded diallyl phthalate meets MIL-M-14 requirements and guarantees electrical continuity between mounting and housing. Glass-alkyd insulation available on request.

Special contacts and clips... Oak-pioneered, double-wiping, self-cleaning contacts assure trouble-free operation. Special AF clips with large windows speed wiring.

What's more, Multidex switches meet commercial and military environmental requirements. Special options available on request. For full details, write today for Bulletin SP-324.



OAK MANUFACTURING CO.

A Division of OAK ELECTRO/NETICS CORP

Crystal Lake, Illinois 60014

PHONE: 815-459-5000 TWX: 910-634-3353

INFORMATION RETRIEVAL NUMBER 112

A New Line You Can Count On...

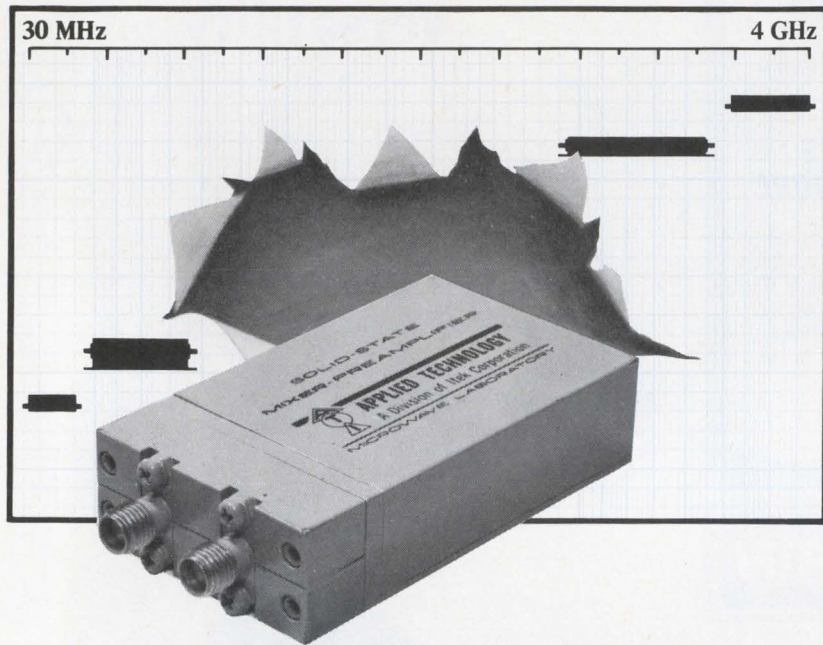

The MPS-1 S-Band Mixer-Preamplifier combines ATI's proven preamplifier experience with advanced mixer design techniques. Covering the band of 2000-4000 MHz with an IF of 500 to 1000 MHz, the MPS-1 eliminates mixer preamplifier interface problems in wideband single or dual conversion systems requiring low spurious response.

- Freq. Range RF: 2-4 GHz
- IF: 500-1000 MHz
- Typical Noise Figure (SSB): 8.5 dB
- Gain: 15 dB
- Gain Flatness: ± 1.0 dB
- Isolation: 6 dB minimum
- LO Power: +6 dBm nominal
- DC Power: +12 VDC @ 15 ma
- Size: 2.8 cu. in.

Other octave bandwidth models available in C- or X-Band.

Write or call collect for additional information or application assistance.

Employment Opportunities for Qualified Engineers

An equal opportunity employer

SOLID-STATE OSCILLATORS • MIXER-PREAMPS • PREAMPS • FREQUENCY MULTIPLIERS

APPLIED TECHNOLOGY
MICROWAVE LABORATORY
A Division of Itek Corporation
3410 Hillview • Palo Alto, Calif. 94304 • (415) 321-5135 • TWX 910 373-1218



INFORMATION RETRIEVAL NUMBER 113

MICROWAVES & LASERS

Wide-dispersion analyzer single-sweeps spectrum



Nytek Electronics, 1028A W. Evelyn Ave., Sunnyvale, Calif. Phone: (408) 245-4142. Price: \$4080.

Covering the frequency range of 0.7 to 18 GHz, a new wide-dispersion spectrum analyzer is a YIG-tuned electronically swept instrument, with the ability to display the entire spectrum in a single sweep. Model 8011B has a ± 2 -dB flatness across the 1-to-14-GHz band, with a 60-dB dynamic range from -45 to $+15$ dBm. The unit does not produce harmonics, cross-modulation products or images.

CIRCLE NO. 340

Spectrum analyzer sweeps to 63 GHz

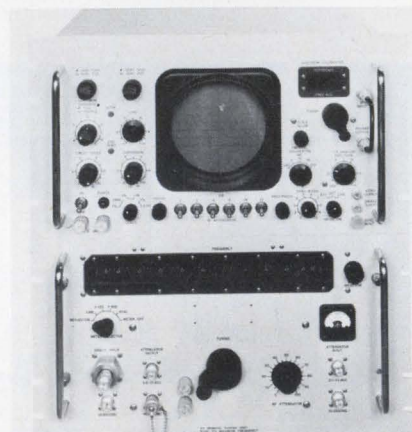

AUL Instruments, Inc., 139-30-34th Road, Flushing, N. Y. Phone: (212) 886-0600.

Over the frequency range of 10 MHz to 63 GHz, a new high-sensitivity frequency-scanning spectrum analyzer displays the detected output as a linear or logarithmic plot, or as a plot of rf signal strength versus frequency on a cathode-ray tube. Model MSA-84WA conforms to MIL-T-21200G and features a variable resolution of 1 to 80 kHz. Its 0.1-dB/dB i-f attenuator permits precision attenuation measurement.

CIRCLE NO. 341

The test our tester flunked.



Six months ago, when we came out with our Model 1410 op amp tester, we called it "the most comprehensive, definitive, easy-to-use tester on the market today."

Which it was. And still is.

But: it couldn't test comparators.

So now we've come out with a brand-new tester. Which *can* test comparators. And we call it—with a burst of poetry—our Model 1420.

(The reason we don't bother showing the 1420 is this: it's almost a look-a-like for the 1410. Except it isn't blushing.)

Like the 1410, our 1420 is a snap to operate. You simply insert a program board, and push a button marked "test." Blink, blink, blink: the machine runs through 14

rugged tests.* And, if a device fails any one of them, you know to what degree—because a screen lights up to tell you in percentage figures!

No fiddly knobs, no mysterious meters. In fact, both testers are so easy to use, a secretary can handle them. Any secretary. Even yours.

If you don't care about comparators, the 1410 is your baby. (It'll handle 75% of the linear IC's around today.) Otherwise, you want the new 1420, which takes care of 90%. And if you opt for options, the 1400 series has a host: classification, data logging, automatic handling, computer calculated program values, 1% or 5% program boards, environmental testing.

The price? So low for both models, our cost accountants are still grumbling.

Put these statements to the test... by writing for specs, prices, addendum on the whole Signetics line of testers. Better yet, call collect to Marketing, Signetics Measurement Data Division, (415) 961-9384, for the name of our nearest distributor.

Please, please do it.

Otherwise, this ad will flunk.

*The fearsome fourteen... 1) power consumption over-range (greater than 200%), 2) power consumption (less than 200%), 3) offset voltage (source resistance zero ohms), 4) offset voltage (source resistance programmed), 5) + supply sensitivity, 6) - supply sensitivity, 7) common mode rejection, 8) bias current, 9) offset current, 10) gain (programmed light load), 11) gain (programmed heavy load), 12) noise, oscillation, 13) + slew rate, 14) - slew rate.

Signetics

MEASUREMENT/DATA



Signetics, Measurement/Data, 341 Moffett Blvd., Mountain View, Calif. 94040 / A subsidiary of Corning Glass Works

INFORMATION RETRIEVAL NUMBER 114

**ATTENTION,
HEAD
HUNTERS!**

**NORTRONICS
SPEAKS
DIGITAL
DIALECT**

If you're exploring the mini-computer jungle—seeking magnetic heads, for desk-top calculators, input/output systems, and other peripheral equipment—beat a path to Nortronics — the world's largest head manufacturer.

Our witch doctors have powerful magic: a complete line of readily available mini-digital recording heads. Any application; cartridge, cassette, 1/4" reel-to-reel, drum, or card stripe formats . . . plus complete market engineering know-how to help you specify.

In the savagely competitive EDP business, the leading manufacturers agree on one thing—Nortronics mini-digital capability. Call or write today, for our mini-digital guidebook.

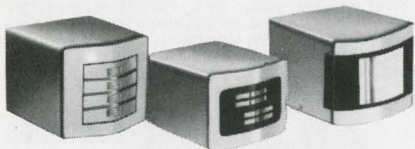

Nortronics
COMPANY, INC.

8101 Tenth Avenue North
Minneapolis, Minnesota 55427
Phone—(612) 545-0401

INFORMATION RETRIEVAL NUMBER 115

PRODUCTION

Solid-state solder gun tips scale at 5 oz



Ungar Div. of Eldon Industries, 233 E. Manville St., Compton, Calif. Availability: stock.

Said to be an industry first, a new solid-state transformerless soldering gun weighs only five ounces. Model 6760 assures damage-free soldering of integrated circuits and field-effect transistors since its soldering tip is electrically isolated from the heating element with a grounded three-wire cord set. Tip temperatures are 500 or 900°F.

CIRCLE NO. 342

Thick-film system quadruples printing

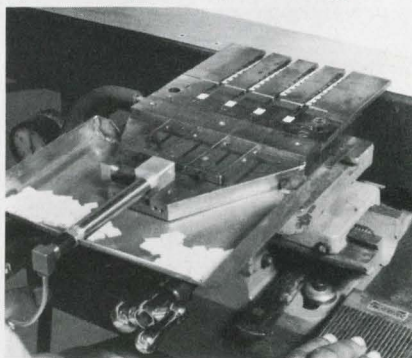

Arecco Products, Inc., P. O. Box 145, Briarcliff Manor, N. Y. Phone: (914) 762-0685.

Coupled to a screen printer through a cam-timer mechanism, a new ejector mechanism helps to screen as many as four substrates at a time. In production, at the end of the printing cycle, the substrates are pushed forward out of the nest automatically. Rates as high as 2500 printed substrates per hour are possible with this semi-automatic system.

CIRCLE NO. 343

Thermal wire stripper removes Kapton safely

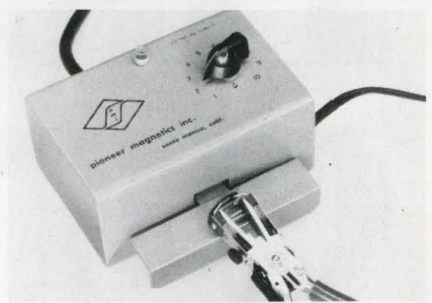

Pioneer Magnetics Inc., 1745 Berkeley St., Santa Monica, Calif. Phone: (213) 393-0136.

Designed for stripping wire with Du Pont H-film (Kapton) insulation, a new thermal wire stripper incorporates high-temperature alloy heater elements and special friction gripper pads. Model 1056H features a no-nicking action that allows the operator to sever and remove the insulation slug from the wire in one combined operation. It also has a Teflon-covered guide-guard.

CIRCLE NO. 344

Hand wiring tool crimps and strips



Hunter Tools, div. of Hunter Industries, 9851 Alburty Ave., Santa Fe Springs, Calif. Phone: (213) 692-7281. Price: \$2.98.

Called the Plike, a new hand wiring tool combines four functions in a single unit. It has serrated needle-nose jaws for gripping, pulling, and bending wire; a crimper orifice for crimping solderless terminals; cutting jaws for cutting wire; and six stripping holes for removing the insulation from solid wire.

CIRCLE NO. 345

CRATEX RUBBERIZED ABRASIVES

**DEBURR
SM-O-O-T-H
POLISH**



\$7.50 BUYS IT ALL—80 piece introductory Kit 777 equally assorted in 4 grit textures: coarse, medium, fine and extra fine. **TRY IT**—Cratex Rubberized Abrasives improve the surface while preserving critical workpiece dimensions by its unique cushioning action. **FINISH THE JOB**—to your most exacting specifications—often in a single operation. **SEND FOR KIT 777**—or your **FREE SAMPLE** and catalog illustrating the full Cratex product line and its applications.

**CRATEX[®] RUBBERIZED
ABRASIVES**

1600 Rollins Road • Burlingame, California
Sold through leading industrial distributors

INFORMATION RETRIEVAL NUMBER 116

WHEN THE
FUSE GOES OUT,
THE LIGHT
GOES
ON!

Littelfuse Indicating Micro-fuse Holders for military and commercial applications. Ranges 2-1/2 thru 250 Volts. Also available with RFI shielding.



LITTELFUSE

DES PLAINES, ILLINOIS

INFORMATION RETRIEVAL NUMBER 117

**New 510 Series Laser Light Modulators
Only 75 volts for 100% modulation @ 632.8nm**

- Suggested Applications:** Laser Printing and Display Systems
- Optical Storage and Readout
 - High Bit Rate Data Links
 - High Resolution Laser Ranging Systems
 - Atmospheric Propagation Studies
 - Ultra High Speed Laser Stroboscopy

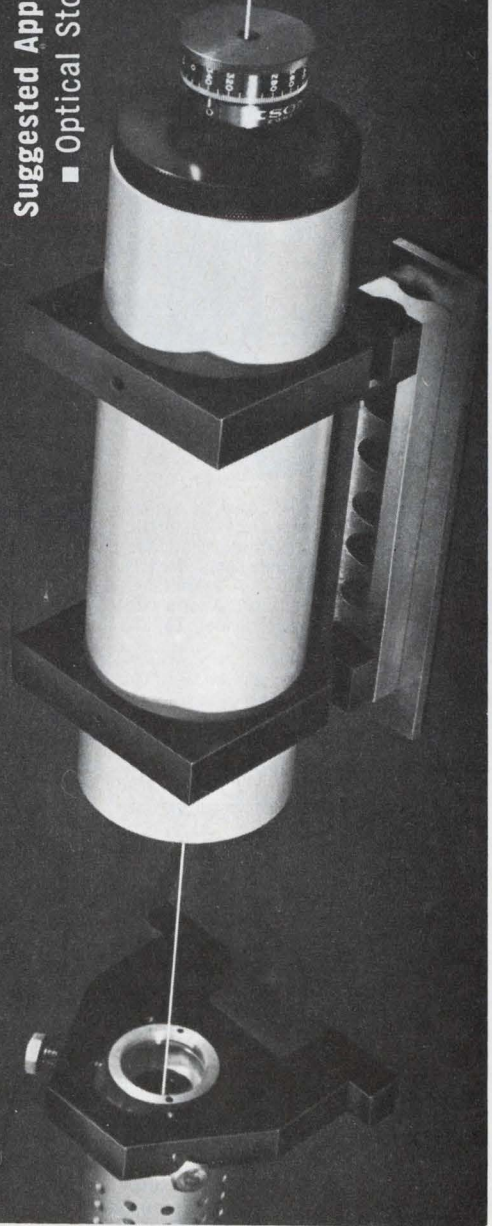

For additional information write: Isomet Corp.,
433 Commercial Ave., Palisades Park, N. J. 07650,
or call (201) 944-4100



INFORMATION RETRIEVAL NUMBER 118

NEW SOLID STATE POWER PACKS

for
regulated
low voltage
applications
from

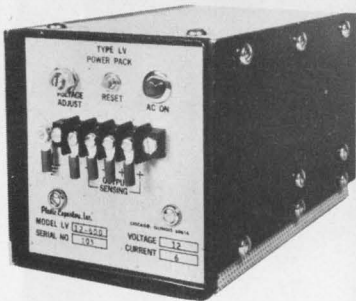

Plastic Capacitor's new LV Series Power Packs, ranging from 12 to 100 volts DC, offer an improved solution to today's system requirements. Models available with DC output voltages of 12, 24, 28, 36, 48, and 100 volts with power ratings of approximately 25, 50, 100 & 150 watts.

FEATURES INCLUDE:

- 0.01% LINE REGULATION
- 0.05% LOAD REGULATION
- 3MV PEAK TO PEAK RIPPLE AND NOISE
- NEGATIVE 0.015%/°C TEMPERATURE COEFFICIENT
- LESS THAN 0.2 OHMS OUTPUT IMPEDANCE
- TEMPERATURE OPERATING RANGE OF 0°C TO 55°C

For positive proof that good things come in small packages... check your power pack needs with Plastic Capacitors. Write for full engineering data today.

Plastic Capacitors INC.

2620 N. Clybourn Chicago, Ill. 60614

INFORMATION RETRIEVAL NUMBER 119

Evaluation Samples

Component protectors

Known as Caplugs, a complete line of low-cost disposable protective devices can prevent mechanical damage to a wide variety of components during shipping and in-plant processes. Other applications include such uses as paint masks potting molds and potting containers. A free sample assortment of these protectors contains a selection of twenty possible different styles. Included are threaded caps and plugs, hydraulic caps and plugs, as well as pipe caps and plugs. All the protective devices are made of virgin polyethylene. A 48-page catalog detailing the full line of Caplugs accompanies the free sample assortment. Protective Closures Co., Inc., Caplugs Div.

CIRCLE NO. 352

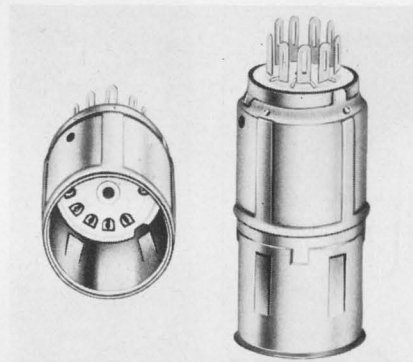

Tube shield/socket

Designed to reduce manufacturing and maintenance costs (particularly in tuner applications), a nine-pin miniature tube socket features an integral collapsible tube shield that permits easy access to the tube. When collapsed, the shield exposes 50% of the tube, thus facilitating tube removal. Four spring lances on the shield press firmly on the tube to resist the effects of vibration and to increase heat dissipation. Solder preforms can be used to mount the socket. Evaluation samples of series 3900 sockets are available free. Elco Corp.

CIRCLE NO. 353

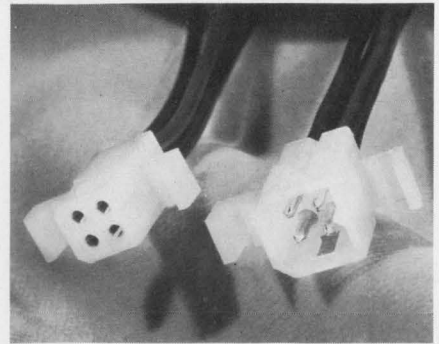

Miniature connector

Type 2004 miniature four-pin connector is designed for use in computers, business machines, medical electronics and home entertainment equipment. This polarized connector has a nylon body with integrally molded mounting ears on both the plug and receptacle. It accepts Molex crimp-type terminals available in tin-plated brass, phosphorus bronze, and gold or silver-plated brass. Free evaluation samples are available. Molex Products Co.

CIRCLE NO. 354

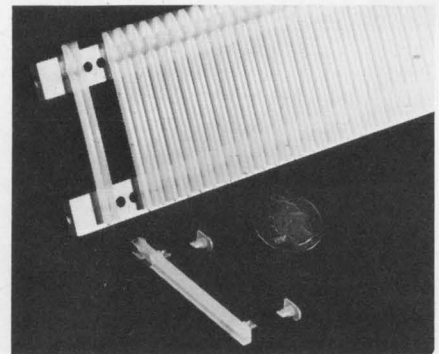

Nylon card guides

Miniature molded nylon circuit-card guides permit high-density packaging with PC boards as thick as 1/32 in. These guides fasten securely to SAE aluminum mounting bars with opposing lock tabs. Their mounting holes can be located on any center, from ± 0.005 in. non-accumulative down to 0.2 in. min. Free samples are available. Stanford Applied Eng.

CIRCLE NO. 355

The easy way to sort R-L-C components

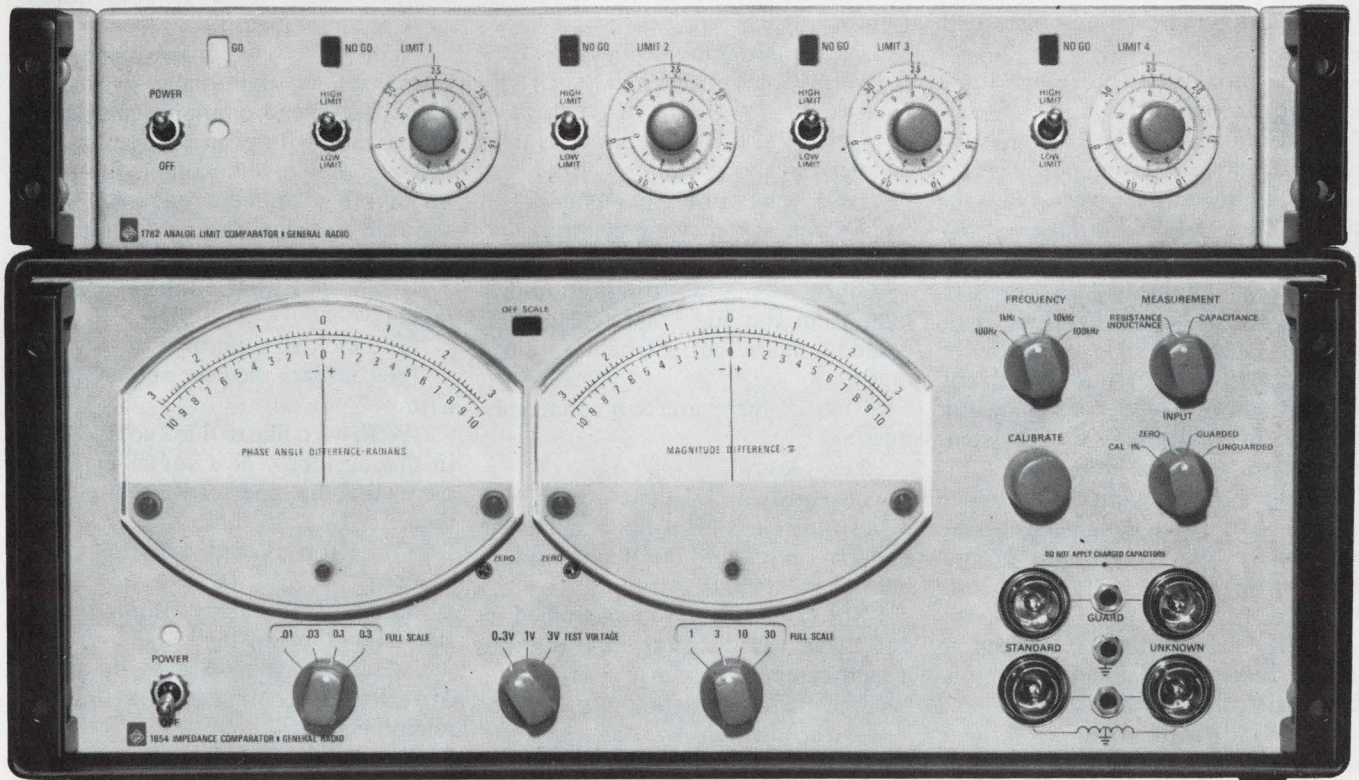

FAST

Measure and sort R-L-C components as rapidly as you can move your hands, using the new 1654 Impedance Comparator and 1782 Analog Limit Comparator. With the optional relay-equipped models of the 1782 you can attain automatic sorting rates as fast as 10,000 components per hour.

FLEXIBLE-VERSATILE

The same setup works for either R, L, or C components because the 1654 measures in terms of impedance difference. Setup is easy. Just connect your production sample or standard to one side of the bridge and your unknowns to the other side. On two large meters read the differences in magnitude and phase-angle between the sample and unknown; for relatively pure components the readout effectively is in terms of ΔR , ΔL , ΔC , ΔQ , or ΔD . Comparison precision is 30 ppm. Manual sorting decisions can be based on the 1654's meter readings or on the 1782's GO/NO GO lights. Or, you don't have to look at anything if you use the relay-equipped models with automatic sorting devices.

The 1782 has four independent limits, each settable to either a high or low limit of either $\Delta\theta$ or ΔZ . Resolution of GO/NO GO limit settings is one percent of full scale and several 1782's can be used with a 1654 for multiple-limit sorting.

LOW COST

One of the best features of this component-sorting system is the price. For \$1250 you can get the basic 1654 Impedance Comparator (rack model) for manual use where meter readout is acceptable. Analog output voltages are available to drive recorders, DVM's, or limit devices. For an additional \$570 you can add the 1782 Analog Limit Comparator and have four preset GO/NO GO limits. Or, for \$645 you can get a 1782 equipped with relays for automatic sorter control. Thus, for \$1250, \$1820, or \$1895 you get a sorting system that can't be beaten in price or performance. Prices apply only in the U. S. A.

Condensed Specifications 1654 Impedance Comparator

Measuring Ranges (dependent upon frequency and voltage): R - 2 Ω to 20 M Ω ; C - 0.1 pF to 1000 μ F; L - 20 μ H to 1000 H.

Test Voltage Across Unknown: 0.3, 1, or 3 V, switch selectable.

Internal Test Frequencies: 100 Hz, 1, 10 and 100 kHz.

For complete information, write General Radio Company, W. Concord, Massachusetts 01781; telephone (617) 369-4400. In Europe: Postfach 124, CH 8034, Zurich 34, Switzerland.

GENERAL RADIO 

The Connector Thing

in which Microdot solves the case of the two missing funny things.

Our story opens in the walnut paneled office of Microdot's Group Elder Statesman, Eldredge Oldadt. We find the graying, self-styled, self-made bureaucrat pacing the Bigelow on the floor and making clicking noises with his tongue.

In the morning's interoffice mail, he'd come across the inventory report. Everything tallied—except in two places. He'd gone over and over the figures, but the answer was always the same. Two pieces were missing. One Lepra/Con. One Golden Crimp.

When he was able to gain some self-control, he sat behind his desk, head in hands, and wept. He wept for the missing Lepra/Con, that wonderful ultraminiature, 50 ohm coax connector with that magnificent all-crimp assembly. Such a beautiful little thing.

And then he'd thought of the Golden Crimp. The 3-piece Golden Crimp. So compact. 1.693 lightweight grams. And now? Gone. Lost. Stolen? Perhaps.

Slowly the door creaked open to reveal a hefty Oriental with a Fu Manchu moustache. Behind him covered what Oldadt took to be a Chinese busboy.

"Sorry to enter without knocking." The Oriental moved to a nearby chair, and the busboy cringed into another. "But much is revealed when one enters room this way. There is much in the sky besides sparrows." A wide smile spread across the visitor's enigmatic countenance.

"You must be the security consultant."

"Charlie Chum, your humble servant."

"And he's your number one son, right?"

"Wrong. He is my busboy."

"Well, Charlie...if I may call you Charlie?"

"Certainly. Is it not correct to light candles under the temple bell?"

"Er...yes...now to business..."

"As you say in your country, OK Joe?"

There was something about this man from the East that Oldadt just couldn't figure out. Something enigmatic.

"Charlie, there are two connectors missing?"

"Yes, I know?"

Astounded, Oldadt could not believe his ears. "But how could you know? I only found out about it a few hours ago?"

"Not so hard when mind trained in detective work. Since busboy and myself came into room you have held two fingers of your right hand together. Either the number two was on your mind, or you were about to administer Cub Scout salute?"

"Remarkable, but how did you know they were connectors?"

"Wild guess?"

"Charlie, we've got to get them back. I've got to have them. I've got..."

"Please do not gnash teeth. Keep pants on, buster. First must have description?"

For the second time that morning Oldadt fought for control. Leaning back in his chair, he fingered his slide-rule tie-clip nervously.

"Well, first of all, a Lepra/Con is missing. It's the smallest all crimp 50 ohm coax available. I don't know whether it was a screw-on or slide-on version, since we make both kinds?"

"Continue, please?"

"It could be one of many configurations, such as: right angle, or straight plugs, bulk-head or plain jacks, front or rear mount, or printed circuit receptacles...they're all available in screw-on or slide-on versions. All very reliable because their contacts are completely protected?"

"I see, and what about other connector?"

"The Golden Crimp?"

"Yes, is it not the year of the Golden Crimp?"

"Well, we'd like to think so. It comes in three pieces. Not seven or eight pieces like the others. It's .620" x .242" diameter by .250" hex.

"Question. What are the three pieces?"

"Contact assembly, inner crimp sleeve and the housing?"

"What, no sealing sleeves, no pieces of teflon dielectric insulators, no retaining rings?"

Once again Oldadt was amazed at
(continued on next page)

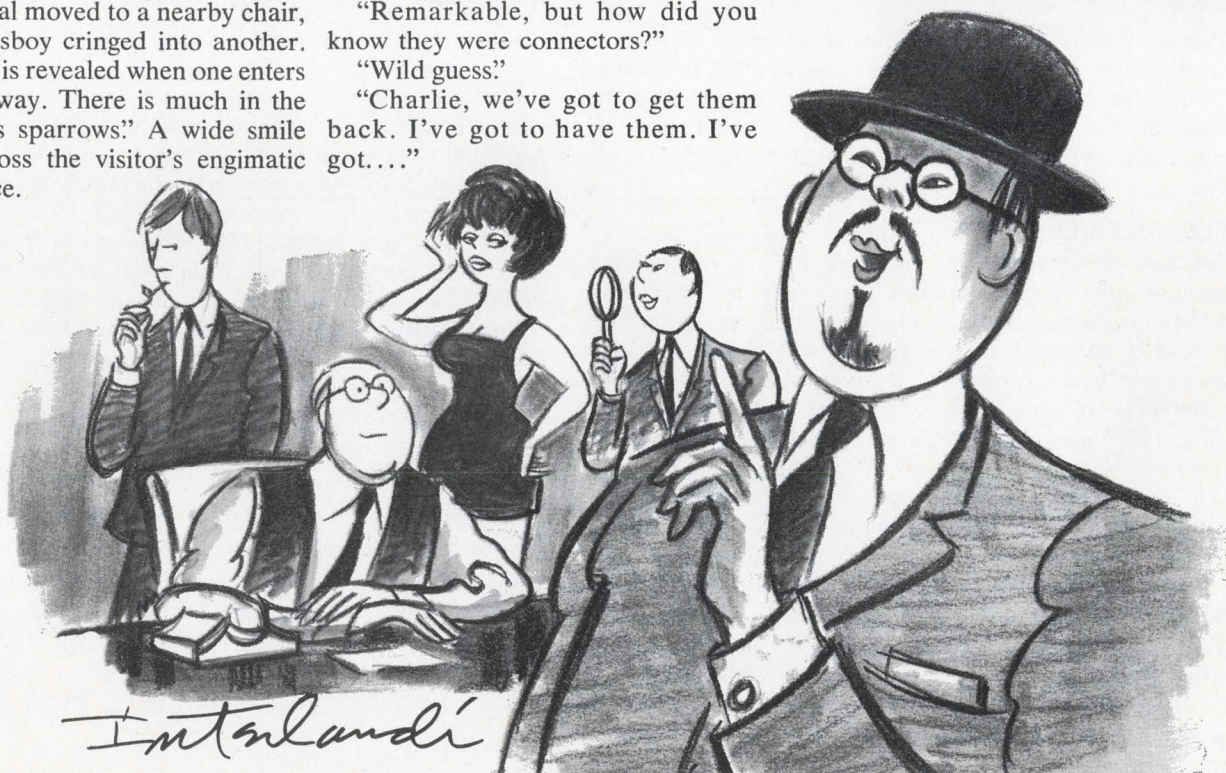

[more Connector Thing]

the Oriental's perception. How enigmatic it all was.

"Yes, that's right. Just three small pieces. Why you can assemble one in less than one-and-a-half minutes. It is capable of operating at 200° C., has a contact resistance of 4 milliohms max., and an insulation resistance of 5K megohms min."

Charlie Chum raised himself from his chair and began shuffling around the office. He went to the indoor plant, plucked a leaf, and began chewing the stuff. He smelled the picture frame by the window, scratched the desk-top with a nail, got down on the floor and listened to the carpet, then gnawed a small hole in one of the office chairs. Seeming well satisfied, he returned to his chair. He and the busboy exchanged enigmatic smiles.

"Would you ask secretary, Miss Brenda, to come into office?" Oldadt reached for the intercom. "Also would like for you to have Mr. Bart Sellital, your product manager, also come to office."

Quickly, Oldadt ordered his two employees to his office. As the two entered, Charlie Chum rose, smiled enigmatically at the busboy, and said, "Case closed."

"But what do you mean? Where's the missing connectors? Where's the Lepra/Con? And where's the Golden Crimp?"

"Please to admire beautiful young secretary's dangly earrings."

"Well I'll be!"

"Bart Sellital, did you give me some hot earrings?" Sellital looked at his feet, and Brenda burst into tears. Oldadt sat spellbound in his chair, his mouth open, still trying to put all the pieces together. At the door with his busboy, Charlie Chum turned to the astounded Group Elder Statesman and said, "It is like the cherry blossoms in spring; they are pink, but a long way from lemonade."

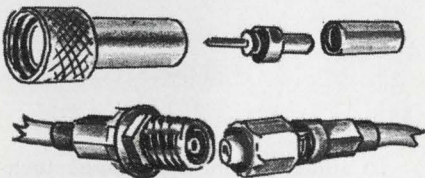

Golden Crimp and Lepra/Con are registered trade marks of Microdot Inc.



MICRODOT INC.

220 Pasadena Ave., So. Pasadena, Calif. 91030

INFORMATION RETRIEVAL NUMBER 121

ELECTRONIC DESIGN 13, June 21, 1969

Design Aids

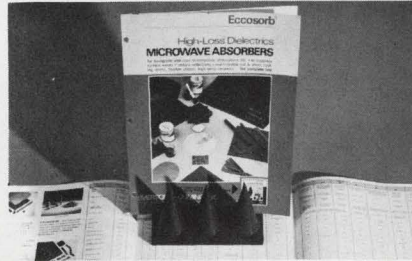

Lossy absorbers

Fully detailing properties, specifications and applications, a six-page fold-out chart covers high-loss dielectrics and electromagnetic absorbing materials. The dielectric data presented is so complete that an engineer could design and build his own free-space or transmission-line absorber for a special application. Emerson & Cuming.

CIRCLE NO. 356

Maintenance schedules

Handy printed forms provide a system for listing dial indicators with make, model, identification number, location, frequency of service, and due dates. Firms engaged in government work that requires periodic indicator inspection and service will find these forms helpful in establishing their surveillance programs. They are available, without cost, in reasonable quantities. The Gage House, Repair Dept.

CIRCLE NO. 357

Printed data forms

Offered at no charge to designers, a useful kit contains samples of a broad line of printed data forms with applications throughout industry. Over the years, these forms have been developed by a leading technical book publisher for thousands of companies. The low-cost forms feature high-quality paper with brown and blue color lithography. Perfect registering of lines insures exact carbon duplication data. Complete price schedules and ordering information are included. Addison-Wesley Publishing Co.

CIRCLE NO. 358

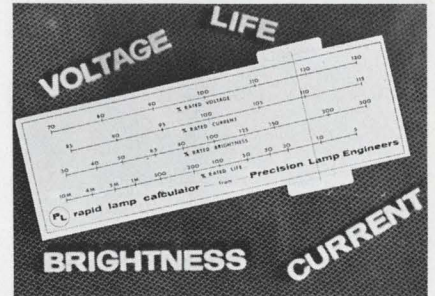

Lamp calculator

Designed to assist the engineer in his computation of the variable characteristics of tungsten filament lamps, the Rapid Lamp Calculator also gives formulas that pertain to the electrical design characteristics of all incandescent lamps. The calculator shows the changes that occur when the basic lamp characteristics of voltage, current, brightness and life are varied. For example, when voltage is decreased by 10%, life can be expected to increase in excess of 300%. Precision Lamp Engineers.

CIRCLE NO. 360

Elastometer chart

Comparing physical characteristics and relative performance of 14 types of elastomers, a fold-out chart evaluates the ratings of each elastomer with respect to physical, resistance and subjective properties. The chart is part of a 15-page guide for evaluating and specifying special rubber compounds for engineered parts. The guide assists design engineers in making preliminary evaluations of rubber compounds to determine which elastomer is best suited to a specific need. Stalwart Rubber Co.

CIRCLE NO. 359

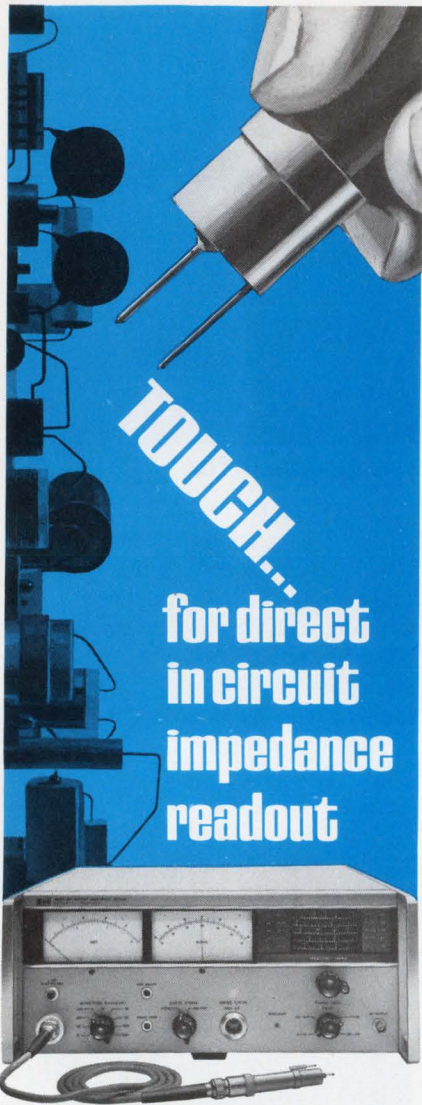

Hewlett-Packard 4815A RF Vector Impedance Meter simplifies impedance measurements. It's fast and simple. No tedious nulling and balancing, you just touch and read positive and negative impedance directly. Measure components, networks or probe right into active circuits in their normal operating environment. Application Note 86 describes many applications of the 4815A RF Vector Impedance Meter. For your copy and complete specifications, contact your local Hewlett-Packard field engineer or write: Hewlett-Packard, Green Pond Road, Rockaway, New Jersey 07866. In Europe: 1217 Meyrin-Geneva, Switzerland.

Pertinent Specifications:

- Frequency Range: 500 kHz to 108 MHz, continuous.
- Impedance Range: 1 ohm to 100,000 ohms.
- Phase Range: 0 to 360°
- Price: \$2,650.



IMPEDANCE INSTRUMENTS

1095

INFORMATION RETRIEVAL NUMBER 122

Application Notes

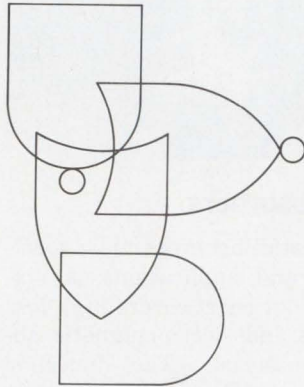

UTILOGIC II HANDBOOK Logic handbook

Revised and expanded, the new 56-page Utilogic II handbook includes detailed specifications on nine new elements, as well as chapters on loading rules, design considerations and applications. The application chapter emphasizes collector logic techniques. Interface guidelines with other logic families such as DTL, TTL and RTL are also detailed. Signetics Corp.

CIRCLE NO. 361

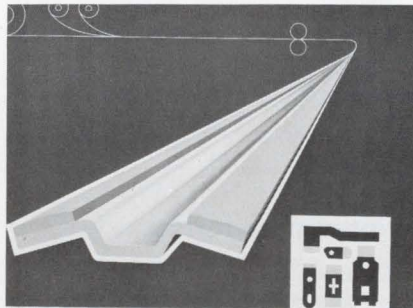

Electrical contact parts

Contact parts

A colorfully illustrated 32-page brochure on contact parts tells of advanced electrical contact applications and fabrication technologies. Complete with charts, tables and engineering data, the brochure covers contact material selection, in addition to designs and applications. Engelhard Minerals & Chemicals Corp.

CIRCLE NO. 362

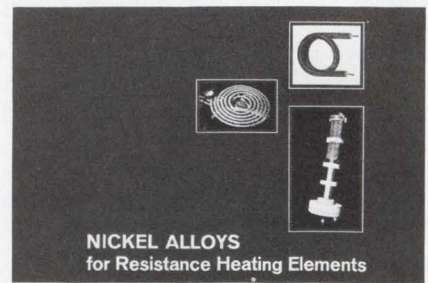

Nickel alloys

Detailing uses, as well as properties, a 65-page booklet aids in the materials selection and design of nickel alloys for resistance heating elements. The data presented includes a heating-element alloy selector guide and various processing techniques and atmospheres. Also noted are basic types of electric heating elements and sheathing material, plus factors to consider in their design for heat transfer. An appendix shows how to select materials for heating elements. The International Nickel Co.

CIRCLE NO. 363

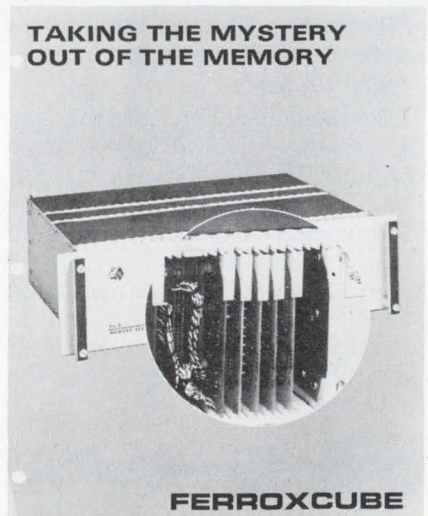

Memory data

In folder form, a six-page technical note, "Taking the Mystery Out of the Memory," provides basic electronic memory-system interface information. It includes definition of terms, in addition to common memory and digital binary mathematics. Ferroxcube Corp.

CIRCLE NO. 364

Wirewound

Because...

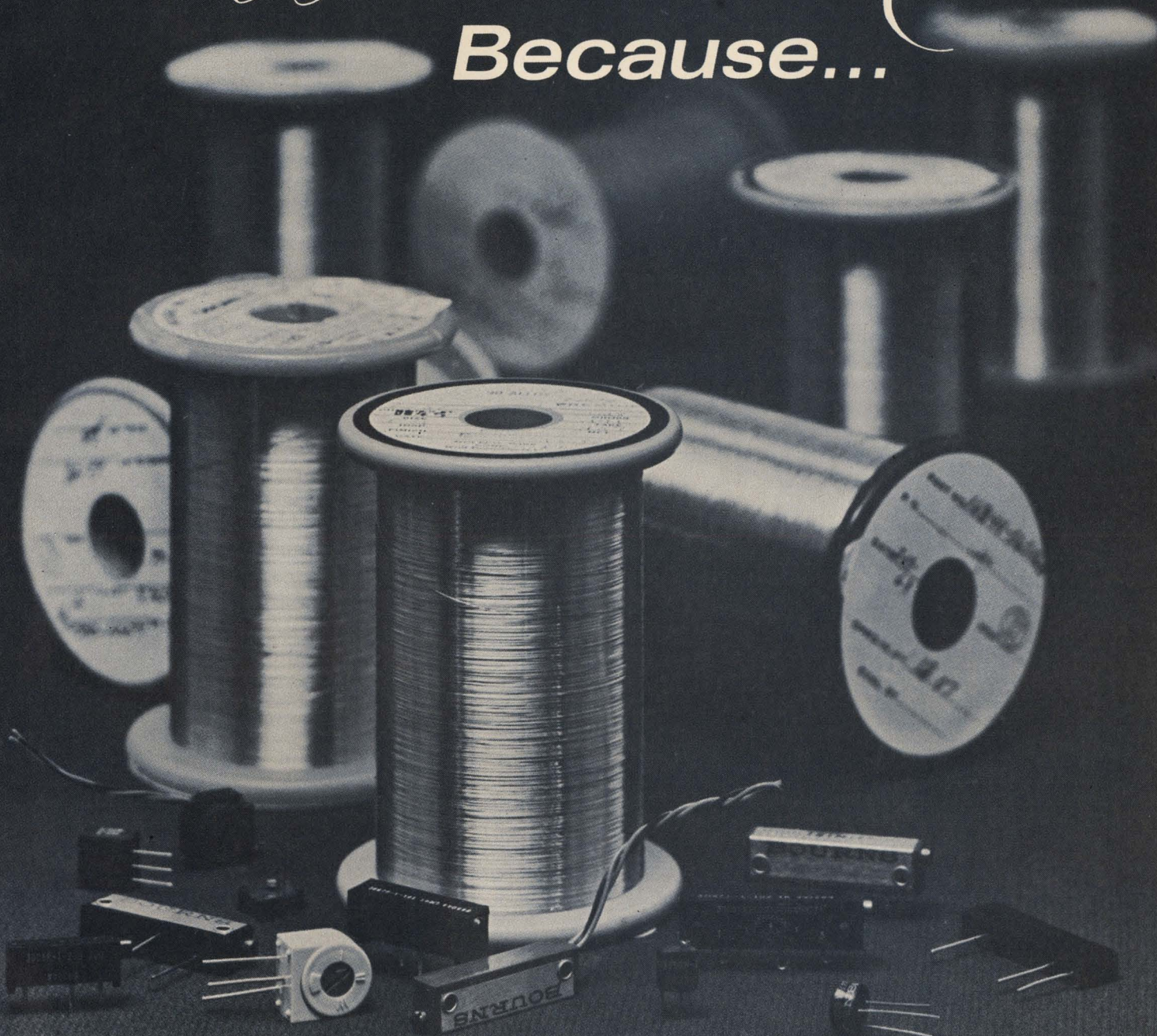

... **Because** the noise in wirewound potentiometers is low—typically 10 ohms ENR in *all* resistance ranges!

... **Because** with temperature coefficient of 50 ppm/°C or less you get exceptional stability!

... **Because** if it's power you need, wirewounds score again and surpass other elements!

... **Because** there's over 20 years of field experience with wirewounds so their reliability can be statistically verified!

... **Because** there's off-the-shelf delivery. We at Bourns stock 500,000 units at the factory while our 63 distributors stock 1,500,000 pieces. Remember . . . whether from factory or distributor stocks *you get the potentiometers you need . . . when you need them* by specifying Bourns wirewound potentiometers—the best in the industry!



A HIGHLY ACCURATE AND STABLE SWEEP MEASUREMENT SET 10 kHz to 36 MHz

THE WM-50

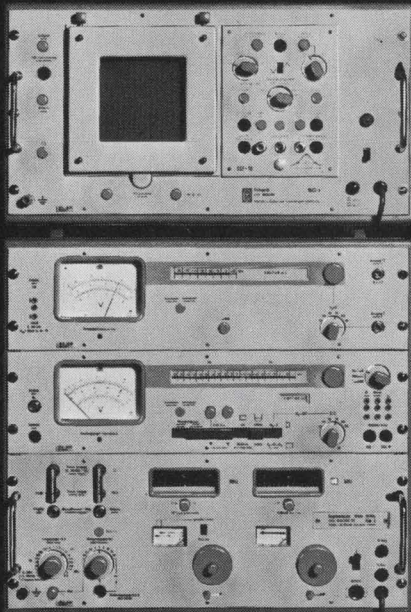

The WM-50 offers filter manufacturers a swept display to 36 MHz with a 100 dB logarithmic dynamic range (sensitivity to -130 dB) and sweep width from 35 Hz to 35 MHz. It is used by laboratories and manufacturers throughout the world where frequency dependent networks must be accurately analyzed and adjusted.

But the WM-50 is fundamentally a carefully engineered and well conceived transmission measuring set (without the display unit it is known as the PSM-5) for use on the most modern carrier communications systems. Telephone people everywhere recognize it as unsurpassed. Our philosophy is to offer only the finest transmission measuring instruments current technology allows and to back them up with comparable service.



11

Wandel & Goltermann

West Germany/represented in U.S.A. by

W & G INSTRUMENTS, INC. 6 Great Meadow Lane, Hanover, N. J. 07936 • Telephone: (201) 887-8700

APPLICATION NOTES

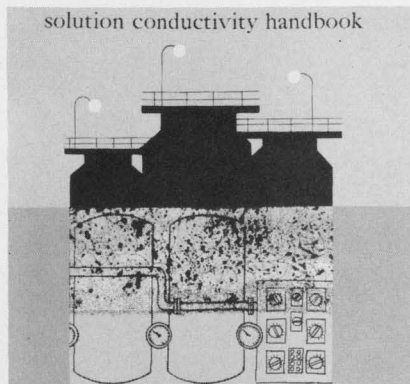

Solution conductivity

With illustrative charts, graphs and diagrams, a 26-page manual reports on the theory and industrial uses of solution-conductivity measurement. This handbook describes principles of measurement, types of equipment, installation of a conductivity system, and typical applications. It also covers the operating principles of measuring circuits, temperature compensators and meters. Beckman Instruments.

CIRCLE NO. 365

Auger spectroscopy

Besides describing the history and operation of Auger spectroscopy and its applications, a 12-page brochure details the specifications of an Auger electron spectrometer. Auger spectroscopy is a practical nondestructive technique for identifying surface atoms. It has important applications in studies of surface composition and the nature of contaminants, surface segregation, surface diffusion and surface reactions. Varian, Vacuum Div.

CIRCLE NO. 366

Shipping and handling

How to understand the shipping/handling environment is the subject of a two-page two-color publication. The presentation covers the vibration and shock phenomena associated with shipping and handling. There are graphs of transportation vibration spectra for shipboard, railroad, truck and aircraft transport. Lord Manufacturing Co.

CIRCLE NO. 367

Synchronous drives

An eight-page bulletin gives detailed instructions on how to design ceramic magnet axial gap synchronous drives for transmitting rotary motion through an air gap. Thirteen sets of design curves—relating torque to air gap—are presented for different numbers of magnetic poles on the faces of the magnetic coupling members. There is also a step-by-step design guide that solves an actual coupling design problem. Indiana General Corp., Magnet Div.

CIRCLE NO. 368

Digital fluidic control

Describing a new approach to direct digital control, a four-page article reprint discusses the benefits of fluidics. Topics include distributed computing control, implementing with fluidics, fluidic controller performance, installation and maintenance and cost considerations. Applied Fluidics Inc.

CIRCLE NO. 369

Signal stabilizer

Application Note 691 describes in detail how a signal generator can be used in conjunction with a stabilizer to generate signals with stability and purity that are normally associated with synthesizers. The frequency of a generator such as the HP8614A can be stabilized to 1 part in 10^8 per second or 1 part in 10^7 per day over a range of 1 to 2.4 GHz. Frequency Engineering Labs., a div. of Harvard Industries, Inc.

CIRCLE NO. 370

Thin-film d/a hybrids

The characteristics and uses of thin-film hybrid microcircuits for digital-to-analog applications are featured in a 14-page technical paper. In addition, data is given for tantalum-nitride and nickel-chromium resistor networks on silicon substrates for use in d/a converters. Sprague Electric Co.

CIRCLE NO. 371

**With EECO 2D
computer-automated
plug-in IC Hardware...**

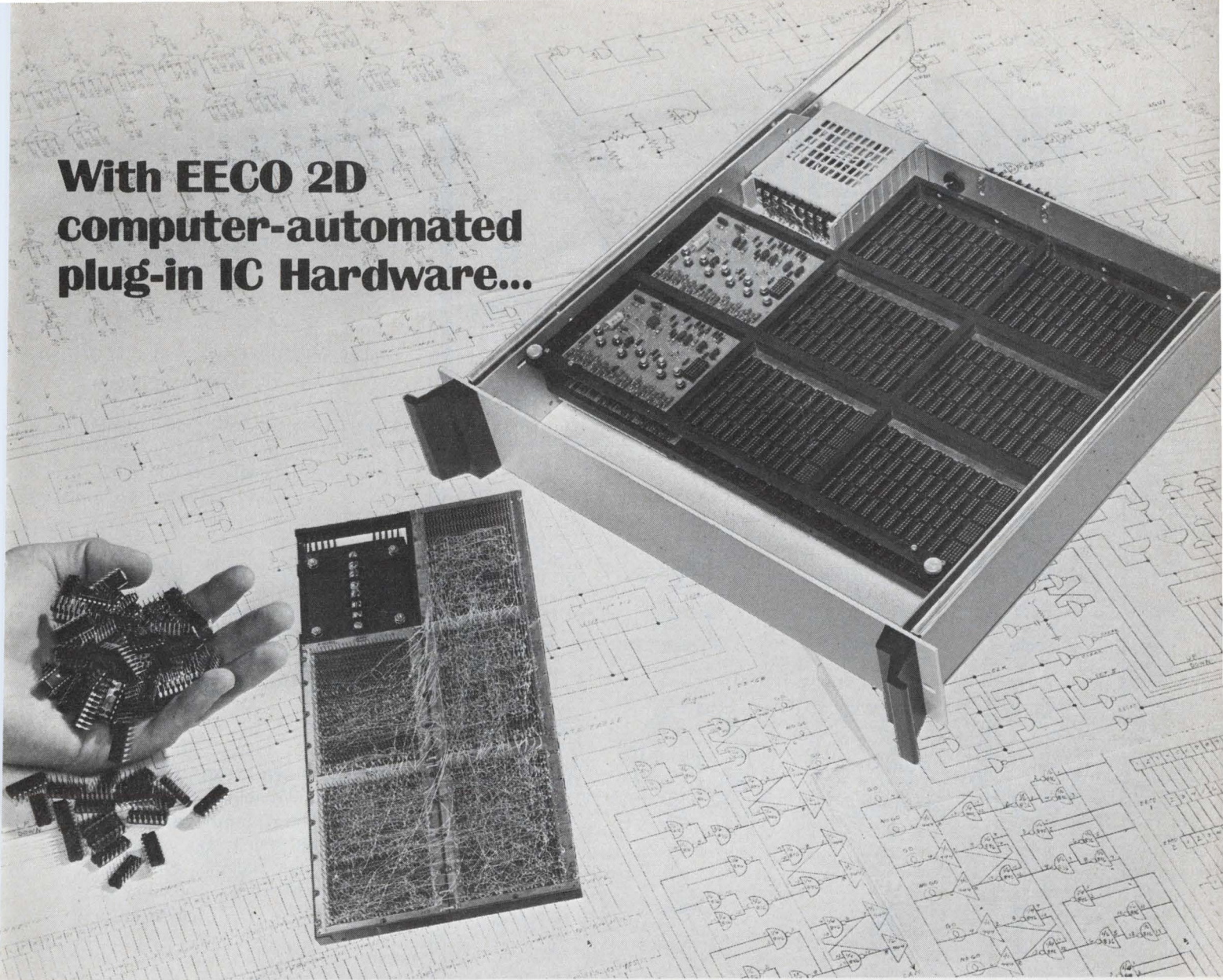

less than 30 days separate schematic and final system...

When you specify EECO 2D Hardware a computer converts your "Pin Logic List**" into a wire plan and checks for errors and omissions before wiring begins. EECO plugs in the IC's, machine Wire-Wraps the back-planes and in days...your schematic is a drawer of working electronics with all necessary computer generated support documentation.

EECO 2D Hardware System provides more than time savings...it's up to 30% more economical...and it's versatile...ready for digital or analog IC's, discrete components, MSI or LSI. It offers higher density — up to 768 IC's and a power supply fit in one 3-1/2" high standard drawer.

Your first step is simple...just phone, write or circle the reply number.

*You simply choose the module and write the signal name by each pin number. You don't worry where the wires go or the order of listing.

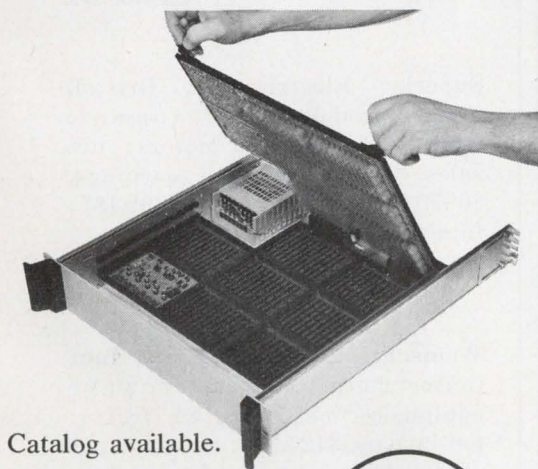

Catalog available.

See EECO 2D
at Wescon Booth
number 3814 thru 3817



ELECTRONIC PRODUCTS DIVISION

ELECTRONIC ENGINEERING COMPANY OF CALIFORNIA

1441 EAST CHESTNUT AVENUE • SANTA ANA, CALIFORNIA 92701 • (714) 547-5651

The Grayhill "Excellent 50's"

Here is an entirely new generation of miniaturized rotary switches that allows you to select your own specifications from all these options:



NUMBER OF POLES:

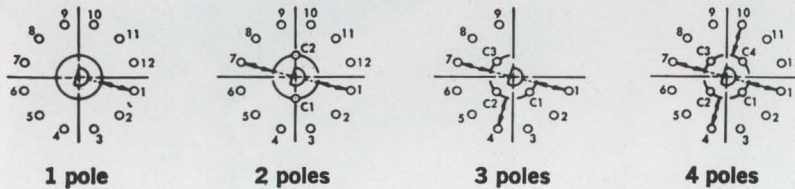

ANGLES OF THROW:

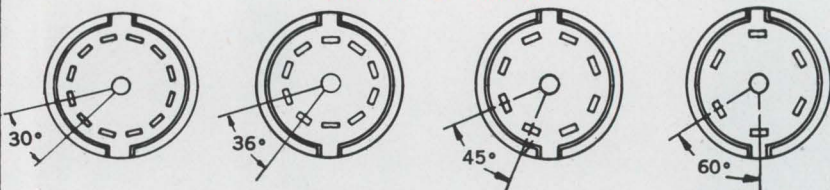

TERMINALS:

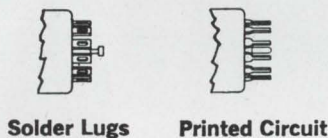

CONTACTS:

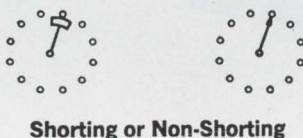

STOPS:

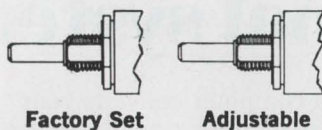

SEAL OPTIONS: Shaft and Panel

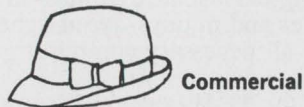
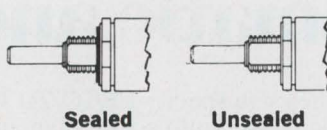

Write for "Excellent 50's" technical data — Switches are available from stock — contact your Grayhill Representative or local Distributor.



565 Hillgrove Avenue
LaGrange, Illinois 60525
Area Code 312, Phone 354-1040

... the Difference Between Excellent and Adequate

INFORMATION RETRIEVAL NUMBER 126

Annual Reports

Learn how to read annual reports in "How to investigate a company." For a copy, circle 474.

American Enka Corp., Enka, N. C.: wire and cable, rayon, nylon and polyester yarns and fibers; net sales, \$238,620,225; net income, \$19,639,153; net income per share, \$3.67; total assets, \$84,341,907.

CIRCLE NO. 372

Cramer Electronics, Inc., 320 Needham St., Newton, Mass.: components; net sales, 31,398,007; net income, \$977,219; gross income, \$7,789,384; total assets, \$13,237,126; liabilities, \$6,469,146.

CIRCLE NO. 373

Leesona Corp., 333 Strawberry Field Rd., Warwick, R. I.: plastics, coil winding, and textile machinery, batteries; net sales, \$78,940,228; net income, \$5,063,270; total current assets, \$46,835,366.

CIRCLE NO. 374

Spedcor Electronics, Inc., 70-31 84th St., Glendale, N. Y.: military equipment, test systems; net sales, \$6,685,436; net income, \$862,128; net income per share, 95¢; total current assets, \$3,360,662.

CIRCLE NO. 375

Superior Electric Co., Bristol, Conn.: production equipment, numerical controls, motors; net sales, \$19,462,940; net earnings, \$687,194; total assets, \$13,392,187; total liabilities \$2,714,978.

CIRCLE NO. 376

Weinschel Engineering Co., Inc., Gaithersburg, Md.: microwave equipment; net sales, \$4,778,726; net income, \$126,570; earnings per share, 41¢; gross profit, \$1,691,506; operating income, \$268,632.

CIRCLE NO. 377

circuit problems?

***Signalite Glow Lamps have
solved problems in these areas:***

- Voltage Regulation & References • Photo-Cell Drivers • SCR Triggering
- Timing • Photo Choppers • Oscillators • Indicator Lights • Counters
- Voltage Dividers • Surge Protectors • Logic Circuits • Flip-Flops
- Memory • Switching • Digital Readouts

Signalite glow lamps combine long life, close tolerance and economy, and are manufactured with a broad range of characteristics to meet individual application requirements. For a creative approach to your design problem . . . contact Signalite's Application Engineering Department.



ULTRA HIGH LEAKAGE RESISTANCE. Devices with leakage resistance in excess of 10^{12} ohms are available for circuits requiring this property. Such applications would include sample and hold for A to D conversion, and capacitor memory systems.

SEE Signalite Application News for TYPICAL APPLICATIONS



PHOTO-CELL APPLICATIONS

The A074 and A083 have been designed for use with Cadmium Sulfide or Cadmium Selenide photocells. Applications include photo choppers, modulators, demodulators, low noise switching devices, isolated overload protector circuits, etc. Speed of operation is limited only by the photo-cells.

SEE Signalite Application News for TYPICAL APPLICATIONS

SIGNALITE APPLICATION NEWS



is used to communicate new and proven techniques and applications of Signalite's neon lamps and gas discharge tubes. Signalite Application News provides a forum for an exchange of ideas to keep the design engineer aware of the versatility of neon lamps and their many applications. Copies are available from your Signalite representative or by contacting Signalite. INFORMATION RETRIEVAL NUMBER 191



VOLTAGE REGULATORS BETTER THAN 1% ACCURACY These subminiature voltage regulators are used in regulated power supplies, as reference sources, photomultiplier regulators, oscilloscopes calibrators, etc. They are available in voltages from 82 to 143 V. They are used in multiples as regulators in KV ranges.

See Signalite Application News for TYPICAL APPLICATIONS.



NEON TIMERS The bi-stable characteristics and high leakage resistance of Signalite's special glow lamps make them ideal as a component for timing circuits. The basic circuit resembles a relaxation oscillator network.

SEE Signalite Application News for TYPICAL APPLICATIONS

Signalite

INCORPORATED
NEPTUNE, NEW JERSEY 07753
(201) 775-2490



A General Instrument Company

313

New Literature

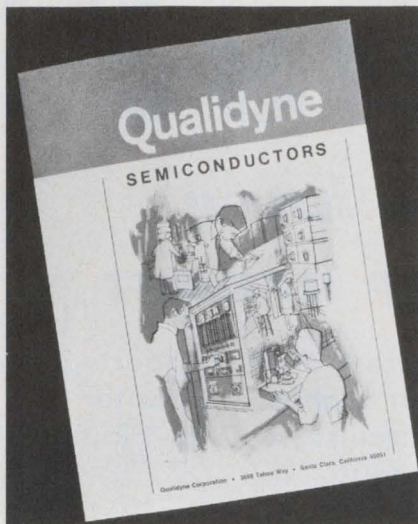

Monolithic amplifiers

Dubbed a "Semiconductor Fact-Pac," a new literature package contains useful data for designers and component specifiers involved with instrumentation, computer and microwave systems. Comprehensive specifications are given for dual transistor families and sense amplifiers, both single- and dual-input units. Included are dimensional data, ratings, and matching, small-signal, and electrical characteristics. Qualidyne Corp.

CIRCLE NO. 378

Vibration control

An updated index to a library on vibration shock and noise control is now available. The index lists 39 published articles and technical papers that are supplied in reprint form. Each entry includes a brief resume of the subject covered. Lord Manufacturing Co.

CIRCLE NO. 379

Op-amp guide

In folder form, a specification guide provides basic information on a line of military and commercial integrated circuit operational amplifiers. National Semiconductor Corp.

CIRCLE NO. 380

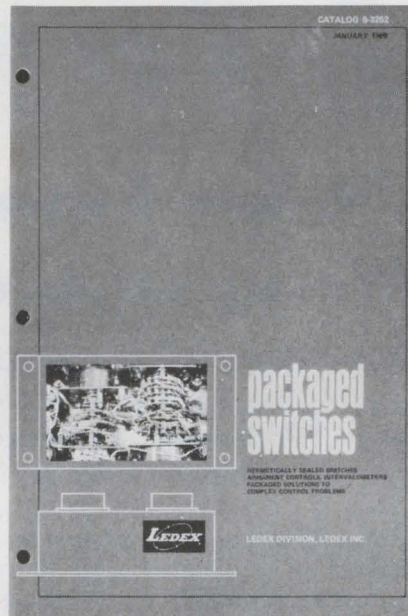

Packaged switches

Comprising 25 pages, a new switch catalog discusses the major reasons why engineers specify hermetically sealed switches and shows how to apply them with schematics of basic control circuits. Also described is a simplified building-block approach for ordering custom made hermetically sealed switches and examples of special switches designed as solutions to complex control problems in armament and aircraft switching. Ledex Inc.

CIRCLE NO. 381

Motor catalog

An enlarged, 16-page motor catalog has been completely revised for easier use. It incorporates the latest information on new SCR adjustable speed/torque drive systems. Data on over 325 stock motors, gearmotors, and dc motor speed controls are given. Motors listed range in horsepower from 1/2000 to 1/4, while parallel-shaft and right-angle gearmotors are available with torques ranging from 2.9 oz-in. to 340 lb-in. Speeds range from 10,000 to 0.7 rpm. Bodine Electric Co.

CIRCLE NO. 382



Photometric instruments

Introducing several new products, a new 24-page catalog itemizes a complete line of light measuring instruments. The new instruments include a picophotometer, a digital picoammeter, and a selection of amplifiers for use with photomultiplier tubes. Pacific Photometric Instruments.

CIRCLE NO. 383

Delay line handbook

Opening with a definition of characteristics, a 12-page engineering handbook discusses lumped constant, distributed constant and variable delay lines. Also included is engineering information on how delay lines should be specified, as well as designs and standard industry test circuitry and complete specifications for six standard types of delay lines. RCL Electronics, Inc.

CIRCLE NO. 384

Template catalog

Containing photographs and descriptions of 127 templates, an 18-page catalog covers a complete line of these design aids. Template types include electrical/electronic, mechanical engineering, lettering, architectural and layout, processing, and miscellaneous symbols and figures. RapiDesign, Inc.

CIRCLE NO. 385

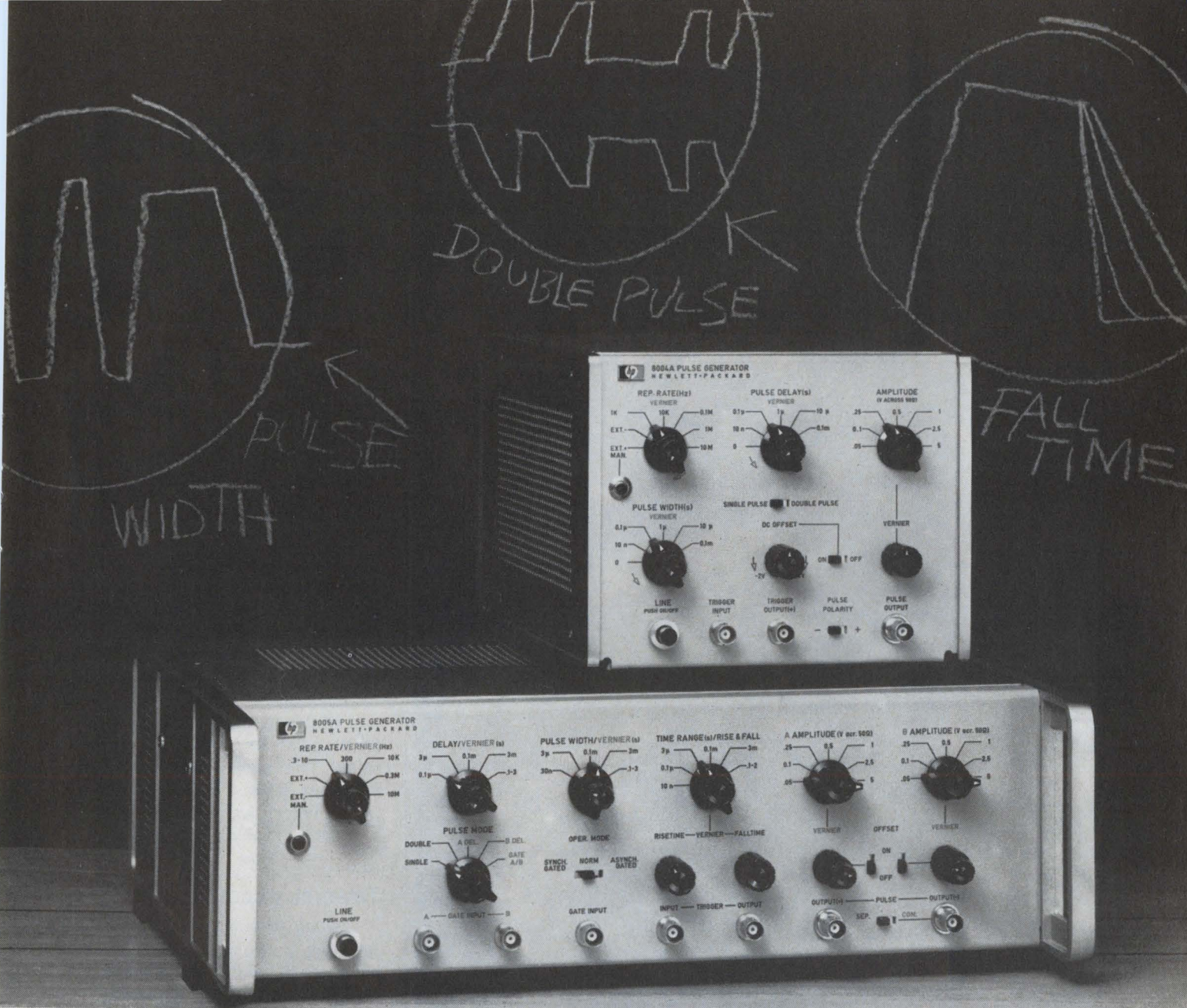

Sculpt a test Waveform

Now you can control pulse shape four ways (rise time, fall time, width, and repetition rate) with these new HP pulse generators.

For maximum control, the 8005A gives you dual outputs — either positive or negative — with variable rise and fall times from 10 nsec to 2 sec, continuous attenuation of each pulse, pulse repetition from 0.3 Hz to 10 MHz, pulse width from 30 nsec to 3 sec, and 100 nsec to 3 sec delay with respect to the trigger output.

If you don't need all that versatility — just an extremely fast rise/fall time — then the 8004A is your instrument. It'll give a variety of pulse shapes with 100 Hz to 10 MHz rep rate. Pulse width is vari-

able from 0 to 1 msec in six ranges, with vernier adjustment.

Both instruments offer high linearity, versatile gating, adjustable dc offset, double-pulse mode for stimulating logic and memory circuits, and a price as low as performance is high. \$1050 for the 8005A, \$720 for the 8004A.

Call your local HP field engineer for a detailed set of specs. Or write Hewlett-Packard, Palo Alto, California 94304; Europe: 1217 Meyrin-Geneva, Switzerland.



PULSE GENERATOR SYSTEMS

INFORMATION RETRIEVAL NUMBER 130

Look what just blew in.

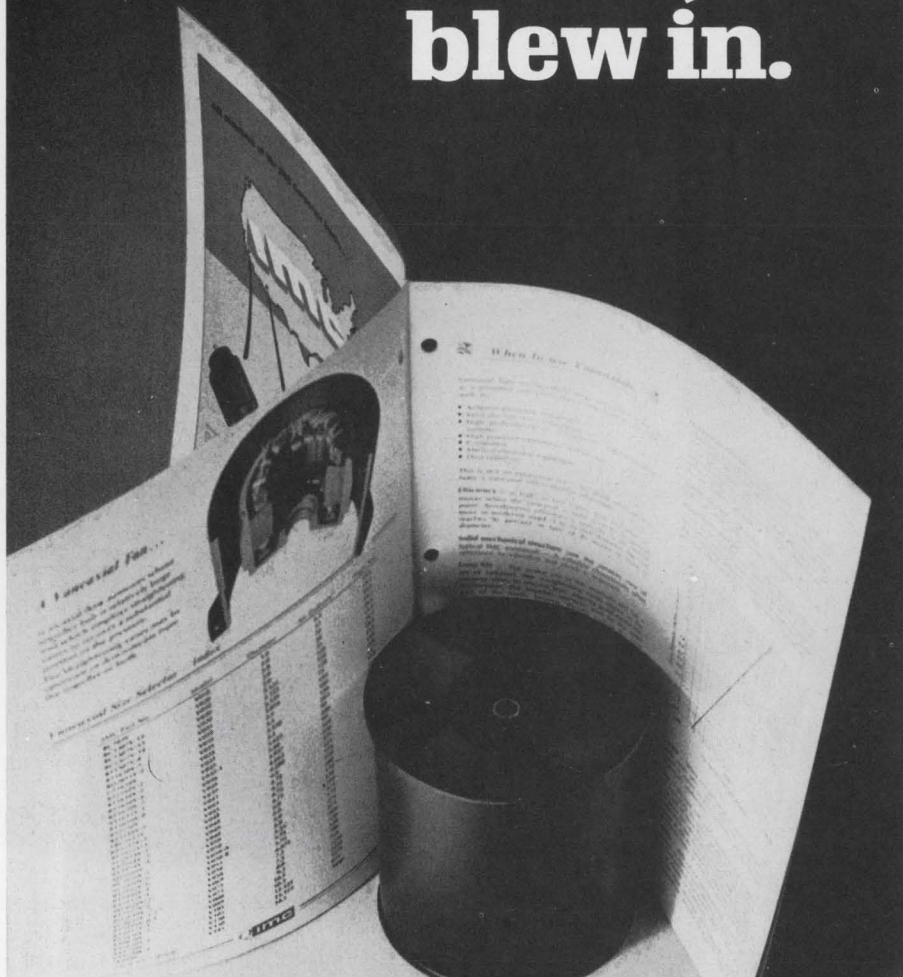

IMC's newest vaneaxial catalog

Prepared especially for designers who need information on vaneaxials, the most efficient and sophisticated of all airmovers. Versatile in application—for cooling electronic enclosures, ECM, klystrons, high-power tubes, and also for inflating shelters, dispensing chaff, refrigeration equipment, dust precipitators, and many others.

The 32-page catalog presents 40 different vaneaxial airmovers ranging in size from one to 15 inches in diameter, from 6.5 to 3450 cfm in output. Ample technical notes precede the detailed presentation of performance parameters, dimensions, and other specifications.

 **IMC** IMC Magnetics Corp., Eastern Division, 570 Main St., Westbury, N.Y. 11591, (516) 334-7070, TWX 510-222-4469.

INFORMATION RETRIEVAL NUMBER 132

NEW LITERATURE



Instrument knobs

A complete line of standard off-the-shelf instrument and control knobs, including 35 new designs, are described in a 20-page catalog. Intended for designers and knob specifiers in electronics, appliances and other OEM fields, the catalog lists hundreds of knobs, dials and assemblies available from stock for commercial and military applications. The knobs come in a wide range of sizes, from 1/2 to 3 in. in diameter. Kurz-Kasch, Inc.

CIRCLE NO. 386

Telemetry components

Listing specifications and characteristics, a 12-page catalog on telemetry components and modules includes amplifiers, multicouplers, filters, converters and multipliers. Described are eight telemetry amplifiers for L- and S-band operation with gain characteristics of 18 to 27 dB. Besides individual or ganged multicouplers, the catalog covers both bandpass and band-reject filters. Applied Research Inc.

CIRCLE NO. 387

MIC microstrip

A 4-page brochure describes a complete line of metalized substrates and circuits for MIC microstrip applications. It gives valuable information to aid microwave design engineers in the selection of substrate material, thickness, metalization and finish. Technical data includes line width vs impedance, wave length vs frequency, and loss data. Tek-wave, Inc.

CIRCLE NO. 388

How AO fiber optic light guides solve illumination problems.

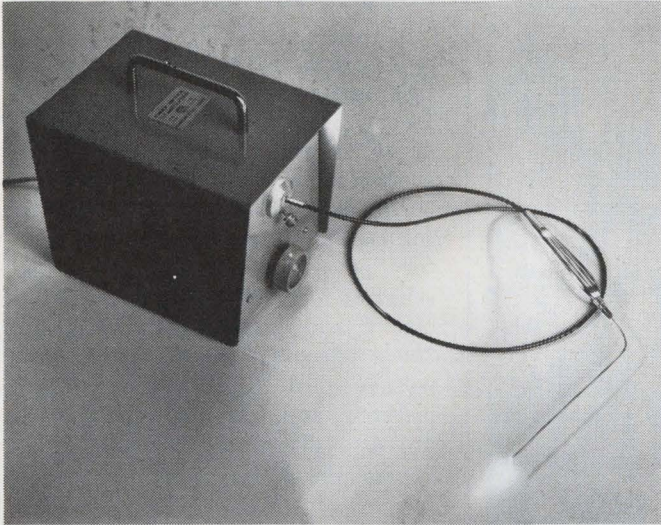

Transmit "cold" light like other forms of energy—by flexible routing to remote or inaccessible locations, hazardous areas, or any abnormal environment.

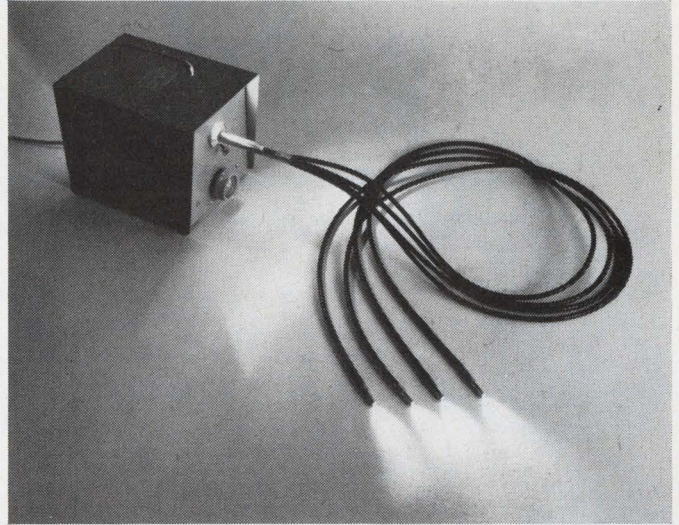

Supply multiple illumination from a single light source, with multi-branched light guides.

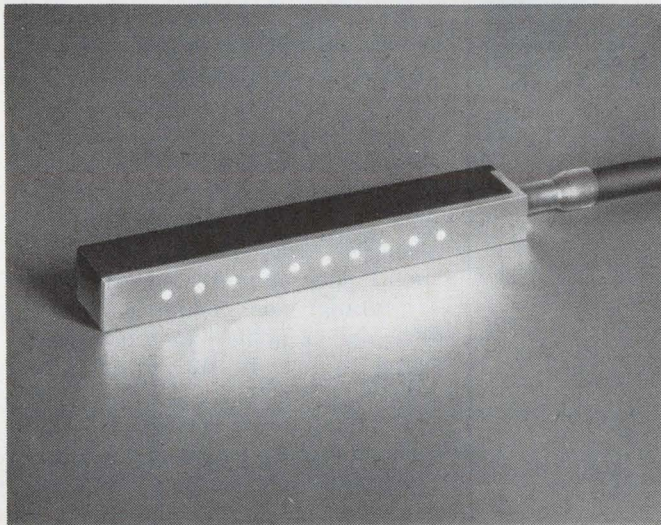

Simplify lighting problems by eliminating lens systems, multiple lamps, complex electrical circuitry.

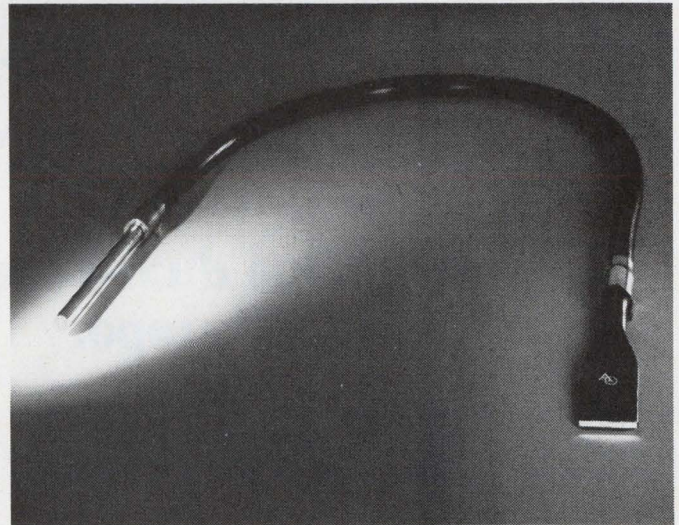

Provide input-output geometry conversions such as round-to-square, round-to-slit, etc.

These are only a few of the ways in which American Optical fiber optic light guides are used to help solve illumination problems. Specific applications range from mark sense readout to electro-optical sensing in data processing, circuit verification, fire control, null detection, light pens, spot illumination, and many others.

Simple, reliable, economical. AO fiber optic light guides are simple, passive elements which remain extremely reliable under normal vibration, temperature or humidity changes, or other environmental fluctuations. This results in long service life with minimum maintenance.

Standard and custom light guides from American Optical have light transmission ranges from 400 to 1500 millimicrons. Standard light guides are

available in bundle sizes from .020" to 1/4", with 30 to 6000 fibers, lengths up to 72", plastic or stainless steel tips, and PVC sheaths. Custom light guides can be supplied in any length desired, with special end tips, sheaths, diameters, input-output face configurations, and branchings.

A leader in optics since 1833, American Optical Company brings a great breadth of related experience to the technology of fiber optics. Our versatility in fiber optics is unmatched by any other manufacturer. In fact, AO scientists already hold more than 200 important patents or patents pending in this relatively new field.

For Fiber Optics Data Kit, write to:

 **AMERICAN OPTICAL CORPORATION**

FIBER OPTICS • SOUTHBRIDGE, MASSACHUSETTS 01550

©TM Registered by American Optical Corporation

Power instruments

All-silicon convection-cooled power instruments for laboratory and test purposes are the subject of a 16-page catalog. Besides performance features, there are detailed specifications and prices for over 50 models of power instruments for rack or bench use. The laboratory power supplies offer a wide selection of voltage outputs up to 500 V and current outputs up to 300 A. Accessories, including over-voltage protectors, chassis slides, metered and non-metered panels, are also described. Lambda Electronics Corp.

CIRCLE NO. 389

Metal tubing guide

Analyzing almost 100 tubing types and their characteristics, a 16-page guide reports on available size ranges for small-diameter cold-drawn tubing, as well as recommended applications. This illustrated bulletin includes information about carbon and alloy steel tubing, stainless steel tubing, nickel and nickel alloy tubing, nickel-iron alloy tubing, glass-sealing alloy tubing, and reactive and refractive metal tubing. It also covers such points as size limits, seamless tubing, standard commercial tolerances, tubing lengths, straightness tolerances and tempers. Superior Tube Co.

CIRCLE NO. 390

Thermistor components

A new eight-page catalog describes in detail the characteristics of precision thermistors and linear output thermistor components. These thermistors offer true interchangeability over a wide temperature range. A convenient chart allows the designer to compare resistance of all thermistors at any temperature. Linear output thermistor components are described in detail. Necessary data to design for linear voltage or linear resistance versus temperature are included with examples of each. Yellow Springs Instrument Co., Inc.

CIRCLE NO. 391

CUT CONSTRUCTION DELAY

with pre-punched
VECTORBORD,*
PLUGBORDS and
Push-in TERMINALS

Make circuits the fast, easy way . . . simply insert Vector push-in terminals (wide variety available) and component wires into pre-punched Vectorbord, or use punched copper clad for do-it-yourself etching; and, for production, we're geared to omit the holes not required and assemble terminals, eyelets, etc. to your specifications. Eleven patterns available with .025", .040", .062", .093" holes in XXXP phenolic, glass silicone, glass or paper epoxy and copper clad. Plugboards supplied in many sizes with etched pads, .040" dia. Edge-Pins or Elco Varicon* contacts.

Save time — Save work — Save money!

° TRADE MARK

Send for complete literature



Vector ELECTRONIC COMPANY, INC.
12460 Gladstone Ave., Sylmar, Calif. 91342

INFORMATION RETRIEVAL NUMBER 135

New, true dual-beam oscilloscope.**And only \$995***

True dual-beam, portable oscilloscope features line or battery operation. Choice of 15 or 30 MHz bandwidth plug-in Y-amplifiers (23 and 12 nsec rise times).** Solid state unit provides differential input, internal voltage calibrator, and both signal and time delay.

For complete data, write for Bulletin TIC 3318A to Motorola Communications & Electronics Inc., 4501 W. Augusta Blvd., Chicago, Ill. 60651.

*Exclusive of options. **15 MHz amplifier, \$395; 30 MHz amplifier, \$595.



MOTOROLA
Precision Instrument Products

INFORMATION RETRIEVAL NUMBER 134

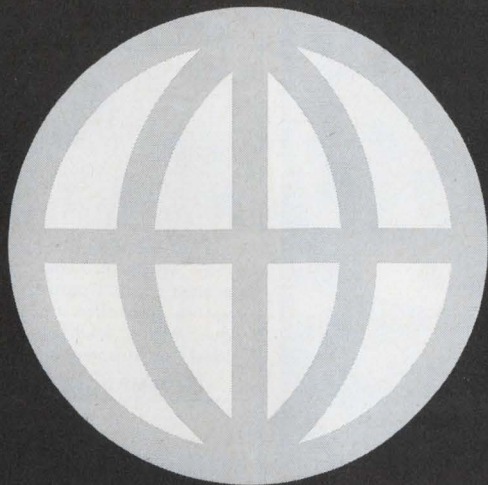

IEC...
a world of ideas

like:

IEC's MX 500 low level, high speed analog multiplexer

- 50,000 samples per second
- 5 mv full scale sensitivity
- about sixty dollars per channel (in a 300 channel system)
- no external amplifiers required.

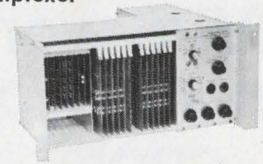

For full information call or write John Norburg,



INTERSTATE ELECTRONICS CORPORATION

707 East Vermont Avenue, P.O. Box 3117,
Anaheim, California 92803 (714) 772-2811

A Subsidiary of
"Automatic" Sprinkler Corporation of America

INFORMATION RETRIEVAL NUMBER 136

80 MHz WIDEBAND RF POWER AMPLIFIER



MODEL RF-805

- 10 Watts Output into 50Ω
- 0.1 Volts In — 22.5 Volts Out
- .05 MHz to 80 MHz Broadband
- Low Distortion
- Solid State
- Flat 47 db Gain

The RF-805 is a solid state amplifier, broadband from .05 to 80 megahertz, which produces ten watts with -30 db harmonic and intermodulation distortion. Lower distortion is available at lower output levels. Gain is 47 db minimum, constant within 1 db, so that full output is developed with less than 0.1 volt at the 50 ohm input. Accurate output metering and overload protection is provided.

The RF-805 will raise the power of most manual and swept tuned signal generators and thus extend the usefulness and versatility of available signal generators. Receiver testing, wattmeter calibration, antenna testing, RFI testing, attenuator measurements, and filter and component testing will be aided with the use of this equipment.

rf R F COMMUNICATIONS, INC.
1680 University Avenue • Rochester, N. Y. 14610

Minelco's BITE is right!

MI70

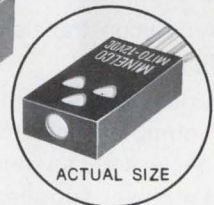

It's the reliable miniature "BITE"* indicator

Where miniaturization and high reliability are the basic criteria, depend on *Minelco's new MI70 BITE Indicator*. Fits all requirements and concepts of modular packaging... meets latest requirements of MIL-E-5400 ... recommended for avionics systems and other uses.

The Minelco MI70 also offers versatility in packaging, through a variety of different electrical configurations, and a dual view visual indication. Either internal switching or isolated signal switching can be provided.

Write for specifications and additional information on MI70 and other Minelco miniature electronic components.

*Built in test equipment

MINELCO

600 SOUTH STREET, HOLBROOK, MASS. 02343 • (617) 963-7717

INFORMATION RETRIEVAL NUMBER 137

ELECTRONIC DESIGN 13, June 21, 1969

INFORMATION RETRIEVAL NUMBER 138

199

FLUKE

If the
Fluke 410B
HVPS won't
do your job,
cool it.
Fluke's
got one
that will!

Designed to meet the most exacting DC power supply requirements, the Fluke 410B is an extremely well regulated, high gain, low noise instrument. Features include:

- Output, 0 to 10,000 volts at 0 to 10 ma
- Adjustable overcurrent trip
- 0.001% regulation
- 5 mv resolution
- All silicon transistor amplifiers
- Modestly priced at \$975.

For complete information on the Fluke 410B as well as other Fluke power supplies, please address Fluke, P.O. Box 7428, Seattle, Washington 98133. Phone 206-774-2211. TWX 910-449-2850. Cable: FLUKE.

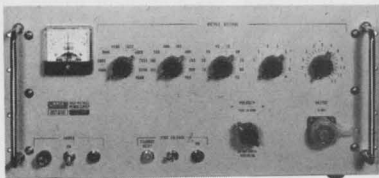

FLUKE

INFORMATION RETRIEVAL NUMBER 139

NEW LITERATURE

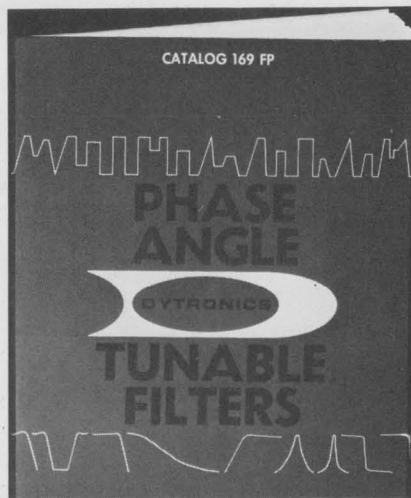

Phase-angle devices

Suggested applications, descriptions and specifications are presented for phase-angle devices and tunable filters in a 36-page catalog. Shown are phase-angle standards that cover frequencies from 0.1 Hz to 500 kHz, phase-sensitive voltmeters operating from 10 Hz to 100 kHz, and phase-angle meter/shifters with accuracies as high as 0.1°. The tunable filters offer tuning range limits of 0.1 Hz and 400 kHz. Dytronics Co., Inc., Instrument Div.

CIRCLE NO. 392



Delay lines plus

Precision delay lines, LC filters and passive laboratory instruments are detailed in a 12-page brochure. A wide variety of custom-built and stock delay lines and filters are covered with descriptions, specifications and charts. Also included is a new miniature fixed delay line that features a very high delay-to-risetime ratio. Allen Avionics, Inc.

CIRCLE NO. 393

EMBEDDED MODULE LIGHT ENOUGH TO FLOAT WITHSTANDS 50,000 G's

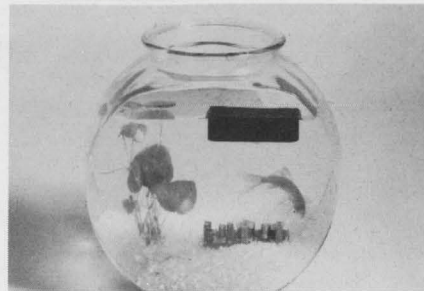

STYCAST® 1090 is a lightweight encapsulating resin which provides outstanding protection against shock. Cured sp. g. is 0.85 (see photo), yet an embedded transmitter fired from a 5" gun into a lead block remained operative. Ideal for airborne and space modules.

INFORMATION RETRIEVAL NUMBER 195

LIGHTWEIGHT FOAM POWDER FOR HIGH DENSITY MODULES

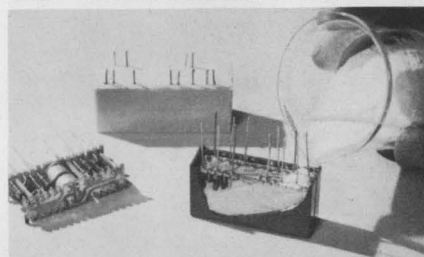

ECCOFOAM® EFF-14 is a fine-grain epoxy powder which vibrates into a cavity and cures at 175°F to a rigid, protective foam with 14 lb/cu ft density and compressive strength above 100 psi. It fills all voids and exerts no pressure on components. Non-burning per ASTM D-1692.

INFORMATION RETRIEVAL NUMBER 196

LOW DENSITY CASTABLE RTV SILICONE

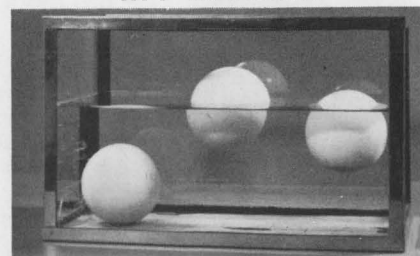

ECCOSIL® 4659 is a castable RTV silicone that cures to a resilient foam with less than half the density of conventional silicones. Photo shows buoyancy comparison of Eccosil 4659 (center) with other silicone foam (R) and conventional silicone (L). Recommended for encapsulation of delicate electronic assemblies.

INFORMATION RETRIEVAL NUMBER 197

Emerson & Cuming, Inc.



CANTON, MASS.
GARDENA, CALIF.
NORTHBROOK, ILL.
Sales Offices
in Principal Cities

EMERSON & CUMING EUROPE N.V., Oevel, Belgium

Superimposed Noise Problems Solved!

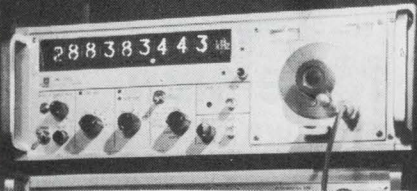

-TR-5589L 250MHz Universal Counter

This counter employs a unique **ANS Circuit** (Automatic Noise Suppressor...patent pending) in its input circuit. If a large signal to be measured and superimposed noises are fed to a counter, the counter may count both the signal and noise since the trigger threshold level is extremely narrow.

The **ANS** solved the noise problems by keeping the input signal level constant at all times regardless of the magnitude of the input, thereby maintaining the trigger threshold level at the optimum value.

When considered from the input side, the trigger threshold level will increase when a large signal is received, or, decrease when a small signal is received. These operation reduces the error due to noise mixed in the input signal. Since the counter has an input sensitivity of 10mV rms, frequency measurement of an extremely low voltage signal is possible, and measurement of 100V rms signal is also possible with the single range without the use of an attenuator because of the 80dB dynamic range.

FREQUENCY RANGE—Counts directly up to 250 MHz in decimal, up to 500 MHz with prescaler plug-in unit, covers 10Hz to **12.5 GHz** with frequency converter plug-in unit.

HIGH STABILITY—Long term stability **5 parts in 10¹⁰** per day.

HIGH SENSITIVITY—10mV to 100V rms in a single range...wide dynamic range...80dB.

DISPLAY—9-digit storage display.

BCD OUTPUT—8-4-2-1 code output.

PLUG-IN VERSATILITY—8 plugin units increase the counter's versatility as required.

Universal Counter, Digital Voltmeter, Digital Integrator, Electrometer, Frequency Counter, Frequency Synthesizer, Frequency Standard, Data Acquisition System, Operational Amplifier.



Takeda Riken Industry Co., Ltd.

1-32-1, Asahi-cho, Nerima-ku, Tokyo, 176, Japan. Tel: Tokyo 930-4111 Telegramme: TRITRONICS TOKYO
Agents:
Lifton Precision Products International Inc.—(West Germany, France, Belgium, Switzerland, England)
Ing. S & Dr. Guido Bellotti Ltd.—(Italy) Nores & Co.—(Finland)
Ingenjorsfirma Carl-Eric Larsson AB—(Sweden)
Semco Semlar & Co.—(Denmark)



PC connectors

Covering printed card and tape cable applications, an 80-page catalog gives details on microminiature, miniature and standard printed-circuit connectors, plus an entire group of test point connectors for printed circuitry. The receptacle-type units are made in a variety of single and dual readouts with sizes from 3 to 210 contact terminations; the test point connectors are available in various sizes from 4 to 63 contacts. Complete electrical and mechanical specifications, outline drawings and ordering information are given. Continental Connector Corp.

CIRCLE NO. 394

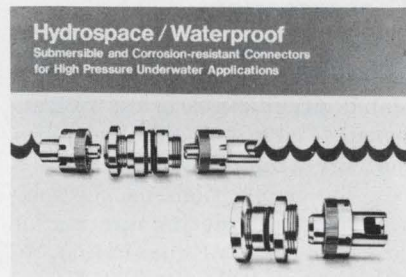

Connector data

An updated catalog reviews hydrospace and waterproof connectors. The hydrospace connectors are resistant to salt-water corrosion and will withstand pressures up to 10,000 psi. They are designed to MIL-C-24217, MIL-C-22249, and MIL-C-22539. The waterproof connectors are for underwater, underground, and outdoor applications requiring sealing against moisture. ITT Cannon Electric, a div. of International Telephone and Telegraph Corp.

CIRCLE NO. 395

FLUKE

If the Fluke 412B HVPS won't do your job, relax. Fluke's got one that will!

Here's a high voltage power supply using silicon transistor amplifiers and series pass tubes to give you a solid 0 to 2100 volt, 30 ma output. As in every Fluke precision power supply, you get the user oriented benefits of design and high performance synonymous with the Fluke name on the front panel including:

- Overcurrent protection
- 1 mv peak-to-peak ripple
- 0.001% regulation
- 5 mv resolution
- 3½" panel height
- Economically priced at \$410.

For complete information on the Fluke 412B as well as other Fluke power supplies, please address Fluke, P.O. Box 7428, Seattle, Washington 98133. Phone 206-774-2211. TWX 910-449-2850. Cable: FLUKE.



FLUKE

INFORMATION RETRIEVAL NUMBER 142

FLUKE

**If the
Fluke 415B
HVPS won't
do your job,
rest easy.
Fluke's
got one
that will!**

The Fluke 415B combines the high reliability of silicon transistor amplifiers with the high voltage capability of series pass tubes to provide a conservatively rated 0 to 3100 volt, 30 ma power supply. Other features include:

- Overcurrent protection
- 100 μ v RMS ripple (1 mv peak to peak)
- 0.0005% regulation
- 5 mv resolution
- 3½" panel height
- priced at only \$525

For complete information on the Fluke 415B as well as other Fluke power supplies, please address Fluke, P.O. Box 7428, Seattle, Washington 98133. Phone 206-774-2211. TWX 910-449-2850. Cable: FLUKE.



FLUKE

INFORMATION RETRIEVAL NUMBER 143

NEW LITERATURE

Photoelectric controls

A 36-page catalog listing 284 pre-engineered photocontrols includes a wide selection of application diagrams. Presented are illustrations, specifications and prices for retro-reflective, specular reflective, fiber-optic, on/off and timing photocontrols. Also shown are high-intensity, dual-filament, adjustable-focus, and miniature and subminiature light sources. Autotron Inc.

CIRCLE NO. 396

Powder metallurgy

Listing current literature available on basic and applied powder metallurgy technology, a 30-page brochure also describes standards, data sheets, directories, bibliographies, manuals, conference proceedings and technical books published or distributed by the Metal Powder Industries Federation and American Powder Metallurgy Institute. In addition, there are directories of parts fabricators and equipment suppliers. Metal Powder Industries Federation.

CIRCLE NO. 397

IC accessories

Three condensed catalogs cover a diversified line of Cambion integrated circuit accessories, TTL integrated circuit logic assemblies, and wire-wrap packaging and services. The publications include specifications and ordering information for high-density dual-in-line IC sockets, circuit boards, card files, power planes, flatpack holders, card connectors and IC patch-cord kits. Cambridge Thermionic Corp.

CIRCLE NO. 398

MICs and transistors

A four-page bulletin gives details on recently developed S-band microwave transistors. In addition, a 12-page brochure tells of an extensive line of thin-film microwave integrated circuit products. Avantech, Inc.

CIRCLE NO. 399



Mite-size miniature 7/16" indicator

These tiny indicators are compact, rugged, versatile and easy to read. They feature a microminiature moving coil core magnet read mechanism. A1-21 Indicators operate in -55°C to $+85^{\circ}\text{C}$ environments and are sealed against dirt and dust. Choice of pointer or flag display in a wide variety of electrical sensitivities and functions. Size: 7/16" in diameter, 31/32" in length. Weight: 11.5 grams. Write today for complete information.

AMMON

AMMON INSTRUMENTS, INC.
345 Kelley Street, Manchester, N.H. 03105

INFORMATION RETRIEVAL NUMBER 144

Looking for a great vacation?

You don't have to look very far.

America with all its natural and man-made marvels is right in your own backyard.

You'll find everything from historical monuments, mile-high mountains, sand-duned deserts, bustling cities—and more. The natives, friendly.

America. It's a great place to visit, and aren't you glad you live here.



Space Contributed By
Hayden Publishing Company, Inc.

STABILITY & QUALITY

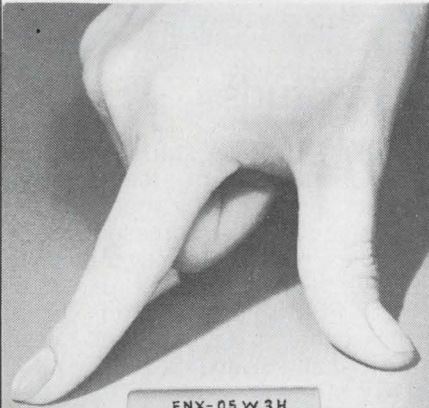

FNX-05 W 3H
3 μ F (K)
100 W.V.

MATSUO

METALLIZED POLYESTER FILM CAPACITOR - "TYPE FNX-H"

Sub-miniature size and oval section ideal for space economy. Lightweight, self-healing and with high insulation resistance. Capacitance values up to 10 MFD. Outer wrap of tough polyester protects against moisture. Perfect in both transistorized and low voltage tube circuits and others where size and cost are paramount.

Specifications:

Operating Temperature Range: -40°C to $+85^{\circ}\text{C}$
Standard Voltage Rating: 100, 200, 400, 600VDC
Standard Capacitance Value: .1 MFD to 10 MFD.
Standard Capacitance Tolerance: $\pm 20\%$ (available $\pm 10\%$)

MATSUO'S other capacitors include:

Solid Tantalum Capacitors: MICROCAP

for hybrid ICs, Type TAX hermetically sealed in metallic case, Type TSX encased in metallic case and sealed with epoxy resin, Type TSL encased in metallic case and sealed with epoxy resin

Polyester Film Capacitors: Type MFL

epoxy dipped, Type MFK epoxy dipped, non inductive,

Type MXT encased in plastic tube, non inductive.

For further information, please write to:

MATSUO ELECTRIC CO., LTD.

Head Office: 3-5, 3-chome, Sennari-cho, Toyonaka-shi, Osaka, Japan
Cable: "NCCMATSUO" OSAKA Telex: 523-4164 OSA
Tokyo Office: 7, 3-chome, Nishi-Gotanda, Shinagawa-ku, Tokyo

Alloy handbook

Technical data and pricing information on more than 90 metals and alloys, produced in wire, rod and strip forms, are included in a completely revised handbook. Quick reference tables give prices and mill limits with tolerances on a full range of products. Technical information covers nominal compositions, physical and mechanical properties, weight tables, comparison of wide gauges, hardness charts and conversion tables, packaging information, and an index to specifications. Technalloy Co., Inc.

CIRCLE NO. 407

RTV silicone rubbers

Packing 15 pages with information, a comprehensive technical data book tells of RTV silicone rubber materials for adhesive/sealant applications, electrical and electronic potting and encapsulating, and such mechanical uses as production molds and gaskets. An outline of curing procedures is described for two-part RTV silicone rubber systems, as well as suggested applications for these rubber products. Also included is a selector guide that lists such pertinent information as uncured and cured properties. General Electric Co., Silicone Products Dept.

CIRCLE NO. 408

Glass-memory displays

Describing glass memories in low-cost computer-driven displays, a two-page illustrated sheet explains how high-speed glass serial memory modules can be coupled to buffer memories to form displays utilizing home television receivers. The serial memory modules provide 63- μ s delays that correspond to the time required to transmit a single line of a normal 525-line television field (image). In effect, the memory delay serves as a buffer between the computer terminal and its slower television receiver readout. Corning Glass Works, Electronic Products Div.

CIRCLE NO. 409

Give Us a Requirement to Build to

Broad Frequency Response?

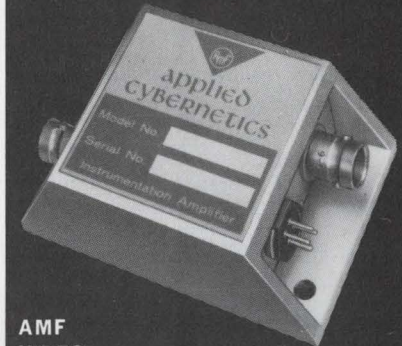

AMF
VIDEO
PREAMPLIFIER

• f_1 .1 Hz thru f_2 25 MHz

Ultra Low Noise?

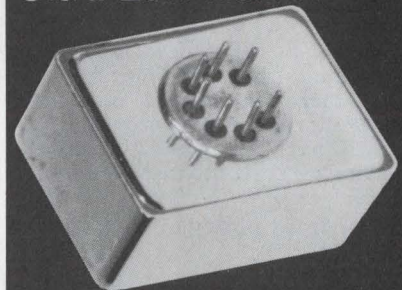

AMF SOLID STATE
MODULAR PREAMPLIFIER

• -165 dBV per cycle

... tailor an AMF
Cybertran
Preamplifier to
fill your needs.

Cybertrons fulfill your needs whether they be ultra-low noise, subsonic requirements or extreme broadband video specifications. The flexibility of our "off-the-shelf" preamplifiers enables AMF to satisfy a wide range of special or standard needs... we call it Cybertran Technology. This new expertise makes it possible for you to specify your preamplifier requirements and have AMF ship it to you. Write or call Jim Campman, Applied Cybernetics Products, AMF Alexandria Division, 1025 North Royal Street, Alexandria, Virginia 22314 Phone (703) 548-7221. TWX 703-931-4209. Representatives in major cities of U.S.A.

AMF
ALEXANDRIA

INFORMATION RETRIEVAL NUMBER 146

ELECTRONIC DESIGN'S function is:

- To aid progress in the electronics manufacturing industry by promoting good design.
- To give the electronic design engineer concepts and ideas that make his job easier and more productive.
- To provide a central source of timely electronics information.
- To promote two-way communication between manufacturer and engineer.

Want a subscription? ELECTRONIC DESIGN is sent free to qualified engineers and engineering managers doing design work, supervising design or setting standards in the United States and Western Europe. For a free subscription, use the postfree application form inside the back cover. If none is included, write to us direct for an application form.

If you do not qualify, you may take out a paid subscription for \$25 a year in the U.S.A., \$35 a year elsewhere. Single copies are \$1.50 each.

If you change your address, send us an old mailing label and your new address; there is generally a prepaid postcard for this inside the back cover. You will have to requalify to continue receiving ELECTRONIC DESIGN free.

The accuracy policy of ELECTRONIC DESIGN is:

- To make reasonable efforts to ensure the accuracy of editorial matter.
- To publish prompt corrections whenever inaccuracies are brought to our attention. Corrections appear at the end of the Letters column.
- To refuse any advertisement deemed to be misleading or fraudulent.

Microfilm copies are available of complete volumes of ELECTRONIC DESIGN at \$19.00 per volume, beginning with Volume 9, 1961. Work is now in process to complete the microfilm edition of Volumes 1-8. Reprints of individual articles may be obtained for \$2.00 each, prepaid (\$.50 for each additional copy of the same article) no matter how long the article. For further details and to place orders, contact the Customer Services Department, University Microfilms, 300 North Zeeb Road, Ann Arbor, Michigan 48106; telephone (313) 761-4700.

Want to contact us? If you have any comments or wish to submit a manuscript or article outline, address your correspondence to:

Howard Bierman, Editor,
ELECTRONIC DESIGN,
850 Third Avenue,
New York, N.Y. 10022.

PEM Self-clinching Captive Studs

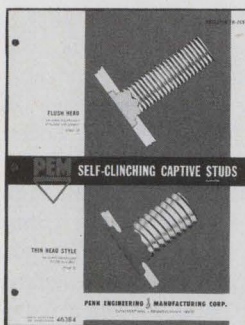

PEM self-clinching captive studs are designed for quick, easy installation in steel or aluminum panels. Providing permanently mounted threads, they are simply squeezed or pressed into drilled or punched holes. They are available in two styles — PEM flush-head studs for panels 0.040" and thicker, and PEM thin-head studs for 0.020" to 0.039" thick panels. Heads of the latter project above the panel surface 0.025". PEM self-clinching studs are stocked in 1/4" to 1 1/2" lengths and #2-56 and #2-56 to 5/16-18 thread sizes. Send for Free Bulletin.

Penn Engineering & Mfg. Corp.
Box 311
Doylestown, Pa. 18901

174

ELECTROMAGNETIC DELAY LINES

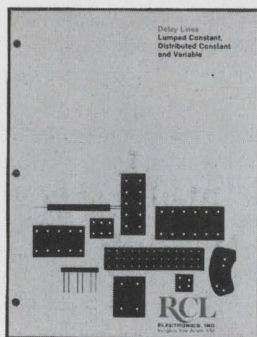

Free engineering handbook with terms, engineering definitions, how to specify delay lines, characteristics of various types, specifications, they're all included in this concise, easy-to-read handbook, yours for the asking. LUMPED CONSTANT, DISTRIBUTED CONSTANT, VARIABLE, all three types are covered in this reference handbook.

RCL Electronics, Inc.
700 South 21st Street
Irvington, N. J. 07111
(201) 374-3311

175

Free: 2,500 Plastic Parts Catalog



New from Nylomatic, molders and fabricators of mechanical plastic components, a highly informative 48-page catalog of more than 2,500 standard parts. It can help you save time and money in design, test and production. Advantages of Nylomatic standard parts: no tooling charges, low unit costs, quick delivery, complete range of sizes. Nylomatic standard parts are made of Nylon, Delrin® and other thermoplastic materials. You'll find our new free catalog a real problem solver for designers, send for it today.

Nylomatic Corporation
Dept. P
Nolan Ave., Morrisville, Pa. 19067

176

Manufacturers

Advertisements of booklets, brochures, catalogs and data sheets. To order use Reader-ServiceCard.
(Advertisement)

Welded stud fasteners — no holes or distortion

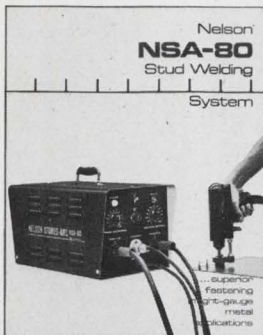

This new brochure describes a solid-state-controlled system for welding threaded stud fasteners to steel and aluminum as thin as .016" and .040", respectively. Welds are reliable and consistent because the control may be adjusted quickly and conveniently to all conditions. The one-side fasteners may be located wherever the best design requires. No holes involved — which means no expenses for sealing, drilling, through-bolting, staking. Standard studs, up to 1/4" in diameter, from stock. System operates from 115-volt AC outlet, welds studs at production rate of 8 per minute, 15 per minute for short periods.

Nelson Stud Welding Division
Gregory Industries, Inc.
Lorain, Ohio 44055

177

A FREE Cross Reference Guide



to better Printed Circuit drafting

No engineer or draftsman should be without the NEW By-Buk Printed Circuit Drafting Aids P-45 Catalog with color-coded MIL-SPEC sizes. Also contains over 2000 pads, shapes, tapes, transistor tri-pads, spaced integrated circuit terminal pad sets and many other drafting aids for faster, more accurate, distortion-free printed circuit master drawings. Send for your FREE catalog.

By-Buk Company
4326 West Pico Blvd., Los Angeles, Calif. 90019
Telephone: (213) 937-3511

178

Bus Bars For Noise Reduction

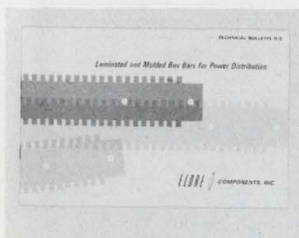

A 16 page Technical Bulletin is now available, describing a new concept in power or signal distribution. Basic mechanical and electrical design principles, along with descriptive pictures and diagrams, are included in this bulletin. These compact buses can replace bulky cable harnesses and repetitive wiring for computer or modular application. This method of construction satisfies the demanding requirements of low inductance and resistance of high speed, solid state systems, while controlling electrical noises.

Send For Free Sample

Eldre Components, Inc.
1239 University Avenue
Rochester, New York 14607

179

Electronic Design

Advertising Sales Staff

New York 10022

Edward F. Clancy
Sales Service Manager
Robert W. Gascoigne
Thomas P. Barth
Samuel M. Deitch
Byron K. Adams
850 Third Avenue
(212) Plaza 1-5530
TWX: 867-7866

Philadelphia 19066

William C. Repetto
P. O. Box 206
Merion Station, Pa.
(215) MA-3-5888

Boston 01945

Richard Parker
P.O. Box 645
Clifton Station
Marblehead, Mass.
(617) 742-0252

Chicago 60611

Thomas P. Kavooras
Berry Conner, Jr.
200 East Ontario
(312) 337-0588

Cleveland

Thomas P. Kavooras
(Chicago)
(312) 337-0588
(call collect)

Los Angeles 90303

Stanley I. Ehrenclou
John V. Quillman
W. James Bischof
2930 Imperial Highway
Inglewood, Calif.
(213) 757-0183

San Francisco 94022

Arthur R. Shields, Jr.
175 San Antonio Rd., S 243
Los Altos, Calif.
(415) 941-3084

London W. 1

For United Kingdom & Holland
Brayton C. Nichols
44 Conduit Street
Tel: REGent 4714

Verviers, Belgium

For Continental Europe
Andre Jamar
1, Rue Mallar, 1
(087) 253.83 Telex.41563

Tokyo

Yoshiro Takemura
IPS Group Ltd.
Box 36, Ohsaki Post Office
Phone (504) 1485
Cable Joshplans, Tokyo



Advertisers' Index

| Advertiser | Page | Advertiser | Page | Advertiser | Page |
|--|---------------|--|--|--|--------------------|
| AMF Alexandria | 203 | Grayhill, Inc. | 192 | Radio Materials Company | 168 |
| Abbott Transistor Laboratories Incorporated | 16 | Greibach Instruments Division of Solitron Devices, Inc. | 147 | Reeves Hoffman Division of Dynamics Corporation of America | 150 |
| Acopian Corp. | 52 | Guardian Electric Manufacturing Company | 60 | Remvac Components, Inc. | 43 |
| Alco Electronic Products, Inc. | 133 | | | | |
| Allen-Bradley Co. | 37 | Hewlett-Packard | 1, 72, 73, 74, 104, 105, 136, 145, 159, 163, 171, 188, 195 | S.O.G.I.E. | 160B |
| American Lava Corporation | 53 | Honeywell, Computer Control Division | 44 | Schweber Electronics | 17 |
| American Optical Company | 197 | | | Scientific Data Systems, Inc. | 71 |
| Ametek/Lamb Electric | 160 | IMC Magnetics Corporation | 196 | Shaffstall-Ball Corporation | 207 |
| Ammon Instruments, Inc. | 202 | ITC Riedon, A Division of Industrial Technology Corp. | 55 | Signalite, Incorporated | 193 |
| Analog Devices, Inc. | 64 A-B | ITT Cannon Electric, A Division of International Telephone and Telegraph Corp. | 175 | Sigmatronics Corporation | 27 |
| Applied Technology A Division of Itek Corporation | 180 | Industrial Electronic Engineers, Inc. | 14 | Sigmatronics Corporation, Measurement Data | 181 |
| Arnold Engineering Company, The | 8, 9 | Interstate Electronics Corporation | 199 | Siliconix Incorporated | 130, 131 |
| Automatic Electric Company | 4, 5 | Isomet Corporation | 183 | Simpson Electric Company | 154 |
| | | | | Singer Company, The, Instrumentation Division | 169 |
| Beckman Instruments, Inc., Helipot Division | 59 | Johanson Manufacturing Corp. | 158 | Solitron Devices, Inc. | 15 |
| Bendix Corporation, The, Semiconductor Division | 69 | Kepeco, Inc. | 54 | Spectrum Control, Inc. | 142 |
| Booker and Wallestad | 179 | | | Spitfire Tool & Machine Co. | 170 |
| Bourns, Inc. | 189 | Littlefuse | 183 | Sprague Electric Company | 18, 20 |
| By-Buk Company | 204 | Lockheed Electronics Company | 149 | Stackpole Carbon Company | 47 |
| | | | | Sylvania Electric Products, Inc. | 32 A-H |
| Capitol Machine & Switch Co. | 174 | 3M Company, Chemical Division | 155 | Syncro Capacitor Corporation | 179 |
| Ceramic Magnetics, Inc. | 179 | Matsuo Electric Co., Ltd. | 203 | Systron-Donner Corporation | 2 |
| Clevite Corporation, Brush Instruments Division | 76 | Mepco, Inc. | 68 | | |
| Clevite Corporation, Burgess Battery Division | 33 | MicroSwitch, A Division of Honeywell | 12, 13 | TRW, Inc., Capacitor Division | 141 |
| Clevite Corporation, Piezoelectric Division | 66 | Microdot, Inc. | 186, 187 | TRW, Inc., Globe Industries | 139 |
| Cohu Electronics, Inc. | 176 | Minelco | 199 | TRW Semiconductors, Inc. | 143 |
| Components, Inc. | 10 | Mohawk Data Sciences Corporation | 167 | Takeda Riken Industry Co. Ltd. | 201 |
| Computer Products, Inc. | 164 | Molex Products Company | 173 | Teledyne Relays, A Teledyne Company | 11 |
| Continental Connector Corporation | 50 | Monsanto Company | Cover III | Tenney Engineering, Inc. | 207 |
| Corning Glass Works, Electronic Products Division | 34, 35 | Motorola Precision Instrument Products | 198 | Texas Instruments Incorporated, Components Group | 48, 48 A-B-C-D, 49 |
| Cratex | 183 | Motorola Semiconductor Products, Inc. | 16 A-H | Texas Instruments Incorporated, Metallurgical Materials Division | 70 |
| | | National Semiconductor Corporation | 96, 97 | Transistor Devices, Inc. | 177 |
| Dale Electronics, Inc. | 207 | Nelson Stud Welding Co. | 205 | Tyco Laboratories, Inc. | 31 |
| Damon Engineering, Inc. | 24 | Nortronics Company, Inc. | 182 | | |
| Delco Radio, Division of General Motors | 112, 113 | Nylomatic Corporation | 204 | United Aircraft Corporation, Electronic Components Division | 23 |
| Dialight Corporation | 58 | | | United Transformer Company, Division of TRW, Inc. | Cover II |
| | | Oak Manufacturing Co. | 179 | U. S. Capacitor Corporation | 146 |
| ESI/Electro Scientific Industries, Inc. | 62, 63 | | | Unitrode Corporation | 29 |
| Eimac, A Division of Varian | 39 | Penn Engineering & Mfg. Corp. | 204 | | |
| Elasco, Incorporated | 172 | Philco-Ford Corporation, Microelectronics Division | 65 | Vactec Inc. | 166 |
| Eldre Components, Inc. | 205 | Philbrick/Nexus Research, A Teledyne Company | 165 | Vector Electronic Co., Inc. | 198 |
| Electro Tec Corp. | 148 | Plastic Capacitors, Inc. | 184 | Veeder-Root | 41 |
| Electronic Enterprises | 178 | Potter & Brumfield Division of American Machine & Foundry Company | 56, 57 | Victoreen Instrument Division | 162 |
| Electronic Engineering Co. of California | 191 | Power/Mate Corp. | 140 | | |
| Electronic Research Associates, Inc. | 144 | | | W. & G. Instruments, Inc. | 190 |
| Emerson & Cuming, Inc. | 200 | RCA Electronic Components and Devices | 111, 127, 129, 161, Cover IV | Waters Manufacturing, Inc. | 152 |
| Erie Technological Products, Inc. | 160A | RCL Electronics, Inc. | 205 | Weston Instruments Inc., Newark Division | 51 |
| | | R. F. Communications, Inc. | 199 | Weston Instruments, Inc., Archbald Division | 157 |
| Fairchild Controls, A Division Fairchild Camera and Instrument Corporation | 67 | Radiation, Incorporated | 153 | | |
| Fluke Mfg. Co., Inc., John | 200, 201, 202 | | | Zeltex, Inc. | 151 |
| | | | | <i>Career Advertising:</i> | |
| G-V Controls, Inc. | 122, 123 | | | | |
| General Electric Company | 64 | | | LTV ElectroSystems, Inc. | 134, 135 |
| General Instrument Corporation | 6, 7 | | | | |
| General Radio Company | 185 | | | | |

Faster, easier set-ups with

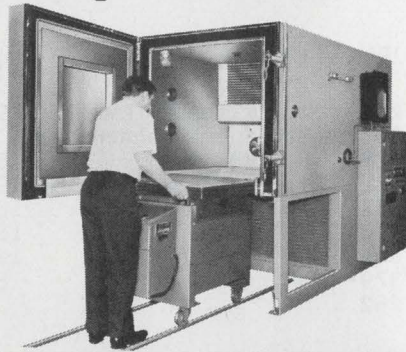

advanced "AGREE" chambers

Tenney's "AGREE" Chambers have always offered the utmost in performance to meet and exceed all test levels of MIL-Std-781A. Now you also get the utmost in operator convenience. Tenney's exclusive "Redi-Seal" (patent applied for) provides a soft cushion of foam to seal between the chamber and L.A.B. or comparable vibration testing machines. No more cumbersome diaphragms...no removable chamber sections...just roll the table in place. Save set-up time. Fully automatic operation of chamber, vibrator, and test item. Make it easy for yourself. For complete information on the latest in "AGREE" testing, write or call



Tenney
ENGINEERING, INC.

1090 Springfield Rd., Union, N. J. 07083 • (201) 686-7870
Western Div.: 15721 Texaco St., Paramount, Calif. 90723

487

INFORMATION RETRIEVAL NUMBER 147

TRUE SOLID-STATE RELAY



Opening New Relay Applications in Multiplexing, Isolated Sensing, High Speed Isolated Control, etc. Offered in A - B - C Contact Configurations for Direct Replacement of Mechanical Types.

- Switching Time less than 65μ sec
- Contact Open Resistance 10^9 ohms
- Contacts Capable of switching D C to 4 M HZ
- Non-Polarized Effective Coil
- Effective Coil Accuate/Release Voltage Hysteresis . . . less than 10 mV . . .
- Non-Polarized Contacts
- No Reference Required Between Effective Coil and Effective Contacts
- Life Expectancy—tested to 10^{10} operations with no failure.

SHAFFSTALL-BALL CORPORATION

5149 E. 65th Street, Indianapolis, Indiana 46220
Phone: 317-257-6296

INFORMATION RETRIEVAL NUMBER 148

ELECTRONIC DESIGN 13, June 21, 1969

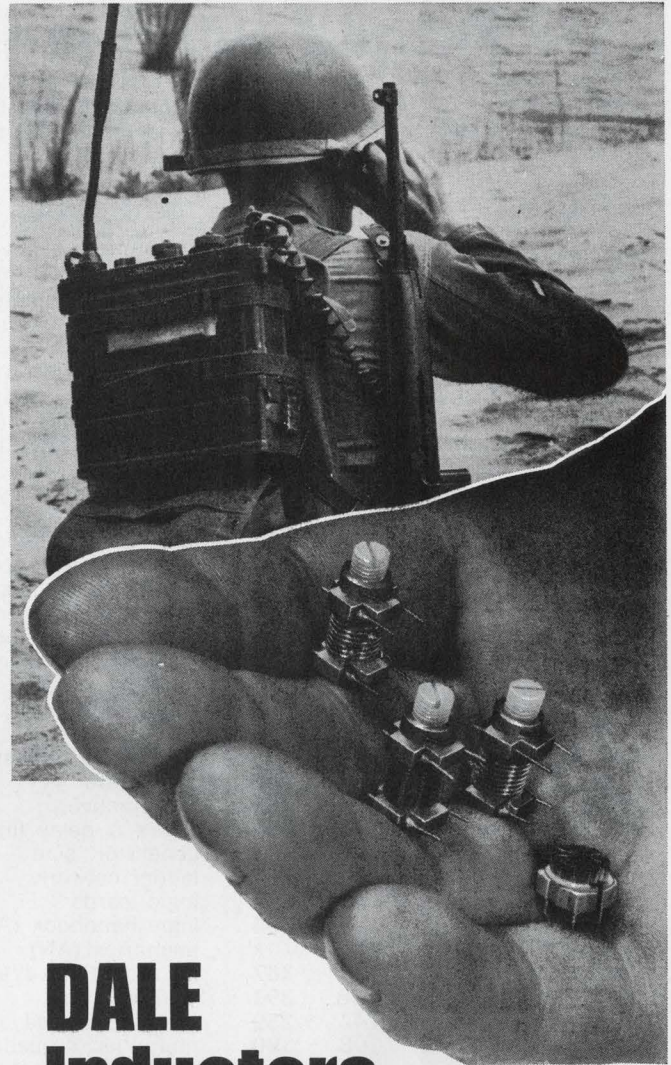

DALE Inductors... high Q in a back-pack

Few radios can take as much abuse as the Army's AN/PRC-25 Back-Pack. Designed for rugged field conditions, this transceiver, built by Memcor, Inc., Division of LTV ElectroSystems, Inc., uses specially-developed Dale miniature high frequency inductors. These tiny core-tuned inductors provide high Q (approx. 170 @ 75 MHz) over a wide inductance range. Once tuned, they stay tuned—because of the positive action of a special core tension spring. Ability to meet the rigid requirements of MIL-C-15305C with mass-produced parts is only one of many broad inductive capabilities of Dale's Sioux Division.

Get the complete story—phone 605-665-9301 or write for new Facilities Report.



DALE ELECTRONICS, INC.
SIoux DIVISION Dept. ED
Yankton, South Dakota 57078

Producers of: Toroids, Series Resonant Traps, Variable Pitch Inductors, Miniature High Frequency Inductors, Degaussing Coils, Industrial and Military Coils, Sub-Miniature Coils, Surge and Lightning Arresters, Custom Assemblies, Motor Driven Potentiometers.

INFORMATION RETRIEVAL NUMBER 149

207

Information Retrieval Service

All products, design aids (DA), application notes (AN), new literature (NL), and reprints (R) in this issue are listed here with Page and Information Retrieval numbers. Reader requests will be promptly processed by computer and mailed to the manufacturer within three days.

| Category | Page | IRN | Category | Page | IRN | Category | Page | IRN |
|---------------------------------|------|------------|--|------|------------|-----------------------------|------|------------|
| Components | | | multiplexer, low-level | 152 | 266 | fluidic control (AN) | 190 | 369 |
| amplifier chips (NL) | 194 | 378 | photo meters (NL) | 194 | 383 | schedules, maintenance (DA) | 187 | 357 |
| capacitors, flatpack | 144 | 256 | power instruments (NL) | 198 | 389 | shipping/handling (AN) | 190 | 367 |
| capacitors, trimmer | 146 | 260 | schedules, maintenance (DA) | 187 | 357 | soldering gun | 182 | 342 |
| card guides (ES) | 184 | 355 | signal stabilizer (AN) | 190 | 370 | stripper, wire | 182 | 344 |
| chip capacitors | 140 | 253 | spectroscopy (AN) | 190 | 366 | templates (NL) | 194 | 385 |
| component protectors (ES) | 184 | 352 | vibration control (NL) | 194 | 379 | wiring tool | 182 | 345 |
| connector, miniature (ES) | 184 | 354 | voltmeters, digital | 148 | 262 | | | |
| connectors, PC (NL) | 201 | 394 | Microwaves & Laser | | | New Literature | | |
| contact parts (AN) | 188 | 362 | diode, HV p-i-n | 178 | 338 | alloy handbook | 203 | 407 |
| delay lines (NL) | 194 | 382 | laser head, plastic | 178 | 337 | amplifier chips | 194 | 378 |
| drives, synchronous (AN) | 190 | 368 | MIC microstrip (NL) | 196 | 388 | connectors | 201 | 395 |
| knobs (NL) | 196 | 386 | oscillators, solid-state | 178 | 339 | connectors, PC | 201 | 394 |
| lamp, neon | 142 | 255 | spectrum analyzer | 180 | 340 | delay lines | 194 | 382 |
| lamp calculator (DA) | 187 | 359 | spectrum analyzer | 180 | 341 | delay lines | 200 | 393 |
| memories (AN) | 188 | 364 | telemetry components (NL) | 196 | 387 | IC accessories | 202 | 398 |
| microcircuits, d/a (AN) | 190 | 371 | transistor | 178 | 336 | knobs | 196 | 386 |
| motors (NL) | 194 | 382 | Modules & Subassemblies | | | memories, glass | 203 | 409 |
| op amps (NL) | 194 | 380 | comparator | 160B | 347 | MIC microstrip | 196 | 388 |
| readout, solid-state | 138 | 252 | filter, active | 160 | 275 | MICS and transistors | 202 | 399 |
| readouts, T-1 | 146 | 261 | filters & delay lines | 156 | 268 | motors | 194 | 382 |
| resistors, cermet chip | 144 | 258 | generator, sine | 160B | 351 | op amps | 194 | 380 |
| socket, tube (ES) | 184 | 353 | ladder network | 160 | 276 | phase-angle devices | 200 | 392 |
| switches (NL) | 194 | 381 | logic cards | 160B | 350 | photo controls | 202 | 396 |
| switches, pushbutton | 144 | 257 | logic handbook (AN) | 188 | 361 | photometers | 194 | 383 |
| switches, thumbwheel | 142 | 254 | memories (AN) | 188 | 364 | powder metallurgy | 202 | 397 |
| telemetry components (NL) | 196 | 387 | microcircuits, d/a (AN) | 190 | 371 | power instruments | 198 | 389 |
| thermistors (NL) | 198 | 391 | mixer, balanced | 160B | 349 | silicone rubbers | 203 | 408 |
| transformer, quad | 144 | 259 | multiplier, 4-quadrant | 160B | 348 | switches | 194 | 381 |
| tubing, metal (NL) | 198 | 390 | op amp, low-cost | 156 | 270 | telemetry components | 196 | 387 |
| | | | op amp, miniature | 156 | 269 | templates | 194 | 385 |
| Data Processing | | | op amp, wideband | 156 | 271 | thermistors | 198 | 391 |
| converter, a/d | 170 | 289 | op amp (NL) | 194 | 380 | tubing, metal | 198 | 390 |
| converter, a/d | 172 | 292 | power instruments (NL) | 198 | 389 | vibration control | 194 | 379 |
| coupler, data | 170 | 290 | power supplies | 158 | 272 | | | |
| data terminal | 170 | 287 | power supplies | 158 | 274 | Application Notes | | |
| data terminals | 172 | 291 | sinusoidal module | 160B | 346 | contact parts | 188 | 362 |
| digitizer, graphic | 172 | 294 | voltage sensor | 158 | 273 | drives, synchronous | 190 | 368 |
| logic handbook (AN) | 188 | 361 | Packaging & Materials | | | fluidic control | 190 | 369 |
| memories (AN) | 188 | 364 | absorbers chart (DA) | 187 | 356 | logic handbook | 188 | 361 |
| memory, 32K | 170 | 288 | bus strips | 176 | 335 | memories | 188 | 364 |
| microcircuits, d/a (AN) | 190 | 371 | component protectors (ES) | 184 | 352 | microcircuits, d/a | 190 | 371 |
| modem, 9600-bit/s | 168 | 286 | connector, miniature (ES) | 184 | 354 | nickel alloys | 188 | 363 |
| printer, electronic | 168 | 285 | connectors, PC (NL) | 201 | 394 | shipping/handling | 190 | 367 |
| reader/printer | 172 | 293 | contact parts (AN) | 188 | 362 | signal stabilizer | 190 | 370 |
| | | | elastomer chart (DA) | 187 | 360 | solution conductivity | 190 | 365 |
| ICs & Semiconductors | | | knobs (NL) | 196 | 386 | spectroscopy | 190 | 366 |
| amplifier chips (NL) | 194 | 378 | nickel alloys (AN) | 188 | 363 | | | |
| driver, dual | 164 | 281 | receptacles, lamp | 174 | 297 | Design Aids | | |
| FETS | 164 | 279 | shipping/handling (AN) | 190 | 367 | absorbers chart | 187 | 356 |
| logic handbook (AN) | 188 | 361 | socket, tube (ES) | 184 | 353 | data forms | 187 | 358 |
| memory, read-only | 164 | 282 | sockets, op amp | 174 | 298 | elastomer chart | 187 | 360 |
| photo-SCRs | 166 | 284 | sockets, transistor | 174 | 295 | lamp calculator | 187 | 359 |
| SCRs, plastic | 162 | 278 | sockets, transistor solution conductivity (AN) | 174 | 296 | schedules, maintenance | 187 | 357 |
| thermistors (NL) | 198 | 391 | tapes, metal-foil | 176 | 334 | | | |
| transistors, 1-A | 162 | 277 | tubing, metal (NL) | 198 | 390 | Evaluation Samples | | |
| transistors, power | 164 | 280 | Production | | | card guides | 184 | 355 |
| transistors, power | 166 | 283 | data forms (DA) | 187 | 358 | component protectors | 184 | 352 |
| | | | ejector mechanism | 182 | 343 | connector, miniature | 184 | 354 |
| Instrumentation | | | | | | socket, tube | 184 | 353 |
| card guides (ES) | 184 | 355 | | | | | | |
| digital analyzer | 152 | 264 | | | | | | |
| digital analyzer | 154 | 267 | | | | | | |
| meter, digital panel | 150 | 263 | | | | | | |
| modem test set | 152 | 265 | | | | | | |



Programmable.

Full-function programmability
 DC to 50 MHz Counting Range
 Universal counter / timer functions
 BCD output

... all for only \$1285

The new Monsanto Model 110A offers you a broader range of operational advantages than any counter/timer in its price range. Front-panel functions are tailor-made for programming with the Monsanto Model 501A Digital Programmer, or with virtually any other contact-closure or logic-level source.

Now consider these other features of the Model 110A: the full complement of counter/timer functions; dc to 50 MHz counting range; marker and gate outputs; provision for external time base; and BCD output. Plus the inherent reliability of Monsanto "4th generation" integrated circuit construction. Plus the 2-year Monsanto warranty.

Price of the Model 110A is \$1285; of the Model 501A, \$375. For a demonstration or technical data call your local Monsanto Field Engineering Representative or contact us direct. Monsanto Company, Electronic Instruments, West Caldwell, New Jersey 07006; (201) 228-3800.

RCA ISOCON CAMERA TUBES ARE

available

right now to meet your low-light-level TV-system mission requirements—and your production schedules

tough

enough to stand up under intense bursts of light

thrifty

—significantly lower in price than other camera tubes for low-light TV

simple

to set up and stable in operation

top performers

—75% response at 400 lines—over 1,000 TV lines limiting resolution—maintained on low-contrast scenes—high resolution pictures right into the corners (RCA supplies the magnetics, too)

modern designed

—bred in the David Sarnoff Research Center where they were conceived as promising low-noise pickup devices years ago. Now they're really delivering on that promise.

RECEIVED
JUN 23 1969
CALMA CO.

For more information, call your local RCA Representative. For technical data, write: RCA Electronic Components, Commercial Engineering, Section F1003, Harrison, New Jersey 07029.

RCA