

Electronic Design 16

VOL. 19 NO.

FOR ENGINEERS AND ENGINEERING MANAGERS

AUG. 5, 1971

Packaging is today's challenge.

The dollar DIP for a 50¢ chip makes as little sense as a 5-lb cable for a 3-lb system. Rapid growth of MSI and LSI puts

new pressure on package cost, size and performance at every level from chip to total system. For a look at the new tradeoffs and design trends, see page 36.

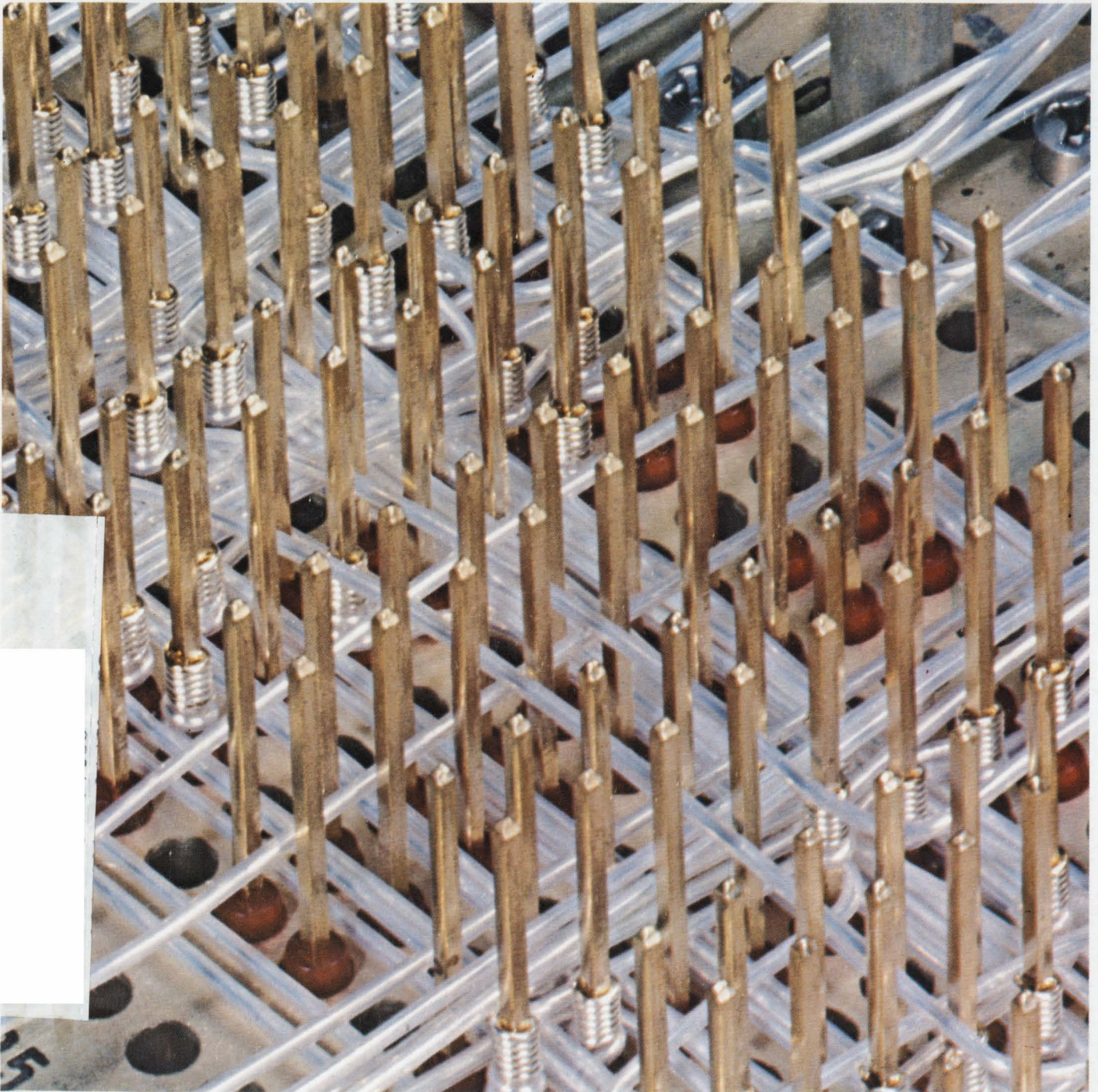

From HP – Three new dimensions in “pulser power” ...

1. Multiphase MOS Testing

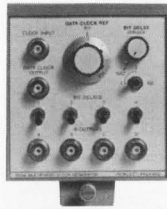

2. 125 MHz Capability

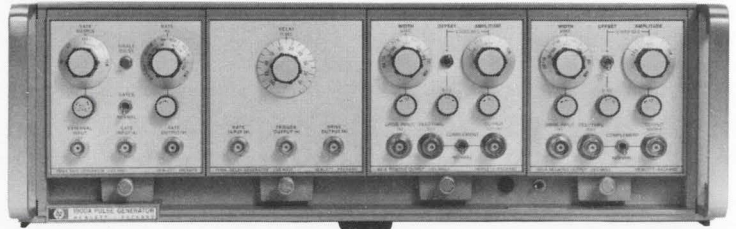

3. Digital Programmability

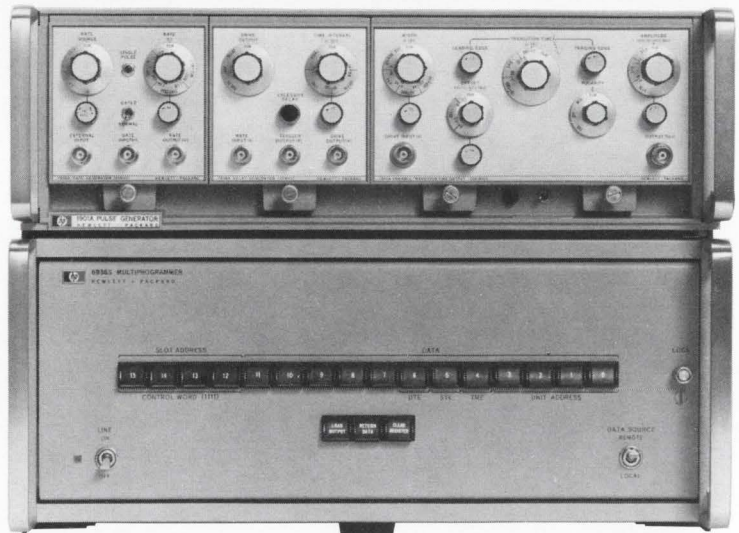

Hewlett-Packard's 1900 System, the pacesetter in pulse generation, now has three new capabilities that put it even farther ahead of all competitive pulsers.

1. Multiphase MOS Testing—The new 1934A Multiphase Clock plug-in lets you use the 1900 System to design and test MOS circuits with a minimum of effort. It gives you four-phase outputs to 12.5 MHz, or two-phase to 25 MHz...with variable phase pattern and variable phase overlap. The 1934A can be used with either high-threshold drivers (the 1915A) or low-threshold drivers (the 1917A); but the 1934A's price is strictly low-threshold...only \$775.

INFORMATION RETRIEVAL NUMBER 101

2. 125 MHz Capability — Now, there are two 1900-System plug-ins that let you generate pulses at rep rates up to 125 MHz. The new 1921A (for positive pulses) and 1922A (negative pulses) are designed for testing fast T²L and ECL logic—in

computers and high-speed digital communications. Both have a fixed transition time of <2 ns, variable amplitude to 5 V, and variable $\pm 5V$ offset. Both have switch-selectable complement capability, plus feed-through pulse-adding capabilities and pulse shaping capabilities. And both are compatible with other 1900-System plug-ins such as the 1930A PRBS generator. Yet you can get either the 1921A or the 1922A for only \$950.

INFORMATION RETRIEVAL NUMBER 102

3. Digital Programmability — Now, your 1900 System can be computer-controlled, for high-speed automatic testing applications... thanks to HP's new 6936S Multiprogrammer. Its 16-line parallel input lets you interface your 1900 System to a computer quickly and easily, using only one I/O slot...and the result is a fully programmable pulser system suitable for almost any testing or control purpose.

To tie together your 1900 System

and the 6936S, HP provides an interfacing package (Option 005), which includes cables, program cards and software. This lets you assemble the combination of capabilities best suited to your own particular needs. For example, you can get the 1900 with three popular plug-ins (1905A rate generator, 1908A delay generator, and 1917A variable-transition-time output) *plus* the 6936S Multiprogrammer and interfacing option 005, for \$5950.

INFORMATION RETRIEVAL NUMBER 103

For further information on any aspect of the pace-setting 1900 System, contact your local HP field engineer. Or write Hewlett-Packard, Palo Alto, California 94304. In Europe: 1217 Meyrin-Geneva, Switzerland.

081/15

HEWLETT  PACKARD

SIGNAL SOURCES

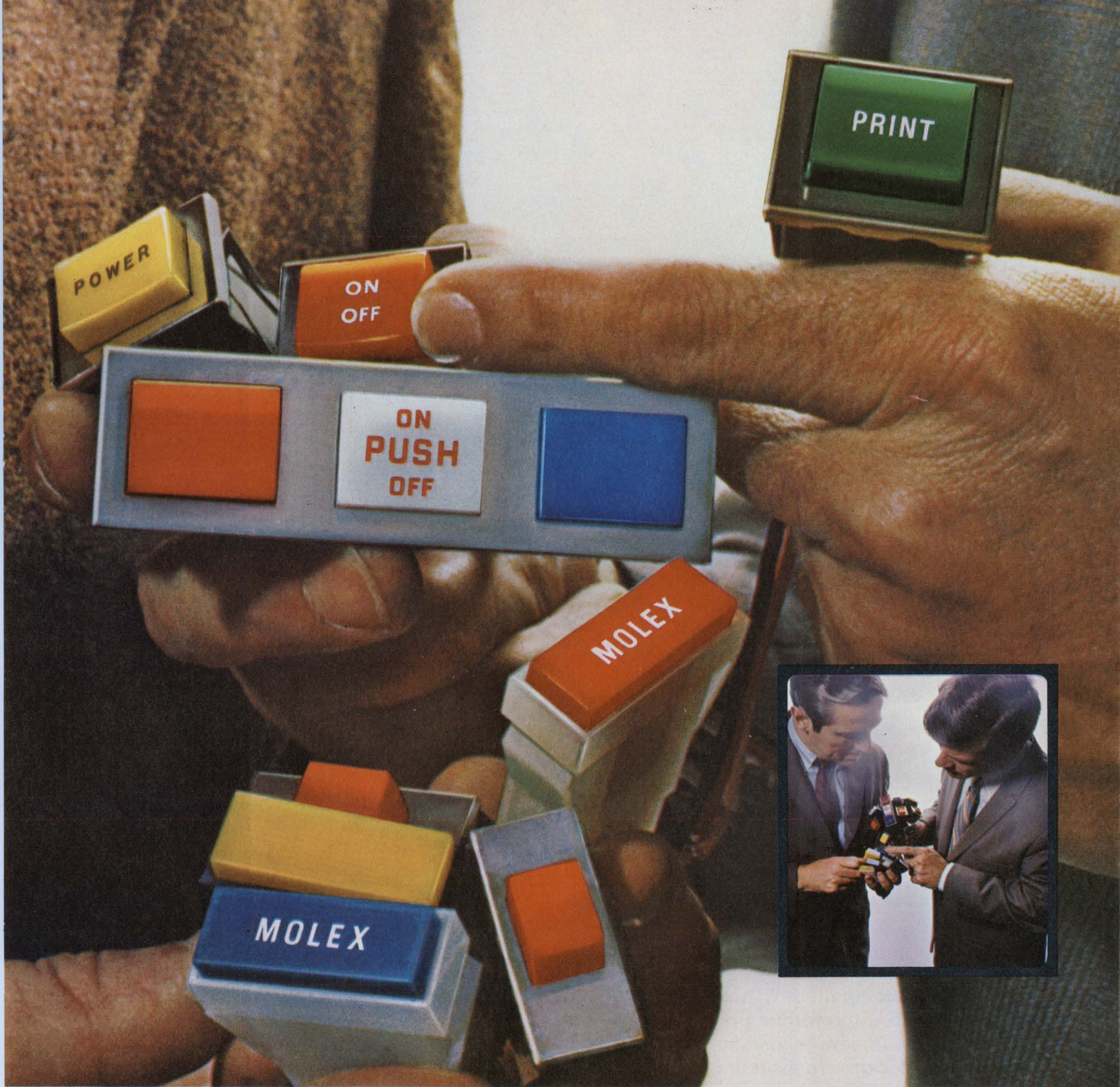

HERE ARE TWO EASY WAYS TO SOLVE LIGHTED PUSH BUTTON SWITCH PROBLEMS. Economically. Reliably. Fast. The Molex 1175 snap mounts. Offers spade or wire terminals for fast, easy assembly. A choice of nine colors, 500 variations. And look at the Molex 1820. You can use one, or a gang of them, for an infinite variety of applications. Lighted push button can be wired to light independently of the switch. And it's available in colors galore. Best of all . . . both switches are priced considerably under one

dollar in quantity. ■ These components are good examples of the Molex creative approach to design problems. And we have the ability to design reliability and ease of assembly into a product without letting costs run wild due to over-engineering. ■ If this makes sense, and you would like a *free sample* of either the 1175 or 1820 switch, write: Molex Incorporated, Downers Grove, Illinois 60515. Or phone (312) 969-4550.

... creating components that simplify circuitry



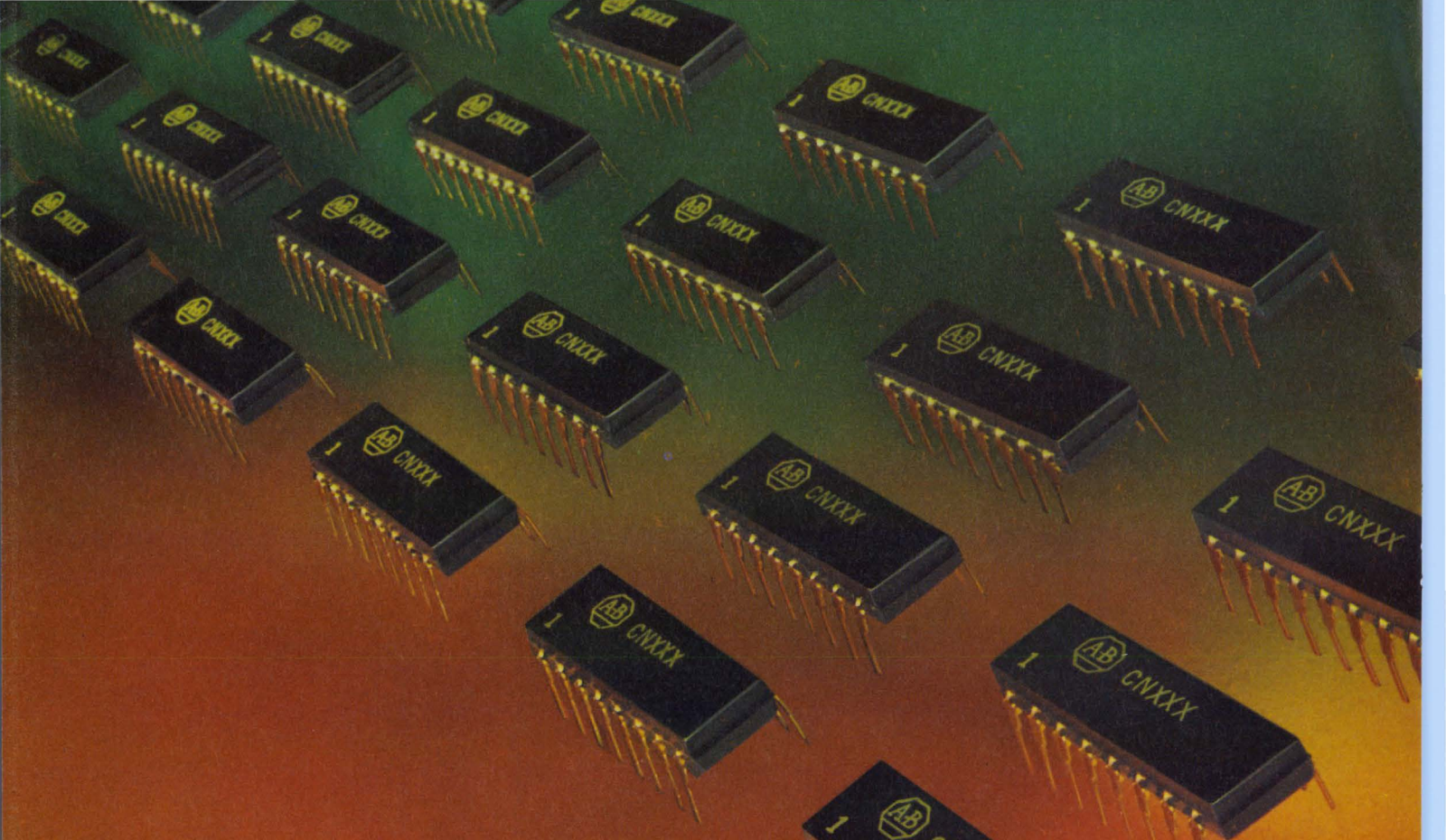

The Allen-Bradley cermet corps: versatile standard packages containing R/C circuitry designed to your needs.

The need: compact R/C networks in DIP's for terminator applications in new generation computer designs. To meet the circuit board space crunch, Allen-Bradley combines resistors and capacitors in a package compatible with automatic insertion equipment. These cermet networks save space and attachment costs. Packaged in dual in-line molded packs that lock out the environment and

match your IC's. Lead frames with built-in stand-offs are weldable or solderable. Volume production available.

SELECTED SPECIFICATIONS

TOLERANCES	Absolute to $\pm .5\%$
TRACKING	Excellent
RESISTANCE RANGE	10 ohms to 10 megs, standard; 1 ohm to 100 megs, special
CAPACITANCE RANGE	To 60,000 pF per cm ²
TCR	As low as ± 100 ppm/ $^{\circ}$ C
CALIBRATION	Abrasive or laser
LEAD SPACING	100 mil standard

Investigate the advantages of Allen-Bradley cermet R/C networks. For information write: Marketing Department, Electronics Division, Allen-Bradley Co., 1201 South Second Street, Milwaukee, Wisconsin 53204. Export office: 1293 Broad St., Bloomfield, N. J. 07003 U.S.A. In Canada: Allen-Bradley Canada Ltd., 135 Dundas Street, Galt, Ontario.

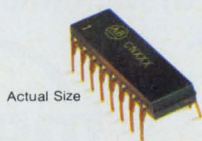

Electronic Design 16

VOL. 19 NO.

FOR ENGINEERS AND ENGINEERING MANAGERS

AUG. 5, 1971

NEWS

- 19 **News Scope**
- 22 **Small active electronic antenna** offers big league reception.
- 23 **Thick-film resistors** are deposited directly onto PC boards.
- 24 **Abolishing laser-display 'speckle'** with new liquid-crystal screen.
- 24 **Lightweight Army thermoelectric source** not fussy about fuel.
- 25 **For future long-term space missions:** a modular computer.
- 26 **Laser detection system** measures air pollution fast.
- 28 **Technology Abroad**
- 31 **Washington Report**

TECHNOLOGY

- 36 **Focus on Packaging:** A Special Report on the tradeoffs and trends in today's packaging techniques from chip to complete system.
- 50 **To simplify digital logic design** use exclusive-OR gates. The trick in applying them is to recognize the patterns with which they are most effective.
- 56 **Let an administrator do it!** You can, as an engineering manager, spend more time in technical work and less knee-deep in administrative odds and ends.
- 58 **Ideas for Design**

PRODUCTS

- 63 **ICs & Semiconductors:** A new 75- Ω junction FET for vhf/uhf systems has a low VSWR of 1.25:1
- 71 **Instrumentation:** Costing \$2450, a 9-digit synthesizer includes programming.
- 73 **Data Processing:** A 7-track incremental recorder operates from a battery.
- 66 **Components** 70 **Modules & Subassemblies**
- 68 **Packaging & Materials** 72 **Microwaves & Lasers**

Departments

- 35 **Editorial:** If we have to talk, let's make it positive
- 7 **Letters** 75 **New Literature**
- 13 **Designer's Calendar** 77 **Bulletin Board**
- 74 **Evaluation Samples** 80 **Advertisers' Index**
- 74 **Design Aids** 80 **Information Retrieval Card**
- 74 **Application Notes**

Cover: Photo: Courtesy Gardner-Denver Co., Grand Haven, Mich.

ELECTRONIC DESIGN is published biweekly by Hayden Publishing Company, Inc., 50 Essex St., Rochelle Park, N.J. 07662. James S. Mulholland, Jr., President. Printed at Brown Printing Co., Inc., Waseca, Minn. Controlled circulation postage paid at Waseca, Minn., and New York, N.Y. Copyright © 1971, Hayden Publishing Company, Inc. 82501 copies this issue.

Feel Free To Flex

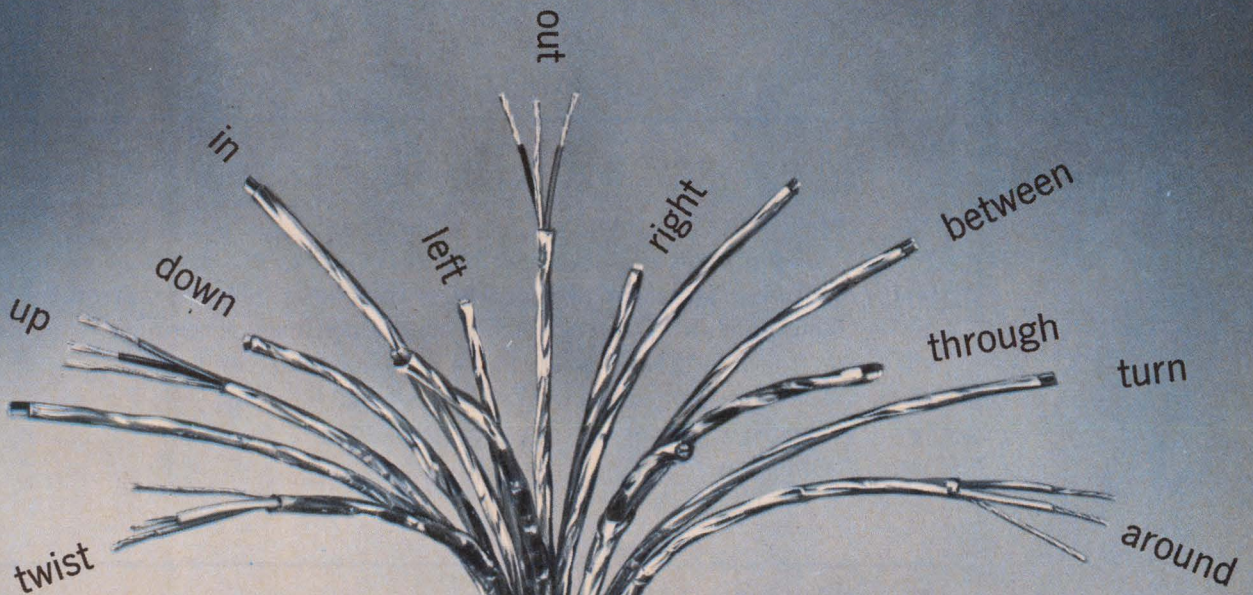

Yes, we know . . . we used to recommend Beldfoil Shielded Cable only for fixed applications. We were too modest. Extended testing proves Beldfoil, even after repeated flexing, provides more physical shield coverage than braided wire or spiral wrapped (served) shields. And greater shield effectiveness. □ Beldfoil is a layer of aluminum foil bonded to a tough polyester film (for insulation and added strength). A Belden invention. We apply it in different ways for different applications. We can even form a unique shield that's like a continuous aluminum tube. This we call ISO-Shield™. □ When new (or in fixed applications) Beldfoil ISO-Shield is extremely effective in limiting crosstalk or interference . . . whether from outside sources or between shielded elements in the same cable. □ Under frequent flexing minor separations may occur in the foil. But special Beldfoil construction features prevent performance from becoming seriously affected. We do, however, recommend that you tell us if cable flexing is to be extreme. We have *special* designs available to meet severe flexing requirements. □ Beldfoil makes possible a small, lightweight cable that terminates easily and is modest in

price. Your Belden distributor stocks or can quickly obtain just about any size or type you need . . . from single conductor audio and sound cable up to data cable having 27 individually shielded pairs (more pairs available on special order). Ask him for the latest "Belden Electronic Wire and Cable Catalog." Or for technical information, contact Electronic Sales Service Dept., Belden Corporation, Richmond, Indiana 47374.

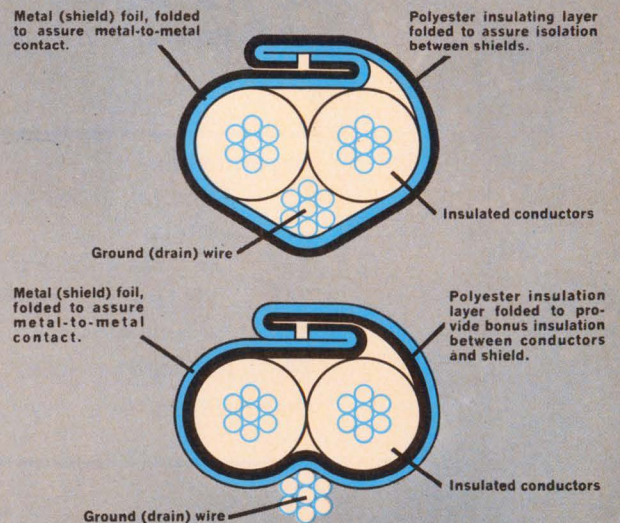

Beldfoil[®] Shielded Cable

-shield effectiveness remains outstanding

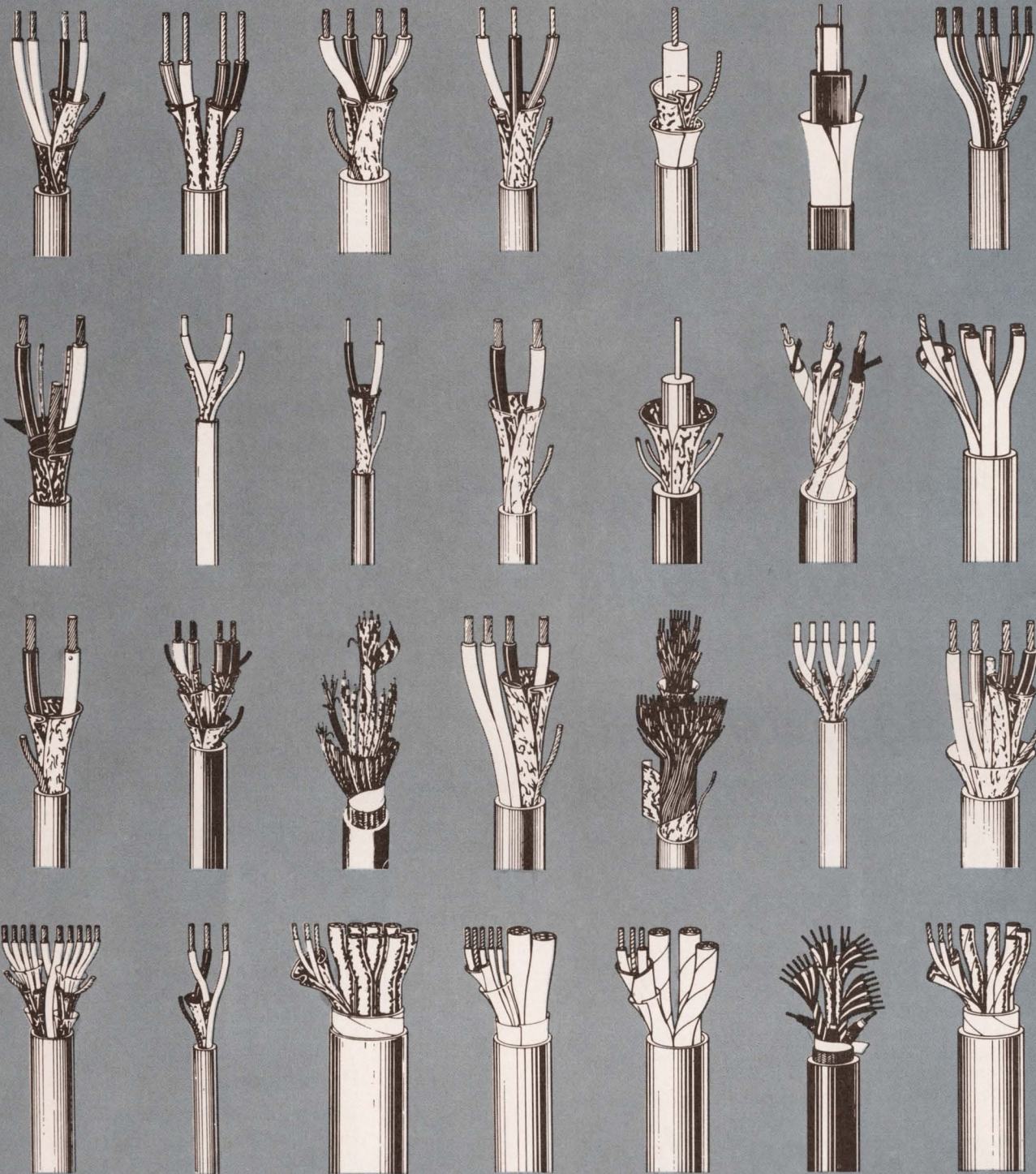

BELDEN



8-5-9B

new ideas for moving electrical energy

INFORMATION RETRIEVAL NUMBER 4

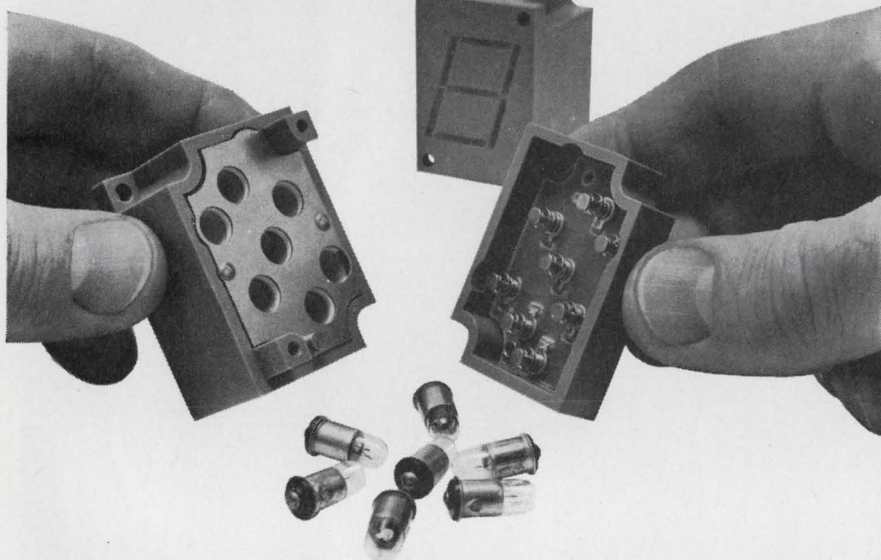

What makes low-cost Dialight readouts so reliable and easy-to-read?

Reliable because of simple module construction and long life lamps. Designed for use with neon or incandescent lamps to meet circuit voltage requirements. Easy-to-read from any viewing angle. 1" high characters are formed by unique patented light-gathering cells, and may be read from distances of 30 feet. Sharp contrast makes for easy viewing under high ambient lighting conditions.

Dialight Readout Features

1. Operate at low power.
2. 6V AC-DC, 10V AC-DC, 14-16V AC-DC, 24-28V AC-DC, 150-160V DC or 110-125V AC.
3. Non-glare viewing windows in a choice of colors.
4. Available with RFI-EMI suppression screen.
5. Available with universal BCD to 7 line translator driver.
6. Can be used with integrated circuit decoder devices now universally available.
7. Caption modules available; each can display 6 messages.

Send for catalog

Catalog-folder contains complete specifying and ordering data on numeric and caption modules, translator drivers, mounting accessories. Dialight Corporation, 60 Stewart Avenue, Brooklyn, New York 11237. Phone: (212) 497-7600.

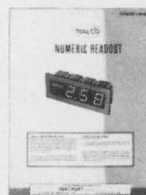

DIALIGHT

INFORMATION RETRIEVAL NUMBER 5

DT-126

Publisher

Peter Coley

Editors

Editorial Offices
50 Essex St.
Rochelle Park, N.J. 07662
(201) 843-0550
TWX: 710-581-2874
Cable: Haydenpubs Rochellepark

Editor: Frank Egan
Managing Editor: Ralph Dobriner
Managing Editor: Raymond D. Speer
Microelectronics, Steven A. Erenburg
Computers, Raymond D. Speer
Microwaves, Michael J. Riezenman
Circuits, Edward A. Torrero
Special Projects, George Rostky
Management, Richard L. Turmail
Military-Aerospace, John F. Mason
News, Michael P. London
New Products, Roger Allan

Field Offices

Massachusetts
Jim McDermott
P.O. Box 272
Easthampton, Mass. 01027
(413) 527-3632

West Coast
David Kaye
2930 Imperial Highway
Inglewood, Calif. 90303
(213) 757-0183

Washington
Don Byrne
1111 S. Army Navy Drive
Arlington, Va. 22202
(202) 296-8982

Editorial Production

Dollie S. Viebig

Art

Art Director, William Kelly
Richard Luce
Anthony J. Fischetto

Production

Manager, Thomas V. Sedita
Helen De Polo
Kathleen McConkey

Circulation

Manager, Nancy L. Merritt

Information Retrieval

Peggy Long

A cheer for editorial, a razz for the System

I found the brief editorial in the April 1 issue ("Control Your Work or It Will Control You") remarkable for its incisive description of the real world of engineering. In an era in which professional journals are barely emerging from the fantasies of the past, when their editorials consisted of mere echoes of drumbeatings by the military-industrial complex, your words are highly commendable. I believe that your three key phrases were:

"Engineers exercise practically no control over their work or over their professional lives."

"If an electric power company decides that it's cheaper to build a power plant that pollutes the atmosphere than one that does not, then its engineers will build a stinkpot." And "if it won't be needing any new plants for a while, then its engineers will be laid off."

"Failure to take such responsibility will insure that [your job] will never be secure."

You certainly did hit the nail on the head! But, in all honesty, you failed to drive the nail home. If I may be permitted to suggest the obvious, inescapable conclusion, it is simply that the Sacred Cow of America, the Profit Motive or Free Enterprise System—or whatever terminology you wish to apply—is now inherently incompatible with the needs of humans, be they professionals or otherwise.

Admittedly this is a radical analysis, but charges of radicalism are no defense against the truth. I realize that one can easily comfort himself by rationalizing around the clarion call for "reform," but

I prefer to acknowledge that the emperor has no clothes.

David Wald

3255 Mauricia Ave.
Santa Clara, Calif.

Electronics for cars must be compatible

Your article in the May 13, 1971 issue titled "The Electronic Car Gets a Green Light in Detroit" (ED 10, pp. 22-26) shows the potential of electronics to improve vehicle performance. However, I was disappointed that no mention was made of the problems encountered in making these systems compatible with each other and with other electronics which may be installed in vehicles—for example, CB and land-mobile transmitters. Care is needed to insure continued performance of safety and anti-pollution circuitry in the presence of such licensed signal sources and in the presence of unexpected noise sources. It is equally important that the added circuitry not generate signals that will interfere with the communication equipment.

R. T. Myers

Consulting Engineer
Support Engineering
General Electric Co.
Lynchburg, Va. 24502

Accuracy is our policy

In our June 10, 1971 issue, P. 91, new IC dividers for Plessey Electronics Corp., were incorrectly headlined as dissipating 600 mW. The current dissipation is 60 mW.

Electronic Design welcomes the opinions of its readers on the issues raised in the magazine's editorial columns. Address letters to Managing Editor, Electronic Design, 50 Essex St., Rochelle Park, N. J. 07662. Try to keep letters under 200 words. Letters must be signed. Names will be withheld on request.

NEW from BULOVA... DC Servo Amps 2.5w to 2,500w

Here's a line of servo amps packaged for flexibility and priced for system saving. It's another example of Bulova's unique capability in producing quality servo products at a price lower than you can make or buy.

Available from 2.5 w to 2.5 Kw —
Styled in flat pack, modular or
rack mount — to meet industrial
or mil-spec — able to operate from
AC or DC — to include power supply
when required.

FEATURES:

- Adjustable Gain
- Current Limiting
- Voltage or Current Feedback
- Wide Bandwidth
- Low Cost

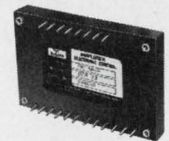

DCA Series

DESIGNED TO DRIVE:

- DC Torque Motors
- Low Inertia Motors
- DC Servo Motors
- Servo Valves
- Deflection Coils



DCAR Series

Don't miss out on this Bulova Servo Special. For new applications or old . . . for help in planning new servo systems . . . for the lowest price on DC Servo Amps . . . Look to Bulova!

Call (212) 335-6000, or write —



Electronic Division of Bulova Watch Company, Inc.
61-20 Woodside Avenue
Woodside, N. Y. 11377 (212) 335-6000

Bulova also offers a complete line of AC servo products, including servo amplifiers, modulators and demodulators, plus a line of power supplies.

Plessey invites you to trade in a big pain for a little pleasure

Male, female, covered, uncovered, side cable entry, top cable entry, with locks, without locks, covers on male plugs, or covers on female sockets. Stocking up on all the varieties of rack and panel connectors that are necessary can give any company a real pain. The combinations begin to sound like chess possibilities.

It can be a real headache.

Well, as any "with it" up-to-date company knows, commonality in design, multiple use and miniaturization are the most efficient and successful methods of designing anything. And that is just what Plessey has done with their 159 series Rack and Panel Connectors.

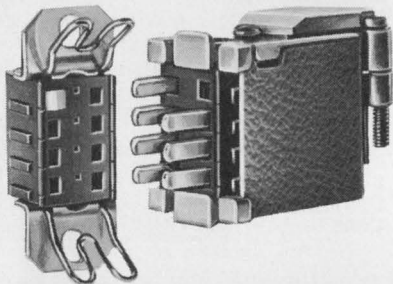

In less than the space that other companies have placed 33 contacts, Plessey has fit 71. And Plessey has 10 more sizes ranging downwards from 59, 55, 47, 35, 31, 23, 19, 15, and 11 to a tiny little $\frac{7}{8}$ " x $1\frac{1}{8}$ " x $1\frac{3}{8}$ " 7 contact connector. All much smaller than anyone else's equivalent connectors. Since smaller means less material used in manufacturing, these units are less expensive than others of similar capacity and elaboration.

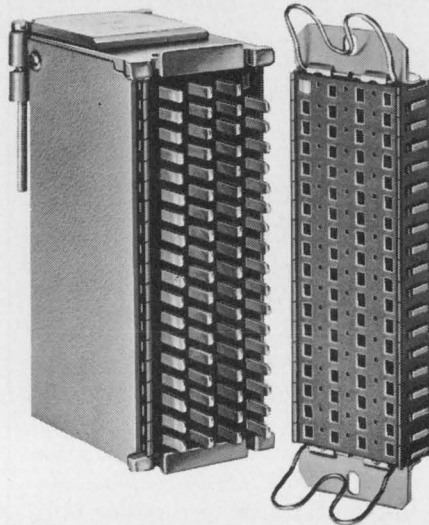

Not satisfied just with this accomplishment, Plessey went on to design "commonality" into this series . . . creating a cover that can be used on plugs as well as sockets and can convert to either top or side cable entry. Where you formerly had to stock all types, you now only need one. Plessey covers can be ordered on male or female connectors or on both for a cable connection

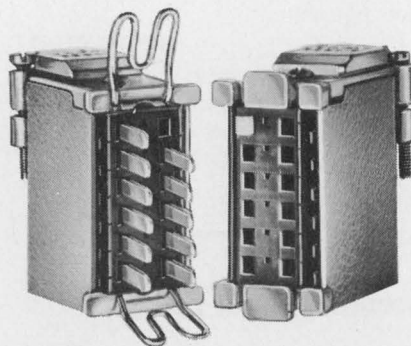

with no chassis mount at all. The covers are of rugged metal, PVC coated in and out, "short" resistant inside and "shock" resistant outside.

The 159 series can be ordered with or without their unique and very positive snap-on lock retainers, at less than the cost of other retaining devices. This retainer is a savings in labor over manually screwed together retainers while being more vibration-proof than spring clip retainers (which require a special notched cover and are even more stock to store).

To sum up, Plessey has a better made, smaller, lighter, more durable and more positive locking series of connectors than anyone else. And less expensive all up and down the line, with extras or without.

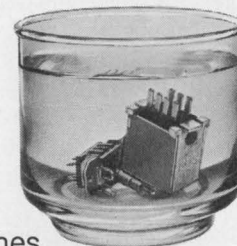

So the next time you feel one of those "stock up time" headaches coming on, reach for a Plessey series 159. For fast relief.

Further information and literature regarding these and other Plessey products may be obtained by contacting one of the representatives listed below.



PLESSEY INCORPORATED/CONNECTOR DIVISION

400 MORELAND ROAD/COMMACK, NEW YORK 11725

TELEPHONE: (516) 543-5000 • TWX: 510-226-3744

REPRESENTATIVES: EASTERN, PAUL D. AARON, Phone: (516) 767-2600 • B. and W. ASSOCIATES, Phone: (617) 275-9177 • BOWSER and SAPECKY, Phone: (716) 839-4170
 JACK ONORE, Phone: (201) 355-0474 • WIRE-CONN CORP. Phone: (609) 234-0569 • SOUTHERN, KIRKWOOD ASSOCIATES, Phone: (813) 894-8240 • MURPHY and COTA, Phone: (919) 723-1001
 WESTERN, RAY OVER SALES, Phone: (206) 454-4551 • ED LANDA CO. Phone: (213) 879-0770 • W. W. POSEY CO. Phone: (415) 948-7771 • MIDWESTERN, INLAND ASSOCIATES, Phone: (913) 362-2366 • R. C. NORDSTROM and CO. Phone: (313) 353-0210 • LGS ELECTRONICS CORP. Phone: (312) 622-8183 • S.A.R.G.E. INC. Phones: (312) 237-9525 • SOUTHWESTERN, AID ELECTRONICS
 Phone: (214) 638-8015 • CANADA, BEN MANIS ASSOCIATES, Phone: (514) 336-4500 • WEBER SEMAD ELECTRONICS, LTD. Phone: (416) 635-9880

A new pushbutton line has come to light.

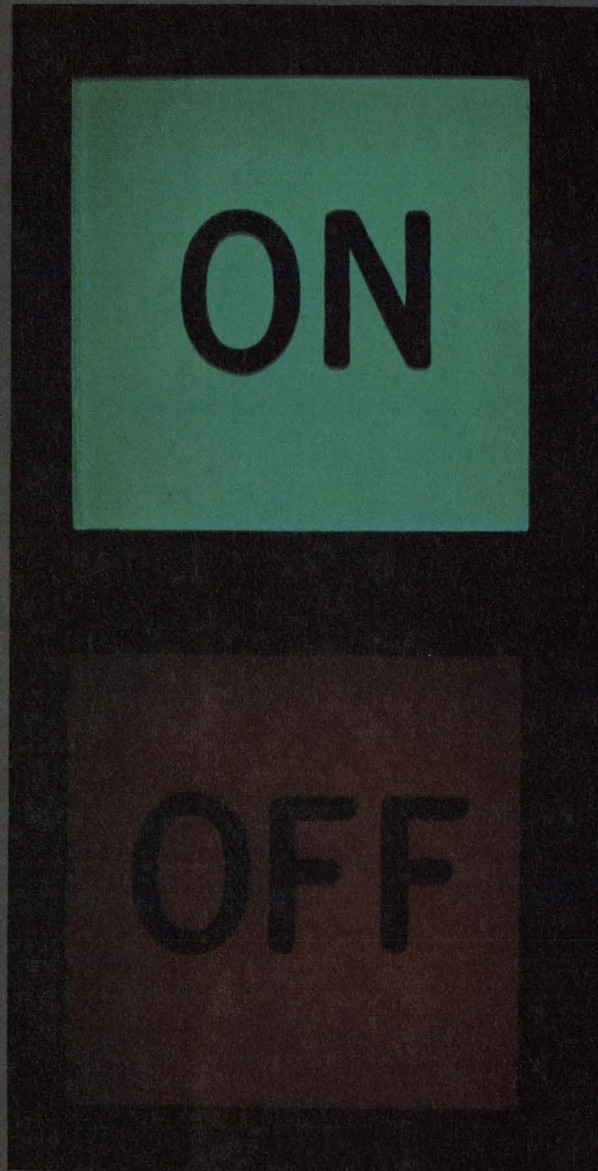

Announcing a medium-priced line of quality lighted pushbuttons and indicators. Our new Series 3.

A complete line with a choice of options that never seems to stop. For example:

Choose from low energy, electronic-duty reed switches with form A circuitry. Or from 5-amp, double-break power switches with a variety of circuit options.

Choose from strip, matrix or individual mount. Each with front relamping or replacement. And with two lamps and $\frac{3}{4}$ " mounting centers.

Choose from five lighted display colors and from momentary or two-level alternate-action.

It all adds up to versatility. The kind that makes the Series 3 ideal for computer peripheral equipment, business machines, instrumentation equipment, communications systems, control panels. Or, maybe a job you're working on that requires a lighted pushbutton or indicator.

For more information, call your MICRO SWITCH Branch Office or Authorized Distributor (Yellow Pages under "Switches, Electric"). Or write for Product Sheet Series 3.



MICRO SWITCH

FREEPORT, ILLINOIS 61032

A DIVISION OF HONEYWELL

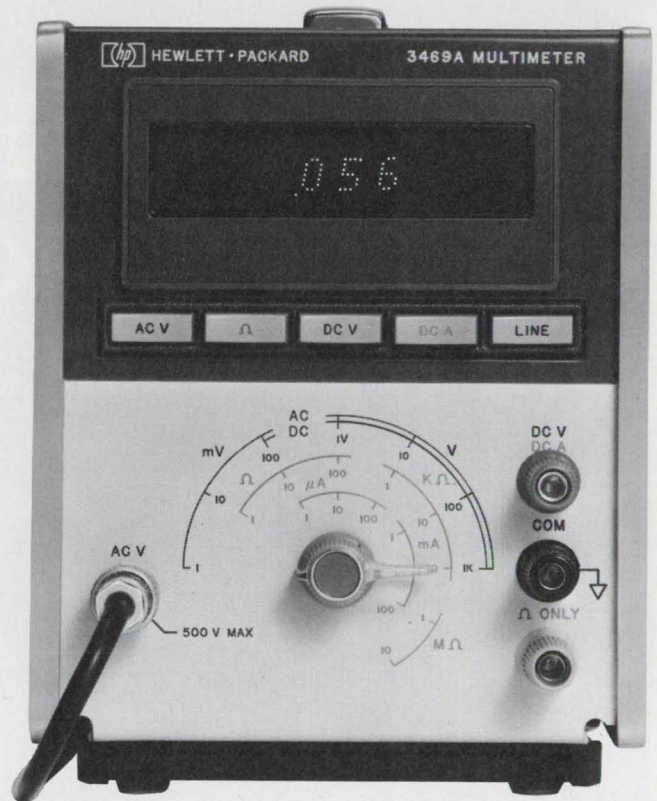
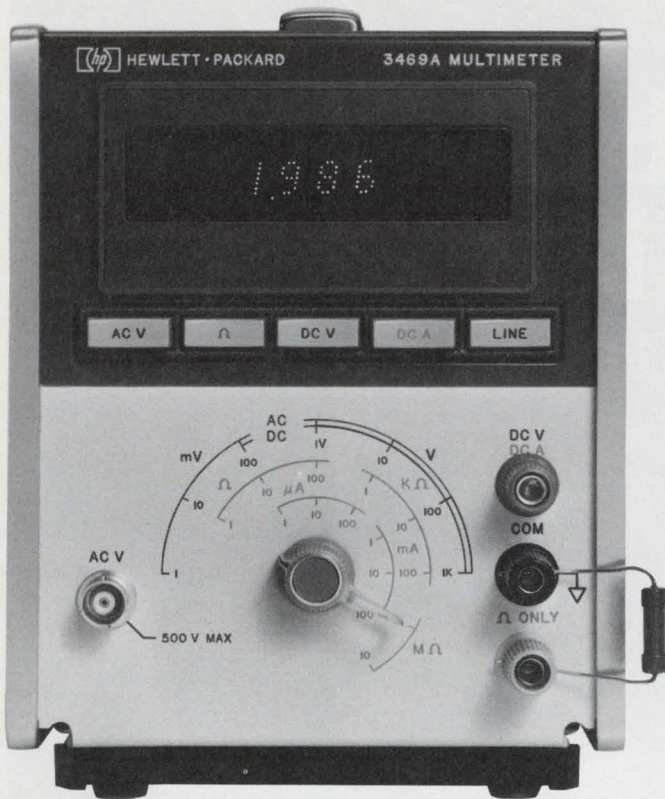

A full-function digital multimeter + A lab-quality digital AC voltmeter

... both for \$595

HP's new 3469A gives you a general-purpose digital multimeter *plus* a lab-quality digital AC voltmeter—for the price of the AC voltmeter alone. Now, you don't have to buy two (or more) instruments to get the capabilities you need—or compromise on quality to stay within your budget.

As a general-purpose multimeter, the 3469A gives you exceptional capabilities. Its 1Ω range lets you measure low-resistance components and even contact resistances of a few milliohms, with an accuracy of ±0.25% reading ±0.5% range. To make the low range easily useable, a unique offset adjustment lets you compensate for lead resistance. In

the higher ranges (100Ω to 10 MΩ), accuracy is ±0.3% reading ±0.2% range. The 3469A also gives you five DC voltage ranges (100 mV to 1000 V) and six DC ampere ranges (1 μA to 100 mA), with accuracy of ±0.2% reading ±0.2% range or better, depending on range.

As an AC voltmeter, the 3469A is unmatched at any price. You get seven voltage scales, ranging from 1000 V full-scale down to 1 mV full-scale—100 times the sensitivity of other digital meters. You also get a 10 MHz bandwidth capability—100 times greater than other digital multimeters—with a basic accuracy of ±0.3% reading ±0.3% range. And

you get a bright, ultra-reliable, shaped-character GaAsP display, that's easier to read than tubes or bar-segment numerals.

Compare the 3469A's specs with any other meter's — and you'll agree that there's no better value, at any price. For further information on the 3469A, contact your local HP field engineer, or write Hewlett-Packard, Palo Alto, California 94304. In Europe: 1217 Meyrin-Geneva, Switzerland.

091/16

HEWLETT  PACKARD

DIGITAL VOLTMETERS

INFORMATION RETRIEVAL NUMBER 9

If you need cool, accurate, reliable DPMs ... Buy Triplet

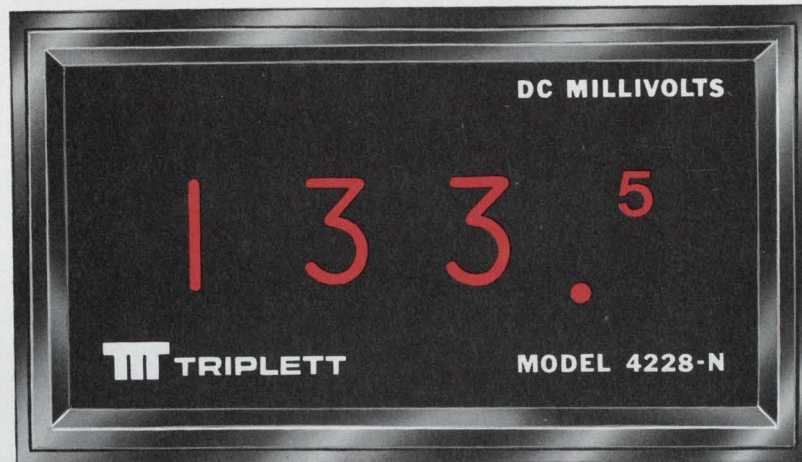

Model 4228-N

actual size

\$140

1. $2\frac{3}{4}$ digits — Provides double the accuracy (0.25% of reading $\pm \frac{1}{2}$ digit) and double the resolution at lower cost.
2. Instantaneous Response — 16-millisecond display rate with 60 times per second sampling rate.
3. Fool-proof Numeral display blurs beyond over-range and with negative polarity.

Designed for OEM applications as well as R&D, production, quality control, maintenance and education use, Triplet's line of digital panel meters combine compactness, convenience and capability with characteristic Triplet accuracy and quality.

To 2 Watts power consumption (for reduced heat and increased reliability) and positive over-range and reverse polarity indications, Triplet's Model 4228-N adds a unique (patent pending) $2\frac{3}{4}$ -digit display that effectively doubles the accuracy and resolution of $2\frac{1}{2}$ -digit instruments . . . at the cost of $2\frac{1}{2}$ -digits. Accuracy is $\pm 0.25\%$ of reading ± 1 digit.

Model

4235-F \$240

1. $3\frac{1}{2}$ digits with auto-polarity.
2. Low Power Drain — provides low operating temperature and long-lived reliability.
3. Single-plane, Seven-bar Readout — for accurate, wide-angle readability.

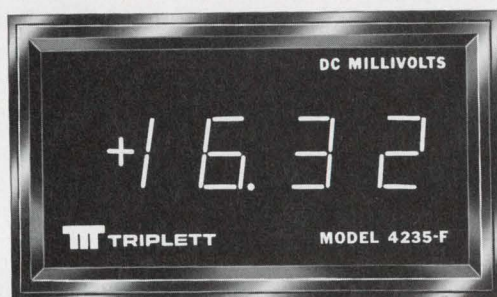

The Model 4228-N is a real value at \$140, so call your local Triplet Sales/Service/Modification Center or Triplet sales representative right now. Either will also be pleased to demonstrate two companion products: Triplet's Model 4225-N at \$125 which merely omits the neon lamp "1" (thus reading to 995) and offers $\pm 0.50\% \pm 1$ digit accuracy; and the Model 4220-N at \$110 — a 2-digit instrument (reading to 99) with $\pm 1\% \pm 1$ digit accuracy.

Mounted in the same size case and boasting the same low power consumption and positive over-range indication, Triplet's $3\frac{1}{2}$ -digit Model 4235-F adds auto-polarity

(with polarity indication) display hold capability, high input resistance (from 10 to 1,000 megohms depending on range) and a $3\frac{1}{2}$ -digit single-plane seven-bar fluorescent display. For many users, the wide-angle viewing capability — enhanced by a green, circularly-polarized viewing window that eliminates confusing internal reflections — will make the 4235-F the obvious choice.

Boasting a voltage accuracy of $\pm 0.10\%$ (current $\pm 0.15\%$) of reading ± 1 digit, Triplet's Model 4235-F sells for \$240. Its companion, the 3-digit Model 4230-F, is \$220. More information, or a free demonstration of both models, is available from your Triplet Sales/Service/Modification Center or your Triplet sales representative. Triplet Corporation, Bluffton, Ohio 45817.

TRIPLET

Manufacturers of the World's most complete line of V-O-Ms.

INFORMATION RETRIEVAL NUMBER 10

Got a job for an old veteran?



Easy to work with, comes cheap.

Amphenol AN connectors first proved their performance 27 years ago on WW II fighters. Today, with constant updating and improvements to the line of AN/MS connectors there are over 100,000,000 in use on everything from computers to pinpotters.

Besides being reliable, our AN connectors are easier to assemble. "D" shaped holes keep contacts

from rotating. Round holes found in other manufacturer's AN's allow the contact to twist.

No other connector beats an Amphenol AN/MS on price. For details on standards, environmental and specials, talk to our salesman or local distributor. Amphenol Connector Division, 2801 South 25th Avenue, Broadview, Illinois 60153.

BUNKER RAMO AMPHENOL

designer's calendar

Aug. 25-27

International- Geoscience Electronics Symposium (Washington, D. C.) Sponsor: IEEE. M. T. Miyasaki, Johns Hopkins Univ., 8621 Georgia Ave., Silver Spring, Md. 20910.

CIRCLE NO. 420

SEPTEMBER 1971

S	M	T	W	T	F	S
			1	2	3	4
5	6	7	8	9	10	11
12	13	14	15	16	17	18
19	20	21	22	23	24	25
26	27	28	29	30		

Sept. 8-10

International Conference on Urban Transportation (Pittsburgh, Pa.) Sponsors: U. S. Dept. of Transportation et al. Arthur V. Harris, P.O. Box 2149, Pittsburgh, Pa. 15230.

CIRCLE NO. 421

Sept. 27-29

International Telemetry Conference (Washington, D.C.) Sponsor: International Foundation for Telemetry, Suite 6, 19730 Ventura Blvd., Woodland Hills, Calif. 91364

CIRCLE NO. 422

OCTOBER 1971

S	M	T	W	T	F	S
					1	2
3	4	5	6	7	8	9
10	11	12	13	14	15	16
17	18	19	20	21	22	23
24	25	26	27	28	29	30
31						

Oct. 6-8

Electronic & Aerospace Systems Convention (Washington, D.C.) Sponsors: IEEE, G-AES, L. Goldmuntz, 29 Kalorama Circle, Washington, D.C. 20008

CIRCLE NO. 423

MORE POWER PER PENNY FROM POWER/MATE

A NEW SERIES OF POWER SUPPLIES FOR INTEGRATED CIRCUITS

ICX SERIES FROM
POWER/MATE CORP.
POWER SUPPLIES
FOR INTEGRATED CIRCUITS

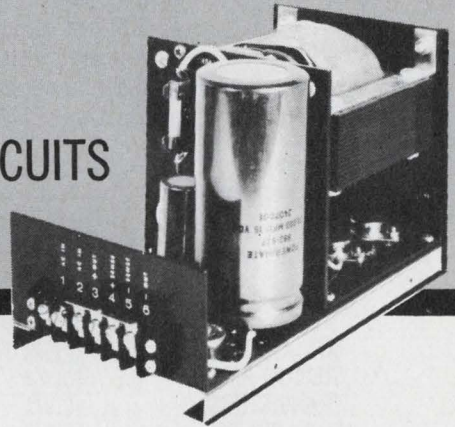

\$75.

WITH LIBERAL OEM DISCOUNTS

THE ICX SERIES GIVES YOU MAXIMUM ECONOMY WITH MAXIMUM RELIABILITY

Using an open chassis construction for economy and IC regulators, the **ICX SERIES** has been designed especially for integrated circuit applications.

Highly flexible...with optional features allow the user to purchase only those requirements needed for his particular application. Ideal for OEM needs.

Each power supply has built in overvoltage protection — and is completely short circuit and overload proof.

ICX SERIES FEATURE:

- * INTEGRATED CIRCUIT REGULATOR
- * BUILT-IN OVERVOLTAGE CROWBAR PROTECTION
- * BUILT-IN OVERLOAD AND SHORT-CIRCUIT PROTECTION
- * ADJUSTABLE VOLTAGE RANGES
- * REMOTE OR LOCAL SENSING REMOTELY PROGRAMMABLE
- * $\pm 0.1\%$ LINE AND LOAD REGULATION
- * 115 VOLT 47-420 CPS AC INPUT
- * TWO MOUNTING SURFACES
- * TOP QUALITY COMPONENTS
- * ALL SILICON SEMI-CONDUCTORS
- * FIVE-YEAR WARRANTY
- * SAME-DAY-SHIPMENT

SEND FOR
FREE CATALOG
giving specs
and prices



POWER/MATE CORP.

514 S. RIVER STREET, HACKENSACK, N. J. 07601
Phone (201) 343-6294 / TWX 710-990-5023

Put us down as the maxi-supplier of mini-transistors

EET can cover just about any requirement you have for miniature silicon transistors. We specialize in a wide variety of mini-types now widely used in hybrid thick film design. A few of these (29 to be exact) are described here. There are many others. The quality of these advanced components is the highest. Prices, however, are surprisingly low. Delivery is whatever you need . . . from prototype to production quantities. PUT US DOWN for an order today.



	EEP TYPE	DESCRIPTION*	V _{ceo} (V)	h _{fe}	f _t (MHz)	PRICE **					
						1-24	25 up	100 up	500 up	1000 up	
MINIATURE SILICON AF TRANSISTORS FOR LOW AND MEDIUM POWER APPLICATIONS	EC156A	NPN general purpose AF transistor for low supply voltages	5	85-220	50	\$1.20	\$.95	\$.70	\$.62	\$.40	
	EC156B		5	200-500	50	1.30	1.05	.78	.68	.44	
	EC156C		5	470-900	50	1.45	1.15	.86	.74	.48	
	EC196A	PNP for AF input and driver stages	25	125-260	200	1.75	1.40	1.10	1.00	.68	
	EC196B		25	240-500	250	1.85	1.50	1.18	1.06	.72	
	EC197A	NPN for AF input and driver stages	45	125-260	300	1.55	1.25	1.00	.90	.55	
	EC197B		45	240-500	300	1.65	1.35	1.08	.96	.59	
	EC198A	NPN for AF input and driver stages	20	125-260	300	1.50	1.20	.92	.85	.51	
	EC198B		20	240-500	300	1.60	1.30	1.00	.91	.55	
	EC198C		20	470-900	300	1.70	1.40	1.08	.97	.59	
SILICON TRANSISTORS FOR IF STAGES AND RF STAGES UP TO THE SW-BAND	EC199B	NPN for low noise AF input stages	20	240-500	300	1.57	1.25	1.00	.90	.55	
	EC199C		20	470-900	300	1.67	1.35	1.08	.96	.59	
	EF227	NPN for non-controlled RF stages up to 50 MHz	25	100	600	2.25	1.82	1.42	1.30	.95	
SPECIAL FOR VHF	EF229	NPN for controlled RF and IF stages and SW-pre-and mixer stages	20	115	260	2.10	1.65	1.32	1.20	.78	
	EF230	NPN for VHF stages	20	67	200	2.20	1.75	1.40	1.25	.92	
SILICON AF TRANSISTORS	EFY87	NPN for RF and AF amplifier stages	red	15	40-65	> 50	1.40	1.10	.85	.80	.50
	yellow		15	55-95	> 50	1.42	1.12	.87	.81	.51	
	green		15	85-140	> 50	1.47	1.14	.88	.82	.52	
	violet		15	130-200	> 50	1.46	1.16	.89	.83	.53	
	white		15	190-310	> 50	1.48	1.18	.90	.84	.54	
	grey		15	290-520	> 50	1.50	1.20	.91	.85	.55	
	EFY87A	NPN - RF amplifier - low noise AF amplifier transistor	yellow	15	55-95	> 50	1.52	1.25	1.00	.90	.55
	green		15	85-140	> 50	1.54	1.27	1.02	.91	.56	
	violet		15	130-200	> 50	1.56	1.29	1.04	.92	.57	
	white		15	190-310	> 50	1.58	1.31	1.06	.93	.58	
SILICON SWITCHING TRANSISTORS	grey		15	290-520	> 50	1.60	1.33	1.08	.94	.59	
	ESW11	NPN t _{on} ≤ 25ns; t _{off} ≤ 50ns	15	> 50	> 400	1.05	.85	.65	.66	.41	
SILICON TRANSISTORS FOR INDICATOR TUBES	ESW12	NPN t _{on} ≤ 40ns; t _{off} < 80ns	15	40-150	> 200	1.15	.90	.72	.65	.40	
	EF228	NPN driver for indicator tubes	80	> 30	> 50	1.90	1.55	1.20	1.10	.74	

* ALL TYPES OFFER 0.05W ** MINIMUM ORDER PER LINE ITEM: \$15.00

MADE IN AUSTRIA



**EUROPEAN
ELECTRONIC
PRODUCTS**
CORPORATION

10150 W. JEFFERSON BLVD.
CULVER CITY
CALIFORNIA 90230 U.S.A.
PHONE (213) 838-1912

Before you buy Mil C-38999 connectors, read this:

When you're designing to a mil spec, performance and reliability requirements are pretty well standardized. However, there are areas where unique features can be introduced. And new methods of production insure absolute reliability for every unit.

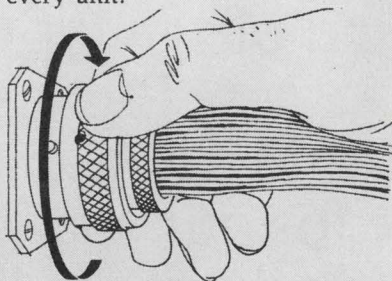

Lightweight low-silhouette sub-miniature round connectors are a case in point. The Burndy Compact Bantam™ incorporates a new coupling nut that offers distinct advantages. Mating and unmating torques are consistently lower even in

tightly restricted areas.

The Burndy design eliminates any problem of contamination. And our uncompromisingly rigid "clean room" standards assure the highest reliability.

The RFI feature of the Compact Bantam has been improved. Burndy does not use solder in fastening the grounding spring to the connector. Grounding springs are recessed as protection against external damage and the unique configuration reduces danger of breakage and permanent set due to overstress, while giving improved electrical performance.

Another advantage—the Compact Bantam is available for *immediate delivery*. Burndy offers 10 shell styles in 9 sizes with a wide variety

of insert arrangements up to 128 contacts for use with wire sizes 12 through 28. Connectors can be supplied for continuous 150° or for 200°C applications. The crimp removable contacts are of rear release design.

Used with Burndy installation insertion/extraction tools, the Compact Bantam gives you the lowest installed cost possible. All Compact Bantam connectors are intermateable and interchangeable with other Mil C-38999 connectors.

So before you buy, send for our new catalog. It gives photos and dimensional drawings of all shell styles as well as insert arrangements for each shell size and its contacts. And it even has a system that makes ordering easy. Write today.



 **BURNDY**
Norwalk, Connecticut 06856

INFORMATION RETRIEVAL NUMBER 14

A better way to maintain oscillator specifications.

A lot of oscillators can't meet their own specs once in operation. That's why we came up with a better way. A die cast zinc enclosure to keep specs what they should be. No other oscillator offers our kind of enclosure. Or our kind of performance:

Models in 1MHz, 3MHz, and 5MHz ranges. And when you write for our spec sheets, what you read is what you get. Write to Motorola Component Products Dept., 4545 W. Augusta Blvd., Chicago, Ill. 60651.

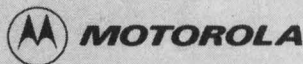

Short circuits.

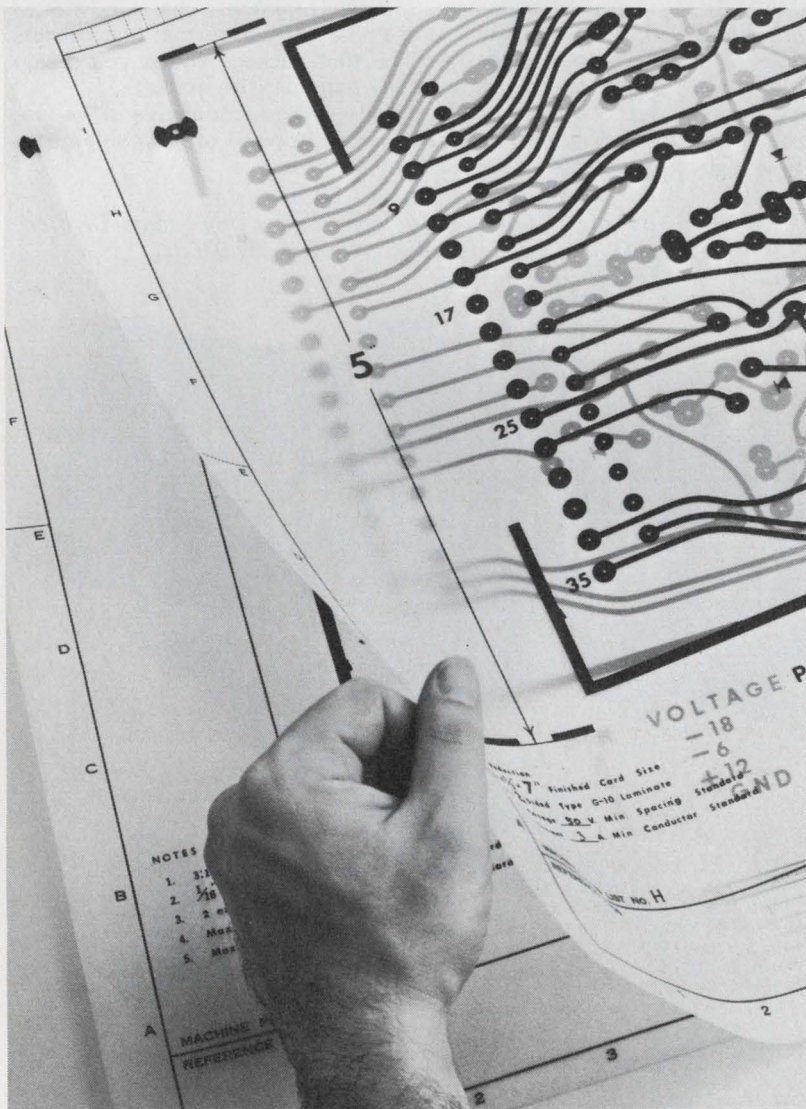

Now you can bypass slowdowns in printed circuit design.

Do your design problems include tape slippage and lack of dimensional stability on master layouts, numerous design changes, and other annoyances that hamper efficient printed circuit design?

If so, we believe that reproducing your taped master on KODAGRAPH ESTAR Base Film is the answer. For more information, contact your Kodak Technical Sales Representative, or write: Eastman Kodak Company, Business Systems Markets Division, Department DP808, Rochester, New York 14650.

DRAWING REPRODUCTION SYSTEMS BY KODAK

Kodak

DOWN WITH CONNECTIONS... OUT WITH WELDS

8-16 DIGITS YOUR ONLY CHOICE IS **PANAPLEX™** NUMERIC PANEL DISPLAY

Burroughs leads today's display revolution with a whole new way of looking at numeric displays — a total cost savings package designed to eliminate all your display problems. Check these advantages:

☑ **LOW COST** — Your initial investment is lower because PANAPLEX panels are the lowest cost panel displays available. Your circuitry costs go down because PANAPLEX panels are specifically designed for time sharing from low cost MOS, LSI circuitry.

☑ **HIGH RELIABILITY** — Your instrument will be more reliable because PANAPLEX panels are one-piece construction and contain NO internal welds. PANAPLEX panels are impervious to shock and vibration. No other multiple digit device has this proven life and failure free operation.

☑ **CUSTOMER DESIGNED PACKAGING** — Your installation costs are lowered because PANAPLEX panels are supplied in packaged units containing your complete display —

prealigned and ready to be plugged into, or soldered onto a mating board. No individual digit alignment required and only two connections per digit.

☑ **HUMAN ENGINEERED READOUT** — Your selling costs go down because of the PANAPLEX panel's esthetic selling features, including large (0.4") easily read characters in perfect alignment; superior brightness characteristics; a 150° viewing angle; and a nine segment format that permits a centered digit "1". The thin package allows you design freedom — a must in today's competitive market.

☑ **AVAILABILITY NOW** — Production quantities are being shipped now and we can respond to your volume requirements faster than any other source.

For additional information, call or write:

*Burroughs Corporation, Electronic Components Division,
P.O. Box 1226, Plainfield, New Jersey 07061.
Tel: (201) 757-3400.*

\$156*
PER DIGIT

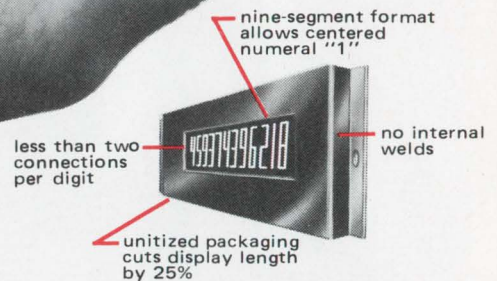
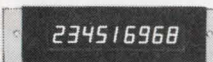

— CALL BURROUGHS TODAY

Burroughs



INFORMATION RETRIEVAL NUMBER 18

*16 digit unit, 1000 quantity.

New group seeks industry help for urban problems

This fall, an independent, non-profit corporation will be established to put private industry's technical and scientific expertise to work solving the growing problems of the cities. The organization at present consists of a small group of engineers and city administrators which has received grants and support from organizations such as the National Aeronautics and Space Administration, the Ford Foundation, the International City Management Association, the National League of Cities and the U.S. Conference of Mayors.

As a corporation, funds will come from cities that call on the organization to solve their problems. "Organized as we will be," says Robert Havlick, a public administrator who has joined the group, "there won't be duplication of effort. We will save money for the cities and enable them to exchange information."

Last fall, the program got off the ground with a meeting of the program president, Porter Homer, with officials from 79 cities and representatives from NASA at Cape Kennedy, Fla. Some 500 city problems evolved as a result of the meeting, and after study and consultation by NASA and the city officials, 15 were given top priority. All 15, NASA says, are solvable by aerospace engineers. Six are now active projects.

The city officials wrote the performance specifications, and NASA engineers are designing the equipment. In the future, much of the work will be farmed out to industry, Havlick says.

Projects now in the design stage are:

- An underground conduit locator—"Ferromagnetic locators find metal pipes well enough," says Don Loren, vice president of the

program, "but some pipes are made of clay and plastic, and a few old ones of wood. To find these we need another system." It could be a seismic device, he notes, something to measure density, a radiometric sensor or a unit that reacts to neutron activation.

- A short range radio communication unit to be used by the police, firemen and utility workers. "The idea," Havlick says, "is to have a common system that works well in any city environment—surrounded by steel, for example."

- Life support system for firemen—"This is basically a breathing apparatus," Loren says, "but it may require toxic atmosphere sensors or a pressure transducer for the breathing gas container."

- Pressure regulator at the nozzle end of a fire hose so the man doing the job can regulate the pressure himself—"The solution may be to use hydraulic controls or electroacoustic transducers to operate at the efficiency levels we need," Loren says.

Two projects the group is monitoring with the hope of interesting cities around the country to use on a trial basis are: a sewage flow measurement system and a man-carried low-light-level television camera for crime and riot surveillance. Both projects are sponsored by NASA and are under way at the Illinois Institute of Technology Research Institute in Chicago.

Philips vies with Dolby over noise circuitry

A battle appears to be shaping up over the question of which noise-reduction system for tape cassettes should be adopted as an industry wide standard—the one by Dolby Laboratories, Inc. of Lon-

don or the other by N. V. Philips, Eindhoven, the Netherlands.

The Dynamic Noise Limiter developed by Philips is a single circuit located between the output of the tape head and the cassette playback audio system. It is effective with all standard cassette recordings, and consequently is compatible with all present tapes.

In contrast, the Dolby system has two circuits. The first is used in recording and increases the magnitude of low-level high-frequency signals. The second, located in the playback unit, is a decoder that reduces these high-frequency signals back to their original level. The noise is reduced in a similar ratio. The Dolby system, therefore, requires specially recorded tapes, and is not compatible with current or planned cassette libraries recorded with conventional cassette equipment.

Philips is concerned that the adoption of systems other than their own will prevent standardization of recorder-playback systems.

"To destroy compatibility when the market is growing so fast will only produce mass confusion," Edward R. Hansen, technical manager of Philips' Home Entertainment Products Div., New York, told ELECTRONIC DESIGN.

"In fact, the cassette system has grown without this confusion simply because of our fetish for standardization."

Hansen explained that their system is an active noise-suppression circuit that operates in quiet or silent stretches where the tape noise is particularly noticeable. High-frequency signals above a certain amplitude bypass the suppressor action. Thus, there is no effect on brilliancy in high-volume passages.

Hansen admitted that the Philips system is somewhat less effective than is Dolby's in reducing tape noise.

"But unweighted measurements show a ratio improvement of more than 10 dB at 6 kHz and 20 dB at 10 kHz," he said.

Dr. Raymond Dolby, inventor of the Dolby system, is unworried about the development. Manufacturers are already beginning to include the Dolby system in their design, he notes.

"And so far," he told ELECTRONIC DESIGN, "Phillips hasn't come

to us or to any of the licensees that we know of and said, 'don't use the Dolby system'."

To encourage use of their circuit, Philips is offering it royalty free to manufacturers willing to adhere to Philips' standards. Dolby's is licensed for a fee.

Automated health center may generate big market

A soaring market for automated health testing equipment is forecast in a report just released by Frost and Sullivan, Inc., a New York-based research firm. The report predicts that the existing 50 automated health testing centers, which performed an estimated \$800,000 worth of tests in 1971, will grow to 400 centers earning \$200 million by 1976 and reach 1000 centers earning \$500 million by 1980.

The 150 page report, entitled "Automated Multiphase Health Testing Market," describes a typical center, traces its evolution and provides an in-depth analysis of its operation.

The study attributes the expansion to a reduction in the number of practicing physicians per capita, the growing demand for federal support of basic health care, and the availability of mechanized medical screening devices.

Although the number of physicians in public practice is slowly increasing, from 239,000 in 1960 to 279,000 in 1975, the population is growing faster. The result, according to Frost and Sullivan, will be a drop in the ratio of physicians per 100,000 population from 132.9 in 1960 to 130.5 in 1970 and an estimated 125.3 in 1975.

The study can be purchased by writing to Frost and Sullivan, Inc., Attention-Joseph Levy, 106 Fulton St., New York, N.Y. 10038.

Water pollution checked by an electronic buoy

A buoy that maintains a round-the-clock watch on water pollution levels is being tested in San Francisco Bay. If experiments with the Ecology-Data Buoy are successful, the Lockheed Missiles and Space Co., in Sunnyvale, Calif., its devel-

oper, will propose design of such a system to state and federal agencies charged with pollution control of waters throughout the United States.

Seven feet long and three feet in diameter, the buoy takes hourly measurements of the water's temperature, electrical conductivity and dissolved oxygen content—three important indicators in water pollution. The measurements are then automatically telemetered to Lockheed's data processing center.

Technicians talk English to IC tester's computer

Bench technicians using simple English language instructions can now readily program a new computerized 10-MHz integrated circuit tester. The new System 90, developed by Instrumentation Engineering, Franklin Lakes, N.J., employs a modified ATLAS test language. ATLAS was originally developed by the airlines to provide a universal test-program language.

While other English-language programs are available for similar equipment, Instrument Engineering's president, Paul Giordano, says that the System 90 language is the simplest yet. He points to the fact that technicians in training have written sophisticated programs the first day of instruction. Giordano says that Instrument Engineering has modified the ATLAS language by adding digital statements that were till now not available.

The new system contains a software generator that stores the technician-compiled English program and transfers it to tape. At the same time, the program is converted, by the computer, to machine language for high-speed execution of the program. After debugging, programs can be stored on tape, disc, or punched tape.

The System 90 provides test rates up to 10 MHz, using a basic configuration of 16 pins, with a pattern of 512 or 1024 bits for each pin.

New firm offers stock for scrap metal parts

Reclamation of precious metals is not a new idea. However, when

you trade scrap plated parts to a new company for stock in that company—that is new. So new, in fact, that the Securities and Exchange Commission has actually had to set up a new framework within which this company will work.

Metals Ecology Inc. in Irvine, Calif., has been set up as a repository wherein companies in the electronics industry may send their scrap plated parts, scrap connectors, scrap platinum wire, etc.

According to Wilfred Smieman, executive vice president of Metals Ecology, "We will reclaim the precious metals from the scrap, keep 40% of the value to cover our costs and profit, and remit the other 60% to the donor of the scrap. That 60% will be given either in cash, or in convertible debentures. We expect most to take the amount in the form of debentures."

Gold, silver, platinum and mercury are the key precious metals that the company will concentrate on.

Eventually, Metals Ecology expects to produce products out of the recycled precious metals. At the present time they will sell the metals.

In addition to the electronics industry Smieman also expects to do a thriving business with dentists.

Airlines seek doubling of FAA spending plans

The Air Transport Association representing the nations airlines have recommended that the Federal Aviation Administration nearly double its R&D spending over the next 5 years. The bulk of the proposed spending would be spent on electronics.

The FAA has budgeted about \$81-million for this fiscal year for B&D while the Association is recommended expenditures of nearly \$135-million.

The ATA proposes that \$24.7-million be spent on the air traffic control system and another \$14.1-million for improved instrument landing systems, lighting, navigational aids, microwave landing systems and satellites. The rest of the money would be spent on solving environmental and noise pollution problems and on other system R&D.

multiply your computer output controls

Get up to 240 low-cost control outputs from one I/O channel

Meet HP's new computer-stretcher, the Multiprogrammer . . . ready to help you solve the many problems encountered in designing automatic test and control systems — at minimal cost.

Minicomputers just don't have sufficient I/O channels and adding more is expensive. What's more important, many devices used in automatic test and control systems require control signals in forms other than the computer's binary output. This is why HP designed the Multiprogrammer System. It's a computer-controlled data distributor and converter that allows you to simultaneously or independently control up to 240 analog (or 2,880 digital) outputs . . . from a single computer I/O channel.

The Multiprogrammer houses a variety of plug-in cards that provide programmable resistance, voltage, contact closure, or TTL outputs. You "custom design" your own system by simply plugging in these cards, and you have the ability to change the system any time you want. There's an additional saving with reduced computer programming time. All outputs are automatically set to a safe state at power turn-on. Digital storage on each output card eliminates the need to refresh each output channel. Special circuits simplify event timing and sequencing. And, because you'll be operating the Multiprogrammer in rugged industrial environments, HP designed and built it to eliminate problems with noise transients, ground loops, and broken cables.

You need one master Multiprogrammer, Model 6936A (\$1,300), which has 15 channels. You can expand this capability at any time by adding on up to 15 Multiprogrammer Extenders with no changes in computer hardware or operating software. Each Multiprogrammer Extender, Model 6937A (\$800), has 15 channels. Programmable output cards now available are: Resistance Output (\$345), Low Speed D/A (\$385), High Speed D/A (\$420), Relay Register (\$370), and TTL Output (\$200).

A detailed brochure on the **HP MULTIPROGRAMMER SYSTEM** including system description, specifications, and applications is yours for the asking. Just contact one of the 220 HP Sales/Service offices.



HEWLETT  PACKARD

100 Locust Avenue
Berkeley Heights, N. J. 07922 • (201) 464-1234

21104

INFORMATION RETRIEVAL NUMBER 10

Small active-electronic antenna offers big-league TV reception

A new approach to the design of multiband television antennas has produced a rugged, miniaturized, active-electronic antenna with sensitivity comparable to that in larger, conventional units.

The new antenna, which lists for \$75, weighs but five pounds and has been tested satisfactorily, its maker says, in winds up to 85 miles an hour.

Developed by JFD Electronics Corp., Brooklyn, N.Y., the antenna uses a printed circuit pattern for its passive elements, together with transistor amplifiers and filters for the vhf low and high bands and the uhf band.

This new design, according to Edward Finkel, JFD's executive vice president, squeezes the performance of three conventional antennas—a vhf low-band, 10-element yagi with a seven-foot boom, a vhf high-band antenna with 14 or 15 elements and a nine-foot boom, plus a four-element uhf driver with a reflector and director—all into a slim plastic housing about 34 inches long, 27 inches wide and 3 inches thick.

Field tests, says Jerry Balash, JFD's marketing manager, have demonstrated that the antenna has sufficient gain to provide high-quality color pictures at 40 miles on the vhf low band, at 70 to 75 miles on the vhf high band, and 40 to 50 miles on the uhf band.

Shown publicly for the first time at the recent Consumer Electronics Show in Chicago, the new antenna, called the Stellar 2001, is the result of over three years of research, starting with fundamental design work by Dr. Paul E. Mayes, professor of electrical en-

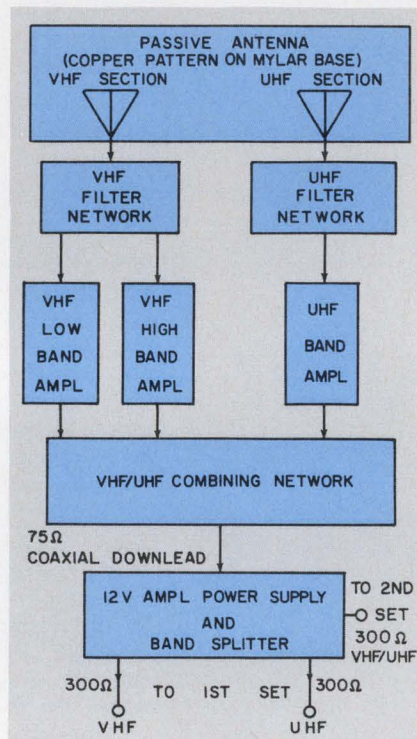

Conventional TV antenna aluminum elements are replaced by printed-circuit antennas plus vhf and uhf transistor amplifiers.



New electronic TV antenna is equivalent to multi-element vhf and uhf antennas, but it weighs only 5 pounds and is aerodynamically stable.

gineering at the University of Illinois and a co-inventor of the log-periodic antenna concept.

The main part of the Stellar antenna is a planar printed-circuit antenna, with both vhf and uhf elements. It is etched from highly conductive copper on a thin mylar base. An immediate gain is the elimination of several lossy mechanical and electrical connections found in conventional antennas. Also, the characteristics of the antenna remain stable over a long period of time.

The outputs of the vhf and uhf sections are fed to filter networks, which are combiners as well as isolators, according to Balash (see diagram). The outputs of the vhf and uhf networks are applied to the inputs of specially designed low-noise amplifiers that have low-noise transistors.

Interaction between the low-band and high-band signals is prevented by the filter networks. The combiners are a part of the printed-circuit pattern, as are PC baluns

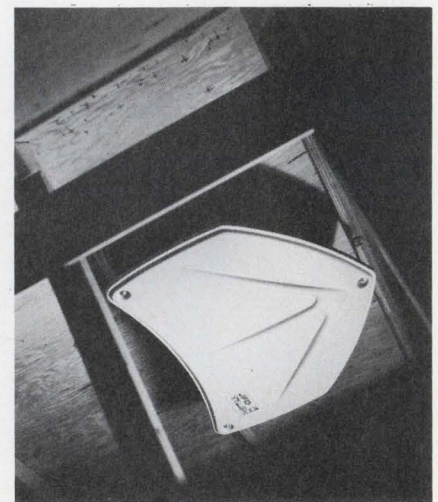

The JFD antenna has a versatile mounting arrangement. Here it is secured to the sloping roof on the inside of an attic.

Jim McDermott
West Coast Editor

that balance out mismatch between the amplifiers and the PC elements.

The three transistor amplifiers are mounted on a PC board, supported by two brackets, about one inch above the PC elements. The rear bracket is solely for mechanical support, while the front bracket also has the mounting hardware for a 75-ohm connector that feeds the output of the vhf/uhf combining network to the coaxial downlead. Use of the 75-ohm shielded coax prevents the pickup of unwanted TV signals and also rejects local interference.

Power (12 V) is supplied to the transistors through the same coaxial cable. Integrated in the power supply is a band-splitting network

that separates the uhf and vhf signals, providing two 300-ohm outputs for the prime set.

A significant reduction in weight in the Stellar was achieved through the use of the mylar substrates, a technique used in aerospace systems, according to Finkel.

So far as directivity of the antenna is concerned, there is a 4 to 5 dB gain on TV Channel 6 of the low-band vhf antenna. This decreases to a conventional figure-eight dipole pattern on Channel 2. The low-band antenna, because of its short length, actually has a loss, Finkel points out. But the gain supplied by the low-band amplifier raises the net antenna gain to 5 to 8 dB.

While the initial work on the

antenna was done at the University of Illinois, Finkel notes that the final antenna gain and environmental testing was done at Maxson Electronics, Great River, N.Y. Maxson, a sister company of JFD in the Riker-Maxson organization, has been heavily involved in military and aerospace work.

Another TV antenna manufacturer, the Wineguard Co., Burlington, Iowa, has had a miniaturized version of an all-channel TV antenna on the market for nearly a year. The signals are amplified in this antenna by transistors. When asked for data on performance of the antenna, however, a company spokesman refused to give ELECTRONIC DESIGN any more technical information. ■■

Thick films deposited onto PC board

A new process makes it possible to deposit thick-film resistors directly onto epoxy-glass printed-circuit boards. Heretofore resistors could be deposited only on glass or ceramic substrates.

What are the advantages of thick-films on PC boards, as compared with discrete resistors soldered in place?

Charles R. Stanfill, chemical laboratory supervisor and developer of the process at the Electronic Engineering Co. of California, Santa Ana, notes that the cost saving over discrete resistors is on the order of five times. Furthermore, he says, each filmed resistor only takes about 1/25th the volume and 1/10 the area of a discrete resistor of the same value.

Stanfill has used a thick-film material that is a combination of two types of resins in a solvent. One is a diallyl phthalate base resin, and the other is a phenolic resin. The solvent used is isophorone.

To apply the ink to the PC board, the pattern is silk-screened on the board, which is then allowed to dry for one hour at room temperature. This is followed by one hour at 212 F to volatilize the solvent. Finally, 10 hours at 312 F allows

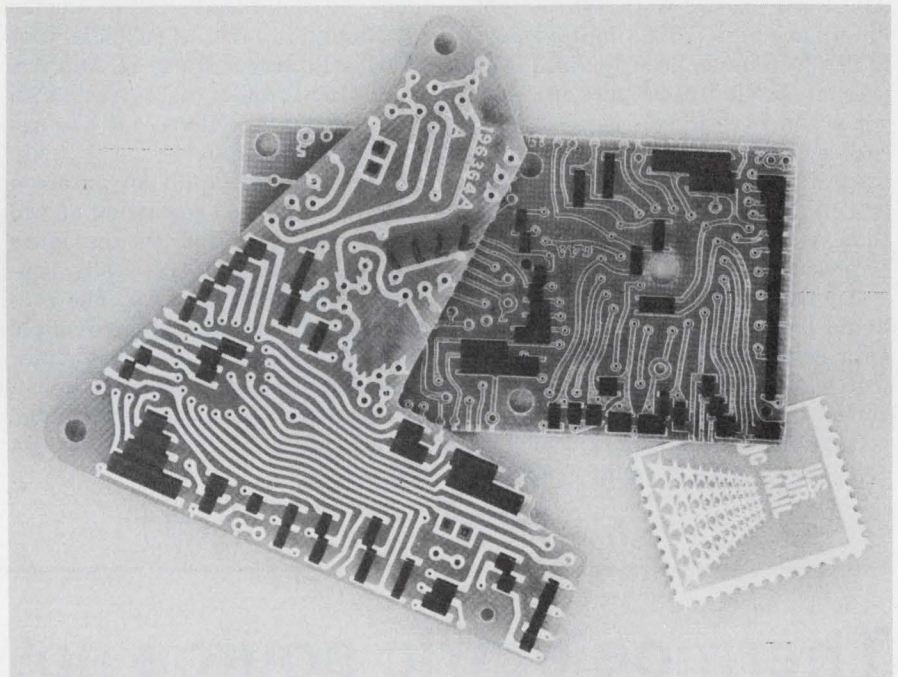

Epoxy-glass printed circuit boards with thick film resistors are produced by Electronic Engineering Co. of California. These will eventually go into airline entertainment systems.

almost complete polymerization of the resins and produces a film with high temperature stability.

According to Stanfill: "These screened resistors can be used safely over a temperature range of from -55 F to +212 F. They can stand up to 100 g's of random vi-

bration and have no problem with humidity."

Stanfill has already produced inks that range in value from 150 ohms/sq. mil to 4000 ohms/sq. mil. Resistor tolerances typically are +20%, with power dissipation on the order of 0.5 W. ■■

Abolishing laser-display 'speckle'

The Air Force has come up with a better way to eliminate an old problem in rear-projection laser displays—laser "speckle."

Speckle, which seriously degrades resolution, is scintillation caused by the interference effects of coherent light reflected from a diffuse surface.

Present methods for eliminating it employ mechanical means, such as vibrating gratings, rotating screens, movable wedges and colloidal suspensions. These devices solve the problem by rendering spatially coherent light incoherent, which in turn eliminates interference effects. But all these techniques are cumbersome.

A better solution: An electro-optical technique, using a nematic liquid-crystal screen. Images projected onto the liquid-crystal screens have better resolution and contrast when either coherent or incoherent illumination is used, the Air Force says. With white-light illumination, a 75% improvement in resolution has been realized over present ground-glass screens. And when the new screen is used with coherent light, it produces an even greater improvement in resolution by eliminating the laser speckle that is present in ground-glass screens.

Another advantage is that the liquid-crystal screen is a variable-gain device—that is, the degree to which the screen scatters can be varied by changing either the voltage or the frequency of the drive signal (see "Liquid Crystals:

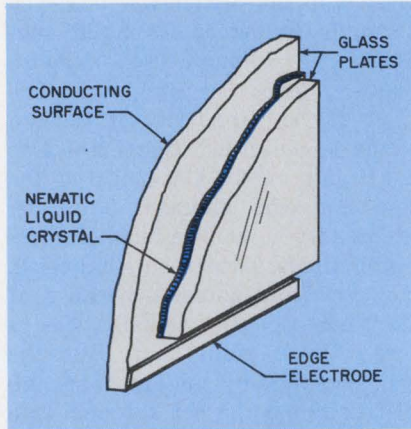

The nematic liquid is contained in a sandwich cell consisting of two glass plates, coated on the inner surfaces with an electrically conductive transparent film. The conductive surfaces are about 50 to 75 μ apart.

Material With a Hot Future," ED 19, Sept. 13, 1970, p. 76).

The developmental work on the new liquid-crystal screens has been done by the Electro-Optics Center of Radiation, Inc., a subsidiary of Harris Intertype Corp. in Ann Arbor, Mich., under a contract with the Air Force's Rome (N.Y.) Air Development Center.

The nematic liquid is contained in a sandwich cell consisting of two glass plates, coated on the inner surfaces with an electrically conductive transparent film. The conductive surfaces are approximately 50 to 75 μ apart. The glass plates are staggered so an electrode can be fastened along an entire edge to provide a uniform field across the screen.

If no voltage is applied, the liquid remains in a quiescent state (virtually transparent). However, as the voltage is increased past a threshold point, dynamic scattering begins.

This scattering causes a wavefront impinging on a liquid-crystal screen to be multiplied by a time-varying random phase function. Therefore if the incident light is spatially coherent, the light emerging is incoherent and interference phenomena, such as laser speckle, disappear.

There is an equivalent phenomenon in white-light illumination. When white light impinges on a ground-glass screen, the matte surface acts as a random array of very small prisms, which break the light up into its component colors. Also, the matte surface acts as a random array of small lenses, which focus the light to generate hot spots and a general sparkling effect, both of which limit viewing a high-resolution target. When a white-light image is viewed on a liquid-crystal screen these problems are diminished because the effects are averaged over a period of time. The result is a smooth, natural image.

This month Radiation, Inc., is delivering two 30-by-30-inch liquid-crystal screens to the Rome Air Development Center. For commercial applications, the company plans to produce screens ranging from 30 by 30 inches to 12 by 12. The smaller screen may sell for as little as \$1000, Radiation says. ■■

Thermoelectric source not fussy on fuel

A new, lightweight Army thermoelectric generator that develops substantial power directly from heat can burn almost any type of fuel—diesel oil, jet fuel or gasoline. The reason: a supersonic transistor oscillator that drives a piezoelectric disc at 77,000 Hz. The fuel, impinging on the disc, is atomized.

Developed by the Army Electronics Command, Fort Monmouth, N.J., the generator produces 500 W at 28 Vdc, and it can operate unattended in the field as long as it is supplied with fuel. It is designed for a minimum of 1000 hours of operation without maintenance.

The thermoelectric phenomenon

—generation of electricity by application of heat to two dissimilar metals in a thermocouple—has been used primarily in the laboratory for temperature measurement, or commercially for temperature controls, according to an Army spokesman.

In the new generator, thermocouples are used, but instead of

being comprised of two different metals, each is a single, lead-telluride semiconductor whose sides are doped or treated separately. One side is positive, the other negative. The 500-W unit has 256 thermocouples.

The thermocouples are hermetically sealed between hot and cold walls. Power is taken from the cold wall. The hot side is maintained at 1100 F by the ultrasonic atomizing and burning of the various fuels. The cold side is held at about 250 F by forced-air cooling. Blower noise is, however, minimized, and is inaudible beyond 100 feet.

A versatile power source

The new 500-W generator has been built for and demonstrated with an Army's aircraft beacon, the AN/TRN-30 (see photo). However, it provides sufficient power for use in energizing field radio transmitters and receivers, radars, data terminals and navigational-aid equipment. It can also be vehicular-mounted or employed as a portable battery charger.

While the thermoelectric generator was designed for an operating output of 500 W at 28 V, its full output is 650 W at 34 V, the Army says. The extra power is used to run the transistor oscillator and the cooling equipment. The voltage is lowered through a regulator circuit that can provide down to 25

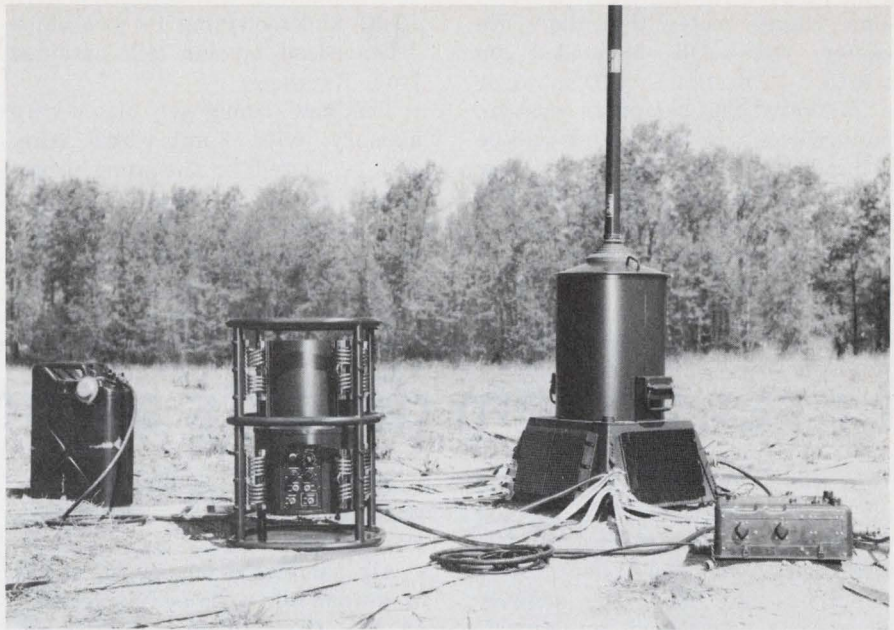

The Army's new 57-pound thermoelectric generator was built for and is shown here with their new low-frequency radio beacon for the guidance of aircraft. The generator is powered from fuel from the can shown at the left. The generator, second from left, has large spring mounts to protect it from shock during drops. The beacon and its control unit are shown at the right. The antenna extends upwards.

V for charging batteries.

Participating with the Army Electronics Command in work on the generator was the Minnesota Mining and Manufacturing Co., which is now building three qualification units.

While the electrical output of the present model has been demonstrated, it is currently being modified to meet the military environmental specification (Mil Std 810

B) for this type of equipment. One of the requirements is that the equipment withstand, without damage, 26 free drops from a four-foot height to the ground.

Other power sources under development at the Army Electronics Command's Electronics Components Laboratory include fuel cells, thermionic diodes, solar cells and several kinds of rechargeable batteries. ■■

For long space missions: a new computer

Looking forward to future long-term space missions—such as space stations and space bases—the Advance Computer Design Office of the Marshall Space Flight Center, Huntsville, Ala., is developing a flexible modular computer that can be adapted to a variety of vehicles. Ultra reliability is the object of the design.

According to Paul Hamby, chief of the Marshall Computer Design Section, the new computer will have, in its prototype version, TTL bipolar logic, using beam-lead chips, plus a new 400-word-by-32-bit miniature plated-wire memory



Probing the plated wire memory is Honeywell's William England.

from the Honeywell Aerospace Div., St. Petersburg, Fla. (see photo).

"We're looking at missions that will last five years," Hamby told ELECTRONIC DESIGN. "For these long-term applications, we're building the computer in modular form, using basic four-bit building blocks. With this system, we can assemble four, eight or 12-bit computers that can be used for rocket engine control, for guidance and navigation, and for housekeeping."

The first computer being designed is, however, a 32-bit ver-

sion. Hamby noted that the space center was still undecided on whether to design a centralized or a decentralized computer system. In any event, he says, there will be a data bus on board, and the way the design is proceeding, the bus system can fit either application.

For the prototype, the Marshall center is building its own sub-

strate and mounting its own chips—beam-lead bipolar MSI obtained from Raytheon.

The new Honeywell plated-wire memory, with 2-mil plated wire, will be tested in the same prototype. Bamby says that the plated-wire memory was chosen because of its potential reliability, non-destructive readout, 250-ns read

500-ns write speeds, readout, low-power requirements and small size.

The Honeywell memory, the first to offer the combined advantages of 2-mil plated wire and MSI circuitry, was under development by the company for two years. In its standard configuration it packages 200,000 bits (8000 words by 24 bits) and 142 cubic inches. ■■

Laser system detects air pollution fast

In the continuing quest to come up with a sensitive, rapid method of analyzing pollutant gases in the air, Bell Telephone Laboratories scientists may have the answer. They have developed an experimental laser detection system that is said to be capable of measuring several kinds of gases in seconds and in quantities as small as ten parts per billion parts of air (see "Designing for the Pollution-Free Industrial Era," ED 10, May 13, 1971, p. 49).

The system consists of two basic devices: a special type of Raman laser designed by C. Kumar N. Patel, director of Bell's Electronic Research Laboratory at Holmdel, N.J., and an opto-acoustic absorption cell developed by Lloyd B.

Kreutzer of the Solid-State Spectroscopy Research Dept. at Murray Hill, N.J.

Air samples from smoke stacks or automobile exhausts are collected in a flask, taken to the laboratory and introduced into the absorption cell. The cell contains a sensitive microphone with a cylindrical diaphragm that converts changes in air pressure into electrical energy.

Tuning in on the pollutant

To measure the quantity of pollutant gas in an air sample, the laser is tuned to the particular absorption wavelength characteristic of known pollutant gases. (Almost all of the known pollutants have

their fundamental absorption bands in the infrared portion of the spectrum from about 2 to 15 μ .) The laser energy absorbed by the gas increases the temperature and pressure of the air sample in direct proportion to the gas quantity. The pressure increase, in turn, is sensed by a microphone that provides an electrical output signal whose strength can be recorded or displayed on a meter or oscilloscope.

The special laser designed by Patel is called a "spin flip" Raman laser. It provides tunable radiation in the 5 to 6 and 9 to 14 μ range. This range is also expected to permit measurement of certain hydrocarbons.

The laser system includes a powerful electromagnet, used to tune the laser beam to a desired frequency, a fixed-frequency CO₂ pump laser and a rotating shutter to interrupt the beam at regular intervals.

With the new technique, Bell scientists report that air samples as small as one cubic centimeter can be tested in four seconds.

One problem with using traditional spectroscopic techniques is that though each gas has its own peculiar "fingerprint" absorption characteristic, there is nevertheless some overlapping of absorption lines from other gases. Another problem has been that pollutant concentrations as small as one part per million have been too small to be measured directly. The new technique, the scientists say, solves both of these problems.

Both Patel and Kreutzer believe that present technology will permit the design of smaller, more portable equipment—perhaps no bigger than a suitcase—for on-the-scene pollution tests. ■■

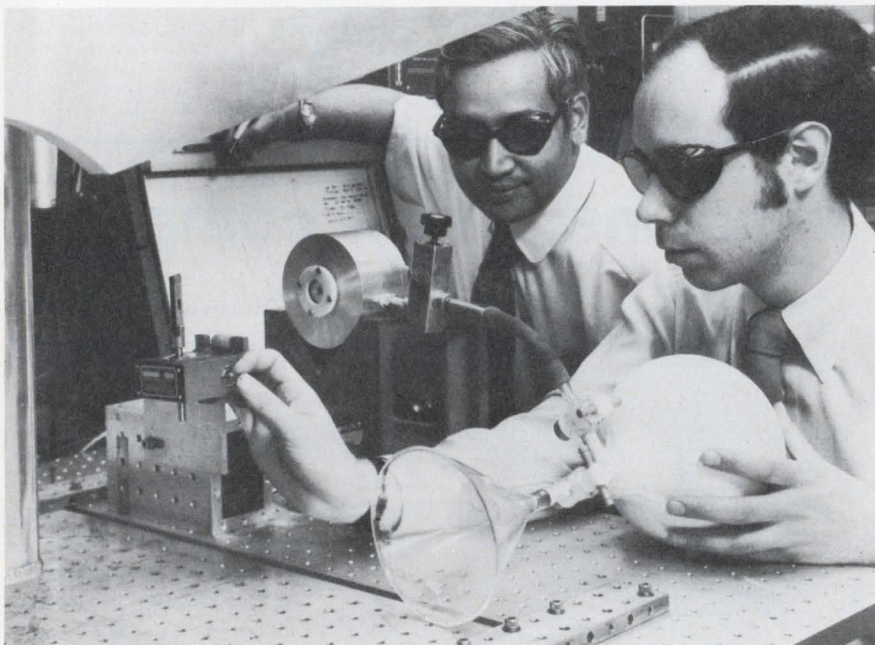

Pollution testers C. Kumar N. Patel (left) and Lloyd B. Kreutzer measure the amount of nitric oxide in an air sample, using a new laser-light absorption technique they devised. The air sample from the flask (right) enters a cylindrical absorption cell (center), where it contacts an infrared laser beam. The gas quantity is plotted on a recorder (left).

LOW POWER TTL CRAM COURSE.

Low power TTL isn't exactly a household word yet among design engineers. So we'd like to offer a quick summary of low power TTL. What it is. Who uses it. Why. Why not. Plus, a list of our products.

After reading this page, you'll probably decide to specify low power for your next system. (If not, you'll at least have lots of cocktail party material.)

PART ONE: A DEFINITION

Low power TTL is an offshoot of the 54/74 family which is fully compatible with DTL and TTL. It is specifically designed for applications requiring very low power dissipation.

PART TWO: WHO USES IT

The military's been using low power TTL for four years, but it's also catching on in portable equipment, data terminals and other industrial applications as well.

PART THREE: ADVANTAGES

Low power TTL offers several nice advantages over standard TTL logic.

First, even at frequencies of 12MHz the devices dissipate very low power and generate less heat on the chip. As a result, low power TTL has proven to be much more reliable than standard TTL. (If you don't believe us, ask NASA.)

Then there's power savings. Typically, low power TTL gives you a *factor of 10* power savings over standard TTL. Which means you can use a 2.5A power supply, for example, instead of a 25A supply. Which means you save money.

Speaking of saving money, perhaps the biggest single advantage to using low power TTL is the money you save in your overall systems costs.

For example, low power TTL eliminates the need for a fan. Which eliminates the need for a thermostat. Which eliminates the need for a filter. And so on and so forth. (In fact, one of our customers says that the fan alone costs them enough money that even if they had to pay 200% more for low power devices in their systems, their overall systems costs would still be less expensive!)

PART FOUR: PRODUCTS

Right now, we have 21 off-the-shelf low power TTL devices (including four MSI functions):
DM54L00/DM74L00 Quad 2-Input NAND Gate

DM54L01/DM74L01	Quad 2-Input NAND Gate, Open Collector
DM54L02/DM74L02	Quad 2-Input NOR Gate
DM54L03/DM74L03	Quad 2-Input NAND Gate, Open Collector
DM54L04/DM74L04	Hex Inverter
DM54L10/DM74L10	Triple 3-Input NAND Gate
DM54L20/DM74L20	Dual 4-Input NAND Gate
DM54L30/DM74L30	Eight-Input NAND Gate
DM54L51/DM74L51	Dual 2-Wide AND-OR-INVERT Gate
DM54L54/DM74L54	Four-Wide 3-2-2-3-Input AND-OR-INVERT Gate
DM54L55/DM74L55	Two-Wide 4-Input AND-OR-INVERT Gate
DM54L71/DM74L71	R-S Flip Flop
DM54L72/DM74L72	J-K Flip Flop
DM54L73/DM74L73	Dual J-K Flip Flop
DM54L74/DM74L74	Dual D Flip Flop
DM54L78/DM74L78	Dual J-K Flip Flop
DM54L86/DM74L86	Quad EXCLUSIVE-OR Gate
DM54L90/DM74L90	Decade Counter
DM54L93/DM74L93	Binary Counter
DM54L95/DM74L95	Four-Bit Right Shift Left Shift Shift Register
DM76L70/DM86L70	Eight-Bit Serial-In Parallel-Out Shift Register

(NOTE: All devices are available in cavity-dip, molded-dip and flat-pack configurations.

We also plan to announce some Tri-State* MSI low power devices.

This ends our cram course. If you'd like to learn more, we'll be happy to send you a free copy of our full course — the liberally-diagrammed, specifications-packed, 36-page National Low Power TTL Brochure. Plus any of our Tri-State or 54/74 product data.

For yours, write, phone, TWX or cable us today. National Semiconductor Corporation, 2900 Semiconductor Drive, Santa Clara, California 95051. Phone (408) 732-5000. TWX (910) 339-9240. Cable: NATSEMICON.

*Tri-State is a Trademark of National Semiconductor Corporation

NATIONAL

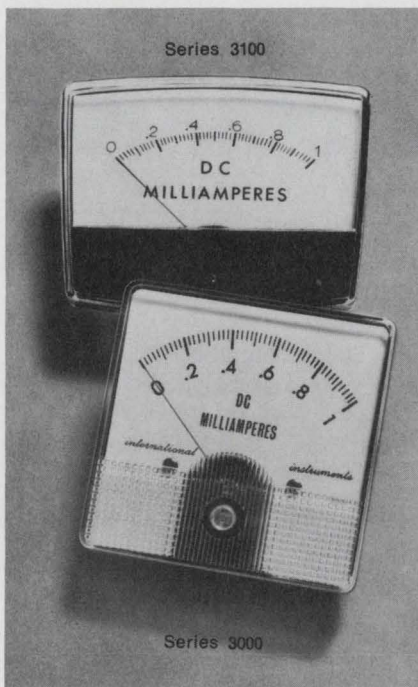

Put quality on your panel for under \$5

Accuracy, readability, response and ruggedness need not be sacrificed for low cost: these International Instruments Series 3000 and 3100 meters will meet your design goals at costs as low as \$4.15 for a 1½" square DC milliammeter. Jeweled D'Arsonval movements, in ranges down to 50 μ a, provide response time to 2 sec. max. and initial accuracy to $\pm 2\%$ DC ($\pm 3\%$ AC), meet shock and vibration requirements of ANS C39.1. Repeatability is maintained over the life of the meter.

Both Series available in 1½, 2, 2½, 3½ and 4 inch sizes, in 61 standard ranges from 50 DC μ a to 500 AC volts. Clear acrylic crystals, sweep scales and red bar-type pointers enhance readability and random-size compatibility. Custom dials carrying your trademark and special colored shrouds available at moderate additional cost. For data and quotes, send requirements to:



INTERNATIONAL INSTRUMENTS

DIVISION OF SIGMA INSTRUMENTS, INC.
88 MARSH HILL RD., ORANGE, CONN. 06477
INFORMATION RETRIEVAL NUMBER 21

technology abroad

Ferryboats that travel a narrow, two-mile stretch of treacherous channel in Umeaa Harbor, Sweden, make the trip safely in the thickest fog by following an electrified cable laid on the bottom of the channel. This cable, carrying a 220-V, 400-Hz signal, produces an electromagnetic field, which is tracked by coils mounted alongside the ship's bridge. The ship's position relative to the cable, is detected and displayed on an oscilloscope.

CIRCLE NO. 451

Continuous 100% sampling for speck impurities in plastic or paper manufacturing can be done with a novel instrument developed by the Scientific Instrument Research Association of South Hill, Chislehurst, Kent, England. Specks down to 75 μ (less than 0.003 inch) can be detected at production line speeds of 70 feet per minute. The number of specks counted is displayed on a digital readout unit. The instrument can detect and count small discolorations in plastics, food, cosmetics and paper. In operation the surface to be inspected is illuminated. A lens projects an image onto a scanning disc that contains a ring of equally spaced pinholes. Light passing through each hole is collected by a second lens and is directed to a photo-detector. When the pinholes scan a clean surface, a constant electrical output is produced. But if the dark speck is traversed, the signal drops and initiates a pulse count.

CIRCLE NO. 452

A six-pound ground-surveillance radar called SPRAT has been developed by the Royal Radar Establishment, Malvern, Worcestershire, England. The radar, built with Gunn oscillators, miniature components and microwave ICs, is being used to detect the move-

ment of men and vehicles in darkness and fog. Ranging is achieved by a manually operated 100-meter range gate. Target movement is detected by a doppler note in the headphones. The radar can detect a man walking up to 700 meters away.

CIRCLE NO. 453

Semiconductor memories are beginning to appear in the mainframes of European computers. Britain's ICL Computer Co. recently unveiled its S-series of computers. The largest model, the 1906S, uses a fast plated-wire memory supplied by the Plessey Co. This memory has a 130-ns access time and a 300-ns cycle time. But ICL's 1904S, 1903S and 1902S computers use a semiconductor memory built up from circuits provided by the Cogar Corp. of Wappinger Falls, N.Y.

CIRCLE NO. 454

A new integrated-circuit manufacturing process can produce bipolar ICs with MOS packing densities. Developed by Philips Research Laboratories in Eindhoven, The Netherlands, the process overcomes production difficulties associated with high-speed, n-channel MOS devices. The new process uses insulating silicon dioxide layers to isolate the IC transistors. The process requires two steps. First, a thin, silicon-nitride layer is grown over the surface of the silicon in selected areas. Then those areas of the silicon not protected by the nitride skin are etched away, and the thick oxide is buried or grown flush to the silicon surface. This technique is an essential element in the Isoplanar process for producing high density bipolar devices, recently announced by Fairchild Semiconductor. Fairchild and Philips have an agreement to exchange technology.

CIRCLE NO. 455

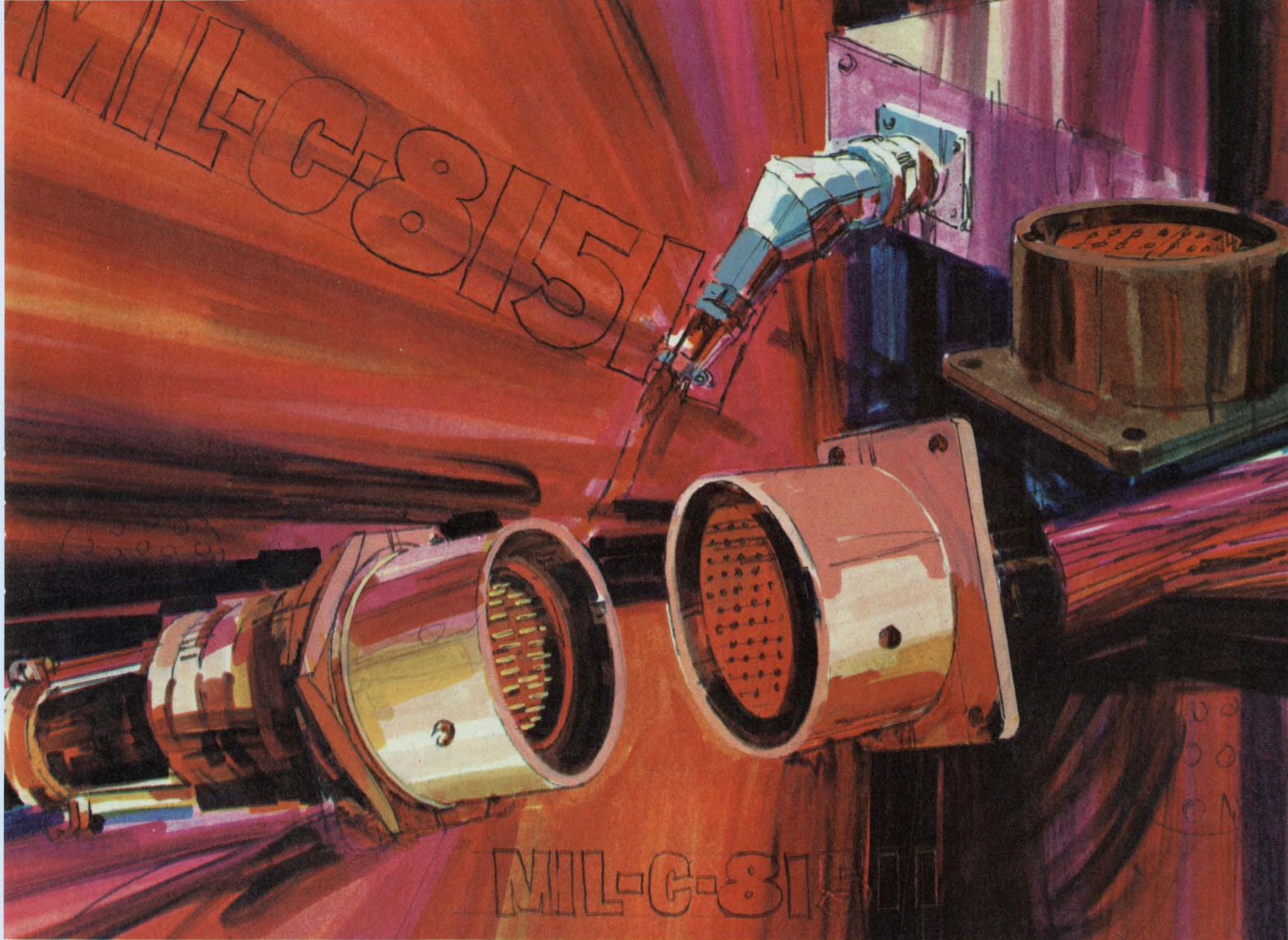

AT CINCH-NULINE WE DON'T REST ON OUR QUALIFICATIONS*

Cinch-Nuline works tirelessly to be sure its MIL-C-81511 connectors exceed the specifications. We are continually improving our material standards, upgrading our manufacturing techniques and inspection procedures. We don't relax—so you can be supplied with an even better connector than you expect!

Maybe that's why our customers are so pleased with the quality record of Cinch-Nuline MIL-C-81511 connectors.

This tri-services approved connector is rapidly becoming the standard for new aerospace programs. If your existing equipment must interface with these new systems, re-designing it to use MIL-C-81511 will solve many problems for you.

For detailed information on these subminiature connectors, contact your nearest Cinch Sales Office, or Cinch-Nuline, a division of TRW Inc., 1015 South Sixth Street, Minneapolis, Minnesota 55415; telephone (612) 339-8301. CN-7160

*Qualified to MIL-C-81511, Revision A on June 30, 1970, to Revision B on July 13, 1970 and to Revision C on March 1, 1971.

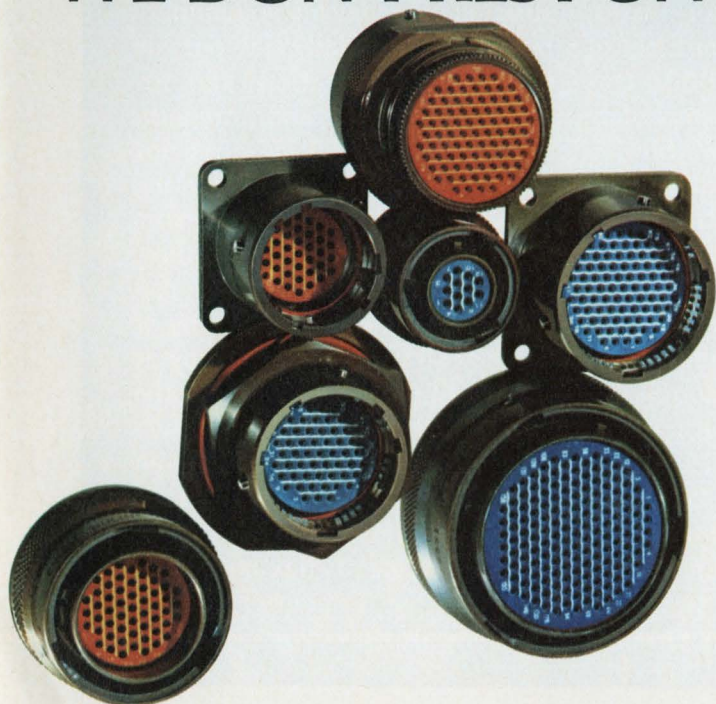

CINCH-NULINE

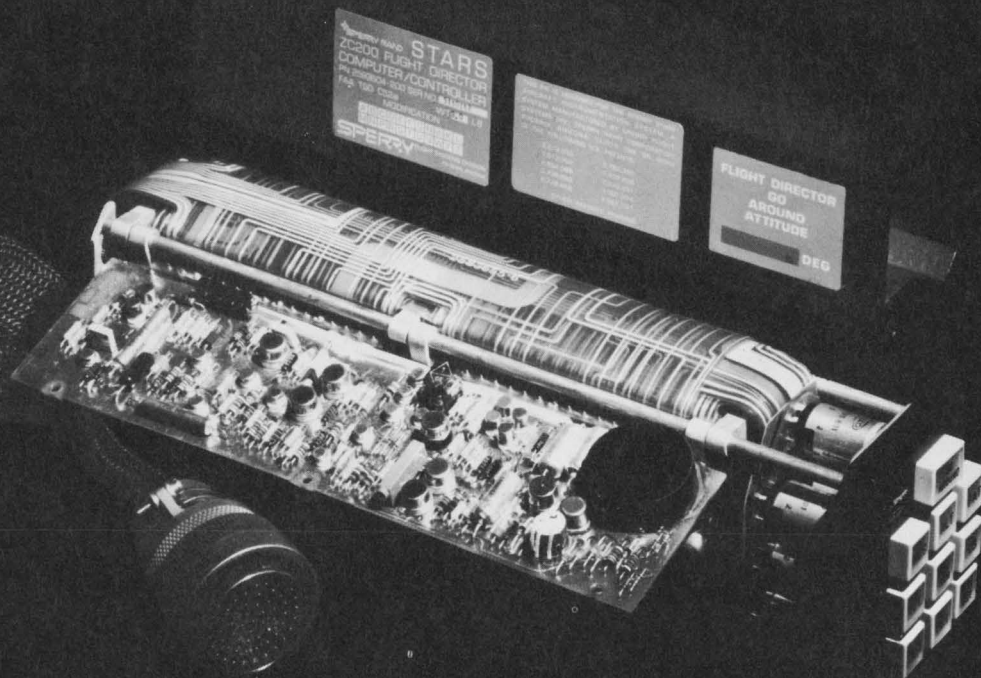

Why does Sperry Flight Systems Division use flexible etched circuitry in its STARS flight director computer?

Because Sperry engineers know that flexible etched circuitry provides high-density packaging and high-reliability at lower cost than conventional wiring.

The flexible laminate used in the Sperry ZC-200 Flight Director Computer, a component of the STARS Flight Director Instrument System, is Teledyne Electro-Mechanisms' Type MC56. This laminate has outside layers of 2-mil Du Pont "Teflon" film — chosen for its outstanding flexibility and excellent electrical characteristics — a 1-mil layer of Du Pont "Kapton" polyimide film, and etched conductors of 2-oz copper foil. These materials are bonded with a thermosetting epoxy adhesive to form the composite laminate.

The Flight Director Computer flexible circuit is made up of six separate etched circuit layers which are installed as a sandwich, soldered to the various termina-

tions, and then folded to form the high density package. The pigtail (or external cable) is also constructed of etched MC56 laminate but has two additional outside layers of 5-mil "Teflon" film for added toughness and strength. The complete package does not use a single wire, thus eliminating the possibility of wiring errors during assembly and maintenance.

Flexible etched circuitry can cut assembly and test costs by as much as 50 per cent, weight by as much as 60 per cent, and volume by as much as 80 per cent. When you couple these savings with an attendant overall reduction in production rework and final test costs you'll specify flexible etched circuitry by Teledyne Electro-Mechanisms.

 **TELEDYNE**
ELECTRO-MECHANISMS
29 Crown Street
Nashua, N.H. 03060

washington report

DON BYRNE, WASHINGTON BUREAU

Quiet torpedo wins \$116-million contract

Excessive noise in its proposed torpedoes has cost Westinghouse Electric Co. a multimillion contract for the Mark 48 torpedo, informed sources have told ELECTRONIC DESIGN. Gould Inc.'s Clevite Div. won the \$116-million Navy production contract.

Westinghouse, the original contractor for the program, has had a series of technical difficulties with the program, and Defense Dept. officials said in Congressional testimony earlier this year that selection would depend on the results of noise-signature tests during firings of the torpedoes of the two bidders. The Mark 48 is designed for use against deep-running nuclear submarines, and spending for it is expected to come to about \$2.6-billion by 1980.

CATV expansion hopes blow hot and cold

Federal Communications Chairman Dean Burch has told the National Cable Television Association he would like to see CATV operators branch out into new areas besides just providing extra TV channels. As examples, he cited two-way communications for educational and medical services. But as Burch extended this hope for CATV operators, Clay T. Whitehead, director of the Office of Telecommunications Policy for the White House, was providing cause for additional worry.

Whitehead told the association at a meeting here that he thought the issues involving cable TV were so important that they should be debated in Congress and by his office. Many believed this meant nothing more than a slowdown on a proposed easing of rules by the FCC to let CATV operators offer wider fare to their subscribers. Some of the more cynical thought that the White House was not about to offend the broadcast networks as an election approaches by allowing cable TV to expand at the expense of the networks.

Good news for Lockheed, for a change

Along with its troubles on Capitol Hill, Lockheed has cause for cheer—a spate of contracts at the end of the fiscal year has brought \$234.1-million into its coffers. The Navy awarded Lockheed \$46.2-million for tactical engineering services on fleet ballistic missile systems, \$162.3-million for 1972 Poseidon submarine missile production and \$1.1 million for engineering studies on the Undersea Long Range Missile System. In addition, the Air Force awarded \$23.3-million for aircraft maintenance, and the Defense Atomic Support Agency \$1.2-million for test-site work in Nevada.

Meanwhile the argument continues over whether the Government should guarantee \$250-million in new loans to Lockheed. Questions are

being raised over whether aerospace company's figures on the Tristar jet-liner program are accurate and whether it could make money on the program as it is presently envisioned. Daniel Haughton, Lockheed's chairman, says that without the loan, the company will go bankrupt. This, he warns, will cost local and federal governments over \$1-billion and create havoc in an already bleak aerospace employment picture.

Air Force heads for the wire

The Air Force expects to make a contract award of about \$100-million next January on its advanced Loran navigational program. Response to requests for proposals sent to 33 companies are due this week. The project will outfit up to 3000 tactical aircraft with Loran C/D equipment for pinpoint battlefield navigation. The Air Force is pushing to develop standardized Loran, built in block components, which could be used in various combinations to meet present and future needs. The Army, too, is looking for similar equipment to equip vehicles and even men with the navigational aid.

GAO criticizes the B-1 bomber program

The B-1 bomber program could be in more trouble as a result of a General Accounting Office report just issued to Congress. The GAO says the \$8.1-billion program ignored the Pentagon's own guidelines on avoiding cost overruns, lower performance standards and delays. The program made no allowance for inflation increases during the life of the program, the report said and an avionics supplier was not picked until four months after the basic contract had been awarded to North American Rockwell and General Electric. The program was not in great favor in Congress before the GAO report, and chances are considered much rougher now.

Capital Capsules: The Dept. of Transportation has awarded contracts totaling \$2.8-million to the Rohr Corp. of Chula Vista, Calif., and Vought Aeronautics of Dallas, Tex., for **development of two tracked air-cushion vehicles** capable of carrying 60 passengers at speeds up to 150 mph. Mockups are expected in six months, and prototypes for testing a year later. The Transportation Dept. has already awarded \$3.5-million to Grumman Aerospace Corp. for research and development on a tracked air-cushion vehicle that could hit speeds up to 300 mph **A data-processing system planned for the Post Office** to give it information on mail volume, employee time and attendance and payroll information **has been something less than successful**, says the General Accounting Office. Estimated costs on hardware have risen 47%, two years after target date the system is not complete, employee costs to handle the automated system are 256% higher than expected, automated payroll operations are more costly than those done manually and the reports generated have "little value to postal management," GAO says. The costs now stand at \$44-million and are still climbing The White House, as expected, has named **Rep. Charlotte T. Reid (R-Ill.) to a seven-year term on the FCC**. Mrs. Reid, a one-time radio vocalist before entering politics, replaces Thomas J. Houser Hard to believe, but the Renegotiation Board has declared that the **ailing aerospace and defense industry made more than \$65-million in "excess profits"** during the fiscal year ended June 30—the largest amount since 1958.

SAVE // GAIN \$\$\$ performance

over any other 50-MHz,
plug-in oscilloscope.

50-MHz oscilloscope with:

5-mV dual-trace amplifier and delaying sweep	\$2200
5-mV dual-trace amplifier and single time base	1900
5-mV single-trace amplifier and single time base	1670

AND LOOK AT THESE BONUSES:

- 3 plug-in compartments and mainframe mode switching
- 6-1/2-inch CRT — 50% larger than 8 x 10 cm CRT's
- time bases have 5 ns/div sweep rate
- amplifiers and time bases accurate within 2%
- high writing-rate CRT gives a brighter trace

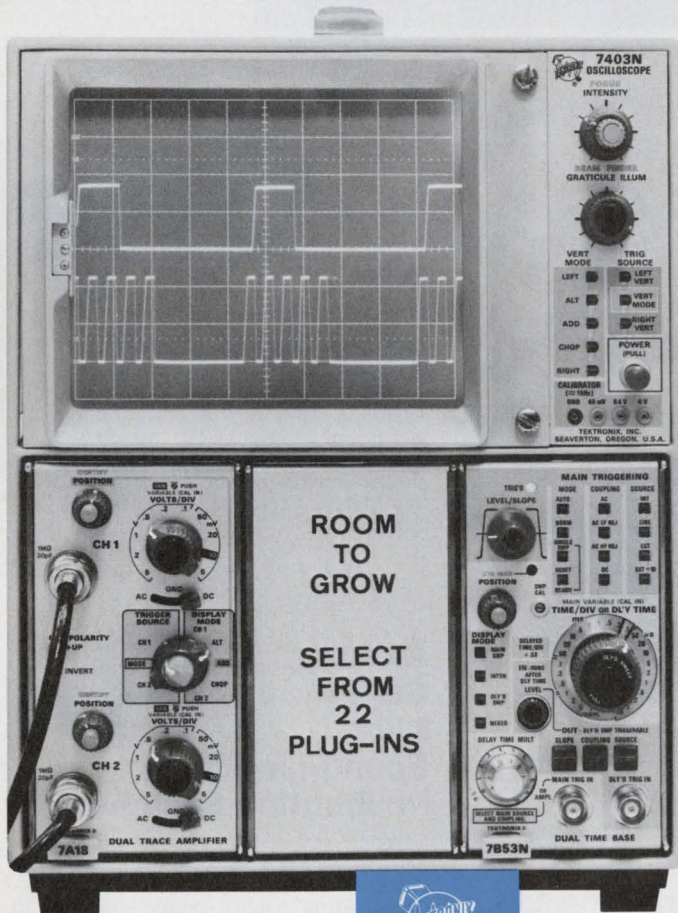

If you wish, select a plug-in for the second vertical compartment to give you 10 μ V/div at 1 MHz or 1 mV/div at 55 MHz or 1 mA/div at 55 MHz or another dual-trace unit for 4-trace capability, etc., etc. Plug-in prices start at a low \$270. Call your nearby Tektronix field engineer today for a demonstration.

7403N Oscilloscope	\$950
7A18 Dual-Trace Amplifier, Option 1	\$500
7A15 Single-Trace Amplifier	\$270
7B53N Dual Time Base	\$750
7B50 Time Base	\$450

U.S. Sales Prices FOB Beaverton, Oregon

Available in U.S. through the Tektronix lease plan.

INFORMATION RETRIEVAL NUMBER 24

TEKTRONIX®

committed to
technical excellence

See The TEKTRONIX Display At WESCON

Ring up a savings on keyboard switches.

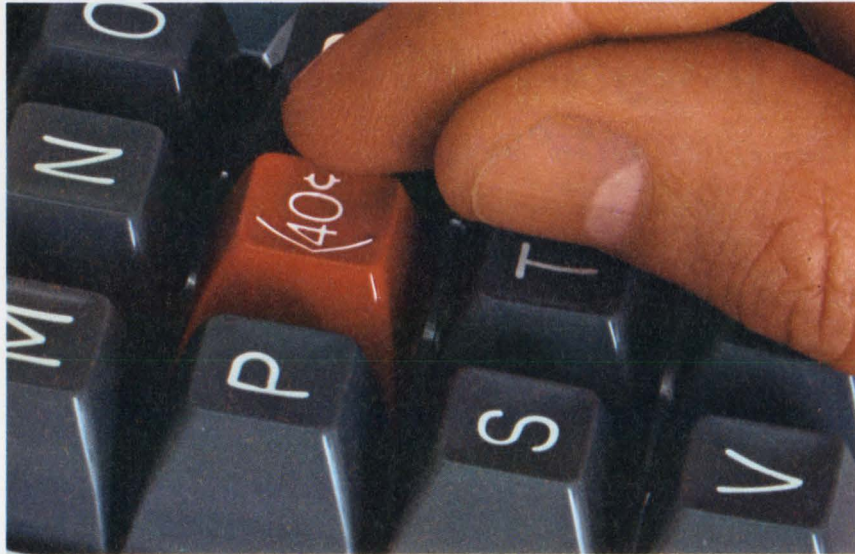

As much as **40%**
[savings per key]

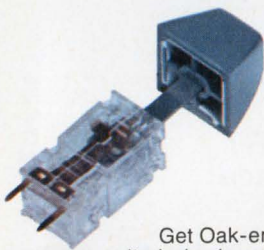

The new Oak Series 400.

Get Oak-engineered quality in keyboard switches with the inherent reliability of electro-mechanical operation. Ideal for peripheral data-processing equipment. Contact bounce is less than 3 milliseconds. Long life, up to 20 million operations per key. Designed with self-cleaning crossbar-wiping contacts.



Under 40¢ each.

For SPST/NO in production quantities. Other versions comparably priced. Keypoint button and snap-in mounting extra.



A feather touch.

We kept the operator in mind. Standard operating force is approximately 85 grams (3 oz.).

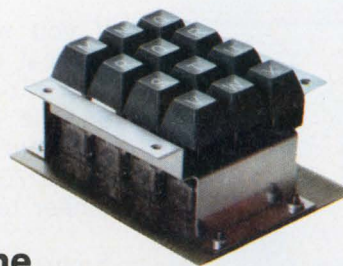

The configurations you want.

The Series 400 is available in limitless arrangements, including standard 10, 12, and 16-button keyboards. And you can specify any of six different contact circuitries. Choose snap-in or plug-in P.C. mounting. Compact—only 1/2" x 1/2" x 1".

Write today for our Series 400 brochure.

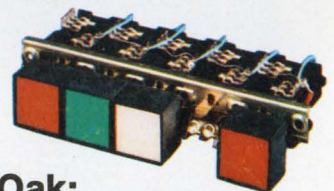

Also from Oak: Series 300 Lighted Pushbutton Switches.

Featuring Oak's exclusive twin-lamp lighting. If one lamp goes out, the other stays on. Double-wiping contact clips. Short stroke. Smooth, quiet operation. Unlimited combinations. Request our Series 300 brochure.

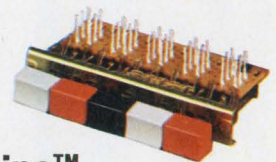

And our Series 800 Econo-Line™ Pushbutton Switches.

Compact—more buttons and more contacts in less space: 1 PST to 8 PDT per button. Your choice of mechanical actuation. Colored buttons, legend engraving to your specifications. Request our Series 800 brochure.

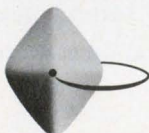

OAK MANUFACTURING CO.

CRYSTAL LAKE, ILLINOIS 60014 • A DIVISION OF OAK ELECTRO/NETICS CORP

Telephone: 815-459-5000

TWX: 910-634-3353

TELEX: 722-447

INFORMATION RETRIEVAL NUMBER 25

If we have to talk, let's make it positive

We've grown a little tired lately of the chorus of voices singing the praises of foreign industries and economies.

Sure, the Japanese have built an impressive and aggressive electronics industry, with their unique combination of industriousness, technology and governmental aid. And, sure, the German economy is as sturdy as they come, and factory automation in many parts of Europe is second to none.

These things are true, and they are a tribute to the people that have accomplished them. The problem is not the validity of such statements, but the impression they leave after excessive repetition. People unfortunately, tend to take the positive side of things for granted, and concentrate on negatives. So a constant extolling of the virtues of foreign industries eventually becomes a depreciation of our own industries. And people who have nothing but good intentions unwittingly become prophets of doom.

The truth, of course, is that U.S. industry in general and the electronics industry in particular, despite the problems of the last 18 months, is still the world leader. We set the technological and economic pace against which others judge their accomplishments. Even when wrestling with problems that would seem insurmountable to others, our electronics industry, in the eyes of the world, is a dynamic force that must be acutely recognized and warily contended with.

This is not misguided chauvenism but cold fact—a fact that sometimes seems to be appreciated more overseas than it is here. We have heard Europeans on more than one occasion say they wished the United States would stop talking itself into a recession. Even if this is an exaggerated statement, it indicates that others are more impressed with our capabilities than some of us are.

Just as we can't talk ourselves into a recession, we can't talk ourselves out of one either. But positive thinking and positive talk is an intangible commodity—one that just might serve as a catalyst in pulling together the positive elements that exist in our industry today.

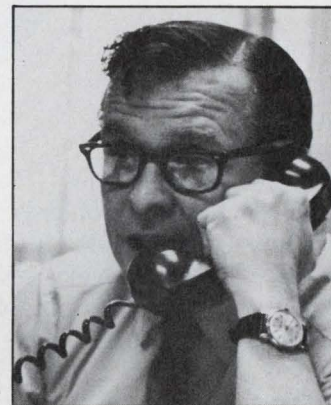

Frank Egan

FRANK EGAN



PACKAGING

on
Packaging

Before we can take full advantage of LSI, we have to overcome some packaging problems.

We have to take sides in disputes stirred at every level of packaging—from chip to complete system—by the hectic growth of semiconductor technology. We have to decide how best to get a device onto a PC board, how to interconnect devices on a board, how to interconnect boards, and how to protect our systems from hostile environments.

Right now, the major disputes surround the choice of package for the semiconductor chip or die. IC manufacturers try to keep lead counts low. Nevertheless the number of leads that must emerge from IC chips and packages is rising. This fact is central to new problems, challenges and opportunities.

Because semi manufacturers have learned to make complex chips with high yield, the package cost becomes significant. Buyers don't object to a dollar package if the semiconductor value is \$40. But if the semiconductor is worth \$4 or \$5, that package dollar is upsetting. Further, before we shove an IC into a board or socket, we generally test it, and that involves handling, where we run the risk of bending or breaking leads. It's tough enough to coax a dual-inline package into a board when it has 14 to 16 leads. But 40? Or 60?

How many DIPs do we kill while trying to force them into sockets? Should we discard sockets and go directly into boards? Perhaps. But should we commit a \$10 or \$20 IC to the finality of soldering?

We all know it's *possible* to unsolder a multi-pin device. But it's not easy—even with only 14 pins. We run too much risk of overcooking the IC or printed wiring.

Perhaps we should go to other packages. But the DIP suffers from an important advantage: engineers like it. With all its drawbacks, it enjoys familiarity which breeds attempt. Having learned to live with the small inconveniences of a 14- or 16-pin DIP or flatpack, we may fail to consider that a "full-grown" 40-pin device may be a monster.

The largest DIP available, a 64-pin ceramic package from American Lava, Chattanooga, Tenn., dodges one traditional DIP weakness—fragility of the lead frame. It uses brazed-in-place rigid pins to connect the lead pattern buried in the IC package to PC pads. This offers greater strength than what's available in DIPs, where the lead frame comes out of the package and is sheared, then bent down to mate with a printed circuit.

Even with this improvement, the DIP probably won't be tomorrow's package. Robert A. Applewhite, American Lava's Composite Products sales supervisor, concedes that though many people still use the DIP, it's a bad approach.

Most engineers agree that large DIPs and flat packs chew up too much board real estate and cost too much. Nevertheless most new packages continue to use the DIP format. With several exceptions, new packages are simply larger versions of old ones.

Which material?

There is no perfect material and no perfect package. Each represents a tradeoff. Plastics offer the lowest materials cost, a powerful motivation. But some earlier plastic packages earned an unpleasant reputation. Under some common combinations of temperature and humidity, they became "pop-top" packages that lifted wire bonds

George Rostky
Special-Projects Editor

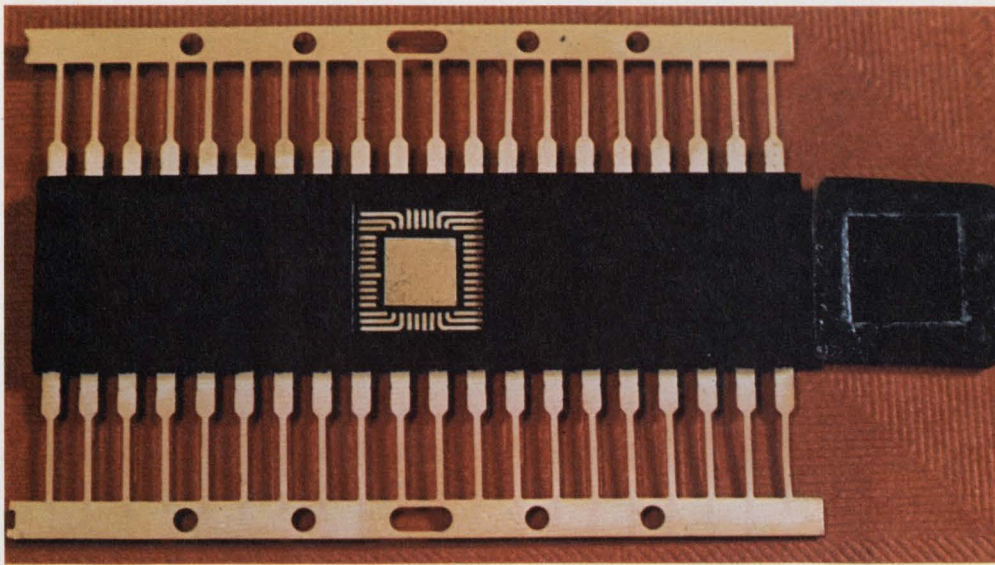

U.S. Electronic Services' 40-lead plastic DIP has inner fingers of the lead frame bent up to meet metalization pattern. The package claims the hermeticity of co-fired ceramics.

as top and bottom halves separated.

The body of the conventional plastic DIP is molded around a 10-mil-thick Kovar lead frame. Since plastic and Kovar have different thermal coefficients, the plastic can pull away from the lead frame during thermal cycling, allowing moisture to enter the package where the lead frame emerges. Further, if the plastic was originally poured around the IC chip, as is usually the case, the cured plastic can lift wire bonds.

Such problems are moderately annoying with 14- and 16-lead packages. They can be devastating to yields of 40-lead devices, which require 80 bonds to awesomely close wires. These problems overshadow the questions of whether epoxy, silicone or phenolic is best from the viewpoints of cost, adhesion to a lead frame, purity, outgassing and porosity.

One supplier, U. S. Electronic Services Corp., Clifton Heights, Pa., feels that his new plastic package eliminates these problems while retaining the cost advantage of plastics.

The company starts by molding an epoxy base around the inner ends of a copper-nickel lead frame, whose tips have been bent up at a right angle to be flush with the surface of the plastic. A lead pattern is metalized from the tips of the lead frame to a chip cavity in the center of the epoxy base.

A second sheet of semi-cured epoxy with a central window is then molded *with* the metalized epoxy base. After die attach and wire bonding, a semiconductor manufacturer can use a moisture-resistant epoxy to seal a lid over the cavity.

According to U. S. Electronic Services vice president R. R. Martino, the package has two dramatic advantages over traditional injection molding. Moisture can't get past the lead frame's right-angle bend, which is embedded in epoxy.

And the chip and its wiring are in a cavity, not in plastic, so bonds can't be lifted.

Martino adds that these packages can take more than a thousand hours of 85°C and 85% relative humidity and still maintain hermeticity of 10^{-8} atmosphere/cc/second. That's equal to the claims of the most expensive co-fired ceramic packages. In million-up quantities, a 40-lead package, with lid and sealant costs 26 cents.

U. S. Electronic Services is not alone in offering a chip cavity in a plastic package. Interbond Systems, Sunnyvale, Calif., has one, too. The Interbond package has an aluminum insert molded into the plastic base for added mechanical strength.

If plastics won't do . . .

Despite such advances, many users remain nervous about plastics. As they move on to more expensive glass and ceramic packages, their problems are by no means over. For the glasses and ceramics are available in seemingly endless variety.

The simplest and least expensive package, often called Cer-DIP, has three pieces—a ceramic base with a chip cavity, a ceramic cover and a lead frame. The prefired ceramic pieces are coated with glass frit.

A semiconductor manufacturer mounts the lead frame (with die-attach pad) on the base and passes this assembly through a furnace, which flows the glass around the frame. The manufacturer then attaches the IC die, bonds lead wires from die to the inner fingers of the lead frame, mounts the ceramic cover on top and passes the assembly through a furnace again.

In theory, at least, this makes a good, simple, low-cost package. Unfortunately the semi manu-

National Beryllia offers a wide array of packages, in alumina or beryllia (for superior heat dissipation), for LSI or discrete devices.



manufacturer needs to do quite a bit of tweaking before the process is going smoothly enough so it doesn't destroy every IC that comes off the end of the line. The manufacturer's yield loss due to packaging can be terrible at the outset, even with 14- and 16-lead devices.

So semiconductor companies tend to use this package only for high-volume devices, where start-up loss is relatively unimportant. So far the package has been used almost exclusively with 14- and 16-lead devices.

Lead frame vs lead pattern

The basic argument against full-lead-frame packages is that thermal mismatch between lead frame and package body, whether it be glass, ceramic or plastic, will eventually result in leaks that allow moisture into the package.

But there isn't universal agreement on this argument. At Sprague Electric's Glass-to-Metal Seal Div., Concord, N. H., sales manager Frank Fandetti maintains that the company's ceramic-loaded glass package has no problem in warpage or in adhesion to the lead frame, even in packages with up to 40 leads.

Further, he adds, the solid lead frame offers far greater mechanical strength than does the external lead frame, which must be brazed to metalized lines in the package. And the glass packages can be manufactured faster than laminated-ceramic types.

Most newer packages, however, use metalized lead patterns, generally of molybdenum manganese or tungsten. Though there are many variations, the package generally starts with a bottom "sheet" (or "lamination," or "strip" or "tape")

of "green" (unfired) alumina ceramic. A die-attach pad may be metalized to the center of this sheet or a hole may be punched out and a die-attach pad bonded to the back.

A second sheet with a punched-out window (to permit later die insertion) goes over the bottom sheet. A fine-line lead pattern, perhaps 150 microns thick, is generally metalized on the upper side of the second sheet. A third sheet has a still larger window to permit wire bonding from chip to exposed fingers at the inner extremities of the lead pattern on the second sheet.

The third-sheet window may be surrounded by a narrow strip of metalization, to which a lid may be brazed or soldered.

Now the entire package is "co-fired" at temperatures up to about 1700°C until it forms a solid "monolithic" block of metal and ceramic.

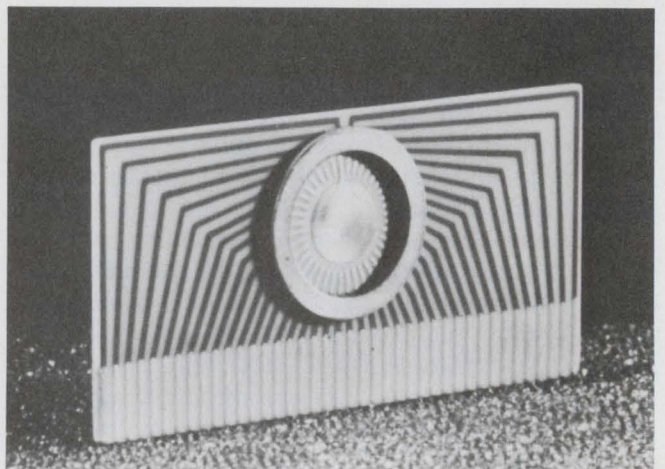

Texas Instruments' 40-lead edgemount package. TI was first to make a connector for this package.

Next, an external lead frame is brazed to the exposed outer fingers of the metalization pattern. Then all exposed metal can be plated.

The process calls for precise matching of the shrinkage of the ceramic to that of the metalization. Co-firing lends itself to many different package shapes and styles in addition to the usual dual-in-line and flat pack. Leads can emerge from four sides in a quad arrangement. Or there can be rows of rigid pins making contact with buried metalization. The pins can go through holes in the various sheets.

Co-fired packages can also have additional layers to provide power or ground planes or impedance matching. Finally, they can include "vias" (like plated-through holes) for interconnection in multilayer packages.

The case for a female package

All these packages have emerging leads. And since ICs are subjected to considerable testing and handling, leads can be bent or damaged. One manufacturer, Diacon of San Diego, responds to this problem with a simple solution: Move the leads from IC package to PC board.

Diacon's package has a 1-mil Kovar-foil lead pattern sandwiched between two ceramic wafers. Both wafers have holes that line up with lands at the outer ends of the lead pattern. A header, brazed to the bottom sheet of ceramic, can be heated with a collet to speed die attach. Or it can be cooled to help protect the IC chip while a lid is brazed or soldered to a seal ring in the top sheet of ceramic.

A device user simply shoves the Diacon package onto pins staked into his PC board. He doesn't have an alignment problem, since the pins have 20-mil diameters and the holes have 40-mil diameters.

The pins, as many as 51 in Diacon's largest package, pierce and make intimate contact with



the pushed-up foil. The IC can now be tested in its final circuit before the package is soldered in place. The pins and underside of the Kovar foil are pretinned, so the package can be soldered in place with a hot-air or hot-nitrogen gun.

Unlike most packages, this one can be removed easily without damage to the PC board by heating the package—not the board—and lifting it. It can be tested in a jig with top and bottom pins that have rounded tips, which don't pierce the foil. Diacon packages can be mounted on both sides of a PC board as well as on top of one another. In quantities of a million and up, the package sells for about a penny a hole, while pins, installed, cost about half a cent each.

There's another approach that eliminates protruding leads—an edgemount package, first developed by Coors Porcelain, Golden, Colo., in col-

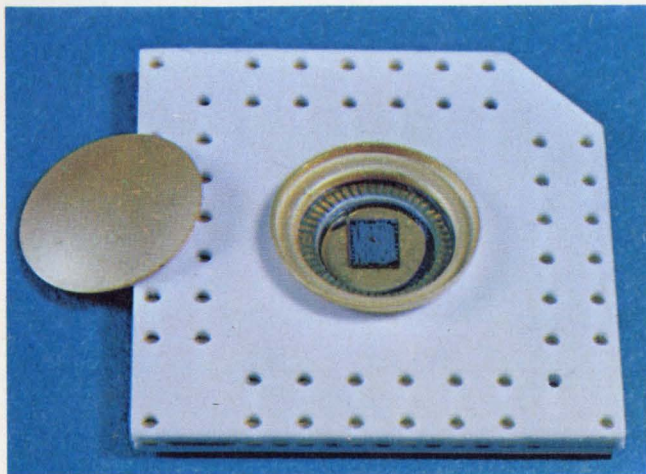

Diacon's leadless ceramic package has buried gold-plated Kovar foil that's pierced by pins staked in a PC board.

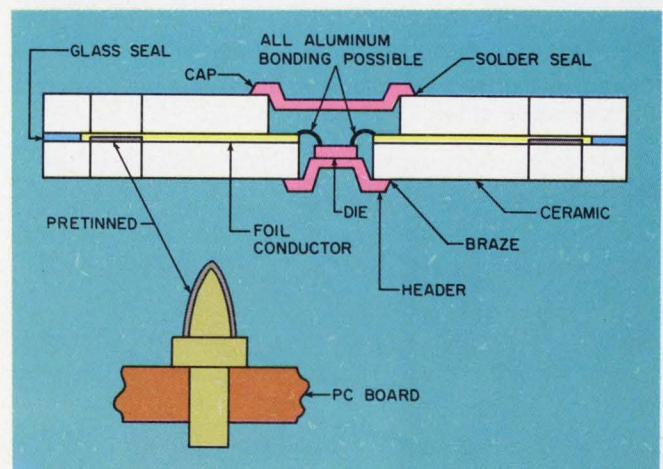

Pins and foil bottom are pretinned for easy soldering with a hot-air gun.

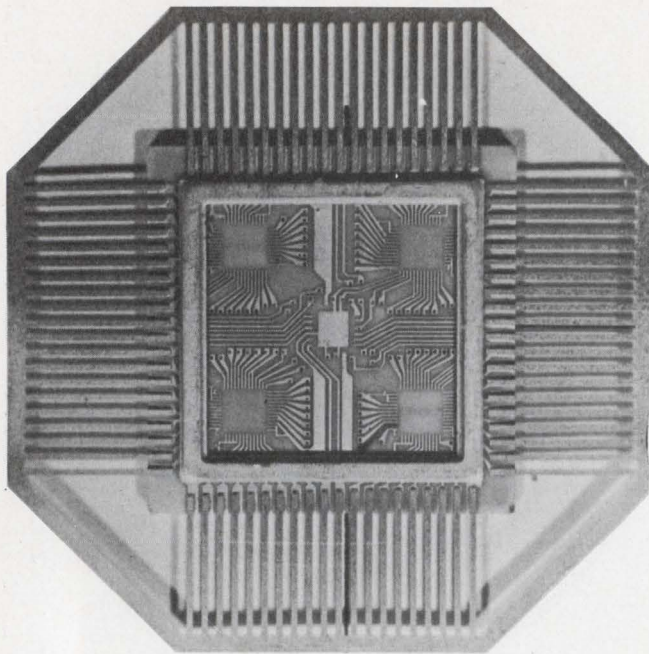

Metalized Ceramics' 80-lead multilayer package accepts four beam-lead chips.

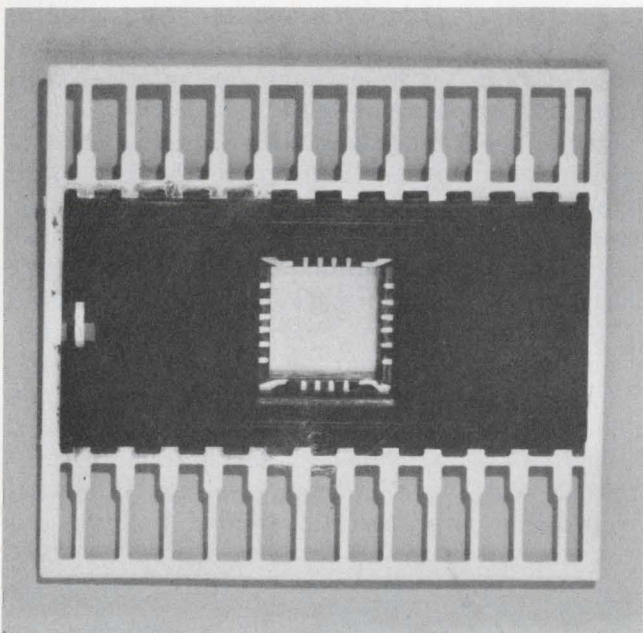

Centralab's DIPs are available in black ceramic to protect light-sensitive chips.

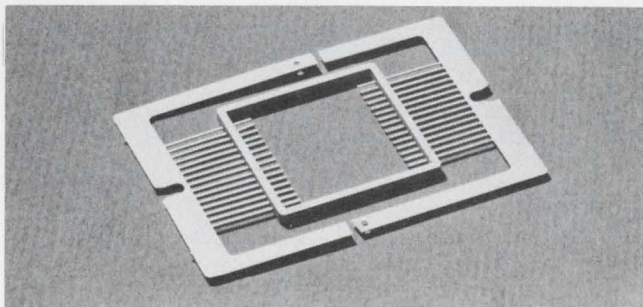

Bendix's Modu-Pack can be reflow soldered to pads on thick-film-hybrid power circuits.

laboration with American Micro-systems, Santa Clara, Calif., which needed a package, and Texas Instruments, Attleboro, Mass., which provided a special edgemount connector.

The Coors package has 40 moly manganese leads metalized on the surface of a 1-by-2-inch, 40-mil-thick sheet of fired ceramic. The leads fan out from a die-attach pad on the surface of the ceramic. Except for the contact-finger area near the edge of the package, the leads are protected by a glaze coating.

A glass seal ring surrounds the die-attach area. It can be gold-plated to accept a soldered lid, or it can be left unplated to accept a lid bonded with adhesive.

There's an obvious merit to the edgemount package: It plugs in. So it's easy to test and discard a bad IC. Further, it can be made with a back-side ground plane, or, with different thicknesses, it can have controlled impedance from 20 to 90 ohms.

The TI socket looks like a conventional edge connector, but it's different. The nickel silver contacts in the glass-filled nylon body have gold inserts, inlaid and bonded at points of contact with the ceramic substrate. The inlaid gold provides extra durability to withstand repeated insertions of the hard ceramic.

In quantities of a million and up, the ceramic edgemount package costs about 55 cents, while the connector costs about 45 cents. In addition to Coors, other vendors now offering edgemounts include Frenchtown/CFI, Frenchtown, N. J.; Metalized Ceramics, Providence, R. I., and Texas Instruments, Dallas. Centralab, Milwaukee, and National Beryllia, Haskell, N. J., are considering early production. And U. S. Electronic Services is producing a plastic version. Others producing edgemount connectors include Winchester Electronics, Oakville, Conn.; Burndy, Norwalk, Conn.; and Amp, Harrisburg, Pa.

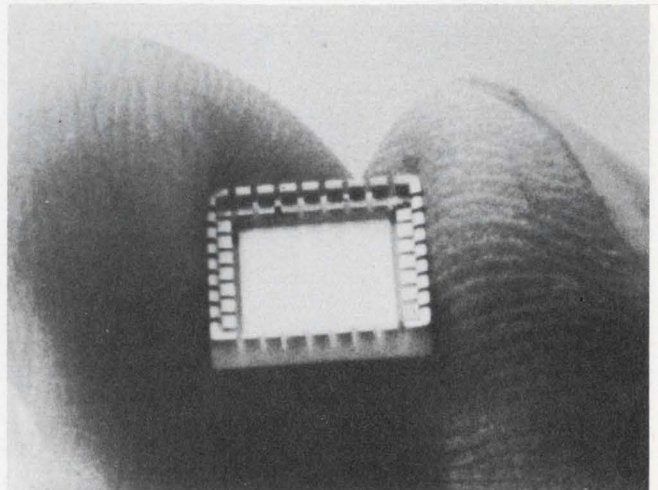

Frenchtown/CFI's LID can be designed with almost any number of termination lands for almost any size chip.

There's still another package that does away with the lead frame and, in fact, with leads and sockets. The leadless-inverted-device (LID) carrier, available from Frenchtown/CFI, has several important advantages and one big limitation. The alumina LID can be furnished with almost any number of terminations for almost any size chip. It's small. And it's inexpensive.

A 32-land device with a die-attach floor about 1/4 inch square has outside dimensions of about 0.35 inch square by 0.13 inch high. It costs 24 cents in quantities of a million and up.

A chip is attached to the floor of the LID. Then wires are bonded from chip to metalization (75 microinches of gold on 75 microinches of nickel) on lands on first-level steps. The metalization from these steps continues up to a second and final level of steps, which are reflow-soldered to corresponding pads on a PC board or ceramic substrate when the LID is inverted.

John Fredericks, Frenchtown/CFI vice president for sales and marketing, concedes that though the LID cavity can be filled with epoxy, the device is not truly hermetic.

The fuzzy price picture

What about price? Each vendor's package, of course, comes out cheapest. Typically, a vendor prepares cost-analysis tables showing that competitors' packages cost more after yield loss.

He assumes costs for package material, molding (for plastics), lead frames (if there is one), plating, die attach, wire bonding, lid attach and IC chip, then assumes a percentage yield. The "fully yielded" cost is always lowest for the man making the calculations.

Of course, cost and yield assumptions vary widely. The difficulty in determining costs is further compounded by the fact that when a vendor tosses out a "typical" price, he's likely to quote



at the million-up level. Yet very few LSI chips are sold—or made—in such quantities.

Though the cost of ceramic LSI packages is coming down toward the penny-a-pin level, many vendors see multichip packages as a good cost-cutting and performance-boosting measure.

Toward fewer packages

One five-layer package, from Metalized Ceramics, has 80 buried interconnects and 80 exit leads in a quad arrangement. The package accommodates four beam-lead chips.

Another package, a 48-pin DIP from Du Pont, Wilmington, Del., can take 12 chips. Called Multilox M-S-I (for Multichip-Standard-Interconnect), the package has six layers of metalization, including two separate power planes and a ground plane. Access to all buried lines and

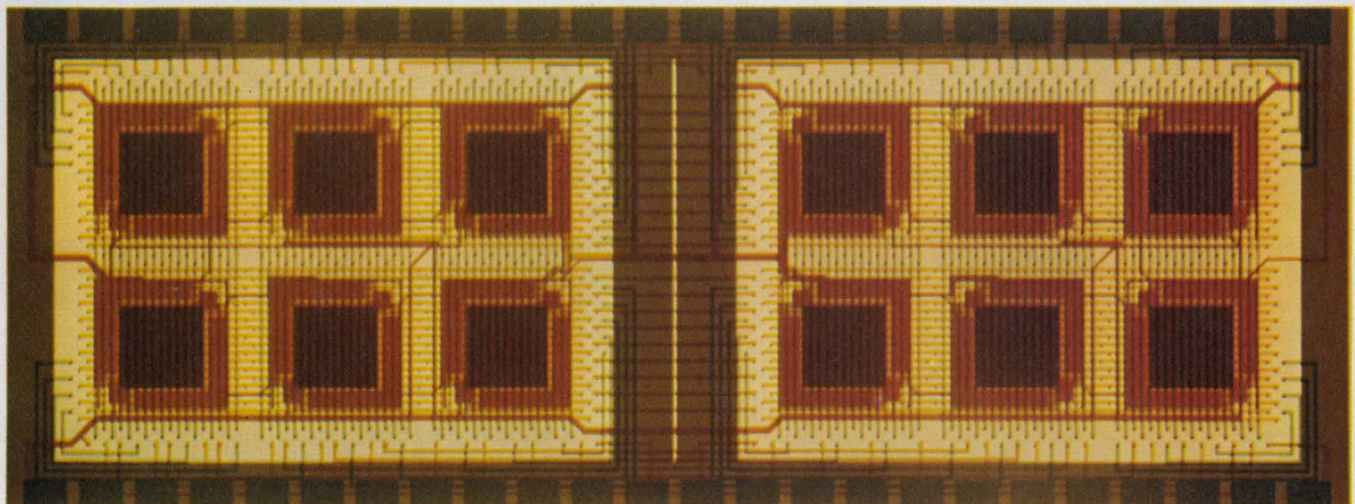

Du Pont's double-cavity Multilox package for up to 12 chips can be sealed with a single over-all lid or two small

ones. The 48-pin DIP has six layers of metalization with vias for access to all buried lines.

planes is provided by vias that come up to the chip-mounting surface.

Another approach to multichip packaging comes from National Beryllia, whose idea is to get rid of the conventional PC board and replace it with a co-fired, multilayer board of alumina or—for superior heat dissipation—beryllia.

The company offers 5-by-7-inch ceramic boards up to eight layers thick. The boards can include cavities and lead-bond fingers for IC chips. Thomas O'Brien, product sales manager for the Microelectronic Packaging Div., points out that the ceramic board is far superior to conventional glass epoxy boards, which can't be truly hermetic and which often suffer from delamination and unreliable plated-through holes. After it is fired, O'Brien says, the co-fired package forms a solid monolithic structure.

Packages for special performance

Though there's a wide selection of packages for MSI and LSI, there are relatively few compatible packages for high-frequency or high-power applications.

One, the Modu-Pack, from the Electrical Components Div. of Bendix, Sidney, N. Y., is designed specifically for high-power thick-film circuits. A user can build his circuit on an alumina or beryllia substrate, then attach the Modu-Pack, whose spring-loaded inner fingers bear down on metalization pads on the thick-film substrate. Reflow soldering can be used instead of wire bonding to each pad.

The external leads can be used in a flat-pack arrangement or bent over to plug into a PC board. A 40-to-80-lead package for a 1-by-1-inch substrate costs about \$2.75 in quantities of 10,000.

Another Bendix package, for high-frequency thick-film hybrids, provides controlled impedance to 5 GHz with VSWR of less 1.15.

From IC to PC

Once we get our LSI packages we have to interconnect them—generally on PC boards. But that's no simple matter when there are long rows of DIP leads on 100-mil centers or quad or flat-pack leads on 50- or 35-mil centers.

If we have several packages on a board, it can be enormously difficult to route (and etch) sufficiently dense wiring on the surfaces of a two-sided printed-circuit board without forbidden crossovers. But, perhaps crossovers aren't all that bad.

Wires can freely cross over one another in a new system, Multiwire, developed by Photocircuits, Glen Cove, N. Y. A numerically controlled machine draws polyimide-insulated magnet wire,

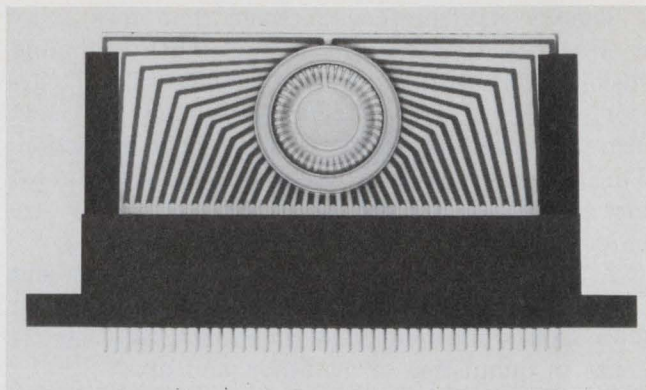

Amp's edgemount connector has cantilever beryllium copper contacts with gold over nickel plating to withstand 100 edgemount package insertions and withdrawals.

about seven mils in diameter, across the surface of a board coated with adhesive.

The wires can easily be run on 25-mil centers and, for straight runs, they can have 10-mil centers. The wires are terminated and connected to others by plating holes drilled through the wires (exposing the copper cross-sections) and the board. The board itself can have conventional printed wiring in addition to the magnet wires.

The problems involved in component placement and wire routing can be severe, even with conventional PC boards. It can often prove fruitful to use services and equipment like those available from Scanbe Manufacturing, El Monte, Calif., or Autologic, San Francisco. With the help of its computerized system, Autologic provides automatic PC-board layout and interconnections.

The system accepts circuit details, parts information and board-blank characteristics as input. The system output can include parts lists, assembly drawings and signal lists, as well as commands for drilling, Wire-Wrap, art-work generation and component insertion.

The computer system tries to place components in the best position for efficient hookup but, since it can't always succeed, it can call for human intervention.

With or without the help of a computer, when wiring on a board is dense enough, we often must use multilayer boards for interconnections. But even these boards don't live alone.

Almost invariably, we must go from one board to another. Traditionally we've used conventional PC connectors that terminate wire bundles. But wire bundles can get massive and heavy—two penalties that many systems can't afford.

The flexibility of flexible wiring

Growingly popular solutions lie in the use of flat, flexible cable or even flexible circuitry—both of which present some challenges.

Flat cable takes one of two forms. The first, pioneered by Burndy's Tape Cable Div., Roches-

ter, N. Y., and now offered by Ansley, Doylestown, Pa.; Amp; Buckbee-Mears, Saint Paul, Minn.; and dozens of other vendors, is often called flat-conductor flat, flexible cable. It generally consists of parallel copper lines of rectangular cross-section in a thin sandwich of Mylar or other dielectric.

The second type of flat cable, offered by companies like Spectra-Strip, Garden Grove, Calif., and 3M, Saint Paul, is called round-conductor flat, flexible cable. It consists of parallel lengths of separately insulated round conductors held together in a web-like structure.

Neither type has been easy to terminate. The first type generally uses a modified PC connector. The dielectric is generally ground away along the width of a strip, leaving the bare copper lines exposed. These lines are generally used, directly or indirectly, as the contacting surfaces in one or both halves of a connector.

Burndy recently attacked this problem with a new termination, Tapecon, a solderless connector that is assembled with a screwdriver. The Tapecon is a three-piece assembly consisting of a housing, contacts with teeth in them, and a backing wedge that forces the cable past the teeth, which skive away the insulation and make connection with the copper.

The method is somewhat similar to that used by 3M for terminating its Scotchflex round-con-



ductor flat cable. The 3M connector uses U-shaped, insulation-piercing contacts.

In many cases an even more powerful interconnection mechanism can be provided by flexible circuitry, like Flexprint, pioneered by Sanders Associates, Manchester, N. H. It can save weight and volume as well as money, since it saves the cost of conventional connectors. Terminating pads on flexible circuitry slip over

Sanders Flexprint flexible circuitry can be bonded to hard-board to support mounting components. The free half left can be soldered to pins on another board, still permitting motion between the boards.

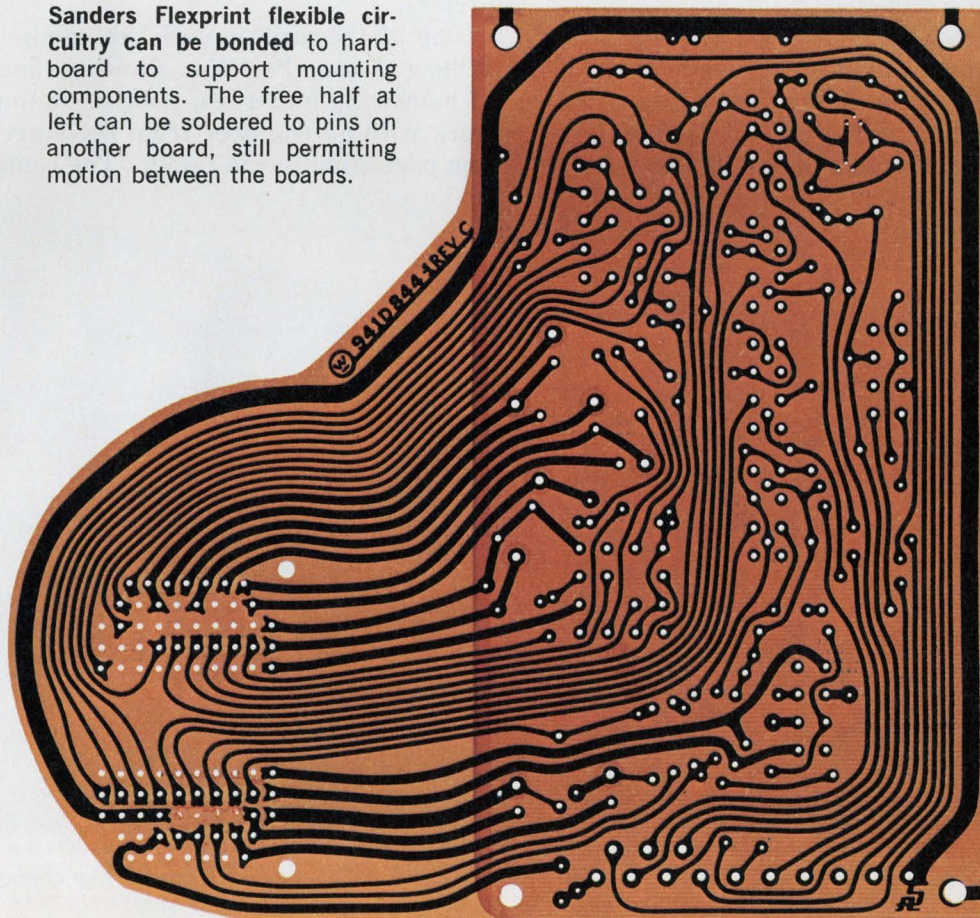

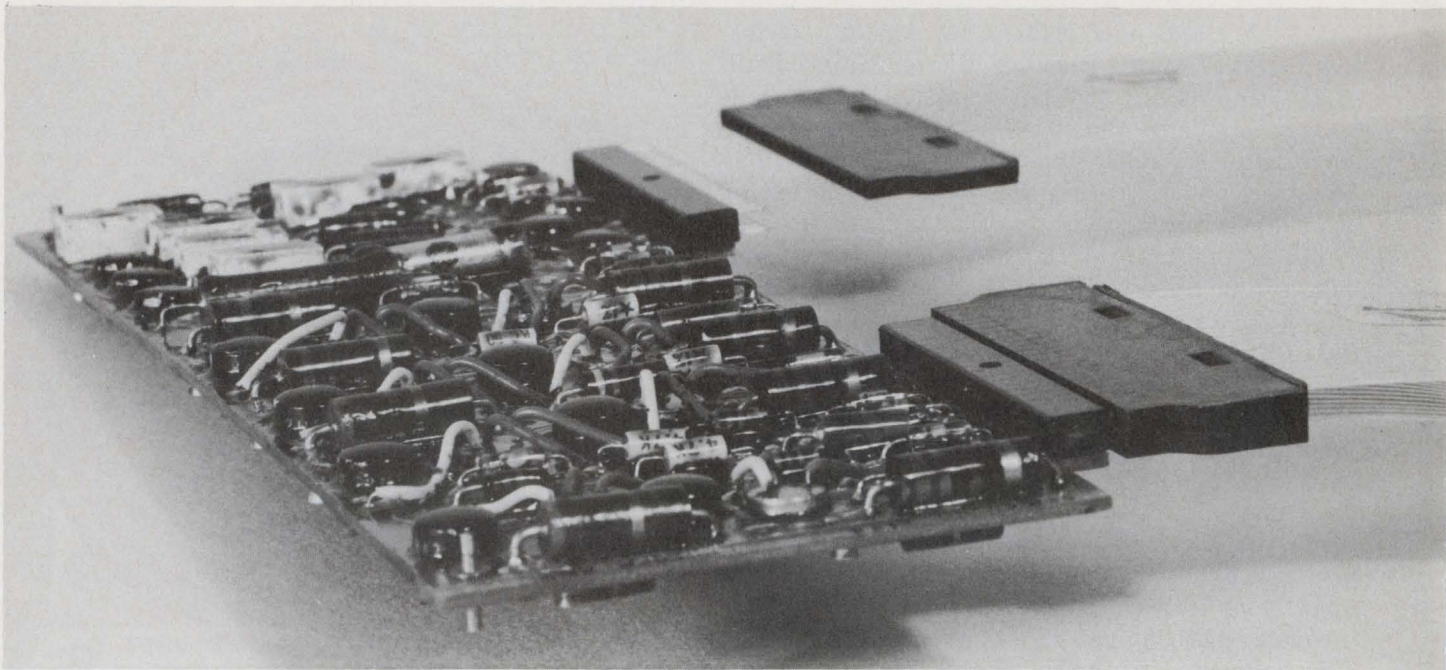

Ansley's flat-conductor, flat flexible cable, Flex-Strip, can be used with the company's thin-profile connectors that

can be stacked on 100-mil centers. The connectors have 20 contacts on 100-mil centers.

matching pins on conventional hardboard circuitry and are soldered in place.

Getting to the back

In large systems individual boards are generally plugged into a back plane for interconnection. But which back plane?

Jerry Hunt, vice president for new products at Cinch, Elk Grove Village, Ill., suggests that the latest trend is to a hybrid back plane in which plastic bushings on the tails of female connectors are pressed through holes in an alumi-

num plate. The front of the connector accepts rectangular blades that poke out of a right-angle plug. Along its side, the plug has pins that mate with pads near the edge of a PC board, to which they are flow-soldered.

Like several other vendors, Cinch makes a large variety of back planes and back-plane connectors.

One of the largest varieties comes from Elco, Willow Grove, Pa. Wm. Judson Clark, director of marketing and sales, points out that Elco will work with an engineer from the start of his system packaging to the finish. The company offers

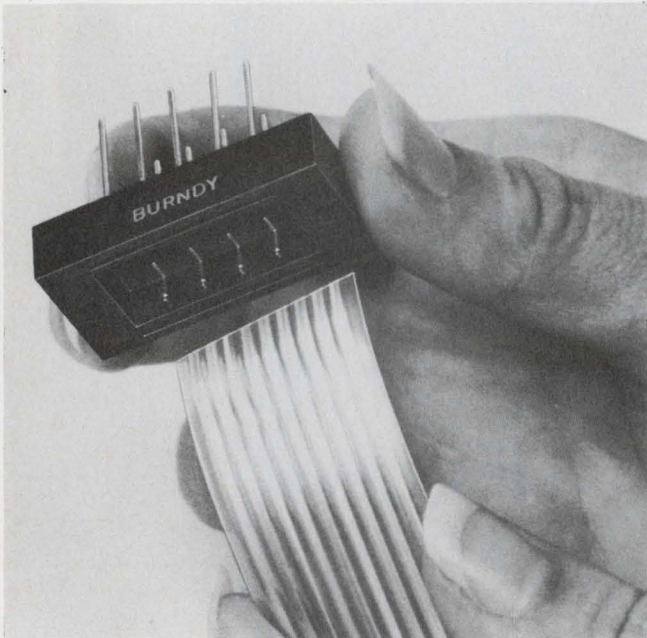

Burndy's Tapecon connector for flat-conductor flat flexible cable is assembled very quickly. The cable is just folded back across the housing cavity. Then the wedge

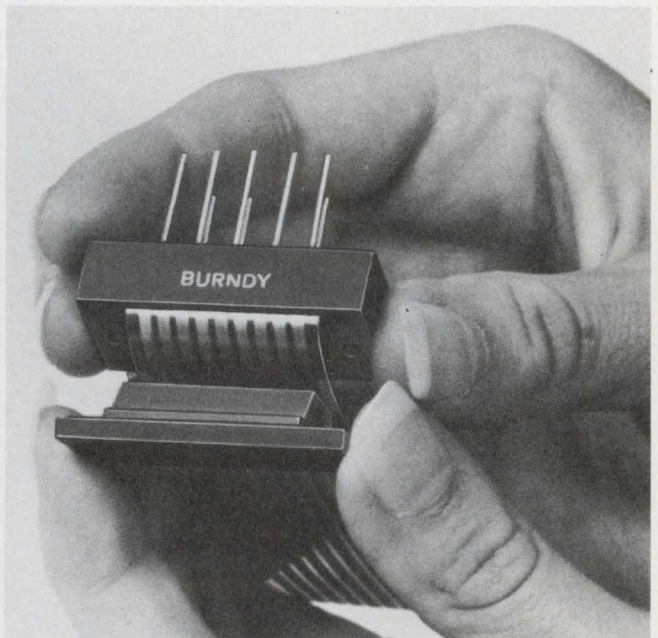

in the cover forces the cable against teeth that scrape away the insulation and contact the copper. The cover is screwed down to a dead stop.

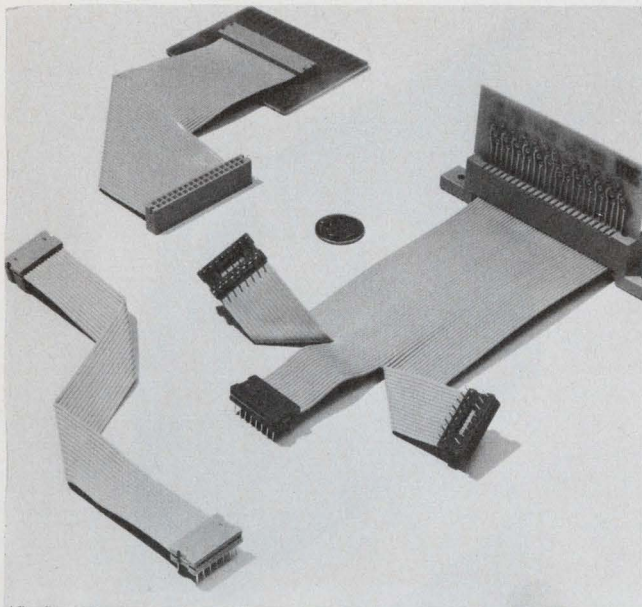

3M's connectors for round-conductor flat flexible cable, like the company's Scotchflex, clamp around the cable, forcing "U"-shaped insulation-piercing contacts to grip the individual conductors.

individual connectors, card guides, cages, three types of back planes and a manual, semi-automatic or fully automatic Wire-Wrap service.

Elco's first back plane, Variboard, is basically a single-sided or multilayer PC board, the front of which accepts individual components or connectors mounted in plated-through or unplated holes. This represents a good approach when there's a high percentage of "hard" wiring that won't be varied from system to system.

The second back plane, Variframe, is a rigid aluminum frame with cutouts for individual connectors that have tails suitable for solderless wrap. The third, Variplate, is an aluminum panel punched with individual holes, precisely and uniformly positioned throughout the panel.

Plastic bushings around contacts poking through the holes provide high capacitance from contacts to panel, thereby reducing noise. Contacts tails are positioned for automatic wrapping. Contacts to be grounded can have aluminum instead of plastic bushings. The panels can have ground planes and one or more voltage strips, separated by vinyl sheets. The panel itself can be anodized to provide color coding. And the vinyl strips can provide additional colors.

Termi-Point alive and well

Though the Wire-Wrap system of Gardner-Denver, Grand Haven, Mich., enjoys overwhelming popularity, it is not alone. The Termi-Point system, introduced in 1962 by Amp, is a lively competitor. The Gardner-Denver system strips the insulation from the ends of solid wire and wraps several turns of wire around rigid posts,

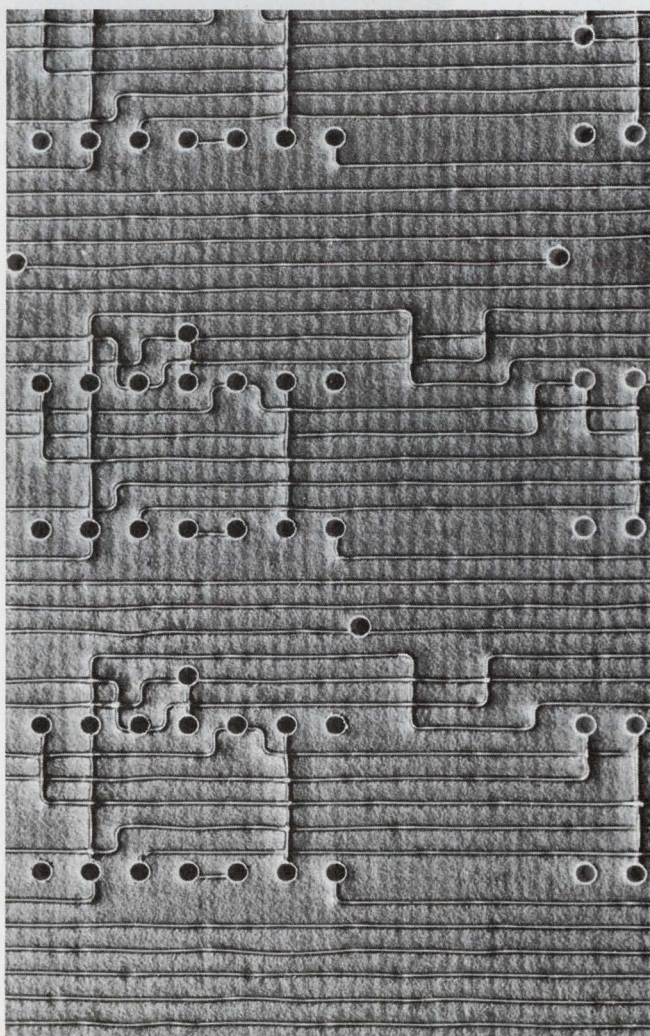

Photocircuits offers a high-density system for laying insulated wires on an adhesive-coated board that can include conventional printed circuitry. Wire crossovers are perfectly acceptable.

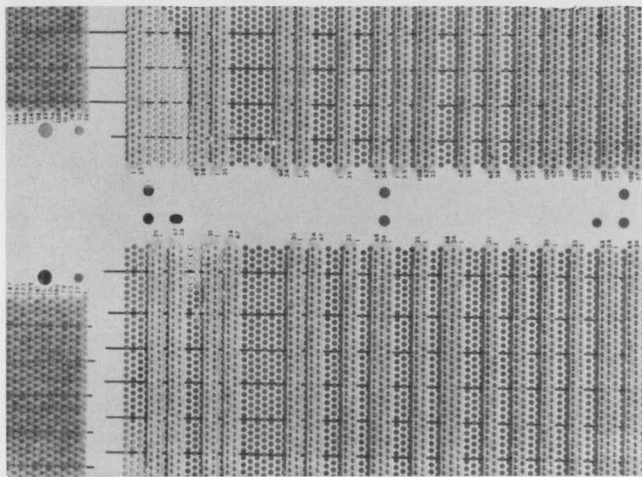
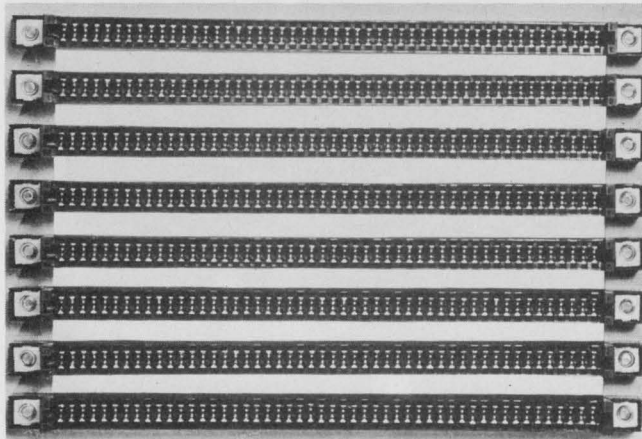
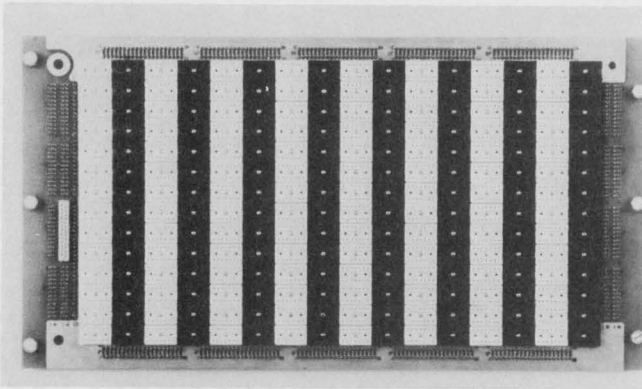

Elco's Variboard (with single-layer or multilayer PCs supporting components or connectors), Variframe (for rigid support of individual PC connectors) and Variplate (with voltage and ground planes and holes for bushing-mounted terminals and connectors).

whose corners bite into the wire, forming a gas-tight joint.

In contrast, the Amp system uses clips to secure the wire ends to posts. While Gardner-Denver requires solid wire, Amp can accept stranded wire (for better tolerance to vibration), or even tinsel wire as well as solid.

One dominant factor that has held back Termi-Point is the fact that Amp does not guarantee its system when used with clips or posts made by competitive vendors, so it hasn't enjoyed their

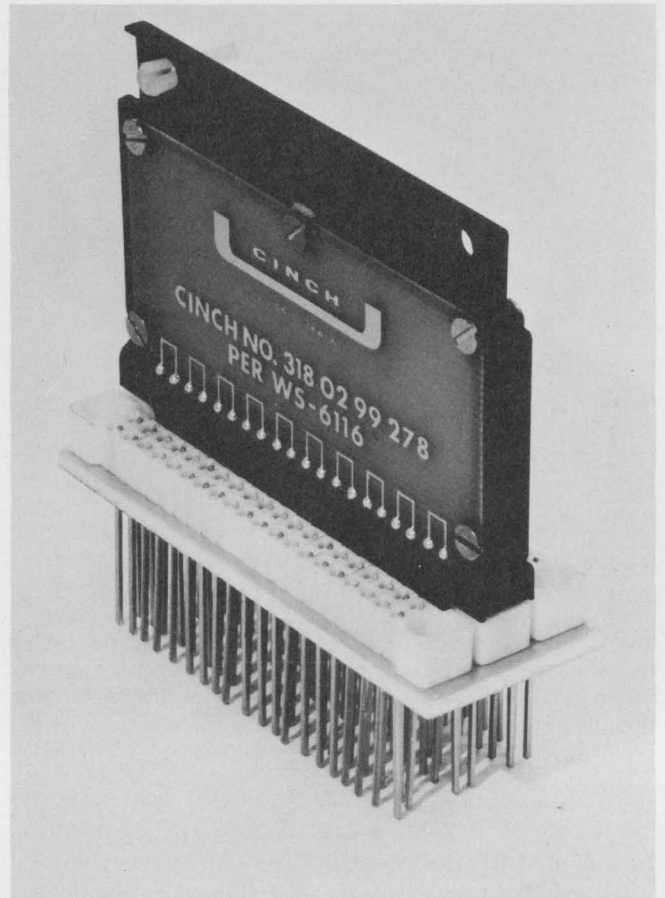

Cinch's connector back plane accepts the rectangular blades of a right-angle plug whose side pins mate with and are reflow soldered to a previously assembled PC-board module. The NAFI (Naval Avionics Facility in Indianapolis) module shown here, developed by Cinch, interfaces with other assemblies in the Navy Standard Hardware Program.

enthusiastic support. Nevertheless, Termi-Point offers several advantages.

It's easy to remove a clip or to move it up or down on a post. And the system can be used with mixed grids having any increment of 1 mil.

Both Amp and Gardner-Denver systems can be wired manually, with hand guns. Semi-automatic wiring is possible with tools that make the connections after an operator has positioned the tool. And fully automatic wiring can be done with numerically controlled tools that position the wires and make the connections.

Another technique can prove very handy, especially for quick back-plane modifications: It involves the use of laminated buss bars and buss interconnects available from Bussco Engineering, El Segundo, Calif., for either Wire-Wrap or Termi-Point posts. A user can push an interconnect strip over many posts. The sole requirement is that the posts be in one row, but they needn't be adjacent. The user can alternate or skip posts at random.

A strikingly different approach to packaging needs no back plane, no wires, no connectors: It

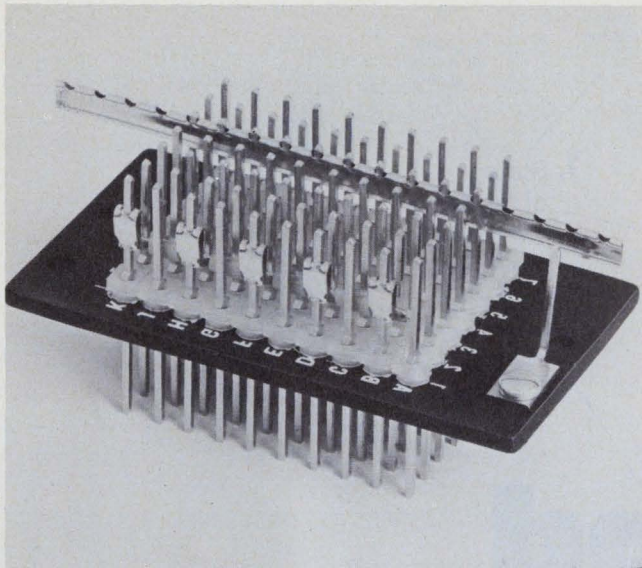

Bussco strips can be used as quick interconnects for in-line Wire-Wrap or Termi-Point posts.

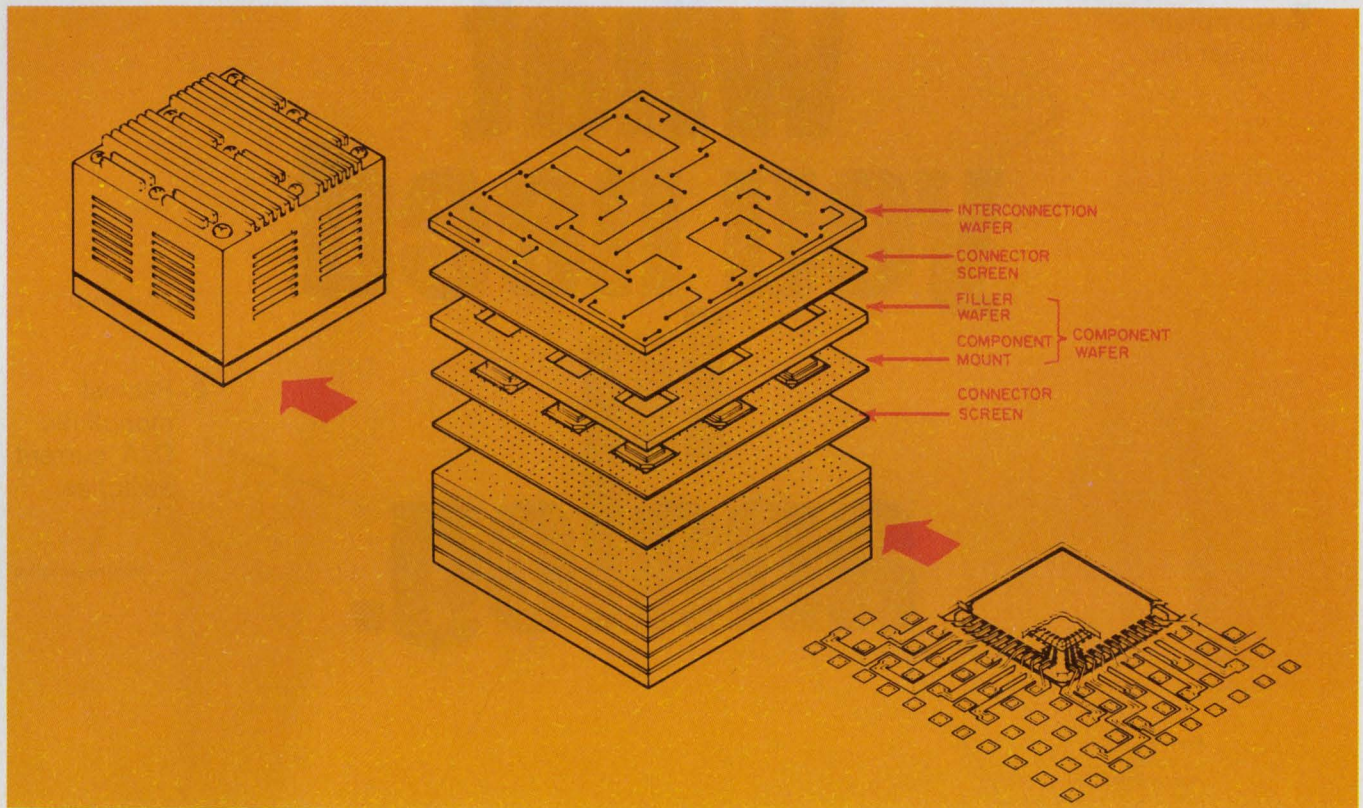

Bunker-Ramo's Planar Coax package has component wafers for holding devices like the 42-lead IC, lower

right. Component and connection wafers are stacked in a multi-decker sandwich and bolted together.

comes from Bunker-Ramo Corp.'s Electronic Systems Div., Westlake Village, Calif. Called Planar Coax packaging, it permits assembly of a complete system in a single small block.

The package uses thin beryllium copper wafers with dielectric where needed. There are three types. One wafer carries IC chips or other components. Another provides X-Y coaxial interconnections on one plane. And the third provides Z-axis coaxial interconnections between

component and X-Y wafers.

The wafers are stacked vertically and bolted together, creating high-pressure contacts where exposed sections of copper meet. Individual wafers are generally from one to three inches square, though a 2-by-2-inch wafer is generally as large as anybody might need. The complete package is usually less than three inches high, and, for large systems, it can serve as a plug-in component. ■■

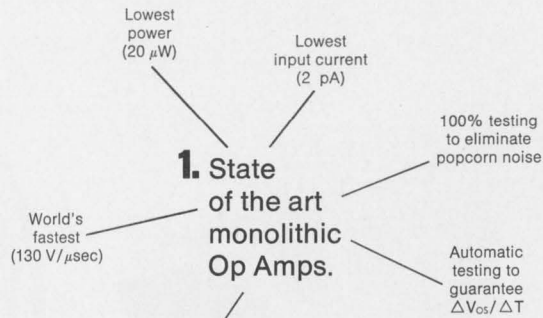

Find what you need in analog.

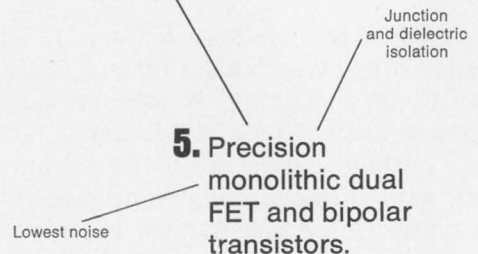
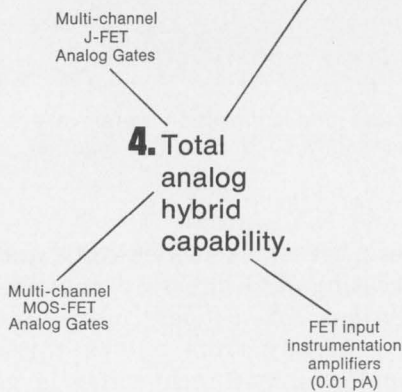
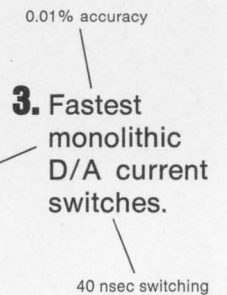
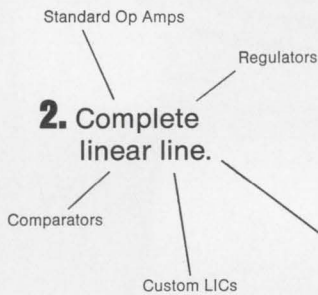

Where you get the choice.

Since Dr. Hoerni founded Intersil we've amassed more kinds of analog technology than any other semi house. Today we're solidly in the business, with people, processes, and products to serve the analog designer.

Pick a winner in linears.

Intersil op amps set the pace in every vital parameter. The 8017 slews 130 V/ μ sec (with 10 MHz bandwidth, 50 nA input). 8021 dissipates less than 30 μ W with ± 1.5 V supplies. 8007 FET-input amp has 2 pA bias. Automated test systems have been developed to select an Intersil amplifier for $\Delta V_{OS}/\Delta T$ down to 3 μ V/ $^{\circ}$ C. Our 741-LN is specified with a "popcorn" noise free guarantee. In standard analog products we offer general purpose op amps (101, 101A, 108, 741, 748), positive and negative regulators (100, 105, 723) and precision comparators (8001).

In hybrids, switches, discretes.

From a combination of dual FET and IC technology, our hybrid analog gates work twice as fast as the nearest competition. And the 8500A Hybrid Electrometer Op Amp has the lowest input bias anywhere: 0.01 pA!

The 8018 D/A Quad Switches feature 100-ns switching with 12-bit accuracy.

We make over 200 monolithic dual J-FETs and transistors with 3 μ V/ $^{\circ}$ C thermal tracking and matching to 1.5 mV. Get all discretes and linears in dice, wafer or flip-chip form. Or let us work with you on custom processes or circuits to suit your special needs. Call Murray Siegel or Dave Fullagar (408) 257-5450 for help in any analog requirement. Intersil. First in analog technology. 10900 No. Tantau Avenue, Cupertino, CA 94014.

Get 'em all here.

Intersil stocking distributors. Schweber Electronics; Century Electronics; Semiconductor Specialists; DeMambro Electronics; R. V. Weatherford Co.

Intersil area sales offices. Los Angeles (213) 370-5766; Metropolitan New York (201) 567-5585; Minneapolis (612) 925-1844; San Francisco Bay Area (408) 257-5450.

Overseas representatives. Clichy, France: Tranchant Electronique. Amsterdam, Holland: Klaasing Electronics. Tokyo, Japan: Internix. Zurich, Switzerland: Laser & Electronic Equipment. London, U. K.: Tranchant Electronique. Munich, West Germany: Spezial Electronics.

U. S. representatives in all major cities.

Intersil

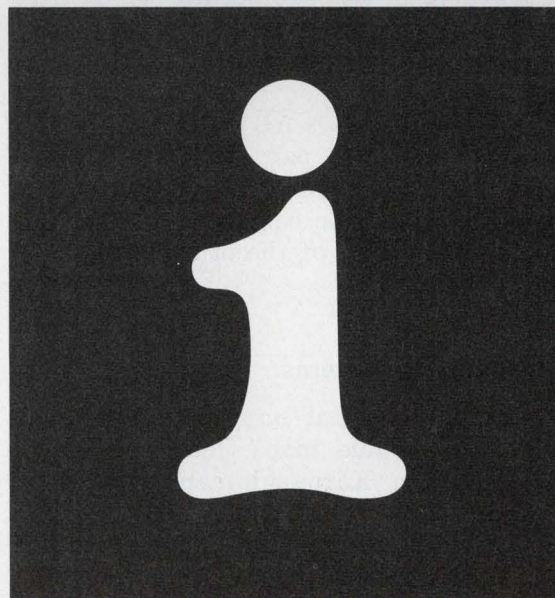

To simplify digital logic design, use exclusive-OR gates. The trick in applying them is to recognize the patterns with which they are most effective.

One of the most useful, yet frequently overlooked, minimization aids available to the logic circuit designer is the exclusive-OR (EX-OR) gate. Now that most of the major digital IC manufacturers are making these gates in quad IC packages, it is more important than ever that the designer learn how to use them in conjunction with NAND and NOR gates to minimize logic circuitry.

Usually adjacent squares on a Karnaugh map are combined to eliminate one variable. Often, though, two squares separated from each other by exactly one square are present. These two squares can be combined most simply by using an EX-OR gate.

To see why, consider the two-variable map in Fig. 1a. Use of the typical NAND gate implementation of Fig. 1b requires three two-input NAND gates, assuming that both the true values and the complements of both inputs are available. Use of the exclusive-OR gate (Fig. 1c) requires only one two-input gate, and only the true inputs or the complemented inputs are needed.

Manipulation of the Boolean expression for the EX-OR gate reveals another function — the equivalence (\oplus) function

$$\overline{A \oplus B} = \overline{A} \oplus B = AB + \overline{A}\overline{B} = A \oplus \overline{B}.$$

Thus the "other" diagonal pair (Fig. 1d) can be implemented with one gate instead of three (Figs. 1e and 1f). Here the complement of one variable and the true input of the other variable are required.

Recognizing combinable patterns

So far, so good. But what happens when we expand to a four-variable map? The problem is to recognize those Karnaugh-map patterns that can be combined by using exclusive-OR gates.

Here are five basic couples (see definitions in box) that can be described with the exclusive-OR and equivalence functions:

1. A one-couple separated from another one-couple by a single one-couple can be combined in

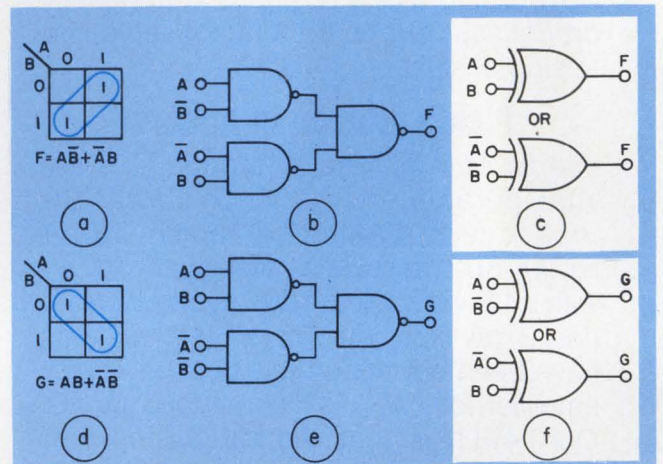

1. One exclusive-OR gate replaces three NAND gates in producing the output $F = \overline{A}B + A\overline{B}$ (a). Note that the NAND implementation needs both inputs A and B and their complements (b). The EX-OR approach uses either A and B or \overline{A} and \overline{B} (c). EX-OR gates enjoy a similar advantage in synthesizing the function $G = AB + \overline{A}\overline{B}$ (d). In this case the NAND implementation still needs all four inputs (e), while the EX-OR approach can get by with either A and \overline{B} or \overline{A} and B (f).

the form of a product of an exclusive-OR and $n-3$ remaining variables. As can be seen in Fig. 2, this results in a greatly simplified logic implementation. In the figure, we note that the one-couple represented by $\overline{A}B\overline{C}$ is separated from the one-couple, $\overline{A}B\overline{C}$, by another one-couple, $\overline{A}B\overline{C}$. Also:

$$\overline{A}B\overline{C} + \overline{A}B\overline{C} = \overline{A}(B \oplus C).$$

2. A two-couple separated from another two-couple by a single two-couple can be combined in the form of a product of an exclusive-OR and $n-4$ remaining variables. In Fig. 3, note that we have a two-couple represented by $A\overline{C}$ separated from another two-couple, $\overline{A}C$, by a third two-couple, AC and $A\overline{C} + \overline{A}C = A \oplus C$. Extrapolating from the two preceding cases, m variables are removed from the expression if an m -couple is separated from another m -couple by a third m -couple. The form of the result will be a product of an exclusive-OR and $(n-m-2)$ variables.

3. An EX-OR two-couple separated from a second EX-OR two-couple by a two-couple can be expressed as a product of two EX-OR functions.

Roger A. May, Martin Marietta Corp., P.O. Box 5837, Orlando, Fla. 32805.

A brief dictionary of digital definitions

Throughout this article, the letter n represents the number of variables being considered. The squares on the Karnaugh map which are ONES of the function are called p -squares of the function. Two adjacent p -squares form a one-couple. This is the familiar combination made to eliminate one variable (Fig. A). Note that

$$A B C D + \bar{A} B C D = B C D \text{ (A eliminated)}$$

$$\text{and } A \bar{B} \bar{C} \bar{D} + \bar{A} \bar{B} \bar{C} \bar{D} = \bar{B} \bar{C} \bar{D} \text{ (A eliminated).}$$

Four adjacent p -squares are called a two-couple and result in the elimination of two variables. By adjacency, we mean that each p -square is adjacent to two other p -squares (Fig. B).

The two-variable exclusive-OR p -squares are called an exclusive-OR two-couple. This refers to two p -squares whose Boolean expression is the product of a two-variable EX-OR and the other $(n-2)$ variables. Examples of this are illustrated in Fig. 1 in the article and in Figs. C and D. In Fig. C we see that the p -squares are $\bar{A} B \bar{C} D + \bar{A} \bar{B} C D = \bar{A} D (B\bar{C} + \bar{B}C) = \bar{A} D (B \oplus C)$, and in Fig. D they are

$$A \bar{B} \bar{C} D + A B \bar{C} \bar{D} = A \bar{C} (\bar{B} D + B \bar{D}) = A \bar{C} (B \oplus D).$$

In general, an EX-OR two-couple can be made whenever a p -square is separated from another p -square by exactly one square.

The two-variable equivalence p -squares are called an equivalence two-couple. This refers to two p -squares whose Boolean expression is the product of a two-variable equivalence and the other $(n-2)$ variables. An example of this is shown in Fig. 1 in the text and in Figs. C and D. The equivalence gate of two variables is logically the same as the exclusive-OR of one of the two variables and the complement of the other variable ($A \oplus B = \bar{A} \oplus \bar{B}$). Thus, the p -squares in Figs. C and D also represent an equivalence two-couple.

The basic couple to be used is the exclusive-OR two-couple. This couple logically ANDed with the $(n-2)$ remaining variables and ORed with the expressions for the remaining p -squares results in a standard sum-of-products form. This is shown in Fig. E along with the implementation.

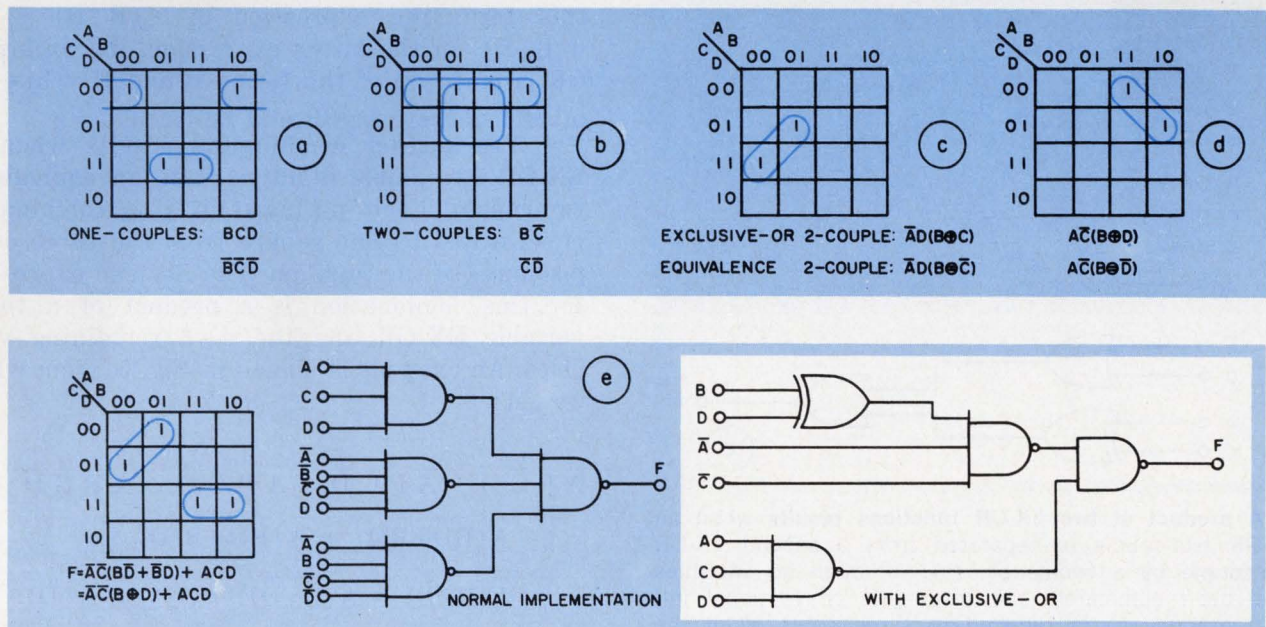

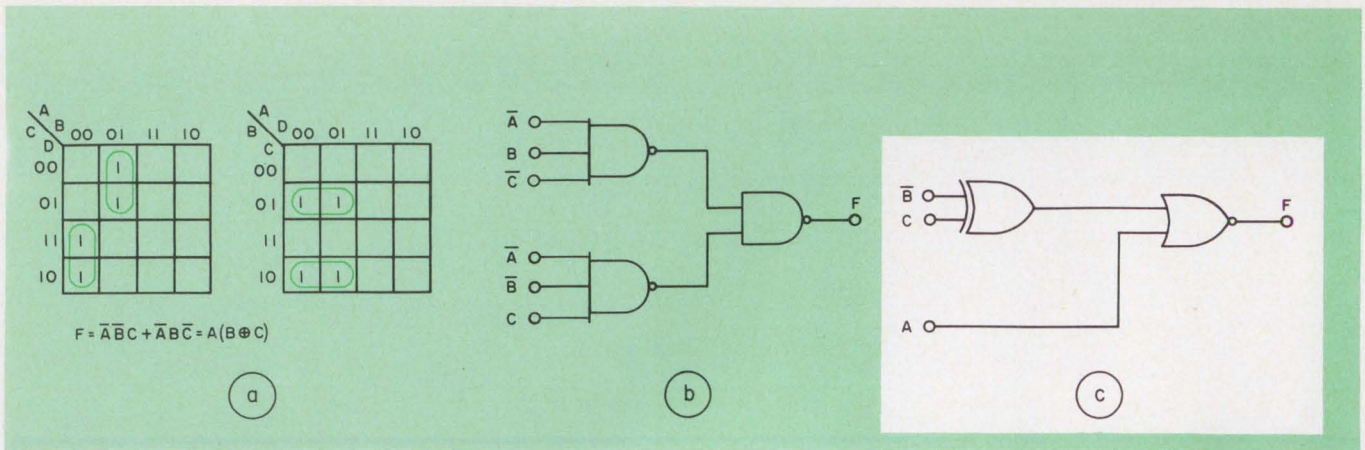

2. If two one-couples are separated by a single one-couple, they can be combined in the form of a product of an EX-OR function and $n-3$ remaining variables (a). In

this case the three gates of the conventional implementation (b) are replaced by two gates (c), one is an exclusive-OR gate, and the other is a two-input NOR gate.

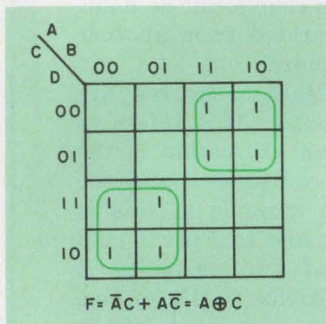

3. When a two-couple is separated from another two-couple by one two-couple, both two-couples can be represented as a product of an EX-OR and $n-4$ remaining variables.

For this case, one square separates each p-square of the function from two of the other p-squares of the function. This combination is demonstrated in Fig. 4, where we see that we have an EX-OR two-couple, $AC(B\oplus D)$, separated from a second EX-OR two-couple, $\bar{A}\bar{C}(B\oplus D)$, by the two-couple $\bar{A}\bar{C}$ (and the two-couple $\bar{A}\bar{C}$).

To reduce this combination to a product of two EX-OR functions, we note that

$$\begin{aligned} A B C \bar{D} + A \bar{B} C D + \bar{A} B \bar{C} \bar{D} + \bar{A} \bar{B} \bar{C} D \\ = A C (\bar{B}D + B\bar{D}) + \bar{A} \bar{C} (\bar{B}D + B\bar{D}) \\ = (A\oplus\bar{C}) (B\oplus D). \end{aligned}$$

No variables have been eliminated here, yet the implementation has been much simplified. In this coupling scheme, the pair of EX-OR two-couples that are separated by a two-couple must have the same EX-OR terms in both EX-OR expressions.

Thus we can combine $\bar{A}\bar{B}(C\oplus\bar{D}) + \bar{A}\bar{B}(C\oplus D) = (\bar{A}\oplus\bar{B}) (C\oplus\bar{D})$, but we cannot combine in this form the expression $\bar{A} C(B\oplus D) + A \bar{C}(\bar{B}\oplus D)$. In the latter expression one exclusive-OR is made up of the terms B and D , while the other has the terms \bar{B} and D .

4. Yet another combination results when an EX-OR two-couple is adjacent to an equivalence two-couple. Each p-square in this combination is separated by one square from the three other p-squares of the function. The Boolean expression for this combination is a product of a three-variable EX-OR and the $n-3$ remaining variables. An example is shown in Fig. 5, from which we get:

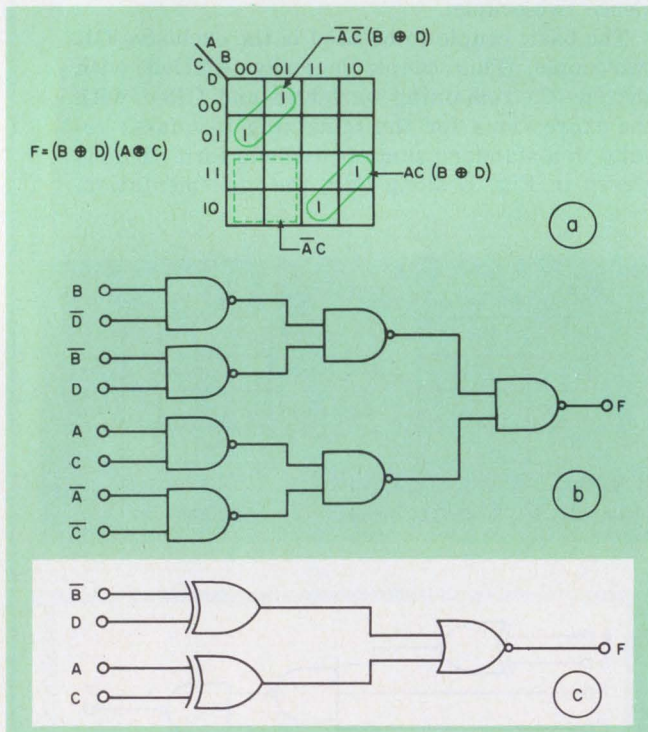

4. A product of two EX-OR functions results when an EX-OR two-couple is separated from a second EX-OR two-couple by a two-couple (a). Although no variables have been eliminated, the seven-gate conventional implementation (b) is reduced to three gates when the exclusive-OR approach is employed.

$$\begin{aligned} \bar{A} \bar{B} \bar{C} D + \bar{A} B \bar{C} \bar{D} + A B \bar{C} D + A \bar{B} \bar{C} \bar{D} \\ = \bar{C} (\bar{A}(\bar{B}D + B\bar{D}) + A(BD + \bar{B}\bar{D})) \\ = \bar{C} (\bar{A}(B\oplus D) + A(\bar{B}\oplus D)) = \bar{C} (A\oplus B\oplus D). \end{aligned}$$

In Fig. 5a an exclusive-OR two-couple, \bar{A}

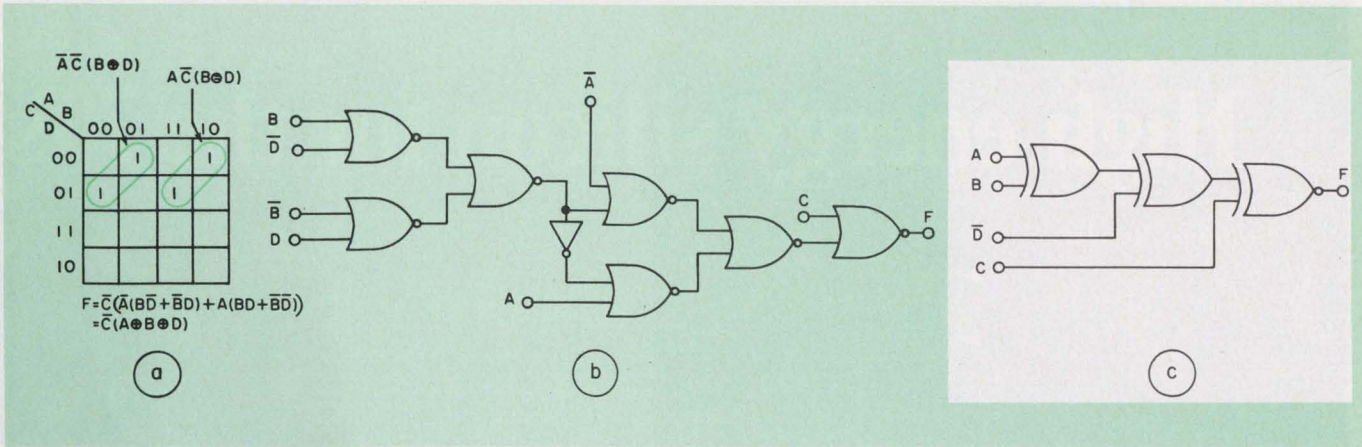

5. When an EX-OR two-couple is adjacent to an equivalence two-couple, the result is a product of a three-variable EX-OR and the $n-3$ remaining variables. In this

example (a), seven gates and an inverter are needed for the standard circuit approach (b), while only three gates are required when the EX-OR technique is used (c).

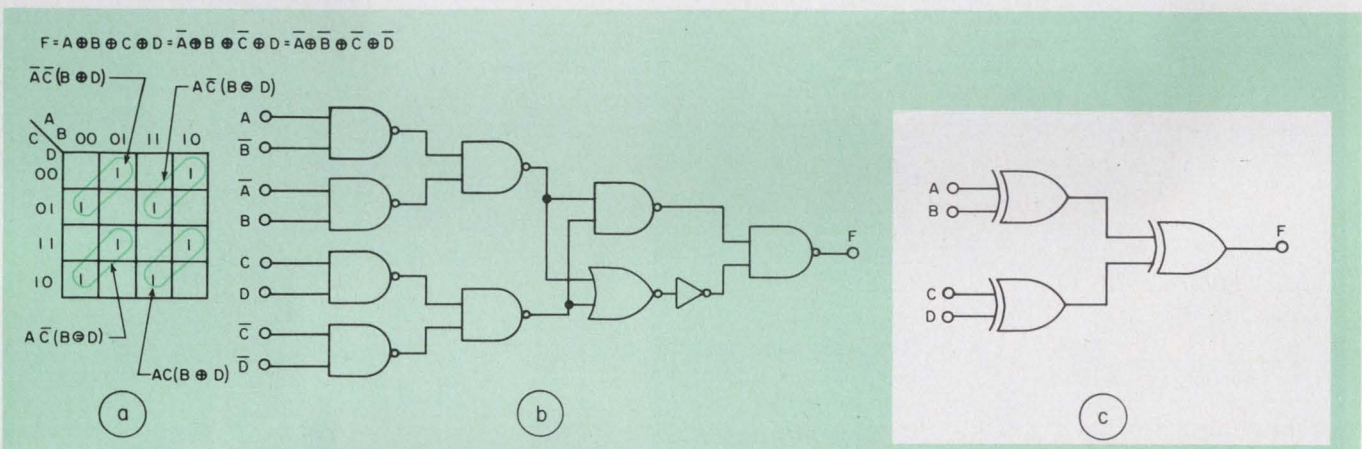

6. When a four-couple is made up of an EX-OR two-couple adjacent to two equivalence two-couples and diagonal to an EX-OR two-couple, the combination can be represented as a product of a four-variable EX-OR and

the $n-4$ remaining variables. For this example (a), the parts saving is spectacular when the EX-OR approach is used: The nine gates and one inverter of the standard circuit (b) are replaced by three EX-OR gates (c).

$\bar{C}(B \oplus D)$, is adjacent to an equivalence two-couple, $A \bar{C}(B \oplus D)$. In this coupling form, the exclusive-OR expression in the EX-OR two-couple must be of the same terms as the equivalence expression in the equivalence two-couple. For instance, if the EX-OR two-couple has the EX-OR term $B \oplus \bar{D}$, then the equivalence two-couple must have the equivalence term $B \oplus \bar{D}$.

5. A final combination results when a four-couple is made up of an EX-OR two-couple adjacent to two equivalence two-couples and diagonal to an EX-OR two-couple. The Boolean expression for this combination is a product of a four-variable EX-OR and the $n-4$ remaining variables. This function will have eight p-squares, each of which is separated by one square from four other p-squares. In Fig. 6 we have shown a four-couple (the whole four-variable map) consisting of an EX-OR two-couple, $A \bar{C}(B \oplus D)$, adjacent on two sides to equivalence two-couples, $A \bar{C}(B \oplus D)$ and $\bar{A} \bar{C}(B \oplus D)$, and diagonal to an

EX-OR two-couple, $\bar{A} \bar{C}(B \oplus D)$. Here again, as in the two preceding cases, if the EX-OR two-couples involve the term $(X \oplus Y)$, then the equivalence two-couples must contain the term $(X \oplus Y)$.

The general rules presented also hold if the word "equivalence" and the word "exclusive-OR" are interchanged. Note also that these rules can be extended for use with any number of variables.

One additional feature of the exclusive-OR function is worthy of note:

$$a \oplus 1 = \bar{a} \text{ and } a \oplus 0 = a.$$

Thus an unused gate can be employed as an inverter or as a noninverting time delay, or it can be switched from one application to the other. ■■

Bibliography:

Miller, Raymond E., *Switching Theory, Vol. 1*, John Wiley & Sons, Inc., New York, 1965.
 Marcus, Mitchell P., *Switching Circuits for Engineers*, Second Edition, Prentice-Hall, Inc., Englewood Cliffs, N.J., 1967.

High energy silicon for the 70's.

Switching Regulator

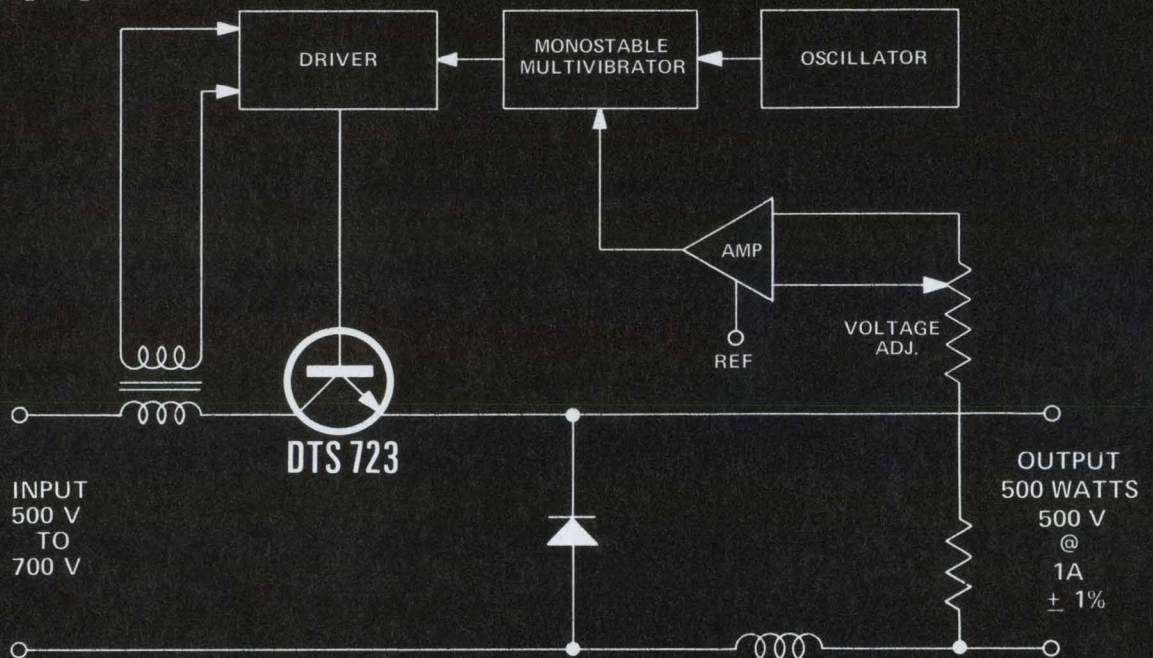

DC Regulator

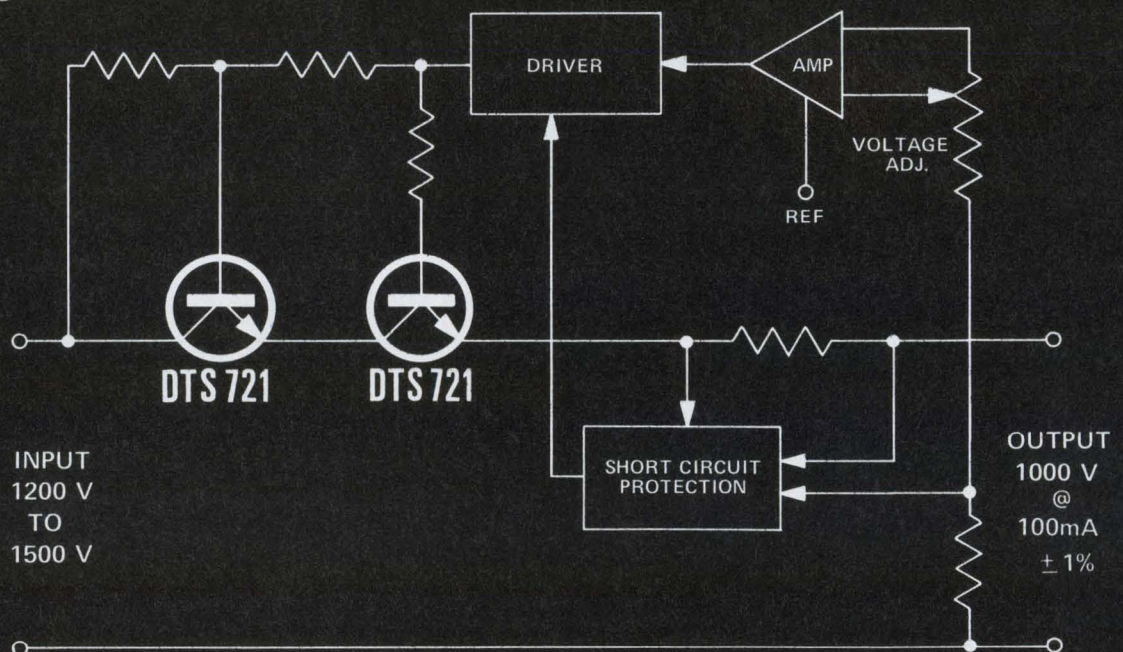

	V _{CEX}	V _{CEO}	V _{CEO} (sus)	I _C (cont)	h _{FE} @ I _C min/max V _{CE} =5.0V	P _T
DTS-721	1000V	1000V	800	3A	20/60 @ 150 mA	50W
DTS-723	1200V	1000V	750	3A	2 min @ 2.5 A	50W

Delco announces two new 1000-volt transistors for high power regulators in small packages.

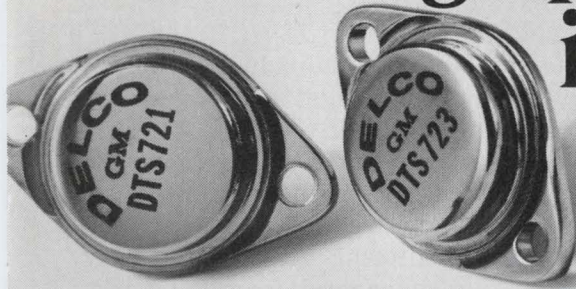

Our new DTS-721 and DTS-723 1000-volt silicon transistors permit you to design solid state circuits for industrial applications with capabilities previously reserved for tubes. Now you can think small.

These two new silicon devices were developed specially for instrumentation and power supply builders, as well as for computer and military applications. They can operate from DC inputs of 1200 volts to 1500 volts. With 1% regulation at full load.

In a switching regulator, they can operate directly from a 220-volt line or from rectified 440-volt single or polyphase sources.

Both devices are NPN triple diffused, packaged in Delco's solid copper TO-3 cases. They are mounted to withstand mechanical and thermal shock because of special bonding of the emitter and base contacts.

The DTS-721 and DTS-723 have been proven by

application tests from production lots by prospective users with stringent reliability requirements.

And their energy handling capability is verified by Delco Pulse Energy Testing.

These new high voltage silicon transistors make it possible for you to take advantage of reduced size, weight and component costs in designing circuits—and get far greater reliability.

The circuits shown are explained in detail in our application notes nos. 45 and 46.

Call the Kokomoans or your Delco Distributor for more information.



Delco Electronics

DIVISION OF GENERAL MOTORS CORPORATION, KOKOMO, INDIANA

Available from these Delco distributors:

ALA., BIRMINGHAM • Forbes Distributing Co., Inc. (205)-251-4104
ARIZ., PHOENIX • Cramer/Arizona (602)-263-1112 • Sterling Electronics (602)-258-4531
CAL., LOS ANGELES • Kierulff Electronics, Inc. (213)-685-5511 • Radio Products Sales, Inc. (213)-748-1271
CAL., PALO ALTO • Kierulff Electronics, Inc. (415)-968-6292
CAL., SAN DIEGO • Milo of California, Inc. (714)-232-8951
COLO., COLORADO SPRINGS • Walker Electronics (303)-636-1661
COLO., DENVER • Cramer/Denver (303)-758-2100 • Denver Walker Electronics (305)-935-2406
ILL., ROSEMONT (Chicago) • Kierulff/F-J-R (312)-678-8560
ILL., SKOKIE (Chicago) • Merquip Electronics (312)-282-5400
IND., INDIANAPOLIS • Graham Electronics Supply, Inc. (317)-634-8486
MD., BALTIMORE • Radio Electric Service Co. (301)-823-0070
MASS., NEWTON • The Greene-Shaw Co., Inc. (617)-969-8900
MICH., ROMULUS • Harvey/Detroit (313)-729-5500
MINN., MINNEAPOLIS • Stark Electronics Supply Co. (612)-332-1325
MO., KANSAS CITY • Walters Radio Supply, Inc. (816)-531-7015

MO., NO. KANSAS CITY • LCOMP-Kansas City, Inc. (816)-221-2400
MO., ST. LOUIS • LCOMP-St. Louis, Inc. (314)-647-5505
N.J., CLIFTON • Eastern Radio Corporation (201)-471-6600
N.M., ALBUQUERQUE • Cramer/New Mexico (505)-265-5767 • Sterling Electronics (505)-247-2486
N.Y., BINGHAMTON • Harvey/Federal (607)-748-8211
N.Y., NEW YORK • Harvey/New York (212)-582-2590
N.Y., WOODBURY • Harvey/New York (516)-921-8700
OHIO, CINCINNATI • United Radio, Inc. (513)-761-4030
OHIO, CLEVELAND • Pattison Supply (216)-441-3000
OHIO, DAYTON • Kierulff/F-J-R (513)-278-9411
OKLA., OKLAHOMA CITY • Radio, Inc. (405)-235-1551
OKLA., TULSA • Radio, Inc. (918)-587-9123
PENN., PHILADELPHIA • Almo Electronics (215)-676-6000
PENN., PITTSBURGH • RPC Electronics (412)-782-3770
S.C., COLUMBIA • Dixie Radio Supply Co., Inc. (803)-253-5333
TEXAS, DALLAS • Adleta Electronics Company (214)-741-3151

TEXAS, FORT WORTH • Adleta Electronics Co. (817)-336-7446
TEXAS, HOUSTON • Harrison Equipment Co., Inc. (713)-224-9131
UTAH, SALT LAKE CITY • Cramer/Utah (801)-487-3681
VA., RICHMOND • Meridian Electronics, Inc., a Sterling Electronics Company (703)-353-6648
WASH., SEATTLE • Kierulff Electronics, Inc. (206)-763-1550
WASH., TACOMA • C & G Electronics Co. (206)-272-3181
CANADA, ONT., SCARBOROUGH • Lake Engineering Co., Ltd. (416)-751-5980
ALL OVERSEAS INQUIRIES:
General Motors Overseas Operations
Power and Industrial Products Dept.,
767 Fifth Avenue, New York, N.Y.
10022. Phone: (212)-486-3723.

Regional Headquarters. Union, New Jersey* 07083, Box 1018 Chestnut Station, (201)-687-3770 ■ El Segundo, Calif., 90245, 354 Coral Circle, (213)-772-5181
■ Chicago, Illinois* 60656, 5151 N. Harlem Avenue, (312)-775-5411 ■ Kokomo, Ind. 46901, 700 E. Firmin, (317)-459-2175 Home Office
■ *Office includes field lab and resident engineer for application assistance.



Let an administrator do it! You can, as an engineering manager, spend more time in technical work and less knee-deep in administrative odds and ends.

Scores of engineering managers have discovered that they can spend 25 to 30% more time doing the thing they like best—engineering—if they rely on help from administrative assistants.

Such assistants can be used to advantage in both large and small companies. Although the requirements of small design and engineering companies may not be as great as those of large concerns, the need is still there—perhaps on a “time sharing” basis. One administrative assistant can serve several department heads.

When you're interviewing administrator applicants look for knowledge of the job and an unselfish attitude—one who is willing to stay in the background and allow you, as the manager, to take the final responsibility. Important, too, are enthusiasm, patience, understanding, the ability to get along with people, and a flair for improving the working environment.

An administrator with those qualities can be useful to you in many ways. Here are 10 that have worked at IBM in San Jose, Calif. They, or adaptations of them, can work for you:

1. As a communications link. Your administrator can enhance the relationship between you and your staff. Make it his responsibility to keep you informed. Instruct him to listen, probe and invite criticism. Advise him to talk about personal things that may be important to the employee: sports, cars, the family, the job. Make him the liaison between you and the employee—and make sure there's a two-way communication.

When practiced with sincerity, this two-way communication generates an atmosphere of frankness in discussing job activities. Without mention of names at times, unsuspected difficulties can be recognized and overcome before real problems develop.

2. In budget preparation and accounting. Budgets may harass you, but they're routine for the administrator. Allow him to work with the various project heads to obtain their proposed ex-

penditures, to combine the individual estimates into an over-all working budget and to present the plan to you for approval or revision.

IBM's administrators in San Jose have gone one step further in serving the engineering manager. Once the budget is approved, they assume full responsibility for monitoring its status. They keep the engineering manager informed by presenting charts or tables that give the story at a glance.

3. In new employee orientation. The administrator is in a good position to acquaint new people with their new place of work. He can tell them about the company's mission, how they fit into the operation and what is expected of them. Although much of this can be covered in brochures and handouts, the personal touch is far more effective and lasting. A private tour of the plant by the administrator and the new employee can add a final touch to the orientation.

The orientation of new managers deserves mention here, too. When a manager is promoted and a replacement comes in, IBM likes to make the transition as smooth as possible. Its administrators take pride in accepting this responsibility. They acquaint the new manager with what's going on, introduce him to his people and familiarize him with other operations, groups or individuals that he'll associate with.

4. By improving working environments. The administrator can be effective in checking the laboratories and offices to see if they need physical improvement. Lighting, heating, soundproofing and the condition of equipment are among the things checked periodically. If the administrator is not expert in these matters, he can call in experts to make sure that the physical surroundings are conducive to promoting efficiency and good morale.

5. By aiding decision making. Too often the facts and figures that cross your desk fall short of the intended goal. They are either too sophisticated or not sophisticated enough, making a decision difficult. Here the administrator can make an important contribution.

In IBM's San Jose laboratory administrators prepare the statistical reports for the engi-

E. E. Henschel, Administrator, International Business Machines Corp., Systems Development Div., San Jose, Calif.

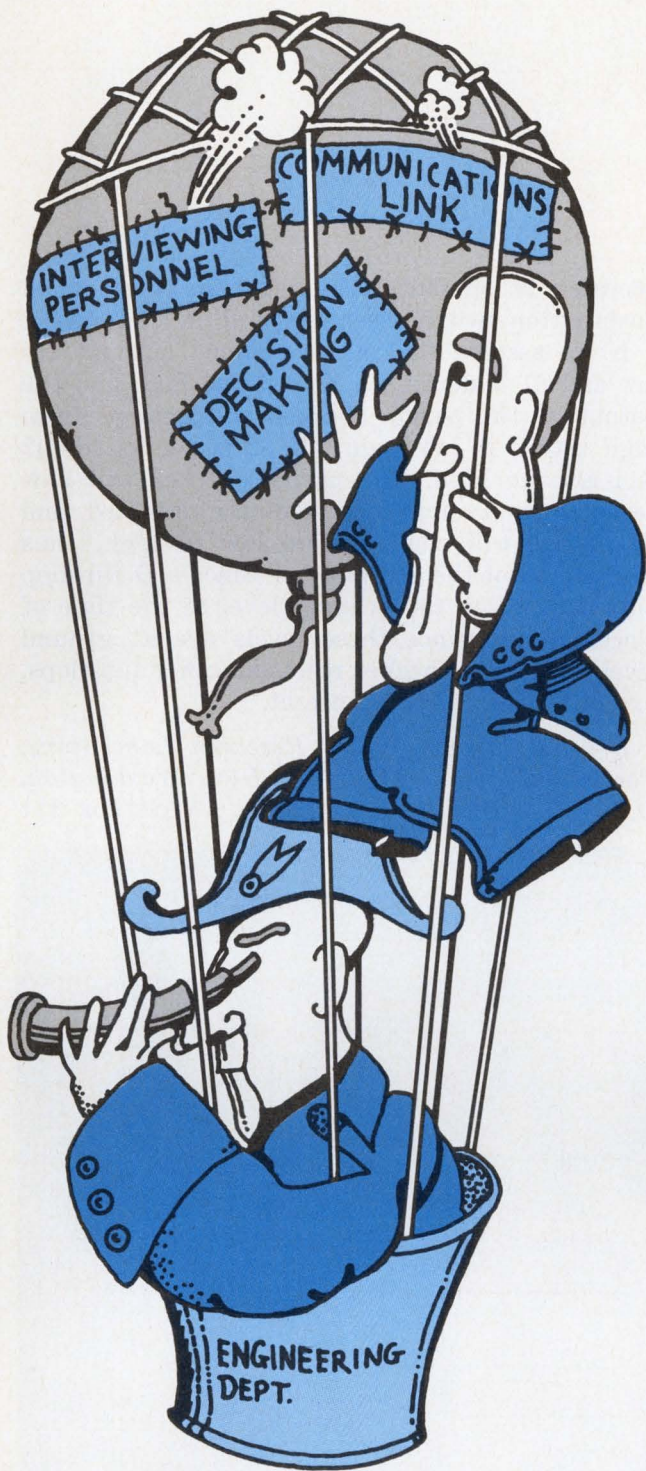

neering manager, or have them prepared for him. They strive to give only the facts that must be known. They make certain the reports are timely, accurate and easy to understand. They also give an oral interpretation of the report to highlight its significance, thus laying the groundwork for better decision-making.

6. By auditing progress and commending employees. Your responsibilities may expand to a point where it will be difficult to follow the day-to-day progress of all projects. A practical solution

is to audit the progress through reports or visits arranged by your administrator. He can provide only the information that you "need to know."

Closely connected to auditing progress is the practice of praising employees for work well done. Everyone seems to enjoy being "patted on the back" for significant accomplishments. Administrators can make certain that such individuals receive a congratulatory letter or personal thanks from the engineering manager. This is very effective in promoting good rapport.

7. By interviewing applicants. Your administrator can be very helpful when you're hiring new people. He can justify to upper management why a new person is needed. The engineering manager suggests what he needs, and the administrator takes it from there. He takes an active part in screening resumes and applicants. He coordinates applicant interviews with department managers and other key people, and follows through with personnel and salary administration to wrap up the agreement. After the applicant is on the payroll, he follows up on appraisals and raises.

8. By eliminating rubber-stamping. Occasionally you might find it necessary to get administrative messages to employees—long-lasting messages that are better transmitted in writing than by the spoken word. A common approach is for someone to prepare the message and then have you sign your name to it. Other documents may come along for the same kind of treatment. Before long, the operation mushrooms and valuable time is used just to sign papers. Administrators can handle some of this work.

9. By conducting tours. School and community groups are often interested in knowing what a company does. Ordinarily they satisfy their curiosity by touring the plant or laboratory. If your operation becomes part of the tour route, some preparation for the event is necessary. Your administrator can serve you well here. He knows what is proprietary and what isn't. He may not know the technical details of the projects, but his general knowledge enables him to pass on the story in easy-to-understand language.

10. By handling publicity. Undoubtedly you are proud of your employees and the work they do. You want other people to know of their achievements, whether new products, job promotions or other attainments. Why not let the administrator handle the publicity?

These are 10 ways in which administrators can help engineering managers do their job more efficiently. They may stir the imagination of some managers, and the delegation of other responsibilities to administrators could result: managing United Fund drives, blood-bank solicitations and social activities. You can, as an engineering manager, gradually return to what you like best—more technical involvement. ■■

Select/Reset IC channels with a parity checker

It's possible to construct an economical channel selector or electronic bail circuit that does not require large gate networks and complicated wiring schemes. And it's unaffected by switch contact bounce, to boot. Shown here as a four-channel selector, the capacity can easily be increased by adding an appropriate number of D-flip-flops and a large enough parity checker (see diagram).

The channel selector, using only three integrated circuits, provides a control output for any one of four possible channels. A specific channel is selected by depressing the appropriate momentary switch, which in turn resets all other channels through a parity checker. Thus the circuit

operates in similar fashion to the mechanical push-button switch assembly used on a car radio.

If we assume that all Q channel outputs are low and S1 is depressed, Q1 will go high and the output of the parity checker will change from high (even) to low (odd). If S2 is depressed, Q2 will also go high. The parity checker will now sense an even number of channels activated, and its output will change from low to high, thus clocking all of the D flip-flops. Since a D flip-flop output takes on the D input level at the time of clocking, and since these levels are at ground level, the parity checker resets all other flip-flops, except for the one being preset.

Bruce J. Brown, Naval Research Laboratory, Tactical Electronic Warfare Div., Washington, D.C.
VOTE FOR 311

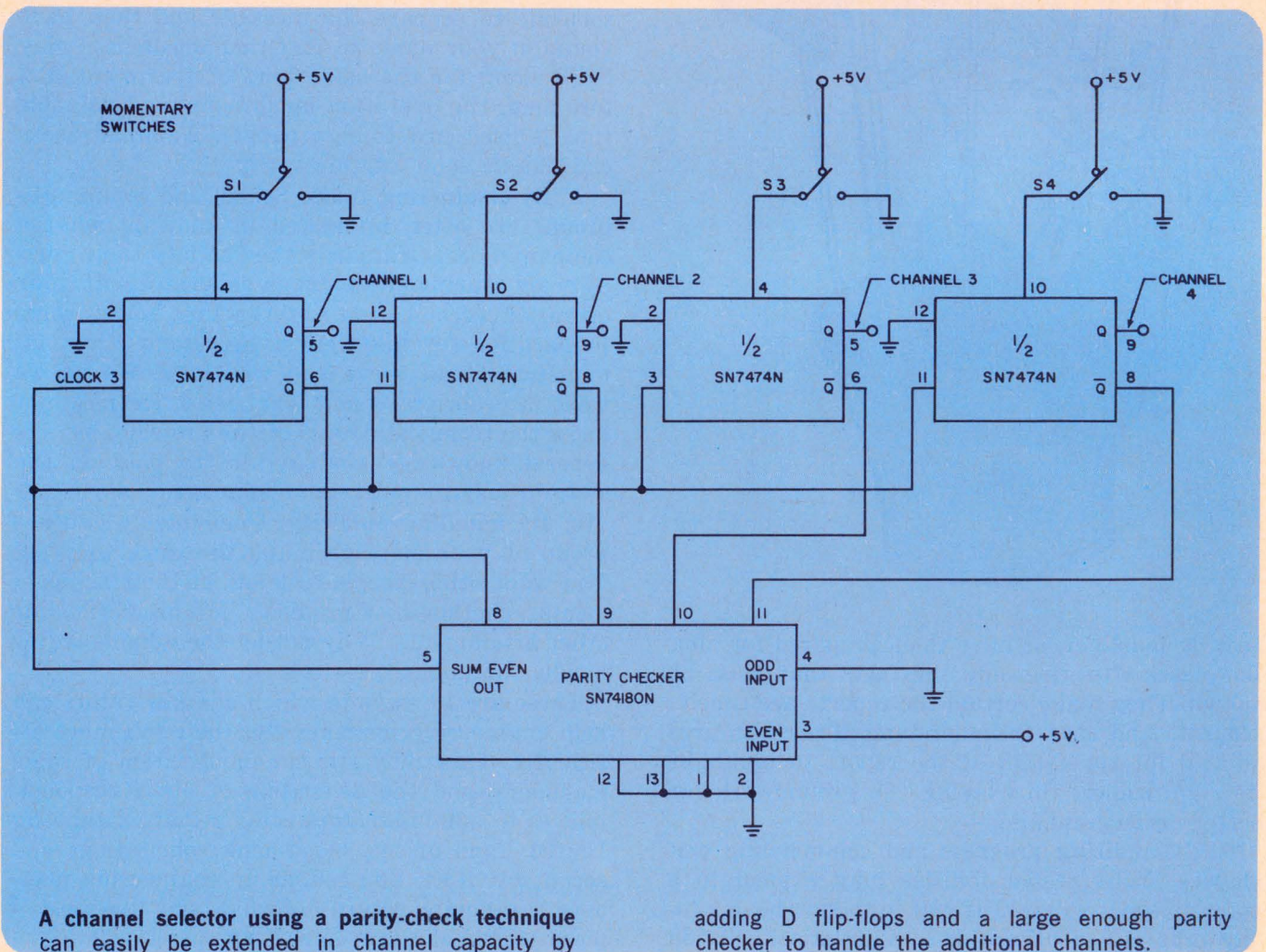

A channel selector using a parity-check technique can easily be extended in channel capacity by

adding D flip-flops and a large enough parity checker to handle the additional channels.

DIGITAL OR ANALOG... SUZY CAN'T DECIDE

(do you blame her?)

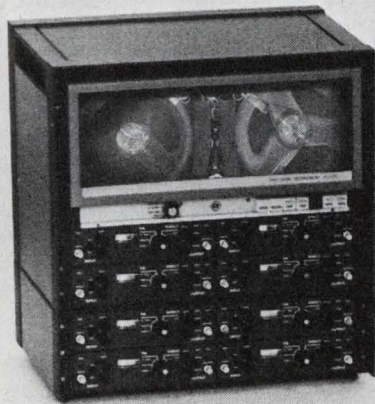

PI-6200 PORTABLE ANALOG LABORATORY/RESEARCH RECORDER

Up to 8 channels of FM/Direct plug-in rec/repro modules on commercial 1/4" tape, bandwidths to 10 KHz FM and 100 KHz Direct. Switchable electronics for 3 speeds on 1:10:100 time base allows 16 hours of silent recording, replayed within 10 minutes. Powered by AC or batteries. Has voice module, built-in test/calibration, fail-safe pushbuttons, remote control, FM squelch output (pen-drive plotter protection), optional IRIG speeds. Widely used in labs and hospitals. Has simple interface to industrial transducers; tape-loop adapter for transient analysis and fault detection.

CIRCLE NO. 141

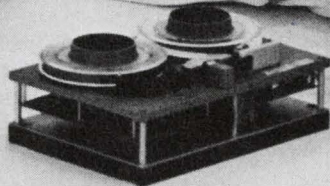

PI-1387 HIGH-ENVIRONMENT, LOW-POWER INCREMENTAL RECORDER

This rugged portable unit writes IBM-compatible tapes in NRZI format on 7" reels powered by 12-v battery. Used in oceanographic studies, vehicular performance datalogging, meteorology, earthquake monitoring and explosion testing. Standard features include TTL compatibility and self-contained shock mounts. Under 1 watt standby power. Weighs 18 lbs.

CIRCLE NO. 142

PI-5100 LONG-TERM IRIG RECORDER

Up to 20 days of continuous data recording with low-power drain on 12-v battery. FM and Direct on 7 or 14 channels with 2 edge tracks at speeds of 15/16 to 3/64 ips. Data can be reduced at higher ips on standard IRIG machines. Operates up to 15,000' altitude in weatherproof, light-weight aluminum case.

Use in monitoring air and water pollution, noise abatement and strain gauge measurements, mining and drilling operations, seismic studies, etc.

CIRCLE NO. 143



PI-1217/19 DIGITAL TAPE SYSTEMS

Variety of IBM-compatible continuous and incremental recorders in 7 or 9 channels, packing densities to 1600 cpi at standard speeds to 45 ips with specials to 112 ips. Choice of read or write only, read/write, or read-after-write electronics plug into a rugged, serviceable and completely documented system. Buffer memory provides asynchronous data transfers to synchronous tape drives, and zero data loss in dual memory version. Modular features find system usage in turn-key operations with computer peripherals; high-speed inputs to EDP equipment; high-speed outputs for electrostatic printers, tape-to-card and COM stations; and data acquisition systems.

CIRCLE NO. 144

"I really can't. I'll let you choose after you've seen the really terrific lines that PI offers — all the way from portable field units to laboratory instrumentation and off-line data processing.

"Just call or write me (ask for Suzy) and I'll introduce you to Bill, our analog products manager. Or I'll let you visit with Hap — he's big on digital and will advise you on plug-compatible systems for minicomputers."



**PRECISION
INSTRUMENT**

Reset dividers faster with a single flip-flop

In the design of high-frequency programmable dividers the main limitation is the resetting of the data into the dividers at the end of the count cycle. In their application notes most IC manufacturers use rather complicated circuits to do the resetting. The main problem with almost all of these circuits is their dependence on the clock pulse width.

These problems of complexity and clock pulse-width can be overcome with a single high-speed (74H series) J-K flip-flop (see diagram).

The AND gates decode the BCD number 97 at the falling edge of the clock pulse when A_0 goes to a logic 1. The next clock pulse then triggers the flip-flop and also the reset pulse. The counter is then held in this reset mode until the 99th clock pulse toggles the flip-flop back, since the J-input is now logic 0.

This allows the reset pulse to be a full clock width wide, and it is not influenced by the counter states as it resets. The requirement on the clock pulse is only that it be able to trigger the J-K flip-flop, which is really just the same requirement as with the counter.

This system has been built and tested in the programmable mode to over 40 MHz, using the components described here, with no variation of clock pulse width.

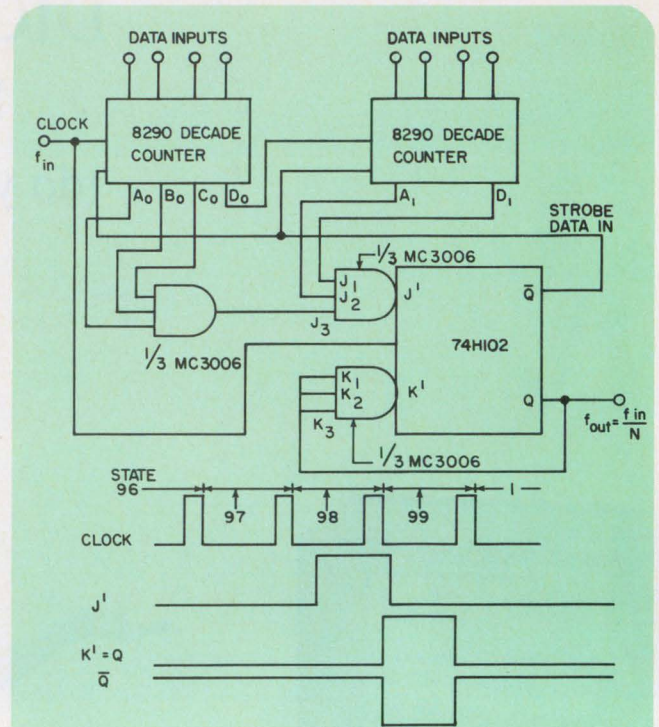

With only one flip-flop, divider resetting time is reduced. No complex circuits or clock pulse-width limitations are necessary; the reset pulse is a full clock-width wide and is not influenced by the counter states.

Doug Clifford, Design Engineer, Hewlett-Packard Co., 1501 Page Mill Rd., Palo Alto, Calif.

VOTE FOR 312

1-GHz oscillator can be made with an FET and microstrips

The design of stable oscillators at uhf frequencies usually requires crystals and multiplier stages. But by using a high-frequency FET and microstrip transmission lines, you can design an L-band oscillator with a stability that is better than 5 ppm/day (see diagram).

The main frequency-determining elements are the drain stub, the source stub and the impedance characteristic of the UT 100 FET. The small-signal S parameters at 1 GHz are used to determine the size of microstrip elements that, when used in conjunction with the transistor characteristics, provide 360 degrees of phase rotation to a 1-GHz signal. In other words, a signal present at the source is amplified and moves through the drain stub, C1 and the source stub, returning in phase to the source terminal of the FET with a regenerative signal.

The oscillator is constructed on 1/16-inch, Rogers RT/durroid 5870 material with microstrip techniques. The UT 100 is mounted between

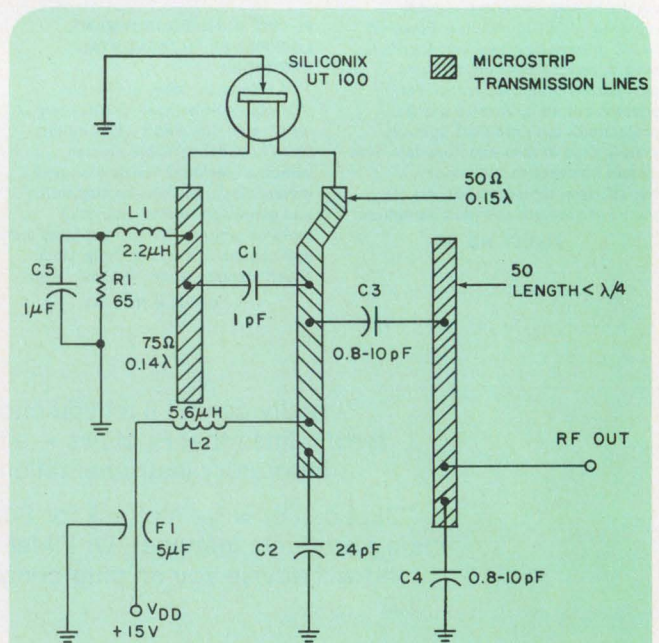

A UT 100 and microstrips form a 1-GHz oscillator. This L-band source offers a stability of 5 ppm/day and VCO capability from the drain-to-gate terminals of the FET. The wavelength λ is at 1.0 GHz.

Put precision into your direct mail program.

BY INDUSTRY

BY PRODUCT SPECIFIERS

BY SIC

BY TITLE

BY FUNCTION

BY DEPARTMENT ACTIVITY

BY STATE OR ZIP

KEY
PROSPECTS

Electronic Design enables you to select your prospects by all sorts of parameters or combinations. Available are over 74,000 OEM engineers and engineering managers known to be currently working ... currently in a position to specify and recommend. Your direct mail program is no better than your mailing list. There are

no better lists available to reach OEM specifiers than those of Electronic Design. Call or write the Direct Mail Manager with your needs. A list will be tailor-made for you.

Electronic Design,
50 Essex Street, Rochelle Park, N.J. 07662
(201) 843-0550

Introducing a completely shielded flexible flat-cable connector



A completely shielded high-density flexible flat cable connector that not only makes cable stacking reliable, but practical by eliminating the possibility of cross-talk or interference.

Major design innovations include:

- automatically crimped terminations to multi-conductor flat or round cable
- shielding throughout all the way to point of connection
- 4-leaf contacts provide consistently clean wiping connection
- connector allows reliable cable mating to any .025 sq. wrapost tail on .100, .125 or .150 centers
- molded connector separates and locks crimped contacts into place—assures solid strain relief

Malco solves another mating problem.

To get all the facts including mechanical and electrical interconnection characteristics write and request Bulletin #705:



MALCO

MALCO MFG COMPANY INC
5150 W. ROOSEVELT RD., CHICAGO, ILLINOIS 60650

We solve your mating problems.

Mini ⚡ Bus by Rogers

For noise and cost reduction

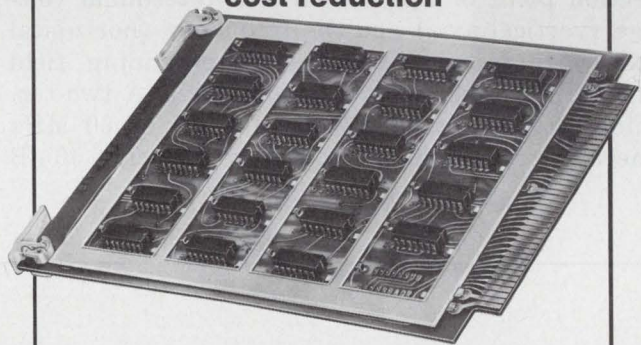

A small, voltage-distributing busbar for PC card application, each Mini/Bus gives you built-in capacitance . . . noise-cutting capacitance that means more reliable, compact circuit packaging at a fraction of multilayer prices. Write for data.



Rogers Corporation / Rogers, Conn. 06263

the source and drain stubs, so lead lengths are as short as possible. A copper ground plane, physically close to the microstrip elements, is provided so all component leads remain short.

The voltage sensitivity of FET junction capacitances leads to the FET's use as a voltage-controlled oscillator. By simple changes of drain-to-gate voltage, the frequency may be varied 15 MHz. Because the device is current-limited, the

output power varies only slightly from the nominal level of 3 mW. The oscillator may also be voltage-tuned by use of a binary varactor in shunt with C2. The varactor would allow digital tuning between two separate frequencies, or analog tuning over a selected band.

Michael Turner, Siliconix Inc., 2201 Laurelwood Rd., Santa Clara, Calif. VOTE FOR 313

Antenna-voltage nomograph gives the field strength

It's often necessary in field-strength measurements to convert the two-terminal voltage indicated by an RFI/EMI receiver to the corresponding field-strength level. This is done by adding a frequency-dependent antenna factor to the measured results. A nomograph that permits field-strength levels to be read easily from measured two-terminal voltages avoids the need for calculation (see diagram). All you need is the measured voltage, frequency and antenna factor.

The antenna factor is provided by the antenna manufacturer and usually includes the frequency-dependent loss for a fixed-length coaxial cable. If additional cable is used, the added loss has to be included as part of the antenna factor.

As an example of how the nomograph is used, consider a typical dipole antenna with an antenna factor of -1.5 dB at 30 MHz to 20 dB at 300 MHz (linear interpolation). The slope of the diagonal lines on the nomograph corresponds to the frequency-dependent antenna factor. First, the intersection point of the measured two-terminal voltage (vertical axis) and the frequency (horizontal axis) are found. Then the corresponding field strength is read off the diagonal axis. A two-terminal voltage of 35 dB above 1 μ V at 60 MHz therefore results in a field-strength level of 40 dB

above 1 μ V/m (dashed-line intersection on the nomograph).

John A. Malack, IBM Corp., Systems Development Div., Endicott, N.Y. 13760 VOTE FOR 314

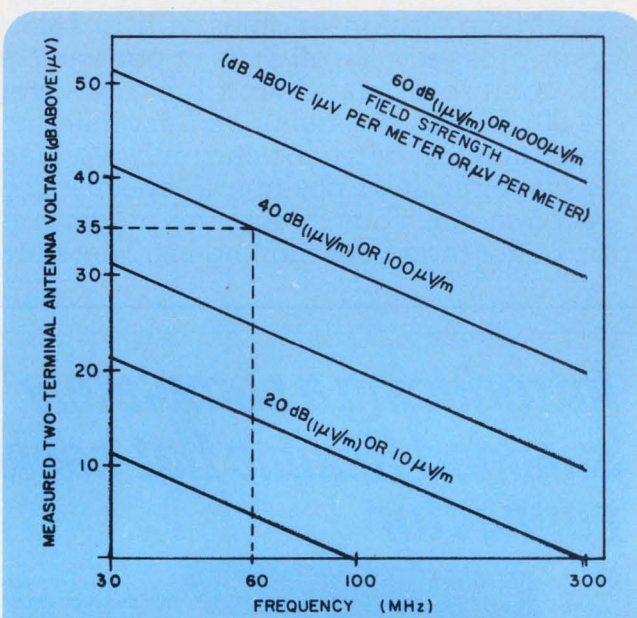

An antenna-voltage nomograph gives a direct reading of field strength corresponding to a two-terminal antenna voltage. The antenna factor, obtained from the manufacturer, specifies which diagonal line to use for a given frequency and voltage.

IFD Winner for April 15, 1971

Don Femling, National Semiconductor Corp.
2900 Semiconductor Dr., Santa Clara, Calif.
95051. His idea, "Digital IC tone detector
responds immediately to inputs" has been
voted the Most Valuable of Issue Award.
Vote for the Best Idea in this Issue.

VOTE! Go through all Idea-for-Design entries, select the best, and circle the appropriate number on the Reader-Service-Card.

SEND US YOUR IDEAS FOR DESIGN. You may win a grand total of \$1050 (cash)! Here's how. Submit your IFD describing a new or important circuit or design technique, the clever use of a new component or test equipment, packaging tips, cost-saving ideas to our Ideas-for-Design editor. You will receive \$20 for each accepted idea, \$30 more if it is voted best-of-issue by our readers. The best-of-issue winners become eligible for the Idea Of the Year award of \$1000.

new products

Vhf FET with 75-Ω input lowers VSWR to 1.25:1

Siliconix, Inc., 2201 Laurelwood Rd., Santa Clara, Calif. Phone: (408) 246-8000. P&A: \$5.75 (100 quantities); stock.

A new FET switch for high-frequency applications has a VSWR of only 1.25:1, and a figure of merit of 2.35×10^9 , typical, for a worst-case input match of 75 Ω.

These characteristics make the new U310 n-channel junction FET ideal for use in CATV and vhf amplifiers, oscillators, mixers, switches, and uhf telemetry.

To achieve a low input VSWR, in transmission-line systems with 75 Ω characteristic impedance, an appropriate source inductor is all that is needed to compensate for the input capacitance of the transmission line.

However, if this direct coupling is undesirable, then a simple "el" input network will offer a broadband low VSWR match. A typical circuit using the new JFET would use an "el" circuit with a 68-pF capacitor and a 136-nH inductor.

It is equally simple to achieve a low 50-Ω input VSWR over a wide band with the U310. For example, a 22-pF capacitor and a 62-nH inductor will provide a VSWR of

less than 1.25:1 over 200 to 400 MHz.

The U310 JFET features high transconductance of 10,000 to 20,000 μmhos and low capacitance. Gate-drain capacitance is 2.5 pF maximum and gate-source capacitance is 5 pF maximum.

One noteworthy characteristic of the U310 is its very low spurious response. Its spurious third-order intercept point occurs at +29 dBm (see curve). This means that a broadband uhf amplifier with low input VSWR and high gain will have a third-order spurious response that is typically 60 dB below the output signal.

Common-gate power gain ranges from 16 to 20 dB at 100 MHz, and is 11 dB at 450 MHz. Noise figure is also quite low—typically 3 dB at 450 MHz.

The new JFET device has a wide dynamic range of 100 dB.

Additional features include low power dissipation of 500 mW at 25°C and storage and operating temperature ranges of -65 to +150°C.

The transistor is packaged in a TO-52 can.

CIRCLE NO. 250

MOSFET for 500 MHz prices down to 49¢

RCA Solid State Div., Route 202, Somerville, N.J. Phone: (201) 722-3200. Price: 49¢ (100 quantities).

A new economy MOSFET, designated 40841, is useful in a wide range of applications from dc to 500 MHz. It provides 32-dB power gain (at 44 MHz), linear-circuit operation and wide dynamic operating range. Its square-law characteristics result in low cross-modulation performance over the agc range. Dual-gate construction reduces feedback capacitance.

CIRCLE NO. 251

Dual MOS 3-MHz register costs \$5.95

Motorola Semiconductor Products, Inc., Box 20912, Phoenix, Ariz. Phone: (602) 273-6900. Price: \$5.95.

The new silicon-gate MC2380G dual 100-bit dynamic shift register is a low-cost IC that is guaranteed to drive TTL circuits at a minimum of 3 MHz. Bipolar compatibility for this p-channel MOS IC is provided at both inputs and outputs. Its silicon gates reduce switching thresholds from about 4 to 2 V. Power dissipation is 0.4 mW/bit (at 1 MHz).

CIRCLE NO. 252

Low-power IC op amp dissipates only 22 mW

Advanced Micro Devices, Inc., 901 Thompson Pl., Sunnyvale, Calif. Phone: (408) 732-2400. Price: \$5

The new Am1660 IC op amp offers only 22 mW of power dissipation with a typical offset current of 800 pA. Input bias current is just 5 nA and input resistance is designed to fill the performance and price gap between type 301A and 308 op amps. It is 100% tested to Mil-Std 883.

CIRCLE NO. 253

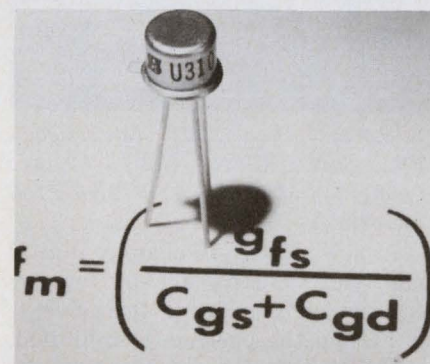

Designed for 50 and 75-Ω transmission lines, a new JFET (above) exhibits low spurious response. When operating as a three-stage uhf amplifier with a 225-MHz fundamental and a 50-MHz bandwidth, its spurious third-order intercept point occurs at +29 dBm (see right curve).

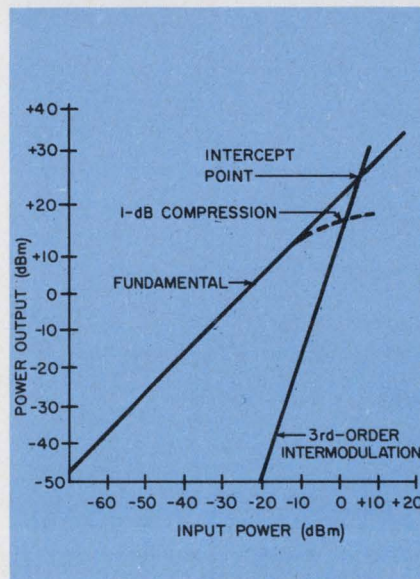

FREE SAMPLE

ANY BOURNS PANEL CONTROL FROM YOUR LOCAL BOURNS DISTRIBUTOR!

Specify one of the following:

**RV6 STYLE
MODEL 3861
MODEL 3852
MODEL 3859
MODEL 3862**

SEE AD ON OPPOSITE PAGE FOR
PRODUCT SPECIFICATIONS

Do it now! Call one of the Bourns distributors listed below for one free sample of your choice. Hurry! This offer expires August 31.

ALABAMA

Cramer/E.W., Inc.
Huntsville, 205 539-5722

ARIZONA

Kierulff Electronics
Phoenix, 602 273-7331

CALIFORNIA

Westates Electronics Corp.
Chatsworth, 213 341-4411

Hamilton Electro Sales
Culver City, 213 870-7171

Liberty Electronics Corp.
Inglewood, 213 776-6252

Elmar Electronics, Inc.
Mountain View, 415 961-3611

Hamilton/Avnet
Mountain View,
415 961-7000

Kierulff Electronics
Palo Alto, 415 968-6292
Electronic Supply Corp.
Riverside, 714 683-8110

Western Radio
San Diego, 714 239-0361

COLORADO

Hamilton/Avnet
Denver, 303 433-8551

Kierulff Electronics
Denver, 303 343-7090

CONNECTICUT

Connecticut Electro Sales
Hamden, 203 288-8266

Cramer Electronics, Inc.
North Haven, 203 239-5641

FLORIDA

Cramer/E. W. Inc.
Hollywood, 305 923-8181

Gulf Electronics
Miami, 305 887-6541

Hamilton/Avnet
Hollywood, 305 925-5401

Hammond Electronics, Inc.
Orlando, 305 241-6601

GEORGIA

Jackson Electronics Co.
Atlanta, 404 355-2223

ILLINOIS

Allied Electronics Corp.
Chicago, 312 421-6800

Newark Electronics
Chicago, 312 421-2400

Hamilton/Avnet
Schiller Park, 312 678-6310

INDIANA

Fort Wayne Electronics
Supply, Inc.
Fort Wayne, 219 742-4346

Graham Electronics Supply, Inc.
Indianapolis, 317 634-8486

KANSAS

Hall-Mark Electronics, Inc.
Kansas City, 913 236-4343

MARYLAND

Pyttronic Industries, Inc.
Baltimore, 301 539-6525

Hamilton/Avnet
Baltimore, 301 796-5000

Washington, 202 935-5600

Schweber Electronics
Rockville, 301 427-4977

MASSACHUSETTS

Electrical Supply Corp.
Cambridge, 617 491-3300

Cramer Electronics, Inc.
Newton, 617 969-7700

MICHIGAN

Harvey-Michigan
Romulus, 313 729-5500

MINNESOTA

Lew Bonn Co.
Edina, 612 941-2770

MISSISSIPPI

Ellington Electronic Supply, Inc.
Jackson, 601 355-0561

MISSOURI

Hamilton/Avnet
Hazelwood, 314 731-1144

Hall-Mark Electronics Corp.
St. Louis, 314 521-3800

NEW JERSEY

General Radio Supply Co., Inc.
Camden, 609 964-8560

Hamilton/Avnet
Cherry Hill, 609 662-9337

Eastern Radio Corp.
Clifton, 201 471-6600

NEW MEXICO

Electronic Parts Co., Inc.
Albuquerque, 505 265-8401

NEW YORK

Standard Electronics, Inc.
Cheektowaga, 716 685-4220

Cramer/Esco, Inc.
Hauppauge, 516 231-5600

Milo Electronics Corporation
Syosset, 516 364-1111

Cramer-Eastern
East Syracuse, 315 437-6671

Hamilton/Avnet
Syracuse, 315 437-2641

Federal Electronics, Inc.
Vestal, 607 748-8211

Schweber Electronics
Westbury, L. I., 516 334-7474

Harvey Radio Company, Inc.
Woodbury, L. I., 516 921-8700

NORTH CAROLINA

Cramer/E.W., Inc.
Winston-Salem, 919 725-8711

OHIO

Hughes-Peters, Inc.
Cincinnati, 513 351-2000

Pioneer Standard Electronics, Inc.
Cleveland, 216 432-0010

Hughes-Peters, Inc.
Columbus, 614 294-5351

Pioneer/Dayton
Dayton, 513 236-9900

OKLAHOMA

Hall-Mark Electronics
Tulsa, 918 835-8458

PENNSYLVANIA

Pyttronic Industries, Inc.
Montgomeryville, 215 242-6700

Powell Electronics
Philadelphia, 215 724-1900

Cameradio Company
Pittsburgh, 412 391-7400

RHODE ISLAND

Wm. Dandreta & Co.
Providence, 401 861-2800

TEXAS

Hall-Mark Electronics Corp.
Dallas, 214 231-6111

Hamilton/Avnet
Dallas, 214 638-0900

Harrison Equipment Co., Inc.
Houston, 713 224-9131

UTAH

Standard Supply Co.
Salt Lake City, 801 355-2971

WASHINGTON

Liberty Electronics/Northwest
Seattle, 206 763-8200

WISCONSIN

Taylor Electric Co.
Mequon, 414 241-4321

CANADA

Cesco Electronics Ltd.
Montreal, Que., 514 735-5511

Cesco Electronics
Ottawa, Ont., 613 729-5118

Cesco Electronics
Quebec City, Que.
418 524-4641

Varatronics Industries, Ltd.
Vancouver, B.C., 604 736-9252

Zentronics Ltd.
Toronto 19, Ont., 416 781-6651

ICS & SEMICONDUCTORS

Keyboard encoder ROM packs in 2376 bits

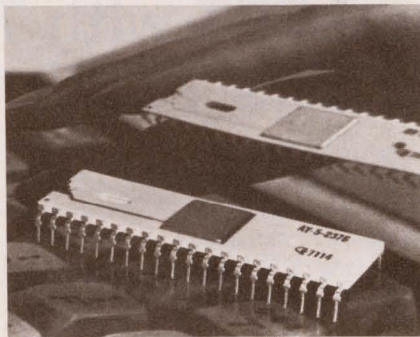

General Instrument Corp., 600 W. John St., Hicksville, N.Y. Phone: (516) 733-3333. Price: \$27.50.

The new AY-5-2376 ROM with 2376 bits increases system flexibility, reduces package count and allows TTL and DTL compatibility without special interface components in keyboard encoder applications. This device is equipped with all the logic to encode spst keyboard closures into a usable 9-bit code. It is available in a 40-lead DIP.

CIRCLE NO. 254

16-channel multiplexer floats its outputs

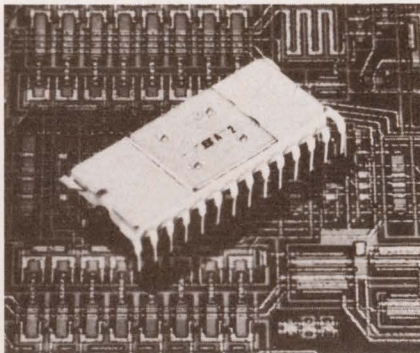

Siliconix, Inc., 2201 Laurelwood Rd., Santa Clara, Calif. Phone: (408) 246-8000. P&A: \$19.90 (100 quantities); stock to 3 wks.

A new CMOS 16-channel digital multiplexer features a buffer circuit which permits a floated output when the package is inhibited, so that multiple outputs may be connected to build digital multiplexers for as many channels as desired. The monolithic DM110 multiplexer chip includes an inverter buffer capable of driving a 3.2-mA load.

CIRCLE NO. 255

YOUR BOURNS TRIMPOT PRODUCTS DISTRIBUTOR

INFORMATION RETRIEVAL NUMBER 31

NEW BOURNS

MODEL
3861

...and
more
to
come

RV6

VARIABLE RESISTOR

...NEWEST ADDITION TO THE GROWING FAMILY OF BOURNS PANEL CONTROL UNITS!

NOW LISTED ON QPL FOR MIL-R-94C, RV6 STYLE, the new Model 3861 with its hot molded carbon element is the ideal answer when your requirements call for long, dependable control life . . . when frequent adjustment is needed . . . or for any RV6 Mil-Spec application. Advantages of the Model 3861 include: metal bushing and case; 1/2 watt power rating at 70°C; resistance to 5 megohms; and, tolerance of $\pm 10\%$. . . and a price of \$1.15 each in 2500-piece quantities.

Also, take a look at the other members of the Bourns Panel Control family — many are cermet for added stability and higher power requirements:

**Model
3852**

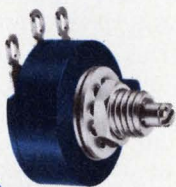

3/4" dia., metal bushing, locking or non-locking, rated 2 watts at 70°C, resistance to 5 megohms, and tolerance of $\pm 10\%$. The price: 81 cents each in 2500-piece lots.

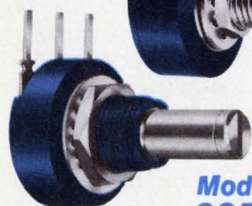

**Model
3859**

3/4" dia., plastic bushing or quickly installed snap-in version, 2 watts at 70°C, resistance to 5 megohms, tolerance $\pm 10\%$. In 2500-piece quantities, just 66 cents each.

**Model
3862**



1/2" dia., rated 1 watt at 125°C, resistance to 5 megohms, tolerance $\pm 10\%$. Price each in 2500-piece quantities, \$1.18.

Complete technical data on these units is available from the factory or your local Bourns Trimpot Products distributor . . . write today!



BOURNS, INC., TRIMPOT PRODUCTS DIVISION • 1200 COLUMBIA AVE., RIVERSIDE, CALIF. 92507

INFORMATION RETRIEVAL NUMBER 32

Low-voltage surge arrestors rate at 145 V

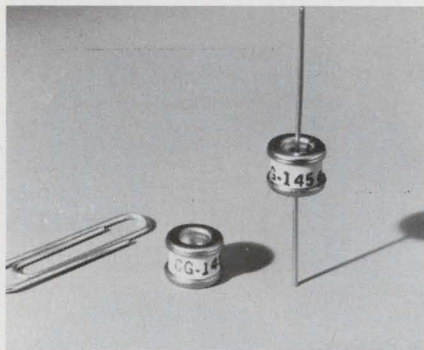

Signalite, 1933 Heck Ave., Neptune, N.J. Phone: (201) 775-2490. Availability: stock.

Two subminiature low-voltage surge arrestors are the CG145 (button type) and 145L (lead type) arrestors rated at 145 V dc. They dissipate current pulses as high as 5000 A and have a guaranteed life of 50 discharges under maximum load conditions. The arrestors present an insertion loss of less than 2 pF and a resistance over 10,000 MΩ.

CIRCLE NO. 256

Panel/PC-board LED lamps cost down to 65¢

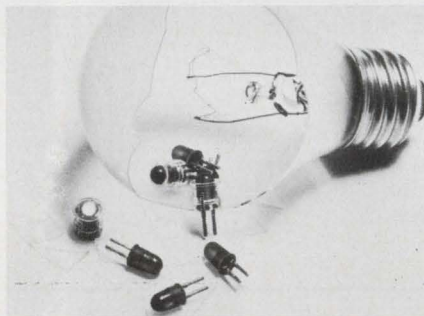

Hewlett-Packard Co., 1501 Page Mill Rd., Palo Alto, Calif. Phone: (415) 493-1501. Price: 65¢ (10,000 quantities).

New low-cost GaAsP LEDs are available for easy panel or PC-board mounting. Using a rugged lead frame and plastic construction, the 5082-4440 and 5082-4444 lamps are designed for panel and PC-board mounting, respectively. They have red diffused plastic lenses with high visibility over a wide viewing angle. A simple snap-in clip is available for front-panel mounting.

CIRCLE NO. 257

TTL/DTL compatible reed relays cost \$1

Self-Organizing Systems, Inc., 3121 Benton St., Garland, Tex. Phone: (214) 276-9487. P&A: see text; stock to 4 wks.

The Zestron series 530 and 540 reed relays combine a 10-VA switch, a 500-Ω 4.5-V TTL/DTL-compatible coil, and magnetic shielding, at a price of \$1 (1000 quantities). These 1-by-0.1-in.-pin-configuration relays give a life expectancy in excess of 10 million operations even with rated loads of 500 mA and 50 V dc.

CIRCLE NO. 258

Four active resonators enhance filter design

Integrated Electronics, Inc., 16845 Hicks Rd., Los Gatos, Calif. Phone: (408) 265-2410. P&A: \$16.75 (1200), \$26.80 (1500), \$23.50 (1700) 100 quantities.

Four new active resonators can be incorporated in the construction of active filters. The uAR1000 series is designed for the subaudio to audio-frequency range. The uAR1200 is designed for a Q of 10 at 16 kHz. The uAR 1500 has high stability over a wide Q range. The uAR1700 offers a Q of 300 at 5 kHz.

CIRCLE NO. 259

10-digit thumbwheel switch has long life

Amp, Inc., Harrisburg, Pa. Phone: (717) 564-0101.

Rated at 3 A and 115 V ac, a new miniature 10-digit thumbwheel switch has a life expectancy of 1 million switch-point cycles while switching 0.125 A. Standard versions include decimal or BCD outputs. Other code formats are available on special request. The unit's housings can be mounted from either the front or rear of panel cutouts. Tie-rod assemblies permit stocking switches in horizontal arrays up to 10 units.

CIRCLE NO. 260

Thick-film resistors rate up to 3 kV

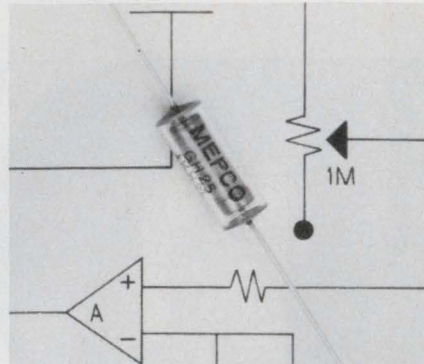

Mepco, Inc., Columbia Rd., Morristown, N.J. Phone: (201) 539-2000. Price: under \$1.75 (1000 quantities).

A new series of thick-film precision resistors come with voltage ratings up to 3 kV and reliability standards compatible with Mil R-55182. The GH series resistors are hermetically sealed in glass enclosures with a benign atmosphere that reduces corona and humidity problems. They range from 7 to 100 MΩ at tolerances of 1% and TCs from 150 to 200 ppm.

CIRCLE NO. 261

Small time-delay relays span 0.05 to 600 s

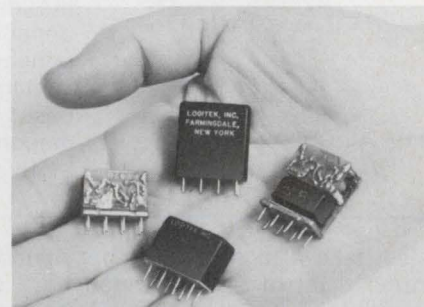

Logitek, Inc., 42 Central Dr., Farmingdale, N.Y. Phone: (516) 694-3080. P&A: from \$150; 3 wks.

A new series of tiny time-delay relays provides extremely precise delays, adjustable from 50 ms to 600 s over an operating temperature range of -55 to +85°C. The relays are very small devices: they each measure only 0.88 by 0.8 by 0.4 in. Series DMNI dpdt relays accept 8 to 31 V dc inputs and are contact-rated at 2 A resistive and 1 A inductive.

CIRCLE NO. 262

Rocker-arm circuit breakers enhance styling

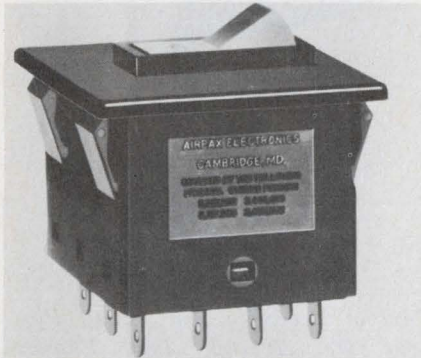

Airpax Electronics, Woods Rd., Cambridge, Md. Phone: (301) 228-4600. P&A: \$8.75; stock.

Type 203 electro-magnetic circuit protectors are characterized by many features such as snap-in or back-of-panel mount, single rocker-arm actuator for multipole assemblies and choice of case and rocker arm colors. They are available in one, two, or three electric poles, all with a single rocker-arm, from 20 mA to 20 A at 250 V dc.

CIRCLE NO. 263

Matrix-board dual plug eases programming

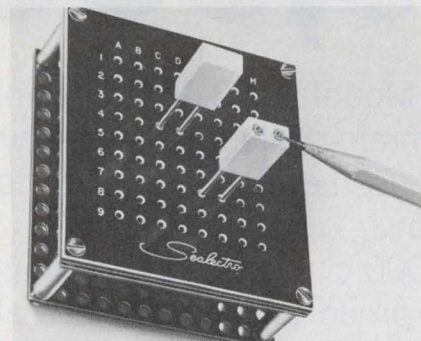

Sealectro Corp., 225 Hoyt St., Mamaroneck, N.Y. Phone: (914) 698-5600.

A Delrin-insulated dual plug provides ready access to input and output junctions on matrix programming boards. The unit permits voltage readings and signal monitoring without circuit interruption. The dual plug has probes on 1/4-in. centers constructed of silver-plated brass. Special plugs are available for signal measurement and injection, and for special-purpose programming.

CIRCLE NO. 264

Pilot lights use light-emitting diodes

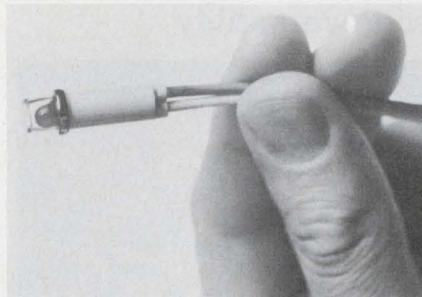

Industrial Devices, Inc., Edgewater, N.J. Phone: (201) 943-4084.

A new series of pilot lights using LEDs is available. These solid-state lamps can be permanently wired into a circuit. For dc applications, they are supplied with an appropriate current-limiting resistor. For ac applications, a rectifier diode is also built in. The Glot Dot 2100 series lamps come in 5/16-in.-dia model lenses.

CIRCLE NO. 265

Let us help you build a custom switch...



...from stock components!

Before you design that *custom* switch, browse through our catalogs. There are literally *hundreds* of types *in stock*. Or you can specify a special and have it assembled pronto from *millions* of components off-the-shelf! Choose from Rotary, Cam, Detent & Snap Action, Pushbutton and other types. Standard specs range from 1/2 up to 200 amps...from one to 75 poles per switch...plus combinations (tandem, gear train, etc.). We can't promise an exact match to your custom needs *every time*...but don't take bets on it!

Send for Bulletin C-1 describing our lines and catalogs or tell us your specific needs for detailed specifications.



ELECTRO SWITCH
CORP

Weymouth, Massachusetts 02188

Telephone: 617/335/5200 TWX: 710/388/0377

INFORMATION RETRIEVAL NUMBER 33

Low-height IC socket offers 0.025-in. profile

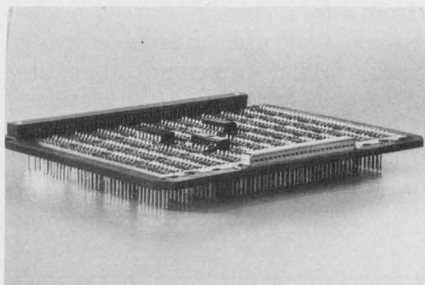

Robinson-Nugent, Inc., 800 E. 8th St., New Albany, Ind. Phone: (812) 945 0211.

A very-low-profile IC socket is the new Allochiral socket with a profile above a PC board of only 0.025 in. It incorporates a one-piece contact/terminal concept. When inserted in a board, the unit becomes a properly aligned, self-supporting connector/socket for ICs, or a complete back-panel solderless interconnection system. Its low profile permits high packaging density.

CIRCLE NO. 266

Fastener line offers wide versatility

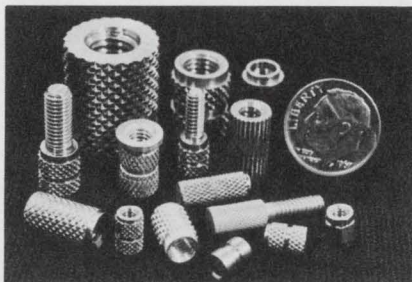

Red-D-Lock, Box 410, N. Hollywood, Calif. Phone: (213) 980-2030. Availability: stock to 3 wks.

A complete line of new fasteners, includes interchangeable miniature inserts, studs, spacers and stand-offs, some of which have internally threaded inserts. External knurled surfaces and closed ends, with either through-threaded or threaded stud styles, are other features. The hardware items are for use in electronic components and assemblies where there is a need for metal bearing threads in soft materials.

CIRCLE NO. 267

DIP socket provides zero insertion force

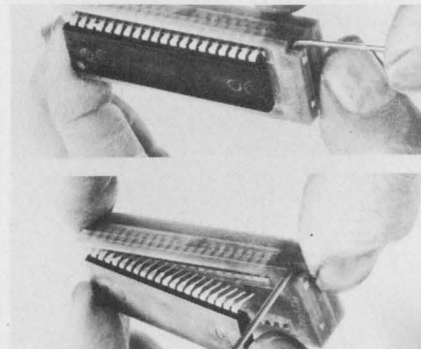

Textool Products, Inc., 1410 Pioneer Dr., Irving, Tex. Phone: (214) ME1-5585. Price: \$2.59 to \$8.55 (100 quantities).

A new zero-insertion-pressure test socket is designed to prevent damage to DIP package leads during hand tests and burn-ins. Named the Zip-Dip socket, the unit uses a unique locking lever which clamps DIP leads securely after insertion of the IC into the socket, and completely releases the unit upon completion of the test.

CIRCLE NO. 268

Tested 9,000,000



Style RTR 22 DP

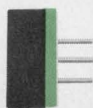

Incredible but true, Weston Models 313-160 HS and 318-160 HS, 1/2-inch square trimming potentiometers have been MIL qualified to 0.01% ("R" Level) failure rate for established reliability per MIL-R-39015.

These units have survived over 9,000,000 consecutive unit-hours of testing without a failure. Weston is proud to announce the attainment of this incredible record.

a good rule to follow...

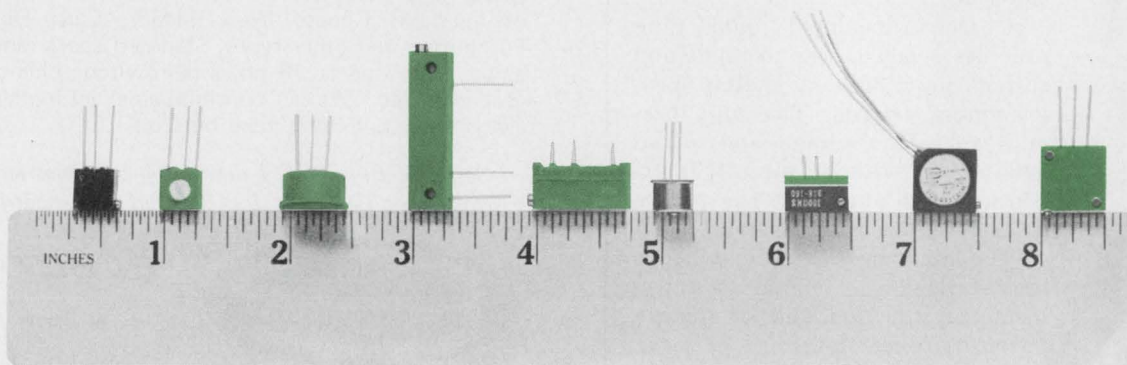

Two-contact connectors are truly miniature

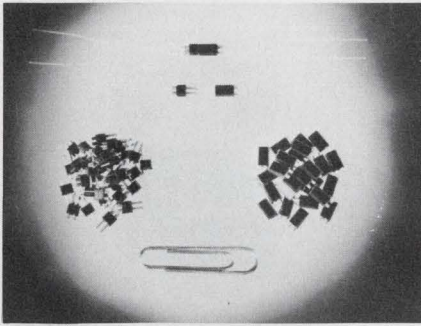

Microtech, Inc., 777 Henderson Blvd., Folcroft, Pa. Phone: (215) 532-3388. P&A: \$1.25; stock to 2 wks.

The G-series of two-contact connectors is in units that consist of a male plug and a female receptacle whose bodies are less than 1/16-in. thick by 1/8-in. wide by 1/8-in. long, and 1/4-in. long, respectively. The pins and sockets are of gold-plated brass. The bodies are made of a high-dielectric vulcanized material that is heat-resistant to soldering.

CIRCLE NO. 269

71-pole plugs/sockets hold cables two ways

Plessey Inc., 400 Moreland Road, Commack, N.Y. Phone: (516) 543-5000.

The 150 range of plugs and sockets is available with 7 to 71 poles and offers a sliding cover that allows either side or top cable entry. Of interest is the 159's new space-saving configuration and the simple but efficient locking device.

CIRCLE NO. 270

Wire-wrap PC boards hold up to 40-pin ICs

Interdyne, 217 Purdue Ave., Los Angeles, Calif. Phone: (213) 477-6051.

Wire-wrappable IC socket assemblies are available on PC boards. Custom configurations of any size can be obtained in epoxy-glass boards with any complement of 14, 16, 24, 36 or 40-pin sockets and standoffs.

CIRCLE NO. 271

SCR/triac heat sink limits temperature rise

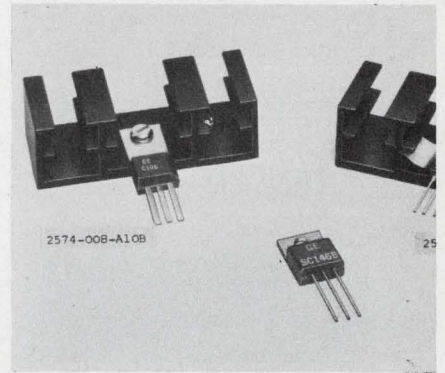

Astrodyne, Inc., 353 Middlesex Ave., Wilmington, Mass. Phone: (617) 658-9191.

A heat sink designed for use with low-current SCRs and triacs with tab anodes limits temperature rise above ambient to 80°C at 3 W dissipation, and to 70°C at 10 W. Model 2574 provides two means of securing devices for heat sinking: by fastening the tabs to its center or with a silver-plated beryllium-copper spring.

CIRCLE NO. 272

hrs. without failure!

Remember Weston's 9,000,000 hr record the next time you need trimming potentiometers for any application. Weston offers the finest, most dependable line of cermet and wire wounds for all types of low-cost industrial and high-performance military applications.

Call 717-876-1500 or write Weston Components Division, Archbald, Pa. 18403, a Schlumberger company.

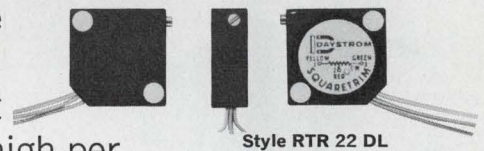

Style RTR 22 DL

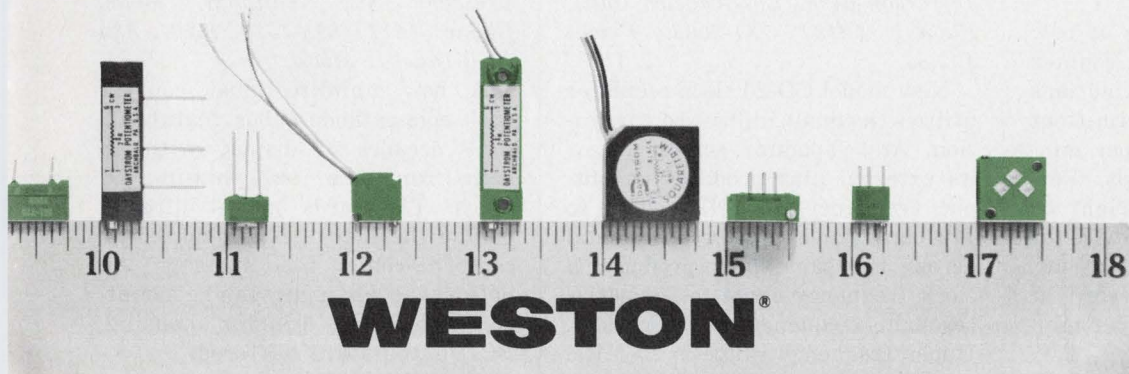

when
ordering
pots.

10-bit d/a converter fits in a 16-pin DIP

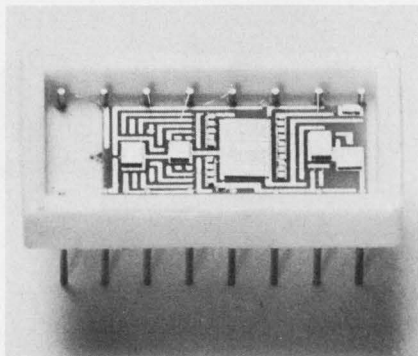

Micro Networks Corp., 5 Barbara Lane, Worcester, Mass. Phone: (617) 756-4635. P&A: \$69; stock.

Model MN325 is a low-cost multichip 10-bit d/a converter in a 16-pin DIP. It is for use with external op amps to achieve high slow rates and fast settling times (0.1 μ s). The unit includes monolithic switches, a thin-film resistor network and internal reference. Power consumption is 500 mW and operating voltage is ± 15 V. Output voltage is 0 to -10 V with a linearity of $\pm 1/2$ LSB.

CIRCLE NO. 273

Square-case electrical counter is small in size

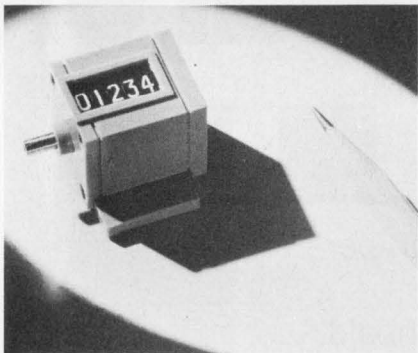

Veeder-Root, 70 Sargent St., Hartford, Conn. Phone: (203) 527-7201. Availability: stock.

The "Little Miracle" is a new small square-case electrical counter that operates at 100 revolutions per minute, with intermittent speeds to 300 revolutions per minute for direct-drive models. Versions are available with right or left-hand shafts and clockwise or counter-clockwise shaft rotations. Revolution-drive models record at 1000 revolutions or counts per minute.

CIRCLE NO. 274

18-W-output supplies range from \$17 to \$24

Viking Electronics, Inc., 721 St. Croix, Hudson, Wis. Phone: (715) 386-5188. P&A: see text; stock.

A new line of low-cost power supplies for logic and linear system applications, range in prices from \$17 to \$24, in single quantities. The OEM 70 series supplies provide typical outputs of 3.5 to 6 V at 3 A, and 8 to 15 V at 1.2 A, with regulation of 0.5 to 0.1% and ripple of 1 to 2 mV dependent on models. Features include current limiting and floating output.

CIRCLE NO. 275

Dual-output 1-A supplies deliver 1.5 to 150 V

Acopian Corp., Easton, Pa. Phone: (215) 258-5441. P&A: \$110 to \$180; 3 days.

The G series of dual power supplies offer output voltages from 1.5 to 150 V up to 1 A. Two identical or different outputs may be specified by the user. Outputs are isolated, and may be independently connected in either polarity. No derating is required through an ambient temperature range of -10 to $+71^\circ\text{C}$. The supplies are housed in extruded aluminum cases.

CIRCLE NO. 276

Clock oscillator comes in a DIP

Paraline Products Co., 4835 W. Jefferson Blvd., Los Angeles, Calif. Phone: (213) 731-2028. Price: \$12.85.

New model CO-20 clock oscillator utilizes a dual in-line configuration. Any capacitor across two of its external pins produces an output frequency, in MHz, equal to 470/capacitance (pF). A crystal across the same pins produces a clock frequency equal to the series resonant frequency of the crystal. Upper frequency range is 20 MHz.

CIRCLE NO. 277

Incremental encoders operate from +5 V dc



Baldwin Electronics, Inc., 1101 McAlmont St., Little Rock, Ark. Phone: (501) 375-7351. P&A: \$149, \$229; 45 days.

Two new lines of optical bidirectional incremental encoders feature integral electronics and operation from +5-V dc power supplies. The low-cost industrial type 5V70 series is available with resolutions up to 4096 counts/revolution. The 5V270 high-performance line extends the resolution to 20,000 counts/turn.

CIRCLE NO. 278

Multi-decade counter uses plug-in logic cards

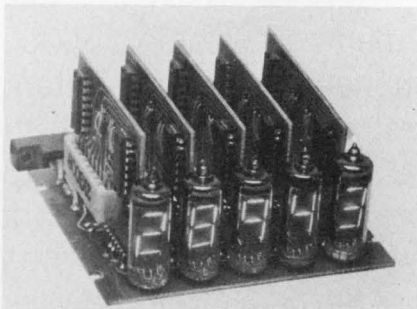

Instrument Displays, Inc., 225 Crescent St., Waltham, Mass. Phone: (617) 894-1577. P&A: \$84 (4 decades); stock.

A new uni-directional counter with cold-cathode tubes features 2 to 8 decades of display with all logic functions on plug-in PC cards. The cards mount directly behind the tubes permitting 0.6-in. center-to-center tube spacings. An optional power supply can be mounted within the counter housing. BCD outputs are buffered.

CIRCLE NO. 279

32-MHz digital/counter retails for \$395



Weston Instruments, Inc., 614 Frelinghuysen Ave., Newark, N.J. Phone: (201) 243-4700. P&A: \$395; stock.

The new model 1250 frequency counter has a full range of coverage of 5 Hz to 32 MHz and offers many special features. These include LED readouts, storage circuitry for nonblinking readout, four ranges with automatic decimal positioning, and a convenient carrying handle which converts to a tiltstand. A panel mounting version is available at no extra cost.

CIRCLE NO. 280

Programmable 9-digit synthesizer costs \$2450



Rockland Systems Corp., 131 Erie St., Blauvelt, N.Y. Phone: (914) 359-1818. P&A: \$2450; fall 1971.

A new low-cost programmable direct-frequency synthesizer is the model 5100 with a frequency range of 0.001 Hz to 2 MHz and a selectivity of 9 decimal digits, in 0.001-Hz steps. Its standard frequency stability is $\pm 2 \times 10^{-8}/^{\circ}\text{C}$, with $\pm 2 \times 10^{-10}/^{\circ}\text{C}$ being optional. The 5100 can use a 1-MHz external standard and provides 0 to 85 dB attenuation in 1-dB steps (programmable is optional).

CIRCLE NO. 281

Logic comparator kit eases IC troubleshooting

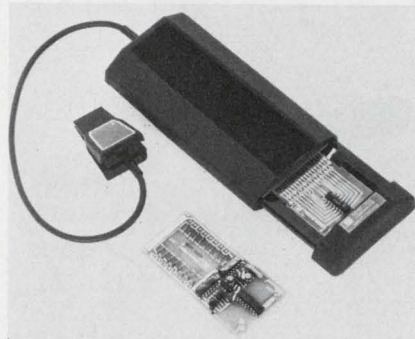

Hewlett-Packard Co., 1501 Page Mill Rd., Palo Alto, Calif. Phone: (415) 493-1501. P&A: see text; 4 wks.

A clever and unique gadget that is useful in design, production, and servicing of digital IC equipment is the model 10529A logic comparator. The new instrument is used for locating faulty ICs in malfunctioning equipment. It's simple to use, self-powered, and costs only \$295. It's also offered as part of a kit which includes the comparator, a logic clip, and a logic probe. The kit is \$495.

CIRCLE NO. 282

16-bit 20-MHz data generator costs \$495



Systron Donner, Datapulse Div., 10150 W. Jefferson Blvd., Culver City, Calif. Phone: (213) 871-0410. P&A: \$495; 8 wks.

The low-cost model 220 data generator with clock rates from 0 to 20 MHz uses MSI circuitry. The 16-bit instrument has TTL/DTL-compatible inputs and outputs. Its clock triggers on TTL/DTL levels, eliminating the need for a trigger-level control. Transition times are typically 6 ns. Upper and lower logic levels are $\pm 5\text{ V}$ into 50 Ω .

CIRCLE NO. 283

Best Buy

**in 1% Tolerance
1-Watt Zeners
SCHAUER**

Immediate Shipment



Low Prices

ANY voltage from 2.0 to 18.0

Quantity	Price each
1-99	\$1.07
100-499	.97
500-999	.91
1000-4999	.86
5000 up	.82

Write for complete rating data and other tolerance prices.

Buy The Kit!



A \$54.57 value for only

\$24.50

Kit contains a 51-piece assortment of SCHAUER 1% 1-watt zeners covering the voltage range of 2.7 to 16.0. Three diodes of each voltage in reusable poly bags. Stored in a handy file box. Contact your distributor or order direct.

Semiconductor Division

SCHAUER

Manufacturing Corp.

4511 Alpine Ave. Cincinnati, Ohio 45242

Telephone: 513/791-3030

Ka-band sources use Impatt diodes



Hughes Aircraft Co., Electron Dynamics Div., 3100 W. Lomita Blvd., Torrance, Calif. Phone: (213) 534-2121. Price: \$1350 to \$2150.

Nine different models of a new solid-state power source in the 30- to 42-GHz range utilize millimeter-wave silicon Impatt diodes. The 44000 series Ka-band sources are designed to replace klystron tubes in millimeter-wave systems. They are offered in two basic categories: with micrometer tuning devices and with screwdriver adjustments.

CIRCLE NO. 286

Four optical isolators come in a DIP

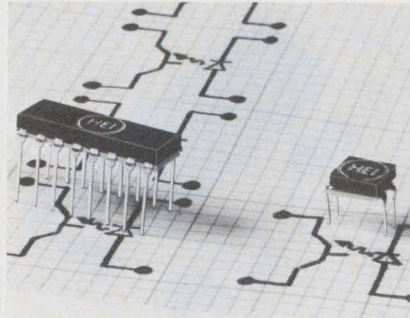

HEI, Inc., Jonathan Industrial Center, Chaska, Minn. Phone: (612) 448-3510.

New 4-PAC optically coupled isolators combine four separate LED-phototransistor pairs in a single 16-pin DIP. Each isolator is available as an IR LED combined with either a phototransistor, a photo-Darlington, or a photodiode. Each of the four isolators in the 4-PAC is completely light-sealed from the other sections. Isolation is up to 1500-V levels (emitter or detector).

CIRCLE NO. 284

Hybrid IR detector fits in a TO-5 can

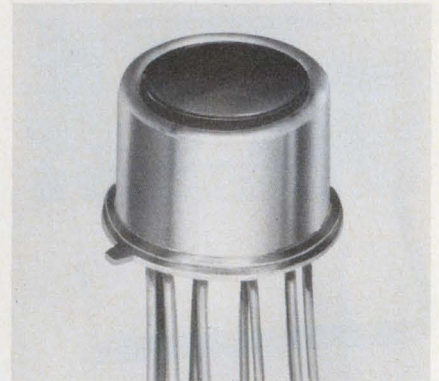

The Carborundum Co., Tem-Pres Research Div., 1401 S. Atherton St., State College, Pa. Phone: (814) 237-7631. Availability: stock.

The LCP-100S is a new pyroelectric detector with a hybrid pre-amplifier completely integrated into a single TO-5 package. It offers high responsivity (300 V/W), low noise-equivalent power (1.77 x 10⁻⁹ W), uniform spectral response for all IR frequencies and room-temperature operation.

CIRCLE NO. 285

UNUSUAL BARGAINS

... MANY U.S. GOV'T SURPLUS

FREE! GIANT CATALOG

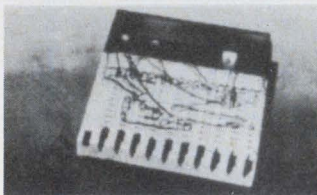

NEW! ELECTRONIC DIGITAL COMPUTER KIT!

Solve problems, play games, predict weather with this actual working model of giant electronic brains. Amazing new fun way to learn all about computer programming... logic, decimal, binary systems. Laws of Sets—even do your own programming after completing simplified 116 page instructive booklet. Includes step-by-step assembly diagrams. Circuits easily changed. Readout from illuminated control panel. Req. 2 'D' batt. (not incl.). Best model we've seen—for home, school, industry. No. 71.434DA (11"x12 1/2"x14") \$31.50 Ppd.

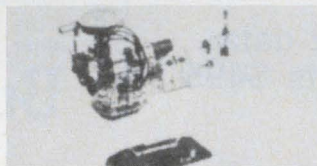

AMAZING NEW WANKEL ENGINE KIT!

Thrill to the fun of building your own see-through motorized model of revolutionary pistonless type engine, rights for which GM recently paid \$50 million! Only engine experts think economically modifiable to meet new pollution standards. Replaces piston, cylinder, crank assemblies with rotating discs (sections removed for firing chambers). Smaller than conventional; fewer parts, greater reliability, same speed w/less horsepower. Feat: flashing plugs, rubber fan belt, stick-shift on-off switch. Req. 2-1.5V batt. (not incl.). (not incl.). No. 71.424DA (4 1/2" 5"x9") \$6.75 Ppd

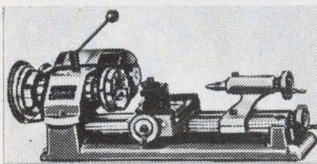

UNIMAT "MINI MACHINE SHOP"

Compact, power tool for metal, plastics, wood with full capabilities of precision machine shop. Works as lathe or vertical drill press. Complete with motor. 1 of a kind for industrial miniaturization, home workshop, model shops, labs, etc. Use basic tool to turn, face, bore, recess, polish. Converts in 1 minute to vertical machine to mill drill, jig-bore, surface grind. 40-p. instr. booklet. No. 85.175DA (33 lbs.) \$149.50 F.O.B.



GIANT FREE CATALOG

Completely new 1971 edition—148 pages. Bargains galore! New categories, items, illustrations, 1,000's of buys for industry — Optics, Science, Math. On-the-job helps, quality control aids, Optics for research labs, design engineers experimenters. Instruments for checking, measuring... to speed work, improve quality, cut costs. Huge selection of telescopes, microscopes, and other hard-to-get war surplus bargains. Write for Catalog DA.

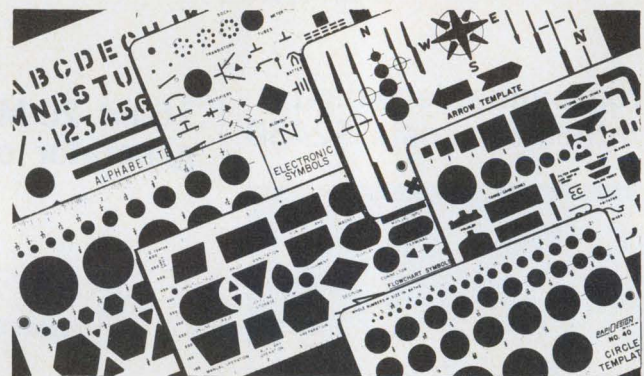

Templates by Mail at discount prices

- Full selection
- Nationally advertised brands

Free Catalog

QUALITY GRAPHIC SUPPLIES
P.O. Box 10158 • Glendale, CA 91209

EDMUND SCIENTIFIC CO. 300 EDSCORP BLDG. BARRINGTON, NEW JERSEY 08007
ORDER BY STOCK NUMBER • OPEN ACCOUNT TO RATED FIRMS • MONEY-BACK GUARANTEE

Incremental recorder operates from a battery

Kennedy Co., 540 W. Woodbury Rd., Altadena, Calif. Phone: (213) 798-0953. Price: \$3125 (with write electronics).

The model 1200 battery-operated incremental recorder is designed for use in remote-location data-acquisition systems and features low current drain. The 7-track, write-only, IBM-compatible transport has 200-characters/in. tape density. Its stepping rate is 0 to 50/s. It operates from 11 to 14 V and draws current only when actually stepping.

CIRCLE NO. 287

Read-after-write head complements cassettes

Magnusonic Devices, Inc., 124 Duffly Ave., Hicksville, N.Y. Phone: (516) 938-4700. Availability: stock to 4 weeks.

A new digital cassette read-after-write head is available. Model 216 has single and two-channel configuration and is obtainable with up to 4 tracks. A trough guide for the tape gives accurate tape guidance over the full width of the head. This eliminates requirements for a costly, accurate guidance system in the cassette.

CIRCLE NO. 288

Rotating 5-megabit disc accesses in 17 ms

Wabash Computer Corp., Phoenix, Ariz. Phone: (602) 943-2311. P&A: from \$5200; 60 days.

A new head-per-track 5-megabit disc memory is the model 640 which has an average access time of 17 ms. Model 640's rotating disc with enclosed head-per-track configuration is designed to prevent internal contamination from mechanical wear and pollution from surrounding environment. The compact 14-in.-dia disc also features a protective overcoat to prevent damage of either heads or disc.

CIRCLE NO. 289

Magnetic-tape viewer checks tape recordings

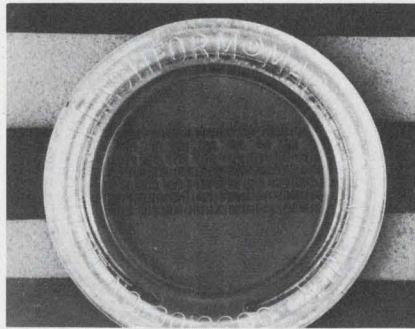

3M Co., Dielectric Materials and Systems Div., Box 3686, St. Paul, Minn. Phone: (612) 733-9654.

A new magnetic tape viewer is designed to provide a simple and fast means of viewing recorded signals on magnetic tape, without the use of chemicals. The Plasti-form brand magnetic-tape viewer is simply placed on the tape to view recorded signals for head alignment, track placement, pulse definition, interblock spacing and drop-out areas in computer and instrumentation work.

CIRCLE NO. 290

Serial impact printer operates unattended



Automated Business Systems Div. of Litton Industries, 600 Washington Ave., Carlstedt, N.J. Phone: (201) 935-2200. P&A: \$2200 (no keyboard), stock.

Model 34 serial impact printer is designed for both operator input and control as well as continuous unattended printing. The 34 operates at up to 35 characters/s using an interchangeable standard 96-character ASCII-code moving print wheel. Custom designed print wheels with different type styles are offered.

CIRCLE NO. 291



the specialist
in silicon mini-components
presents

Photo TRANSISTORS



EPY61

Small diameter glass capsule permits high packing density



EPY62

General purpose detector w/high cutoff frequency



EPX38

Large plane window allows precise imaging of focal spot

EPY11

PHOTOVOLTAIC CELL — ideal for scanning light pulses in supervisory control equipment and for quantitative photometry. $V_R = 1.0V$, $T^{\circ}K = 2400$.

Type	V_{ce}	I_c (mA)		
EPY61/I	25V	0.25 - 0.5		
EPY61/II		0.9 - 15.0		
EPY61/III		1.9 - 3.0		
EPY62/I	25V	1.0 - 2.5		
EPY62/II		2.0 - 4.0		
EPY62/III		3.0 - 4.0		
EPX38	25V	0.5 - 15.0		
Price	1-24	25 up	100 up	500 up
EPY61/I	4.90	4.20	3.50	2.40
EPY61/II	5.50	4.80	3.90	2.90
EPY61/III	6.80	5.80	4.70	3.40
EPY62/I	2.80	2.20	1.60	1.30
EPY62/II	3.00	2.35	1.75	1.40
EPY62/III	3.60	3.10	2.20	1.50
EPX38	4.60	3.60	2.90	2.10
EPY11	3.60	2.80	2.10	1.70

Delivery: ex stock. Order from:



EUROPEAN
ELECTRONIC
PRODUCTS
CORPORATION

10150 W. Jefferson Blvd.,
Culver City, California 90230

(213) 838-1912

evaluation samples

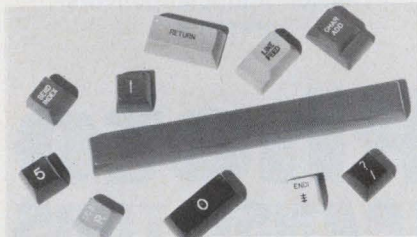

Keytops

Free evaluation samples are offered of the new line of C900 two-shot molded keytops, on which legends are molded into the keytop in a two-step molding operation. The familiar typewriter-style keytops are available in seven standard colors and a large variety of shapes and sizes. Clare-Pendar Co.

CIRCLE NO. 292

Pushbutton switches

Free samples of snap-in, panel-mount, pushbutton switches in a choice of red, green, grey, white or black are available. All samples feature basic momentary action and are available in double-pole or single-pole styles for standard 10-A or low-energy switching. Low-energy switches feature gold contacts. They are compatible with solid-state systems. All samples have snap-in mounting and quick-connect terminals. Cherry Electrical Products Corp.

CIRCLE NO. 293

Fastener assembly

A low-cost, pre-assembled fastener system combines the functions of a pressure-sealing gasket, a lock-washer, a vibration dampener and an electrical insulator. This new fastener provides a good bearing surface to prevent marring of surface finishes due to chipping or crazing. Because it is an electrical insulator, the washer also prevents galvanic corrosion. The Nyltite rolled-nylon washer is pre-assembled to any standard or custom-made screw. Literature and samples are available free. Nyltite Corp. of America.

CIRCLE NO. 294

design aids

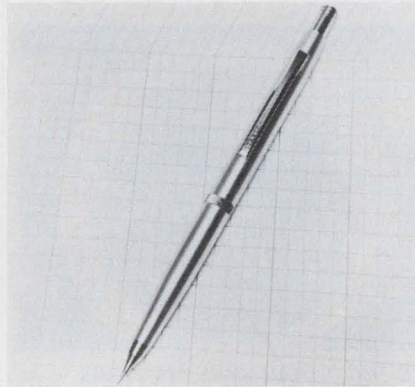

Mechanical pencil

Pinpoint-precision for graph plotting, computer-programming and other close-tolerance tasks is now possible with a new mechanical pencil using 0.3-mm lead. The new lead is composed of a synthetic resin—graphite and carbon-black—and is stronger than the traditional clay-based pencil lead. The 0.3-mm lead assures dimensional line stability, is free of smudges caused by lead residue, and enables smooth, easier writing with minimal pressure. Pentel of America, Ltd.

CIRCLE NO. 295

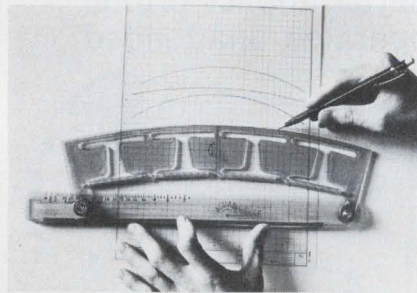

Drafting tool

An improved model of the Acu-Arc adjustable drafting instrument, which can be quickly adjusted to form any circular curve with a radius between 6-3/4 and 200 in., is available. The instrument, which can be used for either drawing or measuring arcs, is constructed of transparent Lexan plastic that allows the draftsman to see the line work underneath the instrument. It also incorporates a stainless-steel stiffener along the bottom edge for rigidity. Price is \$14.50. Hoyle Engineering Co.

CIRCLE NO. 296

application notes

Capacitor fundamentals

A handy pamphlet contains information on the factors that must be taken into consideration when designing circuits that contain capacitors used in tuning, matching and coupling. The discussions relate to capacitors operating at high power levels, or above 100 MHz. American Technical Ceramics, Inc.

CIRCLE NO. 297

Digital recording

A new 28-page design digest is available for mini-digital magnetic recording. The digest is a comprehensive collection of applications information for those working with mini-computers, programmable calculators and I/O systems. It has a nine-page discussion of technical considerations and applications data; information on test procedures; and a 16-page section devoted to the characteristics and specifications of state-of-the-art tape heads. Nortronics Company, Inc.

CIRCLE NO. 298

Encoder interfacing

A comprehensive application note outlines the problem encountered with interfacing uni-directional and bi-directional counters to encoders. In addition, presettable controllers are discussed along with frequency counters and digital stop watches. Instrument Displays, Inc.

CIRCLE NO. 299

Voltage regulators

A new voltage regulator application note shows how to evaluate and apply a regulator's specifications to realize its full potential in a circuit. The eight-page guide discusses constraint and performance specifications for monolithic, hybrid and discrete dc voltages regulators. Teledyne Semiconductor.

CIRCLE NO. 300

new literature

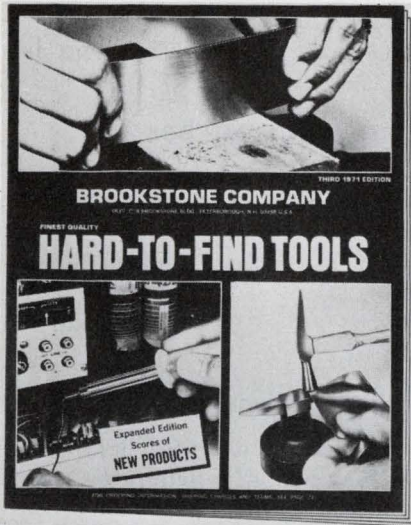

Hard-to-find tools

A 40-page catalog of high-quality professional tools contains scores of new and extremely useful products (many never offered before in this country), rarely found in stores or other catalogs. This unique collection includes hard-to-find hand tools and small power tools. Brookstone Co.

CIRCLE NO. 340

Terminal blocks

A 24-page terminal block selector catalog contains a complete line of terminal blocks and accessories. Curtis Development & Mfg. Co.

CIRCLE NO. 341

Connector tools

A complete line of tools for crimping, inserting and removing connector pins produced by all manufacturers is detailed in a new catalog. Amphenol Connector Div., Bunker Ramo Corp.

CIRCLE NO. 342

Spectrum analyzers

A new six-page bulletin describes new 1000 and 2000-line high-resolution, real-time, low-frequency spectrum analyzers. Federal Scientific Corp.

CIRCLE NO. 343

Tape editing

"Application Notes for Editing Pre-Recorded Tapes" is a document that details problems and procedures in updating selected records on pre-recorded digital magnetic tapes. Each of the interdependent editing considerations is discussed along with precautions to limit detrimental effects and alternate solutions to transient effects, accumulative tolerancing and erase-head interference. Peripheral Equipment Corp.

CIRCLE NO. 344

Flexible ribbon cable

A new data sheet describes ribbon cable which is comprised of highly stranded conductors that are insulated with silicone rubber and then fused in a flat configuration. Calmont Engineering and Electronics, sub. of Varadyne, Inc.

CIRCLE NO. 345

Ultrasonic systems

A catalog illustrates and describes typical applications of new ultrasonic dry-product sensing systems. National Sonics Corp.

CIRCLE NO. 346

Rf inductors

An up-dated catalog on rf inductors describes units ranging in value from 0.1 through 10,000 μ H. Airco Speer Electronics.

CIRCLE NO. 347

Dry reed relays

An eight-page data sheet describes a series of miniature dry reed relays. C.P. Clare & Co.,

CIRCLE NO. 348

PC card enclosures

Printed circuit card enclosures are described in a new eight-page brochure. Electro-Space Fabricators, Inc.

CIRCLE NO. 349

From houston instrument TWO NEW

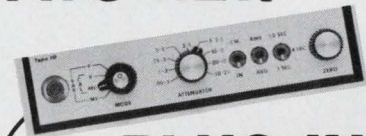

PLUG-IN MODULES

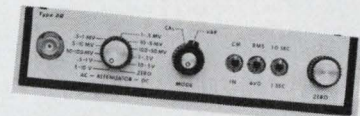

FOR OMNIGRAPHIC®

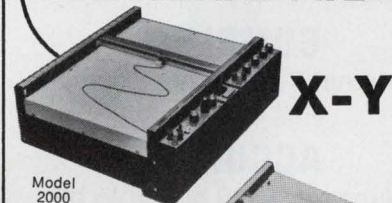

Model 2000

AND

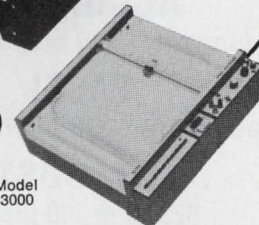

Model 3000

STRIP CHART RECORDING

Type 10 Module: High Sensitivity A.C. to D.C. Converter

- 18 calibrated sensitivities from 100 Micro Volts/in. plus Metric equivalents.
- Frequency response better than ± 0.1 db, 20 Hz to 20 KHz.
- A.C. Offset less than 50 Micro Volts.
- Converter time constants of 0.1, 0.4, 1.0 seconds.
- Front panel selection of average or RMS scaling.
- \$495.

TYPE 20 MODULE: A.C. AND D.C. UTILITY ATTENUATOR MODULE

- 5 calibrated sensitivities from .001 to 10 volts/in plus Metric equivalents, A.C. and D.C.
- Frequency response (A.C.) ± 0.1 db, 20 Hz to 100KC.
- A.C. Offset less than 50 Micro Volts.
- Converter time constants of 0.1 and 1.0 seconds.
- Front panel selection of average or RMS scaling.
- \$495.



® Reg. T.M.

Write for brochures

houston instrument

DIVISION OF BAUSCH & LOMB®

4950 Terminal Avenue Bellaire, Texas 77401
(713) 667-7403 Cable Hoince

houston instrument

European Office

Johanneskirchner Strasse 17, 8043 Unterfohring
München, W. Germany (0811) 97-1673

INFORMATION RETRIEVAL NUMBER 39

ANNOUNCING!

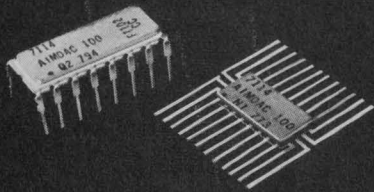

AIM DAC-100 SERIES 10 BIT MINIATURE D/A CONVERTERS

COMPLETE!

Internal Reference and Ladder
Just add op-amp

ACCURATE!

Linearity — 10 bits $\pm 1/2$ bit

FAST!

Settles to $1/2$ LSB in 375 nS max.

LOW COST!

\$23.80 @ 100 pieces

FEATURES

- -55° to $+125^{\circ}$ C Performance
- ± 6 V to ± 18 V Operation
- DTL/TTL Compatible
 - DIP or Flat Pak
 - Available Now!

REMEMBER

*monoOP-01 Fast Settling
op-amp is the perfect
companion to the AIM DAC-100*

- 0.7 μ sec settling to 0.1%
- Internally compensated
- 15V/ μ sec slew rate
- 18nA Input Bias Current
- \$3.65 @ 100 pieces



1500 SPACE PARK DRIVE, SANTA CLARA, CALIFORNIA 95050
TEL. (408) 246-9225 • TWX 910-338-0528 • CABLE MONO

A BOURNS Affiliate

INFORMATION RETRIEVAL NUMBER 40

NEW LITERATURE

The guide to cassettes

An illustrated, information-packed booklet for owners of cassette recorders, "The TDK Guide to Cassettes," contains such practical topics as advantages of the cassette method of recording, range of applications, choice of tape quality and running time with reference to application and what to look for when buying cassettes. Additional topics are the care of cassettes and cassette recorders, choice of microphones, repair of cassettes in the event of accidents, indexing the cassette library and storage. TDK Electronics Corp.

CIRCLE NO. 350

Rf connectors

Rf connectors that provide twist-free mating on crowded front panels and chassis are described in a four-page brochure. Sealectro Corp.

CIRCLE NO. 351

High-alumina ceramics

High-alumina ceramic rods, bars and tubes are featured in a new catalog sheet. Diamonite Products Manufacturing Company.

CIRCLE NO. 352

Optical filters

A fact file is available on a broad line of standard IR, visible and UV filters. Dell Optics Co., Inc.

CIRCLE NO. 353

Precision hand tools

A new catalog on precision hand tools shows a complete line of electronic assembly implements. Janel, Inc.

CIRCLE NO. 354

Telephone equipment

A new telephone brochure presents reasons for end-user ownership of a private automatic branch exchange interconnected with a public utility network. Communications Systems Div. of DuKane Corp.

CIRCLE NO. 355

Reed relays

Epoxy encapsulated reed relays for low-power high-speed switching applications are listed in a catalog. Triridge Corp.

CIRCLE NO. 356

Microwave switches

A line of solid-state microwave switches and limiters which operate from 0.2 to 18 GHz is described in a catalog. Crown Microwave, Inc.

CIRCLE NO. 357

Sweeper/generator

A new solid-state broadband sweeper/signal generator for sweep measurement from 1 to 12.4 GHz is described in a publication. Narda Microwave Corp.

CIRCLE NO. 358

Teflon tapes

A literature kit on Teflon self-adhering tapes incorporates 10 technical data sheets with up-to-the-minute information on tapes and how they are used. Commercial Plastics & Supply Corp.

CIRCLE NO. 359

PC card frames

A new 16-page catalog contains complete technical data and ordering information on a line of PC card-frame systems and accessories. Vero Electronics, Inc.

CIRCLE NO. 360

Instrument enclosures

A folder highlights advantages of the Styleline line of instrument enclosures. Honeywell, Modu-Mount Group.

CIRCLE NO. 361

Pilot/reversing switches

A newly revised publication describes a complete line of pressure governors, vacuum, plugging and anti-plugging, enclosed float, pilot, and manual reversing switches. General Electric Co.

CIRCLE NO. 362

Newer, Higher Quality

NDK Products

CRYSTAL FILTERS

455kHz—Series
(For All Kinds of Receivers)

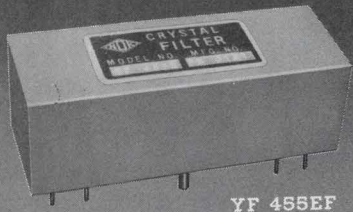

YF 455EF

150MHz Antenna Filter

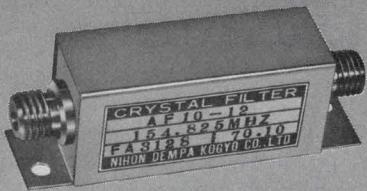

10.7MHz MCF
(Monolithic Crystal Filters)

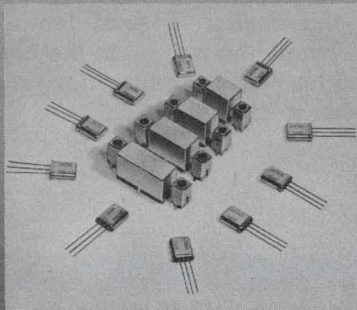

World's Leading
Manufacturer of:

- Synthetic Quartz Crystals
- Water Soluble Crystals (LH, ADP, KDP)
- Quartz Crystal Units
- Crystal Oscillators
- Crystal Filters
- Delay Lines
- Ultrasonic Instruments



**NIHON DENPA
KOGYO CO., LTD.**

Since 1948

1-21 Nishihara, Shibuya-ku, Tokyo, Japan
Tel: 460-2111

Cable: CRYSTALUNITS TOKYO TLX: TK4893

bulletin board

of product news
and development

Electronic Arrays, Inc., has announced the availability of the Japanese character font, Katakana, in its EA4016 read-only memory. The 64-character EBCDIC encoded IC contains a phonetic alphabet to be used primarily as a technical printed language for computer, telegram and animated billboard applications.

CIRCLE NO. 363

Thomas Electronics, Wayne, N.J., will build the world's largest CRT—a 36-in.-dia tube—under a contract from the Farrand Optical Co. The CRT is to be used in an Air Force flight trainer.

CIRCLE NO. 364

Price reductions

Due to more efficient and higher-yield manufacturing methods, Hycomp, Inc., of Maynard, Mass., announces price reductions for its entire line of precision thin-film ladder networks. For example, small-quantity pricing for MIL-specification 12-bit networks has been reduced by 76%, and by 72% for commercial units. Hermetically sealed 8-bit ladders can now also be obtained for as little as \$8, in 1000 quantities.

CIRCLE NO. 365

Teledyne Semiconductor has slashed prices on its 300 series high-noise-immunity logic ICs by as much as 50%. Representative price cuts include those for the 371 decade counter, now costing \$6, down from \$12; the 380 BCD-to-decade decoder formerly costing \$10 is now \$5.50; and the 370 quad D flip-flop is down from \$4.80 to \$2.50.

CIRCLE NO. 366

Signetics Corp. has equalized prices on all its phase-locked loop ICs at \$6.35 each, when ordered in 100 to 999 quantities. This means that some phase-locked loop ICs such as the NE561B, will come down from a price that is as high as \$22.

CIRCLE NO. 367

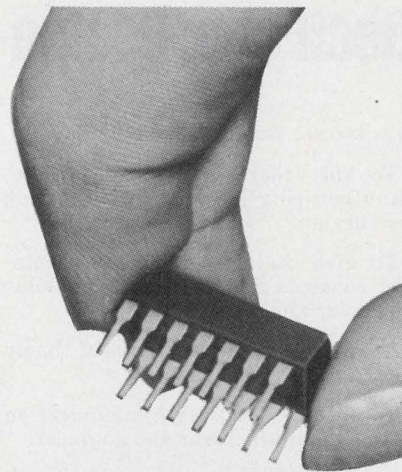

can one LATCHING RELAY offer all this?

- High Reliability (100 x 10⁶ operations)
- Inherent Contact Memory
- Bounce-Free Operation
- Self-Healing Contacts
- Operation in Any Mounting Position
- Miniature Size
- No Latching Current
- Virtually No Noise
- Shock and Vibration Resistance
- For Signals from DC to 120 MHz

Yes... if it's a LOGCELL[®] Mercury Film Relay

Both latching and nonlatching Logcell Relays are available. For more information about Logcell Relays, and Logcell Switches, too, write Fifth Dimension Inc., Box 483, Princeton, New Jersey 08540. Or call (609) 924-5990.

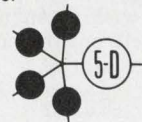

FIFTH DIMENSION INC.

INFORMATION RETRIEVAL NUMBER 42

ELECTRONIC DESIGN'S function is:

- To aid progress in the electronics manufacturing industry by promoting good design.
- To give the electronic design engineer concepts and ideas that make his job easier and more productive.
- To provide a central source of timely electronics information.
- To promote two-way communication between manufacturer and engineer.

Want a subscription? ELECTRONIC DESIGN is sent free to qualified engineers and engineering managers doing design work, supervising design or setting standards in the United States and Western Europe. For a free subscription, use the postfree application form inside the back cover. If none is included, write to our direct for an application form.

If you do not qualify, you may take out a paid subscription for \$25 a year in the U.S.A., \$35 a year elsewhere. Single copies are \$1.50 each.

If you change your address, send us an old mailing label and your new address; there is generally a prepaid postcard for this inside the back cover. You will have to requalify to continue receiving ELECTRONIC DESIGN free.

The accuracy policy of ELECTRONIC DESIGN is:

- To make reasonable efforts to ensure the accuracy of editorial matter.
- To publish prompt corrections whenever inaccuracies are brought to our attention. Corrections appear at the end of the Letters column.
- To refuse any advertisement deemed to be misleading or fraudulent.

Microfilm copies are available of complete volumes of ELECTRONIC DESIGN at \$19.00 per volume, beginning with Volume 9, 1961. Work is now in process to complete the microfilm edition of Volumes 1-8. Reprints of individual articles may be obtained for \$2.00 each, prepaid (\$.50 for each additional copy of the same article) no matter how long the article. For further details and to place orders, contact the Customer Services Department, University Microfilms, 300 North Zeeb Road, Ann Arbor, Michigan 48106; telephone (313) 761-4700.

Want to contact us? If you have any comments or wish to submit a manuscript or article outline, address your correspondence to:

Editor
ELECTRONIC DESIGN,
50 Essex Street,
Rochelle Park, N.J. 07662

Terminal Block Selector

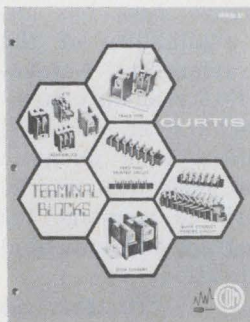

A new 24-page, completely illustrated catalog contains photos, descriptions, ratings, engineering drawings, and prices of the complete line of Curtis terminal blocks. Included are printed circuit, insulated feed-thru, quick disconnect, track type, and high current terminal blocks. Handy selection chart quickly locates the perfect block for your particular requirements. Send today for your free copy.

CIRCLE NO. 171

Curtis Development & Mfg. Co.

3236 North 33rd Street
Milwaukee, Wisconsin 53216

SEE US AT WESCON, BOOTH 2310

How To Write Technical Articles



A guide for the engineer-author, "How to Write Articles for Electronic Design" shows how easy it is to write for publication—once the engineer knows what to write and how to write it. The Author's Guide includes a complete run-down of the types of articles published by Electronic Design—plus detailed instructions on how to prepare technical articles and short special features. A MUST for every "would-be-writer" in the electronics industry. Send for your complimentary copy by circling the number to the right.

CIRCLE NO. 172

Electronic Design

850 Third Avenue
New York, N.Y. 10022

FUNDAMENTALS OF INTEGRATED CIRCUITS

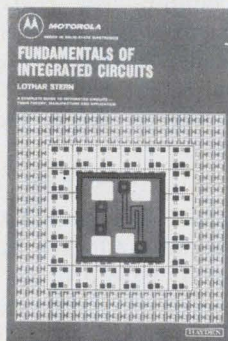

A practical guide to integrated circuits, their theory, manufacture, and applications. This new guide by Lothar Stern offers complete, highly readable coverage of the various techniques of circuit fabrication, and their effect on circuit design and performance. As to marketing considerations, it compares the characteristics of the numerous IC structures devised to date in terms of economics and logistics. A volume in the Motorola Series in Solid-State Electronics. 198 pages, 7 x 10, illustrated. \$8.95, clothbound. Circle the reader-service number below for 15-day examination copies.

CIRCLE NO. 173

Hayden Book Company, Inc.

116 West 14th Street
New York, N.Y. 10011

Manufacturers

Advertisements of booklets, brochures, catalogs and data sheets. To order use Reader-ServiceCard (Advertisement)

On Your Scope: Time History of LF Real-time Spectra



Now you can see the changing character of the frequency content of a signal **in time**, with Federal Scientific's Option 66-2 3-Dimensional Automatic Display Generator. It accepts inputs from any of Federal Ubiquitous® family of Spectrum Analyzers or Averagers and displays spectrum data on a CRT storage-display unit such as Tektronix 611. A three-dimensional display of spectrum amplitude vs frequency vs time is obtained — achieved by displacing successive spectrum traces vertically (in adjustable steps) and horizontally, to simulate a 3-D display through an isometric presentation.

CIRCLE NO. 174

Federal Scientific Corporation
a subsidiary of Elgin National Industries, Inc.
615 West 131st Street, New York, N. Y. 10027

Free — The New 1971 D.A.T.A. BOOKS Brochure

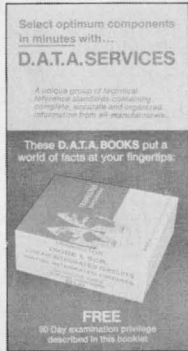

Shows you how D.A.T.A. BOOKS Component Guides put a world of facts at your fingertips to allow you to select optimum components in minutes.

Gives you complete information about the many benefits of these unique D.A.T.A. BOOKS

- TRANSISTOR
- SEMICONDUCTOR DIODE & SCR
- DIGITAL I. C.
- LINEAR I. C.
- SEMICON. HEAT SINK & ASSOC. HARDWARE
- MICROWAVE
- RELAY MINIATURE AND SUBMINIATURE

Write, Call or TWX for your FREE COPY.

CIRCLE NO. 175

D.A.T.A. Inc.
Subsidiary of Computing & Software, Inc.
32 Lincoln Ave., Orange, N. J. 07050
(201) 673-8030 TWX: 710-994-5839 Dept. B

World's Largest Line of Smallest Supplies



Now the world's smallest power supplies for microelectronics are available in the world's largest line of high power density, high efficiency supplies: **54 off-the-shelf models.** From 100W to 500W; from 3VDC to 30VDC; single, dual, triple outputs; commercial, military, export models. Now in use by such leaders as Burroughs, Control Data, Honeywell, IBM, Litton, NCR, RCA, Univac, and many Government installations. Shown (left): Model SP631, 5VDC/100A, typical efficiency 70%, 8.50" x 6.81" x 8.85", 21.5 lbs., \$695. (Right): Model SP601, 5VDC/20A, typical efficiency 65%, 3.25" x 6.50" x 7.50", 6 lbs., \$400. Custom development and production also available.

CIRCLE NO. 176

Trio Laboratories, Inc.
80 Dupont Street,
Plainview, L. I., N. Y. 11803

Electronic Design

Advertising Sales Staff

Bryce Gray, Jr.
Sales Manager

Rochelle Park, N.J. 07662

Robert W. Gascoigne
Samuel M. Deitch
Daniel J. Rowland
50 Essex Street
(201) 843-0550

Philadelphia 19025

Mort Sullivan
P.O. Box 126
Dresher, Pa.
(215) 884-6880

Boston 02154

Joseph F. Palmer
1268 Main Street
Waltham, Mass.
(617) 894-2700

Chicago 60611

Thomas P. Kavooras
Berry Conner, Jr.
200 East Ontario
(312) 337-0588

Cleveland

Thomas P. Kavooras
(Chicago)
(312) 337-0588
(call collect)

Los Angeles 90303

Stanley I. Ehrenclou
Burt Underwood
2930 Imperial Highway
Inglewood, Calif.
(213) 757-0183

San Francisco 94022

Jerry D. Latta
95 Main Street
Los Altos, Calif.
(415) 941-3084

London W. 1

For United Kingdom and Holland
Brayton C. Nichols

For Eastern Europe
Peter Kehr

The American Magazine Group

27 Maddox Street
London, W. 1, England
Phone: 499-0180
Cable: Ammagnic, London

Verviers, Belgium

For Continental Europe
Andre Jamar
1, Ru Mallar, 1
(087) 253.83 Telex 41563

Tokyo

Haruki Hirayama
Electronic Media Service
5th Floor, Lila Bldg.,
4-9-8 Roppongi
Minato-ku
Phone: 402-4556
Cable: Electronicmedia, Tokyo



Our Long Term Life Insurance Policy.

It protects the life of our fans for 10 years.

We call it, "The Grand Prix Sleeve Bearing."

This patented bearing innovation assures continuous lube circulation, positive retention, and inherent oil cooling for longer, cooler, more efficient operation than conventional designs.

Protect the life of your equipment from the damaging effects of heat by specifying a G.P. equipped Boxer, MiniBoxer, or SuperBoxer fan. There are more than 20 models to choose from.

For information on our full line of reliable airmovers, send for catalog No. ND4r.

It's free, and contains performance data, electrical and mechanical specifications on more than 100 units.

And valuable application information too.

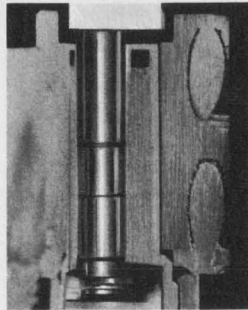

For immediate service, contact us at IMC Magnetics Corp., **New Hampshire Division**, Route 16B, Rochester, N.H. 03867, tel. 603-332-5300. Or the IMC stocking distributor in your area. There are more than 50 nationwide and overseas.



INFORMATION RETRIEVAL NUMBER 44

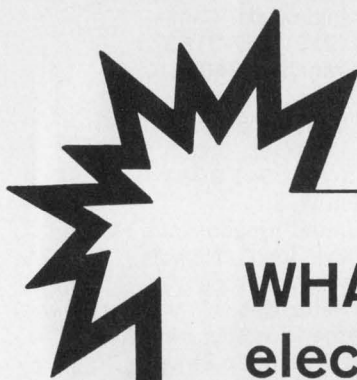

WHAT'S new in electronic insulation?

To find out, plan to attend the 10th Electrical Insulation Conference, Chicago, Sept. 20-23. Daily technical sessions, workshops, educational short courses, exhibits will update you on insulation materials, applications, manufacturing and testing. Write for details today!



ELECTRICAL INSULATION CONFERENCE
Box 2429B, Wilmington, DE 19899

INFORMATION RETRIEVAL NUMBER 45

advertiser's index

Advertiser	Page
Allen-Bradley Co.	2
Amphenol Components Group	12
Belden Corporation	4, 5
Bourns Inc.	64, 65
Bulova Servo Products Electronics Division of Bulova Watch Company	7
Burndy Corporation	15
Burroughs Corporation	18
Cinch-Nuline, A Division of TRW, Inc.	29
Curtis Development & Mfg. Co.	78
D.A.T.A., Inc.	79
Dale Electronics, Inc.	Cover III
Delco Electronics, Division of General Motors Corporation....	54, 55
Dialight Corporation	6
Eastman Kodak Company	17
Edmund Scientific Company	72
Electrical Insulation Conference	80
Electro Switch Corp.	67
Electronic Design	61, 78
European Electronic Products Corporation	14, 73
Federal Scientific Corporation	79
Fifth Dimension, Inc.	77
Hayden Book Company, Inc.	78
Hewlett-Packard	Cover II, 10
Hewlett-Packard, New Jersey	21
Houston Instrument, A Division of Bausch & Lomb	75
IMC Magnetics Corporation	80
Intersil	48, 49
Malco Manufacturing, Inc.	61
MicroSwitch, A Division of Honeywell	9
Molex, Incorporated	1
Motorola Component Products Dept.	16
National Semiconductor Corporation	27
Nihon Dempa Kogyo Co. Ltd.	77
Oak Manufacturing Co.	34
Plessey, Incorporated	8
Power/Mate Corp.	13
Precision Instrument Co.	59
Precision Monolithics, Incorporated..	76
Quality Graphic Supplies	72
RCA Electronic Components and Devices	Cover IV
Rogers Corporation	61
Schauer Manufacturing Corp.	71
Sigma Instruments, Inc., International Instruments Division	28
Tektronix, Inc.	33
Teledyne Electro Mechanisms	30
Trio Laboratories, Inc.	79
Triplett Corporation	11
Weston Instruments, Inc., Archbald Division	68, 69

Interchange.

...and get change!

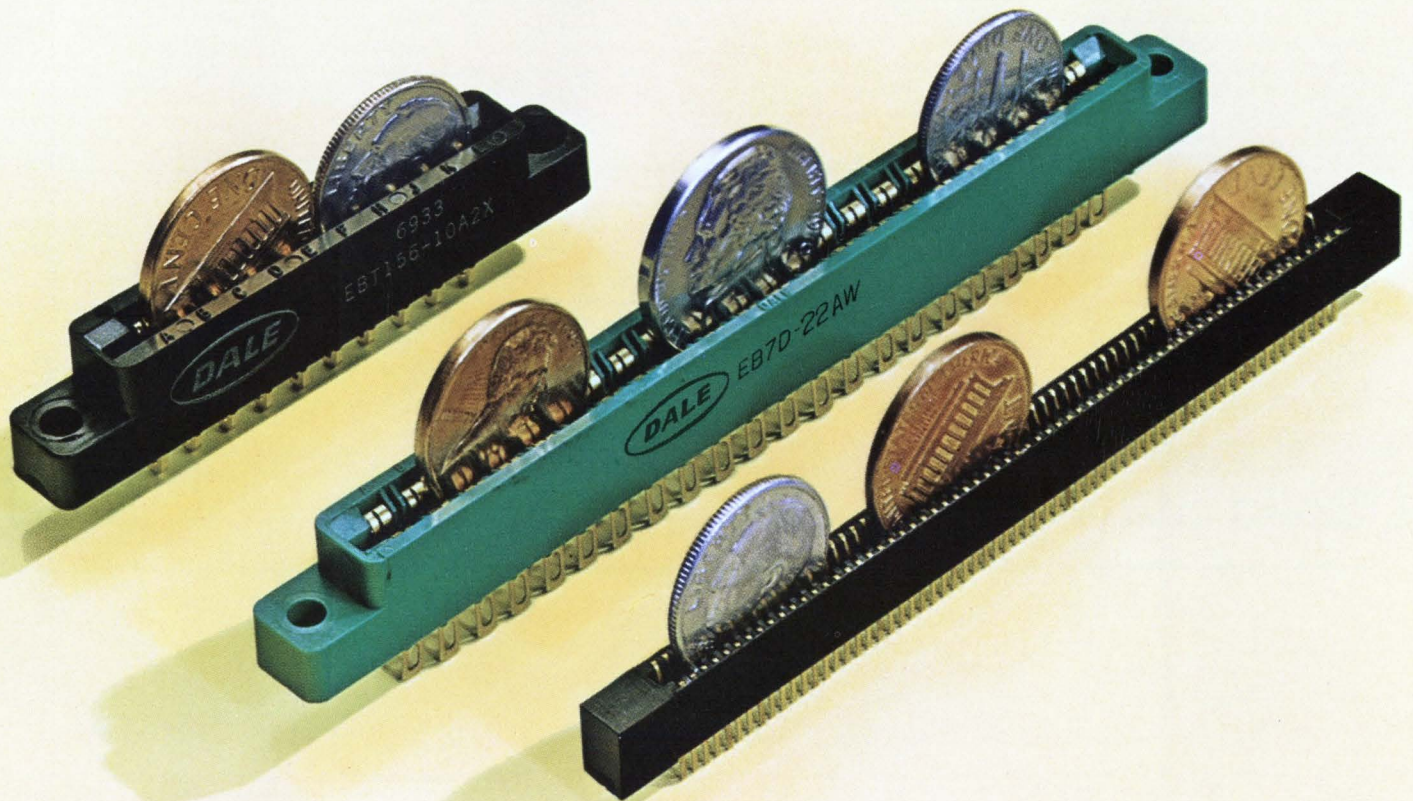

Specify Dale Edgeboards

Dale is ready to deliver your choice of three of the industry's most popular edgeboard connectors...very well made...very interchangeable...very competitively priced. If you're looking for an edge in meeting production schedules and holding the line on costs, contact Dale today.

*Get your edge by
calling 605-665-9301*

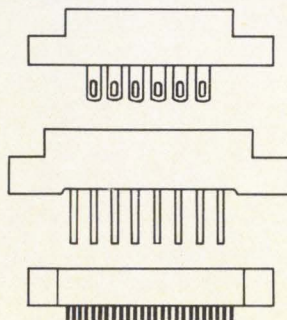

EB 7 New .156" model with reliable bifurcated bellows contacts. Single row (6, 10, 15, 18, 22 contacts). Double row (12, 20, 30, 36, 44 contacts). Solder eye terminals. For 1/16" board.

EBT 156 Top-selling .156" model with rugged tuning fork contacts (8, 10, 12, 15, 18, 22). Dip, solder eye or wrap terminals. For 1/16" boards.

EBTL 050 Industry's thinnest .050" model. Only .158" thick for 1/32" boards; .190" thick for 1/16" boards. Cantilever-style contacts (8, 16, 20, 25, 32, 50, 64 per side).

DALE[®]

DALE ELECTRONICS, INC.

East Highway 50, Yankton, South Dakota 57078. In Canada: Dale Electronics Canada, Ltd., A subsidiary of The Lionel Corporation

GaAs lasers go commercial at new low prices!

RCA GaAs laser diodes have now reached a level of product maturity; many developmental types have been assigned commercial numbers; and they are priced lower than ever — as low as \$6.95 (at 1000-level) for type 40858.

RCA GaAs lasing devices are available as diodes, stacks, and arrays. They feature high peak and average power outputs at exceptionally low drive currents. They are also available in 800 to 900 nanometers in GaAlAs for improved match to image intensifiers. A wide range of custom designs can be provided to meet system needs.

You will find that RCA lasers offer design advantages in data-link communications, fuzing devices, intrusion alarms, ranging equipment, target designation equipment, night-vision systems, and many other infrared systems. Put the competitive advantages of RCA lasers to work in your application.

RCA also offers a line of matching P-I-N Photodetectors for use with laser systems.

For further information see your local RCA Representative or RCA Distributor. Or write: RCA, Commercial Engineering, Section 57H-5/US8, Harrison, N. J. 07029. International: RCA, Sunbury-on-Thames, U.K., or P.O. Box 112, Hong Kong.

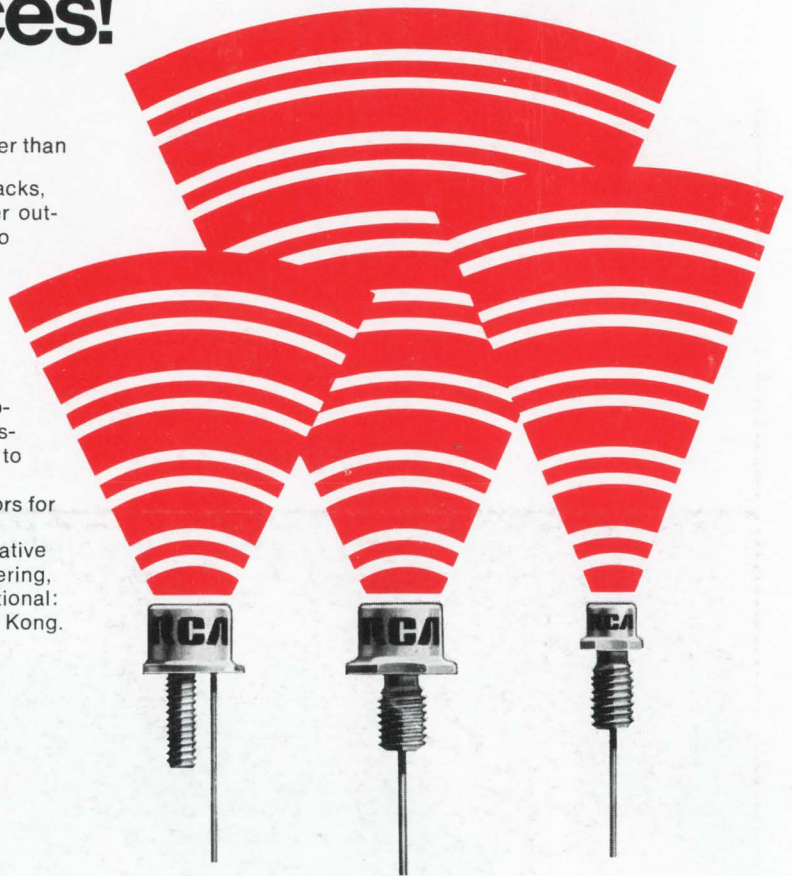

RCA Solid State

Single diode lasers

- efficiency—3%
- wavelength—905 nanometers
- pulse duration—0.2 μ s (max.)*
- case polarity—negative (Reverse-polarity types available)

Type	Pkg	Power Output (W) (min.)	I _{FM} (A)	Source Size (mils)	Duty Factor %
40855	OP-3	0.7	10	3x0.08	0.1
40856	OP-3	1.0	10	3x0.08	0.1
40857	OP-3	2.0	10	3x0.08	0.1
40858	OP-3	3.0	25	6x0.08	0.1
40859	OP-3	5.0	25	6x0.08	0.1
40860	OP-3	5.0	20	6x0.08	0.1
40861	OP-3	7.0	40	9x0.08	0.1
40862	OP-3	10.0	40	9x0.08	0.1
40863	OP-3	10.0	30	9x0.08	0.1
40864	OP-3	12.0	75	16x0.08	0.1
40865	OP-3	15.0	75	16x0.08	0.1
40866	OP-3	15.0	60	16x0.08	0.1
TA7864	OP-12	25.0	75	24x0.08	0.02
TA7763	OP-12	25.0	100	24x0.08	0.02
TA7705	OP-12	40.0	250	55x0.08	0.005
TA7787	OP-12	60.0	250	55x0.08	0.005

*Except 0.1 μ s max for TA7705 and TA7787

Laser arrays

- wavelength—905 nanometers
- series wired
- duty factor—0.02%
- pulse duration—0.2 μ s (max)
- case polarity—negative (Reverse-polarity types available)
- package—OP-4A

Type	No. of Diodes	Power Output (W) (min.)	I _{FM} (A)	Source Size (mils)
TA7687	10	25	25	100x0.08
TA7687A	10	50	25	100x0.08
TA7688	15	35	25	150x0.08
TA7688A	15	75	25	150x0.08
TA7690	30	75	25	160x40
TA7690A	30	150	25	160x40
TA7692	60	150	25	160x60
TA7692A	60	300	25	160x60

GaAlAs laser diodes and arrays

Type	Center Wavelength (nm)	Peak Power Output (W)	I _{FM} (A)	Source Size (mils)	No. of Diodes	Pkg
TA7867	850 \pm 50	3	25	6x0.08	1	OP-3
TA8127	850 \pm 50	7	40	9x0.08	1	OP-3
TA8101	800 \pm 20	85	40	150 x0.08	12	OP-4A
TA8105	850 \pm 30	85	40	150 x0.08	12	OP-4A
TA8106	800 \pm 20	170	40	160 x 40	24	OP-4A
TA8107	850 \pm 30	170	40	160 x 40	24	OP-4A
TA8131	800 \pm 20	300	40	160 x 60	48	OP-4A
TA8132	850 \pm 30	300	40	160 x 60	48	OP-4A

Stacked-diode lasers

- wavelengths—905 nanometers
- series wired
- package—OP-12
- pulse duration—0.2 μ s (max)
- case polarity—negative (Reverse-polarity types available)

Type	No. of Diodes	Power Output (W) (min.)	I _{FM} (A)	Source Size	Duty Factor %
TA7764	3	25	40	9.5x9.5	0.02
TA7964	2	30	75	16x4	0.04
TA7765	2	50	100	24x4	0.02