

Electronic Design 22

VOL. 19 NO.

FOR ENGINEERS AND ENGINEERING MANAGERS

OCT. 28, 1971

Use of electronics in hospitals continues to grow but so does dissatisfaction with the quality of the equipment. Broken cables, misset switches and incorrect

calibrations tell part of the story. A hospital administrator gripes about poorly designed hardware and inadequate quality control. See special report on page 22.

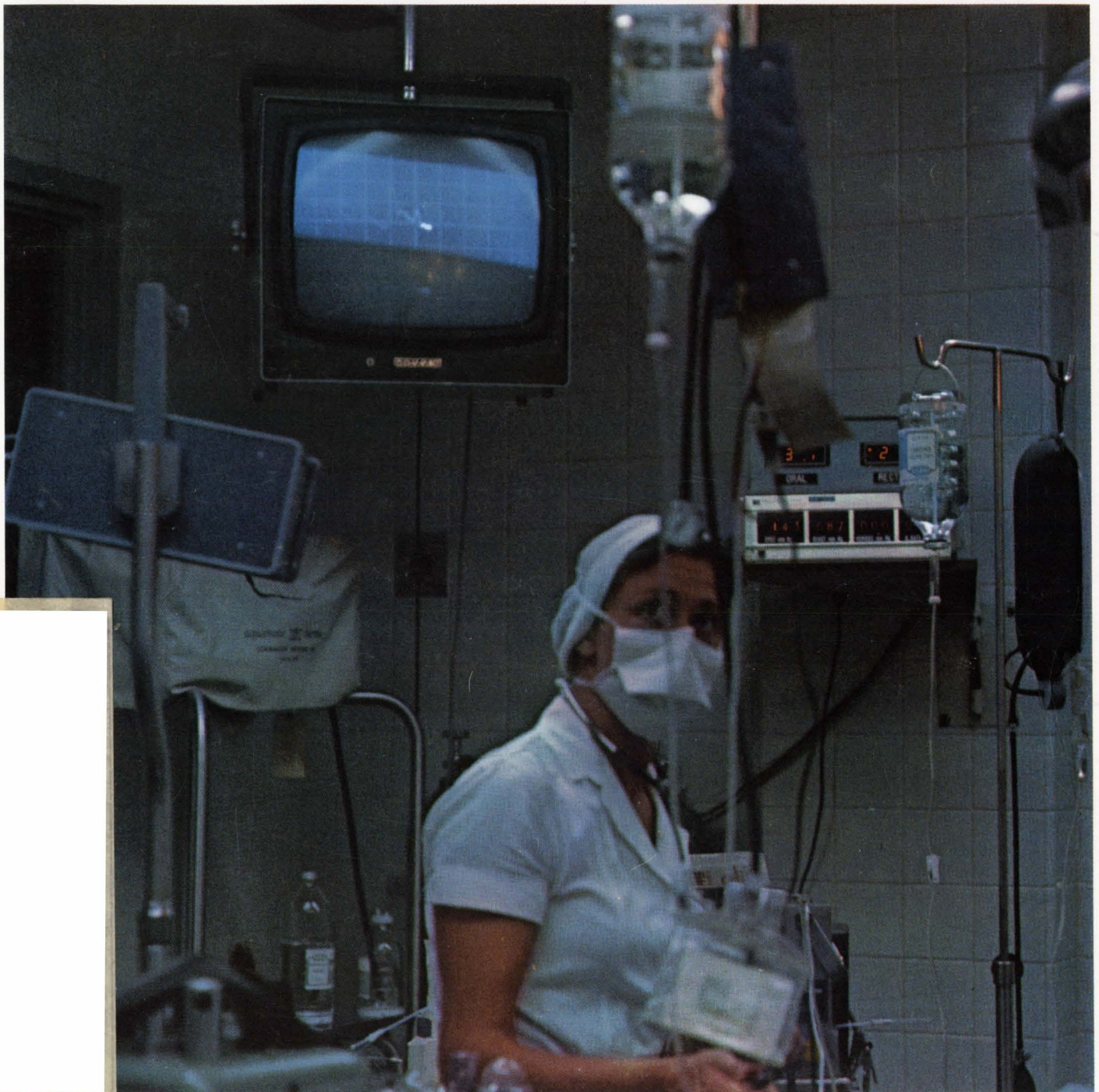

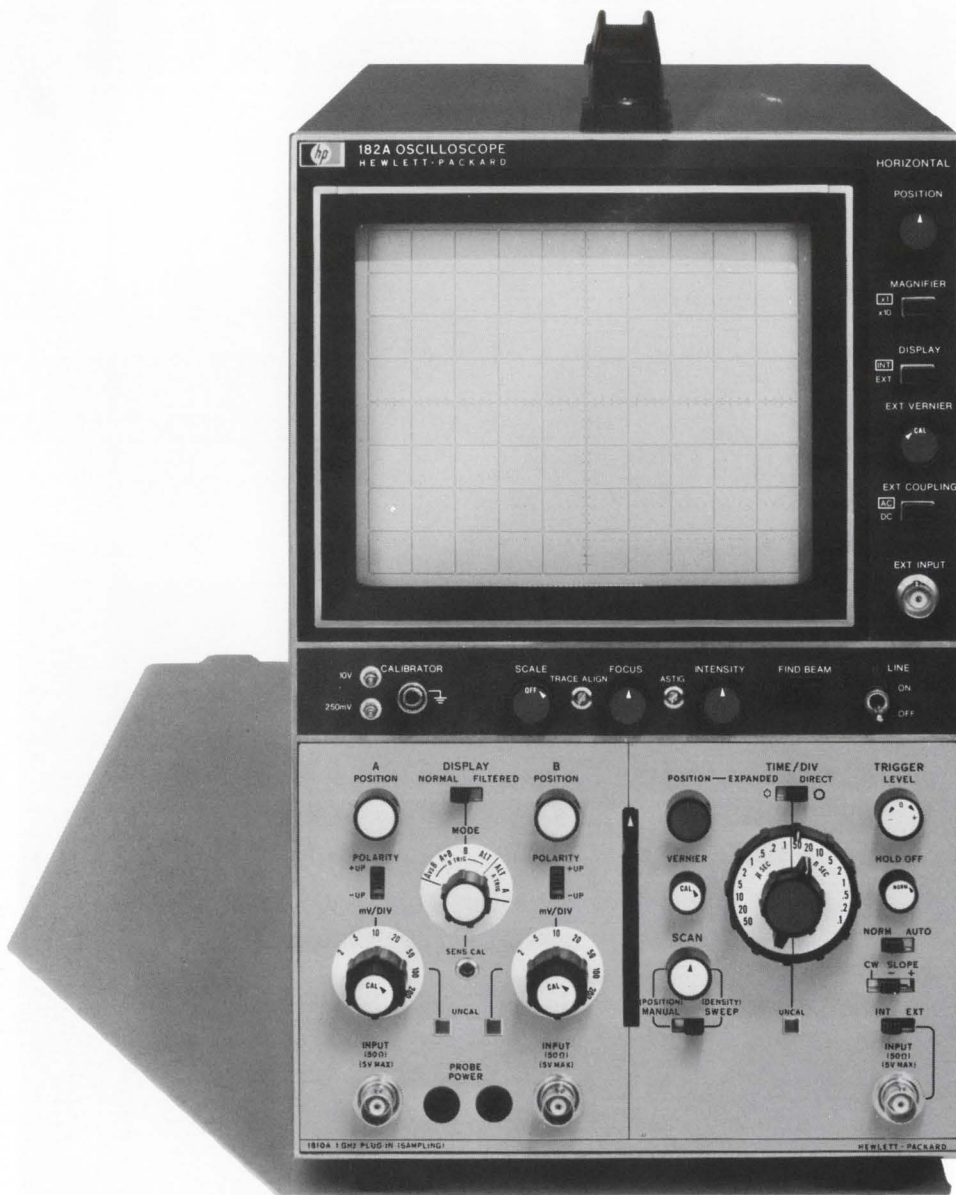

Look again. It's a 1GHz sampling scope!

If, at first glance, you didn't realize that the instrument shown above is a 1GHz sampling scope, it's understandable. HP's new 1810A sampling plug-in for the 180 Scope System is designed to have controls like those of a real-time scope.

The result is the **first truly easy-to-use sampling scope ever**. No longer do you have to pore over a manual or tinker for hours in order to "get the hang of it." If you can use a real-time scope, you can use the 1810A. Internal calibration adjustments are simplified, too—only 13, none of them interacting. And modular construction makes servicing literally a "snap."

Simplified doesn't mean unsophisticated, however. The 1810A gives you <math><350\text{ ps}</math> risetime and 100 ps/div sweep time, with a choice of seven deflection factors ranging from 2 mV/div to 200 mV/div. Accuracy is $\pm 3\%$. Reflection coefficient is <math><6\%</math> (measured with wide-band TDR), at 50 Ω input resistance. And the 1810A's two channels can be operated to give you: channel A; channel B; alternate A and B; A + B; and A vs B.

However, the 1810A's **most exciting feature is its price tag, \$1650**. Use this plug-in in any of the eleven HP 180 Series mainframes—including conventional, variable-persistence and storage, large-screen and

militarized models.

For further information on the new 1810A 1GHz sampling plug-in, or on the 180 System in general, contact your local HP field engineer. Or write Hewlett-Packard, Palo Alto, California 94304. In Europe: 1217 Meyrin-Geneva, Switzerland.

Scopes are
changing.
Are you?

HEWLETT  PACKARD

081/8



MAKE YOUR CONNECTIONS: FAST. With Molex standard and miniature connectors. They're easier to work with. Simplify wiring. Speed production. Save assembly steps. Make installation and servicing extra easy, too. This is why circuitry idea men everywhere are making connections with Molex. From one circuit to 104 or more. Production keyed and available in a variety of colors to meet design requirements. Molex has the

connector. Plus the design and engineering capability to solve the most complex wiring problems . . . fast. For a colorful free sample of the Molex connector write: Molex Incorporated, Downers Grove, Illinois 60515. Or you can make connections by calling (312) 969-4550.

*... creating components that
simplify circuitry*



700v. 10A. 200 nsec.

BREAK
THROUGH

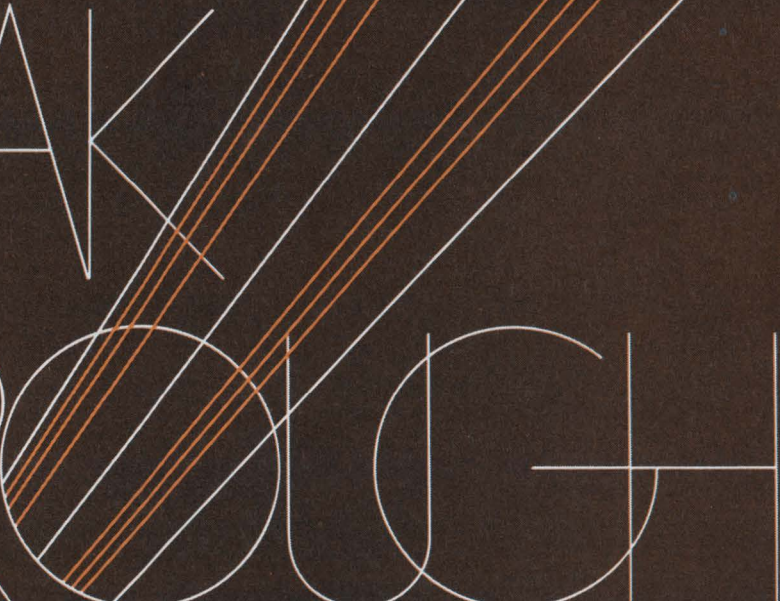

A new dimension in power switching transistors.

Our new SVT7000 series power switching transistors (700 V, 10 A, 200 nsec switching transistors with a pulse energy rating of 4.5 KW for 100 μ sec.) make the impossible possible.

Now you can break through with weight, size and cost reductions in off-line 40 KHz power conversion units. High-speed deflection amplifiers. Power modulators. You name it.

And whatever you build will run

cooler, longer, more reliably than comparable units built around heavy transformers and old-fashioned circuitry.

Only your imagination limits the uses for these remarkable new transistors. To help you along, we've prepared an in-depth paper, "Application Notes for the TRW SVT7000 Series of Power Switching Transistors." Send for your copy today.

Or get the real thing right now.

SVT7000 transistors are on the shelf at TRW stocking distributors. Or call us at our toll-free number: 800-421-2061. (In California, call 213-679-4561, collect.) TRW Semiconductors, 14520 Aviation Blvd., Lawndale, Calif. 90260.

TRW[®]
SEMICONDUCTORS

INFORMATION RETRIEVAL NUMBER 3

Electronic Design 22

VOL. 19 NO.

FOR ENGINEERS AND ENGINEERING MANAGERS

OCT. 28, 1971

NEWS

- 19 **News Scope**
- 22 **Defects in medical electronics** draw heavy fire from hospitals, threatening what could become a half-billion dollar market by 1975.
- 28 **Electronics-laden ship** to drill for oil in 2000-foot waters.
- 30 **Two-wire cable system summons aid** for stranded motorists.
- 30 **Low-cost impact printer** called 10 times faster than Teletype.
- 32 **Technology Abroad**
- 37 **Washington Report**

TECHNOLOGY

- 42 **Any microwave diode will work** in this coaxial resonator structure. Its coupling techniques allow it to accommodate a wide variety of Gunn and Impatt types.
- 49 **Cut noise in switching regulator** by using simple filters. With design tradeoffs, you can still get efficiencies up to 80%.
- 58 **Build gated video amplifiers** with IC differential amps. You can exploit their current-switching capabilities in both single-ended and differential designs.
- 62 **With a sharp eye for forceful presentation**, you could find your company depending on you at bidding time.
- 66 **Ideas for Design**

PRODUCTS

- 77 **Modules & Subassemblies:** Low cost display panels interface to MOS ICs.
- 78 **Modules & Subassemblies:** A 12-bit \$300 a/d converter has 5- μ s total conversion time.
- 84 **ICs & Semiconductors:** Fast new ICs of silicon-on-sapphire consume little power.
- 88 **Components**
- 93 **Data Processing**
- 96 **Instrumentation**
- 97 **Packaging & Materials**
- 98 **Microwaves & Lasers**
- 112 **Product Index**

Departments

- 41 **Editorial:** So What?
- 7 **Letters**
- 13 **Designer's Calendar**
- 100 **Application Notes**
- 102 **New Literature**
- 106 **Bulletin Board**
- 110 **Advertisers' Index**
- 112 **Information Retrieval Card**

Cover: Cover photo by Michael P. London, News Editor, taken at Roosevelt Hospital, NYC.

ELECTRONIC DESIGN is published biweekly by Hayden Publishing Company, Inc., 50 Essex St., Rochelle Park, N.J. 07662. James S. Mulholland, Jr., President. Printed at Brown Printing Co., Inc., Waseca, Minn. Controlled circulation postage paid at Waseca, Minn., and New York, N. Y., postage pending Rochelle Park, N. J. Copyright © 1971, Hayden Publishing Company, Inc. 82501 copies this issue.



Last Spring, you met our thoroughly modern mini.

Hey, look at her now!

Take another look at our gal on the go. Now our 2100's moved up to a minisystem. The new HP 2120. With big system power at a pocketbook price: \$32,950.

This buys a high-speed paper tape reader, teleprinter, our new 5 megabyte, fast access 7900 disc drive — plus our thoroughly modern mini. And when we say modern, we mean a processor with value features like control read only memory (ROM), direct memory access, hardware multiply-divide and the latest in MSI/LSI technology. For special applications, our mini also offers convenient options like floating point hardware. Pulling it all together is the 2120's unique disc operating system. It puts you into the big performance league with program chaining, extended file management, and a job processor that mixes FORTRAN IV, ALGOL, and assembly language programs.

Our new 2120 Minisystem's flexible, too. Its modular design lets you easily expand both capacity and capability. As you need it. For instance, when you want more disc memory, move up in easy

and convenient steps and go all the way to 47 megabytes.

When you need a tape drive, line printer, card reader, or other peripheral, add it. Our minisystem is designed to handle them all. Plus as many as 47 HP instruments. And everything plugs right in.

As your needs change, we have software that keeps pace. Library programs, statistical routines, application packages and more. All are fully compatible with our over three thousand computer installations in industry, science, and education.

Now combine all this with a sales and service organization of 141 offices throughout the free world. They're an important part of our minisystem story. Big support, big performance, reasonable cost. That's our gal on the go.

So why not take a look at her now. Just call your HP computer specialist. Or write for the system brochure. Hewlett-Packard, Palo Alto, California 94304; Europe: 1217 Meyrin-Geneva, Switzerland.

22128

HEWLETT  PACKARD
DIGITAL COMPUTERS

We've added a little something* to the world's biggest RF inductor line



New Pee Dee Ductor world's smallest unshielded RF inductor

Nytronics' newest unshielded microminiature RF inductor for hybrid circuit applications — Pee Dee Ductor — is the smallest in the world. Measuring a wee .140" end to end, it has a diameter of .075", and meets the requirements of MIL-C-15305 Grade 2, Class 5. Minimum Q values at RF frequencies range from 21 to 55. Epoxy encapsulated, it is available in values from 0.1 uH to 1000 uH, with current capabilities ranging from 30 to 600mA. Standard inductance tolerance is $\pm 10\%$, and Pee Dee Ductor meets operating temperatures of -55°C to $+125^{\circ}\text{C}$. Its axial leads will withstand a minimum pull of 3 pounds.

So Nytronics not only has the biggest RF inductor line available anywhere. It has the smallest. Write for a free sample and the rest of the story. *Available off-the-shelf at all Nytronics distributors.*

 **Nytronics, Inc.**
THE QUALITY LINE OF STANDARD COMPONENTS

ORANGE STREET, DARLINGTON, S. C. 29532 • (803) 393-5421 • TWX 810-665-2182

INFORMATION RETRIEVAL NUMBER 5

Publisher

Peter Coley

Editors

Editorial Offices
50 Essex St.
Rochelle Park, N.J. 07662
(201) 843-0550
TWX: 710-990 5071
Cable: Haydenpubs Rochellepark

Editor: George Rostky
Managing Editor: Ralph Dobriner
Managing Editor: Raymond D. Speer
Microelectronics, Steven A. Erenburg
Computers, Raymond D. Speer
Microwaves, Michael J. Riezenman
Circuits, Edward A. Torrero
Special Projects, George Rostky
Management, Richard L. Turmail
Military-Aerospace, John F. Mason
News, Michael P. London
New Products, Roger Allan

Field Offices

Massachusetts
Jim McDermott
P.O. Box 272
Easthampton, Mass. 01027
(413) 527-3632

West Coast
David Kaye
2930 Imperial Highway
Inglewood, Calif. 90303
(213) 757-0183

Washington
Don Byrne
1111 S. Army Navy Drive
Arlington, Va. 22202
(202) 296-8982

Editorial Production

Dollie S. Viebig

Art

Art Director, William Kelly
Richard Luce
Anthony J. Fischetto

Production

Manager, Thomas V. Sedita
Helen De Polo
Maxine Correal
Anne Molfetas

Circulation

Manager, Nancy L. Merritt

Information Retrieval

Peggy Long

letters

Job-hunting advice shot down by readers

I am still not sure whether Richard L. Turmail's article in the Sept. 2 issue ("Help Yourself to Jobs and Retraining," pp. 54-57) was for real or for laughs. But if the reporting is accurate, I cannot believe that the gentleman in the phone booth got anything out of the conference.

I don't know what "developing a positive attitude" means. I do know that when I was laid off, I would have taken any job offered, after I had sent out over 100 copies of my resume and had received six replies and no offers. And I imagine most engineers would feel the same.

As for being motivated and persistent, what urging do you need besides a wife and children? Maybe I didn't sell myself properly, but I am, after all, an engineer, not a salesman. I would willingly have entered a new discipline, but I would have been less than honest if I had not felt some trepidation at the prospect.

The reported remarks of Dr. Charles E. Goshen and Dr. Merl Baker are either fatuous or insulting. They show a complete lack of appreciation of the problems and are unworthy of further comment.

Ernest L. Buckley's ideas, at least, are positive, but scarcely practicable. Where does the money come from to perform these studies, and where are they possible? State-of-the-art, by definition, is not available in books; it can only be found on the job.

The only comment of interest or value in the whole article is that future engineers should accept responsibility for the effects of what they inflict on society. What a hope! This would mean teaching everybody, not just engineers, that in a modern society, everyone has

a responsibility to that society—a responsibility that is increased rather than diminished by accepting a paycheck. Nuclear weapons, for example, may be designed by scientists, but they are built by engineers.

J. Brabham

1163 West Street
Mansfield, Mass. 02048

In the Sept. 2 issue, p. 56, your article "(Help Yourself to Jobs and Retraining)" quotes Dr. Merl Baker, chancellor of the University of Missouri-Rolla, as stating: "There is no major job shortage for college-degree engineers if they have a positive attitude and have personalities to sell themselves." Along with this statement is the remark by Dr. Baker that engineers who have been unemployed for a long time would disagree with him.

As I have been an unemployed engineer, I fit into the group that would disagree with Dr. Baker. I understand the importance of a positive attitude and a good personality, but the statement, as quoted, appears to brush off the fact that there is little demand for some types of engineering talent.

With due respect to Dr. Baker, this quoted statement indicates that Dr. Baker is not in touch with reality. Unfortunately the same opinion is held by a number of college educators. My experience in hunting for an engineering position has been the same as that of many others, as reported in newspapers and magazines. I think that it is an oversimplification to state that a good attitude and a good personality are all that is needed.

Donald L. Huffman, Ph.D.
Wright-Patterson AFB
Ohio

Electronic Design welcomes the opinions of its readers on the issues raised in the magazine's editorial columns. Address letters to Managing Editor, Electronic Design, 50 Essex St., Rochelle Park, N. J. 07662. Try to keep letters under 200 words. Letters must be signed. Names will be withheld on request.

INFORMATION RETRIEVAL NUMBER 6 ▶

ELECTRONIC DESIGN 22, October 28, 1971

Scaled down size

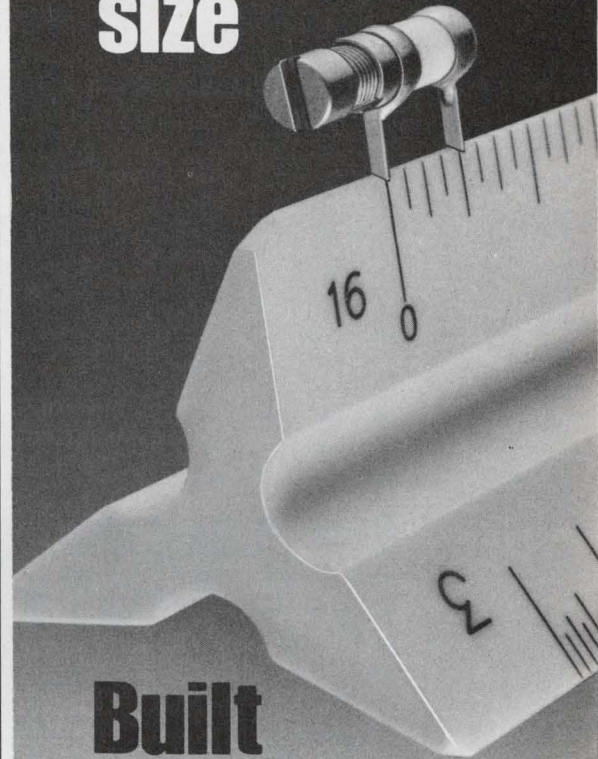



Built up performance

50% more capacity in the same size is now available in these new Johanson *extended range* capacitors. Beautiful for microwave, VHF and UHF applications, they offer fine tuning, ultra high Q, low temperature coefficients and "sizes" for hybrid and microcircuit as well as standard applications.



For detailed specifications on Johanson air capacitors, send for our current catalog.

Compare:

Model No.	Conventional	Johanson
(Actual Size)	Capacitance pf	Capacitance pf
 5452	.8 - 10	1 - 16
 5752	.4 - 6	.8 - 10
 5852	.35 - 3.5	.5 - 5.0

Johanson Manufacturing Corporation
Rockaway Valley Road, Boonton, N. J. 07005
(201) 334-2676

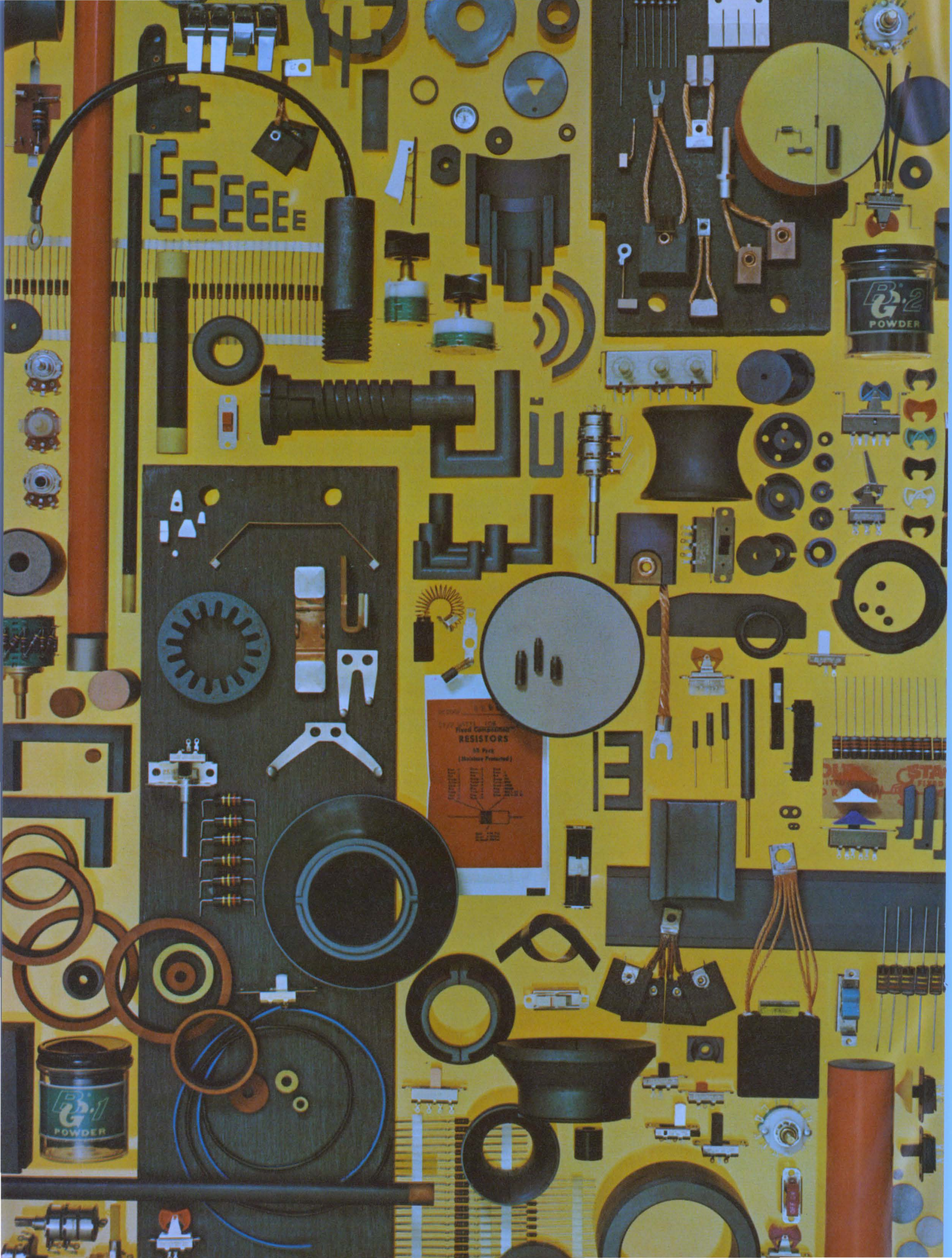

Our part in your product is value

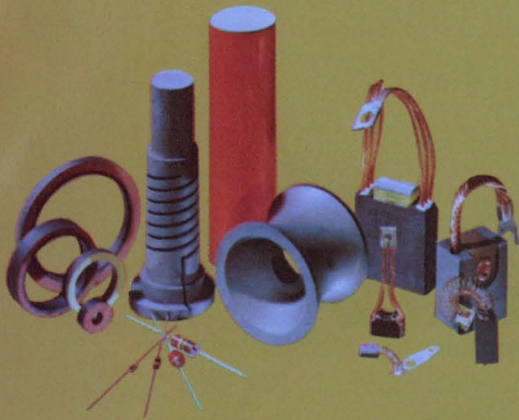

**Carbon and
Graphite
Products**

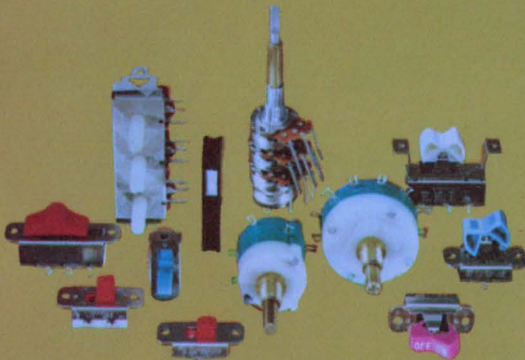

**Electro-
Mechanical
Components**



**Hard and Soft
Ferrites**

*The items shown are produced by Stackpole's
Carbon Division, Electronic Components Division,
Magnet Division and Stackpole Components Company.*

We make a lot of things at Stackpole. Components by the millions. Materials by the ton. But what really makes us different is our philosophy.

Stackpole believes in producing the best possible product, for the lowest practical price, delivered on time and backed by service. Simple? Sure. Perhaps even old-fashioned. But true. And certainly no small task.

Ours is a manufacturing technology. A capability to produce. In volume. To your specific needs.

For sixty-five years, Stackpole has served virtually every industry. To many, we are the known, respected leader. Others in emerging technologies are coming to know the special skills, imagination, experience and quality uniquely Stackpole.

Value. It's determined in performance. For products and companies alike. Let us be a part of your production team.

Stackpole Carbon Company,
St. Marys, Pennsylvania 15857.



STACKPOLE

Dow Corning silicones seal, bond, insulate, cool, encapsulate...

and how's this for repairability?

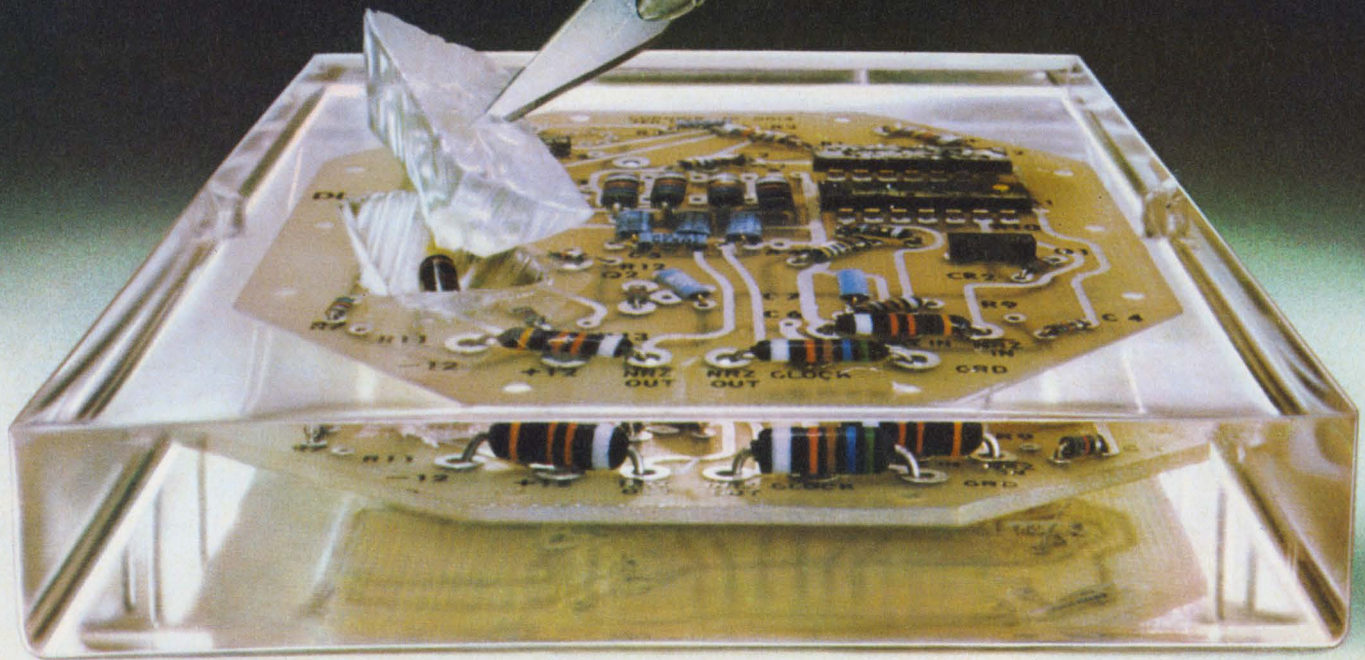

See-through silicone package speeds repair. Encapsulation of microcircuits with a clear resilient Sylgard® brand resin pays off with more than just protection. When circuits are under development, the encapsulant can be cut away to expose components for testing and modification. And, if fast field repair is a factor, defective components are more quickly located and replaced. Voids are merely filled with the silicone resin and protection is again intact. Sylgard resins also eliminate cure shrinkage associated with other encapsulants. They easily meet the most exacting shock, vibration, temperature and moisture resistant requirements. Circle Information Retrieval Number 821.

Silicone materials are unusually versatile. But whether they are used to seal, bond, insulate, impregnate, encapsulate or cool—their one basic function is to protect. And they protect better because of inherent silicone resistance to change—regardless of environment. When electronic equipment must function reliably in hostile atmospheres, look

to silicones from Dow Corning to shut out trouble. Described here are a few ways our materials can ensure the integrity of your designs. Many others are described in our Silicone Electronic Materials brochure available from your Dow Corning distributor. His name appears on the following page. Or write Dept. A-1220, Midland, Michigan 48640.

Electrical / electronic materials from

DOW CORNING

DOW CORNING

Noncorrosive silicone sealants.

For critical electronic insulating requirements on corrosion-sensitive materials. Four noncorrosive, acid-free curing silicone sealants are available from Dow Corning—two are pourable, self-leveling liquids for conformal coatings; the other two are nonslump materials for sealing, mounting and bonding. All are ready to use, cure at room temperature and are serviceable over a wide temperature range. Circle Information Retrieval Number 822.

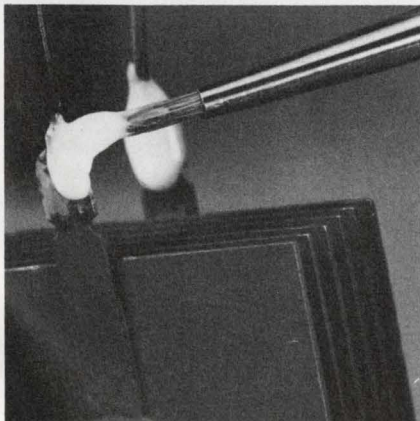

Dissipate heat fast with silicones.

You can use silicone materials to protect from heat, or to get rid of it. A Dow Corning® brand heat sink compound helps cool components such as transistors, diodes and rectifiers by transferring operating heat to heat sink or chassis. Thermal conductivity is effective as high as 200 C with this noncorrosive, metal-oxide filled silicone material. Ask about silicone fluid coolants also. Circle Information Retrieval Number 823.

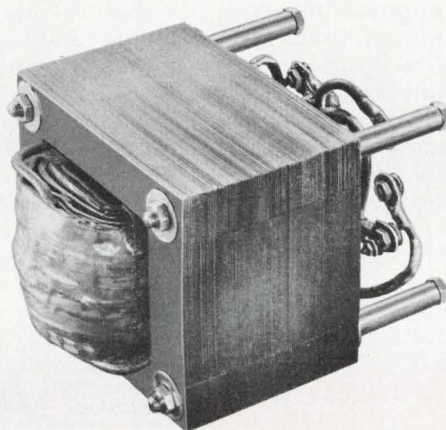

Silicone varnish aids miniaturization.

When operating temperatures of new spacesaving power supplies such as transformers hit the 200 C mark, protection with Dow Corning® brand silicone impregnating varnishes ensures performance. These materials are the most reliable insulating resins available. And they are easy to apply. Stators, chokes, coils, solenoids and other electronic equipment are protected by simply dipping, brushing, flooding or impregnating. Circle Information Retrieval Number 824.

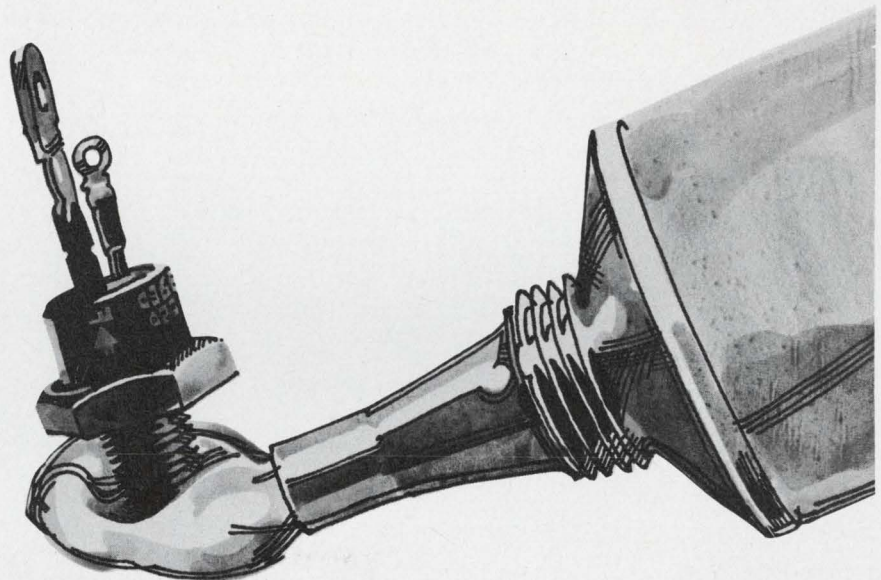

The new Merlin 1[®] connector.

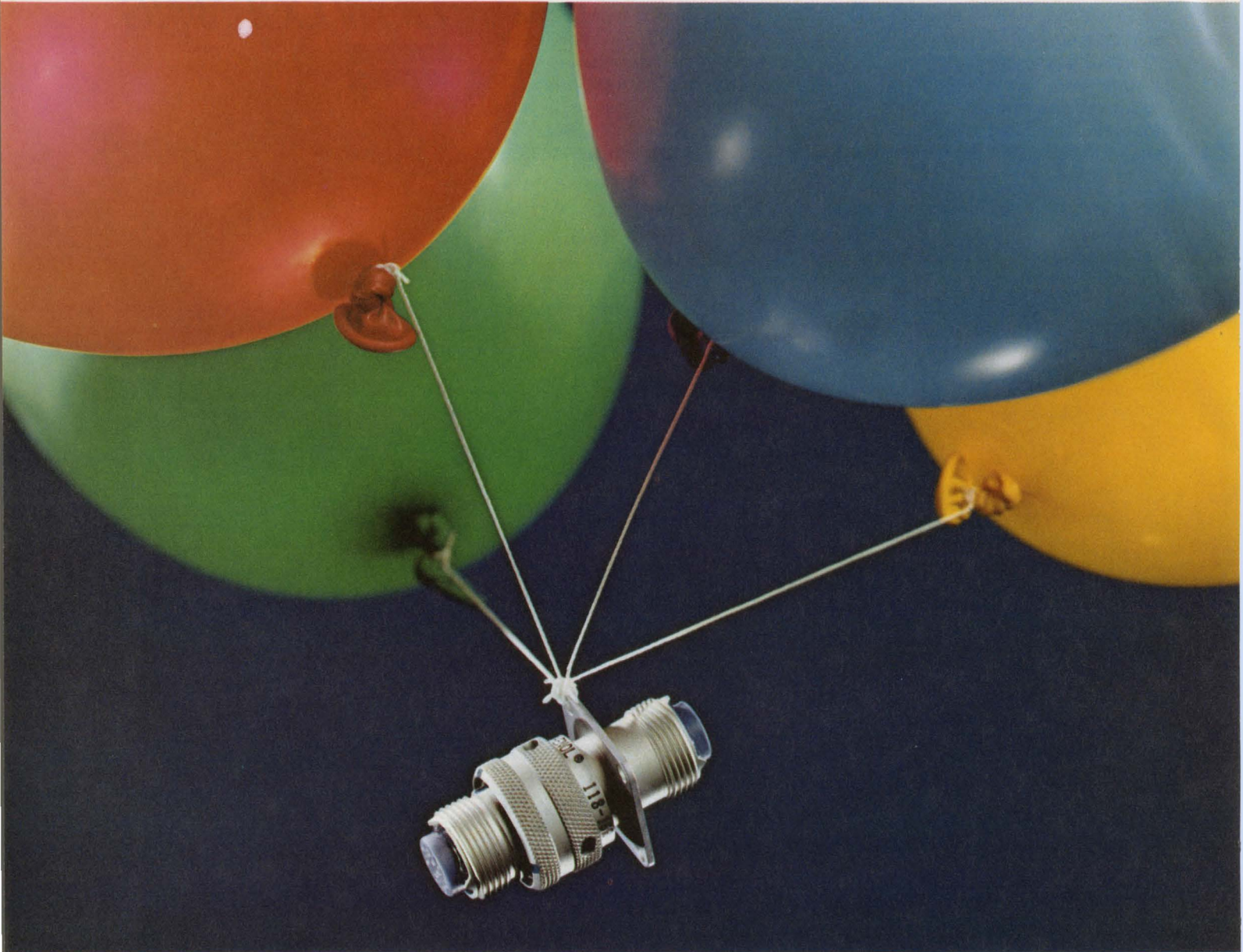

40% lighter than anybody else's.

Through the magic of Amphenol engineering we now bring you a rear-release, cylindrical, environmental connector that is not only 40% lighter than competition, but 1/2-inch shorter than most.

A one-piece thermoplastic retention disc, molded of tough Astrel 360* replaces the individual metal retention clips common in heavier connectors. Therefore, a 61-pin Merlin configuration has one retention disc instead of 61 individual metal clips. The result is a lot less useless weight. And, without all those parts, more reliability.

Adds a little magic to cost-cutting, too.

Our new Merlin exceeds all performance requirements of MIL-C-83723, MIL-C-26482 and NAS-1599 and is fully intermateable and intermountable with all three of these types.

Shell sizes are available in the eight most popular configurations with your choice of straight plug and both wall-mounted or jam-nut receptacles.

To get the full story on the new Merlin 1 connectors, just write or call Steve Kelleher, Amphenol Connector Division, Bunker Ramo Corporation, 2801 S. 25th Avenue, Broadview, Ill. 60153, (312) 261-2000.

*Registered Trade Mark 3M Company.



AMPHENOL

designer's calendar

NOVEMBER 1971

S	M	T	W	T	F	S
	1	2	3	4	5	6
7	8	9	10	11	12	13
14	15	16	17	18	19	20
21	22	23	24	25	26	27
28	29	30				

Nov. 15-18

Fall Joint Computer Conference, (Las Vegas) Sponsors: IEEE, AFIPS, AFIPS Hdqs., 210 Summit Ave., Montvale, N.J. 07645

CIRCLE NO. 416

Nov. 16-19

Conference on Magnetism & Magnetic Materials (Chicago) Sponsors: IEEE, The American Institute of Physics, F.M. Mueller, Argonne National Laboratory, Argonne, Ill. 60439

CIRCLE NO. 417

DECEMBER 1971

S	M	T	W	T	F	S
			1	2	3	4
5	6	7	8	9	10	11
12	13	14	15	16	17	18
19	20	21	22	23	24	25
26	27	28	29	30	31	

Dec. 6-9

Ultrasonics Symposium, (Miami Beach), Sponsor: IEEE, Herbert Matthews, Sperry Rand Research Ctr., Sudbury, Mass. 01776

CIRCLE NO. 418

Dec. 7-9

Vehicular Technology Conference, (Detroit) Sponsor: IEEE, A. E. Marshall, Ford Motor Co., 23400 Michigan Ave., Dearborn, Mich. 01776

CIRCLE NO. 419

DOW CORNING SILICONE PROTECTORS

A full line of silicone encapsulating, insulating, sealing, coating and dielectric materials is available from Dow Corning Distributors at the following warehouse locations:

ARIZONA Phoenix	Essex International Inc.—I.W.I. Div. 602-278-8568
CALIFORNIA Berkeley	C. D. LaMoree 415-841-0601
Culver City	E. V. Roberts & Associates, Inc. 213-870-9561
Los Angeles	Essex International Inc.—I.W.I. Div. 213-264-7000 C. D. LaMoree 213-225-5666
Mountain View	K. R. Anderson Company, Inc. 415-961-6007
San Diego	A. E. Yale Enterprises 714-296-6148
San Francisco	Essex International Inc.—I.W.I. Div. 415-626-5351
COLORADO Denver	Waco Electronics, Inc. 303-322-7708
FLORIDA Fort Lauderdale	Cramer/Florida Inc. 305-947-6517
Orlando	Brownell, Inc. 305-424-5634 Electrical Insulation Suppliers, Inc. 305-855-7100
GEORGIA Atlanta	Electrical Insulation Suppliers, Inc. 404-355-1651
Hapeville	Brownell, Inc. 404-767-9301
ILLINOIS Chicago	Prehler Electrical Insulation 312-384-6100
Mt. Prospect	Magnuson Electronics, Inc. 312-956-0700
Niles	Essex International Inc.* 312-647-0044
INDIANA Fort Wayne	Essex International Inc.—I.W.I. Div. 219-742-7441
Hammond	Electric Supply Corp. 219-932-8840
IOWA Marion	Ensco Distributing Corporation 319-377-6313
KENTUCKY Louisville	E & H Electric Supply 502-587-0991
LOUISIANA New Orleans	Williamson Distributing Corp. 504-486-5584
Shreveport	Williamson Distributing Corp. 318-424-6638
MARYLAND Baltimore	Essex International Inc.—I.W.I. Div. 301-644-0140 Pytronic Industries, Inc. 301-539-6525
MASSACHUSETTS Cambridge	Brownell, Inc. 617-864-7500
Newton	Cramer Electronic, Inc. 617-969-7700
Peabody	Essex International Inc.—I.W.I. Div. 617-531-7100
MICHIGAN Detroit	Essex International Inc.* 313-921-6000
Madison Heights	McNaughton-McKay Electric 313-399-7500
MINNESOTA St. Paul	Magnuson Electronics, Inc. 612-227-8495
MISSOURI Kansas City	Essex International Inc.—I.W.I. Div. 816-842-1613
St. Louis	Ensco Distributing Corp. 314-542-3935 Essex International Inc.—I.W.I. Div. 314-371-2616

NEW JERSEY Livingston	Robert McKeown Co., Inc. 210-992-0700 or 212-267-9264 (NYC)
Moonachie	Essex International Inc.—I.W.I. Div. 201-641-4400 or 212-695-7495 (NYC)
North Bergen	Electrical Insulation Sales 201-864-2376 or 212-564-6273 (NYC)
NEW MEXICO Albuquerque	Waco Electronics, Inc. 505-268-2409
NEW YORK Buffalo	Summit Distributors, Inc. 716-884-3450
New York City	Brownell, Inc. 212-691-7900 or 212-924-6000
NORTH CAROLINA Charlotte	Brownell, Inc. 704-399-9791 Electrical Insulation Suppliers, Inc. 704-392-2306 Essex International Inc.—I.W.I. Div. 704-394-1315
OHIO Cincinnati	Cramer/Tri States, Inc. 513-771-6441 Electrical Insulation Suppliers, Inc. 513-771-4073 Sheridan Sales Co. 513-761-5432 Essex International Inc.* 513-771-6500
Cleveland	Essex International Inc.* 216-781-2310 Prehler Electrical Insulation 216-267-2650
Columbus	McGraw-Edison Co. National Electric Coil Division 614-488-1151
OKLAHOMA Oklahoma City	Essex International Inc.—I.W.I. Div. 405-236-5411
OREGON Portland	Essex International Inc.—I.W.I. Div. 503-665-0138 C. E. Riggs, Inc. 503-226-3286
PENNSYLVANIA Harrisburg	Pytronic Industries, Inc. 717-233-6591
Montgomeryville	Pytronic Industries, Inc. 215-643-2850
Philadelphia	Brownell, Inc. 215-632-3030 Essex International Inc.—I.W.I. Div. 215-236-7100 Prehler Electrical Insulation 215-725-5914
Pittsburgh	Essex International Inc.* 412-244-1145
TENNESSEE Memphis	Brownell, Inc. 901-323-7693 Electrical Insulation Suppliers, Inc. 901-947-4176
TEXAS Dallas	Essex International Inc.—I.W.I. Div. 214-339-8346 Specialized Products Company 214-358-4663 Williamson Distributing Corp. 214-741-5831
Houston	Essex International Inc.—I.W.I. Div. 713-227-6358 Williamson Distributing Corp. 713-672-1715
WASHINGTON Seattle	Atlas Packing & Rubber Co. 206-623-4697 Essex International Inc.—I.W.I. Div. 206-763-8650 C. E. Riggs, Inc. 206-623-5707
WISCONSIN Milwaukee	Essex International Inc.* 414-342-3927 *IMC/I.W.I. Div.

Electrical/electronic materials
from

DOW CORNING

DOW CORNING

This ADC has priced analog multiplexers right out of business.

ADC-8S is so inexpensive you can convert each channel at the transducer and go digital all the rest of the way. Forget pre-amps, noise problems, expensive cabling, time skewing, and last but not least, the analog multiplexer.

Even if ADC-8S didn't save you money, you'd have a better data acquisition system. But it does. Figure each ADC-8S at \$49 (100's) and watch the arithmetic come out our way. Then call or write for an evaluation sample.

ADC-8S is our third entry in the economy converter class. Check the last two issues for our DAC-10Z (a top performer for only \$29) and our DAC-12QZ (at \$49, less than half the price of its competition). But please don't forget

we have a top-of-the-line and a middle-of-the-line — in fact, more and better modular converters than any other company in the world. Analog Devices, Inc., Norwood, Mass. 02062.

(617) 329-4700.

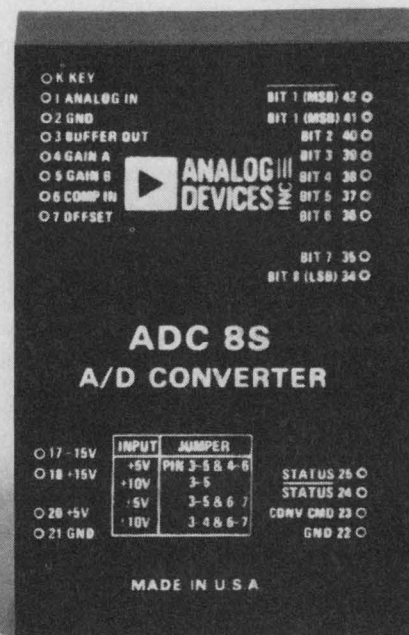

Wedge-Eze^{T.M.}

A story in Three Parts

The WEDGE-EZE coaxial connector shown here has exactly three parts to handle, takes no more than seconds to assemble, and is less expensive than any other coaxial connector on the market! And if that isn't enough to make you rush to the nearest telephone, here are a few more pertinent facts.

Plessey Wedge-Eze connectors will mate with MIL-C-39012 connectors of the same series, and can be used wherever a UG connector is specified. They are available in numerous styles, in series BNC, TNC, N and C.

These connectors are reliable, efficient and far more economical than "crimp" type connectors, and are both field serviceable and reusable!

Due to their unique design, Wedge-Eze connectors reduce the normal time for cable assembly procedures by more than 60%. There are no special tools required for assembly, (although for high speed production, one is available

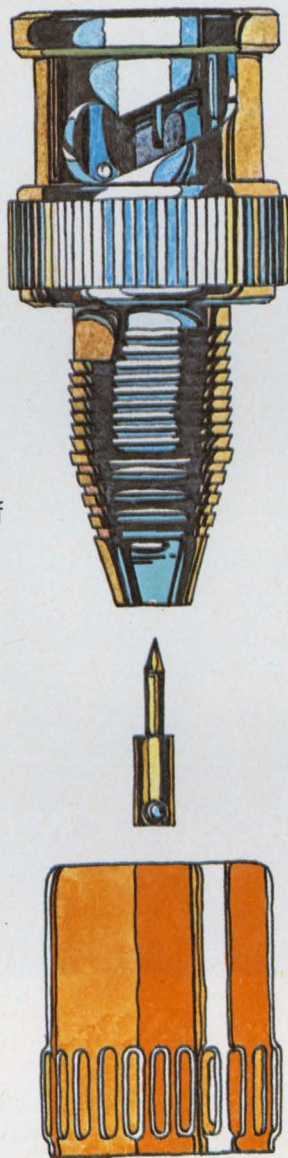

for the very modest sum of \$10.00). Anyone can be taught to assemble them in a matter of minutes. Combing and trimming of the cable braid is no longer required, thereby greatly reducing, (if not completely eliminating), the possibility of "shorting" inside the connector.

Electrical characteristics are excellent. Due to the pre-assembly techniques of manufacture, there is no indentation of the dielectric. Cable clamping is positive, and yet allows for wide variations in tolerances of the coaxial cables used. Wedge caps can be supplied in 15 standard colors to differentiate between cable sizes.

In short, the next time you require UG connectors, order Plessey's WEDGE-EZE. They will save you time, work and money, and they'll always do the job!

Further information, literature, evaluation samples and prices may be obtained by writing us on your company stationery, or contacting your nearest Plessey Representative.



PLESSEY INCORPORATED/CONNECTOR DIVISION

400 MORELAND ROAD/COMMACK, NEW YORK 11725

TELEPHONE: (516) 543-5000 • TWX: 510-226-3744

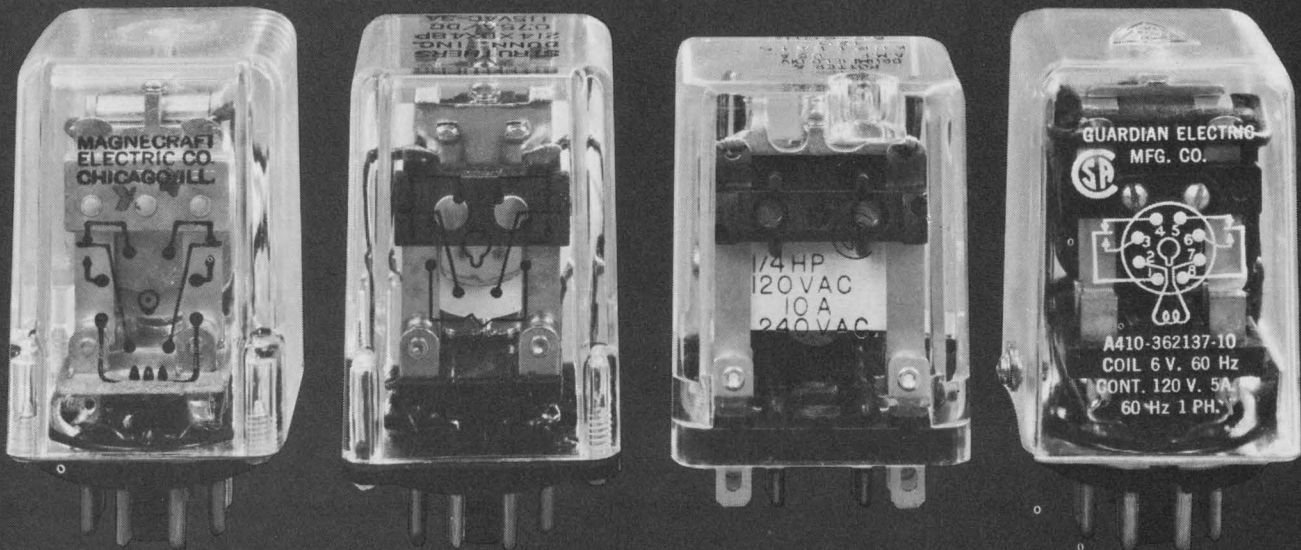

Switching 10 amps with a relay this size?

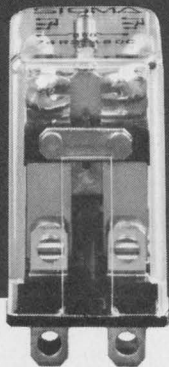

Do it in half the space with Sigma's new "76"

Shown actual size
(1.0" x 0.8" x 1.6")

The new and unique Sigma Series 76 Relay is 50% smaller than any other 10-amp multipole relay available today: the 2PDT version (shown) is 1.0" x 0.8" x 1.6" high and takes only 0.8 sq. in. of chassis space. Yet nothing is sacrificed to gain this small size: reliability is high, operating life is long, price is lower.

The "76" will dependably switch loads such as small motors, solenoids and power contactors a minimum of 100,000 times, in photocopiers and vending machines . . . escalator, conveyor and machine tool controls . . . calculators, duplicators, alarm detectors, refrigerators and air conditioners. Longer

operating life under heavy loads results from significant design differences: a slotted base of Diallyl Phthalate to prevent build-up of vaporized contact material; an arc barrier between contact sets; an interlocked coil and frame to prevent lead wire breakage under vibration.

At present, the 2PDT Series 76 has both UL and CSA approval for component use. 4PDT versions of the Series 76 are also available. You can get immediate delivery from factory or distributor stocks—and lower cost matches the space you'll save. Call or write Sigma Instruments, Inc., 170 Pearl St., Braintree, Ma. 02185. Tel. (617) 843-5000.

SIGMA
INSTRUMENTS INC

INFORMATION RETRIEVAL NUMBER 11

SEMICONDUCTOR NEWSBRIEFS

PUBLISHED BY MOTOROLA SEMICONDUCTOR PRODUCTS INC.

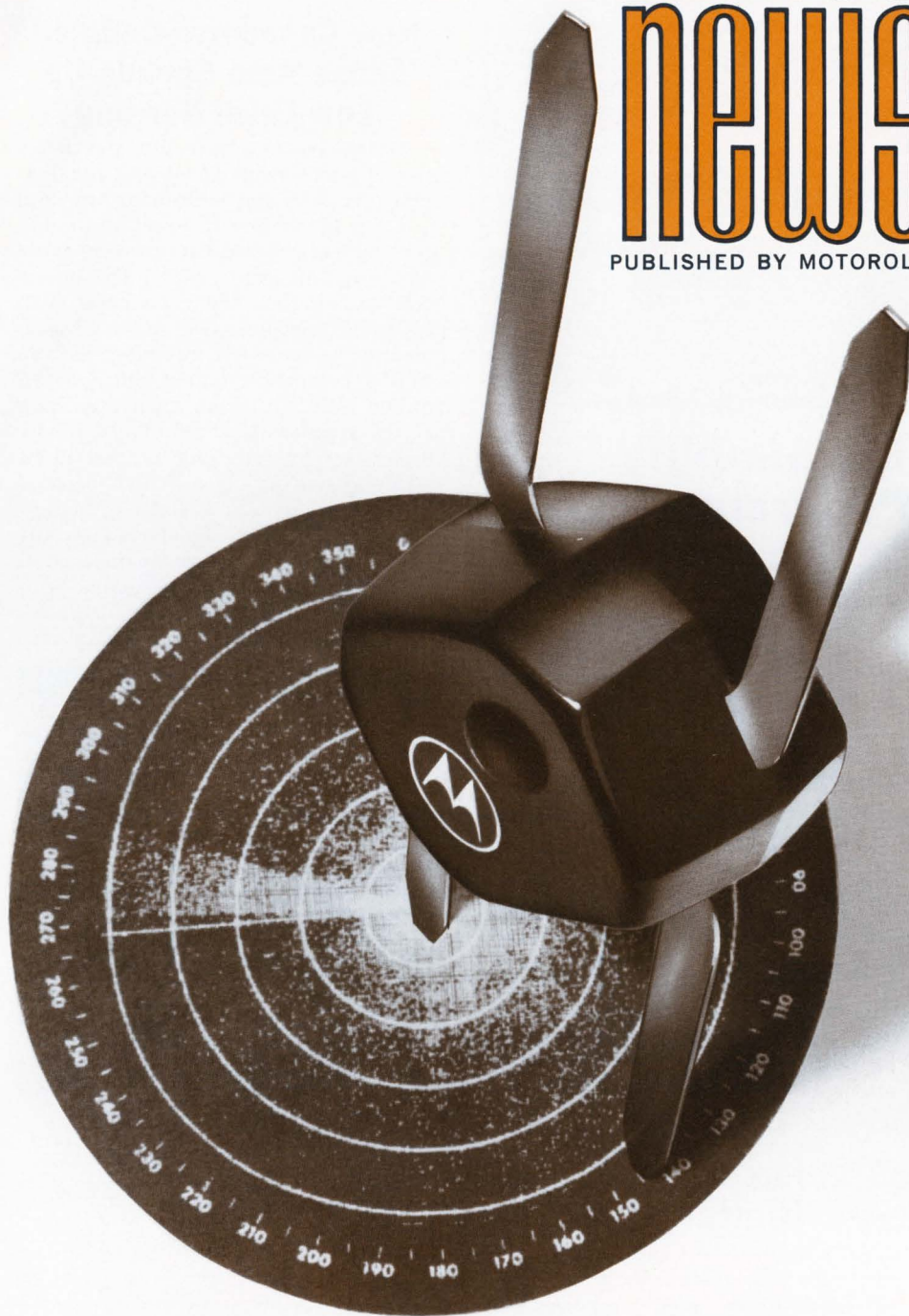

1 GHz, N-Channel, Dual-Gate MOSFET Features Low Distortion

Introduced at the Chicago IEEE Spring Conference in its development stage, the revolutionary, state-of-the-art MPF1000 is now in production.

Designed for UHF and low microwave frequency amplifier applications,

this new silicon, depletion-mode, N-channel dual-gate MOSFET displays exceptionally low distortion characteristics. Use the MPF1000 and your cross-modulation problems will be significantly reduced.

For details, circle 211

The key to the MPF1000's eye-opening combination of low price and 1 GHz frequency capability lies in its new 4-lead plastic package — the MICRO-H. Parasitics were minimized to obtain good high-frequency characteristics and the cost breakthrough came by taking a leaf from the TO-92 book — assembly and encapsulation on high-volume stripline facilities.

MPF1000 also features silicon nitride passivation for excellent long-term stability and has diode protected gates. It has (@ 1 GHz) a power gain of 7 dB (min) and a noise figure of 7 dB. Typical output capacitance of the new MOSFET is 2.5 pF.

Evaluate this exciting transistor now. Its performance is sure to roll back a design boundary or two. And to help you realize the greatest benefit from the MPF1000 in your designs, our friendly MOSFET product marketing group is ready to help, either directly or by arranging for applications assistance. If you've an idea for using this device that you'd like to discuss — particularly in tuning the UHF band — why not give them a call at Code 602/273-4164.

The 1000-up price of the MPF1000 is a surprising 80¢ — low enough for you to evaluate, innovate, and use!



To develop custom functions for your system — fast — call on Motorola's MCM-4004 or MCM-4006 1024-bit read-only memories. Your look-up tables, micro-programs and code translators are just a truth table away.

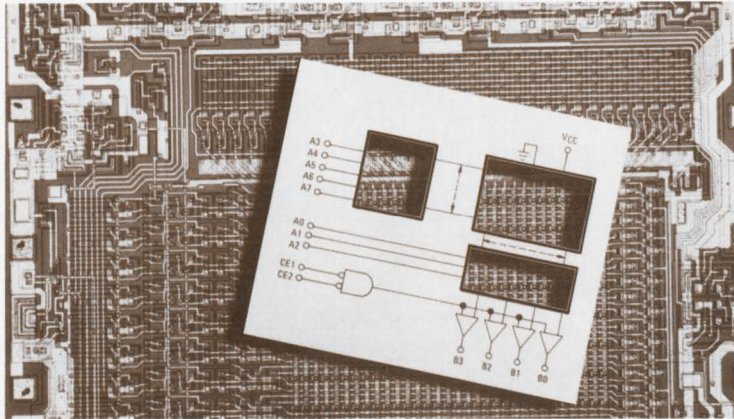

1024-Bit ROMs Simplify System Micro-Programming

When your system needs the advantages of custom micro-programming, code translation, or look-up table functions and you are fighting time plus development cost, Motorola's MCM4004 or MCM4006 1024-Bit ROMs can solve your problem. Just supply your truth table/output option requirement and the final processing step is then completed — the net result is a custom function less developmental program cost and time.

The basic organization of both memories is 256 four-bit words. By removing appropriate emitter connections on the pre-ohmic mask, each bit can be programmed to meet specific logic requirements. Both devices offer optional 2.0 kilohm pullup resistors on the four outputs. The open collector output option is provided by removing pre-ohmic connections to the 2.0 kilohm resistors. The

open collector option allows several memories to be wire-ORed to form large arrays.

The MCM4006 features an address time of 40 ns (typ) and chip select time of 20 ns (typ) with standard TTL input loading of 1.6 mA. The MCM4004 offers reduced input loading (0.1 mA typ) for large systems. Typical MCM4004 address time is 50 ns and typical chip select time is 25 ns.

The devices are supplied in 16-pin white ceramic dual-in-line packages (MCM4004AL, MCM4006AL) or black ceramic (MCM4004L, MCM4006L). 100-up price for either package is \$17.50 and the mask set-up charge is a low \$600 per program with reduced costs for additional masks. Contact your local Motorola representative for ordering information — the option and savings are yours!

For details, circle 212

New Capacitive-Coupled Sense Amp Speeds Up Low-Level Sensing

Designers concerned with the detection of signals from plated-wire and thin-film memories and with other low-level sensing applications will find Motorola's MC1544 ac-coupled four-channel sense amplifier "made to order." The device consists of four input channels with decoding selection, two stages of gain employing capacitive coupling, and an MTTL compatible output gate.

The MC1544 allows fuller utilization of the speed capabilities of plated-wire memories by reducing access times. Older sensing devices such as dc-coupled sense amplifiers were affected by the slow decay of transient signals induced by switching the word current on and off during read cycles. The capacitive coupling of the MC1544 can sense the plated-wire output pulses before the transients



Fast, high-gain sense amp — MC1544 — has level-restoring circuit to maintain TTL levels on its output at the highest repetition rate.

have fully decayed, resulting in faster cycle times and better noise immunity.

Additional MC1544 features include a unique dc level restore circuit on capacitors that eliminates repetition rate problems and helps achieve a typical propagation delay of 18 ns, wired-OR output capability, and a strobe-gated output to inhibit undesirable signals.

Both the -55 to $+125^{\circ}\text{C}$ version, the MC1544L, and MC1444L, the 0 to $+75^{\circ}\text{C}$ version (supplied in 16-pin dual in-line ceramic) are at your nearby Motorola distributor. They are 100-up priced at \$9.00 (MC1544L) and \$8.00 (MC1444L). Evaluate now and speed up your sensing capability.

For details, circle 214

Differential Wideband Video Amplifier Has The Speed For Today's Digital Systems

Recently added to Motorola's linear IC lineup, MC1733 is an excellent general purpose video amplifier. But you'll find it also has the specs for use in magnetic tape or file systems, high speed thin-film or plated wire memory, and pulse amplifier applications. And it can handle video applications as well as directly replace other 733 types.

Essentially a wideband amplifier providing differential input and output with gain fixed at 10, 100, or 400, the MC-1733 also features gain adjustable from 10 to 400 with the addition of a single external resistor. It's the MC1733's

bandwidth though, typically 120 MHz at $A_{vd} = 10$, that gives it the speed needed in today's digital systems. Rise time is just 2.5 ns (typ) and the propagation delay is a good 3.6 ns typical, both measured at $A_{vd} = 10$.

Four variations are available at prices which make them top values. In 100-up quantities, the full temperature range (-55 to $+125^{\circ}\text{C}$) MC1733G (TO-5) and MC1733L (TO-16) are \$5.75. The 0 to $+75^{\circ}\text{C}$ MC1733CG and CL are only \$2.85.

Your Motorola distributor or factory representative will cheerfully serve your product needs.

For details, circle 213



Motorola's latest RAM — the MCM-2372L — employs silicon-gate P-channel enhancement mode devices in a single monolithic structure and uses MOS gate capacitance for information storage.

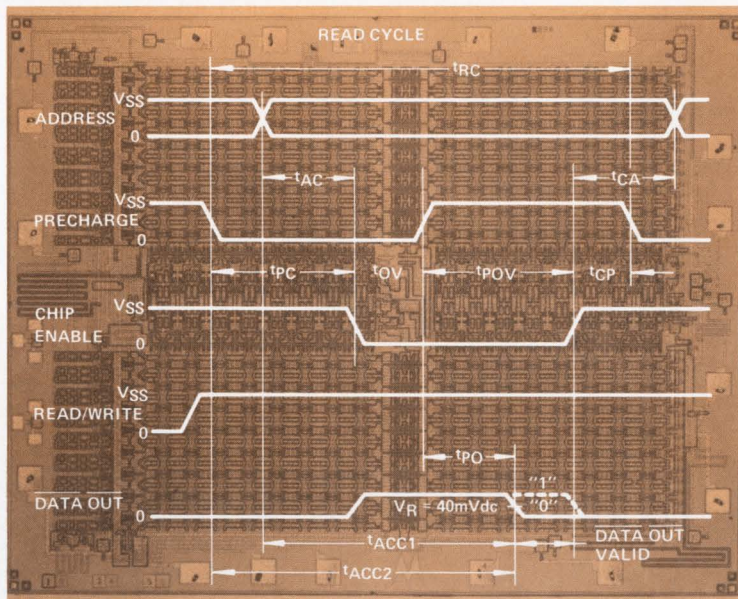

available from a single major manufacturer. The MCM2372 is faster and provides a smaller package for minimizing board size while the MCM1173 offers considerably lower power dissipation. Evaluate your requirements and take your choice.

Access time for the MCM2372L is only 300 ns and the write cycle time is a comparably quick 480 ns. Read cycle time is 540 ns. Overall system speed should be approximately 25% better than in a system utilizing MCM1173's. Refresh time with the MCM2372L is 2 ms (max). System expansion is assisted by a chip enable input for address expansion and wired-OR output capability for memory expansion.

In any sizable system the number of boards required is a significant consideration. The 18-pin, 300 mil width ceramic package of the MCM2372L helps keep the total down.

The total bond size is significantly smaller than possible with either the 600 mil wide, 24 pin MCM1173L or the 400 mil wide MCM1172. (The MCM1172L is a 22 pin version of the MCM1173L.)

Now you can choose either of the industry's most popular MOS RAMs... from your Motorola distributor. In 100-quantity, the MCM2372L — \$35.00.

Silicon Gate 1024-Bit Dynamic RAM Expands Motorola MOS Memory Line

Now, Motorola offers another of the industry's popular 1024-bit MOS Random Access Memories. The MCM2372L Silicon Gate P-MOS, fully decoded,

1024-bit by one word RAM joins the workhorse MCM1173L in Motorola's MOS line, marking the first time both the 6001 and 1103 type RAMs became

For details, circle 215

MECL 10,000 Improves Systems 10 New Ways

Motorola's high-speed, low power MECL 10,000 family has expanded again with the addition of *ten new functions!* Included are eight gates, a line receiver, and a dual latch.

MECL 10,000 uses techniques such as on-chip collector and emitter dotting to

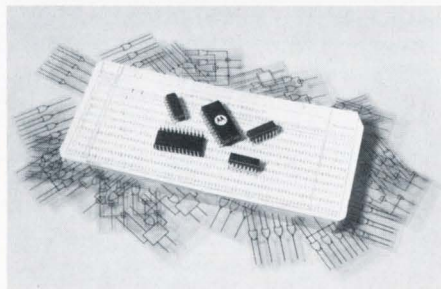

Computer functions, 2.0 ns speed, relatively slow rise and fall times and line driving capability — that's MECL 10,000.

bring you devices that perform multiple functions in virtually single-gate delays. Open emitter outputs and Hi-Z inputs let you select the optimum termination method for your system.

Of particular interest is the MC-10101 Strobed Quad OR/NOR Gate, for distributing 4 bits of parallel information on or off card. With both OR and NOR outputs available, 4 twisted-pair lines may be driven at data rates up to 100 megabits/second. Use its single strobe input to gate the data on or off in just 2 ns. And to reduce system package count just apply the MC10105 Triple 2-3-2 OR/NOR Gate. This versatile logic element typically manipulates Boolean functions in 2 ns.

The MC10115 Quad Line Receiver is recommended for MOS to MECL interfacing and for translating from MOS 1103 type memory to MECL. And the MC10117 is the first available emitter-coupled logic gate performing the powerful OR-AND/OR-AND-INVERT function — in just 2.4 ns. It's a natural for data multiplexing and data distribution.

Check the table for the function you need and call your local Motorola representative for evaluation devices today. Evaluation eliminates the alternatives!

Device Type	Description	Unit Price (100-Up)
MC10101	Strobed Quad OR/NOR Gate	\$2.00
MC10102	Quad 2-Input NOR Gate	2.00
MC10105	Triple 2-3-2 OR/NOR Gate	2.00
MC10106	Triple 4-3-3 NOR Gate	2.00
MC10107	Triple 2-Input Exclusive OR/Exclusive NOR Gate	2.50
MC10115	Quad Line Receiver	2.00
MC10117	Dual 2-Wide OR-AND/OR-AND-INVERT Gate	2.50
MC10118	Dual 2-Wide 3-Input OR-AND Gate	2.50
MC10121	4-Wide OR-AND/OR-AND-INVERT Gate	2.50
MC10130	Dual Latch	5.00

For details, circle 216



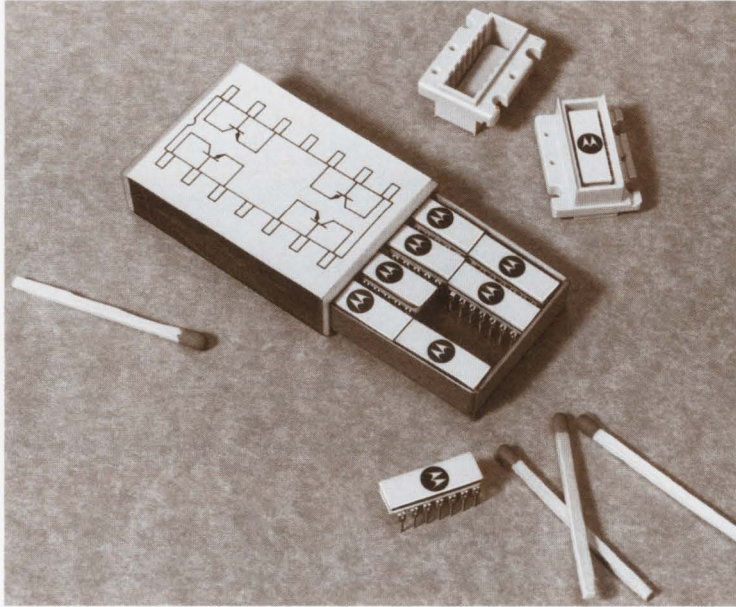

Motorola's quads nestle four silicon Annular devices in one hermetic dual in-line ceramic package to save space and weight in your challenging designs.

Quad Transistors— Match Savings In Space With Lower Assembly Costs

Benefit from quad savings!

Choose from 17 new quad transistors and extirpate your design problems!

Check the application breadth of these new introductions:

- 8 general-purpose devices
- 2 high-speed switches
- 1 memory driver

6 high-gain amplifiers and — there are more to come!

These exciting new quads house four devices in one, hermetic, TO-116 outline, dual in-line ceramic package. One that features a fine-leak rate less than 10^{-7} cc/s and is designed to permit standard PC board layout and

For details, circle 217

take advantage of automatic insertion equipment.

All 17 utilize Motorola's Annular construction that eliminates channeling in the semiconductor bulk material, a field relief electrode (equipotential ring) that stabilizes the transistor surface, and the epitaxial structure that makes ultra-high speed and low collector resistance possible. Result? Stable, reliable transistors that perform!

Quad Device #	Function	Similar to Discrete Device #	100-999 Price
MHQ2221	NPN General Purpose	2N2221	\$2.61
MHQ2222	NPN General Purpose	2N2222	2.85
MHQ2906	PNP General Purpose	2N2906	2.61
MHQ2907A	PNP General Purpose	2N2907A	2.85
MHQ3250	PNP General Purpose	2N3250	2.85
MHQ3251A	PNP General Purpose	2N3251A	3.09
MHQ2369	NPN High Speed Switch	2N2369	2.37
MHQ3546	PNP High Speed Switch	2N3546	4.60
MHQ3798	PNP Low Noise, High Gain Amp.	2N3798	3.32
MHQ3799	PNP Low Noise, High Gain Amp.	2N3799	3.66
MHQ2483	NPN Low Noise, High Gain Amp.	2N2483	3.32
MHQ2484	NPN Low Noise, High Gain Amp.	2N2484	3.66
MHQ3467	PNP Memory Driver	2N3467	3.05
MHQ6001	NPN/PNP Complementary Pair General Purpose	2N2221/2N2906	2.70
MHQ6002	NPN/PNP Complementary Pair General Purpose	2N2222/2N2907	3.04
MHQ6100	NPN/PNP Complementary Pair High Gain Amp.	2N2483/2N3798	2.70
MHQ6100A	NPN/PNP Complementary Pair High Gain Amp.	2N2484/2N3799	3.04

Six Amp Rectifier Bridges Show 200 ns Recovery Time

Encountering stubborn, high-frequency rectification design problems?

Soak them awhile in Motorola's latest problem solvent . . . 5 new molded-assembly rectifier bridges.

Designated MDA952FR-1 thru -5, the bridges are fabricated of individual, hermetically-sealed, fast-recovery rectifiers that are interconnected and encapsulated in molded assemblies. They're for use in applications requiring an output current of 6 amps and they're available in peak reverse voltage ratings of 50 to 400 V. Recovery time of 200 ns (max) provides a high operating efficiency at 250 kHz, or higher.

The new fast-recovery bridges are designed for use in high-frequency power supplies, circuit isolation and high-frequency inverter applications in both industrial and computer areas. The principal advantages provided by fast-recovery over standard devices are the reduction of power losses by improve-

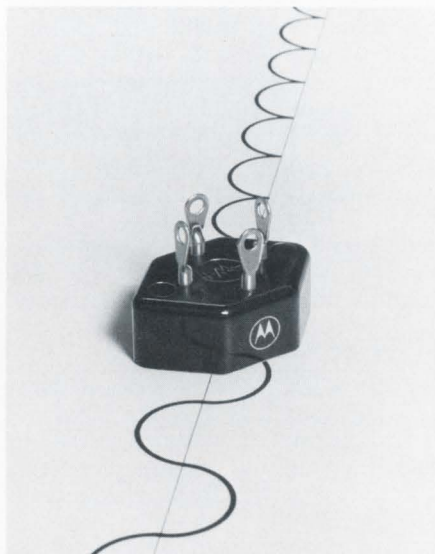

The MDA952FR series of molded-assembly bridges can rectify 6 amps of your single-phase power at peak reverse voltages up to 400.

For details, circle 218

ment in rectification efficiency, and increased switching speed.

Another advantage is the definite cost savings that come from buying the pre-assembled rectifier bridge and eliminating the time and labor you'd invest in assembling the 4 individual diodes. Then there's the fact that the hermetically sealed individual rectifier cells are again sealed *within* Motorola Case 113 that brings you a compact, corrosion-resistant assembly with readily-solderable terminals.

If you're still thinking competition in the face of these advantages, do like the MDA952FRs . . . switch fast!

MDA952FR Device	V _{RM} (wkg)	Price 100-up
-1	50	\$4.85
-2	100	5.00
-3	200	5.50
-4	300	6.00
-5	400	7.25



Now You Need All This For Reliable, Economical, Zero-Point Power Control

Glassivated Triacs With Industry-Assured Specs . . .

Glassivation — Triac technology pioneered and introduced by Motorola over two years ago — now brings you 32 full-wave Triacs that offer you the widest choice of mechanical and electrical features available . . . *plus* performance characteristics registered to standard, EIA specifications!



Motorola 2N-Triacs, for your bidirectional power control applications.

Glassivation advantages are great: sealed, passivated junctions; intimate, void-free bonds between chip and glass; high commutating dv/dt (typically 5 V/ μs). And it's standard, no-extra-cost on *all* Motorola Triacs!

Use them in your ac motor speed, light and heat controls, solid-state circuit breakers, power switches, and welders . . . and for EMI-less zero-voltage switching with the new MFC8070.

Rugged and capable up to 600 V of blocking voltage, the metal Triacs offer utmost flexibility in packaging/mounting with 3-lead, stud, pressfit and isolated stud cases, furnishing the option of mounting "hot" or isolated cathodes to the same heat sink.

4 A Triacs are available in plastic

THERMOPAD packages; 10 A units in larger THERMOPAD or metal ELF packages. THERMOPAD units assure low thermal resistance via the industry's shortest plastic-device chip-to-heat sink thermal path. Typical trigger currents range from 6 to 25 mA and holding current is 6 mA. The metal ELF provides design flexibility and mounting ease combined with ruggedness and reliability.

The 30 A Triacs have: 250 A peak surge current protection, low as 10 mA typical holding and gating currents and big power-handling capability for rugged industrial/military applications! And thermal resistance is only 1°C/W.

Triac Series	I_T (RMS) A	V_{DRM} V	I_{TSM} A	Price 100-up	Package Style
2N6068-75	4	25-600	30	\$0.56-2.10	Plastic (case 77)
2N6151-56	10	200-600	100	1.15-1.75	Plastic (case 90)
2N6139-50	10	200-600	100	1.64-2.22	3-lead, stud, isolated stud
2N6157-65	30	200-600	250	2.74-5.00	Stud, pressfit, isolated stud

For details, circle 219

Zero Voltage Switch That Eliminates Electromagnetic Interference

Some integrated circuit zero voltage switches offer premium features, but at premium prices. Others are cheap, but lack some desirable features. Motorola's new monolithic MFC8070 zero voltage switch offers the best of both worlds . . .

Now you can operate Triacs and SCRs in half or full-wave ac power control applications and forget about EMI. Use the economical MFC8070 in heater,

valve, and photo controls, on-off power controls, threshold detectors, and relay drivers, flasher controls . . . anywhere EMI-less, zero-crossing thyristor triggering is needed.

One key MFC8070 feature is a differential amplifier front end that provides two sensor inputs — the only available switch that has more than one. With the MFC8070 you can monitor a voltage band and obtain full proportional control. Another benefit is internal protection against shorted or open sensor inputs — no need for concern that a sensor will be accidentally disconnected, turning power fully on.

MFC8070 also provides built-in voltage regulation for direct ac line operations. Its peak output current is 50 mA (min) with an excellent output pulse width of 70 μs typical.

The MFC8070 is recommended for use with these 4-mode, switching triacs: 2N6151-53, 2N6139-44, 2N6148-50, and 2N6157-6165.

For economy, the unit is supplied in

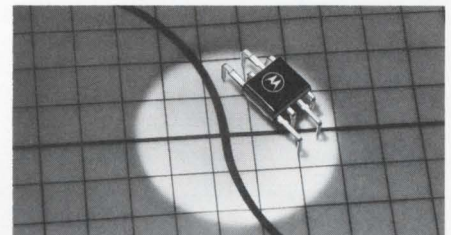

The MFC8070 is capable of triggering triacs in your ac power switching applications.

an 8-pin, staggered-lead package that will dissipate a full watt at $T_A = 25^\circ C$.

In 1000-up quantities, its price is \$1.75. Get the best of two worlds!

For details, circle 220

EPICAP Tuning Diode Series Offers Broad VHF/UHF Design Flexibility

Motorola has added a new 30-volt VVC series to its tuning diode line-up. Packaged in the low-inductance MINI-L plastic case, the new series is comprised of BB105 A, B and G silicon EPICAP diodes.

The diodes are designed for UHF and VHF tuning and AFC, as well as general frequency control and tuning applications. Their addition to the industry's broadest line provides you with an even

greater latitude of device choice and increased design flexibility.

BB105B is used in UHF tuners and other UHF and microwave applications, and the BB105A and G are primarily used as VHF and AFC diodes. This new VVC series features a typical break-down voltage of 40 V, specified minimum Q values (@ $f = 100$ MHz and $C_T = 9$ pF) of 225 for both the BB105A and B, and 150 for BB105G.

The series also displays a controlled

and uniform tuning ratio. C_3/C_{25} is typically 4.9 and min/max values are specified for each device. Where required, the capacitance of all diodes in a set or group can (on request) be matched to within $\pm 1.5\%$ or 0.1 pF, whichever is greater, along the entire specified tuning range.

Part of Motorola's high-volume, strip-line production efficiencies are passed on to you in these 1000-up prices: BB105A — 70¢, BB105B — 75¢, and BB105G — 52¢.

For details, circle 221



NEW PRODUCTS BRIEFS

N-CHANNEL J-FET OPERATES GROUNDED-GATE

— For Low Noise, Large Signal Handling

Motorola's latest silicon N-channel, junction field effect transistor — MPF820 — is a state-of-the-art device designed and specified for grounded-gate operation. In this mode, it has excellent large-signal handling capability for your low-noise RF amplifier applications. The MPF820 can provide a nearly optimum antenna match using no input tuned circuit. Stable, non-shielded RF tuners can be constructed with the new device.

The MPF820 features a low noise figure of less than 4.0 dB (max) and a high gain of 18 mmhos (typ), both measured at 100 MHz.

Encapsulated in Motorola's proven, TO-92 plastic package, the 1000-up price of MPF820 is a low 48¢. And it's in good supply. Get yours now!

For details, circle 222

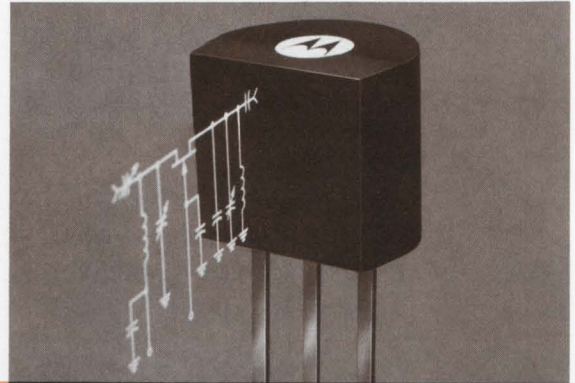

FIRST HTL NIXIE DRIVER

— MC676 Features "Glow-Free" Operation, CMOS Compatibility

Motorola is the first in the industry to offer a Nixie®-driver in high threshold logic — the MC676P, L monolithic BCD-to-Decimal Decoder/Driver.

MC676 is the industry's first high threshold logic driver — designed for use with gas-filled, cold-cathode indicator tubes and other devices requiring high-voltage drivers. The new IC offers 70 V output breakdown voltage (min) over the -30 to +75°C temperature range.

Glow-free operation is made possible principally by the MC676's high output voltage capability. Some devices can't handle the high Nixie voltage and force the tube itself to do so causing unwanted glow.

Operating from a 15-volt power supply, MC676 has an input loading factor of 1 and dissipates 380 mW (typ). Like all Motorola MHTL logic, it has a noise immunity nearly 50% of the supply voltage and is compatible with CMOS.

The new Nixie-driver is supplied in the 16-pin, plastic, dual in-line package (MC676P in case 612) for \$4.85 and in the 16-pin, dual in-line ceramic package (MC676L in Case 620) for \$7.95. Both prices are in 1000-up quantities.

®Trademark of the Burroughs Corp.

For details, circle 223

TRUTH TABLE

INPUT				OUTPUT											
D	C	B	A	9	8	7	6	5	4	3	2	1	0		
0	0	0	0	1	1	1	1	1	1	1	1	1	0		
0	0	0	1	1	1	1	1	1	1	1	1	0	1		
0	0	1	0	1	1	1	1	1	1	1	0	1	1		
0	0	1	1	1	1	1	1	1	1	0	1	1	1		
0	1	0	0	1	1	1	1	0	1	1	1	1	1		
0	1	0	1	1	1	1	1	0	1	1	1	1	1		
0	1	1	0	1	1	1	1	0	1	1	1	1	1		
0	1	1	1	1	1	1	1	0	1	1	1	1	1		
1	0	0	0	1	0	1	1	1	1	1	1	1	1		
1	0	0	1	1	0	1	1	1	1	1	1	1	1		
1	0	1	0	1	1	1	1	1	1	1	1	1	1		
1	0	1	1	1	1	1	1	1	1	1	1	1	1		
1	1	0	0	1	1	1	1	1	1	1	1	1	1		
1	1	0	1	1	1	1	1	1	1	1	1	1	1		
1	1	1	0	1	1	1	1	1	1	1	1	1	1		
1	1	1	1	1	1	1	1	1	1	1	1	1	1		

RF POWER AMPLIFIER

— Offers 100 W, 150 MHz Class C Output

28 V aircraft radio and military ECM equipment will be the better for this new RF device offering 100 W PEP @ 150 MHz and Balanced Emitter Technology construction for ruggedness. In a BET transistor many independent emitters, each with its own nichrome resistor, protect the device against destructive external factors such as load mismatch and detuning.

Packaged in the thermally-conductive, easily-mounted flange case, the new 2N6166 device provides 6 dB power gain at 100 watts power output. Opposed emitter packaging lowers lead inductance and improves broadband capability.

The new data sheet shows all the specs you need for "worst-case" designs: impedance parameters, efficiency, power-out vs. frequency, leakage, etc. Send for yours!

For details, circle 224

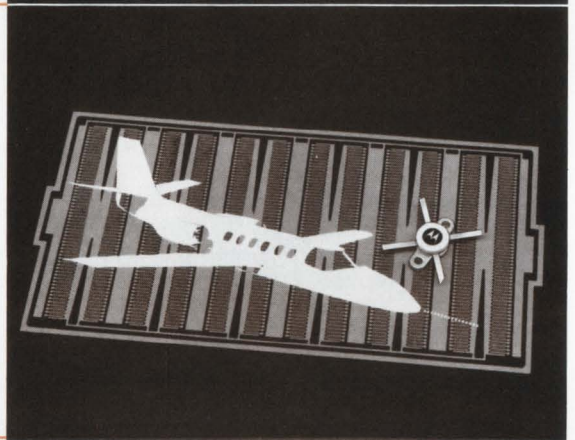

HV, HIGH SPEED SILICON POWER SWITCH

— Fast Relief From Switching Losses

Switches in microseconds . . . offers very high switching efficiency . . . performs at 325 V sustaining voltage! It's called the 2N6233-35 series silicon power device and it's available now for your high-efficiency inverter designs. In the rise and fall portions of the switching cycle where losses in efficiency normally occur, this device doesn't dally. Rise and fall times are both 0.5 μs (max.) at I_c = 1.0 A. Originally qualified for use in the Safeguard program, the family also offers 0.5 V saturation voltage for additional efficiency, 20 MHz f_T and 5 A continuous current capability. Power dissipation measures out at 50 W and h_{FE} ranges from 25 to 120 at 1 A. The series is packaged in the hermetic, space-saving TO-66 case.

For details, circle 225

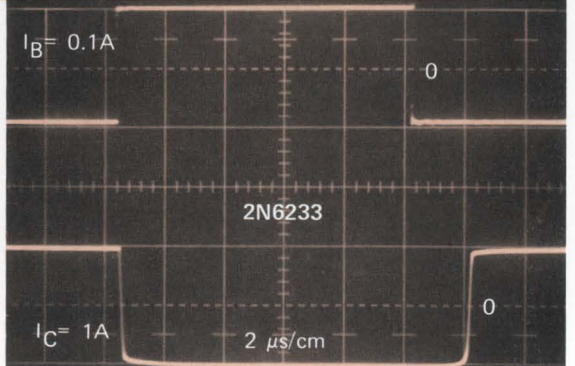

NEWS BREAKS

Microelectronics Book Gets Second Satellite – MECL Data Book Achieves Orbit

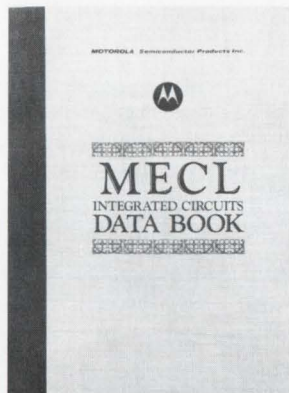

Incorporating information on all products in Motorola's emitter-coupled logic families, the MECL Data Book is successfully launched. Second in a series that will soon see data for each of Motorola's major IC product lines published under its own cover, the new book presents complete specifications, family and system characteristics and applications

information for Motorola's four series of emitter-coupled digital integrated circuits: MECL 10,000, MECL III MC1600, MECL II MC1000/MC1200, and MECL MC300/MC350.

The MECL Data Book is tabbed for quick access to the section of interest. Each section includes full specific information on all currently available devices in a logic series plus general family characteristics such as propagation delay, fan-out, current drain and operating frequency. Helpful system design data is given including: power dissipation, worst-case noise margin, trade-off in characteristics for variation in temperature and supply voltage, clock distribution and system layout rules.

Designers involved in TTL systems will find the recently published MTTL Data Book just as helpful as its MECL counterpart. Keep the product information in your technical library complete and up-to-date. Use the handy order form to obtain your copies of these useful books.

2N404/A PNP Germanium Switching Transistor Now JAN-Qualified

The rugged and dependable 2N404/A – popular PNP Germanium switching transistors, with the proven reliability of the Motorola Mesa system of manufacturing germanium products – have received JAN qualification under MIL-S-19500/20C.

Designed for medium-speed saturated switching principally in military computer, and telephone applications, the JAN2N404/A feature a low collector-emitter saturation voltage of 0.2 Vdc (max) @ $I_C = 24$ mAdc, and high emitter-base breakdown voltages of 12 Vdc (min) for the JAN2N404 and 25 Vdc (min) for the JAN2N404A, both @ $I_E = 20$ μ Adc.

Compared to alloy devices, JAN2N404/A offer more stable betas and lower leakages, plus greater mechanical strength (due to bonding the die to the header). The devices are packaged in the TO-5 metal can. (Corresponding "MM" commercial versions – the MM404 and MM404A – are available in the smaller, space-saving TO-18 package.) 100-up prices are only 29¢ for JAN2N404 and 45¢ for JAN2N404A.

For details, circle 226

Please PRINT clearly (To expedite your literature we may have to use this as return mailing address)

NAME _____

TITLE _____

COMPANY NAME _____

DIVISION _____

DEPARTMENT _____

COMPANY ADDRESS (Street or P. O. Box) _____

CITY _____

STATE _____ ZIP CODE _____

Please circle the Reader Service number of item(s) you are interested in receiving from NEWSBRIEFS No. 13-71.

ED					
211	212	213	214	215	216
217	218	219	220	221	222
223	224	225	226	227	228

List Application Notes you wish to receive below (by number):

Do you wish a Motorola Representative to contact you?

VISIT PHONE

Phone No. _____ Area Code _____

NOTICE: Requests for literature on items described in this publication cannot be honored after Jan. 1, 1972.

Tear Along Perforated Line

DATA BOOKS ORDERING COUPON

MECL DATA BOOK	
Single Copy @ \$2.00 ea.	\$
2-24 copies @ \$1.50 ea.	\$
25-up copies @ \$1.25 ea.	\$
MTTL DATA BOOK	
Single copy @ \$2.50 ea.	\$
2-24 copies @ \$2.00 ea.	\$
25-up copies @ \$1.75 ea.	\$
Total	\$

Fill in your name and address on the other side of this coupon. Tear along perforated lines and enclose in envelope with proper remittance.



FOLD HERE

FIRST CLASS
Permit No. 2565
PHOENIX
ARIZONA

BUSINESS REPLY MAIL
NO POSTAGE NECESSARY IF MAILED IN UNITED STATES

POSTAGE WILL BE PAID BY

Semiconductor NEWSBRIEFS No. 13-71
Motorola Semiconductor Products Inc.
P. O. Box 20924
Phoenix, Arizona 85036

FOLD HERE

SEMICONDUCTOR NEWSBRIEFS

Motorola Semiconductor Products Inc., P. O. Box 20924, Phoenix, Arizona 85036

The circuitry shown external to Motorola products is for illustration purposes only, and Motorola does not assume any responsibility for its use or warrant its performance or that it is free from patent infringement.

The information and prices in this issue are believed to be accurate and correct at the time of publication. However, they are subject to change without notice at any time by Motorola.

CMOS, MECL, M TTL, MHTL, Thermopad, ELF, EpiBase, EPICAP, MINI-L, BET and MICRO-H are trademarks of Motorola Inc. Annular semiconductors are patented by Motorola Inc.

©Motorola Inc. 1971

SEAL HERE
(Please use tape — do not staple)

ORDER COUPON

Be sure to fill out both sides of this coupon, tear along perforated edge, and mail in envelope with check, money-order, or purchase-order (*) to:

Motorola Semiconductor Products Inc.
P. O. Box 20924
Phoenix, Arizona 85036

Note: (*)P.O.'s for less than \$20.00 cannot be accepted. Make checks or money-orders payable to: Motorola Inc.

NAME _____
TITLE _____
COMPANY _____
ADDRESS _____
CITY _____
STATE _____ ZIP CODE _____



NEWS BREAKS

Prices Slashed From 25 To 60% On Current-Limiter Diodes!

As Motorola's production efficiencies go up, prices on its entire 37-device line of current-limiter diodes come down!

Price cuts affecting the thirty-two 600 mW devices of the 1N5283 thru 1N5314 series average between 25 to 50% off regular prices. The series holds current constant up to 100 V and provides current from 0.22 to 4.7 mA at $\pm 10\%$ tolerance.

The new prices listed for the 5-device MCL1300 thru MCL1304 series represent savings up to 60% off the old prices. The series provides currents of 0.5 ± 3.0 mA and 1.0, 2.0, 3.0 and 4.0 mA at ± 0.6 mA respectively with voltages up to 75 V.

Current-Regulator Diode Prices

Device Nos.	1-24		25-99		100-999	
	Price NEW	Price (OLD)	Price NEW	Price (OLD)	Price NEW	Price (OLD)
1N5283 thru 1N5286	\$3.30	(4.45)	\$2.80	(3.90)	\$2.20	(2.95)
1N5287 thru 1N5310	\$2.30	(4.45)	\$2.05	(3.90)	\$1.55	(2.95)
1N5311 thru 1N5314	\$3.30	(4.45)	\$2.80	(3.90)	\$2.20	(2.95)
MCL1300 thru MCL1304	\$1.80	(4.45)	\$1.60	(3.90)	\$1.20	(2.95)

For details, circle 227

120 Zener Chips Now Available

Motorola is making 120 silicon zener diode chips available as "standards." The devices are for use in compact and high performance circuits that are beyond the present state of monolithic production capability — in a word — hybrids.

Standard chip size is 25 mils square with an aluminum anode and gold backing. Larger chips (60, 90 and 120 mils square) with different metalization to handle higher power requirements are available on special order.

All chips are available in $\pm 10\%$ and $\pm 5\%$ tolerance and feature silicon-oxide passivated junctions that provide greater reliability than devices that are subject to contamination from exposed junctions. They are compatible with all standard wire and die bonding techniques used in hybrid circuits.

These zener chips are available for a wide voltage range — from 2.4 through 200 volts in the "A," or high-level series, and from 1.8 to 200 volts in the "B," or low-level series. Limits on four electrical parameters are assured by testing.

The 100-up prices for the MZC2.4A10 thru MAC-200A10 high-level series range from only \$1.26 to 2.00 and, for the MZC1.8B10 thru MZC200B10 low-level series, from \$1.20 to 2.30.

For details, circle 228

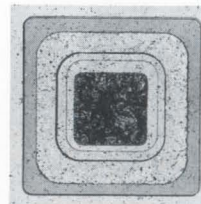

For built-in reliability, design with "Scotchflex" Flat Cable/Connector Systems.

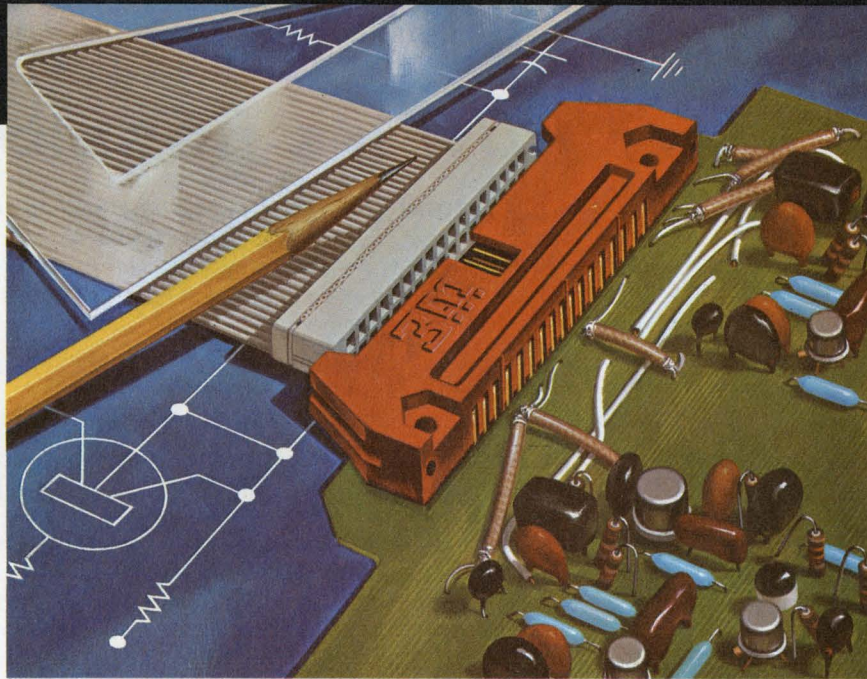

"SCOTCHFLEX" IS A REGISTERED TRADEMARK OF 3M CO.

"Scotchflex" Flat Cable and Connectors can offer you trouble-free packaging for your next generation equipment.

There's built-in reliability for your circuit inter-connects. Our flat, flexible PVC Cable has up to 50 precisely spaced conductors. The gold plated U-contacts are set into a plastic body to provide positive alignment. They strip through the insulation, capture the conductor, and provide a gas-tight pressure connection.

Assembly cost reductions are built-in, too. "Scotchflex" Connectors make up to 50 simultaneous connections without stripping or soldering. No special training or

costly assembly equipment is needed.

Off-the-shelf stock offers you flat cable in a choice of lengths and number of conductors from 14 to 50. Connector models interface with standard DIP sockets, wrap posts on .100 x .100 in. grid, or printed circuit boards. Headers are available to provide a de-pluggable inter-connection between cable jumpers and printed circuit boards (as shown). Custom assemblies are also available on request.

For full information on the "Scotchflex" systems approach to circuitry, write to Dept. EAH-1, 3M Center, St. Paul, Minn. 55101.

3M
COMPANY

INFORMATION RETRIEVAL NUMBER 12

PANEL DISPLAY IT

now it's possible

We've done the hard work— by making the first commercially available panel display subsystem for use in your application. Burroughs new SELF-SCAN panel display subsystem provides 256-character alphanumeric panel display capabilities and all necessary electronics — *drivers, memory, timing and character generation* — in a compact module.

And because SELF-SCAN panel display technology reduces electronics by 90% and cuts display thickness to less than 1½ inch, you get unprecedented flexibility and cost advantages for display applications.

The easily-read characters used in this unit are formed of dots on .040" centers, with eight 32-character rows in a 5 x 7 dot matrix format.

Application versatility is designed-in with options including visual cursor, tab controls and expanded memory capability. The 256-character unit shown is available for off-the-shelf delivery; 64- and 128-character subsystems available soon. Units with only display and driver electronics are also available. Write or call for additional information:

Burroughs Corporation, Electronic Components Division, Box 1226, Plainfield, N. J. 07061 (201) 757-3400.

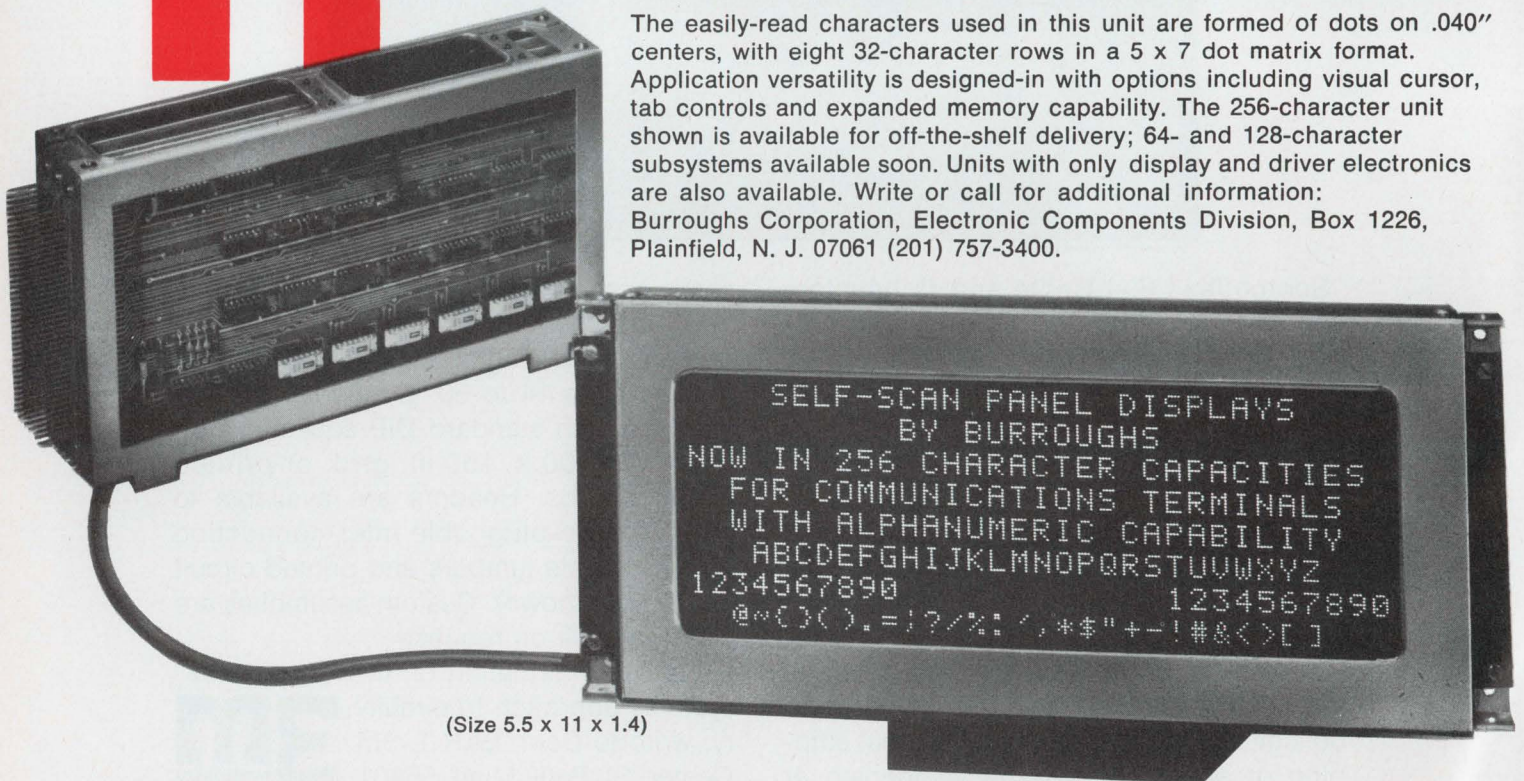

(Size 5.5 x 11 x 1.4)

256-Character **SELF-SCAN™** Panel Display Subsystems

Burroughs



Space shuttle may use off-the-shelf electronics

Off-the-shelf electronics may claim a significant portion of the package on board U. S. space shuttles. This includes electronic systems for such functions as guidance, flight control, communications, data management and electric power.

The feasibility of using off-the-shelf equipment is being examined by the Boeing-Grumman team in line with efforts to design a low-cost version of a two-stage space shuttle. The over-all plan calls for modifying existing Saturn 5 boosters by attaching a wing, 10 air-breathing engines, landing gear and a two-man cockpit for flying the rocket back to earth. The vehicle that is to be placed in orbit would ride piggy-back on the booster.

The timetable calls for expected NASA approval by July 1, 1972, of the final shuttle design, horizontal flight by February, 1976, and orbital flight by June, 1977. All shuttle contractors are to submit their "low-cost shuttle" studies to NASA by Oct. 31.

According to Fred Raymes, Grumman's assistant program director for the space shuttle, Boeing and Grumman are examining a combination of off-the-shelf and military electronics for the shuttle vehicles, while RCA studies existing Apollo and other space equipment and GE a mixed off-the-shelf and Apollo package. Flexibility to graft on future improvements in off-the-shelf equipment is also being considered.

"We are trying to take advantage of less rigorous specifications the commercial world seems able to live with," Raymes says.

"We are now talking about hardwiring the orbiter in much the same way as any other airplane is wired," he adds.

One possibility Raymes mentions is the use of the Carousel 4 pack-

age, developed for Pan Am's 747 jumbo jets by AC Electronics. Other jumbo-jet systems are also being examined.

Savings to the over-all program could be huge. While earlier studies called for \$800-million to a \$1-billion in avionics costs, "we are now talking about something like \$200-million to \$300-million," Raymes says.

The program Grumman is now embarked upon calls for a phased improvement in engine and avionics using Apollo, off-the-shelf and military aircraft equipment "in a particularly clever combination," according to Raymes.

Though this design approach will mean a slower turn-around in shuttle flights, because of more complex ground check-out, it is expected to conform to flight frequencies anticipated during the early phases of the program. It would allow for one shuttle flight a month, instead of one every two weeks, as NASA would like.

New logic gates need 1 picojoule to switch

A new integrated-circuit fabrication technique produces logic gates that require only 1 picojoule to switch. This value approaches the energy used by the neurons of the brain.

Invented by scientists of Philips Research Laboratories, Eindhoven, the Netherlands, the IC logic is called "integrated injection logic" (I²L). The technique eliminates the limiting resistors usually used in series with the transistor's voltage supply. In place of the resistors, the I²L system inserts a series diode, integral with each transistor.

Application of the supply voltage causes the diode to inject charge carriers into the transistors, thus

lowering the required switching energy. Heat dissipation is substantially lowered because no resistors are used. Also, more space is made available on the chip, and higher circuit-packing density can be obtained.

With a conventional T²L gate circuit, an energy of 20 picojoules per logical operation is needed. But with the I²L version, only 1 picojoule is required, Philips says. Brain cells, it adds, require about 0.2 picojoule.

The I²L technique has made it possible to integrate more than 1000 gates on a single chip, with substantially higher numbers a real possibility. Because of the much lower power requirements, the circuit is attractive for battery-operated devices.

Operating speed is dependent on supply voltage: the higher the voltage the faster the switching.

Rise in R&D spending trails growth of GNP

"During the last 5 years, the real growth of R&D spending in the U. S. has been three tenths of one percent, per year. When compared to the 4-5 percent annual growth in gross national product, this means that the U. S. is spending a smaller and smaller part of its total resources on R&D each year."

This warning was issued to the electronics industry by Professor Murray L. Weidenbaum of Washington University in St. Louis, Mo., President Nixon's former assistant secretary of the Treasury. He sounded his warning to industry executives gathered at the EIA fall conference in Los Angeles earlier this month.

Weidenbaum pointed out that for the first time in many years the military budget is shifting its emphasis away from R&D and towards greater expenditures for personnel. On the brighter side, he noted that the R&D portion of the budget alone places greater stress on the larger systems activities like shipbuilding and less on developing small arms.

One way to increase R&D spending, according to Professor Weidenbaum, would be to institute a tax structure that would encourage company-funded research. Without

it, Weidenbaum said, the amount to be spent on R&D would stay constant over the next few years, while the buying power of these dollars is eaten away by inflation.

Automatic controls run entire railroad line

The Richmond, Fredericksburg and Potomac is about to become the first railroad automatically controlled along its entire length from a single traffic-control center. According to The National Cash Register Co., the system will be capable of locating any freight shipment instantly.

The heart of the new system, which is to go on-line by the end of the year, is an NCR Century 200 computer.

Engineer job study finds electronics hit hardest

The results of a survey by the Engineers Joint Council in New York City confirm what most engineers have known for some time—there's a national engineering unemployment problem. The survey reveals that the depressed job market in 1970-71 has created an "unemployment problem rate" for electronics engineers of 7.7%—nearly 60% higher than for engineers in general.

The term "employment problem rate" was used by the council in preference to the more familiar "unemployment rate" used by the United States Dept. of Labor because it was considered a more accurate indication. A laid-off engineer working temporarily in a non-engineering job—such as driving a taxi—would be considered employed in the government statistics, whereas the Engineers Joint Council would consider him clearly part of the employment problem.

The council's figures were obtained by querying one-fifth of the 500,000 members of 23 major engineering societies, representing all fields of engineering. The survey, conducted last summer for the National Science Foundation, was completed in August and the results have just been released by the foundation.

The survey reveals that of every

1000 engineers in the "employment problem" category, 678 were out of work, 119 were doing part-time engineering work while seeking full-time employment, and 203 were working in nonengineering jobs.

According to the survey, engineering unemployment almost doubled between March, 1970 and June, 1971. This compares with an increase of about 27% in total national unemployment over the same period.

The depressed job market has not affected all electronics engineers equally, however. For example, the survey reveals the following:

- Graduates whose highest degrees were in nonengineering curricula were 49% more likely to have employment problems than those with their highest degrees in engineering.

- Self-employed engineers and those in educational and nonprofit institutions had a "problem" rate that was four times higher than Government workers.

- Engineers under 30 and over 55 had the highest rates of unemployment.

A shift in FCC policy on cable vs satellite?

A closed-door meeting in Washington between European, Canadian, U. S. Government and communications industry representatives has ended amid speculation that the Federal Communications Commission may be ready to ease its 5-to-1 ratio policy with respect to cable and satellite communications. The federal agency favors five satellite circuits for each cable circuit until the traffic-carrying capabilities of both are equal. European communications leaders lean toward cable communications.

Laser safety standard disputed by industry

A proposed safety standard for lasers that would limit the maximum permissible exposure to 40 μ W instead of the present 5 mW has come under fire from the laser industry as unrealistic and arbitrary.

The new standard was proposed by the Z136 Laser Safety Committee of the American National Standards Institute, New York, in a draft circulated to committee members. It would, according to C. Harry Knowles, president of Metrologic, Inc., Bellmawr, N. J., one of the largest manufacturers of low-power, helium-neon lasers, eliminate 95% of present applications.

While the industry interprets 40- μ W power level as a limit on the radiation of the laser itself, George Wilkening, general chairman of the Z136 ANSI committee and head of the Environmental Health and Safety Dept. at Bell Telephone Laboratories, Murray Hill, N. J., says the figure is for levels at the eye's cornea and not the laser outputs. The level is based, he explains, on on-site and worst-case viewing.

The ANSI committee, Wilkerson notes, welcomes any new factual data, from manufacturers and users, that will allow it to evaluate the relationship between the levels at the cornea and incidental radiation levels from lasers. The ANSI proposed standard, he says, was derived from a review of studies made with animals.

Allen M. Wilson, manager of the Electronic Industries Association Engineering Dept., says that scientifically it is impossible to draw the conclusion that ANSI did about hazardous radiation from papers submitted by ANSI as evidence.

"In fact," he adds, "the scientific and biomedical community are not in very good agreement as to what levels are hazardous. Our position is that we are proposing that the current 5-mW standard be continued for lasers emitting only incidental radiation."

A spokesman for the U. S. Bureau of Radiological Health—Richard Peterson, chief of the Electro-Optical Section in the Radiation Measurements and Calibration Branch—agrees that there is a lack of proof for the derivation of safe laser output levels, not only by the ANSI committee but also by a number of other sources that the bureau is examining for guidance. As a result, he says, the bureau can't use any of the levels as final, "because we're not sure what references were used and what were not."

GE WILL BEND FOR YOU!

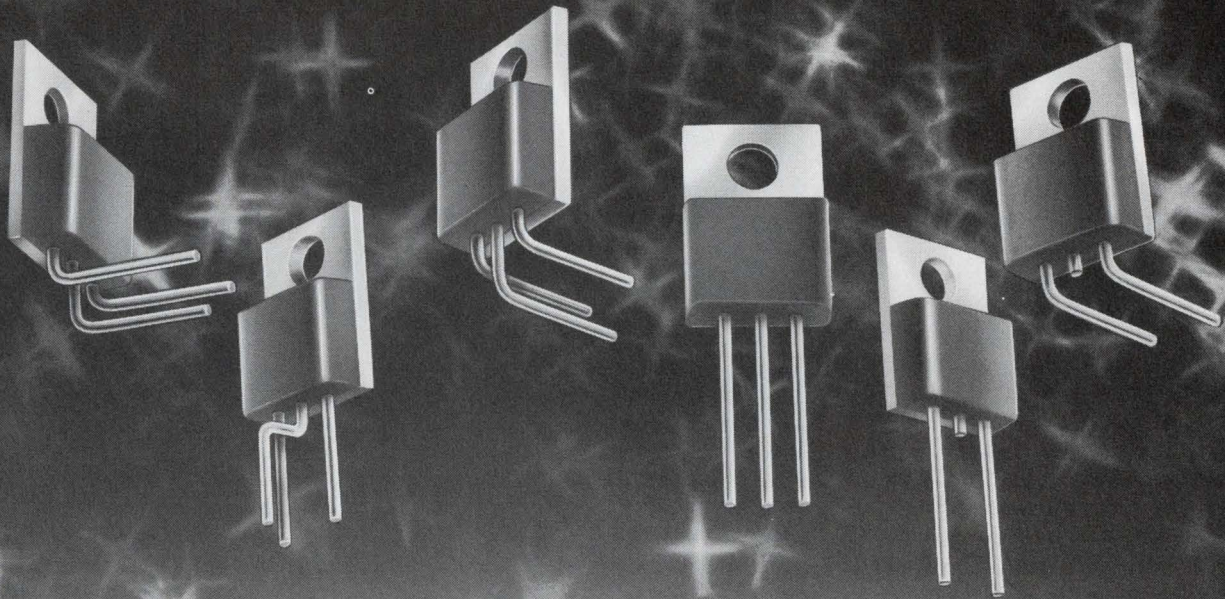







Now you can have performance, stability and a choice of six different lead configurations with GE's **POWER-GLAS** C122 silicone encapsulated SCRs. General Electric makes your mounting procedures simpler by factory forming the C122 round leads to match six standard configurations. The C122 also features a tab mounting hole that permits torque limit free mounting, thus eliminating possible pellet damage associated with center-mounting-hole packages. The 8 ampere C122 is available in 50 to 500 volt types. These features, plus the stability achieved by **POWER-GLAS**

passivation, make the C122 the best value in plastic packaged SCRs. Standard 200V versions in 1000 lot quantities cost 85¢ each.

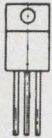
GE offers the industry's broadest line of SCRs, Triacs and Triggers designed for all applications. Contact your local authorized GE distributor for complete information on GE's **POWER-GLAS** SCR and Triac products.

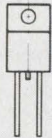
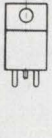
GE'S POWER-GLAS MEANS IMPROVED PERFORMANCE AND RELIABILITY FOR YOU.

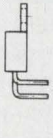
GENERAL  ELECTRIC

BASIC TYPES		TO-66 EQUIVALENT		PRINTED CIRCUIT BOARD TYPES			
							

Defects in medical electronics draw heavy fire from hospitals.

The promise of a medical electronics market that could easily exceed a half billion dollars by 1975 is being threatened by what appears to be widespread customer dissatisfaction. Unreliable and defective equipment is being delivered to hospitals at such an alarming rate that at least one institution refuses to accept any manufacturer's equipment unless the company's quality-control officer is present to inspect it.

The problem has become acute in recent years because of the increasing electronics being used by hospitals as part of their patient-monitoring systems and also because there is a lack of trained personnel to operate and maintain the sophisticated hardware.

Most hospital users believe that manufacturers must perform a far wider role in producing simple, reliable and largely fail-safe equipment. Otherwise the widespread use of medical devices in the quantities projected under Government-sponsored health-care programs may remain illusory.

These facts have emerged from an ELECTRONIC DESIGN spot check in which extended interviews were conducted with a sampling of hospitals, including one where an engineer tested thousands of pieces of electronic equipment and developed a valid set of statistics.

Asked to comment on the findings, major manufacturers of hospital equipment stressed these points: It's difficult to get specifications for medical equipment; there is a lack of communication between doctors and engineers. There also are huge gaps in hospital maintenance procedures, and



Intense activity is a common sight during open-heart surgery; electronic equipment is the last thing doctors and nurses want to worry about. The equipment should be simple and dependable to meet the hospital's needs.

equipment is subject to abuse. And, possibly of prime importance, the medical electronics industry is young and still learning; lapses in technique are unavoidable sometimes.

The Electronic Industries Association emphasized: "Nobody makes schlock equipment on purpose."

Erosion of confidence

ELECTRONIC DESIGN's spot check found that gross failures of equipment that have in the past resulted in patient death and sometimes received much publicity still occur. But in addition there appears to be a subtle nibbling away of confidence in the manufacturer's ability to control the quality of his merchandise.

Here are examples of defects in shipments of electronic equipment arriving at hospitals, as reported to this magazine:

- Of five oscilloscope displays, one was dead on arrival with a defective high-voltage power source. It was taken back by the manufacturer.

- Of five electrocardiograph modules, one was defective because of a high-noise amplifier at the input stage. A transistor had to be replaced by the manufacturer.

- Two out of five arterial pressure transducers did not work on delivery.

- After eight months of service, 18 portable electrocardiograph oscilloscope displays with defective battery packs were taken back by the manufacturer.

Michael P. London
News Editor

■ Of 10 defibrillators, all were defective and one was capable of discharging high voltage into a patient before the physician was ready. Such a shock can lead to fibrillation, where the heart convulses without beating. Both physician and patient could have died.

■ An attenuating switch in the carrier amplifier of a venous pressure monitor was set in the wrong position at the factory and misread by a factor of 10 in the hospital. This resulted in an erroneous reading that contributed to a patient's death.

Dr. Seymour Ben-Zvi, an electrical engineer who is director of scientific and medical instrumentation at the Downstate Medical Center in Brooklyn, N. Y., said his department performed acceptance testing on several thousands of pieces of equipment when the hospital opened over four years ago, and so it was able to develop a set of valid statistics.

"About 40% of the equipment then tested was defective," Ben-Zvi says. "Either it did not meet the manufacturer's performance specifications or it was unsafe for use on patients or by physicians and other medical personnel."

As for equipment received more recently, primarily for use in Downstate's intensive-care and coronary-care areas, Ben-Zvi says: "There are still large numbers of instruments that come in defective, following the same defect patterns we found earlier."

At Roosevelt Hospital in New York City, Ronald Connors, director of medical electronics, has had much the same experience. He believes that "one must assume there will always be defective equipment in any reasonably sized shipment of electronics."

A significant percentage of the equipment has either not been put through quality controls or has incurred some kind of defect in shipping, Connors reports.

Henry S. Littleboy, technical director of the Medical Engineering Group at Massachusetts General Hospital in Boston agrees.

"We have," he says, "on the order of 50% defects that have to be corrected by the manufacturer. Many of the problems are obviously involved in shipping."

But in defense of the manufac-

turers, Littleboy says medical equipment isn't much different from commercial electronic equipment. "Half the commercial electronics must be considered defective, too," he asserts, "if one is going to require that it meet the specifications, as printed."

Littleboy also believes that there is too much special ordering in medical electronics. "The manufacturers are often producing a one-of-a-kind thing, and it is therefore difficult for them to get bugs out of a particular design," he notes.

'Good' and 'bad' manufacturers

One of the more outspoken critics is Arnold St. J. Lee, director of the Dept. of Electronics and Instrumentation at the Columbia Presbyterian Medical Center in New York City. His system for buying electronics equipment is blunt—and apt to be controversial for that reason. There are "good" and "bad" manufacturers, he contends. Those that are good are very good, but those that are bad are likely to be atrocious. Lee keeps score on the performance of equipment and tells his hospital not to buy from companies on his "bad" list.

His qualifications as a judge are impressive. He started in the business in 1940 with a degree in medical physics and is a working electronics and mechanical engineer who consults for Litton and other large companies.

Lee says that the Columbia Presbyterian Medical Center has nowhere near the 40% and 50% defect figures given by other hospitals. "We buy equipment that is pretty good from the start," he says.

Liberal in both his praise and condemnation of manufacturers, Lee plucks two names from his "good" list and says: "When we buy from Hewlett-Packard and Tektronix, the equipment is usually perfect. The equipment works well for long periods of time, and if there is anything wrong with it, the company takes care of it quickly."

But manufacturers on the "bad" list draw comments like these: "We have stuff from [a major manufacturer] that is so bad that we will not buy there any more.

"We also have [another manufacturer's] equipment that is so poorly designed and badly made that I withdrew it from service and wouldn't allow it to be here."

Lee is unhappy, for example, with American Optical defibrillators "that were designed so that one side of the output is actually ground." He does not like Electrodyne monitoring equipment because it "has such an enormous number of controls on the front that it is far too complicated for hospital personnel to use—and the interior is wired like a rat's nest, the way television sets used to be made in the early days."

At the Electrodyne Div. of Becton-Dickinson in Sharon, Mass., the company's president, Allan Belgard, responds to the latter charge:

"It's important to determine the origin of the instrument. I would agree with the statement for instruments made by us between 1955 and 1960, which were vacuum-tube models, and they were hand-wired like an old television set and had 50 million knobs on the front, because doctors wanted 50 million things. But we all learned a lot in the meantime. Our instruments have been solid-state for over eight years, and they employ all printed-circuit boards, so that [Lee has] got to be talking about something that's over eight years old.

"Also, since the equipment was redesigned about eight years ago, there are practically no controls on the front. Most of the stuff today is automated, and where controls are required, they are behind sliding panels. So that for all purposes it's got to be one of the simplest instruments on the market."

Lee recalls that one manufacturer "wanted to sell us a combined defibrillator-monitor that has a ground wire going to the patient, at least according to the wiring diagram; we won't allow something like that into our hospital."

On transducers, he says that Statham strain gauges are "absolutely perfect and reliable—much better than their own specifications as to linearity and accuracy—and they last for years and years." But transducers from Harvard Apparatus, he adds, "showed so much drift and were so sensitive that

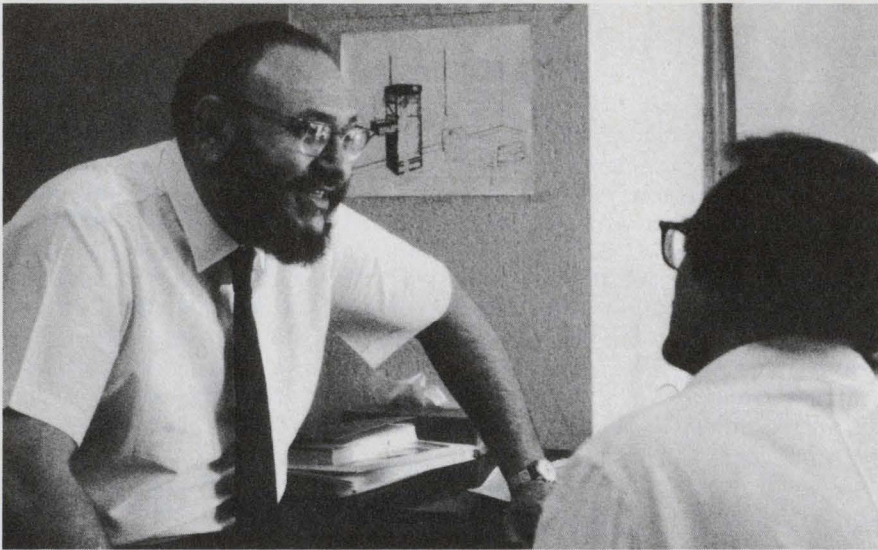

Arnold St. J. Lee at Columbia Presbyterian Medical Center says he holds defects down by keeping offending manufacturers out of the hospital.

output varied when you put pressure on the case."

Tibor Foldvari, vice president of the Harvard Apparatus Co., Millis, Mass., replies that Lee must be referring to the company's original versions of the transducer.

"We have made two runs with this transducer so far," Foldvari reports. The first was made with Noryl, a General Electric thermoplastic material. But later units are made with a glass-filled version of this plastic, which has a much higher dimensional stability.

"Because the transducer is a capacitive device it is, of course, sensitive to any motion of the housing. Having an unfilled plastic housing makes it possible to clasp the transducer so tight that you can shift the position of the capacitor bridge inside. This effect, however, is much diminished in the glass-filled Noryl version."

Quality control criticized

Most hospital users appear to believe that the manufacturers quality control is the source of most trouble, albeit more safety-conscious design could help eliminate problems at an earlier stage. At the Downstate Medical Center Ben-Zvi believes that "many of the defects are attributable to quality control, improper testing and design defects," and that many others relate "to the manufacturers not fully understanding the conditions under which medical electronics instruments are used on a daily

basis within the hospital."

Connors says that Roosevelt Hospital's experience suggests that "equipment coming in, sometimes dead on arrival, has either not been checked at all prior to shipping, or if it has, the check has been superficial and not really representative of its proper operating circumstances."

The problem is considered so serious at Roosevelt that new equipment is not accepted unless quality-control personnel from the manufacturer are present to receive it.

Littleboy's group at Massachusetts General Hospital does the checking to see that all equipment passes both the hospital's and the manufacturer's specs. It then does "stress testing."

"We make certain that defibrillators, for example, can continually perform over a period of time—not simply once—by dumping the load five or six times," Littleboy says. "A defibrillator is often used many times, under pressure, since one shock doesn't always resuscitate a patient. Unfortunately many times the manufacturer will test them, but not under repeated use."

When equipment does arrive faulty, there is no set pattern of defects. Murphy's Law appears to be operating. Components, for example, are apparently not fully checked before they are used in medical devices. Meter relays, for readout and displays of heart rate and arterial pressure, have been

criticized for high failure rate; replacement is expensive and requires maintenance personnel to dismantle the equipment completely before it is accessible. Arterial and venous pressure transducers have been found with defective arms that can produce pressure measurements as much as 50% off from true.

Connors showed how a defective blood-pressure transducer, used with the manufacturer's calibration, appeared as though it were reading correctly when, in fact, both the transducer and the calibration were wrong. His department at Roosevelt Hospital therefore always runs a water manometer check of new transducers, to establish an external calibration, before the unit is placed in service.

"In no case," Connors says, "do we rely on the internal calibrations provided by the manufacturer. Our experience has shown that these are more often incorrect than correct."

Circuit defects are also common. Ben-Zvi reports one instance in which a heart-rate monitor displayed large errors in rate because of a faulty circuit. This was later modified by the manufacturer.

Connors believes that the biggest failure in design, apart from the reliability problem, is the complexity of systems in use today.

"The general tone of the medical community," he says, "suggests that there should be more emphasis on simplicity. Steps should be taken to eliminate such things as gain controls and calibration buttons, which, to naive medical personnel, are complex and require the intervention of highly skilled technicians."

One thing is certain: Complaints about poor hospital electronics are not a recent development. Last year the Michigan Association for Regional Medical Programs investigated medical equipment in 12 hospitals around the Detroit area. The survey turned up such statistics as these:

- 40 of 79 electrocardiograph monitors tested for vertical gain were found inadequate.

- 47% of the monitors had current leakage exceeding 10 μ A and over 10% exceeded 50 μ A; 10 μ A is the recommended maximum.

- Defective components or wiring were found in 21% of the monitors examined.

Pretty much the same results

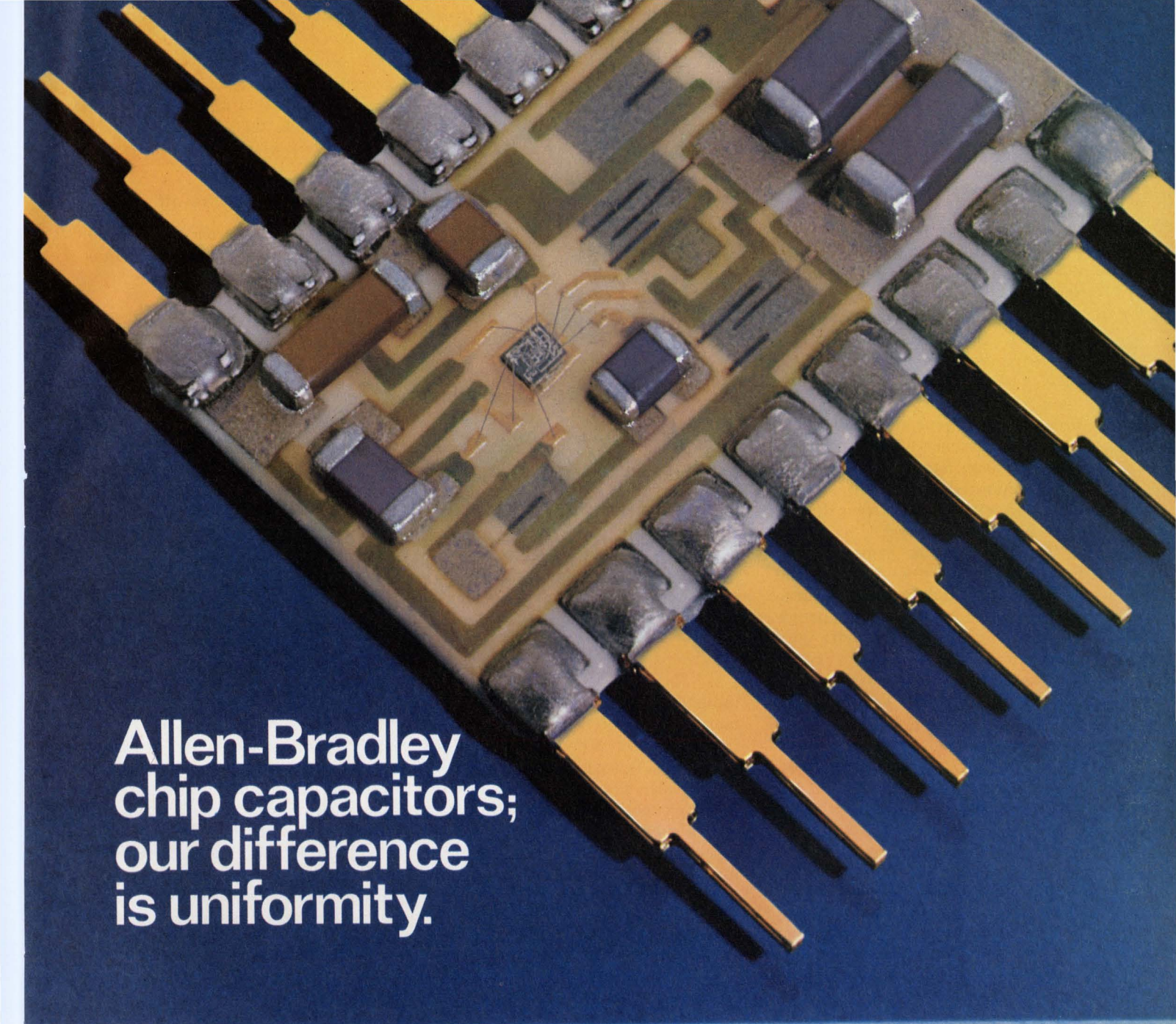

Allen-Bradley chip capacitors; our difference is uniformity.

Now you don't have to put up with a lot of production line problems to capitalize on the advantages of ceramic chip capacitors. We've developed a manufacturing process (different from any other in the industry) that makes our capacitor chips far more uniform. You profit from more stable chip-to-chip performance. Your production control becomes far easier because

we've found the answer to traditional product variables. But that's not all. In our unique manufacturing process, ceramic dielectric and noble metal electrodes are fired into a truly monolithic structure. Mechanically stronger. Virtually void-free. Moisture and contamination resistant. And our multi-layer terminations solve a variety of attachment problems. Standards

available in 50, 100 and 200 Vdc with no derating from -55°C to $+125^{\circ}\text{C}$. Capacitance from 10pF to $1\mu\text{F}$. NPO, stable, semi-stable and Hi-K. Specials available. See your A-B electronics distributor for selected sizes and values. Write for Bulletin 5415. Allen-Bradley, Electronics Division, Milwaukee, WI 53204. Export: Bloomfield, N.J. 07003. In Canada: Galt, Ontario.



NEW DIMENSION ELECTRONICS
ALLEN-BRADLEY



were found among the heart pacers and defibrillators tested.

Hospitals sometimes to blame

Is it always the manufacturer's fault when equipment breaks down or operates inaccurately?

Even so outspoken a critic as Columbia Presbyterian's Lee warns that very often the hospital may be responsible for breaking the sensitive transducers by putting excessive pressure on them. "If you take a small syringe," he notes, "you can easily produce 500 psi pressure with your thumb."

And, in defense of the industry, John Sodolski, staff vice president for communications and industrial electronics in the Electronic Industries Association, says:

"I think that the center of the problem is that the demand, the requirements and the marketplace really haven't shaken down enough so that anybody knows with any specificity what it is he's going to be making for the next year or two. Manufacturers are probably puzzled as to what it is that's going to move in the market well. Nobody is making schlock equipment on purpose."

Edgar Meyer, general manager of American Optical's Medical Div. in Bedford, Mass., notes:

"We design our equipment for the unique requirements of a hospital environment and take into account the fact that hospital personnel are not electrical engineers. Responsible members of the industrial community are constantly working with hospital and medical personnel to make our product more useful and reliable. We do realize, however, that with all of these precautions, we are not perfect. But perfection is our aim."

The fact that the industry is still learning is acknowledged by one of the largest medical-device manufacturers, Hewlett-Packard in Waltham, Mass. John Post, manager of marketing support for HP, says:

"Most companies understand that they are in the medical business, and they are concerned about the reliability and quality of their product. But you must remember that this is a growing industry, and competition is coming in from other fields. There are always new engineers who don't fully understand the business. I think as the

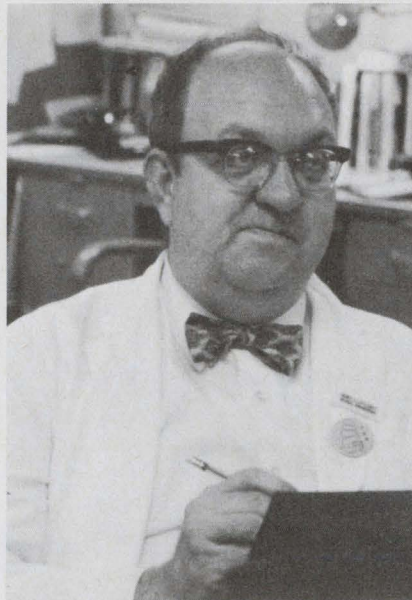

Henry S. Littleboy at Massachusetts General Hospital believes that engineering groups paid by hospitals must police electronics equipment.

industry grows, companies become more sophisticated, and as resources increase, more is devoted to quality control. It is sort of inevitable."

Post also points out that hospitals have obligations, too. He says that a medical electronics product, especially one for patient monitoring, must be considered a life-support instrument.

"You must give it extra care," he emphasizes, "We've seen cases where hospitals don't do preventive maintenance; they never check things and then wonder why the gear isn't any good. You look inside, and the equipment is all dusty; on the outside there is stuff poured all over it. Though hospitals are not very knowledgeable about the use and care of electronics, they do have some obligation to care for it."

Although some of the larger hospitals are beginning to go along with this view, for thousands of smaller ones in the country it really presents a problem. Littleboy at Massachusetts General believes that all hospitals must have competent engineering facilities.

"If a hospital is too small to afford one," he says, "it behooves it to join together with other hospitals, so that together they can afford them."

Littleboy notes that hospitals are

accredited, just as colleges are accredited, and that those who don't develop such facilities soon must face the loss of their accreditation.

Legal controls 'a ways off'

What about controls on medical electronic equipment, governmental or otherwise? Can they prove useful in curbing defects?

The Association for the Advancement of Medical Instrumentation, a national group of physicians, hospital engineers and industry personnel, has about 15 subcommittees developing equipment standards. Michael Miller, the association's executive director, says that the Subcommittee on Electrical Safety has just published its first standards on electro-medical apparatus. They appear in an article, "Safe Power Limits," in the September-October issue of the AAMI Journal.

Miller points out that although the standards are voluntary, they could have teeth if the hospitals insist that manufacturers conform to them.

The Federal Food and Drug Administration is also busy drawing up a set of voluntary standards, but it is only concerned with test classification procedures for cardiovascular and orthopedic devices. David Link, the administration's special assistant for medical-clinical devices, says the FDA will have a panel of experts determine the potential for hazards and the kinds of controls that appear appropriate for those devices. He thinks the results will prove useful in determining what legislation should look like, but he is very pessimistic about the chances for actual legislation.

"Any new legislation is probably a ways off," Link says. "Some bills have been proposed but no hearings have been scheduled. There are other health problems, like health insurance, which appear to be more important in the eyes of Congress than a medical-device safety act."

In the final analysis, the immediate solution may rest with the hospitals themselves. At Massachusetts General, Littleboy says:

"If there is nobody to check the equipment, I don't care what the law is. You must have policemen, and the policemen are the engineering groups that are paid by the hospital." ■■

The RAM built by hindsight.

Being the first 1024-bit MOS RAM, the 1103 was quickly designed into many systems. (A big reason we wasted little time second sourcing it.)

At the same time, we (along with many others) felt that there was plenty of room for improvement in terms of cost and performance on an overall system level.

Hence, we're now building our very own 1024-bit MOS RAM, the vastly superior MM5260.

Like the 1103, our MM5260 comes with chip-select.

Unlike the 1103, the thoughtfully designed MM5260 features a Tri-State logic common data I/O structure with TTL-compatible on-chip decoding and an internal sense amplifier. Plus precharge decoding to reduce system power dissipation significantly.

On a *system* level, the results speak for themselves: A power dissipation savings of almost 66% (two standard supplies versus three supplies); a 100% reduction in the number of overhead

circuits; and a 200% savings in overhead costs. All without sacrificing system speed or performance.

Finally, the new MM5260 comes in a 16-pin dual in-line package and is available for immediate delivery.

(Realizing the hard-core realities of phasing out an existing format, we will also continue to act as a volume supplier of the MM1103.)

All of which means that there's now only one place you need to write, phone, TWX or cable when it comes to 1024-bit MOS RAMs:

National Semiconductor Corp.,
2900 Semiconductor Dr., Santa Clara,
California 95051. Phone (408) 732-5000.
TWX: (910) 339-9240. Cable: NATSEMICON.

(Hot-off-the-drawingboard Dept.:
In a blatant attempt to become the most respected name in RAMs, we will soon announce a couple of highly interesting 2048-bit MOS RAMs.)

National

Electronics-laden ship to drill for oil in 2000-foot waters

A new ship, capable of drilling oil wells more than 2000 feet below the surface of the sea, will have redundant electronics equipment to pinpoint its position on the ocean surface, find the underwater drilling site and hold the ship in position without anchors over the drilling hole.

More than 10.5 MW of ac will be generated on-board for the electronics and the control and drilling operations.

The ship, called the Sedco 445, was designed and built by the South East Drilling Co., Dallas, Tex., at a cost of more than \$16-million to requirements of the Shell International Petroleum Co., London. To be completed this month in the Mitsui shipyard at Tamano, Japan, the Sedco 445 will commence shakedown drilling operations in waters hundreds of feet deep off Borneo in mid-November.

Mounted in the center of the



Sedco 445 will drill wells in waters more than 2000 feet deep.

ship is a 147-foot-high drilling derrick. A 37-foot-diameter hole passes through the ship. Through this hole a 90-ton drill is lowered to the seabed.

The ship will pinpoint her precise surface location by satellite navigation. Once on the spot, heading will be maintained by gyro compass. The ship's position over the drilling hole will be acquired

and held by reference to an underwater sonar beacon system, attached to the drilling rig. The system consists of an acoustic beacon that is lowered to the well head, plus an array of hydrophones secured to the ship. The hydrophone signals will be processed by a Honeywell H-316 digital computer.

The ship's position over the drilling hole will be maintained by a computer-driven "dynamic stationing" system. For lateral thrust and heading control, the system employs 11 special propellers, mounted in pods under the ship.

Each propeller is 6 feet 4 inches in diameter and is driven by an 800 h.p. dc motor. The motors are energized by the output of thyristor modules, which are controlled by commands from the station-keeping computer.

For this system, two H-316 computers are maintained in operation at all times. While only one does the actual station-keeping, both are continuously receiving data from position and sensing instruments.

The computers compare the data for validity, perform control calculations and check upon each other. Should the operating computer fail, control is automatically transferred to the standby unit.

Operation of the positioning system is monitored by displays on both of the two large CRTs in front of the operator. The display shows a bright dot on a large screen, the center of which represents the vessel.

Should both computers fail, the ship can be held over the drilling station either by manipulation of keys on the computer control panels or by manual operation of a joystick (see photo).

In the joystick mode the ship is controlled by motion of a single coordinated control. ■■

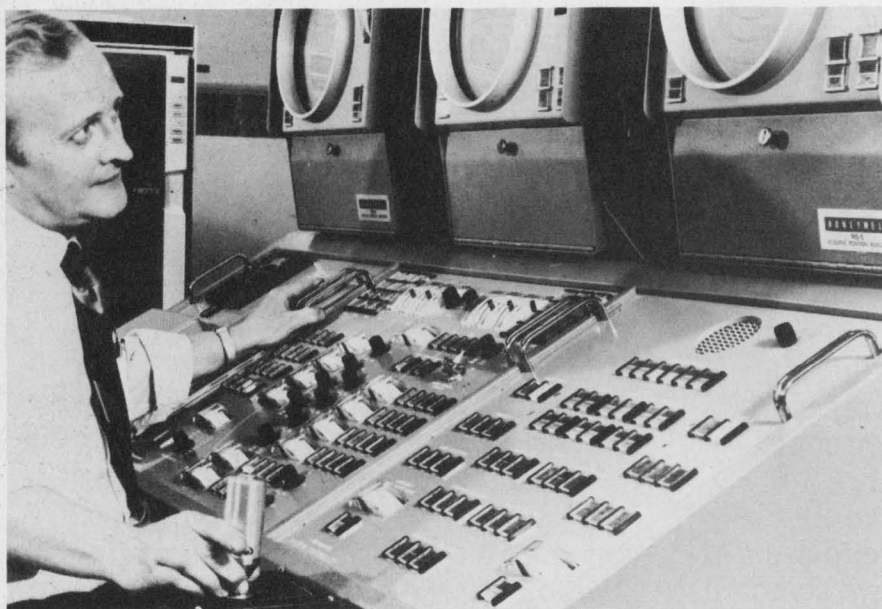

Automatic station-keeping of the ship will be controlled at this Honeywell H-316 console with position-location displays for monitoring.

from space-age technology

Circuitblock™ modules for industrial power supplies

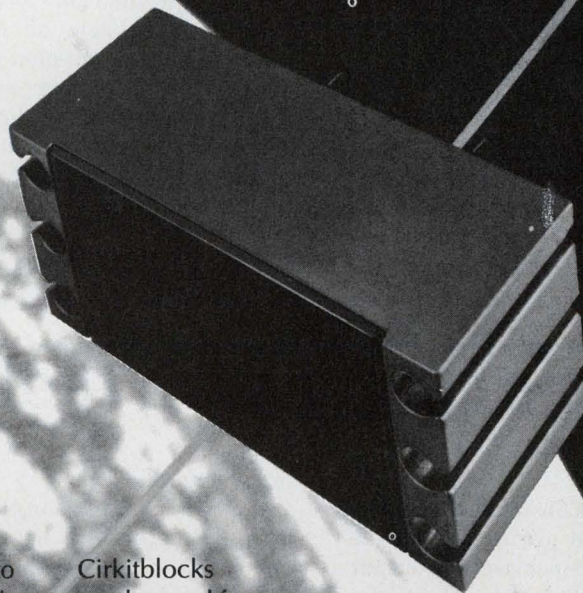

Now space-age technology has fallen out to the industrial area. Similar to the Powercube modules used aboard NASA satellites and probes, new Circuitblock modules let you build instrumentation power supplies at a substantial reduction in size and weight — with industrial-priced, off-the-shelf blocks!

Circuitblock modules offer high efficiency conversion and low thermal rise. They are ruggedly constructed, completely self-contained, easy to install. Three basic types — pre-regulators, power generators, and output modules — are available, (provides outputs from 4vdc — 4000vdc in power range of up to 100w.)

Circuitblocks can be used for breadboarding as well as final systems. Even system changes can be accommodated simply by changing an output module instead of redesigning the system.

If you are involved in the design or manufacture of small, portable instrumentation, you will be interested in Circuitblock power modules. Send for your Circuitblock power supply design chart today. It can help you make the right module selection, to get a power supply that's out of this world.

Request free selection guide



POWERCUBE CORPORATION

214 CALVARY STREET, WALTHAM, MASS. 02154 (617) 891-1830

SUBSIDIARY OF UNITRODE CORPORATION

INFORMATION RETRIEVAL NUMBER 17

Cable summons aid for stranded motorists

A simple system for summoning aid for motorists stranded on superhighways—a two-wire cable with pushbutton shorting switches installed every two hundred feet—has proven feasible in tests conducted by New Jersey.

Co-sponsored by the U. S. Dept. of Transportation as part of a program to seek lower-cost highway-aid systems, the New Jersey test was conducted along eight miles of Interstate highway 287, near Metuchen.

From a monitoring point in the center of the eight-mile stretch, four cable sections—each composed of a four-mile-long pair of 14-gauge wires—were buried along both sides of the highway. Motorists call boxes, featuring a reflector with a central pushbutton, were supplied by Control Products, Inc., of East Hanover, N. J.

The boxes were installed in place

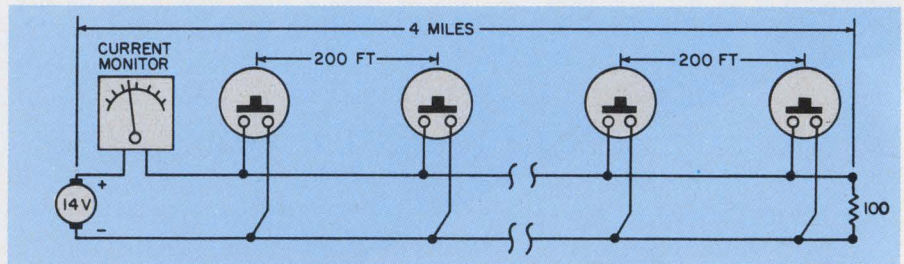

Stranded-motorist locator system has switches shorting out sections of a two-wire cable. Amount of current flowing identifies location.

of regular highway reflectors, one every 200 feet. Each switch was connected to the cable at that point. And each stretch of cable was terminated in a 100-ohm resistor at the end farthest from the monitoring point. The cable current was monitored to determine the location of any shorting switch operated by a motorist.

The no-signal cable current was first balanced out. When any of the pushbuttons were activated, cur-

rent increased.

Using 12 to 14 V, the current varied between 20 and 100 mA. The largest value was indicated when the nearest switch was operated, the smallest when the farthest was pushed. Each increment in current was calibrated in terms of highway distance from the central monitoring point.

For the test, conventional milliammeters were used, but readout display could be easily provided. ■■

Printer called much faster than Teletype

A new, low-cost impact printer is said to be the first full-character, serially operated printer to achieve a 100 character-per-second output—10 times faster than the Teletype's output.

The machine, developed by Printer Technology, Inc., Woburn, Mass., is called Printac-100 and is for use with minicomputers and in

data communications.

A so-called print-on-the-fly machine, Printac-100 uses a print wheel with three sets of characters instead of one. Older models of print-on-the-fly machines, with one set of characters, print at only 25 to 35 characters per second. The new print wheel, explains Steven Kaczeus, inventor and vice presi-

dent of Printer Technology, triples the speed by printing three characters per shaft rotation, instead of one.

An additional gain in speed is achieved by using two print hammers for each character set, instead of the usual one.

Printac-100 has a built-in electronic interface for receiving ASCII input data. The electronic circuitry has TTL logic and a MOS memory that looks like TTL at the interface.

The printer operates by storing a line of characters in the memory (136 characters per line), and then printing out. Total capacity of the memory is 266 characters.

The entire unit is designed on a modular basis, with plug-in circuitry and operating elements secured with three or four screws. An ink wheel, which snaps in place, is good for 30 million impressions.

The \$2200 machine reduces the requirements for auxiliary memories when producing hard copy from a CRT terminal. ■■

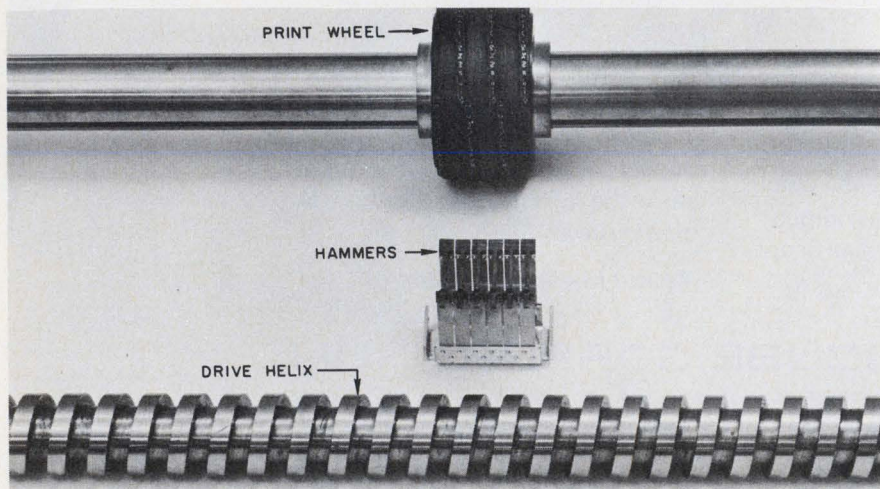

Key to speed of new impact printer is print wheel with three sets of characters. Two print hammers are used for each character set.

From Monsanto... something new for people who count.

We build counters for just about every requirement, but a lot of people who count asked for a mix of capabilities we hadn't yet packaged in a single unit. Now, here it is—the Model 113A Counter/Timer, newest addition to the Monsanto line.

Take a quick look at some of its outstanding features... **Frequency range: DC to 75 MHz... 8 operating modes: frequency, totalize, ratio, period, period average, time interval A to B, positive pulse width, negative pulse width... Monsanto LED display.**

The Model 113A gives you automatic selection of slope when measuring positive or negative pulse widths, so you have one less mental calculation to make, one less knob to turn. And you get Monsanto's two-year warranty. What other major instrument manufacturer offers you that? All this versatility, all this four-figure performance, sells for just \$895. For complete data or a demonstration, write Monsanto Company, Monsanto Electronic Instruments, West Caldwell, N. J. 07006.

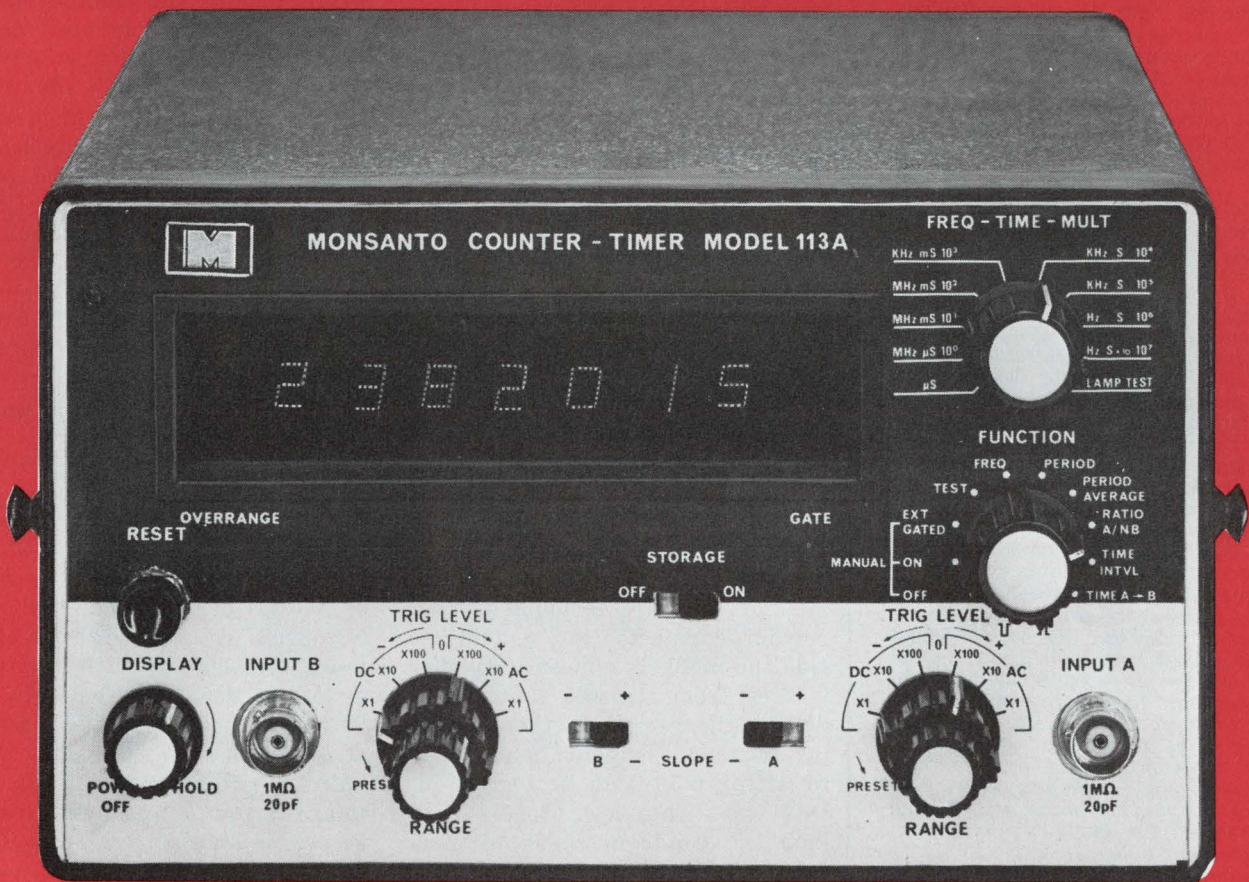

Monsanto

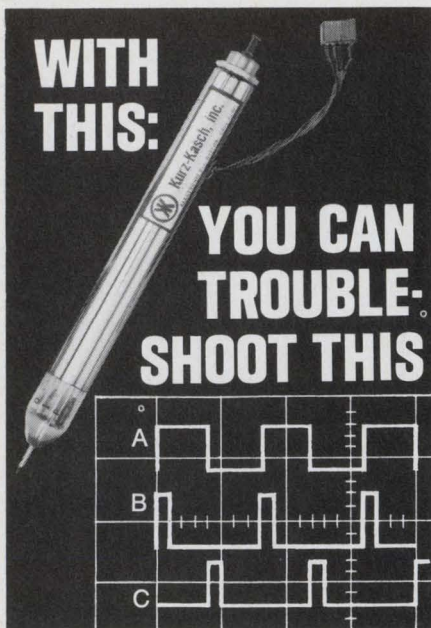

LOOK AT THESE NEW FEATURES ON THE KURZ-KASCH LOGIC PROBES*

Basic Model LP-520 — Provides the color coded (red, white & blue) visual readout system at the probe tip that indicates logic "1", "0" and "pulse" (50 nano-seconds or greater) conditions in any 5v digital logic system. Absence of logic levels is indicated by all readouts remaining off.

The Model LP-520 is priced at \$69.95.

ADD THESE FEATURES: G-S-M Gating Feature(-G) — Pulse indicator displays only when probe tip and gate/gates inputs are in coincidence. (see diagram above.) Example: **A.** Gate 1 input **B.** Probe tip input; pulse indicator displays. Moving probe tip to **C.** pulse indicator does not display. Add \$10.00 and suffix G.

Memory & Stretch(-M) — Push-Pull switch for selecting stretch or latch mode. Stretch mode detects high speed pulse and displays blue "P" lamp for 200 mS. Latch mode captures high speed pulse/trains and latches blue "P" display on until reset. Add \$10.00 and suffix M.

5 Nano-Second Capability(-S) — This allows detection of pulses up to 10 x faster than standard probes. Add \$10.00 and suffix S.

Free Trial Offer — Keep abreast of the state of the art. Kurz-Kasch offers a 15 day free trial period. Select the Kurz-Kasch logic probe model above (or any combination of features) that fit your requirements. At the end of 15 days, you may return the probe, or, send us your check.

All the features you ever needed for testing digital logic now available in one economical probe unit; 3 input channels, 5 nano-second pulse width detection, pulse latching.

Kurz-Kasch offers a complete line of digital logic testing instruments. Want to talk about your instrumentation requirements? Call Tom Barth, or Dick Pitner, now, at (513) 223-8161.

technology abroad

Aircraft-style navigation aids will be used for the safe conduct of ships through The Netherlands' massive Europort—a supertanker-rated harbor that stretches 27 miles from Rotterdam to the North Sea. When harbor pilots go out to meet the ships, they will carry with them an electronics package that contains a coded radar transponder and an alphanumeric display. On-shore computer systems will locate and identify each approaching ship from radar inputs and will plot the data on a master control screen. The ship will be constantly updated as to where it is with respect to the center of the channel and other navigational points. Simpler systems without the transponder but using a voice vhf ship-to-shore link have been designed by Decca Radar for the port of Liverpool and Marconi for Southampton, both in England.

CIRCLE NO. 451

Ferrite components can be produced in a wide variety of shapes with a process developed by GEC-Marconi Electronics of Chelmsford, England. Instead of manufacturing an odd shape by lengthy cutting and grinding operations, Marconi engineers first pack the powdered ferrite material into soft rubber molds of the final design. The mold is immersed in hydraulic fluid, and 15 tons per square inch of pressure is applied. The powder, compacted into a solid inside the mold, is almost completely free from stresses that might distort the ferrite in the processing furnace. Components accurate to within 0.5% can be formed in this way. The new process will initially produce finely drilled ferrite rods for phased-array radar antennas.

CIRCLE NO. 452

A high magnetic field of 105 kilogauss has been obtained by researchers at the German National Physics Laboratory in Brunswick, West Germany. They used a niobium-titanium superconducting magnet. The magnetic core, comprised of many windings of special niobium-titanium alloy, becomes superconducting after it is cooled to 2° K in a cryostat containing liquid helium. The apparatus was built to the laboratory's specifications by the British Oxygen Co. of Morden, England.

CIRCLE NO. 453

An infrared package-sorting machine that is immune to package misalignments and fluctuations in ambient lighting has been developed by MCP Electronics of Wembley, England. Its main advantage is that the infrared light is back-scattered, rather than reflected, from coded stripes on the packages, thus producing a wide-angle beam. The IR reader-to-label distance can vary between six and eight inches. Conveyor-belt speeds can be varied from 0.5 to 2.0 ft/s. The infrared light source is pulsed at 1.5 kHz.

CIRCLE NO. 454

A passive night-vision device that can distinguish a human from 150 meters in an illumination of 10⁻³ lux, has been developed by Eltro of West Germany. The unit, the Nyx-2002, is a low-light-level intensifier telescope with high-power lenses (focal lengths of 75 mm, 90 mm and 135 mm) and a single-stage intensifier tube. The tube gain is greater than 2000. The image is focused on a fluorescent screen by an electron lens system. Two standard 1.5-V cells power the unit for 15 hours.

CIRCLE NO. 455



Kurz-Kasch, Inc.

1421 S. Broadway, Dayton, Ohio 45401

*Patent #3,525,939 applies, others pending

INFORMATION RETRIEVAL NUMBER 19

Have you filled our your REQUESTED DATA DELIVERY SERVICE enrollment form? See page 80.

The toughest lighted switches.

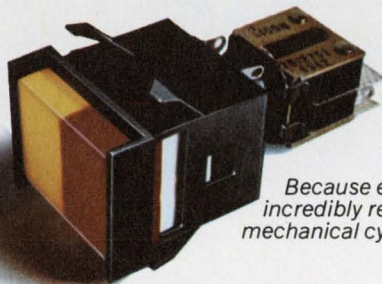
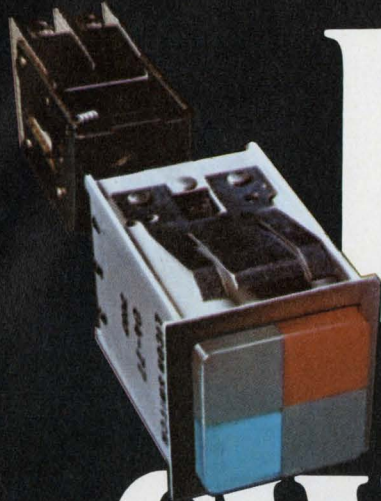

Because every one is based on Licon's incredibly reliable (up to 20 million mechanical cycle) Butterfly switch.

From the tiny inexpensive Type 01-700 to the four-lamp Type 04, every Licon® lighted switch incorporates one or more Licon Butterfly® switches. Thus the ultimate in double-break switches becomes the basis for one of the broadest lines of lighted switches available. Choose the indicating function required... one; two or four lamps... lens cap configuration... screen color and engraved legend. Name your switching

action... momentary, maintained, solenoid-held, indicator light only, or multi-circuit control. Select your mounting style... flange, barrier, bezel, bezel-barrier, horizontal or vertical, single-switch or multiple in matrix. Meet Mil Specs. In every choice, installation and servicing is fast and easy. Because ultra-reliable switching is our business. Test light the line yourself. Call your local Licon distributor or representative for a

lighted demo in your office. Or call or write for a Licon Switch Catalog. **Licon, Division Illinois Tool Works Inc., 6615 W. Irving Park Road, Chicago, Illinois 60634. Phone (312) 282-4040. TWX 910-221-0275.**



itw LICON

The Innovating Electronic Group of ITW... LICON ■ ELECTRO MATERIALS ■ PAKTRON

Miniature
LOW CURRENT—
HIGH VOLTAGE
MULTIPLIERS
and POWER
SUPPLIES

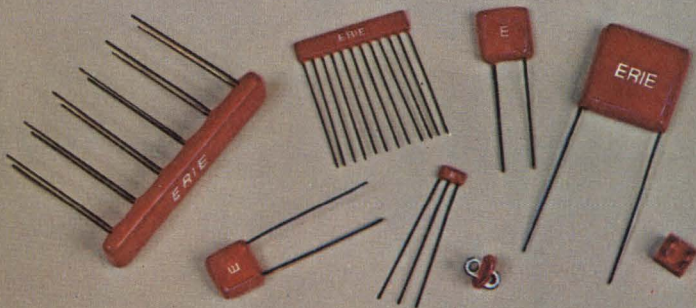
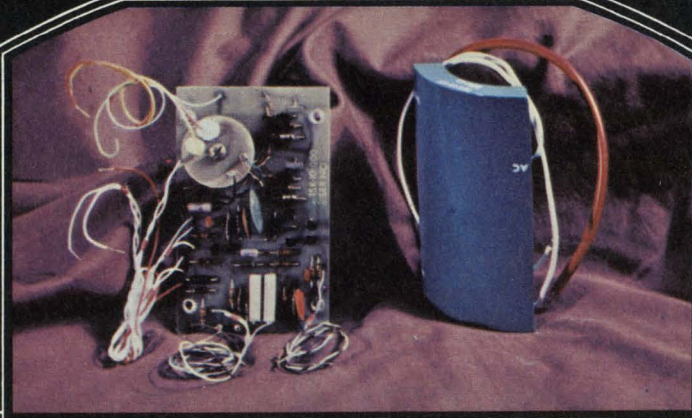

HIGH VOLTAGE CAPACITORS Protected by "JET SEAL"

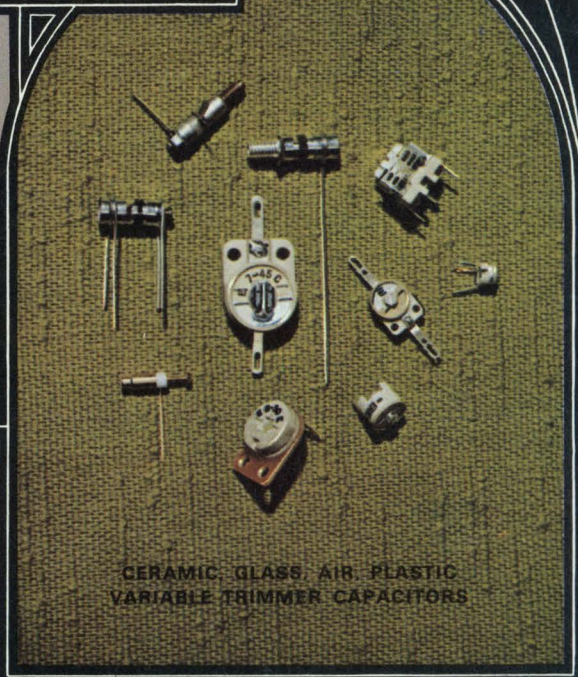

CERAMIC, GLASS, AIR, PLASTIC
VARIABLE TRIMMER CAPACITORS

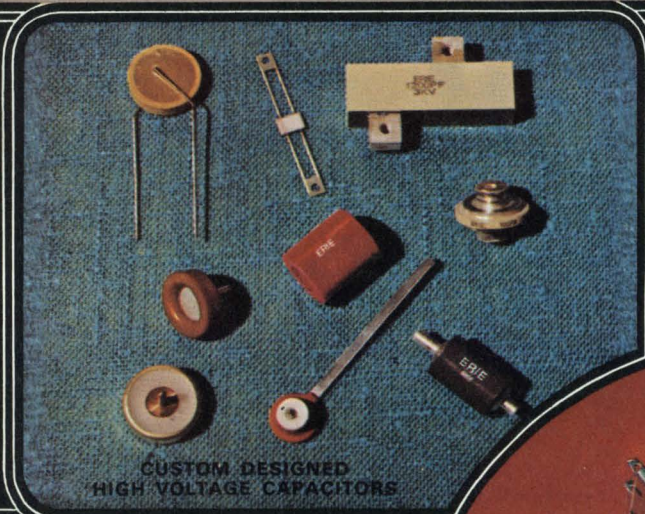

CUSTOM DESIGNED
HIGH VOLTAGE CAPACITORS

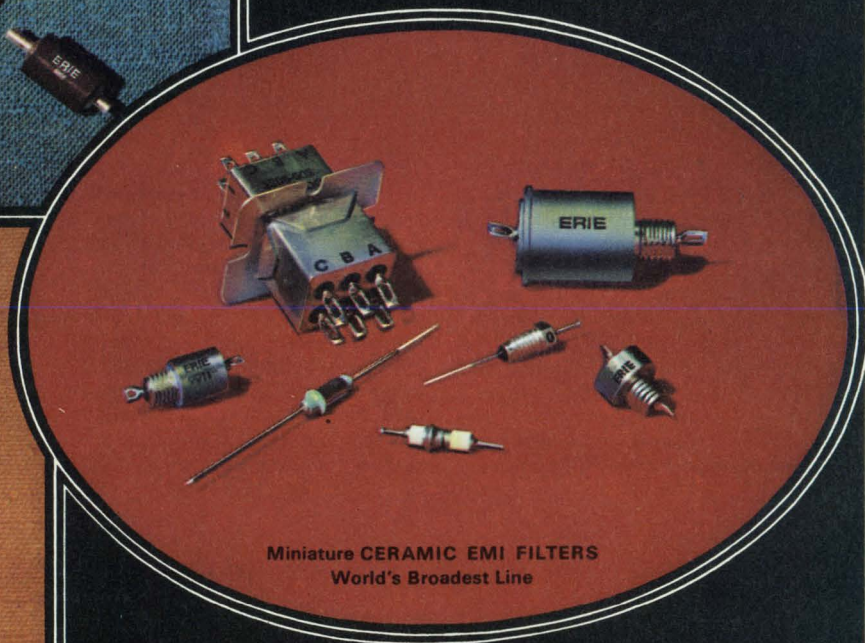

Miniature CERAMIC EMI FILTERS
World's Broadest Line



MICA CAPACITORS and
UHF TUBE SOCKET SYSTEMS

RED CAP[®]
CERAMIC
CAPACITORS
1 pF to 10 uF
21 Temperature
Characteristics
50 to 500 Volts

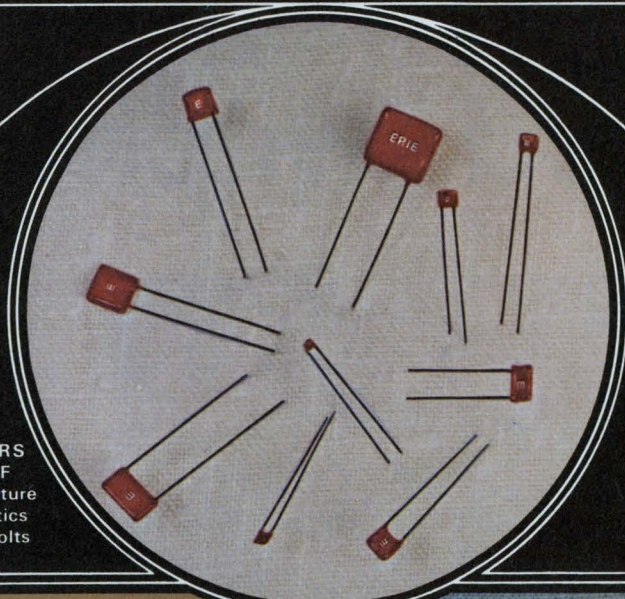

Designing with Quality ERIE Electronic Components makes life just a little simpler. . .

Try to beat this winning combination. A full line of electronic components produced to quality and performance standards that are right on target with *your* design and equipment needs.

ERIE has long been known as the quality name in electronic components. And today we're the IN place to go for top-of-the-line components. ERIE plays a vital role in military, industrial, commercial, home entertainment and communications systems. You name it . . . ERIE's there. Why don't you join the swing to ERIE?

Write TODAY for literature describing any component family illustrated. And if you would like to see your ERIE man, just jot a note. We'll do the rest. Who knows, ERIE components may even make your life just a little simpler.

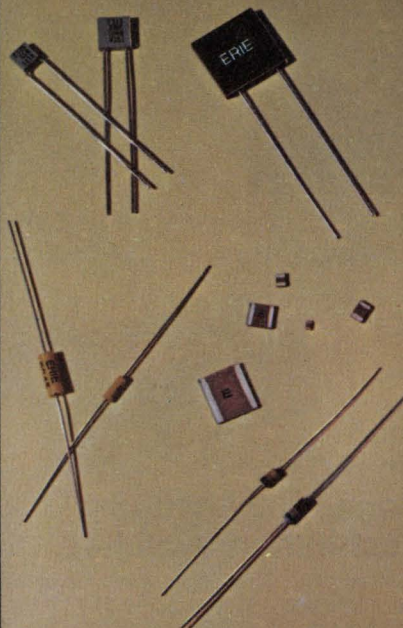

MONOBLOC[®] FIXED
CERAMIC CAPACITORS
Full Range, including
Chips and Glass Sealed Capacitors

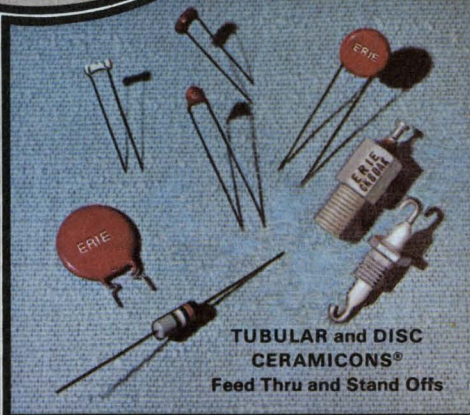

TUBULAR and DISC
CERAMICONS[®]
Feed Thru and Stand Offs



QUARTZ CRYSTALS,
CRYSTAL OSCILLATORS,
CRYSTAL FILTERS, OVENS
Complete Line of Frequency
Control Components

ERIE

ERIE TECHNOLOGICAL PRODUCTS, INC. Erie, Pennsylvania 16512

Ring up a savings on keyboard switches.

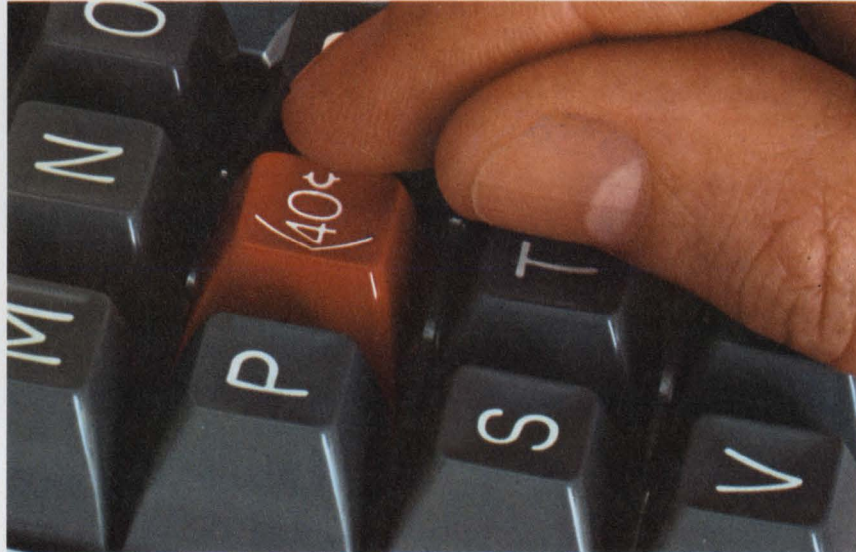

As much as **40%**
[savings per key]

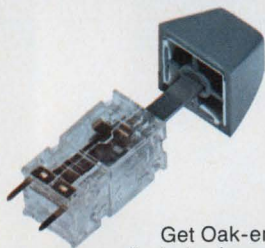

The new Oak Series 400.

Get Oak-engineered quality in keyboard switches with the inherent reliability of electro-mechanical operation. Ideal for peripheral data-processing equipment. Contact bounce is less than 3 milliseconds. Long life, up to 20 million operations per key. Designed with self-cleaning crossbar-wiping contacts.



A feather touch.

We kept the operator in mind. Standard operating force is approximately 85 grams (3 oz.).

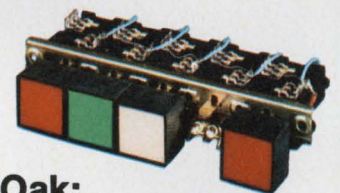

Also from Oak: Series 300 Lighted Pushbutton Switches.

Featuring Oak's exclusive twin-lamp lighting. If one lamp goes out, the other stays on. Double-wiping contact clips. Short stroke. Smooth, quiet operation. Unlimited combinations. Request our Series 300 brochure.

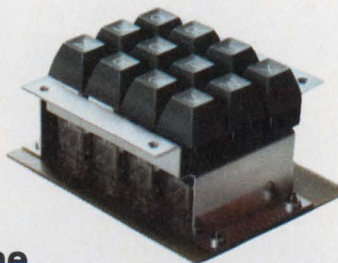

The configurations you want.

The Series 400 is available in limitless arrangements, including standard 10, 12, and 16-button keyboards. And you can specify any of six different contact circuitries. Choose snap-in or plug-in P.C. mounting. Compact—only 1/2" x 1/2" x 1".

Write today for our Series 400 brochure.



Under 40¢ each.

For SPST/NO in production quantities. Other versions comparably priced. Keytop button and snap-in mounting extra.

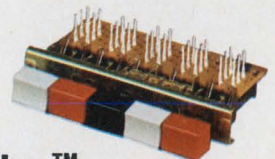

And our Series 800 Econo-Line™ Pushbutton Switches.

Compact—more buttons and more contacts in less space: 1 PST to 8 PDT per button. Your choice of mechanical actuation. Colored buttons, legend engraving to your specifications. Request our Series 800 brochure.

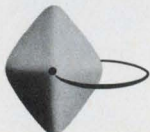

OAK MANUFACTURING CO.

CRYSTAL LAKE, ILLINOIS 60014 • A DIVISION OF OAK ELECTRO/NETICS CORP

Telephone: 815-459-5000

TWX: 910-634-3353

TELEX: 722-447

INFORMATION RETRIEVAL NUMBER 22

washington report

DON BYRNE, WASHINGTON BUREAU

B-1 avionics package assembler to be named soon

Twenty-seven companies have entered the competition for putting together the avionics packages for the B-1 bomber. Replies to the Air Force's requests for proposals are due Nov. 8, and the following have already submitted proposals: Airborne Instrument Laboratory, Bendix, Boeing, Fairchild Industries, General Dynamics, General Electric, GM Delco Div., Grumman Aerospace, Hughes Aircraft, IBM, Lear-Siegler, Litton Industries, Lockheed Aircraft, LTV Aerospace Div., LTV Electronics Div., McDonnell Douglas, United Aircraft Norden Div., North American Rockwell Aerospace Systems, Northrop, Raytheon, RCA, Singer-General Precision Corp., Teledyne Systems, Texas Instruments, TRW Systems, Sperry Rand Univac and Westinghouse.

In addition to packaging the avionics, the contractor company to be chosen—called the “avionics subsystems interface contractor” by the Air Force—will be responsible for the computer software control and displays and stores management systems development. The contractor will work with two associate contractors who will develop electronic countermeasure and infrared surveillance systems. The total package will weigh between 3900 and 5400 pounds and cost about \$4-million per aircraft, the Air Force estimates.

AT&T ends Telepak-sharing discounts

AT&T has hammered the final nail into the coffin of Telepak sharing by filing a new tariff for its private-line service, eliminating sharing provisions. The new tariff becomes effective Dec. 12, and it was no surprise, since the U. S. Court of Appeals had found the old sharing tariffs discriminatory and the Federal Communications Commissioner had ordered their elimination. Large users, such as regulated industries and governments, which had enjoyed lower rates, are expected to move to their own private microwave systems to replace the Telepak service.

Navy seeks new sonobuoys and a sub fence

The Navy is negotiating with Amitek/U. S. Gauge for a unique type of air-dropped sonobuoy that would help detect deep-diving nuclear submarines. The sonobuoys, which would be carried by S-3A antisubmarine aircraft cruising at 30,000 to 40,000 feet, would be used this way: When contact with an enemy submarine is indicated, the sonobuoy is dropped, and a barometric device deploys a parachute at lower altitudes to lower the electronics package into the water. When the target is pinpointed, the S-3A descends to the attack.

In another development, it has been learned that the Navy and seven NATO countries are quietly going ahead with plans to construct an

electronic submarine-detection fence off the Azores. Navy sources have indicated that \$10-million has been spent so far on R&D for the fence, and procurement is expected to start next year. The system is designed to pick up the growing numbers of Russian subs that travel to and from the Mediterranean. Hydrophone arrays on 400-foot towers are being constructed on submerged mountains near the Azores island of Santa Maria to give detection capabilities to depths of 30,000 feet.

Hughes and Grumman get big F-14 awards

The Navy has let two contracts totaling \$368.8-million toward the purchase of 48 production models of the F-14 fighter. Grumman Aerospace Corp. received \$231.7-million for the airframe, while Hughes Aircraft got \$137.1-million for the fire-control system for the Phoenix missile. The F-14 will carry six of the long-range, air-to-air missiles, which can attack multiple targets simultaneously in defense of carrier task forces.

The contracts were let after Navy supporters had beat off several attempts in Congress to kill the F-14 because of alleged lack of performance. In all, the Navy will commit more than \$1-billion for the aircraft in the present fiscal year, including \$806-million for production alone. It ultimately hopes to buy 313 of the planes.

Bids due soon on aeronautical satcom phase

The Federal Aviation Administration expects to issue requests for proposals by Nov. 15 for the first phase of its satellite communications program for aeronautical use. Companies in the United States and Europe will be invited to bid. Contractor selection is expected by next April. U. S. airlines are still opposed to the uhf satellite system, which is to cover the Atlantic and Pacific Ocean areas.

Capital Capsules: Former Rep. Charlotte T. Reid (R-Ill.) has been sworn in as an FCC Commissioner in a rare White House ceremony. FCC Commissioners are usually sworn in by another FCC official. . . . AT&T and the Hawaiian Telephone Co. have filed plans for an 845-circuit submarine cable from California to Oahu. Later moves will link Guam and Australia, Japan and Southeast Asia, Hawaii and Australia and Hawaii and Japan. . . . The Federal Aviation Administration has received responses to its requests for proposals for development of a \$100-million microwave instrument landing system, planned for the 1980s. For some strange reason, the number of companies replying has been "classified" by the FAA. . . . The U. S. Postal Service has begun experimental facsimile transmission of mail between New York and Washington. Designed primarily for documents, the system will have three post offices in each city. Rates are from \$4.25 to \$6 a page, depending on size and delivery service. . . . The National Association of Regulatory Utility Commissioners and the Washington State Utilities and Transportation Commission will file suits in the U. S. Court of Appeals aimed at upsetting the FCC's decision to open up the specialized microwave common carrier field. . . . An Aerospace Industries Association survey shows that 894,000 people will be employed in the electronics industry by next June—a decline of 37,000 jobs in one year. Of the total, 147,000 engineers and technicians will be employed—a 37.5% drop from the peak of 235,000 in 1967.

A low-cost oscilloscope that keeps up with changing applications

When you shop for a low-frequency oscilloscope, you'll want to know about the measurement capabilities, exclusive cost-saving features and flexibility provided by the new TEKTRONIX 5100 Series.

First, you start with the 5103N three plug-in mainframe.

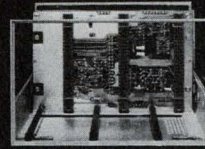

Then, select your display from four interchangeable units with 6-1/2 inch CRT's:

single beam

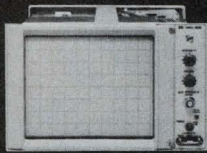

single-beam storage

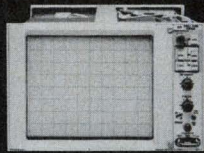

dual beam

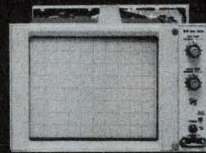

dual-beam storage

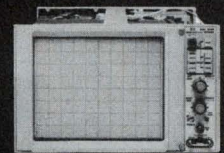

Assemble the mainframe and display unit into a cabinet

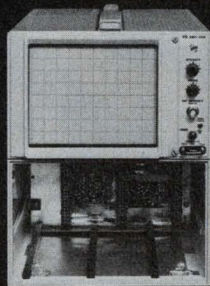

or rackmount.

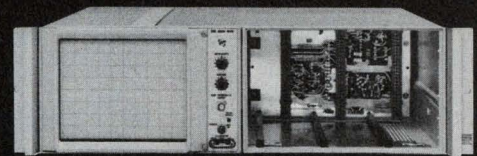

Now, add the low-cost plug-ins of your choice.

Today, there are six vertical amplifiers and three time bases to choose from with more on the way. Bandwidth is DC to 2 MHz, depending upon the amplifier plug-in.



When your applications change, just buy components instead of a complete oscilloscope. Interchangeable display units let you update to dual beam, or storage, or dual-beam storage by simply buying a module—not a new scope. Here's another way to save. When your applications call for a new configuration, you can change these oscilloscopes from cabinet to 5-1/4 inch rackmount and back. It takes only a few minutes and a low-cost kit. And with plug-in flexibility you solve many measurement problems in one mainframe.

The most exciting part—low-cost. If you choose a D10 Single Beam Display Unit assembled with the 5103N, 2 ea. 5A20N 50 μ V/div 1-MHz Differential Amplifiers and the 5B10N Time Base, here's what you get. 

The cost? Only \$1045 in cabinet or rackmount (includes slide assemblies). You can choose an X-Y oscilloscope, cabinet or rackmount, for as little as \$590.

U.S. Sales Prices FOB Beaverton, Oregon



TEKTRONIX®

committed to
technical excellence

Contact your local
Field Engineer for a
demonstration and
complete details.

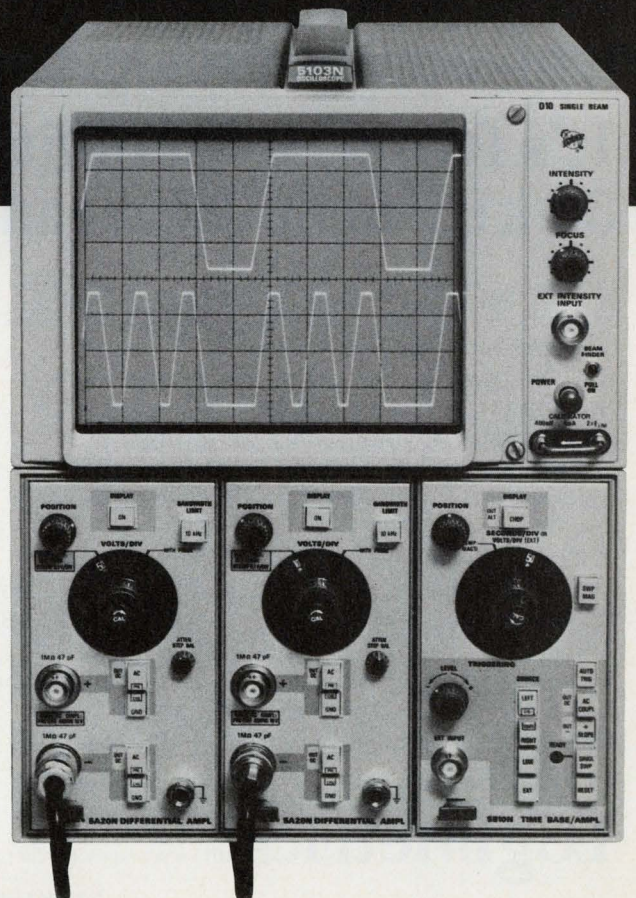



We invented an rf signal generator for people who always dreamed of owning a synthesizer

It's frequency stability is ± 10 Hz over its 50 kHz to 80 MHz range

Until now, you couldn't get this kind of frequency stability — ± 10 Hz — until you bought a synthesizer.

But now the patented Signallock™ circuit provides synthesizer-like stability and accuracy. In addition there's a six-digit built-in counter to directly display your generator frequency.

The counter has variable resolution to 100 Hz and can be used independently to measure external frequencies to 80 MHz.

The Model 925 Signal Generator produces a signal output which is continuously adjustable from 0.1 microvolt (-127 dBm) to 3 volts RMS ($+23$ dBm) and is leveled to within ± 0.5 dB throughout the frequency range. Harmonics are at least 30 decibels below the carrier. Noise and AM hum are 70 dB below the carrier, while residual FM is less than 1 ppm plus 10 Hz.

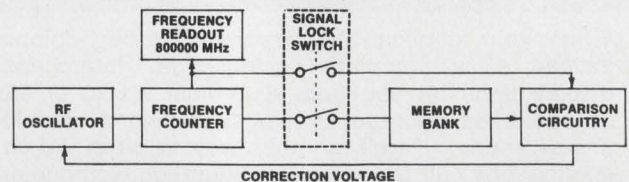

"Signallock" is a patented circuit which enables the output of the built-in rf oscillator to be locked into the crystal time base of the built-in counter. When the Signallock mode is switched in, the digital readout is stored in a memory, and then continuously compared to the generator's output frequency. If an error exists between the output frequency and the memory frequency, a correction voltage is fed back to the oscillator, causing frequency to return to the original setting.

LogiMetrics INC. A Subsidiary of Slant/Fin Corp., 100 Forest Drive, Greenvale, N.Y. 11548 • Phone: (516) 484-2222 • Telex: 96-1371

So what?

We all know that every cub reporter learns that his stories should answer the five W's: Who? What? When? Why? and Where? At ELECTRONIC DESIGN, we feel there's another question that's just as important: So what?

That's not quite the same as "why." In most cases the answer to "why" is simple: An institution developed something because it hoped to get some funding or because it had already received some funds. Or a company built a new product because it hoped to sell it.

The answer to "so what" isn't so obvious. The so-what is the significance—the real importance to you, to the company and to its competitors.

It's an easy matter for us to announce, for example, that Tektronix has a 500-MHz real-time scope. But if you're not watching scope developments every day, you may not know that 500 MHz is the greatest bandwidth in a real-time scope commercially available at present. And you may not remember what the largest bandwidth in a scope was before the Tek took first place. And you may wonder what tradeoffs Tektronix made to take first place in a long-running scope-bandwidth race. We feel it's our business to tell you.

But not just for scopes. Whenever we announce a really important product, we'll tell you what's important about it. We'll tell you it's the fastest, or the cheapest, or the first, or the biggest, or the smallest, or the least noisy or the best regulated, or whatever. And we'll tell you how the new product stacks up against its competitors.

We'll also tell you what's not so good about the product and what's plain bad. We all know that nothing comes free. When you buy high sensitivity, for example, you're also likely to get high noise unless you pay high dollars.

Of course, we can't test all these products. So we'll base our reports on very careful studies of manufacturers' data by product-specialist editors. We'll supplement those studies with lots of questions, sharp ones.

So what? So you'll know where things stand in this competitive industry—that's what.

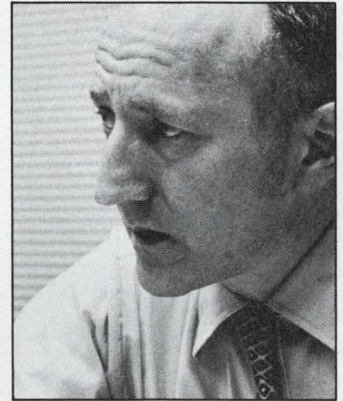

A handwritten signature in cursive script that reads "George Rostky". The signature is written in dark ink and is positioned above the printed name and title.

GEORGE ROSTKY
Editor

Any microwave diode will work in this coaxial resonator structure. Its coupling techniques allow it to accommodate a wide variety of Gunn and Impatt types.

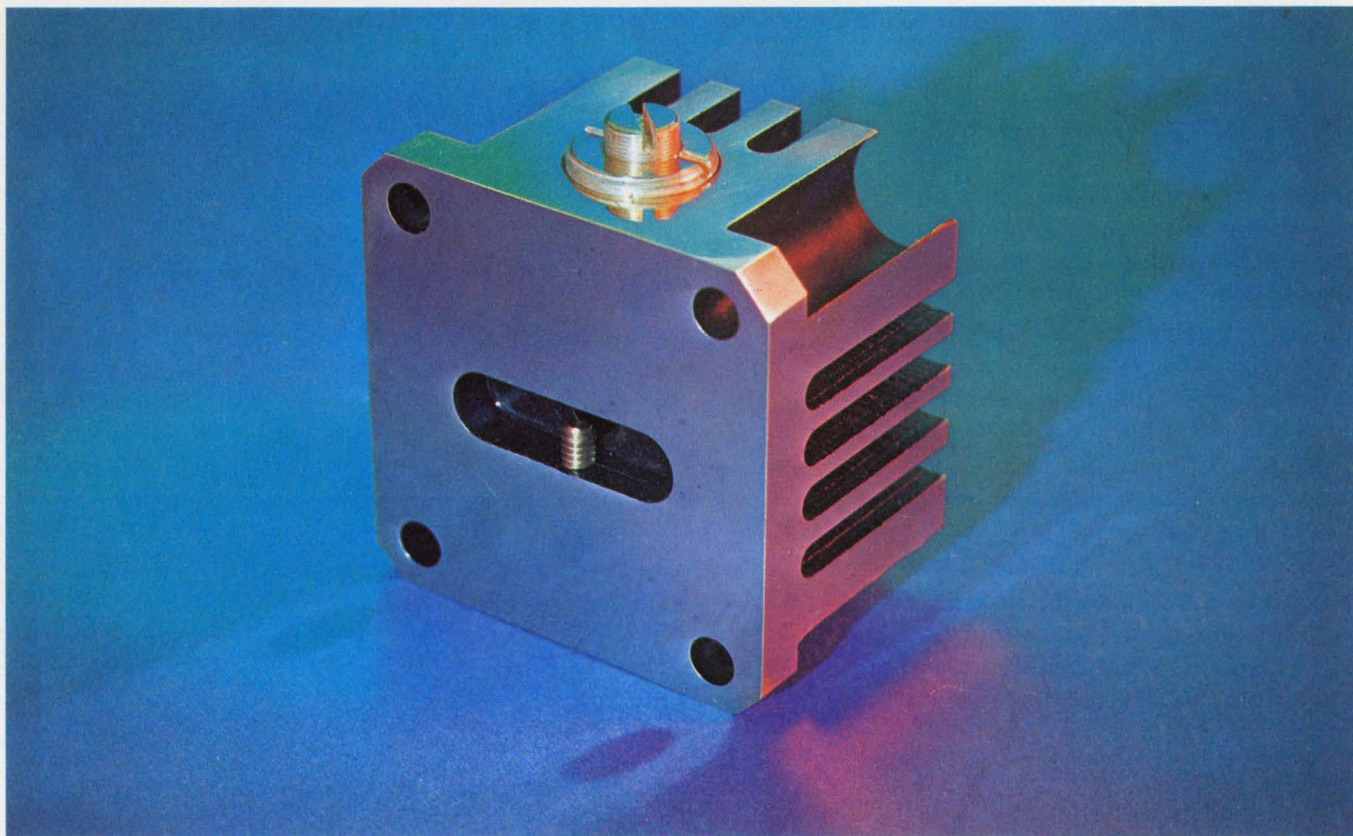

Photograph of microwave oscillator courtesy of James Bailey and Al Giovanelli of Johnson Service Co.

A serious shortcoming that many modern microwave power sources have is that their cavities can't provide a proper match to the wide range of device impedances commonly encountered with Gunn and Impatt diodes. The X-band design presented here overcomes this problem by providing two mechanisms for changing the cavity's reactance: One changes the length of the oscillator's open coaxial transmission line, and the other the capacitive fringing impedance at the open end of the cavity.

You can vary the line length by changing the length of the small "hat" that sits on top of the diode—to make the line longer, substitute a longer hat; to make it shorter, substitute a shorter hat. Likewise the capacitive fringing impedance

can be varied by controlling the depth to which a dielectric rod is inserted into the open end of the cavity by turning the screw to which the dielectric rod is attached (Fig. 1).

Design uses an open-ended line

The oscillator is constructed by coupling an avalanche diode to an open-ended coaxial transmission line through an impedance network that contains diode-to-cavity and cavity-to-load coupling. For the circuit to oscillate, the net impedance of the diode plus the cavity must be equal to zero.

The diode chip, mounted in a standard varactor pill package, can be represented by the equivalent circuit of Fig. 2. For a typical 50-mW X-band silicon avalanche diode, the parameters shown in the equivalent circuit of Fig. 2 are:

Carl F. Klein, Senior Research Engineer, Johnson Service Co., 507 East Michigan St., Milwaukee 53201.

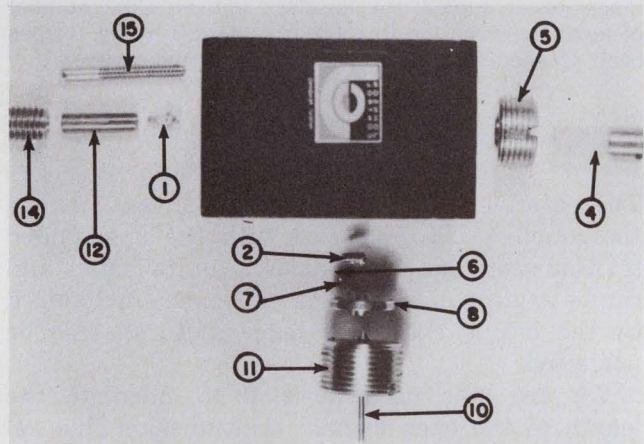
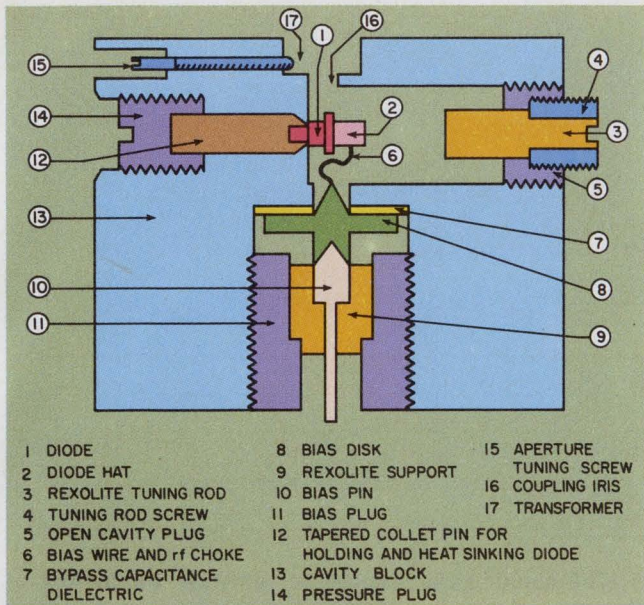

1. This oscillator structure can be made to accommodate a wide range of diode reactances by changing the length of the diode "hat" (2) or adjusting the Rexolite tuning rod (3). The Rexolite rod provides a fairly broad range of frequency adjustment without affecting the output power, while the aperture tuning screw (15) adjusts the output power without changing the frequency.

$$C_{pk} = 0.3 \text{ pF} \quad L_{pk} = 0.4 \text{ nH}$$

$$C_c \cong 0 \quad R_s = 1.5 \text{ ohms}$$

$$C_j = 0.3 \text{ pF} \quad R_d = -1000 \text{ ohms}$$

Using these numbers, the over-all diode impedance turns out to be $Z_d = -6.431 + j28.4$ ohms.

Since the diode's packaging impedance cannot be neglected at X-band frequencies, let us utilize these impedances to form an economical microwave oscillator. The packaging impedance forms a current-divider network around the diode by means of series and shunt impedances (Fig. 3). The diode's packaging impedance can thus be utilized to couple the diode chip to an oscillator cavity. In the circuit of Fig. 1 the diode is coupled to an open-ended coaxial transmission line. An equivalent circuit for the oscillator is shown in Fig. 4.

At microwave frequencies, reactive circuit elements can consist of sections of transmission

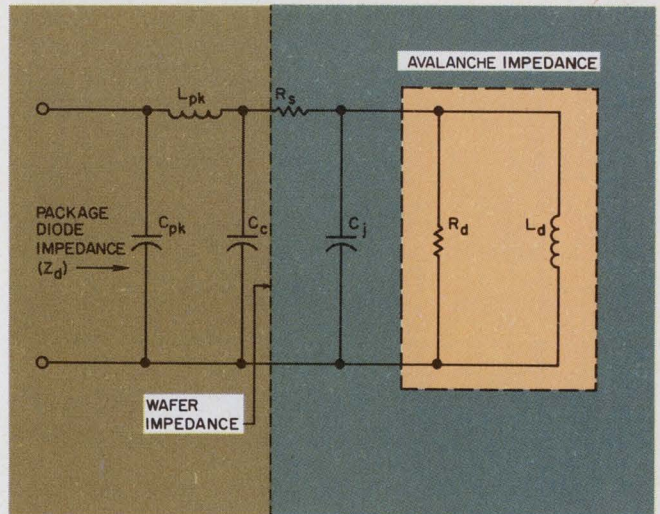

2. You can't neglect the diode's packaging impedance at X-band, as this equivalent circuit shows. For the typical 50-mW packaged avalanche diode described in the text, $Z_d = -6.431 + j28.4$ ohms.

3. The series and shunt packaging impedances form a current-divider network around the diode chip. Z_1 corresponds to the contact capacitance, C_c , in Fig. 2; Z_2 corresponds to L_{pk} and Z_3 corresponds to C_{pk} .

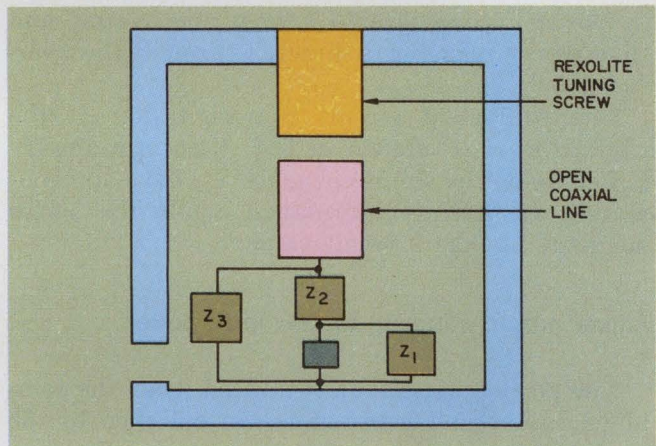

lines. The input impedance of a dissipationless transmission line is given by

$$Z_i = Z_o(Z_L + jZ_o \tan \beta L) / (Z_o + jZ_L \tan \beta L), \quad (1)$$

where Z_o is the characteristic impedance of the transmission line, Z_L is the load impedance, $\beta (= 2\pi/\lambda)$ is the phase constant, and L is the length of the line.

Applying Eq. 1 to an open-ended line—for which $Z_L = \infty$ —we get the result

$$Z_i = -jZ_o \cot \beta L. \quad (2)$$

Microwave output power is transferred from this cavity to a load via a circular or elliptical iris and a reduced-height waveguide impedance transformer. Cutting an iris in the wall of the cavity interrupts a portion of the cavity's surface current and magnetic flux. The surface conduction current is transformed into displacement current in the iris gap. The perpendicular re-

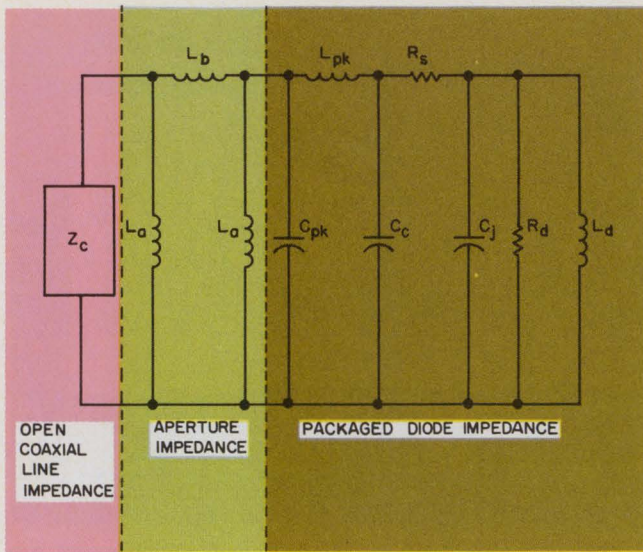

4. The radiating iris is represented as an inductive pi network in this equivalent-circuit representation of an open coaxial cavity microwave oscillator. The shunt elements, L_a , have approximately an infinite impedance, while the series element, L_b , has a small value.

lation between the electric field associated with the displacement current and the magnetic field in the iris gives rise to a Poynting vector, and thus power transfer is directed through the aperture.

The equivalent circuit representation of the radiating iris is shown in Fig. 4 as an inductive pi network. The shunt elements, L_a , have approximately an infinite impedance, while the series element, L_b , has a small value.

Adjust output coupling to maximize power

The power transfer is optimized when the combined cavity and load losses are matched to the generator's impedance. The output coupling can be adjusted with the waveguide impedance transformer tuning screw, as shown in Fig. 1. Here power is maximized, while the oscillator's frequency is held relatively constant.

Oscillation requires that the sum of the coaxial transmission line impedance, the output coupling impedance and the packaged diode impedance equal zero:

$$Z_{\text{diode}} + Z_{\text{coax}} + Z_{\text{out}} = 0. \quad (3)$$

Equating the reactive part of Eq. 3 to zero establishes the frequency of operation. Setting the real part equal to zero yields information on the oscillator's output power capability. Since it is very difficult to obtain definite data on chip negative resistance at present, an analysis of the real portion of the impedance will be omitted. We will assume that the negative resistance of the diode is sufficient to compensate for resistive losses in the cavity.

Neglecting the real impedance components in

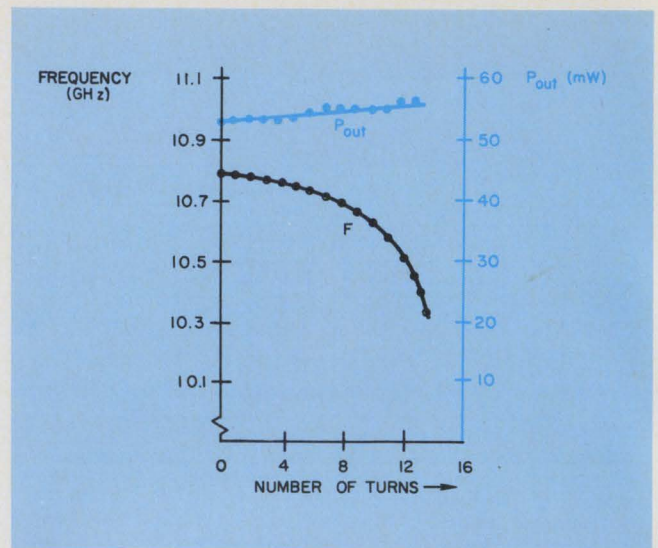

5. The output power (upper curve) stays within 4% of its mean value as the oscillator is tuned over a 470-MHz range (lower curve). The abscissa indicates the number of turns by which the Rexolite rod (item 3 in Fig. 1) has been screwed into the microwave oscillator cavity.

Eq. 3, we obtain

$$X_{\text{diode}} + X_{\text{coax}} + X_{\text{out}} = 0. \quad (4)$$

The reactive coupling impedance introduced by the coupling iris in series with the open-ended transmission line impedance is quite small and can be neglected. The shunt impedance introduced by the iris is extremely large and can also be neglected.

We are now in a position to calculate the length of the open coaxial transmission line required to provide a conjugate match to the reactive impedance at the diode terminals, which we found earlier to be equal to 28.4 ohms. Plugging this number into Eq. 2, we obtain $Z_0 \cot \beta L = 28.4$. For an air dielectric coaxial line, $Z_0 = 138 \log_{10} (D_1/D_2)$, where D_1 and D_2 are the outer and inner line diameters, respectively. Solv-

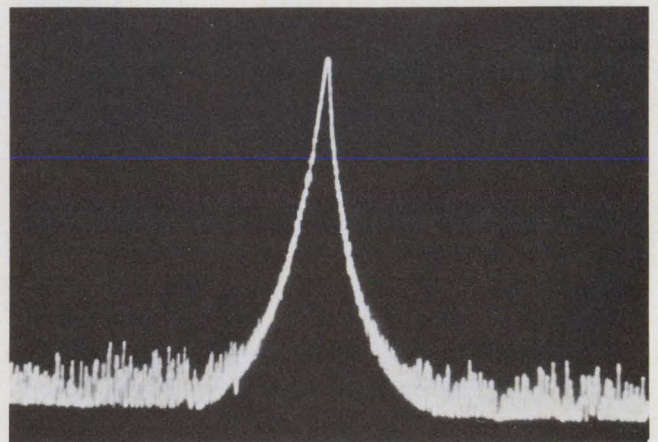

6. The oscillator is quite quiet as this spectrum analyzer photo shows. The photo was taken with the analyzer display in its logarithmic mode at an i-f bandwidth of 100 kHz, and a horizontal calibration of 100 kHz/cm.

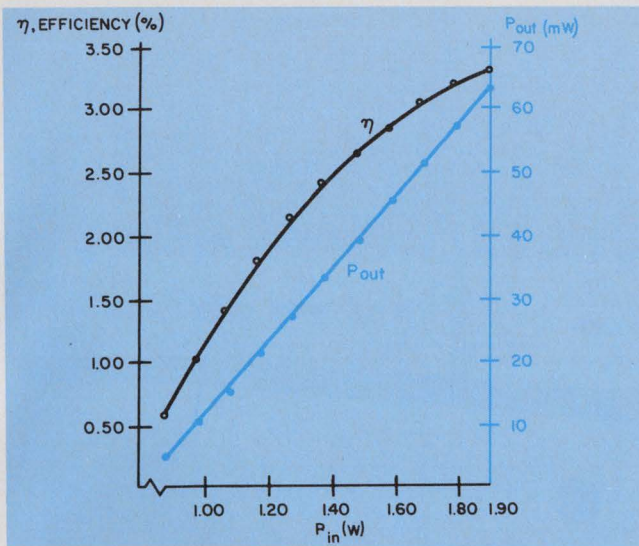

7. Both the output power (lower curve) and the efficiency (upper curve) increase as the input power is raised. Typically, the oscillator is operated near the righthand side of the curve, where it produces about 55 mW of power at an efficiency of about 3.2%.

ing for L with the dimensions of Fig. 1, we obtain $L = 0.175$ inch.

Oscillator tuning can usually be accomplished by mechanically changing some physical dimensions of the circuit. This usually results in excessive power loss and additional mechanical cavity complexity. The cavity used in this design, however, permits simple low-loss frequency tuning while avoiding these problems. This is done by changing the effective dielectric constant of the fringing capacitance at the open end of the cavity.

The dielectric used to perform this function should have a low dissipation factor and a substantial change in relative dielectric constant from that of air. Rexolite was chosen for this application. By inserting a Rexolite rod into the open end of the oscillator's cavity, we obtain a significant amount of frequency tuning capability while maintaining a fairly constant output power level (Fig. 5).

The dc bias potentials must be applied to an oscillator through a network that will prevent rf leakage to the bias circuit. The bias circuit for the oscillator of Fig. 1 uses a meandered length of wire for presenting a high rf choke impedance to the oscillator's circulating cavity currents. The rf choke is terminated in a bypass capacitance. Therefore any rf current not decoupled by the choke is bypassed to ground.

Increased choking is obtained by using a length of meandered wire a quarter-wavelength long. Since the length of meandered wire is placed over a ground plane, which in this case is the bottom of the cavity, what we have essentially is a shorted quarter-wave transmission line. The input impedance to a quarter-wave line is given

by $Z_i = Z_0^2/Z_L$. Since the impedance of the bypass capacitance, or Z_L , is essentially zero, Z_i approaches infinity, thereby providing rf isolation.

Yield factor is 100%

A broad spectrum of avalanche and Gunn diodes from five manufacturers were evaluated in the designed cavity. The oscillator was also sent to three manufacturers for yield-factor determination. In all cases, the oscillator exhibited a 100% yield factor.

This type of performance was possible because a broad range of real and reactive diode impedance values can be very easily obtained. Real-value impedance variations are obtained by changing the position of the oscillator's aperture screw, while variations in reactive impedance are obtained either by changing the length of the oscillator's open coaxial transmission line or by changing the capacitive fringing impedance at the open end of the oscillator cavity.

Because of its relatively high loaded Q ($Q_L \cong 500$), the oscillator produced very little noise (Fig. 6). A plot of its output power and efficiency as functions of input power is given in Fig. 7. ■■

Bibliography

Getsinger, W. J., "The Packaged and Mounted Diode as a Microwave Circuit," *IEEE Transactions on Microwave Theory and Techniques*, Vol. MTT 14, No. 2, February, 1966.

Haitz, R. H., Stover, H. L., Tolar, N. J., "A Method for Heat Flow Resistance Measurements in Avalanche Diodes," *IEEE Transactions on Electron Devices*, Vol. ED 16, No. 5, May, 1969.

Marcuvitz, N., *Waveguide Handbook*, New York, McGraw-Hill, 1951.

The X-band oscillator design described in this article is based upon the general principles discussed in the article, "To Use Gunn or Impatt Diodes . . .," which appeared in the preceding issue of ELECTRONIC DESIGN.

Test your retention

Here are questions based on the main points in this article. Their purpose is to help you make sure you have not overlooked any important ideas. You'll find the answers in the article.

1. What are two ways to adjust a cavity's impedance?
2. Why was a meandered length of wire used to provide dc bias to the diode?
3. What is the equivalent-circuit representation of the coupling iris?

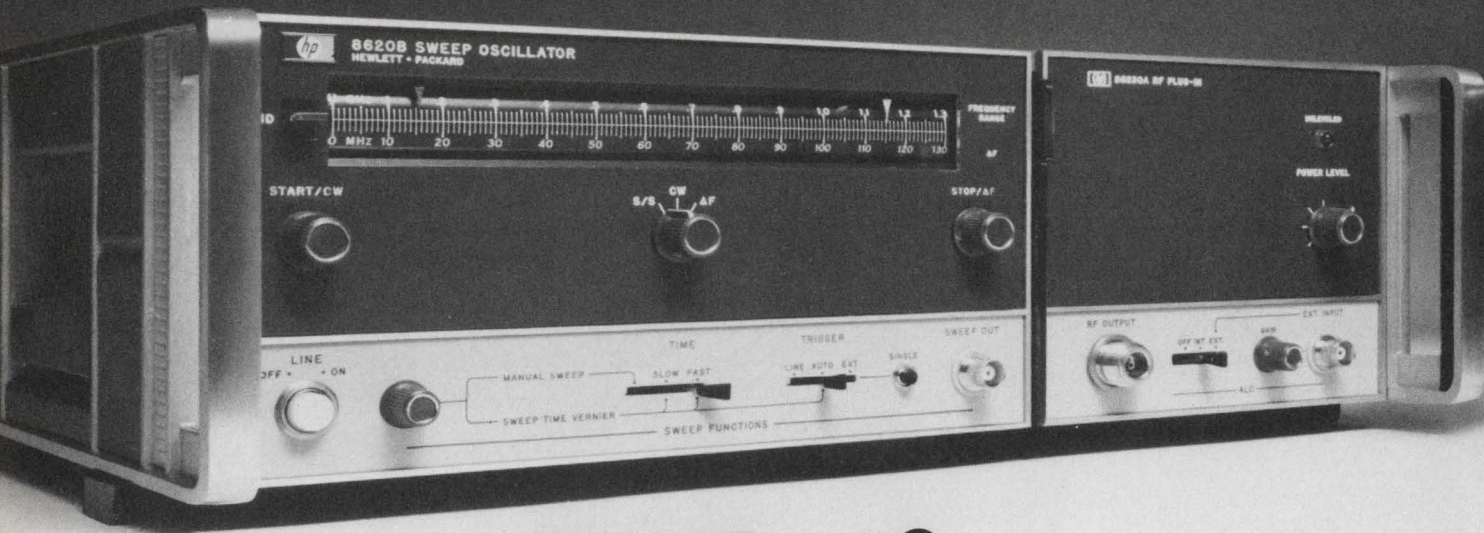

Plain



& Fancy.

Now you can go from 10 MHz to 12.4 GHz in either of two solid-state sweepers: the streamlined 8620B or the flexible 8620A.

The "plain" version will give you highly linear sweeps, stable CW and versatile modulation. Yet, including RF plug-ins, it costs 20 to 40 percent less than any similar combination on the market. The mainframe itself is a mere \$975.

The fancy 8620A mainframe will only set you back \$1450. And it proves once again that good things do come in small packages. Advanced engineering has packed exceptional resolution, great set-

ability and remarkable latitude of control into an instrument about half the size of previous models. Besides having push-button controls, it can even serve as a completely programmable source for systems.

For both plain and fancy versions, nobody can equal our approach to RF coverage. From 10 MHz to 12.4 GHz, you use low-cost octave bandwidth plug-ins or combine RF sources for multiband operation. (For example, you can configure a multiband plug-in to take you from 0.1 to 6.5 GHz or from 5.9 to 12.4 GHz.)

But whatever approach you choose,

you'll get impressive solid-state performance at attractive prices.

It's easy to select the best RF units and mainframe for your application; they're all described in our new sweeper brochure. Ask your local HP field engineer for a copy. Or write us for one at: Hewlett-Packard, Palo Alto, California 94304; Europe: 1217 Meyrin-Geneva, Switzerland.

04114

HEWLETT  **PACKARD**

SWEEP OSCILLATORS

CUTLER-HAMMER HAS THE RIGHT ILLUMINATED SWITCH FOR EVERY DESIGN.

Does your new product design call for an illuminated switch? Or would it be a better, more saleable product if it did?

Then Cutler-Hammer is ready to help with the broadest selection of illuminated switches you'll find anywhere.

We've got lighted toggles and rockers and paddles and pushbuttons. Standard sizes and miniatures. With lots of color choices and decorative hardware.

They come in a broad array of configurations—like double rockers and maintained or momentary action. With a range of electrical ratings that's sure to meet your specs. Including replaceable and non-replaceable lamps in several lamp types and many operating voltages.

Your Cutler-Hammer Sales Engineer or Stocking Distributor is ready to show you these switches in operation and to supply prototypes to match your designs. Contact him today and get the full story.

CUTLER-HAMMER

SPECIALTY PRODUCTS DIVISION, MILWAUKEE, WIS. 53201



Switch
to No.1

More than just switches;
prompt availability,
field help, innovation,
quality assurance, too.

INFORMATION RETRIEVAL NUMBER 26

★ **NOTICE** ★

to all subscribers:

Your Free Subscription MUST BE RENEWED!

A special card and complete instructions for checkoff requalification
will be in the NOVEMBER 11 issue of Electronic Design.

This is a one-time Renewal Opportunity.

*To insure uninterrupted service, your subscription
must be renewed using this special card. Please look
for the November 11 issue and return the card promptly.*

Cut noise in switching regulator

by using simple filters. With design tradeoffs, you can still get efficiencies up to 80%.

The switching voltage regulator is several times more efficient than a conventional linear regulator; so it's the preferred unit for aerospace and portable equipment—any equipment in which power-supply weight must be held to a minimum. Besides allowing the designer to use smaller battery packs or unregulated supplies, the switching regulator needs less cooling hardware, because it dissipates less power. But its efficiency stems from its squarewave-oscillator operation. And that generates switching noise. Moreover applications demanding the high efficiency of a switching regulator often have the most stringent specifications on noise. What's the remedy?

To suppress the noise and protect the regulator from line and load transients, filters must be used. But these dissipate power. The result is a design tradeoff: Noise is suppressed, but efficiency is sacrificed. The problem is to hold down the sacrifice.

Less of the switching regulator's inherently high efficiency—normally up to 95% if noise is not a problem—will be lost if the designer doesn't treat the regulator as a black box with add-on filters. He can achieve efficiencies of 60% to 80%—up to four times as high as those in linear regulators—by building noise suppression into the regulator circuitry.

Look at noise sources

Most of the noise from a switching regulator manifests itself as a long series of harmonic components of the pulse-width modulated square wave, extending into the megahertz region. The intensities of the harmonics decrease with frequency at a rate inversely proportional to some integral order of the frequencies. How rapidly the noise intensities decrease depends mainly on the squareness of the output waveform.

The drop-off with increasing frequency of the power in the harmonics in a true rectangular

wave is only 20 dB/decade, while for the less abrupt transition of a trapezoidal wave, it is 40 dB/decade. For a rounded cosine-squared function, it is roughly 60 dB/decade, and for a fully rounded pulse with the least abrupt transition feasible, it is about 80 dB/decade. Thus the mere rounding off of the corners of the basic square wave can result in a reduction in the level of in-

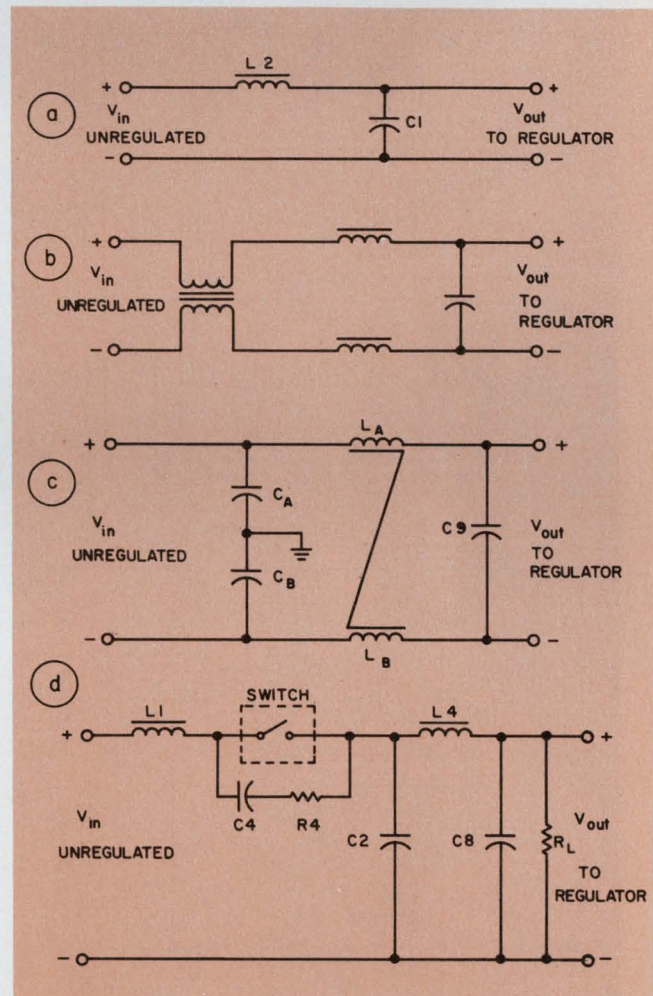

1. Simple filtering reduces noise by attenuating ripple currents and transients that might feed through the regulator (a). Floating the regulator and balancing the input line filter (b) can cut noise further, and capacitors can be added, center-tapped to ground (c). In some circuits suppression filters are added right at the switch (d).

Eugene R. Hnatek, Military/Aerospace Product Marketing Manager, National Semiconductor Corp., Santa Clara, Calif. 95051.

interference generated at the vhf frequencies, ranging from a 80 dB minimum to a probable maximum of 240 dB.

Five kinds of filtering

To build noise suppression in the circuitry, filter networks must be placed in the regulator

circuit. They affect the switching time constants, of course, and are therefore a critical factor in regulator efficiency. Several kinds of filtering are effective.

An input line filter (Fig. 1a) attenuates the ripple current that the regulator would normally reflect back into the battery. Inductor L1 has the primary task of attenuating the ripple current

The basic switching regulator: How it works

A switching regulator includes a switch, amplifier, voltage reference, filter and integrator placed between a direct-current source and its load.

The switch, usually a transistor, chops the unregulated input so only a desired portion of it will be delivered to the load. The output of the switch, a pulse-width-modulated square wave, is

integrated and filtered.

In principle, power is not dissipated to control the output voltage level. The switch, or series-pass transistor, is either fully ON or fully OFF for times determined by the extent to which the input voltage exceeds a reference voltage.

IC switching regulators include the amplifier and pass transistor. Modern IC regulators also

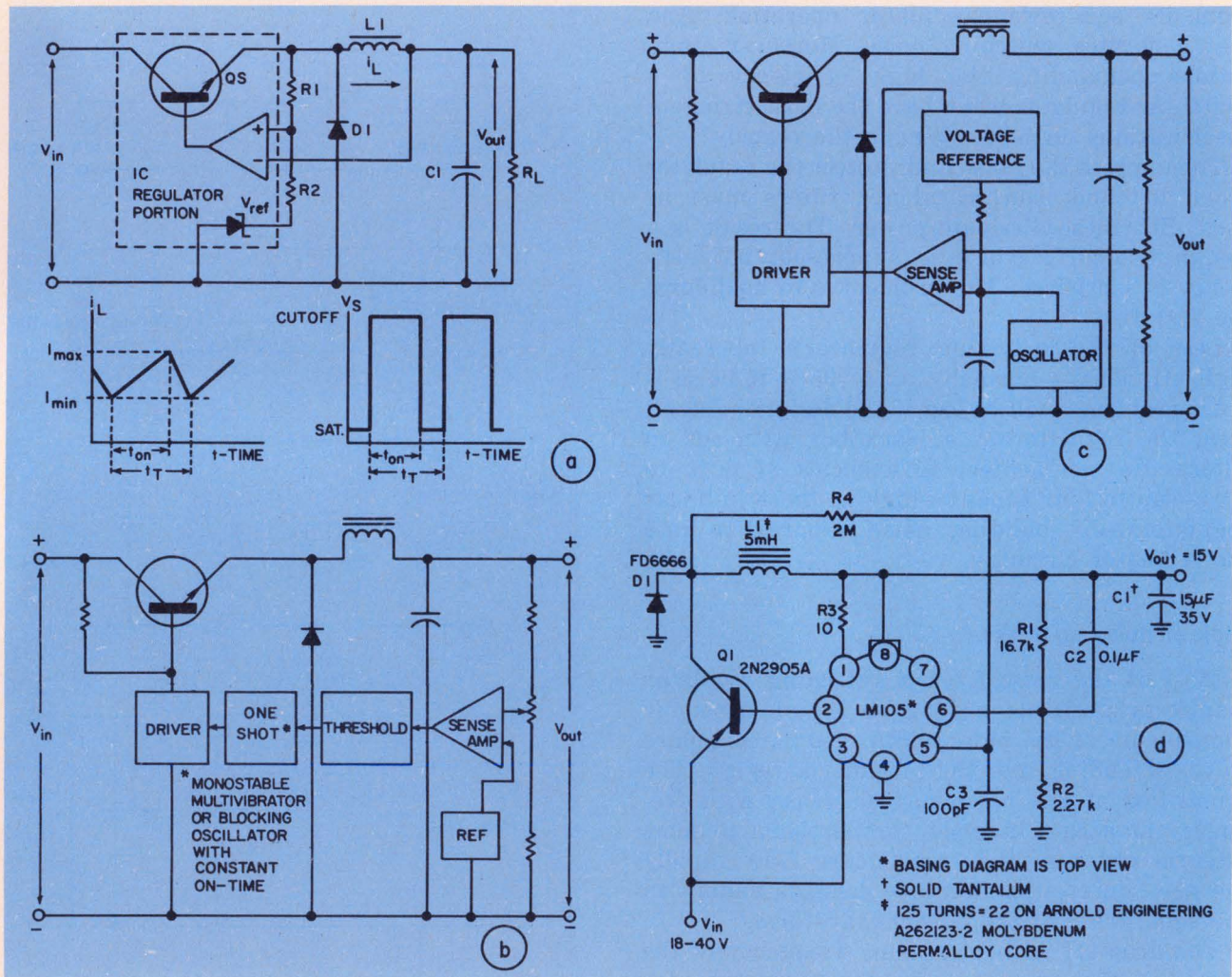

In a simple regulator the switching action of Q_s controls the current through the inductor and hence the voltage across the capacitor and the load (a). The transistor switch operates at variable frequency

with a fixed pulse width (b) or at fixed frequency with a variable ON-time (c). An IC regulator, with the switch, amplifier and voltage reference, can be used as the heart of the switching regulator (d).

created by the regulator to a level acceptable to the system. Because the addition of the inductor makes the battery a high impedance, as seen by the inverter, capacitor C1 is added. It converts the input back into a low impedance, capable of both delivering and absorbing power, and it protects the regulator from noise generated by other equipment in the system.

have an internal voltage reference, which may be supplemented in some applications by an external zener diode.

There is some power loss in the regulator components, of course, but efficiencies as high as 95% are practical. In contrast, a linear regulator's pass transistor is, as a rule, continuously ON, presenting more or less resistance to regulate the voltage. This results in typical efficiencies of 20% to 40%.

For highest efficiency, the switching regulator's pass transistor must traverse its active region, between saturation and cutoff, as fast as possible. Transistor switching losses are minimized by using high-speed transistors, but high speed generates noise that must be controlled. And thus a design tradeoff must be made. The degree to which noise must be controlled is determined by requirements of the system.

In the IC regulator design (d), an on-chip voltage reference is used, but an external pass transistor Q1 is added to get the current capability up to about 500 mA. Transistor Q1 is a pnp, so it can be connected directly to the IC booster output (an npn would require a compound emitter-follower connection that would not be as sensitive to very small voltage differentials).

Resistor R3 sets the base drive of Q1 to ensure saturation. If I_{max} is less than 500 mA, a larger R3 will keep Q1 from being overdriven. Resistor R4 provides positive feedback, which causes ripple that C2 minimizes by feeding it back to pin 6. Capacitor C3 prevents the shunt capacitance of R4 from coupling input spikes into the IC. Transistor Q1 and D1 are both fast-switching devices, so losses are kept low.

The optimum switching frequency for IC switching regulators is between 20 and 100 kHz. At lower frequencies the core becomes unnecessarily large, and at higher frequencies the switching losses in Q1 and D1 become excessive. It is important, in this respect, that both Q1 and D1 be fast-switching devices to minimize switching losses.

The output ripple of the regulator at the switching frequency is determined mainly by R4. The peak-to-peak output ripple is nearly equal to

Another type of input filter is one in which the switching regulator is isolated from the input and output lines, so it can float on its own noise instead of forcing noise onto the lines. The regulator can be allowed to float by inserting inductors or chokes into both input lines. The chokes should be wound with only a single layer, to reduce distributed capacitance.

the peak-to-peak voltage fed back to pin 5 of the LM105. Since the resistance measured at pin 5 is approximately 1000, this voltage will be $\Delta V_{ref} \approx 1000 V_{in}/R_4$.

In practice, the ripple will be somewhat larger than this. When the switch transistor shuts off, the current in the inductor will be greater than the load current, so the output voltage will continue to rise above the value required to shut off the regulator.

It's important that the value of the inductor be large enough so the current through it does not change drastically during the switching cycle. If it does, the switch transistor and the catch diode must be able to handle peak currents that are significantly larger than the load current.

The change in inductor current can be written as

$$\Delta I_L \approx V_{out} t_{OFF}/L.$$

For the peak current to be about 1.2 times the maximum load current, it is necessary that

$$L I = 2.5 V_{out} t_{OFF}/(I_{out})_{max}.$$

A value for t_{OFF} can be estimated from the relation

$$t_{OFF} = (1/f)[1 - (V_{out}/V_{in})],$$

where f is the desired switching frequency and V_{in} is the nominal input voltage. The size of the output capacitor can now be determined from

$$C1 = \left(\frac{V_{in} - V_{out}}{2L1 \Delta V_{out}} \right) \left(\frac{V_{out}}{fV_{in}} \right)^2,$$

where ΔV_{out} is the peak-to-peak output ripple and V_{in} is the nominal input voltage.

It now remains to determine if the component values obtained above give satisfactory load-transient response. The overshoot of the regulator can be determined from

$$\Delta V_{out} = L1(\Delta I_L)^2/C1(V_{in} - V_{out})$$

for increasing loads, and from

$$\Delta V_{out} = L1(\Delta I_L)^2/(C1)V_{out}$$

for decreasing loads, where ΔI_L is the load-current transient. The recovery time, t_r , is

$$2L1\Delta I_L/(V_{in} - V_{out})$$

and

$$2L1\Delta I_L/V_{out}$$

for increasing and decreasing loads, respectively.

Another way to help the regulator float is to place a filter transformer in series with the lines (Fig. 1b), to allow the input to stay constant. Similar techniques apply to the output lines.

In still another variation of the input filter (Fig. 1c), capacitors C_A and C_B are low-impedance capacitors center-tapped to ground. Inductors L_A and L_B have a high-impedance and are bifilar wound on the same core to reduce size. Ac currents are attenuated by the full inductance, but the fluxes cancel normal common-mode current. Capacitor C_9 acts to prevent load transients from entering the regulator when the filter is on the regulator output. Or, if the device is used as an input filter, C_9 is positioned to prevent power-supply transients from entering the regulator.

An approach to rounding off the square-wave corners at the source of the square wave—at the switch—with small RC networks is shown in Fig. 1d. The RC networks suppress higher-order harmonics. The inductors are wound on toroids that are 0.30 or 0.45 inch in diameter and usually have a value of 50 to 100 mH. Lower values may be used if only the high-frequency noise is of concern.

Noise suppression begins at about 50 kHz; the noise is reduced by, typically, 80 dB. Switching spikes are suppressed by the network across the switch. Such networks as these are now commercially available as small components with R and C values of, typically, 15 to 25 ohms and 100 pF.

The two inductor toroids can be potted together if shielding is placed between them. Output, input and switch leads must be well separated, of course, to avoid coupling effects.

A switching-regulator circuit that employs some of the techniques discussed is shown in Fig. 2. Commercial versions of the filter of Fig. 1c

are used. They are “pi” and “T” section filters, made by stringing ferrite beads on a center conductor. High-dielectric ceramic material is fused around the beads, and an outer metal shell with feedthrough connections completes the construction.

Additional elements are added if noise must be more strongly suppressed. Capacitors C_4 and C_5 are added to reduce high-frequency switching transients, by slowing the switching speeds of the output transistors. They also protect the semiconductor devices from transients. Capacitor C_4 protects the emitter-base junction of Q_2 while capacitor C_5 protects both the IC and the collector-base junction of Q_1 by controlling the risetimes of the switching voltages.

In addition capacitors C_6 and C_7 suppress transients on the unregulated input, C_8 minimizes the input impedance seen by the regulator, and C_9 improves the filtering of the switching noise in the regulated output. The other capacitors have the same function as before, except that C_1 is much larger.

This circuit oscillates in the range of 20 kHz to 40 kHz. Resistors R_1 and R_2 determine the output voltage level, and R_6 insures enough positive feedback.

Inductor L_1 has the same function as in Fig. 1a, but the lower V_{out} and the added inductive resistance provided by R_4 allow L_1 in this case to be only 550 μ H. Inductors L_2 and L_3 are high-frequency input and output filters.

To avoid the possibility that problems in the power supply might reverse the input-voltage polarity, or that heavy negative-going transients might be generated on the unregulated input, diodes are placed on the collector of Q_2 .

Although I_{max} is only 500 mA, the higher dissipation of this slower-switching circuit, and the

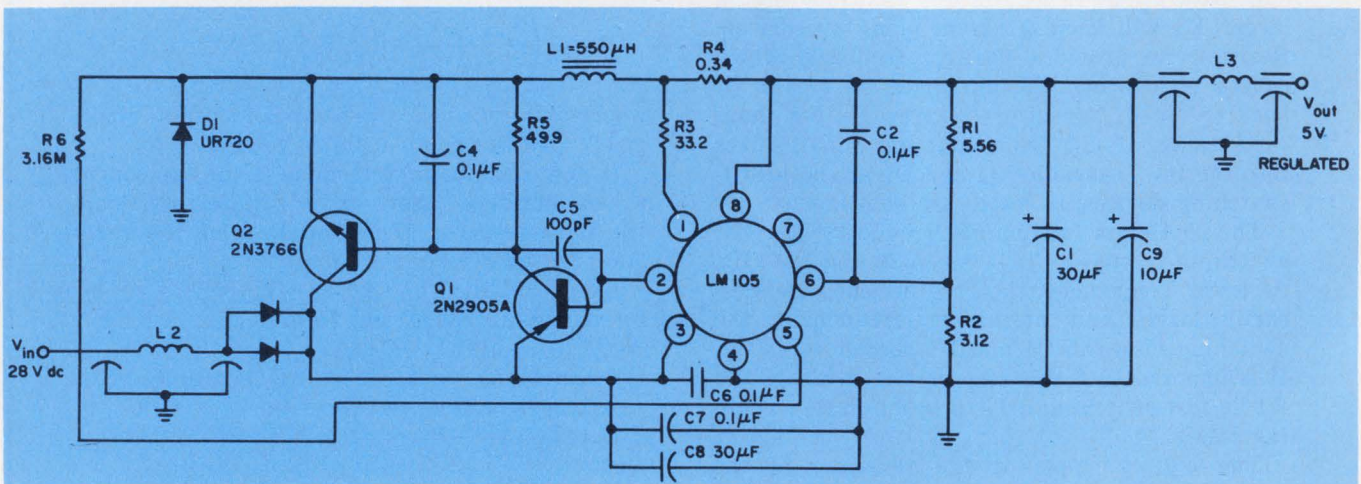

2. In the noise-suppressed regulator, capacitors C_4 and C_5 slow the switching speeds of the switching transistors, C_6 and C_7 suppress transients on the unregulated out-

put, C_8 lowers the impedance seen by the regulator, and C_9 reduces switch noise in the output. Efficiency is 60 to 70%. The circuit oscillates at 20 kHz to 40 kHz.

fact that the regulator has to operate at relatively high temperatures, make it necessary to use two external transistors. Pass transistor Q2 is an npn type for the same reason that Q1 is a pnp—so cascade connections on the IC booster

output can be used. Finally, R5 is added to terminate Q2 and for low OFF leakage.

Losses in this circuit are 30% to 40%, depending on V_{in} . Most of the extra loss builds up in the pass transistors. The efficiency can be

Avoid these pitfalls in your design

A number of precautions should be observed with all switching-regulator designs, especially in high-current applications:

First, fast switching diodes and transistors must be used. Voltages on the order of 10 V can be developed across the ordinary junction rectifier, for example, in the forward direction, when the switch transistor turns OFF (the diode maintains current flow for the OFF condition). This happens because the low-frequency rectifiers are usually manufactured with a p-i-n structure, which presents a high forward impedance until enough minority carriers are injected into the diode base region to increase its conductance. Excessive power dissipation in the diode is a result.

Similarly only high-frequency switch transistors are suitable for switching regulators, since excessive switching losses in low-frequency transistors like the 2N3055 make them overheat.

Second, it is important that the core material used for the inductor have a "soft" saturation characteristic. Cores that saturate abruptly produce excessive peak currents in the switch transistor if the output current becomes high enough to run the core close to saturation.

Powdered molybdenum-permalloy cores are recommended. They exhibit a gradual reduction in permeability with excessive current, so that output currents above the design value cause only a gradual increase in switching frequency.

A third precaution, frequently overlooked in the design of switching circuits, is the proper ripple rating of the filter capacitors. High-frequency ripple can cause capacitors to fail—an especially important consideration for capacitors used on the unregulated input, because the ripple current through them can be higher than the dc load current. The situation is eased somewhat for the filter capacitor on the output of the regulator, where ripple current is only a fraction of the load current. Nonetheless proper design usually requires that the voltage rating of this capacitor be higher than that dictated by the dc voltage across it for reliable operation.

One unusual problem with switching regulators is the excessive power dissipation in the switch transistors caused by high emitter-base saturation voltage. This also shows up as erratic operation if the transistor is the defective device. This saturation voltage can be as high as 5 V, because of poor alloying on the base contact

of the transistor. A transistor defective in this respect may not show up on a curve tracer, because the low base current needed for linear operation does not produce a large voltage drop across the poorly alloyed contact. A bad device can be spotted, however, by probing the bases of the switch transistors while the circuit is operating.

Watch your grounds! It's necessary that the diode used to maintain current when the switch transistor is OFF, and any bypass capacitance on the unregulated input, be returned to ground separately from the other parts of the circuit. These components carry large current transients and develop appreciable voltage transients across even a short length of wire.

Another cause of problems with regulators is severe voltage transients on the unregulated input. Even if these transients do not cause immediate failure in the regulator, they can feed through and destroy the load. If the load shorts out, as is frequently the case, the regulator can be destroyed by subsequent transients.

This problem can be solved, of course, by specifying all parts of the regulator to withstand the transients, but a more logical recourse is to include circuitry that suppresses them. A way of doing this is shown in the diagram.

The size of the inductor is determined from the relation $L = \Delta V \Delta t / I$, where ΔV is the voltage by which the input transient exceeds the breakdown voltage of the diode, Δt is the duration of the transient and I is the peak current that the zener can handle while still clamping the input voltage to the regulator. As shown, the suppression circuit will clamp 70-V, 4-ms transients on the unregulated supply.

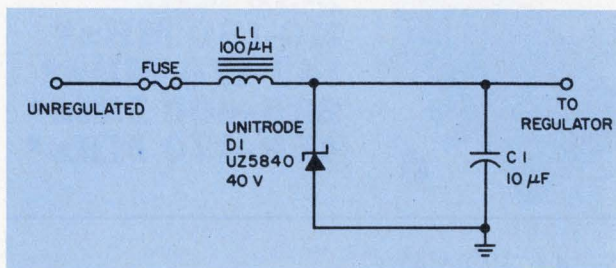

A zener diode clamps the input voltage to the regulator in this transient-suppression circuit. The inductor limits current through the zener during the transient. Up to 70 V is clamped in this circuit.

A few words to those who design circuits without a gaussmeter.

Good luck.

If you design or work with magnetic circuits, a gaussmeter can save you a lot of time. It converts flux density into voltage for measurement. So, you can check faults both magnetically and electrically to track down any trouble as quickly as possible. Our gaussmeter brochures are the place to start. Write. 4949 Freeway Drive East, Columbus, Ohio 43229

E.W. Bell Inc.

A subsidiary of The Arnold Engineering Co.

INFORMATION RETRIEVAL NUMBER 27

RF FILTERS

for Transmitters & Receivers*

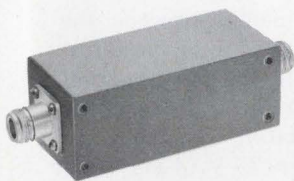

- Low Pass
- Band Pass
- Tunable
- Miniature
- High Power

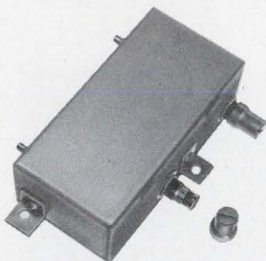

- 2-32 MHz*
- 110-150 MHz*
- 143-178 MHz*
- 225-400 MHz*
- 450-470 MHz*

MICROWAVE
IFC COMPANY, INC.

135 WEST MANLIUS STREET,
EAST SYRACUSE, NEW YORK 13057 (315) 437-4529

INFORMATION RETRIEVAL NUMBER 28

raised to over 75% by eliminating C4 and C5.

Over the input voltage range of 22 to 31 V, the switching rate of this circuit varies from about 20 to 40 kHz. At temperatures from -30 F to 150 F, the total variation in V_{out} over the V_{in} range is $\pm 1.1\%$. The efficiency is 67% at room temperature, with $V_{in} = 22$ V, and 61% with $V_{in} = 31$ V. Maximum power output is 2.3 W.

At the same voltage drops, a comparable linear regulator would have efficiencies ranging from only 15% to 24%.

Measure suppression characteristics

To determine this regulator's noise suppression characteristics, four tests were performed. First, positive and negative 50-V, 10- μ s transients were injected on top of the dc input voltage to the regulator. Noise measured after the input filter (at Q2) was 1.5 V peak-to-peak, and noise at the regulator output was 100 mV peak-to-peak.

Next, a 50-V dc square wave input with a 10-ms period was injected at the input of the regulator. A positive shift of the output voltage of 0.5 V dc was observed. The frequency of the switching regulator decreased to 10 kHz, indicating that the input filter wasn't effective for blocking this type of waveform. Some of the 10-kHz noise appeared on the output as a 400-mV peak-to-peak modulated signal.

In the next test, the output was driven with a 60-mA-to-80-mA load. Time-domain ripple measurements were made on the input. This ripple appeared as a half sine wave (rectified) with the same period as that of the switching regulator. With a V_{in} of 22 V dc, there was 4.5 mA peak-to-peak of input ripple. At the same time the output ripple remained at 100 mV peak-to-peak.

Finally, audio noise was injected at the regulator power input as follows: 4 V peak-to-peak over a frequency range of 6 Hz to 100 kHz, and at least 1 V peak-to-peak over the range 100 to 250 kHz. The response of the input filter to these signals was essentially flat up to 300 Hz, where it began to roll off at 20 dB/decade. The 3-dB point was at 1 kHz. The regulated output had a flat response of -37 dB to 30 kHz, then decreased to -30 dB at 60 kHz (indicating a resonant peak), then went back to -37 dB above 60 kHz (dB are with respect to the input). ■■

Bibliography:

Hnatek, E. R., *Solid-State Power Supply Design Guidelines*, to be published by Van Nostrand Reinhold Co., New York, May 1971.

Widlar, R. J., *An Improved Positive Regulator*, Application Note AN-23, National Semiconductor Corp., January 1969.

Widlar, R. J., *Designing Switching Regulators*, Application Note AN-2, National Semiconductor Corp., March 1969.

Widlar, R. J., *Designs for Negative Regulators*, Application Note AN-21, National Semiconductor Corp., December 1968.

Centralab DIPs have a secret...

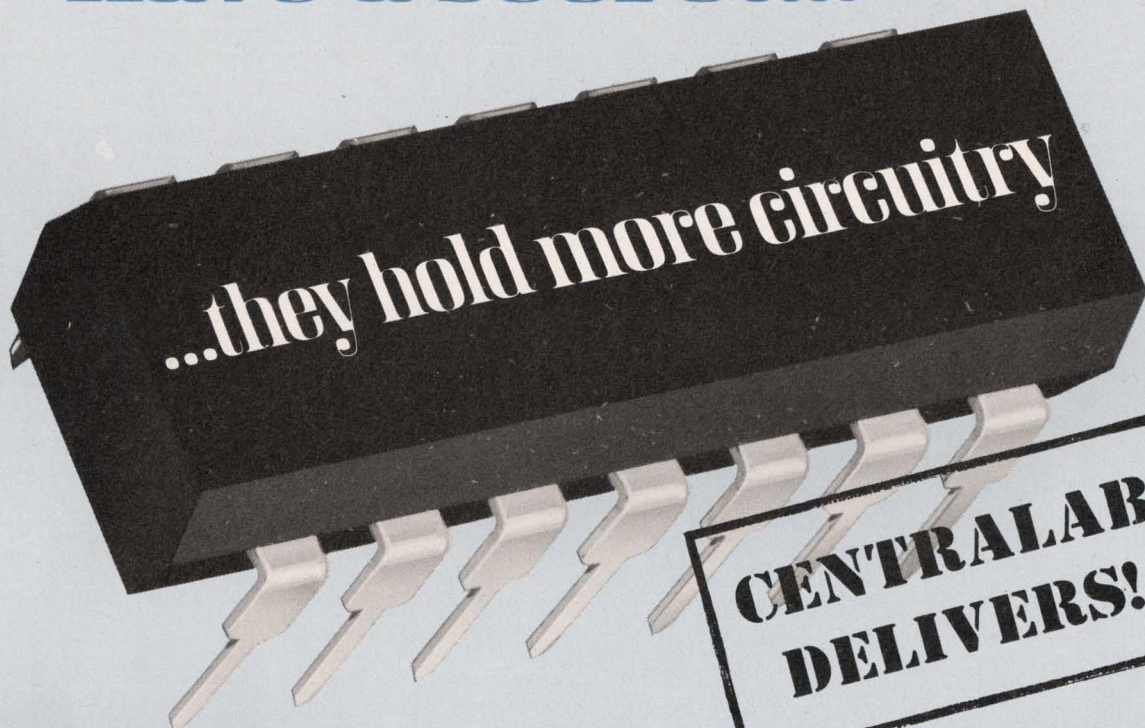
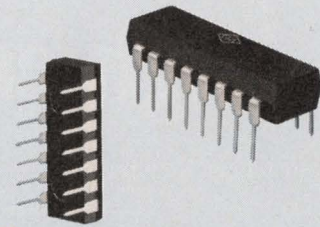

**CENTRALAB
DELIVERS!**

Every dual in-line package may look the same, but Centralab, through a unique manufacturing process, can now provide more circuitry per package. You can reduce the number of packages required for further miniaturization in design.

In resistor networks, including ladder networks, Centralab DIPs can accommodate a maximum of 24 resistors per package in 14 lead (TO-116) configurations. Our new 16 lead package provides up to 28 resistors.

A similar increase in elements is possible in two other general groups of networks:

- Resistor/Capacitor networks, including multi-layer ceramic chip capacitors.
- Active networks, including those with conventional semiconductor chips or beam-leaded devices.

The precision molded packages in either 14 or 16 lead configuration illustrated have a power rating of up to three watts and are designed to meet MIL Standards 883 and 202.

Centralab, the pioneer in thick-film technology, continues to lead with the introduction of these new packages. Laser adjusting techniques reduce resistor size, a special lead-frame material provides greater power handling capabilities, and automated final test equipment insures the reliability you demand. As producers of our own substrates, capacitors, resistor materials and semiconductors, we can provide customized circuitry that meets your standards of performance and reliability . . . with delivery in four weeks.

For complete information and specifications, write Sales Manager, MEC, Centralab.

SPECIFICATIONS*

Ohmic values	10 to 10 Meg.
Tolerance	to 0.5%
Ratio match	to 0.5%
TCR (-55°C to +150°C)	<100 PPM/°C
TC Tracking	10-25 PPM
Operating temperature range	-55°C to +125°C
Power density	up to 3 watts
High temperature stability (2000 hrs. @ 125°C)	$\Delta R < 0.5\%$
Operating load life (1000 hrs. @ 70°C & 2 watts)	$\Delta R < 0.5\%$
Short time overload (2.5 times power rating)	$\Delta R < 0.5\%$

*Typical

ALSO AVAILABLE THROUGH
GLOBE-UNION INC. - INTERNATIONAL DIV.



CENTRALAB

Electronics Division
GLOBE-UNION INC.

5757 NORTH GREEN BAY AVENUE
MILWAUKEE, WISCONSIN 53201

High energy silicon for the 70's.

Switching Regulator

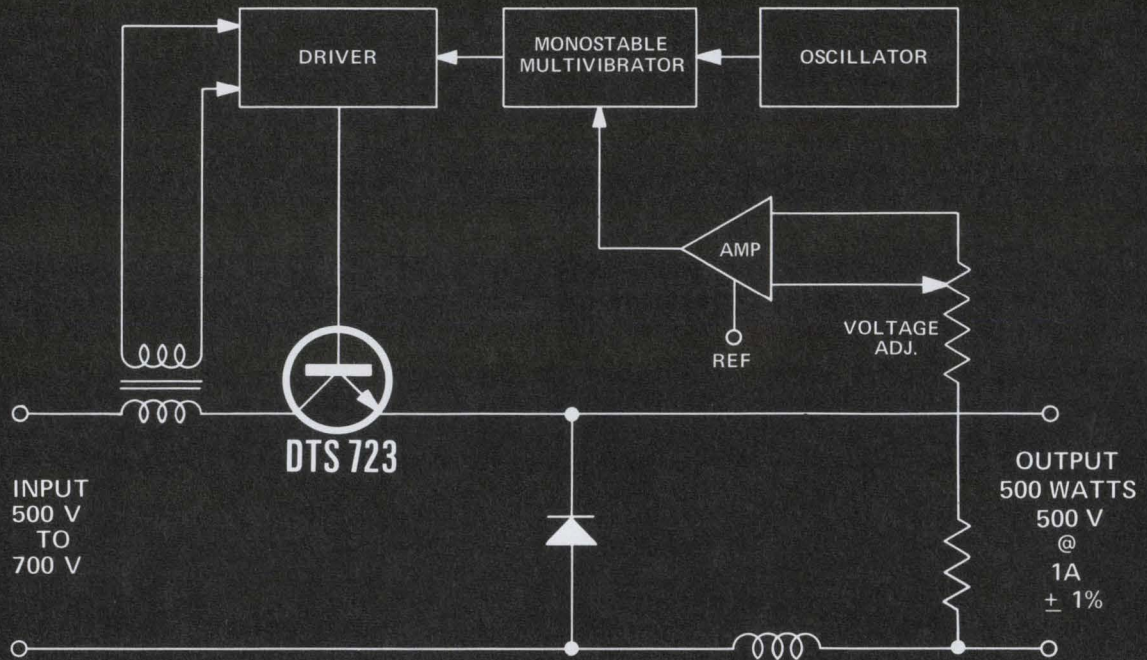

DC Regulator

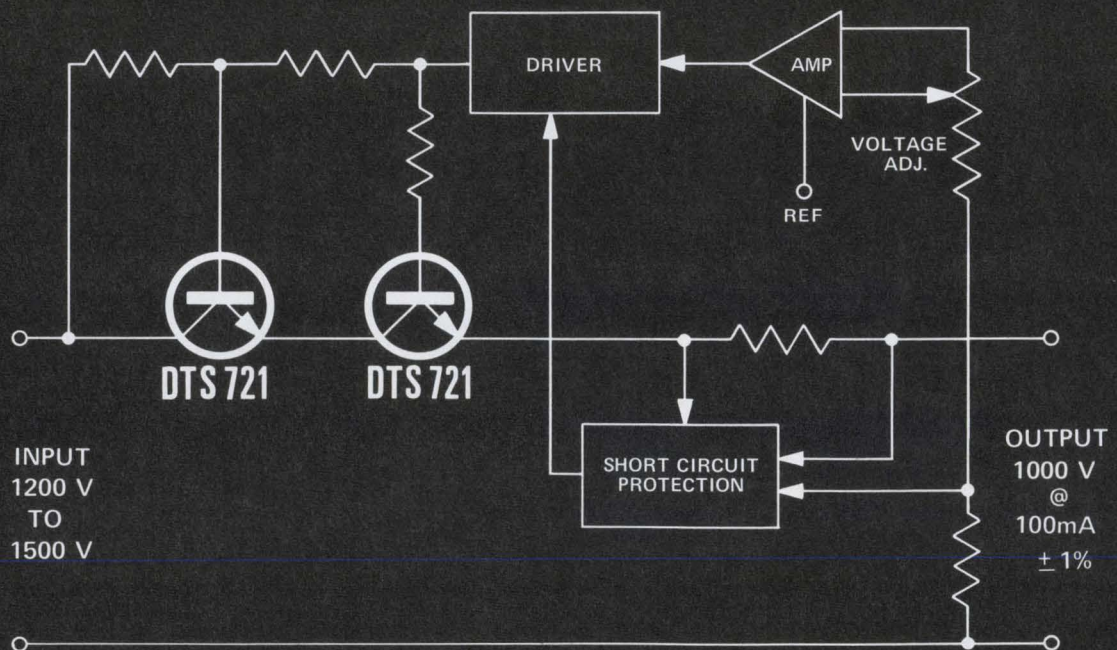

	V _{CEX}	V _{CEO}	V _{CEO} (sus)	I _C (cont)	h _{FE} @ I _C min/max V _{CE} = 5.0V	P _T
DTS-721	1000V	1000V	800	3A	20/60 @ 150 mA	50W
DTS-723	1200V	1000V	750	3A	2 min @ 2.5 A	50W

Delco announces two new 1000-volt transistors for high power regulators in small packages.

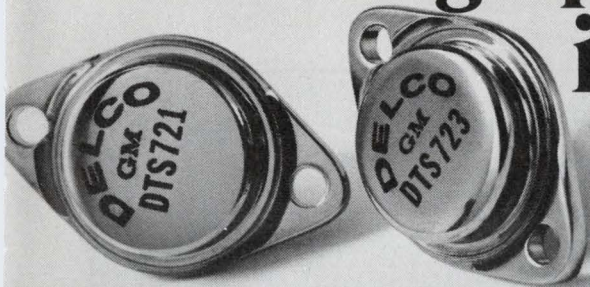

Our new DTS-721 and DTS-723 1000-volt silicon transistors permit you to design solid state circuits for industrial applications with capabilities previously reserved for tubes. Now you can think small.

These two new silicon devices were developed specially for instrumentation and power supply builders, as well as for computer and military applications. They can operate from DC inputs of 1200 volts to 1500 volts. With 1% regulation at full load.

In a switching regulator, they can operate directly from a 220-volt line or from rectified 440-volt single or polyphase sources.

Both devices are NPN triple diffused, packaged in Delco's solid copper TO-3 cases. They are mounted to withstand mechanical and thermal shock because of special bonding of the emitter and base contacts.

The DTS-721 and DTS-723 have been proven by

Available from these Delco distributors:

ALA., BIRMINGHAM • Forbes Distributing Co., Inc. (205)-251-4104
ARIZ., PHOENIX • Cramer/Arizona (602)-263-1112 • Sterling Electronics (602)-258-4531
CAL., LOS ANGELES • Kierulff Electronics, Inc. (213)-685-5511 • Radio Products Sales, Inc. (213)-748-1271
CAL., PALO ALTO • Kierulff Electronics, Inc. (415)-968-6292
CAL., REDWOOD CITY • Cramer/San Francisco, (415)-365-4000
CAL., SAN DIEGO • Milo of California, Inc. (714)-232-8951
CAL., SAN DIEGO • Radio Products Sales, Inc. (714)-292-5611
COLO., COLORADO SPRINGS • Walker Electronics (303)-636-1661
COLO., DENVER • Cramer/Denver (303)-758-2100 • Denver Walker Electronics (305)-935-2406
ILL., ROSEMONT (Chicago) • Kierulff/F-J-R (312)-678-8560
ILL., SKOKIE (Chicago) • Merquip Electronics (312)-282-5400
IND., INDIANAPOLIS • Graham Electronics Supply, Inc. (317)-634-8486
MD., BALTIMORE • Radio Electric Service Co. (301)-823-0070
MASS., NEEDHAM HEIGHTS • Kierulff Electronics, Inc. (617)-449-3600
MASS., NEWTON • The Greene-Shaw Co., Inc. (617)-969-8900
MICH., ROMULUS • Harvey/Detroit (313)-729-5500
MINN., MINNEAPOLIS • Stark Electronics Supply Co. (612)-332-1325

MO., KANSAS CITY • Walters Radio Supply, Inc. (816)-531-7015
MO., NO. KANSAS CITY • LCOMP-Kansas City, Inc. (816)-221-2400
MO., ST. LOUIS • LCOMP-St. Louis, Inc. (314)-647-5505
N.J., CLIFTON • Eastern Radio Corporation (201)-471-6600
N.M., ALBUQUERQUE • Cramer/New Mexico (505)-265-5767 • Sterling Electronics (505)-247-2486
N.Y., BINGHAMTON • Harvey/Federal (607)-748-8211
N.Y., EAST SYRACUSE • Cramer/Eastern (315)-437-6671
N.Y., NEW YORK • Harvey/New York (212)-582-2590
N.Y., ROCHESTER • Cramer/Rochester (716)-275-0300
N.Y., WOODBURY • Harvey/New York (516)-921-8700
OHIO, CINCINNATI • United Radio, Inc. (513)-761-4030
OHIO, CLEVELAND • Pattison Supply (216)-441-3000
OHIO, DAYTON • Kierulff/F-J-R (513)-278-9411
OKLA., OKLAHOMA CITY • Radio, Inc. (405)-235-1551
OKLA., TULSA • Radio, Inc. (918)-587-9123
PENN., PHILADELPHIA • Almo Electronics (215)-676-6000
PENN., PITTSBURGH • RPC Electronics (412)-782-3770
S.C., COLUMBIA • Dixie Radio Supply Co., Inc. (803)-253-5333

application tests from production lots by prospective users with stringent reliability requirements.

And their energy handling capability is verified by Delco Pulse Energy Testing.

These new high voltage silicon transistors make it possible for you to take advantage of reduced size, weight and component costs in designing circuits—and get far greater reliability.

The circuits shown are explained in detail in our application notes nos. 45 and 46.

Call the Kokomoans or your Delco Distributor for more information.



Delco Electronics

DIVISION OF GENERAL MOTORS CORPORATION, KOKOMO, INDIANA

TEXAS, DALLAS • Adleta Electronics Company (214)-741-3151
TEXAS, FORT WORTH • Adleta Electronics Co. (817)-336-7446
TEXAS, HOUSTON • Harrison Equipment Co., Inc. (713)-224-9131
UTAH, SALT LAKE CITY • Cramer/Utah (801)-487-3681
VA., RICHMOND • Meridian Electronics, Inc., a Sterling Electronics Company (703)-353-6648
WASH., SEATTLE • Kierulff Electronics, Inc. (206)-763-1550
WASH., TACOMA • C & G Electronics Co. (206)-272-3181
CANADA, ONT., SCARBOROUGH • Lake Engineering Co., Ltd. (416)-751-5980
ALL OVERSEAS INQUIRIES:
General Motors Overseas Operations
Power and Industrial Products Dept.,
767 Fifth Avenue, New York, N.Y.
10022. Phone: (212)-486-3723.

Regional Headquarters. Union, New Jersey* 07083, Box 1018 Chestnut Station, (201)-687-3770 ■ El Segundo, Calif. 90245, 354 Coral Circle, (213)-772-5181
■ Kokomo, Ind. 46901, 700 E. Firmin, (317)-459-2175
Home Office ■ Office includes field lab and resident engineer for application assistance.



Build gated video amplifiers with IC differential amps. You can exploit their current-switching capabilities in both single-ended and differential designs.

Designers of pulse-circuit systems, such as radars, frequently need amplifiers that will produce an output for the duration of a command signal only. IC differential amplifiers can fill the bill nicely. They have extremely well-matched input transistors and unique current-gating capabilities that permit the design of gated video amplifiers with excellent rise and fall times, small gating spikes and low offsets. These amplifiers make it possible for the system to ignore the error-producing noise that is usually received between pulses.

100 mV is all it takes

The basic differential amplifier circuit (Fig. 1a) has excellent current-switching properties. If the alphas of Q_1 and Q_2 are the same and essentially equal to unity (an excellent assumption for well-matched transistors such as the Motorola MD-918A and for IC differential amps such as the RCA CA-3026 and CA-3049), then the emitter and collector currents will be equal if $V_1=V_2$.

The constant-current source, I_t , constrains the two collector currents to satisfy the relationship

$$I_{c1} + I_{c2} = I_t = \text{constant}, \quad (1)$$

and the two currents are given by

$$I_{c1} = \frac{I_t}{1 + \exp [m(V_2 - V_1)]} \quad (2)$$

and

$$I_{c2} = \frac{I_t}{1 + \exp [m(V_1 - V_2)]} \quad (3)$$

where $m=q/KT$, q is the electronic charge, K is Boltzmann's constant, and T is the absolute temperature.

It is evident when Eqs. 2 and 3 are plotted as functions of $V_2 - V_1$ (Fig. 1b) that a voltage difference of only 100 mV suffices to turn one transistor completely OFF and the other one ON.

The current-switching capability can be exploited to build an excellent gated amplifier, as shown in Fig. 2.

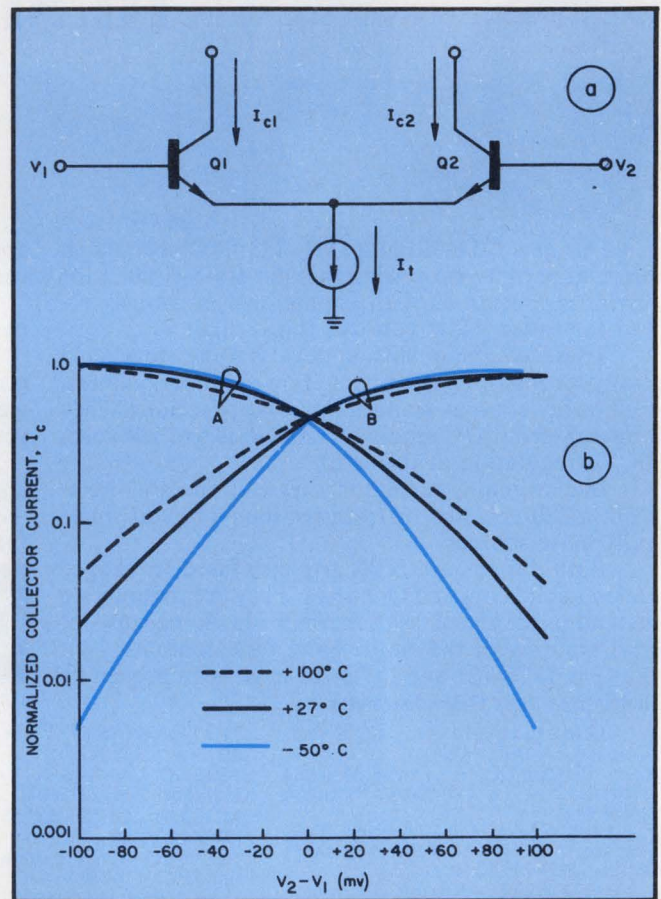

1. The basic differential amplifier circuit (a) has excellent current-switching capabilities if Q_1 and Q_2 are well-matched. A ΔV of only 100 mV will suffice to turn one transistor OFF and the other ON (b).

When the gate signal is low (base of Q_3 is at ground potential), Q_6 is biased ON (by R_1 and R_2) and Q_3 is biased OFF. Thus the differential amplifier formed by Q_1 , Q_2 and Q_3 is OFF, and the one formed by Q_4 , Q_5 and Q_6 is ON.

If the base bias voltages are equal ($V_{b1}=V_{b2}=V_{b4}=V_{b5}$), then, because of the differential nature of Q_4 and Q_5 (both differential stages share the constant-current source I_t), $I_{c4}=I_{c5}=I_t/2$ since $I_{c4} + I_{c5} = I_t$.

Thus the signal on input A will be amplified, and the signal on input B won't. If the gate goes high ($V_{b3} > V_{b6}$), transistor Q_6 will turn OFF

Richard S. Hughes, Senior Electronics Engineer, Code 3527, U.S. Naval Weapons Center, China Lake, Calif. 93555.

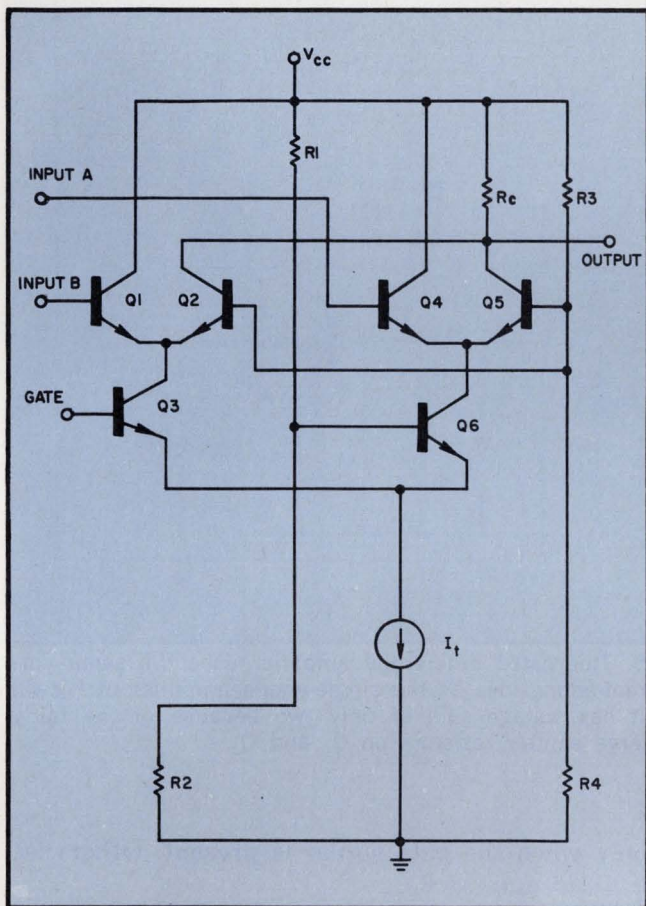

2. Input A is amplified and input B is attenuated when the gate signal is low. Making $V_{b3} > V_{b6}$ turns off transistor Q_6 and turns on Q_3 , thus allowing the signal on input B to be amplified while input A is attenuated.

and Q_3 will turn ON. Note, however, that the current through R_c remains unchanged, because the decrease in I_{c5} as Q_6 turns OFF is compensated for by the increase in I_{c2} as Q_3 turns ON.

The net result is that the collector voltage, V_{c5} (or V_{c2}), remains constant and no offset or spikes are produced by the switching.

For linearity, you'll need feedback

The basic circuit of Fig. 2 has nonlinear voltage gain. Therefore if inputs of greater than a few millivolts are to be linearly amplified, some sort of feedback will have to be used.

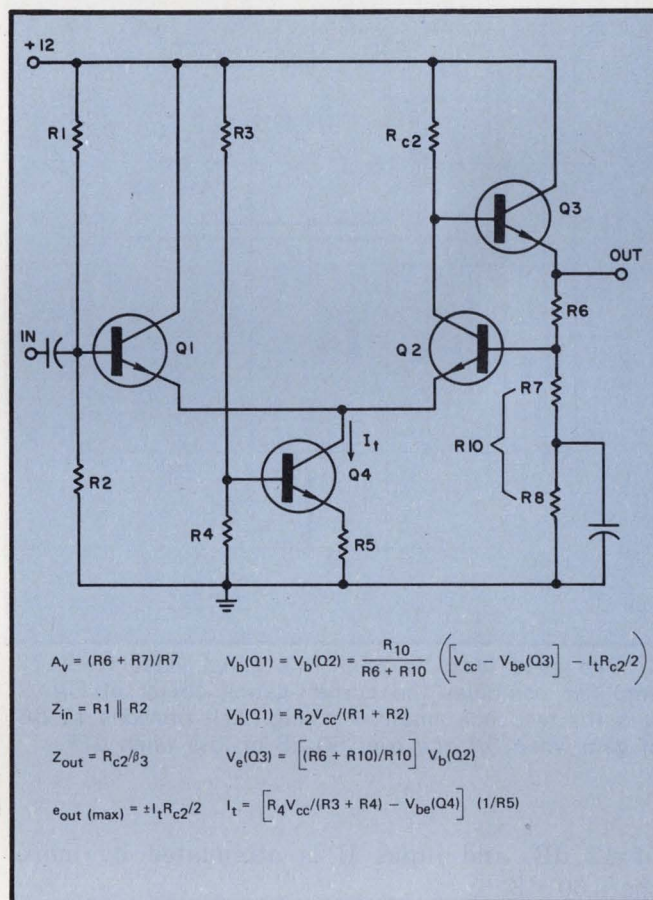

3. Excellent gain stability and ease of construction are two important features of this differential feedback video amplifier. The circuit can be built largely from standard integrated circuits.

An excellent differential feedback video amplifier and the pertinent design equations are shown in Fig. 3.¹ This amplifier has excellent gain stability, and it is easily constructed with ICs.

It's a simple matter to ensure that two such amplifiers share a common load and a common current source (Fig. 4). In the illustrated circuit, Q_1, Q_2, Q_3 and Q_7 make up one differential feedback video amplifier, and Q_4, Q_5, Q_6 and Q_7 make up the other. Transistor Q_8 is the common constant-current source.

Transistor Q_3 is normally biased ON and Q_6 OFF. Input A is therefore amplified with a gain

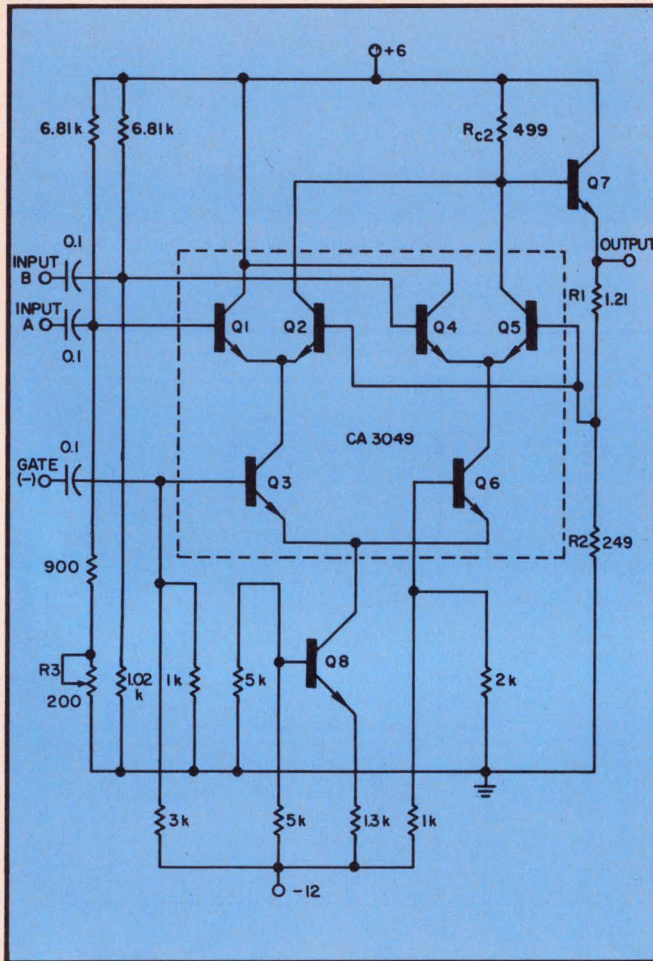

4. Two good ideas in one: This gated video feedback amplifier combines the current-gating circuit of Fig. 2 with the feedback amplifier of Fig. 3. It provides 12 dB of gain when ON and over 60 dB of loss when OFF.

of 12 dB, and input B is attenuated by more than 60 dB.

When the gate goes negative, the situation is reversed. The output spikes for the transition were measured to be 50 mV for a duration of 70 ns. The output rise time is 7.0 ns.

Resistor R_3 can be adjusted for zero offset (this accounts for any mismatch in V_{BE}). With no adjustment (equal base biases), the offset was 30 mV.

How about a gated differential amp?

The amplifier of Fig. 4 switches from one input to the other when a gate pulse is applied. Obviously, if one input is grounded, the circuit will act as a simple gated amplifier.

If, however, you need a gated differential amplifier, the current-switching principle can be applied as shown in Fig. 5. The output of this extremely useful circuit is proportional to $A - B$

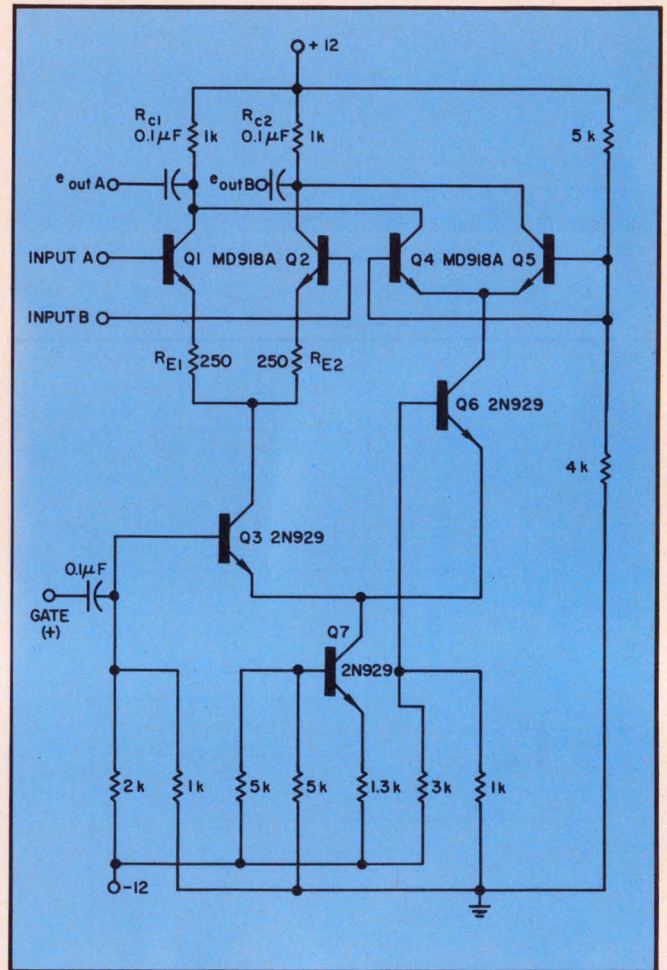

5. This gated differential amplifier uses the same current-gating idea as the single-ended amplifier of Fig. 2. It has voltage gain of only two because of the fairly large emitter resistors on Q_1 and Q_2 .

only when the gate signal is present. Otherwise $e_{out A} = e_{out B} = 0$.

Transistor Q_6 is normally biased ON, and Q_3 is normally biased OFF. Thus the differential amplifier (Q_1, Q_2 and Q_3) is OFF, and no output is obtained.

A positive gate pulse will reverse this situation, yielding two outputs:

$$e_{out A} = (B - A) R_{c1} / (R_{E1} + R_{E2})$$

and

$$e_{out B} = (A - B) R_{c2} / (R_{E1} + R_{E2}).$$

The amplifier has a gain of two with 20-mV turn-on spikes and an 80-ns rise time. The inputs can be either pulses (the bases must then be biased equally), dc levels or a combination of the two. ■■

Reference

1. Hughes, R. S., *Selected Video and Pulse Circuitry*, U. S. Naval Weapons Center, China Lake, Calif., January, 1969 (NWC TP 4672).

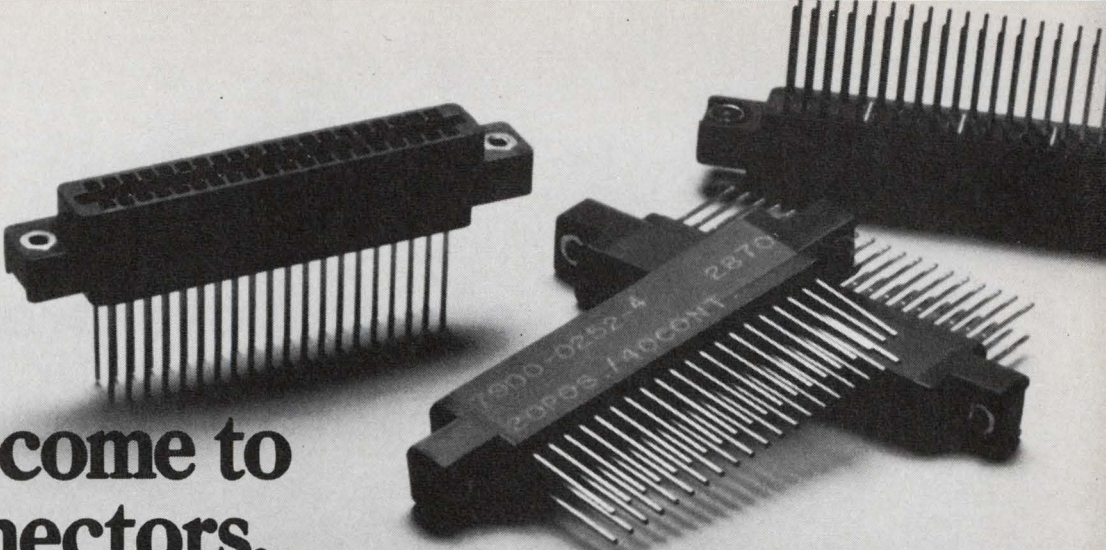

**When you come to
us for connectors,
you could have your whole job
wrapped up.**

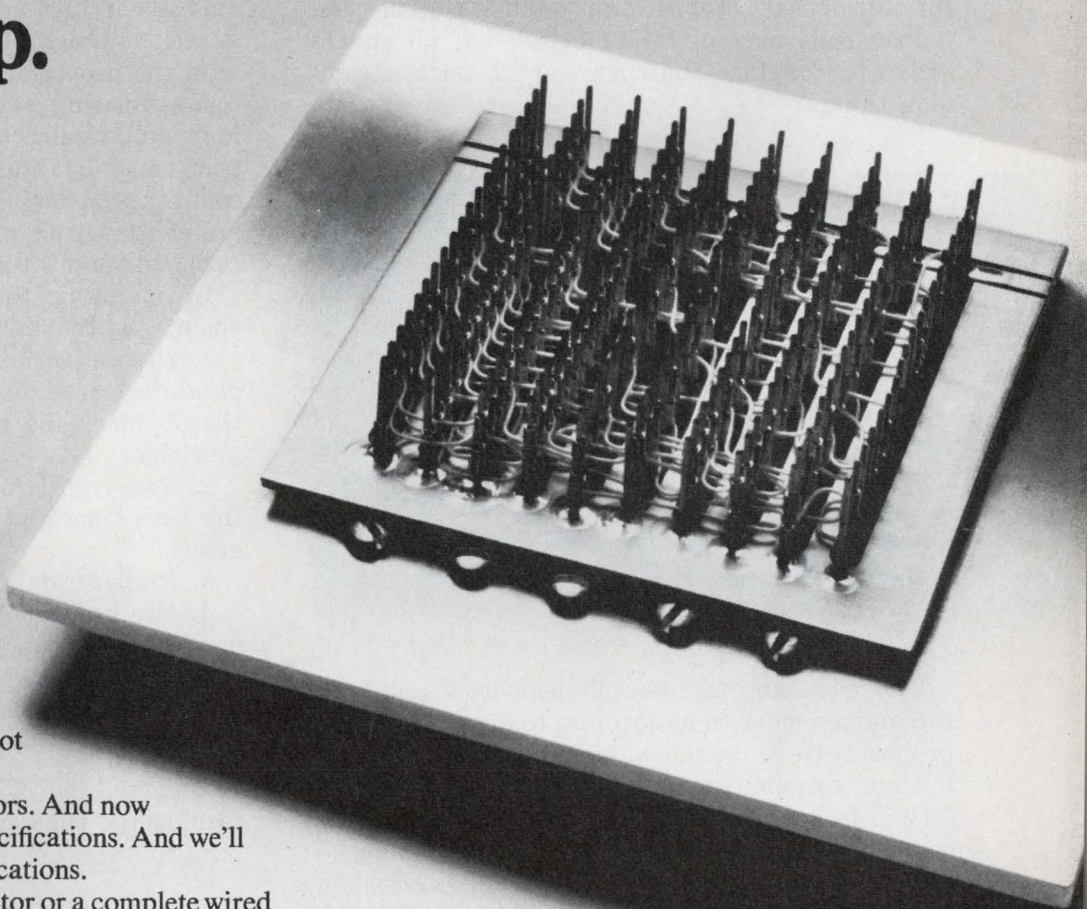

In the old days, we made connectors only to your specifications. We still do. But now we've gone a lot further.

We added off-the-shelf connectors. And now we'll mount either type to your specifications. And we'll have them wrapped to your specifications.

In short, we'll give you a connector or a complete wired backpanel assembly. Or anything else in between.

You save time, money and aggravation, because you don't have to set up an in-house operation.

And we can probably do it at lower cost because we make our own plastic bodies, form our own contacts, and assemble our own connectors. We even draw our own wire for wrapping.

It used to be you could only come to us for connectors.

Now you can throw the whole wrap at us.

To find out what we really can do, call Russ Sanders at 814-723-2000 or write him at GTE Sylvania, Precision Materials Group, Parts Division, Warren, Pennsylvania 16365.

GTE SYLVANIA

Brush up on your proposal preparations.

With a sharp eye for forceful presentation, you could find your company depending on you at bidding time.

Most engineers will tell you that contract proposals to potential customers are written in too little time and with too little money. Since there's a great deal of truth in that, thorough planning for a proposal becomes a prerequisite to success.

Proposals may differ in detail, but all should strive to convince the customer of certain common things:

- Your interest in the problem.
- Your knowledge of the problem.
- The technical soundness and unique features of your proposed solution of the problem.
- Your ability to manage the program, based on a proposed management plan and on experience, facilities and personnel.
- The over-all economy of your proposal—the fact that your product is not only of good initial design but is also reliable and maintainable.

The wise engineer doesn't lean back and wait for management to assign him to draw up such a proposal. He is on the watch for opportunities to initiate unsolicited proposals. At all times he strives to keep himself informed of his company's competitive position; he shares in the responsibility for monitoring the marketing potential of his ideas and the equipment he is developing.

An engineer so prepared may be called upon by management to review proposal requests and to help in making the decision to bid or not to bid. He has learned to make an educated assessment of the practicality of a program and its ultimate dollar potential.

Once a decision to bid has been reached, the real proposal-writing effort begins. In general, the best proposals are those that conform most closely to the standards laid down in the Govern-

Paul Richard, senior engineer, Aerospace Systems Div., Lockheed Electronics Co., Houston, Tex.

ment's Requests for Proposal (RFP).

One other thing that must be clear at the outset: One man, with authority, must be responsible for the total proposal effort. It should be made clear to marketing and production people, as well as other engineers who may be associated with the proposal, who this man is. Writing and cost-estimating assignments will originate from him, and final coordination and review will be performed by him. In preparing proposals for complex systems or services, where many people are contributing writeups on their areas of concern, this man's role is absolutely essential.

In planning the proposal, we begin, oddly enough, at the end. The steps are as follows:

1. *Determination of the final form of the proposal document*, depending on what will impress the customer and how much time and money are available.

2. *Preparation of a schedule* to aid in budgeting both time and money for the total proposal effort.

3. *Preparation of a proposal outline*.

4. *The program game plan*, or how you plan to develop the product for the customer.

Let's consider these, one by one.

Final form and format

A partial list of the decisions to be made concerning the final form of the proposal document is as follows:

- **Layout.** What will be the size of the document—8-1/2 x 10-1/2? Will it be single-column or double-column text? Will a layout artist be required?
- **Typography.** Electric typewriter? Vary-typewriter? Typeset?
- **Illustrations.** Pencilled free-hand sketches? Letter-guide inked drawings? Artist's conceptions? Wash or air-brushed renderings? Photographs?
- **Printing.** Offset lithography? Letterpress? Black and white or color?

Cost is generally the largest single consideration in reaching these decisions.

Drawing up a schedule is an art

With a general idea of the type of document desired, and with an estimate of difficulty of the writing and editing tasks, an over-all schedule can be drawn up. It must have some flexibility, but it should not be so limp as to be meaningless in budgeting either time or money. The principal phases to be scheduled are:

- Technical research, to gain required background information.
- Freezing of the program plan. This step is essential to avoid extraneous or unrelated writing.
- Writing. While of prime importance, it is only one of numerous steps in proposal preparation. Engineers are often involved in all steps.
- Editing, both from a technical and literary point of view. The importance of this phase, and the time required to execute it, increases in direct proportion to the number of sources of written information.
- Approval. Determine exactly which persons must give ultimate approval to the total proposal prior to its delivery to the customer, and allow time for their review.
- Production, including layouts, art work, drafting, typography and printing, as necessary.

Writing the proposal

An outline is highly useful in all proposal writing, and it is an absolute necessity in large, complex proposals. It aids in integrating numerous written inputs, assures that coverage is given to essential elements of the proposal and provides a means of monitoring the progress of writing and production.

There is no universal outline. How detailed it is depends on what is required to define clearly the contents of each section and subsection. The writers of individual sections may find it useful to break down their respective sections further in outline form.

The order and the number of separate main headings in a proposal—foreword, summary, technical section, etc.—will vary according to particular proposal needs. Let's examine just two basic elements as they might be arranged and written:

Foreword. Any background necessary to set the stage for the proposal should be covered here.

This need be no more than a statement identifying the proposal as a response to a particular document (PR, RFP, RFQ, etc) or, in the case of an unsolicited proposal, a brief reason for making the submittal. The foreword may also be used as a guide by describing, as briefly and clearly as possible, the material in the document. Reference should also be made here to any supporting documents, such as the cost proposal or any other volume of the proposal.

Summary. This section should be a capsule proposal, containing such essential information as:

- A precise definition of what is being proposed.
- The unique or outstanding features of your proposal. In some proposals it may be desirable to make this a separate, short section to focus attention on key selling points.
 - The major reasons your company is best qualified to handle the program.

The summary must serve as a broad overview, with the details of the project or task filled in by subsequent sections. It is written to give a complete, general concept of the proposal to a person who reads only in this section. It should contain illustrations and tables giving an over-all picture of the proposal and summarizing the significant characteristics or parameters.

The program game plan

Now for the meat of the proposal: the program game plan. There are three essential sections:

1. *Statement of Work.* This is a brief, definitive description of the items and/or services to be delivered on the contract. In the event that several phases are anticipated but only one is being funded, the Statement of Work should be thorough in detail for the phase being funded, but it may be broad or general for the other phases, if they are covered at all. The Statement of Work often is used as a legal basis for a contract.

2. *Time Schedule.* This, of course, is closely related to the Statement of Work, and the two should be clearly keyed together. A horizontal bar chart is the most common method of presenting schedules for the work you plan to do, with important milestones called out. However, Program Evaluation Review Technique (PERT) and other such methods are available, depending on the complexity of the job and the customer's preference. Charts such as these are often self-explanatory, and the text need only explain unusual items of timing or constraints.

3. *Project Organization.* Through the use of

charts and narrative, this section presents a picture of where responsibility will lie in your company for execution of the contract. The ties between all contributing organizations of the company should be shown. If the program is complex, or if a special project team is assembled for its management, describe briefly the function of the various elements of the organization and the way in which they will work together.

The tone and content of the program plan should instill confidence that you know what the customer wants and have the capabilities and management to assure performance.

These are the basics in any contract proposal. Now let's examine some of the nitty-gritty.

The essential technical sections

The widest variation among proposals probably occurs in the handling of the technical material. So let's review the essential sections.

Analysis of the problem. If the proposal request is written in broad terms, or if a study is an essential first phase of the proposed program, it is important to convince the customer that you understand the problem. Discuss the factors bearing on the problem and the key assumptions involved. A preliminary "Operations Analysis," written concisely but as thoroughly as possible, is required here. Indicate those areas of the analysis that will be further developed and perhaps modified during work on the contract.

Operational discussion. The customer is primarily interested in what the system, equipment or service will do, and therefore a subsection of the proposal should be allocated to satisfy this interest in detail. Write from the point of view of the user, and keep the description performance-oriented. Cover the interrelationships between the proposed equipment and other equipment in the system. Here, artist's conceptions, displays, photographs or other illustrations of controls, displays and equipment installations are very useful. Information flow charts and procedural charts also can clarify this material.

Description of the mechanics. The important point here is to tell how the system or equipment accomplishes the functions covered in "Operational Discussion." In all cases, the ingredients for this portion of the proposal are the same: photographs of hardware, block and logic diagrams, simplified schematics of special circuits, and a clear, readable text. Keep the coverage broad, and go into detail only on those items considered unique selling points or new advances in technology. Physical and electrical characteristics should be covered. Summarize data on performance and parameters in tables, charts and graphs. In general, mathematical treatises have little place in proposals. When they must be used, keep

them as simple as possible and perhaps place them in an appendix. Actual or estimated figures of merit for reliability are important and should be supported with historical data and relevant predicted analyses. Discuss the areas of mechanization where high system reliability might be jeopardized, and present alternate solutions to the problem. Describe your approach to controlling and assuring reliability.

Description of technical services. A large part of many programs—sometimes entire programs—involve the delivery not of hardware but rather of special technical services, such as software or system analysis, engineering studies, site operations and maintenance, or field support. In these instances, the proposal must give a full, precise description of the services to be rendered.

Qualifications, appendices and editing

While every section of the proposal bears evidence of your company's qualifications for the program, reserve a separate section to describe the following:

- Corporate experience on similar or related projects (also include descriptions of such over-all company programs as reliability, value improvement and quality control).
- Corporate facilities available for use on the project.
- Availability and quality of personnel who might work on the program. Avoid the "boilerplate" approach by keeping this section of the proposals as significant and relevant as possible. Emphasize those aspects of the company's and the individual's experience that will be of special value.

Appendices provide an opportunity to include further expansion of significant areas of the proposal. If included in the main body of the proposal, such material might serve to mask a clear, over-all understanding by the reader.

Finally, don't neglect the editing. The styling, the polish, the impact of any proposal document depend on the quality of editing. While most large companies today have professional editorial staffs, it is still highly important for the engineer-author to develop his editorial skills, since many factors—principally time—may prevent another person from improving the manuscript.

The principal elements to be checked in editing are clarity, logic of presentation, continuity, completeness, accuracy and emphasis, along with such literary basics as grammar, spelling, punctuation and style. Don't expect the best editing performance with a single reading; several passes over the manuscript are necessary to pick up all errors and inadequacies. ■■



Just what you'd expect from Dialight... the industry's broadest line of LED light sources, indicator lights and readouts.

Here is every component or package you might need to capitalize on the long life and reliability of LEDs: DIODE-LITE™ light sources . . . indicator lights utilizing DIODE-LITES in cartridges and complete assemblies . . . illuminated pushbutton switches . . . readout modules in .125", .205" and .625" character heights . . . these modules incorporated in readout packages complete with decoder/drivers . . . and finally, display assemblies of 2 to 10 read-

out packages mounted in a bezel frame with window. All are attractively priced. All are available off-the-shelf from Dialight or through selected distributors.

No one else offers you one-stop shopping in LED visual display. And no one has more experience in the visual display field. That's important too: Write today for our Data File on DIODE-LITES and compare it with anybody else's.

®TRADEMARK

DIALIGHT

DIALIGHT CORPORATION, A NORTH AMERICAN PHILIPS COMPANY • 60 STEWART AVENUE, BROOKLYN, N.Y. 11237 • (212) 497-7600

INFORMATION RETRIEVAL NUMBER 32

Correcting false combinations gets you the fastest BCDC

In decade shift counters the false combinations 010 or 101 can circulate indefinitely, thus limiting the use of this fast circuit. The addition of one or two NAND/NOR gates, which reset the counter from state 010 to state 000 and/or from state 010 to state 111, corrects this deficiency. With two gates, the correction is made within five input pulses—faster than all other binary-coded decade counters (BCDCs).

One method of detecting and correcting the decade-shift-counter combination 010 or 101 is shown in Fig. 1. An additional gate, F, is connected to the standard circuit. Each time the false combination 010 reaches bistables C-D-E, it is corrected to 000.

If the signal R_D resets only the slave—the output part of the bistable—the speed of the counter is changed very little by the delay in the resetting gate F. When bistable D is reset, the input, D_D , must be zero; therefore no other change of state of bistable D occurs during the next input pulse. The maximum number of input pulses necessary to correct the false combination ABCDE = 11001 is $n=9$, the same as with ordinary BCDC.

If the master and slave flip-flops are reset simultaneously by the R_D signal, the delay in the resetting gate, F, can reduce the maximum speed of the circuit. But if, instead of signals C and E,

outputs B and E are used to drive the resetting gate, the permissible delay in gate F can be more than half of the total clock period without affecting the speed. This configuration corrects all false combinations but the 01010, or 10101. The latter combination can be changed to a self-correctable 10111 by using the output of the decoding gate 5 as a “set” signal for the flip-flop D (Fig. 2).

Otakar A. Horna, Comsat Laboratories, Box 115, Clarksburg, Md. 20734

VOTE FOR 310

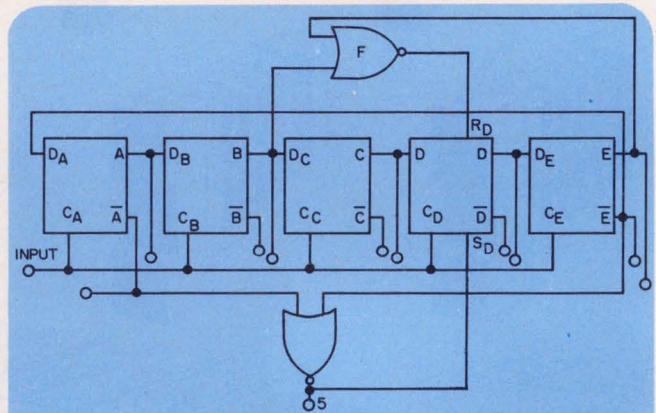

2. Maximum circuit speed is unaffected with this modified counter. Gate F can correct all false combinations but 10101. The decoded output from gate 5 connected to the “set” input of bistable D changes this false combination to 10111.

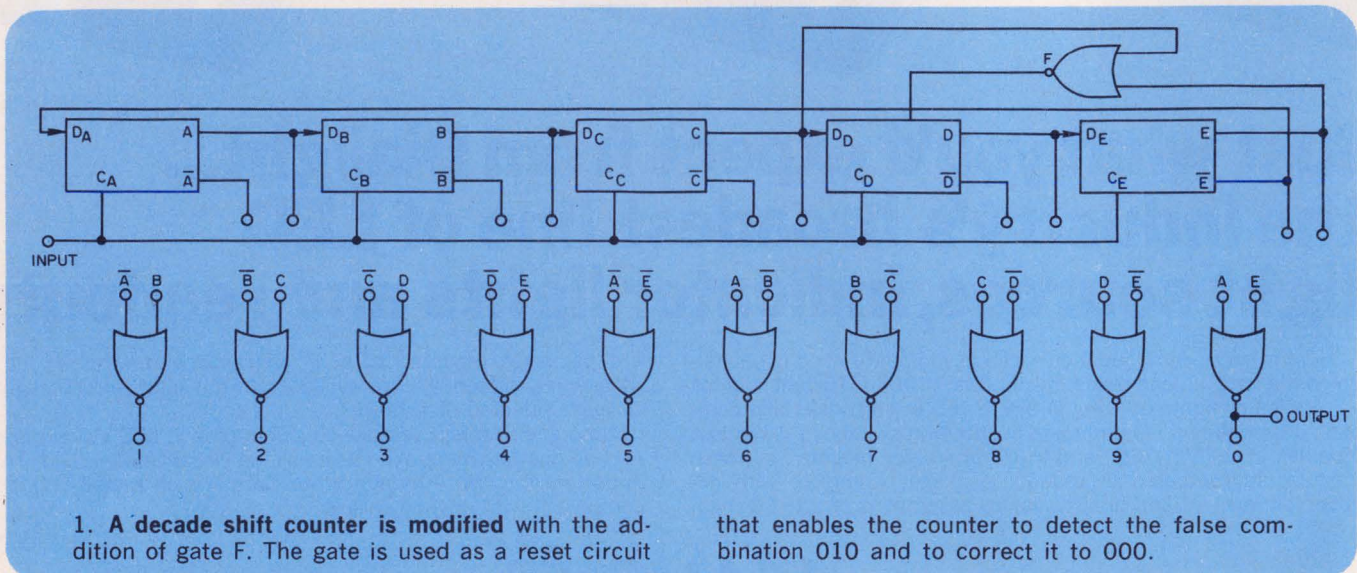

1. A decade shift counter is modified with the addition of gate F. The gate is used as a reset circuit

that enables the counter to detect the false combination 010 and to correct it to 000.



UHF/Microwave front-end components

Preamp, source, and converter, they are your front-end—but only if they work together. To get them to work together, you need components from a supplier that knows about interface problems.

Aertech knows about interface problems. We learned the hard way, by putting front-ends together.

We know you need preamps that are stable; we know you need a clean source; we know that some specs are more critical to you than others, but you still need complete specs. So you can get what you need from us—from our complete line of microwave building blocks—low noise, high power, wide-band, whatever. And if our standard products don't quite fit, we have the experience to build custom components that do. You can even rely on our experience to get the complete package put together in a

single front-end module.

And you can be sure of product reliability because our QA department is sure of it. QA is an independent project review function at Aertech. Our work has been tested and proven in aerospace “high-rel” programs; many of our products have earned a “space qualified” rating. Much of what we learned in these programs is incorporated into our standard products.

UHF/microwave preamps, sources, and converters or complete front-end modules—either way, call Aertech, 825 Stewart Drive, Sunnyvale, CA 94086; 408/732-0880. You won't have a complete bid package without word from us.

Aertech
INDUSTRIES

Another branch of the Aertech family tree.



Obtain asymmetric control in adjustable multivibrator

With just two monolithic monostable multivibrators, you can get a free-running multivibrator with a theoretical frequency range of 0.0125 Hz to 10 MHz. Each unit is capable of an output pulse as narrow as 50 ns or as wide as 40 s.

Two SN74121 ICs are used in a closed-loop configuration. The trailing edge of the waveform from the first unit triggers the second unit, and vice versa. When power is first turned ON, the Schmitt trigger of one of the units reaches 5 V through an RC combination. This unit, therefore, fires after the rest of the circuit has reached full voltage. This initiates the first one-shot. The trailing edge of this first pulse then starts the other one-shot, and so forth.

The pulse width of each unit is defined by the relationship $t_p = C_T R_T \log_e 2$, where t_p is in seconds, C_T is in farads and R_T is in ohms, and the output frequency is defined by $f = 1/(t_{p1} + t_{p2})$.

Everett J. Aho, Digital Signal Processing Group, M.I.T Lincoln Laboratory, P. O. Box 73, Lexington, Mass. 02173

VOTE FOR 311

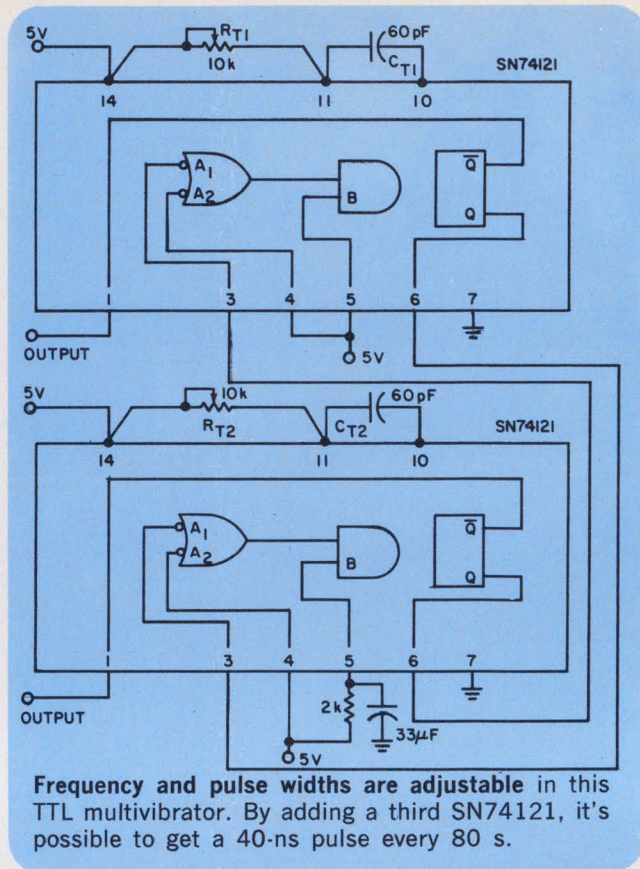

Use a FET to improve uhf amp performance

Bipolar transistor amplifier designs for uhf suffer from spurious responses and intermodulation distortion. These disadvantages are greatly reduced when FETs are employed as the active elements.

Here's a typical design: A 625-MHz common-gate amplifier circuit with about 14-MHz bandwidth (Fig. 1) exhibits an 8-dB gain and a 1-dB compression point of 13 dBm, measured at the output. Input VSWR is 1.2:1; output VSWR is 1.05:1. Power dissipation is only 200 mW.

The amplifier is constructed on double copper-clad board with a Siliconix UT100 FET embedded in a 50-Ω line. The UT100 FET is in a ceramic stripline package laid out for common-gate connection, and it is specifically designed for high-frequency applications.

The maximum gain and matching network were calculated with S parameters because of the relative ease of calculation at high frequencies. The maximum unilateral transducer power gain is given by

$G_u = |S_{11}|^2 / (1 - |S_{11}|^2)(1 - |S_{22}|^2)$, where $|S_{11}| < 1$ and $|S_{22}| < 1$. The formula assumes that $S_{12} \approx 0$ and that the reflection coefficient of

the source and load-matching networks are equal to the conjugate of S_{11} and S_{22} , respectively. These assumptions reflect the actual circuit design.

For a drain current of 6-12 mA, the gain varies from about 6 to 8 dB, and the noise figure is about 5 dB. Isolation varies from about 19 dB at the center frequency to about 23 dB at ± 10 MHz off center. The isolation is improved by about 8 dB when a shield is placed between the source and drain of the FET.

Michael Turner, Siliconix Inc., 2201 Laurelwood Road, Santa Clara, Calif.

VOTE FOR 312

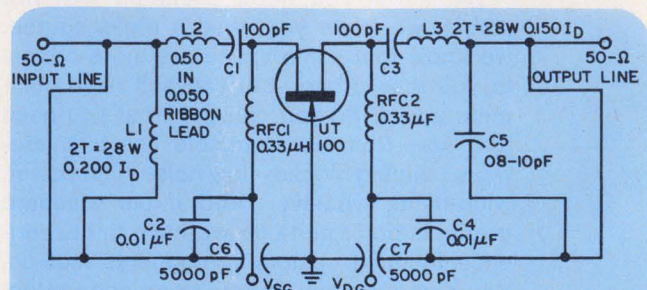

The low intermodulation distortion and cross-modulation products characteristic of a FET make it an ideal active element for this uhf amplifier. Tuned at 625 MHz, the circuit provides an 8-dB gain.

From the wonderful people who brought you the first DAC under \$30

now...



the barrier buster

DAC-9-8B

\$9.95

the first DAC for only in singles

SPECIFICATIONS:

ELECTRICAL	
Digital Inputs	
Resolution	8 binary bits
Coding	straight binary, eight parallel lines
Data inputs	DTL or TTL compatible, positive logic
Update rate	Loading: one standard TTL load I _L max. = 1.6 ma @ V _{in} = 0.4V 5MHZ
ANALOG OUTPUT	
Type of output	current
Output current	+ 2.6 ma
Output voltage compliance	1.2v max.
Output settling time	1 μsec to ± 0.4% of FS
Resolution	10 μa
Linearity	± 1/2 LSB
Temperature coefficient	± 100 ppm/°c of FS
Input power	+ 15 vdc @ 10 ma
Operating temperature range	0°c to + 70°c
Storage temperature range	- 55°c to + 85°c
Size	2"W x 1"L x 0.4"H plug-in module
Weight	2 oz.

FEATURES:

- Fast settling time ... 1 μsec.
- Small size ... 0.8 cubic inches
- DTL/TTL compatible
- Ultra linear ... ± 1/2 LSB
- Low power consumption ... 15 milliwatts
- Complete ... simply apply DC power

ORDERING INFORMATION:

DAC-9-8B
PRICE: \$9.95 each

Clip out and mail to **VARADYNE SYSTEMS • 1020 Turnpike Street, Canton, Massachusetts 02021**

Something old / something new / nothing borrowed

Send today for your **Free New 1971 Fall/Winter Catalog** giving the complete details and specifications on 100 models, 30 of which are brand new. D/A's from \$9.95. A/D's from \$69.00

name _____
 company _____
 street _____
 city _____ state _____ zip _____

VARADYNE
SYSTEMS
A DIVISION OF VARADYNE, INC.

1020 Turnpike Street
 Canton, Massachusetts 02021
 or phone
 (617) 828-6395

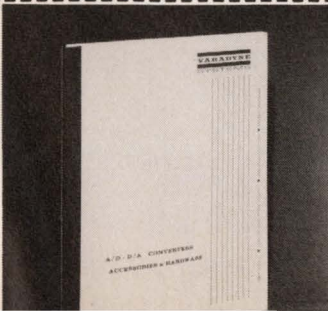

Voltage-regulator circuit improves performance

An improved high-power switching regulator features an LC filter that is independent of the switching frequency (for better transient response and lower ripple) and greater frequency stability than conventional switching regulators.

The heart of the circuit is the IC1 (LM305), which is used as a comparator with an internal reference. The IC1 drives switches Q3 and Q4, which convert the drive voltage to levels that switch Q1 and Q2.

Transistors Q1 and Q2 form a Darlington power switch. The collector of Q2 is returned to a lower voltage through R2, so that the collector-

to-emitter saturation voltage is not included.

The filter consists of L1 and C2. Capacitors C3 and C4 inhibit hf spikes and noise, and voltage divider R9, R10 and R11 determines the output voltage.

Gates G1 and G2 form a free-running multivibrator that oscillates at about 20 kHz. Gates G3 and G4 square the signal. R14 and C7 form an integrator that generates a triangular waveform, which is superimposed on the internal reference, and zener diode D2 and resistor R4 supply the power needed for IC2.

Robert S. Olla, Chief Engineer, Electro Dynamics Co., 3139 Kermath Dr., San Jose, Calif. 95124.

VOTE FOR 313

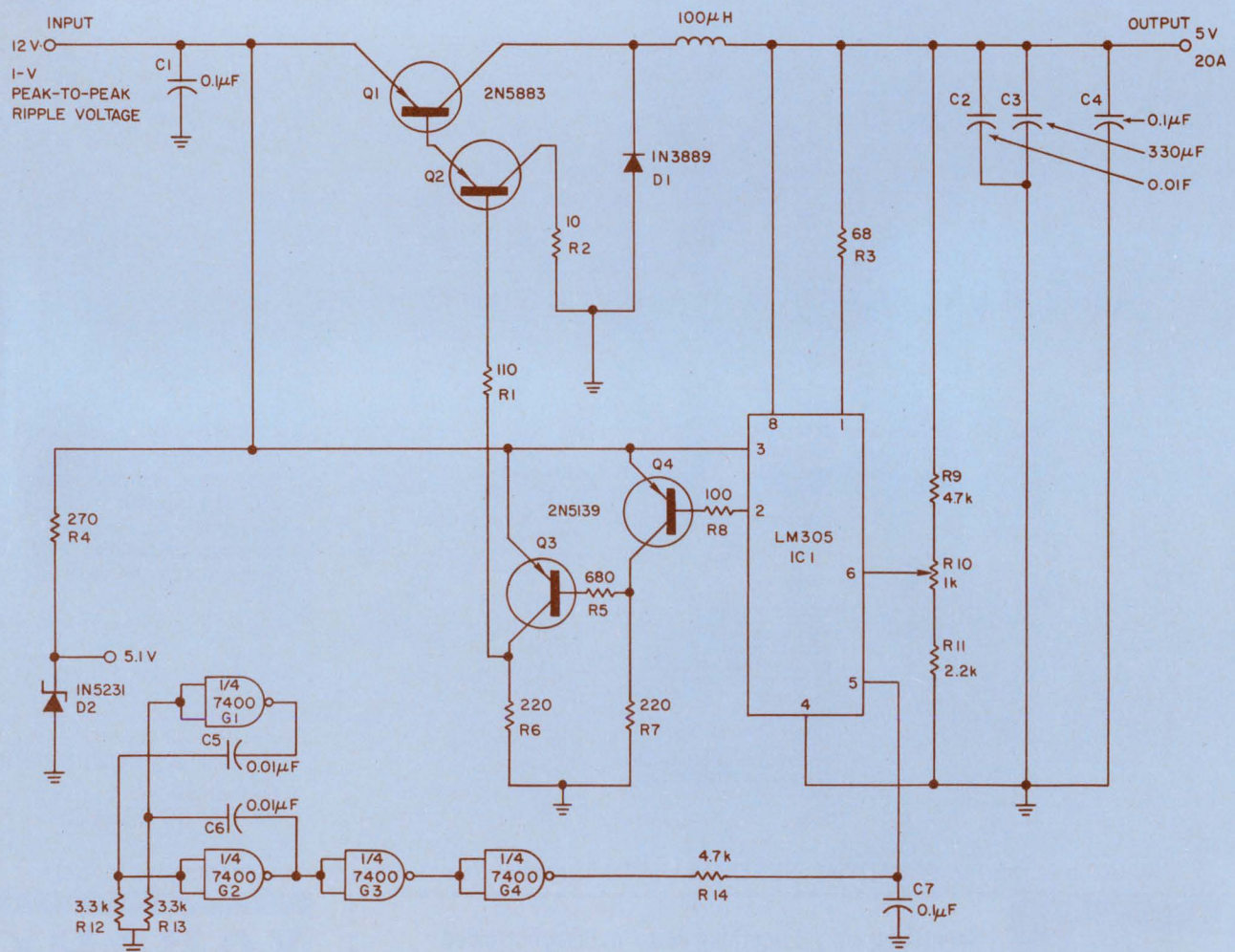

A 100-W switching regulator achieves 0.5% voltage regulation and 10-mV ripple voltage. The sup-

ply efficiency exceeds 80%. The LM305 comparator is the basis of this regulator circuit.

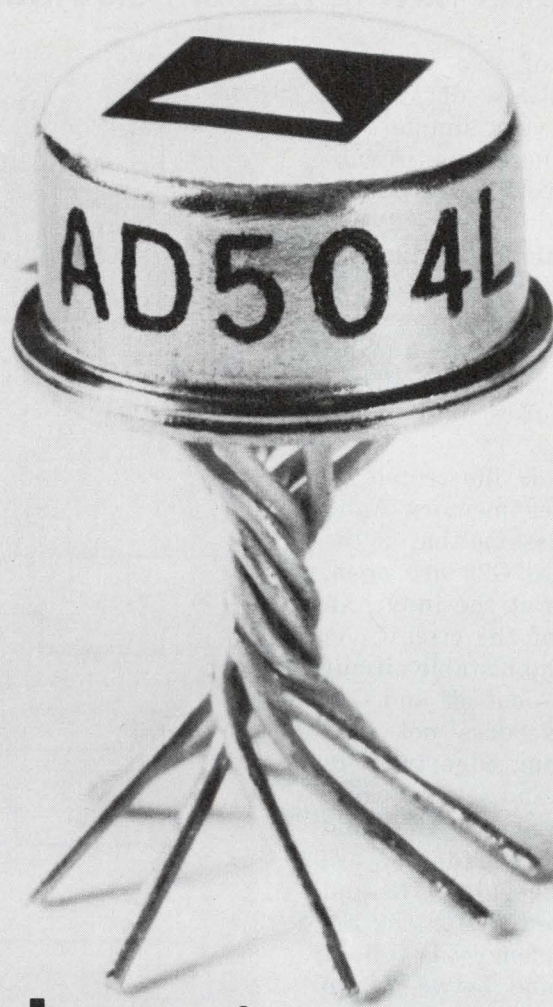

Look deep into my circuit.

You see an operational amplifier, very operational. You see a minimum gain of 10^6 . You see an offset voltage drift of less than $1\mu\text{V}/^\circ\text{C}$. You see CMRR and PSRR errors of less than one part in a million. You are not sleepy.

In fact you are wide awake and asking yourself what we compro-

mised to give you those remarkable specs.

Look deeper. Single capacitor compensation, eliminating stabilizing networks. 1000pF capacitive drive capability, eliminating series output resistors and loss of dc accuracy. Fully protected inputs and output, eliminating outboard components. AC performance comparable to general purpose I.C.

op amps, eliminating extra circuitry to achieve moderate speeds.

The AD504 is honest all the way — as are all of the linear IC's in our growing family. Get our new 20-page brochure: "The New Linear Integrated Circuits." Therein lies the proof. Analog Devices, Norwood, Mass. 02062

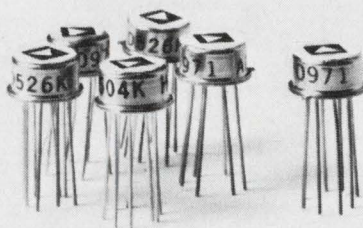

Subtract two pulse trains having random distribution

The continuous subtraction of two nonoverlapping pulse trains of regularly distributed pulses can be achieved with a very simple subtraction circuit. And when it's necessary to subtract randomly distributed nonoverlapping pulses, the standard subtraction circuit can easily be augmented with memory units that eliminate inaccuracies arising from the random distribution.

A subtraction circuit that includes N memory units is shown in Fig. 1. The circuit has a memory capacity of N : At most, N pulses of train N_2 lying between $N-1$ successive pulses of train N_1 can be correctly subtracted.

The operation of the circuit is illustrated by the waveforms in Fig. 2. Three memory units are used in this example. Let's assume that at the beginning all gates from G_{21} to G_{23} are open. If no pulse of train N_2 appears at the input, all pulses of N_1 reach the output of the circuit. As soon as a pulse of N_2 appears, the bistable circuit $BC1$ is triggered, causing G_{21} to cut off and G_{12} to open. The next pulse of N_1 does not pass through gate G_{21} , but its trailing edge triggers $BC1$, causing gate G_{21} to open and G_{12} to close.

If no pulse of N_1 occurs between the first and successive pulses of N_2 , gates G_{21} to G_{23} are closed one after the other, while gates G_{12} and G_{13} are in the same way opened. After the arrival of three pulses of N_2 , the memory is full. If further pulses of train N_2 come between two pulses of train N_1 , they are lost for subtraction.

The pulses of N_1 then reset the bistable circuits into initial states and open gates G_{21} to G_{23} one after the other.

Jozef Sabol, Design Engineer, Technical University of Prague, Brehova 7, Prague 1, Czechoslovakia.

VOTE FOR 314

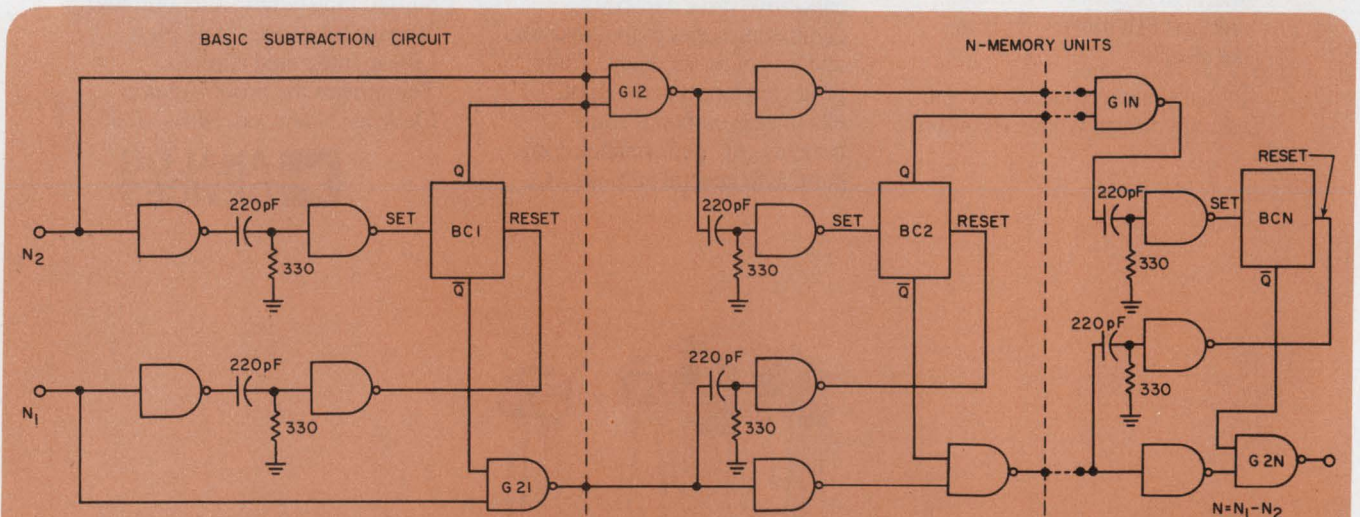
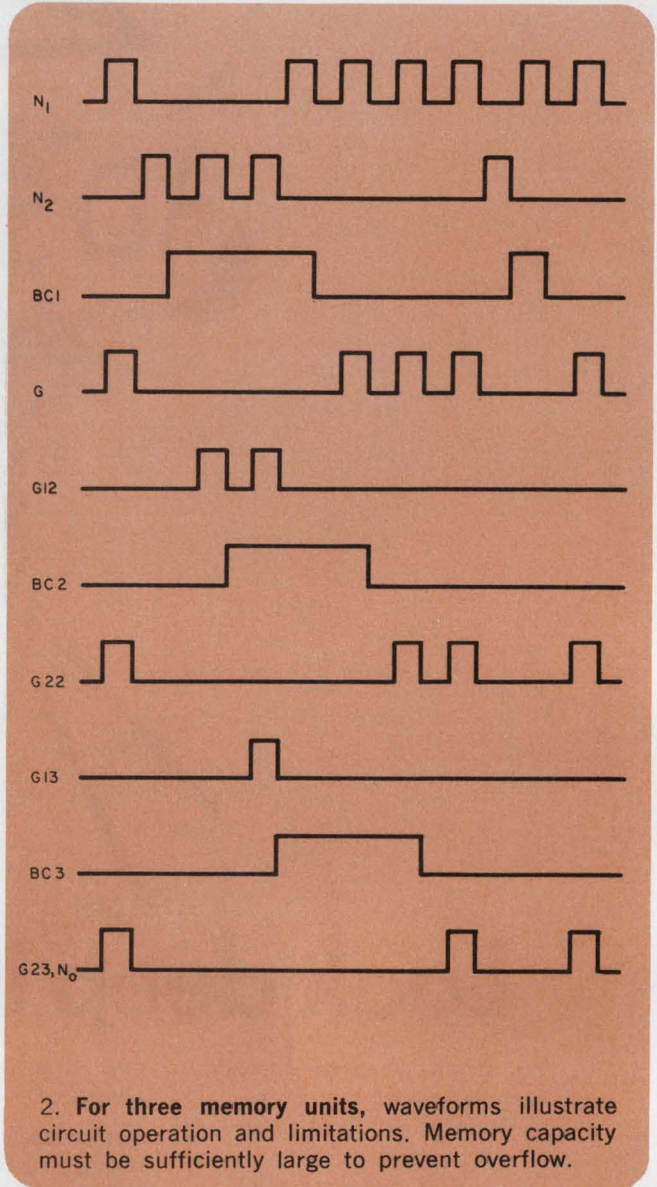

1. Two nonoverlapping but randomly distributed pulse trains can be continuously subtracted here.

If the circuit is preceded by a coincident pulse eliminator, then an idea subtractor is obtained.

NEW! THE PRAM.™

The first 4-channel programmable op amp. With more application possibilities than we could possibly list on this page.

HA-2400/2404/2405

Take a good look at this new linear building block. It's unique and so versatile we keep discovering more and more applications for it.

Each PRAM contains four preamplifier sections, one of which is selected through the DTL/TTL compatible inputs and connected to the output amplifier. The selected analog input terminals and the output terminal form a high performance operational amplifier for just about any use you can dream up. And we hope you'll dream up some. If you do, send them along to us and we'll see what we can dream up by way of a reward.

Features:

Offset current 5nA

Voltage gain 150K

Slew rate

$A_v = +1 \quad \pm 15V/\mu s$

$A_v = +10 \quad \pm 50V/\mu s$

Gain Bandwidth Product

$A_v = +1 \quad 8MHz$

$A_v = +10 \quad 40MHz$

DTL/TTL compatible

	100-999 units
0° to $+75^\circ C$	\$10.45
$-25^\circ C$ to $+85^\circ C$	\$15.95
$-55^\circ C$ to $+125^\circ C$	\$23.65

For more details on the PRAM contact your Harris representative or distributor.

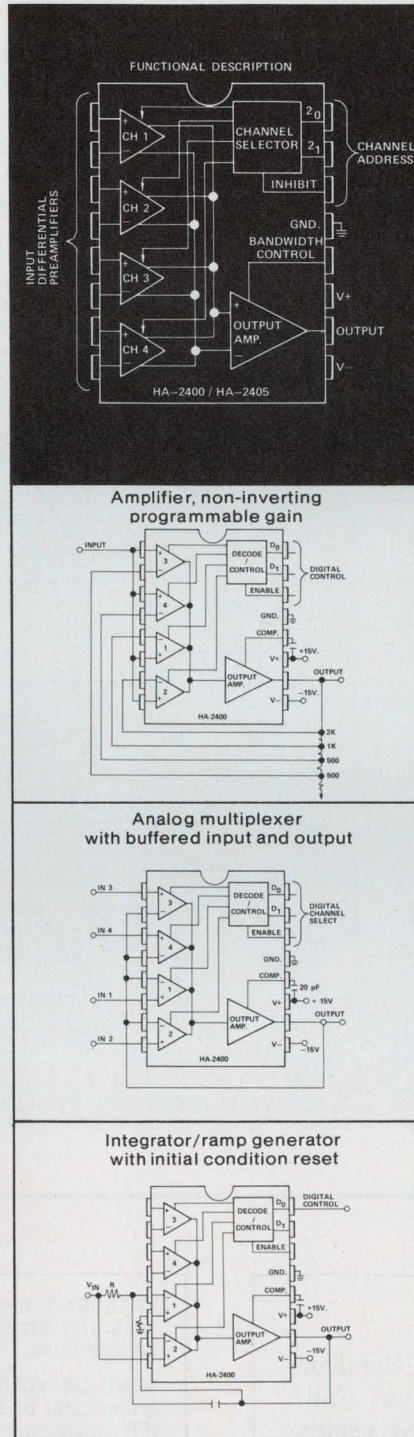

More challenges:

The foregoing diagrams show just three of many applications we've designed using the PRAM. The following lists other possibilities we haven't had time yet to prove out. Why don't you try your hand at designing them or any other ideas you come up with, and send them to:

E. Fernandez
P.O. Box 883
Melbourne, Florida 32901.

A to D converter, Dual Slope Integrating

Active Filter, State Variable Type with Programmable Frequency and/or Programmable "Q"

Amplifier with Programmable D.C. Level Shift

Chopper Amplifiers

Crossbar Switches

Current Source, Programmable

F.M. Stereo Modulator

F.S.K. Modem

Function Generators, Programmable

Gyrator, Programmable

Monostable Multivibrator, Programmable

Multiplier, Pulse Averaging

Peak Detector with Reset

Resistance Bridge Amplifier/Comparator with Programmable Range

Sense Amp/Line Receiver with Programmable Threshold

Spectrum Analyzer, Scanning Type



HARRIS SEMICONDUCTOR
A DIVISION OF HARRIS-INTERTYPE CORPORATION

P.O. Box 883, Melbourne, Florida 32901
(305) 727-5430

DISTRIBUTORS: **Schweber Electronics:** Westbury, New York (516) 334-7474; Rockville, Maryland (301) 881-2970; Hollywood, Florida (305) 927-0511
Harvey/R & D Electronics: Lexington, Massachusetts (617) 861-9200/**Semiconductor Specialists, Inc.:** Chicago (312) 279-1000; Detroit (313) 255-0300; Minneapolis (612) 884-8132; Kansas City (816) 452-3900; St. Louis (314) 428-6100; Dallas (214) 358-5211; Indianapolis (317) 243-8271; Pittsburgh (412) 781-8120; Dayton (513) 278-9455/**R.V. Weatherford Co.:** Albuquerque (505) 265-5671; Anaheim (714) 547-0891; Austin (512) Enterprise 1443; Dallas (214) 231-6051; Denver (303) 427-3736; Glendale (213) 849-3451; Houston (713) Enterprise 1443; Palo Alto (415) 321-5373; Phoenix (602) 272-7144; Pomona (714) 623-1261; San Diego (714) 278-7400; Seattle (206) 762-4200.

Indicator checks relative frequencies

It's often more important to know the relative frequencies of two signals than their absolute frequencies. The circuit shown acts as both a simple comparator and indicator of the relative frequency of two signals sent to the input terminals.

The LM306 compares the voltage at its positive and negative outputs and gives an output dependent on the relative magnitude of these inputs. As the voltage at the inverting input becomes more positive than the noninverting input, the output switches from 3 V to about 0.4 V. The switching point for each signal input is set by its respective threshold potentiometers. The 1N3606 diodes clamp the voltage across the LM306 input to about 0.6 V. This insures that the maximum differential voltage is not exceeded.

The transitions of the comparator outputs go into the MC4044P phase comparator. The internal circuitry of the MC4044P compares the nega-

tive edges of the two input signals and determines the relative frequency and phase of the two signals. The outputs of the MC4044P then drive three SN7400 two-input NAND gates. These NAND gates act as a decoder to drive the associated indicator lamps.

When pin 13 is low, it disables NAND gates 1 and 2, and if pin 2 is high, NAND gate 3 is enabled, causing its output to go low and lighting the $f_a > f_b$ lamp. A similar action occurs if pin 13 is high and pin 2 is low. Here NAND gates 2 and 3 are disabled, and NAND gate 1 is asserted, causing lamp $f_a < f_b$ to light. If both pins 2 and 13 are high, then NAND gate 2 is enabled, causing its output to go low and lighting the $f_a = f_b$ lamp and disabling NAND gates 1 and 3.

Leonard F. Halio, Group Supervisor, Digital Equipment Corp., 146 Main Street, Maynard, Mass. 01754.

VOTE FOR 315

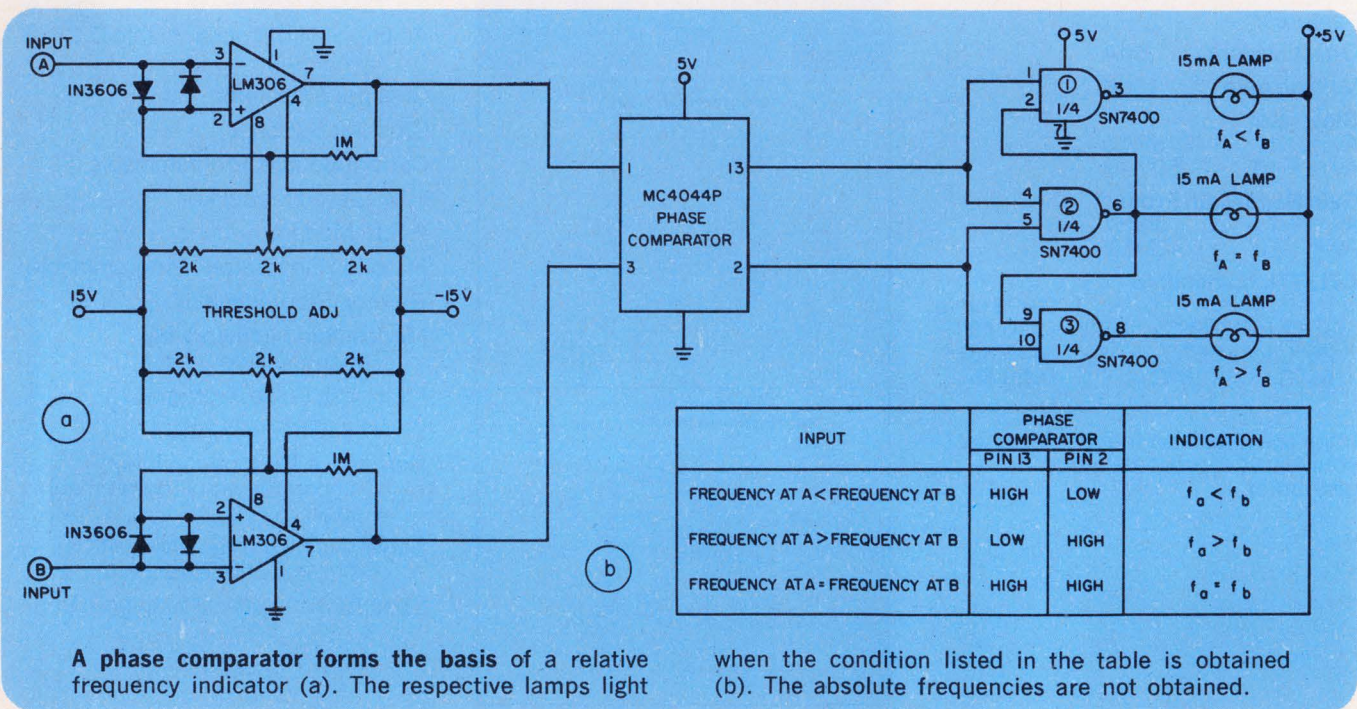

IFD Winner for July 8, 1971

Marvin K. Vander Kooi, Fairchild Semiconductor, 464 Ellis St., Mountain View, Calif. 94040. His idea "Current-controlled oscillator sweeps five-decade band" has been voted the Most Valuable of Issue award.

Vote for the Best Idea in this issue.

VOTE! Go through all Idea-for-Design entries, select the best, and circle the appropriate number on the Reader-Service-Card.

SEND US YOUR IDEAS FOR DESIGN. You may win a grand total of \$1050 (cash)! Here's how. Submit your IFD describing a new or important circuit or design technique, the clever use of a new component or test equipment, packaging tips, cost-saving ideas to our Ideas-for-Design editor. You will receive \$20 for each accepted idea, \$30 more if it is voted best-of-issue by our readers. The best-of-issue winners become eligible for the Idea Of the Year award of \$1000.



P&B engineers left nothing out to make these the most flexible and economical miniature dry reed relays for logic circuitry, instrumentation, and other low voltage applications.

1 through 6 cavity bobbins cover virtually all circuitry requirements. Contact configurations are Form A (SPST-NO), Form B (SPST-NC) and Form C (SPDT using an A and B Forms).

.100" x 1.00" grid-spacing is compatible with the modern printed circuit board design.

In-line termination conforms to industry trend. And JRC series coil leads are designed to terminate at any of four corners.

Low profile construction allows for stacking pc boards on 1/2" centers (only .36" high x 1.14" long).

Low cost. Open style design offers considerable cost savings over enclosed types. And JRC series is available with or without magnetic shielding.

Staked terminals for strength. Terminations are supported by the bobbin. Stresses are transmitted to the standoff flanges instead of the reed extensions, to protect the glass seals of the capsules.

Operating Specifications. Total operate time @ 25°C is 1.0 ms at nominal voltage. Pickup 75% or less of nominal voltage. Coil voltages: 3V DC to 24V DC.

New, too! JRD series with .150" x 1.00" grid-spacing Similar to JRC series except for size. 1, 2, 4, and 6 cavity bobbins. True Form C contact arrangement available.

New JRC and JRD dry reed relays are available from leading electronic parts distributors. Or call your P&B representative. For a 214-page relay catalog, write Potter & Brumfield Division, AMF Incorporated, Princeton, Indiana 47670. 812 385 5251.

A new breed of reed

P&B introduces a whole new family of reed relays.

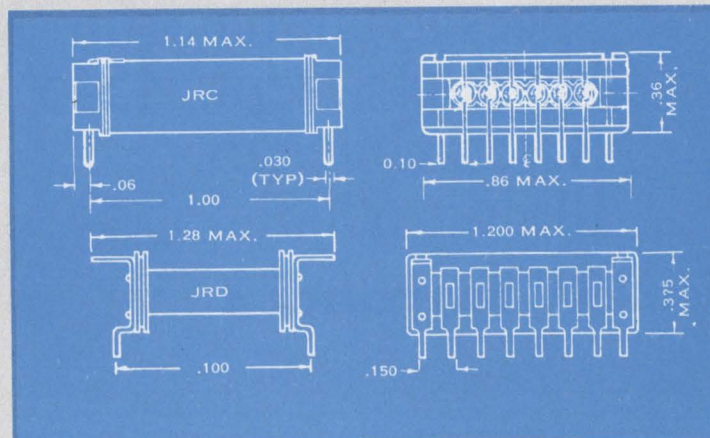

AMF | POTTER & BRUMFIELD

A better way to get quick delivery on monolithic filters.

The better way is you. You tell us when you need the filters. It's that simple. And it's the best way to prevent a supplier from saying one week delivery when he means one month.

Seven standard models are available in ranges from 5MHz to 26MHz. Insertion losses are a nominal 2 to 4db. Each filter is shock protected and hermetically sealed. Other frequencies developed to your order. Specs available from Motorola Component Products Dept., 4545 W. Augusta Blvd., Chicago, Illinois 60651.

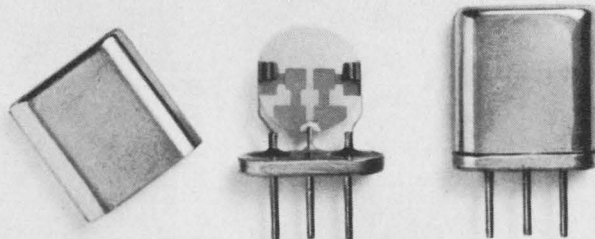

new products

High-performance display panels for only \$1/digit

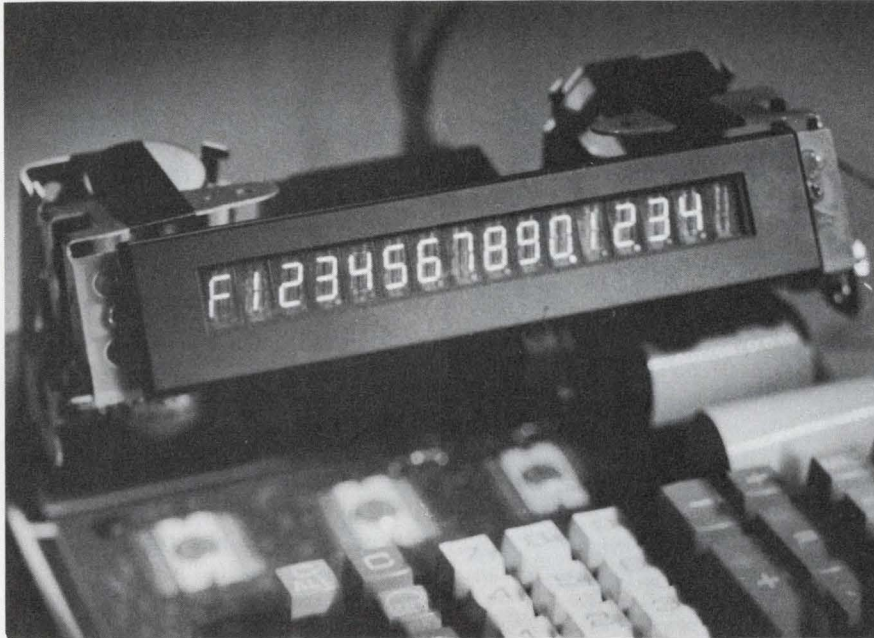

Burroughs Corp., Box 1226, Plainfield, N.J. Phone: (201) 757-5000. P&A: see text.

Panaplex II, a family of 4-1/2 to 13-digit numeric gas-discharge display panels, offers improved reliability and readability, compactness, MOS compatibility, low power dissipation, several character fonts, size flexibility and annunciator and dimming capabilities.

Most important, the price per digit is right—in 1000 quantities, each 12-digit panel costs \$18.25, or about \$1.50 per digit. This drops down to as low as \$1 per digit for 500,000 quantities.

Because of a new panel construction technique that eliminates all welds and requires a minimum of external connections, reliability is enhanced, Burroughs says. And the panel's prepackaged in-line characters assure a perfectly aligned display readable at up to 15 ft within a 150-degree viewing angle.

An important aspect of Panaplex II is that it can be driven from MOS circuits without interface drivers. Although each panel operates from +170 V dc, the narrow voltage swing of 25 to 40 V needed for turning the display ON and

OFF and the peak currents of only a few hundred micro-amperes needed to drive each segment falls within most MOS capability. And the average power consumption is quite low—less than 5 mW per segment.

A 12-digit panel is only 3.5-in.-long by 0.9-in.-high by 0.2-in.-thick, containing 0.255-in.-high characters. The panel's construction techniques also allow custom tailoring of character size and font at minimum cost. Special characters can also be included. Provisions are made in each panel to include commas, decimal points and minus signs in the display.

Each display panel can be dimmed by reducing segment current, without loss of panel brightness uniformity.

Annunciator messages can be included in Panaplex II panels for electronic-cash-register, clock and special-instrument applications.

Panaplex II panels are designed to be strobed or time-shared and will be available by late 1971 in production quantities for 12-digit models, samples of which can be presently supplied.

CIRCLE NO. 250

Pulse/tone dialers for phones come as modules

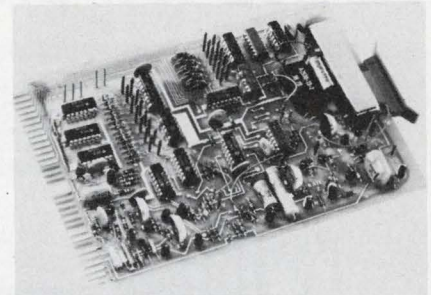

Sola Basic Industries, G. V. Controls Div., 101 Okner Parkway, Livingston, N.J. Phone: (201) 992-6200. P&A: approx. \$100; 60 days.

Offering plug-in building-block design flexibility, two solid-state PC-board automatic dialers—one for pulse and one for tone-dialing operations—can be programmed to dial any telephone number up to 14 digits. They are designated as model 906001 for the pulse dialer and model 906002 for the tone dialer. When combined with additional address boards, as many as 100 addresses per dialer can be provided, as well as multiple-line outputs.

CIRCLE NO. 251

Monolithic discriminator improves afc circuits



Damon Corp., Electronics Div., 115 4th Ave., Needham, Mass. Phone: (617) 449-0800.

Model 6283 MDB monolithic discriminator eliminates extraneous zero crossings that produce false lock-on in afc applications. It provides symmetrical characteristics—even beyond peaks. The new device has a center frequency of 10.2 MHz \pm 250 Hz, and a peak separation of 10 kHz nominal. Sensitivity is 0.2 V/kHz \pm 10%.

CIRCLE NO. 252

Fast, 12-bit a/d converter carries low price of \$300

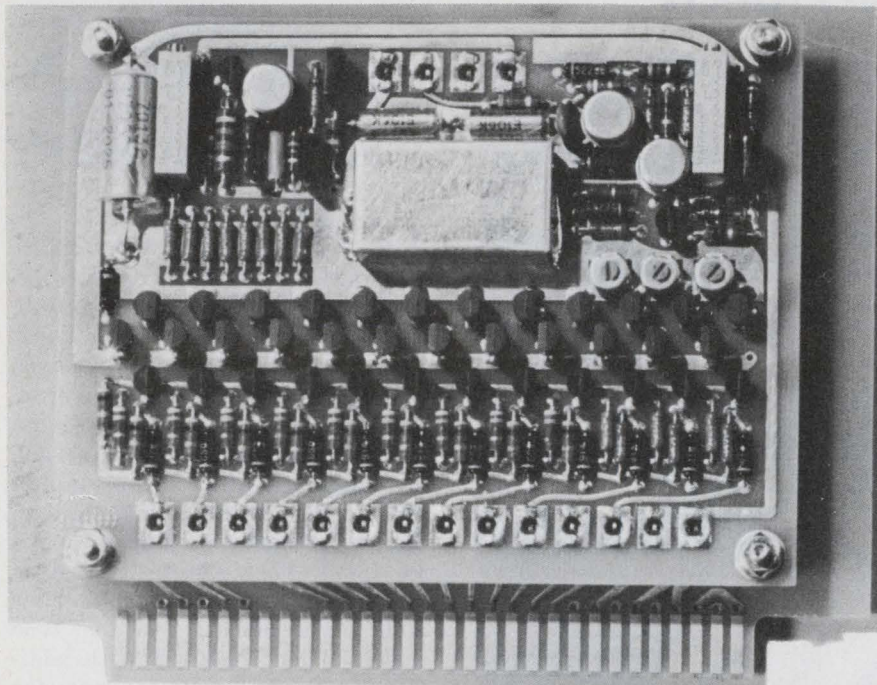

Tustin Electronics Co., 2103 S. Grand, Santa Ana, Calif. Phone: (714) 546-1302. P&A: see text; 30 days.

Excellent performance at a very good price—that's what a new 12-bit a/d converter offers.

Designated as the model 1612, it features a total conversion time of only 5 μ s and accuracy of 0.0125% of full scale. And it is quite stable—over-all temperature coefficient is 10 ppm/ $^{\circ}$ C. Combined with this performance is a low price of \$300 (1 to 9 quantities).

Two versions of this converter are available: one with a PC edge-connector and another packaged in a potted module for mounting on PC boards.

The converter provides both parallel and serial TTL outputs. It allows continuous parallel output of previous analog inputs. Most low-cost a/d converters provide parallel outputs of previous analog inputs only when the a/d converter is not in the process of converting which can cause converter-circuit ground-loop problems.

Additional features include an

input impedance of 1.7 k Ω and an operating temperature range of 0 to +50 $^{\circ}$ C. The converter can sustain a maximum input voltage of ± 20 V without any damage.

This successive-approximation-type a/d converter has two input-voltage ranges: a standard ± 10 -V range, and an input range covering 0 to -10 V for a straight 12-bit binary output (the last range requires slight a/d converter modification by the manufacturer at a nominal charge).

Two power supplies are used for converter operation—a ± 15 -V supply at ± 125 mA and one of +5 V at 325 mA. A power supply sensitivity rating is given for the 1612 converter as 0.002%/ % change in power supply.

The PC edge-converter version is designated as 1612P. It has overall approximate dimensions of 4.6-in. wide by 3.6-in. long by 1-in. high.

The modular converter version for PC-board mounting is the model 1612B. Its dimensions are 5.4-in. wide by 4.2-in. long by 0.8-in. high.

CIRCLE NO. 253

1200-A power blocks forward gain 100 min.



PowerTech, Inc., 9 Baker Ct., Clifton, N.J. Phone: (201) 478-6205. P&A: \$835; stock.

MT-5000 series powerblock systems feature minimum h_{FE} ratings of 100 at collector currents of 1200 A and an h_{FE} of 500 at 750 A. At 1200 A, V_{CE} (sat) is only 2.5 V maximum. Collector-emitter operating-voltage ratings are 60 or 80 V. Each powerblock utilizes 200-A silicon power transistors as its basic building block. The output transistors are factory matched and Darlington interconnected.

CIRCLE NO. 254

DIP 7-segment displays include TTL logic too

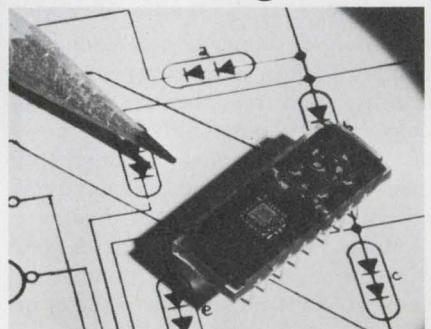

Texas Instruments, Inc., 13500 N. Central Expwy, Dallas, Tex. Phone: (214) 238-2011. P&A: \$11.90 (1000 quantities); 6 wks.

Two new seven-segment LED numeric displays come complete with TTL/MSI logic in the same 16-pin dual-in-line packages. One is designated the TIL306 with a decimal on the left; the other is the TIL307 which has a decimal on the right. Each with 0.270-in.-high characters contains a BCD counter, a four-bit latch and a decoder/LED driver.

CIRCLE NO. 255

Have you filled out your REQUESTED DATA DELIVERY SERVICE enrollment form? See page 80

DANA

453
1679

counters with innovation



A year and a half ago we introduced the best universal counter/timer available on the market . . . the 8000. Now we have made it even better in the **8000B**, by providing the user with increased flexibility through the use of more optional capability and increased performance . . . and it's made to sell from \$1195 with features you wouldn't believe . . . 1 mV sensitivity to 500 MHz; trigger level monitoring and indicator; 8-digit display; 150 MHz direct count; 10ns time interval; 150 pico seconds time interval average; systems interface; and much more. We think it's the best counter you can buy in its price range.

Check us out before you buy. Let us send you complete information on 8000B . . . and our 8100 Automatic Counters too, if you want. We'll prove to you that we make really great counters, 11 of them. You have the budget and the decision . . . Dana has the ELECTRONIC COUNTERS.

DANA
COUNTERS

Dana Laboratories, Inc.
2401 Campus Drive, Irvine
California 92664 (714) 833-1234

When Test and Measurement Count

To Help You Keep
On Top of New Developments...

announcing

REQUESTED DATA DELIVERY

Self-Selected Information

from

Hayden Publishing Company

and It's Absolutely FREE

Here's a *new* way TO STAY AHEAD of all the new developments that affect your work in the fastest moving technology of the seventies . . . it's quick, convenient and right on target.

You get manufacturer's latest technical literature, application notes, catalogs, etc., dealing *specifically* with the products that concern you most.

You can select from 238 categories.

And you get your personally selected data *automatically* without delay . . . not tons of unwanted mail, but only information on the subjects you want. Hayden Publishing offers this service to qualified professionals.

Requested Data Delivery Service makes it possible for you to receive mailings of pertinent material so vital to your decision making process with these extra benefits:

- you choose the categories
- automatic mailings . . . your first request is your last
- add or delete categories as you wish
- your name is always kept confidential
- mailings clearly identified, no confusion with unsolicited mail
- never a cost, sales call or solicitation

ENROLL NOW . . . IT'S EASY . . . USE THE HANDY ENROLLMENT FORM AT RIGHT

(If form has been removed, circle Information Retrieval Number 8,
or write for your enrollment card on your company letterhead.)

Boeing showed the way home.



When the Apollo 15 astronauts went for a drive in their Lunar Roving Vehicle, they could depend on a reliable navigation system to get them "home" to the Lunar Module again.

Distance and heading back to the Lunar Module were displayed continuously on the LRV console, derived from the output of a unique Signal Processing Unit designed and built by Boeing.

This compact digital/analog computer had to meet some of the toughest specs ever for electronic hardware. Such as gravity forces of $12\frac{1}{2}$ Gs during launch. Temperatures from minus 250 to plus 250 degrees. And

hard vacuum.

What's more, the SPU, along with the rest of the navigation system and the complete LRV, was designed, built, tested and delivered to NASA by Boeing in the shortest time ever for Apollo-qualified hardware. It's a typical example of Boeing's total capability for on-time delivery of highly reliable special-purpose computers.

Other Boeing computers now in development include a controller for the USAF Airborne Warning and Control System, a central computer for Mariner/Venus/Mercury '73, and a low-cost attitude computer for

spacecraft. Early development work is under way on advanced configurations for an ultra-reliable Grand Tour computer.

When you need a special-purpose computer, come to Boeing. We can do the exact job you need. At very competitive prices.

Write to Mr. Herbert S. Broadwell, Boeing Electronic Products, P.O. Box 3999, Seattle, Washington 98124. Or call him at 206-773-6116.

**BOEING
ELECTRONIC
PRODUCTS**

INFORMATION RETRIEVAL NUMBER 40

A MESSAGE FOR DADDIES

Get yourself a good, thorough examination once a year. Once a year, let your doctor really look you over. It'll take a little time, and a little patience. And maybe he'll poke around a little more than you'd really like. And so he should.

The whole idea is to keep you healthy. If nothing's wrong (and more than likely, there isn't) hooray! Come back next year. But if anything's suspicious, then you've gained the most important thing of all: time.

We can save 1 out of 2 persons when cancer is caught in time, caught early. That's a good thing to know. All Daddies should know how to take care of themselves so that they can have the fun of taking care of their kids. Don't be afraid. It's what you don't know that can hurt you.

AMERICAN CANCER SOCIETY

MODULES & SUBASSEMBLIES

Redesigned 12-bit d/a converter costs \$49

Analog Devices, Inc., Route 1 Industrial Park, Norwood, Mass. Phone: (617) 329-4700. P&A: \$49 (100 quantities); stock.

Model DAC-12QZ 12-bit d/a converter is a pin-for-pin replacement for the earlier model DAC-12QS. It features the same performance at a three-fold reduction in price. Characteristics include $\pm 1/2$ -LSB linearity, 30-ppm/ $^{\circ}$ C temperature coefficient and a user-programmed output for any one of five different ranges—0 to +5 V and 0 to +10 V, ± 2.5 V, ± 5 V and ± 5 V and ± 10 V. The output settles to 0.0125% in 5 μ s.

CIRCLE NO. 256

Fast a/d converter is 0.015% accurate

Libra Systems Co., Box 161, Collegeville, Pa. Phone: (215) 539-8705. P&A: \$255; stock to 2 wks.

Model 1010 bipolar 4-1/2-digit a/d converter features standard dual input amplifiers, two-channel multiplexer, internal clock, output register, dual-polarity reference supply and an encode clock. When operating with a single input it achieves 0.015% accuracy with a speed of 40 ms. With an equal duty cycle for both inputs, the converter operates at moderate speed with the same accuracy.

CIRCLE NO. 257

Low-cost a/d converters include \$99 12-bit unit

Cycon, Inc., 1080E Duane Ave., Sunnyvale, Calif. Phone: (408) 732-8311.

A family of eighteen low-cost 8 to 12-bit a/d converters includes one unit (the 12-bit CY3235) with 100- μ s settling time and full-scale drift of less than 30 ppm/ $^{\circ}$ C with internal reference, or 10 ppm/ $^{\circ}$ C with external reference. The CY3235 offers three user-selectable input ranges (0 to +10 V, ± 5 V and ± 10 V) and binary or offset-binary parallel TTL/DTL-compatible outputs.

CIRCLE NO. 258

Power supply line expands in capability

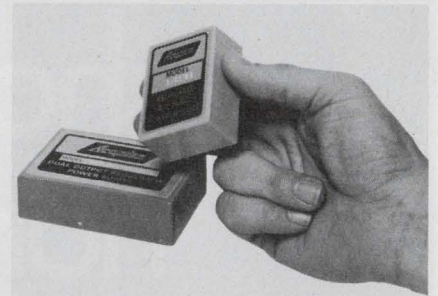

Acopian Corp., Easton, Pa. Phone: (215) 258-5441. P&A: from \$30 to \$78; 3 days.

The E Series of miniaturized power supplies has been expanded to include models with outputs up to 50 V and up to 500 mA. More than 400 single and dual-output models, all with provisions for trim adjustments, are now included in the series. Regulation of most models is $\pm 0.05\%$ and ripple is 0.5 mV rms. Standard input is 105 to 125 V ac.

CIRCLE NO. 259

Numeric display panel has 8 to 16 characters

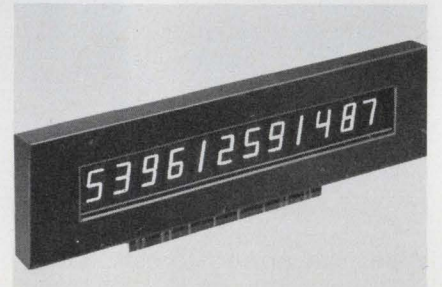

National Electronics, Inc., Geneva, Ill. Phone: (312) 232-4300.

The NDP1250 multi-character numerical display panel is available with 8 to 16 0.6-in.-high nine-segment cold-cathode characters. The display is designed to operate in strobe or time-share modes. The nine segments per character form the numerals 0 through 9 and the signs + and -. Anode supply voltage is 170 V dc and peak cathode current is 3 mA/segment. The neon red characters are 0.2-in. wide.

CIRCLE NO. 260

REQUESTED DATA DELIVERY SERVICE is here . . . see page 80



Get them off-the-shelf!

101A, 201A, 301A

in TO-99, TO-116 and TO-91 packages

also in volume production 709, 741, 748, 107, 723,
747, 1537, 1558 families and the ML6503/7503,
microsystems' unique single-chip dual 748.

Microsystems International adds the 101A family of high-performance operational amplifiers to its ever-expanding line of Selected Linears—produced in all popular packages, at competitive prices, and available to the exacting requirements of

MIL-std-883. Also available is a comprehensive line of MOS LSI silicon-gate RAM's, ROM's and Shift Registers; as well as telecom and datacom standard and custom Hybrids—thin and thick film circuitry.

selected linears from
the performance leaders



microsystems international limited, box 3529 station c, ottawa, canada - montreal, ottawa, toronto, brussels, stuttgart, london, palo alto, union.

For further information—call or write your nearest Microsystems sales office or distributor.

U.S.A.

Microsystems International Limited,
Palo Alto Calif. 415-493-0848,
Orange Calif. 714-637-2330,
Union N.J. 201-964-3131,
Andover Mass. 617-762-8298,
Schaumburg Ill. 312-894-7660;
Intermark Electronics,
San Carlos Calif. 415-592-1614;
Rical Associates,
Santa Ana Calif. 714-557-6543;
Arrow Electronics Inc.,
Farmingdale L.I. N.Y. 212-526-0300,
Baltimore Md. 301-247-5200;

Milgray Electronics Inc.,
Freeport L.I. N.Y. 516-546-6000;
Sterling Electronics,
Watertown Mass. 617-926-9720;
Hall-Mark Electronics Corp.,
Dallas Tex. 214-231-6111;
Minneapolis Minn. 612-925-2944;
Gerber Electronics,
Dedham Mass. 617-329-2400;
ABC Electronic Sales,
Williston Park N.Y. 516-747-6610,
Philadelphia Pa. 215-464-2275;
Geartner Assoc.,
Orlando Fla. 305-299-1000,

Miami Beach Fla. 305-861-3661;
Stan Pierce Inc.,
Norwood Mass. 617-762-3164;
James Sample Assoc.,
Rochester N.Y. 716-342-1413,
Liverpool N.Y. 315-457-1188;
R-J Inc.,
Minneapolis Minn. 612-922-1425;
W. Pat Fralia Co. Inc.,
Fort Worth Tex. 817-738-2394;
Tom Mulligan and Associates,
Columbus Ohio 614-457-2242;
Lou Bacher and Associates,
Itasca Ill. 312-773-1810;

PEM Sales Co.,
St. Louis Mo. 314-427-7200;
L. H. Kolman,
Baltimore Md. 301-752-8756.

CANADA
Microsystems International Limited,
Montreal Que. 514-875-2814,
Ottawa Ont. 613-828-9191,
Toronto Ont. 416-366-7721;
Cesco Electronics Ltd.,
Montreal Que. 514-735-5511;
A. W. Bleue,
Vancouver B.C. 604-685-7914.

High-speed SOS devices drop power dissipation

Inselek, 743 Alexander Rd., Princeton, N.J. Phone: (609) 452-2222. P&A: \$32 (100 quantities) for the RAM, \$17 (500 quantities) for the transistor; Oct. 1971.

Two new IC devices, a 64-bit RAM and a quad transistor, use silicon-sapphire (SOS) construction techniques to reduce input parasitic effects and power dissipation and increase operating speeds.

The RAM, designated type A01, is organized as 16 words by 4 bits and features an access time of 40 ns. Read cycle time is 70 ns. It is input and output compatible with TTL levels.

Of equal importance to its speed is the RAM's low-power dissipation—only 1 mW per bit. This compares favorably with TTL-compatible bipolar RAMs which dissipate

8 mW per bit typical, for the same speed characteristics.

Inselek is planning to announce in the near future 256 to 4096-bit

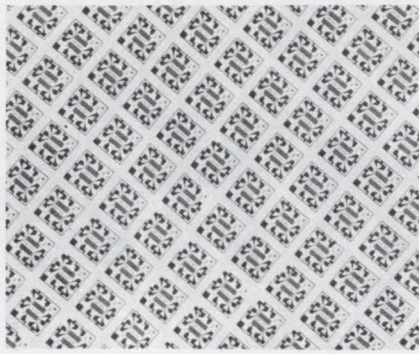

High-speed p-channel MOS transistor quads are constructed of silicon-on-sapphire for low power dissipation. Shown are several of the transistor quads on a wafer.

SOS RAMs that dissipate 100 μ W per bit and have cycle times of about 100 ns. They will be priced in the 1¢ per bit range for OEM quantities.

The second SOS device is the L-01 quad transistor. It consists of four p-channel enhancement-mode MOS transistors that are fabricated on a 40-mil-by-40-mil insulating sapphire substrate.

This new quad transistor has a switching speed of 40 ns. When used as an amplifier it is rated for a 500-MHz bandwidth.

Its use of dielectric isolation offers low input capacitance of 2.5 pF (said to be 50 times lower than conventional competitive devices) to negate any parasitic effects.

The SOS construction allows for low leakage current of 10 nA at 10 V and low power dissipation of 400 mW. ON resistance is 300 Ω and maximum operating temperature is +85°C.

Packaging is in 14 and 16-lead ceramic DIPs for the transistor and RAM, respectively.

CIRCLE NO. 261



Save production costs with the new Automatic Continuity Verifier (ACV)

- Checks all types circuitry — back plane wiring, cables and harnesses, Printed Circuit Mother Boards.
- Automatic operation reduces time, increases profit.
- Automatically checks up to 128 points — finds shorts and opens.

Write for brochure.

SCI SCI ELECTRONICS, INC.
8330 BROADWAY • HOUSTON, TEXAS 77017
713 / 641-0211

INFORMATION RETRIEVAL NUMBER 43



MODEL AF1

UNI-AMP™

- ▶ High Input Resistance > 10¹² ohms
- ▶ Low Input Capacitance < 0.1 pF
- ▶ Fast Rise Time, 30 nS
- ▶ Excellent Linearity, ±0.1% F.S.
- ▶ High Dynamic Range, 120 dB, 10 μ V to 10 V

TYPICAL APPLICATIONS

Photo Amplifiers & Transducers • Wide-Band Electrometer & Charge Amplifiers • Fast Pulse Instrumentation • A/D-D/A Converters • Sample & Hold Amplifiers • High Speed Comparators & Multiplexors • High Impedance Wideband Probes



Send for complete UNI-AMP data.

BIOELECTRIC
INSTRUMENTS

DIVISION OF GENERAL MICROWAVE CORPORATION
155 MARINE ST., FARMINGDALE, N. Y. 11735 • 516-694-3600

INFORMATION RETRIEVAL NUMBER 44

ELECTRONIC DESIGN 22, October 28, 1971



COMPARE CALCULATORS!

If you're looking for a programmable calculator, ask these questions:

- | | | |
|--|---|--|
| <p>YES NO
 <input type="checkbox"/> <input type="checkbox"/> Can you write equations directly on the keyboard in mathematical form, bypassing computer languages?</p> <p><input type="checkbox"/> <input type="checkbox"/> Is correct algebraic hierarchy automatically observed in performing all functions? Press $2 \times 3 + 4 \times 5 =$. Do you get the correct result (26) instead of 50?</p> <p><input type="checkbox"/> <input type="checkbox"/> Will it solve complicated problems and still be easy enough to operate without special training?</p> <p><input type="checkbox"/> <input type="checkbox"/> Is every function and program clearly and uniquely defined by the key sequence (without modification by toggle or rotary switches)?</p> <p><input type="checkbox"/> <input type="checkbox"/> Does it have individual left and right parentheses keys that allow you to solve directly expressions such as: $((a + b) - c \div d) \times (f - g) = ?$</p> | <p>YES NO
 <input type="checkbox"/> <input type="checkbox"/> Does it have a true <i>equals</i> key to display partial sums or total results immediately?</p> <p><input type="checkbox"/> <input type="checkbox"/> After a questionable procedure, does operation continue using the best available data? (With an unmistakable indicator showing an assumption was made?)</p> <p><input type="checkbox"/> <input type="checkbox"/> Is 10 significant-figure accuracy maintained after repetitive sequences such as $\ln x - e^x - \ln x - e^x \dots ?$</p> <p><input type="checkbox"/> <input type="checkbox"/> Are there a sufficient number of stored constants (26 or 100) that are separate and independent from the program steps?</p> <p><input type="checkbox"/> <input type="checkbox"/> When data such as $6378.388125 \times 10^{-13}$ are entered, does the data appear correctly, or as $6.378388125 \times 10^{-13}?$</p> | <p>YES NO
 <input type="checkbox"/> <input type="checkbox"/> Does it have hard-wired x^y, $\sqrt{x^2 + y^2 + z^2 + \dots}$, trigonometric, hyperbolic and other functions?</p> <p><input type="checkbox"/> <input type="checkbox"/> Can you write, store and recall constants and equalities through direct and indirect addressing?</p> <p><input type="checkbox"/> <input type="checkbox"/> Does it have simple key access to a wide range of peripherals including a 5120-step programmer, printer, X-Y plotter and TTY interface?</p> <p><input type="checkbox"/> <input type="checkbox"/> Will the calculator serve as the heart of a data acquisition system or minicomputer for on-line data processing?</p> <p><input type="checkbox"/> <input type="checkbox"/> Can you get prompt, reliable factory service?</p> <p><input type="checkbox"/> <input type="checkbox"/> Is the basic calculator priced at no more than \$3200?</p> <p><input type="checkbox"/> <input type="checkbox"/> Is it still a money-saver if you add on the "cost of learning" for the people who will operate it?</p> |
|--|---|--|

Every answer is yes for one calculator...

The TEKTRONIX Scientist 909

For more information, call your local TEKTRONIX Field Office or write Tektronix, Inc., P.O. Box 500, Beaverton, Oregon 97005



TEKTRONIX®

committed to
technical excellence

1%
AMERICAN MADE

Tolerance
SCHAUER
1-Watt
ZENERS

**Immediate Shipment
Low Prices**

ANY voltage from 2.0 to 18.0

Quantity	Price each
1-99	\$1.07
100-499	.97
500-999	.91
1000-4999	.86
5000 up	.82



All welded and
brazed assembly
No fragile
nail heads

Gold
plated
leads

Write for complete
rating data and other
tolerance prices.

**Buy the kit-
Save
a lot**



Kit contains a 51-piece assortment of SCHAUER 1% tolerance 1-watt zeners covering the voltage range of 2.7 to 16.0. Three diodes of each voltage packaged in reusable poly bags. Stored in a handy file box. Contact your distributor or order direct.

A \$54.57 value for
ONLY \$24⁵⁰

Semiconductor Division
SCHAUER
Manufacturing Corp.

4511 Alpine Ave. Cincinnati, Ohio 45242
Telephone: 513/791-3030

ICs & SEMICONDUCTORS

**256-bit bipolar RAMs
access in only 60 ns**

Intersil, 10900 N. Tantau Ave., Cupertino, Calif. Phone: (408) 257-5450. P&A: from \$25.60 (100 quantities); stock.

The IM5503, 5523 and IM5533 ICs are fast 60-ns-access fully decoded, static bipolar 256-bit RAMs in 256-by-1 organizations. They are DTL/TTL compatible and have on-chip address decoding and high-speed chip select. The IM5503 and IM5533 provide uncommitted collector outputs. The IM5503 provides the IM5523 and IM5533 feature three-chip select inputs. The IM5523 provides a three-state output.

CIRCLE NO. 262

**Multiple-port register
reads/writes at once**

Advanced Micro Devices Inc., 901 Thompson Pl., Sunnyvale, Calif. Phone: (408) 732-2400. Price: from \$5.40 (100 quantities).

The Am9338 is an 8-bit multiple-port register designed for high-speed minicomputers and small memory systems. It is capable of simultaneous read/write operations and is organized as eight words by one bit with a maximum current drain of 99 mA. Write time is guaranteed at 16 ns and read time at 65 ns. Internally, it is organized with eight master and two slave latches.

CIRCLE NO. 263

**IC voltage comparators
lower bias to 60 nA**

Harris Semiconductor, Melbourne, Fla. Phone: (305) 727-5412. P&A: \$12 (100 quantities); stock.

A new series of precision voltage comparators which operate at current levels as high as 50 mA with voltages as high as 50 V feature 60-nA bias currents. They operate from ± 15 -V or +5-V power supplies. Known as the HA-2111 series, the comparators feature flexible output stages that are RTL, TTL, DTL and MOS compatible. They cover the temperature range of -55 to $\pm 125^\circ\text{C}$ and come in TO-99 or DIP cases.

CIRCLE NO. 264

**IC 10-ns switch driver
provides up to 0.4 A**

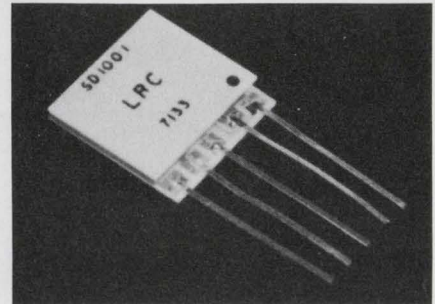

LRC, Inc., 11 Hazelwood Rd., Hudson, N.H. Phone: (603) 883-8001. P&A: \$65; stock.

The SD1001 switch driver provides up to 400 mA of peak current with less than 10 ns of total delay plus risetime. The driver is fully compatible with TTL logic and has fail-safe operation. In addition, it meets the full requirements of MIL-STD-883. Its small size makes it ideal for integration directly into solid state switches or microwave ICs.

CIRCLE NO. 265

**Matched dual n-channel
FETs are low in noise**

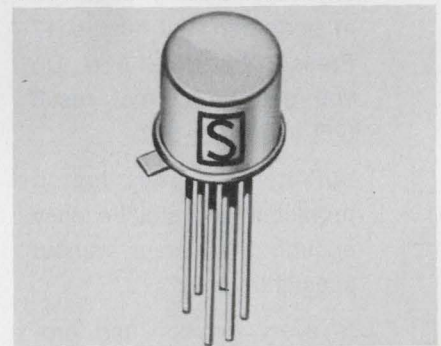

Solitron Devices, Inc., 8808 Balboa Ave., San Diego, Calif. Phone: (714) 278-8780.

Series SDF500 matched dual n-channel FETs feature low noise and drift characteristics. An example of matching is the range of the gate-source differential voltages: for the SDF500, 505 and 510 it is 3 mV; for the SDF501, 506 and 511 it is 5 mV; for the SDF502, 507 and 512 it is 10 mV; for the SDF503, 508 and 513 it is 15 mV; and for the SDF504, 509 and 514 it is 20 mV.

CIRCLE NO. 266

**A new, free Hayden Service
for you see page 80**

Cut yourself in.

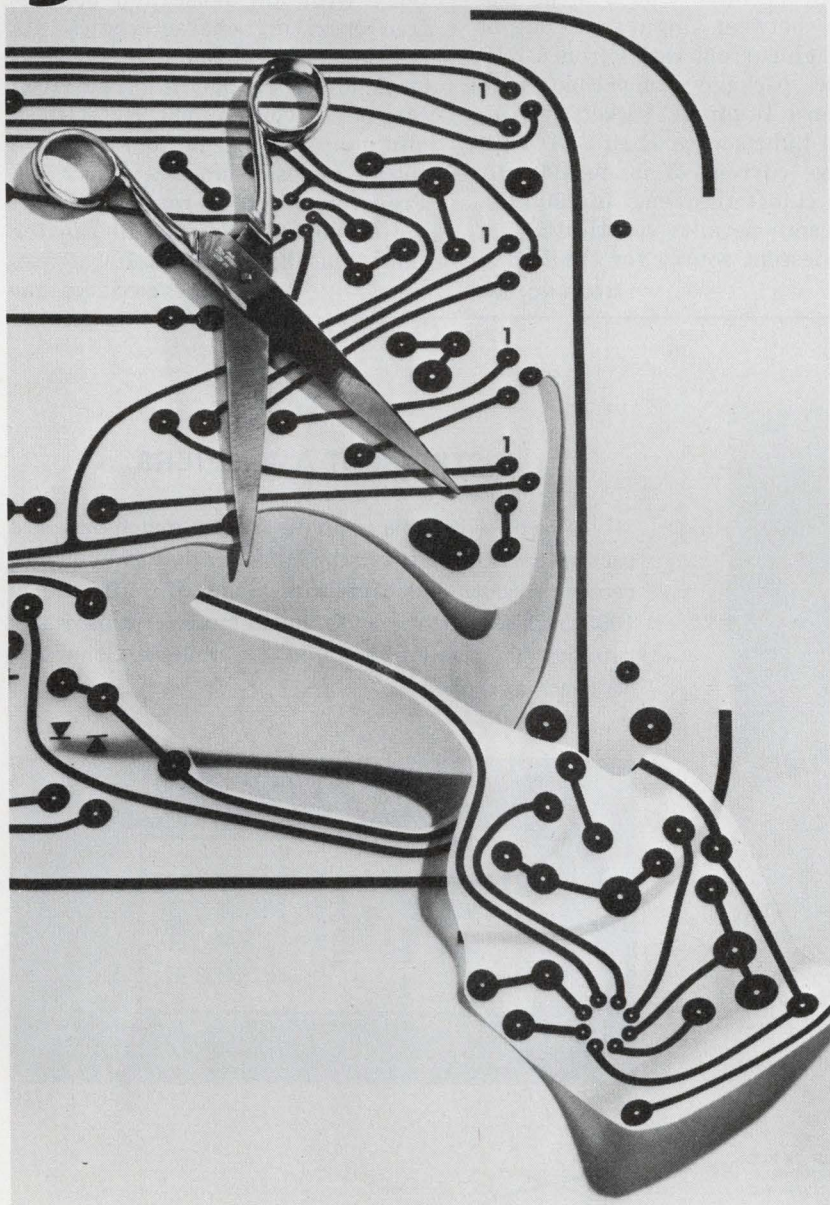

“Scissors draft” your way to increased production with KODAGRAPH Films and Papers.

Why retrace an entire drawing needing only revision? Instead, copy your original photographically on KODAGRAPH Film or Paper. Cut out the unchanged portions (often much of your drawing), mount them on a new drawing form, have a second original made on KODAGRAPH Film, and make your revisions on that.

For more on “scissors drafting” and other time-saving techniques, contact your Kodak Technical Sales Representative, or write Eastman Kodak Company, Business Systems Markets Division, Dept. DP822, Rochester, N.Y. 14650

DRAWING REPRODUCTION SYSTEMS BY KODAK

Kodak

Economy trimmers adjust two ways

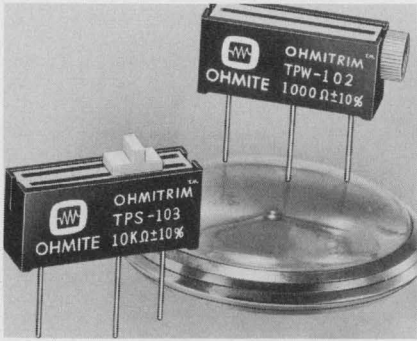

Ohmite Mfg. Co., 3601 W. Howard St., Skokie, Ill. Phone: (312) 675-2600. P&A: 88¢ (5000 quantities); stock.

Designated as the TPW and TPS series, Ohmitrim low-cost wirewound trimmers have a nominal 1-W rating and are offered in values from 10 Ω to 20 kΩ. Leads are gold-plated PC types, spaced for standard 0.1-in. matrix hole patterns. A choice of two actuators are offered. Model TPW is lead-screw operated and model TPS is slide operated.

CIRCLE NO. 267

Optical coupler isolates to 3000 V

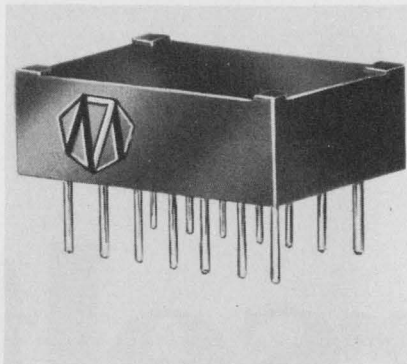

M7, Inc., 210 Campus Dr., Arlington Heights, Ill. Phone: (312) 255-7796.

A new type of optically coupled isolator permits ±3000 V of isolation between input and output from a DIP plastic package compatible with standard 14-pin IC sockets. Its internal light source is an LED with a drive current of 50 to 100 mA and a cutoff frequency of 290 kHz. Its design permits substituting an incandescent source for the LED.

CIRCLE NO. 268

Mercury wetted relay responds under 950 μs

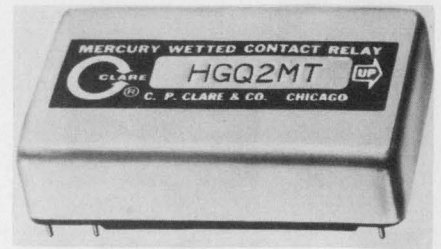

C. P. Clare & Co., 3101 Pratt Ave., Chicago, Ill. Phone: (312) 262-7700.

The low-profile HGQ is a new ultra-high-speed mercury wetted relay with low noise and bounce-free operating characteristics. Its response time at nominal coil power is less than 950 μs. The HGQ can be driven to 500 Hz with a minimum of jitter. Contact noise settles to less than 5 μV in 2 ms. Transfer action is random, bridging or non-bridging, with transfer time typically less than 100 μs.

CIRCLE NO. 269

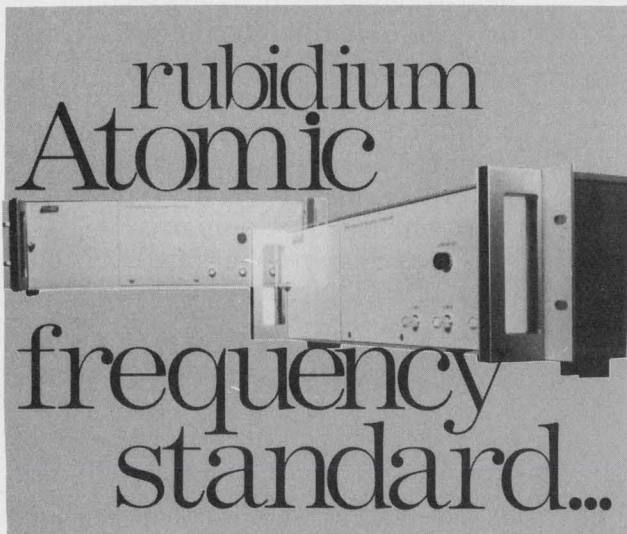

... The Model 304D for both laboratory and field use: now available in two versions: 304D-1 (with guaranteed stability of 1×10^{-11} /month). 304D-2 (with guaranteed stability of 2×10^{-11} /month). MTBF of more than 20,000 hours. Separate buffered outputs on front and rear panels, with built-in time scale selector and optional standby power and clock.

Manufacturers of: Rubidium and Crystal Frequency Standards and Clocks, VLF/LF Phase Tracking and Navigation Receivers, Frequency/Phase Comparators and Frequency Distribution Systems.

Industrial Instruments

6500 Tracor Lane, Austin, Texas 78721, AC 512/926-2800



INFORMATION RETRIEVAL NUMBER 48

INSTRUMENT AMPLIFIERS

A gain switchable amplifier in a match-box size package has been added to the MIN-DEK line of miniature decade resistors and capacitors. Gains of 1-10, 100 & 1000 in differential or single ended modes. Rechargeable batteries that snap into amplifier are available. Connector hardware is supplied.



FULL SIZE



INSTRUMENTS

SANTA FE SPRINGS, CALIF.

INFORMATION RETRIEVAL NUMBER 49

ELECTRONIC DESIGN 22, October 28, 1971

Sharpen your professional skills with these timely new engineering guides



THE SUCCESSFUL ENGINEER-MANAGER

A Practical Guide to Management Skills for Engineers and Scientists

Edited by Robert C. Haavind, Editor-in-Chief, Computer Decisions; and Richard L. Turmail, Management Editor, *Electronic Design*. Want to be on surer ground in directing your career? Need to sharpen your managerial skills? Use this well organized, realistic guide to tutor yourself in the critical areas of technical management: career, decisions, people, projects, finances, and communications. A carefully chosen selection of *Electronic*

Design articles, this book offers valuable pointers on financial analysis, person-to-person dealings, eluding the traps to sound decisions, project scheduling, promoting ideas, and much more. Techniques and the insights of top-flight managers to help you better manage yourself, others, a project, and even a company. 176 pp., 7 1/8 x 9 3/4, illus., #5879, cloth, \$8.95

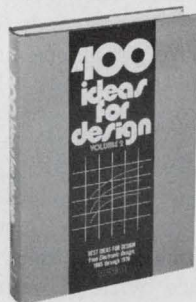

400 IDEAS FOR DESIGN, Volume 2

Selected from *Electronic Design*

Edited by Frank Egan, Editor, *Electronic Design*. Borrow, modify, or adapt any of the more than 400 ideas placed at your disposal in this second collection of top, recent contributions to *Electronic Design's* popular "Ideas for Design" column. Whether highly ingenious or amazingly simple, all offer immediate on-the-job assistance either as parts of larger designs or as aids in measuring the

parameters or testing the effectiveness of other designs. This well-organized book provides rapid access to a wide range of subject areas, extending from amplifiers, through design and laboratory aids, to pulse, digital, and control circuits. Each idea is ready to go, or to touch off creative thinking. 288 pp., 7 1/8 x 9 3/4, illus., #5067, cloth, \$11.95

PROVE THEIR VALUE FOR TWO FULL WEEKS...FREE!

PRACTICAL INSTRUMENTATION TRANSDUCERS

Frank J. Oliver, Formerly Editor, *Electro-Technology*. The most comprehensive and authoritative source on physical-to-electrical transducers. Virtually every known device for industrial or aerospace application is described and illustrated. This well planned volume will bring you up to date on the state-of-the-art, clear up areas of confusion, offer pertinent data for specific applications. Hundreds of diagrams, charts, and tables are included. 340 pp., 7 1/8 x 9 3/4 illus., #5833, cloth, \$20.00

PRACTICAL DESIGN FOR ELECTROMAGNETIC COMPATIBILITY

Edited by Rocco F. Ficchi. An invaluable on-the-job reference, this book places at your disposal all the basic information needed to analyze, predict, control, and reduce unwanted signals in electronic equipment and systems. A team of EMC specialists fully explains measurement techniques and equipment, details recent advances in filtering, shielding, and bonding, and offers complete treatment of the specific problems encountered in computers, semiconductors, and solid-state devices. 272 pp., 7 1/8 x 9 3/4 illus., #5685, cloth, \$13.95

PRACTICAL RELAY CIRCUITS

Also by Frank J. Oliver. This time-saving guide classifies relays by function, providing you with a rapid overview of the circuits that can solve the problem at hand. Operating principles, reliability factors, standards, and specifications of the provisionally chosen circuits can then be checked from manufacturers' data or other sources such as the *Engineers' Relay Handbook*. Diagrams illustrating the discussion use the latest American National Standard graphical symbols. 384 pp., 6 x 9, illus., #5802, cloth, \$14.95

DURABILITY AND RELIABILITY IN ENGINEERING DESIGN

Gilbert Kivenson, Consulting Engineer. Practical and provocative, this path-breaking book surveys findings from all disciplines that have present or future engineering relevance. It discusses key concepts, provides a capsule course in reliability theory, and outlines design philosophies and techniques relating design factors to the requirements of the end user. 186 pp., 6 x 9, illus., #5851, cloth, \$9.95

ENGINEERS' RELAY HANDBOOK

National Association of Relay Manufacturers. The Revised Second Edition of this authoritative reference provides a complete roundup of information on relay operating principles, properties, performance characteristics, application requirements, specification, and testing. New sections enlarge the scope of the book, including material on reed and mercury wetted relays, and solid-state devices. 355 pp., 7 3/8 x 10 1/8, illus., #5867, cloth, \$13.95

ELECTRICAL ENGINEERING AND ECONOMICS AND ETHICS FOR PROFESSIONAL ENGINEERING EXAMINATIONS

John S. Lyons, P.E.; and Stanley W. Dublin, New York University. This concise, up-to-date review for the practicing engineer presents a wide range of typical problems from recent state exams, solved step-by-step. Permitting you to strengthen weak points, two separate tables of contents give rapid access to subject areas and sample problems. 320 pp., 6 x 9, illus., #5715, cloth, \$12.95

FOR 15-DAY FREE EXAMINATION

Please send the book(s) circled on a 15-day examination basis. At the end of that time, I will remit payment, plus postage, or return the book(s) without further obligation.

5879 5685 5802 5715
5067 5833 5867 5851

\$10.00 minimum for free exam orders. Because of higher billing and collection costs, we must ask for payment in full with any order under \$10.00. Books will be shipped postpaid. Same 15-day return privilege for full refund if not satisfied.



Hayden Book Company, Inc., 116 West 14th St., New York, N.Y. 10011

NAME _____

FIRM _____

ADDRESS _____

CITY/STATE _____ ZIP _____

Save money! On all pre-paid orders Hayden pays postage—same return privilege!

71-92.

DIP clock oscillator drives 10 TTL loads

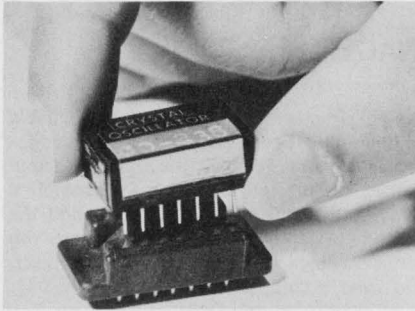

Vectron Laboratories, Inc., 121 Water St., Norwalk, Conn. Phone: (203) 853-4433. P&A: \$85; 1 to 4 wks.

The new CO-238 clock oscillator drives 10 TTL loads at any frequency in the 3-to-30-MHz range. It operates from 5 V dc and provides stability of $\pm 0.0025\%$ over 0 to $+70^\circ\text{C}$. This low-profile module plugs directly into a 14-pin DIP socket and measures only 0.5 by 0.8 by 0.35 in. An option includes the CO-238-2 which provides stability of $\pm 0.0003\%$ over 0 to $+50^\circ\text{C}$.

CIRCLE NO. 270

Magnetic reed relay is TTL IC compatible

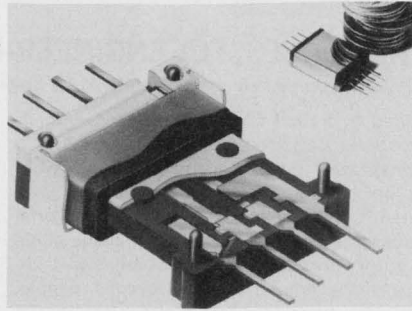

Kam Corp., 845 Commercial St., San Jose, Calif. Phone: (408) 286-8603.

A new integrated reed relay known as the IRR is designed to be totally compatible with TTL ICs. The IRR is a magnetic reed with integral provisions for the inclusion of an electromagnetic coil, coil termination, external packaging and a magnetic shield. Its glassless ferromagnetic reed contacts are simultaneously sandwiched in a ceramic/glass polymer matrix. Only 50 mW at 5 V dc is needed for operation.

CIRCLE NO. 271

Plug-in 4pdt relays detect circuit faults

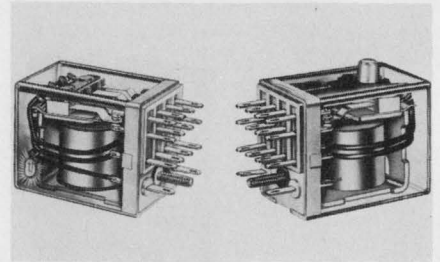

Guardian Electric Mfg. Co., 1550 W. Carroll Ave., Chicago, Ill. Phone: (312) 234-1100.

Two new 4pdt 5-A plug-in miniature relays obsolete circuit testers. The 1310N has a built-in neon test lamp that glows each time the coil is energized, or indicates a circuit fault when the lamp fails to glow. The 1310B push-to-test relay has an accessible button that permits checking the relay circuit performance without applying voltage to the coil.

CIRCLE NO. 272

Announcing REQUESTED DATA DELIVERY see page 80

HOW TO BUY A MINICOMPUTER.

Our free booklet will tell you how to evaluate minicomputer speed, architecture, interfacing, software, service and lots more.

The booklet is informative and authoritative. We're the No. 2 manufacturer of minicomputers. We know that the more you know about minicomputers, the better off we'll be.

FREE.

Name _____
 Company _____
 Address _____
 City _____
 State _____ Zip _____
 Phone _____

DATA GENERAL
 Southboro, Massachusetts 01772
 Tel. (617) 485-9100

INFORMATION RETRIEVAL NUMBER 51

SWITCH/INDICATORS

Unlimited Variety

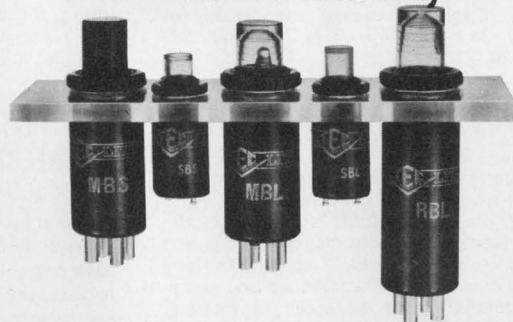

Aren't these what you're looking for? Endless variety and options. Million-cycle reliability! Low, off-the-shelf prices. Compact design. TEC's got 'em . . . in switches matchmated with TEC-LITE Indicators to give your panel a more handsome design. For information about TEC's complete line of switch/indicators • readouts • display panels • data entry keyboards • CRT display terminals, call (602) 297-1111 or write: TEC, Incorporated, 9800 N. Oracle Road, Tucson, Arizona 85704.



INFORMATION RETRIEVAL NUMBER 52

Reed relay operates
2 billion times

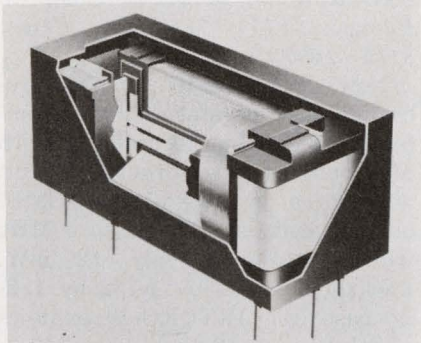

Babcock Electronics Corp., 3501 N. Harbor Blvd., Costa Mesa, Calif. Phone: (714) 540-1234. Availability: stock.

Long life characteristics of a reed relay combined with the contact performance of an electro-mechanical unit is claimed for a new 1-A spdt reed relay. Offered in latching and non-latching versions, the series R relay features a mechanical life of 1 billion operations, bifurcated contacts and operation to 500 Hz. Its contacts offer a resistance of 100 mΩ and limit bounce to 0.3 ms.

CIRCLE NO. 283

Voltage/frequency unit
is housed on a PC board

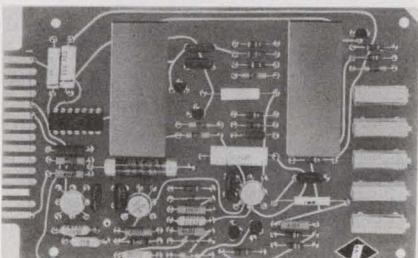

Pioneer Magnetics, Inc., 1745 Berkeley St., Santa Monica, Calif. Phone: (213) 829-3305. Availability: stock.

A new precision voltage-to-frequency converter is contained on a single PC board and features a "card-with-options" construction. Model PM1291 Magaverter produces a directly proportional frequency to an input dc voltage. Output linearity is $\pm 0.005\%$ of full scale. Standard outputs of 0.01, 0.1 and 1 MHz are offered with 0 to 5 V dc input.

CIRCLE NO. 284

180 WATTS - \$22.00 EACH 90 WATTS - \$15.00 EACH DCR Series Power Regulators

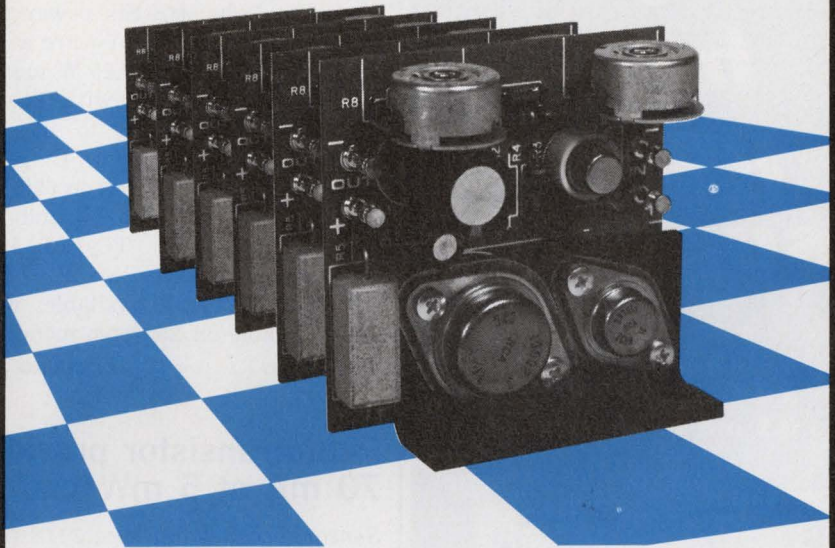

- VARIABLE OUTPUT ■ SIX MINI-PACKAGED MODELS
- VOLTAGES UP TO 24VDC ■ CURRENTS UP TO 12 AMPS

Again, Powertec leads the industry in cost/performance ratios with this new series of power regulators.

The DCRs are complete DC voltage regulators — no external components required. They are specifically designed for use in custom DC power supplies or as point of load regulators in industrial/commercial applications. Also, they are completely wired units containing all necessary small signal and power components.

So why pay twice as much to get $\frac{1}{2}$ the power when you can specify our new DCRs? Get your power from The Power People at The Powerhouse — Powertec. Request free application and catalog.

ALL MODELS DELIVERABLE FROM STOCK IN 24 HOURS.

180 WATT MODEL	DC OUTPUT		90 WATT MODEL	DC OUTPUT	
	VOLTS	AMPS		VOLTS	AMPS
1C5-12	4.5-6.5	12.0	1B5-6	4.5-6.5	6.0
1C15-12	11.5-15.5	12.0	1B15-6	11.5-15.5	6.0
1C24-8	17.5-24.5	8.0	1B24-4.5	17.5-24.5	4.5

SPECIFICATIONS: Input Voltage (max.): 40 VDC; Regulation: Line $\pm 0.075\%$, Load $\pm 0.075\%$; Input-Output Differential (min.): 4.5 VDC; Output Ripple (max.): 4mVP-P (2.0VP-P Input Ripple). Operating Ambient Temperature: -5 to $+75^\circ\text{C}$. Transient Response: 25 μsec . (50% load change). Temperature coefficient: .007% $^\circ\text{C}$ typical; Power Dissipation (max.): 90/180 watts (heat sink @ 25°C); Ripple Reduction (120 Hz): 60 db typical.

POWERTEC INC.

an Airtronics subsidiary

9168 De Soto Ave., Chatsworth, California 91311 (213) 882-0004 TWX 910-494-2092

at prices from \$40
**Hipotronics offers you
 immediate delivery
 on over 800 standard
 models of**

**regulated &
 unregulated**

**hv dc
 power
 supplies**

... with output voltages
 from 1 to 1000 KV and
 current outputs from
 0.1 ma to 50 amperes



7.5 KV, 130 ma,
 air-insulated unit,
 with HV section included in control box.

- Standard regulation ranges:**
 Unregulated 10-18%
 Regulated:
 Electromechanical
 (M Series) 0.5%
 Electronic (R Series) 0.01%

HV components: — transformers, capacitors, rectification assemblies, tanks, etc. — designed and manufactured under our roof.

Custom design units: for wide-range of applications — electrostatics, accelerators, lasers, high power radars, high voltage testing, and more.

For more information call Keith Reed at (914) 279-8091, or send for our 24-page catalog, which lists complete specifications: "High Voltage DC Power Supplies and Components."

High Potential Technology ®



HIPOTRONICS, INC.
 Brewster, N. Y. 10509 / (914) 279-8091

COMPONENTS

**Compact film resistors
 span 10 kΩ to 1800 MΩ**

*Dale Electronics, Inc., Box 609,
 Columbus, Neb. Phone: (402) 564-3131.*

Produced in coated (TCF) and molded (TMF) styles, a new line of film resistors covers a range of 10 kΩ to 1800 MΩ. Six power ratings—from 0.25 to 5 W—are available. TCF and TMF 0.25-W models span 10 kΩ to 39 MΩ with TCs of 250 ppm/°C and 40 to 80 MΩ with TCs of 1000 ppm/°C. Five-watt models cover 20 kΩ to 699 MΩ with TCs of 250 ppm/°C and 700 to 1800 MΩ with TCs of 1000 ppm/°C. Tolerances of 2%, 3%, 5% and 10% are available, with 1% available on 250-ppm models.

CIRCLE NO. 273

**Phototransistor provides
 70 mA at 5 mW/cm²**

*Sensor Technology, Inc., 7118 Ger-
 ard Ave., Van Nuys, Calif. Phone:
 (213) 781-2154.*

The STPT-260 Quantistor photo-transistors provide 70 mA outputs at 5 mW/cm² (11 mA at 1 mW/cm²) and switch in 6 μs. Their low collector-to-emitter bias permits operation from 5-to-15-V power supplies. Peak spectral response is 800 nm (60% of output is at 655 and 960 nm). Crosstalk is minimized in the new phototransistors by a narrow field of view. Units are available in standard TO-5 packages.

CIRCLE NO. 274

**Five-degree step motor
 slews at 6000 pulses/s**

*Computer Devices Corp., 11925
 Burke St., Santa Fe Springs, Calif.
 Phone: (213) 698-2595.*

A fast new five-degree step motor has a variable-reluctance rotor that can handle a 6000-pulse/s slew rate and 25 oz-in. of running torque. The motor is also available with a permanent-magnet rotor for operation from an ac supply. From a 120-V ac 60-Hz source, the motor will operate at 200 revolutions/minute and produce 25 oz-in. of torque. The 23H-300 motor has Class H insulation.

CIRCLE NO. 275

**Hybrid thick-film
 TCXO uses only 12 mW**

*CTS Knights, Inc., Sandwich, Ill.
 Phone: (815) 786-8411. Price:
 \$115 (1000 quantities).*

New JKTCXO-10 temperature-compensated crystal oscillator combines thick-film techniques with MOS circuitry to provide a unit with three or more binary related outputs between 200 Hz to 5 MHz while consuming only 12 mW. Packaged in a 1 by 1-1/2 by 1/2-in. case, the JKTCXO-10 exhibits a stability of ±2 ppm over -40 to +70°C and spans a frequency range of 3 to 5 MHz. Input voltage is ±8 V dc ±1%.

CIRCLE NO. 276

**Low-profile reed switch
 is just 0.56-in. long**

*Hamlin, Inc., Lake Mills, Wis.
 Phone: (414) 648-2361. P&A: 69¢
 (1000 quantities); 3 wks.*

To help achieve compactness in switching keys, the low-profile Mark 6 Form A spst keyboard reed switch includes a glass-enclosure length of only 0.56-in. in a glass dia of only 0.105-in. Its off-center contact arrangement makes one of its reeds longer and more flexible than the other. Pull-in is a low 17.5 ampere-turns. Switching voltage is 10 Vdc, maximum current is 10 mA and maximum contact resistance is 0.15 Ω.

CIRCLE NO. 277

**Spst pushbutton switch
 shrinks down in size**

*C & K Components, Inc., 103 Morse
 St., Watertown, N.Y. Phone: (617)
 926-0800.*

The Micro-Mini model 8631 butt-contact spst momentary action pushbutton switch is quite tiny—0.635-in. long by 0.251 in. in dia. Its coin-silver contacts are rated at 1/2 A resistive at 115 V ac or 28 V dc. Insulation resistance is 10,000 MΩ minimum and initial contact resistance is a maximum of 10 mΩ. The 8631 is rated for a lifetime of 1 million make-and-break cycles and comes with a single-piece bushing mount.

CIRCLE NO. 278

Table-top system measures coordinates

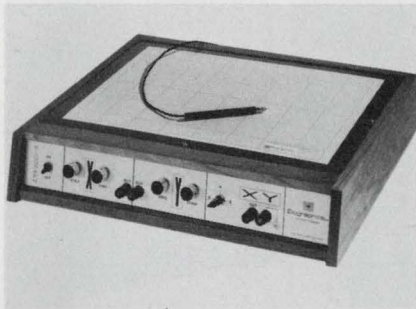

Elographics, Inc., Box 388, Oak Ridge, Tenn. Phone: (615) 482-4039. Price: \$995.

Coordinate measuring from X-Y graphs, strip charts, photographs, maps and PC cards is quickly and easily done with the Elograph E-100. The Elograph's analog or digital outputs are proportional to the X-Y position of its hand-held probe. Its working area is 38 by 25 cm. Coordinate zero can be set over the entire range while scale adjustments permit digital readout of the actual values used on the graph.

CIRCLE NO. 285

Dual-gap 9-track head lowers crossfeed to 3%

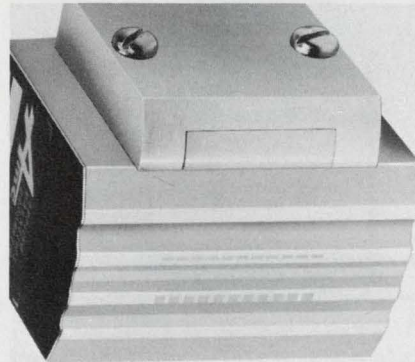

Applied Magnetics Corp., 75 Robin Hill Rd., Goleta, Calif. Phone: (805) 964-4881.

Model ERWA-171909 is a new digital 9-track dual-gap magnetic tape head that offers write-to-read crossfeed of 3% without an external shield. Developed for use with low-speed 45-to-112.5-in./s tape transports, it includes track widths of 0.044 in. and 0.040 in. for write and read functions, respectively. Resolution is 85% for 200-to-800-bit/in. recordings.

CIRCLE NO. 286

Remote terminal verifies data automatically

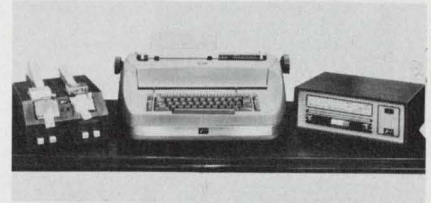

Terminal Equipment Corp., 750 Hamburg Tpke., Pompton Lakes, N.J. Phone: (201) 839-3000.

A new terminal automatically verifies computer-generated data at remote locations on a character-by-character basis. The Holmes Tycom 35/37 model E transmits the ten-element ASCII code format at 30 characters/s allowing the remote terminal to absorb the delay caused by the verification process and still print data at 15 characters/s. Only one detected print error per 1.4 million operations are evident.

CIRCLE NO. 287

REQUESTED DATA DELIVERY SERVICE IS HERE. . see page 80.

SAVE 50%

On printed circuit layouts

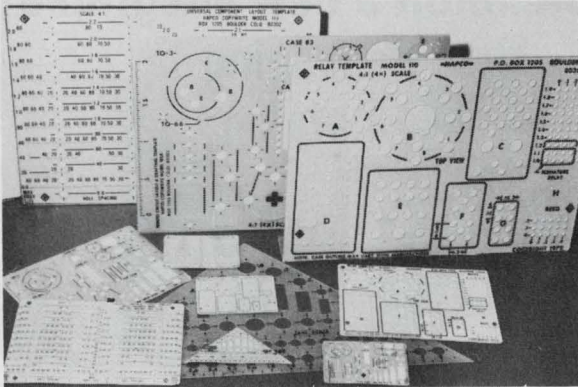

With the HAPCO Designer's Template Set

- 12 templates in 4 different configurations and 3 different scales.
- The complete set \$70.70 FOB Boulder, Colorado Over \$100 if purchased separately.
- Free Printed Circuit Design and Documentation Booklet and Wall Chart with order for complete set.
- Templates sold individually Write for details.

Order from:

HAPCO

POB 1205 Boulder, Colorado 80302

INFORMATION RETRIEVAL NUMBER 81

ELECTRONIC DESIGN 22, October 28, 1971

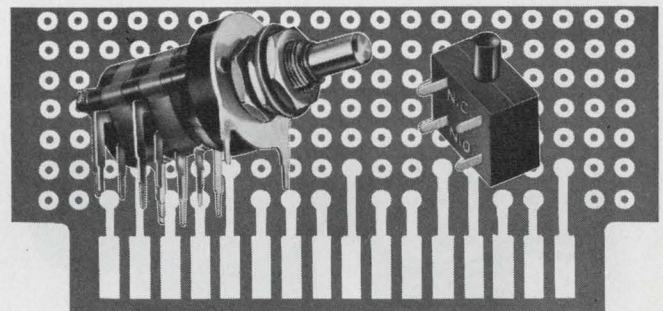

Mix and match mini switches. More power to the PC.

Grayhill mini PC rotary and push button switches were designed especially to fit into a PC Board — saving time and errors in wiring.

NEW! 1 Amp Rotary: Until now, the upper limits for PC multi-deck rotary switches was ¼ amp. Get the 1 amp Series 42P with all ten terminals on one side (with two decks) or with five terminals on two sides (one deck). Life expectancy: 100,000 operating cycles.

Other Mini Rotary PC Switches available with

30°, 36°, 45° or 60° angle of throw, 2 to 12 positions per pole, 1 to 4 poles per deck, 1 to 12 decks.

Push Button PC Switches: Rated ¼ amp —115 VAC resistive, 2 circuits (one NC, one NO).

Like to know more? Write or phone for our latest general engineering catalog. Grayhill, Inc., 565 Hillgrove Ave., La Grange, Ill. 60525, (312) 354-1040.

Grayhill
... the Difference Between Excellent and Adequate

INFORMATION RETRIEVAL NUMBER 82

Portable data terminal comes in a briefcase



MSI Data Corp., 1381 Fischer Ave., Costa Mesa, Calif. Phone: (714) 540-6600.

A complete battery powered portable terminal in a briefcase has full alphanumeric, a strip printer and provides optional two-way communication with a data center. The terminal's standard configuration includes the Source 2002 cassette recorder, the Source 2300 communications module and a rapid recharger for the Ni-Cd battery. The 7-lb recorder and keyboard can be removed for desktop use.

CIRCLE NO. 279

Digital cassette drive stresses reliability

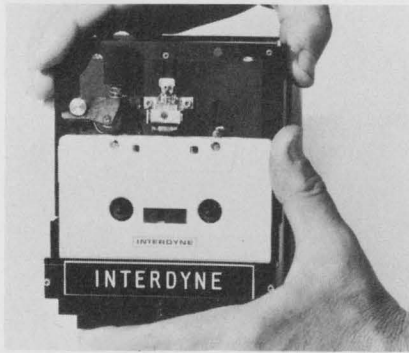

Interdyne, 14761 Califa St., Van Nuys, Calif. Phone: (213) 787-6800. P&A: \$995 (single-gap-head write/read model); 45 days.

Simple mechanical design is featured in the new IC/2500 digital cassette tape drive which has a single servo-controlled capstan motor and a pair of individual reel motors to precisely control tape velocity and tension. Eliminated are all mechanical clutches, belts, brakes and relays. It records synchronously at 9600 bits/s or incrementally at 30 characters/s.

CIRCLE NO. 280

Optical card reader simplifies programming



Hewlett-Packard Co., 1501 Page Mill Rd., Palo Alto, Calif. Phone: (415) 493-1501. P&A: \$750; October, 1971.

A new low-cost eight-channel optical mark-sense card reader inputs 8-bit data to computers and other devices. Called the model 3260A Marked Card Programmer, it detects pencil marks or punched holes on hand-fed cards and gives corresponding digital outputs. The 3260A has its own internal power supply and a maximum capacity of 32 words/card. Reading time for a complete 32-word card is 1.5 s.

CIRCLE NO. 281

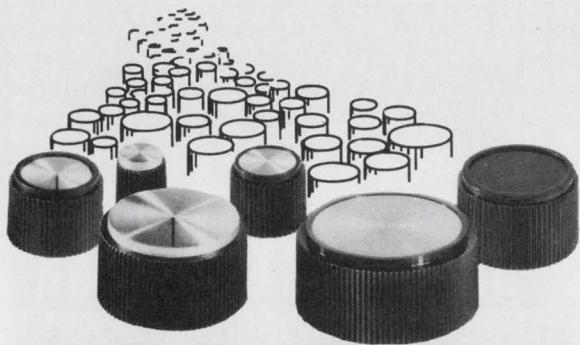

1,500,000

KNOBS TO CHOOSE FROM...

and they're "Warranted for Life"

Kurz-Kasch has over 1½ million low cost, high quality knobs in inventory, ready to ship to you. (You save . . . no tooling cost on stock knobs, specials 4 to 6 weeks delivery.) Your local distributor's stock is available at factory prices. Select instrument and control knobs from 24 families with 367 basic sizes and shapes in general purpose phenolics, melamines and ureas. All Kurz-Kasch knobs are warranted for the life of the product on which they're used. Send now for free 20 page catalog. (Also found in THOMAS REGISTER "THOMCAT."®)



Kurz-Kasch, Inc.
1421 S. Broadway
Dayton, Ohio 45401
513/223-8161

INFORMATION RETRIEVAL NUMBER 56

Catch-up reading. CAMBION'S new Integrated Packaging Catalog.

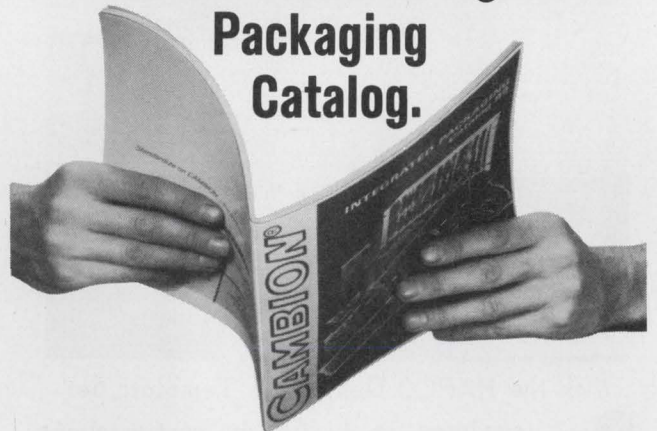

Its 48 pages cover our whole line of high density IC Sockets, Cambi-Card® circuit boards, bread boards, card files, power planes and Wire-Wrap* products and services. Send for Catalog 99. Cambridge Thermionic Corporation, 445ED Concord Avenue, Cambridge, Massachusetts 02138.

*Registered Mark of Gardner-Denver Co.

Standardize on

CAMBION®

The Guaranteed Electronic Components

INFORMATION RETRIEVAL NUMBER 57

ELECTRONIC DESIGN 22, October 28, 1971

Turnkey design digitizer is a complete system

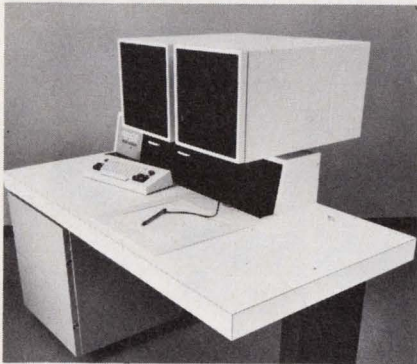

Applicon, Inc., 83 Second Ave., Burlington, Mass. Phone: (617) 272,7070. P&A: \$60,000; 90 days.

A new turnkey, computerized graphical design and drafting system for PC boards, ICs, hybrid circuits and schematic drawings allows designers to free-hand sketch drawings directly into a computer without the need for external software or hardware. Of, if they prefer, designers can digitize their drawings and use the system to check and edit digitized data.

Called the Design Assistant 700, the system is constructed of optional modules, each containing all the necessary hardware and software and capable of stand-alone operation, depending on which options are added to the system (one can enter data into a memory option module, for example, and the data can be communicated to the Design Assistant from a remote location). Several terminal modules can also be connected to a central communications facility.

The system's software includes 150 commands and offers flexibility, with typical options that include disc and expandable core memories, plotters, digitizers, pattern generators, peripheral storage devices and dual-display scopes.

Modules can be remotely located any distance from each other or from file storage devices without affecting the system's response.

The system uses a Digital Equipment Corp. PDP/11 minicomputer and holds 4 million bits of storage. It can be interfaced to other computer-aided design programs and numerical-control machines and may be connected as a remote terminal to larger computers for increased design demands.

CIRCLE NO. 282

A single capable source for both lamps and fiber optic light guide systems

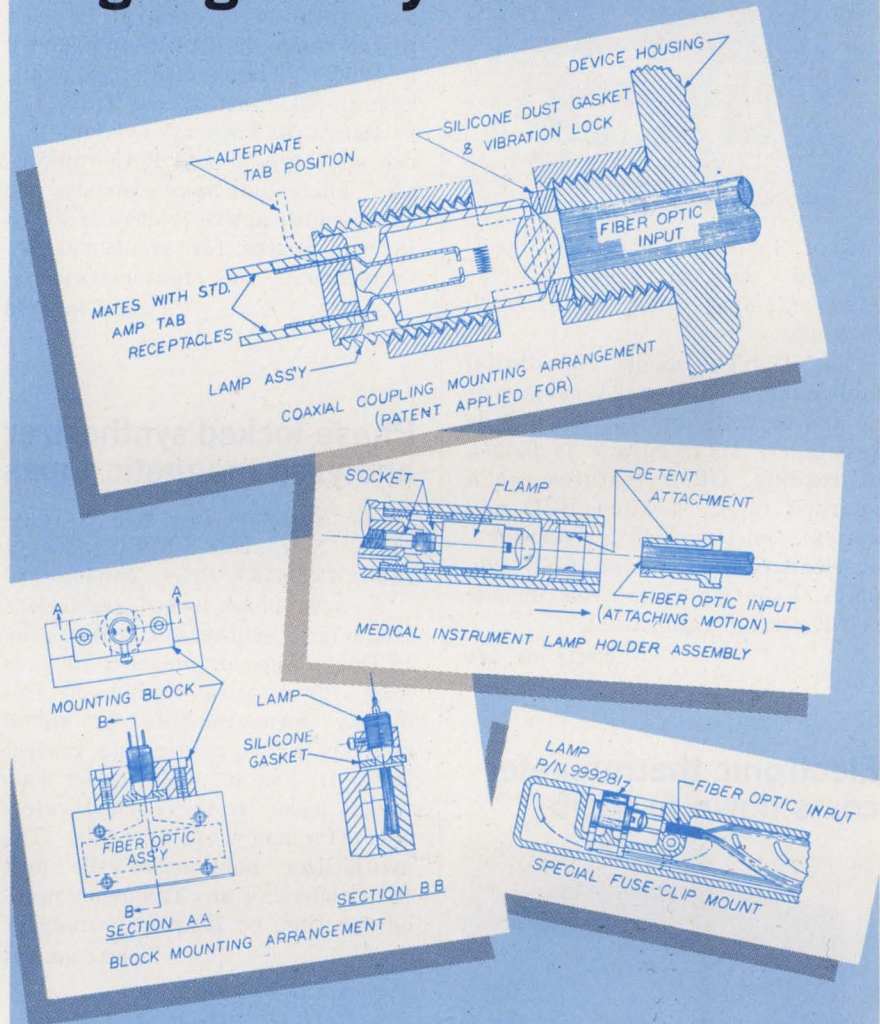

There are obvious advantages in speed, cost and often in efficiency of the ultimate system in having one source produce both miniature lamps and fiber optic assemblies. Welch Allyn has that capability.

We are major suppliers of fiber optics and incandescent illumination sources to principal computer manufacturers and other light guide users.

In addition to our standard lamp designs, we have recently developed a new family of customized miniature vacuum lamps for fiber optic and photo-sensitive device applications with selectable lens-filament combinations and basing for optimum utilization of energy.

Our lamp-fiber optic systems are designed for maximum efficiency and are often less costly than standard multiple-lamp systems.

Phone or write for more information

WELCH ALLYN, INC.
Skaneateles Falls, N.Y. 13153
(315) 685-5788



LED digital multimeter includes 23 ranges



United Systems Corp., 918 Woodley Rd., Dayton, Ohio. Phone: (513) 254-6251. P&A: \$695; stock to 8 wks.

The DigiTec model 269 digital multimeter features 23 ranges of dc and ac volts and current and dc resistance. Its accuracy is 0.02% of reading. Other features are a guarded input, isolated BCD and system functions, 40% overrange, overload protection and LED displays. Front-panel controls include self-checking calibration.

CIRCLE NO. 288

Electronic thermometer costs down to \$195



Stow Laboratories, Inc., Kane Industrial Dr., Hudson, Mass. Phone: (617) 562-9347. P&A: \$195 (with sensor).

New Model 911 PL electronic thermometer is a precision instrument whose measurement ranges are -60 to $+200^{\circ}\text{C}$ or -76 to $+392^{\circ}\text{F}$ and repeatability is $\pm 0.05^{\circ}\text{C}$. Its plug-in platinum RTD sensors are factory compensated for full interchangeability. A 10-mV-per-degree output converts any DVM into a digital thermometer with 0.1° resolution.

CIRCLE NO. 289

Temperature recorders feature small size

Omega Engineering, Inc., Box 4047, Stamford, Conn. Phone: (203) 322-1666. Price: \$130.

A new line of low-cost miniature temperature recorders can be used in the range of 0 to 2000°F and 0 to 1000°C . The recorders are available in 70 chart speeds from 1/8 to 480 in./h. They are available for use with type J and K thermocouples. Their taut-band elements use charts with active widths of 2-1/8 in. and spaces for event markers to record in the right margins.

CIRCLE NO. 290

Phase-locked synthesizer analyzes magnetic tapes

Probe Systems, Inc., 655 N. Pas toria, Sunnyvale, Calif. Phone: (408) 732-6550. Price: \$5850.

A new phase-locked oscillator/frequency synthesizer called the PLO/synthesizer model I-1001 is used for precise timing or frequency measurements in signal analysis of magnetic-tape recordings. It has a phase-locked loop which locks to the normal reference frequency off the tape. The synthesizer portion of the unit then generates any frequency needed for time or frequency analysis.

CIRCLE NO. 291

Guarded-input DPM has 0.01% accuracy

Analogic Corp., Audubon Rd., Wakefield, Mass. Phone: (617) 246-0300. P&A: \$350; stock to 3 wks.

The AN2544 4-3/4-digit DPM features a floating guarded differential input, automatic polarity symbol, externally-positioned decimal point and accuracy of $\pm 0.01\%$ of reading $\pm 0.0025\%$ of full scale ± 1 count. An auto-zero circuit automatically zeroes out all offset and drift errors. Common-mode rejection is 100 dB to 60 Hz and common-mode voltage is 600 V dc or pk-pk ac.

CIRCLE NO. 292

Solid-state wattmeter displays true-rms values

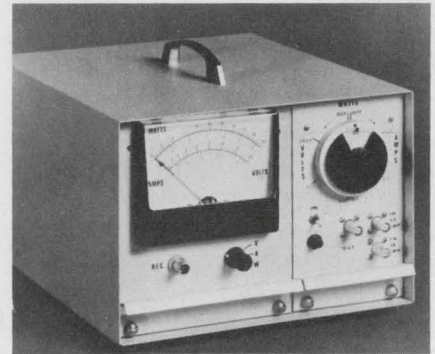

Wave Energy Systems, Inc., Newton Commons, Newton, Pa. Phone: (215) 968-3833. P&A: \$495; stock.

A new solid-state wattmeter, the model M1/SC1, measures true-rms voltage, current and electrical power. The meter operates over a 5-to-100-kHz range which can be extended on request. Irregular wave forms and phase differences are taken into account in the power measurement. Voltage ranges are 200 to 2000 V rms and current ranges are 0.1 to 10 A rms giving 20 W to 20 kW power ranges.

CIRCLE NO. 293

Sweep/mark generator covers 2 to 1000 MHz



Kay Elemetrics Corp., 12 Maple Ave., Pine Brook, N.J. Phone: (201) 227-2000. P&A: \$1495; 3 to 4 wks.

The model 162A sweep and marker generator covers a frequency range of 2 to 1000 MHz in a wide and flat (± 0.5 dB) sweep. It features a digital read-out of center frequency and a selection of variable birdie or harmonic comb marker systems. Swept output is 0.5 V rms into 50 or 75 Ω , with harmonic or spurious response down by 30 dB. Other features include 0 to 80-dB attenuators in 1-dB steps.

CIRCLE NO. 294

Jack panels increase interconnection density

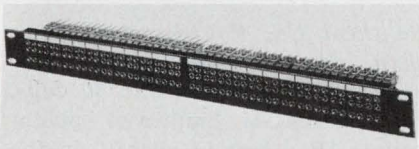

Switchcraft, Inc., 5555 N. Elston Ave., Chicago, Ill. Phone: (312) 792-2700. Price: \$40.

Series B1700 Tini-Telephone jack panels accept up to 48 Tri-Jax phone jacks (a triple jack which features three jacks on a single frame)—for a maximum of 144 connections in each panel. The new jack panels are of extruded aluminum and feature molded panel inserts and designation strips. Two panel inserts have 72 holes each, accepting up to 24 Tri-Jax phone jacks, each on alternate 0.312-in. and 0.37-in. centers.

CIRCLE NO. 295

Relay sockets save up to 37% of panel space

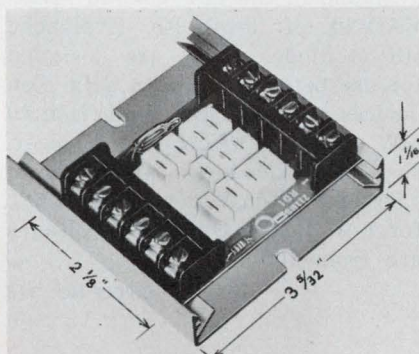

Reed Devices, Inc., 21W183 Hill Ave., Glen Ellyn, Ill. Phone: (312) 858-2050.

A new space-saving socket is available for dpdt or 3pdt and time-delay relays. The Snaptrack 211BS socket for 3pdt devices permits 22 sockets to be secured in a 48-in. length of mounting track—a 37% reduction in panel space compared to conventional sockets. The 218BS socket for dpdt devices permits 34 sockets to be mounted in a 48-in. length of track—a 25% saving in panel space. Both versions are rated at 10 A and 150 V.

CIRCLE NO. 296

A new, free Hayden Service for you... see page 80.

Card-edge connectors use 0.1-in.-center pins

Dynatech Corp., 1225 E. Wakeham Ave., Santa Ana, Calif. Phone: (714) 547-6559.

Card-edge connectors for back-panel assemblies with 0.025-in. square wrap tails on 0.1-in. centers are available. Designed for 0.062-in. PC boards or aluminum and laminated aluminum plates, they feature guaranteed pin alignment to facilitate the use of high-production automatic-termination equipment as well as manual and semi-automatic methods. Series 43000 connectors are available with 25/50, 36/72 and 50/100 contacts or any number of contacts in modular form.

CIRCLE NO. 297

Two-piece connectors withdraw apart easily

Elco Corp., Willow Grove, Pa. Phone: (215) 659-7000.

A new two-piece metal-to-metal connector family for PC card-to-card applications features low-withdrawal-force (1 to 6 oz) Vari-con contacts which meet the requirements of MIL-C-55302. Series 8219 connectors have contacts spaced on 0.05-in. centers. Connectors have 18, 30, 36, 42, 54 and 72 contacts and include glass-filled diallyl phthalate bodies with color-coded metal end guides for polarization. Contacts are rated at 5 A and 6 mΩ.

CIRCLE NO. 298

Dense MOS packages increase chip area 44%

American Lava Corp., Chattanooga, Tenn. Phone: (615) 265-3411. P&A: from 97¢ to \$1.30; 6 wks.

Wide-cavity 28 and 40-lead composite MOS packages are available with up to 44% more chip area than present units. Both Al-SiPak packages are available with 0.24-in.² cavities. The new cavities are 0.04-in. deep with 0.05-in.-wide gold-plated seal rings, identical to the standard packages. Since all AlSiPak composite packages are designed with the leads brazed to the bottom of the package, the cavity can be expanded without extensive modification.

CIRCLE NO. 299



Waiting for you...

Your copy of the best dc power supply catalog in the world.

- Forty-two informative pages
- Specifications
- Drawings
- Photos
- Selection guide
- Prices

To get your copy, write Acopian Corp., Easton, Pa. 18042, or call (215) 258-5441. And remember, every power module you order from it will be shipped with the best tag in the world...



Photodetector bar monitors widths/lengths

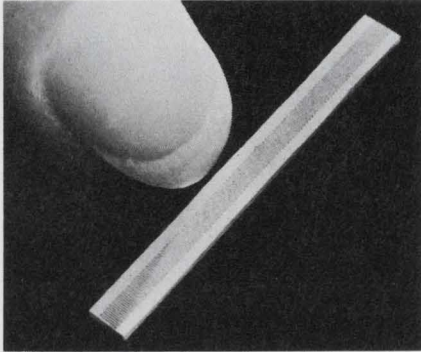

Allen-Bradley Co., Electronics Div., 1201 S. Second St., Milwaukee, Wis. Phone: (414) 671-2000. P&A: \$9.20 (500 quantities); 3 to 4 wks.

A new photoconductor called a PB photobar detector is designed for use on hybrid networks or PC board applications where monitoring of wide band or long length is necessary. Its standard length is 1 in., but greater lengths are available to custom requirements. The new PB photobar contains cadmium sulfide and cadmium sulfoselenide photodetectors. Peak spectral responses are offered at 515, 575 and 625 nm.

CIRCLE NO. 340

405 to 450-MHz 100-W amplifier uses 1/2 W

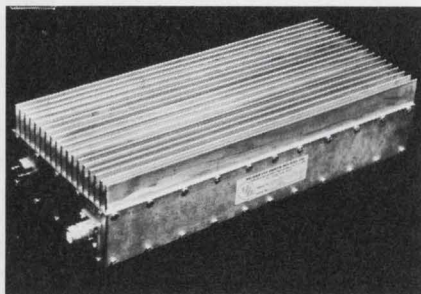

Microwave Devices, Inc., 556 Peninsula Blvd., Hempstead, N.Y. Phone: (516) 538-7520.

A 100-W power amplifier covers the frequency band of 405 to 450 MHz while consuming only 1/2 W. The amplifier features power output control over a 23-dB range and ± 0.2 -dB flatness over the complete frequency range. Input VSWR is 1.5:1 and second harmonic is down by a minimum of 50 dB. The amplifier is protected against any B+ reversal.

CIRCLE NO. 341

Economy phototransistor drops in price to 50¢

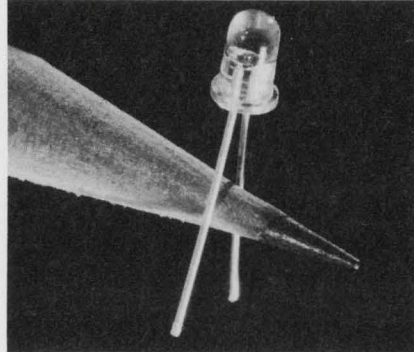

Texas Instruments, Inc., 13500 N. Central Expwy., Dallas, Tex. Phone: (214) 238-2011. P&A: 50¢ (1000 quantities); 6 wks.

A new low-cost phototransistor, the TIL78, is offered in a molded clear epoxy body with two silver-plated dumet leads. It features a light current of 7 mA at 20 mW/cm² and dark current of 25 nA at 30 V reverse voltage. Continuous power dissipation at 25° C is 50 mW. Emitter-collector and collector-emitter voltages are 7 and 50 V.

CIRCLE NO. 342

Optical switch includes a Schmitt trigger

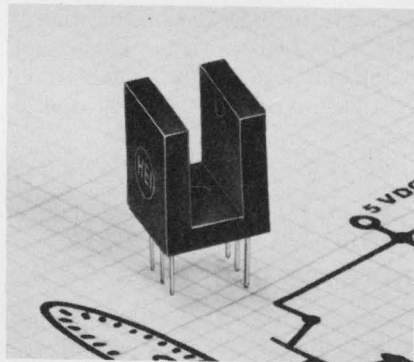

HEI, Inc., Jonathan Industrial Center, Chaska, Minn. Phone: (612) 448-3510. P&A: \$12.90 (100 quantities); stock to 4 wks.

A new optical switch includes a Schmitt trigger circuit which allows the switch to drive TTL/DTL logic directly. The circuit has square-wave rise times of 50 ns and fall times of 200 ns. The model OS-391S-060/200 switch has a 0.06-in. (or 0.2-in.) air gap through which a mechanical device is passed to break the light beam and open the circuit.

CIRCLE NO. 343

IR detectors operate over 8 to 12 microns

Raytheon Co., Foundry Ave., Waltham, Mass. Phone: (617) 899-8400. P&A: \$1995; 30 to 60 days.

A series of improved photovoltaic IR detectors operate in the 8-to-12-micron region of the far-IR spectrum. Models IR101 A and B feature high detectivity with a response time of less than 15 ns. Units in the series have lead-tin-telluride detector elements whose characteristics are comparable to those of copper or mercury-doped germanium units but do not need the low temperatures required by the latter devices for cooling.

CIRCLE NO. 344

C-band impatt diodes offer 1-W cw outputs

Varian, Solid State Div., Salem Rd., Beverly Mass. Phone: (617) 922-6000.

High-power impatt diodes are available in the new C-band series VAO-30 of low-noise, avalanche silicon diodes. They are designed for use between 6 and 8 GHz. Ten devices in the series range from 10 mW to 2 W of rf cw output power. Typical efficiency ranges from 0.8% for 10-mW devices to 7.0% for 1-W diodes. Operating voltages are from 100 to 125 V.

CIRCLE NO. 345

P-i-n diodes optimized for fast switching

Aerotech Industries, 825 Stewart Dr., Sunnyvale, Calif. Phone: (408) 732-0880. P&A: \$55, \$170; stock to 30 days.

P-i-n diodes optimized for fast switching are available in spst and spdt configurations. The A9S111 (spst) has switching times of 10 ns ON and 16 ns OFF. Isolation is 28 to 45 dB and frequency response is from 100 MHz to 18 GHz. The A9S211 (spdt) offers a 40-ns ON time and a 60-ns OFF time. Isolation is 50 to 60 dB and frequency response is from 100 MHz to 18 GHz. Both devices handle 20 W (pulse) and 1.5 W (cw).

CIRCLE NO. 346

1-mW He-Ne laser fits in the pocket

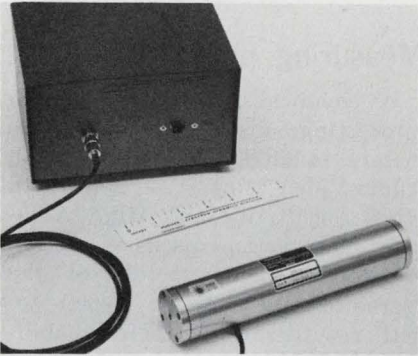

Hughes Aircraft Co., Electron Dynamics Div., 3100 W. Lomita Blvd., Torrance, Calif. Phone: (213) 534-2121. P&A: from \$355; stock.

A small new 1-mW He-Ne version of the 3-mW Hip Pocket laser has been introduced. Designated as model 3078H, it features a TEM₀₀ mode with 1000:1 linear polarization. The Hip Pocket Jr. laser head is 1-3/4 in. in dia and 8-1/2 in. long. The sealed metallic cylinder construction of the head eliminates cleaning of the optics and mirror alignment or adjustments.

CIRCLE NO. 347

Photo-Darlingtons increase light levels

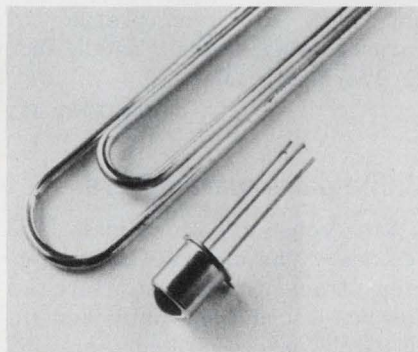

Clairex Corp., 560 S. Third Ave., Mount Vernon, N.Y. Phone: (914) 664-6602. Price: \$1.53 to \$1.79 (500 quantities).

Two new series of Darlington phototransistors provide high light currents at low irradiance levels. The flat-window CLP2000 series is characterized at 0.2 mW/cm². The flat window eliminates the need for critical sensor positioning. The CLR2100 lensed units are characterized at 0.02 mW/cm². The lensed window reduces optical crosstalk.

CIRCLE NO. 348

Phototransistor array contains 120 elements

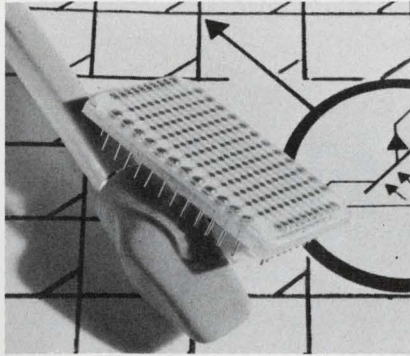

Texas Instruments, Inc., 13500 N. Central Expwy., Dallas, Tex. Phone: (214) 238-2011. P&A: \$120 (1000 quantities); 3 wks.

A new 120-element phototransistor array designated the TIL137 measures 1.3 by 0.9 in. and consists of beam-lead phototransistors bonded on a ceramic substrate. The unit is arranged as 10 rows on 0.063-in. centers by 12 columns on 0.087-in. centers. It can be connected as a 5-by-24 or a 10-by-12 matrix. Light current is 2 mA at 20 mW/cm².

CIRCLE NO. 349

Portable reflectometer weighs a mere 8 lbs

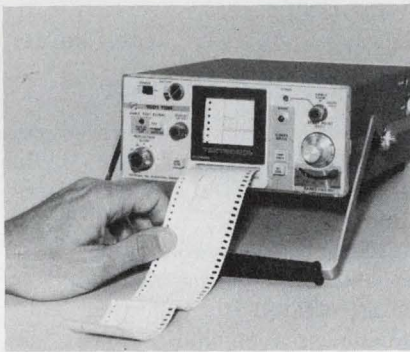

Tektronix, Inc., Box 500, Beaverton, Ore. Phone: (503) 644-0161. P&A: \$1900; October, 1971.

The 1501 is an 8-lb portable time-domain reflectometer system that can be operated from a battery or 115 V ac so that CATV and other communications people can use it anywhere. The power-pack batteries will operate eight hours before the need of recharging. Its easy-to-use plug-in recorder provides high-resolution recordings—4-by-25-cm recordings can be made at the touch of a button.

CIRCLE NO. 350

NEW! transistor driving pulse width modulator

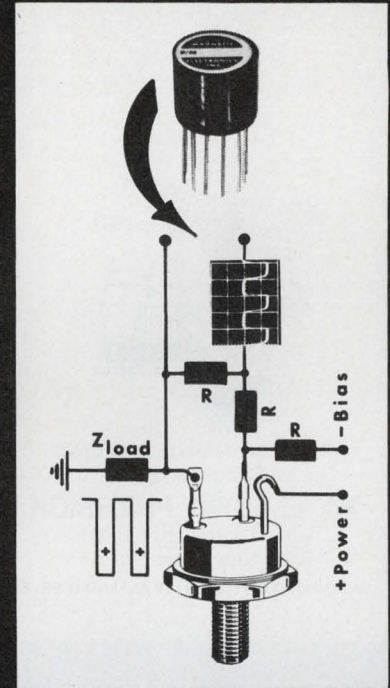

***1F Series Pulse Width Modulator**
A powerful tool for your circuit work which in one unit provides: • 3V peak pulses on 10Ω load • Pulse width controlled by μAmp d.c. signals • One to four isolated signal inputs • Frequency response up to 10 KHz • Full width control 20μW sensitivity (0.5μW sensitivity on special order.) Proper terminal connections to power supply and loads give: • Different pulse sequences • One output, center-taped output or two isolated outputs.

Available 4 to 6 weeks

Now available in sizes of
.56" Dia., .50" Ht.
and .41" Dia., .38" Ht.
Pulse repetition rates:
40 KHz, 100KHz and 200 KHz

Ask for specification sheets
and application notes.

**MAGNETIC ELECTRONICS
INC.**

P.O. Box 25517
West Los Angeles, Calif. 90025

*Patent applied for.

Does everybody make Philbricks?

Sure, there are a lot of imitations, but only one Philbrick.

FOR EXAMPLE, YOU CAN SPOT A GENUINE PHILBRICK BY THE WAY IT MEETS ITS SPECS. A REALLY TOUGH TEST!

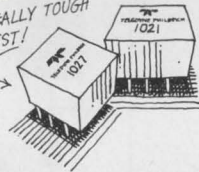

The state-of-the-art standard in Circuit Modules

TELEDYNE PHILBRICK

Allied Drive at Route 128,
Dedham, Mass. 02026

INFORMATION RETRIEVAL NUMBER 64

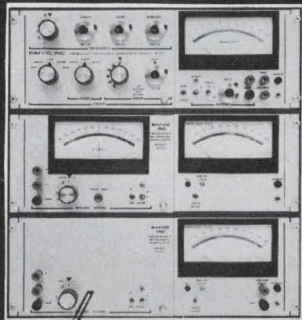

THIS IS A 2 CHANNEL SWEEP FREQUENCY, FREQUENCY RESPONSE ANALYZER

DIRECTLY PLOTS AMPLITUDE RATIO & PHASE SHIFT vs. LOG FREQUENCY .005 to 10,000 hz.

WRITE FOR BULLETIN 7172 ON OUR COMPLETE LINE OF FREQUENCY RESPONSE ANALYZERS.

BAFCO, INC. 717 Mearns Road
Warminster, Pa. 18974
Telephone (215) 674-1700

INFORMATION RETRIEVAL NUMBER 65

application notes

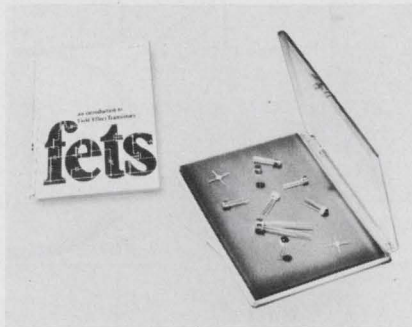

FET design kit

An rf FET design kit is now available for engineers interested in working with state-of-the-art high-frequency FETs. The \$19.95 kit contains the following FETs: three for FM preamplifiers, two for mobile communications, two for CATV amplifiers, two for uhf pre-amplifiers and one for vhf/uhf mixers. In addition, the kit contains a FET handbook, design ideas, application notes and data sheets. Normal cost of the kit, if its parts were to be purchased one at a time, would be \$55.15. The kit is said to be available at Siliconix distributors. Siliconix, Inc., Santa Clara, Calif.

CIRCLE NO. 351

MIL-STD-883 abstract

The test methods and procedures for microelectronics defined in MIL-STD-883 for standardizing military reliability and testing requirements are available in a thirty-page abstract document that is being offered to qualified individuals on a no-charge basis. The document covers those methods and procedures that relate to reliability in a commercial environment. Electronic Test Center.

CIRCLE NO. 352

AM/FM IC amplifier

A seven-page report covers circuit requirements of an AM/FM i-f IC amplifier. It describes the circuit's operation and illustrates the discussion with schematic diagrams of the i-f circuit and its associated circuitry. AEG-Telefunken Corp., Englewood Cliffs, N.J.

CIRCLE NO. 353

Measuring phase

A technical review presents an interesting discussion on phase meters in an article entitled "An Audio-Video Phase Meter with High Sensitivity and High Accuracy." The article discusses the operation of phase meters of the "zero-crossing-detection type" together with some of their capabilities. Included is a brief summary of the operation of this type of phase meter when the measured waveform contains harmonics. Summaries of this review have been prepared in French, German and Japanese. Wiltron Co., Palo Alto, Calif.

CIRCLE NO. 354

Conversion factors

A free wall chart of conversion factors commonly used by designers is offered. The chart contains conversions for Fahrenheit and Centigrade temperatures, thermal conductivity and resistivity, coefficient of thermal expansion, weight/volume/density factors, as well as graphs of viscosity-temperature and peak exotherm profiles of various epoxy resins. Castall, Inc., E. Weymouth, Mass.

CIRCLE NO. 355

Cable-pairs parameters

Line constants or primary and secondary parameters which determine transmission characteristics for non-loaded cable pairs and inductively loaded systems are described in an engineering bulletin. Primary parameters explained and tabulated include uniformly distributed series resistance and inductance and shunt capacitance and conductance. Propagation constant and characteristic impedance comprise the secondary parameters. Additional parameters derived from the propagation constant include attenuation, delay distortion and velocity of propagation. Anaconda Wire and Cable Co., Sycamore, Ill.

CIRCLE NO. 356

Transparent photo mask blank features better resolution and sharper prints on your wafers

Buckbee-Mears has a great new product. It's the DN Color Mask Blank, and it's good. So good, in fact, that it offers both higher resolution and sharper prints on silicon wafers than chrome or glass emulsion plates.

If you manufacture integrated circuits, you know the demand for greater complexity and better device yields is growing. The DN Color Mask Blank has just what you want. It's transparent for easy alignment. It allows high resolution and better prints because of its low surface reflectance. It can be processed into photomasks at lower cost with readily available resists and developers. The DN Color Mask has been tested and proven in Japan for a year by Dai Nippon Printing, Limited. And it's available in the popular sizes right now from Buckbee-Mears.

Want to learn more about this excellent product? Call or write our marketing department. Better still, see your local BMC sales consultant. He'll fill you in on all the details of the DN Color Mask Blank.

Buckbee-Mears is the world's largest volume producer of precision etched, stamped and electroformed parts. You can expect us to deliver, on time, what we say we can deliver. You'll save money with BMC, too, because we can choose from a wide range of capabilities to solve your particular needs.

Fast delivery, reasonable prices, in-depth capability, well trained sales force. Shouldn't you talk to us first?

Buckbee-Mears Company, 245 East 6th St., St. Paul, Mn 55101, Telephone (612) 228-6371, Telex 297080.

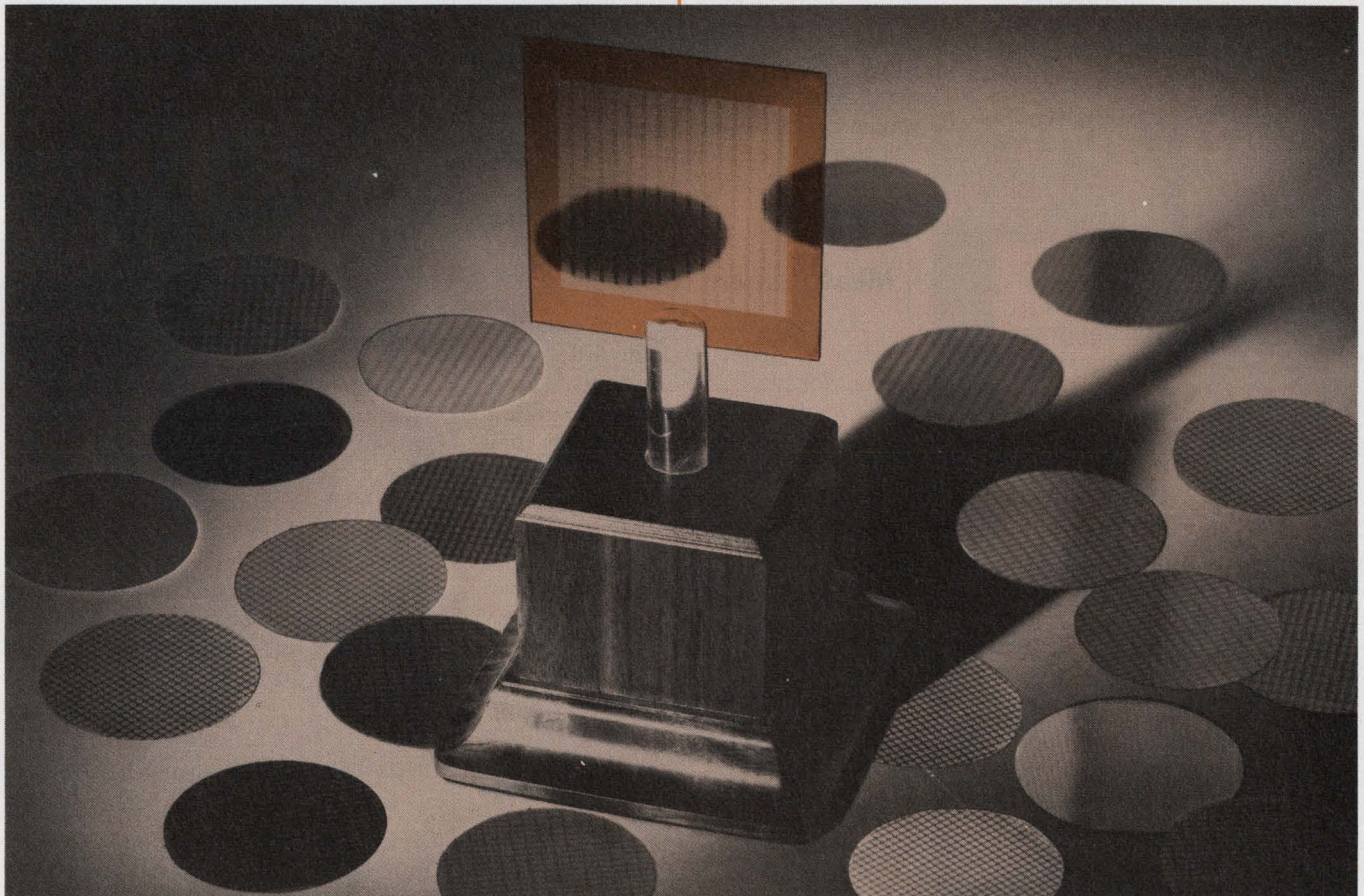

The transparent DN Color Mask Blank is manufactured by Dai Nippon Printing Co., Ltd. and distributed in the U.S. and Canada by Buckbee-Mears. It offers better yields and lower processing costs.

BUCKBEE-MEARS COMPANY
bmc

INFORMATION RETRIEVAL NUMBER 66

Is a Philbrick a black box?

It's whatever you want it to be.

FOR EXAMPLE, PHILBRICK MODELS 4350/4351 LOG OPERATORS MEASURE LOG CURRENT, LOG VOLTAGE OR ANTI-LOGS. A PAIR COMPUTES SQUARES, CUBE ROOTS, INVERSE SQUARES AND CUBES, INTEGRAL AND FRACTIONAL POWERS AND ROOTS. IN LOTS OF 100—ONLY \$73.

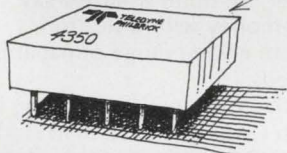

The state-of-the-art standard in Circuit Modules

TELEDYNE PHILBRICK

Allied Drive at Route 128,
Dedham, Mass. 02026

INFORMATION RETRIEVAL NUMBER 67

HEAT PIPES

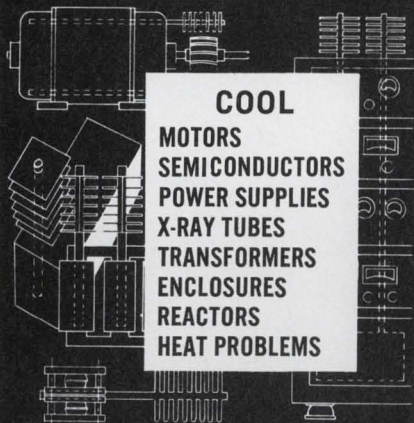

COOL

MOTORS
SEMICONDUCTORS
POWER SUPPLIES
X-RAY TUBES
TRANSFORMERS
ENCLOSURES
REACTORS
HEAT PROBLEMS

ONE 1/2 INCH DIA. HEAT PIPE CAN TRANSPORT 750 WATTS, 3 FEET, WITH A ΔT OF 10°C

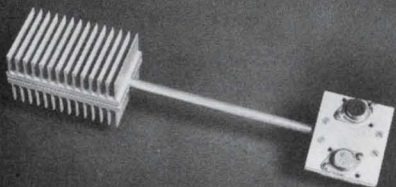

DEPENDABLE, ECONOMICAL, HEAT REMOVAL

HEAT PIPE CORPORATION OF AMERICA

141 PARK PL., WATCHUNG, N. J. 07060
TEL. (201) 887-0887

INFORMATION RETRIEVAL NUMBER 68

new literature

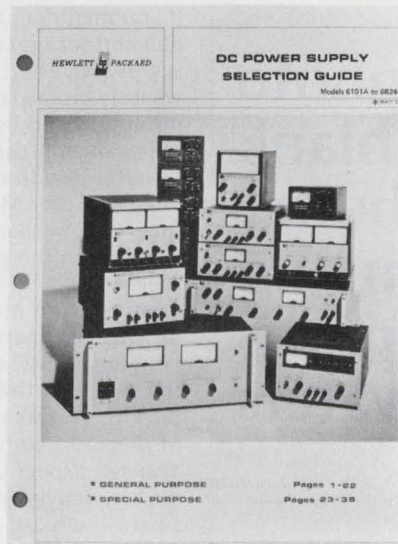

Power supply guide

Choosing the right power supply for application is made easy in a newly revised and updated version of Hewlett-Packard's "Dc Power Supply Selection Guide." Both general and special-purpose supplies are listed by voltage and current in tabular form. The 40-page booklet also contains outline drawings with dimensions. Hewlett-Packard Co., Palo Alto, Calif.

CIRCLE NO. 357

Measurement devices

An eight-page catalog describes a line of linear variable differential transformers, displacement-measuring devices, gauge heads, force and pressure transducers, accelerometers, signal-conditioning and special instrumentation systems. Schaevitz Engineering.

CIRCLE NO. 358

Acoustic couplers

Acoustically coupled data sets for data communications and memory devices are shown in a 12-page catalog. Design Elements, Inc.

CIRCLE NO. 359

Timing controls

A 16-page catalog covers a line of voltage, current and phase monitors and time-delay relays. Diversified Electronics, Inc.

CIRCLE NO. 360

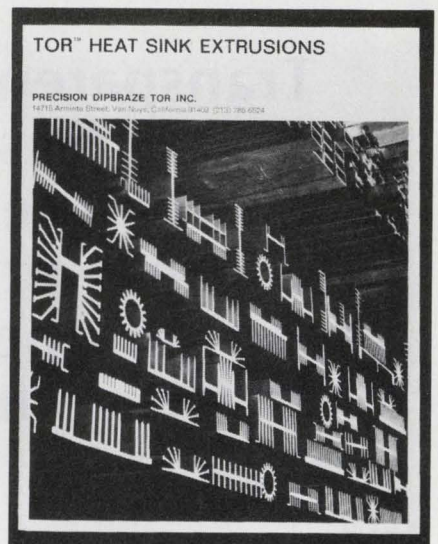

Heat sinks

A new short-form catalog features outline drawings and dimensions for 107 popular models of aluminum heat-sink extrusions. The six-page catalog is designed to open into a quick reference guide in wall-chart form. Highlighted are new forced-convection heat sinks that are half the size and weight of conventional units at a 20% to 40% cost reduction. Tor Heat Sink Div. of Precision Dipbraze Tor, Inc., Van Nuys, Calif.

CIRCLE NO. 361

Teflon terminals

Specifying engineers and purchasing agents will find a new catalog on Teflon insulated terminals a real aid in decision-making. The book contains a full listing of all standard terminal types, including stand-offs, feed-throughs, metal-base types, test jacks, test probes and transistor sockets in miniature, subminiature and micro-miniature sizes. H. H. Smith, Inc.

CIRCLE NO. 362

Flexible cable connectors

A comprehensive eight-page brochure deals with techniques to terminate flexible printed circuitry. Covered in the brochure are a number of developed lightweight connectors for use with flat flexible cabling. Deutsch Co.

CIRCLE NO. 363

Face it.

In panel design, looks are everything.

But, you don't have to sacrifice good looks for the sake of function. Every Rogan control knob and dial is designed to enhance your front panel *and* perform flawlessly.

Rogan offers hundreds of different shapes and sizes and 17 handsome ABS standard colors—with custom colors readily available. So no matter what your application, Rogan control knobs will contribute both functionally *and* aesthetically.

See for yourself. Write for our new "R-71" catalog. Or outline your requirements for quotation. Free samples of particular items will be sent on request.

Rogan

8019 North Monticello Avenue, Skokie, Illinois 60076
Phone: (312) 675-1234 • TWX: 910-223-4547



INFORMATION RETRIEVAL NUMBER 69

Does a Philbrick come only in one size?

Are you kidding?

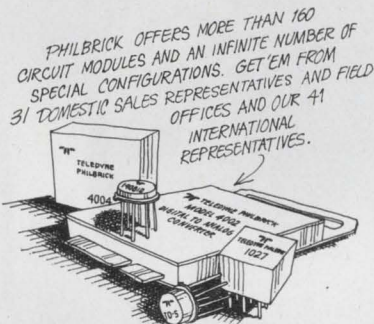

The state-of-the-art standard
in Circuit Modules

TELEDYNE PHILBRICK
Allied Drive at Route 128,
Dedham, Mass. 02026

INFORMATION RETRIEVAL NUMBER 70

Attention Advertisers:

Could you use copies of your ad exactly as it appeared in **ELECTRONIC DESIGN**? Then order your reprints directly from us; the minimum unit order is 500 copies.

Please specify if you would like the reprint line omitted on your copies and mail your written order to **ELECTRONIC DESIGN**, Production Dept., 50 Essex Street, Rochelle Park, New Jersey 07662.

500 1,000 Add'l M

8x10 or smaller

1 color, 1 side	\$74.70	82.95	18.15
2 color, 1 side	95.47	108.00	25.28
4 color, 1 side	311.03	342.00	44.33

Spreads

1 color	113.66	126.65	25.98
2 color	191.19	205.98	29.58
4 color	354.17	380.76	53.19

Prices FOB Waseca, Minn.

NEW LITERATURE

Rf connectors

A four-page brochure describes the new Combomate line of micro-miniature rf connectors which operate from dc to 2.3 GHz with VSWRs of 1.01 to 1.10. Connector Div. of Microdot, Inc.

CIRCLE NO. 364

Op amp testers

A new eight-page guide to automatic and semi-automatic op amp testers provides circuit descriptions and diagrams for testing op amp parameters. Teledyne Philbrick.

CIRCLE NO. 365

Wire/cable hardware

A 16-page brochure describes a complete line of wire/cable harnessing, marking and accessory products. Electrovert, Inc.

CIRCLE NO. 366

IC package thermal study

A technical report entitled "Measured Thermal Resistances of Al₂O₃ and BeO Ceramic Flatpacks" describes the results of a thermal study done by a major semiconductor manufacturer on IC packages. The Brush Beryllium Co.

CIRCLE NO. 367

Digital cassette recorders

A six-page short-form catalog provides typical applications and advantages of bit-by-bit incremental recording versus continuous buffered incremental recording. Fundamental descriptions and comprehensive specifications for a wide, versatile range of continuous and incremental digital cassette recorders and accessories are shown. Memodyne Corp.

CIRCLE NO. 368

Wire and cable

A 92-page wire, cable and cord-set catalog, conveniently organized into 10 sections, includes a wealth of helpful technical data: comparison charts of different types of insulating materials, copper-wire specifications, estimating charts and current ratings. Columbia Electronic Cables.

CIRCLE NO. 369

RTV molding compounds

An eight-page data book lists RTV flexible molding compounds for prototype production, limited-run parts and plastic tooling. General Electric.

CIRCLE NO. 370

Motors/power supplies

Custom-designed dc motors and prong-mounted power supplies are presented in a 16-page brochure. Row Industries, Inc.

CIRCLE NO. 371

Oscillators

A new 20-page catalog defines a complete line of 1-Hz to 250-MHz oscillators, including crystal, voltage-controlled, high-stability, low-current-drain, computer-clock and power types. Accutronics.

CIRCLE NO. 372

Connectors

A new eight-page condensed catalog contains a line of precision electronic connectors for commercial and military applications. Continental Connector Corp.

CIRCLE NO. 373

Acousto-optic accessories

A new four page bulletin describing a series of acousto-optic Q switches and mode-lock modulators is available. Quantronix Corp.

CIRCLE NO. 374

Hardware

A comprehensive 110-page catalog and handy cross-reference lists terminals, pins, hardware and screw machine parts. Concord Electronics Corp.

CIRCLE NO. 375

Acoustical instruments

B & K's new 1971/72 short-form catalog briefly describes the firm's full line of precision transducers and instrumentation for sensing, measuring, and analyzing all aspects of sound, noise and vibration. B & K Instruments, Inc.

CIRCLE NO. 376

Instruments/equipment

Terminated-inventory items at a fraction of OEM costs are shown in a 120-page catalog. It includes thousands of electronic and mechanical instruments including transducers, gyros, synchros, oscilloscopes, oscillographs, amplifiers, voltmeters and many other items. Lee Lab Supply.

CIRCLE NO. 377

Modems

A new four-page catalog covers a line of data modems which range in speed from 1800 to 9600 bits/s. The catalog also covers standard interfaces and modulation techniques of the modems. United Business Communications.

CIRCLE NO. 378

Ceramic substrates

A technical bulletin on ceramic substrates lists the properties of alumina and beryllia materials. American Lava Corp.

CIRCLE NO. 379

Solid-state devices

A condensed catalog covering a full line of solid-state devices is available. Included are single and dual FETs, linear ICs, ROMs, RAMs, dynamic and static shift registers and multiplexers. Solitron Devices, Inc., San Diego, Calif.

CIRCLE NO. 380

Display switches

Details of a new display-screen lighting technique for illuminated pushbutton switches, whereby colors or legends do not show when internal lamps are not lit, are presented in a new product bulletin. Switchcraft, Inc., Chicago, Ill.

CIRCLE NO. 381

Relays

A new eight-page manual/catalog describes a complete line of miniature multi-pole enclosed relays. Guardian Electric Mfg Co., Chicago, Ill.

CIRCLE NO. 382

Mil spec synchro/digital converters:

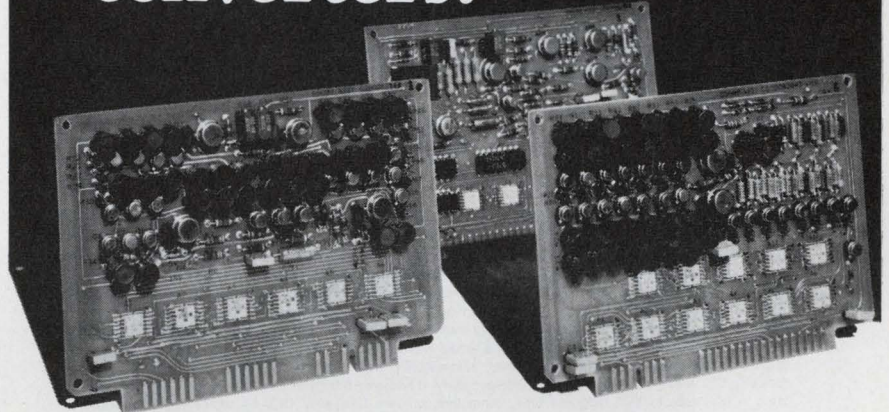

We've got 'em in cards. Or cased. For off-the-shelf delivery.

Kearfott can solve your conversion problems with two production model solid state synchro/resolver digital converters. Both meet MIL-E-5400.

TRIGAC I—A low cost, successive approximation converter, accurate to 12 minutes.

TRIGAC III—Using demodulators, integrators, inverters and zero crossing detectors, this converter offers high accuracy at moderate cost.

	Typical Characteristics	
Model Number	TRIGAC I C70 4773 001	TRIGAC III C70 4773 013
Input Signal	3 wire synchro	11.8 V line-to-line 400 Hz
Output	13 bit BCD code or 13 bit natural parallel	14 bit natural parallel
Resolution	6 minutes arc	LSB—1/9"
Accuracy	12 minutes arc	± 2 LSB
Logic Levels	Logic "1" = ±5V ±10% Logic "0" = 0—0.5 V	

We can supply either cards as shown, or in corrosion-resistant metal enclosures. Write today for new catalog. The Singer Company, Kearfott Division, 1150 McBride Avenue, Little Falls, New Jersey 07424.

SINGER
AEROSPACE & MARINE SYSTEMS

INFORMATION RETRIEVAL NUMBER 71

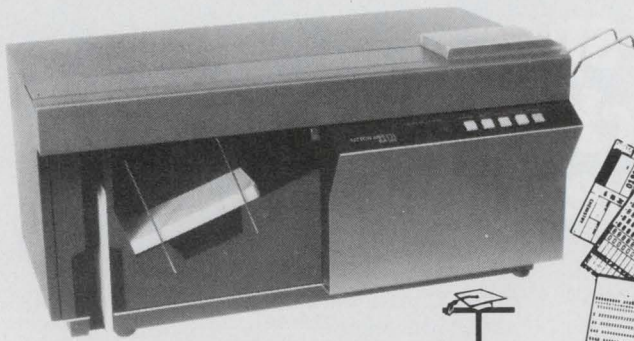

our graduate.

it begins where other card readers leave off.

OEM 64 is the first, true, internally programmed Mark Sense Optical Card Reader. With a minicomputer built in. It reads holes, edge notches, pencil or printed marks. Even in combination on the same card. And, can re-read selective data, can organize and output different messages from one card. It enables you to change its internally stored program easily. In 5-10 seconds. With program cards, which you can encode yourself, by hand. You can check data before entry. Change what you don't like. Without sending it back to the keypunch gals. Account for keypunch errors, without writing new programs. It detects errors at the source. And, it rejects error cards. Segregates them in a supplementary stacker. It provides buffering for an entire card and can hold selective data for retransmit until your system is ready. Has four translators. Up to four coding variations may be used on the same card. It feeds tab cards, automatically. At 2 cards per second. It stacks cards, automatically; 500 in one stacker and 150 in the secondary. It has only 5 buttons and 2 switches. Like, uncomplicated. It interfaces to TTY, magnetic tape, computers, printers. Like, easy. OEM 64, it may not be the end of all your data entry problems. But it comes close. **Summa Cum Laude.**

We'll also be demonstrating punches, readers and printers. At The FJCC, Booth 1824

For more information call Frank Misiewicz
OEM Products
(201) 935-2200

LITTON ABS 
automated business systems
600 WASHINGTON AVENUE, CARLSTADT, NEW JERSEY 07072

INFORMATION RETRIEVAL NUMBER 73

What's a Philbrick?

The best functional circuit module money can buy.

FOR EXAMPLE, PHILBRICK MODEL 1027 DIFFERENTIAL OPERATIONAL AMPLIFIER SLEWS AT 60 V/ μ SEC, SETTLES TO .01% IN 1 μ SEC, YET IN LOTS OF 100 IT'S ONLY \$29.50

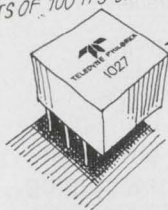

The state-of-the-art standard in Circuit Modules

TELEDYNE PHILBRICK
Allied Drive at Route 128,
Dedham, Mass. 02026

INFORMATION RETRIEVAL NUMBER 74

A mouse has already been saved from leukemia.

Help us save a man.

For years, you've been giving people with leukemia your sympathy. But sympathy can't cure leukemia. Money can. Give us enough of that, and maybe we'll be able to do for a man what has already been done for a mouse.



American Cancer Society 

bulletin board

of product news and development

A small high-energy lithium battery has been developed by Honeywell, Montgomeryville, Pa., for industrial applications, particularly those that require long-term storage. The battery, which uses lithium anodes, is reported to offer long-term storage for special applications at double the voltage of flashlight batteries. About half the size of a standard flashlight cell, it is an inch in diameter, 1.4-in. long and weighs 26.2 grams. Nominal voltage is 3.2 V compared with all-mercury batteries of similar size, which produce 1.2 or 1.23 V.

CIRCLE NO. 383

General Electric's Research and Development Center has commercially produced what it says are the world's strongest permanent magnets—two to three times as strong as the best previously known. The new magnets are said to be made principally from an alloy of cobalt and samarium.

CIRCLE NO. 384

The addition of five new devices to its commercial line of GaAs injection lasers has been announced by the RCA Solid State Div. The new products bring the RCA series of commercial injection lasers to a total of eleven types offering a range of 1 to 15 W of output power.

CIRCLE NO. 385

AMP Inc. has announced the availability of selective solder deposits on most of its posts, PC connectors, and IC sockets designed for point-to-point back-panel wirings regardless of post configuration.

CIRCLE NO. 386

A new intensifier vidicon TV camera tube that is reported to be 50 times more sensitive than conventional vidicon tubes now in use was announced by RCA Electronic Components.

CIRCLE NO. 387

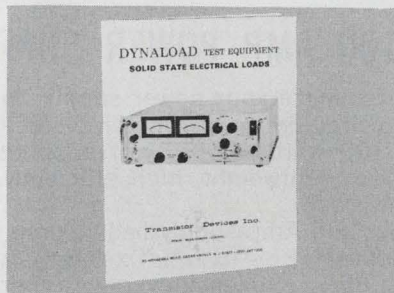

NEW DYNALOAD BROCHURE offers dollar saving suggestions for testing power supplies, servo systems, DC generators, etc., by replacing specially designed test equipments with a single low-cost, solid state instrument with a choice of testing ranges from 100 to 3000 watts, 0 to 400 V and 0 to 150 A. Transistor Devices, Inc., Cedar Knolls, N.J. 07927
INFORMATION RETRIEVAL NUMBER 181

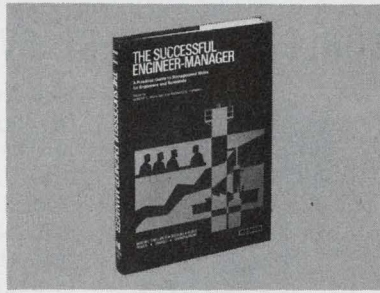

The Successful Engineer-Manager, Edited By R. C. Haavind and R. L. Turmail. Depth discussion and insights of the experts isolate the fine points of management: career, decisions, people, projects, finances, communications. Hayden Book Co., Inc., New York, N. Y. 10011.
INFORMATION RETRIEVAL NUMBER 182

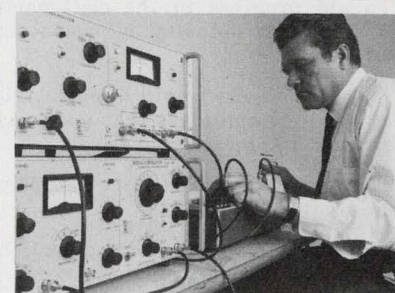

The **PAR™ Correlation Function Computer and Fourier Analyzer** are extremely powerful engineering tools. Typical applications include crosstalk studies, network impulse response analysis and antenna diversity investigations. For a free handbook on correlation analysis circle the number below. Princeton Applied Research Corp.
INFORMATION RETRIEVAL NUMBER 183

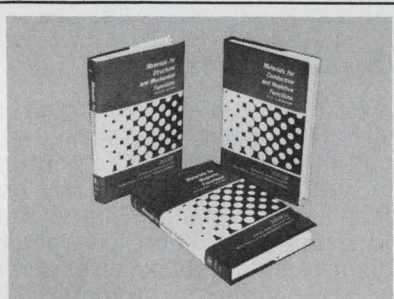

Treating materials according to their function, these design aids combine essential background with immediately workable data and techniques. Series in Materials for Electrical and Electronics Design, Edited by Alex. E. Javitz. Hayden Book Co., Inc., New York, N. Y. 10011.
INFORMATION RETRIEVAL NUMBER 184

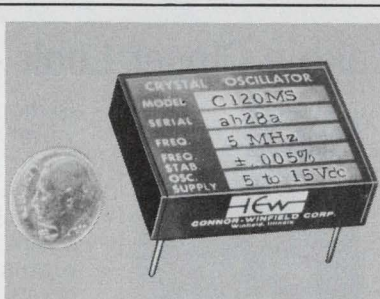

Crystal oscillator drives CMOS. Availability: Stock to 2 weeks ARO. Price: \$58 above 400 kHz. Available 0.01 Hz up to 10 MHz, frequency tolerance and temperature range $\pm 0.001\%$, 0°C to $+50^\circ\text{C}$ to $\pm 0.05\%$, -55°C to $+125^\circ\text{C}$, model C120MSA thru H is 1.6" x 1.2" x 0.4". Connor-Winfield Corp., Winfield, Ill. 60190. Tel. 312-231-5270.
INFORMATION RETRIEVAL NUMBER 185

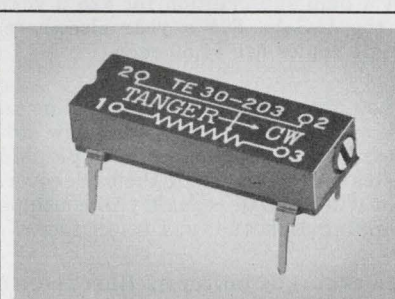

Dip Trimming Potentiometer has manual and automatic insertion; is available in single or multiple load. Wirewound. Resistance range, 10 ohms to 50K ohms. Three point wiper contact. High temperature plastic housing. Less than \$1.00 each per 1,000. Tanger Electronics, Hawthorne, Ca. (213) 757-9161.
INFORMATION RETRIEVAL NUMBER 186

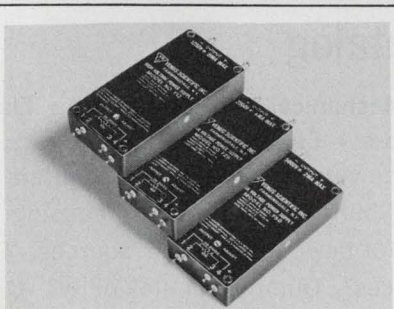

"F" series miniature 10 watt regulated high voltage power supplies Just 6.4 cu. in. 4 models: F-50, 2500 to 5000VDC; F-25, 1250 to 2500VDC; F-12, 600 to 1250VDC; F-6, 300 to 600VDC. Remotely adjustable output floating, input 24 to 31VDC. Ripple .25%. Temp. -55°C to $+100^\circ\text{C}$. Venus Scientific Inc., Farmingdale, N. Y.
INFORMATION RETRIEVAL NUMBER 187

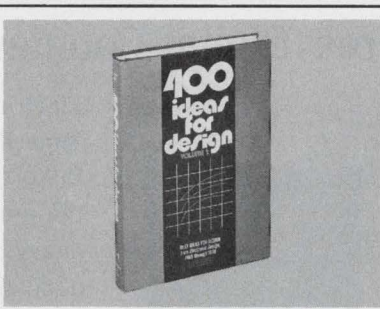

400 Ideas for Design, Vol. 2, Edited by Frank Egan. Ready to borrow, modify, or adapt, the top recent contributions to Electronic Design's popular "Ideas for Design" column. Hayden Book Co., Inc., New York, N. Y. 10011.
INFORMATION RETRIEVAL NUMBER 188



HIGH VOLTAGE SILICON RETROFIT RECTIFIERS feature fully glassivated, non cavity, controlled avalanche silicon diodes. Range: 100-ma to 2.5 amps and 10,000 to 60,000 volts. 1-4 quant. \$7.00 to \$96.00 depending on type. Rectifier Components, Freeport, N.Y. 516-868-0470.
INFORMATION RETRIEVAL NUMBER 189

ELECTRONIC DESIGN's function is:

- To aid progress in the electronics manufacturing industry by promoting good design.
- To give the electronic design engineer concepts and ideas that make his job easier and more productive.
- To provide a central source of timely electronics information.
- To promote two-way communication between manufacturer and engineer.

Want a subscription? ELECTRONIC DESIGN is sent free to qualified engineers and engineering managers doing design work, supervising design or setting standards in the United States and Western Europe. For a free subscription, use the postfree application form inside the back cover. If none is included, write to us direct for an application form.

If you do not qualify, you may take out a paid subscription for \$25 a year in the U.S.A., \$35 a year elsewhere. Single copies are \$1.50 each.

If you change your address, send us an old mailing label and your new address; there is generally a prepaid postcard for this inside the back cover. You will have to requalify to continue receiving ELECTRONIC DESIGN free.

The accuracy policy of ELECTRONIC DESIGN is:

- To make reasonable efforts to ensure the accuracy of editorial matter.
- To publish prompt corrections whenever inaccuracies are brought to our attention. Corrections appear at the end of the Letters column.
- To refuse any advertisement deemed to be misleading or fraudulent.

Microfilm copies are available of complete volumes of ELECTRONIC DESIGN at \$19.00 per volume, beginning with Volume 9, 1961. Work is now in process to complete the microfilm edition of Volumes 1-8. Reprints of individual articles may be obtained for \$2.00 each, prepaid (\$.50 for each additional copy of the same article) no matter how long the article. For further details and to place orders, contact the Customer Services Department, University Microfilms, 300 North Zeeb Road, Ann Arbor, Michigan 48106; telephone (313) 761-4700.

Want to contact us? If you have any comments or wish to submit a manuscript or article outline, address your correspondence to:

Editor
ELECTRONIC DESIGN,
50 Essex Street,
Rochelle Park, N.J. 07662

WORLD'S SMALLEST 5VDC/100 AMP POWER SUPPLY

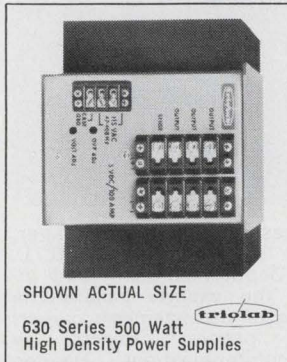

SHOWN ACTUAL SIZE

630 Series 500 Watt
High Density Power Supplies



Now you can squeeze your power supply down to fit your microcircuitry with our complete line of off-the-shelf 100 watt to 500 watt supplies. All offer small size, lightweight, high efficiency, cool operation, low cost.

630 Series 5V/100 Amp supply has volume under 500 cubic inches! ($8\frac{1}{2}'' \times 6\frac{3}{4}'' \times 8\frac{3}{4}''$); weighs under 20 lbs; 65% efficiency even with light load conditions; no forced air or external cooling for full rated output to 55°C; priced lower than large conventional supplies.

The 100 watt series come in single, dual, triple outputs; 5VDC to 30VDC; commercial, Military, and export models available.

CIRCLE NO. 171

Trio Laboratories, Inc.

80 Dupont Street
Plainview, Long Island, N. Y. 11803

Take a Closer Look — It's All There

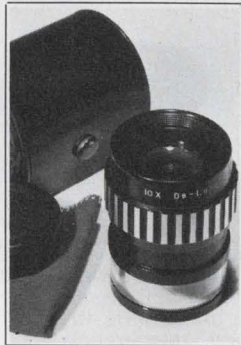

Bishop's Deluxe 10X Optical Comparator has a variety of detachable reticles, for a variety of uses. When you focus this precision instrument on any type of planar material, you can quickly and accurately inspect linear dimensions and designs, check pad and target registration, conductor path widths, hole diameters, line thicknesses. Precision optics include a two-group, achromatic, 35 mm lens system consisting of four coated elements with full-focusing 10X magnification. Send today for illustrated folder showing actual calibrated reticles.

CIRCLE NO. 172

Bishop Graphics, Inc.

7300 Radford Avenue
North Hollywood, California 91605
(213) 982-2000 Telex: 674672

Free Digital Counter Catalog



Electrical • Mechanical • Predetermining • Elapsed Time Indicators • Engine Hour Meters

Bone up on the very latest in digital counters from the amazing young company that's causing engineers to take a new look at their sources. Could it be our prices? Our design flexibility? Or our proven performance? ENM's new Catalog 71-OEC might be just what you need to do a better job for less.

CIRCLE NO. 173

ENM Company
5340 Northwest Highway
Chicago, Illinois 60630
(312) 775-8400

Manufacturers

Advertisements of booklets, brochures, catalogs and data sheets. To order use Reader-ServiceCard (Advertisement)

Fight Fuzziness with New Real-Time 256-point Correlator

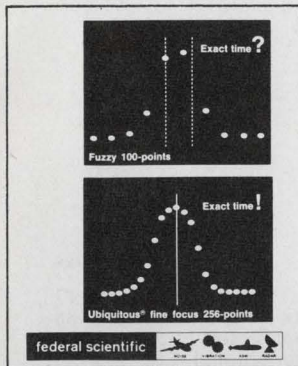

UC-201A Ubiquitous® Correlator is a complete time-domain measurement lab for real-time auto & cross-correlation, signal enhancement, & probability. For underwater acoustics, fluid dynamics, medical research, vibration analysis, noise source identification. Features: exact time measurements with digital dial; computes integral & differential of any stored function (converts probability density to cumulative distribution without rerunning data); pre-computational delay built-in (256 samples); sampling increments from 1/2 usec to 2 sec; complete ext. (computer) control plus digital outputs; built-in test signals for all modes; small, portable, easy to use; reasonably priced. Many options.

CIRCLE NO. 174

Federal Scientific Corporation

a subsidiary of Elgin National Industries, Inc.
615 West 131st Street, New York, N. Y. 10027

Plastic Parts



CUSTOM production to your specs from patented, low-cost tooling. Any size, any quantity in Nylon, Delrin, other thermoplastics. Let us quote. We have 20 years experience.

STANDARD gears, racks, bearings, sprockets, pulleys, washers, insulators, many other components available quickly from stock tools. Over 2,500 items described in our 48-page catalogue. Write today for a free copy.

CIRCLE NO. 175

Nylomatic

11 Nolan Ave., Morrisville, Pa. 19067
A DIVISION OF WEHCO PLASTICS INC.

Revised Digital Computer Brochure

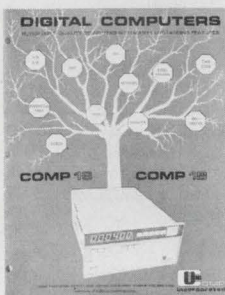

UniComp's 16-page fully illustrated brochure has been completely revised to describe UniComp's FAST FOURIER TRANSFORM PROCESSOR that reduces FFT Computation Time by more than 100 times over software, as well as the increased power of their COMP-16 and COMP-18 Minicomputers, and the expanded Command list.

The revised brochure contains a general description of UniComp's ruggedized Digital Minicomputers, as well as photographs, illustrations, specifications and engineering drawings. A full page is devoted to the COMP-18 and its interface modules available to augment the CPU for specific applications.

CIRCLE NO. 176

UniComp, Incorporated

subsidiary of Hoffman Electronics Corporation
18219 Parthenia Street, Northridge, California 91324
(213) 886-7722

Electronic Design

Advertising Sales Staff

Bryce Gray
Sales Manager

Rochelle Park, N.J. 07662

Robert W. Gascoigne
Daniel J. Rowland
50 Essex Street
(201) 843-0550
TWX: 710-990-5071

Philadelphia

Thomas P. Barth
50 Essex Street
Rochelle Park, N. J. 07662
(201) 843-0550

Boston 02154

Joseph F. Palmer
1268 Main Street
Waltham, Mass.
(617) 894-2700

Chicago 60611

Thomas P. Kavooras
Berry Conner, Jr.
200 East Ontario
(312) 337-0588

Cleveland

Thomas P. Kavooras
(Chicago)
(312) 337-0588
(call collect)

Los Angeles 90303

Stanley I. Ehrenclou
Burt Underwood
2930 Imperial Highway
Inglewood, Calif
(213) 757-0183

San Francisco 94022

Jerry D. Latta
95 Main Street
Los Altos, Calif.
(415) 941-3084

London W. 1

For United Kingdom and Holland
Brayton C. Nichols

For Eastern Europe
Peter Kehr

The American Magazine Group
27 Maddox Street

London, W. 1, England

Phone: 499-0180

Cable: Ammagnic, London

Verviers, Belgium

For Continental Europe

Andre Jamar

1, Ru Mallar, 1

087) 253.83 Telex 41563

Tokyo

Haruki Hirayama
Electronic Media Service

5th Floor, Lila Bldg.,

4-9-8 Roppongi

Minato-ku

Phone: 402-4556

Cable: Electronicmedia, Tokyo



INDUSTRIAL POWER MONITOR AUTOMATICALLY SENSES CHANGES IN VOLTAGE, FREQUENCY AND PHASE

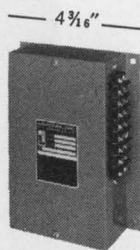

Logitek's Power Monitor is an inexpensive, solid state device that prevents system damage when voltage, frequency or phase go out of spec. The power monitor allows normal

operation when power line characteristics are within pre-set limits. Should voltage or frequency go out of spec, or phase be other than in its proper sequence, the power monitor's relay de-energizes to sound an alarm, begin corrective action, or shut down the system.

A pickup and dropout time delay of from 250 ms to 10 seconds is built in to allow short duration voltage or frequency changes.

The Logitek unit is available in both 3-phase and single phase models and can be made to sense only voltage, only frequency, only phase, or any combination. Prices range from \$100 to \$300.

PARTIAL SPECIFICATIONS

Input Operating

Voltage (nominal)	120/208 VRMS $\pm 20\%$
Frequency	50/60 Hz $\pm 20\%$
Phase	Single or 3-phase

Input Sensing

Voltage Band	} as required
Frequency Band	
Phase Sequence	
Accuracy	$\pm 1\%$

Output Contacts

Form	3 form C (3PDT)
Rating	10A res.

Operating Temperature -10°C to $+70^{\circ}\text{C}$

Delivery Off-the-shelf



LOGITEK

42 Central Drive,
Farmingdale, New York 11735
(516) 694-3080

advertiser's index

Advertiser	Page	Advertiser	Page
Acopian Corporation	97	3M Company	17
Aertech Industries	67	MDC Instruments	88
Allen-Bradley Co.	25	Magnetic Electronics, Inc.	99
Amphenol Components Group.....	12	Microsystems International Ltd.....	83
Analog Devices, Inc.	14, 71	Microwave Filter Company, Inc.....	54
Automated Business Systems.....	106	Molex, Incorporated	1
		Monsanto Company	31
Bafco, Inc.	100	Motorola Component Products	
Bell, Inc., F. W.	54	Dept.	76
Bioelectric Instruments, Division		Motorola Semiconductor Products,	
of General Microwave Corp.	84	Inc.	16A—H
Bishop Graphics, Inc.	108		
Boeing Electronic Products	81	National Semiconductor Corporation	27
Buckbee Mears Company	101	Nylomatic Corporation	109
Burroughs Corporation	18	Nytronics, Inc.	6
Cambridge Thermionic Corporation..	94	Oak Manufacturing Co.	36
Centralab, the Electronics			
Division of Globe-Union, Inc.....	55	Philips Electronic Components	
Conner Winfield	107	and Materials	80C, 80D
Cutler-Hammer	47	Plessey, Incorporated	15
		Potter & Brumfield Division of	
Dale Electronics, Inc.	Cover III	AMF Incorporated	75
Dana Laboratories, Inc.	79	Powercube Corporation	29
Data General	90	Power-Tec, Inc.	91
Delco Electronics, Division of			
General Motors Corporation.....	56, 57	RCA	Cover IV
Dialight Corporation	65	RDSS	80, 80 A-B
Dow Corning Corporation.....	10, 11, 13	Rectifier Components	107
		Rockland Systems Corporation.....	111
ENM Company	108	Rogan Brothers, Inc.....	103
Eastman Kodak Company	87		
Electronic Design	48	SCI Electronics Inc.	84
Erie Technological Products, Inc....	34, 35	Schauer Manufacturing Corp.....	86
		Schweber Electronics	48 A-B
Federal Scientific Corporation.....	109	Sigma Instruments, Inc.	16
		Singer Company, The,	
GPS Instrument Corp.	82	Kearfott Division	105
GTE Sylvania, Electronic		Spectrum Dynamics	107
Components	61	Stackpole Carbon Company.....	8, 9
General Electric Company.....	21		
Grayhill, Inc.	93	TEC, Incorporated	90
		TRW Semiconductor	
Hapco	93	Division of TRW, Inc.....	2
Harris Semiconductor, A Division		Tanger Industries	107
of Harris Intertype Corporation	73	Tektronix, Inc.	39, 85
Hayden Book Company, Inc.....	89, 107	Teledyne Philbrick.....	100, 102, 104, 106
Heat Pipe Corporation of America....	102	Tracor, Inc.	88
Hewlett-Packard	Cover II, 4, 5, 46	Transistor Devices, Inc.....	107
Hipotronics, Inc.	92	Trio Laboratories, Inc.....	108
Hoffman Engineering Company.....	112		
		Uni-Comp, Inc.	109
Johanson Manufacturing Corp.....	7		
Kurz-Kasch, Inc.	32, 94	Varadyne Systems,	
		A Division of Varadyne, Inc.....	69
Licon, Division Illinois Tool		Venus Scientific	107
Works, Inc.	33		
LogiMetrics, Inc.	40	Welch Allyn, Inc.	95
Logitek, Inc.	110		

\$2450



Model 5100

FREQUENCY SYNTHESIZER

- **Full Programmability** BINARY OR BCD
- **0.001 Hz to 2 MHz Range**
- **No Switching Transients**
- **0.001 Hz Resolution**
- **Direct Digital Technique**
NO MIXING OR PHASE LOCKING
- **High Spectral Purity** —70db SPURIOUS
—60db HARMONIC
- **High Stability** $\pm 2 \times 10^{-8}/^{\circ}\text{C}$ STANDARD
 $\pm 2 \times 10^{-10}/^{\circ}\text{C}$ OPTIONAL
- **Precision Attenuator**
0 TO 85db IN 1db STEPS PLUS CONTINUOUS CONTROL
(PROGRAMMABLE ATTENUATION OPTIONAL)
- **High Output Voltage**
10 VOLTS P-P, 50-OHM SOURCE IMPEDANCE

ROCKLAND SYSTEMS CORPORATION

131 Erie Street E., Blauvelt, N. Y. 10913 • (914) 359-1818

ROCKLAND

INFORMATION RETRIEVAL NUMBER 77

Your best choice in enclosures

- oil and dust tight
- EMI/RFI shielded
- rigid one-piece construction
- available from stock

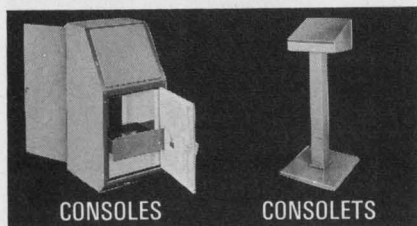

Consoles in versatile stock design, 50" x 24" x 23", with gasketed front and rear doors. Options include rack angles, swing-out and stationary subpanels and writing desk. **Consoles** are offered in eleven stock sizes for desktop mounting of remote controls. Floorstand optional.

All units are heavy gauge steel with all-welded seams, easily shielded.

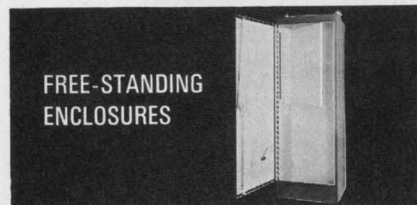

FREE-STANDING
ENCLOSURES

NEMA 12 units in stock sizes up to 90" x 36" x 24". Rigid 12 gauge steel with all-welded seams, gasketed doors front and/or rear. Oil and dust tight. Options include several interior panel arrangements, rack angles and shielding.

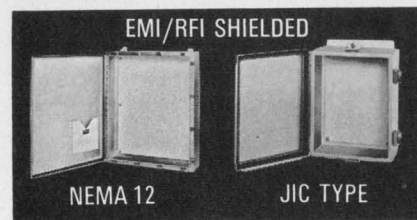

EMI/RFI SHIELDED

NEMA 12

JIC TYPE

Heavy gauge steel boxes with hinged doors, all cadmium plated. Oil and dust tight, fully shielded. Interior mounting panels and terminal block kits optional. Shipment from stock, all sizes.

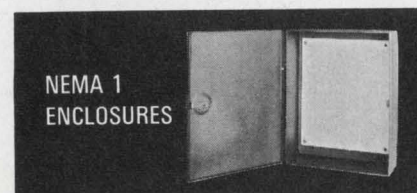

NEMA 1
ENCLOSURES

For mounting controls where oil, dust and water are not a problem. One-piece heavy gauge steel construction, finished in gray prime. Flush latches. Interior panels for mounting components. Wide size range in stock.

Hoffman

HOFFMAN ENGINEERING COMPANY
Division of Federal Cartridge Corporation
Anoka, Minnesota, Dept ED-436

ELECTRICAL ENCLOSURES

INFORMATION RETRIEVAL NUMBER 76

product index

Information Retrieval Service. New Products, Evaluation Samples (ES), Design Aids (DA), Application Notes (AN), and New Literature (NL) in this issue are listed here with page and Information Retrieval numbers. Reader requests will be promptly processed by computer and mailed to the manufacturer within three days.

Category	Page	IRN	Category	Page	IRN			
Components								
converter, voltage	91	284	diodes, impatt	98	345			
isolator, optical	88	268	diodes, p-i-n	98	346			
motor, step	92	275	laser, 1-mW	99	347			
oscillator, clock	90	270	photodetector bar	98	340			
oscillator, crystal	92	276	phototransistor	98	342			
phototransistor	92	274	phototransistors	99	348			
relay, reed	88	269	switch, optical	98	343			
relay, reed	90	271	TDR plug-in	99	350			
relay, reed	91	283	Packaging & Materials					
relays, 4pdt	90	272	cables (AN)	100	356			
resistors, film	92	273	connectors (NL)	102	363			
switch, pushbutton	92	278	connectors (NL)	104	364			
switch, reed	92	277	connectors, card-edge	97	297			
trimmers, wirewound	88	267	connectors, two-piece	97	298			
Data Processing								
card reader, optical	94	281	hardware (NL)	104	375			
coordinate measurer	93	285	heat sinks (NL)	102	361			
couplers, acoustic (NL)	102	259	MOS packages	97	299			
design system	95	282	panels, jack	97	295			
recorders, cassette (NL)	104	368	socket, relay	97	296			
tape drive, cassette	94	280	terminals (NL)	102	362			
tape head, magnetic	93	287	new literature					
terminal, data	93	286	acoustic accessories	104	374			
terminal, data	94	279	acoustical instruments	104	376			
ICs & Semiconductors								
AM/FM amplifier (AN)	100	353	connectors	104	373			
comparators, voltage	86	264	connectors, cable	102	363			
driver, IC switch	86	265	connectors, rf	104	364			
FETs (AN)	100	351	couplers, acoustic	102	359			
FETs, matched dual	86	266	hardware	104	375			
MIL-STD-883 (AN)	100	352	hardware, wire/cable	104	366			
RAMs, bipolar 256-bit	86	262	heat sinks	102	361			
register, multiple-port	86	263	IC thermal study	104	367			
SOS devices	84	261	instruments	105	377			
Instrumentation								
analyzer, tape	96	291	measuring devices	102	358			
DMM, 4-1/2-digit	96	288	modems	105	378			
DPM, 4-3/4-digit	96	292	molding compounds	104	370			
generator, sweep/mark	96	294	motors	104	371			
phase measurements			op amp testers	104	365			
(AN)	100	354	oscillators	104	372			
power supplies (NL)	102	357	power supplies	102	357			
recorders, temperature	96	290	recorders, cassette	104	368			
thermometer, electric	96	289	relays	105	380			
wattmeter, solid state	96	293	solid state devices	105	380			
Modules & Subassemblies								
converter, a/d	78	253	substrates, ceramic	105	379			
converter, a/d	82	257	switches, display	105	380			
converter, d/a	82	256	terminals, Teflon	102	362			
converters, a/d	82	258	timing controls	102	360			
dialers, telephone	77	251	wire and cable	104	369			
discriminator, afc	77	252	application notes					
display, multi-character	82	260	AM/FM IC amplifier	100	353			
display panels, numeric	77	250	cable-pairs parameters	100	356			
displays, LED	78	255	conversion factors	100	355			
power-block, 1200-A	78	254	FET design kit	100	351			
power supplies	82	259	MIL-STD-883	100	352			
Microwaves & Lasers								
amplifier, 100-W rf	98	341	phase measurement	100	354			
array, phototransistor	99	349						
detectors, IR	98	344						

Circuit-Makers.

New DIP Tools from Dale.

DIP TRIMMERS

2600/8600 "Fastpacks". Wirewound model (2600) rated at 1 watt (40°C) over 10-50K ohm range $\pm 10\%$. T.C. 50 ppm/°C. Film model (8600) rated .75 watt (25°C) over 10 Ω -2 Meg. range $\pm 10\%$, $\pm 20\%$. T.C. 150 ppm/°C. Sealed cases, .75" long, machine or hand insertable.

85/87 "Fastpacks". Single or multi-turn models rated at .5 watt (25°C) over 10 Ω to 1 Meg. range $\pm 20\%$. T.C. 150 ppm/°. Sealed cases, .265" wide x .28" long. Machine or hand insertable.

DIP RESISTOR NETWORKS

TKR. Molded or coated networks with 14 (T.O. 116) 16, 18 pins. 1/8 watt max. per resistor, 3/4 watt max. at 125°C per package. 10 Ω to 1 Meg., $\pm 2.5\%$, 200 ppm/°C. Available with DIP or P.C. pins on .3" x .1" or .6" x .1" grid (coated only).

WDP/FDP. Film (FDP) networks in 14 and 16 pin packages. Up to 15 elements, .05 watt max. with .5 watt max. per package; 10 Ω to 1 Meg. per resistor, $\pm 1\%$, 10-200 ppm/°C. Wirewound (WDP) networks have up to 7 elements per 14-pin package, .5 watt per element, 3.5 watts max. per package. 1 to 800 Ω per resistor, .1%-5%, ± 20 , ± 50 ppm/°C.

DIP PULSE TRANSFORMERS

PT-14/PT-16 with 3 (14-pin) or 4 (16-pin) pulse transformers per package. Inductance 1 μ h to 2.0 mh over -55 to +125°C. range. Temperature stability $\pm 10\%$, tolerance $\pm 20\%$. Sealed cases with pins on .3" x .1" grid. Machine or hand insertable.

In addition to these standard DIP packages, we're ready to quote on custom RC networks and hybrids with active and passive devices to your specification. Fast turnaround on prototypes. Write for new DIP Brochure or phone our Application Engineering Department, 402-564-3131 today!

DALE ELECTRONICS, INC., 1300 28th Avenue, Columbus, Nebraska 68601
In Canada: Dale Electronics Canada, Ltd. A subsidiary of The Lionel Corporation

INFORMATION RETRIEVAL NUMBER 243

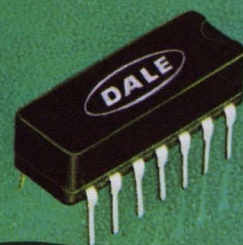
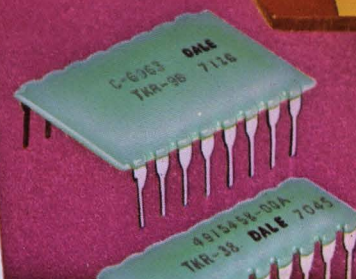
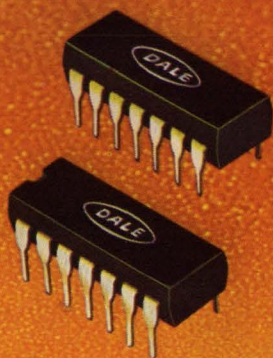

DALE®

Now 3 zero-voltage switches to trigger your thyristors

Here's new flexibility and economy for your zero-crossing Thyristor trigger application—3 RCA zero-voltage switches give you the exact combination of price and performance your application demands.

RCA Zero-Voltage Switches offer:

- Thyristor triggering at zero-voltage crossing for minimum RFI in 50, 60, and 400 Hz applications.
- Self-contained dc power supply

with provision for supply of dc bias current to external components.

- Built-in protection against sensor failure (in CA3058 and CA3059).
- External provision for zero-current switching with inductive loads. Provision for adding hysteresis or proportional control.
- Recommended for use with RCA's 2.5-40 amp., 100-600 volt series triacs, types 40693-40734. These RCA triacs

are rated for operation with the CA3058, CA3059 and CA3079.

For further information see your local RCA Representative or RCA Distributor. For technical data bulletin file Nos. 406 and 490 and Application Notes ICAN-6158 and ICAN-6268, write: RCA, Commercial Engineering, Sec. 57J28/CA64 Harrison, N.J. 07029. International: RCA, Sunbury-on-Thames, U.K., or P.O. Box 112, Hong Kong, or Ste. Anne de Bellevue, 810 Quebec.

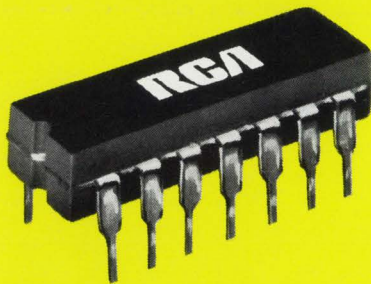

FULL-FEATURE PERFORMANCE PLUS ECONOMY
CA3059 in 14-LEAD DIP
 Built-in protection,
 -40°C to +85°C operation
 \$1.95 (1000-UNIT LEVEL)

NEW ECONOMY TYPE
CA3079 in 14-LEAD DIP
 -40°C to +85°C operation
 \$.99 (1000-UNIT LEVEL)

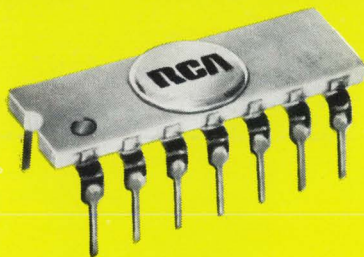

NEW FOR FULL MILITARY TEMPERATURE RANGE
CA3058 in 14-LEAD DIP
 Premium performance,
 -55°C to +125°C operation
 \$3.50 (1000-UNIT LEVEL)

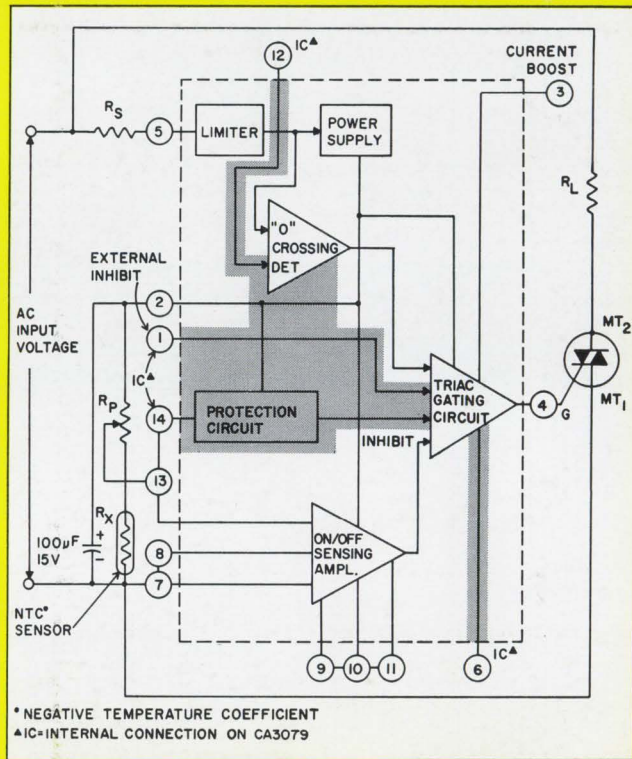

Features

- 24V, 120V, 208/230V, 277V at 50, 60, or 400 Hz operation
- Differential Input
- Low Balance Input Current (max.)- μ A
- Built-in Protection Circuit (Fail-Safe) for opened or shorted sensor (Term. 14)
- Sensor Range (R_x)- $k\Omega$
- DC Mode (Term. 12)
- External trigger & inhibit (Terms. 6 & 1)
- DC Supply Volts (max.)

	CA3058	CA3059	CA3079
✓	✓	✓	✓
✓	✓	✓	✓
1	1	1	2
✓	✓	✓	✓
2 to 100	2 to 100	2 to 100	2 to 50
✓	✓	✓	✓
✓	✓	✓	✓
✓	✓	✓	✓
14	14	10	10

RCA Solid State

INFORMATION RETRIEVAL NUMBER 244