

# Electronic Design

FOR ENGINEERS AND ENGINEERING MANAGERS

VOL. 20 NO.

# 2

JAN. 20, 1972

**M-bit random access memories** are stacking up 1024-bit MOS 1103s against cores. Multiple sources raise confidence level for applications in mini-computer

main frame, data transfer from disc or drum and cathode-ray display terminals. For what the memory designer needs to know about the 1103, see page 40.

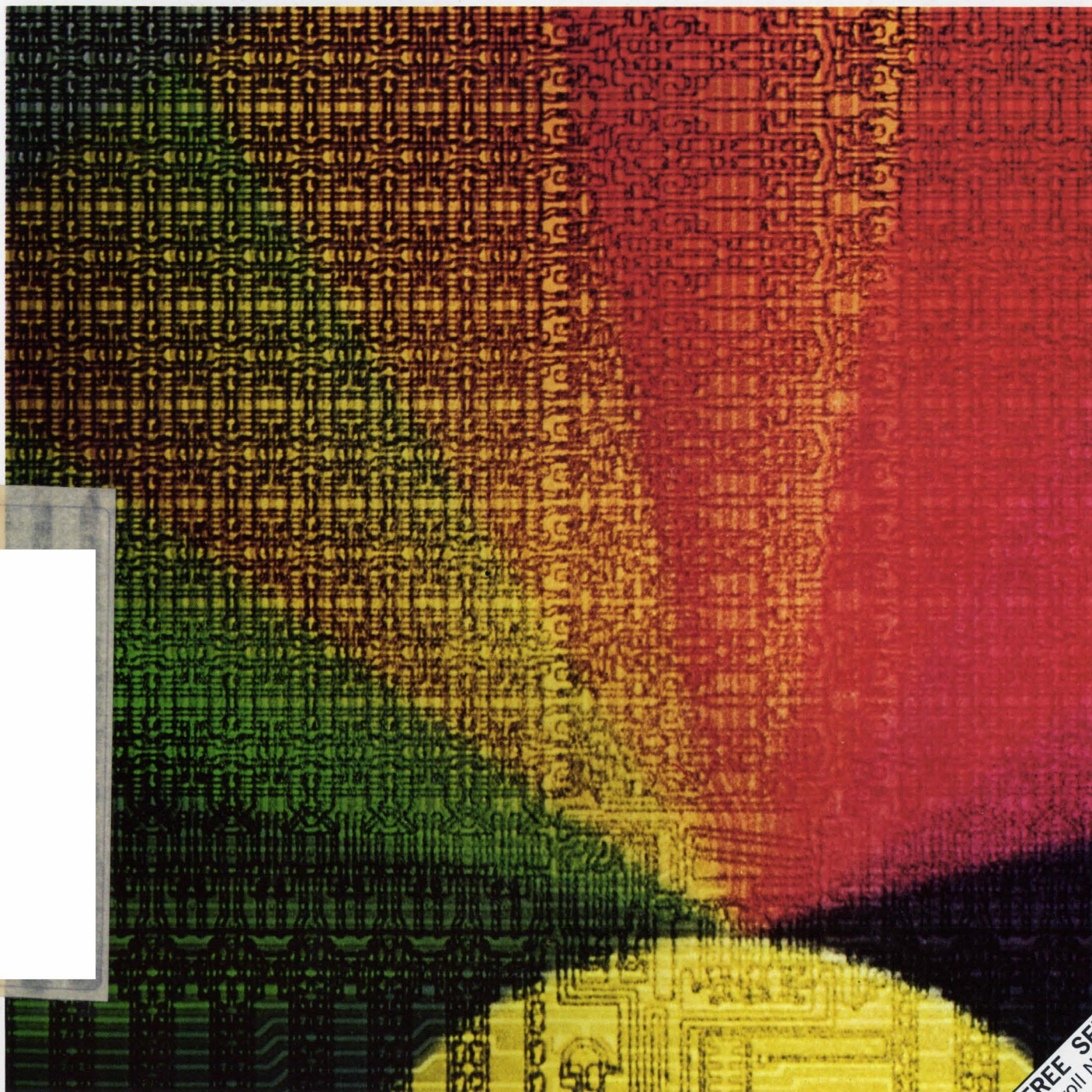

**NEW FREE SERVICE!**  
Enroll Now  
Use Card Inside  
Front Cover



# Are nervous resistors giving your products the jitters?



## **Stabilize with Metal Glaze™**

Stability. The magic word in electronic components. And in resistors, the word for stability is Metal Glaze. And the word is out, because millions are already in field use.

Metal Glaze, noted for its mechanical and electrical ruggedness, is also an extremely stable resistive system. Operated at rated power, and in many cases at twice rated power, Metal Glaze resistors go coolly along, resisting change for thousands of hours. They are truly precision resistors, and we have reams of test printouts to prove our case.

The glass-hard Metal Glaze film is permanently

fused to a solid ceramic core. The lead wire terminations are soldered to the core in a patented process. This makes the resistive element and the terminations one continuous component ready for molding in an environmentally protective envelope.

Competitively priced in power ratings from 1/8 watt to 2 watts, Metal Glaze resistors are available to 1% tolerance, and 100 ppm temperature coefficient.

TRW Metal Glaze resistors are available in quantity from your local TRW industrial distributor. Please contact TRW Electronic Components, IRC Boone Division, Boone, North Carolina 28607. Phone (704) 264-8861.

**TRW**  
IRC RESISTORS



## Fast relief from connector headaches, ARINC included.

If there's one sure cure for most any connector headache, it's Bendix.

Bendix for ARINC 404 connectors. Bendix for printed circuit board connectors. Bendix for rack and panel connectors, too.

Take our new line of ARINC connectors, for instance. They're the ones available with metal-clip retention, for rear-release crimp contacts. And that can mean fewer headaches in the field for you. Choose from environmental and non-environmental types, in double or single-shell configurations, intermateable with connectors of similar design.

You'll find our printed circuit board connectors a big help, too. Choose from rigid or floating pin. (Floating pin is a great cost-cutter, since there's no more need for precise, pin-location drilling.) Choose, too, from wire wrap. Straight or right-angle solder post. Insertable crimp. Fixed contact molded in dielectric.

Consider our rack and panel connectors, also. Standard sizes. Subminiatures. Both available in a wide variety of shell sizes and mounting configurations for most applications.

Bendix connectors. Taken as directed, they bring fast relief for most any connector headache, yours included. The Bendix Corporation, Electrical Components Division, Sidney, New York 13838.

**Bendix**

The Bendix logo consists of the word "Bendix" in a bold, sans-serif font, positioned above a blue graphic element that resembles a stylized wave or a curved banner.



# Signetics has the broadest line-up of ROMs in the industry.

## BIPOLAR

256 Bit Field Programmable ROM (32 x 8) Open Collector Outputs 8223  
256 Bit Mask Programmable ROM (32 x 8) Open Collector Outputs 8224  
4096 Bit Mask Programmable ROM (1024 x 4) Totem Pole Outputs 8228  
2048 Bit Mask Programmable ROM (256 x 8) tri-state Outputs 8204  
4096 Bit Mask Programmable ROM (512 x 8) tri-state Outputs 8205

## MOS

### METAL GATE

1024 Bit Static ROM (256 x 4) Bare Drain or MOS Pull-Down 2410  
1024 Bit Static ROM (128 x 8 or 256 x 4) Bare Drain or MOS Pull-Down 2420  
2048 Bit Static ROM (256 x 8) Bare Drain or MOS Pull-Down 2430

### SILICON GATE

2560 Bit Static Character Generator (64 x 8 x 5) tri-state Outputs 2513  
2560 Bit Static ROM (512 x 5) tri-state Outputs 2514  
3072 Bit Static Character Generator (64 x 6 x 8) tri-state Outputs 2516



# And we make them easy to use.

With our fantastic line-up, we can put you on the air in breadboard and keep you there all the way into production. From design desk to shipping dock your ROM designs will be fully functioning at system operating speeds. In breadboard you'll be using field programmable FROMs or simulators. Through prototype you'll be working on FROMs, ROMs, or simulator. In production you'll be working with FROMs and ROMs—taking advantage of field programming or the Signetics quick turn around ROM mask generation and mask verification capability.

Designs will be de-bugged and into production in weeks or even months less time. And at savings you can measure in thousands of dollars per unit type. No one knows more about ROMs than Signetics. And we help make them easy to use. In addition to what you've already seen, here's the deal we offer.



**5 separate fusers for 3 new FROMs.** 3 new FROMs with 5 separate fusers to custom develop your fused ROMs: for laboratory and prototype use or pre-production through mass production.

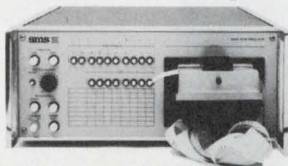

**De-bug your design before you build it.** With the fantastic ROM simulator, you can simulate up to sixteen fully operational ROMs simultaneously, each up to 4096 bits either Bipolar or MOS. Each operating completely independent of the others.

Or use our FROMs which are designed for both prototyping and production usage. Your choice.



**Support.** Application notes, 2 complete manuals covering both MOS and Bipolar, 2 operating programs and a wealth of descriptive data sheets. We put it in writing. Send for it.

Please send me a full literature package.

Name \_\_\_\_\_

Address \_\_\_\_\_

City \_\_\_\_\_ State \_\_\_\_\_ Zip \_\_\_\_\_

**Signetics**

811 E. Arques Ave, Sunnyvale, California 94086  
A subsidiary of Corning Glass Works.



# TWO OF MAN'S OUTSTANDING INVENTIONS



TO-5 Relay

Where would man be in the evolution of progress if through his reasoning and

ingenuity he had failed to invent the wheel . . . or the TO-5? The wheel is basic. So is the TO-5 Transistor Case Relay developed by Teledyne Relays! Like the wheel, the TO-5 didn't just happen . . . It evolved from a need. From its initial beginning as a totally reliable 2-pole double throw relay, the TO-5 has grown to a broad family of configurations — the most advanced and reliable general purpose relays available.

3155 West El Segundo Boulevard  
Hawthorne, California 90250  
Telephone (213) 679-2205

67 Ludwigshafen (Rhein)  
Altripper Strasse 27-31, Germany  
Telephone 0621-576431  
Telex 464760



**TELEDYNE  
RELAYS**



# Electronic Design

FOR ENGINEERS AND ENGINEERING MANAGERS

VOL. 20 NO.

# 2

JAN. 20, 1972

---

## NEWS

- 23 **News Scope.**
- 26 **High negative bias sputtering**, a new way to produce thick-film deposits, could revolutionize the manufacture of thick-film hybrids.
- 28 **Power needs of an ocean-floor monitoring system** designed to operate for a month at 18,000-foot depths have been cut dramatically.
- 30 **Mobile radio capacity upped 100-fold.**
- 32 **Technology Abroad**
- 35 **Washington Report**

---

## TECHNOLOGY

- 40 **The 1103—1024 memory bits on a chip.** With random access, read/write capability and decoding, it's a large-array building block. Here's how to use it.
- 48 **Design your own filters by computer.** Component values for passive five-element L-C units print out in seconds with this BASIC program.
- 52 **Guide your engineers to self-rule**, advises this leader, who says staff-made decisions help him. His challenges? Hiring and pairing people/assignments.
- 56 **Ideas for Design**

---

## PRODUCTS

- 61 **Instrumentation:** Both high and 50-ohm inputs are offered in 100-MHz scope.
- 68 **Modules & Subassemblies:** D/a and a/d line covers the price/performance spectrum.
- 63 ICs & Semiconductors
- 66 Data Processing
- 67 Packaging & Materials
- 70 Components

---

## Departments

- 39 **Editorial:** The curse of courtesy
- 11 Across the Desk
- 72 Application Notes
- 73 New Literature
- 75 Bulletin Board
- 78 Advertisers' Index
- 80 Information Retrieval Card

**Cover:** Photo courtesy of Intel Corp., Santa Clara, Calif.

---

ELECTRONIC DESIGN is published biweekly by Hayden Publishing Company, Inc., 50 Essex St., Rochelle Park, N.J. 07662. James S. Mulholland, Jr., President. Printed at Brown Printing Co., Inc., Waseca, Minn. Controlled circulation postage paid at Waseca Minn., and New York, N. Y., postage pending Rochelle Park, N. J. Copy-right © 1972. Hayden Publishing Company, Inc. 82501 copies this issue.



# The NAKED MINI™

## \$1450

### The bare maximum.

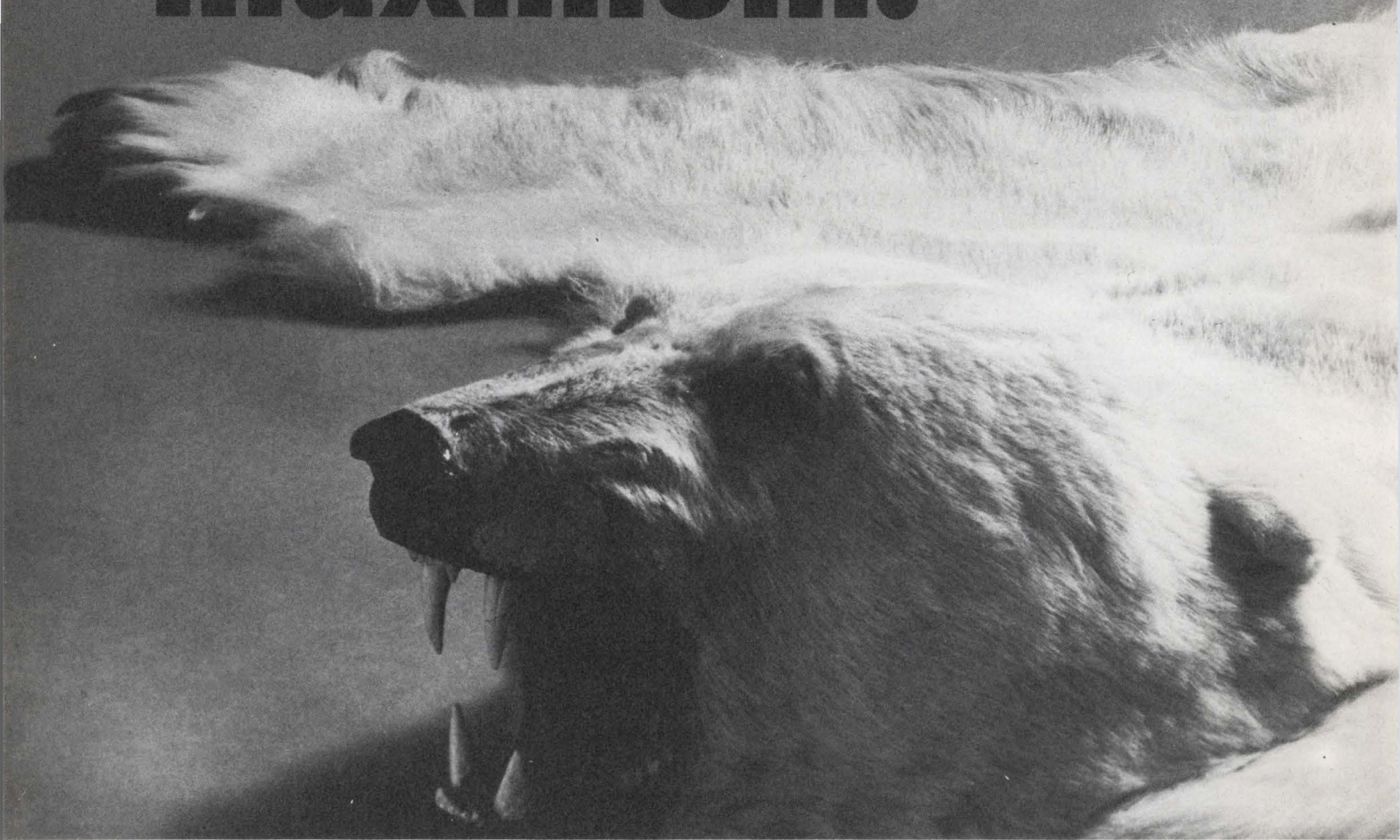

The Computer Automation NAKED MINI™ is naked. But it's not stripped. And that's an important difference.

To us, if a minicomputer is stripped, it's not even a computer. It's only a limited controller. Loose cards and components without even a memory. Sort of a do-it-yourself kit. That's not what you get from us.

The NAKED MINI is a fully-operational, general purpose computer with 4K of expandable memory.

With our NAKED MINI 8-bit and 16-bit computers, the only things missing are the power supply, console, and chassis. That's all.

No, the NAKED MINI is not a stripped computer. Far from it. It has the complete power of a stand-alone system. It's an integral unit, designed for maximum useability and interface-

ability. It's fully tested and warranted. And it comes with a complete line of standard software.

In fact, you get a lot of features that costlier stand-alone computers don't even have. Standard items like our 145 basic instructions (76 with the 8-bit), the most powerful instruction sets on the market. Three direct memory channels. Vectored priority interrupts. Hardware arithmetic features. And 32K of core. Plus hardware multiply/divide and full byte operations on our 16-bit machines.

Even though our NAKED MINI's have all this horsepower and flexibility, think of them as a component. A component ready to be thoroughly buried inside your OEM product.

Because of its low price tag, the NAKED MINI makes it economically feasible to design your product with a mini-



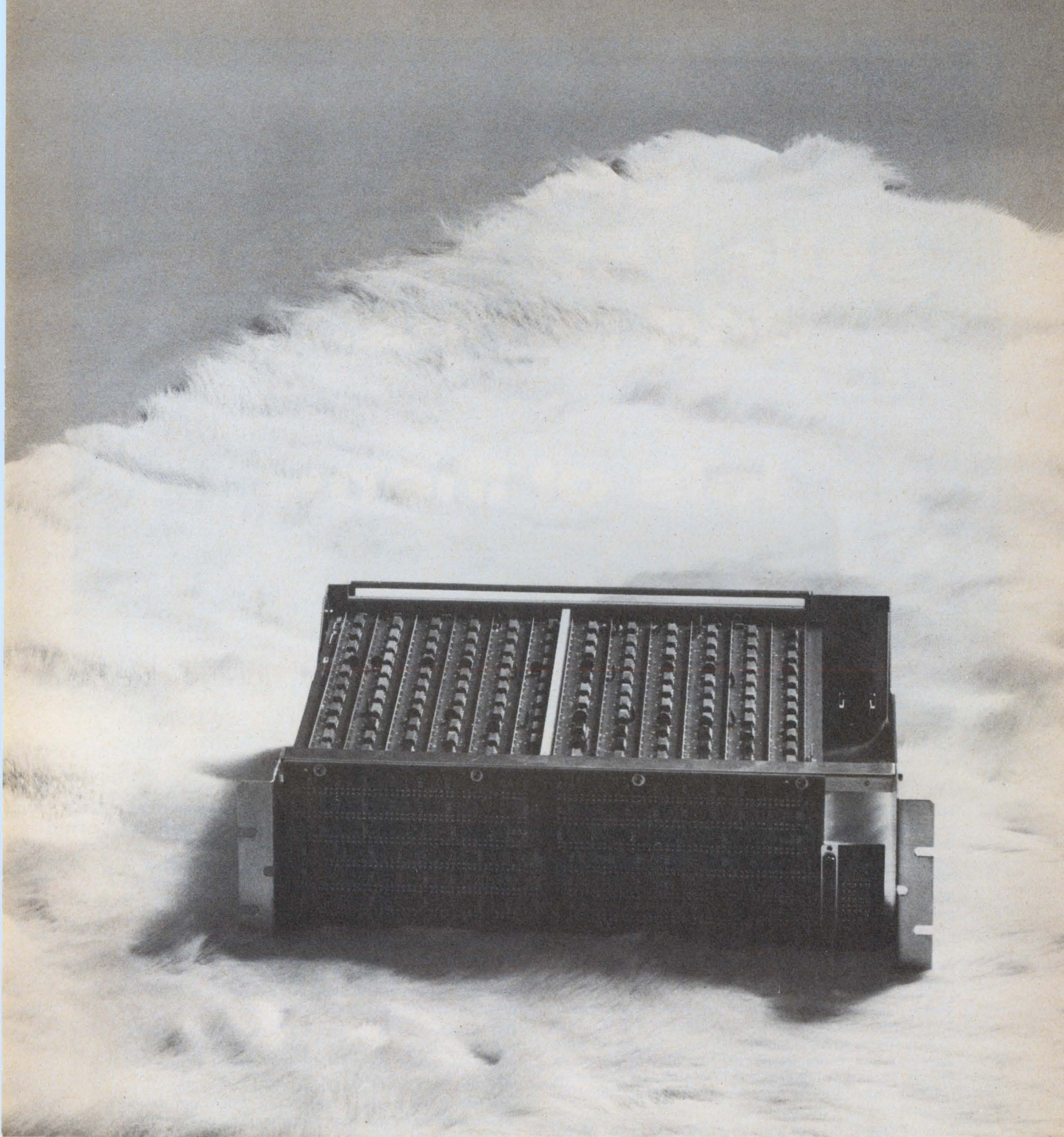

computer, rather than hardwired circuitry. This enhances your system performance, while reducing system costs considerably.

For the systems designer, the NAKED MINI concept means an opportunity to get the full computer power of our packaged machines. But at the price of a component. Take a look at our quantity pricing list. We think you'll agree.



We'll be glad to send you full specification details, including a complete listing of the standard instruction set and software. Just write or call us.

The NAKED MINI has nothing to hide.

### Naked Mini Quantity Pricing

	10-19	20-49	50-99	100-199	200 plus
<b>NAKED MINI-16</b>					
4K	\$2500.	\$2400.	\$2300.	\$2200.	\$1995.
2K	2200.	2100.	2000.	1900.	1725.
<b>NAKED MINI-8</b>					
8K	\$2275.	\$2125.	\$2000.	\$1925.	\$1730.
4K	1975.	1825.	1700.	1600.	1450.

(NAKED MINI's are sold on firm purchase orders in minimum quantities of 10 units.)

**COMPUTER AUTOMATION, INC.**  
 895 West 16th Street • Newport Beach, California  
 92660 • Phone (714) 642-9630 • TWX 910-596-1377



# OPCOA sells LED displays and lamps...

## lots of them.

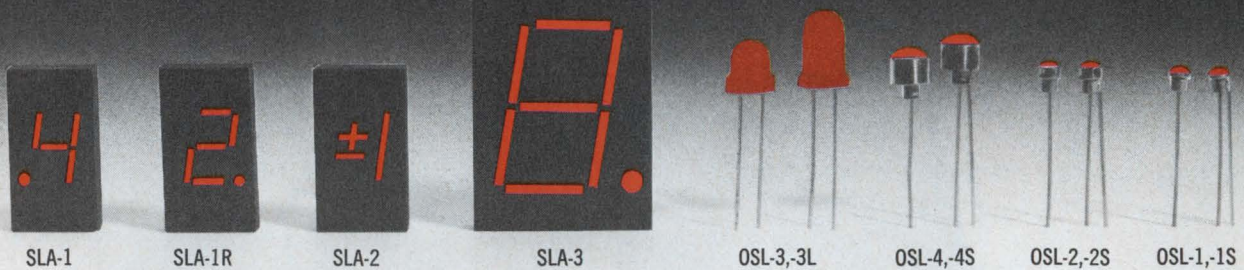

**Lots of displays.** All use gallium phosphide, the most efficient visible light emitting semiconductor with 200,000 hours typical half life. All are operable from standard low-voltage IC's. Numerals are red on an opaque black background. Choose from:

**SLA-1:** A seven-segment numeric display with decimal point featuring a large  $\frac{1}{3}$ -in. character in a standard 14-pin dual-in-line package. Total power is less than  $\frac{1}{4}$  watt. Operates directly from standard TTL decoder/drivers.

**SLA-1R:** Similar to SLA-1 but with right-hand decimal point.

**SLA-2:** For use with SLA-1 or -1R seven-segment displays to indicate the overflow numeral one and polarity.

**SLA-3:** The largest available solid state numeric display with an 0.8-in. character height—readable at distances of over 40 feet. It features a 0.17-in. thin package with 0.100-in. spaced leads for convenient socket mounting or soldering to a p-c board.

**Lots of lamps.** All use gallium phosphide LED's which emit light in all directions to provide an area light source rather than a pinpoint. All provide typical optical power output of 225  $\mu$  watts (4.5 millilumens) at 15 mA. Choose from:

**OSL-1 and -1S:** Full 0.100-in. sources of light in 0.100-in. diameter packages with good visibility over 180° viewing angle. For coaxial or two-wire hookup.

**OSL-2 and -2S:** Provide 2.0 millicandelas at 15 mA in 0.100-in. diameter reflector packages. Recommended where high luminosity with more directional viewing is desired. For coaxial or two-wire hookup.

**OSL-3 and -3L:** Large indicator lamps with 0.200-in. lens diameters offer exceptionally wide viewing angle. Convenient socket or soldered mounting with 0.100-in. lead spacing. Available with short (OSL-3) or long (OSL-3L) dome in either red or clear plastic.

**OSL-4 and -4S:** Directional 0.175-in. diameter "head-light" type lamps provide 2.7 millicandelas. Particularly useful for panel backlighting. For coaxial or two-wire hookup.

**And lots of the model you've chosen.** When your design moves from prototype into production, you can count on OPCOA to meet your requirements.

For technical literature or applications assistance, contact OPCOA, Inc., 330 Talmadge Road, Edison, New Jersey 08817; call (201) 287-0355; TWX 710-998-0555.

## OPCOA

### SOLID-LITE



# Now we offer you the world's first true nonpolar wet tantalum capacitor.

We call it the ANP. And it means protection. *Full* protection from voltage-reversal failures. And from circuit-damaging transients.

Realizing that not every circuit needs full protection, we also came up with the AHS. Type AHS tantalum capacitors are polarized units for operation with a DC bias, including the application of a reverse voltage not exceeding 3 volts.

The new capacitors come in 32 values and 9 case sizes. Stud or PC mounting. Within specified limits, they meet requirements of MIL-C-3965.

So, if you're looking for *true* nonpolarity—or precisely limited polarity—stop looking. We've got both. And bulletin 4-608 explains the details.



**MALLORY**

**MALLORY CAPACITOR COMPANY**

a division of P. R. MALLORY & CO. INC.  
Indianapolis, Indiana 46206

Electrical and Electronic Components • Sequence Timers • Metallurgical Products • Batteries

INFORMATION RETRIEVAL NUMBER 7



# VOICE YOUR CHOICE

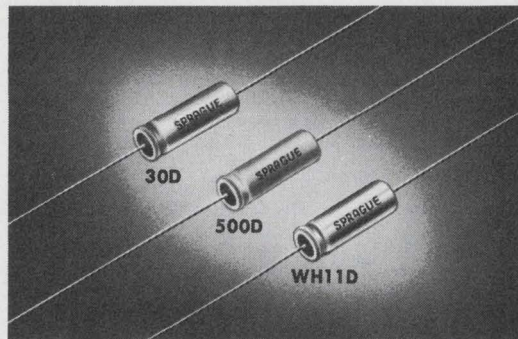

... Sprague makes three!

## SMALL ALUMINUM 'LYTIC CAPACITORS

### TYPE 30D FOR INDUSTRIAL APPLICATIONS

Will withstand 2000 hr. life test at 85C. Excellent stability, dissipation factor, leakage current. Designed for business machines, instrumentation equipment, etc. Write for Engineering Bulletin 3150A or;

CIRCLE 882 ON SERVICE CARD.

### TYPE 500D FOR MODERATE-COST APPLICATIONS

Good operating life characteristics, including stability, ESR, leakage current. Will withstand 1000 hr. life test at 85 C. Ideal for radio, TV, and other entertainment applications. Write for Engineering Bulletin 3149 or;

CIRCLE 883 ON SERVICE CARD.

### TYPE WH11D FOR ECONOMY APPLICATIONS

Welded construction, similar to higher-priced capacitors. Widely used in solid-state equipment where cost is of prime importance. Made by Sprague World Trade Corp. in Hong Kong. Write for Engineering Bulletin 3148C or;

CIRCLE 884 ON SERVICE CARD.

## MORE FROM SPRAGUE ... THE BROAD-LINE PRODUCER OF ELECTRONIC PARTS

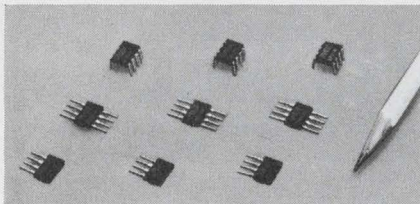

**HALL EFFECT SWITCH ICs.** Actuated magnetically, not mechanically or optically. Hall generator trigger circuit and signal amplification circuit on single silicon chip. Reliable (no moving parts). Easy interfacing with DTL/TTL/MOS logic. High speed. Low cost. Write for Engineering Bulletin 27,402A or;

CIRCLE 885 ON READER SERVICE CARD.



**U.L. LISTED FILTERS.** Series JX5000 for EDP equipment and general-purpose use. Rated 125/250 VAC, 0-60 Hz, 1 thru 50 amps. 60 db @ 150 kHz, 80 db from .5 MHz thru 1 GHz. Special designs and rectangular multi-circuit units also available. Write for Engineering Bulletin 8210 or;

CIRCLE 886 ON READER SERVICE CARD.



**TYPE 36D POWERLYTIC® CAPACITORS.** For use in computer power supplies, control equipment, energy storage, etc. Low impedance construction. Up to 650,000  $\mu$ F at 3 V. Ratings from 3 to 450 V. Can be operated at 85 C. Tapped 10-32 terminals simplify filter bank assembly. Write for Engineering Bulletin 3431C or;

CIRCLE 887 ON READER SERVICE CARD.

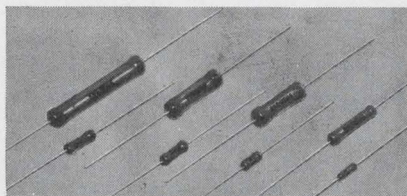

**BLUE JACKET® RESISTORS.** Vitreous-enamel power wirewound. Unique all-welded end-cap construction eliminates moisture paths along leads, anchors leads securely to resistor body. Expansion coefficients of vitreous enamel, ceramic body, and end caps are closely matched. Write for Engineering Bulletin 7410E or;

CIRCLE 888 ON READER SERVICE CARD.



TECHNICAL LITERATURE SERVICE, SPRAGUE ELECTRIC CO., 347 MARSHALL ST., NORTH ADAMS, MASS. 01247

49-1117

10

## Publisher

Peter Coley

## Editors

Editorial Offices  
50 Essex St.  
Rochelle Park, N.J. 07662  
(201) 843-0550  
TWX: 710-990 5071  
Cable: Haydenpubs Rochellepark

Editor: George Rostky

Managing Editors:

Ralph Dobriner

Michael Elphick

Associate Editors:

Roger Allan

Jules H. Gilder

Richard Lee Goldberg

John F. Mason

Nathan Sussman

Edward A. Torrero

Richard L. Turmail

Contributing Editor:

Peter N. Budzilovich

## Field Offices

### East

Jim McDermott

P.O. Box 272

Easthampton, Mass. 01027

(413) 527-3632

### West

David Kaye

2930 Imperial Highway

Inglewood, Calif. 90303

(213) 757-0183

### Washington

Don Byrne

1111 S. Army Navy Drive

Arlington, Va. 22202

(202) 296-8982

## Editorial Production

Dollie S. Viebig

## Art

Art Director, William Kelly

Richard Luce

Anthony J. Fischetto

## Production

Manager, Thomas V. Sedita

Helen De Polo

Maxine Correal

Anne Molfetas

## Circulation

Manager, Nancy L. Merritt

Joan Licari

## Information Retrieval

Peggy Long



### Executive sees trend to microprogramming

The article on microprogrammed computers in the Nov. 25 issue ("Suddenly, Everybody is Building Microprogrammed Computers," ED 24, pp. 23-28) was read with much interest here. Indeed, our experience at Memory Systems, Inc., is that the trend to microprogramming and the use of fast control memories is on the upsurge.

In your excellent article we were somewhat disappointed to see no mention of the plated wire EAROM (Electrically Alterable ROM) concept developed by Memory Systems—especially since ELECTRONIC DESIGN broke the story in a cover article on March 1, 1970. We have come far since that time and have now delivered quantities of a wide variety of EAROMs to customers, who are using them in such applications as writable control stores for minicomputers, peripheral controllers, telephone switching equipment, process control computers, N/C robots, machine-tool controllers, to name a few.

While your article stresses the reduced cost of machine hardware with ROM control, our experience indicates that this is often not the major consideration. The ability to reconfigure instructions sets rapidly as the product life unfolds, as engineering improvements or changes are required, as new competitive features are required and added—these all combine to increase product life. A new form of machine, dynamically microprogrammed, is being developed. In this the instruction set may be optimized for each type of job—ideal for time-sharing systems.

Is the writable control store

more costly? Not from Memory Systems. We are profitably selling complete systems at prices similar to bipolar pROM chips and far below bipolar ROMs at comparable performance.

*Bruce Kaufman,  
President*

Memory Systems, Inc.,  
3341 W. El Segundo Blvd.  
Hawthorne, Calif. 90250

### Right man, wrong time

In "New electronics to make ICBMs more blastproof and easier to aim," ED 23, Nov. 11, 1971, p. 22-23, we quoted Dr. George C. Messenger, but we failed to point out that the particular quotation was taken from the December issue of the *IEEE Transactions on Nuclear Science*. Our identification of Dr. Messenger, an independent consulting engineer, wasn't particularly up to date, either. We said he was with Northrop Corp. of Newbury Park, Calif., but he hasn't been there for five years. He's now working for North American Rockwell.

### A New Year's wish from logic designer

Anno Domini 1972 promises to be a great year for the digital system designer. Fairchild should be in full steam with its Isoplanar process, giving us more bipolar LSI devices with packing densities as high as MOS, and National's announcement of a 54C/74C logic family should bring us all the advantages of MOS in our TTL systems, including truly low power operation—which should just about

Electronic Design welcomes the opinions of its readers on the issues raised in the magazine's editorial columns. Address letters to Managing Editor, Electronic Design, 50 Essex St., Rochelle Park, N. J. 07662. Try to keep letters under 200 words. Letters must be signed. Names will be withheld on request.

# MICROWAVE TUNING SCREWS



Our new microwave tuning screws furnish an accurate means of introducing a variable reactance at a specific point in waveguides, microwave cavities, filters and other resonant structures.

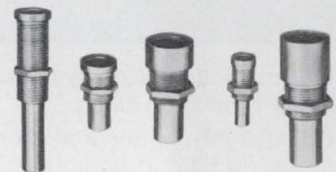

#### FEATURED ARE:

- Fine Tuning Resolution
- Self Locking — Eliminates locking nuts
- Noise Free Tuning
- 10 Sizes — Metallic and Dielectric models available

*Johanson*

MANUFACTURING CORPORATION  
ROCKAWAY VALLEY ROAD  
BOONTON, NEW JERSEY 07005



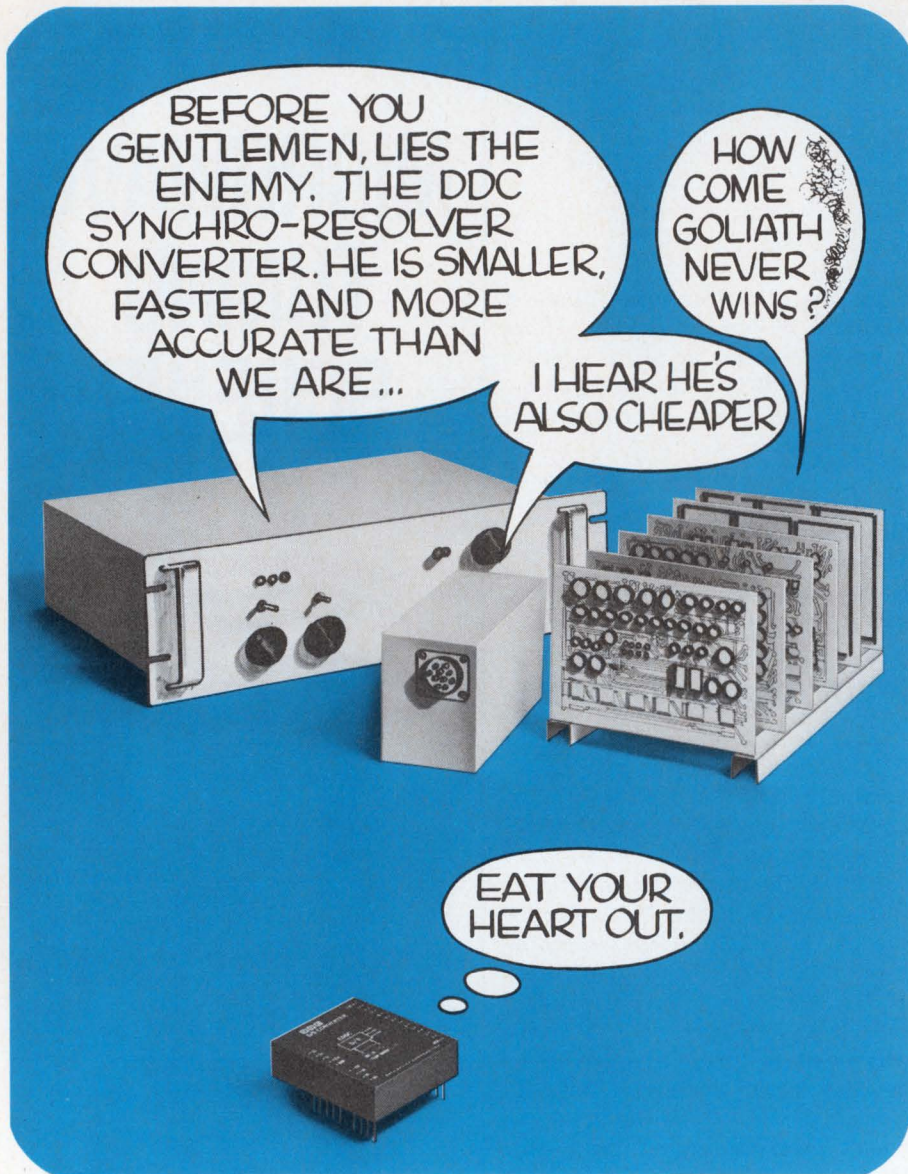

Our matchbox-sized synchro-to-digital converter model ESDC, has every right to be smug.

**It's smaller, lighter and more compact** than those big jobs back there. (In fact, it requires only a fraction of the space of its closest competitor.)

**It's far less expensive** . . . up to 50% of the cost of some of the others.

**It's rugged:** meets the requirements of MIL-STD-202C.

DDC's ESDC series of synchro-to-digital converter modules are complete data conversion systems in subminiature form. These converters employ techniques formerly found only in the most expensive laboratory-grade equipment. They were designed from the start with all the performance factors the synchro engineer wants and needs.

And it's available right now, off the shelf. Why? Because DDC is the largest manufacturer of S/D and similar converters . . . and therefore one of your fastest sources of supply.

**Please let us tell you more about it.** And about the rest of our data conversion and signal conditioning devices. Write us, or phone direct to either Steve Muth or Jim Sheahan. (516) 433-5330.

## SYNCHRO CONVERTERS



**ILC DATA DEVICE CORPORATION**

100 TEC STREET, HICKSVILLE, N.Y. 11801, DEPT. ED1-72

INFORMATION RETRIEVAL NUMBER 10

put milliwatt RTL out of business. But there is still one further development I would like to see in 1972—it is the "half-size" logic chip, or "mini-SSI," call it what you like.

Now that the mini-DIP is becoming widely used for linear ICs and a variety of drivers and couplers, it would be great to see a new series of standard TTL in eight-pin mini-DIPs. Triple hex inverters, duals of the most popular quad gates, singles of the best dual packs and eight-pin versions of the 7490 and 7493 counters would help us small-time logic designers get more logic per board and bypass the need for new ICs, like National's DM8090 triple-hex, dual-NAND package.

And, finally, why can't a U.S. manufacturer produce a double (or even a triple) decade counter in a single 16-pin pack? An Australian firm has been doing it successfully for at least a year.

*Colin S. L. Keay*

*Research Associate*

Lunar and Planetary Laboratory  
University of Arizona  
Tucson, Ariz. 85721

## More on recorders

"Focus on Industrial Chart Recorders" in the Dec. 9, 1971 issue, pp. 48-53 omitted several important lines—from Leeds & Northrup, North Wales, Pa.; Gould, Inc., Cleveland, and Heath Schlumberger, Benton Harbor, Mich.

Morris Leeds of L&N invented the first null-balance mechanical recorder in 1911, and the company marketed the first electronic balancing recorder in 1933. It now offers several lines of Speedomax recorders.

Another leading producer, the Instrument Systems Div. of Gould, Inc., is widely known for the Brush line of recorders.

Heath Schlumberger's Scientific Instrument Div. has a new modular recorder, the EV-205B, with full programmability of all functions.

For more information:

From L&N                      Circle No. 451

From Gould                    Circle No. 452

From Heath                    Circle No. 453



# The new Merlin 1<sup>®</sup> connector.

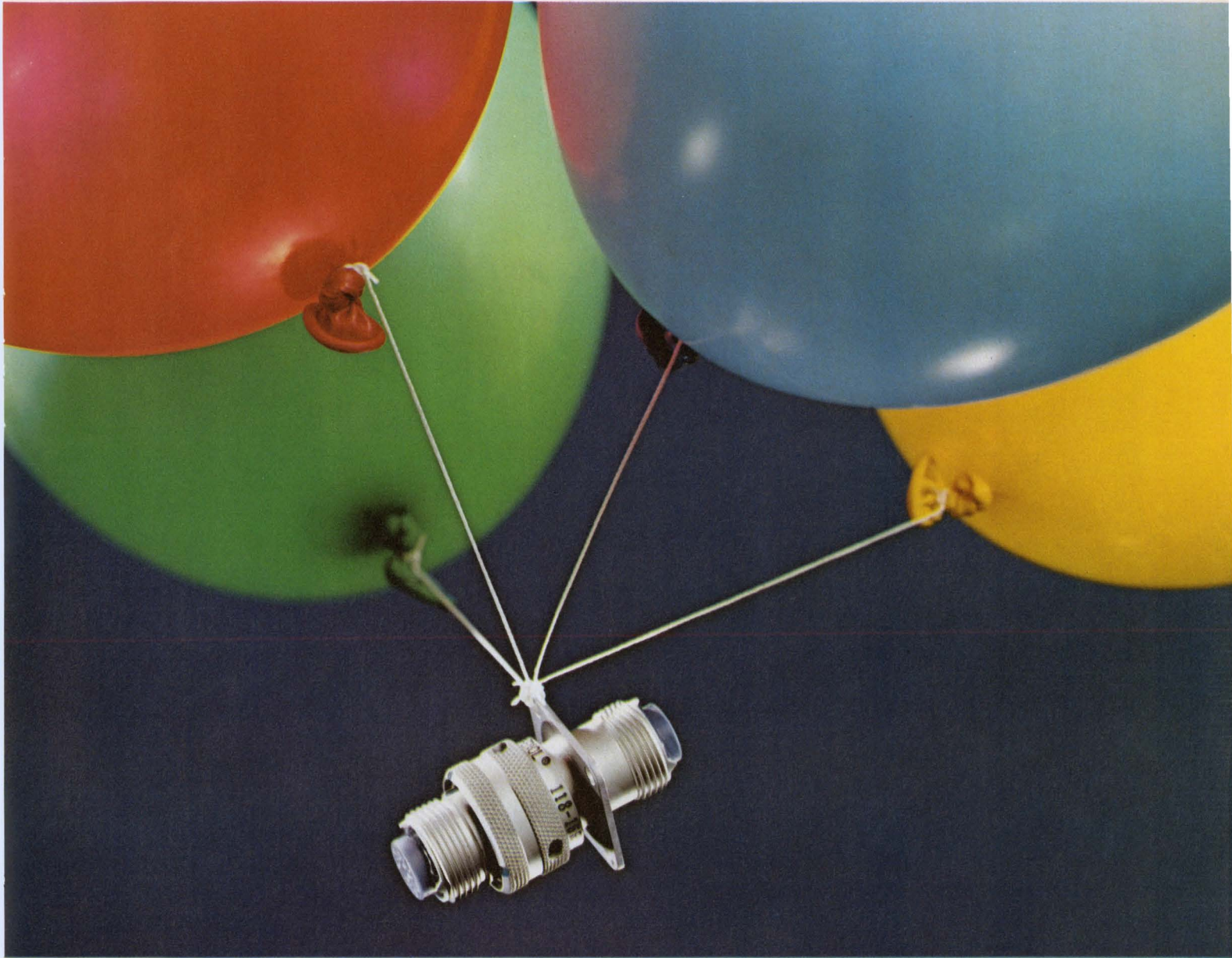

## 40% lighter than anybody else's.

Through the magic of Amphenol engineering we now bring you a rear-release, cylindrical, environmental connector that is not only 40% lighter than competition, but 1/2-inch shorter than most.

A one-piece thermoplastic retention disc, molded of tough Astrel 360\* replaces the individual metal retention clips common in heavier connectors. Therefore, a 61-pin Merlin configuration has one retention disc instead of 61 individual metal clips. The result is a lot less useless weight. And, without all those parts, more reliability.

Adds a little magic to cost-cutting, too.

Our new Merlin exceeds all performance requirements of MIL-C-83723, MIL-C-26482 and NAS-1599 and is fully intermateable and intermountable with all three of these types.

Shell sizes are available in the eight most popular configurations with your choice of straight plug and both wall-mounted or jam-nut receptacles.

To get the full story on the new Merlin 1 connectors, just write or call Steve Kelleher, Amphenol Connector Division, Bunker Ramo Corporation, 2801 S. 25th Avenue, Broadview, Ill. 60153, (312) 261-2000.

\*Registered Trade Mark 3M Company.



# AMPHENOL



# 10 KW?

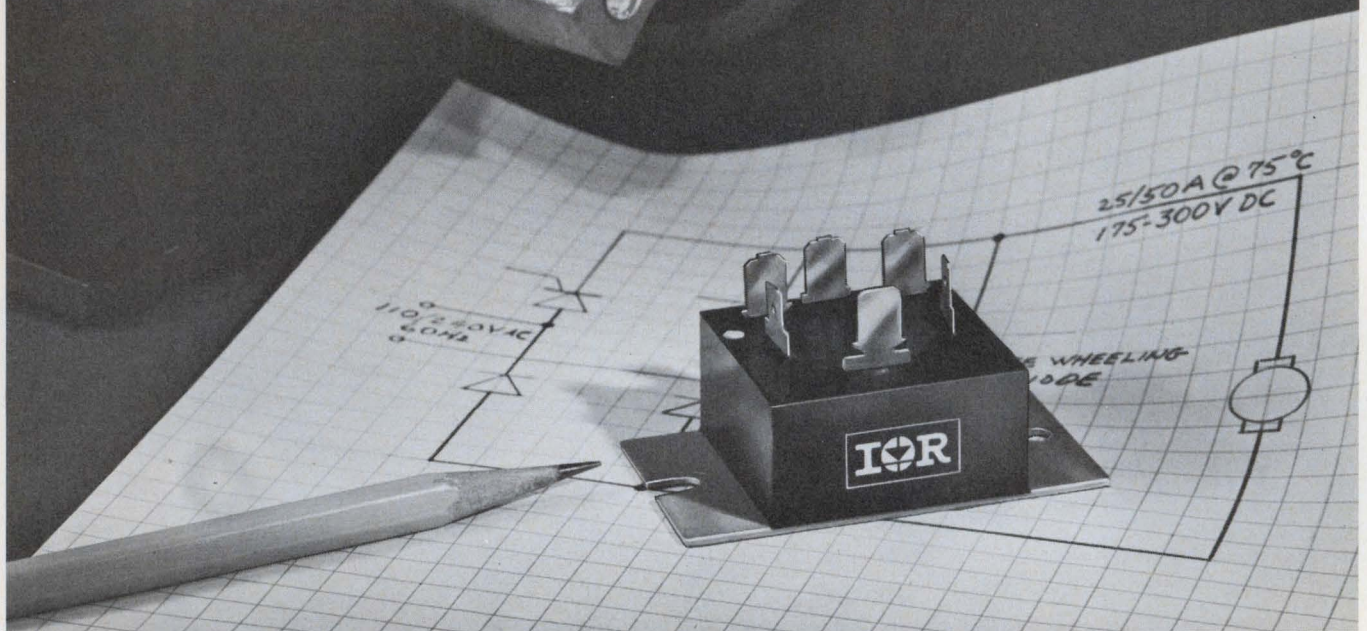

Handle just that, or more, with IR's new PACE/pak™ Passivated Assembled Circuit Elements... first to operate directly from 110-to-240 VAC lines!

Combining long-term know-how in fabricating power semiconductor devices, with advanced passivation methods and the use of proprietary thick-film techniques, IR now introduces a unique series of solid-state encapsulated power circuits. The first such units available, PACE/paks offer a host of benefits for power applications such as: DC motor drives, solid-state circuit breakers, power supplies, generator exciters, welding controls, inverters, chopper drives and heating controls. ■ They provide a number of advantages over conventional power circuits. For example, the savings in assembly and heat-sink costs alone can amount to 50% or more, not to mention as much as a 7-to-1 reduction in piece-

part inventories! And, as fewer interconnections are required, their reliability is greatly extended. In addition, their high thermal efficiencies, electrical isolation and compact, convenient packaging make them ideal for any power design requirement where peak-power-performance, low cost, small size and high reliability are prime requisites. ■ They operate directly from 110-130 or 210-240 VAC and can easily handle current loads in the 50-100 Amp range. IR anticipates fabricating PACE/paks with outputs of up to 800 Amps for 440 Volt line application, in single or three-phase configurations. ■ Contact your local IR representative or write to us now . . . and find out how to optimize your own power equipment!

**INTERNATIONAL RECTIFIER**



Semiconductor Division, 233 Kansas Street, El Segundo, California 90245, Phone (213) 678-6281

INFORMATION RETRIEVAL NUMBER 12

INFORMATION RETRIEVAL NUMBER 13 ►



Unimax lighted pushbutton controls offer you the broadest variety of styles in a wider choice of displays, colors, illuminations and actuations. From simple pilot light applications to the most sophisticated split face switch or circuit breaker, you'll find a Unimax LPB to meet your requirements—with Unimax quality and reliability built-in. At competitive prices.

**Series 2:** A high-rated (5 amps, 250 volts a-c or 28 volts d-c) lighted or unlighted pushbutton switch, available as momentary or alternate action and offering matching indicators. Small in size and price.

**Series 5:** A versatile two lamp double pole lighted pushbutton switch, momentary or alternate action, that can either transmit or project color in full or split display. High rating. High candlepower. Choice of front panel snap-in or sub panel hard mount. Low price.

**Series 9:** Highest quality 4 lamp switch meeting the requirements of MIL-S-22885. Single screw mounting, simple front of panel relamping and wide choice of lamp circuits. One to four pole switching. Features and options not available in any other switch.

**Series 9C:** All the advantages of the Series 9, with the switching mechanism replaced by a hydraulic-magnetic tripping action circuit breaker.

**EAO Series 01, 02, 03:** Just introduced, these economical products are available in round, square and rectangular styles. Up to three pole switching in momentary or alternate action or as indicators, key lock or mushroom cap models. Ratings and electrical and mechanical performance are uniformly high.

# Unimax Switch CORPORATION

A Riker-Maxson Subsidiary / Ives Road, Wallingford, Conn. 06492

Dept. ED-10

Gentlemen:

I'm impressed.  Please have your representative contact me for a demonstration.  Please send information on the following LPB lighted pushbutton controls: Series \_\_\_\_\_

My application: \_\_\_\_\_

Name \_\_\_\_\_ Title \_\_\_\_\_

Company \_\_\_\_\_

Address \_\_\_\_\_

City \_\_\_\_\_ State \_\_\_\_\_ Zip \_\_\_\_\_

## We have more LPB's going for you than anyone else.

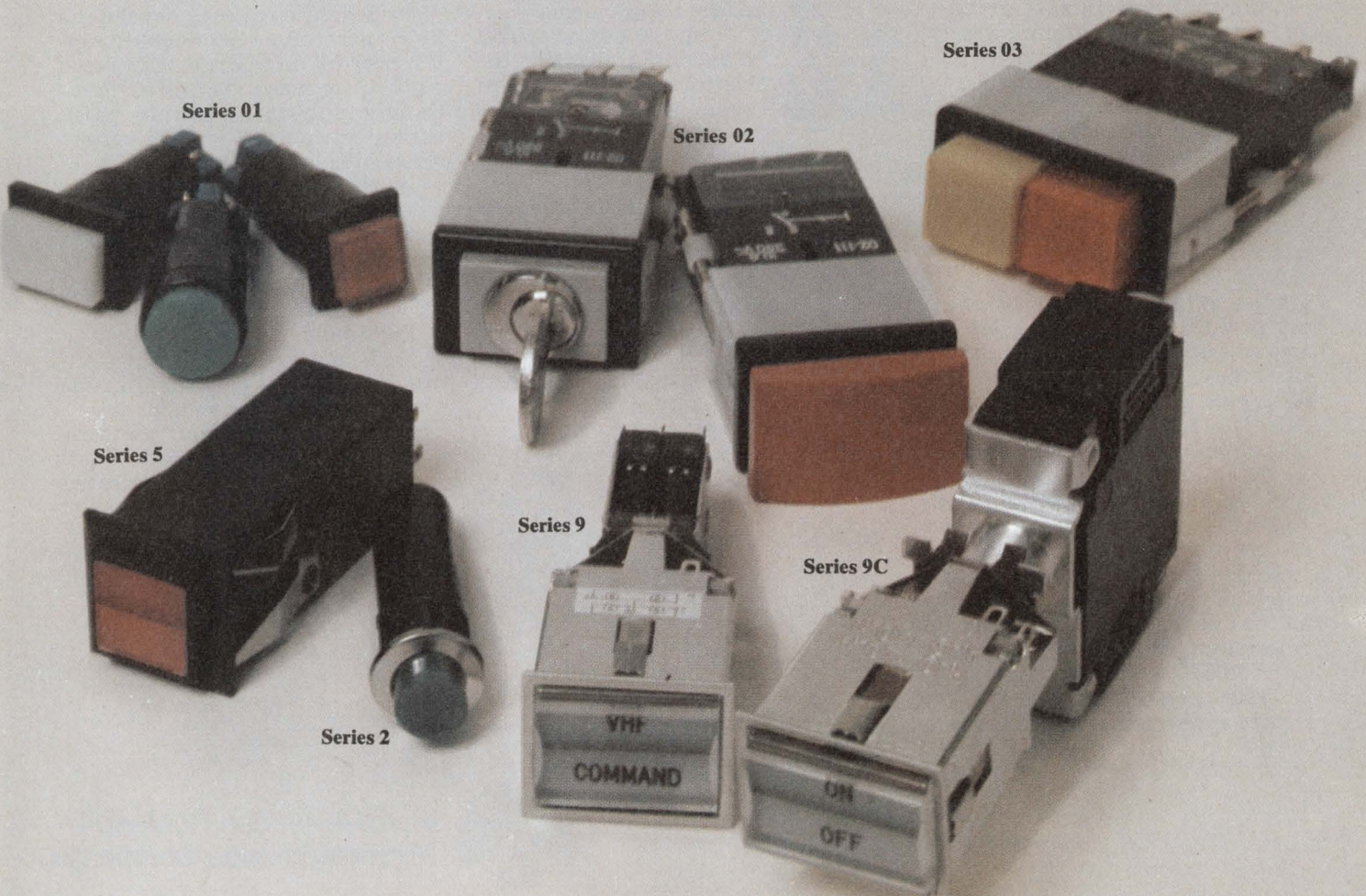



# LET MOS/LSI EXPAND YOUR THINKING- AND YOUR MARKETS.

Looking back two short years, we recall the first commercial use of our MOS/LSI electronics—a multimillion dollar contract to supply microelectronic circuits for desk-top calculators.

Since then, we've designed hundreds of other MOS/LSI circuits. With production running in the millions each year.

Today, under contracts with some 20 major companies, we're working on nearly 30 product programs—applications of MOS/LSI technology for automobiles, trucks, appliances, business machines, musical instruments, computer peripherals, cash registers, calculators, data transmission and telecommunication equipment.

A couple of examples.

Right now we're working with Victor Comptometer Corporation on its development of a completely new line of business machines and calculators. And we supply the circuits for the musical computer of the new Allen electronic organ.

**MOS/LSI reduces systems costs more than 50%.**

Size and weight reductions alone

would be sufficient incentive for using our MOS/LSI technology. So would greater product reliability. So would lower power requirements.

But, in business, cost reduction is usually the key consideration. The cost of our MOS/LSI systems is as much as 50% that of conventional electronic or electro-mechanical systems.

You'll get the other advantages as bonuses, along with the savings.

### **The state of the art— by its innovators.**

Our MOS/LSI technology includes many kinds of digital systems and circuits: switching, arithmetic, counting, driving, multiplexing, digital-analog and analog-digital

conversion, frequency generation and discrimination, digital filtering, modulation, demodulation, and memories of different types.

And right now we're developing future generations of microelectronics: new MOS processes, advanced packaging methods, multi-layer ceramic substrates, nitride passivation, silicon on sapphire, liquid crystal displays and more.

### **A joint product commitment.**

As part of NR's Electronics Group, we're ready to share with you the long-term commitment required for new product design, testing and development.

Even more.

We'll join you in product planning, so that you may share in the progress of current research.

Drop us a line on your company letterhead for a copy of our

new brochure, "The Economics of Change." Write: C.D. Chambers, P.O. Box 3669, Anaheim, California 92803.

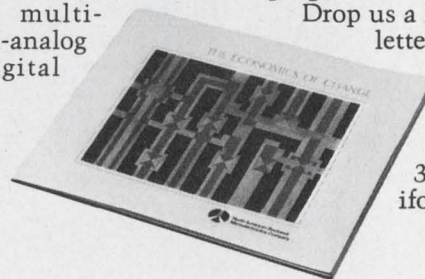
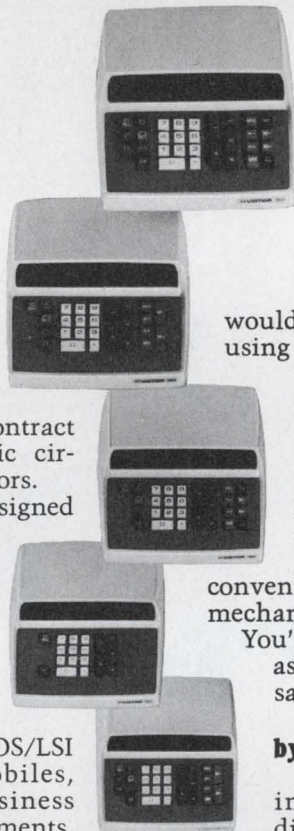

**North American Rockwell  
Microelectronics Company**



# Simpson® has the world's largest selection of

## PANEL METERS and METER RELAYS

OVER 1500 RANGES, SIZES AND TYPES IN STOCK AT ELECTRONIC DISTRIBUTORS NATIONWIDE



**WIDE-VUE**  
1 1/2", 2 1/2", 3 1/2", 4 1/2", 8"



**DESIGNER SERIES**  
3 1/2", 4 1/2"



**NEW CENTURY SERIES**  
1 1/2", 2 1/2", 3 1/2", 4 1/2"



**BOLD-VUE**  
2 1/2", 3 1/2"



**RECTANGULAR**  
2 1/2", 3 1/2"  
round style available

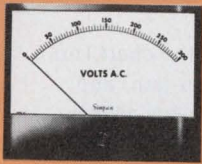

**RUGGED SEAL**  
3 1/2", 4 1/2", 4" x 6"



**STANDARD EDGEWISE**  
1 1/2", 2 1/2"



**STACKABLE EDGEWISE**  
1 1/2", 2 1/2"



**NEW 3 1/2" STACKABLE EDGEWISE METER**

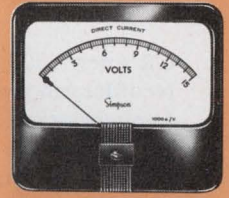

**RECTANGULAR**  
4 1/2"



**DIGITAL**  
Model 2800



**PYROMETERS**  
4 1/2"

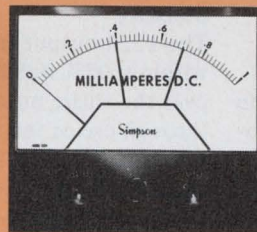

**METER RELAYS**  
3 1/2", 4 1/2", 4" x 6"



**NEW 3 1/2" EDGEWISE CONTROLLER**  
Many features.  
Request Bulletin C1206

- THE ABOVE PANEL METERS ARE AVAILABLE IN AC/DC VOLTMETERS, AMMETERS, MILLIAMMETERS, MICROAMMETERS . . . DC MILLIVOLTMETERS AND GALVANOMETERS . . . RF AMMETERS AND MILLIAMMETERS.
- METER RELAYS AVAILABLE IN DC MICROAMPERES, MILLIAMPERES AND MILLIVOLTS . . . AC AMPERES

- MATCHING WATTMETERS, RADIO FREQUENCY, SEGMENTAL, VU AND DB, RECTIFIER AND ELAPSED TIME METERS ALSO AVAILABLE.

- SIMPSON CAN MAKE CUSTOM PANEL METERS AND METER RELAYS TO YOUR SPECIFICATIONS. ANY PRACTICAL RANGE CAN BE SUPPLIED. SEND US YOUR REQUIREMENTS.

GET "OFF-THE-SHELF" DELIVERY FROM YOUR LOCAL ELECTRONIC DISTRIBUTOR. WRITE FOR NEW CATALOG 4100.

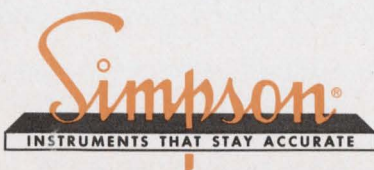

### SIMPSON ELECTRIC COMPANY

5200 W. Kinzie St., Chicago, Ill. 60644 • (312) 379-1121 • Cable: SIMELCO

IN CANADA: Bach-Simpson Ltd, London, Ontario

IN INDIA: Ruttonsha-Simpson Private Ltd, International House,  
Bombay-Agra Road, Vikhroli, Bombay

INFORMATION RETRIEVAL NUMBER 15



MANUFACTURERS OF THE WORLD FAMOUS SIMPSON 250®



# Clock Us!



## Frequency-Response Recordings Up to 3 Times Faster

GR's new 1523 sweep oscillator/recorder can give you accurate frequency-response plots in 1/2 to 1/3 the time you've been accustomed to. And it gives you 1 Hz-to-500 kHz wide-range capability for only \$3800. You can sweep the full range, or selected portions of it, at output levels continuously adjustable from 500  $\mu$ V to 5 V behind 600  $\Omega$ .

### Speed

The 1523 features a "Constant-Q" mode that sweeps slowly at low frequencies and increases the sweep speed automatically as frequency increases. Many devices require slow sweep speed at low frequencies; Constant-Q lets you take advantage of the fact that, as the exciting frequency increases, the sweep speed can be increased without sacrificing measurement accuracy.

Only GR offers Constant-Q to increase sweep speed automatically for accurate answers in minimum time. An example of time savings is a three-decade analysis starting at a rate of 100 seconds/decade. Measurement time is 300 seconds with constant sweep speed but only 115 seconds with the Constant-Q mode.

### Stability

The 1523 output frequency is stable within 0.05% stability (short term) over the entire measurement range through use of the frequency-synthesizer technique. With this method of signal generation, stability is always a constant percentage of output frequency, a considerable improvement over the older beat-frequency-oscillator technique.

### Recorder Reliability

A stepper motor drives the chart (no gears or clutches to fail or jam) and the disposable cartridge pens deliver easy-to-read, skip-free traces at all writing speeds.

**And for \$400 more . . .** Our 1523-P1 Preamplifier plug-in converts the instrument to a 1 Hz-to-500 kHz high-performance level recorder with 100- $\mu$ V sensitivity and chart speeds from 20 hours/inch to 0.5 second/inch. The -P1 plug-in module includes a continuously adjustable 0-to-70 dB attenuator for maximum resolution.

### Write or Call Today

Do it now! Request complete specifications on GR's 1523 sweep oscillator/recorder from your nearest GR office or from GR at 300 Baker Avenue, Concord, Mass. 01742; in Europe write Postfach 124, CH 8034, Zurich, Switzerland.

Prices net, FOB Concord, Mass.

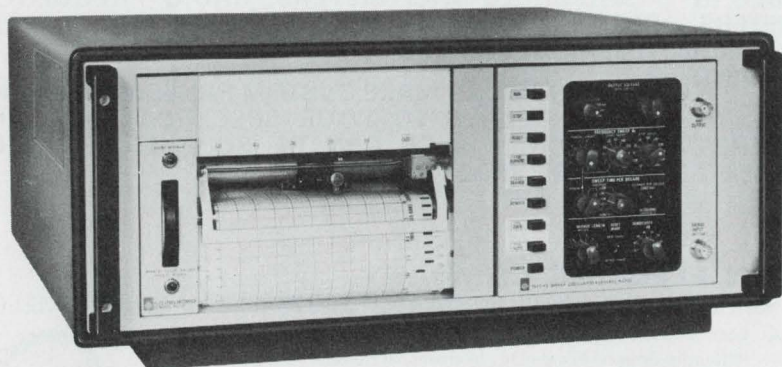

**General Radio**

NEW YORK (N.Y.) 212 964-2722 (N.J.) 201 791-8990 • BOSTON 617 646-0550  
CHICAGO 312 992-0800 • WASHINGTON, D.C. 301 881-5333  
LOS ANGELES 714 540-9630  
TORONTO 416 292-3395 • ZÜRICH (01) 55 24 20  
GRASON-STADLER 617 369-3787 • TIME/DATA 415 327-8322



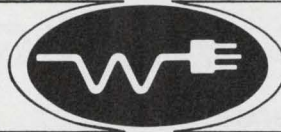

## DC POWER SUPPLIES



ONLY \$16.95  
For 10 Watts\*

\$21.20  
For 20 Watts\*

**Regulated—  
Filtered to 0.3% RMS** \*50-99 quantity

No frills. No fuss. Just the best clean Watts/dollar available. Over 1 Watt per cubic inch and less than 1.6 ounces per Watt make the DPS series your best buy in a supply up to 24 Volts. Overvoltage protection optional. Regulation  $\pm 1\%$ .

Check the table for model numbers. All are in stock for immediate delivery.

Model No.	DC Output	Price
DPS 1	5/6V @ 3/2.5A	\$24.95 (1-9)
DPS 2	12/15V @ 1.5/1.2A	\$23.70 (10-24)
DPS 3	24V @ 0.8A	\$22.45 (25-49) \$21.20 (50-99)
DPS 5	5/6V @ 1.5/1.2A	\$19.95 (1-9)
DPS 6	12/15V @ 0.8/0.6A	\$18.95 (10-24)
DPS 7	24V @ 0.5A	\$17.95 (25-49) \$16.95 (50-99)

Circle Reader Service Number 111 for Data

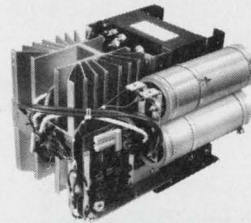

ONLY \$126.00  
For 300 Watts\*

\$166.00  
For 600 Watts\*

\$268.00  
For 1200 Watts\*  
\*50-99 quantity

**High Power 0.1% Regulation**

Workhorses. Brute series I, II, and III put out  $\pm 0.1\%$  or 50 mV regulated power continuously adjustable over either 2-25 or 5-50 Volt ranges. Ripple is less than 1% or 500 mV. Adjustable current limiting protects against overloads and shorts while providing  $\pm 1\%$  current regulation. Options include precise voltage adjust, ripple reduction, overvoltage protection kits.

Check the table for models. Available from stock.

Model No.	DC Output	Prices		
		1-9	10-24	25-49
Brute I	5-50/2-25V/6/12A	\$148.00	\$141.00	\$133.00
Brute II	5-50/2-25V/12/24A	\$195.00	\$195.00	\$176.00
Brute III	5-50/2-25V/25/50A	\$315.00	\$295.00	\$284.00

Circle Reader Service Number 112 for Data

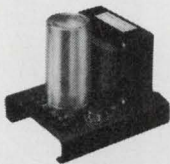

ONLY \$51.00  
For 60 Watts\*

**Regulated—  
Filtered to 0.1% RMS** \*50-99 quantity

The rugged, most popular off-the-shelf supplies in industry. Available in 8 standard DC output voltages. All have  $\pm 1\%$  load/line regulation and built-in overload and short circuit protection through automatic foldback current limiting. Overvoltage protection is optional.

Check the table model numbers. All are in stock for immediate delivery.

Model No.	DC Output	Price
I-OEM-5-5	5V, 5A	
I-OEM-6-5	6V, 5A	
I-OEM-10-5	10V, 5A	\$60.00 (1-9)
I-OEM-12-5	12V, 5A	\$57.00 (10-24)
I-OEM-15-4	15V, 4A	\$54.00 (25-49)
I-OEM-18-3	18V, 3.3A	\$51.00 (50-99)
I-OEM-24-2.5	24V, 2.5A	
I-OEM-28-2	28V, 2.1A	

Circle Reader Service Number 113 for Data

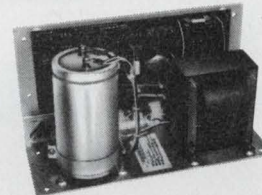

ONLY \$76.00  
For 60 Watts\*

\$116.85  
For 120 Watts\*  
\*50-99 quantity

**0.1% Regulation 1 mV Ripple**

Precisely regulated and filtered. The economical solution to powering OEM systems, ICs, MOS/FETS and op-amps. Standard built-in features include current limiting overload. Short circuit and overvoltage protection, and remote sensing. 120 Watt units also feature series blocking diode for inductive loads.

Check the model numbers. Available from stock.

Model No.	DC Output	Price
III-OEM-5-5	5V @ 5A	
III-OEM-12-5	12V @ 5A	\$89.50 (1-9)
III-OEM-15-4	15V @ 4A	\$85.00 (10-24)
III-OEM-18-3	18V @ 3.3A	\$80.50 (25-49)
III-OEM-24-2.5	24V @ 2.5A	\$76.00 (50-99)
III-OEM-28-2	28V @ 2.1A	
III-OEM-5-10	5V @ 10A	\$137.50 (1-9)
III-OEM-12-5	12V @ 10A	\$130.60 (10-24)
III-OEM-24-5	24V @ 5A	\$123.75 (25-49) \$116.85 (50-99)

Circle Reader Service Number 114 for Data

Call your nearest  
**WANLASS**  
regional office

Albuquerque (505) 247-0458  
Boston (617) 245-5100  
Buffalo (716) 874-4900  
Chicago (312) 392-7370

Cleveland (216) 486-0782  
Dallas (214) 235-3600  
Dayton (513) 293-8095  
Denver (303) 424-5574

Detroit (313) 476-9161  
Hartford (203) 233-5503  
Los Angeles (714) 838-4419  
Minneapolis (612) 333-4511

New York City (201) 444-1400  
Rochester (716) 544-5580  
Seattle (206) 455-3460  
Washington, D.C. (301) 587-3910

WANLASS has 70 stocking distributor locations—one near you.

Allied • Cramer • Intermark • Olive Radio • Newark • Philadelphia Electronics • Pioneer • Radio Products • Stark • Summit • T.I. Supply • Zack

## WANLASS

DIVISION OF

**AMBAC**

Main Plant: 525 Virginia Drive, Fort Washington, Pa. 19034

Phone toll free (800) 523-1882 (in Pa. and Canada call (215) 643-6161 collect)



# DESIGN ENGINEERS—WE'VE GOT YOUR NUMBER

Whether It's Eye-easy Phosphorescent Display Tubes or Crt's and It'll Show You a Thing or Two in Quality, Performance, and Other Important Advantages That Constitute a Big Seeing-Is-Believing Difference

EXCITE  
YOUR  
CREATIVE  
APPETITE

Variety is the spice of life — and here it is on a silver platter. Legi variety comes big so you can design big, and it comes small so you can design small. The choice is yours. But the latitude in physical size isn't all you get with Legi. You also get important quality and performance advantages. Legi phosphorescent display tubes meet portable and circuit-board mounting requirements, have a readout as bright as day, and a dynamic life of 100,000 hrs; 'Multi-Legi' is our special package deal for display electronics system designers; Legi compact decoders and drivers are more designer specials in separate, composite, and Bipolar MOS types; and Legi picture perfect picture tubes let you design from 9" to 5-1/2" down to pocket-size 3" spec. There's a lot more you should know about Legi, if you don't know already. Write today for full particulars, and we'll show you how it pays to think Legi when you're thinking new systems. The spice of life is yours. Now.

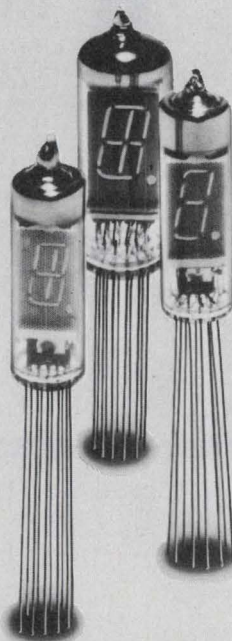

## SPECIFICATIONS (pulse operation)

TYPE	Filament Current <i>I<sub>f</sub></i>	Filament Voltage <i>V<sub>f</sub></i>	Phosphor Segment Voltage <i>V<sub>ps</sub></i>	Control Grid Voltage <i>V<sub>cg</sub></i>	Phosphor Segment Current <i>I<sub>ps</sub></i>
DG12M	85	#1 0.8 ± 10%	50	#2 50	4
DG12H	85	#1 0.8 ± 10%	50	#2 50	3
DG19E	95	#1 1.7 ± 10%	55	#2 55	4
Unit	mA	Va. c	Vd.c	Vp-p	mAp-p

TYPE	Control Grid Current <i>I<sub>cg</sub></i>	Phosphor Segment Cut-off Voltage <i>V<sub>psoc</sub></i> (MAX.)	Control Grid Cut-off Voltage <i>V<sub>cgoc</sub></i> (MIN.)	Brightness
DG12M	19	0	-4	150
DG12H	18	0	-4	150
DG19E	22	0	-4	150
Unit	mAp-p	V	V	Ft-L

#1 Effective Value at 50 or 60 Hz A.C.  
#2 Pulse condition—Duty Factor 1/16 pulse width 60μsec.

*Legi* Sole U.S. Agent

## LEGI ELECTRONICS CORPORATION

3118A, West Jefferson Blvd. Los Angeles, California 90018, U.S.A.  
Tel: (213) 733-9105

**ISE** The Brighter Side of Electronics

## ISE ELECTRONICS CORPORATION

P.O. Box 46, Ise City, Mie Pref., Japan  
Phone: Mie (05963) 2-4944, (05963) 5-2121



# OUR ANGLE: angle position indicators that do more and cost less

## SHOULDN'T YOU TAKE A NEW READING ON THIS COST-PERFORMANCE ANGLE?

For better ways to measure synchro and resolver data, North Atlantic offers the best of both worlds: budget prices for the popular API-8025; superior performance and increased capability of the new 8525. • Both are interchangeable without any mechanical or wiring modifications. North Atlantic's solid-state 8525 offers an accuracy of 0.05° (3 minutes). Following a 180° step input, it synchronizes a five-digit NIXIE readout in 1/2 second flat. And it tracks at up to 1000° per second. Where cost can be traded against performance, the proven electromechanical API-8025 . . . a recognized indus-

MODEL 8525



MODEL 8025

try workhorse . . . is available with its 6 minute accuracy, 25°/second slew speed, and many options. • Input of the 8525 is any 60 or 400Hz resolver/synchro data from control instrumentation. The patented servo design eliminates all inertia and improves dynamic performance many times over. Its digital outputs are especially suited to the computer-oriented requirements of today's automatic test systems. The 8525 . . . priced at \$1885 . . . and the API-8025 priced at \$995 actually cost less because they perform more functions per dollar. And with greater reliability. ®

For complete information on the cost-performance angle, please write or phone now.

**NORTH ATLANTIC**  
*industries, inc.*

200 TERMINAL DRIVE, PLAINVIEW, NEW YORK 11803  
cable: noatlantic / twx: 510-221-1879 / phone: (516) 681-8600

INFORMATION RETRIEVAL NUMBER 19



# Analogic's leadership

in A/D converters & systems  
lets you select exactly what you need  
...at the right price...in the right package  
...from 211 standard designs

## 81 MODULES

Analogic's line of modules covers a broad spectrum of ADC's, DAC's, MUX's, Sample and Holds, Amplifiers, Power Supplies and References in a wide price/performance mix. The exclusive Modupac™ design has the lowest profile (1" x 2", 2" x 2" or 2" x 4" x .39"), is sealed, shielded and pin-compatible. TYPICAL DESIGNS: **2900 Series:** ADC's 8-13 bit hybrids, state-of-the-art speed (to 0.2 $\mu$  sec/bit), linearity, stability, and accuracy. **2800 Series:** ADC's 8-14 bit, lowest cost in 1.2 $\mu$  sec/bit class, state-of-the-art accuracy, linearity, stability. **2600 Series:** Lowest cost integrating ADC's for general purpose instrumentation. Options:  $\pm 100$  mV f.s., binary output coding, current source for transducer offset, ratio mode. **2300 Series:** Analogic's exclusive 3-stage (autozeroed) integrating ADC, 40,000-count resolution fully supported by high stability and linearity, lowest cost ever for 15-bits — plus-sign.

**1900 Series:** 8-16 bit, very high speed current switching DAC's and 8-15 bit "glitchless" DAC's for display application. **1800 Series:** Low cost, computer grade 8-12 bit DAC's. **4100 Series:** General purpose, high-level MUX's and low-level, flying capacitor, 4-channel differential MUX's. **270 Series:** Very high speed, high performance S/H. **200 Series:** High level, single ended and buffer amplifiers.

## 118 CARDS

All Analogic Modupacs are available mounted on cards . . . and in addition, all other components necessary to construct sub-systems or complete systems are available in compatible card formats, i.e. timing generators, multiplexers, decoders, D/A address decoders, counters, etc. Same wide range of price/performance mixes in every class. TYPICAL DESIGNS: **2700 Series:** 12-15 bit, ultra-high-speed ADC's, 0.015% accuracy (15 bit), 1.1 $\mu$  sec/bit, 3-card assembly on motherboard.

## 6 DATA CONVERSION SYSTEM FAMILIES

Analogic is the largest supplier of complete data-conversion systems to the process control and computer markets. These systems are the lowest cost method of assembling Modupacs and cards *in completely tested systems*. They offer modular flexibility, field expandability, computer compatibility, card level maintainability. TYPICAL DESIGNS: **5800 Series:** A major breakthrough in data-conversion systems. 3 $\frac{1}{2}$ " rack package holds: 64 MUX channels, ADC, S/H, Amplifier, Plug-Plug Computer Interface, 8 DAC's, Power Supplies, Supervisory/Interrupt/Override control panel. "Universal Motherboard" construction saves \$1,500-\$2,500/system.

**5900 Series:** Low Level MUX/ADC Systems, essentially the same capabilities as 5800's but for submillivolt signals. Optimized guarding, isolation CMR. Optional: 4-decade gain programming, very high CMV filters. **5000 Series:** MUX-Expanders to 128 channels; include address decoder, power supply, channel-expansion circuits. **AN5116:** Modular Data Acquisition System; single module includes 16 channel MUX, S/H, up to 12 bit ADC, 5V to  $\pm 15$ V. power supply, and all necessary timing and decoding components. **5200 Series:** Simultaneous Sample and Hold Systems; arrays of 8-24 S/H's, plus timing generator, power supply. **7200 Series:** Multi-channel DAC Systems; up to 24 DAC channels, power supply, decoder. **5300 Series (IDS):** Industrial Digitizing Systems. Universal Motherboard uncased or in half-rack enclosure, accepts up to 9 analog and digital modules. OEM savings up to 50%. Provides dozens of computing data-manipulating functions, including auto-zero, auto-tare, unit multiplication, multiple-limit comparison, etc. 5-decimal digit resolution, compatible accuracy, stability. Fully guarded and isolated.

For prompt, informed, professional assistance on every data-conversion requirement . . . call Dick Conant or Perry Pollins at (617) 246-0300 TWX (710) 348-0425 . . . write . . . Analogic Corporation, Audubon Road, Wakefield, Massachusetts 01880.

**ANALOGIC** ■

..The Digitizers

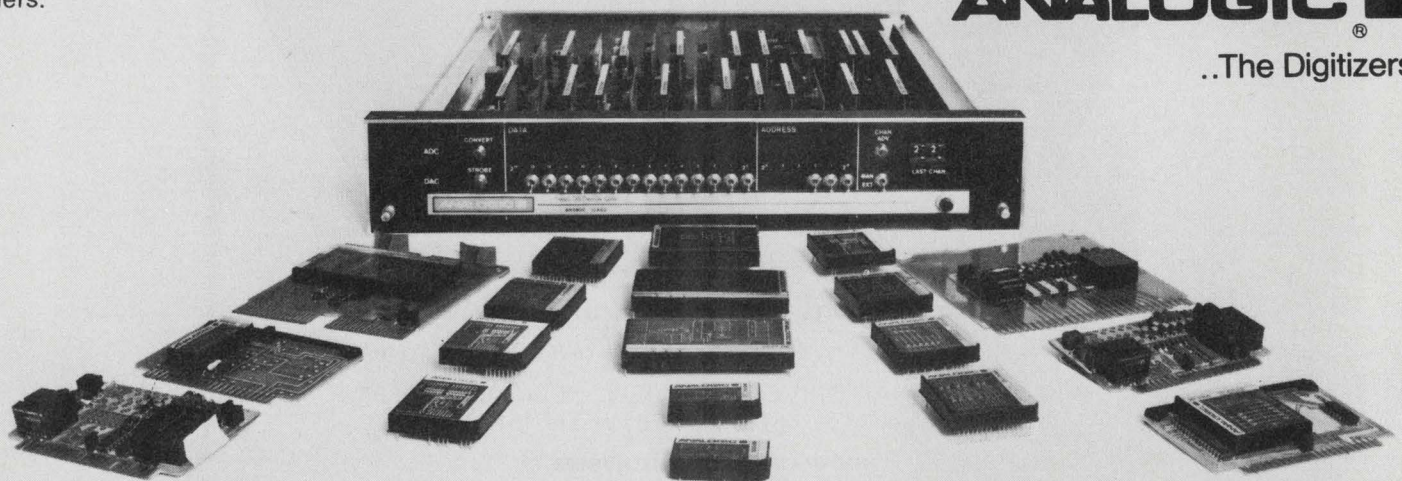



## IEEE strengthening show to boost lagging attendance

The IEEE expects the decline in attendance at its annual International Convention and Exposition to continue this year, but it plans to do all it can to hold the drop to a minimum.

In a preview briefing for the trade press, J. Howard Schumacher Jr., convention manager for the IEEE, said that only about 30,000 engineers were expected this year at the Coliseum Show in New York City, compared with about 37,000 last year and nearly 48,000 in 1970. The show will run from March 20 through March 23.

In an effort to combat declining attendance, this year's show will have a new Science/Technology Center, and the technical program has been strengthened to attract both the high-level specialist and the engineer interested in general knowledge.

The Science/Technology Center will occupy the entire fourth floor of the Coliseum and will contain invited exhibits from leading companies, such as United Aircraft, General Telephone and Electronics, General Electric and, for the first time at an IEEE show, the Ford Motor Co. These exhibits will consist of research projects under development.

United Aircraft will show its Powercell, a fuel cell successfully used in the Apollo program, while GT&E will have an electronic painting exhibition and a magnetic-bubble demonstration. GE's plans are still indecisive.

Ford will show an engine-exhaust sensor, with feedback to the carburetor, for controlling air pollution by cars, and it will demonstrate a sodium sulphur battery that promises higher energy densities than those available in present auto batteries.

The technical program for the IEEE show will revolve around the

theme "New Horizons for Engineering." According to Jack L. Jatlow, chairman of the technical program committee, the aim is to stir interest in areas previously ignored, to a large extent, by engineers. These include the legal aspects of engineering, economics, transportation and the environment, to name a few.

Of the 79 technical sessions planned, 55 will be state-of-the-art reports, to be given in the New York Hilton. The remaining 24 will be "how to" sessions in the Science/Technology Center. The latter sessions will zero in on everyday problems faced by engineers and marketing managers in such areas as the application of minicomputers, MOS user problems, ICs for power and microwave applications, and marketing techniques. In addition there will be a session on "Financing Young Companies."

"An important new feature of each technical session," Jatlow said, "is that the number of papers has been limited to three or four, leaving sufficient time for a panel discussion in each session."

Along with the regular technical program, there will be a four-day seminar on "Engineering in the Hospital," to be held at the Americana Hotel. Organized by Henry S. Littleboy, technical director of medical engineering at Massachusetts General Hospital, the program will cover medical engineering, electronic patient-monitoring techniques and reliability requirements.

### Bipolar device enters desk-calculator field

A bipolar integrated circuit is invading MOS country with what its manufacturer believes are a number of advantages over MOS.

Using the CDI process (collector

diffusion isolation), the bipolar IC will go into a new desk calculator being built by Sumlock Anita, Ltd., in London.

The CDI process, first pioneered by Bell Laboratories in New Jersey, was later refined by Ferranti, Ltd., in Manchester, England, where the bipolar IC is being manufactured under a \$1.25-million order. Ferranti says it's the first breakthrough of bipolar devices in the modern desk-calculator field. Until now, these new, sophisticated machines have been designed with MOS circuits.

The bipolar CDI IC, Ferranti says, has a greater switching speed than its MOS counterparts. Its plastic packaging is simpler and cheaper than the ceramic required by surface-sensitive MOS devices. And the bipolar device will provide the high density of MOS circuits without the corresponding high voltages that an MOS must have, Ferranti says.

The CDI circuit operates with a 1-to-5-V power source, which permits the use of a cheaper, low-voltage battery with a longer operating life.

The Anita calculator will operate with a single chip. And while the company declines to reveal the size of the chip because of proprietary interests, it is known that Ferranti has not made CDI chips smaller than 140 by 140 mils.

"This new bipolar LSI technology," Ferranti says, "could well provide the first high performance 'computer on a slice', or maybe on a single chip."

The cost of the bipolar chip is also secret at this time, but, a company spokesman says, "It compares favorably with the cost of MOS circuits."

### 9 new minis offered by General Automation

Nine new minicomputers have been introduced by General Automation, Inc., in the race for position in the flourishing minicomputer market.

The new models of the Anaheim, Calif., company range from "moderate-power computers costing less than \$2000 to the most powerful minicomputer available for general use." The big one costs nearly \$9000.



Six of the computers are based on the design of General Automation's SPC-16 series, and they can handle conventional minicomputer needs. The three others, based on the SPC-12 model, cover control applications.

The SPC-16/40, 16/60 and 16/80 are equipped with a main memory that is expandable in 4-k increments from a minimum of 4096 16-bit words to 16 k. They have a built-in teleprinter control unit and what the company calls an integral I/O package that enables users to expand the peripheral and controller complement of each system up to data channels. Prices on a single unit are \$5550 for the SPC-16/40, \$6550 for the 16/60 and \$8550 for the 16/80.

Models 16/45, 16-65 and 16/85 are designed for the low and high ends of the market, with prices of \$3950, \$4950 and \$6950, respectively. For the low end, the processors can be bought in small economical modules, so buyers can specify only the capabilities needed for their applications.

The low cost for all three models is made possible, General Automation says, by an external I/O packaging scheme that allows buyers to get a 4-k processor with from one to eight I/O controllers, as required, rather than a minimum number of I/O channels, some of which may not be needed. General Automation believes that "bare bones" systems such as this represent a large portion of the low-end minicomputer market.

The new SPC-12 processors, designated 12/10, 12/20 and 12/30, are described as low-cost control computer with up to 16-k of memory and complete software, interfacing and minicontrollers. The systems are priced at \$2980, \$3480 and \$3980, respectively, in single-unit quantities.

## A rising market seen for electrical vehicles

Recent improvements in rechargeable batteries, small dc traction motors and battery chargers, together with increased social pressure for pollution-free equipment, are opening a market for electrical vehicles.

Mark J. Obert, product planning manager of the Automotive Bat-

tery Div. of Gould, Inc., Mendota Heights, Minn., sees all kinds of battery-powered vehicles replacing gasoline-driven counterparts. His list includes driver-operated lawn mowers and garden tractors, golf carts, small vans and buses, commercial sweepers and cleaners, and personnel carriers. He predicts that the number of these vehicles in use in the U.S. will increase from 58,000 in 1971 to 293,000 in 1975.

The market for battery chargers will go up, too, Obert says, from \$3.2-million in 1971 to more than \$13-million by 1975. The total OEM rechargeable battery market will increase from about \$6.5-million in 1971 to over \$24-million in 1975.

Gene Seider, senior electrical engineer in Gould's research and development group, says that the promise of new markets results from technical progress in the last three years, in which the energy density of lead-acid batteries has been increased from 11 to 11.5 watt hours per pound to 13.5 to 14.5 watt hours. This rise has been obtained from the use of newer, more active oxide compounds in the battery plates and high-strength polpropylene for the cases.

The use of new ceramic permanent magnet materials in motors, instead of wound rotors, has resulted in a 20 to 25 % reduction in weight, Seider points out. This amounts to a decrease of from 24 to 33 pounds for motors in the 10-to-15-hp range.

## New metal-vapor laser may compete with he-ne

Metal-vapor lasers—such as the helium-cadmium type—measure several feet in length and are priced well above a thousand dollars. Hence they have been used primarily as laboratory tools for biological and photochemical studies and analyses.

But a Bell Laboratories scientist in Murray Hill, N.J.—W. T. Silfvast—may alter this trend.

He has devised a new helium-cadmium laser—a source of blue and ultraviolet light—that is about 15 inches long, one-fourth the size of conventional metal vapor laser. It has a 2.5-mW output in the ultraviolet range (3250 Å) and emits 12 mW of blue light at 4416

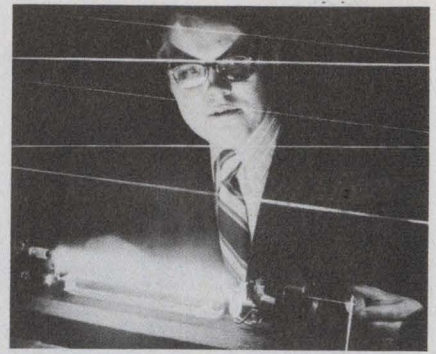

Viewed through beams of metal vapor laser light, Bell Laboratories scientist W. T. Silfvast deflects a coherent blue beam from a new helium-cadmium laser.

Å. This size and consequent price reduction of about one-fourth, he says, could make it competitive as a source of coherent light with helium-neon, one of the most widely used lasers in science and industry today.

The cost of a newly designed he-cd laser should be equivalent to a helium-neon laser of comparable output power, according to Silfvast—\$150 to \$250.

## MOS gyrator replaces conventional inductors

An MOS gyrator has been developed at Marshall Space Flight Center in Huntsville, Ala., by Dr. Erwin Hochmair, a research associate from Vienna.

The gyrator, designed to act as an inductor in an integrated circuit, is capable of providing high inductance in small areas, something not possible with large physical inductors.

While IC gyrators have been produced before, they have always been of the bipolar variety. Thus, they were more difficult to fabricate and consumed more power than the MOS type.

The new gyrator can be made by using either P/MOS or C/MOS technology. The P/MOS version has already been produced and tested and is capable of providing up to 0.2 H of inductance on a 40-by-30 mil chip.

The C/MOS version of the new gyrator, presently in production, uses a larger 80-by-90 mil chip and will be capable of providing hundreds of henrys of inductance, Hochmair says. While the noise is still a bit of a problem this can be overcome Hochmair feels.



# ISOLATION!

## 3 NEW COUPLERS FROM GENERAL ELECTRIC

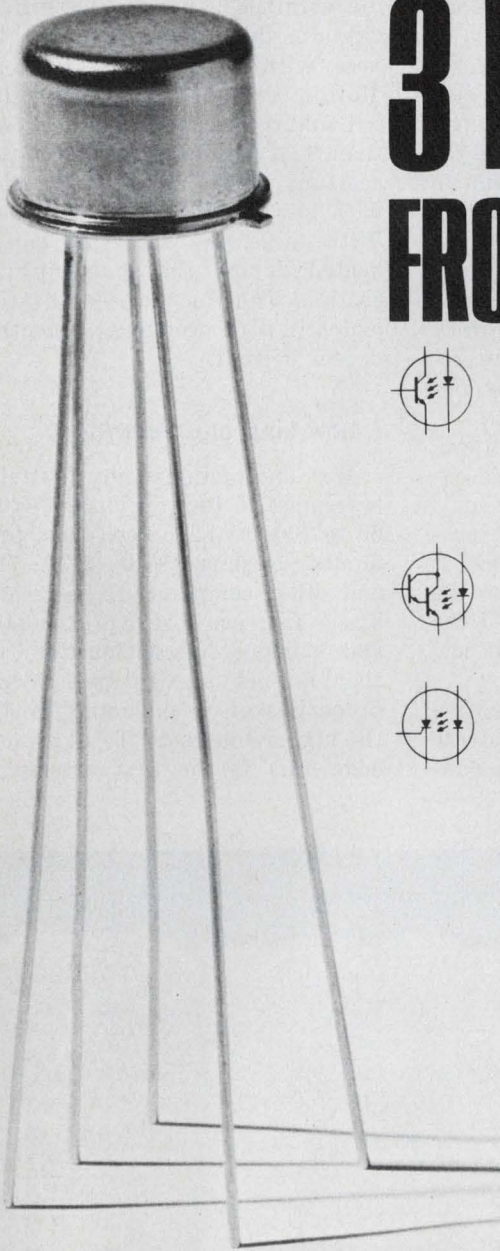

For **SPEED** . . . type **H10A** SSL-Phototransistor Coupler offers typical

- 3  $\mu$ sec turn on time
- 60% transfer ratio
- $\pm 10\%$  variation in transfer ratio — 55 to 100°C



For **GAIN** . . . type **H10B** SSL-Photo Darlington Coupler offers typical

- 500% transfer ratio



For **POWER** . . . type **H10C** SSL-Light Activated SCR Coupler offers typical

- 1 amp output with 15mA input
- 1  $\mu$ sec turn on time

**And** all H10 Series Couplers offer 1000V isolation in a hermetic T0-77 package.

**NEED** 2,500V isolation? Try our PC Series Axial Lead Couplers. PC 4-73 for 125% transfer ratio. PC 15-26 offers 3  $\mu$ sec turn on time.

For the complete story on General Electric Optoelectronics contact any authorized General Electric distributor, or General Electric Electronic Component Sales Office.

**GENERAL**  **ELECTRIC**

Semiconductor Products Department, Syracuse, New York



# High negative bias sputtering: A revolution for thick films?

A new way to produce a thick film deposit that is dense, uniform and controllable within 5%, could revolutionize the manufacture of thick-film hybrids, according to several leading hybrid manufacturers.

The method, which builds a deposit by applying a high negative bias to a substrate while sputtering, was developed at Sandia Laboratories in Albuquerque, N.M.

The operation would, of course, have to be economically competitive with existing techniques, agree Nick Spann, senior engineer at Motorola's Semiconductor Div. in Phoenix, Ariz. and Henry Fenster, manager of the Hybrid Circuit Subsystems Group in RCA's Solid State Div., Somerville, N.J. "Thick-film resistors produced by the conventional screen-print-

ing process now cost about a tenth of a cent each," Spann says.

The cost of mass-producing resistors by Sandia's procedure has not been determined, but its efficiency has, according to Donald M. Mattox, supervisor of Sandia's Surface Physics and Chemistry Div.

Growing deposits by high negative bias would not require trimming, Mattox says, unless very precise resistance values were required. Just how precise has not been determined.

Long used with thin film because of its ability to produce extremely precise thicknesses, sputtering has generally not been successful with thick films because it creates columns rather than the smooth, dense material needed for good structural strength and low electrical resistivity.

But by applying a high negative bias ( $-500$  V) to a substrate while sputtering, scientists at San-

dia obtained a dense, fine-grained film  $6\ \mu$  thick. The potential thickness with a high negative bias, Mattox says, "is a matter of mils."

Usually thicknesses of greater than  $1\ \mu$  are only sputtered successfully when metals and alloys with low melting points are used. With these, the substrate can be heated during the sputtering operation, causing recrystallization, which in turn produces a smoother, denser deposit.

## A new kind of sputtering

Bias sputtering is not new, Mattox explains. "Lower biases—from 50 to 100 V—have been used for a number of purposes by RCA, IBM and other companies. These lower biases increase coverage over steps and surface discontinuities, but they do not modify the physical properties of thick metal films as the higher biases do. To our knowledge, this is the first attempt to

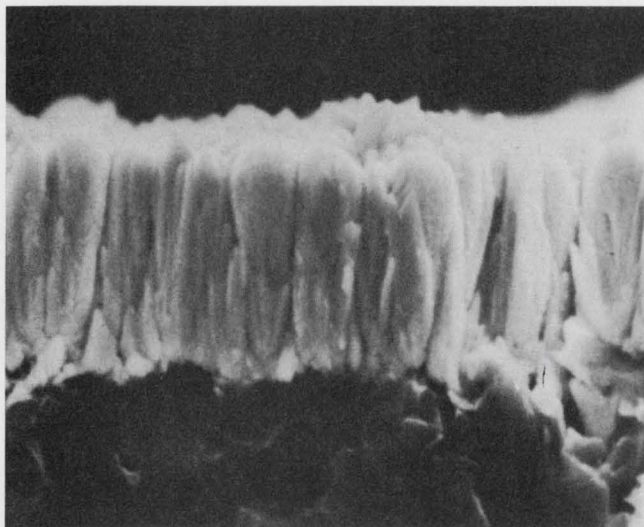

**Sputtering thick films** normally results in columnar material lacking in density and adequate electrical resistivity (left). By applying a high negative bias ( $-500$  V)

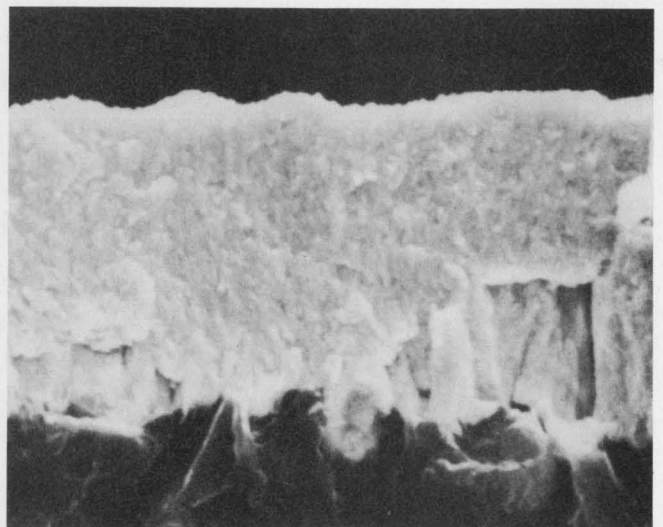

to a substrate while sputtering, Sandia Laboratories produced this dense, smooth, fine-grained film  $6\ \mu$  thick (right). The potential thickness is several mils.



use the higher biases to change the growth of the film and to make it more fine-grained with thicker deposits."

Though Sandia's objective is to build thick-film deposits for their mechanical properties, scientists at the laboratories have also been interested in thick films of refractory metals to cut down their reactions at high temperature.

"If you try to get normal electrode materials, such as platinum, to operate at 400 C or 500 C, it just fuses with the adjacent material and you've lost electrical contact," Mattox says. "Avoiding this is one of our applications."

Sputtering at Sandia is done in

a vacuum chamber at a pressure of from 10 to 100  $\mu$  of argon.

The holder (incorporating the heated or cooled substrate) is separated from the cathode (containing the metal to be deposited) by a gap measuring from 2 to 10 cm across.

This basic configuration is modified by supplying the substrate with a biasing negative potential of up to 500 V. Application of the bias to the substrate causes argon ions to bombard the growing deposit. The ions dislodge metallic atoms from the deposit surface, causing them to relocate and fill in the "valley" vacancies between the growing columns of

materials.

In Sandia experiments, this system produced a highly reflective 6- $\mu$  thick film of tantalum on a carbon substrate heated to 300 C. The density was 16.2 g/cm<sup>3</sup>, compared with 16.6 g/cm<sup>3</sup> for bulk tantalum and 14 g/cm<sup>3</sup> for Ta sputtered at zero target bias. The deposition rate is about as high as that experienced with unbiased sputtering—about 2 mg/cm<sup>2</sup>/hr.

This technique—consisting essentially of ion bombardment during deposition—may be extended to nonmetals and to other deposition techniques, such as chemically vapor-deposited films and electron-beam evaporation, Sandia says. ■

## Laser fax sends newspaper page in 1 min.

A facsimile system that uses a laser beam as a light source can transmit a page of a newspaper in 60 seconds, reportedly with 25 times higher contrast than that of other facsimile systems.

Called Laser Press Fax, the new unit is being offered by Matsushita Graphics Communication Systems, Inc., and Matsushita Research Institute Tokyo, Inc.

The newspaper page (40-cm wide) is scanned optically and divided into 5,200 to 9,600 lines. Each line is further divided into small dots and transformed into electrical signals. These signals are then transmitted via telephone cable and received at the other end of the line. The receiver changes the signals back into light signals, records these on film, and then makes a copy or master proof.

To increase speed in facsimile transmission, the drum revolution speed must be increased. With currently available facsimile systems, the drum transmits one scanned-line per revolution. To make it faster, a correspondingly higher frequency light source is required at the receiving end (100 to 300 kHz). Further, these high frequencies require large currents, which shorten the life of the discharge tube to about 50 hours. Therefore major facsimile systems used in the U.S. and abroad are limited to about 3600 drum revolutions per minute.

Matsushita's equipment uses a He-Ne gas laser beam light source. It is said to last more than 4000 hours, even at 4500 rpm drum speed.

A key element in the new facsimile system is a special acousto-optic light modulator. It consists of a glass block of tellurite coated with lithium niobate. As shown in the diagram, when a high-frequency signal (40 MHz) is applied, the block's index of refraction varies

over a wide range. Therefore the laser beam is intensity-modulated in proportion to the strength of the applied signal.

The tellurite glass is said to have four times greater refraction efficiency—or to pass four times as much light—as the dense flint glass used in conventional facsimile systems. To obtain this brightness, the modulator requires only one-fourth the current that other systems use. ■

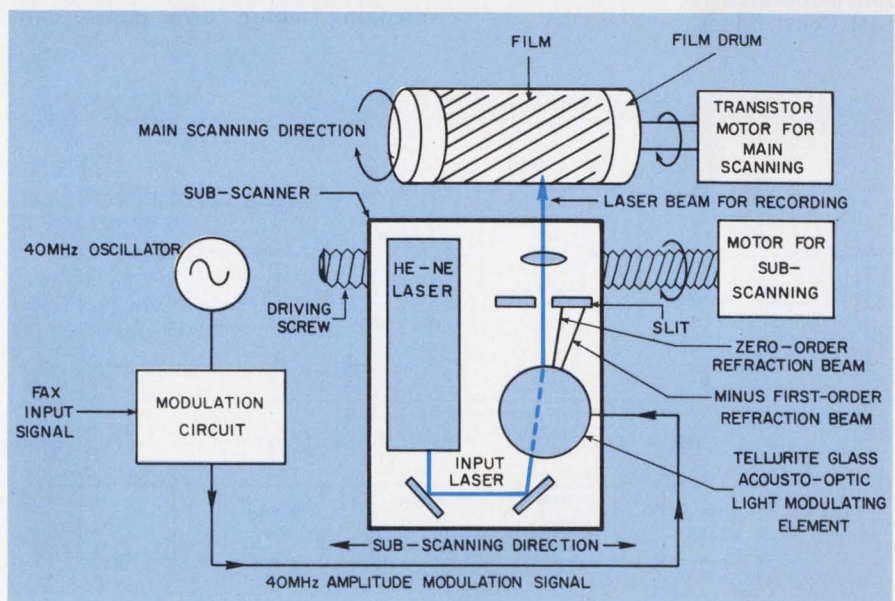

**Laser facsimile system** contains an acoustic-optic light-beam modulator whose index of refraction varies widely upon application of a modulated high-frequency signal.



# Power needs cut dramatically for ocean-floor monitor system

When equipment must go on monitoring duty for a month 18,000 feet below an ocean's surface, low power consumption is not only desirable—it's imperative. Spurred by this requirement, scientists at the University of California of San Diego have designed a seismic monitoring system that cuts the power drain of equipment by orders of magnitude.

The system also has a new seismometer that has higher sensitivity and lower noise than previously attained, according to Dr. William Prothero, research scientist in charge of the project.

The over-all design, developed at the university's Institute of Geophysics and Planetary Physics, has achieved the following dramatic power reductions:

- The standby current needed for the tape recorder is 20  $\mu$ A, compared with 2 to 3 A for conventional models.

- The operating power for the a/d converter is 15 mW, compared with 2.5 W for the average unit.

- The operating power for the data-acquisition and logging system is less than one percent of that used by comparable bipolar systems.

The conservation of power during both standby and operation was made possible by blending standard and unique designs.

- Complementary MOS (CMOS) was used throughout the sensing, monitoring, control and recording electronics, except for the power amplifiers driving the tape recorder reels.

- A special analog-to-digital converter that uses RCA's COS/MOS was designed to operate from a single 12-V supply. It provides its own -12-V supply and draws power only during the actual conversion cycle.

- The recorder, which has an incremental tape drive, has COS/MOS electronics driving the recording head. Its capstan drive, a stepping motor, uses power only

when stepping, and the recording-head current is drawn only when recording. The tape-reel take-up servos are on-off types that use power only when operating.

## Sonar provides communication

The entire system will measure seismic activity on the floors of oceans, initially in the Pacific. To permit scientists on the surface to turn the system on and off; to monitor the operating condition of the various units of the system, and to recall the system from the bottom after a month's recording has been made, sonar communication—a modified Edo 412 Acoustic Telemetry and Command System—is included in the package.

To perform the various remote-control functions, an 8-kHz, frequency-modulated signal is sent down from the surface. The diagnostic system replies with sonar frequency-shifted signals keyed between 13.5 and 15.5 kHz. The surface readout is in digital form.

The complete sub-sea system is

Jim McDermott  
East Coast Editor.

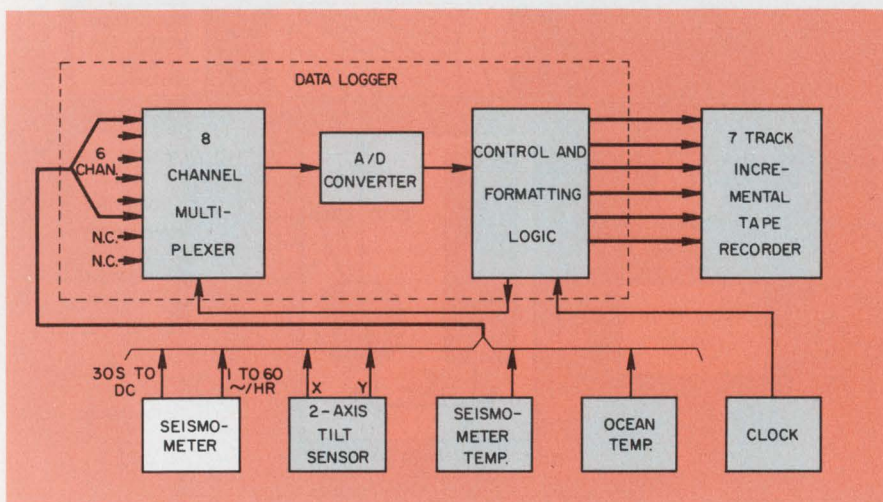

The data acquisition and logging system of the deep-sea seismic monitor feeds a 7-track incremental tape recorder. The recording system can run continuously for over 30 days on the ocean bottom.

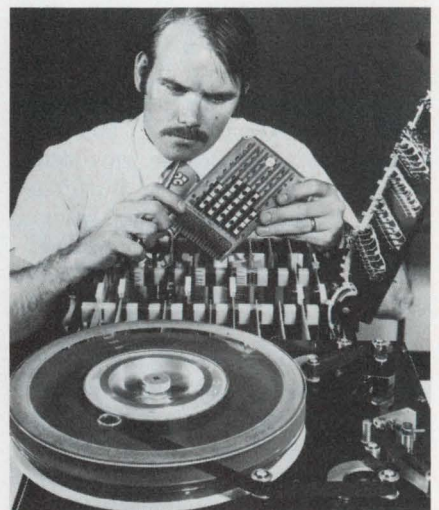

A low-power digital circuit card of the data logging system is checked by James Nick of Honeywell.



# Now JAN high voltage power switching transistors...

it's a point worth repeating.

And they're available from Unitrode — optimized for the best combination of switching speed, saturation voltage and second breakdown to help you design more efficient power switching circuits. The result is performance features like these . . .

Series	$I_C$ (max)	$V_{CE}$ (sus) (min)	$V_{CE}$ (sat) (max)	$E_{SB}$ (min)	$t_{ON}$ (max)	$t_{OFF}$ (max)
2N5660	2A	to 400V	0.8V @ 2A	1.00mj	0.25 $\mu$ s	0.85 $\mu$ s
2N5664	5A	to 400V	1.0V @ 5A	1.25mj	0.25 $\mu$ s	1.50 $\mu$ s

The 2N5660 — 2N5667 series is available in TO-5 and TO-66 packages as JAN and JANTX power switching transistors to MIL-S-19500/454 and /455. Now that the best has been officially accepted, all that's needed is your approval. For fast action, call Sales Engineering collect at (617) 926-0404, Unitrode Corporation, Dept. 1 X, 580 Pleasant Street, Watertown, Mass. 02172.



**UNITRODE**

## Now JAN high voltage power switching transistors...

It's a point worth repeating. And they're available from Unitrode — optimized for the best combination of switching speed, saturation voltage and second breakdown to help you design more efficient power switching circuits. The result is performance features like these . . .

Series	$I_C$ (max)	$V_{CE}$ (sus) (min)	$V_{CE}$ (sat) (max)	$E_{SB}$ (min)	$t_{ON}$ (max)	$t_{OFF}$ (max)
2N5660	2A	to 400V	0.8V @ 2A	1.0mj	0.25 $\mu$ s	0.85 $\mu$ s
2N5664	5A	to 400V	1.0V @ 5A	1.25mj	0.25 $\mu$ s	1.50 $\mu$ s

The 2N5660 — 2N5667 series is available in TO-5 and TO-66 packages as JAN and JANTX power switching transistors to MIL-S-19500/454 and /455. Now that the best has been officially accepted, all that's needed is your approval. For fast action, call Sales Engineering collect at (617) 926-0404, Unitrode Corporation, Dept. 1 X, 580 Pleasant Street, Watertown, Mass. 02172.

**UNITRODE**

## Now JAN high voltage power switching transistors...

It's a point worth repeating. And they're available from Unitrode — optimized for the best combination of switching speed, saturation voltage and second breakdown to help you design more efficient power switching circuits. The result is performance features like these . . .

**UNITRODE**



packaged in three connected 22-inch aluminum pressure spheres. They are set on a frame that also holds ten 12-V lead-acid batteries beneath the capsules to provide system power.

The system is lowered by line, and once on the bottom, the line is cut. The system is equipped to monitor seismic activity, ocean temperature, seismometer temperature and tilt of the package. Data from the sensing instruments is stored on an incremental recorder that has 2400 feet of tape—enough for 33.4 days of continuous use.

During recovery, the spheres disengage from the battery pack on command from the surface and float to the top.

### 3 elements for monitoring

The seismic-monitoring subsystem is comprised of three principal elements: sensing units, the data-converting and logging system and the tape recorder.

The principal sensor is the seismometer, which has a specially designed vertical accelerometer. The mass of the accelerometer is suspended by a quartz fiber, and all operating elements are enclosed in a vacuum.

The seismometer has a bandwidth of from about 1 cycle for every 20 seconds down to dc. Two seismometer outputs are provided for monitoring, one in the band between 1 cycle per every 30 seconds down to dc and another in the band from 1 to 60 cycles per hour.

At a response of 1 cycle per 20 seconds, the noise level (S/N) is roughly equivalent to 10 to 20 microns of ground motion, says Dr. Prothero. This, he points out, is about equivalent to  $1$  to  $2 \times 10^{-9}$  Gs.

To monitor any shift or movement of the stand on the ocean floor—due to large fish bumping the frame or to sediment shift underneath it—a tilt-sensing pendulum is included. A capacitive pickup minimizes power drain and provides high sensitivity and linearity.

Full-scale tilt is  $1^\circ$ , but it can detect as little as  $2 \times 10^{-4}$  degrees of shift of the X or Y axes, which are orthogonal to the vertical.

Thermistors are included for monitoring two temperatures—that inside the seismometer and that of the ocean water.

The data-logging system, developed by Honeywell's Marine System's Center in Seattle, is com-

prised of a multiplexer, which can sample up to eight inputs (only six are used); an a/d converter, which converts the multiplexer outputs to digital form; and control and formatting logic, which converts the digital information to words of two six-bit characters. These characters are fed, together with an added parity bit, to the seven tracks of the incremental recorder.

The total data-sampling cycle takes 64 seconds, with up to eight inputs sampled, one each second for the first eight seconds. For the next 56 seconds, the two inputs from the seismometer are sampled alternately each second.

The a/d converter was designed by Dr. Robert Moore, a University of California staff scientist, in collaboration with James Pastoriza, president of Memodyne Corp., Upper Newton Falls, Mass. Whereas two voltage supplies (+ and -) are usually needed, this converter operates from +12 V dc. However, it generates the -12 Vdc by a special capacitor and clamping-diode circuit. The capacitor provides the -12 V during the 100- $\mu$ s pulse of the conversion period. During the standby portion of the operating cycle, no current is drawn. ■■

## Mobile radio capacity upped 100-fold

A new high-capacity land mobile telephone system being developed by Bell Telephone Laboratories in Whippany, N.J., will be capable of accommodating a half-million mobile units in the same city.

With its present system, Bell is forced to limit its subscribers to several hundred per city to avoid interference.

In the new system a city is divided into a number of small service areas or cells, some as small as two miles in diameter. Each cell is serviced by three low-power transmitter/receiver stations with directional antennas for locating the mobile unit. The mobile units communicate by radio with the stations in their particular cell. These in turn relay the transmissions on by normal telephone lines.

When a mobile unit moves into

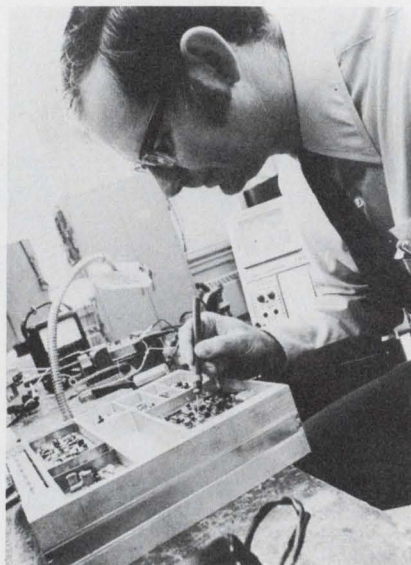

Prototype of mobile telephone unit at Bell Laboratories will be used in a new high-capacity, low-power mobile communication system.

an adjacent cell a centralized control center activates the directional antenna to locate the unit and then assigns it a voice channel in a new frequency—a change the user is unaware of. In this way the same frequency, or channel, can be used in a number of cells throughout the city, provided they are not close enough to permit interference.

Operating on seven channels between 806 and 881 MHz, the propagation is not line-of-sight but takes place by multi-path reflections. Some problems with terrain obstruction can occur but these shadows are minimized by the multiple antennas in each cell. Also the distances are short, Bell says. Development work will continue for the next five years leading to a mobile service offering. ■■



# 15 reasons why Monsanto counts with people who count.

Here are 15 Monsanto counters. Their capabilities are as varied as the requirements of you who read this ad. Frequencies range from DC to 12.5 GHz, prices from \$250 to \$3590.

1.

5 Hz-5 MHz \$250



2.

5 Hz-32 MHz \$475



3.

5 Hz-20 MHz \$350



4.

5 Hz-40 MHz \$575



5.

5 Hz-50 MHz \$695



6.

5 Hz-5 MHz \$795



7.

10 Hz-8 MHz \$815



8.

DC-75 MHz \$895



9.

DC-2.5 MHz \$995



10.

0.1 Hz-20 MHz \$995



11.

5 Hz-150 MHz \$995



12.

5 Hz-512 MHz \$1550



13.

DC-150 MHz \$1285



14.

DC-512 MHz \$1795

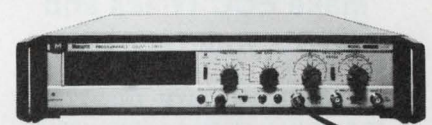

15.

DC-12.5 GHz \$3590

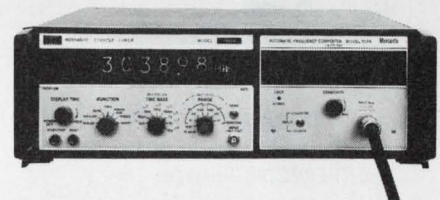

According to an independent, nationwide brand preference survey, we're No. 2 (of 67 counter manufacturers mentioned). Not bad. But not good enough. In the year ahead, we plan to give you even more reasons to specify Monsanto for anything you want to count. Meanwhile, one of the 15 shown here will probably do the job. Write for our catalog and see. Monsanto Company, Monsanto Electronic Instruments, West Caldwell, N. J. 07006.

**Monsanto**



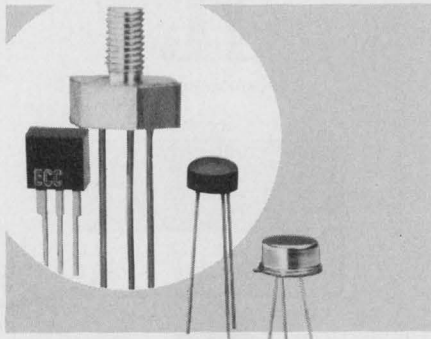

**THE  
LONG  
LINE OF  
ECC  
Sensitive Gate  
TRIACS  
and SCR's**

**Fast delivery and  
competitive pricing  
make ECC Triacs and  
SCR's your best buy.**

**SENSITIVE GATE TRIACS**

TO-5 Metal and Plastic; THERMOPAK\*  
and THERMOTAB® Packages

- $I_{T(RMS)}$  0.8 - 3 amps
- $I_{gt}$  3, 10, 25 ma (all 4 quadrants)
- $I_{TSM}$  20 amps
- $V_{DROM}$  200 - 600 volts

For more information, circle No. 221

**SENSITIVE GATE SCR's**

TO-5 Metal; 5/8" Hex Stud; THERMOPAK  
and THERMOTAB Packages

- $I_{T(RMS)}$  0.8 - 10 amps
- $I_{gt}$  50, 200, 1500  $\mu$ amps
- $I_{TSM}$  50, 100 amps
- $V_{DROM}$  30 - 600 volts

For more information, circle No. 222

All ECC Triacs and SCR's feature heavily  
glass passivated junctions for high re-  
liability.

Detailed technical data on the complete line  
of ECC Triacs and SCR's is available from your  
nearest Sales Representative or Authorized  
Distributor.

\*trademark of ECC

**ECC**  
CORPORATION

P. O. Box 669 • Euless, Texas 76039  
817/267-2601

**technology  
abroad**

An intermediate microwave technique has supplanted precision landing radar in a system recently accepted for NATO's portable instrument approach and landing system. The new system, called the Microwave Aircraft Digital Guidance System, was developed by England's MEL Equipment Co., in collaboration with the Royal Aircraft Establishment and the Mullard Research Laboratories. Transmissions from a beacon in the aircraft are received by a pair of spaced, interferometric antenna arrays in the landing area. The interferometer's receiving system produces outputs from which the aircraft's azimuth angular location and its slant range are obtained. These parameters are derived by comparing the phase difference of the individual antenna elements with a reference phase. Azimuth and elevation data are then transmitted to the aircraft interrogation unit over a data link, for integration and cockpit display. The use of microwave frequencies reduces system noise and also antenna size, for portability. The equipment may eventually be developed as an advanced all-weather instrument landing system for both military and civil aircraft.

CIRCLE NO. 441

A high efficiency diffraction grating for extracting colors from white light has been produced with nematic liquid crystals by West Germany's Siemens. The grating consists of two glass plates each coated with transparent tin oxide electrodes. The liquid crystal is contained between the plates that are held from .3 to 10  $\mu$ m apart with Mylar spacers. As voltage across the plates is increased, the internal structure of the material changes. When this device is sandwiched between crossed-polarizers and white light is shone through it, the crystal produces changes in the color of the transmitted light. The color varies with

a change in voltage. Possible applications are in color displays and controllable optical filters.

CIRCLE NO. 442

A low-noise cathode-ray tube with a high brightness-to-voltage ratio has been adapted by England's EMI Electronics for generating signals from color film for television transmission. The cathode-ray tube, the MX69, gains its improved characteristics from a new phosphor coating. The grain size of the coating is 2 to 5  $\mu$ m, which is much finer than standard phosphor screens. In addition the coating material has been specially processed to minimize grain clustering, which produces noise. EMI says the tube has nearly twice the brightness of conventional tubes used under the same operating conditions. As a result, it can be operated at lower voltages with an accompanying reduction of X-ray radiation. The tube diameter is 125 mm, and has been adapted by EMI for flying-spot scanning of 16 and 35-mm negative color film.

CIRCLE NO. 443

An improved ion-implantation technique for forming high-value linear resistors on silicon substrates has been developed by England's Mullard Research Laboratories. The work, sponsored by the British Defense Ministry, involves the acceleration of neon ions into the region of the silicon resistors on single-chip integrated circuits. Radiation damage from this bombardment reduces carrier mobility and raises resistance. Resistor linearity can be tightly controlled. Mobility reductions of 5 to 1 have been achieved with this technique, and this value remains constant even after annealing at 500 C. Mullard is investigating the application of the technique to both MOS and bipolar circuits.

CIRCLE NO. 444



# Try our straightforward method of reducing fixed resistor costs.

**Uniform manufacturing process results in consistent quality that lowers your installed cost.** And cuts down unnecessary after-purchase expenses. As a result, some of our customers have been able to discontinue incoming inspection. The unique

Allen-Bradley hot-molding process minimizes the variations that make ordinary resistors noisy, thermally sensitive, and poor on power handling ability. If you think all resistors are the same, read: "7 ways to tell the difference in fixed resistors."

Free from your A-B distributor, or write to: Allen-Bradley Electronics Division, 1201 South Second Street, Milwaukee, Wisconsin 53204. Export: Bloomfield, New Jersey 07003. Canada: Galt, Ontario. United Kingdom: Bletchley, Bucks.

**ALLEN-BRADLEY**  
QUALITY ELECTRONIC COMPONENTS





Stackpole's phenomenal  
Ceramag® ferrite bead

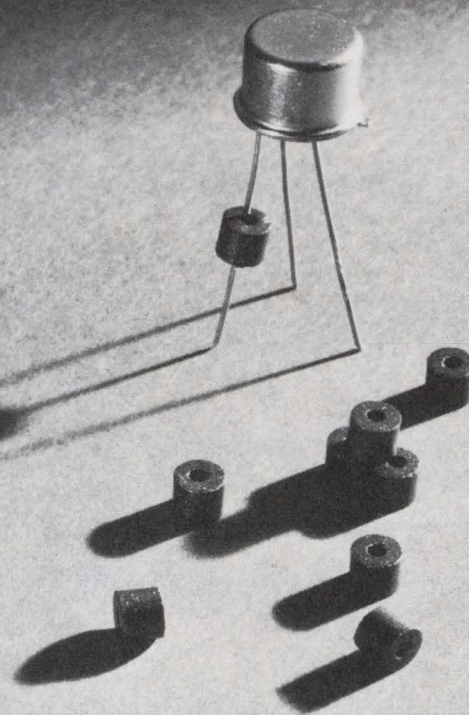

# The Silencers

## Ceramag® Beads Do Away with Noise

Stackpole ferrite beads offer a simple, yet effective means of suppressing spurious RF signals to prevent them from entering areas susceptible to such "noise." No other filtering method is as inexpensive as a ferrite bead.

How can you use a bead? Consider it as a frequency-sensitive impedance (Z) element. Beads are available in a variety of

Stackpole Ceramag® materials. Depending upon the material selected, beads can provide increasing impedances. From 1 MHz to over 200 MHz. Keep in mind, the higher the permeability, the lower the frequency at which the bead becomes effective.

Should a ferrite bead be small? Not necessarily. The unique, giant bead shown below is used by IBM to eliminate the effect of transient noise.

The impedance of Stackpole ferrite beads can be changed by simply varying the length or the O.D.-I.D. ratio.

Installation of Stackpole beads is easy. And inexpensive. Simply slip one (or several) over the appropriate conductor(s) for the desired noise suppression or high frequency isolation.

Additional savings in production time and labor costs are possible by utilizing automatic insertion equipment to install ferrite beads *with leads* in printed circuit boards.

## CERAMAG® FERRITE BEAD CHARACTERISTICS

	24	7D	5N	11
Initial Permeability	2500	850	500	125
Volume Resistivity @ 25°C	1.0x10 <sup>2</sup>	1.4x10 <sup>5</sup>	1.0x10 <sup>3</sup>	2.0x10 <sup>7</sup>
Effective Suppression At:	1 MHz.	20 MHz.	50 MHz.	100 MHz.
Curie Temperature	205	140	200	385

Beads are available in sleeve form in a range of sizes starting at .020 I.D., .038 O.D., and .050 long. For special compact filtering applications, beads can be supplied to tight mechanical tolerances.

Sample quantities of beads and beads with leads are available upon request. Send your requirements to: Stackpole Carbon Company, Electronic Components Division, St. Marys, Pa. 15857. Phone: 814-781-8521. TWX: 510-693-4511.

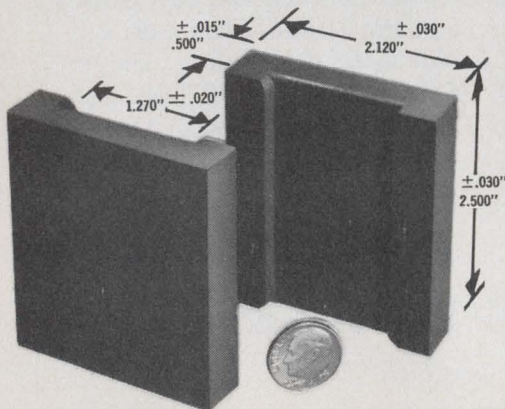



# washington report



Don Byrne  
Washington Bureau

## Defense spending expected to climb \$5-billion

The Department of Defense is expected to seek a fiscal 1973 budget which will approach the \$81.5-billion spending level, an increase of almost \$5-billion over last year's spending request of \$76.5-billion. New obligational authority is projected at more than \$83-billion. These are the budget figures that Defense Secretary Melvin Laird is expected to present to Congress the last week of this month. Chief items in line for funding are new ships for the Navy—nearly \$17-billion—including surface effect ships, high-speed vessels and a fourth nuclear carrier, the CVAN-70, which would cost \$299-million. While it is not scheduled to receive production money in the coming year, the Navy's sea-control ship, a 1970's version of the "Jeep" carrier used in World War II to protect convoys, looms large on the horizon. The project is due for \$12-million in fiscal 1973 to help carry out tests aboard the amphibious assault ship Guam. The tests are expected to prove the concept over the next year and a half. They will also help to develop procedures for operation with the Light Airborne Multipurpose System (Lamps) helicopters and patrol frigates, a new class of ship. The biggest push in the strategic missile field is for the Undersea Long-range Missile System (Ulms), an advanced version of the Poseidon, which in turn is an improved version of the Polaris. Laird is also supposed to recommend large funds for stepping up the tempo of conversion of the Polaris submarines to accommodate the Poseidon. A massive infusion of funds is expected for the Air Force B-1 bomber—reportedly more than \$400-million. On the minus side, the Army will not get the Cheyenne helicopter, the Air Force is not likely to get full authorization for the long-suffering Airborne Early Warning and Control System (Awacs), and the Navy is expected to abandon plans for some of the support and forward combat ships it wanted. Other programs that are in trouble include the Mark-48 torpedo, which DOD feels is costing too much, the C-5A transport plane, the Navy's F-14 fighter and "some shipbuilding programs." Laird is expected to say that his requests for more money are due to the lack of progress in the disarmament talks. Also pay raises will eat up \$3-billion of the \$5-billion increase he requests.

## NASA budget to remain about the same

The fiscal 1973 NASA budget is expected to be around \$3.2-billion, just a hair under the current year's financing of \$3.34-billion. While the \$3.2-billion figure represents something of a victory for NASA since the Bureau of Management and Budget wanted to cut the space agency to \$2.8-billion, it really means that the status quo will prevail for the coming year. In addition, it means a serious blow to the reusable space shuttle



program which would have needed about \$400-million in the coming fiscal year to keep pace with planned developments. NASA sources indicated that the last two shots in the Apollo series are safe. There will undoubtedly be some personnel cutbacks since NASA employees, like all government workers, will receive a 5.5% pay increase starting this month. Personnel will have to be reduced to make up this extra spending.

## **Comsat proposes aeronautical satellite system**

The Communications Satellite Corporation has proposed a plan to the Federal Aviation Administration to launch and operate for FAA a pre-operational (test) aeronautical satellite system. FAA has been proposing putting up its own system but has run afoul of opposition. In a letter to FAA, Comsat president Joseph V. Charyk pointed out advantages of a nongovernmental system. It would not be the offshoot of "competition among hardware manufacturers," he said, which means having to buy from the lowest bidder. As the United States representative, Comsat said, it would be the facility to negotiate with foreign participants in the system and assume the risks. The service would be offered at a fixed price. The international aspect would, incidentally, obviate the need to "buy-American" regardless of quality or price.

## **FCC asks AT&T to explain connector tariff**

A letter from the Federal Communications Commission's Common Carrier Bureau to AT&T has outlined what it felt to be doubtful practices in the telephone company's sale of connecting devices for customer-owned equipment when used with AT&T's telephone system. The FCC noted that when equipment bought from AT&T's competitors was used AT&T required the user to buy a connecting device, but when AT&T equipment was used a connecting device wasn't required. The FCC asked AT&T, Western Union, General Telephone & Electronics and others for proof of damage caused by user-owned equipment connected to common carrier systems.

**Capital Capsules:** **The Army says the ABM is working:** Twenty-one tests so far have resulted in 17 successes, two partial successes and two failures . . . **Skin flicks being shown on cable TV in the New York area** are causing some concern in the FCC here . . . In a press conference here, **Collins Radio** president Robert C. Wilson said the company **may have to put off long-range plans and concentrate on present customers to reduce losses** . . . **Tax experts expect President Nixon to ask Congress to approve a "value-added tax" as an alternative to local property taxes.** The value-added tax would be imposed on manufacturers, wholesalers and retailers and presumably would be passed along to customers via higher prices. It is used in several countries in Europe now . . . **Washington attorney John W. Pettit is expected to be named General Counsel of the FCC,** a position vacated earlier this month by Richard E. Wiley who moved up to the position of Commissioner. Both Wiley and Pettit worked on President Nixon's 1968 campaign . . . **The Air Force will seek funds in fiscal year 1973 for a new all-weather, light-weight precision bombing system** called Scana (Self-Contained Adverse Night Attack). The requirement comes from cancellation—for undisclosed reasons—of development of the Pave Lance bombing system.



# THE GROWING



## TEKTRONIX®

# 7000-Series Oscilloscope Systems

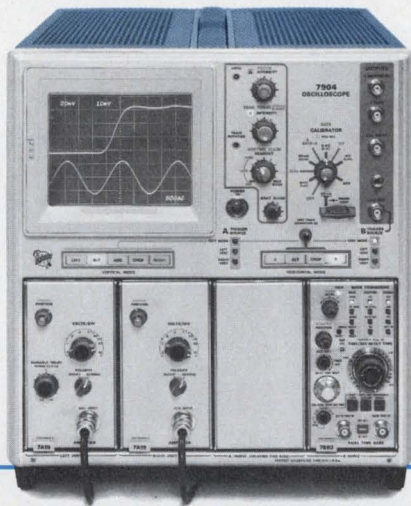

7904 Oscilloscope

### Exclusive to the 7000 Series is:

#### CRT READOUT—

Deflection factors and sweep speeds, the DMM and counter outputs, invert and uncalibrated symbols, etc., are automatically displayed on the CRT—where you look for information. CRT Readout can be ordered initially or as a conversion kit that is easily installed. In each case the cost is only \$400. And it is available in all scopes except the 7403N.

#### MULTIPLE-PLUG-IN MAINFRAMES

Three or four-plug-in mainframes allow up to twenty combinations of vertical and horizontal operating modes. You can now use plug-ins with widely different features . . . simultaneously. If you wish, start with only one horizontal and one

vertical plug-in and add more as your measurement requirements change.

#### PLUG-IN VERSATILITY

Plug-ins are available to make virtually any measurement desired. Examples are:

- single trace
- dual trace
- combinations for multiple trace
- 10  $\mu$ V/div differential
- 1 mA/div current amplifier
- differential comparator
- Sampling to 14 GHz
- 45-ps risetime TDR
- 1.8 GHz spectrum analyzer
- curve tracer
- single time bases
- dual time bases with calibrated mixed sweep
- 500-ps dual time base with triggering to 600 MHz
- 525-MHz direct counter
- digital multimeter.

#### RUGGEDIZED MILITARY VERSION

The AN/USM-281C consisting of mainframe, vertical plug-ins, dual time base and accessory cover is the militarized version of the 7403N Oscilloscope System.

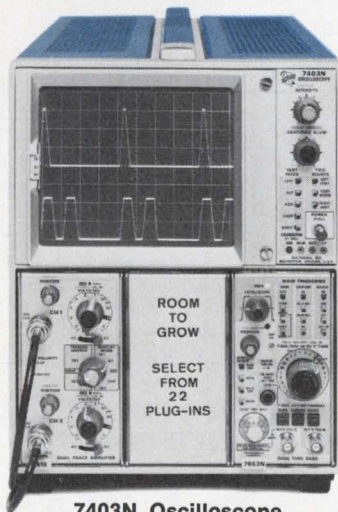

7403N Oscilloscope  
(R7403N 5 1/4-inch rackmount)

*From 500 MHz at 10 mV*

*or: 1 GHz @ <4 V/cm direct access plug-in*

For those who have requirements in between 500 MHz and 50 MHz there's the 150-MHz 7704 (R7704 rackmount), 90-MHz 7504 (7514 storage), all with 4 plug-in compartments; 90-MHz 7503 with 3 plug-in compartments.

*to 50 MHz at 5 mV*

*dual-trace, 6 1/2-inch CRT and delaying sweep for only \$2200*

7000-Series Scopes, complete with plug-ins, start as low as \$1670. Call your nearby TEKTRONIX Field Engineer today for a demonstration of the scopes that make *more* measurements *easier* and *quicker* or write: Tektronix, Inc., P.O. Box 500, Beaverton, Oregon 97005.

U.S. Sales Prices FOB Beaverton, Oregon

Tektronix lease and rental programs are available in the U.S.



# Mil spec synchro/digital converters:

## We've got 'em in cards. Or cased. For off-the-shelf delivery.

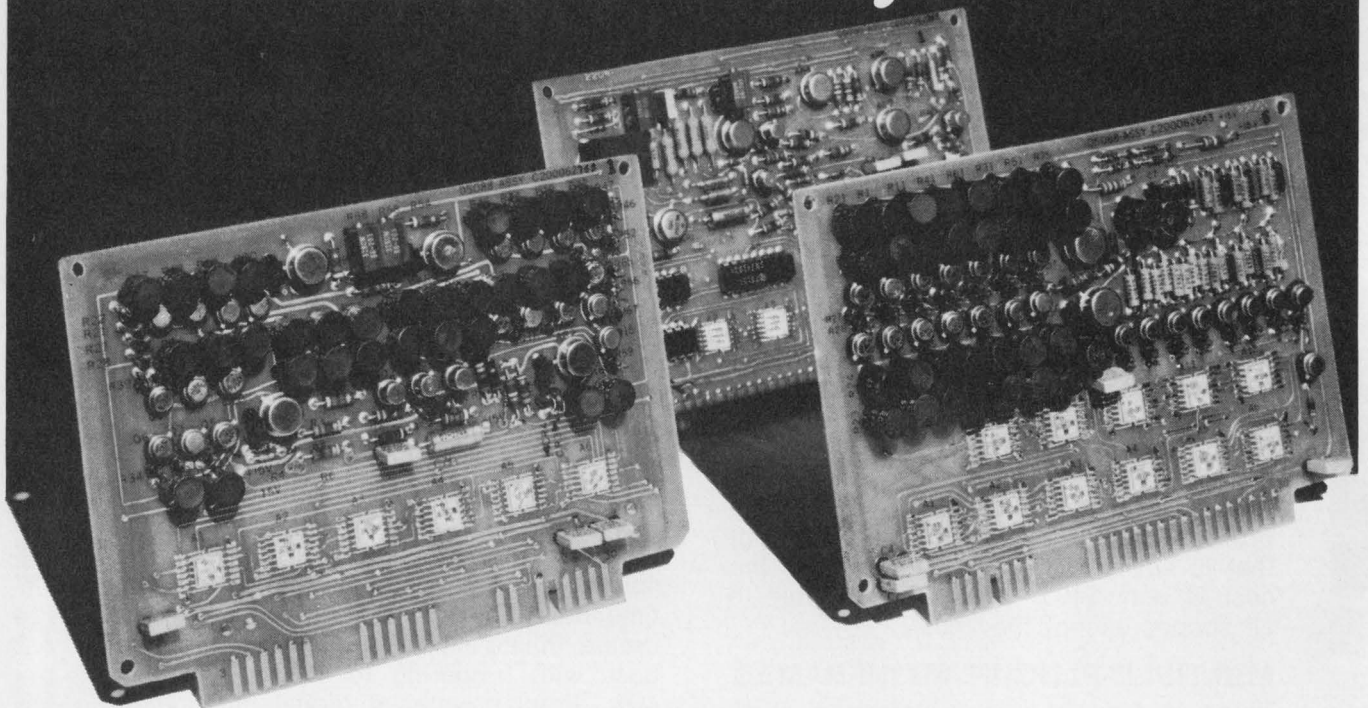

Kearfott can solve your synchro-to-digital and digital-to-synchro conversion problems with three production model solid state converters. All three meet MIL-E-5400.\*

TRIGAC I—A low cost synchro to digital converter, accurate to 12 minutes.

TRIGAC III—Synchro to digital tracking converter dynamically similar to an electro mechanical follow-up servo.

TRIGAC IV—Digital to synchro converter, accurate to four minutes.

### Typical Characteristics

	TRIGAC I		TRIGAC III		TRIGAC IV
Model Number	C70 4773 017	C70 4773 011	C70 4773 019	C70 4773 022	C70 4773 020
Package	2 P C cards	metal enclosure	2 P C cards	3 P C cards	3 P C cards
Input Signal	4 wire resolver	3 wire synchro	4 wire resolver 4 channels	3 wire synchro	12 bit parallel
Output	13 bit BCD			14 bit natural parallel	3 wire 11.8V 400Hz
Resolution	6 minutes of arc				
Accuracy	12 minutes of arc			4 minutes of arc	
Logic Levels	Logic "1" = $\pm 5V \pm 10\%$ , Logic "0" = 0-0.5V				

\*Commercial version available

We can supply any of the cards shown in corrosion-resistant metal enclosures.

Write today for new catalog. The Singer Company, Kearfott Division, 1150 McBride Avenue, Little Falls, New Jersey 07424.

**SINGER**  
AEROSPACE & MARINE SYSTEMS



## The curse of courtesy

We're too damn polite. We cultivate the social art of being inoffensive, even when a sharp jab once in a while can be a high form of true friendship. How many bum designs could we have avoided if someone close had whispered, "Fathead"?

In *Up the Organization*, Robert Townsend argues that an organization should have a vice-president in charge of anti-bureaucratization—a man who can, at appropriate times, shout "Horseshit" at the top of his lungs. That's a really splendid idea—on the personal as well as organizational level.

We all get hung up in our procedures, our traditions, our structures. We tend to substitute "policy" on the organization level, "habit" on the personal level for simple, clear thinking. Many of us do things one way "because we've always done things this way." We keep using solutions to problems that went away because the solutions became policy.

The really sharp engineer keeps challenging himself. He doesn't allow himself to fall prey to structures—even structures he himself created. He doesn't say: "I once designed it this way and it worked so I'll do it this way again." He knows there could be a better way, a simpler way, a cheaper way. The first design might really be best—but he challenges it. The component and the circuit that was great in a piece of 1970 equipment may be too slow, too noisy or too expensive in 1972.

For those of us who haven't yet developed a strong self-challenge reflex, it can prove fruitful to appoint a personal vice-president in charge of anti-bureaucratization. The simplest approach could involve an informal pact: "Look Charlie, let's make a deal. You kick me in the backside when I'm about to pull a big blooper and I'll do the same for you."

Perhaps fortunately, personal goofs don't rate headlines. Corporate goofs do. The pages of the recent history of our industry are splattered with the blood of companies that lacked the man with the authority and guts to shout the right word at the right time.

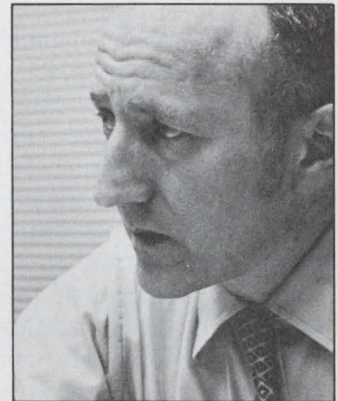

*George Rostky*

GEORGE ROSTKY  
Editor



## The 1103—1024 memory bits on a chip.

With random access, read/write capability and decoding, it's a large-array building block. Here's how to use it.

*First of three articles*

For large-scale memories, the 1103—a semiconductor building block—is emerging as a real contender to core memories. With 1024 one-bit words on one chip, random-access read/write capability and internal address decoding, the MOS 1103 dynamic memory stacks up into megabit arrays. Multiple sources are delivering it, so designers can build on a standard product.

A block diagram of the 1103 is shown in Fig. 1a, and the pin connections in Fig. 1b. The 1024 memory cells are arranged in a matrix: 32 rows by 32 columns.  $A_0$  through  $A_4$  address inputs are internally decoded to select one row.  $A_5$  through  $A_9$  do the same for the columns.

The basic memory bit is a three-transistor cell (Fig. 2). Data are stored as charge on the parasitic capacitance,  $C_s$ , associated with the gate of  $Q_2$  and the connected junction of  $Q_1$ .

To read, the RDATA line (with its associated capacitance,  $C_R$ ) is initially charged HIGH by activating signal  $\phi$ . When line RSEL is activated, the RDATA line discharges if—and only if—the capacitor  $C_s$  contains a high. It remains HIGH—if and only if— $C_s$  contains a low. Thus the RDATA line contains the logic complement of the cell data.

Data are written into  $C_s$  via the transmission gate,  $Q_1$ . The data are placed on the WDATA line, and the WSEL line is activated.

### Three clocks establish timing cycle

Operation of the 1103 always proceeds through a timing cycle. A read cycle is shown in Fig. 3a and write or read/write in 3b.

Cycle timing is established by three clock signals: precharge, "c" enable (chip enable) and read/write. All start HIGH at the level of  $V_{SS}$  approximately. A cycle begins when precharge is brought LOW. The row and column decoders of Fig. 1 are activated and charge all read and write data lines negatively (the ON state for p-channel MOS).

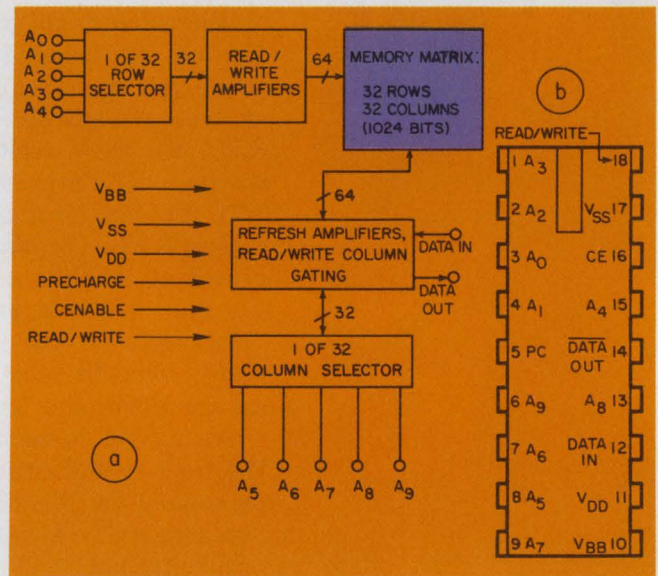

1. **Block diagram of the 1103.** Address bits  $A_0$  through  $A_4$  select one of 32 memory rows and two associated read/write amplifiers (each amplifier drives half a row). The  $A_5$  through  $A_9$  bits select the column. Precharge, "c" enable and read/write lines are timing inputs (See Fig. 3). The data-in line updates the selected-cell contents, and the data-out line carries data from the selected cell. For each read or write cycle, refresh amplifiers regenerate the contents of the selected row (a). Dual-in-line package connections are shown in b.

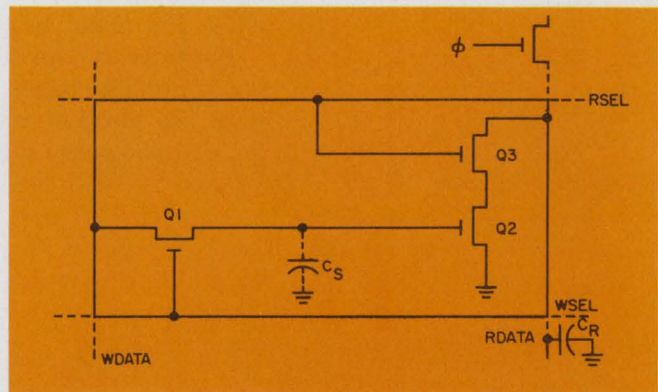

2. **The memory cell requires three transistors, with  $C_s$  storing the cell data.** To read, input signal  $\phi$  first charges  $C_R$  high. When the RSEL line activates  $Q_3$ ,  $C_R$  assumes the logic complement of  $C_s$ . The selected cell data appears on the output. The data are written onto  $C_s$  from the WDATA line when the WSEL line activates  $Q_1$ .

Marcian E. Hoff Jr., Applications Research Manager, Intel Corp., Santa Clara, Calif. 95051



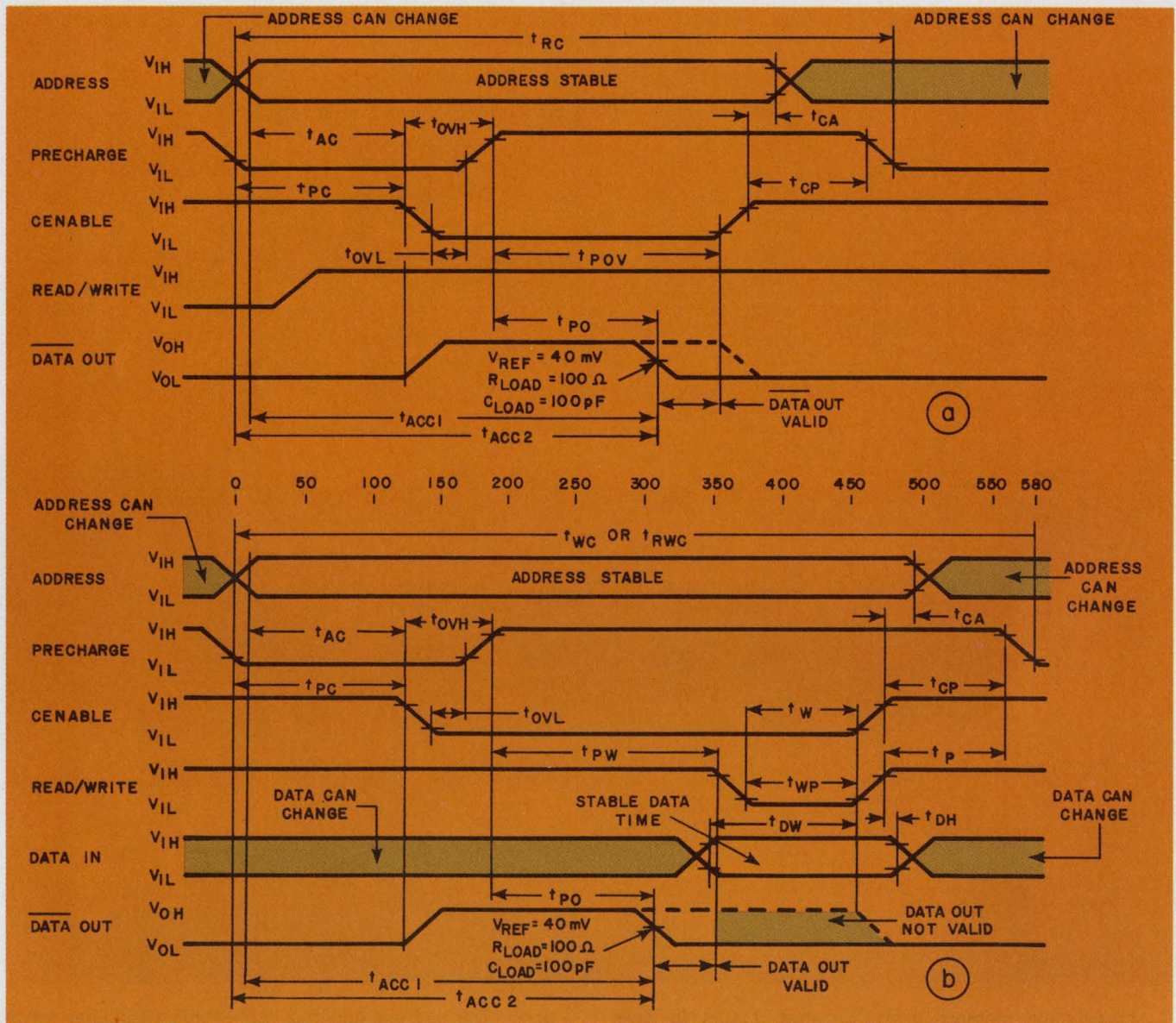

3. Operation of the memory is controlled by timing inputs. The inputs generate a read cycle (a) or a write or

read/write cycle (b). The addressed row data is refreshed in both cycles. The readout access time is 300 ns.

The decoders are faster than the line-charging circuitry. Addresses can therefore stabilize somewhat after precharge is applied without increasing cycle time. This permits use of less expensive (slower) drivers for the address lines than for precharge. The "c" enable line is turned ON next, after precharge and addresses have been present long enough for the data lines to charge and the address decoders to stabilize. "C" enable activates the addressed RSEL line (Fig. 2), and the charging circuits of the RDATA line are disabled. So the data lines discharge and levels approach values corresponding to the complements of the data stored in the selected cell row.

Next, precharge is turned off, removing the charging signals on the WDATA lines and closing the path for discharge. The WSEL line corresponding to the selected RSEL line is also acti-

vated, and the data in the selected row cells are refreshed.

#### Overlap of timing signals affects data

Level on the WDATA line is a function of the overlap time between precharge and "c" enable. For too short an overlap, the RDATA lines will not have discharged sufficiently when the WDATA lines begin discharge, and negative levels in the cells may be reduced. Minimum overlap time is shown as 25 ns when measured at 2 V above  $V_{DD}$ .

Overlap time must not be too long either. A weak cell positive level may result in some discharge of the RDATA line before closure of the write-back path, leading to incomplete discharge of the WDATA line. As a result the level written



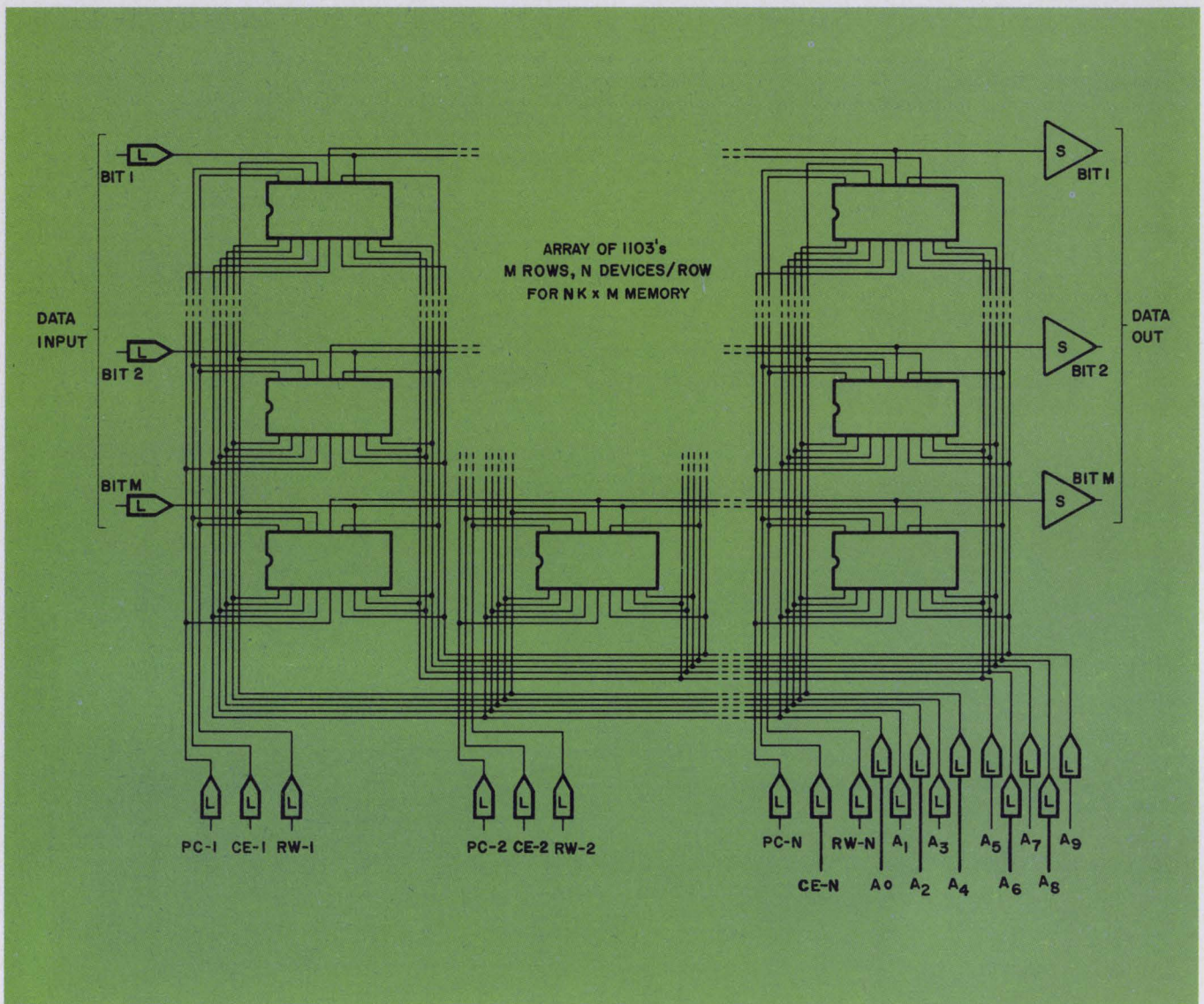

4. Large-scale memory arrays arrange 1103s in rows and columns. As drawn, the number of rows equals the number of bits per word. The number of words equals 1024 times the number of columns. L elements are level shifters from TTL or ECL logic-level inputs to the p-MOS 1103. The address bits  $A_0$  through  $A_9$  drive the entire

array. The address and the "c" enable (CE) lines, once energized, select a word for reading or writing. The timing sequence is established by the precharge (PC), the "c" enable (CE) and the read/write (RW) inputs. Data outputs feed current into signal sensors (S) for operating into bipolar-transistor logic-levels.

## 1. 1103 characteristic capacitances

SYMBOL	TEST	MIN.	TYP.	MAX.	UNIT	CONDITIONS
$C_{AD}$	ADDRESS CAPACITANCE		5	7	pF	$V_{IN} = V_{SS}$ $f = 1 \text{ MHz}$ All Unused Pins Are At A.C. Ground
$C_{PR}$	PRECHARGE CAPACITANCE		15	18	pF	
$C_{CE}$	CENABLE CAPACITANCE		15	18	pF	
$C_{RW}$	READ/WRITE CAPACITANCE		11	15	pF	
$C_{IN1}$	DATA INPUT CAPACITANCE		4	5	pF	
$C_{IN2}$	DATA INPUT CAPACITANCE		2	4	pF	
$C_{OUT}$	DATA OUTPUT CAPACITANCE		2	3	pF	



back is an even weaker zero. Eventually this results in positive levels changing to negative. For the 1103, the maximum overlap must be less than 75 ns, measured at 2 V above  $V_{DD}$ , and 140 ns at 2 V below  $V_{SS}$ .

After the end of precharge, and with an additional delay equal to  $t_{po}$  on Fig. 3, the contents of the selected cell appear on the output data line and all cell contents are refreshed. For a read-only cycle, "c" enable may be turned OFF after a time  $t_{pov}$  from precharge turn-off. Addresses should remain for 20 ns to complete internal operations. A new cycle can begin 85 ns after "c" enable turns OFF. The shortest access time from stable address input until valid output appears is 300 ns. A full read cycle requires at least 480 ns before the next cycle begins.

A write or read/write cycle proceeds the same way, except that "c" enable remains ON for an additional time to enable the write function.

After a time sufficient to stabilize the WDATA lines, the read/write line is activated. The RDATA lines are discharged, disconnecting the refresh amplifiers from the WDATA line. A direct path from the selected cell to the data input line is established, and a signal on this line overwrites the contents of the selected cell.

With restoration of the "c" enable and read/write lines to initial conditions, a new cycle can begin after a 85 ns delay. A full write cycle requires at least 580 ns. In a system both read and write cycle times will increase because of additional delays and tolerances.

Each row of memory cells must be refreshed at least once within any 2 ns-interval. Thus at least 32 memory cycles, one for each state of the five row-address inputs  $A_0$  through  $A_4$ , must be executed in each 2-ms interval. In some applications, including those using a sequential access mode, refresh cycles are accomplished as a by-product of normal operation. Otherwise special provision should be made.

Large-scale memories are built by connecting 1103s in rectangular arrays (Fig. 4). M rows establish M bits per word. N columns generate  $1024 \times N$  words of memory. Thus for a 12k x 8 memory, 96 1103s are arranged in 8 rows and 12 columns. The "c" enable line selects the column and the 10 address lines the word from the column selected.

In general, timing input signals are generated by TTL or ECL high-speed-logic families. Level shifters are required to convert these logic levels to MOS levels. In Fig. 4 the level shifters are marked L.

#### Array input lines have high capacity

The signal input lines to an 1103 memory constitute large capacitive loads. Consider a 4096-word, 16-bits-per-word array. Arranged as in

Fig. 4, there are four rows and 16 columns. The worst-case input capacitances are:

Each of 10 address lines:	$64 \times 7 = 448$ pF
Each of 4 precharge lines:	$16 \times 18 = 288$ pF
Each of 4 "c" enable lines:	$16 \times 18 = 288$ pF
Each of 4 read/write lines:	$16 \times 15 = 240$ pF
Each of 16 data-in lines:	$4 \times 5 = 20$ pF

Stray capacities, including the PC board, increase these values. Charging capacitances draw current from the driver supply. To change the voltage on a capacitor C by E volts in time t requires a charging or discharging current i:

$$i = \frac{CE}{t}$$

With C in pF, E in volts, t in ns, i is in mA.

About 230 mA, average, is required to charge or discharge each precharge or "c" enable line in this example. The peak charge current may be higher. Thus circuits used to drive 1103 arrays must be capable of providing high peak currents. Table 1 shows the capacitances characteristic of the 1103 signal lines.

Although a capacitive load dissipates no power, energy is drawn from the driver power supply when the capacitive load is charged. Some energy is dissipated by the driver; the remainder is stored in the capacitor. When the capacitor is discharged, its stored energy is dissipated in the driver. If a capacitor C is first charged to a voltage V and then discharged f times per second, the minimum average current i drawn from the driver power supply will be given by  $i=fCV$ . With f in MHz, C in pF, and V in volts, i is in mA.

With the power supply also at voltage V, the power dissipated in the driver of the capacitive load is  $P=fCV^2$ , where P is in mW if the same units are used. Thus worst-case dissipation from this source for a precharge or "c" enable driver in the 4k x 16 memory would be about 120 mW per driver at  $V=16$  V. This must be added to any other dissipation associated with the driver.

The capacitive loading associated with the array may also produce ringing if the leads from the drivers to the array have any significant inductance. The use of series-damping resistors in the level-shifter output is usually necessary. The damping-resistor value is a function of the layout and the number of 1103s driven. A 10  $\Omega$  resistor is used in the level shifter of Fig. 5b. Trial and error may result in a different resistor value for the best results in a system.

#### TTL input levels are shifted to MOS

Figure 5 shows three level shifters with TTL logic input. Table 2 lists significant characteristics. The level shifter of Fig. 5a is used primarily for driving data-input lines. In very small arrays, or arrays where severely degraded performance can be tolerated, the same level shifter



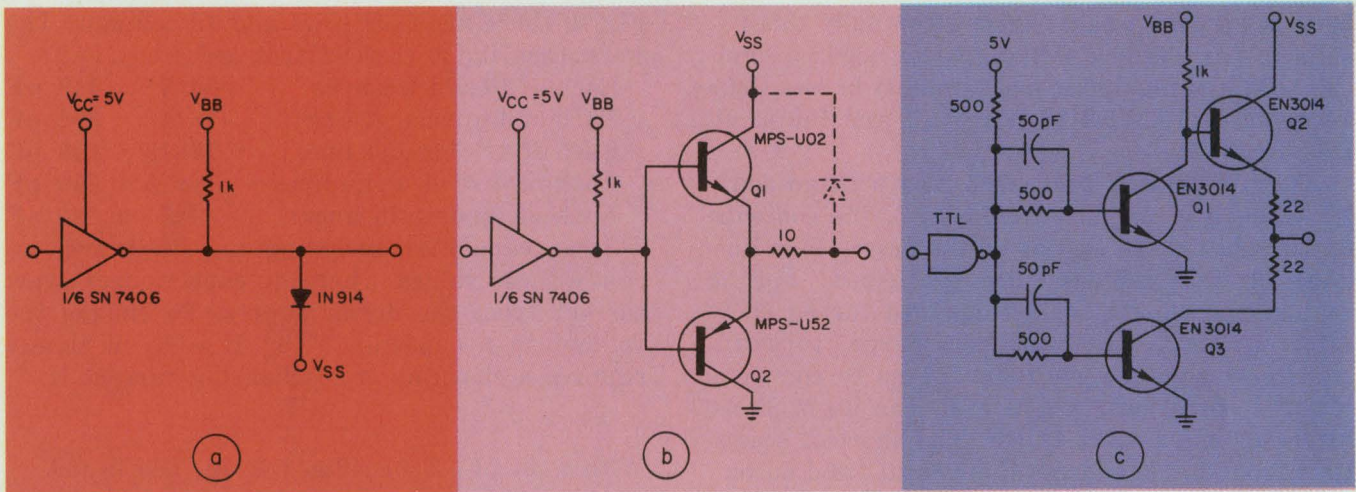

5. Three types of level shifters translate TTL logic inputs to interface with the 1103. A low-power unit drives the data input lines (a). A booster output increases capability,

but it also introduces negative-level output offset (b). A high-drive unit shifts the level with reduced offset. (b) has better capacitive drive capability but (a) is poorer (c).

## 2. Level shifter drive characteristics (at 25C)

	Driver (a)	Driver (b)	Driver (c)
I Low Voltage ( $V_{OL}$ ) No Load Sinking 3 mA	0.25V —	$\approx 0V$ +0.97V	0.04V 0.14V
II High Voltage ( $V_{OH}$ ) No Load Source - 3 mA Sink x 0.5 mA	$V_{SS} + 0.65V$ — —	$V_{SS} \pm 0.01V$ $V_{SS} - 0.05V$ $V_{SS} + 0.01^{(1)}$	$V_{SS} \pm 0.01V$ $V_{SS} - 0.12V$ $V_{SS} + 0.45V^{(1)}$
III Rise time ( $t_R$ ) <sup>(2)</sup> 10 pF 50 pF 100 pF 200 pF 470 pF	25 ns 90 ns — — —	25 ns 25 ns 25 ns 25 ns 40 ns	10 ns 15 ns 20 ns 25 ns 50 ns
IV Fall time ( $t_F$ ) <sup>(2)</sup> 10 pF 50 pF 100 pF 200 pF 470 pF	12 ns 20 ns — — —	6 ns 8 ns 10 ns 14 ns 24 ns	6 ns 9 ns 12 ns 20 ns 35 ns

1. This voltage level is a function of transistor reverse gain. A diode clamp to  $V_{SS}$  is recommended.  
2. These values are measured between the 10% and 90% points.

may also be used for driving address lines. A 1-kΩ load resistor is shown in the figure. Other values may be used. Higher values reduce power dissipation and degrade speed. Lower values increase speed, but also increase power dissipation and may, if too low, exceed the current-sinking capability of the driving gate.

The capacitive-load driving capability of the driver of Fig. 5a is increased by adding a booster stage, as in Fig. 5b. The complementary emitter follower increases capacitive drive capability substantially, as shown in Table 2. However, the

emitter-base drop of  $Q_2$  raises the negative output level to about 1 V. If  $V_{SS}$  falls to 15.2 V, the negative level applied to the clock input is  $V_{SS} - 14.2$  V, degrading performance, and the voltage may fall out its specified operating range at elevated temperatures.

In using the driver of Fig. 5b, the designer has the following choices:

1. To reduce the allowable range of  $V_{SS}$ . This may still result in some speed degradation.
2. To raise  $V_{SS}$  and compensate by biasing the  $V_{dd}$  return from the array at about +1 V.



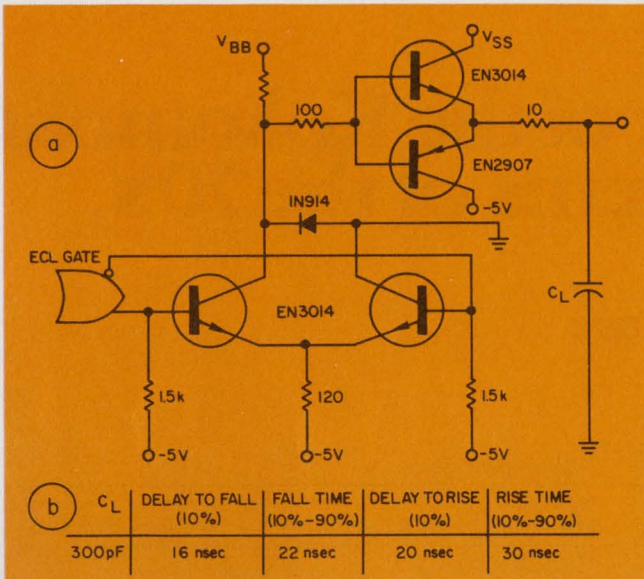

6. ECL logic input levels (ground and  $-5.2$  V) are shifted to match the 1103 input. The negative level offset is negligible. Positive and negative diode clamps (not shown) on the output hold the line levels within tolerance when transients are induced (a). Speed characteristics with 300 pF load are shown (b).

The driver of Fig. 5b holds the output line very close to  $V_{ss}$  when the output level is positive. However, with a layout in which positive transients are capacitively coupled to the driver line, the driver may not hold the line within tolerance because positive transient clamping is a function of the reverse gain of transistor  $Q_1$ . To insure a positive output within limits, a clamping diode (dotted in Fig. 5b) is connected from the output line to  $V_{ss}$ . The driver of Fig. 5c has less capacitive-load driving capability than that of Fig. 5b (see Table 2) but does not have the offset problem at the negative level. Again, a diode clamp from the output to  $V_{ss}$  may be added.

#### Level shifters for ECL

Figure 6a shows a level shifter from ECL, which is biased between ground and  $-5.2$  V, to MOS levels— $V_{dd}$  at ground,  $V_{ss}=+16$ . Figure 6b gives performance characteristics. The circuit output has insignificant negative offset, but it may require a diode clamp to  $V_{ss}$  to reduce positive-going, capacitively coupled noise on the output lines. A negative clamp to ground is also desirable to eliminate ringing, which could charge the output line too negatively and reduce the allowable range of overlap between precharge and "c" enable. ■■

The second article on the 1103 memory will continue the discussion.

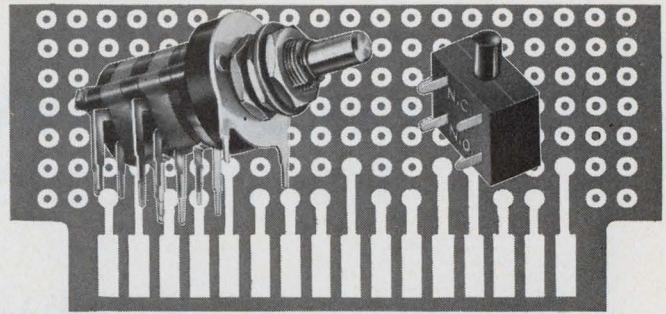

## Mix and match mini switches. More power to the PC.

Grayhill mini PC rotary and push button switches were designed especially to fit into a PC Board — saving time and errors in wiring.

**NEW! 1 Amp Rotary:** Until now, the upper limits for PC multi-deck rotary switches was  $\frac{1}{4}$  amp. Get the 1 amp Series 42P with all ten terminals on one side (with two decks) or with five terminals on two sides (one deck). Life expectancy: 100,000 operating cycles.

**Other Mini Rotary PC Switches** available with

30°, 36°, 45° or 60° angle of throw, 2 to 12 positions per pole, 1 to 4 poles per deck, 1 to 12 decks.

**Push Button PC Switches:** Rated  $\frac{1}{4}$  amp —115 VAC resistive, 2 circuits (one NC, one NO).

Like to know more? Write or phone for our latest general engineering catalog. Grayhill, Inc., 565 Hillgrove Ave., La Grange, Ill. 60525, (312) 354-1040.

**Grayhill**  
... the Difference Between  
Excellent and Adequate

INFORMATION RETRIEVAL NUMBER 29

## World's smallest



## power supply for op amps...\$14

This 2.3x1.8x1-inch module has tracking outputs of  $\pm 15$  V @ 25 ma with regulation of  $\pm 0.1\%$  and ripple of 1 mv. It costs \$14.00 in 1,000 lots and only \$24.00 for one. Requisition Model D15-03. (For  $\pm 12$  V @ 25 ma, order Model D12-03.) Three-day shipment guaranteed.



Acopian Corp., Easton, Pa. 18042  
Telephone: (215) 258-5441

INFORMATION RETRIEVAL NUMBER 30



# Call on the power of the Kokomoans for your systems of the 70's.

## The tough breed of High Voltage Silicon Power Transistors.

Transistor	V <sub>CEX</sub> Voltage	Con- tinuous I <sub>C</sub>	V <sub>CEO</sub> (sus)	Maximum Power Dissipation	Typical Applications
DTS 401	400V	2A*	300V		*I <sub>C</sub> Peak = 5A Vertical magnetic CRT deflection, has good gain linearity.
DTS 402	700V	3.5A*	325V		*I <sub>C</sub> Peak = 10A Horizontal magnetic CRT deflection, features fast switching time, high reliability under horizontal sweep fault condition.
DTS 410	200V	3.5A	200V	80W	Voltage regulator, switching regulator, DC to DC converter, class A audio amplifiers.
DTS 411	300V	3.5A	300V	100W	
DTS 413	400V	2.0A	325V	75W	*I <sub>C</sub> Peak = 10A High V <sub>CB0</sub> and V <sub>CEO</sub> ratings make it practical to operate directly from rectifier 117V or 220V AC line.
DTS 423	400V	3.5A*	325V	100W	
DTS 424	700V	3.5A*	350V	100W	*I <sub>C</sub> Peak = 10A High V <sub>CB0</sub> , V <sub>CEO</sub> (sus) ratings make them ideal for use in deflection circuits, switching regulators and line operating amplifiers.
DTS 425	700V	3.5A	400V	100W	
DTS 430	400V	5A	300V	125W	Voltage regulators, power amplifiers, high voltage switching.
DTS 431	400V	5A	325V	125W	
DTS 701	800V	1A	600V	50W	Vertical magnetic CRT deflection circuits.
DTS 702	1200V	3A	750V	50W	Horizontal magnetic CRT deflection circuits operating off-line.
DTS 704	1400V	3A	800V	50W	
DTS 721	1000V	3A	800V	50W	High voltage DC regulators.
DTS 723	1200V	3A	750V	50W	Very high voltage industrial and commercial switching.
DTS 801	1000V	2A	700V	100W	Color vertical magnetic CRT deflection circuits.
DTS 802	1200V	5A	750V	100W	Color horizontal magnetic CRT deflection circuits.
DTS 804	1400V	5A	800V	100W	
2N3902†	700V	3.5A*	325V	100W	*I <sub>C</sub> Peak = 10A Ideal for switching applications. Can be operated from rectified 117 or 220 volt AC line.
2N5157	700V	3.5A*	400V	100W	For general use in electrical and electronic circuits such as converters, inverters, regulators, etc.
2N5241	400V	5A	325V	125W	
2N2580	400V	10A	325V	150W	
2N2581	400V	10A	325V	150W	
2N2582	500V	10A	325V	150W	
2N2583	500V	10A	325V	150W	
2N3079	200V	10A	200V		
2N3080	300V	10A	300V		

†Mil. qualified units available.

Transistors are NPN triple diffused.



**Delco Electronics**

DIVISION OF GENERAL MOTORS CORPORATION,  
KOKOMO, INDIANA





## Now available from these distributors in production quantities.

ALA., BIRMINGHAM • Forbes Distributing Co., Inc. (205)-251-4104

ARIZ., PHOENIX • Cramer/Arizona (602)-263-1112 • Sterling Electronics (602)-258-4531

CAL., LOS ANGELES • Kierulff Electronics, Inc. (213)-685-5511 • Radio Products Sales, Inc. (213)-748-1271

CAL., PALO ALTO • Kierulff Electronics, Inc. (415)-968-6292

CAL., REDWOOD CITY • Cramer/San Francisco, (415)-365-4000

CAL., SAN DIEGO • Milo of California, Inc. (714)-232-8951

CAL., SAN DIEGO • Radio Products Sales, Inc. (714)-292-5611

COLO., COLORADO SPRINGS • Walker Electronics (303)-636-1661

COLO., DENVER • Cramer/Denver (303)-758-2100 • Denver Walker Electronics (303)-935-2406

ILL., ROSEMONT (Chicago) • Kierulff/F-J-R (312)-678-8560

ILL., SKOKIE (Chicago) • Merquip Electronics (312)-282-5400

IND., INDIANAPOLIS • Graham Electronics Supply, Inc. (317)-634-8202

MD., BALTIMORE • Radio Electric Service Co. (301)-823-0070

MASS., NEEDHAM HEIGHTS • Kierulff Electronics, Inc. (617)-449-3600

MASS., NEWTON • The Greene-Shaw Co., Inc. (617)-969-8900

MICH., ROMULUS • Harvey/Detroit (313)-729-5500

MINN., MINNEAPOLIS • Stark Electronics Supply Co. (612)-332-1325

MO., KANSAS CITY • Walters Radio Supply, Inc. (816)-531-7015

MO., NO. KANSAS CITY • LCOMP-Kansas City, Inc. (816)-221-2400

MO., ST. LOUIS • LCOMP-St. Louis, Inc. (314)-647-5505

N.J., CLIFTON • Eastern Radio Corporation (201)-471-6600

N.M., ALBUQUERQUE • Cramer/New Mexico (505)-265-5767 • Sterling Electronics (505)-247-2486

N.Y., BINGHAMTON • Harvey/Federal (607)-748-8211

N.Y., EAST SYRACUSE • Cramer/Eastern (315)-437-6671

N.Y., NEW YORK • Harvey/New York (212)-582-2590

N.Y., ROCHESTER • Cramer/Rochester (716)-275-0300

N.Y., WOODBURY • Harvey/New York (516)-921-8700

OHIO, CINCINNATI • United Radio, Inc. (513)-761-4030

OHIO, CLEVELAND • Pattison Supply (216)-441-3000

OHIO, DAYTON • Kierulff/F-J-R (513)-278-9411

OKLA., OKLAHOMA CITY • Radio, Inc. (405)-235-1551

OKLA., TULSA • Radio, Inc. (918)-587-9123

PENN., PHILADELPHIA • Almo Electronics (215)-676-6000

PENN., PITTSBURGH • RPC Electronics (412)-782-3770

S.C., COLUMBIA • Dixie Radio Supply Co., Inc. (803)-253-5333

TEXAS, DALLAS • Adleta Electronics Company (214)-741-3151

TEXAS, FORT WORTH • Adleta Electronics Co. (817)-336-7446

TEXAS, GARLAND • Kierulff Electronics, Inc. (214)-271-2471

TEXAS, HOUSTON • Harrison Equipment Co., Inc. (713)-224-9131

UTAH, SALT LAKE CITY • Cramer/Utah (801)-487-3681

VA., RICHMOND • Meridian Electronics, Inc., a Sterling Electronics Company (703)-353-6648

WASH., SEATTLE • Kierulff Electronics, Inc. (206)-763-1550

WASH., TACOMA • C & G Electronics Co. (206)-272-3181

CANADA, ONT., SCARBOROUGH • Lake Engineering Co., Ltd. (416)-751-5980

ALL OVERSEAS INQUIRIES:  
General Motors Overseas Operations  
Power and Industrial Products Dept.,  
767 Fifth Avenue, New York, N.Y.  
10022. Phone: (212)-486-3723.

**Ready Now for Your Systems of the 70's:** The Kokomoans' new breed of silicon power is ready to handle your high energy switching and amplification circuits. Our high voltage transistors permit the design of simplified circuits . . . without the extra weight, bulk and complexity you get with low voltage, higher current systems.

Delco silicon power transistors have earned a reputation for survival in the most rugged applications. Their proven performance in solid state deflection circuits in the new, large-screen color TVs is but one example.

It's because we design Delco transistors to have greater peak energy capability—to be able to withstand higher surges of voltage and current for a specified time. And we back it up with Peak Energy Testing to verify our safe operating curves.

Designing for your new systems of the 70's? The Kokomoans have the silicon power you need.

### Kokomoans' Regional Headquarters.

Union, New Jersey 07083, Box 1018, Chestnut Station, (201) 687-3770.

El Segundo, Calif. 90245, 354 Coral Circle, (213) 640-0443.

Kokomo, Ind. 46901, 700 E. Firmin, (317) 459-2175 (Home Office).



MARK OF EXCELLENCE



# Design your own filters by computer.

Component values for passive five-element L-C units print out in seconds with this BASIC program.

Need passive L-C filter designs fast? Try doing them yourself. You'll need access to a computer, programmable in BASIC. Low and high-pass, five-element (2 Ls and 3 Cs) values print out; capacitors normally come out  $\pm 2\%$ , and the 3-dB cut-off frequency ( $f_{co}$ )  $\pm 20\%$ , but both can be tightened in the program. Capacitor values are standard catalog.  $F_{co}$  from 1 kHz to 10 MHz is normal, but a wider range is achieved by scaling.

The design program (see box) is stored in the computer. After that a design run takes seconds.

Then you merely specify the following to fill your requirements:

- Filter type—high or low pass.
- Desired cut-off frequency,  $f_{co}$ .
- Termination resistances, R.
- Maximum passband ripple,  $A_p$ .

The computer prints out:

- The actual cut-off frequency.
- Component values.
- The actual maximum pass-band ripple,  $A_p$ .

## 14 designs are stored

The computer selects a five-element low or high-pass filter (Fig. 1) from the one Butterworth and 13 Chebyshev designs available.<sup>1,2,3,4</sup> Equal source and load termination are specified in the program as most common. The resultant filter symmetry ( $L_2=L_4$  and  $C_1=C_5$ ) facilitates construction.

Passband attenuation ( $A_p$ ) ranges from zero dB for the Butterworth to 1 dB for the curve 4 Chebyshev (Fig. 2). In-between  $A_p$  values are interpolated. Attenuation in the first stopband octave increases as  $A_p$  increases but component tolerances become more critical with higher values of  $A_p$ . The computer selects the design with the lowest  $A_p$  below the maximum specified, with  $f_{co}$  within  $\pm 20\%$  of that requested. If no such design is available, the computer prints out values

for a filter with a minimum  $A_p$  within the  $f_{co}$  tolerance.

Unfortunately VSWR and reflection coefficient ( $\rho$ ) also increase with  $A_p$ , and in applications like a high-frequency transmission line, which must remain flat with frequency, or when the filter is used with other filters, a low VSWR filter should be used. (Filter VSWR is the ratio

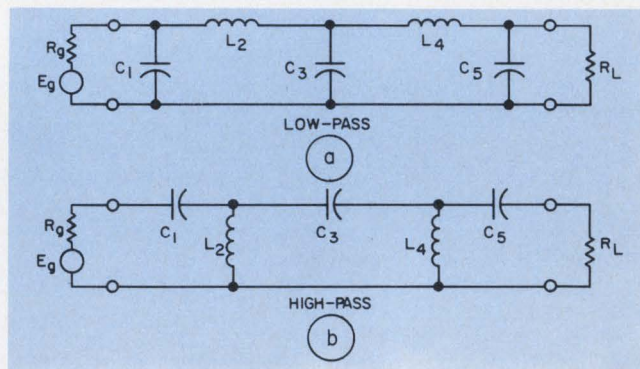

1. Designs for five-element low-pass (a) and high-pass (b) filters. The computer selects the best Butterworth or Chebyshev configuration to meet requirements. All designs are symmetrical:  $R_g=R_L$ ,  $L_2=L_4$ ,  $C_1=C_5$ .

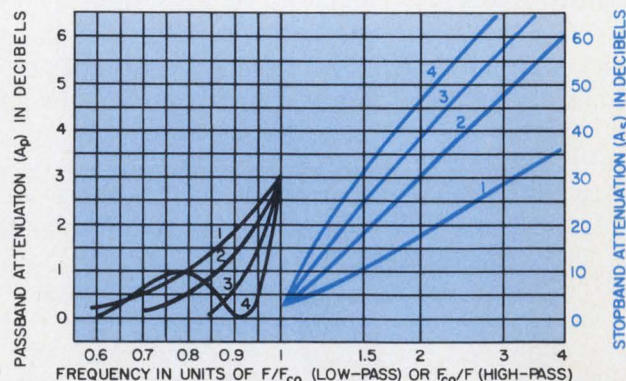

2. Variation of attenuation in passband and stopband for four filter designs. The 14 designs available range from passband ripple ( $A_p$ ) of 0 dB (curve 2) to 1 dB (curve 4). Intermediate values may be interpolated. The five-element Butterworth design with  $A_p=0$  dB (curve 2) has superior attenuation performance over the three-element Butterworth (curve 1), shown only for comparison. The passband attenuation and frequency scales are expanded for clarity. The curves are normalized at the 3-dB  $f_{co}$  frequency.

Edward E. Wetherhold, Senior Engineer, and Harry A. Lee Jr., Engineering Associate, Honeywell Inc., Test Instruments Div., Annapolis, Md. 21404



# BASIC program for L-C filter

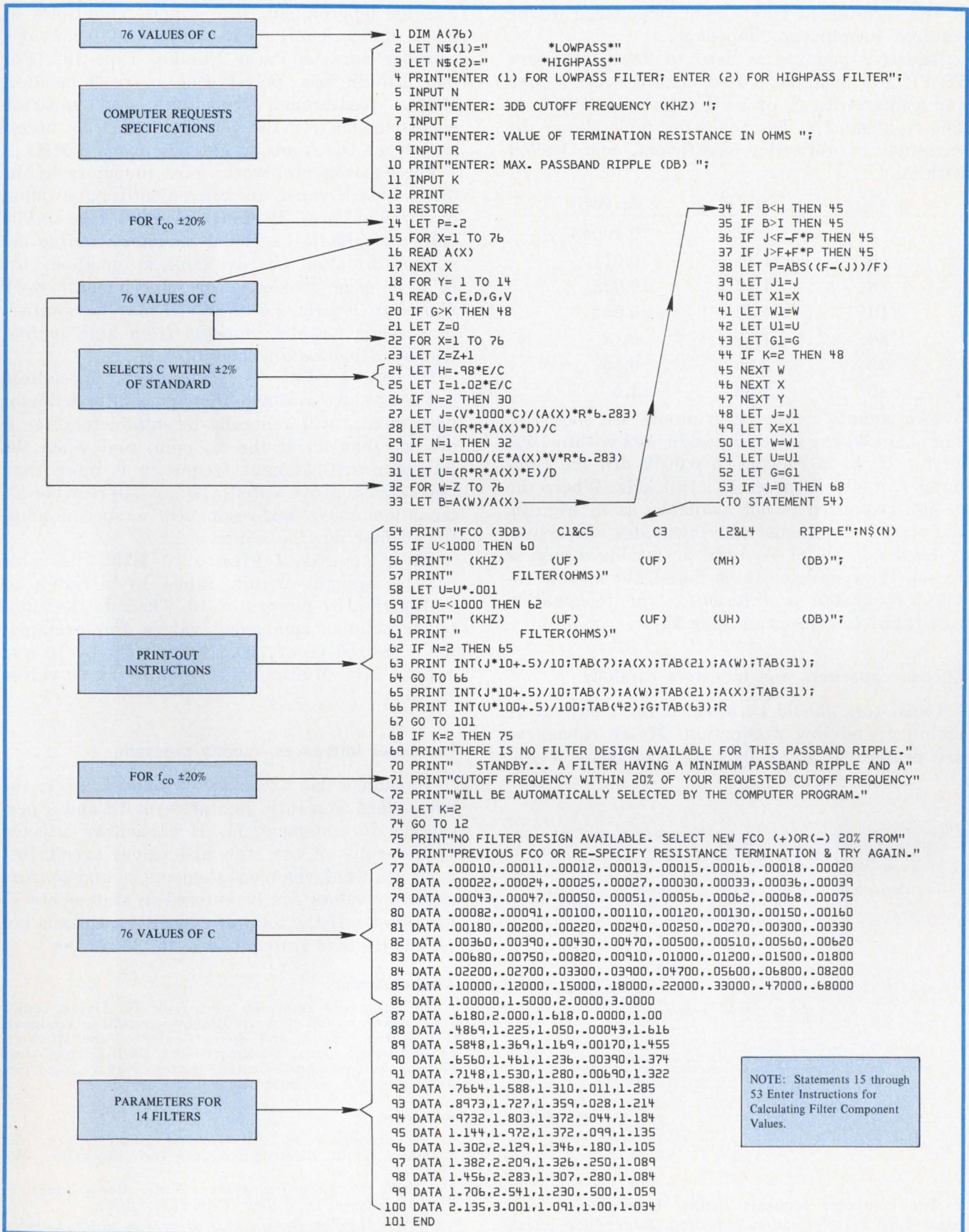

This program requires a one-thousand-word memory, minimum, and contains the following: (1.) Request for inputs: Filter type, desired cutoff frequency, termination resistance and maximum passband ripple; (2.) Instruc-

tions for calculating components values; (3.) 76 capacitor component values; (4.) Parameters for 14 filter designs; and (5.) Data printout instruction. The program language is in BASIC.



of the terminated filter input impedance to the nominal termination impedance.)

Resistive padding is used to lower excessive VSWR. For example, a 10-dB pad between source and a filter with  $A_p$  of 1 dB reduces VSWR from 2.66 to about 1.1. The following table shows the variation of reflection coefficient, and VSWR with  $A_p$ :

$\rho$ (%)	VSWR	$A_p$ (dB)
1	1.02	0.00043
5	1.11	0.011
8	1.17	0.028
10	1.22	0.044
20	1.50	0.18
33	2.00	0.50
45	2.66	1.0

Two sample computer printouts are shown in Fig. 3. In 3a the selected design was within 16% on  $f_{co}$ . If  $A_p$  is relaxed to 0.0039 dB, the computer can offer a closer  $f_{co}$ : 19.1 kHz. Where the design requested is not available, as in Fig. 3b, the computer automatically evaluates successive higher levels of  $A_p$  until a suitable design is found. If no design can be found, the user is advised to choose a different  $f_{co}$  or termination resistance (see program, line 75).

### Choose capacitors and inductors carefully

Capacitors should be selected for temperature stability and low dissipation. Mylar capacitors are preferable above 0.01  $\mu\text{F}$  and below 1  $\mu\text{F}$ .

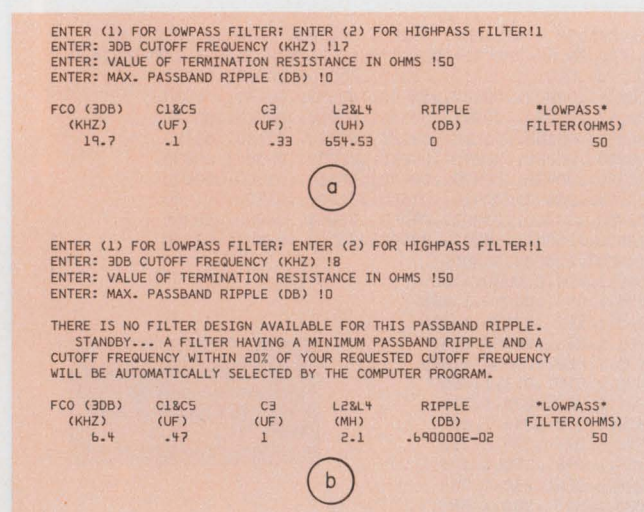

3. The computer requests inputs: Enter low or high pass, 3-dB cutoff frequency desired, termination resistance and maximum passband ripple. The computer can meet requirements and prints out component values (a). The computer has no design meeting ripple requirements but automatically selects the minimum ripple design within  $\pm 20\%$  of requested  $f_{co}$  (b).

For the less-common 10% values (multiples of 0.012, 0.018, 0.027, 0.039, 0.056 and 0.082  $\mu\text{F}$ ) consider Sprague Pacer Filmite, Type 192. For 0.01  $\mu\text{F}$  or less, polystyrene is recommended. Button feedthrough capacitors and separate compartments for the inductors may be necessary when the stopband extends above 5 MHz.

For experimental work, most inductors in the 0.1-to-100- $\mu\text{H}$  range are conveniently handwound on toroidal cores. Q curves over 10 kHz to 200 MHz and practical toroidal inductor winding design information are available at nominal cost in a 64-page booklet.<sup>5</sup> For experimental work from 1 to 30 kHz, 2.5 to 88 mH may be obtained in a single toroidal inductor from high-quality, telephone-line loading coils.

If hand-winding is impractical, specialized coil houses are available. Low-pass filter inductor performance will generally be satisfactory for Q greater than 30 at the  $f_{co}$  point and when the minimum self-resonant frequency is more than two octaves above cutoff. To get appreciable attenuation above self-resonance, a special additional filter may be necessary.

For  $f_{co}$  outside 1 kHz to 10 MHz, the value can be brought within range by dividing or multiplying by powers of 10. Then do the same to the printout component values. For example: for a desired  $f_{co}$  of 100 Hz, multiply by 10 and enter 1 kHz. Multiply the resultant L, C, values by 10.

### For closer tolerances, modify program

To change the  $\pm 20\%$   $f_{co}$  "window," insert the new values as a ratio in statement 14 and a percentage in statement 71. If capacitors selected within  $\pm 2\%$  of the standard values aren't just what you want, change statements 24 and 25. Any capacitor values can be entered in statements 77 through 86. If the total of capacitor values is not 76, change it in statements 1, 15, 22, 32. ■■

### Acknowledgment

The assistance received from Jack W. Davis, senior EMI engineer, and S. Ivan Rambo, consulting engineer, both of the Defense and Space Center of the Westinghouse Electric Corp., Baltimore, and Carl Tannenbaum, systems programmer, United States Naval Academy, Annapolis, Md., is gratefully acknowledged.

### References

1. *A Handbook on Electrical Filters—Theory and Practice*, White Electromagnetics, Inc., Rockville, Md. 1963.
2. Geffe, P., *Simplified Modern Filter Design*, John F. Rider Publisher, Inc., New York City, 1963.
3. Saal, R., *The Design of Filters Using the Catalog of Normalized Low-Pass Filters*, Telefunken GmbH, Western Germany, 1966.
4. Zverev, A., *Handbook of Filter Synthesis*, John Wiley & Sons, Inc., New York City, 1967.
5. *Q Curves for Iron Powder Toroidal Cores*, Micro-metals, 72 E. Montecito Ave., Sierra Madre, Calif.



# Complete RF Network Analysis 500 MHz

400 kHz to 500 MHz with 115-dB dynamic range and 0.005-dB resolution. Precise measurements of transmission and reflection properties — magnitude, phase, group delay, and S-parameters — all direct reading and neatly displayed on a built-in scope. Complete characterization of filters, amplifiers, cables, antennas, delay lines, transistors, or almost anything else that comes to mind — all at the push of a button.

**500 MHz!** A full 400 kHz-to-500 MHz frequency span, automatically swept over the full range or a portion of it — all at the twist of a knob. There's more, of course, including computer-controlled systems or other versions tailored to your needs. Look into it. Better yet, see it — in action — in your application.

For a demonstration of this remarkable system, call your local GR center. The price for the basic 1710 RF Network Analyzer? Only \$6850 (*truly* remarkable).

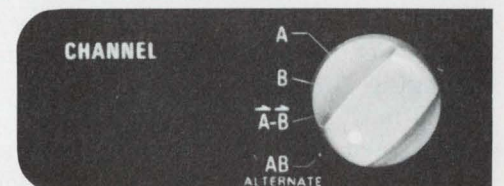
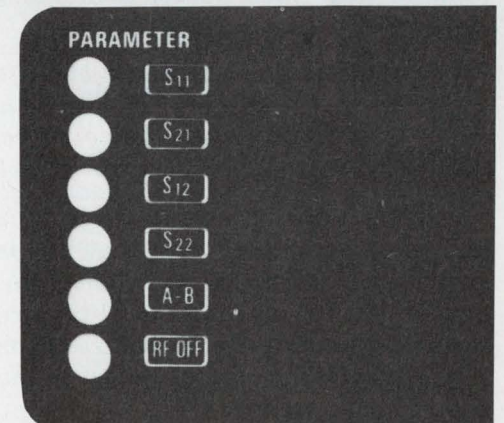
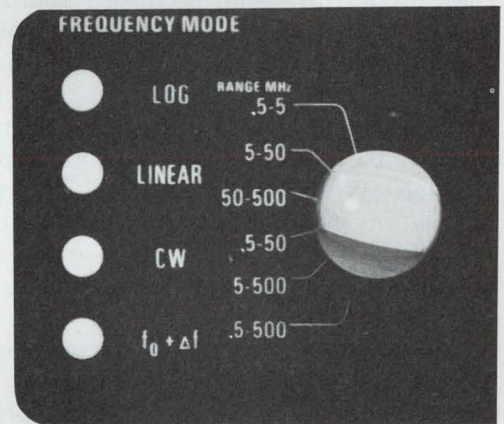
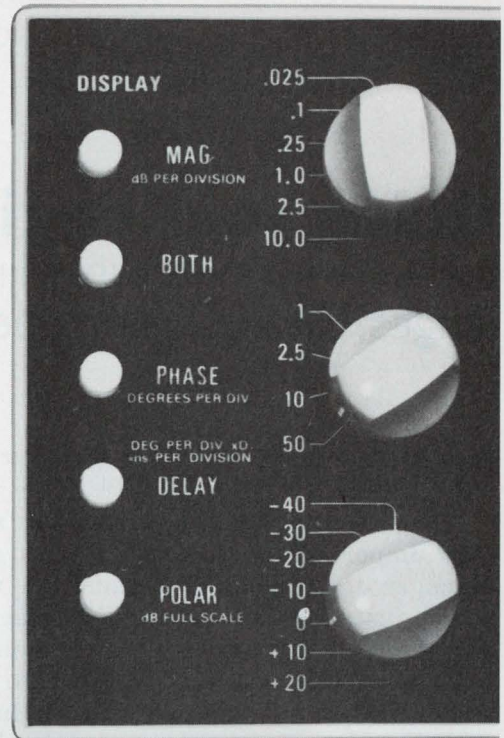

For High-Frequency Measurements



300 BAKER AVENUE, CONCORD, MASSACHUSETTS 01742  
 NEW YORK (N.Y.) 212 964-2722 (N.J.) 201 791-8990 • BOSTON 617 646-0550  
 CHICAGO 312 992-0800 • WASHINGTON, D.C. 301 881-5333 • LOS ANGELES 714 540-9830  
 TORONTO 416 252-3395 • ZÜRICH (01) 55 24 20  
 GRASON-STADLER 617 369-3787 • TIME/DATA 415 327-8322

INFORMATION RETRIEVAL NUMBER 33



## Guide your engineers to self-rule, advises this leader, who says subordinate-made decisions help him. His challenges? Hiring, pairing people/assignments, managing creative EEs.

**Roger Cady**, Manager of PDP-11 Computer Engineering, Digital Equipment Corp., Maynard, Mass.

"People-awareness." I think those are the two most important buzz words for an engineering manager to remember, because he works with people instead of things. Unlike things, however, people are unpredictable; they're going to make irrational decisions; they're going to be temperamental; they're going to respond in human ways. I respect my people and try to help them, rather than dictate to them, because I realize that each has ideas that can help the project. My ability to work with people was probably the most important factor contributing to my promotion.

I developed this ability as an engineer when I learned to interface with technical personnel in the lab. When my job called for me to work with a variety of disciplines outside of engineering, I tried to learn their terminology and thought patterns, so I could communicate with them.

An awareness of people comes down to this: People have their own ideas about how a job should be done. If I can make my people believe that I really care about them and that I really want to hear their ideas, then I'm going to be more effective as a manager.

---

*When you ask engineers for 110% of their capacity and 120% of their knowledge on a project, they realize that they're going to have to learn something new before they can complete the job.*

---

When I want my engineers to do a job a certain way, I don't tell them that this is the way it ought to be done; I want them to decide for themselves, because I'm not always right. If they go through the thought process themselves, they may discover something wrong or they may suggest a better way to do it.

I try to motivate my staff to do a good job the first time, so I don't have to do it myself. Every time I try to do a little engineering myself, the details get lost, because I'm also busy with the managing function.

The most frustrating experience I ever had in this regard was when I supervised system tests for Honeywell's 1200-2200 series machines. I had

45 people on a three-shift basis. It was a good experience for me, because it was a job that I couldn't possibly do by myself. I didn't know the products well enough to test them myself. To be successful I had to work with people.

So now I've learned to develop a group that runs with a minimum of supervision, one that is capable of doing the project their way. I build them up, so they can have confidence in themselves. When they realize that I also have confidence in them, they feel qualified to make decisions on their own. This frees me from the petty details of managing, so I can oversee the entire project with more objectivity.

When I give my people a project, I tell them I want 110% of their capacity and 120% of their knowledge. That stretches them, and I tell them so. When I lay out the job, I make it clear that I don't think they're capable of doing the job right now; that they have to learn something to complete it. I say: "It's going to tax you and put a strain on you, but you'll have to learn something new to be successful." My guys like that, and they go after it.

It's very difficult to manage creative people in a world full of schedules, budgets and products that have to be sold. Creative engineers are more concerned with the product design than they are with schedules and costs. I try to get my creative people to stop improving the design and start manufacturing it. The design could be improved forever and never become a product. I instill in these designers the idea that an almost perfect product is better than no product at all. They must understand that although the product isn't perfect, it has met the goals that were set for it.

A designer should carry a product from its design through the manufacturing cycle, where he learns about the real world. When he discovers all the other factors that go into producing a product, he'll begin to realize that the extra 2% improvement that he could have made in the product is really negligible in the total picture of its production.

Then, too, there are those creative types who are withdrawn because their ideas have been stepped on. I try to stimulate them to present





## ROGER CADY

**Education:** BSEE, Northwestern.

**Experience:** Engineering manager; computer test engineering; systems test; instrumentation design; tool and die making; electronic sub-assembly; production, field and operations engineering; and planning.

**Best Achievement:** Developed the PDP-11 16-bit computer family of digital equipment. Required interface of management with creative design to high-volume manufacturing.

**Papers, Symposia:** "A New Architecture for Minicomputers—the DEC PDP-11"; Infotec symposium on small computers—London, Sept. 1971.

**Personal:** Married; three children; interests include antiques; carpentry; photography; sailing.

**Employer:** Digital Equipment Corp., Maynard, Mass. Founded in 1957 in a converted textile mill by three employees who built/tested manufacturers' computers with a circuit module. Today, with 6800 employees worldwide, and net sales of \$146.8-million in fiscal 1971, DEC produces digital test systems, computers, peripherals, and converters, as well as circuit modules.

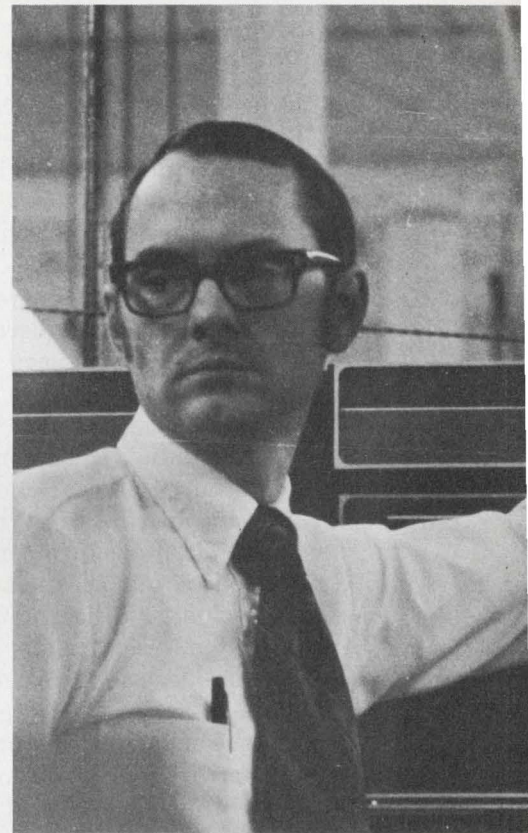



their ideas and then guide them into a realization of why an idea may be a bad one. "Here's my thinking on it," I tell them. Or: "Let's compare the alternative to it." Often the engineer doesn't have the right approach to the problem. He needs to be guided, not led—and certainly not forced.

---

*Win friends, influence people and hire a select staff by asking each job-hungry engineer: "What makes you think you're so good?"*

---

Hiring people is one of the manager's most difficult responsibilities. I can rationalize shortcomings in personnel when I inherit a crew. But to gather the kind of staff I've been talking about, I have to determine if the prospect can do the job.

I like to hire engineers who are generalists rather than specialists, because my work is rather broadbased and I need guys with flexibility. I like a man who's aware, who walks into the plant and asks questions that are not necessarily engineering oriented. If he comments on the construction of our 100 year old building, for example, he may also be the type who'll be aware of the manufacturer's problems.

I try to ask a job prospect a wide variety of questions, including a half dozen or so one-liners—like, "What makes you think you're so good?" That kind of question gives me a chance to see how he reacts to an abrupt subject change.

"What's the most important thing you've ever done in your life?" is another that's designed to lay open his inner feelings. The trick is getting him a bit off balance, so he starts replying naturally rather than how he thinks I want him to reply. For information on his engineering ability, I find out what his specific project function has been, and why he has or has not been successful.

My most difficult challenge after I've hired my people is assigning them to projects and setting goals for the projects. I tend to pattern things after what I think I can do. The trouble is that some people may not have the experience I have.

So I try to understand each person's capabilities and limitations, so I can align him with an assignment he can complete. When I talk about that 110% of capacity, I have to know if he can grow that extra 10%. I never assign a man to a job he doesn't feel he can do. If he doesn't think he'll be successful, he won't be.

When you first become a manager, I think you have to let your engineers do a lot of goal setting. Then closely monitor them until you find out if they can do more or less than they think they can do. Then adjust their load. First, set some short-term goals. Then set the long-term goals. Initially set the goal for the next three months or less, not for the next year. Goals must be set jointly between manager and engineer.

Complicating the problem of goal-setting is the

constantly changing industry I'm in—the computer industry. If a product design takes longer than four weeks to develop, you'll find half a dozen more new integrated circuits available on the market, half of which could be used to improve the design.

---

*A broad experience will give the engineer a breadth of knowledge of a product's function that no engineering spec could ever equal.*

---

Broad experience is another major factor that contributed to my promotion. I was fortunate to attend a cooperative educational program at Northwestern University. I worked for two different companies through that program and got a broad base of experience, a feel for things beyond the textbook. The experience included field work and planning at Commonwealth Edison in Chicago and time in a machine shop, where I got a working knowledge of milling, grinding, injection and die casting.

It's a five-year engineering course for a bachelor's degree under the Northwestern cooperative program. The first year is a normal freshman engineering course. Starting with the sophomore year, I spent school time on a quarterly basis—two quarters in school and two quarters in industry, alternating every three months. I was paid and received credit toward graduation. The course gave me a worldly experience with some control, because I worked my own schedules.

One thing I did to broaden my experience wherever I studied or worked was to figure out how the assembly I had to build fit into the finished product. If it was a photo detector that was to be used on a card reader, for example, I made it my business to find out also how the card reader worked. Then I knew how the item needed to be functionally tested without relying just on the specs. You can rarely write specs that tell you the test that would be optimum from a functional standpoint.

And what is my most difficult problem of the future? As I look ahead, I imagine my function will become less and less technical. I'll get into the business function—marketing, finance, etc.—and that's a problem, because I'm an engineer first. I've got to realize that one day I'll be directing engineering managers, one level back from the design problems. If I can get the engineer to solve his own problems, the better able I'll be to direct him from another level.

Too many people want to become managers when they think they don't have it technically. It's ironic, because a good engineering manager must be a good technical man. He must also have knowledge about all aspects of a project. I've kept abreast of the state of the art and spent time in the field. I'm a firm believer in the idea that the more you learn, the further you'll get. ■■



# NEW! THE PRAM.<sup>TM</sup>

The first 4-channel programmable op amp. With more application possibilities than we could possibly list on this page.

## HA-2400/2404/2405

Take a good look at this new linear building block. It's unique and so versatile we keep discovering more and more applications for it.

Each PRAM contains four preamplifier sections, one of which is selected through the DTL/TTL compatible inputs and connected to the output amplifier. The selected analog input terminals and the output terminal form a high performance operational amplifier for just about any use you can dream up. And we hope you'll dream up some. If you do, send them along to us and we'll see what we can dream up by way of a reward.

### Features:

**Offset current** 5nA

**Voltage gain** 150K

### Slew rate

$A_v = +1$   $\pm 15V/\mu s$

$A_v = +10$   $\pm 50V/\mu s$

### Gain Bandwidth Product

$A_v = +1$  8MHz

$A_v = +10$  40MHz

### DTL/TTL compatible

100-999 units

0° to +75°C **\$10.45**

-25°C to +85°C **\$15.95**

-55°C to +125°C **\$23.65**

For more details on the PRAM contact your Harris representative or distributor.

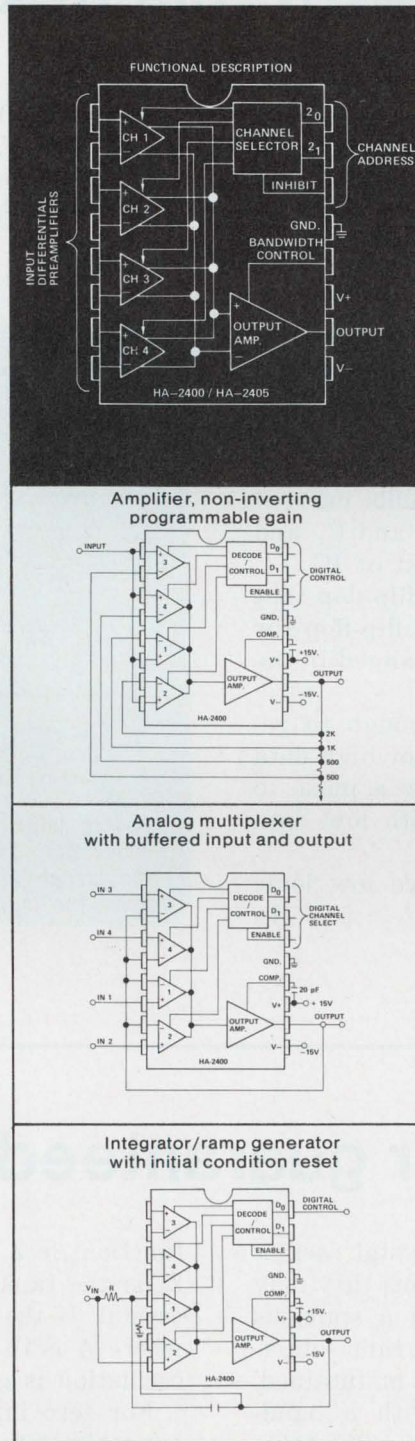

### More challenges:

The foregoing diagrams show just three of many applications we've designed using the PRAM. The following lists other possibilities we haven't had time yet to prove out. Why don't you try your hand at designing them or any other ideas you come up with, and send them to:

E. Fernandez  
P.O. Box 883  
Melbourne, Florida 32901.

A to D converter, Dual Slope Integrating

Active Filter, State Variable Type with Programmable Frequency and/or Programmable "Q"

Amplifier with Programmable D.C. Level Shift

Chopper Amplifiers

Crossbar Switches

Current Source, Programmable

F.M. Stereo Modulator

F.S.K. Modem

Function Generators, Programmable

Gyrator, Programmable

Monostable Multivibrator, Programmable

Multiplier, Pulse Averaging

Peak Detector with Reset

Resistance Bridge Amplifier/Comparator with Programmable Range

Sense Amp/Line Receiver with Programmable Threshold

Spectrum Analyzer, Scanning Type



**HARRIS SEMICONDUCTOR**  
A DIVISION OF HARRIS-INTERTYPE CORPORATION

P.O. Box 883, Melbourne, Florida 32901  
(305) 727-5430

**DISTRIBUTORS:** **Schweber Electronics:** Westbury, New York (516) 334-7474; Rockville, Maryland (301) 881-2970; Hollywood, Florida (305) 927-0511  
**Harvey/R & D Electronics:** Lexington, Massachusetts (617) 861-9200/**Semiconductor Specialists, Inc.:** Chicago (312) 279-1000; Detroit (313) 255-0300; Minneapolis (612) 884-8132; Kansas City (816) 452-3900; St. Louis (314) 428-6100; Dallas (214) 358-5211; Indianapolis (317) 243-8271; Pittsburgh (412) 781-8120; Dayton (513) 278-9455/**R.V. Weatherford Co.:** Albuquerque (505) 265-5671; Anaheim (714) 547-0891; Austin (512) Enterprise 1443; Dallas (214) 231-6051; Denver (303) 427-3736; Glendale (213) 849-3451; Houston (713) Enterprise 1443; Palo Alto (415) 321-5373; Phoenix (602) 272-7144; Pomona (714) 623-1261; San Diego (714) 278-7400; Seattle (206) 762-4200.

INFORMATION RETRIEVAL NUMBER 34



## Transfer data with this flexible circuit

The conversion of many DVM and counter outputs to TTL-compatible levels is generally achieved with circuits that are limited in performance by their source impedances. But this limitation is eliminated when the circuit shown is used. The number of inputs can be extended to  $N$ , and only TTL gates and passive components are required.

The operation of each section is identical to that of the first: If the input data is high and  $CR_1$  is reverse-biased by at least 4 V, no pulse passes  $CR_1$  to the input of  $IC_2$  during a data strobe. But if the data input is low and forward biases  $CR_1$  within about 2 V,  $IC_1$  pulls current from the input of  $IC_2$  via  $C_1$ ,  $CR_1$  and  $C_2$  and causes a pulse to appear at the output of  $IC_2$ .

If  $IC_2$  is part of the set input of a flip-flop that has been reset, a data probe sets the flip-flop for data low. The flip-flop remains unchanged if the data input is high.

Voltage  $V_{REF}$  must be negative enough to reverse-bias  $CR_1$  during a data strobe for high-data input, while positive enough to allow a pulse to pass to  $IC_2$  during a data strobe with low data input.

As an example, a device can have low logic levels of  $\leq -5$  V and high levels of  $\geq 5$  V. In

this case,  $V_{REF} = 0$ . As another example, the low level is  $\leq -10$  V and high level is  $\geq -3$  V. Here  $V_{REF} = -8$  V.

A. Kuramoto, Lawrence Livermore Laboratory, University of California, Livermore, Calif. 94550

CIRCLE NO. 311

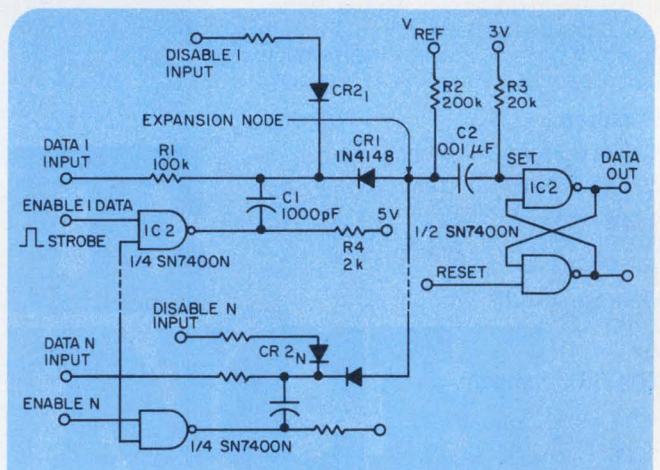

Source impedance is no longer a problem in this conversion circuit for TTL-logic levels. Of course, the usual gain-bandwidth tradeoff still applies, since the input circuit is essentially an integrator.

## Clock oscillator guaranteed to start

The problem with most simple crystal oscillators is that under worst-case conditions they may not start, or they may hang up on a spurious mode. But with this circuit (see diagram) start-up is guaranteed and oscillations are maintained.

The  $\mu A733$ , a video amplifier with a bandwidth of about 80 MHz, has an adjustable gain of 10 to 400. Oscillator positive feedback is provided from pins 6 to 12 via the  $R_2$ ,  $R_3$  voltage divider, the crystal and the tank circuit. The feedback ratio,  $\beta$ , is the network voltage transfer

function  $\beta = Z_t / [(Z_t + Z_x)(1 + R_3/R_2) + R_3]$ , where  $Z_t$  is the tank impedance and  $Z_x$  is that of the crystal. If the product  $A\beta$  is greater than unity, where  $A$  is the amplifier single-ended gain, then oscillation is guaranteed.

For zero input, the  $\mu A733$ 's outputs are both approximately half the positive supply voltage. If oscillation is temporarily absent, the amplifier output hovers in its linear region where the gain is high. Thus starting is assured. When the amplitude becomes sufficient to cause peak saturation,



tion,  $A$  effectively decreases to automatically limit  $A\beta$  to unity.

Most popular crystal cuts exhibit both near and far-frequency spurious responses. Near-frequency is usually defined as responses within  $\pm 20\%$  of the main frequency. A typical specification will usually require that any near "spur" have an impedance level two or three times greater than the main mode, with the implicit presumption that far spurs may be equal to the main mode.

The tank circuit is necessary to discriminate only against far spurs. To design the tank, first choose  $R_1$  about 10 times the crystal's maximum main mode resonant resistance. Then  $L_1 = R_1/\omega_0 Q_t$  and  $C_1 = Q_t/\omega_0 R_1$ , where  $\omega_0$  is the crystal's series-resonant frequency and  $Q_t$  is about 5 to 7.

*Richard Mann, TRW Systems Group, One Space Park, R2/1004, Redondo Beach, Calif. 90278.*

CIRCLE NO. 312

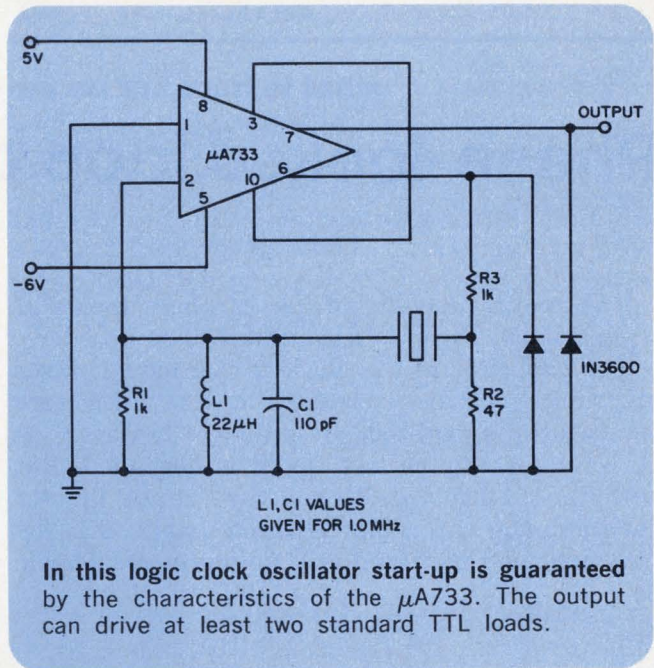

In this logic clock oscillator start-up is guaranteed by the characteristics of the  $\mu A733$ . The output can drive at least two standard TTL loads.

## Use an op amp for simple Schmitt trigger

A Schmitt trigger can be designed around a single op amp to drive DTL and TTL logic devices. A simple choice of component values determines the trigger threshold and hysteresis.

As shown in the figure, the 709 op amp is operated in the open loop mode, with no compensation components added. This produces a fast slew rate and forces the output to remain saturated at  $\pm 15$  V. The threshold level at which a change of state occurs is determined primarily by  $R_1$  and  $R_2$ . A small amount of positive feedback, determined by the voltage drop across  $R_5$ , produces the desired hysteresis and prevents the circuit from oscillating.

Design relationships:

$$\frac{R_4 + R_5}{R_3 + R_4 + R_5} = \frac{5.0}{15} \quad (1)$$

$$V_1 = V_x + (15 - V_x) \frac{R_2}{R_1 + R_2}$$

$$\text{where } V_x = 15 \frac{R_5}{R_3 + R_4 + R_5} \quad (2)$$

$$\text{and } (R_1 + R_2) \gg R_5$$

$$V_2 = 15 \frac{R_2}{R_1 + R_2} \quad (3)$$

$$R_3 \cong 2 \text{ k}\Omega \quad (4)$$

In formulating the equations for the threshold voltages, it was assumed that (a) the 709 output swings from plus  $V_{cc}$  to minus  $V_{cc}$  ( $\pm 15$  V), and that (b) the 709 has no input offset voltage.

The circuit works well with very slow-moving inputs, making it useful in a variety of level-sensing applications. Adding a capacitor between the inverting input of the op amp and the signal ground converts the circuit into an accurate time delay for long pulses or step function inputs.

*John Kramer, Aeronutronic Div., Philco-Ford Corp., Ford Rd., Newport Beach, Calif. 92663*

CIRCLE NO. 313

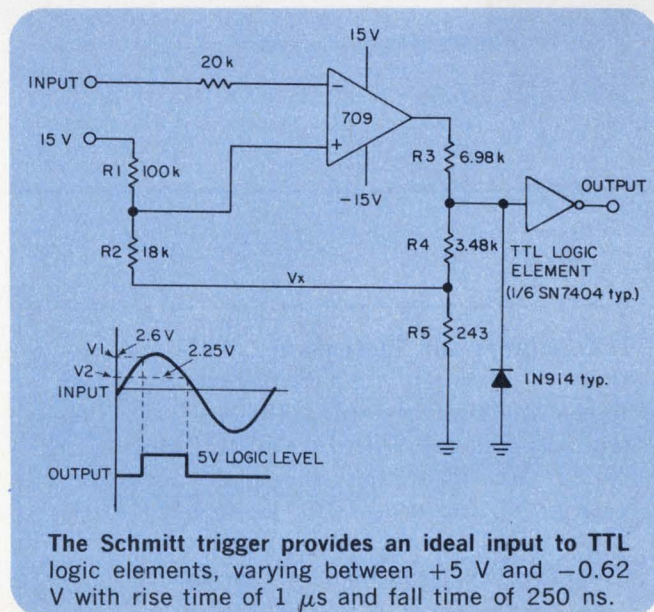

The Schmitt trigger provides an ideal input to TTL logic elements, varying between +5 V and -0.62 V with rise time of 1  $\mu$ s and fall time of 250 ns.



# Phase-locked loop decodes narrow bands

Bandwidth decoding of 1% can be achieved if a phase-locked loop is used with a tone decoder.

The capacitor in the phase-locked loop,  $C_2$  (see diagram), can be increased in size until zero bandwidth is realized. In practice, however, as  $C_2$  is increased, the loop speed is degraded. But with the addition of  $R_A$  and the voltage divider network, you can achieve narrow bandwidths by reducing loop gain and still maintain reasonable

speed. A value of 1 k $\Omega$  for  $R_A$  decreases the bandwidth to 4% total, with  $C_2 = 2.2 \mu\text{F}$  and  $V_{in} = 200 \text{ mV rms}$ . Bandwidth may now be reduced to less than 1% total by reducing the input drive to 50 mV rms.

*Jim Wyland, Linear IC Applications Dept., Signetics, 811 E. Arques Ave., Sunnyvale, Calif. 94086.*

CIRCLE NO. 314

BLOCK DIAGRAM OF SE/NE 567 TONE DECODER

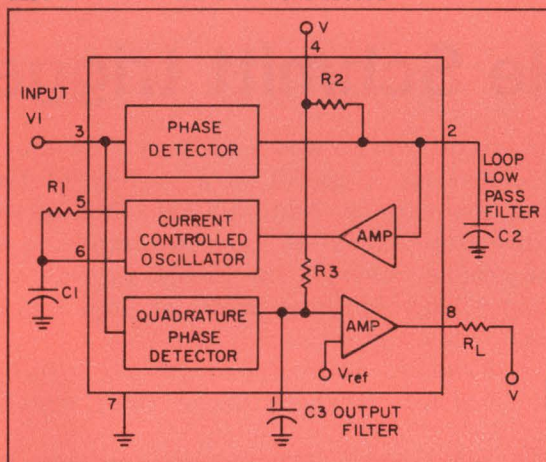

Narrow-band decoding of less than 1% total bandwidth is realized with the SE/NE 567 tone decoder.

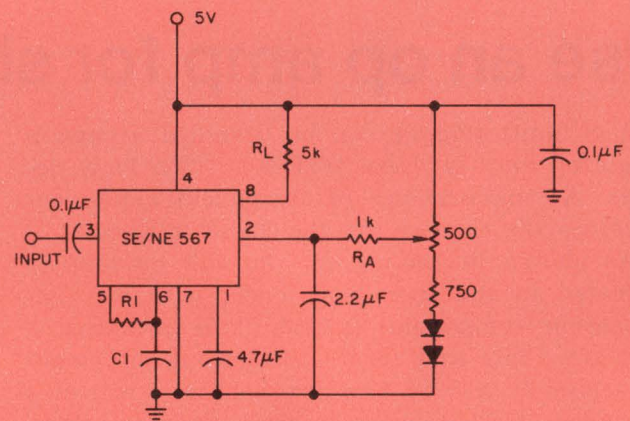

NOTE: CENTER FREQUENCY  $\approx 1/R_1C_1$

er. Applications include speed calibrators for tape transports and precision speed controllers.

## IFD Winner for September 2, 1971

**Dale Pippenger**, Applications Engineer, Texas Instruments, Inc., 13500 North Central Expressway, P.O. Box 5012, Dallas, Tex. 75222. His idea, "Measure rpm accurately with an optical counter," has been voted the Most Valuable of Issue award.

**Vote for the Best Idea in this Issue.**

## IFD Winner for September 16, 1971

**C. A. J. van der Geer**, FOM-Inst. Plasmafysika, Jutphaas, Holland. His idea, "Light-pulse generator works on variable supply voltage," has been voted the Most Valuable of Issue award.

**Vote for the Best Idea in this Issue.**





## Helipot delivers voltage regulators... fast!

Pick an off-the-shelf voltage regulator from Helipot for your application.

DC Voltage Regulators Fully sealed, miniature hybrid cermet thick-film devices:						
Series No.	Fixed	Adjustable	Output Voltage Range (VDC)	Output Current	DC Line and Load Regulation	Price (1-9)
801	X		+9 to +21	Up to 0.5 amp	±0.05%	\$30
802		X	"		35	
851	X		-9 to -21		30	
852		X	"		35	
803	X		+21 to +32		30	
804		X	+20 to +32		35	
853	X		-21 to -32		30	
854		X	-20 to -32		±0.05%	35
805	X		+3 to +9		±0.1%	30
806		X	"		"	35
855	X		-3 to -9	"	30	
856		X	"	Up to 0.5 amp	"	35
807		X	+30 to +60	0.150 amp	±0.05% at -20° to +125°C ±0.1% at -55° to -20°C	30
808		X	+60 to +120	"	"	30
809	X		+5 to +28	0.75 amp	0.003%/mA	8.95
859	X		-5 to -28	"	"	8.95
828A		X	+5 to +30	500 mA	Line: ±0.01%/V Load: ±0.01%	50
838A		X	-5 to -30	"	"	50
844			Dual ±12 to ±20	0.3 amp	Line: ±0.005%/V Load: ±0.005%	20

**Low Cost Series 809 and 859** voltage regulators are small (1" x 0.5" x 0.170" high), complete, fully sealed and compatible with flat pack and dual-in-line packaging. The 809 and 859 circuits consist of a series pass stage, an error amplifier with built-in reference, and a precisely adjusted output voltage sense divider. In addition to being complete voltage regulators, the Series 809 and 859 have the following add-on capabilities: current limiting, load capability to over 10 amps, and adjustable output.

For off-the-shelf voltage regulators, call your local Helipot Sales Representative today.

**Beckman** INSTRUMENTS, INC.

HELIPOT DIVISION  
2500 Harbor Blvd., Fullerton, Calif. 92634



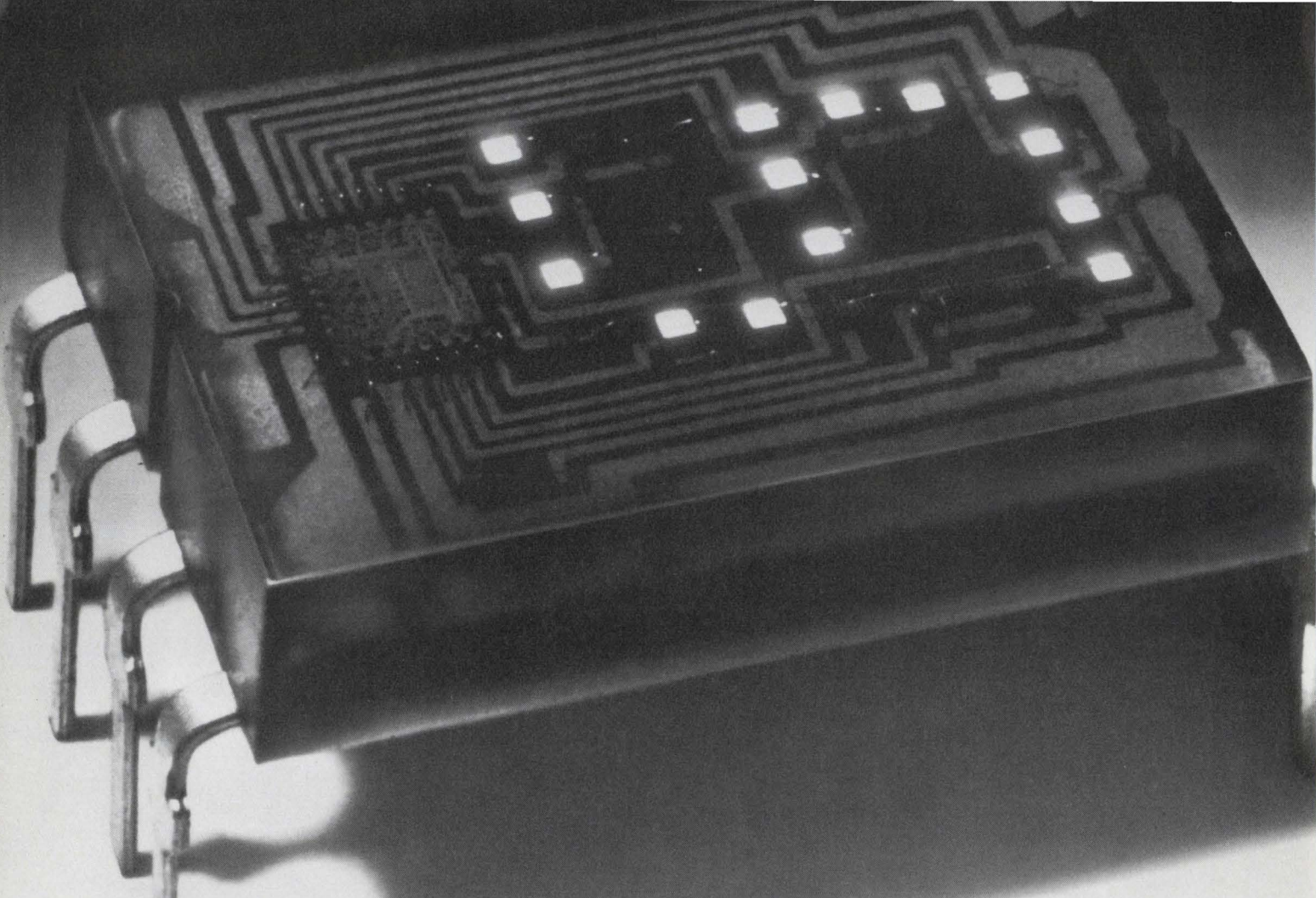

# We built in the decoder/driver so you don't have to.

Not only the decoder/driver but the memory too! Now available for *immediate* delivery is the HP 5082-7300 series solid state display.

It's completely TTL compatible. All you do is address it directly with four-line BCD input. The on-board IC allows for either the storage of input data or real-time display. You save design time, space, and money, and get a completely reliable integrated display system.

A bright .290 inch high, shaped character gives

excellent readability over a wide viewing angle in a compact .600 inch by .400 inch package.

Best of all is the price: \$10.00 each in 1K quantities. So why wait? Order now! For *immediate* delivery on the HP 5082-7300 call your local HP sales office, or Hewlett-Packard, Palo Alto, Calif. 94304. In Europe: 1217 Meyrin-Geneva, Switzerland.

01202

HEWLETT  PACKARD

COMPONENTS



## new products

# Both high and 50-ohm inputs are given in 100-MHz scope

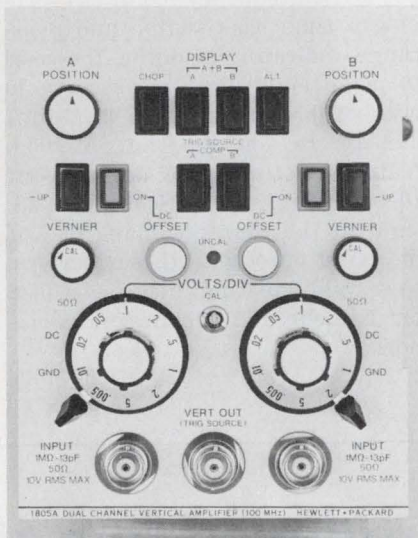

Hewlett-Packard, 1900 Garden of the Gods Rd., Colorado Springs, Colo. Phone: (303) 636-5111. P&A: \$1400; February, 1972.

For precision wideband measurements, a 50-ohm input scope is needed. For probing, high input impedance is generally required. Both impedance levels are now available in one plug-in—the 100-MHz, 3.5-ns-rise-time Model 1805A dual-channel vertical amplifier for the 180 oscilloscope system. Selection is made through a switch on the panel.

The 1-M $\Omega$ , high-input impedance is shunted by only 13 pF. The usual rotary-switch, discrete-resistor attenuator contributes 25 pF. H-P halves capacitance with a thick-film approach, depositing resistances and conductors on an alumina substrate, thus improving attenuator rise time by a factor close to two. Resistors are trimmed to 0.5%, providing an over-all attenuator accuracy of better than 2%.

The 50-ohm input has a low VSWR of 1.35 at 100 MHz on the

5 mV/div range, and an even better 1.1 on all others. In the 50-ohm mode, a substantial 2 W can be dissipated. This permits inputs up to 10V RMS to be safely applied.

Additional standard features of the plug-in are  $\pm 200$  divisions of offset; a vertical signal output with greater than 50 mV/div of display up to 80 MHz, operating into 50 ohms; and pushbutton controls for easy operation. The high-level and low-noise signal output is useful in cascading amplifiers to increase sensitivity for low-level measurements. In this configuration the amplifiers provide a 500 uV/div deflection factor with at least 80 MHz bandwidth.

Offset capability of  $\pm 200$  divisions allows a nonsymmetrical (biased) logic pulse to be positioned on the screen. ECL logic signals operated with 0.5 V swings and biased several volts from ground are a good example. To maintain dc coupling, offset is required to view this type of signal at high amplitude.

Deflection factor ranges from 5 mV/div to 5V/div in 10 calibrated steps in a 1, 2, 5 sequence for both channels. Operation in a  $\pm A$   $\pm B$  mode is included. The dynamic range is six divisions at 100 MHz. A vernier provides continuous adjustment between ranges and extends the maximum deflection factor to 12.5 V/div. Input signals are delayed sufficiently to permit viewing the leading edge of an input pulse without advancing the trigger.

At the heart of the electronics are three medium-scale integrated circuits with approximately 40 active circuits each.

CIRCLE NO. 250

## DVM is insensitive to ac distortion



Dana Laboratories, Inc., 2401 Campus Dr., Irvine, Calif. Phone: (714) 833-1234. P&A: \$3150; 30 days.

A new distortion-insensitive AC converter is used in Dana Laboratories Series 5800 digital multi-meters. The converter measures the rms values of sine waves with distortion up to 5% with little loss of accuracy. Other 5-digit meters may measure such inputs to only 1%. DC accuracy is 0.003% for 24 hours (0.06% for 90 days). Four dc ranges from 1 V to 1000 V provide 10  $\mu$ V resolution. Accuracy for AC from 10 Hz to 100 kHz is 0.04%. Resistance ranges have a resolution of 10  $\mu\Omega$ .

CIRCLE NO. 251

## Sweep generators cover 1500 MHz range



Telonic Industries, Inc., Box 277, Laguna Beach, Calif. Phone: (714) 494-9401. P&A: \$1095 to \$1395; 30 days.

Models 1204 and 1205 sweep generators, designed for "universal" applications, each incorporate a complete sweep oscillator system, an attenuator and up to seven frequency markers in a compact housing measuring 8.75 in. by 6.75 in. by 12 in. overall. Model 1204 bandwidth varies from 200 MHz to a full sweep of 500 MHz. Zero to 1500 MHz in three bands is covered in Model 1205. Attenuator range is 102 dB.

CIRCLE NO. 252



### DPM is available on a case-less card

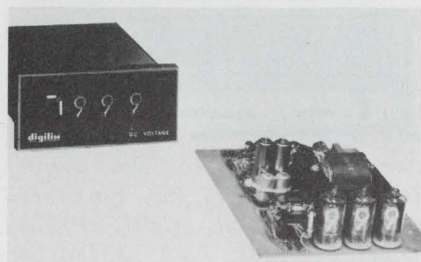

Digilin, Inc., 1007 Air Way, Glendale, Calif. Phone: (213) 240-1200. Price: \$125.

Type 1352 DPM features case-less construction, with the electronics and 0.6-in. gas-discharge display tubes on a single card. Type 2352 adds an all-aluminum housing with room for the optional BCD output. Full scale reading is 1.999 V including overrange, with accuracy 0.1% of reading  $\pm 1$  digit. All integrated circuits undergo active burn-in for long trouble-free life.

CIRCLE NO. 253

### Pulse generator has 2 ns rise time

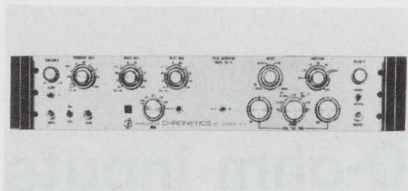

Chronetics, Inc., 500 Nuber Ave., Mt. Vernon, N.Y. Phone (914) 699-4400. P&A: \$1450; stock to 30 days.

Rise time is less than 2 ns at 5 V output for Model PG-14 50 MHz pulse generator. With 20 V unloaded output from a 50  $\Omega$  source, the rise time is under 2.7 ns. The unit provides a double-pulse output to 75 MHz. In addition to four ranges of voltage output, operation in a current mode provides up to 400 mA from a 1 k $\Omega$  minimum source impedance. An output offset of 0 to  $\pm 100$  mA is provided to vary dc pulse position.

CIRCLE NO. 254

### 80 MHz counters make 8-digit measurements



Heath/Schlumberger, Scientific Instruments, Benton Harbor, Mich. Phone: (616) 983-3961. Price: \$350 and \$500.

Models SM-104A and SM-105A 80 MHz frequency counters provide a time base switch and over-range indicator, enabling the user to make eight-digit measurements without prescaling on a five-digit display. In addition the SM-105A features a time base accuracy of 10 ppm. High speed Schottky TTL logic in the counters make one of the first uses of these devices. New light-emitting diodes are used for readout and overrange indication.

CIRCLE NO. 255

## General Radio Introduces Two New

### GR874<sup>®</sup> (75 $\Omega$ )- General Purpose

Now you can add a new degree of confidence and flexibility to your 75- $\Omega$  work with this broad new line of GR874 (75- $\Omega$ ) components. Confidence because you'll be using components with known 75- $\Omega$  characteristic impedance and low SWR to 2000 MHz. Flexibility because of the broad selection of components plus their hermaphroditic design which permits easy interconnection among a variety of connector types with a minimum number of GR874 adaptors.

The GR874 quick-connect/disconnect design has proven reliable electrically and mechanically since the introduction of GR874 50- $\Omega$  components almost 25 years ago. Now you can have this same reliability in 75- $\Omega$ .

The GR874 (75- $\Omega$ ) series includes:

- GR874 75- $\Omega$  Basic Connector (\$3.60\* in lots of 100)
- Cable and Panel Connectors for: RG/11U, RG/59U, RG/187U
- Adaptors to jack and plug types: BNC, N, F, Western Electric small and large, and GR900<sup>®</sup> (50- $\Omega$ )
- Terminations: matched, open-circuit, short-circuit
- Fixed Attenuators: 6 dB, 10 dB
- Matching Pad: 50- $\Omega$  to 75- $\Omega$
- Air Line and Inner Conductor Rod

\*Net FOB Concord, Mass.

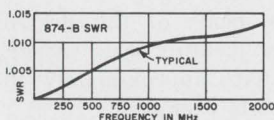

SWR curve for basic connector





## Pulse generator has variable rise time



*E-H Research Laboratories Inc., P.O. Box 1289, Oakland, Calif. Phone: (415) 834-3030. P&A: \$1595; 90 days.*

A pulse generator with output pulse shape completely specified and almost ideal, the 50 MHz Model 135A has rise and fall times variable from 3 ns to greater than 8 ms, pulse width and delay variable from 10 ns to 50 ms and a 10 V output into 50 ohms. A baseline offset of 0 to  $\pm 5$  V and positive or negative output facilitate interface with different types of logic circuitry. The unit can be triggered by low-level logic.

CIRCLE NO. 256

## P-channel FETs halve capacitance

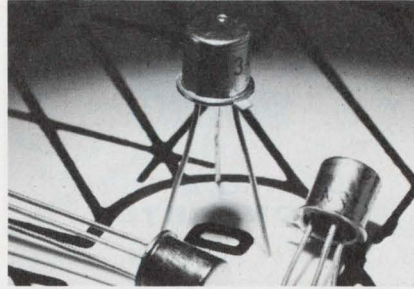

*National Semiconductor Corp., 2900 Semiconductor Dr., Santa Clara, Calif. Phone: (408) 732-5000. Price \$1.50 (PF510) \$1 (PF511); (100 quantities).*

Two new p-channel FETs have  $C_{ISS}$  of 12 pF—about half the typical value of similar FETs. The PF510 is a 30-V device while the PF511 is for 20 V. Both have 10-V max  $V_{GS(OFF)}$ ,  $-2.5$ -mA min  $I_{DSS}$ , 200  $\Omega$  typical  $R_{DS}$ .  $I_{GSS}$  is 10 nA max in the PF510, 100 nA max in the PF511.

CIRCLE NO. 257

## 12-V power transistors operate to 50 MHz

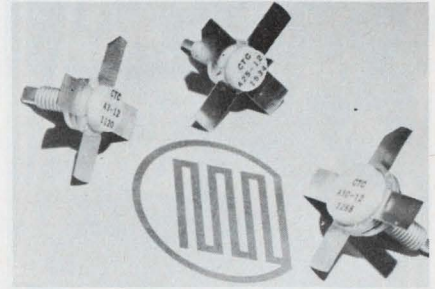

*Communications Transistor Corp., 301 Industrial Way, San Carlos, Calif. Phone: (415) 591-8921.*

A series of transistors for land mobile applications includes the 3-W A3-12, the 25-W A25-12 and the 50-W A50-12. A chain with one 3-W, one 25-W and four 50-W units can deliver 200 W at 25 to 50 MHz with 200-mW drive. Company performs 100% testing and guarantees devices to withstand infinite VSWR at rated power and voltage.

CIRCLE NO. 258

# Lines of 75- $\Omega$ Coaxial Components



## GR900<sup>®</sup> (75 $\Omega$ )- Precision

GR900 (75- $\Omega$ ) coaxial components deliver the precision and repeatability needed for confidence in calibration and standards lab work. This new series of standards is specified to 1000 MHz and useable to 8.5 GHz. SWR for the precision connector is less than  $1.0015 \pm 0.0015$  GHz and repeatability is better than  $\pm 0.002$  dB,  $\pm 0.01^\circ$ .

The GR900(75- $\Omega$ ) series includes:

- Precision Coaxial Connectors
- Precision Standard Terminations
- Precision Matching Pads — 50- $\Omega$  to 75- $\Omega$
- Precision Adaptors to types: GR900 (50- $\Omega$ ), F, and Western Electric small and large

Complete specifications and prices on GR's new 75- $\Omega$  coaxial components are available from your GR sales engineer or from GR, Concord, Mass. 01742. In Europe write Postfach, 124, CH 8034, Zurich, Switzerland.



## General Radio

NEW YORK (N.Y.) 212 364-2722 (N.J.) 201 791-8990 • BOSTON 617 646-0550  
CHICAGO 312 992-0800 • WASHINGTON, D.C. 301 881-5333 • LOS ANGELES 714 540-9830  
TORONTO 416 252-3395 • ZÜRICH (01) 55 24 20  
GRASON-STADLER 617 369-3787 • TIME/DATA 415 327-8322

INFORMATION RETRIEVAL NUMBER 39



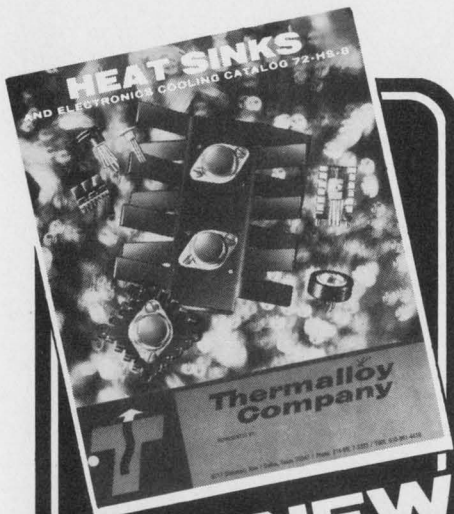

# THE NEW Thermalloy HEAT SINK CATALOG 1972

## FREE CATALOG

An easy to use, 40 page catalog containing over 150 configurations designed to quickly solve your electronic cooling problems. Simple selection guide eliminates complex calculations.

## OVER 40 NEW PRODUCTS

- Including:
- DIP HEAT SINKS
  - PLASTIC POWER HEAT SINKS
  - VERTICAL HEAT SINKS
  - DISC PACKAGE HEAT SINKS
  - LIQUID COOLED SYSTEMS



SEND FOR  
FREE  
CATALOG

**Thermalloy**

8717 DIPLOMACY ROW  
DALLAS, TEXAS 75247  
PHONE: 214/637-3333  
TWX: 910/861-4410

## ICs & SEMICONDUCTORS

### Monolithic d/a has 6 bits in a 14-pin DIP

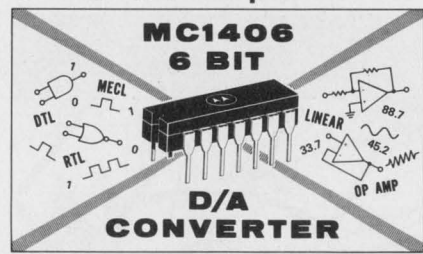

Motorola Inc., Semiconductor Products Div., P.O. Box 20934, Phoenix, Ariz. Phone: (602) 273-6900. Price: \$3.95 (100 quantities).

The MC 1406 is a six-bit monolithic multiplying d/a converter in a 14-pin DIP package. The digital inputs are TTL/DTL compatible and settling time is 200 ns. The output is current, 2 mA maximum, with a drift of about 0.002%/C and an accuracy of 0.7% over 0 to 75 C. An external amplifier can convert the output to a voltage. Applying a varying input to the voltage reference terminal results in an output proportional to the product of this analog voltage with the digital input.

CIRCLE NO. 259

### 3072-bit ROM generates ASCII alphabet font

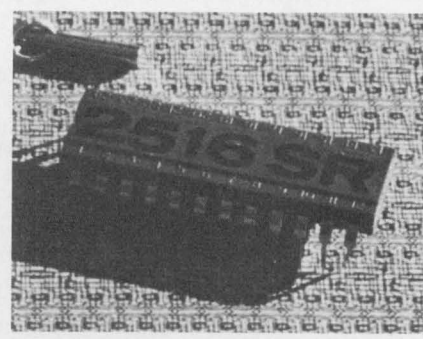

Signetics, 811 E. Arques Ave., Sunnyvale, Calif. Phone: (408) 739-7700. Price: \$19.50 (100 to 249).

The 2516, a 3072-bit static ROM IC, generates the ASCII alphabet font with typical access time of 450 ns. The organization is 64 characters, each of which consists of eight 6-bit columns. Temperature range for normal operation is 0 to 70 C. The 2516 is manufactured in a silicone, dual-in-line 24-pin package.

CIRCLE NO. 260

### Voltage comparators boast 40-ns response

Advanced Micro Devices, 901 Thompson Pl., Sunnyvale, Calif. Phone: (408) 732-2400. P&A: See text; stock.

A high gain of 40,000 leaves only bias and offsets as the factors controlling comparator error in the Am106 family, a pin-for-pin replacement for National Semiconductor's line. The family switches 24 V at 100 mA and provides fan-out of 10 with DTL/TTL. Strobe inputs provide output override. High speed and gain give low hysteresis, making for better Schmitt triggers, line receivers, discriminators. Prices in 100-up range from \$6.80 to \$20, depending on package and temp range.

CIRCLE NO. 261

### Spst, spdt pin diodes optimized for power

Aerotech, 825 Stewart Drive, Sunnyvale, Calif. Phone: (408) 732-0880. P&A: A9S112 (\$55), A9S-212 (\$170); stock to 30 days.

High-power pin diodes in spst and spdt configurations handle 70 W peak, 4 W cw. The spst A9S112 has 20 to 45-dB isolation at -100 mA control current while the spdt A9S212 has 50 to 60-dB isolation. Switching times from 100 MHz to 18 GHz are 50 ns for the spst, 200 ns for the spdt.

CIRCLE NO. 262

### MNOS DDAs solve diff equations in real time

Collins Radio Co., Dept. 600, Newport Beach, Calif. Phone: (714) 833-0600. P&A: See text; stock.

Three LSI arrays—a quad serial summer (CRC9504), a quad gated shift register (CRC1502) and two full adders with overflow (CRC-9503)—perform complex integration and give real-time solutions of differential equations. Chips are compatible with other MOS devices or DTL/TTL. Logic is low-threshold, dynamic, two phase. In 10-up, summer costs \$26.40, shift register \$18.60, R-adder \$26.55.

CIRCLE NO. 263



## IC multiplier operates in four quadrants

RCA Solid State Div., Route 202, Somerville, N.J. Phone: (201) 722-3200. Price: \$6.50 (1000 quantities).

Intended basically for multiplication, division, squaring, square-rooting and power-series approximations, the CA3091D is also useful as an automatic level controller, an rms converter, and a frequency discriminator. The unit includes a multiplier, linearity compensator, current converter, current sources for biasing and a voltage reference. Linearity is 4%, 3-dB bandwidth is 4.4 MHz, power drain is 4 mW from  $\pm 6$  V, low power-supply sensitivity is typically 64 mV/V. The device is packaged in a 14-pin DIP for  $-55$  to  $+125$  C.

CIRCLE NO. 264

## 256 x 4-bit TTL ROM gives 50-ns max access

Fairchild Semiconductor Div., 464 Ellis St., Mountain View, Calif. Phone: (415) 962-3816. P&A: see text; 4 to 8 wks.

A new bipolar, 1024-bit ROM, the 93406, has full on-chip decoding. A chip-select feature allows expansion to 1024 four-bit words without adding more gates. Maximum access time is 50 ns from 0 to 75 C. At 100-to-999 level, the ROM costs \$16.50 in a 16-pin ceramic DIP plus a \$500 one-time mask charge.

CIRCLE NO. 265

## MOS/LSI calculator kit forms desk-top computer

Solitron, 1177 Blue Heron Blvd., Riviera Beach, Fla. Phone: (305) 848-4311.

The latest addition to Solitron's line of calculator products is the 9000 series, an MOS/LSI calculator kit. It contains the entire logic electronics to implement a 10-digit desk-top electronic calculator. Four-function calculations are possible, including constant multiplication and division. The series is also available as a complete system.

CIRCLE NO. 266

# Compare Mox to whatever resistor you're using now.

Our Metal Oxide Resistors offer you:

- Small Size
- Maximum Reliability
- Low Temperature Coefficient
- High Stability
- High Voltage Capability

Set a comparable MOX Resistor beside the wire wound or metal film resistor you're using now. Chances are you'll find ours smaller, giving you greater design possibilities for ultra-critical applications. Our precision? As good as  $\pm 0.5$  per cent. With stability to match, both on the shelf—less than 0.1 per cent drift per year—and off—as little as 1 per cent drift under full load in 2000 hours. MOX Resistors withstand extreme environmental conditions; the effects from temperature cycling are negligible; and they have voltage capabilities far in excess of wire wound and metal film resistors.

We offer you a complete MOX Series to choose from, and we keep them stocked for prompt delivery.

**Mini-Mox**—Miniature high voltage resistors with ratings as high as 5 KV and dissipations to 1 watt. Available with 100 ppm TCR. Compare with bulky metal film types.

**Maxi-Mox**—Rated at 2.5 watts and 7.5 Kv per lineal inch. Available in 1-5" lengths in 1" increments. Approximately  $\frac{1}{2}$  size of film resistors with equivalent ratings. Compare with metal films with inflated voltage ratings.

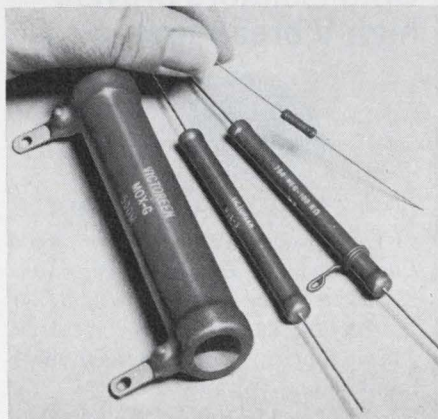

**Divider-Mox**—Single units with one or more taps. Ratios as high as 10,000:1. Input voltages to 37.5 Kv. Output voltage stability  $\pm 0.5$  per cent over temperature extremes. Compare design advantages with discrete resistors.

**Power-Mox**—High voltage, high power resistors with hollow cores for more efficient heat dissipation. Voltages to 45 Kv. Wattages to 45 watts in 70°C air ambient. Compare with voltage limited wire wound resistors.

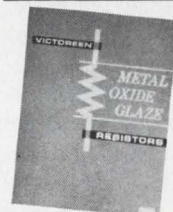

MOX FACTS and Technical Data Sheets are available from: Victoreen Instrument Div. of VLN Corp. 10101 Woodland Avenue, Cleveland, Ohio 44104. Telephone: 216/795-8200

DMA 681

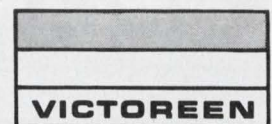

Expertise in high voltage.



# AMPERITE

Top Quality  
STILL AT  
LOW  
PRICE

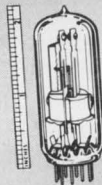

## Thermostatic DELAY RELAYS

Offer true hermetic sealing...  
Assure maximum stability and life.

**Delays: 2 to 180 seconds\***

Actuated by a heater, they operate on A.C., D.C., or Pulsating Current... Being hermetically sealed, they are not affected by altitude, moisture, or climate changes... **SPST only** — normally open or normally closed... Compensated for ambient temperature changes from -55° to +80°C... Heaters consume approximately 2 W. and may be operated continuously. The units are rugged, explosion-proof, long-lived, and inexpensive!

**TYPES:** Standard Radio Octal and 9-Pin Miniature.  
List Price, \$4.00

\*Miniatures Delays: 2 to 120 seconds.

All Amperite Delay Relays are recognized under component program of Underwriters' Laboratories, Inc. for all voltages up to and including 115V.

**PROBLEM? Send for Bulletin No. TR-81.**

## AMPERITE BALLAST REGULATORS

Hermetically sealed, they are not affected by changes in altitude, ambient temperature (-50° to +70°C.) or humidity... Rugged, light, compact, most inexpensive.

List Price, \$3.00

Write for 4-p. Bulletin No. AB-51.

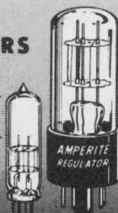

# AMPERITE

600 PALISADE AVE., UNION CITY, N.J. 07087

Telephone: 201 UNion 4-9503

In Canada: Atlas Radio Corp., Ltd.,  
50 Wingold Ave., Toronto 10

## ICs & SEMICONDUCTORS

### CPU on a chip helps make full computer

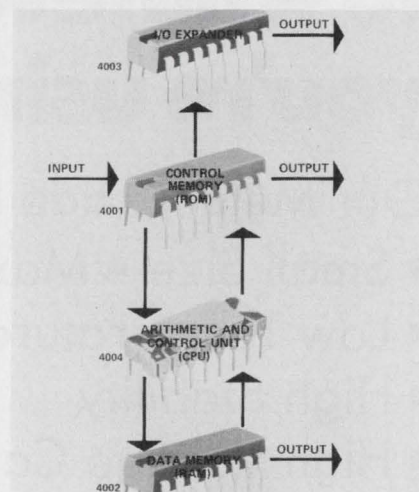

Intel Corp., 3065 Bowers Ave.,  
Santa Clara, Calif., Phone (408)  
246-7501. P&A: see text, stock.

A one-chip central-processing unit with a 4-bit parallel adder, 16 4-bit registers, an accumulator and a push-down stack—the 4004—can form the heart of a computer with the 4001, a 256 x 8-bit ROM, the 4002, a 320-bit RAM, and the 4003, a 10-bit serial-to-parallel register. At the 100-piece level, the 4004 costs \$30, the 4001 \$18, the 4002 \$15 and the register \$3.

CIRCLE NO. 267

### Opto-isolators provide high-V breakdown

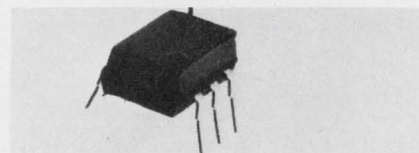

Litronix, Inc., 19000 Homestead Rd.,  
Cupertino, Calif. Phone: (408)  
257-7910. P&A: Iso-Lit 12, \$1.70,  
Iso-Lit 16, \$3.05 in 100-up; stock.

Two optical isolators have high breakdown voltage—1000 V for the Iso-Lit 12, 1500 V for the Iso-Lit 16 with, respectively, 10% and 14% typical current-transfer ratio, and 2 pF and 0.5 pF typical coupling capacitance. In each, a gallium arsenide LED transmits infrared to an npn phototransistor which can directly drive 930 DTL or 7400-series TTL.

CIRCLE NO. 268

## DATA PROCESSING

### Cartridge transport uses single motor



Astro-Science Corp., 9700 Factorial Way,  
S. El Monte, Calif. Phone:  
(213) 443-3211.

A tape transport for audio/instrumentation applications incorporates the recently patented peripheral drive system wherein the two tape packs are driven on their periphery by individual capstans. The Astrodrive transport requires only a single motor, unlike conventional transports that require three motors, to drive the tape reels and capstans. Advantages include: relative immunity to shock, vibration and temperature environments; all parts of the tape move together from one drive source eliminating tape stresses; higher acceleration rates and faster start/stop times; low power consumption.

CIRCLE NO. 269

### Cassette recorder replay on X-Y chart recorders



Tetrahedon Associates, Inc., 7605  
Convoy Ct., San Diego, Calif.  
Phone: (714) 277-2820.

An auto-ranging, eight-channel magnetic tape cassette recorder, the Data Manager, expands, contracts, or rescales data in either axis. Using auto-ranging, all incoming and outgoing signals are scaled in digital format over a 3 decade (1000X) range.

CIRCLE NO. 270



## Buffered tape transport has 2048 character size

*Pertec Peripheral Equipment, 10880 Wilshire Blvd., Los Angeles, Calif. Phone: (213) 475-8464.*

A buffered magnetic tape system allows the transfer of blocked NRZI or phase-encoded formats at rates up to 1 million characters per second, asynchronously. Using a dual-buffer option, data can be transferred continuously at rates up to 60,000 characters per second (phase encoded) or 40,000 characters per second (NRZI), with zero data loss. This is achieved by transferring data into one-half of the buffer until that half is full, and then switching data into the second half while data in the first half is being written on tape.

CIRCLE NO. 271

## ROM compatible with PDP-14, PDP-16

*Datapac Inc., 18872 Redhill Ave., Santa Ana, Calif. Phone: (714) 546-7781. Price: 2¢/bit.*

A fully decoded Read-Only-Memory that includes data registers has performance guaranteed with  $\pm 5\%$  voltage margins and over the 0 C to +70 C temperature range. The dimensions of the unit are 5.2 by 8.5 by 1.25-in. Running from a single +5.0 V power supply, system access times of 200 ns and cycle times of 500 ns are easily attainable.

CIRCLE NO. 272

## Buffer memory stores 1024 8-bit words

*Computer Labs, 1109 S. Chapman St., Greensboro, N.C. Phone: (919) 292-6427. Availability: stock.*

The Model CLM 810-1 is a high speed buffer memory which will accept 8-bit words as parallel data at any random or periodic word rate through 10 MHz. It will output these words as a block of data on a first-in, first-out basis at word rates through 2 MHz. It is non-volatile and has a non-destructive readout characteristic.

CIRCLE NO. 273

## Uniquely shaped heat sink dissipates 200 W

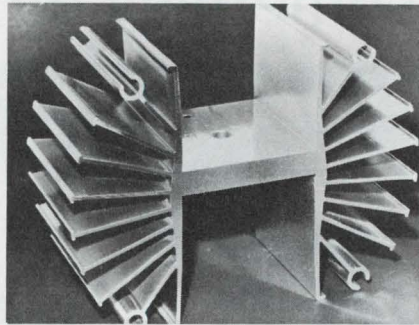

*TOR Heat Sink Div., Precision Dipbrazed Tor, Inc., 14715 Armenta St., Van Nuys, Calif. Phone: (213) 786-6524.*

A large heat sink, Model 1727, has a unique configuration for sinking high power from control circuits, rectifiers and inverters up to 3.5 in. The radial-fin heat sink has 118.3 in.<sup>2</sup>/in. of heat dissipating surface in natural or forced-air convection use. With two power devices mounted on a six in. length and dissipating 100 W each, the surface temperature rises less than 50 C above ambient.

CIRCLE NO. 274

## High reliability power package good at 2 GHz

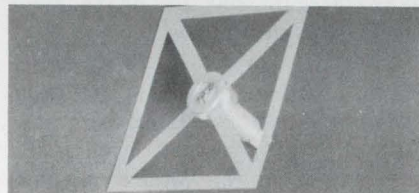

*American Lava Corp., Manufacturers Rd., Chattanooga, Tenn. Phone: (615) 265-3411. Availability: 6 wks.*

A standard high reliability hermetic power package has superior power dissipation characteristics up to 2.0 GHz and is useful into the microwave region. Exceptionally high reliability results by not using glass. A beryllia ceramic serves as a base and is brazed to a multilayer ceramic component, combining the heat sink capability of beryllia and the strength and bonding capability of alumina. Blueprints, technical data and samples are available.

CIRCLE NO. 275

# ME-2

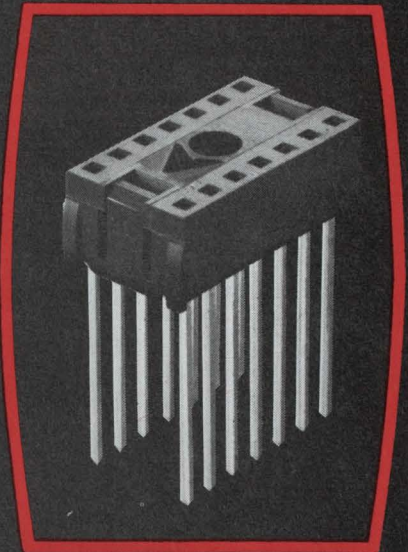

## SCANBE'S NEW DUAL INLINE SOCKETS

- ◆ 14, 16, or 24 pin modules
- ◆ Accepts flat or round leads
- ◆ Tapered entry channels

At first glance, Scanbe's new ME-2 Dual Inline Sockets may appear to be like all others. Appearances can be deceiving. Our new ME-2 includes many exclusive features and offers Scanbe's quality, precision and performance. When it comes to customer benefits, Scanbe's ME-2 socket is a leader not a follower.

Also, custom P.C. board designs using ME-2 sockets to fit your application, software programs and solderless wrap services can complete your hardware system from one source... Scanbe. Write or call for catalogs, price and delivery.



Standard or Custom Logic Panels



**MANUFACTURING CORP.**  
"The Packaging People"

3445 Fletcher Avenue Phone  
El Monte, Calif. 91731 (213) 579-2300

INFORMATION RETRIEVAL NUMBER 43



# D/a and a/d line offers something for everyone

## TEC LED LITE

### TRANSISTOR CONTROLLED LED INDICATOR SAVES PC BOARD SPACE

If you're driving LED's directly from IC outputs you're wasting valuable PC board space! TEC's new L-1017 Series LED Indicator requires 1/10th the current (only 1.6ma) of ordinary LED's (using 15ma) — lets you drive one L-1017, plus nine other loads from one IC logic circuit. Transistor driver and LED are housed in a .284 dia. x 1" long body that mounts in a 1/64" panel hole on 1/2" centers. Wire-wrap terminals standard. L-1017 Series turns on with "high" input, logic "1" (IC driven LED's indicate logic "0"). L-1017 signals: ON, +2.5 to +5VDC; OFF, 0 to +0.8VDC. Supply: +5VDC @ 15ma, maximum. Special lens design increases LED brilliance and side viewing — available in red or clear, spherical or flat top lens style.



2 X SIZE

Immediate Del. \$2.30 ea., 100-499 qty.

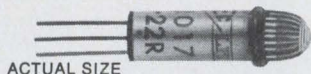

ACTUAL SIZE

### DIRECT DRIVE LED INDICATOR

L-1015 Series LED Indicator is identical to L-1017 Series above in all mechanical details. Internal resistors allow operation directly from 5.0, 6.3, 10 and 24 VDC supplies — permit LED indicator substitution for incandescents.



ACTUAL SIZE

Immediate Del. Price, \$1.30 ea., 100-499.

### TEC LED LITE INDICATOR PACKAGES

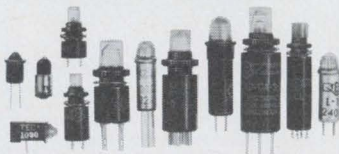

Select a rugged, long life LED indicator or switch/indicator from more than 20 TEC designs. More brilliance, easier mounting, attractive appearance are added to the various LED's packaged by TEC.

See TEC-LITE for the complete line of readouts, indicators, switches, display panels, keyboards, CRT terminals.

TEC, Incorporated; 9800 North Oracle Road, Tucson, Arizona 85704; or phone (602) 297-1111

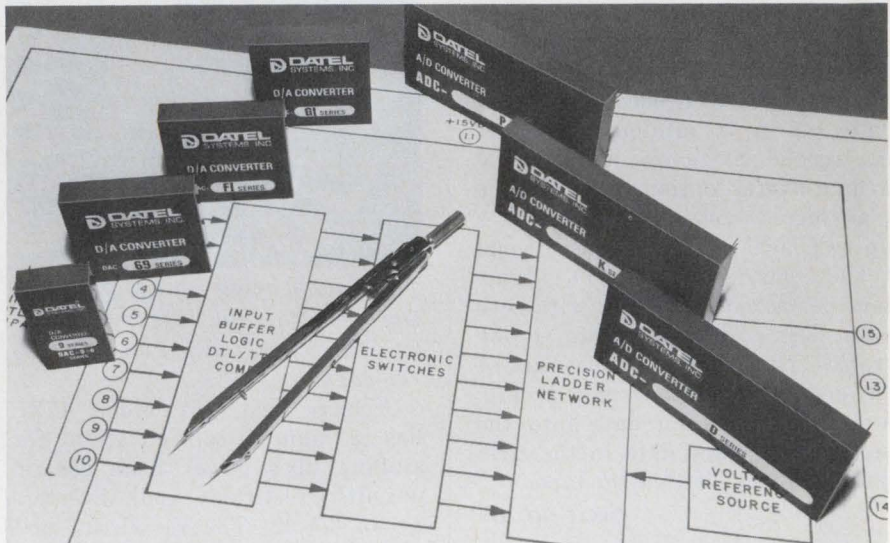

Datel Systems, Inc., 1020 Turnpike St., Canton, Mass. Phone: (617) 828-6395. Prices: See text.

Datel System's full line of d/a's and a/d's carries out this theme: A converter to fit almost any application and pocketbook.

Its a/d converters cover the spectrum in accuracy, conversion speed and resolution, with price matching performance. Where cost governs, consider the ADC-59 series at \$59, converting to eight binary bits in 200  $\mu$ s or to two-digit BCD in 100  $\mu$ s.

Linearity is 0.2% FS with a temperature coefficient of 50 ppm/C over 0 to 70 C. Long-term stability is 0.05% a year. Analog input range can be either unipolar (0 to +10 V) or bipolar ( $\pm 5$  V). For unipolar input, the unit is programmed with a logic zero input, and straight binary, or two-digit, BCD output results. For bipolar inputs, offset binary coding results when the unit is programmed with a logic ONE. The converter module package size is 2 x 3 x 0.4 inches.

At the top of the ADC line are two ultra-high-speed converters: the N12B generates a 12-bit word in 4  $\mu$ s, and the P10B converts to 10 bits in 2  $\mu$ s. The cost is the same: \$695. The temperature variation is 20 ppm/C over a range of 0 to 70 C. Stability is 0.1% a year. Four analog input full-scale rang-

es are available: +5 V, +10 V,  $\pm 5$  V,  $\pm 10$  V. Input impedance is constant at 2 k. The diallyl phthalate case measures 2 x 4 x 0.8 inches.

Series D, K and EX round out the a/d converter line. The D and K types feature a direct serial digital output for single-channel transmission, in addition to standard parallel output. Output coding is straight or offset binary, or two's complement in word lengths of 8, 10 or 12 bits. Conversion time is 50  $\mu$ s for type K.

The price for the d/a converter line of 20 models starts at \$9.95 for the 8-bit Model DAC-98B with current output. Settling time is 300 ns.

For glitch-free operation (< 10 mV) and 25-ns settling time, computer graphic display designers should consider the DAC-GI series. The 10-bit unit in the GI series costs \$139. With 8-bit input and 50-ns settling time, Model F18B in the series costs \$99. Linearity is the same for both series: 1/2 LSB. The temperature coefficient is 15 ppm/C, and accuracy is 0.05% FS. Standard output is +5.0 mA unipolar. Bipolar  $\pm 2.6$  mA is obtained by strapping pins.

All d/a converters require only  $\pm 15$  V dc power input and are packaged in 2 x 2 x 0.4 inch low-profile modules.

CIRCLE NO. 276



## MOS RAM system with 4kx20 bits fits on card

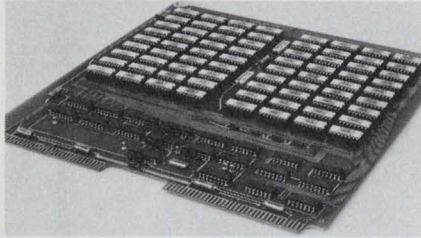

Monolithic Systems Corp., 2700 S. Shoshone, Englewood, Colo. Phone: (303) 761-2275. P&A: 4k x 16 unit \$876 (100 quantities); 30 days.

Monostore IV/Planar is a complete MOS random access memory system with up to 4k x 20 capacity on a single PC card 9-3/4 in. by 12 in. System circuitry for timing, control, refreshing and decoding and the address and data output registers are included. Cycle time is 790 ns with access in 490 ns. Inputs and outputs are TTL-compatible. Multiple cards are packaged on 0.5 in. centers.

CIRCLE NO. 277

## Servo amplifier has fast response

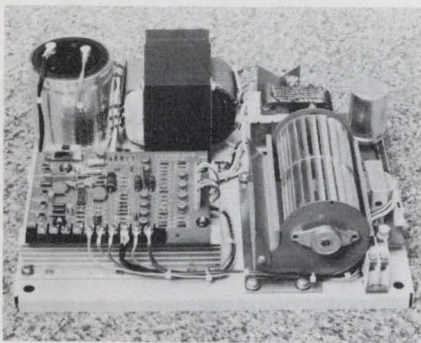

Westamp, Inc., 1542-15 St., Santa Monica, Calif. Phone: (213) 393-0401. Price: \$350.

Model A 5261 servo amplifier will speed a low-inertia motor to 1000 rpm in less than 1 ms, or develop 350 oz-in of continuous torque on a low-speed 40 Frame motor. The amplifier is used in high speed computer-peripheral equipment to position radar antennas or in machine tool axis control. Continuous short-circuit rating is 4.5 A. A power supply is included for operation from 115 and 220 Vac at 50 to 60 Hz.

CIRCLE NO. 278

## S/h amplifier has accuracy of 0.01% FS

Zeltex, Inc., 1000 Chalomar Rd., Concord, Calif. Phone: (415) 686-6660. P&A: \$39 (100 quantities); stock.

ZD 451 sample and hold amplifier features sampling accuracy of 0.01% FS,  $10^{11} \Omega$  input impedance and a settling time of 7  $\mu$ s for a 0 to 10 V step. The user selects inverting or non-inverting operation and gain from +1 to +100. Aperture is 50 ns. The DC input lines can vary from  $\pm 12$  V to  $\pm 18$  V. The low profile plastic case measures 1.96 in. by 1.76 in. by 0.4in. high.

CIRCLE NO. 279

## D/a with eight bits sells for \$9.90 (1-9)

Hybrid Systems Corp., 95 Terrace Hall Ave., Burlington, Mass. Phone: (617) 272-1522. P&A: \$9.90; stock-4 wks.

An 8-bit d/a converter, Model 371-8, with a built in reference, plugs into an IC socket. Full scale current output is 2 mA developing up to 1.25 V across an external resistor. The unit accepts DTL/TTL inputs and settles within 950 ns. Linearity is within  $\pm 1/2$  LSB and temperature variation is 100 ppm/C. The dc power required is +15 V at 10 mA.

CIRCLE NO. 280

## 12-bit d/a converter is specified thoroughly

Burr-Brown Research Corp., International Airport Industrial Park, Tucson, Ariz. Phone: (602) 294-1431. P&A: \$90-\$125; stock to 4 wks.

Performance is spelled out thoroughly on DAC-40 8 to 12-bit high speed d/a converters. Gain drift is 7 ppm/C on the 12 bit unit, linearity 1/2 LSB over 0 to 70 C, offset drift 1 ppm/C and the output settles to 0.01% of final value in 5  $\mu$ s for a full scale input step, 1.5  $\mu$ s for a 1 LSB change. Bipolar or unipolar full scale output up to 10 V can be specified.

CIRCLE NO. 281

# Now the famous 829 has a "G" for good measure!



Calibrate or Measure with the

## RFL Model 829G

RFL's famous 829, for 15 years the industry calibration standard, now gives way to the new 829G — still the industry calibration standard, but now it's twice as useful. The 829G provides a precision source of AC and DC volts, amps and ohms — plus precision measurements of these parameters from external sources. It offers four-terminal sensing in both source and measurement modes, and high accuracy, resolution and regulation, with 5-digit readout. 5 ranges of AC or DC, 0.1 to 1000V. 6 ranges of current, 100  $\mu$ A to 10A. 50, 60, 400, 1000 Hz AC plus EXT. And many other features — all for just \$3,600.  Write for complete data today. RFL Industries, Inc., Instrumentation Div., Boonton, New Jersey 07005. Tel: (201) 334-3100 / TWX: 710-987-8352 / CABLE RADAIRCO, N. J.



RFL Industries, Inc.



**1** / %  
 AMERICAN MADE  
**Tolerance**  
**SCHAUER**  
**1-Watt**  
**ZENERS**

**Immediate Shipment**  
**Low Prices**  
 ANY voltage from 2.0 to 18.0

Quantity	Price each
1-99	\$1.07
100-499	.97
500-999	.91
1000-4999	.86
5000 up	.82

*All welded and brazed assembly*  
*No fragile nail heads*  
 Gold plated leads

*Write for complete rating data and other tolerance prices.*

**Buy the kit - Save a lot**



Kit contains a 51-piece assortment of SCHAUER 1% tolerance 1-watt zeners covering the voltage range of 2.7 to 16.0. Three diodes of each voltage packaged in reusable poly bags. Stored in a handy file box. Contact your distributor or order direct.

**A \$54.57 value for ONLY \$24<sup>50</sup>**

Semiconductor Division  
**SCHAUER**  
 Manufacturing Corp.  
 4511 Alpine Ave. Cincinnati, Ohio 45242  
 Telephone: 513/791-3030

MODULES & SUBASSEMBLIES

**Braided-wire memory is field alterable**

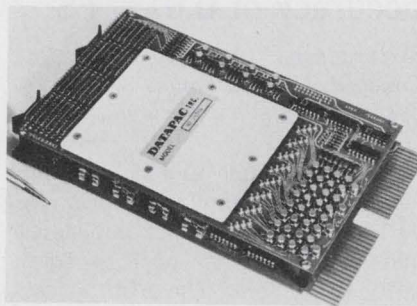

*Datapac Inc., 18872 Redhill Ave., Santa Ana, Calif. Phone: (714) 546-7781.*

A new braided wire alterable read-only memory system organized as 1,024 words of 16 bits each is furnished on a 5.2-in. by 8.5-in. by 1.25-in. PC card. The self-contained, fully decoded system also contains data registers and is TTL-compatible. Operating from a single +5 V power supply, system access times of 200 ns and cycle times of 500 ns are obtained. Individual bits, words or the entire memory contents can be changed in the field.

CIRCLE NO. 282

**Low-cost 8-bit d/a converter costs \$59**

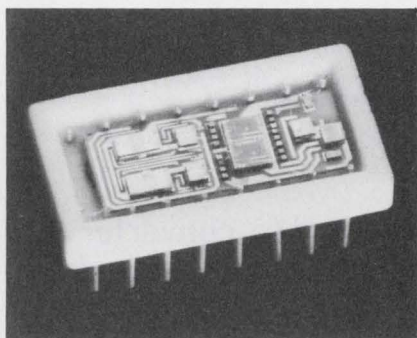

*Micro Networks Corp., 5 Barbara Lane, Worcester, Mass. Phone: (617) 756-4635. P&A: \$59; stock to 2 wks.*

A new low-cost 8-bit d/a converter contains an input storage register, monolithic switches, precision ladder network, internal reference and op amp. The model MN328 is housed in a hermetically sealed 16-pin DIP package and requires only  $\pm 15$  V and  $\pm 5$ -V supplies to operate.

CIRCLE NO. 283

COMPONENTS

**Wirewound trimmer is smallest ever built**



*TRW Electronic Components, 2801 72nd St. North, St. Petersburg, Fla. Phone: (813) 347-2181. P&A: \$1.68; stock.*

The 901 is designed to interchange with all of the popular 1-1/4-in. wirewound trimmers on the market today (RT11P and RT12Y configuration). At 10- $\Omega$ , the lowest resistance value, the 901 has unity resolution. A very low 0.15% resolution is available at 20 k $\Omega$ . This resistor is housed in a flame retardant molded plastic case measuring only one inch long. Offered in a resistance range from 10- $\Omega$  to 50-k $\Omega$ , it has a power rating of one watt at 70 C with an operating temperature range of -55 C to +150 C.

CIRCLE NO. 284

**Transformers are 11/32-in. dia. by 15/32**

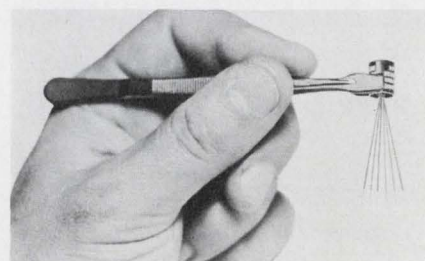

*Pico Electronics, Inc., 316 W. 1st St., Mt. Vernon, N.Y. Phone: (914) 699-5514. P&A: \$3 to \$10; 1 wk.*

A standard line of ultraminiature transformers guarantees all units to pass thermal shock requirements of MIL-STD-202D, Method 107, Test Condition A-1 (25 cycles). Primary and secondary impedances are 3 to 250 k $\Omega$ ;  $\pm 3$  dB 300 Hz - 100 kHz; 600 mW.

CIRCLE NO. 285



## Thin film hybrid rf amps offer 29 dB gain

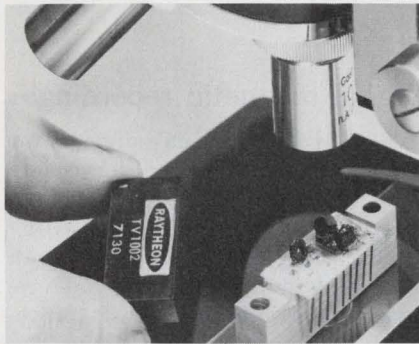

Raytheon Co., Semiconductor Div., 350 Ellis St., Mountain View, Calif. Phone: (415) 968-9211. P&A: \$100, \$80 respectively; 14 days.

The TV1001 and TV1003 thin film hybrid rf amplifier power modules occupy a compact package: the electronics portion measures 0.15 cubic inch, the aluminum heat sink 0.26 cubic inch. The TV1001 has a frequency range of 40 to 300 MHz ( $\pm 0.5$  db) and delivers a minimum gain of 29 db. Noise figure is 9 db. The TV1003 has a frequency range of 2 to 130 MHz ( $\pm 0.5$  db). It has a gain of 17 db and a maximum noise figure of 7 db. Both amplifiers operate from a supply voltage of 24 V and have an input/output impedance of 75  $\Omega$ . The supply current is 310 A (maximum) for the TV1001 and 200 A (maximum) for the TV1003.

CIRCLE NO. 286

## GaAsP LEDs boast 2600 foot lamberts

Chicago Miniature Lamp Works, 4433 N. Ravenswood Ave., Chicago, Ill., Phone: (312) 784-1020. Availability: stock.

A line of high brightness GaAsP light emitting diodes, dubbed the CMA-20 series, is provided with a choice of a clear (transparent) or diffused (translucent) epoxy lens in either clear or red. Rigid terminals permit the device to be connected in a number of ways, soldered, welded, wire-wrapped or plug-in. IC compatible, the CM4-20 series produces 2600 foot lamberts at 70 mA. At 2-10 mA 50 foot lamberts are produced.

CIRCLE NO. 287

## Ceralam capacitors offer volumetric efficiencies

Aerovox Corp., New Bedford, Mass. Phone: (617) 994-9661.

Extended-range axial and radial lead capacitors provide considerable space saving through the use of Ceralam ceramic dielectric. Designated Aerovox Type MC and ML, the units are available in capacitances ranging from 1 pF to 7.5  $\mu$ F in tolerances from  $\pm 1\%$  to 20% and with NPO, X7F and Z7R temperature characteristics. Ceralam volumetric efficiencies make possible units rated at 1  $\mu$ F @ 50 V in a case size only 0.29-in. square, 0.09-in. thick for a radial lead unit, with the largest of the axial lead units only 0.69 by 0.35-in. for 7.5  $\mu$ F @ 25 V.

CIRCLE NO. 288

## Dual-in-line delay has 50 to 150 ns times

Potter Co., 500 W. Florence Ave., Inglewood, Calif. Phone: (213) 678-2651. P&A: \$4; 2 to 6 wks.

The Series 7530 advanced version, dual-in-line delay lines feature a high density package only 0.785-in. long, 0.250-in. high, and 0.240 (or .260) in. wide. Fully encapsulated in epoxy resin, the new delay lines have impedances of 50, 100 and 200 ohms, 10 taps, delay times from 50 to 150 ns, and rise times from 12 to 35 ns. They employ Kovar leads.

CIRCLE NO. 289

## Fuseholder series saves PC board space

McGraw-Edison Co., Bussman Mfg. Div., University & Jefferson St., St. Louis, Mo. Phone: (314) 421-1740.

The BUSS HTA series fuseholder is available in three terminal types: symbol HTA has solder terminals; HTA-HH has 1/4-in. quick-connect terminals and HTA-DD has 3/16-in. quick-connect terminals. The HTA series fuseholder measures only 1-25/32 in. over-all. It extends just 1 in. behind the panel and requires only a 1/2-in. mounting hole. The holder takes 1/4 by 1-1/4-in. fuses.

CIRCLE NO. 290

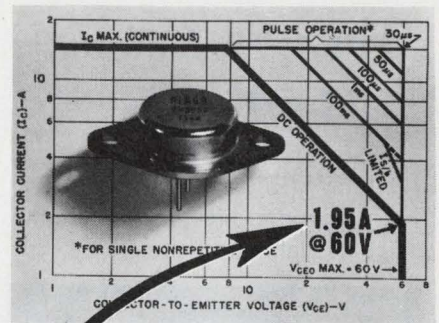

the safe  
operating area  
required for  
**TRUE**  
reliability!

# 2N3055 SINGLE-DIFFUSED 15-AMPERE NPN POWER TRANSISTORS

Hermetically sealed, passivated surface devices designed for industrial and military switching and amplifier applications. Extremely low saturation resistance, uniformly high gain across collector current spectrum, low leakage currents. You can plug it in anywhere Brand 'R' is specified without secondary breakdown problems.

For complete technical data, write today for Engineering Bulletin 31,631 to PIRGO Electronics Inc., Pembroke Road, Concord, N.H. 03301



A Sprague Electric Co. Subsidiary

INFORMATION RETRIEVAL NUMBER 48



## Your best choice in enclosures

- oil and dust tight
- EMI/RFI shielded
- rigid one-piece construction
- available from stock

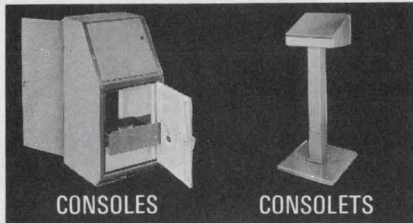

**Consoles** in versatile stock design, 50" x 24" x 23", with gasketed front and rear doors. Options include rack angles, swing-out and stationary subpanels and writing desk. **Consolelets** are offered in eleven stock sizes for desktop mounting of remote controls. Floorstand optional.

All units are heavy gauge steel with all-welded seams, easily shielded.

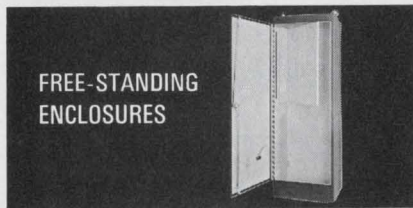

FREE-STANDING  
ENCLOSURES

NEMA 12 units in stock sizes up to 90" x 36" x 24". Rigid 12 gauge steel with all-welded seams, gasketed doors front and/or rear. Oil and dust tight. Options include several interior panel arrangements, rack angles and shielding.

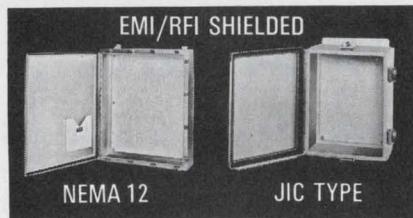

Heavy gauge steel boxes with hinged doors, all cadmium plated. Oil and dust tight, fully shielded. Interior mounting panels and terminal block kits optional. Shipment from stock, all sizes.



NEMA 1  
ENCLOSURES

For mounting controls where oil, dust and water are not a problem. One-piece heavy gauge steel construction, finished in gray prime. Flush latches. Interior panels for mounting components. Wide size range in stock.

# Hoffman

HOFFMAN ENGINEERING COMPANY  
Division of Federal Cartridge Corporation  
Anoka, Minnesota, Dept ED-438

## ELECTRICAL ENCLOSURES

INFORMATION RETRIEVAL NUMBER 49

## application notes

### Digital IC programs

A digital Integrated Circuit Program Library listing all popular digital IC families with associated MSI and special purpose devices is divided into families such as DTL or TTL and is further subdivided into series, for example the 7400 and 9300 series. Each series is separately listed, showing the various manufacturers of the series and their unique designation. Logic gates, flip-flops, adders, decoders, data selectors, etc., require no special programming effort and are grouped as standard programs having a fixed price. More complex programs for MSI and special purpose devices are listed separately with a price for each. Microdyne Instruments, Burlington, Mass.

CIRCLE NO. 291

### Measuring popcorn noise

An eight-page booklet, "Measurement of Burst ("Popcorn") Noise in Linear Integrated Circuits," describes random abrupt output voltage pulses in the order of 0.5 ms to several seconds in duration. This application note details the method by which RCA tests its new low-burst-noise devices (such as the recently announced CA6741T operational amplifier). RCA Solid State Div., Somerville, N.J.

CIRCLE NO. 292

### Circuit breakers

Heinemann's latest Ideafile, "Control 'tricks' that use circuit breakers," contains numerous schematics and special-circuit descriptions. Various special circuits permitting the passage of control signals in addition to lead current through Heinemann circuit breakers are discussed, and their use in simplifying limit-control systems is demonstrated. Heinemann Electric Co., Trenton, N.J.

CIRCLE NO. 293

### Digital magnetic recording

A 32-page design digest for digital magnetic recording covers 1/2-in. IBM-compatible plus 1 and 2-in. heads for digital recording applications. Eight pages of depth design and application factors, five pages detailing test procedures, information on Nortronics new LTC process which extends digital head life by a factor of ten—plus a complete catalog section describing important electrical and mechanical parameters inherent to Nortronics magnetic heads for modern digital applications are included. Nortronics Co., Inc., Minneapolis, Minn.

CIRCLE NO. 294

### Analyzing random signals

Use of signal averaging computers in random processes is described in a four-page application note, T-246. The method described permits measurements never before possible in a wide variety of applications areas, such as in boundary layer turbulence measurements in the field of fluid mechanics. Princeton Applied Research Corp., Princeton, N.J.

CIRCLE NO. 295

### Graphic recorder interface

An eight-page application note describes a versatile instrument interface for graphic recorders. Strip chart and X-Y recorders are probably the most widely used readout devices for instrumentation. Usually, they are built to display a single type of electrical signal. The MPI note describes over twenty setups of signal processing functions. These include typical tasks such as offset, attenuation, amplification and log ratio recording. Less common jobs include derivative, integration, differential, chopped dual channel, overrange alarm, and current to voltage recording, etc. McKee-Pedersen Instruments, Danville, Calif.

CIRCLE NO. 296



## new literature



### DEC small computers

A 500-page handbook describes PDP-8/e and PDP-8/m minicomputers and their varied applications. The brochure details how the PDP-8 family computers are manufactured, designed, and used. Digital Equipment Corp., Maynard, Mass.

CIRCLE NO. 297

### Linear ICs for industry

A quick-reference produce guide is available on 104 RCA linear integrated circuits for industrial applications. This new guide (Form No. LIC-247) includes functional diagrams on a wide variety of op-amps, arrays, voltage regulators, zero-voltage switches, differential amplifiers, broadband video amplifiers; cross-reference of competitor types; a list of application notes and reprints. RCA Solid-State Div., Somerville, N.J.

CIRCLE NO. 298

### Software for the Varian 620

A 12-page brochure detailing the operation of software packages offered with the 620 computer family describes Vortex, a new multi-task real-time operating system for the Varian 620/f. Varian Data Machines, Irvine, Calif.

CIRCLE NO. 299

### How to design memories

A 28-page handbook on instructions for building semiconductor memory systems with Type 1103, the 1024-bit dynamic MOS RAM outlines the internal organization and operation of the chip, describes basic system design, and contains instructions for building the required peripheral circuits for level shifting, timing generation, refresh control and power. Also covered are means of protecting the system from damage, methods of reducing power in large systems, a technique of low-power data retention and the layout of PC boards. Intel Corp., Santa Clara, Calif.

CIRCLE NO. 300

### Microfilm products

A 32-page illustrated catalog describes all microfilm products available from Kodak. "Kodak Microfilm Products: 1972" gives features and specifications of the company's full microfilm products line from basic micrographic equipment (including the Instamatic microfilm system) through computer-output microfilmers, and the new Miracode II information storage and retrieval system. Eastman Kodak Co., Rochester, N.Y.

CIRCLE NO. 301

### Core array test system

A four-page brochure describes the recently introduced M250 Memory Array Test System for use in production testing or a single type or a limited number of individual types of memory core arrays. Computer Test Corp., Cherry Hill, N.J.

CIRCLE NO. 302

### Templates

The 1972 catalog of Templates, a 24-page catalog, illustrates and describes 200 templates. RapiDesign Inc., Burbank, Calif.

CIRCLE NO. 303

# Buying Power?

**NEW-40 PAGES!**

**ERA**  
POWER SUPPLY CATALOG

**CONTENTS**

MIL SPEC - 500 Power Modules	1.0% Regulation, 75-100 VDC	18	500V, 100mA	22
Transistorized Series	1.0% Regulation, 75-100 VDC	19	500V, 100mA	23
500V BEAMS - DC Power Modules	1.0% Regulation, 75-100 VDC	20	500V, 100mA	24
500V BEAMS - AC Power Modules	1.0% Regulation, 75-100 VDC	21	500V, 100mA	25
500V BEAMS - DC Power Modules	1.0% Regulation, 75-100 VDC	22	500V, 100mA	26
500V BEAMS - AC Power Modules	1.0% Regulation, 75-100 VDC	23	500V, 100mA	27
500V BEAMS - DC Power Modules	1.0% Regulation, 75-100 VDC	24	500V, 100mA	28
500V BEAMS - AC Power Modules	1.0% Regulation, 75-100 VDC	25	500V, 100mA	29
500V BEAMS - DC Power Modules	1.0% Regulation, 75-100 VDC	26	500V, 100mA	30
500V BEAMS - AC Power Modules	1.0% Regulation, 75-100 VDC	27	500V, 100mA	31
500V BEAMS - DC Power Modules	1.0% Regulation, 75-100 VDC	28	500V, 100mA	32
500V BEAMS - AC Power Modules	1.0% Regulation, 75-100 VDC	29	500V, 100mA	33
500V BEAMS - DC Power Modules	1.0% Regulation, 75-100 VDC	30	500V, 100mA	34
500V BEAMS - AC Power Modules	1.0% Regulation, 75-100 VDC	31	500V, 100mA	35
500V BEAMS - DC Power Modules	1.0% Regulation, 75-100 VDC	32	500V, 100mA	36
500V BEAMS - AC Power Modules	1.0% Regulation, 75-100 VDC	33	500V, 100mA	37
500V BEAMS - DC Power Modules	1.0% Regulation, 75-100 VDC	34	500V, 100mA	38
500V BEAMS - AC Power Modules	1.0% Regulation, 75-100 VDC	35	500V, 100mA	39
500V BEAMS - DC Power Modules	1.0% Regulation, 75-100 VDC	36	500V, 100mA	40
500V BEAMS - AC Power Modules	1.0% Regulation, 75-100 VDC	37	500V, 100mA	41
500V BEAMS - DC Power Modules	1.0% Regulation, 75-100 VDC	38	500V, 100mA	42
500V BEAMS - AC Power Modules	1.0% Regulation, 75-100 VDC	39	500V, 100mA	43
500V BEAMS - DC Power Modules	1.0% Regulation, 75-100 VDC	40	500V, 100mA	44
500V BEAMS - AC Power Modules	1.0% Regulation, 75-100 VDC	41	500V, 100mA	45
500V BEAMS - DC Power Modules	1.0% Regulation, 75-100 VDC	42	500V, 100mA	46
500V BEAMS - AC Power Modules	1.0% Regulation, 75-100 VDC	43	500V, 100mA	47
500V BEAMS - DC Power Modules	1.0% Regulation, 75-100 VDC	44	500V, 100mA	48
500V BEAMS - AC Power Modules	1.0% Regulation, 75-100 VDC	45	500V, 100mA	49
500V BEAMS - DC Power Modules	1.0% Regulation, 75-100 VDC	46	500V, 100mA	50
500V BEAMS - AC Power Modules	1.0% Regulation, 75-100 VDC	47	500V, 100mA	51
500V BEAMS - DC Power Modules	1.0% Regulation, 75-100 VDC	48	500V, 100mA	52
500V BEAMS - AC Power Modules	1.0% Regulation, 75-100 VDC	49	500V, 100mA	53
500V BEAMS - DC Power Modules	1.0% Regulation, 75-100 VDC	50	500V, 100mA	54
500V BEAMS - AC Power Modules	1.0% Regulation, 75-100 VDC	51	500V, 100mA	55
500V BEAMS - DC Power Modules	1.0% Regulation, 75-100 VDC	52	500V, 100mA	56
500V BEAMS - AC Power Modules	1.0% Regulation, 75-100 VDC	53	500V, 100mA	57
500V BEAMS - DC Power Modules	1.0% Regulation, 75-100 VDC	54	500V, 100mA	58
500V BEAMS - AC Power Modules	1.0% Regulation, 75-100 VDC	55	500V, 100mA	59
500V BEAMS - DC Power Modules	1.0% Regulation, 75-100 VDC	56	500V, 100mA	60
500V BEAMS - AC Power Modules	1.0% Regulation, 75-100 VDC	57	500V, 100mA	61
500V BEAMS - DC Power Modules	1.0% Regulation, 75-100 VDC	58	500V, 100mA	62
500V BEAMS - AC Power Modules	1.0% Regulation, 75-100 VDC	59	500V, 100mA	63
500V BEAMS - DC Power Modules	1.0% Regulation, 75-100 VDC	60	500V, 100mA	64
500V BEAMS - AC Power Modules	1.0% Regulation, 75-100 VDC	61	500V, 100mA	65
500V BEAMS - DC Power Modules	1.0% Regulation, 75-100 VDC	62	500V, 100mA	66
500V BEAMS - AC Power Modules	1.0% Regulation, 75-100 VDC	63	500V, 100mA	67
500V BEAMS - DC Power Modules	1.0% Regulation, 75-100 VDC	64	500V, 100mA	68
500V BEAMS - AC Power Modules	1.0% Regulation, 75-100 VDC	65	500V, 100mA	69
500V BEAMS - DC Power Modules	1.0% Regulation, 75-100 VDC	66	500V, 100mA	70
500V BEAMS - AC Power Modules	1.0% Regulation, 75-100 VDC	67	500V, 100mA	71
500V BEAMS - DC Power Modules	1.0% Regulation, 75-100 VDC	68	500V, 100mA	72
500V BEAMS - AC Power Modules	1.0% Regulation, 75-100 VDC	69	500V, 100mA	73
500V BEAMS - DC Power Modules	1.0% Regulation, 75-100 VDC	70	500V, 100mA	74
500V BEAMS - AC Power Modules	1.0% Regulation, 75-100 VDC	71	500V, 100mA	75
500V BEAMS - DC Power Modules	1.0% Regulation, 75-100 VDC	72	500V, 100mA	76
500V BEAMS - AC Power Modules	1.0% Regulation, 75-100 VDC	73	500V, 100mA	77
500V BEAMS - DC Power Modules	1.0% Regulation, 75-100 VDC	74	500V, 100mA	78
500V BEAMS - AC Power Modules	1.0% Regulation, 75-100 VDC	75	500V, 100mA	79
500V BEAMS - DC Power Modules	1.0% Regulation, 75-100 VDC	76	500V, 100mA	80
500V BEAMS - AC Power Modules	1.0% Regulation, 75-100 VDC	77	500V, 100mA	81
500V BEAMS - DC Power Modules	1.0% Regulation, 75-100 VDC	78	500V, 100mA	82
500V BEAMS - AC Power Modules	1.0% Regulation, 75-100 VDC	79	500V, 100mA	83
500V BEAMS - DC Power Modules	1.0% Regulation, 75-100 VDC	80	500V, 100mA	84
500V BEAMS - AC Power Modules	1.0% Regulation, 75-100 VDC	81	500V, 100mA	85
500V BEAMS - DC Power Modules	1.0% Regulation, 75-100 VDC	82	500V, 100mA	86
500V BEAMS - AC Power Modules	1.0% Regulation, 75-100 VDC	83	500V, 100mA	87
500V BEAMS - DC Power Modules	1.0% Regulation, 75-100 VDC	84	500V, 100mA	88
500V BEAMS - AC Power Modules	1.0% Regulation, 75-100 VDC	85	500V, 100mA	89
500V BEAMS - DC Power Modules	1.0% Regulation, 75-100 VDC	86	500V, 100mA	90
500V BEAMS - AC Power Modules	1.0% Regulation, 75-100 VDC	87	500V, 100mA	91
500V BEAMS - DC Power Modules	1.0% Regulation, 75-100 VDC	88	500V, 100mA	92
500V BEAMS - AC Power Modules	1.0% Regulation, 75-100 VDC	89	500V, 100mA	93
500V BEAMS - DC Power Modules	1.0% Regulation, 75-100 VDC	90	500V, 100mA	94
500V BEAMS - AC Power Modules	1.0% Regulation, 75-100 VDC	91	500V, 100mA	95
500V BEAMS - DC Power Modules	1.0% Regulation, 75-100 VDC	92	500V, 100mA	96
500V BEAMS - AC Power Modules	1.0% Regulation, 75-100 VDC	93	500V, 100mA	97
500V BEAMS - DC Power Modules	1.0% Regulation, 75-100 VDC	94	500V, 100mA	98
500V BEAMS - AC Power Modules	1.0% Regulation, 75-100 VDC	95	500V, 100mA	99
500V BEAMS - DC Power Modules	1.0% Regulation, 75-100 VDC	96	500V, 100mA	100

**ELECTRONIC RESEARCH ASSOCIATES, INC.**  
1000 West 10th Street, Suite 200, Santa Ana, California 92701  
Telephone: (714) 241-1000

**Here's the new, single source for all your power needs.**

- Mil Spec DC Modules
- Wide Range DC Modules
- Slot Voltage DC Modules
- IC Logic Modules
- Full-Range Lab Supplies
- Inverters, Frequency Changers
- High-Voltage Supplies
- AC Regulators
- Full Technical Data
- Full Specifications
- Mechanical Data
- Model Types
- Prices & Availability

**Ask for Your Free Catalog #157 Today!**



**ERA TRANSPAC CORPORATION**

67 Sand Park Road, Cedar Grove, N. J. 07009  
(201) 239-3000

A subsidiary of  
Electronic Research Associates, Inc.



# Highest Speed A/D in Its Class!

(2  $\mu$ s for 12 bits)

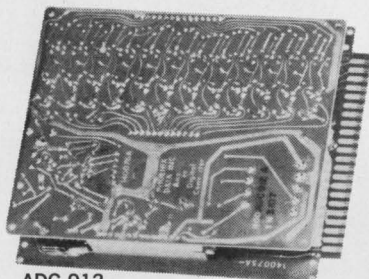

ADC 912

Designed to provide an exceptional speed/performance ratio, units in Phoenix Data's new ADC 900 Series offer fast, accurate, successive-approximation conversion with excellent repeatability, linearity, and monotonicity.

#### FEATURES:

##### High Speed Conversion

- 2 Microseconds for 12 Bits.
- 1 Microsecond for 10 Bits.
- 800 Nanoseconds for 8 Bits.

##### Accuracy

$\pm 0.025\%$  of Full Range — ADC912.

##### Versatility

Binary, pin-compatible with 700 and 70 series.

##### Self-Contained

Including precision reference voltage.

##### Repairable

No potted active circuitry.

Call or write today for the complete ADC 900 Series story.



## PHOENIX DATA, INC.

3384 West Osborn Road  
Phoenix, Arizona 85017  
Ph. (602) 278-8528. TWX 910-951-1364

## NEW LITERATURE

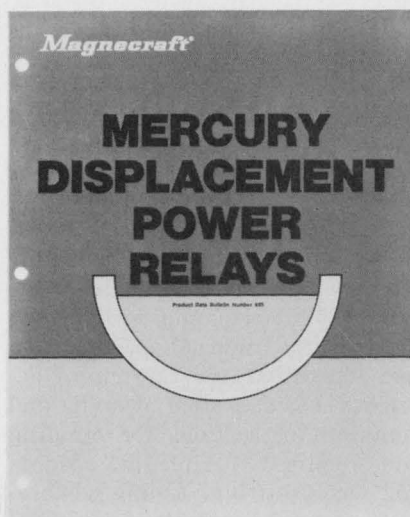

### Mercury power relays

An eight-page, two-color catalog completely describes applications and principles of operation of mercury displacement power relays offering 20 to 100 ampere switching capability. Included are specifications, dimensions, contact ratings, and pricing information. Magnecraft Electric Co., Chicago.

CIRCLE NO. 304

### Peripherals and interfacing

A 294 page handbook on peripherals and interfacing is intended for persons interested in any PDP-11 family system. It describes standard PDP-11 peripherals and options and provides detailed information on interfacing to the PDP-11 Unibus. Digital Equipment Corp., Maynard, Mass.

CIRCLE NO. 305

### RF component catalog

A 16-page rf signal processing component catalog describes the selection and operation of a mixer, and defines the terminology of the mixer industry. It also provides application material, specifications and packaging information on Relcom's rf component line. An application section gives details for using mixers as amplitude modulators, phase detectors, switches, bi-phase modulators, current-controlled attenuators and up-down frequency converters. Relcom, Palo Alto, Calif.

CIRCLE NO. 306

### Cermet trimming pots

The Series 72 Cermet trimming potentiometers are featured in a new catalog sheet. Models 72 PM, 72 P, 72 PX and 72 XW, designed for application in instrumentation, computers, peripheral equipment, and a broad range of industrial uses are fully described. These 3/8-in. singleturn units under full rated power offer a life expectancy of well over five years of continuous duty. Beckman Instruments, Inc., Helipot Div., Fullerton, Calif.

CIRCLE NO. 307

### Digital circuit testers

A four-color booklet describes 720 Series of automatic digital circuit testers. The booklet contents are divided into a product feature section including test patterns each of the test modules is capable of performing, a section illustrating and explaining control and display console features of each tester and a resume of the operation theory behind the series. Microdyne Instruments, Inc., Burlington, Mass.

CIRCLE NO. 308

### Log IF amplifiers

An eight-page technical information bulletin describes ultra-precision matched logarithmic IF amplifiers. Known as Log Amp Bulletin LA 201, it details the problems, considerations, circuit concepts, test methods and computer checkout procedure employed to establish the linearity, stability and matching of their precision log IF amplifiers. RHG Electronics Laboratory, Inc., Farmingdale, N.Y.

CIRCLE NO. 309

### Interconnection components

A 16-page catalog of computer interconnection components includes illustrations, outline drawings and technical data on EMC's line of dual-in-line packaging systems, panels and sockets, soldertail transistor & IC sockets, component adaptor plugs, interfacing plugs, tools and accessories. Electronic Molding Corp., Woonsocket, R.I.

CIRCLE NO. 310



## bulletin board

An expanded line of silicon npn transistors designated **Hometaxial II** including ten new devices produced by the hometaxial process, has been announced by the RCA Solid State Div. With the introduction of these ten new types, RCA provides six balanced hometaxial families with three or four JEDEC registered devices per family, allowing the circuit designer to select from a broad range of types to meet his performance and cost requirements. Six new registered premium types extend the capability of the 2N-3054, 2N3441, 2N3442, 2N3772 and 2N3773, increasing voltage breakdown and providing more power-handling capability and increased safe-area-of-operation. Many low-cost applications do not need premium specifications. In response to this demand, RCA has registered four additional types from these same families to provide circuit designers with standard, economical devices to fit their objectives.

CIRCLE NO. 320

Ten more logic functions have been added to Motorola's MECL 10,000 series. The new devices are a quad OR/NOR gate, quad NOR gate, triple OR/NOR gate, triple NOR gate, triple exclusive OR/NOR gate, quad line receiver, dual OR-AND/OR-AND-INVERT, dual OR-AND gate, 4-wide OR-AND/OR-AND-INVERT, dual "D" latch. MECL 10,000 offers high-speed (2 ns typical gate propagation delay), low-power operation (nominal 25 mW/gate dissipation). Looking toward the designer who seeks medium and large scale integration (MSI/LSI) for his circuits, MECL 10,000 offers an on-chip power dissipation of less than 10 mW/gate.

CIRCLE NO. 321

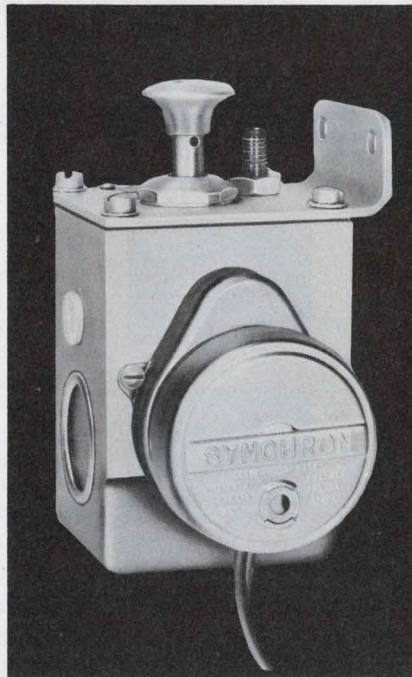

Reliably  
accurate timing  
and drive by Synchron®

Several of the large computer manufacturers now protect their expensive printers with Bijur lubricators. These lubricators accurately meter minute quantities of oil at regular intervals to provide carefully controlled lubrication. Too much oil could result in disfiguring or staining the paper. Too little could result in failure of printers that cost upwards of five figures. Thus, dependability and long life are essential. "That's why we use Hansen Synchron® motors to time and drive lubricating pumps used for this type of application," says Ira Stanley, Bijur Purchasing.



Why don't you depend on Synchron motors when you have a lot at stake?

**HANSEN** MFG. CO., INC.—PRINCETON, INDIANA 47670

**HANSEN REPRESENTATIVES:** Carey & Associates, Houston and Dallas, Texas; R. S. Hopkins Co., Sherman Oaks, Calif.; Melchior Associates, Inc., San Carlos, Calif.; The Fromm Co., River Forest, Ill.; John Orr Associates, Grand Rapids, Mich.; H. C. Johnson Agency, Inc., Rochester, N.Y.; Winslow Electric Co., Essex, Conn.; Kiley Electric Co., Villanova, Pa., and Herbert Rude Associates, Inc., Teaneck, N.J.  
**EXPORT DEPARTMENT:** 2200 Shames Drive, Westbury, N.Y. 11590

INFORMATION RETRIEVAL NUMBER 52

A mouse has  
already been saved  
from leukemia.  
Help us save a man.

For years, you've been giving people with leukemia your sympathy. But sympathy can't cure leukemia. Money can. Give us enough of that, and maybe we'll be able to do for a man what has already been done for a mouse.

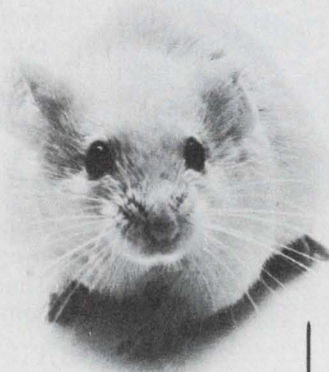

American Cancer Society

Less than 1 $\mu$ V  
Offset!  
New  
Ultra-Low Thermal  
emf Reed Relays!



- Unique new method (pat. pend.) virtually eliminates thermal offsets, permits use of almost any type reed switch... Hg wet, dry, high voltage.
- Remarkably independent of ambient temperature, environment.
- Many contact forms, pin configurations available.
- Units also available at less than 500 nanovolts per switch, or less than 1 $\mu$ V differentially between switches.
- Greater than 10<sup>11</sup> ohms isolation resistance.
- Rugged molded package. Moderate price.

Write for Complete New Catalog MR-6.1



**COTO-COIL COMPANY, INC.**  
59 Pavilion Avenue, Providence, R. I. 02905  
Tel: (401) 941-3355

INFORMATION RETRIEVAL NUMBER 53



ELECTRONIC DESIGN's function is:

- To aid progress in the electronics manufacturing industry by promoting good design.
- To give the electronic design engineer concepts and ideas that make his job easier and more productive.
- To provide a central source of timely electronics information.
- To promote communication among members of the electronics engineering community.

**Want a subscription?** ELECTRONIC DESIGN is sent free to qualified engineers and engineering managers doing design work, supervising design or setting standards in the United States and Western Europe. For a free subscription, use the application form bound in the magazine. If none is included, write to us direct for an application form.

If you do not qualify, you may take out a paid subscription for \$25 a year in the U.S.A., \$35 a year elsewhere. Single copies are \$1.50 each.

**If you change your address,** send us an old mailing label and your new address; there is generally a postcard for this bound in the magazine. You will have to requalify to continue receiving ELECTRONIC DESIGN free.

**The accuracy policy of ELECTRONIC DESIGN is:**

- To make diligent efforts to ensure the accuracy of editorial matter.
- To publish prompt corrections whenever inaccuracies are brought to our attention. Corrections appear in "Across the Desk."
- To encourage our readers as responsible members of our business community to report to us misleading or fraudulent advertising.
- To refuse any advertisement deemed to be misleading or fraudulent.

Microfilm copies are available of complete volumes of ELECTRONIC DESIGN at \$19.00 per volume, beginning with Volume 9, 1961. Work is now in process to complete the microfilm edition of Volumes 1-8. Reprints of individual articles may be obtained for \$2.00 each, prepaid (\$.50 for each additional copy of the same article) no matter how long the article. For further details and to place orders, contact the Customer Services Department, University Microfilms, 300 North Zeeb Road, Ann Arbor, Michigan 48106 telephone (313) 761-4700.

**Want to contact us?** If you have any comments or wish to submit a manuscript or article outline, address your correspondence to:

Editor  
ELECTRONIC DESIGN  
50 Essex Street  
Rochelle Park, N.J. 07662

## King of Korrelators® Conquers Fuzziness

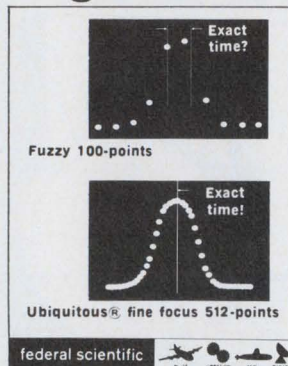

UC-201B is the world's fastest, most sensitive, has finest time resolution. A complete time-domain measurement lab for real-time auto/cross correlation, signal enhancement, probability. For underwater acoustics, fluid dynamics, medical, noise/vibration analysis. Exact time measurements with digital dial; computes integral & differential of any stored function; pre-computational delay built-in (up to 8192 samples optional); zero time can be at center of display; sampling increments 1/2 usec to 2 sec; complete ext. (computer) control plus digital outputs; built-in test signals check all modes; small, portable, easy to use. Many options.

CIRCLE NO. 171

## Federal Scientific Corporation

a subsidiary of Elgin National Industries, Inc.  
615 West 131st Street, New York, N. Y. 10027

## WORLD'S SMALLEST 5VDC/100 AMP POWER SUPPLY

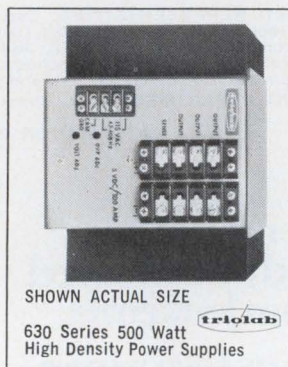

SHOWN ACTUAL SIZE

630 Series 500 Watt  
High Density Power Supplies

Now you can squeeze your power supply down to fit your microcircuitry with our complete line of off-the-shelf 100 watt to 500 watt supplies. All offer small size, lightweight, high efficiency, cool operation, low cost.

630 Series 5V/100 Amp supply has volume under 500 cubic inches! (8 1/2" x 6 3/4" x 8 3/4"); weighs under 20 lbs; 65% efficiency even with light load conditions; no forced air or external cooling for full rated output to 55°C; priced lower than large conventional supplies. Quantity 1-9 \$695 ea.

The 100 watt series come in single, dual, triple outputs; 5VDC to 30VDC; commercial, Military, and export models available.

CIRCLE NO. 172

## Trio Laboratories, Inc.

80 Dupont Street  
Plainview, Long Island, N. Y. 11803

## Ferroresonance is the Key to Simple Voltage Stabilization

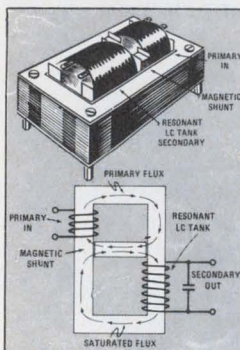

In a new 6-page brochure, Kepco outlines the flux-oscillating stabilizer technique, applied to modern power supplies with special emphasis on the requirements of integrated logic systems.

High reliability, lack of overvoltage risk, exceptional line-noise isolation, inherent current limiting, these power supplies have what it takes at remarkably low cost.

The brochure describes the 58 different Kepco "PRM" stabilizers spanning the range from 4.5V to 240V d-c with ratings from 60W to 300W. There are charts and performance graphs plus complete mechanical installation data.

## Kepco, Inc.

131-38 Sanford Avenue  
Flushing, New York 11352 (212) 461-7000

CIRCLE NO. 173



# Manufacturers

Advertisements of booklets, brochures, catalogs and data sheets. To order use Reader-ServiceCard (Advertisement)

## 1972 Electronic Components Drafting Aids Catalog

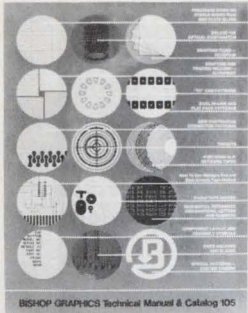

**Free Catalog! Free Samples!** Exciting innovations in pressure-sensitive electronic component drafting aids and methods are detailed in the new 1972 edition of the combined Bishop Technical Manual and Catalog 105.

84 illustrated pages of over 15,000 multi-pad configurations, symbols, tapes, sequential reference designations plus hundreds of time-and-money saving hints in making artwork for PC boards. Includes instructions for using the industry's only red and blue tape system for making two-sided boards in perfect registration.

Send now for free Catalog 105 and free samples.

### Bishop Graphics, Inc.

7300 Radford Avenue, North Hollywood, California 91605  
(213) 982-2000 Telex: 674672

CIRCLE NO. 174

## Free! A/D - D/A Catalog



This comprehensive 12-page catalog contains detailed electrical and mechanical information on ultraminiature A/D and D/A converters, plus accessory sample and holds, multiplexers and miniature D. C. power supplies. Eighty models of 17 series are described in detail. Hardware described in this catalog forms the basic building blocks for many forms of data acquisition, data analysis, data reproducing and graphic display equipment.

D/A's from \$ 9.95 ea.

A/D's from \$59.00 ea.

### Datel Systems, Inc.

1020 Turnpike Street, Canton, Mass. 02021  
Tel. (617) 828-6395 TWX 710-348-0135

CIRCLE NO. 175

## PC Drafting Aids Catalog

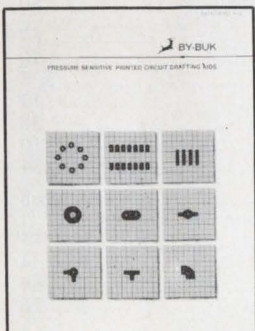

Thousands of time saving, cost saving artwork ideas are found in the By-Buk P-50 catalog of pressure sensitive printed circuit drafting aids. With the most practical artwork patterns for: TO cans, multi-pads, dual-inlines and flat packs featured. Donuts, connector strips, teardrops, ovals, tapes, tees, elbows, etc., by the hundreds are included in the most comprehensive list of sizes. Opaque black, transparent red and transparent blue materials for one and two-sided board designs. For a free copy and samples, write today.

### By-Buk Company

Subsidiary of Webtek Corp., 4326 W. Pico Blvd.  
Los Angeles, California 90019 (213) 937-3511

CIRCLE NO. 176

# Electronic Design

## Advertising Sales Staff

Bryce Gray  
Sales Manager

### Rochelle Park, N.J. 07662

Robert W. Gascoigne  
Daniel J. Rowland  
50 Essex Street  
(201) 843-0550  
TWX: 710-990-5071

### Philadelphia

Thomas P. Barth  
50 Essex Street  
Rochelle Park, N. J. 07662  
(201) 843-0550

### Boston 02154

Joseph F. Palmer  
1268 Main Street  
Waltham, Mass.  
(617) 894-2700

### Chicago 60611

Thomas P. Kavooras  
Berry Conner, Jr.  
200 East Ontario  
(312) 337-0588

### Cleveland

Thomas P. Kavooras  
(Chicago)  
(312) 337-0588  
(call collect)

### Los Angeles 90303

Stanley I. Ehrenclou  
Burt Underwood  
2930 Imperial Highway  
Inglewood, Calif  
(213) 757-0183

### San Francisco 94022

Jerry D. Latta  
95 Main Street  
Los Altos, Calif.  
(415) 941-3084

### London W. 1

For United Kingdom and Holland  
Brayton C. Nichols

For Eastern Europe

Peter Kehr

The American Magazine Group

27 Maddox Street  
London, W. 1, England  
Phone: 499-0180

Cable: Ammagnic, London

### Verviers, Belgium

For Continental Europe

Andre Jamar

1, Ru Mallar, 1

087) 253.83 Telex 41563

### Tokyo

Haruki Hirayama

Electronic Media Service

5th Floor, Lila Bldg.,

4-9-8 Roppongi

Minato-ku

Phone: 402-4556

Cable: Electronicmedia, Tokyo





**A few words to those  
who design circuits  
without a gaussmeter.**

**Good luck.**

If you design or work with magnetic circuits, a gaussmeter can save you a lot of time. It converts flux density into voltage for measurement. So, you can check faults both magnetically and electrically to track down any trouble as quickly as possible. Our gaussmeter brochures are the place to start. Write, 4949 Freeway Drive East, Columbus, Ohio 43229

**F.W. Bell Inc.**

A subsidiary of The Arnold Engineering Co.

INFORMATION RETRIEVAL NUMBER 64

## Attention Advertisers:

Could you use copies of your ad exactly as it appeared in ELECTRONIC DESIGN? Then order your reprints directly from us; the minimum unit order is 500 copies.

Please specify if you would like the reprint line omitted on your copies and mail your/written order to:

**Production Dept.  
ELECTRONIC DESIGN  
50 Essex St.  
Rochelle Park, N.J. 07662**

	500	1,000	Add'l M
<b>8x10 or smaller</b>			
1 color, 1 side	\$74.70	82.95	18.15
2 color, 1 side	95.47	108.00	25.28
4 color, 1 side	311.03	342.00	44.33
<b>Spreads</b>			
1 color	113.66	126.65	25.98
2 color	191.19	205.98	29.58
4 color	354.17	380.76	53.19

Prices FOB Waseca, Minn.

## advertiser's index

Advertiser	Page
Acopian Corporation	45
Allen-Bradley Co.	33
Amperite	66
Amphenol Components Group	13
Analogic Corporation	22
Beckman Instruments, Inc., Helipot Division	59
Bell, Inc., F. W.	78
Bendix Corporation, The Electrical Components Division	1
Bishop Graphics, Inc.	77
By-Buk Company	77
CEM Company	80
Computer Automation, Inc.	6, 7
Coto-Coil Company Inc.	75
Data Device Corporation	12
Datel Systems, Inc.	77
Delco Electronics, Division of General Motors Corporation	46, 47
Dormeyer Industries, Inc.	79
ECC Corporation	32
ERA Transpac Corporation	73
Edsyn, Inc.	79
Federal Scientific Corporation	76
General Electric Company	25
General Radio Company	18, 51, 62, 63, 80
Grayhill, Inc.	45
Hansen Mfg. Co., Inc.	75
Harris Semiconductor, A Division of Harris Intertype Corporation	55
Hewlett-Packard	60
Hoffman Engineering Company	72
ISE Electronics Corporation	20
International Rectifier	14
Johanson Manufacturing Corp.	11
Kepco, Inc.	76
Keystone Electronics Corp.	80
Mallory Capacitor Company	9
Molex, Incorporated	Cover III
Monsanto Company	31
North American Rockwell Microelectronics Company	16
North Atlantic Industries, Inc.	21
OPCOA, Inc.	8
Philips Electronic Components and Materials	48A, B
Phoenix Data, Inc.	74
Pirgo Electronics, Inc.	71
RCA Electronic Components	Cover IV
RFL Industries, Inc.	69
Requested Data Delivery Service	Cover II A-B
Rogan Brothers, Inc.	80
Scanbe Manufacturing Corp.	67
Schauer Manufacturing Corp.	70
Signetics Corporation	2, 3
Simpson Electric Company	17
Singer Company, The Kearfott Division	38
Sprague Electric Company	10
Stackpole Carbon Company	34
TEC, Incorporated	68
TRW Electronic Components, IRC Boone Division	Cover II
Tektronix, Inc.	37
Teledyne Relays, A Teledyne Company	4
Thermalloy Company	64
Trio Laboratories, Inc.	76
Unimax Switch, Division Maxon Electronics Corporation	15
Unitrode Corporation	29
Vero Electronics, Inc.	79
Victoreen Instrument, Div. of VLN Corp.	65
Wanlass Division of AMBAC	19



# 'D' SERIES CASES



## Part of a Complete Packaging Capability

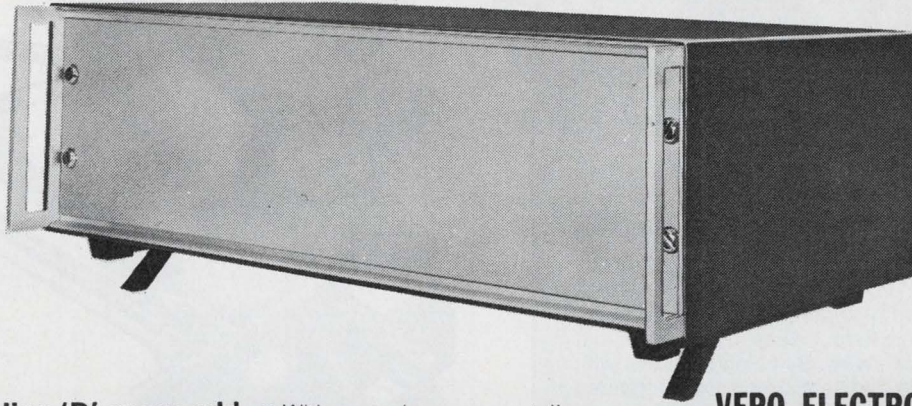

**Vero slim-line 'D' cases add style to any instrument. Features include:**

- Integral front trim with or without handles
- Retractable tilt feet
- Removable bottom and rear panels incorporating ventilation slots
- Wide range in common styling
- 8½", 12½" or 17½" deep
- 10½" or 19" wide
- 1U to 6U heights
- Side handles - standard on 17½" deep version, extra on other sizes
- Chassis runners and front panels also available

### VERO ELECTRONICS INC.

171 BRIDGE ROAD  
HAUPPAUGE, N.Y. 11787  
TEL: 516 234-0400  
TWX: 510 227-8890

**INQUIRE ABOUT OUR  
NEW DESIGN SERVICE**

INFORMATION RETRIEVAL NUMBER 54

## Transformers Unlimited

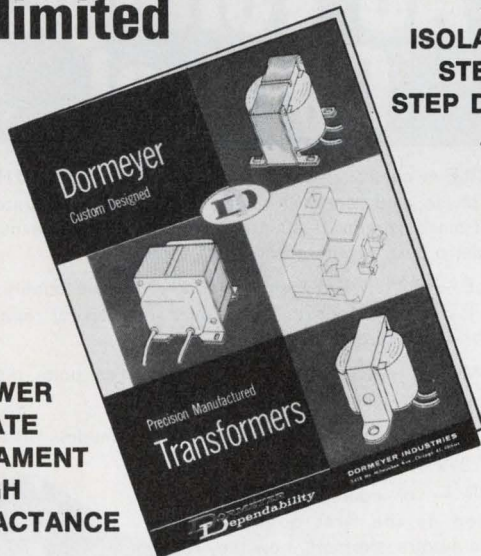

**ISOLATION  
STEP UP  
STEP DOWN  
AUTO**

**POWER  
PLATE  
FILAMENT  
HIGH  
REACTANCE**

Designed and manufactured to your specifications. Uniform quality in any quantity. Maximum economy. Need we say more?

*Request recommendations and quotation.*

### DORMEYER INDUSTRIES, Inc.

3414 No. Milwaukee Ave., Chicago, Illinois 60641  
WORLD'S LARGEST MANUFACTURER OF SOLENOIDS—COILS—TRANSFORMERS



**DORMEYER**  
*Dependability*

INFORMATION RETRIEVAL NUMBER 55

ELECTRONIC DESIGN 2, January 20, 1972

## SOLDERING + DESOLDERING + RESOLDERING =

## SOLDERABILITY

ELEMENTARY TO ELITE  
WORLD'S MOST PRACTICAL SOLDER HANDLING TOOLS

*meets industries demands.....*

with a COMPLETELY PORTABLE SOLDERING/DESOLDERING/RESOLDERING SYSTEM



Send for our FREE 12 page  
**SOLDERABILITY** manual.



**EDSYN**  
15954 ARMINTA STREET  
VAN NUYS, CALIFORNIA 91406  
PHONE (213) 989-2324  
TELEX NO. 65-1469 EDSYNEX VAN

\* U.S. and Foreign Patents Applied For.  
Ads in EEM, MAS, EBG, AE, TR, and  
EPAC Catalogs

INFORMATION RETRIEVAL NUMBER 56



# ROGAN'S NEW 500 SERIES



## VERSATILITY IN CONTROL KNOBS

How can a control knob be versatile? By being available in four sizes in both plain and aluminum-skirted styles. By being available with round shaft hole and set screw or with threaded female insert or with threaded stud.

Achieve a unified front panel appearance by specifying the versatile "500 Series" by Rogan. Write for our complete catalog.

### Rogan

8015 N. Monticello Ave. • Skokie, Ill. 60076  
(312) 675-1234 TWX: 910-223-4547

INFORMATION RETRIEVAL NUMBER 57

# The price of spacers comes tumbling



## Steel- Aluminum

Speedy shipment  
from stock of over  
1000 different sizes.

SEND FOR  
LITERATURE AND  
FREE SAMPLES!

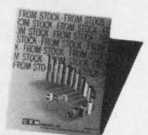

## GEM COMPANY, INC.

116 SCHOOL STREET, DANIELSON, CONN. 06239

INFORMATION RETRIEVAL NUMBER 58

# A ONE SOURCE SUPPLY FOR... TRANSISTOR MOUNTING HARDWARE & SOCKETS

Also mica insulators • Ready to Assemble Kits.

### SOCKETS

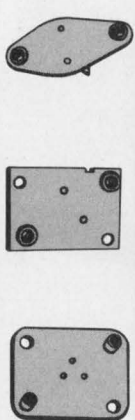

### Available from stock

### HARDWARE

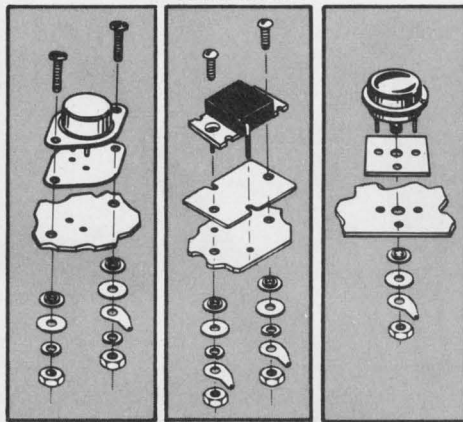

NEW FREE CATALOG ON REQUEST

Manufacturers of Standardized Hardware for Electronics.



## KEYSTONE ELECTRONICS CORP.

49 Bleecker Street • New York, N.Y. 10012

INFORMATION RETRIEVAL NUMBER 59

# AC Voltage Control

**VERSATILE** — control up to 480 V, up to 300 A, 50 to 1200 Hz, single or three phase; and control it quietly without SCR-generated noise. Choose from hundreds of standard models or, as one out of five does, order a custom-tailored special.

**RELIABLE** — specify a device of uncompromising quality, so ruggedly built that only 1 out of 1000 is ever returned for repair during a two-year warranty period.

**ECONOMICAL** — compare; then use economical units, made even more attractive by generous quantity discounts.

**FAST** — receive prompt delivery on standard models off-the-shelf; wait only slightly longer for special units.

**VARIAC®** — of course! Great when introduced as the first commercial adjustable autotransformers, now they're 39 years better.

**NEW!** — A 2-amp unit for only \$13.00 — single-hole mountings, 140-volt output. Catalog and applications handbook for full line FREE on request.

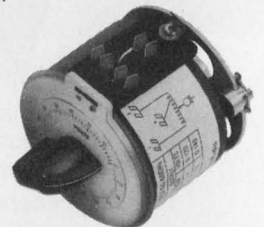

for Line-Voltage Control



## General Radio

CONCORD, MASSACHUSETTS 01742

NEW YORK (N.Y.) 212 964-2722 (N.J.) 201 791-8990 BOSTON 617 646-0550 CHICAGO 312 992-0800  
WASHINGTON, D.C. 301 881-5333 LOS ANGELES 714 540-9830 TORONTO 416 252-3395 ZURICH (01) 55 24 20

INFORMATION RETRIEVAL NUMBER 60



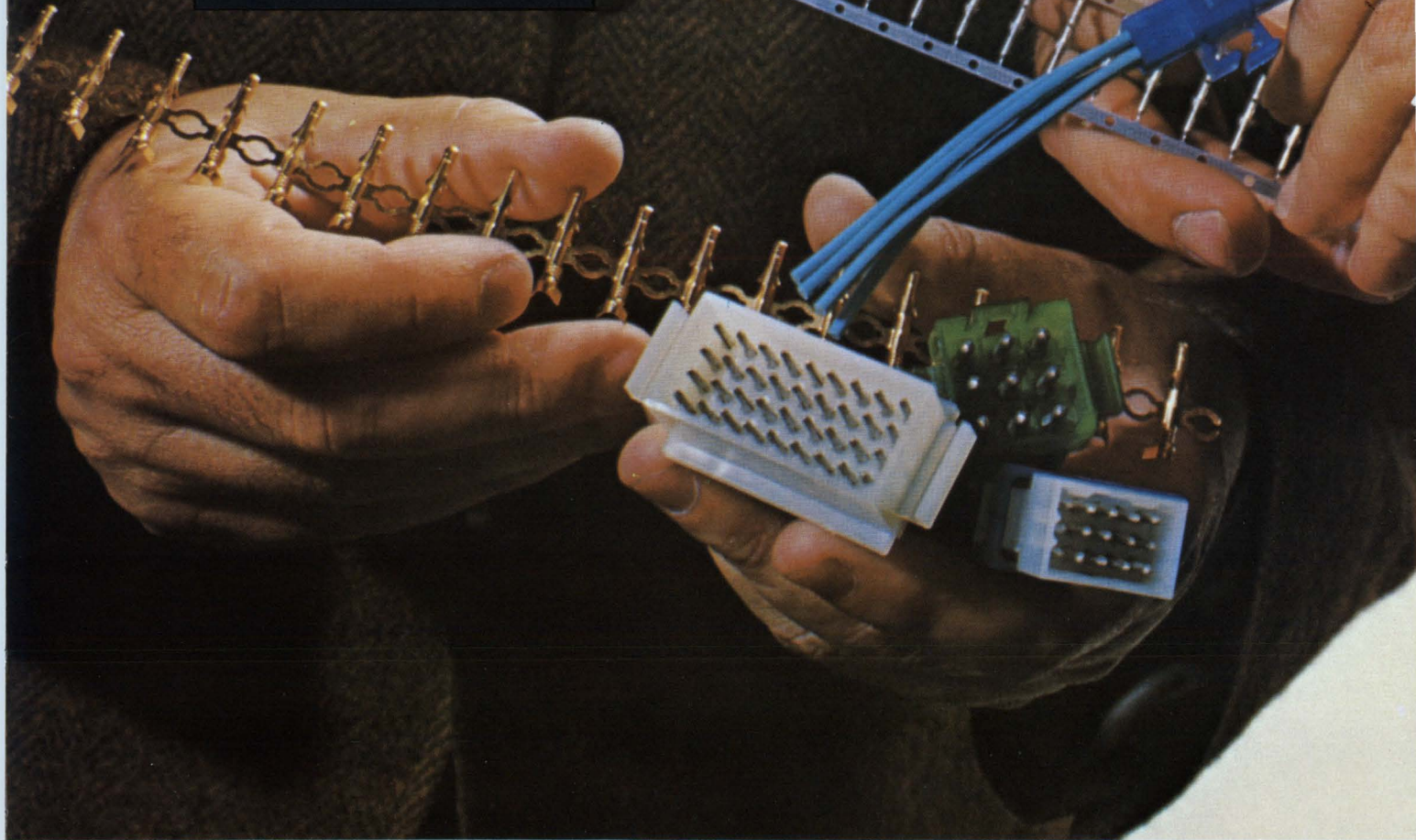

**MAKE YOUR CONNECTIONS: FAST.** With Molex standard and miniature connectors. They're easier to work with. Simplify wiring. Speed production. Save assembly steps. Make installation and servicing extra easy, too. This is why circuitry idea men everywhere are making connections with Molex. From one circuit to 104 or more. Production keyed and available in a variety of colors to meet design requirements. Molex has the

connector. Plus the design and engineering capability to solve the most complex wiring problems . . . fast. For a colorful free sample of the Molex connector write: Molex Incorporated, Downers Grove, Illinois 60515. Or you can make connections by calling (312) 969-4550.

*...creating components that  
simplify circuitry*





# RCA leads the way— with 8 new emitter-ballasted microwave transistors

Type	Frequency (GHz)	Power Out (W) Min.	Supply Voltage (V)
2N6267	2.0	10.0	28
2N6266	2.0	5.0	28
2N6265	2.0	2.0	28
2N6269	2.3	6.5	22
2N6268	2.3	2.0	22
40898	2.3	2.0	22
40899	2.3	6.0	22
40909*	2.0	2.0	25

\*Oscillator

RCA's microwave transistor line keeps growing! Led by state-of-the-art types spec'd at 2.3 GHz and 22 V, these new transistors broaden a total high-power, high-frequency capability designed to meet expanding individual requirements.

Evaluate these new emitter-site ballasted transistors for your circuit. Their unique structure reduces "hot spots," improves safe operating area, and effectively minimizes transistor failure under high VSWR conditions.

At the same time, look over the full range of other RCA devices by getting the complete RCA microwave story. Write for your copy of RCA's Microwave Data Package, 2L1205, which includes

a new Microwave Transistor Brochure describing major design features, device selection criteria, typical circuit designs, and performance data. The package also includes technical data bulletins and a complete price list on all commercially-available RCA microwave power transistors.

For more information see your local RCA Representative or your RCA Distributor. For a copy of the data package, write: RCA, Solid State Division, Section 57A-20/-UF16, Box 3200, Somerville, N. J. 08876. International: RCA, Sunbury-on-Thames, U.K., or P.O. Box 112, Hong Kong. In Canada: RCA Limited, Ste. Anne de Bellevue, 810 Quebec.

**RCA** Solid State  
products that make products pay off

INFORMATION RETRIEVAL NUMBER 244