

DMM, heal thyself. We're not there yet, but a new multimeter with 5 full digits allows a user to make 16 internal-operation and calibration tests with front-panel

switches or a remote program. He can localize faults quickly with the help of software or a pull-out chart stored in the meter. For more details, see page 77.

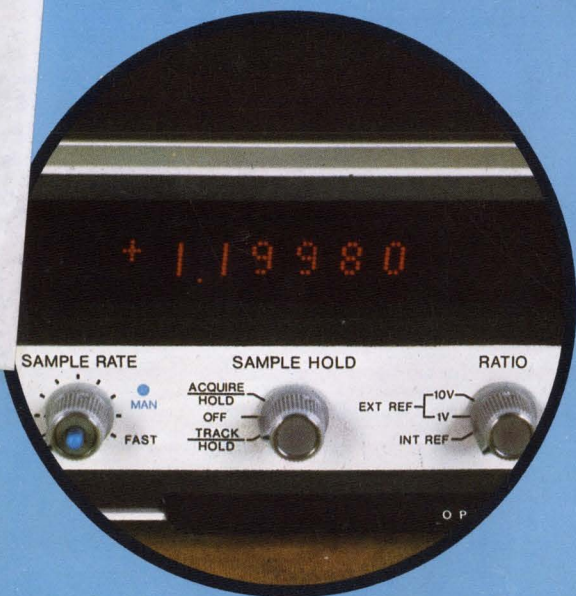

RECEIVED
MAY 24 1972

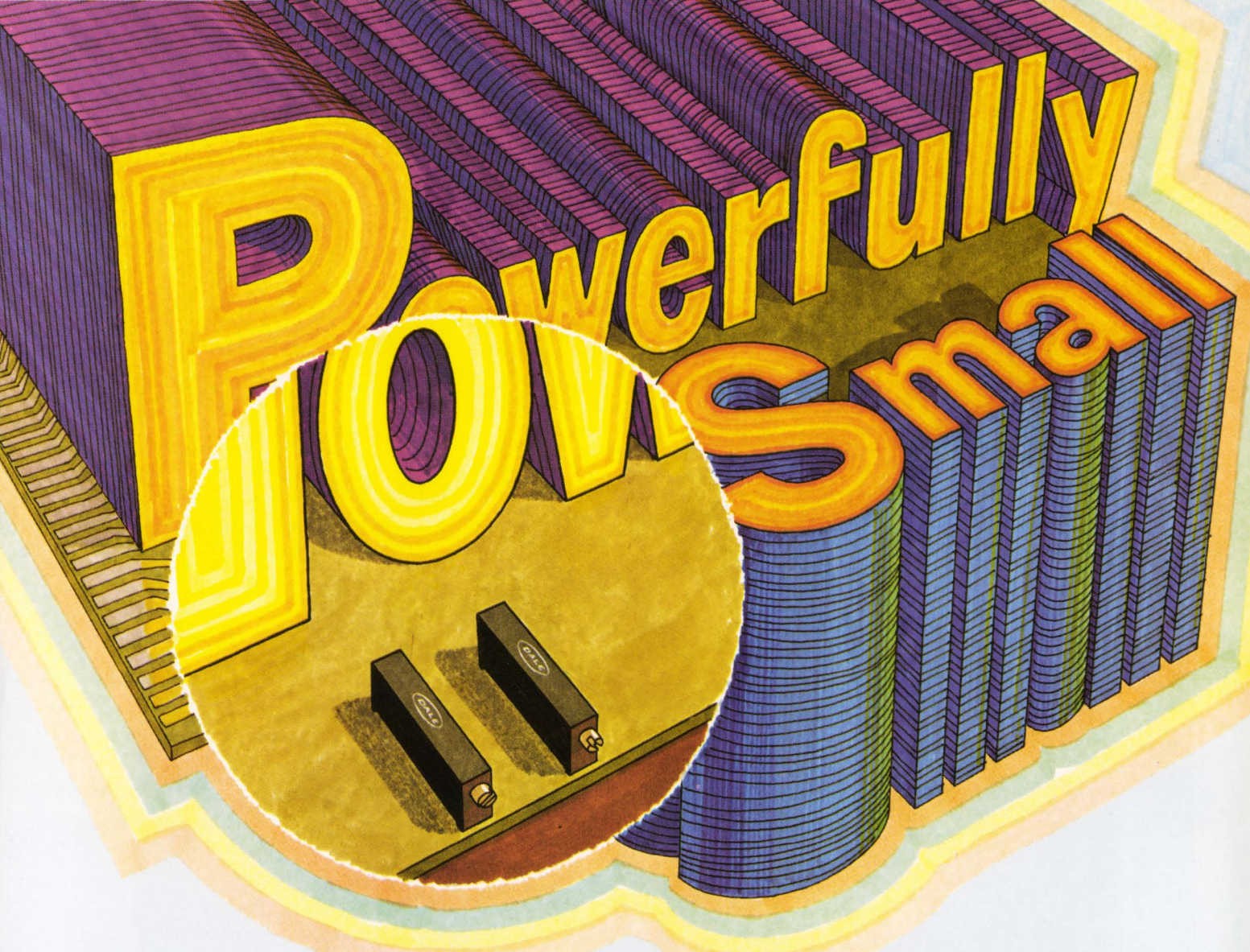

Wirewound or cermet—Dale's new low profile trimmers have important design advantages for your circuit.

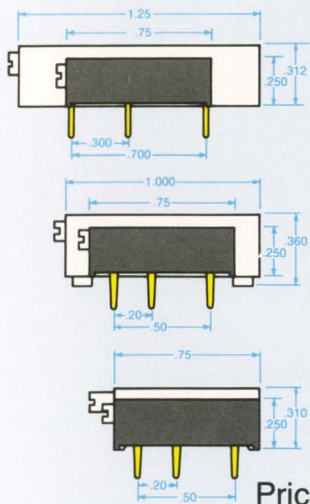

A full watt in less space—You can increase both part density and power handling ability with either the 2700 (wirewound) or 8700 (cermet) series. Both dissipate one watt at 70° C.

More models—greater interchangeability Choose from three different terminal configurations with pin spacing identical to many larger models. Reduce space as much as 64.6% without sacrificing performance.

20-turn adjustability—Wiper arm adjusts smoothly, quickly. Sits tight under vibration and shock inside an immersion-proof case sealed for production soldering and board washing. Flame retardant SE-0 grade material available upon request.

Priced less than 60c in 50,000 quantities. Available fast. Many standard decade values stocked for off-the-shelf delivery. Get the details. Write today or phone 402-564-3131.

SPECIFICATIONS	2700 WIREWOUND	8700 CERMET
Resistance	10-50K ohms	10-2 Meg.
Tolerance	±10%	±10% 100-500K ±20% all other values
T.C.	50 PPM/° C	±100 PPM/° C
Wattage	1 watt/70° C	1 watt/70° C
Operating Temp. Range	-65° C to +150° C	-55° C to +125° C
Adjustability	20 turns (with clutch to prevent overtravel damage)	
Dimensions	.25" high by .165" wide by .75" long	



DALE ELECTRONICS, INC.

1300 28th Ave., Columbus, Neb. 68601

A subsidiary of The Lionel Corporation • In Canada: Dale Electronics Canada, Ltd.

Before you buy another LED, try one of ours. Free!



HP LED's are in stock and available for immediate shipment in any quantity. If you would like one free, just fill out the attached coupon. The only thing we ask is that you tell us briefly about your application.

We know our gallium arsenide phosphide lamp will outshine anything else you can buy. Here are some reasons why:

High brightness.

Wide viewing angle (180°).
Made to panel mount, with free mounting clip provided.
100,000 hour life — minimum.
Low power requirements — 1.6 volts at 2-10 ma.
Low cost.
Rugged leads.
And, last but not least, immediate delivery.
For all the proof you'll need of our

LED's performance, fill out the coupon right away. Then see for yourself. If somebody's beaten you to it, write for your free LED to: Hewlett-Packard, 620 Page Mill Road, Palo Alto, California; Europe: 1217 Meyrin-Geneva, Switzerland.

01007A



COMPONENTS

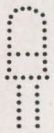

FILL OUT COUPON, SEND IT TO US AND WE'LL SEND YOU A FREE LED AND CLIP!

NAME _____ TITLE _____

COMPANY _____

ADDRESS _____ ZIP _____

MY APPLICATION IS _____

Mail to: Hewlett-Packard, 620 Page Mill Road, Palo Alto, California 94304; Europe: 1217 Meyrin-Geneva, Switzerland.
Offer expires July 31, 1972.

AN INFINITE VARIETY



TO-5 Relay

Every flower is a masterpiece of design . . . The diversity of size, shape, and color variation is

limitless. In the industrial world there is an analogy with the flower — the Teledyne TO-5 Relay offers thousands of different variations for a multitude of industrial, scientific and military applications. Whether your requirement is for one or thousands, you'll find the same extraordinary reliability — backed by years of experience and leadership from *The Pioneers* in the development of miniaturized electro-mechanical relays. That's not all . . . We are continually adding to our rapidly growing species of Solid State Relays to meet the increasing demand for this need. Send us your requirements.

3155 West El Segundo Boulevard
Hawthorne, California 90250
Telephone (213) 679-2205



**TELEDYNE
RELAYS**

**EIA DRIVER
HAS INTERNAL
INHIBIT AND
SLEW RATE
CONTROL.**

Our new 9616 EIA triple line driver provides simple, low-cost solutions to EIA applications. Our new 9617 EIA triple line receiver completes the set.

Our new 9616 Driver and 9617 Receiver meet all EIA-232-C/CCITT V.24 specs. And more. Together they provide the simplest low-cost solution to problems at the interface in data terminal equipment and data communications.

Unlike conventional EIA drivers, which are implemented by a positive NAND function, our 9616 is implemented by an And/Or/Invert function. With this logic configuration, you can perform the inhibit function without any external gating.

In addition, the 9616 incorporates internal slew rate control. No need for an external capacitor for each driver. Result: significant savings on board space, components, assembly.

In meeting RS-232-C recommendations our 9616/9617 feature:

9616 EIA Line Driver

- All inputs TTL compatible
- Each driver is output protected

- Symmetrical driver output voltage levels and current limits
- Supplies are +12V and -12V @ ±10% regulation

9617 EIA Line Receiver

- 3 to 7K Ω input resistance
- Inputs protected to ±25V
- Each Receiver operates in fail-safe mode
- Controllable slicing or hysteresis operation
- Individual response pins to increase AC noise immunity
- Outputs TTL/DTL compatible
- +5V supply operation, ±5% regulation

Both the 9616 Driver and the 9617 Receiver are available from distributor stock. Design-in quantities available now; production quantities in late March. The 9616 @ \$4.50 and the 9617 @ \$3.50 in quantities of 100-999.

Other Fairchild Drivers & Receivers

- 9614 Dual Differential Line Driver
- 9615 Dual Differential Line Receiver
- 9620 Dual Differential Line Receiver
- 9621 Dual Line Driver
- 9622 Dual Differential Line Receiver
- SN75107-108 Dual Line Receivers
- SN75109-110 Dual Line Drivers

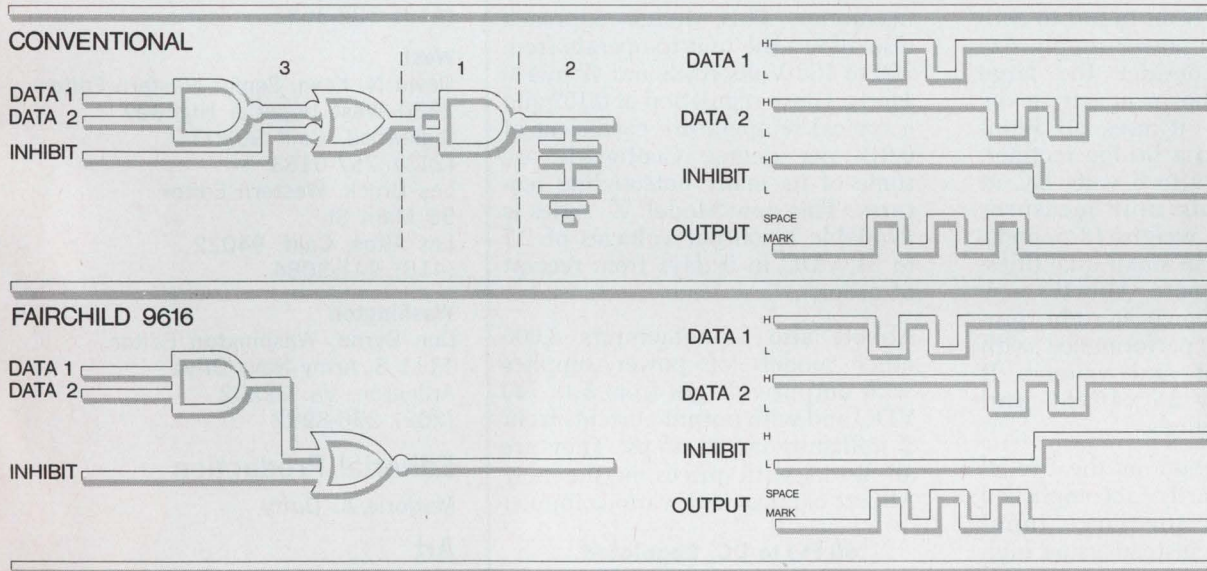

COMPARISON OF CONVENTIONAL AND 9616 EIA DRIVERS
 Conventional EIA Driver (1) requires external slew rate control capacitor (2) and external gating for inhibit function (3). Fairchild 9616 EIA Driver requires neither.



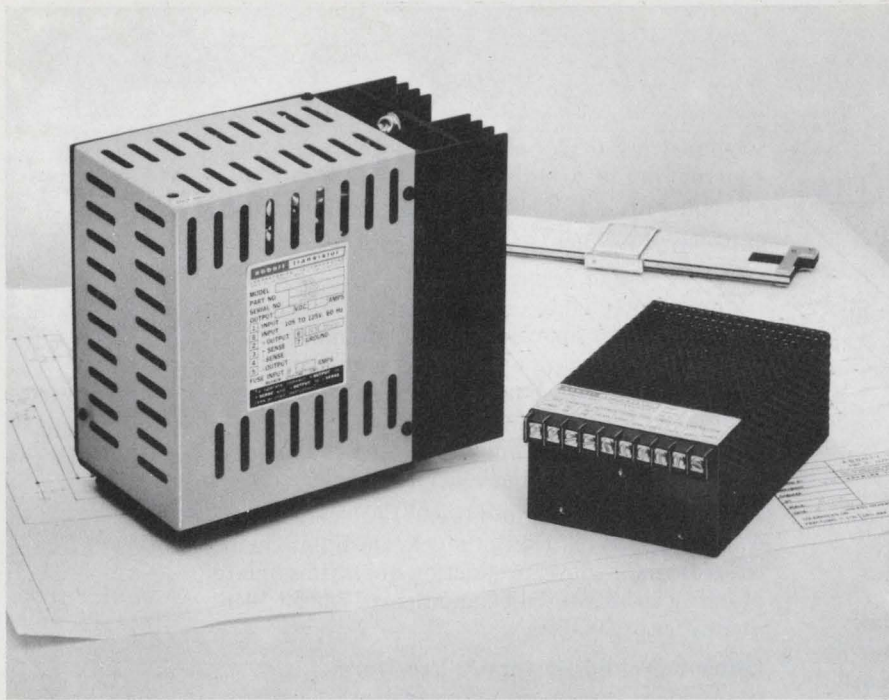

Reduce Your Power Supply Size and Weight By 70% for \$49

A new way has been found to substantially reduce power supply size and weight. Consider the large power supply shown at left in the above photo — it uses an input transformer, into a bridge rectifier, to convert 60 Hz to 5 volts DC at 5 amperes. This unit measures 6½"x4"x7½" and weighs 13 pounds. It sells for \$170 in small quantities. For just \$49.00 more, Abbott's new model Z5T10, shown at right, provides the same performance with 70% less weight and volume. It measures only 2¼"x4"x6" and weighs just 3 pounds.

This size reduction in the Model Z5T10 is primarily accomplished by eliminating the large input transformer and instead using high voltage, high efficiency, DC to DC conversion circuits. Abbott engineers have been able to control the output ripple to less than 0.02% RMS or 50 millivolts peak-to-peak

maximum. This design approach also allows the unit to operate from 100 to 132 Volts RMS and 47 to 440 Hertz. Close regulation of 0.15% and a typical temperature coefficient of 0.01% per degree Centigrade are some of its many outstanding features. This new Model "Z" series is available in output voltages of 2.7 to 31 VDC in 9 days from receipt of order.

Abbott also manufactures 3,000 other models of power supplies with output voltages from 5 to 740 VDC and with output currents from 2 milliamps to 20 amps. They are all listed with prices in the new Abbott catalog with various inputs:

- 60 A to DC, Regulated
- 400 A to DC, Regulated
- 28 VDC to DC, Regulated
- 28 VDC to 400 A , 1 ϕ
- 24 VDC to 60 A , 1 ϕ

Please see pages 618 to 632 of your 1971-72 EEM (ELECTRONIC ENGINEERS MASTER Catalog) for complete information on Abbott modules.

Send for our new 56 page FREE catalog.

abbott transistor

LABORATORIES, INCORPORATED
 general offices eastern office

5200 W. Jefferson Blvd./Los Angeles 90016
 (213) 936-8185 Telex: 69-1398

1224 Anderson Ave./Fort Lee, N.J. 07024
 (201) 224-6900 Telex: 13-5332

INFORMATION RETRIEVAL NUMBER 5

Publisher

Peter Coley

Editors

Editorial Offices
 50 Essex St.
 Rochelle Park, N.J. 07662
 (201) 843-0550
 TWX: 710-990 5071
 Cable: Haydenpubs Rochellepark

Editor: George Rostky

Managing Editors:

Ralph Dobriner
 Michael Elphick

Associate Editors:

Jules H. Gilder
 Richard Lee Goldberg
 Morris Grossman
 John F. Mason
 Stanley Runyon
 Edward A. Torrero
 Richard L. Turmail

Contributing Editor:

Peter N. Budzilovich

Editorial Field Offices

East

Jim McDermott, Eastern Editor
 P.O. Box 272
 Easthampton, Mass. 01027
 (413) 527-3632

West

David N. Kaye, Senior Western Editor
 2930 West Imperial Highway
 Inglewood, Calif 90303
 (213) 757-0183
 Les Brock, Western Editor
 95 Main St.
 Los Altos, Calif. 94022
 (415) 941-3084

Washington

Don Byrne, Washington Editor
 1111 S. Army Navy Drive
 Arlington, Va. 22202
 (202) 296-8982

Editorial Production

Marjorie A. Duffy

Art

Art Director, William Kelly
 Richard Luce
 Anthony J. Fischetto

Production

Manager, Dollie S. Viebig
 Helen De Polo
 Maxine Correal
 Anne Molfetas

Circulation

Manager, Nancy L. Merritt
 Joan Licari

Information Retrieval

Peggy Long

across the desk

Unionization backed to spread work

Congratulations to Robert Bruce on his letter of March 16 (see "A Strong Labor Group Urged for Engineers," ED 6, p. 7). His description of the difficulties in changing engineering specialties reminded me of my own experience. When I graduated, transistors hadn't hit their stride yet, so we used relays and stepping switches. I finally saw the handwriting on the wall, but it was a lot easier to see the trend than to do something about it. The available positions explicitly called for transistor experience. The local university was characteristically four years behind and more devoted to theory than the practical application that the job called for.

Fortunately one company started a transistor-design training program to help offset its shortage. I was lucky enough to get in. But who's going to retrain today's unemployed aerospace engineer? There's no shortage now, and surveys show that the EE field will be "soft" until at least 1975.

I believe that if we are to restore that climate where enough companies are willing to retrain engineers, we shall also have to restore the manpower shortage. We can begin by organizing to end unpaid overtime. This would encourage the hiring of unemployed engineers and end the unfair squeeze on those already employed.

A subsequent goal could be a shorter work week. The steelworkers are going for 32 hours. Considering our unemployment and underemployment, why not organize for a nine-hour, four-day week or five days of seven hours each?

These are only a few of the organized objectives that would re-

duce engineering unemployment as well as benefit those already employed.

Name withheld on request
Los Altos, Calif.

Words in defense of 'paper shufflers'

The editorial in your April 1 issue ("Design or Shuffle Paper, Which Goal?" ED 7, p. 35) took to task those former engineers who had allowed themselves to be promoted to administrative positions, to the detriment of their engineering expertise. It implied that the subsequent shakeout of these "paper shufflers" was nothing less than they deserved for such foolishness.

I question your statement that, as a group, these ex-engineers are worse off now than those who remained in the profession. The older, unemployed engineers—of which there are now large numbers—don't have an easy time finding a professional job, let alone one that suits his particular speciality or talent. But even if it is true that engineers who have gone on to administrative or management jobs have laid themselves open to greater risks, what lesson is to be learned? Are you saying that it is a shame to venture from the safe profession of engineering out into the cold world governed by profit and loss? Or do you believe that the ex-engineer in a management job is somehow being disloyal to his former profession?

Competent men are going to strike for higher goals, regardless of risk. The fact that some will come to grief is an unfortunate fact of life. I see no reason for

(Continued on p. 10)

Electronic Design welcomes the opinions of its readers on the issues raised in the magazine's editorial columns. Address letters to Managing Editor, Electronic Design, 50 Essex St. Rochelle Park, N. J. 07662. Try to keep letters under 200 words. Letters must be signed. Names will be withheld on request.

A Johanson Variable Capacitor for 45¢

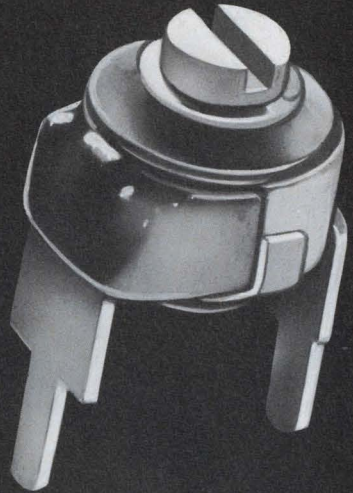

We are pleased to introduce the 9300 series. You will find the unit is truly micro-miniature (.315 high with a .230 diameter and .200 pin spacing). Its rotary assembly is designed with special ceramic materials which provide longer life and complete environmental stability. Capacitance values are available up to 70 pf. For immediate delivery, please phone (201) 334-2676.

STOCK MODELS

MODEL	CAPACITY RANGE pF	TEMP. COEF. @ ±10MHZ	MIN. Q
9312	2.8 — 10	—350 PPM/°C	300
9313	3.2 — 18	—550 PPM/°C	300

45¢ EACH
IN QUANTITIES OF 1000

Johanson

MANUFACTURING CORPORATION

ROCKAWAY VALLEY ROAD
BOONTON, NEW JERSEY 07005

INFORMATION RETRIEVAL NUMBER 6



**THE
CONNECTOR
YOU NEED
IS PROBABLY
IN THE
CONTINENTAL
LINE**

ASK US!

... and ask us, too, about our FREE design service and no-charge tooling. Connectors for printed circuitry are just one broadly-developed group for electronic computers and data processing equipment, telephone communications equipment, aircraft instrumentation and other electronic assemblies. For a detailed view of Continental's other precision electronic connectors, write or phone for our free condensed catalog now.

See EEM and VSMF Directories for Distributor or Sales Representative Nearest You

CONTINENTAL CONNECTORS

Continental Connector Corporation/Woodside, New York 11377/Phone 212-899-4422

INFORMATION RETRIEVAL NUMBER 7





864

Sperry displays have more eye appeal!

Panel meters, DVM's, instruments, calculators, computers, business machines and other equipment have more "buy appeal" with advanced Sperry displays[†] because they have more eye appeal where it really counts — right on the face of your product. These are the unique displays which produce continuous characters, with no irritating gaps or breaks between segments. Sperry displays are also better looking because character shape was determined by human factors engineering — with full consideration given to aspect ratio and form factors.

Sperry displays are brighter, sharper and easier to read than tube-type displays and the much publicized LED's. They have no screens, filaments or "off" numbers to impair readability. In fact, they're so much better looking that it is impossible to show the difference on the printed page. You have to see the actual display to fully appreciate

their excellent appearance. Compare them side-by-side with any other display. You'll find Sperry beats them all.

Sperry displays also come in colors — attractive, easy to read orange or red. Not always true of other types. And Sperry beauty is also more than skin deep. There's the wider viewing angle, low power consumption and proven reliability, not to overlook the cost — \$1.00** per digit in large OEM quantities for either the 1/2" or 1/3" display.

See for yourself.

Find out how great Sperry displays can look on your product. Check the reader service card for sample 1/3" and 1/2" self adhesive, printed display strips and complete technical information, or phone or write: Sperry Information Displays Division, Post Office 3579, Scottsdale, Arizona 85257. Telephone (602) 947-8371.



Sperry 1/2"



Sperry 1/3"



Nixie 1/2"



LED 1/4"

COMPARE THE BRIGHT, NO GAP APPEARANCE OF SPERRY DISPLAYS WITH ANY OTHER DISPLAY.

SPERRY

INFORMATION DISPLAYS

It's a whole new ball game in displays!

 SPERRY RAND

[†]Patent Pending
[®]NIXIE is the registered trademark of the Burroughs Corporation.

**Price is \$2.30 in 5,000 digit quantity.

INFORMATION RETRIEVAL NUMBER 8

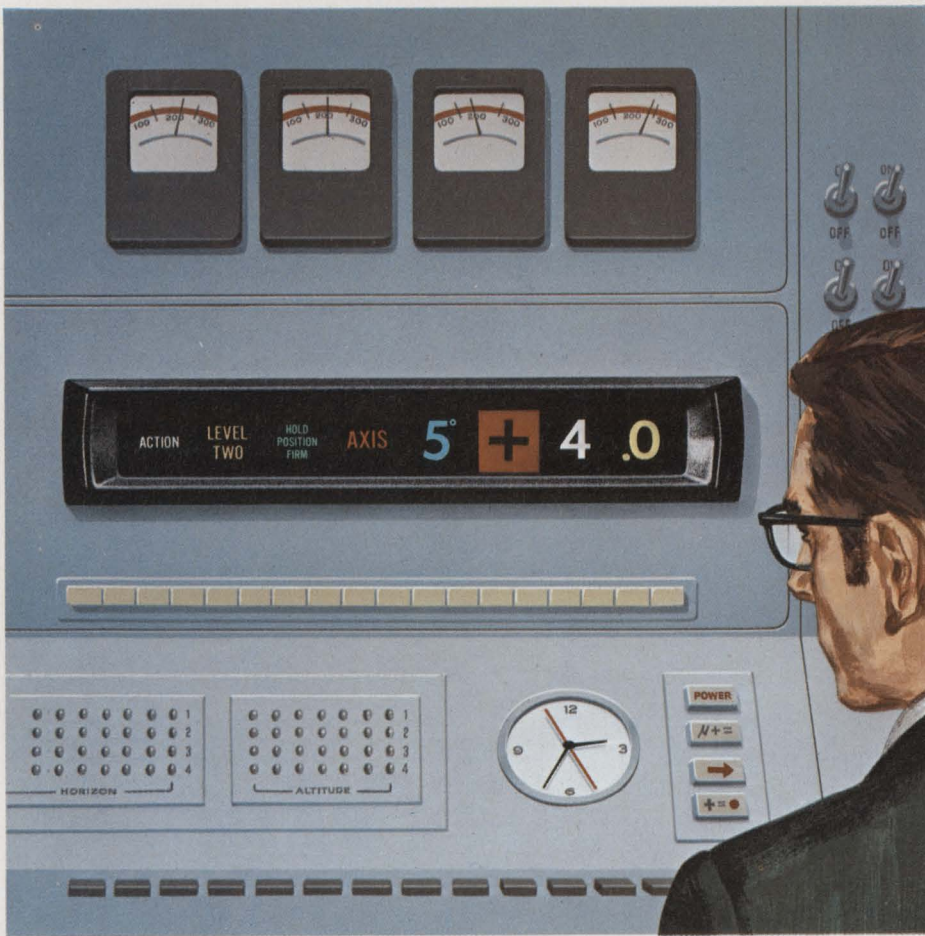

There's more to us than meets the eye!

and it comes in one package, ready to plug in.

Providing the most versatile, eye appealing displays is our main endeavor—but our concern doesn't end there... not by a long shot. We look beyond to the point of application and how we can save you hours of engineering design time and multi-vendor selection procedures. For instance, we can deliver the complete display package (readouts, drive electronics, switches, bezels, mounting hardware, etc.) ready to

plug in at a price that lets you forget about the preliminaries. Typical, are complete assemblies, from low cost commercial equipment, all the way up to complex RFI/safe military systems. It's a total package concept that makes sense in many ways. Give us a call. IEE,



"the plug-in people." Industrial Electronic Engineers, Inc., 7740 Lemona Avenue, Van Nuys, Calif. 91405. Telephone: (213) 787-0311 • TWX 910-495-1707.

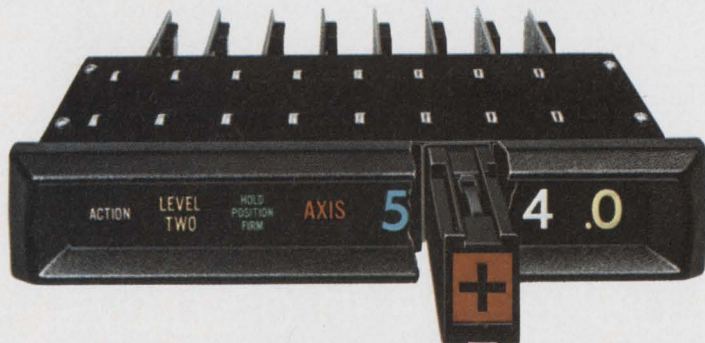

INFORMATION RETRIEVAL NUMBER 9

ACROSS THE DESK

Continued from p. 7

castigating them or for dissuading others who may choose the same route.

John M. Paterson

9201 21st Ave. N.W.
Seattle, Wash. 98107

Regarding your April 1 editorial:

Several gross contradictions and errors in judgment reveal exactly the same "holiness of engineering" attitude that is driving engineers out of the professional societies and out of "engineering" engineering. Your attitude ignores the fact that these one-time engineers are also people—with families, bills, mortgages and personal goals that don't stop at \$20,000 a year after 30 years' service! Why should they deny their families and themselves the gratification of social advancement, as well as the financial comfort that can be attained, just to be "holy"?

If the ex-engineers you interviewed were employed in such positions as chief engineer or manager, you might not expect them to be involved in the details of DVM purchasing. Their "boys" certainly would, however, because that would be what was required at the normally low level of the engineering engineers!

These ex-engineers have such "unholy" and insipid responsibilities as recognizing and coaching the future leaders of their companies, defining task flow, controls and budgets for \$500,000 of company funds and solving personnel morale problems caused by truck drivers who earn 80% more than engineering engineers do.

Maybe the ones you interviewed hadn't made it big, but some may have been close.

As for another period of prosperity for what you call "paper shufflers," the greatest famine in U.S. industry is now for good paper shufflers! They are known as Managers. The agonizing convulsions and spasms that many companies are going through right now are caused by a lack of good paper shufflers.

R. B. Wright

3919 N. Vista St.
Uniontown, Ohio 44685



The perfect combination.

A synthesizer/signal generator that sets a new standard in RF performance—all the way to 1300 MHz!

The new HP 8660B Synthesized Signal Generator has all the precision and stability you'd expect from a synthesizer. Plus performance features, operating functions and ease of operation far surpassing what you would normally find in a signal generator.

The keyboard, plus its 10-digit LED display, gives you error-free fingertip control of operating frequencies. For example, enter your center frequency and then the frequency increment corresponding to channel spacing. Now you can change the frequency up or down by that precise increment just by pushing the STEP button. Similarly you can enter sweep width for precision swept frequency testing. For total operating flexibility you can also tune the generator manually over its entire frequency

range. In all these modes you get accurate signals with synthesizer stability and spectral purity.

The instrument's modular concept allows for great flexibility in both frequency coverage and modulation. Two RF plug-in units have these outstanding characteristics: 0.01 to 110 MHz or 1 to 1300 MHz frequency coverage, settable in 1 Hz steps; -80 dB spurious; < 1.5 Hz residual FM; 3×10^{-8} /day stability; +10 to -146 dBm calibrated output. Precision AM and FM modulation capability, available as an option, greatly increases the 8660's versatility.

The 8660B keyboard-entry mainframe is \$6000. RF plug-ins, 0.01 to 110 MHz, \$1975; 1 to 1300 MHz, \$4800. Modulation plug-in, \$900. A lower cost unit ideally suited for remote pro-

gram applications is the 8660A mainframe. The variety of modular options makes it possible for you to "custom-tailor" a system to your exact needs, with prices for a complete system starting at \$5875.

Ask your field engineer for complete information about the immensely versatile 8660 Synthesized Signal Generators. Or write Hewlett-Packard, Palo Alto, California 94304; Europe: 1217 Meyrin-Geneva, Switzerland.

94204

HEWLETT  PACKARD

SIGNAL GENERATORS

INVERTERS

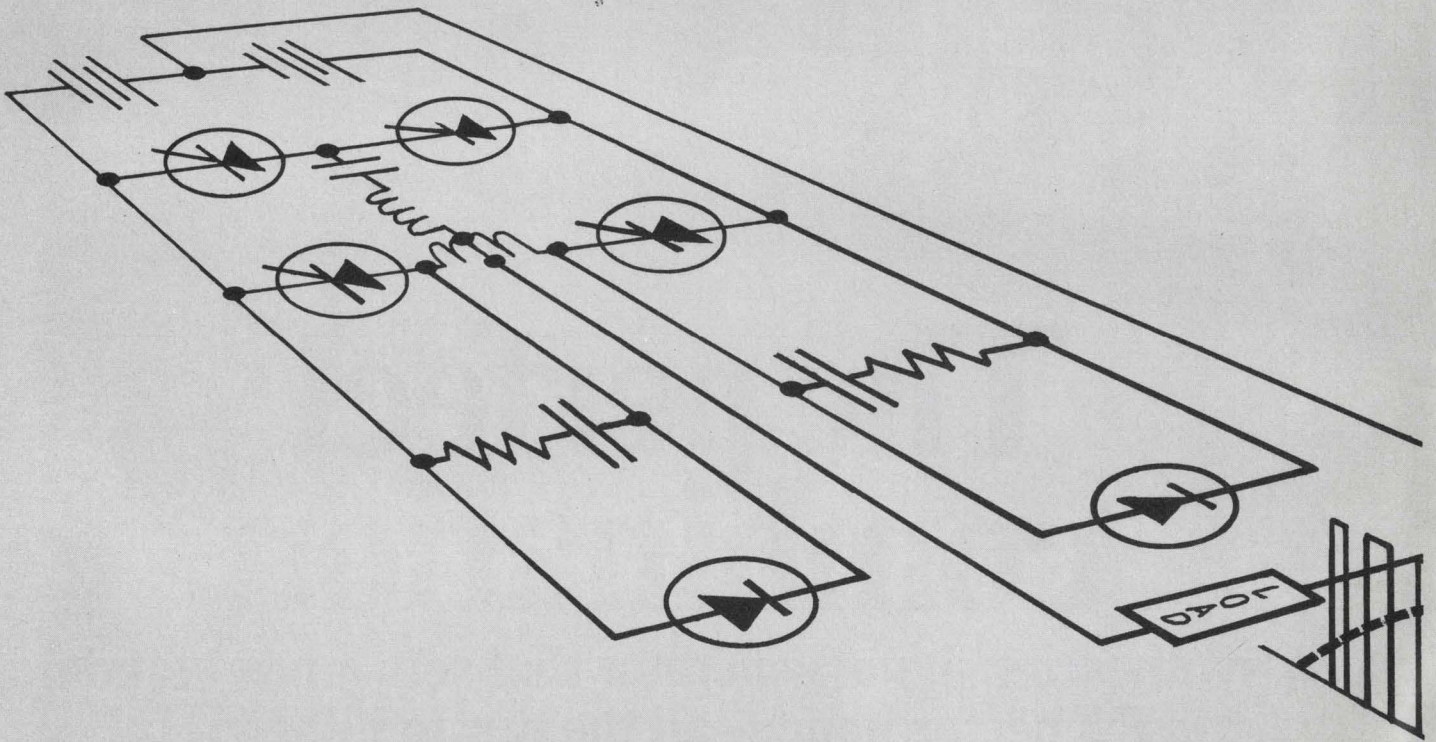

IMPROVE CIRCUIT PERFORMANCE WITH GENERAL ELECTRIC COMPONENTS EXPRESSLY DESIGNED AND CHARACTERIZED FOR INVERTER USE.

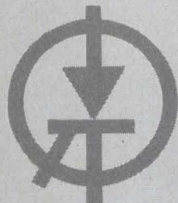

HIGH SPEED SCR's

- World's largest selection
- 25 to 700 Amps., up to 1200 volts
- 10 to 40 μ sec. t_{off} @ rated voltages
- 26 types, 7 package styles



FAST RECOVERY RECTIFIERS

- 2 to 250 Amps., up to 1000 volts
- 100 to 500 nsec recoveries
- 7 types, 5 package styles



COMMUTATION CAPACITORS

- 28F series designed for inverter applications
- 25 to 150 μ f
- 200 to 2000 volts

INTERESTED

- Use inquiry card no. 225 for general information
- Or write on letterhead stating your current and voltage requirements
- Or contact any authorized General Electric distributor or any General Electric electronic component sales office

GENERAL  ELECTRIC

SEMICONDUCTOR PRODUCTS DEPARTMENT
SYRACUSE, NEW YORK 13201

OUR NO. 1 GOAL:
TO MAKE
GENERAL ELECTRIC
YOUR BEST BUY



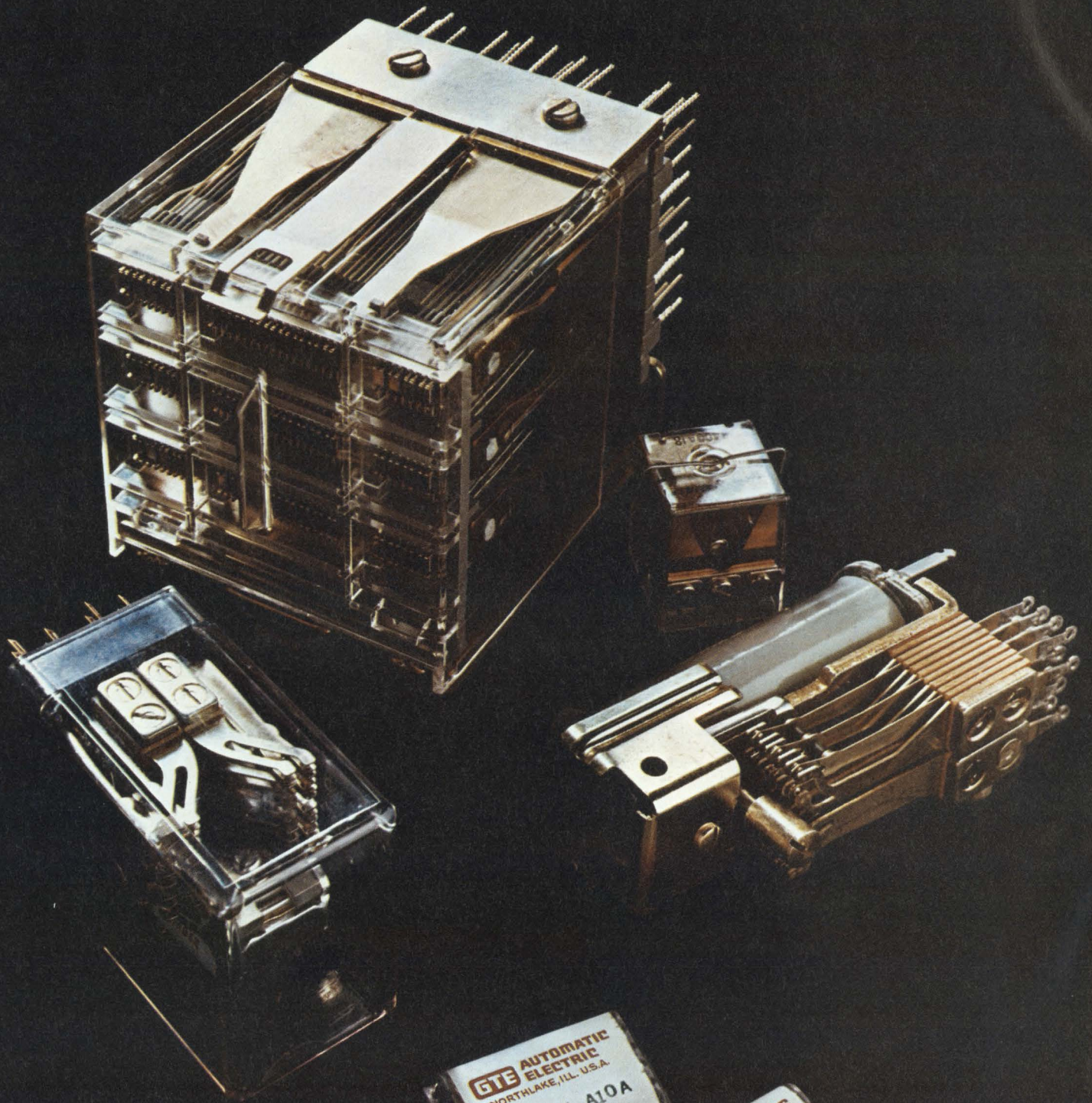

GTE AUTOMATIC
ELECTRIC
NORTHLAKE, ILL. U.S.A.
PD1311 A10A
1930 OHMS

GTE AUTOMATIC
ELECTRIC
NORTHLAKE, ILL. U.S.A.
PD1308 A11A
2600 OHMS

Announcing the rediscovery of the relay.

In an age when most people think solid state is the only way to go, some designers have rediscovered the good old electro-mechanical relay. They found relays still can't be beat when it comes to certain jobs. And when they're dealing with tight fisted cost control committees. Maybe you can save some effort and expense by rediscovering the relay whenever you need these things:

1. Simple logic:

Relays let you combine both power switching and logic functions economically. Memory can usually be retained, even after a power loss. And you don't need special power supplies or noise suppression techniques.

2. Easy troubleshooting:

Most relay failures (and they do occur occasionally) can be identified visually. You can see what's wrong. And fix it easily.

3. Heat resistance:

A relay shrugs off a short dose of overheating. Give a solid state device the same treatment while it's functioning near capacity and it's ruined forever. The amount of heat a solid state device can take is usually dependent on the heat sink used. It can take up all the room you expected to save with solid state in the first place. And finding the right heat sink design can become very involved.

4. Electrical isolation:

Relays have a natural isolation between input

circuits, between output circuits, and between output and input control circuits. You can't get that with junction type semiconductors.

5. High insulation resistance:

Open relay contacts have an insignificant amount of leakage (10^{10} ohms or more). Semiconductors can't match this. And, their leakage rates vary greatly with temperature changes.

6. Wide operating power range:

Relays work with operating power anywhere from milliwatts to watts. And they usually don't require regulated power. Semiconductors do.

7. Transient voltage immunity:

Transient voltage doesn't bother a relay. But high voltage, short duration transients can be sure death to semiconductors.

8. Forgiveness:

Relays give you a little margin of safety should you want to change your mind. Maybe you find you need more contacts, or uncover a timing problem, or discover a need for absolute input-output isolation. You can change your circuit design a lot easier with relays.

If your project or product needs any of these things, just ask our salesman to help you rediscover relays. GTE Automatic Electric, Industrial Sales Division, Northlake, Illinois 60164.



GTE AUTOMATIC ELECTRIC

THE RF CAPACITOR HANDBOOK

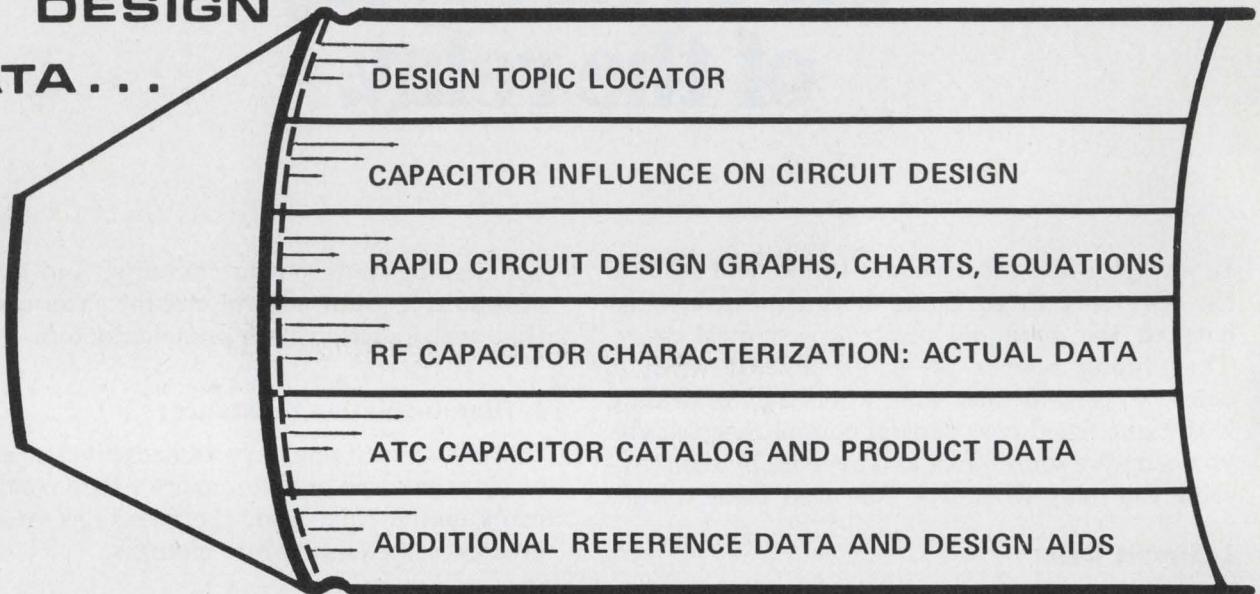
OVER 200 PAGES
OF DESIGN
DATA...

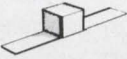

SENT FREE WITH YOUR ORDER FOR ANY
ATC UHF/MICROWAVE CAPACITOR KIT

\$49.95 KIT ED-1	<i>Microstrip Lead</i> <i>Case B</i> 	60 ATC 100 capacitors, four each of the following values and tolerances:									
		pF	Tol.	pF	Tol.	pF	Tol.	pF	Tol.	pF	Tol.
		1.0	C	5.1	D	16	J	51	J	200	J
		2.2	D	7.5	D	24	J	75	J	470	M
		3.6	D	11	J	36	J	100	J	820	M
\$49.95 KIT ED-2	<i>Minicube® Chips</i> <i>Case A</i> 	125 ATC 100 capacitors, five each of the following values and tolerances:									
		pF	Tol.	pF	Tol.	pF	Tol.	pF	Tol.	pF	Tol.
		1.0	B	2.7	D	6.8	K	18.0	K	47	K
		1.3	B	3.3	D	8.2	K	22.0	K	56	K
		1.6	C	3.9	D	10.0	K	27	K	68	K
		1.9	C	4.7	D	12.0	K	33	K	82	K
		2.1	C	5.6	D	15.0	K	39	K	100	K
\$19.95 KIT ED-3	<i>Minicubes®</i> <i>Case A</i> 	40 ATC 100 capacitors, four each of the following values and tolerances:									
		pF	Tol.	pF	Tol.	pF	Tol.	pF	Tol.	pF	Tol.
		1.0	B	2.7	D	4.7	D	12.0	K	47	K
		1.8	C	3.3	D	8.2	K	22.0	K	100	K

® Minicubes is a registered trademark of ATC.



Application information, West Coast, call Sam Klein, 415-961-3322 or:

american technical ceramics

1 NORDEN LANE, HUNTINGTON STATION, N.Y. 11746

516/271-9600 • TWX-510-226-6993



At Last! The Digital Profit Makers!

They're "Money Makers"—

First-class appearance will sell your product, so we designed the NEW 4000 series digital panel meters with big, bright, solid displays that are "No. 1" in national user-preference surveys.

Included is a regulating AC power supply that completely blocks out line transients up to 400 volts peak-to-peak! No more jumpy readings to make you wonder "*—what was that?*"

And extra-low input bias current keeps readings accurate and super-stable, even at the highest operating temperatures.

Give your panel the quality look. Your customers will recognize it—*and buy it, too!*

and "Money Savers," too!

We designed the 4000 series to protect you against profit-robbing failures.

The displays are more reliable (and more readable) because there are no "loose" elements inside.

High quality components, superior workmanship, and wide-safety-margin designs combine to reduce failures, too.

We're so sure we have the answer, we've extended our WARRANTY for **ONE FULL YEAR!**

It won't take you that long to find out how much money you're saving with the 4000 series on your panel.

Don't be fooled by low price tags! This time, buy quality and reliability *right from the start!*

If you have anything left from your last panel meter purchase, give us a call.

If you don't have anything left, call our sales department collect. (714) 546-7160, ext. 567.

We'll understand. That's why we built a totally new kind of DPM—

"the Digital Profit Makers"

**Data Technology
Corporation**

2700 South Fairview Road
Santa Ana, California 92704

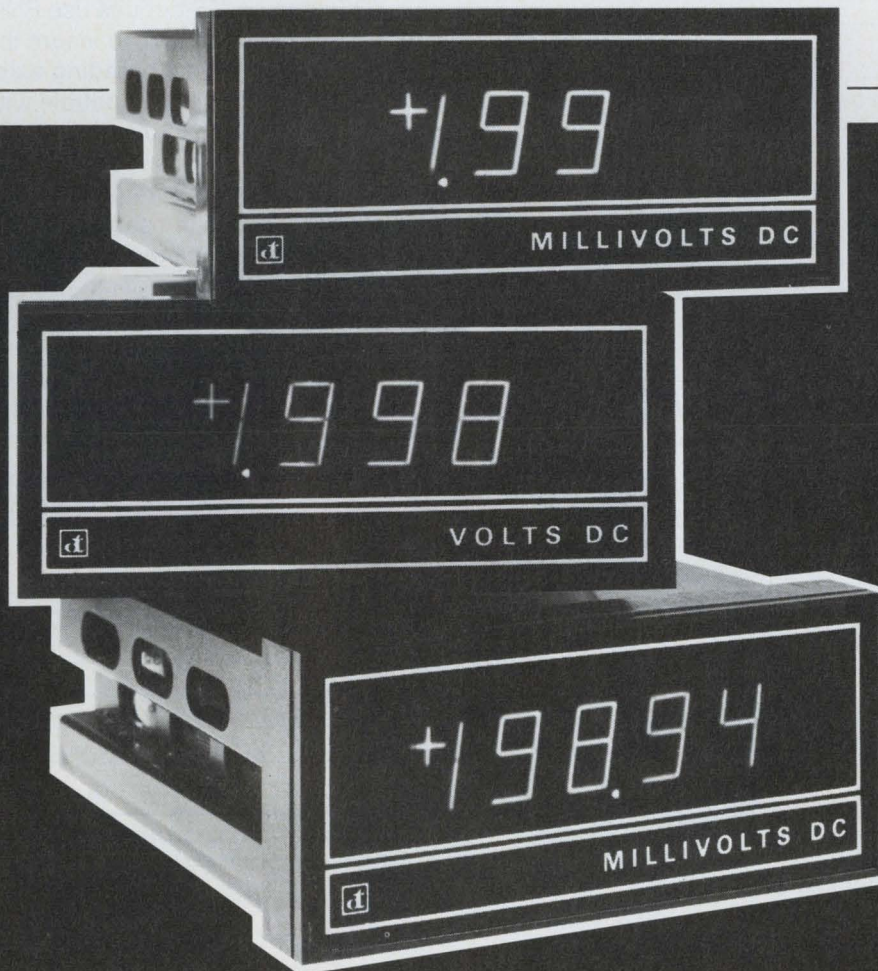

SPEED vs.

The one-nanosecond conundrum.

Schottky or ECL 10,000? How should you commit your engineers, your plant, your production, to get the faster logic that your next system will require?

It's a tough choice. Both major logic families volume-supplied by Signetics can be counted on to boost speed levels far beyond standard TTL. With each offering its own unique advantages, each with built-in drawbacks (sometimes more psychological than real).

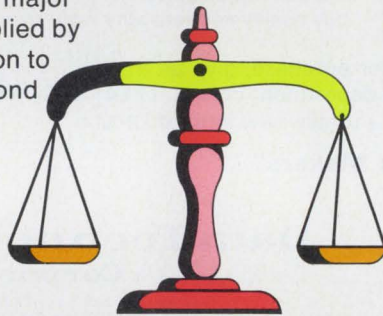

PARAMETER	TYPICAL VALUES	
	74S/82S	ECL 10,000
Propagation Delay (per Gate)	3ns	2ns
Power Dissipation (per Gate)	20mW	25mW
Positive Volt. Supply (+V)	+5V	0V
Negative Volt. Supply (-V)	0V	-5.2V
Logic "1" Level	+2.7V	-0.9V
Logic "0" Level	+0.5V	-1.8V
Output $\Delta V / \Delta T$	1V/ns	.25V/ns

You have to balance where you've been, and where you're going, with a careful probing of both technologies.

For all practical purposes, 74/82 Schottky is third generation TTL enhanced to allow the designer to increase his system speed by replacing present TTL circuits with their Schottky equivalents. Signetics uses a 3 micron epitaxial film thickness to produce extremely small geometries. Combining small geometries with Schottky diode clamped transistors results in optimized T²L performance plus remarkable high-density MSI capability. Since gold doping is no longer required, you get higher betas—making PNP transistors available for innovative circuit ideas. All Signetics 82S circuits use PNP transistors to reduce input loading, to insure that fan-out rules are not violated when upgrading existing systems.

Schottky TTL is compatible with standard TTL circuits, with logic rules familiar to the vast majority of engineers. That's the good news.

The bad news: wiring rules may become more stringent due to the sharper signal edges of Schottky TTL compared to standard T². Careful attention must be paid to PC board geometries and line terminations, as with 74H type circuits. And, of course, there is that one nanosecond difference in gate delay.

ECL 10,000 will drop propagation delay from 3 to 2ns per gate. With MSI frequently twice as fast. But it takes more than speed to make 10K so desirable.

Hands down, ECL 10,000 beats out Schottky 74/82 in performance—delivering the best high speed/low power trade-off yet. But the crucial question facing users: just how critical to your individual designs is that one extra nanosecond knocked off by ECL?

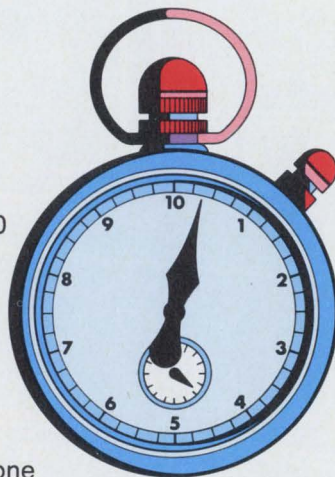

Unless you're into super scale or large scale computers, which have always utilized ECL's maximized performance, there's no pat answer to the question.

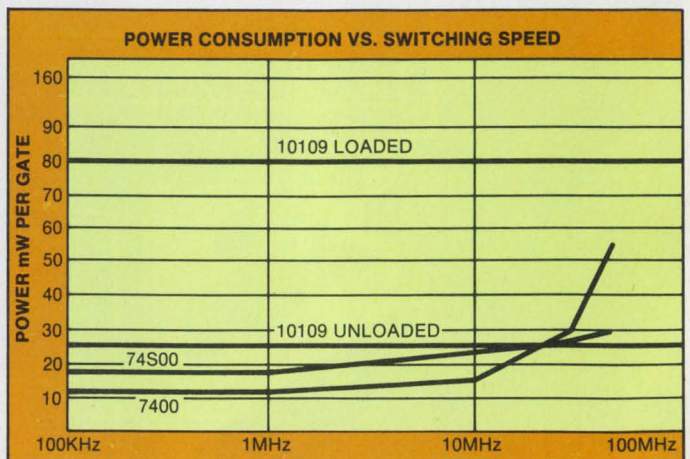

SPEED

The constant current nature of ECL 10K is obvious. Properly loaded ECL gates show very flat power dissipation. This flat power curve means greater ease of power distribution. And the difference between loaded and unloaded curves offers termination freedom: this choice of resistor helps immensely in reducing internal dissipation to allow higher functional densities. ECL combines remarkable design/function flexibility with significant savings in gate and package count.

A fear of the unknown appears to be the key stumbling block to ECL. Probably the prime concern is the relative unfamiliarity with the NOR/OR logic. The system engineer or manufacturer often feels he has enough on his hands mastering the new usage techniques of 74/82 Schottky, where the basic logic is still TTL. Learning to cope with the sharp edge speeds of faster logic is one thing. Being forced to learn a whole new logic besides... that's often the last straw. Is one extra nanosecond worth it? Only you, the user, can tell.

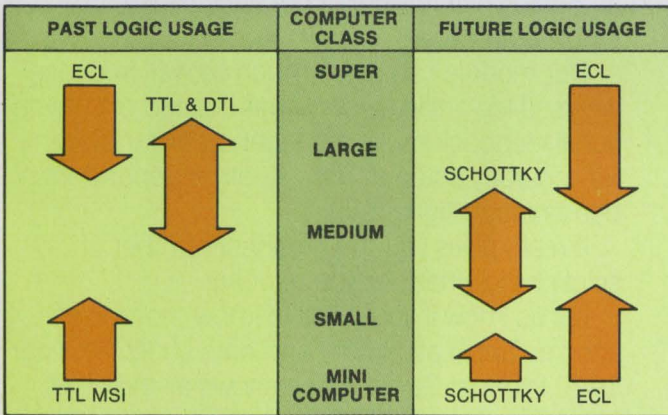

Put yourself in this picture. Match usage to computer category. Match speed requirements to your own best interests, recognizing that the entire industry is trending toward ever-higher speeds. And before you commit to either Schottky TTL upgrading, or a switchover to ECL, consider both alternatives carefully.

74/82 Schottky. Or ECL 10,000. Signetics gives you both ways to go.



SCHOTTKY 82S MSI

82S30/31/32	8-Input Digital Multiplexer
82S33/34	2-Input, 4-Bit Digital Multiplexer
82S41/42	Quad Exclusive-OR/Quad Exclusive-NOR
82S50/52	Binary-to-Octal/BCD-to-Decimal Decoder
82S62	9-Bit Parity Generator and Checker
82S66/67	2-Input, 4-Bit Digital Multiplexer
82S70/71*	4-Bit Shift Register
82S90/91*	Presettable Decade/Binary Counter

SCHOTTKY TTL 74S

74S00	Quad 2-Input NAND Gate
74S03	Quad 2-Input NAND Gate (Open Collector)
74S04	Hex Inverter
74S05	Hex Inverter (Open Collector)
74S20	Dual 4-Input NAND Gate
74S22	Dual 4-Input NAND Gate (Open Collector)
74S112*	Dual J-K Edge-Triggered Flip-Flop
74S113*	Dual J-K Edge-Triggered Flip-Flop
74S114*	Dual J-K Edge-Triggered Flip-Flop
74S40*	Dual 4-Input NAND Buffer
74S140*	Dual 4-Input NAND Line Driver

ECL 10,000

10101*	Quad 1-Input OR/NOR Gate
10102	Quad 2-Input NOR Gate
10105*	Triple 2, 3, 2-Input OR/NOR Gate
10106*	Triple 4, 3, 3-Input NOR Gate
10107	Triple 2-Input Exclusive OR/NOR Gate
10109	Dual, 4, 5-Input OR/NOR Gate
10110	Dual 3-Input 3-Output OR Gate
10111	Dual 3-Input 3-Output NOR Gate
10112	Dual 3-Input 1-OR/2-NOR Gate
10113*	Quad Exclusive-OR Gate/Comparator
10115*	Quad Differential Line Receiver
10116	Triple Differential OR/NOR Line Receiver
10117	Dual 2-wide 2, 3-Input OR-AND/OR-AND Invert Gate
10118	Dual 2-wide 3, 3-Input OR-AND Gate
10119	4-wide 4, 3, 3, 3-Input OR-AND Gate
10121*	4-wide 3, 3, 3, 3-Input OR-AND/OR-AND Invert Gate
10131*	Dual D-Type Master-Slave Flip-Flop
10161	1 of 8 Demultiplexer/Decoder (Low)
10162	1 of 8 Demultiplexer/Decoder (High)
10170*	9 + 2-Input Parity Circuit
10171*	Dual 1 of 4 Demultiplexer/Decoder (Low)
10172*	Dual 1 of 4 Demultiplexer (High)

*Coming soon

SIGNETICS/DIGITAL

811 E. Arques Avenue, Sunnyvale, California 94086

- Please rush us your technical booklet comparing Schottky and ECL 10,000 in detail.
- Send parts lists, pricing and data sheets on both lines.

Name _____

Title _____

Company _____

Address _____

City _____ State _____ Zip _____

Telephone _____

Signetics Corporation, a subsidiary of Corning Glass Works.

signetics

You can make it do things no other module can do. $V=Y(Z/x)^m$



(actual size. \$75 a piece.)

Our little multifunction operator is completely programmable.

By varying only two external resistors, you can make it multiply, divide, or take powers or roots of ratios to the fifth order.

Using feedback, it will perform even more complex transfer functions. Like RMS or vector computation.

You can use our 433 for generating linear or nonlinear functions for on-the-spot computations. Or linearizing a wide range of transducer char-

acteristics in medical, industrial, and process control equipment design.

Everything it does is with excellent overall accuracy of 0.5% and offset drift of 1mV/°C. Which makes it a regular mathematical problem solver.

And a bargain at \$75 a unit and a better one when you order more.

We think its greatest performance is in dividing as it holds high divider accuracies over wide 100:1 input signal ranges.

Our module can do so much so well because we used log-antilog techniques instead of conventional feedback multiplier techniques for dividing. So accuracy and drift are virtually independent of denominator signal level.

It really gives you the broadest number of solutions to whatever you're doing.

Let us know if you'd like to know more. We'll send an application note and data sheet. And our 1972 Product Guide which shows all the other things we make to solve more of your problems better than anyone else.

Analog Devices, Inc., Norwood, Mass. 02062.
(617) 329-4700.



An ECM crisis in Vietnam reported by ex-combat pilot

North Vietnam's downing of a U.S. Air Force EB-66 on April 1 with a surface-to-air SAM missile—the very weapon system that the EB-66 is elaborately equipped to render ineffective—undoubtedly has the Pentagon worried about the effectiveness of its electromagnetic airborne countermeasures (ECM) equipment.

Was the loss of the plane a fluke, or is our ECM equipment relatively ineffective?

A bold appraisal of American ECM has been given to *ELECTRONIC DESIGN* by a former Air Force captain who piloted F-4s and F-105s in Vietnam and RB-47s and U-2s in Turkey. He is an engineer and an expert on ECM. He prefers anonymity so he can comment freely.

"If the military doesn't move fast," he warns, "particularly the Air Force, we're going to find ourselves in the same dangerous and costly position we were in in 1964. Ordered to bomb targets in North Vietnam, neither the Air Force or the Navy had adequate ECM to protect their fighters and bombers from radar-guided missiles. The result was a crash program that the Navy called Shoe Horn, pointing out how the ECM equipment would have to be squeezed into already-crowded aircraft.

"The result was equipment that could have been much better had we had more time—and it could have been built much, much cheaper."

The problem, as he sees it firsthand, is that the North Vietnamese have learned to cope with American ECM, both by adaptation of existing ground-fire equipment and design changes.

"Two other EB-66s were lost to SAM missiles before this one," reports Col. George Hennrikus, an Air Force information officer in New York, "and eight have been

lost due to other causes since we started bombing the North on Aug. 5, 1964. Total losses of all kinds of aircraft to SAM missiles since 1964 come to 105."

These figures do not include the planes that SAM missiles have forced down to lower altitudes, where a lethal bed of antiaircraft artillery fire awaited them—a new trick the North Vietnamese SAM radar operators have learned. Nor do the figures include losses incurred since the renewed air war began April 1—statistics the Pentagon will not disclose at this time.

The solution?

"A mixed bag," the former Air Force captain says, "putting all our assets together, because the more confusion you create, the better."

Better equipment urged

He recommends:

- Development and deployment of new kinds of ECM equipment—optical and infrared—and receivers and transmitters to analyze and jam frequencies in the X-band region and beyond.

- A dedicated ECM aircraft equipped with its normal ECM gear plus the above to accompany fighter-bombers.

- Improved defensive ECM pods on combat aircraft that automatically sense when the aircraft is being tracked by ground radar and automatically jams the radar.

Discussing shortcomings in present ECM equipment, the ex-combat pilot notes the following:

- When a U.S. pilot jams a North Vietnamese ground radar that is measuring his aircraft's azimuth, elevation and range, the North Vietnamese operator merely adjusts the radar antennas to measure the direction of the jamming noise. From this, he gets the

plane's azimuth and elevation. He cannot determine the range, but he doesn't care; if the missile keeps going in the right direction, it will eventually arrive at the correct range and blow up the U.S. plane.

- The North Vietnamese can get their missile-launching information from a burst of radar energy that is so brief that U.S. planes don't have time to jam.

- The North Vietnamese often dispense with the SAM's ground radar altogether and use an optical sight, feeding azimuth and elevation angles from it into the SAM computer. "Needed by U.S. forces is some kind of countermeasure to put those optical sights out of commission—perhaps a laser to blind the operator," the former Air Force officer says.

Soviet radars altered

As for equipment changes, he says that Soviet radars in North Vietnam have had their frequency spreads extended. If the spread covers 200 MHz, for example, and the airborne jamming pod is capable of putting out only 500 W, the effective radiated power is 2.5 W per 1-MHz increment—not enough to do much damage. "To jam properly you need about 1000 W," the ECM expert says.

The Navy is in better shape than the Air Force, he asserts. Its fighters are protected by a newer ECM aircraft, the EA-6A, and by July it will have a follow-on plane, the EA-6B.

But even the EA-6B will not be equipped with optical or infrared devices or jammers that operate in X-band and higher.

The Air Force has only the EB-66, 16 years old and designed originally as a bomber. Although the service denies it officially, rumors have the EB-66 in mothballs by spring.

The Air Force has examined the EA-6B and reportedly likes the ECM equipment but considers the aircraft too slow and without enough range.

In a supplemental budget request for fiscal 1972, the Air Force asked for \$10.2-million to convert two F-111s to EF-111 ECM planes, but Congress turned down the request.

"New equipment is needed, not in Vietnam alone—the war in

Vietnam could soon be over—but elsewhere,” says the ex-Air Force captain. “The Russians have far better ECM in the Middle East than they have in Vietnam. We have no airborne ECM equipment operational today, for example, that can cope with the Soviet SA-3 missile system now set up in Egypt. For it, we’d need all we have now in Vietnam plus a lot more.”

New rubbery material has switching uses

A new conductive, rubber-like material, now available, can be formulated for use as a power switch, power connector contacts or a circuit breaker.

The elastomer, called Pressex, is being offered by Essex International, Inc., of Fort Wayne, Ind., and it can be either spongy or firm. It goes from an essentially open circuit in an uncompressed state to a closed circuit when it is sufficiently compressed. Travel to obtain this on-off action ranges from 0.001 to 0.125 inch.

While applications for the material are still being developed, Essex sees its prime use in automobiles. Initially it will be fabricated as terminal contact material in special terminal block connectors, with switch applications to follow.

Testing of Pressex terminals has been completed in some 2600 cars. Essex says that studies to date show that the connections have about one-half the voltage drop of comparable contacts. The operating force varies from about 3 pounds on a typical 18-gauge wire connector to 50 pounds for multiple-terminal connectors.

Developed originally in the search for a solid-state circuit breaker, the material can break an electrical overload in about 400 μ s, according to its inventor, Gideon A. Durocher, director of advanced design at Essex. As soon as the overload ceases, he says, the material again becomes conductive.

New processor gives instant microfiche

To read out information from computers onto microfilm, the film usually is exposed by a cathode-ray tube, and then developed by a wet

process that takes about 20 minutes. But a new film developed by the 3M Co. of St. Paul, Minn., and a new laser readout system developed by Datalight, Inc., of Bloomfield, Conn., permit the reading out of a page of data and processing in less than a second.

Originally developed for 3M's electron-beam readout microfilm system, the new film, known as a dry silver type, is developed by heat instead of chemicals and is relatively insensitive to light.

Because of its lack of sensitivity, a very-high-intensity light must be used to expose the film, says Walter Crofut, vice president and general manager for Datalight. Thus, he explains, his company developed a low-cost, reliable helium-neon laser system that focuses a beam to a point and writes on the film like a pencil writes on paper. The film is then passed through a heat chamber, where it is developed, and the microfilm is available almost instantaneously.

Called Datawrite, the new microfilm system will be available from Stromberg Datagraphix of San Diego, which has an exclusive agreement to sell it.

The new system, Crofut reports, while competitive in price with existing systems, prints directly on microfiche at a rate of between two and four pages a second. Present systems use roll film that must be developed for 20 minutes and then cut to microfiche size.

Another application to the Datawrite system is in phototypesetting and composing machines. This application, which uses a heat-sensitive paper, will be available exclu-

sively through Photon, Inc., of Wilmington, Mass., and will be part of that company's latest phototypesetting machine, according to Crofut. Datawrite will replace the xenon light source presently used in these machines and will eliminate the need for processing the exposed paper with chemicals. In addition, lower operating costs are expected, because the dry silver paper is cheaper.

Semi show looking for doubled attendance

While general electronics trade shows like the IEEE are declining in attendance, this week's Semicon II show at the San Mateo County Fairgrounds in California expects 8000 visitors—double last year's figure.

The show, being held May 24-26, is designed exclusively for the semiconductor manufacturer—and specialization appears to be the key to higher attendance these days. All exhibitors at Semicon II are manufacturers of materials, equipment and services for the semiconductor industry in the Bay Area.

Howard Moss, president and chairman of the Semiconductor Equipment and Materials Institute, Inc., of Palo Alto, Calif.—sponsor of Semicon II—says there are 196 booths this year, compared with 120 in 1971.

Technical sessions will be held on semiconductor processing, testing materials and assembly, ion-implantation processing, circuit technology, n-channel silicon-gate and other semiconductor technologies.

News Briefs

The first microwave rf power transistor to operate in the linear mode is being developed by RCA's Solid State Div., Somerville, N.J. Under a contract from the Air Force Avionics Laboratory, RCA is designing a 10-W linear uhf power transistor that will operate in the 1.7-to-3.4-GHz range. All present uhf and microwave rf power transistors are intended for use in the nonlinear Class C mode.

Development of the world's most powerful radio transmitting tube

—a two-million watt output tetrode with 17-dB stage gain—is reported by Varian Associates Eimac Div., San Carlos, Calif.

A National Quadraphonic Radio Committee has been established by the Electronic Industries Association Consumer Electronics Group. The purpose? To report to the Federal Communications Commission on the technical aspects of providing commercial four-channel broadcasting. An FCC go-ahead for quadraphonic broadcasts could come within a year or two, EIA predicts.

Pick your course. Pick your city.

TERADYNE MAINTENANCE TRAINING COURSES 1972

C300 Capacitor Bridge	Boston Paris	May 8-12 Nov. 27-Dec. 1
D,R,Z Diode, Resistor, Zener Diode Test Instruments	Boston Paris Palo Alto	Feb. 22-25 Apr. 17-21 July 17-21
J259 IC Test System	Boston Los Angeles Paris	Jan. 25-28 June 5-9 Aug. 21-25
J263 Linear Circuit Test System	Boston Paris Palo Alto Tokyo Boston	Feb. 14-18* Mar. 6-10* May 15-19* Aug. 14-18* Nov. 27-Dec. 1
J271 Analog Circuit Test System	Boston Boston Boston	May 15-19* July 24-28* Nov. 6-10*
J277 MOS Clock-Rate Test System	Palo Alto Boston Paris Palo Alto Boston	Jan. 31-Feb. 4** May 1-5** June 5-9** July 31-Aug. 4** Nov. 13-17**
J283 IC Test System ("The SLOT Machine")	Los Angeles Boston Los Angeles Boston	Jan. 24-28* Apr. 24-28* May 29-June 2* June 5-9* July 24-28* Nov. 6-10*
K147/K148 Relay Test Instruments	Boston Boston	Feb. 16, 17 Aug. 30, 31
L100 Digital Circuit-Board Test System	Paris Boston Palo Alto Paris Boston	Mar. 6-10* Apr. 24-28* Sept. 11-15 Oct. 23-27* 6-10*
M365 Computing Controller	Palo Alto Boston Paris Boston, Paris Boston Paris Tokyo Boston	Feb. 7-21 Feb. 11 Feb. 11-Mar. 3 Apr. 1-11 May 1-11 May 2-11 May 2-11 July 17-21

To make our test systems and instruments extra reliable, we cheat.

Sure, we build in reliability and field a strong service staff. But we also make our customers make us look good.

We train their maintenance people so well they solve four out of five problems themselves. Not that problems occur all that often: most owners of Teradyne systems figure their downtime at something under one percent.

The training doesn't cost a penny either. Customers send us as many people as they like, as often as they like.

If you own Teradyne equipment, send for your copy of our maintenance training schedule. If you don't own our equipment, maybe it's time you did. We specialize in automatic test systems and instruments for ICs, transistors, FETs, diodes, zeners, circuit boards, backplanes, capacitors, resistors and relays.

For the particulars, get your copy of "The Teradyne World of Automatic Testing" by writing Teradyne, 183 Essex St., Boston, Mass. 02111.

**TERADYNE. WORLD LEADER
IN AUTOMATIC TESTING.**

TERADYNE

Space-age technology opening new doors for the blind, deaf and crippled

Jules H. Gilder
Associate Editor

In 1968, Prof. G.S. Brindley, a physiologist at the Institute of Psychiatry, Maudsley Hospital, South London, England, implanted 80 tiny radio receivers and 80 miniature electrodes in the brain of a blind woman. Using transmitters to stimulate those electrodes, he was able to cause the woman to see phosphenes—flashes of light generally produced by stimulation of the retina.

As a result of this preliminary work, Brindley believes that it is possible to develop a sensory aid that will enable blind people to see.

This is only one example of the increasing application of highly sophisticated electronic technology to restore physical functions to the handicapped. Besides visual aids, improved electronic systems are being used to help the deaf and hard of hearing and to assist or replace human limbs.

One system to aid the deaf is an electrotherapy device that improves speech discrimination in people who have a sensorineural hearing loss—more commonly known as nerve deafness. Preliminary results indicate that more than 50% of

the patients treated with this device had at least 15% improvement in speech discrimination.

Work in assisting or replacing human limbs has borrowed heavily from NASA projects. Switches operated by the eye, tongue and breath are some of the technologi-



Night-vision goggles developed by ITT help overcome night blindness.

cal spinoffs from the space program. A special Biomedical Applications Team has been organized at the Southwest Research Institute, San Antonio, Tex., to apply NASA technology to the solution of everyday problems. Dr. David Culclasure, head of the team, says that complete engineering information on products developed by the group is often available free to manufacturers who wish to produce them commercially.

The common denominator in all of these applications is the need for ingenuity on the part of the design engineer. Devices designed originally for nonmedical functions must nearly always be modified for physiological use.

Electronic eye studied

Spurred by Brindley's work on a visual prosthesis, the National Institutes of Health has decided to study the feasibility of an electronic eye. According to Dr. Terry Hambrecht, assistant project officer, a total of seven universities, hospitals and companies are directly involved in the study.

There are many problems with brain implants, says Hambrecht, and the participants in the study will try to clarify them and indicate possible solutions. While Professor Brindley has already tried his technique on a human subject, Hambrecht reports that the National Institutes of Health will require extensive animal studies before the technique is tried out on a human.

In normal vision, electrical impulses from the retina of the eye are transmitted by the optic nerve to the visual cortex of the brain, where an image is formed. Blindness can be caused by a malfunction of either the retina or the optic nerve, resulting in a loss of stimulation to the visual cortex.

The theory behind Brindley's work is to stimulate the cortex to produce phosphenes. By stimulating selected portions of the visual cortex, he believes it is possible to organize the phosphene patterns to enable a blind person to see obstacles in his path, or even to read.

Encouraged by his earlier work, the British professor has developed an improved implant, now being tested. The new unit (see illustration) consists of 180 points on

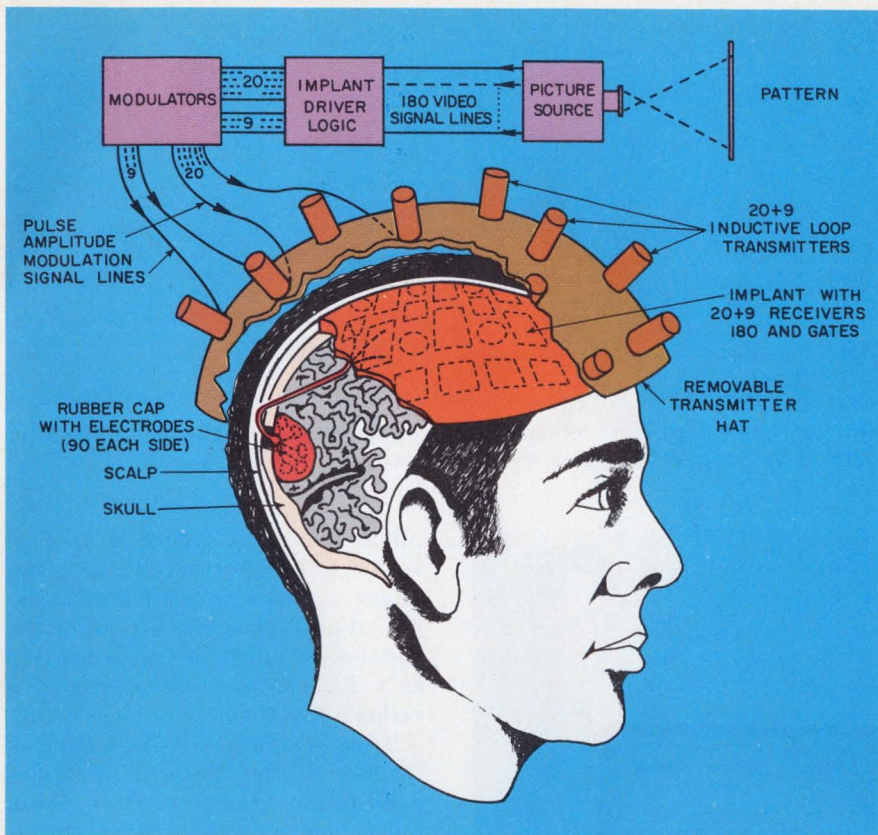

A visual prosthesis now being tested contains 180 implanted electrodes. Because of the bulkiness of available electronic circuitry, only 90 of the implanted electrodes can be stimulated.

the visual cortex—90 on each side of the brain. The 180 points, Brindley says, are sufficient to convey information on the shape of an object and the light and dark features associated with it.

Many problems to be solved

In the U.S., work on a visual prosthesis is progressing at a slower rate. While Brindley has solved some of the initial problems, there are still many that must be overcome before a practical device emerges.

The biggest problem, according to Hambrecht, is that of interfacing an electrode with the neural tissue in the brain. Not only must the electrodes be held in place without damaging the tissue, but a way must be found to convert the electron flow in the electrode into an ion flow in the conducting fluid that surrounds the brain. This must be done, Hambrecht notes without producing toxic products or changing the pH of the body fluids.

Another big problem, he says, is placing enough electrodes on the

surface of the brain to produce a usable phosphene map, or image. The number of electronic components required in the implant is directly proportional to the number of electrodes used. Since the amount of space available is limited, some method of decreasing

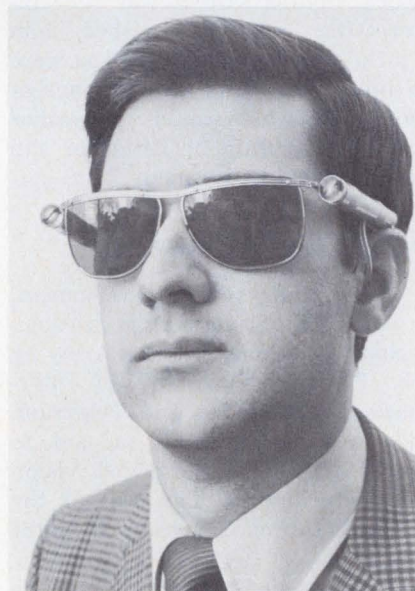

Optical radar system to guide the blind can be mounted on glasses.

space requirements must be found.

Brindley has attempted to solve this problem by arranging the electrodes in a 9 by 20 matrix and by using hermetically sealed integrated circuits. But the sealed packages tend to be bulky, Hambrecht notes. A way must be found to build ICs that can operate reliably for years in a warm bath of saline body fluid, without the need for bulky hermetic packaging.

A problem that may already be moving toward solution is the development of a TV input sensor for the prosthesis. Recent work by RCA and Bell Telephone Laboratories with charge-coupled devices has shown that it is possible to use solid-state technology to reduce drastically the size of television cameras. Further reduction will undoubtedly result from a new \$3-million charge-coupled-device research program sponsored by the Navy.

The Navy's interest in charge-coupled devices can be attributed, at least in part, to the desire to simplify and reduce the size of low-light-level television systems. High-quality TV cameras using charge-coupled devices that cost about \$100 are envisioned.

Sensing with the abdomen

In a related development, the Reticon Corp. of Mountain View, Calif., recently announced a 32-by-32 self-scanning photodiode array that can be mounted on a pair of eyeglasses with a light source and a small lens.

Dr. Carter C. Collins, associate professor at the University of the Pacific's Smith Kettlewell Institute of Visual Science, San Francisco, plans to use the Reticon device in a sensory aid that he has had under development for eight years.

In his system an image is sensed on a photosensitive array. Each point on the image array corresponds to an electrode placed on an individual's abdomen. A lens focuses the image to be viewed onto the array. Elements of the array are illuminated, and electrical pulses are transmitted to the corresponding electrodes. Intensity information is transmitted by varying the width of the pulse. Thus by feeling where pulses are applied



Bell's Code-Com set can enable the deaf to see or feel coded messages.



Portable home-therapy device maintains hearing improvement obtained through treatment with TD 100.

and their intensity, a blind person can sense an image.

Collins is presently using a 256-bit photosensitive array produced by Fairchild Semiconductor, Mountain View, Calif. This provides the blind person who uses the aid with a 5-to-10-degree field of vision. Collins' new aid, using the Reticon array, is expected to be operational by the summer and to provide about a 20-degree field of vision. Both aids, he says, will be used by the blind to read, but neither will provide a sufficient field of vision to allow a person to walk.

For walking, Collins says, a 40-to-50 degree field of vision must be provided. "We hope to do that with a 4096-bit photoarray that Westinghouse has developed for NASA," he adds.

Placement of the electrodes for Collins' sensory aid has been a problem; they occasionally break away from human skin, with consequent loss of electrical contact. However, after talking with textile manufacturers, he is hopeful

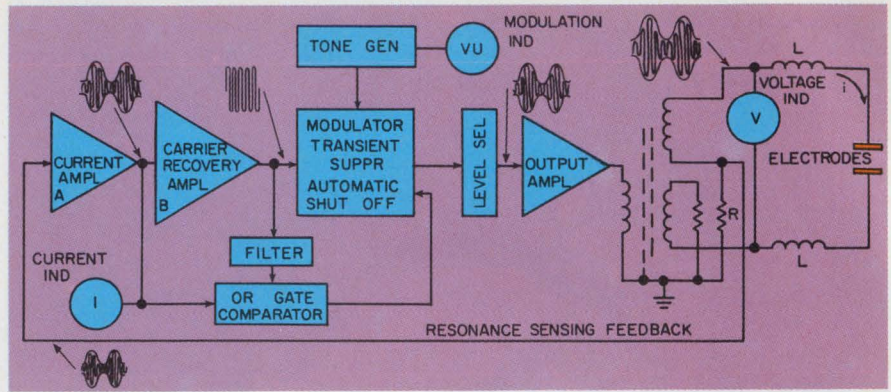

How the Intellectron transdermal therapy device works. A modulated signal is coupled to the patient's head via electrodes.



Intellectron's TD 100 professional therapy unit has improved hearing in patients with nerve deafness.

that this can be overcome by weaving the electrodes into a special garment. The idea is novel and may find use in other applications, such as patient-monitoring systems.

When asked about Brindley's work, Collins said it was very interesting and he wished him "luck," but he asked: "If you were a blind person, looking for a sensory aid, what would you rather do, have a brain operation or slip on a girdle-like garment?"

Night blindness overcome

In another recent development, a pair of night-viewing goggles developed originally for the Army by the Electron Tube Div. of International Telephone and Telegraph has been adapted as an aid to night travelers whose rod vision has deteriorated. The rods of the eye are the main sensors in night vision.

In operation, the lenses in the goggles focus the scene before the viewer onto a miniature image-

intensifier tube, where it is converted to an electronic image. The image is then amplified and displayed on a phosphor screen in the goggles, in much the same manner as a TV picture is displayed on a cathode-ray tube.

Tests carried out by Thomas Coursey of the Western Blind Rehabilitation Center, Palo Alto, Calif., indicate that the night-vision goggles may be a significant aid to people who suffer from night blindness. But image-intensifier tubes are expensive, and before this device can become widely used, the cost must be brought down—a set of goggles costs \$11,600. In addition the packaging of the unit must be changed to make it cosmetically appealing.

A device intended as a mobility aid—not a visual aid—for blind people was recently developed by Forrest M. Mims, a technical consultant in Albuquerque, N.M. The unit is essentially an optical radar system that uses light-emitting diodes. Light is reflected from objects that intersect the emitted beam and the field of view of a sensitive receiver. The received signal is used to control an oscillator that produces a tone, which the user can hear. Variations in the tone indicate the presence or absence of obstacles.

The system has low current consumption, and the entire device can be mounted on a pair of eyeglasses. While it is simple, practical and economical, the device is not yet being manufactured by anyone.

The basic system has many other applications, such as automobile "radar," an intrusion alarm

38% OFF

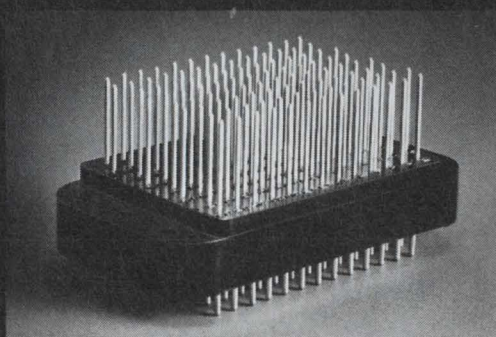

This isn't a discount sale on rack and panel connectors and it's not just a way of getting rid of old inventory.

It's just a plain and simple fact that you can save money by using our P108 rack and panel connector.

And as an even bigger advantage, the savings come on your end of the line, not ours.

You can save on installation cost, because the P108 comes completely assembled. All you need is someone to snap it into place.

In one installation, using fifty-four of our 104-pin P108 connectors, the customer was able to reduce assembly time by 18.6 hours using a combination of automatic and semiautomatic wire wrapping techniques.

This resulted in a 38% reduction in overall assembly labor.

He also got an extra measure of assured reliability, because on any GTE Sylvania connector everything is made by GTE Sylvania — from plastic body to gold-plated contacts.

The standard P108 connector comes with 104 pins. We also have a 50-pin version.

On the 50-pin version, your savings will be a little bit less than on the 104-pin design.

Sorry about that. In any event, why not contact Marv Gustafson at 814-723-2000. He'll tell you all about the P108 and our complete custom facility. GTE Sylvania, Precision Materials Group, Parts Division, Warren, Penn. 16365.

GTE SYLVANIA



An artificial arm, with an electric elbow was developed at Ranch Los Amigos Hospital.

and an industrial counting system. With an increase in the diameter of the lens, a range of several hundred feet can be attained, making the system useful as a range detector for automobiles and future automated highways (for technical details see "Use LEDs, Not Lasers. in Rangefinders," p. 48, this issue).

Systems to enable blind people to read do not have to be big and complex. A small battery-operated optical-to-tactile convertor, known as Optacon, can help the blind "read" conventional print in books and newspapers. Developed by Dr. James C. Bliss and Prof. John G. Linvill at the Stanford Research Institute, Optacon uses a 144-element, light-sensitive array to scan printed material. Each element of the array corresponds to a tiny metal pin set in a finger-sized depression in the device. As the reader scans a letter, the pins vibrate in the shape of the letter. Optacon is being manufactured by Telesensory Systems, Inc., in Palo Alto, Calif.

While the application of electronics to optical aids is relatively new, electronic hearing aids have been used for years by deaf people.

Hearing aids have traditionally been in the forefront of medical electronic technology, says James H. Johnson, president of the Zenith Hearing Aid Sales Corp. in Chicago.

"When the transistor first came out in the 1950s, we were the first industry to use them," he notes. "And when integrated circuits became available in the early 1960s, our industry was again the first to use them."

Present efforts by Zenith to improve hearing aids include special audio ICs that contain compression and automatic-gain-control circuits, together with amplifiers, in one package; a new miniature cardioid microphone, and an implantable hearing aid. The first two developments will almost certainly find application in other branches of electronics, such as communications, Johnson says.

Electrotherapy aids nerve deafness

An electronic system that is designed as a therapy device has been developed by the Intelectron Corp., New York City. The unit, a professional instrument available only to doctors, couples rf signals



An experimental visual aid impresses TV images on the abdomen.



Patient's tongue controls an electric wheelchair by operating a proportional-control system that has strain gauges mounted on cantilever beams.

CUTLER-HAMMER HAS THE RIGHT ILLUMINATED SWITCH FOR EVERY DESIGN.

Does your new product design call for an illuminated switch? Or would it be a better, more saleable product if it did?

Then Cutler-Hammer is ready to help with the broadest selection of illuminated switches you'll find anywhere.

We've got lighted toggles and rockers and paddles and pushbuttons. Standard sizes and miniatures. With lots of color choices and decorative hardware.

They come in a broad array of configurations—like double rockers and maintained or momentary action. With a range of electrical ratings that's sure to meet your specs. Including replaceable and non-replaceable lamps in several lamp types and many operating voltages.

Your Cutler-Hammer Sales Engineer or Stocking Distributor is ready to show you these switches in operation and to supply prototypes to match your designs. Contact him today and get the full story.

CUTLER-HAMMER

SPECIALTY PRODUCTS DIVISION, Milwaukee, Wis. 53201



Switch
to No. 1

More than just switches;
prompt availability,
field help, innovation,
quality assurance, too.

INFORMATION RETRIEVAL NUMBER 19

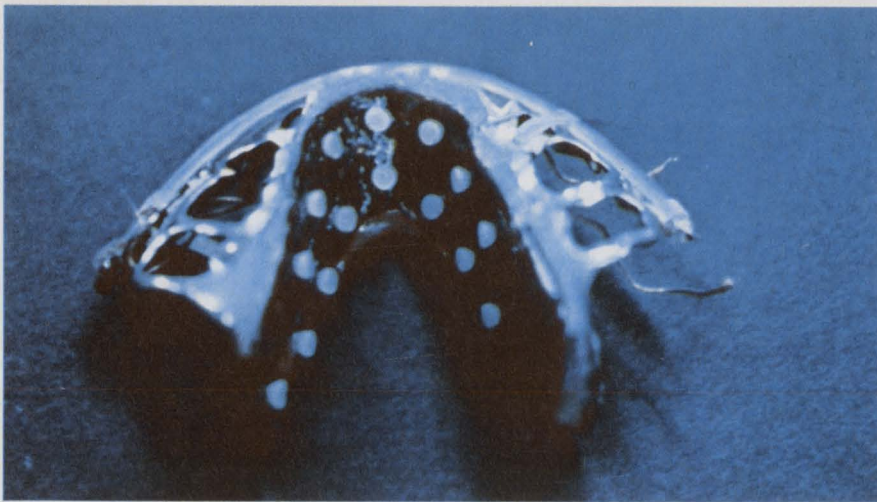

Intra-oral tongue switch under development at Rancho Los Amigos Hospital is activated by pressure on one of the strain-gauge elements.

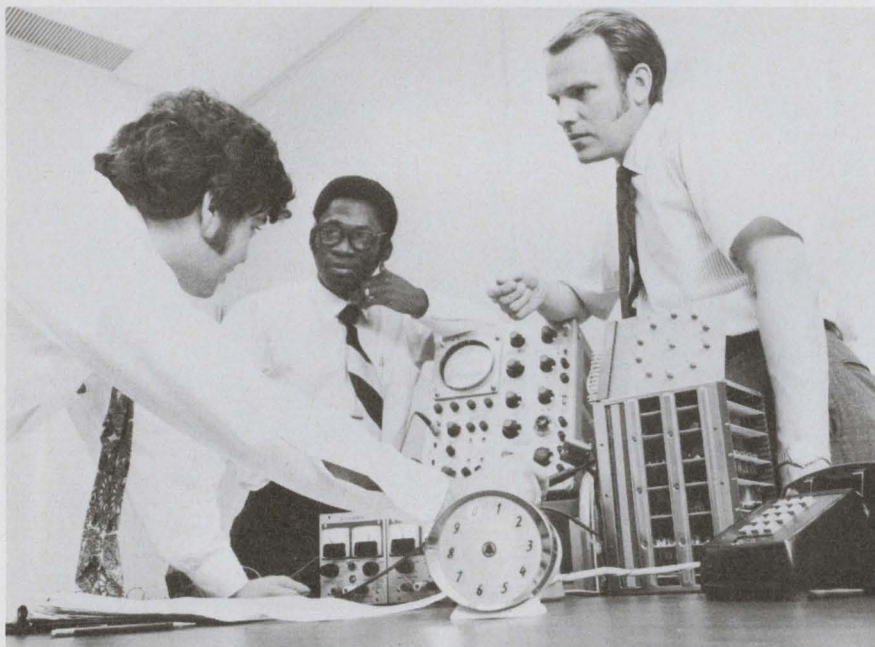

A voice-controlled telephone dialer being developed by Bell Telephone may someday allow handicapped people to dial by speaking into a microphone.

through the skin to nerves in the head. Thus the term "transdermal" has been coined to describe the system.

Richard S. Dugot, Intelectron's vice president of engineering, reports that tests show at least a 15-point gain in speech discrimination for more than 50% of the patients with sensorineural loss who have received transdermal treatments. However, to maintain the hearing improvement, patients must continue therapy, he cautions. This can be done with the TD 200, a special home unit, and it requires only a few hours of treatment each week.

"We don't know exactly how it

works," Dugot comments, "but it does work." The system is presently being evaluated by independent otologists, and plans to investigate the physiological mechanism involved are being formulated.

Two researchers—Dr. James Martin, associate professor of psychology, and Dr. Paul Michael, professor of environmental acoustics, both at Pennsylvania State University—report that preliminary findings of a double-blind program show significant statistical correlation between transdermal therapy and improvement in word discrimination.

The idea for a transdermal therapy device came to light as a re-

sult of Intelectron's earlier work on a hearing aid to be housed in two false teeth. While working on that project, company researchers discovered that a thin metal probe, when attached to the output of an audio amplifier fed by a sound source, could be heard by a normal-hearing person if the probe was placed directly behind one ear and if another probe—to complete the circuit—was in contact with the body at any other point.

This was soon followed by the discovery that an amplitude-modulated carrier, when capacitively coupled to areas around the head by electrodes, could permit intelligible hearing.

Realizing that this phenomenon might be applied in the form of a hearing aid, the developers tested it. As weeks passed, it was found that patients using the new aid were responding to a wider band of pure tones and that their hearing was improving. Tests showed that the device was capable of enhancing speech discrimination.

The electrodes in the system are attached to the patient's head and act as a capacitor, which, with the series inductors, form a resonant circuit (see block diagram). Under electrostimulation, the tissue capacitance of the head changes from one to four times its initial value. To maintain the series resonance during therapy, the generator's frequency must change continuously to follow the changing value of the capacitor.

This requirement led to the development of a novel circuit known as a self-resonating oscillator. This oscillator senses the current in the resonant circuit by measuring the voltage drop in resistor R. In resonance, this voltage and the current in the resistor are in phase, and thus the voltage can be used as the positive feedback.

An electrotactile sound detector that enables deaf persons to detect and localize sounds is being developed by Frank A. Saunders at the Smith-Kettlewell Institute. With a technique similar to the one being used by Collins to aid the blind, Saunders is using the skin to detect pulses, whose magnitude and location convey information as to the site of the sound source and the strength of the sound.

(continued on page 32)

Reduce Custom Power Supply Time and Cost

With a handful of Powercube's new Cirkitblock™ modules and a few clip leads, you can quickly synthesize a virtually infinite variety of supplies covering the gamut of required voltage and current ratings.

Cirkitblock modules have demonstrated capability to meet most design needs and are packaged within a 1" x 1" x 2" basic building block so you can assemble supplies of any complexity to any form factor you need in building block fashion.

Design time to operable prototype can be reduced by more than half because conventional breadboarding is eliminated. Your quickly assembled "breadboard" of Cirkitblock modules becomes your operable prototype.

Cirkitblock modules use space technology, but are specified and priced for industrial applications. They can substantially reduce the "as installed" power supply cost in instruments, calculators, computer peripherals, process control equipment, and communications gear.

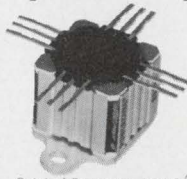

Original Powercube Module®

Cirkitblock functional modules not only save design time and money; they're also a lot of fun to work with. Circle reader service number to learn more about Powercube's Cirkitblock functional modules.

Breadboard Custom Power Supplies In Minutes

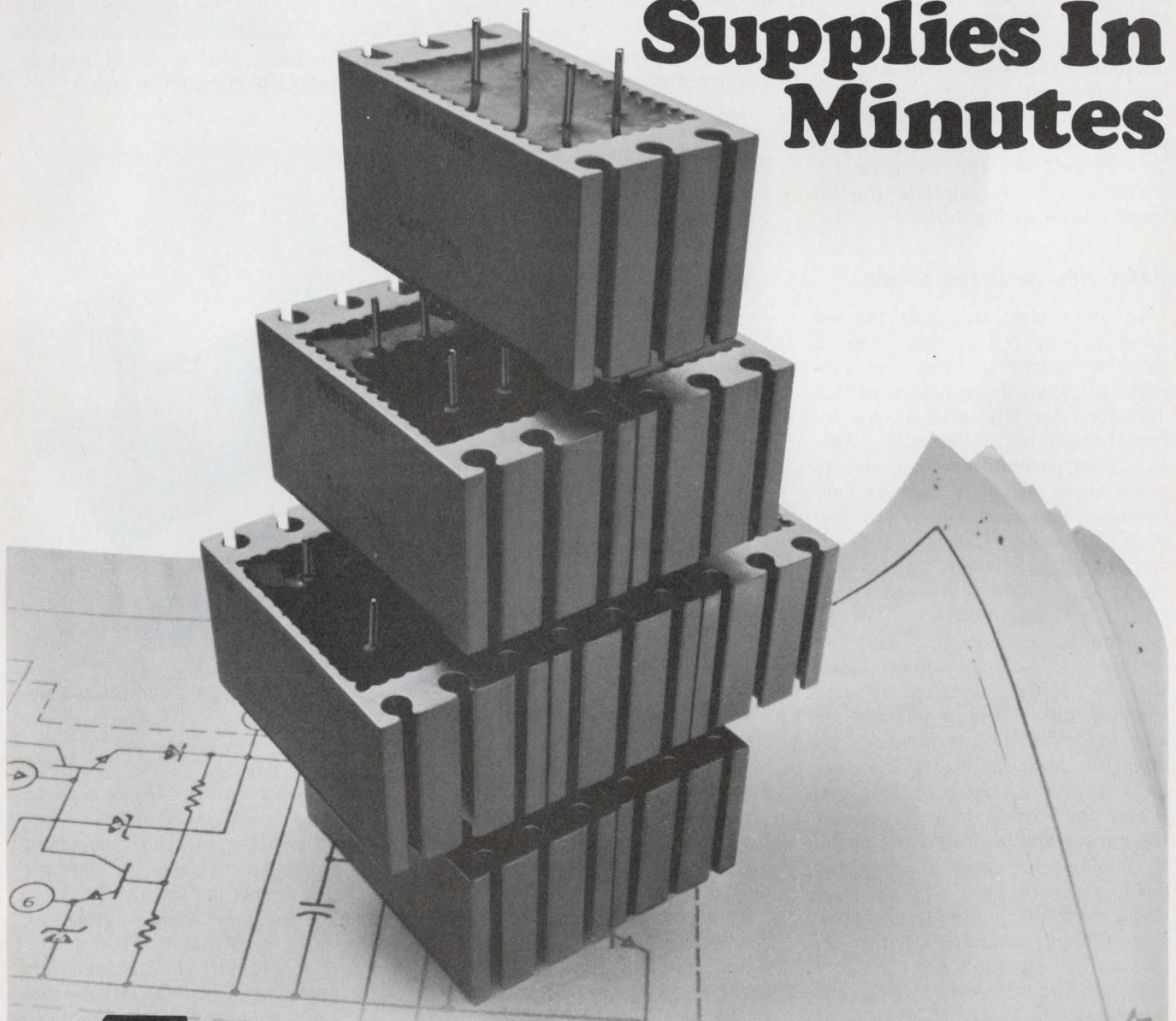

POWERCUBE CORPORATION

214 CALVARY STREET, WALTHAM, MASS. 02154 (617) 891-1830

SUBSIDIARY OF UNITRODE CORPORATION

INFORMATION RETRIEVAL NUMBER 20

(continued from page 30)

The electrotactile sound detector is a portable, battery-operated device mounted on a headband. Signals from bilateral microphones are converted to electrical pulses, which are used to stimulate the skin. The magnitude and frequency of the pulses are proportional to those of the original sound. Sounds originating to the left of the person activate electrodes on the left side of the forehead. The same thing is true for the right side.

Tests with deaf patients show that they are capable of responding to sudden sounds, such as a shout, horn or other warning signal, Saunders says. In addition, a person using this device soon learns to recognize the rhythmic patterns of certain sounds, such as doorbells, the crying of a child, telephones, etc.

Another important feature of this device, Saunders reports, is that it provides the feedback for a deaf person to regulate the intensity level of his voice.

NASA aids paralyzed people

In other electronic aids for the handicapped, NASA has been a valuable source of ideas and support. With an eye-operated switch developed for NASA by Hayes International of Huntsville, Ala., paralyzed patients are now able to move about on their own by controlling a motorized wheelchair. Researchers at the Rancho Los Amigos Hospital, Downey, Calif., have designed a chair that can be operated with the switch.

In addition the same switch can be used to perform other tasks, such as dialing a telephone and turning lights and appliances on and off. The switch operates by directing a low-intensity beam of light into the white of the eye. When the eye is moved, so that the darker iris intersects the beam, a sudden decrease in reflected light is sensed by a photodetector and a switching pulse is generated. Control logic determines which device will be operated.

But while the eye switch has increased the self-sufficiency of paralyzed patients, it also causes irritations of the eyes when the cornea is exposed to the light for extended periods of time. Thus an alternative switching system

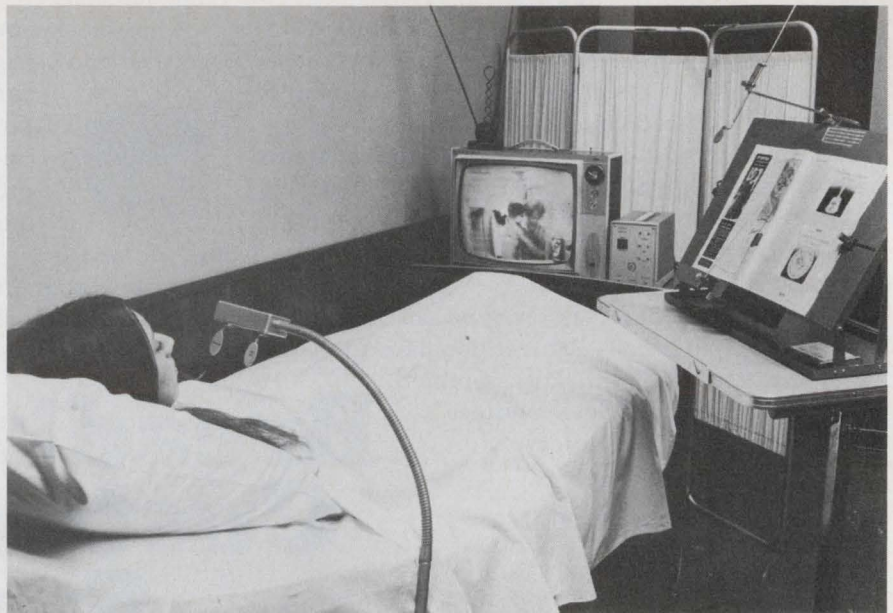

A breath-operated switch and control system developed by NASA enables paralyzed patients to operate appliances by simply blowing on a switch.



Head, foot and hand switches can also be used with NASA's control system. They offer a choice for the less severely handicapped.

has been perfected—a complete control system that can be actuated by a person's breath, or a puff of air directed against a paddle connected to a microswitch.

The breath switch was suggested by NASA's Langley Research Center in Norfolk, Va. With designers from the Southwest Research Institute, NASA engineers have built a system that permits a patient to operate any one of six devices in this way. Extensive testing has proved the feasibility of the system, and patient response

has been favorable, NASA reports.

NASA also is supporting research relating to the development of prosthetic devices. An electric arm, developed by James R. Allen at Rancho Los Amigos Hospital, has been constructed with a tongue-operated switch developed by the space agency. The switch consists of 14 microswitches that can be operated by moving any one of seven levers with the tongue. A more sophisticated intra-oral switch is now being developed by Allen. ■■

We regretfully announce that we were system into our old calculator box.

All we could get in were 52 times as many memory registers plus 16 times as many programming steps, a lot more logic, and a magnetic card reader. The rest of the stuff we had to leave outside.

Our box still weighs 22½ pounds, but it now holds

Up to 522 memory registers, in increments of 64. There's 4-rule arithmetic and special key functions into and out of all registers, and you won't destroy the contents when you turn off the machine.

Up to 4,096 steps of programming, in increments of 512. You can do an entire program from the keyboard and see all your steps printed out for debugging. Symbolic addressing makes branching and jumping very simple. You can backspace, correct errors, and insert steps without having to re-enter the program. You can program the decimal-point printing format, do 16-level nesting.

A magnetic card reader/writer that lets you input programs, write programs, put data into memory, save programs and memory contents.

Fully algebraic keyboard arithmetic, with nesting of parentheses. You enter equations the way you write them, not the way the machine wants them.

Multiple key interlock and rollover, with buffering so you can enter data while the machine is calculating.

Labeled keys for logs, antilogs, a^x , and all common mathematical and trigonometric functions including hyperbolics, and also input/output in degrees-minutes-seconds, full 4-quadrant coordinate conversion, statistical summation (n , x , x^2), standard deviation and mean, factorial, sum-square backout (correction of summations), plus optional user-definable function keys.



Compucorp®

unable to cram all of our new computer

It doesn't hold

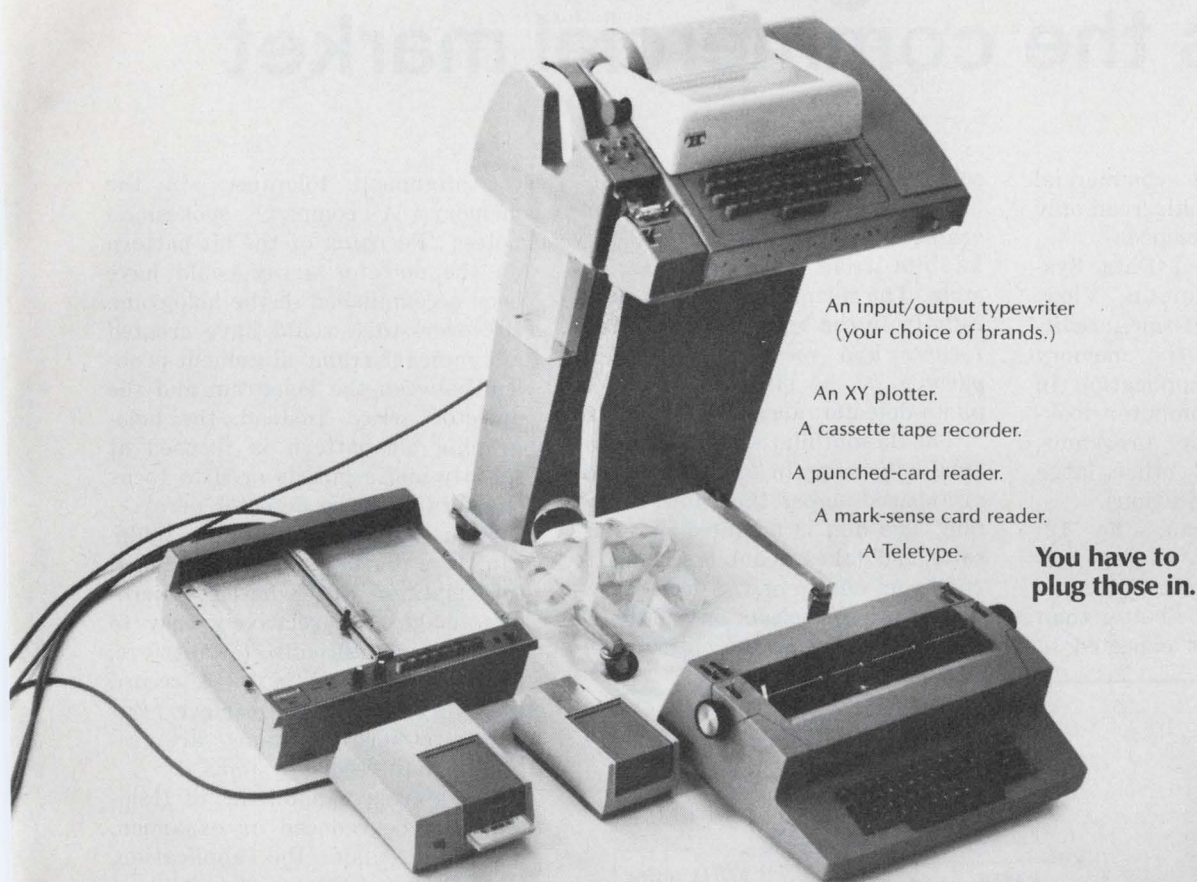

An input/output typewriter
(your choice of brands.)

An XY plotter.

A cassette tape recorder.

A punched-card reader.

A mark-sense card reader.

A Teletype.

**You have to
plug those in.**

We're talking about the new 400 Series of desktop computers that complements and extends our Compucorp calculator line. The Model 425 is for engineers, scientists and surveyors, the 445 is for statistical folks.

We've made more than 30,000 of our other models in the last couple of years. They come in little boxes that sit on a corner of your desk. Each one has an array of powerful one-punch keys that solve the problems of a particular kind of user. They have up to 20 storage registers and 256 steps of programming.

There's a wide range of prices so you can buy enough power to do your job without having to pay for more than you need.

But many customers have said, "That's not enough machine for me." Hence the 400's.

The 400's are as easy to operate as our other models (easier, in fact.) They're enormously powerful and versatile, they interface with an array of peripherals, and they come in the same little box.

The 400's start at \$3,750, our other models a lot lower.

Write down what you need on your letterhead. We'll show you a calculator or a desktop computer that fits your problems and your pocketbook.

Low-cost holographic ROM cracks the commercial market

The first low-cost commercial version of a holographic read-only memory has been developed.

Designed by Optical Data Systems, Inc., of Mountain View, Calif., for the point-of-sale, credit-verification market, the memory is expected to find application in such areas as minicomputer look-up tables, diagnostic programs, archival storage and other large data-based ROM applications.

Known as Holoscan, the 12-megabit store has an average access time of 1.5 seconds. Bit error rates are reported to be better than one part in 10^7 . It is expected to

sell for around \$1500.

In operation, a he-ne laser generates a hologram pattern of 4 by 14 bits from a holographic film strip. The bit pattern is focused at infinity in the hologram, and a lens focuses and reconstructs the bit pattern in the plane of a 4-by-14 photo-detector array.

The 35-mm film strip consists of 5000 holograms in 40 channels that are spaced across the width of the film. The film is mounted in a cassette and takes about 3 seconds to run from end to end. A lead-screw-driven mirror selects one of the 40 channels and runs the entire channel past the laser beam.

The key to the low-cost system lies in minimizing critical mechani-

cal alignment tolerances in the memory. A company spokesman notes: "Focusing of the bit pattern on the detector array could have been accomplished in the hologram. However, this would have created a significant frame-alignment problem between the hologram and the detector array. Instead, the holographic bit pattern is focused at infinity and a lens is used to focus the data onto the detector array."

Both holograms and microfilm can store digital, as well as analog, information. But whereas microfilm images are relatively easy to record and difficult to retrieve, holograms are difficult to record and very simple to retrieve. Far more retrieval systems are required than record systems.

The storage capabilities of Holoscan can be reduced or expanded, depending upon the application. Optical Data Systems says it plans to introduce in the first quarter of next year two new Holoscan systems. Holoscan II will store only 10^6 bits, but it will have an average access time of about 100 ms and sell for about \$500. Holoscan III is expected to store 10^8 bits, sell in the \$2500 range and have a 1.5-second access time.

Previous work on holographic memories has been largely experimental. In 1968, RCA developed a feasibility model of a holographic read-only memory for the Army Electronics Command. It consisted of four holographic pages containing 26 bits of ROM information. A solid-state gallium-arsenide diode laser was used to construct or read the holograms onto a photo-detector array.

RCA is presently working on a random-access read/write holographic memory for NASA that consists of 1024 liquid-crystal holograms of 1024 bits. This RAM system will cost about \$200,000. ■

Les Brock
Western Editor

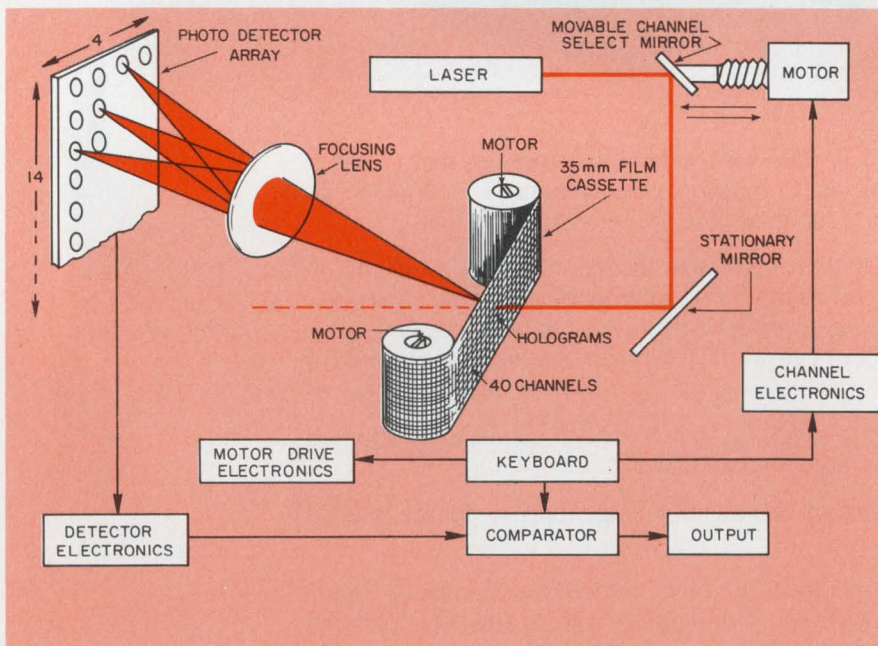

Retrieval of digital information from a holographic ROM in a 35-mm film cassette is done with a laser, two mirrors, a lens and a photo-detector array. One of the mirrors is adjusted by a lead-screw mechanism to position the laser beam on one of the 40 channels across the width of the film. The reconstructed spot-pattern image from the hologram is focused by a lens onto the detector array. The cassette motor-drive system scans the entire film strip past the stationary laser beam, successively reading out each of the tiny holograms along the chosen channel.

NEW! A/D ENCODER CIRCUIT.

Contains all the digital circuitry necessary to build an 8-bit successive approximation A/D converter.

HI-0180

This new device replaces three conventional TTL MSI packages, resulting in significant space and cost savings.

Features:

Both serial and parallel output data compatible with DTL/TTL.

"Data Ready" output pin indicates when conversion is complete and can be used for serial word synchronization, gating of parallel data, or actuating an analog sampling circuit.

"Reset" and "Enable" inputs which allow the device to convert continuously or stop on completion of a conversion until externally restarted.

Applications:

The HI-0180 can be used with the HI-1080, 8-bit D/A converter, the HA-2111 comparator, and a reference voltage source to implement a complete 8-bit A/D system capable of converting unipolar or bipolar signals with 1/2 L.S.B. accuracy at up to 40,000 conversions per second.

Other applications include:

Point of measure A/D converters in data acquisition systems.

Encoders and decoders for digitally multiplexed audio, instrumentation, or control transmission systems.

Supplied:

16-pin ceramic DIP	100-999 units
HI-1-0180-2 (-55°C to +125°C)	\$17.70
HI-1-0185-5 (0°C to +75°C)	\$ 8.85
CFO-0185-6 (Chips)	\$ 5.35

For details see your Harris distributor, representative or write direct.

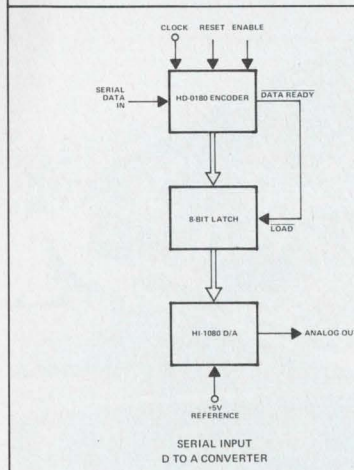
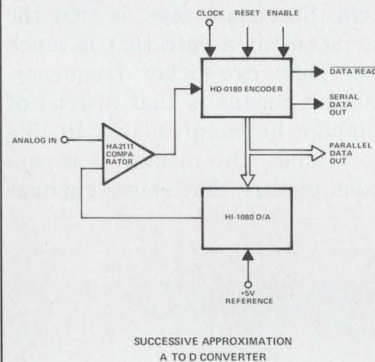
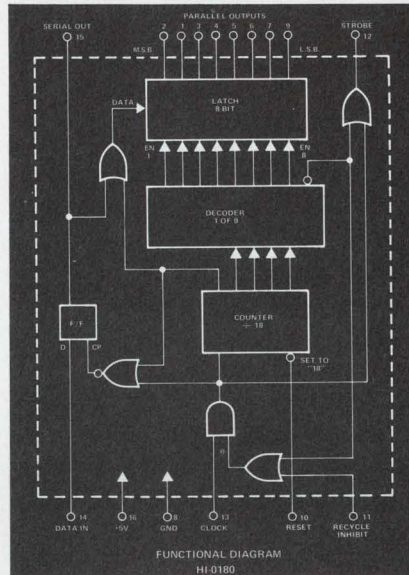

Special Introductory Offer! Complete 8-bit A/D Converter System Kit

For a limited time we are making available a complete 8-bit A/D converter system in kit form for both commercial and military applications. Kits also contain a prewired PC card and information package. Both versions may be ordered only through your Harris distributor, but be sure to place your order early because quantities are limited.

The military version consists of our new HI-0180 encoder, the HI-1080 D/A converter, the HA-2111 voltage comparator. **\$65.00** in 1-99 quantities.

The commercial kit contains our HI-0185 A/D encoder, the HI-1085 D/A converter, and the HA-2311 voltage comparator.

\$36.80 in 1-99 quantities.



HARRIS
SEMICONDUCTOR
A DIVISION OF HARRIS-INTERTYPE CORPORATION

P.O. Box 883, Melbourne, Florida 32901
(305) 727-5430

DISTRIBUTORS: Schwebel Electronics: Westbury, New York (516) 334-7474; Rockville, Maryland (301) 881-2970; Hollywood, Florida (305) 927-0511 / Harvey/R & D Electronics: Lexington, Massachusetts (617) 861-9200 / Semiconductor Specialists, Inc.: Chicago (312) 279-1000; Detroit (313) 255-0300; Minneapolis (612) 884-8132; Kansas City (816) 452-3900; St. Louis (314) 428-6100; Dallas (214) 358-5211; Indianapolis (317) 243-8271; Pittsburgh (412) 781-8120; Dayton (513) 278-9455 / R.V. Weatherford Co.: Albuquerque (505) 265-5671; Anaheim (714) 547-0891; Austin (512) Enterprise 1443; Dallas (214) 231-6051; Denver (303) 427-3736; Glendale (213) 849-3451; Houston (713) Enterprise 1443; Palo Alto (415) 321-5373; Phoenix (602) 272-7144; Pomona (714) 623-1261; San Diego (714) 278-7400; Seattle (206) 762-4200. **HARRIS SALES OFFICES:** Wellesley, Massachusetts (617) 237-5430; Wayne, Pennsylvania (215) 687-6680; Palos Heights, Illinois (312) 597-7510; Melbourne, Florida (305) 727-5430; Palo Alto, California (415) 321-2280; Melville, New York (516) 249-4500; Syracuse, New York (315) 463-3373; Washington, D.C. (202) 337-4914; Dallas, Texas (214) 231-9031; Scottsdale, Arizona (602) 946-3556; Long Beach, California (213) 426-7687.

INFORMATION RETRIEVAL NUMBER 25

Ferrite phased-array radar

developed for smaller planes

For pilots of small, single-engine aircraft, a weather radar to guide them through stormy weather has long been a hope rather than reality. Weather radars were only for bigger planes. They were prohibitively expensive—and, besides, a single-engine plane had no place to mount a rotating radar dish, which generally has been installed in the nose of the plane.

Now, as a result of a new ferrite phase-shifter design, the small-plane owner can have a weather radar that, its manufacturer says, is even better than the present systems in some of the big general-aviation planes. The price of the new radar is expected to be about \$5000 fully installed—still fairly

high for many single-engine plane owners but only half the cost of presently available units.

The new radar is a phased-array system that can be mounted in the wing of the plane. It has no moving parts, and thus offers higher reliability. It uses meander-line, nonreciprocal phase shifters and stripline construction, which results in the 50% cut in costs, according to David Stanislaw, project engineer for the Aradar Corp., Plymouth Meeting, Pa., the manufacturer.

Another advantage of the new system, Stanislaw says, is that the radar scans at a rate that is much higher than eye-flicker frequency. What this means is that instead of the image being presented in discrete frames, the display is a continuous picture that shows changes

instantaneously. Also, regular cathode-ray tubes are used instead of the more expensive high-persistent types.

Ferrite phase shifters used

Phased-array radar systems have been around for some time. They can use either solid-state or ferrite phase shifters. The solid-state, while capable of several kilowatts, are very expensive. Ferrites on the other hand, while inherently cheaper to fabricate, operate at typically, only a few hundred watts, Stanislaw notes.

"Our new ferrite phase shifter, however, can operate at a power level of 10 kW—higher than any other ferrite phase shifters," Stanislaw reports. He's not saying how he is able to do this, though, because patents are still pending.

Jules H. Gilder
Associate Editor

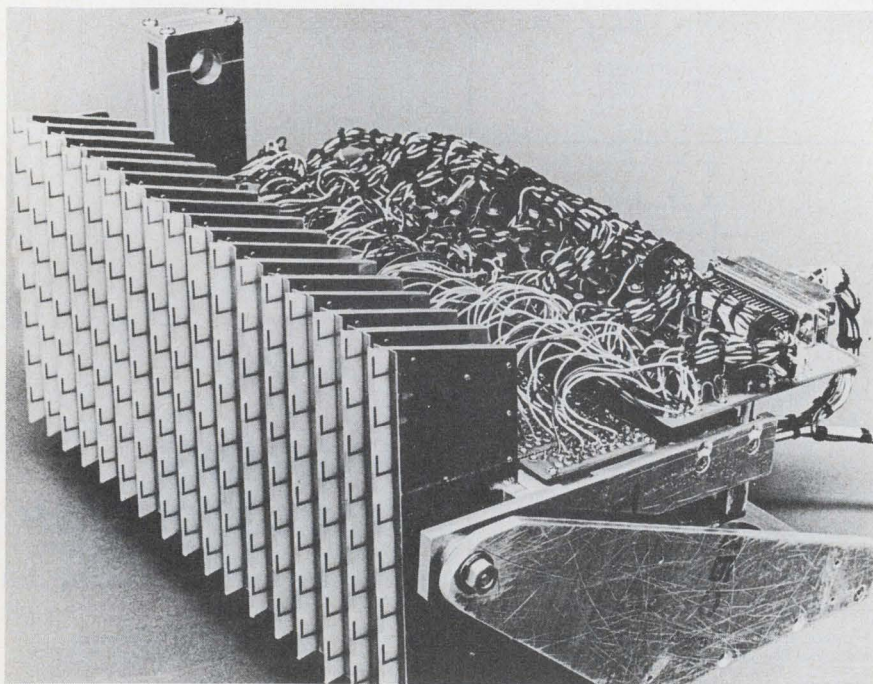

Phased-array weather radar system can be mounted in the wing of an airplane. A fiberglass radome, the same shape as the wing, covers the array.

Based on military technology

The early development work on Aradar's ferrite phase shifters was done by the Syracuse University Research Corp. in New York State. Syracuse was chosen because of extensive work that it did on ferrite devices for the Navy and the Air Force.

The radar system operates in X-band and has a range of 90 miles. It can be mounted in the leading edge of an airplane wing, with lower installation costs than for present nose radars.

Although still in the prototype stage, Stanislaw says that production of commercial units will start by the first quarter of next year. He estimates that the system will sell for about \$3000, with \$2000 required for installation. This contrasts, he says, with present systems selling for \$7000 and requiring \$3000 for installation. ■■

**Silicone breakthrough:
Flame-retardant
pourable elastomer
at general-purpose
prices.**

New Sylgard® 170 A & B silicone elastomer now offers silicone security at prices competitive with organics! This flame-retardant, low-price, two-part silicone cures, when catalyzed, to a rubber with excellent electrical insulating properties. Developed for general potting, encapsulating and conformal coating, Sylgard 170 does more. It now permits designers to utilize the superior resistive advantages of silicones on lower cost, high-volume products.

If this new material stimulates your thinking about silicones in applications where greater safety and improved flame retardance is important, we'd like to help. For a free sample of Sylgard 170, write us on your company letterhead describing your application. Dow Corning, Dept. A-2317, Midland, Michigan 48640.

Encapsulants and sealants from

DOW CORNING

DOW CORNING



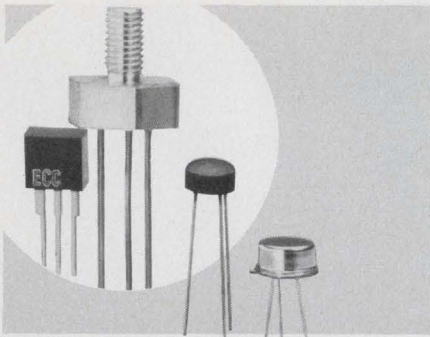

**THE
LONG
LINE OF
ECC
Sensitive Gate
TRIACS
and SCR's**

Fast delivery and competitive pricing make ECC Triacs and SCR's your best buy.

SENSITIVE GATE TRIACS

TO-5 Metal and Plastic; THERMOPAK* and THERMOTAB® Packages

- $I_{T(RMS)}$ 0.8 - 3 amps
- I_{gt} 3, 10, 25 ma (all 4 quadrants)
- I_{TSM} 20 amps
- V_{DROM} 200 - 600 volts

For more information, circle No. 221

SENSITIVE GATE SCR's

TO-5 Metal; 5/8" Hex Stud; THERMOPAK and THERMOTAB Packages

- $I_{T(RMS)}$ 0.8 - 10 amps
- I_{gt} 50, 200, 1500 μ amps
- I_{TSM} 50, 100 amps
- V_{DROM} 30 - 600 volts

For more information, circle No. 222

All ECC Triacs and SCR's feature heavily glass passivated junctions for high reliability.

Detailed technical data on the complete line of ECC Triacs and SCR's is available from your nearest Sales Representative or Authorized Distributor. *trademark of ECC



P. O. Box 669 • Euless, Texas 76039
817/267-2601

**technology
abroad**

The use of low-cost base-metal compounds in thick-film hybrid microcircuit resistors is under study by Britain's Electrical Research Association. The association's work has so far demonstrated that some conductive base-metal compounds, such as molybdenum boride, possess desirable properties and are relatively easy to process. In the latest phase of the program, the association is making differential thermal analyses of the phase changes and related effects that occur in the materials at up to 1500 C in a controlled atmosphere.

CIRCLE NO. 441

New pyroelectric crystals that can detect a one-degree change in a black body at 300 K may replace the costly and bulky nitrogen-cooled detectors in night-vision systems. The new proprietary crystals, which have already been fabricated as the target of a conventional vidicon camera by Thomson-CSF in France, are only an order of magnitude less sensitive than the nitrogen-cooled devices. The new camera has a temperature resolution of 1 C, spatial resolution of 2 mrad and a frame rate of 10/s.

CIRCLE NO. 442

A low-cost digital-to-analog conversion technique eliminates ladder networks and reduces the components to a simple MOS integrated circuit plus a resistor-capacitor integrator. It was developed by the French firm Alstom, a manufacturer of process controls. The output of a 10-bit random number generator is compared with the digital signal, and the difference is applied to the RC network. The average value of the RC network output has a linear relationship to the digital input.

A 10-bit converter, using the simplified technique, has been produced. The French circuit designers say that an analog-to-digital conversion is also possible. The circuit, produced under an Alstom license, is being marketed by General Instrument in Europe.

CIRCLE NO. 443

A hybrid IC that can control loads of 5 or 6 kW when triggered by a standard TTL gate has been developed by International Rectifier in England. The device measures 1 inch by 2-3/4 inches by 1-1/4 inches. Packaged onto a beryllia substrate are encapsulated SCR's, rectifier diodes, zeners and an optical decoupling circuit to isolate the input fully from the output. The two SCR's are connected in inverse parallel, and they switch in the 'zero-voltage' mode. This gives full ac control up to 25 A at either 110 or 240 V without generating radio-frequency interference.

CIRCLE NO. 444

An experimental laser system to measure wind speed, and possibly air turbulence, is being tested by Britain's Royal Aircraft Establishment. The laser beam illuminates particles in the air, and the doppler shift in back-scattered light gives an indication of the particle airspeed. This velocity is displayed on a chart recorder. The present system uses a single laser beam. However, equipment with multiple beams or a scanning system is proposed for constructing wind profiles in real time. Such equipment might be used to detect and investigate turbulence patterns in the wake of large aircraft like the 747 jumbo jet.

CIRCLE NO. 445

**Silicone breakthrough:
Noncorrosive
adhesive/sealant
at general-purpose
prices.**

The protective advantages of bonding and sealing with a noncorrosive silicone can now be extended to a wider variety of products. New Silastic® 738 RTV adhesive/sealant is offered at prices competitive to conventional silicone sealants and even to many organic materials. It will not corrode sensitive metals because it has a curing system different from that of regular silicone sealants. Also, there is no objectionable odor during cure.

Silastic 738 is a ready-to-use, durable sealant that will guard your products with all the superior resistive properties inherent in silicones.

For a free trial sample, fill out coupon:



Encapsulants and sealants from
DOW CORNING



Dow Corning Corporation
Dept. A-2318, Midland, Michigan 48640
Send me a free trial sample of
Silastic 738.

Name _____
 Title _____
 Company _____
 Address _____
 City _____ State _____
 Zip _____ Phone _____

offer expires Sept. 30, 1972

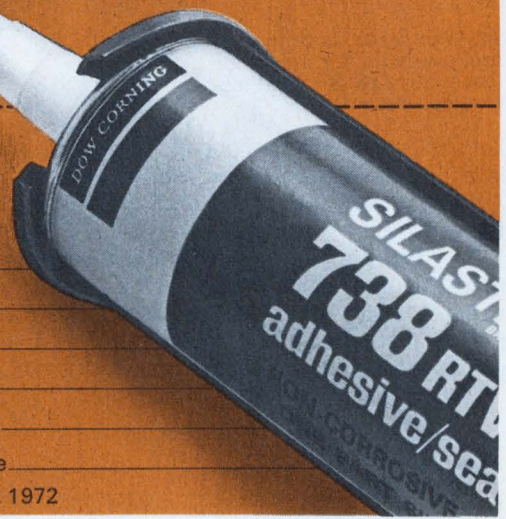

**Never in the history
of instrumentation
has so much counter
been packed into
so little space
for so few dollars.**



All Monsanto instruments are available for rental or lease through Rental Electronics, Inc.

Let's take those factors one at a time. Our new Model 150A is a 5Hz-32 MHz counter with solid-state 5-digit display. Automatic ranging and decimal point positioning are other features.

But the real news is that you can carry all this (and more) counter performance in the palm of your hand and activate it with either 12-32 VDC or 115/230 VAC. A battery pack will soon be available as an option if your work takes you beyond a convenient source of AC or DC.

Newsworthy, too, is the price of the Model 150A: Only \$475. With our standard 2-year warranty too. Who but Monsanto could pack so much value into a space 2"H X 4½"W X 7½"D and weighing less than 3 lbs.?

Write or call for a data sheet on the Model 150A. The Monsanto representative has a Model 150A in his hand and would like to demonstrate it to you.

United Systems Corp., a subsidiary of Monsanto Co., 918 Woodley Road, Dayton, Ohio 45403.

Monsanto

washington report



Don Byrne
Washington Bureau

White House action opens research funds to industry

Administrative action by President Nixon has assured industry of getting more than it usually does of the National Science Foundation's applied research money this year. Acting on a 1968 amendment to the National Science Foundation Enabling Act, President Nixon decided last month that it was "in the national interest" for the foundation to allow organizations "other than academic institutions" to carry out applied research on national problems.

The total money budgeted for 1973, of which industry will have a bigger share, amounts to \$120-million. The entire foundation budget amounts to \$674-million—\$28-million more than was sought by the agency and \$55-million above current spending.

One area in which industry might see more grants or contracts is the Experimental Technology Incentives Program, which will consist of \$40-million divided between the foundation and the National Bureau of Standards. This program was designed to encourage industry to put more dollars into research, especially in cooperation with colleges.

More Federal support planned for industrial technology

In its own bid to aid industry, the NSF's National Science Board has asked in its recent annual report for a national policy statement that by 1974 would free more Government funds to underwrite work by scientists and engineers to solve society's growing needs.

Board member J. Ross MacDonald, vice president of corporate research and engineering of Texas Instruments Inc., says that Government supported research, development and demonstration on problems such as transportation are the innovative keys essential to providing these services to society.

Daniel E. Drucker, Dean of the University of Illinois College of Engineering, said in the report that a "dramatic turn for the worse" is taking place in American industrial technology. "We are deeply concerned," he said, "when our own plants become non-competitive, not on cost alone, but on quality and versatility of their output."

Most oppose FCC's limited entry plan

The majority of the eight applicants and 24 other interested parties are finding some kind of fault with the FCC's proposed "limited entry" plan for a domestic satellite communications system. The plan, drawn up by the FCC's Common Carrier Bureau, would authorize several sys-

tems to be operated by cartels created by the eight applicants.

Western Telecommunications Inc., approved of the FCC's Common Carrier Bureau position on the satellite system. But the Office of Telecommunications Policy, the Justice and Defense Departments all urged major revisions. OTP favored a complete open entry policy permitting any viable applicant to do anything. Defense, as it has stated before, disagrees with the Common Carrier Bureau position on AT&T. The Bureau only wants to allow AT&T to provide long distance and wide area telephone service (WATS) but be precluded from offering private line services which compete with other carriers. Defense buys most of its private lines from AT&T. Verbal arguments in the case will conclude this month.

How to beat foreign competition without subsidies

A low bid of \$91.6-million by Rohr Industries for 60 computer-operated subway cars for the Washington, D.C., subway system now under construction has headed off a prospective battle in Congress. Protectionist, tariff-minded Congressmen feared that Toshiba International Corp. of Japan would be the low bidder and were set to fight for a "Buy American" policy. Happily, Toshiba was the highest bidder of them all—\$142.9 million. Other losers were Vought Aeronautics, bidding \$103.14-million and General Electric with a \$103.13-million bid. Present plans for the capital system call for a total of 300 cars.

EIA data shows magnitude of 1971 semi slump

Figures just released, somewhat belatedly, by the Electronic Industries Association affirm what most in the industry have known for the past two years, namely, that the semiconductor industry has been in a severe recession. Data show that U.S. factory sales of solid state industry products totaled \$1.155-billion during 1971, a 4.5% decline over 1970 sales of \$1.209-billion. Unit sales for 1971 were placed at 2.9-billion while comparable 1970 sales reached 3.1-billion. The total IC market was placed at 482.1-million units (up 14.7%) worth \$534-million (up 19.7%). Discrete device sales reached 2.5-billion units during 1971, off 6.9%, with dollar volume put at \$621.2-million, off 9.4%.

Although year-end sales were down, considerable improvement was noted during the last few months of 1971, according to the EIA.

Capital Capsules: The Commerce Dept. reports that export of electronic measuring instruments dropped 15% last year to \$226.3-million. Imports were also down 13% to \$68.6-million. . . . The Air Transport Association has told Congress that the \$26-million budgeted by the Federal Aviation Administration for navigation aids, landing systems, radar, towers and weather services this year "is far too small." The association has asked Congress to appropriate \$131.35-million for a long-overdue catch-up effort. . . . Boeing will build in-house most of the avionics package for the Air Force B-1 bomber. It will provide the weapons-delivery system, the low-light-level TV, the controls and display and the computer software. Boeing will buy the airborne computer, and the Government will furnish the navigation system.

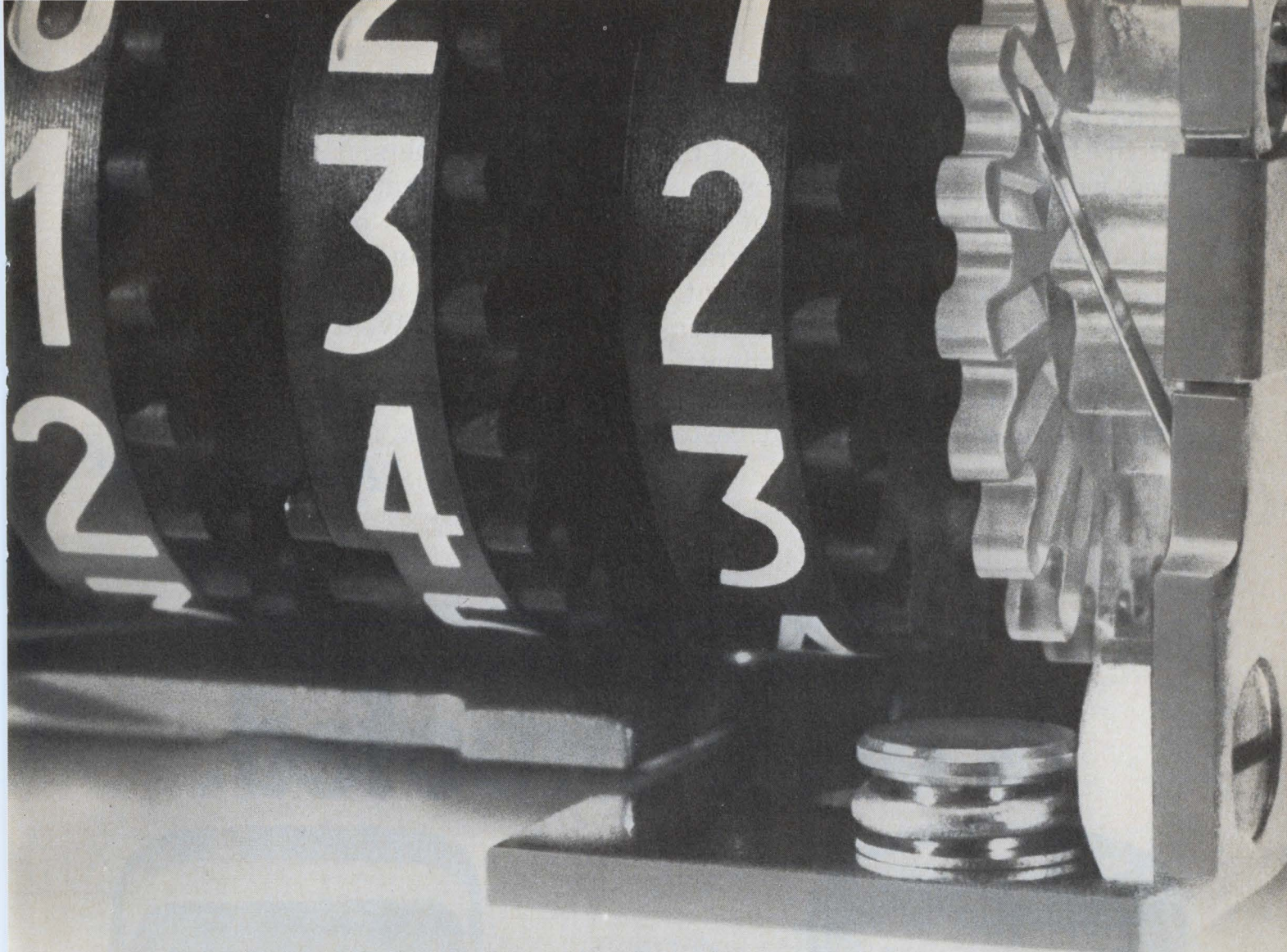

Introducing the Swiss counter revolution.

When you combine Swiss and American engineering and manufacturing know-how, you're bound to come up with a revolutionary product: the Sodeco RG Series counter.

It keeps right on counting long after other counters have quit. Up to 200,000,000 pulses. But you'll be very pleasantly surprised when your RG counter goes on and on... 250,000,000 counts or more... 4 times as long as other electromechanical counters.

Sodeco counters look good in your equipment, too. Compact size, fast plug-in installation, easy-to-read numerals, and outstanding operating ad-

vantages. Their 15% voltage tolerance and capacity to operate with a wide variance of pulse waveforms provide a wide safety margin. Low power consumption (as low as 0.8 W) makes them ideal for solid state applications. They're available in 3, 4, 5, 6 and 8 digit models—in 3 sizes—and 3 mounting styles for versatility. Most are in stock now for off-the-shelf delivery.

For more detailed information, send for our new brochure. Sodeco, 4 Westchester Plaza, Elmsford, New York 10523. Tel: (914) 592-4400; TWX: (710) 567-1219; Telex: 137345. In Canada, 2063 Chartier Street, Dorval

760, Quebec. Tel: (514) 631-9069.

You can count on us longer.

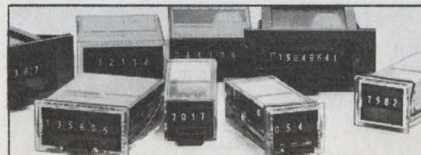

SODECO

A Division of **LANDIS & GYR**

The one in the middle is a Weston Series 660 VOM. And it's the only one of the three that's warranted to keep working even if it's accidentally dropped from a height of five feet. Weston is the only manufacturer who is making that statement.

A Weston Series 660 is also smaller and lighter in weight than competitive meters. It has an easier-to-read scale and range plate. And it costs

no more than the meters that don't offer a drop-proofed warranty.

Like the others, it's available with a protective leather carrying case. But who needs one with a drop-proofed Weston VOM?

Five models are ready for inspection at your Weston distributor. Drop in and try one. Or drop one. Weston Instruments, Inc., 614 Frelinghuysen Ave., Newark, N.J. 07114.

WESTON®

Only one is drop-proofed.

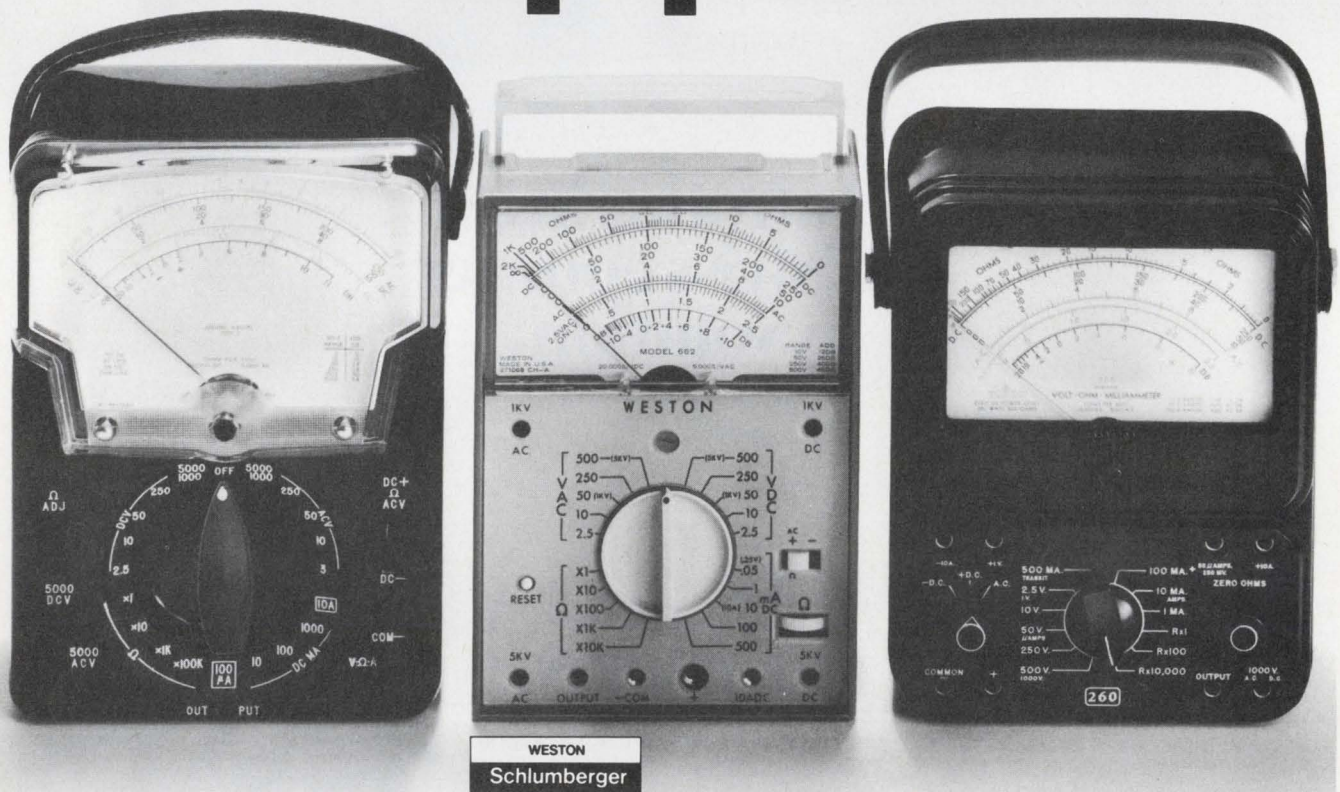

If you want to be a pro, try morality and guts

We're all aware of the almost universal specmanship game that manufacturers play to make their equipment look good. But there's a related problem that receives little publicity: the data-juggling game played by engineers to qualify—or hide—an out-of-spec device or instrument.

Just how widespread is this practice? It's almost impossible to come up with a reliable figure, but one case, reported in a pull-no-punches article in the April issue of *Harper's* dramatically points to the practice.

The article describes a cover-up of the under-design of a fighter aircraft brake. The designer, testing personnel and top management of the company are implicated. During tests, according to the article, the brake overheated and disintegrated. Despite repeated failures with a variety of friction materials, the brake was delivered to the Air Force—but not until both the tests and the test data were manipulated to make the brake appear to have qualified. What followed is obvious: The first pilot who tried to stop his plane upon landing had a rude awakening. Fortunately no lives were lost.

While this is an extreme case involving threat to life, the practice of letting a bad unit go by seems to be more common than most engineers care to admit. How many can recall cases similar to the brake story in their careers? And isn't yielding to pressure to ignore an out-of-spec unit or a marginally performing one immoral, even if no lives are at stake?

In the long run, if engineers want to earn the much-deserved respect of management, they'll stop worrying about their jobs and start realizing their moral responsibilities—to themselves, to their profession and to the public. Until they do, they can't call themselves true professionals.

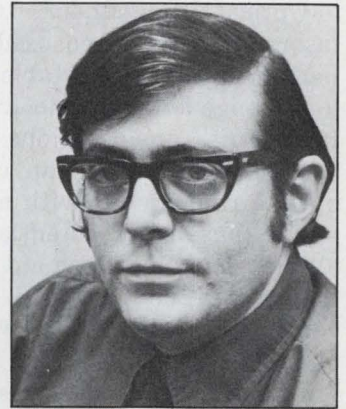

Stanley Runyon

STANLEY RUNYON
Associate Editor

Use LEDs, not lasers, in rangefinders

for a range of just a few yards. LED rangefinders can even provide 'eyes' for the blind.

Optical rangefinders can be built without lasers. LEDs can be used instead—especially in battery-operated portable equipment and when long range and extreme accuracy are not the most important considerations.

With LEDs, you can construct a lightweight optical rangefinder with a range of a few yards, and it has many potential applications—for example, as a mobility aid for the blind. Such a device can be packaged in less than 25 cubic centimeters with a total weight of less than three ounces.

In an optical radar system, a beam of pulsed near-infrared radiation is emitted by a transmitting unit. The reflections from objects intersecting the emitted beam and the field of view of a sensitive receiver are detected. The output from the receiver can be converted to an audible tone. A block diagram of one possible arrangement is given in Fig. 1.

Use of optical-frequency radiation allows effective use of low-power signals, thus simplifying the drive circuitry for the LED or laser. Thus the use of optical frequencies contributes to meeting the important design criteria for portable systems—namely, low power consumption and compact circuitry.

LEDs eliminate portability problems

Injection lasers can generate much more output power than LEDs. In a laser, quasi-coherent radiation is emitted by a narrow junction region into a beam of restricted divergence. This allows collection of nearly all the emitted radiation with a simple $f/1$ lens. But the high current requirements of injection lasers make transmitter design cumbersome and the required narrow driving pulses make receiver design complicated.

Use of a LED eliminates these problems, since it can be driven with simple pulsers that operate at very low current levels. However, the broad beam width and large emission area of LED chips, together with their low power output, work against efficient collection and collimation

Forrest M. Mims, 6901 Zuni SE A-12, Albuquerque, N.M. 87108

of the emitted radiation.

Design of transmitter and receiver units is governed by a set of optical-radar range equations. Factors that influence the range and performance of a rangefinder include target variations—the diffuse or specular nature of the target, reflectance and the size of target with respect to that of the transmitted beam—the collection area of the receiver optics, the transmitter output power and the receiver sensitivity.

Most detected objects are diffuse reflectors—they scatter the incident radiation. The maximum range capability for a diffusely reflecting target large enough to intercept the beam completely is expressed by the equation

$$R_{\max} = \sqrt{\frac{P_o A_{\text{rec}} \rho \tau}{P_{\text{th}} \pi}}, \quad (1)$$

where P_o is the peak power of the transmitted beam,

P_{th} is the threshold power of the receiver,

A_{rec} is the area of the receiver aperture,

ρ is the target reflectance,

τ is the transmissivity of the receiver optics.

The maximum range capability for diffusely reflecting objects that do not intercept the entire beam may be expressed by the equation

$$R_x = \sqrt[4]{\frac{P_o A_o A_{\text{rec}} \rho \tau}{P_{\text{th}} \Omega_o \pi}}, \quad (2)$$

where A_o is the illuminated area of the object intercepting the beam and

Ω_o is the transmitted beam divergence in steradians.

The ratio of power output to power threshold (P_o/P_{th}) appears as a critical factor in both equations. Using Eq. 1, with a detection range R_{\max} of one meter, a reflectance ρ of 0.1 and a receiver lens A_{rec} of 10 mm, we see that the result for P_o/P_{th} is about 5×10^5 . A GaAsSi LED, when driven with current pulses of several amps in amplitude, will emit a peak power P_o of up to 100 mW. A threshold power P_{th} of 200 nW would be required of the receiver.

Such a sensitivity is not unreasonable for a

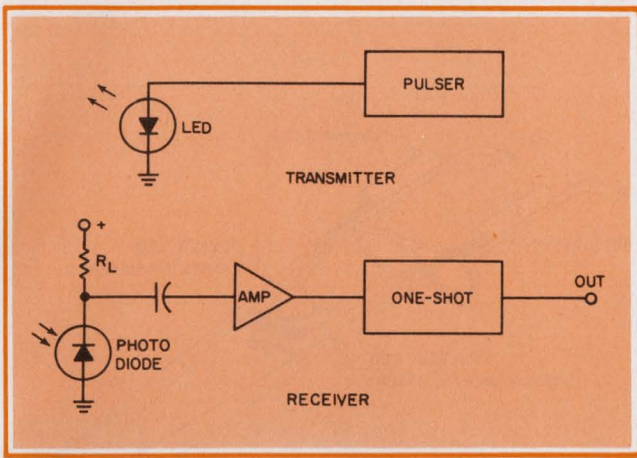

1. Transmitter and receiver units of optical rangefinder that can be used as an aid for the blind. To help reduce noise, an AND gate may be connected between the receiver amplifier and the one-shot, with one input of the gate tied to the pulser output.

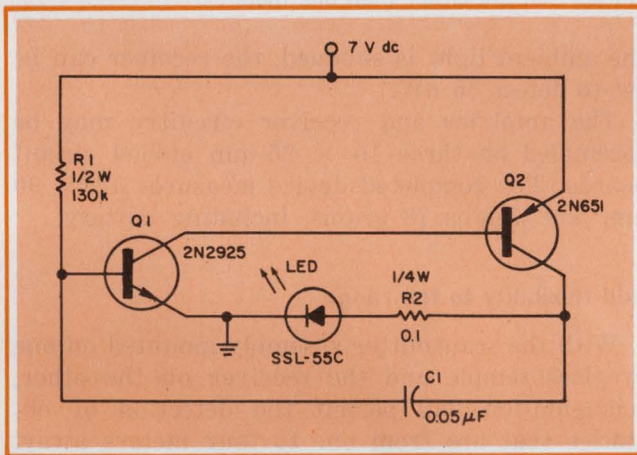

2. Transmitter generates infrared radiation from the LED, which is pulsed by transistors Q1 and Q2.

LED. A GE SSL-55C is a suitable choice. It has high power efficiency because it has a built-in miniature reflector. This LED emits a narrow wavelength band of radiation centered at 950 nm. The flux from the LED is collected by a $f/1.17$ lens, 12 mm in diameter, and collimated into a beam whose divergence is adjustable to a minimum of 70 mrad.

Design of the circuitry

A two-transistor pulse generator (Fig. 2) modulates the LED. The pulser delivers a 20 μ s current pulse with an amplitude of 2.7 A and draws 4 mA from a 6.8-V mercury battery when the pulse repetition rate is 100 Hz. The LED emits 90 mW of infrared when driven by the pulser, but only about 45% of the flux is collected by the lens. All of the flux can be collected by an appropriate lens. Miniaturization requires use of a small diameter $f/1$ lens which will only collect 45% of the flux.

In the pulser circuit of Fig. 2, transistors Q1 and Q2 modulate the LED at a frequency determined by R1. The pulse width may be narrowed by reducing the value of capacitor C1.

The 0.1- Ω resistor R2, used to monitor the circuit, may be omitted if the current does not exceed the maximum allowable for the LED.

The design of the complete receiver involves choice of a detector, design of a high-gain amplifier and selection of an audio output transducer. Phototransistors feature sensitive response to near-infrared radiation and low cost, but usually their response is sufficiently nonlinear to cause saturation in the presence of sunlight. While an optical filter may alleviate the phototransistor sunlight problem, a better solution is

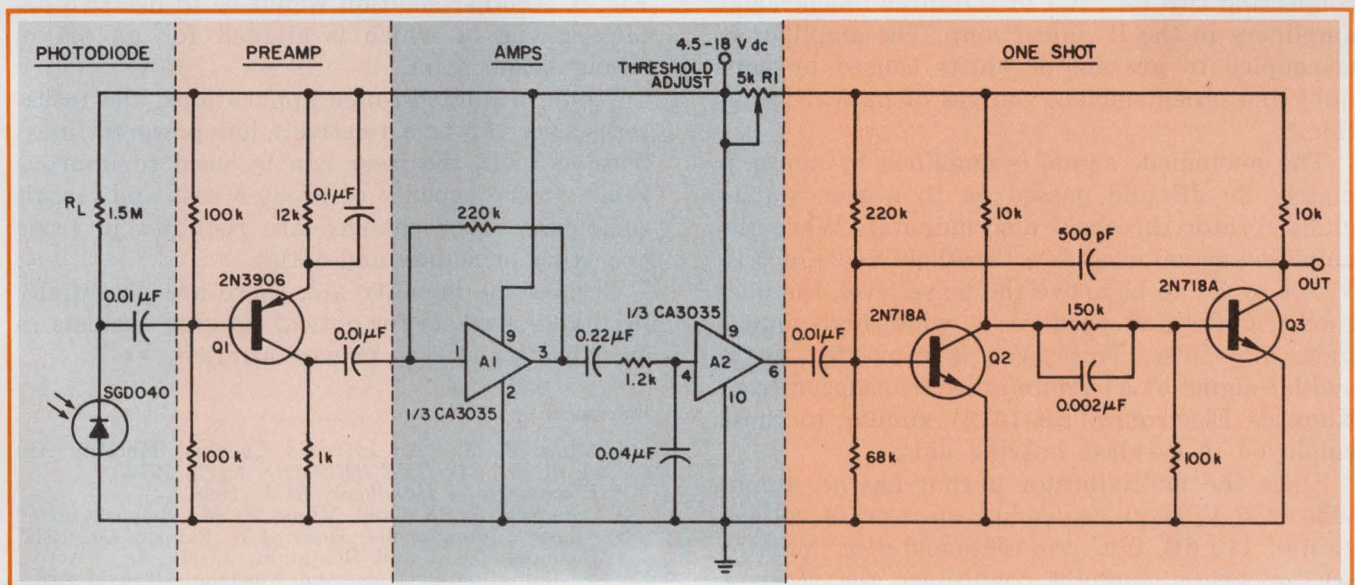

3. Receiver circuit features a maximum sensitivity of 3.5×10^{-8} W for 950 nm radiation.

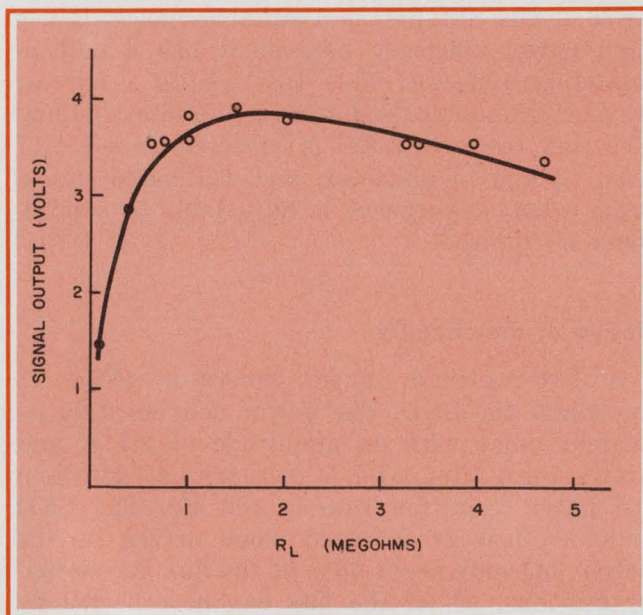

4. **Experimental plot** for a 20 μ s pulse width shows that maximum signal output occurs at a photodiode load resistance of 1.5 M Ω .

to use a PIN photodiode. One such device—the EG&G SGD-040—exhibits a response to optical radiation that is linear over seven orders of magnitude. An f/1.17 lens, 12 mm in diameter, increases the collection area of the photodiode by a factor of 140.

A reverse-biased silicon photodiode serves as a detector of infrared radiation. The R_L resistor in series with the photodiode acts as a load. The optimum value of the load resistor can be experimentally determined by substituting various resistors into the circuit and monitoring the output of the receiver, while illuminating the photodiode with the pulsed LED. As can be seen in Fig. 4, the optimum value of R_L is 1.5 M Ω .

Preamplification is provided by transistor Q1, and high-gain amplification results from series-connecting two (A_1 , A_2) of the three independent amplifiers in the IC linear amp. The amplifier is ac-coupled to prevent dc shifts caused by sunlight and other ambient sources of optical radiation.

The photodiode signal is amplified by approximately 80 dB and passed on to a monostable-multivibrator threshold discriminator. When the amplified signal exceeds a threshold value of 0.15 V, set by R1 to be above the noise level, the one-shot triggers and produces a wide, high amplitude, 5-V pulse. This pulse is converted to an audible signal by a subminiature transducer (e.g., Knowles Electronics BK-1612) similar to those employed in eyeglass hearing aids.

Since the multivibrator output has an amplitude of 5 V, the receiver has an over-all voltage gain of 110 dB. With the threshold discriminator set for bright sunlight conditions, the receiver will detect a minimum signal of 62 nW. When

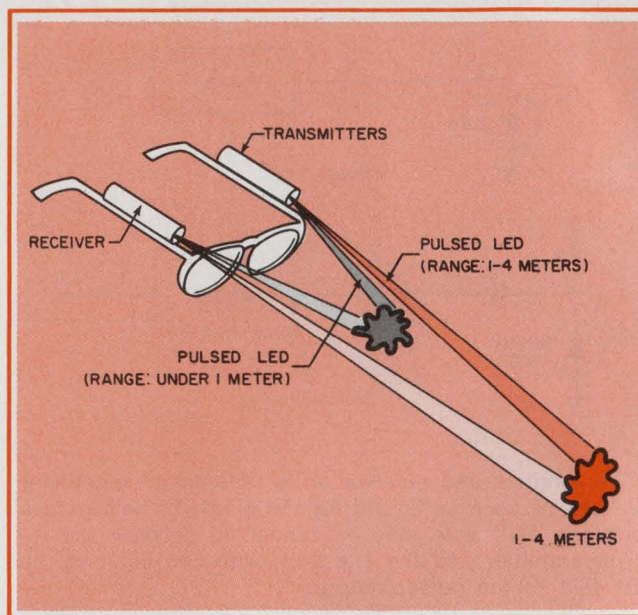

5. **Optical ranging** in a mobility aid is achieved by triangulation. A second LED source allows detection of obstacles that are closer than one meter.

the ambient light is subdued, the receiver can be set to detect 35 nW.

The amplifier and receiver circuitry may be assembled on three 10 \times 25-mm etched circuit boards. The completed device measures 13 \times 90 mm and weighs 78 grams, including battery.

Add flexibility to the range

With the transmitter assembly mounted on one eyeglass temple and the receiver on the other, triangulation will permit the detection of obstacles that are from one to four meters away. But what about obstacles at 0.5 meter?

A possible solution—whereby a second LED, operating at a different repetition rate from the first, detects very close obstacles—is shown in Fig. 5. Another solution would be to use two detectors, one of which is aligned for an 0.5 m triangulation point.

While in limited-range applications, the infrared source can be a relatively low-powered, inexpensive LED, the laser can be used to improve range at the expense of greater cost and circuit complexity. Few changes are required in basic operating principles and optics.

Besides the mobility aid, there are potentially profitable markets for optical ranging systems in cars, boats and even private aircraft. ■■

References

1. Mims, F. M., "An Infrared Eyeglass Mobility Aid for the Blind," *SWIEEE RECORD*, April, 1972.
2. *Electro-Optics Handbook*, RCA, 1968.
3. Campbell, R. W., and Mims, F. M., *Semiconductor Diode Lasers*, Indianapolis: Howard W. Sams & Co., 1972.
4. Benham, T. A. and Benjamin, J. M., Jr., "Active Energy Radiating Systems: An Electronic Travel Aid," *Proceedings of the International Congress on Technology and Blindness*, Vol. I, 1963, p. 167.

Φ-LINE PLASTIC PUTs

24¢

more of the best for less for more types of timing circuits

The Programmable Unijunction Transistor (PUT) has superseded conventional Unijunctions. It has become the preferred device for low-cost timing circuits, oscillators, sensing circuits, and many other variable voltage level threshold applications. Now with the addition of 4 new plastic PUTs, Unitrode has the broadest line available—15 standard types including hermetically sealed. And we will select to meet your specific needs. Unitrode also offers the highest voltage PUTs and the first with better than 1% oscillator timing accuracy guaranteed from -55°C to $+125^{\circ}\text{C}$. Φ-Line plastic PUTs are available off-the-shelf for as low as 24¢ ea. in quantity, and they come complete with the services of a strong applications engineering staff. For fast action and the name of your nearest Unitrode distributor, call Sales Engineering collect at (617) 926-0404. Unitrode Corporation, Dept. 5X
580 Pleasant Street, Watertown, Mass. 02172

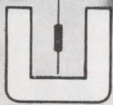

UNITRODE quality takes the worry out of paying less.

Unitrode Corporation

Dept. 5X, 580 Pleasant St., Watertown, Mass. 02172

Please send free samples of Φ-Line plastic PUTs

P13T1 for general purpose, P13T2 for long interval timing
 2N6027 2N6028

Please send PUT information folder, complete with data sheets and application notes.

NAME _____ TITLE _____

COMPANY _____

ADDRESS _____

CITY _____ STATE _____ ZIP _____



PDP-8. PDP-11. For OEM's

A few months ago, we came out with new low cost versions of our PDP-8 and PDP-11 families for the OEM.

With prices as low as \$2436. In quantities of 50.

We made sure they'd have the features, architecture and compatibility that make PDP-11 and PDP-8 the most popular, most imitated minis ever.

We must have hit on the right combination. We've been mixing it up with some of the toughest OEM's around. And coming away with their business.



who hate to spend money.

We're after your business, too.
Because now we have the right
computers. At the right prices.
From the right company.
Come and get 'em.

Digital Equipment Corporation,
146 Main Street, Maynard, Mass.
01754. (617) 897-5111.

digital

European Headquarters: Geneva.

ATTENTION: Members of the Digital Equipment Users Society:
SPRING SYMPOSIUM MAY 11-13, Parker House — Boston, Mass.

Speed computer-aided circuit design

by using random-number inputs to get optimized values. The loss in accuracy is acceptable in most cases.

ECAP, SCEPTRE NET-1, RFAMP . . .

Ever used any of these computer programs to design a circuit? Or other programs like them? If you have, you'll probably agree that unless the input variables are in the right format, you'll end up spending considerable time modeling the problem to derive usable input data.

You can cut programming time and effort drastically by using random numbers as the input data. Then, with a straightforward numerical analysis, circuit values can be optimized by minimizing a function that expresses the desired performance criteria. For example, criteria like these:

- Minimum amplifier output impedance.
- Minimum circuit turn-on time.
- Maximum frequency response.

Some of the different methods for minimizing a function include Fletcher-Powell, steepest descent and conjugate gradient. All these, and other techniques, make use of the function derivative to find the minimum.

Let's consider minimization, rather than maximization, since a function can be maximized by minimizing its negative. Here is why:

Referring to Fig. 1a, let

$$f(x) = \sin x, \quad (1)$$

where $0 \leq x < \pi$.

The minima of $f(x)$ within the limits spelled out in Eq. 1 are at $x = 0$ and $x = \pi$. To determine the maximum by means of minimization, let

$$g(x) = -f(x) = -\sin x, \quad (2)$$

limited to the same range as in Eq. 1.

The minimum of $g(x)$ occurs at $x = \pi/2$. In this simple case, we can see by inspection that this minimum value of $g(x)$ is the maximum point of $f(x)$.

Minimizing with random numbers

Random numbers used in a computer program come from a random-number generator. For simplicity, we will use only positive numbers, thus

Ralph D. Taylor, Senior Engineer, Bendix, Kansas City Div., P.O. Box 1159, Kansas City, Mo. 64141.

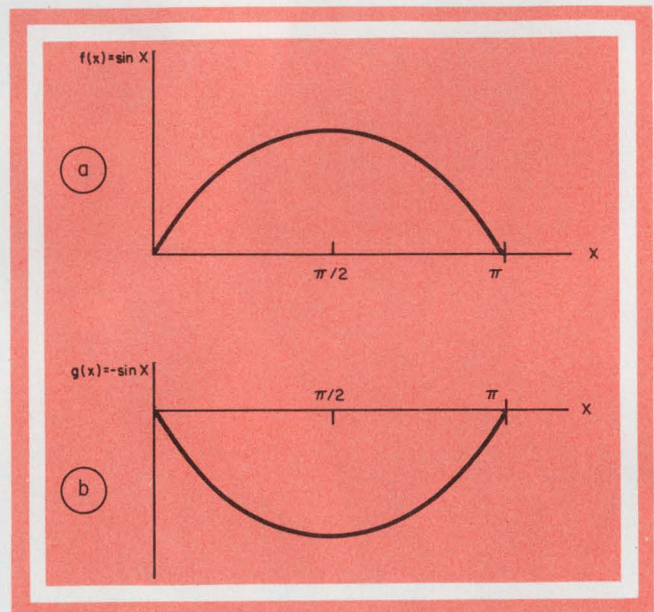

1. Minimizing is the same as maximizing a negative of a function. Here the maximum for the curve in "a" is found by determining the minimum of the curve in "b."

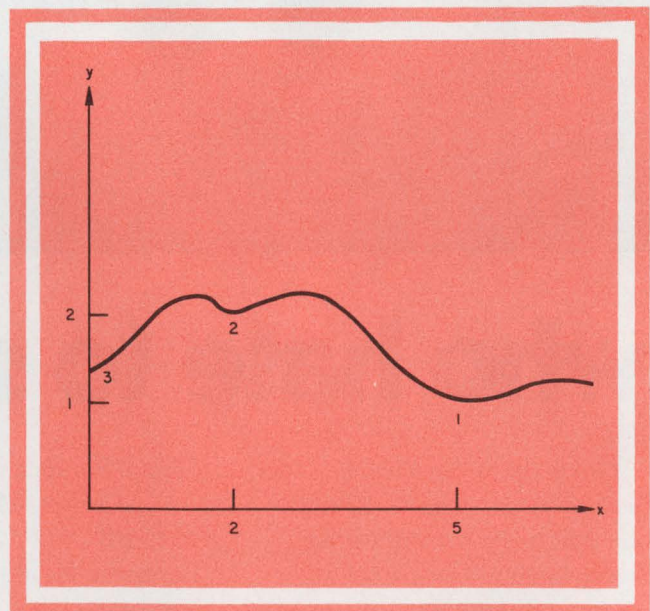

2. The right minimum value of a function will be determined if proper definition of the minimum is used. Otherwise any of the possible minimum values may be selected by the minimization program.

```

B3=10.**6
IX=75773
DO 8 J=1,500
WRITE(3,4)A1,A2,B
4  FORMAT( 20X,3E18.8)
CALL RANDU(IX,IY,A)
IX=IY
A1=10.*A
CALL RANDU(IX,IY,A)
IX=IY
A2=10.*A
X=0.
B=0.
DO 7 I=1,10
X=X+0.1
C
7  B=((EXP(-A1*X))-EXP(-A2*X))-
2  ((EXP(-X))-EXP(-10.*X))**2 +B
IF(B.GT.B3) GO TO 8
B3=B
B1=A1
B2=A2
8  CONTINUE
WRITE(3,33)B1,B2,B3
33  FORMAT(3E18.8)
STOP
END
    
```

3. **Extremely simple programming** is the big advantage of the random-number optimization technique over several other existing methods. This program was used to optimize the values for the active-filter circuit depicted in Fig. 4.

performing a "constrained" minimization. This is not a limitation, since the variables in electrical problems are normally passive elements; resistors, for example, are real positive-valued elements.

The random-number approach is a brute-force one with a digital computer. It consists of choosing a set of values for the variables and checking to see whether or not the values satisfy all constraints. If all constraints are satisfied, the function is evaluated. If not, another set of values is chosen and again checked against the constraints. This process is repeated until the function has been evaluated several times and only the minimal value is retained.

Referring to Fig. 2, we see a simple function with several minima. It also demonstrates that the nominal minimum value of a function often

The Fletcher-Powell method

The Fletcher-Powell method makes use of a gradient that, for a three-dimensional function, is

$$f(x,y,z) = [\delta f(x,y,z)/\delta x]a_x + [\delta f(x,y,z)/\delta y]a_y + [\delta f(x,y,z)/\delta z]a_z,$$

where a_x , a_y , a_z are unit vectors indicating directions. To optimize a function, an iterative program must be written to calculate the gradient of the function. Then this gradient is used, together with the previous values of the gradient, to obtain a new estimate of the minimum. This procedure is repeated until the estimates of desired accuracy are obtained.

All variables are free to assume values anywhere from minus to plus infinity. It can be shown that with the proper choice of starting variables, the method will always yield an answer.

To prepare a FORTRAN program for determining a minimum with the Fletcher-Powell method, the mathematics becomes complex. In addition the program preparation requires a thorough understanding of both the mathematics and the programming. A typical program may have five subroutines and a total of 200 to 300 statements.

depends on the definition of the minimum. In the figure, for instance, if the minimum is defined as the sign change in the first derivative, then there are three minima: at $x=0$, $x=2$ and $x=5$. Yet there is only one absolute, or global, minimum of $y(x)$: at $x=5$.

If we use a gradient approach, one minimum can be found for a starting point. Then more information is needed before we start the search for other minima. With the random-number approach, no prior information is needed, because there is an equal probability of hitting any particular minimum.

A saving in computer time

With a method similar to the Fletcher-Powell, memory in excess of 30-k bytes on an IBM S/360

Comparison of Fletcher-Powell and random-number technique

Characteristic	Fletcher-Powell	Random Number
Starting values	Requires a starting value of accuracy dependent on type of function. Not always possible to pre-determine accuracy prior to starting search.	None required.
Program complexity	Iterative gradient search. Technique fairly complex.	Call random number, generate and evaluate a function. Technique easy.
Execution time	Several minutes for short problems (five variables or less), longer as number of variables increase.	1 min or less for 3 digit accuracy of 5 variables or less.
Accuracy	Limited by machine accuracy. 16 digits double precision for S/360.	Limited by machine accuracy and how many guesses one wishes. Three or four digits most possible.
Language	Any.	Any. Can be programmed for an interactive terminal to search a region.
Prior knowledge of minimums before programming	Need good estimates for starting values.	Need to know minimum within several order of magnitudes or make repeated passes.
Programming knowledge required	Considerable. Must be able to program an iterative constrained search in variables.	Little. Must be able to evaluate function and keep least value.
Time to obtain an operable program.	Three to four weeks	Two or three days or less.
Repeatability	Same for each attempt.	Varies, depending on number of random numbers chosen.

501 might be required, against 1 k needed with the random-number programming. Furthermore program debugging time for a program such as the Fletcher-Powell might run as high as 40 hours. With this random-number method, no debugging is necessary, because of the simplicity of the program (Fig. 3).

Computational time increases rapidly with an increase in the number of variables in the opti-

mizing function. In the case of random numbers, the time depends on how many guesses must be made. For example, for a five-variable function with six constraints, answers within 5% of Fletcher-Powell results were obtained in only 45 seconds with random numbers. The Fletcher-Powell method, by contrast, required two minutes on an IBM S/360 501.

While Fletcher-Powell's results will be accurate to eight decimal places, accuracy to four decimal places should be expected when random numbers are used. Beyond four digits additional accuracy is obtained at the cost of more computer time.

Designing an active filter

The random-number technique evolved after considerable time was spent trying to design an active bandpass filter with the Fletcher-Powell method. The problem was to choose suitable component values for an active filter (Fig. 4), to minimize the filter's sensitivity to environmental and manufacturing changes. The performance

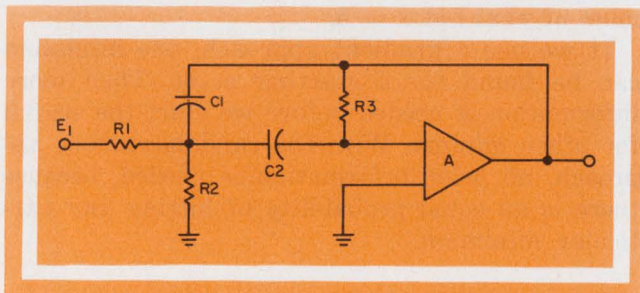

4. Optimum values for this active filter were obtained with a random-number optimization program, and the total programming took only one day while the running time was one minute.

criterion for minimization was the sum of the sensitivities.

By definition, the sensitivity of the Kth element is given by

$$S_k = [e_k / (E_2/E_1)] | \delta(E_2/E_1) / \delta e_k |, \quad (3)$$

where

$$e_k = \text{the value of the Kth element} \\ (E_2/E_1) = \text{the transfer function.}$$

For the circuit of Fig. 4, the sum of the sensitivities becomes

$$S = S_{R1} + S_{R2} + S_{R3} + S_{C1} + S_{C2}. \quad (4)$$

The minimization was carried out subject to the following constraints:

$$e_k \geq 0, \\ 2 \leq (E_2/E_1) \leq 5. \quad (5)$$

Solving this problem with the Fletcher-Powell method took about 20 working days of programming and debugging, then about five minutes on computer.

After that the random-number approach was tried. It took only one day to program and debug the program and only one minute of computer time. The program shown in Fig. 3 was used. This resulted in answers with five-digit accuracy.

The following component values were determined:

$$C1 = 0.022 \mu F \quad R2 = 580 \text{ ohms} \\ C2 = 0.01 \mu F \quad R3 = 1.2 \text{ M}\Omega \\ R1 = 2.2 \text{ k}\Omega$$

Was this the best answer? Perhaps not. The best of all answers was not found. The method merely tested a group of variables and determined and retained the best answer from that group. But the engineering objective was reached quickly and inexpensively. ■■

Bibliography

Box, M. J., "A Comparison of Several Current Optimization Methods and the Use of Transformations in Constrained Problems," *Computer Journal*, Vol. 9, May, 1966.

Calahan, D. A., "Computer Design of Linear Frequency Selective Network," *Proceedings of the IEEE*, November, 1965.

Calahan, D. A., "Sensitivity Minimization in Active RC Synthesis," *IRE Transactions on Circuit Theory*, March, 1962.

Fletcher, R. and Reeves, C. M., "Function Minimization by Conjugate Gradients," *British Computer Journal*, July, 1964.

Leon, A., "A Comparison Among Eight Known Optimizing Procedures," NASA Group NSG-243-62 (University of California, Berkeley).

Powell, M. J. D. and Fletcher, R., "A Rapidly Convergent Descent Method for Minimization," *Computer Journal*, Vol. 6, 1963.

Scheibe, P. O. and Humber, E. A., "The Application of Carroll's Optimization Technique to Network Synthesis," Army contract DA-36-039-AMC 03404 (E).

Schoeffler, J. P., "The Synthesis of Minimum Sensitivity Network," *IRE Transactions on Circuit Theory*, June, 1964.

Temes, G. C. and Calahan, D. A., "Computer-Aided Network Optimization: The State-of-the-Art," *Proceedings of the IEEE*, November, 1962.

Warren, A. D. and Lasdon, L. S., "Practical Filter Design Using Mathematical Optimization," Second Allerton Conference, 1963.

Wilde, D. J., *Optimum Seeking Methods*; Prentice-Hall, 1964.

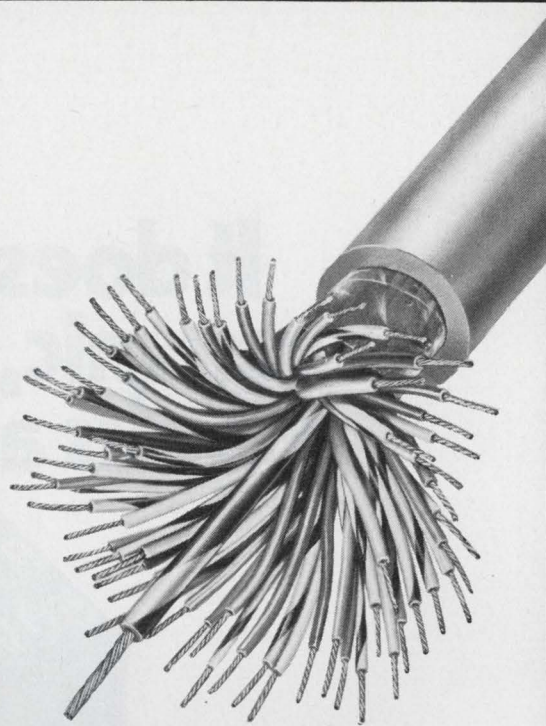

What do you need in Multi-Conductor Cable?

Victor

will make it.

Get exactly what you need in multi-conductor cable. We'll design and produce multi-conductor cable to meet just about any individual requirement.

We have the plant, the equipment, the personnel and the know-how to solve your particular problem.

Victor
Electric Wire & Cable Corp.
WEST WARWICK, RHODE ISLAND

It doesn't look like ceramic, glass or mica. Looks are deceiving.

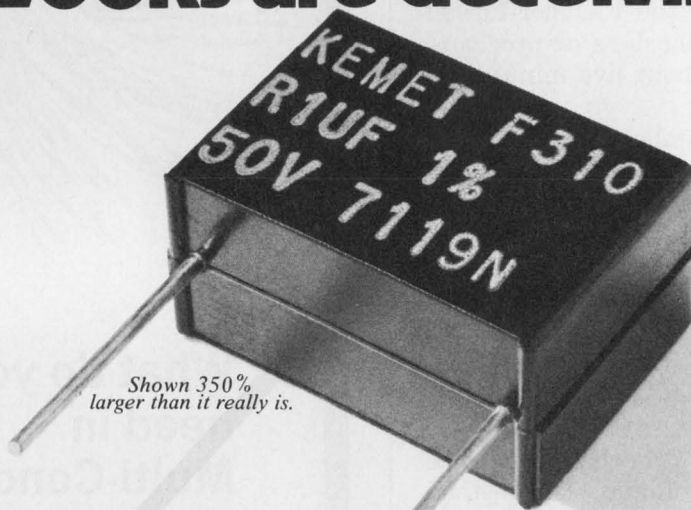

Shown 350% larger than it really is.

The KEMET® Flat-Kap capacitor is made with Parylene film. Which acts in many respects like more expensive materials, to give you more for your money.

Hence, the KEMET Flat-Kap capacitor offers the same insulation resistance as glass. The same dissipation factor as ceramic, mica, glass, and polystyrene, superior to that of polycarbonate and polyester. And dielectric absorption comparable with polystyrene, significantly better than ceramic, mica, glass, or other film dielectrics.

The KEMET Flat-Kap offers a temperature coefficient equal to or better than ceramic, glass, mica, or other film dielectrics. It's smaller than anything else you can buy. It comes with your choice of radial

or axial leads. It's available to $\pm 0.5\%$ capacitance tolerance at prices below any other dielectric.

Now you want proof of all that? Check our comparison chart below. And learn. How to get something you rarely see nowadays.

Your money's worth.

PARYLENE VS. VARIOUS DIELECTRIC MATERIALS							
Characteristic	KEMET® Parylene	Poly-styrene	Polycarbonate	Poly-ester	Mica	NPO Ceramic	Glass
* SIZE (P.C. Board Volume)	.0175 in ³	.143 in ³	.044 in ³	.044 in ³	.141 in ³	.0625 in ³	.082 in ³
STABILITY (Temperature Coefficient in PPM/°C)	Characteristic A - 200 ± 30 B 0 ± 100 C 0 ± 50	-120 ± 30	Varies to ± 350	+1150	Characteristic C ± 200 D ± 100 F - 0 to +70	0 ± 30	+180
ELECTRICAL							
Dissipation Factor - % at +25°C	0.10	0.10	0.30	0.40	0.10	0.10	0.10
Insulation Resistance Megohm at +25°C	1 x 10 ⁷	1 x 10 ⁶	1 x 10 ⁵	1 x 10 ⁵	5 x 10 ⁴	1 x 10 ⁵	1 x 10 ⁷
Dielectric Absorption	0.03	0.02	0.25	0.25	4.80	0.29	5.10

* Per applicable military specification. Parylene Flat-Kap capacitors are described in Mil-C-55514 for a .01 uF capacitor.

Available through your KEMET distributor.



COMPONENTS DEPARTMENT

Box 5928, Greenville, S.C. 29606 • Telephone (803) 963-7421

The most complete line of sweepers between here and 1.4 GHz.

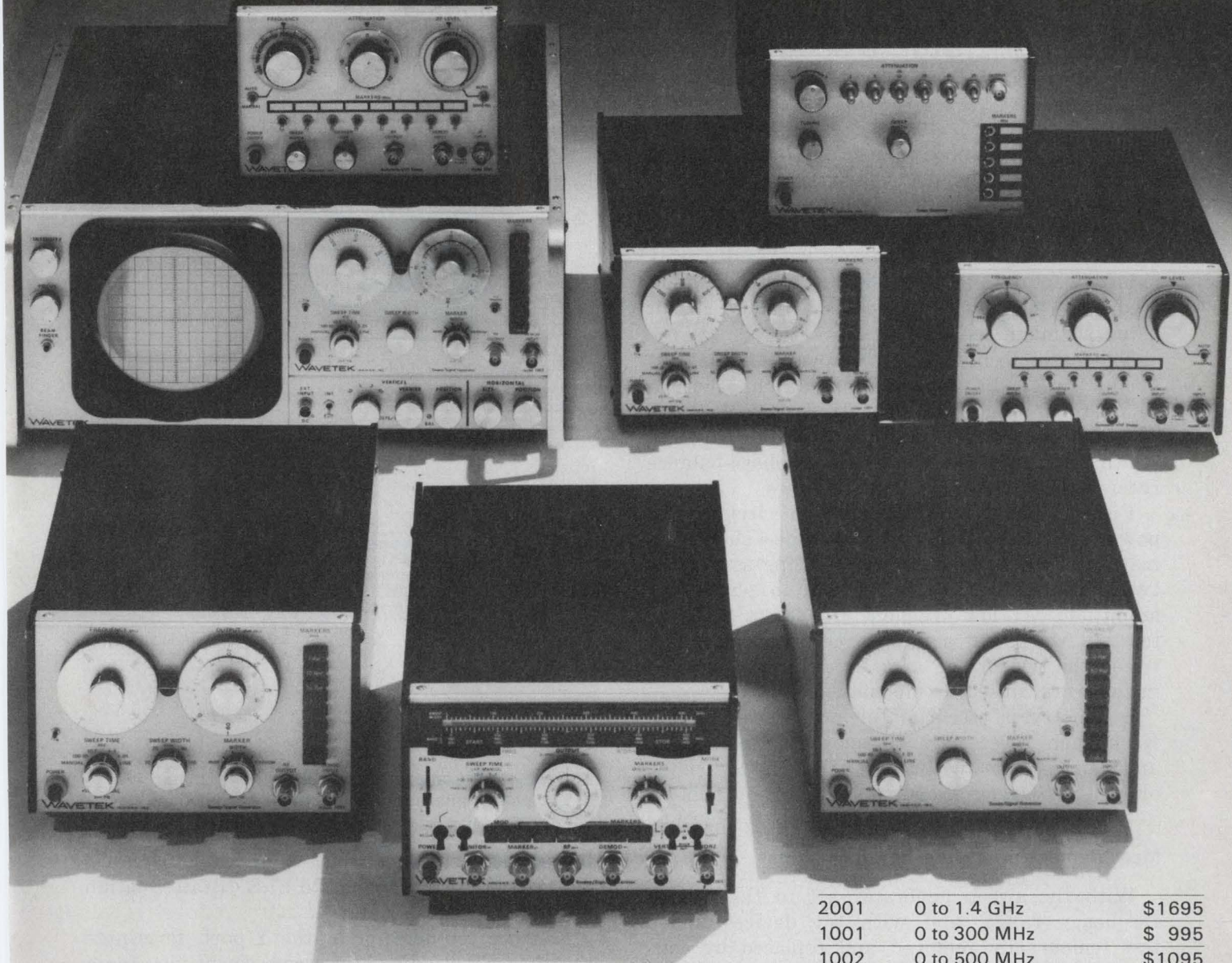

2001	0 to 1.4 GHz	\$1695
1001	0 to 300 MHz	\$ 995
1002	0 to 500 MHz	\$1095
1003	350 MHz to 650 MHz	\$ 995
1004	500 MHz to 1 GHz	\$ 995
1005	700 MHz to 1.4 GHz	\$ 995

No matter what your frequency range or your price range, there's a Wavetek Sweep/Signal Generator to fit it. All have laboratory and production capabilities in a rugged solid-state design. They include such features as pin diode internal or external leveling, front panel crystal-controlled markers with amplitude, width and tilt controls, and up to 90db attenuation. And the frequency, amplitude and sweep width may be remotely programmed. So take your pick.

WAVETEK®

INDIANA INCORPORATED
P. O. Box 190, 66 North 1st Ave.
Beech Grove, Ind. 46107

Measure phase balance easily

with this swept-frequency technique that uses a sweep generator, a scope and a four-port hybrid.

Ever face the need to check phase tracking over a large bandwidth? It's possible, of course, to take point-by-point data with sophisticated test equipment, such as a vector voltmeter or a network analyzer. But there's an easier way using swept frequencies. The key to the swept-frequency technique outlined is a bridge circuit using a "magic-tee" hybrid.

The basic technique works over a wide frequency range. It has been used at vhf (with a commercial broadband hybrid) to tune lumped-constant phase-tracking filters, and at Ku-band (with waveguide magic tees) to phase-balance receiver-protector (TR-limiter) tubes.

Fig. 1 shows the basic bridge circuit. The power-split hybrid can be any type—such as a magic tee fed at its sum port—so long as it gives two outputs that are equal both in phase and amplitude. At low frequencies even a resistive tee will work, but some degree of isolation between the two bridge arms is desirable to minimize errors caused by mismatches.

Symmetry is essential for proper calibration. Keep such accessories as adapters, transitions and flanges the same in both arms of the bridge, or you won't get a broadband calibration null.

Measurement procedure has four steps

With the sweep generator set to the proper frequency range, and with the devices under test temporarily removed and replaced by connecting links, follow these steps:

1. Check the bridge symmetry by detecting a null at the Δ port, with the Σ port terminated in a load. For this step, set the calibrated attenuator to minimum attenuation and the scope to maximum gain. The amplitude of the scope trace at null should be negligible when compared to the calibration level that will be used in Step 3.

2. Refer to the CALIBRATE curve of Fig. 2. Find the attenuation value that corresponds to the phase-unbalance specification and set the cali-

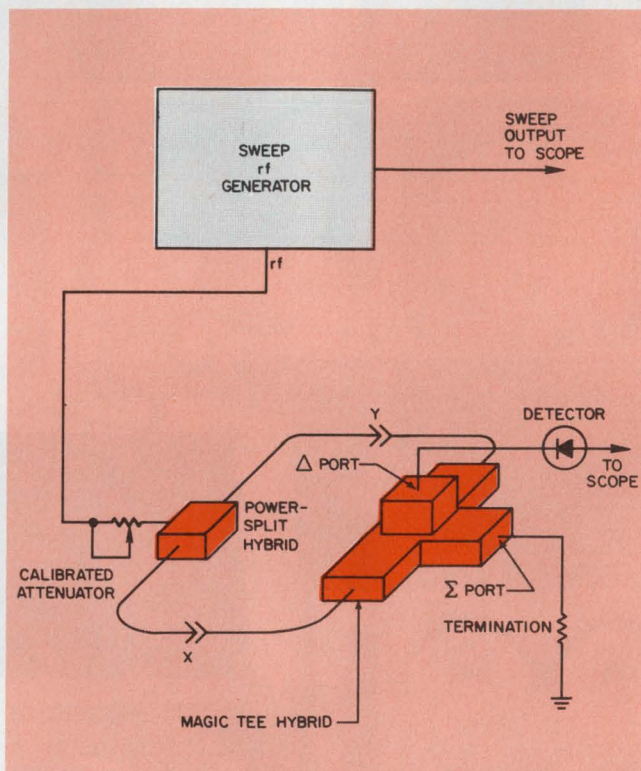

1. Test configuration uses a bridge and magic tee to detect phase unbalance in the two devices under test.

brated attenuator to this value. For example, $\pm 5^\circ$ tracking corresponds to 27.2 dB attenuation on the CALIBRATE curve.

3. Place the detector at the Σ port, terminate the Δ port and adjust the scope sensitivity for a convenient trace. If no base line exists, square-wave modulate the rf and mark the base and calibration lines. If the amplitude of this calibrate trace is not much greater than the null trace of Step 1, then the bridge arms must be more carefully balanced.

4. Change the detector and termination back to the ports indicated in Fig. 1 (i.e. reverse them). Remove the same amount of attenuation set in Step 2 from the attenuator. Insert the phase-tracking devices at X and Y in Fig. 1 and watch your scope trace. Any detected level of less than the calibration indicates a phase match, or unbalance, better than your specification.

John C. Deriso, 11659 North Shore Drive, Reston, Va. 22070.

Note that phase unbalances that yield trace levels of greater than the calibration level can be measured by attenuating the rf until the observed and CALIBRATE traces align. For example, 6 dB of attenuation must be added to bring an observed trace down to the level set for the $\pm 5^\circ$ unbalance. Referring to Fig. 2, and using $27.2 - 6 = 21.2$ dB, we see that the phase unbalance is $\pm 10^\circ$.

Amplitude unbalance causes errors

A word about measurement uncertainty: the technique described here depends on small differences in the bridge arm attenuations—particularly for small phase unbalances. The auxiliary curves of Fig. 2 point out the degree of uncertainty of phase measurement for devices that have up to 0.5 dB of amplitude unbalance. For

Derivation of calibration curves

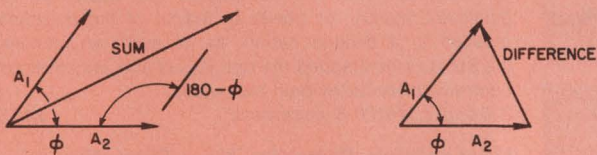

Let a_1 and a_2 be the magnitudes of voltages A_1 and A_2 , respectively.

$K = a_2/a_1 =$ voltage ratio

$$\begin{aligned} (\text{Sum})^2 &= a_1^2 + a_2^2 + 2a_1 a_2 \cos(180-\phi) \\ &= a_1^2 + K^2 a_1^2 + 2Ka_1^2 \cos(180-\phi) \end{aligned}$$

$$\begin{aligned} (\text{Difference})^2 &= a_1^2 + a_2^2 + 2a_1 a_2 \cos(\phi) \\ &= a_1^2 + K^2 a_1^2 + 2Ka_1^2 \cos(\phi) \end{aligned}$$

Isolation = 10 Log

$$\begin{aligned} &\left[\frac{a_1^2 + K^2 a_1^2 + 2Ka_1^2 \cos(180-\phi)}{a_1^2 + K^2 a_1^2 + 2Ka_1^2 \cos(\phi)} \right] \\ &= 10 \text{ Log} \left[\frac{(\text{Sum})^2}{(\text{Difference})^2} \right] \\ &= 10 \text{ Log} \left[\frac{1 + K [K + 2 \cos(180-\phi)]}{1 + K [K + 2 \cos(\phi)]} \right] \end{aligned}$$

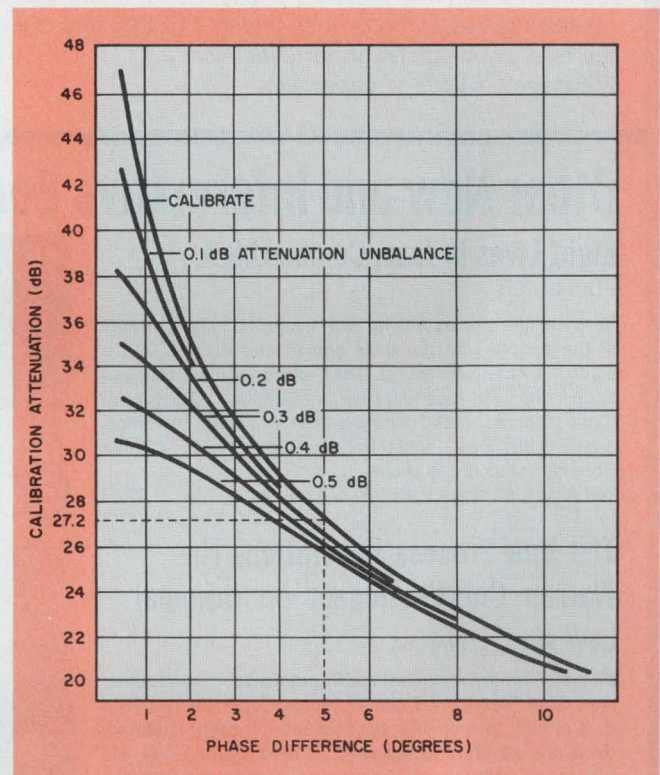

2. Curves are used to calibrate the test set-up and to determine errors caused by unbalanced bridge arms.

instance, an amplitude differential of 0.5 dB could make a “true” phase balance of $\pm 4^\circ$ yield a scope trace equivalent to $\pm 5.2^\circ$. In any event, the CALIBRATE curve will give the worst-case condition, so that if two devices do have an amplitude unbalance, the true phase difference will be less than that observed.

Note also that since only one detector is used, this is not a true differential measurement. If active devices—those having gain—are to be measured, the total circuit gain must be kept identical to that used in the calibration step.

For example, to check the phase balance of two amplifiers, each with 15-dB gain and each having a phase balance specification of $\pm 5^\circ$, the calibration is made at 27.2 dB, as in Step 2, but the variable attenuator must be set at $27.2 - 15 = 12.2$ dB during the actual measurement. ■■

Do you want to have the whole picture on Japan's great leap forward?

The Japanese Miracle and Peril Willard Price

Leading the world's nations in electronics, shipbuilding, cameras, watches, literacy rate . . . gaining rapidly in other areas, Japan has risen meteorically from the ashes of World War II. Such is the Japanese miracle. Within it looms the peril, expansionism, a Japanese passion that has recurred throughout her history. Willard Price, who has been interpreting Japan to the West for more than half a century, provides a fascinating, informative account of these inter-related themes as he probes Japan's history and the Japanese character for the root explanations of her dynamism.

256 pages, #6103-x, paperback

\$3.85

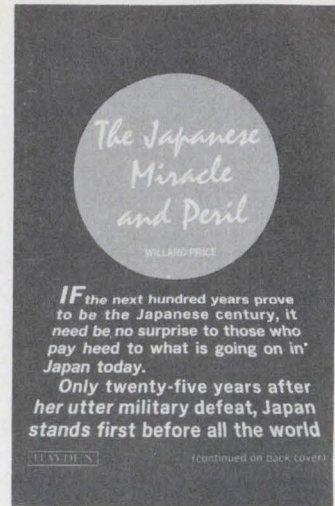

Other New and Informative Books from Hayden

Eight Lives in Jazz: Combo U.S.A.

RUDI BLESCH

Here are the stories behind the music, intimate portraits of the people who put their genius and dreams into a distinctly American sound. They all come alive in these pages: the late, legendary Louis "Satchmo" Armstrong; Sidney Bechet, Jack Teagarden; Lester Young; the bitter-sweet "Lady Day", Billie Holiday; Gene Krupa; Charlie Christian; and Eubie Blake.

240 pages, illustrated, #6104-8, paperback

\$3.65



America the Vanishing: Rural Life and the Price of Progress

Edited by SAMUEL OGDEN

From paradise to pollution-riddled land, the sorry fate of the American countryside is recounted by some of our best-known writers. Audubon, Muir, Twain and others evoke the small-town and rural life that has virtually disappeared. In stark contrast, E. B. White, Rachel Carson, and other contemporaries portray the impact of progress on our environment and way of life.

256 pages, illustrated, #6105-6, paperback

\$3.95

The Due Process Revolution: The Warren Court's Impact on Criminal Law

FRED P. GRAHAM

Demolishing the myth that the Supreme Court handcuffed the police, New York Times Supreme Court reporter Fred P. Graham reveals the background of such landmark decisions as Mapp, Escobedo, Miranda, and Wade. He places in perspective the Warren Court's courageous affirmation of the Constitution's promise of equality to all Americans.

377 pages, #6101-3, paperback

\$3.75

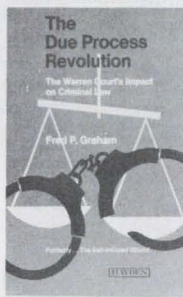

The Politics of Fear:

Joseph R. McCarthy and the Senate

ROBERT GRIFFITH

This compelling, award-winning study of a shameful episode in recent American history views McCarthyism as a political phenomenon created and sustained by politicians hungry for power or fearful of the passions aroused in a divided nation. In its eventual censure, the Senate side-stepped the real issues and assumptions upon which McCarthy built his career.

376 pages, #6100-5, paperback

\$3.75

The Electronic Invasion

ROBERT M. BROWN

Anyone concerned with Big Brother's methods will find this best-selling exposé fascinating and instructive. It details all types of snooping gadgetry, names major manufacturers and buyers. The extent of governmental and corporate bugging is surveyed, and legal strictures are fully covered.

188 pages, illustrated, #0779-5, paperback

\$4.95

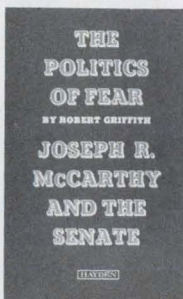

Humanizing Schools: New Directions, New Decisions

DOUGLAS H. HEATH

A disturbing analysis of today's youngsters and of where their schools are failing them. Reporting as one intimately involved as both educator and psychologist, Douglas H. Heath presents a realistic framework for deciding what must be done, and a compelling argument, why?

240 pages, #6003-3, cloth

\$6.95

At your bookstore or by mail with this convenient coupon.

 HAYDEN BOOK COMPANY, INC., 116 W. 14th St., New York, N.Y. 10011

Please send the book(s) whose code numbers I have circled below. Enclosed is my check for the total amount, plus 25¢ to cover postage and handling on my order.

6103-X 6101-3 6105-6 6003-3 6104-8 0779-5 6100-5

If not satisfied, I may return the book(s) for full refund.

Amount enclosed: \$ _____

Send free 96-page catalog of all Hayden Books.

Name _____

Address _____

City _____

State _____ Zip _____

72-35 ED

**50 watt
signal generator**

**10 to 2,500 MHz
with six heads**

**solid state for
high reliability**

**frequency stability
 $\pm 0.003\%/10$ minutes**

**power stability
 ± 0.2 db/hour**

Pick a frequency between 10 and 2,500 MHz and the Model 15022 will deliver the reliable power you need for amplifier drive, component testing, calibration, and antenna pattern measurements.

Reliability is built in with conservative design and all solid state components (except osc. tube). So you get frequency and power stability at low cost. Easy servicing. And full protection against mismatch or loss of load.

Front panel meter reads forward power in 10 and 50 watt scales. Single control tuning to 1% of actual frequency can be read directly for rapid setup.

Model 15022 has an internal and external modulation capability. An isolated RF output 20 db down is available for error-free monitoring. Meets MIL specs for RFI shielding.

For complete specifications on today's newest RF power source, call (312) 354-4350 or write: MCL, Inc., 10 North Beach Avenue, La Grange, Illinois 60525.



**MCL
INC**

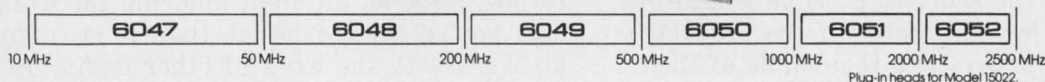

*Opportunities developing now for RF engineers at MCL, Inc. —
an equal opportunity employer.*

INFORMATION RETRIEVAL NUMBER 35

Adjust to the management role gracefully.

You can, says this new manager, if you make prompt decisions, keep a log and realize that promotion won't stifle your creativity.

Rick Spofford, Manager of Converter Products Engineering, Analog Devices, Inc., Norwood, Mass. 02062

Making the adjustment from bench engineering to management has got to be the biggest challenge of my career. I think that move is an important milestone in every engineer's career, because once he goes into management, he more often than not has reached a point of no return. If he doesn't make good as a manager, his career could go downhill from then on, and the door to the managerial office could be slammed shut forever. And that's only half of it. Once an engineer has decided to become a manager, he'll probably find, too, that it's very difficult to return to bench engineering.

The toughest problem for me in making the adjustment to management was learning how to organize and oversee about 20 projects at the same time. Where, as a project engineer, I was responsible for three or four simultaneous projects, I'm now responsible for five engineers, who are responsible for three or four simultaneous projects each. My organizational viewpoint has gone up by a factor of five.

One adjustment a new manager finds he must make is to take immediate action on whatever comes up, instead of deferring it for a couple of days as he could have done when he was an engineer.

Some of the project products have originated from common components, which makes them fairly easy to oversee. But, generally, I have to keep track of five different product categories. So the first problem I had when I became a manager was to try to come on board the projects at roughly the same level as the project engineers themselves were. It was sort of like jumping on a fast-moving train. Time was the problem. I had to find out as much information about the projects as I could in the shortest possible length of time. I had to review the status of the products' developments and understand the details of their technical innards.

I had known what everyone was working on

before I was promoted, because we communicate well in the department, but I had to attain a deeper understanding of all projects: So I had each project engineer fill me in on each of his projects—what he's doing, where he's at with it, what's going into it and where his difficult areas are. I had each show me his schedules and all the drawings that were pertinent to his projects, and I asked each: "What kind of 'new components' is the company about to purchase? What are the long-lead parts procurement items that'll show up in the product's development cycle?"

It took me about two months before I really "weighed anchor" with all the projects under way. I had thought it would take me about a month to pull even, but I hadn't counted on the technical depth of the projects.

Keeping up with five engineers and 20 projects requires me to keep straight in my mind which problems go with what projects. So I commit everything to paper: where I ought to be, what commitments I've made and have been made to me. If I write it down once, I've got it locked in my mind. I call this record a "chase sheet." It's a listing of everything that has to be done in the next two weeks. It helps me to keep the projects on course.

Another way to keep pace is to take action immediately on whatever comes up. You can't afford to jot a problem down on your calendar and pick it up again in two or three days, as you did when you were an engineer.

A manager shouldn't feel that to motivate his people he must be more technically competent than any member of his staff.

The second problem I had in adjusting to management was motivating a group of engineers I'd worked with before I was promoted. I got to know them and their work on a peer level, and then suddenly I was giving them their quarterly review. It's a lot different knowing the work of a man you've worked beside than it is comparing his work with the work of other engineers.

I think my toughest assignment as a manager is appraising my men. I tell each man that it's



RICK SPOFFORD

Education: BSEE, Syracuse University (1961).

Experience: design engineer; applications engineer; supervisor (linear integrated circuit designs); marketing engineer; project engineer; engineering manager.

Patents and Papers: Three patents; application notes; technical conferences; magazine articles. Most recent is NEREM paper—"High Speed Versatile D/A Quad—Current Switch."

Personal: Age, 32; married, three sons. Sports include tennis; skiing; skating. Hobbies are carpentry, and various home electronics projects.

Employer: Analog Devices, Inc., Founded in Cambridge, Mass., in 1966, to produce operational amplifiers. The company now also makes d/a and a/d converters; integrated circuits; and a new line of digital panel meters. Sales have risen from \$500,000 the first year to \$12,300,000 in 1971. The company moved to a 65,000 square foot facility in Norwood, Mass., last year; it also maintains manufacturing facilities in Wilmington, Mass., and Santa Clara, Calif., and has 400 employees world wide.

my review as well as his. If his review is bad, I ask him to tell me if I'm standing in his way, keeping him from performing well. We review the engineer for his past three months and set up goals (management by objectives) for him to meet in the next quarter.

I don't think a manager, to motivate his people, should feel that he must be more technically competent than any member of his staff. My strong point as a catalyst is that I can bring the experiences of engineers I've known together with the experiences of my staff and point out the similarities of the problems. My years in marketing as an applications engineer have helped to broaden my background in that regard. If my career course had not included a couple of passes at marketing, my development as a manager might have been slower.

Also, I believe that an engineer's work should be varied. I don't think any engineer should be kept on any one product line for extended periods of time. Even though one may be the most qualified for the product, we're continually turning over new project responsibilities to all our engineers in the hope that they'll eventually get a smattering of problems in different areas. As the engineer becomes available, he picks up the most pressing product needed at that point in the development cycle. This doesn't run entirely open loop; at the beginning of every year we review a total product plan for the following fiscal year and match know-how with projects.

I think designers should be encouraged to think broadly, instead of vertically or elegantly. I ask them to explore, say three alternatives to the design problem before they start. A designer can make the mistake of starting with one particular approach to a problem, pursue it further downstream, believing it to be the ultimate approach to solving the problem, and come to that point in time when he should be completing that phase, only to be left with an elegant solution that doesn't quite work on a production basis. If the engineer has alternatives, chances are one of them will be more producible. What works best for me is to leave the judgment of which design to pursue to the project engineer. But following the breadboard phase we hold a formal design review on the circuit. It's crucial that changes from this point on be in the component area and not in the basic technique.

I try to convince the engineer that his solution isn't the only one. I try to get him to work laterally with his peers on the same project, so he'll profit by other points of view. We take definite steps to make sure we're communicating on each other's projects. We have formal biweekly presentations given by the project engineer on the breadboard phase of a product's developments. At that time engineers have a chance to point out

specific design changes that they've made—and which ones could be used for the product being presented.

I like to think that I know my men well, and that I'm continually sensitive to their personal problems on and off the job. I try to find out what motivates each man, what excites and interests each, and gear his work effort to that.

One reason engineers fail as managers is their fear that administrative duties will strip away their bench time and stifle their creative ability, and turn them into paper shufflers.



And the third problem of adjusting to management is probably the adjustment itself. I think just finding out how the people at the management level function and how they communicate and fit into the company picture is as important a single factor to learn as any other. Basically that problem has been handled for me because people communicate openly here. When I first became a manager, I attended formal management meetings at this level on a weekly basis, and it gave me a chance to see how the other departments function.

New managers can succeed by communicating openly with the other departments of their company. But I've known engineering managers who think that their time is much too valuable to talk to a marketing man or a salesman about generalities, or even about a \$100,000 order.

But perhaps the most prevalent reason for the engineer's failure to come to terms with his adjustment is fear—his fear that management responsibilities will strip away his bench time, stifle his creative ability and turn him into a paper shuffler.

I think that the fear is unfounded. My own technical experience has broadened considerably since I was an engineer, because as a manager I've been constantly exposed to all projects at once, instead of just one or two at a time. ■■

Here's a line that never fails to work with the government.



We have a whole line of toggle switches listed by the government for aerospace/defense use.

ENVIRONMENTALLY SEALED TOGGLES. The

ET is a magnetically-held toggle that's both explosion-proof and immersion-proof (MIL-S-5594).

When you require a variety of toggle levers and a wide choice of circuitry, consider the versatile, immersion-proof (MIL-S-3950) TL.

BUSHING SEALED TOGGLES. TS toggles have a molded seal (MIL-S-3950) within the bushing. This keeps out moisture and other contaminants.

Miniature TW toggles (MIL-S-3950) offer the versatility of much larger switches. Choose from 1/4" or 15/32" bushings.

TP's are TL switches with rocker actuation. Although unlisted, they're dust tight and good for temperatures from -65°F to $+160^{\circ}\text{F}$.

For information, call your MICRO SWITCH Branch Office or Authorized Distributor (Yellow Pages, "Switches, Electric"). Or write.

MICRO SWITCH makes your ideas work.

ideas for design

Three-LED circuit indicates ac or dc and polarity

Here's a circuit that can be added to a digital voltmeter to indicate whether the input signal is ac or dc. In the case of dc inputs, the circuit also indicates polarity. Three LEDs act as indicators, and a $\mu A741$ op amp functions as a voltage comparator.

When the input is negative dc, transistor Q1 saturates and its collector (point A) goes LOW. Since transistor Q2 remains turned OFF, its collector (point B) stays HIGH. The output of NAND gate G1 is thus HIGH, while the output of G2 is LOW, and only LED 2 will glow.

For positive dc inputs, transistors Q1 and Q2

both remain turned OFF and both collectors (points A and B) stay HIGH. The output of G1 is thus LOW, while the output of G2 is HIGH. Under these conditions only LED 1 will glow.

Transistor Q2 saturates only for an ac input. Its collector (point B) then goes LOW, and LED 3 glows. Because point B is LOW, the outputs of G1 and G2 are HIGH, so that LEDs 1 and 2 will not light.

T. J. Steen, Pres. Kennedylaan 36, Roosendaal, The Netherlands.

CIRCLE No. 311

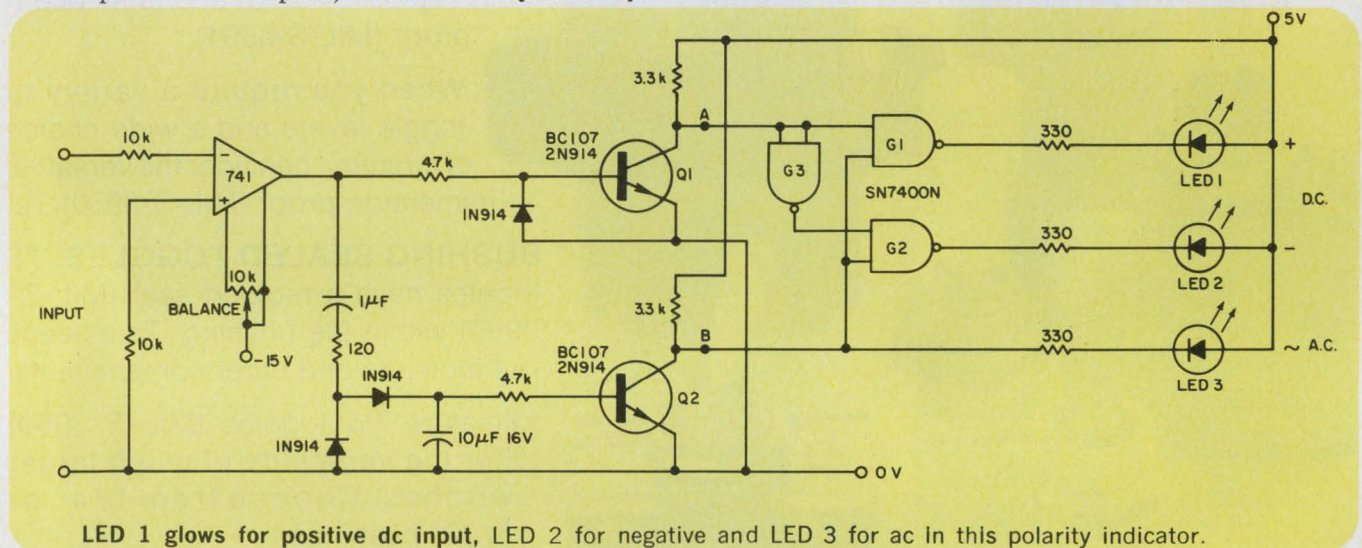

CMOS logic expands use of variable duty cycle oscillator

The nearly infinite input impedance of a CMOS logic gate offers negligible loading to the RC frequency-determining network of a cross-coupled oscillator. This allows large-valued resistors and relatively small capacitors to produce long oscillation periods (three minutes with the component values shown). The following equation defines the oscillation period:

$$t = 3t_d + RC$$

where

$$t = \frac{\text{period}}{2}$$

t_d = delay of each gate

C = capacitance in farads

R = resistance in ohms for either charge (OFF period) or discharge (ON) path.

Helipot delivers voltage regulators... fast!

Pick an off-the-shelf voltage regulator from Helipot for your application.

DC Voltage Regulators Fully sealed, miniature hybrid cermet thick-film devices:							
Series No.	Fixed	Adjustable	Output Voltage Range (VDC)	Output Current	DC Line and Load Regulation	Price (1-9)	
801	X		+9 to +21	Up to 0.5 amp	±0.05%	\$30	
802		X	"	↕	↕	35	
851	X		-9 to -21			30	
852		X	"			35	
803	X		+21 to +32			30	
804		X	+20 to +32			35	
853	X		-21 to -32			30	
854		X	-20 to -32			±0.05%	35
805	X		+3 to +9			±0.1%	30
806		X	"			"	35
855	X		-3 to -9			"	30
856		X	"	Up to 0.5 amp	"	35	
807		X	+30 to +60	0.150 amp	±0.05% at -20° to +125°C ±0.1% at -55° to -20°C	30	
808		X	+60 to +120	"	"	30	
809	X		+5 to +28	0.75 amp	0.003%/mA	8.95	
859	X		-5 to -28	"	"	8.95	
828A		X	+5 to +30	500 mA	Line: ±0.01%/V Load: ±0.01%	50	
838A		X	-5 to -30	"	"	50	
844			Dual ±12 to ±20	0.3 amp	Line: ±0.005%/V Load: ±0.005%	20	

Low Cost Series 809 and 859

voltage regulators are small (1" x 0.5" x 0.170" high), complete, fully sealed and compatible with flat pack and dual-in-line packaging. The 809 and 859 circuits consist of a series pass stage, an error amplifier with built-in reference, and a precisely adjusted output voltage sense divider. In addition to being complete voltage regulators, the Series 809 and 859 have the following add-on capabilities: current limiting, load capability to over 10 amps, and adjustable output.

For off-the-shelf voltage regulators, call your local Helipot Sales Representative today.

Beckman INSTRUMENTS, INC.

HELIPOT DIVISION
2500 Harbor Blvd., Fullerton, Calif. 92634

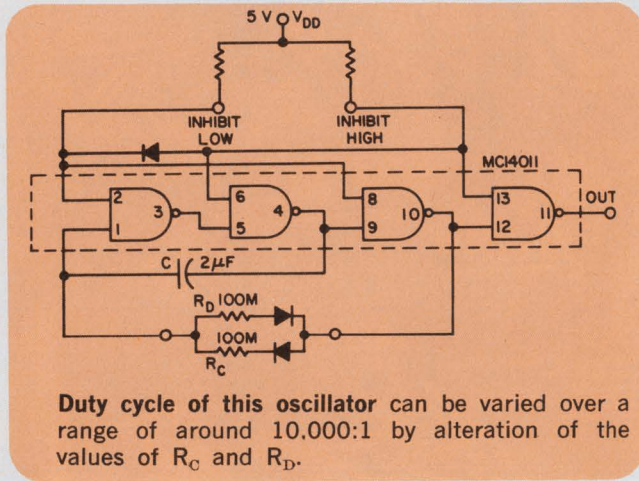

The diodes in series with R_C and R_D provide two different charge and discharge paths, to generate a nonsymmetrical waveshape. If the resistors R_C and R_D are made variable, the HIGH and OFF states can be controlled independently to provide whatever combination of frequency and duty cycle are desired.

Grounding of the Inhibit HIGH or Inhibit LOW terminals permits oscillation to be stopped in either state, if the oscillator phase is of interest. The low inhibit does not affect timing accuracy. The diode connected between pins 2 and 6 of the gate insures 10% accuracy for even the first half cycle after removal of a HIGH Inhibit command.

Jim Barnes, Senior Applications Engineer, Systems Engineering, Motorola Semiconductor Products Div., 5005 E. McDowell Rd., Phoenix, Ariz. 85008.

CIRCLE NO. 312

Clamp negative outputs without introducing spikes

A simple op-amp circuit (Fig. 1) provides linear amplification with positive outputs, but it quickly clamps to zero if the output tries to go negative. The clamping action is accomplished with a distinct absence of switching spikes. Total offset amounts to only the few millivolts of offset inherent in an NH002 op amp. The input-output characteristics are shown in Fig. 2.

For negative inputs, the loop is closed around

A1, Q1 and A2. The inverting input of A1 is at virtual ground. When the input goes positive, the negative output of A1 turns off Q1. Because of the low output impedance of A2, the output is effectively clamped at zero. Hot-carrier diode D1 and resistor R1 prevent the loop around A1 from opening and causing a latch-up when Q1 turns off. These components also allow rapid return to linear operation when the input signal again goes negative.

Mike Black, Texas Instruments, M.S. 257, P.O. Box 6015, Dallas, Tex. 75222.

CIRCLE NO. 313

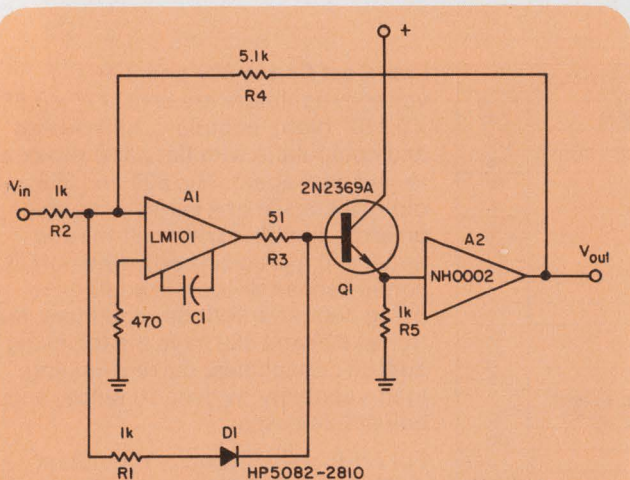

1. Switching resistor Q1 controls amplifier A2 so that the circuit provides linear amplification of positive inputs and clamps negative signals at zero.

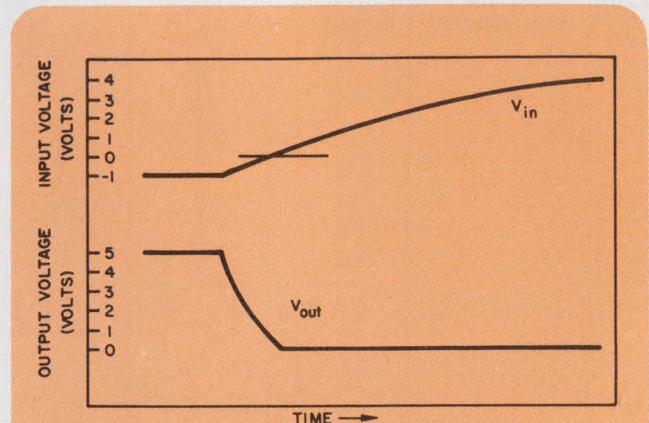

2. Input-output voltage characteristic shows circuit operation for positive and negative inputs.

CANNON® CENT-SIBLE CONNECTORS.

The performance you need, at a price you can afford.

BURGUN-D

The most versatile connectors you can buy, at a price that's right... that's ITT Cannon's Burgun-D subminiatures. Look at the facts. Over one million pairs in the field. Off-the-shelf distribution with assembly facilities around the country. One stamped, crimp, snap-in pin or socket contact accommodates the entire wire range from #20 through #30 AWG stranded wire, or two #22 or smaller wires, for low cost economic applications. Also available: machined contacts and snap-in, right angle or straight printed circuit contacts. Intermateable and intermountable with existing D sub-miniature types. Five shell sizes from 9 to 50 contacts. Six different layouts. Contacts are rear insertable/removable. Complete accessories including locking devices. Semi-automatic crimping machines capable of 1,500 terminations per hour, lease or buy.

All this adds up to greater connector standardization, greater versatility in contacts and contact terminations, and smaller inventories. So if you want to save money, and your application is in business machines, computers and peripherals, medical or industrial

instrumentation, communications, vending machines, controls, or commercial aviation, it will pay you to follow the leader — Burgun-D, a Cent-sible connector.

For a catalog and the name of your distributor, write Dept. BD, ITT Cannon Electric, International Telephone and Telegraph Corporation, 666 E. Dyer Rd., Santa Ana, Calif. 92702. (714) 557-4700.



ABT 500 semi-automatic crimping machine.

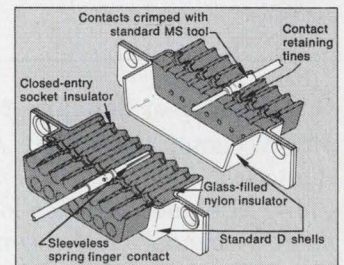

CANNON **ITT**

Divide two pulse rates with TTL logic

The ratio of two pulse rates can be determined continuously for both periodic and stochastic inputs with two NAND gates and two flip-flops (Fig. 1). Errors can be minimized to less than 1% for periodically distributed pulses, but they will be higher for random distribution. The input pulse rates, with mean values N_1 and N_2 , must satisfy the condition that between two N_1 pulses at least two N_2 pulses occur.

Each N_1 pulse produces one output pulse with a width equal to $1/N_2$. If this output pulse train is externally integrated, the resulting level will be proportional to the ratio of N_1/N_2 .

The N_1 pulse enters gate G_1 , and its leading edge sets flip-flop FF_1 so that Q is HIGH. When FF_1 has Q LOW, the N_2 pulses cannot pass gate

G_2 because the other input is LOW. When FF_2 has its Q output LOW, two successive N_2 pulses pass G_2 and switch FF_2 —first, so that Q is HIGH, and then to its initial position with Q LOW—on the trailing edges of the first and second N_2 pulse.

The timing diagram (Fig. 2) shows the sequence of operation. The resulting train of N pulses can then be fed into an external integrator from output Q of FF_2 .

Josef Seda and Jozef Sabol, Faculty of Nuclear Science and Physical Engineering, Technical University of Prague, Prague 1, Brehova 7, Czechoslovakia.

CIRCLE NO. 314

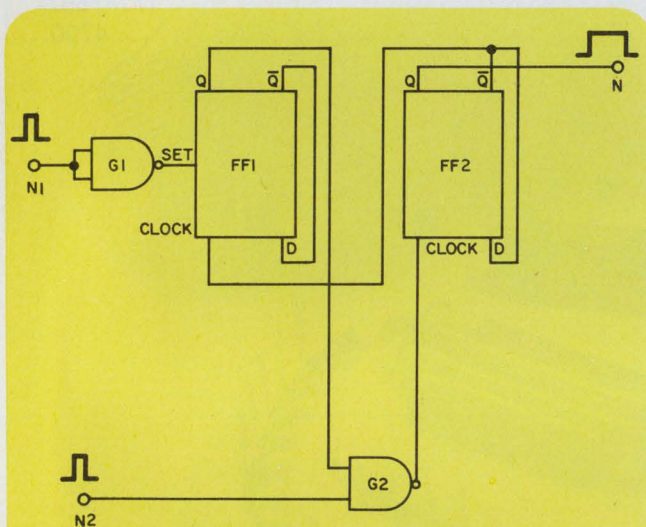

1. TTL pulse-ratio circuit uses half of a quadruple two-input NAND gate and two D-type, edge-triggered flip-flops.

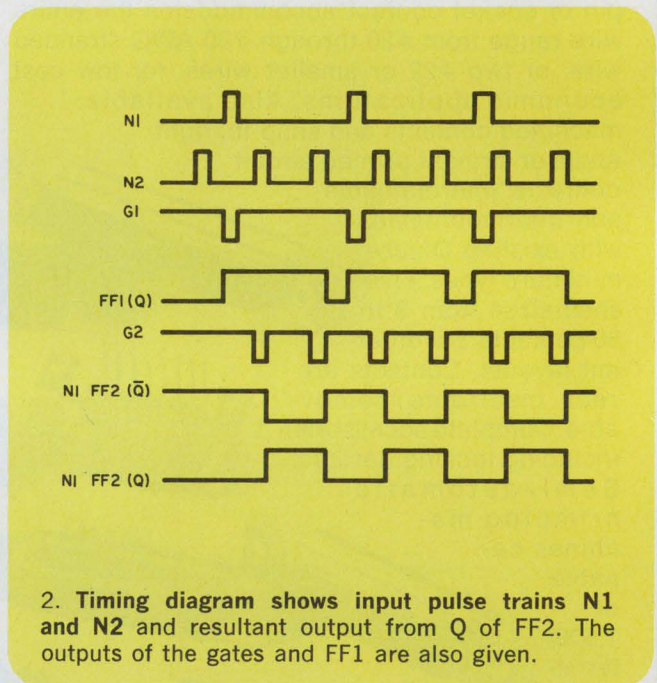

2. Timing diagram shows input pulse trains N_1 and N_2 and resultant output from Q of FF_2 . The outputs of the gates and FF_1 are also given.

IFD Winner of January 20, 1972

Jim Wyland, Linear IC Applications Dept., Signetics, 811 E. Arques Ave., Sunnyvale, Calif. His idea "Phase-locked loop decodes narrow bands" has been voted the Most Valuable of Issue award.

Vote for the Best Idea in this Issue.

SEND US YOUR IDEAS FOR DESIGN. You may win a grand total of \$1050 (cash)! Here's how. Submit your IFD describing a new or important circuit or design technique, the clever use of a new component or test equipment, packaging tips, cost-saving ideas to our Ideas for Design editor. Ideas can only be considered for publication if they are submitted exclusively to ELECTRONIC DESIGN. You will receive \$20 for each published idea, \$30 more if it is voted best of issue by our readers. The best-of-issue winners become eligible for the Idea of the Year award of \$1000.

BOURNS®

NEW VARIABLE RESISTORS... a new deal for you.

for openers... TWO are interchangeable with the CTSX201...

...and provide a standard thumbwheel adjust.

ONE offers much better performance for a few pennies more.

PLUS... ALL MODELS OFFER...

SUPERIOR MOISTURE RESISTANCE — Bourns actually calls out this important specification.

MULTIPLE TEMPERATURE RANGE — Why pay for more operating temperature range than you need? Bourns offers you a choice.

TAILORED POWER — Select from two different power capabilities.

SOLVENT-RESISTANT — Less than 1% resistance change after normal circuit-board cleaning processes; that's the best in the industry.

PIN AND MOUNTING VERSATILITY — Select from popular pin patterns and both vertical and horizontal mounting configurations.

PRICES YOU CAN'T IGNORE — Compare the prices VS performance capability: they're very competitive. 15¢ to 50¢ in 1000-1999 quantities (U.S. dollars, F.O.B., U.S.A.)

FAST DELIVERY — That means fast, not next week. In-depth stocking is the key. Bourns distributors are stocked NOW.

50¢ MODEL 3359 50¢



CERMET

RESISTANCE: 100-2 megohms
POWER: 1/2 watt at 70°C
OP. TEMP. —65°C to +125°C
HUMIDITY: ±1% T.R. change
LOAD-LIFE: 1000 hrs. at 70°C, 2% TRS

50¢ MODEL 3359 50¢

20¢ MODEL 3353 20¢



COMPOSITION

RESISTANCE: 1,000-5 megohms
POWER: 1/3 watt at 60°C
OP. TEMP.: 0 to +100°C
HUMIDITY: ±12.5% T.R. change
LOAD-LIFE: 500 hrs. at 60°C 10% TRS

20¢ MODEL 3353 20¢

15¢ MODEL 3351 15¢



COMPOSITION

RESISTANCE: 1,000-1 megohm
POWER: 1/3 watt at 60°C
OP. TEMP.: 0 to +70°C
HUMIDITY: ±7.5% T.R. change
LOAD-LIFE: 100 hrs. at 60°C 10% TRS

15¢ MODEL 3351 15¢

ENTER YOUR ORDER NOW
AT A LOCAL BOURNS DISTRIBUTOR,
SALES OFFICE, REPRESENTATIVE,
OR THE FACTORY- DIRECT.



BOURNS, INC., TRIMPOT PRODUCTS DIVISION • 1200 COLUMBIA AVE., RIVERSIDE, CALIF. 92507

INFORMATION RETRIEVAL NUMBER 39

JUST SNAP THEM IN PLACE!

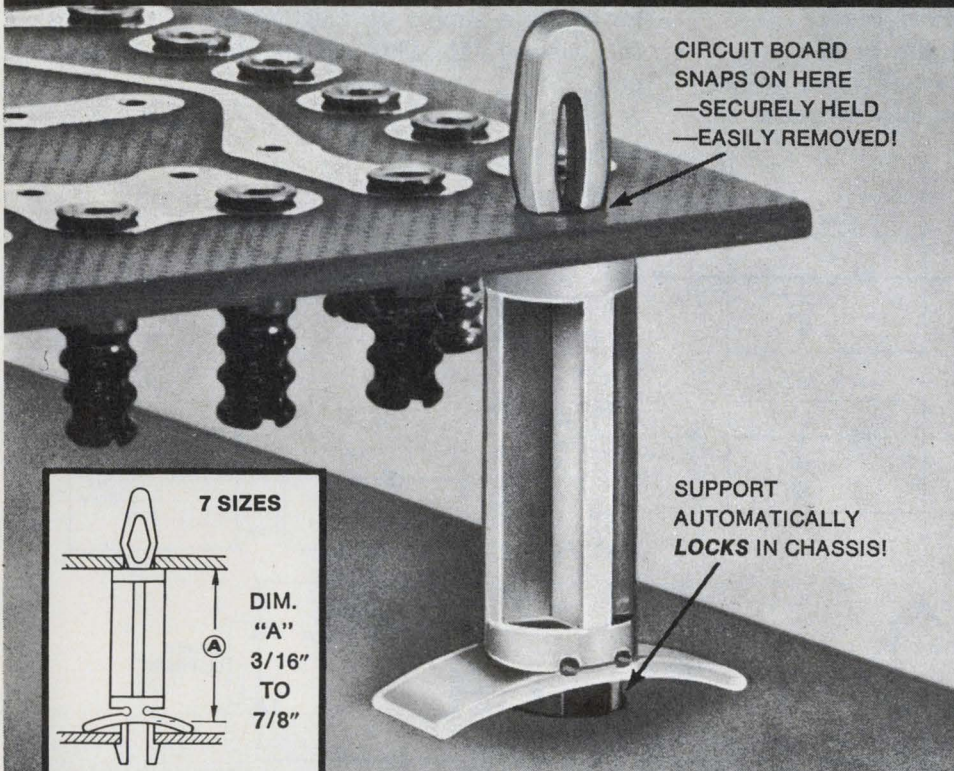

RICHLOK® CIRCUIT BOARD SUPPORTS!

CUT ASSEMBLY
COSTS SUBSTANTIALLY!

STRONG, TOUGH NYLON
WITH HIGH
DIELECTRIC STRENGTH!

ALSO AVAILABLE
IN FLAME RETARDANT
MATERIAL

Write For Free Samples!

RICHLOK® CORPORATION

5835 NO. TRIPP AVE., CHICAGO, ILL. 60646
PHONE: (312) 539-4061

INFORMATION RETRIEVAL NUMBER 40

Feedback to bridge regulates scope high voltage

A simple circuit, used in the Ballantine Laboratories Model 1066A oscilloscope, regulates CRT high voltage by adjusting the ac transformer secondary voltage from which the HV is derived.

Most scopes use an expensive dc/dc converter/regulator to generate, and minimize fluctuations in, the high voltage. The converter usually switches at rates between 10 and 100 kHz—frequencies that can lead to troublesome electromagnetic interference problems. Ballantine avoids this, and saves money, by using the circuit shown in the figure. Regulation is accomplished at line frequency, simplifying the requirements for internal shielding and decoupling and also minimizing EMI.

By connecting the secondary winding of the power transformer to ground through the bridge, the designers have held the regulation to $\pm 0.5\%$. The voltage across the bridge opposes the unwanted variations in the ac line voltage.

The voltage dropped across the bridge is essentially the V_{ce} of Q2, which is controlled by the base current of the transistor; any increase in

the current pumped into the base causes Q2 to conduct more, thereby lowering the collector-emitter drop.

Changes in the line, and hence the HV, are sensed by sampling the -1-kV supply and by using any variations in the sample to control the conduction of emitter follower Q1, which acts as a current sink. Variations in the HV cause Q1 to conduct more, or less, thereby controlling the base current of Q2. C1, at the base of Q2, is charged through D101, which conducts for the positive half-cycle only. In effect, C1 integrates any variations over several cycles.

The potentiometer R1 is set to give full power-line tracking of the regulating bridge, so that the -1 kV can actually fall anywhere between -940 and -1050 V .

Additional compensation for line changes is obtained by connecting R3 from the unregulated low-voltage supply to the summing junction at the base of Q1. This assists the main feedback path.

CIRCLE NO. 319

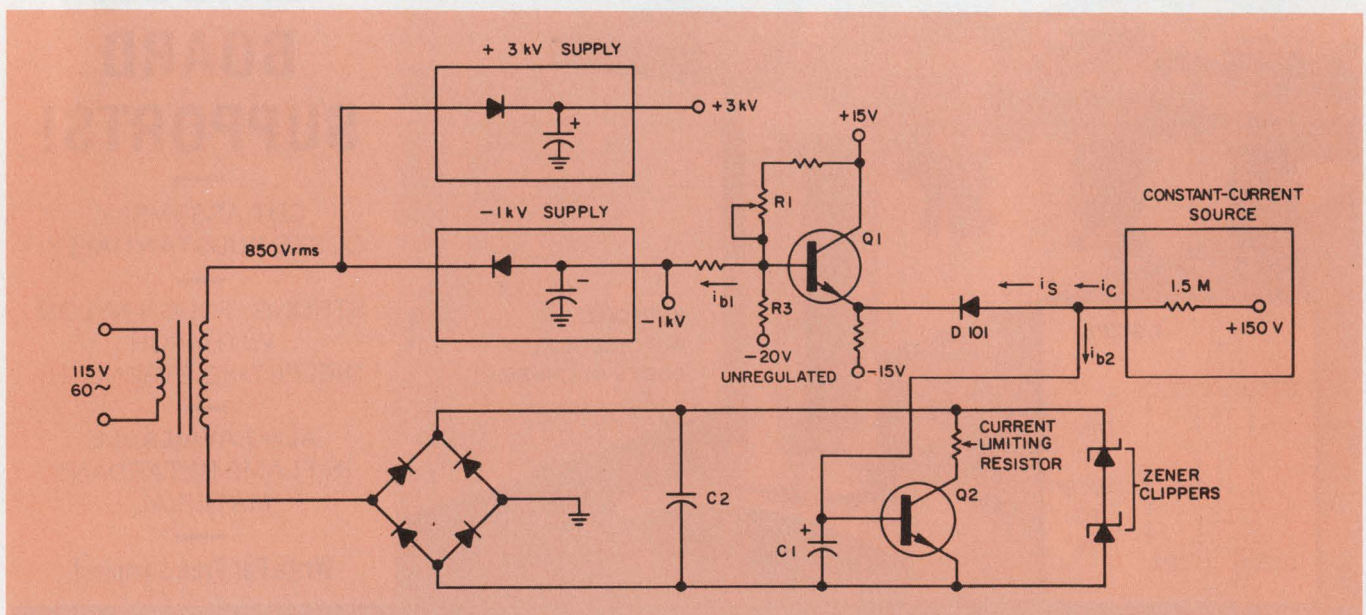

Bridge regulator reduces scope shielding and decoupling requirements by operating at line frequency. The

cost savings is passed on to the scope buyer. The technique also minimizes EMI.

SRL Power Supplies... Performance. Versatility.

Check the specs.

Model	Output Power			Ripple (PARD)			Regulation Line & Load (Comb.)		Full Load Change Transient Response Time (μ S)	Programming*				U.S.A. List Price	
	Voltage Range (Vdc)	Current (A dc)			Volts		RMS	Voltage		Current	Voltage Mode		Current Mode		
		55°C	60°C	71°C	RMS (4V)	P-P (mV)					Ohms/Volt ($\pm 0.5\%$)	Volts/Volt	Ohms/Amp ($\pm 10\%$)		mV/Amp
SRL10-25	0-10	25	22	16.7	350	20	10mA	↑	0.02% +4mA	150	200	1	40	20	\$450
-50	0-10	50	44	33.5	300	10	20mA	↑	0.02% +4mA	150	200	1	20	8	\$650
-100	0-10	100	88	67	300	20	30mA	↑	0.02% +6mA	150	200	1	10	2.5	\$825
SRL20-12	0-20	12	10.5	8	200	20	3mA	↑	0.02% +4mA	70	200	1	80	80	\$435
-25	0-20	25	22	16.7	300	20	10mA	↑	0.02% +4mA	150	200	1	40	20	\$525
-50	0-20	50	44	33.5	500	40	10mA	↑	0.02% +4mA	150	200	1	20	8	\$775
SRL40-6	0-40	6	5.3	4	200	20	0.5mA	↑	0.02% +1mA	70	200	1	150	150	\$435
-12	0-40	12	10.5	8	300	20	1mA	↑	0.02% +4mA	150	200	1	80	80	\$525
-25	0-40	25	22	16.7	500	10	10mA	↑	0.02% +4mA	150	200	1	40	20	\$630
-50	0-40	50	44	33.5	700	40	10mA	↑	0.02% +4mA	150	200	1	20	8	\$850
SRL60-4	0-60	4	3.5	2.68	300	20	0.5mA	↑	0.02% +1mA	70	200	1	250	250	\$450
-8	0-60	8	7	5.36	300	20	1mA	↑	0.02% +1mA	70	200	1	125	125	\$580
-17	0-60	17	14.9	11.4	500	10	3mA	↑	0.02% +4mA	150	200	1	50	40	\$690
-35	0-60	35	31	23.4	700	40	10mA	↑	0.02% +4mA	150	200	1	25	15	\$970

*Selectable: write for Sorensen performance note, PAN-1.

Sorensen's SRL line. A family of high performance, general-purpose power supplies designed for laboratory and systems applications. Outstanding features include built-in overvoltage protection that is quickly set and checked even under full load. Selectable programming coefficient and voltage gain. Great ripple and transient response performance. But, check the specs. Evaluate SRL total performance and value for yourself.



Get information on our other power supplies too. Write for your free complete line catalog. Sorensen Company, a unit of Raytheon Company, 676 Island Pond Road, Manchester, New Hampshire 03103. Tel. (603) 668-1600.

Sorensen
POWER SUPPLIES

INFORMATION RETRIEVAL NUMBER 41

When RFI problems get sticky, try **stickn fingers**®

Attaches faster, shields better than anything else!

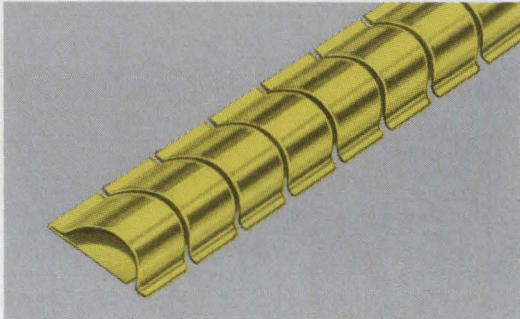

SERIES 97-500 The original Sticky Fingers with superior shielding effectiveness.

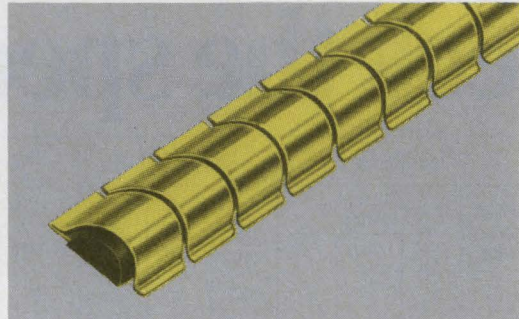

SERIES 97-510 Provides even better magnetic shielding with Magnefil® insert strips.

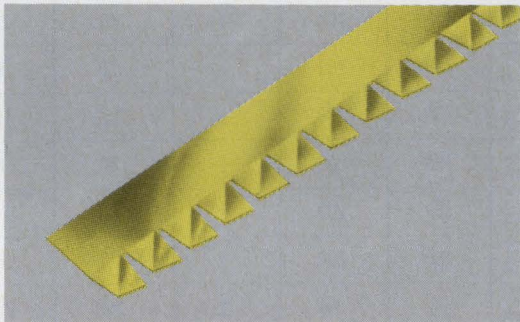

SERIES 97-555 New Single-Twist Series for use when space is at a premium. Measures a scant $\frac{3}{8}$ " wide.

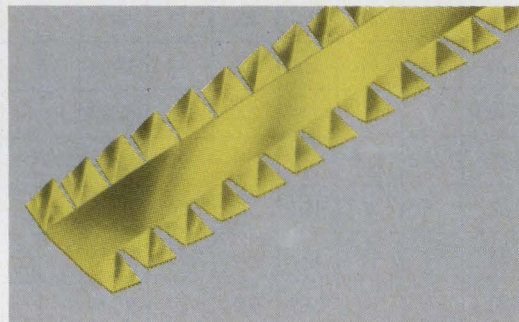

SERIES 97-560 New $\frac{1}{2}$ " wide Double-Twist Series, ideal for panel divider bar cabinets.

Now you can specify the exact type beryllium copper gasket that solves just about every RFI/EMI problem. Perfect for quick, simple installation; ideal for retro-fitting. Self-adhesive eliminates need for special tools or fasteners. Write for free samples and catalog.



INSTRUMENT SPECIALTIES COMPANY, Dept. ED-65

Little Falls, N.J. 07424

Phone—201-256-3500 • TWX—710-988-5732

new products

Self-test, 5-digit DMM helps alleviate uncertainty

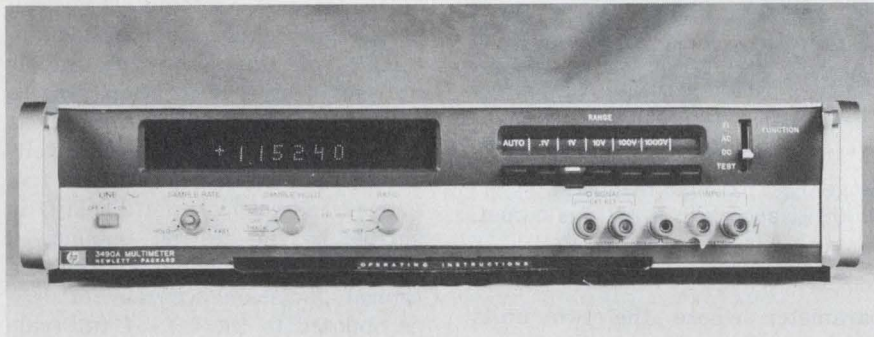

Hewlett-Packard Co., Loveland Instrument Div., P.O. Box 301, Loveland, Colo. (303) 667-5000. \$1650. July.

At the flip of a switch, HP's 3490A digital multimeter sequences itself through 10 tests that check timing signals and auto-ranging circuits, validate the performance of 70% of the logic-circuit ICs and check the six-digit LED display. These tests, and others provided by six additional, front-panel switches, cut calibration cost and time, reduce the number of external standards required and assure a user that his DMM is ready to make accurate measurements.

In a few seconds, a user can measure the zero offset of the dual-slope integrator, isolate thermal-voltage errors, check the reference voltage, locate offsets in the ratio amplifier, calibrate all dc-voltage ranges with only a single, 10-V source, and check the power supply for the ohms function.

Test results on the LED display can be compared with the "right answers" on a pull-out chart. If there's a discrepancy, the user can refer to the operations manual (and, if he likes, an accessory video tape) to help him localize faults to major circuits. Then, to isolate faulty components, he can use something like HP's \$295 logic comparator, Model 10529A, which uses a clip-on probe to test in-cir-

cuit DIP ICs with up to 16 pins.

If the user doesn't want to look at charts, he can store the right answers in a calculator or computer and use a simple software routine for the comparisons. This suggests, of course, that future DMMs could contain complete diagnostic routines that would not only interrogate all key points in the instrument but also guide the user to faulty components.

The unique self-test features in the 3490A stem from a microprogram in a 4096-bit IC ROM, designed and manufactured by HP. These features supplement the normal functions one might expect in a fine meter. There are five full digits, with a sixth to show 20% overrange on all but the 1000-V range.

The fully guarded instrument has five dc ranges from 100 mV to 1000 V, four ac ranges from 1 to 1000 V (with a maximum HzV product of 10^7), and six four-wire resistance ranges from 100 Ω to 10 M Ω . Input resistance is 10^{10} Ω for the 100-mV-to-10-V ranges and 10 M Ω for 100-V and 1000-V ranges. Input impedance for ac is 2 M Ω , shunted by 75 pF without rear terminals, and by 100 pF with them. The reading rate is five per second for dc voltage, and for resistances in the ranges from 100 Ω to 100 k Ω , it's four per second for resistances in the 1-M Ω range, two

per second for the 10-M Ω range and one per second for ac voltages.

Accuracies, specified for 30 days at 23 C \pm 5 C, range from \pm (0.008% rdg \pm 0.002% f.s.) for 1 to 1000-Vdc ranges to a worst case of \pm (0.75% rdg + 0.05% f.s.) at 100 kHz to 250 kHz in the 1-V and 10-V ranges.

Options include digital output, remote control, single-bus, ASCII-coded data-control and data-output and ratio measurements. The instrument uses a dot-matrix LED display, rather than the more common seven-segment display, to minimize the ambiguity that can result from failure of a single diode.

CIRCLE NO. 252

Electrostatic voltmeter ignores source distance



Trek Inc., 8460 Ridge Rd., Gasport, N.Y. 14067. (716) 433-6779. \$1875 w/o probe; 30 days.

The Model 300 electrostatic voltmeter is a 0.05%, 200 Hz bw instrument used to make noncontacting electrostatic voltage measurements in the range of \pm 0.05 V to \pm 3000 V ac or dc. This technique presents a load impedance of 10^{20} Ω to the voltage source. The instrument features a \pm 0.75% meter as well as high accuracy recorder outputs. Drift is less than 0.1 V/hr and tempo is less than 0.1 V/ $^{\circ}$ C. Output noise, referred to input, is 0.1 V max. or 0.003% F.S.

CIRCLE NO. 253

Digital-readout sig gens battle on price, accuracy, stability and modulation



LogiMetrics: Five-digit readout; 0.05% accuracy; 1.0 V rms output.

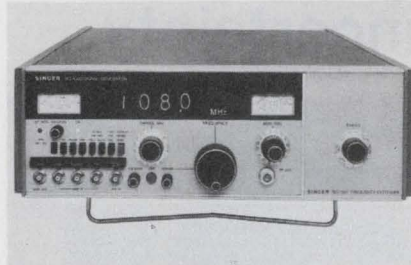

Singer: 3-1/2 digit readout; 0.008% accuracy; 2.2 V rms output.

LogiMetrics, Inc., 100 Forest Drive, Greenvale, N.Y. 11548. (516) 484-2222. \$2575. 90-120 days.

It started in late 1968, when LogiMetrics introduced the first line of digital-readout signal generators. Singer followed in 1970 with its SG-1000, which covered frequencies to 512 MHz, more than double the 230-MHz top frequency in the LogiMetrics line. Now LogiMetrics bounces back with the Model 750, which extends the frequency range to 520 MHz and offers the user challenging trade-offs.

While the frequency ranges (9.5 to 520 MHz for the LogiMetrics 750; 7.75 to 512 MHz for the Singer SG-1000) are similar, the price of the 750 is significantly lower—\$2575 vs. \$4250. Further, the 750 offers a full, five-digit readout, while the SG-1000 has 3-1/2 digits, with a X100 expansion for higher resolution. Pushing a button moves the two most significant digits off the display to the left and adds two least significant digits.

Both manufacturers offer variable resolution. But LogiMetrics defines variable resolution as “blanking out the digits you don’t need,” while the Singer unit switches the decimal point with changes in frequency setting.

The maximum error of the LogiMetrics display is 0.05% while Singer specs its worst-case at 0.008%.

Frequency stability is one

parameter where the two units crash head-on. Singer specifies a “typical” drift of 10 ppm/10 minutes after a one-hour warmup and a tempo of 50 ppm/°C, while LogiMetrics doesn’t specify. And while the SG-1000 claims a residual FM of 0.25 ppm *peak*, the spec sheet for the 750 lists a more liberal residual FM of 0.25 ppm +50 Hz *rms*.

The absence of stability figures can probably be traced to LogiMetrics’ method of generating the output: the Model 750 heterodynes the outputs of two cavity oscillators—one fixed and one variable—and amplifies the beat frequency to obtain the output. While this offers the advantage of performing all the modulation functions on the fixed oscillator only, instabilities or drifts in the frequency of either oscillator show up in the beat frequency, often magnified by a large factor.

The SG-1000, on the other hand, uses a binary chain to divide down the output of a cavity-tuned oscillator. Use of the binary chain also permits output-frequency band-switching over six octave-bands. The LogiMetrics unit uses a continuous crank to tune the desired frequency.

The peak FM deviation of the Model 750 can be varied from zero to ± 300 kHz at rates from dc to 100 kHz. Further, one can read the deviation on a front-panel meter. This is especially convenient

when the operator changes the output frequency: no re-calibration of deviation is necessary.

In contrast, setting the peak deviation, which is limited to $\pm 0.5\%$ of range, on the Singer unit involves a calibration process whereby the reference frequency is first set. An internal reference voltage is then adjusted until the frequency (as read on the display) is shifted by the desired amount.

While this technique gives a typical deviation accuracy of 1%, as opposed to the 5% of full-scale attained with the 750, the deviation resulting from applying an external modulating voltage must be calculated from the Hz/volt gradient obtained in the calibration process.

A comparison of other key specs of the two generators shows:

For the 750:

- In FM, a maximum distortion of 0.5% at 75 kHz deviation.

- In AM, a maximum distortion of 1% at 30% AM and 3% at 70% AM.

- A pulse modulation on/off ratio of 40 dB, minimum.

For the SG-1000:

- In FM, a maximum distortion of 0.5% at 0.1% deviation.

- In AM, a maximum distortion of 2% at 30% AM and 5% at 70% AM.

- A pulse modulation on/off ratio of 60 dB up to 200 MHz and 40 dB up to 512 MHz.

While the LogiMetrics unit provides a big rf output range of +13 to -127 dBm into 50 ohms, the Singer engineers have stretched their output by 26 dB to give an even bigger range of +20 to -146 dBm. Don’t be surprised, though, when the output level meter drops 6 dB when switching to AM: the range for this mode is +14 to -146 dBm.

For more information:

From LogiMetrics **CIRCLE NO. 250**

From Singer **CIRCLE NO. 251**

TRAKATRON

The Whereabouts Machine

Today we can track astronauts all the way to the moon, but we can't locate them instantly in a building on earth. Trakatron closes this communications gap.

Trakatron stands for "tracking people electronically." Trakatron is available in three modes — manual (Trakapen), semiautomatic (Trakascan) and fully automatic (Trakafone).

With the basic manual Trakapen system, operation is manual through a standard touchtone keyboard which indicates on a readout the location of any person at any instant.

The semiautomatic Trakascan system automatically and continuously scans multiple numbers of people and displays their whereabouts on a TV-like (CRT) terminal.

Trakafone is a completely automatic mode in which the room sensors and other interface equipment are incorporated in the telephone system. This system automatically "searches" and rings the phone nearest to where a person being called may be at a particular moment. Trakafone also has a built-in memory which indicates when a person being called is not available, and notifies the caller automatically when the party becomes available.

Here's how one mode, Trakascan, works: a processor holds a list (see diagram) of all people tracked by the

system and their Trakatron pen numbers. At specific time intervals, the processor sends a coded message, on private or telephone wires, to all ultrasonic transmitter-receivers (sensors) installed throughout a building, or buildings. In the room, or designated areas of this building, the pen code addressed by the processor will respond with its own coded signal to the receiving sensor in that particular room, or area.

That receiver will then send a coded message to the processor which identifies the area of the coded pen. The processor now places the room number, phone extension, or other code opposite the name of the person in the list and then moves on to locate the next coded person. By scanning the list, a complete directory of people is ultimately built up and is kept current by constant repetition of the scanning process.

TV monitors placed at strategic locations throughout the building can display the contents of the list continuously, thus making the current information immediately available to interested parties.

As people move from one area to another, the Trakascan system locates and displays their present location. If a person is unavailable, or has left the building, it will also report that fact. Personnel may be added, or deleted

at any time.

Trakatron systems are designed to incorporate a number of options; digital synchronized clocks in any room sensor; after hours intrusion alarm; fire detection; provision for Trakavision internal video picture phone interface (the same screen can scan and display data on location of personnel and display actual live pictures of the person talking on the phone).

The versatility of the Trakatron system makes it possible to incorporate other features such as Penlok access control which permits a doorlock to "recognize" the pen of an individual without any conscious personal human involvement, insuring access only by cleared personnel.

Trakatron — automated locating systems for medium and large corporations, institutions, terminal facilities, etc.

For more information on licensing, write:

R. W. Lester, President
Recognition Devices, Inc.
101 Park Avenue, New York, N.Y. 10017

Trakatron patents and trademarks Pend.

 **Recognition Devices Inc.**

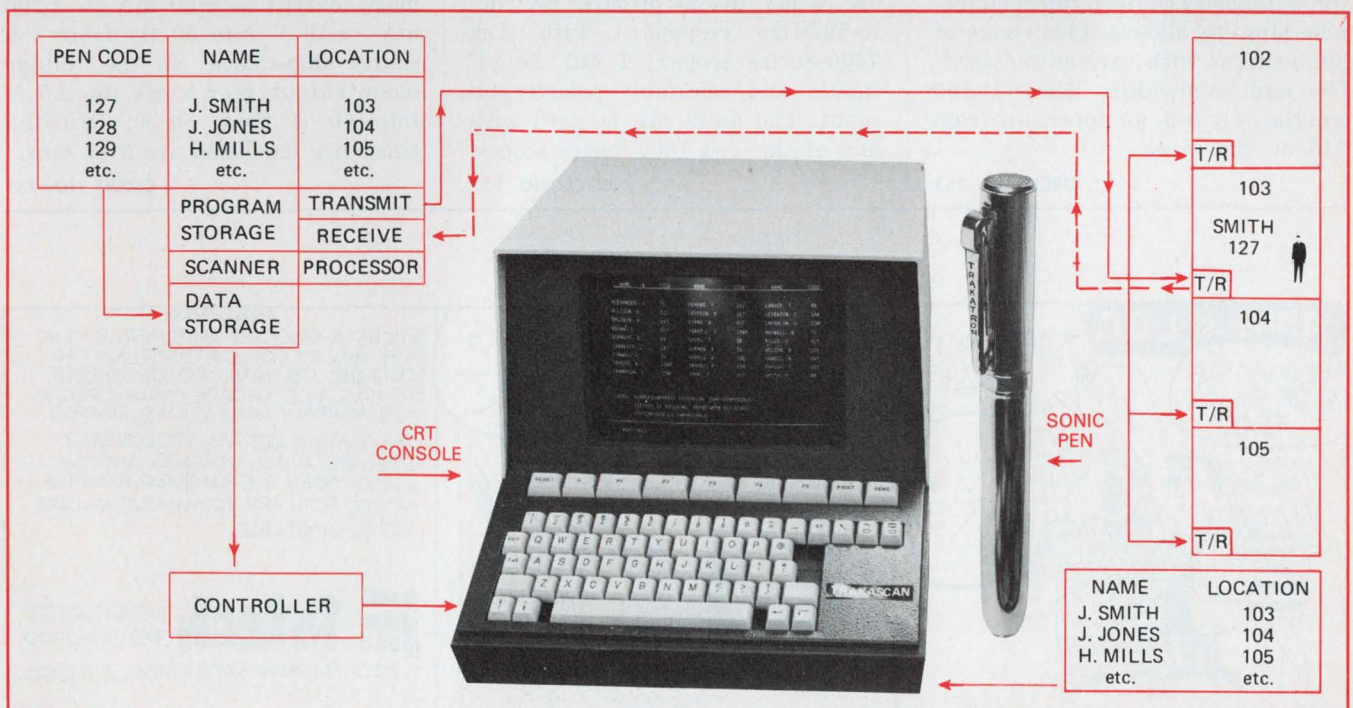

Portable, 4-1/2 digit DMM has single IC

Dana Laboratories, 2401 Campus Dr., Irvine, Calif. (714) 833-1234. \$650; 30 days.

The 4300 weighs 5-1/2 pounds (7-1/2 with battery pack) and can operate from battery power for eight continuous hours. The unit then shuts off automatically. When the battery falls below an acceptable operating level, the readout is blanked out and the batteries are automatically disconnected. Five dc, four ac and five ohms ranges are provided, with 120 dB CM rejection. The unit has 100% over-ranging. Over-voltage protection is 1000 V on any ac or dc range and 250 V on any ohms ranges.

CIRCLE NO. 254

Non-contact sensor resolves a microinch

Mechanical Technology, Inc., 968 Albany-Shaker Rd., Latham, N.Y. (518) 785-2330. \$1600 approx.; 4 wks.

The KD-100 uses a fiber-optic probe to measure displacement and motion of targets. It resolves movements of 1 μ in. from dc to 100 kHz and is said to be very stable. The instrument features a 3-1/2 in. center-zero, meter, a calibration reference point, and a step/vernier light-intensity control. Interchangeable plug-ins allow a wide range of applications with various sensitivities and bandwidths. The KD-100 weighs only 8 lb and operates from 115 or 230 V ac.

CIRCLE NO. 255

Digital millivoltmeter resolves 1 μ V



United Systems Corp., 918 Woodley Rd., Dayton, Ohio (513) 254-6251.

The Digitec Model 268 digital millivoltmeter offers 6 ranges, has resolution to 1 μ V, and handles up to 1000 V dc. Features are: 4-1/2 digit LED display, accuracy of 0.02% of reading on 4 highest ranges, 0.05% of reading on lowest two ranges, guarded input and isolated BCD and system functions. Front panel controls include self-check zero and calibration.

CIRCLE NO. 256

Scope plug-in has 500 μ V/div

Tektronix, Inc., P.O. Box 500, Beaverton, Ore. (503) 644-0161. 7A15A; \$280, 7A15AN; \$250; stock.

The 7A15A and 7A15AN plug-in vertical amp provide extended sensitivity to 500 μ V/div. Features include: 500 μ V/div at 10-MHz bw; 5 mV/div at 50-MHz bw; dc-to-50-MHz response (with Tek 7400-Series scope); 1 M Ω , 20 pF input; and selectable polarity on input. The units can be used with any of the Tek 7000-Series scopes.

CIRCLE NO. 257

IC tester sells for less

Macrodata Co., 20440 Corisco St., Chatsworth, Calif. (213) 882-8880. \$34,520 and up; 30-60 days.

The MD-183 dc functional/parametric tester, is said to sell for about half the price of other computer-controlled systems. Sequential testing, binning, and logging are performed automatically; and the logging counters record all passes and failures, as well as actual test values. The system can be set up for either single-pin or multiple-pin tests, including stress, leakage, continuity, and threshold.

CIRCLE NO. 258

\$495 pulse generator has 50 MHz rep rate

Chronetics, Inc., 500 Nuber Ave., Mt. Vernon, N.Y. (914) 699-4400. \$495; stock to 30 days.

The Model PG-10 pulse generator provides positive or negative current or voltage pulses with variable baseline offset, single (delayed) or double (plus manual one-shot), normal or inverted (complement) over a rate range of 0.1 Hz to 50 MHz. It may be driven by the internal clock or be externally triggered from dc to 50 MHz. The unit may also be synchronously or asynchronously gated from dc to 25 MHz. In the current mode, output is ± 20 mA to ± 200 mA (± 10 V into 50 Ω) from 1 k source impedance; in the voltage mode output is ± 5 mV to ± 5 V into 50 Ω from 50 Ω . Rise/fall times are fixed and are 5 ns max.

CIRCLE NO. 259



ANALOGY
 INTECH'S A-4350 LOG AMPLIFIER IS THE EASY WAY TO SCALE A CURRENT OR VOLTAGE. IT'S SMALL AND INEXPENSIVE, BUT HAS AN 8 DECADE DYNAMIC RANGE, $\pm 1\%$ ACCURACY AND $\pm 0.04\%$ TEMP CO. SENSITIVITIES ARE 2/3 V/DECADES, 1 V/DECADE, AND 2 V/DECADE. AND THE A-4351 DOES THE SAME FOR NEGATIVE INPUTS. BOTH ARE TRIMMABLE, NULLABLE AND UNSHORTABLE.

intech INCORPORATED
 (408) 244-0500
 1220 COLEMAN, SANTA CLARA CA. 95050

are you a designer who demands ultimate reliability at lowest possible cost?

then consider Telex TERMI SERIES
digital cassette recorders!

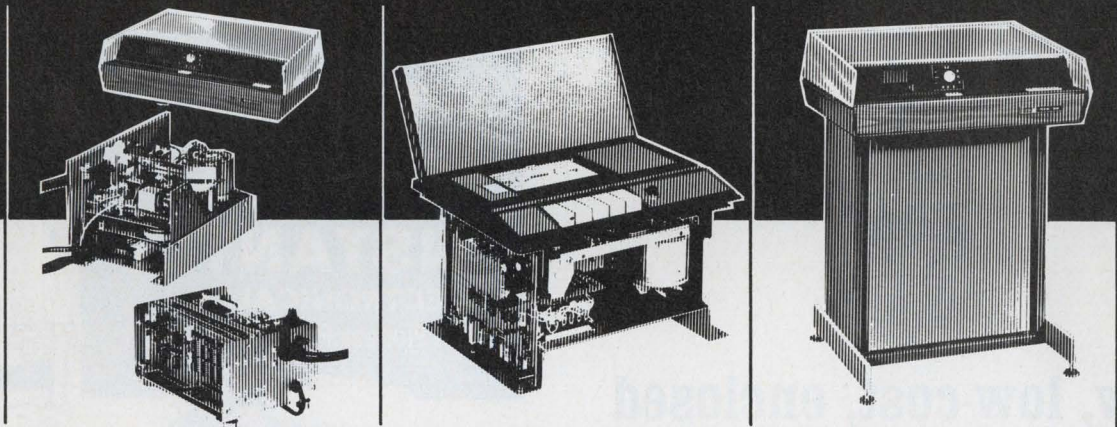

Telex — world's leading manufacturer of recording equipment — offers industry's most comprehensive series of high-reliability, low-cost digital cassette recorders and memories; pre-engineered, field-proven units for virtually every modern application.

TERMI SERIES includes models ranging from basic cassette transports to complete systems designed for buffered terminals, data capture, point-of-sale equipment, peripheral storage, numerical control and other digital data handling missions.

Perhaps most important, Telex provides decks with unique mechanical enhancements; subsystems with Read/Write electronics, Power Supply and a range of data interfaces from phase encoded, NRZ, parallel to communications RS-232; and complete high-performance computer peripheral memory systems for low-speed paper tape replacement (10, 15, 30 CPS) or high-speed paper tape replacement to 300 CPS.

Telex has combined more than thirty-five years of recording expertise to create TERMI SERIES — the *only* complete line of digital cassette recorders and memories expressly designed for high-volume OEM applications where low cost and high reliability are critical specifications.



new-breed™
digital recorders

Contact Telex today for detailed technical literature and application data.

TELEX®
COMMUNICATIONS DIVISION

9600 Aldrich Avenue South
Minneapolis, Minnesota 55420
Tel: (612) 884-4051

Plug-in d/a settles within 50 ns

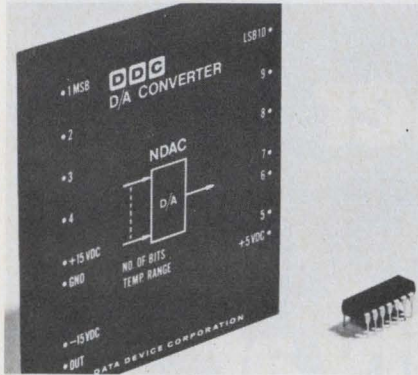

ILC Data Device Corp., 100 Tec St., Hicksville, N.Y. (516) 433-5330. \$350 (0-70 C), \$450 (-55 to +85 C); stock.

A d/a high-speed converter, designated the Model NDAC, provides a resolution of 10 binary bits, a settling time of 50 ns and accuracies of up to $\pm 0.05\%$. The plug-in module measures only $2.6 \times 3.1 \times 0.6$ in, yet drives a 50- Ω coaxial load. The unit provides an output power capability of 0 to 5 volts at 100 mA.

CIRCLE NO. 260

Numeric display panel features eight digits

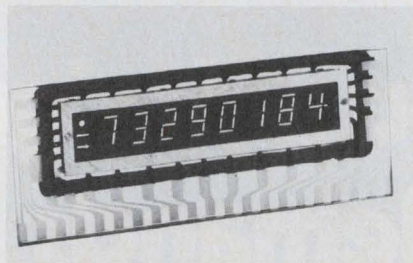

National Electronics, Inc., Geneva, Ill. (312) 232-4300.

The NDP 1252 is an eight-character numeric display designed to operate in the time-share mode. The cold-cathode gas-discharge panel features a seven-segment (.255-in. high) character with decimal points, and left-hand minus, overflow and dot symbols. Anode supply and cathode prebias voltages are 190 V dc and 115 V dc, respectively. Peak cathode currents range from 0.15 to 0.85 mA. Refresh rate is 75 to 750 Hz and character duration varies from 75 to 750 μ sec. Overall size is $3.30 \times 1.32 \times 0.630$ in.

CIRCLE NO. 261

Logic status indicator checks 4 bits, costs \$4

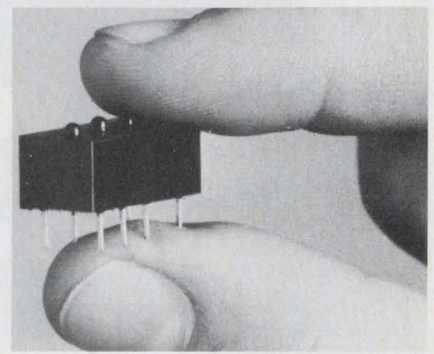

Unique Devices Co., P.O. Box 70, Bountiful, Utah. (801) 295-4252. \$3.99 (5000).

The LD-4 logic-status indicator lets you monitor your circuit continuously and inexpensively. Plugged in among the ICs, each LD-4 indicates status of 4 logic bits. It is housed in a DIP-like package. Indicator facilitates design checks and troubleshooting of individual circuits or complete systems. LEDs are mounted in 0.1 in. centers and require only 3 mA. Various models are available.

CIRCLE NO. 262



New, low-cost, enclosed miniature rotary switch

Another Grayhill innovation. New, low cost, enclosed miniature rotary switches—with 30°, 36°, 45°, 60° and 90° angles of throw!

Series 50A and 51A available with 1 to 4 poles per deck . . . 2 to 12 positions per pole (depending on number of poles) . . . solder lug or printed circuit terminals.

Available as-low-as \$3.10 per switch in one hundred quantity orders.

For our new Engineering Catalog G 308 write or phone: Grayhill, Inc., 565 Hillgrove Ave., La Grange, Illinois 60525. (312) 354-1040



INFORMATION RETRIEVAL NUMBER 46

MEASURE RPM's INSTANTLY ELECTRONICALLY with Pioneer Photo Tachometer

For speeds up to 12,000 RPM

The photo tachometer is easy to use. Hold in the hand like a flashlight, just point, press button, read RPM instantly—no wires or mechanical connections required.

Send complete information.

Available Under GSA Contract No. GS-OOS-04519

THE Pioneer

ELECTRIC & RESEARCH CORPORATION

Subsidiary of Penn Controls, Inc.
743 Circle Ave. • Forest Park, Ill. 60130
Phone: 312 771-8242

USE FOR:

GRINDING WHEELS

DRILL PRESSES

ENGINES AND MOTORS

COUNTING

VACUUM AND PRESSURE PUMPS

LABORATORIES

INFORMATION RETRIEVAL NUMBER 47

Two-quad d/a multiplies signals fast



Datel Systems, Inc., 1020 Turnpike St., Canton, Mass. (617) 828-6395. P&A: See text. Stock to two weeks.

A two-quadrant, multiplying d/a converter, the Model DAC-MI series, multiplies any dc or ac analog reference by up to 12 binary bits. The input can range from dc—2 MHz and can be a sine wave, ramp, sawtooth, or other arbitrary shape.

Other specs include a choice of input coding—straight binary, BCD, offset binary or two's complement. The analog input range is 0 V to +10 V and requires a source current of 1 ma. Full scale analog output can be either unipolar (0 to 2 mA @ 1.2 V) or bipolar (± 1 mA @ ± 1.2 V) without the use of external components. Accuracy specs include $\pm 1/2$ LSB linearity, $\pm 0.002\%/^{\circ}\text{C}$ temperature coefficient and $\pm 0.01\%$ full scale accuracy at 25 C.

Five models (8-12 bits, binary or BCD) feature typical output settling times of 150 nsec (250 ns, max.) for a full scale digital change, and 500 nsec (750 ns, max.) for a full scale reference voltage change.

The units also have a built in voltage reference (+6.2 V) which can be externally pin strapped for conventional d/a operation. DAC-MI series require ± 15 V dc and are packaged in a $2 \times 3 \times 0.4$ in. module.

Prices for the DAC-MI series are \$100 for the 8-bit unit; \$119 for the 10-bit unit; and \$139 for the 12-bit module.

CIRCLE NO. 263

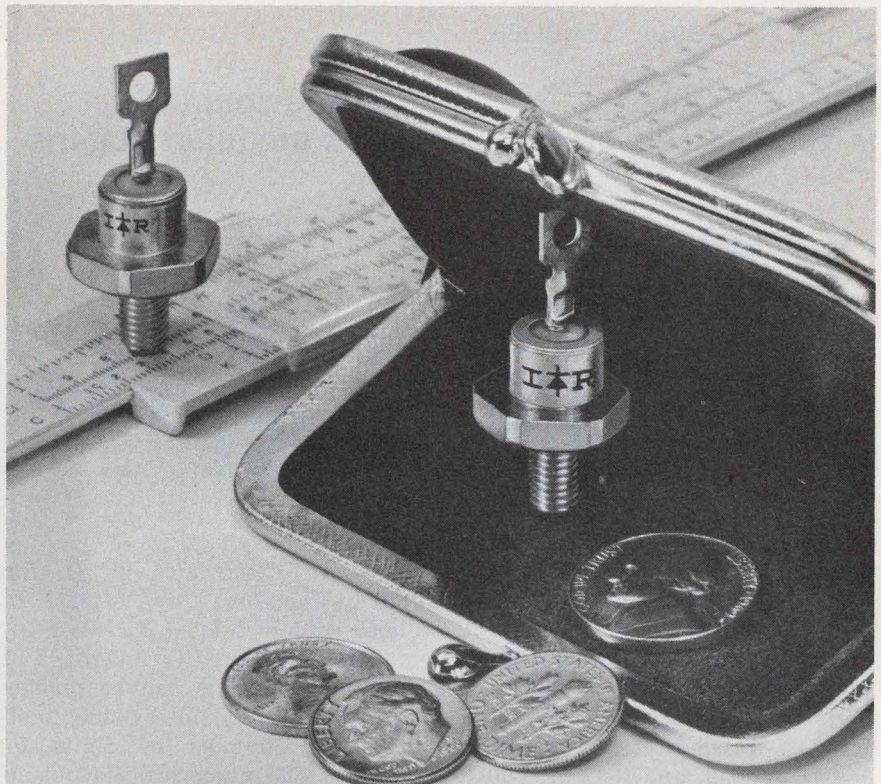

35 Amps. Better Specs. Better Prices.

When it comes to price vs. performance trade-offs, nobody can beat our new 35H rectifier series. Presumptuous statement? Not at all, when you consider all their reliability extras and lower costs, that give your systems a competitive edge.

For instance, they handle a full 35 Amps, and they directly replace most any DO-5 packaged device — yet their smaller can diameters save you space. Their 600-Amp one-cycle surge rating is roughly 25% more than the best offered by others. Provides added protection against current overloads. And their low junction-to-case thermal resistance reduces junction temperature rise by 15% ($0.85^{\circ}\text{C}/\text{W}$ vs. $1.0^{\circ}\text{C}/\text{W}$ for a typical competitive 35-Amp unit).

The 35H, which comes in 100, 200, 300 and 400 maximum repetitive peak blocking voltages, also simplifies inventories. Now, one universal series can do the job of more than a dozen diverse JEDEC types.

Find out how you can get more rectifier performance for fewer dollars. Call your local IR sales office, distributor, or the factory.

from IR...
the innovative power people

INTERNATIONAL RECTIFIER 

Semiconductor Div., 233 Kansas St., El Segundo, CA 90245 • (213) 678-6281

5 V dc supply is short-circuit proof

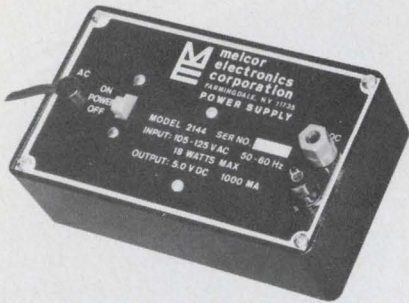

Melcor Electronics Corp., 1750 New Highway, Farmingdale, N.Y. (516) 694-5570. \$15 ea; stock.

The model 2144 power supply provides an isolated, regulated 5 V dc from 115 V, 50-60 Hz. It offers 2% regulation for 10% line, 0 to 1 A load, and 0 C to +60 C temperature variations. The unit is equipped with built-in short circuit and foldback current protection. The compact unit measures only 6-1/8 x 3-3/4 x 2 in.

CIRCLE NO. 264

Decade counter gives modular plug-ins

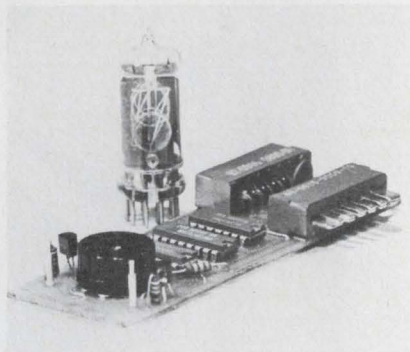

Compton Electronics, P. O. Box 5326, Compton, Calif. \$38.50 ea. with readout tube.

The DECAPLUG line of TTL counters/readouts can be plugged into each other, side-by-side, to obtain any number of digits for counter and numerical readout applications. The DEC-1A contains a counter, memory and decoder plus decimal point for right and left sides of number. Counting rate is 20 MHz.

CIRCLE NO. 265

High voltage CRT supply offers small package

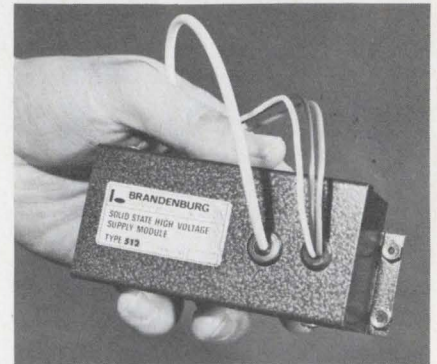

Brandenburg Ltd., 939 London Rd., Thornton Heath, Surrey CR4 6JE, England. £ 15.

The model 512, a modular high voltage supply for CRTs, provides between 4 and 7 kV at a maximum of 120 μ A. It can withstand an output short-circuit for up to 10 seconds without damage. The impregnated HV components are fully screened in a metal can only 2 x 1-1/2 x 4-1/2 in.

CIRCLE NO. 266

Now we have two sides to our Pin Bar story.

Now you can pick up every pin with a single new Lear Siegler Pin Bar™. The new design utilizes both sides of the bar to pick up adjacent pins. Your installation time and production costs therefore are significantly reduced. Unlike most common connection methods, no soldering is required so making

terminal connections has never been easier or less expensive.

So if you'd like to simplify your bussing operation for as low as 2 or 3 cents per terminal, pin us down for details and a free sample.

LEAR SIEGLER, INC.  ELECTRONIC INSTRUMENTATION DIVISION
714 NORTH BROOKHURST ST
ANAHEIM, CALIFORNIA 92803
PHONE (714) 774-1010

New Opto-Isolator...



has transfer ratio of 600% with 1mA input.

Clairex now offers a series of opto-isolators with a wide range of transfer ratios and speeds, and a minimum of 1500 volts isolation.

Clairex opto-isolators, utilizing LED's to drive Clairex photo-transistors, offer minimum transfer ratios of 20% at speeds as fast as 2 μ sec and 600% minimum transfer ratios at slower speeds.

For more information or for special assistance with your isolation problems, call (914) 664-6602 or write Clairex, 560 South Third Avenue, Mount Vernon, New York 10550.

CLAIREX ELECTRONICS

A DIVISION OF CLAIREX CORPORATION

Portable data terminal has editing capability



Data Products, 6219 DeSoto Ave., Woodland Hills, Calif. (213) 887-8246. \$1450; 90-120 days.

The PortaCom portable data terminal, with a magnetic tape cassette, has full editing capability. Its impact printer, produces letter-size printout with up to three carbons at a transmission rate of 30 cps. It also has a built-in acoustic coupler and alphanumeric keyboard. Over 50,000 characters can be stored on a single cassette.

CIRCLE NO. 267

Unit ties teleprinter to message-switching net

Pulse Communications, Inc., 5714 Columbia Pike, Falls Church, Va. (703) 820-0652. \$1000 and up.

The Model 461-1 is a terminal control unit that interfaces standard private-line teleprinters with AT&T-85A1 message-switching systems. The line and terminal sides interface either current-operated or EIA RS-232-C circuits. Optical coupling isolates the current-operated input.

CIRCLE NO. 268

Wideband tape recorder stores visual material

AmpeX Corp., 401 Broadway, Redwood City, Calif. (415) 367-4151.

An instrument tape recorder attains twice the bandwidth (12MHz vs 6MHz) of previous rotary-head recorders. One-inch-square areas of visual material are scanned and recorded on 2-inch-wide magnetic tape. Location of the material on the tape is noted digitally. Rotary-head recording uses four heads mounted on a rotating drum. The heads sweep across the longitudinally moving tape at right angles.

CIRCLE NO. 269

Tape unit features full remote-control



Techtran Industries, Inc., 580 Jefferson Rd., Rochester, N.Y. (716) 271-7953. \$1650; 30-45 days.

The 4100 cassette tape unit is plug compatible with most data terminals and minicomputers. Features include switch-selectable speeds from 110 to 2400 baud, high-speed search, data-edit ability, and remote-control for unattended data station operation.

CIRCLE NO. 270

Stunt-box recognizes call code on party line

Logic Systems Corp., 1567 Cypress Dr., Jupiter, Fla. (305) 746-5181. Baudot: \$335.

The Model 2028 remote selector a selective calling unit or "stunt box," permits selective control of remote equipment, such as a teleprinter, from a central location on a broadcast or party-line circuit on detection of a predetermined code. The selector operates on Baudot, typesetting or ASCII codes.

CIRCLE NO. 271

Expand mini memory with plug-to-plug add-on

Cambridge Memories Inc., 285 Newtonville Ave., Newtonville, Mass. (617) 332-3100. \$4000 & up; 45-60 days.

ExpandCore-11 is a self-contained add-on memory for PDP-11 computers with a basic size of 4 k expandable to 28 k words. A single enclosure is wired and powered for up to 16 k of capacity. Cycle time is 1.2 μ s; 900 μ s when interleaved.

CIRCLE NO. 272

The Elegant DCA Module

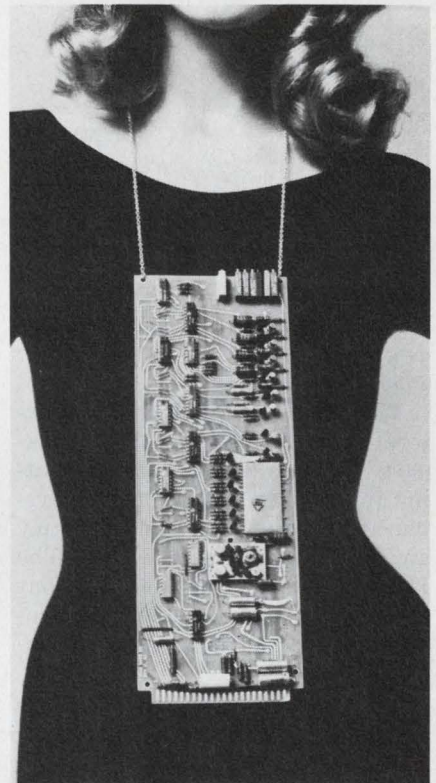

New. And very sophisticated. Our 14-bit, DCA (digitally controlled attenuator) is a multi-faceted gem. In process-control and CRT systems. In automatic-test and data-acquisition applications.

Because this two-quadrant, multiplying, digital-to-analog converter gives you less than .1 phase shift, a T.I.D.E. of less than .18% at 1 kHz. A bandwidth of over 500 kHz. Plus many other attractive features. On a card that's 12.2 x 4.3 inches. Priced in lots of 100:

About \$175 each

Precise specs from precise craftsmanship. Delivered economically through computer-aided design. That's what you'll find in all components by EAI: Capacitors. Thick-film audio and servo amps. Other special function modules. Transformer kits. Molded plastic parts. Custom coils. Solenoids. And a growing list of other elegantly crafted etceteras.



Electronic Associates, Inc.
193 Monmouth Parkway
West Long Branch, New Jersey 07764
Tel. (201) 229-1100

Three LSI chips contain logic for calculator

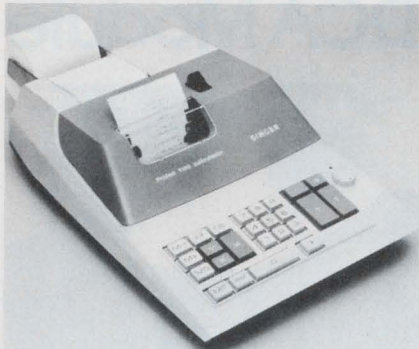

Singer, Business Machines Div., 2350 Washington Ave., San Leandro, Calif. (415) 357-6800. 1101: \$595; 1201: \$695.

The model 1101 and 1102 calculators have all logic in three packages. Both calculators use a floating input, fixed output decimal system with up to nine digit accuracy and provide a printed output. The 1102 is the same as the 1101, but includes a fully independent memory for more complex business problems.

CIRCLE NO. 273

Computer can dial numbers with this unit

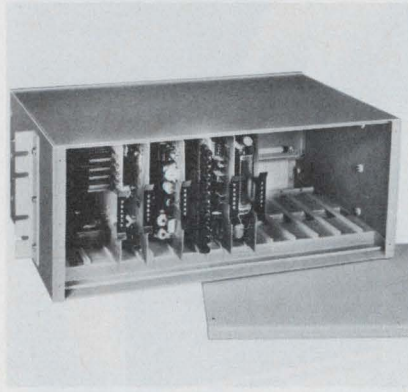

G-V Controls Div., Sola Basic, 101 Okner Pkwy., Livingston, N.J. (201) 992-6200. \$1160; 60 days.

The 907801 series of automatic calling units accepts BCD code and converts to serial digits for automatically dialing telephone numbers. There are several models with different EIA interfaces under RS-366 specifications. Some models can store a limited quantity of phone numbers. When large lists are necessary they are stored in the computer. All models are available in either pulse or tone dialing.

CIRCLE NO. 274

Optical reader can read marked or punched card



United Business Communications, 6405 Metcalf, Shawnee Mission, Kan. (913) 362-5300.

The MR-300 optical-mark, medium-speed card reader is plug-to-plug compatible with the PDP-8 and PDP-11. It can read key-punched cards, pencil-marked cards or a combination of both at rates up to 300 cards per minute. Its vacuum picking technique allows it to process damaged cards. The unit's read amplifiers automatically adjust to changes in card reflectivity.

CIRCLE NO. 275

Designing high-speed drives?

Consider Long-Life LTC™!

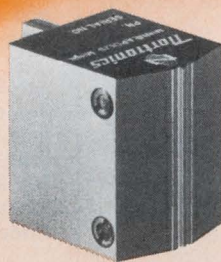

Nortronics' new LTC (Life Time Ceramic) digital heads extend head life ten times, cut replacement costs and eliminate the frequent electronic field adjustments normally required with conventional designs used in modern, high-speed tape drives. The secret? Nortronics tough, new ceramic finish which is permanently applied to the face of digital heads. LTC is another example of Nortronics innovation—a significant breakthrough in magnetic head reliability and long-term survival. Write or call today for detailed information.



'world's leader in magnetic heads'

NORTRONICS COMPANY, INC.

8101 Tenth Avenue North
Minneapolis, Minnesota 55427 • (612) 545-0401

NCR

SENIOR R&D ENGINEERS

The successful candidate will conceive, develop and carry out programs for exploration and exploitation of basic physical phenomena to create new and useful devices and/or subsystems.

These positions require a record of accomplishment with experience in electronic devices, optics, logic or circuitry design. The ideal candidate will be a creative, analytical individual with an MSEE or PhD and at least 3 years applicable experience.

Are you interested in joining some of the world's outstanding scientists and engineers? If so, send your resume plus complete salary history in confidence to:

Mr. V. L. Mirre
Corporate Executive &
Professional Placement

NCR
Main & K Streets
Dayton, Ohio 45409

An Equal Opportunity Employer M/F

Cassette data logger stores 10⁶ 8-bit words



Incre-Data Corp., 6405 Acoma Rd., S. E., Albuquerque, N.M. (505) 265-9575. \$2000.

The 6000 Series Incre-Logger is a cassette recording system for the acquisition of data in digital form. Over 100,000 eight-bit words may be recorded on each track of a 300-ft Philips-type cassette. The unit is housed in a half-rack instrument case with height of 5-1/4 in. Data and channel number displays are provided. Other versions are available.

CIRCLE NO. 276

Accumulating printer accepts BCD input



Veeder-Root, 70 Sargeant St., Hartford, Conn. (203) 527-7201.

The series 7726 accumulating digital printer uses a conventional adding machine print mechanism and tape. Using IC electronics, it operates at up to 3 lines/s from parallel BCD data input. It is compatible with TTL, DTL or unloaded RTL. It has a 7-column print capacity and 8 columns for totalizing. Totals print in red. Though low cost is claimed, manufacturer gave no price.

CIRCLE NO. 277

NEW from RMC

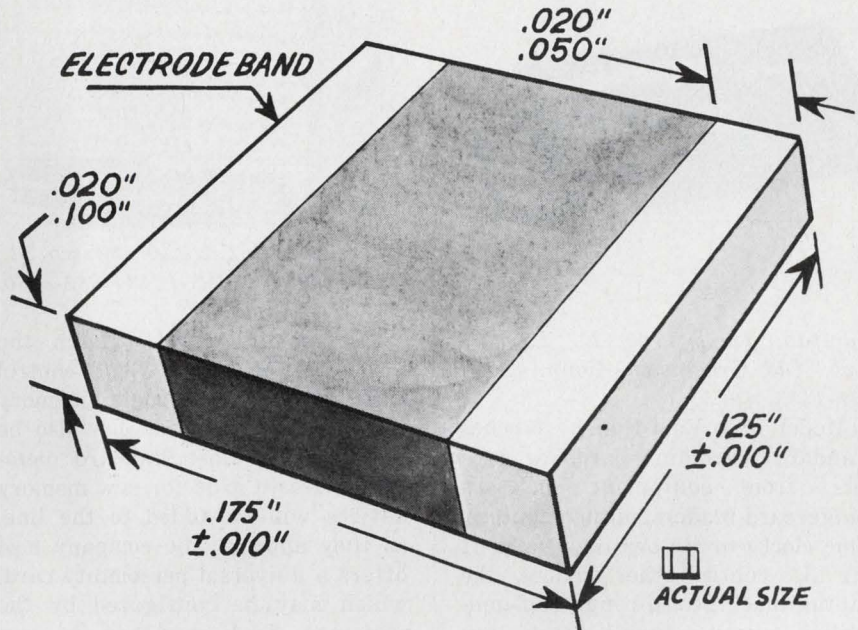

MULTILAYER CAPACITORS

RMC's expertise in ceramics is evident in our new Multilayer Capacitors. Manufactured from a unique process, a high density ceramic film produces high uniformity in internal construction. RMC Multilayer Capacitors feature rugged construction and outstanding reliability in a complete line of T.C. and Hi-K dielectrics. Fired on silver electrode band is available with or without solder pretinning.

RMC engineers will help you with your application requirements. Write for complete information.

Typical Capacity Ranges Available

Cap.	NPO			K2000			K6500		
	25V	50V	100V	25V	50V	100V	25V	50V	100V
Min.	20pf	20pf	20 pf	1000pf	1000pf	1000pf	5000pf	5000pf	5000pf
Max.	3300pf	2000pf	1200pf	.15uf	.08uf	.05uf	.33uf	.18uf	.10uf

Specifications

	NPO	K2000	K6500
Temperature Coefficient:	NPO	Y5P	Z5U
Minimum Capacitance Tolerances:	±5%	±10%	±20%
Minimum Q 1 MHz:	1000		
Maximum DF 1 KHz:		2.5	2.5
Temperature Range:	-55°C - +125°C		
Working Voltage:	25 VDC, 50 VDC and 100VDC		
Life Test:	Per EIA RS—198B		
Flash Test:	2.5 X Rated Voltage for 1 Second		

DISCAP
CERAMIC
CAPACITORS



RADIO MATERIALS COMPANY

A DIVISION OF P. R. MALLORY & CO., INC.
GENERAL OFFICE: 4242 W. Bryn Mawr Ave., Chicago 46, Ill.
Two RMC Plants Devoted Exclusively to Ceramic Capacitors
FACTORIES AT CHICAGO, ILL. AND ATTICA, IND.

Portable keypunch unit provides I/O functions



Varifab, Inc., 1700 E. Putnam Ave., Old Greenwich, Conn. (203) 637-1434. \$975.

Model 403 Vari-Punch punches standard 80-column cards or card sets, from equipment such as badge/card readers, minicomputers, time clocks or its own keyboard. It can also control other devices, like adding machines, through self-generated output signals. Data are punched at 12 characters per second. Speed exceeds three cards per minute.

CIRCLE NO. 278

Personality card stores program for tester

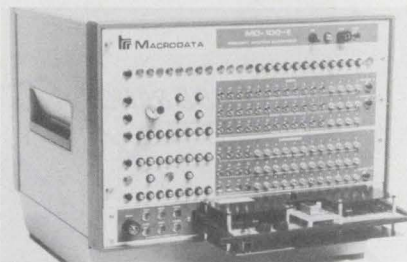

Macrodata Co., 20440 Corisco St., Chatsworth, Calif. (213) 882-8880. \$650.

"Personality cards" match the 1103-1 RAM and UAR/T control logic to the Macrodata memory tester, MD-100. Cards can also be obtained for most standard memory devices. Cards for new memory devices will be added to the line, as they appear. The company also offers a universal personality card, which may be configured by the customer. Each card has its own pass/fail indicators but needs a ROM to provide the specific test sequences.

CIRCLE NO. 279

Portable card punch enters data manually

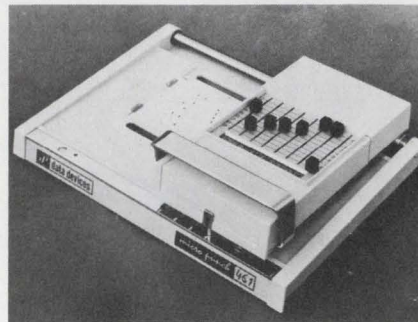

Data Products, 6219 DeSoto Ave., Woodland Hills, Calif. (213) 887-8000. \$395; 30 days.

A portable card punch for use in source data entry applications simultaneously punches up to eight columns of numerics on a standard 80-column tab card. It weighs less than eight pounds, and has printing and bar-program capabilities. The Micropunch 461 was previously marketed solely to end users rather than OEMs.

CIRCLE NO. 280

Multiple-Output Power Supply Assemblies

... shipped in only 9 days

Why get tied down with the details of designing and building power supply assemblies. Instead, let Acopian do it for you. Call us at (215) 258-5441 and tell us your requirements. We'll answer your questions, recommend the optimum complement of power modules, quote a firm price and assign a reference number for ease of requisitioning.

Your completely wired assembly will be shipped nine days after receipt of your order.

Acopian Corp., Easton, Pa. 18042
Telephone: (215) 258-5441

INFORMATION RETRIEVAL NUMBER 54

\$350.

the Elite*3 BREADBOARDING SYSTEM

Use it FREE for 5 days!

Design, test, layout and build circuits with any combination of components and modules... FREE!

This advanced concept circuit design test system features built-in independent circuit monitor lights, built-in isolated pushbuttons, toggle arrays, universal acceptance with ELI's SK-10, common hook-up wire interconnection and unlimited fan in/fan out capability. Try it absolutely FREE for 5 days. If not satisfied, return it and you won't be billed. Trying is believing! How can you go wrong?

Don't use the BINGO card... order now!

EL INSTRUMENTS, INCORPORATED
61 First Street, Derby, Conn. 06418
Telephone: 203/735-8774

INFORMATION RETRIEVAL NUMBER 55

ELECTRONIC DESIGN 11, May 25, 1972

Op-amp cost plummets with introduction of 2 quads

Motorola Semiconductor Products, 5005 E. McDowell Rd., Phoenix, Ariz. (602) 962-2292. \$1.75 (100). National Semiconductor Corp., 2900 Semiconductor Dr., Santa Clara, Calif. (408) 732-5000. 75¢ (100).

Introduction of the industry's first quad op amps—by Motorola and National—brings with it the lowest-cost op amp available—from National. Unlike Harris Semiconductor's PRAM, which allows the digital selection of one out of four op amps, the Motorola and National devices include four independent, internally compensated op amps.

Motorola's device, the MC 3401P, sells for \$1.75 in quantities of 100, while National's LM 3900 sells for 75¢ in the same quantities—which makes for the lowest-cost per op amp (less than 19¢ apiece). That's half to a third of the going price of 709s (which aren't internally compensated) and 741s (which are). The price gap between the Motorola and National quads suggests that an adjustment could be expected, especially since the devices appear quite similar.

Both are current amplifiers, rather than the usual voltage amplifiers. Both are single-ended, inverting amplifiers, but both provide

noninverting inputs through the use of a "current mirror," where current equal to that entering the noninverting input is pulled out of the inverting input and shunted to ground.

At 25 C, with a supply of +15 V, Motorola specifies a minimum low-frequency, open-loop gain of 1000, while National quotes 800. Typical unity-gain bandwidth in the inverting mode is 5 MHz for Motorola, 2.5 MHz for National.

Motorola quotes a typical slew rate of 0.6 V/μs (with a load of 5 k shunted by 100 pF and gain unspecified), while National quotes 0.5 V/μs (with load and gain unspecified, though National quotes output swing with a 5.1-k load).

Both units operate from a single supply (+5 to +18 V for Motorola, +4 to +36 V for National) and, though National's device can also operate with a dual supply, Motorola's unit cannot.

One big difference between the two quad op amps is that the National version contains an internal transient-sinking transistor (Q5 in the schematic) that can sink currents of over 40 mA. Motorola's device doesn't have this feature.

For Motorola **CIRCLE NO. 300**
For National **CIRCLE NO. 301**

Augat accessories give you more to plug in.

Wouldn't you know that Augat, the leader in wire-wrap panels, would come up with the most complete line of plug accessories around?

Like Augat interfacing plug assemblies for I-O connections. Or Augat adapter plugs to interpose discrete components or to let you build working modules on-the-spot. Or flat cable plugs with a unique "U" contact design for easy assembly without crimping, stripping or soldering. Plus header and jumper assemblies, too.

We'll also give you single-source supply for all panel interconnecting needs, including panels, sockets and enclosures. For quick information on price and delivery, call us at (617) 222-2202. Or write for our catalog. Augat Inc., 33 Perry Ave., Attleboro, Mass. 02703. Our representation and distribution is nationwide and international.

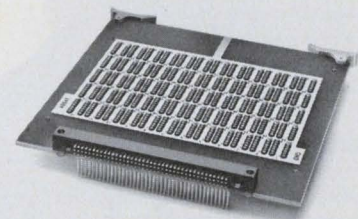

Plug into Augat®

See our new packaging developments at the NEPCON EAST Show, New York, Booths 4521-4523.

INFORMATION RETRIEVAL NUMBER 56

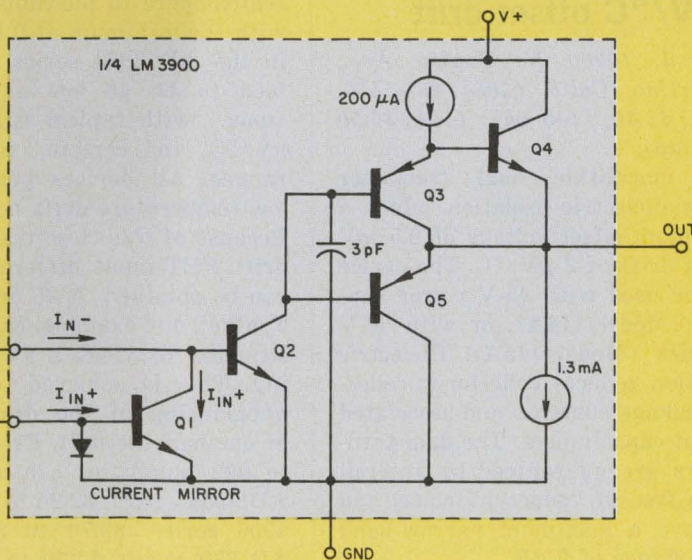

By connecting GND to V- and adding 2 resistors LM 3900 operates as a 741.

OPCOA

lamps and displays

with

SOLID-LITE

Gallium Phosphide LED's..

THE HIGH-EFFICIENCY DIODES FOR BRIGHT LIGHT AT LOW CURRENT.

New SOLID-LITE SLA-3 Numeric Display with 0.8-in. character

- Largest available solid state numeric display
- Low voltage operation compatible with TTL and DTL IC's
- Single-plane wide viewing angle
- High reliability—200,000-hr. half life
- Excellent shock and vibration resistance
- Thin package—0.100-in. lead spacing



New SOLID-LITE OSL-3 and -3L Lamps with exceptionally wide viewing angle

- Large 0.200-in. diameter lens with long or short dome
- Red or clear lens available
- Low voltage, low power operation
- Area light source—not a pinpoint
- IC compatible
- Excellent shock and vibration resistance
- High reliability—200,000-hr. half life
- Socket or soldered mounting—0.100-in. lead spacing
- Low cost

For technical information or applications assistance, contact OPCOA, Inc., 330 Talmadge Road, Edison, New Jersey 08817; (201) 287-0355; TWX 710-998-0555.

OPCOA

ICs & SEMICONDUCTORS

CMOS analog driver/SW has ± 15 -V signal range

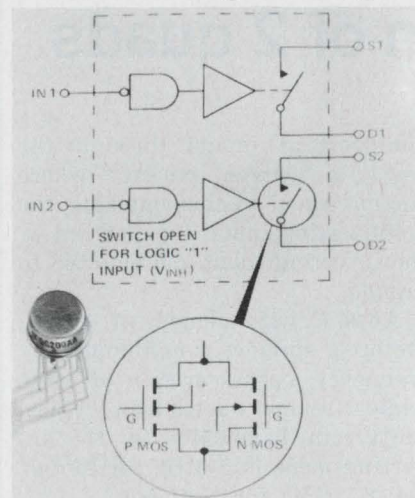

Siliconix Inc., 2201 Laurelwood Rd., Santa Clara, Calif. (408) 246-8000. Stock.

A dual SPST analog driver/switch combination employing complementary MOS (CMOS) technology offers a ± 15 -V analog signal range when ± 15 -V supplies are used. Designated the DG200, the transmission gate features break-before-make switching action, and t_{OFF} and t_{ON} ratings of 500 and 1000 ns at 25 C. The ON resistance, r_{DS} , is less than 100 Ω over the full signal and rated temperature range. In quantities of 100, prices are \$8.75 for the military version, \$3.50 for the industrial version.

CIRCLE NO. 302

Dual transistor boasts $2 \mu V/^{\circ}C$ offset drift

Intersil, 10900 N. Tantau Ave., Cupertino, Calif. (408) 257-5450. 115A, \$4.50, (100 up); 114A, \$5.50 (100 up).

A monolithic dual transistor using dielectric isolation offers a maximum offset voltage of 0.5 mV and a drift of $2 \mu V/^{\circ}C$. The device can be used with 45-V power supplies (Model 114A), or with 60-V supplies (Model 115A). Dielectric isolation reduces collector-to-collector leakage currents and associated output capacitances. The dual transistors are guaranteed by Intersil to be free of "popcorn" noise, and to have a maximum narrow-band noise figure of 2 dB.

CIRCLE NO. 303

ECL line compensates voltage and temperature

Fairchild Semiconductor Components Group, 464 Ellis St., Mountain View, Calif. (415) 962-3816. \$1.80 (100-999).

On-chip voltage compensation as well as temperature compensation is now featured in the company's 95100 line of emitter-coupled logic circuits. The on-chip voltage compensation provides noise margins between devices with supply voltage differentials ranging from -4.7 to -8 V. Temperature compensation on 95100 ECL devices assures constant noise margins between devices at more than 50 C temperature differentials. The first devices in the new line are three SSI gates—the 95102, 95103 and 95104 dual, triple and quad OR/NOR gates.

CIRCLE NO. 304

Dual JFETs boast low bias, low drift

Analog Devices, Inc., Route 1 Industrial Park, Norwood, Mass. (617) 329-4700. Stock.

A line of monolithic dual junction FETs, termed Trakfets, feature extremely low bias currents and extra low input drift characteristics. The new devices are available in the AD 3954 series—optimized for 200- μA drain-current operation—and the AD 5906 and AD 830 series—optimized for 30- μA drain-current operation. In the AD 830 series, leakages are in the femtoampere to picoampere region, with the minimum at 0.1 pA. Drift in the AD 3954 series is guaranteed to be as low as $5 \mu V/^{\circ}C$ (max.) with typical values of $1.1 \mu V/^{\circ}C$ in certain temperature ranges. All devices boast a very low temperature-drift nonlinearity. Because of this close tracking, low-drift FET-input differential amps can be obtained. A 25 or 50 $\mu V/^{\circ}C$ Trakfet, for example, can easily be adjusted to yield $1 \mu V/^{\circ}C$ tracking. This is achieved by a slight unbalancing of the drain current of one-half the unit. Prices for 100 to 999 quantities are as follows: AD 3954 series, \$2.25 to \$7.70; AD 5906 series, \$3.70 to \$13.60 and AD 830 series, \$4.50 to \$22.90.

CIRCLE NO. 305

256-bit read/write memory in CMOS

Solid State Scientific, Montgomeryville, Pa. (215) 855-8400. \$37.50 (100 up); stock.

A 256-bit read/write memory, the SCL 5553, is fabricated in CMOS. The IC features a power dissipation of less than 200 nano-watts/bit (around 60 μ W in the quiescent mode), supply range of 6 to 15 V and a typical access time of 100 ns (150 ns max). The memory is fully decoded and is organized as 256 words by 1 bit. A chip select strobe enables the memory array to be expanded in the word direction in increments of 256 words. Cycle times are less than 300 ns.

CIRCLE NO. 306

N-channel 1024-bit RAM has 85-ns access

Electronic Arrays, 501 Ellis St., Mountain View, Calif. (415) 964-4321. \$25 (100 up).

An n-channel silicon-gate 1024-bit RAM, the EA 1500, has an access time of 85 ns—that's four times the speed of a typical p-channel RAM. In active operation, the new RAM dissipates only 160 mW—35% to 40% of p-channel dissipation. In addition, it can be logically brought to "standby" between accesses by bringing all inputs to logic ZERO. This reduces standby power dissipation to 35 mW. Any address input to a memory module will turn on the EA 1500 in several nanoseconds.

CIRCLE NO. 307

Glass-coated transistor chips for hybrids

Dionics, Inc., 65 Rushmore St., Westbury, N. Y. (516) 997-7474. Stock.

Glass-coated versions of the company's leading transistor-chip series are now available for hybrid circuit applications. The transistors being offered with glass coatings include the npn 2N2222A, 2N2484 and 2N3725 families, and the pnp 2N2605 and 2N2907A series. The glass coating is a 7000-Å-thick deposition of Pyrolytic Oxide over the metalization in the active top area of the chip. Only the aluminum bonding pads remain exposed.

CIRCLE NO. 308

4 × 8-bit RAMs in CMOS

RCA/Solid State Div., Route 202, Somerville, N.J. (201) 722-3200. \$25 (1-99).

Two COS/MOS memories—the CD4036A for binary addressing, and the CD4039A for direct word-line addressing—are 4-word × 8-bit random access NDRO memories. Special features include

memory bit expansion, memory bypass capability for all bits, buffering on all outputs and memory word expansion via Wire-OR capability. The memories are intended for use in digital equipment where low power dissipation and/or high noise immunity are primary design factors. The CD4036A and CD4039A are currently available on a limited sampling basis in 24-lead DIPs.

CIRCLE NO. 309

Got Reject-itis from your tying operation?

Are you suffering through an extra amount of rejects? Things popping loose—work losing its shape after it comes off the board—vibration and heat causing havoc—systems and tools that tear up hands and tempers—that add too much weight and cost to the finished product? Tapes and ties that can't handle fungus or chemicals and refuse to hold a knot . . . ???



Want a better system?



TALK TO GUDEBROD!

Write to this address Now for prompt return of our Product Data Catalog

Electronics Division

Dept. 425

Gudebrod Bros. Silk Co., Inc. 12 South 12th Street, Philadelphia, Pa. 19107

INFORMATION RETRIEVAL NUMBER 58

NEW Low-Cost, 12-Bit A/D Converter



Takes Ratios Too!

ADC560-12C-E

- Fast — Converts in 20 μ S
- Input — 10V Range
- Compact — 2" x 4" x 0.4"
- Complete — Ready to Use

\$99.

in singles

Absolute and Ratio Measurements — The ADC 560 can operate as a conventional A/D converter with its own built-in reference . . . plus it can take measurements relative to an external signal. Perfect for transducer monitoring and signal processing applications of all kinds.

The unit is complete with built-in reference, logic, clocks, etc., with full DTL, TTL compatibility — all pretrimmed and ready to convert. Contact us for full details.

HYBRID SYSTEMS CORPORATION
87 Second Ave., Northwest Industrial Park, Burlington, Mass. 01803
Telephone: 617-272-1522 TWX: 710-332-7584

INFORMATION RETRIEVAL NUMBER 59

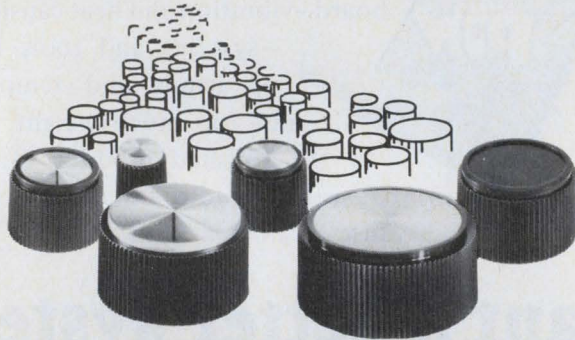

1,500,000

KNOB TO CHOOSE FROM...

and they're "Warranted for Life"

Kurz-Kasch has over 1½ million low cost, high quality knobs in inventory, ready to ship to you. (You save . . . no tooling cost on stock knobs, specials 4 to 6 weeks delivery.) Your local distributor's stock is available at factory prices. Select instrument and control knobs from 24 families with 367 basic sizes and shapes in general purpose phenolics, melamines and ureas. All Kurz-Kasch knobs are warranted for the life of the product on which they're used. Send now for free 20 page catalog. (Also found in THOMAS REGISTER "THOMCAT."®)



Kurz-Kasch, Inc.

1421 S. Broadway
Dayton, Ohio 45401
513/223-8161

INFORMATION RETRIEVAL NUMBER 60

MICROWAVES & LASERS

CO laser believed a commercial first

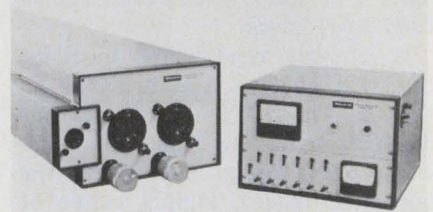

Molelectron Corp., 930 Thompson Pl., Sunnyvale, Calif. (408) 738-2661.

A CO laser system, the Model C200, is believed to be the first CO laser product supplied on a commercial basis. The complete system is capable of providing cw laser radiation at CO, CO₂ and N₂O emission lines. Stable single-mode output as well as multi-wavelength operation is available. The output is 20 W multi-line and 2 W single mode at the CO lines between 5 and 6 microns.

CIRCLE NO. 320

Optical components in variety of shapes

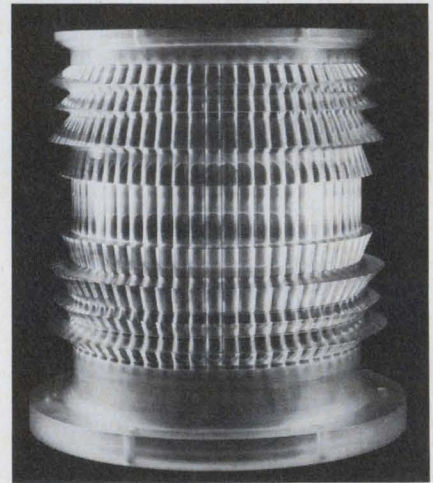

Applied Products Corp., 437 Caradean Rd., Horsham, Pa. (215) 675-1880.

Complex acrylic and polystyrene optical components with irregular configurations and complicated optical patterns can be custom machined in sizes from 4 to 78 inches \times 10-1/2 inches thick. The acrylic lens shown is 13 inches in diameter \times 13 inches high and has 53 internal axial flutes as well as 8 external peripheral facets. The complex lens is used as an infrared homing beacon for night operations.

CIRCLE NO. 321

Double balanced mixer operates at 0.01-4 GHz



Technical Research and Manufacturing, Inc., Kelly Ave., Grenier Field, Manchester, N.H. (603) 668-0120. \$190 (1-5); stock to 3 wks.

The Model MD-101 double balanced mixer provides 6.0 dB typical conversion loss over the frequency range of 10 MHz to 4 GHz. The i-f range is dc to 3 GHz and port-to-port isolation is 20 dB minimum. With 50- Ω input/output lines, the mixer can handle 400 mW of power and 50 mA of i-f current (maximum values). The unit is available with BNC, TNC and SMA connectors.

CIRCLE NO. 322

YIG discriminators cover 500 MHz to 18 GHz range



Advanced Microwave Labs., 825 Stewart Dr., Sunnyvale, Calif. (408) 245-5770. 45 to 60 days.

A line of voltage-tuned YIG discriminators, the D2201 series, operates from 500 MHz to 18 GHz. These devices present a linear frequency discrimination window that can be positioned anywhere in standard octave-frequency ranges. The discriminator window is 15 to 40 MHz wide depending on the band. Tuning linearity is better than 0.1%.

CIRCLE NO. 323

Solid-state limiter good at 1 GHz

Raytheon Co., Micro State Products, 130 Second Ave., Waltham, Mass. (617) 899-8080.

The new solid-state limiter, designed for use as a receiver protector, operates at 1.0 to 1.2 GHz. Designated the RLH-5011, it has an rf input capacity of 1 kW peak and 25 W average. Pulse width is 10 μ s. Isolation is 40 dB with in-

sertion loss of 0.3 dB, and the input VSWR is 1.30. Excluding connectors, the RLH-5011 measures 3-1/4 \times 1 \times 1 inches. The operating temperature range is -50 to +70 C. Connectors are Type N male for input and Type SMA male for output. The new device was designed specifically for use as a receiver protector in TACAN systems.

CIRCLE NO. 380

It Works Every Time...

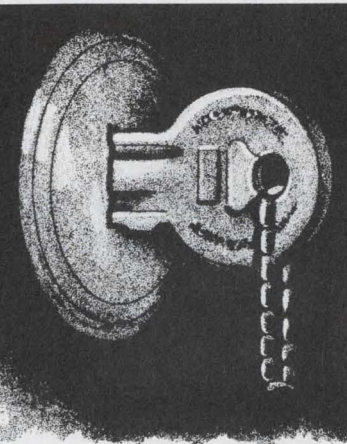

Durability testing is the reason why.

Stringent "in-process" quality control durability testing by Controls Company of America, a Division of the Singer Company, insures highest MTBF for their automobile electric switches.

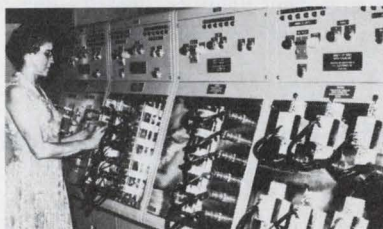

CCA's durability testing stands, manufactured by K. & L. Electronics, Inc., were designed to accept and test switches of several sizes, randomly selected from "in-process" production runs.

K. & L. Electronics required a compact, well-constructed, readily available, well-regulated power supply with low ripple. Electronic Measurements' SCR Power Supplies met these requirements.

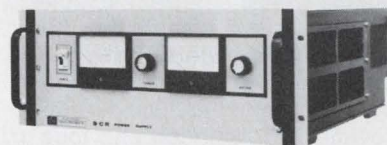

IF YOU DEMAND RELIABILITY AND NEED A LOW WEIGHT/SMALL SIZE, LOW RIPPLE, WELL-REGULATED POWER SUPPLY AT 2.5, 5 OR 10 KW . . . CALL TOLL FREE 800 - 631-4298, OR WRITE FOR OUR LATEST CATALOG.



ELECTRONIC MEASUREMENTS INC.

405 ESSEX ROAD, NEPTUNE, NEW JERSEY 07753

plug in at any circuit point

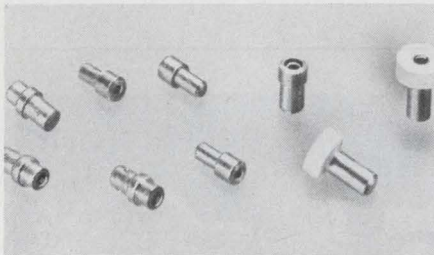

with Sealectro uninsulated individual sockets

- will accept test leads of .017" to .080" diameter
- long contact performance and life
- low electrical resistance
- high retention capabilities

Use these miniature individual sockets with the newest flexible circuitry or as receptacles for jack-in connections between components or chassis. Supercon contacts of beryllium copper provide high retention and long contact performance at low resistance.



Send today for
free catalog of
the complete
line of
Sealectro
Test Jacks
and
Test Points.



CIRCUIT HARDWARE DIVISION

INFORMATION RETRIEVAL NUMBER 62

PACKAGING & MATERIALS

Hot polyester offers new tradeoffs

General Electric Co., One Plastics Ave., Pittsfield, Mass. (413) 494-4803. In colors, 95¢/lb; natural, 85¢/lb. in truckloads; stock.

Combining high heat and flame resistance with fine moldability, lubricity, dimensional stability, solvent resistance and electrical properties, Valox 310-SEO includes no fillers (which make plastics more rigid but less ductile). The thermoplastic polyester meets UL's SE-0 requirements for self-extinguishment and no dripping after a flame is removed. It's thus superior to nylon, though slightly more costly. It's similarly superior to and more expensive than unreinforced, self-extinguishing polypropylene, which lacks heat resistance and toughness.

CIRCLE NO. 324

IC thick film packages offer hermetic sealing

Du Pont Co., 11444 Nemours Bldg., Wilmington, Del. (302) 774-2358.

A fully hermetic sealing system useful with silver/tin preforms satisfies MIL STD 883, Class A and promises to significantly reduce total package costs by as much as seven cents in lid and preform expense. Also, the first IC package ever to offer circuit elements on both sides of the ceramic substrate opens the door to more compact, lower cost hybrid circuitry.

CIRCLE NO. 325

Rubber heating blanket resists breakage

Tayco Engineering, Inc., 441 E. 4th St., Long Beach, Calif. (213) 427-0387. \$5; 2-3 wks.

A rugged line of flexible, vulcanized rubber, electric heating blankets, Tay-Flex, defies breakage of the heating wire under continuous bending and flexing. This is attributed to the design of the resistance wire, which is wound around a core of fiber glass in a helix configuration, so the wire simply expands as a spring and relocates around the fiber glass core without kinking or fracturing.

CIRCLE NO. 326

COMPONENTS

Adjustable inductor fits DIP socket

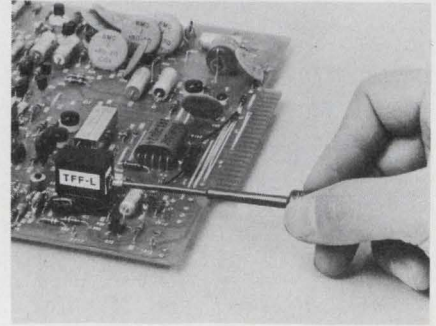

The Five Friends, P.O. Box 7541, Stanford, Calif. (415) 326-3377. \$22.00 (unit).

The TFF-L-V10/20 semiconductor plugs into a standard DIP socket for circuits that were previously impractical because of unrealizable L. Type V10 is adjustable over a 10% range and type V20 over a 20% range in sizes from 10 mH to 10 H. The unit, 0.78 × 0.56 × 0.49 in. weighs less than 10 grams, and operates from ±12 V to ±20 V, or +24 to +40 V unipolar. Setting may be manual, or automatic by voltage control.

CIRCLE NO. 327

Keyboard array offers many satellite clusters

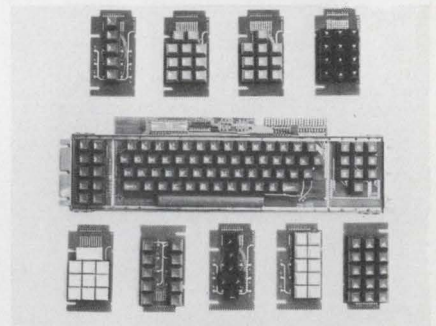

Mechanical Enterprises Inc., 5249 Duke St., Alexandria, Va. (703) 751-3030. \$87.15 (500 and up).

Ten types of alphanumeric arrays and over 100 combinations of satellite clusters designated, Uni-cluster, are offered. The assembly is mounted in a steel frame, and all outputs terminate at a single card edge. Keyswitches use a bounce-free, long-life, mercury switch sealed in a flexible tube. With MOS/LSI encoding logic, the assemblies provide two-key rollover and tri-mode or quad-mode shifting.

CIRCLE NO. 328

evaluation samples

Slide and rocker switches

UID slide and rocker switches are available with the new U.L. TV-1 and TV-2 listings. The company claims that this is the first time a TV-2 rated rocker switch has ever been offered in the very economical 24¢ price range. UID Electronics Corp.

CIRCLE NO. 329

Cable ties

A line of AMP-TY nylon cable ties incorporates dual stainless steel pawls to provide up to twice the bundling tensile strength of all-plastic cable ties. The ties are available in the four sizes to accommodate bundles from 1/16 to 4 inches diameter, with each size being infinitely adjustable within its range. AMP Inc.

CIRCLE NO. 330

Fastener components

A sample board contains physical samples of 24 popular fastener and holding components. The 10 × 14-in. board, which is suitable for wall mounting, includes such devices as PCB supports and guides, spacers, clamps, clips, bushings, perforated straps, wire ties, hangers, wire saddles, harness wrapping, grommets and idler pulleys. Richco Plastic Co.

CIRCLE NO. 331

Adhesive-backed material

Seventeen samples of adhesive-backed materials are presented in a new four-page catalog. The catalog presents specifications and information regarding the complete range of materials, adhesives and fabricating services available. Decofelt Corp.

CIRCLE NO. 332

Coil bobbins

Coil bobbins of fiberglass laminated epoxy are molded in thousands of sizes from open stock tooling in thicknesses from 5 mil up. Lengths up to 18 inches are available. Stevens Products, Inc.

CIRCLE NO. 333

application notes

Tracking a/d converters

A new 8-page application note provides complete details on the design, construction and performance of a compact high-performance 8-bit tracking a/d converter. Operation in military applications may be obtained by simply specifying suitable military temperature range components. A complete components list and full size P.C. board layout is provided to enable construction in minimum time. Precision Monolithics, Inc., Santa Clara, Calif.

CIRCLE NO. 334

Phase jitter

A four-page applications note, "The Effect of Channel Noise and Other Additive Signals on the Measurement of Phase Jitter," presents a factual discussion of the various causes of channel noise and "T" carrier quantizing noise and the relationship of each to the measurement objectives. Hekimian Laboratories, Inc., Rockville, Md.

CIRCLE NO. 335

Filter response

"Phase and Amplitude Response of a Variable Electronic Filter" is the title of a new 16-page application note (IAN-101). A simple, general method for determination of phase and amplitude response of high-pass, low-pass, and band-pass filters is provided for four-pole Butterworth and Bessel Filters. Ithaco Inc., Ithaca, N.Y.

CIRCLE NO. 336

Measuring impedance

A two-page application note, AN-102, describes the use of two-phase lock-in amplifiers to measure the complex impedance of semiconductor junctions at specific frequencies. Use of the lock-in amps permit simultaneous determination of in-phase and quadrature components of junction impedance. Princeton Applied Research Corp., Princeton, N.J.

CIRCLE NO. 337

POWERTEC

XR

SERIES

DC POWER MODULES



for low power applications

from **\$41.⁵⁰**
(with OVP)

This standard series high performance power module line offers 36 different low power outputs from three small case sizes. The enclosed modular design offers light weight and rugged construction.

EXCLUSIVE FEATURES:

- High grade military and computer components throughout.
- 40 to 50% smaller than competitive models.
- Full power rating to 71°C.
- Over Voltage Protection standard on all models.
- All models deliverable in 24 hours.

SPECIFICATIONS:

- Input: 115 VAC ±10% 47 to 440 Hz;
- Outputs: From 5 to 28 VDC, Current to 3 AMPS;
- Ripple: 1 MV RMS;
- Response: 20 to 50 μsec typical;
- Temperature: 0°C to 71°C;
- Foldback current limiting overload Protection.

The best power/cost ratios in the industry... consistently from Powertec. Write or call for our new catalog.

POWERTEC, INC.

An Airtronics Subsidiary
9168 DeSoto Ave., Chatsworth, Ca. 91311
(213) 882-0004 TWX (910) 494-2092

POWERTEC

INFORMATION RETRIEVAL NUMBER 63

NEW...

A complete family of low cost,
high performance packaged
AC-DC regulated power supplies



**"THE
PRACTICALS"**TM

... they make
systems engineers
cost-efficiency
experts!

FROM **\$39⁷⁵**

10 combined units.
OEM quantity prices upon request.

- Out-specs all comparatively priced units.
- Available in single, dual, triple, and quadruple models.
- Immediate delivery from inventory.
- 5-28 volts standard. Other voltages available.
- Single input standard. Dual output available.
- Remote sensing standard.
- Overvoltage protection either standard or at slight additional cost.

**U.L. APPROVED
5-YEAR WARRANTY**

Call, wire, or write today
for complete specs.

TECHNIPOWER
A BENRUS SUBSIDIARY

Benrus Center, Ridgefield, Ct. 06877
203-438-0333
TWX: 710-467-0666

INFORMATION RETRIEVAL NUMBER 64

new literature



Time code references

A complete reference book of time code formats gives drawings and characteristics of about two dozen of the most commonly-used codes, including the IRIG standards, NASA, various range codes and special serial codes. All codes conform to Document 104-70. A glossary of terms, abbreviations and reference is included. Datum, Timing Div., Anaheim, Calif.

CIRCLE NO. 338

Test instruments

A 12-page catalog describes four lines of electronic test instruments. Descriptive copy, photos and specifications are given for a series of fully automatic counters, a series of universal counter/timers, two series of five-digit voltmeters, two series of four-digit voltmeters, a series of three-digit voltmeters, two series of data amplifiers and a series of frequency synthesizers. Dana Laboratories, Irvine, Calif.

CIRCLE NO. 339

Data storage

Application Note 133-3, "A Guide to Using Data Storage," describes the many advantages of a data storage option. Specific applications in three categories are discussed: A to D conversion, high-speed scanning and DVM measurement speeds independent of system speeds. Operation with various DVM plug-ins and advantages of sample-and-hold are discussed. This new 14-page booklet contains 30 illustrations. Hewlett-Packard Co., Palo Alto, Calif.

CIRCLE NO. 340

Transistor chips

A transistor chips catalog describes a series of standard chips including FETs, PNP and NPN switching transistors, integrated choppers and monolithic interface circuits. These chips can be supplied in the following forms: probed chips, 100% tested pre-mounted chips and carrier-mounted chips. Teledyne Crystalonics, Cambridge, Mass.

CIRCLE NO. 341

Analog Devices guide

A 180-page guide provides descriptions and prices of converter, amplifier and linear ICs, digital panel meters, function modules and accessories. The guide also classifies products, presents extensive selection criteria and offers interpretative commentary relevant to optimum product choice. Analog Devices, Inc., Norwood, Mass.

CIRCLE NO. 342

TO-5, TO-18 sockets

Bulletin No. 7002 describes series sockets 131-55 for TO-5 and TO-18 devices. The bulletin contains material descriptions, line drawings, specifications and a photograph of the sockets. The sockets are usable on a wide variety of production applications. The series sockets 131-55 are designed to press fit into a double-D shaped chassis hole or dip solder to the top of a printed circuit board. The socket leads can be both hand or flow soldered. Barnes Div. of Bunker-Ramo Corp., Lansdowne, Pa.

CIRCLE NO. 343

Large core store

A brochure describes an extended core memory system capable of increasing the performance and lowering the cost of IBM's System/360 computer. The six-page brochure outlines the System/6000 large core store for use with IBM System/360, Models 50 and up. Data Products, Woodland Hills, Calif.

CIRCLE NO. 344

Digital tape unit

A 4-page brochure describes operations and specifications of the Model TMX digital tape unit. The TMX is a compact and reliable unit offering 7 or 9-track recording at speeds up to 25 inches per second for use with minicomputers, data terminals and acquisition systems. Ampex Corp., Redwood City, Calif.

CIRCLE NO. 345

Linear IC handbook

A new 304-page Linear Integrated Circuit Applications Handbook provides a fully indexed and cross-referenced collection of linear applications using both monolithic and hybrid circuits. Product areas covered include regulators, op amps, comparators, JFET amplifiers, analog switches, pin diode drivers and phase locked loops. Applications span a wide range of areas including instrumentation communications, consumer and high reliability military. National Semiconductor Corp., Santa Clara, Calif.

CIRCLE NO. 346

Opto-electronics guide

A 4-page selection guide contains information on LEDs, couplers and detectors. General Electric, Cleveland, Ohio

CIRCLE NO. 347

Coax components

A new 36-page booklet describes hundreds of components and accessories for high-frequency applications to 9 GHz. Included are complete and highly detailed specifications for general-purpose and precision 50- Ω and 75- Ω connectors, adapters, attenuators, terminations, 2 and 3-port coupling elements, cables, air lines and a unique broad-band directional coupler. General Radio, Concord, Mass.

CIRCLE NO. 348

GaAs and GaP lamps

A 4-page brochure describes gallium arsenide and gallium phosphide solid-state lamps. Application concepts and specifications are given. General Electric, Cleveland, Ohio

CIRCLE NO. 349

Compare Maxi-Mox to whatever resistor you're using now.

Our Metal Oxide Resistors Offer You Small Size and Reliability at High Voltage.

Compare our Maxi-Mox with a wire wound resistor. Stability and power capability are equal but they are about half the size of a comparable wirewound and give you far greater stability and service life at high voltage.

Maxi-Mox resistors have resistance and voltage capabilities that far exceed metal film types. And size . . . Maxi-Mox resistors are three to ten times smaller than comparable value metal film units.

It hardly bears mentioning, the capabilities of Maxi-Mox far exceed those of carbon film resistors.

If you're looking for a reliable, small size resistor for high voltage applications such as divider circuits, bleeders, meter multipliers, high voltage probes, oscilloscopes, vacuum tube voltmeters, plate load resistors, pulse forming networks or similar applications, don't overlook the advantages of Maxi-Mox.

Maxi-Mox is available for fast delivery from stock in five standard sizes. With 100 ppm TCR available.

Model	Resistance Range	Power Rating @ 70°C	*Max. Oper. Volts	Length Inches	Diameter Inches
MOX-1	10K— 500 megs	2.50W	7,500V	1.062	.284
MOX-2	20K—1000 megs	5.00W	15,000V	2.062	.284
MOX-3	30K—1500 megs	7.50W	22,500V	3.062	.284
MOX-4	40K—2000 megs	10.00W	30,000V	4.062	.284
MOX-5	50K—2500 megs	12.50W	37,500V	5.062	.284

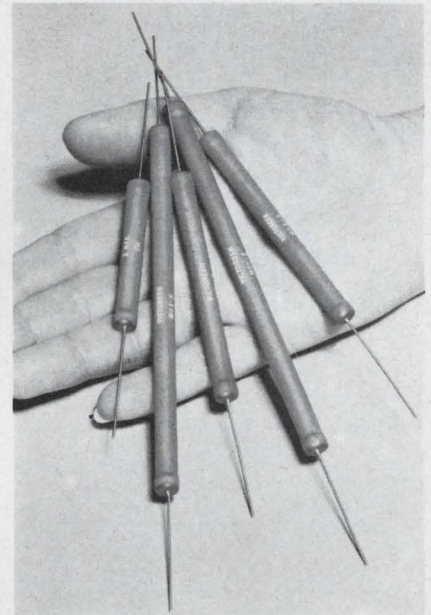

For detailed specifications on Maxi-Mox send for this technical bulletin. Victoreen Instrument Division of VLN Corp., 10101 Woodland Ave., Cleveland, Ohio 44104. Telephone 216/795-8200

DMA 685

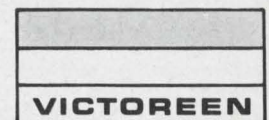

Expertise in high voltage.

FOR IC & MOS DRIVERS



3 AMP SENSITIVE GATE TRIACs

- 3mA, 4mA, 5mA, 10mA & 25mA (I_{GT}).
- All quadrant gating
- 50V to 600V (V_{DROM})
- Glass-passivated chips
- Di-Mesa* Construction
For improved operational reliability

Also from Hutson:
4 Amp Sensitive Gate
SCR's. 200 μ A & 1mA
(I_{GT}). 50V to 600V (V_{DROM})

Hutson's complete line includes:

- Ratings to 40 Amp [$I_{T(RMS)}$]
- All popular packages plus chip form TRIAC's & SCR's.
- Center-gate, shorted-emitter design
- Void-free, glass-passivated chips



*T.M. HUTSON INDUSTRIES

HUTSON INDUSTRIES

BOX 34235 • 2019 W. VALLEY VIEW
DALLAS, TEXAS 75234 (214) 241-3511
TWX 910-860-5537

Distributed by:

BODELLE CO., INC., Chicago, Ill. 312/468-1016
Detroit, Mi. 313/273-6920 ■ NEWARK ELECTRONICS
CORP., Inglewood, Cal. 213/678-0441
THOR ELECTRONICS, Elizabeth, N.J. 201/354-2420
Canada: WEBER-SEMAID ELECTRONICS, Downsview, Ont.

European Marketing Director:

30 Rue Pierre Semard, Yerres, 91 France
Tel: Paris 925-8258 TELEX 21-311

Distributed in Europe by:

Switzerland: D. LEITGEB, Dubendorf
Sweden: ELEKTROFLEX, Sundbyberg
Spain: BELPORT, Madrid
Holland: RODELCO, Den Haag

NEW LITERATURE

Transistor references

A completely revised 64-page "Semiconductor Cross Reference and Transistor Data Book" contains over 35,000 listings, including 10,000 types not previously shown. Types included are transistors, diodes, zeners, capacitors, rectifiers and SCRs. Specifications, electrical characteristics and outline drawings are given for the line of silicon and germanium transistors. The cross reference book features new "computer logic" sequencing of listings, which makes it faster and easier to use. International Rectifier Corp., El Segundo, Calif.

CIRCLE NO. 350

Data conversion

A 14-page short form catalog contains electrical and mechanical information on dc amplifiers, dc power supplies, dc-dc converters plus a/d and d/a converters. The hardware described forms the basic building blocks for many forms of data acquisition, data analysis, data reproducing and graphic display equipment. Datel Systems, Inc., Canton, Mass.

CIRCLE NO. 351

Lasers

An illustrated catalog shows seven laser models—including a new modulated laser—and a wide range of accessories to extend their use for education and research. The catalog describes low-cost education kits which capitalize on laser light to teach optics and light theory. Other pages carry descriptions of holographic equipment, laser kits, accessories and optics bench equipment. Metrologic Instruments, Inc., Bellmawr, N.J.

CIRCLE NO. 352

Quartz crystal filters

A revised catalog brings within one compact volume information on the extensive range of SEI quartz crystal filters. Salford Electrical Instruments Ltd., Manchester M30 OHL, England.

CIRCLE NO. 353

Solid-state pushbuttons

A 16-page brochure describes the company's full line of solid-state pushbuttons. Product brochure SN lists features, typical applications, switching concept, operating characteristics, reliability, performance parameters, electrical data and general calculations for interfacing. It describes lighted and unlighted direct printed circuit board mounting modules and panel mounted modules, button varieties (shapes, legends and colors) and ordering information. Micro Switch, Freeport, Ill.

CIRCLE NO. 354

Heat sinks

The 1972 short-form catalog of heat sinks and dissipators for transistors and ICs presents concise information including thermal test curves on the broadest line of such devices in the industry. The edition features a variety of new models specially configured for DIP packages, double DIP, square metal packages and many other new ICs and hybrids. International Electronic Research Corp., Burbank, Calif.

CIRCLE NO. 355

Epoxy FETs, bipolars

A new catalog listing operating parameters of more than 100 types of epoxy-encapsulated field-effect and bipolar transistors is available. The catalog also covers plastic semiconductors produced by Siliconix, Inc. and Ledel Semiconductors, Inc. The catalog contains a detailed FET cross-index, in addition to data on general-purpose, switching, RF FETs and NPN/PNP bipolar devices. Siliconix Inc., Santa Clara, Calif.

CIRCLE NO. 356

New Teledyne quarterly

A quarterly magazine contains technical articles and new product information pertinent to the field of analog switching. RF tuning and low noise amplification. Also included are application stories and a short circuits department. Teledyne Crystalonics, Cambridge, Mass.

CIRCLE NO. 357

MOS testing procedures

A 4-page application note describes test procedures used on the MK4006P and MK4008 MOS RAMs. The tests are all performed under worst-case address change, refresh, and other applicable conditions. Mostek Corp., Carrollton, Tex.

CIRCLE NO. 358

Used computer prices

The spring issue of the "Computer Price Guide," the Blue Book of Used Computer Prices, lists current market prices for all classes of used computers. While a large number of its 28 pages are devoted to IBM equipment, computers of every major manufacturer are represented. TBI Equipment Div., Elmsford, N.Y.

CIRCLE NO. 359

Microwave devices

A 24-page catalog describes a broad line of octave and multi-octave solid-state switches, limiters and switch and limiter modules. Both single and multi-throw switches, as well as a series of TTL compatible switch drivers are included in the new catalog. Crown Microwave, Inc., Burlington, Mass.

CIRCLE NO. 360

Computer terms glossary

A revised and updated pocket size Glossary of Computer Terms includes definitions of computer acronyms frequently encountered in the computer industry. General Automation, Inc., Anaheim, Calif.

CIRCLE NO. 361

Data communication tips

An illustrated 14-page brochure entitled "Mr. Datafella's Dilemma and How the Man from Tran Tamed the Trunk Dragon" provides the vehicle for a fun trip through one man's data communications nightmare and his awakening. The booklet probes seven common data-distribution problems and demonstrates networking techniques that eliminate "on-site" data sets and provide unlimited expansion capabilities and data communications for all kinds of low, medium and high-speed terminals. Computer Transmission Corp., Los Angeles, Calif.

CIRCLE NO. 362

National MOS/LSI

The 280-page MOS/LSI data catalog provides complete specification data for all MOS RAMs, ROMs, shift registers, clock drivers, analog switches, character generators, code converters and logic elements. The catalog also contains application notes and briefs for a variety of MOS functions. National Semiconductor Corp., Santa Clara, Calif.

CIRCLE NO. 363

Solid-state publications

The Solid-State Technical Publications, Form No. SMF-109, describes the broad range of technical publications on solid-state devices. These publications include the new Databook series, technical manual series, a reference handbook on solid-state power circuits and a variety of catalogs and brochures. They provide information on the theory of operation, mounting and handling techniques, circuit applications and definitive ratings and characteristics. RCA Solid State Div., Somerville, N.J.

CIRCLE NO. 364

Power modules

A comprehensive 56-page catalog describes and illustrates complete lines of power modules and has complete electrical specifications, operating parameters, dimension charts and prices. Three types of power conversion are covered in the catalog for military, aerospace and commercial applications. They are ac to dc, dc to ac and dc to dc. Abbott Transistor Labs, Inc., Los Angeles, Calif.

CIRCLE NO. 365

Burroughs newsletter

Readout, a monthly newsletter, is designed to open another communications link between the display manufacturer and the OEM building displays into his equipment. Readout will describe interesting or novel applications selected to stimulate ideas and to give others an opportunity to see how application problems are solved. Product line changes, new products and general news items will be included. Readout, Burroughs Corp., Plainfield, N.J.

CIRCLE NO. 366

NEW!

- Simplify design
- Reduce manufacturing costs
- Eliminate one or more power supplies

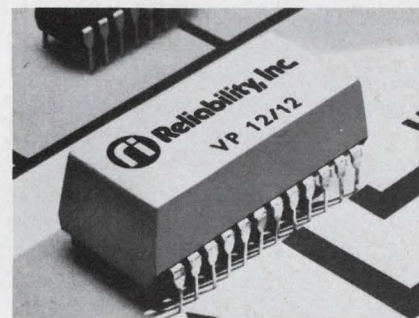

with the V-PAC* POWER SOURCE

Now use standard +5v supply for MOS, too, with the V-PAC power source. Less than one-third cubic inch, standard DIP pin configuration, it mounts on the same PC card with MOS and ICs, even with boards on half-inch centers. Get performance and reliability, too.

Type:	VP5	VP10	VP12	VP14	VP15
Voltage/s:	±5	±10	±12	±14	±15

VP10/10	VP12/12	VP14/14	VP15/15
±10/±10	±12/±12	±14/±14	±15/±15

Write or call for full specs, name of nearest sales representative. Include applications and voltages required.



Reliability, Inc.

5510 Greenbriar, Houston, Texas
77005 • 713-529-5817

TWX: 910-881-1739 *TM, Reliability, Inc.

INFORMATION RETRIEVAL NUMBER 67

bulletin board

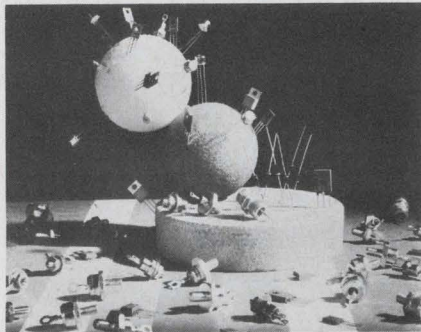

The Electronic Components Group of **GTE Sylvania Inc.** has added several new families of solid-state devices, designed for industrial applications, to its **ECG semiconductor replacement line.** The added industrial families include: ECG 5000 series of zener diodes ranging from one-half to 50 W; ECG 5400 series of SCRs from a sensitive 800 mA unit to a rugged 35 A device; ECG 5600 and 5700 series of triacs having current ratings from 2.5 to 40 A; ECG 5800 series of axial lead rectifiers varying from 50 to 1000 V peak reverse voltage, stud-mounted rectifiers ranging from 3 to 70 A with reverse polarity basing construction, and ECG 6400 series which comprises special devices such as silicon unilateral, bilateral and asymmetrical switches; diacs, programmable and non-programmable unijunction transistors.

CIRCLE NO. 367

Price reductions

General Instrument Corp. has reduced the price, by up to 33%, of its **Disstor Model 500 FR**, a 19-inch, RETMA, rack-mounted fixed-disc memory. New prices will range from \$2400 to \$4300 per unit in OEM quantities.

CIRCLE NO. 368

Inselek has announced a general price reduction in its **silicon-on-sapphire wafer products.** Standard products, 1 μ SOS films with tight control on doping density, can now be purchased in quantity for less than \$15.00/wafer.

CIRCLE NO. 369

vendors report

Annual and interim reports can provide much more than financial-position information. They often include the first public disclosure of new products, new techniques and new directions of our vendors and customers. Further, they often contain superb analyses of segments of industry that a company serves.

Selected companies with recent reports are listed here with their main electronic products or services. For a copy, circle the indicated number.

Sprague Electric Co. Capacitors, semiconductors and ICs, resistors, network assemblies.

CIRCLE NO. 370

Zenith Radio Corp. Consumer-electronic equipment, acousto-optic components.

CIRCLE NO. 371

Amp, Inc. Connectors and interconnection systems, programming systems, power supplies.

CIRCLE NO. 372

Belden Corp. Wire and cable.

CIRCLE NO. 373

National Cash Register Co. Business computers and data terminals.

CIRCLE NO. 374

Burroughs Corp. Computer systems and subsystems, terminals, encoders.

CIRCLE NO. 375

The Bunker-Ramo Corp. (Amphe-nol) Connectors and interconnection systems, lighted pushbutton switches, keyboards, trimming resistors and potentiometers.

CIRCLE NO. 376

Analog Devices, Inc. Function modules and ICs.

CIRCLE NO. 377

The Foxboro Co. Process-control instrumentation (pneumatic and electronic).

CIRCLE NO. 378

CTS Corp. Variable resistors, selector switches, loudspeakers, thick-film hybrid networks, quartz crystals.

CIRCLE NO. 379

Electronic Design

ELECTRONIC DESIGN's function is:

- To aid progress in the electronics manufacturing industry by promoting good design.
- To give the electronic design engineer concepts and ideas that make his job easier and more productive.
- To provide a central source of timely electronics information.
- To promote communication among members of the electronics engineering community.

Want a subscription? ELECTRONIC DESIGN is sent free to qualified engineers and engineering managers doing design work, supervising design or setting standards in the United States and Western Europe. For a free subscription, use the application form bound in the magazine. If none is included, write to us direct for an application form.

If you do not qualify, you may take out a paid subscription for \$25 a year in the U.S.A., \$35 a year elsewhere. Single copies are \$1.50 each.

If you change your address, send us an old mailing label and your new address; there is generally a postcard for this bound in the magazine. You will have to requalify to continue receiving ELECTRONIC DESIGN free.

The accuracy policy of ELECTRONIC DESIGN is:

- To make diligent efforts to ensure the accuracy of editorial matter.
- To publish prompt corrections whenever inaccuracies are brought to our attention. Corrections appear in "Across the Desk."
- To encourage our readers as responsible members of our business community to report to us misleading or fraudulent advertising.
- To refuse any advertisement deemed to be misleading or fraudulent.

Microfilm copies are available of complete volumes of ELECTRONIC DESIGN at \$19.00 per volume, beginning with Volume 9, 1961. Work is now in process to complete the microfilm edition of Volumes 1-8. Reprints of individual articles may be obtained for \$2.00 each, prepaid (\$.50 for each additional copy of the same article) no matter how long the article. For further details and to place orders, contact the Customer Services Department, University Microfilms, 300 North Zeeb Road, Ann Arbor, Michigan 48106 telephone (313) 761-4700.

Want to contact us? If you have any comments or wish to submit a manuscript or article outline, address your correspondence to:

Editor
ELECTRONIC DESIGN
50 Essex Street
Rochelle Park, N.J. 07662

Electronic Design

Advertising Sales Staff

Bryce Gray
Sales Manager

Rochelle Park, N.J. 07662

Robert W. Gascoigne
Daniel J. Rowland
50 Essex Street
(201) 843-0550
TWX: 710-990-5071

Philadelphia

Thomas P. Barth
50 Essex Street
Rochelle Park, N. J. 07662
(201) 843-0550

Boston 02116

Richard L. Green
20 Columbus Avenue
Boston, Mass.
(617) 894-2700

Chicago 60611

Thomas P. Kavooras
Berry Conner, Jr.
200 East Ontario
(312) 337-0588

Cleveland

Thomas P. Kavooras
(Chicago)
(312) 337-0588
(call collect)

Los Angeles 90303

Stanley I. Ehrenclou
Burt Underwood
2930 Imperial Highway
Inglewood, Calif
(213) 757-0183

San Francisco 94022

Jerry D. Latta
95 Main Street
Los Altos, Calif.
(415) 941-3084

London W. 1

For United Kingdom and Holland
Brayton C. Nichols
For Eastern Europe
Peter Kehr

The American Magazine Group
27 Maddox Street
London, W. 1, England
Phone: 499-0180
Cable: Ammagnic, London

Verviers, Belgium

For Continental Europe
Andre Jamar
1, Ru Mallar, 1
(087) 253.83 Telex 41563

Tokyo

Haruki Hirayama
Electronic Media Service
5th Floor, Lila Bldg.,
4-9-8 Roppongi
Minato-ku
Phone: 402-4556
Cable: Electronicmedia, Tokyo



NEW LOW COST DIP PACKAGED DOUBLY BALANCED MIXER (.2 - 500 MHz)

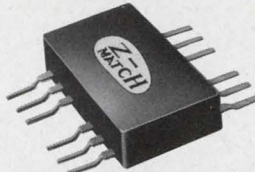

The new Z-Match Model DBM-166 is offered for low cost general purpose use in CATV translators; low cost receivers; modulators; and other commercial communication equipments. Mil grade Schottky barrier diodes and specially designed Z-Match wideband transformers are used in this unique low cost unit. Operation is specified for rugged environments from -55°C to $+100^{\circ}\text{C}$.
Overall Frequency Range: R and L Ports .2 - 500 MHz
X Port DC - 500 MHz

PERFORMANCE SPECIFICATIONS (Typical*)

OPERATING RANGE	CONV. LOSS SSBNF	INTERPORT ISOLATIONS		
		LO - RF	LO - IF	RF - IF
1-100 MHz	6.0 dB	40 dB	35	30
1-400 MHz	7.5 dB	30 dB	25	20
.2-500 MHz	9.0 dB	30 dB	20	15

* LO Power Level: +7 dBm; RF Power Level: -10 dBm

TYPICAL APPLICATIONS:

- AM, pulse and bi-phase modulators
- Fast rise time SPST switch
- Wide dynamic range front-end frequency up/down converters
- Locked loop phase detectors

Price: (1-24, \$15.00) (100-999, \$6.95)

Complete specifications are available in Bulletin #106-C

VARI-L Company, Inc.

3883 Monaco Parkway
Phone: (303) 321-1511

Denver, Colorado 80207
TWX: 910-931-0590

INFORMATION RETRIEVAL NUMBER 68

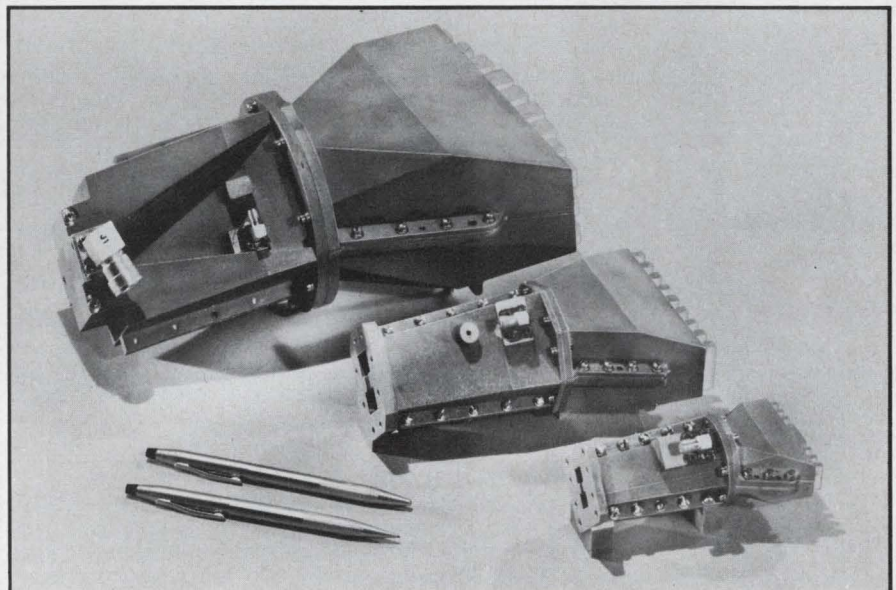

ECM Transmitting Antennas



ECM Transmitting Antennas...asymmetrical patterns, circularly polarized, high power, octave bandwidth, military environment. Request our catalog, over 25 other antenna types.

Transco Products, Inc., 4241 Glencoe Ave., Venice, Calif. 90291

INFORMATION RETRIEVAL NUMBER 69

Design Data from Manufacturers

Advertisements of booklets, brochures, catalogs and data sheets. To order use Reader-Service Card.
(Advertisement)

Free Wallchart Of Waveform Comparisons

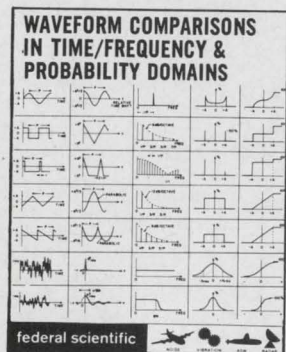

For analyzing random data such as noise, vibration, shock, underwater acoustic signals, and radar, this unique new engineering tool is a convenient picture-reminder of how 10 different basic waveforms look in terms of 5 different processing domains. The waveforms consist of 5 examples of repetitive waveshapes & 5 different random signals. The typical functions shown are: time, auto-correlation, averaged frequency spectrum (PSD), probability density, & cumulative distribution. Printed on heavy glossy stock, the 10" x 12" wallchart is free by writing directly to Federal Scientific, originators of the Ubiquitous® brand of real-time spectrum analysis equipment.

FEDERAL SCIENTIFIC CORP.

CIRCLE NO. 171

a subsidiary of Elgin National Industries, Inc.
615 West 131st Street, New York, N.Y. 10027

1972 Electronic Components Drafting Aids Catalog

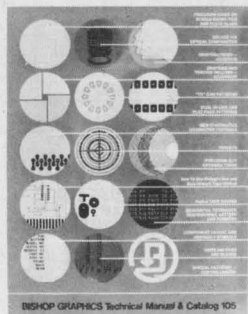

Free Catalog! Free Samples! Exciting innovations in pressure-sensitive electronic component drafting aids and methods are detailed in the new 1972 edition of the combined Bishop Technical Manual and Catalog 105.

84 illustrated pages of over 15,000 multi-pad configurations, symbols, tapes, sequential reference designations plus hundreds of time-and-money saving hints in making artwork for PC boards. Includes instructions for using the industry's only red and blue tape system for making two-sided boards in perfect registration. Send now for free Catalog 105 and free samples.

Bishop Graphics, Inc.

CIRCLE NO. 172

7300 Radford Avenue, North Hollywood, California 91605
(213) 982-2000 Telex: 674672

Automatic Crossover Power Modules



With the PTR Design, Kepco, Inc., offers six OEM power modules in the ranges 0-7V/5.5A to 0-100V/0.6A with a monolithically controlled automatic crossover system for the control of either voltage or current. You get the full output over a temperature span from -20°C to +71°C with no derating for temperature!

PTR power modules are meant for systems compatibility. Both the voltage and the current stabilization levels are programmable (digitally if you use the Kepco low-cost SN programmers); a "flag signal" is fed back so your system can know which mode is operative.

The Kepco PTR power modules cost \$225.00 and are backed by a five (5) year warranty. Send for our 4-page PTR data sheet.

CIRCLE NO. 173

Kepeco, Inc.

131-38 Sanford Ave.
Flushing, N.Y. 11352

advertiser's index

Advertiser	Page
Abbott Transistor Laboratories, Incorporated	6
Acopian Corp.	88
American Technical Ceramics.....	16
Analog Devices, Inc.....	20
Augat, Inc.	89
Beckman Instruments, Inc., Helipot Division	69
Benrus Corporation	96
Bishop Graphics, Inc.	102
Bourns, Inc., Trimpot Products Division	73
Burroughs Corporation	Cover IV
Clairex Electronics, A Division of Clairex Corporation	88
Computer Design Corporation.....	34, 35
Continental Connector Corporation..	8
Cutler-Hammer	29
Dale Electronics, Inc.....	Cover II
Data Technology Corporation.....	17
Digital Equipment Corporation.....	52, 53
Dow Corning Corporation.....	39, 41
ECC Corporation	40
EL Instruments, Incorporated.....	84
Electronic Associates, Inc.....	85
Electronic Measurements, Inc.....	93
Fairchild Semiconductor, A Division Fairchild Camera and Instrument Corporation	2
Faratron Corp.	103
Federal Scientific Corporation.....	102
GTE Automatic Electric.....	14, 15
GTE Sylvania, Precision Materials Group, Parts Division	27
General Electric Company.....	12, 13
Grayhill, Inc.	82
Gudebrod Bros. Silk Co., Inc.....	91
Harris Semiconductor, A Division of Harris Intertype Corporation....	37
Hayden Book Company, Inc.....	62
Hewlett-Packard	1, 11
Hutson Industries	98
Hybrid Systems Corporation.....	92
ITT Cannon Electric, A division of International Telephone and Telegraph Corp.	71
Industrial Electronic Engineers, Inc.	10
Instrument Specialties Company.....	76
Intech, Incorporated	80
International Rectifier	83
Johanson Manufacturing Company....	7

Advertiser	Page
Kepeco, Inc.	102
Kurz-Kasch, Inc.	92
Lambda Electronics Corp.	Cover III
Lear Siegler Inc.	84
MCL, Inc.	63
MicroSwitch, A Division of Honeywell	67
Monsanto Company	42
NCR	86
Nortronics Company, Inc.	86
OPCOA, Inc.	90
Pioneer Electric & Research Corporation	82
Powercube Corporation	31
Power-Tec, Inc.	95
Radio Materials Company.	87
Recognition Devices, Inc.	79
Reliability, Inc.	99
Richlok Corporation	73
Sealectro Corporation	94
Shakeproof Division Illinois Tool Works, Inc.	104
Signetics Corporation	18, 19
Simpson Electric Company.	33
Sodeco, A Division of Landis & Gyr.	45
Sorenson Operation, Raytheon Company	75
Sperry Information Displays.	9
Teledyne Relays, A Teledyne Company	2
Telex, Communications Division.	81
Teradyne	23
Transco Products, Inc.	101
Union Carbide Corporation.	58
Unitrode Corporation	51
Vactec Inc.	103
Vari-L Company, Inc.	101
Victor Electric Wire & Cable Corp.	57
Victoreen Instrument, Div. of VLN Corp.	97
Wavetek Indiana Incorporated	59
Weston Instruments, Inc.	46

LED

New low cost LED Vactrol photon isolator

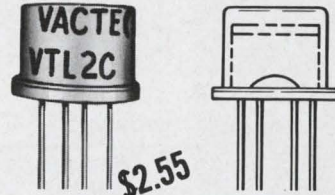

as low as ~~\$9.10~~ **\$2.55** each in 1,000 quantities

- all solid state
- 4 types of photoconductors combined with LEDs
- hermetically sealed TO-5 enclosure
- unlimited life — no filaments
- ideal for environments where shock and vibration are a problem
- applications include photochoppers, linear isolators, noiseless switching, SCR and triac turn-on, audio level controls, etc.

Write
for Bulletin VTL2C

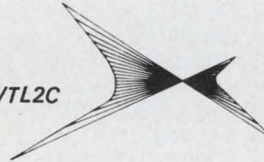

VACTEC, INC.

2423 Northline Ind. Blvd.
Maryland Heights, Mo. 63043
Phone: (314) 872-8300

Specializing in standard Cd, CdSe, and Se sells; custom engineering for every photocell need. Listed in EBG under "Semi-Conductors" and in EEM Sec. 3700

INFORMATION RETRIEVAL NUMBER 70

When a 3¹/₂ digit DPM is more than you need... Faratron has a 2³/₄ answer:

The Faratron 2700 series 2³/₄ digit DPM interchanges mechanically with Weston. Functionally, it's ahead with 7-segment incandescent display and an LED option. Three power options. BCD output included. Priced at \$68*, considerably less than competitive 3¹/₂ digit DPM's. Also available: 2¹/₂ digit 2500 series at \$65*. Faratron Corp., 290 Lodi St., Hackensack, N.J. 07601, area (201) 488-1440

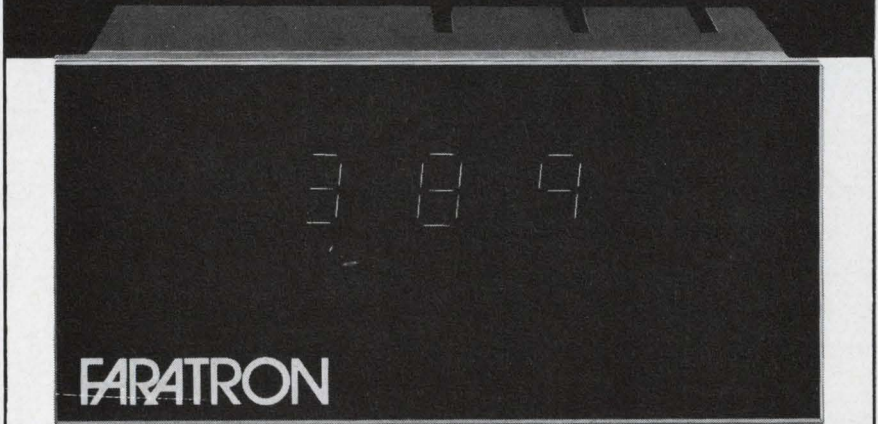

*in OEM quantities with AC or +5V power

Actual size

INFORMATION RETRIEVAL NUMBER 71

A customer asked us to provide a spring washer that could help maintain his assembly quality.

We did!

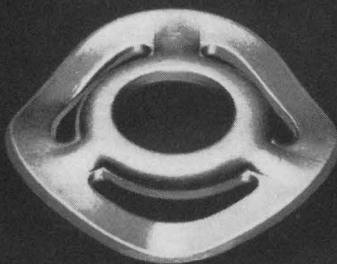

Custom Spring Washers

Shakeproof Standards and Special Spring Washers are available in hundreds of types and sizes—all engineered to eliminate rattles, provide accurate spacing, assure proper resilience and tension and provide consistent performance. Want more? A custom special will be engineered for your specific need.

THEY'RE AVAILABLE. RIGHT NOW!

Send for samples and literature.

SHAKEPROOF
DIVISION ILLINOIS TOOL WORKS INC.
ST. CHARLES ROAD • ELGIN, ILLINOIS 60120

Copyright 1972 Illinois Tool Works Inc.

INFORMATION RETRIEVAL NUMBER 72

product index

Information Retrieval Service. New Products, Evaluation Samples (ES), Design Aids (DA), Application Notes (AN), and New Literature (NL) in this issue are listed here with page and Information Retrieval numbers. Reader requests will be promptly processed by computer and mailed to the manufacturer within three days.

Category	Page	IRN	Category	Page	IRN
Components			Packaging & Materials		
inductors, adjustable	94	327	heating blanket	94	326
keyboards	94	328	polyester	94	324
			thick-film packages	94	325
Data Processing			new literature		
calculator	86	273	computers	99	361
calling unit	86	274	computers, prices	99	359
card punch	85	267	converter modules	98	351
card punch, portable	88	280	coupling components	97	348
cassette drive	85	270	data storage	96	340
cassette recorder	87	276	displays	99	366
coded card	88	279	epoxy transistors	98	356
decoder, party line codes	85	271	function modules	96	342
interface, teleprinter	85	268	heat sinks	98	355
keypunch, portable	88	278	lasers	98	352
memory	85	272	linear ICs	97	346
printer, accumulating	87	277	memory, core	96	344
reader, optical	86	275	MOS/LSI	99	363
tape recorder, wide band	85	269	MOS testing	99	358
			modems	99	362
ICs and Semiconductors			opto-electronics	97	347
CMOS analog switch	90	302	power conversion		
CMOS memory	91	306	modules	99	365
dual JFET	90	305	publications, solid-state	99	364
glass-coated transistors	91	308	pushbuttons	98	354
ICs, ECL logic	90	304	quartz filters	98	353
op amp	89	300	semiconductors	98	350
op amp	89	301	sockets, TO-5, TO-18	96	343
RAMs, CMOS, IC	91	309	solid-state lamps	97	349
transistor, dual	90	303	switches	98	357
1024-bit RAM	91	307	switches	99	360
			tape drive	97	345
Instrumentation			test instruments	96	339
generator, pulse	80	259	time codes	96	338
millivoltmeter, digital	80	256	transistor chips	96	341
multimeter, digital	77	252			
multimeter, digital	80	254	application notes		
scope amplifier, plug in	80	257	converters, a/d	95	334
sensor, travel, velocity	80	255	filter response	95	336
signal generator, rf	78	250	lock-in amps	95	337
signal generator, rf	78	251	phase measurements	95	335
test equipment, IC	80	258			
voltmeter, electrostatic	77	253	evaluation samples		
			adhesive backings	95	332
Modules & Subassemblies			cable ties	95	330
converter, d/a	82	260	coil bobbins	95	333
converter, d/a	83	263	fasteners	95	331
counter, decade	84	265	switches, rocker and slide	95	329
display, digital	82	261			
indicator, logic	82	262			
power supply, dc	84	264			
power supply, high voltage	84	266			
Microwaves & Lasers					
discriminator	93	323			
laser, CO	92	320			
lasers	98	352			
limiter	93	380			
mixer	93	322			
optical components	92	321			

Do you face a make or buy decision on power supplies?

BUY LAMBDA LX SERIES

Now 39 models in 7 package sizes...
single, dual & triple outputs

new
dual output model
in "CC" package



DUAL OUTPUT

LXD-CC-152: $\pm 15V$ to $\pm 12V$, 4.0A, \$235

new
dual and triple output
models in "D" package

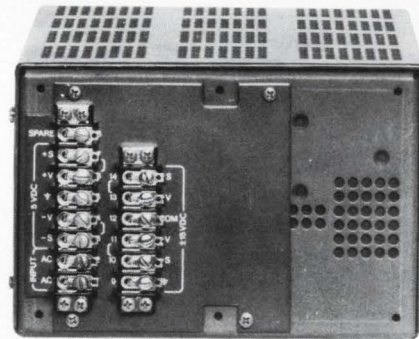

DUAL OUTPUT

LXD-D-152: $\pm 15V$ to $\pm 12V$, 6.2A, \$280

TRIPLE OUTPUT

LXT-D-5152: $\pm 15V$ to $\pm 12V$, 3.1A, \$375
5 \pm 5% VOLTS 12.0 AMPS (WITH O.V.)

**all listed in Underwriters'
Recognized Components Index***

**all designed to meet MIL
environmental specifications**

all in stock for 1-day delivery

all guaranteed 5 years

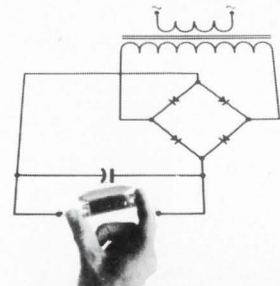

**WHETHER
YOU MAKE
OR BUY...**

**LAMBDA
ELECTRONICS CORP.**

A Veeco Company

*Dual and triple models presently undergoing qualifying tests.

MELVILLE, NEW YORK 11746 515 Broad Hollow Road Tel. 516-694-4200 ARLINGTON HEIGHTS, (CHICAGO) ILL. 60005 2420 East Oakton St., Unit Q Tel. 312-593-2550
NORTH HOLLYWOOD, CALIF. 91605 7316 Varna Ave. Tel. 213-875-2744 MONTREAL, QUEBEC 100C Hymus Blvd., Pointe-Claire, Quebec-730 Tel. 514-697-6520

INFORMATION RETRIEVAL NUMBER 247

SELLS ON SIGHT

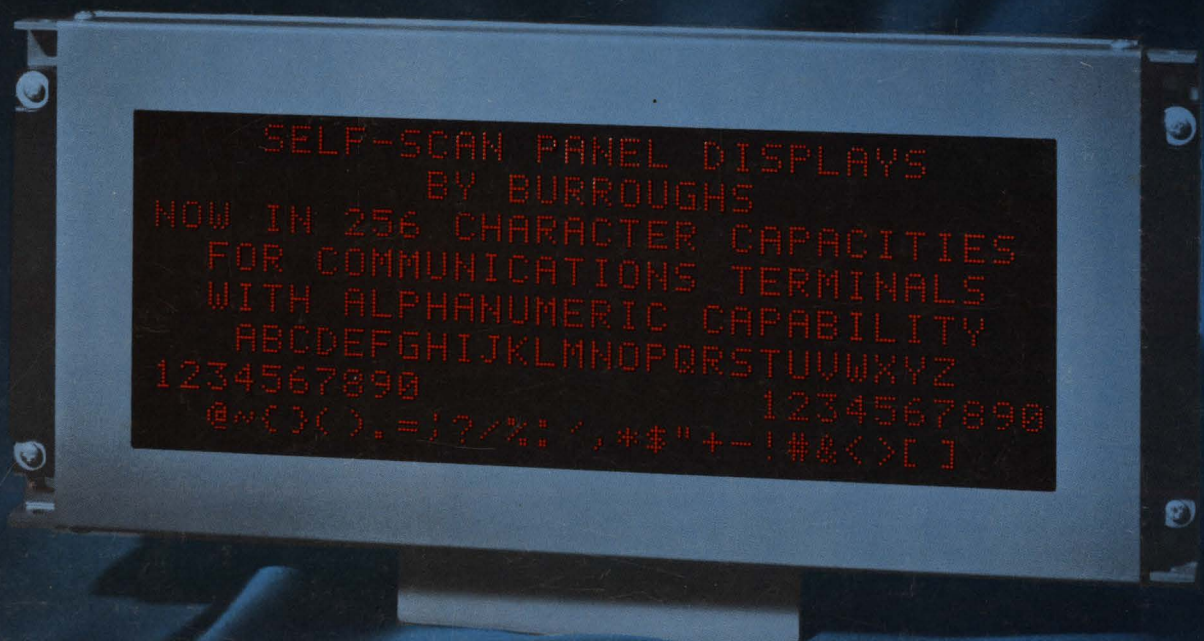

superior readability that competitors can't match

One look at an operating SELF-SCAN[®] panel display and you will know why you should be featuring one in your system. SELF-SCAN displays are a new solution to the operator machine interface that provides advantages to the system builder, to the system user, and to the system operator.

You can offer your customer the advantage of a custom-stylized unit that his operators can use efficiently. SELF-SCAN panels are measurably superior to CRT for operator accuracy while significantly reducing fatigue level in day in-day out high volume production applications.

The 0.2" high characters are in the popular 5x7 dot matrix format and are made up of dots on .040" centers. The unit is ASCII compatible and displays a modified 64-character ASCII character set.

256-character display subsystems are available from stock for immediate delivery. Call or write Burroughs Corporation, Electronic Components Division, Box 1226, Plainfield, New Jersey 07061, Phone: (201) 757-3400. Ask to have a Burroughs sales engineer stop by your office and show you his 256-character SELF-SCAN panel, keyboard, and power supplies packaged in a standard Samsonite[®] briefcase.

Burroughs

