

**Photon-coupled devices emerge** as major elements in computer, control and instrumentation data links. In these circuits, optical couplers suppress common-mode

interference, permit mixed logic interfacing and give high-voltage isolation. A host of nonstandard devices makes selection tough. Watch the tradeoffs. See p. 26.







# FILM RESISTOR DALE SUPERMARKET

## Everything you've always wanted to know about film resistors...but didn't know who to ask

You can do a lot more with Dale Film Resistors—and we're ready to send you a chart that proves it. Adding the Welwyn Group to our film resistor lines lets you rely on Dale for practically every resistance function in the book—and opens up new possibilities for saving time and cash.

Dale's expanded film resistor line now includes everything from the most exotic, to the least expensive. For example:

**HIGHER VALUES**—glass enclosed metal oxide film resistors to 1 billion ohms at 1% tolerance.

**LOWER VALUES**—down to .27 ohms at 1% tolerance.

**HIGHER VOLTAGES**—to 50KV pulse, 14KV continuous, with values to 150KM.

**LOW-COST POWER**—3 through 10 watt styles, 2%, 5% with flameproof coating.

**CARBON COMP. COMPETITION**—Beyschlag (W. Germany) carbon film resistors. Up to 2 watts in 2%, 5% tolerance.

Circle 3 for  
**FREE Film Resistor  
Reference Guide**  
or call 402-564-3131 for  
immediate information.



## FILM RESISTOR GUIDE

*The Industry's  
Broadest Range  
of Functions  
...Faster from...*

**DEPENDABLE  
DALE**

**DALE ELECTRONICS, INC.**

1300 28th Avenue, Columbus, Nebraska 68601

A subsidiary of The Lionel Corporation • In Canada: Dale Electronics Canada, Ltd.



# 3,500 VOLT ISOLATION 100% CURRENT TRANSFER OPTO COUPLER

## HOW GENERAL ELECTRIC DOES IT

General Electric's unique glass isolation produces precise alignment and controlled spacing between the LED and the silicon detector thus optimizing photon coupling...minimizing the effect of the inverse relationship of isolation voltage and current transfer ratio...and yielding optoelectronic couplers with BOTH high isolation voltage and high current transfer ratios.

3 new models 4N35, 36, 37 are characterized for high isolation voltage and high current transfer ratios. 4N35 offers 3,500 volts (peak) and 100% transfer ratio for \$1.85 each in 1,000 lot quantities.

Available now from any authorized GE Semiconductor distributor or GE Electronic Components Sales Office.

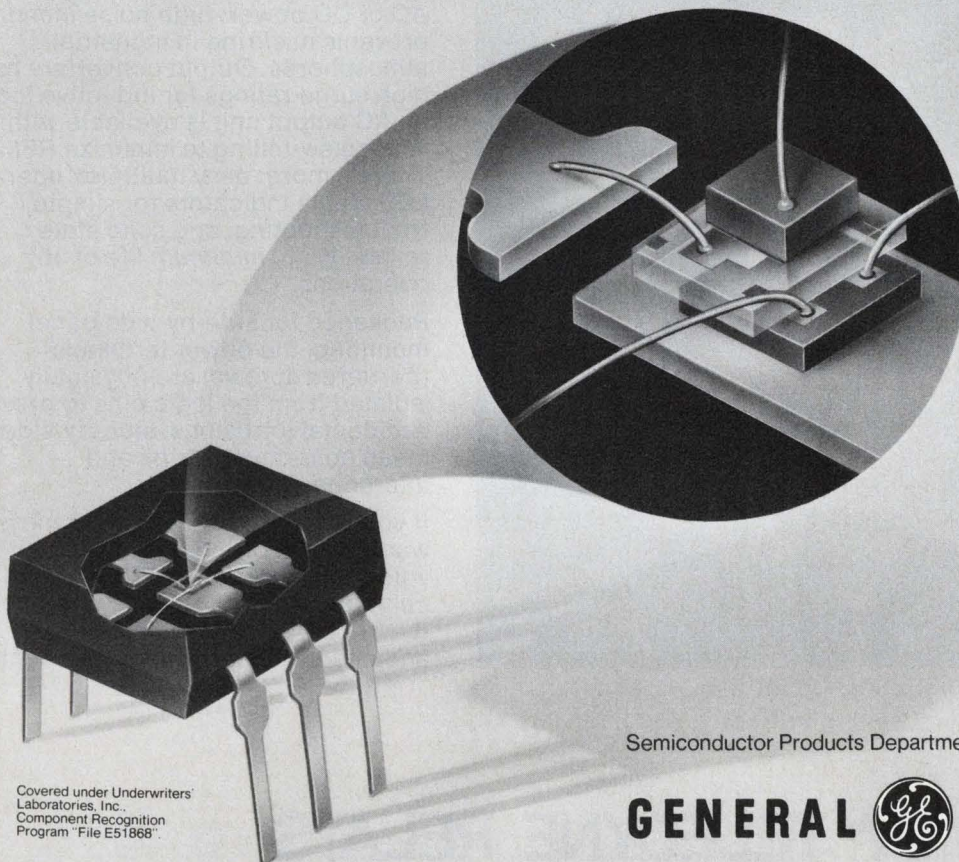

Covered under Underwriters' Laboratories, Inc. Component Recognition Program "File E51868".

Semiconductor Products Department, Syracuse, New York.

**GENERAL**  **ELECTRIC**



# Teledyne in solid control

## AC and DC I/O converters for programmable controllers

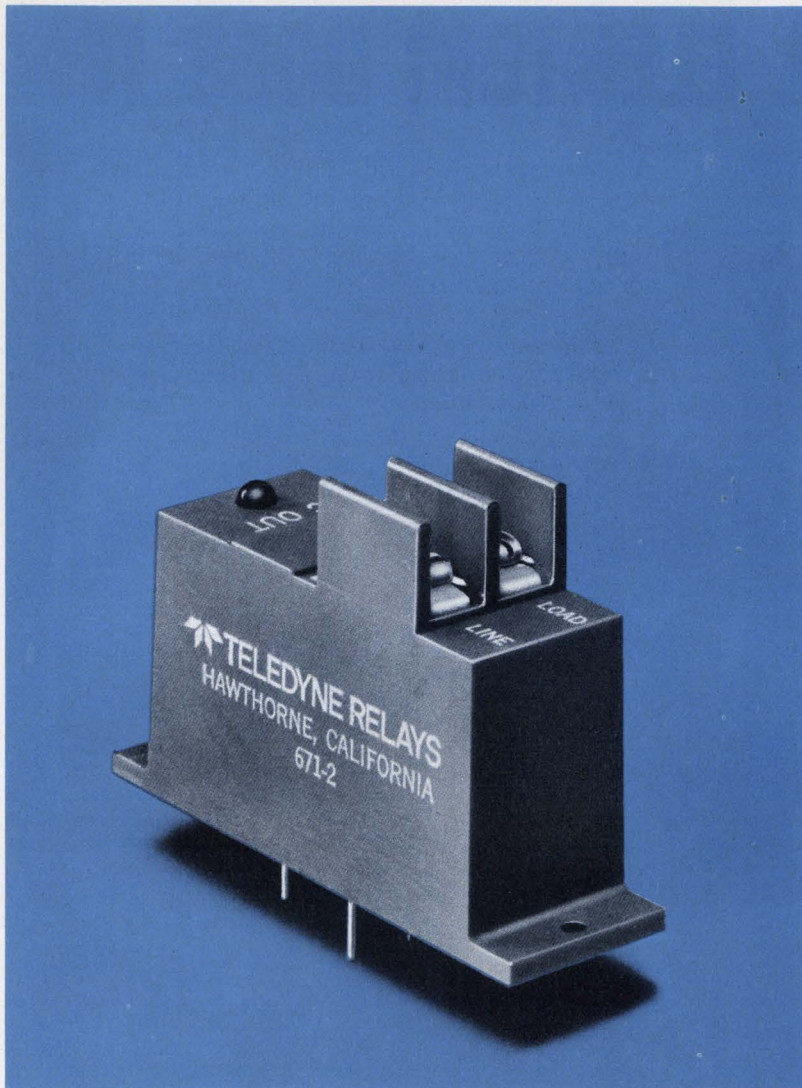

The boundary of the minicomputer mainframe or CPU world — of sensitive IC logic families — and the process control or machine tool world of motors, solenoids, lamps, and electro-mechanical switches is a tough place, demanding devices for fast quiet switching and load sensing — reliably.

Teledyne, the world's leader in solid state relays, offers the 671 series AC or DC input and output converter modules — state of the art in circuitry and packaging.

**ALL SOLID STATE**, the 671's are optically isolated between logic and AC or DC power; high noise immunity prevents misfiring in industrial atmospheres. Output converters have high surge ratings for inductive loads; an AC output unit is available with zero voltage switching to minimize RFI. There's more: easy multiplex operation, LED status indicators for simple troubleshooting, and solid state reliability . . . *minimum* life of  $10^8$  operations.

Packaged for side-by-side panel mounting, the power terminals (barriered screws) are physically isolated from the logic pins to prevent accidental intrusions; side-by-side units mean no terminal strips and interconnect wiring.

If you're in the mainframe business and want to offer process control, or if you're in the processing world and want computer control, write or call about the 671 series; our application engineers will put you in solid control.

 **TELEDYNE RELAYS**

3155 West El Segundo Boulevard Hawthorne, California 90250  
Telephone (213) 973-4545

INFORMATION RETRIEVAL NUMBER 2



# Electronic Design 3

VOL. 22 NO.

FOR ENGINEERS AND ENGINEERING MANAGERS

FEB. 1, 1974

---

## NEWS

- 23 **News Scope**
- 26 **After 13 years, standardization of optical isolator technology** is finally beginning—An Electronic Design special report.
- 40 **4096-bit dynamic RAMs** are finally getting into the hands of memory designers as an alternative to cores.
- 47 **Washington Report**

---

## TECHNOLOGY

- 52 **The hows and whys of log amps:** Semiconductors used as feedback elements form the log response. And you can avoid drift and instability with carefully designed circuits.
- 62 **Which IC timer to buy?** To choose from among single and dual types, and now counter-timers, know the tradeoffs and spec limitations.
- 68 **Use pulse-width modulation** to control dc motors. With this approach, both speed and direction can be controlled by a single potentiometer.
- 72 **Switch high inductive loads fast** with a push-pull current source that also cuts power consumption and boosts performance.
- 76 **Ideas for Design:** Multiplexed operation of MOS registers more than doubles the data rate . . . EXCLUSIVE-OR circuit handles wide range of input levels without power supply . . . Edge-triggered R-S flip-flop built without capacitors.
- 82 **International Technology**

---

## PRODUCTS

- |    |                       |     |                         |
|----|-----------------------|-----|-------------------------|
| 85 | Data Processing       | 92  | Components              |
| 88 | ICs & Semiconductors  | 96  | Instrumentation         |
| 90 | Packaging & Materials | 101 | Modules & Subassemblies |

---

## Departments

- |     |                                   |     |                            |
|-----|-----------------------------------|-----|----------------------------|
| 51  | <b>Editorial:</b> The bureaucracy |     |                            |
| 7   | Across the Desk                   | 110 | Advertiser's Index         |
| 105 | New Literature                    | 112 | Product Index              |
| 107 | Bulletin Board                    | 114 | Information Retrieval Card |

**Cover:** Photo taken by Art Director, Bill Kelly.

---

ELECTRONIC DESIGN is published biweekly by Hayden Publishing Company, Inc., 50 Essex St., Rochelle Park, N. J. 07662. James S. Mulholland, Jr., President. Printed at Brown Printing Co., Inc., Waseca, Minn. Controlled circulation postage paid at Waseca, Minn., and New York, N. Y., postage pending Rochelle Park, N. J. Copyright © 1974, Hayden Publishing Company, Inc. 84,392 copies this issue.



- **Independent control of pulse high and low levels**
- **Pulse amplitude to 5 volts**
- **Output window +5 V to -5 V**
- **Less than 1 ns risetime**
- **250 MHz rep rate**

The Tektronix PG 502 Pulse Generator is a high performance instrument ideal for designing, testing, or maintaining the logic circuitry in high-speed digital computers, and similar applications. It is a general purpose signal source with rise and fall times less than 1 ns. Both the pulse duration and period of the PG 502 output can be controlled and independent control of the pulse high and low levels is offered. The trigger circuit includes external trigger input, manual triggers, and pre-trigger output.

Tektronix offers a range of signal sources in addition to the PG 502.

- FG 501 Function generator; 0.001 Hz to 1 MHz, five waveforms . . . . . \$ 325
- FG 502 Function generator; 0.1 Hz to 11 MHz, 25 ns rise and fall, five waveforms . . . . . \$ 425
- PG 501 Pulse generator; 5 Hz to 50 MHz, 3.5 ns rise and fall . . . . . \$ 295
- PG 502 Pulse generator; 250 MHz, 1 ns rise and fall, independently controllable logic 1 and 0 levels . . . . . \$ 995
- PG 505 Pulse generator; 100 kHz, 80 V floating output, independently variable rise and fall times . . . . . \$ 265
- RG 501 Ramp generator; 10- $\mu$ s-to-10-s ramp, with four scope type trigger controls . . \$ 175

# Signal Sources: Another way to think of Tektronix



SG 502 RC oscillator; 5 Hz to 500 kHz, sine and square-waves, 0.1% distortion . . . . \$ 295

SG 503 Sinewave oscillator; regulated, constant-amplitude variable from 250 kHz to 250 MHz . . . . . \$ 600

TG 501 Time-mark generator; 1-ns-to-5-s markers, measures timing errors with resolution within 0.1% over timing-error range of 7.5% . . . . . \$ 650

Signal sources are just one category of instruments in the Tektronix TM 500 Series. Presently, 24 general purpose modular test and measurement instruments are available including digital counters, digital multimeters, power supplies, signal processors, and CRT

monitors. These interchangeable instruments plug into power units with single (\$115) or triple (\$150) compartments. In the triple compartment power unit, the modules can be interconnected via a common interface board and optional rear panel connectors. This results in increased intermodule capabilities and can actually produce a synergistic effect. The modularity feature also saves bench space. The TM 500 Series is based on the latest technology and proven principles developed in building oscilloscopes.

Send for a free brochure and spec sheets on signal sources, and Tektronix other TM 500 test and measurement instruments. They're all new ways to think of Tektronix!

Write: Tektronix, Inc.  
P. O. Box 500  
Beaverton, Oregon 97005

In Europe write:  
Tektronix Ltd.  
P.O. Box 36  
St. Peter Port, Guernsey, C.I., U.K.



INFORMATION RETRIEVAL NUMBER 4  
FOR DEMONSTRATION, CIRCLE 151

Digital Multimeter  
Price, \$395

Pulse Generator  
Price, \$995

Counter  
Price, \$1,195

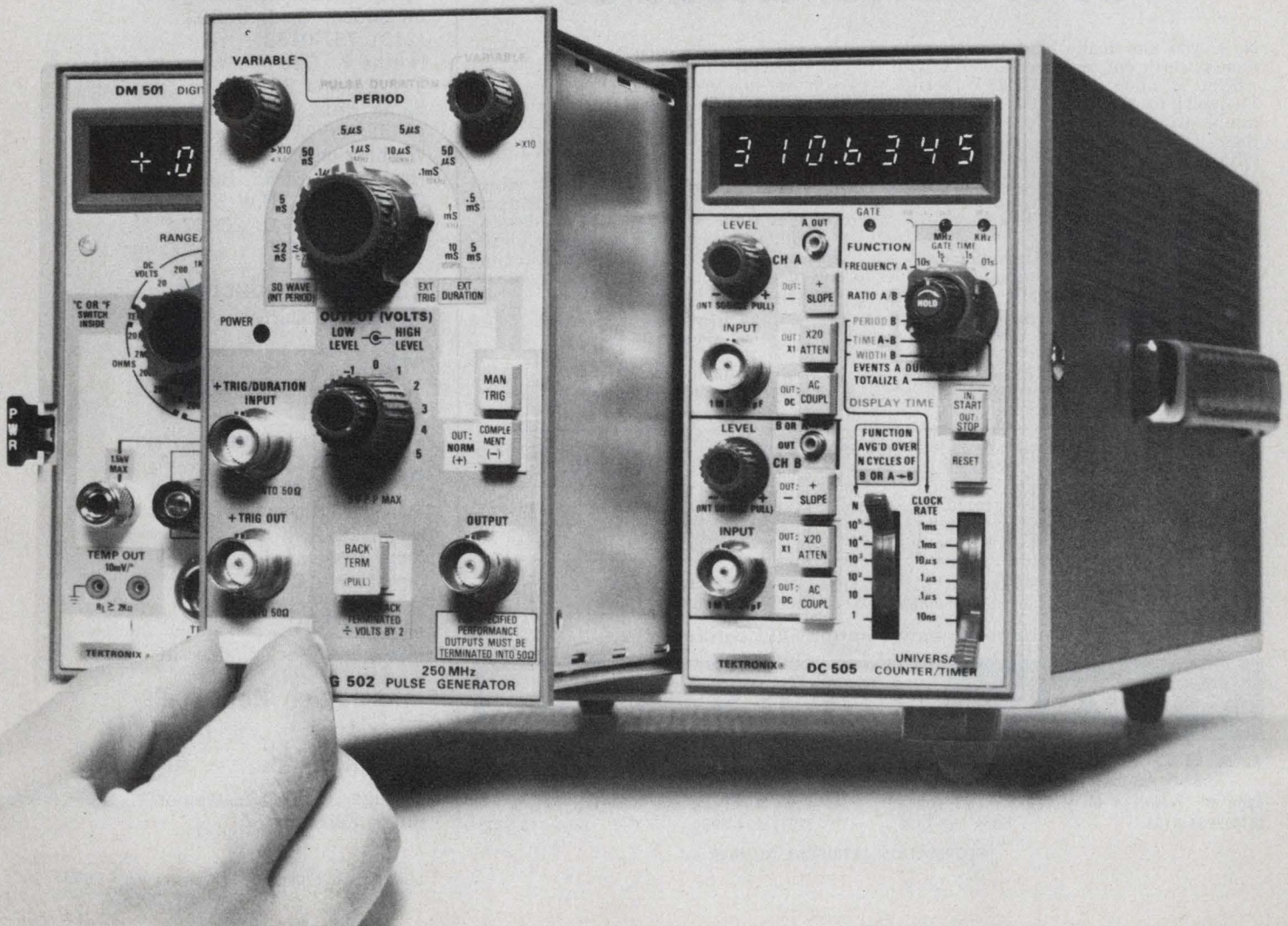



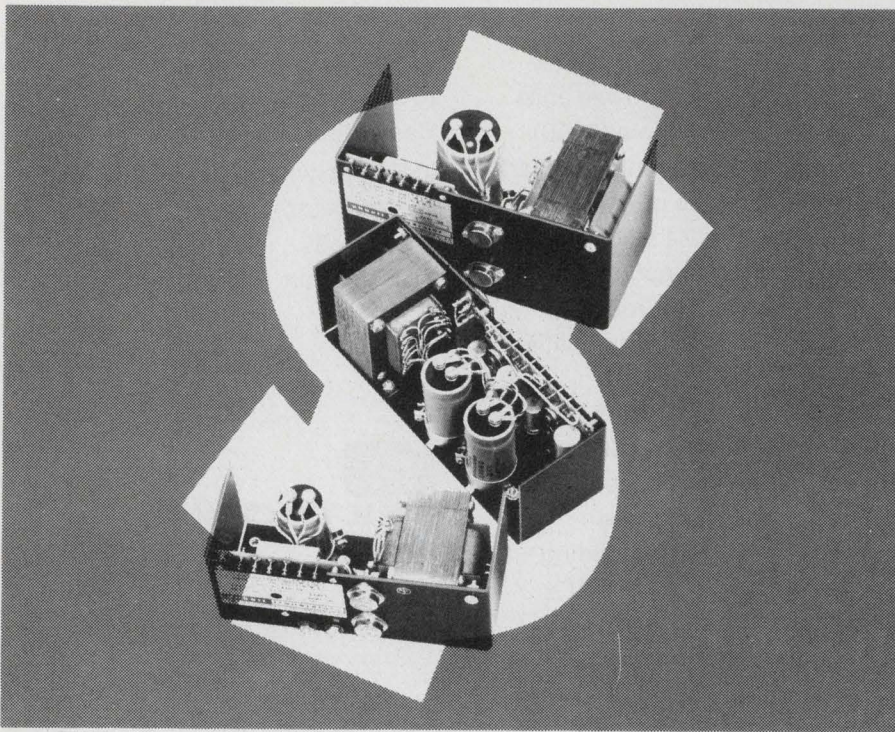

# Start Getting Your Money\$worth Out of Power Modules





Now, you can really start getting your moneysworth out of power modules with Abbott's new LOW COST series. Designed to give you 100,000 hours of trouble-free operation (that's 11½ years), these reliable units meet the needs of OEM engineers. Their purchase price is about \$7 per year of service. The model LC series feature:

- 47-420 Hz Input Frequency
- 0.1% Regulation
- +50°C. Ambient Operation
- Single and Dual Outputs
- 1 Day Stock Delivery

These units provide more quality per dollar compared to similar items on the market. See table below for prices on some of our LC models. Many other LC models are listed in our catalog.

If analyzing the many similar power supplies on the market is confusing; if you are concerned about the long-term reliability of those units, then decide on an Abbott power supply for your system. Your best buy in OEM power modules is ABBOTT.

Abbott also manufactures 3,000 other models of power supplies with output voltages from 5 to 740 VDC and with output currents from 2 milliamps to 20 amps. They are all listed with prices in the new Abbott Catalog with various inputs:

60  to DC  
 400  to DC  
 28 VDC to DC  
 28 VDC to 400   
 12-24 VDC to 60 

5V @ 6 Amps	5V @ 10 Amps	12V @ 10 Amps	15V @ 4 Amps	28V @ 1 Amp	±12V @ 1.2 Amps	±15V @ 4 Amps
LC5T6	LC5T10	LC12T10	LC15T4	LC28T1	LLC12T1.2	LLC15T4
\$72	\$81	\$99	\$81	\$72	\$99	\$135

Please see pages 581-593 of your 1973-74 EEM (ELECTRONIC ENGINEERS MASTER Catalog) for complete information on Abbott Modules.

Send for our new 56 page FREE catalog.

**abbott transistor**

**LABORATORIES, INCORPORATED**  
 general offices eastern office

5200 W. Jefferson Blvd./Los Angeles 90016  
 (213) 936-8185 Telex: 69-1398

1224 Anderson Ave./Fort Lee, N.J. 07024  
 (201) 224-6900 Telex: 13-5332

INFORMATION RETRIEVAL NUMBER 5

**Vice President, Publisher**  
 Peter Coley

## Editors

Editorial Offices  
 50 Essex St.  
 Rochelle Park, N.J. 07662  
 (201) 843-0550  
 TWX: 710-990 5071  
 Cable: Haydenpubs Rochellepark

**Editor-in-Chief** George Rostky

## Managing Editors:

Ralph Dobriner  
 Michael Elphick

## Associate Editors:

Dave Bursky  
 Jules H. Gilder  
 Morris Grossman  
 Seymour T. Levine  
 John F. Mason  
 Stanley Runyon  
 Edward A. Torrero  
 Richard L. Turmail

## Contributing Editors:

Peter N. Budzilovich

## Editorial Field Offices

### East

Jim McDermott, Eastern Editor  
 P.O. Box 272  
 Easthampton, Mass. 01027  
 (413) 527-3632

### West

David N. Kaye, Senior Western Editor  
 2930 West Imperial Highway  
 Inglewood, Calif. 90303  
 (213) 757-0183  
 Northe K. Osbrink, Western Editor  
 112 Coloma St.  
 Santa Cruz, Calif. 95060  
 (408) 426-3211

### Washington

Heather M. David, Bureau Chief  
 2506 Eye St., N.W.  
 Washington, D.C. 20037  
 (202) 338-3470

## Editorial Production

Marjorie A. Duffy

## Art

Art Director, William Kelly  
 Richard Luce  
 Anthony J. Fischetto

## Production

Manager, Dollie S. Viebig  
 Helen De Polo  
 Anne Molfetas  
 Christopher G. Hill

## Circulation

Manager, Nancy L. Merritt

## Information Retrieval

Peggy Long

## Promotion

Manager, Jeffrey A. Weiner  
 Karen Kerrigan



# across the desk

## White WOMman named

The man destined to become famous immediately has become famous—if not immediately, at least after a short while. In its highly educational advertisement headlined “Become Famous Immediately” (ED No. 13, June 21, 1973, pp. 67-74), Signetics promised not mere fame, but immortality, to the person who figured out the best use for its 25120 WOM. That fortunate person would have a WOM named after him.

Since this Write-Only Memory has an endless variety of applications, the challenge was no small one—but it was finally mastered by Robert A. White of Albuquerque, N.M. He pointed out, understandably, that the schematic and wiring diagrams of the multiport WHITE WOM (Cooler WOM) were business secrets that could not be disclosed. But he furnished the application diagram, shown here for the first time in history. Well-versed readers will immediately recognize that summer snow (job) production is one of its many functions.

Though White walked off with the honors of immortality, in that a WOM now bears his name, others provided notable contributions. Here are some excerpts. Accompanying illustrations, schematics and truth tables have been entered in a WOM.

“After all, it, like any other sci-

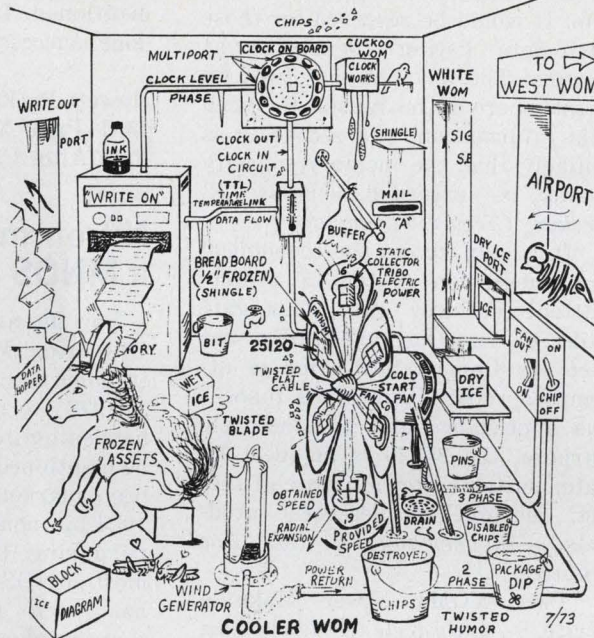

entific break-in, can be misused. Even the atomic bomb has been used in ways which endangered the health of some people.”—C. A. Irvine, *The National Cash Register Co.*

“An ideal use would be allowing a few data sheets and a sample or two to leak to a Soviet agent. If it causes as much misspent time over there as it has around here, you will have indeed done an inestimable service to your government, to say nothing of possibly helping provide victory against them dirty, rotten Commie aggressors.”—William Nurnberger, *Dept. of the Navy.*

“In the rare event that stored data need be retrieved, hypnosis of the original author, or even of the WOM, may not be attempted. Sodium pentathol (truth serum) may be injected up the drain (pardon

(continued on page 8)

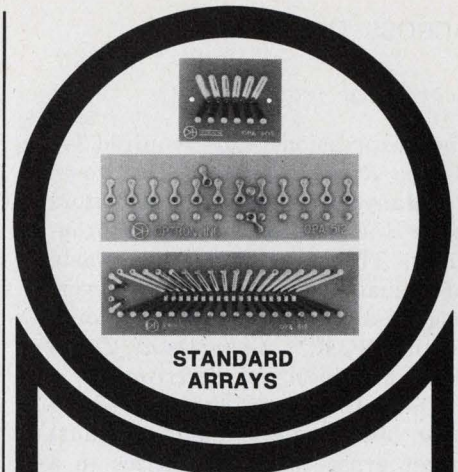

## OPTRON OPTOELECTRONIC ARRAYS

IMMEDIATE DELIVERY  
COMPETITIVE PRICING  
CUSTOM CAPABILITIES

OPTRON sensor and emitter arrays are ideal for information input for such applications as tape readers, card readers, shaft encoders, level indicators, optical character recognition, etc.

They consist of discrete LED's and phototransistors in microminature, hermetically sealed packages with collimating glass lenses and are mounted in printed circuit boards. This design enables pre-screening and tight matching of LED's and sensors, as well as accurate location to mounting holes.

Standard OPTRON arrays are available from stock with six and nine channels on 0.100" centers for tape readers, and with 12 channels on 0.250" centers and 18 channels on 0.087" centers for card readers. With a spacing of 0.100" between emitter and sensor arrays and an input of 30 mA, a typical output of 4 mA assures TTL compatibility.



In addition to standard arrays, OPTRON specializes in custom designed arrays (photo, above) to the most exacting specifications. All arrays, either single or in matched sensor-emitter pairs, are delivered tested and ready for installation.

Detailed technical data on standard arrays as well as other OPTRON products ... chips, discrete components and assemblies ... is available from your OPTRON sales representative or the factory direct.



**OPTRON, INC.**

1201 Tappan Circle  
Carrollton, Texas 75006  
214/242-6571

Electronic Design welcomes the opinions of its readers on the issues raised in the magazine's editorial columns. Address letters to Managing Editor, Electronic Design, 50 Essex St. Rochelle Park, N.J. 07662. Try to keep letters under 200 words. Letters must be signed. Names will be withheld on request.



(continued from page 7)

the expression) if required."—*James Rieger, Dept. of the Navy.*

"Many programmable calculators have the ability to use subroutines. This is a dangerous waste of valuable memory space. Never-used subroutines could be stored in the WOM."—*Gary Davis, Davis Photographics and Electronics.*

"Scientists and engineers have long been taught that they must never erase incorrect entries in a notebook, but rather, cross them out. The Signetics WOM makes it possible to store incorrect entries—to the vast relief of science teachers and patent attorneys."—*Paul Wiener, Burroughs Corp.*

"Error-detecting codes and programs shall be employed such that a reasonable percentage of error bits shall be detected. These bits shall then be written into the WOM. As these bits are detected and stored in the WOM, they cannot be used again. Since the errors are taken out of circulation, the system will gradually improve and show a decreasing error rate."—*Peter Lefferts, Electro Audio Research.*

"You can use the WOM as an ecologically sound solution to the ear pollution from many standard broadcast stations. The program line is broken at the input to the transmitter. The offending signal is digitized and the digital signal fed to the WOM."—*W. J. J. Hoge, Nashville Audio Group.*

"You said that neatness counts, so I showered and shaved before writing this letter."—*Summer Weisman, Electrodyne.*

"Package the WOM with a tube of rubber cement and sell the package to automobile service stations as wheel-balancing kits. The stations could then advertise wheel balancing by computer technology."—*Larry LaCourse, Computer and Communications Service.*

"When I first heard about the Signetics fully encoded 9046  $\times$  n random access, write-only memory, I thought it was a gigantic hoax. But then I recalled that I thought waveguides were a hoax when they were first introduced (I still do). So I checked them out with an ohmmeter and I must admit that they passed the same test that the

original waveguide did, so they must be real."—*John A. Piper, Sanders Associates.*

"The WOM can be used to supplement the conventional memory in a computer-dating-service system. It would be reserved for those customers listing themselves as virgins. The advantage is twofold. First, there is no reason to recall this information, and second, it is unlikely that the memory capacity would be exceeded."—*Barry E. Becker, Circuit Technology.*

"It finally allows the economical implementation of the IF (Intermittent Failure) gate. This gate fails to function arbitrarily but recovers immediately prior to attempted repair. Due to its innocuous appearance and unfathomable purpose, the 25120 is an ideal IF gate, suitable for all state-of-the-art, designed-obsolence products."—*Liebermann & Co., Los Angeles.*

"Two WOMs Never Make a Write."—*Andy Kyle, Houston, Tex.*

## Gray spots noted in 'load of wash'

"Name Withheld's" letter headlined "Laundry Editorial Brings a Load of Wash" (ED No. 21, Oct. 11, 1973, p. 11) raises several questions. The example involving Fairchild's faster diode arrays and HP curve tracers might seem to imply some special knowledge, but what it indicates to me is a special ignorance (or perhaps a specially unfortunate random choice of examples). Fairchild does not sell diode arrays—fast, slow or in between—to HP. Individual diodes, yes; LED arrays, sometimes.

Further HP does not build and has not built curve tracers; if we had ever sold any to Fairchild, it would have had to be secondhand ones. Fairchild used to build its own, of course; we did buy a few of those. But that may not be really pertinent.

The writer speaks about the "last-look"/auction mode of procurement. The letter claims that "every major purchase" is involved with this practice, one for which

we all agree there are very few justifiable moral arguments. It does happen that HP's approach to corporate procurement contracts, has, for over 10 years, succeeded in avoiding the very pitfalls mentioned. It can be and is being done successfully.

*Lawrence W. Johnson*

Hewlett-Packard  
1501 Page Mill Rd.  
Palo Alto, Calif. 94304

## Nitron marketing a MNOS memory

For the article "MNOS Memory Upstaging MOS and Fixed Heads in Some Areas" (ED. No. 18, Sept. 1, 1973) to represent fully what is happening in the industry, it should be mentioned that Nitron Corp. has been marketing two versions of a 1024-bit nonvolatile MNOS memory during 1973. In contrast with most MNOS memory work, which has been Government-sponsored, these products were developed with in-house funding and made available to the commercial market.

*A. C. Tickle  
Manager*

*Advanced Product Development  
Nitron Corp.  
10420 Bubb Rd.  
Cupertino, Calif. 95014*

*Ed. Note: Nitron did not announce the availability of its 1024-bit MNOS memories until Sept. 20, and thus it was not included in ELECTRONIC DESIGN's Sept. 1 article.*

## A slip spotted in subroutine

This letter is in reference to the article "How to Build a Microcomputer" (ED No. 19, Sept. 13, 1973, pp. 60-65). The subroutine—DECHL, for decrementing the combined H and L register memory address—shown in Table 2, p. 62, requires that the accumulator (A register) contain the contents of the L register before the CPI 377B instruction is executed. The LAL instruction must be inserted between the DCL instruction and the CPI 377B instruction for this

(continued on page 19)





# MEASUREMENT COMPUTATION

innovations from Hewlett-Packard

# NEWS

FEBRUARY, 1974



## in this issue

Learn about logic

New solution to  
component test problems

Two new oscilloscopes

## New, large computer concept at a small system price

The HP 3000 multiprogramming, multilingual computer system gives you flexible, advanced computing capability at a price no other system can match.

Built around a unique operating system, the new HP 3000 multiprogramming system provides powerful computational capabilities to multiple users concurrently, whether they use interactive terminals or traditional batch devices for access. (This makes it easier for people and computers to work together.) You can program in high-level COBOL, FORTRAN, BASIC and SPL (System Programming Language) in any access mode. The HP 3000 combination of immediate access and powerful multiple capability is available at a cost no other computer system can match.

Convenient terminal access enables full-range program development, pro-

*(continued on page 3)*

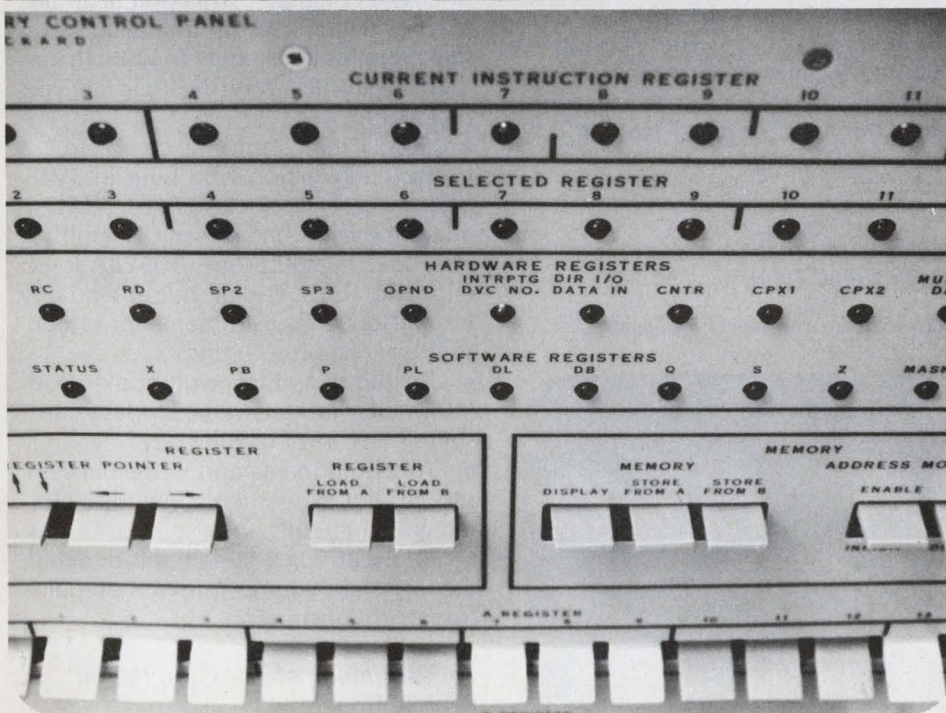



## Solid-state sweepers offer BWO-type power output

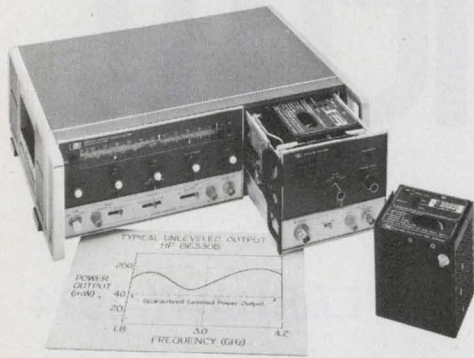

New solid-state RF power module for HP 8620 series sweepers delivers BWO-equivalent power, 1.8 to 4.2 GHz.

Swept frequency testing of high-loss S-band devices is now simpler and more practical. HP offers the first solid-state sweep oscillators whose power output above 2 GHz is comparable to that delivered by BWO-type sweepers.

The HP 86330B RF module for the HP 8620 series sweepers produces a guaranteed minimum of 40 mW levelled power from 1.8 to 4.2 GHz. Typically, power levels of 100 mW and above can be obtained. A wider band version, model 86331B, covers 1.7 to 4.3 GHz with some reduction in power at the band edges.

Altogether, solid-state RF units for the 8620 series sweepers span 3 MHz to 18 GHz to provide maximum flexibility for your swept measurement needs.

*For full details, check N on the HP Reply Card.*

## Low profile recorder with options for varied applications

HP's 7123A strip-chart recorder is an ideal choice for applications where space is limited. Fast response time, high reliability and wide range flexibility are combined in a package only 3.5 in. (8.9 cm) high. The recorder fits easily into OEM equipment and saves valuable rack space, yet still provides an easy-to-read 10 in. (25 cm) chart.

Over 50 options for span sensitivity, chart speed and other performance features guarantee flexibility to meet any need at minimum cost. Three special options satisfy analytical needs, such as gas chromatography applications.

Solid performance and low-silhouette design—the 7123A recorder is an ideal running mate for the HP 5700A gas chromatograph.

Reliability—the keynote of analytical recording—is achieved by a unique linear servo motor system with only one moving part: the slider/pen assembly. There are no ink spills or priming problems; you use convenient quick-change disposable pens, available in several colors. The chart drive is slanted so that you can make notes during operation. The entire magazine swings out for easy paper loading.

*For more information, check K on the HP Reply Card.*

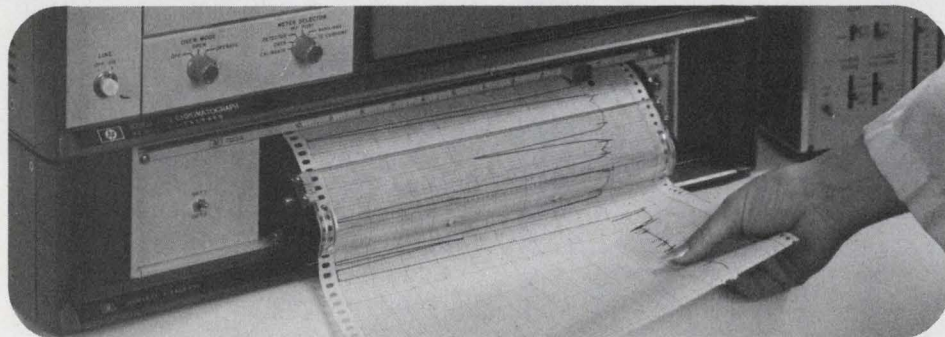

## A new way to teach or learn digital logic



The logic lab's solderless, plug-in connection technique lets you breadboard circuits quickly and easily.

For a complete, concise course in practical digital electronics, try HP's new educational package. The 5035T logic lab contains all equipment and instructional material necessary to learn digital logic.

Designed for use in industrial training programs, high schools, technical institutes and universities, the 5035T is also handy for breadboarding logic circuits in engineering labs. This practical aid teaches digital logic in a realistic way that prepares the student to work in modern electronics. With the logic lab, you receive:

- 5035T mainframe—a complete, portable lab station with built-in 5V power supply, 2 clock sources, 4 LEDs, and removable breadboard assembly.
- 10525T logic probe, 10528A logic clip, and 10526T logic pulser—quality troubleshooting instruments for circuit stimulus-response testing.
- Textbook and lab workbook—both in modular format so the student can start at any level of difficulty.
- All components and wires necessary for the experiments including 30 integrated circuits.

Since learning is largely self-directed, the logic lab requires minimal preparation by the instructor.

*To learn more, check G on the HP Reply Card.*



## New low-cost pulse generator for MOS circuits

HP's new 8011A pulse generator is an economical instrument ideal for testing newer MOS circuitry as well as linear circuits. It can drive all saturated logic families, low threshold MOS, CMOS and analog devices.

Amplitude ranges from 250 mV to 16V; rep rate, from 0.1 Hz to 20 MHz; and pulse width, from 25 ns to 100 ms with square wave selectable. Transition times are fixed at <10 ns. Source impedance on the lower ranges is 50 $\Omega$  while in the 4V-16V range, impedance can be 50 $\Omega$  or higher.

Choose positive, negative or symmetrical pulse polarity to change rapidly from positive to negative logic, or to enable duty cycles up to 100%.

To help overcome the problems of logic circuit design and troubleshooting, a counted pulse burst option is available. With this option, you simply pre-select the number of pulses you need, from 1 to 9999. You can clock circuits at

their operational clock rate, then analyze them under static conditions.

The 8011A is probably the lowest priced pulse generator of its kind...only \$435. Add \$300 for the pulse burst option.

*For more information, check M on the HP Reply Card.*



The 8011A with HP's unique counted burst option offers a new concept in logic test and troubleshooting.

## New mainframe and plug-ins for HP 183 scopes

Two new plug-in modules and a new high speed scope mainframe enhance HP's proven 183 series oscilloscopes.

The new plug-ins add 200 MHz two-channel (model 1835A) or four-channel (1834A) general purpose measurements for both digital and analog applications. You can also couple these wide bandwidths with an HP time base module for accurate timing measurements in ECL and TTL logic circuits. Additional capability for high frequency timing applications is provided with the 4-channel chop rate of 500 kHz and the 2-channel chop rate of 1 MHz.

Both plug-ins have 10 mV/div deflection factors to 200 MHz. Selectable trigger source lets you reference any one channel while retaining time relationships with other channels. Composite triggering allows each channel to trigger independently with an alternate or added display.

Model 183B, option 005, is a new mainframe with high writing speed. The option 005 provides up to 24 cm/ns transient recording capability for the most demanding high-energy physics or laser detection applications. A direct-access plug-in allows real time, large signal transient analysis to greater than 600 MHz, as well as 10 mV/div capability to 250 MHz.

The 183B opt 005 costs \$2975. The 1835A dual channel amplifier, \$1400; the 1834A four-channel plug-in, \$1900.

*For specifications, check C on the HP Reply Card.*

Four-trace capability simplifies digital circuit testing.

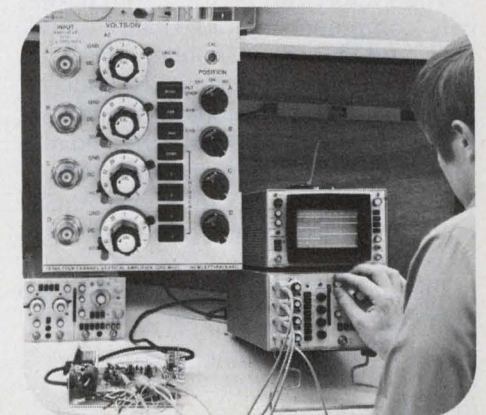

*(continued from page 1)*

vides dedicated terminals for specific applications, and eliminates keypunching. Batch access to advanced computing power or batch execution gets batch production jobs done, while terminal users are also accessing the system. Full system capability is available to every user independent of access method, so people can use the method best suited for their problems.

A state-of-the-art multiprogrammed operating system (MPE/3000) assures maximum use of central processing resources through overlapping I/O and computation. MPE automatically schedules users for maximum operating efficiency.

The basis of the HP 3000 contribution is a unique architecture that provides advanced computer system concepts,

including separation of code and data, data stack, virtual memory through code separation, and a microprogrammed instruction set. Core memory options of 64, 96, and 128 kilobytes are available, along with a wide range of peripherals and terminals.

HP 3000 users are supported by comprehensive system training, documentation, regional and local service offices, and a flexible financial program ranging from lease arrangements to direct purchase.

The HP 3000 is currently in use in the U.S., Canada and Europe. For availability in other countries, contact your HP sales office. System prices start at \$175,000.

*For more information, check D on the HP Reply Card.*



## Digitizer inputs graphic data for HP calculators

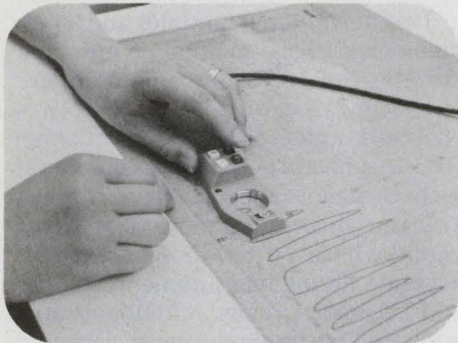

Here, the lab technician is digitizing a blood-analyzer strip-chart for medical data analysis and quality control.

The HP 9864A digitizer lets you enter analog data directly into an HP 9800 series programmable calculator for analysis without tedious manual measurements, conversion, and entry of

data. Simply move the cursor over the map, chart, or source material. The HP calculator then analyzes the digitized data according to your program. Resolution is .01 in. (.25 mm) and accuracy, 0.15 in. (.38 mm).

Applications for the digitizer are almost infinite. Use it to analyze contour maps, profile plots of terrain, mathematical curve fitting, nuclear data, cardiac plots, photographs, etc. Analog data can be in virtually any graphic form.

The standard platen will handle material up to 17 in. by 17 in. (43 cm by 43 cm). Options extend the platen maximum up to 42 in. by 60 in. (105 cm by 152 cm).

For more information, check P on the HP Reply Card.

## Universal card reader inputs 300 cards per minute

HP's 300 cards-per-minute optical mark reader is flexible as well as fast: model 7260A accepts all types of punched or marked cards, even specially-designed forms. With appropriate clock marks, single cards may be both punched and marked—in any number of columns from 1 to 80. This desktop reader is quiet enough for your office; fast enough to keep up with your computer.

The 7260A can be used with terminals, computers or remote data systems via a modem or direct connection. Data rates are switchable from 110 baud to 2400 baud. Data is stored in buffers so that you can optimize the card feed rate for high transmission efficiency. The 7260A transmits data in 7-level ASCII code; other decoding options are available.

OEM and quantity discounts are also available.

For more information, check L on the HP Reply Card.



Students can mark cards at their desks or at home, then handle other tasks while their programs are read and processed.

## New application notes on spectrum analysis



Three new spectrum analysis application notes are now available from HP. One is a general discussion of noise measurements; another treats CRT photography and x-y recording techniques; and the third is a "how-to-use" text about a versatile new HP analyzer.

AN 150A, *Using the 8558B Spectrum Analyzer*, introduces you to the operation, use and measurement capability of this 100 kHz to 1500 MHz instrument. A plug-in module that fits into any HP 180 series oscilloscope, the 8558B combines high performance with simple operation.

AN 150-4 shows how useful the spectrum analyzer can be for noise measurements. After distinguishing between random noise and impulse noise, the note deals with carrier-to-noise ratio, white noise loading, amplifier noise figure, and spectral purity characterization of several oscillator types.

Many spectrum analysis applications require photographs and plots for permanent records. AN 150-5 gives practical tips for making cathode ray tube photographs and x-y recordings of spectrum displays. Two types of CRTs and four types of recorders are covered.

Let us know which application note(s) you want; check T, U, or V on the HP Reply Card.



## New A/D converter for HP computer systems

Now there's a new low-cost analog measurement capability for research labs or production test stations that measure a few analog channels along with their digital work. The 91000A is a 16-channel, 12-bit analog-to-digital interface subsystem for HP 9600 series measurement and control systems or HP 2100 series computers. It's easy to install—simply slip the A/D card into an I/O channel in the computer.

The 91000A card includes all necessary interface and control logic, 250-ns sample-and-hold amplifier, A/D converter, and an input multiplexer with capacity for 16 single-ended or 8 differential inputs. You can input, sample and digitize analog data at rates up to 20 kHz. The card accepts TTL-level external pacing signals.

Multiple A/D interface cards can be used together in a single 2100 series computer. And if your needs grow, your system can grow with them, to over 1000 analog channels, without changing your existing programs. Simply step up to the larger HP 2313B A/D interface system.

*There's more. Just check O on the HP Reply Card.*

The 91000A is a complete package with BCS or RTE driver software (interfaced to FORTRAN, ALGOL or real-time BASIC programs) and an operation and service manual.

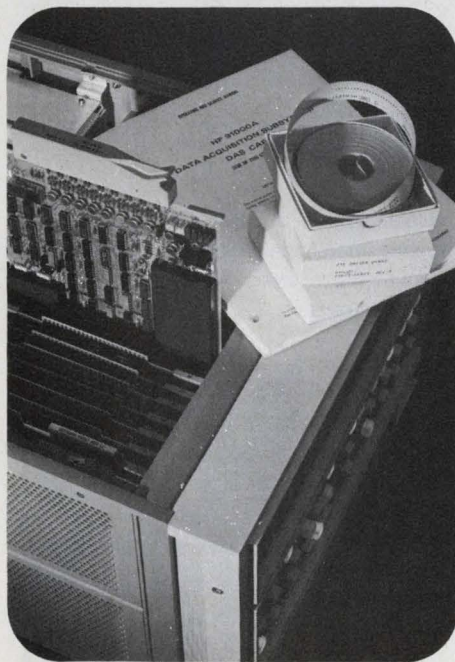

## New data link communications tester pinpoints system problems

With a new combination of measuring functions never before available, the 1645A lets you quickly troubleshoot modems, channels, or terminals.

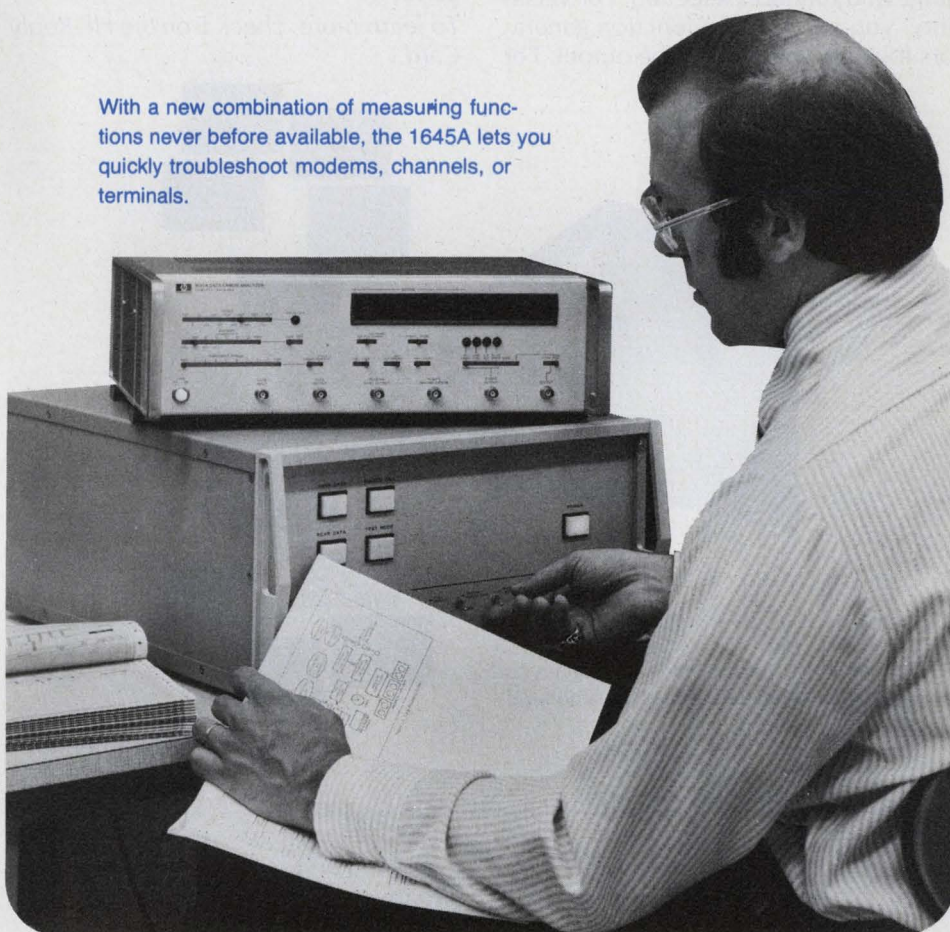

HP's new 1645A data error analyzer quickly isolates data communications link problems with six simultaneous measurements. You can use it to test modems, data channels, whole data communications systems, or low-speed memories. Yet it's easy enough to operate with little or no technical knowledge.

The 1645A measures bit error and block error rates directly—requiring no recalculation or interpretation—and maintains synchronization throughout a test, even in the presence of dropouts. Information appears on a digital LED display.

The analyzer also measures data error skew; counts the number of times carrier loss occurs; measures jitter or total peak distortion (the sum effect of jitter and bias); and counts the number of clock slips. With all these measurements taken simultaneously, you can locate the faulty system components in your communications link. And the storage feature leaves you free to work on other projects while the 1645A makes long unattended transmission analyses.

*To learn about easier troubleshooting, check B on the HP Reply Card.*



## Great way to make waves and save money

Sine waves, square waves, triangular waves—our low-cost function generator can produce them all, on 7 decades of range from 0.1 Hz to 1 MHz. The 3311A signal source also has dc offset and external sweep capabilities.

For convenience, there's pushbutton range and function selection. For versatility, you can put two function generators together and sweep the output. For

added value, the 3311A contains several features usually not found in this price range, such as 10:1 voltage control and separate pulse output for driving up to 20 TTL logic circuits. It also has a 15% duty cycle and 25 ns rise time.

All for an amazingly low price: just \$249.

To learn more, check E on the HP Reply Card.

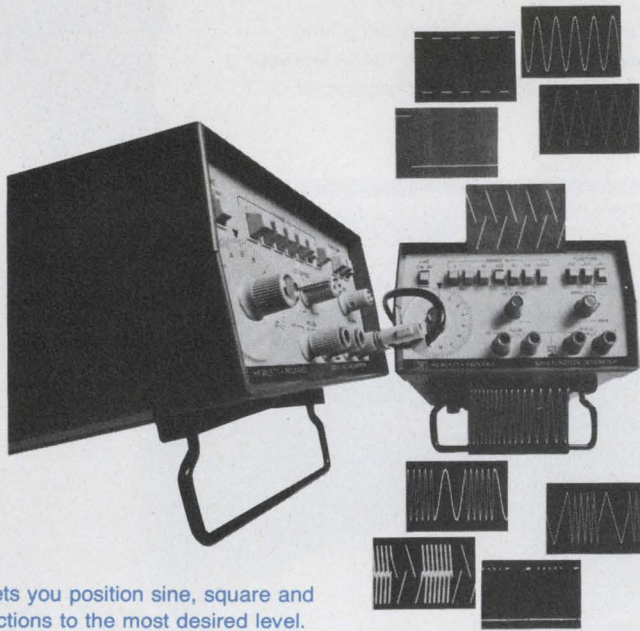

DC offset lets you position sine, square and triangle functions to the most desired level.

## New guide to HP electronic counters

Ever had to wade through mountains of specs to select a counter? Now, the HP counter brochure is here, making it easy to select from the most complete counter line available today. You'll find all types of counters here: simple low-cost units, battery-operated portables, universal counters/timers/DVMs, and models with versatile front-panel plug-ins. With HP counters, you buy just what you need, without paying for features you won't use.

Check R on the HP Reply Card and you can count on us to send your free copy.

## Design tips on microwave transistor bias

To help the microwave circuit designer, HP offers a new application note, *Microwave Transistor Bias Considerations* (AN 944-1).

In microwave transistor circuit design, the dc bias network significantly influences such RF parameters as gain and noise figure. Inattention to bias conditions can sacrifice RF performance. AN 944-1 is a practical guide that relates dc stability factors to RF performance.

For your free copy, check S on the HP Reply Card.

## New power supplies have dual output

Now, dual output capability has been added to HP's growing line of modular power supplies. Four models are offered:  $\pm 12\text{V}$  at 1.40A and 3.30A, and  $\pm 15\text{V}$  at 1.25A and 3.00A. A single front panel control provides  $\pm 5\%$  adjustment of both outputs. These series-regulated supplies deliver full-rated output from 0 to  $40^\circ\text{C}$  with derated operation up to  $71^\circ\text{C}$ . All models are specified at 0.01% line or load regulation, 1 mV rms and 5 mV p-p ripple and noise, and  $\pm 1\%$  tracking accuracy.

Standard features include cut-back current limiting, overtemperature and reverse voltage protection, and remote sensing. Overvoltage protection is available as an option. These dual output power supplies are packaged in  $\frac{1}{8}$  and  $\frac{1}{4}$ -rack width cases.

For all the specifications, check I on the HP Reply Card.

These new power supplies are designed for powering operational amplifiers, core drivers, D/A and A/D converters, MOS devices, and voltage comparators.

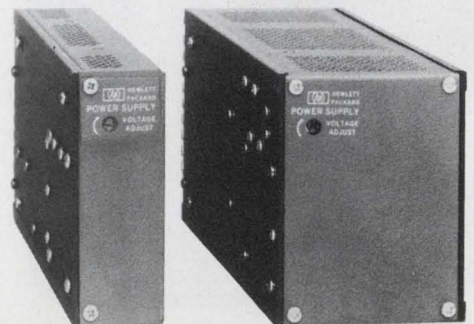



## New two and three digit low-power displays

Low power and MOS compatibility characterize HP's new series of solid-state numeric displays. They require only 300  $\mu$ A per segment, thereby eliminating the need for segment drivers when you interface them with MOS circuits.

These monolithic displays have a character height of 0.11 in. (.28 cm) and a standard lower right-hand decimal point. They are end stackable; digits

are on 200 mil centers. Built-in magnification increases luminous intensity.

The new indicators are available in two-digit clusters (5082-7432) and three-digit clusters (5082-7433).

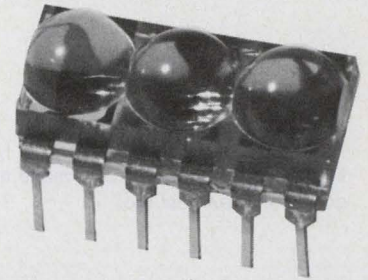

The new 5082-7430 series are ideally suited for use in handheld calculators and portable instruments.

For specifications, check H on the HP Reply Card.

## Send for a new diode and transistor catalog

Hewlett-Packard offers a wide range of diodes and transistors to meet your power, frequency, design and reliability requirements. The latest HP Diode and Transistor Catalog contains key specifications for the following products:

- Small signal microwave transistors.
- Schottky diodes—for mixing and detecting, microwave Schottky diode quads for double balanced mixers, beam lead and other Schottky and PIN diodes for hybrid ICs.
- RF, general purpose and switching Schottky diodes for high volume applications.
- PIN diodes for VHF, UHF and microwave applications.
- IMPATT diodes.
- Step recovery diodes.
- High reliability products.

The catalog includes packaging specs and drawings to aid the circuit designer.

For your copy, check Q on the HP Reply Card.

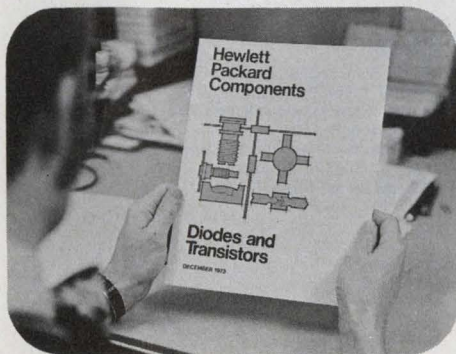

## Test components fast with new LCR meter



Typical uses for the 4271A LCR meter are: testing discrete components and varicap diodes, checking semiconductors, and L or C examinations of delay lines.

If you're testing diodes and capacitors or trimming IC capacitors and resistors, you need fast precise inductance, capacitance, resistance and loss measurements. Plug the new HP 4271A digital LCR meter into your system and you get 10,000 measurements or more per hour.

Using a four-pair measurement technique that reduces stray capacitance and residual inductance, this 1 MHz digital meter measures capacitance from 0.001 pF to 19,000 nF with an accuracy of 0.1%, and inductance from 0.1 nH to 1900.0  $\mu$ H. Capacitance loss components are measured as parallel conductance or as dissipation factor (as low as 0.0001). Inductance loss components are measured as series resistance (10  $\Omega$  to 10 K $\Omega$ ) or dissipation factor (as low as 0.0001). And you can vary dc bias from 0 V to 39.9V in 0.1 V increments.

The LCR meter has a four-digit LED display with 90% overrange, and it interfaces easily with HP computers, calculators, and digital recorders.

To learn how to improve component testing, check F on the HP Reply Card.

## New efficient dc supplies save watts and dollars

Low cost, high efficiency, compact size, outstanding reliability—you get them all with HP's 6427B-6483C family of high-power dc supplies. Using an advanced SCR-regulator design with up to 75% efficiency, these constant-voltage/current supplies are well suited to applications requiring high power with moderate regulation and ripple. You can use them for testing component aging, battery charging and discharging, station batteries, precision welding, and dc motor control.

Standard features include remote sensing, remote V and R programming, and auto-series, auto-parallel and auto-tracking operation. Nineteen different models provide outputs from 0-8 V to 0-600 V at currents up to 1000A.

To learn more, check J on the HP Reply Card.

High-efficiency dc supplies come in 300W, 1000W, 3500W and 11,000W power ratings.

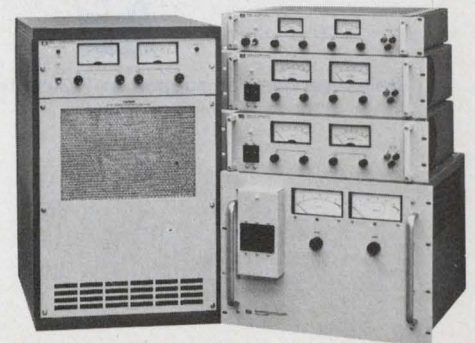



## New high value oscilloscopes for manufacturing, service and education

High reliability and low cost make the 1220A scope an ideal test tool.

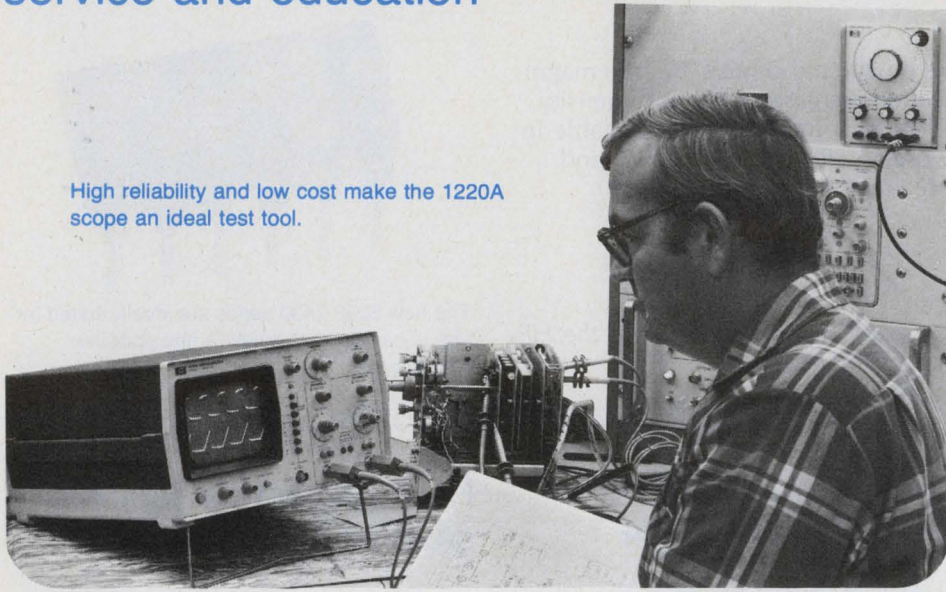

Two new 15 MHz oscilloscopes offer quality performance at minimum prices. Choose either the new 1220A dual channel scope, or the 1221A single channel model. Both have deflection factors from 2 mV/cm to 10 mV/cm for basic analysis of audio, video, logic circuits, FM, or direct output of mag pickups and heads. Built-in TV sync separation circuits make television servicing easy. And rugged construction makes these scopes useful in applications such as production and service of numerically-controlled machinery, process control equipment, automotive, aircraft, and marine electronics.

The large 8 by 10 cm graticule is internal, which eliminates parallax error.

Vertical accuracy of 3% and time base accuracy of 4% increase the validity of your measurements. Dc coupling is available for directly measuring absolute voltage levels, even on mixed ac and dc signals. A times-ten sweep expander makes it easy to examine signal details. The front panel controls are grouped functionally for easy understanding, and the pushbuttons are color-coded for easy use.

There's more: the automatic trigger sweep (just one control knob) assures stable displays. A bright base line is provided for fast setup in the absence of an input signal.

Built-in TV sync separation offers stable, automatic triggering on frame or

line for convenient TV troubleshooting. And, with the instrument's times-ten magnifier, vertical interval test signals can be "pulled out" for examination. The calibrated sweep helps identify timing problems in vertical or horizontal TV circuits.

An x-y mode makes reliable phase measurements with a phase shift of less than 3° at 100 kHz. The horizontal input also accepts horizontal drive signals from swept frequency oscillators for checking out tuners.

The 1220A displays two signals either in alternate for high sweep rates or, for lower rates, by chopping each sweep into short segments with blanking. The scope automatically selects the mode that will give you the best display. With dual channels, you can also compare input vs. output directly.

Solid-state design with its low power consumption and conservative component ratings makes for long, trouble-free life.

Check A on the HP Reply Card for more information.

**HEWLETT**  **PACKARD**

Sales, service and support in 172 centers in 65 countries.

**East**—W 120 Century Road, Paramus, N.J. 07652, Ph. (201) 265-5000.

**South**—P.O. Box 2834, Atlanta, Ga. 30328, Ph. (404) 436-6181.

**Midwest**—5500 Howard Street, Skokie, Ill. 60076 Ph. (312) 677-0400.

**West**—3939 Lankershim Boulevard, North Hollywood, Calif. 91604, Ph. (213) 877-1282.

**Europe**—Post Office Box 85, CH-1217 Meyrin 2, Geneva, Switzerland, Ph. (022) 41 54 00.

**Canada**—275 Hymus Boulevard, Pointe Claire, Quebec, Canada, Ph. (518) 561-6520.

**Japan**—Yokogawa-Hewlett-Packard, 1-59-1, Yoyogi, Shibuya-ku, Tokyo, 151.



## ACROSS THE DESK

(continued from page 8)

subroutine to work correctly. The subroutine uses the A register, and the main program must be written so that a change in the accumulator data, when this subroutine is called, will not produce erroneous results.

A subroutine to accomplish the same results without affecting any CPU scratch-pad register or the accumulator is as follows:

DECHL	DCL	decrement L
	INL	increment L
	JFZ	A jump if L ≠ 0
	DCH	decrement H
A	DCL	decrement L
	RET	return

The purpose of the INL instruction that follows the DCL instruction is to set the zero flag bit, if the L register was all zero when the subroutine was called. The rest of the subroutine is self-explanatory.

*John M. Schulein*  
Engineer

Philco-Ford Corp.  
Western Development  
Laboratories Div.  
3939 Fabian Way  
Palo Alto, Calif. 94303

## The author replies

Mr. Schulein is correct in his criticism of the subroutine DECHL. The subroutine, as shown, will not work without the missing instruction LAL between DCL and CPI 377. His subroutine is also correct.

It is true that the A register is used in the execution of the subroutine, and thus data cannot be retained in the A register. This must be considered when writing a program that uses the subroutine. The subroutine—as well as the one that Mr. Schulein has introduced—changes the contents of the zero flip-flop. Thus this status flag cannot be retained while the subroutine is executed. When a small microprocessor is used, this is a fact that one has to live with.

*Donald R. Lewis*  
*W. Ralph Siena*

Lewis Associates  
P.O. Box 33  
New York, N.Y. 11415

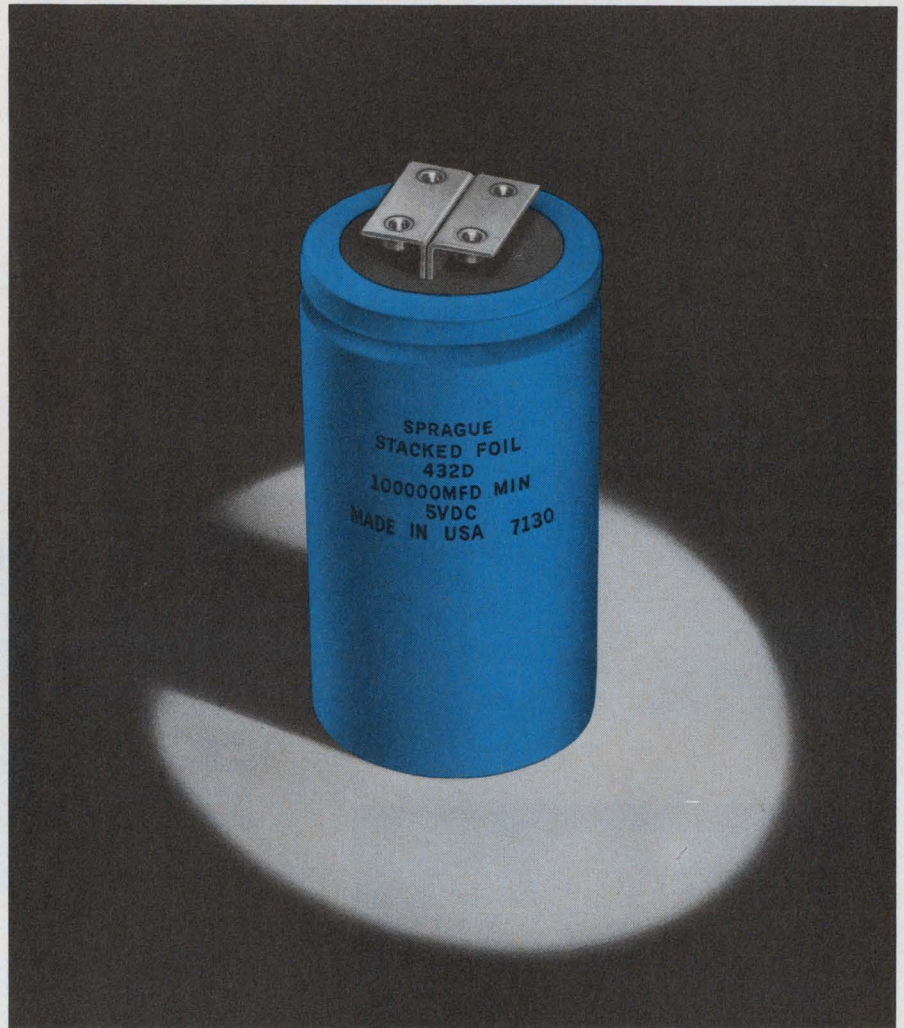

## Stacked...with beautiful curves!

(stacked-foil construction with ultra-low impedance, ultra-low ESR, ultra-low inductance)

Revolutionary new Type 432D COMPULYTIC® Aluminum Electrolytic Capacitors offer capacitance values to 100,000  $\mu$ F with equivalent series resistance of typically less than 0.001 ohm and inductance of only 1 nH in a 3" x 5½" case. This same capacitor will handle 93 amperes of ripple current at 65 C and 1 kHz.

Impedance limits at 10 kHz are as low as 0.001 ohm with typical values of only half of the specified limits.

Now available in two additional smaller case sizes for space-saving applications in smaller-wattage power supplies, with typical impedance of five milliohms.

Terminals are ideal for use with laminated-bus power distribution systems found in modern EDP equipment, where the low ESR and impedance of Compulytic capacitors help insure continued operation of logic circuits even during momentary power outages.

Sprague Type 432D Capacitors are available in nine voltage ratings from 5 to 50 volts d-c, and are designed for operation over the temperature range from -40 to +85 C.

For complete technical data, write for Engineering Bulletin 3443 to: Technical Literature Service, Sprague Electric Co., 347 Marshall St., North Adams, Mass. 01247.

THE BROAD-LINE PRODUCER OF ELECTRONIC PARTS

INFORMATION RETRIEVAL NUMBER 7

**SPRAGUE**®  
THE MARK OF RELIABILITY

4SM-2122R1



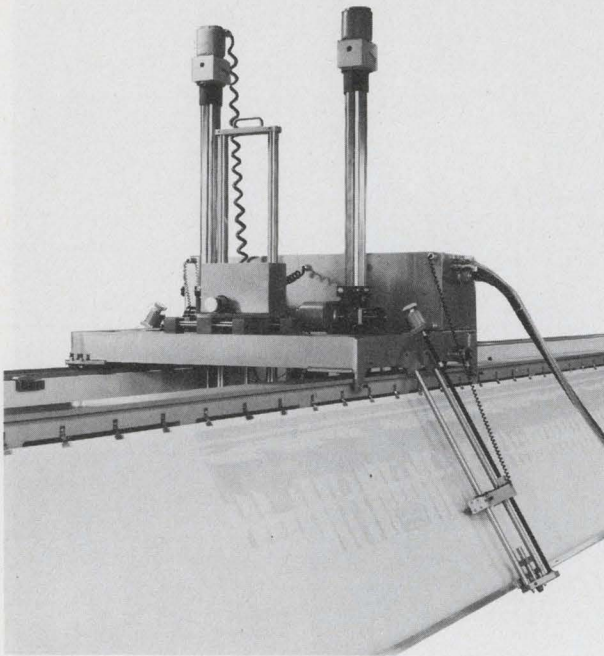

## A Recorder...

If all recorder requirements were the same, it wouldn't make any difference what recording paper you used. All recording papers would be the same also.

But the recording equipment you design is unique. Its recording speed, dynamic range, resolution and other characteristics are not identical to all other recorders. So if you are going to get peak performance, you must use a recording paper which matches your unique design requirements.

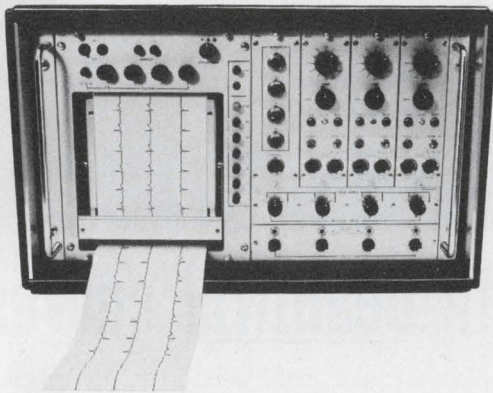

## is a recorder

At Fitchburg CPI we have ten different lines of coated recording paper. With literally hundreds of standard variations to meet practically every recording requirement. We have recording papers to meet the special requirements of sonar, computer print out, electrocardiograph, non-destructive testing, industrial event recording, photo facsimilies and voice characteristic sonagrams.

If we don't have a recording paper to exactly match the characteristics of your machine, we can develop one. Our lab facilities and R & D department are at your disposal.

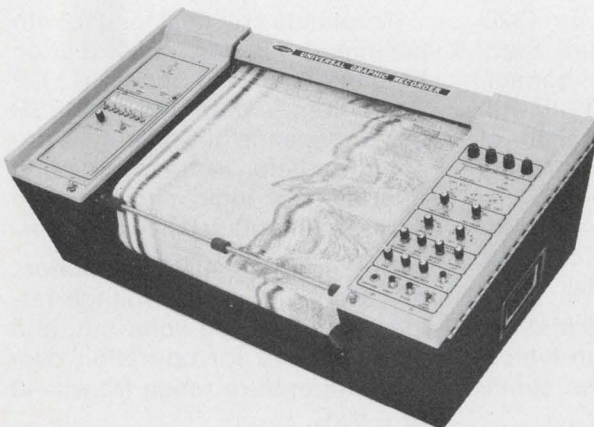

## is a recorder

Fitchburg CPI is the world's largest manufacturer of electro-sensitive recording paper. Our technical personnel will select or develop a recording paper for your machine that will record all the detail and fidelity of your recording signal.

If you build specialized recording equipment, why not allow us to advise you on the selection of electrosensitive, heat writing, pressure writing or other recording media. As a start, we would like to send you a free copy of our technical brochure "The dry electrosensitive process". It's yours for the asking.



**FITCHBURG COATED PRODUCTS**

Litton Box 1106, Scranton, Pa. 18501 Phone: 717-347-2035





# Jermyn

Europe's widest range of semiconductor hardware

Have you had a copy of our new  
80 page catalogue?

If not,  
write or telephone giving name, company, position,  
telephone number etc.

712 Montgomery Street San Francisco CA 94111  
Telephone (415) 362-7431

Sevenoaks (0732) 5827 Telex 95142 Munich (089) 39 88 01 Paris 744 29-71 San Francisco (415) 362-7431



If time is your business, you need Burroughs' new PANAPLEX™ clock panels\* for clear, legible display. In two character heights (0.5" and 0.7"), four or six digits per panel, with AM/PM indicator, for maximum design flexibility. Easy to see and read; wide viewing angle; low power requirements; compatible with MOS circuits; assured long life and dependability because PANAPLEX clock panels are backed by Burroughs' years of pioneering technology and manufacturing know-how . . . and they are available at competitive prices. Time will tell how much that means to you and your customers. For more information, write Electronic Components Division, P.O. Box 1226, Plainfield, N.J. 07061, or call (201) 757-3400 or (714) 835-7335.

*\*Sample quantities of panels available immediately.*



Burroughs 

INFORMATION RETRIEVAL NUMBER 10



## With a \$3.1-billion budget, NASA sees year of growth

Funds available to NASA in 1974 are expected to remain stable around \$3.1-billion, having found a level of apparent acceptability to Congress and to the public.

The largest expenditures again will be on those programs that are already well into engineering development: the Apollo-Soyuz project, which will be launched in 1975, and the space shuttle.

Work is under way and will continue on two Viking unmanned orbiter lander spacecraft, scheduled for launching to Mars in 1975, and on the Mariner spacecraft for the Jupiter/Saturn fly-by mission, scheduled for launching in 1977.

Advanced space technology projects will get adequate funding at Jet Propulsion Laboratory, according to Frank J. Sullivan, director of NASA's Guidance Control and Information Systems Div. in the Office of Aeronautics and Space Technology.

Robotics, or machine intelligence, is one area to be developed, with a planetary rover for Mars as the initial hardware. Because of the distances that result in a communications lag between the earth and Mars of perhaps 30 minutes to 1-1/2 hours, the robot must be able to initiate action without instructions from the earth. Based on what it encounters—obstacles in its way or the elements in the atmosphere or soil that it finds—the robot will take the appropriate next step.

NASA plans to have a laboratory demonstration of the robot this year and hopes to test an autonomous rover in a desert area by 1978.

In laser communications the space agency hopes to work with the Air Force to flight-test a laser in a synchronous satellite by 1977, Sullivan says. The object would be

to determine the influence of the atmosphere on signal propagation and capacity. This would, in turn, determine how much bandwidth would be required.

NASA is leaning toward a CO<sub>2</sub> laser, although it is also studying the neodymium YAG. The YAG is not as well developed as the CO<sub>2</sub>, but it does promise more capacity.

NASA will also develop ways to use the laser to detect and identify pollutants. The size of the wavelength of the tunable laser would identify the size of the particular pollutant being encountered, thereby identifying it and measuring the particle density.

Tuned rhodium dye lasers that can penetrate water up to 20 feet will be investigated for determining the health of the ocean by detection of chlorophyll, plankton and other matter.

Lasers will be tested as radar systems for mapping the shallow areas of the ocean, where it might be difficult for ships to operate. NASA's Langley Research Center, near Norfolk, Va., is working on this project with the Navy.

The space agency is intensely interested in extending the life of attitude-control systems for planetary probes. The problem lies in achieving efficient computer control of sensors, star trackers and thrusters. The computer system must be designed to discover any failure in a sensor or thruster system and then switch to alternate arrangements so the mission can be successfully continued.

NASA will investigate a low-cost attitude-control system for earth orbital missions that carry a large number of experiments, each requiring a different stabilization accuracy. The aim is to eliminate the need for separate gimballed platforms for each experiment.

Control moment gyroscope tech-

nology for earth orbital and planetary missions is being examined to see if energy can be drawn off the spinning gyroscope and stored in a flywheel. The energy could then be converted to electrical power, Sullivan notes.

An optical computer is to be developed with the hope that the high speed of the device will permit photographic data to be processed aboard satellites. The speed would have to equal that of parallel processing systems.

NASA is working on a solid-state bubble-memory recorder to replace the present magnetic-tape recorders, which store data and periodically "dump" the information to earth stations. The magnetic recorders, with their moving parts, have had a high failure rate, Sullivan says, and the bubble memories promise more reliability. NASA presently is trying to design a bubble-memory system with a capacity of 10<sup>8</sup> bits.

## U.S. gets its first domestic satcom net

The nation's first domestic communications satellite system went into full operation last month, using Canada's Anik II spacecraft and four U.S. earth stations. Operated by RCA Global Communications and RCA Alaska Communications, the network provides channels between the East and West Coasts of the U.S. and Alaska.

The four earth stations, which cost \$10-million are near New York City, San Francisco and Anchorage and Juneau in Alaska. Soon additional earth stations will be built in Alaska, and eventually, when the second phase of the program gets under way, RCA will put up its own satellites and build more stations in the U.S.

At present RCA uses two rf channels in the Canadian satellite—one full-time and a second part-time. The satellite channels operate in the 4-to-6-GHz band and have a nominal bandwidth of 36 MHz. The up link operates between 5925 and 6425 MHz, and the down link from 3700 to 4200 MHz.

The full-time transponder is capable of operation in any of the following modes:

- Up to 1000 one-way FDM/FM



voice channels on a single FM carrier.

■ 600 one-way voice channels with use of the single-channel-per-carrier technique.

A television channel to Alaska will cost about \$1200 an hour, as opposed to the \$2000 now charged voice channels on a single FM carrier.

RCA's Phase II system will consist of three 24-channel satellites in stationary orbits and a network of major earth stations. The first of the spacecraft is scheduled for delivery by October, 1975.

Two developments will make possible the 24-channel service without exceeding the weight and volume capacity of the launch vehicle: First, lightweight, graphite-fiber, epoxy-composite material is to be used as the basic material for each of 24 input and output multiplex filters, as well as for waveguide sections and antenna feeds. This material will replace the invar used in conventional designs. Second, three-axis attitude control will allow extra weight and power margins, compared with those available with current dual-spin satellites.

The main body of the spacecraft is to be approximately 5.3 by 4.1 by 4.1 feet and its orbiting weight approximately 1000 pounds. The orbiting satellites will be powered by solar energy derived from two arrays.

Each of the RCA Phase II satellites is designed to carry single-carrier analog transmissions, such as FDM/FM voice or FM/color TV, or single-carrier digital transmissions. Channels will also be capable of operating in the multiple-access mode for transmission of multiple-carrier analog or digital signals.

## Optical design slashes encoded altimeter price

A new generation of encoding altimeters for private planes, designed as substitutes for expensive brush and magnetic-encoded devices, has been announced by Kollsman Instrument Co., Syosett, N.Y.

The new device uses an optical shaft encoder to convert the position of the altimeter needle to an electrical signal. Encoded altimeters are not new, a company

spokesman notes; commercial airliners have been using them for years. But until now they have cost \$5000 to \$6000. New rules by the Federal Aviation Administration, however, require private planes flying in high traffic areas to have encoded devices; a cheaper alternative to the magnetic and brush devices was considered essential.

By attaching an optically encoded wheel to the altimeter shaft and using light-emitting diodes to illuminate it, Kollsman has cut the price of the encoded altimeter to about \$1300. In addition the size and weight of the device have been considerably reduced.

## New approach radar proves highly accurate

A new solid-state approach-control radar, with improved rejection of weather and ground clutter, has demonstrated marked superiority over older, comparable systems.

Developed by the Air Force Electronic Systems Div., Bedford, Mass., the new system—the AN/TPN-19—demonstrated 100% success in recent tests in tracking aircraft landing in rainfall as heavy as five inches an hour. In contrast, a nearby AN/FPN-16—a standard Air Force approach-control radar—was able to track only 6% of the same aircraft.

The tests were conducted at Eglin Air Force Base in Florida.

The new TPN-19 is a dual radar system that provides approach surveillance up to 60 miles and precision landing surveillance up to 20 miles. According to Wayne Wootton, deputy director of the TPN-19 program, the system has several other advantages over present radars. These include:

■ A phased-array precision approach radar with 15-by-20-degree constant coverage; current equipment is limited to a very narrow areas swept by a moving antenna.

■ Simultaneous landing control of up to six aircraft, separated by three minutes each; present radars handle one aircraft at a time.

■ An adjustable glide path from 2 to 13 degrees in increments of 0.1 of a degree; current equipment uses one fixed glide path, so that a helicopter is required to use the

same flat approach as a large aircraft.

■ Changeable antenna-beam direction via an automatic five-minute operational sequence. Present systems require turning the antenna manually.

Nine of the AN/TPN-19 radar systems will be produced by the Raytheon Co.'s Equipment Div. in Wayland and Waltham, Mass., under an \$18.32-million contract.

Modular packaging of the TPN-19 permits partial system use. The surveillance radar can be set up as far as 10 miles away from the precision-approach van. This permits matching the system to the terrain, rather than placing both antennas alongside the runway.

## EIA components show geared to designers

A "new kind" of electronics show to bring component designers and the manufacturers' application engineers together will be held by the Electronic Industries Association from May 13 to 15 in Washington, D.C.

The show will run at the same time as the joint EIA-IEEE Electronic Components Conference, at which technical papers are presented. Both events will be held in the Statler-Hilton Hotel.

According to Bruce Vinkenulder, chairman of the organizing committee for the new show: "This is a new kind of a show, in that it is planned to be a one-to-one conference between the engineers of the parts manufacturers and the users' engineers."

Exhibitors are being urged to have high-level members of their engineering departments man the exhibit booths, so they can sit down with the user and discuss application problems on the spot.

## TI challenge to HP-35

Texas Instruments has just introduced a new electronic slide rule that will compete with Hewlett-Packard's HP-35. Dubbed the SR-50, the new calculator does everything the HP unit does. In addition, it has hyperbolic, factorial,  $X^2$  and sum of products functions. It costs \$169.95 compared to \$295 for the HP-35.



# The first interactive graphic calculator.

## Just \$7500.

### It's the 31/10 system.

A powerful calculator, graphic terminal and software combination. The first ever to place math-power, graphics and alphanumeric display at your fingertips!

The 31/10 is personal. Fast. And highly interactive. It lets you explore ideas and concepts on the spot. Plot single variable functions, specify X-Y coordinates and a lot more. Corrections and plot changes are immediate. From data entry to display, your ideas are quickly brought to light. That's responsive!

Plug in our software packages. They put the 31/10 to work. No heavy programming experience

needed. So you can deal in your concepts and not the mechanics of programming. And get graphic and alphanumeric output from natural math input.

There's more to our 31/10. Such as add-on memories for long programs. The optional silent thermal printer for listing and keeping track.

Peripherals like our hard copy unit to put in hand what's on the screen.

The costs are low, the results are priceless.

Get the facts about the 31/10 and the Tektronix reliability and worldwide service behind it. See your Tektronix sales engineer for a demonstration or write: Dwain Quandt, IDD Calculators, Tektronix, Inc., P. O. Box 500, Beaverton, Oregon 97005.

**Our programmable calculators. Natural. Powerful. Significantly less expensive.**



**TEKTRONIX®**

INFORMATION RETRIEVAL NUMBER 11





# After 13 years, standardization of opto-isolators is beginning

A move toward standardization of optical isolators is under way 13 years after the introduction of the devices.

The trend has been made possible by the advent of light-emitting devices together with the use of silicon photosensor technology. These solid-state elements can be put in standard IC plastic packages.

For the designer, standardization means that, for the first time, second-sourcing of optical isolators will be available. Standardization will also give him a group of generic devices around which to design for mass production. And prices are dropping, too.

**Jim McDermott**  
Eastern Editor

Optical isolators are photon-coupled devices in which an electrical signal is converted into light that is projected through an insulating interface and reconverted to an electrical signal. For years, there has been a broad variety of light-emitter/photosensor combinations in nonstandard packages. Standardization is beginning with dual-in-line plastic packages. A few JEDEC-registered devices have begun to appear, offered by Texas Instruments, Motorola and General Electric.

## DIP package is popular

Other manufacturers using the DIP packages include Clairex, Dialight, Fairchild, Litronix, Monsanto and Vactec. Micro-sized opto-

isolators for incorporation in hybrid circuits are being produced by Spectronics (see photo).

Despite the industry efforts at standardization, however, many nonstandard devices are available, and they appear destined for use for some time to come. The variety of both devices and specifications makes it difficult to compare data; there is little consistency in the specs.

"Optical couplers are tough to specify," says William Sennhouser, district optoelectronic marketing manager for Texas Instruments, "because you have three sets of parameters. What does the input stage do? What does the output stage do? And what do they do together?"

Sennhouser notes: "One of the

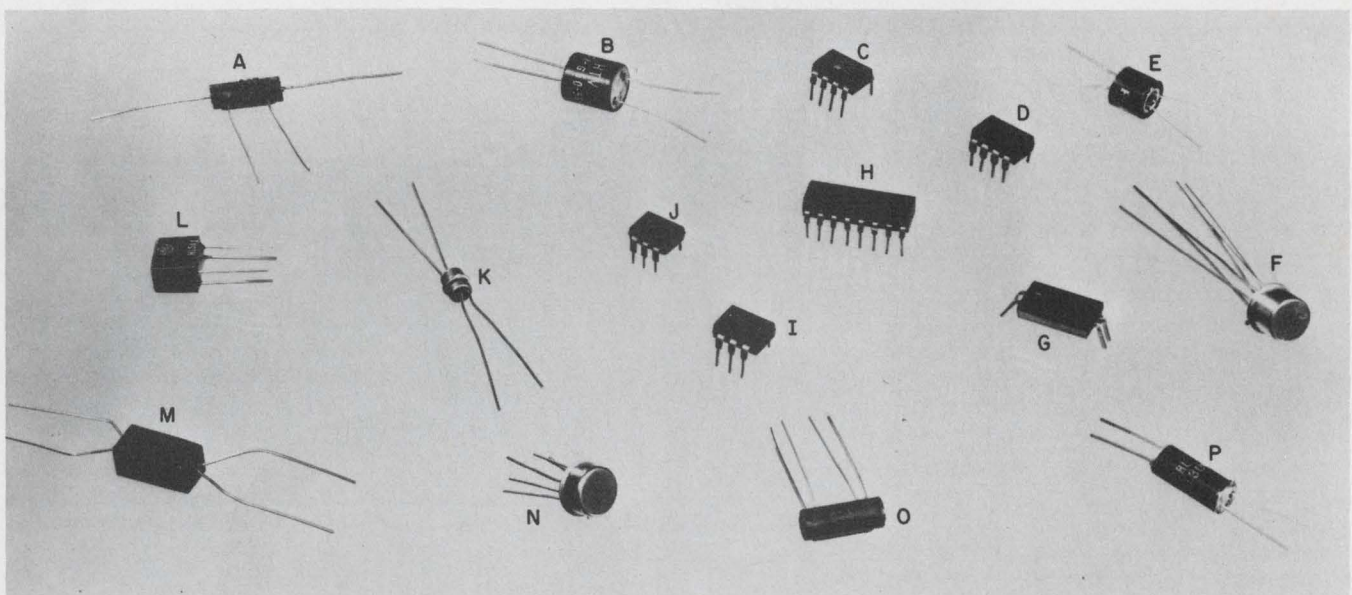

Opto-isolators using combinations of LEDs and silicon photosensors come in a wide variety of packages and voltage ratings. LED/phototransistors by Spectronics (A, O), National Semiconductor Ltd. (E), Centralab (P), Dialight (G), Texas Instruments (K,M) have no base connection. Similar devices by Centralab (F), Fairchild (I),

General Electric (L) and T.I. (N) have base pins. Motorola unit (J) has a photo-Darlington output. Device by Monsanto (C) houses a photo-SCR, while that by Hewlett Packard (D) is a high-speed logic gate. The 16-pin DIP by Litronix (H) is a quad phototransistor device, while the device by Hamamatsu (B) is a LED/photodiode combination.



# MONO-KAP™



**RADIAL LEADED  
MONOLITHIC CAPACITOR**

Underneath its epoxy coating, it's got a chip for a heart — a USCC/Centralab ceramic chip capacitor, 100% monolithic construction. Solid reliability for business machines, computer and communications use; rugged enough to meet mil-spec requirements yet priced for commercial applications.

Capacitance from 4.7 pF to 10 Mfd, working voltages 50 to 200 VDC and a variety of dielectric characteristics.

Best of all — AVAILABLE. USCC has recently improved chip capacitor deliveries . . . now radial leaded

Mono-Kaps are available in as little as 12 weeks for non-stock items.

Remember. USCC/Centralab or your local Centralab industrial distributor.

We deliver.



**USCC/Centralab**

Electronics Division • Globe-Union, Inc.



2151 North Lincoln Street ■ Burbank, California 91504  
(213) 843-4222 ■ TWX: 910-498-2222

INFORMATION RETRIEVAL NUMBER 12



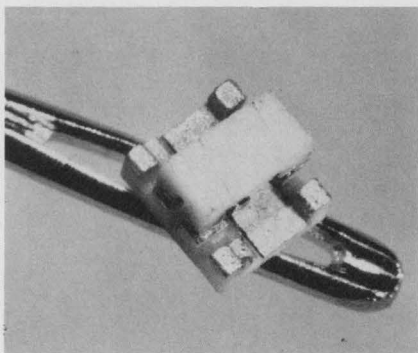

This tiny opto-isolator is a miniature version designed for hybrid applications. The device, by Spectronics, Inc., comes with a LED and photodiode, a phototransistor or in a photo-Darlington isolator version.

critical parameters of solid-state opto-isolators is the current-transfer ratio." This is the ratio of the input, or forward, current  $I_F$  to the LED and the isolator output current. It is almost invariably expressed in percent.

Another major parameter, Sennhouser says, is the device's ability to withstand high voltages between input and output.

From the design point of view, these parameters are tradeoffs, Sennhouser explains. "To maximize the current-transfer ratio, the gap between the LED and the photodetector must be decreased," he points out. "But if you decrease the input-output gap, you lower the device's ability to isolate a higher voltage."

As an example, Sennhouser points to the TIXL 109, which is rated at 5 kV—about three times the usual device rating. To obtain this isolation, the LED and phototransistor have been separated enough to reduce the current-transfer ratio to a very low value of about 0.5%. Also, Sennhouser notes, the phototransistor output is down in the microampere region, whereas all the other TI devices are characterized in the low milliampere region.

The breakdown voltage of the usual device is specified at 1.5 or 2 kV. In special designs, like those by Sigma Instruments, it can run as high as 25 kV (see photo).

The manner in which the breakdown voltage is specified is frequently not the same from manufacturer to manufacturer or from device to device of the same supplier.

"These breakdown-voltage rat-

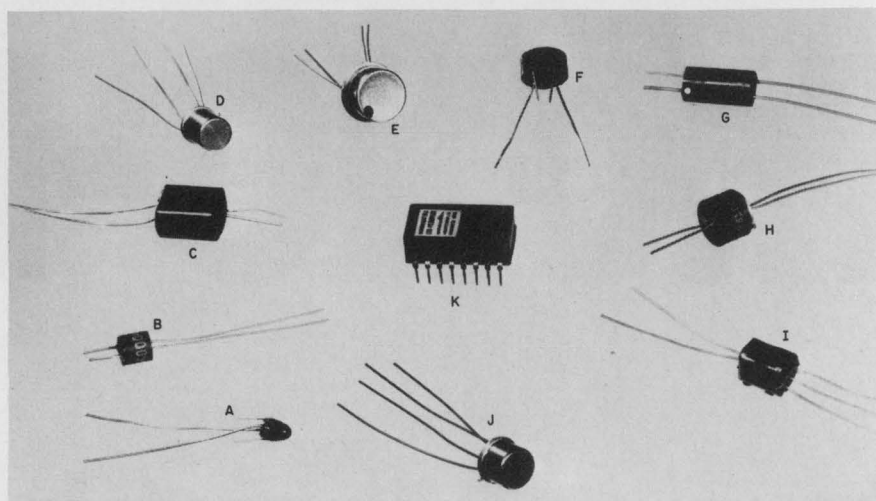

Isolation voltages of from 300 V to 10 kV are found in these isolators using LEDs to drive photoresistive cells. The OFF resistances range from a few hundred kilohms to megohms, while the ON resistances may be as low as a few hundred ohms. Single photo-isolator units include those by Quantrol Electronics (A,E,F); Clairex (B,H); Hamamatsu (C); National Semiconductor Ltd. (D,G)—the G device has the 10 kV rating; and Vactec (J,I)—the I unit has a single LED and twin photoresistors. A multiple isolator by Hamamatsu (K) has four photo-isolator devices in the 16-pin package. Isolation voltage for the quad devices is 1 kV, and up to 100 V can be placed across the photoresistor cells. The LED operating currents are 25 mA.

ings are one of the pitfalls in isolator specifications," says Henry Wearsch, advanced engineer at Reliance Electric, Cleveland. Responsible for the use of these devices as control-computer interface elements, he points out:

"If breakdown voltage listed happens to be dc and you apply an ac-rms voltage of that value, you'll exceed the rating. More than likely the unit will be destroyed."

Wearsch's advice is to make your own tests to be sure of what the device will actually handle. He has found a definite spread in the high-voltage tolerances between various devices and their specs.

#### Low capacitance gives isolation

The capacitive isolation obtained with optical coupling is typically 0.5 to 2 pF. The capacitance is measured with both leads of the input LED tied together and all leads of the output phototransistor shorted together.

David Barton, senior member of the technical staff at Litronix, points out that most of this capacitance is between the lead frames of the LED and transistor.

"Perhaps only 10 or 15% is directly to the transistor die, and perhaps half again is to the transistor base," he notes. "So we're

talking about 0.02 pF between the input and the base."

These low values of capacitance provide the isolation against electrical noise and common-mode signals on the input side of the coupler.

#### Transfer ratios have spread

Manufacturers' guaranteed minimum current transfer ratios generally have a wide spread for phototransistor opto-isolators. The guaranteed minimum ranges from 20 to 100%, depending upon the device and operating temperature, says William Sahm, application engineering consultant at General Electric, Auburn, N.Y. The outside limits of opto-isolator operation are normally specified at -55 to 100 C, with the high mark generally established by the reduced quantum efficiency of the LED at that temperature.

The current-transfer ratio is of major interest to the user over a range of LED input current. Yet most specification sheets simply give it at some nominal value of current and temperature. Curves may, but frequently don't, accompany the data from which the designer can interpolate his own spread.

Use of the values on the spec





Stable Trimmers  
Small Duals  
Rugged Pots

If you're really  
serious about cost,  
be serious about quality.

Type FD trimmer. Type GD pot. Ideal variable resistors for CATV attenuators. Or any Bridged-T or L pad application requiring minimum size, stability and long life in severe environments. Exclusive hot-molded composition resistance elements permit peak set-ability. Diameter 1/2

inch (12,70 mm). Immersion-sealed (can be potted). Standard resistance values from 100 ohms to 5 megs and many popular impedance values. Single turn. For complete technical details request Publication 5231 (FD trimmer), Publication 5213 (GD potentiometer), Publication 5221 (FD/

GD attenuators). Allen-Bradley Electronics Division, 1201 South Second Street, Milwaukee, Wisconsin 53204. Export: Bloomfield, New Jersey 07003. Canada: Allen-Bradley Canada Limited, Cambridge, Ontario. United Kingdom: Jarrow, County Durham NE32 3EN.

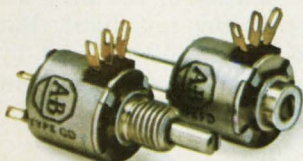

Actual Size

INFORMATION RETRIEVAL NUMBER 13



**Allen-Bradley**

Milwaukee, Wisconsin 53204



sheets can lead to design trouble, cautions Virgil Merkel, senior development engineer at Potter & Brumfield, Princeton, Ind. "The transfer ratio for different input currents can vary widely from supplier to supplier," he notes, "and also from isolator to isolator within a given group."

Merkel points out that the current-transfer ratios of LED/phototransistor devices that he has tested range from about 6 to 200%. For higher transfer ratios, he has found that LED/photodarlington configurations range from 100 to 600%.

### Output can vary widely

GE's Sahn points out that one of the biggest problems in applying LED opto-isolators is in determining just how much output current can be reliably expected for a given operating ambient temperature. The reason? The output is not only a function of temperature but also of the device's forward current transfer ratio, and the latter is subject to wide variation.

For example, in a 30-C ambient, 40 or 50 mA can generally be applied to opto-isolator LEDs. For a device with a 100% current-transfer ratio, 40 or 50 mA may be expected from the phototransistor. However, few applications can be designed on this low temperature margin. For a safe operating temperature, 60 C is more realistic. Use of this temperature reduces the allowable input to about 20 mA.

If the device has 100% current transfer, this would mean an output of 20 mA, but with a 20% device, only 4 mA could be obtained. It is therefore necessary to make sure that the guaranteed minimum current transfer ratio is high enough to provide sufficient current.

If, for example, 20-mA output were needed in a 60-C application, one answer would be to use an isolator with a photodarlington amplifier. The guaranteed minimums with these devices range from 100 to 600%.

"Photodarlington are used for the higher ambients or for heavier loads," says Sahn. "As the temperature rises, the Darlington beta goes up much more than that for

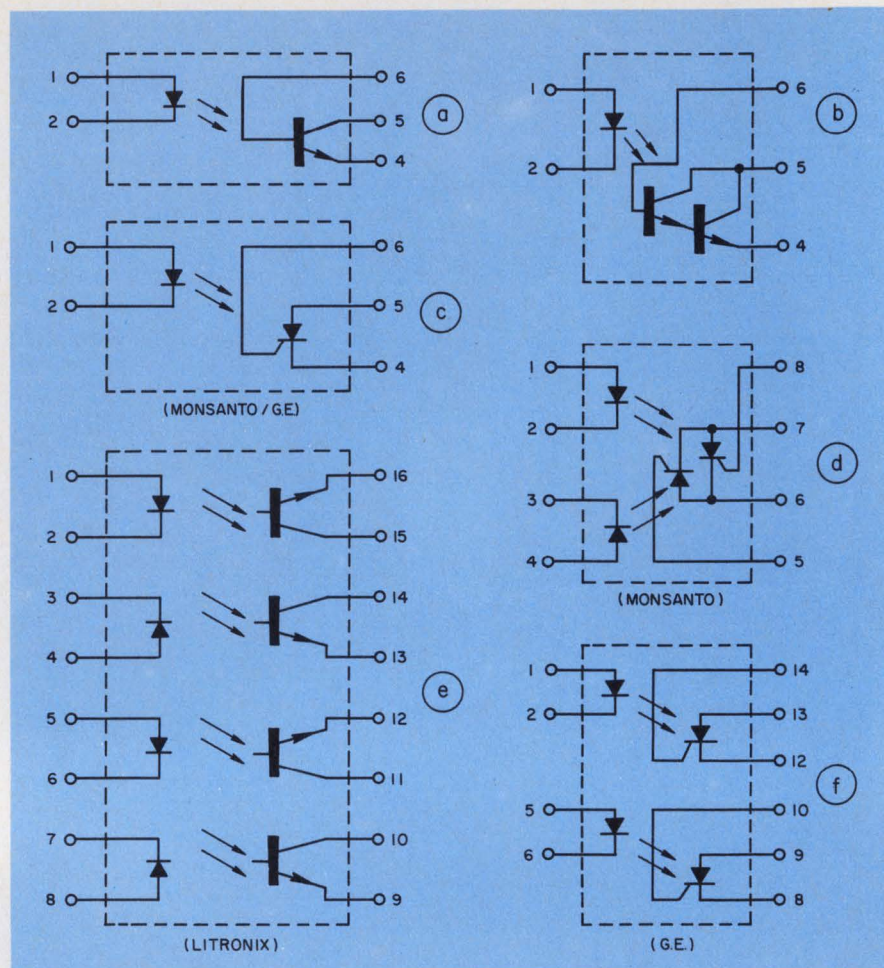

1. These photo-isolators with LEDs and silicon photosensors are available in DIP packages. The phototransistor (a) and photo-Darlington (b) are multi-sourced. The photo-SCR (c), bidirectional SCR (d) and the dual SCR (f) and the quad phototransistor unit (e) are made by the manufacturers indicated.

a transistor, giving a higher current transfer ratio. As a result, you can operate at a higher temperature for a given output current with the photo-Darlington than with a regular phototransistor."

The penalty paid is the reduced operating speed of the Darlington, which is typically around one-tenth that of the phototransistor. But for some applications, Sahn notes, this may be an advantage. For example, if noise spikes are present on the LED input, the slower response of the photo-Darlington can prevent the spikes from appearing at the output of the device.

### Isolator speed is variable

Typical low-cost phototransistors generally specify turn-on and turn-off speeds of 3  $\mu$ s, says Sahn.

"But speed can be varied by orders of magnitude by biasing

the coupler," he notes, "so make sure you have the proper bias for the desired switching speed."

Most of the six-pin DIP packages with the LED/phototransistor combination have the base connected to one of the pins. However, for highest sensitivity, the base is usually left open. But sensitivity can be traded for higher speed by loading the base.

Sahn points out that using phototransistor isolators gives reasonably good linearity of response from ranges of LED input current of 1 or 2 mA up to 20 or 40 mA. And the response over a range of temperature is fairly linear because of a fortunate circumstance: The output of the LED has a negative temperature coefficient—that is, as temperature increases, the quantum efficiency of the LED decreases, producing less light. But this is offset to some degree by the positive temperature coefficient of the transistor.



# GI stable mates



Stable because nature gives mica its conformity and volumetric efficiency. Mica capacitors are perfectly mated to the needs of communications, instrumentation and navigation circuitry. They're best suited for critical circuits requiring maximum long life stability over a temperature range of  $-50^{\circ}\text{C}$  to  $+150^{\circ}\text{C}$ . For circuits involving delay, timing and frequency discrimination.

A tough epoxy coating provides a long lasting moisture barrier. GI mica capacitors deliver close capacitance tolerance, are available in commercial and military types, from 1 to 100,000 pF and working voltages from 100 to 2,000.

For more information write for a copy of "Mica Capacitor Technical Bulletin MC-2". Capacitor Division, General Instrument Corporation, 165 Front Street, Chicopee, Mass., 01014, Phone (413) 594-4781. In Canada (416) 763-4133.

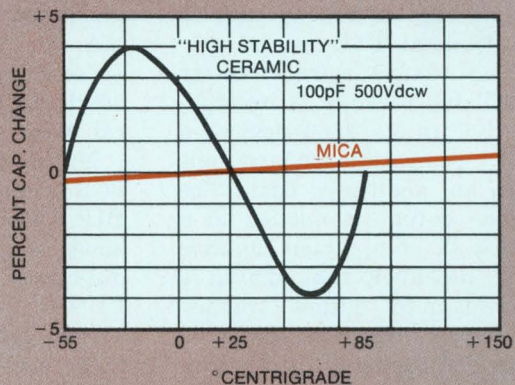

**GENERAL INSTRUMENT  
CORPORATION**





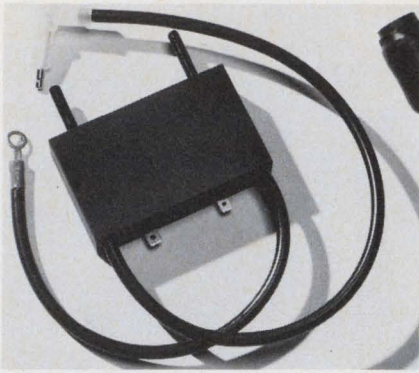

**Special isolators are designed for high voltages.** These units, by Sigma Instruments, are rated at 15 kV rms (left) and 1 kV (right). The 15 kV unit is a tungsten lamp/photoreistor device. The other has a LED.

By far the fastest opto-isolators are those using photodiodes. But since the diodes are operated in the back-biased condition, the output is usually small. Some diodes are designed for relatively high outputs. For example, in Monsanto's MCD2 isolator, the current output ranges from 40 to 100  $\mu$ A. For six-pin DIP devices, with a phototransistor, the base-collector diode can be used, with the emitter open.

In any event, the diode output must be amplified, either by an external transistor amplifier or by an amplifier stage on the same chip, as Hewlett-Packard does in its 4351 high-speed, optically coupled unit. Packaged in an eight-pin DIP, this device is useful up to 10 MHz. Current transfer ratios of 10 to 20% are realized, with outputs on the order of 1 to 10 mA. The HP device has the fastest isolator speed currently available. Its output can be directly coupled to TTL loads at TTL speeds.

A trend toward more circuitry in an isolator package is exemplified by HP in its 4360 device—a DTL/TTL-compatible isolated logic gate in an eight-pin DIP. The photodiode output is applied to a monolithic IC chip, which contains a linear amplifier that drives a Schottky-clamped output transistor. A 5-mA input to the 4360 sinks an eight-gate (13 mA) fan-out at the output. The device can operate at a 20-megabit rate.

Monsanto has an eight-pin DIP—the MCL 610—with a gallium-arsenide LED and a fast photodiode. The diode output is amplified with a differential amplifier/

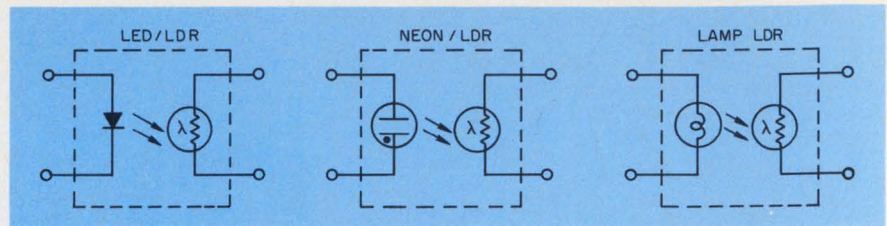

**2. Photo-isolators with photoresistor (LDR) outputs** use light sources of visible LEDs, neon lamps and tungsten lamps. The bidirectionality of the LDR units makes them useful in applications using ac voltages.

comparator that drives a Schmitt trigger. The output of the Schmitt drives a standard TTL totem-pole circuit that has both sourcing and sinking capability. The operating speed is 1 MHz.

Litronix has gone in another direction with the "more-in-one" package by incorporating in a 16-pin DIP four separate LED/phototransistor isolators. The device—the ILQ-74—specifies a 35% typical transfer ratio for the quad units.

### SCR isolators switch power

Light-activated SCRs are packaged with gallium-arsenide diodes to provide isolation between low-power circuitry and ac line voltages carrying switching or relay functions. Monsanto's LED/SCR combination is packaged in a six-pin DIP, with 1500-V dc isolation and an anode rating of 200 V for the MCS2 and 400 V for the MCS-2400. The maximum anode current for both is 150 mA.

General Electric has equivalent units—the MC11C1 and the HC-11C2, with surge voltage isolation of 2500 and 1500, respectively. The maximum forward current is 300 mA, and the minimum peak reverse voltage is 300. GE also has a single LED/SCR unit in a TO-77 can with slightly higher ratings.

Monsanto packages a dual LED/SCR combination in an eight-pin DIP, with the SCRs connected anode to cathode internally or bidirectional switching. GE has two LED/SCR isolators in a 12-lead, 14-pin DIP. Connections to the SCRs are independent.

The majority of applications of optical isolators are digital, says David Barton, senior member of the technical staff at Litronix. Many methods of incorporating these devices into logic systems have been published, he says. But

his cardinal rule is: "To keep out of trouble, keep it simple." If you're going to drive the LED with a standard TTL, drive it in the current-sinking mode—never the current-sourcing mode.

To drive TTL logic with the phototransistor output, Barton continues, use the phototransistor collector as the output feeding into the gate input.

"Put a resistor of 15 K from the phototransistor collector-gate junction to  $V_{CC}$  and ground the emitter—that's all there is."

A generic class of opto-isolators uses photoresistive materials—cadmium sulfide, cadmium selenide, and cadmium sulfo-selenide—for the photosensor.

The latest isolators of this type are using visible gallium-arsenide-phosphide LEDs, because the photoresistive materials have peak sensitivity in the visible region.

For the LED-driven photoconductor isolators, the response speed is limited solely by that of the photosensor—normally on the order of a few milliseconds. This is also the case with neon units. With tungsten light sources, the thermal hysteresis of the filament can be the governing factor.

Tungsten-lamp devices have played important roles in telephone equipment, with life expectancies of 10 years or more obtained when the lamp is derated. But LEDs are replacing the tungsten lamps.

Norman Wolff, chief engineer at Vactec, points out that the big application for LED/photoreistor units is in audio circuits and similar applications, where the bilateral characteristic of the photoconductor is needed. A second big use, he says, is in high-voltage circuits, such as those that turn on triacs.

With a neon/photoreistor coupler, he points out, it is possible to apply line voltage to both sides of the device. For monitoring ac



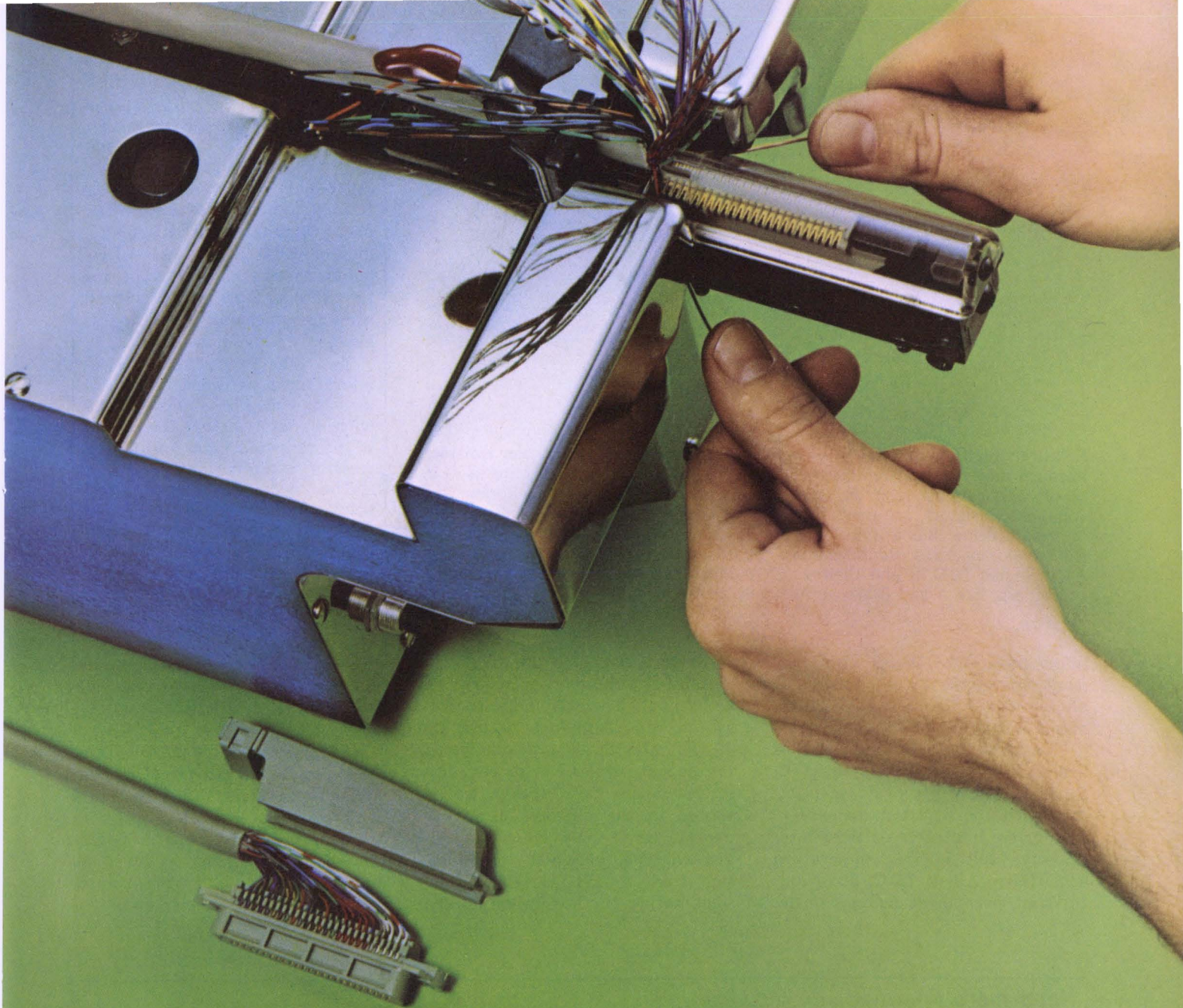

## You can factory-install this 25-pair connector in less than 3 minutes. Without solder.

Impressive? Yes—especially since you can do it in your plant with our CHAMP 25-pair connector and semiautomatic application machine.

The machine automatically cuts to length and terminates 50 individual wires in highly reliable, easily replaceable, solderless contacts. In just over 2 minutes. Intermateable with existing connectors.

You can install the same

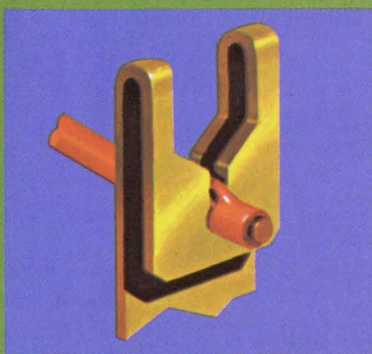

Unique design of contact provides insulation-displacing, gastight termination.

connector in the field—and save time and cable—with our CHAMP hand applicator tool. With it, you can terminate our 25-pair connector to a cable in just 5 minutes. Again—without the problems of solder.

Find out more about our CHAMP products for telecommunications. Call (717) 564-0101 or write for a demonstration. AMP Incorporated, Harrisburg, Pa. 17105.

AMP and CHAMP are trademarks of AMP Incorporated.

**AMP**  
INCORPORATED  
INFORMATION RETRIEVAL NUMBER 16



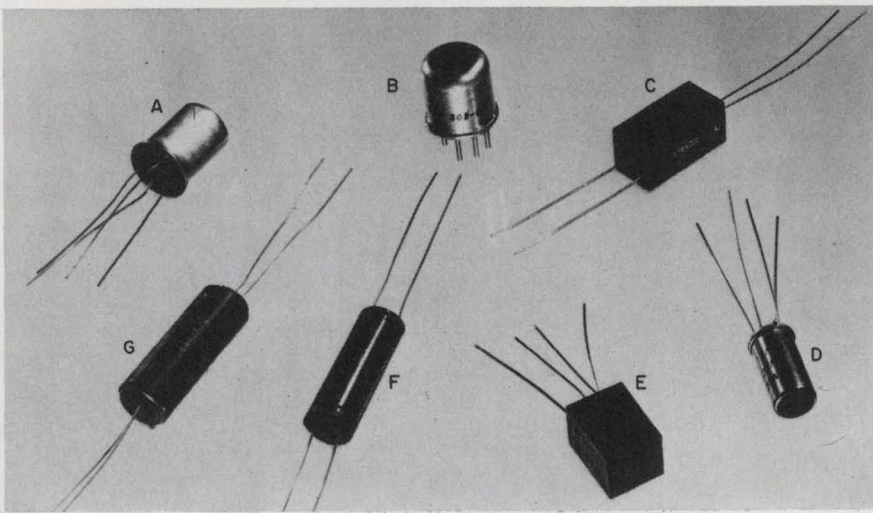

Relatively high input voltages are applied to neon-lamp/photoresistor isolators because they require from 80 to 125 V dc to fire the lamp. They are used in on-off applications such as firing SCRs and triacs or for monitoring line voltages. Resistors are used in series with the neon bulb to limit current to a safe value. Some units incorporate this resistor as an integral part of the isolator package. Representative types shown are by Quantron Electronics A,C); Vactec (B,D,F) and Clairex (E,G). Most units are packaged in plastic, but others, like A and B are hermetically sealed.

line voltage and voltages with transient spikes, the slow speed of the photosensor filters out the 120-Hz ripple and other line pulses.

Tungsten lamps for the isolators are usually rated from 6 to 24 V. Sigma Instruments provides isolators with 150-V, 2 mA lamps.

A prime limitation of the photoresistive cell is its temperature sensitivity. Above 75 C, according to Wolff, permanent changes in the

characteristics can occur.

Another photon-coupled device being applied widely is the optical switch. Simple in form, it may be of the interrupter type, in which the output of a LED in one arm of the device falls upon a photosensor in the opposite arm (see photo). Or it may be of the reflective type, in which the radiation from a LED is reflected by some active surface back into the

## The basic opto-couplers

There are five basic optical couplers that use LEDs—either gallium arsenide or gallium-arsenide-phosphide—as the source of radiation. They are LED/phototransistors, LED/photo-Darlington, LED/photodiodes, LED/SCRs and LED/photoresistive cells. Except for the LED/photoresistive cell, all are now appearing in DIP packages as well as nonstandard.

Two other types of opto-isolators have preceded the LED devices. One is a neon lamp with a photoresistor; the second is the tungsten lamp and photoresistor combination.

The neon-photoresistor and tungsten-photoresistor combinations are relatively slow, compared with solid-state devices, and specifications are fairly simple. The main specification problems arise with the solid-state devices that use LEDs as the light source.

phototransistor. These devices are fabricated with a single or a double LED/photosensor pair.

For the interrupter module, typical applications include optical shaft encoders, proximity detectors and choppers. The opto-reflectors are used for end-of-tape or beginning-of-tape sensing as well as mark sensing and in optical automobile ignition systems. ■■

## Need more information?

The companies and products cited in this report have been selected for illustrative qualities. The photon-coupled devices of these and other companies are identified below. The code to these products indicates the available combination of optical emitter and photosensor; LD—LED/photodiode; LT—LED/phototransistor or photo-Darlington; LS—LED/silicon-controlled rectifier; LR—LED/photoresistor; NR—neon/photoresistor; TR—tungsten lamp/photoresistor; PS—photoswitch.

Centralab Semiconductor Products, 4501 N. Arden Dr., El Monte, Calif. 91734. (213) 686-0567. (L. Merrill Palmer) LD, LT, PS **Circle No. 420**

Clairex Electronics, 650 S. 3rd Ave., Mount Vernon, N.Y. 10550. (914) 664-6602. (Gerald F. Smith) LT, LR, NR, TR **Circle No. 421**

Dialight Corp., 60 Stewart Ave., Brooklyn, N.Y. 11237. (212) 497-7600. (Chester Dombroski) LT **Circle No. 422**

Fairchild Optoelectronics Div., 4001 Miranda Ave., Palo Alto, Calif. 94303. (415) 493-3100. LT, PS (Ralph Miller) **Circle No. 423**

General Electric Co., W. Genesee St., Auburn, N.Y. 13021. (315) 253-7321. (William Sahn) LT, LS, LR, PS **Circle No. 424**

General Electric, Hendersonville, N.C. 28739. (704) 692-1431. (David Stephenson) LR, TR **Circle No. 425**

Hamamatsu Corp., 120 Wood Ave., Middlesex, N.J. 08846. (201) 469-6640. (Ralph Eno) LD, LR, NR, TR **Circle No. 428**

HEL, Inc., Jonathan Industrial Center, Chaska, Minn. 55318. (612) 448-3510. (Peter Spaulding) PS **Circle No. 429**

Hewlett Packard, 640 Page Mill Rd., Palo Alto, Calif. 94304. (415) 493-1212. (Gary Spear) Amplified LD, Logic Gate **Circle No. 426**

Litronix, Inc., 19000 Homestead Rd., Cupertino, Calif. 95014. (408) 257-7900. (Robert Santos) LT **Circle No. 427**

Monsanto Electronic Special Products, 3400 Hillview Ave., Palo Alto, Calif. 94304. (415) 493-3300. (Daniel Balfe) LD, LT, LS, PS, Logic Gate **Circle No. 430**

Motorola Semiconductor Products, Inc., Optoelectronics Dept., POB 20912, Phoenix, Ariz. 85306. (602) 244-6900. (Ron Schilling) LT **Circle No. 431**

National Semiconductors, Ltd., 331 Cornelia St., Plattsburgh, N.Y. 12901. (518) 561-3160. (Duncan Clifton) LD, LR, NR, TR **Circle No. 432**

National Semiconductor Corp., 2900 Semiconductor Dr., Santa Clara, Calif. 95051. (408) 732-5000. (Henry Carbajal) LT **Inquire Direct**

Optron, Inc., 1201 Tappan Circle, Carrollton, Tex. 75006. (214) 242-6571. (Charles Bates) LD, LT, PS **Circle No. 433**

Quantron Electronics, Inc., 1820 Mills Ave., El Paso, Tex. 79901. (915) 532-4651. (Rhodes Chamberlain) LR, NR, TR **Circle No. 435**

Sensor Technology, Inc., 21012 Lassen St., Chatsworth, Calif. 91311. (213) 882-4100. (Irwin Ruben) PS **Circle No. 436**

Sharp, Shigoto Industries Ltd., 350 Fifth Ave., N.Y., N.Y. 10001. (212) 695-0200. (Norman Axelrod) LT, PS **Circle No. 437**

Sigma Instruments, Inc., Braintree, Mass. 02148. (617) 843-5000. (William Cook) LR, NR, TR **Circle No. 438**

Solar Systems, Inc., 8124 N. Central Park, Skokie, Ill. 60076. (312) 676-2040. (William Megberg) LR, NR, TR, PS **Circle No. 439**

Spectronics, Inc., 830 E. Arapaho, Richardson, Tex. 75080. (214) 234-4271. (R. M. Stringer) LD, LT, PS **Circle No. 440**

Texas Instruments, P.O. Box 5012, Mail Sta. 12, Dallas, Tex. 75222. (214) 238-3821. (William Senhauser) Amplified LD, LT, PS **Circle No. 441**

Vactec Inc., 2423 Northline Industrial Blvd., Maryland Heights, Mo. 63043. (324) 872-8300. (M. D. Levy) LT, LR, NR, TR **Circle No. 442**



# 1937-1973





# The Danameter.

## \$195.



### 1 Year Battery Life.

In a digital instrument, you'd expect to fool with a battery regularly, recharging it or replacing it.

Not with The Danameter.

The battery will last you at least one year. And even if you find a way to wear it out, you're only talking about 69¢.

### Liquid Crystal Readout.

The specifications on the Danameter show at a glance that this is a more accurate instrument than the one it's designed to replace.

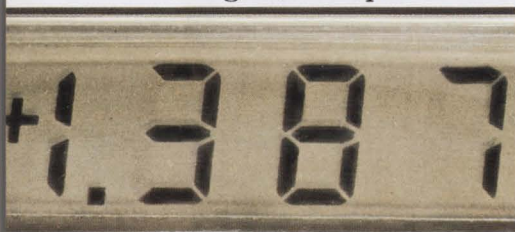

Yet there is another type of inaccuracy The Danameter solves—in an even more dramatic way.

These are the errors that occur every day in reading an analog voltmeter. Scales are hard to separate. Increments of measurement are greatly restricted. Precise readings are difficult to make.

When you measure with The Danameter, you interpret nothing. All you are shown is a number that is precisely the information you require.

It's accurate to a degree that you never imagined possible in an instrument at this price.

Once you have selected the proper function position, The Danameter instantly interprets, selects, and converts your information. It shows in a large liquid crystal display that adjusts to all light conditions. Even direct sunlight.



### Automatic Polarity.

In measuring voltage, you're accustomed to swapping leads to get a reading.

The Danameter instantly determines polarity, and then displays it as either positive or negative. All in a fraction of a second, with no help from you.

### Almost indestructible.

The Danameter has only one function selector. It's recessed behind the molded edges of its cyclac case. You can drop it on concrete. You can kick it down the hall.

When you pick it up, it'll be working perfectly.

It's the first true portable instrument of its kind. For \$195.





# 1974.

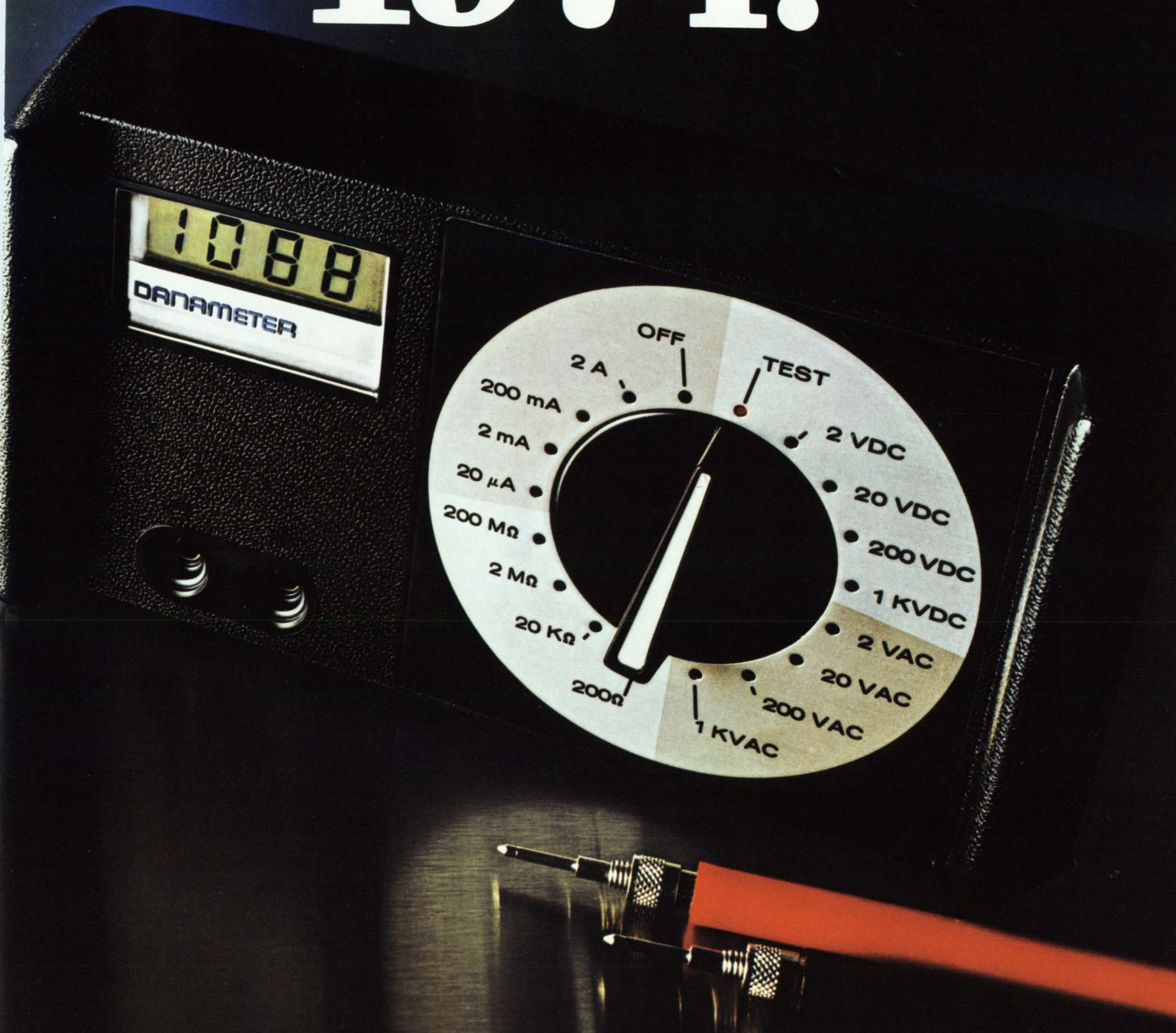

Actual size



## Model 2000 Danameter Specifications

Warranty: 1 year.

Measurement Functions: (4) DC volts, DC current, AC volts and ohms.

Typical Specifications:	
<b>DC Volts</b>	
Ranges	2V, 20V, 200V, and 1KV
Resolution	1mV
Overload protection	1000V DC or peak AC, any range
Accuracy	±(5% Rdg. + .05% Range)
Polarity	Automatic
Input Resistance	10 Megohms
Normal mode rejection	50 dB min. at or near 60 Hz

AC Volts	
Ranges	2V, 20V, 200V, and 1KV
Resolution	1mV
Overload protection	1000V peak AC, 250V DC, any range
Accuracy	±(1.5% Rdg. + .15% Range) to 5 KHz
Input Resistance	2 Megohms

DC Current	
Ranges	20 $\mu$ a, 2 mA, 200 mA and 2A
Resolution	.01 $\mu$ a
Accuracy	±(1.5% Rdg. + .1% Range)
Overload protection	250V DC or RMS

OHMS	
Ranges	200 $\Omega$ , 20K $\Omega$ , 2M $\Omega$ and 200M $\Omega$
Resolution	.1 ohm
Accuracy	±(2% Rdg. + .15% Range)
Maximum current through unknown	1 mA
Overload	250V DC or RMS

General	
Battery	One 9V dry battery
Est. battery life	1 year at normal usage
Test leads	Included
Size	4"H x 7 $\frac{1}{4}$ "W x 2 $\frac{1}{4}$ "D
Weight	1 lb.
Overload	Fully protected on all ranges

Price	
Model 2000 Danameter	\$195.00

Accessories	
<b>Part No.</b>	
2040	R.F. Probe (to 200MHz)
2030	H.V. Probe (to 30Kv)
2020	Carrying Case
2060	Extra Test Leads

**Contact your nearest Dana representative.  
Ask him to show you The Danameter.**

Alabama, Huntsville — (205) 534-9771  
 Arizona, Phoenix — (602) 957-9110  
 California, Los Angeles area — (213) 772-7320  
 California, Sunnyvale — (408) 245-3700  
 California, La Jolla — (714) 459-3351  
 Colorado, Denver — (303) 771-0140  
 Connecticut, Hamden — (203) 281-0810  
 Florida, Orlando — (305) 894-4401  
 Illinois, Chicago — (312) 539-4838  
 Indiana, Indianapolis — (317) 253-1681  
 Kansas, Shawnee Mission — (913) 722-1030  
 Maryland, Wheaton — (301) 942-9420  
 Massachusetts, Wakefield — (617) 246-1590  
 Michigan, Farmington — (313) 477-7700  
 Michigan, Kalamazoo — (616) 349-9666  
 Minnesota, Minneapolis — (612) 537-4501  
 Missouri, St. Louis — (314) 567-3636  
 New Jersey, Fort Lee — (201) 224-6911  
 New Mexico, Albuquerque — (505) 255-2330  
 New York, Rochester — (716) 328-2230  
 New York, Vestal — (607) 785-9947  
 New York, Metro New York Area — (516) 487-4949  
 New York, Syracuse — (315) 437-6666  
 North Carolina, Burlington — (919) 227-3630  
 Ohio, Dayton — (513) 278-5873  
 Ohio, Cleveland — (216) 333-5650  
 Ohio, Worthington — (614) 888-4466  
 Oklahoma, Norman — (405) 364-8320  
 Pennsylvania, Pittsburgh — (412) 824-3760  
 Pennsylvania, Blue Bell — (215) 542-1490  
 Texas, Houston — (713) 686-9627  
 Texas, Dallas — (214) 358-4643  
 Texas, San Antonio — (512) 828-0937  
 Utah, Salt Lake City — (801) 272-3861  
 Washington, Seattle — (206) 763-2755  
 Wisconsin, Brookfield — (414) 786-1940

#### Canada:

B.C., Vancouver — (604) 732-7317  
 Manitoba, Winnipeg — (204) 475-1732  
 Nova Scotia, Halifax — (902) 455-0670  
 Ontario, Downsview — (416) 638-9218  
 Ontario, Ottawa — (613) 728-4624  
 Quebec, Montreal — (514) 735-4565

#### Europe:

B	— Brussels	02-33 96 00
CH	— Mutschellen	05754655
D	— Darmstadt	06151-26661
DK	— Naerum	01-804200
F	— Paris	027 5686
GB	— Luton	582-24236
I	— Milan	02- 4982451
N	— Oslo	02-674590
NL	— Baarn	02154-6110
S	— Solna	820410
SF	— Tapiola	90-460 844



**Dana Laboratories, Inc.**, 2401 Campus Drive, Irvine, California 92664, U.S.A.  
 Telephone (714) 833-1234, Teletype 910-595-1136, Telex 678-341

Other countries: Contact DANALAB INT'L Headquarters 119/121 Rue Anatole France, 1030 Brussels, Tel.: 02-41 45 50/Trx: 23662



# Who's afraid of Augat?



What's Augat got that we don't? Size? Momentum? Identity? As far as we can tell, that's it.

Because we've got socket boards with better packaging density. Better plug-in hardware. More versatility. Faster delivery. And lower price. Not to mention our own wiring service.

And we've got more card file, frame and drawer options and combinations than anybody else in the industry.

We're not afraid of Augat. So you don't have to be afraid of us.

Try us. We'll see you through.

## EECO

1441 East Chestnut Avenue  
Santa Ana, California 92701  
Phone 714/835-6000

Also from G. S. Marshall Company nationwide.

FREE SOCKET BOARD AND PACKAGING  
HARDWARE CATALOG!

We'll send it to you if you'll send us the  
information below.

Name \_\_\_\_\_

Position \_\_\_\_\_

Company \_\_\_\_\_

Address \_\_\_\_\_



# 4096-bit RAMs making the scene as an alternative to core—finally

After many delays and a few false starts, 4096-bit dynamic RAMs are finally getting into the hands of memory designers. It now appears that they will live up to their promise of being a cheaper and higher speed alternative to core. The 4-k RAMs are also reducing the number of packages and power dissipation in solid-state memories. All are n-channel types except for one company's.

Some of the manufacturers of 4096-bit RAMs have been in pilot

production for a few months; others are not too far behind. Frank L. Rittiman, product marketing manager for American Microsystems, Santa Clara, Calif., says there will be plenty of 4-k RAMs this year.

"In 1974," he says, "several manufacturers will be getting into actual production. As the memory boards are designed, there will be enough RAMs to fill them."

One industry spokesman predicts: "I bet that in the last half of 1974 we will see a couple of small to medium solid-state memories in production using the 4-k's.

The mainframe applications should start appearing in '75."

## They're quite similar

With a few notable exceptions, the RAMs are similar in performance and packaging. All, except one, are provided in the 22-pin DIP. Access times range from 180 to 390 ns, cycle times from 340 to 575 ns and active power dissipations from about 250 to 400 mW. The units also vary in clocks required, refresh cycles and pin-outs.

The first 4096-bit RAM offered

**Northe K. Osbrink**  
Western Editor

## Specifications of the latest 4096-bit dynamic RAMs

	TI	Motorola AMI	Intel (B)	EA (B)	Mostek (C)	MIL	SMC	AMS
Model No.	TMS 4030	6605	2107A	1504	MK 4096P	MF 7112 (E)	N4412 (G)	6004
Transistors in cell	1	3	3	1	1	3	3	3
Chip size in mils	160 × 180	168 × 195	137 × 167	—	157 × 185	149 × 166	159 × 170	200 × 209
Type (gate)	NMOS(Si)	NMOS(Si)	NMOS(Si)	NMOS(Si)	NMOS(Si)	NMOS(Si)	NMOS(Metal)	PMOS(Metal)
Access time (ns)	300 Max	230 Max	Approx 300	Approx 300	300 (D)	390	180	350
Cycle time (Read-write) (ns)	470-470 Max	470-430	Approx 500	Approx 500	450 (D)	510-455	340-340	575
Power dissipation Active (mW)	400	70 $\mu$ W/bit	—	400	<100 $\mu$ W/bit	<100 $\mu$ W/bit	300 TYP	60 $\mu$ W/bit max
Power Dissipation STBY (nonrefreshed) mW	2	5 $\mu$ W/bit	—	—	—	—	—	—
Power dissipation STBY (refreshed) mW	—	0.5 $\mu$ W/bit	—	50	<2.5 $\mu$ W/bit	<10 $\mu$ W/bit	2 TYP	50 $\mu$ W/bit max
Power								
V <sub>BB</sub>	-3	-5	-5	-5	-12	-2	-2	+8
V <sub>CC</sub>	+5	+5	+5	+5	+5			
V <sub>DD</sub>	+12	+12	+12	+12	+12	+12	+15	-15
V <sub>SS</sub>					0	0	0	+5
Inputs (compatible)	MOS/TTL	MOS/TTL	MOS/TTL	TTL	TTL	NMOS(H)	TTL	MOS/TTL
Outputs (compatible)	TTL	TTL(A)	TTL	TTL	TTL	Current(F)	Current(F)	Current(F)
Refresh rate (ms)	2	2	—	—	4	2	1	2
Refresh cycles	64	32	—	—	64	16	64	64
Clocks required	1-12 V(CE)	1-12 V(CE)	1-12 V(CE)	—	2-TTL	3-12 V	1-12 V	3-15 V
(A) Also available with ECL output for faster access time—as type 6606		(C) Uses 16-pin DIP, all others 22-pin		(E) E-Mask version			(G) Equivalent to four 1103-1 1-k RAMs	
(B) Approx values—data sheet not yet available		(D) Becomes 200, 300 ns in page mode		(F) External driver required for TTL compatibility			(H) Must be driven with a bi- polar to NMOS driver such as the MIL-MD6154	



# Strength where it's needed!



A broken line when you're interconnecting p.c. boards can be disastrous too.

Sure you can catch a 12 pounder on light line. It takes skill. But there's more to it than that. That lightweight, flexible rod is made to take the stress over its entire length. And that is just what you get in Ansley FLEX STRIP® Jumpers. When you flex an Ansley Jumper the pins don't bend . . . the Jumper does.

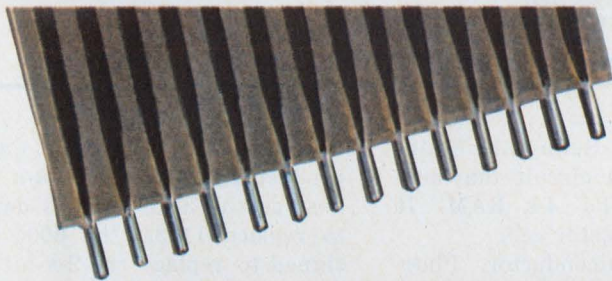

The secret is round pins and flat conductors. Round pins to fit p.c. board hole patterns. Flat conductors for flexibility . . . to take the bends.

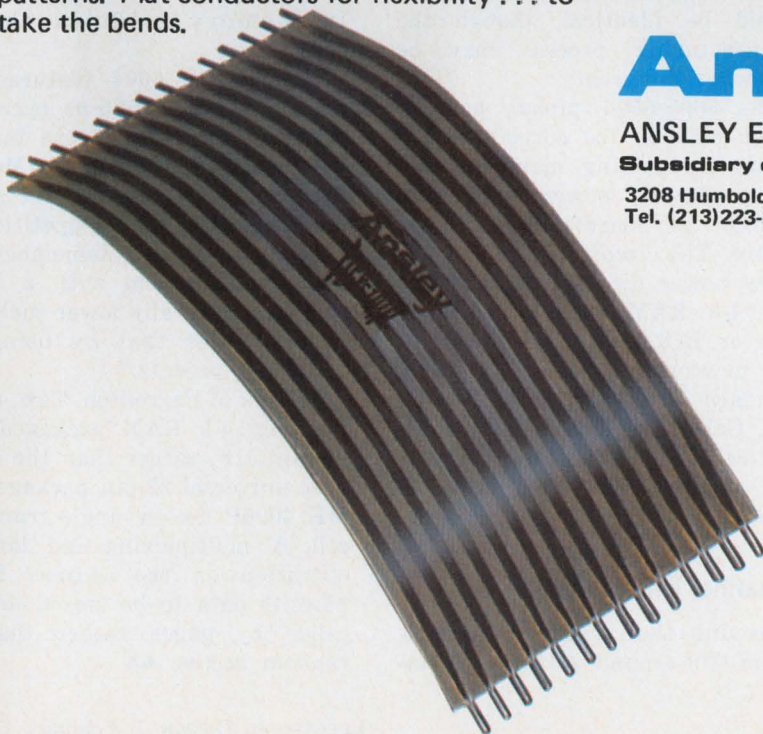

Four insulating materials are available to cover a wide range of temperature (and cost requirements). Nomex\*, Mylar\*, Teflon\*, Kapton\* are available. Standard lengths are 1", 2" and 3". Conductor pin spacing can be .050, .100, .125, .150 or .200.

\* Dupont Trademark

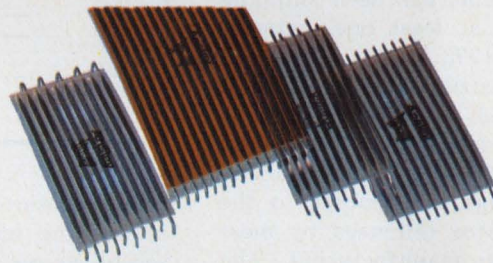

Four pin configurations are also options. Straight, 90° bend, straight or 90° staggered and you have a complete line of the best Jumpers money can buy.

## Ansley

ANSLEY ELECTRONICS CORP.

Subsidiary of Thomas & Betts Corporation

3208 Humboldt St., Los Angeles, Ca. 90031  
Tel. (213)223-2331, TWX 910-321-3938

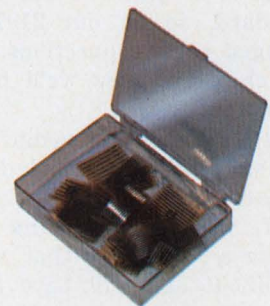

Get a sample and see for yourself.

INFORMATION RETRIEVAL NUMBER 17



commercially was the MF 7112 by Microsystems International Ltd., Ottawa, Canada. The original version—Model A, introduced in late 1972—was a large chip, 168 by 172 mils. Gradually Microsystems has been increasing the performance and decreasing the chip size. The current memory, Model E, is 149 by 166 mils, one of the smallest.

The Microsystems unit may be more difficult to design into a system than most of the other 4-k's, since it requires three high-level clocks and an external circuit to make the input TTL-compatible. John Roberts, senior applications engineer for the company, points out:

"The mainframe computer manufacturer who uses large numbers of memory packages usually feels that the peripheral circuitry is of relatively little importance. What he needs are parts that are producible, inexpensive and dependable."

Microsystems has been shipping the 7112 to at least one customer since early 1973.

Texas Instruments in Dallas, which stayed out of the scramble to produce 1-k RAMs, has developed the TMS 4030—a one-transistor cell design, as opposed to the three-transistor cell used by most of the other manufacturers. The TI pinout arrangement has established itself as an early leader in the race to become the industry standard. A number of manufacturers are adopting it, even at the expense of redesigning parts well into the development stage.

Initially Intel in Santa Clara introduced its 2107 4-k RAM with its own pinout. But Mike Markkula, marketing manager for Intel, explains:

"TI liked our pinout and was going to use it, but somewhere in development there was a slip and their connections were different. There is no question that TI is the standard, so on our 2107 A we changed some connections, rotated the chip, and now we'll be using their pinout."

At least six other manufacturers are said to have adopted the TI pinout. Intersil in Cupertino, Calif., will be introducing in early spring a 4-k RAM that uses the TI pinout and will have basically the same electrical characteristics, although it uses a three-transistor

## Pinout arrangement of 4-k dynamic RAMs

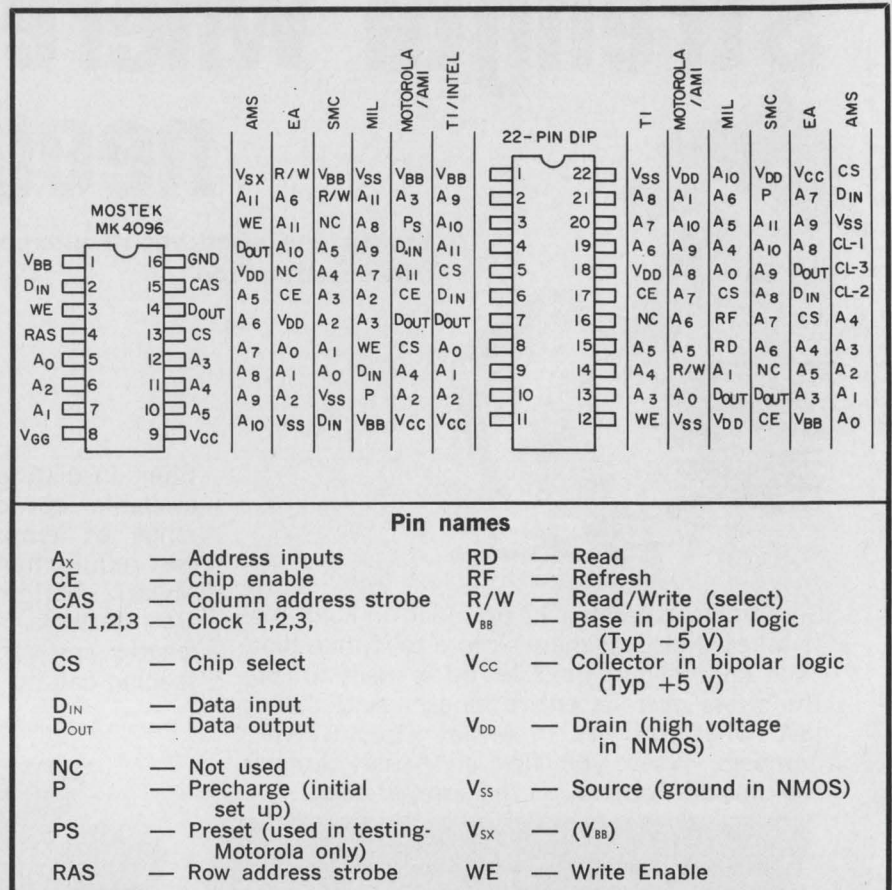

cell. Signetics in Sunnyvale, Calif., is working on a circuit that may second-source TI's 4-k RAM. It uses a one-transistor cell.

Motorola Semiconductor, Phoenix, and American Microsystems have jointly developed the masks for their RAMs. The 6605-6606 series from either manufacturer should be identical, though the manufacturing process may be somewhat different.

The 6605-6606 pinout has all power pins on the corners of the package, providing maximum isolation between power supplies in case of board or component failure. The circuit is fast and has a low power dissipation. It is the only 4-k RAM with a choice of TTL or ECL output.

A newcomer in the RAM field, Standard Microsystems of Sunnyvale, Calif., has based its memory on the 1103-1, a high-speed version of the widely used 1103 1-k RAM.

### P-channel isn't dead

Proving that p-channel technology is still around, Advanced Mem-

ory Systems of Sunnyvale, Calif., is producing a p-channel 4-k RAM. Just as the SMC 4412 is designed to replace 1103s, the 6004 is designed to replace the 2-k-bit 6003. One user of the circuit will definitely be Advanced Memory Systems itself, since it uses a good percentage of its own production in memory modules that it sells.

The PMOS 6004 features 350-ns access and a 575-ns cycle. Because of the use of the familiar technology, one Advanced Memory Systems official says: "We should be ahead of the competition in making a profit. Remember, the only real problem with a larger chip is a generally lower yield. We make up for that by using the p-channel process."

Mostek of Carrollton, Tex., makes the only 4-k RAM packaged in a 16-pin DIP, rather than the otherwise universal 22-pin package. The MK 4096P uses a single transistor cell. A multiplexing and latching operation on the address inputs permits data to be stored and recalled by pages rather than by random access. ■■



# the 'best buy' counters are here!

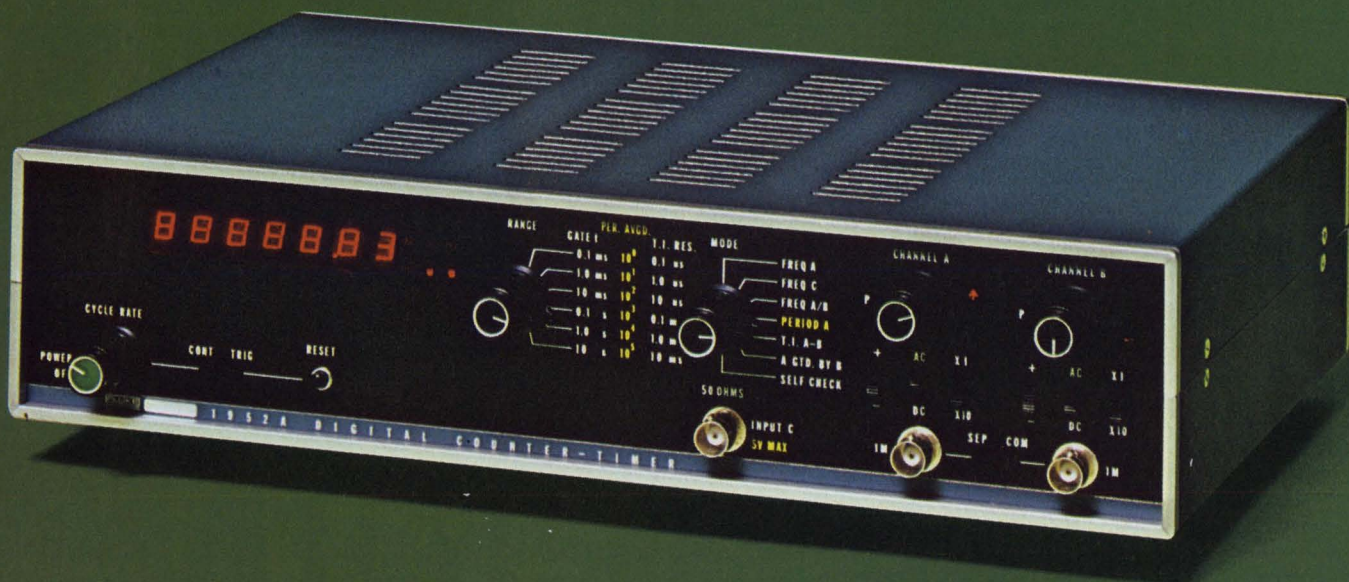

Now is the time for all of us to carefully consider every purchase.

For instance, if you are planning to purchase a new counter/timer, we invite you to take a flinty eyed look at the new Flukes. Nowhere in the entire market place are there better buys. Nowhere will you find a counter line where owner benefits are constantly raised and at the same time owner costs are being lowered.

Take our Model 1952 for instance. Here's an instrument which counts from DC to 80 MHz or 515 MHz optionally. It offers 50 mV sensitivity. It provides six functions: 1. frequency, 2. frequency ratio, 3. single period, 4. multiple period average, 5. time interval measurement, and 6. gateable totalize. Read-out is 7-digit LED or optionally 8 and 9 digits. Matched input channels feature full control of coupling, slope and trigger level. Features include units annunciation, overflow, gate and trigger level status lamps. Optionally you can add BCD output and a TCXO with improved temperature stability. Yet the base price is only \$695. Add every option we've got and you're still under \$1400.

Or look at our Model 1980A VHF/UHF Telecommunications Frequency Counter. Here's the precision instrument to service



mobile land, sea, and air communications systems quickly, accurately. Measure frequencies in the field or in the lab from 5 Hz to 515 MHz with a sensitivity of 50 mV over the entire range. Read frequency from a 6-digit LED display. For total portability, add a snap-on battery pack for completely portable operation with up to 5 hours continuous use. And the cost of this little gem is only \$795. Add all of the options and you're still under \$1200.

Then there's our blue plate special, the full five function Model 1950A. Measure frequency, frequency ratios, single periods, multiple period averages, or totals. Features include 6-digit LED display with automatic annunciation, variable trigger level control with status lamps and a switch selectable input attenuator. For field use, remember the instrument weighs only 5 pounds and will operate from 12 vdc.

Optional features include BCD output and TCXO for super stability as well as full accuracy. Price of the basic unit is just \$445. All the options are less than \$300 more.

So you see, the Fluke counter attack has been launched with a vengeance. Perhaps you should join our army.

In the continental U.S., dial our toll free number 800-426-0361 for the name and address of your nearest local source. Abroad and in Canada, call or write the office nearest you listed below, John Fluke Mfg. Co., Inc., P.O. Box 7428, Seattle, Washington 98133. Phone (206) 774-2211. TWX: 910-449-2850. In Europe, address Fluke Nederland (B.V.), P.O. Box 5053, Tilburg, The Netherlands. Phone 013-67-3973. Telex: 844-52237. In the U.K., address Fluke International Corp., Garnett Close, Watford, WD2 4TT. Phone, Watford, 33066. Telex: 934583. In Canada, address ACA, Ltd., 6427 Northam Drive, Mississauga, Ontario. Phone 416-678-1500. TWX: 610-492-2119.





It's nice to know that there's a super source for large quantities of 12 and 50 Volt ceramic capacitors. Nichicon can meet your immediate needs, or help you plan for long range requirements. When 30 weeks lead time seems to be a stock answer from almost every capacitor manufacturer, it's nice to know you can count on Nichicon for fast delivery. And when we make a delivery promise, we deliver as promised.

# We've got millions more where these came from.

## 12V.DC Disc Capacitors—Y5S

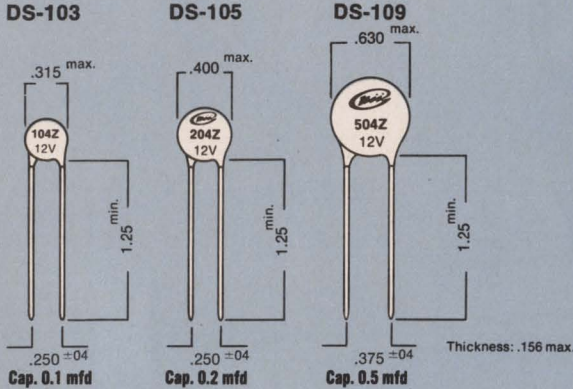

### SPECIFICATIONS

Temperature Characteristics: Y5S  
 Operating Temperature Range:  $-30^{\circ}\text{C}$  to  $+85^{\circ}\text{C}$   
 Lead Wire: #22  
 Applications: By-pass and audio couplings in transistorized circuits.  
 Equivalent to: Centralab's "Ultra-Kap" UK series, and RMC's "Magna-Cap" M-12 series.

## 50V.DC Disc Capacitors—Z5P, Z5U and Z5V

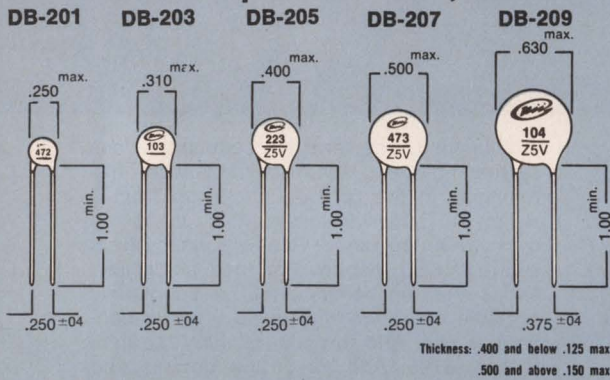

### SPECIFICATIONS

	Capacitance Range	Capacitance Tolerance
Z5P	180 pF thru 10,000 pF	$\pm 10\%$ or $\pm 20\%$
Z5U	1,000 pF thru 22,000 pF	$\pm 20\%$
Z5V	1,00 pF thru 100,000 pF	$+80\%$ $-20\%$

### TYPICAL CAPACITANCE vs TEMPERATURE

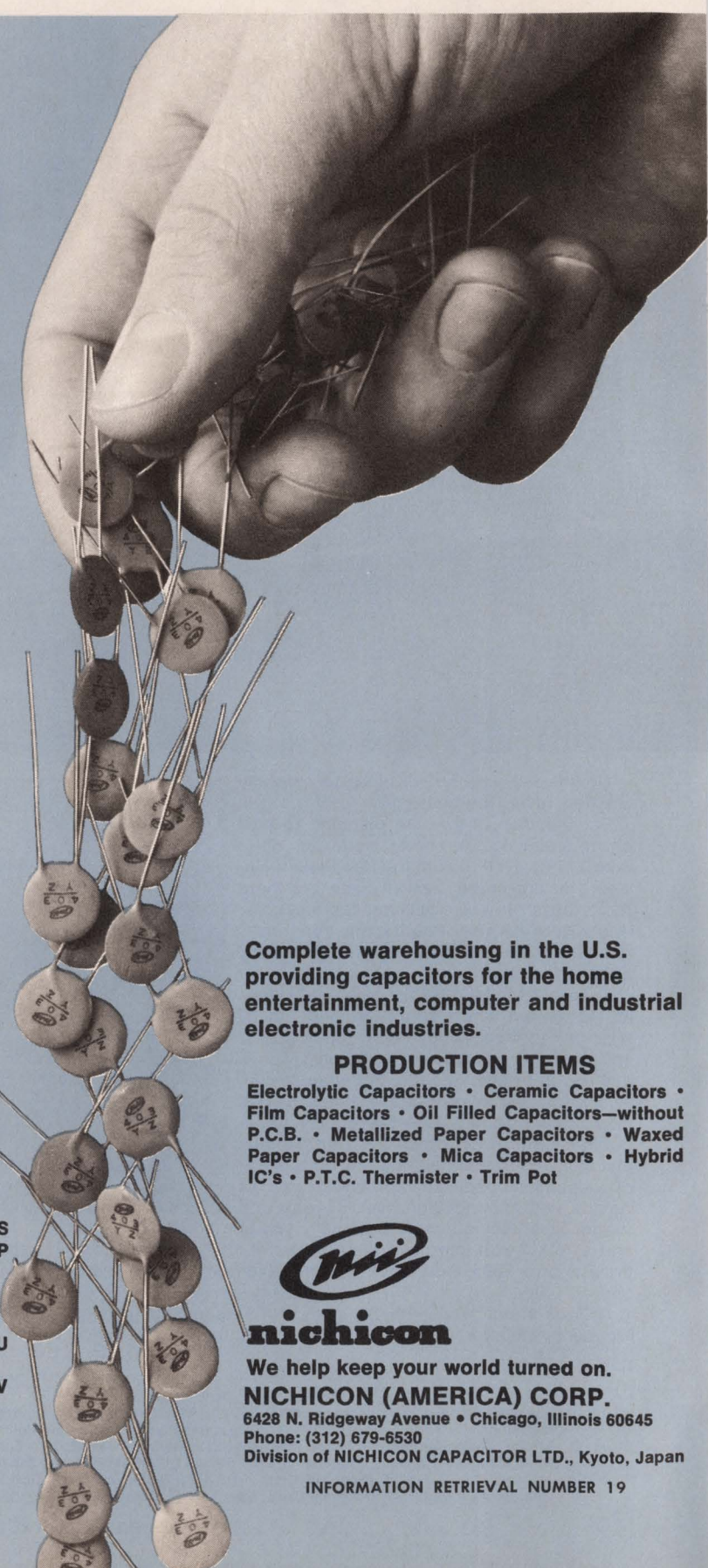
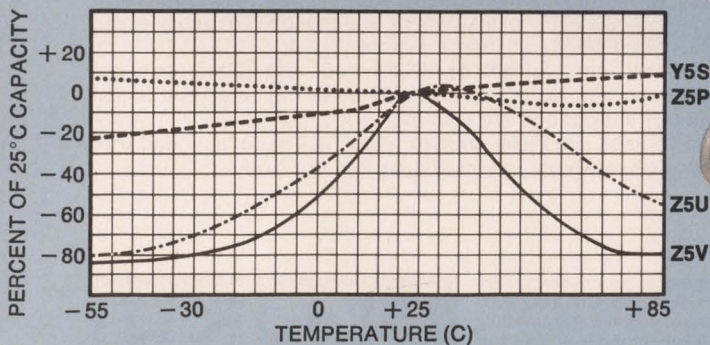

Complete warehousing in the U.S. providing capacitors for the home entertainment, computer and industrial electronic industries.

### PRODUCTION ITEMS

Electrolytic Capacitors • Ceramic Capacitors • Film Capacitors • Oil Filled Capacitors—without P.C.B. • Metallized Paper Capacitors • Waxed Paper Capacitors • Mica Capacitors • Hybrid IC's • P.T.C. Thermister • Trim Pot



**nichicon**

We help keep your world turned on.  
**NICHICON (AMERICA) CORP.**  
 6428 N. Ridgeway Avenue • Chicago, Illinois 60645  
 Phone: (312) 679-6530  
 Division of NICHICON CAPACITOR LTD., Kyoto, Japan

INFORMATION RETRIEVAL NUMBER 19



# ULTRA-MATCHED TRANSISTORS...*made easy!*

$$V_{OS} - 100\mu V$$

$$TCV_{OS} - 0.5\mu V/^{\circ}C$$

$$\Delta h_{FE} - 3.0\%$$



## Max!

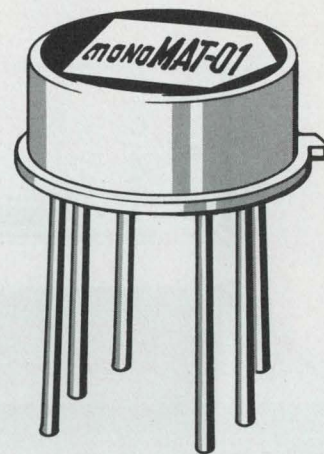

## YOUR TOUGHEST APPLICATION HAS MET ITS MATCH!

Unparalleled matching at a price you can afford — and with off-the-shelf delivery too! The monoMAT-01 makes it easy to realize your toughest-spec special purpose amplifier designs! And super-matching isn't the only feature monoMAT-01's got — the extremely linear  $V_{be}$  vs  $\log I_c$  is ideal for current sources, log-antilog and multiplier circuits. Micro-power circuitry will love the extremely low noise and high beta at very low collector currents ( $h_{FE} = 590$

typ at  $I_c = 10nA!$ ). Of course, the monoMAT-01 receives Precision Monolithics' famous "Triple-Passivation Process" for the ultimate in reliability and long term stability.

*Try one and see! (It's easy! — the 6 pin TO-99 type package directly replaces most popular duals.) You'll find the monoMAT-01 is more than a match for your toughest dual transistor application! Get 'em off-the-shelf from your Precision Monolithics distributor!*

### GUARANTEED MIN/MAX SPECIFICATIONS

	monoMAT-01AH	monoMAT-01H	monoMAT-01FH	monoMAT-01GH	
$V_{OS}$ @ 25°C	0.1	0.1	0.5	0.5	mV
$TCV_{OS}$ (-55° to +125°C)	0.5	0.5	1.8	1.8	$\mu V/^{\circ}C$
$h_{FE}$ @ $I_c = 10\mu A$	500	330	250	250	•
$I_{OS}$ @ $I_c = 10\mu A$	0.6	0.8	3.2	3.2	nA
$TCI_{OS}$ (-55° to +125°C)	90	110	150	150	$pA/^{\circ}C$
$I_B$ @ $I_c = 10\mu A$	20	30	40	40	nA
$BV_{CEO}$	45	60	60	45	V
Price @ 100 pcs.	\$6.00	\$5.00	\$3.75	\$2.50	•

#### AUTHORIZED DISTRIBUTORS

NEW YORK METROPOLITAN AREA Harvey Radio, Woodbury, N.Y.: (516) 921-8700 • NEW ENGLAND AREA Gerber Electronics, Dedham, Mass.: (617) 329-2400 • UPSTATE NEW YORK Harvey Federal Electronics, Binghamton, N.Y.: (607) 748-8211 • NORTHEAST Newark Electronics, Woburn, Mass.: (617) 935-8350 • BALTIMORE-WASHINGTON Whitney Distributors, Baltimore, Md.: (301) 944-8080 • PHILADELPHIA Hallmark Electronics, Huntingdon Valley, Pa.: (215) 355-7300 • MICHIGAN RS Electronics, Detroit, Mich.: (313) 491-1000 • SOUTHEAST Kirkman Electronics, Winston-Salem, N.C.: (919) 724-0541 • EAST CENTRAL Pioneer/Cleveland, Cleveland, Ohio: (216) 587-3600 • Pioneer/Dayton, Dayton, Ohio: (513) 236-9900 • CENTRAL Hallmark Electronics, Elk Grove Village, Ill.: (312) 437-8800 • Minneapolis, Minn.: (612) 925-2944 • St. Louis, Mo.: (314) 521-3800 • TEXAS-OKLAHOMA Sterling Electronics, Houston, Texas: (713) 623-6600 • Dallas, Texas: (214) 357-9131 • SOUTHWEST Sterling Electronics, Albuquerque, N.M.: (505) 345-6601 • Phoenix, Ariz.: (602) 258-4531 • WEST Westates Electronics Corp., Chatsworth, Calif.: (213) 341-4411 • Sterling Electronics, San Carlos, Calif.: (415) 592-2353 • Intermark Electronics, Sunnyvale, Calif.: (408) 738-1111 • Denver, Colo.: (303) 936-8284 • Salt Lake City, Utah: (801) 359-0531 • San Diego, Calif.: (714) 279-5200 • Santa Ana, Calif.: (714) 540-1322 • Almac-Stroum, Seattle, Wash.: (206) 763-2300 • Portland, Ore.: (503) 292-3534.



1500 SPACE PARK DRIVE, SANTA CLARA, CALIFORNIA 95050  
TEL. (408) 246-9225 • TWX 910-338-0528 • CABLE MONO

INFORMATION RETRIEVAL NUMBER 20



# interface- ability

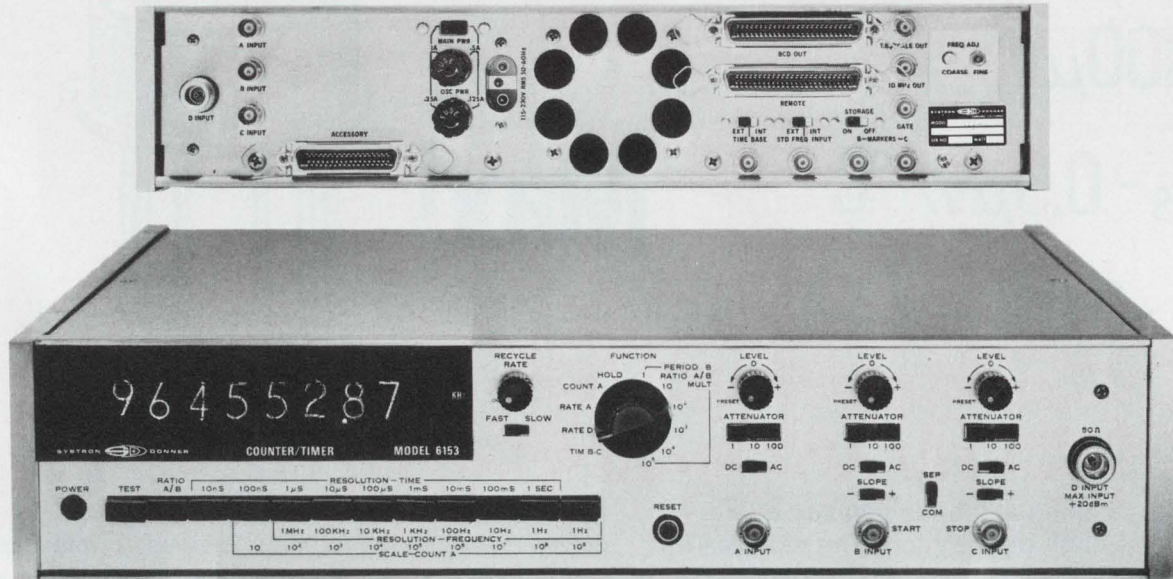

## Or why **systems people** buy more S-D counters

- 6 remote **programming** options
- 4 **BCD** outputs (low and high level)
- Special codes, formats, logic levels
- Universal counter / timer functions
- 50, 200, 512 MHz, 3 GHz

For details or a demo on series 6150 counters, call your Scientific Devices sales and service office (listed below). Or contact Concord Instruments Division, 10 Systron Drive, Concord, CA 94518. Phone (415) 682-6161. In **Europe**: Systron-Donner GmbH, Munich, W. Germany; Systron-Donner Ltd., Leamington Spa, U.K.; Systron-Donner S.A. Paris (Le Port Marly) France. **Australia**: Systron-Donner Pty. Ltd., Melbourne.

SYSTRON  DONNER

Albuquerque, (505) 268-6729; Baltimore, (301) 788-6611; Boston, (617) 894-5637; Burlington, NC (919) 228-6279; Chicago, (312) 297-5240; Cleveland, (216) 261-2000; Denver, (303) 573-9466; Dayton, (513) 298-9904; Dallas, (214) 231-8106; Detroit, (313) 363-2282; Ft. Lauderdale, (305) 721-4260; Hamden CT (203) 248-9361; Huntsville, AL (205) 536-1969; Houston, (713) 623-4250; Indianapolis, (317) 783-2111; Kansas City, KS (913) 631-3818; Los Angeles, (213) 641-4800; Minneapolis, (612) 544-1616; New York City area (201) 871-3916; Norfolk, (703) 499-8133; Orlando, (305) 424-7932; Philadelphia, (215) 825-9515; Phoenix, (602) 834-1682; Rochester, NY (716) 334-2445; San Antonio, (512) 694-6251; San Diego, (714) 249-6642; San Francisco area (415) 964-4230; Seattle, (206) 454-0900; St. Louis, (314) 731-2332; Syracuse, (315) 457-7420; Washington, DC area (703) 451-6500.

INFORMATION RETRIEVAL NUMBER 21



# washington report



Heather M. David  
Washington Bureau

## Pentagon sees threat in technology exports

Defense Dept. R & D officials are expressing fear that the Russians may learn vital techniques of microminiaturization of electronic components through proliferating sales of U.S. technology to the Soviet Union. The fears were expressed after Representative Ben Blackburn (R-Ga.) charged that the sale of a scientific computer by a British subsidiary of Control Data Corp. "enabled the Soviet Union to shorten by about two years the time required to create and perfect their first MIRV (Multiple Independent Re-entry Vehicle)."

The Pentagon sources said there was less concern about the sale of computational ability itself than the fact that the Soviet could learn techniques of microminiaturization by studying the equipment. As one official put it: "The Soviets can do the computer work, but it may take them a computer the size of a barn to do what we can do on an aircraft." Rep. Blackburn is collecting other data on U.S. technology sales to the Russians for hearings that may be held this month by the House Banking and Currency Subcommittee on International Trade. Blackburn will introduce a bill embargoing exports to any country that conducts a "policy intended to harm the economy or endanger the security of the United States."

The National Security Council meanwhile is urging a more lenient line than the Administration was considering last fall in permitting U.S. companies to sell computers and related technology to Communist-bloc countries. The Administration is now expected to okay a proposed American bid on a Soviet air-traffic-control system. The bid proposal is headed by IBM and would include IBM 9020 computers, smaller Univac computers and alphanumeric displays by Raytheon and Texas Instruments.

## Government to spend \$15-billion for electronics in '75

The Federal Government should spend about \$15-billion for electronics during FY 1975, unless there are serious market disruptions because of the energy crisis. This is the average prediction of member companies of the Electronic Industries Association. The EIA predicts that military electronics spending estimated at \$12-billion for FY 1975, will go to \$14.9-billion by FY 1980.

In the area of defense, EIA sees the most important growth areas for the electronics industry over the decade to be strategic weapons, intelligence and communications projects, shipboard electronics and R&D. And as weapons become more sophisticated electronics will take an increasingly larger percentage share of the program dollars. For the fiscal year beginning July 1, EIA says the Defense Dept. should spend about \$7.9-billion for aircraft, with 27.9% for electronics; \$5.3-billion for missiles, 45.1% for electronics; \$586-million for military space, 46.6% electronics;



\$4.3-billion for ships, 23.1% electronics; \$1.1-billion for electronics and communications systems, 88% electronics; and \$21.8-billion for operations and maintenance weapons including spare parts, 11.3% of which would go for electronic equipment and parts.

EIA members surveyed said that NASA should spend about 37.7% of its approximately \$3.1-billion budget for electronics. This would include \$1.2-billion for manned spaceflight, 37.1% electronics; \$70.7-million for space sciences and applications, 46.8% electronics; \$68.8-million for space research and technology, 34.8% electronics; and \$176.6-million for aerospace technology and research, 26.8% electronics. The Federal Aviation Administration, EIA says, should spend about \$229.7-million in FY 1975 for electronics, a figure that should go to more than \$300-million a year by 1980.

The agency with the biggest potential growth in electronics, the industry association survey indicated, will be the Environmental Protection Agency, which will increase spending on pollution monitoring instrumentation over the next few years. EPA's FY 1975 electronics spending should reach \$158-million, a figure that could go to \$512-million in FY 1980, EIA said.

Other estimates made for FY 1975 electronics spending are: Coast Guard, \$82.6-million; Federal Highway Administration, \$131-million; Federal Railroad Administration, \$11-million; Urban Mass Transportation Administration, \$36-million; National Highway Traffic Administration, \$22-million; Housing and Urban Development, \$67-million; Health, Education and Welfare, \$996-million; Commerce, \$50-million; Law Enforcement Assistance Administration, \$86-million; and Postal Service, \$50-million in Government funding. The complete forecast is available from the Government Products Division, EIA, 2001 Eye Street, Wash., D.C. 20006.

## Televised conferences by satellite and microwave

Comsat General and Microband Corp. of America, both of Washington, D.C., are discussing the feasibility of coupling Comsat's digital television transmission and Microband's microwave multipoint distribution system to provide the means for holding televised industrial conferences. Comsat says that business conferences or TV programs could be distributed to customers within a 20 to 25-mile radius of an omnidirectional antenna transmitting at 2150 to 2160 MHz to individual two-foot microwave dishes at each customer's location. The system would be able to receive and decode the digitized data for viewing on an unused channel of a standard TV set or a large screen display.

**Capital Capsules:** Garrett Corp.'s AiResearch Mfg. Co., Torrance, Calif., won an \$8-million contract for development of an advanced-technology rail vehicle. Garrett's design for the two-car train calls for a new flywheel propulsion system that stores energy aboard the train rather than dissipating it in wasted heat. . . . The Dept. of Transportation has issued a report called "Technology Sharing" for use by organizations and individuals interested in using federally developed technology and information. The report is available from the department at 400 Seventh St., S.W., Washington, D.C. 20590. . . . The Defense Dept.'s top telecommunications post may be downgraded from the Assistant Secretary of Defense slot to a lower post, following a recommendation by Edward Goldstein, vice president of AT&T, who made a 30-day management study. Some Capitol Hill sources disagree, saying that any office trying to get the three military services to cooperate and centralize their communications systems needs all the high-level clout it can get.





# Opto-Isolators

Because Clairex makes them all, you can get exactly what you need

When you need an opto-isolator, you can select exactly what you need from Clairex because we're tooled to make them all . . . select from:

Three kinds of light sources: Tungsten, Neon and LED

Three kinds of detectors: Photoconductors, Photo-transistors and Photo-Darlington

Five different packages: DIP, Plug-in and three axial-lead sizes

For data or special assistance with your isolation problems, call (914) 664-6602 or write Clairex<sup>®</sup>, 560 South Third Avenue, Mount Vernon, New York 10550.

**CLAIREX ELECTRONICS**  
A DIVISION OF CLAIREX CORPORATION



# 150 Microwatt Triple Op Amp

The L144 monolithic triple op amp draws only  $50\mu\text{A}$  of current per amplifier, from a  $\pm 1.5\text{ V}$  supply. What's more, it is

**AVAILABLE NOW FROM YOUR LOCAL DISTRIBUTOR!**

L144 features include:

- Monolithic triple op amp in DIP or Flatpac packages
- Wide power supply range— $\pm 1.5\text{ V}$  to  $\pm 15\text{ V}$
- Internal compensation
- Programmable power dissipation
- Programmable input bias current
- Single programming resistor
- 80 dB gain with  $20\text{ K}\Omega$  load
- Cost effective: \$1.63 per single op amp<sup>(1)</sup>

<sup>(1)</sup>L144CJ 100-piece price

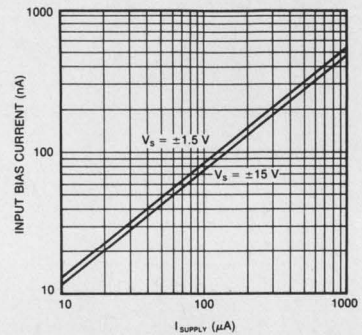

Applications examples:

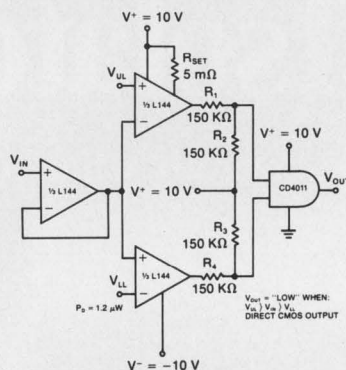

DOUBLE-ENDED LIMIT COMPARATOR

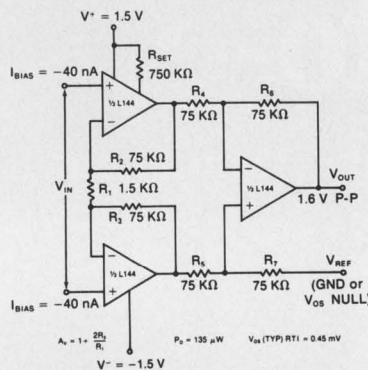

INSTRUMENTATION AMPLIFIER

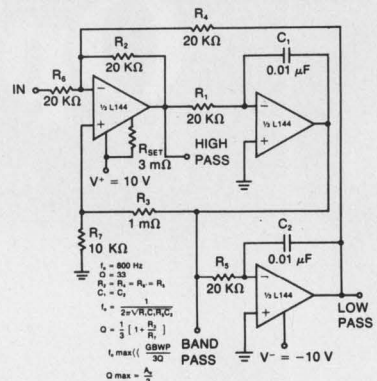

ACTIVE FILTER

The L144 is a practical industry-standard operational amplifier for use when low current drain, low voltage, low power, or very small physical size are controlling criteria. If your circuit requirements are unique—and whose aren't—our applications people are eager to help.

For complete information

**write for data**

IC Applications: (408) 246 8000, Ext. 120



**Siliconix incorporated**

2201 Laurelwood Road, Santa Clara, California 95054

INFORMATION RETRIEVAL NUMBER 23

ELECTRONIC DESIGN 3, February 1, 1974



## The bureaucracy

In "The 900 Days," Harrison Salisbury tries to paint an unemotional picture of the siege of Leningrad by the German armies during World War II. He describes the despair of people trying to survive on sawdust, library paste and other such "nutrients" in a city whose streets were littered with corpses that the survivors weren't strong enough to bury.

What makes this saga terrifying, though, is more than the human suffering and the loss of a million lives—almost all through starvation. It's the behavior of the top Soviet bureaucrats. Until the Germans actually dropped bombs on Leningrad on June 22, 1941, Stalin refused to accept the copious evidence that the Germans were planning to violate his 1939 pact with Hitler. He issued orders that overflying German planes were not be fired at, lest Hitler be provoked. He punished or even executed "panic-mongers" who dared to prepare for a German invasion of the Soviet Union. When he finally began to fight back, he appointed generals and fired them on the basis of their loyalty to his administration—not on the basis of their military experience or acumen. He defended every decision, however disastrous, with the banner of "national security." He tolerated no criticism, for criticism could come only from "enemies of the State."

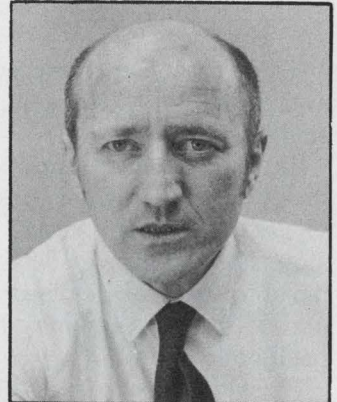

As we look back over the 30 years that have elapsed since January, 1944, when the Russians broke the siege of Leningrad, can we feel secure in knowing that we, here, are safe from bureaucratic bungling? How many of our designs come about because our boss wanted it that way? And how many times is the boss right because he's boss? And how easy is it for a boss to justify every decision "in the interests of the company" and to blast every critic as a "disruptive troublemaker"?

Certainly, one man (or woman) must make a final decision and be accountable for it. We can't accomplish anything if everybody pulls in a different direction. And disagreements are inevitable—especially on complex design or management decisions.

But disagreements should be aired—and welcomed. In more than a few companies—fortunately not the majority—disagreements and controversy are stifled—subtly, if not overtly. People know that a boss likes to have his own way, so, when they think he's wrong, they shut up. Or, worse, fearing retribution at salary review or promotion time, they pretend agreement.

When I was in the Army, we had a name for such people, and we could all feel superior to them. Sadly, weak managers (and the "I'm always right" managers are weak) force their people to be weak, too—and hurt their companies while they're at it.

GEORGE ROSTKY  
Editor-in-Chief



# The hows and whys of log amps: Semiconductors used as feedback elements form the log response. And you can avoid drift and instability with carefully designed circuits.

How do logarithmic conversion circuits work, and how do the circuit techniques affect performance?

In brief, log amplifiers use the nonlinear properties of transistors, diodes and other devices to perform signal compression or expansion. But, like most active circuits, they are vulnerable to errors caused by temperature changes and drift, and they may have closed-loop stability problems.

The engineer, of course, has a choice of buying or building the unit he needs. He can create the design from the ground up by use of the most appropriate technique—linear approximation, diodes, matched-dual transistors or other components characterized by logarithmic transfer curves. Or he can buy a low-cost module that contains the necessary logging transistors, reference-current source, frequency-compensating networks and op amps. Table 1 shows several forms in which the more popular circuits are commercially available, with some pros and cons for each.

## The basic log element: How it works

For a log amplifier to function properly, its nonlinear element—a diode or transistor—must have a logarithmic transfer function.

The current that flows through an ideal semiconductor diode is governed by this relationship:

$$I = I_0 \left( e^{\frac{qV}{kT}} - 1 \right).$$

In this equation  $I_0$  is the theoretical reverse-saturation current,  $q$  is the value of a unit charge;  $k$  is Boltzmann's constant, and  $T$  is the absolute temperature. By dividing both sides by  $I_0$  and taking logs to the base 10, we can rewrite the equation as:

$$V = \frac{kT}{q} (2.3) \log (I/I_0), \text{ provided } I/I_0 \gg 1.$$

When  $T$  is 302.4 K (29.25 C)  $\Delta V$  is 60 mV

for a 10:1 change of  $I$ . If ideal (decade) elements were available the simple circuit of Fig. 1 would yield the desired response. Here the diode is connected in the feedback path of an op amp.

The direction of the diode determines the operating polarity of the circuit. Also, diodes can be stacked in series to increase voltage range, and can operate without grounding.

However, in practice, diodes have a limited logarithmic range. At the high end, ohmic and bulk resistances produce an additional voltage drop,  $IR_B$ , and at the low end, the slope of the characteristic undergoes one or more changes due to diffusion-current flow in extended regions—such as surface-inversion layers or channels—and to generation-recombination mechanisms in space-charge regions. The changes in slope can be represented by a multiplying factor,  $m$  ( $1 \leq m \leq 4$ ). Thus the combined voltage for a real diode equation would be:

$$V = m \frac{kT}{q} (2.3) \log (I/I_0) + IR_B.$$

Since both the magnitude of  $m$  and the value of voltage at which the slope changes are functions of the individual diode (within a family), general purpose diodes provide a one or two-decade dynamic range at best. A better alterna-

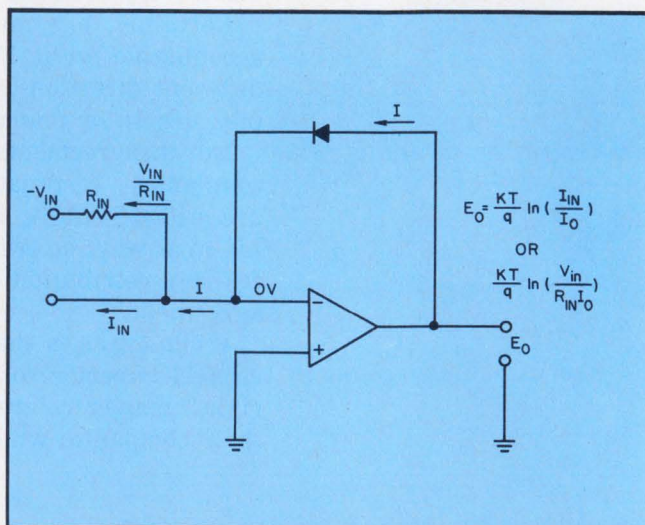

1. The ideal diode log circuit delivers an output voltage proportional to the log of the input current divided by a reference current.

**Dan Sheingold**, Technical Information Manager, and **Fred Pouliot**, Product Manager, Analog Modules, Analog Devices, Route 1 Industrial Park, Norwood, Mass. 02062.



tive is to use dual matched transistors, connected as diodes.

### Using the transdiode connection

If a transistor is connected to feed back around an op amp (Fig. 2) the collector current is determined by the input current or voltage. Ideally the op amp will maintain the collector voltage equal to the input current and will hold the collector voltage at zero. Since the base is grounded, the collector and base are at the same potential, even though the base current flows independently. The amplifier output voltage—which is also the emitter-to-base voltage—must meet the collector restraints, while furnishing any needed emitter current.

To investigate the relationship that controls the circuit of Fig. 2, use the modified Ebers and Moll equations<sup>1</sup> for emitter and collector currents of a grounded-base bipolar transistor:

$$I_E = I_{ES} \left( e^{\frac{qV_E}{kT}} - 1 \right) - \alpha_I I_{CS} \left( e^{\frac{qV_C}{kT}} - 1 \right) + \Sigma I_{ES_j} \left( e^{\frac{qV_E}{m_j kT}} - 1 \right)$$

$$I_C = -\alpha_N I_{ES} \left( e^{\frac{qV_E}{kT}} - 1 \right) + I_{CS} \left( e^{\frac{qV_C}{kT}} - 1 \right) + \Sigma I_{CS_j} \left( e^{\frac{qV_C}{m_j kT}} - 1 \right)$$

Here  $V_E$  and  $V_C$  are the emitter-base and collector-base voltages;  $I_{ES}$  and  $I_{CS}$  are the emitter and collector saturation currents;  $\alpha_N$  and  $\alpha_I$  are the current-transfer ratios in the normal and reverse directions, and  $m_i > 1$  and  $m_j > 1$  are "un-collected" current components that flow through the base circuit. Since  $V_C$  is held at zero for Fig. 2 the relationship between  $I_C$  and  $V_E$  becomes

$$I_C = \alpha_N I_{ES} \left( e^{qV_E/kT} - 1 \right).$$

But the op amp holds  $I_C$  equal and opposite to the

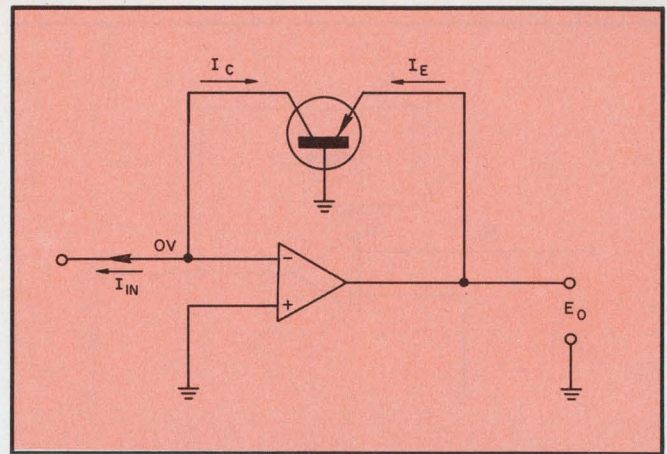

2. The transdiode connection grounds the base of the feedback transistor (pnp shown here).

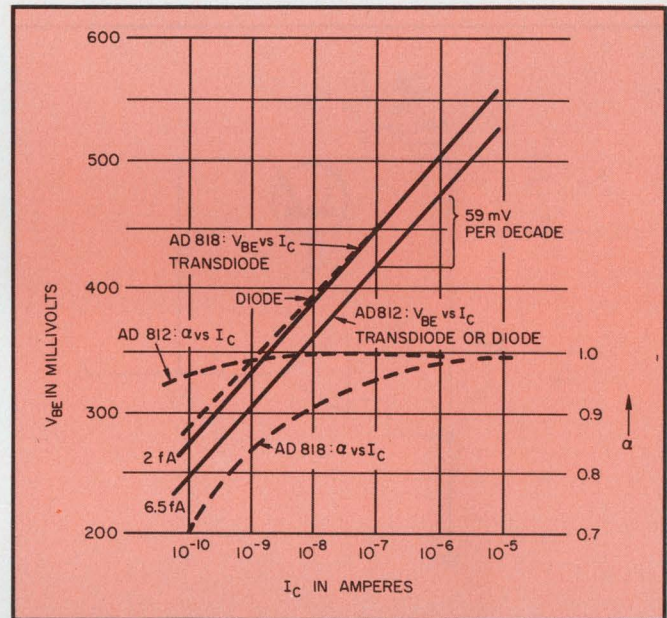

3. Some matched transistor pairs used as transdiodes and diodes are compared for  $\alpha$  vs  $I_C$  and  $V_{be}$  vs  $I_C$ .

## Table 1. Comparison of several log module types

Log module	Description of contents and applications	Advantages	Disadvantages
Basic log element	Two matched log transistors scaling and temperature compensating resistors For special-purpose log designs	Lowest cost, greatest flexibility	Most complex to apply, requires at least two external op amps plus dynamic stabilization in conventional log application
Log transconductor	Basic log element, has reference-current source to optimize operation at low levels	Best performance obtainable through op amp choice	Requires external op amp, gain trim, $I_{REF}$ trim
Log amplifier	Log transconductor FET-input op amp The initial choice of all fixed-reference log applications	Easiest to apply, meets specs with no trimming or external components Best performance over a wide range	Op amp is optimized for most (but not all) applications



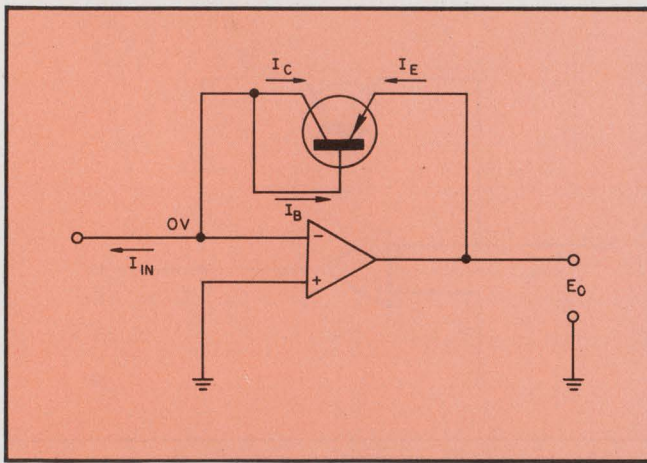

4. The 2-terminal diode-connected transistor can handle either polarity of input current.

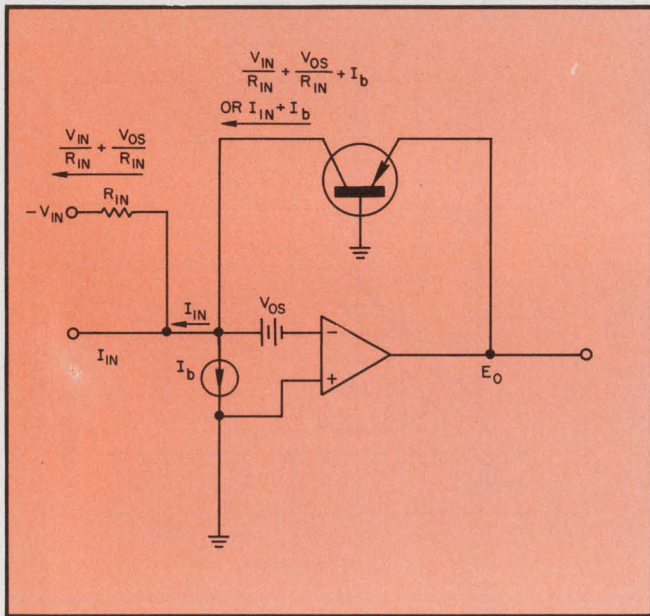

5. When the circuit of Fig. 4 is modified to show the op amp error sources, its performance becomes more complex.

input current, so  $V_E$  must be

$$V_E = \frac{kT}{q} (2.3) \left[ \log \frac{I_{IN}}{I_{ES}} - \log \alpha_N \right] \text{ for } \frac{I_{IN}}{I_{ES}} \gg 1.$$

For silicon-planar transistors,  $I_{ES}$  is typically  $10^{-13}$  A or less. Therefore the  $V_E$  relationship in the previous equation is valid over a wide current range. The current transfer ratio  $\alpha_N$  is nearly unity; thus  $\log \alpha_N$  becomes negligible. (If  $\alpha_N = 0.99$ , its error contribution would be about 0.25 mV of constant offset.) Fig. 3 shows plots of  $V_{BE}$  and the grounded-base current gain,  $\alpha(I_C/I_E)$ , for two matched-transistor types designed for logarithmic circuits.

If the transistor's base and collector are physically shorted together (Fig. 4), the result is a two-terminal diode that conforms to the first of the two Ebers and Moll equations. In this equa-

Table 2. Values of error, as a function of  $h_{FE}$ , increase as  $h_{FE}$  decreases

$h_{FE}$ ( $\alpha_N \approx 1$ )	$\alpha/\alpha_N$	$\frac{-kT}{q} \ln(\alpha/\alpha_N)$ mV at 25 C
$\infty$	1	0
1000	0.999	0.03
200	0.995	0.13
100	0.99	0.26
50	0.98	0.51
19	0.95	1.32
11.5	0.92	2.14
9	0.9	2.7
4	0.8	5.7
3	0.75	7.4
1	0.5	17.8

tion the first term almost equals the collector current; the second term is zero, and the sum of the  $m_i > 1$  terms thus equals the base current. Since the relationship,  $I_{IN} = -(I_C + I_B)$ , holds for any transistor,  $I_B$  can be replaced by  $I_C/h_{FE}$  and  $I_{IN}$  then becomes

$$I_C = -I_{IN} \left( 1 + \frac{1}{h_{FE}} \right) = \alpha_N I_{ES} (e^{qV_E/kT} - 1) \cdot \left( 1 + \frac{1}{h_{FE}} \right).$$

When this equation is solved for  $V_E$  (using natural logs) we get:

$$V_E = \frac{kT}{q} \ln(I_{IN}/I_{ES}) - \frac{kT}{q} \ln \left[ \alpha_N \left( 1 + \frac{1}{h_{FE}} \right) \right].$$

The term  $1/h_{FE}$  can also be equated to  $(1 - \alpha)/\alpha$ , and if this form is substituted into the error term, the net result makes  $V_E$  equal to

$$V_E = \frac{kT}{q} \ln(I_{IN}/I_{ES}) + \frac{kT}{q} \ln \frac{\alpha}{\alpha_N}.$$

This result is shown in Table 2.

From Table 2 it should be clear that any transistor used as a two-terminal log diode requires that the  $h_{FE}$  be high and that it be maintained over a wide range of input current.

#### Other error sources compound the problem

If  $V_{CB} \neq 0$ , the terms in the second of the Ebers and Moll equations will contribute error currents that can significantly affect  $V_E$ , especially for low values of input current. In the forward conduction region

$$V_E = \frac{kT}{q} \ln \left[ \frac{I_{IN}}{\alpha_N I_{ES}} + \frac{I_{CS}}{\alpha_N I_{ES}} (e^{qV_{CB}/kT} - 1) + \Sigma \dots \right].$$

For grounded-base circuits, the amplifier offset voltage,  $V_{OS}$ , will bias the collector, as any common-mode input voltage will do. And when the base is driven, the designer must ensure that the expected swing of  $V_{CB}$  is compatible with the



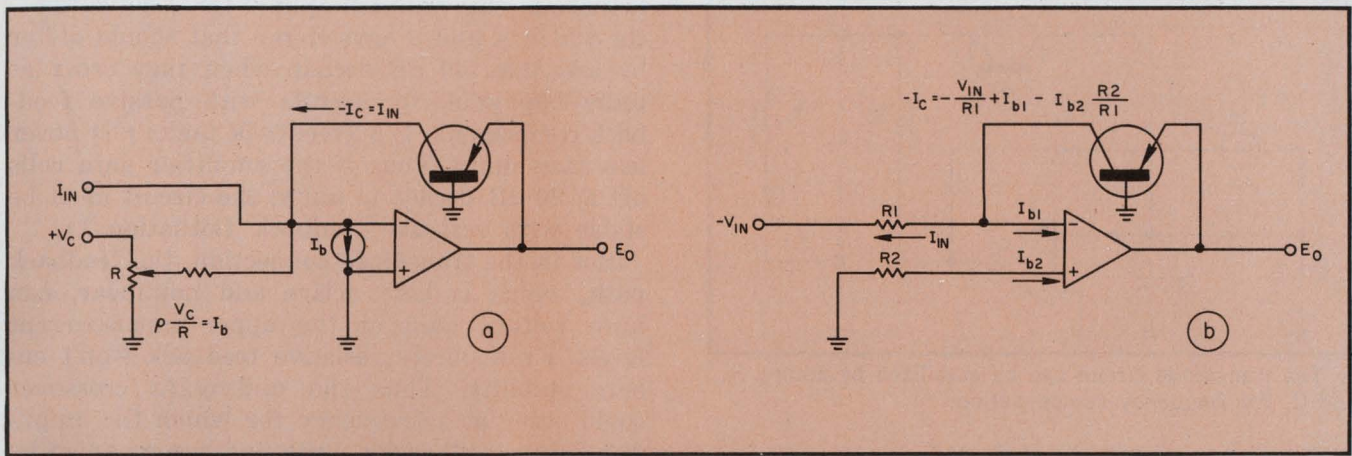

6. To compensate for the error current  $I_b$  (a) a compensating current,  $I_C = PV_C/R = I_b$  is added. Symmetry can

also be used (b) to null out the effects of  $I_b$ , both initially and with temperature.

desired low-current range.

Amplifier bias current,  $I_b$ , causes linearity errors that appear at the output as log-conformity errors. Offset voltage,  $V_{OS}$ , also causes an error current in the feedback path that is a function of the input resistance  $V_{OS}/R_{IN}$ . This current has the same effect as bias-current error (Fig. 5). There are several ways to reduce errors caused by bias current. Aside from the most obvious and expensive route (use of an amplifier with the necessary performance), Fig. 6 shows ways to null the effects of  $I_b$  by modifying the circuitry. In Fig. 6b a compensating resistor, in series with the positive input, provides bias-current compensation. If the amplifier input currents track one another

$$-I_C = I_{IN} - I_{b1} + I_{b2}(R_2/R_1).$$

And, for example, with  $I_{b1} = I_{b2}$  and  $R_1 = R_2$ , then  $-I_C = I_{IN}$ . Thus  $R_2 I_{b2}$  should be small enough to avoid significant errors due to  $V_C$ .

When the amplifier is zeroed at one temperature, current errors due to  $V_{OS}$  are temporarily reduced. Since  $I_{ES}$  could be  $10^{-14}$  A or less, it is important to select the op amp with care and to minimize summing-point leakage current from all sources. Besides amplifier problems, there are also device problems. The temperature dependence of  $I_{ES}$  (doubling for every 10-C increase) and of the ratio  $kT/q$  ( $0.33\%/^{\circ}\text{C}$  at 27 C) total about  $2 \text{ mV}/^{\circ}\text{C}$ —an intolerable change for accurate log circuits. As we shall see this problem can be circumvented by adding additional components.

### Log amps also have stability problems

A necessary condition for stability of op-amp circuits is that the phase shift around the feedback loop be less than  $180^{\circ}$  at the frequency where the loop gain,  $A\beta$ , drops through unity. The hypothetical Bode plot of Fig. 7 corresponds

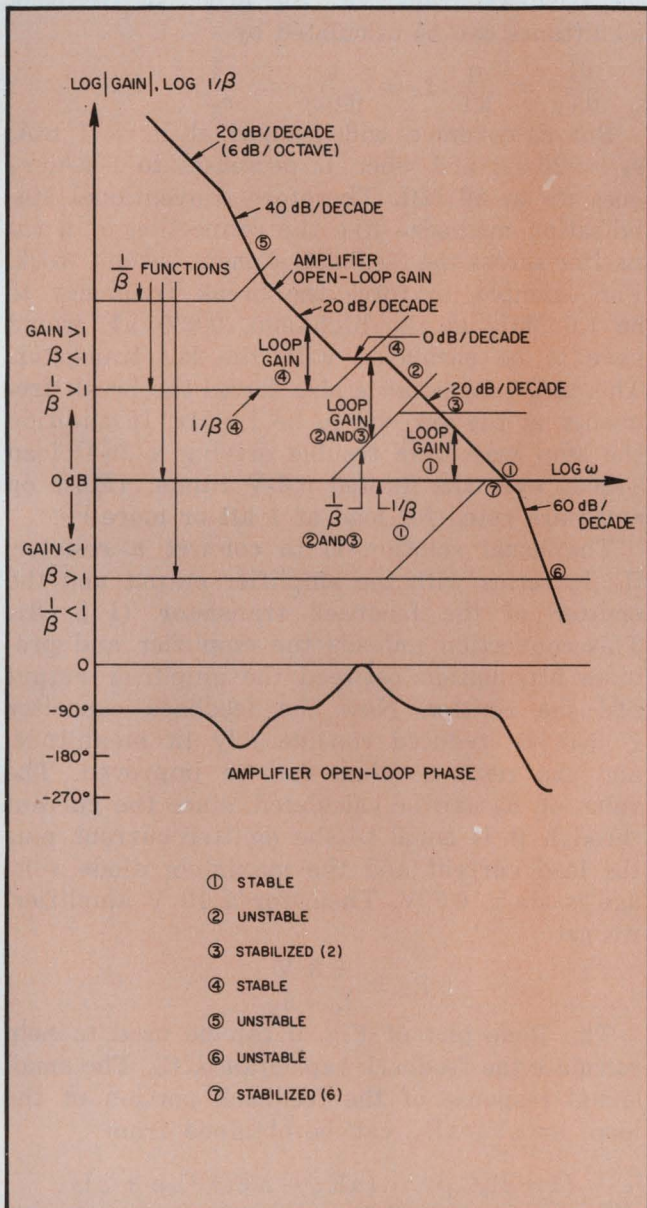

7. The Bode plot for stability analysis shows stable and unstable loop gain ( $A\beta$ ) situations.



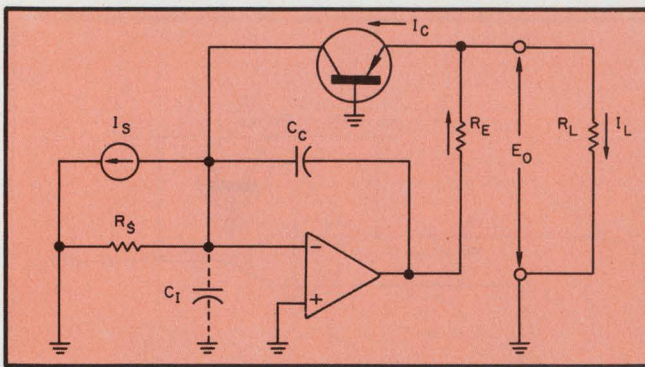

8. The transdiode circuit can be stabilized by adding  $R_E$  and  $C_C$  for frequency compensation.

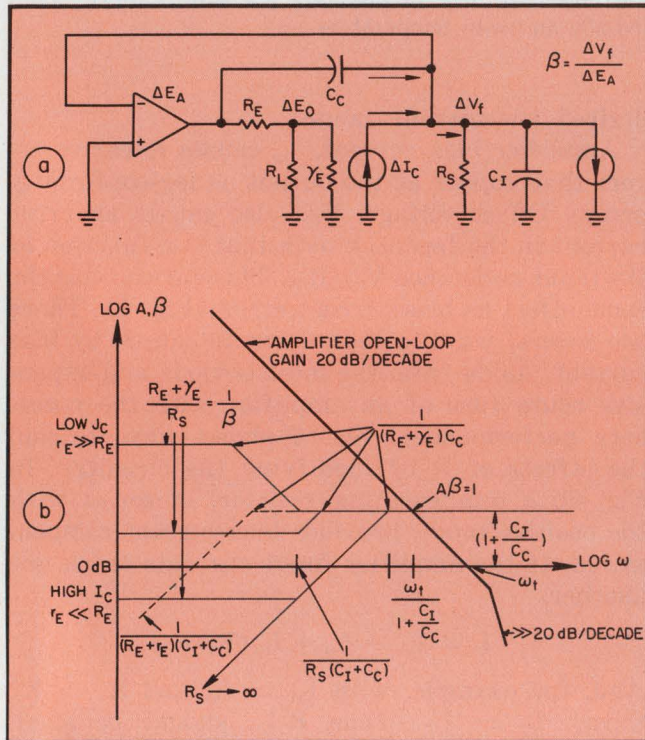

9. The stability model for the circuit of Fig. 8 (a) can be used along with the Bode plot (b) to do a stability analysis of the transdiode circuit.

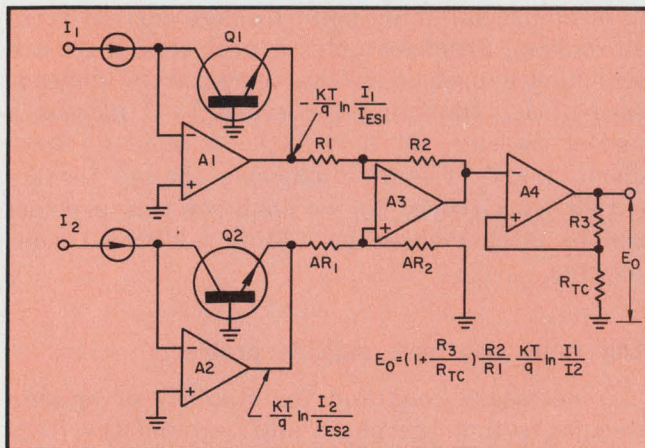

10. Amplifier A3, used as a subtractor of logarithms to perform a log-ratio calculation, has compensation for both  $I_{ES}$  and  $KT/q$  variations.

to a circuit with minimum-phase (RC) networks—for which  $A$  and  $\beta$  have slopes that should differ by less than 40 dB/decade when they cross at unity-loop gain. In circuits with passive feedback components,  $1/\beta$  (feedback factor) is never less than unity. Thus if the amplifier gain rolls off at 20 dB/decade to unity, the circuit must be stable with resistive feedback (situation 1).

But in the transdiode connection, the feedback path, which is both active and nonlinear, can have voltage gain at the upper input-current levels. Even purely resistive feedback won't ensure stability. Thus the unity-gain crossover could occur at a frequency for which the amplifier gain is well under unity and accompanied by a large phase shift (situation 6). Also, since the gain is a function of signal level, a choice must sometimes be made between stability at high levels and bandwidth at low levels.

For small changes in the emitter current of the feedback transistor, the effective feedback admittance can be calculated by

$$\frac{dI_C}{dV_E} = \frac{q}{kT} I_C = \frac{I_C}{0.026} = \frac{1}{r_E}$$

But  $r_E$  covers a wide range: at  $I_C = 1$  mA,  $r_E = 26 \Omega$ ; and when  $I_C$  decreases to 1 nA,  $r_E$  goes up to 26 M $\Omega$ . Therefore conventional stabilization methods—like the connection of a capacitor across the feedback element—won't work. For example, to force the break frequency to be 1.6 MHz at the high end, 0.039  $\mu$ F would have to be paralleled with the log transistor. This large capacitance also forces the break frequency at the low end to be 1.6 Hz. In addition the amp may have trouble driving a 26- $\Omega$  load—even over the limited 0.6-V range. (Most op amps are rated for load of 1 k $\Omega$  or more.)

The usual solution is to connect a resistor,  $R_E$ , in series with the amplifier output and the emitter of the feedback transistor (Fig. 8). This connection unloads the amplifier and provides attenuation between the amplifier output and the emitter. Now the feedback capacitor  $C_C$  can be reduced considerably in magnitude, and the response time can be improved. The value of  $R_E$  can be calculated, since the current through it is equal to the emitter current plus the load current and the maximum diode voltage is about 0.7 V. Then, for a 10 V amplifier, we get

$$R_E = \frac{9.3 \text{ V}}{I_C + I_L}$$

The Bode plot of Fig. 9 can be used to help calculate the feedback capacitance,  $C_C$ . The small signal response of the feedback portion of the loop,  $\beta = \Delta V_f / \Delta E_A$ , can be obtained from

$$\frac{\Delta V_f}{R_S} (1 + R_S C_I p) = (\Delta E_A - \Delta V_f) C_C p + \Delta I_C,$$

$$\text{where } \Delta I_C = \frac{\Delta E_O}{r_E} = \frac{\Delta E_A}{R_E + r_E}.$$



If this equation is solved for  $\beta$ ,

$$\beta = \frac{\Delta V_F}{\Delta E_A} = \frac{R_S}{R_E + r_E} \left[ \frac{1 + (R_E + r_E) C_C p}{1 + R_S (C_I + C_C) p} \right]$$

Now approximations can be made. If the input is a current source ( $R_S \rightarrow \infty$ ) and the frequencies are high ( $p \rightarrow j\omega \gg 2\pi f_t$ ),  $\beta$  becomes  $C_C / (C_I + C_C)$ . At low frequencies and a voltage-source input,  $\beta$  becomes  $R_S / (R_E + r_E)$ . Since  $r_E$  is inversely proportional to  $I_C$ , the time constants that contain  $r_E$  will be proportional to  $r_E$  for low values of  $I_C$  and constant ( $\approx R_E$ ) for high values of  $I_C$ .

To achieve small-signal stability, the numerator break frequency,  $\omega_c = 1 / (R_E + r_E) C_C$ , should be at least one octave less than the frequency at which  $1/\beta = 1 + C_I/C_C$  crosses the amplifier's open-loop gain plot at the highest value of  $I_C$ .

For example, if  $R_E = 2.2 \text{ k}\Omega$ ,  $\omega_t = 10^7 \text{ rad}$ ,  $C_I = 10 \text{ pF}$  and  $r_E$  at  $1 \text{ mA} = 26 \Omega$ , then

$$\frac{1}{2200 C_C} = \frac{1}{2} \cdot \frac{\omega_t}{1 + C_I/C_C}$$

When this equation is solved for  $C_C$ , we get  $C_C = 88 \text{ pF}$ ; therefore a  $100 \text{ pF}$  standard value would be reasonable.

### Making the circuits work

The temperature sensitivity of the circuits mentioned earlier gives them very limited practical value. In addition the output depends upon the value of  $\alpha I_{ES}$  (reference current), which differs from device to device.

If two similar transistors are matched for  $V_{BE}$  at constant collector current and temperature, the ratio of the  $\alpha I_{ES}$  terms would be almost constant over a wide temperature range. Compensation by use of matched pairs results in the following mathematical simplification: If  $\frac{\alpha I_{ES2}}{\alpha I_{ES1}}$

is approximately unity, then

$$E_{IN} = \frac{kT}{q} \left[ \ln \left( \frac{I_1}{I_{ES1}} \right) - \ln \left( \frac{I_2}{I_{ES2}} \right) \right] \quad (1)$$

$$= \frac{kT}{q} \ln \frac{I_1}{I_2} \quad (2)$$

If the subtraction operation of Eq. 1 is carried out with use of circuit of Fig. 10, the reference current is  $I_2$  (zero output voltage when  $I_1 = I_2$ ), and the output voltage becomes proportional to the resistance ratios that determine the gain of amplifiers  $A_3$  and  $A_4$ , allowing arbitrary scale factors (e.g.,  $1 \text{ V/decade}$ ).

Another possible subtraction method is shown in Fig. 11a. Fig. 11b shows the antilog connection for the two log circuits and the current source.

Performance of these circuits is practically independent of  $I_{ES}$  and temperature. For a single input,  $I_1$ , the reference current,  $I_2$ , can be set to normalize  $I_1$ . And since  $kT/q$  is not usually con-

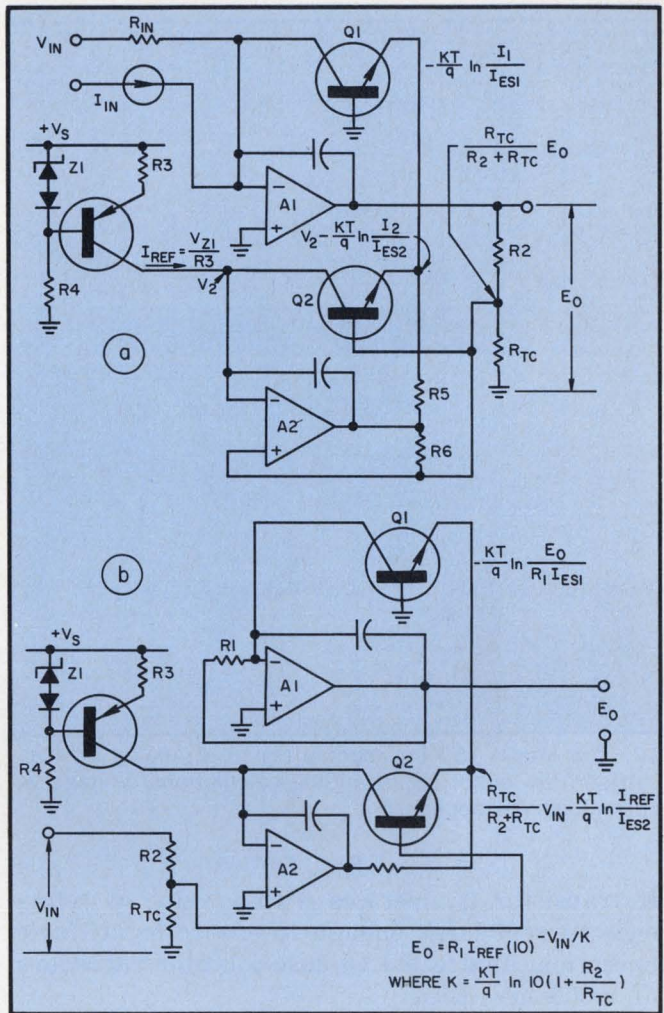

11. By using a controlled current reference, the temperature-compensated log circuit performs ratio calculations referred to  $I_{REF}$  (a). When some of the leads are reconnected as shown here the log circuit produces an antilog output (b).

sidered a convenient value of voltage with which to work,  $R_2/R_1$  can be scaled to provide an appropriate value of gain.

For example, if a scale factor of  $1 \text{ V}$  per decade is desired,  $E_0 = K \log_{10} (I_1/I_2)$ , and  $K$  must equal  $1$ . For  $K = 1$ ,  $R_2/R_1$  must equal  $q / (k \cdot T \cdot \ln 10)$ , or  $16.9$  at  $300 \text{ K}$ . If the temperature sensitivity of this circuit is too great ( $0.33\% / ^\circ\text{C}$ ) for the desired stability and range of temperature variation, a gain stage can be added with an equal but opposite temperature coefficient.

The circuit of Fig. 10 uses resistor  $R_{TC}$  for compensation. The resistor is chosen so that the gain equation of  $A_4$  becomes  $G = 1 + R_3/R_{TC}$  and has a  $-0.33\% / ^\circ\text{C}$  sensitivity. Fig. 11a incorporates a fixed-current reference whose current is set by  $V_{Z1}/R_3$ . Resistor  $R_6$  allows the high end of the dynamic range to be extended through  $1 \text{ mA}$ —its negative-resistance effect tends to cancel the voltage drop of the bulk resistance of  $Q_1$ .

In the antilog circuit, the output voltage,  $E_0$ , has an exponential relationship:



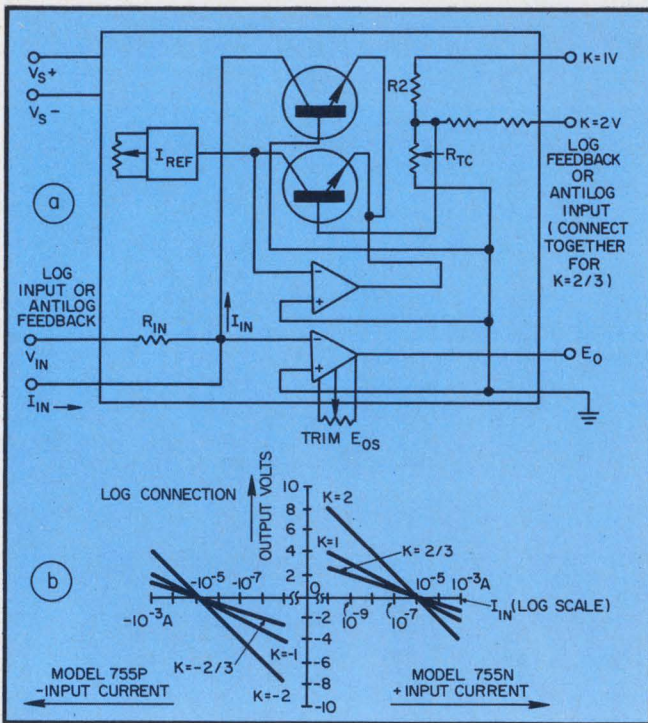

12. The Model 755 log module (a) from Analog Devices can perform either log or antilog calculations. Voltage vs current curves appear in b.

$$E_o = -E_{REF} 10^{-V_{IN}/K}$$

If transistor  $Q_2$  operates with a value of reference current large enough to ensure logarithmic operation, unaffected by base-collector variations of  $\pm 600$  mV, then

$$\frac{-kT}{q} \ln \left( \frac{E_o}{R_1 \alpha I_{ES_1}} \right) = \frac{R_{TC}}{R_2 + R_{TC}} V_{IN} - \frac{kT}{q} \ln \frac{I_{REF}}{\alpha I_{ES_2}}$$

and, when terms are rearranged,

$$\frac{q}{kT} \left( \frac{R_{TC}}{R_2 + R_{TC}} \right) V_{IN} = -\ln \left( \frac{E_o}{R_1 I_{REF}} \cdot \frac{\alpha I_{ES_2}}{\alpha I_{ES_1}} \right) \quad (3)$$

If the previous assumption is used,  $\alpha I_{ES_2} \approx \alpha I_{ES_1}$ , and Eq. 3 is changed back to exponential form,

$$E_o = R_1 I_{REF} \left[ \text{Exp} \left( \frac{-q}{kT} \cdot \frac{R_{TC}}{R_2 + R_{TC}} \cdot V_{IN} \right) \right] \quad (4)$$

In the antilog connection, the same error sources are present; but some of them now appear in the exponent and others that were in the exponent have been repositioned as constant multipliers.

Dynamic errors, such as speed and frequency response, depend upon scaling, signal level and direction of change. Above currents of around  $1 \mu\text{A}$ , the response is dominated by the integrator time constant, changing little with signal level. Below about  $1 \mu\text{A}$ ,  $r_E C_C$  dominates the response; thus speed is reduced in proportion to the input current. A typical log amp might have

the following response times:

$I_{IN}$ (increasing)	time
1 to 10 nA	1 ms
10 to 100 nA	100 $\mu\text{s}$
100 nA to 1 $\mu\text{A}$	7 $\mu\text{s}$
1 $\mu\text{A}$ to 1 mA	4 $\mu\text{s}$
$I_{IN}$ (decreasing)	time
10 to 1 nA	4.5 ms
100 to 10 nA	400 $\mu\text{s}$
1 $\mu\text{A}$ to 100 nA	30 $\mu\text{s}$
1 mA to 1 $\mu\text{A}$	7 $\mu\text{s}$

The frequency response of log amps is measured at low-signal levels (3% to 10% of the average input level) to reduce distortion caused by log compression. Typical response figures might read as follows:

$I_{IN}$	-3 dB frequency
1 nA	80 Hz
1 $\mu\text{A}$	10 kHz
10 $\mu\text{A}$	40 kHz
1 mA	100 kHz

### Designing with log amps

Log circuits can be applied easily to data collection and compression. For example, if a signal is introduced into a computer system or data link and it is desired to keep signal accuracy to within 1% throughout its entire range a circuit that responds to the log of the input can be used.

The standard linear approach would be to select an analog-to-digital converter with sufficient resolution to meet the accuracy requirement. If the input range is  $-1$  to  $-10$  V, the dynamic range would be from  $-0.01$  V (i.e. 1% of 1 V) to  $-10$  V, or about 1000:1. To obtain this resolution, a 10-bit converter could be used ( $2^{10} = 1024$ ), and one least-significant bit would then represent 1% of the smallest signal. If the range is increased to  $-10$  mV to  $-10$  V, the converter would require a resolution of 0.1 mV to  $-10$  V, or 1:100,000. In this case a 16-bit converter would barely be sufficient ( $2^{16} = 65,536$ ).

An alternative approach uses a log-conversion circuit for signal compression over a three-decade range and a 12-bit a/d converter. The log circuit for this application is shown in Fig. 13a. To convert the log output to a unipolar signal, a current source can be used to shift the reference point to one end of the range. Resistor  $R_1$ , added in series with the  $K = 1$  output, adjusts the scale-factor setting. To provide a realistic design example, the Analog Devices 755 series of log amplifiers is used (Fig. 12).

The first step in the design is to select the proper polarity amplifier. If we assume the input ranges from  $-10$  V to  $-10$  mV, the "P" version of the 755 (for negative inputs) is required.

After selection of the log amp, the region of



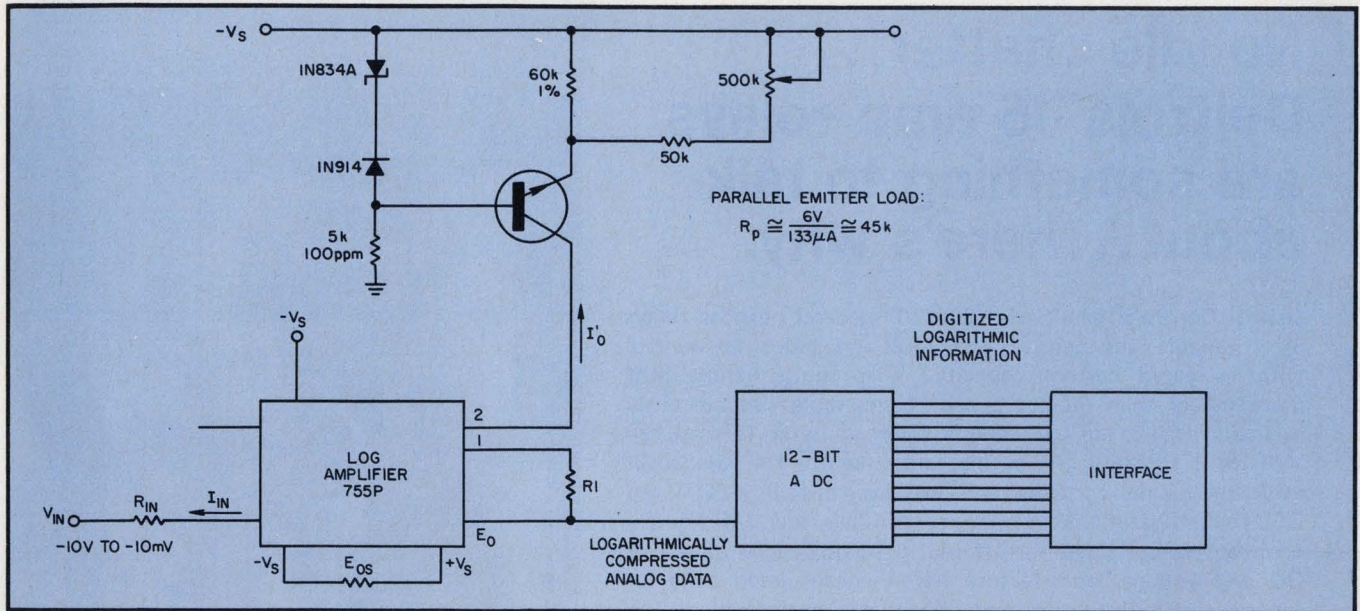

13. A data compression system can be built with log amps. These amplifiers can reduce a wide ranging ana-

log signal to a more restricted range with no loss in dynamic range or increase in distortion.

best log conformity should be chosen for operation. For the 755P, the best log conformity is 0.5%—over 10 nA to 100  $\mu$ A. Resistor  $R_{IN}$ , used at the current input, determines the highest current needed at the highest input voltage magnitude:

$$R_{IN} = 10 \text{ V} / 100 \mu\text{A} = 100 \text{ k}\Omega$$

To find  $K$ , the input requirements of the following stage must be examined. If the a/d converter input covers a range from 0 to +5 V,  $K$  can be calculated as follows: The total output voltage is 5 V, and the input spans three decades. Thus  $K = 5 \text{ V} / 3 = 1.67 \text{ V}$ . From the data sheet for the log amplifier selected, a value of 15 k $\Omega$  is given for the input resistance of the 1 V per decade terminal. The total resistance then required is

$$R_t = (5/3) (15 \text{ k}\Omega) = 25 \text{ k}\Omega.$$

Thus a 10-k $\Omega$  resistor in series with the  $K = -1$  terminal will provide a nominally correct scale factor. To allow for tolerances of the internal resistor, use a 10-k $\Omega$ , 10-turn, pot in series with a 5-k $\Omega$  resistor as  $R_1$ .

To produce a zero output from the amplifier at one end of the range,  $I_{REF}$  should be adjusted to match  $I_{IN}$ . The curves for the 755P (Fig. 12b) indicate that a -2 V output would result if 100 nA is the input (with  $K = -1 \text{ V}$ ). Since this is the current at which zero output is desired, the current  $I_o$  injected into the unused scale factor terminal must shift the output in the positive direction. To do this, the current input must be derived from a negative voltage reference. Calculate the input current from the total resistance connected to the scale-factor terminal, the output and the amount of voltage the output is to be shifted for  $K = 1 \text{ V}$ :

$$I = 2K/R_T = (2) (5/3) / 25 \text{ k}\Omega = 133 \mu\text{A}$$

A resistor to the negative supply (15 V/133  $\mu$ A = 30 k $\Omega$ ) can be used to obtain this current. But shifts in the offset voltage at the dummy summing junction caused by the 60 mV/decade response to the input can cause noticeable errors. For example, if  $I_{REF}$  is adjusted as indicated, a shift of 180 mV would occur as the input signal increases to 100  $\mu$ A (3 decades at 60 mV/decade), resulting in a shift of offset current of

$$(180 \text{ mV}) / 15 \text{ V} \times 100 = 1.2\%.$$

To avoid this problem, a fairly simple current source is used, as shown in Fig. 13.

The trimming procedure for the log circuit is as follows: First  $E_{OS}$  should be adjusted for zero output; this can be done by grounding the input voltage. The trim pots for  $I_{REF}$  and scale factor should be left in mid-range to reduce interaction. The  $E_{OS}$  trim would then be adjusted for

$$E_o = -K \log (10 \mu\text{V} / E_{REF}) = -5 \text{ V}.$$

Adjusting for any voltage between -5 V and -6 V will ensure that  $E_{OS}$  has been adjusted to within 10  $\mu$ V. This adjustment should be performed carefully, since the gain is quite high at the 2.5 to 10  $\mu$ V level (about 100,000), and the reading will be noisy.

Next, to adjust  $I_{REF}$ , set  $V_{IN} = 10 \text{ mV}$  and trim  $I_{REF}$  to force the zero output.  $K$  is then easily adjusted by increasing the input signal to its full value of -10 V, and adjusting  $R_1$  for 5 V output.

Some interaction between adjustments cannot be avoided, all trims should be repeated at least once in the same order as initially performed. ■■

#### Reference

1. Paterson, W. L., "Multiplication and Logarithmic Conversion by Operational-Amplifier-Transistor Circuits," *The Review of Scientific Instruments*, 34-12, December, 1963.



# No idle chatter... Deltrols' 15 amp relays are something to talk about...here's why.

Deltrol Controls' new Series 262/267 general purpose relays offer reliable, inexpensive appliance and industrial control with increased current capacity. These units handle 50% more power than most types of comparable size currently available. Relays are UL listed and carry a hefty 15 amp/120 VAC or 1 HP/240 VAC rating. Units feature 1/4" dia. silver cadmium oxide contacts and are available in SPDT and DPDT configurations. Standard terminals are 1/4" quick-connect type. Relays are offered in a wide range of AC or DC coil voltages and feature nylon encapsulated coils for superior heat dissipation and dependable performance. Terminals and frame are locked into panel to eliminate breakage and provide rigid support. Units are available with or without durable Lexan case.

**DELTROL**  
*controls*  
Division Of Deltrol Corp.

2745 South 19th Street,  
Milwaukee, Wisconsin 53215  
Phone (414) 671-6800  
Telex 2-6871

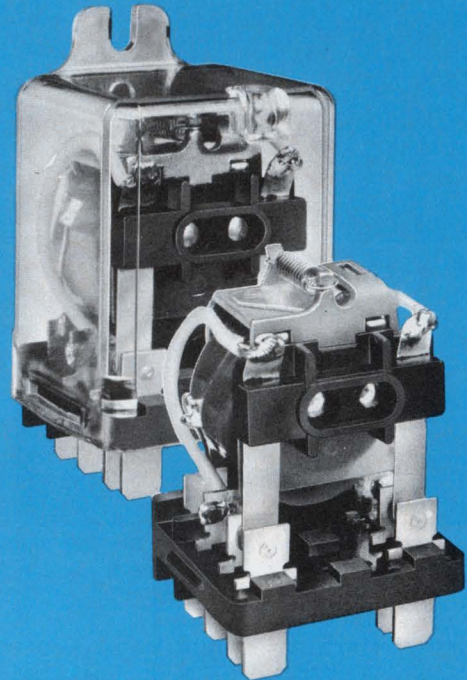

INFORMATION RETRIEVAL NUMBER 24

**IC** Kyodo Electronic Laboratories Inc.

# Numerical Indication Tube Driver

	TYPE	APPLICATION	CCT/PACK	FUNCTION	FEATURES
LED DRIVER	KB-6400	Segment	7	Invert	: Bipolar IC and thin-film resistors use for high performance and high reliability.
	KB-6401	Digit	6	Invert	
	KB-6402	Digit	4	Invert	
# NIXIE TUBE DRIVER	KH-6286	Segment	9	Convert	: High break-down voltage. BVces ≥ 150V : High performance, high reliability. : High density packaging.
	KH-6288	Segment	8	Invert	
	KH-6800	Digit	6	Invert	
	KH-6811	Digit	9	Invert	
	KH-6813 KH-6814	Digit Digit	6 9	Convert Convert	
FLUORESCENT TUBE DRIVER	KM-6608	Segment	4	Convert	: Direct connection possible to LSI. : High performance, high reliability. : High withstanding voltage-low power consumption.
	KM-6609	& Digit	6	Invert	
PRINTER DRIVER	KH-6270	Channel	10	Invert	: Low input through use of Darlington transistors. : High density packing. : Direct connection possible to LSI. : Includes spark killer diodes.
	KH-6298	Channel	7	Invert	
	KH-6275	Channel	9	Invert	
	KH-6269	Channel	7	Invert	

# Trademark of Burroughs corporation.

**IC KYODO**  
ELECTRONIC  
LABORATORIES INC.

11-18, 2 Chome, Sonan, Sagami-hara-shi,  
Kanagawa-ken, Japan  
TEL: 0427-42-6731 ~6  
CABLE ADDRESS: KELIC MACHIDA  
TELEX: 2872-239 KELIC

INFORMATION RETRIEVAL NUMBER 25



# BARGAINS GALORE on LEDs from DIALIGHT

## FEATURES:

- High luminous intensity
- Low cost
- Low power consumption
- IC compatible
- Vibration/shock resistant
- Solid state reliability
- Life measured in years
- Wide viewing angle

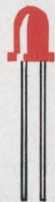

Dialight's high brightness 521-9200 LED is an intense large area light source that has this typical luminous intensity:  
@  $I_F = 20 \text{ mA}$   $I_0 = 2.0 \text{ mcd}$ .

## APPLICATIONS:

Panel lighting • Circuit-status indicators • Back lighting of annunciators • Alpha-numeric displays • Automobile dashboards • Appliances • Desk-top calculators • Housewares



# 9¢

Quality LEDs are 9¢ each when purchased in million piece quantities



# 21¢

LEDs from 100 to 999 are only 21¢ each.

# 17¢



If you need LEDs from 1000 to 9999, Dialight has them for 17¢ each.

# 28¢



Even if you only need LEDs from 1 to 99, Dialight has them for 28¢ each.

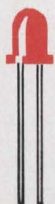

# 16¢

Quantities from 10,000 are a low 16¢ each and Dialight can fill your order today

# FREE!

With this coupon you can get a free LED sample. Send this coupon to your nearest Dialight distributor or give him a call.

All prices are domestic and subject to change without notice.

## DIALIGHT

Dialight Corporation, A North American Philips Company  
60 Stewart Avenue, Brooklyn, N.Y. 11237 (212) 497-7600

## AVAILABLE NOW FROM THESE STOCKING DISTRIBUTORS

**ARIZONA**  
Moltronics of Arizona, Inc.  
602-272-7951

**CALIFORNIA**  
Western Electromotive  
213-870-7621  
Bell Electronics Corp.  
415-323-9431  
Fisher/Brownell  
408-244-6182  
Richey Electronics, Inc.  
213-875-2862  
Westates Electronics Corp.  
213-341-4411

**COLORADO**  
Meter Master Instrument Corp.  
303-722-5766

**FLORIDA**  
Hammond Electronics, Inc.  
305-241-6601

**ILLINOIS**  
Newark Electronics  
312-638-4411

**INDIANA**  
Graham Electronic Supply, Inc.  
317-634-8202  
Radio Distributing Co.  
219-287-2911

**MARYLAND**  
Pioneer Washington Elect. Co.  
301-424-3300  
Radio Electric Service Co.  
301-823-0070

**MASSACHUSETTS**  
Cramer Electronics, Inc.  
617-969-7700  
DeMambro Supply Co., Inc.  
617-787-1200  
Gerber Electronics, Inc.  
617-329-2400  
Sager Electrical Supply Co.  
617-542-2281

**MICHIGAN**  
RS Electronics  
313-491-1000

**MINNESOTA**  
Gopher Electronics Co.  
612-645-0241

**MISSOURI**  
Lcomp-St. Louis, Inc.  
314-647-5505

**NEBRASKA**  
Scott Electronic Supply  
402-434-8308

**NEW JERSEY**  
Federated Electronics  
201-376-8900  
Resco Electronics  
609-662-4000  
State Electronics  
201-887-2550

**NEW YORK METROPOLITAN AREA**  
Arrow Electronics, Inc.  
516-694-6800  
Harrison Radio Corp.  
516-293-7990  
Harvey Radio Co., Inc.  
516-921-8700  
Melville Radio Corp.  
914-592-7100  
Peerless Radio Corp.  
516-593-2121

**NEW YORK STATE**  
Summit Distributors, Inc.  
716-884-3450

**NORTH CAROLINA**  
Hammond Electronics of Carolina, Inc.  
919-275-6391

**OHIO**  
Hughes-Peters, Inc.  
614-294-5351  
Pioneer-Cleveland Div.  
Pioneer-Standard Electronics  
216-587-3600  
Stotts-Friedman Co.  
513-224-1111  
Sun Radio Co., Inc.  
216-434-2171

**OKLAHOMA**  
Radio, Inc.  
918-587-9124

**PENNSYLVANIA**  
Almo Electronics Corp.  
215-676-6000  
George D. Barbey Co.  
215-376-7451  
Cameradio Co.  
412-288-2600

**TEXAS**  
Harrison Equipment Co., Inc.  
713-224-9131

**UTAH**  
Standard Supply Co.  
801-355-2971

**WASHINGTON**  
Almac/Stroum Electronics  
206-763-2300

**WISCONSIN**  
Parts Mart Corp.  
414-276-4160

**CANADA**  
Saynor Electronics Ltd.  
416-445-2347  
L. A. Varah Ltd.  
604-736-9252  
Wackid Radio TV Labs, Ltd.  
613-726-1821

# FREE!

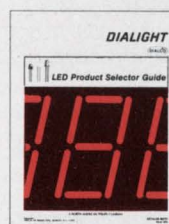

Ask for free LED Product Selector Guide. 60 pages of LEDs: discretes, indicators, displays, fault indicators, opto-isolators, etc.



# Which IC timer to buy?

To choose from among single and dual types, and now counter-timers, know the tradeoffs and spec limitations.

IC timers, though versatile, tend to be relatively simple circuits. But you may not find it so easy to pick the right one for your application.

For one thing, the choice is expanding rapidly, with alternate-sourcing of several models. For another, the total cost to the user isn't always obvious. IC timers generate precise timing pulses or time delays with just a few external components. But the cost of the components sometimes greatly exceeds that of the timer itself.

Other key considerations, as you check the specs and analyze the tradeoffs, include these:

- Timers list an impressive range of possible delays—from microseconds to hours—but not all timers can provide those delays and still maintain accuracy and stability.

- Newer counter timers can be cascaded to provide accurate delays of up to a year or more. However, acceptable stability may not be achievable without an external reference oscillator connected to the timer.

## IC timers: A wide selection

As a start in making your choice, consider the types of timers that are available (Fig. 1). The first class to gain acceptance was the single-cycle, or "one-shot," circuit. This type provides time

**Alan B. Grebene**, Vice President of Engineering, Exar Integrated Systems, Inc., 750 Palomar Ave., Sunnyvale, Calif. 94086.

delays in the range of microseconds to minutes. Available "dual" versions of these timers contain two identical timer sections in the same IC package.

The basic one-shot IC timers have evolved into more complex counter-type timer ICs. These circuits contain a binary counter, in addition to a time-base oscillator, on a single chip.

The timing interval consists of a number of cycles of the internal time-base oscillator. And the over-all time delay results from a simple count down of the oscillator frequency. Hence time delays up to months or years are provided without the need for external large-value timing resistors or capacitors.

## Timers contain simple circuitry

The single-cycle timers operate by charging an external capacitor through a resistor or a current source to generate a timing interval, T. This interval is proportional to the value of the external timing capacitor. Fig. 2 gives a simplified block diagram of such a timing circuit. Normally the internal switch  $S_1$  is closed and the voltage across C is clamped to ground.

The timing cycle begins with the application of a trigger pulse to set the flip-flop and to open the switch  $S_1$  across C. The voltage across C then increases exponentially with a time constant, RC. When this voltage reaches a threshold,  $V_{ref}$ , the voltage comparator changes state. This

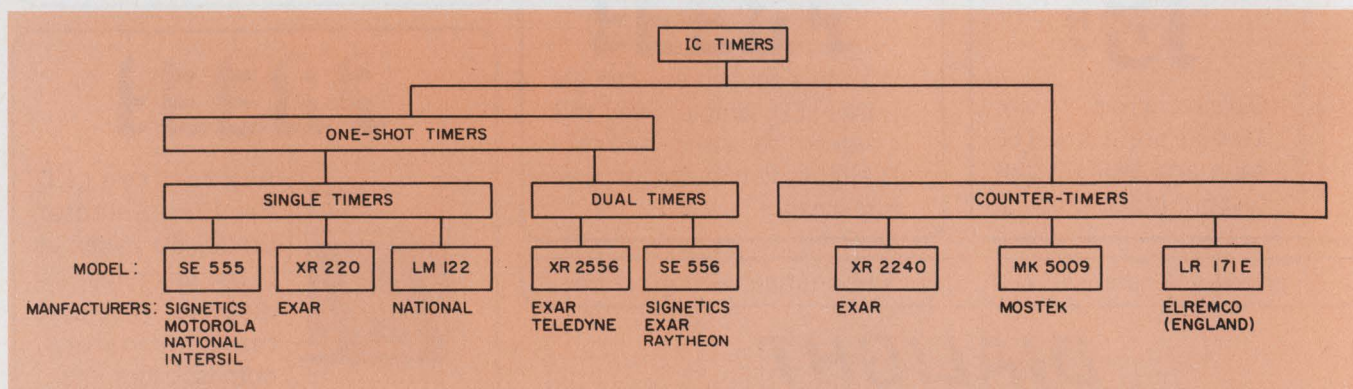

1. IC timers presently include several one-shots and counter-timers. More are expected to follow.



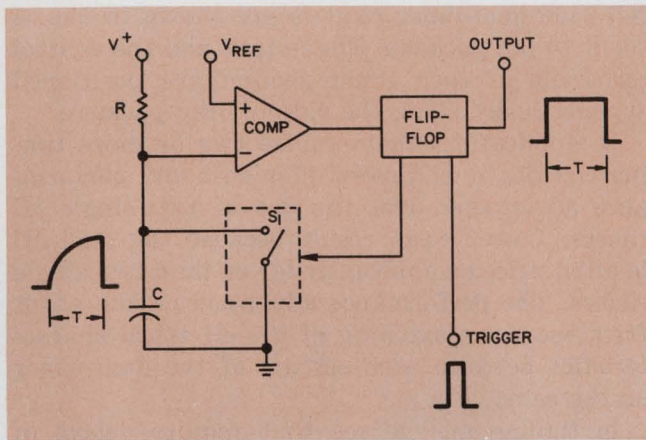

2. A basic single-cycle—or one-shot—IC timer generates a logic pulse whose duration is proportional to the external RC.

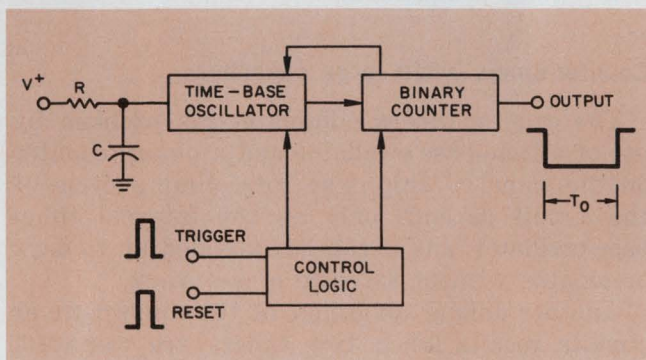

3. A counter-timer has a total timing interval that consists of multiple cycles of the time-base-oscillator period.

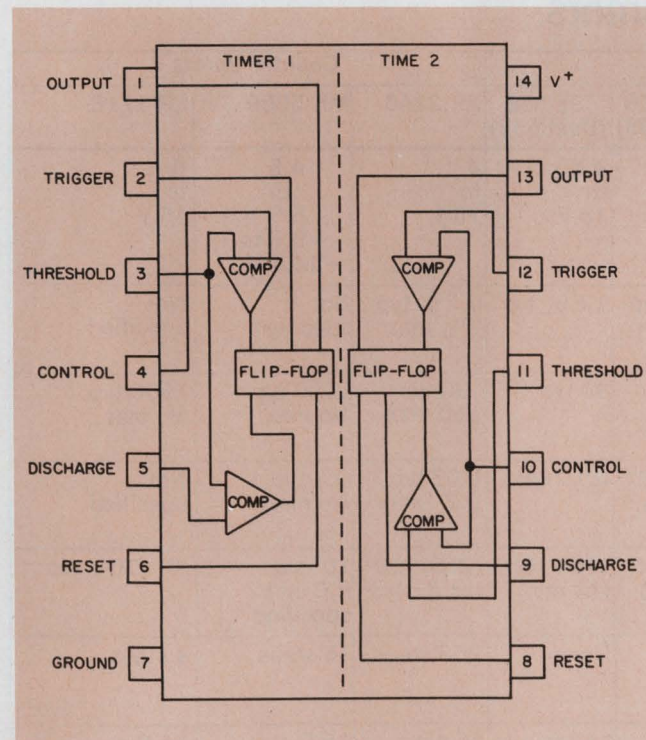

4. The XR-2556 dual-555 timer—in a 14-pin DIP—has a pinout with a symmetrical distribution of output and control terminals.

change resets the flip-flop, closes  $S_1$  and ends the timing cycle. The output of the timer is a logic pulse of duration  $T$ , which is proportional to the external RC.

Counter-timers operate on a somewhat different principle. As shown in Fig. 3, they consist of three sections: (1) a stable time-base oscillator; (2) a binary counter, and (3) a control flip-flop. When the circuit is at rest, the time-base oscillator is off and the binary counter is reset to zero. An applied trigger pulse sets the control flip-flop and keys on the time-base oscillator to initiate the timing cycle.

The time-base oscillator generates precise timing pulses whose period,  $T$ , is proportional to the external RC time constant. The generated pulses are counted by the binary-counter section. When a preprogrammed count is reached, the circuit completes the timing cycle and resets itself.

The total timing duration,  $T_0$ , of the circuit equals  $NT$ , where  $T$  is the time-based period and  $N$  is an integer equal to the divide ratio of the binary counter. The total timing interval consists of multiple cycles of the time-base oscillator—hence the common reference to this kind of circuit as a “multiple-cycle” timer.

### Three basic single-cycle versions

Three different ICs plus alternate-source versions fall into the category of single-cycle timers. These are the SE-555, introduced by Signetics, the XR-220, available from Exar, and the LM-122, from National Semiconductor. All of these circuits are extremely easy to use, requiring only an external RC network to set the timing interval.

Both the SE-555 and the LM-122 use the exponential-ramp principle already described and provide time delays of  $1.1 RC$  and  $1.0 RC$ , respectively. The XR-220 uses a constant-current source to charge the timing capacitor. The resulting time delay is  $2.0 RC$ .

All three timer ICs can be used in a self-triggering mode as oscillators or clock generators. Typical applications include precision and sequential timing, pulse and clock generation, and pulse-width and pulse-position modulation.

For short-duration timing applications—up to several minutes—the three circuits have similar accuracy and stability characteristics. And they require similar values of external resistors and capacitors. A comparative listing of their electrical characteristics is given in the table.

Since each IC manufacturer specifies somewhat different test conditions for his circuit, the data in the table are intended only as a relative guideline for comparison of circuit performance. Here are some of the salient features and limitations



of the three IC timers:

- The SE-555 comes in an easy-to-use 8-pin package, has a high-current capability of 200 mA and offers an adjustable duty cycle. However, triggering and output levels are of single polarity.

- The XR-220 has multiple-polarity triggering and outputs, and it produces a linear ramp output. But it does not have a duty-cycle control.

- The LM-122 can operate up to 40 V, and has a multiple-polarity output that is also protected against short circuits. Hence it is more versatile than the SE-555. But the versatility may also make the 122 harder to use. And drive capabilities are limited to only 50 mA.

### Dual timers simplify some uses

Monolithic dual-timer ICs contain two independent timing circuits in the same IC package. These ICs are particularly useful for those timing applications—such as sequential or delayed timing—that inherently require two or more timer circuits.

Presently two dual-timer ICs are available. These are the XR-2556 from Exar and Teledyne Semiconductor, and the SE-556 from Signetics, Exar and Raytheon Semiconductor. As shown in the table, both circuits have virtually identical electrical characteristics but different package pinouts. Both are designed as direct replacements for a pair of independent 555-type timers, and both designs have TTL-compatible outputs. The

XR-2556 dual-timer pinouts are shown in Fig. 4 for a 14-pin package. The output and the control terminals of each timer section are positioned symmetrically along the sides of the package.

In applications that require two or more timing circuits, dual timers offer cost and performance advantages over the use of two single IC timers. Lower costs result because the dual IC is often priced significantly lower than two single timers. The performance advantages come about from the close matching of the electrical characteristics between each section of the dual timer on the same chip.

In timing applications that require delays of several minutes, the conventional one-shot-type timers often require excessively large values of timing capacitance. And timing accuracy deteriorates due to the leakage currents associated with circuit components.

### Counter-timers avoid large capacitors

The counter-timers eliminate this problem by use of a time-base oscillator and a binary counter on the same IC chip. The total timing cycle of the circuit depends only on the internal time-base oscillator, and it can be extended up to days or months without sacrifice of accuracy.

Another unique advantage of the counter-timer circuits results when two timers are cascaded. The total time delay associated with the system increases in geometric progression. For example,

**Table. Comparison of available IC timers**

	Single-cycle timers					Counter-timers		
	SE-555	XR-220	LM-122	XR-2556 (Dual 555)	SE-556 (Dual 555)	XR-2240	MK-5009	LR-171E
Supply voltage range	4.5 to 18 V	4.5 to 20 V	4.5 to 40 V	4.5 to 18 V	4.50 to 18 V	4 to 15 V	4.5 to 5.5 V, -9.6 to -14.4 V	6 to 45 V
Timing accuracy for given R,C (prime unit)	0.5% typ 2% max	0.5% typ 2% max	2% max	0.5% typ 2% max	1.5% typ	0.5% typ 2% max	Not specified	Not specified
Temperature stability ppm/°C (prime unit)	30 typ 100 max	100 typ 300 max	30 typ	30 typ 100 max	90 typ	30 typ 150 max	2000 typ No max	1500 typ No max
Power supply stability %/V (prime unit)	0.005 typ 0.02 max	0.07 typ 0.2 max	Internally regulated	0.005 typ 0.1 max	0.15 typ	0.07 typ 0.2 max	0.3 typ No max	Not specified
Maximum timing range. R = 10MΩ; C = 100 μF	1100 sec (18 min)	1000 sec (17 min)	1000 sec (17 min)	1100 sec (18 min)	1100 sec (18 min)	(256) (10 <sup>3</sup> ) sec 3 days	10 <sup>8</sup> sec R,C not specified	(5) (10 <sup>6</sup> ) sec
Programming capability for fixed R,C	None	None	None	None	None	256 steps	16 steps	8 steps
Package type	8-Pin DIP	14-Pin DIP	14-Pin DIP, or 10-Pin TO-5	14-pin DIP	14-pin DIP	16-pin DIP	16-Pin DIP	14-Pin DIP



if a counter-timer circuit produces time delays equal to, say,  $2^8$  cycles of the time-base oscillator, then a cascade of two such circuits would produce delays of  $(2^8)^2$  or  $2^{16}$  cycles of the time base.

In this manner, time delays of several months or years can be obtained readily from a single external RC network, without degrading the timing accuracy. But even in timing applications requiring delays of just a few minutes, counter-timers may be more economical to use than the one-shot types since the counter type requires a smaller and less expensive timing capacitor.

Another unique feature common to most counter-timers is their programming capability. A preset count in the binary divider determines the total timing cycle. As a result, the counter section can be programmed to generate various time delays from a single external RC setting.

The combination of a stable time base and a programmable binary counter on the same IC chip opens up a wide range of applications that reaches far beyond conventional timing functions. Some of these applications cover such diverse fields as a/d conversion, frequency synthesis and digital sample/hold.

At present several counter-timer circuits are available, with more promised. The accompanying table provides a comparative listing of the electrical characteristics of available circuits.

The Exar XR-2240 contains a 555-style timer and an 8-bit programmable binary counter in a 16-pin, monolithic IC package. Each of the binary counter sections has a buffered open-collector output. The total time delay can be programmed from 1 RC to 255 RC if you simply connect the desired combination of counter outputs to a common-load resistor, as shown in Fig. 5. In addition to conventional timing applications with delays from microseconds up to five days, the circuit can be used with an external resistor ladder as a digital sample-hold or 8-bit a/d converter, as shown in Fig. 6.

The major advantages of the XR-2240 include TTL-compatible outputs, a high accuracy of 0.5%, 256-step programming capability and a temperature stability of 50 ppm/°C. But the IC does not operate with an external crystal, and it has a relatively short divider chain—only up to a divide-by-256.

The Mostek MK-5009P, an MOS chip, contains an oscillator and frequency divider. A functional block diagram of the circuit appears in Fig. 7. The divider chain can be programmed in 16 discrete steps by the four address pins. The circuit can count down the local oscillator frequency by  $36 \times 10^8$  and generate up to one hour of time delay from a 1-MHz crystal frequency reference.

Compared with other counter-timer circuits, the advantages of the MK-5009 include operation with an external crystal, 16-step programming

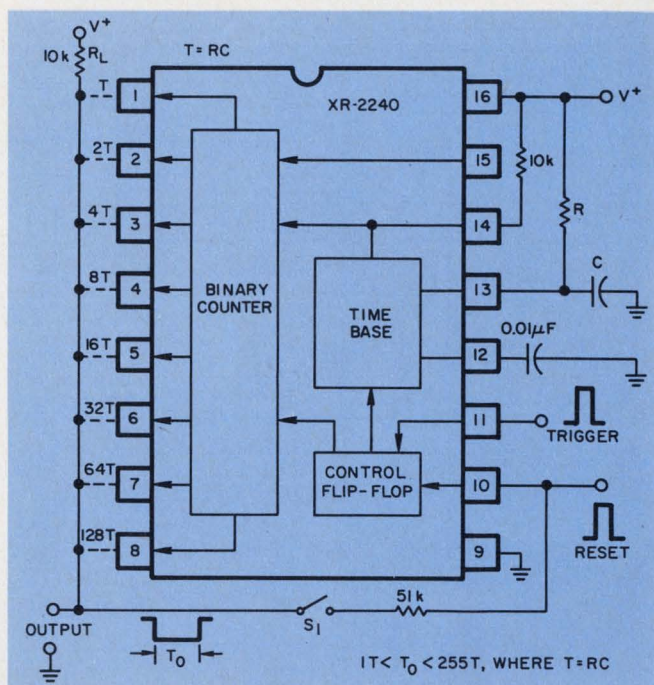

5. Counter-timers can be used as digitally programmed time-delay generators.

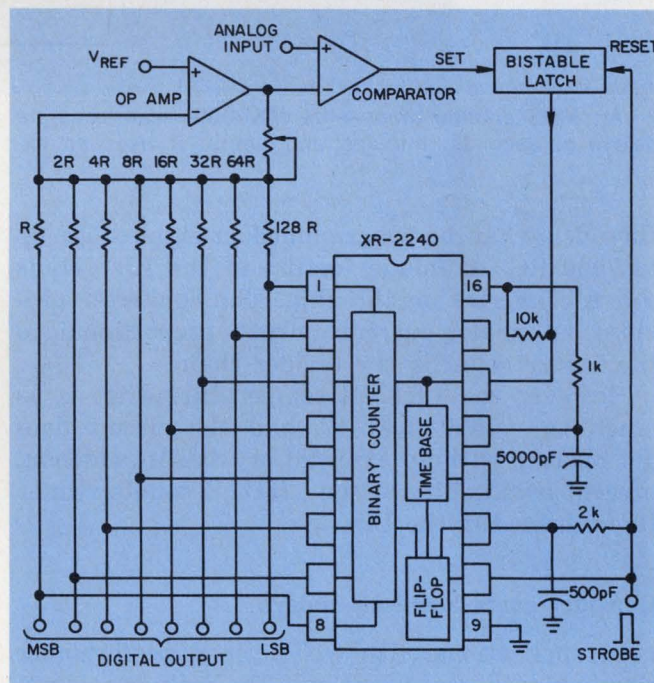

6. Even analog-to-digital converters can be built with counter-timer ICs.

capability and a long divider chain. And the timer gives seconds, minutes and hours of delay from a 1-MHz crystal. But the circuit requires split power supplies, and exhibits poor stability—up to 2000 ppm/°C—when an external RC network is used to set frequency.

The LR171E is manufactured by the Electronics Remote Control Company of England. This counter-timer contains a 12-bit binary counter and an RC oscillator in a 14-pin package. Total



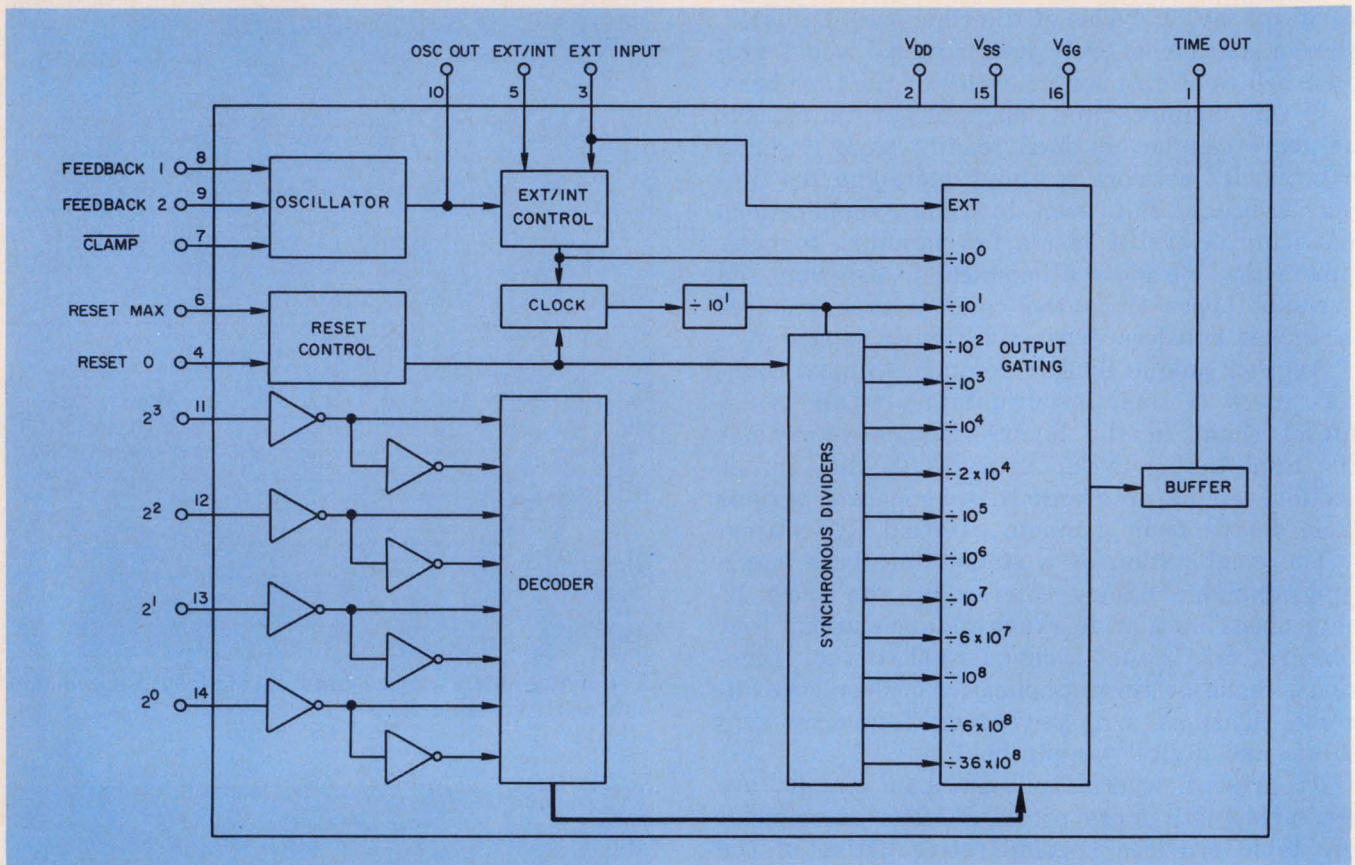

7. An MOS counter-timer—the MK5009—can generate delays of seconds, minutes and hours. It uses an ex-

ternal 1-MHz crystal and has a 16-step programming capability. The IC can count down by  $36 \times 10^8$ .

time delay can be programmed in eight steps up to 7500 RC. A unique feature of the LR171E is a d/a converter on the chip. The converter provides an analog-current output proportional to the binary count in the divider chain.

However the LR171E temperature drift is as much as  $-1500 \text{ ppm}/^\circ\text{C}$ , and the circuit does not operate with an external crystal. In addition, present availability of the LR171E counter-timer IC is limited in the U.S.

### Consider costs and total delays

In applications with well-defined performance requirements, cost represents the main consideration when you choose an IC timer. But, remember, cost also includes the price of external components—the timing Rs and Cs to operate the circuit. In some applications—like those requiring fairly long time delays of a minute or so from one-shots—the cost of the external Rs and Cs easily exceeds the cost of the IC.

After cost, total time delay is the most important factor governing choice of the IC timer. In simple timing applications that require delays ranging from microseconds to seconds, the one-shot timers, such as the XR-220 or the SE-555, offer the most economical solution. For accurate

delays in the minutes or hours range, the counter-timers are by far the better choice.

The counter-timers are somewhat more complex, and are consequently more expensive than the one-shots. At present the commercial-grade one-shot timers are priced at 75 cents to \$1 in 100-up quantities, while the counter-timers are in the \$3 range. However, for timing applications of more than several minutes, this price differential is more than offset by savings in the external component cost.

For example, a time delay of approximately two minutes, with an error of less than  $\pm 3\%$  over the 0-to-70-C temperature range, can be obtained with a one-shot timer. But the timer would require a  $12\text{-}\mu\text{F}$  polycarbonate capacitor that costs about \$8. With a counter-timer, such as the XR-2240, the same delay can be achieved with a  $0.05\text{-}\mu\text{F}$  capacitor, which costs about 50 cents.

Among counter-timers, the choice can be made on the basis of the required delay. For extremely long delays—of greater than a year—or for operation with an external crystal, a circuit such as the MK-5009, with a long divider chain, is best suited. However, the XR-2240 would be better for applications in the seconds-to-days range that do not require an external reference. ■■



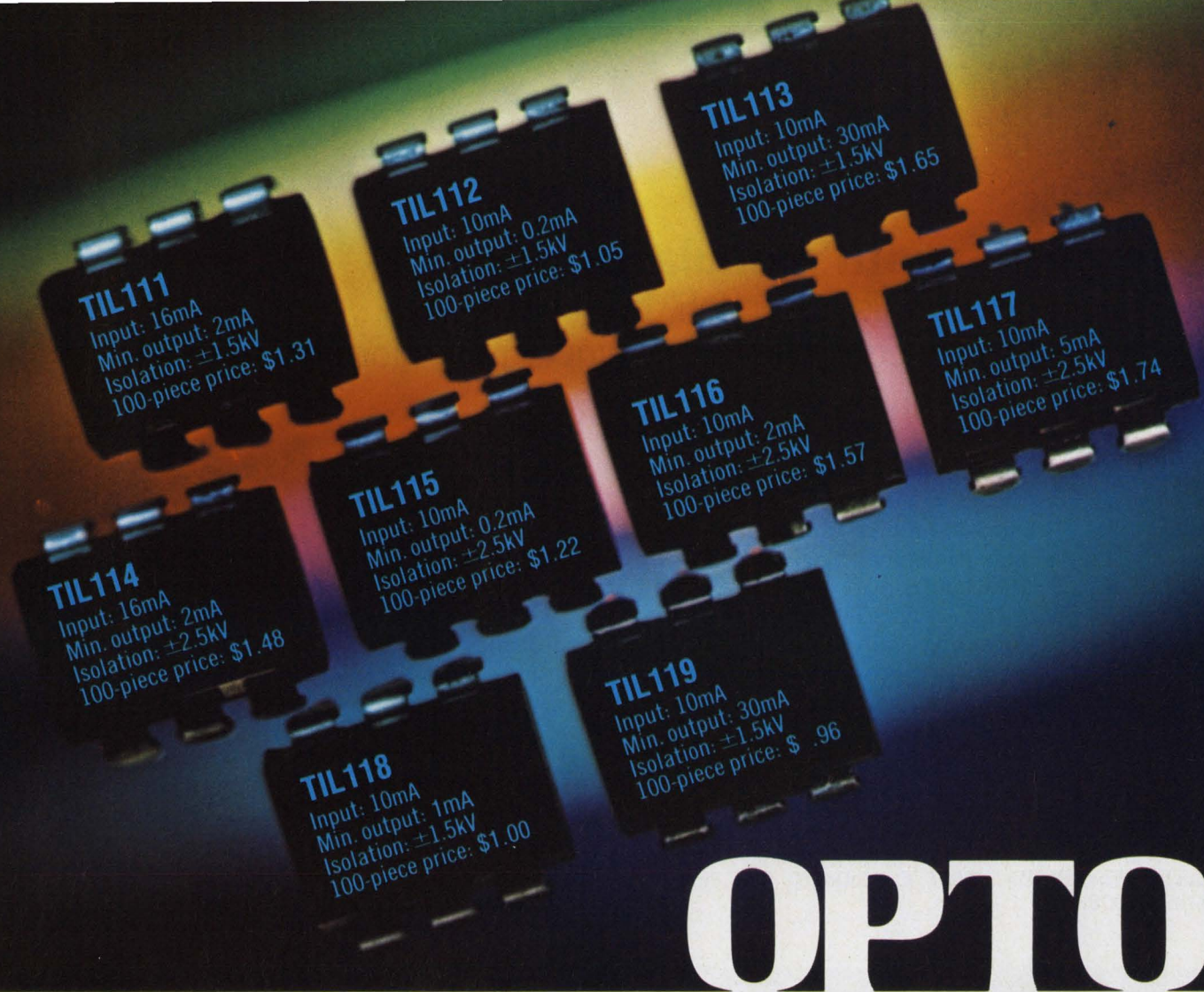

# OPTO

The right coupler  
at the right (very low) price.

You'll find it in TI's big new opto isolator line.

TI's newly expanded optically coupled isolator line now gives you two ways to lower system costs.

First, TI's broad selection (including six new units) allows you to more closely match device performance and circuit requirements. You won't have to pay for more coupler than you need.

Second, they're all available in economical six-pin plastic dual-in-line packages — at prices up to 50% lower than you'd expect to pay. For example, TI's TIL118 is \$ .83 in 1000-piece quantities.

**Also available: Metal can couplers.**  
If you need hermetically sealed units, TI also has these metal can JEDEC-registered optically coupled isolators:

Device type	Current transfer ratio		Electrical isolation rating
	Minimum	@ I <sub>F</sub>	
4N22	25%	10mA	± 1 kV
4N23	60%	10mA	± 1 kV
4N24	100%	10mA	± 1 kV

A call to your local TI distributor (he's already well stocked) can get you quick quotes on the devices you need. Or call your local TI sales office.

But broad choice at low cost isn't the whole story.

TI introduced the industry's first optically coupled isolator back in 1965 — and since then has amassed more design and volume production experience than any other supplier. The result: Excellent availability, unsurpassed quality, proven reliability.



TEXAS INSTRUMENTS  
INCORPORATED



# Use pulse width modulation to control dc motors. With this approach, both speed and direction can be controlled by a single potentiometer.

Here's a way to use multiple-device ICs—such as hex inverters and quad transistor pairs—to control both the speed and direction of a dc motor with a single potentiometer. The method uses pulse-width modulation instead of the more common, SCR-phase-angle approach, and eliminates the need for a reversing switch.

With just one pot, two ICs and a few discrete components, you can control small, instrument-type dc motors rated at up to 15 V at 100 mA. For larger motors, power capability is increased

by addition of power transistors, which operate at higher voltages and currents.

## Only two ICs are needed

The circuit consists of three basic blocks: a pulse-width modulated oscillator, a time-delay circuit and a bridge that acts as the motor driver (Fig. 1). A CMOS hex inverting buffer forms the oscillator and time-delay circuit, while the driver is composed of quad complementary transistor pairs. For larger motors, an npn transistor quad drives a complementary Darlington bridge circuit (Fig. 2).

The common-emitter bridge is driven in complementary fashion by two pulse-width-modu-

**Al Pshaenich**, Applications Engineer, Motorola Semiconductor Products Div., 5005 E. McDowell Rd., Phoenix, Ariz. 85008.

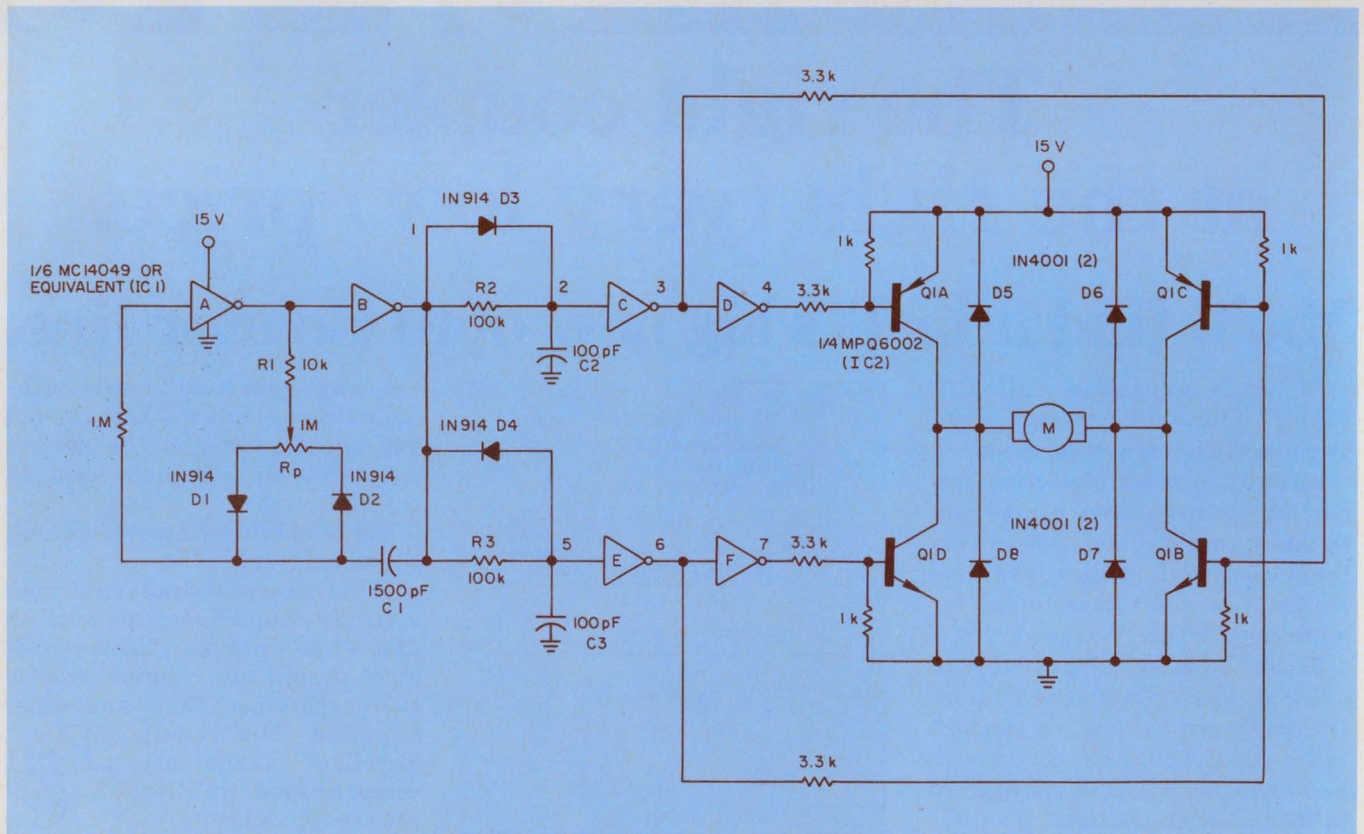

1. Both speed and direction of a small dc motor are controlled by a single pot in this pulse-width modula-

tion circuit. The oscillator and time-delay portion of the circuit use a CMOS hex inverting buffer.



lated signals derived from time-delay circuits. Thus opposite legs of the bridge are turned on alternately. The resultant algebraic current through the motor is a function of the pulse-width signal.

For example, if one pair of transistors, such as  $Q_1$  and  $Q_4$  in Fig. 1, are turned on by a waveform with a 75% duty cycle, then the complementary transistors,  $Q_2$  and  $Q_3$ , will be driven by one with a 25% duty cycle. The net, or integrated, motor

current is the difference between the two bridge currents, and determines both the speed and direction of the motor.

When the bridge is driven with a 50% duty cycle, the average current through the motor is zero and the motor is de-energized. At the maximum duty cycle of 95% (potentiometer  $R_P$  at one extreme), the motor rotates at maximum speed, either cw or ccw. As the potentiometer is turned toward the other extreme, the motor

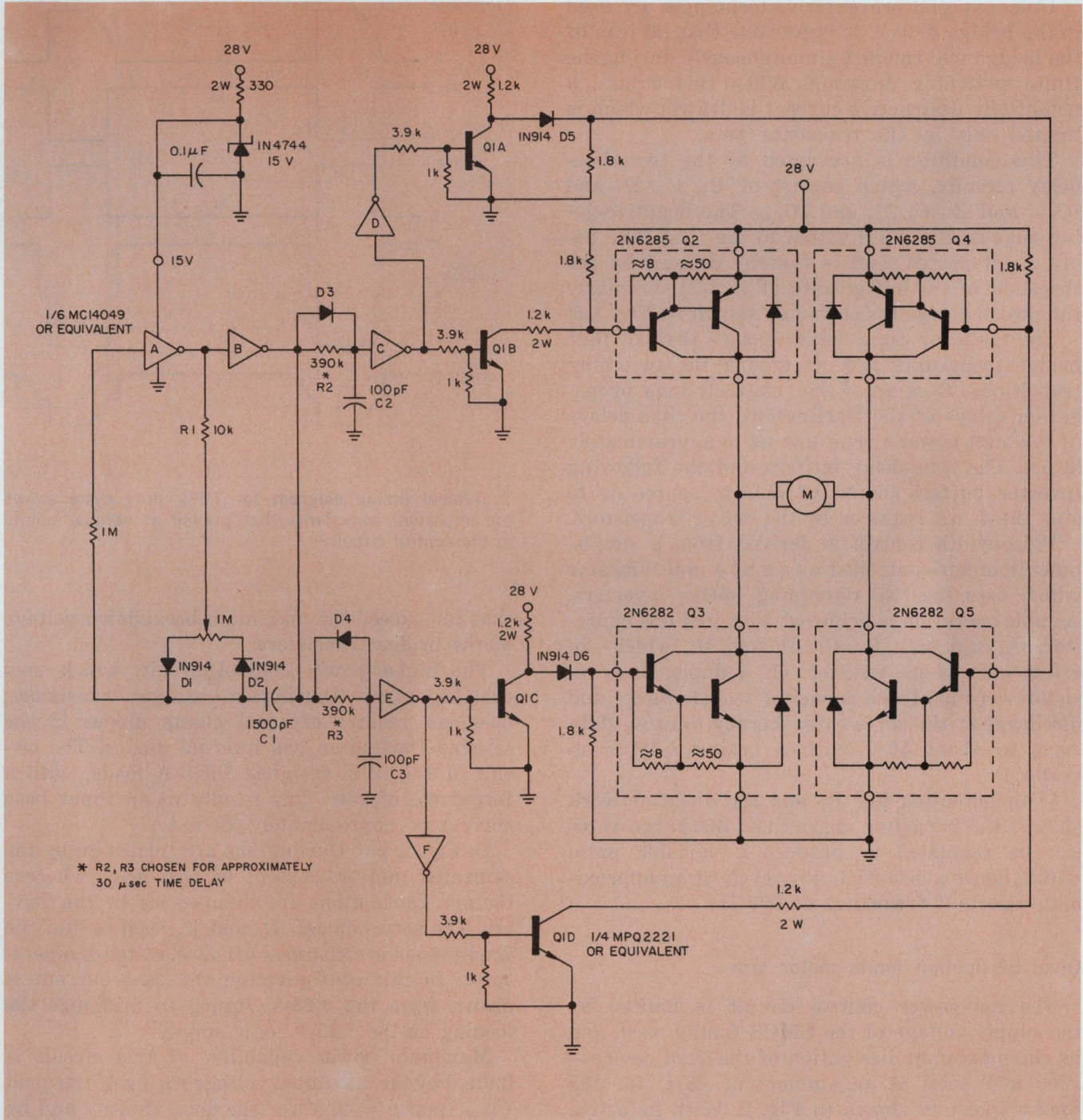

2. Larger motors, which draw up to 5 A, can be controlled by use of power-Darlingtons in the bridge driver

and by use of a heftier supply. The input base current, about 20 mA, is drawn from the 28-V supply.



slows down, stops at the 50% setting, and then increases speed to the maximum in the opposite direction. Thus motor speed and direction are controlled by a single potentiometer.

Note that because of the absence of motor counter emf, the circuit draws maximum current when the motor is de-energized. However, this zero-speed current can be readily eliminated by ganging a switch to turn off oscillator power when the pot is at its center position.

### Time delays prevent problems

Unless special preventative techniques are used in the bridge driver, it is possible that all legs of the bridge will conduct simultaneously during the finite switching duration. When this occurs, a potentially destructive current is drawn, which is limited only by the transistor beta.

This condition is prevented by the two time-delay circuits, which consist of  $R_2, C_2, D_3$  and  $IC_{1(C)}$  and  $R_3, C_3, D_4$  and  $IC_{1(E)}$ . The negative-going edge of the input signal to the first time delay is integrated, and is thereby delayed by the threshold of the buffer gate (Fig. 3-2). Similarly the positive edge is delayed as shown in Fig. 3-5.

The resulting time delays ensure that all four bridge transistors are off during the switching transitions. Because of the relatively long propagation delays of the Darlingtons, the time delays of the high-power circuit are set to approximately 30  $\mu$ s. The time-delay buffers and the following inverter buffers should be able to source or to sink the 4 mA required by the driver transistors.

Pulse-width control is derived from a simple, potentiometer-controlled a s t a b l e multivibrator which uses the two remaining buffer inverters. Astable operation is achieved with just one capacitor,  $C_1$ , and with  $R_1, R_P, D_1$  and  $D_2$ , which—in effect—act as one resistor. (If a single, fixed resistor were used, the capacitor would charge and discharge at the same rate, thereby limiting duty cycle to about 50% with a typical CMOS inverter.)

With potentiometer  $R_P$  and the diode network shown, the capacitor charge and discharge rates can be regulated to produce a variable pulse width, hence a 5-to-95% duty cycle at an approximate constant frequency of 600 Hz.

### Quad dissipation limits motor size

The low-power control circuit is limited by the supply voltage of the CMOS family used, and by the maximum dissipation of the quad device—1200 mW total at an ambient of 25 C for the four transistors shown in Fig. 2. With inductive loads, the bridge requires clamp diodes,  $D_5$  through  $D_8$  in Fig. 1, to prevent inductive spikes

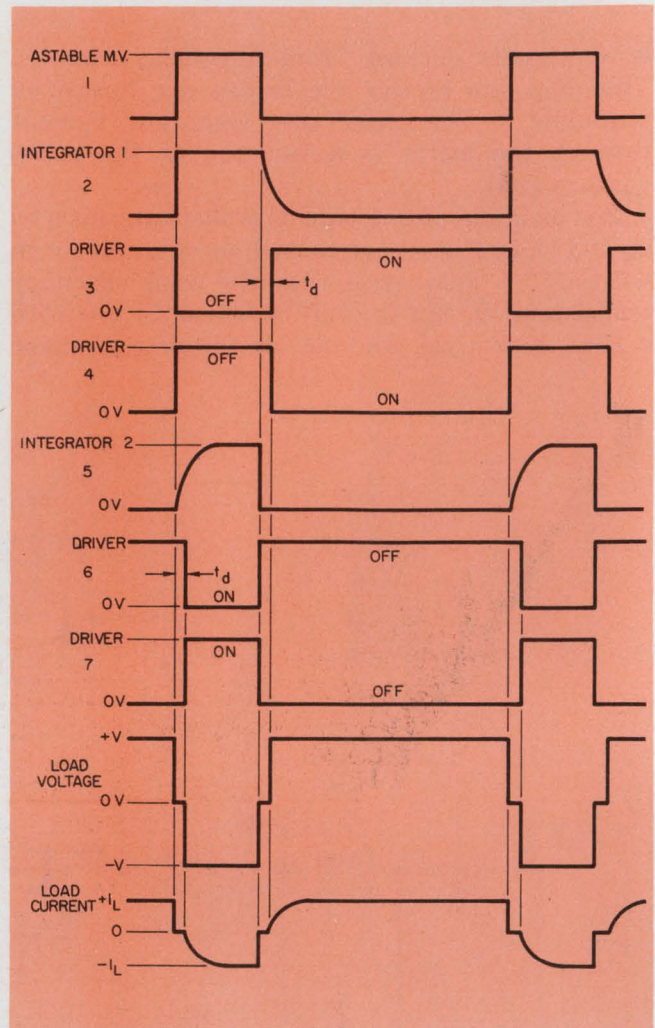

3. Typical timing diagram for 75% duty cycle shows the important waveforms that prevail at various points in the control circuit.

that can exceed the maximum breakdown voltage of the bridge transistors.

The higher-power control circuit, which uses complementary Darlington bridge transistors, does not require external clamp diodes if the selected Darlington has internal diodes. The circuit of Fig. 2 is designed for 5-A loads, with a forced  $h_{FE}$  of 250. This results in an input base current of approximately 20 mA.

In Fig. 2, pnp Darlingtons are turned on by the saturated npn transistors of the quad, whereas the npn Darlingtons are clamped off by the drivers. The series diodes,  $D_5$  and  $D_6$ , ensure that the Darlingtons are clamped off at elevated temperatures. In this configuration the base current is drawn from the +28-V supply to minimize the loading on the +15-V logic supply.

Maximum power capability of this circuit is limited by the maximum voltage rating of the quad ( $V_{CE0(max)} = 40$  V for the quad shown) and by the maximum collector current of the Darlington (in this example,  $I_C(max) = 20$  A). ■■



# 1974 solid state databooks

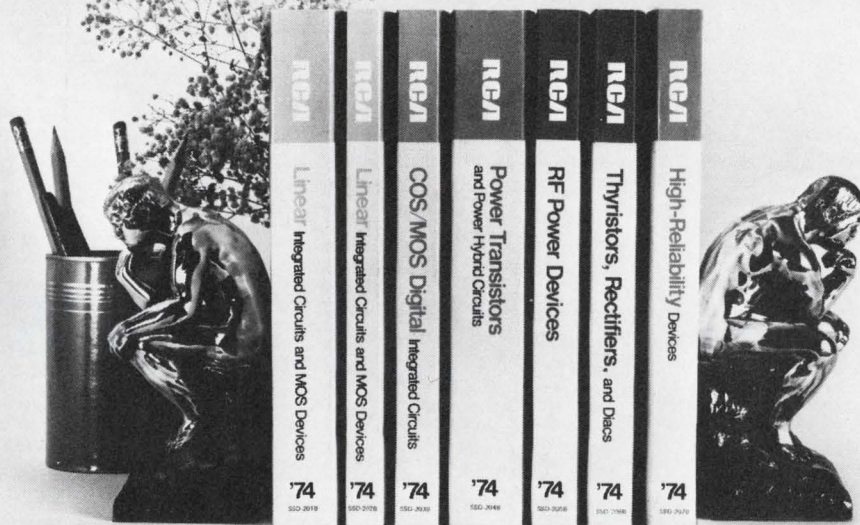

**Your guide to state-of-the-art in RCA Solid State devices.**

Get off to a fast start in 1974 with RCA's Solid State DATABOOK Series. You'll find the new seven volume series an invaluable desk reference... with all the technical data you need about RCA devices at your fingertips.

The new Solid State DATABOOK Series has been expanded, revised, and improved to bring you up-to-date information on all RCA commercial solid state devices through January 1, 1974.

You get the latest Technical Data Sheets and Application Notes on all devices, including digital COS/MOS and linear IC's, power transistors, hybrids, RF and microwave devices, thyristors, rectifiers — and, for the first time, a new volume on RCA "High-Reliability" devices to MIL-STD-883 and MIL-M-38510.

Designed to save you time in locating data, each volume provides a comprehensive subject index with reference to both volume number and page number, and a complete cross-

reference index of RCA development-to-commercial devices. The price of the seven volume set is \$14.00. This includes a subscription to "What's New in Solid State" to keep you aware of all new devices and literature available from RCA in 1974.

Send the coupon along with your check or money order (payable to RCA Corporation). If the coupon is missing, write: RCA Solid State, Section 57-B-1, Box 3200, Somerville, N.J. 08876.

RCA Solid State  
Section 57-B-1, Box 3200  
Somerville, New Jersey 08876

Please rush my order for the seven-volume  
1974 RCA Solid State DATABOOK Series.  
My cost, only \$14.00.

Provide prices for individual DATABOOKS.

Name/Title \_\_\_\_\_

Company \_\_\_\_\_

Address \_\_\_\_\_

City \_\_\_\_\_ State \_\_\_\_\_ Zip \_\_\_\_\_

I enclose payment by:  Check  Money Order

Offer good only in U.S. and Canada. Direct other inquiries to RCA sales offices or distributors.

**RCA Solid State**  
products that make products pay off



# WE WANT TO HAND YOU A LINE ABOUT VOLTAGE REGULATION THAT'S COMPLETE, OFF-THE-SHELF, AND RELIABLE.

Sola wrote the book on voltage regulation, a long time ago. And ever since, we've been adding a line here, a product there, an engineering refinement just about everywhere.

Now you can really capitalize on this total capability. No matter what your requirement—power supplies, constant voltage regulators, transformers,

Solatron®—Sola's complete range of voltage regulating equipment is standard. And available right now for off-the-shelf shipment. It means you save in basic product design, production, inventory and headaches.

Contact your local Sola Electric Representative. Let him hand you our line. Or contact Sola Electric directly

for immediate engineering application assistance. Call (312) 439-2800 or write

Sola Electric, 1717 Busse Road,  
Elk Grove Village, Illinois 60007.

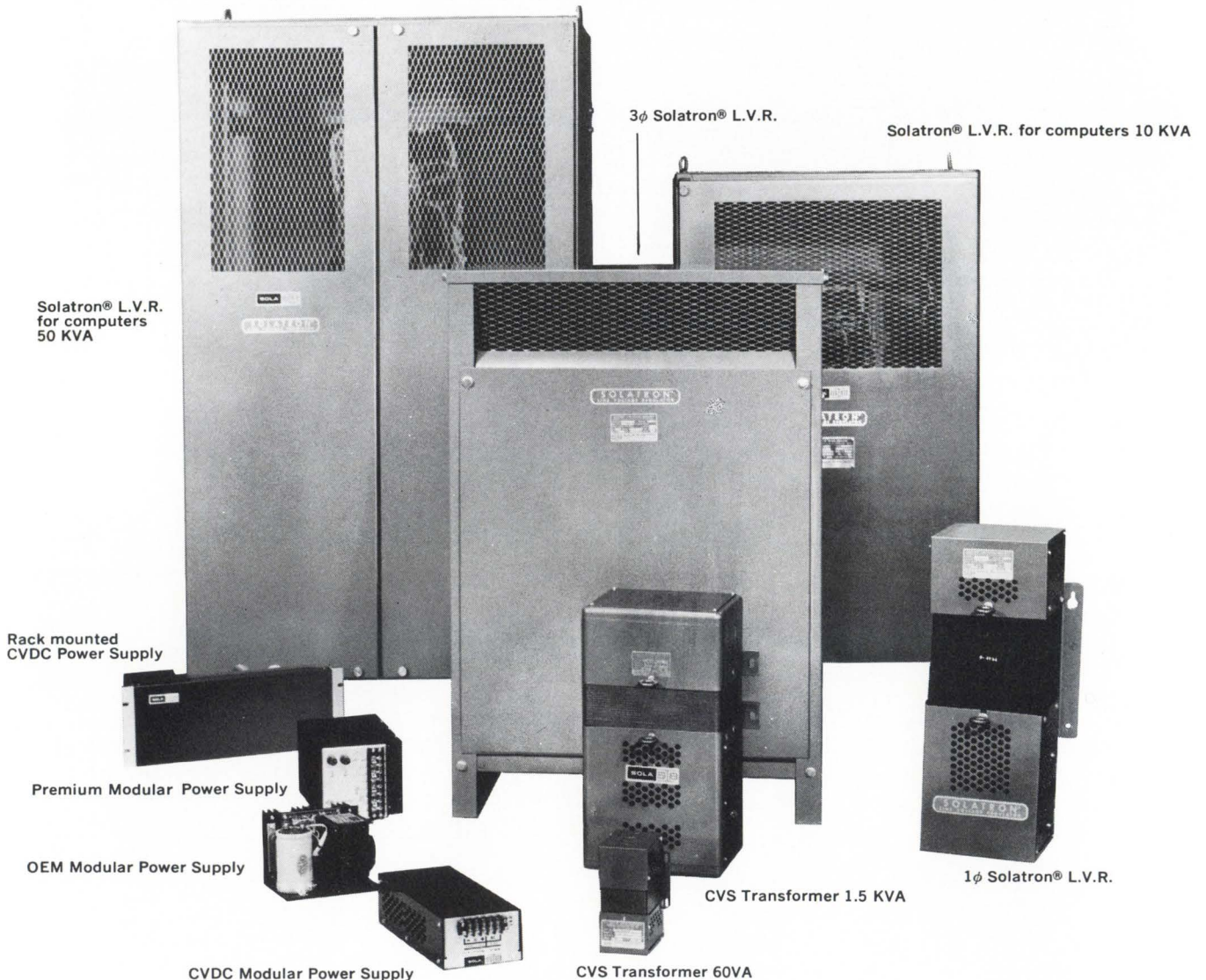

SOLA BASIC DIVISIONS ANCHOR ELECTRIC · BISHOP ELECTRIC · DIELECTRIC COMMUNICATIONS · DOWZER ELECTRIC · GUTH LIGHTING  
HEVI-DUTY ELECTRIC · LINDBERG · NELSON ELECTRIC · SIERRA ELECTRIC · SOLA ELECTRIC · TEMPRESS

INFORMATION RETRIEVAL NUMBER 85



# INTRODUCING THE LATEST ROCKWELL MOS/LSI ADVANCE... AND NEW VERSATILITY IN MACHINE DESIGN: NEW PPS.

## What it does

Our new Parallel Processing System (PPS) has the potential of cutting the cost of many machines—professional and programmable calculators, business machine terminals and system controllers. Even for small volume applications, PPS circuit costs will be in the range of volume-produced circuits. That's because the entire PPS system—except for one circuit—is pre-designed to work in *all* these machines. Only one circuit is unique to *your* machine—and, once you've mastered microprogramming, you can design it yourself, with no Rockwell design involvement. Even if you're already using MOS/LSI, you should evaluate our new PPS. The "Characteristics" chart at right shows you its design advantages. And here's another advantage: Rockwell has ready for you a complete package of design aids: a time-tested program for Microprogramming



through Tymshare . . . special equipment for micro-program assembly and ROM emulation . . . evaluation board for prototype testing . . . programmer's reference manual, and all required documentation.

## What it is

The PPS performs the arithmetic and logic functions of a four-bit parallel microprocessor. It's based on a powerful one-chip CPU controlled by ROM microprogramming and possessing its own discrete I/O capabilities. The other building blocks are pre-designed compatible ROM/RAM, ROM, RAM and I/O circuits plus a crystal-controlled clock generator circuit. The smallest PPS is a 2-chip set capable of executing 704 eight-bit program instructions and storing 76 four-bit words. It can be expanded into a 30-circuit system without need for additional buffering or drive circuitry. As a digital processor, the PPS can readily be interfaced with a variety of sensors—card readers,

keyboards, displays, etc.

## What you should do about it

Just drop us a line on your company letterhead and we'll send additional information so you can make your own micro-processor comparison. Marketing Services, Microelectronic Device Division, Rockwell International, P.O. Box 3669, Anaheim, Ca. 92803, U.S.A.

ROCKWELL PPS CHARACTERISTICS	
Instructions.....	50
Instructions Cycle Time— $\mu$ S.....	5
Addition of Two 8-Digits— $\mu$ S.....	240
Nesting of Subroutines—Levels.....	Unlimited
ROM Chip Size.....	1024 x 8 (16K Words Max.)
RAM Chip Size.....	256 x 4 (8192 Words Max.)
I/O Capability.....	24/CKT +12 CPU

**Write us today for an appointment for a PPS demonstration at IEEE in New York.**



Microelectronic Device Division  
Rockwell International

...where science gets down to business

INFORMATION RETRIEVAL NUMBER 86



Always select the best materials...assure your product's performance, reliability and profitability

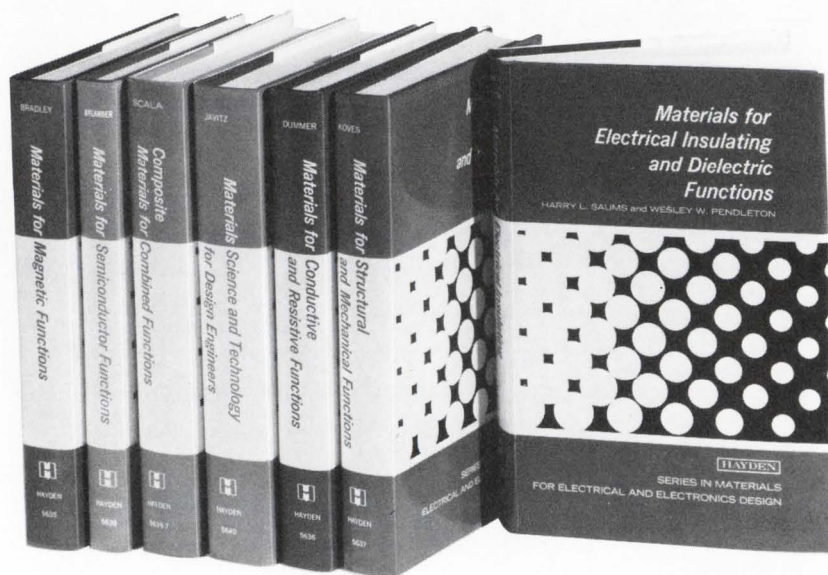

## Hayden Series in Materials for Electrical and Electronics Design

ALEX. E. JAVITZ, *Editor-in-Chief*

Practical design references specifically planned to help you and your colleagues meet the challenge of proper materials selection on all fronts. These volumes place at your disposal the concepts, data, and techniques you need to:

- understand how fundamental properties of materials affect their ultimate performance.
- exploit the potential of advanced materials.

- make optimum use of conventional materials.
- use the latest techniques in processing, fabrication, test and measurement.
- specify materials that resist environmental damage.
- guard against misuse of materials that may be hazardous or produce pollutants.

**All books are 6 x 9, illustrated,  
cloth editions and include:**

### **MATERIALS SCIENCE AND TECHNOLOGY FOR DESIGN ENGINEERS**

(An interdisciplinary volume surveying the entire spectrum of design considerations) 560 pp., #5640-0, \$23.95.

### **MATERIALS FOR ELECTRICAL INSULATING AND DIELECTRIC FUNCTIONS**

352 pp., #5634-6, \$21.95.

### **MATERIALS FOR SEMICONDUCTOR FUNCTIONS**

220 pp., #5638-9, \$13.50.

### **COMPOSITE MATERIALS FOR COMBINED FUNCTIONS**

392 pp., #5639-7, \$14.95.

### **MATERIALS FOR MAGNETIC FUNCTIONS**

360 pp., #5635-4, \$14.95.

### **MATERIALS FOR STRUCTURAL AND MECHANICAL FUNCTIONS**

360 pp., #5637-0, \$13.95.

### **MATERIALS FOR CONDUCTIVE AND RESISTIVE FUNCTIONS**

360 pp., #5636-2, \$13.95.

**Review any of these books  
on 15-day free examination!**

Please send the book(s) checked on 15-day free examination. At the end of that time, I will remit payment plus postage, or return the book(s) with no further obligation.

- |                                 |                                 |                                 |
|---------------------------------|---------------------------------|---------------------------------|
| <input type="checkbox"/> 5640-0 | <input type="checkbox"/> 5635-4 | <input type="checkbox"/> 5638-9 |
| <input type="checkbox"/> 5636-2 | <input type="checkbox"/> 5637-0 | <input type="checkbox"/> 5639-7 |
|                                 |                                 | <input type="checkbox"/> 5634-6 |

### **Save Money!**

Payment Enclosed. Publisher will pay all shipping and handling charges. Same 15-day return privilege and full return if not satisfied.

Name \_\_\_\_\_

Firm \_\_\_\_\_

Address \_\_\_\_\_

City/State \_\_\_\_\_ Zip \_\_\_\_\_

ISBN Prefix 0-8104

**HAYDEN BOOK COMPANY, INC.**  
50 Essex Street, Rochelle Park, N.J. 07662

73-72



# OUR CASSETTE RECORDER WAS JUST TOO GOOD TO KEEP TO OURSELVES.

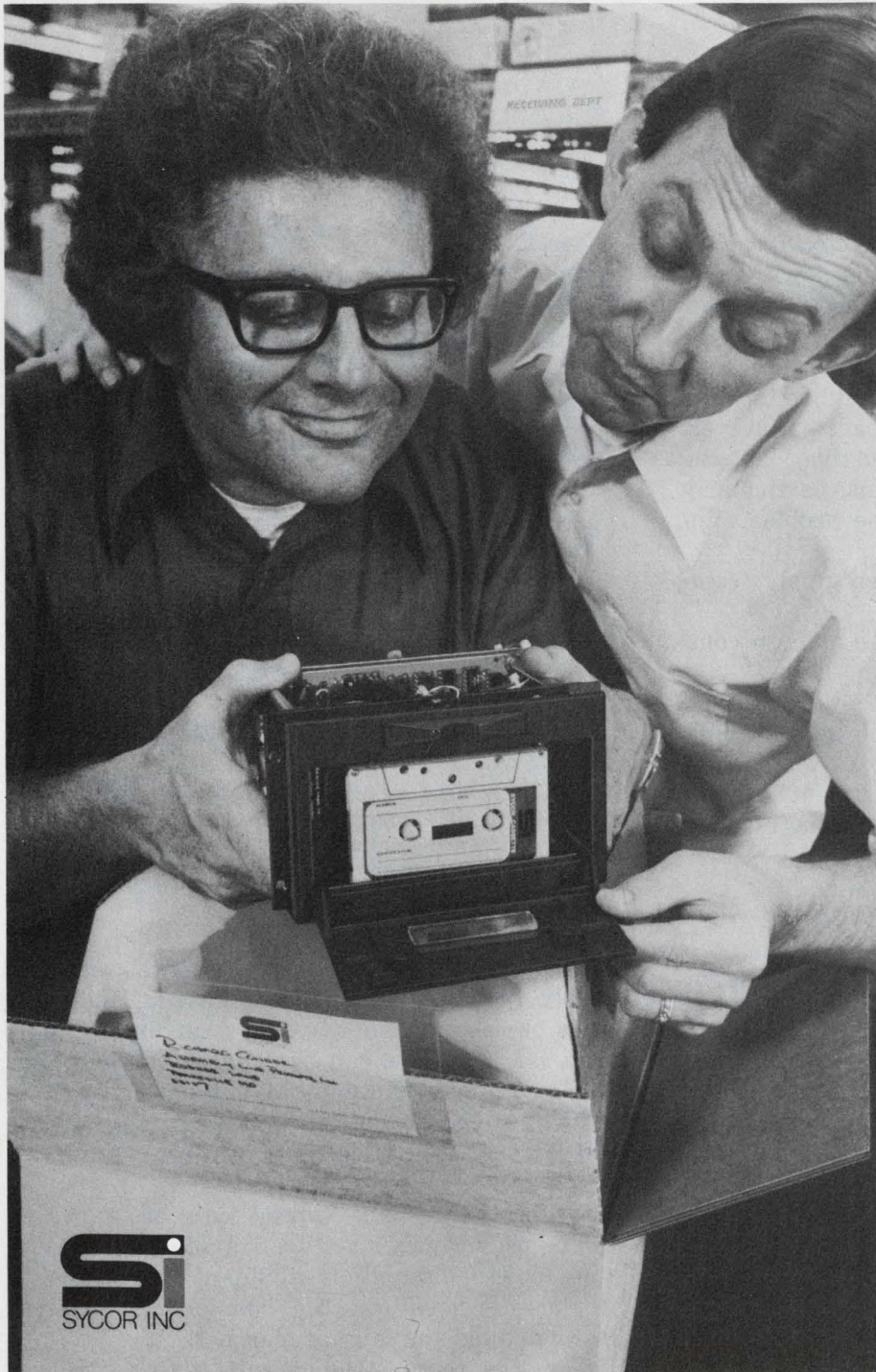

We designed the Sycor Model 135 cassette recorder to stand up to the toughest standards in the world.

Our own. For use in our own Sycor terminals.

But when we finished, we knew we had a cassette recorder capable of meeting a world of OEM and other users' needs.

The 135, for instance, has a unique capacity for record overwrite. You can edit a complete data block without disturbing the data on either side of the new record.

The 135 reads/writes at a fast 12.5 ips with quick starts and stops for high throughput. A dual-gap head gives it the capacity for Read-After-Write verification. And when you need quick access to specific data, it'll search through a cassette at a rapid 60 ips.

Every day, in 34 countries around the globe, over 20,000 Sycor cassette recorders prove their reliability. Look into our Sycor 135 yourself. You'll find why we found it too good to keep to ourselves.

## SYCOR

For complete product information—or for assistance with any design or application problem you may have—contact OEM Department, Sycor, Inc., Ann Arbor, Michigan 48104. Telephone (313) 971-0900.

*Internationally represented by Munzig International in London, Paris, Munich, and Geneva, and by STG International in Tel Aviv.*

INFORMATION RETRIEVAL NUMBER 28



# Switch high inductive loads fast with a push-pull current source that also cuts power consumption and boosts performance.

With a push-pull current-source driver to power an inductive load, you can improve switching times by over 30% and cut average power consumption by 50%—even for loads that draw pk-pk current of more than 7 A.

The driver uses essentially two circuits: One puts out high voltage to get the fast-flowing current into the inductive load; the other takes over during the steady state.

The design of push-pull current sources with outputs proportional to the input voltage is relatively simple for resistive loads. However, when it comes to driving an inductive load, the designer has a new set of problems, particularly when fast response is needed. The problems include these:

- Increased driver and power-supply complexity.
- Decrease in reliability because of high component stress.
- A need for some means for circuit cooling.
- Wasted power because of the use of high-voltage power supplies to get the fast response.

Carefully designed push-pull current sources can provide a solution to such inductive-load problems.

## Start with resistive-load driver

Fig. 1a shows a basic circuit for a current source, with the output current proportional to the input voltage. Voltage across the sensing resistor,  $R_s$ , depends on the magnitude of the input voltage,  $E_{in}$ , and the closed-loop gain of the circuit. When the load is placed in series with the  $R_s$ , the standard voltage amplifier turns into a current amplifier. The current in the load is directly proportional to the voltage developed across the  $R_s$ , and is given by

$$I_o = E_{in} (A/R_s), \quad (1)$$

where

- $E_{in}$  = input voltage,
- $A$  = closed-loop gain,
- $R_s$  = sensing-resistor value in ohms.

**John Logis and Ronald C. Scheerer**, Design Engineers, Westinghouse Electric Corp., Friendship Airport, Baltimore, Md. 21203.

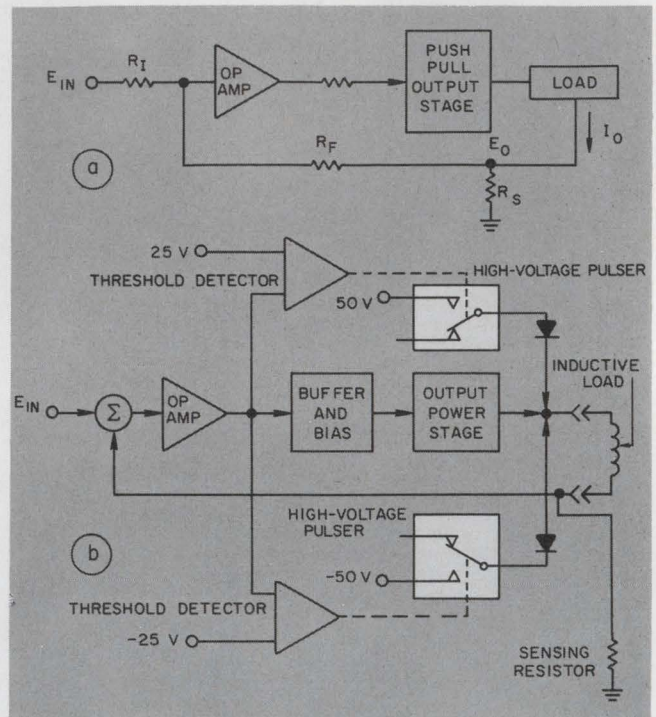

1. Relatively slow switching time and excessive power consumption of a standard feedback current amplifier (a) can be greatly improved by the addition of high-voltage pulsers that cause faster current build up in an inductive load (b).

The circuit of Fig. 1a works quite well with purely resistive loads. In the case of inductive loads, however, one question that immediately rises is: How fast can the current through the load be changed? In general, current through an inductive load is limited by the  $Ldi/dt$  of the coil, or, more specifically, by the voltage applied to the coil.

While the response speed can be increased by the use of higher-voltage supplies, the steady-state power dissipation would also increase, as would the stress on the components involved in switching the higher currents.

For this reason, the circuit in Fig. 1b was developed. Basically it has two signal-flow paths: one for steady-state operation, the other for fast switching. Note that the steady-state portion of the circuit is very similar to that of Fig. 1a. The load current is proportional to the voltage de-



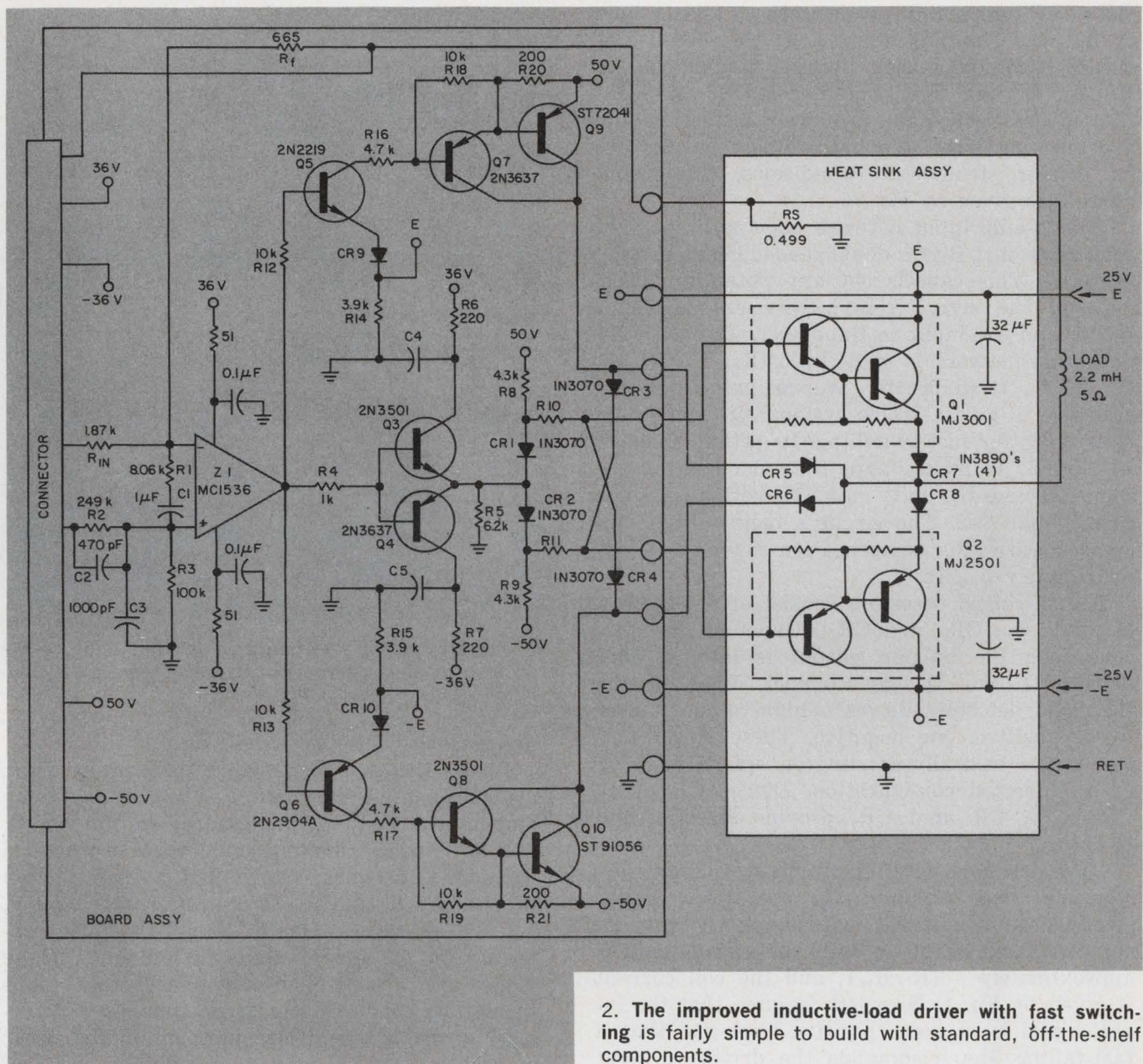

2. The improved inductive-load driver with fast switching is fairly simple to build with standard, off-the-shelf components.

veloped across the sensing resistor. The only added circuitry is the buffer-and-bias networks to accommodate the fast switching feature.

The second signal path bypasses the buffer and bias circuits and the output stage. To understand its operation, let's look at what happens when a step voltage is applied to the circuit input.

As the input changes at a fast rate from one level to another, the output cannot follow it because of the  $Ldi/dt$  of the coil, and the op amp goes into saturation. Normally the op amp would stay saturated until the coil current reached the desired value, and then the circuit would begin to operate in a closed-loop configuration. From Fig. 1b, however, it is obvious that when the feedback path is opened and the op amp saturates (either at positive or negative level), one of the threshold-detector circuits is triggered. This, in turn, switches in the high-voltage supply

and causes coil current to build up at a higher rate.

Once the current reaches some desired level, the closed-loop configuration takes over, threshold detectors switch off, and the high-voltage supply is disconnected from the coil. Thus the approach in Fig. 1b yields two benefits:

1. Switching-time reduction, due to the presence of higher-than-normal voltage.
2. Power-consumption reduction, because a lower steady-state voltage can now be used.

### Here is the actual circuit and its operation

Fig. 2 shows a practical circuit based on the approach, described in Fig. 1b. The basic feedback configuration is made up of resistors  $R_{in}$ ,  $R_f$ ,  $R_4$  and  $R_s$ , op amp  $Z_1$ , and transistors  $Q_1$  and  $Q_2$ . The buffer stage (an emitter follower) con-



sists of  $R_5$ ,  $R_6$  and  $R_7$ , capacitors  $C_4$  and  $C_5$ , and  $Q_3$  and  $Q_4$ . The bias network, needed because of the high-voltage pulser circuits, is made up of  $R_8$ ,  $R_9$ ,  $R_{10}$  and  $R_{11}$ , and diodes  $CR_1$  and  $CR_2$ . The diodes reduce the crossover distortion and are blocking when the high-voltage pulsers are on. Under steady-state conditions, the output current is given by Eq. 1.

The op-amp input network plays an important role. Note that it is a double-ended compensation network. This cancels out any potential difference in the signal return between the input origin and the input to the driver. The RC compensation network is made up of  $R_{in}$ ,  $R_1$ ,  $R_2$ ,  $R_3$ ,  $C_1$ ,  $C_2$ ,  $C_3$ . It shapes the over-all gain-frequency response to give a stable system with maximum bandwidth for fast switching. Its action is shown in Fig. 3. It makes sure that the over-all response crosses the unity gain axis with a  $-1$  slope rather than  $-2$ . The circuit's bandwidth is increased with this compensation network to approximately 5 kHz.

The threshold detectors consist of  $Q_5$ ,  $Q_6$ ,  $R_{12}$ ,  $R_{13}$ ,  $R_{14}$ ,  $R_{15}$ ,  $CR_9$ , and  $CR_{10}$ . Under steady-state conditions the op-amp output is low, so that neither  $Q_5$  nor  $Q_6$  can conduct. Each of the threshold detectors drives a high-voltage pulser—one positive, one negative. These pulser networks are basically Darlington stages working in an inverted configuration. Diodes  $CR_3$ ,  $CR_4$ ,  $CR_5$ ,  $CR_6$ ,  $CR_7$  and  $CR_8$  provide steering and blocking.

To understand how the circuit works, let's go, step by step, through its operation. Under steady-state conditions, with a slowly varying signal applied to the op amp, the voltage gain is approximately  $-(R_7/R_{in})$ , and the coil current is given by Eq. 1. Now let's assume that the input signal is at some positive level and that a fast-falling step commands the driver to reset the coil current to some new positive level. Because of the inherent coil lag, the output of the driver cannot slew as fast as the input. Thus the feedback loop is opened and the op amp saturates at a positive level. This causes  $Q_5$  to conduct, triggering the Darlington pair,  $Q_7$  and  $Q_9$ , thus apply approximately +50 V dc to the junction of steering diodes  $CR_3$  and  $CR_5$ . Diode  $CR_5$  permits the +50 V dc to appear across the coil, speeding up the coil current change.

While this process is taking place, certain protection measures are being enforced to guard other components from overstress. Thus  $CR_7$  is forward-biased during steady state and allows positive current to flow to the coil from  $Q_1$ . When the high voltage is applied directly to the coil by the pulser, this diode prevents the base-emitter junction of  $Q_1$  from reverse-biasing beyond its maximum rating. Note that  $Q_2$  does not conduct at this time, because its base and emitter

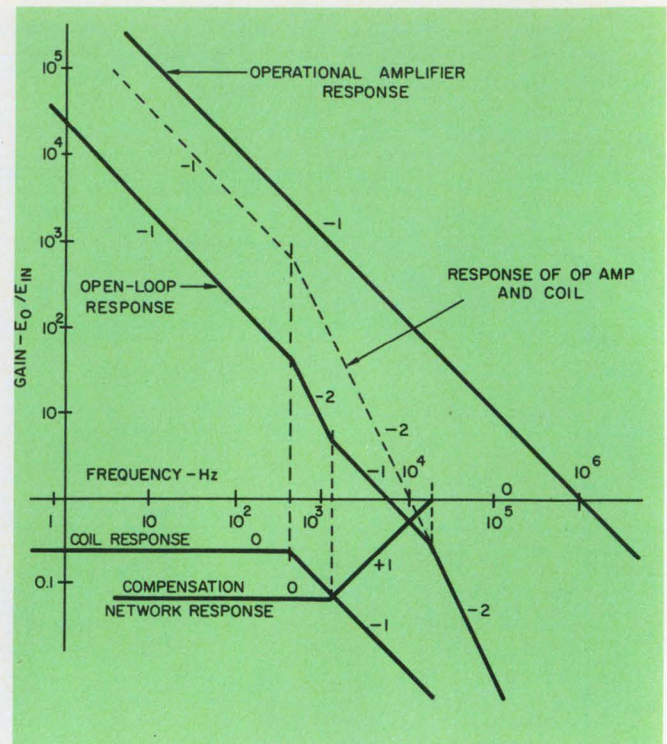

3. Amplifier stability is improved by the action of the op amp input compensation network (see Fig. 2) that introduces a positive unity slope.

are essentially at the same potential.

Diodes  $CR_1$  and  $CR_2$ , within the bias network, also perform an important function. With the op amp saturated, the voltage at the emitters of  $Q_3$  and  $Q_4$  is approximately equal to that provided by the bias network. The voltage at the junction of resistors  $R_9$  and  $R_{11}$  is approximately +50 V, and  $CR_2$  is reverse-biased. Thus this diode protects both  $Q_3$  and  $Q_4$  and the op amp. These diodes also ensure that only one of the output transistors conducts at a given time, by reverse-biasing the base-emitter junction of the other transistor.

After the current in the coil reaches the new desired level, the closed-loop operation takes over, the high-voltage pulser is de-energized, and the driver functions as a feedback amp.

A prototype model of the circuit of Fig. 2 was built and tested with an inductive load. The characteristic impedance of the coil was 2.2 mH and 5  $\Omega$ . The maximum differential switched current was 7.2 A. The circuit was compared with the standard feedback current amplifier, with the following results:

The switching time for the maximum differential current was reduced from 650  $\mu s$  to 450  $\mu s$ —a gain of more than 30%. The average power dissipation, based on the same switching time, was cut in half. The actual closed-loop bandwidth was 4.5 kHz. All theoretical assumptions used in the initial design were confirmed during test, and the circuit worked as anticipated. ■■



# broad band- rated™

Ferramic® components  
guarantee circuit  
performance

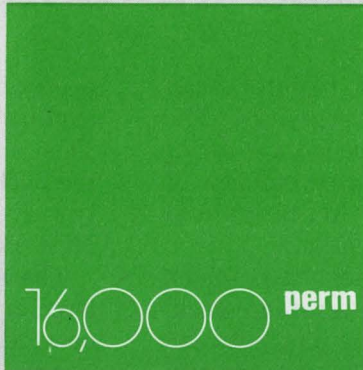
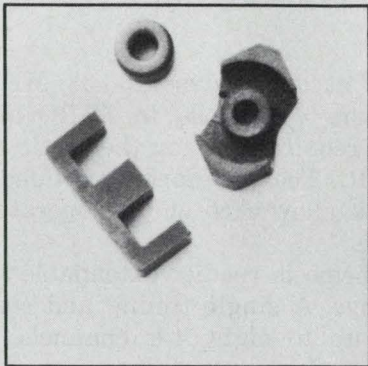

### New expanded line

Now you can get *Broad Band-Rated* components designed specifically for your critical bandwidth applications from 100 Hz to above 250 MHz. New shapes include mated parts in pot core, RM6 and E core configurations.

### Best specs available

Ferramic components give you the highest effective permeability available today with values above 5,000. Toroidal perm in small toroids over 16,000. All our specs are based on your circuit requirements—not just routine magnetic parameters.

We give you the data you need to make broad band circuit design easier and more precise. Our complete specs on each component include shunt resistance and reactance per turn squared, temperature coefficient, disaccommodation and hysteresis core constant.

### Application tested

We test these components under applied conditions to assure performance in your circuit. The complete line features closer magnetic tolerances and is guaranteed to meet specified electrical characteristics.

We end the guesswork by giving you components you can design with and depend on.

### Free design manual

Our new design manual 132 gives you all the facts, a few suggestions and complete design examples for both high and low frequency applications.

For your copy and details on how you can apply the latest ferrite technology to your broad band circuits, check the reader service card and get 32 pages of help. Or call (201) 826-5100 for right-now answers to your broad band ferrite requirements.

Either way, if you're talking ferrites, talk to the ferrite experts.

That's us.

Indiana General  
Electronic Products  
Keasbey, N.J. 08832

*National distribution  
through Permag in Atlanta,  
Boston, Chicago, Dallas,  
Detroit-Toledo, Los Angeles,  
New York and  
San Francisco.*

**indiana general** 

a division of Electronic Memories & Magnetics Corp.



## Multiplexed operation of MOS registers more than doubles the data rate

With multiplexing, static MOS registers can compete in speed with dynamic registers. The scheme gives more than double the data rate of a static register, yet retains the convenience of static registers—no low-frequency limitation and use of a single-phase TTL-level clock.

The control circuitry generates two clock waveforms,  $\phi_A$  and  $\phi_B$ , from the system clock. These alternate the incoming data bits between the two pairs of 2533 registers. The quarter section of the 8233 demultiplexes the output data of the 2533s. The resultant register has a 4096-bit capacity.

The system clock waveform shown permits

operation at data rates of 3.33 MHz. The one-shot returns  $\phi_A$  and  $\phi_B$  to ZERO after 100  $\mu\text{s}$ . This is a requirement for the static operation of the 2533 IC. The waveforms provided by the control circuit allow each chip to operate at a 1.666-MHz rate.

The scheme is readily extendable to shift register arrays. A single timing and control circuit operates up to eight 4-k channels. Two 8233s handle the eight output lines.

*Bruce Threewitt, Applications Engineer, Signetics, 811 E. Arques Ave., Sunnyvale, Calif. 94086.*

CHECK NO. 311

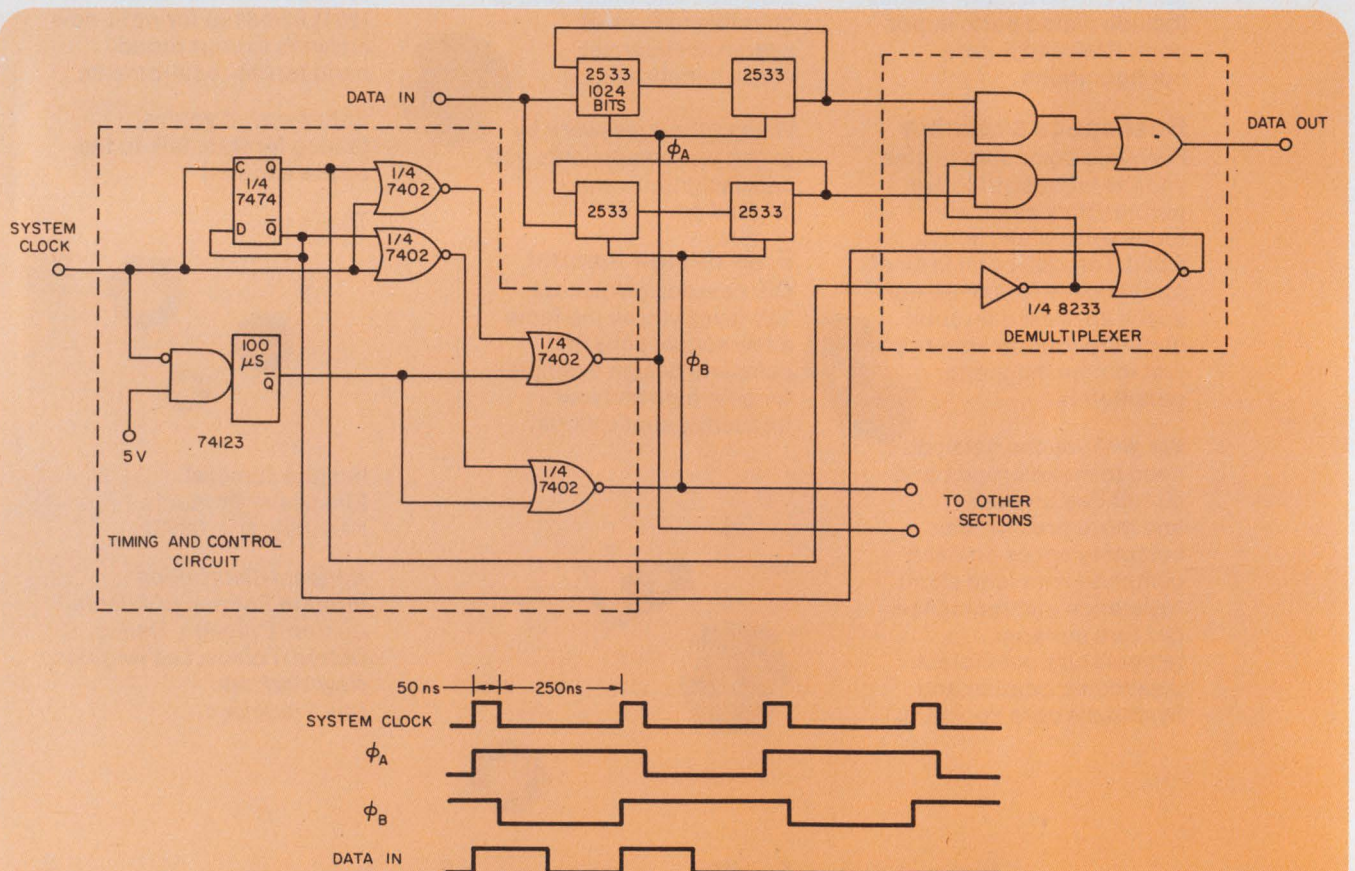

Multiplexed static MOS registers allow more than double the speed of a single register—in this case

3.33 MHz rather than  $2 \times 1.5$  MHz. The control circuit handles up to eight 4096-bit channels.



# OUR 5V POWER MINI'S STACK UP LIKE THIS



OUTPUT VOLTAGE	OUTPUT CURRENT AMPS.	REGULATION LOAD $\pm\%$	REGULATION LINE $\pm\%$	RIPPLE MV RMS	PRICE	MODEL	SIZE INCHES
5	.250	.05	.05	0.5	\$39.00	5E25	2.3 x 1.8 x 1.00
5	.500	.1	.05	1	49.00	5E50A	3.5 x 2.5 x 1.00
5	1.0	.2	.05	1	69.00	5E100	3.5 x 2.5 x 1.25
5	1.5	.3	.1	1	98.00	5E150	3.5 x 2.5 x 1.25
5	2.0	.15	.05	1	110.00	5E200	3.5 x 2.5 x 2.00
5	2.5	.15	.05	1	125.00	5E250	3.5 x 2.5 x 2.00

...and the model you choose will be shipped 3 days after Acopian receives your order. With a 105-125 VAC input, use it at full rated load to 71° C. Short circuits won't damage it. These mini-modules can be mounted on a printed circuit

board in a space of only a few cubic inches. Generous quantity discounts are available. Or, if you're working with other voltages, choose from hundreds of other models. Single outputs from from 1 to 75 volts.

Duals for op-amps with output currents from 25 to 500 ma. Even triple outputs. Complete details on these plus a comprehensive line of other power supplies and systems are included in the Acopian 73-74 catalog. Request a copy.



Corp., Easton, Pa. 18042. Telephone: (215) 258-5441.

INFORMATION RETRIEVAL NUMBER 30



# EXCLUSIVE-OR circuit handles wide range of input levels without power supply

Binary bits from a variety of sources can be compared with an EXCLUSIVE-OR circuit. The circuit shown (Fig. 1) requires no power supply and handles a wide range of input-signal level and load requirements.

The circuit obeys the standard EXCLUSIVE-OR truth table. When A is ZERO and B is a ONE, CR<sub>1</sub> and CR<sub>2</sub> are reverse-biased; therefore Q<sub>1</sub> will not conduct. The output is a ONE. Load current is conducted by R<sub>3</sub> and CR<sub>3</sub>. When A is ONE and B is a ZERO, CR<sub>3</sub> is reverse-biased, the current through R<sub>1</sub> is shunted to ground and Q<sub>1</sub> is off. The output is again ONE, with load current conducted by R<sub>2</sub> and CR<sub>2</sub>. If both A and B are ONE, CR<sub>1</sub> is reverse-biased and Q<sub>1</sub> conducts. And Y is a logic ZERO.

Choose R<sub>2</sub> and V<sub>OUT</sub> according to the application, subject to limitations imposed by the input voltage.

Compute

$$I_L = \frac{V_{OUT}}{R_L} \quad (1)$$

Then calculate R<sub>2</sub> and R<sub>3</sub> (assumed to be equal here). Now

$$R_2 = R_3 = \frac{V_{IN} - V_D - V_{OUT}}{I_L} \quad (2)$$

With both inputs a logic ONE, the parallel combination of R<sub>2</sub> and R<sub>3</sub> determines

$$I_{C(Q1)} = \frac{V_{IN} - V_D - V_{CE(SAT)}}{R_2 \parallel R_3} \quad (3)$$

Then set

$$R + R_1 = \frac{V_{IN}}{I_{C(Q1)}/h_{FE}} \quad (4)$$

Choose R<sub>1</sub> to be much greater than the forward resistance of CR<sub>1</sub>; then find R from Eq. 4. The circuit outputs with a variety of operating voltages, and the components are given in Fig. 2.

P. R. K. Chetty, Indian Space Research Organization, A 3-6, Peenya Industrial Estate, Bangalore, India 560022.

CHECK NO. 312

TRUTH TABLE		
A	B	Y
0	0	0
0	1	1
1	0	1
1	1	0

1. An EXCLUSIVE-OR circuit that needs no power supply. Transistor Q<sub>1</sub> is reverse-biased, except when A and B are both ONE, at which point the output is pulled to ground.

INPUT VOLTS		OUTPUT VOLTS
A	B	Y
0	0	0
5	0	3.2
0	5	3.6
5	5	0.7

INPUT VOLTS		OUTPUT VOLTS
A	B	Y
0	0	0
9	0	6.3
0	9	7.0
9	9	1.6

INPUT VOLTS		OUTPUT VOLTS
A	B	Y
0	0	0
18	0	14
0	18	15
18	18	2

INPUT VOLTS		OUTPUT VOLTS
A	B	Y
0	0	0
30	0	23
0	30	26
30	30	8

2. EXCLUSIVE-OR outputs for a variety of input signal levels and load resistances demonstrate the versatility of the circuit. The first circuit is designed to give a 3.5-V output.



# Select RCA film pick-up vidicons for your camera...

no matter who made it.

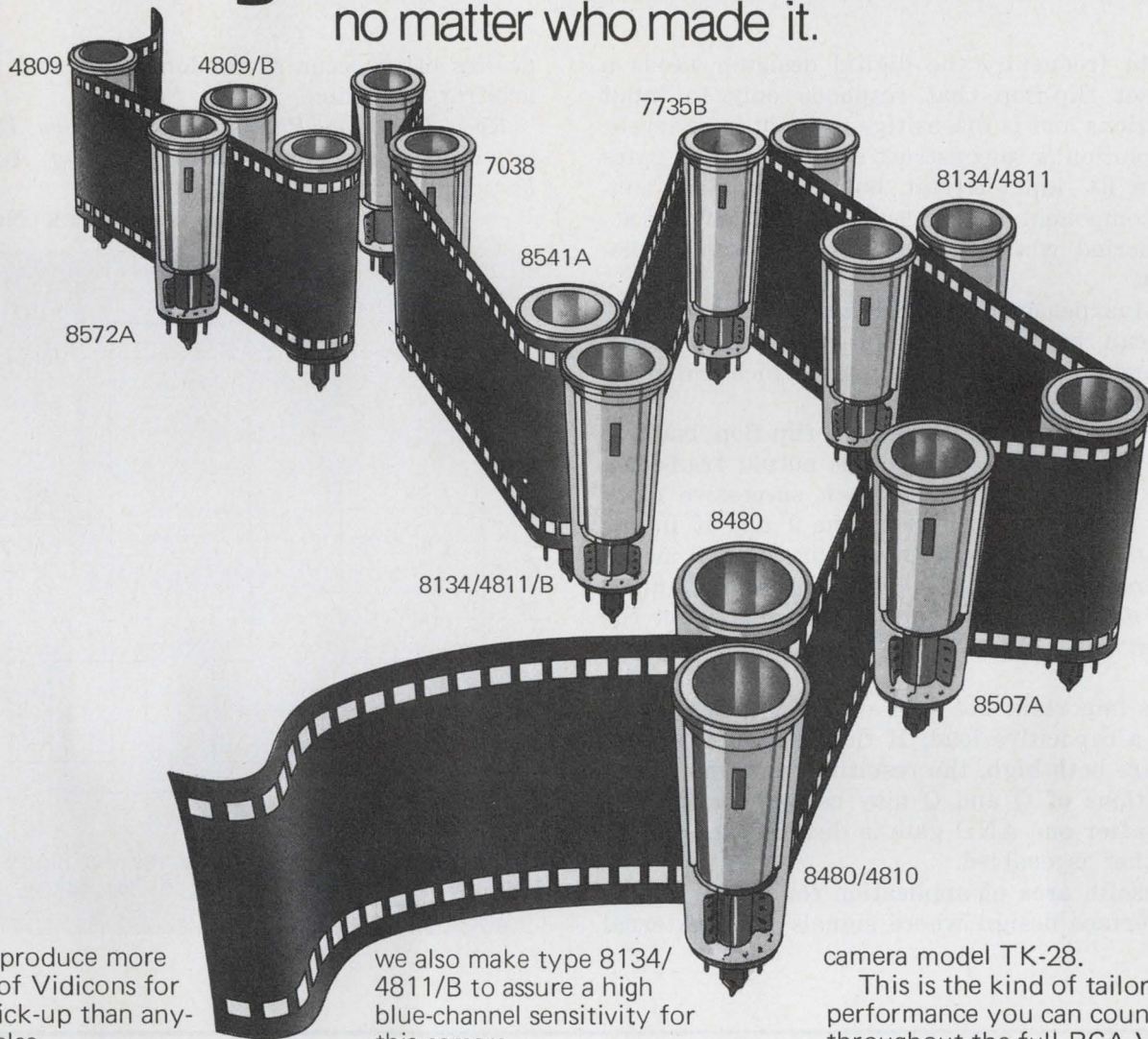

We produce more types of Vidicons for film pick-up than anybody else.

We make so many because we've learned that top film camera performance requires tailoring Vidicons to camera requirements. And our applications engineers have studied them all.

Take our 8480/4810 and 8134/4811 film pick-up Vidicons, for example. The specifications defining their performance characteristics are controlled to provide exceptional service in the RCA camera model TK-27. And

we also make type 8134/4811/B to assure a high blue-channel sensitivity for this camera.

Or consider our 4809 and 4809/B Vidicons. They're recommended because they are specifically designed, manufactured and tested to produce best performance under conditions imposed by today's 3-tube color film pick-up requirements. The 4809/B is specifically processed and tested to meet blue-channel sensitivity requirements. Both of these tubes have been successfully applied in the RCA

camera model TK-28.

This is the kind of tailor-made performance you can count on throughout the full RCA Vidicon line. Take advantage of it now. Just call your RCA Camera Tube Distributor or RCA Representative for complete information. Or write Commercial Engineering, RCA, Harrison, N.J. 07029 for your copy of the new RCA Camera Tube Product Guide (CAM-703B).

**RCA** Electro Optics

INTERNATIONAL SALES OFFICES: ARGENTINA—Casilla de Correo 4400, Buenos Aires/BRAZIL—Caixa Postal 8460, São Paulo/CANADA—21001 No. Service Rd., Ste. Anne de Bellevue, 810 Quebec/ENGLAND—Sunbury-on-Thames, Middlesex/HONG KONG—P.O. Box 112/MEXICO—Apartado 17-570, Mexico 17, D.F./SWITZERLAND—118 rue du Rhone CH1204, Geneva

INFORMATION RETRIEVAL NUMBER 31



# Edge-triggered R-S flip-flop built without capacitors

Quite frequently the digital designer needs a set-reset flip-flop that responds only to input transitions and is insensitive to input logic levels. One solution is to construct a flip-flop with gates and an RC input circuit, but this requires non-DIP components and results in a brief refractory period while the capacitors charge or discharge.

An inexpensive circuit that avoids these problems can be built with an AND-OR-INVERT gate and a J-K flip-flop—both of which are available in dual IC versions.

Feeding the outputs of the flip-flop back to the inputs allows only a single output transition direction upon receipt of each successive clock pulse. Compared with tying the J and K inputs for complementary operation, this method makes the circuit operation independent of the initial state of the flip-flop. The outputs also select the earliest valid input signal for clocking the flip-flop.

It is important not to slow the output with too great a capacitive load. If the Set and Reset inputs are both high, the resulting nonsymmetrical transitions of Q and  $\bar{Q}$  may cause a brief clock pulse after one AND gate is disabled and before the other is enabled.

A useful area of application for this circuit is in interface design where signals from external

devices often occur at random times and are of arbitrary duration.

*Rudy Engholm, Phonetics Laboratory, University of Michigan, 1079 Frieze Building, Ann Arbor, Mich. 48104.*

CHECK NO. 313

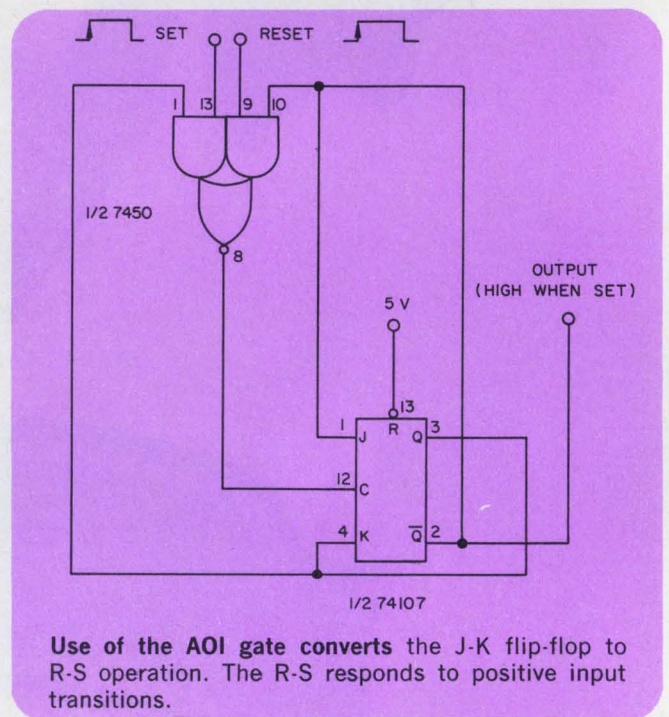

**IFD Winner of September 27, 1973**

**R. Dale Hefner**, Electronics Director, The University of Tucson, College of Liberal Arts, Dept. of Chemistry, Tucson, Ariz. 85721. His idea "Variable-speed, synchronous-motor control operates from 12-V battery or 120-V-ac line" has been voted the Most Valuable of Issue Award.

**Vote for the Best Idea in this issue** by circling the number for your selection on the Information Retrieval Card at the back of this issue.

**SEND US YOUR IDEAS FOR DESIGN.** You may win a grand total of \$1050 (cash)! Here's how. Submit your IFD describing a new or important circuit or design technique, the clever use of a new component or test equipment, packaging tips, cost-saving ideas to our Ideas for Design editor. Ideas can only be considered for publication if they are submitted exclusively to ELECTRONIC DESIGN. You will receive \$20 for each published idea, \$30 more if it is voted best of issue by our readers. The best-of-issue winners become eligible for the Idea of the Year award of \$1000.

ELECTRONIC DESIGN cannot assume responsibility for circuits shown nor represent freedom from patent infringement.



# When you need a custom high voltage power supply, ELDEC designs, packages, and builds them so you can rely on them.



Power supplies for CRT displays. Small size. Light weight. Look to ELDEC. We have years of experience combined with field proven reliability. ELDEC specializes in high voltage, custom mil-spec requirements. Air, ground, or shipboard.

Now by-pass that make or buy decision. When reliability is on the line, rely on proven experience. And ELDEC delivers. No gap between promises and prototype. High quality levels of manufacturing? You can bet on it!

We understand the custom business. Plenty of back-up documentation and service support. A successful track record you can check on. Ask for our brochure. Write me, Kevin Hall, Marketing Manager, ELDEC Corporation, 16700 - 13th Ave. W., Lynnwood, Washington 98036. Phone (206) 743-1313.



*Formerly Electro Development Corporation*

INFORMATION RETRIEVAL NUMBER 32



## Display linked to computer lets operator intervene

By combining a graphical display terminal with a computer-controlled process, Siemens of West Germany has made it possible for an operator to have both a visual presentation of complex information and the capability to intervene in the process by way of a keyboard.

The terminal, called 3976, allows displays of up to 2048 characters or symbols. A total of 64 characters and 122 symbols can be used to compile different texts or figures in seven colors. The transmission rate is 9600 bits/sec.

The screen is divided into 32 lines, each with 64 positions—a total of 2048 positions—and an al-

phanumeric character or a symbol can be inserted at each position. Graphical representations are obtained when the symbols are joined in rows. Characters have a resolution of  $5 \times 7$  dots, and symbols one of  $7 \times 9$  dots.

The display terminal allows intervention in a complex process. Characters and symbols are fed in via keyboard and a stick that controls a light spot on the screen. Points are located with the control stick, and the selected position automatically fed to the computer. Additional information can also be inserted with special keys.

Any number of terminals can be connected in parallel.

CIRCLE NO. 319

## Silicon IMPATT diodes show reduced noise

Improved, large-signal noise performance from silicon IMPATT diodes that use a new junction structure has been obtained by researchers at Thomson-CSF in Orsay, France. The diodes differ from the abrupt-junction kind in that a high-resistive, p-type layer forms a large part of the avalanche region. Modification of the avalanche region reduces noise that arises mainly from the avalanche-multiplication process.

The significant mechanisms in the effect are: a widening of the avalanche region, lowering of the electric field at breakdown, flattening of the electric field profile and more pronounced space-charge effects. Typical FM noise is 9 Hz/kHz<sup>1/2</sup>, with a Q factor of 500.

CIRCLE NO. 317

## Low-cost glasses made for optic communication

High-purity, low-cost glasses for fiber-optical communication systems have been produced by researchers at Sheffield University, England. In conjunction with the Standard Telecommunication Laboratories and the British Post Office, the researchers prepared soda-lime/silicate glasses by coupling rf power to glass that is held in a cold silica crucible.

This technique reduces contamination caused by the crucible and furnace refractories. The method has resulted in fiber-optics glasses that show losses approaching target specification for communication systems of 20 dB/km. The high-purity conventional glass can be fabricated as single or multimode optical waveguides.

CIRCLE NO. 318

## Y circuit uses logs to derive products

A technique of adding logarithms in an npn bipolar circuit to derive the algebraic product of two variables has been developed by Plessey of Towcester, England. The Y circuit—ideal for integrated-circuit implementation—uses a simple method of distortion cancellation that is independent of the device's current gain and base spreading resistance. Accuracy is within 0.1% with current gains of about 150.

## Memory cell built with CDI process

A memory cell that uses the collector-diffusion-isolation (CDI) process has been developed at Manchester University in England. The design draws an average power of 1 mW/bit in the unselected quiescent state. Power dissipation of the selected cell is about 15 mW/bit, and the sense current is more than 1 mA.

Because of the high ratio of selected to unselected power, many cells with a short cycle time can be provided on a single chip. A memory of 256 bits with a total power dissipation of 500 mW has been constructed.

## Higher frequency devices built with ion implants

The implanting of ions on the quartz substrate of a surface-wave device increases the velocity of the surface waves. Higher frequency devices can then be built. Produced by researchers at Thomson-CSF in Orsay, France, the 100-keV ions modify the quartz surface from crystalline to amorphous.

Various ions have been used, with an ion-bombardment flux of about  $10^{16}$  ions/cm<sup>2</sup>. The greatest velocity increase—about 1.1% at 180 MHz—was obtained with positive lithium and helium ions. The insertion losses of surface-acoustic-wave delay lines are not significantly changed by ion implantation.



# Frame them any old way

## Or any new way.

Then sit back and watch your Ise display electronics get your ideas across. Beautifully.

In an eye-easy fluorescent green glow.

At the same time, they're low on voltage and current drain.

High on stability.

Pick the readouts that offer more of everything, including variety, for a whole host of digital display ideas.

They're a difference you can see.

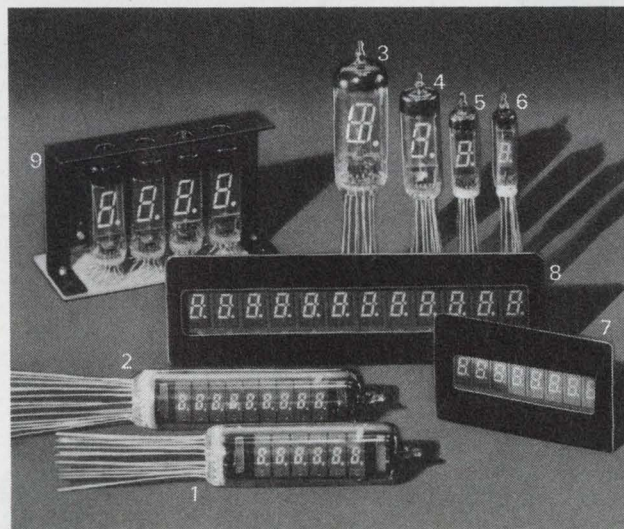
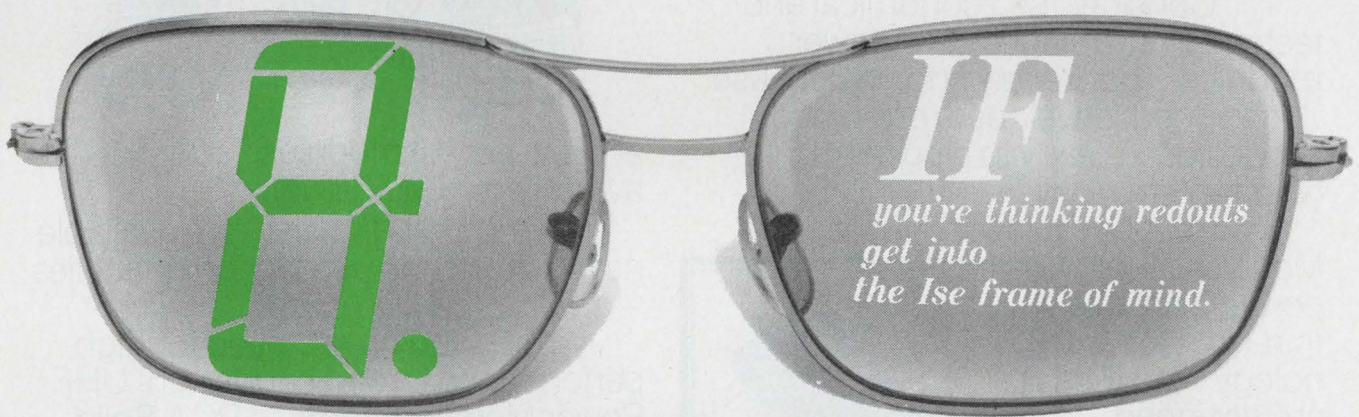

1. DP60A
2. DP90A
3. DG19E
4. DG12H
5. DG10F1
6. DG 8F
7. DP 89A
8. DP127F
9. DMCL12H (NEW)

Display module w/counter & latch  
 • Fluorescent green glow.  
 • 12-pin connector.  
 • Three performance perfect models.  
 • Custom ROM programming with other than BCD and seven-segment output.

International Div.

**ISE INTERNATIONAL CORP.**

No.2-7-7, Higashi-Shinbashi, Minato-ku, Tokyo, Japan  
 Tel: 433-6616~9 Telex: J26546  
 Cables: "ISEWORLDREP" TOKYO



The Brighter Side of Electronics

**ISE ELECTRONICS CORP.**

P.O. Box 46 Ise-city, Mie Pref., Japan

Representative: Los Angeles, Paris, Munich, Amsterdam, Stockholm, Vienna, Milan, Bombay, Hong Kong, Taipei.

INFORMATION RETRIEVAL NUMBER 33



# Available! RCA UHF Power Amplifier Modules... in production quantities.

RCA Solid State invites you to meet its broad family of UHF Power Amplifier Modules. This complete line covers the 395 MHz to 512 MHz band with three different power levels of 10, 13, and 15 watts.

Consider the economical and technical advantages of IC power modules. They're ready for instant use... designed, developed, pre-tuned and tested... ready to plug them into your system.

RCA UHF Power Amplifier Modules incorporate a reliable thin-film technology. And they are designed to meet stringent reliability specs. All modules feature 50-ohm input and output impedance, infinite load-VSWR

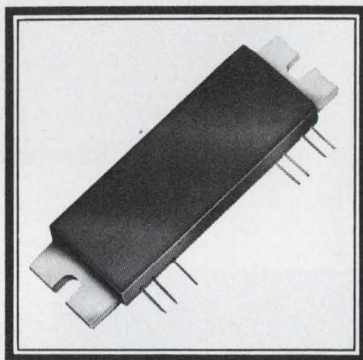

and compact size for high density packaging. Take a look

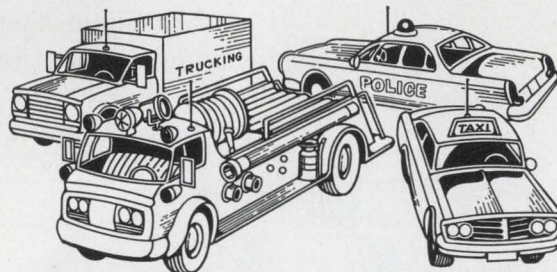

at the variety of modules available to you.

And best of all they are available now... in volume production quantities — at very attractive prices.

So if you have a need for high performance, broad bandwidth UHF Power Modules, come to RCA Solid State—the home of the RF Performance Expanders.

Want more information? Write:  
RCA Solid State, Section 57A-4  
Box 3200, Somerville, N.J. 08876.  
Or phone: (201) 722-3200.

CHARACTERISTICS	R44M10	R44M13	R44M15	R47M10	R47M13	R47M15	R51M10	R51M12
Frequency Range (MHz)	395-440	395-440	395-440	440-470	440-470	440-470	470-512	470-512
Power Output, Min. (W)	10	13	15	10	13	15	10	12
Supply Voltage, Nom.	12.5	12.5	12.5	12.5	12.5	12.5	12.5	12.5
Power Gain, Min. (dB)	20	20	20	20	20	20	20	20
Overall Efficiency, Min. (%)	35	35	35	35	35	35	35	35

RCA Solid State family of UHF Power Modules

**RCA Solid State**  
products that make products pay off



## new products

### Data loggers catalog events by group size



Edmac Associates Inc., 333 W. Commercial St., East Rochester, N.Y. 14445. (716) 385-1440.

A line of event recorders and companion playback-printout unit can present time-event data in histogram form. The recorders—model 2042, a single channel unit or model 2043, a two-channel unit—record yes-no events at rates up to two a second on ordinary C-60 cassettes. The information is accumulated by group size in the memory of the playback unit, model 2150. The 2150 furnishes total event count per channel and total number of events in each group size. The counts are printed out on an adding machine tape. Thirty-one group classes are provided. An adjustable delay determines the grouping of multiple events.

CIRCLE NO. 250

### Versatile CRT terminal also handles peripherals

Computer Communications, 5933 W. Slauson Ave., Culver City, Calif. 90230. (213) 391-0328. Under \$3000.

The CC-40 CRT terminal consists of a TV monitor, keyboard and a controller. The terminal has a storage capacity of 1920 characters and can display the dot-matrix characters in a single 24 × 80 page or two 12 × 80 pages. Transmission rates up to 50,000 bit/s can be used. Multiple terminals can be attached to a single line and polled. Available options include printers, tape cassettes and a light pen.

CIRCLE NO. 251

### Flexible disc file accepts 3740 media

Memorex Corp., San Tomas at Central Expressway, Santa Clara, Calif. 95052. (408) 987-2200. From \$595.

Designed for manufacturers of IBM-compatible equipment, the 652 is a flexible-disc drive that reads and writes data on 3740 media. The unit can write and read at a transfer rate of 250-k bit/s. Data can be formatted in sector or index mode at the users option. The maximum capacity of the 652 is 77 tracks at 41-k bits each or a total of 3.1-M bits. Access time to data includes 10 ms settling time, 10 ms positioning time and 83 ms average latency. The model 651—without 3740 compatibility—affords higher data rates and storage capacity.

CIRCLE NO. 252

### Controller adds eight data channels to mini

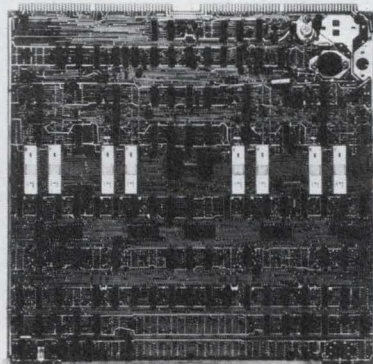

Digital Computer Controls, Inc., 12 Industrial Rd., Fairfield, N.J. 07006. (201) 227-4861. \$2000; 45 days.

A communications controller designated the 116431 handles eight asynchronous channels. The units, mounted on a 15 by 15-in. board, plug into a slot of the company's D-116 minicomputer. Each channel has its own independent send/receive speed with rates from 110 to 19,200 baud. The user can also specify parity, number of data bits (5, 6, 7 or 8), number of stop bits and auto answer (if desired). EIA RS-232 or 20 mA current loop operation is available on any channel.

CIRCLE NO. 253

### Small POS terminal has 10-digit display



Mega Products Corp., P.O. Box 534, 622 Lancaster Ave., Berwyn, Pa. 19312. (215) 647-6422. Under \$300; 60-90 days.

A visual display and inquiry terminal that costs less than \$300 in quantity, the model 10-9, has a 10-digit display area, nine backlit panels, a 16-character keyboard and a "transmit" indicator light. The 10-digit display shifts from right to left as each character is entered. The panels have pre-printed legends that illuminate when the computer responds. Up to four panels can be lit at one time. The terminal provides buffering for up to 48 received or transmitted characters. Data communication is bit-serial at speeds of 150, 300, 600 and 1200 baud. Additional flexibility is provided by the terminal's micro-computer architecture. Options include check-digit verification, addition of arithmetic functions and provision for external input from point-of-sale reading devices.

CIRCLE NO. 254

### Floating-point firmware for microprocessors

Recognition Systems, 15531 Cabrito Rd., Van Nuys, Calif. 91406. (213) 785-2179. \$495; 2 wks.

A four-PROM floating point package for Intel's 8008 and 8008-1 Microprocessors provides the basic four arithmetic operations as well as square root and floating point-to-positional BCD output for display purposes. Floating point numbers are represented by three 8008 words; a two word mantissa (16 bit accuracy) and a third word which carries the mantissa sign and the characteristic. Included in the above are a number of double-word subroutines such as left-shift, right-shift, add, subtract, compare, transfer, and a fixed-to-floating point converter.

CIRCLE NO. 255



## LED's

High-efficiency, solution-grown epitaxial gallium arsenide



### SE-2460

Standard pill package  
Replaces TIL-23, TIL-24; OP  
100, 122, 123



### SE-1450

For high-density applications  
Replaces SSL-15, SSL-315



### SE-5455

Recessed chip mount for improved performance.  
Replaces TIL-31, SSL-55 Series

## Phototransistors



### SD-1441

For high-density applications  
Replaces TIL-613-616



### SD-1440

Ideal for single-sided PC boards. Replaces L15E



### SD-2440

Standard pill package  
Replaces TIL, MRD & OP 601-604; LS 600



### SD-5443

Replaces TIL-81, CLT 2130 thru 2160; L14F Type; MRD 300 and 3000 Series

**IMMEDIATE  
DELIVERY  
FROM  
COMPLETE  
STOCK**

WRITE FOR  
CATALOG ON  
COMPLETE LINE



**Spectronics**  
INCORPORATED

830 E. Arapaho • (214) 234-4271  
Richardson, Texas 75080

## DATA PROCESSING

### PDP-11 family gains two midrange minis

Digital Equipment Corp., 146 Main St., Maynard, Mass. 01754. (617) 897-5111. See text.

Two new computers, an expanded PDP-11/05 and the PDP-11/35, have been added to the PDP-11 line. The expanded 11/05 has a larger chassis than the standard 11/05, comes with a minimum of 8 k core—instead of 4 k—and has increased power supply capacity. The price \$6495 is \$1700 more than its predecessor. The PDP-11/35 is available in two packaging configurations. The 10.5-in. high PDP-11/35 comes with 8 k words expandable in 8 k increments to 128 k and is priced from \$9495. The 21-in. high version begins with 32 k, but expands to 128 k in 32 k increments. The price: \$20,495.

CIRCLE NO. 256

### Modular CRT systems have desk-top cabinets



Ann Arbor Terminals, 6107 Jackson Rd., Ann Arbor, Mich. 48103. (313) 769-0926. From \$900; 15 days.

The Design III series of CRT terminals are complete desk-top terminals. But, their modular circuit cards are directly interchangeable with the company's Series 200 controllers and keyboards. All units have a 14-in. monitor and provide 9600 baud asynchronous communications. The series—available in 16 models—provides display formats to 40 lines × 80 characters and can drive up to 10 video monitors. Optional configurations include graphics, printer add-ons and multidrop systems.

CIRCLE NO. 257

### Display system creates patterns with numbers

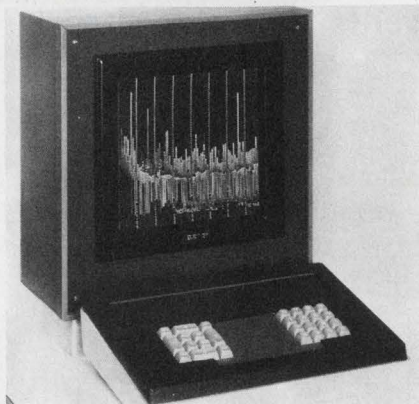

Digicom, Inc., Paramount Building, North Chelmsford, Mass. 01863. (617) 251-8595.

Designed to permit visual interpretation of raw digital data the plasma-graph display system uses specially designed figures to represent binary digits from 0 to 15. These characters are optically weighted in proportion to their numerical value. The resulting patterns provide an analog representation of data content or meaning, yet retain the absolute value of each individual data point. The display system can operate on-line or off-line. An entire display of 10,800 characters takes less than 10 seconds to complete.

CIRCLE NO. 258

### Data system transmits 16-bit parallel words

Kantronics Co., 1202 E. 23rd St., Lawrence, Kan. 66044. (913) 842-7745. \$880; 90 to 120 days.

Two model LLI-16 interfaces give bidirectional 16-bit parallel data transmission over distances up to 1000 feet. Each interface contains a receiver and transmitter that operate independently of one another. The transmitter takes data, adds a parity bit and sends 17 bits over the interconnecting cable. The receiver recomputes parity then presents 16 data lines to the local computer as well as a "parity correct" or a "parity error" flag. The maximum transmission rate is 65-k words/s in either direction.

CIRCLE NO. 259



# MOSTEK's 1024-bit static RAM, the MK 4102P, gives you 450 ns access time. Another big move forward in MOS RAMs!

MOSTEK's MK4102P-1 features two industry firsts: it's the fastest 1024-bit static RAM (450 ns access time) and the first to combine N-channel silicon-gate and ion-implantation technologies, industry's most advanced processing technique. Plus, it's a pin-for-pin replacement for the 2102-1.

All inputs are directly compatible with TTL circuitry. The high impedance "off state" coupled with "chip select" input

permits large memory array construction with a minimum of additional circuitry.

**Volume production capacity backs-up the 4102.** MOS RAM production at MOSTEK, bolstered through increasing use of 3-inch wafers, is currently exceeding 250 million bits per month with total deliveries to date of more than two billion bits. With this record, MOSTEK is now one of the world's largest producers of MOS RAMs. So you can be assured that your biggest orders will be handled promptly.

MOSTEK's memory heritage includes other popular RAM

circuits. The MK4006P dynamic RAM was the first TTL compatible 1024-bit RAM. The MK4007P 256-bit dynamic RAM was first to combine low power, high performance and wide voltage range. MOSTEK RAMs are available in volume now from distributor stocks.

Performance and volume production capacity — good reasons to call MOSTEK for random access memories. *And watch for the next big development in RAMs — coming soon from MOSTEK.*

For a data sheet on the MK4102P-1 contact: MOSTEK, 1215 West Crosby Road, Carrollton, Texas 75006, (214) 242-0444. Or call the MOSTEK representative nearest you.

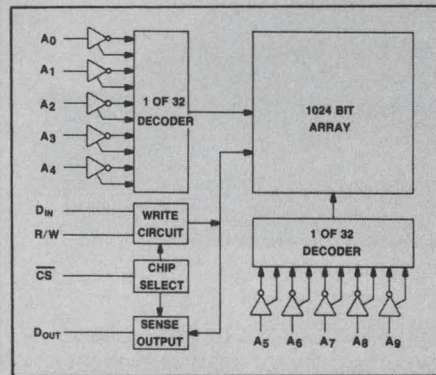

**MOSTEK**®

**MOSTEK moves forward...in memories.**

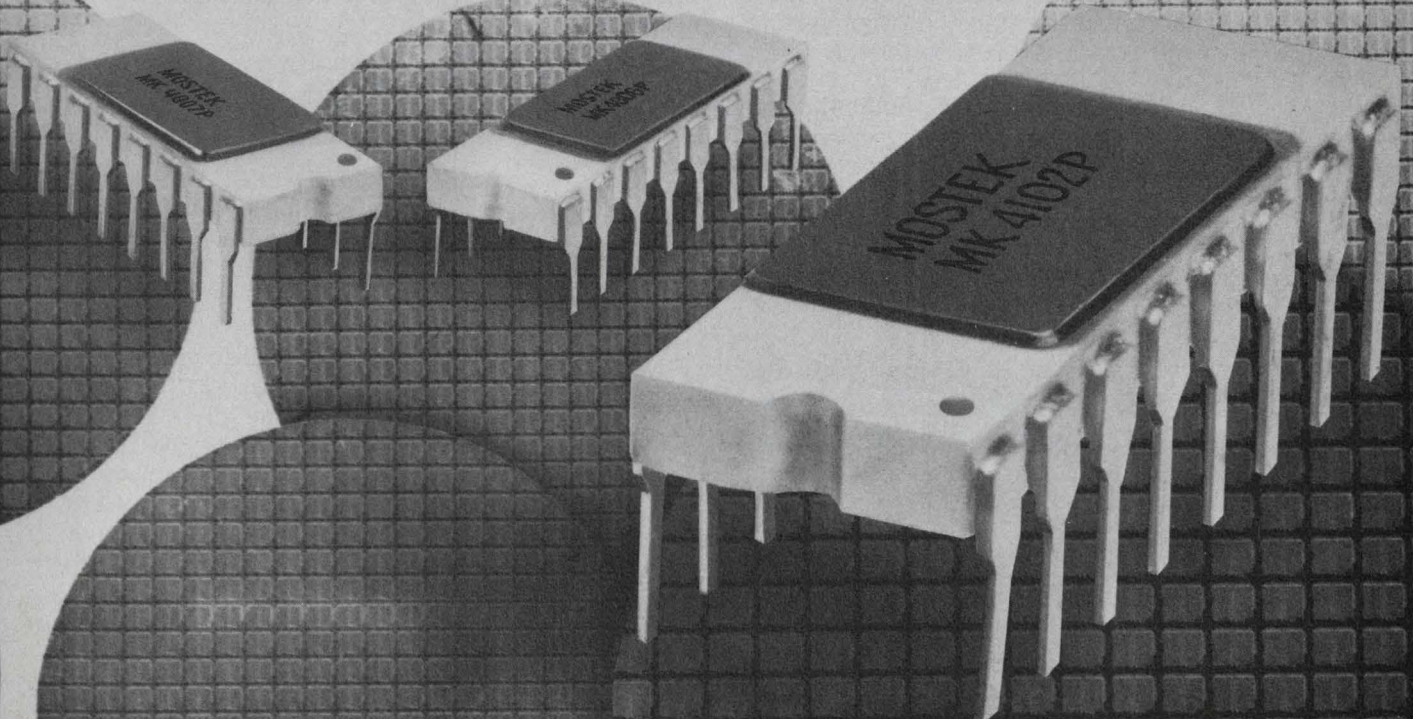



# Super Cop



Super protection with the unique adjustable Crowbar Overvoltage Protector. Makes the Sorensen SRL a great supply for lab/system uses. Fast front panel adjustment of overvoltage level without removing the load . . . instant front panel meter monitoring of set point, plus these additional SRL features: resistance and signal programmability; fast response time — 70 to 150  $\mu$ sec. — through full load range; low — 3½" to 7" — rack panel height; high power-density . . . in 14 models with outputs from 250 to 2000 watts. SRL — the super choice for maximum reliability, stability and value in medium power, low voltage applications. For complete data, contact the Marketing Manager at Sorensen Company, a unit of Raytheon Company, Manchester, N.H. (603) 668-4500.

## Representative Specifications — SRL

- |  |  |
|--|--|
| <ul style="list-style-type: none"> <li>• Voltage Mode               <ul style="list-style-type: none"> <li>Regulation (combined line &amp; load) .01%</li> <li>Ripple (PARD) rms: 350 <math>\mu</math>v.</li> <li>p-p: 20 mv.</li> <li>Temperature Coefficient <math>\Delta</math>/°C .01% + 200 <math>\mu</math>v.</li> </ul> </li> <li>• Voltage Ranges               <ul style="list-style-type: none"> <li>0-10 volts to 0-60 volts (14 models)</li> </ul> </li> </ul> | <ul style="list-style-type: none"> <li>• Current Mode               <ul style="list-style-type: none"> <li>Regulation (combined line &amp; load) .02% + 4 ma.</li> <li>Ripple (PARD) rms: 0.5 to 30 ma.</li> <li>Temperature Coefficient <math>\Delta</math>/°C .01% + 1 ma.</li> </ul> </li> <li>• Price Range               <ul style="list-style-type: none"> <li>\$500-1025</li> </ul> </li> </ul> |
|--|--|

**Sorensen**  
POWER SUPPLIES

INFORMATION RETRIEVAL NUMBER 37

## Matched transistor arrays offer low-noise

*Plessey Semiconductors, 1674 McGaw Ave., Santa Ana, Calif. 92705. (714) 540-9979.*

A series of matched arrays, featuring low noise figures and  $f_T$  values greater than 2.5 GHz, consist of the following models: The SL360C, a matched pair, lists an  $h_{FE}$  of 65, noise figure of 4 dB and a minimum  $BV_{C10}$  of 30 V. The SL362C matched pair has an  $h_{FE}$  of 70, noise figure of 2 dB and minimum  $BV_{C10}$  of 20 V. The SL3145, a differential pair with a triplet array, has an  $h_{FE}$  of 80, noise figure of 3 dB and minimum  $BV_{C10}$  of 20 V. All arrays operate over the —55-to-125-C temperature range.

CIRCLE NO. 260

## MSI register and arith units use less power

*Fairchild, 464 Ellis St., Mountain View, Calif. 94042. (415) 962-3816. 93L38: \$5.90; 93L41: \$7.77 (100-999).*

Low-power versions of the company's 9338 multiport register and 9341 arithmetic logic unit are now available. The 93L38 8-bit register dissipates only about one-fourth as much power while operating at half the speed of the standard circuit, according to the company. Similarly, the 93L41 4-bit arithmetic logic permits reduced costs through less power dissipation.

CIRCLE NO. 261

## 256-bit ECL pROM accesses in 15 ns

*Signetics, 811 E. Arques Ave., Sunnyvale, Calif. 94086. (408) 739-7700. \$20.80 (100); 5 wk.*

The 10139, a 256-bit ECL programmable ROM, features a typical access time of only 15 ns. The new pROM also offers full compatibility with ECL 10,000 and uses nichrome fuses as the memory elements. The 256-bit capacity of the 10139 is organized into 32 words of eight bits each. The words are selected through five binary address lines. Typical power dissipation is 580 mW.

INQUIRE DIRECT



## Three ICs added to MECL 10,000 Line

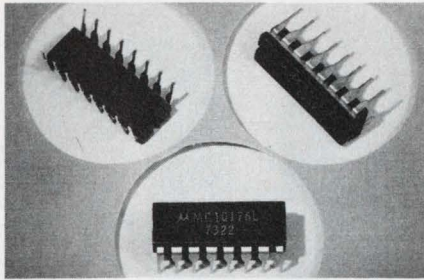

Motorola, P.O. Box 20924, Phoenix, Ariz. 85036. (602) 244-3466. MC-10123L: \$2.09; MC10172L: \$5.42; MC10176L: \$7.97 (100-999); stock.

Three ECL 10,000 ICs can be used to reduce system component count, and thus, cut costs. The MC10176L hex master-slave D flip-flop has a 125-MHz guaranteed toggle rate. The six flip-flops in a package reduce costs per function. The MC10172L dual binary-to-1-4 decoder can be used as a 2-line-to-4-line demultiplexer. The MC-10123L triple 4-3-3 input-bus driver provides twice the driving capability of other drivers.

CIRCLE NO. 262

## Quad op amp uses only 340 $\mu$ W

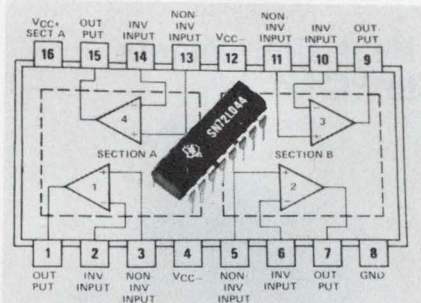

Texas Instruments, P.O. Box 5012, M/S 308, Dallas, Tex. 75222. (214) 238-3741. \$4.15 (100); 12 wk.

A quad low-power monolithic op amp, believed to be the first of its type, uses only 340  $\mu$ W at  $\pm 2$  V. Called the SN72L04, the new IC also has a low supply current of 0.25 mA at  $\pm 15$  V for all four amplifiers and a low equivalent input noise voltage of 50 nV/ $\sqrt{\text{Hz}}$ . Power can be applied to one section, consisting of two amplifiers while the other section with the other two amplifiers remains unpowered. Other important features include internal frequency compensation, absence of latch-up and short-circuit output protection.

CIRCLE NO. 263

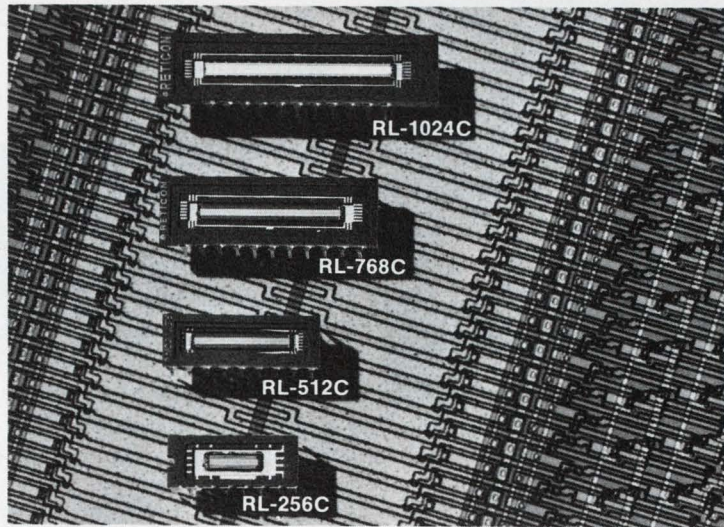

## Solid State Image Sensing

Reticon offers the most complete line of solid state image sensors for OCR, facsimile, page/document reader, film scanning, real time spectroscopy, non contact measurement and inspection applications.

High resolution of up to 1024 elements on 1 mil centers is available on a single monolithic chip with serial video readout. Charge storage mode operation provides high sensitivity with scan rates up to 10 MHz. Low power dissipation of less than 10 mwatts and the highest quality silicon gate process assures minimum dark currents and maximum dynamic range.

Circuit cards (RC series) containing complete drive and video amplifier circuits are also available from inventory for any Reticon image sensor.

Our RL256C through RL1024C devices are much improved pin compatible replacements for previous designs.

Write or call for detailed data sheets and external circuit information.

## RETICON®

450 E. Middlefield Road, Mountain View, CA 94043

(415) 964-6800 TWX 910-379-6552

HOTLINE (415) 964-3033

This SPECIAL OFFER is to introduce our "C" devices, which will be shipped complete with the RC series circuit cards providing all external drive and video amplifier circuits. Specify RL256C/RC, RL512C/RC, RL768C/RC and RL1024C/RC. Order must be received within 30 days from publication date and must be entered directly with the factory. Only one per customer. Offer is for U.S.A. domestic sale only.

**\$100/bit**  
plus \$250 (for inclusion of complete drive & video circuitry)  
as low as 25¢/bit in large OEM quantities

INFORMATION RETRIEVAL NUMBER 38



PUT  
OUR SMOS  
STAR IN  
YOUR SHOW

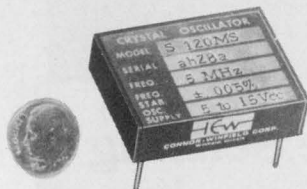

## CONNOR-WINFIELD'S SMOS Oscillator

### Frequency:

Available at any fixed frequency, 50 kHz to 30 MHz.

### Frequency Tolerance:

(accuracy + stability)  
16 different combinations of tolerance and temperature range ranging from  $\pm 0.001\%$ ,  $+20^\circ\text{C}$  to  $+40^\circ\text{C}$ , to  $\pm 0.05\%$ ,  $-55^\circ\text{C}$  to  $+125^\circ\text{C}$ .

### Supply Voltage:

Any supply voltage from 4 Vdc to 15 Vdc, with supply current from .2 ma to 13 ma, depending on supply voltage.

### Output Waveform:

Square wave.  
Rise time 50 ns nominal.

### Output Amplitude:

from 2.6 Vpp to 12 Vpp into a 2 K $\Omega$  load, or  
from 3.6 Vpp to 18 Vpp into a 10 K $\Omega$  load, depending on supply voltage.

### Termination:

.03" diameter gold plated pins.

### Dimensions:

1.6" L x 1.2" W x 0.4" H.

### Delivery:

Stock to 4 weeks.

CONNOR-WINFIELD CORP.



West Chicago,  
Illinois 60185  
Phone: (312) 231-5270

INFORMATION RETRIEVAL NUMBER 39

## PACKAGING & MATERIALS

### Mounting package handles any DIP LED

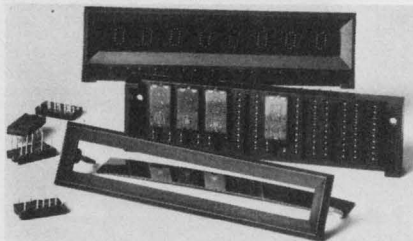

Industrial Electronic Engineers, Inc., 7720-40 Lemona Ave., Van Nuys, Calif. 91405. (213) 787-0311.

Universal LED mounting hardware accepts any dual-inline LED display with 0.3 in. row spacing, regardless of manufacturer. The package consists of a one-piece nylon bezel, a circular polarizing window and a one-piece, behind-the-panel socket assembly, which eliminates all individual DIP sockets. Dual-inline displays with 14 or 16 pins can accommodate from two to eight units. The socket assembly has wrap terminations.

CIRCLE NO. 264

### Paint your circuit with this conductive coating



Acheson Colloids Co., Box 288, Port Huron, Mich. 48060. (313) 984-5581. \$35; experimenter's kit.

Care to make a microphone wire out of a ball of twine? Or paint your own electric circuit? Acheson's new series of +500 Electrodag high-temperature, nonsilicone coatings can be used for printed or painted circuitry, for heating elements and high temperature static-bleed applications. Important features include: ambient working temperatures of over 260 C; remains flexible over temperature range of  $-40$  to over 260 C; and cures at room temperature.

CIRCLE NO. 265

### Connectors use wrapped terminations

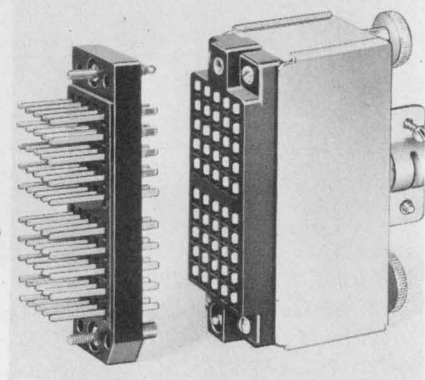

Underwriters Safety Device Co., 7300 W. Wilson Ave., Chicago, Ill. 60656. (312) 867-4600.

Originally developed for the telephone industry, these wire-wrappable connectors come in two sizes—50 or 72 connections. Contacts are gold-plated and rated at 3 A. The plug cover contains a cable strain-relief clamp and jack screws with a thumbwheel for mating and securing to the receptacle half of the connector. The plug and receptacle can have female or male contacts.

CIRCLE NO. 309

### Heat sink solders to PC board

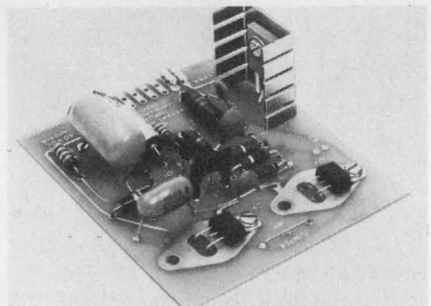

International Electronic Research Corp., 135 W. Magnolia Blvd., Burbank, Calif. 91502. (213) 849-2481.

PB1-36ND is a heat sink for TO-126 and other plastic power transistors. It solders directly and at right angle to a PC board. It measures only 1 W x 1/2 D x 1-3/16 H in. A 2N4442 transistor can dissipate 4 W with a temperature rise of about 70 C above ambient, when it is mounted on the heat sink. Only half as much power would cause the same temperature rise without the sink.

CIRCLE NO. 310



## Plastic buttons replace screws and rivets

Richlok Corp., 5835 N. Tripp Ave., Chicago, Ill. 60646. (312) 539-4061.

A new line of Series MB rigid, natural-nylon, mounting buttons in 18 sizes for snap-in fastening applications can replace screws, nails or rivets. The buttons are offered in 0.37 and 0.48-in. holding widths that fit 0.156 and 0.187-in. dia holes. Each width is available in nine heights for thicknesses from 1/32 to 17/32 in. and in 1/16-in. increments.

CIRCLE NO. 266

## DIPs packaged densely on page-hinged panels

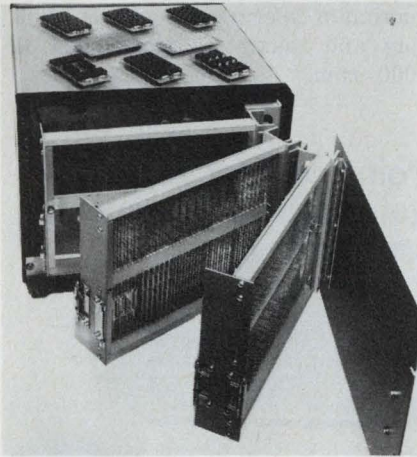

Standard Logic Inc., 2215 S. Standard Ave., Santa Ana, Calif. 92707. (714) 979-4770.

The C-A-S-H page packaging system is compatible with standard 19-in. racks and cabinets and it features up to four mounting panels. The system is slide mounted and all the panels hinge like the pages of a book for convenient access to both the component and wiring sides of all panels. A single system with four pages can mount 160 C-A-S-H cards that can hold up to 4960 ICs. Input-output connectors are located adjacent to the panel hinges to permit minimum cable lengths. Other salient features of the packaging system include: over 100 cards with various combinations of DIP/IC sockets, I/O connectors and discrete component mounting provisions; large power capability with heavy-duty bus bars; and noise reduction features because of a laminated power-distribution plane that has high distributed capacitance.

CIRCLE NO. 267

## Marking kit labels special panels

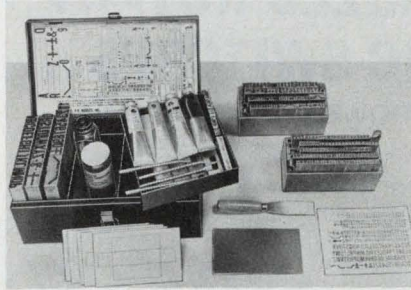

P. K. Neuses, Inc., Box 100, Arlington Heights, Ill. 60006. (312) 253-6555.

The Neuses' N-2315 numbering and lettering kit contains everything needed for the permanent marking of panels, junction boxes, subassemblies and chassis. The kit is intended for marking those few-of-a-kind assemblies; it is not intended for production marking. It comes in a steel carrying case and replacement supplies are available.

CIRCLE NO. 268

# LOWEST POWER, HIGHEST SPEED 256 BIT SOS/ CMOS RAM IN THE INDUSTRY. IT'S HARD TO BE MODEST.

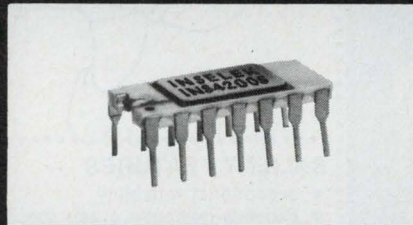

Our 256x 1 bit RAM is fully compatible with other CMOS & TTL devices. Its 26mW operating power dissipation & 140nS write, 180nS read cycle offer you the most optimum combination of speed and power available in the industry. This makes our INS4200S ideally suited for use in scratch pad, buffer and main memory applications where high speed and low power are required.

Other features include: 5-15 volt supply range, full address decoding and bipolar compatible Pin-Cuts in 16 pin DIP.

Available immediately in sample quantities, the INS4200S is priced at \$26 in quantities of 100-999.

For some immodest information call or write: **Inselek, Inc.**, 743 Alexander Road, Princeton, N.J., 08540 (609) 452-2222.

**INSELEK**™  
SALES OFFICES IN CONCORD,  
MASS. (617) 369-5298 AND  
AGOURA, CALIF. (213) 889-2788



DISTRIBUTORS: WEST COAST—WESTATES (213) 341-4411  
NEW ENGLAND—GREEN SHAW (617) 969-8900  
MID-ATLANTIC—WILSHIRE ELECTRONICS (609) 786-8990



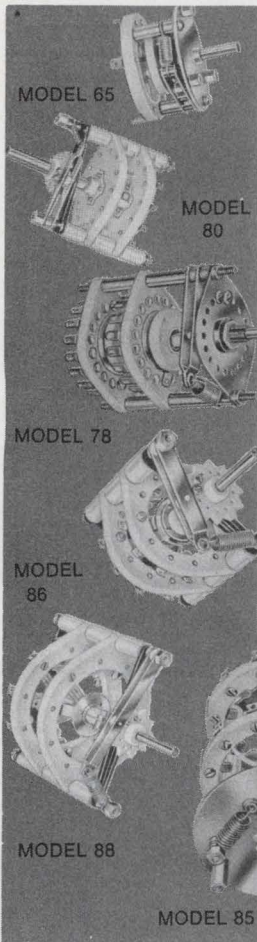

# A complete line of CUSTOMIZED ROTARY CERAMIC SWITCHES...

For RF and POWER APPLICATIONS

RSC switches are available in a variety of switching models. RSC high precision, quality built units are designed for applications requiring long life maintenance-free service. Types include shorting and non-shorting, single and multi-deck, up to 18 pole positions. Features include, 10 to 100 amp current carrying capacity, 20° to 90° detents, 2000 to 24000 volts flashover and corrosion-proof construction.



Write for catalog no. 960  
and complete information.  
**RADIO SWITCH CORPORATION**  
Rt. 79, Marlboro, N. J. 07746

INFORMATION RETRIEVAL NUMBER 42

## COMPONENTS

### Rotary transducer has absolute output

*Astrosystems, Inc., 6 Nevada Dr.,  
Lake Success, N.Y. 11040. (516)  
328-1600.*

Up to 4000 BCD counts (0.1 degree) or 12 binary bits per revolution can be absolutely encoded with Model ST-11E transducer, which measures 1.062 D by 2 L in. and weighs only 4 oz. Every position of the transducer has a unique output that is instantly recoverable, should the system lose power. The transducer is a single-turn device, needs no adjustment or maintenance and operates over a temperature range of -20 to 85 C. Starting torque is 0.07 oz-in., maximum operating speed is 1200 rpm and maximum slew-speed is 3000 rpm.

CIRCLE NO. 269

### Point contact replaces gold in board connector

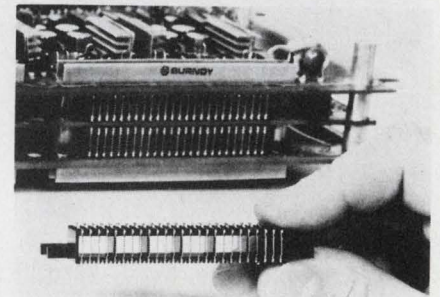

*Burndy Corp., Richards Ave., Norwalk, Conn. 06856. (203) 838-4444.*

Many connector makers have tried to substitute nonprecious metals for gold, but the replacements have often proved unreliable. The secret of Burndy's success with its GTH (gas-tight high-pressure) design is in its geometry. Concentration of the contact's spring force on a sharply pointed tip, causes the contact material to flow or extrude. This breaks down tarnish and corrosion films to establish fresh metal-to-metal junctions. Contact resistance with GTH is commonly as low as with gold—sometimes lower, according to Burndy. One GTH connector design connects a small circuit board to its master board with an easy push instead of with the use of a conventional gold-plated edge connector.

CIRCLE NO. 270

### The tough little competitor can deliver. Fast.

Call us on your OEM power supply requirements.

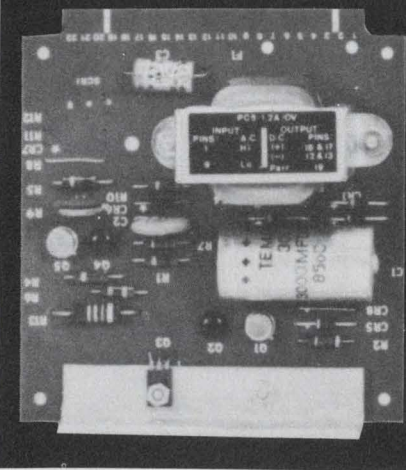

**Typical Specifications — PC Series**  
\$22.00 (10-99 unit quantity)

Input: 105-125VAC,  
60 to 400 Hz  
Line Regulation: ±25MV. Max.  
Load Regulation: ±25MV. Max.  
Ripple & Noise: 10MV. RMS Max.  
Stability: ±5MV. After warm up.  
Temperature Coefficient: ±2.5MV/°C  
Operating Temperature: -20°C to +71°C.  
Storage Temperature: -20°C to 85°C



Mighty Mouse © Viacom International

#### SALIENT FEATURES

- exceptional reliability
- exceeds computer grade specifications
- packaged for computer peripheral equipment
- meets U.L. and C.S.A. requirements

All standard supplies available in both discrete and I.C. versions. Liberal mix or match discounts available. All AMPSCO products are backed by unconditional 10-year guarantee.

Power Supplies by

**AMPSCO**  
**WVBS**

A Tough Little Competitor

American Power Systems Corp. • 51 Jackson St. • Worcester, Massachusetts 01608 • (617) 753-8103

INFORMATION RETRIEVAL NUMBER 43



# Mini Bus<sup>®</sup> by Rogers

For noise and  
cost reduction



A small, voltage-distributing busbar for PC card application, each Mini/Bus gives you built-in capacitance . . . noise-cutting capacitance that means more reliable, compact circuit packaging at a fraction of multilayer prices. Write for data.



Rogers Corporation / Rogers, Conn. 06263

INFORMATION RETRIEVAL NUMBER 44

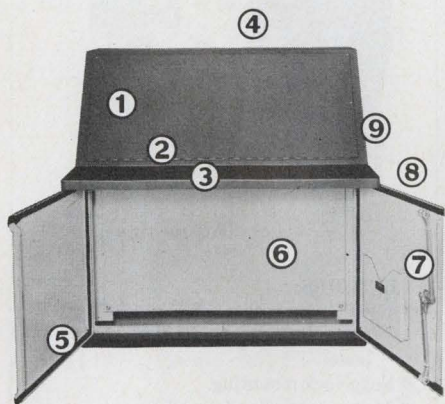

1. 24", 36", 48", or 60" width. 2. Hinged sloping control panel. 3. Optional writing desk. 4. Instrument panel top available. 5. Neoprene gaskets for complete oil tightness. 6. Accessory subpanel. 7. Three-point latches and key-locking handles. 8. Doors on both front and back. 9. All seams continuously welded. 10. NEMA-12 construction. 11. Many modifications available. Write for Bulletin C-14.

# CONSOLE ENCLOSURES

**Hoffman<sup>®</sup>** ELECTRICAL ENCLOSURES  
HOFFMAN ENGINEERING COMPANY  
Division of Federal Cartridge Corporation  
Anoka, Minnesota, Dept. ED52

INFORMATION RETRIEVAL NUMBER 45

ELECTRONIC DESIGN 3, February 1, 1974



## Light-Reflecting Electromagnetic Display Components

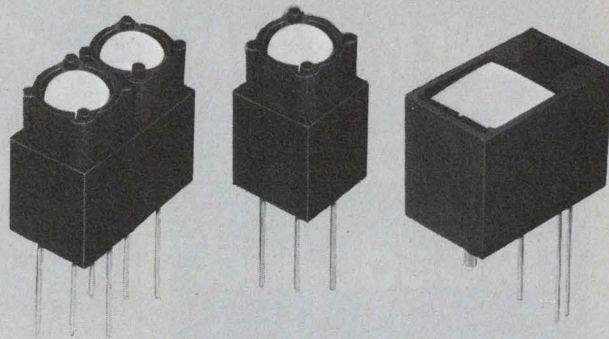

**SERIES 32**  
0.3 inch (7.62 mm)  
dual

**SERIES 30**  
0.3 inch (7.62 mm)  
single

**SERIES 50**  
0.5 inch (12.7 mm)  
single

### STATUS INDICATORS

**MEMORY** — inherent remanent magnetism maintains the display state.

**LOW POWER** — one milli-watt second set/reset energy. Zero power to retain state. Drive voltages from 3-48 volts.

**VISIBILITY** — rotating fluorescent discs and flags provide excellent visibility over a wide range of ambient light conditions and wide viewing angles.

**RELIABILITY** — only one moving part rated for over 20 million operations. No lights or mechanical linkages to wear out. Virtually maintenance free.

### FERRANTI-PACKARD STATUS INDICATORS

Ideal for

- Transient Recorders
- Industrial Process Displays
- Contact Status Indicators
- High Density Matrix Displays
- Portable Field Equipment.

Fluorescent discs and flags available in a range of colors.

The electromagnetic operation requires zero energy to maintain status.

Unique memory retention eliminates the need for memory circuits and reduces power supply and circuitry costs. Indicators are fully operational over a wide range of environmental conditions.

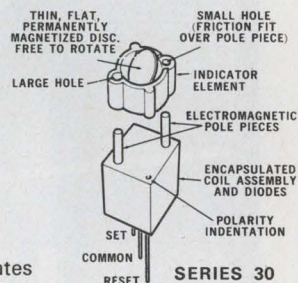

Ferranti-Packard's status indicators are light weight (Series 30, 0.17 oz (5 grams)) and are ideal for mounting on printed circuit boards and high density matrices.

For full information and specifications, contact the Display Components Department.

## FERRANTI-PACKARD LIMITED

ELECTRONICS DIVISION  
121 Industry Street,  
Toronto, Ontario, M6M 4M3, Canada.  
Telephone: (416) 762-3661.  
Telex: 06-22007.

7304

INFORMATION RETRIEVAL NUMBER 46





# THE NEXT GENERATION OF Broadband Power Amplifiers

Starts with  
The

**jsi** M403

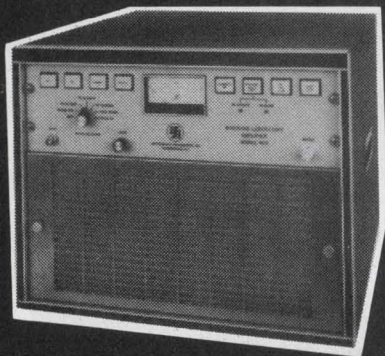

.01-250MHz  
100W min.  
50db gain

**SMALLER  
LIGHTER  
QUIETER**

**DESIGNED FOR RELIABILITY  
AND  
EASE OF MAINTENANCE**

Solid State protection and control circuitry with complete remote control capability. *Write or Call.*



**instruments  
for industry,  
inc.**

(516) 694-1414

151 Toledo Street,  
Farmingdale, N.Y. 11735

INFORMATION RETRIEVAL NUMBER 47

## COMPONENTS

Capacitors to 3.7  $\mu$ F  
fit hybrid packages

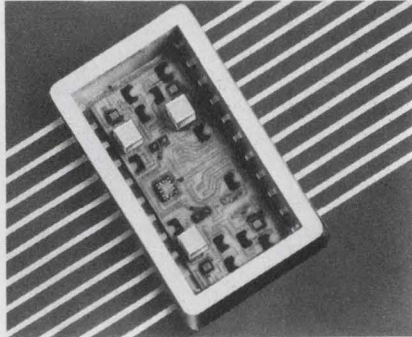

*Johanson, Monolithic Dielectrics  
Div., Box 6456, Burbank, Calif.  
91505. (213) 848-4465. 10 wk.*

New extended-range ceramic chip capacitors feature capacitances of 1 pF to 3.7  $\mu$ F in seven standard sizes. The smallest size is 0.040 L  $\times$  0.030 W  $\times$  0.015 T in.

CIRCLE NO. 271

Small tantalum-film  
resistor handles 1/4 W

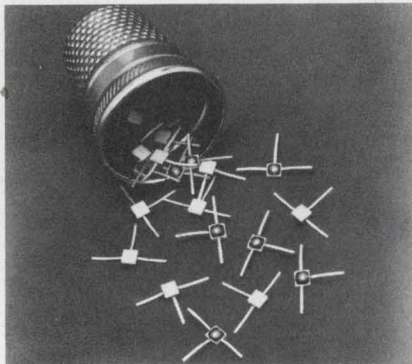

*TRW/IRC Resistors, P.O. Box 887,  
Burlington, Iowa 52601. (319) 754-  
8491. \$0.58 (10,000 up); 4 to 8  
wks.*

These Tanfilm 1/4-W dual-resistor networks provide high component density. They consist of two tantalum-film resistors on a 0.075  $\times$  0.075-in. ceramic chip. The resistors' three-leads provide values of 1/2R, R or 2R. The resistance range is 20  $\Omega$  to 20 k $\Omega$  for the series combination with a tolerance of  $\pm 5\%$ . Power is rated 0.25 W at 70 C and the temperature coefficient is  $-100 \pm 25$  ppm/ $^{\circ}$ C. Tantalum-nitride film is deposited on a 25-mil thick chip and protected by an epoxy coating. Gold-plated-copper leads are bonded to termination pads on the chip. Leads are planar configured and can be formed for PC-board insertion.

CIRCLE NO. 272

Have you  
ever seen  
a button  
that fits  
your  
finger?

We now offer the new  
**LIGHTED PUSH-  
BUTTON SWITCH**  
SERIES LPS-100

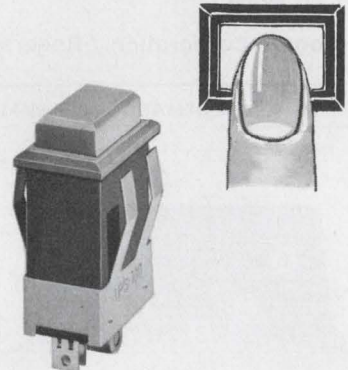

(Actual size)

### FEATURES:

- Small space—only .750"  $\times$  .550" mounting space and 1.100" behind panel.
- Snap-lock mounting.
- Matrix mounting is available.
- Momentary or alternate actions. DPST, SPST, N.O., N.C.
- Light touch button—operation force 8 oz.
- Clean Color Button—Transparent cap with white diffusion filter. —Permit insertion of film with any LOGO or picture.
- Front lamp replacement.

• Ask informations to:

**WAMCO Technical Sales, Inc.**

705 W. 16th Street, Costa Mesa, California  
92627 TEL: (714) 642-5100 TELEX: 678459

© **OSHINO ELECTRIC LAMP  
WORKS, LTD.**

TOKYO, JAPAN

INFORMATION RETRIEVAL NUMBER 48  
ELECTRONIC DESIGN 3, February 1, 1974



## Keyboard assembly provides switching feel

Chromerics, 77 Dragon Court, Woburn, Mass. 01801. (617) 935-4850.

The ER family of keyboards features slightly convex key surfaces that deflect 0.035 in. under 4 to 6 oz of pressure. These keyboards provide the operator with a distinct feel of switch closure. They are available with 12 or 16 keys on 0.75 or 0.5-in. centers and a variety of formats and coded outputs. The ER switches have a life in excess of 10 million operations, a contact rating of 40 mA at 30 V, a contact resistance of 0.1  $\Omega$  and an operating temperature range of -40 to 180 F.

CIRCLE NO. 273

## Switches made with a one-piece nylon toggle

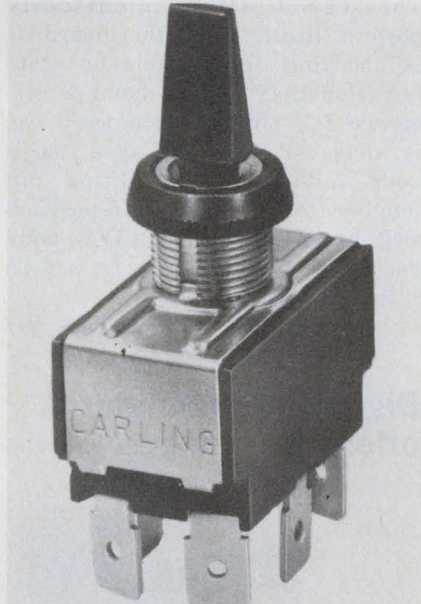

Carling Switch, Inc., Suite 800, 1428 Brickell Ave., Miami, Fla. 33131. (305) 358-5400.

One-piece nylon toggle G-Series switches eliminate the problem of the toggle separating from its pivot base. The pivot ball is reinforced with metal that adds strength to the fulcrum point and minimizes wear by providing metal-to-metal contact in the bushing. The nylon paddle toggle is available in a range of colors. The series has single and double-pole switches with both maintained and momentary contacts. Neoprene sealed bushings for marine and automotive applications are available.

CIRCLE NO. 274

NEWS  
FROM  
AIRPAX

# about Magnetic and Digital PICK-UPS

Airpax manufactures "passive" analog and "active" digital transducers (pick-ups) to provide the most effective and accurate means of converting mechanical motion into usable voltage control signals...without mechanical linkage. These magnetic pick-ups operate by accurately detecting moving ferrous discontinuities. Want to know more about pick-ups?...How is the selection made? How does the gear or discontinuity affect the pick-up output?

## These questions are answered

in the new 20 page AIRPAX Text #8510

### "MAGNETIC PICK-UPS AT WORK."

Send for it today!

AIRPAX  
Controls Division  
P.O. Box 8488  
Fort Lauderdale, Florida 33310

Phone 305 587-1100

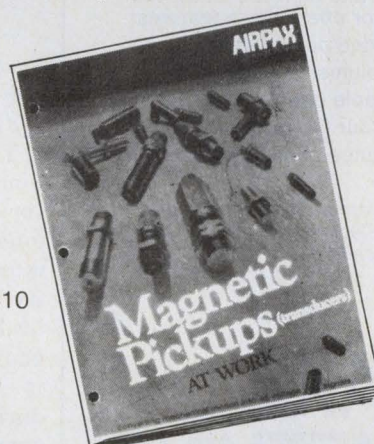

# AIRPAX™

INFORMATION RETRIEVAL NUMBER 49



# GENERAL ELECTRIC'S TYPE 84F TUBULAR ALUMINUM CAPACITOR...



New from General Electric — an axial leaded, all welded tubular capacitor meeting the high CV small case size requirements of today's transistorized electronic equipment. Excellent for industrial and entertainment applications requiring maximum capacitance with limited space. Quality constructed for long life and high reliability, the 84F capacitor offers these features:

- All welded construction
- High volumetric efficiency
- High ripple current capacity
- 1,000 hour life rating at 85 C
- Wide range of case sizes and voltages

For more information on these, or any of General Electric's wide range of capacitors, call your nearest GE sales office today, or write Section 430-54, Schenectady, N. Y. 12345.

## MAKE SOMETHING OUT OF IT!

GENERAL  ELECTRIC

INFORMATION RETRIEVAL NUMBER 50

## INSTRUMENTATION

### Tiny DMM uses throwaway battery



Dana Laboratories, 2401 Campus Dr., Irvine, Calif. 92664. (714) 833-1234. \$195.

The Danameter is a miniature, portable DMM with a 3-1/2-digit liquid-crystal display and automatic polarity. The 1-lb. unit draws only 1 mW so that the internal battery can be thrown away after about a year. Ranges include ac and dc V, ohms and dc current.

CIRCLE NO. 275

### Communications counter meets FCC specs



Syston-Donner, 10 Syston Dr., Concord, Calif. 94518. (415) 682-6161. \$1095; 60 days.

This new 512-MHz Frequency Counter, Model 6252, is designed for monitoring and measuring frequency carriers in the mobile communications bands. Input sensitivity of the unit is 25 mV rms to 50 MHz and 50 mV rms for inputs above 50 MHz. The measurement is displayed on a solid-state 8-digit readout with leading-zero suppression. Included in the field-portable counter, designed to FCC requirements, are a level meter coupled to the input for indication of signal level, an overload relay circuit to prevent damage to the input when overloads occur, and a frequency multiplier with a phase-locked local oscillator.

CIRCLE NO. 276

### Pocket logic tester diagnoses ICs

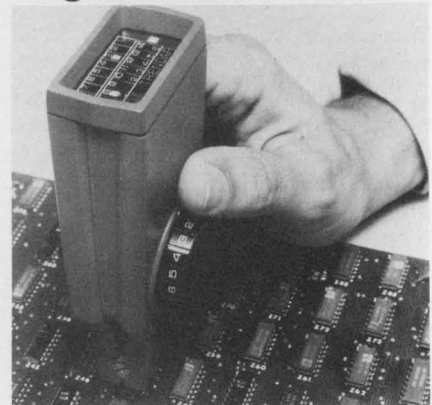

Fluke Trendar, 500 Clyde Ave., Mountain View, Calif. 94040. (415) 965-0350. \$395; stock.

A new hand-held instrument for testing ICs in-circuit is called the Model 200 IC TESTCLIP. The unit combines a logic probe, a logic clip and a logic comparator. The TESTCLIP automatically powers itself from the board it is checking. Truth-table or state behavior that differs from a reference IC, plugged into the case, is detected and displayed as a node failure at the failing pin number of the IC. A 16-position switch on the TESTCLIP's body enables the instrument to act as a logic probe.

CIRCLE NO. 277

### Digital thermometer offers two ranges



Hewlett-Packard, 1501 Page Mill Rd., Palo Alto, Calif. 94304. (415) 493-1501. \$700 (w/o probe); stock.

Model 2802A platinum resistance digital thermometer has two ranges: from -200 to +600 C, with a resolution of 0.1 C, and from -100 C to +200 C with a resolution of 0.01 C. Accuracy over both ranges is  $\pm 0.5 C \pm 0.25 \%$  of reading. A linear analog output is standard. The unit operates within its rated accuracies over ambient conditions from 0 to 55 C and relative humidity to 95% at 40 C.

CIRCLE NO. 278



## FOR THE UTMOST IN RELIABILITY

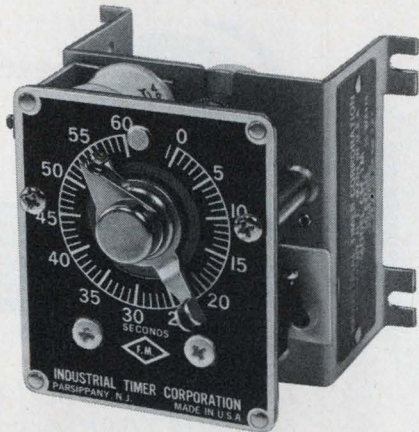

### TIME DELAY TIMER Series CSF

It is one of industry's most versatile compact delay timers, offering dial adjustability, automatic reset, external clutching and 10 amp. SPDT snap action load contacts. Repeat accuracy is 1 1/2%. Resets in 1/2 second at maximum settings. Voltages: 120, 240/50-60 hertz. All of our timers are made to give you service far beyond what you'd reasonably expect. Our line consists of 17 basic types, each available in various mountings, voltages, cy-

cles, circuits and load ratings... and with whatever special wrinkles you may need. Bulletin 305 tells all about our reliable Delay Timers. Write for it or a catalogue of the entire line. If you have an immediate timer requirement, send us your specifications. Or for fastest service call (201) 887-2200.



Industrial Timer Corporation, U.S. Highway 287, Parsippany, N.J. 07054  
INFORMATION RETRIEVAL NUMBER 51

Send us your problems on

# Magnetic Shielding

#### Standard Shields

We make all types — CRT, PM, DVST, TWT, BWO, scan converter, transformer.

#### Custom Shields

Let us make your special shields. We can save you both time and money.

#### Sheet and Foil

Tests show our exclusive alloys provide more permeability per dollar.

#### Tape Preservers

Protect your valuable tapes from stray magnetic fields during storage and transfer.

#### Plus a choice of these shielding services...

*Design • Engineering • Fabrication  
Heat Treating • Testing • Finishing*



Send for catalog and shield selection guide

P. O. Box 24283  
Indianapolis, Ind. 46224  
Phone (317) 297-1030

INFORMATION RETRIEVAL NUMBER 52

INFORMATION RETRIEVAL NUMBER 53 ►



## Licon takes the "butterflies" out of the rush hour.

By putting its double-break, double reliable Butterfly® switches to work in mass transit systems.

Licon® switches are at work 24 hours a day, in automatic door devices, on thousands of mass transit vehicles throughout the world. Rugged, dependable, and able to withstand countless trouble free operations under most severe conditions.

The same rugged dependability is yours in every basic Licon switch. What are your load requirements? What kind of actuator or mounting will best suit your needs?

Look to Licon: Your Licon representative or distributor has a switch solution for you.

**ITW LICON**

Division Illinois Tool Works Inc.  
6615 W. Irving Park Road  
Chicago, Illinois 60634  
Phone (312) 282-4040  
TWX 910-221-0275



# LICON

puts ideas to work  
in electronics

*The Innovative Electronic Group of ITW...*  
LICON • ELECTRO MATERIALS • PAKTRON

© ILLINOIS TOOL WORKS INC. 1974



**I'm an L.E.D.  
illuminated  
Capitol Switch**

**..QUALITY and  
DEPENDABILITY . . .  
that's where I shine!**

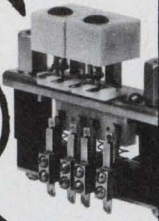

**We're just part of  
the gang . . . .**

**Top quality, dependable  
circuit selector  
push-button and  
lever switches . . .**

**many custom combinations  
and assemblies**

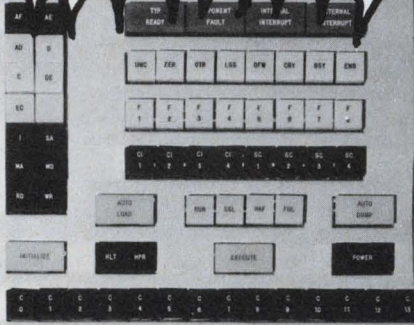

**ALTERNATE ACTION PUSH BUTTON  
SWITCHES**  
ILLUMINATED, NON-ILLUMINATED  
SINGLE POSITION, MULTIPLE  
POSITION

**LEVER SWITCHES**  
ILLUMINATED, NON-ILLUMINATED

**MOMENTARY PUSH BUTTON  
SWITCHES**  
ILLUMINATED, NON-ILLUMINATED  
SINGLE POSITION

**INTERLOCKING PUSH BUTTON  
SWITCHES**  
ILLUMINATED, NON-ILLUMINATED

**INDICATOR LITES**  
SINGLE POSITION, MULTIPLE  
POSITION

**Write for our 24 page catalogue**  
Representatives in principal cities.

**CAPITOL SWITCHES**

THE CAPITOL MACHINE & SWITCH CO.  
87 NEWTOWN RD. DANBURY, CONN. 06810

**INSTRUMENTATION**

**Level meter  
covers 17-MHz range**

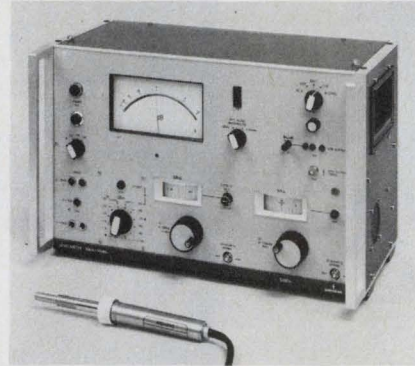

Siemens, 186 Wood Ave. S., Iselin, N.J. 08830. (201) 494-1000. D 2006: \$6550; W 2006: \$5450; stock.

The D 2006 L5 selective level meter has two calibrated film scales for accurate frequency tuning. The entire 17 MHz are continuously tuned without range switching and can be phase locked in 100-kHz increments. Within this range, the other scale fine tunes within 100 kHz. Frequency accuracy is  $2 \times 10^{-5}$  with level accuracy at  $\pm 0.1$  dB over-all. Sensitivity is  $-120$  dBm.

CIRCLE NO. 279

**50-MHz pulser  
sells for \$875**



Interstate Electronics, 707 E. Vermont Ave., Anaheim, Calif. 92803. (714) 772-2811. \$875; 30 days.

P24 pulser is the newest addition to the company's SERIES 20 line. The unit offers all the specs and modes of the 50-MHz P23 and P25 but differs in output. The other SERIES 20 pulse generators provide positive/negative dual outputs with full offset to generate direct and complementary pulses. P24, basically a single-output version of the P25, at a 20% price reduction, offers single-channel selectable positive/negative pulses, full offset, and adjustable rise/fall to 5 ns, with independent rise and fall controls variable as much as 100:1.

CIRCLE NO. 280

**Meter relays use  
battery power**

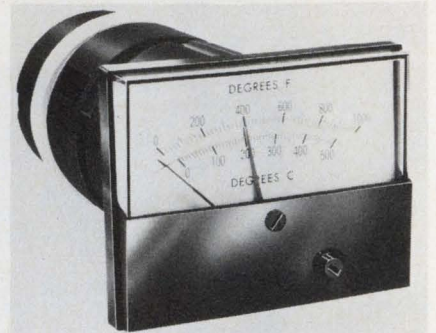

General Electric, 727 Lynnway, Lynn, Mass. 01910. (617) 594-5547. \$115 (100); approx. 10 wk.

This new line of ultra-precise Type 195 and 196 meter relays and pyrometers are now available in dc-powered versions. Covering five power ranges, from 12 to 125 V dc, the new models offer all of the features of their ac-powered counterparts, and may be used with either batteries or generated dc power.

CIRCLE NO. 281

**Signal averager displays  
real-time amplitude**

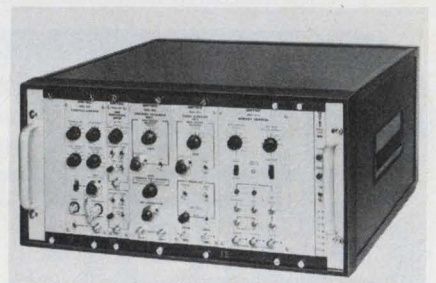

Ortec Inc., 203 Midland Rd., Oak Ridge, Tenn. 37830. (615) 482-4411. \$2915.

The 4623/4620 signal-averaging system displays a true average at every sweep, so that you need not count and then divide by the number of sweeps. The noise level can actually be watched receding on each successive sweep. The true signal amplitude can be read on a calibrated scope screen at any given time. As soon as the signal emerges clearly above the noise, averaging can stop and a permanent recorder or photographic record can be made. Heart of the signal-averaging system is the 4620 memory control, a 256-data-point MOS memory with 128 addresses and circuitry for control and readout.

CIRCLE NO. 282



# The Ballantine 512 MHz DIGITAL COUNTER

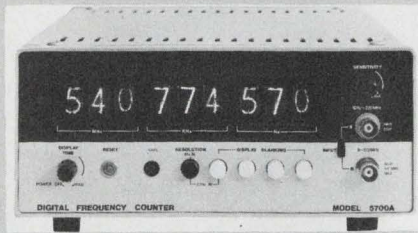

The 5700A Frequency Counter. Range 10 Hz to more than 512 MHz. Nine digit display. Carrier measurements to 1 Hz resolution in 2 seconds of keyed transmitter time. Selective signal tone checks to 0.1 Hz resolution. Sensitivity 10 mV rms with AGC. Stability 3/10<sup>7</sup>/month. 3/10<sup>9</sup>/day optional.

- HIGHEST SENSITIVITY
- BEST RESOLUTION
- FASTEST COUNT RATE
- LOWEST PRICE **\$895**

Meets FCC Requirements



**Ballantine Laboratories, Inc.**  
P.O. Box 97, Boonton, New Jersey 07005  
201-335-0900, TWX 710-987-8380

INFORMATION RETRIEVAL NUMBER 55

## WEBBER Environmental Chambers

STANDARD AND SPECIAL UNITS • 8 EXCLUSIVE PATENTS

For controlled  
atmospheric conditions

- TEMPERATURE
- HUMIDITY
- ALTITUDE

ALL UNITS HAVE  
MECHANICAL  
REFRIGERATION



Interior: 30' x 10' x 10'.  
Range: -100° F to  
+250° F with humidity

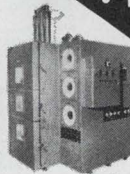

Shock test  
chamber.  
Programmed from  
-125° F to +300° F

Altitude chambers  
in any size and  
combination of  
temperatures

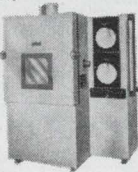

For  
pharmaceutical  
storage  
and other  
applications



Agree models  
in all sizes and  
temperature ranges



Write for new  
brochure No. 6900

Forty-eight pages of  
helpful data on Webber  
environmental chambers

phone  
317-357-8681

**Webber MANUFACTURING CO. INC.**

P. O. BOX 217 • Indianapolis, Indiana 46206

INFORMATION RETRIEVAL NUMBER 56

ELECTRONIC DESIGN 3, February 1, 1974

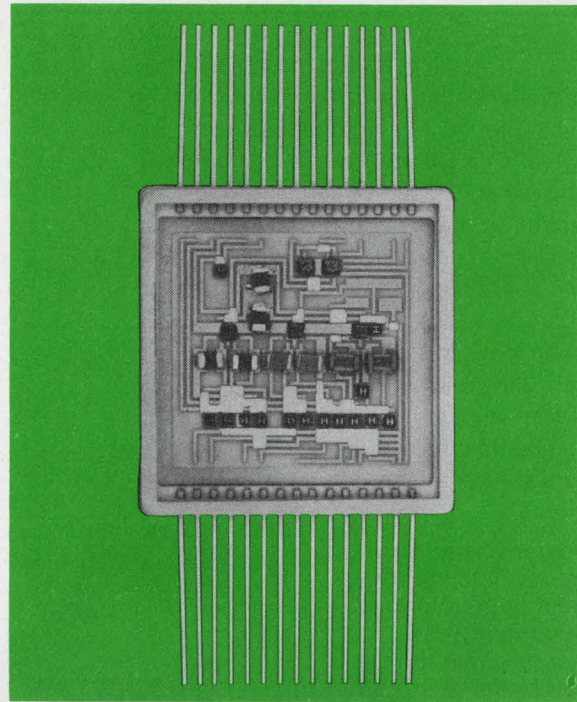

## Custom Hybrids from the custom shop.

## Dickson.

They call us "The Specialists" with good reason when it comes to custom hybrid integrated circuits.

Dickson has over 7 years solid experience in manufacturing custom hybrids to the most exacting Government and customer specifications. In addition to our knowledgeability in thick film techniques, we offer you extensive experience in hermetically sealed packaging for special needs.

Reliability? Dickson custom hybrids are manufactured to Mil-STD 883.

So come to the "Custom Shop" for your custom hybrid needs. And be sure.

"Where Quality Makes the Difference"



**DICKSON**  
ELECTRONICS CORPORATION

PHONE (602) 947-2231 TWX 910-950-1292 TELEX 667-406  
P. O. BOX 1390 • SCOTTSDALE, ARIZONA 85252



INFORMATION RETRIEVAL NUMBER 57



Call Kathy collect at (201) 542-1902 to get all the facts (prices, delivery, samples) on our 2 through 25 amp bridges, and especially our 40 amp full wave rectifier. The Power Physics 40PPR series can significantly reduce your assembly costs. They replace two discrete devices, are electrically isolated and easily handle high cyclic loading rates.

If you're really serious, call Kathy now; or, circle the reader service number to obtain a data sheet.

**Power Physics –  
Specialists in Power  
Semiconductor  
Technology**

Industrial Way West,  
Eatontown,  
N.J. 07724

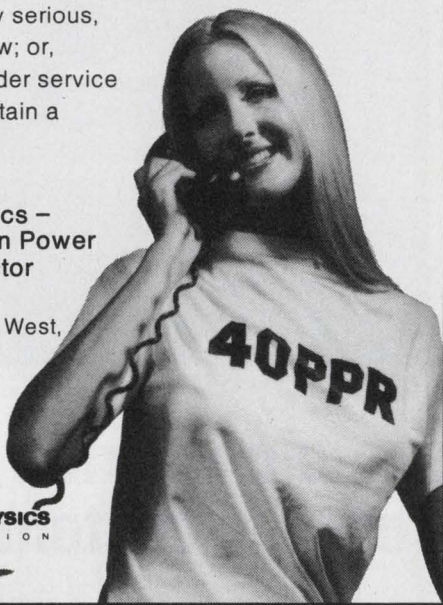

INFORMATION RETRIEVAL NUMBER 58

# Optics can be troublesome!

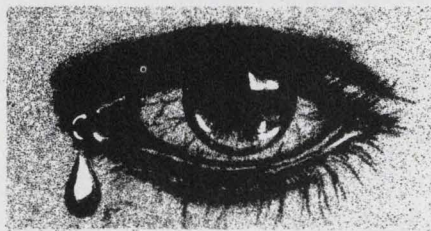

... Consider the alternatives offered by Electro's Sensors:

■ **DI-PROX® Proximity Sensors** — for low-speed motion detection or position control.

■ **DI-MAG® Digital Magnetic Sensors** — for the ultimate in high-speed sensing and synchronization accuracy.

Call or write for complete information



1845 57TH STREET, SARASOTA, FLORIDA 33580  
AREA CODE (813) 355-8411 • TELEX 5-2683

INFORMATION RETRIEVAL NUMBER 59

## ALCOSWITCH

MAGNET & REED SENSOR

Activates at 1 inch distance or less. Wiring simplified with push-in locking connectors. Rated .05 amps @ 100 VAC, 150 VDC. The life expectancy is over 10,000,000 cycles.



RS-51

**ALCO®** ELECTRONIC PRODUCTS, INC.  
1551 Osgood Street, North Andover, Mass. 01845

INFORMATION RETRIEVAL NUMBER 60

## ALCOSWITCH

REMOTE CONTROL RELAY

SPDT Relay plugs directly into AC outlet. Side receptacle accepts remote switch. Available N.O. or N.C. No additional wiring necessary. Operates on 117 VAC.

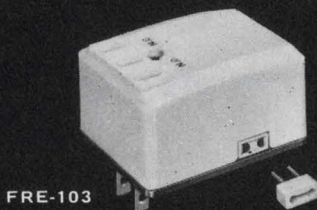

FRE-103

**ALCO®** ELECTRONIC PRODUCTS, INC.  
1551 Osgood Street, North Andover, Mass. 01845

INFORMATION RETRIEVAL NUMBER 61

## THE TRANSFORMER YOU ARE LOOKING FOR IS HERE...

Virtually an unlimited selection—standards, specials or custom designed to your specs. Precision manufactured at very competitive prices. Uniform quality guaranteed.

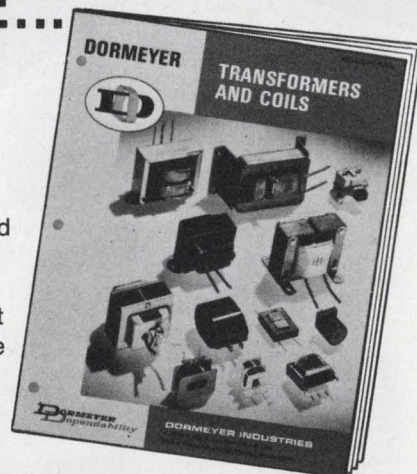

Let us help you.  
Send your specs or requirements.  
Request Bulletin TC73-A for general information.



### DORMEYER INDUSTRIES

A Division of A. F. Dormeyer Mfg. Co., Inc.  
3414 N. Milwaukee Ave., Chicago, Ill. 60641  
Factories: Chicago, Ill., Kentland and Rockville, Ind.  
Telephone: 312-283-4000

Solenoids, Converter Chargers, Transformers, Coils

INFORMATION RETRIEVAL NUMBER 62

ELECTRONIC DESIGN 3, February 1, 1974



## Log amplifiers cover 80 dB dynamic range

Varian, Solid State East, Salem Rd., Beverly, Mass. 01915. (617) 922-6000. \$525.

The ITL-7 detection and video i-f amplifiers provide an input dynamic range of  $-80$  to  $0$  dBm and log accuracy of  $\pm 1$  dB with operating frequencies of 30, 60, 70 or 160 MHz. They also have rise times as low as  $0.03 \mu\text{s}$ . The amplifiers are designed primarily for pulse or AM signals, but most can be supplied with dc coupled input to process cw information. Eight standard versions of the ITL-7 are available, as are special models having linear and limited i-f output. They can also be supplied as matched pairs with the log-video amplitude matched to input within 1 dB.

CIRCLE NO. 283

## Adjustable-speed drives handle 1/4 to 3 hp

Cleveland Machine Controls, 7550 Hub Pkwy., Cleveland, Ohio 44125. (216) 524-8800.

The Series 50 adjustable-speed dc drives operate on 115/230 V, single-phase, 50/60 Hz. They include zero-overshoot current limiting, made possible by cascaded speed and current amplifier stages. Backup safety provisions include fast-acting line fuses or line circuit breakers, a control relay which prevents automatic restart after ac power interruption, plus suppressors for transient voltage and high-frequency electrical noise. Series 50 adjustable-speed drives are available in three basic models: Type O, an open chassis design that saves panel space for OEMs. Type P, that mounts directly on rear of equipment panel with speed pot, start and stop pushbuttons on front side and Type E, a nonventilated, totally enclosed unit offering protection against dust and oil—all models are available in 1/4 to 3 hp ratings, featuring nonreversing and coast-to-stop capability. Several off-the-shelf options are also available, such as tachometer feedback for 1% speed regulation and 100:1 range.

CIRCLE NO. 284

**“ECI is a good place to work, if you’re a good engineer.”**

BRUCE MYERS,  
Senior  
Principal  
Engineer

“We get to design state-of-the-art equipment instead of doing the same old thing all the time. We get to do new and exciting things. We deliver hardware, not paperwork. And there’s no problem of gaining responsibility and advancing yourself. We have a very positive outlook.”

### Career opportunities for electronic engineers:

We have openings at all levels for electronic engineers experienced in the design and development of communications systems, RF, digital, and modem equipment. You’ll be working with major UHF command and control systems, satellite relay and telemetry systems, and a variety of other challenging long-term projects including advanced mail handling systems.

### If your specialty doesn’t match exactly:

If you’re a creative Electronic Design or R & D engineer, really know the fundamentals of electronics, and are highly flexible, we’d like to hear from you. It may well be that you’re the man for us.

ECI is on Florida’s West Coast in sunny, cosmopolitan St. Petersburg. If you’re interested in a career opportunity on long-term programs in a stimulating environment, write in confidence today to William A. Peterson, Personnel Manager, Electronic Communications, Inc., Box 12248, St. Petersburg, Fla. 33733.

**ELECTRONIC COMMUNICATIONS, INC.**

A subsidiary of NCR  
An equal opportunity employer.

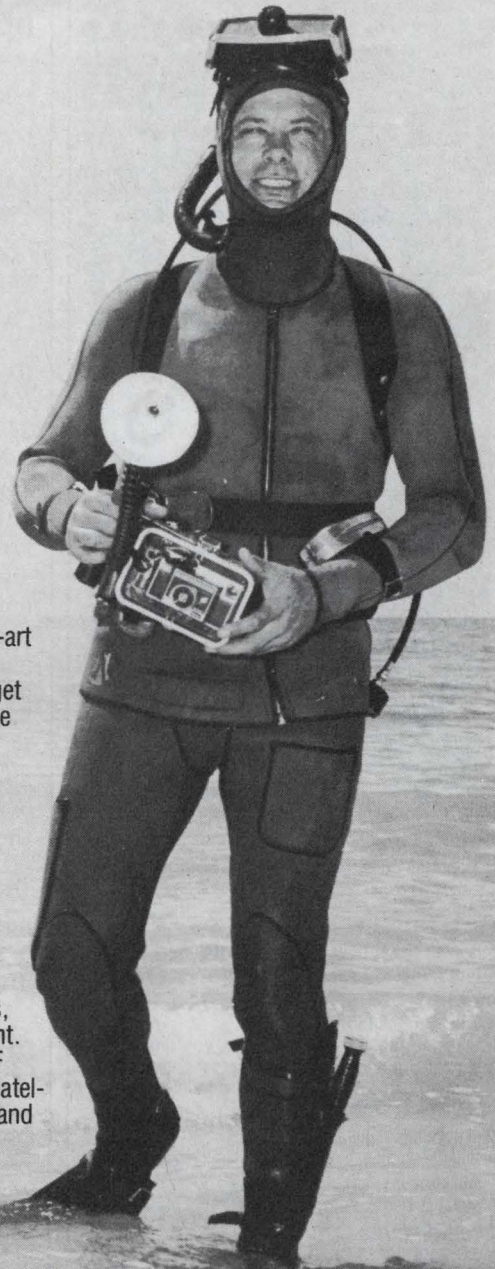



# It pays to be narrow minded

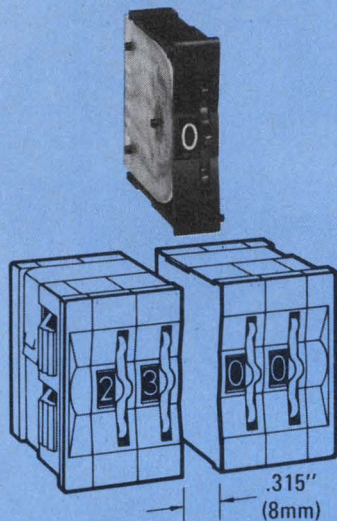

It pays in many ways to use our new Series 23000 narrow SNAP-IN SLIMSWITCHES. They cost less to buy, less to assemble, less to install. They conserve panel space too.

#### "LESS TO BUY"

Prices start at only \$2.50 per switch module... that's only 25¢ per switch function for a 10 position switch.

#### "LESS TO ASSEMBLE"

Using our unique assembly strap, you can stock parts and put switch assemblies together yourself without using tools. We will also build them for you at no extra cost.

#### "LESS TO INSTALL"

Snap-in mounting eliminates installation hardware and tools. The molded-on bezels cover irregular panel cut outs, chipped paint and panel abrasions.

#### "CONSERVES PANEL SPACE"

Width is only .315" (8mm) so you can put more switches into a given space with better readability.

So think "narrow"...think SLIMSWITCH...it really pays.

Send for more information today.

There is a Digitran distributor and sales engineering group near you.

**SNAP-IN SLIMSWITCH**  
SERIES 23000 • ANOTHER SWITCH FROM THE  
**DIGITRAN** COMPANY

Division of Becton, Dickinson and Company [B-D]  
855 South Arroyo Parkway / Pasadena, Ca. 91105  
Telephone: (213) 449-3110 / TWX 910-588-3794

INFORMATION RETRIEVAL NUMBER 63

## MODULES & SUBASSEMBLIES

### Audio amp accepts up to eight inputs



General Aviation Electronics, 4141 Kingman Dr., Indianapolis, Ind. 46226. (317) 546-1111. \$99.95.

The TAU/88 high power audio amplifier delivers 10 W of audio output power. The unit operates from 14 or 28 V dc and can handle eight audio inputs. It has built-in muting circuitry for fast, economical operation and good aircraft-generated noise rejection. The amplifier input impedance is 680  $\Omega$ , low level and 4  $\Omega$ , high level. Sensitivity for low levels is 1 V rms and the high level sensitivity is 5 W into 4  $\Omega$ . Power output for the 3.25  $\times$  2  $\times$  4.625 in module is 10 W at a supply voltage of 14 V dc and 16 W at 28 V dc. Output impedance stays between 3 and 6  $\Omega$  while input isolation is -50 dB.

CIRCLE NO. 285

### V/f converter delivers 0.008% linearity

Intech, 1220 Coleman Ave., Santa Clara, Calif. 95050. (408) 244-0500. \$55 (1 to 9); stock.

The A-847 voltage-to-frequency converter has 0.008% linearity and an adjustable output frequency. It has input range of 0 to 10 V and output of 0 to 10 kHz. Guaranteed operating temperature range is -25 to +85 C. Package size is 1.125  $\times$  1.125  $\times$  1.4 in. The output is an uncommitted collector permitting interface with DTL and TTL logic families. Resolution achieved is equivalent to that of a 13-bit a/d converter. Serial output format allows for two-wire data transmission to magnetic tape or strip-chart recorders. Custom designs for other input voltages or output frequencies are also available.

CIRCLE NO. 286

### Wideband op amp needs only 55 mW

Optical Electronics, P.O. Box 11140, Tucson, Ariz. 85706. (602) 624-8358. \$41 (10 to 29).

The 9827 wideband low-power operational amplifier has differential inputs and a typical power consumption on  $\pm 15$  V supplies of 55 mW. It can operate from batteries with reduced voltage at less than 8 mW and maintain a 30 MHz gain bandwidth product. The 9827 is packaged in a 1.125 in. square by 0.44 in. high module and features: a  $\pm 10$  V/ $\mu$ s minimum slew rate,  $\pm 10$  V at  $\pm 20$  mA minimum output swing,  $\pm 4$  to  $\pm 20$  V power supply voltage range and -55 to +100 C operating temperature range.

CIRCLE NO. 287

### Regenerative drive uses back-to-back SCRs

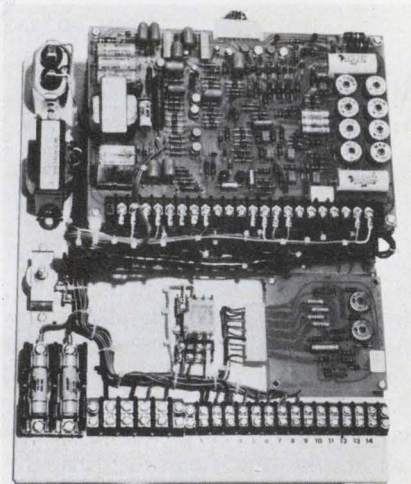

Cleveland Machine Control Inc., 7550 Hub Pkwy., Cleveland, Ohio 44125. (216) 524-8800.

The Series 500 regenerative drive is basically two back-to-back SCR power sources capable of applying controlled current to a dc motor. The power can be applied in either direction—regardless of which way the motor is turning. It can start, accelerate, drive, hold back, decelerate, stop, and reverse a motor in a rapid, smooth, completely controlled manner at a high cycling rate. Series 500 regenerative drives are available in 1/4 to 7-1/2 hp ratings. Input power is 115/230 V, single phase, 50/60 Hz. They include a zero-center potentiometer for changing forward and reverse modes and speed range.

CIRCLE NO. 288



**NEW  
24-page  
Catalog  
FREE**

**RAPIDESIGN**

*makes the  
Professional  
more  
Professional*

1974 CATALOG OF TEMPLATES  
AND LETTERING GUIDES

Write for this new 1974 catalog of our line of quality templates. Over 200 templates including new metric ones are illustrated and described accurately. If you have a special group of symbols and designs that are used constantly our custom-made templates may be a time-saving solution to your problem.

**RAPIDESIGN TEMPLATES... MAKE THE  
PROFESSIONAL MORE PROFESSIONAL**

RapiDesign, Inc., P.O. Box 6039, Burbank, Calif. 91510  
a subsidiary of BEROL CORPORATION

**BEROL**®

INFORMATION RETRIEVAL NUMBER 64

**ABSOLUTELY**  
the world's most  
accurate rulings  
using vacuum deposit  
chrome, etch and fill  
or emulsion processes.  
They're produced on  
the worlds largest 1  
micro inch numerically  
controlled ruling engine  
with interferometric  
feedback controls. Need  
precision scales, grids,  
slits, reticles, Ronchis  
numbers, letters, circles,  
dots, or nickel mesh? We  
stock many items for  
immediate delivery. Send  
for brochure No. 38-36.

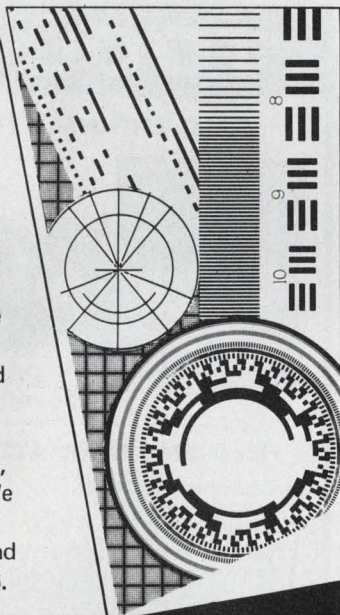

**SCALES RULINGS RETICLES  
& GRIDS FROM THE WORLDS  
LEADING SCALE MAKERS.**

**MICRO-LINE**  
DIVISION OF  
**BAUSCH & LOMB**

JAMESTOWN, NY 14701 716/488-1958

INFORMATION RETRIEVAL NUMBER 65

ELECTRONIC DESIGN 3, February 1, 1974

**10 amps of switching in a 1" cube**

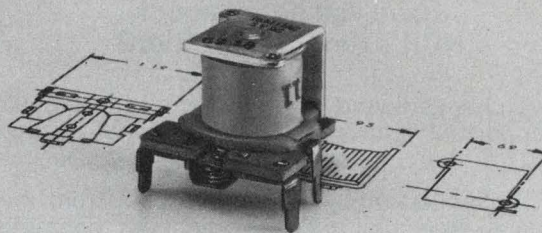

**Series 19 Relay. One of the most compact  
and reliable relays you'll ever use.**

In just one cubic inch, the remarkable Series 19 relay combines the advantages of miniaturization with a capacity to handle heavy switching loads. Result: more performance in a smaller overall package. Yet the cost is low — less than \$2.00 each in 100-piece quantities.

Contact arrangement is SPDT. Rating is 10 amps, 28 vdc or 115 v, 60 hz. Available coil voltages range from 3 to 24 vdc.

Consider the Series 19 relay for low level to 10 amp switching applications such as remote control, alarm systems and similar industrial and commercial uses.

**Send for information now!**

PRICE ELECTRIC RELAYS

**NORTH AMERICAN PHILIPS CONTROLS CORP.**

E. Church & 2nd St. · Frederick, Md. 21701 · (301) 663-5141

INFORMATION RETRIEVAL NUMBER 66

**Greater torque.  
Smaller package.**

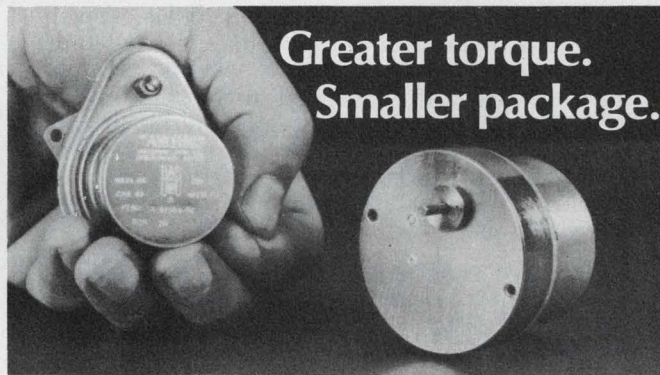

**Compact...reversible...synchronous.  
These low-cost motors are real workhorses.**

When your constant speed applications call for high torque, low power or reversibility, consider these miniature permanent magnet synchronous motors. They not only conserve space but they'll save you money. Low rotor speeds and permanently lubricated bearings assure quiet operation and extended life, as well.

Torque at the rotor shaft is .75 oz-in. @ 300 rpm for the 81300 series (in the hand). Input power is 1.5 watts nominal. Gearing gives a choice of 92 different speed combinations to 1/360 rpm.

Series 81400 gives you 2 oz-in. @ 300 rpm at the rotor shaft. Input power is 3 watts nominal. Gear trains available to lower output speed to 1 rpm.

**Send for information now!**

A. W. HAYDON CO. PRODUCTS

**NORTH AMERICAN PHILIPS CONTROLS CORP.**

A NORTH AMERICAN PHILIPS COMPANY  
Cheshire, Conn. 06410 · (203) 272-0301

INFORMATION RETRIEVAL NUMBER 67



# ENGINEERS

Have you heard about  
NCR's new organization?

We've changed! And in that change there could be opportunity for greater professional involvement for you!

We've changed many of our products from mechanical free-standing equipment to complete electronic systems for business, industry, and diverse government functions. Among other things, they include

- Accounting Computer Systems
- Data Entry Systems
- Data Processors
- Electronic Communication Systems
- Financial Systems
- Postal Systems
- Retail Systems

And we've changed our location! NCR Engineering was once basically in Dayton, Ohio. Now it is California, Ohio, New York, Florida, Kansas and Delaware — wherever the product itself is made!

Now we must staff to meet our goals. Developing the many current products (as well as those yet to come) for complete systems requires professionals with advanced understanding of applied electronics and innovative minds in people who think fresh and new. Business systems is the fastest growing segment of the electronic industry, and our invitation to you is come, grow with us!

If you have experience in digital logic and circuit design for business systems, or if you are software-oriented and knowledgeable with the firmware and hardware that goes into computerized systems, terminals, or mini-computers, contact us now!

Let us know your product interest, your geographic preference and your professional credentials. One of our many divisions will be happy to explore employment with you.

**NCR Worldwide Headquarters**

**Corporate Executive & Professional Placement**

**Dayton, Ohio 45479**

# NCR

An Equal Opportunity Employer M/F

INFORMATION RETRIEVAL NUMBER 902

# LOW-COST ABSOLUTE OPTICAL ENCODERS

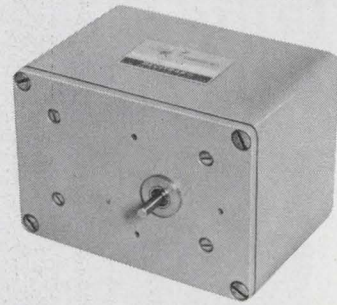

- BCD outputs are DTL/TTL compatible.
- Available range up to 99,999.
- Ultra-reliable LED light source.
- Low-torque, high-speed operation.
- Rugged heavy duty industrial design.
- Operates at 5 VDC.
- External electronics not required.

Contact Theta application specialists today for further details, and ask for our brochure.

*Theta* **INSTRUMENT CORP.**

Specialists in Digital Automation  
Fairfield, New Jersey 07006  
Phone: 201 - 227-1700

INFORMATION RETRIEVAL NUMBER 68

## TOOL KITS

### FIELD ENGINEER TOOL KIT JTK-17



Write for brochure!

More than 100 fine tools used for maintenance and adjustment of electronic equipment, computers and office machines. Small tools are held securely on two removable pallets. Three roomy compartments in the bottom of the deluxe attache' case hold larger tools, optional test meter and parts boxes. A space for service manuals and schematics is provided in the cover.

### FIELD ENGINEER ATTACHE TOOL CASES

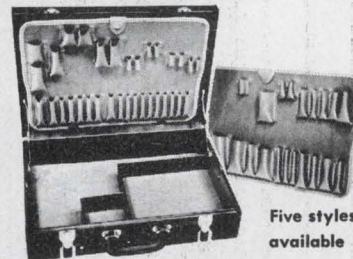

Five styles available

Jensen attache' cases provide a convenient way to carry a large number of tools. Three models are offered: thin-line, standard and extra deep. All cases feature solid wood frames with mahogany paneling and dovetail corners, solid brass hardware and anodized aluminum partitions. Covering is scuff-proof Marvelon. Removable small-tool pallets and partitioned compartments in bottom of the case hold tools securely in a well organized manner. Write for brochure giving dimensions and full details.

### Free Catalog ELECTRONIC ASSEMBLY TOOLS

Lists over 1700 hard-to-find tools used by electronic technicians, instrument mechanics, engineers and scientists. Includes a solder section and four pages of useful "Tool Tips" with valuable data on insulations, color coding, fasteners, and tool selection. Write for your free copy!



**JENSEN TOOLS and ALLOYS**  
4117 N. 44th Street, Phoenix, Arizona 85018

INFORMATION RETRIEVAL NUMBER 69

ELECTRONIC DESIGN 3, February 1, 1974



## new literature

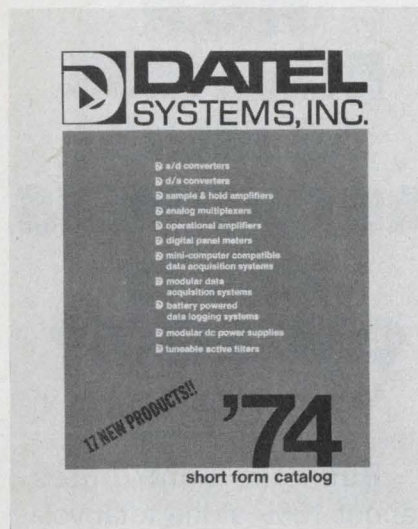

### Data conversion products

A 40-page short-form catalog contains 17 new data conversion products along with electrical and mechanical specifications and over six pages of application information. Datel Systems, Canton, Mass.

CIRCLE NO. 289

### Single-phase bridges

A series of bulletins describes single-phase bridges, doublers, center-tap and three-phase bridges. General Instrument, Hicksville, N.Y.

CIRCLE NO. 290

### PM synchronous motor

A two-page data sheet highlights the Model 105 high-torque permanent magnetic synchronous motor with both mechanical and electrical control. Cramer Div., Conrac, Old Saybrook, Conn.

CIRCLE NO. 291

### Test equipment

A four-page short-form catalog of electrical test equipment includes specifications and operating characteristics for insulation and dielectric breakdown testers, megohmmeters, electrostatic voltmeters, precision kV dividers and high-voltage power supplies. Also included are high-voltage connectors and switches, Wheatstone bridges and resistance decade boxes. Beckman Instruments, Cedar Grove, N.J.

CIRCLE NO. 292

### Microwave power transistors

"Microwave Power Transistors," a 16-page brochure, contains basic design and application information on power transistors for microwave frequencies. RCA, Somerville, N.J.

CIRCLE NO. 293

### Control knobs and switches

Panel knobs and miniature switches are featured in two catalogs. Raytheon, Waltham, Mass.

CIRCLE NO. 294

### Sockets and heat sinks

An 84-page catalog describes and illustrates many types of sockets, heat sinks, washers, mounting pads and heat pipes. Prices are given. Jermyn, San Francisco, Calif.

CIRCLE NO. 295

### Mixers and rf transformers

A 52-page catalog provides data on double-balanced mixers, power splitter/combiners and rf wide-band transformers. The catalog includes definition of terms, reliability considerations, applications, specifications and 365 performance curves. Mini-Circuits Laboratory, Brooklyn, N.Y.

CIRCLE NO. 296

### Microcircuit equipment

A 24-page catalog includes data and pricing for such microcircuit equipment as screen printers, substrate cutoff equipment, substrate drills, diamond scribes, diamond wheels, vacuum encapsulators and furnaces. Aremco Products, Ossining, N.Y.

CIRCLE NO. 297

### Consoles and cabinets

Standard cabinets, monitoring consoles, small instrument cabinets, poly-dimensional instrument/control cabinets are some of the styles illustrated in a 22-page catalog. AMCO Engineering, Chicago, Ill.

CIRCLE NO. 298

# Detectors Are Our Middle Name

United Detector Technology offers the widest variety of silicon photodetectors for the greatest number of applications.

SCHOTTKY BARRIER devices for applications requiring the highest UV sensitivity, largest active areas on fast response.

PLANAR DIFFUSED devices for low noise fast response applications.

MESA DEVICES for high volume low cost ruggedized large area devices.

At UDT our middle name is truly DETECTORS. Write for FREE wall chart, "Spectral Response of Silicon Photodiodes."

Write or call today, United Detector Technology, 1732 21st St., Santa Monica, Calif. 90404, telephone number: (213) 829-3357.



UNITED DETECTOR TECHNOLOGY, INC.

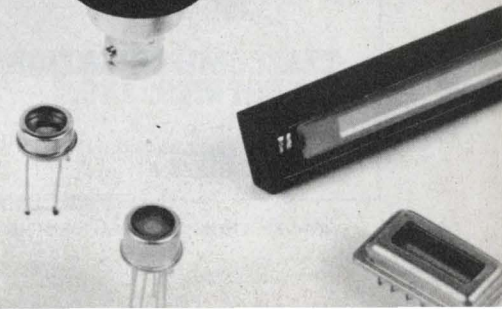



# PURGE THE SURGE

USE TII's 3 ELECTRODE GAS TUBE ARRESTER FOR TOTAL PROTECTION AGAINST METALLIC SURGES

REA ACCEPTED  
UL LISTED

Worldwide Patents:

1,121,300; 1,120,361; 1,455,343;  
3,281,625; 763,540; 3,333,153;  
3,340,431; 788,066; 792,356;  
3,535,779; 3,522,570.



Model 16 (left) is used in all TII Surge Protectors such as Model 316 shown.

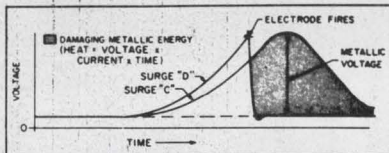

#### TWO-ELECTRODE OPERATION

Graph shows the relatively high transient voltages and, more important, the long duration of heating time applied to the equipment (solid state junctions).

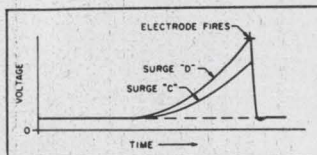

#### THREE-ELECTRODE OPERATION

Graph shows the same spike as before... being arrested and now simultaneously grounding the second leg to achieve two important results. 1 - The transient is reduced. 2 - Solid state punch-throughs are prevented. Metallic Surge Is Eliminated!

DETAILED LITERATURE ON REQUEST



**TELECOMMUNICATIONS INDUSTRIES, INC.**

1375 Akron Street  
Copiague, New York 11726  
(516) 842-5000

## NEW LITERATURE

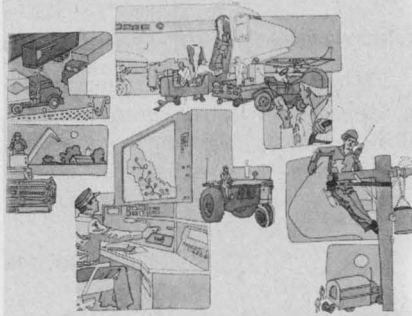

Book 5 Visual Communications

### CCTV accessories

"Visual Communications" describes state-of-the-art features that make CCTV equipment ideal for a variety of applications. The 12-page color brochure covers equipment needed for an effective CCTV installation from low-light-level and high-resolution cameras to video monitors, camera control consoles and other video accessories. Motorola, Schaumburg, Ill.

CIRCLE NO. 299

### Cable ties

Cable ties, clamps, marker ties, push-mount ties and lashing ties are described in an eight-page brochure. Panduit Corp., Tinley Park, Ill.

CIRCLE NO. 300

### Tracking adaptor

Model SAI-502 tracking adaptor, for use with the company's real-time spectrum analyzer/digital integrator, is featured in a two-page bulletin. Features are listed along with a description of controls and indicators, operational specifications and a block diagram. Honeywell, TID, Signal Analysis Operation, Hauppauge, N.Y.

CIRCLE NO. 301

### Integrated packaging

An integrated socket packaging brochure provides the basis for a new concept of electronic packaging. The brochure describes the integrated socket and its supportive hardware, plus outlines on how to work with this concept in a design project. Cambridge Thermionic, Cambridge, Mass.

CIRCLE NO. 302

# DO COLLEGES HELP BUSINESS AS MUCH AS BUSINESS HELPS COLLEGES?

Yes, they do. But not in the same proportion.

Business contributes about 15% of the total voluntary support received by colleges.

But today, business gets half the college-trained people who are employed. Tomorrow, it will need even more.

As a result, businessmen should think seriously about increasing the level of corporate giving to education. Can you, as a businessman, think of a better investment?

For the latest national figures on corporate giving to higher education, write on your letterhead for "CFAE Survey of Corporation Support of Higher Education," and enclose \$2.00 to help cover costs. Mail to: Council for Financial Aid to Education, 6 East 45th Street, New York, N.Y. 10017.

Give to the college of your choice. Now.



Advertising contributed for the public good.



# THE FUTURE IS NOW MODERN TECHNOLOGY AND PACKAGING



# WITH MERET QUALITY OPTOELECTRONIC TRANSMITTERS AND RECEIVERS



Pick a pair of MERET fast response, high performance hybrid transmitter and receiver modules and build your own fuzing, optical communications, rangefinders or power measurement system. MERET can solve your front end problems.

Priced from \$1-\$1,000, available off-the-shelf, ready for immediate delivery or customized. MERET puts them all together.

For more information and a copy of our catalogue, write or phone: MERET, Inc., 1815 24th Street, Santa Monica, California 90404; 213/828-7496.



INFORMATION RETRIEVAL NUMBER 74

ELECTRONIC DESIGN 3, February 1, 1974

## bulletin board

An a/d and d/a converter applications contest has been announced by Micro Networks. The company will reward the most original, complete, and useful application submitted using these devices with a \$1000 U.S. savings bond. Several electronic calculators will be given as runner-up prizes. The contest ends Feb. 15, 1974.

CIRCLE NO. 303

Plessey Semiconductors has introduced a series of vhf frequency dividers, operating at input frequencies to 350 MHz and consuming half the power of comparable devices.

CIRCLE NO. 304

Improvements in execution time by factors of 2 to 28 can be demonstrated for FORTRAN with Hewlett-Packard's 2100 minicomputers. Twelve of the most-often used FORTRAN subroutines are implemented in a 196 ns microcode with the 1290A Fast FORTRAN Processor (FFP). This plug-in package is priced at \$1250.

CIRCLE NO. 305

Electronics interfacing CDC 1700 computers and the company's 6600 television display system have been introduced by Data Disc.

CIRCLE NO. 306

The models Am 8820/20A and Am 8830, high-speed differential line drivers and receivers—pin replacements for similar devices from Texas Instruments and National Semiconductor—are available from Advanced Micro Devices.

CIRCLE NO. 307

Teledyne Semiconductor has announced that 25 popular JFET types are available in the TO-92 package in volume quantities. TO-92 part types include the 2N5457-59, 2N5484-86, 2N5555, 2N5638-40, 2N5653 and 54 and 2N5668-70. Other types are the MPF102 and MPF111 series.

CIRCLE NO. 308

# DOUBLE-BALANCED MIXERS

Great Value at

**\$7<sup>95</sup>**  
500 piece quantities.

\$9.95 in 6-piece quantities.

DC-500MHz  
6dB conversion loss  
40dB isolation  
EMI shielded case

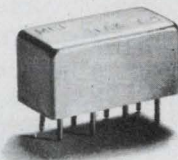

A breakthrough in technology and high production volume enables Mini-Circuits Laboratory to offer these new products at an unprecedented low price.

In today's tough competitive market can you afford not to use these remarkably low priced and high performance units?

Ruggedness and durability are built in the SRA-1. These new units are packaged within an EMI shielded metal enclosure and hermetically sealed header. They use well matched hot-carrier diodes and uniquely designed transmission line transformers.

We invite you to convince yourself. Place your order now and check our delivery, product performance and reliability.

## Mini-Circuits Laboratory

2913 Quentin Rd., Brooklyn, N.Y. 11229  
(212) 252-5252, Int'l Telex 620156  
A Division Scientific Components Corp.

\*FRANCE: S.C.I.E., \*31, rue George-Sand, Palaiseau 91, France \*GERMANY, AUSTRIA, SWITZERLAND: Industrial Electronics GMBH, \*Klüberstrasse 14, 6000 Frankfurt/Main, Germany \*UNITS IN STOCK

ENGLAND: Dale Electronics: Dale House, Wharf Road, Frimley Green, Camberley, Surrey. JAPAN: Denisho Kaisha, Ltd.: Eguchi Building, 8-1, 1-Chrome, Hamamatsucho, Minato-Ku, Tokyo. ISRAEL: Hamashbir Electronics, 76 Giborei Israel St., Tel-Aviv, Israel. \*UNIT IN STOCK.

INFORMATION RETRIEVAL NUMBER 75

107



ELECTRONIC DESIGN's function is:

- To aid progress in the electronics manufacturing industry by promoting good design.
- To give the electronic design engineer concepts and ideas that make his job easier and more productive.
- To provide a central source of timely electronics information.
- To promote communication among members of the electronics engineering community.

**Want a subscription?** ELECTRONIC DESIGN is sent free to qualified engineers and engineering managers doing design work, supervising design or setting standards in the United States and Western Europe. For a free subscription, use the application form bound in the magazine. If none is included, write to us direct for an application form.

If you do not qualify, you may take out a paid subscription for \$30 a year in the U.S.A., \$40 a year elsewhere. Single copies are \$1.50 each.

**If you change your address,** send us an old mailing label and your new address; there is generally a postcard for this bound in the magazine. You will have to requalify to continue receiving ELECTRONIC DESIGN free.

**The accuracy policy of ELECTRONIC DESIGN is:**

- To make diligent efforts to ensure the accuracy of editorial matter.
- To publish prompt corrections whenever inaccuracies are brought to our attention. Corrections appear in "Across the Desk."
- To encourage our readers as responsible members of our business community to report to us misleading or fraudulent advertising.
- To refuse any advertisement deemed to be misleading or fraudulent.

Microfilm copies are available of complete volumes of ELECTRONIC DESIGN at \$19.00 per volume, beginning with Volume 9, 1961. Work is now in process to complete the microfilm edition of Volumes 1-8. Reprints of individual articles may be obtained for \$2.00 each, prepaid (\$.50 for each additional copy of the same article) no matter how long the article. For further details and to place orders, contact the Customer Services Department, University Microfilms, 300 North Zeeb Road, Ann Arbor, Michigan 48106 telephone (313) 761-4700.

**Want to contact us?** If you have any comments or wish to submit a manuscript or article outline, address your correspondence to:

Editor  
ELECTRONIC DESIGN  
50 Essex Street  
Rochelle Park, N.J. 07662

## The First 500-Line Real-Time Spectrum Analyzer-Averager

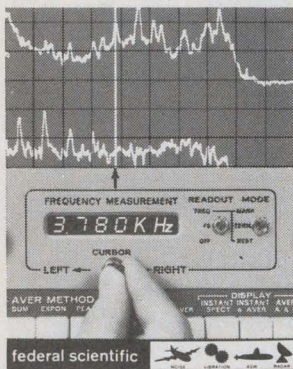

New UA-500, the most powerful analyzer of its type, offers the only standard built-in dual memory averager. Unique digital cursor reads directly in Hz. Portable, small (8-3/4"), for field and lab. **Fastest speed** minimizes test time, presents flicker-free display: real-time to 10 KHz, max. range of 100 KHz, 20 sweeps/sec display rate. **Best possible resolution:** sharpest analysis filter (proprietary 24dB/octave slope) so that 500-line analyzer has effective **650 lines**. Dual memory averager allows simultaneous display of continually updated exponential average & previously stored average. To **verify quality of data**, instantaneous spectra can be viewed on the same CRT as average . . . input time function can also be displayed. Plus other standard features: transient capture, exponential & peak averaging, lin-log scales both vertical & horizontal, complete plotter set-up & recording, computer compatibility with remote sensing or control.

### Federal Scientific Corporation

An Affiliate of Nicolet Instrument  
615 West 131st St., New York, N.Y. 10027 (212) 286-4400

CIRCLE NO. 171

## Low-Noise High-Gain Pre amplification

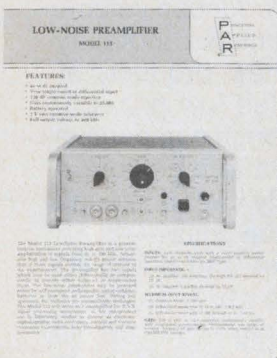

Complete specifications of a variable-bandwidth high-gain preamplifier are contained in the Model 113 data sheet, T-224. Included are typical noise figure contours illustrating the amplifier's exceptionally low noise, which is as low as .05 dB at mid frequencies with a 1 megohm source. Other illustrations include typical plots of the equivalent input noise and common mode rejection, which exceeds 100 dB at 60 Hz at all gain settings. The data contained in the specification sheet will be of interest to all engineers and researchers looking for a preamplifier with calibrated gain and rolloffs from dc to 300 kHz.

### Princeton Applied Research Corporation

Box 2565, Princeton, New Jersey 08540 - (609) 452-2111

CIRCLE NO. 172

## DIGITAL FOURIER ANALYSIS SYSTEM 306

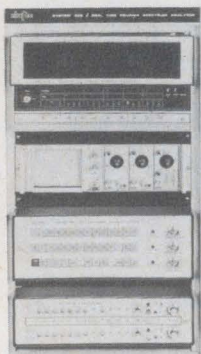

Provides complete spectral, cross spectral, correlation, cross correlation and related analysis.

- One Push Button per function eliminates programming.
- Simultaneous display of two spectra or phase and magnitude.
- Digital storage provides uninterrupted display (flicker-free).
- Drives two XY Plotters simultaneously (doubles throughput).
- Zoom FFT analysis for super high resolution.
- Unique Fourier-Fortran™ for your own non-standard or automated analysis.
- 1/3 and 1/15 octave analysis.

OPTIONAL: Magnetic tapes and discs, high speed plotters, multi processor configurations, multi channel analog multiplexer, teletypes and CRT Terminals.

ALSO AVAILABLE: Medium and high speed hardwired FFT and general purpose array processors for Data General Nova Computers.

### ELSYTEC INC.

212 Michael Drive, Syosset, N.Y. 11791  
Phone (516) 364-0560

CIRCLE NO. 173



# Electronic Design

## Advertising Sales Staff

Tom W. Carr  
Vice President &  
Sales Manager

## Rochelle Park, N.J. 07662

Robert W. Gascoigne  
Daniel J. Rowland

(Recruitment, Quick Ads, Classified)

Allen Weinberg  
50 Essex Street  
(201) 843-0550  
TWX: 710-990-5071

## Philadelphia

Thomas P. Barth  
50 Essex Street  
Rochelle Park, N.J. 07662  
(201) 843-0550

## Boston 02178

Gene Pritchard  
P.O. Box 379  
Belmont, Mass. 02178  
(617) 489-2340

## Chicago 60611

Thomas P. Kavooras  
Berry Conner, Jr.  
200 East Ontario  
(312) 337-0588

## Cleveland

Thomas P. Kavooras  
(Chicago)  
(312) 337-0588  
(call collect)

## Los Angeles 90303

Stanley I. Ehrenclou  
Burt Underwood  
2930 Imperial Highway  
Inglewood, Calif.  
(213) 757-0183

## San Francisco 94022

Jerry D. Latta  
P.O. Box 1248  
Los Altos, Calif.  
(415) 965-2636

## London

For United Kingdom and Europe

John Ashcraft  
John Ashcraft & Co.  
12, Bear St.  
Leicester Square  
London WC2H 7AS England  
Phone: 01-930-0525  
W. J. M. Sanders  
John Ashcraft & Co.  
Herengracht 365  
Amsterdam C., Holland  
Phone: 020-24-09-08

## Tokyo

Haruki Hirayama  
Electronic Media Service  
5th Floor, Lila Bldg.,  
4-9-8 Roppong  
Minato-ku  
Phone: 402-4556  
Cable: Electronicmedia, Tokyo



# OPEN-LINE REED RELAYS

Quality Engineered at Low Cost  
Broad Line . . . From Distributor Stock

An exceptionally high quality line of Form A and Form C open frame reed relays — with up to 6 contacts (Form A) and 4 contacts (Form C) per relay! Available in standard coil voltages 5 to 48 VDC . . . Capable of switching up to 1/2 amp, 250 VDC (Form A) or 1/4 amp, 28 VDC (Form C). Only .350" high by 1.125" long, with terminals on .1" or .15" grid spacing. Electrostatic and electromagnetic shielding optional. Top performance at low cost . . . Tailored to fit your cost/environmental requirements.

Phone, wire or write.

## ELEC-TROL, INC.

26477 N. Golden Valley Road  
Saugus, California 91350  
(213) 788-7292  
TWX 910-336-1556

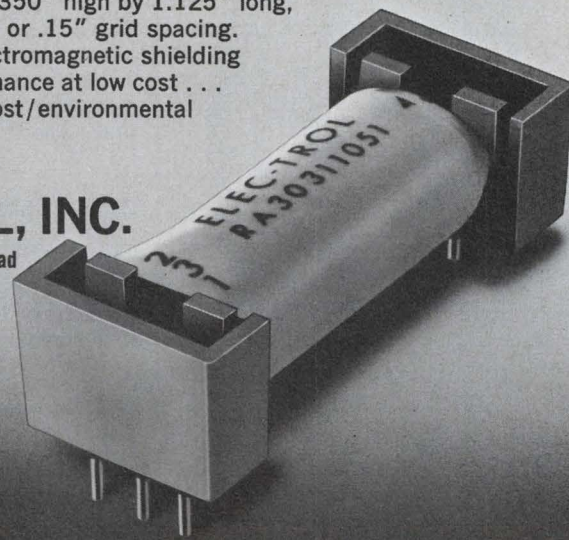

1973-74  
eem  
VOL. TWO

INFORMATION RETRIEVAL NUMBER 76

## LOWEST COST, COMPACT PAGE PRINTER FACIT 4553

- 15 cps
- 80 column
- 5 x 7 dot matrix for character flexibility
- Few moving parts — easy operation, quiet running
- Single print hammer
- No ribbon
- Easy paper loading
- Contains drive circuits and control electronics with character generation
- ASCII code standard
- Also same print method in a strip printer-4552
- Delivery from stock



Facit-Addo, Inc.  
501 Winsor Drive  
Secaucus, N.J. **FACIT-ADDO, INC.**

Gentlemen: I am interested in receiving detailed data on your  4553 Page printer  4552 Strip printer

Name  Title

Phone

Company

Address

City  State  Zip

INFORMATION RETRIEVAL NUMBER 77



# advertiser's index



## hot stuff

or cold, CHR's family of TEMP-R-TAPE of Kapton provides outstanding endurance. They retain their excellent mechanical and electrical properties over a wide temperature range, -100 to +500F.

Available in thicknesses from .001" to .0045" with a choice of several adhesive systems including adhesive two sides.

Find your CHR distributor in the Yellow Pages under "Tapes, Industrial" or in industrial directories. Or write for complete specification kit and sample. The Connecticut Hard Rubber Company, New Haven, Conn. 06509.

# CHR

an ARMCO company

INFORMATION RETRIEVAL NUMBER 78

### Advertiser Page

AMP, Incorporated ..... 33  
Abbott Transistor Laboratories, Inc. .. 6  
Acopian Corp. .... 77  
Airpax, Controls Division ..... 95  
Alco Electronic Products, Inc. ....100  
Allen Bradley Co. .... 29  
American Power Systems Corp. .... 92  
Ansley Electronics Corp. .... 41  
Arnold Magnetics Corp. ....111

Ballantine Laboratories Inc. .... 99  
Burroughs Corporation ..... 22

Capitol Machine & Switch Co.,  
The ..... 98  
Clairex Electronics, A Division of  
Clairex Corporation ..... 49  
Computer Conversions Corp. ....111  
Connecticut Hard Rubber Co., The..110  
Conner-Winfield Corp. .... 90

Dale Electronics, Inc. ....Cover II  
Dana Laboratories, Inc. ..35, 36, 37, 38  
Deltrol Controls ..... 60  
Dialight Corporation ..... 61  
Dickson Electronics Corporation .... 99  
Digitran Company, The .....102  
Dormeyer Industries, Inc. ....100

ECCO ..... 39  
Eagle Magnetic Company, Inc. .... 97  
Eldec Corporation ..... 81  
Elec-Trol Inc. ....109  
Electro Corporation .....100  
Electronic Design .....114  
Electronic Communications, Inc. ....101  
Elsytec, Inc. ....108

Facit-Addo, Inc. ....109  
Federal Scientific Corporation .....108  
Ferranti-Packard, Ltd. .... 93  
Fitchburg Coated Products,  
Division of Litton Industries ..... 20  
Fluke Mfg. Co., Inc., John ..... 43

General Electric Company ..... 96  
General Electric Company, Semi-  
conductor Products Department .. 1  
General Instrument Corporation ..... 31

Hayden Book Company, Inc. ..70D, 111  
Hewlett-Packard .....9 thru 18  
Hoffman Engineering Company .... 93

Ise International Corp. .... 83  
Indiana General, Electronic  
Products ..... 75  
Industrial Timer, A Unit of  
Esterline Corporation ..... 97  
Inselek, Inc. .... 91  
Instruments for Industry Inc. .... 94

Jensen Tools and Alloys .....104  
Jermyn Manufacturing ..... 21  
Johanson Manufacturing Corp. ....111

### Advertiser Page

Kyodo Electronic Laboratories Inc. .. 60

Licon, Division of Illinois Tool  
Works, Inc. .... 97

Meret Inc. ....107  
Microelectronic Device Division,  
Rockwell International .....70C  
Micro-Line, Division of  
Bausch & Lomb .....103  
Mini-Circuits Laboratory .....107  
Mostek Corporation ..... 87

National Cash Register Company,  
Inc. ....104  
Nichicon Corporation ..... 44  
North American Philips Controls  
Corp. ....103  
Nye, William F., Inc. ....111

Optron, Inc., ..... 7  
Oshino Electric Lamp Works, Ltd. .. 94

Power Physics Corporation .....100  
Precision Monolithics, Incorporated.. 45  
Princeton Applied Research Corp. ..108

RCA Electro Optics ..... 79  
RCA Solid State ...70A, 84, Cover IV  
Radio Switch Corporation ..... 92  
RapiDesign, Inc. ....103  
Reticon, Inc. .... 89  
Rogers Corporation ..... 93

Siliconix, Incorporated ..... 50  
Sola Electric, Division of Sola Basic  
Industries ..... 70B  
Sorensen Company, A Unit of  
Raytheon Company ..... 88  
Spectronics, Incorporated ..... 86  
Sprague Electric Company ..... 19  
Sycor, Inc. .... 71  
Syntronic Instruments, Inc. ....112  
Systron-Donner ..... 46

TRW/Cinch Connectors, An Electronic  
Components Division of TRW,  
Inc. ....Cover III  
Tektronix, Inc., .....4, 5, 25  
Telecommunications Industries, Inc. 106  
Teledyne Relays, A Teledyne  
Company ..... 2  
Texas Instruments, Incorporated ..... 67  
Theta Instrument Corp. ....104

USCC/Centralab Electronics Division,  
Globe-Union, Inc. .... 27  
United Detector Technology,  
Inc. ....105, 111

Webber Manufacturing Co., Inc. .... 99



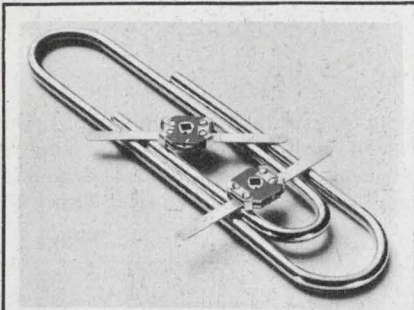

**Thin-Trim variable capacitors** provide a reliable means of adjusting capacitance without abrasive trimming or interchange of fixed capacitors. Series 9401 has high Q's and a range of capacitance values from 0.2-0.6 pf to 3.0-12.0 pf and 250 WVDC working voltage. Johanson Manufacturing Corporation, Boonton, New Jersey (201) 334-2676.

INFORMATION RETRIEVAL NUMBER 181

## UDT PHOTOPS 600

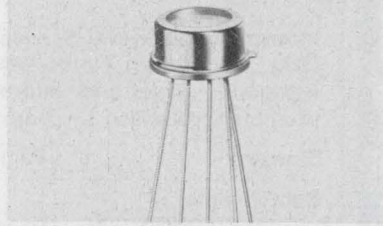

**UDT PHOTOPS 600** high speed detector/amplifier combination has response to 10 megahertz with sensitivity to  $5 \times 10^{-12}$  watts. All PHOTOPS utilize latest FET circuitry and are available to  $1\text{cm}^2$  active area. PHOTOPS may be used as replacements for photomultipliers. United Detector Technology, Inc., 1732 21st Street, Santa Monica, CA.

INFORMATION RETRIEVAL NUMBER 182

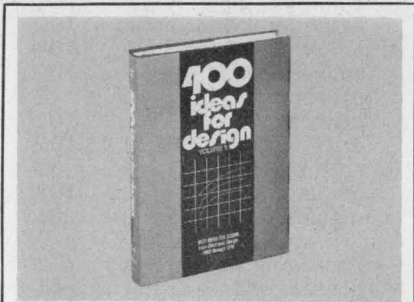

**400 Ideas for Design, Vol. 2**, Edited by Frank Egan. Ready to borrow, modify, or adapt, the top recent contributions to Electronic Design's popular "Ideas for Design" column range from amplifiers to switching circuits. 288 pp., illus., cloth, \$11.95. Circle below for 15-day examination copies. Hayden Book Co., New York, N.Y. 10011

INFORMATION RETRIEVAL NUMBER 183

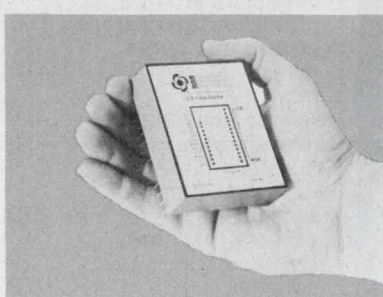

"**Synchro to digital converters** - 10, 12, or 14 bit output, errorless tracking up to 4 r.p.s., accuracy  $\pm 4$  min. of arc  $\pm .9$ LSB, resolution - 1.3 minutes, 60 or 400 Hz input, Module 2.6 x 3.1 x .82" H, Price From \$350 in qty. Computer Conversions Corp., East Northport, N.Y. 11731 (516) 261-3300."

INFORMATION RETRIEVAL NUMBER 184



**Electric contact lubrication and oil creep control** with special aerosols. NYETACT 505 reduces wear and noise on sliding contacts, incl noble metals. NYETACT 510 prevents tarnish, reduces wear on stationary separable contacts. NYE-BAR-F prevents oil creep onto contacts. Wm. F. Nye, Inc., Box G-927, New Bedford, Mass. 02742. (617) 996-6721.

INFORMATION RETRIEVAL NUMBER 185

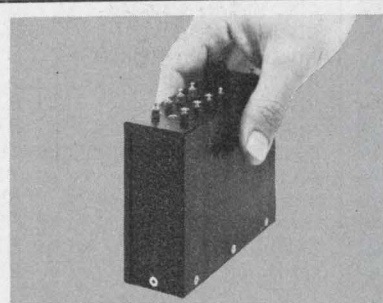

**Big power supply for little spaces.** 115 VAC, 50-500 Hz input. 1 to 6 isolated & regulated DC outputs. 120 W per output. 3.9 W delivered per cu. in. Modular construction lets you "Design-As-You-Order". Over 1200 configurations using off-the-shelf modules. Immediate deliveries! Arnold Magnetics Corp., Culver City, Ca. (213) 870-7014.

INFORMATION RETRIEVAL NUMBER 186

Advertisers wishing to reserve Quick Ad units should note the following mechanical requirements: Specs—Supply glossy photo of product and approximately 40 words which will set no more than 10 lines of 34 characters each. AFTER SUBMISSION NO COPY CHANGES CAN BE ACCEPTED. Quick Ads cost only \$300 per insertion, less for frequency advertisers.

### RATES:

1x  
\$300

7x  
\$280

13x  
\$255

19x  
\$250

26x  
\$245

39x  
\$240

52x  
\$235

104x  
\$230



# syntronic

## OPTIMUM CORNER FOCUS

Is a function of ...

- deflection angle
- light output
- yoke impedance
- display speed
- CRT neck diameter
- CRT length
- yoke production capability

To produce one or one hundred yokes having optimum corner focus requires a thorough knowledge of system design trade-offs.

To see the difference our 25 years of experience can make, let us focus on your yoke problem.



SYNTRONIC INSTRUMENTS, INC.  
100 Industrial Road, Addison, IL 60101  
Phone: (312) 543-6444

## product index

**Information Retrieval Service.** New Products, Evaluation Samples (ES), Design Aids (DA), Application Notes (AN), and New Literature (NL) in this issue are listed here with page and Information Retrieval numbers. Reader requests will be promptly processed by computer and mailed to the manufacturer within three days.

Category	Page	IRN	Category	Page	IRN
<b>Components</b>			counter	96	276
arrays, optoelectronic	7	6	counter, digital	99	55
capacitor, ceramic chip	27	12	DMM	96	275
capacitors	96	50	generator, pulse	98	280
capacitors, electrolytic	19	7	meter	35	243
capacitors, mica	31	14	meter, level	98	279
chips, capacitor	94	271	recorder	20	8
components	75	29	relays, meter	98	281
connector	92	270	scales	103	65
detectors	105	70	tester, IC	96	277
displays	83	33	thermometer, digital	96	278
keyboard	95	273	transmitters, receivers	107	74
LEDs	61	26			
motors	103	67	<b>Modules &amp; Subassemblies</b>		
opto-coupler	1	1	amplifier, log	101	283
protector, overvoltage	88	37	amplifier, power audio	102	285
protectors, surge	106	72	amplifiers, power	94	47
relays	100	60	converter, v/f	102	286
relays	103	66	converters, I/O	2	2
relays, general-purpose	60	24	drive, dc-speed	101	284
relays, reed	109	76	drive, regenerative	102	288
resistor, film	94	272	op amp	50	23
resistors, film	11	3	op amp, low power	102	286
sensors	100	59	regulators, voltage	84	34
sensors, proximity	100	58			
switch, toggle	95	274	<b>Packaging &amp; Materials</b>		
switches	97	53	boards, PC	41	17
switches	98	54	boards, socket	39	16
switches	102	63	chambers, environmental	99	56
switches, pushbutton	94	48	consoles	93	45
switches, rotary	92	42	fasteners, snap-in	91	266
timers, delay	97	51	magnetic shielding	97	52
transducers, rotary	92	269	marking kit	91	268
transformers and coils	100	63	mini/bus	93	44
trimmers	29	13	mounting for LEDs	90	264
tube driver	60	25	page packaging system	91	267
yokes	112	79	paint, conductive	90	265
			tape	110	78
<b>Data Processing</b>			templates	103	64
calculator, graphic	25	11	tools	104	69
disc drive, flexible	85	252			
display, plasma	87	258	<b>Power Sources</b>		
floating-point device	85	255	supply, power	81	32
interface, data	85	253	supply, power	92	43
interface, data	87	259			
minicomputers	87	256			
parallel processing system	79	31	<b>new literature</b>		
recorder, cassette	71	28	adaptor, tracking	106	301
recorders, event	85	250	bridges, single-phase	105	290
terminal, CRT	85	251	CCTV accessories	106	299
terminal, CRT	87	257	consoles and cabinets	105	298
terminal, POS	85	254	control knobs, switches	105	294
			data conversion products	105	289
<b>ICs &amp; Semiconductors</b>			equipment, microcircuit	105	297
ICs	89	262	equipment, test	105	292
op amp, quad	89	263	mixers, rf transformers	105	296
RAM, SOS/CMOS	91	41	motor, PM synchronous	105	291
register and arith. logic unit	88	261	packaging, integrated	106	302
transistor	88	260	sockets and heat sinks	105	295
transistors	45	20	ties, cable	106	300
			transistors, microwave	105	293
<b>Instrumentation</b>					
averager, signal	98	282			



# recruitment and classified ads

## FREE ALARM CATALOG

Full line of professional burglar and fire alarm systems and supplies. 80 pages, 400 items. Off the shelf delivery, quantity prices.

 mountain west alarm  
4215 n. 16th st., phoenix, az. 85016

CIRCLE NO. 231

## Engineers / Technicians

We are representing several suburban N.Y.C. electronics firms who are currently seeking many qualified Engineers and Technicians on all levels with diverse Analog/Digital, Hydraulic and optical backgrounds.

R. W. STERLING LTD.  
140 MAMARONECK AVE.  
WHITE PLAINS, N.Y. 10601 (SUITE 6)  
(914) 428-5140

## SCOPES UNLIMITED IS NOT LIMITED TO SCOPES

Complete line of new and used electronic test equipment.

## SCOPES UNLIMITED, INC.

1938 S. Anaheim Blvd.  
Anaheim, Ca. 92805  
(714) 772-0330  
East Coast Office (617) 894-5670



## Take stock in America.

### Buy U.S. Savings Bonds

Now E Bonds pay 5½% interest when held to maturity of 5 years, 10 months (4% the first year). Bonds are replaced if lost, stolen, or destroyed. When needed they can be cashed at your bank. Interest is not subject to state or local income taxes, and federal tax may be deferred until redemption.



The U. S. Government does not pay for this advertisement, it is presented as a public service in cooperation with The Department of the Treasury and The Advertising Council.

## IMMEDIATE DELIVERY

Minis & Peripherals  
DEC - HIS - NOVA  
SEL - HP - MOHAWK

CPU, Card, Printer, Tape, Disk  
NEW • MOHAWK 4320  
PRINTERS

PDP11 PERIPHERALS  
CPU, MEMORY

PDP 8 CPU \$1500

\$750 Minis

TELETYPE 35 & 37  
DEC & HONEYWELL Modules  
617/261-1100

Send for Free Report "Maintenance of Computers"

AMERICAN USED COMPUTER CORP.  
P.O. Box 68, Kenmore Sta.  
Boston, MA 02215

CIRCLE NO. 232

**PERSONNEL  
RECRUITMENT  
ADVERTISING  
IN  
Electronic Design  
REACHES THE  
RIGHT PEOPLE  
AT A LOWER COST  
PER THOUSAND**

*Call the  
HOTLINE  
today  
for complete  
information:  
(201) 843-0550  
extension 203*





# Don't Miss This Boat!

There's still time to enter *Electronic Design's* 1974 Top Ten Contest. You can win a free Windjammer Cruise in the Caribbean . . . \$1,000 in cash . . . free jet transportation . . . color TV . . . Bulova electronic timepieces . . . free ad reruns. There are 100 prizes in all!

Complete information and rules appeared in the Jan. 4 issue. Dig out your Jan. 4 copy and enter the contest now. (If the entry cards are all torn out, you can use the form that is printed below.) Entries must be postmarked before midnight, February 15.

**DO NOT SELECT ADS FROM THIS ISSUE — USE ELECTRONIC DESIGN ISSUE NO. 1 — THE TOP TEN CONTEST ISSUE — PUBLISHED JANUARY 4, 1974**

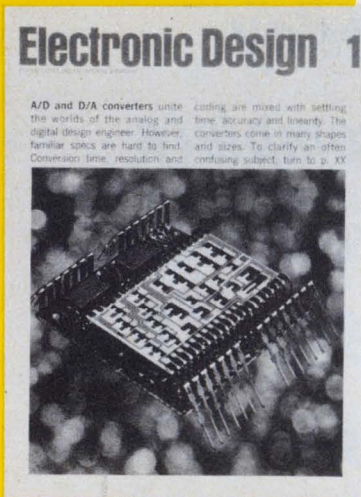

## 1974 SUPER TOP TEN CONTEST

HERE'S MY ENTRY FOR:

READER CONTEST       ADVERTISER CONTEST

I have read all of the rules and estimate that the "Top Ten" advertisements receiving the highest Reader Recall "Percent Seen" scores in the January 4, 1974 issue will be:

ADVERTISEMENT OF: (Company or Organization)		INFORMATION RETRIEVAL NUMBER
1		
2		
3		
4		
5		
6		
7		
8		
9		
10		

Do not include the advertisements of Electronic Design, Hayden Publishing Company, or divisions. Show Information Retrieval Number. DO NOT show page numbers.

**ENTRY MUST BE POSTMARKED BEFORE  
MIDNIGHT FEBRUARY 15, 1974**

ENTRANT'S NAME \_\_\_\_\_  
 COMPANY \_\_\_\_\_ TITLE \_\_\_\_\_  
 ADDRESS \_\_\_\_\_  
 CITY \_\_\_\_\_ STATE \_\_\_\_\_ ZIP \_\_\_\_\_

Clip and mail to: Top Ten Contest, c/o Electronic Design,  
50 Essex Street, Rochelle Park, New Jersey 07662.



# Cinch Dura-Con 0.050" centers Small. Dependable. Available.



Now you have an effective source for your micro-miniature connector needs. Cinch can produce and deliver these rugged reliable connectors on a timely basis, with size 24 contacts on 0.050" centers.

These connectors utilize the proven pin-socket contact system, where the pin, made from a precision spring cable, is the spring member. The seven cable strands are fused in a hemispherical weld, resulting in a strong flexible shock and vibration resistant contact with assured alignment and no discontinuities.

The Dura-Con pin is available in five sizes of Dura-

Con D-configurations as well as single row strip configurations. It can also be supplied in custom insulators.

The size 24 contacts with 0.050" centers are supplied factory terminated, with pigtail or wire leads. Size 22 contacts, on 0.075" and 0.100" centers, are crimp removable.

Cinch Dura-Con Micro-Miniature Connectors are described in Bulletin PBC-174, available from Cinch Connectors, an Electronic Components Division of TRW Inc., 1501 Morse Avenue, Elk Grove Village, Illinois 60007, (312) 439-8800

CM-7305

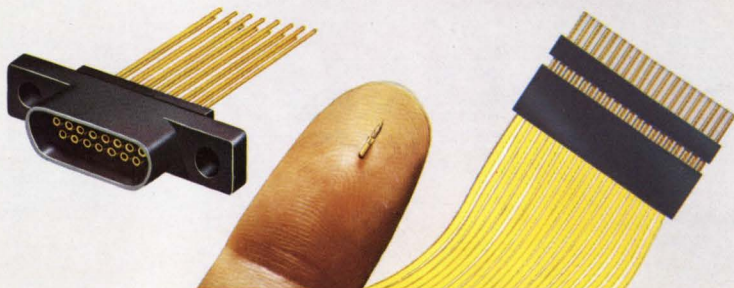

**TRW** CINCH CONNECTORS

INFORMATION RETRIEVAL NUMBER 245



# Linear COS/MOS... RCA's CA3600E premieres

CA3600E schematic diagram

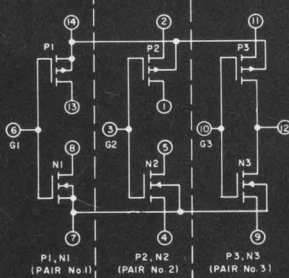

CA3600E transistor pair biased for linear-mode operation

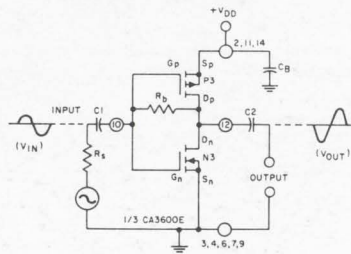

Analog timer using CA3600E

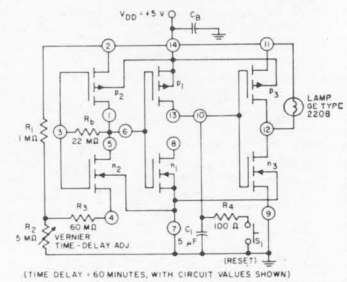

Meet the linear IC with the advantages of COS/MOS. The new RCA CA3600E Transistor Array... three pairs of complementary enhancement-type MOS (p-channel/n-channel) transistors on a single chip.

The CA3600E is designed for a great variety of applications requiring virtually infinite input impedance, wide bandwidth, matched characteristics, lower power consumption and general purpose circuitry.

And that's not all. With the new CA3600E you get performance advantages that include square-law characteristics, superior cross-modulation performance, and a greater dynamic range than bipolar transistors.

Whether you're working in timing, sensing and measuring or any other applications, or if you're tired of fighting beta variation in your bipolar circuit, let your "linear" imagination run wild. The features offered in the new CA3600E COS/MOS Linear IC

are too good to pass up.

- Virtually infinite input resistance/ 100 gigohms
- Each transistor rated for operation up to 15V and 10 mA
- Low gate-terminal current/ 10 picoamps
- No "popcorn" (burst) noise
- Matched p-channel pair/gate-voltage differential ( $I_b = -100\mu A$ ) ...  $\pm 20mV$  (max)
- Stable transfer characteristics over a temperature range of  $-55^\circ C$  to  $+125^\circ C$
- High voltage gain/up to 53dB per COS/MOS pair.

Supplied in the 14-lead dual-in-line plastic package, the CA3600E is available in production quantities from your local distributor or direct from RCA.

For complete data sheet/application note write: RCA Solid State, Section 57B-1, Box 3200, Somerville, N.J. 08876. Or phone: (201) 722-3200.

**RCA** Solid State  
products that make products pay off