

Electronic Design. 14

FOR ENGINEERS AND ENGINEERING MANAGERS

VOL. 24 NO. 7
JULY 5, 1976

Trace μ P hangups automatically.
A new troubleshooter checks out the hardware and software of any μ P system. Use the instrument to unravel program loops without

tedious manual steps. A search mode runs through thousands of instructions in a flash. LEDs show binary addresses and data. Jump into the loop on page 75.



Unique wrap-around wiper offers superior setting stability...

Wrap-around, multi-finger wiper reduces contact resistance variation and open circuit problems. Micro-photograph shows trimmer wiper magnified 28X.

... here today at no extra cost in every Trimpot® Potentiometer

Bourns multi-fingered, wrap-around wiper design delivers more consistent, more reliable performance. More stable during setting ... more stable in your circuit.

The unique wrap-around design significantly reduces CRV fluctuations and open circuit problems due to thermal and mechanical shock ... by maintaining a constant wiper pressure on the element. As you can see in the enlarged photograph of a sectioned single-turn trimmer, the wiper is shaped so that its upper section works somewhat like a lever arm, keeping the contact fingers under constant tension.

Bourns wrap-around wiper design is essentially self-aligning and self-retaining. Therefore, more reliable ... because there is very little chance of error during manufacture. Designs that do not "wrap-around" usually require very critical heat-staking procedures to lock the wiper into a plastic slot in the rotor (slider). Our tests indicate that such designs are much less resistant to thermal and mechanical shock, and are often mis-assembled.

HERE'S PROOF:

Send for a copy of our new engineering report on TRIMMER PERFORMANCE. Tell us about your application, and we'll provide qualification samples that best suit your needs.

Bourns reliability is available at ordinary prices ... off-the-shelf from nearly 100 local distributor inventories ... plus our largest-ever factory stock. TRIMMER PRODUCTS, TRIMPOT PRODUCTS DIVISION, BOURNS, INC., 1200 Columbia Avenue, Riverside, California 92507. Telephone 714 781-5320 — TWX 910 332-1252.

Swage-Bond™ ... a revolution in trimmer reliability

Bourns exclusive Swage-Bond process virtually eliminates pin termination failure ... and provides a marked improvement in temperature coefficient consistency. In the Swage-Bond process, the P.C. pins are secured through the trimmer substrate, with a high-pressure compression swage on both the top and bottom sides. The pressure locks the pins solidly into the element, and thoroughly bonds them to the termination material. Compare Swage-Bond™ to less reliable clip-on termination designs.



The seal that seals ... without springback

Bourns trimmers stay sealed when others fail. We know. We've tested them all. Bourns uses a chevron-type sealing technique, that seals without O-rings ... eliminating the windup and springback that frequently occurs with such seals. The result is faster and more precise adjustability ... with a seal that really works.

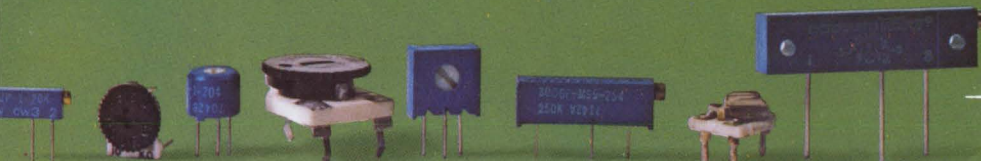

International: HQ Switzerland, 042/23 22 42 • Belgium 02/218 2005 • France 01/2039633 • Germany 0711/24 29 36 • Italy 02/32 56 88 • Netherlands 070/88 93 18 • United Kingdom 01/572 6531 • Japan 075 92 1121 • Australia 86 9410 • Brazil 257-3535 • India 373 544



Buy our ASCII programmable function generators and you'll be ready for the bus.

If you've been looking for a function generator that plugs into an automatic system about as easily as it plugs into the wall, Wavetek is your stop. Our Models 152 and 159 are both ASCII coded and are fully compatible, which means they can be used with the new IEEE Std. 488 instrumentation bus . . . and just about any computer. They also have pushbutton manual controls if

you'd rather keep them on the bench. Either way, you'll be able to see what's happening with the LED digital display panels.

Model 159 is a general-purpose low-cost function generator with programmable frequency, amplitude, offset and waveform. Its frequency range is 1 Hz to 3 MHz.

Model 152 provides two to

eight separate outputs, each with individually programmable phase, amplitude, waveform and offset. Frequency is programmable from 1 Hz to 100 kHz. For more information, contact Wavetek, P.O. Box 651, San Diego, CA. 92112. Telephone (714) 279-2200, TWX 910-335-2007.

WAVETEK®

CIRCLE NUMBER 2

The only Double-Balanced Mixers with a 2-YEAR GUARANTEE*

featuring Hi-Rel tested diodes-

still only

\$7.95

(500 pieces)
\$9.95 (1-49)

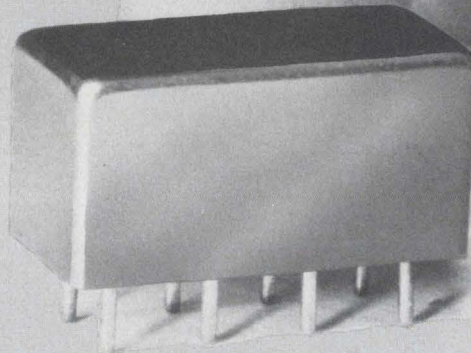

* including diodes!

Yes, a two-year guarantee for DBM's is now a reality . . . made possible by an accelerated-life diode screening program adopted at Mini-Circuits.

Each Schottky diode used in Mini-Circuits' SRA-1 mixers is now preconditioned by the HTRB (High Temperature Reverse Bias) technique, previously reserved almost exclusively for semiconductors assigned to space applications. With HTRB testing, each diode is operated for 168 hours at 150°C with one volt reverse bias applied.

To screen out "infant mortality", the diodes are deliberately stressed to accelerate aging and to force time-related failure modes to take their toll. In conventional testing or "baking", the diode does not experience anywhere near the stress encountered with the HTRB program. Hence, the ability at Mini-Circuits' to locate the potentially-unreliable diodes before they are assembled into SRA-1 units And, with double-balanced mixers, the overall reliability hinges almost entirely on the diodes used.

Yes, the HTRB procedure costs us more and screens out more devices. But our goal is to improve reliability to a level unmatched for off-the-shelf DBM's at no increase in cost to our customers. You — our customers by your overwhelming confidence in our product line have made us the number one supplier of DBM's in the world.

To earn your continuing support, we are now employing HTRB Hi-Rel testing for every diode used in the SRA-1, at no increase in cost to you. So, for the same low price of \$7.95, you can purchase our SRA-1, with a two-year guarantee, including diodes.

To ensure highest system reliability demand highest quality diodes on your source-control drawings and purchase orders. Specify SRA-1 mixers, with HTRB tested diodes from Mini-Circuits!.. where low price now goes hand-in-hand with unmatched quality.

MODEL SRA-1

Freq. range (MHz) LO - 0.5-500, RF 0.5-500, IF dc-500

Conversion loss (dB) **Typ. Max.**

One octave from band edge 5.5 7.5

Total range 6.5 8.5

Isolation (dB) **Typ. Min.**

Lower band edge to LO-RF 50 35

one decade higher LO-RF 45 30

Mid range LO-RF 45 30

LO-IF 40 25

Upper band edge to LO-RF 35 25

one octave lower LO-IF 30 20

Min. Electronic attenuation (20 mA) 3 dB

Signal, 1 dB compression level + 1 dBm

Impedance all ports 50 ohms



Mini-Circuits Laboratory

A Division Scientific Components Corp

837-843 Utica Avenue, Brooklyn, NY 11203
(212) 342-2500 Int'l Telex 620156
Domestic Telex 125460

International Representatives:

AUSTRALIA General Electronics Services, 99 Alexander Street, New South Wales, Australia 2065; **ENGLAND** Dale Electronics, Dale House, Wharf Road, Frimley Green, Camberley Surrey; **FRANCE** S. C. I. E., D. I. M. E. S., 31 Rue George Sand, 91120 Palaiseau, France; **GERMANY, AUSTRIA, SWITZERLAND** Industrial Electronics GMBH, Klüberstrasse 14, 6000 Frankfurt/Main, Germany; **ISRAEL** Vectronics, Ltd., 69 Gordon Street, Tel Aviv, Israel; **JAPAN** Denso Kaisha, Ltd., Eguchi Building, 8-1 1 Chome Hamamatsucho Minato-ku, Tokyo; **EASTERN CANADA** B. D. Hummel, 2224 Maynard Avenue, Utica, NY 13502 (315) 736-7821; **NETHERLANDS, BELGIUM, LUXEMBOURG:** Coimex, Veldweg 11, Hattem, Holland; **NORWAY** Datamatik AS, Ostensjoveien 62, Oslo 6, Norway

US DISTRIBUTORS:

NORTHERN CALIFORNIA Cain White & Co., Foothill Office Center, 105 Fremont Avenue, Los Altos, CA 94022 (415) 948-6533; **SOUTHERN CALIFORNIA, ARIZONA** Crown Electronics, 11440 Collins Street, No. Hollywood, CA 91601 (213) 877-3550

For complete product specifications and U.S. Rep. listing see MicroWaves "Product Data Directory," Electronic Designs' "Gold Book" or Electronic Engineers Master "EEM"

NEWS

- 17 **News Scope**
- 20 **High-resolution electron-beam pictures** reveal hidden LSI-chip defects.
- 22 **Satellite-borne microwave sensors** to improve weather forecasting.
- 26 **Pulse-compression antennas** developed by Air Force convert milliwatts into watts.
- 31 **Washington Report**

TECHNOLOGY

- 35 **MICROPROCESSOR DESIGN**
- 40 **FOCUS on crystals for frequency control:** Manufacturers' data—for characteristics like frequency stability, aging rate, pullability and spurious response—may be inadequate or misleading for the circuit designer.
- 46 **Blend a wideband PLL** with a narrowband loop, and boost frequency-synthesizer performance. The benefits: low noise, high resolution and low cost.
- 52 **The average efficiency** of rf power amplifiers depends upon the type of signal. A nomogram can easily convert point-value efficiencies to over-all averages.
- 56 **Build precision reference sources** without expensive parts or tight error budgets. With functional trimming, individual component errors are all compensated together.
- 62 **Ideas for Design:**
Simple regulator circuits provide tracking bipolar reference voltages. Computer sound effects generated with only four ICs. Logarithmic amplifier's range is extended down to 1 pA.
- 72 **International Technology**

PRODUCTS

- 75 **Instrumentation:** Microprocessor analyzer untangles knots in both software and hardware.
- | | |
|----------------------------|----------------------------|
| 78 Modules & Subassemblies | 86 Integrated Circuits |
| 82 Power Sources | 88 Discrete Semiconductors |
| 84 Components | 89 Packaging & Materials |

DEPARTMENTS

- 39 **Editorial:** Abolish the first day
- | | |
|-----------------------|-------------------------------|
| 7 Across the Desk | 96 Product Index |
| 90 New Literature | 96 Information Retrieval Card |
| 94 Advertisers' Index | |

Cover: Photo by William Skeahan, courtesy of Systron-Donner Corp.

Programmable, parallel I/O lets you define the direction and data transfer characteristics of six 8 bit I/O ports. Reconfigure the interface or entirely alter the I/O structure by changing no more than four program instructions.

Plug-in standard TTL drivers or line terminators to easily tailor the I/O interface to meet your system requirements.

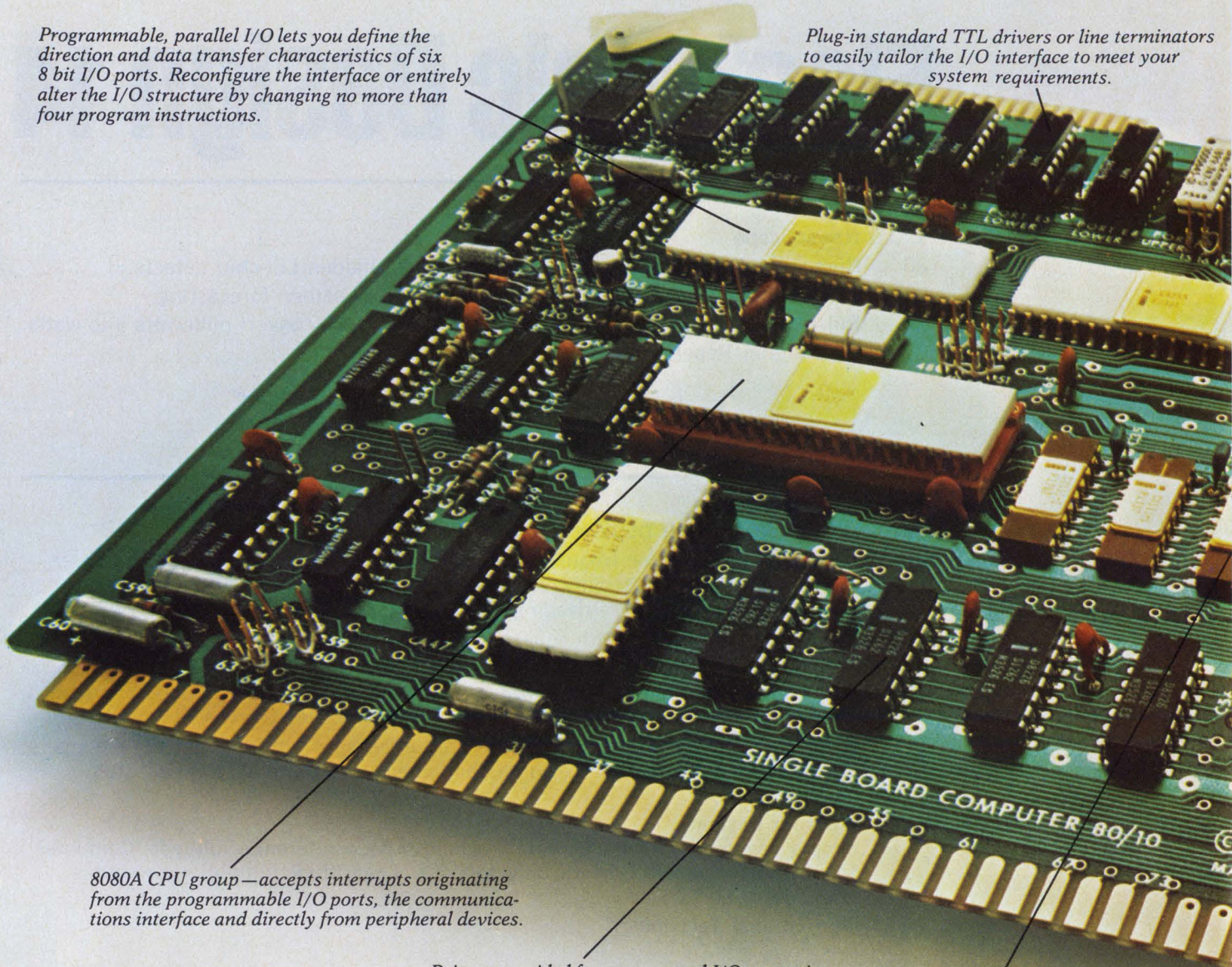

8080A CPU group—accepts interrupts originating from the programmable I/O ports, the communications interface and directly from peripheral devices.

Drivers provided for memory and I/O expansion. Simply plug any of the SBC 80 RAM, EPROM/ROM, I/O or Combination expansion boards into the standard SBC 80 card cage.

1K bytes of high speed, low power static RAM.

The first complete single

The Intel® SBC 80/10 Single Board Computer, with programmable I/O, is designed for the profit conscious OEM in a hurry. The SBC 80/10 is the fastest and lowest cost way of getting your products to market. And when your equipment sales increase to the point where it makes sense to build your own Single Board Computer, we'll make arrangements for you to use our bill of material, fab and assembly drawings, and artwork.

Now it's possible to standardize on one computer board for all your products. Everything you need—CPU, ROM, RAM and I/O is on a single 6.75" x 12"

board. And since we've extended the programmable nature of the CPU to the I/O interface you can use the same board even when you make an interface change or completely redesign your product's input/output section. Just initialize the programmable I/O devices with the appropriate program instructions and you have individually defined the direction and data transfer characteristics of the six on-board ports. Programmable I/O makes your products more versatile and cuts parts cost and development time.

Cut development costs even more with the Intellec

Programmable serial interface lets you choose virtually any asynchronous or synchronous communications technique. Data format, control character format, parity, and asynchronous serial transmission rates are all under program control.

Both teletypewriter and RS 232C interfaces are included, choose the one you need.

Selectable baud rate generator—pick the communications frequency you want.

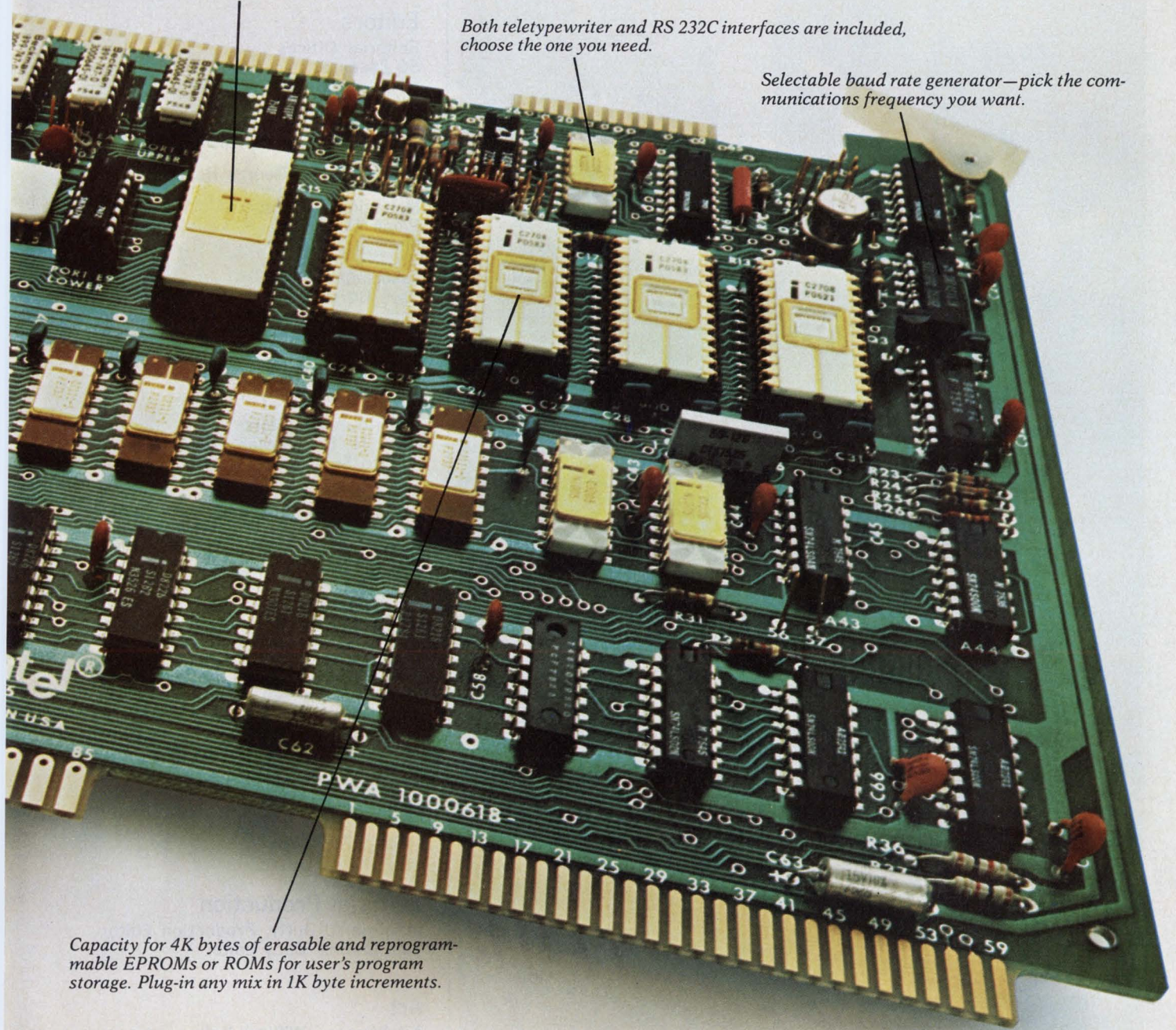

Capacity for 4K bytes of erasable and reprogrammable EPROMs or ROMs for user's program storage. Plug-in any mix in 1K byte increments.

board computer for \$295.*

MDS™ Microcomputer Development System with optional Diskette Operating System and unique ICE-80 In-Circuit-Emulator. Develop and debug your system software directly on the SBC 80/10 using the symbolic debugging capability of ICE-80.

The 80/10 is supported by macroassemblers, text editor, Intel's PL/M™ compiler, a user's library with over 150 programs, and comprehensive documentation.

Training is available at training centers or scheduled at your plant. For additional technical assistance contact your Intel Field Applications Engineer.

The Intel® SBC 80/10 is available from distributor stock. To order contact: Almac/Stroum, Component Specialties, Components Plus, Cramer, Elmar, Hamilton/Avnet, Industrial Components, Liberty, Pioneer, Sheridan, or L.A. Varah.

For your copy of the SBC 80/10 brochure, use the bingo card or write: Intel Corporation, 3065 Bowers Avenue, Santa Clara, California 95051.

intel® delivers.

CIRCLE NUMBER 4

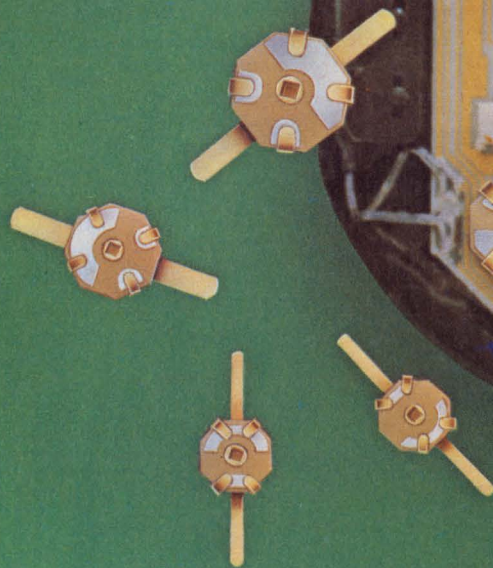

Thin-Trim[®] capacitors

Tucked in the corner of this Pulsar Watch is a miniature capacitor which is used to trim the crystal. This Thin-Trim capacitor is one of our 9410 series, has an adjustable range of 7 to 45 pf, and is .200" x .200" x .050" thick.

The Thin-Trim concept provides a variable device to replace fixed tuning techniques and cut-and-try methods of adjustment. Thin-Trim capacitors are available in a variety of lead configurations making them easy to mount.

A smaller version of the 9410 is the 9402 series with a maximum capacitance value of 25 pf. These are perfect for applications in sub-miniature circuits such as ladies' electronic wrist watches and phased array MIC's.

The logo for Johanson, featuring the name "Johanson" in a stylized, cursive script font, enclosed within a thin, dark oval border.

Johanson Manufacturing Corporation
Rockaway Valley Road
Boonton, New Jersey 07005
(201) 334-2676 TWX 710-987-8367

Sr. Vice President, Publisher
Peter Coley

Editors

Editorial Offices
50 Essex St.
Rochelle Park, NJ 07662
(201) 843-0550
TWX: 710-990-5071
Cable: Haydenpubs Rochellepark

Editor-in-Chief George Rostky

Managing Editors:

Ralph Dobriner
Michael Elphick

Associate Editors:

Dave Bursky
Samuel Derman
Morris Grossman
John F. Mason
Stanley Runyon
Michael Shunfenthal

Contributing Editors:

Peter N. Budzilovich, John Kessler
Alberto Socolovsky, Nathan Sussman

Editorial Field Offices

East

Jim McDermott, Eastern Editor
P.O. Box 272
Easthampton, MA 01027
(413) 527-3632

West

David N. Kaye, Senior Western Editor
8939 S. Sepulveda Blvd., Suite 510
Los Angeles, CA 90045
(213) 641-6544
TWX: 1-910-328-7240

Jim Gold, Western Editor
1537 Shasta Ave.
San Jose, CA 95128
(408) 279-8588

Editorial Production

Marjorie A. Duffy, Production Editor
Tom Collins, Copy Editor

Art

Art Director, William Kelly
Richard Luce, Anthony J. Fischetto

Production

Manager, Dollie S. Viebig
Helen De Polo, Anne Molfetas

Circulation

Manager, Barbara Freundlich
Trish Edelmann, Gene M. Corrado

Information Retrieval

Peggy Long

Advertising Promotion

Paul K. Hogue

Across the Desk

Bicentennial bedtime stories

You and your staff are to be congratulated for the excellent job you did on the Bicentennial issue (ED No. 4, Feb. 16, 1976). I leafed through the magazine at the office here, then took it home for a much more relaxed close study while propped up in my bed. I think I spent a couple of hours reading the thing, and several times I pointed out features and details to my wife, who was likewise leafing through Playboy.

As I got up to the recap of more contemporary electronic history, I realized how truly unusual my own personal experiences have been. As a journalist (of sorts) I didn't actually participate in any of the landmark discoveries of the solid state era, but I had a once-in-an-era opportunity to know (and work with) a great many of the people who made history.

It was in 1959 that I joined Hoffman Semiconductor in Evanston, IL, and in those days a lot of the drawings and documents still carried the imprint of *National Fabricated Products, Inc.* The business of the day was making silicon junction diodes, zener regulators, and silicon solar cells. I wish I still had my old Hoffman Solaradio, which would be a collector's item. Unfortunately, one of my kids left it out in the rain, and it was ruined.

People back then were discovering methods right and left. I worked with Martin Wolf, who did work on solar-cell efficiency; with Jack Madigan, who increased the power ratings of silicon rectifiers; with Earl Riggs, who developed many of the methods of mass production; and with a lot of other bright people.

Then I moved over to Fairchild, and spent time with Bob Noyce,

Gordon Moore, Bib Widlar, Charlie Sporck, and many, many others. We certainly knew we were doing important things back then, but I never thought I would see all those names in an editorial history of significant electronic technology.

I used to eat lunch with Buck Rogers, who tried to get my interest expanded in the DIP package, but I never thought it was worth a conversation. Buck worked hundreds of hours developing, as I recall, a nickel-gold-molybdenum system for sealing the packages.

Now most of those people run their own companies. Pierre Lamond, Jerry Sanders, Charlie Sporck, *et al.* And me? I still drive a typewriter for a living. But I'm just as happy, I suppose, and I don't have to worry about any yields other than my own output of words. But it was certainly *some* time we had.

Dick Molay

Lawrence & Lierle
277 Town & Country Village
Palo Alto, CA 94301

A matter of class

In regard to your editorial of Jan. 19th and as a resident of the San Francisco Bay area, I abhor the term "Frisco" as do all San Franciscans. However, proper etiquette demands that we never correct the speech of others, even that of boors.

Gordon Keller

Pick & Associates, Inc.
17911-E Sky Park Circle
Irvine, CA 92714

A matter of limp software

The article by Ralph D. Taylor (ED No. 1, Jan. 5, 1976, p. 102)

(continued on page 13)

Electronic Design welcomes the opinions of its readers on the issues raised in the magazine's editorial columns. Address letters to Managing Editor, Electronic Design, 50 Essex St. Rochelle Park, N.J. 07662. Try to keep letters under 200 words. Letters must be signed. Names will be withheld on request.

Switches-

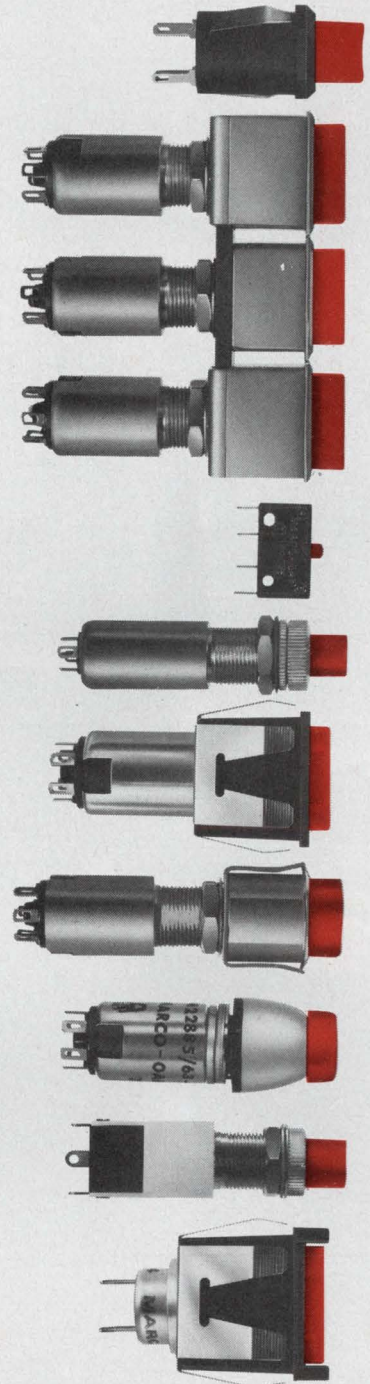

We've got them all

Lighten your decisions
contact . . .

ILLUMINATED PRODUCTS INC.

(formerly MARCO-OAK)
A Subsidiary of OAK Industries Inc.

207 S. Helena St., P.O. Box 4011
Anaheim, CA 92803
Tel: (714) 535-6037 TWX 910-591-1185



Easy does it. Fairchild's Low Power Schottky becomes the TTL logic to beat.

Standard TTL was terrific in its time.

But for most new designs today, Fairchild's Low Power Schottky is simply better.

How LS changed the TTL rules.

In the first place, Fairchild LS beats standard TTL for speed.

Low Power Schottky actually operates as fast as standard TTL. Or faster. Typically, LS delivers speeds of just 5ns per gate, or

10ns worst case.

Better yet, you get all this speed at a power demand of just 2mW per gate — about *one-fifth*

the power requirement of conventional TTL.

Of course, you already know the basic advantages of low

power. Less heat. Lower noise. Simplified system design. Easy MOS-to-TTL interface.

Which means on a system basis, Fairchild's LS can more than save you work, effort and performance.

It can save you *money*.

Redesign now. And beat the rush.

The point is, if you're still designing with standard TTL,

FAIRCHILD 9LS (54LS/74LS) DEVICES AVAILABLE

*LS00	*LS12	LS32	*LS77	LS112	LS151	*LS163	LS192	LS258	LS298
*LS01	LS13	LS37	*LS83	LS113	LS152	*LS168	LS193	LS259	LS365
LS02	LS14	LS38	*LS85	LS114	LS153	*LS169	LS194	LS260	LS366
LS03	LS15	LS40	LS86	LS125	LS155	LS170	*LS195	*LS266	LS367
LS04	LS20	*LS42	*LS89	LS126	LS156	*LS173	LS196	LS279	LS368
LS05	LS21	LS51	LS90	*LS132	LS157	*LS174	LS197	*LS280	*LS375
LS08	LS22	LS54	LS92	LS133	LS158	LS175	LS251	*LS283	*LS390
LS09	LS26	LS55	LS93	LS136	*LS160	*LS181	*LS253	LS290	LS393
LS10	LS27	LS74	*LS95	LS138	LS161	LS190	*LS256	LS293	*LS395
LS11	LS30	*LS75	LS109	LS139	*LS162	LS191	LS257	*LS295	*LS490
									LS670

*Available 3rd Quarter 1976.



Fairchild's Low Power Schottky can really move you ahead.

And the best time to make your move may be right now.

As TTL logic comes into short supply today, you'll find most additional production comes in Low Power Schottky.

So if you start redesigning your system to LS now, you can beat the rush for TTL availability later.

If you're already designing

with LS, now's the time to place your order with Fairchild to insure earliest delivery.

Several other things you should know about LS.

First, Fairchild has led in the development of Low Power Schottky, and we have every kind you need — more than 100 devices. All pin-for-pin compatible with standard TTL.

Order today from your local Fairchild Sales Office,

Representative or Distributor.

Free LS offer.

We've also put together a whole book on LS. And its free.

Just write to Fairchild Camera & Instrument Corp., Digital Division, 464 Ellis Street, Mountain View, CA 94042. Or phone (415) 962-3716 or TWX: 910-379-6435.

The new logic. Low Power Schottky by Fairchild.

FAIRCHILD

WHO ELSE?

CIRCLE NUMBER 7

"Now you can build a for less than the cost of

"Our new monolithic CMOS A/D converter makes low-cost, 3-digit DVMs a reality. With it you can put precision digital readouts into applications that did not make economic sense in the past. With the Siliconix LD130, you can modernize products such as thermometers, dashboards, test consoles, industrial meters and controls at a cost competitive with ordinary analog meters."

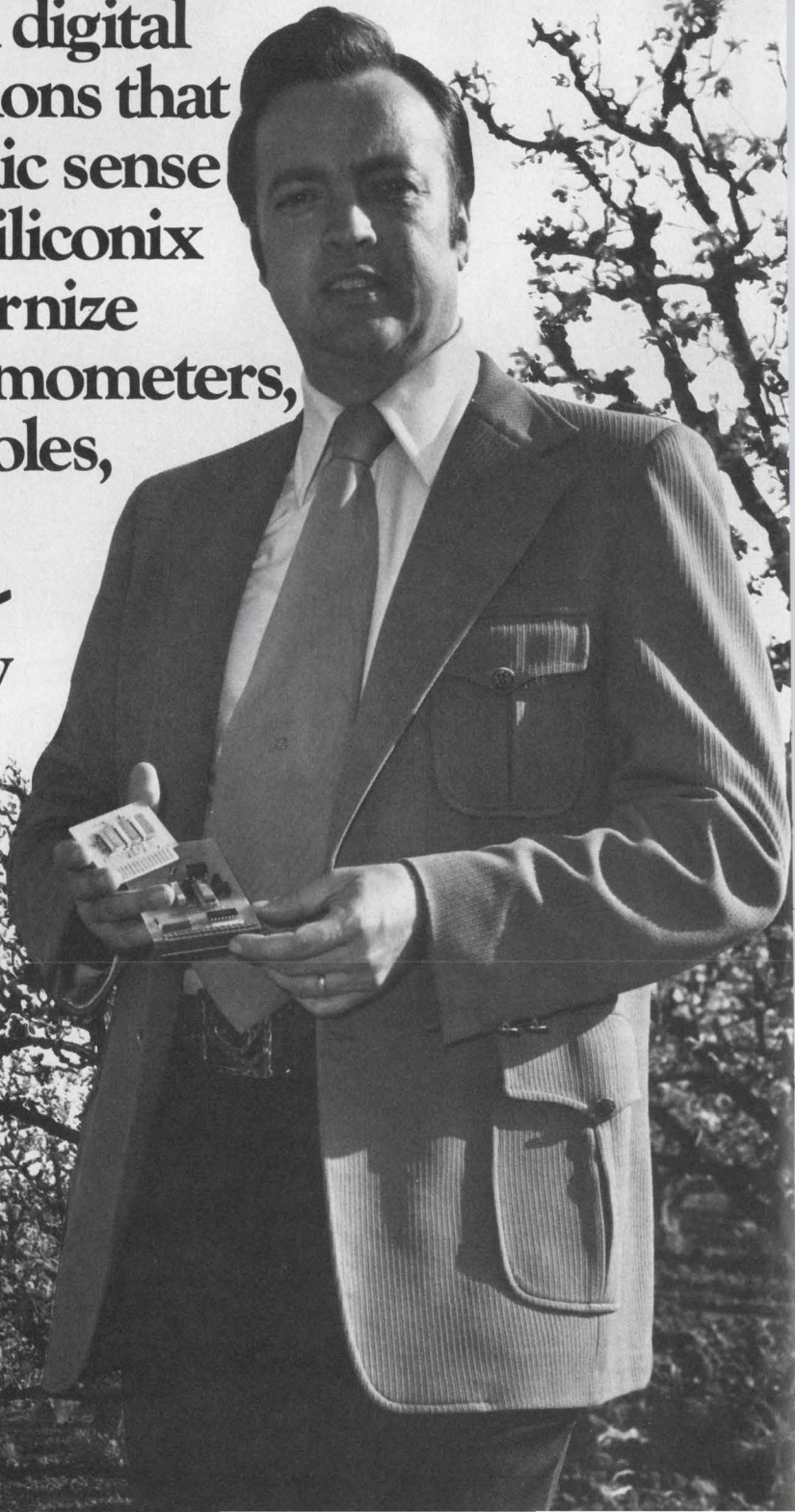

quality digital meter a cheap analog meter."

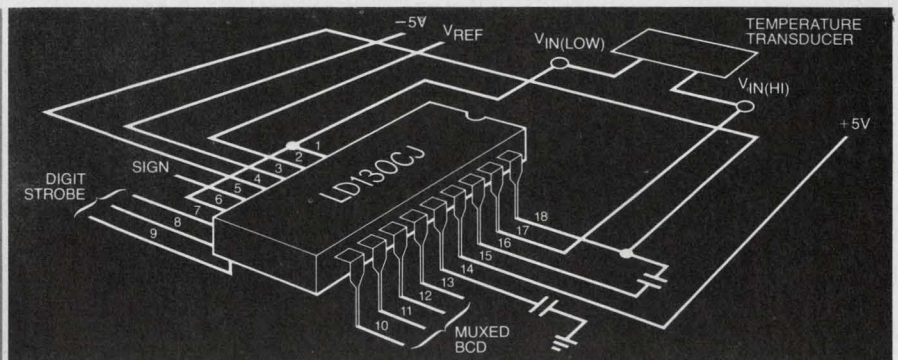

"At Siliconix, we call the LD130 'everyman's digital voltmeter chip'.

"Almost any high volume product that requires a meter can be made more attractive and useful with this sophisticated, low power, 3-digit DVM chip. In addition to the visibility and style of digital readout, the LD130 provides 10 to 20 times the accuracy and much higher resolution than analog meters.

"Moreover, the LD130 imposes none of the design restrictions of 'cheap' analog meters. Its full 3-digit range of ± 999 allows almost any variable, such as very high and very low temperatures, to be measured. In contrast, a person can at best resolve one part in 100 using an inexpensive analog meter.

"Automatic zeroing, automatic polarity outputs, and auto-ranging outputs eliminate zero adjust potentiometers, switch the \pm sign, and allow automatic control of decimal points and range scaling resistors.

" $\pm 5V$ CMOS construction enables the LD130 to operate efficiently with any standard CMOS or TTL logic. The multiplexed BCD outputs are easily interfaced with 'intelligent' microprocessor-based systems. This format is also ideal for the widest range of digital displays.

"Accuracy is $\pm 0.1\%$ of reading ± 1 count. Accuracy is maintained automatically by Siliconix' exclusive quantized feedback design (patent applied for) which continuously corrects for zero drift. This same feature has made the Siliconix $\pm 3\text{-}1/2$ digit LD110/LD111 DVM set the most widely used by designers of professional instruments and control systems.

"Just as important, the LD130 is easy and inexpensive to use. Unlike most DVMs, it requires no precision resistors and capacitors, no external temperature compensation, no dual tracking references, no operational amplifiers or input buffers. These have been eliminated by state-of-the-art chip design.

"Since only low-cost components are needed with the 18-pin LD130, it allows complete meter/display subsystems to be built into products for less than \$15 (1K quantities).

"The LD130 is your opportunity to create new products and upgrade your present ones. Now you can build a quality digital meter for your system at a cost you can afford."

To order the LD130CJ (\$8.75 at 100 lot), contact our franchised distributors: Components Plus, Cramer, Elmar, Hamilton/Avnet, Pioneer, Quality Components or R. A. E. For more details, call or write Siliconix, 2201 Laurelwood Road, Santa Clara, CA 95054, (408) 246-8000.

Siliconix incorporated

AMP 1-piece pc edge connectors use UL 94V-O flame resistant material rated to 120°C.

Which gives you just the edge you need.

AMP's family of pc edge connectors with Bifurcated leaf-type contacts are designed to be an economic yet strong link in your printed circuitry.

Here's why. These durable AMP connector housings are molded of a material which offers resistance to high temperatures and to flame.

Recognized under the component recognition program of Underwriters Laboratories, Inc. they meet industry need and requirement for single sided pc boards of .062" thickness, with pads on .156" centers.

The housing material provides a temperature performance up to 120°C and is available in several styles for board-to-board or board-to-wire applications. A full line of accessories like card guides and keying plugs is also available.

AMP Bifurcated leaf-type contacts develop a redundant wiping action on the board that assures positive, dependable electrical conductivity.

Contacts accept wire ranges 24-18, 30-24 AWG. And with high speed automatic termination equipment provide reliability on production lines, at low installation cost.

You get an edge on design when you choose AMP. That's because the engineers at our home office and in our district sales offices are eager to share their experience with you. Worldwide experience at that.

Write for more information.

Or give us a call. It's faster that way.
AMP Incorporated, Harrisburg, PA 17105.
(717) 564-0100.

AMP

INCORPORATED

AMP is a trademark of
AMP Incorporated.

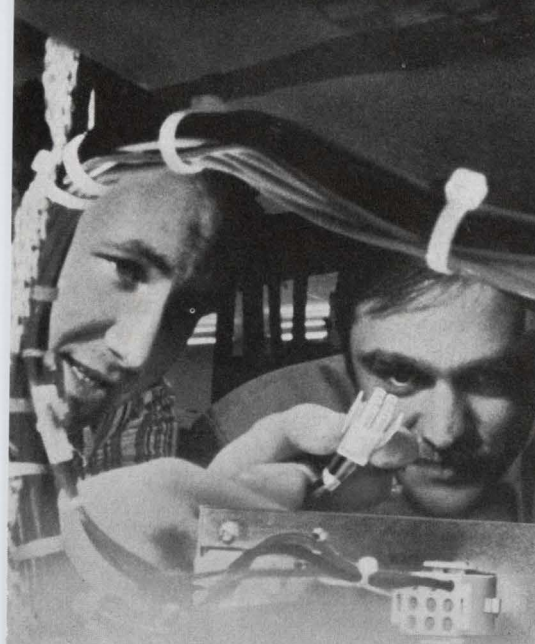

AMP EUROPE

Austria — AMP Austria. Branch of AMP Deutschland GmbH. Markgraf-Ruediger Str. 6-8, 1150 Vienna. Phone: 924191/92

Belgium — AMP Belgium. Branch of AMP-Holland B.V., Rue de Brabant 62-66, Brussels. Phone: 322.17.55.17

France — AMP de France. 29 Chaussée Jules-César. Boite Postale No. 39. 95301 Pontoise France. Phone: 030 82 20, 030 92 30

Germany — AMP Deutschland GmbH. Ampèrestrasse 7-11, 607 Langen, B. FFM., West Germany. Phone: (06103) 7091

Great Britain — AMP of Great Britain Limited, Terminal House, Stanmore, Middlesex, England. Phone: 01-954-2356

Holland — AMP Holland B.V., Papierstraat 2-4 's-Hertogenbosch, Holland. Phone: (04100) 25221

Italy — AMP Italia S.p.A., Via Fratelli Cervi 15, 10093 Collegno (Torino), Italy. Phone: 785-656

Spain — AMP Española, S.A., Apartado 5294. Pedro IV, 491, 495, Barcelona 5, Spain. Phone: 307-75-50

Sweden — AMP Scandinavia AB, Datavägen 5, 17500 Jakobsberg, Sweden, Mailing Address: Fack S-175 20 JARFALLA 1, Sweden. Phone: 0758/10400

Switzerland — AMP AG, Haldenstrasse 11, 6006 Luzern, Switzerland. Phone: (414) 235421, 235422, 235423

AMP NORTH AMERICA

Canada — AMP OF CANADA LTD., 20 Esna Park Drive, Markham, Ontario, Ph: 416-499-1251

Mexico — AMP de Mexico, S.A., Apartado Postal 179, Naucalpan de Juarez, Edo, de Mexico, Phone: Mexico City 576-41-55

Puerto Rico — AMP OF CANADA LTD., 677 Calé de Diego, Rio Piedras, Puerto Rico 00924, Phone: (809) 766-2346

United States — AMP Incorporated, Harrisburg, Pa. 17105, Phone: 717-564-0100

AMP SOUTH AMERICA

Argentina — AMP S.A. Argentina 4 de Febrero, 76 Villa Zagla — SAN MARTIN, Buenos Aires, Argentina, Phone: 752-4612

Brazil — AMP do Brasil Ltda., AV Comendador Martinelli 185, Lapa, Sao Paulo, Phone: 262-4353

AMP PACIFIC

Australia — Australian AMP Pty. Limited, 155 Briens Road, Northmead, N.S.W. 2152 Australia, Mailing Address: P.O. Box 194, Baulkham Hills, N.S.W. 2153 Aus. Ph: 630-7377

Japan — AMP (Japan), Ltd., No. 15-14, 7-Chome, Roppongi Minato-Ku, Tokyo, Japan, Ph: 404-7171

Products and services for many specialized industries are provided by the AMPLIVERSAL Division. In the United States, this division is known as AMP Special Industries.

For AMP products and services in other countries, write: AMP International Division, Harrisburg, PA 17105, USA.

ACROSS THE DESK

(continued from page 7)

titled, "Software Links A/D's to Computers" contains a series of errors in Fig. 1c, which shows code for a PDP-11. A list of errors and a corrected version of the program are attached.

Paul F. Fitts
Dir. Syst. Dev.

Innovatek Microsystems Inc.
Smithfield Rd.
Millertown, NY 12546

The author replies

In response to Mr. Fitts' letter concerning errors in my article, I have the following comments:

1. The LDA R2, #BUF is a mistake, since it is a combination of the Nova and PDP-11 instruction set. The correct instruction would be MOV #BUF, R2. This answers both items 1 and 2 of his letter.

2. On point 3: the placement of the colon immediately adjacent to the label "NEXT" was not a necessity on the PDP-11 assembler shipped with the machine I used. At this date I cannot confirm or deny his statement about the particular version of the assembler in use by Mr. Fitts

3. For items 4, 5, 6, 7 the TST instruction does only test sign. I should have used the TIT test and as a result a BEQ -6.

4. On item 8: I do not necessarily agree that .WORD 50 is more correct, because the assembler for the CTR label will correctly, without warnings, assemble this statement as well as the .WORD 50 statement.

5. Point 9: one could use .+100 for 50 words or use the block directive of .BLK 50 to assign a 50 word buffer.

6. Item 10 states that the counter (CTR) would require initialization for each time used, which is true for both the PDP-11 and Nova programs. I made no statement indicating this was re-entrant code, but did say these programs are the type required for use with an a/d and that the user would be expected to merge this into his routine.

7. The final point, No. 11, says the code of Fig. 2b will not work with the code of Fig. 1c. That is

```

AS SHOWN:
1 LDA R2, #BUF
NEXT: MOV #1, ADC
TST R2, ADC
IF ADC, (P2)
MOV #1, ADC
DEC R2
BNE NEXT
HALT
CTR: .WORD 50
BUF: .+50

JSTART ADC
JBSY=0
JNO, LOOP
JYES, READ AND INCREMENT
JLAST READING
JNO, ANOTHER
JYES, STOP

JTAKE 50 READINGS
JBUFFER

SHOULD BE:
MOV #50, CTR
MOV #BUF, R2
NEXT: MOV #1, ADC
BIT #2, ADC
BEQ -6
MOV #1, ADC, (P2)+
DEC R2
BNE NEXT
HALT

CTR: .WORD 0
BUF: .+100

JINITIALIZE CTR
JINITIALIZE PTR
JSTART ADC
JSTART ADC
JST BIT 2
JBSY = 0, LOOP
JSTOPE READING
JLAST READING ?
JNO, TAKE ANOTHER
JYES STOP

JCOUNTER LOCATION
JBUFFER FOR 50 WORDS

EPPROPS
1. NON-EXISTENT MNEMONIC
2. OPERANDS ORDER REVERSED
3. COLON RIGHT AFTER NEXT
4. TST ONLY DETERMINES SIGN, ZERO
5. TST ONLY PERMITS ONE OPERAND
6. SHOULD BE CONDITIONAL BRANCH
7. .+1 IS AN ODD (ILLEGAL) ADDRESS
SHOULD BE .-4 FOR A TWO WORD INSTRUCTION
8. MORE CORRECTLY, .WORD 50
9. RESERVE BUFFER SPACE REQUIRES .+100
FOR 50 WORDS (128 BYTES)
10. CTR TO BE INITIALIZED EACH TIME USED
11. FIG. 2B PDP 11/28 WILL NOT WORK
WITH SUBROUTINE OF FIG. 1C

```

correct, but I never stated or indicated it would.

R. D. Taylor
Sr. Project Engineer

DITMCO
5612 Brighton Terr.
Kansas City, MO 64130

Misplaced Caption Dept.



Thanks for the help. The circuit works!

Sorry. That's Giovanni Bellini's "St. Francis in Ecstasy," which hangs in the Frick Collection, in New York.

Not a \$400 bargain

In the May 24 issue of ELECTRONIC DESIGN (Vol. 24, No. 11) on page 131 a k was somehow omitted from the headline of the Digital Equipment Corp. product announcement. The headline should have read "Time-Sharing Computer Sells for Under \$400k."

Who provides the industry's broadest line of electronic packaging hardware ... including A New High-Density Lever Switch?

SAE does! We're proud to announce the development of a completely new and patented switching concept called the SAE switch (which stands for *Side And Edge™*). The switch consists of multiple positions; each actuated by a lever that interconnects opposite sides of a PCB with a horseshoe-shaped terminal.

Based upon the layout of the circuit board, the switch allows for SPST, SPDT, SPST-DB and DPDT contact closures.

Mounting in either a horizontal or vertical position, the SAE switch reduces overall front panel area; eliminates the need for interconnecting cables or connectors, as well as knobs or dials. Levers are on .140" or .156" centers for easy actuation.

Available in an unlimited number of switching positions in length and in up to three board widths, the switch can accommodate 150 switching positions in only 34 square inches! Our new brochure gives the complete details ... send for it now!

™-Stanford Applied Engineering, Inc.

For an immediate reply, call the following toll-free "ZIP QUOTE" number at the factory ... 800-538-6843.

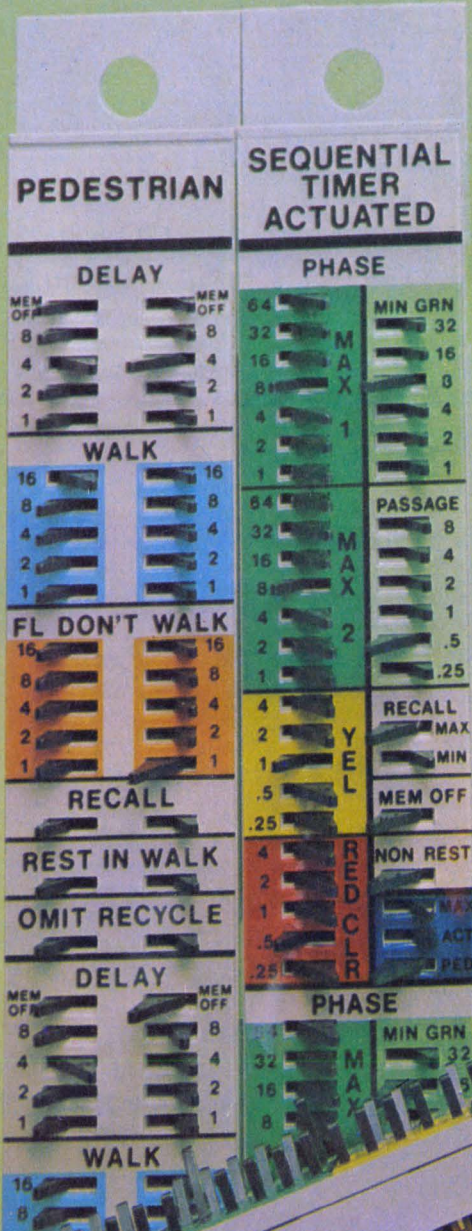

Stanford Applied Engineering, Inc.

340 Martin Ave., Santa Clara, CA 95050
(408) 243-9200 TWX 910-338-0132

CIRCLE NUMBER 15

We guarantee our crystal oscillators for one full year. Which is a year longer than any of our major competitors will guarantee theirs.

If you're in the business of making or marketing computers and information systems, you know how important a guarantee is. It's your way of letting your customer know you're so confident about your product's performance that, for a specified amount of time, you will assume full responsibility for that performance.

Well, at MF Electronics, we feel the same way about our products. Especially the crystal clock oscillators that are our specialty. We make them the best way we—or anyone—know how. So we're able to guarantee them for a full year.

The difference between oscillators.

What separates good oscillators from bad is space. Space is one thing there shouldn't be any of inside an oscillator. But the way most oscillators are made, space is one thing you can count on.



The hollow truth about crystal oscillators.

Look at this oscillator. The fact that we can lift the cap to show you what's wrong with it shows you what's wrong with it.

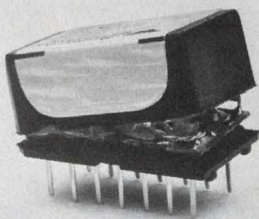

The MF Guarantee

MF Electronics warrants this molded crystal oscillator to be free from defects for one year from date of purchase.

Any oscillator found to be defective during this period may be returned to the factory, postage paid, for repair or, at our option, replacement without charge.

MF Electronics limits its liability to the repair and/or replacement of the returned MF oscillator.

MF ELECTRONICS CORP.

118 E. 25th St., New York, N.Y. 10010 (212) 674-5360 TWX: 710-581-4109

After the crystal and other parts are attached to the base, the cap is glued on, creating a bond that's tenuous at best.

Air seeps through this bond, allowing dirt and moisture to collect. You've got a leaky oscillator, one that's prone to loose parts and electrical shorting. That's how deadly a breath of fresh air can be to the inside of an oscillator.

The un-holey oscillator: It's molded. What a blessing.

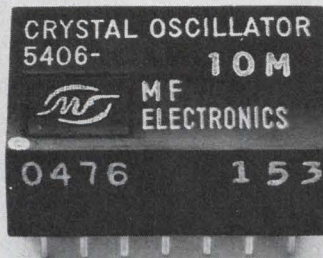

A molded oscillator, on the other hand, has no holes, no open spaces, nothing to hide and nowhere to hide it. Its crystal is hermetically sealed and set in a monolithic block of solid black plastic. There are no spaces for air to penetrate, no room for dirt or moisture to accumulate. Wave soldering can't even deteriorate the unit, so there's no danger of loose pins or joints.

A test that rings true.

One of our customers, who is also one of the country's largest users of crystal clock oscillators, tested the performance of

various oscillators. He found that MF's molded oscillator lasted 3000 hours in an 85°C/85% relative humidity test. If you've ever done any oscillator testing yourself you know how remarkable that is.

Two more solid reasons to use MF Crystal Oscillators.

3rd overtone crystals are used in MF's molded oscillators to provide greater electrical and mechanical stability in frequencies exceeding and including 20 MHz.

And an MF molded oscillator is the only one made that meets the UL oxygen index guideline of 28%.

Because we're solid, your product is more solid.

So when you use MF molded crystal oscillators, you're giving your product a more efficient component, a heart that will beat longer. And your customers will be giving you fewer complaints and service calls.

MF Electronics is the only company that makes molded crystal oscillators. We invented them.

We make what we think are the best crystal oscillators you can buy. And we guarantee them, so your product can be "the best you can buy."

And that's the solid truth.

THE MF GUARANTEE

MF Electronics warrants this molded crystal oscillator to be free from defects for one year from date of purchase.

Any oscillator found to be defective during this period may be returned to the factory, postage paid, for repair or, at our option, replacement without charge.

MF Electronics limits its liability to the repair and/or replacement of the returned MF oscillator.

MF ELECTRONICS CORP.

118 E. 25th St., New York, N.Y. 10010 (212) 674-5360 TWX: 710-581-4109

CIRCLE NUMBER 12

PLASTIC

THERMAL INTERMITTENCE, 125°C

311 lots
23,759 units
0 rejects

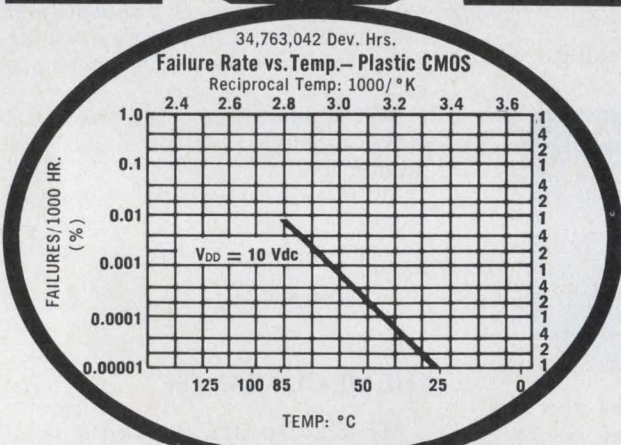
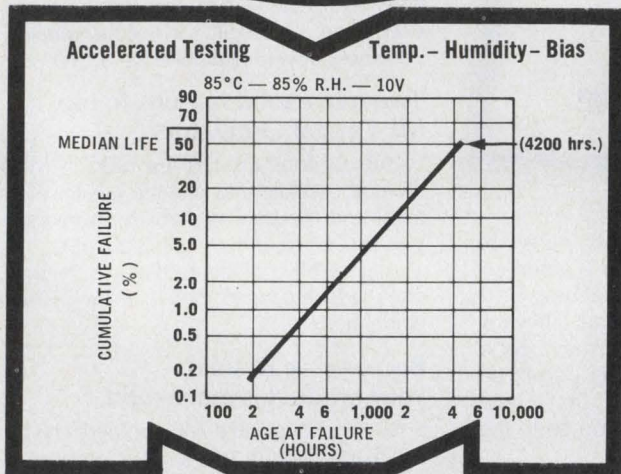

S

TEMPERATURE CYCLING, -65°C TO +150°C

52 lots
5,751 units
699,835 device cycles
1 reject

MOTOROLA CMOS RELIABILITY

You correctly demand it. We're committed to CMOS reliability, and results demonstrate it: results from testing, and results in the operating systems of the real world.

There are no exotic secrets to our reliability formula, just very careful attention to details and a process keyed to reliability. Inspections and testing keep everyone on the ball, and we do a lot of testing as standard procedure.

We believe that's the reason users and independent authorities recognize Motorola's CMOS reliability as the industry's best, with plastic leading the way. See why.

Read our two '76 CMOS* reliability reports. Circle the reader service number or send your request to Motorola Semiconductors, P.O. Box 20912, Phoenix, AZ 85036, for CMOS Plastic IC Packaging System Reliability, and CMOS Life Stress Testing.

If you're now considering CMOS, or selecting a CMOS supplier, we invite you to compare plastic or ceramic reliability results. Other customers have. Take an adequate sample of Motorola's CMOS, and your choices of competing CMOS and run:

1. 125°C, 15V High temp. life stress — to data sheet specs.
2. 85°C, 85% RH, 10 V THB — to data sheet specs.
3. Temp. cycling, -65°C to +150°C
4. Thermal intermittence @ 125°C

B Series Benefits, Too.

Although the bulk of our testing was performed before the introduction of B Series CMOS, you get the same reliability with our B Series as with all CMOS. It's produced with the same process, on the same lines, with the same design rules, by the same people.



MOTOROLA
Semiconductors

— CMOS reliability at its best

*Trademark of Motorola Inc.

JULY 5, 1976

Shutterbugs bait 'Nessie' in search for fabled monster

The Loch Ness monster, if it exists at all, had better make an appearance soon. An impressive (and expensive) array of optical and electronic equipment ferried from the United States out to the remote Scottish lake, stands ready to photograph the legendary creature as soon as it shows its face—or whatever else it chooses to show.

This summer's monster-hunting expedition is not the first of its kind by any means, but is the most technologically sophisticated to date. It is outfitted with equipment such as: an automatic 16-mm time-lapse camera (one color picture every 45 seconds), a pair of stereo cameras with synchronized strobe lights, a Polaroid SX-70 camera, and a closed-circuit low-light-level TV monitor . . . all designed to operate under water.

In addition, a "side looking" sonar is in use to probe the murky lake, whose depths reach 900 feet in places.

Sponsored by the New York Times and the Boston-based Academy of Applied Science, this latest attempt to photograph the Scottish dragon currently numbers 10 members, but the figure is expected to double soon.

The group is headed by Dr. Robert Rines, a Boston lawyer and educator, trained as a physicist. It includes specialists in electronics, photography, zoology, and biology.

Seventy-three year old Dr. Harold Edgerton, emeritus professor of electrical measurement at MIT, is senior advisor to the group. The strobe-flash setup used in the current expedition originated in the stroboscope, one of Edgerton's many inventions in high-speed photographic technology.

All the photographic and television camera equipment is mounted on two metal rigs, shaped like stepladders, and submerged about

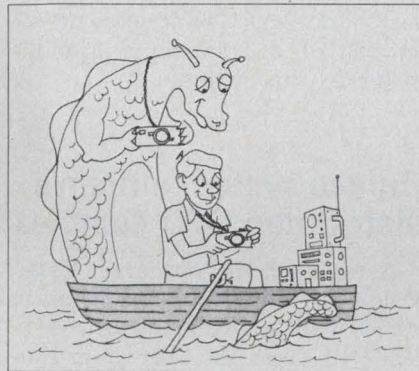

40 ft. below the lake's surface. The TV camera, connected by cable to an on-shore viewing screen provides round-the-clock surveillance. It also supplies the signal for a video-tape output of all underwater activity within range of the TV camera. In the event something does appear on the monitor screen, the cameras are triggered.

Resolution available from the photographic equipment is expected to exceed that obtained in earlier searches. The labels of submerged beer cans, for example, should be clearly legible.

Sonar operations on the lake began June 13 using equipment manufactured by Klein Associates, Salem, NH. The sonar's transducer array is mounted inside a 35-lb aluminum torpedo (dubbed "the fish"), and is towed behind a boat on a 300-ft cable. This equipment has reportedly been successful in locating the wooden ribs of small sunken-ships, and a half-inch diameter cable on the sea bottom.

Later this summer an infra-red probe will be added to the arsenal of monster-detection apparatus. Dr. George Newton, professor of engineering at MIT, plans to scan the surface of the lake with an infra-red detector set atop a castle over-

looking part of the lake. The detector is said to be capable of resolving temperature differences of less than one degree.

The persevering research group banks its hopes on the fact that the Loch Ness monster is not camera shy. There have been numerous reports in the past of sightings of a "creature" in and near Urquhart Bay, site of the current effort.

Earlier expeditions, led by Rines in 1972 and 1975 obtained photographs of "something." Photo-analysis experts studying the photographs have discerned a flipper, and a long neck and head.

An earlier picture, taken through a telescopic lens by a London physician, appeared to show a similar long neck and head (or perhaps it was the other end) poking above the water.

Patiently waiting in the background throughout all this activity, is a film crew from NBC ready to bring the monster live to millions of TV viewers. Move over, King Kong.

μ W generator produces most powerful pulses

A unique microwave generator has been produced that delivers pulses 50 times more powerful than those of today's largest conventional sources of microwave energy.

It does so by combining a new technology of high-voltage kilo-ampere pulse generation with the magnetron of WWII fame.

The new generator, developed by researchers at the Massachusetts Institute of Technology, has produced 4-GW, 30-ns bursts of microwave power. Even more significant, the efficiency of MIT's invention has averaged 50%, with some experiments converting as much as 75% of the input into useful power. This compares with efficiencies ranging from 1 to 20% of the best competing sources.

"Conventional magnetrons have a thermionic cathode that draws 10A/cm² of current at best," says Professor George Bekefi of the MIT Department of Physics, who developed the microwave device with staff researcher Dr. Thaddeus Orzechowski.

"The new generator uses a field emission technique, which supplies

a voltage high enough to rip out electrons from a cold cathode. That way we can increase the magnetron currents from amps to kiloamps per square centimeter by using high-voltage pulse technology. Electron beams of 10 to 100 kA are produced by accelerating voltages of anywhere between 100 kV to a few million volts.

"For our purpose we took one of those generators and in effect wrapped the electron beam into a magnetron configuration."

The magnetron itself is less than 5 in. in diameter. It has a graphite core that serves as a negative electrode and source of electrons. An outer aluminum cylinder, with internal microwave cavities, serves as the positive electrode.

The high-voltage generator has 12 capacitors, each of which can be charged to 50 kV—a total of 600 kV. This stored energy is transferred to a larger, water-filled capacitor before being applied to the microwave device.

When several hundred kilovolts are discharged between the two magnetron electrodes, electrons are ripped out of the negative graphite core, creating a radial beam of electrons traveling almost as fast as light. Beam current is in tens of thousands of amperes of current.

The electrons are confined to a circular path inside the magnetron by applying a strong magnetic field along the axis of the magnetron electrodes.

The electron energy is converted into microwaves by the chain of resonant cavities that project radially from the inside of the aluminum cylinder. A rapid build-up of radiation occurs in just a few revolutions of the electrons around the magnetron circuit.

The wavelength of the microwave radiation is determined by the dimensions of the cavities. In the MIT device 10-cm waves have been produced.

Radiation of shorter wavelengths is desirable for such applications as communications, but the researchers see a lower limit on the present magnetron configuration of about 3 cm.

To further decrease the wavelength, the researchers plan to work with the Naval Research Laboratory in Washington, D.C. on a "moving electron mirror." This

scheme exploits the Doppler effect—the change in the wavelength of radiation that occurs when waves are bounced off of an object that is either moving towards the source, or away from it.

Researchers would produce a head-on collision between a beam of accelerated electrons and a high-power beam of microwaves. As the beams collide, the front of the electron beam will act as a mirror and reflect the microwaves, Bekefi says.

But because the electron mirror is moving towards the microwaves, the wavelength of the reflected waves will be shortened. The researchers expect to produce wavelengths of a fraction of a millimeter in this manner.

Univac system employs distributed CPU complex

A new high-performance, large-scale computer, the Sperry Univac 90/80, has a virtual memory system that frees the user from concern about program sizes and complex overlay techniques.

The 90/80, recently announced by Sperry Univac, Blue Bell, PA, is the fourth and largest system of that company's series-90 family.

One architectural feature of the system is the incorporation of a distributed central-processor complex that is composed of an instruction processor and a peripheral processor. Unlike most large CPUs, each of these processors has independent processing capabilities that permit work to be distributed efficiently between the two.

The instruction processor (IP) provides the processing and control function for the 90/80 system. The peripheral processor (PP) controls the input-output processing facilities through microprogramming. The PP frees the IP from handling input-out processing.

The peripheral processor supports the full line of series-90 peripheral devices through a maximum of eight IO channels and a minimum of a single-byte multiplexer and a single-block multiplexer. Data are transferred to main storage by the PP at the rate of 8-M bytes/s. The maximum byte-multiplexer transfer rate is 183-k bytes/s.

Data transfer between the peripherals and main storage can be performed by all channels simultaneously. Both the IP and PP can access main storage independently of one another.

The 90/80 is also equipped with extensive communication capabilities.

It can serve up to 256 communication lines via multichannel communication controllers.

The main storage is semiconductor memory using 4-k, N-channel MOS chips. The basic memory module contains 524,000 bytes.

Wang introduces family of CRT word processors

Wang Laboratories has introduced a new family of three CRT-based word-processing machines aimed at the full range of users: Word Processor "10" for a single user, the "20" for a small cluster of users, and the "30" for a large word-processing center.

The company feels confident in taking on IBM, which dominates 87 percent of the market, "because IBM has not yet come out with a CRT-based machine," says a spokesman for the Tewksbury, MA company. "IBM produces magnetic-card-based units that are not upward compatible. With the Wang 30, up to 14 stations can share a disc storage unit that holds up to 4000 pages of material."

Wang feels it can compete with other CRT-based systems because of price and performance. Wang's machines range from \$12,000 to over \$75,000 per system with costs per machine in medium and large systems falling under \$11,000.

Microprocessors are "exploited to the full," Wang officials say. Every station, whether it is a video work station, a daisy printer, a line-printer or a diskette controller, contains a μ P to perform logic functions that formerly required up to several hundred ICs. Wang's word processor is, in fact, a small version of a microcomputer network.

The new family uses coaxial cables to connect the stations. With this approach, the transfer of information between stations takes place at 4.25 MHz, using only a two-wire cable.

We saw your microprocessor

coming. So we designed an entire family of socket homes for it. Socket cards for card file mounting, and we've even got the card files. Socket boards for LSI mounting in frames, drawers, and racks,

and we've even got the frames, drawers, and racks. Our socket cards, the 3D Series, come with built-in test points, a ceramic monolithic bypass capacitor

at each socket, and solder tab connection to pins on LSI chips. Our socket boards, the 2D Series,

offer a good selection of socket complements, and are compatible with other boards for hybrid installations. We also offer automated wiring service. We're ready for you.

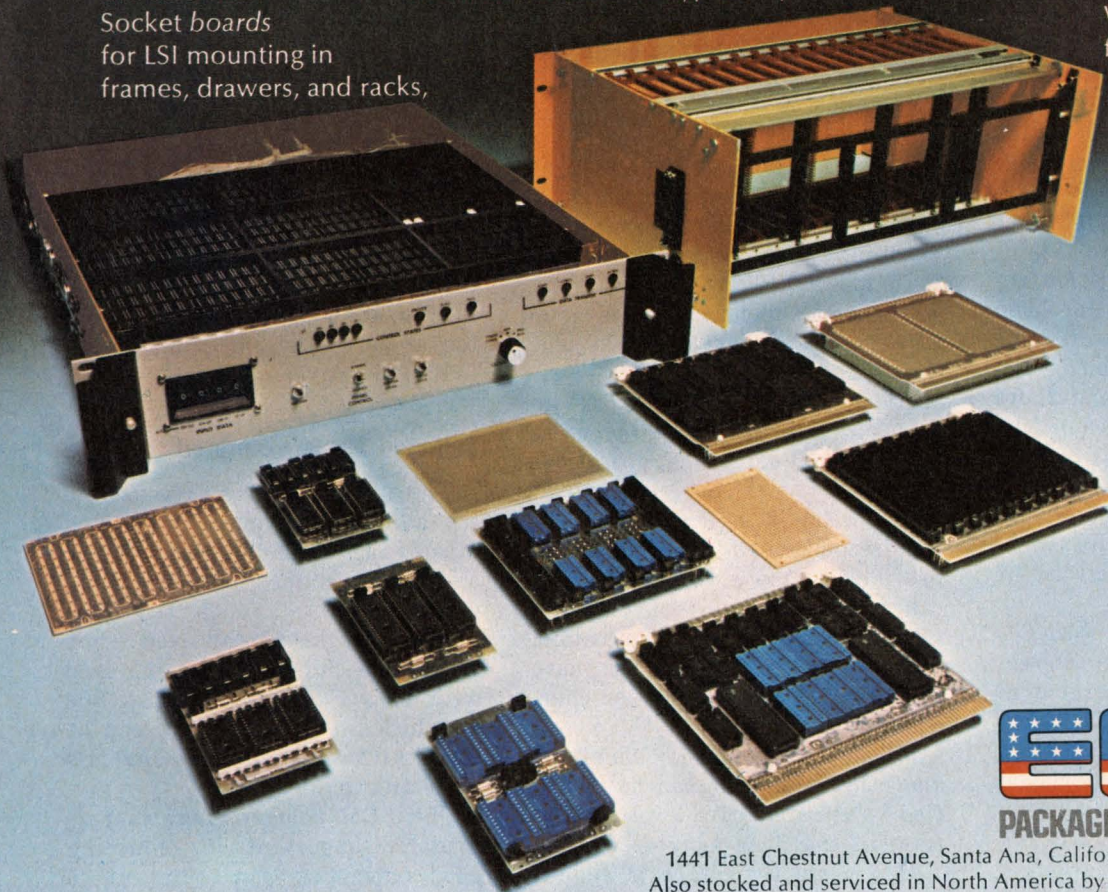

EECO
PACKAGING/SWITCHES/READERS

1441 East Chestnut Avenue, Santa Ana, California 92701 Phone 714/835-6000
Also stocked and serviced in North America by G. S. Marshall, R-A-E, Zentronics.

Electron-beam pictures reveal hidden defects in LSI chips

If one bit in an LSI RAM or ROM isn't working, a unique trouble-shooting technique that gives real-time pictures of the chip's circuits in operation can pinpoint that bit's location.

The technique, developed by the British Post Office, uses a scanning electron microscope (SEM) and a 17-inch monitor. LSI-chip element voltages are displayed as bright patterns that change throughout an operating cycle. The system can identify both IC-design errors and fabrication-process flaws.

Rapid location and identification of a wide variety of IC faults has been demonstrated by researchers at the Post Office Research Dept., Dollis Hill, London. Conductors buried under one or more insulating layers can be seen, according to M. R. Child, Dollis Hill section head. It is possible to detect oxide pinholes, junction breakdowns, residual oxide in windows, and other flaws degrading reliability.

The English trouble-location approach solves a major problem of LSI-circuit manufacturers—the analysis of defective chips. Because the LSI elements and flaws are so small, many faults cannot be detected with traditional optical microscopy. As a result, the location and nature of faults must be deduced through a costly, time-consuming computer analysis of the device.

The key element in the Post Office system is a Cambridge Stereoscan 600 SEM that is operated in a voltage-contrast mode. The location of a flaw on an LSI chip can be pinpointed in the displayed

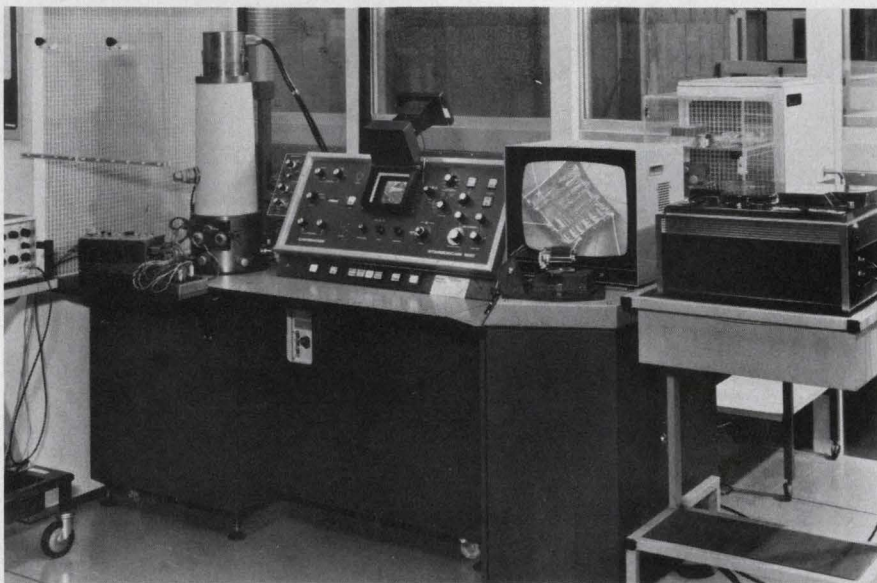

Microscopic flaws in LSI circuitry can be displayed and identified with the scanning electron microscope and TV-monitor system developed by the British Post Office. A video tape recorder preserves test records.

micrograph at low-power magnifications. Its cause is determined by examining the defective area at high power.

The instrument can resolve 25 nm—1/20 the wavelength of blue light—but according to the researchers, most of the work involves examination of large areas of the chip using magnifications of 100 X.

The SEM is used principally in the secondary-emission mode to provide a topographical view—called a micrograph—of the integrated circuit under examination. Each of the chip's materials have their own secondary-emission characteristics.

Silicon, polysilicon, aluminum and other materials can be identified by their relative levels of contrast in the SEM-monitor image.

If a negative voltage is applied to a specific area of the chip, the

brightness of that area of the image increases substantially. For example, two voltage-contrast patterns of a 128-bit RAM are shown in Fig. 1. The bright tracks are the areas of the chip that are at -12 V relative to system ground.

Selected areas examined

The photos in Fig. 2 illustrate the ability to examine a selected area of the device in greater detail, and shows sections of the RAM in enlarged views.

These tracks appear even when the silicon chip surface is covered with a layer of silicon dioxide 800 nm thick, so an LSI device can be examined without removing its protective oxide layer.

The SEM beam voltage is particularly important in obtaining good contrast. A beam voltage of 1.5 kV, the lowest value for the Stereo-

scan equipment, has been used for the best contrasts that have been observed. The voltage-contrast effect is thought to arise at the oxide surface where secondary electron emission is modified by the electric field of buried conductors. Experiments are in progress to verify this hypothesis.

Used by RAMs and ROMs

The voltage-contrast technique has been applied to both RAMs and ROMs. The circuit to be tested is plugged into a standard dual-inline header mounted on a specimen holder, and the holder inserted into the SEM's vacuum chamber.

The multi-bit address is cycled using internal circuitry through all combinations. The memory outputs are compared with those of a known good device. The driving circuitry detects errors in memory output, and the SEM provides a dynamic picture of the device in operation.

The major benefits of the voltage-contrast technique arise once the external circuitry has detected a fault condition in the device under test. For example, a 1024-bit (256×8) ROM produced a false output when a logic ONE was applied to a particular address input. Examination of the corresponding input lead and pad shown in the SEM monitor revealed that the lead wire was bright. That indicated the presence of the correct voltage level, but the bonding pad was dark. It turned out an open electrical contact between lead wire and pad was caused by a thin layer of oxide on the pad. The fault could not have been detected optically.

In another case, a ROM functioned correctly for about half of

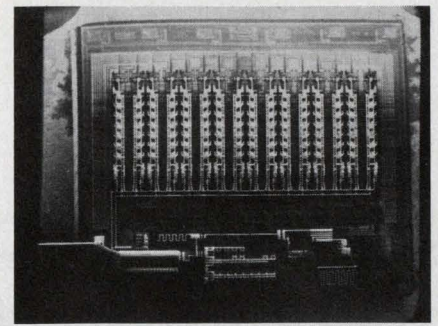
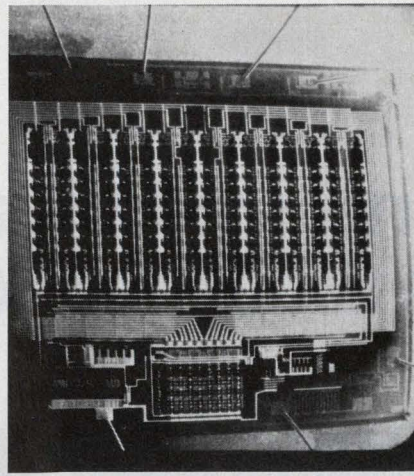

1. Voltage-contrast electron-beam micrographs, obtained at low magnification, show two states of a 128-bit RAM. The bright lines and areas are energized by negative supply and memory-control voltages.

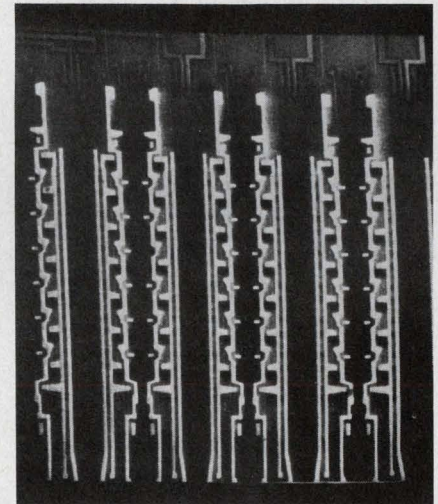
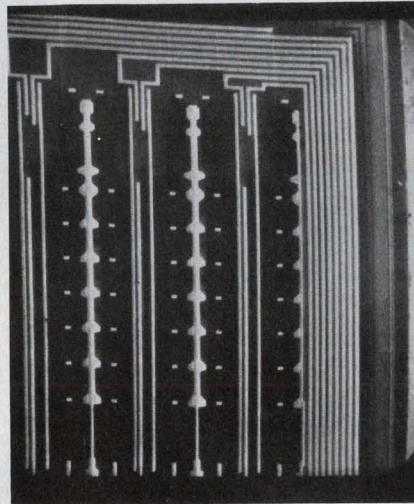

2. Electron-beam pictures taken at high magnification show enlarged portions of the 128-bit RAM in Fig. 1. Each picture is an expanded portion of the voltage-contrast patterns shown above.

the addresses and gave spurious outputs for the remainder. The defect was quickly detected when it was noticed that two rows of memory cells were addressed simultaneously. The flaw was traced to an underpass diffusion that failed to make contact with a metal track.

An abnormally large number of bright lines caused the condition to be spotted easily.

Other faults that can be detected include: short circuits between aluminum tracks, open circuits in aluminum and polysilicon, and short-circuits in gate-protection diodes. ■■

Small weather radar is low in cost, and versatile

A light aircraft, digital weather radar, one of the smallest and least expensive on the market, has been introduced by the Collins Radio Group of Rockwell International, Dallas, TX.

The 21-lb unit incorporates a number of features not typically found in low-cost radars of this type. They include:

- Capability for pilot to hold or

“freeze” the image for close study.

- Sufficient display brightness so that no viewing hood is necessary.
- Pilot-selectable receiver gain.
- Self-test and fault monitoring.
- Weather identification mode. In this mode the normal contoured image is reversed, and the radar displays only heavy rainfall areas.
- Use of a 5-kW positive-pulse magnetron, the first use of pulsed

magnetrons of such high power in weather radar for a commercial aircraft.

The radar's parabolic antenna can be tilted 15° up or down, and 22.5° to either side. The sideways tilt capability results in a sector scan of 90° . Maximum range of the Collins radar is 120 nautical miles. Power requirements are about 69 W standby and 97 W operating. ■■

Satellite-borne microwave sensors may improve weather forecasts

By the 1980s, accurate world-wide weather forecasts will be possible two days in advance. By the 1990s, when modeling of weather changes is better understood, forecasts may be possible for as much as an entire week.

How? By receiving and interpreting microwave energy emitted by, and reflected from, the world's ocean surfaces.

With the right combination of active and passive microwave transmitters and receivers in a satellite, according to a study by the Jet Propulsion Laboratory, it will be possible to measure such conditions as: wind velocity and direction, falling rain, and wave height, as well as water temperature, salinity, organic and pollutant content, and speed and direction of ocean currents.

All this is done by measuring the level of microwave energy and studying the pulse shape of both natural and reflected radiation.

The Seasat satellite, which is sponsored by the National Aeronautics and Space Administration, will acquire this information with five microwave sensors—active and passive to achieve an all-weather capability, a short-pulse altimeter, a long-pulse scatterometer, a synthetic aperture radar, a microwave radiometer and a visible and infrared radiometer.

The satellite, which is being built by Lockheed Missiles and Space, Sunnyvale, CA, will be launched before the middle of 1978. It will operate in a high-inclination, circular orbit (800 km), circling the earth every 100 minutes. With such a trajectory, sensors with 1000-km cross-track cov-

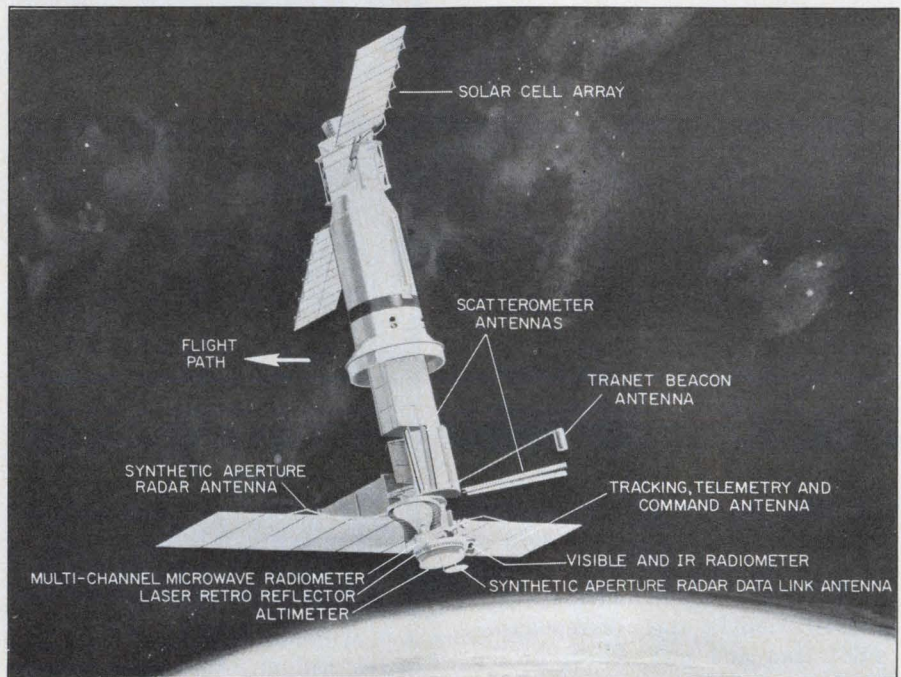

Seasat-A will carry five sensors into orbit in mid-1978 to send back data on such ocean conditions as wave height and water temperature.

erage will provide global repeat coverage every 36 hours, using both day and night passes to complete the fill in.

A compressed or short-pulse altimeter, which was also used on Skylab and the GEOS-C satellite, will detect the currents and surges of the world's oceans, as well as the height of waves, directly beneath the satellite, with an accuracy of from 0.5 to 1.0 m.

The altimeter transmitter will operate at 13.49 GHz (± 160 MHz) using a 1-m parabolic antenna. Bandwidth is 320 MHz; pulse width, 3.2 μ s. Peak transmitted power is 2.5 kW. Pulse-repetition frequency is 1100 pulses/s. Data output is 8 kb/s.

The long-pulse scatterometer will detect global wind in any direction with an accuracy of 20 degrees and

velocities of from 3 to 25 m/s with an accuracy of 2 m/s or 10%. The scatterometer was used on Skylab.

The scatterometer's antenna for Seasat A will be a 2.7-m stick. Average power output will be 165 W. Later Seasat satellites will be given a larger array and higher power.

L-band radar was chosen

The synthetic aperture radar, which was derived from the radar used on Apollo 17, will detect the length of ocean waves with an accuracy of 10% and their direction within 15 degrees. The resolution will be 50 m.

The radar will also reveal the presence of ore deposits and icebergs, measuring their areas with an accuracy of ± 25 m. It will look

INTERFACE AGE

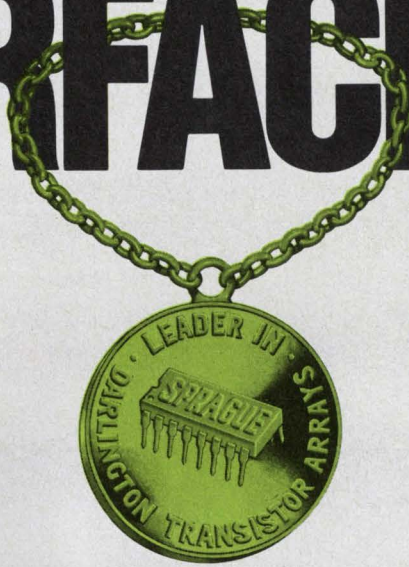

For High-Voltage, High-Current Interface with PMOS, CMOS, TTL . . . Sprague Darlington Transistor Arrays Have No Equal

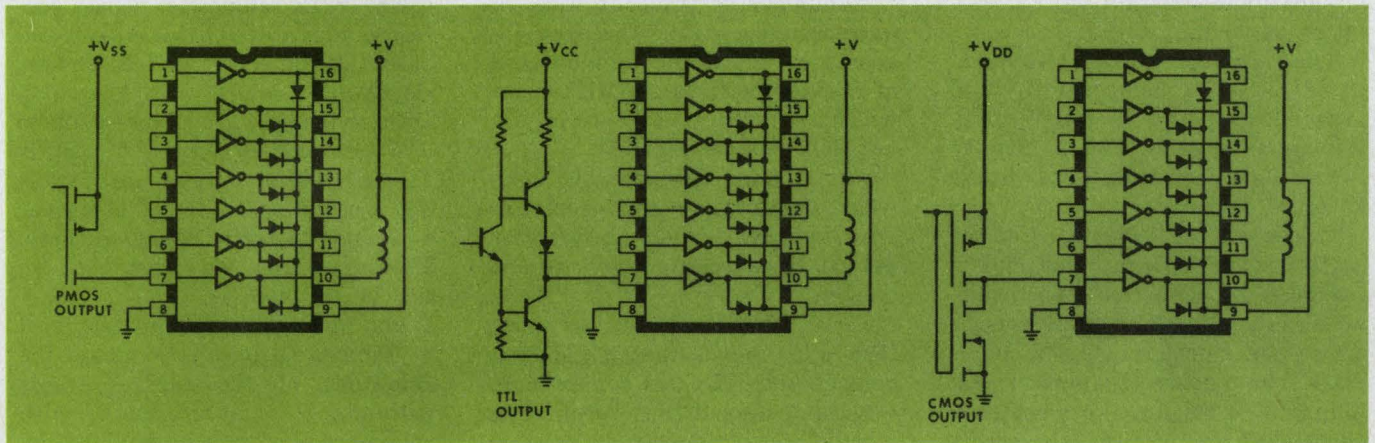

A new exclusive Sprague development, Series 2000 Transistor Arrays are high-voltage, high-current integrated circuits comprised of seven silicon NPN Darlington pairs on a common monolithic substrate. They feature open collector outputs and integral suppression diodes for inductive loads.

Supplied in 16-pin dual in-line plastic, these devices greatly reduce the number of discrete components used to

interface between digital logic and high-voltage and/or high-current loads. In some applications, all discrete components can be replaced by a single DIP, resulting in substantial space and cost reduction.

With broad commercial/industrial application, these unique arrays are an excellent choice for interfacing to LEDs, solenoids, relays, lamps, and small stepping motors in printing calculators,

cash registers, and control equipment.

Type ULN-2001A is a general-purpose array, pinned with inputs opposite outputs to facilitate circuit board layout. Type ULN-2002A is designed for use with 14 to 25 V PMOS inputs. Type ULN-2003A interfaces with TTL or CMOS operating at a 5V supply voltage. ULN-2004A has series input resistor to allow operation directly from CMOS and PMOS outputs utilizing 6V to 15V supplies.

For more information, write or call George Tully, Semiconductor Division, Sprague Electric Co., 115 Northeast Cutoff, Worcester, Mass. 01606. Tel. 617/853-5000.

For Engineering Bulletin 29304, write to Technical Literature Service, Sprague Electric Co., 347 Marshall St., North Adams, Mass. 01247.

For the name of your nearest Sprague Semiconductor Distributor, write or call Roger Lemere, Sprague Products Company, North Adams, Mass. 01247. Tel. 413/664-4481.

THE BROAD-LINE PRODUCER OF ELECTRONIC PARTS



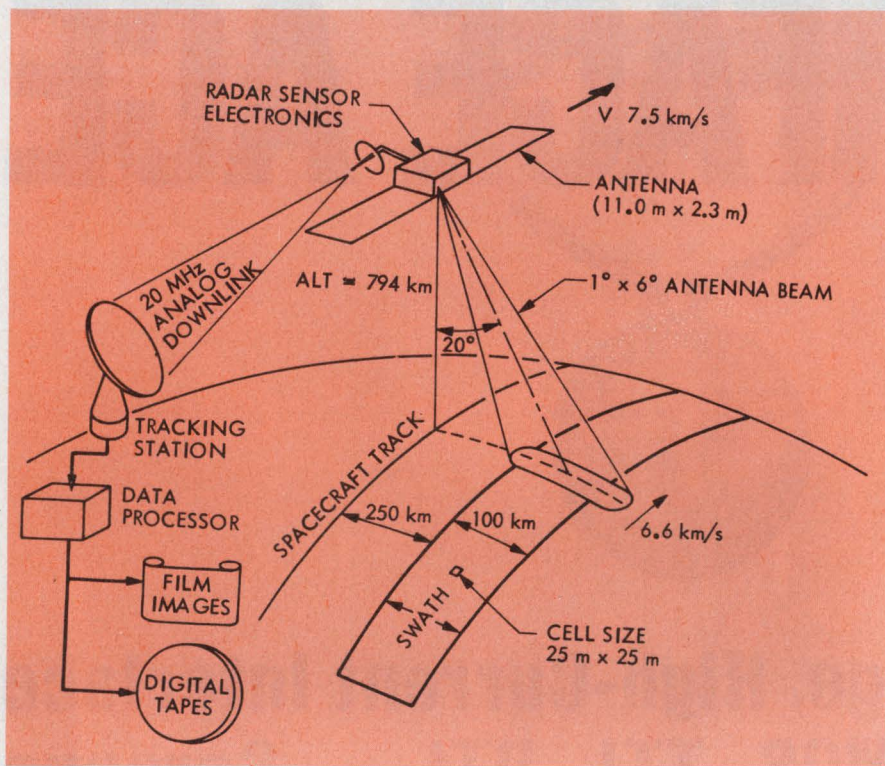

Synthetic aperture radar for Seasat-A evolved from experience gained with the Apollo Lunar Sounder operated on Apollo 17.

at shoals and currents, with a resolution of 25 m.

The radar operates at a frequency of 1.35 GHz, using a 14 by 2-m array. Peak output is 800 W, pulling an average of 200 to 250 W for its own operation. Data rate is 15 to 24 Mb/s.

Pulses will be transmitted at the earth via an antenna that has a 1-degree by 6-degree fan beam, which is pointed 20 degrees off nadir to the right-side of the spacecraft. The 6-degree beamwidth will illuminate a 100-km swath centered about 300 km off the spacecraft track.

Radar reflections from the oceans and land will be collected by the same antenna. These echoes will be amplified, translated to an S-band telemetry frequency, and because there is no on-board storage for the radar, immediately transmitted to a ground tracking station.

At the ground station, the radar echoes will be recovered from the S-band telemetry-link, digitized and recorded on magnetic tapes. These tapes will be transported to a data processor where they will be converted to film images or digital tapes by radar processing adapted to orbital parameters.

A number of tradeoffs were required in designing the synthetic aperture radar. The unit operates at L-band with a 19-MHz bandwidth centered at 1275 MHz; the wavelength is 23.5 cm.

This L-band frequency is somewhat slower than the usual aircraft-imaging radar frequencies, but it was selected for several reasons.

First, L-band requires less power than other bands that might have been chosen—X-band, for example.

Second, L-band can operate with a solid-state (bipolar transistor) power amplifier that is practical, low-cost, and available.

Frequency bands above L-band require TWT amplifiers, which have significant development problems related to high-voltage power-supply developments, corona suppression and operating-life limitations caused by cathode wear-out.

A third factor that led to the selection of L-band is antenna stabilization. For a given data-processing capability, the stabilization requirement is proportional to the frequency. The L-band antenna is stabilized in azimuth to ± 0.5 deg—well within the capability of current hardware. X-band would require ± 0.05 deg stabilization,

which would mean an expensive independent antenna-pointing system.

Once the L-band echoes are received by the satellite they are amplified and sent to the radar data link where they are translated to S-band and transmitted to the ground tracking stations.

The radar will be operated in real time when it is over appropriate high-data-rate ground stations. Present plans call for the system to use existing stations in Alaska, California and Maryland and a new Canadian station at St. John's Newfoundland.

Two passive microwave sensors

A visible and infrared radiometer scans horizon to horizon but only the middle 70 degrees of scan (or about 1000 km) on the ground produce accurate temperatures. The angular distortions at the higher angles plus increasingly long atmospheric path lengths make accurate interpretation much more difficult.

The V/IR radiometer senses surface temperatures between -2 and 35 C; it detects sea ice, shores, clouds and islands.

Its windows are from 0.52 to $0.73 \mu\text{m}$ and 10.5 to $12.5 \mu\text{m}$. It uses a 12.7-cm optical unit, scans 360 degrees, uses 10 W of power and sends to earth 12 kb/s of data. The instrument was first used on the ITOS satellite.

The microwave radiometer, used in Nimbus G, passively senses the amplitude of the surface winds within a 7 to 50-m/s range with an accuracy of m/s or 10%. It detects surface temperature within a -2 to -35 C range (accuracy is between 1 and 1.5 degrees). It measures the extent of sea ice over a 10 to 15-km area. And it sees and measures water vapor and liquid in the atmosphere.

Data from the satellite's sensors will be received by ground stations, which in turn will transmit the information to the United States Navy's Fleet Numerical Weather Center, Monterey, CA. From there it will be distributed to a host of government and civilian agencies.

Once Seasat-A has demonstrated its value, NASA spokesmen say, a three-satellite network will probably be put into operation. ■■

Crystals as Fine as Your Ideas



Sentry produces high quality quartz crystals for all types of industrial, scientific, governmental and consumer uses. Microprocessors. Monitors. Precision timepieces. Two-way communicators. The list is virtually endless. Because we customize our crystals to fit your specifications.

And whatever specifications our crystals fit, they all meet the same exacting standards. We start with the finest natural Brazilian quartz. For frequency stability. Then we plate each crystal with gold. For longevity. And we use the latest state-of-the-art technology every step of the way.

But Sentry offers more than quality. We offer service, too. Our large bank of semi-



finished communication crystals and file of correlation data on existing equipment allow us to fill many orders the same day. We treat small orders with the same care and precision as large ones. And we'll be glad to develop crystals for your new designs. To place your order,

phone 1-800-654-8850 toll free outside Oklahoma. Or write Fred Zelinger, Sales Director, Sentry Mfg. Co., Crystal Park, Chickasha, OK 73018. For a copy of our latest catalog, fill out the coupon below and send it along with \$1.50, deductible from your first order.

Sentry Mfg. Co. • Crystal Park • Chickasha, Okla. 73018
 Please send me the complete 1976 Sentry Catalog. Enclosed is my check or money order for \$1.50, deductible from my first order.

Name _____

Company _____

Address _____

City _____ State _____ Zip _____

Sentry Manufacturing Company
 Crystal Park,
 Chickasha, Oklahoma 73018
 TXW: 910-830-6425
 Cable: Sentry OKC
 Phone: 405-224-6780
 or 405-232-1431

CIRCLE NUMBER 16

Pulse-compression antenna converts milliwatts to watts

Put milliwatts into a pulse-driven antenna and get watts out! A paradox? Not at all, according to a new method of feeding antennas revealed in Air Force studies of broad-band, frequency-independent antennas.

The Air Force approach is based on a seldom-recognized characteristic of these antennas used for radar or communications. They act as dispersive filters or pulse-stretching networks. When these antennas are driven by a sharp rf pulse—on the order of 100 ps—they ring.

The radiated outputs are chirp signals that expand to hundreds of times the period of the driving pulse. (See photo). As a result, the power density of the driving pulse—the amount of power packed into a given unit time and space—is reduced in the radiated pulse by orders of magnitude.

But surprisingly, high radiated pulse-power densities can be achieved with these antennas by employing the radiator as a net-

work for pulse-compression rather than for pulse stretching.

By properly matching the transmitter's waveform with the antenna's dispersion characteristics, the electromagnetic peak power density can be increased by an amount that is approximately the time-bandwidth product of the antenna, according to Paul Van Etten, project engineer at Rome Air Development, Griffis Air Force Base, NY.

(The time-bandwidth product is the time over which the radiated chirp pulse is stretched, multiplied by the bandwidth of the antenna.)

A 4-W power density

For off-the-shelf antennas this product has been demonstrated to be as high as 4000. That means that for an antenna with a time-bandwidth product of 4000, 1 mW input can produce a radiated EM-field pulse-power density of 4 W.

As in pulse compression networks, the pulse in space is also compressed by an amount equal to the time-bandwidth product.

One advantage of using antennas as pulse-compression networks is that such use can substantially improve the poor efficiency of present types of impulse-driven antennas. Their efficiency is compromised to get signal fidelity and directivity.

Another important application of

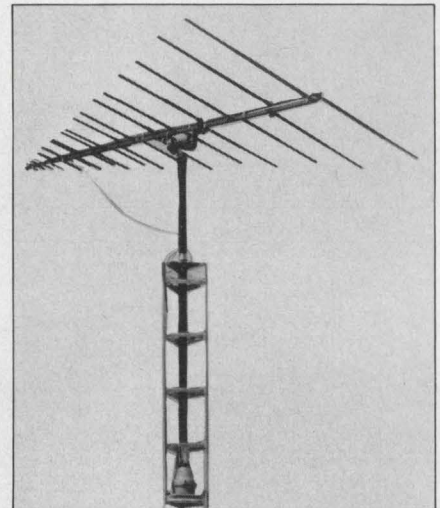

Log-periodic antennas, such as this American Electronics APN-995, can be used as pulse-compression elements that compress mW chirp-signal inputs into ps pulses with peak power densities of Watts.

pulse-compression antennas is to obtain very strong electromagnetic fields when the transmitter's peak-power is limited, or when the power-handling capability of the transmission line is limited.

Another significant fact is that pulse compression can be performed on both transmission and reception. In that case, the effective time-bandwidth product is greater than for the radiator alone.

The Air Force has tested the dis-

Jim McDermott
Eastern Editor

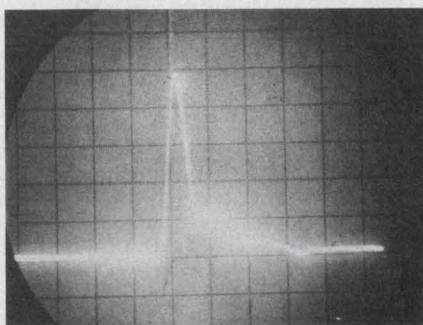

The log-periodic antenna, above, acts as a pulse-expansion network when driven by a 100-ps pulse, left. The antenna expands the pulse and radiates it as a chirp signal, below. The chirp has an instantaneous frequency that decreases logarithmically. By driving this antenna with the conjugate waveform of the chirp signal, the antenna radiates a pulse that has high power density. The time scale of the waveforms is 1 ns per division.

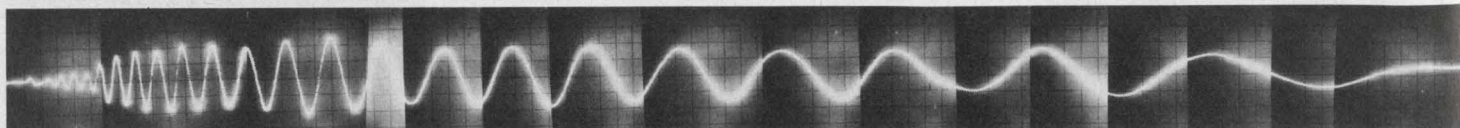

introducing

THE NEW WESTON AUTORANGING PORTABLE DMM

The best buy ever in a portable digital multimeter

ONLY
\$195

Performance, quality, reliability and price. The new Weston Model 6000 is a total value package and the best buy ever in a portable digital multimeter. Just check these performance and convenience features:

Autoranging-plus factor in a portable

The simplicity, speed and accuracy of automatic ranging is a big advantage in a low cost portable digital multimeter. And in the Model 6000, it's available for the five standard measurement functions . . . AC/DC Volts, AC/DC Amps, Resistance. . . in 26 broad ranges. . . with full overload protection. Zero adjustment for all ranges is built-in . . . automatically.

A bonus feature is a 10 Amp AC/DC current range . . . not usually available in digital instruments. And a special "Hold" input jack provides a convenient memory retention capability for remote measurements.

Superior performance in a portable

Even in a low priced portable, Weston quality proves itself. The high performance capability of the Model 6000 is typified by an accuracy of 0.35%, with resolution of 100 μ v, 1 μ a and 0.1 ohm.

Large, easy-to-read-anywhere display

Even in bright sunlight, it's easy to read the large 0.5" high LCD 3½ digit display. Alternate

blinking of the LCD's provides an over-range indication that prevents erroneous readings. And minus polarity is measured and displayed automatically without reversing leads.

Low power operation

Power source for the Model 6000 is two inexpensive, easily available 9V transistor batteries. Long battery life is assured by special circuits designed by Weston for low power drain. And when the batteries do run low, the LCD display blinks to tell you.

Small and lightweight . . . but rugged

The Model 6000 portable is small in size and weighs less than two pounds. The rugged glass-filled Lexan® case can withstand tough treatment. A combination carry handle/display cover/tilt stand makes it convenient and practical for field or bench use.

® Trademark, General Electric Co.

Weston service back-up

The Model 6000 is backed-up with the Weston total service commitment. Complete full year warranty, with service available at any of Weston's domestic or foreign service centers. Another plus factor for a low priced portable DMM.

The new Weston Model 6000 Autoranging Portable DMM doesn't scrimp on performance, quality or reliability . . . it just brings them to you at a better price.

MODEL 6000
A field type multimeter with
bench instrument performance



See the Model 6000 at any Weston Distributor. Or, write direct to Weston for additional information.

Weston Instruments, Inc., 614 Frelinghuysen Ave., Newark, N.J. 07114

Canada: 1480 Dundas Highway, Mississauga, Ontario
Europe: Ingolstadter Str. 67a 8 Munchen 46, W. Germany

WESTON® WESTON
Schlumberger

RCL

Offers

"EXPRESS DELIVERY"

At Standard Pricing...

On Rotary & "PIP" Switches

Industry's Best Delivery at Non-Premium Prices.

PROTOTYPE OR PRODUCTION RUNS—ALL AT STANDARD PRICING

Send For New '76 Catalog Or Call our Hotline For Name Of Your Local Representative Or Stocking Distributor.

(201) 374-3311

AMF

RCL Electronics

General Sales Office:
700 So. 21st Street
Irvington, N. J. 07111

CIRCLE NUMBER 18

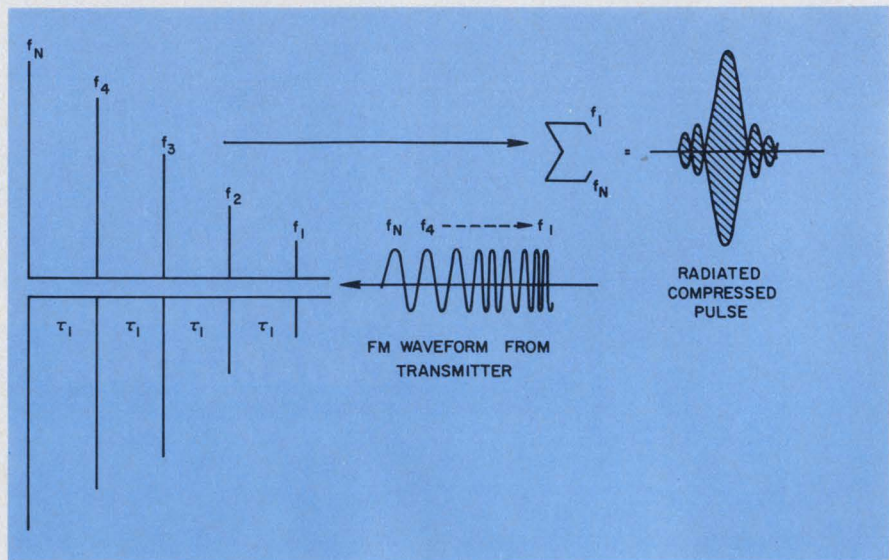

A pulse with high power density can be generated by the coplanar log-periodic antenna. Feed the antenna with a swept waveform that starts with the resonant frequency of the longest element and ends with that of the shortest. The sweep can be linear or nonlinear.

persive qualities of over a dozen antennas of different types, including: the cavity-backed spiral, pyramidal log-periodic, coplanar log-periodic and crossed-planar log-periodic.

Van Etten uses a coplanar-log-periodic antenna (see photo) to explain how the dispersion of an antenna can be used to compress power in a pulse.

These antennas are fed in a way that excites the highest frequency element first, then the next highest element and so on. There is a time delay between the elements that depends on the propagation velocity through the feed structure. Additional time delay is encountered upon radiation. This sequence of element feed plus the time delays, play a major role in producing the chirp pulse.

To compress the power in a radiated pulse, the antenna is fed "backwards" with a chirp pulse having an instantaneous frequency increasing from that of the lowest resonant element to that of the highest resonant element.

The sweep of the instantaneous frequency may be linear, logarithmic or any other function, as long as it is the conjugate of the time-delay/frequency relationship between each of the elements, in sequence. Essentially the conjugate is the inverse waveform of the radiated chirp pulse. When this conjugate waveform feeds the an-

tenna, the peak of each cycle of each of the various element's frequencies will all arrive in the far-field at the same time and be in phase. The result is a radiated pulse that is compressed in space, a pulse similar to one emerging from a pulse-compression network.

Because of the spatial compression the power density of the compressed electromagnetic wave is equal to the product of three factors: the bandwidth of the chirp waveform, the time duration of the chirp (or fm) pulse, and the power density of the antenna when radiating continuous waves.

Present efforts are being directed at developing equipment to generate the complex conjugate chirp pulses for driving antennas with differing dispersion.

The most apparent application for pulse-compression antenna systems is in long-range, high-resolution radars. But a potential application of electromagnetic field compression exists in secure communications. For example, it should be possible for amplitude-modulated information to be coded onto a long duration, frequency-modulated pulse without upsetting the conjugate phase relationship between transmitter and antenna.

Then if the same conjugate-matched filter characteristic is used at the receiving antenna, any information coded onto the waveform can be decoded. ■■



Increase Reliability and Performance with Custom Quartz Crystals.

MCCoy Electronics offers a larger variety of Quartz Crystals than any other supplier. With a frequency range of 700 Hz to 250 MHz and a variety of housings available such as solder seal, glass, and cold weld, MCCoy crystals have found broad uses in commercial, industrial, military, and high reliability applications.

MCCoy specializes in applications where strict control of motional parameters is dictated, tight stabilities are needed, or in any program requiring experienced technological resources.

In addition, MCCoy crystals are proven to be economical for the buyer in terms of consistent performance and high quality, thereby eliminating the costly burden of replacement.

We invite your use of MCCoy's expert engineering and marketing staffs in developing specifications for custom crystals individually tailored to meet your needs.

Please write for our free catalog.

LMC **MCCOY**
ELECTRONICS COMPANY

a subsidiary of **OAK Industries Inc.**

MT. HOLLY SPRINGS, PA. 17065 • 717-486-3411 - TWX: 510-650-3548

CIRCLE NUMBER 19

LED Super-Brights

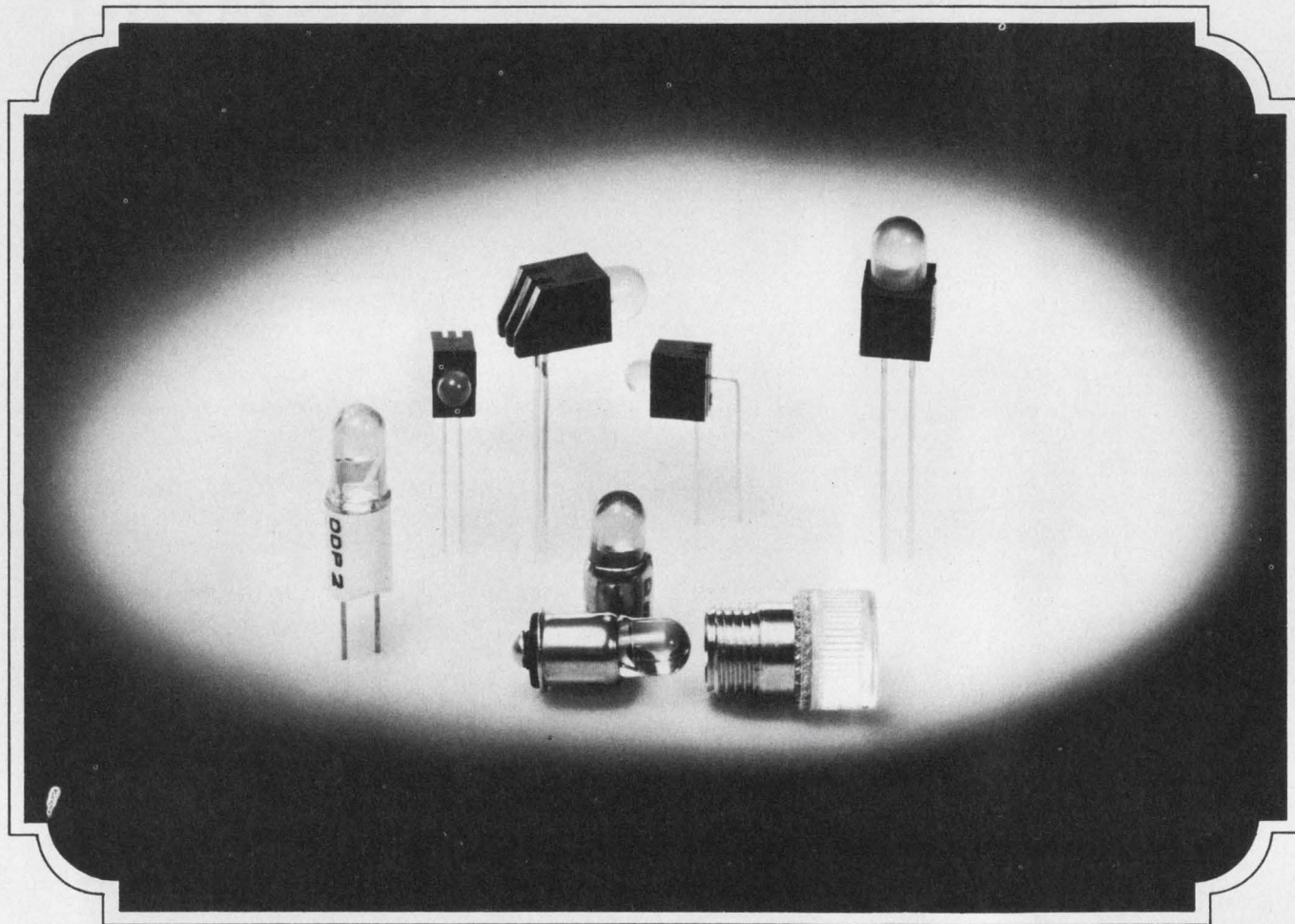

Ideal replacements for incandescents!

Here come the LED Super-Brights . . . red, amber and green. Their high brightness (50 MCD @ 20mA — typical clear red) make them the perfect cost and power saving replacements for incandescents. Available with built-in resistors for all popular voltage ranges.

PCB LED's — Horizontal or vertical viewing . . . optional built-in resistor for 5V applications.

Bi-Pin (T1-3/4) LED's — Ideal for dead front panel applications, e.g. DEC's PDP Series computers.

Midget-Flanged (T1-3/4) LED's — Direct replacements for incandescents in panel light and switch applications.

Replacement Lenses — Specially designed for use with Midget-Flanged LED's.

There's lots more too. Send for our Catalog today: Data Display Products, 5428 W. 104th Street, Los Angeles, Ca. 90045, (213) 641-1232.

We're the original "little light" people.

DATA DISPLAY PRODUCTS ●●●

Washington Report

WWMCCS defined as a \$11-billion command system

The Pentagon's ambitious program to tie together all its strategic command-and-control systems into a single integrated network called the World-Wide Military Command-and-Control System (WWMCCS) will go into operation in the mid-1980s and cost \$11 billion, according to Air Force Secretary Thomas Reed.

Reed told last month's Armed Forces Communications and Electronics Assn. (AFCEA) conference in Washington that additions to the baseline system would include secure conferencing, message processing, and mobile hardened, fixed command posts. These additions will add \$1 billion to the original network of satellites and their ground stations, airborne and ground-based command posts, secure voice and message networks, information display systems and the extremely-low-frequency (ELF) communications system being developed by the Navy under its Seafarer program. IBM has served as the WWMCCS architect for the past two and a half years.

Commerce Dept. opposes FCC's clear-channel plan

The Commerce Dept.'s Office of Telecommunications has announced its opposition to a proposal by the Federal Communications Commission to increase the permissible power level of clear-channel AM stations from 50,000 W to 750,000 W. The FCC's objective is to improve nighttime service in poor-reception areas.

The Office of Telecommunications is against the move because of the interference problems it believes so much power may create. According to research conducted by the Office's Institute for Telecommunication Sciences at Boulder, CO, radio waves of 500,000 W can modify certain regions of the ionosphere sufficiently to cause cross-modulation, scattering and fading. Before allowing stations to broadcast at such power levels, the office recommends field tests.

AT&T criticized for interconnect "monopoly"

AT&T was attacked from two sides recently for what its critics charge are monopolistic practices in the interconnect field.

Legislation sponsored by AT&T and independent telephone companies amounts to "totally unsubstantiated scare tactics to preserve their monopoly at the expense of the public," charged John Eger, director of the White House Office of Telecommunications, at an Electronic Industries Assn. communications meeting. The telephone industry has been urging legislation to limit competition in interconnect equipment on the grounds that it would have to pass along any losses from that business

in the form of rate increases to subscribers.

In what is believed to be the strongest criticism of AT&T yet by a member of the Ford administration, Eger called the proposal "sheer folly," adding, "to my knowledge after months of intense promotion, the industry has not been successful in enlisting the support of a single consumer group." He said the bill would strip consumers of all options in their choice of communications services and leave them to the mercy of a sole supplier.

Litton Industries soon joined the fray by filing a \$111-million anti-trust suit against AT&T and its operating subsidiaries in Federal court in New York City, charging monopoly of the telephone terminal-equipment market.

The suit, which seeks trebled damages of \$333 million, contends that AT&T has eliminated competition to give itself more than 98% of that market, and is fixing prices to exclude competitors. AT&T is selling terminal equipment below cost in the commercial market and subsidizing these losses by higher charges to residential users, according to the Litton complaint.

Litton is basing its suit on the historic Carterfone decision of 1968, which opened the way for competition, and on the more recent FCC decision of March 18, 1976, which held that AT&T could not require its own interface devices on all interconnected equipment.

Six firms compete for Navy's AN/AYK-14 computer

Six companies are in the final competition for the Navy's AN/AYK-14 standard airborne computer, which will go aboard both the Navy's F-18 air combat fighter and the LAMPS MK-3 helicopter (Light Airborne Multi-purpose System). The winner will be named by Sept. 30.

The bidders are Control Data, IBM, Lear Siegler, Rolm, Teledyne and Univac. Univac is considered to have an advantage because the Navy chose its AN/UYK-20 software for the computer. Companies that were active in the preliminary phases of the program, but who chose not to bid, are Delco, Litton and Westinghouse.

Reliability requirements are stringent, with the Navy demanding a mean-time-between-failure (MTBF) of 2000 hours plus reliability-assurance warranties (RAWs) in the contract that would penalize the producer for failing to meet reliability specifications.

Computer-industry sources project a market for more than 5000 of the AYK-14 computers over the next decade, because it is also being considered for future Navy systems. Even if the Navy holds to its projected \$33,000 ceiling price per unit, which the sources doubt, that still means a market for more than \$150 million.

Capital Capsules: Aerospace Corp. is developing a low-cost burglar-alarm system for the Law Enforcement Assistance Administration, and **needs suppliers for a custom MOS LSI chip.** The chip is intended to transmit a 16-bit coded signal plus framing pulses. . . . **The Navy last month successfully tested the McDonnell Douglas terrain-contour-matching guidance system of its Tomahawk cruise missile.** The Air Force will test the same system on its own Air Launched Cruise Missile later this summer. . . . **Cutler-Hammer's AIL Div. has delivered the first of two microwave scanning beam landing systems to NASA to handle the final approach and landing of the Space Shuttle.**

Look what you get when Tektronix builds a 50 MHz portable

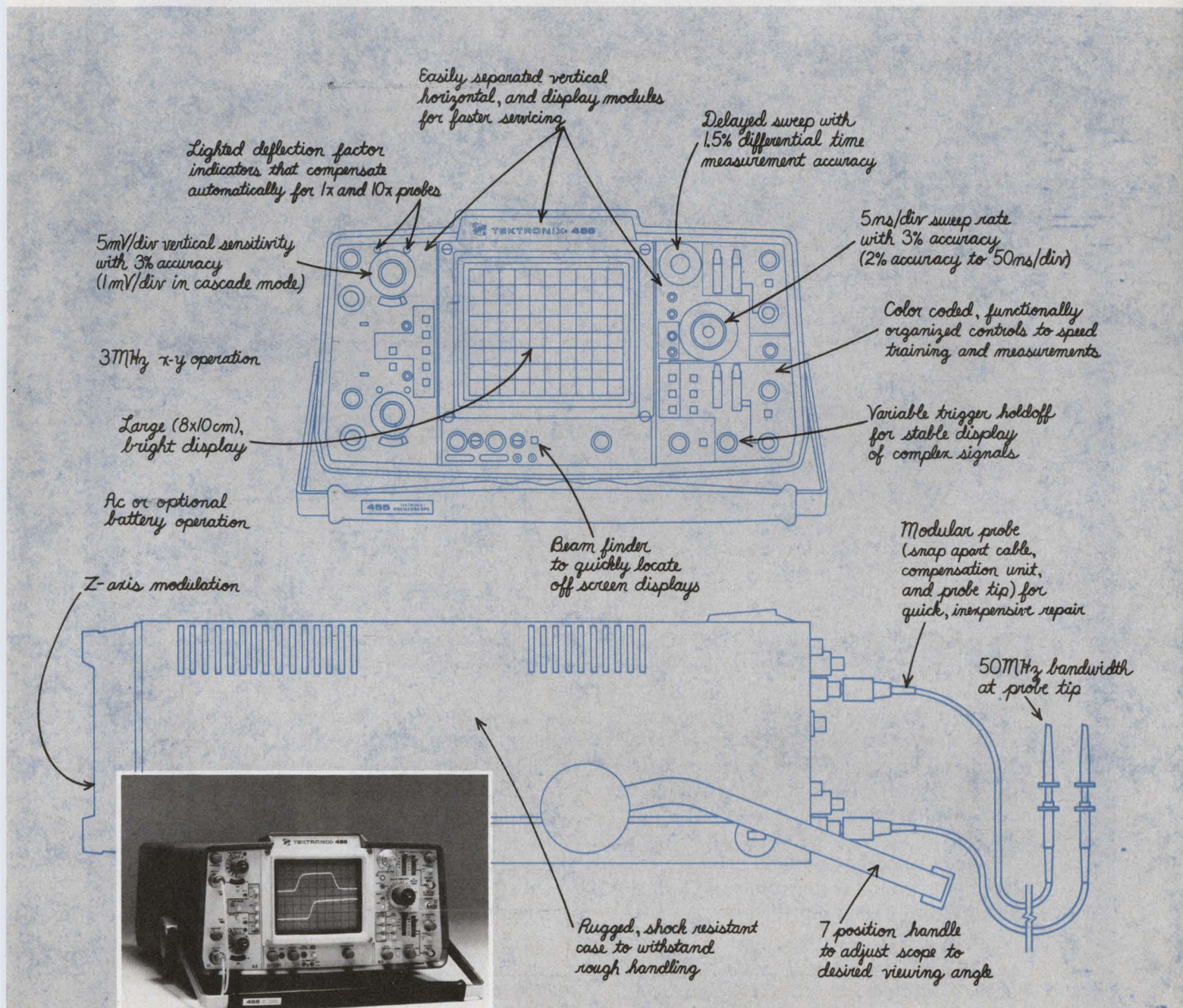

TEKTRONIX 455 - \$1745

And the 455 offers the quality, reliability, and service you expect from Tektronix.

If your application requires higher bandwidth and/or storage, the high performance TEKTRONIX 400 Series offers 6 other outstanding portable oscilloscopes. Bandwidths include 100 MHz, 200 MHz, and 350 MHz. Also offered are a fast transfer storage model capable of displaying single-shot, 100 MHz signals and a split screen, bistable storage model.

For a no obligation demonstration of how the 455 and other TEKTRONIX Portable Oscilloscopes deliver performance, convenience, and cost effectiveness for your

application, contact your Tektronix, Field Engineer. Or for complete information write: Tektronix, Inc., P.O. Box 500, Beaverton, Oregon 97077. In Europe write: Tektronix Limited, P.O. Box 36, St. Peter Port, Guernsey, Channel Islands.



U.S. Sales Prices FOB Beaverton, Oregon

FOR TECHNICAL DATA CIRCLE #284
FOR DEMONSTRATION CIRCLE #285

**Monolithic capacitors have been
our business for nearly three decades.**

We build them better

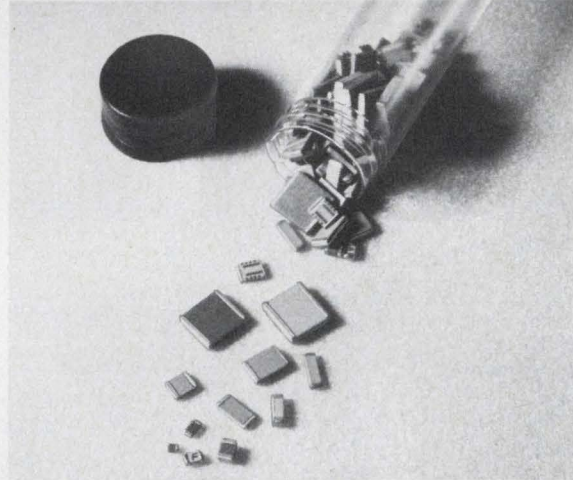
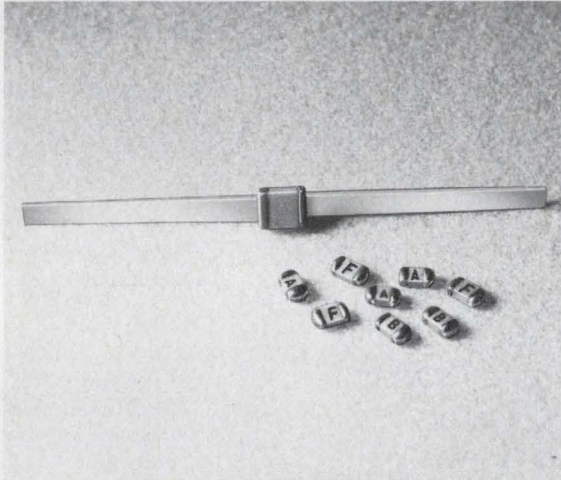

Our 53 styles of Chip Capacitors prove it.

In short, we make monolithic chip capacitors in many sizes and dielectrics — for all hybrid circuit applications in the industry. And we deliver them in the quantity you need, with the traditional 'Vitramon' product quality.

You can select the parts to meet your requirements from a wide variety of Ceramic NPO, BX, X7R and Z5U types . . . Cer-

amic and Porcelain Microwave devices . . . Military approved CDR chips . . . special features such as silver-ribbon leads and marked parts . . . 'Vee Cal' Chips that you can adjust in or out of your circuit.

Look over our chip selector: We'll supply what you need from these 53 styles . . . and deliver what we offer.

Type	Cap. Range	Type	Cap. Range
NPO Ceramic	1 pF-.018 μ F	7156 Microwave	1 pF-330 pF
BX Ceramic	100 pF-.47 μ F	'VY' Porcelain	1 pF-330 pF
X7R Ceramic	100 pF-1.0 μ F	CDR (BP)	10 pF-.01 μ F
Z5U Ceramic	6800 pF-1.5 μ F	'Vee Cal'	1-680 pF
		Adjustable-Fixed	



Vitramon[®]

**Vitramon North America
Division of Vitramon, Incorporated
Box 544, Bridgeport, Conn. 06601**

Subsidiaries: Vitramon Limited (London) • Vitramon GmbH (Stuttgart) • Vitramon France S.A.R.L. (Paris) • Vitramon Pty. Limited (Sydney) • Vitramon Japan Limited (Tokyo)

Microprocessor Design

16-bit microprocessors speed things up in high precision computing

Despite some rumblings to the contrary, the 16-bit microprocessor is here to stay. Some compelling reasons for using the 16-bit μ Ps are discussed by Paul Ahrens of General Instrument Corp., Hicksville, NY and by Al Lofthus of Texas Instruments, Houston.

Paul Ahrens offers his views first.

There are lots of applications—in process control or in the military, for example—where you have to have the accuracy provided by 16-bit data words.

By using a 16-bit word you can express a number to one part in 2^{16} (about 65,000). With an 8-bit μ P you can express a single-word number to only one part in 2^8 (256).

Of course you can get 16-bit precision with an 8-bit machine too. In fact you can do anything you want, even with a 4-bit μ P, but it takes more time. To do 16-bit computation with, say, an 8-bit machine you resort to double precision. What you do is break up each word of data into two 8-bit parts, and then use two sequential locations in memory to store each word of data.

But we've found that if you're doing a



computation with 8 bits that really should be 16 bits, you pay a penalty in computation time. It turns out that the penalty is not merely twice the time of an 8-bit machine, but

(continued on page 36)

8080-compatible μ P claims fastest instruction time

The Am9080A-4 is claimed by Advanced Micro Devices (901 Thompson Pl., Sunnyvale, CA 94086. 408-732-2400) to be the world's fastest 8080A-compatible μ P. It has an instruction-cycle time that is half that of the industry standard and 22% less than that of the fastest part previously available.

The 8-bit μ P has a 250-ns cycle time that provides a 1 μ s (maximum) instruction cycle time. And, the Am9080A-4 has a maximum power dissipation of 1.1 W, compared with the 1.3 W of the 8080A units.

In addition to offering the 1 μ s unit, the company offers three other speed versions. The Am9080A-4 is pin compatible with all 8080-type circuits and offers two full TTL loads of output drive (3.2 mA at 0.4 V) on all outputs. These units also have an input HIGH voltage of 3 V to provide a larger noise margin.

The Am9080A-4 costs \$55 in 100-up quantities and is available from stock.

CIRCLE NO. 551

(continued from page 35)

anywhere from 4 to 10 times.

Here's a trivial example: To do a 16-bit addition takes only one instruction with a 16-bit machine. But in an 8-bit μ P it becomes a subroutine up to 6 steps long. The time to do a computation in a 16-bit device, compared to the time required by an 8-bit machine, does not simply decrease linearly. Instead, the combination of many working registers (6 or more) and longer word length in the 16-bit machine socks you with a "double-whammy."

Everyone points out that in process control applications, electromechanical devices like relays and switches work much more slowly than a computer. So they imply there's no need for high-speed μ Ps.

But what usually happens before a given switch can be operated, is that the μ P has to complete some involved numerical calculations. There is only a fixed amount of time allowed from the instant information reaches the sensors to the instant when an output must be delivered, so during that period the μ P is going full blast. That's why process-control people, among others, want faster and faster machines.

Consider these examples.

Suppose you have a machining operation in which you have to move an XY-positioned table around. The full span of movement may be 3 or 4 in. If the application is in the semiconductor industry, you'd need to be able to position the table to a precision of something like 0.1 mil, which implies a resolution of about 0.0001 in. out of 4 in. For that kind of precision, life would be much easier with a 16-bit machine.

The second example concerns a possible military situation.

Imagine two airplanes approaching each other at top speed, each going at Mach 2. In order for the μ P on one plane to track the other aircraft, it must perform calculations (angles, tangents, etc.) extremely rapidly.

Most of the time the processor is doing nothing, just waiting. But for the two seconds that the planes are speeding past each other, the μ P is running full out, generating the necessary calculations. At that time it's crucial to have available the full capability of a 16-bit machine.

Sixteen-bit μ Ps are also important when using a/d and d/a converters. In these conversion processes 12 or 14 bit accuracy is required. Such programming is much easier with a 16-bit machine than with an 8, where each data word has to be split up into two words.



Al Lofthus adds these comments.

In general, a 16-bit microprocessor gives you greater flexibility in programming. We've found that most of the personnel doing designing—particularly in the software end—are ex-minicomputer people. They're used to words of 16-bit length, and they feel more comfortable in it.

The point, however, is that with 16-bits, a programmer has a great deal of flexibility, more than he would have using an 8-bit machine.

With 16-bits, the instruction set is more powerful, you certainly achieve higher-precision arithmetic, and you can move blocks of data in a shorter time.

In comparing the expense of 16-bit and 8-bit μ Ps, you really need to consider what the entire system is going to cost you. Include how much memory you require, how much interfacing you need, and how many special chips are necessary to do the job. The cost of the μ P itself may represent a relatively small fraction of the total cost.

For example, Texas Instruments' 9900, a 16-bit μ P, has a price tag of three or four times, that of the 8080. But if you compare the over-all system cost of each, the 16-bit system becomes pretty cost effective.

Breadboard 8080A development system has all you need

Developed as an educational breadboard system for microcomputers, the Mini-Micro MMD-1 can also be used to test out complex μ P-based designs. The breadboard was developed by E&L Instruments and comes complete with hardware, firmware and easy-to-understand training manuals.

The MMD-1 is designed around the 8080A μ P and has socket provisions for one 8224 clock generator, two 8111-2 (256 \times 4) static RAMs, two 8216 4-bit bidirectional bus drivers, and one 1702 (256 \times 8) erasable PROM in addition to the 8080A. Also on the breadboard are a 16-switch keypad organized for machine programming in octal coding and one of the company's SK-10 universal breadboards, which can hold up to six 16-pin DIPs and a wide range of discrete components. Inside the cabinet are supplies that provide +5 and \pm 12 V.

There are several versions of the MMD-1 available. The completely assembled and tested unit costs \$500. The kit, which includes all parts ready for assembly (including manuals), costs \$350. A set of MMD-1 printed-circuit boards with interface sockets and keyboard is also

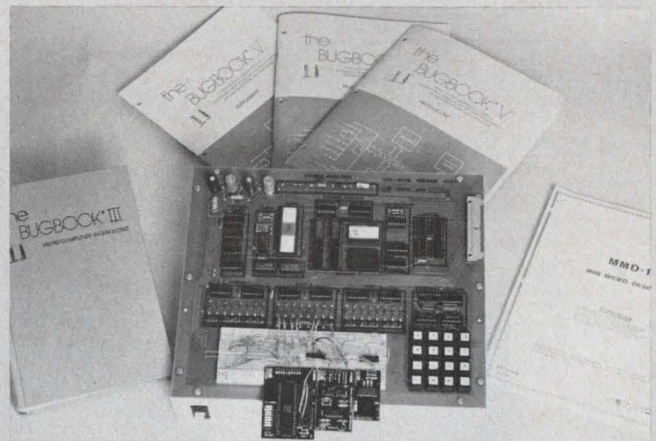

available for those who need custom cases and have access to a supply of components. The completely assembled MMD-1 measures 10 \times 12 \times 3 in. and has a sloped front. Total weight is 7 lb.

Additional experiments, sets of ICs and hardware are available as separate items. Delivery of the μ P breadboard is from stock. E & L Instruments, 91 First St., Derby, CT 06418. (203) 735-8774.

CIRCLE NO. 552

'Make the world a better place to live' μ P contest

Schweber Electronics has announced a competition to design a microprocessor system that will "make the world a better place to live in." There will be a \$1000 Grand Prize, \$500 second prize and three \$250 third prizes.

"The microprocessor will be used in products that will help solve our problems in energy, materials, pollution, health, agriculture and communications," according to Seymour Schweber, president of Schweber Electronics.

The competition requirements include a systems concept, block diagram, list of components, a program source listing, and a 50-word project description. Entries must be postmarked on or before Oct. 17, 1976.

For more information and a complete entry kit, write to:
Mel Kuzin, MPU Center, Schweber Electronics Corp., Westbury, NY 11590. (516) 334-7474.

8080 emulator kit uses bipolar bit-slice family

A bipolar emulator for the 8080 μ P is being readied for introduction by Signetics (811 E. Arques Ave., Sunnyvale, CA 94086. 408-739-7700). It is software compatible with all existing 8080 programs, and runs between 2 and 12 times as fast.

The kit uses a 3000-series bipolar bit-slice μ P that comes microprogrammed, and it includes all clocking, status, and transceiver functions. The instruction set may be expanded through additional microcoding if desired. The 8080 emulator is fully static, allowing cycle times from 110 ns through dc.

This kit is the first of a series being prepared by Signetics to provide designers with an easy entry into the field of microprogrammable μ Ps. Also scheduled is a designer's evaluation kit that includes parts, PC board, and all schematics and flow charts. Follow-up kits will include an emulator for the Signetics 2650 μ P, a floppy-disc controller, and a terminal kit. All kits will be priced in the \$200 range.

CIRCLE NO. 553

DATEL



YOUR \$59* DPM

Choose Datel's DM-350 for your next design . . .
And take a look at these Datel Digital Panel Meters:

MODEL	NUMBER OF DIGITS	POWER SUPPLY	FEATURES	PRICE (1-9)
DM-350D1	3-1/2	+5VDC @ .3A	UNIPOLAR, LOW POWER, DISPLAY ONLY	\$69 (1-9) \$59 (100's)*
DM-350D2	3-1/2	+5VDC @ .3A	BIPOLAR, LOW POWER, DISPLAY ONLY	\$75
DM-350A1	3-1/2	115/230 VAC	UNIPOLAR, XFMR-ISOLATED, DISPLAY ONLY	\$79
DM-350A2	3-1/2	115/230 VAC	BIPOLAR, XFMR-ISOLATED, DISPLAY ONLY	\$89
DM-4000	4-1/2	+5VDC @ .6A	OPTOISOLATED RATIOMETRIC AUTO ZERO XTAL LINE FILTER	\$219 less BCD \$239 with BCD
DM-4300	4-3/4	+5VDC @ .6A	OPTOISOLATED RATIOMETRIC AUTO ZERO XTAL LINE FILTER	\$235 less BCD \$255 with BCD
DM-2000AR	3-1/2 DIGITS AUTORANGING OVER 3 DECADES	+5VDC @ .8A	AUTOMATIC RANGING OVER $\pm 200\text{mV}$, $\pm 2\text{V}$ $\pm 20\text{V}$ FULL SCALE	\$169 less optoisolation \$218 with optoisolation



1020 Turnpike St., Canton, Ma 02021 • Phone (617) 828-8000
 • Santa Ana, Calif. (714) 835-2751 • Santa Ana (L.A. Exchange) (213) 933-7256
 • Sunnyvale, Calif. (408) 733-2424 • Gaithersburg, Md. (301) 840-9490

Abolish the first day

I had this brilliant idea. In a flash of inspiration I saw the solution to the problem of poor first days at trade shows: Eliminate the first day and start with the second.

When I mentioned this to a friend, he said he had a concept that was even more significant. Since many people don't like work, he wanted to abolish the first work day of every week. Well, there are kinks in both schemes. We'll have to send them back to engineering for redesign.

But wait. These ideas are absurd. Any show will have a first day, and every week must have its first working day, be it Monday, Tuesday or whatever. So there's no point in sending these ideas back to the lab. The ideas are too nutty; they can never work.

Maybe that's true in these cases. But is it always true? How many ideas turned out, later, not to be so nutty? Did no one ever tell our technical ancestors that if God intended man to work with electrons, He would have made them big enough to see? Did no one tell Wilbur or Orville Wright that if God intended man to fly, He would have furnished tickets? Did no one ever tell Mr. Bell that a telephone was not only impossible, but useless as well?

But that was long ago. We're smarter now. We now know that man can make electrons work, that man can fly and that man can speak across wires.

We don't kill new ideas anymore. Or do we? It's almost 20 years since we laughed at the idea that silicon transistors, which were very costly, might virtually wipe out germaniums. It's almost 10 years since we last scoffed at the idea that active components could be cheaper than passives. And it's not much more than five years since we stopped laughing at the thought that a \$20 pocket calculator could outperform an \$800 desk-top unit. What are we laughing at now?

We can smile in retrospect at our limited vision of yesterday. But what about tomorrow's engineers? What will they say of our vision? Or will they smile, instead, at our blindness?



ELECTRONIC DESIGN is deeply honored to have received official recognition as a participant in the American Revolution Bicentennial Celebration, with authority to display the Bicentennial Symbol.

GEORGE ROSTKY
Editor-in-Chief

on Crystals for Frequency Control

EDUS

Millions of quartz crystals are used today in an expanding host of frequency-control applications ranging from watches and TV games to computers and communications equipment. As components, these crystals are unusual in that though they are mass produced they are essentially custom products. For example, Citizen's Band transceiver crystals, though fabricated for standard frequencies, must be tailored to the particular crystal-load capacitance of an individual manufacturer's sets.

Crystal manufacturers' literature, much of which is general information that has been passed on, without revision, for generations of catalogs, is unfortunately of little help if you're trying to pick the right crystal for the job.

For one thing, to correctly and precisely specify a crystal you must understand the equivalent circuits for two modes of operation: series and parallel resonance (often called antiresonance). Yet detailed analyses of these modes is seldom found in crystal vendors' catalogs.

Another important characteristic, stability of a crystal with temperature variations, is specified differently by different manufacturers even though the crystal type and cut may be the same.

Other specs that can give an oscillator designer grief—like spurious response, which can produce unwanted effects in broadband digital circuits—are seldom included in manufacturers' data.

Tolerances of crystal characteristics, such as temperature stability and aging for the same type and cut of crystal, vary between vendors. This indicates differences in fabrication, but it's difficult to find out what they are.

Specifications are frequently omitted because a manufacturer simply hasn't tested all of the parameters that can be specified.

Almost never do vendors tell you exactly how



Precisely controlled frequencies ranging from kilohertz to over 150 MHz are produced by this range of quartz crystals from McCoy Electronics.

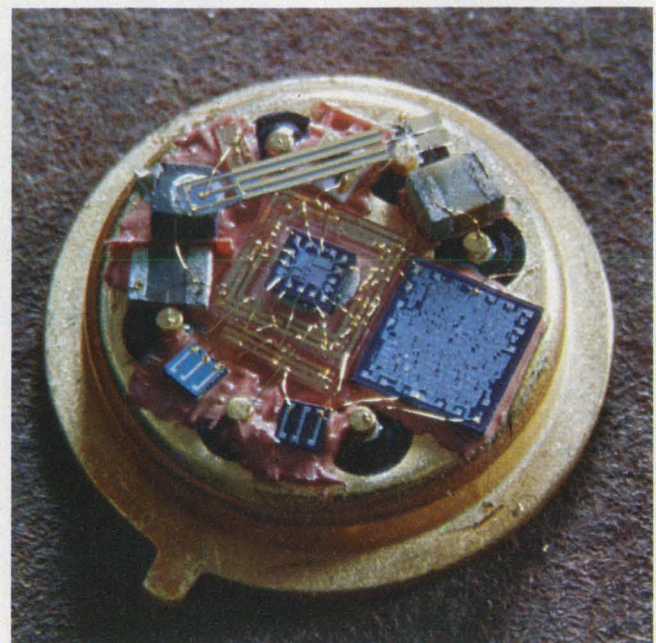

This hybrid, long-period (1 pps) timer uses a micro-miniature tuning fork, by Statek.

Jim McDermott
Eastern Editor

they test their crystals. This information, of course, is crucial to crystal oscillator designers.

Most of the industry is still using MIL specs as the basis for the listings in catalogs of "standard" crystals. But these specs are based on tests with vacuum-tube equipment that was designed years ago for crystals to be used in tube-type oscillators.

Specs based on equivalent circuits

The complex electromechanical system that's formed by a vibrating quartz resonator can be described by an equivalent electrical circuit (Fig. 1). Quartz crystals naturally vibrate in several simultaneous resonance modes. Usually one of these is designed to be dominant at the desired operating frequency.

The frequency of a mode of elastic vibration is coupled, through the piezoelectric effect, to an electrical system. The vibrating mass of the crystal is equivalent to a series motional inductance, L_s . The inductance value ranges from thousands of henries for low-frequency crystals to millihenries for elements working at over 100 MHz.

The mechanical losses of the crystal appear as an equivalent series resistance, R_s , while the mechanical elasticity of the crystal is equivalent to a small series capacitance, C_s .

In a practical circuit, a parallel capacitance appears between the crystal-holder terminals. This is the sum of two factors: One is the static capacity, C_o , between the plated electrodes of the crystal plus internal stray lead and holder-pin capacitances. The second factor, C_L , is the capacitance associated with external wiring plus a crystal load capacitance that is included by design.

Crystals are designed to resonate at either a series resonant frequency, f_s , or a parallel resonant frequency, f_p , that is slightly higher than f_s . Alternatively, by altering the capacitive load for the parallel-resonant circuit, you can operate the crystal at some frequency between f_p and f_s .

At series resonance, the reactances of the series capacitor C_s and series inductance L_s are equal and opposite, and the net reactance of the series circuit is zero. The series-resonant circuit is then equivalent to R_s in parallel with C_o . Because R_s is very small compared to the reactance of C_o , series resonance occurs at the minimum impedance and with zero phase shift.

At a frequency slightly higher than f_s the inductive reactance increases and the capacitive reactance decreases. Then capacitance C_o forms a parallel resonant circuit with inductance L_s . When the net inductive reactance equals that of C_o , the crystal vibrates at a frequency, f_p . At f_p the crystal has a very high impedance and an

inductive reactance.

Any external capacitance, such as load capacitor, C_L , then becomes a portion of the frequency determining network, and the actual working frequency is slightly decreased from that of the theoretical antiresonant frequency.

The difference in frequency between the series resonant point and parallel resonant point can be obtained from the equation:

$$f_p - f_s = 0.5 f_s (C_s/C_o).$$

The essential difference between a crystal operating in series or parallel resonance is the addition of a capacitive load.

For applications where the frequency of the oscillator may need to be trimmed either during installation or later, the use of a parallel-resonance crystal is preferable because the frequency

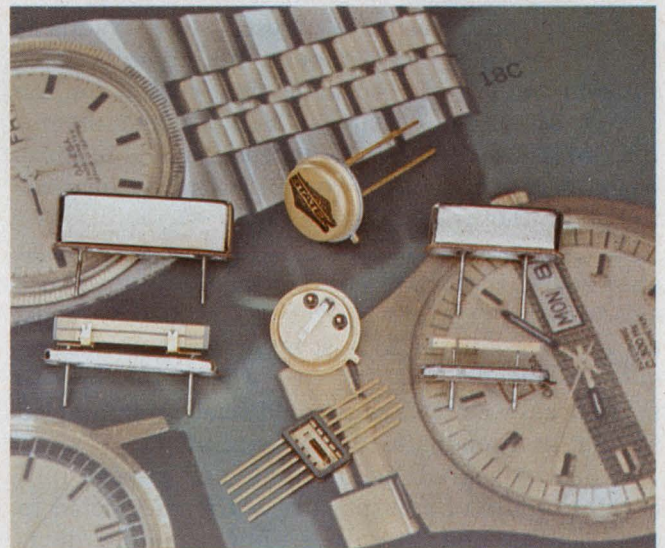

Three types of 32-kHz crystals used in watches are: the NT cut (left), tuning forks (center) and XY bar (right).

shift can then be obtained by varying the value of the load capacitor.

For operation below 1 MHz, the recommended value for the load capacitance is 20 pF.

For crystals operating above 1 MHz, 32 pF has been the U.S. standard for over 25 years. However, this value was established for tube circuits, and today the actual value is usually much less, especially with the semiconductors and ICs. For example, to minimize power drain on CMOS circuits, the load capacitance is normally less than one half the 32 pF value.

A very useful spec—notable for its absence in many data sheets and catalogs—is "pullability." This describes how much you can change the operating frequency—over a limited range—by varying the load capacitance. The pullability spec helps you decide how much trimming will be

required to compensate for circuit-component variations. It also helps you design circuits for voltage control.

The bandwidth over which the frequency can be varied is bounded by the series-resonant frequency at one end and the parallel resonant operation at the other (Fig. 2).

If pullability is a factor in design, collaboration with the crystal manufacturer is advisable; bandwidth can be controlled to some extent, during fabrication, by varying the crystal parameters. An approximation of the pulling limits for standard crystals can be obtained from the following formula:

$$\Delta f = 0.5 f_s [(C_s/C_o + C_L)]$$

The exact limits also depend upon the Q of the crystal as well as associated stray capacitances. Pullability can be approximately doubled by modified crystal fabrication and by adding capacitance or inductance external to the crystal.

The spurious response of oscillator crystals is seldom specified even though all crystals have spurious modes of resonance. One reason for the dearth of specs is that the number and magnitude of these "spurs" is expensive to minimize. Also, testing for spurs would drastically increase the manufacturer's costs.

But, in many cases, it's necessary to request spur specs. In your circuit, an unwanted response close to the crystal's operating frequency might cause the oscillator to lock onto the spurious frequency during startup. Or, where the crystal is used as a clock, spurs could lead to scrambled timing in broadband digital circuits.

Other undesired signals that may appear in a crystal oscillator's output are widely neglected in data sheets and literature. For example, it is possible for an ac power line to introduce modulation components into the oscillator output at the line frequency. Proper shielding and avoidance of ground loops are needed to prevent this.

Where a crystal may be subject to vibration, such as in an industrial application, undesired

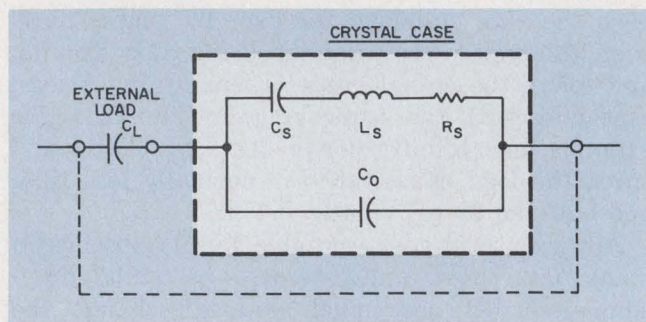

1. The equivalent circuit of a quartz crystal consists of electrical quantities associated with the crystal itself (C_s , L_s , R_s and C_o) plus external capacitive loading C_L .

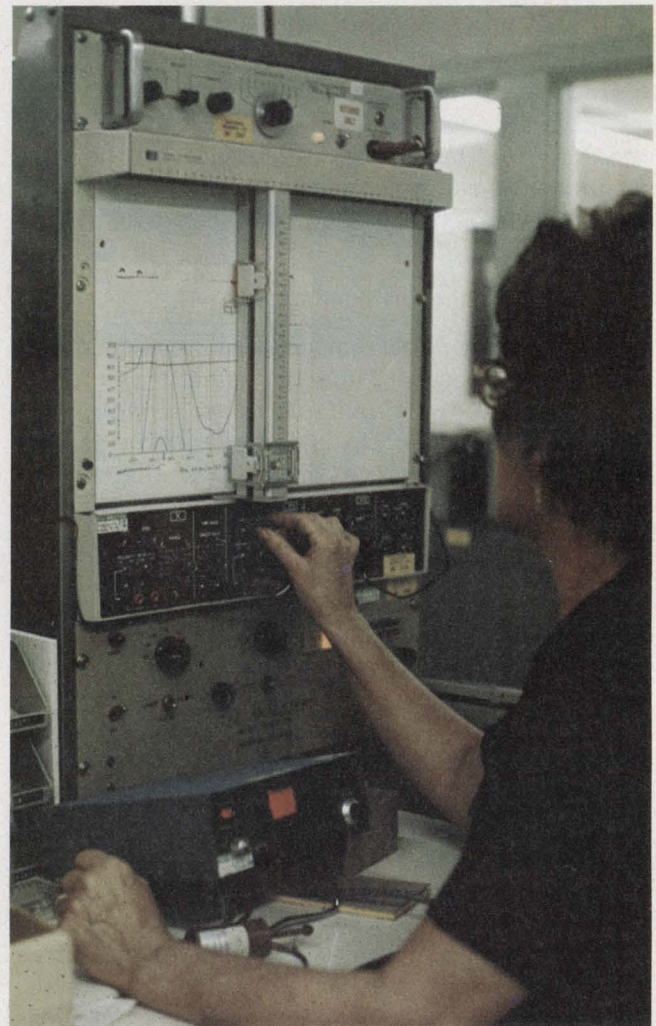

Crystal-characteristic data are obtained with instrumentation like that at Electronic Research. These data do not normally appear in data sheets, but can be requested.

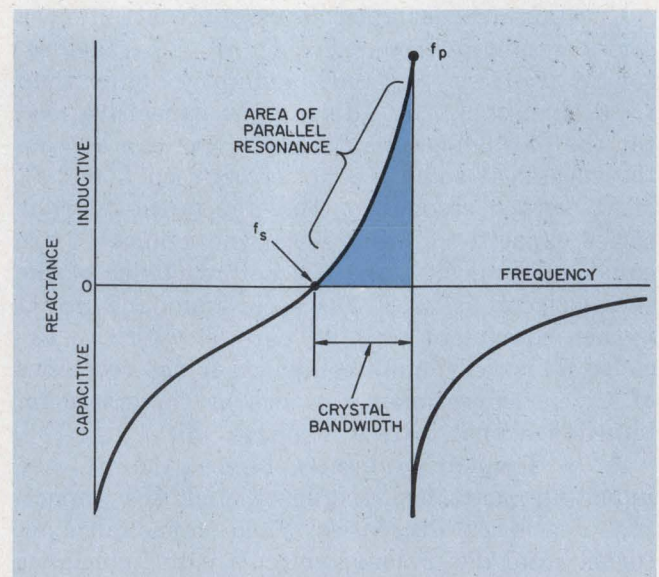

2. Quartz crystals operate in series resonance at f_s , in parallel antiresonance at f_p , or at some frequency in between, depending upon the external capacitive load.

sidebands can appear in the oscillator output. Ruggedized crystals can cure this situation. But before specifying more expensive crystals, check whether or not the sidebands can be tolerated or, possibly, can be filtered out. Ruggedized crystals, in addition to their higher cost, have poorer parameters—like Q, temperature stability, and aging—than do standard crystals.

Test equipment poses problems

The test equipment used by crystal manufacturers is never described in their literature. One reason is that the crystal industry is, to a great extent, still based on MIL specs that require the use of old vacuum-tube testers. There is industry-wide agreement that this equipment is outdated, but no new standard exists. Manufacturers now have newer generations of non-MIL-spec equipment tailored to semiconductor applications. Much of the new equipment produced by suppliers like Saunders and Associates, Phoenix, AZ and RFL Industries, Boonton, NJ is also suitable, in both design and price, for crystal users.

However, crystal specs still show high crystal-drive levels characteristic of vacuum tubes. These levels are substantially above those found in today's discrete semiconductor and integrated-circuit oscillators. The end result is that the crystal buyer may find his oscillator frequency outside the tolerance guaranteed by the manufacturer.

It is therefore important to have the manufacturer check the crystals under the same drive levels as in your circuit. In fact, the sure-fire procedure is to provide the crystal producer with a test oscillator configuration exactly like that in which the crystal is to be used.

A fertile area for specsmanship is frequency stability—the drift from a design-center frequency due to external influences. The two most important factors here are variations in temperature and aging.

Temperature stability is often stated simply in terms of ppm/°C, which looks good—that is, until it is compared with frequency drift over a realistic operating-temperature range. To get an insight into crystal tempco characteristics, it's necessary to take a look at how the various tempcos are derived during crystal manufacture.

Crystal cutting affects tempcos

Piezoelectric elements are sliced from synthetic or natural quartz boules to obtain crystals that resonate at frequencies ranging from 1 kHz to 800 kHz for low-frequency cuts up to 200 MHz for high-frequency plates. The angle at which the cuts are made with respect to the crystallographic axes determines the temperature-vs-fre-

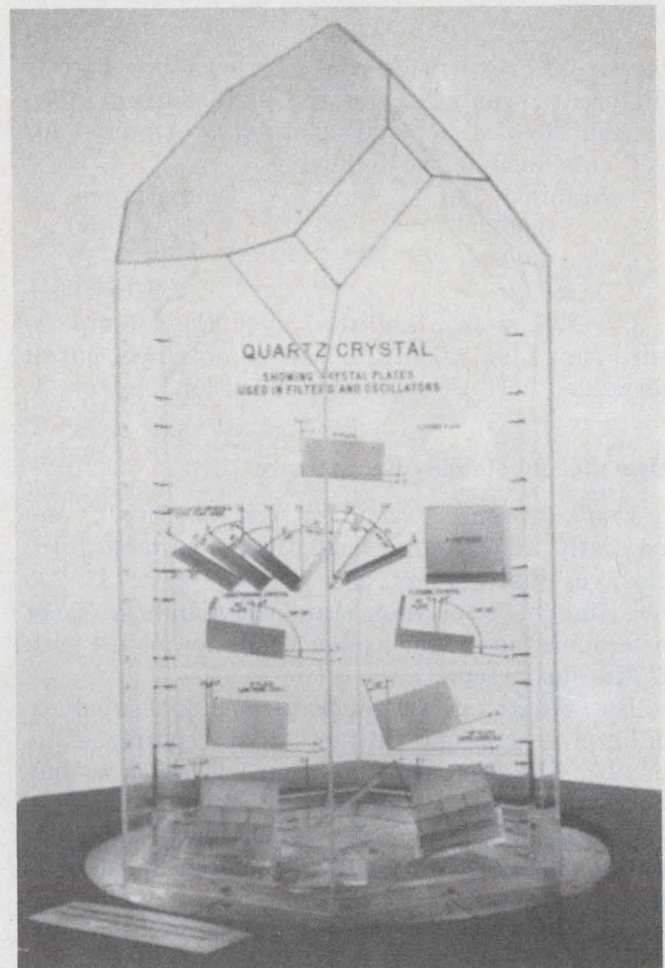

The temperature characteristics of crystals depend upon the angles at which they are cut from the boule. AT-cut crystals are most stable and have the lowest cost.

quency characteristics of the crystal.

Cuts are made so that at one point, usually at room temperature, there is essentially a zero-frequency shift for small temperature variations about that point. For certain cuts, like those for NT and DT crystals, this "turning point" can be adjusted, during fabrication, over a wide range—such as from -50 to over 100 C. This range is usually included in the specs for low-frequency crystals.

The frequency-vs-temperature curves are parabolic for all of the low-frequency cuts—for frequencies from 1 to about 800 kHz. This is also true for the characteristics of so-called "tuning-fork" crystals.

But the best frequency-vs-temperature characteristics are exhibited by AT-cut crystals—which, fortunately, fit the vast majority of applications. Fundamental frequencies for this cut range from about 0.5 to 40 or 50 MHz. And operation at the third, fifth and seventh overtone frequencies produces oscillators useful from 10 to 200 MHz.

The basic AT temperature characteristics can

be varied over a wide range by selecting slightly different orientations of the plate during fabrication. Typical frequency-stability figures for AT cuts include the following:

Stability, %	Temperature, °C
±0.002	0 to 50
±0.003	-20 to 70
±0.005	-55 to 105

Crystals with stabilities, over their temperature range, of ±0.0025% can be obtained, but at an added cost for special fabrication.

Overspecing stability is expensive

Don't overspecify temperature stability. It can be costly. If a figure of ±0.01% is suitable for a clock oscillator don't ask for ±0.005%. If you need much better than standard stability, either a temperature-compensated oscillator or an oven is the next step.

But design of a temperature-compensated oscillator is a tricky business that requires experience. The less costly approach is often to buy one from any of a number of suppliers.

For the ultimate in temperature stability, use an oven. It can improve that factor by at least three orders of magnitude. But then, watch out for aging, which becomes a predominant factor. Also aging rate increases with temperature. And oven-controlled units are usually operated 10 to 15 degrees above the highest expected ambient. Typical specs for ovens cover an adjustable set-point range of 65 to 85 C.

Frequency stability on the order of 10 ppm can be obtained with an oven-stabilized crystal held to within 5 C of its turnover point. Maintaining crystal temperature to within 1 C can give 1 ppm.

Aging specs are ambiguous

Specs for the frequency drift of a crystal with age are frequently incomplete and ambiguous. Some data sheets give short-term stability in terms of frequency drift per second. Others use what they call an "intermediate aging rate" of drift per day. But short-term aging measurements are almost useless because daily ambient changes of temperature can completely mask aging effects.

Probably the shortest realistic period over which aging can be measured is about one month, after which time daily variations due to temperature change, and other effects such as ambient vibration, can be averaged out.

Where an oscillator is to be used at other than room ambients, watch out for the aging figure,

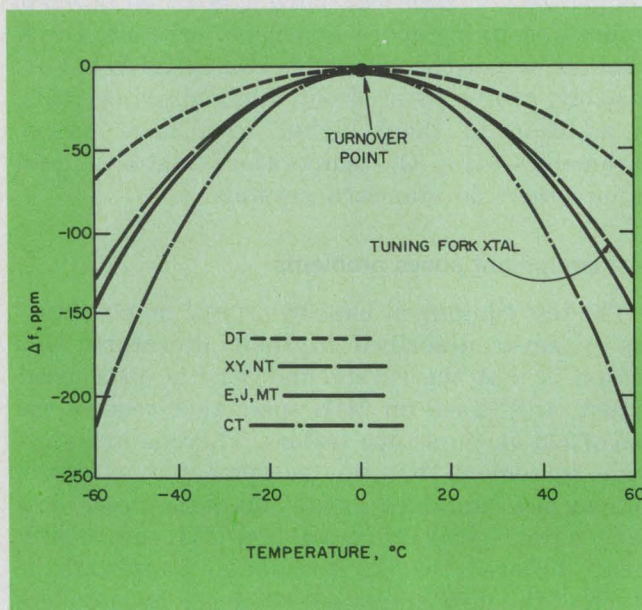

3. The frequency variation with temperature of low-frequency crystals is parabolic. This graph shows how the frequency deviates as relative temperature is changed.

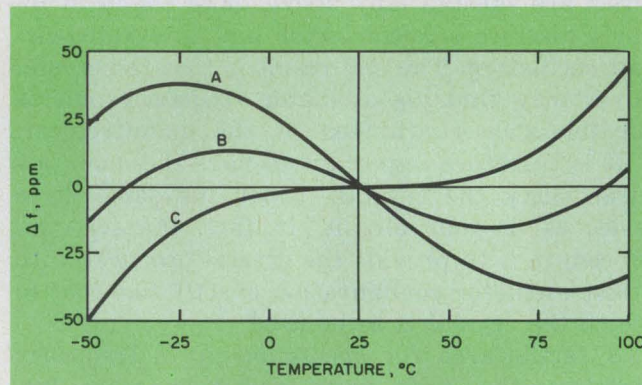

4. The best temperature stability is obtained with AT-cut crystals. Curve A shows minimum drift over a wide temperature range, while B is typical of compensation for room-temperature operation. For operation in ovens or high ambients, curve C is typical.

because this is invariably specified at 25 C. At lower temperatures the aging is reduced, but at higher temperatures aging is increased.

The rate at which a crystal ages is affected to a large extent by the type of package. The best units are glass sealed, with cold-welded units closely following. Solder-sealed cans usually display the highest aging rates of all three.

For a good sealed holder, the aging rate of low-frequency room-temperature crystals is in the order of 10 ppm per year. For similar rated AT crystals it is about half that.

Fortunately, most of a crystal's aging occurs

within the first two or three months of operation in a circuit and then levels off to a constant low rate of change.

For applications in which the aging rate must be unusually low, crystals can be pre-aged by the manufacturer, but at substantially increased cost.

Shock, vibration and overdriving of a crystal can all increase the aging rate, but only the manufacturers know how much, and they don't tell in their literature. For any specific environment the crystal maker must be consulted.

Where specs are nonexistent

Today, an ever-growing multitude of IC systems require crystals as a frequency determining element. Examples include ICs for touch-tone signalling, digital system clocks, phase-locked loops and digital-communication devices.

But try to find the specs for these crystals

and you'll run into a dead end. The IC manufacturer doesn't give crystal specs. Rather, he recommends a crystal from a particular manufacturer. But ask the crystal manufacturer for specs and he'll probably send you back to the IC producer.

What's the reason for the hassle? It's this: Each type of IC has its own unique electrical characteristics. For example, it's well known that second-sourced items never perform exactly like the original did.

As a result, the IC manufacturers work with individual crystal manufacturers in developing crystals that will work reliably in their circuits. But don't try to buy an apparently identical crystal from another supplier, because chances are, it won't work. And don't try to use a crystal recommended by one IC vendor in a second-source IC.

At this stage of the game about all the designer can do is accept the IC manufacturer's recommendations. ■■

Need more information?

For manufacturers' literature, detailed specs and other information helpful in selecting and applying crystals in frequency-control applications the reader is referred to the crystal producers listed below. For the most cost-effective approach to oscillator design close collaboration with selected manufacturers is suggested.

Alpha Crystal Corp., 4107 N.E. Sixth Ave., Oakland Park, Fort Lauderdale, FL 33334. (305) 563-6149. (W. Wilder) **Circle No. 542**

Atomergic Chemetals Co., 584 Mineola Ave., Carle Place, NY 11514. (516) 333-5600. (C.J. Monteleone) **Circle No. 501**

Austron, 1915 Kramer Lane, Austin, TX 78758. (512) 836-3523. (R. Ellis) **Circle No. 543**

Bliley Electric Co., 2545 W. Grandview Blvd., Erie, PA 16512. (814) 838-3571. (D.M. Bliley) **Circle No. 502**

Bulova Watch Elec. Div., 61-20 Woodside Ave., Woodside, NY 11377. (212) 335-6000. (W. Carnos) **Circle No. 503**

Clark Crystal Div., 7 Hayward St., Hopkinton, MA 01748. (617) 435-6821. **Circle No. 504**

Crown, Ltd., Div. W. Kidde & Co., 500 Beech St., Whitby, Ontario, Canada. (416) 668-3324. (R.E. Dix) **Circle No. 505**

Crystal Network Products, 818 Parade St., Erie, PA 16503. (814) 459-2351. **Circle No. 506**

Crystek Crystals Corp., 1000 Crystal Dr., Fort Myers, FL 33901. (813) 936-2109. (E. Fox) **Circle No. 507**

CTS Knights Inc., 222 Reimann Ave., Sandwich, IL 60548. (815) 786-8411. (K. Mooibroek) **Circle No. 508**

Deltronic Crystal Inds., Inc., P.O. Box 323, Denville, NJ 07834. (201) 361-2222. (B.R. Sax) **Circle No. 509**

EBL Co., Inc., 78 Tolland St., Rear E., Hartford, CT 06108. (203) 289-5429. (C.R. Lewis) **Circle No. 510**

Electronic Research Co., P.O. Box 913, Shawnee Mission, KS 66201. (913) 631-6700. (G.J. Dehnert) **Circle No. 511**

Erie Frequency Control, 453 Lincoln, Carlisle, PA 17013. (717) 249-2232. (L. Goss) **Circle No. 512**

Erie Tech. Products, 644 W. 12 St., Erie, PA 16512. (814) 453-5611. (P.E. Snyder) **Circle No. 513**

Frequency Elecs. Inc., 3 Delaware Dr., New Hyde Park, NY 11040. (516) 328-0100. (A. Lazar) **Circle No. 514**

Frequency & Time Systems Inc., 182 Conant St., Danvers, MA 01923. (617) 777-1255. (A.O. McCoubrey) **Circle No. 515**

Harris Corp., 55 Public Square, Cleveland, OH 44113. (216) 861-7900. (H.R. Silbaugh) **Circle No. 516**

Hughes Aircraft Co., Microelectronic Products Div., 500 Superior Ave., Newport Beach, CA 92663. (714) 548-0671.

(F.H. Weisel, Jr.) **Circle No. 517**

International Crystal Manufacturing, 10 N. Lee St., Oklahoma City, OK 73102. (405) 236-3741. **Circle No. 518**

Leader Instruments Corp., 151 Dupont St., Plainview, NY 11803. (516) 822-9300. (S. Nihei) **Circle No. 519**

McCoy Elecs. Co., Watts St., Mt. Holly Springs, PA 17065. (717) 486-3411. (M.L. Myers) **Circle No. 520**

Monitor Products Co., Inc., 3018 San Luis Rey Rd., Ocean-side, CA 92054. (714) 433-4510. (J.W. Blaisir) **Circle No. 521**

Motorola/Components Products Dept., 2553 N. Edgington St., Franklin Park, IL 60131. (312) 451-1000. **Circle No. 522**

M-Tron Ind., P.O. Box 630, Yankton, SD 57078. (605) 665-9321. (T. McGuire) **Circle No. 523**

Northern Engineering Labs Inc., 357 Beloit St., Burlington, WI 53105. (414) 763-3591. (J.D. Holmbeck) **Circle No. 524**

Oven Industries, P.O. Box 229, Mechanicsburg, PA 17055. (717) 766-0721. **Circle No. 544**

Peterson Radio, 2800 W. Broadway, Council Bluffs, IA 51501. (712) 323-7539. (N. Anderson) **Circle No. 525**

Piezo Crystal Co., 100 K St., Carlisle, PA 17013. (717) 249-2151. (W. Wilson) **Circle No. 526**

Piezo Tech. Inc., 2400 Diversified Way, Orlando, FL 32804. (305) 425-1574. (J.J. Dinnan) **Circle No. 527**

Precision Crystal, 11240 W. Olympic, Los Angeles, CA 90064. (213) 473-1281. **Circle No. 528**

Quaker Elecs., Box 215, Hunlock Creek, PA 18621. (717) 256-3477. (A. Yascavage) **Circle No. 529**

Reeves-Hoffman Div., 400 W. North St., Carlisle, PA 17013. (717) 243-5929. (J.D. Harlin) **Circle No. 530**

Savoy Electronics, P.O. Box 5727, Fort Lauderdale, FL 33065. (305) 563-1333. (O. E. Lussier) **Circle No. 545**

Sawyer Research Products, Inc., 35400 Lakeland Blvd., East-lake, OH 44094. (216) 942-8747. (D.P. Larsen) **Circle No. 531**

Sentry Manufacturing Co., Crystal Park, Chickasha, OK 73018. (405) 224-6780. (B. Torbett) **Circle No. 532**

SGC Inc., 13737 S.E. 26, Bellevue, WA 98005. (206) 746-6310. (D.L. Stoner) **Circle No. 533**

Standard Crystal Corp., 1 Cupania Circle, Monterey Park, CA 91754. (213) 724-5004. (J.B. Fisher) **Circle No. 534**

Stetek Corp., 1200 Alvarez Ave., Orange, CA 92668. (714) 639-7810. (G. Markley) **Circle No. 535**

Tedford Crystal Labs., 4914 Gray Rd., Cincinnati, OH 45232. (513) 542-5555. (J.A. Vella) **Circle No. 536**

TMC Systems Arizona Inc., 930 W. 23 St., Tempe, AZ 85282. (602) 967-7874. (D.R. Robinson) **Circle No. 537**

Torotel Inc., 13402 S. 71 Hwy., Grandview, MO 64030. (816) 761-6314. (J. Beecroft) **Circle No. 538**

Tyco Crystal Products, 1510 Mc Gee Trafficway, Kansas City, MO 64108. (816) 842-9731. (D. Kemper) **Circle No. 539**

Valtec Corp., 99 Hartwell St. W., Bolyston, MA 01583. (617) 835-6082. (T. Gallagher) **Circle No. 540**

Xtron Elecs. Inc., 1869 National Ave., Hayward, CA 94545. (415) 783-2145. (R.M. Hossack) **Circle No. 541**

Blend a wideband PLL with a narrowband loop and boost frequency-synthesizer performance. The benefits: low noise, high resolution and low cost.

Looking for an indirect digital synthesizer in the hf region? Design one yourself using several phase-locked loops (PLLs), instead of the usual single-loop approach. By combining a wideband PLL with a narrowband PLL, you get tuning in fine steps, and low phase noise.

Perhaps the simplest design consists of a dual-loop, tandem arrangement (Fig. 1).¹ Here, two variable dividers are simply ganged together—no mathematical computation is needed. Also not needed is a mixer to combine the signals from the wideband voltage-controlled oscillator (VCO) and the narrowband voltage-controlled crystal oscillator (VCXO). One such synthesizer operates with 100-Hz steps in the 50-to-59.9999-MHz band.

The performance of the simple, dual-loop synthesizer is superior to that of a single-loop, 100-Hz system. Although a more complex design could yield even better results, the cost would be far greater.

The performance of the single-loop synthesizer depends on the value of the reference frequency at which phase comparison takes place. The higher the reference frequency, the wider the loop's bandwidth will be, the shorter the tuning time and the less the phase jitter. For single-loop systems, the reference frequency can be as high as the desired frequency steps of the VCO, but not higher.

The only other possibility with the single-loop system is to synthesize at a VCO frequency several times higher, in steps several times larger, and then place fixed frequency dividers between the VCO and the synthesizer output. For simple, low-frequency synthesizers, this is usually a good design choice.

But for hf synthesizers, not only must the VCO operate in either the vhf or uhf region, but the programmable dividers must have very fast variable-modulus prescalers, state-of-the-art units that operate up to 500 MHz. Unfortunately,

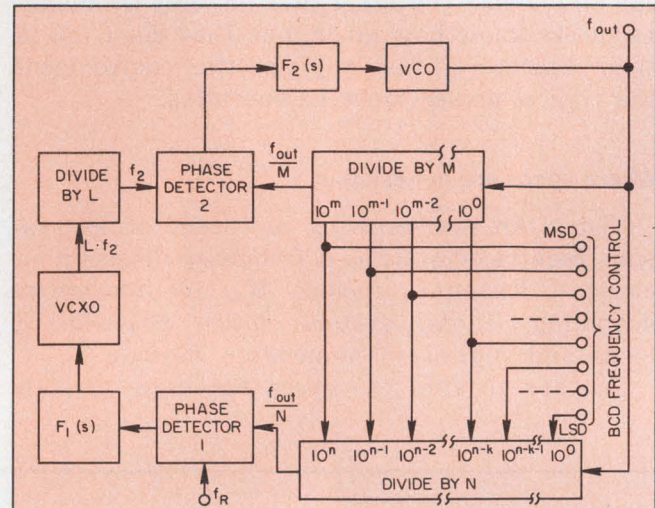

1. Advantages accrue when two phase-locked loops are arranged in tandem. The double-loop results in improved noise characteristics and finer steps.

since such dividers are expensive and require relatively high power, the performance gain is not usually high enough to justify use in a relatively simple system.

Calculating system parameters

When the system shown in Fig. 1 is in the synchronous state, the mean values of the frequencies at the phase-detector inputs must be equal. The synthesizer output frequency, f_o , can be expressed as:

$$f_o = Nf_R \quad (1)$$

$$f_o = Mf_2 \quad (2)$$

where the tuning steps of the system equal f_R , the same as in the single-loop system. You can express the moduli N and M of the variable dividers as summations of decimal digits multiplied by weighting factors. Thus:

$$N = N_n 10^n + N_{n-1} 10^{n-1} + \dots + N_1 10 + N_0$$

$$= \sum_{i=n}^0 N_i 10^i \quad (3)$$

$$M = M_m 10^m + M_{m-1} 10^{m-1} + M_1 10 + M_0$$

$$= \sum_{i=m}^0 M_i 10^i \quad (4)$$

Jan Fadrhons, Research Engineer, Institute of Radio Engineering and Electronics, Czechoslovak Academy of Sciences, Lumumbova 1, 180 88 Praha 8, Czechoslovakia.

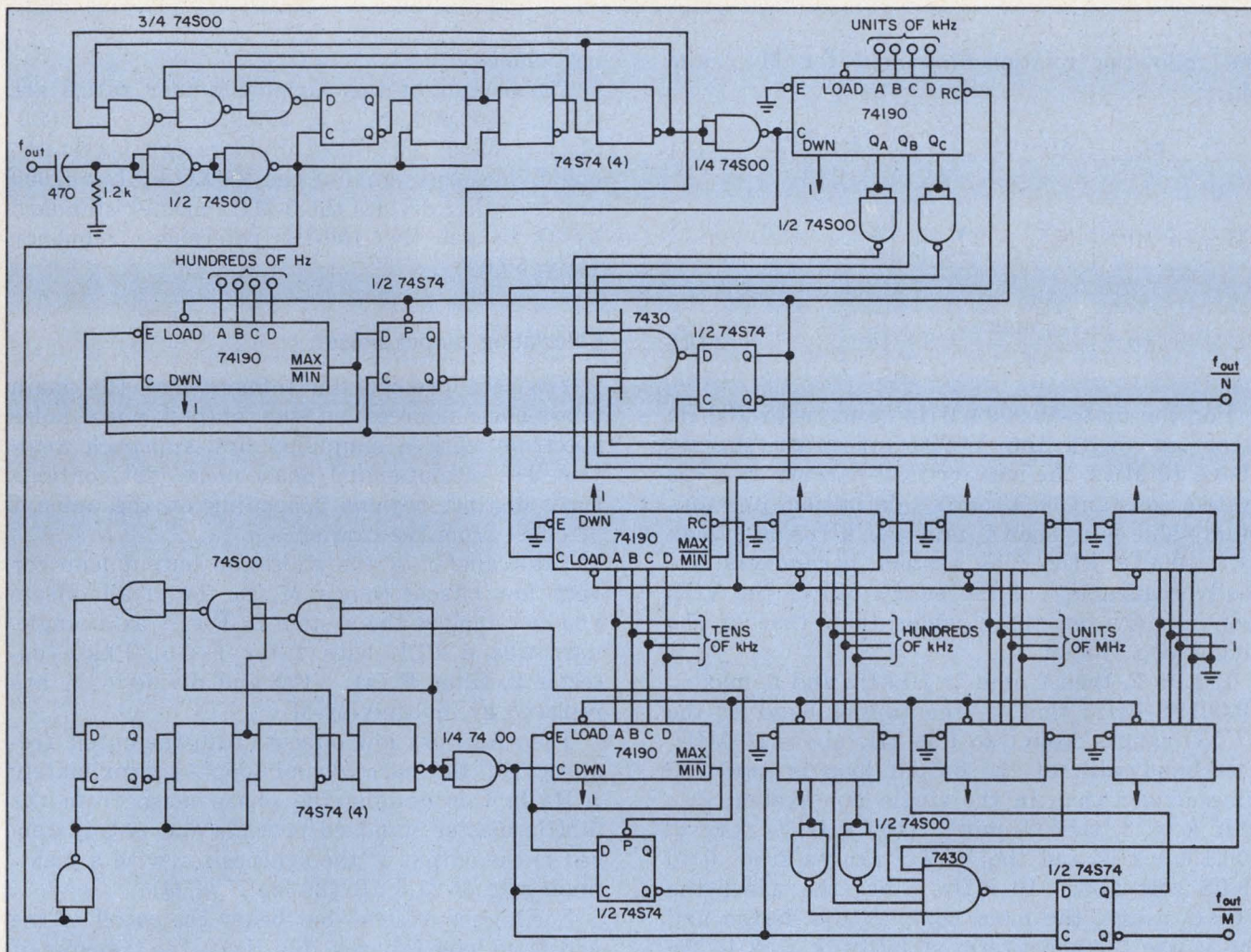

2. Ganging of the loop's two dividers (divide-by M and N) provides BCD control of output frequency.

From Fig. 1, it follows that:

$$\left. \begin{aligned} N_n &= M_m \\ N_{n-1} &= M_{m-1} \\ N_{n-m} &= M_0 \end{aligned} \right\} \quad (5)$$

Define the system constant k as a difference, $k = n - m > 0$. (6)

From Eqs. 5 and 6 it is evident that $M_i = N_{k+i}$ for $0 \leq i \leq m$. (7)

Now express N in terms of M and k by using Eqs. 1, 2, 6 and 7:

$$\begin{aligned} N &= \sum_{i=n}^0 N_i 10^i = \sum_{i=n}^k N_i 10^i + \sum_{i=k-1}^0 N_i 10^i \\ &= \sum_{i=n-k}^0 N_{k+i} 10^{k+i} + \sum_{i=k-1}^0 N_i 10^i \\ &= 10^k \sum_{i=m}^0 M_i 10^i + \sum_{i=k-1}^0 N_i 10^i \end{aligned}$$

Finally,

$$N = 10^k M + \sum_{i=k-1}^0 N_i 10^i \quad (8)$$

From Eqs. 1, 2 and 8, determine the reference frequency of phase detector 2:

$$f_2 = \frac{N}{M} f_R = \left[10^k + \frac{1}{M} \sum_{i=k-1}^0 N_i 10^i \right] f_R \quad (9)$$

For decimal digits N_i , that is, in the range from 0 to 9, express the minimum and maximum values of f_2 as:

$$f_2 \text{ min} = 10^k f_R$$

$$f_2 \text{ max} = \left[10^k + \frac{9}{M_{\text{min}}} \sum_{i=k-1}^0 10^i \right] f_R. \quad (11)$$

Minimum and maximum values of N are given by Eq. 1, after the substitution for the minimum and maximum output frequencies. Using Eq. 8, express M in the form

$$M = 10^{-k} \left[N - \sum_{i=k-1}^0 N_i 10^i \right]. \quad (12)$$

Before you calculate the minimum and maximum values of M, consider that M is always an integer. Then, from Eq. 12, it follows that to obtain M from N, just drop k least-significant digits of N. Good design usually dictates that in N_{min} k or more least-significant digits equal zero, and that in N_{max} the same digits equal nine. Then

the following relationships hold for M_{\min} and M_{\max} :

$$M_{\min} = 10^{-k} N_{\min} = 10^{-k} \frac{f_{\text{out min}}}{f_R} \quad (13)$$

$$M_{\max} = 10^{-k} \left[N_{\max} - 9 \sum_{i=k-1}^0 10^i \right] \\ = 10^{-k} \left[\frac{f_{\text{out max}}}{f_R} - 9 \sum_{i=k-1}^0 10^i \right] \quad (14)$$

For the 50-to-59.9999-MHz band, with 100-Hz steps and with the VCXO operating slightly above 10 MHz, the most critical parameter is the system constant, k . From k 's definition, its minimum value is 1. Then $f_2 \text{ min} = 1 \text{ kHz}$ and $f_2 \text{ max} = 1.000018 \text{ kHz}$. The system parameters are easily realizable, but the bandwidth of the VCO loop is only ten times wider than that of the single-loop system.

If $k = 2$, then $f_2 \text{ min} = 10 \text{ kHz}$ and $f_2 \text{ max} = 10.00198 \text{ kHz}$; that is, the tuning band of the VCXO ranges from 0 to 1.98 kHz above 10 MHz. The bandwidth of the output loop is now 100 times wider than in the single-loop system.

If $k = 3$, then $f_2 \text{ min} = 100 \text{ kHz}$, $f_2 \text{ max} = 100.1998 \text{ kHz}$ and the VCXO ranges from 0 to 19.98 kHz above 10 MHz. Since the wider the VCXO range, the more complex the design and the worse the short-term stability, $k = 2$ is the

best choice.

The bounds of the variable-divider ratios are $N_{\min} = 500,000$, $N_{\max} = 599,999$, $M_{\min} = 5000$, $M_{\max} = 5999$. Two fixed dividers are necessary, one divides the signal of the VCXO by $L = 1000$ and the other divides the 5-MHz master standard by Q to get the 100-Hz reference frequency ($Q = 50,000$).

Calculating output noise

You can predict the influence of the main phase-noise sources on the output phase-noise spectrum with a simplified first-approach analysis. The output-signal phase-noise plot contains three distinct regions depending on the amount of offset from the carrier:

The transfer of the wideband output loop for very low offsets equals M , so for small offsets you can analyze the system in Fig. 1 as a single, narrowband PLL with filter $F_1(s)$. Phase detector 2, filter $F_2(s)$, VCO and divide-by- M are replaced by multiply-by- M .

Then for very low offsets up to the cutoff frequency of the narrowband loop—approximately 1 Hz in this design—the phase noise from the 5-MHz master standard prevails and is transferred to the output of the synthesizer with a maximum gain of 21.6 dB ($20 \log N_{\max}/Q$).

For higher offsets—but below the cutoff of the wideband loop (approx. 100 Hz)—the transfer of

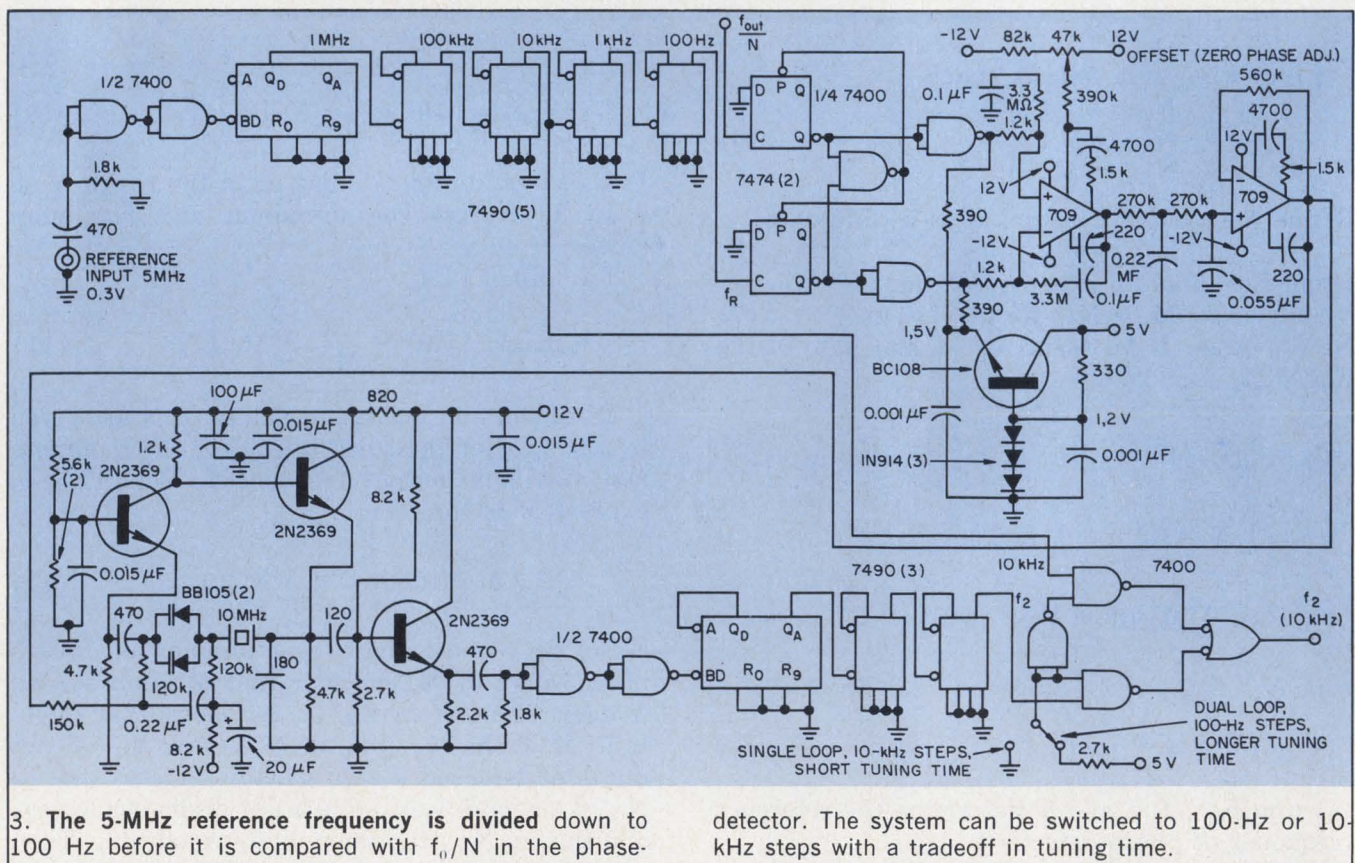

that has a zero steady-state phase error after each frequency step.

It is important to suppress the reference-frequency component of the oscillator control signal because the phase detector used has a minimum reference-frequency feedthrough at zero phase error, which occurs at lock. At this point, only very narrow correction pulses with little energy are delivered to the inputs of the differential integrator.

All dc offsets, as well as amplitude changes within the correction pulses, appear as phase errors. Consequently, the phase-detector outputs are arranged to feed open-collector gates (7403s) that function as precision switches. The pull-up resistors of the switches connect to the stabilized voltage source. The narrow, negative corrective pulses at one input of the differential integrator are approximately 1.5-V high; a logic HIGH (dc level) appears on the second input.

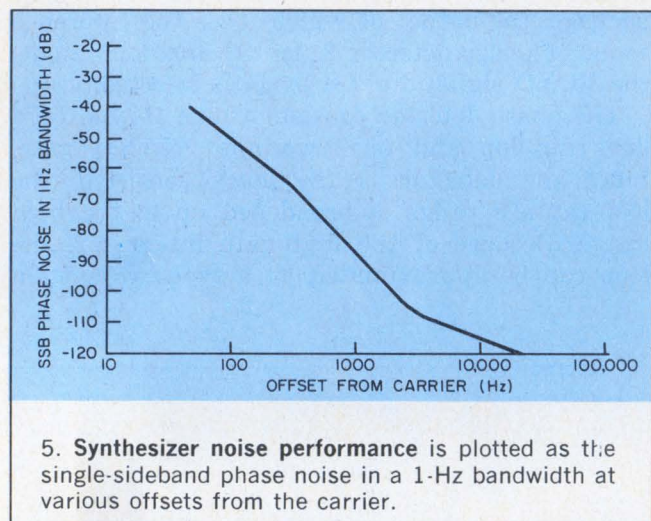

In the unlocked case, one input to the integrator is high, and the other is pulsing. Thus the integrator tunes the oscillator in the direction of the locked-frequency value.

Final adjustments are easy

Testing the phase detector, integrator and VCXO for correct operation is simple. Set the variable-divider ratio much higher than the current system value, then much lower. The circuit must saturate for the first setting at some frequency above the normal operating range, and saturate for the second setting somewhere under the normal range. Then adjust the op-amp offset control for zero phase error in lock: observe the coincidence of the rising edges of the phase-detector input signals on a dual-channel, delayed-time-base oscilloscope.

Observe that the signal from the integrator

goes through additional low-pass filters to the varicaps in the VCXO. A two-complex-poles active filter with damping of 0.5—plus one real-pole, passive filter—further suppress the 100-Hz reference frequency, as well as power-supply ripple. The filter's cutoff frequency is high enough—about 5 Hz—to accommodate the narrowband loop, assuming a second-order system.³ The entire wideband loop is approximated by a real transfer function, M .

The narrowband loop has a natural frequency of 0.635 Hz, a damping of 0.66, a 1-s tuning time to 10% of the frequency step and a 3-dB loop bandwidth of 1.27 Hz. Careful screening and grounding of all analog parts is very important. Perhaps the best solution is to have independent analog signal grounds for the integrator, for the additional filters and for the varicap bias line.

At line frequency the locked VCXO signal shows -95 dB of undesired sidebands; at the reference frequency, sidebands are down 74 dB, as measured with an Adret Model 6303 spectrum analyzer. With the op amps, the tuning range of the VCXO extends from 9999.063 to 10,003.264 MHz. The range allows up to 47 percent overshoot, or a damping coefficient as low as 0.3. The VCXO gain changes from 150 to 221 Hz/V within the tuning range.

Phase detector 2 and loop filter $F_2(s)$ have a design similar to those in the narrowband loop, but adapted for a reference frequency 100 times higher (Fig. 4). The VCO is a MOSFET Hartley oscillator; the transistor's dc parameters (Tesla KF 521 or Hitachi 3 SK 21) include an I_{DSS} of 7.6 mA and a V_p of -3.1 V.

The oscillator's operating point is stabilized by the dc voltage drop across the R-C combination in the source.⁴ You can also use a good rf JFET—for example, the 2N4416—and stabilize the operating point by peak detection with a gate-to-channel diode. With the latter method you must remove the network from the source and use a different RC network in the gate to ensure peak detection.

The signal from the source-follower buffer is amplified in the wideband common-emitter stage and coupled, through two emitter followers, first to the Schottky TTL shaper, then to the synthesizer's output connector. The VCO's gain varies between 0.5 MHz/V and 2.5 MHz/V, for the entire tuning range.

Pinning down stability

Cutoff for the additional filters is high enough—about 1 kHz—to consider the integrator's transfer function as dominant for the purpose of a first design. As in the case of the narrowband loop, you can use the formulas of the second-order, type-two control system. But even if

your wideband loop is stable (with additional filters) the over-all two-loop system will be unstable because of the interaction between the loops.

To investigate stability mathematically, substitute a single loop for the two-loop control system. Then, express the open-loop transfer function as that of a wideband open loop multiplied by the sum of one plus the transfer function of the narrowband loop, where the whole wideband loop is substituted by the positive, real transfer function, M .

It is usually assumed that the active, corrective filter in a PLL has a pole at zero frequency.^{3,5} In reality, this isn't possible because the op amp never has infinite gain—even if the integrator's time constant is relatively high (tens of seconds for the wideband loop). You can use the type-two loop formula for the first design but this approach is quite misleading when you calculate the open-loop transfer at very low frequencies.

For the purpose of stability analysis, the integrator transfer is determined with a finite amplifier gain, with all additional poles accounted for, and with worst-case approximations for the time delays in the frequency dividers.

A program can be written so that the HP 9820 calculator can plot a polar diagram of the substituted open-loop transfer with gains from -200 to 200 dB. Various loop-filter designs can be tested on the real synthesizer and, with the Nyquist method, on the polar plot. For a final setting of the filter parameters, the computed worst-case gain margin at 50 MHz is about 11 dB.

Measurements with the Adret spectrum analyzer result in the phase-noise plot shown in Fig. 5. Phase-noise performance is comparable to that of the more complex triple-loop system that has 100-Hz steps, but the tuning time is much longer because of the narrowband loop's slow reaction.⁶

Although the VCXO frequency step drops to the 10-percent level during the theoretical tuning time of about 1 s, it takes the entire synthesizer up to several tens of seconds to reach within 10 Hz of the final frequency (as measured using the Adret 6303 as a selective-level meter on the final frequency). ■■

References

1. Stokes, V. O., "Techniques of Frequency Synthesis," *Proceedings of the IEE*, Vol. 120, No. 10R, October, 1973.
2. Fadrhons, J., "60 MHz Variable Dividers with STTL Two Modulus Prescalers," *Electronic Engineering*, to be published.
3. Gardner, F. M., "Phaselock Techniques," Wiley, New York, NY, 1966.
4. Fadrhons, J., "FET LC Oscillator Design," *Czech Slaboproudny obzor*, Vol. 33, No. 12, 1972, pp. 566-570.
5. Kroupa, V. F., "Frequency Synthesis," Halsted Press, New York, NY, 1973.
6. Bikker, P., "Frequency Synthesizer RY 746 for HF Receivers and Transmitters," *Philips Telecommunication Review*, Vol. 30, No. 3, August, 1972, p. 96.

If we haven't made the mechanical filter you need yet, we can.

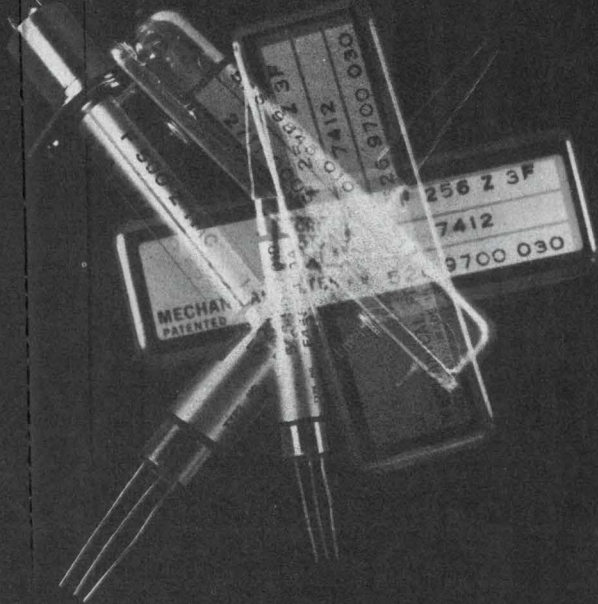

Call Collins.

The worldwide reputation of Collins' standard mechanical filters is the same today as it has been for the past two decades: high quality and reliability. Their excellent rejection of unwanted signals has been demonstrated in applications ranging from CB transceivers to missile guidance systems.

Today, as a direct result of our years of experience in these diverse applications, we have a cost-effective solution to your filtering problems readily available.

Moreover, we have the engineering know-how to create an original design concept for your custom requirements.

For information call or write: Mechanical Filters Marketing, Collins Radio Group, Rockwell International, 4311 Jamboree Road, Newport Beach, California 92663. Phone: 714/833-4632.



Rockwell International

...where science gets down to business

CIRCLE NUMBER 24

The average efficiency of rf power amplifiers depends upon the type of signal handled. A nomogram can easily convert point-value efficiencies to over-all averages.

Need over-all average efficiency values for rf power amplifiers? A nomogram organizes and simplifies an otherwise tedious process of numerical integration.

You can't make accurate comparisons of amplifier efficiencies, estimate total power needs or solve packaging problems such as the size of heat sinks and the capacity of cooling fans with only point efficiency values—the efficiency at a single voltage or power output.

Point values, determined by standard methods, are plotted on the graph of the nomogram and form the first step in solving for the average efficiency. Mere linear averaging of an amplifier's point-efficiency values doesn't give the correct answer, because all the possible amplitude values of commonly used signals are not present in equal proportions. Low amplitudes are often more prevalent, but the large amplitudes contribute a greater weighted proportion to the average efficiency.^{1,4}

Probability densities tell them apart

The average power that results from the distribution of amplitudes present in three common signal types—amplitude modulated (AM), single sideband (SSB) and voice—are readily handled by the nomogram. A function that describes the distribution of the amplitudes in a signal can be treated as if it were a probability-density function (PDF) even though the signal is deterministic,² as are the two-tone signals used in SSB testing and a modulated single tone in AM. The integral of such a function, from one amplitude to another, represents the fraction of time that the signal has amplitudes between these two values (Fig. 1).

The concept of PDFs is usually associated with random processes; thus, the random-like voice signal can be approximated by a "true" random probability distribution function.

The proportion of time that an amplitude, E , of

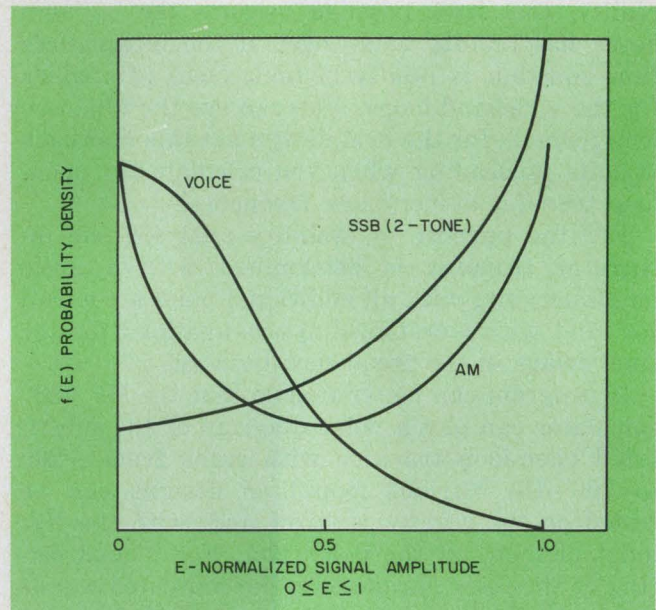

1. Mathematical techniques involving probability density functions can be used to determine the amplitude distribution of both random and deterministic signals.

a signal, lies between E_n and $E_n + \Delta E_n$ can be expressed by

$$p_n = \int_{E_n}^{E_n + \Delta E} f(E) dE,$$

where $f(E)$ is the so-called probability density function of the signal. If E is single-valued over a range of time, or phase, θ , then the proportion of time that E lies between θ_n and $\theta_n + \Delta\theta_n$ is also p_n ; thus

$$p_n = \int_{E_n}^{E_n + \Delta E} f(E) dE = \int_{\theta_n}^{\theta_n + \Delta\theta_n} \frac{d\theta}{\theta}$$

Since only the absolute amplitude of the signal affects power, phase and polarity can be ignored. By equating differential areas of the PDF with differential areas of the signal envelope,

$$f(E) = \frac{1}{2\pi} \left| \frac{d\theta}{dE} \right|.$$

The envelope of a two-tone SSB signal (Fig. 2a), normalized to have a peak of $E(\max) = 1$, is

$$E(\theta) = |\sin \theta|.$$

Frederick H. Raab, Polhemus Navigation Sciences, Inc., A Subsidiary of The Austin Company, P.O. Box 1011, Burlington, VT 05401.

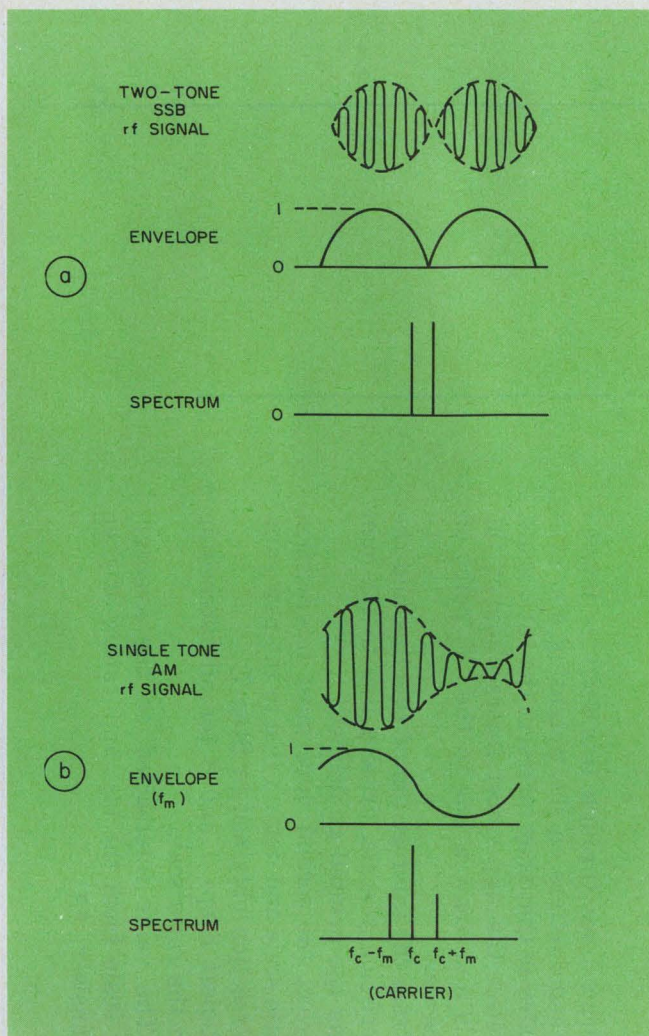

2. **Deterministic signals** like two-tone SSB (a) and "single-tone" AM (b) are often used in testing rf amplifiers and each produces a different average efficiency.

As a result,

$$\theta = \pm \arcsin E + m\pi/2 \quad (m = 1, 2, 3 \dots),$$

and

$$\left| \frac{d\theta}{dE} \right| = \frac{1}{\sqrt{1-E^2}}.$$

Since the envelope amplitude distribution is the same in all four quadrants of signal phase, there are four equal contributions from each value of E,

$$f(E) = \frac{2}{\pi} \frac{1}{\sqrt{1-E^2}}.$$

For an AM signal (Fig. 2b), the envelope can be expressed as

$$E(\theta) = 1/2 + 1/2 \sin \theta.$$

Then

$$\theta = \pm \arcsin (2E - 1) \pm m\pi$$

$$\left| \frac{d\theta}{dE} \right| = \frac{2}{\sqrt{1-(2E-1)^2}}$$

and

$$f(E) = \frac{2}{\pi} \frac{1}{\sqrt{1-(2E-1)^2}},$$

since $0 \leq \theta < \pi$, there are two equal contribu-

tions from each value of E.

And since voice signals resemble a random process, a truncated Gaussian PDF is used for the envelope of a single or double-sideband, suppressed-carrier signal.

$$f(E) = \frac{2}{\sqrt{2\pi}\sigma} \exp\left(-\frac{E^2}{2\sigma^2}\right).$$

This approximation is accurate for peak-to-average ratios of 6 dB or more.

Normalized weighting factors,

$$w_j = f_j(E_n) \left(\frac{P_{oj}}{10P_o} \right)$$

for each type of signal are incorporated into the nomograph for ten plotted, point-valued efficiencies.

The factor

$$\left(\frac{P_{oj}}{10P_o} \right)$$

is the ratio of a normalized point-valued power output,

$$P_{oj} = 1/2 E_n^2, \quad 0 < E_n < 1$$

and the normalized maximum-average output, $\overline{P_o}$, that a particular type of signal can provide: $\overline{P_o} = 1/4$ for a two-tone SSB signal and $3/16$ for a 100% modulated AM signal. The 10-dB peak-to-average ratio used for voice in the nomograph provides a $\overline{P_o} = 0.05$.

In the nomograph, after application of these normalized weighting factors to each normalized point-valued efficiency, the results are summed to obtain the over-all average efficiency,³

$$\eta = \sum_{j=1}^{10} \eta_j / w_j.$$

The nomograph thus provides a graphical means for determining the average efficiency of an rf amplifier for SSB (two equal tones), AM (single tone, 100% modulated) or voice (single or double sideband with 10-dB peak-to-average power ratio). A plot of point-cw-efficiency input data are required. ■■

(continued on next page)

References

1. Livshits, I. I., "Influence of the Type of Transmitted Information on the Energy Parameters of an Amplifier," *Telecommunications and Radio Engineering*, Part 2, Vol. 28, No. 4, April, 1973, pp. 91-95.
2. Beckman, P., *Probability in Communications Engineering*, Harcourt, Brace and World, NY, 1967.
3. Morris, C. M., Milam, W. T., and Raab, F. H., *High Efficiency Linear SSB Power Amplifier*, fourth quarterly report, 80045 TRC 11/1972 (AD909, 926L), Cincinnati Electronics Corp., OH, February, 1973.
4. Baert, D., "The Design of Power Amplifiers Driven by Signals with Known Probability Density Functions," *International Journal of Electronics (GB)*, Vol. 39, No. 2, August, 1975, pp. 219-227.

Acknowledgement

This nomograph was developed at Cincinnati Electronics Corp. under contract DAAB07-71-C-C0220. The author wishes to thank program managers C. Mike Morris (now with Southcom International) and Mike Kaluzinenski (USAECON, now retired) for the advice and encouragement they provided.

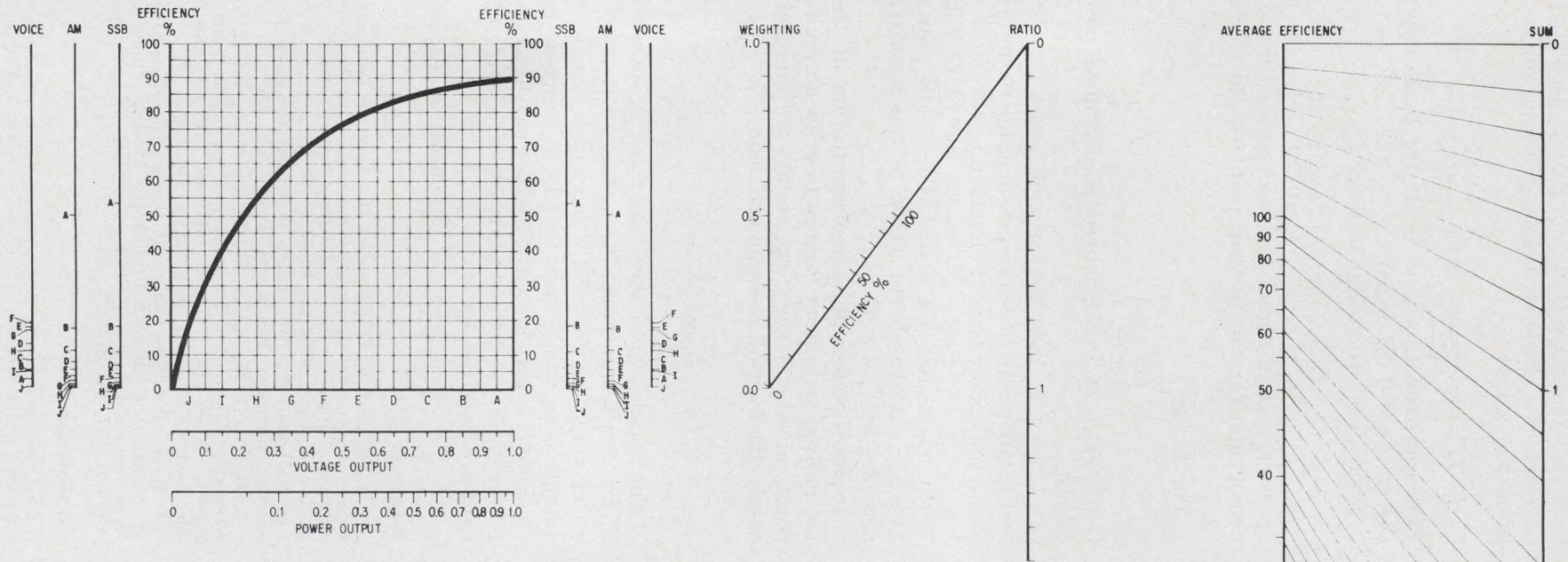

COPYRIGHT HELD BY CINCINNATI ELECTRONICS CORPORATION

Using the nomograph

To use the nomograph, follow these 10 steps:

(1.) Plot a complete point-value efficiency curve on the graph. You may use either the output voltage or power X-axis scale.

(2.) For each of the 10 X-axis values (A through J), draw a horizontal line from the curve to intersect the weighting scale.

(3.) From each intersection of the weighting scale, draw another line to point "1" on the ratio scale. Mark corresponding letters A, B, C, etc., where each line crosses the efficiency scale.

(4.) For the type of signal being used—SSB, AM or voice—lay a straightedge between alike pairs of letters (A, B, C, . . . J) on the signal-identification scales, and mark corresponding letters A, B, C, etc. on the weighting scale.

(5.) Draw lines through intersections labeled with the same letters on the weighting and efficiency scales so that they intersect the ratio scale.

(6.) Select the uppermost intersection of the ratio scale and draw a line to the "0" point on the sum scale.

(7.) From the intersection of this line and the average-efficiency scale, draw a line to the sum scale using the printed guidelines.

(8.) Select the second uppermost intersection on the ratio scale and draw a line to the new sum-scale intersection obtained in Step 7.

(9.) Repeat Steps 7 and 8 for all succeeding points on the ratio scale.

(10.) The value intersected on the average-efficiency scale from the last application of Step 8 is the answer. ■■

HUGHES

FREQUENCY CONTROL DEVICES

TCXO

Hughes temperature compensated crystal oscillators provide optimum frequency stability in a variety of temperature ranges.

- Optimum frequency stability is obtained through a computer synthesized selection process. Small size, light weight, low power drain, and instant warm up are achieved without an oven.

- TCXOs in hybrid configurations with high stability over wide temperature ranges are available at Hughes.

- Available frequency spectrum extends from 1 Hz to 200 MHz with a stability of: (a) ± 1 ppm over temperature range of -55°C to $+85^{\circ}\text{C}$, or (b) .1 ppm over temperature range of 0°C to $+70^{\circ}\text{C}$.

TC/VCXO

Compatible with the frequency stabilities of the TCXOs indicated above, Hughes is capable of manufacturing TC/VCXOs with the following typical parameters:

- Frequency range to 200 MHz
- Frequency deviation to 3000 ppm
- Deviation sensitivity to ± 250 ppm/volt
- Linearity to $\pm 1\%$ of best straight line
- Short term stability to ± 1 ppm/sec

Input voltages from ± 10 VDC to ± 50 VDC are acceptable for either TCXOs or TC/VCXOs. Input power, dependent upon application can be as low as 10 mw.

CRYSTAL FILTERS

- **Types**

Band pass filters	Shape Factors (3 to 60 db)
Band stop filters	1.15 to 1
Upper sideband filters	1.5 to 1
Lower sidebands	1.11 to 1 (carrier side)
Gaussian (linear phase)	1.11 to 1 (carrier side)
Phase (or delay) Compensated filters (to $\pm 1\%$)	5.0 to 1
	1.15 to 1
- **Discriminators** Frequencies and bandwidths similar to filters
- All filters, discriminators and oscillators are capable of meeting commercial, military or space-qualified environments.

GENERAL OPERATING REGION (SHADED AREA)

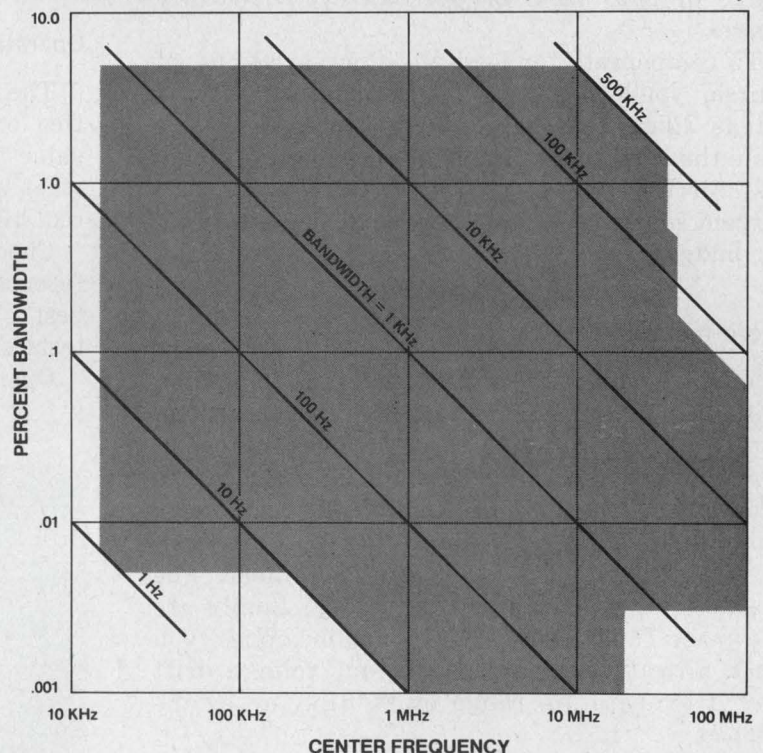

Hughes is the country's leading supplier of precision crystal filters and related frequency control devices. A partial list of major programs using these products includes BMEWS, Apollo, Pioneer, Syncom, Surveyor, Mauler, Hawk, Minuteman, Talos, Phoenix and Standard Missile. A staff of competent engineers, backed by the industry's most advanced quality control and test facilities, stands ready to handle your toughest assignment. Call collect or contact your nearest Hughes representative for assistance.

Hughes Aircraft Company
Microelectronic Products Division
500 Superior Avenue, Department D-6
Newport Beach, California 92663
Telephone (714) 548-0671
TWX 910-596-1374



Build precision reference sources without expensive parts or tight error budgets. With functional trimming, individual component errors are all compensated together.

If you're designing a high-resolution data conversion or an analog instrumentation system, you'll probably need a precision voltage reference. Generally, the reference voltage should be stable to within 0.05%, or better, over the operating-temperature range for the system. That doesn't sound like a big problem, does it?

After all, you can buy a zener diode with a temperature coefficient better than 0.0005%/°C. The trouble is, once you're into the design, things start coming up. You may run into a nonlinear tempco, for example. That could mean the voltage variation you'd expected over the full temperature range, -55 to +125 C, shows up over a range of 0 to 70 C or over an even narrower range.

To compensate for load and line variations, of course, you'll need some additional circuitry—things like an op amp, precision resistors to scale the reference voltage, a trimming pot to adjust for the 5% zener tolerance, and a constant current source. Now you'll have to calculate an error budget, and 0.05% moves quickly out of sight.

There must be a better way

There is a better way: functional trimming. With this technique, you measure the actual temperature changes due to various causes, and compensate for them in one lump. This procedure takes care; but it isn't as difficult as it may sound, and results in better accuracy at less cost.

Let's consider the zener reference diode. The characteristics of the popular 1N821 family are shown in Table 1. Because of nonlinearities, you can't directly calculate the actual voltage drift over a temperature range by multiplying by the tempco.

Most manufacturers use the "box" method to characterize zeners. They measure and record the zener voltage at a few (say, five) specific temperatures. The difference between the highest and lowest voltage, ΔV_z , is then guaranteed not

to exceed some maximum. The tempco specified is merely an average, ΔV_z divided by the ΔT .

Let's look at the 1N829, listed in Table 1 as having a tempco of $\pm 0.0005\%/^{\circ}\text{C}$. The ΔV from 25 to 0 C should not be greater than 0.0125% (25×0.0005). But the guaranteed maximum for the 1N829 as indicated in the table is ± 5 mV. This full shift can occur over the more limited temperature range. The resulting 0.08% error is a long way from 0.0125%.

Nonlinear tempcos are real enough. In Fig. 1, which shows the voltage changes of various 1N829 zeners with temperature, the curves for diodes 1 and 2 clearly illustrate the point.

Operation to 125 C

The 1N829 series, and many others, are specified only up to 100 C. The tempco above this value may increase drastically (Fig. 1). And what about long term stability? That can be a real time bomb.

Choose your vendor carefully; there are big differences among manufacturers. Since even the best choice may not be good enough, stability tests should be made on every device.

Operation at elevated temperature helps to

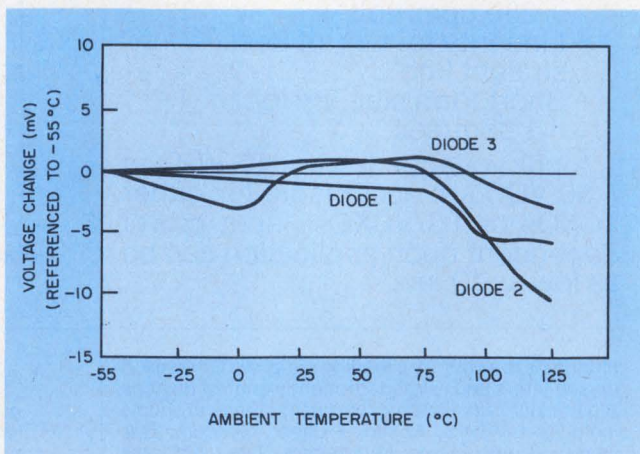

1. A precision zener diode's voltage may show large changes over a limited temperature range. Drift increases rapidly above 100 C—the maximum temperature for which error is specified.

Don Pouliot, Applications Manager, and Bob Calkins, Circuit Development Manager, Micro Networks Corp., Worcester, MA 01606.

stabilize zeners. With experience, long term stability can be predicted from monitoring at high temperature for several days.

If the designer is building his own precision reference, he will have to buy his reference diodes screened to special specifications, or perform the same special processing himself. Unless very high volume is involved, either approach is costly. But there is a better alternative.

The circuit affects stability

The circuit in Fig. 2 couldn't be simpler, but it also has serious limitations. First, there's no way to adjust the voltage. The tolerance on most zener diodes is 5%, so some form of gain adjustment must be added.

Second, the dynamic impedance is low (Table 1), but high enough to cause significant errors when the line or load varies. Thus a load change of 10 k Ω results in a voltage change of 0.1% (6.2 mV). The effect of line changes is also serious: a 3% line change causes a 0.06% reference error.

Fig. 3 shows an improved voltage-reference circuit. An independent current source biases the diode at its proper current. The op amp trans-

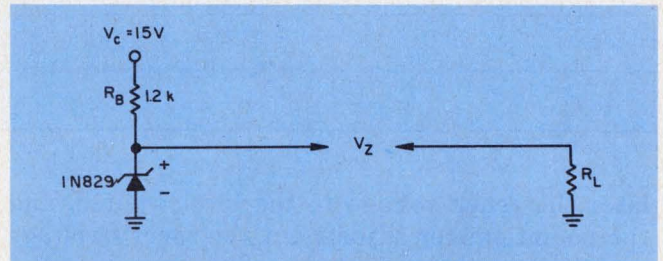

2. This biasing network provides the simplest voltage reference, but its output changes substantially with line and load variations.

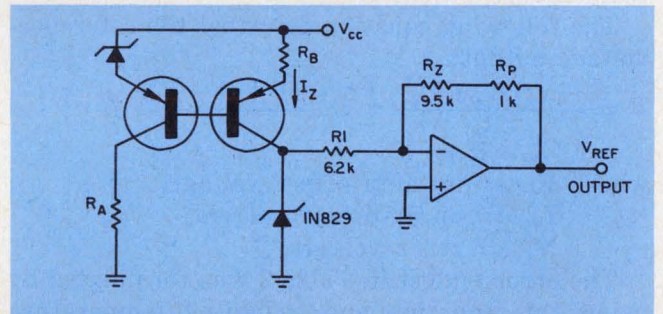

3. This circuit is stable with line and load changes and can be adjusted to give a precise voltage. But resistor tempco, op-amp current and voltage drifts, and the zener tempco, can build up substantial errors over the temperature range.

Table 1. Specified limits for the 1N821 family.

Diode type	Maximum voltage change (V)	Temperature coefficient (%/°C)	Maximum dynamic impedance (Ω)
1N821	0.096	0.01	15
1N823	0.048	0.005	10
1N825	0.019	0.002	10
1N827	0.009	0.001	10
1N829	0.005	0.0005	10

Note: All diodes are 6.2 V \pm 50%, biased at 7.5 mA. Manufacturers test at -55, 0, 25, 75 and 100 C.

Table 2. Error budget for voltage reference

Circuit component	Component tempco	Worst-case error (%)	
		0 to 70 C	-55 C to +125 C
R ₂ and R ₁	5 ppm/°C	0.025	0.05
R _p	10 ppm/°C	0.005	0.01
op-amp E _{os}	3 mv/°C	0.004	0.008
op-amp I _{bias}	1 na/°C	0.005	0.01
Sub total		0.039	0.078
Zener		0.050	0.050
Total		0.089	0.128

lates the zener voltage to the level wanted, and the potentiometer adjusts out the zener's voltage variation.

The circuit provides better than ±0.01% line and load regulation. But the improved circuit costs more—not only in dollars and parts, but in temperature stability.

The following equation describes the reference-voltage output:

$$V = \frac{-V_z(R_z + R_p)}{R_1} \pm E_{os} \frac{(1 + R_z + R_p)}{R_1} \pm I_b(R_z + R_p),$$

where E_{os} = op amp offset voltage,

I_b = op amp bias current,

V_z = zener voltage.

The error budget in Table 2 was formulated by using this equation and assigning temperature coefficients to the components. Not including the zener-diode change, the table predicts just under 0.04% change over 0 to 70 C, and 0.08% over -55 to +125 C.

Note, however, that even using the best components available (resistors with 1-ppm/°C tracking), nulling the op amp to 0.5 mV, and adding a resistor to compensate for bias current, the circuit of Fig. 3 will achieve an accuracy of only about 0.015% *plus* the zener diode change.

So how can a 0.05% reference be built from readily available parts with success assured? Only by temperature compensating the circuit as a complete unit.

Functionally trim the circuit

Functional temperature trimming corrects for all temperature changes—including those of the zener, the op amp and resistor mistracking. There are two basic ways to trim:

(1) Change the zener diode's quiescent current, thus changing its tempco to compensate for the tracking errors.

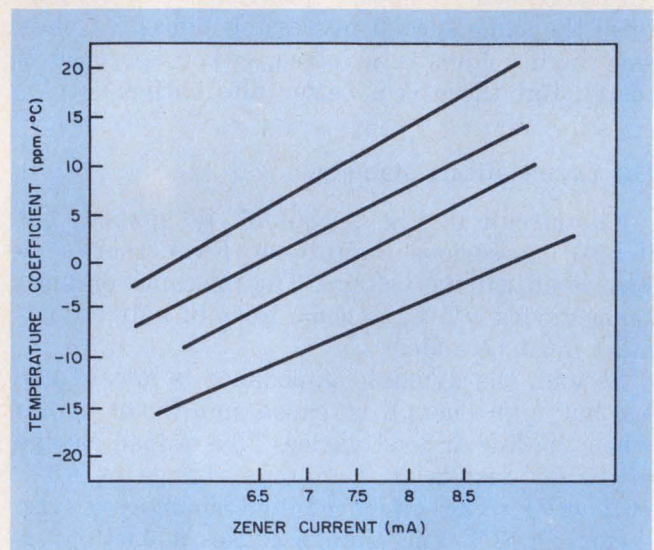

4. Zener diodes show a substantially linear change of temperature coefficient with zener current. The curves for four different diodes have nearly the same slope. All four diodes are type 1N829.

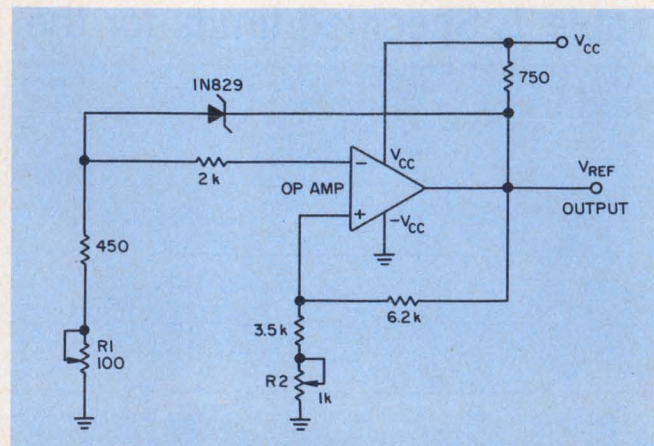

5. This circuit may be functionally trimmed for minimal voltage-output change over temperature. Trimmer R₁ changes zener current and tempco, R₂ adjusts the voltage, though there is some interaction.

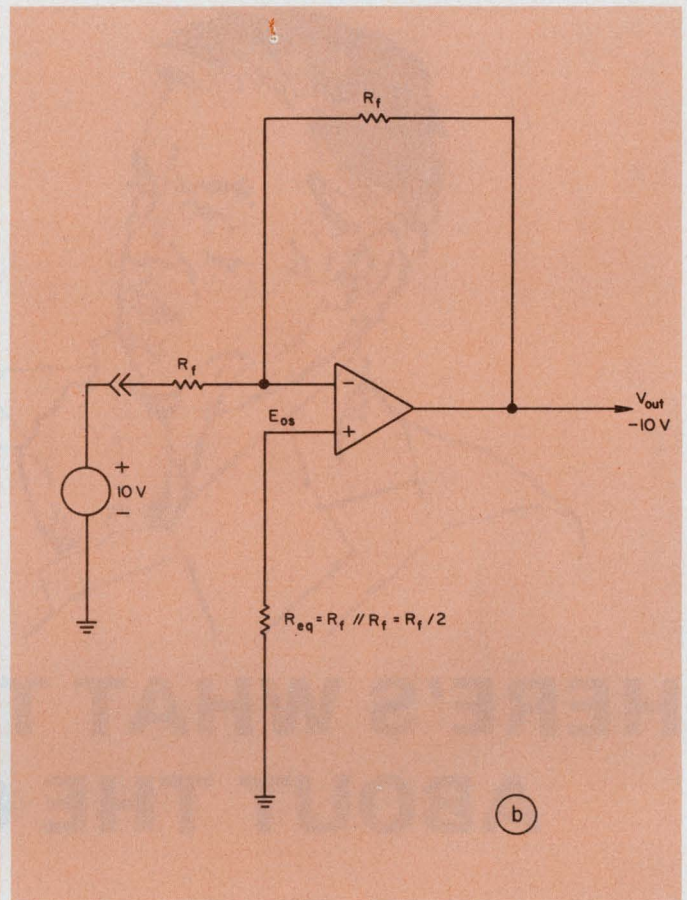
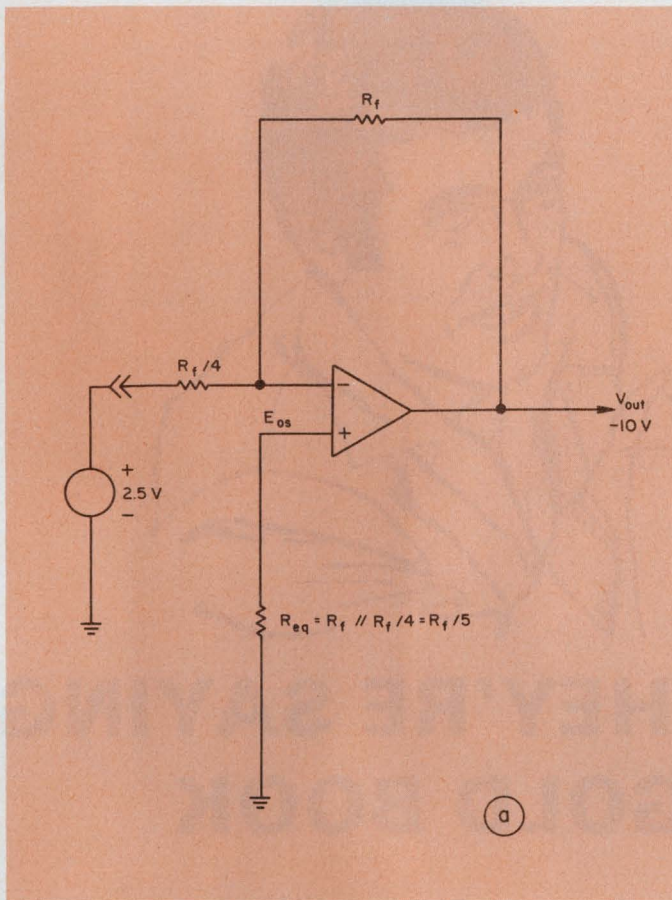

6. Functional trimming permits wide latitude in the choice of a zener reference device. For a 10-V output, a 2.5-V zener-diode circuit (a) has more temperature

drift than one with a 10-V zener (b). This occurs because of the first circuit's greater sensitivity to offset drift in the op amp.

(2) Use a thermometer circuit to sense temperature, and inject an equal but opposite correction factor.

With care, good results can be obtained either way, but, for the purpose of illustration, let's explore the first method: It's important to note that the rate at which the tempco changes with current should be linear and almost the same for all reference diodes used. It's been demonstrated experimentally that this holds well for diodes in the same family from the same vendor and lot.

Fig. 4 is a plot of tempco vs. bias current for four 1N829 diodes. The approximate slope of the curves in Fig. 4 is 5 ppm per °C per mA. To trim functionally, we measure the voltage change over the desired temperature range, calculate the actual tempco, and then change the bias current to compensate. Two temperature cycles are usually required. Once the correction factor has been confirmed, the initial value of the reference voltage is readjusted.

Fig. 5 shows a circuit suitable for functional trimming. The pots adjust tempco and reference voltage. Since these adjustments interact, an alternating-adjustment technique must be used. Patience yields good results.

With functional trim, there is almost complete

freedom in selecting the zener reference voltage. A proper selection can lead to much better performance. Figs. 6a and b show equivalent circuits to produce -10 V out, using 2.5 V and 10-V diodes, respectively.

Drift depends on zener voltage

The effects of op-amp bias and offset drifts are described by

$$V = \pm E_{os} (1 + R_f/R_{in}) \pm I_{os} R_f,$$

where E_{os} is the op-amp offset drift,

I_{os} is the op-amp offset current drift,

R_{in} is the summing-point resistance.

R_f is the same in both circuits, so current effects are also the same. However, the 2.5-V reference voltage must be amplified. As the equation shows, offset drift is magnified by five for the 2.5-V reference, but by only two for 10-V source.

Manufacturers of precision reference sources use functional trimming to produce high-accuracy miniaturized modules at a reasonable cost. For example, the top-of-the-line Model MN2000H, from Micro Networks Corp., guarantees an output of 10 V to within $\pm 0.05\%$ over the range -55 to 125 C, with typical stabilities of 50 $\mu\text{V}/\text{day}$, 200 $\mu\text{V}/\text{month}$ and 500 $\mu\text{V}/\text{year}$. ■■

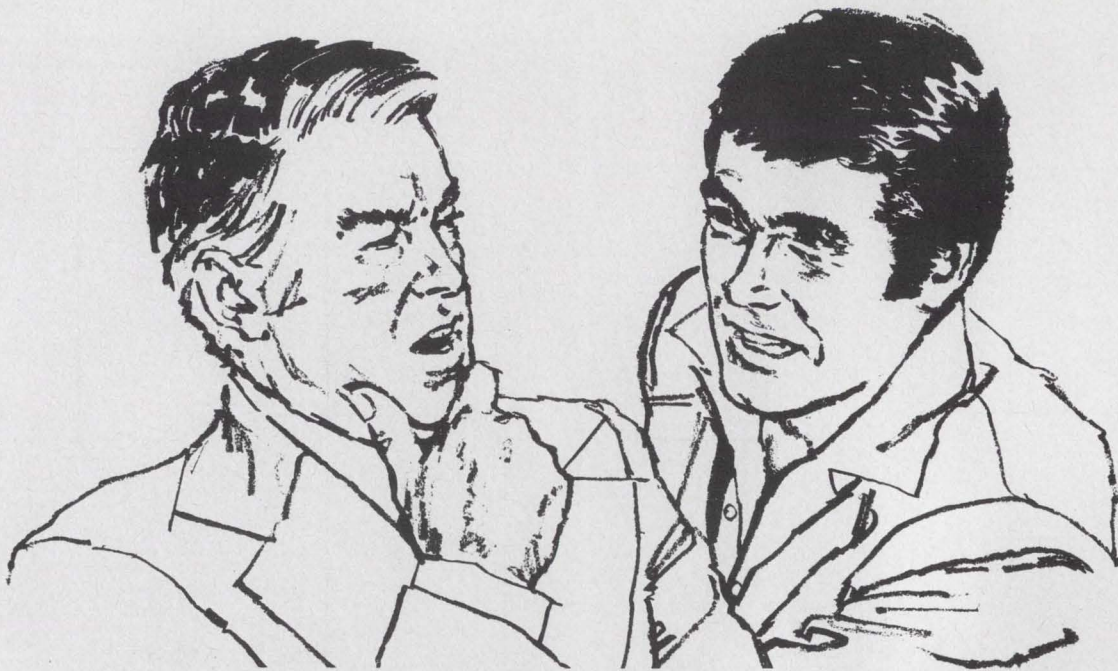

HERE'S WHAT THEY'RE SAYING ABOUT THE GOLD BOOK

The GOLD BOOK is outperforming its nearest competitor 3 to 1 — and is providing \$75 in sales for every \$1 invested! Reports George A. O'Sullivan, President, Abacus Controls.

"We're switching to the GOLD BOOK this year!" Says Peter G. Wittenberg, Sales Manager, North Atlantic Industries.

"The GOLD BOOK just brought in two pending order for \$75,000!" Says James Zaros, Vice President Sales, Datel Systems, Inc.

"It's fantastic. We receive numerous calls and letters, both from the U.S.A. and all over the world, which we can readily ascribe to the GOLD BOOK!" Says Stephen J. Scorza, General Manager, Nobel Electronics, Inc.

"Our catalog in the GOLD BOOK paid for itself on the very first day!" Says Len Kornfeld, Executive Vice President, U.S. Box Crafts, Inc.

"I am a believer. We have attributed a number of inquiries and orders directly to our GOLD BOOK pages!" Says Alex M. Polner, Vice President, Power Tech, Inc.

**ELECTRONIC DESIGN'S GOLD BOOK IS WORKING
... IT'S WORKING FOR READERS ... AND IT'S
WORKING FOR ADVERTISERS, TOO.**

HAYDEN PUBLISHING COMPANY, INC.
50 Essex Street, Rochelle Park, N.J. 07662 • (201) 843-0550
WORLD LEADER IN ELECTRONICS PUBLISHING

Ise introduces five new ways to make the competition turn green.

Your competition probably already thinks they're using the perfect display in whatever it is they make. Let them keep thinking it. While you prove them wrong with a new Itron display. They're designed to make the competition turn green. Which also happens to be the color of the segments.

All 17 of them on the 17-digit Itron. All 5 on the FG-512A1. Next comes an Alfa-Numerical Itron. A Linear-Analog Itron. And a Digital Clock Itron. Five ways to be heartless if you put a little heart into it.

itron[®]

Alfa-Numerical Display



FG209M2

ef=10V
ec=eb=40Vp-p
ic=10mA-p-p
ib=8mA-p-p
Wd. 205mm
Lg. 40mm
Segment 9mm

Instruments & Large Calculator Display



FG179F2

ef=7V
ec=eb=35Vp-p
ic=7mA-p-p
ib=5.5mA-p-p
Wd. 170mm
Lg. 40mm
Segment 9.5mm

Instruments & Terminal Units Display

FG512A1
ef=3.5V
ec=eb=24Vp-p
ic=4mA-p-p
ib=3mA-p-p
Wd. 100mm
Lg. 40mm
Segment 12mm



Digital Clock Display



FG425A1

ef=5.5V
ec=eb=35Vp-p
ic=8mA-p-p
ib=6.5mA-p-p
Wd. 140mm
Lg. 59mm
Segment 25mm

Linear Analog Display

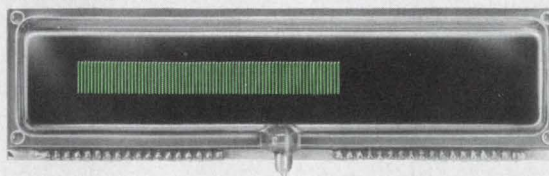

FG120S1

ef=5.5V
ec=eb=35Vp-p
ic=4mA-p-p
ib=0.2mA-p-p
Wd. 140mm
Lg. 40mm
Segment 8mm

NORITAKE CO., LTD.

Electronics Office (U.S.A.)
22410 Hawthorne Blvd. Torrance California 90505, U.S.A.
Phone: (213) 373-6704.
Telex: "230674910"

Electronics Division
1-1, Noritake-Shinmachi, Nishi-ku, Nagoya-City, Japan.
Phone: NAGOYA (052) 561-7111.
Telex: J59738 NORITAKE

ISE ELECTRONICS CORP.

London Office
c/o NORITAKE (U.K.) LTD.
Nortlake House 2, York Street W1H 1 Be., England.
Phone: (01) 935-7543 Cable: "LUCTUAL" LONDON

Muenchen Office
c/o NEUMULLER GmbH 8 Muenchen 2, Karlstrasse 55, West Germany. Phone 592-421 Telex 522106

Hong Kong Office
Room 1403 Shing Loon Bldg.
24~26 Stanley Street, Hong Kong
Phone: 5-232420 Telex: HX83151

Taipei Office
72-9 SEC. 2, JEN AI RD., Taipei
Phone: 351-0293 Telex 11176

CIRCLE NUMBER 27

Simple regulator circuits provide tracking bipolar reference voltages

The circuits in the figures are low-voltage reference or bias sources. They supply mirror-image tracking voltages for bipolar trimming networks, symmetrical clamping arrays and other circuits.

Although forward-biased silicon diodes and low-voltage zeners often provide such low voltages, generally these devices can be used only for low-accuracy applications. For high precision circuits that demand low drift and good regulation with both line and load variations, you need a regulator circuit (Fig. 1).

With little complexity, this circuit uses an AD580 as a three-terminal reference within the feedback loop of an inverting op amp. This arrangement generates bipolar voltages at low source impedances. The 580 output is a constant 2.5 V between its output and the common terminals. The voltage is split by the inverting op amp into two ground-referenced voltages, ± 1.25 V.

The V_{o+} output is limited to 10 mA by the 580; comparable negative (sink) current is supplied by the op amp. Typically, the 580 provides 80 dB of line-variation rejection at the V_{o+} terminal; the V_{o-} line has better rejection. Load regulation is about $500 \mu\text{V}$ for a 5-mA load change. With a low temperature-coefficient 580 (for example the AD580M, which has a tempco of 10 ppm/ $^{\circ}\text{C}$) the circuit is very temperature stable. Also this version of the 580 holds initial voltage accuracy to within 1%.

Balance between the output voltages is maintained by the match between R_1 and R_2 , which should be low tempco tracking resistors. And, of course, the op amp also should be a low-drift unit, such as the AD301AL, which has a $5 \mu\text{V}/^{\circ}\text{C}$ max drift and 0.5-mV max offset.

A lower-cost, higher-current, less-accurate circuit is shown in Fig. 2. This one uses a 78L26—a 2.6-V three-terminal regulator—as a reference. A 100-mA maximum output can be drawn from the V_{o+} terminal. Output-voltage tolerance is only $\pm 4\%$; the balance is consistent with the match of R_1 and R_2 . Regulation for the V_{o+} terminal is

poorer—approximately 50 dB—because of the 78L26. However, regulation on the V_{o-} terminal is similar to the circuit in Fig. 1 when the same op amp is used.

The Fig. 2 circuit can generate ± 2.5 , ± 3.1 , ± 6 , or ± 7.5 V outputs by use of 5, 6.2, 12 or 15-V versions of the 78L series, respectively.

Walter Jung, Pleasantville Laboratories, 1946 Pleasantville Rd., Forest Hill, MD 21050.

CIRCLE NO. 311

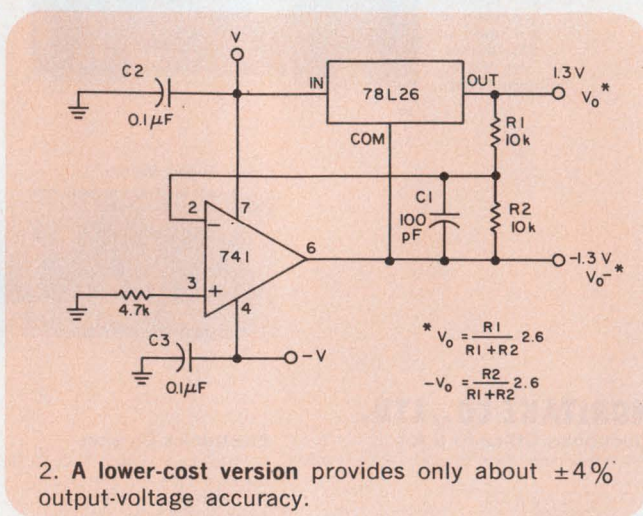
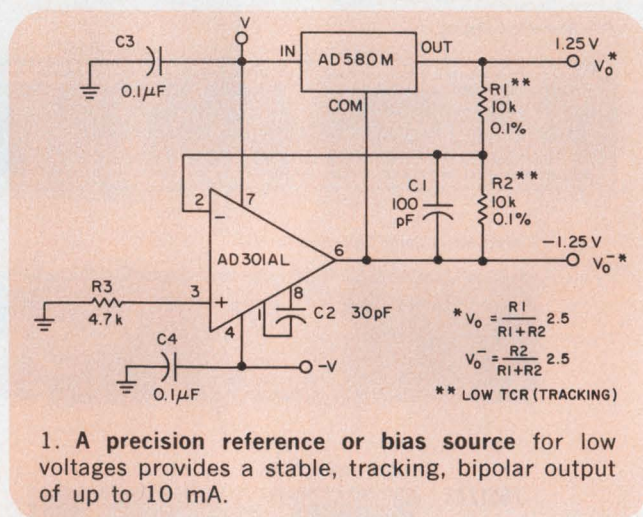

sticks sticks sticks!



Preassembled LED displays cut price per digit and save labor

Big Sticks are what's new in LED packaging. And naturally Litronix is coming on first and strongest with eight different preassembled displays of 1" and 1/2" digits.

Price per digit is 20% to 25% less than earlier single-digit mounts. Add to that the saving in assembly and inventory costs and you've found the best LED display bargain of the year.

Inch-high displays come in modules of 2, 3, and 4 digits—the last with a colon for clocks and indicator lamps for AM, PM and alarm.

Half-inch displays are available with 2, 3 1/2, 4 and 6 digits per stick. The 3 1/2 digit module has plus and minus signs, and can be combined with the other modules to create instrument displays of almost any length. There are two half-inch 4-digit modules, one for general use with closely spaced digits, and one for clocks with a colon, built-in multiplexing, and indicator lamps for AM, PM and alarm.

If you need big digits, you'll prefer Big Sticks. Can we throw some your way?

Litronix, 19000 Homestead Road, Cupertino, California 95014. Phone (408) 257-7910.

No wonder
we're No. 1
in LEDs

litronix

Computer sound effects generated with only four ICs

An electronic music circuit that generates random tone sequences can be built with only four low-cost ICs (Fig. 1). The circuit simulates sounds the public associates with large computer-based systems, which can be used as sound effects for electronic games and dramatic performances.

The CMOS shift-register and Exclusive-OR gate, G_4 , generate a pseudorandom sequence of 127 binary numbers that are decoded into voltage levels by resistor-array R_1 through R_7 and op-amp A_1 . Varying voltage levels thus generated control the output frequency of a 555 timer, connected in an astable-multivibrator mode.

The 200-mA output capability of the 555 easily drives a small loudspeaker. Also, the output may

be used with a standard audio amplifier-speaker system. The remaining Exclusive-ORs (G_1 to G_3), configured as an oscillator, are used as a clock to control the repetition of the output tones. The clock's frequency can be adjusted from 2 to 20 Hz.

A power-up circuit formed with R_1 and C_1 introduces ONEs into the shift register during the first few clock pulses. The circuit arrangement avoids a possible all-ZERO lock-up state. Diode D_4 discharges C_1 at turn-off, so that the power-up circuit is immediately available for reuse. The momentary Sequence Reset switch is used to introduce an all-ONEs state into the shift register as a starting-point reference for the sequence.

Standard 5% resistors can be used for the

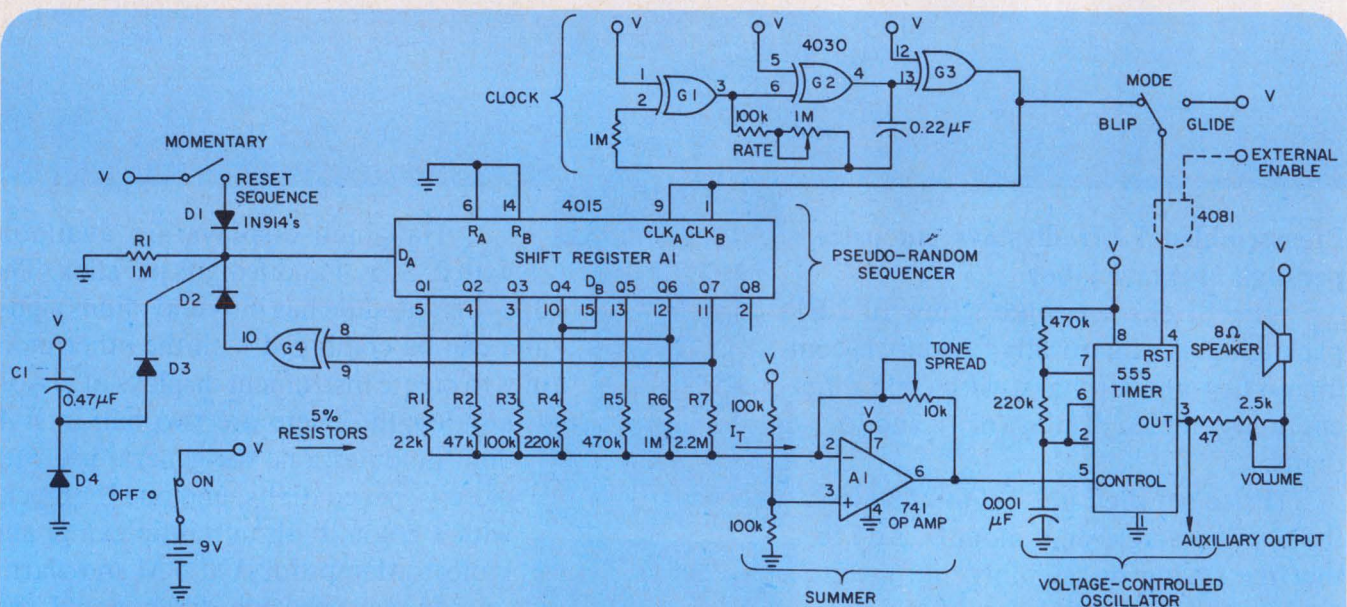

1. The sound effects of a computer are generated from the conversion of a pseudorandom sequence

of binary numbers into corresponding tones in a staccato or gliding succession of notes.

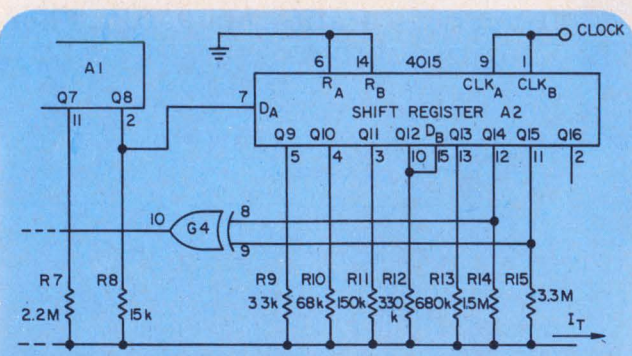

2. The length of the tone sequence can be greatly extended by the addition of one shift register.

digital-to-analog converter array, because precision tones are not required. For the same reason, the nonlinearity of the timer VCO is acceptable.

With the Mode switch in the glide position, the output of the 555 tone generator "glides" continuously through the note sequence. The blip position resets the tone generator on alternate half-cycles of the clock, causing a staccato sequence of musical half-notes.

The simulator can be easily expanded to a longer (32,767) binary-number sequence by use of eight more shift-register stages (Fig. 2).

Michael S. McNatt, Senior Engineer, LaBarge Inc., Electronics Div., 6540 E. Apache, P.O. Box 36, Tulsa, OK 74101.

CIRCLE NO. 312

If you spend more than 20 minutes picking a P.C. connector

It's your guide to the broadest line of printed circuit connectors made by any single manufacturer. We have just about everything and in more combinations and more depth than anyone — more types of contact terminations, insulator materials, mounting styles, contact designs, types of plating.

Send for our catalog. Browse through it and you'll discover that picking out the right printed circuit connector for your job is as simple as it should be.

Quick delivery.

And you can get your hands on our connectors, too — in a hurry if need be. We keep a large inventory; so do our distributors.

Our "Whatever-you-need-we've-got" department.

As you can guess, we have a lot of tooling filed away. Our production engineers have a unique talent at taking an existing bit of tooling, fiddling with it, and turning out a "custom" connector that's exactly what you need. Your extra cost is only a modest set-up charge... a long way from a full retooling cost.

Use the coupon.

...you don't have this catalog.

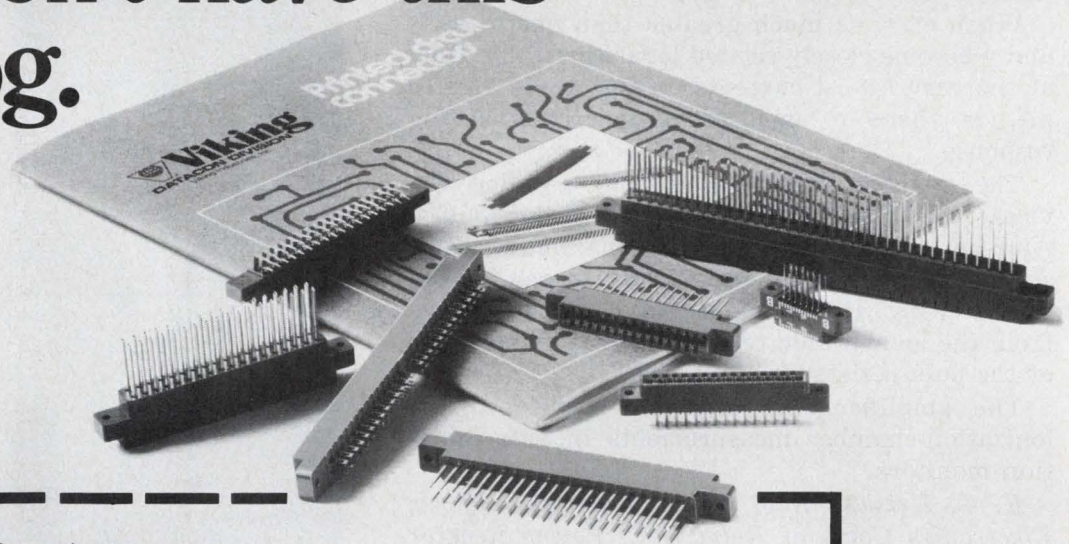

Ok. Send me: Your latest printed circuit connector catalog.
 ...and your nearest rep. I want to talk to him about a particular problem I have.

NAME: _____

TITLE: _____ TELEPHONE: _____

COMPANY: _____

ADDRESS: _____

CITY: _____ STATE: _____ ZIP: _____

Viking
CONNECTORS

Viking Industries, Inc./21001 Nordhoff Street
Chatsworth, CA 91311 U.S.A./ (213) 341-4330/ **DATA CON DIVISION**

CIRCLE NUMBER 28

Logarithmic amplifier's range is extended down to 1 pA

The use of a low-leakage FET as a feedback element can extend the range of a logarithmic current amplifier down to 1 pA. In conventional log amplifiers, leakage of the usual transistor feedback element limits the response in low-current ranges.

When a FET's drain and source are connected together, a very-low-leakage diode is formed. Its forward current can be expressed by

$$I_f = I_o (ce^{qV/KT} - 1),$$

where I_o is the diode's reverse saturation current and v is its forward-voltage drop.

When $e^{qV/KT}$ is much greater than one, then I_f and v become closely related logarithmically. Only at the very lowest currents, in the range 1 to 10 pA, is there a small deviation from a log response.

The matched-FET pair, AD830 (Analog Devices), provides excellent temperature stability. And its leakage is only 0.1 pA maximum; thus, six decades of logarithmic response can be obtained easily. However, beyond 1 μ A, deviations from the logarithmic relationships result because of the bulk resistance of the FET.

The amplifier was originally developed for ionization-chamber measurements in area-radiation monitors.

K. G. Krishna Rao, Senior Technical Officer, Electronics Corp. of India Ltd., Power Reactor Instrumentation Div., Industrial Development Area, Hyderabad - 500 762 India. CIRCLE NO. 313

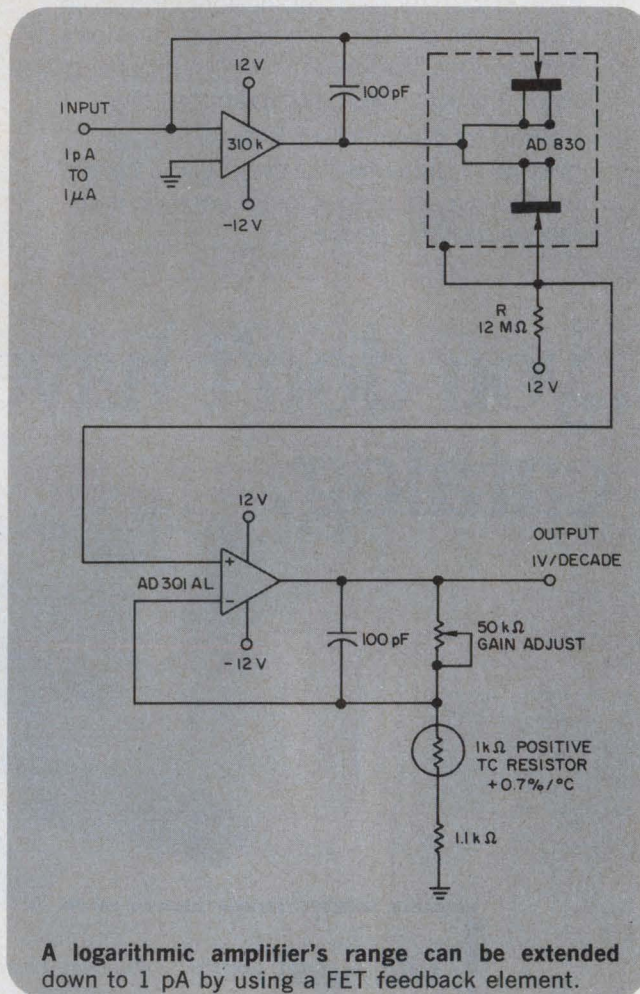

IFD Winner of March 1, 1976

Pekka Ritamaki, Electronic Engineer, Oy Nokia, Ab, Cable Works, Capacitor Dept., PL 60, 33101 Tampere 10, Finland. His idea "Convert Keyboard or Computer Signals to Serial Pulses for Automatic Dialing" has been voted the Most Valuable of Issue Award.

Vote for the Best Idea in this issue by circling the number of your selection on the Reader Service Card at the back of this issue.

SEND US YOUR IDEAS FOR DESIGN. You may win a grand total of \$1050 (cash)! Here's how. Submit your IFD describing a new or important circuit or design technique, the clever use of a new component or test equipment, packaging tips, cost-saving ideas to our Ideas for Design editor. Ideas can only be considered for publication if they are submitted exclusively to ELECTRONIC DESIGN. You will receive \$20 for each published idea, \$30 more if it is voted best of issue by our readers. The best-of-issue winners become eligible for the Idea of the Year award of \$1000.

NATIONAL ANTHEM



A Review of New Products and Literature from

National Semiconductor • No. 3, May, 1976

UPWARD-compatible 4K, 8K, and 16K Static ROMs

Fabricated using N -channel enhancement- and depletion-mode silicon gate technology, our three-member family of static ROMs is ideally suited to a wide range of uses such as table look-up, microprogramming, random logic synthesis, control logic, etc.

The MM5238 (512 x 8), MM5242 (1024 x 8), and MM5246 (2048 x 8) are TTL/DTL-compatible and operate from a single +5 V supply. They feature a 500-ns (max.) access time, full decoding, and true static operation.

In addition, the MM5238/5242/5246 have programmable Chip Select inputs that control their Tri-State® outputs, which means that bus interfacing and memory expansion is simple indeed. //

SC/MP: a Simple to use Cost-effective/Microprocessor

National's single-chip sc/MP marks the birth of a new generation of microprocessors. As the first, low-cost true microprocessor, sc/MP needs only one memory chip (any standard ROM, PROM, or RAM) to form a complete, fully programmable, general-purpose microprocessor system.

And this system, because of its low cost, is ideally suited to replace "sheet metal" logic in toys and games, traffic controls, home appliances, vending machines, home and building security and environment controls, on-board automotive computers, and so on.

sc/MP's features make it all happen: 8-bit data handling is combined with 16-bit addressing; an on-chip clock simplifies system design; a serial i/o port makes for easy interfacing; built-

in flags and jump conditions simplify control tasks; an interrupt structure that gives fast response to asynchronous events; a delay instruction to simplify timer systems. And all of these are supported by a set of 46 control-oriented instructions.

Getting started with sc/MP is super simple. Aside from the CPU chip itself, we offer two kits. The basic kit includes all ICs, firmware, discretes, and mechanical hardware to let you explore sc/MP's capabilities. The sc/MP LCDS (Low-Cost Development System) goes further, and includes a keyboard, a display, more memory, etc.—it's a complete microcomputer, in fact, which lets you rapidly develop and debug programs, and experiment with interrupts and interface structures. //

Three New 4K Static RAMs In Two Organizations, Two Lead Counts



While all three family members share the same operating specs, the organizations, package pin-outs, and lead functions differ. The MM5255, for example, is organized 1024 x 4, has four common i/o ports, and is housed in an 18-pin DIP. The MM5256, also 1024 x 4, has four input pins, four output pins, and is in a 22-pin DIP. The MM5257, with its 4096 x 1 organization, has, of course, one input pin and one output pin, and is packaged in an 18-pin DIP.

All the parts are TTL compatible and operate from a single +5 V supply. These RAMs feature fast access (250 ns), a standby mode controlled by the Chip Enable (standby power is less than 200 mW typ.), low operating power (less than 400 mW typ.), and on-chip address and data registers.

You can sample the MM5255/5256/5257 next month (June), and have production quantities in the third calendar quarter of this year. //

We've got a family of ion-implanted N -channel, silicon gate, non-refresh RAMs that'll satisfy a great number of your 4K read/write users out there.

8-bit ADCs Combine Low Cost, High Performance

A new, National-proprietary ladder design is the key to the low, low price/performance ratio of our MM4357/MM5357. There simply is nothing comparable on the market at anything near the prices we've put on these monolithic ADCs—less than \$8.00 each in 100-piece lots!

The MM4357, for example, is fully spec'd over the military temperature range—and there are many, far more costly ADCs around that cannot make such a claim. While the MM5357 is for commercial (0°–70°C) temperature range uses, both ADCs feature ±5 V or 0–10 V input ranges, no missing codes, high input impedance (100 MΩ, min.), ratiometric conversion, TTL compatibility, built-in output latches, and Tri-State® outputs.

Key specifications include 8-bit resolution, ±1/2-LSB linearity (a "B" version loosens this spec slightly), 40-μs (max.) conversion speed, and clocking rates from 5 kHz to 2 MHz. Supply voltages required are +5 V and -12 V. The MM4357/MM5357 are available in both cavity and molded 18-pin DIPs. //

INTERFACE CIRCUITS IN HIGH-DISSIPATION MOLDED DIPS

National's new, high-dissipation DIPS use a copper lead frame, rather than the common Kovar lead frames. And this means increased power dissipation capabilities with improved reliability and increased part life.

If this sounds a bit too much like eating your cake and having it still, consider this: a circuit that in a Kovar lead frame is limited to a 625-mW dissipation in a 75°C ambient can, with a copper lead frame, dissipate 938 mW in the same ambient. Put another way, at a dissipation of 625 mW, a device in a Kovar lead frame will have a junction tem-

perature of 150°C, while in a copper lead frame the junction temperature will drop to 125°C.

At last count, we've switched 45 interface parts to this wondrous package—dual peripheral drivers (including CMOS-compatible types), RAM interfaces, relay drivers, clock drivers, core memory drivers, etc. (See our Interface Data Book for specific thermal ratings.)

And by the way . . . If you think you can get similar high-dissipation parts from the competition, better forget it. Because there *isn't* any. *⚡*

PROCESSOR IS CALCULATOR- ORIENTED

Looking for a versatile, low-cost, dedicated or custom-programmable calculator or control system? We've got it! Our MM5799 contains all system timing functions, all arithmetic and logic functions, all RAM functions (384 bits), and all control ROM functions (1536 microinstructions 8-bits wide, 10- μ s/microcycle) that you'll need to implement a variety of small control and microprocessor systems.

A single MOS/LSI chip, the MM5799 can scan 56 keyboard switches, or you can enter BCD data words. Its eight outputs present information in either a BCD or a seven-segment-plus-decimal-point format, and four additional latched outputs give you encoded digit-timing information. Further, a serial-in port and a serial-out port let you expand the basic RAM store and interface to peripherals.

And speaking of peripherals and extra storage, our MM5788 printer interface, DS8664 Series oscillator and decoder/drivers, MM5785 RAM interface, and MM2102 and MM74C930 1-K static RAMS are a perfect match to an MM5799-based system.

A special purpose microprocessor, our MM5799 uniquely bridges the gap between the overkill of general purpose processors and inflexible, costly, custom LSI. *⚡*

Universal Timer Circuit



The MM5865 is a new timing circuit ideal for use in stop watches, kitchen and oven timers, event timers/counters, rally and navigation timers, etc. Its single chip contains all the logic required to control the timer's two 4-digit counters, to compare them, to blank leading zeros, and to cascade another MM5865.

Input-pin functions start, stop, reset, and set the counters, and determine which of the timer's seven functions is to be performed, the display resolution (0.01, 0.1, 1.0 sec., or external clock), and the divide modulo.

The MM5865's seven functions are start/stop with total elapsed time, start/stop with accumulative event time, split, sequential with total elapsed time, rally with total elapsed time, program up-count, and program down-count. The circuit uses either a 32.8-kHz crystal or an external clock, and is packaged in a 40-pin molded DIP. *⚡*

Bi-FET™ Sample/Hold:

Fast Acquisition, Ultra-High Accuracy, Low Droop Rate

The headline tells the story. National's BI-FET™ technology, which combines FET and bipolar devices on the same chip, first yielded fantastic new op amps (*National Anthem* No. 1, January 1976). Now BI-FET technology yields new sample-and-hold circuits: dc gain accuracy of 0.002% (typ.) in a unity-gain follower configuration; acquisition times as low as 6 μ s to 0.01% with a 1000-pF hold capacitor; droop rates as low as 5 mV/minute with a 1- μ F hold capacitor!

We're talking about our LF198/298/398, which eliminate input/output feed-through in the hold mode even for signals equal to the supply voltages— ± 5 V all the way to ± 18 V. In addition, these parts feature a single-pin input offset adjustment that does not degrade input offset drift; an input impedance of 10^{10} ohms, which means that high source impedances will not degrade accuracy; a bandwidth sufficient to allow stable insertion of these circuits within the feedback loop of 1-MHz op amps; and a TTL/PMOS/CMOS-compatible logic input . . . all contained in a little, 8-pin, TO-5 metal can. *⚡*

High Voltage, High Slew Rate Op Amps

Unique characteristics of our LM144/344 op amps include operation from ± 4 V to ± 36 V, a 30-V output swing capability, a slew rate of 30 V/ μ s (typ.) and an externally compensated power bandwidth of 120 kHz (both at $A_v \geq 10$), a low input-bias current of 8 nA (typ.), an input offset current of only 1 nA (typ.), and a high voltage-gain of 100k (min.).

With specs such as these, the LM144/344 increase both accuracy and useful frequency range in many existing applications. The LM144, for example, is a direct replacement for the LM101A, and can replace other general purpose op amps as well.

The LM144 operates between -55° and $+125^\circ$ C; the LM344, intended for less severe supply voltage and temperature environments, is spec'd from 0° to $+70^\circ$ C. Both parts are available in a 14-pin cavity DIP, a 10-lead flat pack, and an 8-pin TO-5 can. *⚡*

How to symmetrically limit the output of an op amp

A common way to symmetrically limit the output of an op amp is to use back-to-back Zeners across the feedback resistor. One of our readers, realizing that this is not the best way to do things, has asked us for a better way, and also wants to know what to expect from an op amp when symmetrical limiting is attempted by tying back-to-back Zeners from the output to ground, making use of the amp's current-limiting characteristics. Since we suspect that a great many of you are perplexed by the same problem, here are our answers.

Answering the last question first: we do not recommend clamping an op amp's output. Current limiting in an op amp is provided to protect the amp against short-circuit currents, which otherwise would destroy the amplifier. But short-circuit currents are not well

defined, nor is the recovery time of the amplifier from such conditions. Further, positive and negative current-limiting may not be symmetrical. Thus, using the current-limiting characteristics to limit an output signal really is an attempt to make ill-defined internal parameters yield a well-defined external result. Not a good idea.

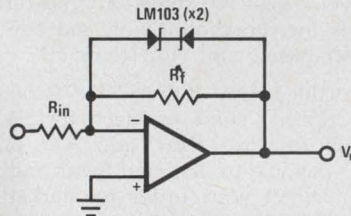

Figure 1.

In the current-limited mode the op amp's feedback loop opens, which forces the internal biases away from their nominal values. Some amps may

take several milliseconds to recover, in addition to the recovery time of the external feedback component itself. If the amp is connected as an integrator, for example, the recovery time may be several minutes.

If you're still not dissuaded from clamping the amp's output, consider the radical increase in power dissipation in such a situation. This increases chip temperature, which degrades the op amp's dc parameters.

Now let's get back to back-to-back limiting. Figure 1 shows a typical circuit. It suffers from a lowered high-frequency corner (thanks to the Zener's capacitance), Zener leakage across R_f at low and medium voltages, asymmetrical limiting, and possibly even soft limiting if the Zeners have poor knees. At low voltages, use of our LM103 active Zener improves things, but only to a certain extent.

And now... A full line of Durawatt 92-Plus™ Power Transistors

Durawatt 92-Plus™ . . . National's unique power transistor package concept that actually improves performance and reliability while letting you retain a cost-effective design. As described in *National Anthem* No. 1, January 1976, Durawatt 92-Plus packaging eliminates the no-man's land of power transistor usage, that limbo between 800 mW and 2 W dissipation.

Our new, standard line of 92-Plus transistors operates at a solid 1.2 W, and features a 6-W maximum dissipation rating! The series comprises six generic families of general purpose complementary power types and Darlingtons (rated at 2 A/45-100 V), and high-voltage line drivers (100-500 mA/250-300 V)—21 92PXXX types, and only National has them.

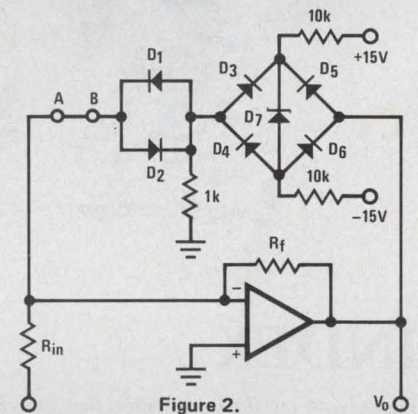

Figure 2.

Figure 2, however, improves limiting, and in fact performs quite well. Here, the diodes do not add much capacitance across the feedback resistor. And all diode leakages are absorbed by the 1-k Ω resistor. D_7 will be, typically, a 9.1-V Zener for an 11.8-V limit. At $V_o = 10$ V, leakage will be less than a nanoamp; but at ± 11.8 V the limiting circuitry will conduct more than 2 mA. As the same Zener conducts for both polarities of the input, output symmetry is very good.

For most applications, D_3 through D_6 can be low-capacitance, fast-recovery 1N914s. But operation at elevated temperatures may require the use of low-leakage types, such as 1N457s or FD300s. (D_7 isn't critical; it never turns off, so its capacitance and knee characteristics are unimportant.)

For super-critical low-leakage applications, add an extra stage of resistor-diode network between points A and B. For non-critical work, you can delete D_1 and D_2 .

Using NSC's dual JFETs? Not yet? Then... Get your head examined!

Tactless? Perhaps. But if the headline caught your attention you're already ahead of the game. After all, National invented the monolithic dual JFET. And we still supply the best quality parts in the marketplace, and supply them to the tightest specs. Period.

Take our new NPD5564 Series, for example. Low noise (spot NF = 1 db max. at 10 Hz, $R_g = 1$ M Ω) . . . high speed, wide bandwidth ($C_{iss} = 12$ pF max.) . . . low offset and offset drift (5-20 mV max., and 10-50 μ V/ $^{\circ}$ C max., depending on the type) . . . an easily guarded gate pin for low leakage

operation . . . and an 8-lead molded MiniDIP package that's ideal for auto-insertion (also a 6-pin, TO-71 can). Top these features with low cost, and you're guaranteed the lowest price/performance ratio JFETs that money can buy.

Samples of the NPD5564 Series—or of any of our JFETs—are available through your local National rep, or by a letterhead request to Mike Turner, JFET marketing manager here in Santa Clara. And while you're at it, check out our new NPD8301 Series—three MiniDIP duals that replace 39 different metal can and plastic duals!

NATIONAL ANTHEM

ALL THE NEWS THAT FITS

SC/MP HANDBOOK TELLS ALL!

Amplly illustrated, the 65-page *SC/MP Technical Description* matches *sc/MP's* applications-oriented design in that the text stresses applications and how-to-use information.

Opening with a discussion of *sc/MP's* general features and support components, the *SC/MP Technical Description* proceeds to a detailed description of the *cpu* chip, and from there to *sc/MP's* application cards. *sc/MP's*

Development Systems are also described. Based on *sc/MP's* *cpu*, the Development Systems are powerful tools for the prototyping and use of *sc/MP*-based control systems.

To order a copy of the *SC/MP Technical Description*, send a check for \$3.00 (California residents add 6% sales tax) payable to National Semiconductor. Direct your order to Marketing Services/520.



LARGEST-DISPLAY CLOCK MODULES NOW AVAILABLE

The outstanding feature of our new MA1010 electronic clock module is its stand-out display: a 0.84-inch, 4-digit, LED display with mitred corners, which shows hours and minutes; a blinking colon indicates seconds. There's nothing else as large, as readable, or as attractive on the market. We repeat: *nothing*. You've just got to see this one to believe it.

The module is complete on a single, 1.75 x 3.75-inch *pc* board, and all connections are at the bottom of the card. You add only a power transformer and switches to complete a pre-tested digital clock ideal for clock radios, desk and wall clocks, alarm clocks, *tv*/stereo clocks, instrument panel clocks, etc.

Timekeeping may be from 50 or 60 Hz, and you may choose a 12-hour or 24-hour format. Features include alarm *on*, *pm*, and power failure indicators, an alarm output that drives an 8-Ω speaker, sleep and snooze timers, fast and slow set controls, and a display brightness-control output (you determine the method of control appropriate to your design). Direct (non-mux'd) LED drive eliminates *rfl*. Use of the module allows a low-cost, extremely compact clock design.

Prototyping quantities of the MA1010 module are already available, and volume production quantities will be available in June.

ED75



VIP CARD

Complete card and mail to
NATIONAL SEMICONDUCTOR
Attn: Marketing Services
2900 Semiconductor Drive,
Santa Clara, CA 95051

INDEX

Please send me the information that I have checked:

- | | |
|--|---|
| <input type="checkbox"/> SC/MP, Page A, Col. 2 | <input type="checkbox"/> LF198 Sample-and-Hold, Page B, Col. 3 1. 3 |
| <input type="checkbox"/> SC/MP Kit, Page A, Col. 3 | <input type="checkbox"/> LM144/344 Op Amps, Page B, Col. 3 |
| <input type="checkbox"/> SC/MP LCDS, Page A, Col. 3 | <input type="checkbox"/> MM5799 Processor, Page B, Col. 1 |
| <input type="checkbox"/> MM4357/5357 ADCs, Page A, Col. 3 | <input type="checkbox"/> MM5865 Timer, Page B, Col. 2 |
| <input type="checkbox"/> MM5255/56/57 RAMs, Page A, Col. 1 | <input type="checkbox"/> NPD5564/8301 JFETs, Page C, Col. 1 |
| <input type="checkbox"/> MM5238/42/46 ROMs, Page A, Col. 1 | <input type="checkbox"/> Durawatt 92-Plus Parts, Page C, Col. 1 1 |
| <input type="checkbox"/> Hi-Diss. Interface Ccts, Page B, Col. 1 | <input type="checkbox"/> MA1010 Clock Module, Page D, Col. 3 3 |

Please send me the literature that I have checked:

- | | |
|--|---|
| <input type="checkbox"/> AN-135 IMP-16L DMA—What It Is and How To Use It | <input type="checkbox"/> AN-156 Specifying A/D and D/A Converters |
| <input type="checkbox"/> AN-154 1.3-V IC Flasher, Oscillator, Trigger or Alarm | <input type="checkbox"/> μSpec 10 IMP-16P/004A RAM Memory Card |
| <input type="checkbox"/> AN-155 Digital Voltmeters and the MM5330 | <input type="checkbox"/> μSpec 11 IMP-16P/008P ROM/PROM Memory Card |

Your End Product or Application: _____
Have Salesman Call YES NO

Please print clearly; this information will be used for our mailing list.

NAME _____ TITLE _____
COMPANY _____
ADDRESS _____
CITY _____ STATE _____ ZIP _____

D **A Review of New Products and Literature from National Semiconductor**

MAIL TO:

Electronic Design

P.O. BOX 13803, PHILADELPHIA, PA. 19101

FREE SUBSCRIPTION APPLICATION

Do you wish to receive (continue to receive)

ELECTRONIC DESIGN? Yes No

Date: _____

Signature: Does not obligate me or my company

I wish to receive (do not wish to receive) other solicitations. Yes No

ALL SUBSCRIBERS: Please fill out completely, the name and address portion, even if the information on your label is the same. (For prompt, accurate processing remember to affix label in the space provided above.) Do not use periods, commas etc.

To qualify please answer all questions carefully. Independent consultants must attach business card.

MR.
MS.

Area Code	Office Telephone
-----------	------------------

1st Initial	2nd Initial	Last Name	Title
Company Name (Do not abbreviate if possible)		Division	
Parent Company (if subsidiary) (Do not abbreviate if possible)			
Department		Internal Mail Code	
Company Street Address or P.O. Box No.			
Company City		State/Country	Zip Code/Postal Code
Home Address			
Home City		State/Country	Zip Code/Postal Code

Use this form for Change of Address or New Subscription Only.

1 Title: (Insert letter)

- | | |
|---------------------------------|--------------------|
| A President | J Project Engineer |
| B Vice President | K Senior Engineer |
| C Vice President of Engineering | L Group Leader |
| D Technical Director | M Dept. Head |
| E Chief Engineer | N MTS |
| F Principal Engineer | O Engineer |
| G Research Director | P Consultant |
| H Section Head | R Scientist |
| | S Physicist |

2 Your principal job function: (Insert code)

- General and Corporate Management
- Design and Development Engineering (circuits, components, equipment systems)
- Engineering Services (evaluation, quality control, reliability, standards, test)
- Basic Research
- Manufacturing and Production
- Engineering Assistants (draftsman, lab assistant, technician)
- Purchasing and Procurement
- Marketing including Sales
- Other Personnel (explain)

3 Plant Your own work

The primary end product (or service performed) at your plant, and the product (or service) that is your own work. (Insert code in each box even if the same)

- | | |
|---|---|
| A | A Large Computers |
| B | B Mini-Computers |
| C | C Computer Peripheral Equipment |
| D | D Data Processing Systems (Systems Integration) |
| T | T Office and Business Machines |
| E | E Test, Measurement and Instrumentation Equipment |
| F | F Communications Systems and Equipment |
| H | H Navigation and Guidance Systems and Equipment |
| J | J Consumer Entertainment Electronic Equipment |
| G | G Consumer Electronic Appliances |
| N | N Other Consumer Electronics |
| K | K Industrial Controls, Systems and Equipment |
| L | L Components and Sub Assemblies |
| M | M Materials and Hardware |
| Q | Q Aircraft, Missiles, Space and Ground Support Equipment |
| P | P Oceanography and Support Equipment |
| R | R Medical Electronics |
| U | U Industrial Companies within the OEM incorporating Electronic Equipment in their end product, not elsewhere classified |
| V | V Independent Research, Test and Design Laboratory and Consultant. (Only if you are not connected with a manufacturing company.) |
| X | X Government Agency and Military |
| 2 | 2 Industrial Companies using and/or incorporating any Electronic products in their manufacturing, research or development activities. |
| 1 | 1 Commercial Users of Electronic Equipment |
| 3 | 3 Distributor |
| 4 | 4 School, University or Library |
| 5 | 5 Other (explain) |

4 Your design function: (Insert each letter that applies)

- I do electronic design or development engineering work
- I supervise electronic design or development engineering work
- I set standards for, or evaluate electronic design components, systems and materials

5 Your principal responsibility: (Insert code)

- | | |
|-------------------------------------|---------------|
| 1 Management other than Engineering | 3 Engineering |
| 2 Engineering Management | |

6 Please estimate: (Insert letter)

- The number of electronic engineers at this address:
- (A) 1 (B) 2-5 (C) 6-19 (D) 20-49 (E) 50-99
(F) 100-249 (G) 250-499 (H) 500-999 (J) Over 1000

8 Products you specify or authorize purchase of: (Check all codes that apply.)

- | | |
|--|--|
| <input type="checkbox"/> 1 Resistors and Capacitors | <input type="checkbox"/> 12 Computer Peripherals |
| <input type="checkbox"/> 2 Connectors | <input type="checkbox"/> 13 Computer Components |
| <input type="checkbox"/> 3 Switches and Relays | <input type="checkbox"/> 14 Cabinets and Enclosures |
| <input type="checkbox"/> 4 Function Modules: Op Amps, Converters, etc. | <input type="checkbox"/> 15 Panel Meters, Analog or Digital |
| <input type="checkbox"/> 5 Potentiometers | <input type="checkbox"/> 16 Readout and Display Devices |
| <input type="checkbox"/> 6 Test and Measurement Equipment | <input type="checkbox"/> 17 Rotating Components |
| <input type="checkbox"/> 7 Computers, Medium and Large | <input type="checkbox"/> 18 Cooling Products |
| <input type="checkbox"/> 8 Electronic Power Supplies | <input type="checkbox"/> 19 Printed Circuits |
| <input type="checkbox"/> 9 ICs and Semiconductors | <input type="checkbox"/> 20 Calculators |
| <input type="checkbox"/> 10 Microwave Devices | <input type="checkbox"/> 21 Indicators including LEDs |
| <input type="checkbox"/> 11 Minicomputers | <input type="checkbox"/> 22 Materials, Potting and Stripping |
| | <input type="checkbox"/> 23 Communications Equipment |

7 Please write in box total number (other than self) to be served by this subscription at this address and list individuals and their titles below. If no other person is served please indicate "0" in the box at left.

Name (Please Print)	Title

9 Do you specify or buy through distributors?

YES NO

10 Minicomputers at this address:

	Model	Qty.	Model	Qty.
3	Cincinnati Milacron			
C	Computer Automation			
D	Control Data			
E	Data General			
F	Digital Equipment			
I	General Automation			
K	Hewlett Packard			
M	Honeywell			
O	IBM			
N	Interdata			
7	Microdata			
	Modular Computer			
	ROLM			
V	Systems Engineering Labs			
9	Texas Instruments			
x	Varian			
	Other			

This questionnaire conforms to the guidelines of the Business Publication Audit of circulation for eliciting comparable data. The publisher reserves the right to serve only those individuals who qualify for a free subscription.
ELECTRONIC DESIGN is sent free to qualified engineers and engineering managers doing work, supervising design or setting the standards in the United States and Western Europe.

For change of address only attach old mailing label here.

Spectrograph with μP analyzes speech sounds

A spectrograph for the analysis of speech sounds is being developed by Cossor Electronics of Harlow, England. The instrument uses a microprocessor to control a set of digital filters, which have many advantages over analog techniques.

A major limitation of the approach is that the filter parameters are determined by digital coefficients that bear no simple relationship to them. The coefficients must be calculated separately for each analytical problem.

The μP creates an interface between the digital filter and the hu-

man operator so that known parameters can be inserted into the instruments to control the filter's performance. The analog input signal of the Cossor spectrograph is first converted into digital form by an a/d converter. The resulting data are held in a 64-k memory. Fast digital filters retrieve these data from the memory for analysis. Parameters such as bandwidth, center frequency, upper and lower frequency limits, and frequency increments are entered in the spectrograph via a keyboard.

The μP operates upon these

parameters to derive a set of coefficients that are then loaded into the digital filter whose output is fed back into the microprocessor for gain scaling and then to a d/a converter to drive a recorder. The recorder's dynamic range can be adjusted by 20 to 60 dB. Up to 10 sets of parameters can be processed.

The spectrograph is being developed under a Ministry of Defense contract for the Joint Speech Research Unit, but the use of microprocessors to control digital filters has applications in seismic

MULTIPLE VOLTAGES FOR PCB'S

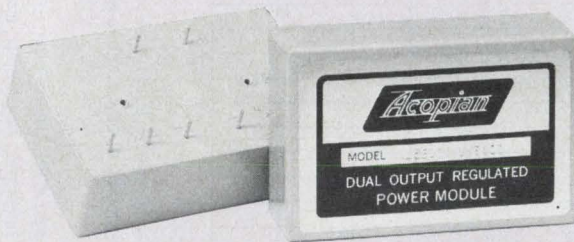

Simplify pc board layout with multiple output power mini's. Duals supply two isolated like or dissimilar outputs, 1 to 28 volts each. Op amp supplies provide ± 12 or ± 15 volts. Triples have two balanced, tracking outputs, a third for powering other circuits. Guaranteed 3-day shipment.



Corp., Easton, Pa. 18042 Tel: (215) 258-5441

MIL-TESTED PLUG-IN POWER

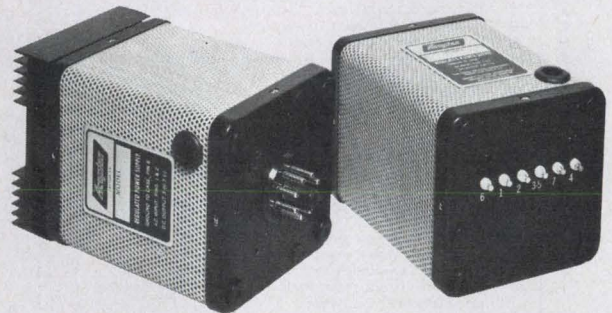

MIL-tested power supplies withstand unusually severe environmental conditions. These extended-temperature plug-in modules exceed MIL specs for humidity, altitude, vibration and shock. Hundreds of single output models, thousands of dual output combinations, all guaranteed for 3-day shipment.



Corp., Easton, Pa. 18042 Tel: (215) 258-5441

recording, vibration analysis, audio equipment, or transmission line testing and in all kinds of high-frequency filtering.

Electroplating method forms contacts on chips

A simpler and cheaper method of forming metal contacts on semiconductors than with the commonly used evaporation and sputtering techniques has been developed by the Royal Signal and Radar Establishment at Baldock, Herts, England. The new technique is called selected-area electroplating and comprises two simple steps.

First, an ion beam is used to selectively damage the semiconductor chip. This operation produces a potential difference between the bombarded areas and the undamaged parts of the chip. The chip is then immersed in a plating solution and illuminated by an ordinary 60-W light bulb. The light generates free carriers in the semiconductor and a plating current flows through the electrolyte, de-

positing a metal film on the damaged areas.

The technique has been successfully applied in the manufacture of n-type Schottky GaAs FETs. It is applicable to all types of semiconductor devices. Films of gold, palladium, platinum and silver up to 2 μm thick have shown strong adhesion. Multiple metal layers can be sequentially deposited by using successive plating solutions.

Major advantages of the process are two: simplicity—no electrical connections are made to the chip during plating; and low cost—low-voltage ion-implantation is used, requiring only a 5-kV machine.

Semiconductor laser has life of 2500 hours

A semiconductor laser with a working life in excess of 2500 hours has been developed by Standard Telecommunications Laboratories of Harlow, England. This lifetime is considerably greater than that of early solid-state lasers. The

English laser is a three-layer, double heterostructure gallium-aluminum-arsenide device.

The laser emits between the infrared wavelengths of 0.85 and 0.87 μm . Its emission is almost monochromatic. Peak output is about 100 mW for a 5% duty cycle. After 2500 hours of use, power output drops by a maximum of 20%.

The laser is being used in the development of an infrared beacon for military and civilian use. Ranges of 200 to 500 m have been achieved with this system.

Blue and Green LEDs have high efficiency

Green and blue electroluminescent gallium-nitride diodes with high efficiency have been developed jointly by two French companies—RTC Laboratories at Caen, and the Laboratories d'Electronique et de Physique Appliquée at Limeil-Brévannes. External quantum efficiencies of 0.3% for the blue-emitting diodes and 1.0% for the green have been achieved.

NEED A POWER SYSTEM?

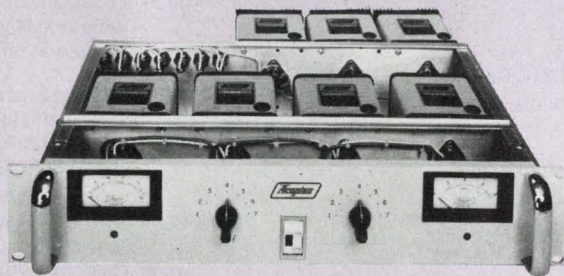

Order multiple output power systems without searching through a catalog, preparing mechanical layouts, item-by-item pricing and detailed purchase requisitions. Instead, call Acopian. We'll listen to your needs, quote a firm price, and then ship your built-to-order system, fully wired and tested, in just 9 days.

Acopian

Corp., Easton, Pa. 18042 Tel: (215) 258-5441

GUARANTEED 3 DAY SHIPMENT

ACOPIAN

POWER SUPPLY CATALOG 1976-1977

Every power module listed in the Acopian 48-page catalog is shipped within 3 days of order. Guaranteed! Miniaturized supplies, narrow profile and plug-in modules, premium performance models, and a wide choice of other types are described in detail. Ask for your copy.

Acopian

Corp., Easton, Pa. 18042 Tel: (215) 258-5441

Arrow-M Amber Relays

An important communication for the telecommunications industry.

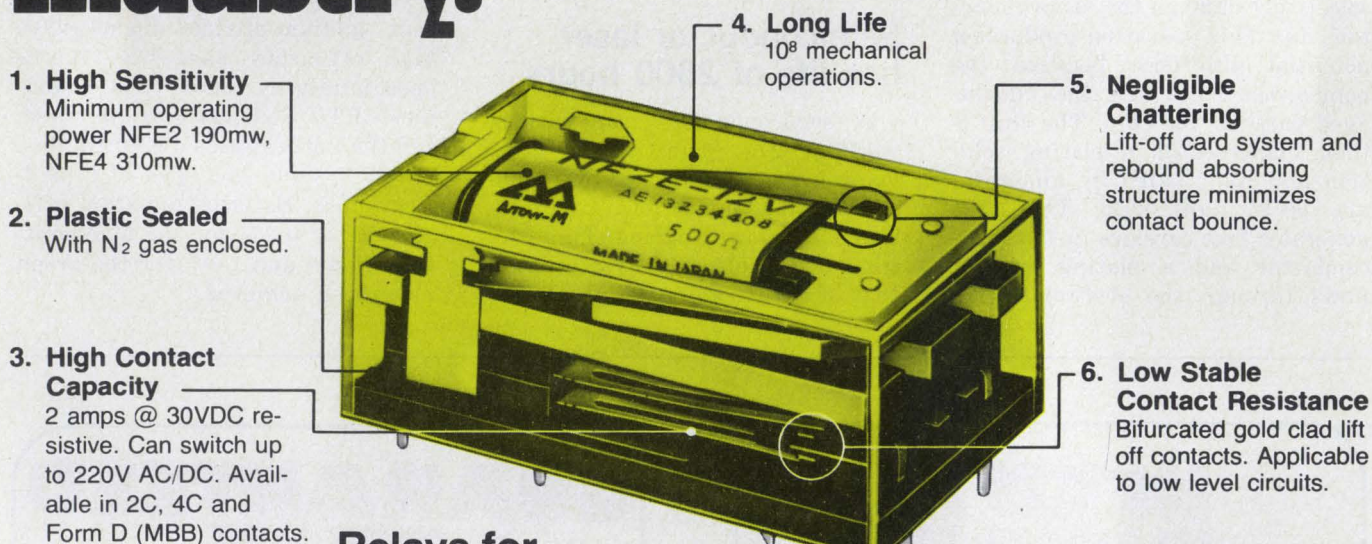

Relays for advanced technology.

Arrow-M NFE Amber relays give you high sensitivity with half the power drain... N₂ gas-filled plastic sealed for automatic wave soldering and ultrasonic cleaning.

The low power requirements of most telecommunications computer installations demand critical sensitivity and reliability in the relay systems.

Arrow-M Flatpack NFE relays offer maximum reliability and sensitivity using half the power of ordinary relays. The Flatpack design, only .425 inches high, is ideal for high density PC board packaging. The unique automated modular assembly insures extra long life and total reliability. And the gas-filled plastic sealed construction allows for economical automatic wave soldering and ultrasonic cleaning.

For NFE relays providing maximum sensitivity and reliability with minimum power drain, look to Arrow-M, the Company with over 50 years of meeting and advancing needs of modern technology.

For more information on exact specifications, write or call your nearest Arrow-M office.

Arrow-M Corporation
250 Sheffield St.
Mountainside, N.J. 07092
(201) 232-4260

Western Office:
22010 South Wilmington Ave.
Suites 300 & 301
Carson, California 90745
(213) 775-3512

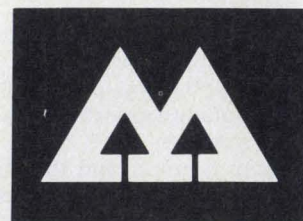

Arrow-M
Member of Matsushita Group

New Products

Microprocessor analyzer untangles knots in both software and hardware



Systron-Donner, 10 Systron Drive, Concord, CA 94518. (415) 676-5000. See text.

Systron-Donner's Model 50 is not another logic analyzer. Nor is it another microprocessor (μ P) development system. A string of unique features sets the Model 50 apart:

- It's the first universal μ P analyzer.
- It's the first analyzer that can interact with a μ P, not just passively monitor μ P operation.
- It's the first instrument that can search through program loops and find the beginning and end points.
- It's the first to keep track of the number of loop traversals so that you can enter and trace a loop at any pass.
- It's the first to give three ways to step through instructions—in machine cycles, instruction cycles or loop increments.
- It's the first to give three ways to delay the display of address and data-bus information—by program loops, by clock (or instruction) cycles or by a combination of both.

And that isn't all.

Despite its small size and big performance, the Systron unit sells for an eyebrow-lifting \$895—over \$2000 less than the only other μ P analyzer, Motorola's MPA-1, and way under the price of any available logic analyzer or development system.

In appearance, the 50's front panel reminds you of a minicomputer, which has similar display and control features. The resemblance goes no further, however.

In operation, you clip the 50's two umbilicals to any μ P system's address and data busses, and you're ready to troubleshoot both the software and hardware. To do so, select any binary address and load it into the 50's address-match register using the 8-bit front-panel switches.

If the processor executes the selected address, the 50 "spots" the match, generates a strobe and displays both the address and the data on the front-panel LEDs. Up to 16 bits of address and 16 bits of data or instructions can be displayed. Data can consist of two 8-bit bytes or parallel, 16-bit information.

Should you want to see informa-

tion "downstream" from the selected address, all you need do is delay the strobe in any of three ways: by a predetermined number of address matches up to 65,000; by a preset number of clock (or instruction) cycles, also up to 65,000; or by a combination of matches and cycles—up to 256 of each.

When the strobe does occur, you can latch the display to capture a one-shot event. Or use the 50's arming mode to strobe repeatedly with a variable display time.

If your problem is a hung-up program loop, go into the 50's search mode. Here, the instrument will tell you where a loop starts and ends, that is, the first and last address and instructions in the loop. And it won't take hours to track down the unknown addresses, but minutes.

The Model 50 can search through, say, 50,000 instructions in a fraction of a second. Try to do that with manual steps, and you'll grow a beard before you're through.

But you can also set the 50 to halt the μ P (those that allow it) at the strobe, and you can single-step your way through a program. Again, you can do that in several ways.

In fact, the 50 has six modes of halting and stepping, including machine-cycle steps, instruction-cycle steps and loop increments. Each of these can be "singly or multiply stepped."

In the 50's N-1 or N+1 mode—in which you advance or delay the strobe by one clock cycle—you can observe all calls to a subroutine to see if one call is missing. Or you can transfer a strobed address to the match register automatically and "walk" your way through the program forward or backward while you look for problems like missing bits.

Just as important, the N-1/N+1 mode lets you look at all subroutine return addresses or new

(continued on page 76)

If you've got a complicated problem with EMI we've got a simple solution

Electromagnetic Interference. It shows up as static on radio and snow on TV. It can make computer terminals register input error. Make a pacemaker or an EKG malfunction. And interfere with sensitive navigation equipment.

Obviously, you've got to shield your equipment against EMI. You can use sheet metal. Or foil. Or a plating process. These are fine for small enclosures with flat surfaces. But when it comes to large cases and complex shapes, you need a better solution.

And here it is. Electrodag® coatings. We've engineered a whole range of them. To give you from 10-70 dB attenuation from 1 MHz to 10 GHz. With varied physical properties that let you apply them to almost any material.

This means that you can build your enclosures out of light plastic, coat them with Electrodag, and still get perfect skintight shielding. Even on honeycomb structures and flexible parts made from foamed resins.

And you can forget about expensive techniques like plating, metallizing and vacuum deposition. With Electrodag, all you need is a spray gun, a simple dipping technique, or a paintbrush.

You can use these new coatings for everything from CB radios and EKG units to data terminals and microphones.

This is a new field, but we're the oldest company in it. With the greatest experience, the biggest R&D staff and the most EMI coatings. For technical advice on specific applications, write: Acheson Colloids Company, Electrical Products, Port Huron, Michigan 48060. Or call (313) 984-5581.

 **Acheson**
high technology coatings

© AC Co., 1976

CIRCLE NUMBER 37

INSTRUMENTATION

(continued from page 75)

locations on indirect jumps.

What else can the Systron-Donner analyzer do? Lots. You can hook a couple of units together to display 32-bit information. You can arm one unit with the strobe output from the other so that you can set up complex address matching and trigger arrangements.

You can control register loading and address sampling in the 50 with a qualifier—a signal from the μ P such as "valid memory address" or an I/O read/write flag. By using the 50's dual-clock provision, you open up still more measurement possibilities.

With dual-clock inputs, you can look at two bytes that appear on the data bus at different times. That is, you can select an internal μ P state, or microcycle, up to eight, and the 50 will show you what's on the data bus at the selected cycle.

The Systron-Donner analyzer can do even more. Contact Systron for full details. If you decide to buy one, you'll have to wait 60 to 90 days.

Systron-Donner
Motorola

CIRCLE NO. 301
CIRCLE NO. 302

Autoranging counters offer fast update



Hickok, 10514 Dupont Ave., Cleveland, OH 44108. (216) 541-8060. Start at \$259; stock.

Four new autoranging frequency counters, the 380 series, offer autoranging with autodecimal for "hands-off" operation. Displays are 0.3-in. LED numerals (seven-digits). Fast update is featured in the 380 series with 1.1-s update in auto mode below 10 MHz and 5-s update in speed-read mode or above 10 MHz. Model 380 is the basic 80-MHz autoranging counter.

CIRCLE NO. 303

Superior performance...
 Significant cost advantages...
 Off-the-shelf delivery.

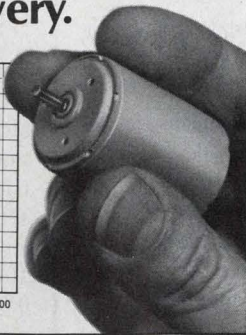
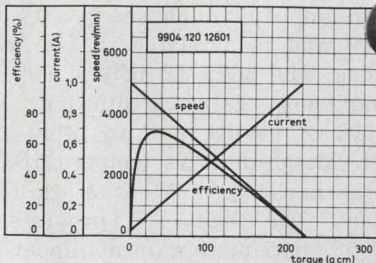

**Miniature ironless rotor DC motors.
 Ideal for cassette drives.**

The typical performance graph shown above speaks for itself. Our miniature ironless rotor 12 VDC motors not only have the desired characteristics for cassette drives, they also offer an important price advantage—under \$10.00 in 500-piece lots. As low as, if not lower than, any competitive motor. Fast, off-the-shelf deliveries, too!

Motor time constant is 23 MS; rotor torque 50 gcm; starting torque 230 gcm. Plus, low noise levels and smooth cog-free operation. The motor can also be ordered with double shaft for use as a tach motor. 24 VDC models also available.

Send for information today!
 A. W. HAYDON CO. PRODUCTS

NORTH AMERICAN PHILIPS CONTROLS CORP.

Cheshire, Conn. 06410 • (203) 272-0301
 CIRCLE NUMBER 49

**SEIKO'S
 MECHANICAL FILTERS
 AND OSCILLATORS**

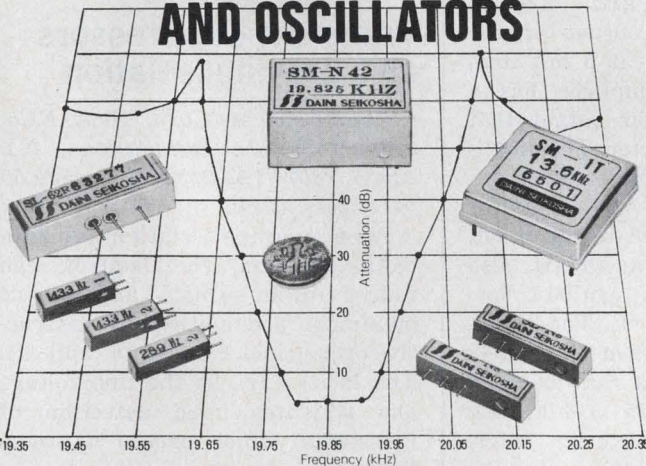

1. Utilizes the precision machining technology of SEIKO, manufacturer of fine timepieces.
2. A wide assortment of types from miniature filters ideal for pagers to high performance filters used in communications equipment are available.
3. Frequency range from 280Hz to 100kHz.
4. See the 1976 edition of the "GOLD BOOK" for details.

• Sales Office: **SEIKO INSTRUMENTS, INC.**
 2990, West Lomita Blvd., Torrance, Calif. 90505, U.S.A.
 Phone: (213) 530-3400
 Telex: 259103477307 SEIKOINST TRNC

• Manufacturer & Exporter: **DAINI SEIKOSHA CO., LTD.**
 Industrial Electronics Div.
 31-1, 6-chome, Kameido, Koto-ku, Tokyo 136, Japan.
 Phone: (03) 682-1111
 Telex: 2622410 DSEIKO J

SEIKO mechanical filters have been developed and commercialized through the precision machining technology of SEIKO.

CIRCLE NUMBER 50

ELECTRONIC DESIGN 14, July 5, 1976

**CRYSTALS
 CRYSTALS
 CRYSTALS**

from
**1kHz to
 185 MHz**

**Wide Variety of Cuts
 Dozens of Holder Selections
 Coldweld and Solderseal**

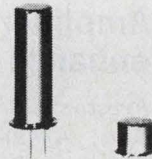

Bulova's Electronics Division has been one of the major suppliers of crystals for oscillator and filter applications for over 30 years. You are invited to draw on this extensive experience and Bulova's unsurpassed engineering and production facilities for your current and future requirements. For free catalog covering the frequency spectrum from 1kHz to 185MHz just drop a line to our Frequency Control Products Group or call (516) 335-6000.

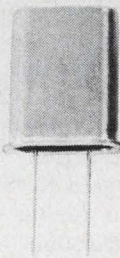
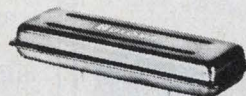
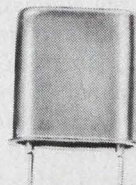

Send for
**NEW
 Free Catalog**

Also available from Bulova's Frequency Control Products Group:
 High Stability Oscillator
 Packages: PCOXO's, TCXO's, XO's and Tuning Fork.



BULOVA®

ELECTRONICS DIVISION
 OF BULOVA WATCH CO., INC.
 61-20 WOODSIDE AVE.,
 WOODSIDE, N. Y. 11377 (212) 335-6000

CIRCLE NUMBER 51

ANOTHER WINNER

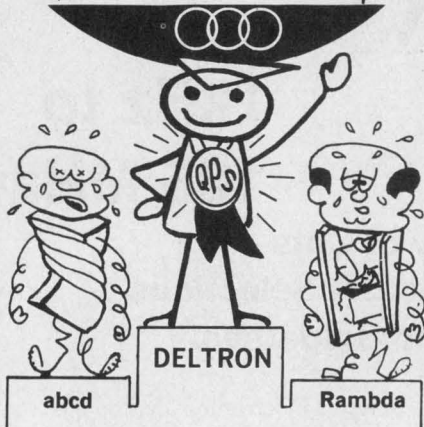

QPS series Power Supplies

\$21⁵⁰

One year warranty.
From stock.
U.L. recognition.
Barrier block interface.



Socketed I.C.
regulator.
Crowbar
accessory.

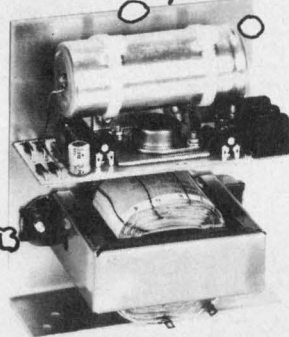

MODEL	QPS-1	QPS-2	QPS-3
RATINGS Volts/Amps	5/3 or 6/2.5	12/1.5 or 15/1.2	24/1
QTY.	1	100	250
PRICE	\$24.00	\$22.50	\$21.50

Deltron inc.

Wissahickon Avenue
North Wales, PA 19454

Tel: 215/699-9261 Twx: 510/661-8061

AC-10

CIRCLE NUMBER 41

MODULES & SUBASSEMBLIES

Power decoder/driver handles six-line ASCII

Refac Electronics, P.O. Box 809, Winsted, CT 06098. (203) 379-2731. \$53 (100-up); stock.

PLAND-76, an alphanumeric decoder/driver, can decode six-line ASCII inputs into 16-segment alphanumeric characters. It can drive Pinlites' displays number 0-43, 0-63, 0-64, 0-65 and DIP-1050A. Currents of up to 20-mA/segment can be handled. The unit is packaged in an encapsulated, 24-pin module and has an operating range of 0 to 70 C.

CIRCLE NO. 304

Amplifier/filter ckt's enhance performance

Preston Scientific, 805 E. Cerritos Ave., Anaheim, CA 92805. (714) 776-6400. See text.

A direct-coupled amplifier/filter module enhances low level signals in the company's GM series of a/d conversion systems. The modules in the DMD series can have fixed gains of 1 to 1000 and contain a fixed two-pole output filter that permits full power bandwidths from 1 Hz to 60 kHz (-3 dB points). Full-scale output of the amplifier is ± 10 V at 5 mA and, in addition, the amplifier has a high-level multiplexer output that feeds the a/d converter. The amplifier/filter has a common-mode rejection of 120 dB at a gain of 1000. Noise, referred to the input, is less than $2 \mu\text{V}$ and drift, also referred to the input can be ordered as low as $1 \mu\text{V}/^\circ\text{C}$. The GMD-10 through -1000 is a completely enclosed system in a rack-mounted enclosure that is 5.25 in. high and contains the a/d converter, internal clock and addressing circuits, a central power supply and as many as 30 differential-amplifier filter channels. The amplifier input system can be expanded to cover 1024 channels in groups of 48 channels per chassis. A typical system could consist of a 15-bit a/d converter with 128 analog input channels and would cost \$24,116. Delivery for a system like this is 60 to 90 days.

CIRCLE NO. 305

Instrumentation amp squeezed into 14-pin DIP

Burr-Brown, International Airport Industrial Park, Tucson, AZ 85734. (602) 294-1431. See text.

The 3662 hybrid instrumentation amplifier is housed in a 14-pin DIP and is available in two versions. The 3662 JP offers a 0.1% maximum gain nonlinearity, a CMR of 96 dB, and an input-offset-voltage drift vs temperature of less than $6 \mu\text{V}/^\circ\text{C}$ at a gain of 1000. The 3662 KP provides a 0.05% maximum gain nonlinearity, a CMR of 104 dB, and input-offset-voltage drift of less than $2.5 \mu\text{V}/^\circ\text{C}$ at a gain of 1000. Both units have typical common-mode input impedances of $2 \times 10^{10} \Omega$ in parallel with 3 pF. Typical differential input impedance ranges from $2 \times 10^{10} \Omega$ in parallel with 9 pF at low gain to 20 M Ω at a gain of 1000. Input bias current is less than 300 nA. The instrumentation amplifiers have an operating temperature range of 0 to +70 C and operate from a supply voltage of ± 15 V dc. Price in 100-up quantities are: \$9.75 (JP version) and \$14.95 (KP version). Delivery is from stock to 4 weeks.

CIRCLE NO. 306

Transient suppressors also provide isolation

Control Concepts Corp., Dept. EE5, 333 Front St., Binghamton, NY 13905. (607) 724-2484. From \$39.50 (1 to 9); stock.

An active line isolation and protection system, the Islatrol, can reduce unwanted noise and provide maximum attenuation to destructive or spurious transients (spikes). The Islatrol tracks the line voltage and activates upon detection of transients, which exceed a predetermined voltage spike (as low as 10-V peak). The filter has low 60-Hz leakage and no ground loops. Standard voltage inputs are 105 to 130 V rms and 205 to 240-V rms, from 50 to 400 Hz. Standard units have maximum current ratings of 2.5, 7.5 or 15 A. Typical package sizes are as follows: 2.5 A, $2 \times 4 \times 1.5$ in.; 7.5 A, $3.75 \times 6.25 \times 2$ in.; and 15 A, $5.5 \times 7 \times 2.25$ in.

CIRCLE NO. 307

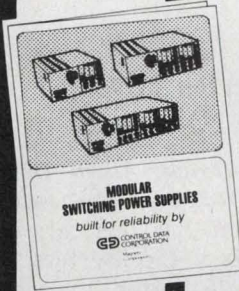

MODULAR SWITCHING POWER SUPPLIES
built for reliability by
CONTROL DATA CORPORATION

OEM DESIGNERS Get this FREE Design File on CDC's new modular switching power supplies

These compact, modular power supply switchers simplify design in 300-600 watt applications and keep costs down too. (They're priced at less than 90¢ per watt!) Benefits to the end user include **low EMI noise levels** (we are designed to meet VDE STD 0875) and **highly reliable operation** plus convenient maintenance and easy add-on capability up to 1200 watts in a single, 19 in. rack. Get specs, prices and feature details today from:

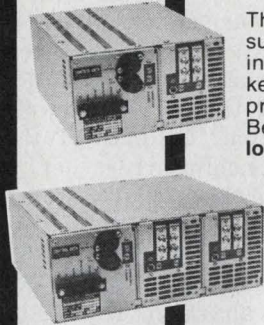

Magnetic Components Group

CONTROL DATA CORPORATION

7801 Computer Avenue South, Minneapolis, MN 55435
(612) 830-5800 TWX 910 576 2978

CIRCLE NUMBER 56

ABSOLUTELY

the world's most accurate rulings using vacuum deposit chrome, etch and fill or emulsion processes. They're produced on the world's largest 1 micro inch numerically controlled ruling engine with interferometric feedback controls. Need precision scales, grids, slits, reticles, Ronchis numbers, letters, circles, dots, or nickel mesh? We stock many items for immediate delivery. Send for brochure No. 38-36.

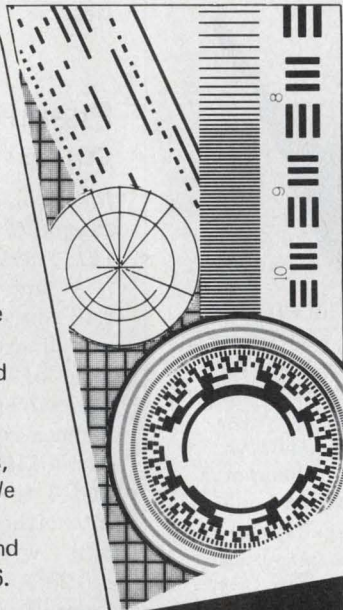

SCALES RULINGS RETICLES & GRIDS FROM THE WORLDS LEADING SCALE MAKERS.

MICRO-LINE
DIVISION OF
BAUSCH & LOMB

JAMESTOWN, NY 14701 716/488-1958

CIRCLE NUMBER 57

ELECTRONIC DESIGN 14, July 5, 1976

FABRI™-PAK

THE INTEGRATED BACKPANEL SYSTEM

Here's an all-in-one backpanel featuring edgecard circuit connectors integrated with the p.c. backpanel for single and multiple board sandwiching.

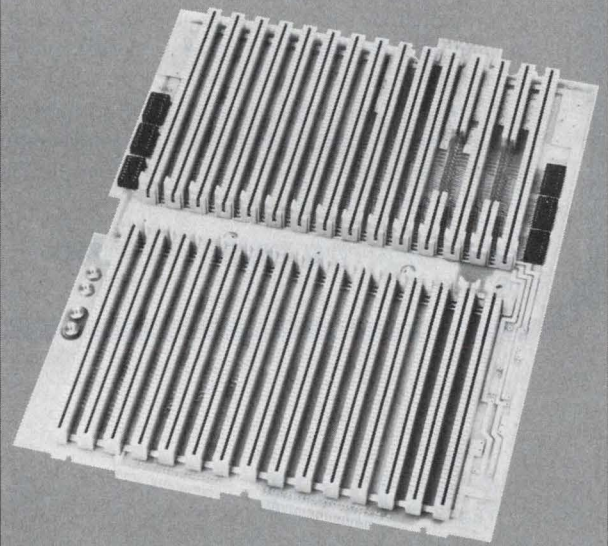

Versatile: Accommodates up to 8 planes of circuitry, two-sided and multilayer boards. Unlimited choice of p.c. edgecard terminations.

Reliable: Press-fitted contacts provide gas tight interfaces. No soldering. Easy field repair of contact and housing elements.

Low cost: Ground planes, voltage busses, signal lines etched directly into p.c. board. No external wiring required.

Grid spacings available: .100, .125, .150, .156.

We design and manufacture the entire system to your specifications. Superior quality, quick delivery. Write or call for details.

FABRI-TEK INC.
NATIONAL CONNECTOR DIVISION

9210 Science Ctr. Drive/Minneapolis, MN 55428/(612) 533-3533

CIRCLE NUMBER 58

V/f converters deliver accurate, 10-kHz signals

Teledyne Philbrick, Allied Dr. at Rte. 128, Dedham, MA 02026. (617) 329-1600. See text; stock.

Two 10-kHz v/f converters, the 4715 and 4725, offer linearities from 0.015 to within 0.005%. There are four versions of the 4715 available that have full-scale tempcos of 50 ppm/°C for the 4715, 15 ppm/°C for the 4715-01 and 4715-02, and 5 ppm/°C for the 4715-03. Full-scale nonlinearities of the units range from 0.01% for the 4715 to 0.005% for the other three units. The four 4715 series converters operate over supply voltages that can range from ± 6 to ± 18 V. The other unit, the 4725, has a nonlinearity of no more than $\pm 0.015\%$ of full scale $\pm 0.015\%$ of signal. Its frequency error is less than 0.05% and zero error is only 10 mV. Prices for the converters start at \$29.50 for the 4725 and \$39, \$49, \$59 and \$69, respectively for the 4715, 4715-01, 02 and 03—all for 1 to 9 quantities.

CIRCLE NO. 308

Pneumatic/electric converter draws 5 mA

Robinson-Halpern, One Apollo Rd., Plymouth Meeting, PA 19462. (215) 825-9200. See text.

A low-power pneumatic-to-electric converter requires less than 5 mA of excitation current. Warmup time of the circuit is negligible; the converter need only be powered when a reading is to be taken. The basic 110B unit converts 3 to 15 and 3 to 27 psi pneumatic signals into either voltage or current outputs with accuracies to within $\pm 0.25\%$. Output options range from 10 mV to 10 V or from 0 to 1 mA up to 4 to 20 mA. A two-wire, 4-to-20-mA output is also available. Units are self-contained, compensated for environmental temperature changes, stabilized against power input fluctuations and are housed in weatherproof cases. The 110B with voltage output costs \$225, and with a current output costs \$250.

CIRCLE NO. 309

A New High in Stability

Centre Engineering has met the challenge of providing ultra-high reliable sub-miniature ceramic capacitors for the space programs. Now, design engineers in the tele-communications, computer and instrumentation industries can have ceramic capacitors in high volume for low cost applications, using the same processes and manufacturing techniques from Centre Engineering.

Ceramic capacitors are available in 40 various formulations with a capacity range of 1 pf to 10mfd. For applications requiring large volume, low cost ceramic capacitors consider Centre Engineering. Catalog available upon request.



2820 E. COLLEGE AVE., STATE COLLEGE, PA. 16801
814-237-0321 ■ TWX 510-670-3517

CIRCLE NUMBER 45

Better... ...across the board.



Our PLP-550 logic probe is internally programmed to select C-MOS, HTL, TTL/DTL logic.

Stretch memory catches single, short pulses you can't see.

Unique three lamp system gives you duty cycle information you'd otherwise need a scope to see.

Next time out, take the Kurz-Kasch PLP-550 with you... and leave your scope back at the shop. Soon to be available are single and dual family probes in the same rugged, functionally designed package.

Call or write.....



Kurz-Kasch, Inc.
Electronics Division,

1501 Webster Street, P.O. Box 1246, Dayton, Ohio 45401 (513) 223-8161

CIRCLE NUMBER 46

Super-fast d/a converter units take up to 7-bits

Phoenix Data, 7235 N. 9th Ave., Phoenix, AZ 85201. (602) 943-6210. From \$3900; 60 days.

The DAC1100 series of high-performance d/a converters has conversion rates of 60 to 100 MHz. Three different models provide a choice of 5, 6 or 7-bit resolution. Every unit contains an ECL-compatible input holding register, analog switches, precision ladder network, temperature compensated internal voltage reference generator and a low-impedance output driver circuit. All units are fully tested, calibrated and accept two's-complementary binary inputs through SMA connectors. All converters measure $5 \times 5 \times 1.25$ in.

CIRCLE NO. 310

Hybrid rf amplifiers operate up to 400 MHz

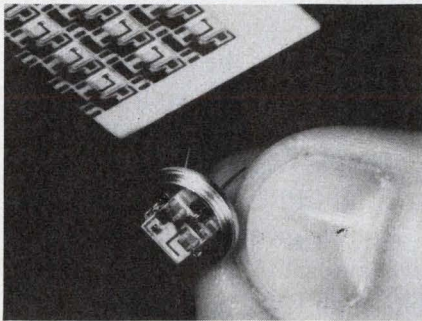

Optimax Div. of Alpha, P.O. Box 105, Advance Lane, Colmar, PA 18915. (215) 822-1311. \$25 (1 to 9); stock.

Six thick-film, rf amplifiers operate at frequencies to 400 MHz. The units are housed in plug-in TO-12 (4-lead TO-5) transistor packages and are known as the AH-401, AH-402, AH-403, AH-461, AH-462 and AH-463. The AH-461, AH-462 and AH-463 must have external-input, output and bypass capacitors to establish low frequency roll-off. Models AH-403 and 463 have a minimum gain of 9 dB all others have a minimum gain of 13 dB. All amplifiers have a gain flatness of ± 1 dB. Models AH-401 and 461 have a -2 -dBm power output at 1-dB compression; the 402 and 462, $+6$ dBm and the 403 and 463, $+15$ dBm. Noise figures are 4, 6 and 7.5 dB, respectively, for the amplifiers.

CIRCLE NO. 320

Mod/demod unit accepts 10-to-100-V-dc inputs

Technology Products, 8900 Eton Ave., Canoga Park, CA 91304. (213) 998-8555. Under \$50; 30 days.

The M603 modulator/demodulator module handles input voltages of ± 10 to ± 100 V dc. The input impedance is over 10 k Ω and the output impedance is less than 1 Ω .

The null voltage and gain are adjustable with a built-in potentiometer. Units are insensitive to reference supply variations of up to $\pm 20\%$ from nominal values of ± 15 V dc. The M603 output voltage can reach ± 20 V pk-pk when the unit operates in the modulator mode. Linearity of the modulator is to within $\pm 0.05\%$. The unit measures $2.5 \times 1 \times 0.625$ in.

CIRCLE NO. 321

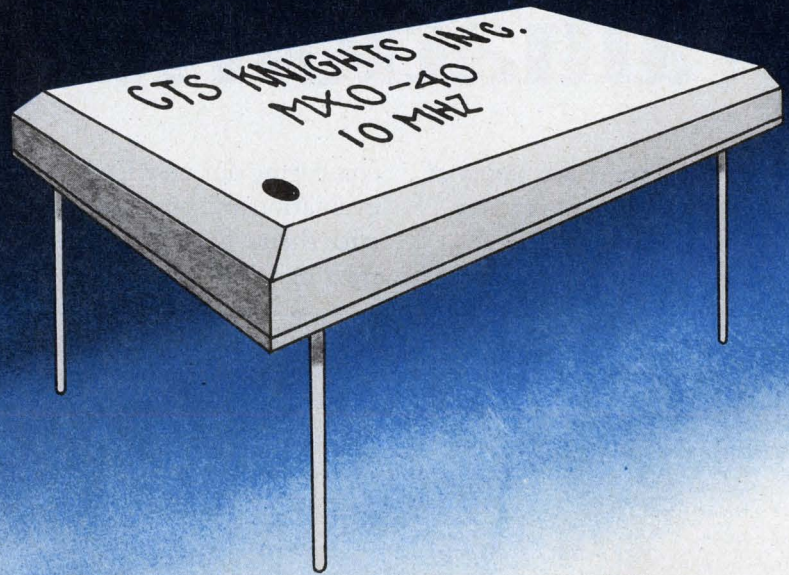

New low-profile, high-performance crystal oscillator.

Here's a completely new ceramic packaged crystal oscillator that can add more performance per dollar to your time base application.

The new MXO-40 is only .200" high, .800" long and .500" wide. Frequency range: 31.5 KHz to 26 MHz. Frequency stability (calibration, environment and aging for 5 years): $\pm 0.01\%$ and $\pm 0.1\%$ standard; as low as $\pm 0.0025\%$ available upon request. Temperature range: 0° to 70°C . Symmetry: 45/55. TTL Compatible square wave output. Guaranteed startup of 2 msec. assured

by bias feedback circuitry. Input voltage: $+5$ VDC ± 0.5 VDC. 96% alumina ceramic case compatible with 14 pin dual-in-line layouts. Newly developed fully hermetic, epoxy seal. Solder seal available.

A good example of CTS Knights research which produces a continually expanding line of precision frequency control products. Write **CTS Knights, Inc.**, 400 Reimann Ave., Sandwich, IL 60548, phone (815) 786-8411.

CTS Knights.
The frequency specialists.

CTS CORPORATION
Elkhart, Indiana



CIRCLE NUMBER 47

How can you pick the smartest microprocessor system with a dumb evaluation kit?

You can't. But there are plenty of companies that want you to try.

With the AMI 6800, it's a different story. Look at the chart

comparing our new EVK 300 evaluation and prototyping system with theirs. See what you've been missing?

FEATURES	COMPETITORS—TOP OF THE LINE			
	AMI	MOTOROLA	INTEL	FAIRCHILD
Model Designation	6800 EVK 300	6800 MEK 6800	8080 SDK 80	F8 F8S
Board Size	10.5" x 12"	6" x 9"	6.75" x 12"	8" x 10"
Built-In EPROM Programmer (UV Erasable)	Yes	No	No	No
RAM Supplied (Bytes)	1024	256	256	1024
ROM Supplied (Bytes)	2048	1024	0	1024
EPROM Supplied (Bytes)	2048 (UV Erasable)	0	1024 (UV Erasable)	0 (Sockets for 2K Bipolar Fuse Link)
I/O Lines (Parallel)	58	16	24	16
I/O Interface (Serial)				
• RS232C	Yes	Yes	Yes	Yes
• 20 mA Current Loop-TTY	Yes	Yes	Yes	No
Provisions for Slow Memory	Yes	No	Yes	No
Power Requirements	+5 VDC @ 3.5A +12 VDC @ 0.035A -12 VDC @ 0.15A -50 VDC @ 0.035A (For EPROM Programming Only)	+5 VDC @ 1.0A +12 VDC @ 0.1A -12 VDC @ 0.05A	+5 VDC @ 1.3A +12 VDC @ 0.35 A -10 VDC @ 0.20A	+5 VDC @ 2.5A +12 VDC @ 0.5A
DMA Modes	3	0	1	0
Interval Timer	Yes	No	No	Yes
Fully Buffered MPU Lines	Yes	No	No	No
Monitor Commands	10	5	6	6
Built-In Software Utility Routines	23	0	2	7
Breakpoints				
• Print	Yes	Yes	Yes	Yes
• Snap-Shot	Yes	No	No	Yes
Clock				
• Crystal Controlled	Yes	Yes	Yes	No
• Alternate Variable Frequency	Yes	No	No	No
Baud Rate				
• Selection Range	0 to 19,200	110 to 300	75 to 4800	110 to 300
• Crystal Controlled Independent of System Clock	Yes	No	No	No
Price				
• Assembled	\$950.	\$595.	—	\$995.
• In Kit Form	\$595. Designated EVK200. Supplied with 512 bytes EPROM. Sockets for 2K bytes.	\$149.	\$350.	—

Prices and specifications accurate 5/1/76, but subject to change.

To begin with, on-board EPROMs make the difference between a meaningful tool and a hobby toy. Without them, program development is cumbersome and very expensive.

Then there's the on-board EPROM Programmer. It adds to the cost of the EVK 300. But without it, you pay a much higher price for EPROM programming.

And we give you another exclusive bonus: AMI 6800 Tiny Basic. This high-level interpretive language, derived from the standard Dartmouth Basic, comes to you free when we receive your EVK 300 warranty registration.

You'll find plenty of other essential features that the others don't feature at all. So compare. Then call your local AMI sales office, distributor or representative, and ask to see our EVK 300. (He also has an unassembled kit with one EPROM, and a basic kit with none.) Or write to: AMI, 3800 Homestead Road, Santa Clara, CA 95051.

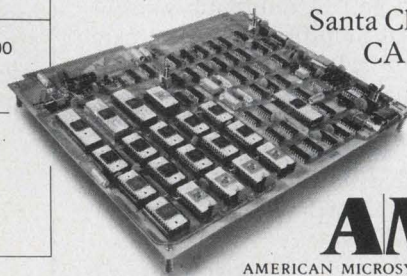

AMI
AMERICAN MICROSYSTEMS, INC.

CIRCLE NUMBER 76

Here's AMI:

SALES OFFICES

Long Beach CA • (213) 595-4768
 San Jose CA • (408) 249-4550
 Altamonte Springs FL • (305) 830-8889
 Elk Grove Village IL • (312) 437-6496
 Norwood MA • (617) 762-0726
 Livonia MI • (313) 478-9339
 Minneapolis MN • (612) 559-9004
 Monsey NY • (914) 352-5333
 Cleveland OH • (216) 292-6850
 Amblar PA • (215) 643-0217
 Richardson TX • (214) 231-5721

DISTRIBUTORS

ARROW ELECTRONICS:
 Minnesota—Bloomington (612) 888-5522
CENTURY ELECTRONICS:
 New Mexico—Albuquerque (505) 292-2700
 Utah—Salt Lake City (801) 487-8551
CESCO ELECTRONICS, LTD.:
 Canada—Montreal (514) 735-5511
COMPONENT SPECIALISTS, INC.:
 Texas—Dallas (214) 357-4576
 Houston (713) 771-7237
INTERMARK ELECTRONICS:
 Washington—Seattle (206) 767-3160
SCHWEBER ELECTRONICS:
 California—Costa Mesa (213) 924-5594
 and (714) 556-3880
 Connecticut—Danbury (203) 792-3500
 Florida—Hollywood (305) 927-0511
 Georgia—Atlanta (404) 449-9170
 Illinois—Elk Grove Village (312) 593-2740
 Iowa—Cedar Rapids "Lorenz Sales"
 (319) 393-6912
 Maryland—Rockville (301) 881-3300
 Massachusetts—Waltham (617) 890-8484
 Michigan—Troy (313) 583-9242
 Minnesota—Edina (612) 941-5280
 New Jersey—Somerset (201) 469-6008
 New York—Rochester (716) 461-4000
 Westbury (516) 334-7474
 Ohio—Beachwood (216) 464-2970
 Texas—Austin (512) 837-2890
 Dallas (214) 661-5010
 Houston (713) 784-3600
 Canada—Mississauga, Ont. (416) 678-9050

SEMCOMP CORP.:
 California—Newport Beach
 (213) 971-5253 and (714) 833-3070

STERLING ELECTRONICS:
 Arizona—Phoenix (602) 258-4531
 Louisiana—Metairie (504) 887-7610
 Massachusetts—Watertown (617) 926-9720
 New Jersey—Perth Amboy (201) 442-8000
 New Mexico—Albuquerque (505) 345-6601
 Texas—Dallas (214) 357-9131
 Houston (713) 627-9800
 Virginia—Richmond "Meridian Electronics"
 (804) 359-0221

R. V. WEATHERFORD CO.:
 Arizona—Phoenix (602) 272-7144
 California—Anaheim (714) 547-0891
 Glendale (213) 849-3451
 Palo Alto (415) 493-5373
 Pomona (714) 623-1261
 San Diego (714) 278-7400
 Colorado—Englewood (303) 761-5432
 New Mexico—Albuquerque (505) 842-0868
 Texas—Dallas (214) 243-1571
 Houston (713) 688-7406
 Washington—Seattle (206) 243-6340

REPRESENTATIVES

AMMON & RIZOS:
 Oklahoma—Oklahoma City (405) 373-2748
 Texas—Dallas (214) 233-5591
 Houston (713) 781-6240

BARNHILL FIVE:
 Colorado—Denver (303) 426-0222

BENEKE & McCAUL:
 Missouri—Grandview (816) 765-2998
 St. Louis (314) 567-3399

CAN TEC REPRESENTATIVES, INC.:
 Ontario—Ottawa (613) 225-0363

COULBOURN DEGREIF, INC.:
 Maryland—Baltimore (301) 247-4646

HADDEN ASSOCIATES:
 California—San Diego (714) 565-9445

HECHT, HENSCHEN & ASSOCIATES, INC.:
 Arizona—Phoenix (602) 275-4411

LOWREY & ASSOCIATES:
 Michigan—Brighton (313) 227-7067

MASIN-ESCO, INC.:
 New Jersey—North Caldwell (201) 226-2550
 New York—Syosset (516) 364-0310

NORTHWEST MARKETING ASSOCIATES:
 Washington—Bellevue (206) 455-5846

OASIS SALES, INC.:
 Illinois—Elk Grove Village (312) 640-1850

PRECISION SALES COMPANY:
 New York—Syracuse (315) 458-2223

REP. INC.:
 Alabama—Huntsville (205) 881-9270
 Georgia—Tucker (404) 938-4358

North Carolina—Raleigh (919) 851-3007

TECHNICAL REPRESENTATIVES, INC.:
 Indiana—Indianapolis (317) 849-6454

POWER SOURCES

HV unit supplies all CRT voltages



*Keltron Corp., 225 Crescent St.,
 Waltham, MA 02154. (617) 894-
 0525. \$68 (25).*

Model 601.5 high-voltage power supply has all of the voltages required to operate a small CRT tube and features in one complete package: +1.5 kV for the anode, 6.3 V for the heater, -1.5 kV for the cathode and -1.5 kV floating supply for blanking. Input power is unregulated 24 V dc. Line and load regulation are 1% on each of the outputs.

CIRCLE NO. 322

110-W dc/dc converters accept 48-V input

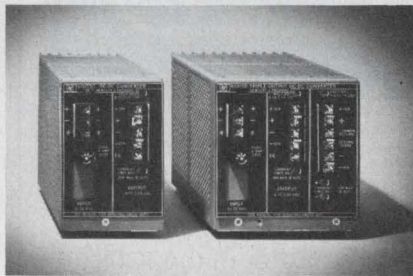

*Hewlett-Packard, 1501 Page Mill
 Rd., Palo Alto, CA 94304. (415)
 493-1501. 61315D, \$525; 61005C,
 \$400; 2 wks.*

Two new 110-W switching-regulated dc/dc converters operate from a 48-V-dc source. These off-the-shelf models—a triple and a single-output converter—are designed for use in the telephone industry and in systems powered by a 48-V common bus. Model 61315D offers three outputs of 4.75 to 5.25 V, +11.4 to +15.75 V and -11.4 to -15.75 V. The single-output converter, Model 61005C, has an output of 4.75 to 5.25 V.

CIRCLE NO. 323

UPS protects against short and long losses

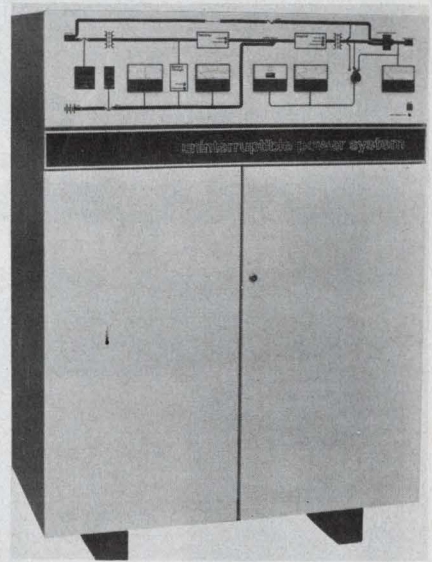

*Topaz Electronics, 3855 Ruffin Rd.,
 San Diego, CA 92123. (714) 279-
 0111. Start at under \$5000; 1-4
 wks.*

The 81000 Series UPS protects critical loads against ac power line disturbances and loss of commercial ac power. Loads are protected from instantaneous and subcycle power losses as well as from longer-term power outages. The new UPS line has single-phase outputs and comes in 3, 5, 10 and 15-kVA ratings. Options include static transfer switch, audible alarm and acknowledgement switch, output-frequency meter, battery float-equalize capability with timer, and battery ammeter.

CIRCLE NO. 324

250-W switcher sizes in at 1-1/2-in. high

*Alpha Power, 9020 Eton Ave., Ca-
 noga Park, CA 91304. (213) 998-
 9873. \$349; stock-2 wks.*

Said to have the lowest profile of any 250-W power supply, the Flat-Pak 250 Series measures only 9 × 12 × 1-1/2 in. Available in ratings of 5 V at 50 A, 12 V at 21 A, 15 V at 17 A, 20 V at 13 A and 24 V at 11 A, these convection cooled units feature full rated output at 40 C without baseplate cooling. Specs include regulation of ±0.075% max, ripple and noise spikes of 50 mV pk-pk max and typical efficiency of 75%.

CIRCLE NO. 325

ICM

Crystal processing has your number!

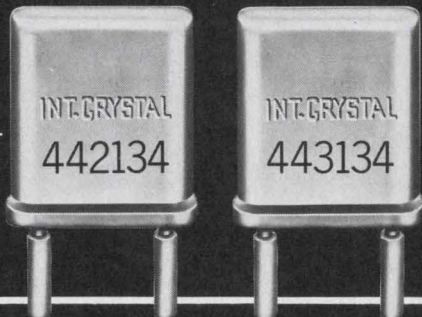

To order new crystals for this equipment specify number below plus quantity and new channel frequency.

442134

TRANSMIT ICM CAT. NO.

443134

RECEIVE ICM CAT. NO.

CALL OR WRITE:



International Crystal Mfg. Co., Inc.

10 North Lee, Oklahoma City, Okla. 73102 405/236-3741

The numbers on the label refer to ICM crystals for a specific two-way unit. The data includes calibration temperature, holder type, crystal type and calibration load. When you need replacement crystals . . . refer to the ICM label for catalog numbers. The purpose of our new system is to make ordering simpler, faster and as error free as possible for our customers. Request the ICM label kit with your next order. The new crystal catalog numbers can be used for ordering by phone or letter, or in connection with our new *Priority Crystal Processing.

*Pre-punched customer address card and Mark Sensing order cards.



International Crystal Manufacturing Co., Inc.

10 North Lee
Oklahoma City, Oklahoma 73102
405/236-3741

CIRCLE NUMBER 53

COMPONENTS

Trimmer features finger-tip adjustment

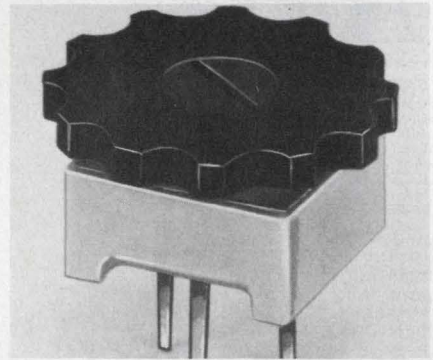

Spectrol Electronics Corp., 17070 E. Gale Ave., City of Industry, CA 91745. (213) 964-6565. \$1.24 (100 up); stock.

A low-profile knob-adjustment option is available for the seven different single-turn 3/8-in. square trimmers in the Model 63 cermet line. The knob (height 0.269 in. ± 0.02) allows reliable settability and stability. Both top-adjust and side-adjust models are available. Each trimmer is sealed to resist common solvent cleaning.

CIRCLE NO. 326

Low-priced varistors protect relay circuits

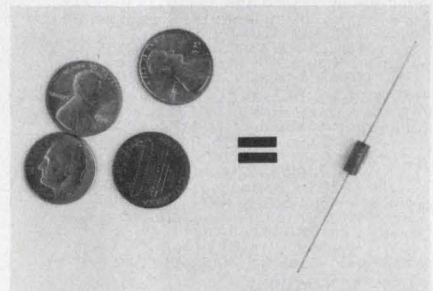

General Electric Co., Electronics Park, Bldg. 7, Mail Drop 49, Syracuse, NY 13201. (315) 456-2021. See text; stock.

General Electric Semiconductor announces a line of new low-cost GE-MOV varistors—13¢ each, suggested resale price in 10,000-lot quantities or 10¢ each in 1,000,000-lot quantities—for any of 10 models covering 14 to 250 V ac and 14 to 56 V dc. A typical application for this economy varistor is in light-duty transient protection for relay circuits. Write for a free sample and a detailed product specification sheet on your company letterhead.

CIRCLE NO. 327

Smart timer fools potential burglars

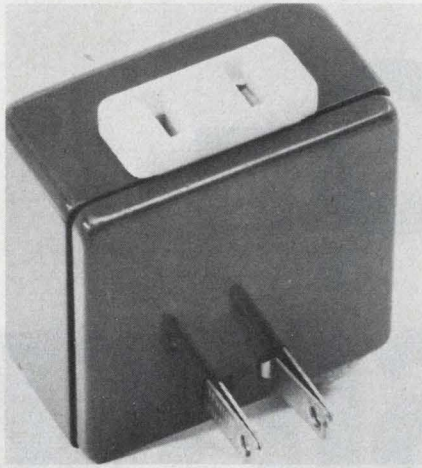

Mountain West Alarm Supply Co., 4215 N. 16th St., Phoenix, AZ 85016. (602) 263-8831. \$19.80 (unit qty).

Smart Switch P10 is a device that controls lights for lifelike activity while you are away. Just plug it into a wall outlet and it turns a lamp or appliance on and operates it for about 25 min. Then it automatically goes off for about 25 min and repeats this cycle for 6 h. The unit turns off and then on again 18-h later to repeat the 25-on/25-off cycle for 6 h. To reset for a new starting time, simply unplug the switch and plug it back when you desire the 6-h cycling to start.

CIRCLE NO. 329

Chip kit contains 144 tantalum capacitors

National Components Industries, Inc., 5900 Australian Ave., West Palm Beach, FL 33407. (305) 842-3201. \$99.95 (unit qty); stock.

A tantalum capacitor-chip kit, Blue Chip, can aid in hybrid-circuit development and evaluation. The kit contains 144 medical/industrial-grade tantalum chip capacitors consisting of six units each of 24 different ratings in the range of 0.1 through 100 μ F at eight standard voltages from 4 to 50 V dc. The capacitors can be operated over the range of -55 to 125 C. Eight chip sizes range from 0.05 \times 0.05 \times 0.1 to 0.11 \times 0.15 \times 0.285 in., similar to the sizes described in MIL-STD-55365A, Type CWR-06. The kit is contained in a vinyl-covered binder with individual storage packets for each rating.

CIRCLE NO. 330

Thermocouple reference handles two couples

Hades Manufacturing Corp., 151 A Verdi St., Farmingdale, NY 11735. (516) 249-4244. \$59.30 (1-9); stock; to 4 wks.

A series of Delta-T thermocouple reference junctions, designated the NDT Series, makes it possible to measure two separate tempera-

tures and their differences accurately and simultaneously. Both reference temperatures of the unit are held to better than ± 0.25 C over ambient temperatures of 0 to 50 C. System errors are minimized, since both references track to better than ± 0.1 C. The reference junctions are lightweight (under 30 g) and consume little current (under 1 mW).

CIRCLE NO. 331

Experience can't be bought at any price and with over 30 years in the design and manufacture of high voltage ceramic capacitors, Murata has experience that's unsurpassed in the field. This experience has made Murata the world's largest producer of high voltage ceramic capacitors and generated a reputation for quality and performance second to none. What's more, our line covers virtually every high voltage application requirement. Check some of the brief features listed below and we're sure you'll want to

know more. Our complete information package is yours for the asking. Write or call today.

DH, DHL, DHG Types. For Power Supplies and Power Distribution Systems: 10-30 KVDC WV. 40, 50 & 60 KVDC WV also in DH. 500-5,000 pF. Z5V, Y5P & N4700 Temp. Char. Epoxy Resin Encapsulation.

DHR Type. For Color TV Doublers and Triplers: 500-1,000 pF. 10, 12 and 15 KVDC WV. Z5P & N4700 Temp. Char. Extremely Low Noise Level. (Higher Capacities are also available.)

high voltage ceramic capacitors

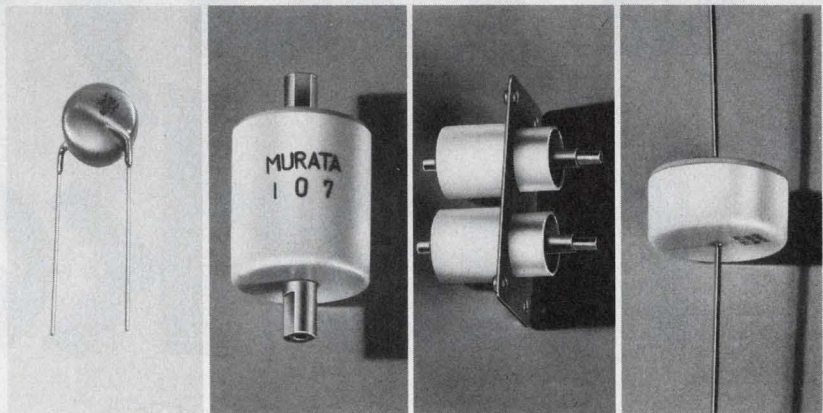

experience makes the difference

Rockmart, Georgia 30153
Phone: 404-684-7821
TWX: 810-766-1340
Telex: 54-2999

muRata
CORPORATION
OF AMERICA

CIRCLE NUMBER 54

**Micro-
processing
becomes
a buyer's
market.**

If you're a MOS microprocessor customer, the last few years haven't been a whole lot of laughs.

One supplier had all the good stuff, made all the rules, told you what you could buy. And when. And for how much.

But something happened to change all that: Advanced Micro Devices.

We make the best microprocessor in the world, the Am9080A, and we make all the support circuits you need. They're yours now, off the shelf, at competitive prices. That's right. Competitive.

But we make more than microprocessor products. We make you a promise:

We'll sell you any part, in any quantity, bundled or unbundled. You're the customer.

So, if you suddenly find yourself having an easier time buying microprocessors, just remember why. And who.

If you're shy, and you're just not sure how to say thank you, an order would be really nice.

Write or phone Advanced Micro Devices, The Buyer's Market.

Ours and Theirs.

(The 9080A)

Specification	AMD	Intel
Minimum Instruction Cycle Time	1 microsecond	1.3 microseconds
Maximum Power Dissipation (at 1.3 microsec. 0-70°)	829 milliwatts	1307 milliwatts
Output Drive	3.2mA @ .4V	1.9mA @ .45V
Minimum Input High Voltage	3.0V	3.3V
MIL-STD-883	Standard	Special
Price per 100	\$21.00 (Am9080A)	\$40.00 (C8080A)

Ours and Ours.

(Am9080A System Circuits)

AMD Part Number	Description	Availability	AMD Part Number	Description	Availability
CPU					
Am9080A/-2/-1/-4	Speeds to 250 nsec. 0 to 70°C	In Dist. Stock			
Am 9080A/-2	Speeds to 380 nsec. -55 to +125°C	In Dist. Stock			
Static Read/Write Random Access Memories					
Am9101A/B/C/D	256x4, 22 Pin Speeds to 250 nsec.	In Dist. Stock			
Am91L01A/B/C	256x4, 22 Pin Speeds to 300 nsec.	In Dist. Stock			
Am9102A/B/C/D	1Kx1, 16 Pin Speeds to 250 nsec.	In Dist. Stock			
Am91L02A/B/C	1Kx1, 16 Pin Speeds to 300 nsec.	In Dist. Stock			
Am9111A/B/C/D	256x4, 18 Pin Speeds to 250 nsec.	In Dist. Stock			
Am91L11A/B/C	256x4, 18 Pin Speeds to 300 nsec.	In Dist. Stock			
Am9112A/B/C/D	256x4, 16 Pin Speeds to 250 nsec.	In Dist. Stock			
Am91L12A/B/C	256x4, 16 Pin Speeds to 300 nsec.	In Dist. Stock			
Am9130A/B/C/D/E	1024x4, 22 Pin Speeds to 200 nsec.	In Dist. Stock			
Am9140A/B/C/D/E	4096x1, 22 Pin Speeds to 200 nsec.	In Dist. Stock			
Dynamic Read/Write Random Access Memories					
Am9050C/D/E	4Kx1, 22 Pin Speeds to 200 nsec.	In Dist. Stock			
Am9060C/D/E	4Kx1, 18 Pin Speeds to 200 nsec.	In Dist. Stock			
Mask Programmable Read-Only Memories					
Am9208/B/C/D	1Kx8 Speeds to 250 nsec.	Available Now			
Am9214	512x8, 500 nsec.	Available Now			
Am9216B/C	2Kx8, 300 nsec.	Available Now			
Erasable Read-Only Memories					
Am1702A	256x8, 1.0 μsec.	In Dist. Stock			
Am2708	1024x8, 450 μsec.	3rd Q. 1976			
Processor System Support Circuits					
Am8212	8-bit I/O Port	In Dist. Stock			
Am8216	Non-Inverting Bus Transceiver	3rd Q. 1976			
Am8224	Clock Generator	In Dist. Stock			
Am8226	Inverting Bus Transceiver	3rd Q. 1976			
Am8228	System Controller	In Dist. Stock			
Am9557	Direct Memory Access Controller	1st Q. 1977			
Am9559	Priority Interrupt Controller	1st Q. 1977			
Am25LS138	1-of-8 Decoder	In Dist. Stock			
Am25LS139	Dual 1-of-4 Decoder	In Dist. Stock			
*Am25LS240	8-bit Inverting Bus Transceiver	3rd Q. 1976			
*Am25LS241	8-bit Non-Inverting Bus Transceiver	3rd Q. 1976			
*Am25LS273	8-bit Common Clear Latch	3rd Q. 1976			
*Am25LS374	8-bit 3-state Latch	3rd Q. 1976			
*Am25LS377	8-bit Common Enable Latch	3rd Q. 1976			

*All combine high performance and low power in space saving 20-pin package.

CPU: 9080A = 480 nsec. -2 = 380 nsec. -1 = 320 nsec. -4 = 250 nsec. MEM: A = 500 nsec. B = 400 nsec. C = 300 nsec. D = 250 nsec. E = 200 nsec.

Advanced MOS/LSI



Advanced Micro Devices • 901 Thompson Place, Sunnyvale, California 94086 • Telephone (408) 732-2400 •
Distributed nationally by Hamilton/Avnet, Cramer and Schwebel Electronics.

CIRCLE NUMBER 75

Another Grayhill
DIP Switching
Exclusive

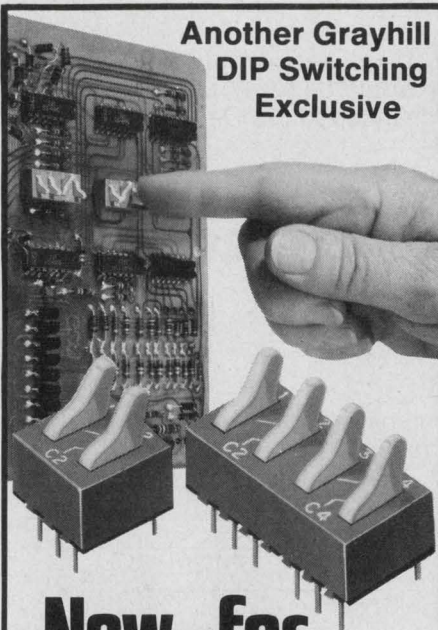

Now—for front panels: Grayhill's TOGGLE-DIP™

Life-rated at 50,000 operations,
toggle actuated
for fingertip operation

- Extraordinary life of 50,000 operations or more at logic levels, 25,000 at 125 mA, 30VDC.
- Positive feel provided by unique spring-loaded sliding ball contact and detent system.
- Available with SPDT circuitry, two, three or four stations; DPDT with one or two stations; switches may be stacked side to side for multi-station arrays.
- Provides Double Throw switching, satisfying logic '1' and logic '0' input requirements.

Now for the first time, you can secure the many benefits of DIP switches along with the performance characteristics necessary for front panel usage. Grayhill's new TOGGLE-DIP™ Switches supplement our extensive and acclaimed line of rocker DIP switches. They bring you the fingertip ease of actuating well-spaced toggles along with the mechanical and electrical life ratings provided by Grayhill's unique construction method.

Delivery is from stock for prototype quantities, and may be arranged through your local Grayhill distributor. Grayhill's new TOGGLE-DIP™ Switches are fully described in Bulletin 259, available free on request from Grayhill, Inc., 561 Hillgrove, La Grange, Illinois 60525 (312) 354-1040.



CIRCLE NUMBER 55

INTEGRATED CIRCUITS

HiNIL logic family drives 250-mA loads

Teledyne Semiconductor, 1300 Terra Bella Ave., Mountain View, CA 94043. (415) 968-9241. \$1.07 (100-up); stock.

The HiNIL 390 family of high-noise-immunity logic circuits can handle load currents of up to 250 mA. All are dual configurations that operate from 10-to-16-V supplies and are housed in standard ceramic DIPs. The inputs require only 0.6 mA, thus permitting the circuits to be directly driven by standard CMOS. The 390 family consists of the 391 AND, 392 NAND, 393 OR, 394 NOR, the 390 dual four-input AND with expander, and 395 dual four-input NAND with expander.

CIRCLE NO. 332

Fastest 4-k RAM offers two extra timing modes

Mostek, 1215 W. Crosby Rd., Carrollton, TX 75006. (214) 242-0444. \$24.20 (100-up); stock.

The MK 4027-2 is claimed to be the industry's fastest 4-k RAM. It has an access time of 150 ns and TTL-compatible inputs (with less than 5-pF capacitance). The RAM can operate with power supplies that can vary by $\pm 10\%$. In addition to the usual read, write, and read-modify-write cycles, the MK 4027-2 is capable of page-mode timing and RAS-only refresh cycles. Page-mode operation provides 100 ns access times with no increase in power dissipation. RAS-only refresh is a simplified refresh operation that results in lower system power. The timing required by the MK 4027 is less restrictive than other 4-k RAMs since the circuit offers "gated-CAS," a feature that gives you a timing window to compensate for timing skews. This window for the MK 4027 is a full 25% of over-all access time. The output of the MK 4027 will source 5 mA and sink 3.2 mA, in addition to driving 100-pF capacitance load. The MK 4027 is available in a 16-pin DIP.

CIRCLE NO. 333

PMOS-input op amp fills many 741 applications



RCA, Solid State Div., Route 202, Somerville, NJ 08876. (201) 685-6423. See text; stock.

The CA3140 BiMOS op amp has a PMOS input stage and a bipolar output stage. It can fill many 741 op amp applications since it has the same pinout. The PMOS input stage is similar to the one used in the company's CA3130 op amp but includes internal compensation and high supply voltage operation. The op amp can operate from single or dual supplies that range from 4 to 44 V. Typical performance features for the CA3140 include: an input impedance of 1.5 T Ω , an input current of 10 pA at ± 15 V, an input-offset voltage of 5 mV, a common-mode input voltage range to -0.5 V below the negative supply, an output swing to within 0.2 V of negative supply, a slew rate of 9 V/ μ s, a gain-bandwidth product of 4.5 MHz, and settling time of 1.4 μ s to within 10 mV, with a 10 V pk-pk signal. The op amp is available in six versions, three of them as a "T" version in TO-5 packages, and three in an "S" version in TO-5 cases but with DIP pinouts. Prices start at \$0.52 and go up to \$9.95 ea. for 1000-piece lots.

CIRCLE NO. 334

Uhf/vhf prescaler IC works at over 950 MHz

Plessey Semiconductors, 1764 McGaw Ave., Santa Ana, CA 92705. (714) 540-9979.

The SP4020 prescaler provides a $\div 64$ function and operates at frequencies in excess of 950 MHz. It has a typical power dissipation of 470 mW. Designed as a prescaler for TV synthesizer tuners, the prescaler has dual ports for vhf and uhf inputs and has an input dynamic range of 300 to 900 mV over its entire frequency range. Clock inputs are self-biasing, and the bandchange, input is TTL/MOS-compatible. The output is also TTL-compatible to simplify system interfacing requirements.

CIRCLE NO. 335

**SOUTH BAY CABLE
SOLVES
TOUGH
CABLE
PROBLEMS!**



For computer applications,
business machines . . . or
a custom design to fit your
particular requirement.
Write for catalog or send
details of your needs.

*Manufacturers of cable for electronic
use both military and commercial.*

SOUTH BAY CABLE CORP.

Idyllwild, California 92349 • Tel. (714) 659-2183

CIRCLE NUMBER 38

**the
light
heavyweights**

When you insist on excellence, go with the winner. Shigoto. Makers of the most complete line of miniature, sub-miniature, micro-miniature, neon, and axial lead lamps. Every Shigoto lamp is designed to optimize efficiency at lower costs. Engineered to perform exactly or higher than rated. To do what it promises to do. Dependably. With delivery that makes sure your ideas can see the light fast. Get our Catalog. You'll find just what you're looking for. Or we'll make it up for you . . . no matter how exacting your specifications. Our other outstanding O. E. M. components, will help you see a bright light too.

shigoto

WE CAN MEET YOUR CHALLENGE

Write or phone for our
catalog and more information.

Shigoto Industries Ltd.

350 Fifth Ave., N.Y. 10001 • (212) 695-0200 / Telex 224219
One of the World's Largest Manufacturing Importers

CIRCLE NUMBER 39

ELECTRONIC DESIGN 14, July 5, 1976

**The
CROWN
M-600
will drive
shake tables,
speaker coils,
sonar
transducers
or servo motors.**

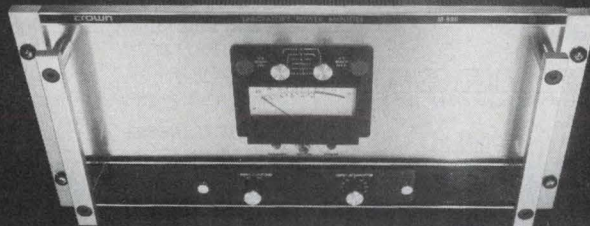

The Crown M-600 Amplifier is good at driving transducers, no matter what they're used for.

It's immune to damage from shorted, open or mismatched loads.

It operates continuously at full rated power.

It will give you up to 78 volts RMS. It will give you up to 1000 watts into 4 ohms, DC to 15 KHz. It works into any impedance. Compare the M-600 to any other amp in its frequency range, no matter what it's used for.

We're especially interested in helping you answer any application questions you might foresee for the M-600. Tell us your problem. We may already know a solution.

**CROWN
INDUSTRIAL**

1718 W. Mishawaka Road, Elkhart, Indiana 46514
219 / 294-5571

CIRCLE NUMBER 40

Mu 10. Quiz #2

Prototype Magnetic Shields

1	2	3	4	5	6
Who gives you 4-day prototype service—the fastest in the industry?	How do you determine optimum shield design and specs in advance?	Who will fabricate a number of prototypes, in different thicknesses, so you can determine exactly how much shielding you really need?	Who tests every prototype shield, using Helmholtz coils, to ASTM standards, and gives you guaranteed attenuation data?	Who's the leader in custom-designed magnetic shields?	What magnetic shield application is growing fastest?

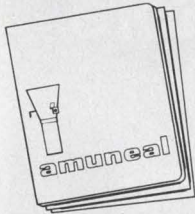

Answers: 1. Amuneal; 2. You don't have to, Amuneal will do it for you—or work to your print if you prefer; 3. Amuneal; 4. Amuneal guarantees that production shields will meet the same high standards of our prototype; 5. Amuneal is the biggest in the industry; 6. Shields for CRT terminals. Nobody wants wiggling displays.







For all the answers on custom and standard shields, send today for your free Magnetic Shield Source Book.

amuneal
MANUFACTURING CORP.

4737 Darrah St., Philadelphia, Pa. 19124, Telephone: 215-535-3000

CIRCLE NUMBER 62

Get more current at lower light levels

-  highest sensitivity in the industry
-  guaranteed light currents
-  broad line of types
-  glass windows or lenses
-  hermetically sealed
-  three package sizes
-  can be designed to your requirements

Call (914) 664-6602 or write Clairex® 560 South Third Avenue, Mount Vernon, New York 10550

...with **Clairex**
photodarlingtons and
phototransistors.

CLAIREX ELECTRONICS
A Division of Clairex Corporation

CIRCLE NUMBER 63

DISCRETE SEMICONDUCTORS

Switching transistors handle up to 8-A loads

Sescosem, Div. of Thomson-CSF, 50, rue Jean-Pierre Timbaud, B.P. 120-92403 Courbevoie, France.

The BUX 46, 47 and 48 series of high voltage switching transistors have $V_{CEO(sus)}$'s of more than 400 V. The transistors have an I_C (sat) of 2.5, 6 and 8 A, respectively, and fall times of less than 0.3 μ s. All three types have a V_{CEX} of 850 V and are housed in TO-3 packages.

CIRCLE NO. 336

Disc packaged SCRs have 5600-A surge ratings

International Rectifier, 233 Kansas St., El Segundo, CA 90245. (213) 678-6281. For 250PAC-20: \$23.15 (10-up); stock.

The 250PAC and 300PAC series of SCRs have surge current ratings of up to 5600 A. The units are pressure assembled "Hockey-Puk" types and have forward and reverse voltage ratings to 600 V. The dv/dt is 200 V/ μ s at a junction temperature of 125 C. The 250PAC SCRs have a nominal, rms on-state current of 400 A, while 300PAC units are rated for 470 A. Both series contain six devices rated for peak reverse voltage and peak off-state voltages from 100 to 600 V in 100-V increments. Weight of the SCRs is approximately 2 oz. (56.7 grams) and their thermal resistance (per side) is 0.006 C/W.

CIRCLE NO. 337

High-voltage transistors handle up to 10 W

Silicon Transistor Corp., Katrina Rd., Chelmsford, MA 01824. (617) 256-3321. From \$1.42 (100-up); stock.

Both the JAN 2N3439 and JAN 2N3440 are high voltage npn power transistors. They have 250 and 350 V, V_{CEO} ratings, respectively. The devices can dissipate up to 10 W when housed in TO-5 packages and have an I_s/b rating of 50 mA at 200 V. Their 15 MHz F_T and 10 pF collector capacitance makes them useful in high-frequency amplifiers and switching circuits.

CIRCLE NO. 338

We've Got a Family of Little CUS's...

CURTIS RELAY SOCKETS

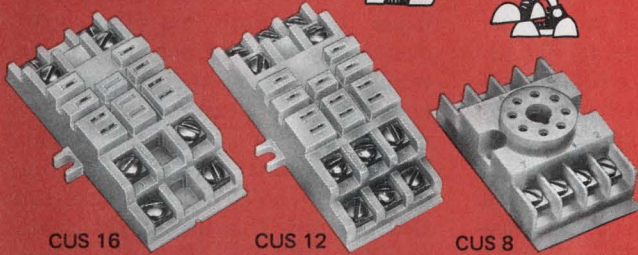

CUS 16

CUS 12

CUS 8

They're unitized, compact, heat-resistant and panel or track-mounted. Just the sockets for most of your relay and plug-in timer needs.

Write for free engineering specs.

CURTIS INDUSTRIES, INC.

8000 West Tower Avenue, Milwaukee, WI. 53223
Call (414) 354-1500 for the name of a representative or distributor near you.
In Canada: A.C. Simmonds & Sons, LTD, Willowdale, Ontario.

1877

CIRCLE NUMBER 67

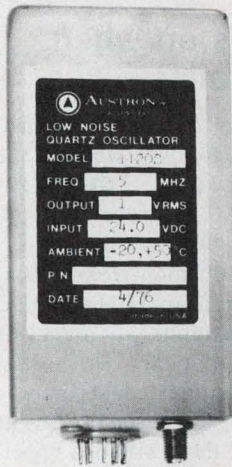

NO
PHASE
NOISE ?

NOT EXACTLY.

But you'll begin to think so when you test **AUSTRON's New 5 MHz Model 1120S Low Noise Quartz Oscillator.** Phase noise to signal ratio at the 5 MHz output is typically a superlow -174 db/Hz at only 100 Hz offset from the carrier... and an even lower -180 db/Hz at 1 kHz and above. To find out about this breakthrough frequency source, call or write:



Astron, Inc.

1915 Kramer Lane, Austin, Texas 78758
512/836-3523 TWX 910/874-1356

CIRCLE NUMBER 68

ELECTRONIC DESIGN 13, June 21, 1976

Dialight sees a need:

(Need: The widest choice for your every application.)

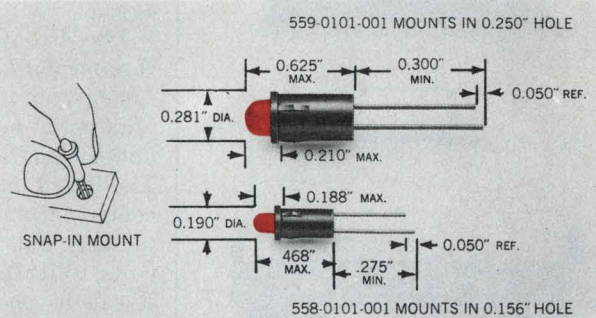

558 and 559 SERIES Available in red, green or yellow LEDs, with and without integral current limiting resistors. Snap-in mounting requires no additional hardware. Straight terminals suited for wire-wrapping and/or soldering. Low power requirements—15 to 20mA. In 1000-lot quantities each
558-0101-001 . . \$.33. 559-0101-001 . . \$.33.

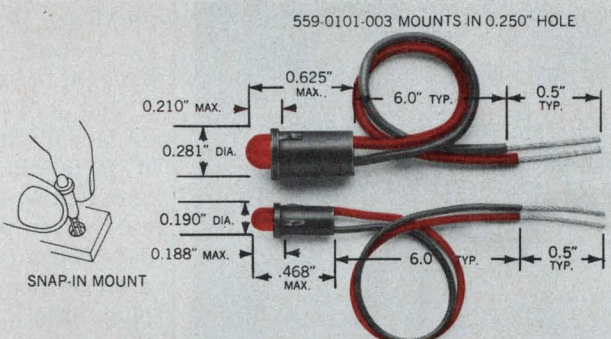

558 and 559 SERIES Available with 6" wire leads, these red, green or yellow LEDs are designed for quick positive insertion in 0.031" to 0.062" panels. Compact design allows high density packaging. In 1000-lot quantities each
558-0101-003 . . \$.75. 559-0101-003 . . \$.71.



Dialight, the company with the widest choice in switches, LEDs, indicator lights and readouts, looks for needs . . . your needs . . . and then they develop solutions for your every application. No other company offers you one-stop shopping in all these product areas. And no other company has more experience in the visual display field. Dialight helps you do more with these products than any other company in the business, because we are specialists that have done more with them. Talk to the specialists at Dialight first. You won't have to talk to anyone else. Send for your free new copy of Dialight's current catalog.

DIALIGHT

Dialight, A North American Philips Company
203 Harrison Place, Brooklyn, N. Y. 11237
(212) 497-7600

See Dialight.

CIRCLE NUMBER 69

a little A-300 goes a long way.



In high frequency transmission. RF power generation for industrial and research processes. RFI/EMI and general laboratory applications, too.

The Model A-300 is a totally solid state power amplifier, covering the frequency range of 0.3 to 35MHz with a gain of 55dB. Capable of delivering 300 watts of linear Class A power and up to 500 watts in the CW and pulse mode, the A-300 is the ultimate in reliability.

Although the unit is perfectly matched to a 50 ohm load, it will deliver its full output power to any load (from an open to a short circuit) without oscillation or damage.

Complete with power supply, RF output meter and rack mount, the A-300 weighs a mere 89 pounds and operates from ordinary single phase power.

High power portability goes a long way for \$5350.

For further information or a demonstration, contact ENI, 3000 Winton Road South, Rochester, New York 14623. Call 716-473-6900 or TELEX 97-8283 E N I ROC

ENI
The World's Leader
in Solid State
Power Amplifiers

SEE
Electronic Design's
GOLD BOOK
FOR COMPLETE
PURCHASING
INFORMATION

CIRCLE NUMBER 48

DATA PROCESSING

Core memory board has 32-k × 18-bit capacity

Standard Memories, 4120 Birch St., Suite 105, Newport Beach, CA 92660. (714) 752-8455. \$2400; 30 days.

The Ecom R is a single-board core-memory system with a storage capacity of 32-k × 18-bit words. Maximum access time is 300 ns and memory cycle time is 750 ns. The board has complete timing and control circuitry, memory bus interface, and core-array drive circuits. With byte control, the Ecom R can be operated as a 65-k word by 9-bit memory. The unit measures 11.5 × 15 × 0.75 in.

CIRCLE NO. 339

Bus converter enables computer control of I/O

Computer Products, 1400 N.W. 70th St., P.O. Box 23849, Fort Lauderdale, FL 33307. (305) 974-5500. \$450; 45 days.

The RTP7410/63 I/O bus converter allows Computer Products' RTP family of I/O measurement and control equipment to be operated under the control of an Interdata computer. The unit comes on a single printed-circuit board that plugs into a half controller slot in the computer. Standard I/O instructions will then control the RTP family.

CIRCLE NO. 340

Data terminal has 5-in. CRT display

Bunker Ramo, Information Systems Div., 35 Nutmeg Dr., Trumbull, CT 06609. (203) 377-4141. \$950; 90 days.

The Model 90/11A terminal consists of a 5-in. CRT and keyboard. Up to 480 alphanumeric characters may be displayed. The keyboard contains an 11-key numeric keypad, 12 function keys, nine edit and control keys and six special symbol keys. The 90/11A measures 11 × 16 × 5-7/8 in. high and weighs 17 lb. It is fitted with a lazy-Susan turntable allowing it to be positioned for shared use by several operators.

CIRCLE NO. 341

Calculator prints on paper tape

Victor Comptometer Corp., 3900 N. Rockwell St., Chicago, IL 60618. (312) 539-8200. 305: \$149.50, 306: \$169.50.

The Medalist line of two calculators, Models 305 and 306, prints in two colors across 12 columns on paper tape. Both machines have oversized add, subtract, cipher and total keys. Using the nonadd date key, they will print and space the month, day and year. An eight-position decimal selector gives the operator a choice of add-mode, full floating or floating input with rounded results. The 306 has "equals plus" and "equals minus" keys for automatic accumulation of products and quotients, and a round-off truncation switch. The perpetual subtotal prints every added or subtracted entry, followed by an automatic subtotal. The units weigh 6 lb with dimensions of 8-3/8 × 10-7/8 × 3-1/8 in.

CIRCLE NO. 351

Unit sounds off when computer fails

CRU, subsidiary of Computer Resources, Inc., 4650 W. 160th St., Cleveland, OH 44135. (216) 267-6400. S360A1P (1 probe) \$1200, S360A3P (3 probe); \$1800.

The Sentry 360 monitors a location in memory in an IBM or DEC computer, and sounds an alarm if incorrect data appear. In operation, the programmer must include a command in his program that will place a "1" data bit in a specified memory address. The Sentry 360 monitors this predetermined location every 5 s, when that location is accessed by the program, and generates an audible alarm when this location does not have the correct value. The signals required by the Sentry 360 are located on the control consoles of the computers. Only a cable connector, supplied with high impedance probes, is required for hookup. The unit comes with either one or three probes, depending on computer requirements.

CIRCLE NO. 352

mi Instant Modulation

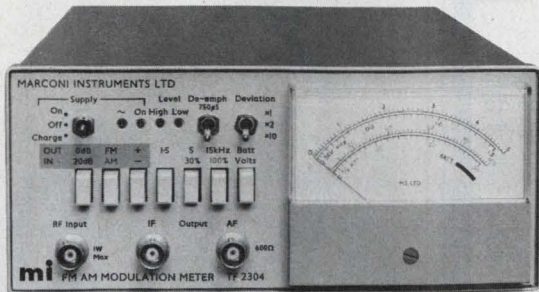

Just Plug-in and Read...

Because the New **mi** Modulation Meter Model 2304 Tunes ... Levels ... Automatically ... and Presents the Read-Out Within 2 Seconds! Ideal for Mobile Radio Production and Maintenance. Covers All Bands Thru 960 MHz.

mi MARCONI INSTRUMENTS
DIVISION OF MARCONI ELECTRONICS INC
 100 STONEHURST COURT, NORTHVALE, NEW JERSEY 07647
 TELEPHONE: 201-767-7250 • TWX: 710-991-9752

CIRCLE NUMBER 42

SP-G10, H-10 SPEEDEX RECORDER

3 different power supplies available!!

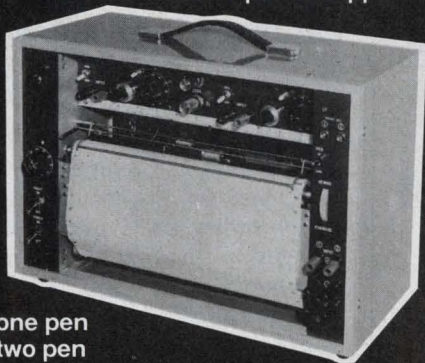

G10...one pen
 H10...two pen

FEATURES

1. High sensitivity. Switchable from 0.5mV/250mm full scale to 500V in 12 steps.
2. 3 different power supplies.
 - a) Internal battery
 - b) AC power line (110, 220V 50/60Hz)
 - c) External 12V power supply
3. Easy to operate.
4. Durable plastic potentiometer.
5. All solid-state circuitry.
6. Pulse motor chart feed also permits chart feed by external pulse. Chart can be freely wound and un-wound.

• Please write us on your letterhead for detailed information.

Riken Denshi Co., Ltd.

5-5-2, Yutenji, Meguro-ku, Tokyo, Japan. TEL: 711-6656 TELEX: 0246-8107

CIRCLE NUMBER 43

ELECTRONIC DESIGN 14, July 5, 1976

A STEP AHEAD

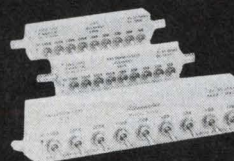
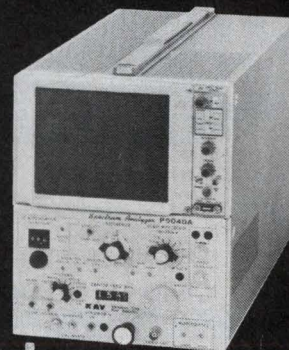

and the best step New Performance Engineered

New Half Rack Sweep Generators featuring a range of 1 to 1500 MHz in just TWO bands:

- Band 1 — 1 to 900 MHz sweep width
- Band 2 — 800 to 1500 MHz with 700 MHz sweep width

New Spectrum Analyzer (9040) with a dynamic range of 72 dB, phase lock, 1 KHz resolution, frequency and level calibration, and manual / automatic filter control.

Attenuators — in-line and rotary attenuators for the lowest VSWR and insertion loss — operating up to 4000 MHz in 50, 75, and 90 ohms.

KAY

Elemetrics Corp.
 1ED Pinebrook, N.J. 07058

CIRCLE NUMBER 44

WHAT'S NEW IN LAPPING?



The PR2 - 15T, A compact table model machine designed for the quartz crystal processor who's need is for a machine which will process high frequency fundamentals.

PR2 - 15T features include:

- * Air Motor Drive
 - smooth start up
 - instant stop
 - noise-free monitoring of quartz crystals during lapping
- * Simultaneous Double-Sided Processing
 - produces parts with a high degree of flatness and parallelism

For more good news write or call today:

**Aiken Industries
P.R. Hoffman Div.**

321 Cherry St. Carlisle, Penna. 17013 (717)243-2011

CIRCLE NUMBER 65

PACKAGING & MATERIALS

Work station protects ICs during assembly

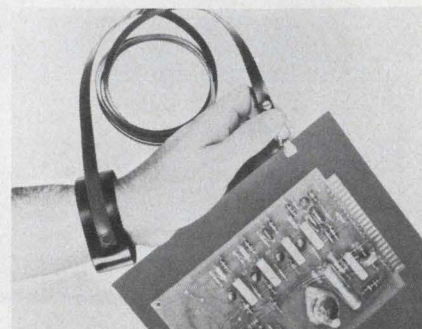

Wescorp, 1501 Stierlin Rd., Mountain View, CA 94040. (415) 969-7717. \$9.95.

The Model W-9000 Work Station consists of a set of three conductive plastic parts necessary to reduce static-electricity build-up when assembling or handling ICs. The set contains an 18 x 24-in. bench or table cover, a wrist strap and a grounding strap. The covers can be rolled or folded. The grounding straps have an all-size wrist enclosure on one end and a clip on the other. The 6-ft grounding straps have clips on both ends.

CIRCLE NO. 353

Heat-sensitive label cards are inexpensive

Omega Engineering, Box 4047, Stamford, CT 06907. (203) 359-1660. \$4.50 (10-49 cards); stock.

The Series-20 temperature sensitive monitors are low priced. They cost between \$0.10 and \$0.25 each, depending on quantity. The monitors come mounted in groups of 20 on a dispenser card. Each monitor consists of a heat-sensitive indicator sealed under a transparent window. When the temperature increases to within 1% of label rating, the indicator circle turns from a light grey to black. The color change is nonreversible and provides a permanent temperature history of the surface being monitored. Monitors can be removed and attached to documents such as inspection reports.

CIRCLE NO. 354



Use them with confidence.

The Hamlin line of stock displays is long—one of the longest in the industry. Selection from distributor or factory stocks includes:

- 12 and 24 hour watch
- 12 and 24 hour clock
- 8 digit calculator
- 3½ and 4½ digit instrument
- 16 Segment Alphanumeric
- 2 and 4 digit numeric

Features include: Transmissive or reflective modes, 5 Vrms input, CMOS compatibility, 250 Ms operate time,

and a wide viewing angle. Edge-mount connector or dual-in-line termination.

Custom displays? Hamlin offers complete design and production services for displays with special format, electric or environmental requirements. For technical and pricing information, call your Hamlin distributor or representative. Hamlin Inc., 614 Lake St., Lake Mills, Wisconsin 53551 414/648-2361 TWX 910/260-3740.

HAMLIN
glass experts since 1949

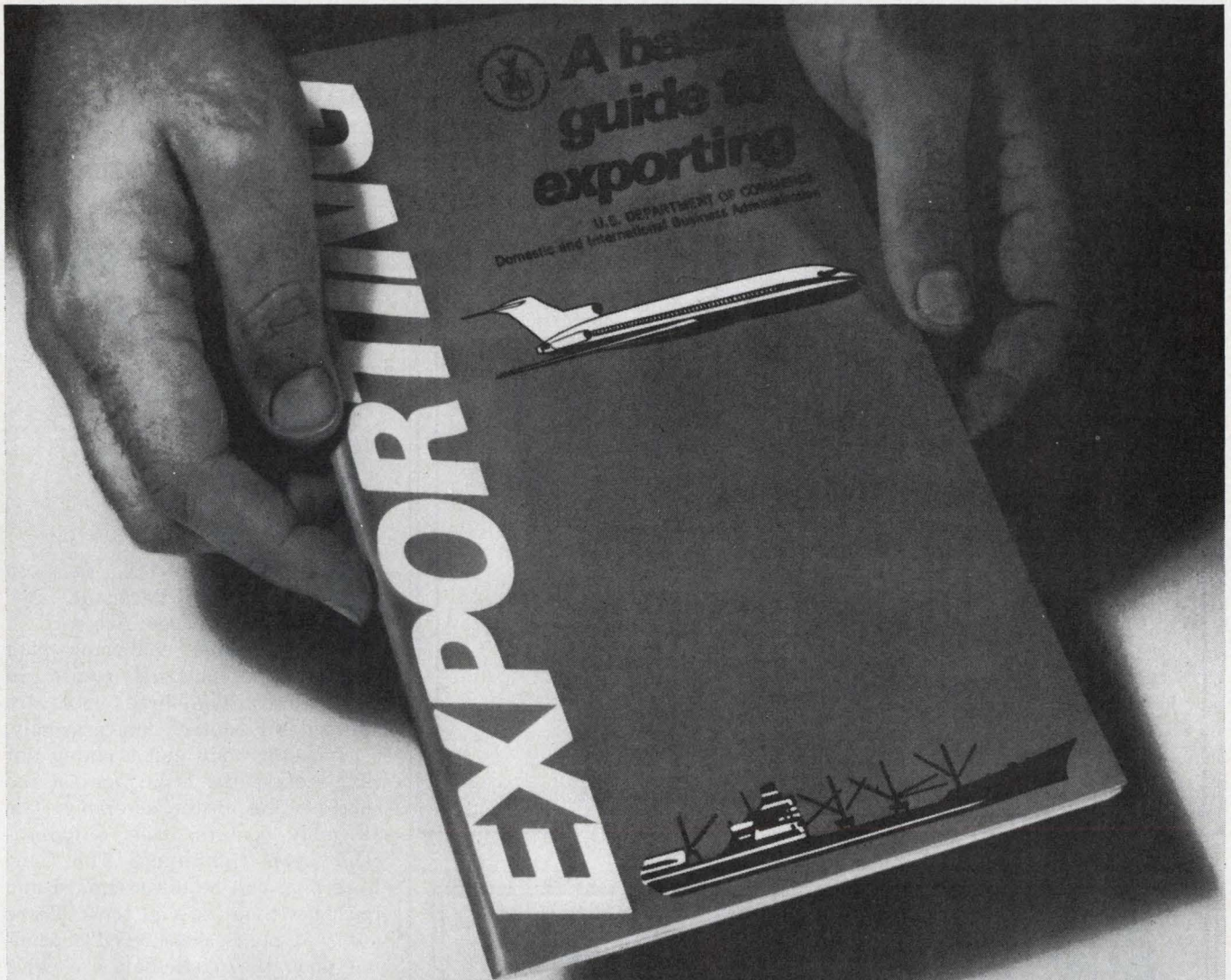

The book that turns businessmen into best sellers.

Many who've read it are now reaping the rewards. Because they've found that U.S. exports are a \$95 billion a year business, that exporting creates both company profits and company growth, that U.S. goods have never been more competitive in international markets. Above all, they've found that, with the help available from the U.S. Commerce Department, selling overseas is no more difficult than selling at home. And this fact-filled book can prove the same to you. Send us the coupon today and start sending your products where the money is.

U.S. Department of Commerce

The Secretary of Commerce
U.S. Department of Commerce, BIC 1A
Washington, D.C. 20230

Please send me a copy of "A Basic Guide to Exporting."

Name _____

Title _____

Company _____

Address _____

City _____

State _____

Zip _____

A Public Service of This Magazine
& The Advertising Council





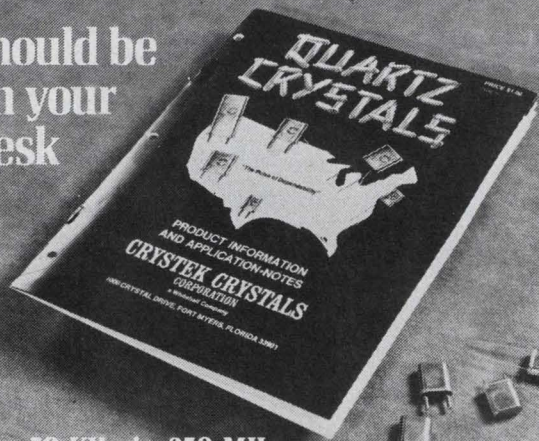

CRYSTEK CRYSTALS "Best Seller"

should be
on your
desk



From 50 KHz to 250 MHz
Crystek Crystals offers you...

- | | |
|--|--|
| <ul style="list-style-type: none">  ON FREQUENCY dependability  CUSTOM MANUFACTURING to your specifications  SINGLE SOURCE for all uses  PACKAGING as your require | <ul style="list-style-type: none">  COOPERATION • Quotations • Competitive Prices • Quick normal delivery • Speedy emergency delivery |
|--|--|



Send for your free copy of catalog as shown above

CRYSTEK CRYSTALS CORPORATION
A Whitehall Company

1000 Crystal Dr. • Ft. Myers, Fl. 33901 • Tel: (813) 936-2109 • TWX 510-951-7448

CIRCLE NUMBER 59

Erie Solves Five Tough Crystal Frequency Control Problems

- Solution One —
CRYSTALS— $\pm .0005\%$ Crystals in the High Frequency Range for hand held mobile telephones.
- Solution Two —
OSCILLATOR—A 20 position Oscillator for military aircraft communications.
- Solution Three —
FILTER—21.4 MHz Filter, BW for 10-50 kHz, shape factor 1 . . . 2.5 to 60 dB.
- Solution Four —
CB CRYSTALS—Hundreds of thousands of CB Crystals from our high production plant.
- Solution Five —
1 kHz CRYSTAL—1 kHz Crystal utilizing a 3" quartz blank.

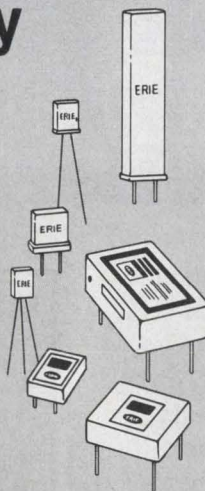

Erie has a complete in-house capability for low and high frequency crystals, oscillators and filters . . . combined with deliveries that meet your needs. Send us your specifications today. Bring ERIE into your Frequency Control program.

ERIE

ERIE FREQUENCY CONTROL
Division of Erie Technological Products, Inc.
453 Lincoln Street, Carlisle, Pa. 17013
Phone: 717/249-2232

CIRCLE NUMBER 60

PACKAGING & MATERIALS

BNC cable connector contains three parts

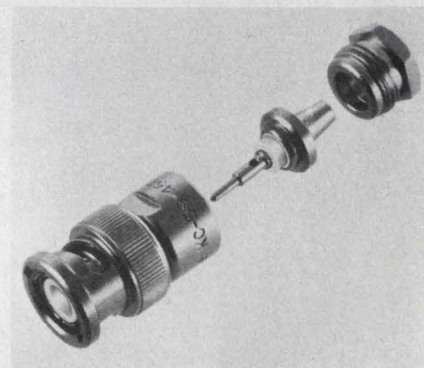

Kings Electronics Co., Inc., 40 Marblehead Rd., Tuckahoe, NY 10707. (914) 793-5000. See text.

A BNC cable connector plug designated Cone-Lock comes in three pieces. The three pieces are an insulator/contact/cone assembly, a connector body and a clamp nut that secures the braid against the cone portion of the assembly. The assembly centers itself automatically upon tightening. The Cone Lock plug can be disassembled and reused without special tools. Three kinds of plugs are offered depending upon the particular size cable being used. Prices range from \$0.95 to \$1.18 ea in 500-up lots.

CIRCLE NO. 355

Conductive coating sprays on, shields

Acme Chemicals and Insulation Co., P.O. Box 1404, New Haven, CT 06505. (203) 562-2171. \$12.75; single qty.

E-Kote 61 produces an electrically conductive coating when sprayed onto a surface, and shields against electromagnetic and rf interference. It is packaged in an aerosol spray can. Spray-on coating is used for electrostatic control and electromagnetic interference shielding of structural foam enclosures and other plastic components. A single can will coat an 18-ft² area with a thickness of 1 mil. At this thickness, volume resistivity at 25 C is 0.1 ohm/cm. The coating may be used where the ambient temperature is 125 C or less.

CIRCLE NO. 356

The best talents in your business can be bought...

PRACTICAL DESIGN FOR ELECTROMAGNETIC COMPATABILITY

edited by ROCCO FICCHI

A complete guide to electromagnetic compatibility for electronic systems and equipment. Includes the current techniques for analyzing, predicting, controlling and reducing unwanted signals, along with numerous charts, graphs and nomographs. Recent advances in filtering and shielding, and exhaustive treatment of the special problems encountered in computers, semiconductors and solid-state devices. #5685-0, \$17.20

PRACTICAL VALUE ANALYSIS METHODS

by JOHN H. FASAL

This step-by-step guide transforms sophisticated VA-VE theory into concrete techniques and methods enabling you to literally take apart and scrutinize every facet of your operation—streamline everything from product costs to worker efficiency. An unlimited planning tool in the hands of today's ambitious executive or manager. #5845-4, \$13.75

MODERN DATA COMMUNICATION

by WILLIAM P. DAVENPORT

An on-the-job handbook mapping out the latest techniques, systems and services for the most efficient data transmission. Includes simplified coding techniques; ways of dealing with distortion, distraction, interference; efficiency and control techniques; modulating and multiplexing methods; and advice on using today's commercially available services. #5810-1, \$10.30

BASIC TELEPHONE SWITCHING SYSTEMS

by DAVID TALLEY

Offers the full array of switching techniques—from the early step-by-step type, through the common electro-mechanical group, to today's sophisticated electronic system. Special attention given to the No. 1 ESS type being installed by many companies. Here's a versatile, clearly-written handbook for the engineer, executive, and trainee alike. #5750-4, \$6.60

RELIABILITY, MAINTAINABILITY AND AVAILABILITY ASSESSMENT

by MITCHELL O. LOCKS

All the techniques and formulas you need for calculating the reliability, maintainability and availability of your repairable and non-repairable systems and components. You'll find sample models using point and interval values, and time-to-failure and time-to-repair data; binomial and other bernoulli-type distributions; simplified goodness-to-fit techniques, and much more. #9204, \$15.95

VIBRATION AND ACOUSTIC MEASUREMENT HANDBOOK

edited by MICHAEL BLAKE & WILLIAM S. MITCHELL

This giant, field-tested, 680-page manual enables you to master today's vibration equipment and techniques—shows you how to spot up to 90% of equipment problems months in advance and take corrective action before trouble starts. Uses scores of actual industrial problems and solutions in outlining specific procedures and techniques. #9195, \$34.50

on a 15-day money-back guarantee.

I'm buying! Please send me the books listed below to read and use FREE for 15 days. At the end of that time I will send payment, plus postage, or return the book(s) and owe nothing.

Number	Title	Price
_____	_____	_____
_____	_____	_____
_____	_____	_____
_____	_____	_____
		TOTAL _____

Name _____
 Firm _____
 Street _____
 City/State/Zip _____

I want to save money! Payment enclosed. Publisher pays postage. Same 15-day guarantee. 75-50



Hayden Book Company, Inc., 50 Essex St., Rochelle Park, N. J. 07662

New Literature

Sensors and controls

Solid-state proximity sensors and controls are covered in a four-page catalog. Electro Corp., Sarasota, FL

CIRCLE NO. 342

Cylindrical connectors

Standard miniature environmental cylindrical connectors with Merlin polymer contact retention are described in a 16-page catalog. Bunker Ramo, Connector Div., Broadview, IL

CIRCLE NO. 343

Soft ferrite products

The properties and frequency characteristics of soft ferrite products are described in a six-page brochure. Application and design notes are provided. Stackpole Carbon, Electronic Components Div., St. Marys, PA

CIRCLE NO. 344

High-Accuracy

Phase Meters

0.5 Hz to 2 MHz

Digital or meter readouts

As low as \$1150



930 E. Meadow Dr. • Palo Alto, CA 94303
(415) 494-6666

CIRCLE NUMBER 77

Learning aid for μ Ps

μ Primer 4/8, a complete software-supported learning aid/development system for microprocessors, is described in a four-page bulletin. Technitrol, Philadelphia, PA

CIRCLE NO. 348

Instrumentation

Assembled instruments such as frequency counters, generators, testers, oscilloscopes and power supplies are the subject of a 32-page catalog. Heath/Schlumberger, Benton Harbor, MI

CIRCLE NO. 349

Physical vapor deposition

"Physical Vapor Deposition" is intended for an engineer who is not a specialist in vacuum technology but wishes to explore the possibility of applying physical vapor deposition to his own fields of interest. The book costs \$10 each, plus 25¢ postage and applicable state and local sales tax. Airco, 2850 Seventh St., Berkeley, CA 94710.

INQUIRE DIRECT

Magnetic alarm switches

The 9200 Series UL-listed magnetic alarm switches are covered in a four-page catalog. Descriptions of mechanical and reed switches with Form A, B and C contacts, specifications, dimensional line drawings and installation sketches are included. North American Philips Controls, Frederick, MD

CIRCLE NO. 350

Memory data book

A 544-page Memory Data Book covers most of National's memory and memory-related products, including MOS, CMOS RAMs, field and mask-programmable ROMs (bipolar and MOS), MOS shift registers and PLAs. Specifications, applications, characteristics, diagrams and special features are included. To purchase the book, send a check for \$3 (CA residents add 6% sales tax) to Marketing Services Dept., National Semiconductor, 2900 Semiconductor Dr., Santa Clara, CA 95051.

INQUIRE DIRECT

Electronic Design

ELECTRONIC DESIGN's function is:

- To aid progress in the electronics manufacturing industry by promoting good design.
- To give the electronic design engineer concepts and ideas that make his job easier and more productive.
- To provide a central source of timely electronics information.
- To promote communication among members of the electronics engineering community.

Want a subscription? ELECTRONIC DESIGN is sent free to qualified engineers and engineering managers doing design work, supervising design or setting standards in the United States and Western Europe. For a free subscription, use the application form bound in the magazine. If none is included, write to us direct for an application form.

If you do not qualify, paid subscription rates are as follows: \$30.00 per year (26 issues) U.S., \$40.00 per year (26 issues) all other countries. Single copies are \$2.00 U.S., \$3.00 all other countries. The Gold Book (27th issue) may be purchased for \$30.00 U.S. and \$40.00 all other countries.

If you change your address, send us an old mailing label and your new address; there is generally a postcard for this bound in the magazine. You will have to requalify to continue receiving ELECTRONIC DESIGN free.

The accuracy policy of ELECTRONIC DESIGN is:

- To make diligent efforts to ensure the accuracy of editorial matter.
- To publish prompt corrections whenever inaccuracies are brought to our attention. Corrections appear in "Across the Desk."
- To encourage our readers as responsible members of our business community to report to us misleading or fraudulent advertising.
- To refuse any advertisement deemed to be misleading or fraudulent.

Microfilm copies are available of complete volumes of ELECTRONIC DESIGN at \$19 per volume, beginning with Volume 1, 1952 through Volume 20. Reprints of individual articles may be obtained for \$3.00 each, prepaid (\$.50 for each additional copy of the same article) no matter how long the article. For further details and to place orders, contact the Customer Services Department, University Microfilms, 300 North Zeeb Road, Ann Arbor, Michigan 48106 telephone (313) 761-4700.

Want to contact us? If you have any comments or wish to submit a manuscript or article outline, address your correspondence to:

Editor
ELECTRONIC DESIGN
50 Essex Street
Rochelle Park, N.J. 07662

ELECTRONIC DESIGN 14, July 5, 1976

**If you buy ovens
READ THIS CASE HISTORY**

PROBLEM: To find an oven that could temperature stabilize special crystal to $\pm 0.0005^{\circ}\text{C}/^{\circ}\text{C}$. and oscillator to $\pm 0.1^{\circ}\text{C}$.

SOLUTION: Oven Industries builds double cavity oven with dual controls. Locate crystal cavity in oscillator cavity—Result: Required thermal gain minimized by reduced ambient change.

We have hundreds of designs—many relatively inexpensive—any of which can be modified for your individual requirement.

When you buy an oven from us, you buy *more* than a stock item. You buy our *unique capability* to solve your particular problem.

And remember, Oven Industries is *not* in the crystal or oscillator business.

**FOR COMPLETE
INFORMATION—
CALL OR WRITE TODAY!**



OVEN INDUSTRIES, INC.

SILVER SPRING INDUSTRIAL PARK PO BOX 220
MECHANICSBURG, PA. 17035 PH. (717) 766-0721 Cable "OVENMETRIC"

CIRCLE NUMBER 78

**Malco Rectangulars...
they'll help you out in a tight spot.**

Malco offers a complete line of rectangulars including some of the smallest high-density connectors available to meet your tightest packaging requirements. Like our MCDM 1 Micromate™, a metal-shell connector with as many as 184 straight-through connections, centers as small as .050" and very little weight.

Whether you're designing with conventional wire, flat cable, coax or ribbon cable, Malco has the rectangulars you can plug into your circuitry—all with the Twist/Con high reliability contact system. Write Malco, 12 Progress Drive, Montgomeryville, Pennsylvania 18936 or call our South Pasadena facility (213) 682-3351 for price and delivery.

MALCO
A Microdot Company
Helping industry put things together.™

CIRCLE NUMBER 79

new from Hayden!

*"... well-organized, extremely well written ...
highly recommended for practicing engineers..."*
IEEE Transactions

DIGITAL SIGNAL ANALYSIS

Samuel D. Stearns

This is an ideal master handbook on today's signal processing procedures and systems, containing recent advances, new design material, and a comparison between continual and digital systems that's extremely helpful to newcomers to the field. Featuring a foreword by Richard Hamming, the book contains a review of linear analysis; sample-data systems; analog-to-digital and digital-to-analog conversion; the discrete Fourier transform and the fast Fourier transform algorithm; spectral computations; non-recursive and recursive digital systems; computer simulation of continual systems; analog and digital filter designs, and more. 288 pages

FORTRAN served up just right for the engineer...

FORTRAN FUNDAMENTALS

Jack Steingraber

You'll find this a fast and efficient guide to the fundamentals of FORTRAN. The main objective here, in fact, is to provide an abbreviated means of learning the language and of becoming familiar with language manuals — so it's just right for the engineer whose main interest may lie elsewhere. You'll find lots of sample problems along with complete solutions, although you're constantly encouraged to try various routines and analyze your own success or failure. The step-by-step format is perfect for self-study. 96 pages

HAYDEN BOOK COMPANY, INC.
50 Essex Street, Rochelle Park, New Jersey 07662

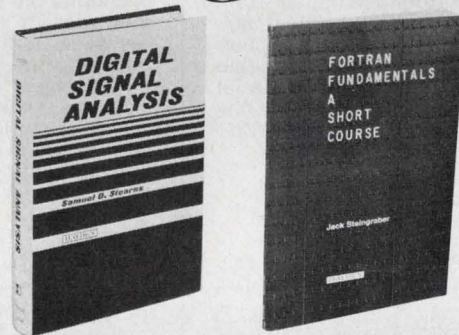

Order today—15-day examination!

Please send me the following book(s) to read and use FREE for 15 days. At the end of that time, I'll either send the amount indicated, plus postage and handling, or return the book(s) with no obligation.

- DIGITAL SIGNAL ANALYSIS, #5828-4, \$18.95
- FORTRAN FUNDAMENTALS, #5860-8, \$4.45

Name _____
Company/Institution _____
Address _____
City/State/Zip _____

SAVE MONEY! Payment Enclosed. Publisher will pay all shipping and handling charges. Same 15-day return privilege and full refund if not satisfied.

\$10.00 minimum for free exam orders. Because of higher billing and collection costs, we must ask for payment in full with any order for less than \$10.00. Books will be shipped postpaid. Same 15-day return privilege for full refund if not satisfied. 76-28

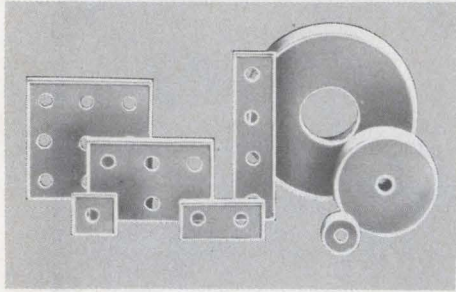

CIRCLE & MULTI-FEED-THRU CAPACITORS; available in a wide range of sizes and configurations, with NPO, BX, Z5U and Y5V characteristics. For use as feed-through elements, where volume efficiency of capacitance performance is required. Applications also include filter networks, pulse and logic circuitry, and signal bypass to ground elements in broadband circuits. Available in configurations suited to customer needs. Johanson/Dielectrics, Inc., Box 6456, Burbank, CA 91510 (213) 848-4465.

CIRCLE/MULTI-FEED CAPACITORS 181

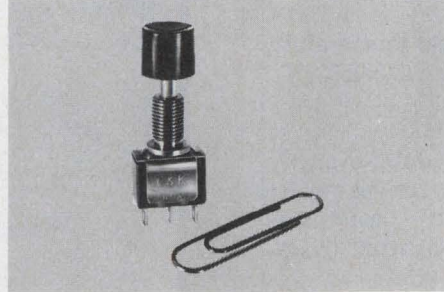

Model 8161/8168 Alternate Action and Momentary Pushbutton Switch, subminiature SPDT. Electrical life: 100,000 operations at full load. Contact rating: 6 amps with resistive load @ 120 VAC or 28 VDC; 3 amps with resistive load @ 250 VAC. 8161 is **push on/push off** model, and 8168 is **momentary** model. Free Engineering samples on request. C&K Components, Inc. 103 Morse St., Watertown, MA 02172, Tel: (617) 926-0800 TWX: 710-327-0460 TELEX: 92 2546

PUSHBUTTON SWITCH 184

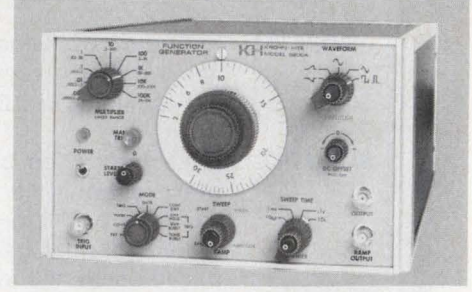

Function generator features WAVE-GUARD™ circuit to protect main output against accidentally applied voltages. Krohn-Hite Model 5200A provides sine, square & triangle waveforms and ramps over a 0.002Hz to 3 MHz range plus an independent linear sawtooth over a 0.1Hz to 100KHz range. 9 modes including continuous waveform & sawtooth, fixed freq bursts, freq sweeps or pulses. 1000:1 Internal Sweep + VCO. \$595. 4-wks. ARO. Krohn-Hite Corp. Avon Ind. Pk, Avon, MA 02322. (617) 580-1660.

2 GENERATORS IN 1 187

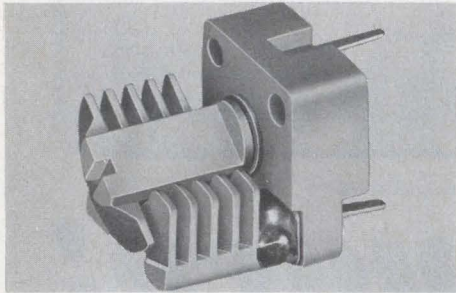

Miniature Type "U" air variable capacitors. Rotors and stators machined from solid brass extrusions offer excellent stability. High Q and low temperature coefficient (plus 45 ± 15 ppm/°C). Available in single section, differential and special order butterfly types. Choice of PC or discreet wiring terminals. E. F. Johnson Co., Waseca, MN., (507) 835-5222.

TYPE "U" CAPACITORS 182

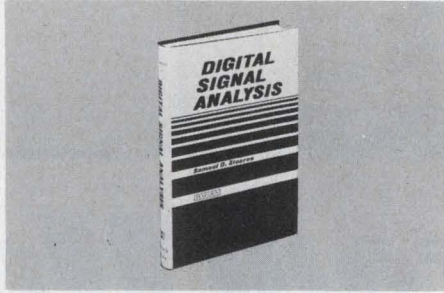

DIGITAL SIGNAL ANALYSIS, S. Stearns. Contains the most recent advances, brand-new design material, and a comparison between continuous and digital systems, making it an ideal master reference to today's signal processing techniques and systems. #5828-4, 288 pages, \$18.95. Circle the Info Retrieval Number to order 15-day exam copy. When billed, remit or return book with no obligation. Hayden Book Co., 50 Essex Street, Rochelle Park, N.J. 07662.

DIGITAL SIGNAL ANALYSIS 185

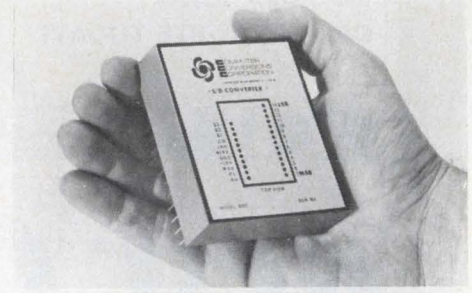

"Synchro to digital converters - 10, 12, or 14 bit output, errorless tracking up to 4 r.p.s., accuracy ± 4 min. of arc ± 9 LSB, resolution - 1.3 minutes, 60 or 400 Hz input, Module 2.6 x 3.1 x .82" H, Price From \$350 in qty. Other CCC products are Synchro to BCD or DC, Digital or DC to Synchro Converters, Solid State C.T.'s or CDX's, and Absolute Encoders. Send for Free Catalog & Application Notes. Computer Conversions Corp., East Northport, NY 11731 (515) 261-3300.

SYNCHRO TO DIGITAL 188



LOW COST MAGNETIC FLUX DETECTOR Model FD01 series provides continuous north reference when used with directional gyro or servo compass. TSO'd for autopilots and ideal for guidance and control systems for RPV's, drones, marine vehicles, buoys. Sensing element uses flux gate windings suspended in pendulous position. Freedom to $\pm 45^\circ$ pitch and roll. Operates on 14 mA, frequency 400-Hz. 2.28" dia. x 1.91" high. Humphrey, Inc., 9212 Balboa Ave., San Diego, CA 92123. (714) 565-6631.

FLUX DETECTOR 183

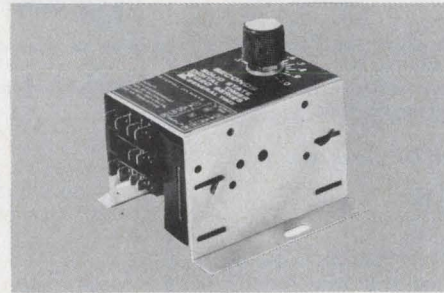

CMOS DIGITAL TIMERS by General Time. Low prices enable their use in lieu of both low and high accuracy analog timers and many electromechanical timers. $\pm 0.5\%$ typical repeat accuracy. On-delay, off-delay, and interval modes available in four different packages; AC and DC. Short reset, recycle and abort times; fast startup. From the industrial control specialists at Industrial Controls Division, General Time, Main Street, Thomaston, CT. 06787. Tel. (203) 283-5881. Telex 96-2445. Helpful literature available on request.

CMOS DIGITAL TIMERS 186

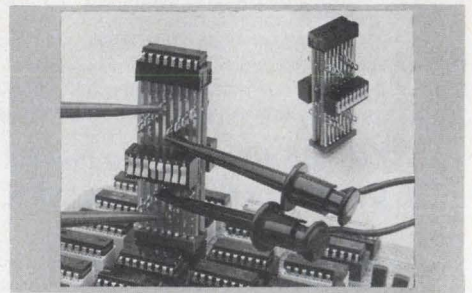

Dual-in-Line circuit TEST/MODIFICATION fixture for plug in IC's provides a means of non destructive testing or circuit modification. Switches provide isolation of each circuit lead, test points are provided on each side of the switches for testing or circuit modification. 14 pin \$21.95, 16 pin \$22.95, other sizes and prices on request. Pat. applied for. EMD Co., 7655 Bradley Rd., Moorpark, CA 93021 805-649-1513

TEST/MODIFICATION FIXTURE 189

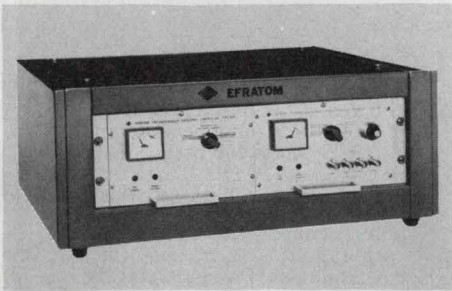

LF/VLF Receiver EFR/controls freq. std. FRT using std. freq. 10 to 200 KHz eg WWVB, Propagation anomalies are integrated to derive error signal for control of rubidium oscillators or VCXO. System capability 10^{-12} AT. EFRATOM CA., INC. 3303 Harbor Blvd., El, Costa Mesa, CA 92626 Tel.: (714) 556/1620

FREQUENCY CALIBRATION SYSTEM 190

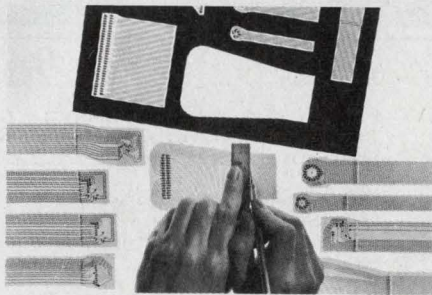

PROTOTYPE YOUR OWN FLEXIBLE CIRCUITS Exacto knife, soldering iron, plus our kit make all circuits shown—and more! Kit includes sheet of 1 oz. copper conductors on 1 mil polyimide film, plus matching sheets with about 15 connector patterns. 100's of combinations possible. . . . Easy instructions, parts list, dimensional drawings included. Flexible Circuit Kit, \$25 from stock. Rogers Corporation, Chandler, AZ 85224 (602) 963-4584. (EUROPE: Mektron NV, Ghent Belgium; JAPAN: Nippon Mektron, Tokyo)

FLEXIBLE CIRCUITS KIT 193



Basic Electricity & Basic Electronics by Van Valkenburgh, Nooger & Neville, Inc. Derived from the COMMON-CORE Training Program initially developed for the U.S. Navy. Thorough, comprehensive coverage. Available in separate paperbacks or cloth volume. Write for FREE brochure. Hayden Book Co., Inc., 50 Essex St., Rochelle Pk, N.J. 07662 (201) 843-0550.

TRAINING TEXT 191

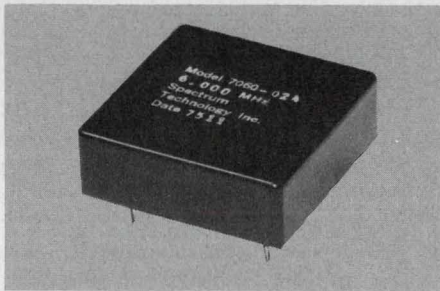

WHY BE CONCERNED ABOUT CRYSTAL SPECIFICATIONS? Spectrum Model 7060 Crystal Oscillator/Logic Clock eliminates specifying crystals, 15 other parts, and their assembly and inspection. Spectrum does it for you and provides $\pm 0.01\%$ or $\pm 0.05\%$ accuracy, 0 to 70°C from 0.8 to 20 MHz. \$7.75 each in 100's, less than \$5.00 each for 20,000. Standard frequencies in stock, production quantities 5 weeks ARO. SPECTRUM TECHNOLOGY, INC., P. O. Box 948, Goleta, CA 93017 (805) 964-7791

OSCILLATOR/CLOCK 194

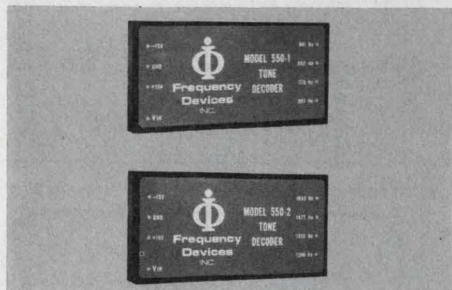

Modular Tone Detectors require no assembly or adjustments. Model 550-1 and 550-2 Tone Detectors detect the standard Bell System Touch Tones*. Non-ambiguous detection of 40 ms on/off DTMF tone bursts is provided for input tone amplitudes from -30 dBm to 0 dBm with twists of up to 15 dB. Dial Tones, Trunk Tones, and adjacent Band Tones are rejected. Open collector logic outputs, interface with CMOS/TTL. Frequency Devices, Inc., 25 Locust Street, Haverhill, MA 01830 Tel. (617) 374-0761

TOUCH TONES* DETECTOR *(TM) 192



The PMK04 is a portable off-line terminal tester. It can be used with your system up to exercise serial ASCII terminals such as Digital's VT50/52 CRT's, LA 30/36 terminals and other teleprinters and CRT's using 20 MA current loop or EIA interfaces. Priced at a low of \$1425 per unit with discounts available. Digital Equipment Corporation, Customer Spares, Parker Street, Maynard, MA 01754

TERMINAL TESTER 195

Advertising Sales Staff
Tom W. Carr, Sales Director
Jean Bunfield, Sales Coordinator

Rochelle Park, NJ 07662
Robert W. Gascoigne
Daniel J. Rowland
Thomas P. Barth
Stan Tessler
50 Essex St.
(201) 843-0550
TWX: 710-990-5071

Philadelphia
Thomas P. Barth
(201) 843-0550

Boston 02178
Gene Pritchard
P.O. Box 379
Belmont, MA 02178
(617) 489-2340

Chicago 60611
Thomas P. Kavooras
Berry Conner, Jr.
200 East Ontario
(312) 337-0588

Cleveland
Thomas P. Kavooras
(312) 337-0588

Los Angeles 90045
Stanley I. Ehrenclou
Burt Underwood
Neil Canavin
8939 Sepulveda Blvd.
(213) 641-6544

Texas
Burt Underwood
(213) 641-6544

San Francisco
Robert A. Lukas
3579 Cambridge Lane
Mountain View, CA 94040
(415) 965-2636

London
Constance McKinley
50 Essex St.
Rochelle Park, N.J. 07662
Phone: (201) 843-0550

Amsterdam, Tokyo, Seoul
Sanders, B. V.
Raadhuisstraat 24
Graft-De Ryp, Holland
Phone: 02997-1303
Telegrams: Euradteam-Amsterdam

Haruki Hirayama
Electronic Media Service
5th Floor, Lila Bldg.,
4-9-8 Roppongi
Minato-ku, Tokyo, Japan
Phone: 402-4556
Cable: Electronicmedia, Tokyo

Mr. O-kyu Park, President
Dongbo Intl Corp.—
World Marketing
C.P.O. Box 4010
Seoul, Korea
Tel. 76-3910/3911
Cable: DONGBO SEOUL
Telex: EBKOREA K27286

ABP

BPA

Advertiser's Index

Advertiser	Page	Advertiser	Page	Advertiser	Page
AMP, Incorporated	12, 13	Fairchild Camera & Instrument Corp., Digital Division	8, 9	Mini-Circuits Laboratory, A Division of Scientific Components Corp.	2
Acheson Colloids Company	76	Frequency Devices, Inc.	101	Motorola Semiconductor Products, Inc.	16
Acopian Corp.	72, 73	*Germanium Power Devices Corp.	70	MuRata Corporation of America	85
Advanced Micro Devices	86, 87	Gold Book, The	60, *68, *69, *72, *73, 103	National Semiconductor Corporation	67, 68, 69, 70
Aiken Industries	94	Grayhill, Inc.	88	North American Philips Controls Corp.	77
American Microsystems, Inc.	82, 83	Hamlin, Inc.	94	Oven Industries, Inc.	99
Amunel Manufacturing Corp.	90	Hayden Book Company, Inc.	97, 99, 100, 101	RCA Solid State	Cover IV
Arrow-M Corp.	74	Hughes Aircraft Company, Micro-electronic Products Division	55	RCL Electronics	28
Austron, Inc.	91	Humphrey, Inc.	100	R.A.F. Electronic Hardware Inc.	102
Bourns, Inc., Trimpot Products Division	Cover II	ISE Electronics Corporation	61	Riken Denshi Co., Ltd.	93
Bulova Electronics Division of Bulova Watch Co. Inc.	77	Illuminated Products Co.	7	Rockwell International	51
C & K Components, Inc.	100	Industrial Controls, Division General Time	100	Roger Corporation	101
CTS Knights, Inc.	81	Intel Corporation	4, 5	*SGS Ates Semiconductor Corporation	67
Centre Engineering	80	International Crystal Manufacturing Co., Inc.	84	Savoy Electronics Inc.	104
Clairex Electronics, A Division of Clairex Corporation	90	JS&A National Sales Group	Cover III	Sentry Manufacturing Company	25
Computer Conversions Corp.	100	Johanson Manufacturing Corp.	6	Shigoto Industries, Ltd.	89
Crown International	89	Johanson/Dielectrics Inc.	100	Siliconix, Incorporated	10, 11
Crystek Crystals Corporation	96	Johnson Company, E. F.	100	South Bay Cable Corp.	89
Curtis Industries, Inc.	91	Kay Elemetrics Corp.	93	Spectrum Technology, Inc.	101
Daini Seikosa Co., Ltd.	77	Krohn-Hite Corporation	100	Sprague Electric Company	23
Data Display Products	30	Kulka Electric Corp.	104	Stanford Applied Engineering Inc.	14
Data General Corporation	23	Kurz-Kasch, Inc.	80	Tektronix, Inc.	33
Datel Systems, Inc.	38	Litronix, Inc.	63	Viking Industries, Inc.	65
Deltron, Inc.	78	MF Electronics Corp.	15	Vitramon North America Division of Vitramon Incorporated	34
Dialight, A North American Philips Company	91	Magnetic Components Division, Control Data Corporation	79	United States Department of Commerce	95
Digital Equipment Corporation	101	Malco, a Microdot Company	99	Wavetek San Diego, Inc.	1
EECO	19	Marconi Instruments	93	Weston Instruments, Inc.	27
EMD Co.	100	McCoy Electronics Company	29	Wiltron Company	98
Efratom California, Inc.	101	Micro-Line, Division of Bausch & Lomb	79		
Electronic Design	*70, 71				
Electronic Navigation Industries	92				
Erie Frequency Control, Division of Erie Technological Products, Inc.	96				
Fabri-Tek, Inc., National Connector Division	79				

*Advertisers in non-U.S. edition

Design Data from Manufacturers

Advertisements of booklets, brochures, catalogs and data sheets. To order use Reader-Service Card (Advertisement)



Here's how over 5,000 buyers get immediate delivery of top-quality ELECTRONIC HARDWARE

... from this **free 110 page R.A.F. catalog.** Request yours today

- Spacers & standoffs.
- Captive screws & retainers.
- Shoulder & flat insulating washers.
- Thumbscrews; custom items.
- Aluminum, brass, plastics, steel, st. steel, phenolics.

R.A.F. ELECTRONIC HARDWARE, INC.
260 Hathaway Drive, Stratford, Ct. 06497 Telephone: (203) 377-6393

CIRCLE NUMBER 171

classified ad

HEXADECIMAL CALCULATOR

8 digits, credit balance-complement, pocket size, leather case: \$35.95

OCTAL CALCULATOR

6 digits, credit balance-complement, pocket size, leather case: \$14.95

Prepaid orders sent postpaid. COD's plus postage. Rated firms invoiced plus postage. Literature free. Radix Precision, Box 95114-E, Atlanta, GA 30347

Help your
Heart...
Help your
Heart Fund

American Heart Association



"I've purchased \$50,000

worth of products through the GOLD BOOK"



M.G. Stickler, P.E.
General Manager
Computer Engineering Division
Pentamation Enterprises, Inc.

"The GOLD BOOK provides a convenient comparison of products from multiple sources, as well as vendor phone numbers," writes M.G. Stickler, P.E., General Manager, Computer Engineering Division, Pentamation Enterprises, Inc.

Mr. Stickler is involved with design, production, installation, and maintenance of minicomputer and microcomputer systems for his Bethlehem, Pa., Computer Facilities Management firm.

"I find the GOLD BOOK extremely useful...I've probably used it about 70 times, and as a result, we've purchased \$10,000 worth of power supplies, \$2,000 in keyboards, \$30,000 in microcomputers — about \$50,000 to date."

This is the GOLD BOOK in action. This is the GOLD BOOK working for you. (The GOLD BOOK goes essentially to *Electronic Design's* audience of known specifiers.)

Mr. Stickler, like 78,000 engineers, engineering managers, purchasing agents and distributors throughout the U.S.A. (plus 13,000 overseas) has his own personal copy of the GOLD BOOK. He uses it to specify and buy products.

THIS IS ELECTRONIC DESIGN'S AUDIENCE WORKING FOR YOU!

Electronic Design / GOLD BOOK

HAYDEN PUBLISHING COMPANY, INC.

50 Essex Street, Rochelle Park, New Jersey 07662. Tel: 201-843-0550

NEW Thermoplastic

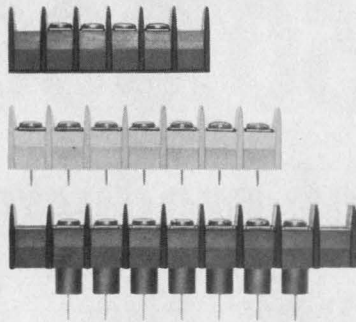

Flat mounts, PC mounts or insulated feed-thru turrets - we have them all in our new flexible thermoplastic terminal board line. Available in a variety of bottom terminations and surface hardware configurations. So whatever your requirements, Kulka can deliver. Complete specs shown in our new catalog. Send today.

Kulka
A NORTH AMERICAN PHILIPS COMPANY
KULKA ELECTRIC CORPORATION
520 S. Fulton Ave., Mount Vernon, N.Y. 10551

CIRCLE NUMBER 71

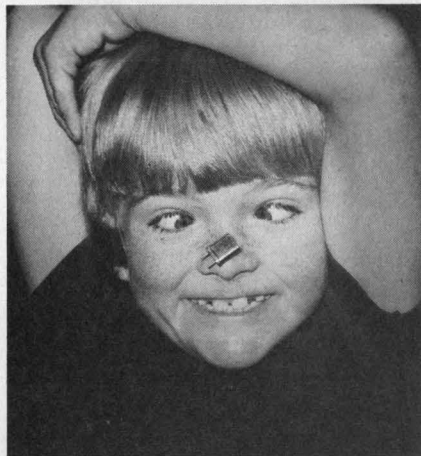

**DON'T GET BENT
OUT OF SHAPE
OVER QUARTZ
CRYSTALS**

Write or Call



Savoy Electronics Inc.

Manufacturers of Quality Quartz Crystals Since 1937
Dept. EC-376 P.O. Box 5727, Fort Lauderdale, Florida, 33310.
305/563-1333

CIRCLE NUMBER 72

Product Index

Information Retrieval Service. New Products, Evaluation Samples (ES), Design Aids (DA), Application Notes (AN), and New Literature (NL) in this issue are listed here with page and Information Retrieval numbers. Reader requests will be promptly processed by computer and mailed to the manufacturer within three days.

Category	Page	IRN	Category	Page	IRN
Components			op amp, BiMOS	86	334
capacitor, chip kit	85	330	prescaler, ÷64	86	335
capacitors	6	5	RAM, 4-k	86	333
capacitors	34	22	Microprocessor Design		
capacitors	80	45	breadboard, μ P	37	552
capacitors, ceramic	85	54	emulation kit	37	553
cermet trimmer	84	326	learning aid for μ Ps (NL)	90	348
components (NL)	90	346	microprocessor	35	551
cylindrical connectors (NL)	90	343	Modules & Subassemblies		
displays	61	27	amplifier, instrument	78	306
displays	91	66	amplifiers, hybrid	81	320
lamps	77	39	converter, pneumatic	80	309
magnetic alarm switches (NL)	90	350	converters, d/a	81	310
micromotors (NL)	90	347	converters, v/f	80	308
miniature rotor	83	49	crystal oscillator	81	47
quartz crystals	29	19	crystal oscillators	15	12
quartz crystals	104	72	driver, decoder	78	304
relays, solid state	84	52	modulator, demodulator	81	321
rotary code switch	84	328	modules, amp/filter	78	305
sensors and controls (NL)	90	342	oscillators	55	25
switches	28	18	oscillators	83	50
thermocouple reference	85	331	quartz oscillator	85	67
timer switch, aniburgler	85	329	sensors and controls (NL)	90	342
toggle-DIP	86	55	suppressor, transient	78	307
varistors	84	327	Packaging & Materials		
Data Processing			backpanel	87	58
bus converter, I/O	89	340	breadboard, μ P	37	552
core memory board	89	339	cables	77	38
data terminal	89	341	connectors	13	10
emulation kit	37	553	connectors	63	28
learning aid for μ Ps (NL)	90	348	connectors	95	68
Discrete Semiconductors			cylindrical connectors (NL)	90	343
LED	30	20	magnetic shields	89	62
photoDarlington	89	63	resolution distortion (NL)	90	345
SCRs, high power	88	337	sockets	19	14
transistors	14	11	soft ferrite products	90	344
transistors, power	88	338	terminal boards	104	71
transistors, switching	88	336	Power Sources		
Instrumentation			dc/dc converter	82	323
amplifier	77	40	high-voltage supply	82	322
amplifier	82	48	power supplies	78	41
counters	76	303	power supplies	87	56
generators	79	44	switchers	82	325
instrumentation (NL)	90	349	UPS	82	324
logic probe	80	46	new literature		
meters	88	60	components	90	346
oscilloscopes	33	21	cylindrical connectors	90	343
portable DMM	14	11	instrumentation	90	349
recorder	79	43	learning aid for μ Ps	90	348
scales	87	57	magnetic alarm switches	90	350
sensors and controls	90	342	micromotors	90	347
solid-state amplifier	90	64	resolution distortion	90	345
transceiver	111	273	sensors and controls	90	342
μ P analyzer	75	301	soft ferrite products	90	344
Integrated Circuits					
circuits, HiNIL	86	332			
low power Schottky	9	7			

Pocket CB

New integrated circuit technology and a major electronic breakthrough brings you the world's smallest citizens band transceiver.

SMALL ENOUGH FOR YOUR POCKET

Scientists have produced a personal communications system so small that it can easily fit in your pocket. It's called the PocketCom and it replaces larger units that cost considerably more.

MANY PERSONAL USES

An executive can now talk anywhere with anybody in his office, his factory or job site. The housewife can find her children at a busy shopping center. The motorist can signal for help in an emergency. The salesman, the construction foreman, the traveler, the sportsman, the hobbyist—everybody can use the PocketCom—as a pager, an intercom, a telephone or even a security device.

LONG RANGE COMMUNICATIONS

The PocketCom's range is limited only by its 100 milliwatt power and the number of metal objects between units or from a few blocks in the city to several miles on a lake. Its receiver is so sensitive, that signals several miles away can be picked up from stronger citizens band base or mobile stations.

VERY SIMPLE OPERATION

To use the PocketCom simply turn it on, extend the antenna, press a button to transmit, and release it to listen. And no FCC license is required to operate it. The PocketCom has two Channels—channel 14 and an optional second channel. To use the second channel, plug in one of the 22 other citizens band crystals and slide the channel selector to the second position. Crystals for the second channel cost \$7.95 and can only be ordered after receipt of your unit.



The PocketCom components are equivalent to 112 transistors whereas most comparable units contain only twelve.

A MAJOR BREAKTHROUGH

The PocketCom's small size results from a breakthrough in the solid state device that made the pocket calculator a reality. Mega scientists took 112 transistors, integrated them on a micro silicon wafer and produced the world's first transceiver linear integrated circuit. This major breakthrough not only reduced the size of radio components but improved their dependability and performance. A large and expensive walkie talkie costing several hundred dollars might have only 12 transistors compared to 112 in the Mega PocketCom.

BEEP-TONE PAGING SYSTEM

You can page another PocketCom user, within close range, by simply pressing the PocketCom's call button which produces a beep tone on the other unit if it has been left in the standby mode. In the standby mode the unit is silent and can be kept on for weeks without draining the batteries.

SUPERIOR FEATURES

Just check the advanced PocketCom features now possible through this new circuit breakthrough: 1) Incoming signals are amplified several million times compared to only 100,000 times on comparable conventional systems. 2) Even with a 60 decibel difference in signal strength, the unit's automatic gain control will bring up each incoming signal to a maximum uniform level. 3) A high squelch sensitivity (0.7 microvolts) permits noiseless operation without squelching weak signals. 4) Harmonic distortion is so low that it far exceeds EIA (Electronic Industries Association) standards whereas most comparable systems don't even meet EIA specification. 5) The receiver has better than one microvolt sensitivity.



EXTRA LONG BATTERY LIFE

The PocketCom has a light-emitting diode low-battery indicator that tells you when your 'N' cell batteries require replacement. The integrated circuit requires such low power that the two batteries, with average use, will last weeks without running down.



The PocketCom can be used as a pager, an intercom, a telephone or even a security device.

MULTIPLEX INTERCOM

Many businesses can use the PocketCom as a multiplex intercom. Each employee carries a unit tuned to a different channel. A stronger citizens band base station with 23 channels is used to page each PocketCom. The results: an inexpensive and flexible multiplex intercom system for large construction sites, factories, offices, or farms.

NATIONAL SERVICE

The PocketCom is manufactured exclusively for JS&A by Mega Corporation. JS&A is America's largest supplier of space-age products and Mega Corporation is a leading manufacturer of innovative personal communication systems—further assurance that your modest investment is well protected. The



The PocketCom measures approximately 3/8" x 1 1/2" x 5/8" and easily fits into your shirt pocket. The unit can be used as a personal communications link for business or pleasure.

PocketCom should give you years of trouble-free service, however, should service ever be required, simply slip your 5 ounce PocketCom into its handy mailer and send it to Mega's prompt national service-by-mail center. It is just that easy.

GIVE IT A REAL WORKOUT

Remember the first time you saw a pocket calculator? It probably seemed unbelievable. The PocketCom may also seem unbelievable so we give you the opportunity to personally examine one without obligation. Order only two units on a trial basis. Then really test them. Test the range, the sensitivity, the convenience. Test them under your everyday conditions and compare the PocketCom with larger units that sell for several hundred dollars.

After you are absolutely convinced that the PocketCom is indeed that advanced product breakthrough, order your additional units, crystals or accessories on a priority basis as one of our established customers. If, however, the PocketCom does not suit your particular requirements perfectly, then return your units within ten days after receipt for a prompt and courteous refund. You cannot lose. Here is your opportunity to test an advanced space-age product at absolutely no risk.

A COMPLETE PACKAGE

Each PocketCom comes complete with mercury batteries, high performance Channel 14 crystals for one channel, complete instructions, and a 90 day parts and labor warranty. To order by mail, simply mail your check for \$39.95 per unit (or \$79.90 for two) plus \$2.50 per order for postage, insurance and handling to the address shown below. (Illinois residents add 5% sales tax). But don't delay.

Personal communications is the future of communications. Join the revolution. Order your PocketComs at no obligation today.

\$39.95 NATIONAL INTRODUCTORY PRICE

Credit Card Buyers Call Toll Free

JS&A NATIONAL SALES GROUP

DEPT. ED JS&A Plaza
Northbrook, Illinois 60062

CALL TOLL-FREE . . . 800 325-6400
In Missouri call . . . 800 323-6400

©JS&A Group, Inc., 1976

What's new in solid state ...

RCA races on with popular memory types: 14 now, 10 coming up.

From a virtual standing start in 1974, we've already introduced 14 of the most popular RAMs and ROMs. By year's end there will be 24—a comprehensive lineup of devices that are directly interchangeable or pin compatible with 62 types from 19 manufacturers of industry standards ... often with improved performance as a dividend.

RCA memories span NMOS, CMOS, and SOS technologies. Organizations range from 4 words x 8 bits up to 512 words x 8 bits, with emphasis on standard 1K and 4K arrangements. And these products are now available in volume from several facilities including our newest, most highly automated plant, designed and equipped to produce with a high degree of uniformity.

All of which shows RCA is totally committed to winning your confidence as a front-running, wide-range memory supplier. To help you program RCA memory products into your design we've put together a pocket-size Memory Interchangeability Guide. Ask for it at your local RCA Solid State distributor. Or contact RCA.

1974			
NMOS	MW7001ID	CMOS	CD4039AD
CMOS	CD4036AD	CMOS	CD4061AD
1975			
SOS	MWS5001D	SOS	MWS5501D
SOS	MWS5040D	SOS	MWS5540D
Now ...		1976	
NMOS	MW4050D	NMOS	MW4060D
NMOS	MW4050DVI	NMOS	MW4060DVI
NMOS	MW4050DV2	NMOS	MW4060DV2
Coming ...		SOS	MWS5001A
NMOS	MW4051	SOS	MWS5580
NMOS	MW4101	CMOS	CD40024
NMOS	MW4104	CMOS	CD40032
NMOS	MW4111	CMOS	CD40061
NMOS	MW4112		

Write: RCA Solid State, Box 3200, Somerville, N.J. 08876; Ste. Anne de Bellevue H9X 3L3, Canada; Sunbury-on-Thames, U.K.; Fuji Bldg., Tokyo, Japan.

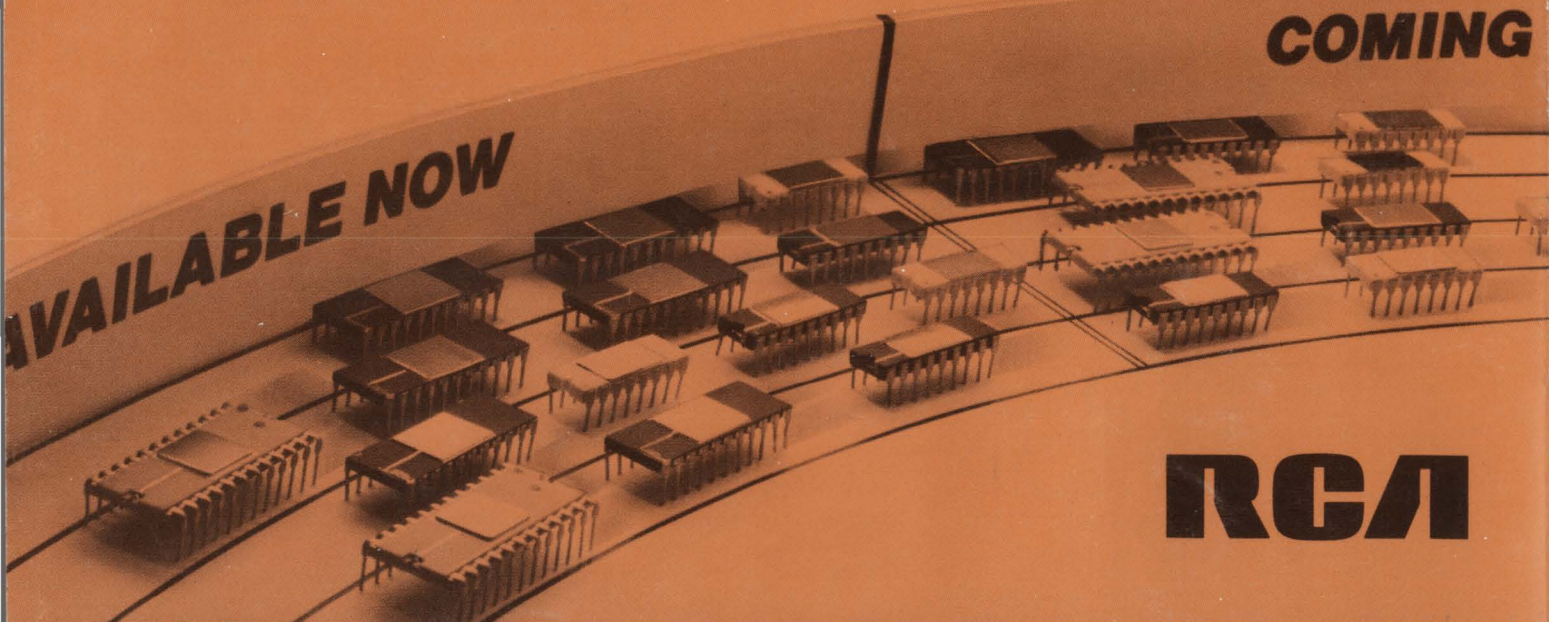

RCA. Fastest moving house in memory.